

The University of North Texas Health Science Center

CAMPUS MASTER PLAN

August 2007



UNIVERSITY of NORTH TEXAS
HEALTH SCIENCE CENTER

STEERING COMMITTEE

J. Warren Anderson, EdD
Senior Vice President, Academic Affairs
Dean, School of Health Professions

Stephen Barrett
Director of Facilities Management

Richard Escalante
Vice Chancellor for Administrative Services

Marc Hahn, DO
Senior Vice President, Clinical Affairs
Dean, Texas College of Osteopathic Medicine

M. Christine Kalish
Executive Director to the President

Fernando Trevino, MPH, PhD
Dean, School of Public Health

Greg Upp
Senior Vice President
Community Engagement

Thomas Yorio, PhD
Senior Vice President for Research
Dean, Graduate School of Biomedical
Sciences

ADVISORY COMMITTEE

COMMUNITY MEMBERS INCLUDE

Garland Asher
Monticello Neighborhood Representative

Ed Bass
Cultural District & Stock Show Representative

Fernando Costa
City Planning Representative

Marty Craddock
General Neighborhood Representative

Geraldine Herman
Arlington Heights Neighborhood
Representative

Bill Meadows
Stock Show Representative

Cathy Moates
North Hi Mount Neighborhood Representative

Phillip Poole
Associated Businesses of the Cultural District
Representative

John Robinson
Carter Foundation & Museum Representative

UNTHSC MEMBERS INCLUDE

Warren Anderson, EdD
Senior Vice President of Academic Affairs and
Dean of the School of Health Professions

Stephen Barrett
Director of Facilities Management

Thomas Fairchild, PhD
Associate Vice President for Institutional
Planning

Marc Hahn, DO
Senior Vice President for Clinical Affairs & Dean
of the Texas College of Osteopathic Medicine

Fernando Treviño, PhD
Dean of the School of Public Health

Greg Upp
Senior Vice President for Community
Engagement

Thomas Yorio, PhD
Senior Vice President for Research and Dean
of the Graduate School of Biomedical
Sciences

Chris Kalish
Executive Director to the President

Amy Kalina
TCOM Student Representative

UNT SYSTEM MEMBERS INCLUDE

Richard Escalante
Vice Chancellor for Administrative Services for
UNT System

777 Main Street
Fort Worth, TX 76102
817.735.6000
www.c-b.com

CARTER & BURGESS, Inc.

Charles W. Nixon, AIA	Principal In Charge
Bryan Floth, AIA	Project Manager
Pete Thomas	Facilities Programmer
Bob Lundeen, AIA	Medical Planning Specialist
Ed Werth, AIA	Senior Design Architect
David Gustaf, AIA, LEED	Project Architect
Tasi Hines, AIA	Interior Design
Randy Sorensen, FASLA	Landscape Architect
Kevin Fox, PE, LEED, CEM	Mechanical Engineer
Chris McEnery, PE	Electrical Engineer
Cesar Vallenilla, PE	Structural Engineer

320 West 13th Street
New York City, NY 10014
212.807.7171
www.polshek.com

POLSHEK PARTNERSHIP ARCHITECTS, LLP

James S. Polshek FAIA	Principal Design Planner
Joseph L. Fleischer FAIA	Quality Control Manager
Kevin P. McClurkan AIA	Project Manager
Wm. Jack T. Phillips AIA	Senior Design Planner

912 S. Capital of Texas Hwy, Suite 320
Austin, TX 78746
512.329.8343
www.jankedesign.com

JANKEDESIGN

Kamela Janke, SEGD	Graphics/Wayfinding Consultant
Tim Janke, SEGD	Graphics/Wayfinding Consultant

17311 Dallas Parkway, Suite 300
Dallas, TX 75248
972.250.2727
www.dal-tech.com

DAL-TECH ENGINEERING, Inc.

Wayne Barton, PE	Civil Engineer
------------------	----------------



A LETTER FROM THE PRESIDENT

Creating a campus master plan is an exciting, all inclusive process involving numerous stakeholders from the city, community and campus. At the core of any campus master plan is the alignment of the physical development of the campus to the strategic or academic plan. This ensures that specific planning priorities are supported, furthering the mission of the institution.

The University of North Texas Health Science Center boasts a long history of successful health education programs. With these programs comes the need for a long term vision for the campus which allows for population growth as well as collaboration between existing departments. The future of the Health Science Center is contingent upon a strategic, appropriate master plan geared toward future goals of expanding campus facilities to meet the needs of increased growth. Also, a guide to campus development is needed to allow the UNTHSC to become a unique but complimentary character in the fabric of the surrounding area. Influences from the Cultural District to the south and traditional neighborhoods to the north and east influence the UNTHSC ambience.

While this process has been exciting and rewarding, the publication of this master plan will create much more excitement on our campus as we look to growing and expanding our institution with the addition of new facilities and other programs. I wish to take this opportunity to thank all involved in this process, and to express my deepest thanks and gratitude to the campus master plan Advisory and Steering Committees, and our consulting team of Carter & Burgess, Inc. (Fort Worth, Texas) and Polshek Partnership Architects, Inc. (New York City, New York).

Sincerely,

Scott Ransom, DO, MBA, MPH

A. INTRODUCTION

Introduction	A-3
Health Science Center Mission Statement	A-5
The Campus Master Plan Process	A-7
Guiding Principles	A-8

B. OBSERVATIONS

Introduction	B-3
Campus History	B-4
Existing Campus	B-6
Precinct Walks	B-8
Representative Campus Buildings	B-10
Nearby Developments	B-16
Campus Observations	
Major Roadways & Linkages	B-18
Periphery Use	B-20
Easements	B-22
Existing Massing	B-23
Topography	B-24
Vistas	B-26
Figure Ground	B-27
Existing Parking	B-28
Impervious Surface	B-29
Campus Edges	B-30
Landscape	B-32
Signage and Wayfinding	B-34
Electrical Distribution	B-38
Storm Sewer	B-39
Potable Water	B-40
Sanitary Sewer	B-41
Programming	B-42

C. FINAL PLAN

Introduction	C-3
Planning Concepts	C-5
Long Term Vision	C-8
Final Plan Strategies	
Campus Spine	C-10
Campus Quads	C-12
Campus Gardens	C-14
Landscape Connections	C-17
Campus Front Door	C-18
Montgomery Street Plan	C-19
Phase I Plan	C-20
Signage and Wayfinding	C-22
Traffic and Parking	C-26
Utility Infrastructure	C-31

D. GUIDELINES

Introduction	D-3
Architectural Design Guidelines	
Concepts	D-4
Site - Building Position and Setbacks	D-6
Site Entrances	D-7
Circulation / View Corridors	D-8
Building Edge Flexibility	D-9
Building Edges to Street	D-10
Massing Concepts	D-12
Massing Strategies	D-13
Articulation Variations	D-14
Facade Relationship	D-17
Building Materials	D-18
Building Colors	D-19
Lighting Character Concepts	D-20
Landscape Design Guidelines	D-22

E. APPENDIX

Traffic Study	E-2
---------------	-----

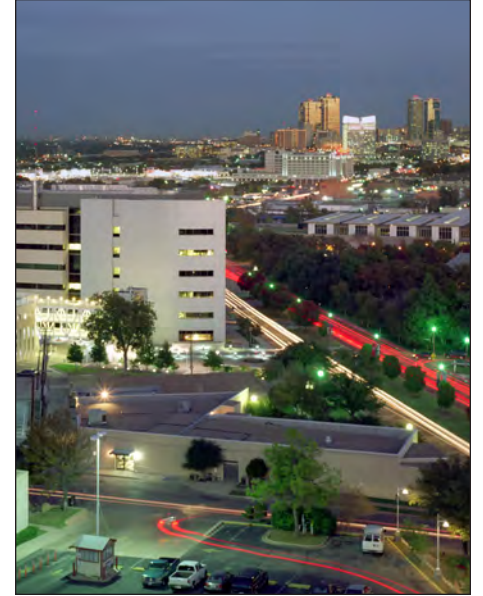
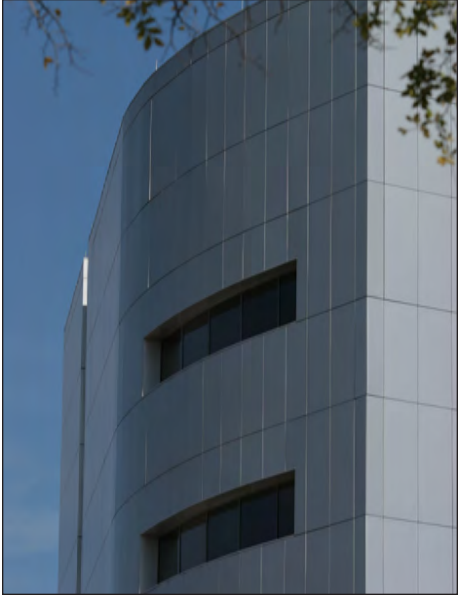

INTRODUCTION

A



INTRODUCTION

In the summer of 2005, The University of North Texas Health Science Center (UNTHSC) at Fort Worth purchased the adjacent Texas Osteopathic Hospital and additional land surrounding this facility (approximately 15 acres), almost doubling the size of the campus. With this additional land increase and projected student and research growth, the UNTHSC embarked on a strategic planning process to help shape the future development of the campus's built environment.

A campus master plan allows for the opportunity of an institution to reflect upon its history, assess its current condition, and establish a vision for its future growth and prosperity. The master planning team of Carter & Burgess, Inc. and Polshek Partnership Architects, LLP were chosen in early 2006 to lead the planning process and help in translating these institutional goals and objectives of the University. Contributions from an Advisory Committee made up of leaders from the community, members of nearby neighborhoods, and faculty and staff from the UNTHSC were invaluable to the master planning team through meetings and workshops in identifying and prioritizing objectives and goals for the University and the surrounding area.

The planning team began by studying the surrounding context, developing key strategies to unite the campus with the mission of the University and develop concepts which bring connections and a sense of community to the areas many constituents. A series of Guiding Principles were developed with the University to describe the ideals and aspirations this master plan is to foster. Although it is a Health Science Center, the UNTHSC boldly shifted from convention and embraced the idea of the academic campus. This 'collegial environment' for the campus creates both interactive indoor as well as outdoor spaces that support not only the faculty, staff, and students but also the surrounding community.

The Final Vision Plan sets out to strategically outline the responsible growth of the University over time while maintaining the consistency and values established by the Guiding Principles.



THE UNIVERSITY OF NORTH TEXAS HEALTH SCIENCE CENTER

The University of North Texas Health Science Center is a research, teaching, and public service institution that focuses on the health and well-being of its patients, students, faculty, staff and administration. Recognizing the campus itself as a "living entity," the UNTHSC is looking to the master plan as an outline of its specific needs, within the campus itself as well as the larger community. Options for planned growth and change at the UNTHSC should support the integration of the ideals of healthy lifestyles and community that are taught and practiced daily within the classrooms and health care facilities of the campus. With a planned campus that reflects the aspirations and traditions of the Health Science Center and region, the university can continue attracting and retaining the best faculty, staff, and students.

MISSION STATEMENT

To improve the health and quality of life for the people of Texas and beyond through excellence in education, research, clinical care and community engagement and to provide national leadership in primary care.

1. OBSERVATIONS / PRINCIPLES



2. DATA GATHERING / ANALYSIS

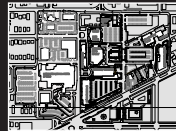

3. GAMING / CONCEPT PHASE



4. FINAL PLAN / DESIGN GUIDELINES

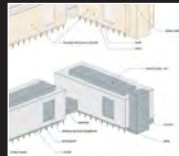
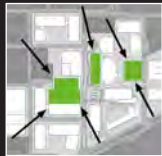

THE CAMPUS MASTER PLANNING PROCESS

PLANNING PHILOSOPHY

Campus planning is guided by the principles of the UNT System and informed by the hopes and goals of the Health Science Center stakeholders, faculty, staff, students, surrounding neighborhoods, and area developers. Architects and planners serve as facilitators to provoke discussion among the groups and record responses that inform the concept design of the campus plan.

Buildings, landscaping, roadways, and signage are considered as parts in a composition, with each contributing to the overall UNT Health Science Center image, accessibility, and experience. Specialists, such as a signage consultant and landscape architect, offer insight into particular pieces that make up the plan, while the design team of architects and planners oversee the process so that all of the parts are consistent with the overall solution.

PROJECT APPROACH

The project approach involved a four step process of on-site workshops, meetings, and campus tours:

1. Observations / Principles
2. Data Gathering / Analysis
3. Gaming / Concept Phase
4. Final Campus Plan / Final Guidelines

Two committees were designated to provide input during the master planning process. The Steering Committee consisted of a group from the University of North Texas System (UNTS) and Health Science Center (HSC) stakeholders. The Advisory Committee was made up of members from the Steering Committee and public members who have been previously appointed. Meetings with the Steering and Advisory Committees were organized monthly. In the beginning stages of planning, members voiced their hopes and concerns, alerting the planners to areas of the campus which could particularly benefit from their attention. Campus walks took place during the early phase, which helped to encourage discussion between the committees and planners. In addition, public meetings were held to afford the larger community an opportunity to provide input to the master planning process. While developing design principles during the Observations phase, a survey was sent to the HSC community requesting responses. The input of the UNTHSC community was critical in the development of the master plan.

1. OBSERVATIONS

The planning team recorded overall observations of on and off-campus circulation, the needs of surrounding neighborhoods, and the locations of developments on the periphery. In addition, observations were recorded regarding topography, landscaping, parking, building masses and uses, mechanical and civil infrastructure on campus. Input from the Steering and Advisory Committees was welcomed.

2. DATA GATHERING / ANALYSIS

Further information was collected by the planning team about the UNTHSC Fort Worth campus and the goals of the Center for its future. During Campus Walks, the existing campus layout, entries, facilities, landscaping, parking and ease of orienteering were assessed. Research was undertaken to discover how the UNTHSC campus became the center for research, medical care, and teaching that it is today. Diagrams were developed to illustrate the data collected, and to be presented to the Steering and Advisory Committees, President Ransom and the City of Fort Worth Planning Department. Early design considerations, such as how to further connect the campus together as a whole and tie it into the surrounding neighborhood and cultural centers, emerged out of these studies.

3. GAMING / CONCEPT PHASE

During the Gaming and Concept Phase, planning principles began to come together in various schemes. Overall organizational strategies and particular concerns for a master plan for the Health Science Center were discussed at planning charettes, interactive work sessions in which members of the Steering and Advisory Committees were invited to participate as the planning team sketched ideas.

4. FINAL CAMPUS PLAN / FINAL GUIDELINES

Based upon the observations recorded during earlier meetings and Campus Walks, guidelines were developed, and a final plan was presented to the Steering and Advisory Committees and the public. Information, direction, and conclusions from the planning process were documented. The master plan is a record of a vision for the campus and community and is a document of the discussions that took place during the planning process.

MASTER PLANNING GUIDING PRINCIPLES

Principles were established with the input of the Steering and Advisory Committees to guide the master plan process. The planning team referenced HSC mission statements and academic goals while listening to the aspirations of University of North Texas System, and community representatives for the master plan. During the planning process, schemes were developed that could translate these core values into the physical environment of the campus.



ACADEMIC VALUES

The physical plan promotes, reflects, and supports the UNTHSC core values of Academic Advancement, Discovery, Collaboration, Diversity and Entrepreneurship. Every investment in the campus supports the mission of the UNTHSC.



CREATING COMMUNITY

The UNTHSC, Neighborhoods, Cultural District and the City, will benefit from the creation of 'Community' within and around the campus. The UNTHSC is an active, essential partner that respects and supports its neighbors.



SPACES AND LINKAGES

The campus takes advantage of the surroundings by creating and linking usable outdoor spaces. The campus encourages and facilitates these linkages through identifiable pathways and gathering areas.



ENVIRONMENTAL & SUSTAINABLE PRINCIPLES

The campus respects and is informed by the natural systems of the Region. The UNTHSC encourages stewardship and efficient use of the environment, Campus and UNTHSC resources.



RESPONSIBLE IMPLEMENTATION

Develop a strategic planning matrix of future buildings, open landscape, circulation and infrastructure for the campus that will enable an orderly accommodation of future growth.



CAMPUS IDENTITY AND AESTHETICS

Develop a clear recognizable campus precinct along with consistent guidelines for architecture, landscape and way finding.

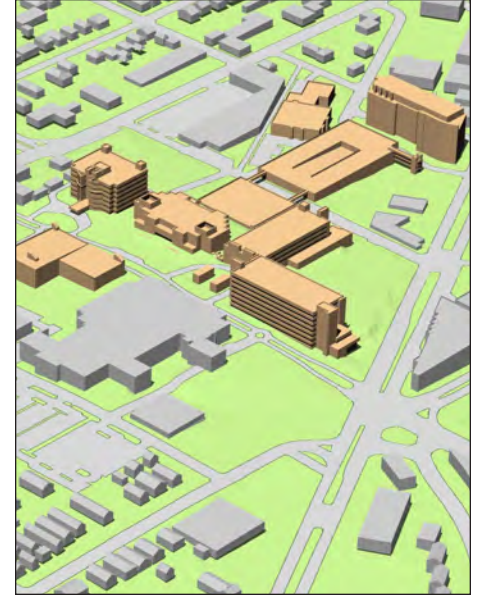

OBSERVATIONS

B



OBSERVATIONS

During the early part of the master planning process, the planning team recorded the overall observations of the existing conditions of the University of North Texas Health Science Center campus.

On and off-campus circulation, the needs of surrounding neighborhoods, and the locations of developments on the periphery were noted, as well as topography, landscaping, parking, building masses and uses, and mechanical and civil infrastructure on campus. Input from the Steering and Advisory Committees was welcomed and several public meetings encouraged input from interested citizens.

These studies helped planners formulate an attitude about the site of the campus within the boundaries and the urban surroundings in the area. Understanding the character of several eclectic adjacent communities surrounding the campus played a major part in influencing the future identity of the campus.

This section summarizes these observations, each playing a crucial role in shaping the final master plan for the Health Science Center.

CAMPUS HISTORY

THE 1960's

Responding to a national need for more osteopathic physicians, George Luibel, D.O.; D. D. Beyer, D.O.; and Carl Everett, D.O. began to develop an osteopathic college in Texas. Initial planning efforts included seeking donations and determining a suitable campus site. Administrative leaders held meetings in a building which was to the northeast of where the campus is today.

THE 1970's

Beginning as a small private college, Texas College of Osteopathic Medicine (TCOM) opened with a class of 20 students on the fifth floor of Fort Worth Osteopathic Hospital. Soon afterwards, and most memorable to those who studied and worked in its interior, a bowling alley on Camp Bowie Boulevard was renovated with classes, laboratories, and administrative offices. The first community outpatient clinic, located to the east of the Patient Care Center of today, was opened. The early buildings that TCOM occupied were separated from each other and not yet centralized into a campus.

While focused on Fort Worth, TCOM began early partnerships with surrounding regions, opening a rural clinic in Justin, Texas, and offering basic science instruction to beginning medical students in Denton at North Texas State University (the University of North Texas).

Within five years of its opening, TCOM became a state-supported medical school. The first permanent building, Medical Education Building 1, was constructed on the TCOM campus in 1978. The eight stories of MedEd-I, as it is commonly referred to today, were designed to include a library and administrative offices, as well as science and clinical teaching space.

THE 1980's

Goal statements were developed, emphasizing the importance of preventative medicine at TCOM, such as nutrition and lifestyle, basic and clinical research, admissions, recruitment of minorities, and teaching. In 1987, goals were service-oriented, focusing on community service, service to professional organizations, and continuing medical education. TCOM service activities varied from hosting a high school art competition, to receiving a Kellogg Foundation grant in 1989 for community-oriented primary care programs.

The campus grew with the construction of Medical Education Building II in 1982 as a biomedical research facility with classrooms, basic science offices, laboratories, and animal facilities. Medical Education Building III was constructed in 1984, with a library, computing services, and space for biomedical communications.

TCOM continued to focus on healthy lifestyles, designating itself as a smoke-free environment in 1987. Service to the community and hands-on learning for students increased at the Robert L. Thompson Strategic Hospital at Carswell Air Force Base, an affiliated teaching hospital.

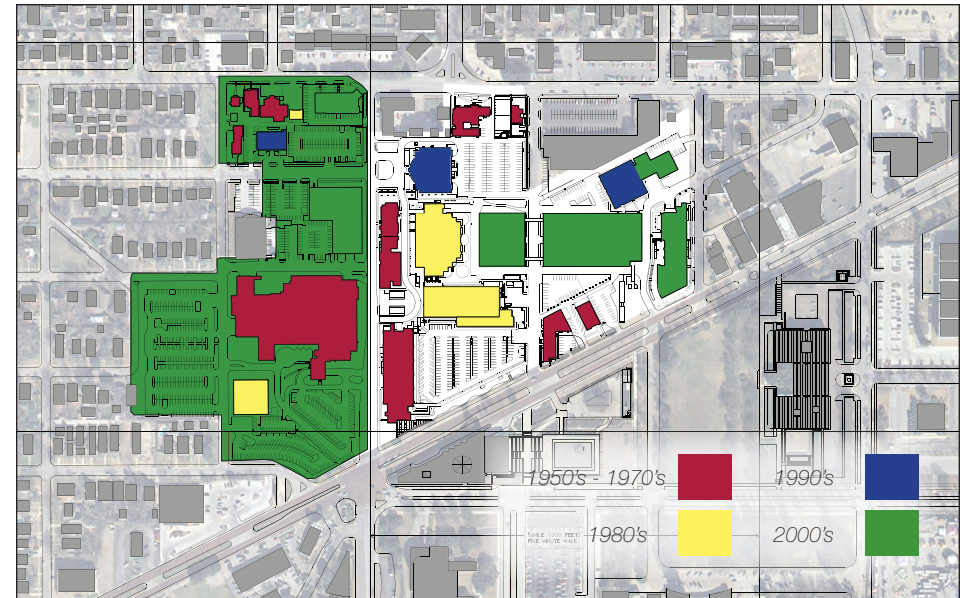

Campus development through the decades



Aerial of TCOM in 1972



The first community outpatient clinic in 1974

EXISTING CAMPUS

Including the 2005 acquisition of land west of the main campus, the UNTHSC campus currently encompasses more than 33 acres. The following pages include descriptions detailing each campus facility.

BUILDINGS

1. Education & Administration (Med Ed I)
2. Research & Education (Med Ed II)
3. Gibson D. Lewis Library (Med Ed III)
4. Patient Care Center (Med Ed IV)
5. Education Annex
6. Founder's Activity Center
7. Geriatrics Annex
8. Parking Garage West
9. Parking Garage East
10. General Services/Police & Facilities Management
11. Center for BioHealth (Med Ed V)
12. Administration Annex
13. Renal Center
14. Fort Worth Osteopathic Hospital (to be demolished)
15. Professional Offices
16. Day Care Center
17. Adjacent One-Story Buildings Under Lease
18. Parking Garage
19. Medical Center Professional Building

SURROUNDING BUILDINGS

20. Modern Art Museum of Fort Worth
21. Amon Carter Museum
22. Kimbell Art Museum
23. Fort Worth Community Arts Center
24. Fort Worth Museum of Science & History
25. Church
26. Fort Worth Orthopedic Surgery
27. Retail Center (CVS)
28. Physicians Surgery Center
29. Will Rogers Memorial Colliseum
30. Chicotsky's Center (Retail/Restaurant)

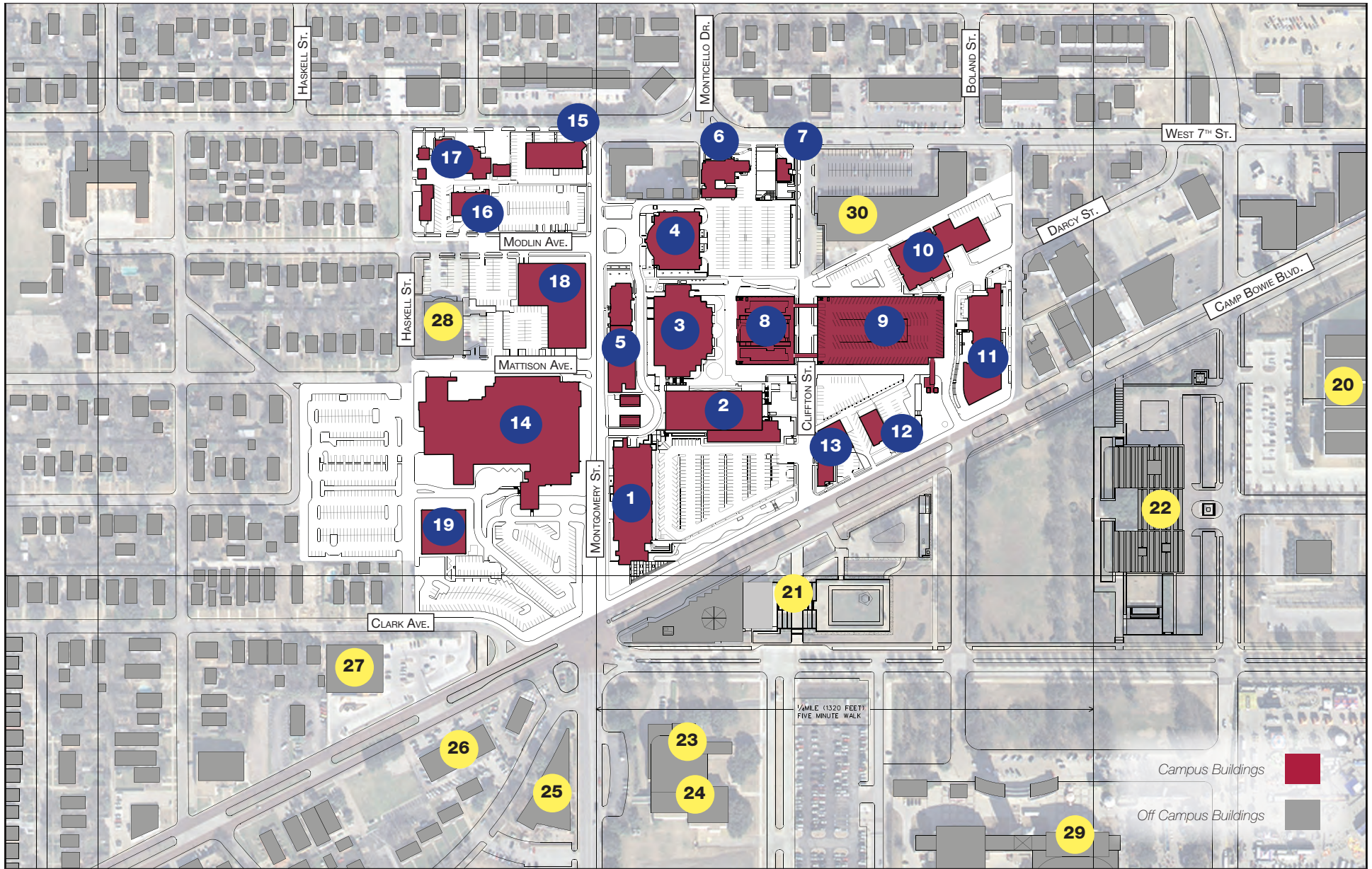

PRECINCT WALKS

Guided walks through the core and around the perimeter of the campus were held in September 2006. Members of the planning team, Steering Committee and Advisory Committee were invited to attend. Ed Bass, representing various organizations in the Cultural District; Timothy Janke, signage consultant with Jankedesign; Trina Finney with CDDI (Cultural District Development Initiatives), and Philip Poole with Townsite Company were present. A resident from each of the Crestline, Arlington Heights, Monticello, and North-Hi Mount neighborhoods participated in the walks. Photographers from the Fort Worth Star-Telegram, Kay Colley, Manager of News and Information at the UNTHSC, documented the event.



The interior of key buildings on campus were toured

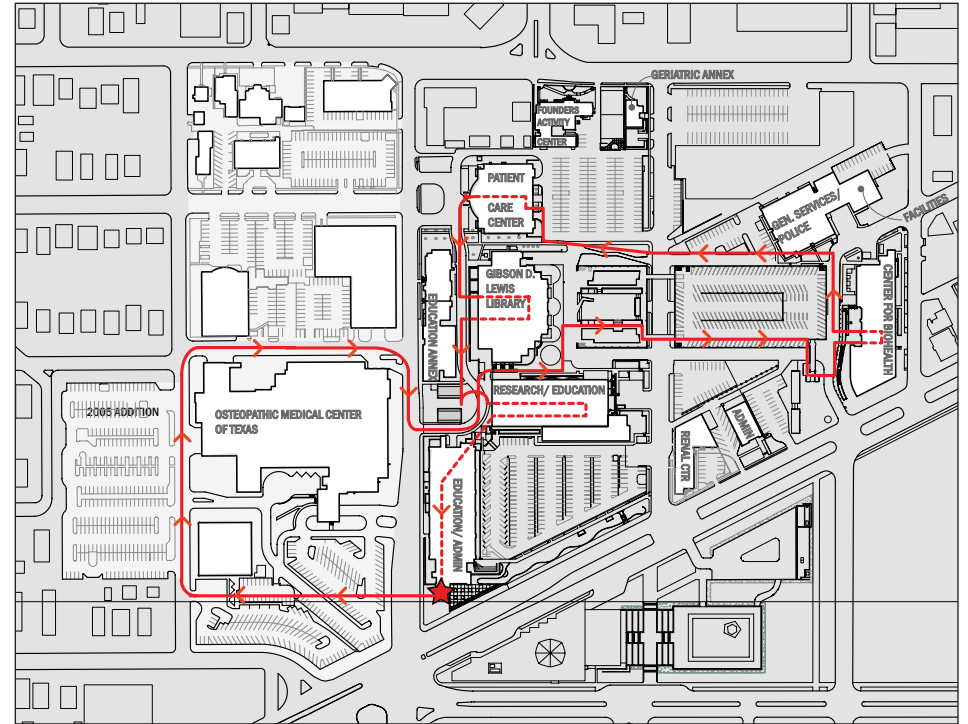

Precinct Walk Map - Campus Core Walk



The group met with faculty and staff during the walk

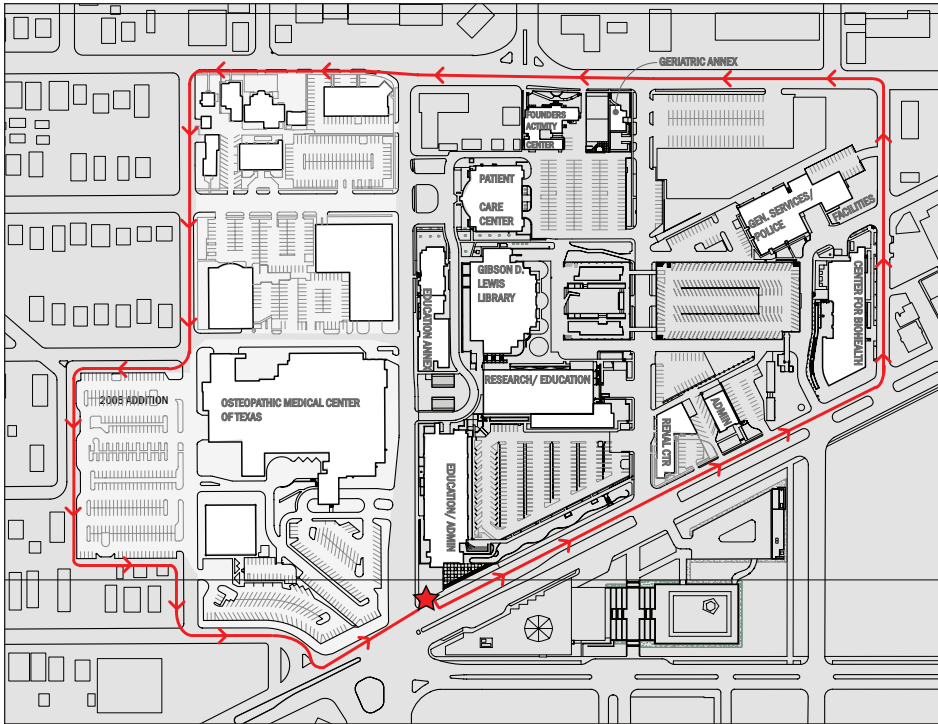

Precinct Walk Map - Perimeter Edge Walk



Discussions raised programmatic questions

PRECINCT WALK RESULTS

Programmatic questions emerged regarding the use of spaces inside buildings during the Core Walk. Discussions continued on the topics of building scale, entries, signage, parking and paths between diverse locations on campus. During the Edges Walk, the group addressed issues of campus entry, landscape, topography, traffic and signage, while walking around the perimeter of the campus.



Members from the Advisory and Steering Committees



Campus view from parking garage

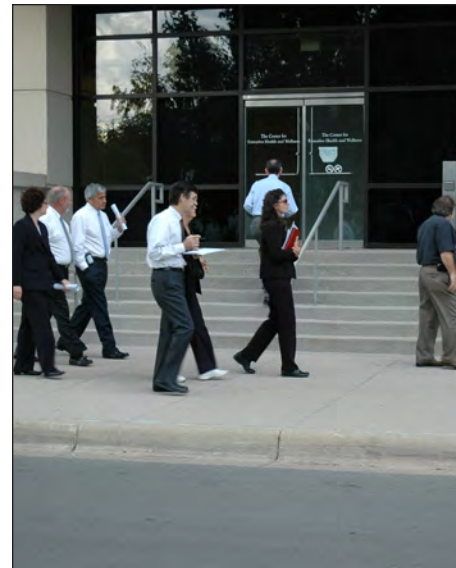

Touring the campus perimeter

REPRESENTATIVE CAMPUS BUILDINGS

The following pages document details about each facility on campus. Information presented about each building includes construction dates, gross square footages, building type, construction type, floor count and programs within.



EDUCATION & ADMINISTRATION BUILDING (MED-ED-I) - 502

Constructed: 1978
 Gross Square Footage: 227,458
 Building Type: General Purpose
 Construction Type: Reinforced Concrete Frame
 Number of Floors: 8
 Programs: Offices, Labs, Exam Practice Rooms

Building Summary

The Education & Administration Building is home to administration and support services, teaching labs and research. Administrative offices and a board room can be found on the 8th floor, while the School of Public Health is on the 7th floor. Floors three, four, five and six host wet labs for research and some various office administration suites. The lower floors include a large auditorium classroom that seats 250 students which is used for both the UNTHSC and community events.



RESEARCH & EDUCATION BUILDING (MED-ED-II) - 504

Constructed: 1982
 Gross Square Footage: 150,520
 Building Type: General Purpose
 Construction Type: Reinforced Concrete Frame
 Number of Floors: 8
 Programs: Lab Animal Medicine, Dept. of Anatomy, Pharmacology, Integrative Physiology, Cell Biology & Genetics, Department of Physiology, Environmental Health/Safety, Molecular Biology

Building Summary

Classrooms, laboratory spaces and faculty offices are provided in the Research and Education Building. The building is currently supporting a variety of programs, including Molecular Biology and Integrated Physiology.



GIBSON D. LEWIS LIBRARY (MED-ED-III) - 507

Constructed: 1986
 Gross Square Footage: 131,010
 Building Type: General Purpose
 Construction Type: Reinforced Concrete Frame
 Number of Floors: 4
 Programs: Library services, Biomedical Communication, Telecommunications, Information Technology Services, Offices

Building Summary

At the Gibson D. Lewis Library, books, electronic resources, offices, archives and a limited number of meeting rooms are available. A small eating area and cafeteria are available downstairs from the library. Representatives of the UNTHSC would like to see more meeting rooms at the Lewis Library in the future, and students would be happy to have more small group study areas either in the library or in the buildings where labs and classes are held.

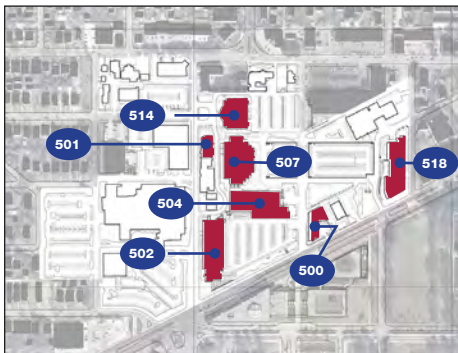



**PATIENT CARE CENTER
(MED-IV) - 514**

Constructed: 1997
 Gross Square Footage: 135,172
 Building Type: General Purpose
 Construction Type: Reinforced Concrete Frame
 Number of Floors: 6
 Programs: Pediatrics, UNT Health, Clinical Research, Family Medicine, Internal Medicine, Psychiatry, Surgery, OB/GYN, Manipulative Medicine

Building Summary

The Patient Care Center is a clinical center open to patients and run by staff and faculty of the UNTHSC. Its entry from a steep parking lot has proved a challenge for some patients.

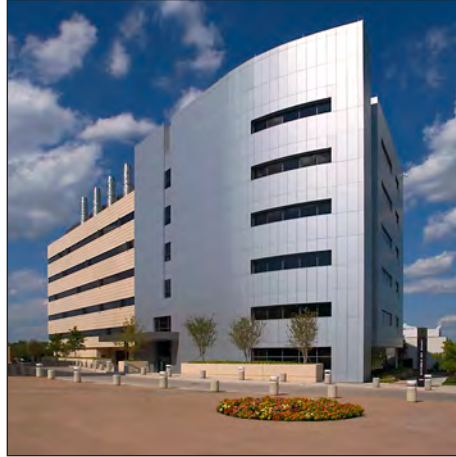

**CENTER FOR BioHEALTH
(MED-ED-V) - 518**

Constructed: 2004
 Gross Square Footage: 153,265
 Building Type: General Purpose
 Construction Type: Reinforced Concrete Frame
 Number of Floors: 6
 Programs: Epidemiology, Biostatistics, Environmental and Occupational Health, Pharmacology

Building Summary

The Center for BioHealth is the home for various groups and departments, research centers, and labs. Radiology and the Center for Research Management can be found on the first floor. Classrooms are located on the second floor, with plans to expand for laboratory spaces. Public Health is on the third floor, and additional labs are on the 5th floor.



**ADMINISTRATION ANNEX 2 / DIALYSIS
CENTER - 500**

Constructed: 1974
 Gross Square Footage: 9,927
 Building Type: General Purpose
 Construction Type: Steel Frame
 Number of Floors: 2
 Programs: Institutional Planning, Strategic Evaluation Analysis, Dialysis Clinic



ENX1: EDUCATION ANNEX 1 - 501

Constructed: 1973
 Gross Square Footage: 6,003
 Building Type: General Purpose
 Construction Type: Load-bearing Masonry Walls
 Number of Floors: 1
 Programs: Offices & Exam Rooms, UNTHSC Physician Assistant Studies



FOUNDER'S ACTIVITY CENTER - 505

Constructed: 1955
 Gross Square Footage: 13,773
 Building Type: Auxiliary Services
 Construction Type: Wood Frame w/Masonry
 Number of Floors: 2
 Spaces: Gym, Work out Rooms, Locker Rooms, Offices, Conference Room



ENX2: EDUCATION ANNEX 2 - 506

Constructed: 1964
 Gross Square Footage: 11,077
 Building Type: General Purpose
 Construction Type: Wood Frame w/Masonry
 Number of Floors: 1
 Programs: Manipulative Medicine, Pathology - DNA



CHEMICAL STORAGE - 509

Constructed: 1990
 Gross Square Footage: 807
 Building Type: General Purpose
 Construction Type: Reinforced Concrete Masonry
 Number of Floors: 1
 Spaces: Storage



GENERAL SERVICES BUILDING - 510

Constructed: 1991
 Gross Square Footage: 15,965
 Building Type: Auxiliary Services
 Construction Type: Reinforced Concrete Masonry
 Number of Floors: 1
 Programs: Campus Police, Property Control, PaintShop, Carpenter, Property Control/ Receiving, Central Receiving, Pharmacy/ Central Supply, Automotive

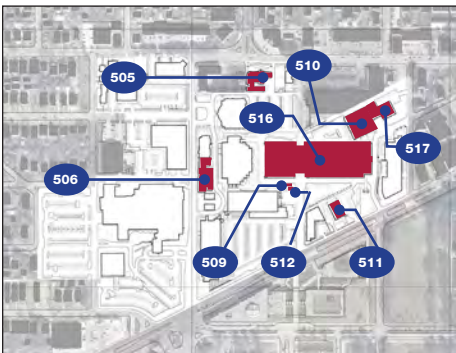



ADMINISTRATION ANNEX 1 - 511

Constructed: 1968
 Gross Square Footage: 4,100
 Building Type: General Purpose
 Construction Type: Load-bearing Masonry Walls
 Number of Floors: 1
 Programs: Offices, UNT Health



SOLVENT STORAGE BUILDING - 512

Constructed: 1982
 Gross Square Footage: 432
 Building Type: General Purpose
 Construction Type: Reinforced Concrete Frame
 Number of Floors: 1
 Spaces: Storage



PARKING GARAGE - 516

Constructed: 2001
 Gross Square Footage: 232,765
 Building Type: Auxiliary Services
 Construction Type: Reinforced Concrete Frame
 Number of Floors: 4
 Spaces: 730 Parking Spaces



FACILITIES MANAGEMENT BUILDING - 517

Constructed: 2000
 Gross Square Footage: 8,020
 Building Type: Physical Plant Building
 Construction Type: Steel Frame
 Number of Floors: 1
 Spaces: Facilities Administration, Construction, Custodial, Maintenance, Utilities and Energy Management



FORMER OSTEOPATHIC MEDICAL CENTER OF TEXAS - 519

Constructed: 1946
 Gross Square Footage: 325,310
 Building Type: Hospital
 Construction Type: Reinforced Concrete Frame
 Number of Floors: 6



3621 WEST 7TH STREET - 520

Constructed: 1957
 Gross Square Footage: 5,615
 Building Type: Auxiliary Services
 Construction Type: Wood Frame w/Masonry
 Number of Floors: 1



3632 MODLIN AVENUE - 521

Constructed: 1955
 Gross Square Footage: 270
 Building Type: Auxiliary Services
 Construction Type: Wood Frame w/Masonry
 Number of Floors: 2
 Programs: Internal Medicine, Seep Study Center



3629 WEST 7TH STREET - 522

Constructed: 1965
 Gross Square Footage: 3,188
 Building Type: Auxiliary Services
 Construction Type: Wood Frame w/Masonry
 Number of Floors: 2

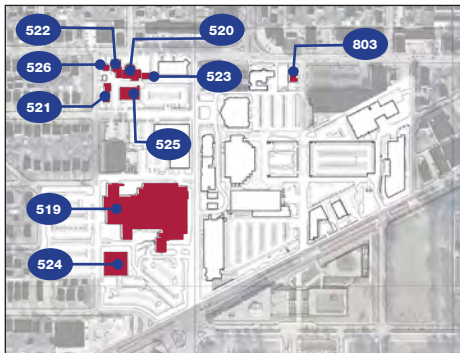



ST. EMILION RESTAURANT - 523

Constructed: 1985
 Gross Square Footage: 1,560
 Building Type: Rental Property
 Construction Type: Wood Frame w/Masonry
 Number of Floors: 2
 Spaces: Restaurant (Leased)



MEDICAL PROFESSIONAL BUILDING - 524

Constructed: 1981
 Gross Square Footage: 26,370
 Building Type: Rental Property
 Construction Type: Steel Frame
 Number of Floors: 2
 Programs: Medical Professional Offices



CHILD CARE AND ASSOCIATES - 525

Constructed: 1995
 Gross Square Footage: 5,725
 Building Type: Rental Property
 Construction Type: Lightweight Metal Walls
 Number of Floors: 1
 Programs: Child Care



3633 WEST 7TH STREET - 526

Constructed: 1955
 Gross Square Footage: 1,604
 Building Type: Auxiliary Services
 Construction Type: Wood Frame w/Masonry
 Number of Floors: 1
 Programs: Geriatric



3501 WEST 7TH STREET - 803

Constructed: 1923
 Gross Square Footage: 2,481
 Building Type: Auxiliary Services
 Construction Type: Wood Frame w/Masonry
 Number of Floors: 2
 Programs: Leased

NEARBY DEVELOPMENTS

WEST 7TH STREET URBAN VILLAGES

The West 7th Street Urban Villages, an area bordering the UNTHSC to the north and east, is surrounded by five significant areas of Fort Worth: the Cultural District to the southwest, Downtown to the east, the Medical District to the southeast, the Stockyards to the north, and Trinity Uptown to the northwest. Because of its strong cultural surroundings, this area has been the focus of strategic development including preserving several Fort Worth landmarks located within its boundaries.

The West 7th Street Urban Villages will include four distinct neighborhoods, each with established development patterns and distinctive character, that will provide residential and commercial areas near important districts.

CULTURAL DISTRICT & WILL ROGERS MEMORIAL CENTER

Immediately to the south of the Health Science Center lies the world renowned Cultural District with its museums and Will Rogers Memorial Center. This area is home to six world class museums in addition to many local shops and restaurants. The Will Rogers Memorial Center is a multi-purpose entertainment complex which hosts numerous venues year-round including the annual Fort Worth Stock Show and Rodeo.

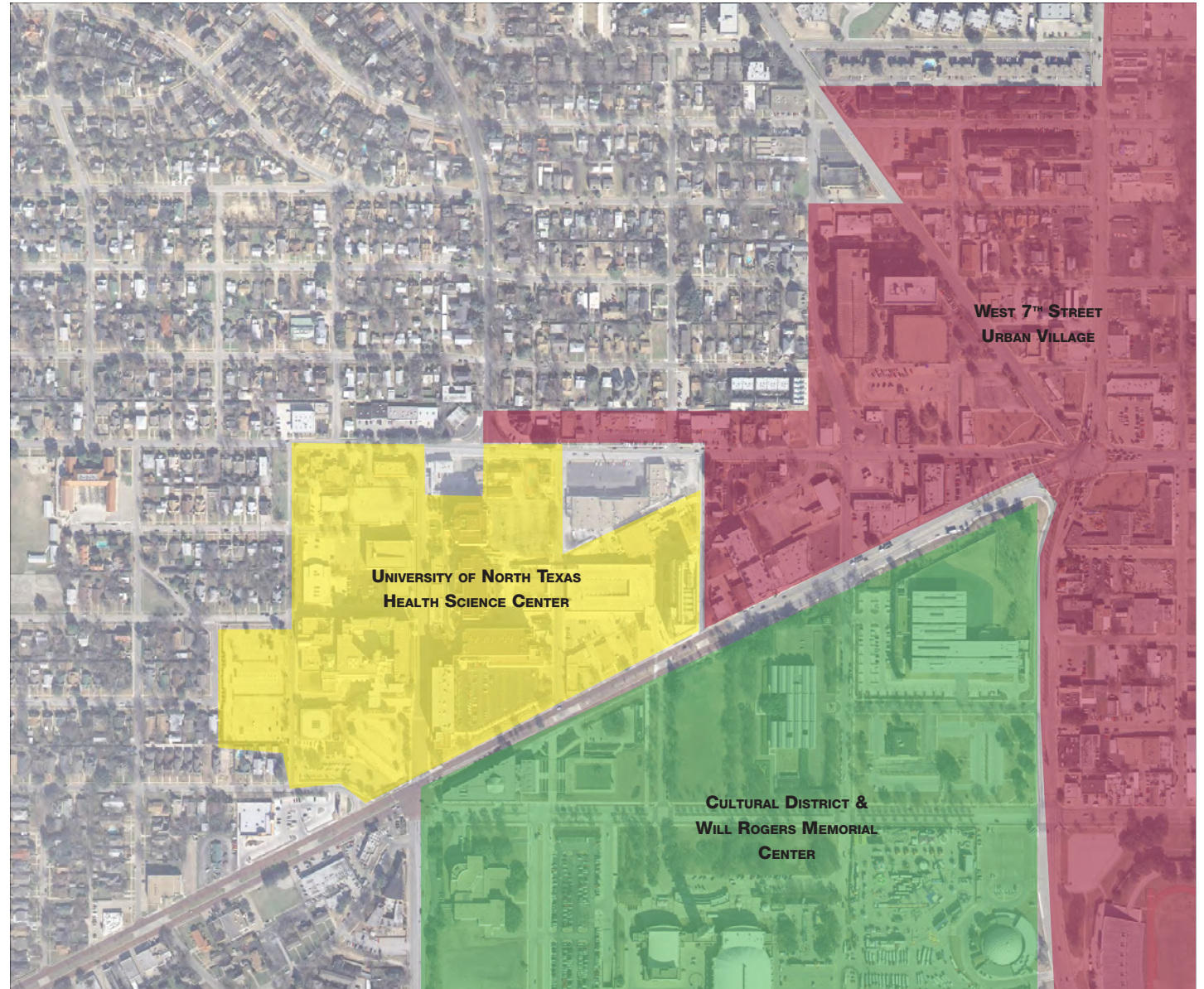

Several developments surround the UNTHSC including a planned 7th Street Urban Village, the Cultural District and several historic neighborhoods



FUTURE DEVELOPMENTS

MUSEUM PLACE

Located west of the intersection of Camp Bowie, West 7th and Bailey Streets, the Museum Place development is likely to have an impact on the UNTHSC campus. A mixed-use development with a combination of residential, office, retail and restaurant spaces, Museum Place is planned to increase the amount of people living, working and shopping in the area near the UNTHSC campus. West 7th Street will become more prominent as the number of retail spaces increase, and Museum Place may effectively fulfill the need for retail around the UNTHSC campus. Some of the proposed mixed-use buildings are likely to be about eight stories tall, which is quite a difference from the typical one-story commercial development that is currently at the 7th Street and Bailey intersection. Closer to the scale of the UNTHSC than to its surroundings, this development could either help the UNTHSC buildings to blend in better with their surroundings or mask them. To help lessen the impact of this large development on surrounding areas, traffic calming strategies are to be employed at the intersection and on West 7th Street.

Concept Sketch: Museum Place†



Proposed View from the 7th Street Roundabout†



Plan of Museum Place Development

†Representative sketch of Museum Place at time of publishing. May not represent final built environment.



1

View of Camp Bowie Boulevard looking toward downtown Fort Worth



2

Vehicular and pedestrian access is blocked by fences installed across Modlin Avenue and Mattison Avenue to prohibit campus entry from the west



3

Campus access from the north is from Montecello Drive

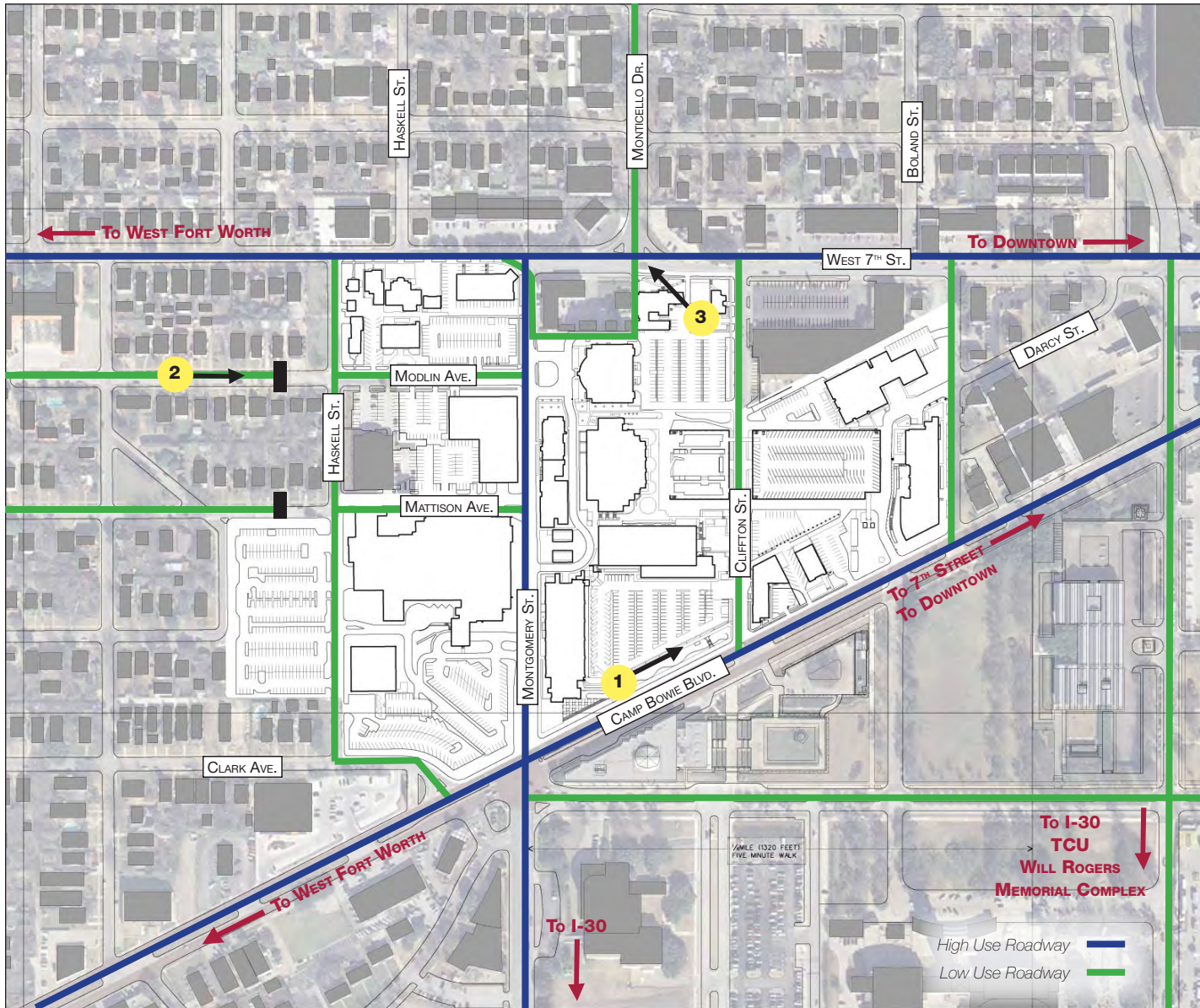

MAJOR ROADWAYS & LINKAGES

The UNTHSC is accessible via highways, major and minor streets in the urban area. The campus is bordered on the north by West 7th Street and on the south by Camp Bowie Boulevard. Montgomery Street runs between the existing campus and the recently acquired Osteopathic Hospital property to the west. These three thoroughfares are very important to both the UNTHSC and the Cultural District overall. Camp Bowie serves as the main interior arterial that connects both the HSC and the museum district with downtown to the east. Its brick laid construction is a reminder of the culture and history of the area. As nearby commercial projects develop and expand, both pedestrian and automobile traffic will increase. West 7th Street is currently a minor interior feeder street which, with the completion of the Museum Place mixed use development, will become a more prominent connection to both retail and pedestrian destinations. West 7th has also been identified as a potential light rail corridor from downtown. Montgomery Street runs north-south and is the major connection to I-30. Traffic on Montgomery will now transition through campus before reaching 7th Street. This will create a new "front door" which will need to be reinforced with streetscape, signage and landscape improvements to be successful.

PERIPHERY USE

To the North of campus, retail and restaurants can be found along W. 7th Street. Additional commercial developments are located to the East of campus, and are planned to increase with the construction of the proposed Museum Place development. Neighborhoods border the campus further to the North and to the West. Famed cultural institutions, such as the Amon Carter Museum and The Kimbell Art Museum, are within walking distance to the South of the Campus across Camp Bowie Boulevard. Private medical and health business, as well as office, art and gallery spaces are scattered in each direction near the edges of the campus.

At meetings with the public, Steering and Advisory Committees communicated that protection of existing residential neighborhoods should be of primary concern for the master plan. Residential neighborhoods to the North and West of the campus would likely be most impacted by any changes on the UNTHSC campus. Representatives from the adjoining neighborhoods were active participants in the Advisory Committee and Public Meetings. The HSC acknowledges that growth of the UNTHSC has not necessarily been seen as positive from the perspective of the neighborhoods, and would like future development to remain within its current boundaries if possible. In the wake of the closing of the former Osteopathic Hospital, the UNTHSC has an opportunity to enhance community and HSC relations.

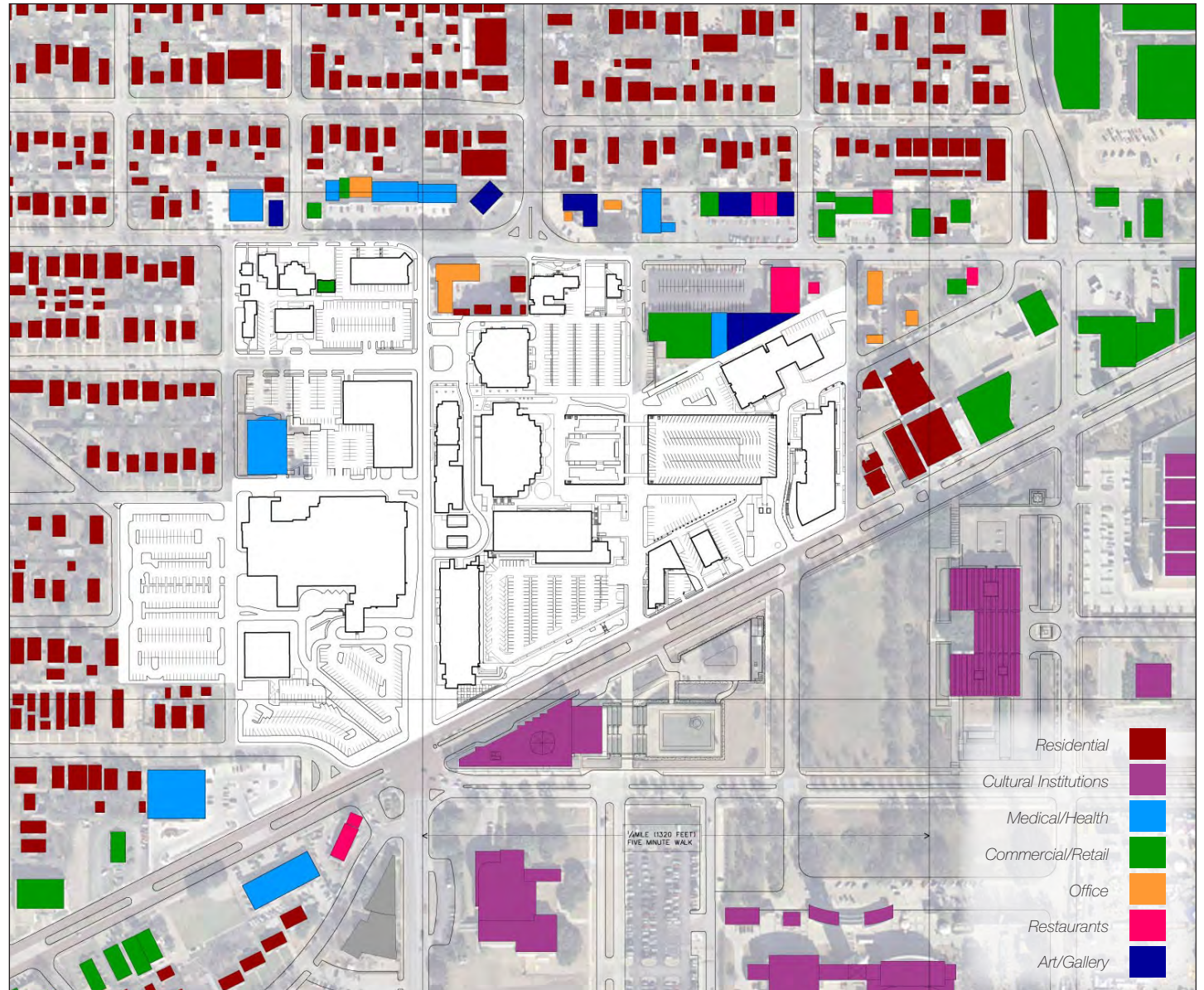



The Amon Carter Museum neighbors the UNTHSC on the South of campus



The Kimbell Museum

Retail and restaurant spaces within walking distance could become more student-oriented as the UNTHSC campus develops. Students would like to see healthy food, a fitness center, and a bookstore nearby, which could be either on or off-campus. Developers were welcomed to participate in discussions of the master plan.

During planning sessions, connections to the neighboring cultural institutions were discussed. Ideas ranged from art galleries or sculpture on the UNTHSC campus to a shared large lecture room. Representatives of the cultural institutions were invited to be part of the Advisory Committee and public meetings.



The Fort Worth Cultural District



The Chicotsky's Center along West 7th Street

EASEMENTS

Civil plans from the City of Fort Worth for the UNTHSC included information about city streets, easements, water infrastructure, storm and sanitary sewer, as well as planned utility and street improvements. Meanwhile, gas, power, phone and cable utilities are governed by private enterprise. The buildable area of the UNTHSC campus is somewhat restricted by current utility easements, which can be moved or abandoned as required. The existing configuration of city water lines and city sanitary sewer lines are at the periphery of the property and subsequently not in the way of any UNTHSC development. Because of the campus's location on a high topographical spot in the area, there is very little underground storm sewer or infrastructure on campus. Almost all of the existing property is drained at grade with the exception of some minor infrastructure that supports truck docks and low spots on campus. A series of minor utility improvements are underway in the surrounding neighborhoods, which are not likely to impose any additional limits on the campus.

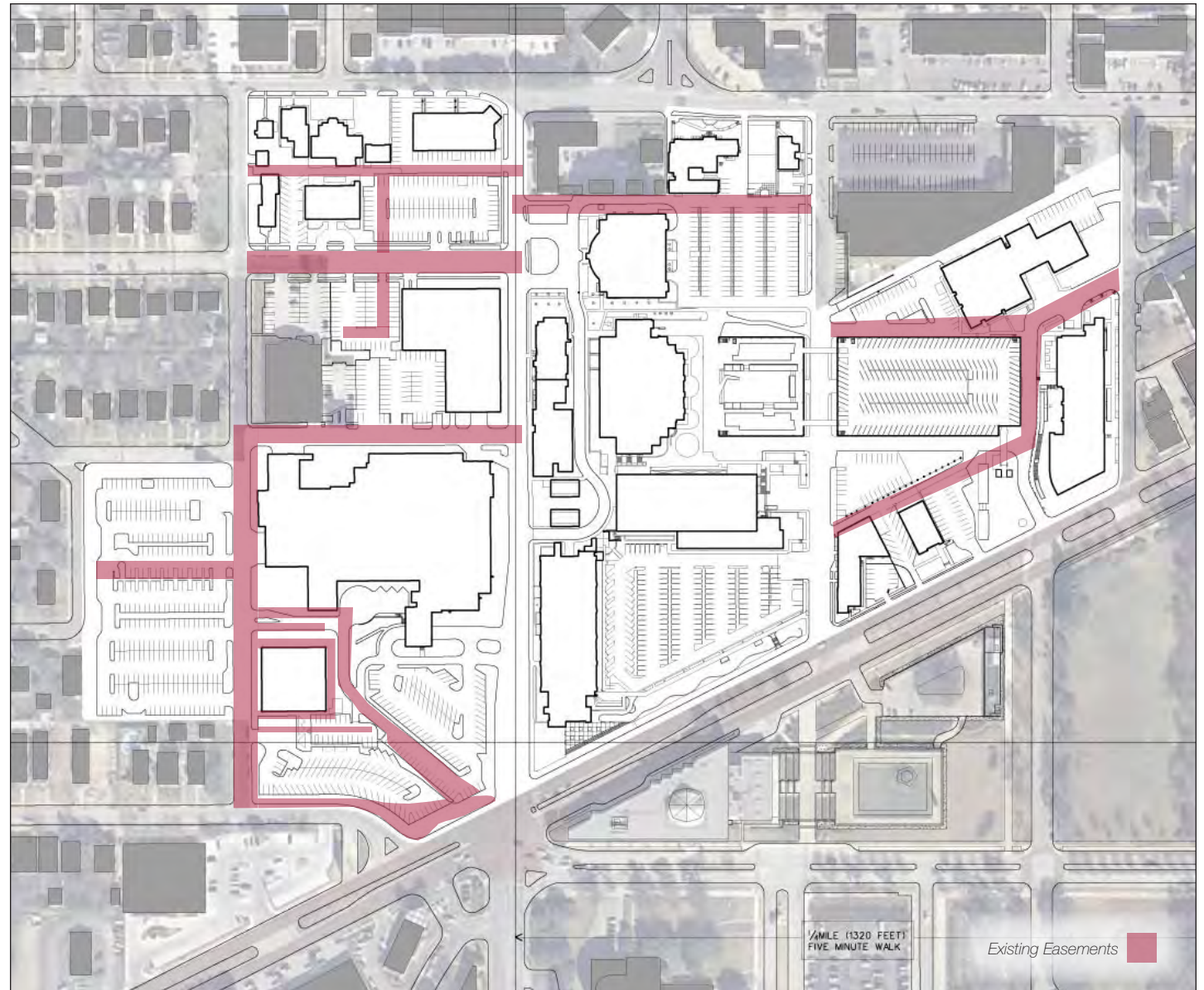

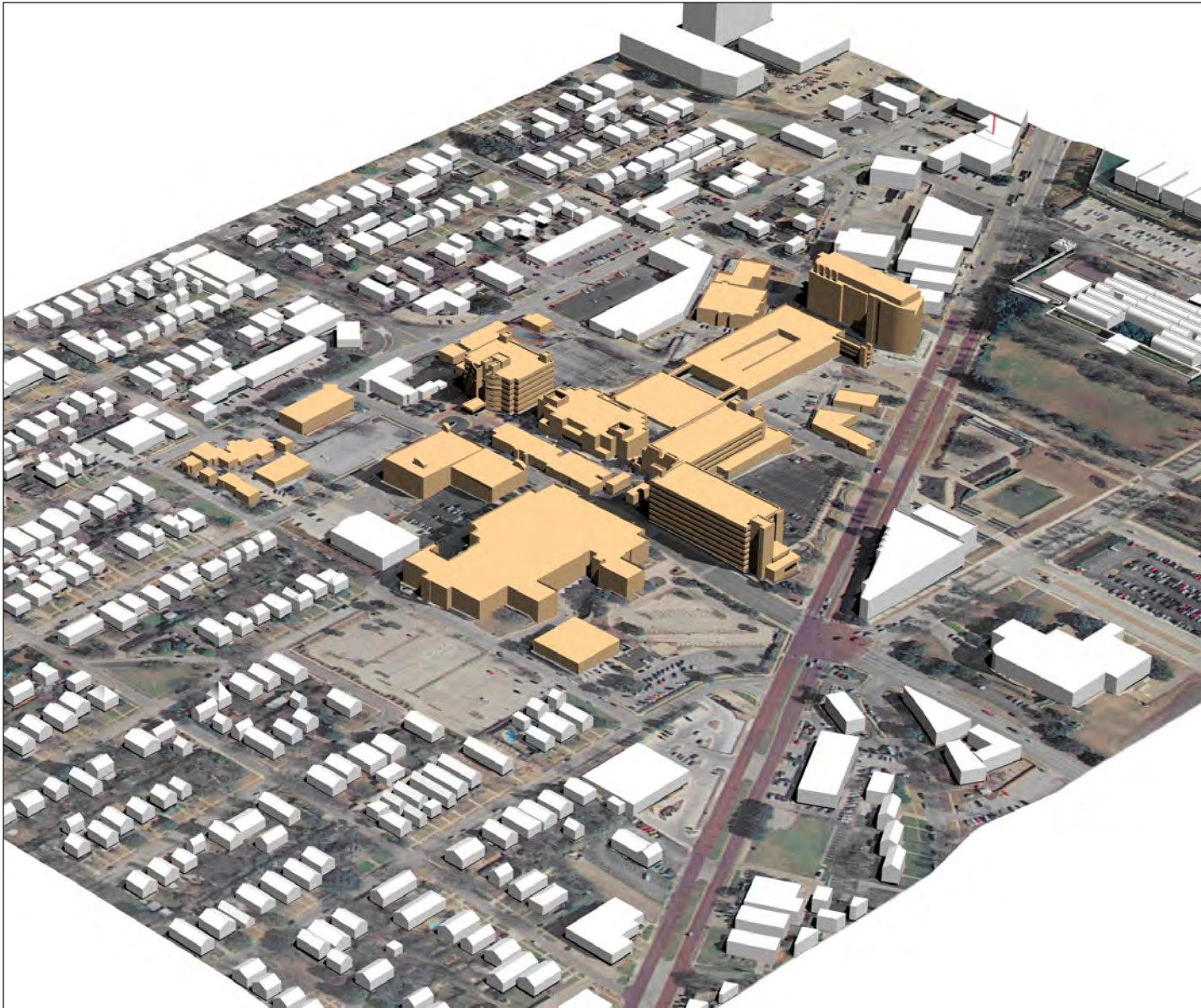

EXISTING MASSING

Shown in the massing model to the left, on-campus buildings vary in their ratios of height to breadth.

Building masses have a direct impact on the ease in locating building entries. Some of the entries of taller buildings may be visually blocked by shorter buildings at the pedestrian level, as in the case of the entry to the library. The former Osteopathic Hospital and its surrounding land, newly acquired by the UNTHSC in 2005, is a large area that almost doubles the size of campus. Careful orientation of entries and building masses in the development of this new property are necessary for campus wayfinding.

Streets also have a role to play in the overall massing of the UNTHSC campus. Buildings are built close to the edges along the streets running North to South, such as on Montgomery Street. Greater setbacks can be seen along Camp Bowie Boulevard, however. As an intersection of two relatively wide streets, Montgomery and Camp Bowie could be considered to be a main campus entry.

TOPOGRAPHY

The topography of the University of North Texas Health Science Center campus in Fort Worth present both challenges and opportunities in planning a campus that is pedestrian-friendly, accessible, and well-landscaped. From west to east, the elevation drops approximately 80 feet from Montgomery to the east curb of Bolland Street. Further west, at the location of the former Osteopathic Hospital, the grade level rises an additional ten feet.

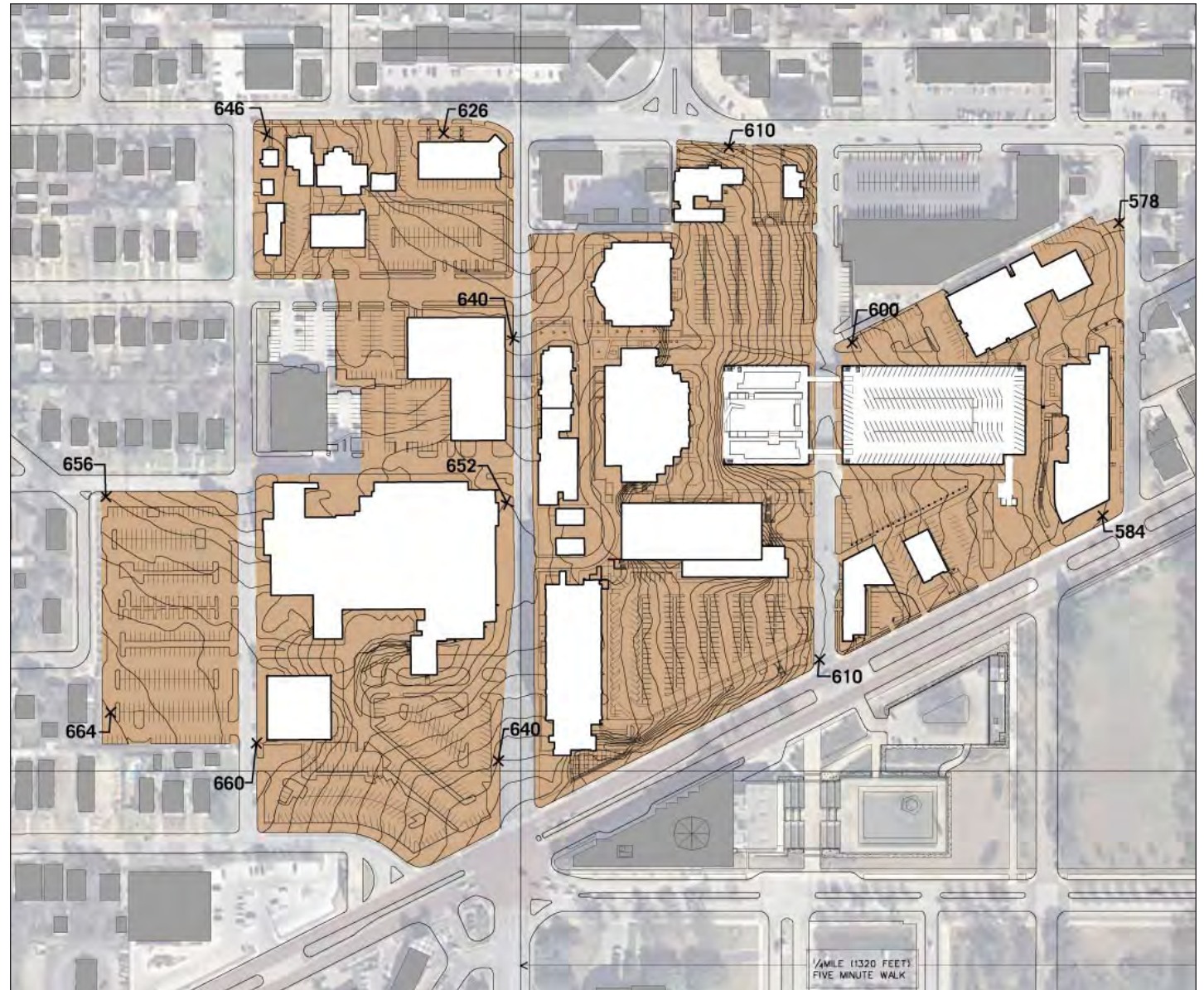

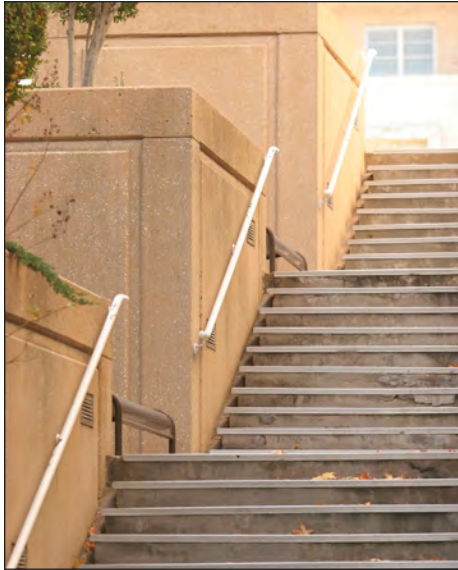

EFFECTS OF TOPOGRAPHY

As a positive, the existing buildings located on the higher areas on campus near Montgomery enjoy unique views of the downtown Fort Worth skyline. From the upper floors of both MedEd-I building and the Center for BioHealth the views of both the museum district and the downtown skyline are memorable. However, this same topography presents serious limitations on the overall accessibility of the campus. The result of these steep grade changes has been noted to be most problematic in the Patient Care Center Parking lot. It is here that the topography is so extreme that it presents a physical barrier to visiting patients. Currently, the UNTHSC employs a small motorized vehicle to intercept patients at their parking space and transport them to the entry of the Patient Care Center. The topography limits the "walkability" of the campus, specifically from east to west. Walking from the Center for Biohealth at Boland to MedEd-I on Montgomery (in the summer) can be quite an undertaking. Another more serious campus challenge created by topography is the limited visibility on Montgomery street. The topography of the campus creates a crown in the street halfway through campus (when traveling north or south). This crown limits the visibility of drivers as they approach the heavily used pedestrian crossing between the main HSC campus and the new Osteopathic property on the west side of Montgomery.

The campus topography has, and will have, an effect on the guidelines for building heights across campus. The existing tall buildings in the center of campus near Montgomery appear even taller because of the high elevation at that location. They block the view corridors for the neighborhoods to the west. Even tall buildings placed on the east edge of campus appear much shorter in comparison. As an example, the Center for Biohealth is six stories tall but does not impede the view to downtown from the second floor of MedEd-I up the hill to the west. Site elevation changes do present a unique opportunity for multi-level building design solutions address grade at two levels that might present a mix of interesting landscaping, paths, parking, buildings and retail space.

VISTAS

The UNTHSC campus is set atop the apex of a gradual hill, providing several magnificent views of the adjacent community and picturesque scenes of the downtown skyline. Approaching visitors begin to view the campus profile long before entering the Center's vicinity.

Because of this location, the UNTHSC is presented with a challenge to take advantage of its prominent location. In addition, the transition between cultural surroundings to the south and the commercial enterprise to the north and east presents another challenge for the direction of the campus's future development. These factors have influenced the concepts and planning strategies of the master plan.

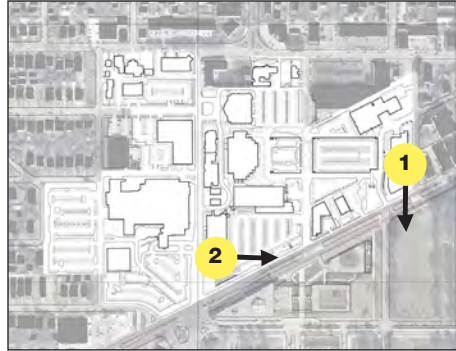

1

View from 3rd floor conference room - Center for BioHealth



2

View from 8th floor of MedEd-I

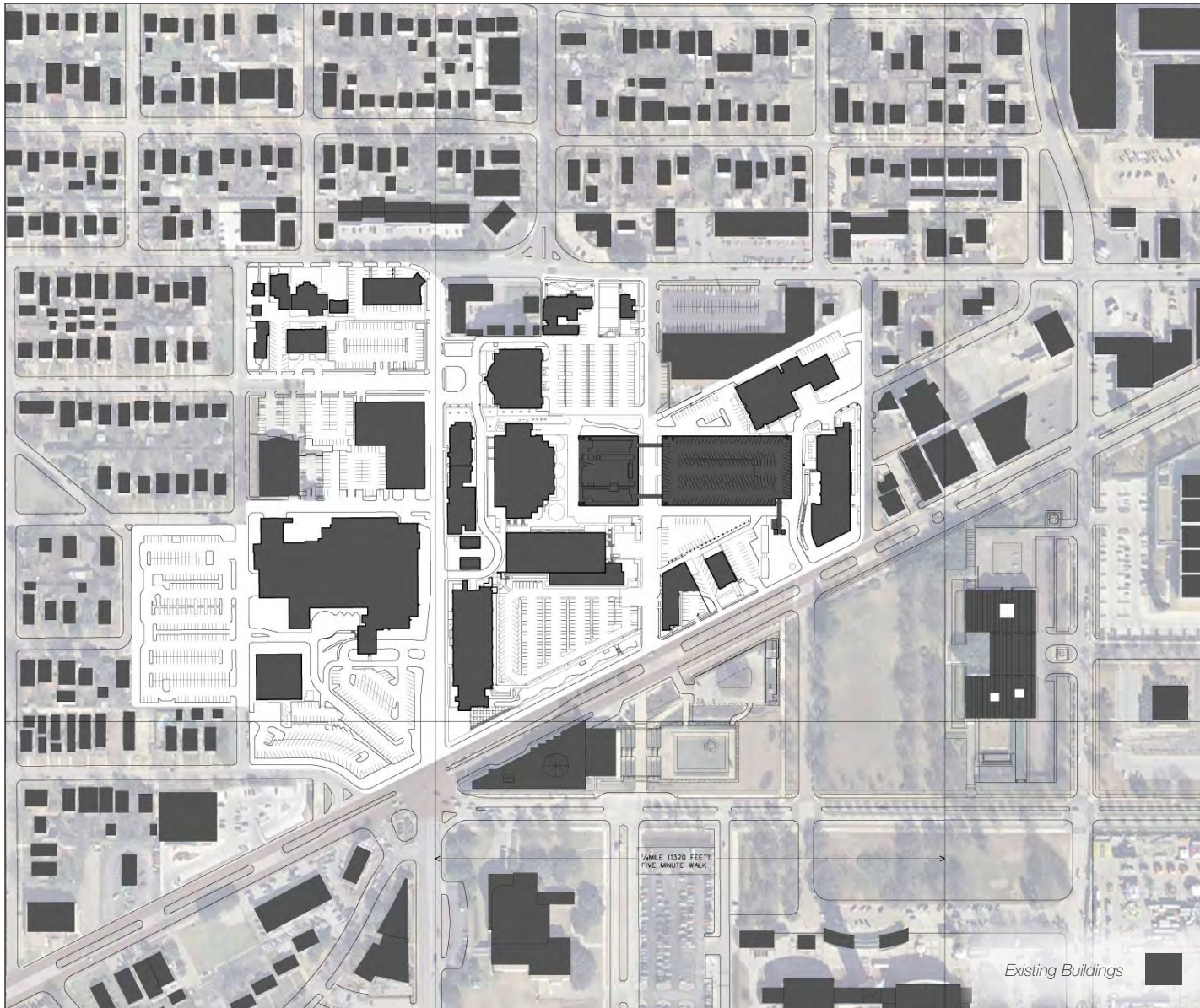

BUILDING-GROUND RELATIONSHIPS

The relationship of building to ground plays a part in the overall perception of the UNTHSC campus at a pedestrian scale. As shown in the diagram on this page, there is a definite difference in the building to ground relationship on campus as opposed to that of the surrounding neighborhoods to the west and north, and to the museum district to the south.

The neighborhoods are represented with a dense network of small footprint structures evenly spaced in a traditional street grid configuration. The apparent changes in the neighborhood pattern is the transition of an individual residential footprint to a more dense multi-housing town home footprint at interior lot locations and a retail like pattern at the edges.

In the museum district south of campus, the building-ground pattern is more park like with buildings located as objects in a landscape. This is in sharp contrast to the UNTHSC campus where a more commercial, large scale footprint is surrounded by open parking. The master plan team used this diagram to align the proposed building to ground of the future campus with its neighbors. The goal is to position the campus as a transitional zone rather than a third different element.

EXISTING PARKING

Parking spaces are provided for students, faculty, staff, patients and tenants at the University of North Texas Health Science Center. Over half of the existing parking inventory, or 1,136 spaces, are located on surface lots. An additional 1,044 spaces are available in garages, with the West Garage providing 74 spaces for faculty and staff, and the East Garage providing 656 spaces for students and general parking. The parking garage associated with the former Osteopathic Hospital contains 325 spaces that are currently not in use, but awaiting some improvements to update it to current parking garage standards. Overall, parking lots account for over half of the impervious surface area of the campus.

The existing campus parking lots and garages are not completely utilized. To avoid parking fees, many students and staff, especially those enrolled in rotations off site, park in the surrounding neighborhoods and on the street in the museum district south of Camp Bowie.

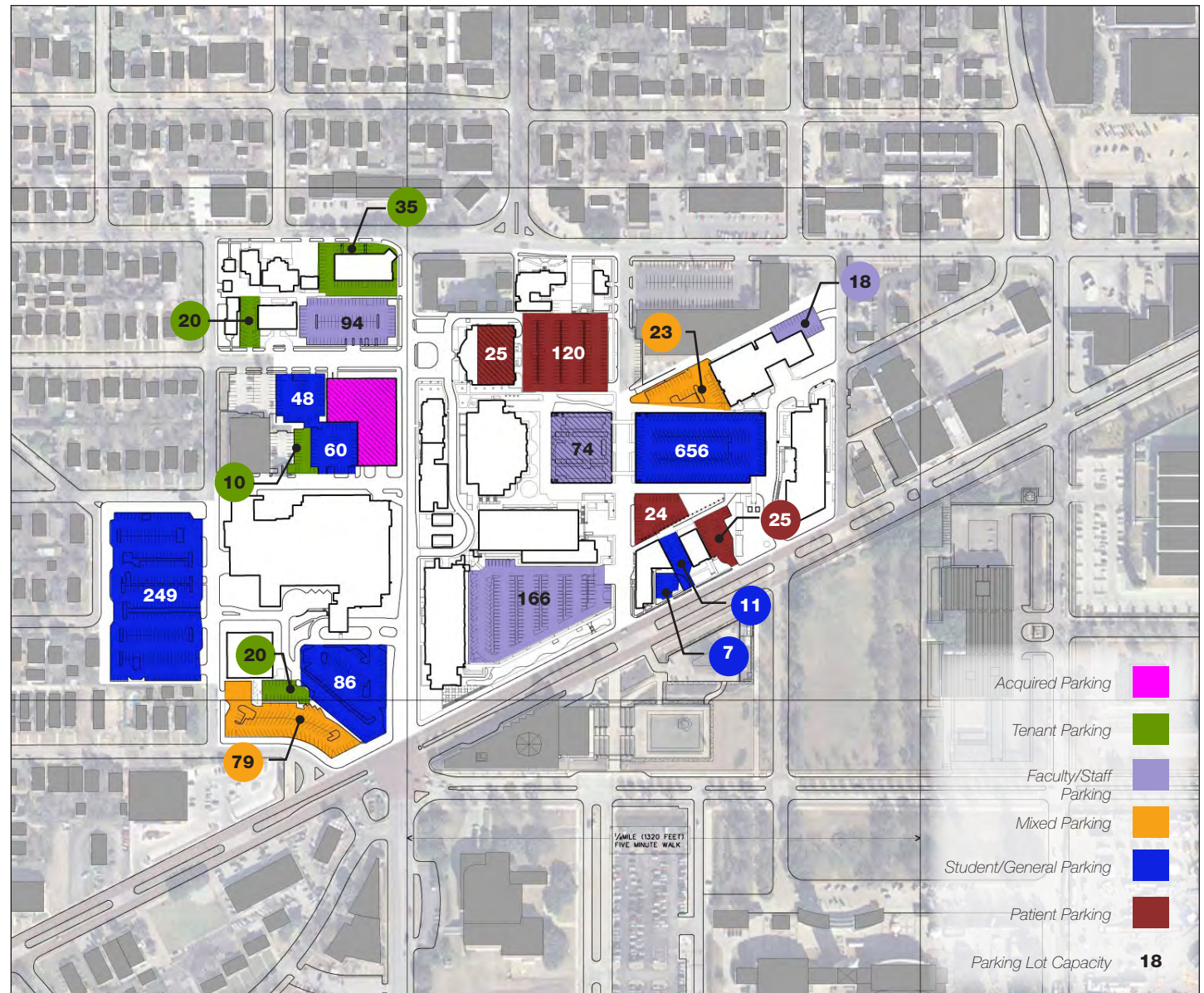

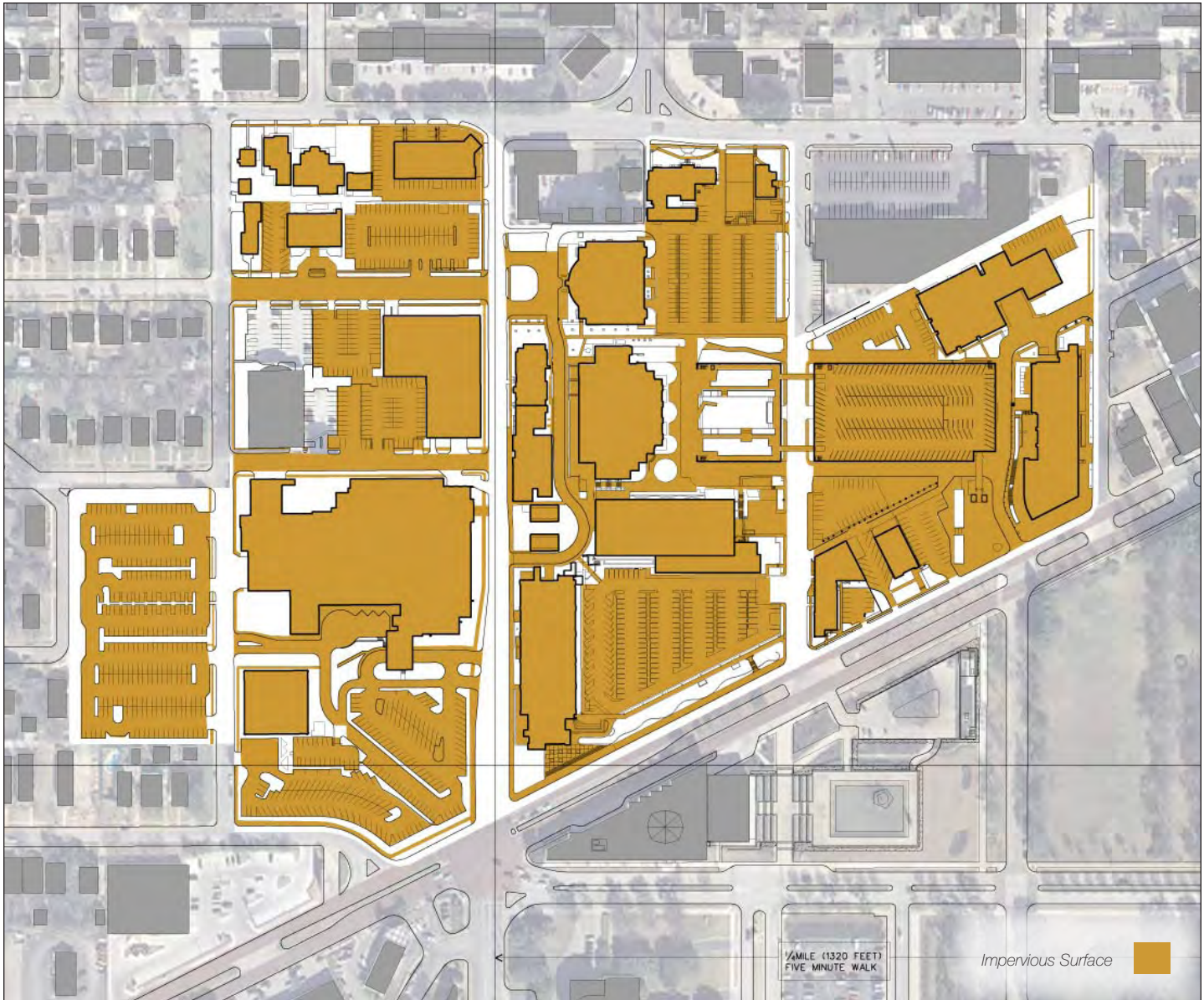

IMPERVIOUS SURFACE

As shown in the impervious surface diagram, almost all of the existing campus property is either concrete surface, building rooftop, or asphalt parking. Very little area on campus has been preserved as green space. This diagram was the most telling of the overall observation process. The diagram re-confirmed the pre-conceptions of both the Advisory and Steering Committees, who agree that landscaping is an important consideration for planning a campus that is to be conducive to student life and promotes healthy living. The planning team founded its initial master plan concept on an improvement of this condition. This concept will work to alter the existing impervious surface conditions through the creation of landscape pockets, linkages, green view corridors and paths.

CAMPUS EDGES

Campus edges were studied to determine the character of the area surrounding the Health Science Center. These edges were examined to understand how each campus edge blends into the bordering neighborhood or community. The study recognized cues or linkages between the campus and surrounding areas.

The campus serves a threshold from neighborhoods, cultural and commercial districts into campus. Unlike a precise boundary, it is a fluid transition from the commercial area to the south and east of the UNTHSC to the north and west where traditional neighborhoods reside. This research served to break down the tendency to view each boundary as a barrier and begin to understand the relation of the UNTHSC as a collective piece of the area's puzzle. A summary of each edge is provided on the opposite page.



Retail shopping on West 7th Street



View of the UNTHSC from the Amon Carter Plaza

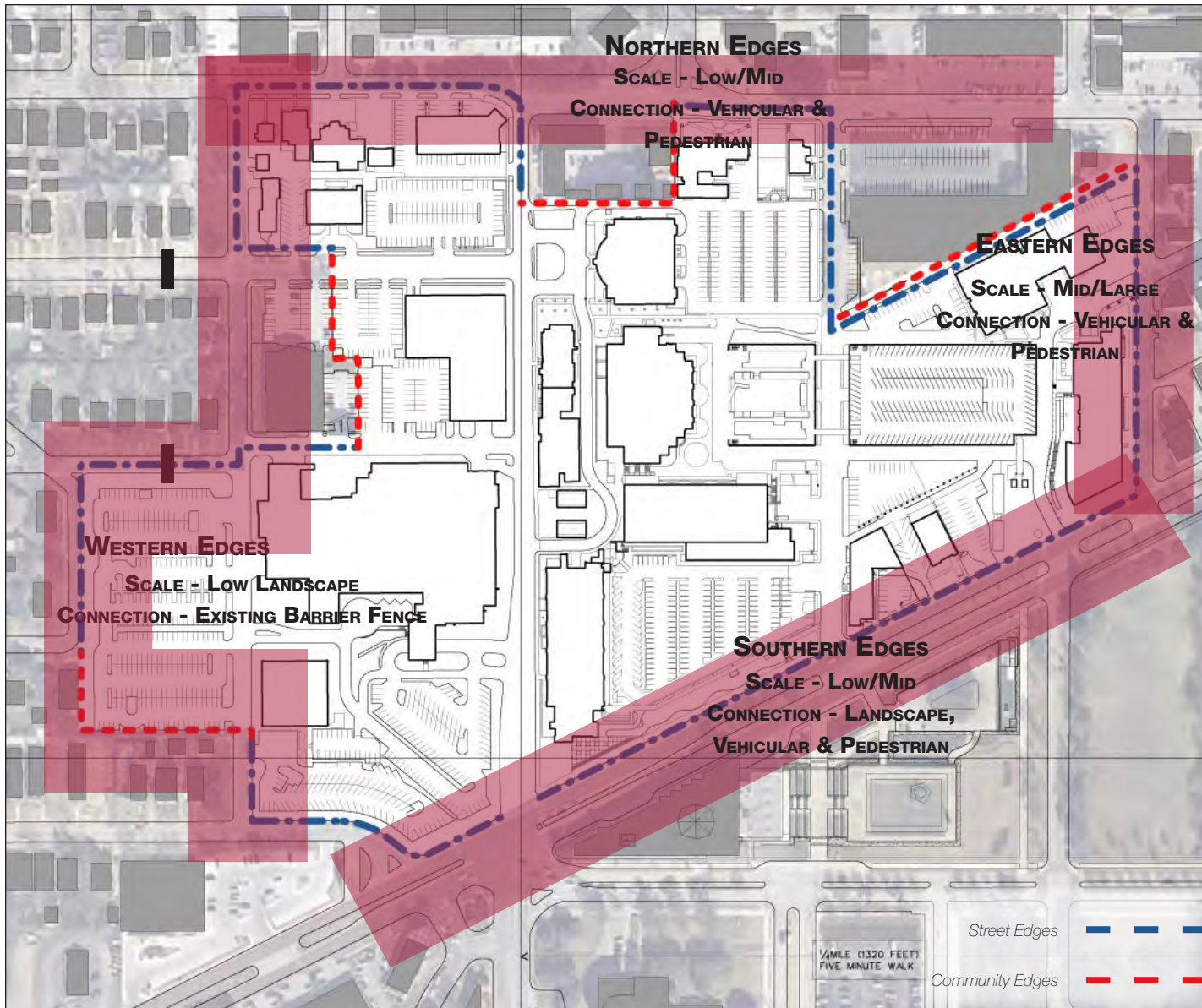

WESTERN EDGES

This area contains a constructed fence which impedes pedestrian access to campus. Building scale and density is low. This zone is naturally quiet due to the bordering neighborhoods.

NORTHERN EDGES

Vehicular and pedestrian connections are interwoven in this area. The relationship of this area of campus is different than the neighborhood to the west boundary due to commercial zones that exist along West 7th Street. The scale of the area is low.

SOUTHERN EDGES

The character of Camp Bowie Boulevard defines this edge. The pedestrian connection between the Cultural District and the southern end of campus is important. The configuration of the Cultural District gives the sense that buildings within this area are placed as objects in a landscape.

EASTERN EDGES

Retail and commercial zones along West 7th Street and Camp Bowie Boulevard make up this edge. Midsize and large scale development exists. There is a strong pedestrian connection but vehicular connection is also present.

LANDSCAPE

The landscape diagram to the right shows the disparity in green space between the Health Science Center and its neighbors.

Landscape observations include the need for further definition of building entries and a campus gateway, as well as an increase in overall green space and planting.



Existing landscaping on campus and in surrounding area



Existing open space atop Parking Garage West

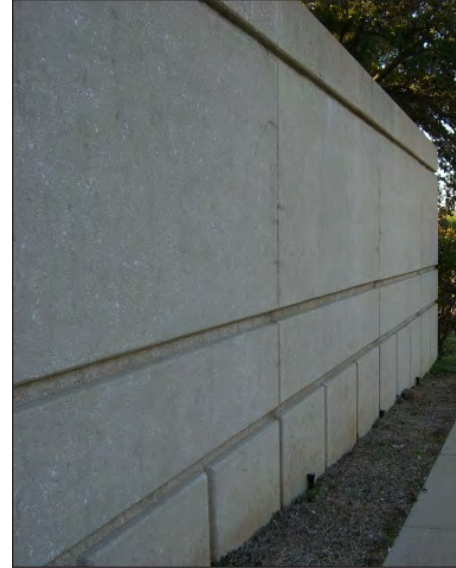

Retaining walls frame existing landscaping

LANDSCAPE FEATURES

On campus, certain landscape features enhance the quality of the campus environment, while others need improvement. The existing open green space over the west garage is the main campus open area. It is often used for outdoor functions but lacks the required shade for comfortable use during Spring and Summer months.



Topography changes create landscaping opportunities



Transition spaces between buildings on campus

SIGNAGE & WAYFINDING

While there are many parts to a campus master plan, signage and wayfinding are two of the key components in helping create a positive first time visitor or patient experience. As the team looks at improving the overall visitor experience, the following signage categories will be further studied:

1. Creating a sense of place
2. Defining the campus boundary
3. Orient the visitor to the campus
4. Identify the destinations
5. Route the visitor properly
6. Reconfirm their route
7. Celebrate their arrival

Most of the sign types throughout the campus will need to be replaced with the new master plan sign program. Creating a strong brand extension, typographical legibility, effective sign locations and messaging hierarchy will be the primary goals for this program. The signage program presented herein is planned to meet the needs of the current campus configuration and grow with the UNTHSC.

The following signage observations and survey photos are from the design team's interior campus and perimeter campus precinct walks.



Off-Campus Wayfinding

OFF-CAMPUS WAYFINDING

Website: UNTHSC's website map section, with travel directions, is a good use of off-campus wayfinding.

Interstate Highway Signage: Adjacent Interstate Highway sign types are critical in aiding in a visitor's first positive experience, when visiting the Health Science Center. While these signs are not a part of this plan, UNTHSC's Off-Campus Wayfinding was observed. Coordination efforts should be with the City and TxDot to ensure that directional information is provided at each applicable exit ramp sign.



Existing front door at Montgomery Drive and Camp Bowie Boulevard

INNER-CITY TRAILBLAZER SIGNS

Located at certain intervals, or decision points from the Highway, trailblazing signs could be located along the approach path as a way to confirm the route. These signs may be designed as a brand extension of the new signage program and make use of the new graphic voice.

CAMPUS FRONT DOOR

The campus currently falls short of having a true "Front Door" for visitors, due to the current road and pedestrian sidewalk configurations, lack of designed landscape, or space, and lack of appropriate monumentation. A "Front Door" should have a presence that identifies the campus grounds, through many disciplines, and creates an entryway into the HSC campus.



Existing signage at Front Door



Parts of the campus' edge have a weak presence



More effective information booths are needed



Vehicular directionals should direct visitors to the nearest Information Center



Parking Directionals & Parking Garage Identification



Appropriate sign types define the campus perimeter

CAMPUS PERIMETER IDENTIFICATION

Even though there are several various sign types visible from the primary thoroughfares, there are still parts of the campus' edge, such as the corners, that have a weak presence. Through future landscape design and a hierarchy of appropriate sign types, combined with new designs and graphic voice, the campus perimeter can become more prominent.

VISITOR INFORMATION CENTER / BOOTH

Vehicular oriented visitor information centers are currently represented by two small shed structures located in parking lots A and C, which do not appear to be true information booths, as noted on the UNTHSC website.

These booths appear to be occupied by the campus police, to provide parking information, and not formal HSC wayfinding information. The team observed the need for more effective information / orientation distribution to visitors and more legible identification of the Information Center.

VEHICULAR DIRECTIONALS

Overall, parts of the original design intent of the current sign program have been built on a firm design and wayfinding foundation. There is an opportunity to introduce a more current and consistent brand message to help define the campus better, as well as include all new messages for a more legible sign face layout. Wayfinding to parking areas need improvements.

PARKING DIRECTIONALS

Vehicular directionals need to include parking lot, or garage, directional information. The team observed the lack of any international parking "P" symbols on the signs.

PARKING GARAGE IDENTIFICATION

Parking areas are one of the primary destinations for first time visitors, therefore, parking garages need to be identified well. The existing garages' identifications are minimal. While students may know where the garage entries are, new visitors will question whether they're parking in the correct garage. As future parking is added to the campus plan, the garage naming and designation should take the long-term master plan into consideration for clear vehicular wayfinding and pedestrian orientation.



Parking Lot Identification



Building Top & Ground Mounted Building Identification



Building Identification - Building Facade



Building Identification - Building Facade

PARKING LOT IDENTIFICATION

The observed parking areas do not make use of the international parking "P" symbol. Visitor parking areas should be identified with this symbol, with color blue, as well as notifying specific tag requirements for each lot. Different parking areas within lots, such as Patient, Faculty, Staff and Student need to be consistently identified.

BUILDING TOP IDENTIFICATION - BUILDING FAÇADE

Existing building top signage is considered large but visible from good distances off campus.

BUILDING IDENTIFICATION - GROUND MOUNTED

Various types of building identification signs were observed. A successful design hierarchy and consistent messaging methodology are important. The team observed an opportunity to incorporate more unique designs that accentuate the UNTHSC brand into the sign design.

BUILDING IDENTIFICATION - BUILDING FAÇADE

Overall, parts of the original sign program have been built on a firm design methodology. The facade identification signs need a more consistent design and mounting approach. A hierarchy of sign types is needed to meet the

needs of the different mounting configurations. There is a design opportunity for introducing a more current and consistent brand identity message.

BUILDING IDENTIFICATION - PEDESTRIAN ENTRANCE

Many secondary building entrances lack building identification, leaving the first time visitor or student unsure of their arrival. By adding this basic sign type at the doorway, the visitor's arrival is celebrated by knowing they have arrived at their destination. In addition to the building name, there may be a need for directional information for destinations within the building.

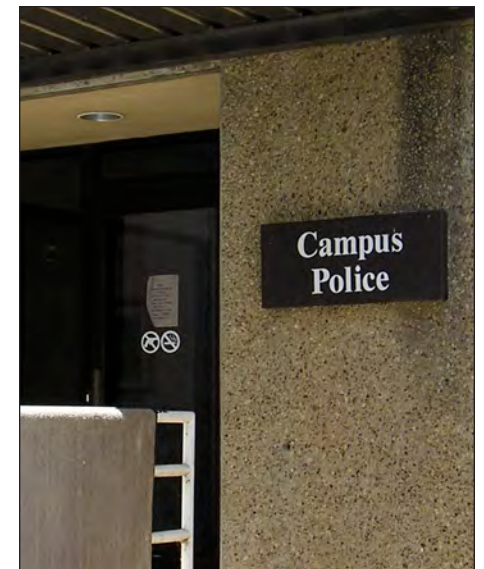

Building Identification - Pedestrian Entrance



Pedestrian Site Map



Accessibility Signage



Pageantry

PEDESTRIAN ORIENTATION SITE MAP

Three enclosed site map locations were noted on site, with the locations appearing to be at the most accessible locations for patient/visitor. Exact locations need to be reviewed further. The map's physical orientation to the campus should face into the campus, while all maps are to be custom rotated for each view of campus from each specific map location.

PEDESTRIAN WAYFINDING

None observed. Because of the heavy pedestrian traffic at Camp Bowie & Montgomery Street, pedestrian directionals may need to be considered. Other high traveled locations or

intersections throughout the campus may also desire the same type of wayfinding for consistency and to reinforce the visitor's first-time experience.

HANDICAP DIRECTIONALS

Directionals should be designed to feel a part of the overall sign program.

PAGEANTRY

Pedestrian oriented banners, currently located in campus interior, are used effectively. Additional campus locations may help define the campus in weaker areas. Banner design needs to be consistent with UNTHSC's brand

image. Banner locations, for both pedestrian and vehicular banners, to be contained within certain viewing corridors for effectiveness.

STORYTELLING, ART & SCULPTURE OPPORTUNITIES

None observed. While this category of signing is not a part of this plan, there is an opportunity to create storytelling "moments" for students and visitors with historical or interesting facts about different areas of the campus or alumni. This type of artistic expression helps create an inviting sense of place while enriching spirit and pride. Lack of sculptural elements were noticed, which would enhance the campus feel. Recommend consideration of outdoor

sculpture, or architectural statements, in strategic locations for orientation and meeting areas, along pedestrian pathways.

STREET IDENTIFICATION

While these signs are not a part of this plan, the street sign designs are encouraged to reinforce the sense of place, while creating a more legible color combination. A UNTHSC logo is recommended as part of the sign face layout.

BUS STOP IDENTIFICATION

None observed. Should there be an opportunity for a bus stop on the perimeter of the campus, the team would recommend creating a unique structure that reflects the UNTHSC brand and spirit.

ELECTRICAL DISTRIBUTION

The electrical distribution system at the UNTHSC is owned and operated by TXU Electric Delivery. The distribution system consists of both overhead and underground medium voltage feeders serving both pad mounted switchgear and transformers, and switchgear and transformers located inside utility vaults. The utility transformers step down the voltage to 480 volts and below at the point of service to the campus buildings.

A majority of the campus has both overhead and underground utility feeders running along the streets within the campus. The smaller buildings are served from pole-mounted transformers with 208 volt or 240 volt service drops to metering equipment installed on the buildings. Larger buildings are served from underground primary feeders serving either pad mounted switchgear and transformers, or switchgear and transformers installed in underground utility vaults. Transformer secondary power is routed underground to the building's main electrical room.

The buildings along the east and west sides of Montgomery Street all have utility vaults located below grade and just outside the building footprint. The vaults contain primary switchgear and transformers to serve the buildings.

The overhead and underground utility feeders are connected together at multiple locations. Each feeder also has at least two connections to the area distribution system originating from off campus. This allows sections of the feeders to be isolated and de-energized without affecting the entire campus.

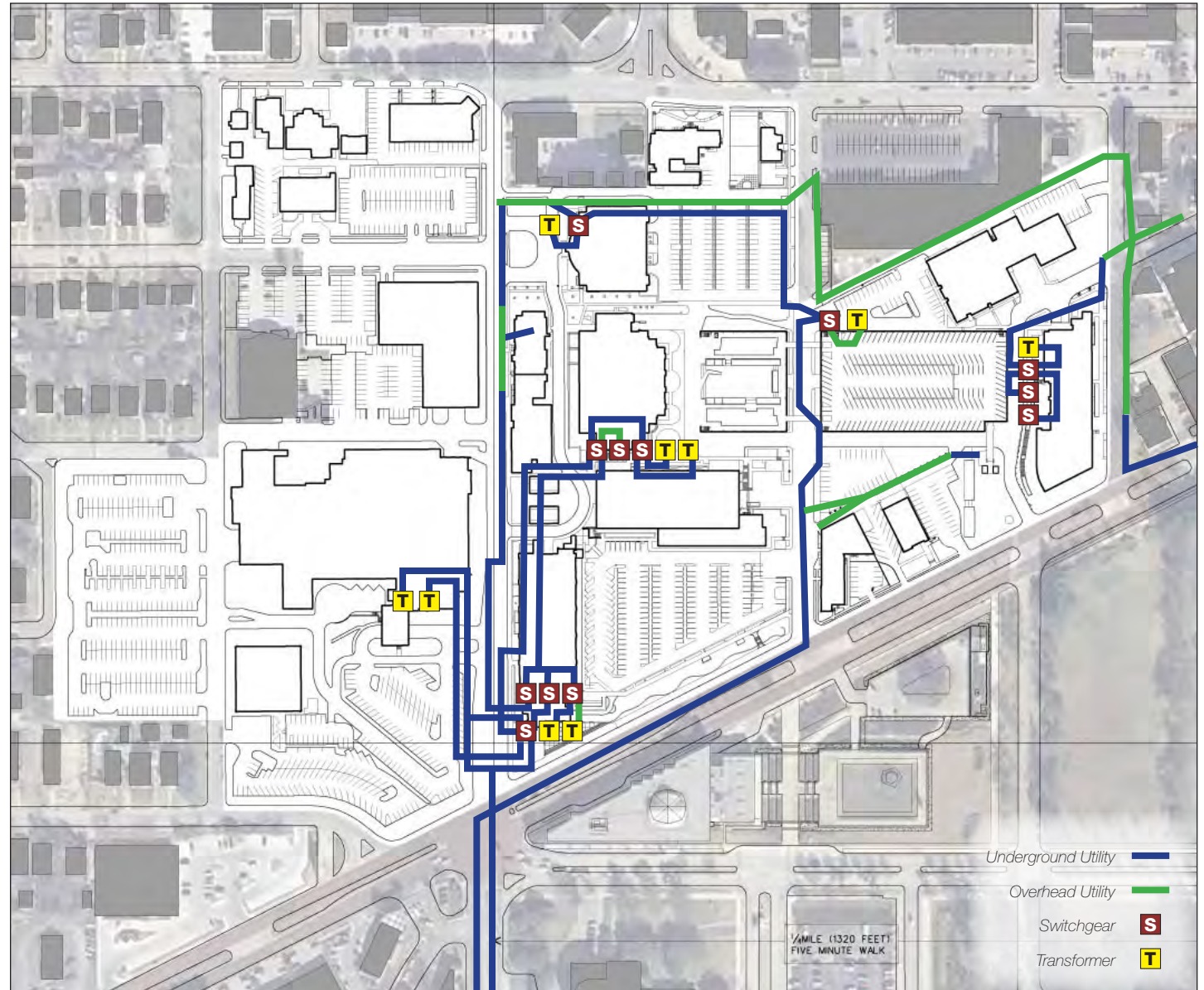

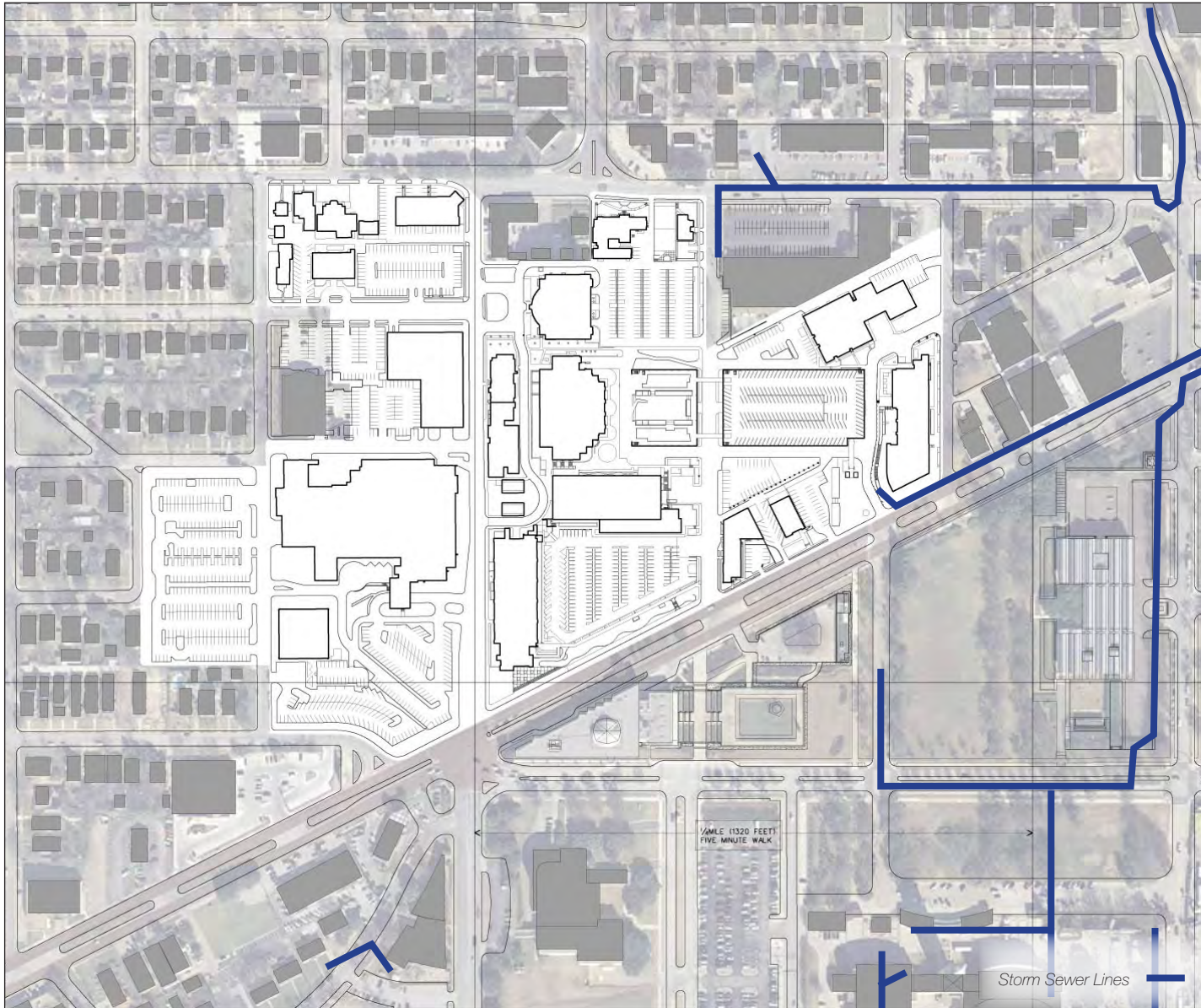

STORM SEWER

As depicted in the diagram on this page, there is little if any underground storm water infrastructure in the area of the UNTHSC campus. This is primarily a result of the region's topography and the siting of the campus atop a bluff. An aspect of this condition is the potential impact of the campus on the surrounding neighborhoods. In the absence of vegetation and green space, very little storm water is retained on the campus. One goal of the master plan will be to add green space to reduce the storm water runoff.

POTABLE WATER

The UNTHSC obtains its potable water via the City of Fort Worth from two water treatment plants (Holly and Southside), located in and maintained by the City of Fort Worth. Both of these plants continue to meet or exceed the minimum requirements of all water quality standards and regulations. Water is distributed throughout the UNTHSC campus by city maintained water mains that range in size from 6 to 30 inches in diameter. The city provides water to the UNTHSC buildings through individual meters located at each building. Fire sprinkler systems water pass through check valves in vaults prior to connecting to the buildings.

The UNTHSC consumed the following amounts of water over the past three years:

- Sept 03 to Aug 04 – 20.1 million gallons
- Sept 04 to Aug 05 – 30.3 million gallons
- Sept 05 to Aug 06 – 28.4 million gallons

There are five suggested water improvements:

- *Water Improvement Area 1* – Six-inch water main extends from the intersection of Haskell Street and Bunting Avenue to intersection of Camp Bowie Boulevard and Montgomery Street. This northwest to southeast water line, and other utilities that may also exist in the same corridor, may need to be relocated to facilitate campus development northwest of the intersection of Camp Bowie Boulevard and Montgomery Street.

- *Water Improvement Area 2* – Water mains do not exist along Haskell Street from Clark Avenue to West 7th Street. 8-inch water main, including three fire hydrants, should be constructed along Haskell Street from Clark Avenue to West 7th Street.
- *Water Improvement Area 3* – Six-inch water main in Clifton Street from alley south of West 7th Street (opposite service drive to Lewis Library) to Camp Bowie Boulevard should be replaced with a minimum 8-inch and preferably a 12-inch water main.
- *Water Improvement Area 4* – Six-inch water main in Modlin Avenue from Haskell Street to Montgomery Street should be replaced with an 8-inch water main.
- *Water Improvement Area 5* – Six-inch water main in Mattison Avenue from Haskell Street to Montgomery Street should be replaced with an 8-inch water main.

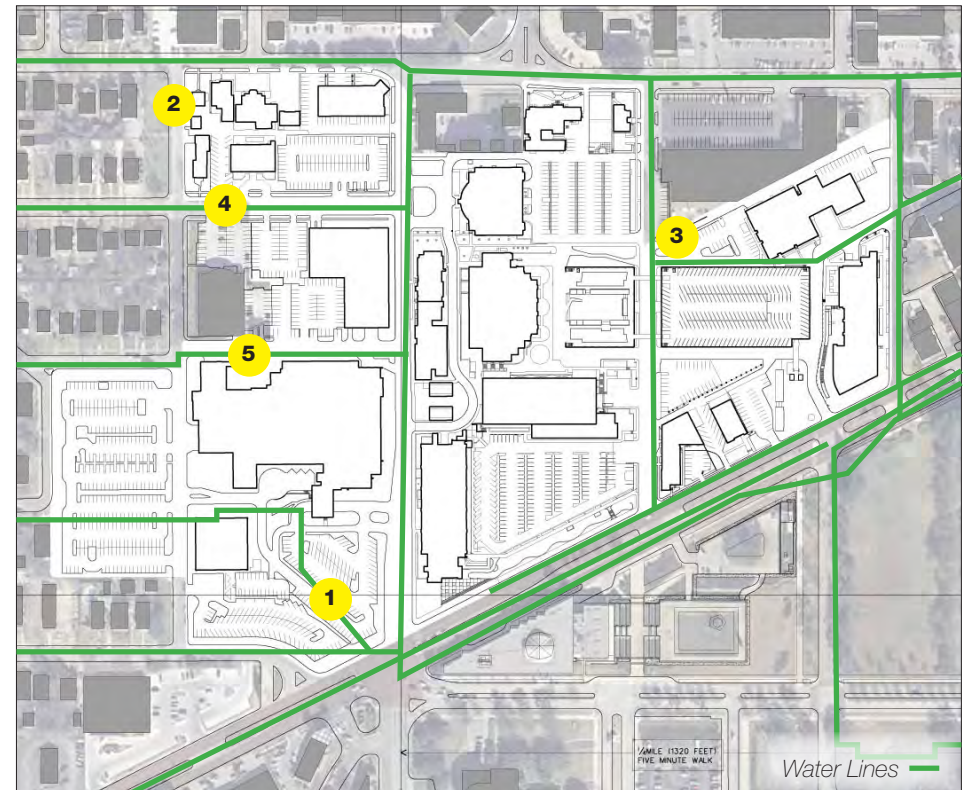

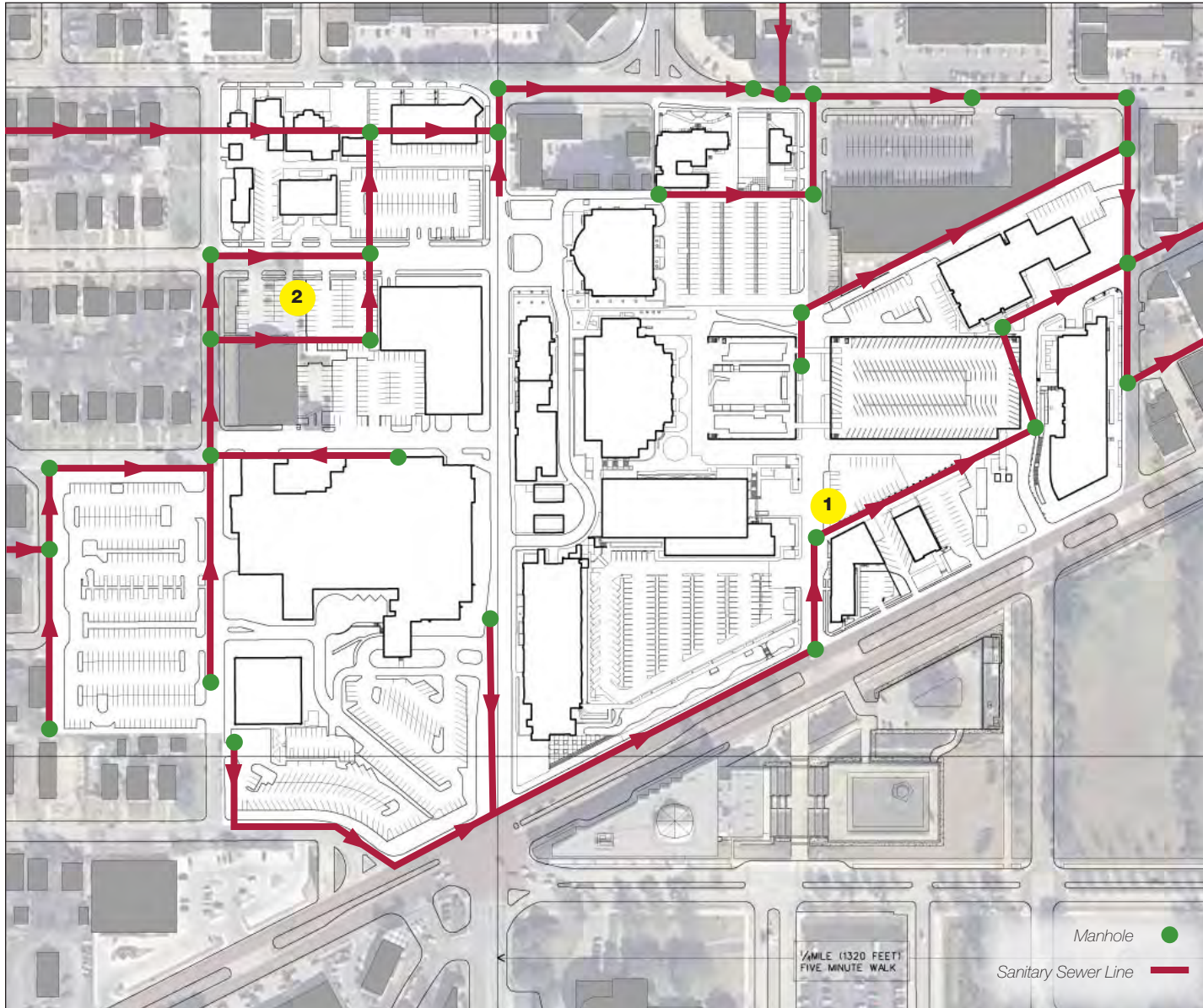

SANITARY SEWER

The UNTHSC is located within the City of Fort Worth Certificate of Convenience and Necessity (CCN) service area. Sanitary sewer flows from within the UNTHSC facilities to the City of Fort Worth sanitary sewer system. The sanitary sewer flows to a 12-inch sanitary sewer main in Darcy Street draining east of Boland Street and is then conveyed to the Central Wastewater Treatment Plant and treated by the Trinity River Authority. UNTHSC generates approximately 20 million gallons of sanitary sewage annually.

There are two areas where sanitary sewer improvements should occur:

- *Sewer Improvement Area 1* - Sanitary sewer main M-32R is a 12-inch main that extends from Clifton Street northeast behind the Renal Center to the drive on the west side of the Center for Biohealth. The location of this sanitary sewer main restricts the development of the land between Camp Bowie Boulevard and the East Parking Garage.
- *Sewer Improvement Area 2* - Sanitary sewer main M-43 is an 8-inch main that extends from the intersection of Haskell Street and the alley north of Mattison Ave to the east to the mid-block between Haskell Street and Montgomery Street, then extends north to the alley south of West 7th Street, and then extends east to Montgomery Street. The location of this sanitary sewer main restricts the development of the land between Haskell Street and Montgomery Street from the West 7th Street to Mattison Ave.

PROGRAMMING

INTRODUCTION

In order to develop a greater understanding of the overriding issues associated with the facilities and operations at the University of North Texas Health Science Center, the master planning team conducted on-site interviews with the deans and other representatives from each of the campus' primary departments.

During these meetings discussions focused on any number of themes that each department viewed as critical issues related to their own activities, those of the UNTHSC and the campus as a whole. Planning team members recorded many of these ideas as small vignettes on large index cards so that they could be identified in their simplest form and sorted for content at a later date.

A representative of the UNTHSC administrative interests accompanied the master planning team to each of the interviews to provide historical insight as well as understanding of current and future projects already in the making. The table below identifies the groups interviewed and a primary contact for each. This list, represents only a portion of the faculty and staff that spent time with the master planning team at different steps in the process.

Stakeholders

President
Osteopathic Medicine
Biomedical Sciences/
Research
Public Health
Health Professions
Community Engagement
Library
Administration

Interview Contacts

Dr. Scott Ransom
Dr. Marc Hahn
Dr. Thomas Yorio
Dr. Fernando Trevino
Dr. Warren Anderson
Greg Upp
Bobby Carter
Steve Russell

Discussion topics varied widely between groups, but the results of these conversations could be broken down into several basic categories. A separate programming summary report provides a brief interview summary for each department and an itemized list of each of the major themes uncovered during the meetings. While reviewing the report and the index cards therein, it is important to keep in mind that many of these thoughts represent a portion of a larger discussion and not necessarily a foregone conclusion. Each of the ideas presented were considered a part of the overall master planning exercise and woven appropriately into the plan while accounting for other conditions.



OVERRIDING THEMES

Each of the groups interviewed were able to provide insights on the inner workings, problems and concerns related to the character and operation of the campus as a whole. These themes, stemming from interviews with all of the deans have been collected in this report.

SUMMARY

While discussions with the HSC deans and administrators touched on a wide range of critical issues, addressing everything from specific operational requirements to general interests in the development of the campus, a few recurring themes were addressed by virtually everyone. This core set of ideas covered such things as development of the overall campus, shared facilities, key operational trends, faculty and staff interests, meeting spaces, and support spaces. While a summary of the specific interests of each department can be found later in this report, a summary of these overriding themes are addressed below.

TRADITIONAL CAMPUS

At the highest level, virtually all of the HSC deans expressed an interest in the development of the UNT Health Science Center's campus as that of a more traditional campus as opposed to that of a "sprawling complex". The focal point of these discussions typically expressed the hope that the HSC campus would grow into an environment with quads and other green spaces found at more of the traditional and iconic universities. A compo-

ment of this imagery and functionality includes effective links between buildings that might connect the two "halves" of the campus as it expands, at the same time it prevents the slope of the existing campus from acting as a barrier to pedestrian traffic. Discussions also touched on the universal interest of expanding parking capacity while minimizing the views of any vast or seemingly extensive parking lots. Along with the development of a traditional higher education campus, virtually all discussions touched on the idea that the campus should serve as a good neighbor to the surrounding community, perhaps even acting as an extension of the Cultural District.

INCREASING INTERDISCIPLINARY FUNCTIONS

In addition to the development of the campus itself, a vast majority of the interview topics addressed operational, as well as faculty and staffing trends. Specifically, there is an expectation that the HSC, students, faculty and staff alike will benefit from an increase in interdisciplinary work. Where practical, facilities should accommodate a broad range of functions, allowing and encouraging interaction between departments. Not only do funding opportunities look favorably upon research and academic activities that reach across a broader range of disciplines, but by removing "silos" from the physical and organizational structure of the campus, educational and work experiences at the HSC will be broadened as well. This type of growth is expected to require an increase in the number of interdisciplinary spaces and similar facilities for students, as well as the general need for laboratories that

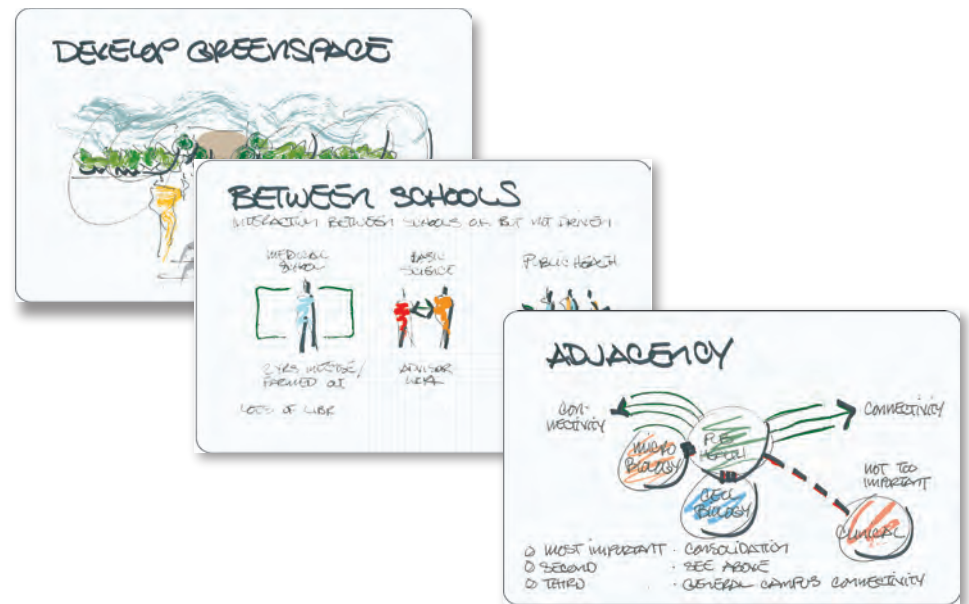

provide a maximum amount of flexibility. Along with an increase in the number of faculty offices across the board an interest was expressed in increasing the size of faculty offices and improving the general equity between them.

CRITICAL FACILITY REQUIREMENTS

Aside from the campus and some of its inherent operational trends, HSC deans also tended to agree on some of the critical facility and general support requirements for the HSC. At the forefront of these ideas was a consistent interest in establishing a core facility that would serve as a "Center of Excellence", consolidating facilities and support for the four areas of focus for the HSC. Through the master planning process, the concept of this facility manifested itself as the Health Institutes of

Texas (HIT). This facility is expected to serve as a focal point for the development of the campus, and while it may include or interact with other support facilities, it is expected to be an early phase project for the campus. A conceptual facility program describing area requirements for the HIT facility is provided later in this report.

A second facility requirement, specifically addressed in virtually all interviews, is the need for a state-of-the-art large lecture hall/auditorium facilities that can serve to expand the lecturing capacity of the campus at the same time it allows the Health Science Center to host large forums with up to one thousand (1,000) seats and semi-formal reception areas. Although a practical solution needs to be investigated, the initial requirement is described as an interest in

three (3), 250- to 300-seat lecture hall/auditorium that can be used (“converted”) into a single auditorium. Actually creating these spaces as an environment that can be converted back and forth might not be practical, but an appropriate solution with a mix of dedicated auditoriums might be constructed.

A third basic facility requirement covered in most of the planning interviews was described as an interest in providing a consolidated food service facility that could serve students, faculty, and staff alike on a daily basis, while supporting a consolidated meeting center as described above. This facility should likely be centrally located on campus and may well be associated with the meeting center itself or other facilities. While no specific requirements were outlined regarding the number of meals to be served in any given period or the number of guests to be seated, a conceptual facility program for this facility is provided later in this report.

GATHERING SPACES

There were a number of other similar interests described by HSC deans and administrators that further support the themes described above. Another often expressed theme seemingly rooted in the shape and operation of the environment is the interest in the campus and its facilities providing gathering spaces of all types for students, faculty, staff and visitors. Whether break-out rooms of varying sizes for students to study in, informal lounges for students or faculty and staff, or simple outdoor nodes scattered throughout the campus, the

master plan should seek to support the impromptu and unstructured interactions of its users and visitors.

CRITICAL ISSUES

A complete list of these and other critical issues identified during stakeholder interviews is provided in the bulleted lists below. Specific lists addressing the discussions of specific stakeholder interviews are provided in a separate programming report.

CAMPUS

- Traditional university campus environment / Avoid feel of “sprawling complex”
- Linking two halves of campus as well as “lower” and “upper” portions
- Tie facilities together
- Tie into Cultural District complex
- Develop walkways through campus and linkages between buildings
- Parking needs expansion, but should not be focal point
- Lounge / Break / Interaction zones and facilities

FACILITIES

- Core meeting facility / “World Class Auditorium”
- Center of Excellence – “HIT” supporting four (4) areas of focus
- Food Service to support meeting center and campus as a whole
- Breakout rooms / supports “teamwork” approach

OPERATIONS

- Interdisciplinary work / consolidate operations but avoid “silos”
- Increasing use of academic space during daytime hours
- Students working in team environments
- Space for simulation labs
- Flexible laboratories

FACULTY / STAFF

- Increase number of offices
- Improved quality and size of offices
- Improve equity between offices
- Consolidation of faculty and staffing by program

MEETING SPACE

- Need multiple venues with 250-300 seats
- Need to seat up to 1,000 people, imagine creating from combining 250- to 300-seat lecture halls
- Breakout space associated with meeting center and throughout campus
- Meeting facility includes world-class reception spaces

SUPPORT SPACE

- Food service location / cafeteria shared by campus
- Interactive environments outside of classes
- Student lounges
- Faculty lounges
- Collaboration space
- Breakout rooms



E&G¹:SF/Student
326

Years Out	Year	FTE Students	% Growth
	2007	1,171	
1	2008	1,246	6.4%
2	2009	1,376	10.4%
3	2010	1,510	9.7%
4	2011	1,626	7.7%
5	2012	1,702	4.7%
6	2013	1,781	4.6%
7	2014	1,843	3.5%
8	2015	1,901	3.1%
9	2016	1,961	3.1%
10	2017	2,023	3.1%
11	2018	2,086	3.1%
12	2019	2,152	3.1%
13	2020	2,220	3.1%
14	2021	2,289	3.1%
15	2022	2,361	3.1%
16	2023	2,436	3.1%
17	2024	2,512	3.1%
18	2025	2,591	3.1%
19	2026	2,673	3.1%
20	2027	2,757	3.1%

Ratio EG:GSF ²
2.40

E&G:SF Existing	E&G:SF Required	E&G:SF Increase	GSF Existing	Total GSF Required	GSF Increase ³
370,186	381,746	11,560	889,391	917,164	27,773
	406,196	36,010		975,907	86,516
	448,576	78,390		1,077,727	188,336
	492,260	112,074		1,182,680	293,289
	530,076	159,890		1,273,535	384,144
	554,852	184,666		1,333,061	443,670
	580,606	210,420		1,394,936	505,545
	600,818	230,632		1,443,496	554,105
	619,726	249,540		1,488,924	599,533
	639,229	269,043		1,535,781	646,390
	659,346	289,160		1,584,112	694,721
	680,096	309,910		1,633,965	744,574
	701,499	331,313		1,685,387	795,996
	723,575	353,389		1,738,427	849,036
	746,346	376,160		1,793,136	903,745
	769,834	399,648		1,849,566	960,175
	794,061	423,875		1,907,773	1,018,382
	819,051	448,865		1,967,811	1,078,420
	844,827	474,641		2,029,739	1,140,348
	871,414	501,228		2,093,616	1,204,225
	898,837	528,651		2,159,503	1,270,112

PROGRAMMING

As part of the overall concept for the physical plan, the planning team analyzed the growth of the campus population to determine how much physical growth (in square feet) should be expected over the next 20 years. Referencing the HSC academic plan, the team extracted year by year program enrollment growth projections. In short, the academic plan projected a high level of growth over the next five years. These high growth levels were interpolated into several planning calculations to determine the population of the student body in a year by year analysis. In combination with student growth the master plan team also analyzed a paralleled growth of the faculty and staff. With a total enrollment cap of 3,500 students, the chart to the left was prepared to track both how the population would increase and how the required physical space supporting that growth would also expand.

In summary, the analysis determined that within the range of the master plan, the physical space required would have to almost double from just over one million square feet to almost two million square feet.

¹ Education & General (E&G): Space used for teaching, research, of the preservation of knowledge, including the proportional share used for those activities in any building or facility used jointly for auxiliary enterprise, or space that is permanently unassigned. E&G space is supported by state appropriations.

² Ratio of E&G space to GSF space (Ratio EG:GSF) is based on buildings possessing E&G space per 2006 UNTHSC Building Inventory. Although EG:G ratio will change over time in response to the character of new building construction, the existing ratio of 2.40 is used for planning purposes.

³ SF growth rate is predicated on enrollment growth rate estimates.

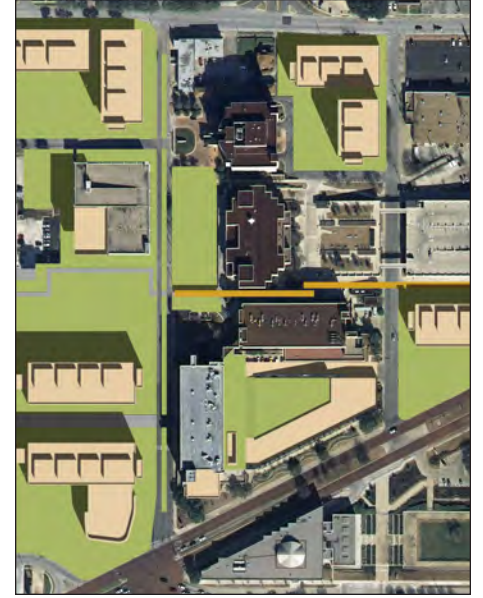

FINAL PLAN

C



The University of North Texas Health Science Center's long term vision includes the addition of several campus facilities and parking garages to accommodate population growth

INTRODUCTION

Throughout the Observations/Data Gathering phase, there were two important issues that continued to arise as focal points of many discussions. First, the relationship of the Health Science Center with the neighboring communities, commercial areas, and the Cultural District. Second, the policy question of whether the HSC considers itself a 'usually conceived' health science center or a collegially planned academic institution. As mentioned in the guiding principles, the HSC and this master plan must focus on generating concepts and providing real opportunities for the UNTHSC to extend its premier academic institution status. The Center will accomplish this by providing its faculty, students, visitors and the larger community a place that externally speaks to the principles of sharing, collaboration, and discovery.

During the Final Plan phase, the process focused on collaboration and open discussions between the planning team, HSC faculty, staff, students, and community representatives. This combined group collaborated to devise a Long Term Vision for future development of the UNTHSC that will be sensitive and compatible with the unique groups and characteristics surrounding the campus.

Conceptually, the typical master planning approach was reversed to allow for input from the charged entities surrounding the Health Science Center. Neighborhoods to the north and west, commercial development to the east and the Cultural District to the south influenced the master planning process greatly. A green canvas was first established for the campus; not a blank slate but rather a landscape for the campus. The planning began as a 'subtractive' process to carefully carve away green space for building opportunities. This 'Greening of the Campus' became the conceptual linkage that primarily formulated a series of landscape spaces which foster exchange, interaction, and a collegial atmosphere.

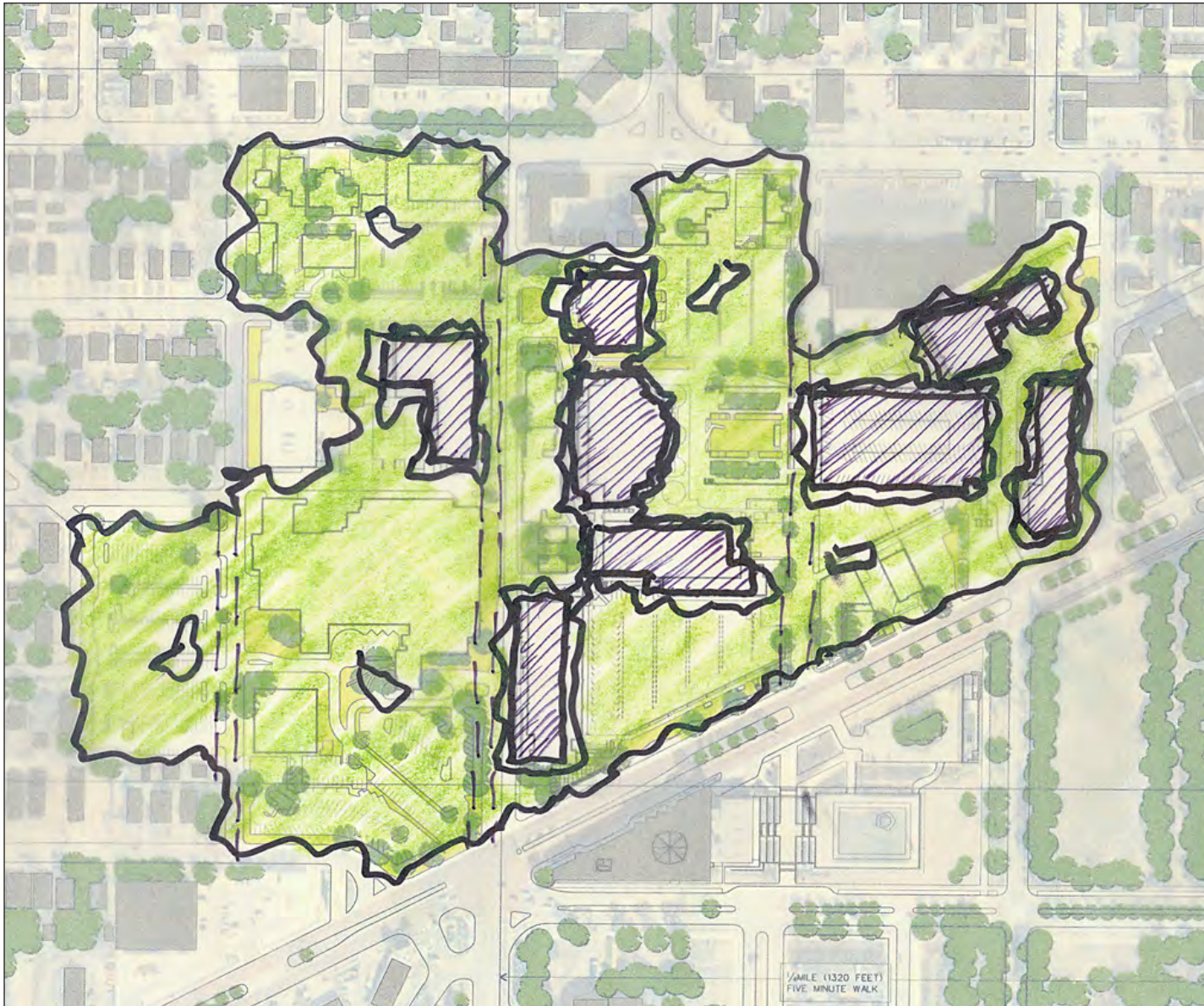

The image above depicts an abstract starting point where by the campus was 'greened' and then space was carved away for future buildings

PLANNING CONCEPTS

CONCEPTS

As the 'Greening of the Campus' focused on the conceptual compass, the site design focused on investigation of the parts. These parts of the plan, which provide the character and specificity to the final plan, were investigated on various scales. City, campus and pedestrian approaches were investigated to understand and determine relationships of density, bulk, and relationship both internally and externally to the campus. Additionally, the determination, location, and implications of the integrated landscapes across the campus began a focused shaping of the character of the campus. And finally, the building overlap or site planning of clusters of academic precincts nestled into the landscape began to strategically balance the green space with the built places.

PLANNING CONCEPTS

The following concept strategies define the implementation of the campus planning ideas.

Campus 'Greening'

This conceptually re-thinks the master planning approach from an additive process towards a subtractive one. Establishing a conceptual 'green canvas' across the existing campus provides an opportunity to carefully carve away this 'fabric' as indicated by the existing primary campus buildings. This thoughtful planning approach strengthens the prospect of responsible implementation, strategic building planning, and integration with the surrounding context.

Linkages and Exchanges

These connective "corridors", both physical and visual, bind the overall precinct of the campus together as a place, a destination. As an institution, the campus precinct sponsors exchange, collaboration, and linkages through a series of pedestrian passageways and a variety of internal open spaces. The campus serves as an important threshold, both as a destination and in transition, binding together its surroundings.

Interdisciplinary Collaboration

The 'Greening' additionally offers opportunities for a variety of open space from which various scales and hierarchies may be explored. The master plan provides for interactive exchange at many scales by creating small clusters of buildings amongst a larger complex. Academic interaction among small clusters fosters greater exchange with the UNTHSC and the community.

Identity and Coherence

Visual consistency and relationships are vital to establishing a coherent identity to a campus. General guidelines will address and encourage a series of palettes that guide development toward visual consistency.

Pedestrian Connections

Pedestrian linkages provide both physical and visual connections between the city, campus, and buildings. The pedestrian spine serves as an organizing structure for the major public quads of the campus and a connector weaving the eastern campus to the new western campus.

Campus Entryways

As the UNTHSC campus is primarily accessed by vehicular traffic, gateways are critical in marking the precinct of the campus.



Campus 'Greening'

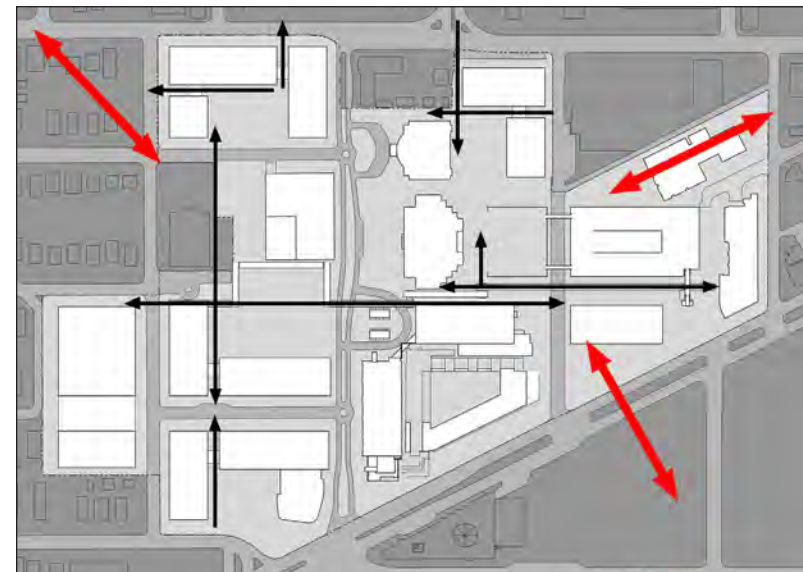

Linkages and Exchanges

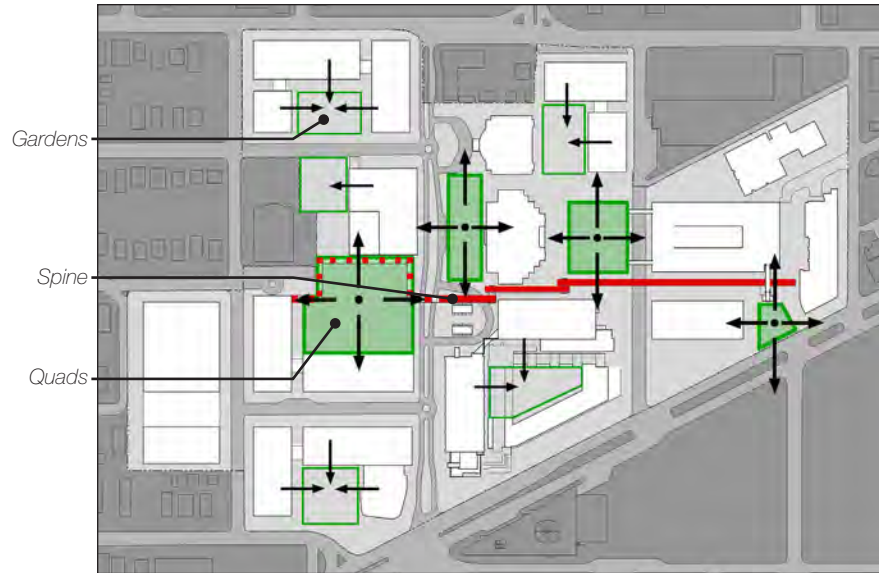

Gardens

Spine

Quads

Interdisciplinary Collaboration

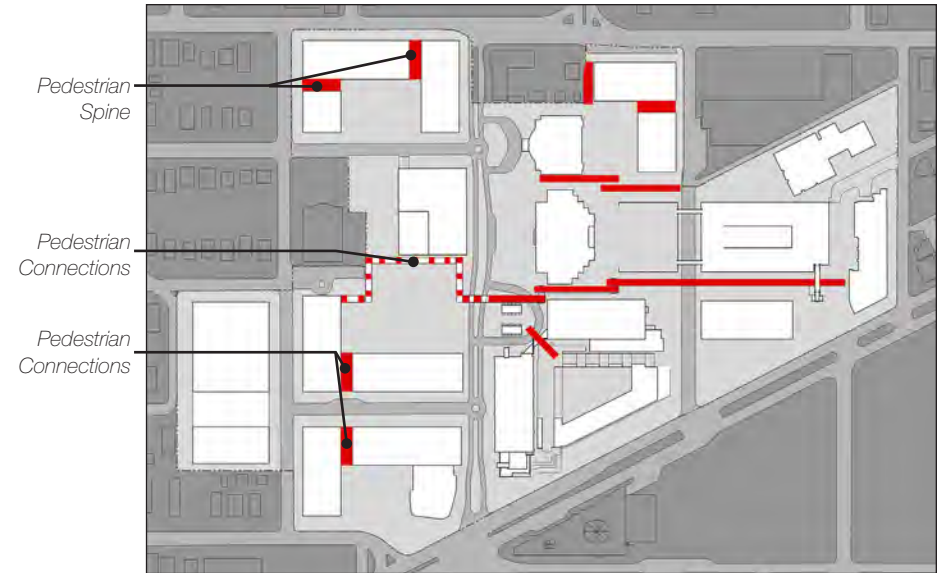

Pedestrian Spine

Pedestrian Connections

Pedestrian Connections

Pedestrian Connections

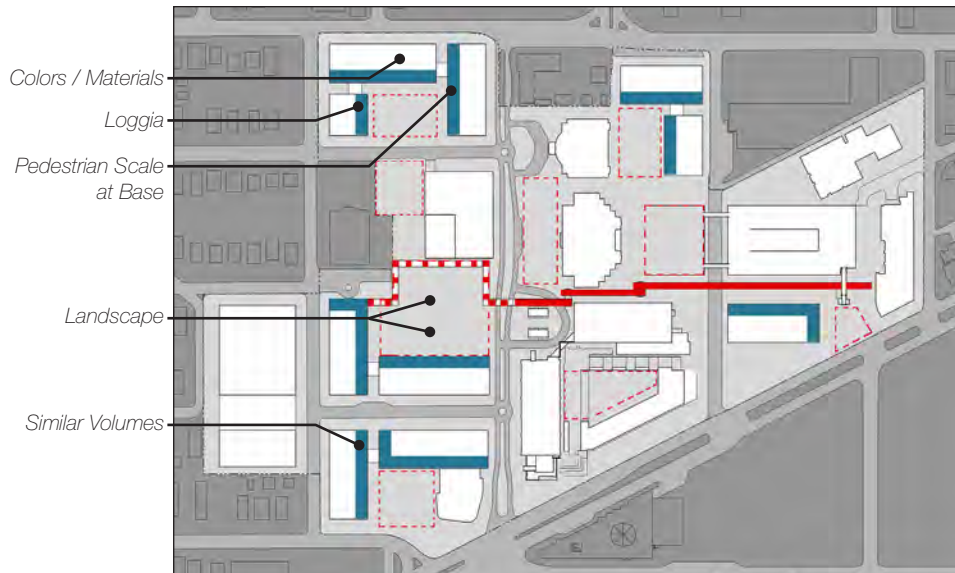

Colors / Materials

Loggia

Pedestrian Scale at Base

Landscape

Similar Volumes

Identity and Coherence

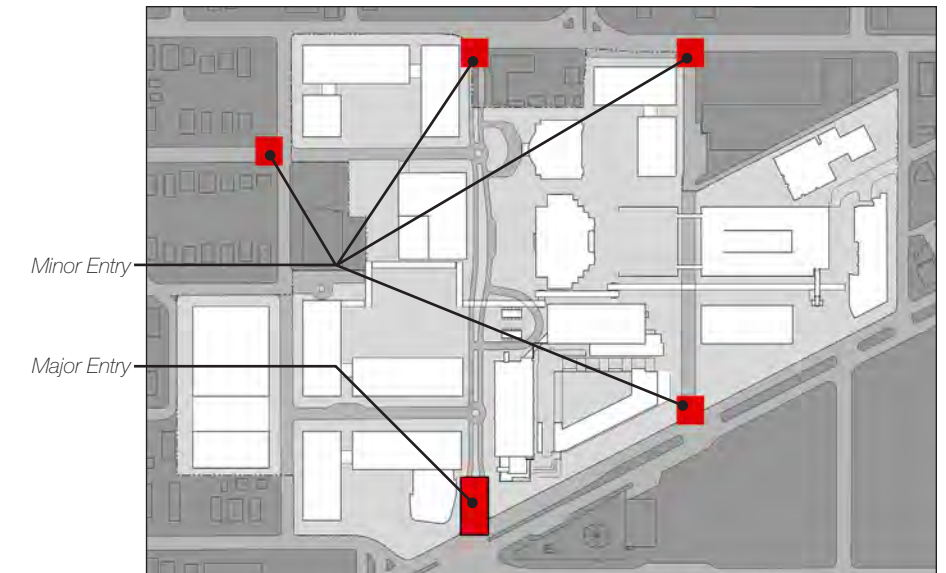

Minor Entry

Major Entry

Campus Entryways

LONG TERM VISION

The Long Term Vision provides for extended growth for the UNTHSC in a responsible, sensitive manner and allows for the continued integration and linkage to the surrounding communities, neighborhoods, and districts.

Harmonious with the UNTHSC's long term academic goals, the objective of the Vision is to provide a meaningful strategy of academic, research, and service facilities for future growth within each department on campus. As academic programs grow and flourish within the Health Science Center, additional facilities will create a well-planned collegial atmosphere, continually fostering learning and development.

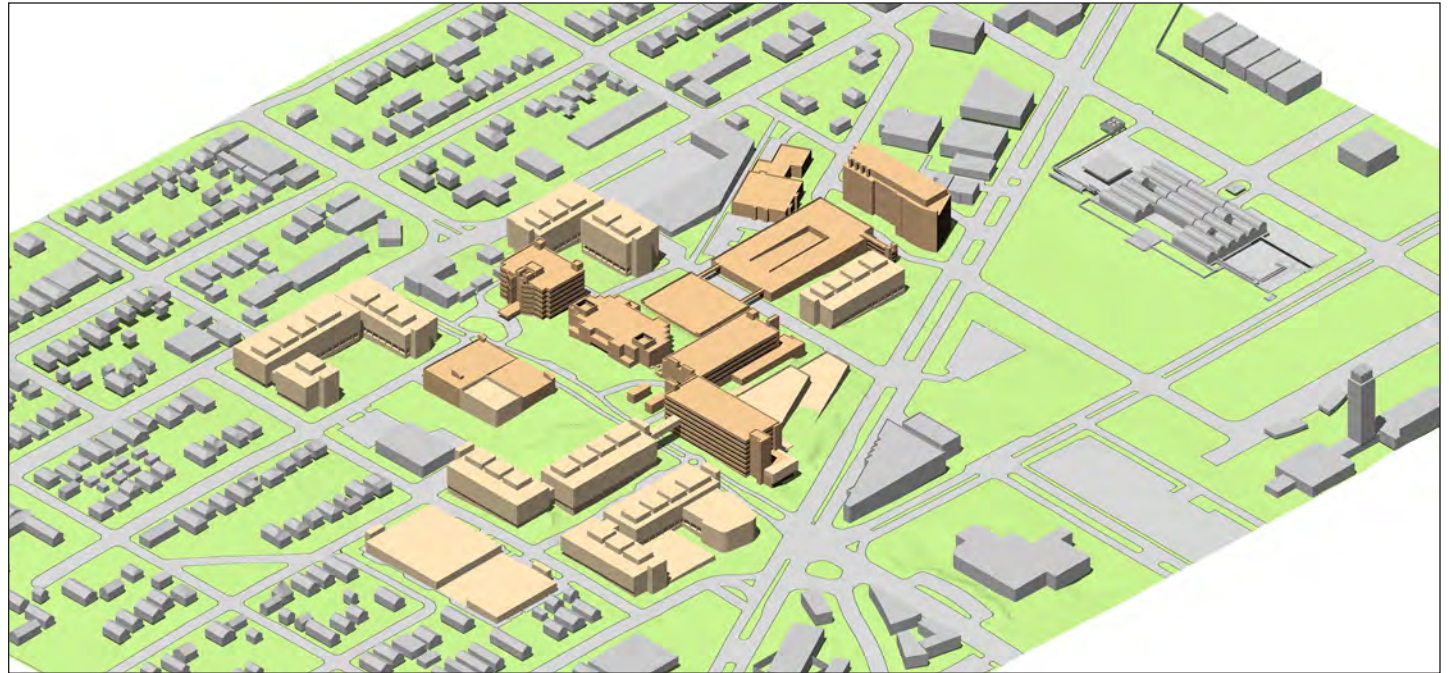

BLDG	TOTAL AREA	PROGRAM FLOORS	BASEMENT	MECH/ PENTHOUSE	PARKING
BLDG A	120,000 SQ. FT	5	0	1	0
BLDG B	108,000 SQ. FT	4	0	1	0
BLDG C	52,000 SQ. FT	5	0	1	0
BLDG C-1	45,000 SQ. FT	3	0	1	0
BLDG D	99,000 SQ. FT	6	0	1	0
BLDG E	148,800 SQ. FT	4	1	1	0
BLDG F	46,200 SQ. FT	4	0	1	0
BLDG G	97,800 SQ. FT	4	0	1	0
BLDG H	128,000 SQ. FT	5	0	1	0
BLDG J	156,700 SQ. FT	6	0	1	1
BLDG K	97,800 SQ. FT	4	0	1	0
GARAGE A	-	3	-	-	-
GARAGE B	336,000 SQ. FT	3	-	-	-
PARKING C	-	-	-	-	-
CENTRAL PLANT	-	To Match Adj Garage	-	-	-

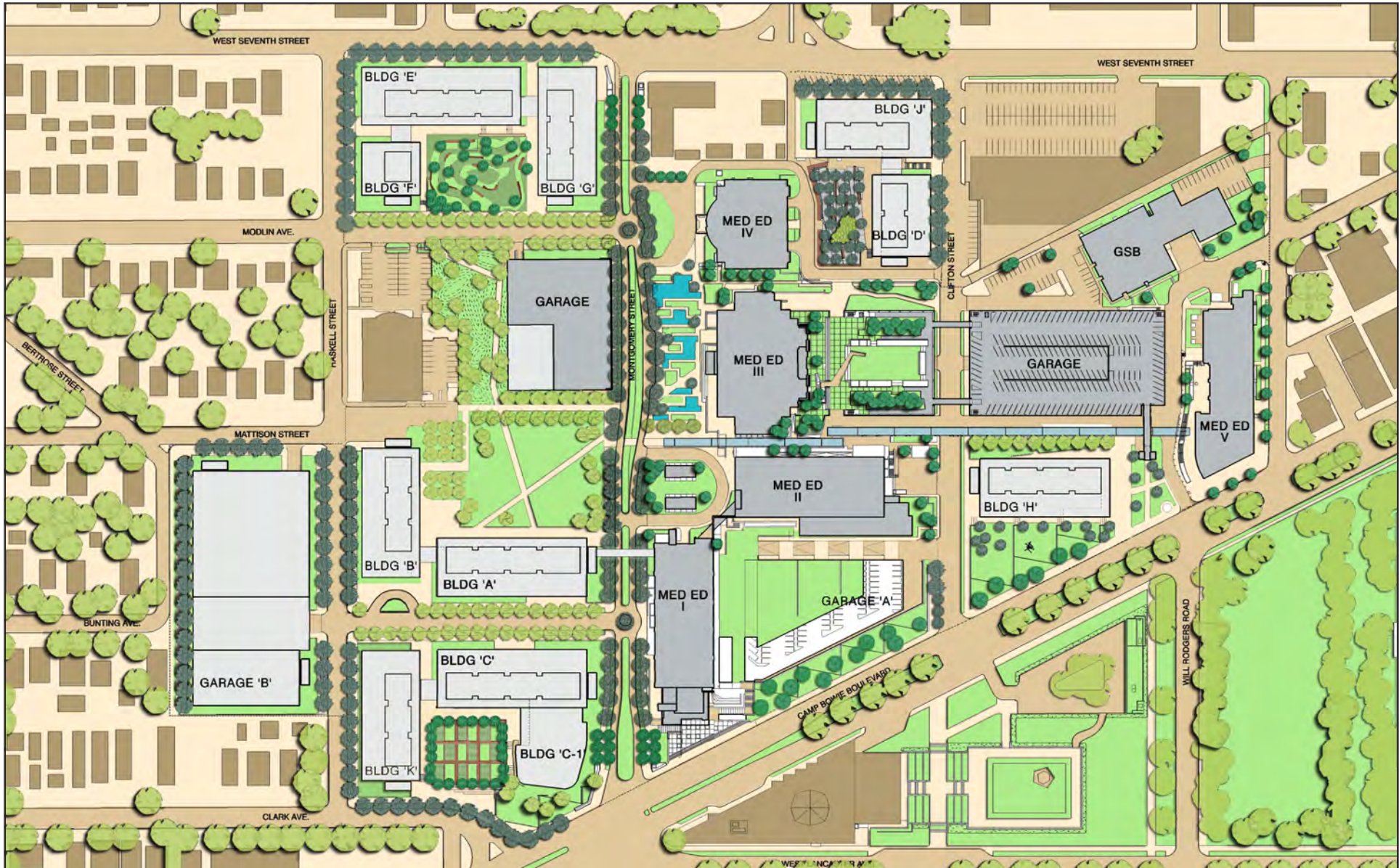

The long term vision for the University of North Texas Health Science Center provides the campus with additional buildings, green spaces, and defined campus edges

FINAL PLAN STRATEGIES

CAMPUS SPINE

The Campus Spine is the organizing pedestrian 'backbone' for the Health Science Center and provides clear east/west movement across campus during both day and night. At night this backbone transforms itself into a 'Walk of Light', a metaphor for eternal health, and will serve as a directional compass relative to one's position on campus.

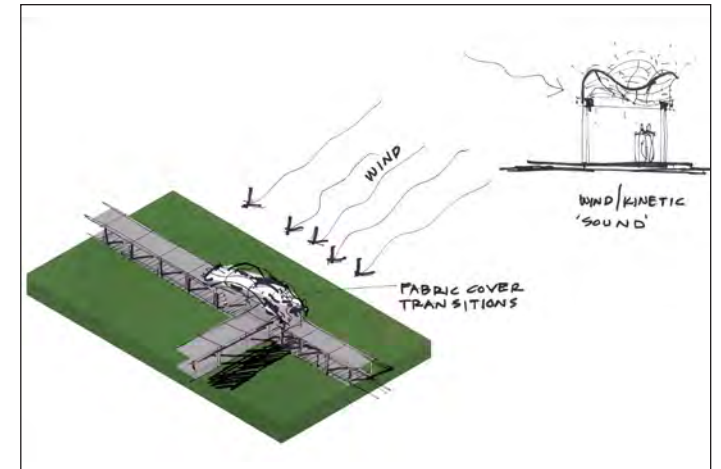
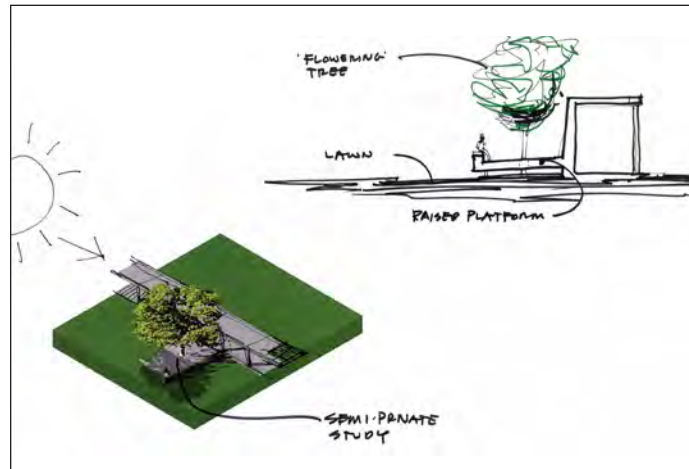

Small landscaped areas can be designed to enhance the spine and characterize portions of campus

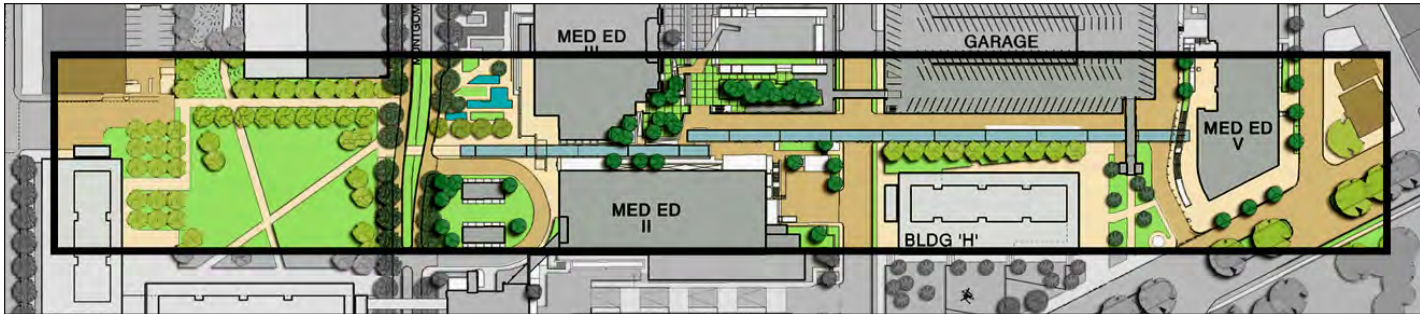

The Campus Spine will be the backbone of connection for the Health Science Center. Stretching from the far west boundary of campus to the east boundary, this campus 'Walk of Light' will serve as the primary connection for the entire campus.



Example Imagery: Covered walkways on the Campus Spine provide shelter from weather conditions while also providing a linear linkage within the Campus.



Example Imagery: Exterior lighting reinforces the spine to visually link the eastern and western precincts of Campus at night while also defining it as a special focal point.



Example Imagery: Campus trees will line portions of the spine to help define certain edges and provide variety along its length.

FINAL PLAN STRATEGIES

CAMPUS QUADS

As part of the new campus, a series of large 'Campus Quads' or 'Campus Greens' are defined as destination points within the campus to provide linkages to the broader scale of the Community and City of Fort Worth. These Quads establish a series of cores for the campus and act as thresholds for the Community, Cultural District and the City at large.

Three main campus quads have been developed from the master planning process. These include the Main Green, the Academic Green, and Community Green. These major focal points within the campus provide a variety of opportunities to integrate with the community and help strengthen and extend the connections through the surrounding constituents.

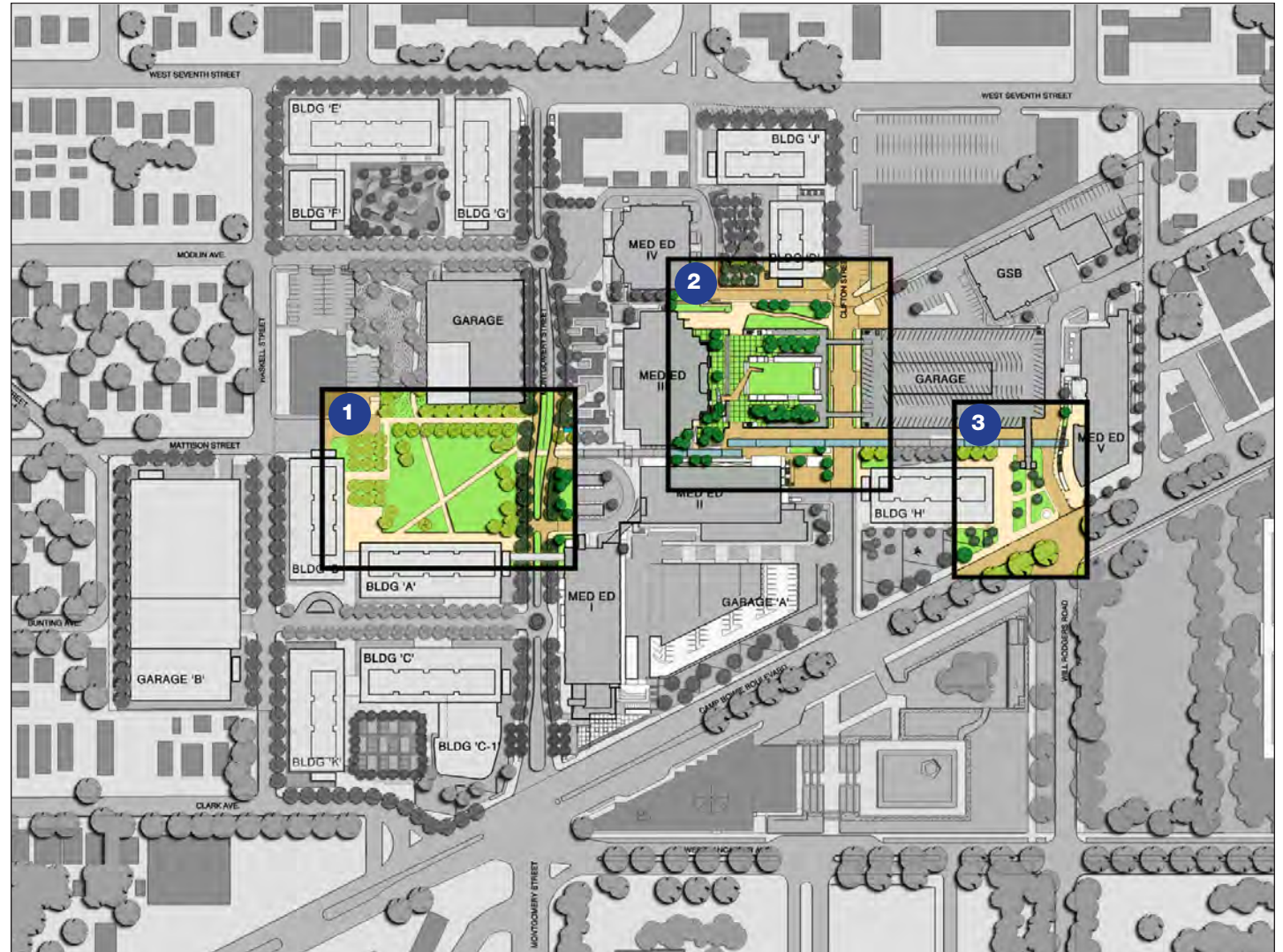

Campus Quads

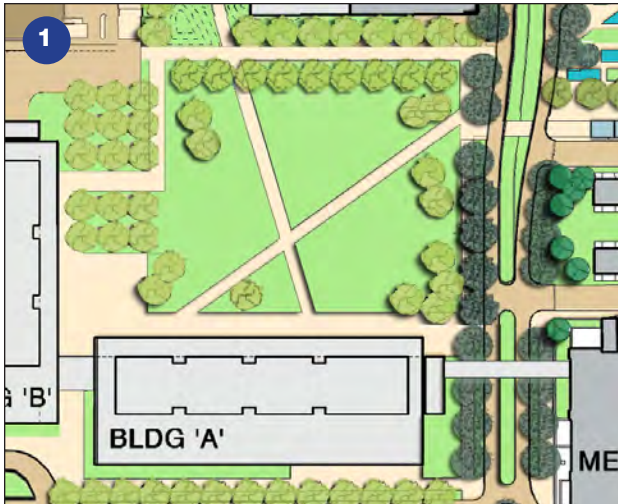

THE MAIN GREEN

This active campus quad defines the new campus core, and provides opportunities for campus wide gatherings, events and student leisure. Additionally, this Quad will define the institution, its collegial environment, and its focus on academic excellence.



Example Imagery: Open green space will provide the campus a more 'collegial' feel

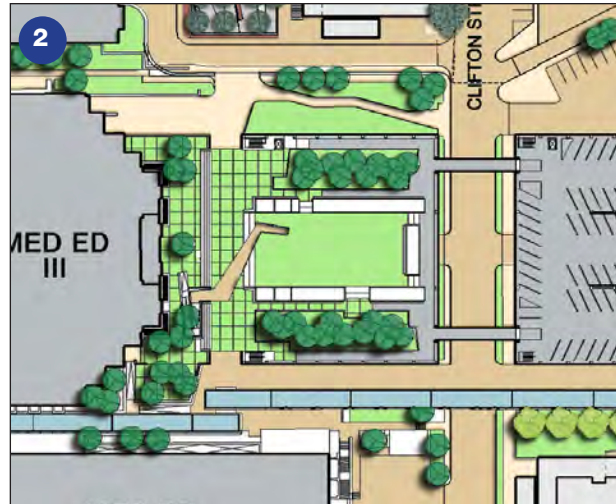

THE ACADEMIC GREEN

This passive campus quad is an extension of an existing green space that will provide passive opportunities for study, quiet leisure and contemplation. Improvements here include the addition of shading devices in and near the open lawn area.



Example Imagery: Open quads link clustered buildings with others to create one large interconnected campus

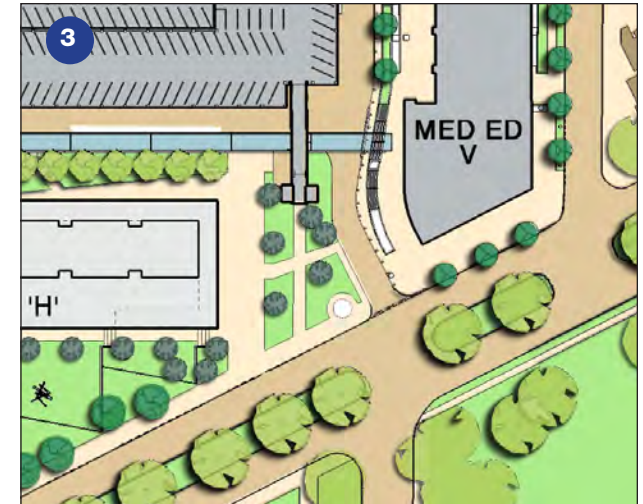

THE COMMUNITY GREEN

This campus quad is a redefined public space along Camp Bowie adjacent to the city partnered parking facility. The expansion of this public space on campus is to help bridge and connect the academic, cultural and city interests as well as share in the future development and expansion. Improvements here include repositioning the crosswalk across Camp Bowie to that shown above. Also, this concept calls for a possible integration of a public oriented program into the ground floor of Building H.

FINAL PLAN STRATEGIES

CAMPUS GARDENS

As the Quads establish linkages with the community from a macro scale, the Gardens attempt to link the internal, or micro scale, workings of the campus. This network of internal gardens are defined and planned as individual internal precincts around which each is accompanied by a collection of new academic buildings. These individual zones and assemblies of academic buildings help to provide variety and difference within the overall master plan. Also, this collection of unique gardens is defined by the precepts for total health - Mind, Body, Spirit, Soul and Emotion. This conceptual programming provides tangible spaces that link and support the principles of the UNTHSC. Additionally, these Gardens enhance the internal workings of the adjacent buildings.



Campus Gardens

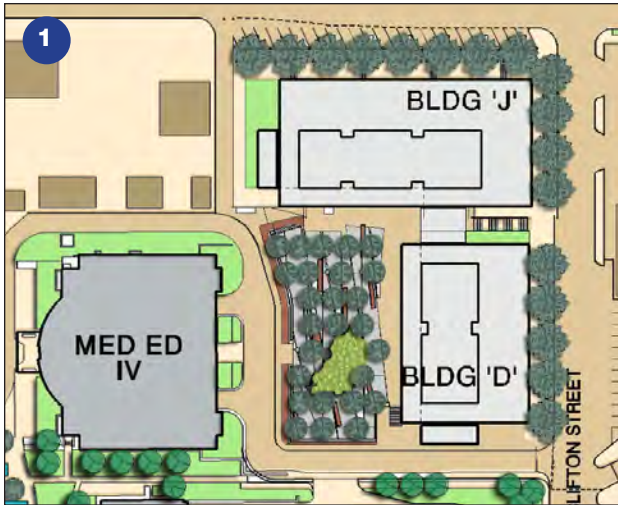

THE GARDEN OF EMOTION

This space provides a garden of crushed gravel and flowering trees which creates a quiet, passive space for reflection and thought. Located adjacent to the patient care facilities on campus, this garden will provide direct links between patients, students, doctors and nature, building on the healing and teaching principles of the UNTHSC.

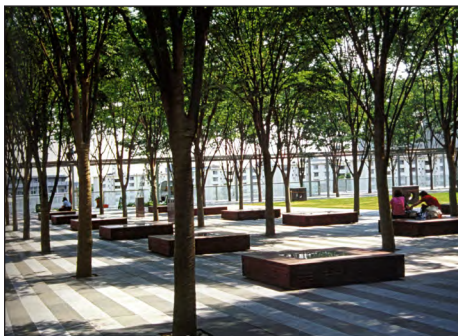

Example Imagery: Combining paved areas with landscaping will compliment the Center's urban location

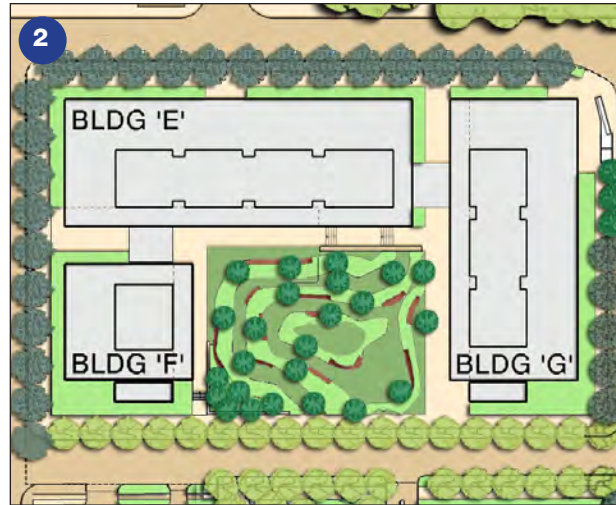

THE GARDEN OF THE MIND

This garden provides the conceptual underpinning for the an outdoor teaching amphitheater space, extending the academic into the public realm. Slightly sloped seating, landscape plantings and garden trees help to define the characteristics of the space and provide shade for the teaching zone.



Example Imagery: Open gardens can include large trees to give height to surrounding low-scale areas

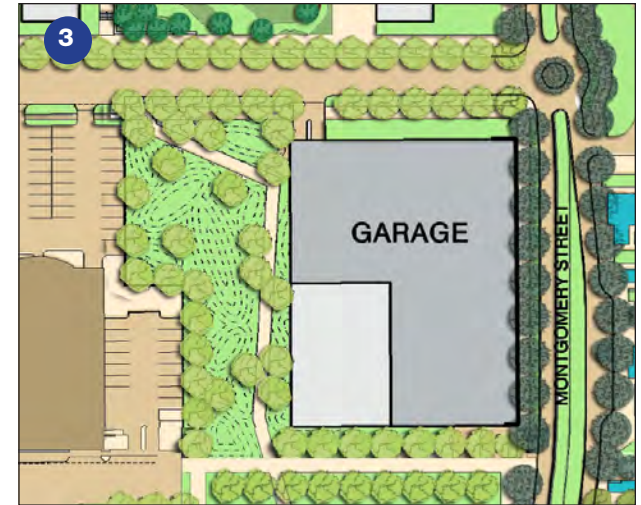

THE GARDEN OF SPIRIT

This green space provides a series of landscaped mounds creating more singular spaces for introspection and contemplation. The surface landscaping and tree types are designed to strengthen and support the conceptual planning of the space.

FINAL PLAN STRATEGIES

CAMPUS GARDENS

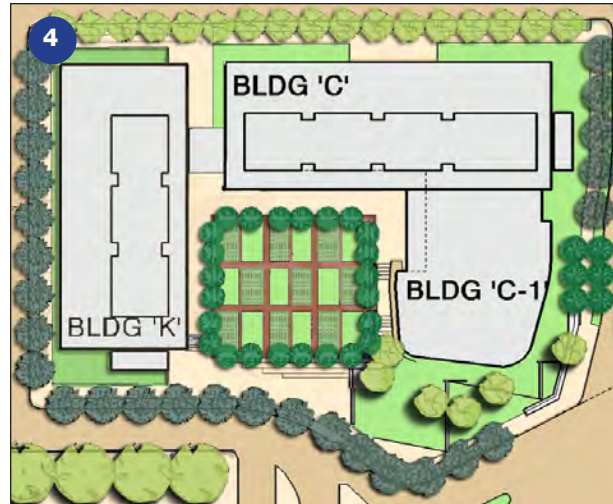

THE GARDEN OF THE BODY

This space provides the conceptual underpinning for an outdoor teaching herbal garden to assist in homeopathic research and development. This garden will provide for a variety of herbal plant types related to the academic programs of the UNTHSC.



Example Imagery: Organized plantings can be incorporated in gardens where a structured context is preferred

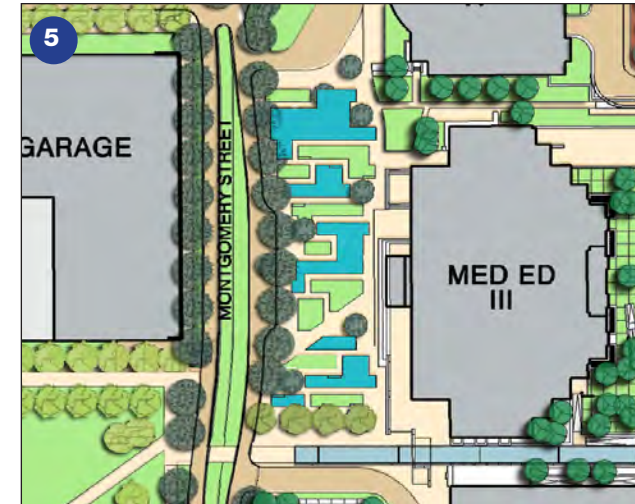

THE GARDEN OF THE SOUL

This garden is designed to be an outdoor water garden located in front of the entrance to the main library. It is made up of a series of shallow surface pools reflecting and expanding the sky to create a vertical extension of space and time. These smooth surfaces of paving stones, the varied sizes of the shallow pools and the special landscaping define a space for meditation and thought.



Example Imagery: A quad of small individual pools will bring an innovative type of landscape character to the campus

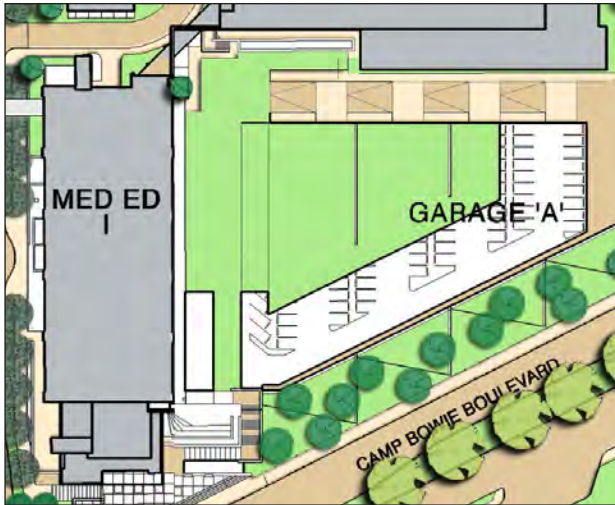

MED Ed I CONNECTION SPACE

This space, located atop the proposed Garage A, will connect MedEd-I and MedEd-II with the Camp Bowie Boulevard edge. Serving as a covering for parking below, this landscape connection will contain a wide expanse of open green space for use by the existing MedEd-I and MedEd-II buildings.

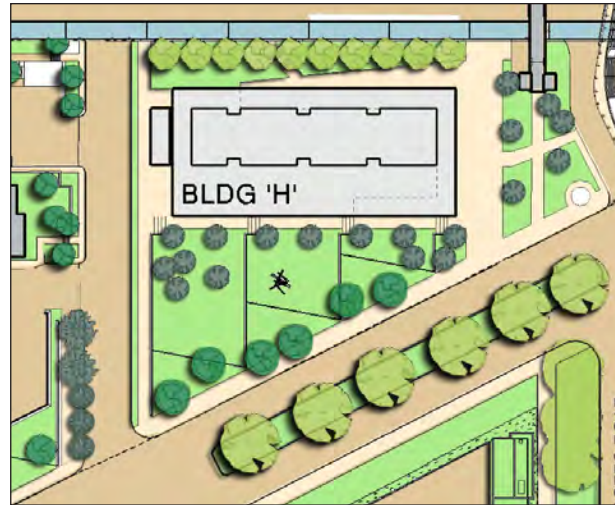

BUILDING H CONNECTION SPACE

This landscape connection links Building H with Camp Bowie Boulevard and the Museum District to the south. Its design should compliment the open space across Camp Bowie to form a larger open quad that the street bisects.

FINAL PLAN STRATEGIES

LANDSCAPE CONNECTIONS

In addition to quads and gardens, other landscape connections can be incorporated into the final vision to mirror adjacent communities and their planting concepts. These additional landscaped areas on the south side of campus will serve as connections with the Cultural District rather than destinations for students to lounge and study.

FINAL PLAN STRATEGIES

CAMPUS FRONT DOOR

Since the inception of the HSC, Montgomery Street has served as the western boundary of the campus. While there has always been strong interaction with the hospital across Montgomery, a sense of separation has existed with the hospital on one side of the street and the campus on the other. Montgomery Street was a natural divider which separated the two different uses. The acquisition of the Osteopathic Hospital property and the expansion of the campus to the west side of the street will transition Montgomery from a divider or edge street, to a campus entrance and internal corridor. Montgomery street at Camp Bowie should be developed as the new main campus entrance. Landscaping, signage, lighting and paving improvements should be implemented to support this new entrance. Detailed recommendations include the narrowing of the street to two drives lanes, two parking lanes, a center landscape median, street trees and the addition of pedestrian friendly paved sidewalks.

Because of its critical location, Montgomery Street was discussed with the planning committee in great detail. This discussion is summarized on the following page.



The planning committee agreed that several steps should be taken to develop a campus front door

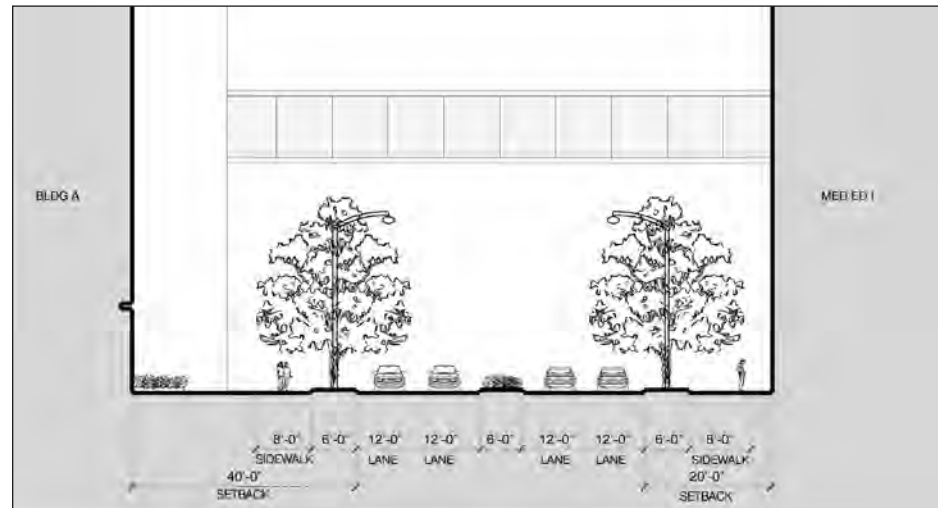

Proposed Section of Montgomery Street



Montgomery Street & 7th Street looking South



Raised crosswalks can be incorporated to calm traffic along Montgomery Street



The final master plan proposes traffic calming solutions along Montgomery Street

FINAL PLAN STRATEGIES

MONTGOMERY STREET PLAN

Many ideas regarding Montgomery Street were discussed during the Observations and Concept Planning stages of the master plan activities. Considerations included everything from closing the street to excavating and putting it “under” the campus, to narrowing the street and slowing traffic. The realization of its importance to not only the campus but to the surrounding neighborhoods came at the conclusion of the Observations and Concept Planning stages of the master planning process. The importance was further documented and supported by a traffic study conducted during the planning process which documents the vehicular movements on Montgomery Street.

After considerable discussion and input among the planning team, the City of Fort Worth Planning and Traffic/Transportation departments and public meetings regarding traffic along Montgomery Street, the master plan recommends

implementing traffic calming techniques which could be incorporated on the street. These techniques and their effects are described in the traffic analysis portion of this master plan. The techniques include the addition of raised crosswalks, landscaping, medians, speed limit reduction and traffic circles to slow traffic. With these alterations, safety could be increased for pedestrians crossing the street while retaining vehicular access both to and through the campus.

THE FINAL PLAN

PHASE I PLAN

During Phase I, the UNTHSC will focus campus development on the newly acquired property to the west, specifically the site of the former Osteopathic Hospital. This development area will be the first in instituting the concepts and strategies set forth in the master plan.

Two new facilities will be added to the campus in addition to the first campus quad and garden. The campus spine will be initiated starting at the west boundary of campus.



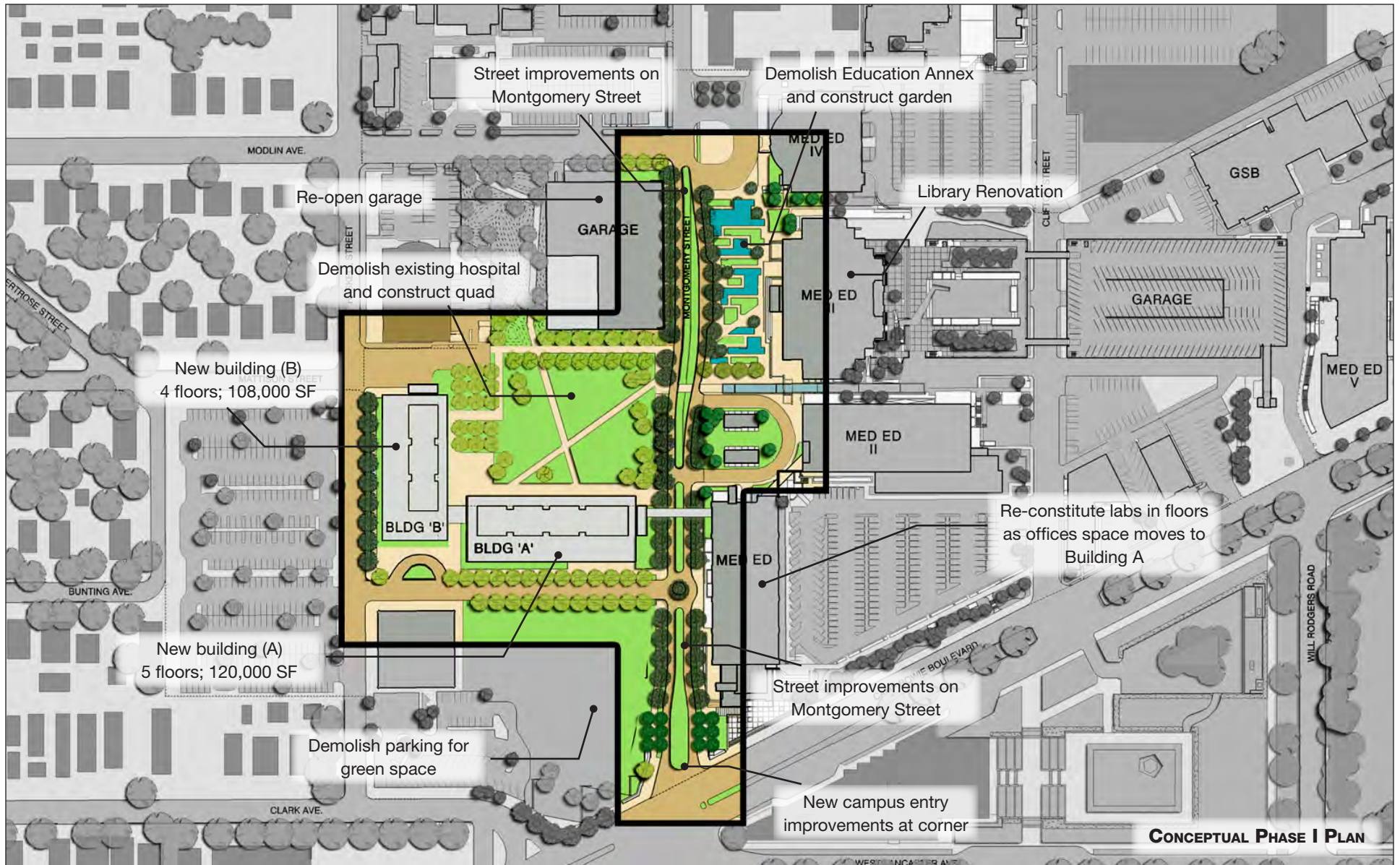

SIGNAGE AND WAYFINDING RECOMMENDATIONS

The UNTHSC's wayfinding system requires the prioritization of information in a logical structure of ordered levels. This structuring and editing of information will facilitate the most common or desired user objectives as they traverse the surrounding roadways and campus property. Future sign messaging should be based on logical or expected groupings and classifications, time critical information, and pertinence to proximity to available destinations.

WAYFINDING OBJECTIVES

This plan has been prepared as a spring board for the development and implementation of the environmental graphics and wayfinding program contained.

The objectives for this plan are:

1. To provide an aesthetically pleasing yet functional sign design program that strengthens the brand into the future
2. Direct vehicular traffic to appropriate parking areas
3. Provide effective pedestrian directionals

THE GRAPHICS & MATERIAL PALETTE

Through fonts, colors and materials, the signage and wayfinding components are viewed as an extension of the UNTHSC brand. Consistent brand colors will be used on the signs, pulled from the current graphic standards.



The official campus logo will be used on signs to further enforce the UNTHSC brand



The master plan details opportunities to strengthen the perimeter of campus to create a stronger sense of place and arrival

WAYFINDING SIGN TYPES

This section introduces the various wayfinding sign types and their functions. The sign types are presented in the order in which a first time visitor to the campus might experience them.

The first sign type, or monument, identifies the campus “front door” which celebrates the arrival to the campus entrance. The second set of sign types are perimeter and interior campus vehicular wayfinding signs, then pedestrian kiosks and directionals. Lastly, the building identification sign concludes the exterior sign program and celebrates the arrival sequence.

Each of these sign types have their own particular needs for materials, finishes, sizes, illumination, changeability and water-proofing. It shall be in the design development of these sign types where all said materials and details shall be determined.

The design development phase shall take all locations and messaging into consideration, prior to finalizing the sign sizing, material specifications and bidding. A complete sign location plan and message schedule should be created, prior to finalizing the design development of each sign type, to ensure proper messaging per sign location, in advance. Precise locating of signs shall occur in the construction documentation phase, and verified by a sign manufacturer and the UNTHSC, prior to shop drawings. Signs requiring electrical shall also be coordinated at this time.

“FRONT DOOR” MONUMENT

A monument is a significant location along the campus perimeter environment that defines, or symbolizes, an entry point or clear boundary from one environment to another. The monument may be a portal in the physical sense or simply a point, which is passed, that signals a change in the character of the environment. Monuments are located at vehicular entrances to the campus, or specific areas, and provide an excellent opportunity to celebrate the university's identity and create a sense of place.

Each monument location is defined as either a primary or secondary entrance, receiving a primary or secondary treatment. While the design approach may be different for the two, both types of monuments will be unique in their scale and use of materials, but consistent with the way they resemble each other, while identifying the campus. Pending the street and landscape design of each campus approach, the differences between the two monuments may be in their prominence at the entry, location in relationship to the immediate roads, scale, massing, graphics and illumination.

The primary entrance shall receive the more prominent feature of the two types of entries. Final concept and design of this primary entrance should be determined during a later study.

VEHICULAR DIRECTIONALS

On-site vehicular directional signs, along the perimeter and within the campus boundaries, offer vehicular directional information for the purpose of assisting in the flow and sorting of traffic. The signs provide pertinent information, at key decision points, for destinations that are accessible by vehicle. The physical location of the sign, its size, and the scale and complexity of its communicating elements are appropriate for interpretation by the driver of a vehicle traveling at the posted roadway speeds.

As the signs are located in the future development and implementation phases, the UNTHSC shall provide a list of destinations, with their hierarchy of importance, for the designers use in determining which message are to be placed on the signs. Consistency between the different wayfinding sign types and their intended locations, along with the use of materials, colors and typography are to support the wayfinding and graphic framework of the UNTHSC sign program and identity.

PARKING LOT IDENTIFICATION

Vehicular parking areas are a primary destination for visitors, therefore require clear, legible identification and wayfinding from the perimeter of campus. Parking area nomenclature shall be provided by the UNTHSC, taking existing and all future parking areas into consideration, to clearly identify each parking lot and/or garage throughout the campus. Locations of the primary (garage) and secondary (surface lot) identification signs are recommended at parking area entries, perpendicular to the street.

PEDESTRIAN DIRECTORY

Located along the pedestrian pathways leading into and around the heart of the campus, this pedestrian directory will provide campus orientation information such as, colored isometric campus map and changeable strips containing alphabetical listings of all the UNTHSC destinations. The directory shall appear as other wayfinding signs and contain an interior lit, water-tight directory cabinet with a locking device. Mapping area shall be a translucent film with interior illumination. Destination listings shall be a changeable strip material for the UNTHSC facilities to change out as needed.

Colored campus maps with dimensional building shapes are recommended, containing alphabetical destination indexes with keyed locations recommended for greater visitor understanding. Each directory map orientation is to be created individually, with campus map rotated as if "looking into the campus" from the directory location. A pedestrian directory concept is depicted on the following page.



The vehicular directionals should be made up of painted aluminum sign panels with exposed aluminum red cores

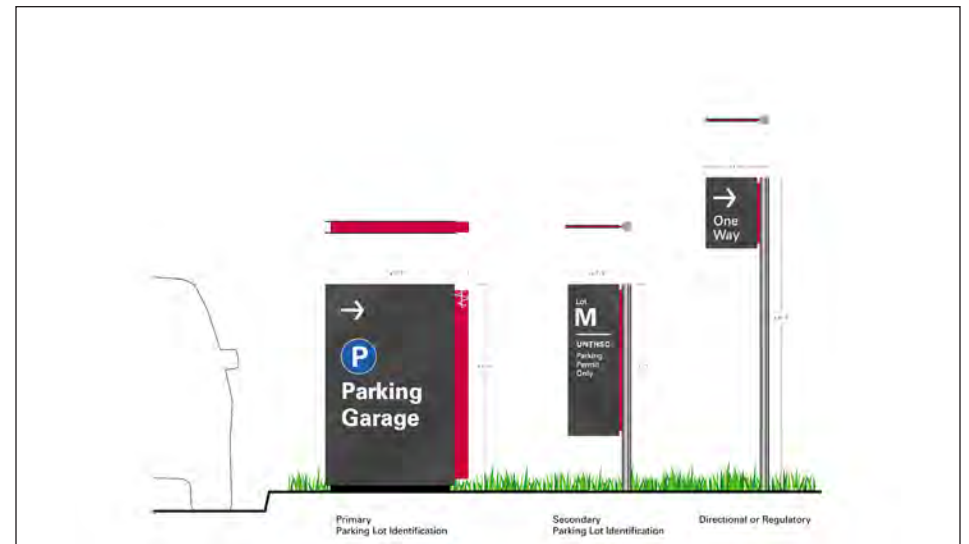

Parking lot identifications will be located at parking area entries that are perpendicular to the street

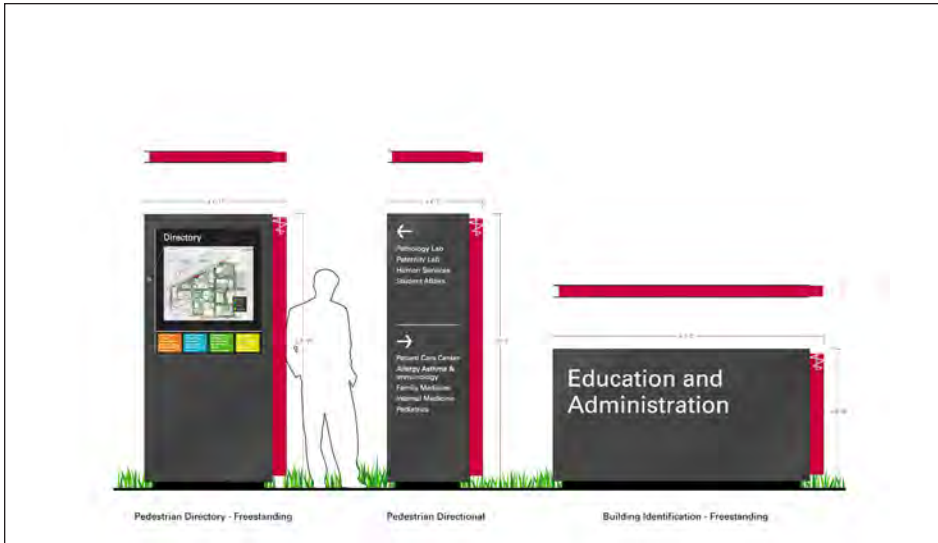

Pedestrian directional signs including directories, directionals, and building identification signs will orient the visitor while walking on campus

PEDESTRIAN DIRECTIONAL

A pedestrian wayfinding directional offers pertinent directional information for pedestrians on foot. The sign clearly lists destinations that are accessible by a pedestrian route, within a reasonable range. The wayfinding device is located in close proximity to key decision points along pedestrian pathways, without becoming an obstacle. Text elements are presented at a size suitable for pedestrian viewing and may be interpreted from a short walking distance or from arm's length. The information content can vary per sign location, while containing the assigned hierarchy of information that works, in order, with all other locations.

BUILDING IDENTIFICATION

Freestanding Building Identification

The Building Identification sign may be oriented for either vehicular viewing or pedestrian oriented locations along streets or sidewalks in strategic locations close to the building entries.

Existing Building Identification

Existing building mounted identification is currently used throughout the campus. It is the design teams recommendation to update all building identification on facades with new designed letters that match the new wayfinding program aesthetic. The new lettering would be one of the graphics standard UNTHSC fonts, individually cut-out, or ribbon cut, appropriately sized letters mounted to the building face. Successful dimensional letter designs shall be approx. 6 inches minimum in height, made of aluminum, and finished in the dark warm gray color to create significant contrast with the wall background.

CONCLUDING REMARKS

This environmental graphics and wayfinding plan provides a road map that combines the long range planning and present day needs.

Particular phasing of the program will need to be determined and aligned with future funding. A cohesive implementation plan needs to be determined in order to prevent fragmented routing and identification and orientation messaging that would defeat in primary goal of providing a positive visitor experience. The message hierarchy should be at the forefront of each sign location decision.

As the master plan implementation progresses, each wayfinding element will need to be studied and developed to determine the design details, most visible locations, as well as the clearest messaging. Messages, locations, materials, consistent color and typography are integral in providing a strong brand identity for the UNTHSC.

TRAFFIC AND PARKING ANALYSIS

Traffic and parking considerations relating to the master plan are addressed in this section. Existing conditions were observed and documented, including available parking supply and general utilization characteristics for the existing facilities. Traffic counts were collected to analyze existing traffic flow patterns. New facilities recommended in the master plan were considered to evaluate their impact on future traffic and parking.

METHODOLOGY

A traffic analysis of Montgomery Street from West 7th Street to Camp Bowie Boulevard was conducted to identify the current traffic volumes and traffic flow patterns. Existing roadway and traffic conditions were observed within the study area, and geometric and traffic information for intersections; such as number of lanes, speed limits, and intersection traffic control were collected. Photographs for the three intersections are included in the Appendix.

Twenty-four (24) hour traffic volume counts (at Montgomery Street between West 7th Street and Camp Bowie Boulevard., and at West 7th Street on the east and west sides of the intersection of West 7th Street and Montgomery Street) and AM and PM peak hour turning movement counts (at the intersection of Montgomery Street and West 7th Street, and the intersection of Montgomery Street and Camp Bowie Boulevard) were collected on Wednesday, April 25, 2007. Detailed records of the 24-hour traffic counts and peak period turning movement counts are included in the Appendix.

EXISTING TRAFFIC CONDITIONS

Montgomery Street is the central transportation spine of the campus. Therefore, it is expected to carry relatively large number of vehicles. However, the collected traffic data shows that the stretch of Montgomery Street passing through the campus (between West 7th Street and Camp Bowie Boulevard) carries just over 8,000 vehicles a day. This is almost equal to the traffic on West 7th Street east of Montgomery. West 7th Street is an important link between residential areas in western portions of Forth Worth and downtown. Montgomery Street dead-ends just north of the campus at 7th Street

As traffic counts show, during the morning peak hour, from 7:45 A.M. to 8:45 A.M. (highlighted in Table 1), 278 vehicles use Montgomery Street to enter the campus from the North, and 276 vehicles exit the campus to the South. These numbers suggest a very high percentage of traffic on Montgomery Street consists of cut-through traffic using Montgomery only to get to other destinations south of the campus.

Intersection	West 7th @ Moticello						West 7th @ Montgomery						
	W. 7th Street		Monticello		Southbound		W. 7th Street		Montgomery				
	Eastbound	Westbound	Southbound	Left	Right	Eastbound	Westbound	Northbound	Left	Right			
Time Starts	7:00 AM	12	22	3	12	14	9	16	9	7	18	6	22
	7:15 AM	12	26	2	21	20	19	25	5	9	31	5	17
	7:30 AM	12	37	5	33	27	24	32	10	20	40	5	26
	7:45 AM	13	40	2	51	30	21	29	9	21	63	10	35
	8:00 AM	26	40	9	31	26	24	30	5	10	44	13	41
	8:15 AM	17	46	9	32	26	13	34	12	17	43	6	35
	8:30 AM	10	41	6	27	29	9	28	10	14	41	6	26
	8:45 AM	19	48	6	23	29	14	23	8	14	39	6	45
	AM Peak Hour (7:30 - 8:30)	68	163	25	147	109	82	125	36	68	190	34	137
Time Starts	4:30 AM	28	44	40	19	16	11	22	5	22	37	5	49
	4:45 AM	17	45	70	21	20	8	17	5	41	50	5	45
	5:00 AM	37	55	70	36	28	7	32	8	40	69	7	62
	5:15 AM	43	44	81	18	22	8	30	9	44	62	6	60
	5:30 AM	20	33	74	16	20	5	21	10	41	55	7	34
	5:45 AM	27	32	58	26	15	6	17	9	26	47	8	45
	6:00 AM	20	32	50	19	24	8	18	6	34	39	6	31
	6:15 AM	24	34	44	15	11	5	21	7	31	22	6	38
	PM Peak Hour (5:00 - 6:00)	96	283	127	164	85	26	100	36	151	233	28	201

Table 1 Turning Movement Counts

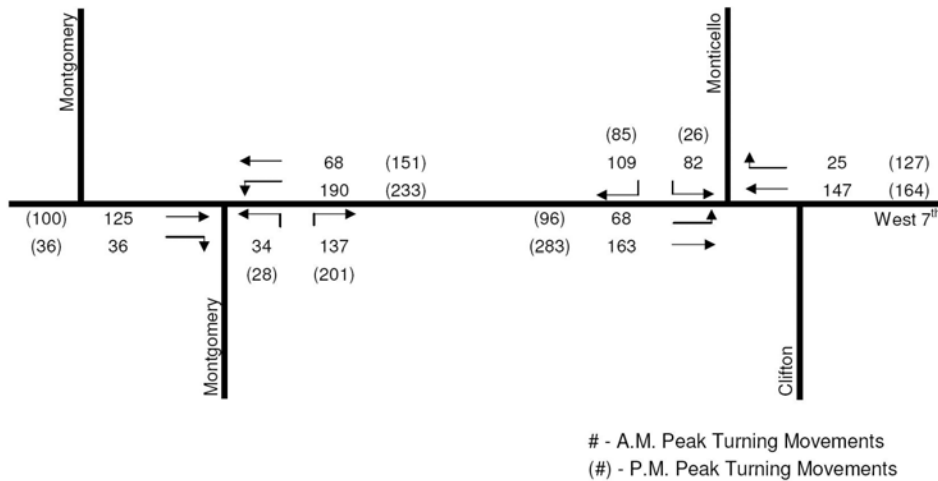

Figure 1 Peak Hour Turning Movement Counts

Turning movement counts (shown in Figure 1), performed at the intersection of West 7th Street and Montgomery Street suggest that 90% of morning peak-hour volume on Montgomery Street comes from westbound traffic on West 7th Street. Over 75% (190 of 258) of all westbound traffic on West 7th Street turns left on to Montgomery Street.

Since all the traffic east of the intersection of West 7th Street and University Drive can take Camp Bowie Boulevard to get to Montgomery Street, it can be concluded that none of the cut-through traffic westbound on West 7th Street is coming from east of the intersection of West 7th Street and University Drive. Therefore, all the cut-through traffic westbound on West 7th Street is actually getting onto West 7th Street through streets from the residential neighborhoods such as Monticello Drive, Boland Street or Arch Adams Street (further to the east).

The turning movement counts performed at the intersection of West 7th Street at Monticello Drive suggest that about 40% (111 of 278) of westbound traffic on West 7th Street at Montgomery Street comes from the residential neighborhood to the north through Monticello Drive. Therefore, about 36% (40% of 90%) of cut-through traffic on Montgomery Street comes from the residential neighborhood to the north of West 7th Street through Monticello Drive. The remaining 64% of cut-through traffic on Montgomery Street comes from either Boland Street or Arch Adams Street.

During the evening peak hour, from 5:00 P.M. to 6:00 P.M. (highlighted in Table 1), the reverse pattern can be witnessed, as shown in Table 1 and Figure 1. Therefore, there is a lot of cut-through traffic using Montgomery Street to go south of the campus.

However, Montgomery Street, between Camp Bowie Boulevard and West 7th, is not a thoroughfare street. It is primarily a campus street with a high level of pedestrian traffic. There are a large number of pedestrian-vehicular conflicts areas all along the length of Montgomery Street that pose potential risks for the students and drivers alike.

Considering the two observations, a large percentage of cut-through traffic uses Montgomery as a thoroughfare. This poses a potential risk for drivers and pedestrians. It is recommended that Montgomery Street be made more pedestrian friendly by application of some traffic calming devices discussed on the following pages.

TRAFFIC AND PARKING RECOMMENDATIONS

Specific traffic calming techniques for Montgomery Street are recommended as part of the final master plan. A variety of techniques are detailed below.

TRAFFIC CALMING DEVICES

Traffic calming can be achieved by a series of physical treatments that when properly applied can reduce traffic speed and volume. These treatments are typically classified as active or passive traffic calming devices. Active traffic calming devices are those which alter the horizontal or vertical movement of a vehicle. Examples of active devices include traffic circles, raised intersections, speed tables, speed humps and curb radius reductions. Passive traffic calming devices are those which are primarily visual in nature but may also provide a sound or feel sense to vehicle occupants. Examples of passive devices include roadway narrowing, decorative paving, lighting, bollards, and trees. Traffic calming devices recommended for application on Montgomery Street within the UNTHSC campus are described in the following paragraphs.

SPEED TABLE / RAISED CROSSWALKS

These are flat-topped speed humps that can be located at mid-block (speed table) or at intersections (raised crosswalks). Changes in texture and color help define edges of the crossing. Detectable warning strips at edges enable vision impaired pedestrians to detect

the crossings. Speed table or raised crosswalks typically cost up to \$1,500 (Asphalt) to \$20,000 (Brick).

Speed table / raised crosswalks considerably reduce vehicular traffic, improve crosswalk visibility, and enhance the environment for pedestrians at the crossings. It may be noted, however, that speed tables and raised crosswalks increase Emergency Management System response times, may require modifications to the drainage system, divert traffic to other streets, and increase noise levels in the area of the device. Besides, the drivers tend to speed between the devices to make up for the lost time.

ROADWAY NARROWING

Roadway narrowing can be achieved by reducing the lane widths from the existing typical 15-16 ft to 10-11 ft. This can be achieved by relocating curbs or by striping the remaining pavement. This may reduce vehicular speeds along a roadway section and enhance pedestrian movement and their safety. It may also increase space for landscaping or creation of roadway medians. The typical costs for roadway narrowing ranges from \$1,000 per mile for shoulder striping to 10,000-\$20,000 for Chicane.



Speed tables or raised crosswalks reduce vehicular traffic, improve crosswalk visibility and enhance the environment for pedestrians



Changes in texture and color help define edges of the crossing



Roadway narrowing increases safety of the drivers and the pedestrians and provides an opportunity to redistribute space to pedestrians



Additional example of roadway narrowing

Traffic calming devices, like speed table / raised crosswalks or roadway narrowing, will improve pedestrian safety and reduce vehicular traffic and speed on Montgomery Street. However, to determine if the intersection of Montgomery Street and West 7th Street requires a traffic signal to improve traffic circulation, and evaluate the existing traffic operating conditions, a Traffic Signal Warrant Analysis and a Level of Service Analysis were performed.

TRAFFIC SIGNAL WARRANT ANALYSIS

To determine if the intersection of Montgomery Street and West 7th Street requires a traffic signal to improve traffic circulation, a Traffic Signal Warrant Analysis was conducted according to the methodology described in the Texas Manual of Uniform Traffic Control Devices (MUTCD), for the recorded conditions. Detailed traffic signal warrant analysis sheets are included in the Appendix of this document.

The intersection of Montgomery Street and West 7th Street satisfied Warrant 3B-Peak Hour Volume, but failed all other warrants of the Traffic Signal Warrant analysis. Warrant 3B suggests that during the PM peak hours, Montgomery Street traffic suffers undue delay when entering West 7th Street, and satisfies the need for a traffic control signal. However, the condition occurs only for a very short period (less than 1 hour), and thus, it is not economical to install a traffic control signal.

LEVEL OF SERVICE ANALYSIS

To determine the existing traffic operating conditions on Montgomery Street and West 7th Street, a capacity and level of service analysis was conducted for the intersection of the two streets. Level of Service (LOS) is a qualitative measure of the traffic operating conditions experienced at an intersection, or along an arterial roadway, when it is subject to varying traffic volumes. There are six levels of service, ranging from LOS A, being the best, to LOS F, being the worst. LOS A through D are considered acceptable operating conditions in urban areas. LOS E is considered at or near capacity of an intersection, and LOS F represents a breakdown in traffic operations. The capacity analysis summary sheets are included in the Appendix of this document.

The eastbound and westbound West 7th Street traffic operates at LOS A for both AM and PM peak periods. These LOS values suggest that the West 7th Street is operating at the best traffic operating conditions. The traffic on Montgomery operates at LOS B and LOS C during AM and PM peak periods. These traffic operating conditions are also within acceptable range.

PARKING RECOMMENDATIONS

The campus master plan proposes a number of new facilities, including two new garages, throughout the campus. One of the new garages, Garage B, is proposed to replace the existing surface lot west of Haskell Street between Mattison Ave and Clarke Ave. Primary access to this garage will be from Haskell Street, and secondary access from Mattison Ave. The other garage (Garage A) is proposed adjacent to the administration building and west of Clifton Street. Access to this garage will be from Clifton Street near Camp Bowie Boulevard.

Once the new garages are commissioned, a large portion of campus population is expected to use them. Due to the location and access points of the new garages, a lot of traffic, which is currently on Montgomery Street, will shift to Haskell Street and Clifton Street. As a result, a significant reduction in vehicular traffic on Montgomery Street is expected.

Apart from the new garages, considerable improvements are recommended to pedestrian walkways and sidewalks throughout the campus, including Montgomery Street. Improvements along Montgomery Street will include wider and well-lit sidewalks with street furniture, which will significantly increase pedestrian safety and comfort.

CONCLUSIONS

Montgomery Street is the central transportation spine of the campus. The data shows that the stretch of Montgomery Street passing through the campus (between West 7th Street and Camp Bowie Boulevard) carries over 8,000 vehicles a day. Because Montgomery Street is primarily a campus street with high level of pedestrian traffic, it is recommended that Montgomery Street be made more pedestrian friendly and the vehicular speeds be reduced by application of traffic calming devices such as speed tables / raised crosswalk and/or roadway narrowing.

Traffic study has shown that a large percentage of vehicles on Montgomery Street use the street solely as a cut through to get to the intersection of Montgomery Street and Camp Bowie Boulevard. Almost all of this cut-through traffic comes from the residential neighborhood to the north of West 7th Street. Implementation of traffic calming measures and reduced speed limits will deter cut-through traffic from using Montgomery Street.

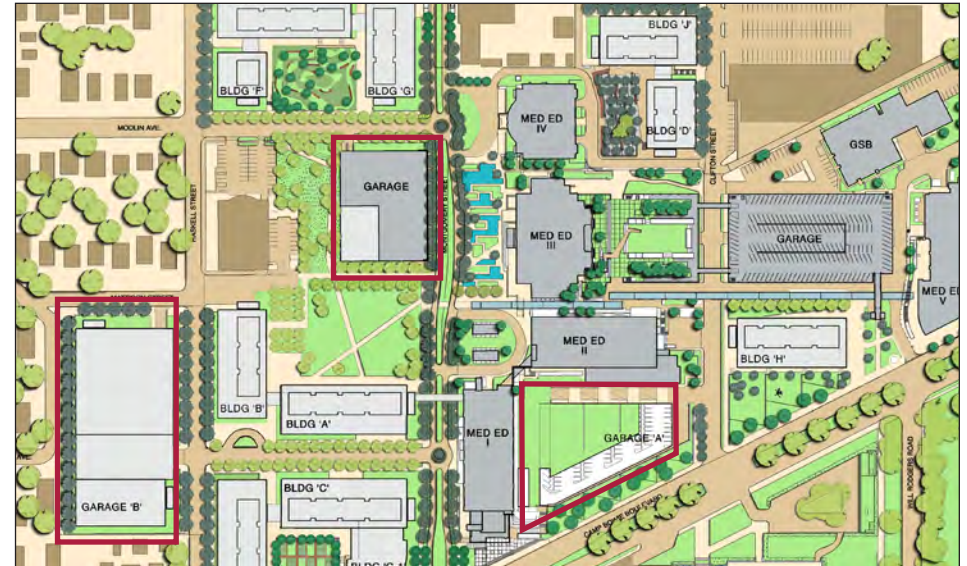

Proposed campus parking garages in the final master plan

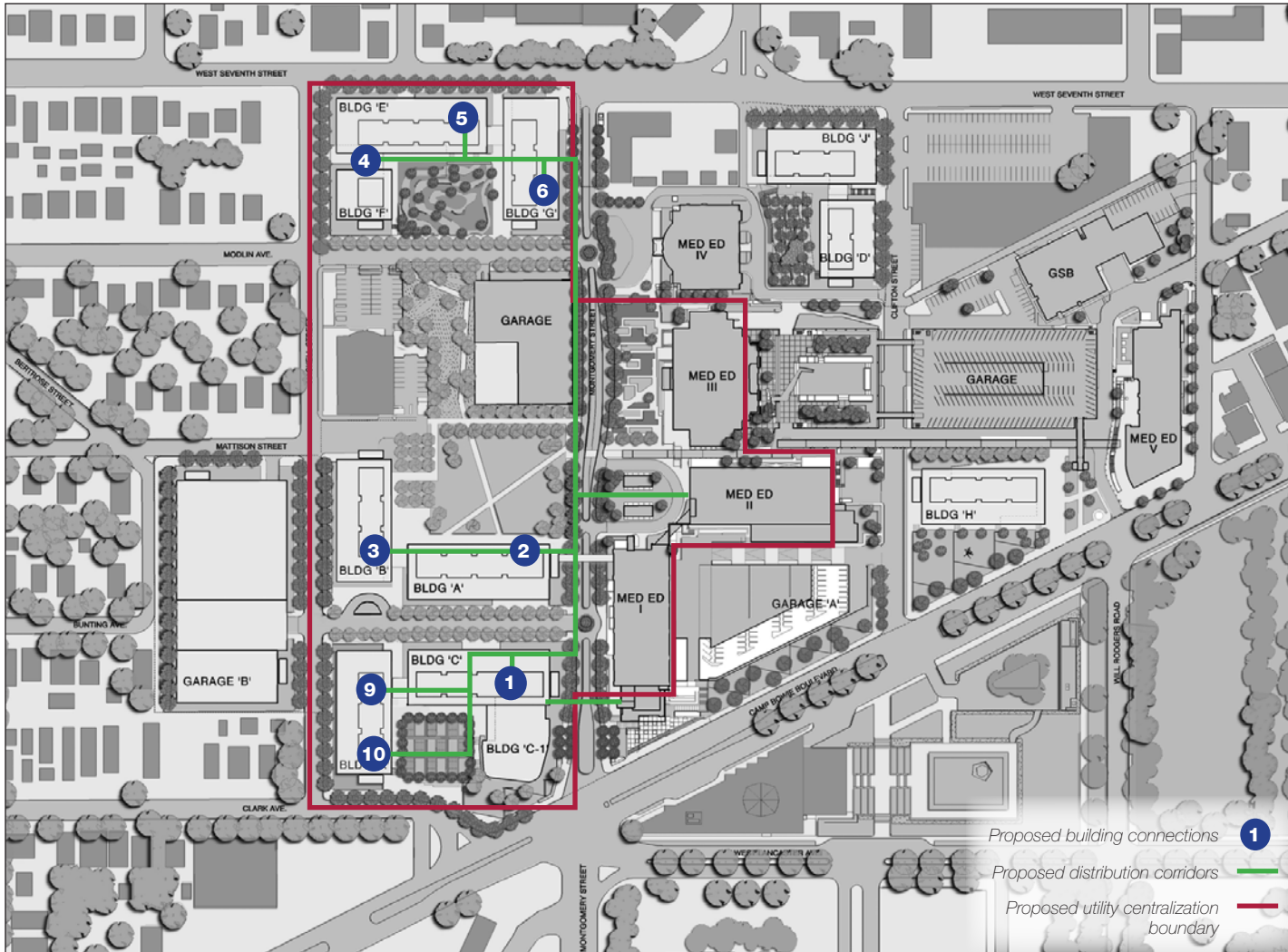

UTILITY INFRASTRUCTURE

Three options were evaluated to determine the optimal means of supplying mechanical utilities (chilled water and heating hot water) for the planned construction on the west side of Montgomery Street. The three system options evaluated were:

1. A new central utility plant located in the basement of Building A, producing chilled and heating hot water.
2. A new central utility plant producing chilled water and hot water, located in an infill section of the existing Parking Garage.
3. Individual chilled and heating hot water plants dedicated to serve each individual building.

Options 1 and 2 would serve future buildings through underground distribution piping, as shown on the proposed campus piping distribution layout to the left. The third option is comprised of individual building systems dedicated to each building, with no interconnection or centralization of utilities.

UTILITY INFRASTRUCTURE

CENTRAL PLANT PHASING

The new central plant options are proposed to be implemented using a phased approach, to grow in proportion with the addition of new facilities. The central plant options (Options 1 and 2) would also have the capacity to serve the existing Education and Administration (EAD) and Research and Education (RES) Buildings through interconnection of piping systems between the new plant and these existing systems. It was noted that the existing piping interconnection between EAD and RES needs to be modified in order to fully allow cross-service of utilities between the two building systems.

The production of chilled water and heating hot water from a centralized plant facility offers many advantages over a collection of individual building systems. Centralization dramatically improves the overall operating efficiency of the chilled and heating hot water systems compared to standalone building systems. A central plant also simplifies maintenance and operations activities, since all equipment is housed in one location. Further, centralization ensures system uniformity while providing a higher degree of reliability than is possible with a collection of building systems using different types of equipment with different operating parameters, setpoints and design conditions.

The proposed location for the new central plant in Option 1 is the basement of Building A. For this option, a portion of the basement would

be delegated to house the central plant which would house chillers, hot water boilers, cooling towers, primary, secondary, condenser water and hot water pumps and associated mechanical equipment. The location of the central plant for Option 2, housing the same mechanical equipment, uses the corner of the parking garage west of Montgomery Street. For this option, the corner of the L-shaped parking garage would be in-filled and constructed to form a three story central plant, with levels for cooling towers, chillers, boilers and pumps.

Both central plant options have been proposed to minimize utility interruptions throughout the proposed project build out while limiting the capital impact of utility construction to match the cost of the standalone building plant option as closely as possible. The proposed phasing for each plant option is as follows:

PHASE 1 (OPTIONS 1 AND 2)

The chilled water system for Phase 1 includes the installation of two 2,000 ton centrifugal chillers (one unit redundant), two primary chilled water pumps, three secondary chilled water pumps, two 2,000 ton field-erected cooling towers, two condenser water pumps into Building A. The hot water system for Phase 1 includes the installation of two 350 horsepower hot water boilers, two primary hot water pumps and two secondary hot water pumps. Also included is chilled water and hot water distribution direct bury preinsulated steel piping to allow the future connection of Buildings A and B to Building C, forming the first stage of a distribution loop.



Central energy plant example

PHASE 2 (OPTIONS 1 AND 2)

Beyond the first three planned buildings, the load growth is such that an additional chiller is required to provide system capacity for sustained operation. The chilled water system for Phase 2 includes the installation of one additional 2,000 ton centrifugal chiller, one primary chilled water pump, two secondary chilled water pumps, one 2,000 ton field erected cooling tower, one condenser water pump. The hot water system for this phase includes the installation of one secondary hot water pump. Chilled water and hot water distribution piping to connect Buildings E, F and G to the distribution loop established in Phase 2.

PHASE 3 (OPTIONS 2 AND 3)

The chilled water system Phase 3 includes the installation of one additional 2,000 ton centrifugal chiller, one 1,500 ton centrifugal chiller, two primary chilled water pumps, four secondary chilled water pumps, two 2,000 ton field erected cooling towers and two condenser water pumps. Also included is chilled water distribution piping to connect Building K, as well as the Education and Administration Building, and Research and Education Building to the loop. The hot water system for Phase 2 includes the installation of four additional 350 HP hot water boilers, four primary hot water pumps, four secondary hot water pumps, and hot water distribution piping to match the chilled water piping.

The phasing plan above is adequate for either central plant Option 1 or 2, as the new building loads are the same in either instance. The only difference between the two options is building costs and distribution piping cost per phase. Cost estimates for each phase of both central plant options were prepared and are shown in Table 1 below:

TABLE 1: CENTRAL COOLING AND HEATING PLANT COST SUMMARY	
Option 1 - Plant in Basement of Building A	
PHASE 1	\$4,876,568
PHASE 2	\$2,450,952
PHASE 3	\$4,498,008
TOTAL BUILD OUT COST	\$11,825,527
Option 2 - Plant in Parking Garage	
PHASE 1	\$10,622,035
PHASE 2	\$2,205,037
PHASE 3	\$4,498,008
TOTAL BUILD OUT COST	\$17,325,079

As seen in the summary table above, the cost of building the central plant in the parking garage will be approximately \$5,500,000 more than locating a plant in the basement of Building A. This is due to additional building costs and distribution piping associated with the location of the proposed parking garage central plant.

To then evaluate the Option 1 (central plant alternative) against Option 3, (standalone building systems), a life cycle cost comparison was conducted. A life cycle analysis compares the true cost of ownership between alternatives, including first cost, operations and maintenance as well as energy and utility costs. Results of this evaluation, indicate that Option 1 offers a tremendous savings benefit (\$60+ million) over a 20 year term.

However, the savings above do not take into account first cost capital availability, or the burden on the Health Science Center's debt service rating. The HSC may lack funding for such a centralized plant as no TRB funding is available to support it as a stand alone project.

Therefore, it is recommended that a hybrid approach to a central plant be conceived in conjunction with the phased development of the west campus. Specifically, the first building proposed for the west campus (Building A) is recommended to be designed with shell space in the mechanical area which could accommodate a future expansion of that area into a small central plant. This concept would most likely include only the chiller and boiler capacity required for the first building. It should also include stub out piping connections so that the next building built can connect back to this location in conjunction with the addition of more chiller and boiler capacity. The cooling tower location should also be designed to accommodate a later expansion. The system should, as funding allows, connect back

across the street to MedEd-I. This concept may result in only the interconnection of three or four of the proposed west campus buildings over time (instead of ten). However, if successful, this plant could be connected into another remote central plant in one of the later five buildings (implemented using the same strategy). This hybrid central plant concept is financially feasible from a first cost perspective and will grant the HSC most of the benefits of a central plant including plant efficiency, simplification of maintenance, system uniformity and reliability.

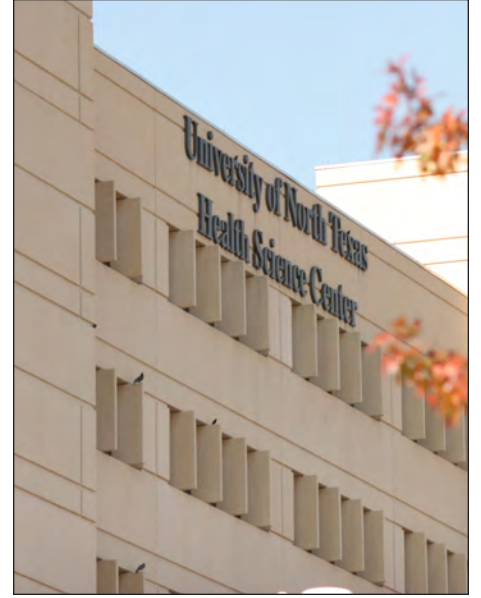
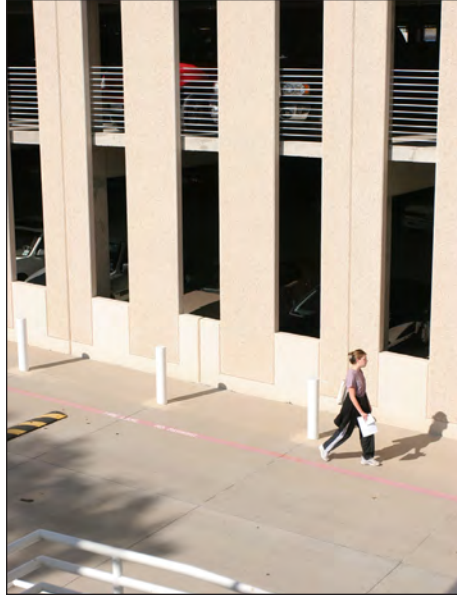
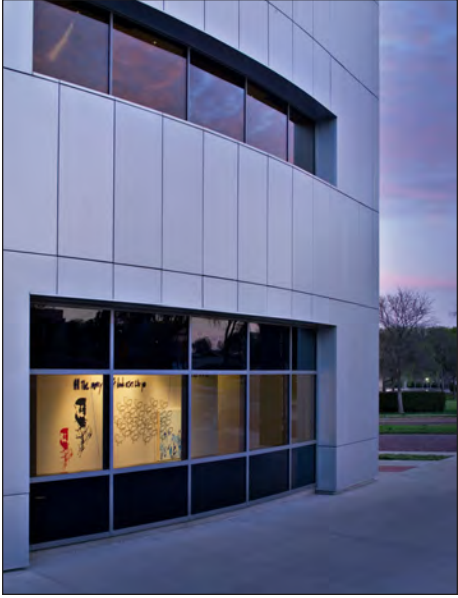

GUIDELINES

D



INTRODUCTION

The UNTHSC Design Guidelines are intended to aid in the design, development and character of the campus. These guidelines will be incorporated into the Health Science Center construction standards. They attempt to facilitate quality and consistency in future design across campus and aim to interweave existing techniques with future expansion.

ARCHITECTURAL DESIGN GUIDELINES

CONCEPTS

The architectural methodology set forth in these design guidelines will embrace several existing conditions while expanding and defining a new character for the UNTHSC. The development strategies in the guidelines will help define the campus in two major ways. First, they will identify spatial boundaries for landscape spaces on campus. Second, they will support, strengthen and further develop a strong architectural image for this collegial institution. These guidelines will also outline building position for future campus growth. Furthermore, this framework will define and provide basic visual consistency and similarity for an overall unified campus image.

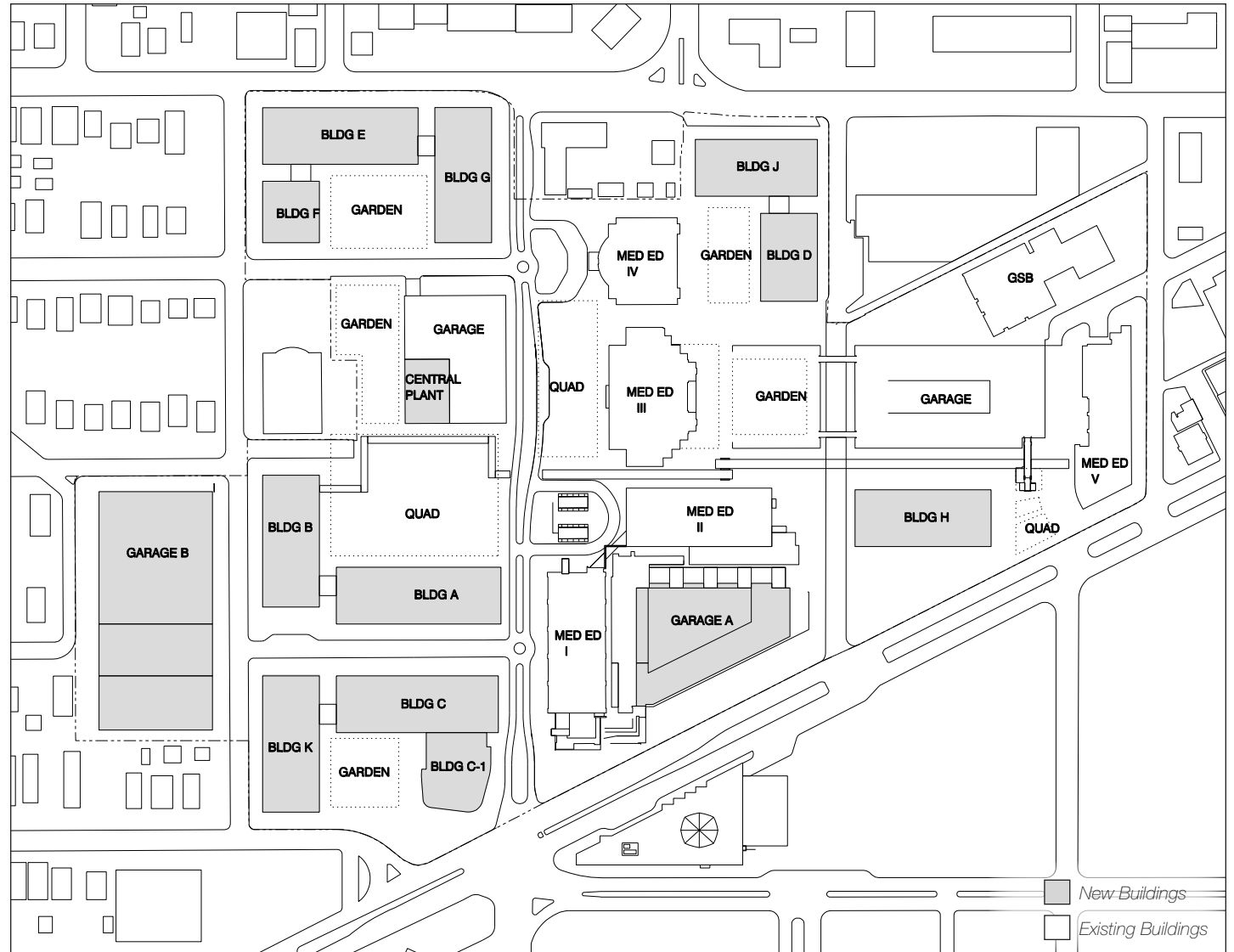



ARCHITECTURAL DESIGN GUIDELINES

CONCEPTS

These defining characteristics will address and describe several areas of importance such as:

- Building Position
- Building Massing
- Building Organization
- Building Articulation
- Building Materials and Color

Each will provide a careful range of concepts while allowing for flexibility and variation, thus bestowing richness and character to the campus. The objective is to promote innovation while maintaining visual cohesiveness and consistency. The existing architecture on campus provides and defines several important attributes, which will assist in presenting a coherent and blended campus of old and new.

ARCHITECTURAL DESIGN GUIDELINES

SITE - BUILDING POSITIONS AND SETBACKS

This master plan has defined and determined a conceptual layout for future capital projects for the Health Science Center, and while many of the buildings are yet to be programmed, key information such as floor count and estimated square feet are provided.

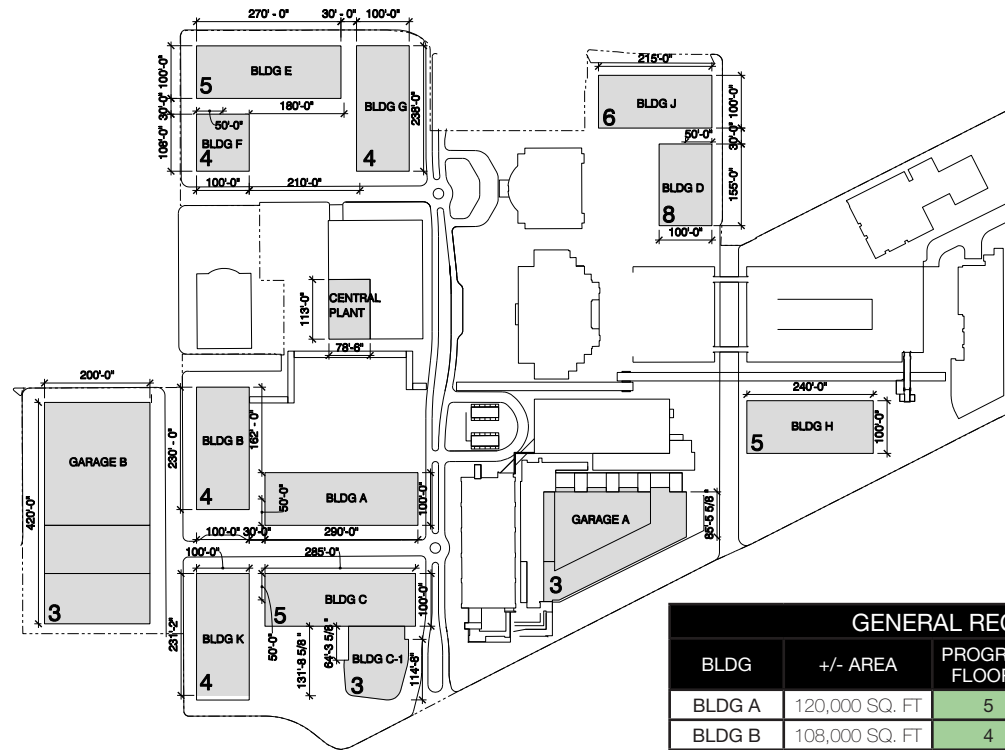

GENERAL RECOMMENDATIONS					
BLDG	+/- AREA	PROGRAM FLOORS	BASEMENT	MECH/ PENTHOUSE	PARKING
BLDG A	120,000 SQ. FT	5	1	1	0
BLDG B	108,000 SQ. FT	4	1	1	0
BLDG C	52,000 SQ. FT	5	0	1	0
BLDG C-1	45,000 SQ. FT	3	0	1	0
BLDG D	99,000 SQ. FT	6	0	1	0
BLDG E	148,800 SQ. FT	4	1	1	0
BLDG F	46,200 SQ. FT	4	0	1	0
BLDG G	97,800 SQ. FT	4	0	1	0
BLDG H	128,000 SQ. FT	5	0	1	0
BLDG J	156,700 SQ. FT	6	0	1	1
BLDG K	97,800 SQ. FT	4	0	1	0
GARAGE A	-	3	-	-	-
GARAGE B	336,000 SQ. FT	3	-	-	-
PARKING C	-	-	-	-	-
CENTRAL PLANT	-	To Match Adj Garage	-	-	-

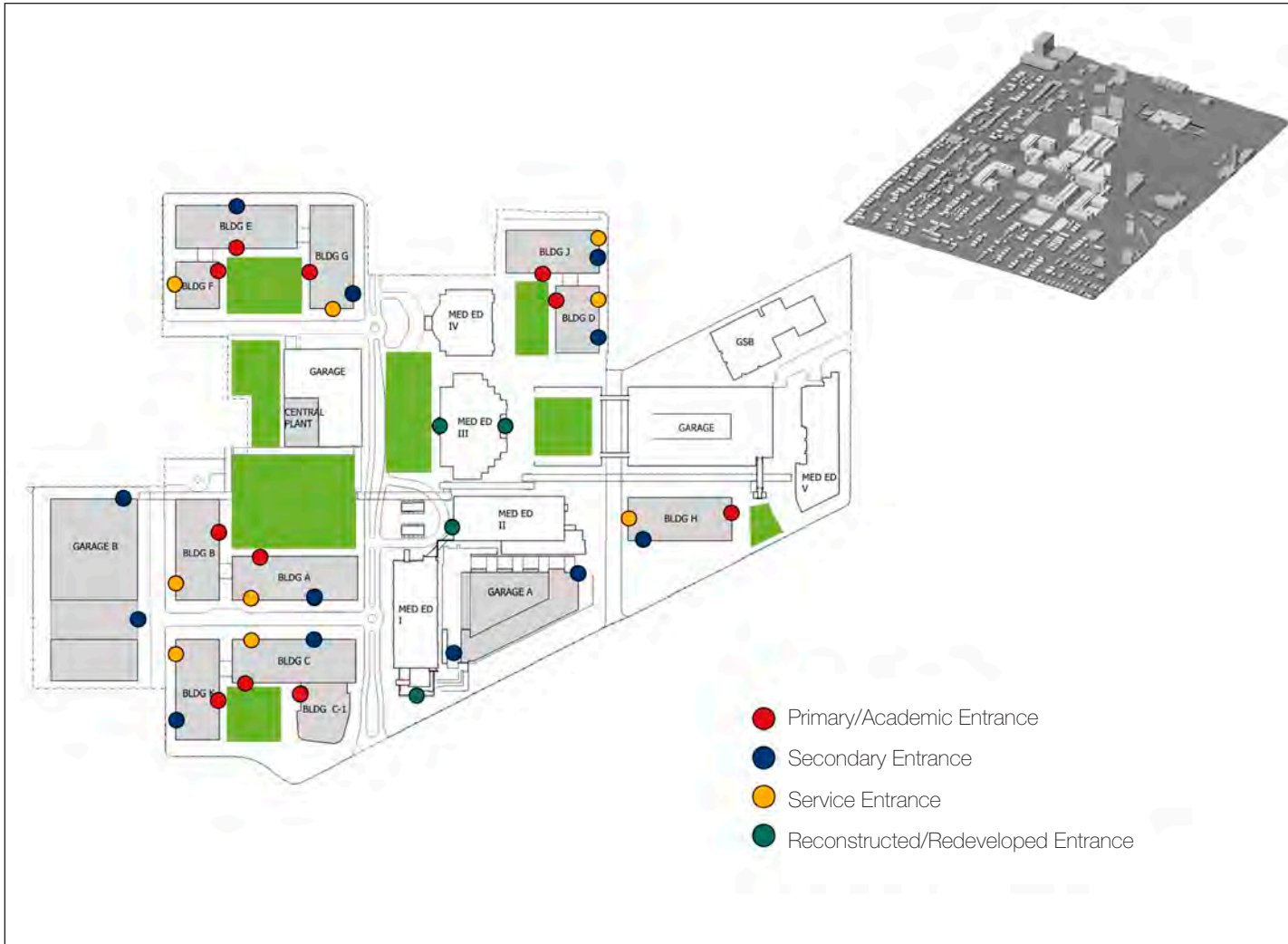

ARCHITECTURAL DESIGN GUIDELINES

SITE ENTRANCES

Primary/Academic Entrances

The primary entrances provide linkages between the outdoor open spaces of the Quads and Gardens, the academic and the public. These are the ceremonial passages into the buildings and help to create a sense of exchange and collaboration.

Secondary/Public Entrances

The secondary entrances provide alternate and off-hour entrances to buildings and provide a public face to the academic setting. These entrances have a direct linkage and access to the primary entrances.

Service Entrances

The service entrances are located in positions that minimize the impact, function and flow of academic life.

Reconstructed/Redeveloped Entrances

These entrances have been identified as future enhancements and further defined entryways for existing buildings on campus.

ARCHITECTURAL DESIGN GUIDELINES

CIRCULATION / VIEW CORRIDORS

The planning principles that define and create linkages with the community and city suggest a more open, perforated arrangement of building opportunities and arrangements. Circulation variety and visual connections make for a more accessible campus, sponsoring openness and sharing. The preservation and extension of the city grid is important to suturing the campus fabric back within the community through campus roads and view corridors.

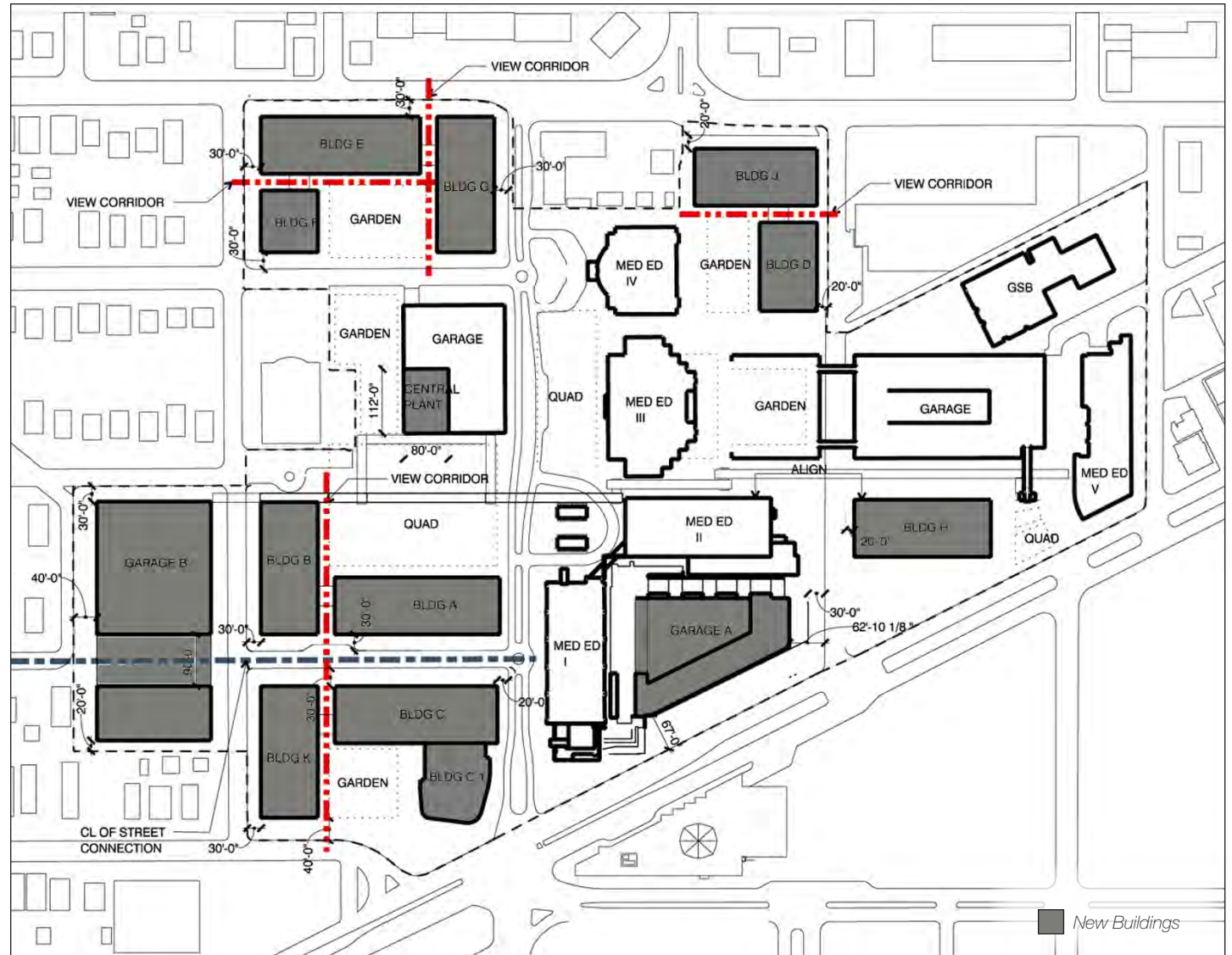

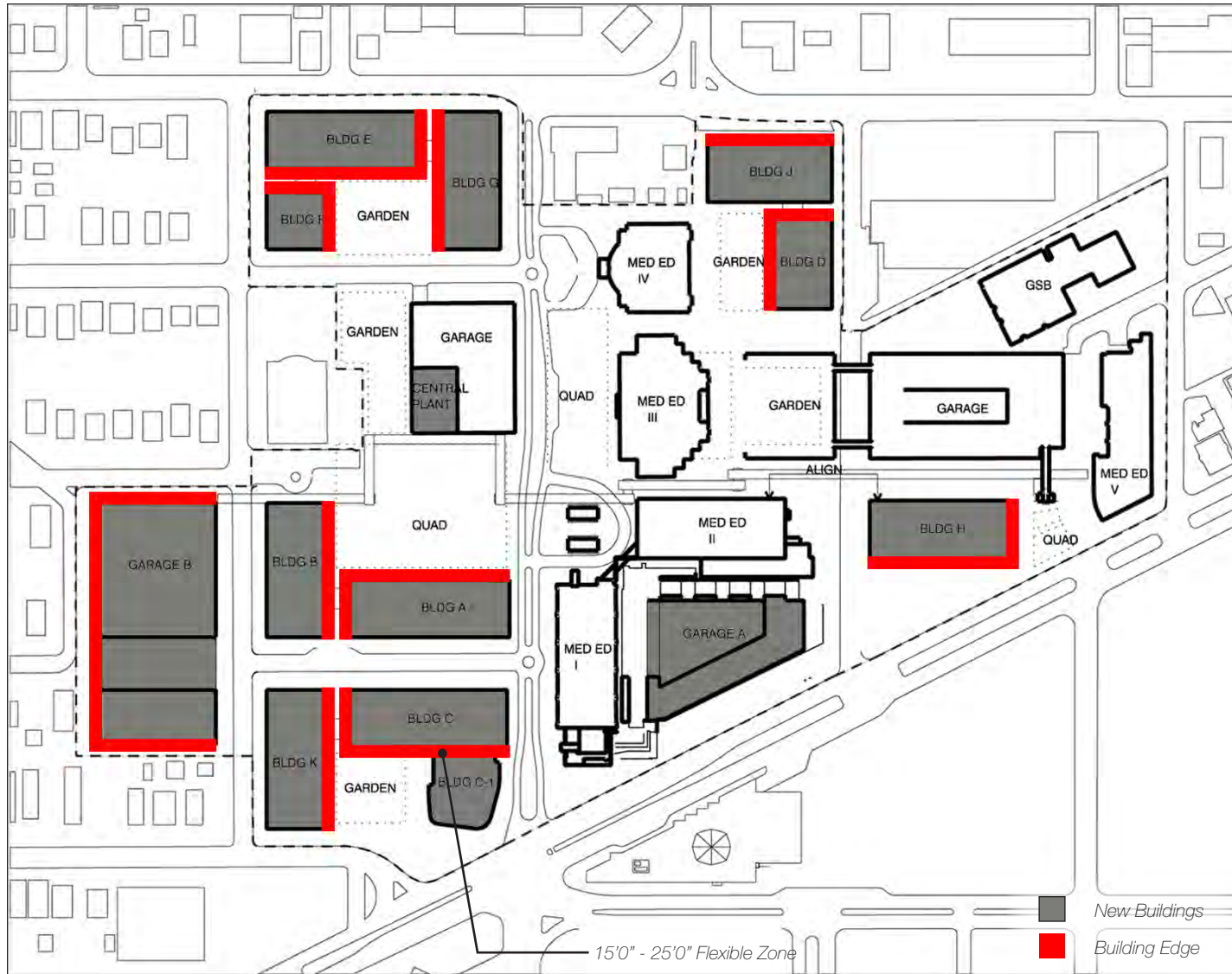

ARCHITECTURAL DESIGN GUIDELINES

BUILDING EDGE FLEXIBILITY

As the planning process developed open campus rooms and building opportunities, the planning principles also determined a need for a degree of flexibility within each building location. Each building site was determined to set the maximum and minimum width of each building: 100 feet maximum to 75 feet minimum, allowing for the optimal laboratory to academic building types. The perimeter location of building sites and city streets are defined and set with landscaped setbacks from the property lines to provide consistency and to ensure sensitivity to adjacent residential property. The interior edges are to be a more flexible zone allowing for programmatic development over the life of the campus development.

ARCHITECTURAL DESIGN GUIDELINES

BUILDING EDGES TO STREET

The perimeter location of building sites and city streets are defined and set with landscaped setbacks from the property lines and are further defined by the surrounding developments with related edge conditions. The edges on the new western precinct of the campus have been determined to provide a 30'-0" distance between building edges to streets. The edges east of Montgomery along 7th Street have been determined to provide a 40'-0" distance with the incorporation of head-in parking to further blend this edge with the commercial developments underway further east along 7th Street. The edges along Clifton Street have been determined to provide a 20'-0" distance. The Camp Bowie Blvd. corridor edge is to be a varied condition to help blend the two edges, north to south, and link the Cultural District with the campus.



ARCHITECTURAL DESIGN GUIDELINES

BUILDING EDGE SETBACKS

These street sections identify how setbacks differ across campus.

CAMP BOWIE BOULEVARD

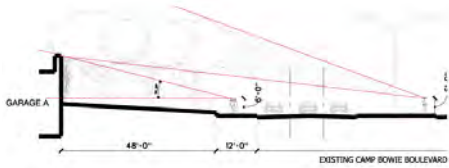

Section at Camp Bowie Boulevard
(Perimeter Neighborhood)

HASKELL STREET

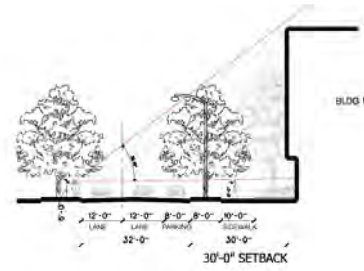

Section at Haskell Street (Perimeter)

CLIFTON STREET

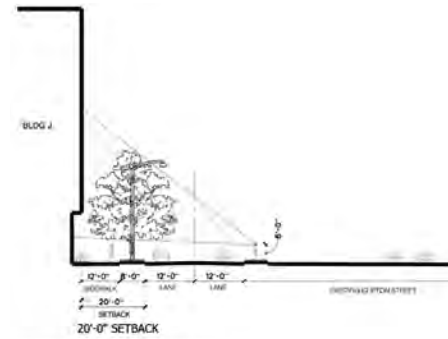

Section at Clifton Street

WEST 7TH STREET

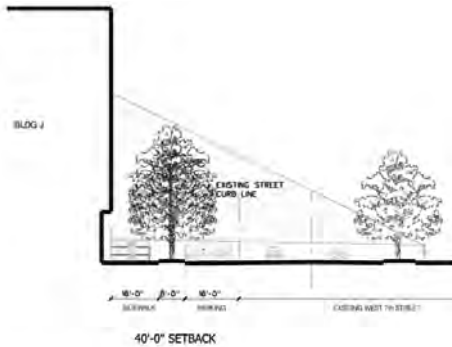

Section at West 7th Street

INTERIOR STREETS

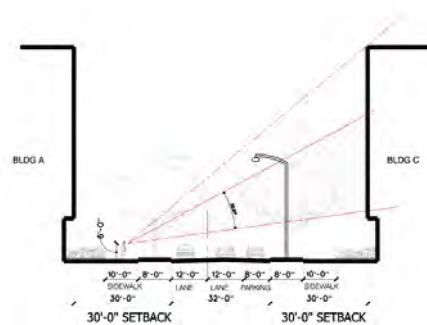

Section: Internal Campus

ARCHITECTURAL DESIGN GUIDELINES

MASSING CONCEPTS

As simple geometric forms define many of the existing campus buildings, the same strategy is to be followed for the development of new buildings on campus. Additionally, each new building is to be designed with similar vertical massing; base, body and top. The expression of base condition offers opportunities to engage and visually connect this zone with the pedestrian. The body of the building may be articulated in a variety of ways although each is defined by its association with open space; building elevation to street, quad, garden, etc. The top / penthouse section of each building is to be defined by simple cornice lines or flush masses (see existing buildings) while the penthouse is to be set-back away from the facade to diminish their presence from the ground. Examples of relevant building bases, middles and tops are shown to the right.

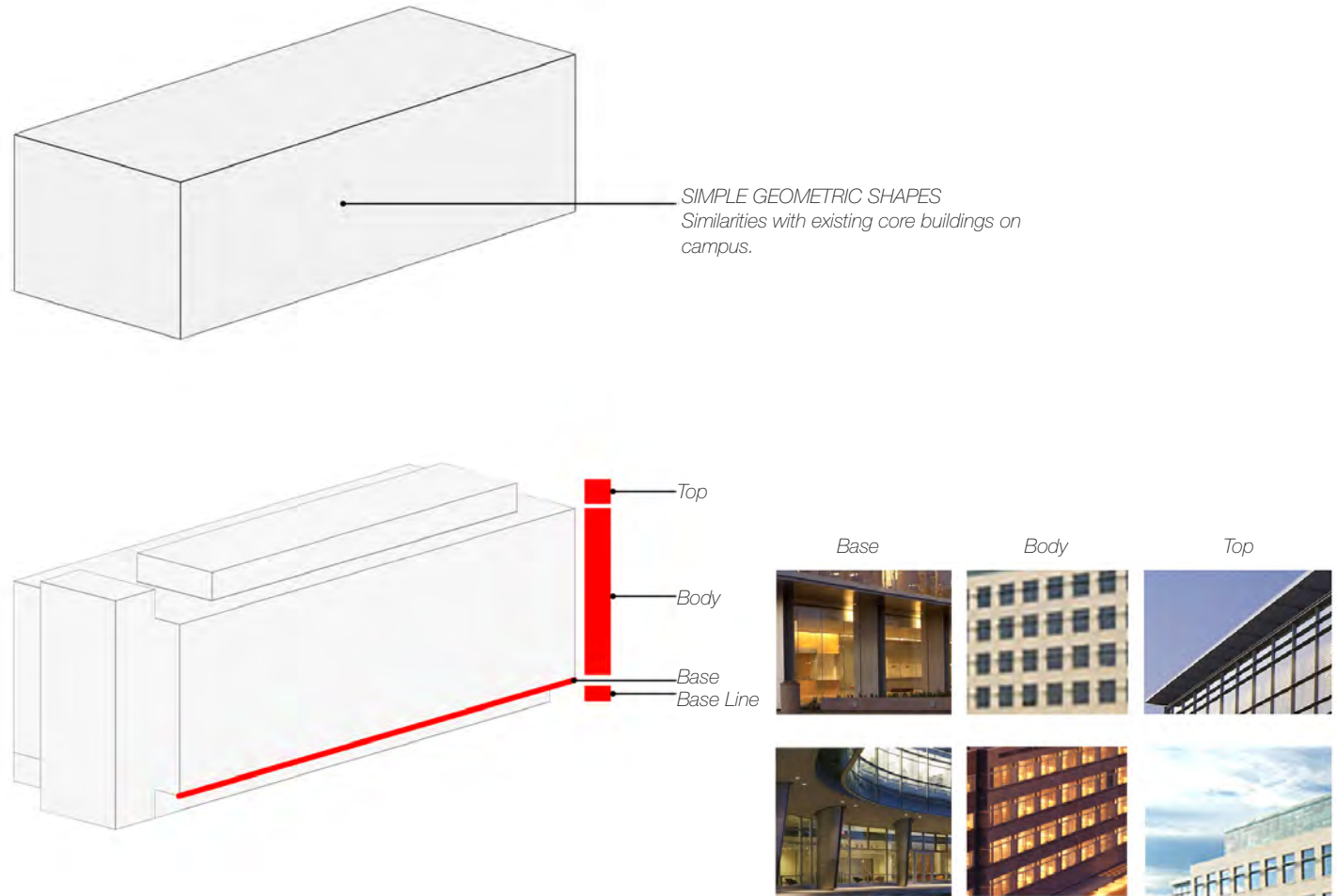

ARCHITECTURAL DESIGN GUIDELINES

MASSING STRATEGIES

Strategies for building massing are defined and categorized into two types; fabric and figural. Fabric strategy or core buildings, which are the predominate type for campuses, are defined as maintaining connections and cohesion within the existing campus. Also, these buildings are to be sensitive to scale, bulk and critical neighborhood relationships. The figural strategy is defined by the Camp Bowie Blvd. corridor. The relationship and visual connection with the Cultural District museums suggest a more active, participatory association. The recently completed Center for BioHealth is a fine example of this strategy.

Flexible articulated zones allow programmatic flexibility in building height. This massing strategy causes quads and gardens to extend beyond their own boundaries to the building edges.

Fabric: This massing strategy conforms to the existing grid pattern of the of campus. Rectangular masses are placed in organized settings throughout the interior of HSC.

Figural: This massing responds to the configured Camp Bowie edge. Building mass, like the existing BioHealth building, focuses on surrounding landscape and how each building relates to the adjacent Cultural District.

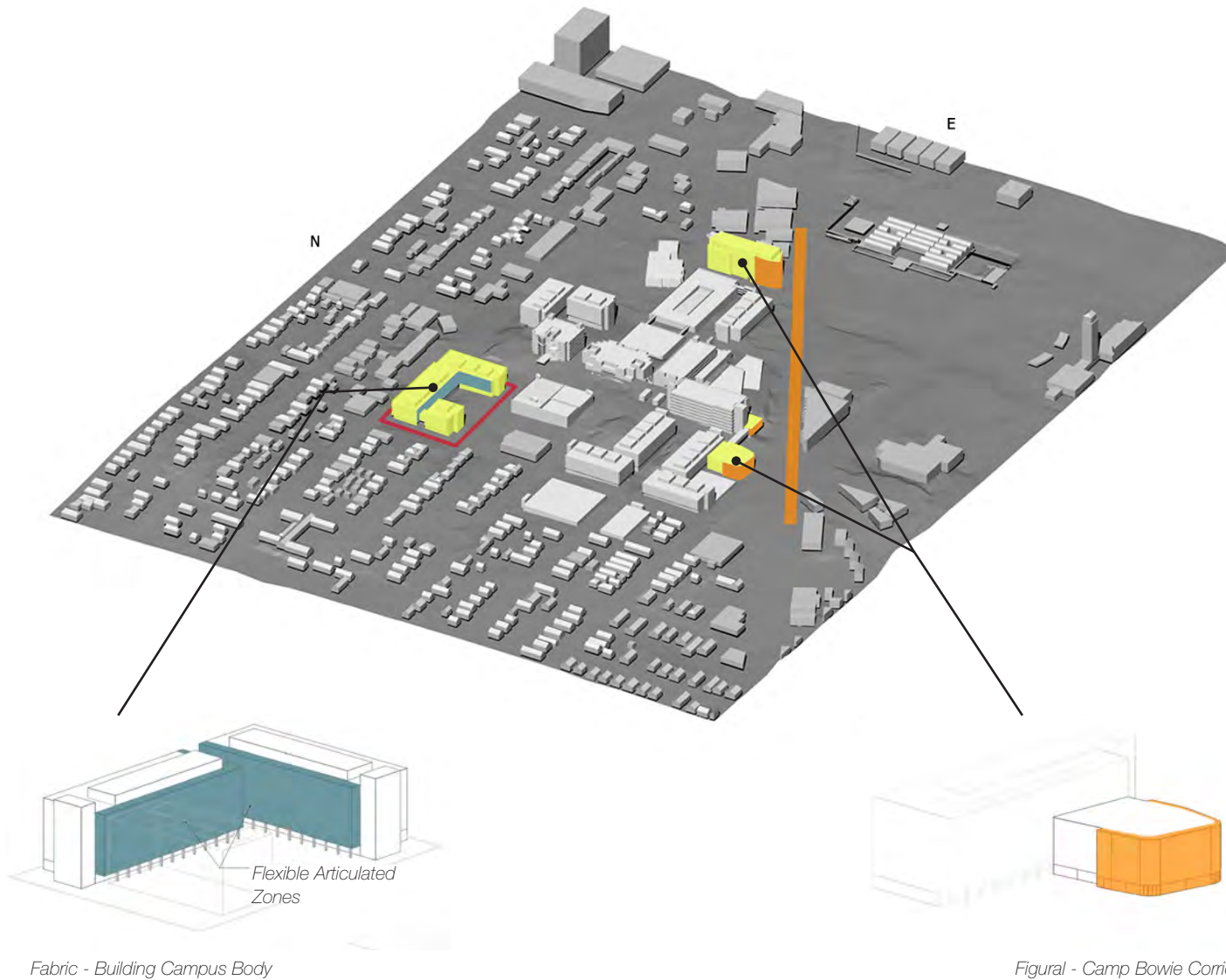

ARCHITECTURAL DESIGN GUIDELINES

ARTICULATION VARIATIONS

Base Zone

It is important to define the base zone of buildings, the ground floor and base datum line to articulate the active pedestrian areas and help reinforce this linkage with other campus buildings. This active zone will promote interaction and collaboration between faculty, staff and students as well as strengthen the new outdoor campus and public spaces. This base zone datum line will define a higher first floor to reinforce entry and provide an exterior shadow and material transition line for a natural change above.

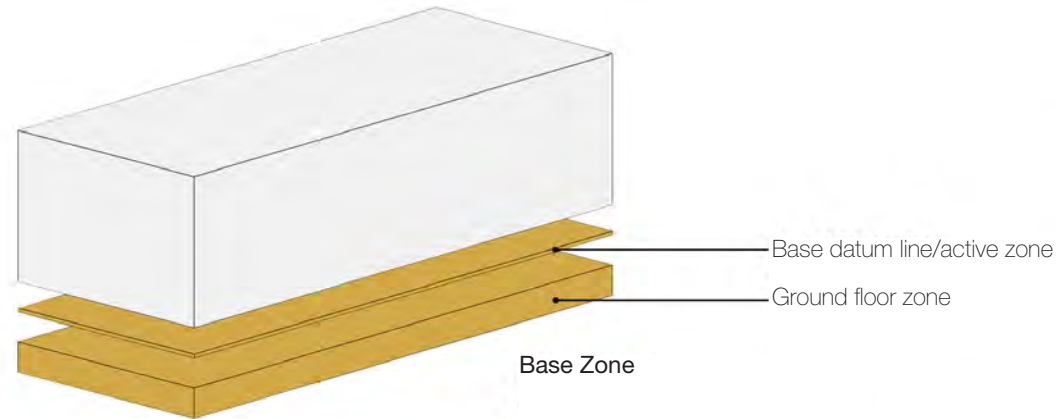

Loggia / Covered Circulation

To add to this base zone, a covered walkway located along the perimeter of the quads and gardens will provide additional cover and protection while providing linkages between inside and outside. This will strengthen pedestrian activity and exchange among and between buildings.

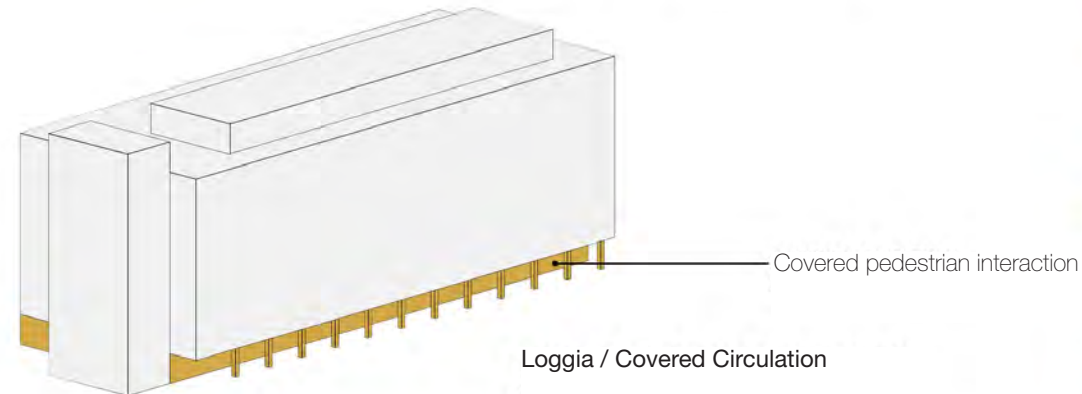

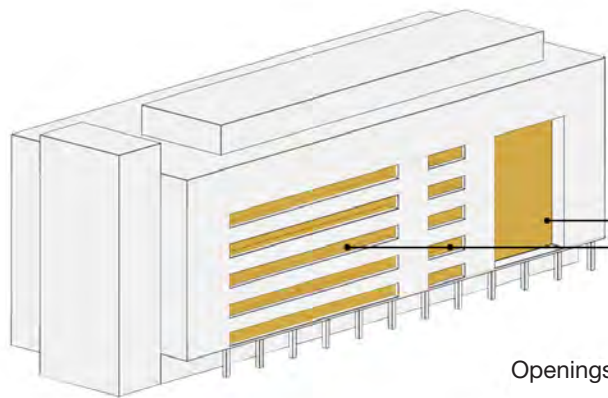

Large carved openings
 Subtractive process for openings similar to existing campus buildings

Openings

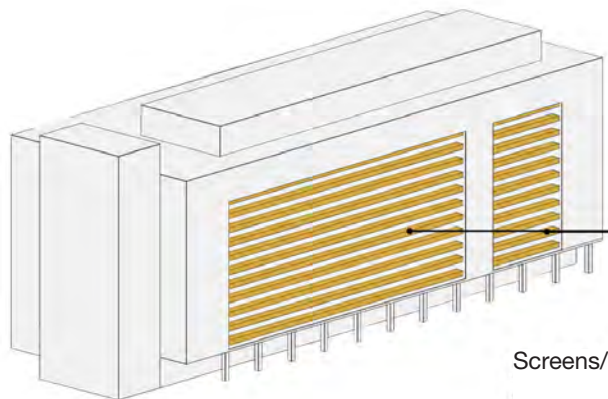

Screen on south facade for sun protection

Screens/Louvers



ARCHITECTURAL DESIGN GUIDELINES

ARTICULATION VARIATIONS

Openings

In following the guideline principles and instituting the focus on simple volumes, a subtractive strategy is to be followed with the development of building openings. These windows are to be provided for all office, academic and public spaces and reinforce linkages with the outdoor spaces and rooms. In developing a common vocabulary for the exterior, windows may be horizontal or punched along elevations of less exchange while multistory windows or curtain walls are to be considered along elevations adjacent to campus quads and gardens.

Screens and Louvers

Screens and louvers are to be used on elevations with large multi-storied windows and curtain walls facing south. These screens and louvers are to be integrated into the wall as carved elements and not added fins.

ARCHITECTURAL DESIGN GUIDELINES

ARTICULATION VARIATIONS

Stair Towers

Commonly, stair towers are an important building element among the existing building stock on campus. In developing the common vocabulary for the exterior development of campus, these elements are to be detached and expressed as independent building elements.

Pedestrian Linkages

Pedestrian passageways have been developed to provide linkages between adjacent building assemblies. They also provide opportunities for student and faculty exchanges and provide visual outdoor interaction with activities inside. All the while, these serve to link the academic to the community.

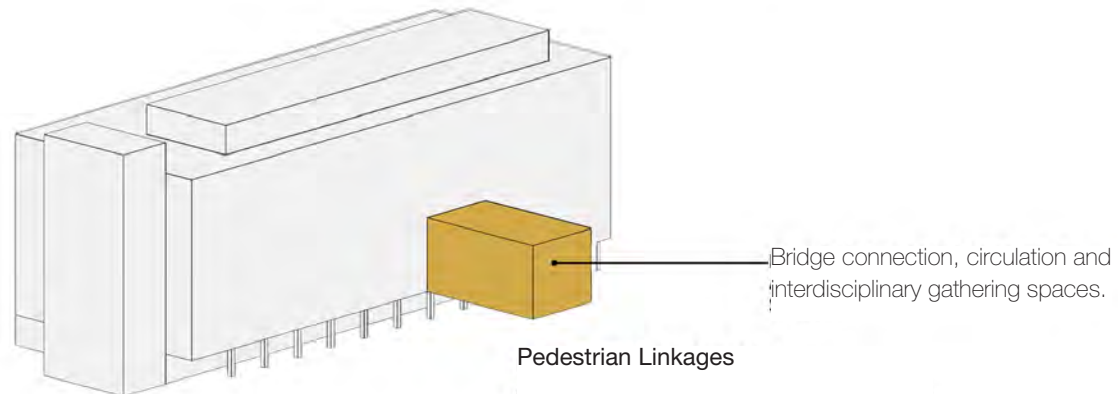
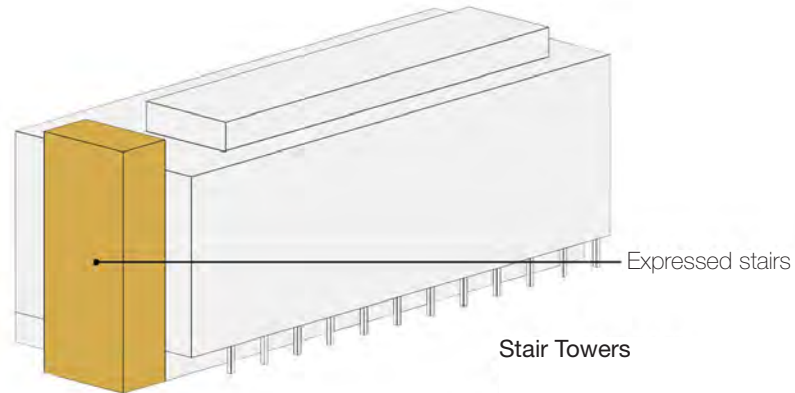

ARCHITECTURAL DESIGN GUIDELINES

FACADE RELATIONSHIP

The development of the architectural guidelines define variability in façade design. Due to contextual variability, intricacy of the sites and the specificity of program, several approaches are to be considered in the design of these elevations. These façades are as follows: Street, Quads/Gardens, Camp Bowie Blvd., Green Walls.

Street

Street elevations are to be developed with sensitivity to scale, rhythm and order with smaller openings defining a more collegial sense along the perimeter. Also, these façades should respond and be sensitive to the street and vehicular traffic along these relationships.

Quads / Garden

These elevations are to be developed with more open pedestrian friendly characteristics. The relationships to outdoor open spaces foster a direct connection and academic collaboration between inside and outside settings.

Camp Bowie Boulevard

As Camp Bowie Blvd. is such an iconic thoroughfare through Fort Worth, façades along this boulevard are to be developed similarly to the recent BioHealth Research Building on campus.

Green Walls

Green Walls, or vertically landscaped garden walls, are to be developed along parking facility walls to mitigate the building scale and soften vertical edges.

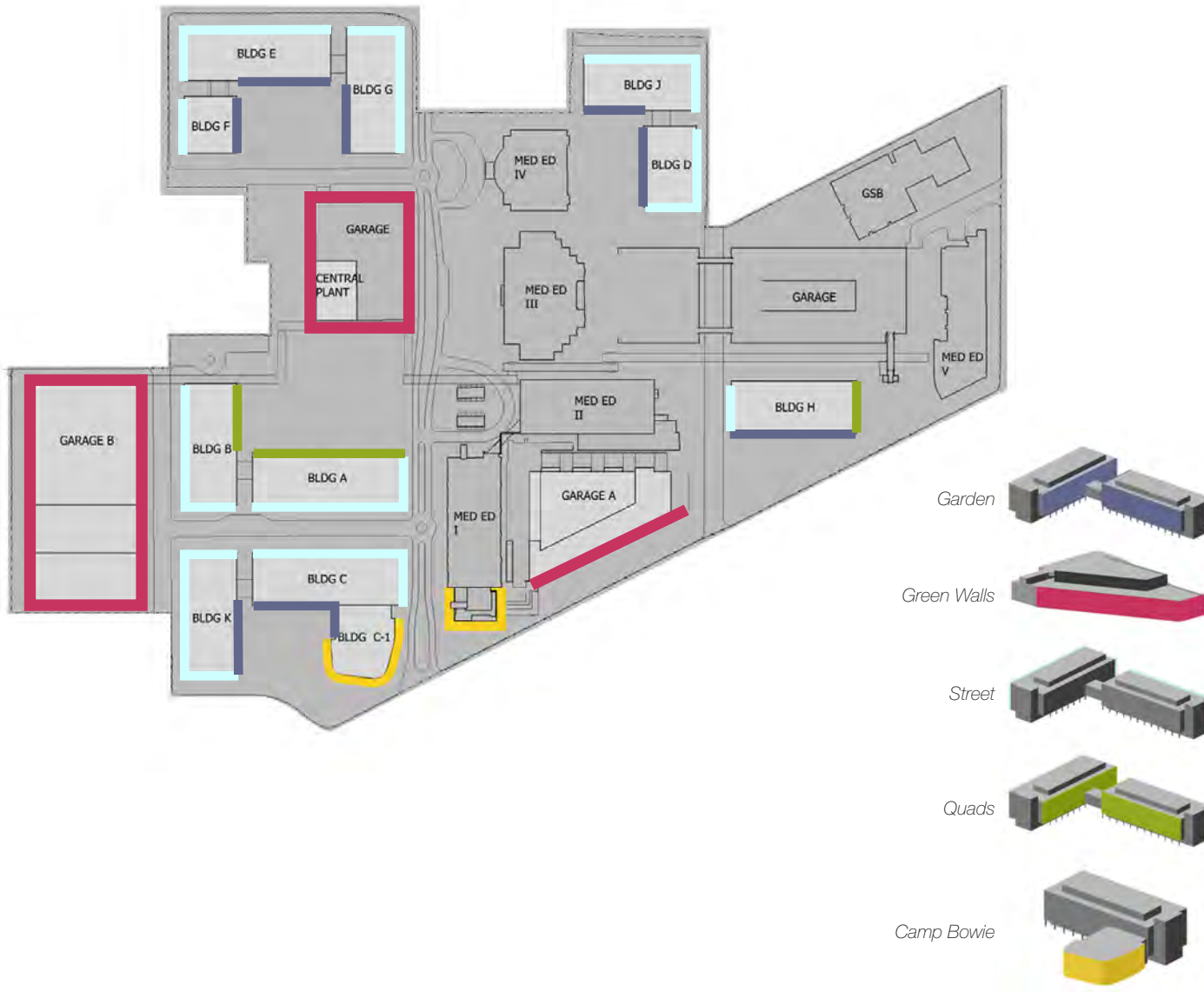

ARCHITECTURAL DESIGN GUIDELINES

BUILDING MATERIALS

Building materials are categorized in three parts; primary, secondary and accent. Primary materials will define the main building surfaces and will take cues from the existing campus. These materials should consist of limestone, cast stone or precast. Secondary materials will define those special conditions of the building such as base, bridges, loggia, glazing and screen/louvers. Additionally, quad and garden facades, transparency and open facades are to be designed to promote interaction between the inside and out. These materials consist of the following: glass, metal panel, metal screen and special textured precast. Accent materials can be used in smaller quantities and in special accent conditions of the building such as stair towers, base line condition and loggia.

Primary

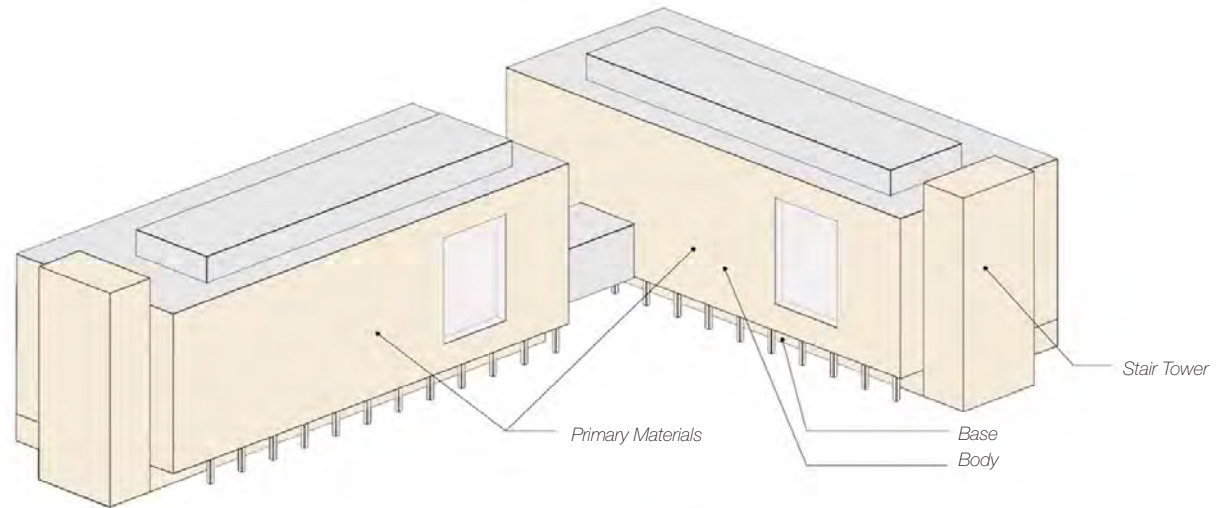

Secondary and Accent

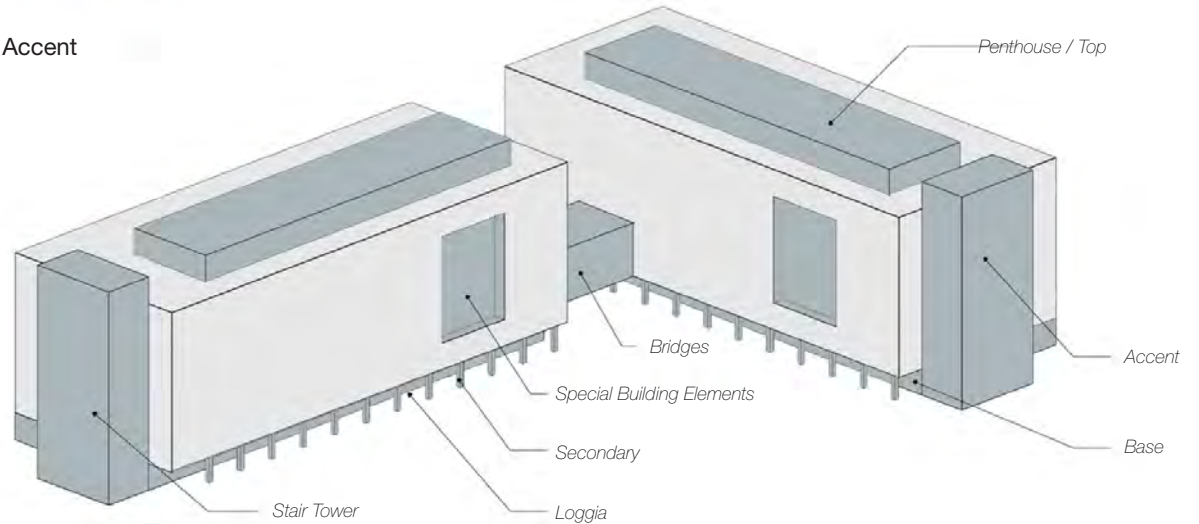

ARCHITECTURAL DESIGN GUIDELINES

Primary BUILDING COLORS

Building colors are categorized in two parts: primary and accent. Primary materials will define the main building surfaces and will be derived from the color of the material and take cues from the existing campus precast. Accent colors can be used in smaller quantities and in special conditions to accent specific building areas such as entrances, bridges, stair towers, base, loggia and base lines. These colors should be rich and harmonious with the natural material for the building's body.

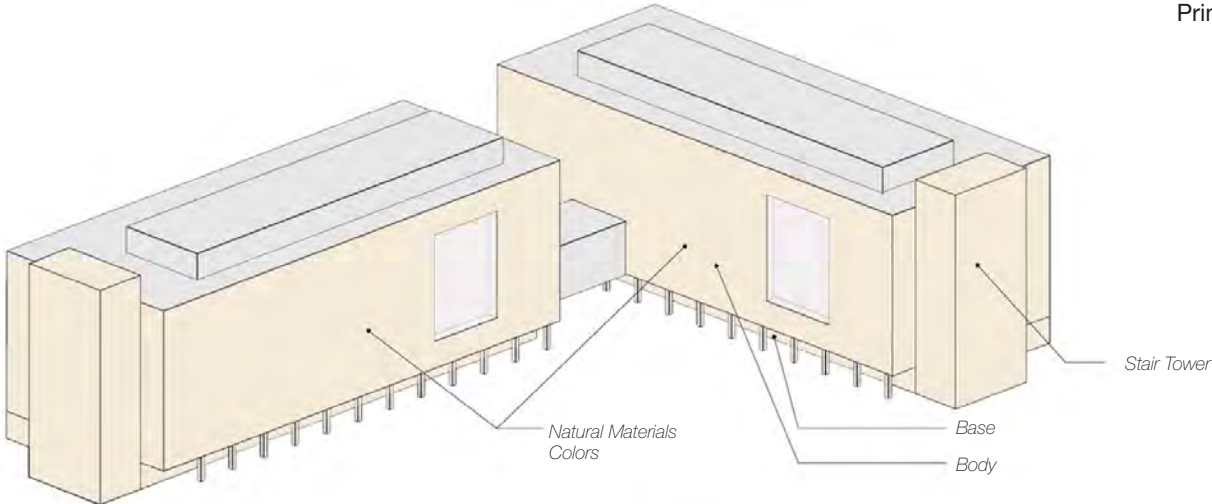

Accent

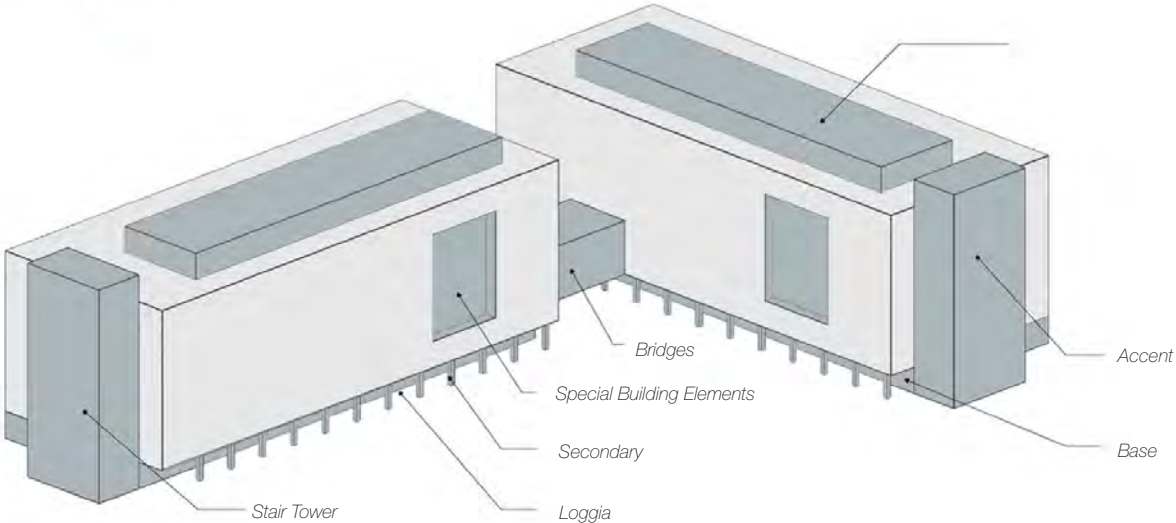

ARCHITECTURAL DESIGN GUIDELINES

LIGHTING CHARACTER CONCEPTS

Campus lighting concepts have been summarized to strengthen and further define the planning, architectural concepts and use hierarchy developed in the master plan. These concepts define the different characteristics of scale and ambiance of the final plan from the Campus Quads and Gardens, the Campus Spine and the campus walkways and streets. The nighttime character of the campus is as important of a face to the community as the daytime and offers different and exciting opportunities for defining many special conditions and visual interests.



ARCHITECTURAL DESIGN GUIDELINES

INTERNAL / PEDESTRIAN LIGHTING

The major internal campus spaces to be defined are the Campus Quads, Campus Gardens and Campus Spine. The Campus Quads are to be defined and illuminated as the primary spaces on campus. Each will vary and respond to the individuality each quad defines. The Campus Gardens are designed to respond and strengthen the characteristics defined in their designs. The Campus Spine is to be defined as the primary east/west pedestrian circulation and provide a well-lit point of reference for the campus.



EXTERNAL / STREET LIGHTING

The development of the external lighting scheme is an important visual marker and a first impression of the campus. As the master plan has attempted to bridge the different adjoining constituencies, the lighting would follow and blend the different perimeter lighting conditions, that reinforces this consistency with the neighborhoods and Cultural District. These different characteristics are separated in part by the sensitivity to adjacent conditions as well as importance: Perimeter Streets, Perimeter Residential Streets, North/South Public Streets, and East/West Public Streets.



LANDSCAPE DESIGN GUIDELINES

INTRODUCTION

Landscape guidelines are provided to insure the consistency and success of the overall campus landscape. These guidelines are presented only to establish a design direction for future landscape installations. The goal is to achieve a comprehensive campus landscape fabric that is practical and cost-effective to maintain. The landscape should also integrate and reinforce the overall design principles of the Health Science Center and the surrounding Cultural District.

A great deal of what is proposed in this master plan is related to a re-constitution or re-birth of a campus landscape. The design guidelines call for the creation of several gardens to both link campus pedestrian areas and unite the surrounding buildings. The landscape guidelines should be used a reference to future designers when designing those gardens. As proposed, each garden is intended to have its own identity and a great deal of flexibility in the plant palette used create it. However, all future landscape design campus should be responsible to the use of water and to ease of maintenance.

The following guidelines provide a framework and design principle that will bring consistency to the continued evolution of the campus landscape. It is proposed that new and future landscape design recognize the existing features of the campus and build from, rather than work against, them. The overall principle of the campus over the next 20 years will be to turn grey to green in order to mitigate the

amount of impervious cover. These landscape guidelines should be used in pursuit of those goals. Each new building project should be designed and funded as a “building and landscape” project so that the appropriate level of density is achieved.

PLANTING PLAN CONCEPTS

Plants selected for use on campus should be native to the bio-region, long lived, relatively pest free, and practical to maintain. This will enhance the possibility for long-term success of the plants and the campus landscape. Non-native plants may be used on campus but should be non-invasive and possess visual traits that are similar to the native flora.

The design of campus plantings should be simple and seek to evoke a mood of tranquility and higher education. Designs that result in too much fragmentation and variety should be avoided. This approach will result in a campus landscape that is regionally appropriate, sensitive to water conservation, and practical to maintain.

Evaluate and protect existing Post Oak, Live Oak and Red Oak trees. This includes mitigation of root disturbance and root compaction within the areas surrounding existing trees. The drip-line surrounding the trees should be protected through low plantings or decorative edging/fencing. Compacted soils created by pedestrian short cut paths should be aerated and developed into formal paths through the



use of shredded mulch or crushed granite to allow continued foot traffic without further soil compaction.

The uniform presence of street trees will be a significant means for reinforcing a unified campus image and for continuing to distinguish the campus as an identifiable character in the urban area.

Optimize the scale and texture of plantings to define spaces and reinforce the edges of the built environment. Use the landscape to define the shape, size, and sequence of outdoor spaces in conjunction with the buildings and streetscapes.

The scale of landscape elements should be considered with respect to the campus build-

ings, roads, and open spaces. Plantings that are too small or sparse will appear out of scale in relationship to large buildings. Landscape elements should not be overly intricate but simple in massing and form as to compliment the surrounding campus but not compete with it.

IRRIGATION

The university has proposed the introduction of a natural water well for supply of irrigation water. A preliminary cost study on an irrigation well validates it as a financially viable alternative for irrigation water. Most of the existing east campus is already tied together with a centralized irrigation loop so the placement of a well to serve the campus' irrigation needs is very viable. The University should explore this opportunity in more detail and move fro-



Perimeter Trees



Street Trees



Campus Trees



Plants should be native to the bioregion and practical to maintain.



ward with the correct solution related to the long term needs of the campus and the legal issues related to state owned wells and water ownership.

In order for the campus to become more pedestrian-friendly, surfaces other than concrete could form pathways and seating areas with benches and trash receptacles. Low walls in the landscape should relate more to the scale of pedestrians than buildings, and traffic could be calmed to make the streets safe for pedestrian crossing.

The largest open green space on campus could be used as a gathering place, study space, or break area for students, faculty, and staff. However, it needs adequate shading to make it a comfortable space during the hot summer and spring months. Additional benches and trash receptacles could also help make the area more conducive to campus life. Trees, such as Crepe Myrtles, Live Oaks, Sweet Gums and Yaupon Hollies, effectively shade some of the walkways between buildings, with benches and shrubbery provided at intervals. Other walkways could use more definition of paving material, benches, and landscaping. Low walls could be an opportunity to break up the prevalence of hard concrete surface on the campus with other materials and plantings.

TREE SPECIES

Campus trees have been categorized based on size and organized to set the ambiance to particular areas of campus. Plant materials used should be coordinated with the Cultural District landscape and planting guidelines in order to reinforce a consistent linkage between the Health Science Center and its neighbors to the south.

Perimeter Streets

Gaps in existing tree canopies along pedestrian walkways and streetscapes should be in filled with large caliper trees of the same or similar species, should the existing species be threatened. New planting should be sized large enough to have an immediate impact on the quality of the landscape.

Street Trees

Street trees play an important role in visually unifying the campus. Repetitive rows of trees with a consistent canopy have the ability to control a great variation of landscape and building treatments. Uniform rows of trees can minimize the differences in building setbacks, alignments, materials, and style, thus bringing a consistent identity to the campus.

Campus Streets

The planting objective for campus streets is to establish a continuous shade of canopy along both sides of the street pavement. This will have a positive effect on reducing solar heat gain and heat reflection, shading the sidewalks, improving pedestrian comfort, and visually unifying the campus streets in a way that will make the campus more inviting to residents and visitors alike.

PLANT LIST

The following pages provide an example plant list of native plantings whereby the UNTHSC can select trees and other vegetation. Selection of species should mirror landscaping on the campus edge.

CANOPY TREE LIST									
Canopy Trees	Height	Spread	Decid./ Ev'grn	Spring Color	Summer Color	Fall Color	Winter Color	Native/ Adapted	Notes
CaddoMaple <i>Acer barbatum</i>	60'	40'-60'	D			Multi		N	
River Birch <i>Betula nigra</i>	20'-30'	15'-20'	D			Yellow		A	Nice Bar, Multi-Trunk, Needs Moist Soil
Texas Ash <i>Fraxinus texensis</i>	30'-45'	20'-30'	D			Multi		N	Prefer Male Tree
Sweet Gum <i>Liquidambar styraciflua</i>	50'-60'	20'-30'	D			Multi		A	Produces Spiky Balls, Needs moist soil
Magnolia <i>Magnolia grandiflora</i>	50'	30'	E	White				A	
Chinese Pistacio <i>Pistacia chinensis</i>	40'-50'	30'-40'	D			Multi		A	Prefer Male Tree
Bur Oak <i>Quercus macrocarpa</i>	50'-60'	40'-60'	D					A	
Texas Red Oak <i>Quercus shumardii/texana</i>	50'-60'	40'-60'	D			Red		A	
Live Oak <i>Quercus virginiana</i>	30'-40'	40'-50'	E					N	
Soapberry <i>Sapindus drumondii</i>	30'-50'	15'-25'	D			Yellow		N	Translucent Fruit, Remove Suckers
American Elm <i>Ulmus americana</i>	60'-80'	30'-40'	D			Yellow		A	Disease-prone
Cedar Elm <i>Ulmus crassifolia</i>	50'-60'	30'-40'	D			Yellow		N	
Lacebark Elm <i>Ulmus parvifolia</i>	40'-60'	30'-50'	D					A	Salmon/gray brown bark

ORNAMENTAL TREE LIST

Ornamental Trees	Height	Spread	Decid./ Ev'gm	Spring Color	Summer Color	Fall Color	Winter Color	Native/ Adapted	Notes
Redbud <i>cersos canadensis</i>	25'-35'	20'-30'	D	Rose Pink		Yellow		N	
Desert Willow <i>Chilopsis linearis</i>	15'-25'	10'-15'	D	White/ Bur- gundy				A	
Dogwood <i>cornus florida</i>	15'-25'	8'-15'	D	White		Red		A	Acid soil, good drainage, no afternoon sun
Smoke Tree <i>cotinus coggygria</i>	12'-15'	8'-10'	D	Purple/ Pink		Yellow/ Red		A	Wispy flowers
Possumhaw <i>Ilex decidua</i>	12'-15'	12'-15'	D			Red Berries		N	Berries on female plant only
American Holly <i>Ilex opaca</i>	40'-50'	15'-30'	E			Red Berries		N	Berries on female plant only. Needs acid soil
Yaupon <i>Ilex vomitoria</i>	15'-20'	12'-15'	E			Red Berries		N	Berries on female plant only
Skyrocket Juniper <i>Juniperus virginiana</i>	20'	5'-8'	E					A	Columnar
Crape Myrtle <i>Lagerstroemia indica</i>	12'-10'	10'-15'	D	Red/ Pink/		Red to yellow		A	Peeling bark adds interest in winter, multi-trunked
Crabapple <i>Malus sp.</i>	20'-25'	20'-30'	D	Red/ Pink/ White				N	
Wax Myrtle <i>Myrica cerifera</i>	6'-12'	8'-15'	E			Blue Berries	Blue Berries	A	Multi-trunked
Photinia <i>Photinia serrulata</i>	10'-15'	8'-12'	E	White		Red	Red	A	
Mesquite <i>Prosopis glandulosa</i>	35'-40'	30'-35'	D					N	Thornless varieties available
Purple Plum <i>Prunus cerasifera</i>	20'	15'-20'	D	Pink				A	Purple foliage
Mexican Plum <i>Prunus mexicana</i>	15'-35'	20'	D	White				N	Bears fruit
Bradford Pear <i>Pyrus calleryana</i>	30'-40'	20'-25'	D	White		Red		A	
Flame Leaf Sumac <i>Rhus lanceolata</i>	10'-20'	10'-15'	D			Red		N	Vivid color in fall
Vitex <i>Vitex agnus castus</i>	10'-18'	12'-20'	D	Purple				A	Olive green foliage

GROUND COVER LIST

Ground Covers	Height	Spread	Decid./ Ev'grn	Spring Color	Summer Color	Fall Color	Winter Color	Native/ Adapted	Notes
Purple Wintercreeper <i>Euonymus fortunei "Colorata"</i>	8-16"		E		Green		Magenta	A	
English Ivy <i>Hedera helix</i>	6"-10"		E					A	Needs morning sun / Afternoon shade
Trailing Junipers (<i>Juniperus</i> sp.) <i>J. conferta</i> "Blue Pacific"	12"-15"	6'-8'	E					A	Blue/Green
<i>J. horizontalis</i> "Bar Harbor"	12"	5'-6'	E				Plum Red	A	Blue/Green, Plum Red in Winter
<i>J. horizontalis</i> "Wiltoni"	4"	6'-8'	E					A	Steel Blue
<i>J. sabina</i> "Tamarisefolia"	18"	6'-8'	E					A	"Tam" Juniper
Liriope <i>Liriope muscari</i>	12-18"	Clumps	E	Purple	Purple			A	Spiked flowers, variegated varieties
Honeysuckle Lonicera <i>japonica "Purpurea"</i>	8'-20'		E						
Mondgrass <i>Ophiopogon japonicus</i>	6"-12"	Clumps	E					A	Protect from p.m. sun, variegated varieties available
Asian Jasmine <i>Trachelospermum asiaticum</i>	12 "		E					A	Variegated and bronze varieties available

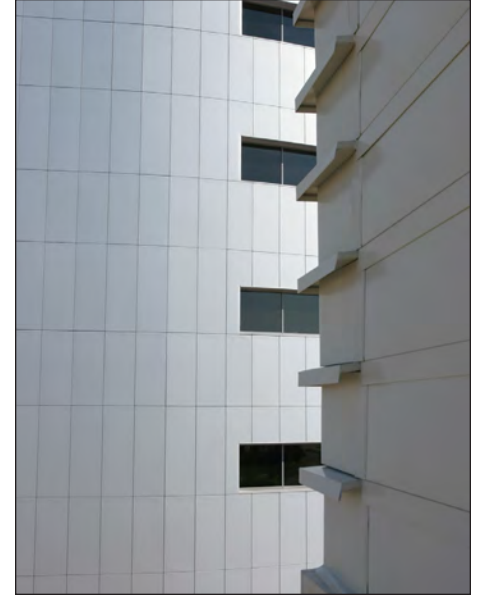
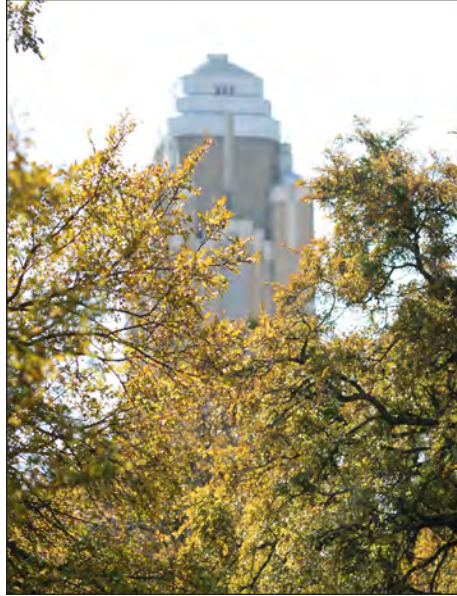

APPENDIX

E

TABLE OF CONTENTS

TRAFFIC AND PARKING REPORT

Intersection Photographs	E-2
Traffic Counts	E-5
Signal Warrant Analysis	E-7
Intersection Capacity Analysis	E-13

TRAFFIC AND PARKING

INTERSECTION PHOTOGRAPHS



7th and Monticello - Looking East



7th and Monticello - Looking West



7th and Montgomery - Looking East



Camp Bowie and Clark - Looking East



Camp Bowie and Montgomery - Looking East



Camp Bowie and Lancaster - Looking East



Montgomery and 7th - Looking South



Montgomery and 7th - Looking North

TRAFFIC AND PARKING

INTERSECTION PHOTOGRAPHS



Montgomery between Camp Bowie and 7th - Looking North



Montgomery and Tulsa Way - Looking North



Montgomery and Camp Bowie - Looking South

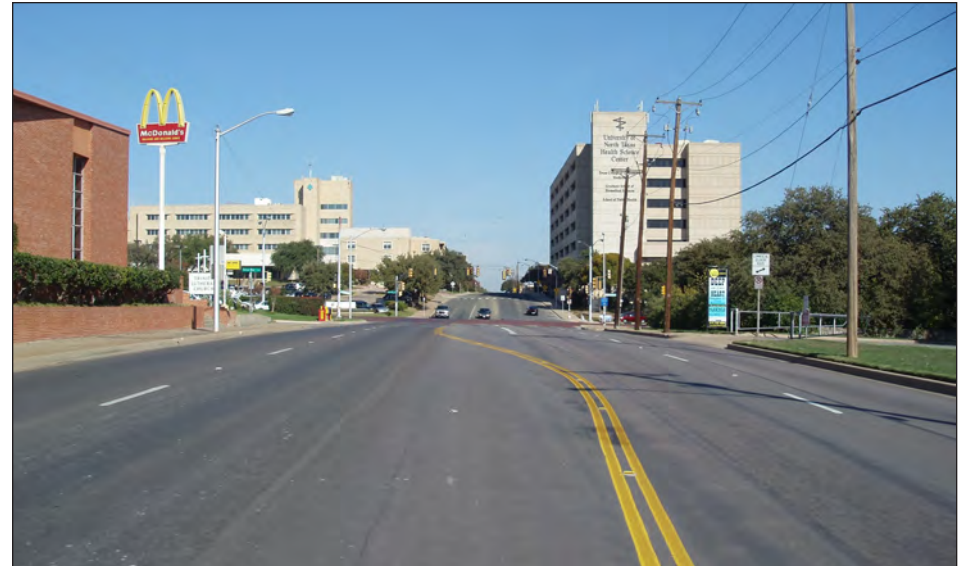

Camp Bowie - Looking North

7th Street at Montgomery
Intersection Traffic Movement Counts - April 25, 2007

Roadway:	Montgomery						7th Street					
Approach:	Northbound			Southbound			Eastbound			Westbound		
Movement:	Left	Thru	Right	Left	Thru	Right	Left	Thru	Right	Left	Thru	Right
Time Start												
6:00 AM	0	0	0	0	0	0	0	0	0	0	0	0
6:15 AM	0	0	0	0	0	0	0	0	0	0	0	0
6:30 AM	0	0	0	0	0	0	0	0	0	0	0	0
6:45 AM	0	0	0	0	0	0	0	0	0	0	0	0
Hour Total	0	0	0	0	0	0	0	0	0	0	0	0
7:00 AM	5	0	21	0	0	0	0	9	9	22	13	0
7:15 AM	4	0	22	0	0	0	0	18	13	23	14	0
7:30 AM	4	0	29	0	0	0	0	37	12	51	23	0
7:45 AM	4	0	31	0	0	0	0	39	11	58	25	0
Hour Total	17	0	103	0	0	0	0	103	45	154	75	0
8:00 AM	11	0	43	0	0	0	0	44	13	62	19	0
8:15 AM	9	0	40	0	0	0	0	28	14	61	14	0
8:30 AM	9	0	59	0	0	0	0	20	17	42	13	0
8:45 AM	7	0	55	0	0	0	0	23	10	35	17	0
Hour Total	36	0	197	0	0	0	0	115	54	200	63	0
9:00 AM	0	0	0	0	0	0	0	0	0	0	0	0
9:15 AM	0	0	0	0	0	0	0	0	0	0	0	0
9:30 AM	0	0	0	0	0	0	0	0	0	0	0	0
9:45 AM	0	0	0	0	0	0	0	0	0	0	0	0
Hour Total	0	0	0	0	0	0	0	0	0	0	0	0
10:00 AM	0	0	0	0	0	0	0	0	0	0	0	0
10:15 AM	0	0	0	0	0	0	0	0	0	0	0	0
10:30 AM	0	0	0	0	0	0	0	0	0	0	0	0
10:45 AM	0	0	0	0	0	0	0	0	0	0	0	0
Hour Total	0	0	0	0	0	0	0	0	0	0	0	0
11:00 AM	0	0	0	0	0	0	0	0	0	0	0	0
11:15 AM	0	0	0	0	0	0	0	0	0	0	0	0
11:30 AM	0	0	0	0	0	0	0	0	0	0	0	0
11:45 AM	0	0	0	0	0	0	0	0	0	0	0	0
Hour Total	0	0	0	0	0	0	0	0	0	0	0	0

Carter::Burgess

June 25, 2007

TRAFFIC AND PARKING

TRAFFIC COUNTS

Observed traffic counts are detailed in the following tables.

7th Street at Montgomery

Intersection Traffic Movement Counts - April 25, 2007

Roadway: Approach: Movement: Time Start	Montgomery						7th Street					
	Northbound			Southbound			Eastbound			Westbound		
	Left	Thru	Right	Left	Thru	Right	Left	Thru	Right	Left	Thru	Right
12:00 PM	0	0	0	0	0	0	0	0	0	0	0	0
12:15 PM	0	0	0	0	0	0	0	0	0	0	0	0
12:30 PM	0	0	0	0	0	0	0	0	0	0	0	0
12:45 PM	0	0	0	0	0	0	0	0	0	0	0	0
Hour Total	0	0	0	0	0	0	0	0	0	0	0	0
1:00 PM	0	0	0	0	0	0	0	0	0	0	0	0
1:15 PM	0	0	0	0	0	0	0	0	0	0	0	0
1:30 PM	0	0	0	0	0	0	0	0	0	0	0	0
1:45 PM	0	0	0	0	0	0	0	0	0	0	0	0
Hour Total	0	0	0	0	0	0	0	0	0	0	0	0
2:00 PM	0	0	0	0	0	0	0	0	0	0	0	0
2:15 PM	0	0	0	0	0	0	0	0	0	0	0	0
2:30 PM	0	0	0	0	0	0	0	0	0	0	0	0
2:45 PM	0	0	0	0	0	0	0	0	0	0	0	0
Hour Total	0	0	0	0	0	0	0	0	0	0	0	0
3:00 PM	0	0	0	0	0	0	0	0	0	0	0	0
3:15 PM	0	0	0	0	0	0	0	0	0	0	0	0
3:30 PM	0	0	0	0	0	0	0	0	0	0	0	0
3:45 PM	0	0	0	0	0	0	0	0	0	0	0	0
Hour Total	0	0	0	0	0	0	0	0	0	0	0	0
4:00 PM	15	0	56	0	0	0	0	17	11	53	27	0
4:15 PM	18	0	62	0	0	0	0	16	9	56	33	0
4:30 PM	7	0	73	0	0	0	0	22	13	67	33	0
4:45 PM	8	0	55	0	0	0	0	24	11	40	31	0
Hour Total	48	0	246	0	0	0	0	79	44	216	124	0
5:00 PM	12	0	82	0	0	0	0	15	18	66	36	0
5:15 PM	11	0	77	0	0	0	0	22	13	57	39	0
5:30 PM	3	0	72	0	0	0	0	17	8	64	46	0
5:45 PM	12	0	66	0	0	0	0	22	6	38	32	0
Hour Total	38	0	297	0	0	0	0	76	45	225	153	0
6:00 PM	0	0	0	0	0	0	0	0	0	0	0	0
6:15 PM	0	0	0	0	0	0	0	0	0	0	0	0
6:30 PM	0	0	0	0	0	0	0	0	0	0	0	0
6:45 PM	0	0	0	0	0	0	0	0	0	0	0	0
Hour Total	0	0	0	0	0	0	0	0	0	0	0	0

13-Hour Total	139	0	843	0	0	0	0	373	188	795	415	0
% of Approach	14.2%	0.0%	85.8%	#####	#####	#####	0.0%	66.5%	33.5%	65.7%	34.3%	0.0%
% of Movements	35.7%			0.0%			20.4%			44.0%		
% of Intersection	35.7%						64.3%					

7TH STREET AT MONTGOMERY

Intersection Approach Counts - April 25, 2007

Time Start	EBD 7th Street					WBD 7th Street					NBD Montgomery					SBD Montgomery					
	:00	:15	:30	:45	Ttl.	:00	:15	:30	:45	Ttl.	:00	:15	:30	:45	Ttl.	:00	:15	:30	:45	Ttl.	
12 AM	0	0	0	0	0	0	0	0	0	0	0	0	0	0	0	0	0	0	0	0	0
1 AM	0	0	0	0	0	0	0	0	0	0	0	0	0	0	0	0	0	0	0	0	0
2 AM	0	0	0	0	0	0	0	0	0	0	0	0	0	0	0	0	0	0	0	0	0
3 AM	0	0	0	0	0	0	0	0	0	0	0	0	0	0	0	0	0	0	0	0	0
4 AM	0	0	0	0	0	0	0	0	0	0	0	0	0	0	0	0	0	0	0	0	0
5 AM	0	0	0	0	0	0	0	0	0	0	0	0	0	0	0	0	0	0	0	0	0
6 AM	0	0	0	0	0	0	0	0	0	0	0	0	0	0	0	0	0	0	0	0	0
7 AM	18	31	49	50	148	35	37	74	83	229	26	26	33	35	120	0	0	0	0	0	
8 AM	57	42	37	33	169	81	75	55	52	263	54	49	68	62	233	0	0	0	0	0	
9 AM	0	0	0	0	0	0	0	0	0	0	0	0	0	0	0	0	0	0	0	0	
10 AM	0	0	0	0	0	0	0	0	0	0	0	0	0	0	0	0	0	0	0	0	
11 AM	0	0	0	0	0	0	0	0	0	0	0	0	0	0	0	0	0	0	0	0	
12 PM	0	0	0	0	0	0	0	0	0	0	0	0	0	0	0	0	0	0	0	0	
1 PM	0	0	0	0	0	0	0	0	0	0	0	0	0	0	0	0	0	0	0	0	
2 PM	0	0	0	0	0	0	0	0	0	0	0	0	0	0	0	0	0	0	0	0	
3 PM	0	0	0	0	0	0	0	0	0	0	0	0	0	0	0	0	0	0	0	0	
4 PM	28	25	35	35	123	80	89	100	71	340	71	80	80	63	294	0	0	0	0	0	
5 PM	33	35	25	28	121	102	96	110	70	378	94	88	75	78	335	0	0	0	0	0	
6 PM	0	0	0	0	0	0	0	0	0	0	0	0	0	0	0	0	0	0	0	0	
7 PM	0	0	0	0	0	0	0	0	0	0	0	0	0	0	0	0	0	0	0	0	
8 PM	0	0	0	0	0	0	0	0	0	0	0	0	0	0	0	0	0	0	0	0	
9 PM	0	0	0	0	0	0	0	0	0	0	0	0	0	0	0	0	0	0	0	0	
10 PM	0	0	0	0	0	0	0	0	0	0	0	0	0	0	0	0	0	0	0	0	
11 PM	0	0	0	0	0	0	0	0	0	0	0	0	0	0	0	0	0	0	0	0	
24 Hour	561					1,210					982					0					

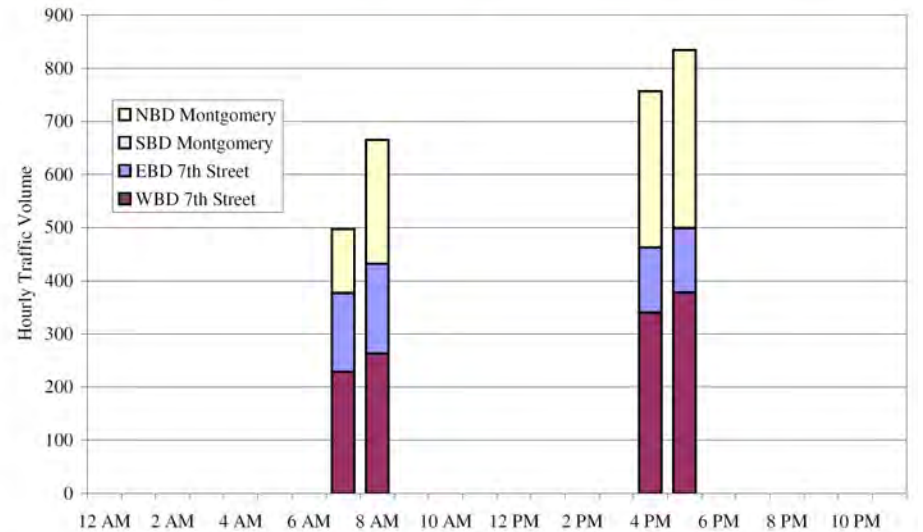

WARRANTS FOR TRAFFIC SIGNAL INSTALLATION

for 7th Street at Montgomery

June 25, 2007

Prepared by Carter-Burgess

Prepared for Texas Department of Transportation - Dallas District

Warrants 1 through 8 for Traffic Signal Installation were analyzed for the intersection of 7th Street at Montgomery. The results are summarized below. Detailed analyses of all applicable warrants are contained in the following pages.

Warrant	Result	Comments
1A. Eight-Hour Vehicular Volume	Not Satisfied	
1B. Eight-Hour Vehicular Volume	Not Satisfied	
1A/B. Eight-Hour Vehicular Volume	Not Satisfied	
2. Four-Hour Vehicular Volume	Not Satisfied	
3A. Peak Hour Volume	Not Satisfied	
3B. Peak Hour Volume	Satisfied	
4. Pedestrian Volume	Not Satisfied	
5. School Crossing	Not Satisfied	
6. Coordinated Signal System	Not Satisfied	
7. Crash Experience	Not Satisfied	
8. Roadway Network	Not Satisfied	

Based on Warrants 1 through 8, a traffic signal installation is warranted at the intersection of 7th Street at Montgomery.

TRAFFIC SIGNAL WARRANT 1: EIGHT-HOUR VEHICULAR VOLUME (CONDITION A - MINIMUM VEHICULAR VOLUME)

7th Street at Montgomery

The Minimum Vehicular Volume warrant, Condition A, is intended for application where a large volume of intersecting traffic is the principal reason to consider installing a traffic control signal. The need for a traffic control signal shall be considered

Yes	Is the 85th percentile speed on the major street greater than 40 mph?
No	Does the intersection lie within a built-up area of an isolated community having a population less than 10,000?
1	Number of major street approach lanes.
1	Number of minor street approach lanes.

Minimum traffic volume for major street approach = 350 vehicles.
Minimum traffic volume for minor street approach = 105 vehicles.

Start Hour	EBD 7th Street	WBD 7th Street	NBD Montgomery	SBD Montgomery	Major Street Total	High Volume Minor Street	Meets Requirement
12 AM	0	0	0	0	0	0	No
1 AM	0	0	0	0	0	0	No
2 AM	0	0	0	0	0	0	No
3 AM	0	0	0	0	0	0	No
4 AM	0	0	0	0	0	0	No
5 AM	0	0	0	0	0	0	No
6 AM	0	0	0	0	0	0	No
7 AM	148	229	120	0	377	120	Yes
8 AM	169	263	233	0	432	233	Yes
9 AM	0	0	0	0	0	0	No
10 AM	0	0	0	0	0	0	No
11 AM	0	0	0	0	0	0	No
12 PM	0	0	0	0	0	0	No
1 PM	0	0	0	0	0	0	No
2 PM	0	0	0	0	0	0	No
3 PM	0	0	0	0	0	0	No
4 PM	123	340	294	0	463	294	Yes
5 PM	121	378	335	0	499	335	Yes
6 PM	0	0	0	0	0	0	No
7 PM	0	0	0	0	0	0	No
8 PM	0	0	0	0	0	0	No
9 PM	0	0	0	0	0	0	No
10 PM	0	0	0	0	0	0	No
11 PM	0	0	0	0	0	0	No

The minimum requirements are met for 4 of the 4 hours observed.

Based on the above data, the intersection of 7th Street at Montgomery does not meet the minimum requirements of Warrant 1A.

**TRAFFIC SIGNAL WARRANT 1: EIGHT-HOUR VEHICULAR VOLUME
(CONDITION B - INTERRUPTION OF CONTINUOUS TRAFFIC)**

7th Street at Montgomery

The Interruption of Continuous Traffic warrant, Condition B, is intended for application where the traffic volume on a major street is so heavy that traffic on a minor intersecting street suffers excessive delay or conflict in entering or crossing the major street.

- Yes Is the 85th percentile speed on the major street greater than 40 mph?
- No Does the intersection lie within a built-up area of an isolated community having a population less than 10,000?
- 1 Number of major street approach lanes.
- 1 Number of minor street approach lanes.

Minimum traffic volume for major street approach = 525 vehicles.
Minimum traffic volume for minor street approach = 53 vehicles.

Start Hour	EBD 7th Street	WBD 7th Street	NBD Montgomery	SBD Montgomery	Major Street Total	High Volume Minor Street	Meets Requirement
12 AM	0	0	0	0	0	0	No
1 AM	0	0	0	0	0	0	No
2 AM	0	0	0	0	0	0	No
3 AM	0	0	0	0	0	0	No
4 AM	0	0	0	0	0	0	No
5 AM	0	0	0	0	0	0	No
6 AM	0	0	0	0	0	0	No
7 AM	148	229	120	0	377	120	No
8 AM	169	263	233	0	432	233	No
9 AM	0	0	0	0	0	0	No
10 AM	0	0	0	0	0	0	No
11 AM	0	0	0	0	0	0	No
12 PM	0	0	0	0	0	0	No
1 PM	0	0	0	0	0	0	No
2 PM	0	0	0	0	0	0	No
3 PM	0	0	0	0	0	0	No
4 PM	123	340	294	0	463	294	No
5 PM	121	378	335	0	499	335	No
6 PM	0	0	0	0	0	0	No
7 PM	0	0	0	0	0	0	No
8 PM	0	0	0	0	0	0	No
9 PM	0	0	0	0	0	0	No
10 PM	0	0	0	0	0	0	No
11 PM	0	0	0	0	0	0	No

The minimum requirements are met for 0 of the 4 hours observed.

Based on the above data, the intersection of 7th Street at Montgomery does not meet the minimum requirements of Warrant 1B.

TRAFFIC SIGNAL WARRANT 1 - COMBINATION OF CONDITIONS A&B

7th Street at Montgomery

The combination of Condition A and B should be applied only after an adequate trial of other alternatives that could cause less delay and inconvenience to traffic failed to solve the traffic problems. The need for traffic control shall be considered if t

- 80% of minimum traffic volume for major street approach (Warrant 1) = 400 vehicles
- 80% of minimum traffic volume for minor street approach (Warrant 1) = 120 vehicles
- 80% of minimum traffic volume for major street approach (Warrant 2) = 600 vehicles
- 80% of minimum traffic volume for minor street approach (Warrant 2) = 60 vehicles

Start Hour	Major Street Total	High Volume Minor Street	80% of Warrant 1	80% of Warrant 2
12 AM	0	0	No	No
1 AM	0	0	No	No
2 AM	0	0	No	No
3 AM	0	0	No	No
4 AM	0	0	No	No
5 AM	0	0	No	No
6 AM	0	0	No	No
7 AM	377	120	No	No
8 AM	432	233	Yes	No
9 AM	0	0	No	No
10 AM	0	0	No	No
11 AM	0	0	No	No
12 PM	0	0	No	No
1 PM	0	0	No	No
2 PM	0	0	No	No
3 PM	0	0	No	No
4 PM	463	294	Yes	No
5 PM	499	335	Yes	No
6 PM	0	0	No	No
7 PM	0	0	No	No
8 PM	0	0	No	No
9 PM	0	0	No	No
10 PM	0	0	No	No
11 PM	0	0	No	No
Volume Requirements			Not Satisfied	Not Satisfied

In order to satisfy the Combination Warrant, both portions of the warrant must be satisfied. Based on the above data, the intersection of 7th Street at Montgomery does not meet the minimum requirements for Warrant 1 (Combination).

TRAFFIC SIGNAL WARRANT 2 - FOUR HOUR VEH. VOLUME (70% Factor)
7th Street at Montgomery

The Four-Hour Vehicular Volume signal warrant conditions are intended to be applied where the volume of intersecting traffic is the principal reason to consider installing a traffic control signal. The need for a traffic control signal shall be considered

Yes	Is the 85th percentile speed on the major street greater than 40 mph?
No	Does the intersection lie within a built-up area of an isolated community having a population less than 10,000?
1	Number of major street approach lanes.
1	Number of minor street approach lanes.

Start Hour	Major Street Total	High Volume Minor Street	Meets Requirement	Start Hour	Major Street Total	High Volume Minor Street	Meets Requirement
12 AM	0	0	No	12 PM	0	0	No
1 AM	0	0	No	1 PM	0	0	No
2 AM	0	0	No	2 PM	0	0	No
3 AM	0	0	No	3 PM	0	0	No
4 AM	0	0	No	4 PM	463	294	Yes
5 AM	0	0	No	5 PM	499	335	Yes
6 AM	0	0	No	6 PM	0	0	No
7 AM	377	120	No	7 PM	0	0	No
8 AM	432	233	Yes	8 PM	0	0	No
9 AM	0	0	No	9 PM	0	0	No
10 AM	0	0	No	10 PM	0	0	No
11 AM	0	0	No	11 PM	0	0	No

Based on the above data, the intersection of 7th Street at Montgomery does not meet the minimum requirements of Warrant 2.

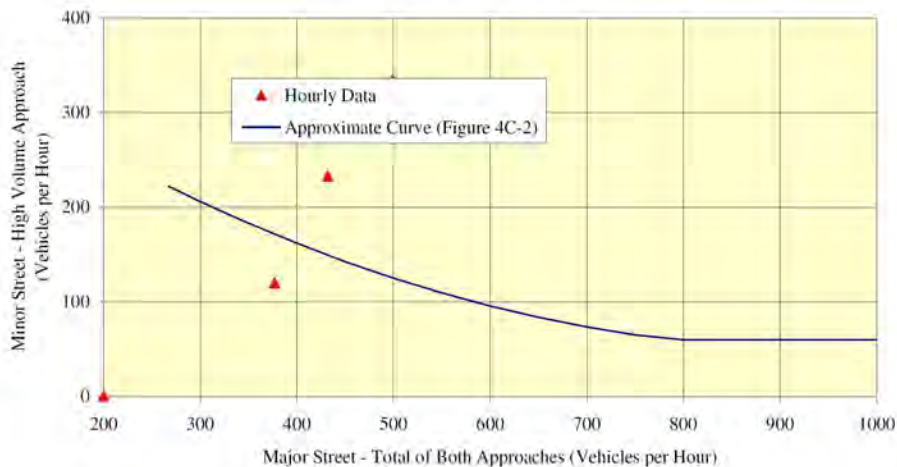

TRAFFIC SIGNAL WARRANT 3A - PEAK HOUR
7th Street at Montgomery

The Peak Hour signal warrant is intended for use at a location where traffic conditions are such that for a minimum of 1 hour of an average day, the minor-street traffic suffers undue delay when entering or crossing the major street. This signal warrant

Number of Approaches to the Intersection: 3
 Number of Approach Lanes on Minor Street: 1

Condition	Existing	Required	Meets Requirement
The total delay experienced by the traffic on the minor street approach		4 hours	No
Traffic Volume on Minor Street Approach	335 vehicles	100 vehicles	Yes
Total Entering Traffic Volume from all Three (3) Approaches	834 vehicles	650 vehicles	Yes

Based on the above data, the intersection of 7th Street at Montgomery does not meet the minimum requirements of Warrant 3A.

TRAFFIC SIGNAL WARRANT 3B - PEAK HOUR (70% Factor)

7th Street at Montgomery

The Peak Hour signal warrant is intended for use at a location where traffic conditions are such that for a minimum of 1 hour of an average day, the minor-street traffic suffers undue delay when entering or crossing the major street. This signal warrant

- Yes Is the 85th percentile speed on the major street greater than 40 mph?
- No Does the intersection lie within a built-up area of an isolated community having a population less than 10,000?
- 1 Number of major street approach lanes.
- 1 Number of minor street approach lanes.

Start Hour	Major Street Total	High Volume Minor Street	Meets Requirement	Start Hour	Major Street Total	High Volume Minor Street	Meets Requirement
12 AM	0	0	No	12 PM	0	0	No
1 AM	0	0	No	1 PM	0	0	No
2 AM	0	0	No	2 PM	0	0	No
3 AM	0	0	No	3 PM	0	0	No
4 AM	0	0	No	4 PM	463	294	Yes
5 AM	0	0	No	5 PM	499	335	Yes
6 AM	0	0	No	6 PM	0	0	No
7 AM	377	120	No	7 PM	0	0	No
8 AM	432	233	No	8 PM	0	0	No
9 AM	0	0	No	9 PM	0	0	No
10 AM	0	0	No	10 PM	0	0	No
11 AM	0	0	No	11 PM	0	0	No

Based on the above data, the intersection of 7th Street at Montgomery meets the minimum requirements of Warrant 3B.

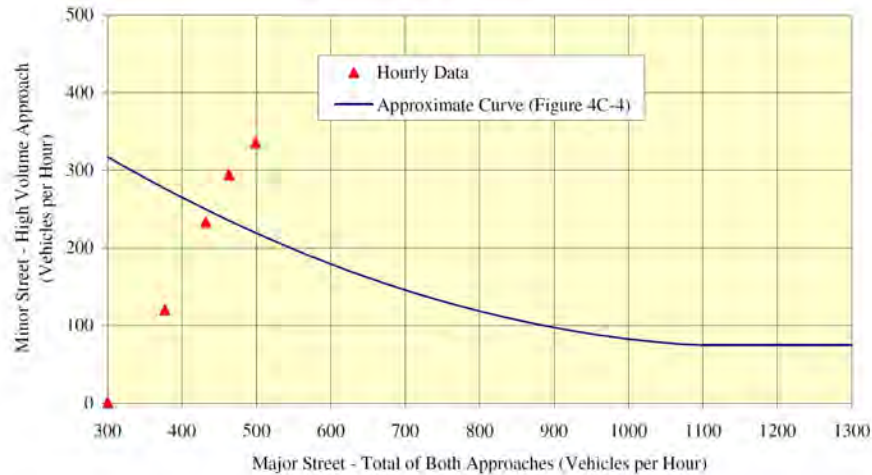

TRAFFIC SIGNAL WARRANT 4 - PEDESTRIAN VOLUME

7th Street at Montgomery

The Pedestrian Volume signal warrant is intended for applications where the traffic volume on a major street is so heavy that pedestrians experience excessive delay in crossing the major street. The Pedestrian Volume warrant shall not be applied at local

No Is the average crossing speed of pedestrians less than 4 feet per second?

Minimum pedestrian volume per hour for one (1) hour on high volume crosswalk = 190 pedestrians.
Minimum pedestrian volume per hour for four (4) hours on high volume crosswalk = 140 pedestrians.

Start Hour	Pedestrian Volume Crossing Major Street	Number of Gaps in EBD Traffic	Number of Gaps in WBD Traffic	Meets 1 Hour Requirement	Meets 4 Hour Requirement
12 AM	0	100	100	No	No
1 AM	0	100	100	No	No
2 AM	0	100	100	No	No
3 AM	0	100	100	No	No
4 AM	0	100	100	No	No
5 AM	0	100	100	No	No
6 AM	0	100	100	No	No
7 AM	0	100	100	No	No
8 AM	0	100	100	No	No
9 AM	0	100	100	No	No
10 AM	0	100	100	No	No
11 AM	0	100	100	No	No
12 PM	0	100	100	No	No
1 PM	0	100	100	No	No
2 PM	0	100	100	No	No
3 PM	0	100	100	No	No
4 PM	0	100	100	No	No
5 PM	0	100	100	No	No
6 PM	0	100	100	No	No
7 PM	0	100	100	No	No
8 PM	0	100	100	No	No
9 PM	0	100	100	No	No
10 PM	0	100	100	No	No
11 PM	0	100	100	No	No
				Not Satisfied	Not Satisfied

Based on the above data, the intersection of 7th Street at Montgomery does not meet the minimum requirements of Warrant 4.

TRAFFIC SIGNAL WARRANT 5 - SCHOOL CROSSING

7th Street at Montgomery

The school crossing signal warrant is intended for application where the fact that school children cross the major street is the principal reason to consider installing a traffic control signal. Before the decision is made to install a traffic control s

- No Is the number of gaps in the traffic stream during the period when the children are using the crossing less than the number of minutes in the same period?
- No Are there at least 20 students crossing the major street during the highest hour? crossing less than the number of minutes in the same period?

Based on the above data, the intersection of 7th Street at Montgomery does not meet the minimum requirements of Warrant 5.

TRAFFIC SIGNAL WARRANT 6 - COORDINATED SIGNAL SYSTEM

7th Street at Montgomery

Progressive movement in a coordinated signal system sometimes necessitates installing traffic control signals at intersections where they would not otherwise be needed in order to maintain proper platooning of vehicles.

- No Are the adjacent signals in a signal system?
 - Yes Would the resultant spacing be 1000 feet or more?
 - No On a one-way street or a street that has traffic predominantly in one direction, are the adjacent traffic control signals so far apart that they do not provide the necessary degree of vehicular platooning?
- OR
- On a two-way street, would the proposed and adjacent traffic control signals provide the necessary degree of platooning that is not currently provided by the adjacent traffic control signals.

TRAFFIC SIGNAL WARRANT 7 - CRASH EXPERIENCE

7th Street at Montgomery

- No Have adequate trials of less restrictive remedies with satisfactory observance and enforcement failed to reduce the accident frequency?
- No Have five (5) or more accidents, of types susceptible to correction by traffic signal control, occurred within a 12-month period, each accident involving personal injury or property damage to an apparent extent of \$250 or more?
- Yes A signal installation will not seriously disrupt progressive traffic flow.

80% of minimum traffic volume for major street approach (Warrant 1A) = 280 vehicles
 80% of minimum traffic volume for minor street approach (Warrant 1A) = 84 vehicles
 80% of minimum traffic volume for major street approach (Warrant 1B) = 420 vehicles
 80% of minimum traffic volume for minor street approach (Warrant 1B) = 42 vehicles
 80% of pedestrian traffic volume crossing major street (Warrant 4) = 152 vehicles
 80% of pedestrian traffic volume crossing major street (Warrant 4) = 112 vehicles

Start Hour	Major Street Total	High Volume Minor Street	Pedestrian Volume Crossing Major Street	80% of Warrant 1 (Condition A)	80% of Warrant 1 (Condition B)	80% of Warrant 4 (1 Hour)	80% of Warrant 4 (4 Hour)
12 AM	0	0	0	No	No	No	No
1 AM	0	0	0	No	No	No	No
2 AM	0	0	0	No	No	No	No
3 AM	0	0	0	No	No	No	No
4 AM	0	0	0	No	No	No	No
5 AM	0	0	0	No	No	No	No
6 AM	0	0	0	No	No	No	No
7 AM	377	120	0	No	No	No	No
8 AM	432	233	0	Yes	No	No	No
9 AM	0	0	0	No	No	No	No
10 AM	0	0	0	No	No	No	No
11 AM	0	0	0	No	No	No	No
12 PM	0	0	0	No	No	No	No
1 PM	0	0	0	No	No	No	No
2 PM	0	0	0	No	No	No	No
3 PM	0	0	0	No	No	No	No
4 PM	463	294	0	Yes	No	No	No
5 PM	499	335	0	Yes	No	No	No
6 PM	0	0	0	No	No	No	No
7 PM	0	0	0	No	No	No	No
8 PM	0	0	0	No	No	No	No
9 PM	0	0	0	No	No	No	No
10 PM	0	0	0	No	No	No	No
11 PM	0	0	0	No	No	No	No
Hours Required				8	8	1	4
Volume Requirements				Not Satisfied	Not Satisfied	Not Satisfied	Not Satisfied

No Are one or more of the three volume warrants satisfied?

Based on the above data, the intersection of 7th Street at Montgomery does not meet the minimum requirements of Warrant 7.

TRAFFIC SIGNAL WARRANT 8 - ROADWAY NETWORK

7th Street at Montgomery

A traffic signal installation at some intersections may be warranted to encourage concentration and organization of traffic flow networks.

No Is the intersection an intersection of two or more major routes?

A major route as used in the above warrant has one or more of the following characteristics:

1. It is part of the street or highway system that serves as the principal network for through traffic flow.
2. It includes rural or suburban highways outside, entering, or traversing a city.
3. It appears as a major route on an official plan such as a major street plan in an urban area traffic and transportation study.

No Does the intersection have a total existing, or immediately projected, entering volume of at least 1,000 vehicles per hour during the peak hour of a typical weekday and have 5-year projected traffic volumes, based on an engineering study, that meet one of

OR

Does the intersection have a total existing, or immediately projected, entering volume of at least 1,000 vehicles per hour for each of any 5 hours of a nonnormal business day (Saturday or Sunday)?

Based on the above data, the intersection of 7th Street at Montgomery does not meet the minimum requirements of Warrant 8.

TRAFFIC AND PARKING

INTERSECTION CAPACITY ANALYSIS

	→	↘	↙	←	↖	↗
Movement	EBT	EBR	WBL	WBT	NBL	NBR
Lane Configurations	↖			↖	↖	↖
Volume (veh/h)	131	55	223	71	33	173
Sign Control	Free			Free	Stop	
Grade	0%			0%	0%	
Peak Hour Factor	0.92	0.92	0.92	0.92	0.92	0.92
Hourly flow rate (vph)	142	60	242	77	36	188
Pedestrians						
Lane Width (ft)						
Walking Speed (ft/s)						
Percent Blockage						
Right turn flare (veh)						
Median type	None			None		
Median storage veh						
Upstream signal (ft)	191			560		
pX, platoon unblocked						
vC, conflicting volume			202		734	172
vC1, stage 1 conf vol						
vC2, stage 2 conf vol						
vCu, unblocked vol			202		734	172
tC, single (s)			4.1		6.4	6.2
tC, 2 stage (s)						
tF (s)			2.2		3.5	3.3
p0 queue free %			82		89	78
cM capacity (veh/h)			1370		319	871
Direction, Lane #	EB 1	WB 1	NB 1			
Volume Total	202	320	224			
Volume Left	0	242	36			
Volume Right	60	0	188			
cSH	1700	1370	682			
Volume to Capacity	0.12	0.18	0.33			
Queue Length 95th (ft)	0	16	36			
Control Delay (s)	0.0	6.6	12.8			
Lane LOS		A	B			
Approach Delay (s)	0.0	6.6	12.8			
Approach LOS			B			
Intersection Summary						
Average Delay			6.7			
Intersection Capacity Utilization			48.8%		ICU Level of Service	A
Analysis Period (min)			15			

	→	↘	↙	←	↖	↗
Movement	EBT	EBR	WBL	WBT	NBL	NBR
Lane Configurations	↖			↖	↖	↖
Volume (veh/h)	76	45	225	153	38	397
Sign Control	Free			Free	Stop	
Grade	0%			0%	0%	
Peak Hour Factor	0.92	0.92	0.92	0.92	0.92	0.92
Hourly flow rate (vph)	83	49	245	166	41	432
Pedestrians						
Lane Width (ft)						
Walking Speed (ft/s)						
Percent Blockage						
Right turn flare (veh)						
Median type	None			None		
Median storage veh						
Upstream signal (ft)	191			560		
pX, platoon unblocked						
vC, conflicting volume			132		762	107
vC1, stage 1 conf vol						
vC2, stage 2 conf vol						
vCu, unblocked vol			132		762	107
tC, single (s)			4.1		6.4	6.2
tC, 2 stage (s)						
tF (s)			2.2		3.5	3.3
p0 queue free %			83		87	54
cM capacity (veh/h)			1454		310	947
Direction, Lane #	EB 1	WB 1	NB 1			
Volume Total	132	411	473			
Volume Left	0	245	41			
Volume Right	49	0	432			
cSH	1700	1454	803			
Volume to Capacity	0.08	0.17	0.59			
Queue Length 95th (ft)	0	15	98			
Control Delay (s)	0.0	5.4	15.7			
Lane LOS		A	C			
Approach Delay (s)	0.0	5.4	15.7			
Approach LOS			C			
Intersection Summary						
Average Delay			9.5			
Intersection Capacity Utilization			63.9%		ICU Level of Service	B
Analysis Period (min)			15			