

ESL TExES Prep--Test #154



Region 10 ESC
Experience the Power of 10

ELLs in Texas

- There are **over 120 different home languages** represented in Texas schools;
- 90% of ELL students speak Spanish

Source TEA: PEIMS Data Spring 2016

In 2016, there were a total of 980,487 identified ELLs in Texas. Of these identified ELLs, 55% participated in a Bilingual Program, and 45% in an ESL program.

In Texas, there was an increase of 31,413 identified ELLs from 2015 to 2016.

ELLs represent about 19% of the total student population in Texas.



Something to consider:
English Language Learners must have

- a 15 month academic gain
- each 10 month school year
- for six consecutive years

in order to reach grade equivalence with their English only peers.



ESL TExES 154 Prep

DOMAIN III - FOUNDATIONS OF ESL EDUCATION, CULTURAL AWARENESS, AND FAMILY AND COMMUNITY INVOLVEMENT

- Competency 008
 - The ESL teacher understands the foundations of ESL education and types of ESL programs.
- Competency 009
 - The ESL teacher understands factors that affect ESL students' learning and implements strategies for creating an effective multicultural learning environment.
- Competency 010
 - The ESL teacher knows how to serve as an advocate for ESL students and facilitate family and community involvement in their education.

30%

DOMAIN I - LANGUAGE CONCEPTS AND LANGUAGE ACQUISITION

- Competency 001
 - The ESL teacher understands fundamental language concepts and knows the structure and conventions of the English language.
- Competency 002
 - The ESL teacher understands the processes of first-language (L1) and second-language (L2) acquisition and the interrelatedness of L1 and L2 development.

25%

DOMAIN II – ESL INSTRUCTION AND ASSESSMENT

- Competency 003
 - The ESL teacher understands ESL teaching methods and uses this knowledge to plan and implement effective, developmentally appropriate instruction.
- Competency 004
 - The ESL teacher understands how to promote students' communicative language development in English.
- Competency 005
 - The ESL teacher understands how to promote students' literacy development in English.
- Competency 006
 - The ESL teacher understands how to promote students' content-area learning, academic-language development, and achievement across the curriculum.
- Competency 007
 - The ESL teacher understands formal and informal assessment procedures and instruments used in ESL programs and uses assessment results to plan and adapt instruction.

45%



DOMAIN III

FOUNDATIONS OF ESL EDUCATION,
CULTURAL AWARENESS, AND
FAMILY AND COMMUNITY
INVOLVEMENT

Competency **008**, 009, 010

30% of test



Competency 008

The ESL teacher understands the foundations of ESL education and types of ESL programs.



Competency 008 Components

- Knows the **historical, theoretical, and policy foundations of ESL** education and uses this knowledge to plan, implement, and advocate for effective ESL programs.
- Knows **types of ESL programs** (e.g., self-contained, pull-out, new comer centers, dual language immersion) their characteristics, their goals, and research findings on their effectiveness.
- **Applies knowledge of the various types of ESL programs** to make appropriate instructional and management decisions.
- Applies knowledgeable of research findings related to ESL education, including research on instructional and management practices in ESL programs, to **assist in planning and implementing effective ESL programs.**



Historical Perspective

Fact or Myth?

Until the recent emergence of bilingual activists, the nation's schools have always immersed immigrant children in English and this method has proven its effectiveness.

MYTH

Historical Perspective

- The issue of how to best educate immigrants has been a controversial subject throughout our history.
- During the last great wave of immigration, from 1880 to 1915, very few Americans succeeded in school, immigrants least of all.
- By 1930 half of all American 14 to 17 year-olds either didn't enter high school or dropped out before graduating.

Historical Perspective

- Historically, immersing immigrants in an English language school program has been effective, **but only by the third generation.**
 - In general, immigrant children spoke their native language.
 - their children were bilingual but not fluent enough to excel in school.
 - the third generation was fluent in English and successful in school.

Historical Perspective

- **Before World War I**, U.S. schools were very tolerant regarding the use of multiple languages for instructional and social purposes.
 - Native language instruction through public schools occurred in many communities around the country.
 - This attitude changed **after WWI** as diversity was repressed in favor of a national identity.



Changes Begin—Key Court Case

Lau V. Nichols – 1974

- San Francisco public schools **offered no programs for second language learners.**
 - Anyone could enroll; everyone had the same classes.
 - Parents of Asian students brought suit against the district, contending this practice was not fair to non-English speakers.

Lau V. Nichols

The case was eventually heard by the U.S. Supreme Court which decided that the **civil rights of non-English speaking students were violated** when the school took no steps to help them acquire the language of instruction.



Lau V. Nichols

The decision said,

“...there is **no equality of treatment** merely by providing students with the same facilities, textbooks, teachers, and curriculum....We know those who do not understand English are certain to find their classroom experiences **wholly incomprehensible** and in no way meaningful.”

Implications of Lau V. Nichols

- Court did not mandate bilingual education, but it did mandate that schools **take effective measures to overcome the educational disadvantage faced by non-English speakers.**
- Office of Civil Rights interpreted the court's decision as effectively requiring transitional bilingual education unless a school district could prove that another approach would be equally or more effective.
- The resulting debate still rages.



Other Court Decisions and Policy Foundations

- **Plessy vs. Ferguson (1896)**: Separate but Equal (segregation) is constitutional
- **Meyers vs. Nebraska (1923)**: 14th Amendment provides protection for language minorities
- **Brown vs. Board of Education (1954)**: Intentional segregation is unequal
- **Lau Remedies (1975)**: Mandated bilingual education
- **Castañeda vs. Pickard (1978)**: Mandates for effective language programs
- **Plyler vs. Doe (1982)**: Rights for undocumented immigrant students
- **No Child Left Behind (2001)**: Language instruction for limited English proficient students, Funded under Title III



Bilingual Education Programs (4 types)

Program Type	Program Description
(1) Transitional bilingual / early exit	English language learners receive a portion of their content instruction in their primary language for one to three years and then are integrated into all-English instruction.
(2) Transitional bilingual / late exit	English language learners receive content instruction in both L1 and L2 for four to six years.

Bilingual Education Programs (4 types continued)

Program Type	Program Description
(3) Dual language immersion / two-way	Biliteracy program model that integrates English proficient students with English Language Learners. Academic subjects are taught to all students through both English and the other language.
(4) Dual language immersion / one-way	Biliteracy program model that serves only English Language Learners. Academic subjects are taught in L1 and L2 (English).



English as a Second Language (ESL) Programs (2 types)

Program Type	Program Description
(1) ESL / Content-based	English language learners are given ESL content support services within the content areas with an ESL certified teacher.
(2) ESL / Pull-out	English language learners are given ESL support. They are taught basic vocabulary and language structure, usually outside their homeroom classroom and are then integrated into all English instruction for the rest of the day.

Research on BE/ESL Program Models

Recent research (1996 – 2001) by Wayne **Thomas** and Virginia **Collier** for the Center for Research on Education, Diversity and Excellence (CREDE) compared long-term effectiveness of various programs for English language learners.

www.crede.ucsc.edu



Remedial v. Enrichment Models for Closing the Academic Achievement GAP

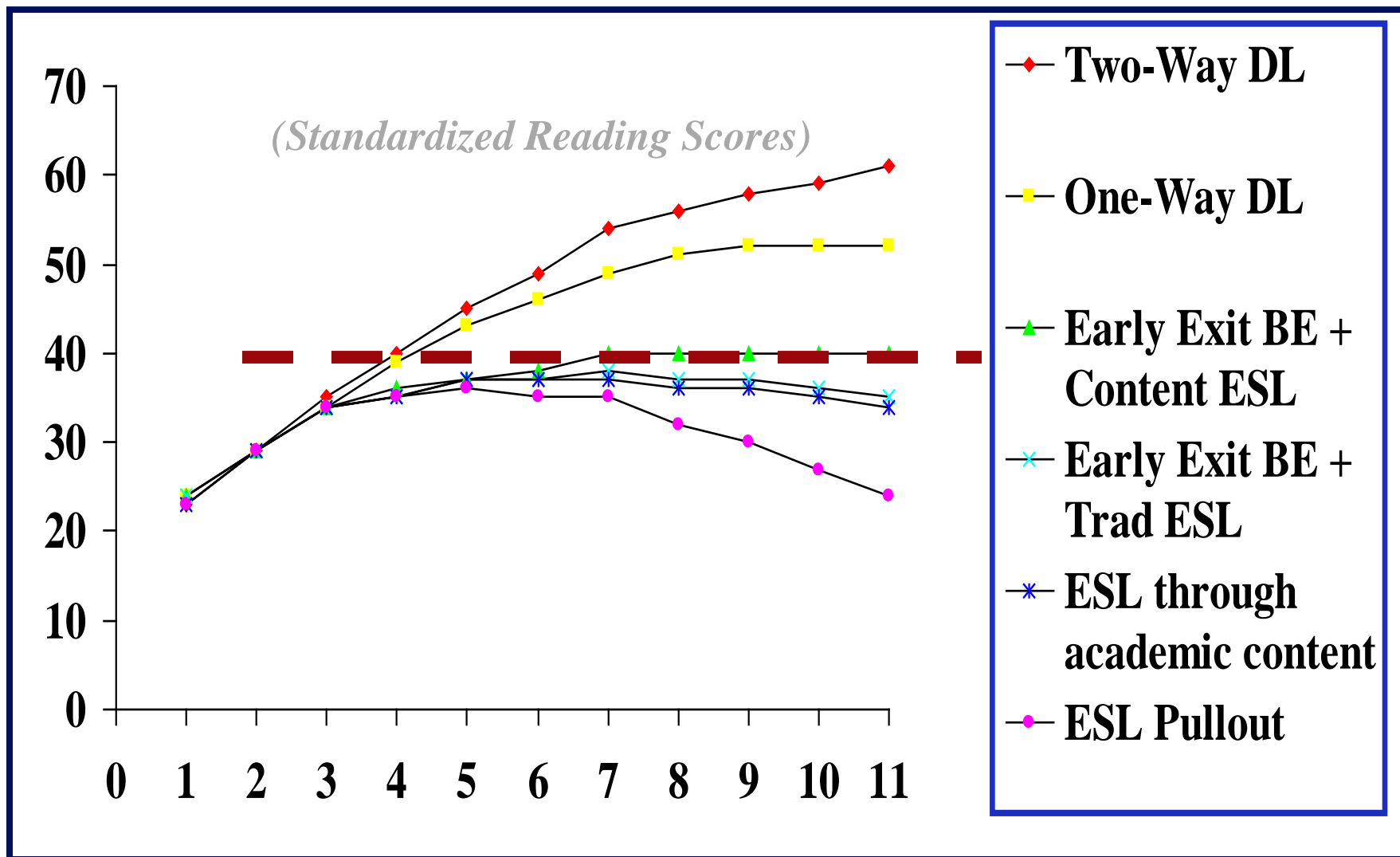

--- = average Reading score of native English speaker

(Thomas & Collier, 2000)



Thomas and Collier Research Findings

The programs that assist students to fully reach their English only peers in both L1 and L2 in all subjects and to maintain that level of high achievement through the end of schooling – and have fewest dropouts were **Bilingual Dual Language Programs.**

Additional Findings

- **ESL taught through academic content** is more effective than ESL Pullout.
- Strongest predictor of L2 student achievement is the **amount of formal L1 schooling**. The more L1 grade-level schooling, the higher L2 achievement.
- Bilingually schooled students outperform comparable monolingually schooled students in academic achievement in all subjects, **after 4-7 years of dual language schooling**.

Difference between ESL and Special Education

- It is important to note that **ESL is not a remedial** or special education program.
- **Special education students** have conditions that **require appropriate modifications**. In most cases, those conditions and the need for the same kind of modifications will continue throughout the student's schooling.
- **ESL accommodates**; it does not modify content.

Difference between ESL and Special Education (continued)

- Teachers of ESL students need to be continually aware of **each student's level of English proficiency** and his progress or lack of progress, so that the accommodations that are necessary at the beginning of the school year are not the accommodations needed in the middle or end of the school year. **(Adjust accommodations.)**
- It's true that many special education strategies are effective for ESL students, but teachers must constantly monitor and adjust their expectations so ESL students' progress is acknowledged and they are encouraged to achieve more. **(Hold high expectations.)**



DOMAIN I

LANGUAGE CONCEPTS AND
LANGUAGE ACQUISITION
Competency **001, 002**

25% of test

Competency 001

The ESL teacher understands fundamental language concepts and knows the structure and conventions of the English language.



Competency 001 Components

- Understands the nature of language and basic concepts of language systems (e.g., **phonology, morphology, syntax, lexicon, semantics, discourse, and pragmatics**) and uses this understanding to facilitate students learning in the ESL instruction.
- Knows the **functions and registers of language** (e.g., **social versus academic language**) in English and uses this knowledge to develop and modify instructional materials, deliver instruction, and promote ESL students' English language proficiency.
- Understands the **interrelatedness of listening, speaking, reading and writing** and uses this understanding to develop ESL students' English language proficiency.
- Knows the **structure of the English language** (e.g., **word formation, grammar sentence structure**) and the patterns and conventions of written and spoken English and uses this knowledge to model and provide instruction in English.





“Language fills every part of our lives, it gives words to our thoughts, voice to our ideas and expression to our feelings. It is a rich and varied human ability – one we can use without even a thought, that children seem to acquire automatically, and that linguists have discovered to be complex yet describable.”

Language Files

Department of Linguistics

Ohio State University

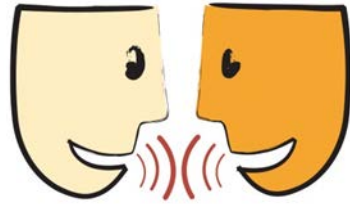

Language is our innate ability
to use abstract symbols
to communicate meaning.

The medium used can be speech, writing, signs.
(Speech and language are not interchangeable terms.)

General Principles of Human Languages

- Language is **personal** (varies by person, topic, purpose, situation, region, social group).
- Languages are **diverse**, yet they share many **universal properties**.
- Each language uses a finite set of discrete **sounds to form words** to convey meaning/words combine to form an infinite variety of sentences.

General Principles of Human Languages

(continued)

- Each language is governed by **complex rules**, many of which are unknown to speakers (linguistic competence).
- **Speech** is primary/**writing** is secondary.
- Languages change over time/languages are **flexible and responsive**.



Functions of Languages

- Instrumental – satisfy needs
- Personal – tell about one's self
- Interactional – communicate/relate to others
- Regulatory – control behavior of others
- Heuristic – question, infer
- Imaginative – dream, create
- Informative – inform, educate



Concepts of Language Systems

What is the concept?
**What are the
implications for ELL's?**

Phonology

Morphology

Syntax

Lexicon

Semantics

Discourse

Pragmatics



Phonology



...is the study of the system and pattern of speech sounds of a language



Phoneme

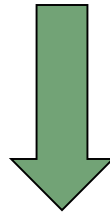

Phonetics



Phonics



Phoneme is a speech sound.

There are consonant and vowel phonemes.

- Consonant Phoneme Example:

Letter	Sound	Key Word
b	/b/	bus

- There are about 25 consonant phonemes or sounds:
 - 18 consonant phonemes, such as /d/ and /t/, are represented by a single letter.
 - 7 phonemes such as /ch/ and /sh/, are represented by two letters.
- The letters c, q, and x do not have a unique phoneme assigned to them. The sounds that they represent are more commonly represented by other letters and spellings; the sound /k/ or /s/ for c, the sounds /kw/ for qu, and the sounds /ks/ for x.

Phonemes continued

- Vowel Phoneme Example:

Letter	Sound	Key Word
a	/ā/	take
a	/a/	bat

- Generally, there are about 18 vowel phonemes, or sounds.
- The letters *a*, *e*, *i*, *o*, and *u* are classified as vowels.
- These 5 letters are used to represent many different sounds.
- Every syllable has a vowel sound.
- To produce a vowel sound the air flow is unobstructed by any portion of the mouth.

Phonetics is the study of how phonemes are physically produced.

- Consonant phonemes may be classified according to:
 - Place of articulation
 - Manner of articulation
 - And whether they are **voiced or unvoiced**
 - They can be further classified as continuous or stop sounds
- To produce a consonant phoneme the air flow is cut off either partially or completely.



Phonetics continued

- In order to produce a vowel phoneme, the air flow is unobstructed, or continuous.
 - Vowel phonemes are classified as continuous sounds.
- Tongue Position
 - Is the tongue high, mid, or low in the mouth?
 - Is the tongue near the front, central, or back of the mouth?
- Mouth Position
 - How rounded are the lips?
 - How tense are the mouth and jaw muscles?

Phonics



- The study and use of **sound/spelling correspondences** to help students identify written words.
- Phonics instruction teaches students the relationships between letters (graphemes) and speech sounds (phonemes).
- Phonics instruction can help students learn how to figure out pronunciation of new words that they encounter in print.



Not all languages have the same phonemes. This may pose a problem for students.



Problem English Sounds for L2 Speakers

- Chinese

b	ch	d	dg	f	g	j	l
m	n	ng	ō	sh	s	th	<i>th</i>
v	z	l-clusters		r-clusters			

- Spanish

b	d	dg	h	j	m	n	ng
r	sh	t	th	v	w	y	z
s-clusters			end clusters				



Problem English Sounds for L2 Speakers

Korean

b l ō ow p r sh t
th l-clusters r-clusters

Urdu

ā a d ē e f n ng
s sh t th *th*

Problem English Sounds for L2 Speakers

Vietnamese

ā ē k l ng p r sh
s y l-clusters r-clusters

French

ā ch ē h j ng oo oy
s th th sh shwa



Morphology

The study of meaningful parts of words and how they are put together.

Morphemes are the smallest meaningful spoken units of language. "Morphos" means "form or structure" in Greek; "eme" means "an element or little piece of something."



Morphemes

- A morpheme can be one syllable (pig) or more than one syllable (elephant).
- It may be a whole word or a part of a word.
- There are two basic types of morphemes: free and bound.
 - Free morphemes
 - Bound morphemes

Morphemes

Free Morphemes

- Base words
 - Like
 - Differ
 - truth
- Compound words
 - Light + house = Lighthouse

Bound Morphemes

- Affixes
 - Prefixes
 - Anti
 - Re
 - Suffixes
 - ed
 - ing

Chunking Into Manageable Units

**Families or
Phonograms**

**-ade
-ick
-ill**

**Inflectional
Endings**

**-es
-s
-ing
-ed**

Affixes

**-fore
dis-
mis-
-ity
-ency**

Morphemes

play

play + s

play + er + s

un + play + able

re + play + ed

play + ful + ly

Adding morphemes changes the meaning.

Teach Affixes

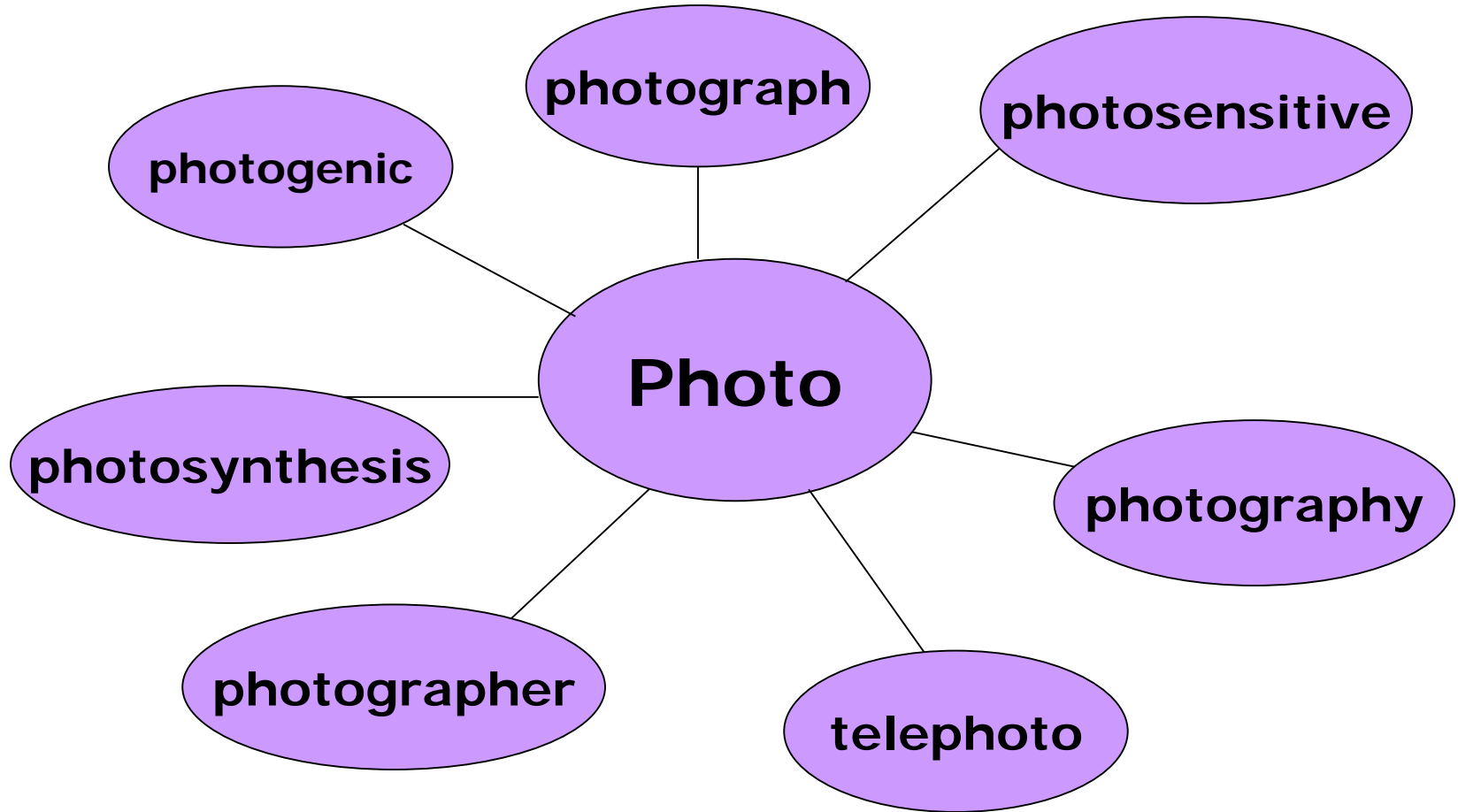

Syntax

The study of the way in which sentences are constructed and how sentences are related to each other.

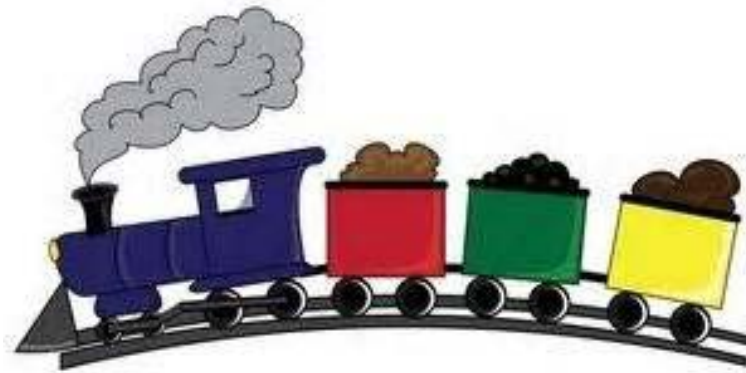

Syntax

Combine phonemes into morphemes, morphemes into words, words into sentences.

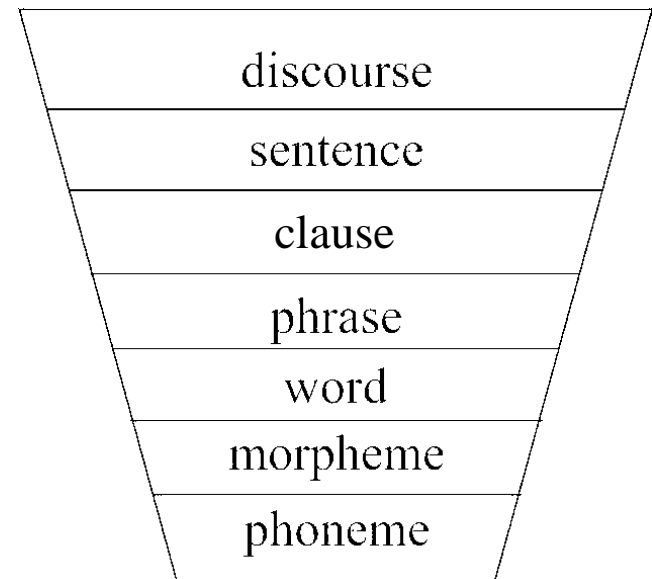

Categories of Syntax

Lexical

- Noun (N) Harry, boy, wheat, policy, moisture, bravery
- Verb (V) arrive, discuss, melt, hear, remain, dislike
- Adjective (A) good, tall, old, intelligent, beautiful, fond
- Preposition (P) to, in, on, near, at, by
- Adverb (Adv) silently, slowly, quietly, quickly, now

Nonlexical

- Determiner (Det) the, a, this, these
- Degree word (Deg) too, so, very, more, quite
- Qualifier (Qual) always, perhaps, often, never, almost
- Auxiliary (Aux) will, can, may, must, should, could
- Conjunction (Con) and, or, but



English Syntax Examples

"We will go home after school."

Not: "After school to home we will go."

"a big blue house"

Not: a house big blue

Not: a blue big house



Syntactic Ambiguity

- A situation where a sentence may be interpreted in more than one way due to ambiguous sentence structure.
- Examples:
 - **I gave a few olives to my friend that I stabbed with a fork.**
 - Fix it: *I gave a few olives, which I stabbed with a fork, to my friend.*
 - **Sitting quietly on the porch swing, the wasp startled the old man.**
 - Fix it: *Sitting quietly on the porch swing, the old man was startled by the wasp.*



Lexicon is one's mental list of the words in a language, including information about the meaning, grammatical function, pronunciation, etc.

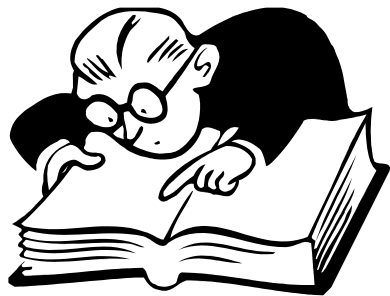

(A written lexicon is a list of all the words in a language; dictionary.)



Lexical Ambiguity

A situation in which a word has **two or more meanings**

Examples:

- On my way to the **bank** to cash my paycheck, I passed by the park and saw the most colorful ducks swimming by the **bank** of the river.
- While taking notes about the farm, I dropped my **pen** into the **pen** where the pigs were playing in the mud.



Semantics is the study of linguistic meaning.

- It studies the meanings of words and ways in which the meanings change and develop.
- It is concerned with the meanings of words, morphemes, phrases, and sentences.
- Semantics includes synonyms, antonyms, homonyms, and multiple-meaning words.



Semantic Ambiguity

The individual meaning of words has been resolved, but the context is needed for understanding.

Examples:

- **I haven't slept for 10 days.**
 - For a duration of 10 days? In the last 10 days?
- **There was not a single man at the party.**
 - Not one? Not any that were unmarried?

Semantic Mapping

(Heimlick and Pittelman, 1986)

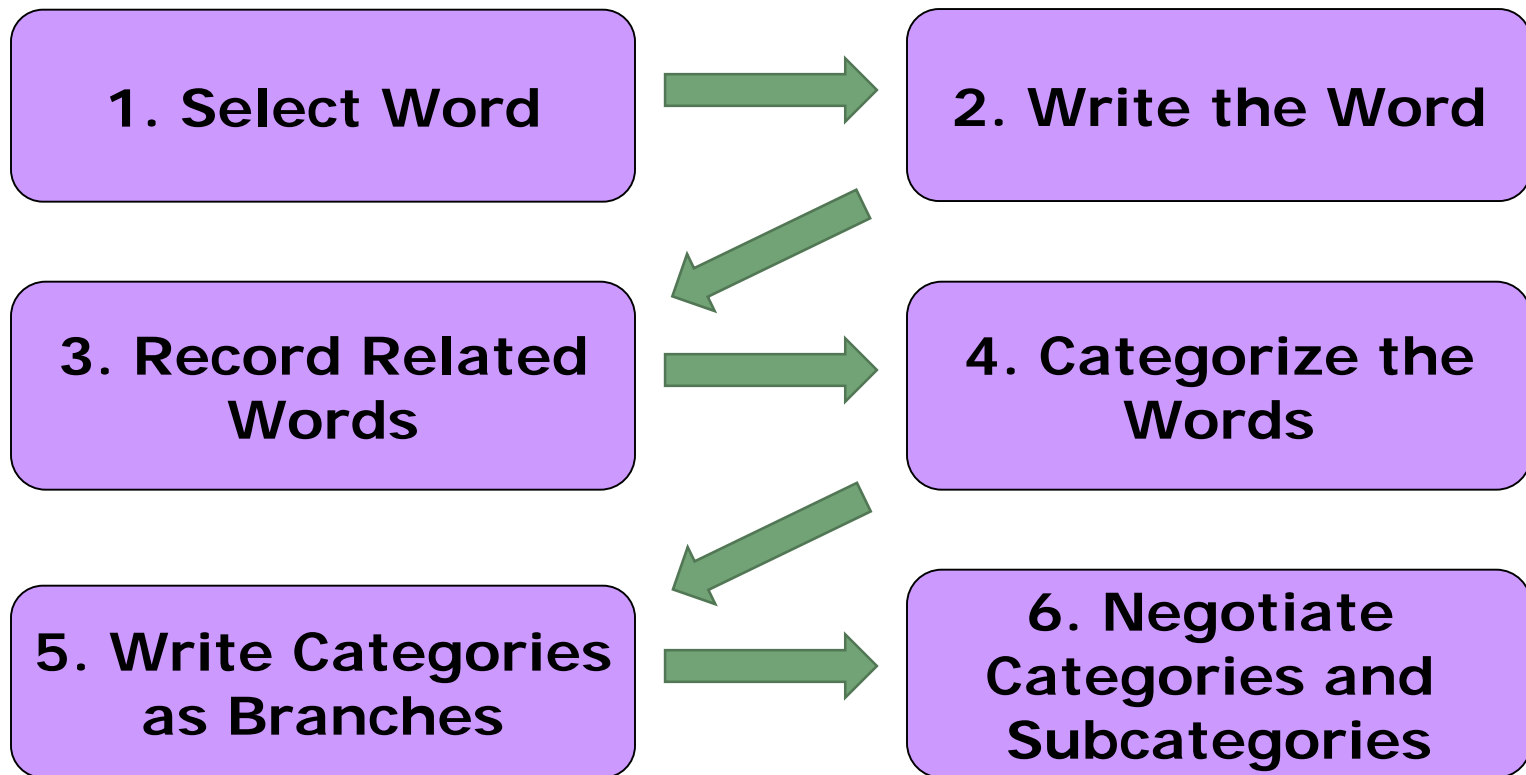

Semantic Word Map

(Moats 2000)

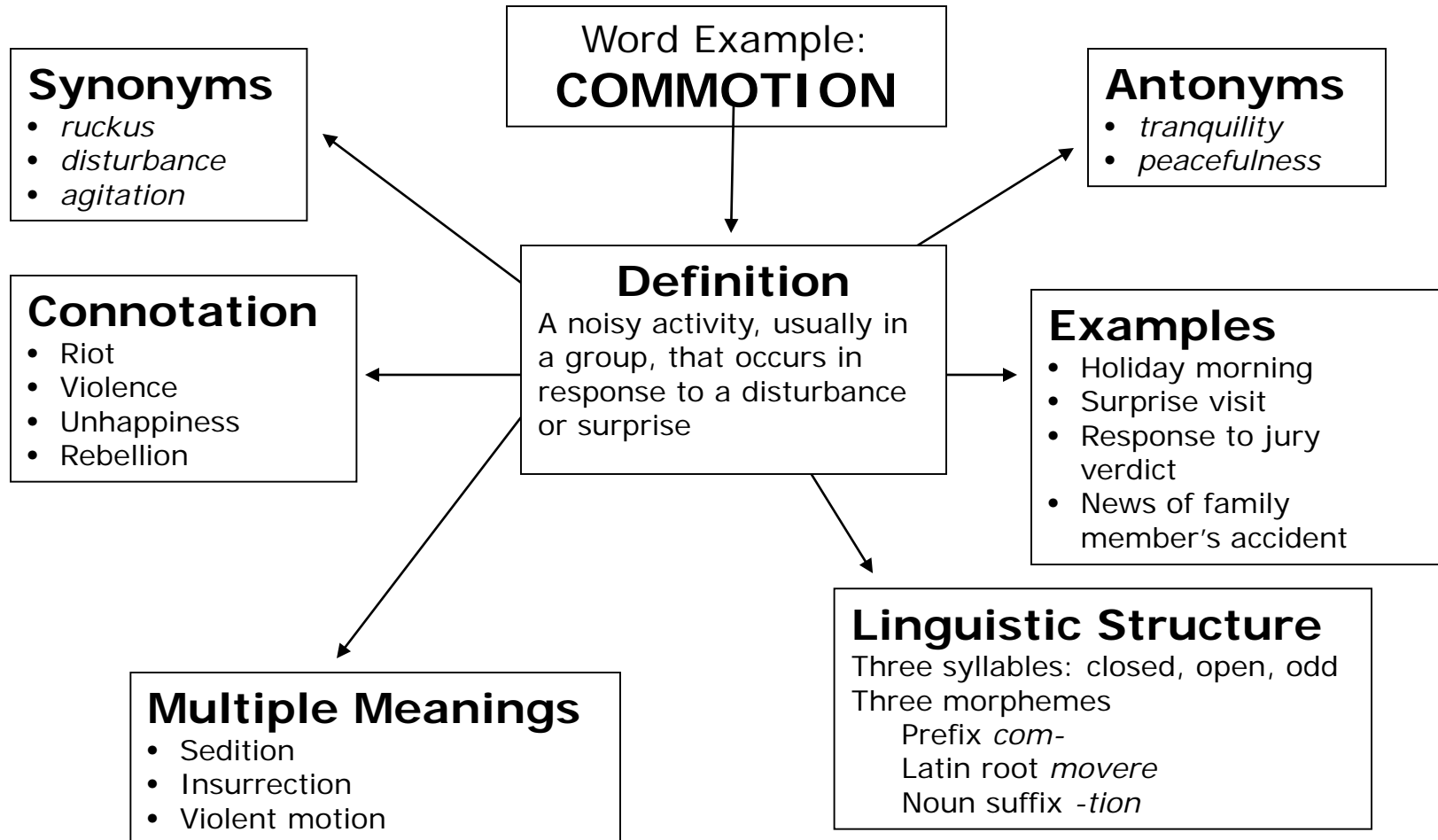
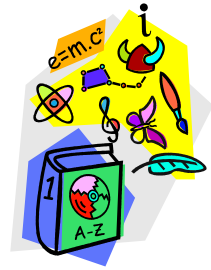

Semantic Cluster

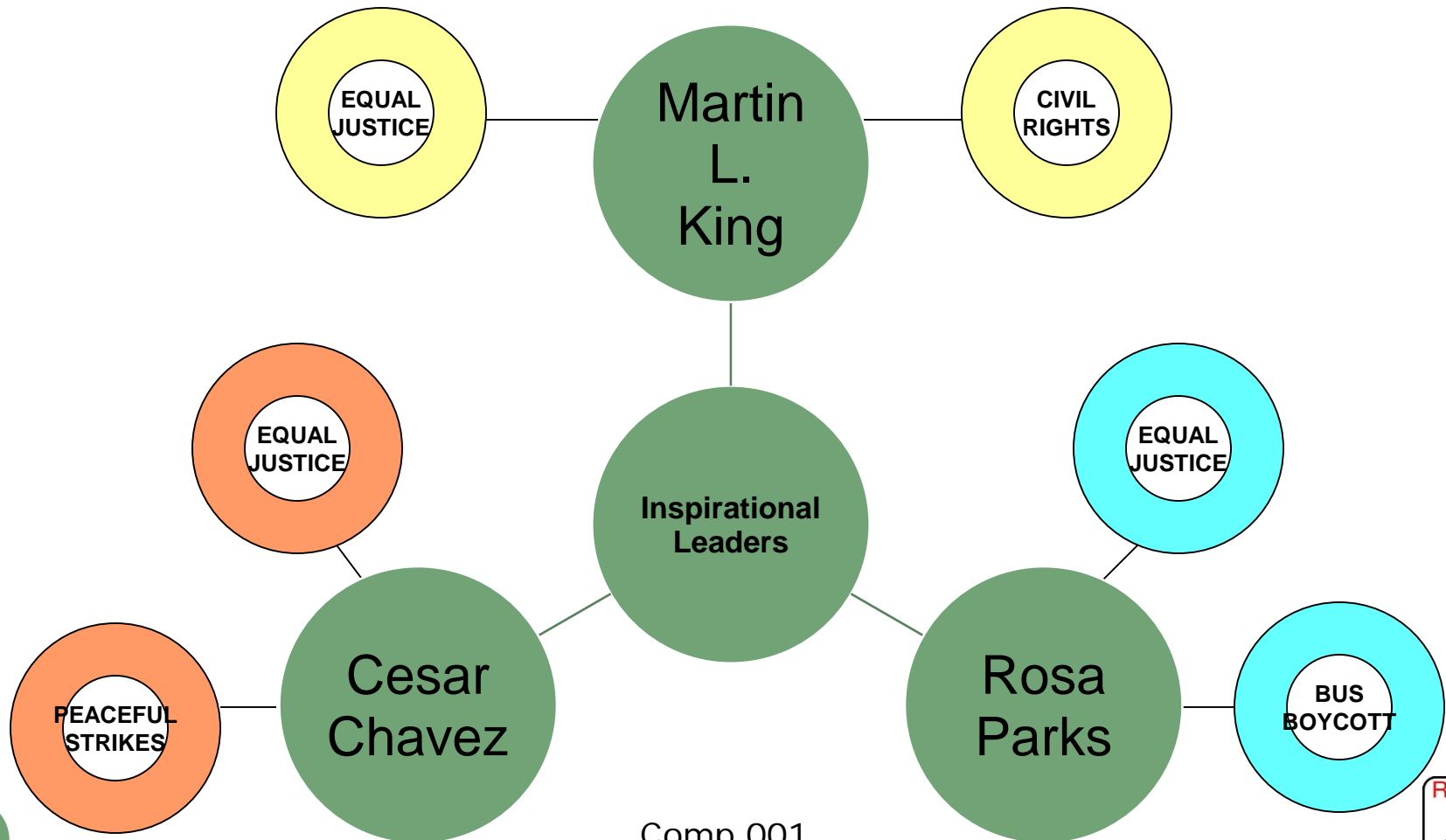

Cognates



Cognates are words from different languages that are spelled almost the same and share similar meanings.

- For example, there are many words in English and Spanish that look alike and have similar meanings.
- There are three levels of cognates:
 - True Cognates
 - Partial Cognates
 - False Cognates

True Cognates

Words are spelled the same, the meaning is the same.

The difference will be in pronunciation and placement of accent.

Example:

- (English) cafeteria
- (Spanish) cafetería



Partial Cognates

Words are spelled from the same origin, but the spelling will have a different suffix or prefix.

Example:

- (English) fragrance
- (Spanish) fragancia

The meaning is the same but the spelling is different and pronunciation will be different.

False Cognate

Words spelled from the same origin, but the spelling will have a different suffix or prefix and the meaning will be different than anticipated according to common origin.

Example:

- (English) exit = to go out or leave
- (Spanish) éxito = success



Discourse

A continuous **stretch** of speech or written text, going beyond a sentence to express thought.

For example: style in writing or rules of conversation



Discourse: Things to consider

- Cultural rules for conversation
 - ex: taking turns, opening conversation (How are you?)
- Differences between written and spoken discourse
- Rhetorical patterns – ways information is ordered in text
 - ex: linear vs. curvilinear
- Cohesion Devices – help connect sentences together in a text
 - Reference (ex: pronouns)
 - Conjunctions (then, therefore, afterwards, etc.)
 - Substitution (ex: I do too.)
 - Lexical cohesion (I opened the box. The lid broke.)

Pragmatics

The study of how the meaning conveyed by a word or sentence depends on the context in which it is used.



Ex: Such as time, place, social relationship between speaker and hearer, and speaker's assumption about the hearer's beliefs.



Pragmatics Examples

- The language of a waiter who wants a good tip
- Politically correct language
- The language used by a teenager who wants to borrow the car
- Sarcasm

Dialect

A variety of a language defined by both geographical factors and social factors, such as class, religion and ethnicity.



Tonal Register

level of tone of speech
(high, medium, low)
includes stress.



In tonal language, pitch at which syllables in a word are pronounced can make a difference in word meaning.

(ex. Thai, Mandarin and dialects of Chinese, Vietnamese, some African languages, some Native-American languages)

Language Register Categories

1. Frozen (ex. "Happy Birthday", "The Pledge of Allegiance")
2. Formal – standard English
3. Consultative – less direct than formal English
4. Casual – general vocabulary, maybe poor syntax
5. Intimate – language of lovers and twins

Language Register Examples

	Informal Register			Formal Register	
--	--------------------------	--	--	------------------------	--

- The water disappeared.
- It sucks it up.
- The car follows the magnet.
- He is psycho.
- You're in my bubble.

- The water evaporated.
- A vacuum was created because...
- The magnet force pulled the metal car through the thickness of the desk.
- He had a nervous breakdown.
- My personal space is being violated.

Understanding Language Proficiency in Social and Academic Settings

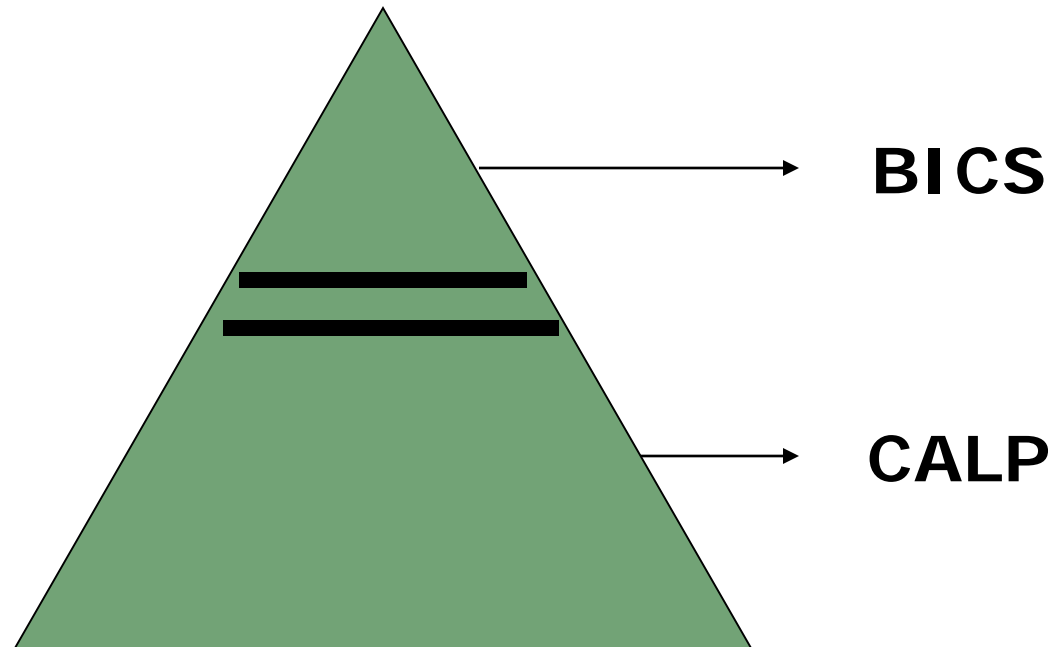

- BICS: Basic Interpersonal Communicative Skills
- CALP: Cognitive Academic Language Proficiency

BICS



Factors:

- Casual
- Practical
- Social
- Everyday
- Context embedded
- 1 to 2 years to reach native fluency

Purpose:

- Express wants / needs
- Make jokes
- Exchange greetings
- Express agreement or disagreement
- Make personal conversation

CALP

Factors:

- Academic
- Higher level vocabulary
- Language of education, textbooks, literacy, content areas, formal writing
- 5 to 7 years to reach native fluency

Purpose:

- Comprehend written text
- Produce written text
- Ask/answer informational and clarifying questions related to academic content
- Make connections involving academic information
- Conduct research



Cummins' Model of Academic Language

Cognitively Undemanding

Context Embedded	A. <ul style="list-style-type: none">• Follow simple directions• Face-to-face conversations	C. <ul style="list-style-type: none">• Telephone conversations• Note on refrigerator• Texting	Context Reduced
	B. <ul style="list-style-type: none">• Demonstrations• A-V assisted lesson• Science experiments• Social Studies projects	D. <ul style="list-style-type: none">• Reading a textbook• New, abstract concepts• Lecture, few illustrations• Math concepts & application	

Cummins, J. - The Role of Primary Language Development in Promoting Educational Success for Language Minority Students, 1981

Cognitively Demanding

Brain Lateralization

The allotment of certain functions to the left or right hemispheres of the brain.

- Affects language acquisition
- Left-Logic, literal, grammar & vocabulary, fact retrieval
- Right-Holistic, pragmatic, contextual, artistic, spatial



Language Arts – An Interrelated Process

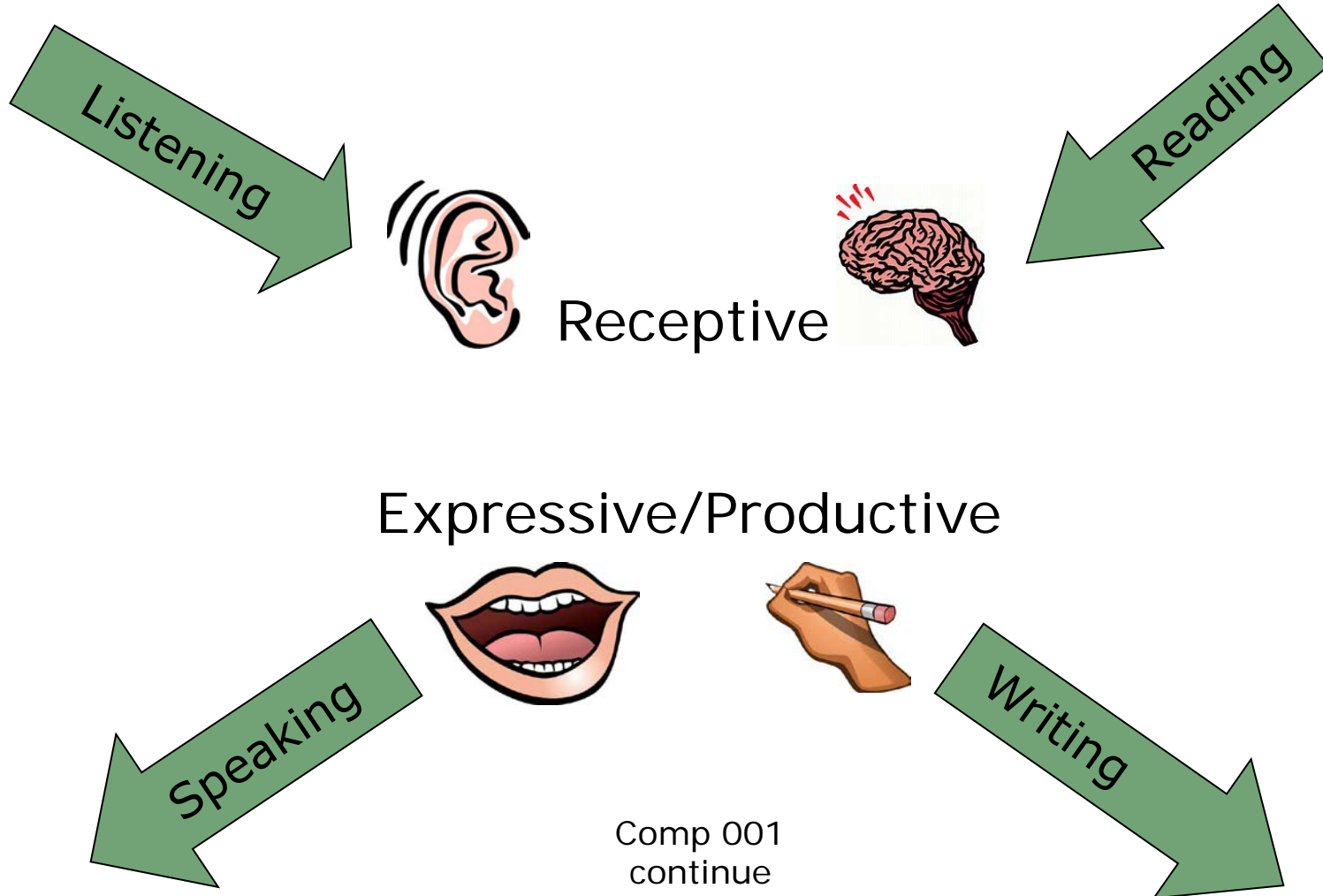

Comp 001
continue

Language Instruction

Step 1: Integrate the Skills

- Four domains (listening, speaking, reading, and writing) should be taught in an integrated manner as they are used in **authentic communication**.
- Skills reinforce one another.

Language Instruction

Step 2: Use Content-Based Instruction

- Opportunities for meaningful communication
- Concurrent social and cognitive development
- Wide range of academic concepts and language functions

Language Instruction

Step 3: Use Task-Based Instruction

- Real-life tasks combine languages with non-linguistic function
- Focus on meaning
- Requires information gathering, comprehension, interaction, language production



Competency 002

The ESL teacher understands the process of first-Language (L1) and second-Language (L2) acquisition and the interrelatedness of L1 and L2 development.



Competency 002 Components

- Knows **theories, concepts, and research related to L1 and L2** acquisition.
- **Uses** knowledge of **theories, concepts, and research related to L1 and L2 acquisition** to select effective, appropriate methods and strategies for promoting students' English language development at various stages.
- Knows **cognitive processes** (e.g. **memorization, categorization, generalization, metacognition**) involved in synthesizing and **internalizing** language rules for second language acquisition.
- **Analyzes the interrelatedness of first and second language acquisition** and ways in which L1 may affect development of L2.
- Knows **common difficulties** (e.g., **idiomatic expressions; L1 interference in syntax, phonology, and morphology**) experienced by ESL students in learning English and effective strategies for helping students overcome those difficulties.



Stages of First Language Development

(Pre-linguistic)

1. Babbling
2. Holophrastic
3. Two-Word
4. Telegraphic
5. School Age

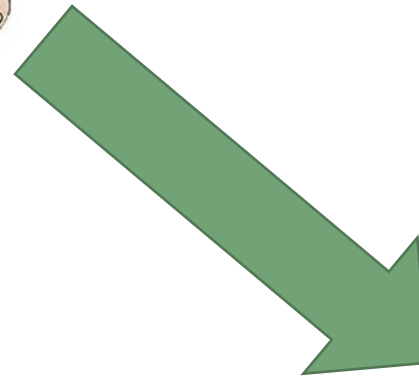

Stages of Language Development

Pre-linguistic

- Universal sounds
- Cries, whimpers, coos
- Stimulus-controlled, involuntary
- Not creative, so not language yet



Stages of Language Development

Babbling (6 months)

- Large variety of sound
- Learning to distinguish native language sounds
- Begin to resemble adult speech pitch

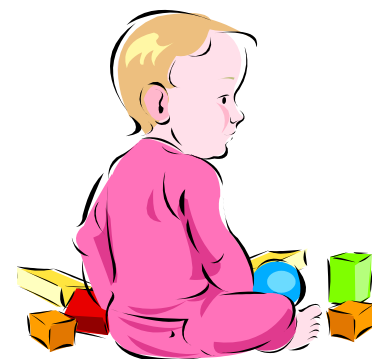

Stages of Language Development

Holophrastic (8-14 months)

- Complete ideas in one word sentences
- Sound/meaning connected
- Concerns actions, emotions, naming
- Can comprehend more than can produce



Stages of Language Development

Two-Word (12-18 months)

- Holophrastic strings at first
- Evolves to clear syntactic and semantic relations

(ex: bye bye boat, all gone sticky, here pretty, me go)



Stages of Language Development

Telegraphic (18-24 months)

- Main message words (content)
- Sentence-like grammar
- *-ing* morpheme, in and on prepositions, regular plurals

(ex: Andrew want that, No sit there, What that?)



Stages of Language Development Preschool and School Age

- Simple syntactic structures (3-4 yrs.)
- Speech sounds correctly pronounced (4-8 yrs.)
- Improves language deductively
- Formal teaching introduced
- Language learning (pragmatics, registers)
- Most semantic distinctions understood (9-11 yrs.)



Language Development Theories

- Nativism / Innatist
- Behaviorism
- Constructivism / Interactionist
- Communicative Approach

Nativism / Innatist (Chomsky)

- Learn through natural ability
- Cannot fully utilize language without the presence of other humans
- Do not require formal teaching
- The principles of language are possible because they are **innate**.



Behaviorism (Skinner)

- Brain is a blank slate
- Imitation of input from environment
- Habit formation by repetition
- Errors due to habits
- Contrastive analysis can predict L2 errors (L1 interferes with L2 acquisition)
- Audio-lingual methods (in classroom)

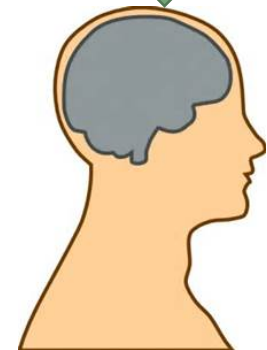

Constructivism (Piaget)

- Learning result of social interaction
- Children construct understanding in context of their activities
- Early language is egocentric
- Brain learns when ready
- Progress from concrete to more abstract, from figurative to operative
- Exploratory, discovery learning (in classroom)

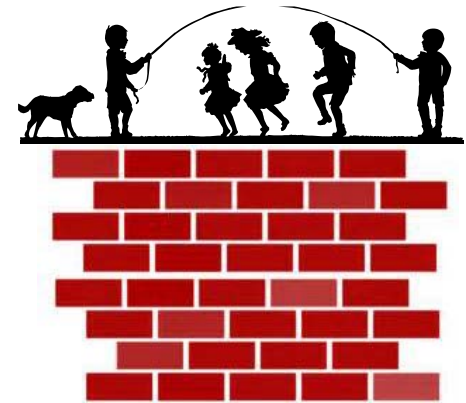

Communicative Approach (Krashen)

Two separate processes
in development of language –

acquisition and **learning**



Communicative Approach: Language Acquisition

- Natural, subconscious process
- Occurs when person lives and functions in a language
- Begins with oral language
- Natural Order Hypothesis (grammatical structures internalized subconsciously in predictable order, similar in L1 and L2 but not same)
- Errors part of developmental process

Communicative Approach: Language Learning

- Formal, conscious process
- Occurs in formal classroom setting
- Includes rules for spelling, grammar, punctuation (learned and consciously applied). Some grammatical forms may not develop without explicit instruction.
- Most effective when focus is on limited number of rules at a time
- Should not be emphasized in early stages



Communicative Approach: **Krashen's Model**

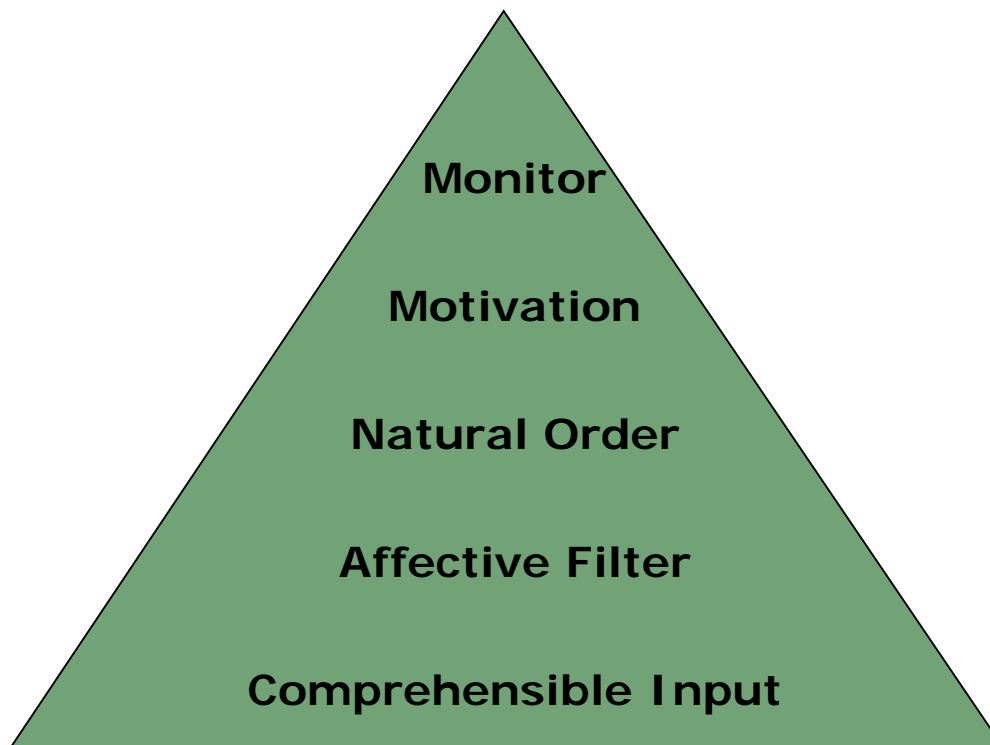

Communicative Approach: Comprehensible Input

- A hypothesis that learners will acquire language best when they are given the **appropriate input**.
- The input should be easy enough that they can understand it, but **just beyond their level of competence**.
- Activities
 - Illustrations/Visuals (Visual Narrative)
 - Experiments
 - Cloze Activities
 - Mix and Match Word Sorts



Communicative Approach: **Affective Filter**

- This hypothesis states that students must have a **risk-free environment** in which to acquire and learn a second language.
- The **needs and emotional states** of students will affect whether or not input will be readily available and comprehensible to them.

Affective Variables



Inside the Classroom

- Teacher expectations
- Grouping practices
- Opportunities

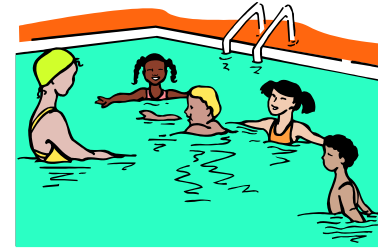

Outside the classroom

- Peer interaction
- Grouping practices
- Community characteristics (subtractive or additive bilingualism)

Communicative Approach: Natural Order

- States that students acquire the rules of language in **predictable sequence**
- According to Lightbrown and Spada (1996, p. 29), developmental sequences are **similar across learners from different backgrounds**: “What is learned early in one language is learned early by others.”

Communicative Approach: Motivation

- The primary reason most of us learn our first language is grounded in the **need to belong** to the community in which we were born.
- A large portion of motivation to learn a second language comes from the same sense of **need for acceptance** and the **desire to interface** with the new community or culture.

Communicative Approach: **Monitor**

- Grammatical structures acquired in a natural order
- **Conscious knowledge** of rules comes later
- With conscious knowledge comes **ability to edit** (monitor) oral and written language
- Must have **sufficient time**



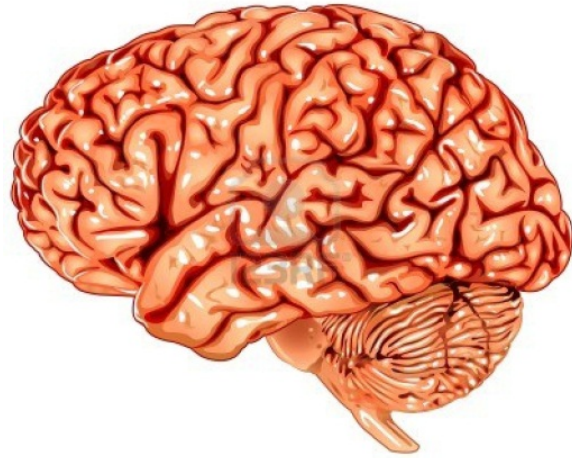

Instructional Implications of Second Language Acquisition Theories



L1 Influence on L2 Acquisition

- Learners fall back on L1 if forced to use L2 before they are ready
- Borrowing (incorporation of linguistic material from one language into another) is common throughout most languages
- Code-switching (alternating between one language and another among bilinguals) is normal

Other Language Implications in L2

Idiomatic Language:

- Ex: "It's raining cats and dogs."
- Meaning: very heavy rainfall

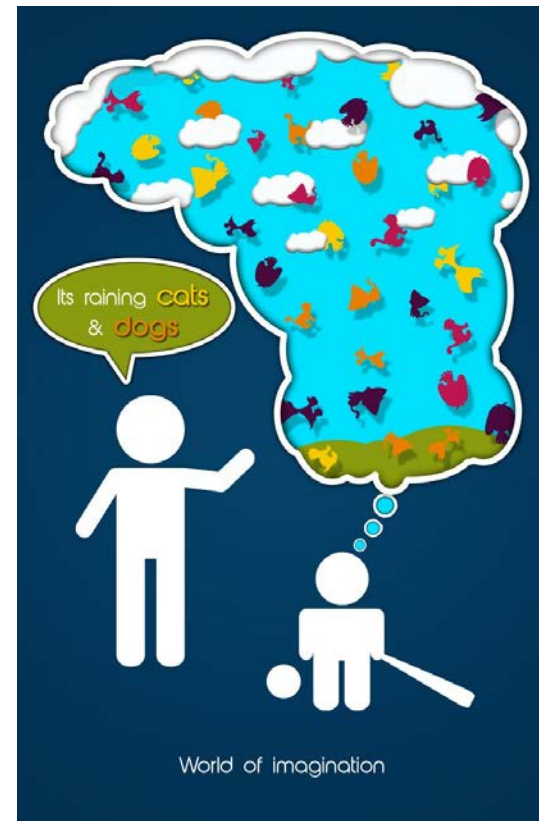

Language Structure Transfer Difficulties

English Structure	Language Transfer Issues	Sample English Errors
Pronouns	No subject or object pronoun distinction	<ul style="list-style-type: none">• I gave the form to she. = I gave the forms to her.• She hurt the leg. = She hurt her leg.

Acquiring a Second Language for School: A Conceptual Model

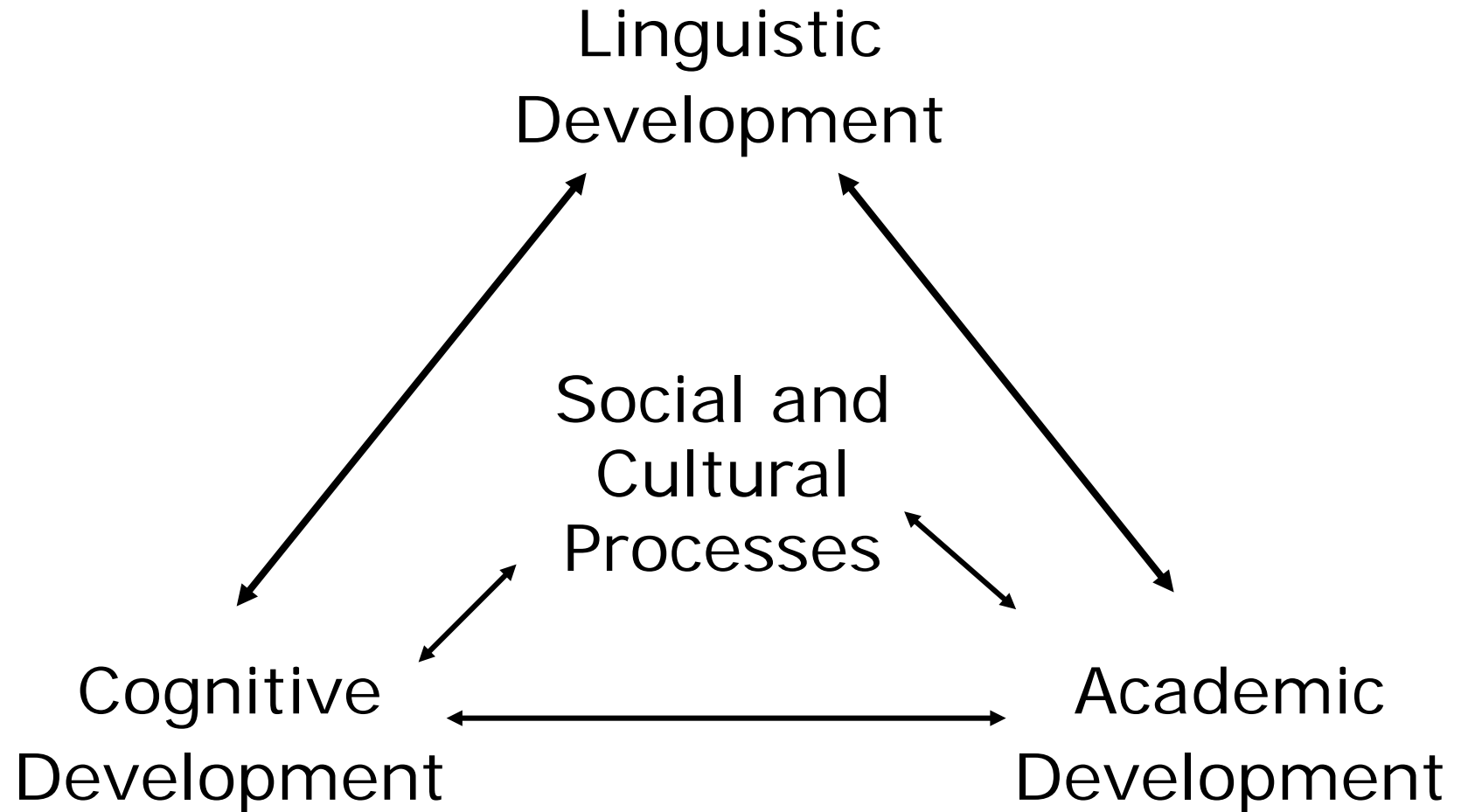

(Thomas & Collier)



Acquiring a Second Language for School: **Sociocultural Processes**

- Past Experiences: War, insecure living arrangements, economic situation, amount of past schooling, type of past schooling
- Current Experiences: Socioeconomic status, home literacy, exposure to standard L2, cultural stereotyping, minority status, patterns of assimilation or acculturation
- Personal: Self-confidence, self-esteem, lowered anxiety

Acquiring a Second Language for School: **Linguistic Development**

Includes:

- Subconscious aspects of language development (innate ability)

AS WELL AS...

- Conscious, formal teaching of language and acquisition of the written system of language

Acquiring a Second Language for School: **Cognitive/Academic Development**

- Acquisition of academic L2 (CALP) closely connected to cognitive development in L1
- Skills transfer from L1 to L2
- L1 maintenance/L1 literacy in home correlate positively

Learning Strategies to Increase CALP

(Chamot and O'Malley)

Metacognitive

- Planning for learning
- Monitoring one's own comprehension and production
- Evaluating how well one has achieved a learning objective

Cognitive

- Manipulating material to be learned mentally (ex: imagery elaborating)
- or physically (ex: group items to be learned, taking notes)

Social / Affective

- Interacting with another person to assist learning (ex: cooperative learning)
- Asking for clarification
- Using affective control to assist learning tasks





Metacognitive Strategies

- Students need to develop a mind set that **reading is thinking** and need to demand that **what they are reading makes sense**.
- They need to be able to **interact, engage, and construct** meaning using different strategies to develop their own comprehension.

Cognitive Strategies

3 Categories:

Rehearsal

Organization

Elaboration

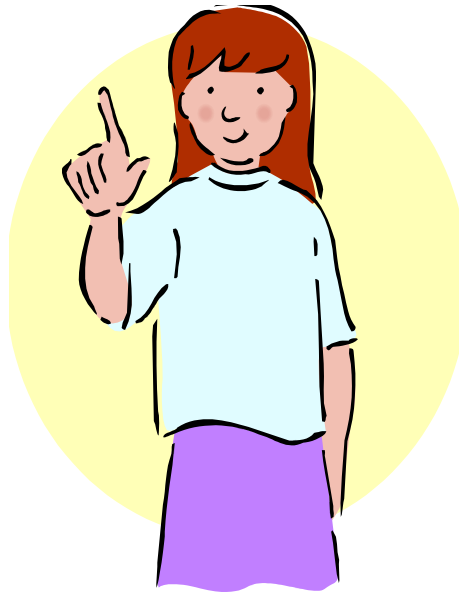

Examples:

- Identifying similarities & differences
- Note taking
- Reading Comprehension Strategies
- Vocabulary Strategies
- Visualization
- TPR
- Brainstorming techniques

Social/Affective Strategies

**Require
Cooperation**



Why Strategies are Important

Help to create more effective learners



Comp 002
continue

Why Strategies are Important

- Strategies represent the dynamic **processes** underlying learning
- Active learners are better learners
- Strategies can be learned
- **Academic language** learning is more effective with learning strategies
- Learning strategies **transfer** to new tasks

How to Teach Strategies

- Develop the students' awareness by providing a **variety** of activities
- Strategies are **taught explicitly** by:
 - Modeling how to use the strategy
 - Naming the strategy
 - Telling students how the strategy will assist them in learning the material
 - Describing when, how, and for what kinds of tasks the strategy can be used

How to Teach Strategies

- Provide ample **instructional supports** while students **practice** and **apply** the strategy
- Help students be aware of which strategies work for them and why through **self-evaluation**
- Encourage students to use the strategies in **other learning situations**



Remember to teach at the
strategy level not just the
activity level.

How to Select Strategies

- The **curriculum** determines the strategy
- Start with a **small number** of strategies
- Use tasks of **moderate** difficulty
- Choose strategies with strong empirical **support** (ELPS, Marzano)
- Use strategies that **apply to different content areas**

ELPS Learning Strategies

- A. use prior knowledge and experiences to understand meanings in English;
- B. monitor oral and written language production and employ self-corrective techniques or other resources;
- C. use strategic learning techniques such as concept mapping, drawing, memorizing, comparing, contrasting, and reviewing to acquire basic and grade-level vocabulary;
- D. speak using learning strategies such as requesting assistance, employing non-verbal cues, and using synonyms and circumlocution (conveying ideas by defining or describing when exact English words are not known);
- E. internalize new basic and academic language by using and reusing it in meaningful ways in speaking and writing activities that build concept and language attainment;
- F. use accessible language and learn new and essential language in the process;
- G. demonstrate an increasing ability to distinguish between formal and informal English and an increasing knowledge of when to use each one commensurate with grade-level learning expectations; and
- H. develop and expand repertoire of learning strategies such as reasoning inductively or deductively, looking for patterns in language, and analyzing sayings and expressions commensurate with grade-level expectations.



Myths for Discussion

1. Students can learn a language quickly and easily.
2. Students automatically learn another language when immersed in an environment where everyone speaks that language.
3. All students learn a second language in the same way.
4. Students have acquired a second language once they can speak.
5. Students need to learn grammar and vocabulary before they can speak.
6. The first language significantly interferes with acquisition of a second language.



Myths for Discussion continued

7. Second language learners will lose proficiency in L2 if they continue to speak L1 at home.
8. A second language speaker must always translate from L1 to L2.
9. Accented pronunciation indicates a lack of proficiency in a second language.
10. Certain home countries and languages are more conducive to a student's learning of a second language.
11. L2 students need to be taught basic skills before they can do more complex tasks.
12. L2 students must have a large oral language base before reading and writing can be introduced.



DOMAIN II

ESL INSTRUCTION AND ASSESSMENT

Competency **003**, 004, 005, 006, **007**

45% of test

Competency 003

The ESL teacher understands ESL teaching methods and uses this knowledge to plan and implement effective, developmentally appropriate instruction.



Competency 003 Components

- **Knows applicable Texas Essential Knowledge and Skills (TEKS) and the English Language Proficiency Standards (ELPS)** and knows how to design and implement appropriate instruction to address the domains of listening, speaking, reading, and writing.
- **Knows effective instructional methods, resources, and materials** appropriate for addressing specified instructional goals and promoting learning in students with diverse characteristics and needs.
- **Applies knowledge of effective practices, resources and materials** for providing **content-based ESL instruction**, engaging students in **critical thinking**, and **fostering students' communicative competence**.
- Knows how to **integrate technology tools** and resources into the instructional process to facilitate and enhance student learning.
- Applies **effective classroom management** and teaching strategies for a variety of ESL environments and situations.



TEKS

- ELLs are responsible for mastery of the **same grade level content area TEKS** as native English speaking students.
- Teachers must teach **all of the content area TEKS** and develop **higher order thinking skills** for ALL students regardless of their language proficiency level.

ELPS Framework

A. Introduction

- Required curriculum
- Integrate social and academic English in content areas
- Apply to K-12



Required in all content areas

B. District Responsibilities

- Identify student proficiency levels
- Linguistically accommodated content instruction:
Communicated, Sequenced, Scaffolded
- Content-based language instruction
- Instruction for B/I ELLs:
Focused, Targeted, Systematic

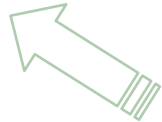

Applies to your daily instruction

C. Student Expectations

- Learning strategies
- Listening
- Speaking
- Reading
- Writing

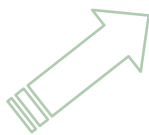

Use to write Language Objectives

D. Language Levels

(Proficiency Level Descriptors)

- Beginning
- Intermediate
- Advanced
- Advanced High

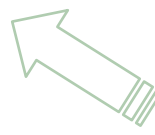

Use to evaluate student progress



TEKS/ELPS Connection: Writing Language Objectives

- **Content Objective:**

- SWBAT _____ by _____.
(TEKS) (academic task)

- **Language Objective:**

- SWBAT _____ using _____.
(ELPS) (specific terms/stems/tools)

Example of Content and Language Objectives

Content Objective:

- SWBAT compare/contrast states of matter by creating a 3 circle chart.
(TEKS) (academic task)

Language Objective:

- SWBAT write using matter, mass, volume, and atom appropriately.
(ELPS) (specific words/stems/tools)

Combined Content and Language Objective Example:

- SWBAT compare and contrast states of matter **in writing**, using a graphic organizer **and summarizing with new vocabulary**.

Why the ELPS?

- ELL's benefit from content area instruction that is **accommodated to their need for comprehensible input**. (Krashen, 1983; Echevarria, Vogt, and Short, 2008)
- ELL's benefit from academic language instruction **integrated** into content area instruction. (Crandall, 1987; Snow et. al, 1989)
- ELL's benefit from programs that hold **high expectations** for students for academic success. (Samway and McKeon, 2007)
- Language proficiency standards provide a **common framework** for integrating language and content instruction for English learners. (Short, 2000)



Meeting Needs of All Learners

- Students' feelings of comfort with instructional settings and activities come from both cultural and individual preferences.
- **Use a variety of formats to meet the multiple needs of your diverse students.**

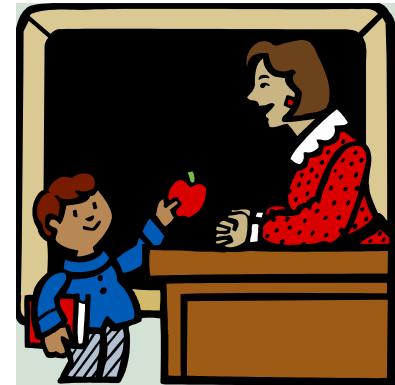

Maslow's Hierarchy of Human Needs

Need for safety and security



- Assign buddies
- Establish predictable classroom routines



Need for a sense of belonging

- Make personal contact with students – greetings, smiles, eye contact

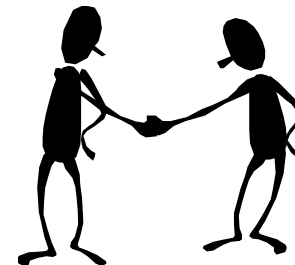

Socioculture/Communicative Theory (Vygotsky)

Learning occurs within the interpersonal space of teacher-student interactions. Temporary support (scaffolding) is essential.

Zone of Proximal Development

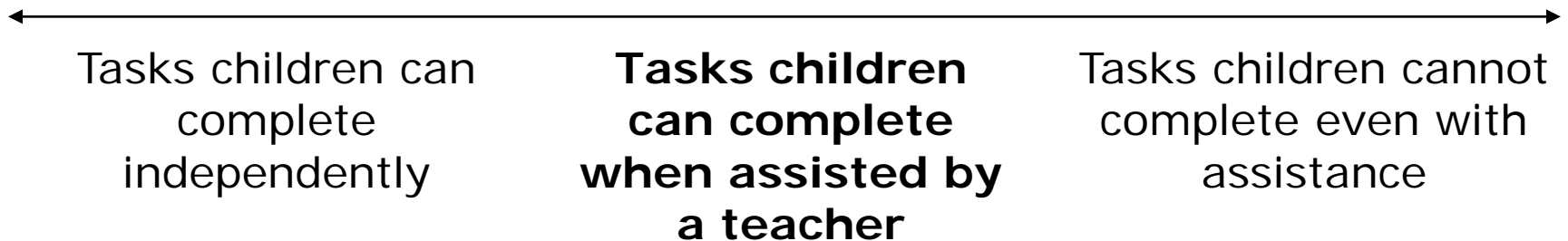

Scaffolding

It is important to work through all four stages.

1. Teacher does. Student watches.
2. Teacher does. Student helps.
3. Student does. Teacher helps.
4. Student does. Teacher watches & is ready to step in with support when necessary.



Appropriate ESL Instruction

- Grounded in second language acquisition
- Integrates all language arts skills
 - Listening
 - Speaking
 - Reading
 - Writing
- Is provided on a continuous and daily basis



Importance of Integrating Skills

“Practice in any one process contributes to the overall reservoir of second language, which is then available for other acts of listening, speaking, reading, or writing.”

Peregoy & Boyle, 2001



ESL Teaching Methodology

Old

Inconsistent and
poorly defined
ESL programs

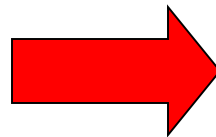

New

Structured oral ESL
and literacy-based
ESL instruction

ESL Teaching Methodology

Old

Generic English reading strategies

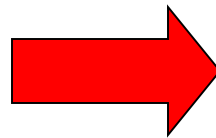

New

Language specific teaching strategies

(adapted from Escamilla, 2004)

Just good teaching?

- Sheltered instruction uses many of the strategies found in high quality non-sheltered instruction.
- However, it also includes careful attention to second language development needs not found in mainstream classes.

What is Sheltered Instruction?

A means for **making grade-level academic content** (e.g. science, social studies, math) **more accessible** for English language learners **while** at the same time **promoting their English language development.**

SIOP Model

- SIOP (Sheltered Instruction Observation Protocol): researched-based model of instruction used to improve academic language proficiency in English language learners.
- Attention to content objectives, language objectives, background knowledge, interaction, meaningful activities



CALLA Model (Chamot & O'Malley)

Cognitive **A**cademic **L**anguage **L**earning **A**pproach

- Through carefully designed lesson plans tied to content curriculum, teachers explicitly teach learning strategies and have students apply them to instructional tasks.
- Plans are based on these assumptions:
 1. Mentally active learners are better learners.
 2. Strategies can be taught.
 3. Learning strategies transfer to new tasks.
 4. Academic language learning is more effective with learning strategies.

Currently accepted ESL methods all use these basic strategies:

- Visuals – pictures, realia, video
- Vocabulary development – attention to teaching core vocabulary
- Active learning – process and apply new content and skills
- Interaction – use multiple grouping configurations
- Learning Strategies – help students monitor their own learning



Accommodations for Mathematics

Instructional strategies may include the following objectives:

- to help students build card files and glossaries on mathematics vocabulary
- to show the same information through a variety of difference graphs and visuals
- to encourage students to underline key words or important facts in their written assignments
- to encourage students to underline key words into meaningful groups to pair students for team learning
- to teach English expressions for mathematical operations such as “square”, “add”, and “multiply”
- to teach words that indicate quantitative relationships such as “more”, “less”, “larger”, and twice as many”

Texas Education Agency Bilingual/ESL Unit 136 September 2007

Comp 003
continue



Accommodations for Social Studies

Instructional strategies may include the following objectives:

- to help students build individual card files on needed vocabulary for social studies
- to show the same information through a variety of different graphs and visuals
- to build vocabulary needed to read maps and legends as these are discussed
- to encourage students to underline key words or important facts in their written assignments
- to teach necessary vocabulary for sorting categories of social studies concepts into groups and
- to explain this vocabulary in words known to the student



Accommodations for Social Studies

Instructional strategies may include the following objectives:

- to use student pairs for team learning (cooperative learning) especially for reports
- to teach the vocabulary helpful in evaluating material for logic of written expression and for categorizing as opinion or fact
- to write shorter and less complex sentences and paragraphs with fewer sentences for easier comprehension
- to use language experience techniques in discussing concepts and ideas
- to teach the words that signal sequence
- to check understanding of written language that may convey complex concepts



Accommodations for Language Arts

Instructional strategies may include the following objectives:

- to explain special vocabulary terms in words known to the students
- to write shorter and less complex sentences
- to assign short homework tasks that require reading
- to teach the words that signal sequence
- to check understanding of written language that may convey complex concepts



Accommodations for Language Arts

Instructional strategies may include the following objectives:

- to rewrite story problems in simpler English by using shorter sentences and pictures
- to teach new vocabulary in each day's unit and to review terms already mastered
- to tape short stories for independent listening assignments
- to de-emphasize speed and emphasize accuracy of reading
- to help students organize their materials, set realistic goals, and develop independent study habits



Accommodations for Science

Instructional strategies may include the following objectives:

- to practice cause and effect relationships in the environment, laboratory, and on field trips facilitated by providing language and visual cues
- to teach the special vocabulary of the scientist, particularly verbs such as discover, classify, and hypothesize
- to help students build notebooks of their hypotheses, materials, procedures, data, and conclusions or experiments and field experiences
- to ask numerous questions which require higher level thinking responses
- to limit the number of variables in laboratory experiments



Accommodations for Science

Instructional strategies may include the following objectives:

- to show the same information through a variety of different charts and visuals
- to develop meanings through the science materials and activities rather than in terms of the equivalent words of the students' vernacular since direct translations often do not convey the exact meaning
- to stress definitions of terms based on the students' observations
- to read a variety of sources to highlight contributions of scientists, inventors, and researchers
- to contrast interrogative, negative, and affirmative statements drawn from the science lesson



Accommodations for Science

Instructional strategies may include the following objectives:

- to encourage careful, thoughtful reading of short selections in which one main idea is presented
- to encourage students to underline key words or important facts in written assignments
- to teach interrogative words and expressions and show how they are used in science to answer such questions as who, how, when, and where and higher level questions
- to encourage complete sentences, correct spelling, and accuracy of expression of science methods and language



Overall, Teachers Must...

- Make content comprehensible
- Build academic language
- Provide linguistic accommodations
- Teach higher order thinking skills

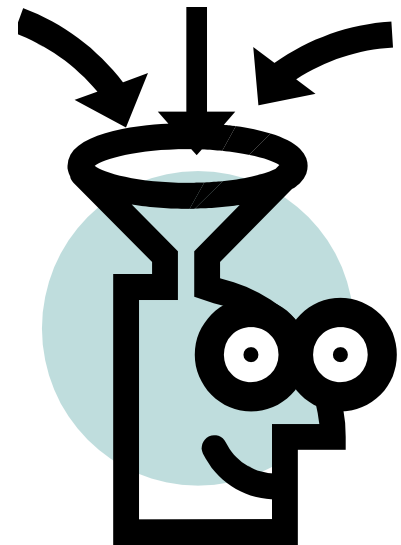

Higher Order Thinking Skills...

Are Not...

Questioning techniques that ask students to recall:

- *Who was the main character?*
- *What is the setting?*

Are ...

Questioning techniques that require students to analyze, evaluate and synthesis...

- *How does character A compare to character B?*
- *Why do you think the character made that choice?*
- *What would you have done different if you were the character?*

Keep in mind...

Classroom Management

Behavior is affected by:

- Cultural factors
- Maslow's hierarchy of basic human needs

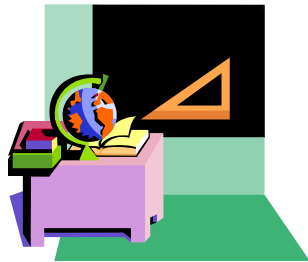

Competency 007

The ESL teacher understands formal and informal assessment procedures and instruments used in ESL programs and uses assessment results to plan and adapt instruction.



Competency 007 Components

- Knows basic concepts, issues, and practices related to test design, development, and interpretation and uses this knowledge to **select, adapt, and develop assessments for different purposes** in the ESL program.
- Applies **knowledge of formal and informal assessments** used in the ESL classroom and knows their characteristics, uses, and limitations.
- Knows **standardized tests commonly used in ESL programs in Texas** and knows how to interpret their results.
- Knows **state-mandated LEP policies**, including the role of the LPAC, and procedures for implementing LPAC recommendations for LEP identification, placement, and exit.
- Understands **relationships among state-mandated standards, instruction, and assessment** in the ESL classroom.
- **Knows how to use ongoing assessment to plan and adjust instruction** that addresses individual student needs and enables ESL students to achieve learning goals.



Two Types of Assessment

Assessment may fall into two categories:

- **Formal assessments** have data which support the conclusions made from the test. Usually referred to as standardized measures.
- **Alternative assessments** (also called Informal or Authentic) are not data driven but rather content and performance driven.

Formal Assessments

- Designed according to rigorous testing theory and principles including field testing.
- Has established *validity* – items closely reflect the knowledge or skills to be measured.
- Has established *reliability* – gives similar results when retaken.

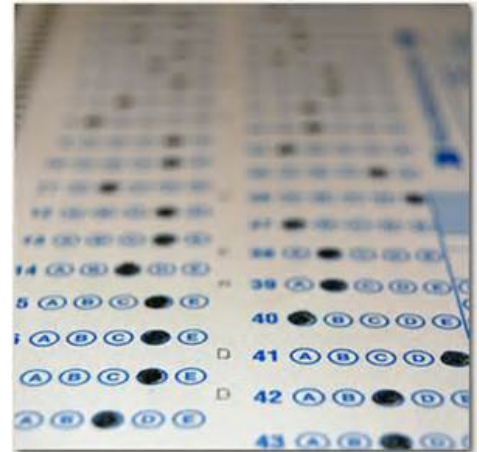

Alternative Assessment

- Developed within the context of the classroom
- Provides direct measure of student's ability
- Shows how student learns, the strategies used
- Reveals higher-order thinking skills: synthesis, inference, etc.
- Informal – ongoing, performance and content based
- Authentic – contextualized or “real world” tasks



Drawbacks of Formal Assessment

- Tends to fragment skills – knowing grammatical structures doesn't mean the student can write
- May not show whether students really know the material – students may randomly choose correct answers on multiple choice tests
- “Single-occasion” tests don't necessarily measure a student's competence, only how he performed on that occasion
- Could be culturally biased; norms are set for students from the mainstream culture

Drawbacks of Alternative Assessments

- Time-consuming to create and evaluate
- Cannot ensure validity and reliability of results
- Requires informed judgment to reach sound conclusion about student's learning and student progress

Examples of Alternative Assessments

- Oral interview – teacher asks student questions and makes note of responses
- Story or text retelling
- Writing samples
- Projects/Demonstration – individual or group
- Constructed response items – written response to open-ended questions
- Teacher observation of student attention, response to instructional activity, interaction with other students
- Portfolios – collection of student work to show progress over time



Guidelines for Alternative Assessments

1. Decide what students **should know and be able to do** at the end of the lesson or unit.
2. **Set the criteria** for excellent performance and for minimum passing performance. Create a scoring **rubric**. Unless language conventions are the purpose of the lesson, scoring criteria should be based on evidence of content knowledge not language proficiency.
3. Select an alternative assessment or allow **student choice** of several options. Use options that appeal to different learning styles: an analysis, a practical solution, an artistic interpretation, etc.

Guidelines for Teacher-made Assessments

Look at your test from an ESL student's point of view:

- Items are clearly written.
- Directions are easily understood.
- Examples of how to respond are provided.

Guidelines for Teacher-made Assessments

continued...

- Readability level of items should be commensurate with the language of the students.
- Example: A beginning level English speaking student would not be able to read a fifth grade text, so the teacher must take the fifth grade text and align it with appropriate strategies for the beginning student.
- Test has logical groupings of items of related content.

Guidelines for Teacher-made Assessments

continued...

- Higher-order thinking questions should be included on every test.
- Test covers important concepts, not trivia.
- Teacher grades short answer and essay questions based on student's meaning, not on grammatical errors.
- Test is not too long for time allowed.



Tests for ELLs in Texas

- The List of Approved Tests for Assessment of Limited English Proficient Students, Texas Education Code (TEC), §29.056(a)(2), **authorizes TEA to compile a list of approved assessments** for the purposes of **identifying** students as limited English proficient for **entry into or exit** (when appropriate) from bilingual education and/or English as a second language (ESL) programs; **annually assessing oral language proficiency** in English and Spanish when required; and measuring **reading and writing proficiency** in English and Spanish **for program placement**.

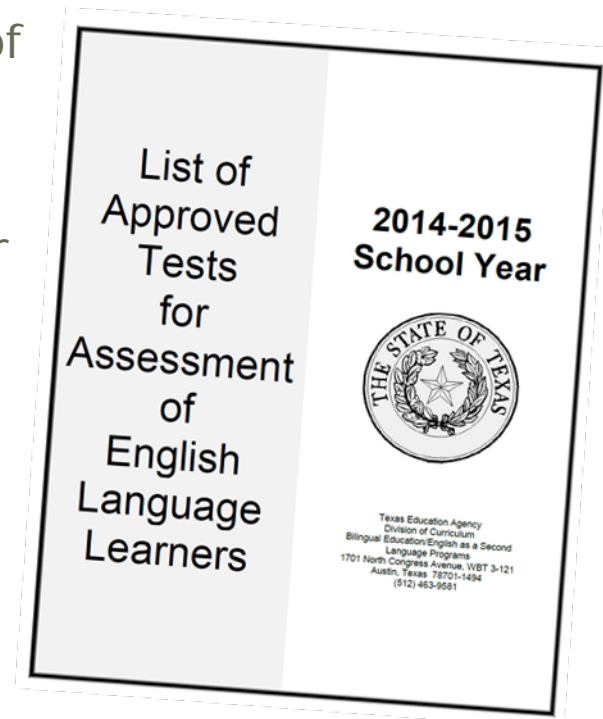

State-mandated LEP Policies

- *Commissioner's Rules Concerning Limited English Proficient Students:*
 - Chapter 89. Subchapter BB
(State Plan for Education LEP Students)
- *Texas Education Code:*
 - Chapter 29.063 (LPAC Committees)
- *Texas Administrative Code:*
 - Chapter 101. Subchapter AA (Participation of LEP Students in State Assessments)

ESL Program Components

Programs should address affective, linguistic, and cognitive needs through TEKS-based curriculum including:

- Oral language development
- Literacy
- Grade-level content
- Academic strategies

Assess progress with:

- TELPAS (language development)
- STAAR (academic development)





Every School District Must:

- Identify LEP students
- Provide the required bilingual education and/or ESL program for identified students
- Seek certified bilingual and ESL teachers



BE/ESL Requirements

- A district is required to provide:
 - bilingual education program if the district has 20 or more LEP students who speak the same language at the same grade level across the district
 - ESL program if the district has even one LEP student.

Required Curriculum for ELLs

Chapter 74.4 English Language Proficiency Standards (ELPS)

- School districts shall implement this section as an integral part of each subject in the required curriculum.
- The ELPS are to be published along with the TEKS for each subject in the required curriculum.

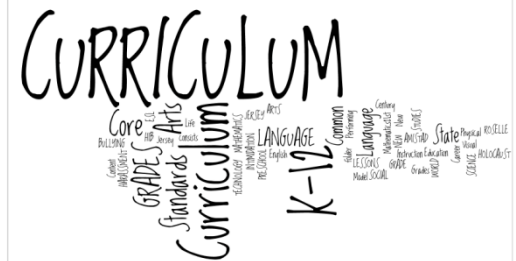

LPAC

Language Proficiency Assessment Committee

- The Language Proficiency Assessment Committee must be set up and trained by the district.
- Districts must establish a sufficient number of LPACs to enable them to discharge their duties.
- Required documentation regarding LPAC:
 - Certificate of training
 - Oath of confidentiality (parent member)
 - Minutes of meeting

LPAC Membership



Chapter 89.1220

(b) In school districts required to provide a bilingual education program, the language proficiency assessment committee shall be composed of the membership described in the Texas Education Code (TEC), §29.063:

- a professional bilingual educator,
- a professional transitional language educator,
- a parent of a limited English proficiency student,
- and a campus administrator.

LPAC Membership



Chapter 89.1220

(c) In school districts and grade levels not required to provide a bilingual education program, the language proficiency assessment committee shall be composed of

- one or more professional personnel
- a campus administrator
- a parent of an English language learner participating in the program designated by the school district



LPAC Responsibilities

- Review all pertinent information on all students whose home language survey indicates a language other than English
- Based on state criteria, determine whether or not the student qualifies as LEP
- Recommend appropriate language placement
- Determine appropriate tests and accommodations for state assessment
- Notify parents of designation and placement
- Obtain parent permission for placement

LPAC Responsibilities

continued...

- Keep documentation current (including PEIMS)
- Annually evaluate each student's progress
- Facilitate the participation of ELLs in other special programs for which they are eligible
- Exit students from BE/ESL when they have met state criteria
- Monitor exited students for two (2) years
- Notify parents of exit and document notification of exit

Parental Rights



Districts:

- Must request parental permission to place student in BE or ESL program
- Must provide information describing the benefits of the program

Parents:

- Must approve child's placement within the program
- May deny placement

Students:

- In grades 9-12 may sign their own home language survey (HLS)

Identification of ELL Students

Note: Identification and Entry are two distinct steps.

PreK – 1st

Assessed by TEA approved oral language proficiency test (OLPT) for each student who has a language other than English on the HLS.

Grades 2 – 12

Assessed by TEA approved OLPT for each student who has a language other than English on the HLS

and

Norm-referenced test from TEA list to check literacy and academic achievement.

List of approved tests is available at:
<http://elltx.org/assessment.html>

Uses of Assessment

Assessments are used for:

- Identification
- Program Placement
- Annual Assessment
- Formative Assessment
- Gifted/Talented
- Exit

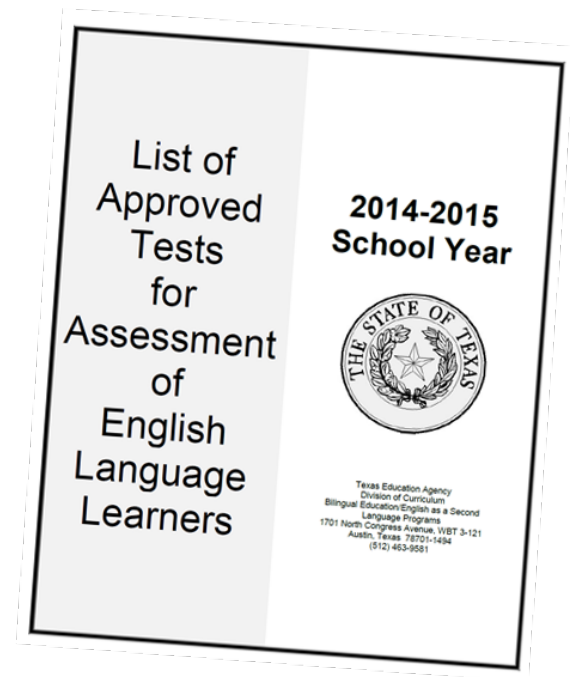

<http://tea.texas.gov/index4.aspx?id=25769814359>

Entry into BE/ESL Program

NEW TO TEXAS SCHOOLS ONLY

PK – 1

Qualifies for program if the student:

- Meets the qualifying criteria on the **OLPT** indicating limited English proficiency indicated on the TEA List of Approved Test, and
- Parents have approved and signed the parent permission form.

Grades 2 – 12

Qualifies for program if the student:

- Meets the qualifying criteria on the **OLPT** indicating limited English proficiency indicated on the TEA List of Approved Tests, or
- Meets the qualifying criteria on the **norm-referenced test** indicating limited English proficiency indicated on the TEA List of Approved Tests, and
- Parents have approved and signed the parent permission form.

Entry into BE/ESL Program

COMING FROM OR PREVIOUSLY IN TEXAS SCHOOLS...

Identification of Transferring Students

If the student transfers from a school in Texas:

- Review the withdrawal form, if available, to see if he/she was being served in a program or identified LEP in PEIMS.
- Try to get as much original documentation as possible, especially the HLS (document your attempts).
- The LPAC identifies and places student within the first **20 school days** of enrollment. Be sure that all of the necessary signed documents are in the student's LPAC folder.

22

Exit from BE/ESL Program

- Exit can only take place at the end of the year, **and** a student may not be exited in PK or K.
- Parent approval is considered valid until exit criteria are met.
- LEP students for whom the LPAC has recommended linguistic accommodations on the STAAR Reading or Writing test **may not** be considered for exit.

Exit from BE/ESL Program

Exit is determined by the LPAC at the end of the year, using the TEA Exit Criteria Chart which is based on the following criteria:

2015–2016 English Proficiency Exit Criteria Chart											
At the end of the school year, a district may transfer (exit, reclassify, transition) a LEP student out of a bilingual or ESL education program for the first time or a subsequent time if the student is able to participate equally in a regular all-English instruction program as determined by satisfactory performance in all three assessment areas below and the results of a subjective teacher evaluation. ¹											
For State of Texas Assessments of Academic Readiness (STAAR) English reading and English writing, the performance level for program exit is Level II (Satisfactory Academic Performance) or above.											
	1st	2nd	3rd	4th	5th	6th	7th	8th	9th	10th	11 th /12 th
Current School Year Oral = Listening & Speaking	Scored Fluent on English OLPT ²	Scored Fluent on English OLPT ²	Scored Fluent on English OLPT ²	Scored Fluent on English OLPT ²	Scored Fluent on English OLPT ²	Scored Fluent on English OLPT ²	Scored Fluent on English OLPT ²	Scored Fluent on English OLPT ²	Scored Fluent on English OLPT ²	Scored Fluent on English OLPT ²	Scored Fluent on English OLPT ²
English Reading ³	Norm-Referenced Standardized Achievement Test ² (Rdg./Lang.) 40th percentile or above	Norm-Referenced Standardized Achievement Test ² (Rdg./Lang.) 40th percentile or above	STAAR ⁵	STAAR ⁵	STAAR ⁵	STAAR ⁵	STAAR ⁵	STAAR ⁵	STAAR ^{4/5}	STAAR ^{4/5}	Norm-Referenced Standardized Achievement Test ² (Rdg./Lang.) 40th percentile or above Agency-Approved Writing Test ²
English Writing ³	Agency-Approved Writing Test ²	Agency-Approved Writing Test ²	Agency-Approved Writing Test ²	STAAR ⁵	Agency-Approved Writing Test ²	Agency-Approved Writing Test ²	STAAR ⁵	Agency-Approved Writing Test ²			
Subjective Teacher Evaluation	Assessments, anecdotal notes, portfolios, etc.										
¹ 19 TAC §89.1225(h) ² In the 2015–2016 List of Approved Tests for Assessment of Limited English Proficient Students available on the following web page: http://tea.texas.gov/bilingual/esi/education/ ³ For STAAR, English reading and English writing refer to the grade-level tests in grades 3–8 and to the applicable end-of-course English I and II reading and writing assessments. ⁴ Exception: Texas English Language Proficiency Assessment System (TELPAS) Reading and Writing Advanced High will be used for all students with the Texas Assessment of Knowledge and Skills (TAKS) as their graduation requirement under state policy. ⁵ Includes STAAR A without linguistic accommodations.											
Note: LEP students may be exited only after the end of first grade based on 19 TAC §89.1225(i). Note: LEP students for whom the LPAC has recommended linguistic accommodations on the STAAR reading or writing test should not be considered for exit.											



Exit from BE/ESL Program

All criteria for exit must be met based on the current TEA English Proficiency Exit Criteria Chart:

- Oral language fluency
- Academic competency
- Writing proficiency
- Teacher recommendation



Note: Exit cannot be based on TELPAS scores unless indicated in a specific section from the list of approved tests.

TELPAS

Texas English Language Proficiency Assessment System

- Students are rated based on the annual assessment of their proficiency in listening, speaking, reading, and writing.
- Designed specifically for all LEP students, including students who are parent denials
- All LEP students take the TELPAS annually until they meet exit criteria and are reclassified as non-LEP.
- Reports the progress LEP students make in English acquisition along a continuum of Beginner, Intermediate, Advanced, and Advanced High
- Every student should make adequate yearly progress by improving a level each year from beginning to advanced high, based upon the Proficiency Level Descriptors (PLDs).

TELPAS

Texas English Language Proficiency Assessment System

- **Grades K–1:** TELPAS includes holistically rated listening, speaking, reading, and writing assessments based on ongoing classroom observations and student interactions.
- **Grades 2–12:** TELPAS includes multiple-choice reading tests, holistically rated student writing collections, and holistically rated listening and speaking assessments. The listening and speaking assessments are based on ongoing classroom observations and student interactions.



TELPAS Holistic Rating

A holistically rated assessment process which is performance-based (using the Proficiency Level Descriptors—PLDs) is used for the following grades and language domains of TELPAS:

- Grades K-1: listening, speaking, reading, writing
- Grades 2-12: listening, speaking, writing

Proficiency Level →

Summary Statement →

Descriptors {

ELPS-TELPAS Proficiency Level Descriptors Grades K-12 Listening			
Beginning	Intermediate	Advanced	Advanced High
<p>Summary Statement: The student can understand and respond to simple spoken messages.</p> <p>Descriptors:</p> <ul style="list-style-type: none"> • understands simple spoken messages • understands simple spoken messages in context • understands simple spoken messages in context • understands simple spoken messages in context • understands simple spoken messages in context 	<p>Summary Statement: The student can understand and respond to simple spoken messages.</p> <p>Descriptors:</p> <ul style="list-style-type: none"> • understands simple spoken messages • understands simple spoken messages in context • understands simple spoken messages in context • understands simple spoken messages in context 	<p>Summary Statement: The student can understand and respond to simple spoken messages.</p> <p>Descriptors:</p> <ul style="list-style-type: none"> • understands simple spoken messages • understands simple spoken messages in context • understands simple spoken messages in context • understands simple spoken messages in context 	<p>Summary Statement: The student can understand and respond to simple spoken messages.</p> <p>Descriptors:</p> <ul style="list-style-type: none"> • understands simple spoken messages • understands simple spoken messages in context • understands simple spoken messages in context • understands simple spoken messages in context

TELPAS Writing - Grades 2 - 12

- Taken from authentic, performance-based classroom instruction that is grounded in the content area TEKS and ELPS
- Students are scored based on the Proficiency Level Descriptors (PLDs).
- TELPAS Writing collections are required to contain at least five writing samples including:
 - At least one narrative about a past event
 - At least two expository texts from math, science, or social studies.



TELPAS Reading - Grades 2 - 12

- Multiple-choice tests administered online
- Designed around the stages of second language acquisition, while language arts reading tests are designed around grade-level reading expectations.

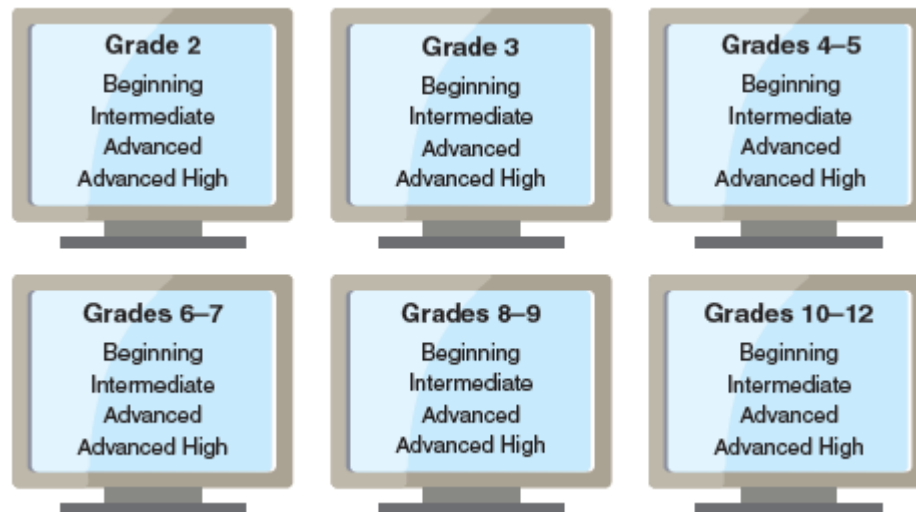

STAAR L

Linguistically Accommodated Assessment

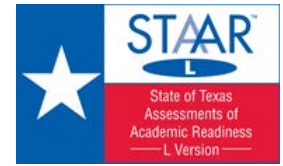

- Online, linguistically accommodated STAAR math, science and social studies assessments
- Available for ELLs who
 - Are not most appropriately assessed with STAAR Spanish, AND
 - Have not yet attained a TELPAS advanced high reading rating in grade 2 or above, AND
 - Have been enrolled in U.S. schools for 3 school years or less starting with first grade (5 years or less if a qualifying unschooled asylee or refugee)
 - Not permitted for an ELL whose parent has denied bilingual or ESL program services
 - Provides more substantial linguistic accommodations than the general STAAR

ELLs served by Special Education LPAC Membership vs. ARD*

*ARD = Admission, Review and Dismissal committee for Special Education

How is an LPAC different than an ARD?

- The LPAC can discuss multiple children in the same meeting.
- The LPAC has a parent representative for all LEP students, not just the individual child's parent.
- The Bilingual/ESL Program does not need parent permission for testing language proficiency.
- The **key members of the ARD** in conjunction with the **key members of the LPAC** committee determines appropriate assessment for entry, exit and state assessment.
- The ARD committee in conjunction with the LPAC make all determinations regarding identification and placement for LEP students with disabilities.

ELLs served by Special Education LPAC Responsibility for SpEd ELLs

Students with disabilities whose score indicates limited English proficiency on the assessment as determined by the **key members of the ARD** committee in conjunction with the **key members of the LPAC** are identified as LEP.



ELLs served by Special Education LPAC / ARD Coordination

The key members of the LPAC in conjunction with the key members of the ARD can determine that:

- a student was identified as LEP and does not have any disability; therefore, the student should be served by the Bilingual/ESL education program and *NOT referred to special education unless there is data that indicates a disability.*
- a student has a disability identified by the special education program and is also limited English proficient (LEP). The student could be served by both programs, special education and Bilingual/ESL education.

ELLs served by Special Education LPAC/ARD Committee Collaboration

- ARD committee needs the LPAC to help identify potential language barriers in the evaluation process
- LPAC needs the ARD committee to help identify disabilities that may be barriers in the language assessment process



ELLs served by Special Education

LPAC / ARD Collaboration - Entry

TAC §89.1225(f)(4)

- The admission review and dismissal (ARD) committee in conjunction with the language proficiency assessment committee (LPAC) shall determine an appropriate assessment instrument and designated level of performance for indicating limited English proficiency...for students for whom those tests would be inappropriate as part of the individualized education program (IEP). The decision for **entry** into a bilingual education or English as a second language program shall be determined by the ARD committee in conjunction with the language proficiency assessment committee.

ELLs served by Special Education LPAC / ARD Collaboration - Exit

TAC §89.1225(k)

- The ARD committee in conjunction with the language proficiency assessment committee shall determine an appropriate assessment instrument and performance standard requirement for exit...for students for whom those tests would be inappropriate as part of the IEP. The decision to exit a student who receives both special education and special language services from the bilingual education or English as a second language program is determined by the ARD committee in conjunction with the language proficiency assessment committee.

ELLs served by Special Education LPAC / ARD Collaboration

The ARD committee and the LPAC must work collaboratively.

Timeline challenge

- Initial Placement
 - Bilingual/ESL timeline – 20 school days
 - TAC §89.1225(g)
 - Special Education – 90 calendar days
 - CFR §300.301(c) and 300.323
- Exit Decision
 - End of the year
 - TAC §89.1225(h)



ELLs served by Special Education LPAC / ARD Collaboration

The work

- Determine appropriate participation
 - Assessments for entry and exit
- Design appropriate instruction
- Formative assessment
 - Benchmarks/Progress Monitoring
- Determine how instruction will be provided
- Measure effect of instruction based on annual goals



Group Activity

Key Concepts of Competencies

9 (Culture)

10 (Family/Community)

4 (Listening/Speaking)

5 (Literacy Development)

6 (Content-Based Language)



Competency 009

The ESL teacher understands factors that affect ESL students' learning and implements strategies for creating an effective multicultural and Multilingual learning environment.



Competency 009 Components

- Understands **cultural and linguistic diversity** in the ESL classroom and other factors that may affect students' learning of academic content, language, and culture (e.g., age developmental characteristics, academic strengths and needs, preferred learning styles, personality, sociocultural factors, home environment, attitude, exceptionalities)
- Knows how to create an effective **multicultural and multilingual learning environment** that addresses the affective, linguistic, and cognitive needs of ESL students and facilitates students' learning and language acquisition.
- Knows factors that contribute to **cultural bias (e.g., stereotyping, prejudice, ethnocentrism)** and knows how to create a culturally responsive learning environment.
- Demonstrates **sensitivity to students' diverse cultural and socioeconomic backgrounds** and shows respect for language differences.
- Applies strategies for creating among students an awareness of and **respect for linguistic and cultural diversity.**



What is culture?

“Culture is the shared beliefs, values, and rule governed patterns of behavior that define a group.”

~Peregoy & Boyle 2001

So, culture includes what people know and believe, what people do, and what people make and use.



Impact of Culture

Culture is like water to a fish: essential, but not noticed while we are surrounded by it.

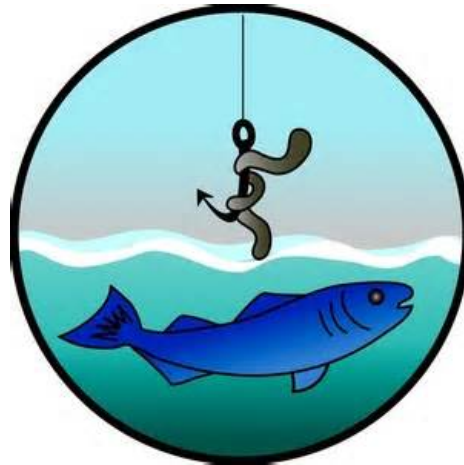

We become aware of culture, ours and others, when we come up against different beliefs, values, and behaviors.



Deep and Surface Culture

Part of culture is visible, like the tip of an iceberg.

- Language
- Clothing
- Food
- Customs
- Art

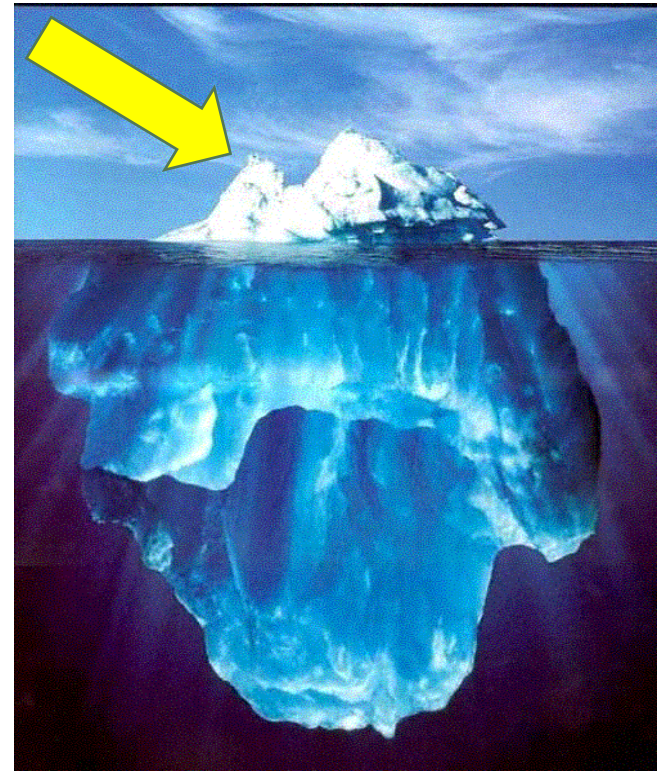

Deep and Surface Culture

Below the surface are the more meaningful and powerful aspects of culture:

- Beliefs – What we see as truth.
- Norms – Unwritten rules for behavior.
- Values – What we hold most important.

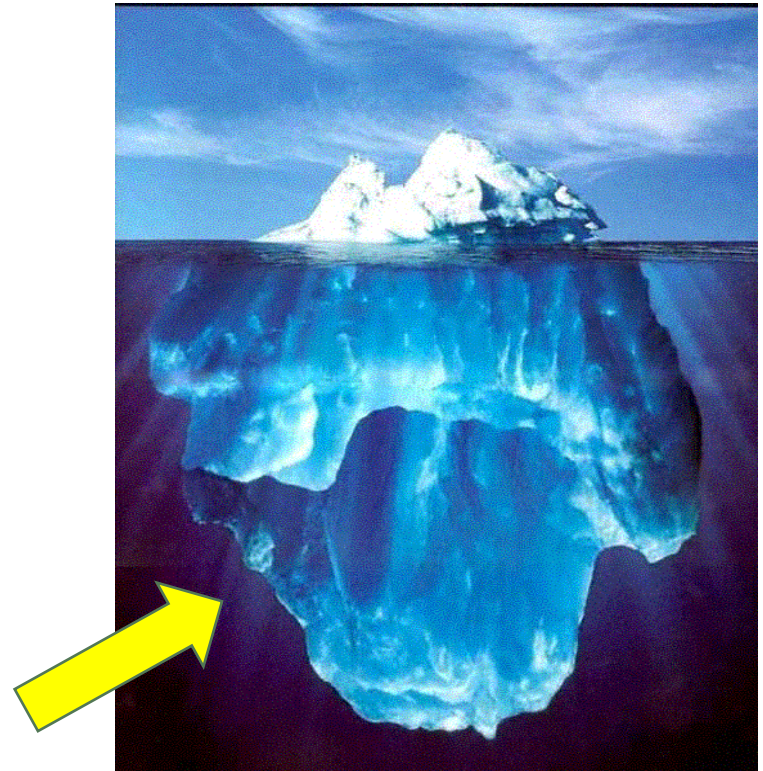

Culture and School

ESL students bring these deep aspects of culture into schools and **classrooms set up and operated by a culture different from theirs.**



Discomfort and misunderstanding are inevitable but not insurmountable.



Areas of Cultural Difference

1. View of the self:
 - a. Independent Self – “I” – U.S. Americans of Western European heritage.
 - b. Interdependent Self – “We” – Native Americans, African-Americans, Hispanics, Asians.
2. Sense of time:
 - a. Focus on past
 - b. Focus on present
 - c. Focus on future
3. Uncertainty avoidance:
 - a. Difference is curious
 - b. Difference is ridiculous
 - c. Difference is dangerous

Examples of Cultural Misunderstanding in the Classroom

- If home culture says children only speak when spoken to, they may not volunteer answers in class.
- If home culture is more interdependent, students may not volunteer answers because it draws attention to the individual.
- If “wait time” for response is longer in another culture (Asian, for example) than it is in U.S., students may not volunteer answers because they see it as interrupting.



Awareness of Cultural Influence

- No one can be aware of all the details of culture that students bring with them.
- Teachers should always be alert to the possibility of cultural misunderstanding.
- Realize that lack of participation or any out of the ordinary behavior may have a cultural basis.
- Don't assume a negative motive for the behavior until you have talked with the student and explored a cultural explanation.

Support for Students Experiencing Cultural Change

- Be attentive
- Listen
- Be understanding
- Show empathy for various cultures
- Acknowledge difference
- Create an environment of **mutual adaptation**



Support for Students Experiencing Cultural Change

When teachers value and encourage the home culture,

- students' self-esteem is much higher,
- a stronger identity is developed,
- and linguistic, social, and emotional adaptation is more successful.

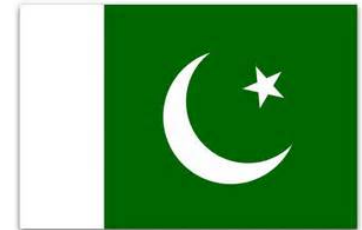

Stages of Acculturation (4 stages)

Acculturation: A general term for the process of becoming adjusted to another culture.



- **STAGE 1: Euphoria** – excitement and happiness with new place and new experiences

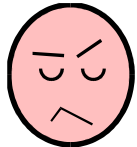

- **STAGE 2: Culture Shock** – realization of the depth of difference between home culture and the new culture; may cause frustration, anger, depression

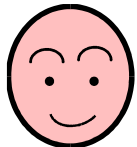

- **STAGE 3: Tentative Recovery** – finding ways to cope with the new culture; forming friendships and support systems

Stages of Acculturation (4 stages continued)

- **STAGE 4: Assimilation or Adaptation** – a choice
 - **Assimilation** – deciding to become like members of the new culture, to accept their surface and deep culture; giving up the original culture
 - **Adaptation** – finding ways to adapt to and become part of the new culture while maintaining important values and customs of the original culture



Factors Contributing to Cultural Bias

- **Stereotyping:** overgeneralization or oversimplification of beliefs about a particular group based on hearsay or limited personal experience
- **Prejudice:** Unfair and unreasonable opinion formed without adequate knowledge or thought
- **Ethnocentrism:** belief by an individual or group that their beliefs, values, and customs are the only right way. Inability to see value in difference.



Multicultural Education

- Means that the school has the willingness and capacity for **success for all students**.
- The teachers have the skills knowledge and strategies to ensure **equity** of all the students.
- A multicultural education offers **equal opportunity** for each child to develop their full potential (pluralism).
- The teacher facilitates effectively **various learning styles** and is constantly observing the verbal and nonverbal language of the students.



Effective Learning Environment

- Create a **safe environment** based on a trusting relationship where support is readily available.
- Be sure that all children **know you believe** they can learn.
- **Show interest** in children's culture and language; incorporate them into class activities whenever possible.
- **Acknowledge difference**; model interest and respect.



Competency 010

The ESL teacher knows how to serve as an advocate for ESL students and facilitate family and community involvement in their education.



Competency 010 Components

- Applies knowledge of effective strategies **advocating educational and social equity for ESL students** (e.g. participating in LPAC and ARD meetings, serving in SBDM committees, serving as a resource for teachers).
- Understands the importance of **family involvement** in the education of ESL students and knows how to facilitate parent/guardian participation in their children's education and school activities.
- Applies skills for **communicating and collaborating effectively with the parents/guardians of ESL students** in a variety of educational contexts.
- Knows how community members and resources can positively affect student learning in the ESL program and **is able to access community resources to enhance the education of ESL students.**



How Schools Can Assist Parents

- Offer **native language orientation** for families about the U.S. school system.
- Create **classes for parents** in ESL, literacy, citizenship, and parent education.
- Family involvement specialists and teachers can **facilitate family attendance** at orientation nights and parent/teacher conferences.
- Create **family learning projects** for parents and students to finish together at home after activity is introduced to students in the classroom.

Helping Parents Promote Literacy

- Parents can collaborate in creating books to share with their children.
- Educators plan a series of meetings where they read illustrated children's books with parents in small groups.
- Educators model reading skills such as looking at pictures to predict, making inferences, and summarizing.



Parent Involvement: Parents as Resources

Invite parents to serve as resource speakers to the classroom to share aspects of their culture that apply to a particular curriculum unit such as geography, language, music, system of government, transportation, etc.

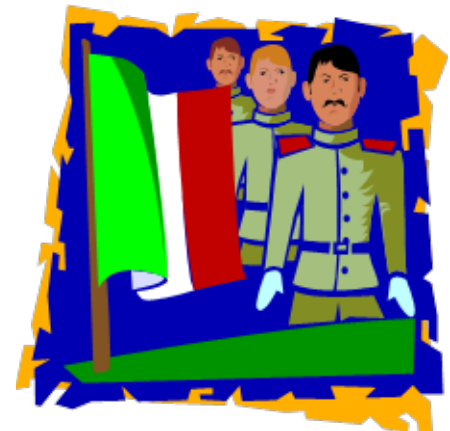

Parent Involvement: Decision-Making

- Encourage parents to become deeply involved in the decision-making in their children's schools.
- Families can help to ensure that the education is culturally and linguistically appropriate by participating as
 - Grade-level volunteers
 - LPAC members
 - Site-based decision making committee members
 - Textbook selection committees
 - Curriculum committees
 - Budget committees and attend
 - School board meetings
- Make parents aware of opportunities to participate in local, regional, and state professional organizations, such as TESOL, NABE, and Title I Conferences.

Communicating with Parents

- Send invitations and announcements in the parent's language.
- Make contact by phone or in person.
- Provide school calendar and handbook in primary language whenever possible.
- Have interpreters available at meetings to facilitate communication, improve comprehension of content, and mediate cultural differences.



Community Resources

- Work with school **counselor and nurse** to access community agencies to assist students and their families with physical and mental health needs:
 - immunization, physicals, vision, dental, food bank, “clothes closet”, and stress associated with immigration.

Community Resources

- Work to link students with opportunities to **continue their education**:
 - For example, helping students contact local community colleges for assistance with the application process, scholarships, and financial aid.
- Seek out and **welcome volunteers** to tutor and/or mentor ESL students.



Competency 004

The ESL teacher understands how to promote student's communicative language development in English.



Competency 004 Components

- **Knows applicable Texas Essential Knowledge and Skills (TEKS) and the English Language Proficiency Standards (ELPS)** and knows how to design and implement appropriate instruction to address **the proficiency level descriptors for the beginning, intermediate, advanced and advanced-high levels in the listening and speaking domains.**
- Understands the **role of the linguistic environment and conversational support** in second-language development, and uses this knowledge to provide a rich, comprehensible language environment with supported opportunities for communication in English.
- Applies knowledge of practices and resources, and materials that are effective in **promoting students' communicative competence in English.**
- Understand the interrelatedness of listening, speaking, reading and writing and uses this knowledge to select and **use effective strategies for developing students' oral language proficiency in English.**
- Applies knowledge of effective strategies for **helping ESL students transfer language skills from L1 to L2.**
- Applies knowledge of **individual differences (e.g., developmental characteristics, cultural and language background, academic strengths, learning styles)** to select instructional strategies and resources that facilitate communicative language development.
- Knows how to **provide appropriate feedback** in response to students' developing English skills.



Instructional Conversation

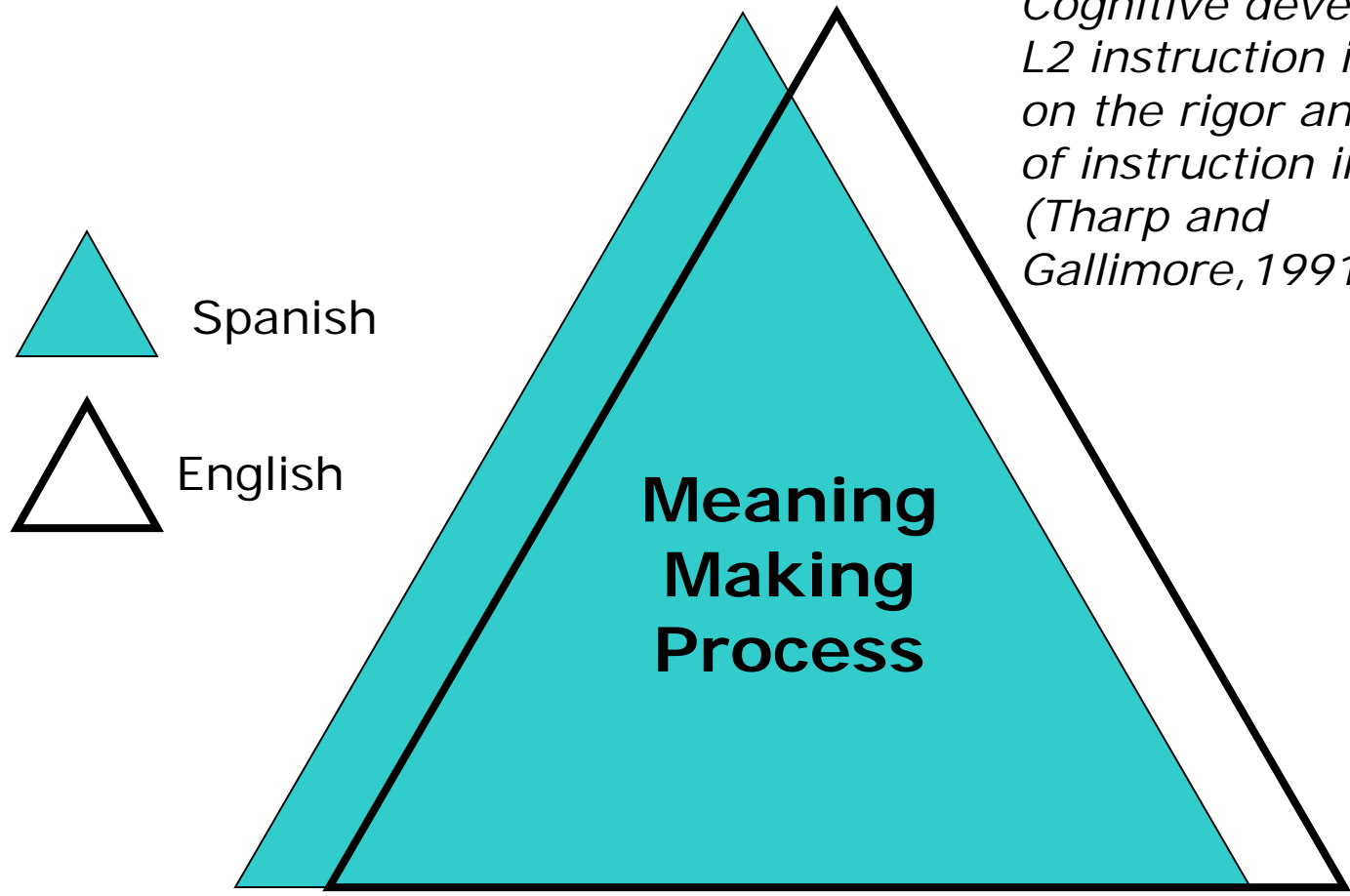

*Cognitive development in L2 instruction is dependent on the rigor and relevance of instruction in L1.
(Tharp and Gallimore, 1991)*

Scaffolding Language to Promote Reading Comprehension for ELLs

Optimal Oral
Language
Development



Student's
Current Oral
Language
Development

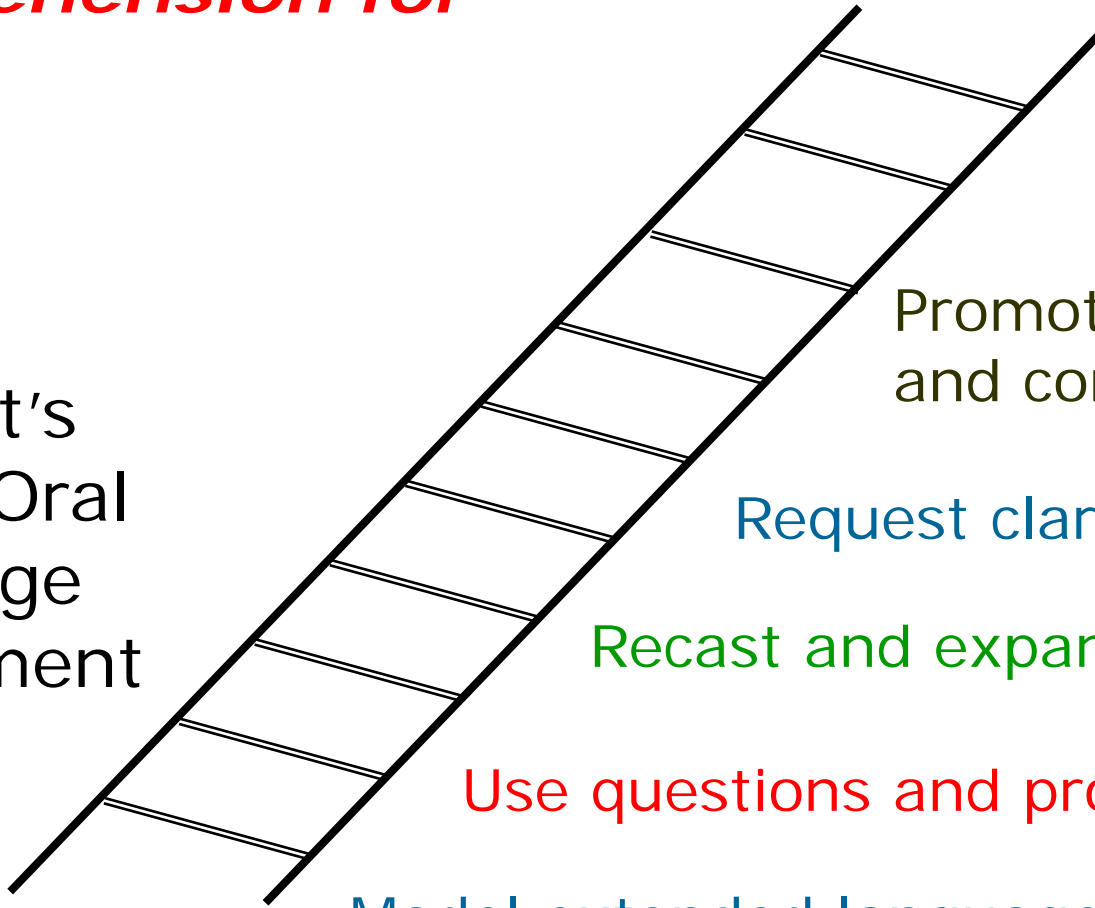

Provide
feedback

Promote questions
and conversation

Request clarification

Recast and expand ideas

Use questions and prompts

Model extended language



Promoting Language Acquisition

- Comprehensible input (from listening and reading) alone does not account for language acquisition.
- Output (speaking and writing) must be considered.
- As with L1, oral language – listening and speaking – generally develops before reading and writing in the second language.



Assumptions about Listening and Speaking



- Learners acquire language in an environment that is full of talk and that invites response.
- Students will speak when they are ready.
- Fluency precedes accuracy.
- Acceptance of all attempts, correct or incorrect, will promote confidence.

Law & Eckes, 2000

To Develop Competency in Listening and Speaking



Students need:

- teachers who understand stages of language acquisition
- teachers who are tolerant of errors
- many opportunities to interact with others
- time.

Stages of Second Language Acquisition and Texas Proficiency Level Descriptors (PLDs)

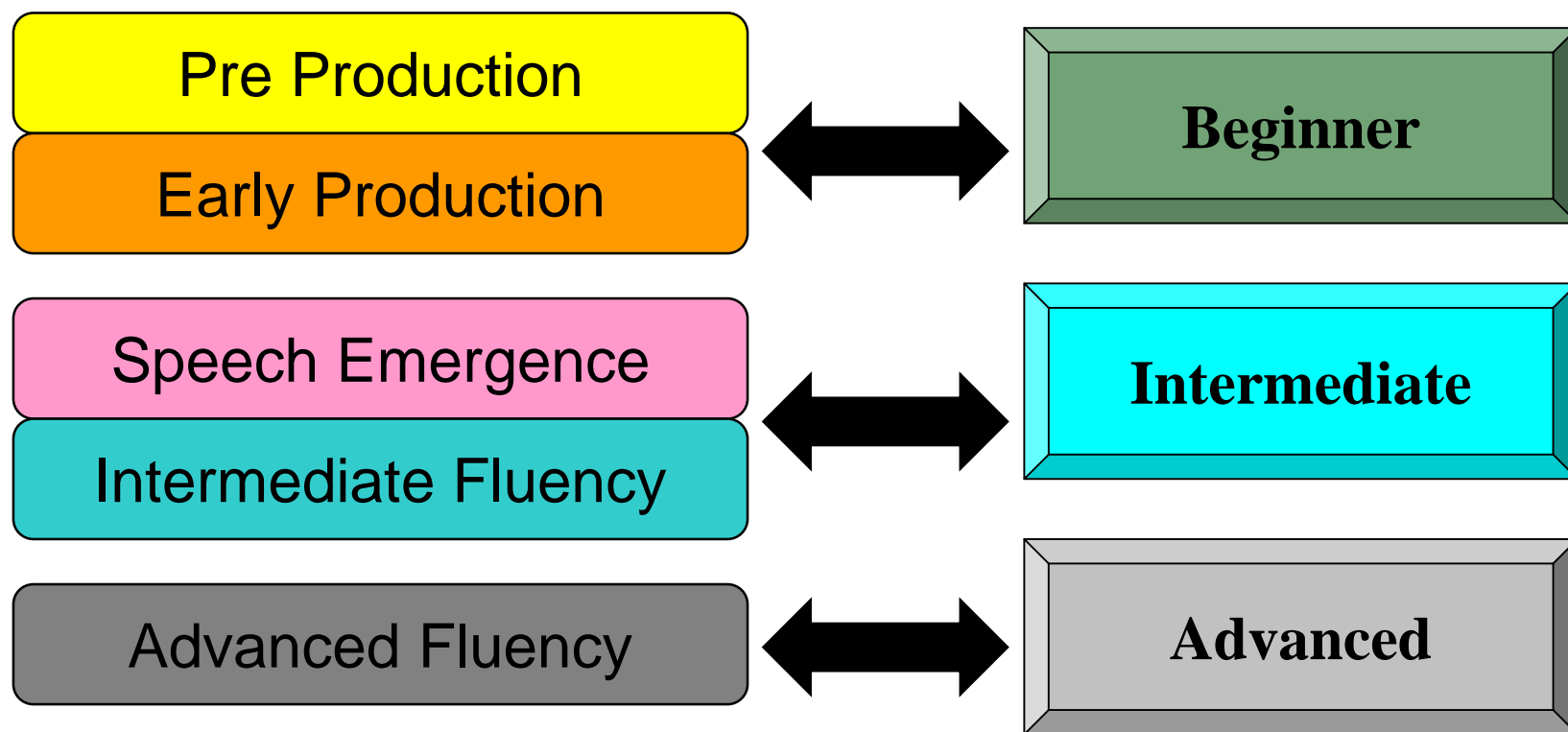

Advanced High – minimal support, almost native-like



Stages of Second Language Acquisition

	PREPRODUCTION	EARLY PRODUCTION	SPEECH EMERGENCE	INTERMEDIATE FLUENCY
DESCRIPTION: Period given is accurate if no interventions are implemented.	*The silent period – students are completely new to English – a time for receptive language acquisition; lasting from a few weeks to 3 months	*Period of limited production. Students are “low beginners;” progress varies; generally lasts from a few months to a year	*Period of expanded production; progress varies; students are “beginners,” may last from 1 to several years	*Period of continued development of higher levels of language use in content areas. Students are “high beginners” to “intermediate.” Five to ten years required to achieve fluency in academic settings.
CHARACTERISTICS OF THE STUDENT	*Non-English speaker *May include students with some understanding who are too shy to speak *Should not be forced to speak	*Has limited understanding *Can speak one or two word phrases	*Understanding has expanded *Begins to use language more freely *Uses short phrases and sentences *Less hesitation to speak	*Understanding has expanded beyond social language *Participates in reading and writing activities to acquire new information *Limited or no hesitancy to speak
GOALS FOR THE STUDENT	*Develop listening comprehension skills *Build a receptive vocabulary	*Put words together into simple sentences *Carry on meaningful dialogues	*Put words together into simple sentences *Carry on meaningful dialogues	*Continue to expand receptive and expressive skills *Produce connected oral and written narratives
NATURAL PROGRESSION	(Silent period)	*Yes or No responses *One-word sentences *Name words on list *Short phrases Comp 004 continue	*Speech production is longer and more complex *Long phrases; simple sentences *More extensive vocabulary *Extended dialogue *Narrative	*Able to produce fluent speech *Conducts casual conversation *Participates in academic and problem-solving discussions *May debate

Stages of Second Language Acquisition

	PREPRODUCTION	EARLY PRODUCTION	SPEECH EMERGENCE	INTERMEDIATE FLUENCY
TEACHER ACTIVITIES	<ul style="list-style-type: none"> *Seeks to develop listening comprehension *Uses gestures *Uses visual aids *Emphasizes and repeats key words *Speaks more slowly *Acts out scenes *Does not force oral participation 	<ul style="list-style-type: none"> *Asks questions that require single word responses: yes/no; either/or *Seeks to maintain an accepting, low-stress classroom climate *Allows for mistakes in pronunciation, form, grammar and usage *Models correct responses 	<ul style="list-style-type: none"> *Focuses on key concepts *Uses extended vocabulary *Asks open-ended questions that encourage language production *Seeks to develop high level thinking skills *Uses performance-based assessment 	<ul style="list-style-type: none"> *Seeks to encourage concept development and literacy through content-rich curriculum *Continues to use active learning strategies *Teaches thinking and study skills
STUDENT ACTIVITIES	<ul style="list-style-type: none"> *Performs an action *Points to item in picture *Nods *Says yes or no *Manipulates items to show understanding 	<ul style="list-style-type: none"> *Gives yes or no answers *Gives list of words *Uses two-word strings *Categorizes *Listens and recalls 	<ul style="list-style-type: none"> *Uses longer phrases *Explains concepts with greater detail *Compares and contrasts *Defines new vocabulary *Greater fact recall *Gives descriptions 	<ul style="list-style-type: none"> *Contributes to discussion *Write stories *Retells stories *States and supports opinions with persuasive language *Reports on events
QUESTIONING TECHNIQUES	<ul style="list-style-type: none"> *Point to ... *Find the ... *Put ___ next to ___ *Do you have ___? *Is this a ___? *Who has the ___? 	<ul style="list-style-type: none"> *Yes/no *Is this a ___ or a ___? *One word response *Questions that encourage a list (What do you see in this picture?) 	<ul style="list-style-type: none"> *Why? *How? *How is this like that? *Tell me about ... *Describe *How would you change this? *Describe/compare 	<ul style="list-style-type: none"> *What would you recommend? *What will happen next? *What is your opinion about this? *What would happen if ...? *Why? *Create.

Comp 004
continue

Promoting Oral Language Development in the Classroom

- Use vocabulary related to a predictable schedule and repeated classroom routines: roll call, recess, lunch, dismissal.
- Repeat instructional practices:
circle time, literary circles, process writing, group projects.

Verbal Strategies to help students understand teacher's talk

- Speak clearly
- Paraphrase
- Repeat key vocabulary in context
- Summarize main points
- Limit use of idioms



Stages of Development in Communication Skills

Stage 1: One-way communication

- Learners **listen** to the new language but do not speak .
- This is the “silent period”.
- During this period learners are acquiring knowledge about the new language, including vocabulary, syntax, and content knowledge.



Stages of Development in Communication Skills

Stage 2: Partial two-way communication

- The learners listen to communication and **respond with either gestures or their native language.**
- Students can show comprehension without speaking (ex: nodding, pointing, drawing, gesturing).



Stages of Development in Communication Skills

Stage 3: Full two-way communication

- Learners **listen and respond** effectively in the target language.
- Progress through the stages is enhanced when the **level of activity matches the learners' stage of development.**



Oral Language Development Strategies

- Songs
- Drama
- Show and Tell
- Dubbing a video
- Choral reading
- Riddles and jokes





High-Quality Oral Language Development

- Read-alouds and role-playing (using culturally relevant classic and contemporary literature)
- Legends
- Riddles
- Poetry
- Analogies
- Idioms/ figurative language

Learning Styles

- Defined as a biological and developmentally imposed set of personal characteristics that **make the same teaching methods effective for some and ineffective for others.**
- Teaching methods should include an **auditory, visual, and tactile learning model.** These 3 models will meet most students' needs for retention and comprehension.

Learning Styles

- Linguistic (auditory)
- Mathematical
- Spatial (visual)
- Musical
- Kinesthetic (tactile)
- Interpersonal
- Intrapersonal



(as defined by Dunn and Dunn)



Appropriate Feedback

- Emphasize communication and meaning, not correctness.
- Provide some patterned language to practice specific areas such as verb tense, conjunctions, or transitions.
- Use modeling - restate student's sentence correctly.



Competency 005

The ESL teacher understands how to promote student's literacy development in English.



Competency 005 Components

- **Knows applicable Texas Essential Knowledge and Skills (TEKS) and the English Language Proficiency Standards (ELPS)** and knows how to design and implement appropriate instruction **to address the proficiency level descriptors** for the beginning, intermediate, advanced and advanced-high levels in the **reading and writing** domains.
- Understands the interrelatedness of LSRW and uses this knowledge to select and use **effective strategies for developing students' literacy in English.**
- Understands that English is an alphabetic language and applies **effective strategies for developing ESL students' phonological awareness and skills (e.g., phonemic awareness, knowledge of common English phonograms) and sight word vocabularies.**
- Knows factors that affect ESL students' reading comprehension (vocabulary, text structures, cultural references) and applies effective strategies for **facilitating ESL students' reading comprehension in English.**
- Applies knowledge of effective strategies for helping students transfer literacy knowledge and skills in L1 to L2.
- Knows personal factors that affect **ESL students' English literacy development (e.g., interrupted schooling, literacy status in the primary language, prior literacy experiences)** and applies effective strategies for addressing those factors.



Language Proficiency

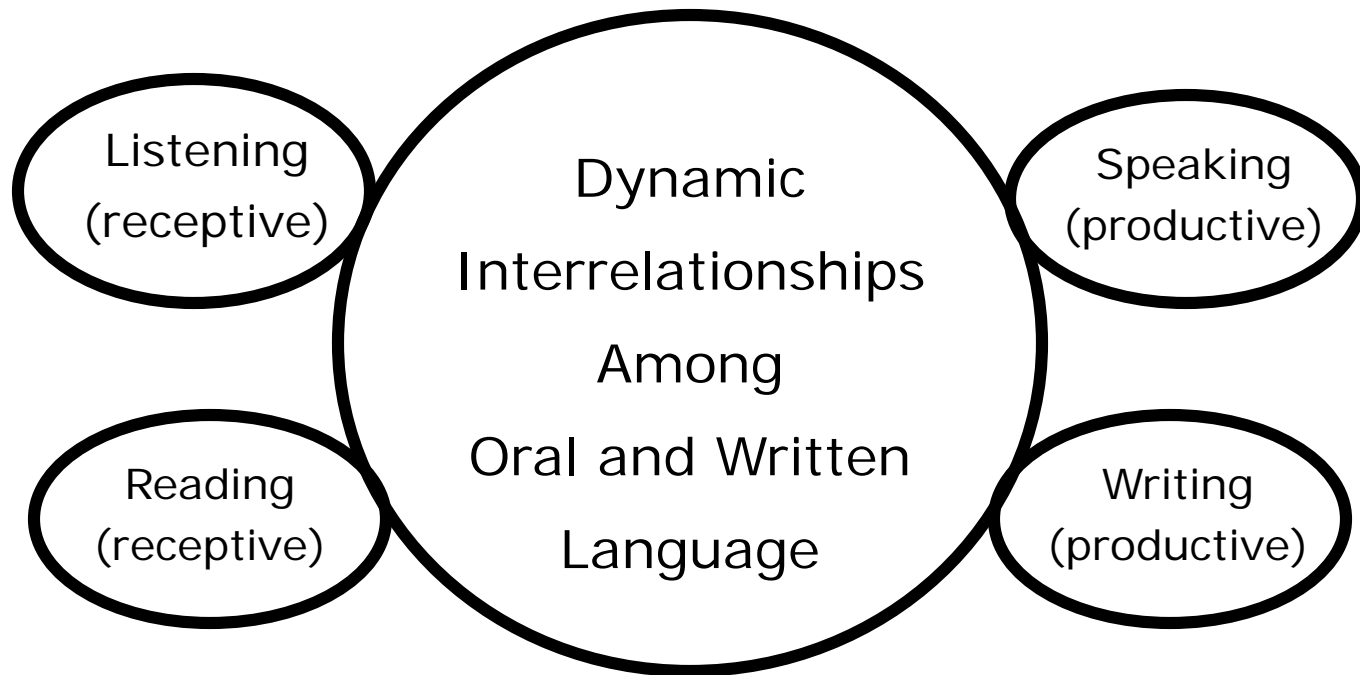

from Reading, Writing & Learning in ESL
by Suzanne F. Peregoy & Owen F. Boyle

Comp 005
continue



- In all literate societies, oral and written language intermingle.



- Listening, speaking, reading and writing occur naturally together in learning activities at all grade levels.



- Listening and reading – receiving words and recreating the message in order to comprehend



- Speaking and writing – creating an understandable message through words



Listening

Speaking

Reading

Writing

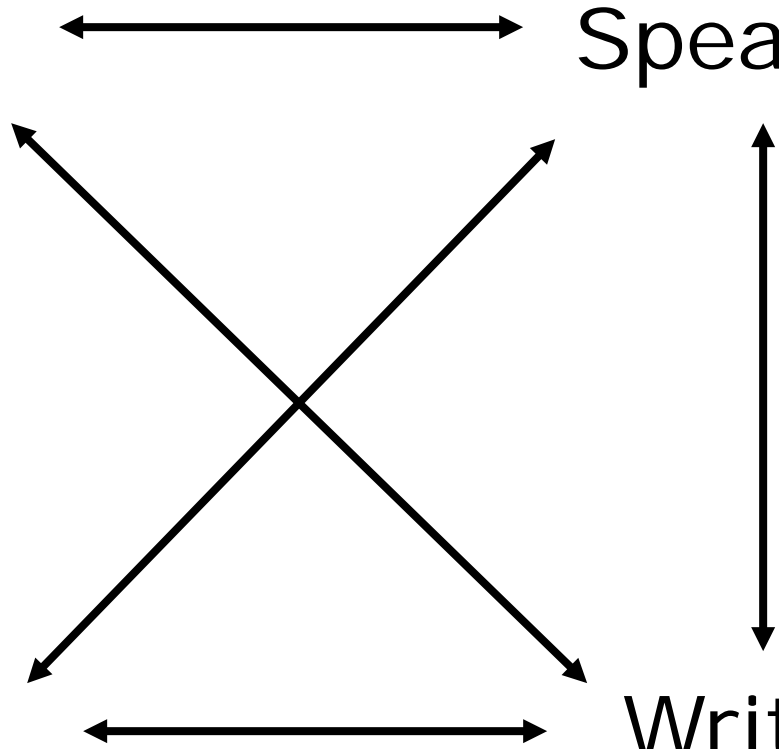

Teachers should be aware that --

- In **L1**, oral language development occurs earlier than written language development.
- In **L2**, younger learners develop this way, but older L2 learners who are literate in their native language, may develop written L2 more fully before oral L2.
- English can be developed from written input as well as oral **if the input is comprehensible** to the L2 learner.
- L2 learners **do not** need to be fully proficient in oral English before they start to read or write English.

Relationship Between L1 and L2

- Values and concepts of literacy transfer (print represents a systematic code and carries meaning).
- Well-developed academic skills and strategies transfer.
- Concept knowledge in content area transfers.



L2 Literacy

- In early stages of L2 development, developing **literacy in L1 is a shortcut to English literacy** because we learn to read by reading; it's easier to understand text in L1, and literacy ability transfers.
- Once some proficiency in English is achieved, **free voluntary reading in English increases English literacy** and development of academic English.
- **There is no reason to stop reading in L1.** Continued reading in L1 has cognitive benefits. Also, bilingualism is stronger, and there are life/career benefits.

Variables Affecting Motivation/Development of L2

- Language learning environment (immersion vs. foreign language)
- Age (affected by sociocultural, cognitive, personality factors)
- Cognitive development (the older the L2 student the larger the gap, yet older students may have advantage of being literate and schooled)
- Cultures of home and school
- Comprehensible input
- Social interaction



Ideas About Print

(all emergent readers – L1 and L2 – must grasp)

1. Print **carries meaning**, conveying a message.
2. Spoken words can be **written down and preserved**.
3. Written words **can be spoken**, that is, read out loud.
4. In English, words are read from **left to right, top to bottom**.

Ideas About Print

(all emergent readers – L1 and L2 – must grasp)

5. In English and other languages that use alphabets, the speech stream can be divided into sounds, and these sounds are represented by letters or groups of letters (grapho-phonemic units). This is the **alphabetic principle**.
6. The speech stream has a **linear sequence** in time that corresponds to written languages' linear sequence on the page.
7. Sound/symbol correspondences are consistent, but in English, there are **many exceptions**.



Ideas about print are learned through immersion in a literacy-rich environment with multiple opportunities to hear stories and to write.



Thus, teaching strategies should emphasize immersing students in meaningful, functional uses of reading and writing **combined with** explicit instruction to assist students to become independent readers and writers.



Beginning L2 Readers

- May be unfamiliar with English alphabet and spelling patterns
- Have limited sight word vocabulary
- Can read predictable text
- Need more experience with written English
- If preliterate, need to learn value of reading
- Need practice to solidify sound/symbol correspondences and aspects of English reading (left to right, top to bottom)
- It is sometimes not possible to translate a word from one language to another.
- Translation may result in misinformation. (ex: tools in English has many specific words in Spanish)
- A word specifying one concept in a language may specify several concepts in another. (ex: en in Spanish means both in and on)



L2 Reading Process

L2 proficiency
still developing

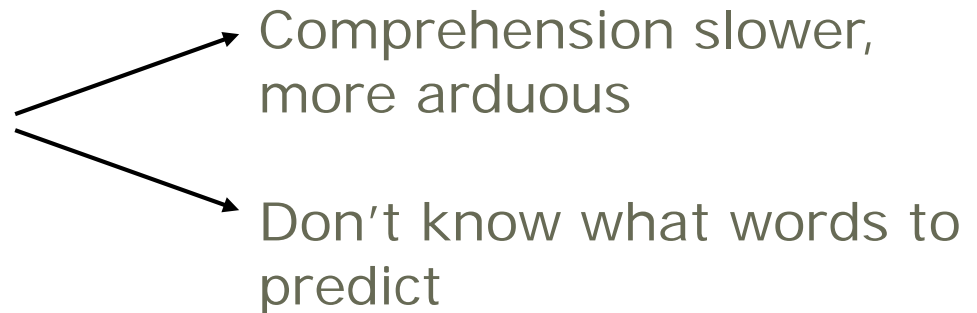

Lack background
knowledge

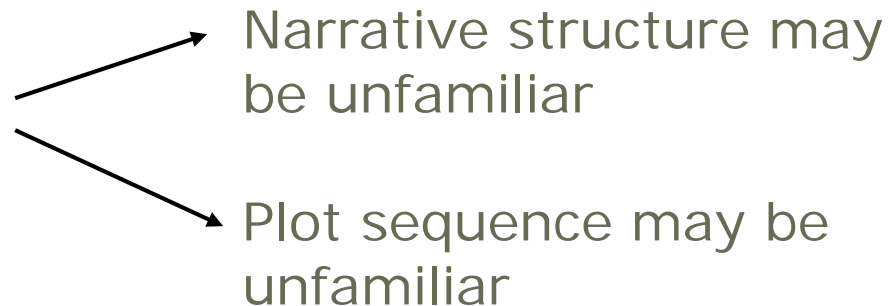

Reading Process



A reader uses linguistic and background knowledge while interacting with print. The good reader has automatic word recognition so he/she can concentrate on comprehension.

Cueing Systems

1. Graphophonic – letters/sounds & visual clues

- What would you expect to see?



2. Semantics – sense, meaning

- Does it make sense?

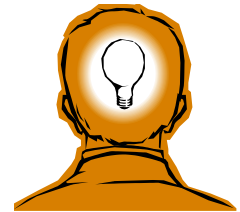

3. Syntax – structure, grammar

- Can we say it that way?



Supporting the L2 Reading Process

1. Phonemic Awareness

Spoken words made up of sounds



Ex: cake, take, fake, make, bake, sake, lake

L2 learners **should not** be involved in phonics instruction that isolates sounds and letters from meaningful use of text.

Phonemic awareness **develops as children are read to and have opportunities to read**; it can also be acquired as children learn to write.



Problems with Word Recognition

(Phonics Instruction First)

1. Idea that written language develops only after oral language is mastered delays reading.
2. Pronouncing a word is not same as understanding its meaning. (ex: homonyms, multiple meaning words)
3. Assumption that if students can identify words, they can put meanings together
4. Danger in assuming that a child who pronounces words easily is comprehending

Supporting the L2 Reading Process

2. Successful Strategies for Teaching Vocabulary

Choose words that:

- relate to human motivation
- will generate discussion
- are critical for literary analysis
- are difficult for L2 learners
- have the power to sharply increase comprehension

Explain words through:

Dramatization, visualization, personification, contextualizing, simplified definition



Limit new words. Revisit words over a period of days.
Connect words. Categorize words.

Supporting the L2 Reading Process

3. Semantics + Syntax

1. Provide support to make sense of text.
2. Call attention to way language is used in text.
3. Discuss meaning and interpretation of sentences and phrases in text.
4. Point out words that have been encountered before.
5. Help readers discover grammatical cues that indicate relationships such as cause and effect, antecedence and consequences, comparison and contrast, etc.



Reading Comprehension Model

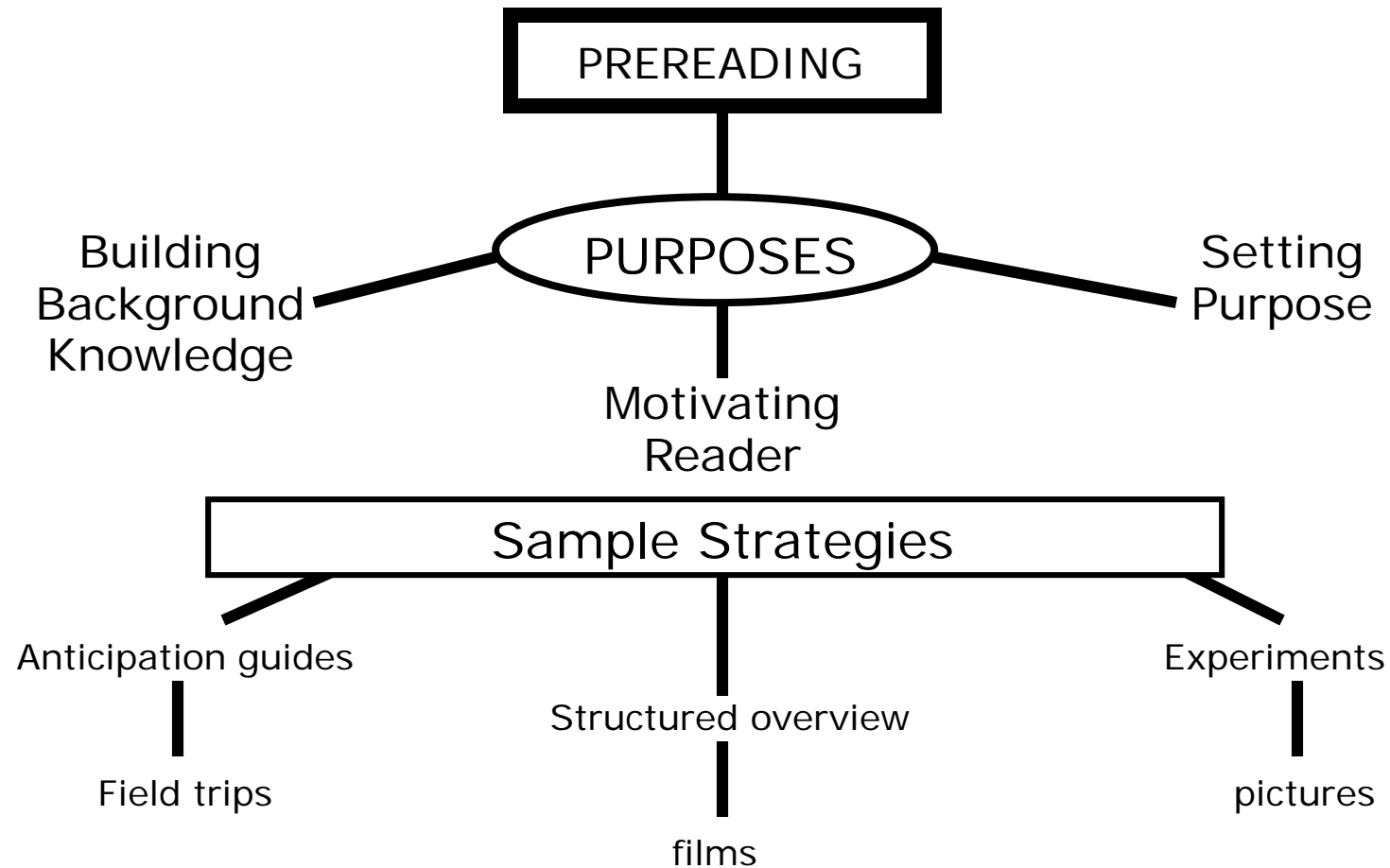

Reading Comprehension Model

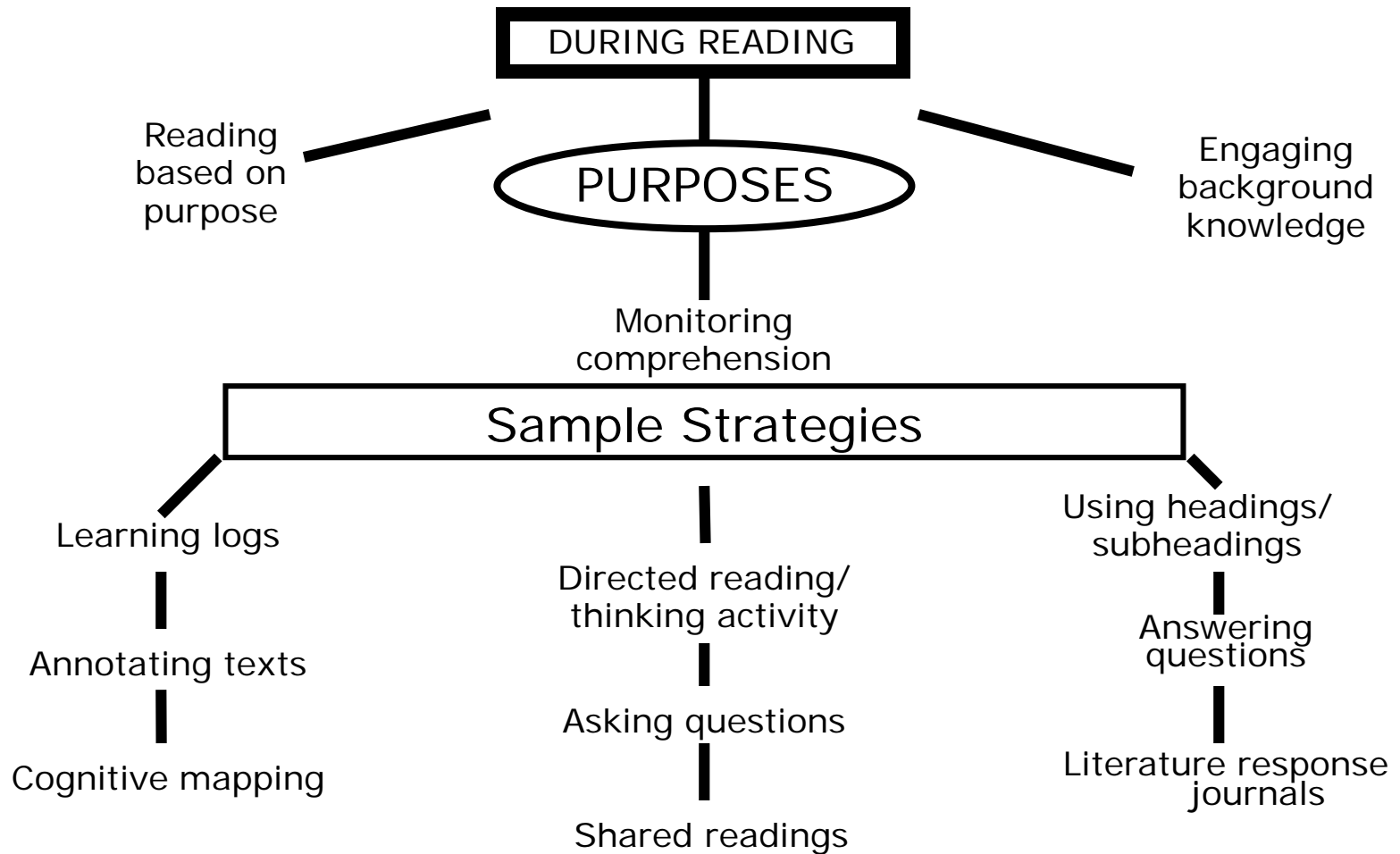

Reading Comprehension Model

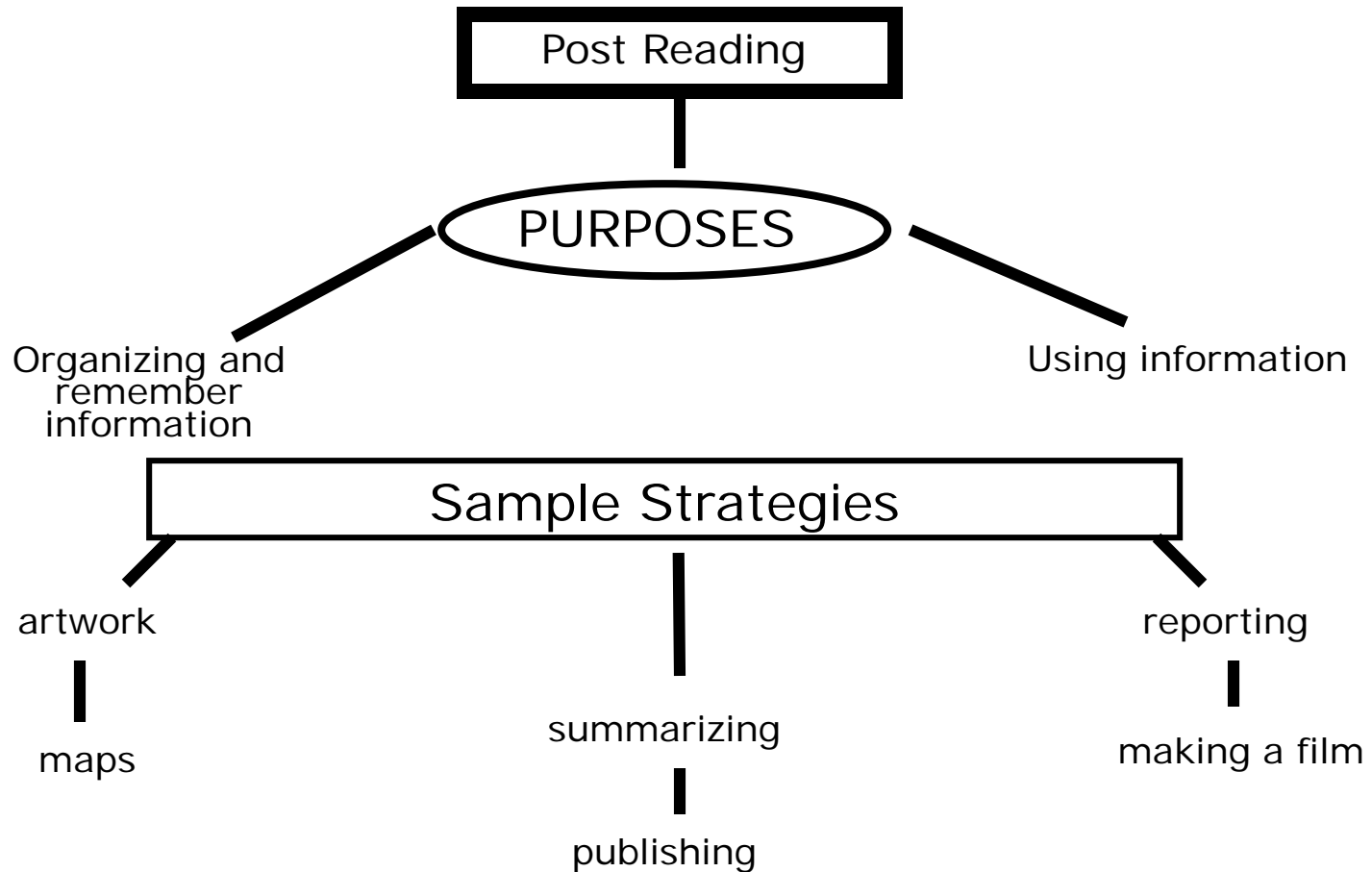

L2 Reading Conclusions

- Students learn to read by reading, so **time for reading is crucial**.
- Patterns of graphophonics are discovered, word meanings negotiated and confirmed, syntax acquired and reinforced.
- Research data supports **4 components of an effective reading program**:
 1. Large amounts of time for actual text reading
 2. Teacher-directed instruction in comprehension strategies
 3. Opportunities for peer and collaborative learning
 4. Occasions for students to talk about their responses to reading

L2 Reading Conclusions

- Reading comprehension is best promoted by **extensive exposure to meaningful and varied texts** with some explicit phonemic awareness and phonics instruction as well as instruction that develops effective learning strategies for both
 - *decoding (metalinguistic awareness) and
 - *comprehending (metacognitive awareness) text.



Fluency

Fluent reading is reading in which words are recognized automatically.



**Formula for fluent reading:
Read and reread decodable
words in connected text.**

Strategies and Activities to Develop Fluency

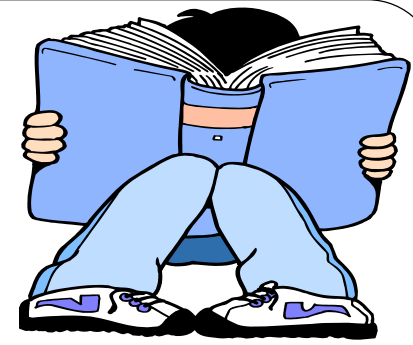

- Repeated Reading - fosters fluent word recognition through multiple exposures to words, and enhances comprehension
 - Teacher-assisted Reading
 - Audio-assisted Reading
 - Computer-based Reading
 - Partner Reading
 - Readers' Theater

Fluency: Monitoring Student Progress

- Track fluency progress by using a graph and/or audio recording.
 - Motivates students to practice fluency
 - Provides immediate feedback
 - Shows progress
- Work collaboratively with students to record, discuss, and interpret fluency data.
- Set goals for fluency building.



L2 Writing

1. L2 learners have limitations in vocabulary, syntax, idioms.
2. L2 learners have confidence and skill gained in L1 writing.
3. Opportunities for L2 students to write enhance L2 acquisition.
4. Strategies effective in teaching L1 writing are effective when accommodated for L2 learners. (ex: process writing)

Process Writing

- Especially effective for L2 learners

because it allows them to write

about their own experiences

and thus opportunities for L2 development are

enhanced.

- L2 writers benefit from L1 models and cooperative assistance.

- Promote fluency first and then address editing.



The Writing Process: Prewriting

Purpose:

- Generating and gathering ideas for writing
- Preparing for writing
- Identifying purpose and audience for writing
- Identifying main ideas and supporting details

Strategies:

- Discussion/oral activities
- Brainstorming, clustering
- Questioning, reading, keeping journals in all content areas.

The Writing Process: Drafting

Purpose:

- Getting ideas down on paper quickly
- Getting a first draft that can be evaluated according to purpose and audience

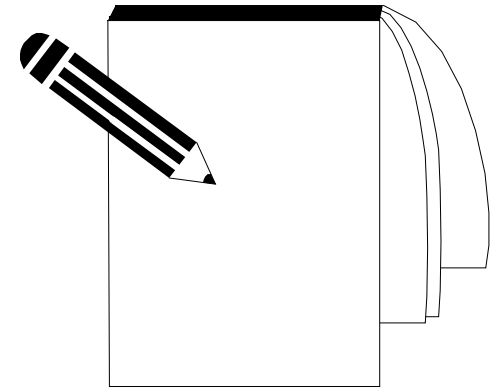

Strategies:

- Fast writing
- Daily writing
- Journals of all types: buddy journals, dialogue journals, learning logs

The Writing Process: Revising

Purpose:

- Reordering arguments or reviewing scenes in a narrative
- Reordering supporting information
- Reviewing or changing sentences

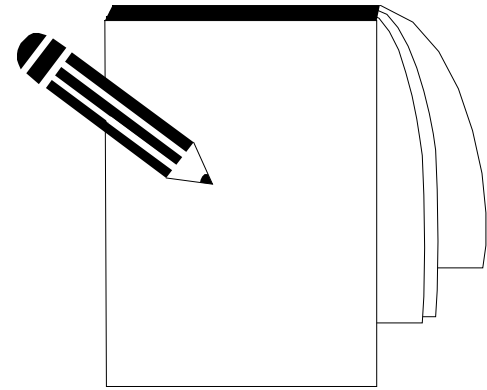

Strategies:

- Show and not tell
- Shortening sentences
- Combining sentences
- Peer response groups
- Teacher conferences.

The Writing Process: Editing

Purpose:

- Correcting spelling
- Grammar
- Punctuation
- Mechanics, etc.

Strategies:

- Peer editing groups
- Proof reading
- Computer programs for spelling
- Mini lessons.

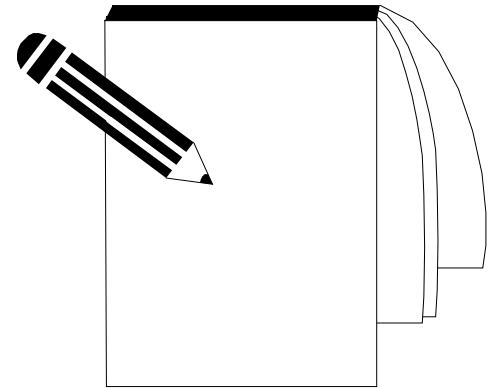

The Writing Process: Publishing

Purpose:

- Share writing with one another, with students, with parents
- Showing that writing is valued
- Creating a classroom library
- Motivating writing

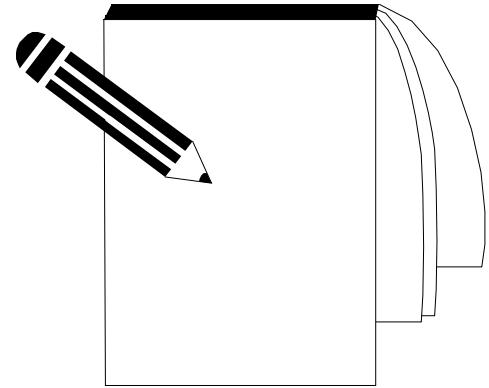

Strategies:

- Writing may be shared in many formats:
 - papers placed on bulletin boards
 - paper published with computers
 - paper shared in school book fairs, etc.



The Beginning ESL Writer Needs:

- Time to write
- To write about what he/she knows
- An authentic purpose for writing
- To learn spelling, grammar, and mechanics in context
- Support in reaching beyond expectations
- Prompt feedback
- Models for writing.



Competency 006

The ESL teacher understands how to promote student's content area learning, academic language development, and achievement across curriculum.



Competency 006 Components

- Applies knowledge of effective practices, resources, and materials for critical thinking; and **developing students' cognitive academic language** proficiency.
- Knows instructional delivery practices that are effective in facilitating ESL students' comprehension in content-area classes (**pre-teaching key vocabulary, helping students apply familiar concepts from their cultural backgrounds and prior experiences to new learning; using hands on and other experiential learning strategies; using realia, media, and other visual supports to introduce and/or reinforce concepts**).
- Applies knowledge of individual differences (e.g., developmental characteristics, **cultural and language background**, academic strengths, learning styles) to select instructional strategies and resources that facilitate ESL students' cognitive-academic language development and content-area learning.
- Knows personal factors that affect ESL students' content-area learning (**prior knowledge**, familiarity with the structure and uses of textbooks and other print resources) and applies effective strategies for addressing those factors.



Content-based Instruction

Communicative approach led to content-based ESL instruction to prepare student for mainstream classes.

- Taught by ESL educators
- Addresses key topics in grade-level curriculum
- Seeks to develop students' English proficiency through study of subject area content
- Addresses academic skills

Sheltered Instruction

Sheltered Instruction developed to support the needs of English language learners in content area classes.

- Grade-level curriculum
- Taught by content-area educators trained in sheltered instruction strategies
- Uses modified instruction strategies
- Uses modified instruction to make grade-level content comprehensible



Components of Sheltered Instruction

- Content objectives (grade-level TEKS)
- Language objectives (ELPS)
- Background Knowledge
- Comprehensible input
- Meaningful activities
- Variety of strategies and scaffolding
- Meaningful assessment

Content Objectives Aligned to the TEKS

Teachers should be

- very familiar with TEKS for their course.
- able to **focus English language learners on the most fundamental concepts** in a unit or lesson first.
- knowledgeable about ways to make the content comprehensible.



Language Objectives Aligned to the ELPS

Language Objectives: aspects of language the teacher is explicitly trying to develop

- Basic vocabulary of content or academic skills (compare, predict, recommend, etc.)
- Functional language (discuss in a group, conduct a survey, reach a consensus, request information, etc.)
- Identify and preteach essential vocabulary



Background Knowledge

- What appears to be poor comprehension or memory skills may be lack of schema (prior knowledge) or cultural mismatch.
- Use what students do know as a starting place. Talk to them about the topic; use a KWL or similar chart.
- Explicitly point out how past learning is related to the new information.

Vocabulary Acquisition

Can be done through:

- Instruction
 - Meanings of new words
 - Differences between words of similar meanings
 - Connotations of words
 - Correct usage of words based on context
- Read Alouds and Reading Independently
 - Many new words and concepts in a variety of different genres

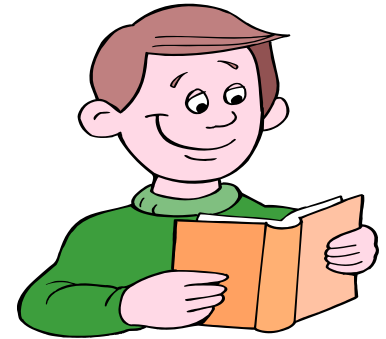

Guidelines for Teaching Vocabulary

- Relate words and concepts to **personal experiences**.
- Explain new vocabulary in **less complex language**.
- Highlight vocabulary words by using **oral or written cloze procedures**.
- **Categorize words** to show relationships.
- Help students use **visual imagery** to remember words.



Narrative and Expository Text

- Builds and extends world knowledge about a variety of topics
- Extends vocabulary
- Connects to real life experiences
- Shows how different texts are organized and written
- Helps children distinguish different genres and fact from fantasy



Comprehensible Input

Teachers must make choices of how to communicate information so that it is comprehensible.

- **Oral Language** – slower rate of speech, repeat significant information, clearly identify main ideas, use models, give demonstrations
- **Written Information** – adapted texts, graphic organizers
- **Strategies** – cognates, vocabulary, reading

How can we promote high cognitive development in ELL's?

- By utilizing students' knowledge of their first language to build on their knowledge of the second
- By capitalizing on *what they know* rather than be troubled by *what they do not know*
- By using the language functions that are important for *analyzing, evaluating, justifying* and *persuading*

Questioning Continuum

Ask questions before, during and after reading.

Simple



Complex

Who? What? Where? When?

How? Why? What if?

Responses should

- Focus on the information on the page.
- Rephrase text that has just been read.
- Recall facts, events, and names (labeling).

Responses should

- Move away from what can be seen on the page (making inferences).
- Analyze characters' actions and motivations.
- Focus on vocabulary and concepts.
- Connect story and students' experiences.

Meaningful Activities

Ways for ELL students to process and use new information:

- take surveys- collate and analyze results
- produce a product incorporating the new content: news article, play, brochure, poster, poem, illustration
- conduct an interview and present results
- make models

Meaningful Activities

- Teach the **learning strategies** that are needed for your content.
- Discuss/model what it means to study for your content area. What does study look like?
- Teach how to get information from your textbook.
Model reading and thinking about the information in the text.
- Teach how to take notes and use graphic organizers.

Scaffolding

- Provide substantial amount of assistance and support in early stages of new concepts.
- Divide tasks into smaller chunks (and be ready to divide again).
- Plan several rounds of activities for new concepts so students need less teacher guidance and have the opportunity to become more independent.

Guidelines for Scaffolding Discussions

- **Model** different ways to respond to questions.
- Use **questions and prompts** to help students express their ideas.
- **Paraphrase** and expand students' responses.
- Request **clarification**.
- Build world knowledge of the topic and relate to **real life experiences**.

Guidelines for Scaffolding Discussions

- Promote **questions and conversations** among students.
- Provide **positive reinforcement** for all types of responses.
- Incorporate **small group discussions** as often as possible to actively involve students.

Interaction

- Students clarify their understanding of new information by talking about it.
- ESL students need the opportunity to interact with peers to discuss and use new information.
- Students benefit from using English to express their ideas, opinions, and answers in cooperative groups.
- Use a variety of grouping strategies.



Assessment

ESL students may understand significant amounts of the content, but not be able to demonstrate their understanding on a test.

- Give test **orally**. Students can often say more than they can read or write.
- **Simplify the language** of the test. Try to avoid words you have not taught.
- Test only the **specific skills** and concepts you have taught; don't test language. In other words, grade content, not form. Look for evidence of understanding of content.
- Have students fill in a **graphic organizer or label a drawing**.

