

IN THE MATTER OF

MAGNETIC THERAPEUTIC TECHNOLOGIES, INC., ET AL.

CONSENT ORDER, ETC., IN REGARD TO ALLEGED VIOLATION OF
SECS. 5 AND 12 OF THE FEDERAL TRADE COMMISSION ACT

Docket C-3897. Complaint, Sept. 7, 1999--Decision, Sept. 7, 1999

This consent order, among other things, prohibits Magnetic Therapeutic Technologies, Inc. and its officer, the promoters and distributors of magnetic therapy products, from representing that such products are effective in treating various medical conditions and illnesses, unless the respondents possess and rely upon competent and reliable scientific evidence that substantiates the representation. The consent order also prohibits the respondents from representing that the experience presented in user testimonial or endorsement represents the typical or ordinary experience of the user of the product or program, unless: it is substantiated; or certain disclosures are made. In addition, the consent order prohibits any unsubstantiated claims regarding the health benefits, performance, or efficacy of any such product or program.

Participants

For the Commission: *Christa Vecchi, Richard Cleland and Dean Graybill.*

For the respondents: *Pro se.*

COMPLAINT

The Federal Trade Commission, having reason to believe that Magnetic Therapeutic Technologies, Inc. and Jim B. Richardson, individually and as an officer of the corporation, have violated the provisions of the Federal Trade Commission Act, and it appearing to the Commission that this proceeding is in the public interest, alleges:

1.a. Respondent Magnetic Therapeutic Technologies, Inc. ("MTT") is a Texas corporation with its principal office or place of business at 1915 Peters Road, Suite 106, Irving, Texas.

1.b. Respondent Jim B. Richardson, is the majority shareholder, President, Treasurer, and Secretary of the corporate respondent. He formulates, directs, and controls the acts and practices of the corporate respondent, including the acts and practices alleged in this complaint. His principal office or place of business is the same as that of the corporate respondent.

2. Respondents have promoted, offered for sale, sold, and distributed to the public magnetic therapy products. Therapeutic

magnets are "devices" within the meaning of Sections 12 and 15 of the Federal Trade Commission Act.

3. The acts and practices of respondents alleged in this complaint have been in or affecting commerce, as "commerce" is defined in Section 4 of the Federal Trade Commission Act.

4. Respondents have disseminated or have caused to be disseminated advertisements or promotional materials for magnetic therapy products, including but not necessarily limited to the attached Exhibits A through G. These advertisements and promotional materials contain the following statements:

A. APPLICATIONS OF BIOMAGNETISM

* * *

In the treatment of chronic conditions such as some forms of arthritis, degenerative joint conditions, diabetes ulcers and cancer, magnetic field therapy has shown dramatic results in aiding the reduction or reversal of the condition.

* * *

Some researchers, such as Nordenstrom and Wollin, have reported using supermagnet and electrical therapies to successfully treat lung and breast cancers.

* * *

[Exhibit A, MTT00030][Consumer Brochure]

B. SUMMARY OF BENEFICIAL INFLUENCE OF MAGNETS.

The beneficial influence of magnets may be summed up as follows:

* * *

2. Movement of haemoglobin [sic] in blood vessels is accelerated while calcium and cholesterol deposits in blood are decreased. Even the other unwanted materials adhered to the inner side of blood vessels, which provoke high blood pressure, are decreased and made to vanish. The blood is cleansed and circulation is increased. The activity of the heart eases and fatigue and pain disappear.

3. Functions of autonomic nerves are normalized so that the internal organs controlled by them regain their proper function.

* * *

[Exhibit B, at MTT00026][Consumer Brochure]

C. WHY SHOULD YOU HAVE a MAGNETICo SLEEP PAD??

* * *

MAGNETICo SLEEP PAD OWNERS TELL BENEFITS...

... a variety of fringe benefits are reported by delighted customers, such as:

* * *

Increased - Circulation/Oxygenation
 - Resistance to Disease
 - Bone Density

* * *

Lowered - Blood Pressure

Other - . . .
 - Multiple Sclerosis
 - Lupus

* * *

[Exhibit C, at MTT00051][Consumer Brochure]

Complaint

128 F.T.C.

* * *

7. How long will it be before I can feel the benefits of the MagnetiCo Sleep Pad?

Because every person is different, it is impossible to predict when you will feel a difference. Some lucky people feel benefits the first night, others it may take 6 months. The most common time is 1-2 months. **The important thing to remember is that some benefits, such as increased immunity, increased oxygen saturation and lowered blood pressure, may be taking place even though you can't feel them.**

[Exhibit C, at MTT00053][Consumer Brochure]

* * *

Sleep Pad Success Stories

(Excerpts from Testimonial Letters on File)

ARTHRITIS

(2 months on Sleep Pad)

"... For months I was walking the floor at night with tearful, intense pain, resorting to Tylenol #3 every 3 hours. I have not taken painkillers since ... and I sleep like a baby! ... I do not hesitate to encourage anyone to put this to the test!!!"

Leola Christensen

Resident, Canada & California.

* * *

MULTIPLE SCLEROSIS

(6 months on Sleep Pad)

"... In 1980, I was diagnosed with MS ... loss of balance, poor coordination, constant muscle spasms, fatigue and limited mobility are daily symptoms I have learned to live with. I have slept on the magnetic pad now for six months ... [W]hat I have found to be the most beneficial is that it seems to allow my body to 'bounce back' at a more-rapid rate than previous ... It has also assisted in less frequent muscle spasms ... It is not a cure for me but is of great assistance to me in allowing me to live a(n) ... active lifestyle with additional energy. I consciously have not changed any aspect of my daily living habits to give it a fair evaluation and now can recommend it to others ..."

Arni Skoretz,

Alberta Social Services Professional

RED DEER, AB.

HIV POSITIVE

(12 months on Sleep Pad)

"In January '92, I tested HIV Positive. ... After you telling the report of improved T-cell count in mice placed in an increased magnetic field, I decided it was definitely worthwhile for me to try one of your MagnetiCo Sleep Pads. I am pleased to report that I have had no drop in T-Cell count since, although it did hold at the same level for a few months, it is now up to 638, which is a substantial increase. ..."

Name withheld, Age 37

Los Angeles, CA.

EXTREME DIABETIC COMPLICATIONS

SLEEP DISORDER (8 months on Sleep Pad)

"HEALTH SUMMARY: Val Laugton

- a. Diabetic neuropathy (nerve death) - causing excruciating pain in extremities (1 -3 bouts daily, lasting from 45 minutes to two hours).

* * *

380

Complaint

IMPROVEMENTS SINCE SLEEPING ON PAD:

- a. The nerve spasms took 5-6 months to improve to a marked amount . . . now they are reduced by 80%-90%, with no occurrences at all for 4 to 5 days at a time.

* * *

*Dave & Val Laughton, Age mid-40's
Moosejaw, Sask.*

* * *

[Exhibit C, at MTT00055-00058][Consumer Brochure]

D.

* * *

HEART CONDITION

(6 weeks on Sleep Pad)

"I am 72 years old and have had five heart attacks . . . tried all that modern medicine had to offer, but was left a virtual invalid, unable to do the smallest task. In just six weeks on the MagnetiCo Sleep Pad, my color is greatly improved, blood pressure down ten points, and energy levels up enough that I can even work some. Best Purchase I have ever made!"

Joe Subich, Retired
OHIO.

[Exhibit D, MTT000153][Internet Ad]

E. MagnetiCo Survey Results (1993) . . .

95% of ARTHRITICS received at least 25% PAIN RELIEF

75% of ARTHRITICS received at least 50% PAIN RELIEF

* * *

[Exhibit E, at MTT00049][Consumer Brochure]

F. MAGNETIC THERAPY

Here's an economical alternative to pain killers and costly traditional drug therapy.

. . .

[Exhibit F, at MTT000164][Reader's Digest Catalog]

G. RELIEF FROM PAIN!

Do you suffer from PAIN, inflammation of the joints, nerves or tendons? Do you lie awake at night rubbing the parts of your body that ache and refuse[] to react to strong medicines.

* * *

MANY EXPERIENCE RELIEF WITHIN 24 HOURS

. . . . Magnetotherapy Products have hundreds of written testimonials stating that the person experienced RELIEF from PAIN and DISCOMFORT within just a few hours. Please remember, the MAGNETIC SUPPORTS are not a cure; neither are aspirin or other pain relief products. M+ flexible magnets can be an alternative to the high cost of doctor's visits and expensive prescriptions.

* * *

**LET'S HEAR FROM SOME SATISFIED USERS OF
THE MAGNETIC SUPPORT PRODUCTS**

* * *

"I have arthritis in my right hand and severe swelling along with the nerve damage in my carpal tunnel. Due to intense pain, I had to quit golf. After using the magnetized wrist supports, I was able to swing a golf club again with confidence.

Complaint

128 F.T.C.

My wife suffered from chronic back pain and back spasms. She was surprised at the relief she had after such a short time. . . . " Bum Phillips & Debbie
former Head Coach Houston Oilers and New Orleans Saints

* * *

THE GREATEST SURPRISE IS THE LOW COST

The average person suffering from pain has visited the doctor numerous times, spending \$35-\$50 and more for each visit. This is not counting the hundreds of dollars spent for prescription medicines. One lady writes she has been going to the doctor for over ten years and he was treating her for arthritic pain ... the cost was into hundreds of dollars. It still didn't satisfy the patient, as she still complained of pain. Her problem was arthritis in the knees and ankles. When she found out that the cost of a knee support was a one-time purchase price of \$59.95 plus the state sales tax, all she could do was say . . . "Give me one now, she exclaimed" [sic]. The product was shipped UPS and she was wearing it three days later

* * *

[Exhibit G, MTT000215-000216][Price List]

5. Through the means described in paragraph four, respondents have represented, expressly or by implication, that respondents':

A. Magnetic therapy products are effective in treating cancer, including lung and breast cancers, diabetic ulcers, some forms of arthritis, and degenerative joint conditions.

B. Magnetic therapy products significantly lower high blood pressure.

C. Magnetic sleep pads stabilize or increase the T-cell count of HIV patients.

D. Magnetic sleep pads significantly reduce muscle spasms in persons with Multiple Sclerosis.

E. Magnetic sleep pads significantly reduce nerve spasms associated with diabetic neuropathy.

F. Magnetic sleep pads significantly increase bone density, immunity, and circulation.

G. Magnetic therapy products are as effective as prescription pain medicine in alleviating severe pain caused by conditions such as arthritis, carpal tunnel syndrome, and chronic back pain.

6. Through the means described in paragraph four, respondents have represented, expressly or by implication, that testimonials from consumers appearing in the advertisements or promotional materials for respondents' magnetic therapy products reflect the typical or ordinary experience of members of the public who use the products.

7. Through the means described in paragraph four, respondents have represented, expressly or by implication, that they possessed and relied upon a reasonable basis that substantiated the representations set forth in paragraphs five and six, at the time the representations were made.

8. In truth and in fact, respondents did not possess and rely upon a reasonable basis that substantiated the representations set forth in paragraphs five and six, at the time the representations were made. Therefore, the representation set forth in paragraph seven was, and is, false or misleading.

9. The acts and practices of respondents, as alleged in this complaint, constitute unfair or deceptive acts or practices, and the making of false advertisements, in or affecting commerce, in violation of Sections 5(a) and 12 of the Federal Trade Commission Act.

Complaint

128 F.T.C.

EXHIBIT A

APPLICATIONS OF BIOMAGNETISM

It should be made clear that magnets themselves do not heal anything - they only stimulate the body to heal itself. Magnetism is a wholly natural event. It is neither magic nor medicine. It merely allows body cells to exist at their best level.

In recent years, developments in healing through electrical and magnetic therapies have increased exponentially. In the treatment of sprains, strains, broken bones, burns and cuts, not only does magnetic field therapy aid in the recovery, but it allows these conditions to heal better, more quickly, and with less scar tissue and better symmetry. In injuries, magnetic treatment has been shown to decrease healing time by half or more.

In the treatment of chronic conditions such as some forms of arthritis, degenerative joint conditions, diabetic ulcers and cancer, magnetic field therapy has shown dramatic results in aiding the reduction or reversal of the condition.

A Reader's Digest article in October, 1982, titled, "Biomagnetism: An Awesome Force in our Lives," quoted Dr. Bassett as predicting: "Electricity will become as ubiquitous in medical practise as surgery or drugs are; in many instances it will replace them."

Dr. Robert O. Becker has written extensively in his books, "The Body Electric" and "Cross Currents," about the future usage of magnetic and electrical therapy, predicting discoveries and advancements that today would only be considered impossible or miraculous.

Doctors in both Europe and the United States are obtaining results using electromagnetic fields to treat damage ranging from decubitus ulcers to severe burns. Soft tissue injuries are responding; as well as those of bone and joint. In the Soviet Union, doctors regularly use magnets to speed wound healing after surgery, to improve circulation, and to strengthen and mend bones.

Some researchers, such as Nordenstrom and Wollin, have reported using supermagnet and electrical therapies to successfully treat lung and breast cancers.

An American dentist, Dr. Jack Prince, has successfully used magnets on acupuncture points to reduce bleeding, gagging and pain sensitivity. Dr. Prince found that magnets could bring immediate relief of chronic pain from jaw dislocations as well as from TMJ syndrome, headaches and teethgrinding.

Exhibit A

MIT 00030

EXHIBIT B

SUMMARY OF BENEFICIAL INFLUENCE OF MAGNETS.

The beneficial influence of magnets may be summed up as follows:

1. When a magnet is applied to the human body, magnetic waves pass through the tissues and secondary currents are induced. When these currents clash with magnetic waves, they produce impacting heats on the electrons in the body cells. The impacting heats are very effective to reduce pains and swellings in the muscles, etc.
2. Movement of haemoglobin in blood vessels is accelerated while calcium and cholesterol deposits in blood are decreased. Even the other unwanted materials adhered to the inner side of blood vessels, which provoke high blood pressure, are decreased and made to vanish. The blood is cleansed and circulation is increased. The activity of the heart eases and fatigue and pain disappear.
3. Functions of autonomic nerves are normalized so that the internal organs controlled by them regain their proper function.
4. Secretion of hormones is promoted with the result that the skin gains lustre, youth is preserved and all ailments due to lack of hormone secretion are relieved and cured.
5. Blood and lymph circulations are activated and, therefore, all nutritions are easily and efficiently carried to every cell of the body. This helps in promoting general metabolism.
6. Magnetic waves penetrate the skin, fatty tissues and bones, invigorating the organs. The result is greatly enhanced resistance to disease.
7. The magnetic flux promotes health and provides energy by eliminating disorders in, and stimulating the functions of the various systems of the body, namely the circulatory, nervous, respiratory, digestive and urinary.
8. The magnetic treatment works by reforming, reviving and promoting the growth of cells, rejuvenating the tissues of the body, strengthening the decayed and inactive corpuscles and increasing the number of new, sound corpuscles.

MIT 00026

Exhibit B

Complaint

128 F.T.C.

EXHIBIT B

9. Magnets have exceptional curative effects on certain complaints like toothache, stiffness of shoulders and other joints, pains and swellings, cervical spondylitis, eczema, asthma as well as on chilblains, injuries and wounds.
10. The self-curative faculty (Homoestatis) of the body is improved and strengthened which ensures all the benefits mentioned above. One feels in full vigour and can walk and work, more and more without feeling tired.

How Magnets Affects Human Metabolism?

11. The magnetic treatment has the effect of energizing all the systems of the body. The effect remains in the body for several hours after each sitting with the magnets.
A continued treatment for a week or two, once daily for about state of health, in general routine cases.
(NOTE: This refers to very strong magnets as used by the medical profession.)

NOTE:

As magnets work on human metabolism mainly through the circulation of blood, which contains haemoglobin and iron, it will be relevant to state the position of iron contained in the body. The adult human body contains 4 to 5 grams of iron and it can be traced in all parts of the body. Most of it is present in blood as a component of haemoglobin and a smaller amount remains in muscles and is called myoglobin. The function of these components is to carry oxygen from the lungs to muscles and other parts. Without iron there would be no energy, and without energy, the beating of the heart and respiration would stop. Thus we see that iron is very essential for our life and magnetism influences iron radically and magnificiently.

Above MAGNETIC THERAPY by Dr. H. L. Bansal.

MIT 00027

EXHIBIT C

**WHY SHOULD YOU HAVE
a MAGNETICo SLEEP PAD ??**

YOU ARE AN ELECTRO-MAGNETIC BEING!

Magnetic Fields are essential to maintain health. There are two primary sources available — **Your Brain and The Earth**. These two fields supplement each other and bring needed **magnetic resonance** in the body tissues and provide up to **30% of total body energy needs**.

REDUCTION IN AVAILABLE NEGATIVE⁽⁻⁾ MAGNETIC FIELD

Aging, trauma, lack of oxygen to the brain, all reduce the brain's ability to put out sufficient magnetic field for optimum body function. These factors along with a dramatic reduction of the earth's magnetic field, makes supplementary **NEGATIVE⁽⁻⁾ magnetism** necessary for continued good health and function... enter the **MAGNETICo Sleep Pad[®]!**

ALTERNATING CURRENT (AC) ELECTRO-MAGNETIC FIELDS

Most of us live and work surrounded by these electro-magnetic fields in our modern environments. Unfortunately, their higher frequency stimulation throws body cells (which function at very low frequencies) out of resonance, causing cell fatigue and increased likelihood of malfunction. The beneficial Negative⁽⁻⁾ Magnetic Field in the **MAGNETICo Sleep Pad[®]** in conjunction with the **brain's pulsed low frequency Negative⁽⁻⁾ Magnetic Field** helps to **counteract** these cell-stressing **AC** higher frequencies.

REVITALIZE YOUR BODY... NATURALLY AND IN COMFORT!

Sleeping nightly on the **MAGNETICo Sleep Pad[®]** allows magnetic energy from **permanent, ceramic magnets** to energize all the tissues of the body through a process called "**magnetic resonance**". This enables your body to operate at a higher level of efficiency. There just isn't a pill or treatment anywhere that can come close to providing such an **OVERALL** benefit to assist your body in maintaining **WELLNESS** and **FUNCTION**... in such a comfortable, **NATURAL** way!!!

MAGNETICo SLEEP PAD[®] OWNERS TELL BENEFITS...

Besides the overall "energy-support-system" provided (not necessarily "felt"), a variety of fringe benefits are reported by delighted customers, such as:

Relief of	- Allergy Symptoms	Improved	- Energizing Sleep
	- Arthritic Symptoms		- Athletic Performance
	- PMS Symptoms		- Healing (muscle/ligament injuries in athletes, broken bones)
Pain relief from	- Stressed, tight muscles		- Energy Levels
	- Migraine Headaches	Lowered	- Blood Pressure
	- Back Problems	Other	- Chronic Fatigue Syndrome
	- Fibromyalgia Syndrome		- Post Polio Syndrome
Increased	- Circulation/Oxygenation		- Multiple Sclerosis
	- Resistance to Disease		- Lupus
	- Bone Density		- Emphysema

Note: Persons with **PACEMAKERS** should not use a magnetic sleep pad as it will interrupt the function of the pacemaker.

Magnetic^o inc.

MIT 00051

Exhibit C

EXHIBIT C

Commonly asked Questions and their Answers!***1. How is the MagnetiCo Sleep Pad different from other pads?***

This is the **only** magnetic pad made to simulate the earth's magnetic field of over 4,000 years ago when it was 10 times stronger than it is today. To do this, we had to use hundreds of block magnets placed so close together that they act like one big magnet. This results in a magnetic field that is **unidirectional**, extending several feet up above the bed before it returns back around outside the edge of the bed to the bottom of the bed (see diagram on next page). Because of the size and the volume of the magnets used the field is of ample strength to penetrate the mattress and the person laying on it and still extend 4 feet into the air above.

A mattress engineered in this way, with the negative(-) side up and with proper spacing of the magnets, gives a **pure negative(-) field to the body**. Other company's designs, due to lack of size, strength and number of magnets, result in a mixed magnetic field, both positive(+) and negative(-). This is not natural to the body, so the body responds as though it were an emergency (acupuncture type response). While this is OK on a short-term basis, extended periods of use cause fatigue of the body's vital resources, which are normally reserved for emergencies. Therefore, mixed field magnetic products should only be used for short periods of time (not longer than 2 months at a time). The natural purely negative(-) fields (such as the MagnetiCo Sleep Pad), on the other hand, may be used continually and indefinitely.

2. What is the difference between positive(+) and negative(-) fields and how do they affect my body?

The positive(+) (or mixed field) causes an emergency response by slowing down the electrons and protons which spin around the structural atoms and molecules in the body. This causes a reduction in the molecular action and hence the cellular function. As a result you will get an increase in blood flow to the area of stimulus as well as increased electrical flow from the brain. This increased electrical flow does increase molecular action. The problem with this method is that it is **using up** the body's emergency supply of vitality, which would normally be held in reserve for emergencies.

The pure negative(-) field, on the other hand, is natural to the body — it only enhances molecular action by speeding up the electrons and protons of the structural atoms and molecules in the body. The negative field replicates the earth's natural magnetic field in all but a few countries in the Southern Hemisphere. The molecular structure of the structural cells of the body orientate themselves to the type of magnetic field in which they have divided. By putting your body in an enhanced magnetic field the same as the earth's, you are **adding** to your vitality, not using it up.

380

Complaint

EXHIBIT C

3. *Is it possible for me to get too much of a negative(-) field? Will it harm me in any way?*

In our research, we have experimented using pure negative(-) fields a thousand times more powerful than the Sleep Pad for extended periods of time. In ALL cases, we have found only an enhancement of benefits, with no negative side effects.

4. *Why can't I have another person sleep beside my pad?*

Because of the design of the MagnetiCo Sleep Pad, the return (or positive) field comes down outside the edge of the pad. This would subject the person beside you to the positive(+) field, rather than the negative(-). This will fatigue the person over time, depending on their level of vitality.

5. *Do I need to wear magnets during the daytime?*

It is sometimes necessary to place single magnets on injured or diseased areas to enhance healing by giving increased molecular action 24 hours a day. (Note: you should NOT wear a single magnet while you are resting on the sleep pad as you will get conflicting magnetic fields.) A rule of thumb is to use a magnet larger than the area you are trying to treat.

6. *Will the field from the Inner Power Pad be affected by any of the metal in my mattress or boxspring?*

Yes, it affects it in a good way. The springs actually conduct the negative(-) magnetic field up into the body.

7. *How long will it be before I can feel the benefits of the MagnetiCo Sleep Pad?*

Because every person is different, it is impossible to predict when you will feel a difference. Some lucky people feel benefits the first night, others it may take 6 months. The most common time is 1 - 2 months. The important thing to remember is that some benefits, such as increased immunity, increased oxygen saturation and lowered blood pressure, may be taking place even though you can't feel them.

MIT 00053

EXHIBIT C

MAGNETICO Supplemented Magnetic Field

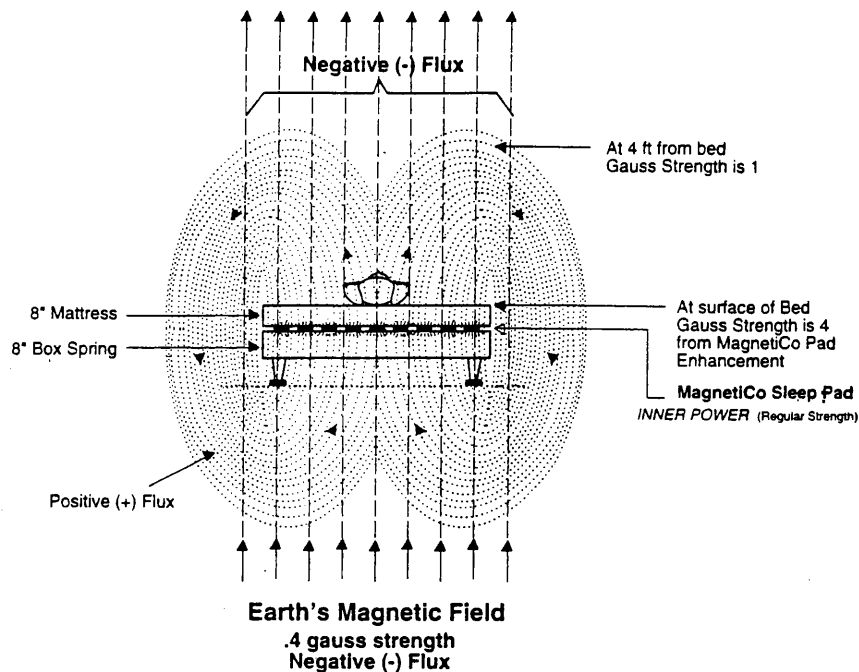

Other Brands Supplemented Magnetic Field

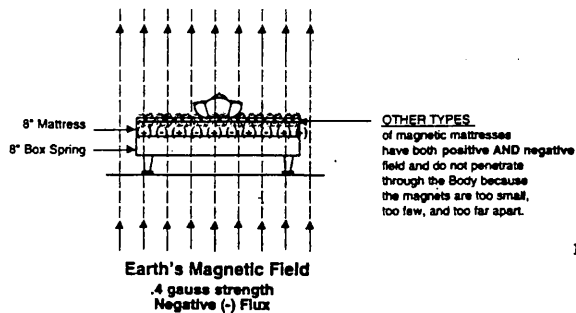

MIT 00054

EXHIBIT C

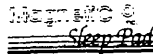

Dear Friend,

I wish I could share with you the excitement I hear from **Magnetico Sleep Pad[®]** people nearly every day! The following "Success Stories" indicate a sampling of benefits obtained by sleeping in a cocoon of beneficial **Negative (-)** magnetic field.

The **Magnetico Sleep Pad[®]** provides energy to every charged particle of the body, enabling each cell to perform its particular function more efficiently. This produces an enhancing effect to any other supplementation, dietary, or exercise programs that you already practice, making the **Sleep Pad[®]** a **BASE-LINE Healthcare / Wellness** product.

Energy is the stuff life is made of!!!! Supplementing a depleted **environmental source** only makes sense! Let me strongly encourage you to make this wise, one-time investment in your **present well-ness and performance**. At the same time you will be adding an important building block in your **future quality of life**.

Wishing you **WELL...**

Dr. DEAN BONLIE

Magnetico Sleep Pad Success Stories
(Excerpts from Testimonial Letters on File)

ARTHRITIS

(2 months on Sleep Pad)

"...For months I was walking the floor at night with tearful, intense pain, resorting to Tylenol #3 every 3 hours. I have not taken painkillers since... and I sleep like a baby! ...I do not hesitate to encourage anyone to put this to the test!!!"

*Leola Christensen,
Resident, Canada & California*

ARTHRITIS & MIGRAINE RELIEF

(3 months on Sleep Pad)

"...I had been fighting a migraine-type headache for about a week... take 4 aspirin every 4 hours. After receiving my mattress and sleeping on it for two nights, my headache was gone.

...When the stress of the day begins to turn into a bad headache... I always know that I will find relief when I sleep on the mattress. "I don't wake up sore and stiff in the morning. ...having trouble with the tendons in my ankle (previous injury) ...not been bothered by that since. Thanks again..."

*Evelyn Strawn - First Grade Teacher
CALEXICO Academy*

RHEUMATOID ARTHRITIS

(4 months on Sleep Pad)

"I've suffered for ten years... many sleepless nights due to pain! Hands and feet deformed with some corrective surgery... three months ago I was unable to hold a pen to write, now am writing this letter! Since sleeping on the Magnetico Sleep Pad, my joint pain is minimal... sleep restful. I would not be without it... words cannot express my satisfaction!"

*Wm. Burke, Age 74
Ontario, Canada*

ARTHRITIS

(3 weeks on Sleep Pad)

"...I love to go to bed on my Pad and hate to get up and leave my Pad... I have a severe case of arthritis and since using this Pad 'I feel like a new man'."

*Fred Midlane
Desert Hot Springs, CA*

ARTHRITIS & VENUS INSUFFICIENCY

(2 months on Sleep Pad)

"...Have arthritis in elbow, neck, both hips and knee... controlled by taking Motrin twice daily and rollerblade an hour a day... taking 20 minutes to get pain and stiffness to subside. By the end of the first week of sleeping on the pad, I could rollerblade without stiffness and pain... totally off Motrin in two weeks..."

Venus insufficiency: "My doctor prescribed support hose... for the rest of my life. After the third week on the Magnetic Pad, I could see and feel a difference in the toes... I have not worn them (support hose) since, no more swelling. The flow of blood and the valves in my legs have improved."

*Duane Winchester - Retired
Bell Tel. Executive, UTAH*

ARTHRITIS

(10 months on Sleep Pad)

"I have been an osteo-arthritis sufferer for the past 12 years. I experienced many sleepless nights because of pain in my back, neck and shoulders and each morning my hands were stiff and swollen shut. I was introduced to the magnetic mattress ten months ago and have experienced gradual improvement in my whole body. Thanks to the magnetic mattress I can now enjoy a good game of golf and other activities."

*John E. McDonald, Retiree
Hope, B.C.*

ARTHRITIC NECK - PAIN RELIEF - IMPROVED SLEEP

(8 months on Sleep Pad)

"I had broken my C-2 vertebra in my neck 1 1/2 years before getting my Sleep Pad. My neck had developed arthritic stiffness and would crack when I turned my head... which anybody sitting next to me could hear and would comment on it. After four weeks on the sleep pad the cracking noise was gone and I could turn my head without the arthritic pain and there was decreased stiffness. My sleep has improved... on an ordinary mattress, I require 7 1/2-8 hours of sleep... on the magnetic sleep pad, I awaken refreshed in 6 hours. Thanks for your research, Dean... here's to a higher quality of life!"

*Ray Price, Age 34
Edmonton, AB*

5000
MIT

EXHIBIT C

MagnetiCo Sleep Pad Success Stories (cont.)

FIBROMYALGIA - "TRIGGER FINGERS"

(2 months on Sleep Pad)

"...My 24-hour pain from fibrocitis (fibromyalgia in Canada) has been chronic... 25 years. Expected improvement to be gradual... already I have new energy and pain is starting to decrease... color in my face instead of grey pallor. I've suffered for several years with "trigger fingers" consisting of painful curling and locking... requiring hours of stretching and massaging... to release... Tried surgery, months of rehab, cortisone, hoping to avoid more surgery with only temporary results. NOW - NO MORE TRIGGER FINGERS! I can even type again!! I'm elated, delighted and grateful!"

*June McKeown, Retiree
from Portland, OR to Vancouver, BC*

CHRONIC FATIGUE SYNDROME

(felt instant relief on Sleep Pad)

"Dear Dr. Bonlie,
I had generally good health prior to the birth of our son... then it was debilitating back and leg pain, sleeplessness, fatigue, depletion of immune system, little energy... I exhausted every medical lead I could find for relief. My sleep from the first night on the Pad was deep and wonderful... no more pain at night. Daytime pain took longer to disappear... I found I could lay down on my bed to recharge and get relief... We've had our Sleep Pad for nearly two years... notice the difference in energy levels if we are away from it for more than a few days... wouldn't be without it!!! ...definitely recommend your wonderful magnetic Sleep Pad to anyone and everyone!"

*Ron & Shelley Conn, mid-30's
Consultant & Executive
Surrey, B.C.*

SLEEP DISORDER - FIBROMYALGIA

(1 month on Sleep Pad)

"I am very grateful to Dr. Scott Olson for introducing the MagnetiCo Sleep Pad. I have had a sleeping disorder for the last 15 years, due to Fibromyalgia and Rheumatism that attacks the muscles. I am pleased to say that I sleep all night, and it's so wonderful to get up in the morning without the stiffness. Thank You."

*Leona Piche, Age 43
BRITISH COLUMBIA*

CHRONIC FATIGUE SYNDROME

(8 months on Sleep Pad)

"I had been off work for 5 years due to severe chronic fatigue syndrome. Before getting your MagnetiCo Sleep Pad, the smallest tasks around the house were exhausting to me. I had the Sleep Pad for exactly 120 days with no particular results other than improved immunity... evidenced by not being plagued by colds and flu all winter, as per normal. On the 121st day, my energy returned so that I felt like going to work again!... I am very grateful for this product which enabled me to return to normal life and work!"

*Ted Jones, 40+ years, Engineer
Ontario, Canada*

PRE-MENSTRUAL SYNDROME (PMS)

(4 months on Sleep Pad)

"For many years, PMS made my life absolutely miserable for two weeks of every month. Sleeping on the MagnetiCo Sleep Pad solved this problem almost immediately! I sleep much more... soundly now and am enjoying a marked increase in stamina. Also, my immune system must have improved, since this year I did not get my customary one-month long cold. Thank You, Dr. Bonlie, for turning my life around! I can highly recommend the MagnetiCo Sleep Pad as an economical way of protecting one's health."

*Pat Roman, Businesswoman
Vancouver, B.C.*

PAIN RELIEF

(6 weeks on Sleep Pad)

"Following an auto accident five years ago, I have been searching for a solution to pain in the soft tissue of my neck, arm, lower back and leg. After six weeks of sleeping on the magnetic Sleep Pad, I anticipate total recovery. With the combination of good food, nutritional supplements and therapy, the Sleep Pad has supplied the final piece of the puzzle. I sleep comfortably all night and awaken refreshed and am full of energy. As a matter of fact, I don't recall ever having this much energy. Thank You!"

*Name Withheld,
Virginia, USA*

*"...I don't ever recall
having this much
energy..."*

BACK PAIN RELIEF - TRUCK DRIVING

(3 months on MagnetiCo Seat Cushion)

"Since you introduced me to your "Seat Pad" ... I have been virtually free of pain in my mid/lower back... my right leg often 'went to sleep' after hours on the accelerator - not anymore! ... I also lay on the Pad on the 'sleeper' bunk quite often and find that I awake feeling much more rested than when I 'moter'... the severe pain in my 'back to shoulder' muscle was gone within the first three days and has not bothered me since. ... Many thanks for your research and development of this correctly designed and comfy product."

*Darol Rick, Line-Haul Trucker
HOPE, B.C., Canada*

MULTIPLE SCLEROSIS

(8 months on Sleep Pad)

"...In 1980, I was diagnosed with MS... loss of balance, poor coordination, constant muscle spasms, fatigue and limited mobility are daily symptoms I have learned to live with. I have slept on the magnetic pad now for six months... what I have found to be the most beneficial is that it seems to allow my body to 'bounce back' at a more rapid rate than previous... It has also assisted in less frequent muscle spasms and I am now waking up more refreshed with more energy. It has also assisted in my breathing due to... various allergies. It is not a cure for me but is of great assistance to me in allowing me to live a(n)... active lifestyle with additional energy. I consciously have not changed any aspect of my daily living habits to give it a fair evaluation and now can recommend it to others..."

*Arni Skoretz - Alberta Social Services Professional
RED DEER, AB*

HIV POSITIVE

(12 months on Sleep Pad)

"In January '92, I tested HIV Positive. Otherwise I have excellent health, am careful about what I eat and am very physically fit. After you telling the report of improved T-cell count in mice placed in an increased magnetic field, I decided it was definitely worthwhile for me to try one of your MagnetiCo Sleep Pads. I am pleased to report that I have had no drop in T-Cell count since, although it did hold at the same level for a few months, it is now up to 638, which is a substantial increase. You can be sure I will continue to give myself this health advantage and certainly recommend it to others!"

*Name withheld, Age 37
Los Angeles, CA*

MIT 00056

EXHIBIT C

MagnetiCo Sleep Pad Success Stories (cont.)

**EXTREME DIABETIC COMPLICATIONS
SLEEP DISORDER** (8 months on Sleep Pad)
HEALTH SUMMARY: Val Laughton
 a. Diabetic neuropathy (nerve death) – causing excruciating pain in extremities (1 – 3 bouts daily, lasting from 45 minutes to two hours).
 b. Extreme bloating after meals – Internist tried various medications with little success.
 c. Sleep Disorder – Many years (average amount of sleep: 1-3 hrs per night)
IMPROVEMENTS SINCE SLEEPING ON PAD:
 a. The nerve spasms took 5 – 6 months to improve to a marked amount. ...now they are reduced by 80%-90%, with no occurrences at all for 4 to 5 days at a time.
 b. Bloating stopped the first night.
 c. Sleep problem relieved in the first few nights. This was all hard to believe, it was so dramatic.
 Val is a R.N. and thought a magnetic mattress was the equivalent of a "flying carpet" when we got it. Now she looks upon it as one of the most important purchases we have ever made and is very, very grateful!

*Dave & Val Laughton, Age mid-40's
Moosejaw, Sask.*

"P.S. I have been fortunate to have pretty good health, however, I have had pretty consistent indigestion all of my life. It disappeared after the first night on the magnetic mattress and I have not had any since! (Dave)"

IMPROVED SLEEP/GENERAL HEALTH CONDITION
(2 months on Sleep Pad)

"Health Condition at Time of Sleep Pad Purchase: Always tired with sore back and numerous other aches and pains. Not getting enough sleep. ... Our first week was kind of odd, as we had numerous headaches, but Dr. Fleming told us that was quite common. The second week was much better, as we found out we never got up more than once or twice a night. By the third week, we were starting to look forward to going to bed at nights. It's been very good to us. So now we have accepted the MagnetiCo Pad as one of the family and would recommend it to anyone."

*Victor and Angie Lemieux (Ages 79 & 77)
LANGLEY, B.C., Canada*

HEART CONDITION
(6 weeks on Sleep Pad)

"I am 72 years old and have had five heart attacks... tried all that modern medicine had to offer, but was left a virtual invalid, unable to do the smallest task. In just six weeks on the MagnetiCo Sleep Pad, my color is greatly improved, blood pressure down ten points, and energy levels up enough that I can even work some. ...Best Purchase I have ever made!"

*Joe Subich, Retired
OHIO*

LIVER DISEASE
(3 weeks on Sleep Pad)

"I have a congenital liver disease... with multiple symptoms affecting me, so I could barely get up to eat and drink. Was unable to sleep well... take 2 to 3 hours to fall asleep... and waken at 4 or 5 a.m. The first night on the Sleep Pad I fell right to sleep and slept so good... it was delicious! After the first week of sleeping on the Pad, I noticed I had energy... Now I'm back to cooking and have started gardening again. The aches and pains, and fluid retention are gone too. I wish I'd had the Sleep Pad years ago!"

*Neena McLean
San Francisco, CA*

**CHILD – Extreme Chemical/Environmental Allergies:
Behavioral Disorder**

SLEEP PAD – Immediate Relief Insomnia

Summary: "Amy has been diagnosed with zinc deficiency and immune dysregulation, which will be an ongoing condition. She took Ritalin for five years, with all its undesirable side effects, and became allergic to that. I had come to expect only 4-5 hours sleep (in segments) per night. The first night on the Sleep Pad, Amy had a full night's sleep... and it has continued for 2-1/2 months now. She awakes pleasant and alert. We thank you for everything..."

*Jayne Vaughan
ONTARIO, CANADA*

NATUROPATHIC PHYSICIAN
(8 months on Sleep Pad)

"Thank you for introducing me to the MagnetiCo Sleep Pad... I am delighted... In my practice the results have been remarkable. The patients to whom I have introduced the MagnetiCo Sleep Pads have responded well and are happy with the results. With my degrees in Chiropractic and Naturopathic Medicine, and studies in acupuncture, physical therapy, Australian Bowen technique, and various other therapies, I have naturally been led into a practice of physical medicine, including the use of small taped-on magnets, so it is with some amazement that I find a process that gives such relief and comfort in such a simple manner. After all, everyone has to lie down to sleep on a regular basis, so what better way to have therapy! I am sure other benefits will be found from the use of the magnet pads as time goes by, so there is no doubt in my mind that the use of magnetic sleep pads will become one of the major therapeutic agents of the future. Again, thank you!"

*Robert Fleming, B.Sc., D.C., N.D.
WHITE ROCK, B.C.*

*"...Extra energy
for extra life!
Thanks!"*

**IMPROVED IMMUNITY – MORE ENERGY
LESS SLEEP REQUIRED**
(8 months on Sleep Pad)

"Since January 1993 I have been sleeping on a MAGNETICo Sleep Pad and have observed significant differences... First, I have more mental energy... with less sleep. Secondly... free from colds, flu or sickness when others have succumbed... I picked up a sore throat while away... within 2 days of being back home on my sleep pad, the infection was gone... In the past it would have lingered on for 2 weeks. Extra energy for extra life! Thanks!"

*Vertie Ward, Ph.D.
Walla Walla College, WA*

EXHIBIT C

MagnetiCo Sleep Pad Success Stories (cont.)

GENERAL HEALTH CRISIS
 (3 months on Sleep Pad)

"Dear Dr. Bonlie,
 As you know, I have "crawled out of hell"... I was diagnosed with... hypoglycemia, fibromyalgia, allergies, depression, vitamin/ mineral deficiencies, toxicity, etc.... Many doctors had valid observations, but no wholistic approach. I was forced to experiment with products on my own to see which ones would help me on my journey to wellness. Your magnetic bed provides a nightly "cradle" which augments the power of all else that I do! Thank you for your wonderful product!"

*E.H., Age 20
 Victoria, B.C.*

INCREASED ENERGY
 (6 months on Sleep Pad)

"I can't say enough about my Sleep Pad! I awake refreshed and get through a hard day's work and still have some energy left at the end of the day. I'm only sorry I didn't know of your Sleep Pads sooner! Each day (since sleeping on the pad) my wife feels a bit better than the previous day. I have looked into other sleep pads and feel that your's is the only one worth using."

*C.A. Riggs
 Harwood Heights, IL*

INSOMNIA

(2 months on Sleep Pad)

"...For the first time in twenty years, I am getting a decent night's sleep! Before, I suffered bouts of insomnia all the time, and if I did manage to get to sleep, I would waken at least 3 or 4 times a night. Now... I can count on sleeping straight through! Thank you, Dr. Bonlie, for this wonderful product!"

*Joan Meals, Mid-30's
 Everett, WA*

PASSIVE, EASY-TO-USE ENERGY SUPPLEMENT
 (12 months on Sleep Pad)

"Dear Dr. Bonlie,
 You have one of the best overall health products on the market today! What I like about the MagnetiCo Pad is the fact that it is passive... everyone can have one in the privacy of their own home. There is no preparation, no measuring, no calculations, nowhere to go for a treatment — just sleep on the pad!! The benefits are there for you every single night. Health benefits can't come any easier than that! I believe that everyone needs a pad to rebalance in this hectic world of ours."

*Rupert Ravens, Health Enthusiast
 Jersey City, NJ*

**"My finishes and run times
 have improved consistently...
 ...recuperative time
 dramatically reduced..."**

(runner)

RUNNER

(3 months on Sleep Pad)

"...I have been running for 9 years... Since using the MagnetiCo Sleep Pad, I have run in 3 formal 5K races. My finishes and run times have improved consistently with each race. In addition... my recuperative time has been dramatically reduced. I am also the mother of an 11-year-old son who is very active... Thanks to my MagnetiCo Pad I never seem to run out of energy these days!"

*Laurel Van Ark, Age 37
 Dana Point, CA*

ATHLETE - BACK PAIN RELIEF / TENNIS ELBOW
 (4 months on Sleep Pad)

"Re: evaluation of the magnetic pad, it was a raging success. Just as you, Dr. Bonlie and Dr. Philpott attested, the pad brought wonderful results... Anybody that has circulatory problems, lower back or other related pain should never sleep without the pad."

*Jim Everett, Quarterback
 Los Angeles RAMS*

"...a raging success!"

ATHLETE

(6 months on Sleep Pad)

"...regarding improvements in performance due to sleeping on the magnetic pad... observations:

- Less latent muscle soreness at the onset of higher intensity training.
- Rapid stimulation of cardiovascular strength (faster improvement).
- Increased recovery time after running, working (monitored by heart rate).
- Muscular strength levels have been maintained at a higher level, most significantly in a full squat and bench press.
- Lower Resting Heart Rate (55 beats per minute).
- Deeper and more sound sleeping and more energy as soon as I get out of bed...

I will keep you posted as to further findings."

*Richard Hesketh - Decathlete
 Canadian National Team Member since 1987
 Calgary, AB*

INCREASED STAMINA - MARATHONS
 (3 years on Sleep Pad)

"I've been running marathons for 10 years. Since sleeping on the MagnetiCo Sleep Pad, I've noticed a substantial increase in endurance during the latter third of the race, allowing me to finish first or second in my age category. Also it has eliminated most of my post-race nausea, soreness and extreme exhaustion. I can now go out and enjoy a celebration dinner after!"

*Lillian Miller, 60+ years, Realtor
 California*

IMPROVED FITNESS - ATHLETE

"As a 'past-my-prime' athlete, I feel the Sleep Pad has helped my body return to the coordination and stamina of 15-20 years ago! I could never gain weight before and now have put on 10-12 lbs. of muscle in two months. Thanks again for your helpful insight into this technology, and I once again shout the praises from the rooftops about this wonderful product!"

*Gary Robinson
 Micaville, NC*

MIT 00058

380

Complaint

EXHIBIT D

why.htm at www.mplasmagnet.com

Page 5 of 6

years... notice the difference in energy levels if we are away from it for more than a few days... wouldn't be without it!!! ...definitely recommend your wonderful magnetic Sleep Pad to anyone and everyone!"

Ron & Shelley Conn, mid-30's

Consultant & Executive

Surrey, B.C.

HEART CONDITION

(6 WEEKS ON SLEEP PAD)

"I am 72 years old and have had five heart attacks... tried all that modern medicine had to offer, but was left a virtual invalid, unable to do the smallest task. In just six weeks on the Magnetic Sleep Pad, my color is greatly improved, blood pressure down ten points, and energy levels up enough that I can even work some. Best Purchase I have ever made!"

Joe Subich, Retired

Ohio

MIT 000153

ORDER NOW WHILE ON-LINE!!

Exhibit D

Complaint
EXHIBIT E



Exhibit E

MIT 00045

SECRET

MAGNETIC STORY:
by Magnetico
Sleep Pad

EXHIBIT E

A Long, Long Time Ago...

This Earth was surrounded by a much stronger Magnetic Field than that which exists today. Scientists have been recording the strength of the Earth's Magnetic Field over the last 155 years. This decline has also been determined by measurement of decrease of north-south orientation of magnetite crystals in deposits which have occurred at known times in history such as in volcanic flows and sediments. 5, 7, 12, 13

GAUSS - Unit of measurement of magnetic fields.

EARTH'S MAGNETIC FIELD:
4,000 years ago - 4.0 Gauss
Today - 0.4 Gauss
(varies by location and time) 5, 7, 12

Necessary to Life...

We are all very much aware of our constant need for air, water, and food! However, the need for the Earth's magnetic force to maintain health was not recognized until the advent of modern space travel.

Early cosmonauts were found to have experienced up to 80% bone-calcium loss and muscle cramps when in space above the earth's magnetic field for extended periods.

In addition, scientists have discovered that the magnetic field of the earth is cyclic, with die-outs of biological life forms occurring in times of Magnetic Field decline and reversals. 2

Confirming evidence of die-outs determined by studies of core samples from ocean floor. 2

Historic Uses...

References to the early use of the forces of magnetism in the healing arts are found in most civilizations of the world. The first usage is recorded by the Chinese in the book "Yellow Emperor's Book of Internal Medicine" (approx. 2000 B.C.). Reference is made to the use of Magnetism in conjunction with the practice of acupuncture. 1

Cleopatra is claimed to have worn a lodestone on her forehead to prevent aging. 1

Ancient Hindu scriptures, Egyptian and Persian history, and Tibetan monk practices indicate therapeutic lodestone usage.

Famous Persian physician Ali Abbas, describes using magnetism to relieve spasms and gout - A.D. 1000. 8

More modern contributions to scientific and medical knowledge of electrical and magnetic energy were made by William Gilbert, private physician to Queen Elizabeth I, Volta, Galvani, and Mesmer. Mesmer was particularly noted for successful treatment of a variety of ills in the mid-1700's. 1

Galen, noted Greek physician, author and educator, referred to magnetism as an excellent purgative (laxative). 8

Beginning of Modern Research...

"Magnetic Field Deficiency Syndrome" was identified in Japan in the late 1950's. It is characterized by symptoms such as: Lack of Energy, Insomnia, Generalized Aches & Pains, Upper Back & Neck Stiffness, Frequent Headaches, Dizziness, Constipation, etc. (These symptoms seem to closely correlate with our North American version - "Chronic Fatigue Syndrome".) 12

The external application of a magnetic field to the human body was found to alleviate the symptoms of "Magnetic Field Deficiency Syndrome". 12

30 million Japanese use a therapeutic magnetic device according to Nikken Corporation.

Current Health-Related Uses...

- Pulsed Direct Current Magnetic Therapy
Used by physiotherapists, massage therapists, chiropractors and sports trainers.
- Direct Current Electro-Magnetic Field Therapy
Used by Orthopedic Surgeons
- Hospital Diagnostic Tests — MRI, MEG, MKG, SQUID

For relief of deep muscle pain, stiffness, arthritic symptoms and other related problems.

For healing of non-union fractures - speeds healing time dramatically.

A Magnetic Resonance Imaging (MRI) machine is a valuable diagnostic tool for visualizing internal organs such as the brain, spine, and liver, etc.; this machine uses up to 40,000 Gauss.

MIT 00046

Magnetic[®]

EXHIBIT E

 Bio-Magnetic Theory... By Dr. Dean R. Bonde

In Brief...

The Earth's Magnetic Field has Decreased by approximately 90% over the last four thousand years.

This Geomagnetic Field is an Essential Environmental Factor for Life and Health on this Planet.

The human body has adapted to this loss of natural energy, but it seems a reasonable assumption that there would be a corresponding Loss of Physiological Vitality and Efficiency in all the functions of the body.

By placing the body in a restored, pure, Negative (-) Magnetic Field equal in strength to that of earth 4,000 years ago, I theorize that over-all body performance should be greatly enhanced.

 Effect of Geomagnetic Field
 on the Human Body...

The human body is electro-magnetic by design, being composed largely of charged particles such as atoms, electrons, protons, and ions (e.g., potassium, sodium, calcium, etc.). These all perform vital life functions.

Consider how the following basic principles of Physics regarding geomagnetic (directional) fields affect atoms in that field.

- ✓ When the field is increased, there will be a temporary increase in electromagnetic force or charge on the atom which will result in a higher velocity of some of the orbiting electrons and protons (primarily outer ring un-paired electrons).⁹
- ✓ This increase in velocity of some electrons and protons and not others will cause precession or wobble of the atom, leading to enhanced electron transfer.^{9, 10}
- ✓ Enhanced electron transfer, is the basic action in all chemical reactions of the body.

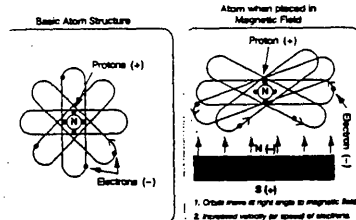

Summarized, an increase of the geomagnetic field (which is a directional magnetic field) acts as a catalyst to improve chemical reactions occurring in the human body. This should improve all body functions. Examples are: oxygen carrying capacity, assimilation of nutrients, manufacture of enzymes, metabolic waste removal, reduction of free radicals, tissue regeneration and healing.

MIT 00047

 INCREASED GEOMAGNETIC FIELD
 equals
 ENHANCEMENT OF BODY CHEMISTRY
 BASIC PHYSICS PRINCIPLE

Magnetic (or cyclotronic) resonance of body tissues is also improved by increased electron velocity, making an even higher level of chemical activity possible.

By applying the above principle to human physiology, it would be expected that ALL chemical and electrical actions of the body would be improved. Some examples are:

- ✓ Faster diffusion of ions and gases through cellular membranes³ (e.g., lungs, circulatory system)
- ✓ Increased lymphocyte production¹¹

Benefits Substantiate Theory...

as reported by individuals sleeping regularly on my design of magnetic sleep pad:

- ✓ Up to 30% increase in the ability of the body to pick up and utilize oxygen from the air inhaled.*
- ✓ Major increase in strength and endurance.*
- ✓ Up to 80% reduction in muscle soreness after major workouts.*

* Noted in performance records of professional athletes.

- ✓ Most arthritics experience relief from pain and symptoms.
- ✓ Most chronic headaches relieved.
- ✓ Many sleep disorders relieved.
- ✓ Many feel more energized and require less sleep.
- ✓ Many report improved resistance to disease (colds, flu, etc.)

Magnetic[®]

Sleep Pad

EXHIBIT E

Scientific Validation...Red Blood Cell Studies

BEFORE-MAGNETICO SLEEP PAD



Before...

Note the clumping of red blood cells, typical of stress, health problems or fatigue. Fatigue is normally experienced by everyone at the end of the day and can be explained as "loss of charge" on body cells.

AFTER-20 MINUTES ON MAGNETICO SLEEP PAD

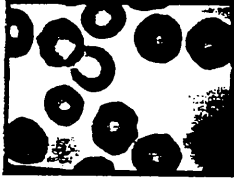

After...

With increased Negative (-) magnetic field supplementation, chemical reactions are enhanced, building up the charge on cell walls. The cells will then repel each other, eliminating the clumping. With more surface area available, the oxygen-carrying capacity of the cells is greatly increased.

Pulse oximeter tests also confirm substantial increases in oxygen saturation levels in the blood of individuals who had 20 minute sessions on the Magnetico Sleep Pad.

Natural Magnetic Field... The magnetic field produced by Permanent Magnets is a **safe natural energy source**. Large and small magnets of this type have been **used safely** in industry for years. There are no known harmful exposure levels and no limitations by governmental agencies.

Electromagnetic Fields... Many people confuse **Natural Permanent Magnetic Fields** used in the **MAGNETICO Sleep Pads** with **Alternating Current (AC) Electro-Magnetic Fields** put out by power lines and electrical devices. These AC fields are **Positive⁽⁺⁾** and **Negative⁽⁻⁾** with a frequency of 60 cycles/second. This is 7.66 times too fast for the average body organ resonance frequency of 7.83 and can cause **cell fatigue** in time. The enhanced **Negative⁽⁻⁾** Field of the **MAGNETICO Sleep Pads** helps counteract the effects of **electro-magnetic pollution** to your body. ⁴

Resources...

1. Becker, Robert O., M.D., "Cross Currents", 1990, p.15
2. Ibid., pp. 178-191
3. Ibid., pp. 233-238
4. Ibid., pp. 248-253
5. Cox, Allen, "Magnetic Field Reversals", *Scientific American*, Feb. '67, pp. 44-54
6. Davis, Albert R. and Rawls, Walter C. Jr., "The Magnetic Effect", 1975, p. 19
7. Gubbins, David and Blozhan, Jeremy, "The Secular Variation of the Earth's Magnetic Field", *NATURE*, Volume 317, Oct. 31, 1985
8. Gubbins, David and Blozhan, Jeremy, *Scientific American*, Dec. '89, pp. 71-75
9. Xie, "Fundamentals of Electricity and Magnetism", 1968, pp. 354-357
10. Kolm, Henry H. and Freeman, Arthur J., "Intense Magnetic Field", *Scientific American*, April '65, pp. 66-69
11. Lefebvre, M. and Wiesendanger, M., Cherin, D., Blackinton, D., and Mehta, S., "Modulation of Lymphocyte Function in Low Frequency Electric and Magnetic Environments", *FASEB Journal*, 1992, Abstract #2433
12. Nakagawa, Kyoichi, M.D., "Magnetic Field Deficiency Syndrome and Magnetic Treatment", *Japanese Medical Journal No. 2745*, Dec. 4, '76
13. Velikovskiy, Immanuel, "Earth in Upheaval", p. 146

Additional recommended reading: "Discovery of Magnetic Health", G. Washnis, Dec. '83.
This 346 page book provides an excellent overview of the topic. Call 1-800-265-1119.

The information presented in this brochure is for educational purposes only.
It is not to be construed as a prescribed medical treatment.
Regular medical evaluation and care by your physician are advised at all times.
Any self-help application is the responsibility of the user of the information.
No medical claims are made for these products.

MIT 00048

Magnetico
Sleep Pad

Complaint

128 F.T.C.

EXHIBIT E

The Inventor...

D.R. Bonlie, D.D.S.
President, MagnetiCo Inc.

DR. DEAN BONLIE graduated with honors from Loma Linda University. His questioning mind soon got him involved in active research. This resulted in the development of several marketable dental products.

More recently, the relatively unexplored topic of the effects of magnetism on the human body intrigued him. He became convinced that tapping this natural energy source could be a wonderful means of providing an **improved quality of life**.

Dr. Bonlie's magnetic sleep pad design (patent pending) has a unique concept. It is the **ONLY** design of sleep pad engineered to produce a **Pure Negative⁽⁺⁾ Magnetic Field** equivalent to that of the earth 4,000 years ago.

His **MAGNETICo Sleep Pads[®]** allow you to '**Power-Sleep**' in a **cocoon of energy**, supplementing a drastically reduced environmental source.

NOTE: A MAGNETICo Sleep Pad[®] can be used continuously . . . **YOUR BODY DOES NOT NEED A REST FROM IT . . .** as it is properly engineered according to geo-magnetic and physiological principles.

THE BODY DOES REQUIRE A REST from other magnetic pads using Positive⁽⁺⁾, Mixed Positive⁽⁺⁾ and Negative⁽⁻⁾ or incorrectly designed Negative⁽⁻⁾ fields.

EXCEPTION: Persons with Pacemakers can not use a magnetic sleep pad as it will interrupt the function of the pacemaker.

MagnetiCo Survey Results (1993)...

95% of ARTHRITICS received at least 25% PAIN RELIEF
75% of ARTHRITICS received at least 50% PAIN RELIEF

92% of INSOMNIACS were SLEEPING 25% BETTER
69% of INSOMNIACS were SLEEPING 50% BETTER

46% of INSOMNIACS received **TOTAL RELIEF** from their SLEEP PROBLEMS

41% reported a Noticeable **INCREASE IN ENERGY**

91% of these MAGNETICo Sleep Pads[®] owners were well-pleased with the overall results obtained.

The Survey was taken of 100 persons randomly selected who had slept on a MagnetiCo Sleep Pad for over seven months. The number of participants by age grouping are as follows:

# of Persons	Years
25	0-50
35	51-70
40	70+

63 out of 100 purchased the Pad for relief of **Arthritic symptoms**

13 out of 100 were interested in help for **sleep problems**

24 persons received **Significant** help with the following conditions:

Poor Blood Circulation	High Blood Pressure	Constipation
Migraine Headaches	Prostatitis	Varicose Veins
Fibromyalgia	Chronic Fatigue Syndrome	Back Injuries
Osteoporosis	Depression	Emphysema

(Summarized Results)

MIT 00049

MagnetiCo

Sleep Pad

380

Complaint

EXHIBIT E

MAGNETICo 'POWER' Sleep Pads ^{pat. pend.}

ONLY Sleep Pad Engineered to Simulate Earth's Magnetic Field 4,000 Years Ago...

'POWER-SLEEP'
IN A COCOON OF
RESTORED MAGNETISM!

ENHANCE VITALITY & BODY PERFORMANCE !!

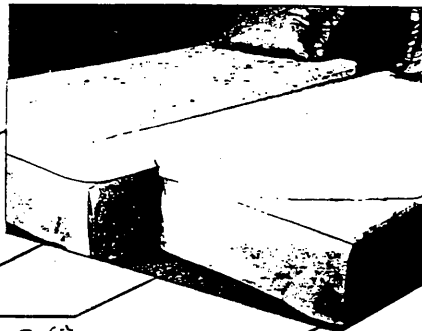

'TOP POWER' Sleep Pad ☆
Placement: **ON TOP** of Mattress
4" thick, quilted zippered cover
(for waterbeds or professional use)

'INNER POWER' Sleep Pad ☆
Placement: **BETWEEN** Mattress & Box Spring
1 1/2" thick, non-quilted fabric zippered cover
(recommend Extra Strength for extra-thick mattresses)

COMPARE...

MAGNETICo Sleep Pads ☆

- ✓ TOP POWER or INNER POWER MODELS
- ✓ REGULAR or EXTRA STRENGTHS AVAILABLE IN BOTH MODELS
- ✓ MOST EFFECTIVE ON MARKET
- ✓ MOST MAGNET WEIGHT PER DOLLAR
- ✓ MATERIALS & WORKMANSHIP GUARANTEE
- ✓ PERSONALIZED CUSTOMER SUPPORT
- ✓ SHIPPING INCLUDED IN PRICE

Same Magnetic Core in Both Models
permanent ceramic magnets - 3950 gauss
Mfr's. Rating



CALL TODAY

PRICES*	'TOP POWER'			'INNER POWER'		
	STRENGTHS:	REG.	EXTRA	STRENGTHS:	REG.	EXTRA
Professional	30"x74"	\$ —	\$ 550	Travel	30"x74"	\$ 320 \$ 450
Single	39"x74"	595	800	Single	39"x74"	435 600
Double	54"x74"	795	1000	Double	54"x74"	595 800
Queen	60"x80"	995	1200	Queen	60"x80"	735 1000
King	76"x80"	1195	1500	King	76"x80"	895 1200
Calif-King	72"x84"	1195	1500	Calif-King	72"x84"	895 1200

MIT 00050

*Prices subject to change without notice

"Give Yourself the ENERGY Advantage — 'POWER SLEEP' !!!"

Complaint

128 F.T.C.

EXHIBIT F

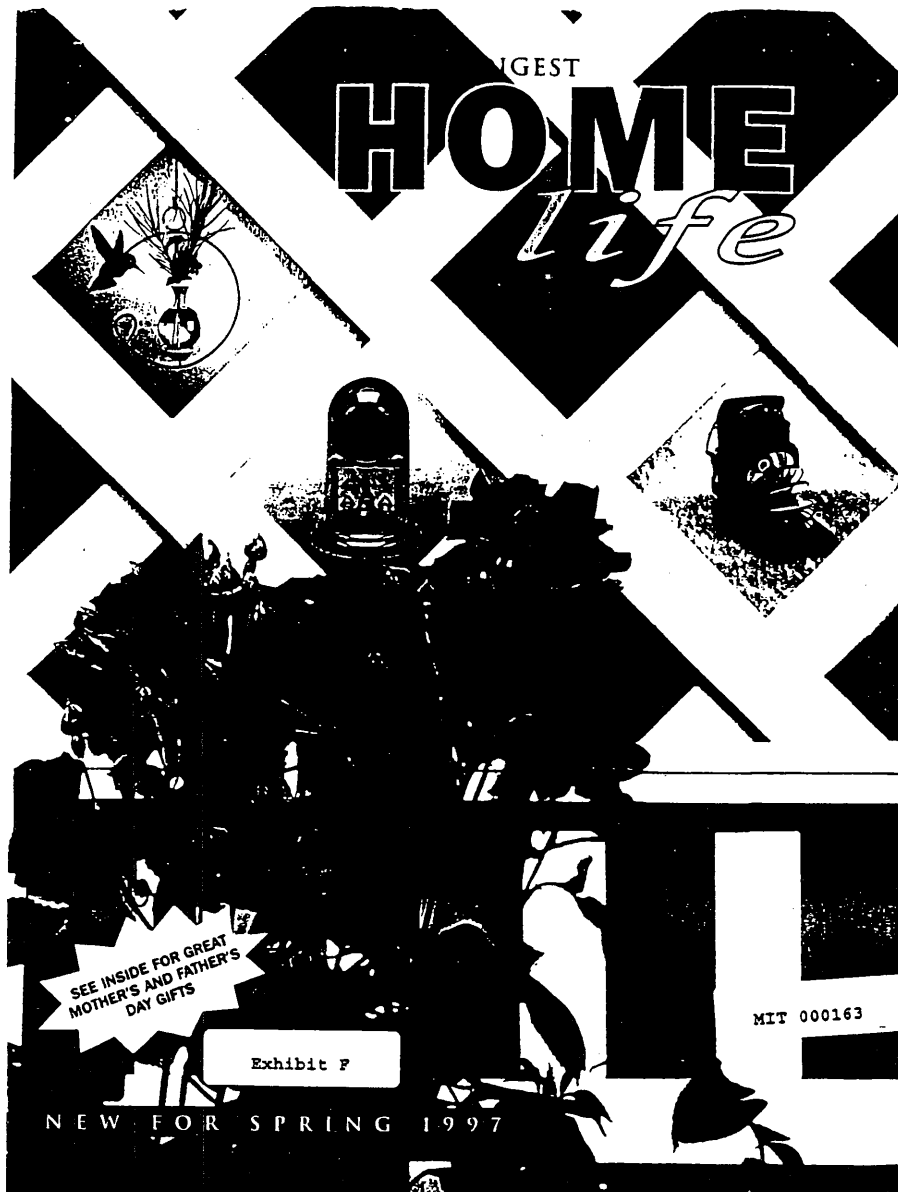

380

Complaint

EXHIBIT F

Readers Digest
Catalog

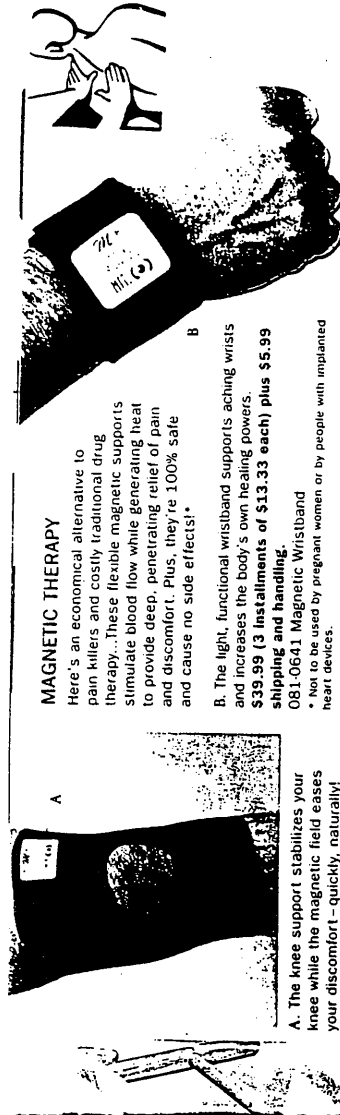

MAGNETIC THERAPY

Here's an economical alternative to pain killers and costly traditional drug therapy... These flexible magnetic supports stimulate blood flow while generating heat to provide deep, penetrating relief of pain and discomfort. Plus, they're 100% safe and cause no side effects!*

B. The light, functional wristband supports aching wrists and increases the body's own healing powers.

\$39.99 (3 installments of \$13.33 each) plus \$5.99 shipping and handling.

081-0641 Magnetic Wristband

* Not to be used by pregnant women or by people with implanted heart devices.



A. The knee support stabilizes your knee while the magnetic field eases your discomfort - quickly, naturally!

\$59.95 (5 installments of \$11.99 each)

plus \$6.99 shipping and handling.

081-0642 Magnetic Knee Support

YOUR GUARD AGAINST ALLERGIES

Let outdoor freshness in - even at the peak of allergy season! The window ventilator with sturdy aluminum rust-proof frame and coated screen barriers traps pollen dust, soot and other allergens and impurities. Vacuums clean.

\$34.98 (3 installments of \$11.66 each)

plus \$5.99 shipping and handling.

081-0645 Window Guard for Allergies



NEW! NATURE'S SPA HERBAL TUB TEAS

Sleep yourself in the relaxing pleasure of a fragrant tub tea bath. The oversized sachet is filled with an aromatic blend of essential oils, lavender, rosemary and rose petals.

Package of 6.
\$19.98 (2 installments



MIT 000164

Complaint

128 F.T.C.

EXHIBIT G

NEW: By reading this article you will learn how **MAGNETS** applied to the human body greatly effect the reduction of **PAIN and DISCOMFORT and INFLAMATION.**
If your doctor has treated you for any of these symptoms, please read further for an alternative treatment to medicine.

YOU SAW IT ON TELEVISION
"The Good Morning America" Show

Professional Distributorships
Available 214-756-6667

RELIEF FROM PAIN!

Do you suffer from PAIN, inflammation of the joints, nerves or tendons? Do you lie awake at night rubbing the parts of your body that ache and refuses to react to strong medicines. Magnetic therapy has been around for over 70 years in America and before that you can trace its use to the Greeks in the Province of Magnesia in Asia Minor, hence the name magnets and magnet. The therapeutic value of MAGNETS was recognized centuries before our current era.

MAGNETOTHERAPY, AN ALTERNATIVE TO MEDICATION

When a magnet is applied to the human body, magnetic waves pass through the tissue and secondary circuits are induced. When these currents clash with magnetic waves, impacting heats are produced. These impacting heats generated within blood vessels expand them and allow an increase in blood flow. Increasing blood flow allows your circulatory system to carry the healing properties to the afflicted area and the lymphatic system to carry away toxins aiding the body's natural healing process.

Magnetotherapy uses these magnets in supportive wraps which are flexible and comfortable to wear. Seven into neoprene wraps, the M+ flexible magnet is placed around the area of the body that is experiencing PAIN and causing the individual discomfort.

WHERE CAN THESE WRAPS BE WORN? HOW ARE THEY ADMINISTERED?

There are MAGNETIC SUPPORT WRAPS FOR THE KNEE, ankle, elbow, back and wrist. Since thousands of people suffer from pain in wrists and hands, a special wrap is designed for this discomfort.

Another specially-designed support is manufactured for the KNEE that allows you to wear it in comfort, without hindering mobility. Many times the swelling goes down and the individual experiences no pain within a few hours of its use.

MANY EXPERIENCE RELIEF WITHIN 24 HOURS

Since the effects of static magnetic fields vary from one person to another and from one application to another an exact duration exposure is difficult to prescribe. Magnetotherapy Products have hundreds of written testimonials stating that the person experienced RELIEF from PAIN and DISCOMFORT within just a few hours. Please remember, the MAGNETIC SUPPORTS are not a cure; neither are aspirin or other pain relief products. M+ flexible magnets can be an alternative to the high cost of doctor's visits and expensive prescriptions.

LET'S HEAR FROM SOME SATISFIED USERS OF THE MAGNETIC SUPPORT PRODUCTS

"I've had seven operations on my knee in eight years. I still experienced excruciating pain after the last operation. My knee was stiff and swollen, and the ache was unbearable. I decided to try the M+ magnetic knee support and after just three hours I could feel a tremendous relief of pain. By the next morning, the swelling was gone and I was pain free. I no longer have to wear the support because the pain and swelling have not come back. I'd recommend the magnetic knee support to anyone. It really does work!"

John S.J., Linden, Michigan

"I have arthritis in my right hand and severe swelling along with the nerve damage in my carpal tunnel. Due to intense pain, I had to quit playing golf. After using the magnetized wrist supports, I was able to swing a golf club again with confidence. My wife suffered from chronic back pain and back spasms. She was surprised at the relief she had after such a short time. Thanks, we'll tell everybody about the support wraps."

Bum Phillips & Debbie
former Head Coach Houston Oilers
and New Orleans Saints

"I experienced some relief in 24 hours, but a big difference in 48 hours. I now have no pain in my wrists."

William M., Ft. Charlotte, FL

"I had arthritis in my knee. I got the knee support and over night the swelling and pains went away and also the pain. I sleep well for the FIRST TIME in months. I would recommend this product for anyone with pain."

Mrs. Caroline M., Punta Gorda, FL

THE GREATEST SURPRISE IS THE LOW COST

The average person suffering from pain has visited the doctor numerous times, spending \$35 - \$50 and more for each visit. This is not counting the hundreds of dollars spent for prescription medicines. One lady writes she has been going to the doctor for over ten years and he was treating her for arthritic pain ... the cost was into hundreds of dollars. It still didn't satisfy the patient, as the unit complained of pain. Her problem was arthritis in the knees and ankles. When she found out that the cost of a knee support was a one-time purchase price of \$59.95 plus the state sales tax, all she could do was say ... "Give me one now, she exclaimed". The product was shipped UPS and she was wearing it three days later.

NO SIDE EFFECTS HAVE BEEN ATTRIBUTED TO PERMANENT MAGNETIC FIELDS

It is not to be considered a medical treatment for conditions mentioned above, however, use may help to relieve pain and discomfort. We do not believe that Magnetic fields heal by themselves, and we will not make that claim. We do believe, however, that they can aid your body's natural healing powers.

LIFETIME MAGNETIC GUARANTEE

Upon receipt of the product within 30 days (as evidenced by the post-mark date), MIT will replace the magnet at no extra charge to the original purchaser providing the product is not stretched, punctured, mutilated or damaged in any way. Purchaser will be responsible for shipping costs to MIT, Inc.

The suggested retail price of the Magnetized Silicone Support Products are listed here. Prices are subject to change so we suggest you order TODAY for the lowest INTRODUCTORY PRICE in your community.

DO NOT USE

- on open wounds or infected areas
- when pregnant
- close to the heart, if wearing a pacemaker or other cardiac stimulator
- if skin irritation occurs
- in case of hematoma, wait 24 hours before applying

LET'S SUMMARIZE

First, consider the pain you have suffered for weeks, months and possibly years from the pain of ARTHRITIS. Secondly, consider the money you have spent on medicine and doctor's office visits during that time. Then visualize the relief you may experience in a very SHORT TIME when you try one of our M+ MAGNETIC SILICONE PRODUCTS ... THEN, consider the LOW, LOW COST of purchasing this AMAZING PRODUCT that may give you RELIEF OF PAIN you haven't had in the past. You now can enjoy life, if you golf, go golfing, if you bowl, go bowling, if you only want to sit in your recliner and dream of the life you want it to be ... sit, smile and dream ... the future is there for the asking.

CALL TOLL FREE 1-800-371-1113

Have your VISA, MC, AE or DISCOVER cards handy when you call. It is AMAZINGLY EASY to order. You should add \$4.00 for shipping and handling. Dial TOLL FREE 1-800-371-1113 NOW and the product you ordered will be shipped by UPS. REMEMBER, DON'T SUFFER ANOTHER DAY, CALL THAT NUMBER TODAY, if you wish to pay by check or money order, mail to:

MIT 000215

Revised 6

380

Complaint

EXHIBIT G

MAGNETIC SUPPORT PRODUCTS

Professional Distributorships Available

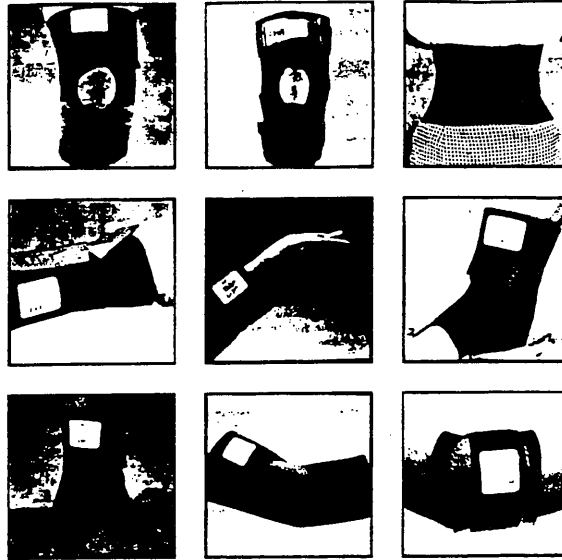

- 1. KNEE SUPPORT
- 4. WRISTLET
- 7. ACHILLES ANKLE
- 2. KNEE BRACE
- 5. SPORT BAND
- 8. ELBOW SUPPORT
- 3. LUMBAR SUPPORT
- 6. ANKLE SUPPORT
- 9. TENNIS ELBOW

Mail or fax to order to... **MTT, Inc.**
 1915 Peters Rd., Suite 508
 Irving, Texas 75061
 Phone 972-721-9227
 Fax 972-721-1279

MTT INC.
 MAGNETIC THERAPEUTIC TECHNOLOGIES, INC.

NOT TO BE CONSIDERED A MEDICAL TREATMENT FOR THE CONDITIONS ABOVE. HOWEVER, USE MAY HELP TO RELIEVE PAIN & DISCOMFORT. UNITED STATES GOVERNMENT AGENCY APPROVAL HAS NOT BEEN OBTAINED.



ITEM	END USER PRICE
WL Magnetic Wristlet (Left)	\$49.95
WR Magnetic Wristlet (Right)	\$49.95
SB Magnetic Sports Band	\$49.95
UTE Universal Tennis Elbow	\$49.95
UES Universal Elbow Sleeve	\$59.95
UKS Universal Knee Support	\$69.95
UAS Universal Ankle Support	\$49.95
ULS Universal Lumbar Support	\$129.95
DA-2 Direct Application	\$49.95
SI Shoe Inserts #SI-A Women 5-8, Men 5-6 #SI-B Women 9-10, Men 7-8 #SI-C Women 11-12, Men 9-10 #SI-D Men 11-13	\$49.95
Sub-Total	
Sales Tax (8.25%)	
Shipping & Handling \$5.50	
Total	

MIT 000216

CIRCLE ONE: Home/Office/Discover # Exp. _____

Name _____

Address _____

City _____ State _____ Zip _____

Phone (____) _____ Date _____

OR CALL 1-800-371-1113
FOR FASTER SERVICE

DECISION AND ORDER

The Federal Trade Commission having initiated an investigation of certain acts and practices of the respondents named in the caption hereof, and the respondents having been furnished thereafter with a copy of a draft of complaint which the Bureau of Consumer Protection proposed to present to the Commission for its consideration and which, if issued by the Commission, would charge respondents with violation of the Federal Trade Commission Act; and

The respondents and counsel for the Commission having thereafter executed an agreement containing a consent order, an admission by the respondents of all the jurisdictional facts set forth in the aforesaid draft of complaint, a statement that the signing of said agreement is for settlement purposes only and does not constitute an admission by respondents that the law has been violated as alleged in such complaint, or that the facts as alleged in such complaint, other than jurisdictional facts, are true, and waivers and other provisions as required by the Commission's Rules; and

The Commission having thereafter considered the matter and having determined that it had reason to believe that the respondents have violated the said Act, and that a complaint should issue stating its charges in that respect, and having thereupon accepted the executed consent agreement and placed such agreement on the public record for a period of sixty (60) days, now in further conformity with the procedure prescribed in Section 2.34 of its Rules, the Commission hereby issues its complaint, makes the following jurisdictional findings and enters the following order:

1.a. Respondent Magnetic Therapeutic Technologies, Inc. ("MTT") is a Texas corporation with its principal office or place of business at 1915 Peters Road, Suite 106, Irving, Texas.

1.b. Respondent Jim B. Richardson is the majority shareholder, President, Treasurer, and Secretary of the corporate respondent. Individually or in concert with others, he formulates, directs, or controls the policies, acts, or practices of the corporation. His principal office or place of business is the same as that of MTT.

2. The Federal Trade Commission has jurisdiction of the subject matter of this proceeding and of the respondents, and the proceeding is in the public interest.

ORDER

DEFINITIONS

For the purposes of this order, the following definitions shall apply:

1. "*Competent and reliable scientific evidence*" shall mean tests, analyses, research, studies, or other evidence based on the expertise of professionals in the relevant area, that has been conducted and evaluated in an objective manner by persons qualified to do so, using procedures generally accepted in the profession to yield accurate and reliable results.

2. "*Clearly and prominently*" shall mean as follows:

A. In an advertisement communicated through an electronic medium (such as television, video, radio, and interactive media such as the Internet and online services), the disclosure shall be presented simultaneously in both the audio and video portions of the advertisement. Provided, however, that in any advertisement presented solely through video or audio means, the disclosure may be made through the same means in which the ad is presented. The audio disclosure shall be delivered in a volume and cadence sufficient for an ordinary consumer to hear and comprehend it. The video disclosure shall be of a size and shade, and shall appear on the screen for a duration, sufficient for an ordinary consumer to read and comprehend it. In addition to the foregoing, in interactive media the disclosure shall also be unavoidable and shall be presented prior to the consumer incurring any financial obligation.

B. In a print advertisement, promotional material, or instructional manual, the disclosure shall be in a type size and location sufficiently noticeable for an ordinary consumer to read and comprehend it, in print that contrasts with the background against which it appears. In multipage documents, the disclosure shall appear on the cover or first page.

C. On a product label, the disclosure shall be in a type size and location sufficiently noticeable for an ordinary consumer to read and comprehend it, in print that contrasts with the background against which it appears.

The disclosure shall be in understandable language and syntax. Nothing contrary to, inconsistent with, or in mitigation of the disclosure shall be used in any advertisement or on any label.

3. "*Magnetic therapy products*" shall mean any product that contains a magnet of any kind purporting to relieve the symptoms of, treat, mitigate, cure, relieve, heal or alleviate any disease or health condition, including but not limited to Magnetic Sleep Pads, M+ Flexible Magnetic Pads, Magnetic Insoles, Magnetic Knee Support, Magnetic Knee Brace, Magnetic Lumbar Support, Magnetic Wrist Support, Magnetic Sports Band, Magnetic Ankle Support, Magnetic Elbow Sleeve, and Magnetic Tennis Elbow Support.

4. Unless otherwise specified, "*respondents*" shall mean MTT, its successors and assigns; Jim B. Richardson, individually and as an officer of the corporation; and each of the above's agents, representatives and employees.

5. "*Distributor*" shall mean any purchaser or other transferee of any product or program covered by this order who acquires product or program from respondents, with or without valuable consideration, and who sells, or who has sold, such product or program to other sellers or to consumers, including but not limited to individuals, retail stores, or catalogs.

6. "*Commerce*" shall mean as defined in Section 4 of the Federal Trade Commission Act, 15 U.S.C. 44.

I.

It is ordered, That respondents, directly or through any partnership, corporation, subsidiary, division, or other device, including franchisees, licensees or distributors, in connection with the manufacturing, labeling, advertising, promotion, offering for sale, sale, or distribution of magnetic therapy products in or affecting commerce, shall not represent, in any manner, expressly or by implication, that such products:

- A. Are effective in treating cancer, including lung and breast cancers, diabetic ulcers, arthritis, or degenerative joint conditions;
- B. Lower high blood pressure;
- C. Stabilize or increase the T-cell count of HIV patients;
- D. Reduce muscle spasms in persons with Multiple Sclerosis;
- E. Reduce nerve spasms associated with diabetic neuropathy;
- F. Increase bone density, immunity, or circulation; or
- G. Are comparable or superior to prescription pain medicine,

unless, at the time the representation is made, respondents possess and rely upon competent and reliable scientific evidence that substantiates the representation.

II.

It is further ordered, That respondents, directly or through any partnership, corporation, subsidiary, division, or other device, including franchisees, licensees or distributors, in connection with the manufacturing, labeling, advertising, promotion, offering for sale, sale, or distribution of any product or program in or affecting commerce, shall not represent, in any manner, expressly or by implication, that the experience represented by any user testimonial or endorsement of the product or program represents the typical or ordinary experience of members of the public who use the product or program, unless:

A. At the time it is made, respondents possess and rely upon competent and reliable scientific evidence that substantiates the representation; or

B. Respondents disclose, clearly and prominently, and in close proximity to the endorsement or testimonial, either:

1. What the generally expected results would be for users of the product or program, or

2. The limited applicability of the endorser's experience to what consumers may generally expect to achieve, that is, that consumers should not expect to experience similar results.

For purposes of this Part, "endorsement" shall mean as defined in 16 CFR 255.0(b).

III.

It is further ordered, That respondents, directly or through any partnership, corporation, subsidiary, division, or other device, including franchisees, licensees or distributors, in connection with the manufacturing, labeling, advertising, promotion, offering for sale, sale, or distribution of any product or program, in or affecting commerce, shall not make any representation, in any manner, expressly or by implication, about the health benefits, performance, or efficacy of any such product or program, unless, at the time the

representation is made, respondents possess and rely upon competent and reliable scientific evidence that substantiates the representation.

IV.

It is further ordered, That:

A. Respondents shall not disseminate to any distributor any material containing any representations prohibited by this order.

B. Respondents shall not, directly or indirectly, authorize any distributor to make any representations prohibited by this order.

C. Within thirty (30) days after service of this order, respondents shall send by certified mail, return receipt requested, an exact copy of the notice attached hereto as Attachment A to each distributor with whom respondents have done business since January 1, 1994, to the extent that such distributor is known to respondents through a diligent search of their records, including but not limited to computer files, sales records, and inventory lists. The mailing shall not include any other documents.

D. For a period of three (3) years following service of this order, respondents shall send by certified mail, return receipt requested, an exact copy of the notice attached hereto as Attachment A to each distributor with whom respondents do business after the date of service of this order who has not previously received the notice. Such notice shall be sent within one (1) week from the first shipment of respondents' products or programs to said distributor. The mailing shall not include any other documents.

E. Respondents shall monitor distributors' advertising and promotional activities. In the event that respondents receive any information that subsequent to receipt of Attachment A pursuant to subparts C and D of this Part, any distributor is using or disseminating any advertisement or promotional material or making any oral statement that contains any representation prohibited by this order, respondents shall immediately terminate said distributor's right to market respondents' products or programs and immediately provide, by certified mail, all relevant information, including name, address, and telephone number of the company at issue, the nature of the violation, and any relevant materials used or disseminated, to the Associate Director, Division of Enforcement, Federal Trade Commission, Washington, D.C. 20580.

F. Respondents shall require distributors to submit to respondents all advertising and promotional materials and claims for any products or programs covered by this order for approval prior to their dissemination and publication. Respondents shall not authorize distributors to disseminate these materials and claims unless they are in compliance with this order.

V.

It is further ordered, That respondent Magnetic Therapeutic Technologies, Inc. and its successors and assigns, and respondent Jim B. Richardson shall, for five (5) years after the last correspondence to which they pertain, maintain and upon request make available to the Federal Trade Commission for inspection and copying: copies of all notification letters sent to distributors, communications between respondents and distributors referring or relating to the requirements of Part IV, and any other materials created pursuant to Part IV of this order.

VI.

It is further ordered, That respondent Magnetic Therapeutic Technologies, Inc. and its successors and assigns, and respondent Jim B. Richardson shall, for five (5) years after the last date of dissemination of any representation covered by this order, maintain and upon request make available to the Federal Trade Commission for inspection and copying:

A. All advertisements and promotional materials containing the representation;

B. All materials that were relied upon in disseminating the representation; and

C. All tests, reports, studies, surveys, demonstrations, or other evidence in their possession or control that contradict, qualify, or call into question the representation, or the basis relied upon for the representation, including complaints and other communications with consumers or with governmental or consumer protection organizations.

VII.

It is further ordered, That respondent Magnetic Therapeutic Technologies, Inc. and its successors and assigns, and respondent Jim B. Richardson shall deliver a copy of this order to all current and

future principals, officers, directors, and managers, and to all current and future employees, agents, and representatives having responsibilities with respect to the subject matter of this order, and shall secure from each such person a signed and dated statement acknowledging receipt of the order. Respondents shall deliver this order to current personnel within thirty (30) days after the date of service of this order, and to future personnel within thirty (30) days after the person assumes such position or responsibilities.

VIII.

It is further ordered, That respondent Magnetic Therapeutic Technologies, Inc. and its successors and assigns, and respondent Jim B. Richardson shall notify the Commission at least thirty (30) days prior to any change in the corporation(s) that may affect compliance obligations arising under this order, including but not limited to a dissolution, assignment, sale, merger, or other action that would result in the emergence of a successor corporation; the creation or dissolution of a subsidiary, parent, or affiliate that engages in any acts or practices subject to this order; the proposed filing of a bankruptcy petition; or a change in the corporate name or address. Provided, however, that, with respect to any proposed change in the corporation about which respondents learn less than thirty (30) days prior to the date such action is to take place, respondents shall notify the Commission as soon as is practicable after obtaining such knowledge. All notices required by this Part shall be sent by certified mail to the Associate Director, Division of Enforcement, Bureau of Consumer Protection, Federal Trade Commission, Washington, D.C. 20580.

IX.

It is further ordered, That respondent Jim B. Richardson, for a period of ten (10) years after the date of issuance of this order, shall notify the Commission of the discontinuance of his current business or employment, or of his affiliation with any new business or employment. The notice shall include respondent's new business address and telephone number and a description of the nature of the business or employment and his duties and responsibilities. All notices required by this Part shall be sent by certified mail to the Associate Director, Division of Enforcement, Bureau of Consumer Protection, Federal Trade Commission, Washington, D.C. 20580.

X.

It is further ordered, That respondent Magnetic Therapeutic Technologies, Inc. and its successors and assigns, and respondent Jim B. Richardson, within sixty (60) days after the date of service of this order, and at such other times as the Federal Trade Commission may require, file with the Commission a report, in writing, setting forth in detail the manner and form in which it has complied with this order.

XI.

This order will terminate on September 7, 2019, or twenty (20) years from the most recent date that the United States or the Federal Trade Commission files a complaint (with or without an accompanying consent decree) in federal court alleging any violation of the order, whichever comes later; provided, however, that the filing of such a complaint will not affect the duration of:

A. Any Part in this order that terminates in less than twenty (20) years;

B. This order's application to any respondent that is not named as a defendant in such complaint; and

C. This order if such complaint is filed after the order has terminated pursuant to this Part.

Provided, further, that if such complaint is dismissed or a federal court rules that the respondent did not violate any provision of the order, and the dismissal or ruling is either not appealed or upheld on appeal, then the order will terminate according to this Part as though the complaint had never been filed, except that the order will not terminate between the date such complaint is filed and the later of the deadline for appealing such dismissal or ruling and the date such dismissal or ruling is upheld on appeal.

Decision and Order

128 F.T.C.

ATTACHMENT A

BY CERTIFIED MAIL, RETURN RECEIPT REQUESTED

[To Be Printed on Magnetic Therapeutic Technologies, Inc. letterhead]

[date]

Dear [distributor's name]:¹

Magnetic Therapeutic Technologies, Inc. recently settled a civil dispute with the Federal Trade Commission (FTC) and the State of Texas involving advertising claims for the magnetic therapy products that we sell. As a part of the settlement, we must make sure that you comply with the FTC order.

Our settlements with the FTC and the State of Texas prohibit us from making unsubstantiated written and oral claims in promoting health-related products or programs. In addition, the FTC requires us to review and approve all advertising and promotional materials and claims used by our distributors prior to their dissemination to ensure compliance with the FTC settlement. We are also required to monitor our distributors' marketing and promotional activities, terminate those distributors who refuse to comply with the FTC settlement, and inform the FTC of their activities. Therefore, please send us all promotional and marketing materials and oral representations you intend to disseminate for approval before disseminating them in promoting our products.

We request your assistance by asking you NOT to use, rely on or distribute any advertising or promotional materials containing unsubstantiated claims and NOT to make unsubstantiated oral representations. Please also notify any of your retail or wholesale customers to do the same.

Although we do not admit that the FTC's allegations are true, we have agreed to send this letter as a part of our settlement with the FTC.

Thank you very much for your assistance,

Jim B. Richardson
President
Magnetic Therapeutic Technologies, Inc.

¹ "Distributor" shall mean any purchaser or other transferee of any product or program covered by this order who acquires product or program from respondents, with or without valuable consideration, and who sells, or who has sold, such product or program to other sellers or to consumers, including but not limited to individuals, retail stores, or catalogs.

IN THE MATTER OF
PAIN STOPS HERE! INC., ET AL.

CONSENT ORDER, ETC., IN REGARD TO ALLEGED VIOLATION OF
SECS. 5 AND 12 OF THE FEDERAL TRADE COMMISSION ACT

Docket C-3898. Complaint, Sept. 7, 1999--Decision, Sept. 7, 1999

This consent order, among other things, prohibits Pain Stops Here! Inc. and its officer, the promoters and distributors of magnetic therapy products, from representing that such products are effective in treating various medical conditions and illnesses unless the respondents possess and rely upon competent and reliable scientific evidence that substantiates the representation. The consent order also prohibits the respondents from representing that the experience presented in user testimonial or endorsement represents the typical or ordinary experience of the user of the product or program unless: it is substantiated; or certain disclosures are made. In addition, the consent order prohibits any unsubstantiated claims regarding the health benefits, performance, safety, or efficacy of any such product or program.

Participants

For the Commission: *Christa Vecchi, Richard Cleland and Dean Graybill.*

For the respondents: *Pro se.*

COMPLAINT

The Federal Trade Commission, having reason to believe that Pain Stops Here! Inc. and Sande R. Caplin, individually and as an officer of the corporation, have violated the provisions of the Federal Trade Commission Act, and it appearing to the Commission that this proceeding is in the public interest, alleges:

1.a. Respondent Pain Stops Here!, Inc. ("PSH") is a New York corporation with its principal office or place of business at 100 Fox Hill Drive, Baiting Hollow, NY.

1.b. Respondent Sande R. Caplin, is the President and majority shareholder of the corporate respondent. He formulates, directs, and controls the acts and practices of the corporate respondent, including the acts and practices alleged in this complaint. His principal office or place of business is the same as that of the corporate respondent.

2. Respondents have promoted, offered for sale, sold, and distributed to the public magnetic therapy products. Therapeutic magnets are "devices" within the meaning of Sections 12 and 15 of the Federal Trade Commission Act.

3. The acts and practices of respondents alleged in this complaint have been in or affecting commerce, as "commerce" is defined in Section 4 of the Federal Trade Commission Act.

4. Respondents have disseminated or have caused to be disseminated advertisements or promotional materials for magnetic therapy products, including but not necessarily limited to the attached Exhibits A through D. These advertisements and promotional materials contain the following statements:

A. *Magnetized Water*

Magnet Therapy is being more researched each day. Soon it will be a therapy of choice [.] Dr. Kenneth McLean, M.D., after spending many years helping people with magnet therapy, especially his cancer patients, confessed: "I can't say anything officially but let us face it; this treatment is a Godsend. It's good for almost anything." Magnets and Magnetized Water are the two hands of magnet therapy; they compliment each other.

* * *

NORTH POLE MAGNETIZED WATER

This water is recommended in cases of infectious diseases, urinary infection and gastric ulcers. Also for dysentery and diarrhea as it slows down peristaltic movements. Dr. N. Bengali recommends it in cancerous conditions.

North pole magnetized water has a healing effect on skin ulcers such as bed sores. Bed sores washed daily with the water heal faster. When applied once daily over two weeks, the condition has been found not to reoccur.

SOUTH POLE MAGNETIZED WATER

* * *

South pole water encourages growth activity in plants. Plants have been found to grow 20 to 40 percent faster when irrigated with this water. The water should be applied at the roots. Enthusiastic farmers have reported giant-size produce.

* * *

BI-POLAR (NORTH AND SOUTH) MAGNETIZED WATER

* * *

This simple treatment was very effective in breaking up kidney and gallbladder stones into small enough particles to be passed through urine without any pain or danger to the patient. [T]he water also prevented further formation of stones [in] the kidneys and gallbladder.

* * *

Similarly to the way magnetized water dissolves the settled salts on the walls of boilers and radiators, so it has been reported to help unclog the arteries and veins of deposits of cholesterol and salts and normalize the circulatory system.

* * *

[Exhibit A, PHS000032-33][Consumer Brochure]

B. EXPERT OPINIONS

* * *

Dr. Philpott states that negative magnetic energy is capable of filling indented skin where a tumor has been. He also reports that no scar tissue will form where a

417

Complaint

cancerous tumor is neutralized by North pole magnetic energy. The same magnetic energy field eliminates scar tissue formation when a cut heals.

* * *

Dr. Philpott postulates that when a negative magnetic field is applied to a diseased internal organ, such as the liver, a three month application of negative energy may be required to cure the disease. An additional three month application may be required to repair the organ. His advice is to ensure that the magnet being used is larger than the lesion being treated and that sustained treatment with negative energy from a permanent magnet be applied.

* * *

In Dr. Nakagawa's classic study, Magnetic Deficiency Syndrome, he outlined that lack of magnetism may cause stress, mental disorders, headaches, arthritis, muscle pain, osteoporosis, chronic fatigue, allergies, insomnia, inflammation, circulatory problems, bowel disorders and other degenerative problems afflicting people today. Universal cure-all? In the search for a universal cure-all, none fit [sic] the description nearly as well as magnetic energy therapy.

* * *

Because it potentates the body's free radical scavenger and antioxidant system, magnetotherapy is reported to be valuable in counteracting degenerative processes causing heart and circulatory disease, arthritis and auto-immune illness, as well as neuro-degenerative and allergic afflictions. Drinking magnetic water is said to impart many similar benefits.

* * *

Nighttime magnetic field therapy has a calming and sleep inducing effect on the brain and body due to stimulating production of melatonin, an anti-stressful, anti-aging and anti-infections hormone.

* * *

[Exhibit B, PSH000035-38][Consumer Brochure]

C. The Pain Stops Here

If You Suffer From...

Knee Pain

Arthritis

Shoulder Pain

Neck Pain

Bursitis

Gout

Back Pain

Sciatica

Tennis Elbow

Sports Injuries

* * *

Biomagnetic Therapy has proven to be one [of] the most Economical and Effective means in the Treatment of the many Aches and Pains of the competitive Horse. The "MAGNETIC FORCE" Products has [sic] been designed to fit most animals for the Treatment of ARTHRITIS, BURSITIS, TENDONITIS [sic], SPRAINS, STRAINS, SCIATICA, LAMENESS, NAVICULAR and Foot Growth Problems.

* * *

With over 25 years of diligent research and testing, magnets have been used on both humans and animals, and thousands have had remarkable results as to the effectiveness in alleviating pain and initiating the healing process.

* * *

A Brief Explanation of How Magnetic Therapy Works:

Magnetic therapy products enable you to safely and economically treat the human and animal bodies' many aches and painful conditions without the use of injections, salves and drugs. Clinical tests have proven that when magnets are applied to the painful areas of the body a favorable reaction takes place. Neodymium rare earth magnets deeply penetrate the flesh and create a magnetic field that *energizes and oxygenates* the blood, especially the white corpuscles which are the body's natural healing agent. The charged ion particles in the blood are moved about, creating heat. This constant heat helps increase blood flow, which helps to ease body pain and enables the body to perform its natural healing process. Magnetic therapy is *safe, non invasive, non addictive* and the Neodymium rare earth magnets are permanent and can be used over and over.

Do Magnets Really Work?:

Throughout Eastern cultures, magnetism has been used for centuries, as many have been aware of the beneficial effects of magnets on the body. Magnetic therapy has now finally come to America. The cost of staying healthy and pain free has become so expensive that the American public clamored for an alternative therapy that would release them from the addiction of PAIN KILLER PILLS, needles, salves and restore their body's health.

* * *

If you suffer from back pain (from injury, chronic pain, etc.), our Magnetic Force therapeutic Back Band is a must.

* * *

- Great for easing chronic back pain

* * *

If you suffer from back pain (from injury, chronic pain, etc.), our *Magnetic Force* therapeutic Seat Pad is a must.

* * *

- Great for easing chronic back pain
- ...
- Increases blood flow and oxygen flow to the back area

* * *

[Exhibit C, at PSH000051, PSH000052, PSH000057, PSH000062 & PSH000081][Internet Ad]

D. "MAGNETIC SLEEP PAD"

* * *

The high energy magnets within the Sleep Pads oxygenate the blood cells, stimulate production of the hormone Melatonin which is a natural relaxant and sleep aid.

* * *

[Exhibit D, PSH000010] [Consumer Brochure]

5. Through the means described in paragraph four, respondents have represented, expressly or by implication, that:

A. Water magnetized by respondents' product is effective in the treatment of cancer.

417

Complaint

B. Respondents' magnetic products cure liver disease and other diseased internal organs.

C. Water magnetized by respondents' product is effective in the reduction of cholesterol deposits in the arteries and veins and normalizing the circulatory system.

D. Water magnetized by respondents' product is effective in breaking up kidney and gallbladder stones and in the prevention of further formation of stones.

E. Water magnetized by respondents' product is effective in the mitigation and treatment of infectious diseases, urinary infection, gastric ulcers, dysentery, diarrhea, skin ulcers, and bed sores.

F. Respondents' magnetic products prevent or reverse heart disease, circulatory disease, arthritis, auto-immune illness, neurodegenerative disease, and allergies.

G. Respondents' magnetic products are effective in the mitigation and treatment of arthritis, bursitis, tendinitis, sprains, strains, sciatica, lameness, navicular, and foot growth problems in animals.

H. Respondents' magnetic sleep pads significantly stimulate the body's production of the hormone Melatonin.

I. Respondents' magnetic products are effective in the mitigation and treatment of pain caused by conditions such as arthritis, bursitis, and sciatica.

J. Water magnetized by respondents' product is effective in stimulating significant growth in plants causing them to grow 20 to 40 percent faster than those watered by water not magnetized by respondents' product.

6. Through the means described in paragraph four, respondents have represented, expressly or by implication, that they possessed and relied upon a reasonable basis that substantiated the representations set forth in paragraph five, at the time the representations were made.

7. In truth and in fact, respondents did not possess and rely upon a reasonable basis that substantiated the representations set forth in paragraph five, at the time the representations were made. Therefore, the representation set forth in paragraph six was, and is, false or misleading.

8. Through the means described in paragraph four, respondents have represented, expressly or by implication, that studies prove that respondents' magnetic products are effective in the mitigation and

treatment of pain caused by conditions such as arthritis, bursitis, and sciatica.

9. In truth and in fact, studies do not prove that respondents' magnetic products are effective in the mitigation and treatment of pain caused by conditions such as arthritis, bursitis, and sciatica. Therefore, the representation set forth in paragraph eight was, and is, false or misleading.

10. The acts and practices of respondents, as alleged in this complaint, constitute unfair or deceptive acts or practices, and the making of false advertisements, in or affecting commerce, in violation of Sections 5(a) and 12 of the Federal Trade Commission Act.

EXHIBIT A

Magnetized Water

Magnet Therapy is being more researched each day. Soon it will be a therapy of choice. Dr. Kenneth McLean, M.D., after spending many years helping people with magnet therapy, especially his cancer patients, concluded: "I can't say anything officially but let us face it: this treatment is a Godsend. It's good for almost anything." Magnets and Magnetized Water are the two hands of magnet therapy; they complement each other.

Water can be magnetized and thereby acquire new properties in both the physical and biological realms. Magnetized water is used in industry to dissolve and to prevent the formation of sediments in pipes and radiators. It is used in the drilling of oil wells. The strength of concrete made with magnetized water is increased by 25 to 35 percent. Light concrete becomes almost twice as strong. The effects of magnetized water on living organisms are even more surprising:

THERE IS BETTER FOOD ABSORPTION. This is because magnetized water has a lower surface tension and is therefore "wetter" and more penetrating than ordinary water. A lower surface tension allows the water to attach itself more actively to foods and to become a more effective transporter of nutrients into the cells and of toxins out of the system. There results an increased biological activity. Vitamins and foods are better absorbed.

Years ago, Dr. Henri Coanda discovered that the water in Hunza Land in Northern Tibet contained a secret that enabled those who drank it to live long lives in good health: the water there has a lower surface tension and is wetter.

BETTER BLOOD CIRCULATION. Biomagnetic researchers have found that magnetism accelerates the blood ionization process. The increased quantity of ions in the blood facilitates blood circulation. The blood loses its stagnant condition, the improved circulation is helpful in easing accumulated stiffness and dull pain in shoulders or scruff of the neck and other areas of the body and in reducing the danger of blood clotting.

Above taken from *MAGNETIC THERAPY* by Dr. H. L. Bonser

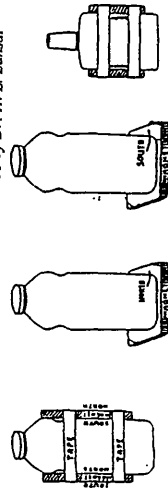

Biopole: North pole. Magnetized water. Reproduced by permission of the author. The illustration shows the use of a typical "Tumbler" type water bottle.

Magnetized water has been reported helpful for tiredness in daily activities. Biophysicist Albert R. Davis, a pioneer in magnet therapy research, wrote in his book "The Magnetic Effect" that he and his coworkers found they could overcome the early afternoon lull by drinking a glass of magnetized water while relaxing for a few minutes.

NORTH POLE MAGNETIZED WATER

Water treated solely with the North pole develops an alkaline condition as shown on a pH detector. There is a diminution in the acid content in the system. North pole energy slows down or inhibits organ activity; it has a soothing effect, reduces congestion, sedates, relieves pain.

North pole treated water has been observed to be calming and has been suggested for those who are restless, tense, overactive or sleepless.

This water is recommended in cases of infectious diseases, urinary infection and gastric ulcers. Also for dysentery and diarrhea as it slows down peristaltic movements. Dr. N. Bengali recommends it in cancerous conditions.

North pole magnetized water has a healing effect on skin ulcers such as bed sores. Bed sores washed daily with the water heal faster. When applied once daily over two weeks, the condition has been found not to recur.

SOUTH POLE MAGNETIZED WATER

South pole energy increases the hydrogen ion concentration. It makes the water slightly acid, it energizes and stimulates. It promotes or increases the acid levels present in the cells and organs.

South pole water is recommended for poor digestion and constipation. It has been proven that all forms of digestion can be improved by increasing acid levels which break down the food for better absorption.

This water should never be used when bacterial infections are present because it stimulates indistinctly all forms of life, your own as well as that of the unwanted bacteria.

South pole water encourages growth activity in plants. Plants have been found to grow 20 to 40 percent faster when irrigated with this water. The water should be applied at the roots. Enthusiastic farmers have reported giant-size produce.

WRITER OF THIS ARTICLE: Albert J. Muller, Prof. Dipl., N.D. 1988

Complaint

128 F.T.C.

EXHIBIT A

Primarily to the way magnetized water dissolves the settled salts on the walls of boilers and radiators, so it has been reported to help unclog the arteries and veins of deposits of cholesterol and salts and normalize the circulatory system.

Similarly to the way magnetized water dissolves the settled salts on the walls of boilers and radiators, so it has been reported to help unclog the arteries and veins of deposits of cholesterol and salts and normalize the circulatory system.

Magnetized water has been found effective in alleviating colds, coughs, bronchitis, all types of fever, and more. Dr. H.P. Bansal found it helpful in the regularization of women's menses.

TO PREPARE BI-POLAR WATER: Take a glass 1-gallon or 1/2-gallon container and fill it with water. Fasten the North side of a large biomagnetic (6 x 2 x 1/2") to a flat side of the container and the South side of another similar magnet to the opposite side. Use scotch tape lined with nylon threads for extra strength. Leave the magnets fastened permanently to the bottle. Add water as needed. You have magnetized bi-polar water ready at all times.

TO PREPARE NORTH POLE OR SOUTH POLE WATER: Place a large, powerful biomagnetic (6 x 4 x 1/2") under your water container; North side against its bottom for North pole water; the South side against the bottom surface for South pole water.

DOSAGE. Up to three to four glasses a day. Not over a glass at a time. Do not take in excessive quantities like plain water. The following pages tell you which type of magnetized water to use for specific problems. For general purposes, bi-polar magnetized water is used.

MAGNETIZING OTHER FLUIDS, FOODS AND LOTIONS. Fluids like juice, milk, tea, coffee, beer, wine and liquid type foods can be magnetized the way water is magnetized. This makes them more refreshing and invigorating and they may use less energy for metabolic processes. Magnetize the food or drinks only when not too warm as considerable heat tends to weaken the magnets.

Similarly oils, ointments, lotions used in ailments like rheumatism or for beauty can be magnetized. Magnetized facial cream is already available commercially. The magnets used should match or be proportional to the size and amount of material being magnetized; use small magnets for small bottles.

THE MAGNETIC FORCE

Pain Stops Here! Inc., 100 Fox Hill Dr., Baiting Hollow, NY 11933
516 369-6400

that, when water is magnetized, its hydrogen ion activity is increased. The hydrogen ion controls the acidity and alkalinity of our organs and tissues. In childhood the human body is more acid and, as a consequence, more disease-resistant and healthier. The adult body becomes more alkaline, therefore more disease-prone. The greater hydrogen ion activity promotes the acid levels in the cells and organs; this means: greater energy and vitality.

Water can be magnetized by magnets placed on the outer surface of its container because magnetism passes through glass, plastics and porcelain. There are three types of magnetized water: bi-polar (with North & South poles), North pole water and South pole water.

BI-POLAR (NORTH AND SOUTH) MAGNETIZED WATER

Bi-polar magnetized water (treated with both North and South poles) is the most often used form of magnetized water for alleviating most common ailments. The Russians are the pioneers in the use of magnetized water. They call it "Wonder Water".

Magnetized water was first used in Russia by three specialists: Drs. G. Gerbenshchikow, I. Sletsov and K. Tovstoles, all three specialists is urology at the Kirov Military Medical Academy in Leningrad. They had their patients drink bi-polar magnetized water. This simple treatment was very effective in breaking up kidney and gallbladder stones into small enough particles to be passed through urine without any pain or danger to the patient. The water also prevented further formation of stones in the kidneys and gallbladder.

Soviet physicians have been giving internally magnetized water to patients for over 30 years for digestive, urinary and nervous problems, ailments like mastitis, pain and swellings, painful urination and many other disorders.

Because magnetized water is a wetter water and therefore more penetrating, it furthers better assimilation of the various nutrients and vitamins in the cells. The Soviet biologist Kumarov had experimentally doubles the life span of flies by feeding them magnetized sugar.

In his book "Magnets For Your Health" Dr. Louis Dorned, M.D. wrote magnetized water can be helpful in weight control, as an adjuvant to a correct diet. He states (page 82) he has seen over 100 successful cases.

Because this water improves metabolic activity; it may be helpful in burning up excessive fatty tissue. This writer does not give any guarantee in this matter, however, because he considers weight control such a baffling problem that no one can offer a satisfactory solution to it.

PSH 000033

EXHIBIT A

417

Complaint

EXHIBIT B



EXPERT OPINIONS

In his book, The Body Electric, Dr. Robert Becker observed that an injury site registers South-positive immediately. It changes to North-negative during the healing process, indicating that a North-negative field promotes healing.

Dr. William Philpott explains the pH factor and the calcium factor in his book, Cancer The Magnetic/Oxygen Answer.

- Reduced ionized calcium plays a major role as a common denominator in degenerative disease, in addition to acidosis. Reduced ionized calcium is not necessarily related to a lack of calcium in the diet. It is more likely related to reactions to environmental pollutants that cause an acid response in the body. He states that calcium and other minerals can only remain in a soluble state in the presence of an alkaline medium. In acid mediums they become soluble.
- Negative magnetic fields oxygenate and alkalize by aiding the body's defense against bacteria, fungi, and parasites, all of which thrive in an acid medium. In degenerative diseases, calcium is found deposited around inflamed joints, bruised areas on the heel, and in bones and kidney stones. Infections occur because they function well in an acidic, oxygen deficient state.
- A negative magnetic field combats inflammation and infection and enables the body to resolve troublesome calcium and mineral deposits.
- A negative magnetic field is effective in relieving pain due to its oxygenation and alkalizing action.
- A negative magnetic field enhances deep restorative sleep. The pineal gland produces melatonin in the presence of a negative magnetic field.
- Oxygen and water are paramagnetic and can carry a magnetic field to all parts of the body through blood circulation.

Dr. Philpott states that negative magnetic energy is capable of filling indented skin where a tumor has been. He also reports that no scar tissue will form where a cancerous tumor is neutralized by North pole magnetic energy. The same magnetic energy field eliminates scar tissue formation when a cut heals.

PSH 000035

EXHIBIT B

Complaint

128 F.T.C.

EXHIBIT B

Dr. Philpott's findings support Dr. J. Bischo's studies at the Ludwig Boltzmann Clinic in Vienna, Austria. Dr. Bischo used bipolar magnetic pads.

Dr. Philpott postulates that when a negative magnetic field is applied to a diseased internal organ, such as the liver, a three month application of negative energy may be required to cure the disease. An additional three month application may be required to repair the organ. His advice is to ensure that the magnet being used is larger than the lesion being treated and that sustained treatment with negative energy from a permanent magnet be applied.

Dr. K. Nakagawa's study, Magnetic Field Deficiency Syndrome, states the human body is under the influence of the earth's magnetic field and is keeping some sort of a balanced relationship with it. However, under modern day living conditions, the effect of this magnetic field has decreased. Consequently, in some situations we can assume that this lack of magnetism has caused some abnormalities. By applying a magnetic field on the human body to supplement this deficiency, such abnormal conditions can be improved. In other words, there is a direct relationship between the decrease in the earth's magnetic field on the human body and the improvement of abnormal conditions by the application of magnetic fields.

NASA reported the early astronauts suffered from a magnetic field deficiency while orbiting in space away from the earth's magnetic field. This caused some serious medical problems including a rapid loss in bone density. This deficiency was corrected by providing an artificial magnetic field in the spacecraft.

Research by Dr. J. Bischo and Dr. Peter Kokoshinegg at the Ludwig Boltzmann Acupuncture Institute, and the Institute of Biophysics and Ray-Research in Vienna, Austria, indicated the following: Scar tissue breaks down and new skin forms when an alternating field magnetic pad is applied.

TDK Industries of Japan carried out three important studies where magnetic necklaces were tested to find their effectiveness in treating stiff shoulders. The conclusion was that magnetic necklaces effectively reduced discomfort in 81.1% to 96.3% of subjects. No noticeable side effects were found in respect to the clinical examination results. (Magnetic necklaces produce alternating pole energy.)

Dr. Ken Wiancko MD, wrote an article (Health Naturally, April 1996) that stated: "Though they seem magical in their ability to heal, magnets are not magic. Their function is very simple. Magnetotherapy helps the body to regain its self-healing electromagnetic balance naturally because each organ and each cell of every organ in the body is influenced by electromagnetism. Cell regulation, tissue function and life are controlled by electromagnetic currents."

PSH 000036

EXHIBIT B

EXHIBIT B

In Dr. Nakagawa's classic study, Magnetic Deficiency Syndrome, he outlined that lack of magnetism may cause stress, mental disorders, headaches, arthritis, muscle pain, osteoporosis, chronic fatigue, allergies, insomnia, inflammation, circulatory problems, bowel disorders and other degenerative problems afflicting people today. Universal cure-all? In the search for a universal cure-all, none fit the description nearly as well as magnetic energy therapy. The application of magnets has given proven pain relief in seven out of ten users, as good as or better than "orthodox" medicine. Magnetotherapy is far less expensive and lacks the dangerous side effects often associated with prescription drugs. Treatment with magnets is not addictive and does not interfere with other therapies, but should not be used if a pacemaker or defibrillator is worn.

Researchers have stated that magnetic field therapy rebalances altered metabolic functions that cause pain, edema (tissue swelling), excess acid in the tissues, and lack of oxygen in the cells, thereby initiating tissue healing and pain relief. Skin calcification, the cause of skin aging and wrinkles, disappears. Joint mobility increases and muscles become more flexible. Digestion improves, prostates shrink and kidneys eliminate body wastes more effectively. Mental function increases, energy levels go up and sleep is better. Test have even shown that organisms placed under a magnetic field live longer.

Because it potentiates the body's free radical scavenger and antioxidant system, magnetotherapy is reported to be valuable in counteracting degenerative processes causing heart and circulatory disease, arthritis and auto-immune illness, as well as neuro-degenerative and allergic afflictions. Drinking magnetic water is said to impart many similar benefits. Wearing back, neck or joint supports with permanent magnets imbedded in the material often relieves painful conditions.

Treatment of discomfort from strains and arthritis with low frequency, pulsating magnetic fields created by tiny portable devices may be as effective as larger ultrasound units.

Stress causes hundreds of diseases but can be tempered by using magnets day or night. Nighttime magnetic field therapy has a calming and sleep inducing effect on the brain and body due to stimulating production of melatonin, an anti-stressful, anti-aging and anti-infections hormone. Sleeping on magnetic mattress pads can improve of quality of sleep and eliminate morning stiffness.

Magnetotherapy may often be used as a first line treatment for pain and to promote healing, not to suggest that there is no place for standard prescription drugs. Many distressing conditions yield to magnetics, but if magnets don't help, it's important that you visit your doctor.

Dr. Ulrich Warnke: Magnetic energy has a beneficial effect on blood circulation, lymph flow, hormone production, nerves and muscles.

PSH 000037

EXHIBIT B

Complaint

128 F.T.C.

EXHIBIT B

Dr. Evelyne Holzapfel: The application of a magnetic field has the virtues of simplicity, freedom from danger and low cost.

Dr. Madeleine F. Barnothy: The magnetic field will develop into a powerful new analytic and therapeutic tool of medicine.

Dr. Kenneth S. McLean: This treatment (magnetic therapy) is a godsend. It's good for almost everything.

Dr. Ralph U. Sierra: We now stand on the verge of a great new age in magnetic science and its applications - a tool that has been provided by Mother Nature herself.

Neville S. Bengali MD: The astounding results obtained through magnet therapy give it a place of considerable importance in the field of therapeutics.

Dr. J.B. Baron MD: This is a revolution in the therapy of muscle injuries, joint pain, and posture problems. We have treated 4,000 patients with whiplash injuries by means of the magnet and cured 80 percent of them.

The First Congress in Magnetotherapy organized by the Coghill Research Laboratories was held at the Royal Society of Medicine in London, England, in May 1996. The proceedings introduced over 50 studies and research reports on magnetic therapies, the majority of which were very positive. For example, three doctors from Croatia published an outstanding report outlining the treatment of 1261 patients in a rehabilitation hospital using PMF therapy.

Eastern Bloc countries have traditionally researched magnetic therapy much more vigorously than the West. Many of the studies presented at the First Congress in Magnetotherapy originated in countries where magnetic therapy was seen as an economical option to drug therapy.

This article was reprinted from **THE INVISIBLE FORCE**, Fred Rinker C.M.T.A.



Pain Stops Here! Inc., 100 Fox Hill Drive, Baiting Hollow, NY 11933 Tel# 1-888-933-6400

PSH 000038

EXHIBIT B

417

Complaint

EXHIBIT C

The Pain Stops Here

If You Suffer From...

Knee Pain

Arthritis

Shoulder Pain

Neck Pain

Bursitis

Gout

Back Pain

Sciatica

Tennis Elbow

Sports Injuries

Individual Neodymium Magnets
with water proof tape
MF2

Golf-Tennis Elbow Band
GT-2181
2"X 18"

Back Band
BB483
2"X 48"

Wafer Thin Neodymium Magnets
with water proof tape
MF-6

Wrist Band
WB-191
1"X 9"

Knee Band
KB-1182
1"X 18"

Ankle Band
AB-1121
1"X 12"

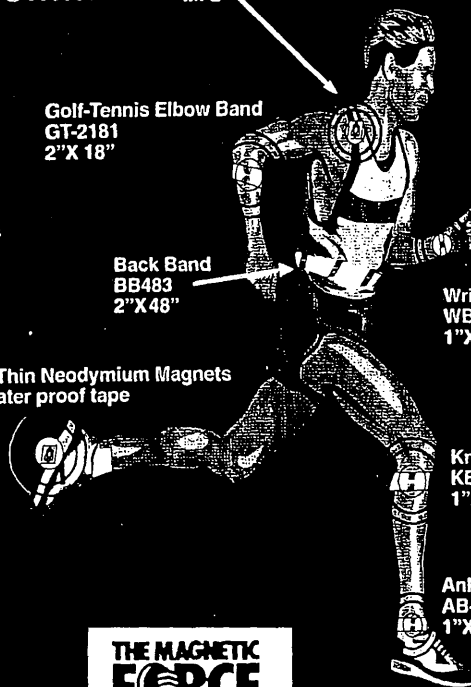

PSH 000051

EXHIBIT C

Biomagnetic Therapy
The Amazing Therapeutic Power of Magnets

Complaint

128 F.T.C.

EXHIBIT C

The Pain Stops Here

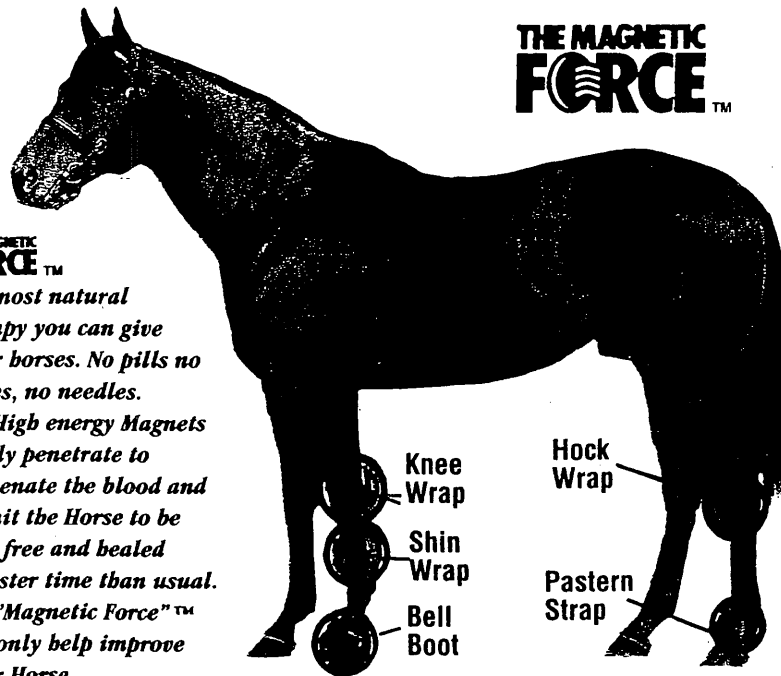

THE MAGNETIC
FORCE™

*The most natural
therapy you can give
your horses. No pills no
salves, no needles.
The High energy Magnets
deeply penetrate to
Oxygenate the blood and
permit the Horse to be
pain free and healed
in faster time than usual.
The "Magnetic Force"™
Can only help improve
your Horse.*

Biomagnetic Therapy has proven to be one the most Economical and Effective means in the Treatment of the many Aches and Pains of the competitive Horse. The "MAGNETIC FORCE"™ Products has been designed to fit most animals for the Treatment of ARTHRITIS, BURSITIS, TENDONITIS, SPRAINS, STRAINS, SCIATICA, LAMENESS, NAVICULAR and Foot Growth Problems.

PSH 000052

THE MAGNETIC
FORCE™

EXHIBIT C

417

Complaint

EXHIBIT C

WELCOME TO THE WONDERFUL WORLD OF MAGNETIC THERAPY

Pain

Magnets have been used for centuries to relieve pains of Arthritis, Sciatica, Tendonitis, Headaches, Back & Neck Pain, and many other ailments.

Pain Stops Here! with **The Magnetic Force™**

With over 25 years of diligent research and testing, magnets have been used on both humans and animals, and thousands have had remarkable results as to the effectiveness in alleviating pain and initiating the healing processes.

Click on the Area that Ails you for Complete Product Descriptions and Secure On-Line Ordering

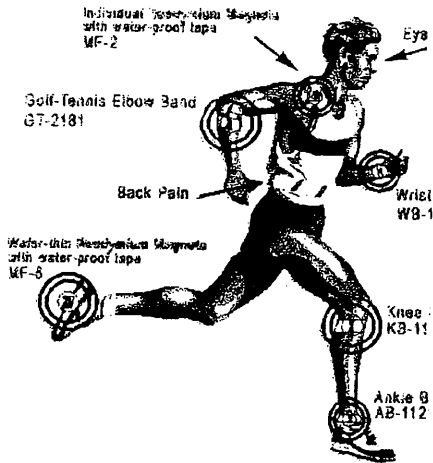

Click Here If You Have Questions or For Additional Information



PSH 000057

©Pain Stops Here! Inc. 1997
100 Fox Hill Dr.

EXHIBIT C

10/3/97 8:35 AM

Complaint

128 F.T.C.

EXHIBIT C

*Baiting Hollow, NY 11933
1-(888)-933-6400
FAX: 1-516-369-4107*

Use Netscape 2.0 or higher for best results !

Designed and Hosted by Nexwave Communications



PSH 000058

EXHIBIT C

10/3/97 8:35 AM

417

Complaint

EXHIBIT C

**Rare Earth Magnets For the Relief of Pain:**

Rare earth magnets such as Neodymium-Iron-Boron have permanent magnetic capabilities and are far more advanced than rubber and plastic magnets. Their characteristics and properties are stronger and very distinctive. Neodymium introduced a whole new era to the magnetic therapy field in the treatment and management of body pain. With its permeance, high energy and depth of penetration, Neodymium leads the field of magnetism in pain therapy. Due to its power, Neodymium permits a much smaller and more manageable magnet to be applied to the parts of the body requiring magnetic energy. Research has proven that Neodymium magnets get faster therapeutic results than plastic and rubber magnets *ten times larger* in size.

A Brief Explanation of How Magnetic Therapy Works:

Magnetic therapy products enable you to safely and economically treat the human and animal bodies' many aches and painful conditions without the use of injections, salves and drugs. Clinical tests have proven that when magnets are applied to the painful areas of the body a favorable reaction takes place. Neodymium rare earth magnets deeply penetrate the flesh and create a magnetic field that *energizes and oxygenates* the blood, especially the white corpuscles which are the body's natural healing agent. The charged ion particles in the blood are moved about, creating heat. This constant heat helps increase blood flow, which helps to ease body pain and enables the body to perform its natural healing process. Magnetic therapy is *safe, non invasive, non addictive* and the Neodymium rare earth magnets are permanent and can be used over and over.

Do Magnets Really Work?:

Throughout Eastern cultures, magnetism has been used for centuries, as many have been aware of the beneficial effects of magnets on the body. Magnetic therapy has now finally come to America. The cost of staying healthy and pain free has become so expensive that the American public clamored for an alternative therapy that would release them from the addiction of PAIN KILLER PILLS, needles, salves and restore their body's health.

About the Users of Magnets:

PSH 000062

People from all walks of life use magnets for "Pain Therapy." In the May 1997 issue of a worldwide sports magazine several Senior Pro Tour Golfers said "They're great. Without them, you'd have 20 guys who couldn't play." Seniors, who want long drives and longevity, tape magnets to their bodies. Several golfers wear magnets in their shoes to soothe aching feet. Many sleep on magnetic mattress pads. Other golfers who have been off the tour for months at a time due to aches

Complaint

128 F.T.C.

EXHIBIT C

and pains are now playing on a weekly basis and wear magnets all over their bodies! Many athletes in health clubs are seen wearing magnetic therapy products.

Athletes aren't the only people to wear magnets. Our company, Pain Stops Here! Inc. has hundreds of written testimonials from people from all walks of life thanking us for the wonderful results that they have gotten from the use of magnets!

Click Below for our Complete line of
Biomagnetic Therapy Products.



©Pain Stops Here! Inc. 1997
100 Fox Hill Dr.
Baiting Hollow, NY 11933
1-(888)-933-6400
1-516-369-4107

Use Netscape 2.0 or higher for best results!
Designed and Hosted by Nexwave Communications



PSH 000063

EXHIBIT C

10/5/97 8:26 AM

417

Complaint

EXHIBIT C



Welcome to the wonderful world of Magnetic Therapy Products to order **SECURELY ONLINE**. If you suffer from back pain (from injury, chronic pain, etc.), our *Magnetic Force™* therapeutic Seat Pad is a must. It is as comfortable and affordable as it is useful and practical. Bring it to the office, or use it at home or in the car.

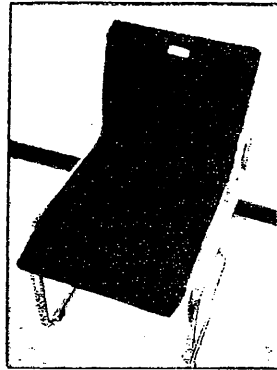

Magnetic Force™ Seat Pad Model: SP-333

- Great for easing chronic back pain
- 50 Ceramic Magnets are used, and will last for years
- Magnets are encased in a soft, cloth material
- Convenient Stretch Strap for securing to car seat or chair
- Helps alleviate back pain caused by driving
- Increases blood flow and oxygen flow to the back area
- Dimensions:
 - SP-333 16" X 32"

Magnetic Seat Pad - SP-333 - Only \$73.00(US)

Press the "Magnetize Me" Button Below to begin placing your **SECURE ONLINE** order.

SP-333 for \$73.00

Click Below for our Complete line of Biomagnetic Therapy Products.



PSH 000081

EXHIBIT C

10/5/97 9:00 AM

Complaint

128 F.T.C.

EXHIBIT C



Welcome to the wonderful world of Magnetic Therapy Products to order *SECURELY* ONLINE. If you suffer from depression or sluggishness, our *Magnetic Forcetm* therapeutic Sleep Pad is a must. It is as comfortable and affordable as it is useful and practical.

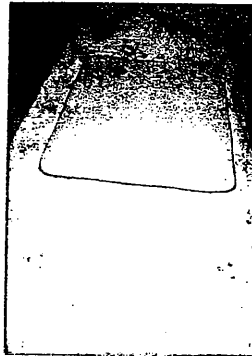

Magnetic Forcetm Sleep Pad Model:
SP-101

- Rejuvenates and energizes
- Quality Ceramic magnets are used, and will last for years
- 66 quality ceramic magnets are used throughout the pad
- Get a great night's sleep and wake up energized!
- Dimensions: 24" X 36"

Magnetic Sleep Pad - SP-101 - Only \$84.00(US)

Press the "Magnetize Me" Button Below to begin placing your *SECURE* ONLINE order.

Magnetize Me

Click Below for our Complete line of
Biomagnetic Therapy Products.



PSH 000082

EXHIBIT C

10/3/97 8:39 AM

417

Complaint

EXHIBIT C



You have selected KN401 for \$165.00 /pair, Magnetic Knee Pads.
 Quantity: 1 pair

This site is now SECURE! You may place your Credit Card order SECURELY ON-LINE, or print out the Order Verification Page which will follow, to fax directly to us.

Please note that there is a \$5.00 (US) Shipping and Handling Fee added to each order.

Ship To:

Please fill out the following information for the person you are sending this item to.

First Name:	<input type="text"/>
Middle Name:	<input type="text"/>
Last Name:	<input type="text"/>
Company Name:	<input type="text"/>
Street Address:	<input type="text"/>
Apt Number:	<input type="text"/>
City:	<input type="text"/>
State or Province:	<input type="text"/>
Zip:	<input type="text"/>
Country:	<input type="text"/>
Phone:	<input type="text"/>

Customer Information:

As per your credit card company's information.

First Name:

PSH 000083

EXHIBIT C

10/5/97 9:23 AM

Complaint

128 F.T.C.

EXHIBIT C

Middle Name:
Last Name:
Your Address:
Apt. Number:
City:
State or Province:
Zip:
Country:
Home Phone:
Work Phone:
E-Mail Address:

Credit Card:

CARD HOLDER NAME:
CREDIT CARD NUMBER:
CREDIT CARD EXPIRATION:

When you have completely filled out the above form, please click here to process/verify your order:

Disclaimer

Pain Stops Here! Inc. makes no claims or guarantees as to the effectiveness of magnets for healing or pain easing, except as to the experience we have had in researching, and the results of the magnetic effects on many persons using magnets in this country and around the world. Magnets are not intended to replace any therapy, instructions or prescriptions prescribed by your doctor or other medical professional.

Please note that magnets should not be used if you are wearing a pacemaker or electrical implants of any kind. Keep magnets away from computers, computer disks, video tapes and other magnetic media (including but not limited to credit card and ATM/Debit cards). For serious injuries or illness, it is always best to consult your physician!

PSH 000084

EXHIBIT C

10/5/97 9:23 AM

417

Complaint

EXHIBIT C



Quickly fill out the Following fields, and we will contact you with more information on our Exciting Magnetic Therapy Distributor Program. It's as easy as that!

First Name:	<input type="text"/>
Last Name:	<input type="text"/>
Company Name:	<input type="text"/>
Street Address:	<input type="text"/>
Apt Number:	<input type="text"/>
City:	<input type="text"/>
State or Province:	<input type="text"/>
Zip:	<input type="text"/>
Country:	<input type="text"/>
Phone:	<input type="text"/>
E-Mail Address:	<input type="text"/>

PSH 000085

EXHIBIT C

10/5/97 9:42 AM

Complaint

128 F.T.C.

EXHIBIT D



“MAGNETIC SLEEP PAD”

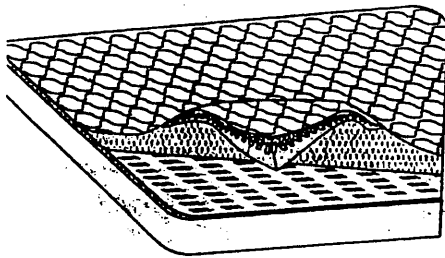

\$84.00 (SP101)

- ** Get A Relaxed Nights Sleep
- ** Wake Up Energized
- ** Helps To Ease Muscle Pain
- ** Helps Promote Sleep
- ** Helps To Reduce Stress
- ** Enhances Body Healing
- ** 24" X 36"
- ** Contains 66 Ceramic Magnets

 The Magnetic Sleep Pads are manufactured to help PROMOTE SLEEP, REDUCE STRESS, EASE PAINS, ENHANCE BODY HEALING, AND PUT WELLNESS BACK INTO YOUR BODY. The high energy magnets within the Sleep Pads oxygenate the blood cells, stimulate production of the hormone Melatonin which is a natural relaxant and sleep aid. Magnetic Therapy as used all over the world for centuries is a known therapy for the many aches and pains within humans and animals. You have the assurance that there are no side effects with the use of Permanent Magnets as applied to the Human and Animal body.

Ask about our other MAGNETIC THERAPY PRODUCTS!

“MAGNETIC THERAPY HAS COME OF AGE”

PAIN STOPS HERE! INC.
 100 FOX HILL DRIVE
 BAITING HOLLOW, NY 11933

1 (888) 933-6400

Distributed By:

PSH 000010

EXHIBIT D

417

Complaint

EXHIBIT D

MAGNETIC SEAT & BACK CUSHIONS

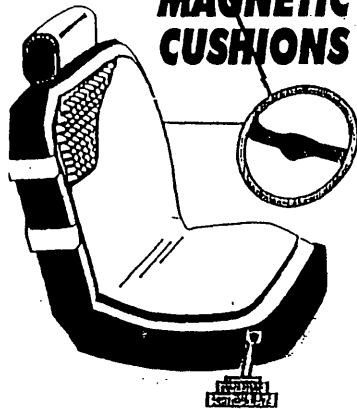

** Sit in Relaxed Comfort for Extended Periods
** Feel More Energized...Helps to Relieve Pain

\$73.00
(Full 16" x 32")
SP-333

\$36.50
(Seat 16" x 16")
SP-475

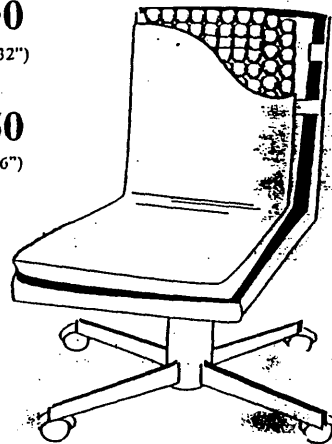

- ** Contains Ceramic Magnets
- ** 2 Sizes Available
- ** Soft Terry Cloth Cushion
- ** Convenient Strap Included
- ** Lightweight & Portable
- ** Helps You Relax

Our Magnetic Seat & Back Cushion is great for anyone who sits for long periods of time. You will feel more relaxed & comfortable. The seat cushion can be used anywhere. Soft terry cloth fabric is hand washable with mild soap and water & then air dry. Full cushion contains 50 magnets and the seat cushion contains 25 magnets. Our Seat Cushion can be used in automobiles, boats, office and home....anywhere!! You can't go wrong....feel more relaxed.

PAIN STOPS HERE! INC.
100 FOX HILL DRIVE
BAITING HOLLOW, NY 11933



1 (888) 933-6400

Distributed By:

PSH 000011

EXHIBIT D

DECISION AND ORDER

The Federal Trade Commission having initiated an investigation of certain acts and practices of the respondents named in the caption hereof, and the respondents having been furnished thereafter with a copy of a draft of complaint which the Bureau of Consumer Protection proposed to present to the Commission for its consideration and which, if issued by the Commission, would charge respondents with violation of the Federal Trade Commission Act; and

The respondents and counsel for the Commission having thereafter executed an agreement containing a consent order, an admission by the respondents of all the jurisdictional facts set forth in the aforesaid draft of complaint, a statement that the signing of said agreement is for settlement purposes only and does not constitute an admission by respondents that the law has been violated as alleged in such complaint, or that the facts as alleged in such complaint, other than jurisdictional facts, are true, and waivers and other provisions as required by the Commission's Rules; and

The Commission having thereafter considered the matter and having determined that it had reason to believe that the respondents have violated the said Act, and that a complaint should issue stating its charges in that respect, and having thereupon accepted the executed consent agreement and placed such agreement on the public record for a period of sixty (60) days, now in further conformity with the procedure prescribed in Section 2.34 of its Rules, the Commission hereby issues its complaint, makes the following jurisdictional findings and enters the following order:

1.a. Respondent Pain Stops Here! Inc. ("PSH") is a New York corporation with its principal office or place of business at 100 Fox Hill Drive, Baiting Hollow, N.Y.

1.b. Respondent Sande R. Caplin is the President and majority shareholder of the corporate respondent. Individually or in concert with others, he formulates, directs, or controls the policies, acts, or practices of the corporation. His principal office or place of business is the same as that of PSH.

2. The Federal Trade Commission has jurisdiction of the subject matter of this proceeding and of the respondents, and the proceeding is in the public interest.

ORDER

DEFINITIONS

For the purposes of this order, the following definitions shall apply:

1. "*Competent and reliable scientific evidence*" shall mean tests, analyses, research, studies, or other evidence based on the expertise of professionals in the relevant area, that has been conducted and evaluated in an objective manner by persons qualified to do so, using procedures generally accepted in the profession to yield accurate and reliable results.

2. "*Magnetic therapy products*" shall mean any product that contains a magnet of any kind purporting to relieve the symptoms of, treat, mitigate, cure, relieve, heal or alleviate any disease or health condition, including but not limited to Magnetized Water Ceramic Magnetic Ring, Sleep Pad, Seat Pad, Pillow Insert, Thigh Band, TMJ Band, Wrist Band, Back Band, Ankle Band, Calf Band, Eyemask, Arm Band, Knee Band, Neodymium Magnets, Soft Magnetic Pad, and Neck Band.

3. Unless otherwise specified, "*respondents*" shall mean PSH, its successors and assigns; Sande R. Caplin, individually and as an officer of the corporation; and each of the above's agents, representatives and employees.

4. "*Distributor*" shall mean any purchaser or other transferee of any product covered by this order who acquires product from respondents, with or without valuable consideration, and who sells, or who has sold, such product to other sellers or to consumers, including but not limited to individuals, retail stores, or catalogs.

5. "*Commerce*" shall mean as defined in Section 4 of the Federal Trade Commission Act, 15 U.S.C. 44.

I.

It is ordered, That respondents, directly or through any partnership, corporation, subsidiary, division, or other device, including franchisees, licensees or distributors, in connection with the manufacturing, labeling, advertising, promotion, offering for sale, sale, or distribution of magnetic therapy products in or affecting commerce, shall not represent, in any manner, expressly or by implication, that such products:

- A. Are effective in the treatment of cancer;
- B. Cure liver disease or other diseased internal organs;
- C. Are effective in the reduction of cholesterol deposits in the arteries and veins or normalizing the circulatory system;
- D. Are effective in breaking up kidney or gallbladder stones or in the prevention of further formation of stones;
- E. Are effective in the mitigation or treatment of infectious diseases, urinary infection, gastric ulcers, dysentery, diarrhea, skin ulcers, or bed sores;
- F. Prevent or reverse heart disease, circulatory disease, arthritis, auto-immune illness, neuro-degenerative disease, or allergies;
- G. Are effective in the mitigation or treatment of arthritis, bursitis, tendinitis, sprains, strains, sciatica, lameness, navicular, and foot growth problems in animals;
- H. Stimulate the body's production of the hormone Melatonin;
- I. Are effective in the mitigation or treatment of pain caused by conditions such as arthritis, bursitis, and sciatica; or
- J. Are effective in stimulating significant growth in plants,

unless, at the time the representation is made, respondents possess and rely upon competent and reliable scientific evidence that substantiates the representation.

II.

It is further ordered, That respondents, directly or through any partnership, corporation, subsidiary, division, or other device, including franchisees, licensees or distributors, in connection with the manufacturing, labeling, advertising, promotion, offering for sale, sale, or distribution of any product or program in or affecting commerce, shall not misrepresent, in any manner, expressly or by implication, the existence, contents, validity, results, conclusions, or interpretations of any test, study, or research.

III.

It is further ordered, That respondents, directly or through any partnership, corporation, subsidiary, division, or other device, including franchisees, licensees or distributors, in connection with the manufacturing, labeling, advertising, promotion, offering for sale, sale, or distribution of any product or program, in or affecting commerce, shall not make any representation, in any manner,

expressly or by implication, about the performance, safety, efficacy, or health benefits of any such product or program, unless, at the time the representation is made, respondents possess and rely upon competent and reliable scientific evidence that substantiates the representation.

IV.

It is further ordered, That:

A. Respondents shall not disseminate to any distributor any material containing any representations prohibited by this order.

B. Respondents shall not, directly or indirectly, authorize any distributor to make any representations prohibited by this order.

C. Within thirty (60) days after service of this order, respondents shall send by first class mail an exact copy of the notice attached hereto as Attachment A to each distributor with whom respondents have done business since January 1, 1998, to the extent that such distributor is known to respondents through a diligent search of their records, including but not limited to computer files, sales records, and inventory lists. The mailing shall not include any other documents. Respondents shall require each distributor to execute and return the original of the letter as a condition of remaining or once again becoming a distributor of Pain Stops Here! Inc.

D. For a period of three (3) years following service of this order, respondents shall send by first class mail an exact copy of the notice attached hereto as Attachment A to each distributor with whom respondents do business after the date of service of this order who has not previously received the notice. Such notice shall be sent within one (1) week from the first shipment of respondents' product or program to said distributor. The mailing shall not include any other documents. Respondents shall require each distributor to execute and return the original of the letter as a condition of remaining or becoming a distributor of Pain Stops Here! Inc.

E. Respondents shall use reasonable efforts to monitor distributors' advertising and promotional activities. In the event that respondents receive any information that, subsequent to receipt of Attachment A pursuant to subparts C and D of this Part, any distributor is using or disseminating any advertisement or promotional material or making any oral statement that contains any representation prohibited by this order, respondents shall immediately

terminate said distributor's right to market respondents' product or program and immediately provide, by certified mail, all relevant information, including name, address, and telephone number of the company at issue, the nature of the violation, and any relevant materials used or disseminated, to the Associate Director, Division of Enforcement, Federal Trade Commission, Washington, D.C. 20580.

F. Respondents shall require distributors to submit to respondents all advertising and promotional materials and claims for any product or program covered by this order for review prior to their dissemination and publication. Respondents shall not authorize distributors to disseminate these materials and claims unless they are in compliance with this order.

Respondents may also comply with the obligations set forth above in this subpart by:

(1) Disseminating marketing material(s) that contain representations not prohibited by this order to distributors; and

(2) Requiring these distributors to submit for review all advertising and promotional materials for a particular product or program covered by this order that contain representations that are not substantially similar to the representations for the same product or program contained in the advertising and promotional material(s) most recently forwarded to the distributors by respondents.

V.

It is further ordered, That respondent Pain Stops Here! Inc. and its successors and assigns, and respondent Sande R. Caplin shall, for five (5) years after the last correspondence to which they pertain, maintain and upon request make available to the Federal Trade Commission for inspection and copying all notification letters sent to distributors, communications between respondents and distributors referring or relating to the requirements of Part IV, and any other materials created pursuant to Part IV of this order.

VI.

It is further ordered, That respondent Pain Stops Here! Inc. and its successors and assigns, and respondent Sande R. Caplin shall, for five (5) years after the last date of dissemination of any representation covered by this order, maintain and upon request make available to the Federal Trade Commission for inspection and copying:

- A. All advertisements and promotional materials containing the representation;
- B. All materials that were relied upon in disseminating the representation; and
- C. All tests, reports, studies, surveys, demonstrations, or other evidence in their possession or control that contradict, qualify, or call into question the representation, or the basis relied upon for the representation, including complaints and other communications with consumers or with governmental or consumer protection organizations.

VII.

It is further ordered, That respondent Pain Stops Here! Inc. and its successors and assigns, and respondent Sande R. Caplin shall deliver a copy of this order to all current and future principals, officers, directors, and managers, and to all current and future employees, agents, and representatives having responsibilities with respect to the subject matter of this order, and shall secure from each such person a signed and dated statement acknowledging receipt of the order. Respondents shall deliver this order to current personnel within thirty (30) days after the date of service of this order, and to future personnel within thirty (30) days after the person assumes such position or responsibilities.

VIII.

It is further ordered, That respondent Pain Stops Here! Inc. and its successors and assigns, and respondent Sande R. Caplin shall notify the Commission at least thirty (30) days prior to any change in the corporation(s) that may affect compliance obligations arising under this order, including but not limited to a dissolution, assignment, sale, merger, or other action that would result in the emergence of a successor corporation; the creation or dissolution of a subsidiary, parent, or affiliate that engages in any acts or practices subject to this order; the proposed filing of a bankruptcy petition; or a change in the corporate name or address. Provided, however, that, with respect to any proposed change in the corporation about which respondents learn less than thirty (30) days prior to the date such action is to take place, respondents shall notify the Commission as soon as is practicable after obtaining such knowledge. All notices required by this Part shall be sent by certified mail to the Associate

Director, Division of Enforcement, Bureau of Consumer Protection,
Federal Trade Commission, Washington, D.C. 20580.

IX.

It is further ordered, That respondent Sande R. Caplin, for a period of ten (10) years after the date of issuance of this order, shall notify the Commission of the discontinuance of his current business or employment, or of his affiliation with any new business or employment involved in the manufacturing, labeling, advertising, promotion, offering for sale, sale, or distribution of any health-related products or program. The notice shall include respondent's new business address and telephone number and a description of the nature of the business or employment and his duties and responsibilities. All notices required by this Part shall be sent by certified mail to the Associate Director, Division of Enforcement, Bureau of Consumer Protection, Federal Trade Commission, Washington, D.C. 20580.

X.

It is further ordered, That respondent Pain Stops Here! Inc. and its successors and assigns, and respondent Sande R. Caplin, within sixty (60) days after the date of service of this order, and at such other times as the Federal Trade Commission may require, file with the Commission a report, in writing, setting forth in detail the manner and form in which it has complied with this order.

XI.

This order will terminate on September 7, 2019, or twenty (20) years from the most recent date that the United States or the Federal Trade Commission files a complaint (with or without an accompanying consent decree) in federal court alleging any violation of the order, whichever comes later; provided, however, that the filing of such a complaint will not affect the duration of:

- A. Any Part in this order that terminates in less than twenty (20) years;
- B. This order's application to any respondent that is not named as a defendant in such complaint; and
- C. This order if such complaint is filed after the order has terminated pursuant to this Part.

417

Decision and Order

Provided, further, that if such complaint is dismissed or a federal court rules that the respondent did not violate any provision of the order, and the dismissal or ruling is either not appealed or upheld on appeal, then the order will terminate according to this Part as though the complaint had never been filed, except that the order will not terminate between the date such complaint is filed and the later of the deadline for appealing such dismissal or ruling and the date such dismissal or ruling is upheld on appeal.

Decision and Order

128 F.T.C.

ATTACHMENT A

FIRST CLASS MAIL

[To Be Printed on Pain Stops Here! Inc. letterhead]

[date]

Dear [distributor's name]:

Pain Stops Here! Inc. settled a civil dispute with the Federal Trade Commission (FTC) on ___ involving advertising claims for our magnetic therapy products. As a part of the settlement, we must make sure that you comply with the FTC order.

Our settlement with the FTC prohibits us from making false or unsubstantiated claims for health related products or programs, including, but not limited to, claims that these products or programs are effective in the treatment, cure, or mitigation of any medical condition or disease, such as cancer, liver disease, heart disease, arthritis, bursitis, tendinitis, sciatica, gastric ulcers, pain, diarrhea, among others.

We request your assistance by asking you NOT to use, rely on or distribute any advertising or promotional materials containing unsubstantiated claims and NOT to make unsubstantiated oral representations. Please also notify any of your retail or wholesale customers to do the same. If you or your retail or wholesale customers continue to use such materials or make such representations, we are required by the FTC settlement to stop doing business with you and to inform the FTC of your activities.

In addition, the FTC requires us to ensure that advertising and promotional materials and claims for any product or program covered by this order is in compliance with the FTC settlement requirements. Please see Part IV of the enclosed Agreement Containing Consent Order for detailed information.

Although we do not admit that the FTC's allegations are true, we have agreed to send this letter as a part of our settlement with the FTC.

Please sign, date, and return this letter to Pain Stops Here! Inc. at the above address acknowledging your agreement to the terms set forth herein.

Thank you very much for your assistance,

Sande R. Caplin
President
Pain Stops Here! Inc.

ACKNOWLEDGMENT AND AGREEMENT

The undersigned acknowledges receipt of this letter and hereby agrees to its terms and conditions.

Date _____

Signature _____

IN THE MATTER OF

CONTINENTAL GOWN CLEANING SERVICE, INC., ET AL.

CONSENT ORDER, ETC., IN REGARD TO ALLEGED VIOLATION OF
SEC. 5 OF THE FEDERAL TRADE COMMISSION ACT

Docket 9287. Complaint, May 20, 1998--Decision, Sept. 8, 1999

This consent order, among other things, prohibits the New York-based advertisers and distributors of the Zurcion Method of cleaning and other cleaning or preservation methods from providing any labels or tags that misrepresent the Zurcion Method as the only safe and effective cleaning method or providing any means that violate the Care Labeling Rule. In addition, the consent order prohibits the respondents from making any representations regarding the safety or efficacy of any cleaning or preservation method, service, company, or product, unless the respondents possess and rely upon competent and reliable scientific evidence to substantiate the representation.

Participants

For the Commission: *Constance Vecellio, Edwin Rodriguez, Mary Engle, Elaine Kolish and Genevieve Fu.*

For the respondents: *Jeff Morgenstern and Ira Furman, Freeport, N.Y.*

COMPLAINT

The Federal Trade Commission, having reason to believe that Continental Gown Cleaning Service, Inc., Nationwide Gown Cleaning Service, Inc., Prestige Gown Cleaning Service, Inc. (also doing business as Prestige Gown Service, Inc.), Gown Cleaning Service, Inc., and Jonathan Ashley, Ltd., corporations, and Lewis Weissman and Gary Marcus, individually and as officers of the corporations ("respondents"), have violated the provisions of the Federal Trade Commission Act, and it appearing to the Commission that this proceeding is in the public interest, alleges:

1. Respondents Continental Gown Cleaning Service, Inc., Nationwide Gown Cleaning Service, Inc., Prestige Gown Cleaning Service, Inc. (also doing business as Prestige Gown Service, Inc.), Gown Cleaning Service, Inc., and Jonathan Ashley, Ltd., are New York corporations with their principal offices or places of business at 189-07 Union Turnpike, Flushing, New York.

2. Respondent Lewis Weissman is an officer of the corporate respondents. Individually or in concert with others, he formulates, directs, controls, or participates in the policies, acts, or practices of the corporations, including the acts or practices alleged in this complaint. His principal office or place of business is the same as that of the corporate respondents.

3. Respondent Gary Marcus is an officer of the corporate respondents. Individually or in concert with others, he formulates, directs, or controls the policies, acts, or practices of the corporations, including the acts or practices alleged in this complaint. His principal office or place of business is the same as that of the corporate respondents.

4. Respondents have advertised, offered for sale, and sold to the public a drycleaning service for the cleaning and preservation of wedding gowns and other formal wear by use of a process referred to by respondents as the "Zurcion Method." No cleaners other than respondents offer to the public a cleaning process referred to as the "Zurcion Method."

5. The acts and practices of respondents alleged in this complaint have been in or affecting commerce, as "commerce" is defined in Section 4 of the Federal Trade Commission Act.

6. The Commission's Trade Regulation Rule Concerning the Care Labeling of Textile Wearing Apparel ("Care Labeling Rule" or "Rule"), 16 CFR Part 423, promulgated by the Commission on December 9, 1971, was amended by the Commission in 1983 under Section 18 of the Federal Trade Commission Act. The amended Rule became effective on January 2, 1984, and since that date has remained in full force and effect. The Care Labeling Rule requires that manufacturers and importers of textile wearing apparel attach care labels to such apparel that is offered for sale to consumers.

7. In connection with the advertising, offering for sale, and sale of respondents' drycleaning service, respondents have provided, to manufacturers or importers of wedding gowns and other formal wear, care labels to be affixed to such garments. These manufacturers and importers include, but are not limited to, Mori Lee, Inc., Ilissa Bridals, Ltd., and Alyce Designs, Inc. One or more of these care labels have been used by these companies. The care labels provided by respondents to such manufacturers and importers contain the following statements:

- A. "Dryclean Only by Zurcion Method, Prestige, 1-800-292-GOWN, Manufacturers Guaranteed Processing."
- B. "Dryclean Only by Zurcion Method, Nation-wide, 1-800-242-GOWN guarantee processing."
- C. "Dryclean Only by Zurcion Method Continental 1-800-441-GOWN Made in U.S.A."
- D. "Dryclean Only by Zurcion Method Continental 1-800-441-GOWN Manufacturers Guaranteed Processing."

8. The care labels described in paragraph 7 do not comply with the requirements of the Care Labeling Rule for reasons including, but not limited to, the following:

A. Section 423.6(b)(2)(i) of the Rule requires: "If a drycleaning instruction is included on the label, it must also state at least one type of solvent that may be used. However, if all commercially available types of solvent can be used, the label need not mention any types of solvent." The care labels provided by respondents contain a drycleaning instruction but fail to state at least one type of solvent that may be used on the garment. Typically, the care labels provided by respondents were intended for and have been affixed to garments on which all commercially available types of solvents cannot be used without damage to the garment, which means the label must state a type of solvent that can be used without damage. The use of these labels on such garments by manufacturers or importers constitutes a violation of this section of the Rule.

B. Section 423.6(b)(2)(ii) of the Rule requires: "If there is any part of the drycleaning procedure which consumers or drycleaners can reasonably be expected to use that would harm the product..., the label must contain a warning to this effect." The care labels provided by respondents contain a drycleaning instruction but fail to provide warnings (*e.g.*, "short cycle" or "cabinet dry cool") against parts of the normal drycleaning procedure that might harm the types of garments for which these labels were provided. The use of these labels on such garments by manufacturers or importers constitutes a violation of this section of the Rule.

C. Section 423.6(c) of the Rule requires that a manufacturer or importer "establish a reasonable basis for care information" on labels attached to its garments. A reasonable basis must include "reliable evidence that the product...was harmed when cleaned by methods

warned against on the label." The care labels provided by respondents, which state "Dryclean Only by Zurcion Method," were used by various manufacturers or importers of wedding gowns and other formal wear, including, but not limited to, Mori Lee, Inc., Ilissa Bridals, Ltd., and Alyce Designs, Inc., who did not possess reliable evidence that all cleaning methods other than that used by respondents would harm the garments to which respondents' care labels were attached. The use of these labels on such garments constitutes a violation of this section of the Rule.

9. Through the means described in paragraph 7, respondents have furnished manufacturers or importers of wedding gowns and other formal wear with the means and instrumentalities to engage in violations of the Care Labeling Rule, as described in paragraph 8. Pursuant to Section 18(d)(3) of the Federal Trade Commission ("FTC") Act, a violation of the Care Labeling Rule constitutes a violation of Section 5 of the FTC Act.

10. In connection with the distribution of the care labels described in paragraph 7 to manufacturers or importers of wedding gowns and other formal wear, and in connection with the marketing of their cleaning and preservation services to consumers, respondents have disseminated or have caused to be disseminated promotional materials for the Zurcion Method, including but not necessarily limited to the attached Exhibits A through F. These materials contain the following statements:

A. THE FEDERAL TRADE COMMISSION'S CARE LABELING RULE STATES THAT A MANUFACTURER MUST SEW IN OR AFFIX A LABEL INSIDE THE GARMENT GIVING CARE INSTRUCTIONS ON A PERMANENT LABEL THAT WILL ALLOW THE CONSUMER TO HAVE "ORDINARY USE AND ENJOYMENT" OF THE ARTICLE.

THE FEDERAL TRADE COMMISSION RULE ALSO STATES THAT THERE MUST BE AT LEAST ONE METHOD OF CARE PROCEDURES THAT IS DESCRIBED ON THE AFFIXED CARE LABEL. THIS IS FOR THE DRYCLEANER OR FOR THE PERSON THAT IS SERVICING THE ARTICLE, SO THAT THE ARTICLE WILL RECEIVE THE PROPER CARE AND TREATMENT FOR WEAR OR FOR PURPOSES OF STORAGE.

THE ZURCION* METHOD IS A METHOD THAT IS WIDELY USED BY THE BRIDAL AND FORMAL WEAR INDUSTRY. THIS TYPE OF PROCESSING IS A SPECIALIZED METHOD WHICH REGULAR DRYCLEANERS CANNOT USE FOR REGULAR GARMENT CARE, FOR SEVERAL REASONS WHICH ARE 1) SPECIALIZED PROCESSING

EQUIPMENT NEEDED FOR ZURCION SOLVENTS 2)-SOLVENT COST FACTOR (SOLVENT MADE FROM PURE CHEMICAL COMPOUNDS NOT INDUSTRIAL) 3)-SPECIAL TRAINING NEEDED TO HANDLE ZURCION FLUIDS 4)-NOT AVAILABLE TO THE GENERAL DRYCLEANER ONLY TO OUR COMPANY.

THE CARE LABELING INSTRUCTIONS IN EVERY GARMENT HAVE TO BE FOLLOWED AS FAR AS CARE PROCEDURES ARE CONCERNED ACCORDING TO THE FEDERAL TRADE COMMISSION, THEREFORE IF A GOWN HAS THE LABEL AFFIXED THAT STATES DRYCLEAN BY ZURCION METHOD, THE CLEANER IS COMPELLED TO CLEAN AND SERVICE THE GOWN AS STATED BY THE MANUFACTURER. IF THE CLEANER IGNORES THE CARE LABEL OR SERVICES THE GOWN BY REGULAR DRYCLEANING PROCEDURES HE IS RESPONSIBLE FOR WHAT EVER DAMAGE IS INCURRED BY HIS METHODS.

SUMMARY IF FOR ANY REASON A GOWN IS DAMAGED BY A DRYCLEANER WITH THE ZURCION LABEL AFFIXED IN THE GOWN DO NOT HESITATE TO CONTACT OUR COMPANY. WE WILL SUPPLY YOU WITH A FACT SHEET FROM OUR COMPANY AND THE FEDERAL TRADE COMMISSION EXPLAINING THE FEDERAL TRADE COMMISSION'S LABELING ACT, AND IF THE ARTICLE SHOULD NEED ANALYSIS WE WILL SUPPLY YOU WITH A COMPLETE ANALYSIS REPORT.

CONCLUSION - IF ANY CLEANER CLEANS A WEDDING OR EVENING GOWN WITH ANY OTHER METHOD THAN THE ONE DESCRIBED HE (THE CLEANER) RUNS THE RISK OF DAMAGING THE GOWN AND HAS TO BY LAW COMPENSATE FOR THE DAMAGE OR LOSS OF THAT ARTICLE.

-----REMEMBER-----

ZURCION - IT'S GUARANTEED

*PATENTED METHOD (Exhibit A).

B. FROM THE CONSUMER PROTECTION DIVISION:

* WARNING * WARNING * WARNING * WARNING * WARNING *
BEWARE * BEWARE * BEWARE * BEWARE *

PLEASE BEWARE OF FALSE ADVERTISEMENTS AND MISLEADING STATEMENTS MADE BY OTHER GOWN CLEANING AND PRESERVATION SERVICES:

AT NATIONWIDE GOWN CLEANING SERVICE, WE ARE THE SPECIALISTS OF THE BRIDAL AND FORMAL WEAR INDUSTRY. WE ARE THE ONLY GOWN CLEANING COMPANY THAT IS RECOMMENDED BY 54 OF THE WORLDS [sic] LARGEST BRIDAL GOWN AND FORMAL WEAR MANUFACTURERS. NO OTHER CLEANER OR SO CALLED SPECIALIST CAN MAKE THIS STATEMENT.

...
DON'T BE MISLEAD [sic] BY DRYCLEANERS WHO CLAIM TO HAVE THE KNOWLEDGE OF CLEANING YOUR FINE APPAREL. ONLY SEND YOUR FINE APPAREL TO THE ONE PLACE THAT HAS PROVEN TO LIVE UP TO IT'S [sic] RELIABLE REPUTATION.

DON'T BE MISLEAD [sic] BY PRICE - REMEMBER THE SAYING "YOU GET WHAT YOU PAID FOR". TRUST YOUR FINE APPAREL TO THE PEOPLE WHO HAVE THE KNOW-HOW ON CLEANING YOUR WEDDING GOWN AND/OR FORMAL WEAR.

PLEASE FOLLOW THE CARE LABEL INSTRUCTION INSIDE YOUR GARMENTS. (Exhibit B).

C. PLEASE BE AWARE THAT THERE ARE REGULAR DRY-CLEANERS THAT TRY TO IMITATE OUR SERVICE, BUT THEY CAN NOT IMITATE OUR ZURCION PROCESS OR METHOD. BEWARE OF THE SO CALLED GOWN SPECIALIST, IT COULD PROVE TO BE DISASTROUS.

CONTINENTAL IS THE ONLY GOWN CLEANING AND PRESERVATION SERVICE TO BE RECOMMEND [sic] BY OVER 80% OF THE BRIDAL AND FORMAL WEAR INDUSTRY BY USING THE PATENTED ZURCION METHOD. (Exhibit C).

D. There is only one cleaning method that has proven to be safe on all gowns and formal wear. It's the ZURCION METHOD, 71 bridal and formal wear manufactures [sic] can't be wrong. (Exhibit D).

E. THE TRUE FACTS ABOUT ZURCION -- SPECIAL REPORT

...
FACT: ZURCION IS THE SAFEST METHOD THAT IS USED TODAY FOR CLEANING AND PROCESSING GOWNS AND FORMAL WEAR.

...
FACT: NATIONWIDE IS THE ONLY GOWN CLEANER IN THE UNITED STATES THAT ONLY PROCESS [sic] GOWNS AND FORMAL WEAR, SIMPLY BECAUSE IT IS A SPECIALIZED ITEM THAT SHOULD BE PROCESSED BY A SPECIALIZED COMPANY WITH A SPECIALIZED METHOD (ZURCION).

FACT: DON'T BE FOOLED BY CON ARTISTS THAT TELL YOU THEY HAVE A SPECIAL PROCESS CALLED WETCLEANING. THE DEFINITION OF WETCLEANING IS TO WASH AS PRESCRIBED IN SOAP AND WATER. BEWARE OF THESE CLAIMS THEY ARE GRABBING FOR STRAWS. (Exhibit E).

F. OUR PRESERVATION PROCESS IS SO UNIQUE, WE OFFER A GUARANTEE THAT YOUR GOWN WILL BE AS FRESH AND LOVELY ON HER WEDDING DAY AS IT WAS ON YOURS....

REMEMBER, WE GUARANTEE THE PROCESS. (Exhibit F).

11. Through the means described in paragraph 10, including but not necessarily limited to Exhibit A, respondents have represented, expressly or by implication, that the labels described in paragraph 7 comply with the requirements of the Care Labeling Rule.

12. For the reasons set forth in paragraph 8, the labels distributed by respondents are in violation of the requirements of the Care Labeling Rule. Therefore, the representation set forth in paragraph 11 was and is false or misleading.

13. Through the means described in paragraphs 7 and 10, respondents have represented, expressly or by implication, that:

A. The Zurcion Method is patented.

B. The Zurcion Method is the only safe and effective method for cleaning and preserving wedding gowns and other formal wear, including but not limited to those garments to which the labels described in paragraph 7 are attached.

C. Respondents are the only cleaners that are capable of providing safe and effective cleaning and preservation of wedding gowns and other formal wear, including but not limited to those garments to which the labels described in paragraph 7 are attached.

14. In truth and in fact:

A. The Zurcion Method is not patented.

B. The Zurcion Method is not the only safe and effective method for cleaning and preserving wedding gowns and other formal wear, including but not limited to those garments to which the labels described in paragraph 7 are attached.

C. Respondents are not the only cleaners that are capable of providing safe and effective cleaning and preservation of wedding gowns and other formal wear, including but not limited to those garments to which the labels described in paragraph 7 are attached.

Therefore, the representations set forth in paragraph 13 were, and are, false or misleading.

15. Through the means described in paragraphs 7 and 10, respondents have represented, expressly or by implication, that they possessed and relied upon a reasonable basis that substantiated the representations set forth in paragraphs 11 and 13, at the time the representations were made.

16. In truth and in fact, respondents did not possess and rely upon a reasonable basis that substantiated the representations set forth in paragraphs 11 and 13, at the time the representations were made. Therefore, the representation set forth in paragraph 15 was, and is, false or misleading.

17. In connection with the marketing of their cleaning and preservation services to consumers, respondents have disseminated or have caused to be disseminated promotional materials for the Zurcion method, including but not necessarily limited to the attached

Exhibits F through H. These materials contain the following statements:

A. Our preservation process is so unique, we offer a guarantee that your gown will be as fresh and lovely on her wedding day as it was on yours....

Remember, We Guarantee the Process. (Exhibit F).

B. But **Continental** has a No-Fault Cleaning Process that absolutely GUARANTEES the processing of gowns. . . .

Continental cleans thousands of gowns every month and we have NEVER ruined one! (Exhibit G).

C. Remember, We Guarantee the Process. (Exhibit H).

18. Through the means described in paragraph 17, respondents have represented, expressly or by implication, that there are no material limitations or conditions that apply to respondents' guarantee of the Zurcion process. In truth and in fact, a consumer who has sent a garment to respondents for cleaning and preservation cannot examine the garment to determine whether it has been satisfactorily cleaned and preserved because the garment is returned to the consumer in a sealed container with a printed warranty that includes a warning to the consumer not to break the seal or the container in any manner. The warranty further states that if the garment is to be reused, it must first be returned to respondents, in its sealed container, so that respondents can "unpreserve" the garment and that failure to adhere to these instructions will invalidate respondents' warranty of their service. Thus, the consumer cannot examine the garment serviced by respondents to determine whether the garment has been satisfactorily cleaned, and cannot reuse the garment, without first returning the garment for further processing by the respondents. Respondents have failed to disclose these conditions or limitations to consumers in promotional materials. These facts would be material to consumers in their purchase of respondents' cleaning and preservation service. The failure to disclose these facts, in light of the representations made, was, and is, a deceptive practice.

19. The acts and practices of respondents as alleged in this complaint constitute unfair or deceptive acts or practices in or affecting commerce in violation of Section 5(a) of the Federal Trade Commission Act.

By the Commission, Commissioner Swindle voting in the affirmative but dissenting from the inclusion of Part III of the Notice Order.

EXHIBIT A

METHOD AND USE OF ZURCION

CARE LABELING INSTRUCTIONS

THE FEDERAL TRADE COMMISSION'S CARE LABELING RULE STATES THAT A MANUFACTURER MUST SEW IN OR AFFIX A LABEL INSIDE THE GARMENT GIVING CARE INSTRUCTIONS ON A PERMANENT LABEL THAT WILL ALLOW THE CONSUMER TO HAVE "ORDINARY USE AND ENJOYMENT" OF THE ARTICLE.

THE FEDERAL TRADE COMMISSION RULE ALSO STATES THAT THERE MUST BE AT LEAST ONE METHOD OF CARE PROCEDURES THAT IS DESCRIBED ON THE AFFIXED CARE LABEL. THIS IS FOR THE DRY CLEANER OR FOR THE PERSON THAT IS SERVICING THE ARTICLE, SO THAT THE ARTICLE WILL RECEIVE THE PROPER CARE AND TREATMENT FOR WEAR OR FOR PURPOSES OF STORAGE.

THE ZURCION METHOD IS A METHOD THAT IS WIDELY USED BY THE BRIDAL AND FORMAL WEAR INDUSTRY. THIS TYPE OF PROCESSING IS A SPECIALIZED METHOD WHICH REGULAR DRYCLEANERS CANNOT USE FOR REGULAR GARMENT CARE, FOR SEVERAL REASONS WHICH ARE 1) SPECIALIZED PROCESSING EQUIPMENT NEEDED FOR ZURCION SOLVENTS 2) -SOLVENT COST FACTOR (SOLVENT MADE FROM PURE CHEMICAL COMPOUNDS NOT INDUSTRIAL) 3) -SPECIAL TRAINING NEEDED TO HANDLE ZURCION FLUIDS 4) -NOT AVAILABLE TO THE GENERAL DRYCLEANER ONLY TO OUR COMPANY.

THE CARE LABELING INSTRUCTIONS IN EVERY GARMENT HAVE TO BE FOLLOWED AS FAR AS CARE PROCEDURES ARE CONCERNED ACCORDING TO THE FEDERAL TRADE COMMISSION, THEREFORE IF A GOWN HAS THE LABEL AFFIXED THAT STATES DRYCLEAN BY ZURCION METHOD, THE CLEANER IS COMPELLED TO CLEAN AND SERVICE THE GOWN AS STATED BY THE MANUFACTURER. IF THE CLEANER IGNORES THE CARE LABEL OR SERVICES THE GOWN BY REGULAR DRYCLEANING PROCEDURES HE IS RESPONSIBLE FOR WHAT EVER DAMAGE IS INCURRED BY HIS METHODS.

SUMMARY--IF FOR ANY REASON A GOWN IS DAMAGED BY A DRYCLEANER WITH THE ZURCION LABEL AFFIXED IN THE GOWN DO NOT HESITATE TO CONTACT OUR COMPANY. WE WILL SUPPLY YOU WITH A FACT SHEET FROM OUR COMPANY AND THE FEDERAL TRADE COMMISSION EXPLAINING THE FEDERAL TRADE COMMISSION'S LABELING ACT, AND IF THE ARTICLE SHOULD NEED ANALYSIS WE WILL SUPPLY YOU WITH A COMPLETE ANALYSIS REPORT.

CONCLUSION- IF ANY CLEANER CLEANS A WEDDING OR EVENING GOWN WITH ANY OTHER METHOD THAN THE ONE DESCRIBED HE (THE CLEANER) RUNS THE RISK OF DAMAGING THE GOWN AND HAS TO BY LAW COMPENSATE FOR THE DAMAGE OR LOSS OF THAT ARTICLE.

-----REMEMBER-----

ZURCION-IT'S GUARANTEED

*PATENTED METHOD

EXHIBIT A

00089

Complaint

128 F.T.C.

EXHIBIT B



FROM THE CONSUMER PROTECTION DIVISION:

* WARNING * WARNING * WARNING * WARNING * WARNING *
 BEWARE * BEWARE * BEWARE * BEWARE *

PLEASE BEWARE OF FALSE ADVERTISEMENTS AND MISLEADING
 STATEMENTS MADE BY OTHER GOWN CLEANING AND PRESERVATION
 SERVICES:

AT NATIONWIDE GOWN CLEANING SERVICE, WE ARE THE SPECIALISTS
 OF THE BRIDAL AND FORMAL WEAR INDUSTRY. WE ARE THE ONLY GOWN
 CLEANING COMPANY THAT IS RECOMMENDED BY 54 OF THE WORLDS
 LARGEST BRIDAL GOWN AND FORMAL WEAR MANUFACTURERS. NO OTHER
 CLEANER OR SO CALLED SPECIALIST CAN MAKE THIS STATEMENT.

YOU PURCHASE YOUR FORMAL WEAR AND WEDDING GOWNS AT SPECIALTY
 STORES. THIS IS WHY WE ARE AVAILABLE TO YOU.

WE ARE NOT JUST A STANDARD DRY CLEANER. WE DO NOT CLEAN ANY
 KIND OF "REGULAR" GARMENTS. WE WILL ONLY CLEAN AND/OR
 PRESERVE YOUR WEDDING GOWN AND FORMAL ATTIRE.

DON'T BE MISLEAD BY DRY CLEANERS WHO CLAIM TO HAVE THE
 KNOWLEDGE OF CLEANING YOUR FINE APPAREL. ONLY SEND YOUR FINE
 APPAREL TO THE ONE PLACE THAT HAS PROVEN TO LIVE UP TO IT'S
 RELIABLE REPUTATION.

DON'T BE MISLEAD BY PRICE - REMEMBER THE SAYING "YOU GET
 WHAT YOU PAID FOR". TRUST YOUR FINE APPAREL TO THE PEOPLE
 WHO HAVE THE KNOW-HOW ON CLEANING YOUR WEDDING GOWN AND/OR
 FORMAL WEAR.

PLEASE FOLLOW THE CARE LABEL INSTRUCTION INSIDE YOUR
 GARMENTS.

00095

EXHIBIT B

EXHIBIT C



Continental Gown Cleaners, Inc.

For Those Who Demand Excellence!
2965 Blue Point Court, Wantagh, N.Y. 11793
1-800-441-GOWN

DELUXE PROMOTIONAL PACKAGE
=====

When accepting CONTINENTAL GOWN SERVICE'S PROMOTION PACKAGE, you are accepting the best package in the industry. We, at CONTINENTAL, feel that just showing a picture of a bridal chest to a bride is not enough. The consumer wants to know exactly what she is getting for her money. We supply you with these promotional aids free of charge.

- 1). One mini gold bridal chest for display purposes.
- 2). SALES LEAFLETS: These leaflets explain the process that the gown goes through in laymen terms so that there is little explaining on your part. Plus a toll free 800 number for information that you or your bride might want to obtain.

WARNING.....WARNING.....WARNING.....WARNING

PLEASE BE AWARE THAT THERE ARE REGULAR DRY-CLEANERS THAT TRY TO IMITATE OUR SERVICE, BUT THEY CAN NOT IMITATE OUR ZURCION PROCESS OR METHOD. BEWARE OF THE SO CALLED GOWN SPECIALIST. IT COULD PROVE TO BE DISASTROUS.
CONTINENTAL IS THE ONLY GOWN CLEANING AND PRESERVATION SERVICE TO BE RECOMMEND BY OVER 80% OF THE BRIDAL AND FORMAL WEAR INDUSTRY BY USING THE PATENTED ZURCION METHOD.

00019

Complaint

128 F.T.C.

EXHIBIT D

*Continental Gown Cleaners, Inc.*

For Those Who Demand Excellence!
 2965 Blue Point Court, Wantagh, N.Y. 11793
 1-800-441-GOWN

-2-

C). When a gown is received by CONTINENTAL GOWN CLEANERS the gown is immediately analyzed to determine what the problem is and analyzed as to how the problem came about. At which time a complete analysis report goes out to you the manufacturer, the consumer, the Bridal Shop and last but not least the cleaner.

This procedure is the most applicable way of settling any claims and keeps your Bridal accounts happy knowing that you have every angle of your business covered.

In recent months so called copy cat gown cleaning services have tried to duplicate our expert service, don't be fooled by these fly by night services. There is only one cleaning method that has proven to be safe on all gowns and formal wear. It's the ZURICON METHOD, 71 bridal and formal wear manufactures can't be wrong.

Remember, integrity and caring but most of all reputation.

If you would like to see one of representatives to discuss complete details of our service at no cost or obligation just call us at 1-800-441-GOWN. Over 700,000 customers are pleasantly satisfied with our service that must say something for integrity and reputation.

Looking forward to hearing from you.

Very truly yours,

Lewis Weissman
 CONTINENTAL GOWN CLEANERS, INC.

00071

THERE WILL ALWAYS BE IMITATORS
 THERE IS ONLY ONE CONTINENTAL!
 THE ONE TO TRUST

EXHIBIT D

EXHIBIT E

THE TRUE FACTS ABOUT ZURCION
SPECIAL REPORT

FACT: ZURCION IS RECOMMENDED BY 76 OF THE WORLDS MOST PRESTIGIOUS GOWN AND FORMAL WEAR MANUFACTURES.

FACT: ZURCION IS THE SAFEST METHOD THAT IS USED TODAY FOR CLEANING AND PROCESSING GOWNS AND FORMAL WEAR.

FACT: THE ZURCION METHOD HAS NEVER DAMAGED A WEDDING GOWN OR FORMAL GOWN.

FACT: UNLIKE OTHER CLEANING COMPOUNDS, ZURCION IS NOT AVAILABLE TO ANY REGULAR DRYCLEANER.

FACT: ZURCION IS A TRADE MARKED METHOD THAT HAS BEEN APPROVED BY THE UNITED STATES PATENT AND TRADE MARK OFFICE UNDER REG. NO. 1,582,960.

FACT: WHEN DEALING WITH ANY GOWN SERVICE THAT GIVES YOU CREDENTIALS CHECK THEM OUT FULLY. DON'T ALWAYS BELIEVE WHAT YOU HEAR.

FACT: ZURCION HAS BEEN RECOGNIZED BY THE INTERNATIONAL FABRICARE INSTITUTE (FABRIC NEWS DIGEST OCTOBER 1990).

FACT: OTHER GOWN CLEANERS WHO ARE ACTUALLY REGULAR DRYCLEANERS WHO PROCESS REGULAR EVERYDAY WEARING APPAREL TRY TO SUBSIDIZE THERE CLEANING STORES WITH GOWN CLEANING. THEY LEAD YOU TO BELIEVE THAT GOWN CLEANING IS THERE ONLY BUSINESS, WHEN IT'S JUST A SIDE LINE.

FACT: NATIONWIDE IS THE ONLY GOWN CLEANER IN THE UNITED STATES THAT ONLY PROCESS GOWNS AND FORMAL WEAR, SIMPLY BECAUSE IT IS A SPECIALIZED ITEM THAT SHOULD BE PROCESSED BY A SPECIALIZED COMPANY WITH A SPECIALIZED METHOD (ZURCION).

FACT: DON'T BE FOOLED BY CON ARTISTS THAT TELL YOU THEY HAVE A SPECIAL PROCESS CALLED WETCLEANING. THE DEFINITION OF WETCLEANING IS TO WASH AS PRESCRIBED IN SOAP AND WATER. BEWARE OF THESE CLAIMS THEY ARE GRABBING FOR STRAWS.

FACT: NATIONWIDE GOWN CLEANERS INC, HAS A PROCESS THAT IS REGARDED AS A TRADE SECRET SO THAT THE LEVEL OF QUALITY AND REPUTATION CAN BEST BE SERVED TO YOU THE CONSUMER.

FACT: NATIONWIDE GOWN CLEANER INC, IS AND ALWAYS WILL BE THE MOST REPUTABLE AND DISTINGUISHED GOWN CLEANER IN THE BRIDAL INDUSTRY ALWAYS THERE TO SERVE YOU THE CONSUMER WITH INTEGRITY.

FACT: NATIONWIDE GOWN CLEANERS INC. WILL ALWAYS STAND ABOVE THE REST WITH HONESTY, INTEGRITY AND QUALITY. THIS IS OUR PLEDGE TO YOU.

Complaint

128 F.T.C.

EXHIBIT F



A Fable ...

"The Ravages of Time"

When grandmother got married she was a lovely bride in her gown of fine hand made lace. Everyone told her how beautiful she looked in her delicate gown. After the wedding, she thoughtfully decided to save her gown and veil for her daughter to wear some day. But Continental wasn't available then so she folded her gown with loving care in tissue paper and moth flakes and placed it tenderly in the bottom of her cedar chest. When it was time for the lovely gown to be worn by her daughter, she found it had discolored and the beautiful lace was ruined.

The moral of the story: Don't trust your wedding gown to home methods or ordinary dry cleaning, they can't prevent the ravages of time but Continental Gown Cleaners can.

Your antique gowns can be cleaned and restored to a like-new finish.

What a Lovely Bride, What a Lovely Gown*Cleaning Gowns is our only Business.*

Cherish this moment in your special memories and in a very special way Continental will preserve your beautiful gown.

For more than forty years we have been preserving fine delicate gowns so they retain all the beauty they had on that special day. After the gown has been cleansed and carefully treated to resist soil, dust, and moisture, we pack it in a sealed contained (with a window for you and your daughter to enjoy its lasting beauty).

Our preservation process is so unique, we offer a guarantee that your gown will be as fresh and lovely on her wedding day as it was on yours.

Preserve your wedding gown today.

To Enjoy Forever

The Professionals

Continental is recommended by
the World's Leading Wedding Gown Manufacturers

FOR BEST RESULTS, SEND GOWN OR CALL

Continental
Gown Cleaners, Inc.

Flushing, NY • Dallas, TX • Campbell, CA

1-800-441-GOWN

Free Pick-Up Worldwide

Remember, We Guarantee the Process

Exhibit F
200.2

Complaint

EXHIBIT G

FACT: Continental Gown Cleaners, Inc. is the only leading gown cleaners and restorers in the nation and is the choice of the bridal industry.

FACT: The average cleaner will not clean a gown that is glued up or that has glued or pearlized beading. But-Continental has a No-Fault Cleaning Process that absolutely GUARANTEES the processing of gowns. With our Fabric Analysis Department we examine and analyze gowns.

FACT: Continental cleans thousands of gowns every month and we have NEVER ruined one! So why take chances with so called safe methods. trust the choice of the bridal gown industry and here's why:

Continental is geared for gown processing. We utilize the most modern equipment in the industry. With expert technicians trained to handle the cleaning and processing of delicate gowns.

The average cleaner uses a regular dry cleaning machine used for every day dry cleaning. To clean one or two gowns a month, he cannot be expected to alter his methods.

CONTINENTAL USES SPECIALIZED:

Gown processing units
Trained personnel
Chemical formulas for different gowns
Finishing equipment

An Average Cleaner with:
Average cleaning equipment
Average personnel
Average spotting techniques

If you have any questions, please feel free to call our toll-free numbers:
New York call: 718-468-1992 • Outside New York call: 1-800-441-GOWN

FACT: We appreciate your interest in Continental Gown Cleaners, Inc., the choice of the Bridal Industry.

THE STORY BEHIND YOUR WEDDING GOWN

As soon as your wedding gown is received at Continental, we begin a long and timely procedure to insure that your gown is given the finest care:

STEP ONE: Your gown is carefully analyzed to determine the type of care required.

STEP TWO: The gown is thoroughly soaked in a special formulated solution designed to:

- A). Rid the garment of all perspiration
- B). Remove all hem soil
- C). Surface all stains for easy removal
- D). Whiten the fabric

STEP THREE: The gown is cleansed in special fluids. It is then submerged in to a preservative. The preservative is formulated to resist moisture, soil, dust, and to reflect some harmful light rays.

STEP FOUR: Your gown is then air dried and pressed and placed in a box designed for wedding gowns.

At Continental we take the time to make it right! Exhibit G 00010

Complaint

128 F.T.C.

EXHIBIT H

FOR BEST RESULTS CALL

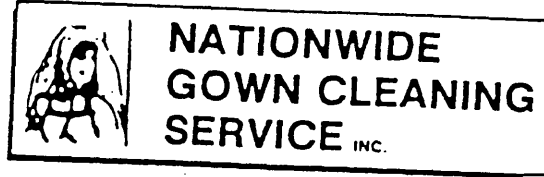

New York, NY
Dallas, TX
Campbell, CA

1-800-242-GOWN

REMEMBER
WE GUARANTEE THE PROCESS

Free Pick Up Worldwide

MEMBER OF B.M.A.A.

00057

DECISION AND ORDER

The Federal Trade Commission having issued its complaint charging the respondents named in the caption hereof with violation of Section 5(a) of the Federal Trade Commission Act, as amended, and the respondents having been served with a copy of that complaint, together with a notice of contemplated relief; and

The respondents, their attorneys, and counsel for the Commission having thereafter executed an agreement containing a consent order, an admission by the respondents of all the jurisdictional facts set forth in the complaint, a statement that the signing of said agreement is for settlement purposes only and does not constitute an admission by respondents of facts, other than jurisdictional facts, or of violations of law as alleged in the complaint issued by the Commission.

The Secretary of the Commission having thereafter withdrawn this matter from adjudication in accordance with Section 3.25(c) of its Rules; and

The Commission having considered the matter and having thereupon accepted the executed consent agreement and placed such agreement on the public record for a period of sixty (60) days, now in further conformity with the procedure prescribed in Section 3.25(f) of its Rules, the Commission hereby makes the following jurisdictional findings and enters the following order:

1. Respondents Continental Gown Cleaning Service, Inc., Nationwide Gown Cleaning Service, Inc., Prestige Gown Cleaning Service, Inc. (also doing business as Prestige Gown Service, Inc.), Gown Cleaning Service, Inc., and Jonathan Ashley, Ltd., are New York corporations with their principal offices or places of business at 189-07 Union Turnpike, Flushing, New York.

2. Respondent Lewis Weissman is an officer of the corporate respondents. Individually or in concert with others, he formulates, directs, controls, or participates in the policies, acts, or practices of the corporations, including the acts or practices alleged in this complaint. His principal office or place of business is the same as that of the corporate respondents.

3. Respondent Gary Marcus is an officer of the corporate respondents. Individually or in concert with others, he formulates, directs, or controls the policies, acts, or practices of the corporations, including the acts or practices alleged in this complaint. His principal

office or place of business is the same as that of the corporate respondents.

4. The Federal Trade Commission has jurisdiction of the subject matter of this proceeding and of the respondents, and the proceeding is in the public interest.

ORDER

DEFINITIONS

For purposes of this order, the following definitions shall apply:

1. "*Care Labeling Rule*" shall mean the Federal Trade Commission's Trade Regulation Rule Concerning the Care Labeling of Textile Wearing Apparel, 16 CFR Part 423, or as the Rule may hereafter be amended.

2. Unless otherwise specified, "*respondents*" shall mean Continental Gown Cleaning Service, Inc., Nationwide Gown Cleaning Service, Inc., Prestige Gown Cleaning Service, Inc. (also doing business as Prestige Gown Service, Inc.), Gown Cleaning Service, Inc., and Jonathan Ashley, Ltd., corporations, their successors and assigns and their officers; Lewis Weissman and Gary Marcus, individually and as officers of the corporations; and each of the above's agents, representatives and employees.

3. "*Commerce*" shall mean commerce as defined in Section 4 of the Federal Trade Commission Act, 15 U.S.C. 44.

4. "*Clearly and prominently*" shall mean as follows:

A. In an advertisement communicated through an electronic medium (such as television, video, radio, and interactive media such as the Internet and online services), the disclosure shall be presented simultaneously in both the audio and video portions of the advertisement. Provided, however, that in any advertisement presented solely through video or audio means, the disclosure may be made through the same means in which the ad is presented. The audio disclosure shall be delivered in a volume and cadence sufficient for an ordinary consumer to hear and comprehend it. The video disclosure shall be of a size and shade, and shall appear on the screen for a duration, sufficient for an ordinary consumer to read and comprehend it. In addition to the foregoing, in interactive media the disclosure shall also be unavoidable and shall be presented prior to the consumer incurring any financial obligation.

B. In a print advertisement, promotional material, or instructional manual, the disclosure shall be in a type size and location sufficiently noticeable for an ordinary consumer to read and comprehend it, in print that contrasts with the background against which it appears. In multipage documents, the disclosure shall appear on the cover or first page.

C. On a product label, the disclosure shall be in a type size and location on the principal display panel sufficiently noticeable for an ordinary consumer to read and comprehend it, in print that contrasts with the background against which it appears.

The disclosure shall be in understandable language and syntax. Nothing contrary to, inconsistent with, or in mitigation of the disclosure shall be used in any advertisement or on any label.

5. "*Competent and reliable scientific evidence*" shall mean tests, analyses, research, studies, or other evidence based on the expertise of professionals in the relevant area, that has been conducted and evaluated in an objective manner by persons qualified to do so, using procedures generally accepted in the profession to yield accurate and reliable results.

6. "*Manufacturer's or importer's written statement of reasonable basis*" shall mean a written statement in the form attached as Appendix A signed by an authorized officer of the manufacturer or importer that produces the garments or products to which the statement relates, describing the reasonable basis for a particular care instruction, warning or other representation.

7. "*Solvent*" shall mean any common organic solvent that is commercially available for purchase for use in drycleaning.

I.

It is ordered, That respondents, directly or through any corporation, subsidiary, division, or other device, in connection with the advertising, promotion, offering for sale, sale, or distribution of the Zurcion Method of cleaning and preservation or of any garment cleaning or preservation method, service, or product in or affecting commerce, shall not provide to retail or wholesale stores or to manufacturers or importers of textile wearing apparel subject to the Commission's Care Labeling Rule, the means and instrumentalities to violate the Federal Trade Commission Act and/or the Care

Labeling Rule, including without limitation, providing any labels or tags that:

(A) Fail, when the label or tag requires or recommends drycleaning, to state at least one type of solvent that may be used without damage to dryclean the garment to which the label or tag is to be attached, unless all solvents can be used without damage; or

(B) Fail to provide warnings about parts of the normal drycleaning process or the normal washing process (as these processes are described in the Care Labeling Rule) that may harm the garment to which the label or tag is to be attached or others being washed or drycleaned with it; or

(C) Warn against the use of washing or drycleaning (as described in the Care Labeling Rule), or against the use of professional wetcleaning, when no warning is needed; or

(D) Violate the Care Labeling Rule, including without limitation, in the manner described in subparts (A), (B), and (C) of this Part; or

(E) State "Dryclean Only by Zurcion Method" or otherwise misrepresent that the Zurcion Method is the only cleaning method that can be used safely and effectively to clean the garments to which the labels or tags are to be attached; or

(F) Represent that respondents are the only cleaners who can clean the garments to which the labels or tags are to be attached;

Provided that, for any and all labels or tags provided by respondents that include care instructions, respondents must possess and rely upon the manufacturer's or importer's written statement of reasonable basis to substantiate the care instructions.

For purposes of this Part, labels and tags are defined as written material provided by respondents for purposes of attachment to textile wearing apparel that is offered for sale to consumers.

II.

It is further ordered, That respondents, directly or through any corporation, subsidiary, division, or other device (including without limitation providing materials or information intended for use or distribution by others), in connection with their advertising, promotion, offering for sale, sale, or distribution of any garment cleaning or preservation method, service, or product in or affecting

commerce, shall not make any misrepresentations regarding the Care Labeling Rule or compliance with the Care Labeling Rule.

III.

It is further ordered, That respondents, directly or through any corporation, subsidiary, division, or other device, in connection with the advertising, promotion, offering for sale, sale, or distribution of the Zurcion Method of cleaning or preservation or any other method of cleaning or preservation, in or affecting commerce, shall not misrepresent in any manner, expressly or by implication, that such method is patented.

IV.

It is further ordered, That respondents, directly or through any corporation, subsidiary, division, or other device, in connection with the advertising, promotion, offering for sale, sale, or distribution of any garment cleaning or preservation method, service, company or product in or affecting commerce, shall not make any representation, in any manner, expressly or by implication, regarding the comparative or absolute safety or efficacy of any cleaning or preservation method, service, company, or product, unless the representation is true and, at the time it is made, respondents possess and rely upon competent and reliable evidence, which when appropriate shall be competent and reliable scientific evidence, that substantiates the representation.

V.

It is further ordered, That respondents, directly or through any corporation, subsidiary, division, or other device, in connection with the advertising, promotion, offering for sale, sale, or distribution of a garment cleaning or preservation service in or affecting commerce, shall not make any representation, in any manner, expressly or by implication, that such service is guaranteed or warranted, unless they disclose, clearly and prominently, and in close proximity to the representation, any material limitation or condition on the guarantee or warranty, including, but not limited to the fact, if true, that an item preserved by respondents must be kept sealed in the special preservation container and if opened for inspection must be returned for reboxing within thirty (30) days.

VI.

It is further ordered, That respondents Continental Gown Cleaning Service, Inc., Nationwide Gown Cleaning Service, Inc., Prestige Gown Cleaning Service, Inc., Prestige Gown Service, Inc., Gown Cleaning Service, Inc., and Jonathan Ashley, Ltd., and their successors and assigns, and respondents Lewis Weissman and Gary Marcus, shall, within sixty (60) days after the date of service of this order, send by first class certified mail, return receipt requested, to (a) all garment manufacturers or importers to whom respondents have provided Zurcion labels or promotional materials since January 1, 1996, and (b) as many as possible of respondents' customers identified during discovery for whom addresses can be found, a notice, in the form attached as Appendix B, informing the recipient of this order and that the recipient should cease all use of the Zurcion labels and promotional materials. No information other than that contained in Appendix B shall be included with the mailing, nor shall any other material be transmitted with it.

VII.

It is further ordered, That respondents Continental Gown Cleaning Service, Inc., Nationwide Gown Cleaning Service, Inc., Prestige Gown Cleaning Service, Inc., Prestige Gown Service, Inc., Gown Cleaning Service, Inc., and Jonathan Ashley, Ltd., and their successors and assigns, and respondents Lewis Weissman and Gary Marcus, in any communication with persons other than manufacturers or importers regarding the cleaning or preservation of garments to which labels stating "Dryclean Only by Zurcion Method" or substantially similar instructions have been attached prior to the date of issuance of this order, shall disclose that other cleaning methods may be safely and effectively used, shall instruct the person to contact the manufacturer or importer to obtain cleaning instructions, and shall provide information about how to contact the manufacturer or importer. The disclosures required by this Part VII may be made using the statement attached as Appendix C.

VIII.

It is further ordered, That respondents Continental Gown Cleaning Service, Inc., Nationwide Gown Cleaning Service, Inc., Prestige Gown Cleaning Service, Inc., Prestige Gown Service, Inc.,

Gown Cleaning Service, Inc., and Jonathan Ashley, Ltd., and their successors and assigns, and respondent Lewis Weissman, for five (5) years after the date of issuance of this order, shall maintain and upon request make available to the Federal Trade Commission for inspection and copying business records demonstrating their compliance with the terms and provisions of this order, including but not limited to:

A. All advertisements and promotional materials for any garment cleaning or preservation method, service, or product offered for sale by respondents;

B. All materials that were relied upon in disseminating any representation covered by this order;

C. All tests, reports, studies, surveys, demonstrations, or other evidence in their possession or control that contradict, qualify, or call into question any representation covered by this order, or the basis relied upon for the representation, including complaints and other communications with consumers or with governmental or consumer protection organizations; and

D. All materials provided by respondents to manufacturers, importers, retailers, or wholesalers of textile wearing apparel.

Respondent Gary Marcus shall comply with the provisions of this Part VIII if at any time during the five (5) years after the date of issuance of this order he owns or controls a majority interest in any of the corporate respondents, or in any business involving or connected with the advertising, promotion, offering for sale, sale, or distribution of any garment cleaning or preservation method, service, or product.

IX.

It is further ordered, That respondents Continental Gown Cleaning Service, Inc., Nationwide Gown Cleaning Service, Inc., Prestige Gown Cleaning Service, Inc., Prestige Gown Service, Inc., Gown Cleaning Service, Inc., and Jonathan Ashley, Ltd., and their successors and assigns, and respondents Lewis Weissman and Gary Marcus shall deliver a copy of this order to all current and future principals, officers, directors, and managers, and to all current and future employees, agents, and representatives having responsibilities with respect to the subject matter of this order, and shall secure from

each such person a signed and dated statement acknowledging receipt of the order. Respondents shall deliver this order to current personnel within sixty (60) days after the date of service of this order, and to future personnel within thirty (30) days after the person assumes such position or responsibilities.

X.

It is further ordered, That respondents Continental Gown Cleaning Service, Inc., Nationwide Gown Cleaning Service, Inc., Prestige Gown Cleaning Service, Inc., Prestige Gown Service, Inc., Gown Cleaning Service, Inc., and Jonathan Ashley, Ltd., and their successors and assigns, shall notify the Commission at least thirty (30) days prior to any change in the corporation(s) that may affect compliance obligations arising under this order, including but not limited to a dissolution, assignment, sale, merger, or other action that would result in the emergence of a successor corporation; the creation or dissolution of a subsidiary, parent, or affiliate that engages in any acts or practices subject to this order; the proposed filing of a bankruptcy petition; or a change in the corporate name or address. Provided, however, that, with respect to any proposed change in the corporation(s) about which respondents learn less than thirty (30) days prior to the date such action is to take place, respondents shall notify the Commission as soon as is practicable after obtaining such knowledge. All notices required by this Part shall be sent by certified mail to the Associate Director, Division of Enforcement, Bureau of Consumer Protection, Federal Trade Commission, Washington, D.C.

XI.

It is further ordered, That, for a period of ten (10) years after the date of issuance of this order:

(a) Respondent Lewis Weissman shall notify the Commission of the discontinuance of his current business or employment, or of his affiliation with any new business or employment; and

(b) Respondent Gary Marcus shall notify the Commission of his affiliation with any new business or employment involving or connected with the advertising, promotion, offering for sale, sale, or distribution of any garment cleaning or preservation method, service, or product.

The notices required in this Part XI shall include respondents' new business address and telephone number and a description of the nature of the business or employment and their duties and responsibilities. All notices required by this Part shall be sent by certified mail to the Associate Director, Division of Enforcement, Bureau of Consumer Protection, Federal Trade Commission, Washington, D.C. 20580.

XII.

It is further ordered, That respondents Continental Gown Cleaning Service, Inc., Nationwide Gown Cleaning Service, Inc., Prestige Gown Cleaning Service, Inc., Prestige Gown Service, Inc., Gown Cleaning Service, Inc., and Jonathan Ashley, Ltd., and their successors and assigns, and respondents Lewis Weissman and Gary Marcus shall, within sixty (60) days after the date of service of this order, and at such other times as the Federal Trade Commission may require, file with the Commission a report, in writing, setting forth in detail the manner and form in which they have complied with this order. This report shall include, but shall not be limited to, a detailed description of the Zurcion Method of cleaning or preservation, any substantially similar method of cleaning or preservation, or any other specialized method of cleaning or preserving textile wearing apparel advertised by respondents, including the solvent(s) used in such method. Pursuant to Rule 4.9(c) of the Commission's Rules of Practice, respondents may designate material included in the report as confidential and request that it be withheld from the public record.

XIII.

This order will terminate on September 8, 2019, or twenty (20) years from the most recent date that the United States or the Federal Trade Commission files a complaint (with or without an accompanying consent decree) in federal court alleging any violation of the order, whichever comes later; provided, however, that the filing of such a complaint will not affect the duration of:

- A. Any Part in this order that terminates in less than twenty (20) years;
- B. This order's application to any respondent that is not named as a defendant in such complaint; and
- C. This order if such complaint is filed after the order has terminated pursuant to this Part.

Provided, further, that if such complaint is dismissed or a federal court rules that the respondent did not violate any provision of the order, and the dismissal or ruling is either not appealed or upheld on appeal, then the order will terminate according to this Part as though the complaint had never been filed, except that the order will not terminate between the date such complaint is filed and the later of the deadline for appealing such dismissal or ruling and the date such dismissal or ruling is upheld on appeal.

APPENDIX A

WRITTEN STATEMENT OF REASONABLE BASIS

1. This statement is being provided to [name of respondent] to satisfy the conditions of an Order of the Federal Trade Commission dated September 8, 1999. I have received a copy of this Order.
2. Attached to this statement is a copy of [label(s) or tag(s)] attached to garments manufactured or imported by [name of manufacturer or importer].
3. [Name of manufacturer or importer] possesses and relies upon a reasonable basis in accordance with the Federal Trade Commission's Care Labeling Rule, 16 C.F.R. Part 423, for the care instructions [or specify other representations] made on the attached [label or tag]. This reasonable basis consists of the following reliable evidence: [describe nature of evidence].

[NAME OF MANUFACTURER OR IMPORTER]

BY: _____
[Name of authorized officer]
[Title of officer]

DATE: _____

451

Decision and Order

APPENDIX B

[Respondents' Letterhead]

Dear [name of manufacturer or importer]:

During the past several years you received garment labels, tags or other information materials about the Zurcicion method of cleaning and preserving wedding gowns and other formal wear. We are providing this notice pursuant to the terms of a Consent Order that our company agreed to have entered by the Federal Trade Commission. A copy of the Consent Order is attached.

The Consent Order is the result of allegations by the Commission that our materials violated the Care Labeling Rule or were otherwise misleading. The labels, tags and other materials said "Dryclean Only by Zurcicion Method," or words to that effect, or suggested that our company or cleaning methods are the only ones that could successfully clean certain garments. According to the Commission's Complaint, other cleaners and other methods may be able to clean and preserve these garments as well as we can. To comply with the Care Labeling Rule (found at 16 C.F.R. Part 423 or at www.ftc.gov -- click on "Legal Framework" and then "FTC Regulations and Guides," or at www.access.gpo.gov/nara/cfr/waisidx/16cfr423v1.html), you should always take appropriate steps to determine what cleaning or preservation methods will work for your company's garments.

Under the terms of the Consent Order, we can no longer (among other things) use the labels, tags or other materials you have received from us. Accordingly, please stop using them and destroy the unused supply. To satisfy the Rule's requirements, you may want to recall and/or retag garments in distribution that include Zurcicion labels.

For more information about the Care Labeling Rule, contact Steven Ecklund at the Federal Trade Commission, 202-326-2841 or secklund@ftc.gov.

Very truly yours,

Lewis Weissman
President

APPENDIX C

[You may use the following text to communicate the information required by Part VII of the Order. When dealing with drycleaners or retailers, the text may be modified to indicate that the order or inquiry is being made on behalf of a customer or customers, rather than by the customer directly. If there's any confusion about the message, the underlined text is to be the starting point for any further response.]

Since the manufacturer sewed a "Zurcion" label in your gown, it has been determined that other methods also may successfully and safely clean your gown.

We cannot provide the detailed cleaning instructions necessary for other cleaners to service your gown. If you want to consider other cleaners, contact the gown's manufacturer or importer for specific cleaning instructions. They will tell you if other cleaning methods exist and whether other cleaners may be able to follow the manufacturer's instructions.

If you don't know how to contact your gown's manufacturer or importer, we can help.

(If you know the manufacturer or importer's name, we can check a listing for their contact information.)

(If you don't know the name, look on your gown's label for the federal registered identification number or "RN" number. It will help us get the contact information for you.)