



United States  
Department of  
Agriculture

Animal and  
Plant Health  
Inspection  
Service

Plant Protection  
and Quarantine

# Treatment Manual

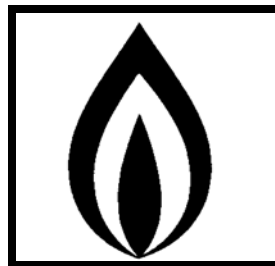
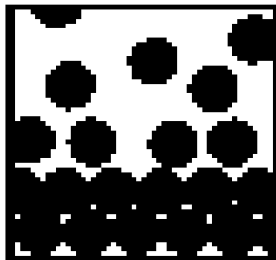
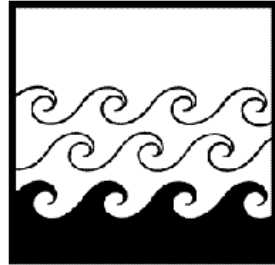

The U.S. Department of Agriculture (USDA) prohibits discrimination in all its programs and activities on the basis of race, color, national origin, age, disability, and where applicable, sex, marital status, familial status, parental status, religion, sexual orientation, genetic information, political beliefs, reprisal, or because all or part of an individual's income is derived from any public assistance program. (Not all prohibited bases apply to all programs.) Persons with disabilities who require alternative means for communication of program information (Braille, large print, audiotape, etc.) should contact USDA's TARGET Center at (202) 720-2600 (voice and TDD). To file a complaint of discrimination, write to USDA, Director, Office of Civil Rights, 1400 Independence Avenue, S.W., Washington, D.C. 20250-9410, or call (800) 795-3272 (voice) or (202) 720-6382 (TDD). USDA is an equal opportunity provider and employer.

Mention of companies or commercial products does not imply recommendation or endorsement by the U.S. Department of Agriculture over others not mentioned. USDA neither guarantees nor warrants the standard of any product mentioned. Product names are mentioned solely to report factually on available data and to provide specific information.

This publication reports research involving pesticides. All uses of pesticides must be registered by appropriate State and/or Federal agencies before they can be recommended.

**CAUTION:** Pesticides can be injurious to humans, domestic animals, desirable plants, fish, or other wildlife—if they are not handled or applied properly. Use all pesticides selectively and carefully. Follow recommended practices for the disposal of surplus pesticides and pesticide containers.

# Contents

## Contents

*page 1-1-i*

## Figures

*page 1-1-v*

## Tables

*page 1-1-ix*

## Introduction *page 1-1-1*

## Chemical Treatments

Overview *page 2-1-1*

Fumigants *page 2-2-1*

Fumigants • Methyl Bromide *page 2-3-1*

Fumigants • Methyl Bromide • Tarpaulin Fumigation *page 2-4-1*

Fumigants • Methyl Bromide • Chamber Fumigation *page 2-5-1*

Fumigants • Methyl Bromide • Ship Fumigation *page 2-6-1*

Fumigants • Methyl Bromide • Structure Fumigation *page 2-7-1*

Fumigants • Methyl Bromide • Special Procedures for Container Fumigations  
Without a Tarpaulin *page 2-8-1*

Fumigants • Sulfuryl Fluoride *page 2-9-1*

Fumigants, Phosphine *page 2-10-1*

Aerosols and Micronized Dusts *page 2-11-1*

Dips *page 2-12-1*

Dusts *page 2-13-1*

Sprays *page 2-14-1*

## Nonchemical Treatments

Overview *page 3-1-1*

Heat *page 3-2-1*

Heat, Hot Water Immersion Treatment *page 3-3-1*

Heat • Steam Treatments *page 3-4-1*

Heat • Vapor Heat and Forced Hot Air Treatment *page 3-5-1*

Heat • Forced Hot Air • Niger Seed *page 3-6-1*

Cold Treatment (CT) *page 3-7-1*

Irradiation *page 3-8-1*

## Residue Monitoring

Overview *page 4-1-1*

Instructions for Collecting, Packaging, and Shipping Residue Monitoring  
Samples *page 4-2-1*

## Treatment Schedules

Index to Schedules *page 5-1-1*

T100 - Schedules for Fruit, Nuts, and Vegetables *page 5-2-1*

T200 - Schedules for Propagative Plant Material *page 5-3-1*  
T300 - Schedules for Miscellaneous Plant Products *page 5-4-1*  
T400 - Schedules for Miscellaneous Products *page 5-5-1*  
T500 - Schedules for Plant Pests or Pathogens *page 5-6-1*  
T600-Controlled Atmosphere Temperature Treatment System *page 5-7-1*  
Certifying Facilities  
    Overview *page 6-1-1*  
Certifying Facilities  
    Certification of Vacuum Fumigation Chambers *page 6-2-1*  
    Certifying Atmospheric Fumigation Chambers *page 6-3-1*  
    Certification of Cold Treatment *page 6-4-1*  
    Certification of Hot Water Immersion Facilities *page 6-5-1*  
    Certification of Forced Hot Air and Vapor Heat Treatment  
        Facilities *page 6-6-1*  
    Certification of Niger seed Treatment Facilities *page 6-7-1*  
    Certifying Irradiation Treatment Facilities *page 6-8-1*  
    Certifying Facilities for the Heat Treatment of Firewood *page 6-9-1*  
Emergency Aid and Safety  
    Fumigation Exposure *page 7-1-1*  
    Pesticide Exposure *page 7-2-1*  
    Guidelines for Managing Pesticide Spills *page 7-3-1*  
    Hazard Communication and Material Safety Data Sheets *page 7-4-1*  
Equipment *page 8-1-1*  
Glossary *page 9-1-1*  
Appendix A  
    Forms *page A-1-1*  
Appendix B  
    Coast Guard Regulations *page B-1-1*  
Appendix C  
    Maintenance: Supporting and Updating Manuals *page C-1-1*  
Appendix D  
    Conversion Tables *page D-1-1*  
Appendix E  
    Directory of Treatment Facilities *page E-1-1*  
Appendix F  
    List of Integral Containers Approved for Intransit Cold  
        Treatment *page F-1-1*  
Appendix G  
    List of Vessels Equipped for Intransit Cold Treatment *page G-1-1*  
Appendix H  
    Reference Guide to Commercial Suppliers of Treatment and Related Safety  
        Equipment *page H-1-1*  
Comment Sheet  
    *page CS-1-1*  
Index

*page Index-1-1*



# Figures

- [FIGURE 2-3-1: Section 18 Exemptions](#) *page 2-3-3*
- [FIGURE 2-4-1: Container Arrangement in Two Rows](#) *page 2-4-9*
- [FIGURE 2-4-2: Container Arrangement in Two Rows](#) *page 2-4-9*
- [FIGURE 2-4-3: Gas Lead Position \(Side View\)](#) *page 2-4-12*
- [FIGURE 2-4-4: Typical Stack Arrangement with Fans, Leads, Introduction Line, Padding, and Sand Snakes](#) *page 2-4-14*
- [FIGURE 2-10-1: NIOSH-Recommended Respiratory Protection](#) *page 2-10-8*
- [FIGURE 2-10-2: Amount of Phosphine Liberated by Various Products](#) *page 2-10-9*
- [FIGURE 2-10-3: Diagram of ECO2FUME® Gas Cylinder](#) *page 2-10-10*
- [FIGURE 2-10-4: Diagram of One Type of Dispensing Equipment](#) *page 2-10-12*
- [FIGURE 2-10-5: Diagram of One Type of Blending Equipment](#) *page 2-10-16*
- [FIGURE 2-10-6: Diagram of VAPORPH3OS® and Forced Air Blending Equipment](#) *page 2-10-18*
- [FIGURE 2-10-7: Commodity temperature and exposure period](#) *page 2-10-33*
- [FIGURE 2-10-8: Fan sizes required based on volume of the hold](#) *page 2-10-34*
- [FIGURE 2-10-9: Side view of a recirculation system](#) *page 2-10-35*
- [FIGURE 2-10-10: Three-dimensional view of a recirculation system](#) *page 2-10-36*
- [FIGURE 2-10-11: Tolerance Levels and Minimum Aeration Periods](#) *page 2-10-37*
- [FIGURE 3-7-1: Proper Placement of Pulp Sensor within Larger Fruit](#) *page 3-7-7*
- [FIGURE 3-7-2: Proper Placement of Pulp Sensor within Smaller Fruit](#) *page 3-7-8*
- [FIGURE 3-7-3: Fruit stack with middle row temperature probe placement](#) *page 3-7-10*
- [FIGURE 3-7-4: 40 foot Refrigerated Container with 18 Pallets of Fruit \(not drawn to scale\)](#) *page 3-7-11*
- [FIGURE 3-7-5: Proper placement of cardboard between the last pallet row of fruit and the back doors of the container](#) *page 3-7-12*
- [FIGURE 3-7-6: Number of Sensors in a Warehouse](#) *page 3-7-21*
- [FIGURE 5-2-1: Commodities Ineligible for Quick Freeze Treatment](#) *page 5-2-79*
- [FIGURE 5-5-1: Example of International Plant Protection Convention Marking](#) *page 5-5-20*
- [FIGURE 6-1-1: Number of Temperature Sensors per compartment](#) *page 6-4-6*

- FIGURE 6-1-2 Example of a Completed Application for USDA Vessel Approval, page 1 of 2 *page 6-4-9*
- FIGURE 6-1-3 Example of a Completed Application for USDA Vessel Approval, page 2 of 2 *page 6-4-10*
- FIGURE 6-1-4 Example of a Completed Application for USDA Container Certification, page 1 of 2 *page 6-4-12*
- FIGURE 6-1-5 Example of a Completed Application for USDA Container Certification, page 2 of 2 *page 6-4-13*
- FIGURE 6-1-6 Number of Temperature Sensors *page 6-4-15*
- FIGURE 6-1-7 Example of a Completed Application for USDA Warehouse Approval, page 1 of 3 *page 6-4-18*
- FIGURE 6-1-8 Example of a Completed Application for USDA Warehouse Approval, page 2 of 3 *page 6-4-19*
- FIGURE 6-1-9 Example of a Completed Application for USDA Warehouse Approval, page 3 of 3 *page 6-4-20*
- FIGURE 6-1-1 Hypothetical Certification Results: Treatment Tank with Multiple Set Points *page 6-5-3*
- FIGURE 7-3-1: Abbreviated Spill Plan, Personal Reference Card (Wallet-size) *page 7-3-2*
- FIGURE 7-3-2: Emergency Contacts for Pesticide Spills *page 7-3-3*
- FIGURE 7-3-3: Poison Control Center *page 7-3-4*
- FIGURE 7-3-4: Medical Emergency Facility *page 7-3-4*
- FIGURE 7-3-5: Federal Aviation Administration (FFA) Office *page 7-3-5*
- FIGURE 7-3-6: Community-Right-To-Know or Emergency Planning Coordinator (Fire Marshall) *page 7-3-6*
- FIGURE 7-3-7: Fish and Game Department *page 7-3-6*
- FIGURE 7-3-8: Regional Veterinary Services (VS) Office *page 7-3-6*
- FIGURE 7-3-9: Regional Safety and Health Coordinator *page 7-3-7*
- FIGURE 7-3-10: Local Police *page 7-3-7*
- FIGURE 7-3-11: Local Hazardous Waste Official *page 7-3-7*
- FIGURE 7-4-1: Appendix E—Guidelines for Employer Compliance *page 7-4-2*
- FIGURE 8-1-1: Fumiscopes® *page 8-1-2*
- FIGURE 8-1-2: GowMac® *page 8-1-2*
- FIGURE 8-1-3 Spectros Methyl Bromide Monitor *page 8-1-9*
- FIGURE 8-1-4: Methyl Bromide Volatilizer Coil *page 8-1-25*
- FIGURE 8-1-5: Tubing Specifications *page 8-1-26*
- FIGURE 8-1-6: Auxiliary Pump *page 8-1-28*
- FIGURE 8-1-7: Example of Pressure Measurement in an Open-arm Manometer *page 8-1-29*
- FIGURE 8-1-8: Example of U Tube Manometer *page 8-1-31*
- FIGURE A-1-1: APHIS Form 205-R, Instructions and Worksheet for Calibrating Portable Temperature Sensors *page A-1-3*
- FIGURE A-1-2: APHIS Form 206-R, Test of the Accuracy of the Permanent RTD Sensors Installed in Hot Water Tanks *page A-1-4*
- FIGURE A-1-3: APHIS Form 207-R, Sensor Location Diagram Fruit Weights and Pulp Temperatures *page A-1-5*



- FIGURE A-1-4: Calibration of Temperature Probes (Cold Treatment) *page A-1-7*
- FIGURE A-1-5: Location of Temperature Sensors in Containerized Cargo (Cold Treatment) *page A-1-8*
- FIGURE A-1-6: Example of PPQ Form 429, Fumigation Record (Front) *page A-1-9*
- FIGURE A-1-7: Example of PPQ Form 429, Fumigation Record (Back) *page A-1-10*
- FIGURE A-1-8: Example of PPQ Form 519, Compliance Agreement *page A-1-14*
- FIGURE A-1-9: Example of PPQ Form 523, Emergency Action Notification *page A-1-17*
- FIGURE A-1-10: Example of PPQ Form 449-R, Temperature Recording Calibration Report *page A-1-27*
- FIGURE A-1-11: PPQ Form 203, Foreign Site Certificate of Inspection and/or Treatment *page A-1-29*
- FIGURE A-1-12: PPQ Form 556, In Transit Cold Treatment Clearance Report *page A-1-32*
- FIGURE H-1-1 DC Scientific Glass - Approved Thermometers *page H-1-56*
- FIGURE H-1-2 Fisher Scientific - Approved Thermometers *page H-1-56*
- FIGURE H-1-3 VWR - Approved Thermometers *page H-1-57*
- FIGURE H-1-4 Cole Parmer - Approved Thermometers *page H-1-58*



# Tables

- TABLE 2-4-1:Determine Reporting Requirements *page 2-4-3*
- TABLE 2-4-2 Number of Thermocouples *page 2-4-5*
- TABLE 2-4-3:Determine the Temperature for the Proper Dosage Rate *page 2-4-15*
- TABLE 2-4-4:Determine the Need to Add Gas and Adjust Exposure *page 2-4-24*
- TABLE 2-4-5:Determine the Extended Exposure Period *page 2-4-26*
- TABLE 2-4-6:Determine Gas Concentration Values and Corrections for Fruits and Vegetables at the 30-Minute Reading of T101-a-1 or Equivalent Schedules. *page 2-4-28*
- TABLE 2-4-7:Determine Gas Concentration Values and Corrections for Fruits and Vegetables at the 2-Hour Reading of T101-a-1 or Equivalent Schedules. *page 2-4-29*
- TABLE 2-4-8 Determine Gas Concentration Values and Corrections for Oak Log Fumigations using schedule T312-a *page 2-4-31*
- TABLE 2-4-9 Determine Gas Concentration Values and Corrections for Oak Log Fumigations using schedule T312-a-Alternative *page 2-4-34*
- TABLE 2-4-10:Determine Responsibility for Aerating the Commodity *page 2-4-36*
- TABLE 2-4-11:Determine the Aeration Procedure *page 2-4-38*
- TABLE 2-4-12:Determine When to Release the Commodity *page 2-4-39*
- TABLE 2-4-13:Determine When to Release the Commodity for Outdoor Fumigations *page 2-4-41*
- TABLE 2-4-14:Determine When to Release the Commodity for Indoor Fumigations *page 2-4-41*
- TABLE 2-4-15:Determine Number of Fans *page 2-4-42*
- TABLE 2-4-16:Determine When to Release the Commodity *page 2-4-43*
- TABLE 2-4-17:Determine when to Release the Commodity *page 2-4-44*
- TABLE 2-4-18:Determine When to Release the Commodity for Indoor Fumigations *page 2-4-45*
- TABLE 2-4-19:Determine when to Release the Commodity *page 2-4-46*
- TABLE 2-4-20:Determine when to Release the Commodity *page 2-4-47*
- TABLE 2-5-1:Determine Whether to Use Commodity or Air Temperature for Determining Dosage Rate *page 2-5-3*

[TABLE 2-5-2:Determine the Responsibility for Monitoring the Aeration](#) *page 2-5-4*

[TABLE 2-5-3:Determine the Aeration Procedure](#) *page 2-5-4*

[TABLE 2-5-4:Determine When to Release the Commodity](#) *page 2-5-5*

[TABLE 2-5-5:Determine When to Release the Commodity](#) *page 2-5-6*

[TABLE 2-5-6:Determine When to Release the Commodity](#) *page 2-5-7*

[TABLE 2-6-1:Determine Pre-fumigation Procedures](#) *page 2-6-7*

[TABLE 2-6-2:Determine Time for Extended Exposure](#) *page 2-6-12*

[TABLE 2-6-3:Determine the Responsibility for Monitoring the Aeration](#) *page 2-6-12*

[TABLE 2-7-1:Deterimne the Number of Sampling Tubes](#) *page 2-7-9*

[TABLE 2-7-2:Determine the Responsibility for Monitoring the Aeration](#) *page 2-7-15*

[TABLE 2-0-30:Effect of Hose Inside Diameter on Rate of Gas Introduction through a 25 Foot Hose](#) *page 2-9-4*

[TABLE 2-9-1: Effect of Hose Length on Rate of Gas Introduction through a inch Inside Diameter Hose](#) *page 2-9-4*

[TABLE 3-5-1 Example of a Treatment Schedule](#) *page 3-5-4*

[TABLE 3-8-1 Pest-Specific Minimum absorbed dose \(Gy\)](#) *page 3-8-4*

[TABLE 5-2-1: Determine Dip Time Based on Origin of Fruit](#) *page 5-2-52*

[TABLE 5-2-2: Determine Dip Time Based on Origin of Fruit](#) *page 5-2-52*

[TABLE 5-2-3: Determine Dip Time Based on Origin of Fruit](#) *page 5-2-53*

[TABLE 5-2-4 Pest-Specific Minimum absorbed dose \(Gy\)](#) *page 5-2-61*

[TABLE 5-2-5 Origin and Approved Commodity List for 150 Gy](#) *page 5-2-62*

[TABLE 5-2-6 Origin and Approved Commodity List for 400 Gy](#) *page 5-2-63*

[TABLE 5-2-7 Origin and Approved Commodity List for 300 Gy](#) *page 5-2-63*

[TABLE 5-4-1: Amount of Phosphine Liberated by various Products. Calculate amount of product needed by using the amount of phosphine released as shown in the right column.](#) *page 5-4-30*

[TABLE 5-5-1: Airbus Industries](#) *page 5-5-30*

[TABLE 5-5-2: Antonov](#) *page 5-5-31*

[TABLE 5-5-3: ATR](#) *page 5-5-31*

[TABLE 5-5-4: BAC \(British Aircraft Corp\)](#) *page 5-5-31*

[TABLE 5-5-5: BAC \(Aerospatiale\)](#) *page 5-5-31*

[TABLE 5-5-6: Boeing](#) *page 5-5-32*

[TABLE 5-5-7: Canadair](#) *page 5-5-33*

[TABLE 5-5-8: Casa](#) *page 5-5-33*

[TABLE 5-5-9: Cessna](#) *page 5-5-34*

---

TABLE 5-5-10: Convair *page 5-5-34*

TABLE 5-5-11: de Havilland *page 5-5-34*

TABLE 5-5-12: Dornier *page 5-5-35*

TABLE 5-5-13: Embraer *page 5-5-35*

TABLE 5-5-14: Fairchild *page 5-5-36*

TABLE 5-5-15: Fokker *page 5-5-36*

TABLE 5-5-16: Lockheed *page 5-5-36*

TABLE 5-5-17: McDonnell-Douglas *page 5-5-36*

TABLE 5-5-18: SAAB *page 5-5-39*

TABLE 5-5-19: Shorts *page 5-5-39*

TABLE 5-5-20: Sidely *page 5-5-39*

TABLE 5-5-21: Tupolev *page 5-5-39*

TABLE 5-5-22: Vickers *page 5-5-40*

TABLE 5-5-23: Military Aircraft *page 5-5-40*

TABLE 5-5-24: Amount of Phosphine Liberated by Various Products *page 5-5-47*

TABLE 5-7-1 Summary of CATTs treatments *page 5-7-5*

TABLE 6-1-1 Vacuum Chamber Classification Table *page 6-2-3*

TABLE 7-1-1: Fumigant Monitoring Devices and Sources of Exposure *page 7-1-6*

TABLE 8-1-1: Threshold Limit Values of Fumigants *page 8-1-13*

TABLE 1-1-1: Instructions for Completing PPQ Form 519, Compliance Agreement *page A-1-15*

TABLE A-1-2: Instructions for Initiating an EAN *page A-1-19*

TABLE A-1-3: Determine Paperwork to Be Presented upon Arrival of a Precleared Commodity *page A-1-30*

TABLE A-1-4: Distribution of PPQ Form 203, Foreign Site Certificate of Inspection and/or Treatment *page A-1-31*

TABLE A-1-5 Application for Approval of Self-refrigerated Containers (page 1 of 5) *page A-1-33*

TABLE A-1-6 Application for Approval of Self-refrigerated Containers (page 2 of 5) *page A-1-34*

TABLE A-1-7 Application for Approval of Self-refrigerated Containers (page 3 of 5) *page A-1-35*

TABLE A-1-8 Application for Approval of Self-refrigerated Containers (page 4 of 5) *page A-1-36*

TABLE A-1-9 Application for Approval of Self-refrigerated Containers (page 5 of 5) *page A-1-37*

TABLE D-1-1: Conversion Tables *page D-1-1*





# Introduction

---

## Contents

Purpose [page 1-1-1](#)  
Restrictions [page 1-1-1](#)  
Scope [page 1-1-2](#)  
Users [page 1-1-2](#)  
Related Documents [page 1-1-3](#)  
Application [page 1-1-3](#)  
How to Use This Manual [page 1-1-3](#)  
Reporting Problems [page 1-1-4](#)  
Conventions [page 1-1-4](#)

---

## Purpose

The procedures and treatment schedules listed in this manual are administratively authorized for use in Plant Protection and Quarantine (PPQ). The treatment of listed commodities prevents the movement of agricultural pests into or within the United States. An officer may determine that other commodities require treatment to prevent similar pest movement.



**Do not** treat unlisted commodities until consulting and receiving approval from the Center for Plant Health Science & Technology (CPHST) in Raleigh, North Carolina.

Approval from CPHST **must** be obtained each time a treatment schedule is used that is **not** an approved schedule from this manual.

---

## Restrictions

Treatment recommendations listed in this manual are based on uses authorized under provisions of the Federal Insecticide, Fungicide, and Rodenticide Act (FIFRA), as amended. Directions appearing on the label, Section 18 Emergency Exemptions, and manual instructions must be followed. Nevertheless, some treatments may damage commodities.

PPQ personnel may not make any warranty or representations, expressed or implied, concerning the use of these pesticides.

The occasional use of registered trade names in this manual does not imply an endorsement of those products or of the manufacturers by the U.S. Department of Agriculture, Animal and Plant Health Inspection Service (USDA, APHIS).

---

## Scope

This manual covers all treatments for import, export, and those domestic plant pests which are of quarantine significance. This manual is broadly divided into ten sections:

- ◆ Chemical Treatments
- ◆ Nonchemical Treatments
- ◆ Residue Monitoring
- ◆ Treatment Schedules
- ◆ Certifying Facilities
- ◆ Emergency Aid and Safety
- ◆ Equipment
- ◆ Glossary
- ◆ Appendixes
- ◆ Index

Each section is tabbed and contains a Table of Contents, an Overview, and where appropriate, a Methods and Procedures section. The Overview is a broad, general description of what is covered in the section. Methods and Procedures cover the “how to” of that particular activity as well as procedural and reference material for performing tasks associated with each activity.

The Appendixes contain information directly associated with treatment activities, but are placed in the back so they do not interfere with the flow of procedural instructions.

---

## Users

This manual is used primarily by PPQ officers, Headquarters personnel, and State cooperators involved in conducting treatments. The secondary users of this manual are other government agencies, fumigators, pest control operators, foreign governments, and other interested parties.



## Related Documents

The following documents are related to the treatment manual:

- ◆ Pesticide labels and labelling
- ◆ Material Safety Data Sheet (MSDS)
- ◆ APHIS Safety and Health manual
- ◆ Federal Insecticide, Fungicide, Rodenticide Act as amended
- ◆ Plant Import manuals (Propagative and Nonpropagative)
- ◆ Code of Federal Regulations (CFR)
  - ❖ Title 7 (Agriculture)
  - ❖ Title 46 (Shipping) Chapter 1, Part 147—Interim Regulations for Shipboard Fumigation
- ◆ Occupational Safety and Health Administration (OSHA) treatment manual

---

## Application

This manual serves both as a field manual for employees conducting treatments and as a reference for PPQ officers, program managers, and staff officers. Under APHIS policy, only certified pesticide applicators may conduct or monitor treatments. This manual will also serve as a reference for researching the types of treatments available for imports and to answer questions from importers, industry, and foreign countries.

---

## How to Use This Manual

Review the content of this manual to get a feel for the scope of material covered. Glance through the section that you will be using and familiarize yourself with the organization of information. Major headings such as Chemical Treatments and subheadings such as Fumigants will be tabbed. Each section is divided by tabs so when you want to find information on taking residue samples, you would turn to the tab labeled “Residue Monitoring” and check the Table of Contents for the page number.

Use the Table of Contents which follows each tab to quickly find information. If the Table of Contents is not specific enough, then turn to the Index to find the topic and page number.

## Reporting Problems

If you want to suggest an improvement or identify a problem with the content of this manual, complete and mail the “Comment Sheet” at the back of this manual. If the problem is urgent, call Josie Cooley (240) 529-0358. If you disagree with the guidelines or policies contained in this manual, contact Quarantine Policy, Analysis and Support (QPAS) through channels.

---

## Conventions

The following are terms that are widely recognized and used throughout this manual:



Indicates that people can easily be hurt or killed



Indicates that people could possibly be hurt or killed



Indicates that people could possibly be endangered and slightly hurt

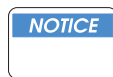

Indicates a possibly dangerous situation, goods might be damaged



Indicates helpful information

---

**EXAMPLE:** indicates additional information that helps to clarify the content in the manual

---

Treatment schedules which are FIFRA Section 18 Exemptions (such as the sample below) are followed by an “Important” note to help you determine the current exemption status.

Temperature	Dosage Rate (lb/1,000 ft <sup>3</sup> )	Minimum Concentration Readings (ounces) At:			
		0.5 hrs	2 hrs	3 hrs	3.5 hrs
90 °F or above	2 lbs	26	19	19	—
80-89 °F	2.5 lbs	32	24	24	—
70-79 °F	3 lbs	38	29	24	—
60-69 °F	3 lbs	38	29	—	24



**Important**

**Do not** use this treatment schedule if its FIFRA Section 18 Exemption has expired. For the current exemption status, call your local State Plant Health Director (SPHD).



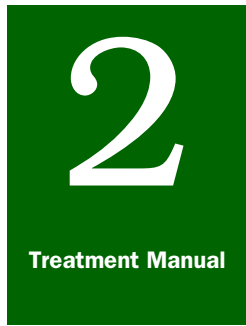

# Chemical Treatments

## *Overview*

---

### Contents

Overview [page 2-1-1](#)  
Fumigants [page 2-2-1](#)  
Aerosols and Micronized Dusts [page 2-11-1](#)  
Dips [page 2-12-1](#)  
Dusts [page 2-13-1](#)  
Sprays [page 2-14-1](#)

---

### Introduction

The Chemical Treatments section of this manual is organized by chemicals tabbed as follows:

- ◆ Fumigants
- ◆ Aerosols and Micronized Dust

Use the Contents in this section to quickly find the information you need. The subjects listed in the Contents are also marked on the tabs in this manual. If the Contents is not specific enough, then turn to the Index to find the topic and its page number.



# 2

Treatment Manual

## Chemical Treatments

### *Fumigants*

---

#### Contents

- Fumigants • Methyl Bromide [page-2-3-1](#)
- Fumigants • Sulfuryl Fluoride [page-2-9-1](#)
- Fumigants, Phosphine [page-2-10-1](#)

---

#### Introduction

Fumigation is the act of releasing and dispersing a toxic chemical so it reaches the target organism in a gaseous state. Chemicals applied as aerosols, smokes, mists, and fogs are suspensions of particulate matter in air and are not fumigants.

The ideal fumigant would have the following characteristics:

- ◆ Highly toxic to the target pest
- ◆ Nontoxic to plants and vertebrates (including humans)
- ◆ Easily and cheaply generated
- ◆ Harmless to foods and commodities
- ◆ Inexpensive
- ◆ Nonexplosive
- ◆ Nonflammable
- ◆ Insoluble in water
- ◆ Nonpersistent
- ◆ Easily diffuses and rapidly penetrates commodity
- ◆ Stable in the gaseous state (will not condense to a liquid)
- ◆ Easily detected by human senses

Unfortunately, no one fumigant has all the above properties, but those used by APHIS and PPQ have many of these characteristics.

The toxicity of a fumigant depends on the respiration rate of the target organism. Generally, the lower the temperature, the lower the respiration rate of the organism which tends to make the pest less susceptible. Fumigation at lower temperatures requires a higher dosage rate for a longer exposure period than fumigation at higher temperatures.

Fumigants vary greatly in their mode of action. Some kill rapidly while others kill slowly. In sublethal dosages, some fumigants may have a paralyzing effect on the pest while others will not allow the pest to recover. Some fumigants have no effect on commodities while others are detrimental even at low concentrations. Commodities vary in their sorption of fumigants and in the effort required to aerate the commodities after fumigation.

Due to the reduction in number of labeled fumigants, there is seldom a choice in selecting fumigants. When there is a choice, factors such as the commodity to be treated, pest and stages present, type of structure, and cost should be considered in selecting a fumigant.

The only authorized fumigants are the following:

- ◆ Methyl bromide (MB)
- ◆ Sulfuryl fluoride (SF) (Vikane)
- ◆ Phosphine (PH) (There are two chemicals used for phosphine, AP—aluminum phosphide and MP—magnesium phosphide)

Much of the information on fumigants is based on MB with modification as needed for the other fumigants.

---

## **Monitoring of Quarantine Treatments**

Monitoring of program fumigations is performed to ensure that effective fumigant concentration levels are maintained throughout the treatment to prevent the introduction of quarantine pests. Quarantine fumigations employing restricted use pesticides require careful monitoring to assure efficacy and personal safety, to maintain pesticide residues within acceptable limits, and to preserve commodity quality. These requirements are included in the fumigant label, and it is a violation of Federal law to use fumigants and pesticides in a manner inconsistent with its labeling.

### **Nonperishable Commodities in Temporary Enclosures**

PPQ officers will provide onsite monitoring from introduction of the fumigant through completion of the 2 hour gas concentration readings. Half hour and 2 hour readings are required for these treatments. These readings and general observations permit the officer to determine how a particular treatment is progressing and to make necessary corrections to the enclosure or fumigant concentration level.

### **Perishable Commodities in Temporary Enclosures**

The monitoring officer will remain on the site through the entire fumigation of perishable commodities. Continuous monitoring allows the officer to alert the pest control operator at any time to implement



necessary corrective measures. Due to the nature of the commodity and the length of treatment, onsite monitoring of yam and chestnut fumigations may be interrupted after the 2 hour reading when efficacy and safety considerations warrant.

These instructions do not prevent the officer from leaving the immediate fumigation site for brief periods when it is necessary and safe to do so. The pest control operator must be notified of the PPQ officer's intended absence. These absences would ordinarily be limited to 20 minutes and do not constitute a break in service. These practices are in place in many locations and will require only minor modifications in other areas.

### **Fumigation Guidelines**

The following fumigation guidelines are in common usage throughout this manual:

- ◆ Dosage rate is based on 1,000 cubic feet of enclosure space, whether chamber, tarpaulin, van, freight car, ship hold, etc. Dosage should be calculated from the volume of the tarped fumigation enclosure.
- ◆ Dosages are listed by weight in the Treatment Schedules. If liquid measures are needed, convert from weight to volume by using the conversion figures.
- ◆ Ounces per 1,000 cubic feet (oz/1000 ft<sup>3</sup>) is equal to milligrams per liter (mg/liter) and is equal to grams per cubic meter (g/m<sup>3</sup>).
- ◆ Volume of commodity being treated should not exceed two-thirds of enclosure volume unless otherwise specified in a schedule.
- ◆ Specified vacuum should be held throughout the exposure period.

- ◆ Blowers or fans should be operated as follows:
  - ❖ for propagative material (T200-series schedules), the entire period of exposure, whether NAP or vacuum
  - ❖ under tarpaulin (and vacuum fumigation for other than propagative material), fans should operate for 30 minutes after gas introduction, or until gas readings from an APHIS-approved gas detection device indicate uniform gas distribution
  - ❖ for all bulk material, forced recirculation is required, check for uniform gas distribution by taking gas readings at four or five locations including at least three from the commodity



Important

Phosphine fumigations do not require fans.

- ◆ In this section, all NAP treatments that refer to chamber fumigations should be conducted in USDA-approved chambers. (see Section 6, *Certification of Vacuum Fumigation Chambers* on **page 6-2-1**).
- ◆ Methyl bromide treatment schedules are indicated as “MB.” MB generally refers to any methyl bromide label. Specific MB label restrictions are noted in this manual for the “Q” label. Always check the label of the fumigant to be sure the commodity is listed on the label. Commodities that are not listed on the fumigant’s label are not authorized for fumigation with the manufacturer’s gas.

## Physical Properties of Fumigants

Fumigant	Chemical Formula	Boiling Point	Specific Gravity <sup>1</sup>	Flammability Limits in Air
Methyl Bromide	CH <sub>3</sub> Br	3.6 °C 40.1 °F	3.27	Normally nonflammable. Flame propagation at 13.5 to 14.5% by volume only in the presence of an intense source of ignition.
Phosphine	PH <sub>3</sub>	-87.4 °C -126 °F	1.214	1.79% by volume
Sulfuryl fluoride	SO <sub>2</sub> F <sub>2</sub>	-55.2 °C -67 °F	2.88	Nonflammable

1 Air = 1, anything greater is heavier than air.

<b>Fumigant</b>	<b>Odor</b>	<b>Effects on Metals</b>	<b>General</b>
Methyl Bromide	No odor at low concentration. Strong musty or sweet at high concentrations.	Reacts with aluminum, may damage electronic equipment	Discharged from cylinders, 1.5 lb cans
Phosphine	Garlic-like or carbide due to impurities	Copper, brass, gold and silver severely damaged; electronic equipment damaged. Other metals slightly affected in high humidity.	Evolved from aluminum phosphide or magnesium phosphide preparations
Sulfuryl fluoride	None	Non-corrosive	Discharged from cylinders



# 2

Treatment Manual

## Chemical Treatments

### *Fumigants • Methyl Bromide*

---

#### Contents

Properties and Use	<a href="#">page-2-3-1</a>
“Q Labels” and Section 18 Exemption Treatment Schedules	<a href="#">page-2-3-2</a>
Leak Detection and Gas Analysis	<a href="#">page-2-3-5</a>
Effects of Temperature and Humidity	<a href="#">page-2-3-5</a>
Penetration and Aeration of Boxes and Packages	<a href="#">page-2-3-5</a>
Plastic Wrappings and Impermeable Papers	<a href="#">page-2-3-5</a>
Kraft Paper and Corrugated Cartons	<a href="#">page-2-3-6</a>
Wooden Boxes	<a href="#">page-2-3-6</a>
Sorption	<a href="#">page-2-3-6</a>
Residual Effect	<a href="#">page-2-3-7</a>

---

#### Properties and Use

Methyl bromide (MB) (CH<sub>3</sub>Br) is a colorless, odorless, nonflammable fumigant. MB boils at 38.5 °F and has a very low solubility in water. As a gas, MB is three times heavier than air. As a liquid at 32 °F, 1 pound of MB is equivalent to 262 ml. For ease in transportation and handling, MB is compressed and stored in metal cylinders as a liquid.

MB is an effective fumigant for treating a wide variety of plant pests associated with a wide variety of commodities. MB is the most frequently used fumigant in quarantine fumigations. MB may also be used to devitalize plant material. MB is effective in treating the following pests:

- ◆ Insects (all life stages)
- ◆ Mites and ticks (all life stages)
- ◆ Nematodes (including cysts)
- ◆ Snails and slugs
- ◆ Fungi (such as oak wilt fungus)

MB is effective over a wide range of temperatures (40 °F and above). In general, living plant material tolerates the dosage rate specified, although the degree of tolerance varies with species, variety, stage of growth, and condition of the plant material. MB accelerates the decomposition of plants in poor condition.

Since MB is three times heavier than air, it diffuses outward and downward readily, but requires fans to ensure upward movement and equal gas distribution. Fan circulation also enhances penetration of

MB into the commodity. A volatilizer is used to heat the liquid MB in order to speed up its conversion to a gas. Once the gas is evenly distributed, it maintains that condition for the duration of the treatment unless an outside event such as excessive leakage occurs.

---

## “Q Labels” and Section 18 Exemption Treatment Schedules

Methyl bromide fumigants, except those with “Q” labels, may be subject to requirements of the FIFRA Section 18 Quarantine Exemption. When commodities intended for food or feed are fumigated with methyl bromide under the FIFRA Section 18 Quarantine Exemption, one additional EPA *requirement* must be met: PPQ must monitor aeration by sampling the gas concentration to determine when a commodity may be released.

In this manual, fumigation schedules under the FIFRA Section 18 Quarantine Exemption are followed by an “Important” note to help you determine the current exemption status. For example:



**Important**

Do not use this treatment schedule if its FIFRA Section 18 Exemption has expired. For the current exemption status, call your local State Plant Health Director (SPHD).



Always use the label of the fumigant to determine if the commodity can be treated. Fumigation schedules in this publication are intended to clarify and expand commercial labels for methyl bromide. The EPA only authorizes fumigation for commodities that are listed on the label of the gas being used for the fumigation. Also, to comply with State requirements, a fumigant must be registered in the State where it is being used. If you are uncertain that a fumigant is registered in a state where the fumigation is being performed, contact a major port in that state or the Center for Plant Health Science Technology (CPHST).

The following Table is a list of commodities covered by the FIFRA Section 18 exemption. This list will expire on March 03, 2010.

Commodity	Minimum Temperature (F)	Maximum Dosage Range (lb/1000 ft <sup>3</sup> )	Exposure Period (hours)
Avocado	70	4	4
Banana and Plantain	40	4	2
Blackberry and raspberry	40	4	2
Cucurbit seeds, edible, shelled/unshelled	40	9	12
Cucurbit vegetables not on the Q-label (except gherkins)	40	4	2
Dasheen (root and tuber)	40	4	4
Gherkin (cucurbit)	50	3	2
Herbs and spices, fresh	40	4	2
Ivy gourd	40	4	2
Kiwi	40	4	4
Leafy Vegetables not on the Q-label (including Brassica)	40	4	2
Longan	60	4	2
Lychee fruit	40	4	2
Mint, dried	40	3	24
Mint, fresh	40	4	2
Opuntia	40	4	3.5
Plumcot and Pluot	40	4	2
Pointed gourd	40	4	2
Rambutan	60	4	2
Root and tubers not on the Q-label (except Dasheen)	60	3	3.5
Dasheen (root and tuber)	40	4	4
Edible Podded Legume Vegetables	40	4	2

**FIGURE 2-3-1: Section 18 Exemptions**

To better accommodate the requirements of quarantine and regulatory fumigations with methyl bromide, the Animal and Plant Health Inspection Service (APHIS) and the Great Lakes Chemical Corporation have developed a premium 100 percent methyl bromide fumigant that is only intended for quarantine and regulatory use. This methyl bromide fumigant is provided by several companies and generally referred to as a “Q label”. It is labeled for many uses which were previously covered by FIFRA Section 18 Exemptions. Additional features of the “Q label” include the following:

- ◆ Use of additional fumigant to maintain the required concentration is allowed.
- ◆ The commodity must be allowed to aerate for at least one hour before completely removing the tarp. However, the aeration procedures described in this manual require a longer period than required on the label, and must be followed. Be sure that the fumigator is placed under a compliance agreement, and that he follows the aeration procedures outlined in this manual.

Although there is some overlap in the “Q label” and other methyl bromide labels, substitution of the products may result in non-compliance. Use the Treatment Manual to determine when a “Q” labeled fumigant must be used:

- ◆ When the treatment schedule is marked MB, any methyl bromide fumigant may be used for the fumigation if the commodity is on the fumigant label.



When the treatment schedule is marked MB (“Q” label only), the fumigation is restricted to methyl bromide “Q” labels. This restriction is based on the “Q” label replacement of FIFRA Section 18 exemptions.

- ◆ A few schedules restrict the use of a label based on temperature range. In this case, the specific temperature range is marked and noted (“Q” label only).

Always read and follow the “Q label” label and use directions. The “Q-label” allows fumigation of certain commodities and pests at sites and rates that are not allowed under other labels. The label is purposely flexible to handle unforeseen emergencies and other special situations formerly covered by FIFRA Section 18 label exemptions.

Although the use of “Q label” fumigants eliminates the requirements for residue and aeration monitoring, the “Q label” requires fumigations using the product be conducted under the monitoring of a state or federal agency. Monitoring does not necessarily require the actual presence of a regulatory agent during the entire fumigation, but does mean that the monitoring agent be able to certify that the fumigant was done in compliance with the label and other requirements.

To show that the fumigation using the “Q” label was monitored by a regulatory agent, the fumigator should record the name, title, telephone number and mailing address of the monitoring regulatory agent(s) in his restricted use pesticide application records, even if the same information is recorded on other documents (e.g., phytosanitary certificate).



## Leak Detection and Gas Analysis

Use an APHIS-approved gas detection device to measure gas concentration levels in tarpaulins and chambers. Use an APHIS-approved leak detection device primarily to check for leaks around tarpaulins, chambers, application equipment, and as a safety device around the fumigation site. For a partial list of manufacturers refer to “[Photo Ionization Detector](#)” on [page-H-1-36](#). Colorimetric tubes, which are supplied by the fumigator, are used to measure gas concentration levels during aeration.

## Effects of Temperature and Humidity

MB is effective at the same temperatures plants are generally handled (usually 40 °F and above). In general, increases in temperature give a corresponding increase in the effectiveness of MB. All treatment schedule temperatures are listed with the corresponding dosage rate. Follow the dosage rates listed. A Federal Insecticide, Fungicide, and Rodenticide Act (FIFRA) Section 3 registration (the labeled rate of MB provided), or a Section 18 Exemption must be in effect at the time of treatment.

For live plant material which is actively growing or with leaves, maintain a high percentage of humidity (above 75 percent) in the chamber by placing wet sphagnum or excelsior in the chamber or by wetting the chamber walls and floor. Protect actively growing or delicate plants from the direct air flow of fans. Do not add any moisture to the chamber when fumigating seeds. Too much moisture on the material to be fumigated may prevent the fumigant from reaching some of the pests.

## Penetration and Aeration of Boxes and Packages

### Plastic Wrappings and Impermeable Papers

Plastic wrappings such as cellophane, films, and shrink wrap, and papers that are waxed, laminated, or waterproofed are not readily permeable and must be perforated, removed, or opened before fumigation. If wrappings are perforated to facilitate fumigation, holes should be at least 3/16-inch in diameter every 3 square inches or 1/4-inch in diameter every 4 square inches over the entire surface of the wrapping. Also acceptable are plastic wraps containing numerous pinholes (at least 49 per square inch). These holes enhance permeability through the plastic fruit trays, which are frequently used for transport of fruit.



Inform prospective importers that the wrappings on their shipments may have to be perforated to PPQ specifications, removed, or opened if PPQ requires fumigation. If wrappings on shipments are designed to satisfy PPQ requirements for fumigation readily, importers could save time and money. Shippers should send a complete bag/wrap sample to CPHST for inspection and approval.

USDA-APHIS-PPQ-CPHST  
Treatment Quality Assurance Unit  
1730 Varsity Drive, Suite 400  
Raleigh, NC 27606  
919-855-7450

### **Kraft Paper and Corrugated Cartons**

Kraft paper is permeable to MB and does not need to be removed prior to fumigation. Corrugated cartons are also permeable to MB and unless impermeable liners are present, aeration will be satisfactory, although it will be slower in closed boxes.

### **Wooden Boxes**

Although MB penetrates wooden boxes, aeration of tight boxes may be slow, particularly if sorptive packing materials are present. To aid in aeration, have the lids removed and boxes placed on their sides prior to fumigation. If removing lids is not practical, then increase the aeration time.

---

## **Sorption**

Sorption is the process of chemically or physically binding free MB on or within the fumigated commodity. Sorption makes the fumigant unavailable to kill the plant pest. There are three types of sorption—absorption, adsorption, and chemisorption. Sorption rate is high at first, then gradually reduces to a slow rate. Sorption increases the time required for aeration.

Commodities known or believed to be highly sorptive should not be fumigated in chambers unless concentration readings can be taken to ensure the required minimum concentration is met. Additional readings may be necessary in order to properly monitor gas concentration sorptive commodities in chambers.

For tarpaulin fumigation, additional gas readings are necessary to monitor concentration of gas to determine the rate of sorption. The following is a partial list of commodities known to be highly sorptive:

- ◆ Burlap bales
- ◆ Carpet backing
- ◆ Cinnamon quills

- ◆ Cocoa mats
- ◆ Cotton
- ◆ Flour and finely milled products
- ◆ Gall nuts
- ◆ Hardboard (Masonite™)
- ◆ Incense
- ◆ Myrobalan
- ◆ Pistachio nuts
- ◆ Polyamide waste
- ◆ Polystyrene foam (Styrofoam)
- ◆ Potato starch
- ◆ Rubber (crepe or crude)
- ◆ Vermiculite
- ◆ Wood products (unfinished)
- ◆ Wool (raw, except pulled)

Call CPHST if you are concerned about the sorptive properties of other commodities.

---

## Residual Effect

MB may adversely affect the shelf life of fresh fruits and vegetables, the viability of dormant and actively growing plants, and the germination of seed. Although MB may adversely affect some commodities, it is a necessary risk in order to control pests. Some dosage rates are near the maximum tolerance of the commodity, so care must be exercised in choosing the proper treatment schedule and applying the treatment.

MB may also adversely affect nonplant products. In general, articles with a high sulfur content may develop "off-odors" on contact with MB. In some commodities the odors are difficult or impossible to remove by aeration. If possible or practical, remove from the area to be fumigated any items that are likely to develop an undesirable odor.

Ordinarily, the following items should *not* be fumigated:

- ◆ Any commodity not listed on the label or lacking a FIFRA Section 18 Exemption
- ◆ Any commodity lacking a treatment schedule
- ◆ Automobiles

- ◆ Baking powder
- ◆ Blueprints
- ◆ Bone meal
- ◆ Butter, lard, or fats, unless in airtight containers
- ◆ Charcoal (highly sorptive)
- ◆ Cinder blocks or mixed concrete and cinder blocks
- ◆ Electronic equipment
- ◆ Feather pillows
- ◆ Felt
- ◆ Furs
- ◆ High protein flours (soybean, whole wheat, peanut)
- ◆ Horsehair articles
- ◆ Leather goods
- ◆ Machinery with milled surfaces
- ◆ Magazines and newspapers (made of wood pulp)
- ◆ Magnesium articles (subject to corrosion)
- ◆ Paper with high rag or sulfur content
- ◆ Photographic chemicals and prints (not camera film or X-rays)
- ◆ Natural rubber goods, particularly sponge rubber, foam rubber, and reclaimed rubber including pillows, mattresses, rubber stamps, and upholstered furniture
- ◆ Rug pads
- ◆ Silver polishing papers
- ◆ Woolens (especially angora), soft yarns, and sweaters; viscose rayon fabrics
- ◆ Yak rugs

# 2

Treatment Manual

## Chemical Treatments

*Fumigants • Methyl Bromide •  
Tarpaulin Fumigation*

---

### Contents

Methods and Procedures	<a href="#">page-2-4-1</a>
Materials Needed	<a href="#">page-2-4-1</a>
PPQ Official Provides	<a href="#">page-2-4-1</a>
Fumigator Provides	<a href="#">page-2-4-2</a>
Preparing to Fumigate	<a href="#">page-2-4-3</a>
Conducting the Fumigation	<a href="#">page-2-4-20</a>
Aerating the Enclosure	<a href="#">page-2-4-36</a>
Responsibility for Aerating the Commodity	<a href="#">page-2-4-36</a>
Materials Needed	<a href="#">page-2-4-37</a>
Securing the Area	<a href="#">page-2-4-37</a>
Wearing Respiratory Protection	<a href="#">page-2-4-38</a>
Aerating Nonsorptive, Containerized Cargo—Indoors and Outdoors	<a href="#">page-2-4-38</a>
Aerating Nonsorptive, Noncontainerized Cargo—Indoors and Outdoors	<a href="#">page-2-4-40</a>
Aeration Procedures for Fresh Fruits, Vegetables, and Cut Flowers—Indoors or Outdoors	<a href="#">page-2-4-42</a>
Aerating Sorptive, Noncontainerized Cargo—Indoors and Outdoors	<a href="#">page-2-4-43</a>
Aerating Sorptive Commodities in Containers—Indoors and Outdoors	<a href="#">page-2-4-45</a>

---

### Methods and Procedures

The procedures covered in this section provide PPQ officials and commercial fumigators with the methods, responsibilities, and precautions for tarpaulin fumigation.

---

### Materials Needed

#### PPQ Official Provides

- ◆ Calculator (optional)
- ◆ Colorimetric tubes (Draeger/Kitagawa)
- ◆ Desiccant (Drierite®)
- ◆ Forms (PPQ Form 429 and APHIS Form 2061 if necessary)
- ◆ APHIS-approved leak detection device
- ◆ Self-contained breathing apparatus (SCBA) or supplied air respirator to be used by PPQ official
- ◆ Tape measure (as back-up for fumigator)

- ◆ APHIS-approved gas detection device<sup>1, 2</sup>
- ◆ Thermometer (as back-up for fumigator)

### **Fumigator Provides**

- ◆ Auxiliary pump for purging long gas sample tubes
- ◆ Carbon dioxide filter (Ascarite®)
- ◆ Colorimetric tubes (Draeger/Kitagawa)
- ◆ Desiccant (Drierite®)
- ◆ Electrical wiring (grounded, permanent type), three prong extension cords
- ◆ Exhaust blower and ducts
- ◆ Fans (circulation, exhaust, and introduction)
- ◆ Framework and supports
- ◆ Gas introduction line
- ◆ Gas sampling tubes (leads)
- ◆ Heat supply
- ◆ Insecticides and spray equipment
- ◆ Loose sand
- ◆ Measuring Tape
- ◆ Methyl bromide
- ◆ Padding
- ◆ Sand or water snakes or adhesive sealer
- ◆ Scales or dispensers<sup>3</sup>
- ◆ Self-contained breathing apparatus (SCBA) or supplied air respirator
- ◆ Tape
- ◆ Tape measure
- ◆ Tarpaulin and supports
- ◆ Temperature recorder
- ◆ APHIS-approved gas detection device<sup>1 2</sup>

---

1 If fumigating oak logs or lumber for export, the unit must be capable of reading 400 oz.

2 The gas detection device must be calibrated annually. Contact the Center for Plant Health Science & Technology (CPHST) (919-855-7450) in Raleigh, North Carolina, for calibration information.

3 All scales must be calibrated by the State, a company that is certified to conduct scale calibrations, or by the fumigator under the supervision of PPQ. The source and date of calibration must be posted in a visible location on or with the scale at all times. The scale must be calibrated a minimum of every six months.

- ◆ Thermocouples (maximum number of 12)
- ◆ Thermometer
- ◆ Volatilizer
- ◆ Warning signs

## Preparing to Fumigate

### Step 1—Selecting a Treatment Schedule

Select a treatment schedule to effectively eliminate the plant pest without damaging the commodity being fumigated.

Turn to the Treatment Schedule Index and look up the available treatment schedule(s) by commodity (example—apples, pears, or citrus) or by pest (e.g., Mediterranean fruit fly). Some commodities may have several treatment schedules. Refer to **Residual Effect** on **page 2-3-7** for a list of those commodities which may be damaged by MB. Each treatment schedule lists the target pest or pest group (e.g., *Ceratitidis capitata*, surface feeders, wood borers...), commodity, or both pest and commodity. If there is no schedule, the commodity may not be fumigated. Refer to **Figure 2-3-1** on **page 2-3-3** to determine if a schedule is available under a FIFRA Section 18 Exemption. If a treatment is required, go to **Table 2-4-1** on **page 2-4-3**.

**TABLE 2-4-1: Determine Reporting Requirements**

If a treatment is required:	Then:
As a result of a pest interception	GO to Step 2
As a condition of entry	GO to Step 3

### Step 2—Issuing a PPQ Form 523 (Emergency Action Notification)

When an intercepted pest is identified and confirmed by a PPQ Area Identifier as requiring action, issue a PPQ Form 523 (Emergency Action Notification - EAN) to the owner, broker, or representative. Be sure to list all treatment options when completing the PPQ Form 523. Follow instructions in Appendix A for completing and distributing the PPQ Form 523.

### Step 3—Determining Section 18 Exemptions and Sampling Requirements

After selecting the treatment schedule, you will be able to determine which treatment schedules are FIFRA Section 18 Exemptions. The schedule will be followed by an "IMPORTANT" note to help you determine the current exemption status. Some treatment schedules

are only FIFRA Section 18 Exemptions at specific temperature ranges. Check the treatment schedule and temperature to determine if the fumigation will be a FIFRA Section 18 Exemption.

Residue monitoring by taking samples of the commodity prior to the start of the fumigation and after aeration is no longer required.

#### **Step 4—Selecting a Fumigation Site**

Consider the following factors in selecting a fumigation site:

- ◆ Well-ventilated, sheltered area
- ◆ Ability to heat area (in colder areas)
- ◆ Impervious surface
- ◆ Nonwork area that can be effectively marked and safeguarded or isolated
- ◆ Electrical power supply
- ◆ Water supply
- ◆ Well-lighted area
- ◆ Aeration requirements

#### **Well-Ventilated, Sheltered Area**

Select sites that are well-ventilated and in a sheltered area. A well-ventilated site is required for exhausting gas before and when the tarpaulin is removed from the stack. Most piers and warehouses have high ceilings and a number of windows/doors which can be used for ventilation. Some gas will escape from the tarpaulin even in the best conditions. Avoid areas where strong drafts are likely to occur.

In warehouses, an exhaust system must be provided to exhaust MB to the outside of the building. Ensure that the exhausted gas does not reenter the building nor endanger people working outdoors.

When treatments are conducted in a particular location on a regular basis, a permanent site should be designated. At such sites, the fan used to remove the fumigant from the enclosure during aeration must be connected to a permanent stack extending above the roof level.

If fumigations are conducted outside, select a site that is semi-sheltered such as the leeward side of a warehouse, pier, or building that offers some protection from severe winds. Severe winds are defined as sustained winds or gusts of 30 m.p.h. or higher for any time period. Do not conduct outdoor fumigations if there is a forecast from the National Weather Service of severe winds and/or thunderstorms at the beginning of or for the entire length of the fumigation.



## Ability to Heat Area

When cooler temperatures (below 40°F) are expected, the site must be heated to maintain commodity temperatures above 40°F. Take the ambient temperature 12 inches above the floor. For treatments lasting 6 hours or longer, temperatures must be maintained at or above the starting treatment temperature for the entire duration of the treatment. Additionally, the temperature of the enclosure must be monitored using temperature thermocouples and a temperature recorder. The thermocouples must be evenly placed throughout the enclosure or container. The placement of the thermocouples will vary depending on the item fumigated and the configuration of the fumigation site. Contact CPHST for instructions regarding exact placement of the thermocouples. Use **Table 2-4-2** to determine the number of thermocouples needed based on size of the enclosure:

Size of Enclosure	Number of Thermocouples
Up to 10,000 ft <sup>3</sup>	3
10,001 - 25,000 ft <sup>3</sup>	6
25,001 - 55,000 ft <sup>3</sup>	9
Larger than 55,000	12

**TABLE 2-4-2 Number of Thermocouples**



Do not use flame or exposed electrical element heaters under the tarpaulin during treatment because MB may cause the formation of hydrogen bromide. Hydrogen bromide (hydrobromic acid) is a highly corrosive chemical which can cause damage to the heater and to surrounding materials including the commodity. Hot air or radiator type heaters can be used for heating under tarpaulins. When using space heaters to heat warehouses, there must be adequate ventilation.

## Impervious Surface

Select an asphalt, concrete, or tight wooden surface—not soil, gravel, or other porous material. If you must fumigate on a porous surface, cover the surface with plastic tarpaulins. For large fumigations, covering the surface is not usually practical because pallets must be rearranged and heavy equipment used to move the commodity. On docks, wharfs, and piers, check for cracks, holes, and manhole covers which will allow the MB to escape through the floor. Have all cracks, holes, and manhole covers sealed.

## Nonwork Area

Select a secure area where traffic and people are restricted from entering and which is isolated from people working. You want a nonwork area to help prevent accidents such as a forklift piercing a tarpaulin and for other safety reasons. Consider either the entire structure area or an area which extends 30 feet from the tarpaulin and is separated by a physical barrier such as ropes, barricades, or walls as the fumigation area. If a wall of gas-impervious material is less than 30 feet from the tarpaulin, the wall may serve as the edge of the secured area. Some states, for example California, require a 100 foot buffer zone. Place placards clearly in sight of all who come near. Placards must meet label requirements regarding specific warnings,

information, and language. Placards generally include the name of the fumigant, the fumigation date, time, and the name of the company conducting the fumigation. Restrict access to the fumigation area to the fumigator's employees and PPQ employees monitoring the treatment. Use rope or marker tape to limit access within 30 feet of the enclosure. Do not allow motor vehicles (includes forklifts) to operate within 30 feet of the enclosure during the fumigation and aeration periods. The area outside the 30-foot perimeter is usually regarded as a safe distance from the tarpaulin. Gas concentrations exceeding 5.0 ppm (TLV for MB) are seldom recorded by gas monitoring, except during aeration. PPQ officials that work within the 30-foot perimeter must wear (and use) respiratory protection (SCBA), unless the gas levels are safe to breath and validated as safe by gas monitoring. The 30-foot perimeter is not specifically mentioned on the MB label, but is required for PPQ officials. When space is tight, it is permissible to overlap two adjoining 30-foot perimeters. However, there must be sufficient space for a person wearing SCBA to walk between the tarpaulins.

### **Electrical Power Supply**

An adequate electrical source must be available to run the circulation fans and the gas detection device. A separate line should be available for the gas detection device. Electrical outlets must be ground and conveniently located in relation to the fumigation area. Generators may be used as a power source *only* under emergency conditions.

### **Water Supply**

A water supply is necessary for safety purposes. Water is necessary for washing off MB if the liquid form is spilled on someone. Water is also used to fill the volatilizer. If no permanent water is present on site, the fumigator must provide a portable, 5-gallon supply of clean water.

### **Well-Lighted Areas**

The area should have adequate lighting for safety purposes and for ease in reading gas detection device, thermometers, and for determining whether a tarpaulin has holes or tears.

### **Aeration Requirements**

Assuming that you've already restricted access and secured the fumigation area, you now must restrict access to the area where the exhaust duct extends beyond the enclosure. Before you start a fumigation, make sure the exhaust duct is located in a safe place.

During the first 10 minutes of aeration, there should be no people within 200 feet down wind of the exhaust duct outlet. If the exhaust duct is not used, then the requirement for a 200 foot down-wind buffer zone does not necessarily apply. However, personnel in the immediate area should be aware that a release of fumigant gas is about to take place and given the option of wearing SCBA if they choose to continue working in the area. If it is impossible to restrict people from the area of aeration during regular work hours, consider aeration during another time of the day. When securing the duct outlet area, consider

the direction of the wind. Face the duct outlet toward an open area, and away from people. Point the duct outlet upward to aid in dispersing the exhausted gas.

After the first 10 minutes of aeration, if an exhaust duct is not used, then a perimeter of 30 feet or more from the stack is usually regarded as a safe distance for personnel. However, for personal safety, gas levels should occasionally be monitored at greater distances, especially downwind. Experience provides the best guide.

### Step 5—Arranging the Stack

#### Break Bulk Cargo

Have the cargo arranged in a square or rectangular shape, if possible, to make it easy to cover and to calculate the volume of the stack. An even shaped stack is easy to tarp. The height of the stack should be uniform so dosage can be calculated accurately. For loose cargo, the tarpaulin should be 2 feet above the load and one foot from the sides and ends. Unless specified in the treatment schedule, cargo should not exceed two-thirds of the volume of the area to be fumigated. The maximum size for an enclosure is 25,000 ft<sup>3</sup>. Contact the Center for Plant Health Science & Technology (CPHST) in Raleigh, North Carolina, to get approval for any enclosures larger than 25,000 ft<sup>3</sup>. For very large enclosures, it may be necessary to:

- ◆ Install extra circulation fans
- ◆ Add more sampling leads
- ◆ Introduce the fumigant at several sites, using multiple volatilizer
- ◆ Run the circulation fans longer than just the first 30 minutes, if the difference between the highest and lowest gas concentration readings exceeds 4 ounces

Once CPHST has approved the site and enclosure, it does not require additional approvals for subsequent fumigations. The commodity should be on pallets to permit air movement along the floor and between the cargo. Allow an inch or more of space between pallets. By arranging the stack evenly and with space between pallets or cartons, the fumigant will be effectively distributed and dosage calculation should be easier and more accurate. Dosages are easier to calculate when the dimensions are uniform.

When the fumigation involves multiple stacks, allow 10 feet of space between each uncovered stack. After the stack is tarped, there should be approximately 5 feet between enclosures.

#### Containerized Cargo

Place no more than eight containers that are 20 to 40 feet in length under a single tarpaulin. APHIS recommends that containers not be stacked. Stacking may create too great a safety risk to the person placing the tarp, fans, and gas monitoring leads. If fumigating multiple containers in a single row, have all the rear doors opening on the same

side. If multiple containers are placed in two rows, then have all the doors opening on a center aisle toward each other (see **Figure 2-4-1** on **page 2-4-9**). The aisle must be at least 3 feet wide. The aisle must be at least 3 feet wide. All doors should be completely open, if possible.

However, APHIS will allow fumigation of containerized cargo with one door open on each container using a configuration such as the one shown in **Figure 2-4-2** on **page 2-4-9**, or in a single row of eight containers. Gas should be introduced at both ends of this long row configuration, either at the same time or half at one end and half at the other end. In any case, the single open door on each container must be kept from closing during the fumigation, either taped or blocked open.



APHIS recommends that perishable commodities be fumigated outside their containers. Because it is difficult to aerate the container, the commodity may be damaged by the fumigant if left in the container. Therefore, it is best to remove perishable commodities from their containers before fumigation. When a commodity is removed from the container, spray the emptied container with Malathion as a precaution against leaving the container contaminated with live pests. Pests such as hitchhikers may not remain with the commodity.

However, because of the cost of devanning the commodity most importers choose to have their commodity fumigated inside the container.

Due to safety considerations, containers to be fumigated should not be stacked. Also, to conserve methyl bromide use, CPHST recommends that containers be removed from their chassis prior to fumigation. (If this is not done, then the space beneath the container must be calculated as part of the total volume being fumigated.)

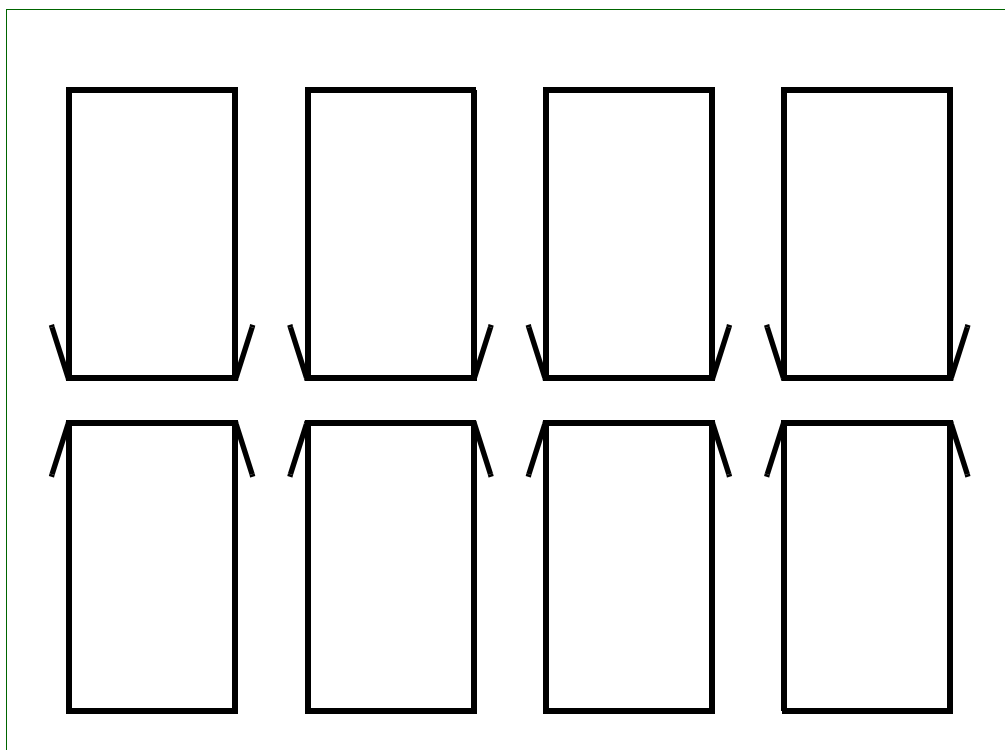

**FIGURE 2-4-1: Container Arrangement in Two Rows**

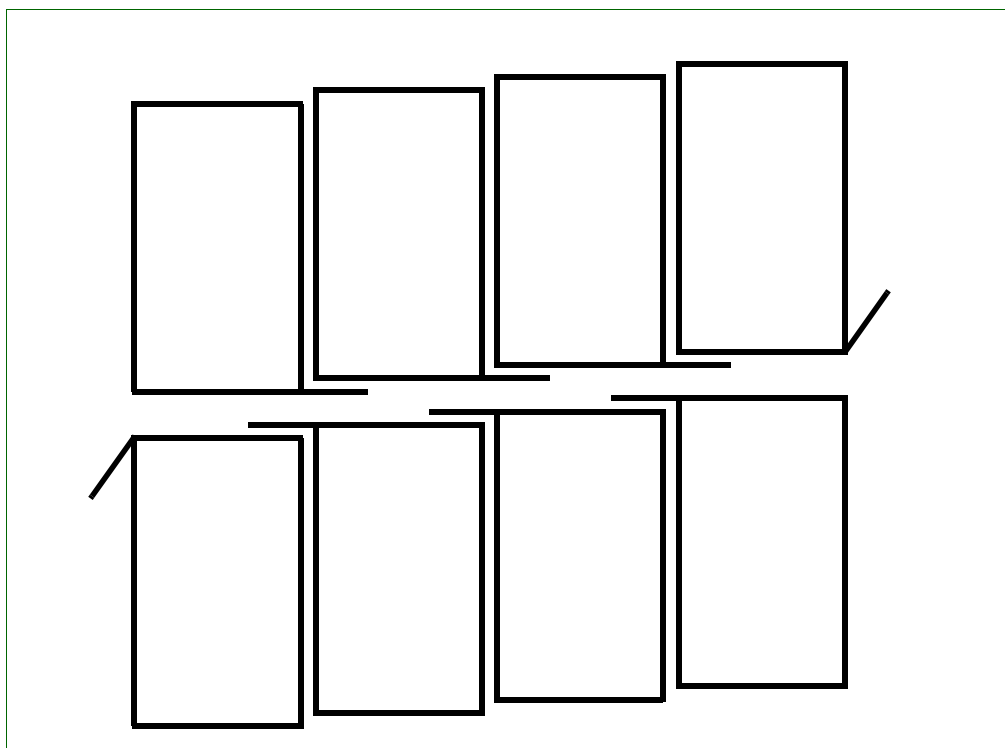

**FIGURE 2-4-2: Container Arrangement in Two Rows**

Containers should ordinarily not be loaded beyond 80 percent of their capacity. A space of 20 percent (18 inches) should be provided above the commodity. This allows a crawl space for placing the gas monitoring leads and fans, and to facilitate uniform gas distribution. (Some restacking of cargo may be necessary to meet this requirement.) Adequate space (2 inches) should be provided below the commodity. No additional head space is required between the roof of the container and the tarp, unless the pest is found on the outside of the container.

If fumigating multiple containers in a single row, the rear doors should all open on the same side of the stack. If containers are parked parallel to one another and close together, it is permissible to open only the door on the right side of each container, overlapping and taped to the closed left door of the container adjacent to it. In such circumstances, however, one must have a fan positioned high, blowing into the open door of each container, to assure uniform fumigant distribution. If containers are not parked closely together, all doors must be completely open.

### **Gas Penetration and Distribution**

MB will penetrate most cargo easily. When fumigating finely milled products (such as flour, cottonseed meal, and baled commodities), provide space every 5 feet in any direction. Penetration is enhanced by the availability of free MB.

Some of the more common types of impermeable materials are cellophane, plastic, wax coated materials, laminated, and waterproofed papers. Tight wooden packing cases are also relatively gas tight. Impermeable materials will allow some gas to penetrate, but make it difficult to aerate and evacuate the gas. Remove, perforate, or open all impermeable materials.

For impermeable wrappers or containers, open the entire top or side and place the package with the open portion on the side.

### **Step 6—Arranging and Operating Fans**

### **Break Bulk Cargo**

Use fans which have the capacity to move a volume in cubic feet per minute equivalent to the total volume of the enclosure. For a 5,000 ft<sup>3</sup> enclosure, use two axial-type (blade) fans of approximately 2,500 cfm. Place one fan on the floor at the rear of the stack facing the front and the other fan at the top front (where the gas is introduced) facing the rear. For enclosures from 5,000 to 7,500 ft<sup>3</sup>, add a third fan near the upper middle facing the rear. For enclosures from 7,501 to 10,000 ft<sup>3</sup>, add a fourth fan on the floor near the middle facing the front. Enclosures from 10,001 to 25,000 ft<sup>3</sup> may require up to seven fans to provide adequate gas circulation. Enclosures larger than 25,000 ft<sup>3</sup> require approval from the Center for Plant Health Science & Technology (CPHST) in Raleigh, North Carolina.

Turn on all fans to make sure they work. Operate fans during gas introduction and for 30 minutes after the gas is introduced. If after taking gas concentration readings the fumigant is not evenly distributed, run the fans until the gas is evenly distributed as indicated by concentration readings (within 4 oz. of each other). Operate fans when adding gas, but only long enough to get even gas distribution.

### **Containerized Cargo**

Use an appropriate number of fans which have the capacity to move the equivalent cubic feet per minute of the total volume of the enclosure. In addition, place one additional fan of at least 2,500 cfm at the top of the load (near door) of each container facing the opposite end of the container.

Place air introduction ducts, for aeration, into the far ends of each container. Also, place exhaust ducts on the ground in front of the end doors of the containers. Place the end of the ducts near the edge of the tarpaulin so they can be pulled under the tarpaulin when aeration begins.

### **Step 7—Placing the Gas Introduction Lines**

MB is converted from a liquid into a gas by a volatilizer. The line that runs from the MB cylinder into the volatilizer must be 3000 PSI hydraulic high pressure hose with a 3/8 inch interior diameter (ID) or larger. From the volatilizer, MB gas is introduced into the structure by means of a gas introduction line. The gas introduction line must be a minimum of 350 PSI with a 1/2 inch ID or larger.

### **Break Bulk Cargo**

Place the gas introduction line directly above the upper front fan. Attach the line to the top of the fan to prevent movement of the hose. An unsecured introduction line could tear the tarpaulin, move the line, or direct it out of the airflow. The fan should be firmly attached to the cargo or have a base that prevents it from toppling (not a pedestal type). Place a piece of impermeable sheeting (example—plastic or rubberized canvas) over the commodity below and to the front of each gas supply line. The sheet will prevent any liquid MB from coming in contact with the cargo.

### **Containerized Cargo**

The number and placement of gas introduction lines will depend upon the number and arrangement of containers to be fumigated.

For single containers, place the introduction line directly above the fan near the rear door of the container.

For multiple containers, place the introduction line near the door end of the containers, but aimed across the open doors rather than directly into one container.

If you are fumigating four or more containers under one tarpaulin, then use two gas introduction lines.

## Break Bulk Cargo

### Step 8—Placing the Gas Sampling Tubes

Place a minimum of three gas sampling tubes for fumigations up to 10,000 ft<sup>3</sup>. Position the gas sampling tubes in the following locations (see **Figure 2-4-3** on **page 2-4-12**):

- ◆ Front low—front of the load, 3 inches above the floor
- ◆ Middle center—center of the load, midway from bottom to top of load
- ◆ Rear high—rear of the load, at the extreme top of the load

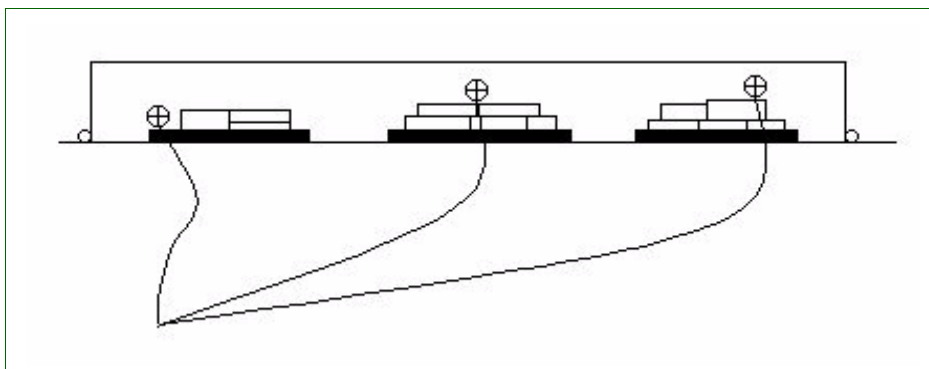

**FIGURE 2-4-3: Gas Lead Position (Side View)**

For fumigations from 10,001 to 25,000 ft<sup>3</sup>, use six gas sampling tubes. Position the gas sampling tubes in the following locations:

- ◆ Front low—front of the load, 3 inches above the floor
- ◆ Upper front quarter section
- ◆ Middle center—center of the stack, midway from bottom to top
- ◆ Upper rear quarter section
- ◆ Lower rear quarter section
- ◆ Rear high—rear of the stack, at the extreme top

Contact the Center for Plant Health Science & Technology (CPHST) in Raleigh, North Carolina, for approval of fumigations larger than 25,000 ft<sup>3</sup>, for instructions for number of gas sampling tubes, and for other technical information.



For khapra beetle cargo containing baled, packaged, finely milled, or closely packed commodities, place two additional gas sampling tubes in the center of the bags, packages, or bales. Before placing gas sampling tubes in commodities, place burlap over the end of the tube and secure the burlap to the tube with tape.



## Containerized Cargo

For multiple containers (either 20 or 40 feet in length) under the same tarpaulin, use at least three tubes per container. Also, for single containers, use at least three tubes, and for khapra beetle infestations, use two additional tubes. Position the gas sampling tubes as follows:

- ◆ Front low—near the floor at the door end of the container
- ◆ Rear high—rear of the load at the high end opposite the fan
- ◆ Middle center—mid way from front to back, at mid depth

If treating commodities for khapra beetle, you will need the following additional gas sampling tubes:

- ◆ High (in the commodity)
- ◆ Low (in the commodity)

Cover the end of the gas sampling tube with burlap taped to the tube before insertion into the commodity.

## Break Bulk and Containerized Cargo

Use gas sampling tubes of sufficient length to extend from the sampling position inside the enclosure to at least 30 feet beyond the tarpaulin. Have all the gas sampling tubes meet in one area for ease and safety in taking gas concentration readings. Do not splice gas sampling tubes. Before starting the fumigation, test all gas sampling tubes for tightness by connecting each gas sampling tube to the gas detection device and placing a finger over the far end of the gas sampling tube. The ball in the flow meter will fall to zero if the gas sampling tube connections are tight. Replace any defective gas sampling tubes. Before starting the fumigation, check for gas sampling tube blockage or pinching by connecting each tube for a short time. If the tube is blocked, the flow meter will drop sharply.

Fix all gas sampling tubes securely in place under the tarpaulin and label each one at the end where the gas concentration readings will be taken. By labeling each gas sampling tube, you will be able to record concentration readings easily.

### Step 9—Padding Corners

Look for corners and sharp angles which could tear the tarpaulin. Never use commodity to support the tarpaulin. If the sharp angles or corners can not be eliminated, they must be covered with burlap or other suitable padding (e.g., old tires or cloth) (see [Figure 2-4-4](#) on [page 2-4-14](#) below).

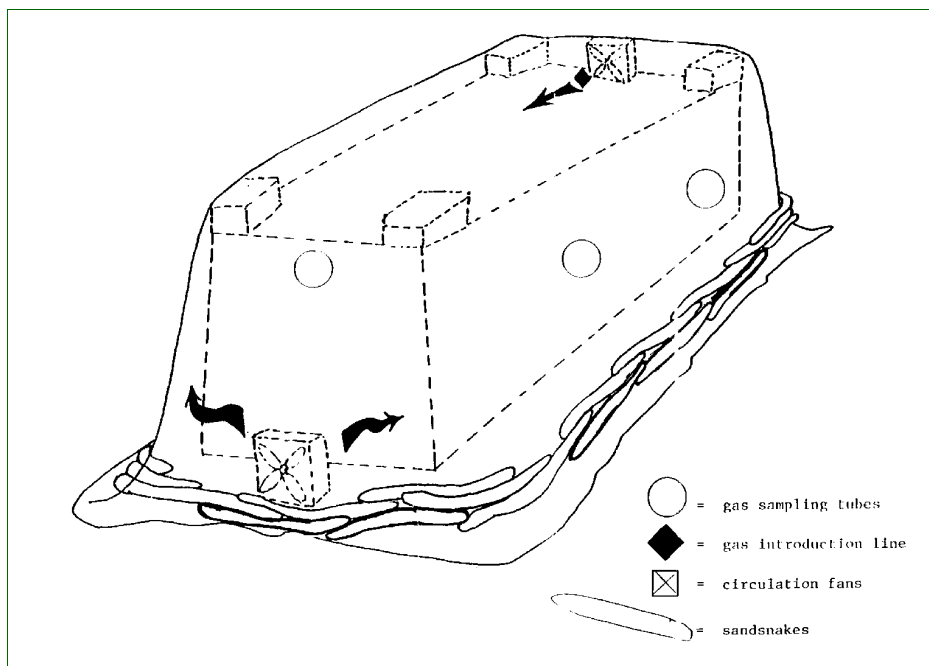

**FIGURE 2-4-4: Typical Stack Arrangement with Fans, Leads, Introduction Line, Padding, and Sand Snakes**

### Step 10—Measuring the Temperatures



Regardless of the commodity, never fumigate at temperatures below 40 °F.

Temperature recordings should be rounded to the nearest tenth of a degree (C ° or F °)

Determine the temperature to use in selecting the proper dosage rate:

- ◆ For pulpy fruits, pulpy vegetables, or logs use only the commodity temperature.
- ◆ For all other commodities use [Table 2-4-3](#) on [page 2-4-15](#) to determine the temperature for the proper dosage rate.

To take the temperature readings, use a bimetallic, mercury, or digital long-stem thermometer that has been calibrated. Use [Table 2-4-3](#) on [page 2-4-15](#) to determine which temperature to use when selecting the proper dosage rate for commodities other than fresh fruits, vegetables, or logs.

**TABLE 2-4-3: Determine the Temperature for the Proper Dosage Rate**

If the air temperature is:	And:	Then, for commodities other than pulpy fruits, pulpy vegetables, or logs and lumber:
Higher than the commodity temperature	→	Use the single lowest commodity temperature for determining the dosage rate (Do Not use the average commodity temperature).
Lower than the commodity temperature	By 9 degrees or less	
	By 10 degrees or more	Use the average of the single lowest air and commodity temperatures for determining the dosage rate (Never initiate a fumigation if any commodity temperature reads lower than 40°F.)

**EXAMPLE:** You are about to fumigate guar gum and the commodity temperature is 82°F and the air temperature is 69°F. Average the air and commodity temperatures to determine the dosage rate because the air is 13 degrees lower than the commodity temperature. The average of the two temperatures is 75.5°F. Use 75°F to determine the dosage rate.

If the commodity is fruits, pulpy vegetables, or logs, see the specific procedures that follow.

### Pulpy Fruits and Pulpy Vegetables

For pulpy fruit and pulpy vegetables, insert the thermometer into the pulp. Peppers are also included in the category of pulpy vegetables. For commodities which have been refrigerated, probe the fruit that have the lowest pulp temperature. Again, fumigate only when the fruit pulp is at 40°F or higher.



Fresh fruits and vegetables that require fumigation treatment as a condition of entry, must meet the minimum temperature requirement of 40 °F (4.4°C), at the time of discharge. This may require the gradual warming of the shipment over the later course of the voyage to ensure that the commodity achieves the proper minimum temperature of 40 °F (4.4°C).

This process will facilitate whether or not the fumigation treatment of the cargo takes place on the same day of arrival.

However, if the commodity has no pulp (for example, peas, beans, grains, herbs, spices, etc.), take the temperature of the air space immediately surrounding the commodity as well as the commodity temperature. With these temperatures, use **Table 2-4-3** to determine the correct temperature for use when selecting the proper dosage rate.

### Logs and Lumber

Select several representative locations within the stack at the ends of the logs or pieces of lumber and drill holes in them to accommodate a thermometer. After drilling, wait at least 10 minutes to allow the wood

around the holes to cool. Insert the thermometer into the holes drilled. Record the temperature from each hole, and average the readings. All readings (not just the average) must be above 40°F.

Take temperature readings in each hold. Base the dosage calculation on the lowest reading obtained. (Do not average temperatures.) All readings must be above 40°F to initiate the fumigation. If not, you must postpone it.

Record the temperatures in Block 22 of the PPQ Form 429.

If using the electronic 429 database, record the temperatures in the space and commodity fields in the Treatment form.



When the commodity and air temperature drastically differ, moisture may condense inside the gas sampling tubes or inside the gas detection device and cause inaccurate gas concentration readings. Check the gas sampling tubes frequently for possible puddling of condensed water, and drain it off, as needed, before taking a reading. If used, check the Drierite frequently, and change it as soon as it becomes saturated with water [turns pink], to obtain true gas concentration readings. Never fumigate commodities that are frozen.

### **Step 11—Covering the Stack**

After covering the stack, check the tarpaulin for rips, tears, and holes. Look at the spots that have been taped, and verify they are properly sealed. Have the fumigator repair all holes.

The tarpaulin should be made of a material such as vinyl, polyethylene plastic, or coated nylon. 4 mil vinyl or polyethylene plastic tarpaulins are only approved for one usage; 6 mil vinyl or polyethylene plastic tarpaulins may be used up to four times with the PPQ official's approval for each usage; 10 to 12 mil rubber or plastic coated nylon tarpaulins may be approved for multiple use with the PPQ official's approval for each usage.

The fumigator should cover all corners and sharp ends with burlap or other padding to prevent the tarpaulin from ripping. Have the fumigator pull the tarpaulin over the stack, being careful not to catch or tear the tarpaulin. Make sure there is sufficient structural support to raise the tarpaulin 2 feet above and 1 foot beyond the sides of the commodity.

The tarpaulin must be large enough to provide a floor overlap of at least 18 inches around all sides of the stack. Carefully lay the tarpaulin out to prevent excess folds or wrinkles along the floor, especially around corners.



Sealed containers and vans cannot be considered as "fumigation chambers," and therefore **must be covered by a tarpaulin**, unless they can pass the pressure-leakage test.

### Step 12—Sealing the Tarpaulin

Sealing may be accomplished with loose, wet sand, sand snakes, water snakes, adhesives, or a combination. If there is danger of crushing or crimping the gas sampling or introduction tubes, use the loose, wet sand. If using snakes, use two rows of snakes along the sides and three rows on the corners. The snakes should overlap each other by approximately 1 foot. The goal in sealing the tarpaulin is to get the tarpaulin to lie flat against the floor to prevent gas from leaking out. When wind is not a factor, plastic tape may be used for sealing the tarp. The tape must be at least 2 inches in width, and applied (only to a smooth surface) with the aid of high-tack spray adhesive.

Seal corners by laying two sand snakes around the corner and working the tarpaulin until it is flat. Place a third snake on top of the two other snakes to provide additional weight to force the tarpaulin against the floor. Loose, wet sand can be used in the area where the gas introduction line, electrical cords, and gas sampling tubes extend from under the tarpaulin.

### Step 13—Measuring the Volume

Using a 100-foot tape measure, carefully measure the length, width, and height of the enclosure. *Never* estimate the measurements. An error in measurement of as little as 12 inches can result in miscalculation of the dosage by as much as 15 percent. When measuring, round off to the nearest quarter foot (example—3 inches =.25 feet). In the case of fumigations of edible commodities, an error can result in an unacceptable level of residue on the commodity. If the sides of the enclosure slope outward from top to bottom, measure both the top and bottom and average the two to determine the dimension. Enclosure height should always be uniform and not require adjustment.

Formula for determining volume:

Length × width × height = volume in cubic feet

---

EXAMPLE: A stack with measurements H=10'6", L=42'3", and W=10'9"  $10.50 \times 42.25 \times 10.75 = 4,768.9 \text{ ft}^3$  round to 4,769  $\text{ft}^3$

---

Record volume in Block 26 of the PPQ Form 429.

If using the electronic 429 database, record the length, width and height in the corresponding fields under the "AMT of Gas Introduced" heading on the Treatment form. The total volume of the enclosure will be calculated.

### Step 14—Calculating the Dosage

Calculate dosage by doing the following:

1. Refer to the treatment schedule for the correct dosage rate (lbs./1,000 ft<sup>3</sup>) based on temperature (°F) (Step 10).
2. Multiply by the dosage (lbs./1,000 ft<sup>3</sup>) rate by the volume (ft<sup>3</sup>) to get the dosage in pounds.
3. Rules for rounding. Round to nearest 1/4 pound.

Formula for calculating dosage:

$$\begin{aligned}\text{dosage (lbs.)} &= \text{volume (ft}^3\text{)} \times \text{dosage rate (lbs./1,000 ft}^3\text{)} \\ &= \frac{\text{volume (ft}^3\text{)} \times \text{dosage rate (lbs.)}}{1,000 \text{ ft}^3}\end{aligned}$$

If using the electronic 429 database, enter the dosage rate in the "dosage" field and the total amount of gas required for the fumigation will be displayed in the "GAS REQUIRED" field.

---

**EXAMPLE:** You need to determine the dosage for a stack with a volume of 3,000 ft<sup>3</sup>. For 72 °F (air and commodity temperatures), the treatment schedule lists the dosage rate at 2 pounds MB/1,000 ft<sup>3</sup>. Determine dosage by doing the following:

1. Volume = 3,000 ft<sup>3</sup>
2. Dosage rate = 2 lbs. MB/1,000 ft<sup>3</sup>
3. Dosage (lbs.) = volume (ft<sup>3</sup>) × dosage rate (lbs./1,000 ft<sup>3</sup>)  
= 3,000 ft<sup>3</sup> × 2 lbs. MB/1,000 ft<sup>3</sup>  
=  $\frac{3,000 \text{ ft}^3 \times 2 \text{ lbs. MB}}{1,000 \text{ ft}^3}$   
= 6 lbs. MB

---

### Step 15—Making a Final Check

Just prior to introducing the gas, do the following:

- ◆ Turn on all fans and gas detection devices to make sure they work.
- ◆ Warm up gas detection device at least 30 minutes before zeroing in.
- ◆ Start volatilizer and heat water to 200 °F or above. A minimum temperature of 150 °F is required at all times during the introduction process.

- ◆ Place fumigant cylinder with gas introduction line on scale and take initial weight reading. Make sure the gas introduction line is attached to the cylinder. After obtaining the correct weight, subtract the dosage to be introduced into the enclosure. After you have introduced the proper amount of gas, the scale will be balanced.
- ◆ Check that tarpaulin is placarded and the area is secured. Only people working on the fumigation may be in the area.
- ◆ Check tarpaulin to make sure it is free from rips and tears.
- ◆ Check that all gas sampling tubes are labeled and are not crimped or crushed. Inspect tubes visually, or use an electric or Mityvac hand pump to check tubes. Either a fumiscope or vacuum pump may be used to test leads for unrestricted flow.



When conducting fumigations with methyl bromide, sulfuryl fluoride or phosphine, erroneous readings may occur if the monitoring leads become blocked or crimped. It would be impossible to install a new monitoring lead during a fumigation treatment. Therefore, to avoid an unsuccessful fumigation, you should test monitoring leads before the treatment begins.

Use the following procedure to detect blocked monitoring leads with the use of a Mityvac hand-held pump (for supplier, see [Vacuum Pump](#) on [page H-1-65](#)):

1. Prior to fumigant introduction, connect the Mityvac hand-held vacuum pump to a monitoring lead.
2. Squeeze the handle on the Mityvac unit. If the lead is blocked, a vacuum will be indicated on the vacuum gauge of the Mityvac unit. (The handle should be squeezed two or three times for monitoring leads longer than 25 feet. The Mityvac hand-held pump has the capacity to attain and hold 25 inches of Hg vacuum and a minimum of 7 psig pressure.)
3. Disconnect the Mityvac hand-held pump from the monitoring lead, and repeat this procedure for each monitoring lead. (Connect monitoring leads to the gas analyzer prior to fumigant introduction.)

- ◆ Check that there is enough gas in the cylinder and if necessary, that other cylinders are available.
- ◆ Check the gas introduction line connections to make sure they are tight and free of leaks (wearing the SCBA).
- ◆ Check all safety equipment, especially SCBA, is available and in working order.
- ◆ If using a T/C unit, install Drierite<sup>®</sup> tube on gas sample line attached to the T/C unit and check to make sure granules are blue, if pink—replace Drierite<sup>®</sup>. If humidity is high, additional Drierite<sup>®</sup> tubes or frequent changes may be necessary.

- ◆ If using a T/C unit, install Ascarite® tube in line with the Drierite® tube if fumigating living plant and plant products, including fruits and vegetables, timber, flowers, and seed.



Other gas detection devices may not require the use of Drierite® or Ascarite®.

---

## Conducting the Fumigation

### Step 1—Introducing the Gas



The acceptable air concentration level for methyl bromide (MB) is 5 ppm. A respirator (approved SCBA or MSHA/NIOSH) is required if the MB concentration level in the air is greater than 5 ppm at any time. You and the fumigator must use your SCBA while introducing the gas, checking for leaks, and when taking aeration readings.

Turn on all fans before introducing the gas. When using large cylinders of MB, have the fumigator open the cylinder valve slightly, then close the valve. With an APHIS-approved leak detection device, check all connections on the gas introduction line for leaks. If leaks are found, advise the fumigator to tighten the connections and repeat the test. If no leaks are found, then open the valve to the point where 3 to 4 pounds of MB are being introduced per minute. The water temperature in the volatilizer should never go below 150°F at any time during gas introduction. The water in the volatilizer may include an antifreeze and should be handled with the appropriate safeguards.



Don't touch the introduction line with your bare hands—you could get burned! Close the cylinder valve once the proper dosage has been introduced.

**The fumigation time begins once all the gas has been introduced.** Record the time gas introduction was started and completed in Block 32 on the PPQ Form 429.

If using the electronic 429 database, record the fumigation date, gas introduction start and finish time in the corresponding fields under the "GAS INTRODUCTION" heading on the Treatment form.

Run the fans for 30 minutes to achieve even gas distribution. Take the initial concentration reading 30 minutes after all the gas has been introduced.





Do **not** begin counting fumigation time until all the gas has been introduced and valve on the MB tank is closed.

### Step 2—Testing for Leaks

Wear the SCBA while checking for leaks. Use an APHIS-approved leak detection device to test for leaks before the 30 minute reading or anytime when the concentration level is unknown or above 5 ppm. Test around the perimeter of the tarpaulin on the floor, corners, and especially where electric cords, gas sampling tubes, or gas introduction lines are present. When you detect leaks, have them sealed using more sand or sand snakes for floor leaks and tape for sealing small holes in the tarpaulin.

If you detect excessive leakage (concentration readings of 50 percent or less of the minimum concentration) in a tarpaulin which cannot be corrected in a practical way, do not attempt to correct the problem by adding more gas. Quickly evacuate the remaining gas from the enclosure, eliminate the problem, and construct a new enclosure. Aerate as usual following procedures on [page 2-4-36](#). Restart the fumigation in the new enclosure.



Commodities used for food or feed may not be re-treated. If commodities fall into this category, the only options are the following:

- ◆ Return to the country of origin
- ◆ Reexported to another country if they will accept the shipment
- ◆ Destroy by incineration

### Step 3—Taking Concentration Readings



Before taking a reading, always purge sampling lines with a mechanical or hand pump. If using a T/C analyzer, connect it to the sampling lead, adjust the gas flow rate to 1.0, and wait until the meter registering "ounces per thousand cubic feet" stabilizes before taking a reading. (This may take a minute or more, depending upon the length of the tubing and whether or not an auxiliary pump is used.)

Take concentration readings with a gas detection device to determine the gas concentration and distribution within the enclosure. If used, check desiccant tubes before each reading and change Drierite<sup>®</sup> if its color is pink.



Living plant and plant products generate carbon dioxide gas, which interferes with the MB reading from the T/C. In order to remove CO<sub>2</sub>, install an Ascarite<sup>®</sup> tube in line with the Drierite<sup>®</sup> tube if fumigating living plant and plant products, including fruits and vegetables, timber, flowers, and seed. Ascarite<sup>®</sup> is not required for infrared spectroscopy devices.

Depending upon the length of exposure period, take concentration readings at the following times<sup>4</sup>:

- ◆ 30 minutes
- ◆ 2 hours
- ◆ 4 hours
- ◆ 6 hours
- ◆ 12 hours
- ◆ 24 hours
- ◆ 36 hours
- ◆ 48 hours
- ◆ 72 hours
- ◆ Any final concentration reading



Avoid using hand-held two-way radios near the T/C unit. Using two-way radios near the T/C unit will interfere with an accurate concentration reading.

### Thirty-Minute Reading

The 30-minute reading shows the initial concentration and distribution of gas. The 30-minute reading can indicate leakage, sorption, incorrect dosage calculation, or error in fumigant introduction—all of which require immediate attention. Concentration readings should not differ more than 4 ounces among the leads.

### Two-Hour Reading

In comparison with the 30-minute reading, the 2-hour reading also will indicate if the tarpaulin is leaking or the commodity is sorbing gas. Readings more than 15 percent lower than the 30-minute reading will require close monitoring and possible corrective action.

---

<sup>4</sup> If fumigating oak logs or lumber for export, see “Special Procedures for Adding Gas to Oak Logs and Lumber.”

---

EXAMPLE: Your dosage for the fumigation was 4 pounds (64 ounces). The 30 minute reading was 50 ounces (3.125 pounds). The 2-hour reading is 42 ounces (2.625 pounds). The 2-hour reading is more than 15 percent less than the 30 minute reading and would indicate that either a leak or sorption problem may exist. You would need to monitor the fumigation closely until the concentration level stabilizes.

---

### Final Reading

The final reading is required for all tarpaulin fumigations in order to determine if the fumigation has been successfully completed. You may start the final reading before the finishing time of the treatment so that aeration commences at the finishing time. Starting the final reading before finishing time is especially critical when fumigating perishables.

### Additional Readings

Decide the need to take additional readings based on the following:

- ◆ Rate of gas concentration decrease
- ◆ Any condition which could change the gas concentration such as severe winds, or rain.

When concentration readings differ by more than 4 ounces, run the fans to equalize the gas and record readings on the APHIS 429. Generally, at the 1/2 hour reading, gas should be evenly distributed, and you should not have to restart the fans unless you added gas. If readings continue to differ by more than 4 ounces, continue running the fans.

If unpredicted severe winds occur, additional readings must be taken. Any sharp or unusual decreases of the readings in relation to previous readings is a clue to take corrective action and supplementary readings. Take additional readings every 30 minutes until problems are rectified.

Sorptive commodities may also require additional concentration readings.

### Step 4—Determining the Need to Add Gas and Adjust Exposure

Use the following table to determine when to add gas or extend the exposure period:

**TABLE 2-4-4: Determine the Need to Add Gas and Adjust Exposure**

If the lowest gas reading is:	And the schedule is:	Then:
Below the required minimum concentration	T101-a-1* or equivalent	SEE <a href="#">Table 2-4-6</a> on <a href="#">page 2-4-28</a> for corrections at 0.5 hour, or <a href="#">Table 2-4-7</a> on <a href="#">page 2-4-29</a> for corrections at 2 hours
	Other than T101-a-1 or equivalent	See <a href="#">Special Procedures for Adding Gas and Extending Exposure Period</a> on <a href="#">page 2-4-24</a> below
At or above required minimum concentration	T101-a-1* or equivalent	SEE <a href="#">Table 2-4-6</a> on <a href="#">page 2-4-28</a> for corrections at 0.5 hour, or <a href="#">Table 2-4-7</a> on <a href="#">page 2-4-29</a> for corrections at 2 hours
	Other than T101-a-1	No action necessary



Important

\* T101-a-1 or equivalent treatment schedules are those schedules that are not greater than 2 hours long (exposure time), and the dosage rate is not greater than 4lbs per 1000ft<sup>3</sup>, anywhere on the schedule.

## Special Procedures for Adding Gas and Extending Exposure Period<sup>5</sup>

### Adding Gas to Commodities that are Fumigated Using Treatment Schedules other than T101-a-1 or Equivalent (may include perishables)



Important

T101-a-1 or equivalent treatment schedules are those schedules that are **not** greater than 2 hours long (exposure time), and the dosage rate is **not** greater than 4lbs per 1000ft<sup>3</sup>.



To avoid injuring the commodity, add fumigant using the following formula:

$1.6 \times \text{number of oz. below minimum} \times \text{volume in ft}^3 / 1,000 \text{ ft}^3 = \text{oz. of gas to add}$   
or  $\text{oz. of gas to add} / 16 \text{ oz./lbs.} = \text{pounds (lbs.) of gas to add.}$

When adding gas, these procedures must be followed:

1. Heat water in volatilizer.
2. Turn on fans.

<sup>5</sup> The MB label does allow the extension of exposure time due to low gas readings for non-food commodities.

3. Take weight of the cylinder.
4. With SCBA on, open valve on cylinder and introduce the gas.
5. Close valve when the weight of the cylinder indicates that the needed amount of gas has been added.
6. Record quantity of fumigant added in Block 34 and the additional fan time in Block 30 of the PPQ Form 429.
7. If using the electronic 429, record the amount of additional gas listed in the Treatment Manual in the "Additional Gas Recommended" field and the actual amount of additional gas added in the "ACTUAL ADDITIONAL GAS" field. Record the additional fan time in the "TIME FANS OPERATED" field in the Treatment form.

Note the time the fumigator started introducing additional gas and the time the fumigator finished introducing gas and record in Block 40 (Remarks) of the PPQ Form 429 or in the "Remarks" form in the electronic 429 database. Run the fans for 30 minutes. Turn off fans, then take a concentration reading. If all readings are above minimum concentration levels, then proceed as usual with the remaining scheduled concentration readings.

Excessive leakage in any one tarpaulin enclosure, which cannot be eliminated in a practical way, must *not* be corrected by the addition of MB. (Excessive leakage has occurred when concentration readings are less than or equal to 50 percent of minimum concentration reading). Quickly evacuate remaining gas from such an enclosure, eliminate the problem, and construct a new enclosure. Start a new treatment in the new enclosure.



Commodities used for food or feed may not be re-treated. If commodities fall into this category, the only options are the following:

- ◆ Return to the country of origin
- ◆ Reexport to another country if they will accept the shipment
- ◆ Destroy by incineration

## Extending the Exposure Period for Food, Nonfood, Feed, or Nonfood Commodities

Use the following table to determine how long to extend the exposure period.

**TABLE 2-4-5: Determine the Extended Exposure Period**

If the exposure time is:	And any individual reading is below minimum by: <sup>1</sup>	Then extend exposure:
Less than 12 hours	10 oz. or less	10 percent of the time lapse since the last acceptable reading
	11 oz. or more	30 minutes
12 hours or more	10 oz. or less	10 percent of the time lapse since the last acceptable reading
	11 oz. or more	2 hours or 10 percent of time lapse since last acceptable reading, whichever is greater

- 1 If any individual reading is 50 percent or more below the minimum concentration reading, then abort the treatment. For example, if the minimum reading is 38 ounces then the reading 50 percent below the minimum is 19 ounces [38 ounces – (38 ounces × .50) = 19 ounces]. For oak logs (T312-a and T312-a-alternative), refer to [Special Procedures for Adding Gas to Oak Logs Using T312 or T312-a-Alternative on page 2-4-30](#) for specific instructions.

## Special Procedures for Fruits, Vegetables, or Perishable Commodities Using Schedule T101-a-1 or Equivalent

Use these instructions only for fruits and vegetables being fumigated under treatment schedule T101-a-1 or equivalent.



Fresh fruits and vegetables are sensitive to MB so you should double check volume calculations and dosage measurements to avoid accidental overdoses. If any 30-minute readings are 50 percent or more above the minimum concentration, it indicates a miscalculation of the dosage. Include a brief report on the PPQ Form 429 stating possible reasons for the overdose. Exposure periods are decreased for fumigations where concentration readings are much higher than required. see table on the following pages to determine when to reduce exposure periods.

Use [Table 2-4-6 on page 2-4-28](#) and [Table 2-4-7 on page 2-4-29](#) for fresh fruits and vegetables to determine if you need to add gas or extend or decrease the exposure time.



**DO NOT** average the concentration readings before using the tables. Base your decision on whether to add gas from the **LOWEST** gas concentration of any individual gas reading.

Select the proper table based on the time of the gas reading (30 minutes or 2 hours).



These tables apply **only** to those T101 schedules lasting 2 hours or less at a dosage rate of 4lbs/1000ft<sup>3</sup> or less. They do not apply to schedules of longer duration.

## Adding Gas



To avoid injuring the commodity, add fumigant using the following formula:

$1.6 \times \text{number of oz. below minimum} \times \text{volume in ft.}^3 / 1,000 \text{ ft.}^3 = \text{oz. of gas to add}$   
or  $\text{oz. of gas to add} / 16 \text{ oz./lbs.} = \text{pounds (lbs.) of gas to add.}$

When adding gas, these procedures must be followed:

1. Heat water in volatilizer.
2. Turn on fans.
3. Take weight of the cylinder.
4. With SCBA on, open valve on cylinder and introduce the gas.
5. Close valve when the weight of the cylinder indicates that the needed amount of gas has been added.
6. Record quantity of fumigant added in Block 34 and additional fan time in Block 30 of the PPQ Form 429.
7. If using the electronic 429, record the amount of additional gas listed in the Treatment Manual in the "Additional Gas Recommended" field and the actual amount of additional gas added in the "ACTUAL ADDITIONAL GAS" field. Record the additional fan time in the "TIME FANS OPERATED" field in the Treatment form.

Note the time the fumigator started introducing additional gas and the time the fumigator finished introducing gas and record in Block 40 (Remarks) of the PPQ Form 429 or in the "Remarks" form in the electronic 429 database. Run the fans until there is even gas distribution throughout the stack. Turn off fans, then take a concentration reading 30 minutes after the gas has been introduced. If all readings are above minimum concentration levels, then proceed as usual with the remaining scheduled concentration readings.

**TABLE 2-4-6: Determine Gas Concentration Values and Corrections for Fruits and Vegetables at the 30-Minute Reading of T101-a-1 or Equivalent Schedules.**

<b>If the schedule is:</b>	<b>And the minimum concentration reading (oz.) in schedule is:</b>	<b>And the lowest concentration reading (oz.) is:</b>	<b>Then:</b>
40-49 °F 4 lbs for 2 hrs	48	65 or greater <sup>1</sup>	REDUCE exposure by 15 minutes
		64-48	TAKE 2 hour reading as scheduled
		Lower than 48	1. ADD gas, and 2. EXTEND exposure 15 minutes
50-59 °F 3 lbs for 2 hrs	38	52 or greater <sup>1</sup>	REDUCE exposure by 15 minutes
		51-38	TAKE 2 hour reading as scheduled
		Lower than 38	1. ADD gas, and 2. EXTEND exposure 15 minutes
60-69 °F 2.5 lbs for 2 hrs	32	48 or greater <sup>1</sup>	REDUCE exposure by 15 minutes
		47-32	TAKE 2 hour reading as scheduled
		Lower than 32	1. ADD gas, and 2. EXTEND exposure 15 minutes
70-79 °F 2 lbs for 2 hrs	26	37 or greater <sup>1</sup>	REDUCE exposure by 15 minutes
		36-26	TAKE 2 hour reading as scheduled
		Lower than 26	1. ADD gas, and 2. EXTEND exposure 15 minutes
80-89 °F 1.5 lbs for 2 hrs	19	27 or greater <sup>1</sup>	REDUCE exposure by 15 minutes
		26-19	TAKE 2 hour reading as scheduled
		Lower than 19	1. ADD gas, and 2. EXTEND exposure 15 minutes

1 If concentration reading is more than 50 percent above the minimum concentration reading, it indicates a problem. An immediate check should be made to determine the cause and to correct it



**TABLE 2-4-7: Determine Gas Concentration Values and Corrections for Fruits and Vegetables at the 2-Hour Reading of T101-a-1 or Equivalent Schedules.**

If the schedule is:	And the lowest concentration reading at 2 hours is:	Then do not add gas, but:
40-49 °F 4 lbs for 2 hours	38 and above	AERATE commodity
	37-28	EXTEND exposure by 15 minutes
	27-25	EXTEND exposure by 30 minutes
	Lower than 25	ABORT
50-59 °F 3 lbs for 2 hrs	29 and above	AERATE commodity
	28-24	EXTEND exposure by 15 minutes
	23-21	EXTEND exposure by 30 minutes
	Lower than 21	ABORT
60-69 °F 2.5 lbs for 2 hrs	24 and above	AERATE commodity
	23-21	EXTEND exposure by 15 minutes
	20-18	EXTEND exposure by 30 minutes
	Lower than 18	ABORT
70-79 °F 2 lbs for 2 hrs	19 and above	AERATE commodity
	18-16	EXTEND exposure by 15 minutes
	15-13	EXTEND exposure by 30 minutes
	Lower than 13	ABORT
80-89 °F 1.5 lbs for 2 hrs	14 and above	AERATE commodity)
	13-12	EXTEND exposure by 15 minutes
	11-10	EXTEND exposure by 30 minutes
	Lower than 10	ABORT

### Special Procedures for Adding Gas to Oak Logs Using T312 or T312-a-Alternative

There are two alternative treatments for the MB fumigation of Oak logs. Refer to **Table 2-4-8** and **Table 2-4-9** for actions to take during the fumigation of Oak Logs using T312-a or T312-a-Alternative.

Use the following formula to calculate the amount of gas to add to the enclosure:

$1.6 \times (\text{number of oz. below the required minimum}) \times (\text{volume in ft}^3) / 1,000 \text{ ft}^3 = \text{oz. of gas to add}$ . To convert ounces to pounds, use the formula:

$$\frac{\text{oz. of gas to add}}{16 \frac{\text{oz.}}{\text{lbs.}}} = \text{pounds (lbs.) of gas to add}$$

After adding gas, run the fans for 30 minutes and take additional gas concentration readings.

Refer to **Table 2-4-8** if using T312-a and **Table 2-4-9** if using T312-a-Alternative to determine how much additional time must be added to the fumigation to compensate for the low gas concentrations.

---

EXAMPLE: The treatment schedule is T312-a-Alternative. The size of the enclosure is 2400 ft<sup>3</sup>. The required reading at 48 hours must be a minimum of 140 ounces. The actual lowest reading is 132 ounces. Calculate the amount of gas to add to the enclosure using the formula:  $1.6 \times (\text{the number of ounces below 140}) \times (\text{volume in ft}^3) / 1000 \text{ ft}^3$   
ANSWER:  
 $140 - 132 = 8$   
 $1.6 \times 8 \times 2400 = 30,720 / 1000 = 30.72$  ounces of gas to add  
 $30.72 / 16 = 1.92$  pounds of gas to add

Determine the amount of time to add by referring to **Table 2-4-9**. In this example, 1 hour will be added to the total fumigation time. Take the regularly scheduled reading at 72 hours (the minimum should be 100 ounces.)  
Take another reading at 73 hours (the minimum should be 100 ounces.)  
If the minimum is not 100 ounces, add more gas and time according to **Table 2-4-9**.

---

### Instructions for Adding Gas and Time to schedule T312-a

Do not combine schedules T312-a and T312-a-Alternative. The treatment must be aborted if any individual gas concentration reading is 50% or more below the minimum required concentration.

**TABLE 2-4-8 Determine Gas Concentration Values and Corrections for Oak Log Fumigations using schedule T312-a**

If the Reading is Taken At:	And the lowest individual concentration reading is:	Then:
0.5 hour	121-239	1. ADD gas, and 2. EXTEND exposure by 0.5 hour
	0-120	ABORT
2 hours	160-239	1. ADD gas, and 2. EXTEND exposure by 0.5 hour
	121-159	1. ADD gas, and 2. EXTEND exposure by 1.0 hour
	0-120	ABORT
12 hours	190-199	1. ADD gas, and 2. EXTEND exposure by 0.5 hour
	180-189	1. ADD gas, and 2. EXTEND exposure by 1.0 hour
	170-179	1. ADD gas, and 2. EXTEND exposure by 1.5 hours
	160-169	1. ADD gas, and 2. EXTEND exposure by 2.0 hours
	150-159	1. ADD gas, and 2. EXTEND exposure by 2.5 hours
	140-149	1. ADD gas, and 2. EXTEND exposure by 3.0 hours
	130-139	1. ADD gas, and 2. EXTEND exposure by 3.5 hours
	120-129	1. ADD gas, and 2. EXTEND exposure by 4.0 hours
	110-119	1. ADD gas, and 2. EXTEND exposure by 4.5 hours
	101-109	1. ADD gas, and 2. EXTEND exposure by 5.0 hours
	0-100	ABORT

**TABLE 2-4-8 Determine Gas Concentration Values and Corrections for Oak Log Fumigations using schedule T312-a (continued)**

<b>If the Reading is Taken At:</b>	<b>And the lowest individual concentration reading is:</b>	<b>Then:</b>
24 hours	120-239	1. Add gas to bring the total concentration to 240 ounces. 2. DO NOT ADD TIME.
	110-119	1. ADD gas, and 2. EXTEND exposure by 1.0 hour
	100-109	1. ADD gas, and 2. EXTEND exposure by 2.0 hours
	90-99	1. ADD gas, and 2. EXTEND exposure by 3.0 hours
	80-89	1. ADD gas, and 2. EXTEND exposure by 4.0 hours
	70-79	1. ADD gas, and 2. EXTEND exposure by 5.0 hours
	61-69	1. ADD gas, and 2. EXTEND exposure by 6.0 hours
	0-60	<b>ABORT</b>
36 hours	150-159	1. ADD gas, and 2. EXTEND exposure by 1.0 hour
	140-149	1. ADD gas, and 2. EXTEND exposure by 1.5 hours
	130-139	1. ADD gas, and 2. EXTEND exposure by 2.5 hours
	120-129	1. ADD gas, and 2. EXTEND exposure by 3.0 hours
	110-119	1. ADD gas, and 2. EXTEND exposure by 4.0 hours
	100-109	1. ADD gas, and 2. EXTEND exposure by 4.5 hours
	90-99	1. ADD gas, and 2. EXTEND exposure by 5.5 hours
	81-89	1. ADD gas, and 2. EXTEND exposure by 6.0 hours
	0-80	<b>ABORT</b>

**TABLE 2-4-8 Determine Gas Concentration Values and Corrections for Oak Log Fumigations using schedule T312-a (continued)**

If the Reading is Taken At:	And the lowest individual concentration reading is:	Then:
48 hours	110-119	1. ADD gas, and 2. EXTEND exposure by 1.0 hour
	100-109	1. ADD gas, and 2. EXTEND exposure by 2.0 hours
	90-99	1. ADD gas, and 2. EXTEND exposure by 3.0 hours
	80-89	1. ADD gas, and 2. EXTEND exposure by 4.0 hours
	70-79	1. ADD gas, and 2. EXTEND exposure by 5.0 hours
	61-69	1. ADD gas, and 2. EXTEND exposure by 6.0 hours
	0-60	<b>ABORT</b>
72 hours	70-79	1. ADD gas, and 2. EXTEND exposure by 3.0 hours
	60-69	1. ADD gas, and 2. EXTEND exposure by 6.0 hours
	50-59	1. ADD gas, and 2. EXTEND exposure by 9.0 hours
	41-49	1. ADD gas, and 2. EXTEND exposure by 12.0 hours
	0-40	<b>ABORT</b>
 <b>Important</b>	<p>If additional time has been added to the treatment, the 72 hour reading AND the extended time reading MUST be taken. If the minimum of 80 ounces is not met, time and gas MUST be added according to this Table.</p>	

## Instructions for Adding Gas and Time to schedule T312-a-Alternative

Do not combine schedules T312-a and T312-a-Alternative.

**TABLE 2-4-9 Determine Gas Concentration Values and Corrections for Oak Log  
 Fumigations using schedule T312-a-Alternative**

If the Reading is Taken At:	And the any individual concentration reading is:	Then:
0.5 hours	121-239	1. ADD gas, and 2. DO NOT EXTEND exposure.
	0-120	ABORT
2 hours	160-239	1. ADD gas, and 2. DO NOT EXTEND exposure
	121-159	1. ADD gas, and 2. EXTEND exposure by 1.0 hour
	0-120	ABORT
24 hours	140-239	1. Add gas to bring the total concentration to <span style="color: red;">240</span> ounces. 2. DO NOT ADD TIME.
	130-139	1. ADD gas, and 2. EXTEND exposure by 1.0 hour
	120-129	1. ADD gas, and 2. EXTEND exposure by 2.5 hours
	110-119	1. ADD gas, and 2. EXTEND exposure by 4.0 hours
	100-109	1. ADD gas, and 2. EXTEND exposure by 5.5 hours
	90-99	1. ADD gas, and 2. EXTEND exposure by 7.0 hours
	80-89	1. ADD gas, and 2. EXTEND exposure by 8.5 hours
	71-79	1. ADD gas, and 2. EXTEND exposure by 10.0 hours
	0-70	ABORT

**TABLE 2-4-9 Determine Gas Concentration Values and Corrections for Oak Log Fumigations using schedule T312-a-Alternative (continued)**

If the Reading is Taken At:	And the any individual concentration reading is:	Then:
48 hours	130-139	1. ADD gas, and 2. EXTEND exposure by 1.0 hour
	120-129	1. ADD gas, and 2. EXTEND exposure by 2.5 hours
	110-119	1. ADD gas, and 2. EXTEND exposure by 4.5 hours
	100-109	1. ADD gas, and 2. EXTEND exposure by 6.0 hours
	90-99	1. ADD gas, and 2. EXTEND exposure by 8.5 hours
	80-89	1. ADD gas, and 2. EXTEND exposure by 9.5 hours
	71-79	1. ADD gas, and 2. EXTEND exposure by 11 hours
	0-70	<b>ABORT</b>
72 hours	90-99	1. ADD gas, and 2. EXTEND exposure by 1.5 hours
	80-89	1. ADD gas, and 2. EXTEND exposure by 4.0 hours
	70-79	1. ADD gas, and 2. EXTEND exposure by 7.5 hours
	60-69	1. ADD gas, and 2. EXTEND exposure by 8.5 hours
	51-59	1. ADD gas, and 2. EXTEND exposure by 11.0 hours
	0-50	<b>ABORT</b>
 <b>Important</b>	<p>If additional time has been added to the treatment, the 72 hour reading AND the extended time reading MUST be taken. If the minimum of 100 ounces is not met, time and gas MUST be added according to this Table.</p>	

### Step 5—Exhausting the Gas

Exhaust the gas at the completion of the exposure period. If the treatment schedule is a FIFRA Section 18 Exemption, then the PPQ official must monitor the aeration of the commodity. Detector tube readings and the time interval from the aeration must be recorded in the corresponding fields in the "DETECTOR READINGS" form.

---

## Aerating the Enclosure

Aeration procedures are designed to provide safe working conditions during the aeration period and to assure that commodities are safe for handling, storage, and transportation. A fumigant must be aerated in accordance with Environmental Protection Agency (EPA) label requirements, the Occupational Safety and Health Administration (OSHA), and the PPQ Treatment Manual.

When treatments are conducted in a particular location on a regular basis, a permanent site should be designated. At such sites, the fan used to remove the fumigant from the enclosure during aeration must be connected to a permanent stack extending above the roof level.

Aeration of fumigated structures and ships are covered within those particular sections.

---

## Responsibility for Aerating the Commodity

The label requires that at least two people trained in the use of the fumigant must be present at all times during gas introduction, treatment, and aeration. The PPQ official, however, is not required to be continuously present at the fumigation site throughout the aeration process unless specified by the label or by State or local regulations.

If the fumigation is performed under a Section 18 Exemption, then a PPQ official must be present at the initiation of aeration and to verify the final aeration readings.

**TABLE 2-4-10: Determine Responsibility for Aerating the Commodity**

If the Treatment Schedule is:	Then:
A FIFRA Section 18 Exemption	1. PPQ must MONITOR the aeration of the enclosure, and 2. USE <a href="#">Table 2-4-11 on page-2-4-38</a> to determine which aeration procedure to follow
A labeled Treatment Schedule	1. RELEASE the fumigation to the fumigator to aerate according to label instructions and the conditions of the compliance agreement. 2. RELEASE the commodity.



## Materials Needed

The following materials will be needed to aerate the enclosure:

- ◆ SCBA<sup>6</sup>
- ◆ Colorimetric tubes (Draeger or Kitagawa for example)
- ◆ Exhaust fan<sup>7</sup>
- ◆ Exhaust duct<sup>7</sup>
- ◆ Danger signs and materials for limiting access to area (barricades, rope)<sup>7</sup>
- ◆ PPQ Form 429<sup>6</sup>

The following procedures apply to the aeration of all tarpaulin fumigations.

## Securing the Area

Assuming that you have already restricted access and secured the fumigation area, you now must restrict access to the area where the exhaust duct extends on the ground beyond the enclosure.



During the first 10 minutes of aeration, it is recommended that no one be within 200 feet of the exhaust duct outlet.

If this buffer zone is regulated by the State or municipality where the fumigation takes place, local regulations must be followed.

If it is impossible to restrict people from the area of aeration during regular work hours, consider aeration during another time of the day. When securing the duct outlet area, consider the direction of the wind. Face the duct outlet toward an open area, and away from people. Point the duct outlet upward to aid in dispersing the exhausted gas.

Advise the fumigator to use a physical barrier such as ropes, barricades, or walls to secure the area.

Placard the secure area near the exhaust outlet with the appropriate DANGER/PELIGRO signs. Make sure the placards meet the appropriate fumigant label or labeling requirements. The skull and crossbones should be present as well as “AREA UNDER FUMIGATION, DO NOT ENTER/NO ENTRE”; date of the fumigation; name of the fumigant used; and the name, address, and telephone number of the fumigator.

<sup>6</sup> Materials required for both PPQ and the commercial fumigator.

<sup>7</sup> Materials to be furnished by the commercial fumigator.

Unless you authorize their use, do *not* allow motorized vehicles to operate within the secure area.

## Wearing Respiratory Protection

The fumigator and the PPQ official monitoring the aeration must wear approved respiratory protection (SCBA, air supplied respirator, or a combination unit) when:

- ◆ Installing the exhaust system
- ◆ Opening the tarpaulin for aeration
- ◆ Removing the tarpaulin if measured levels of fumigant are above 5 ppm
- ◆ Anytime during the aeration process when a risk of exposure to concentrations above 5 ppm exists. This includes any time the concentration is unknown.

Refer to the following table to determine which Aeration Procedure to use when monitoring aeration.

**TABLE 2-4-11: Determine the Aeration Procedure**

If:	And:	And:	Then:
Nonsorptive	Containerized	—————➔	GO to <a href="#">page 2-4-38</a>
	Noncontainerized	Fresh fruits and vegetables, and cut flowers	GO to <a href="#">page 2-4-42</a>
		Other than fresh fruits and vegetables, and cut flowers	GO to <a href="#">page 2-4-40</a>
Sorptive, including yams and chestnuts (See <a href="#">page 2-3-6</a> for list of sorptive commodities)	Containerized	—————➔	GO to <a href="#">page 2-4-45</a>
	Noncontainerized	—————➔	GO to <a href="#">page 2-4-43</a>

## Aerating Nonsorptive, Containerized Cargo—Indoors and Outdoors

### Step 1—Installing Exhaust System

Advise the fumigator to:

1. Install an exhaust fan (minimum of 5,200 cfm capacity) to a 16 inch, or greater, diameter duct located at the floor near rear doors of the container.
2. Install an air introduction duct system consisting of a 3,750 cfm, or greater, fan attached to a 12 inch, or larger, duct which reaches two-thirds of the length of the container at the top of the

load. Have the ducts installed prior to the start of the fumigation. For indoor fumigation, extend the exhaust duct at least 30 feet beyond the building or through a vertical stack extending through the roof. For outdoor fumigations, extend the exhaust duct at least 30 feet beyond the container.



**Important**

(1) Volume of enclosure (in cubic feet) divided by the sum of cubic feet per minute (cfm) of the exhaust fan(s) or exhaust blower equals the number of minutes required per complete gas volume exchange. (2) Sixty minutes divided by the number of minutes per gas volume exchange equals the number of complete gas exchanges per hour. The result should be in the range of 4 to 15. The faster the rate of aeration the better, particularly for perishable commodities. If the exhaust flow is connected to a methyl bromide recovery system, this device must not impede the flow rate to less than 4 volumes per hour.

## Step 2—Aerating the Commodity

Advise the fumigator to:

1. Connect the exhaust duct to the exhaust fan.
2. Start the exhaust fan(s) and lift the end of the tarpaulin opposite the end at which the exhaust fan and duct are located.
3. Aerate for **3 hours**.
4. Stop the aeration fans.
5. Use a colorimetric tube to take a concentration reading in the airspace around and, when feasible, within the carton or box. Exceptions may include compressed cotton and other very difficult to probe commodities. Obtain prior approval from CHPST for exceptions to this rule.

For FIFRA Section 18 exemptions, record the concentration reading (in ppm), date, and time in Block 39 of PPQ Form 429. If using the electronic 429 database, record the date, time and detector reading (in ppm) in the "Detector Readings" form.

Then use **Table 2-4-12** to determine when to release the commodity.

**TABLE 2-4-12: Determine When to Release the Commodity**

If the gas concentration level is:	Then:
5 ppm or less	RELEASE the commodity
6 ppm or more	1. CONTINUE aeration until the concentration is 5 ppm or less, then 2. RELEASE the commodity

## Aerating Nonsorptive, Noncontainerized Cargo—Indoors and Outdoors

### Step 1—Installing the Exhaust System



This step is optional for outdoor fumigations, but must be done for indoor fumigations.

Advise the fumigator to:

1. Install an exhaust duct (minimally one 3,500 cfm capacity fan connected to an exhaust duct). An exhaust duct is optional for outdoor fumigations.
2. Extend the exhaust duct outlet to an outside area where there is adequate ventilation and at least 30 feet away from the building or through a vertical exhaust stack extending through the roof.



(1) Volume of enclosure (in cubic feet) divided by the sum of cubic feet per minute (cfm) of the exhaust fan(s) or exhaust blower equals the number of minutes required per complete gas volume exchange. (2) Sixty minutes divided by the number of minutes per gas volume exchange equals the number of complete gas exchanges per hour. The result should be in the range of 4 to 15. The faster the rate of aeration the better, particularly for perishable commodities. If the exhaust flow is connected to a methyl bromide recovery system, this device must not impede the flow rate to less than 4 volumes per hour.

### Step 2—Aerating the Commodity

Advise the fumigator to:

1. Start the exhaust fan.
2. Lift the end of the tarpaulin opposite the end with the exhaust fan and duct (if used).
3. Aerate the enclosure for **2 hours**.

### Outdoor Fumigations

Advise the fumigator to:

1. Stop the fans.
2. Remove the tarpaulin.
3. Take concentration readings with colorimetric tubes in the airspace around and, when feasible, inside the box or cartons.

For FIFRA Section 18 exemptions, record the concentration reading (in ppm), date, and time in Block 39 of PPQ Form 429. If using the electronic 429 database, record the date, time and detector reading (in

ppm) in the "Detector Readings" form. If using the electronic 429, record the time and detector reading (in ppm) in the "Detector Readings" form.

Then use **Table 2-4-13** to determine when to release the commodity.

**TABLE 2-4-13: Determine When to Release the Commodity for Outdoor Fumigations**

If the gas concentration level is:	Then:
5 ppm or less	RELEASE the commodity
6 ppm or more	1. CONTINUE aeration and take concentration readings until the level is 5 ppm or less, then 2. RELEASE the commodity

## Indoor Fumigations

Advise the fumigator to:

1. Stop the fans.
2. Take concentration readings with colorimetric tubes in the airspace around and, when feasible, in the carton or box.

For FIFRA Section 18 exemptions, record the concentration reading (in ppm), date, and time in Block 39 of PPQ Form 429. If using the electronic 429, record the time and detector reading (in ppm) in the "Detector Readings" form.

Then use **Table 2-4-14** to determine when to release the commodity.

**TABLE 2-4-14: Determine When to Release the Commodity for Indoor Fumigations**

If the gas concentration level is:	Then:
5 ppm or less	1. ADVISE fumigator to REMOVE the tarpaulin, and 2. RELEASE the commodity
6 ppm to 99 ppm	1. ADVISE fumigator to REMOVE the tarpaulin, and 2. CONTINUE aeration until the concentration is 5 ppm or less, then 3. RELEASE the commodity
100 ppm or above	1. CONTINUE aeration and take concentration readings until the concentration level is below 100 ppm, then remove the tarpaulin, and 2. CONTINUE aeration until concentration is 5 ppm or less, then 3. RELEASE the commodity

## Aeration Procedures for Fresh Fruits, Vegetables, and Cut Flowers—Indoors or Outdoors



Important

Do **not** use these procedures for fresh chestnuts or yams. (see procedures for sorptive commodities on [page 2-4-46](#))

### Step 1—Installing Exhaust System

Use [Table 2-4-15](#) to determine which size fan to use.

**TABLE 2-4-15: Determine Number of Fans**

If the enclosure is:	Then:
Up to 1000 cu ft	USE one fan, 67-350 cfm
1001-15,000 cu ft	USE one or 2 fans. The volume of the enclosure divided by the sum of the cfm of the fans should equal a figure of 15 or less. Connect fan(s) to 3-ft diameter exhaust duct(s) 3 ft in diameter.
15,001-25,000 cu ft	USE two fans, each 1,000 to 5,000 cfm. The volume of the enclosure divided by the sum of the cfm of the fans should equal a figure of 15 or less. Connect fan(s) to exhaust duct(s) 3 ft in diameter.
More than 25,000 cu ft	CONTACT the Center for Plant Health Science and Technology (CPHST) in Raleigh, North Carolina, for advice prior to conducting the first fumigation.

An alternate procedure to using exhaust fans and ducts is to aerate through a vertical stack.



Important

(1) Volume of enclosure (in cubic feet) divided by the sum of cubic feet per minute (cfm) of the exhaust fan(s) or exhaust blower equals the number of minutes required per complete gas volume exchange. (2) Sixty minutes divided by the number of minutes per gas volume exchange equals the number of complete gas exchanges per hour. The result should be in the range of 4 to 15. The faster the rate of aeration the better, particularly for perishable commodities. If the exhaust flow is connected to a methyl bromide recovery system, this device must not impede the flow rate to less than 4 volumes per hour.

### Step 2—Aerating the Commodity

Advise the fumigator to:

1. Connect the exhaust duct to the exhaust fan.
2. Start the exhaust fan(s) and lift the end of the tarpaulin opposite the end at which the exhaust fan and duct are located.
3. Aerate for **2 hours**.
4. Remove the tarpaulin and allow **2 hours** for passive aeration.

5. Stop the fans and take concentration readings with colorimetric tubes in the airspace around and, when feasible, inside the cartons or boxes.

For FIFRA Section 18 exemptions, record the concentration reading (in ppm), date, and time in Block 39 of PPQ Form 429. If using the electronic 429, record the time and detector reading (in ppm) in the "Detector Readings" form.

Then use **Table 2-4-16** to determine when to release the commodity.

**TABLE 2-4-16: Determine When to Release the Commodity**

If the gas concentration level is:	Then:
5 ppm or less	RELEASE the commodity
6 ppm or more	1. CONTINUE aeration and take concentration readings until the level is 5ppm or less, then 2. RELEASE the commodity



If using the electronic 429 database, follow the instructions for distribution in the "Help" section of the database. If using a paper copy of the form 429, give the original and one copy to your supervisor for review. The supervisor should keep the original for port files and send one copy to:

USDA, APHIS, PPQ, CPHST  
Treatment Quality Assurance Unit  
1730 Varsity Drive, Suite 400  
Raleigh, NC 27606  
919-855-7450

## Aerating Sorptive, Noncontainerized Cargo—Indoors and Outdoors

### Step 1—Installing the Exhaust System



This step is optional for outdoor fumigations, but must be done for indoor fumigations.

Advise the fumigator to:

1. Install an exhaust duct (minimally one 3,500 cfm capacity fan connected to an exhaust duct).
2. Extend the exhaust duct outlet to an outside area where there is adequate ventilation and at least 30 feet away from the building or through a vertical exhaust stack extending through the roof.

## Step 2—Aerating the Commodity

### Outdoor Fumigations

Advise the fumigator to:

1. Lift both ends of the tarpaulin.
2. Start the circulation fans and exhaust fans (if available).
3. Aerate Oak logs and lumber a minimum of **48 hours**. If, after 48 hours, the concentration is 5 ppm or greater, continue aeration for 24 more hours. Continue this procedure until concentration readings are less than 5 ppm.
4. Run the fans for **4 hours** for commodities other than Oak logs and lumber.
5. Remove the tarpaulin.
6. Stop the fans and take concentration readings with colorimetric tubes in the airspace around and, when feasible, inside the cartons or boxes.

For FIFRA Section 18 exemptions, record the concentration reading (in ppm), date, and time in Block 39 of PPQ Form 429. If using the electronic 429 database, record the date, time and detector reading (in ppm) in the "Detector Readings" form.

Then use [Table 2-4-17](#) to determine when to release the commodity.

**TABLE 2-4-17: Determine when to Release the Commodity**

If the gas concentration level is:	Then:
5 ppm or less	RELEASE the commodity
6 ppm or more	1. CONTINUE aeration and take concentration readings until the level is 5ppm or less, then 2. RELEASE the commodity

### Indoor Fumigations

Advise the fumigator to:

1. Complete the installation of the exhaust duct.
2. Start the circulation fans and exhaust fans.
3. Lift the end of the tarpaulin opposite the exhaust fan.
4. Aerate Oak logs and lumber a minimum of **48 hours**. If, after 48 hours, the concentration is 5 ppm or greater, continue aeration for 24 more hours. Continue this procedure until concentration readings are less than 5 ppm.
5. Run the fans for **4 hours** for commodities other than Oak logs and lumber.
6. Stop the fans and take concentration readings with colorimetric tubes in the airspace around and, when feasible, inside the carton or box.



7. Remove the tarpaulin.

For FIFRA Section 18 exemptions, record the concentration reading (in ppm), date, and time in Block 39 of PPQ Form 429. If using the electronic 429 database, record the date, time and detector reading (in ppm) in the "Detector Readings" form.

Then use **Table 2-4-18** to determine when to release the commodity. Take successive readings at intervals of not less than 2 hours.

**TABLE 2-4-18: Determine When to Release the Commodity for Indoor Fumigations**

If the gas concentration level is:	Then:
5 ppm or less	1. REMOVE the tarpaulin, and 2. RELEASE the commodity
6 ppm to 99 ppm	1. REMOVE the tarpaulin, and 2. CONTINUE aeration until the concentration is 5 ppm or less, then 3. RELEASE the commodity
100 ppm or above	1. CONTINUE aeration and take concentration readings until the concentration level is below 100 ppm, then remove the tarpaulin, and 2. CONTINUE aeration until concentration is 5 ppm or less, then 3. RELEASE the commodity

## Aerating Sorptive Commodities in Containers—Indoors and Outdoors

### Step 1—Installing the Exhaust System



This step is not required for outdoor fumigations.

Advise the fumigator to:

1. Install an exhaust fan (minimum of 5,200 cfm capacity) to a 16 inch or greater diameter duct located at the floor near rear doors or the container.
2. Install an air introduction duct system consisting of a 3,750 cfm or greater fan attached to a 12 inch or greater duct which reaches two-thirds of the length of the container at the top of the load. Have the ducts installed prior to the start of the fumigation. For indoor fumigations, extend the exhaust duct at least 30 feet beyond the building or through a vertical stack extending through the roof. For outdoor fumigations, extend the exhaust duct 30 feet beyond the container.

## Step 2—Aerating the Commodity

### Indoors

Advise the fumigator to:

1. Complete installation of exhaust duct and begin exhaust fan operation.
2. Lift both ends of the tarpaulin and begin exhaust fan operation. Do not remove the tarpaulin until the gas concentration level is below 100 ppm (see [Table 2-4-19](#)).
3. Start the circulation and air introduction fans. Require a minimum of **4 hours** aeration for all sorptive commodities. Sorptive commodities generally require 12 hours or longer to aerate, however, since sorptive commodities vary in their rates of desorption, aeration may be completed in less than 12 hours.
4. Aerate Oak logs and lumber a minimum of **48 hours**. If, after 48 hours, the concentration is 5 ppm or greater, continue aeration for 24 more hours. Continue this procedure until concentration readings are less than 5 ppm.
5. Stop the fans and take concentration readings with colorimetric tubes in the airspace around and, when feasible, inside the carton or box.

For FIFRA Section 18 exemptions, record the concentration reading (in ppm), date, and time in Block 39 of PPQ Form 429. If using the electronic 429 database, record the date, time and detector reading (in ppm) in the "Detector Readings" form.

Then use [Table 2-4-19](#) to determine when to release the commodity.

**TABLE 2-4-19: Determine when to Release the Commodity**

If the gas concentration level is:	Then:
5 ppm or less	1. ADVISE fumigator to REMOVE the tarpaulin, and 2. RELEASE the commodity
6 ppm to 99 ppm	1. HAVE fumigator REMOVE the tarpaulin, and 2. CONTINUE aeration until the concentration is 5 ppm or less, then 3. RELEASE the commodity
100 ppm or above	1. CONTINUE aeration and take concentration readings until the concentration level is below 100 ppm, then remove the tarpaulin, and 2. CONTINUE aeration until concentration is 5 ppm or less, then 3. RELEASE the commodity

### Outdoors

Advise the fumigator to:

1. Complete installation of exhaust duct and begin exhaust fan.
2. Lift both ends of the tarpaulin that are furthest from exhaust fan.

3. Start the circulation and air introduction fans. Require a minimum of **4 hours** aeration for all sorptive commodities. Sorptive commodities generally require 12 hours or longer to aerate, however, since sorptive commodities vary in their rates of desorption, aeration may be completed in less than 12 hours.
4. Aerate Oak logs and lumber a minimum of **48 hours**. If, after 48 hours, the concentration is 5 ppm or greater, continue aeration for 24 more hours. Continue this procedure until concentration readings are less than 5 ppm.
5. Remove the tarpaulin after 4 hours aeration.
6. Stop the circulation fans and take concentration readings with colorimetric tubes in the airspace around and, when feasible, inside the cartons or boxes.

For FIFRA Section 18 exemptions, record the concentration reading (in ppm), date, and time in Block 39 of PPQ Form 429. If using the electronic 429 database, record the date, time and detector reading (in ppm) in the "Detector Readings" form.

Then use **Table 2-4-20** to determine when to release the commodity.

**TABLE 2-4-20: Determine when to Release the Commodity**

If the gas concentration level is:	Then:
5 ppm or less	RELEASE the commodity
6 ppm or more	1. CONTINUE aeration and take concentration readings until the level is 5ppm or less, then 2. RELEASE the commodity



# 2

Treatment Manual

## Chemical Treatments

### *Fumigants • Methyl Bromide • Chamber Fumigation*

---

#### Contents

Methods and Procedures	<b>page-2-5-1</b>
Materials Needed	<b>page-2-5-1</b>
Conducting the Fumigation	<b>page-2-5-2</b>
Aerating the Chamber	<b>page-2-5-3</b>
Normal Atmospheric Pressure Chamber—Aerating Noncontainerized Cargo	<b>page-2-5-4</b>
Normal Atmospheric Pressure Chamber—Aerating Containerized and Noncontainerized Cargo	<b>page-2-5-5</b>
Vacuum Fumigation Chambers—Aerating Containerized and Noncontainerized Cargo	<b>page-2-5-6</b>

---

#### Methods and Procedures

##### Materials Needed

The procedures covered in this section provide commercial fumigators with the methods, responsibilities, and precautions for chamber fumigation.

- ◆ Colorimetric tubes (Draeger, Kitagawa, or equivalent)<sup>1</sup>
- ◆ APHIS-approved leak detection device<sup>1</sup>
- ◆ Methyl bromide
- ◆ Scale or graduated cylinder for volume (liquid measurements)
- ◆ SCBA or supplied air respirator<sup>1</sup>
- ◆ APHIS-approved gas detection device
- ◆ Thermometer<sup>1</sup>
- ◆ Volatilizer
- ◆ Warning signs

The chamber operator is responsible for supplying the above materials as well as ensuring that the chamber is certified for conducting PPQ quarantine treatments.

---

<sup>1</sup> You will need to bring these items unless the chamber is operated by PPQ, in which case all materials are provided by PPQ.

## Conducting the Fumigation

### Step 1—Selecting a Treatment Schedule

Select an appropriate treatment schedule to effectively eliminate the plant pest without damaging the commodity to be fumigated.

Turn to the treatment schedule Index and look up by commodity or by pest the treatment schedule(s) available. Treatment schedules which are approved for chambers will be listed as either “NAP” (normal atmospheric pressure) or as “vacuum.”

### Step 2—Determining Section 18 Exemptions and Sampling Requirements

After selecting the treatment schedule, determine which treatment schedules are FIFRA Section 18 Exemptions. The schedule will be followed by an "IMPORTANT" note to help you determine the current exemption status. Some treatment schedules are only FIFRA Section 18 Exemptions at specific temperature ranges. Check the treatment schedule and temperature to determine if the fumigation will be a FIFRA Section 18 Exemption.

Residue monitoring by taking samples of the commodity prior to the start of the fumigation and after aeration is no longer required.

### Step 3—Measuring the Temperature

Determine the temperature to use in selecting the proper dosage rate:

- ◆ For fruits, pulpy vegetables, or logs use only the commodity temperature.
- ◆ For all other commodities use both the commodity and air temperature.

To take the temperature readings, use a bimetallic, mercury, or digital long-stem thermometer that has been calibrated. Use [Table 2-5-1](#) on [page 2-5-3](#) to determine which temperature to use when selecting the proper dosage rate for commodities other than fresh fruits, vegetables, or logs. Record the temperatures in Block 22 of the PPQ Form 429.

If using the electronic 429 database, record the temperatures in the space and commodity fields in the Treatment form.



Commodity and space temperatures must be 40°F or above.

**TABLE 2-5-1: Determine Whether to Use Commodity or Air Temperature for Determining Dosage Rate**

If the air temperature is:	And:	Then, for commodities other than fresh fruits or vegetables or logs and lumber <sup>1</sup> :
Higher than the commodity temperature	→	Use the single lowest commodity temperature for determining the dosage rate (Do Not use the average commodity temperature).
Lower than the commodity temperature	By 9 degrees or less	
	By 10 degrees or more	Use the average of the air and commodity temperature for determining the dosage rate

1 Use commodity temperature for fresh fruits or vegetables or logs and lumber.

### Step 4—Calculating the Dosage

In order to calculate dosage, you must have the following information:

- ◆ Treatment schedule
- ◆ Volume of the fumigation chamber (ft<sup>3</sup>)
- ◆ Temperatures of commodity and air (°F)

Refer to the specific treatment schedule to determine the dosage rate (pounds/ft<sup>3</sup>).

The formula for calculating dosage is:

$$\begin{aligned} \text{dosage}(\text{lbs.}) &= \text{volume}(\text{ft}^3) \times \text{dosage rate}(\text{lbs./1,000 ft}^3) \\ &= \frac{\text{volume}(\text{ft}^3) \times \text{dosage rate}(\text{lbs.})}{1,000 \text{ ft}^3} \end{aligned}$$

**EXAMPLE:** Using a fumigation chamber which has a volume of 500 ft<sup>3</sup>, you determine the temperature of the commodity and space is 72°F. The treatment schedule requires 2 lbs. MB/1,000 ft<sup>3</sup> at 70°F or above. To calculate dosage multiply the volume (500 ft<sup>3</sup>) by the dosage rate (2 lbs. MB/1,000 ft<sup>3</sup>). This equals 1.0 lbs. of MB needed for the dosage.

### Step 5—Conducting the Fumigation

Since fumigation chambers vary by manufacturer and model, refer to the manufacturer's operating manual to determine how to use the chamber. However, in any case, circulation fans in a chamber should be kept running for 15 minutes following introduction of the gas.

## Aerating the Chamber

Responsibility for aerating the chamber and releasing the commodity depends on whether the treatment schedule used was a labeled use or FIFRA Section 18 Exemption. Use the following table to determine responsibility for monitoring the aeration of the fumigation.

**TABLE 2-5-2: Determine the Responsibility for Monitoring the Aeration**

If the fumigation chamber is:	And the treatment schedule is:	Then:
Privately or State owned	A labeled treatment	RELEASE the fumigation to the fumigator to aerate and release the commodity
	A FIFRA Section 18 Exemption (noted in the treatment schedules)	1. PPQ must MONITOR the aeration, and 2. USE the following table to determine which aeration procedures to follow
PPQ owned	—————▶	

Use the following table to determine which procedures to follow for aerating normal atmospheric pressure (NAP) and vacuum chambers.

**TABLE 2-5-3: Determine the Aeration Procedure**

If the chamber is:	And the cargo is:	Then:
NAP	Noncontainerized	Use the procedures on <a href="#">page 2-5-4</a>
	Containerized	Use the procedures on <a href="#">page 2-5-5</a>
Vacuum	—————▶	Use the procedures on <a href="#">page 2-5-5</a>

Each chamber must be equipped with at least one permanent, metal gas sampling tube to allow you to take colorimetric tube readings during the aeration. Any extensions of the gas sampling tube or flexible connectors must be made of Teflon™ tubing or metal. The gas sampling tube must extend outside the chamber to allow for colorimetric tube readings.

## Normal Atmospheric Pressure Chamber—Aerating Noncontainerized Cargo

### Step 1—Securing the Area

Assuming that you’ve already secured the fumigation area, allow only the chamber operator and the PPQ officer monitoring the fumigation into the secure area.



Do **not** allow motorized vehicles to operate within the secure area.

### Step 2—Aerating the Chamber

Run the exhaust long enough to obtain at least four complete changes of air (about 4 to 15 minutes per change of air or 1 hour).



### Step 3—Taking Concentration Readings

Use a colorimetric tube to take a concentration reading **within the carton or box**. Exceptions may include compressed cotton and other very difficult to probe commodities. Obtain prior approval from CHPST for exceptions to this rule.

For FIFRA Section 18 exemptions, record the concentration reading (in ppm), date, and time in Block 39 of PPQ Form 429. If using the electronic 429 database, record the date, time and detector reading (in ppm) in the "Detector Readings" form.

Use [Table 2-5-4](#) on [page 2-5-5](#) to determine when to release the commodity

**TABLE 2-5-4: Determine When to Release the Commodity**

If the gas concentration is:	Then:
5 ppm or less	RELEASE commodity
6 ppm or above	1. TAKE concentration readings, and 2. RELEASE commodity when the concentration level is 5 ppm or less

## Normal Atmospheric Pressure Chamber—Aerating Containerized and Noncontainerized Cargo

### Step 1—Securing the Area

Assuming that you've already secured the fumigation area, allow only the chamber operator and the PPQ officer monitoring the fumigation into the secure area.



Do **not** allow motorized vehicles to operate within the secure area.

### Step 2—Aerating the Chamber

Run the exhaust long enough to obtain at least four complete changes of air (about 4 to 15 minutes per change of air or 1 hour). If the containers have internal fans, run them unless they are operated by internal combustion engines. Remove container from the chamber at the conclusion of four complete changes of air to a secure outdoor area for passive aeration. Wear the SCBA while the container is being moved outdoors.

### Step 3—Taking Concentration Readings

Use a colorimetric tube to take a concentration reading **within the carton or box**. Exceptions may include compressed cotton and other very difficult to probe commodities. Obtain prior approval from CHPST for exceptions to this rule.

For FIFRA Section 18 exemptions, record the concentration reading (in ppm), date, and time in Block 39 of PPQ Form 429. If using the electronic 429 database, record the date, time and detector reading (in ppm) in the "Detector Readings" form.

Use the following table to determine when to release the commodity.

**TABLE 2-5-5: Determine When to Release the Commodity**

If the gas concentration is:	Then:
5 ppm or less	RELEASE commodity
6 ppm or above	1. CONTINUE passive aeration 2. TAKE concentration readings, and 3. RELEASE commodity when the concentration level is 5 ppm or less

## Vacuum Fumigation Chambers—Aerating Containerized and Noncontainerized Cargo

### Step 1—Securing the Area

Assuming that you've already secured the fumigation area, allow only the chamber operator and the PPQ officer monitoring the fumigation into the secure area.



Do **not** allow motorized vehicles to operate within the secure area.

### Step 2—Aerating the Chamber

Adjust any vacuum remaining at the end of the fumigation to zero by temporarily opening the air intake valve, then closing it. Draw a 15 inch vacuum and adjust it to zero. Repeat this process of drawing a 15 inch vacuum and releasing it four times or as many times as experience indicates is necessary.

### Step 3—Taking Concentration Readings

Use a colorimetric tube to take a concentration reading **within the carton or box**. Exceptions may include compressed cotton and other very difficult to probe commodities. Obtain prior approval from CHPST for exceptions to this rule.

For FIFRA Section 18 exemptions, record the concentration reading (in ppm), date, and time in Block 39 of PPQ Form 429. If using the electronic 429 database, record the date, time and detector reading (in ppm) in the "Detector Readings" form.

Use **Table 2-5-6** on **page 2-5-7** to determine when to release the commodity.

**TABLE 2-5-6: Determine When to Release the Commodity**

If the gas concentration is:	Then:
5 ppm or less	RELEASE commodity
6 ppm or above	<ol style="list-style-type: none"><li>1. Do two more vacuum washes</li><li>2. TAKE concentration readings, and</li><li>3. RELEASE commodity when the concentration level is 5 ppm or less</li></ol>



Some vacuum chambers do not have sampling tubes. After four air washes, while wearing the SCBA, open chamber door and take colorimetric reading within the carton or box.



# 2

Treatment Manual

## Chemical Treatments

### *Fumigants • Methyl Bromide • Ship Fumigation*

---

#### Contents

Methods and Procedures	page-2-6-1
Materials Needed	page-2-6-1
PPQ Officer Provides	page-2-6-1
Fumigator Provides	page-2-6-2
Taking Safety Measures When Fumigating Ships	page-2-6-3
Preparing to Fumigate	page-2-6-3
Conducting the Fumigation	page-2-6-10
Aerating the Hold or Storeroom	page-2-6-13

---

#### Methods and Procedures

The procedures covered in this section provide commercial fumigators with the methods, responsibilities, and precautions for ship fumigation.



These procedures are used primarily for fumigation of ships that are infested with khapra beetle.

Generally, fumigation of commodities within the structure of a ship, such as cargo holds, cannot meet APHIS standards for fumigation, and these fumigations are not recommended by APHIS. However, on a case by case basis, commodities may be fumigated within the structure of a ship if Methods Development first approves the fumigation. For approval, call the Center for Plant Health Science & Technology (CPHST) (tel: 919-855-7450)

In general, ship fumigations present problems not encountered in other types of fumigations. The large amount of gas required and the varying space configurations from ship to ship make it essential that experienced pest control operators and PPQ officers with extensive fumigation experience perform ship fumigations.

---

#### Materials Needed

##### PPQ Officer Provides

- ◆ PPQ Form 429
- ◆ Calculator (optional)
- ◆ Colorimetric tubes (Dräger/Kitagawa)

- ◆ Desiccant (Drierite<sup>®</sup>)
- ◆ APHIS-approved leak detection device
- ◆ SCBA or supplied air respirator
- ◆ Tape measure
- ◆ APHIS-approved gas detection device<sup>1</sup>
- ◆ Thermometer

### **Fumigator Provides**

- ◆ Adhesive sealer, tape, and putty or other pliable material for sealing off holes around pipes
- ◆ Auxiliary pump for purging long gas sample tubes
- ◆ Carbon dioxide filter (Ascarite<sup>®</sup>)
- ◆ Colorimetric tubes (Draeger/Kitagawa)
- ◆ Electrical wiring (ground, permanent type), three prong extension cords
- ◆ Exhaust blower and ducts
- ◆ Fans (circulation, exhaust, and introduction)
- ◆ Framework and supports
- ◆ Gas sampling tubes (leads)
- ◆ Gas supply line
- ◆ Heat supply
- ◆ Insecticides and spray equipment
- ◆ Methyl bromide
- ◆ Padding
- ◆ Portable generator as backup unit to operate gas detection device, auxiliary pump, and lights
- ◆ Sand or water snakes
- ◆ Scales or dispensers
- ◆ SCBA or supplied air respirator
- ◆ Tape
- ◆ Tarpaulin and supports
- ◆ APHIS-approved gas detection device
- ◆ Volatilizer

---

<sup>1</sup> The gas detection device must be calibrated annually. Contact the Center for Plant Health Science & Technology (CPHST) (919-855-7450) in Raleigh, North Carolina, for calibration information.

- ◆ Warning signs

PPQ officer and fumigator should be prepared to use auxiliary power if shore power is not available as most ships' power is 220 volts.

---

## Taking Safety Measures When Fumigating Ships

The most important consideration when fumigating ships is the protection of human life. The commercial fumigator has the following safety responsibilities when fumigating ships:

- ◆ Observe all safety precautions while fumigating
- ◆ Prevent access of unauthorized personnel, including the ship's crew, to the fumigated area
- ◆ Conduct fumigation properly to result in an effective treatment
- ◆ Evacuate gas from ship and aerate when fumigation is completed
- ◆ Test, with a gas detector, all areas aboard ship to ensure freedom from MB before allowing crew members access to the ship

The commercial fumigator must abide by the following guidelines when fumigating ships:

- ◆ Have a representative present throughout the entire fumigation. The representative must be familiar with directions for using the fumigant, warnings, antidotes, etc., shown on the label, on the gas cylinder, and contained in the manufacturer's application manual.
- ◆ Have adequate first-aid equipment, SCBA, and other safety equipment available
- ◆ Have all areas of the ship tested with a gas detector prior to crew reentry. Pay particular attention to all fumigated areas, crew quarters, and the engine rooms
- ◆ Provide for immediate contact with the responsible ship's officer to provide information and access to areas of the ship which may be needed to assure a safe fumigation

---

## Preparing to Fumigate

### Step 1—Meeting With Ship's Captain and Agent

When planning a ship fumigation, meet with the ship's captain, agent, and the fumigation company representative to discuss the conditions of the fumigation. If cargo is present in an area about to be fumigated, determine if any materials might be adversely affected by the fumigant

(see Methyl Bromide—Properties for a list of commodities adversely affected by MB). Notify the ship's agent of possible effects and if conditions permit, allow removal of the material from the hold for an alternate treatment.

Discuss plans for removing all crew from the ship. It is the responsibility of the commercial fumigator to comply with all label requirements, and with State, local, and U.S. Coast Guard regulations (see **Coast Guard Regulations** on **page B-1-1** in **Appendix B**) concerning shipboard fumigation.

### **Step 2—Selecting a Treatment Schedule**

Refer to treatment schedule T402 (SHIPS) for the correct treatment. Select a treatment schedule based on the plant pest and commodity to be fumigated. Consider all the commodities present in the area to be fumigated when determining the best treatment available. In the case of khapra beetle fumigation, determine if finely milled products (example—flour) will be fumigated. If finely milled products are to be fumigated, give the captain the option to use the 12 hour schedule. Have the finely milled products destroyed either by incineration or by sterilization after the fumigation has been completed. If the captain elects not to remove and destroy the finely milled products, then use the 24 hour treatment schedule.

### **Treating Deck Areas**

Areas which may be pest contaminated or suspected of being contaminated, such as the deck, hatch covers, drain channels, crevices around hatches, hallways, and similar areas that cannot be fumigated, should be treated with a 3 percent malathion emulsion spray (0.5 pint, 57 percent premium grade to a gallon of water). Spray at the rate of 2 gallons/1,000 sq. ft., or to the point of runoff.



Malathion emulsion sprays may break down asphalt surfaces. For asphalt surfaces, prepare a spray from a 25 percent wettable powder (1 pound to a gallon of water), rather than the emulsion.

### **Step 3—Determining Section 18 Exemptions and Sampling Requirements**

After selecting the treatment schedule, you will be able to determine which treatment schedules are FIFRA Section 18 Exemptions. The schedule will be followed by an "IMPORTANT" note to help you determine the current exemption status. Some treatment schedules are only FIFRA Section 18 Exemptions at specific temperature ranges.

If food is fumigated, alert the captain that there may be higher than permitted residues.



#### **Step 4—Preparing Areas to Be Fumigated**

##### **Storerooms**

Open all bins, drawers, and cupboards. Stack all bagged commodities so gas can penetrate all sides of the commodity. Stacking bagged commodities on pallets will facilitate gas distribution and penetration.

##### **Cargo Holds**

Prepare to fumigate the entire hold regardless of the location of the infestation within the hold. If you want to fumigate a single deck (lower hold, lower 'tween deck, upper 'tween deck, etc.), you must get approval from your Regional Director. The decision to approve single deck fumigations should only be made after all sections of the hold have been inspected and there is no possibility of gas escaping to other parts of the hold.

In most cases, it is unnecessary to open or rearrange cargo containers within the hold. Occasionally, some rearrangement may be required to ensure uniform gas distribution. Have the hatch coverings between decks opened in such a manner as to permit adequate distribution and circulation of the gas.

#### **Step 5—Arranging and Operating Fans**

##### **Storerooms**

Storerooms normally require a minimum of two, 1,800 cfm fans. Place one fan at a low level and the other at a high level. Fans with capacity above 1,800 cfm create strong air currents which could result in gas leakage around the seals. If you're fumigating an area which includes the galley and adjoining storerooms, be sure to place the fans to evenly distribute gas. Make certain that fans can be turned on and off from an area outside the fumigation site.

##### **Cargo Holds**

Use the volume of the hold (ft<sup>3</sup>) in determining how many fans you will need. The total cfm's of all the fans should approximate the volume of the hold. Use fans capable of 2,500 cfm or greater during gas introduction and for 30 minutes following the introduction. Placement of fans within holds depends on the presence or absence of cargo. Normally, place two fans in the lower hold at opposite ends facing across the hold. The number of fans can be reduced by using fans greater than 2,500 cfm. Fans should be labeled as to location and have the capability of being turned on and off individually in case of low readings in certain locations or pockets of gas.

Test all fans to ensure that they are in good operating condition. Operate fans during the gas introduction and for 30 minutes after introduction is completed.

#### **Step 6—Placing Gas Sampling Tubes**

Place gas sampling tubes in areas and commodities which will give representative samples within the fumigated area. Have all leads brought to one central point at least 30 feet upwind from the area being fumigated. Label all gas sampling tubes so they can be easily identified

when you take concentration readings. Label each tube by identifying the level of the hold and whether the gas sampling tube is in a commodity or space.

### **Storerooms**

Place a minimum of two gas sampling tubes in open space and at least one gas sampling tube within the commodity considered to be the most difficult for the fumigant to penetrate.

### **Cargo Holds**

Within cargo holds, the exact location will depend primarily on the location of cargo within the hold. Place a minimum of two leads for each level of empty hold space. The average size hold of three levels is approximately 125,000 ft<sup>3</sup>. Use one additional lead for every 50,000 ft<sup>3</sup> over 125,000 ft<sup>3</sup>.

When cargo is present in the hold, place two additional gas sampling tubes in the commodity at each hold level. For mixed cargo, place additional gas sampling tubes in the cargo considered to be the most difficult for the fumigant to penetrate.

### **Step 7—Placing the Gas Introduction Lines**

#### **Storerooms, Galley, Quarters**

Numerous gas introduction lines may be necessary in order to obtain even gas distribution throughout the fumigation area. Place the gas introduction line directly through an opening from the outside (example—a door or window) directly above a fan. Attach the introduction line securely to the top of the fan to prevent movement of the hose. An unsecured introduction line could move the line out of the airflow. Place a piece of nonpermeable sheeting (example—plastic or rubberized canvas) over the commodity in front of and below each gas supply line. The nonpermeable sheet will prevent any liquid MB from coming in contact with commodities and will prevent damage.

#### **Cargo Holds**

Numerous gas introduction lines may be necessary in order to obtain even gas distribution throughout the fumigation area. Place the gas introduction line directly into the air stream in front of one of the fans on the upper 'tween deck. Attach the introduction line securely to the top of the fan because gas passing through the line will cause the line to vibrate. An unsecured introduction line could be moved out of the airflow. Additional introduction lines can be used to hasten introduction and distribution of the gas. Place a piece of nonpermeable sheeting (example—plastic or rubberized canvas) over the commodity in front of and below each gas introduction line. The sheet will prevent any liquid MB from coming in contact with the cargo and prevent damage.

### **Step 8—Measuring the Temperature**

Take temperature readings of the air (space) and of the commodity. Use a calibrated thermometer. Record the temperatures in Block 22 on the PPQ Form 429.

If using the electronic 429 database, record the temperatures in the space and commodity fields in the Treatment form.

If the temperature is below the minimum listed for the treatment schedule, then the hold or other space to be fumigated will need to be heated.

**TABLE 2-6-1: Determine Pre-fumigation Procedures**

If the temperature is:	Then:
At or above the minimum temperature listed for the treatment schedule	GO to Step 10 (Sealing Stores)
Below the minimum temperature listed for the treatment schedule	GO to Step 9 (Heating the Cargo Hold)

### Step 9—Heating the Cargo Hold

If heating a hold is necessary, negotiate the method with the fumigator and get the concurrence of the Center for Plant Health Science & Technology (CPHST), in Raleigh, North Carolina.

### Step 10—Sealing Stores

One of the most important steps in preparing for a ship fumigation is sealing all openings and areas which have the potential to leak gas. Consider the entire area to be fumigated as a natural atmospheric chamber and make the area as gastight as possible. The most important task is to locate all openings (e.g., drain pipes, bilge drain holes, or air ducts) and seal them.

Do **not** seal out or make gastight recessed areas, ducts, or similar apertures which may harbor an infestation. In some cases it is better to seal sources of leaks on the outside of the area to be fumigated. Use caulking compound or tape for sealing small spaces. For sealing larger areas, use polyethylene or similar material secured with tape or adhesive spray. Seal doors and other openings with either polyethylene or spray with vinylite plastic. When practical, seal air ventilation ducts on the outside of the space being fumigated so sealing tape can be removed when you get ready to evacuate the gas and begin aeration. Large openings such as hatch cover openings should be covered with polyethylene and securely taped. When necessary, lace rope across the tarpaulin to prevent billowing in high winds. Look for and seal off the following ship areas when preparing a ship for fumigation:

- ◆ Air vents
- ◆ All passageways, engine room, and other crew areas for electric pipeline or other duct work common with cargo holds

- ◆ Bilge and drainwell vents and drains to all cargo holds sometimes common with more than one hold or engine room bilges
- ◆ CO<sub>2</sub> piping to all cargo holds; degassing systems (older ships) which usually run from hold to hold
- ◆ Drains
- ◆ Dumb-waiter openings
- ◆ Emergency escape hatches from shaft alley and escape hatches from all holds
- ◆ Engine room—recirculation air systems controlled from and common with the engine room areas—especially on newer ships; check for drilled holes or other openings in fore and aft bulkheads of engine room spaces, all engine room vent systems, and housing or casing leading into spaces to be fumigated
- ◆ Galley intake and exhaust systems (may be common with the dry stores)
- ◆ Heating, air conditioning, and ventilation systems common with or to cargo holds, engine room, crew quarters, storerooms, or other spaces that use intake from the vent systems common with cargo holds
- ◆ Inner bottom and deep tank covers to ensure that they are closed prior to fumigating
- ◆ Pipes and other utility conduits through decks and bulkheads
- ◆ Speaking tubes and fire and smoke detector systems from fumigated areas
- ◆ Steam-smothering systems for connection between holds
- ◆ Vents in shaft alley and gear lockers to holds; breaks in bulkhead
- ◆ Wall plates

### **Step 11—Measuring Volume**

Obtain the volume of the cargo holds from the chief mate, captain, or the ship's plan, which is usually posted outside the captain's office. If actual hold measurements are available, then figure the volume by multiplying the length, width, and height of the hold. If actual measurements are not available, then look on the ship's plan for the grain cube. Use the grain cube as the volume in lieu of actual hold dimensions. Consider all hold areas such as deep tanks, security lockers, and refrigerated spaces when calculating the volume of the area to be fumigated.

For dry stores, galleys, and crew quarters, measure the actual dimensions to calculate volume.

### Step 12—Calculating Dosage

The formula for calculating dosage is:

$$\begin{aligned} \text{dosage(lbs.)} &= \text{volume(ft}^3\text{)} \times \text{dosage rate(lbs./1,000 ft}^3\text{)} \\ &= \frac{\text{volume(ft}^3\text{)} \times \text{dosage rate(lbs.)}}{1,000 \text{ ft}^3} \end{aligned}$$

---

EXAMPLE: Number 3 Hold is infested with khapra beetle. The volume is 80,000 ft<sup>3</sup>, and the temperature is 65°F. The treatment schedule lists the dosage rate as 6 lbs. MB/1,000 ft<sup>3</sup>. To calculate the dosage multiply the volume (80,000 ft<sup>3</sup>) by the dosage rate (6 lbs./1,000 ft<sup>3</sup>). This equals 480 lbs. of MB needed for the dosage.

---

### Step 13—Making a Final Check

Just before introducing the gas, you and the fumigator must do the following:

- ◆ Take gas concentration readings to determine if any contaminant gases are present
- ◆ Turn on all fans and the gas detection device to make sure they work
- ◆ Start volatilizer and heat water to 200 °F or above
- ◆ Place fumigant cylinder with gas introduction line on scale and take initial weight reading. Make sure the gas introduction line is attached to the cylinder. After obtaining the correct weight, subtract the dosage to be introduced into the enclosure. When the entire dosage has been introduced, the scale will be balanced.
- ◆ Check to make sure the ship's gangway and areas to be fumigated are properly placarded and the area is secured. A guard should be present at the entrance to the gangway to restrict access to the ship. If the crew has been removed, walk through the quarters and other areas to make sure no one is aboard.
- ◆ Check all sealed areas to make sure they are securely taped and free from holes
- ◆ Check the gas introduction line connections to make sure they are tight
- ◆ Check to make sure all safety equipment is available and in working order

## Conducting the Fumigation

### Step 1—Introducing the Gas



PPQ Officers must wear the SCBA anytime they are within 30 feet of area being fumigated. You and the fumigator both must use SCBA while introducing the gas, checking for leaks, and when taking aeration readings.

Turn on all fans while introducing the gas. When using large cylinders of MB, have the fumigator slightly open the valve then close the valve. Using an APHIS-approved leak detection device, check all connections on the gas introduction line for leaks. If leaks are found, have the fumigator tighten the connections and repeat the test. If no leaks are found, have the fumigator open the valve to the point where 3 to 4 pounds of MB are being introduced per minute. The gas introduction line should always feel hot and the volatilizer must read at least 150°F.



Do not touch the introduction line with your bare hands—you may get burned! Have the fumigator close the cylinder valve once the proper dosage has been introduced.

The fumigation time begins when all the gas has been introduced. Record the time gas introduction was started and completed in Block 32 on the PPQ Form 429.

If using the electronic 429 database, record the fumigation date, gas introduction start and finish time in the corresponding fields under the "GAS INTRODUCTION" heading on the Treatment form.

Run the fans for 30 minutes after all the gas has been introduced. Take the initial concentration reading 30 minutes after all the gas has been introduced.

When using cylinders, getting the final amounts of gas out of the cylinder may take a long time. Consider taking gas readings 30 minutes after the gas is first introduced. If the gas distribution is even (all readings within 4 ounces of each other) and at an adequately high concentration, then you can turn off the fans. Running the fans longer may contribute to gas leakage. Allow the remainder of the gas to discharge at its slow rate with intermittent running of the fans for dispersal.

### Step 2—Taking Concentration Readings

Take concentration readings with a gas detection device to determine the gas concentration and distribution within the area being fumigated (galley, storeroom, or cargo holds). If using a T/C, check Drierite<sup>®</sup> tubes before each reading and change Drierite<sup>®</sup> if its color is

pink. Depending upon the length of exposure period, take concentration readings at the following times after the introduction of the fumigant:

- ◆ 30 minutes
- ◆ 2 hours
- ◆ 4 hours
- ◆ 6 hours
- ◆ 12 hours
- ◆ 24 hours
- ◆ 48 hours
- ◆ 72 hours (for *Cochlicella*, *Helicella*, and *Monacha* spp.)

Consult the treatment schedule being used for the actual concentration readings. You may start the final concentration reading 30 minutes prior to the end of the exposure period.

Take additional readings when there is indication that the gas is not properly distributed or the minimum gas concentration is not being maintained. Record readings on PPQ Form 429.

### Step 3—Testing for Leaks

Wearing the SCBA, use an APHIS-approved leak detection device to test for leaks after all the gas has been introduced. Test around the perimeter of the area being fumigated, especially where doors, windows, pipes, electric cords, gas sampling tubes, and gas introduction lines are present. If you detect leaks, be sure they are sealed with additional tape, adhesive, or by placing more polyethylene and adhesive over the leaking areas.

### Step 4—Adding Gas and Extending Exposure

You may add gas at the following rate when concentration readings fall below the minimum:

$1.6 \times \text{number of oz. below minimum} \times \text{volume}/1,000 = \text{oz. of gas to add}$

---

EXAMPLE: You are fumigating a ship's storeroom for khapra beetle and the minimum concentration for the 2-hour reading is listed at 50 oz., but your readings average 45 oz. The volume of the storeroom is 1,500 ft<sup>3</sup>. Using the above formula, you would figure the following:

$$1.6 \times 5 \text{ (oz. below min.)} \times 1,500/1,000$$
$$8 \times 1.50 = 12 \text{ oz. gas to be added}$$

---

## Extending Exposure Period

Use **Table 2-6-2** on **page 2-6-12** to determine how long to extend the exposure period:

**TABLE 2-6-2: Determine Time for Extended Exposure**

If the exposure time is:	And the reading is below minimum by:	Then extend exposure:
Less than 12 hours	10 oz. or less	10 percent of the time lapse since the last reading
	11 oz. or more	30 minutes
12 hours or more	10 oz. or less	10 percent of the time lapse since the last reading
	11 oz. or more	2 hours or 10 percent of time lapse since last reading, whichever is greater

### Step 5—Exhausting the Gas

Exhaust the gas at the completion of the exposure period. If the treatment schedule is a FIFRA Section 18 Exemption, then the PPQ Officer must monitor the aeration of the fumigated area. Use **Table 2-6-3** on **page 2-6-12** to determine who should monitor the aeration of the fumigated area:

**TABLE 2-6-3: Determine the Responsibility for Monitoring the Aeration**

If the treatment schedule is:	Then:
A FIFRA Section 18 Exemption	PPQ must MONITOR the aeration of the commodity. FOLLOW “Aerating the Hold or Storeroom” steps which follow.
A labeled treatment	RELEASE the fumigation to the fumigator and RELEASE the ship.

Removal of the fumigant from cargo holds is facilitated by using an outside blower to force fresh air through portable canvas, plastic, or similar ducts. Another method is to use compressed air hoses to force fresh air into the bottom of the hold. Use fans or blowers within the fumigated space to help aerate the hold. Use suction type fans with portable ducts to evacuate gas from storerooms to outside, downwind areas away from crew areas, preferably on the offshore side of the ship. Do not point the ducts upward, since dissipation onto the deck may occur. Use the ship’s aeration/ventilation equipment if possible. Make sure that use of ship’s equipment will not distribute the exhausted gas to other areas within the ship.



---

## Aerating the Hold or Storeroom

### Step 1—Securing the Area

Assuming that the fumigation access is restricted and the area is secured, restrict access to the area where the exhaust duct extends beyond the enclosure. During the first 10 minutes of aeration, there should be no one within 200 feet of the exhaust duct outlet. When securing the duct outlet area, consider the direction of the wind. Face the duct outlet toward an open area, and away from people. Point the duct outlet upward to aid in dispersing the exhausted gas.

Have the fumigator use a physical barrier such as ropes, barricades, or walls to secure the area.

Placard the secure area near the exhaust outlet with the appropriate DANGER/PELIGRO signs. Make sure the placards meet the appropriate fumigant label or labeling requirements. The skull and crossbones should be present as well as “AREA UNDER FUMIGATION, DO NOT ENTER/NO ENTRE”; date of the fumigation; name of the fumigant used; and the name, address, and telephone number of the fumigator.

Unless you authorize their use, do *not* allow motorized vehicles to operate within the secure area.

### Step 2—Aerating the Area

Wearing the SCBA, advise the fumigator to open doors, hatches, tarpaulins, and areas to facilitate aeration. Start the exhaust system (minimum 3,500 cfm exhaust fan connected to an exhaust duct) and aerate the hold or storeroom.

### Step 3—Taking Concentration Readings to Determine When to Release the Ship

Stop the aeration fans. While wearing SCBA, take a concentration reading with a colorimetric tube in the airspace within the storeroom or hold. If the concentration is above 5 ppm, but less than 100 ppm, continue aeration.

Record the date, concentration reading, and time on PPQ Form 429. If using the electronic 429 database, record the time and detector reading (in ppm) in the corresponding fields on the "Detector Readings" form.



# 2

Treatment Manual

## Chemical Treatments

### *Fumigants • Methyl Bromide • Structure Fumigation*

---

#### Contents

Methods and Procedures	<a href="#">page-2-7-1</a>
Materials Needed	<a href="#">page-2-7-1</a>
PPQ Officer Provides	<a href="#">page-2-7-1</a>
Fumigator Provides	<a href="#">page-2-7-2</a>
Taking Safety Measures When Fumigating Structures	<a href="#">page-2-7-3</a>
Preparing to Fumigate	<a href="#">page-2-7-3</a>
Conducting the Fumigation	<a href="#">page-2-7-12</a>
Aerating the Enclosure	<a href="#">page-2-7-15</a>

---

#### Methods and Procedures

The procedures in this section provide guidelines for the methods, responsibilities, and precautions for structure fumigation. These procedures relate to structure fumigation primarily for khapra beetle.

In general, structure fumigations present problems not encountered in other types of fumigations. The large amount of gas required and the fact that the structure configurations vary from structure to structure make it essential that experienced fumigators and PPQ officers with extensive fumigation experience perform structure fumigations.

---

#### Materials Needed

##### PPQ Officer Provides

- ◆ Calculator (optional)
- ◆ Colorimetric tubes (Draeger/Kitagawa)
- ◆ Desiccant (Drierite®)
- ◆ Forms (PPQ Form 429 and APHIS Form 2061 if necessary)
- ◆ APHIS-approved leak detection device
- ◆ SCBA or supplied air respirator
- ◆ Tape measure
- ◆ APHIS-approved gas detection device<sup>1</sup>
- ◆ Thermometer

## Fumigator Provides

- ◆ Adhesive sealer, tape, and putty or other pliable material for sealing off holes around pipes
- ◆ Auxiliary pump for purging long gas sample tubes
- ◆ Carbon dioxide filter (Ascarite®)
- ◆ Colorimetric tubes (Draeger/Kitagawa)
- ◆ Device for adding nitrogen into MB cylinders
- ◆ Electrical wiring (ground, permanent type), three prong extension cords
- ◆ Exhaust blower and ducts
- ◆ Fans (circulation, exhaust, and introduction)
- ◆ Framework and supports
- ◆ Gas sampling tubes (leads)
- ◆ Gas supply line
- ◆ Heat supply
- ◆ Insecticides and spray equipment
- ◆ Methyl bromide
- ◆ Padding
- ◆ Portable generator as backup unit to operate gas detection device, auxiliary pump, and lights
- ◆ Sand or water snakes
- ◆ Scales or dispensers
- ◆ SCBA or supplied air respirator
- ◆ Tape
- ◆ Tarpaulin and supports
- ◆ APHIS-approved gas detection device
- ◆ Volatilizer
- ◆ Warning signs

---

1 The gas detection device must be calibrated annually. Contact the Center for Plant Health Science & Technology (CPHST) (919-855-7450) in Raleigh, North Carolina, for calibration information.

## Taking Safety Measures When Fumigating Structures

The most important consideration when fumigating structures is the protection of human life. The commercial fumigator has the following safety responsibilities when fumigating structures:

- ◆ Observe all safety precautions while fumigating
- ◆ Prevent access of unauthorized personnel to the fumigated area
- ◆ Conduct fumigation properly to result in an effective treatment
- ◆ Evacuate gas from the structure and aerate when fumigation is completed
- ◆ Test, with a gas detector, the fumigated areas within the structure to ensure freedom from MB before allowing access to the fumigated areas

The commercial fumigator must abide by the following guidelines when fumigating structures:

- ◆ Have a representative present throughout the entire fumigation. The representative should be familiar with the directions for using the fumigant, warnings, antidotes, etc., shown on the label, on the gas cylinder, and contained in the manufacturer's application manual.
- ◆ Have adequate first-aid equipment, SCBA, and other safety equipment available
- ◆ Have all fumigated areas and any adjoining areas that were not fumigated tested with a gas detector prior to worker reentry
- ◆ Contact all necessary local and State authorities (fire, police, etc.)

---

## Preparing to Fumigate

### Step 1—Determining Type of Treatment Required

Consider the following factors in selecting a treatment for the structure:

- ◆ Type of commodities involved (e.g., grain, spices, or flour)
- ◆ Degree of infestation (light, moderate, heavy)
- ◆ Potential risk of spread from infestation
- ◆ Nature of the business—business shipping materials that could spread pest (e.g., a spice wholesaler or specialty foods distributor)

- ◆ Availability of food supply—is food available or is the find incidental
- ◆ Type of structure(s) infested
- ◆ Environmental conditions—warm, humid areas favor reproduction

In locations where reproduction occurs, or the potential for reproduction exists (warm temperature, humidity, and available food supply), seriously consider fumigation. Fumigation is not mandated every time an infestation is found.

In locations where reproduction is not occurring or the potential for reproduction does not exist (unfavorable temperature, low humidity, and no available food supply), consider using alternative treatments.

Make the final determination of which type of treatment to use with the concurrence of the following:

- ◆ PPQ line (Officer in Charge and Regional Director)
- ◆ PPQ staff (Riverdale/Raleigh (CPHST))
- ◆ Responsible State regulatory official

Options consist of the following:

- ◆ Complete Property Fumigation and Treatment (Category 1)
- ◆ Selective Property Fumigation and Treatment (Category 2)
- ◆ Interior Fumigation (Category 3)
- ◆ Alternate Treatment (Category 4)
- ◆ Selective Property Fumigation plus Alternative Treatments (Category 5)

The following is a detailed description of each of the above options:

### **Category 1—Complete Property Fumigation and Treatment**

Fumigate all structures of similar usage on a single property. Place all structures under a gastight tarpaulin(s) and fumigate with MB.

Spray the area surrounding the structure(s) within the confines of the property at least twice with a registered malathion formulation. Make the last application after covering the structure(s) with the tarpaulin.

Free the surface area of all debris by raking or sweeping all debris toward the structure, include the debris under the cover.

Depending upon local conditions as determined by the PPQ Officer in Charge and the responsible State regulatory official, you may unconditionally release the structure after fumigation or hold the release until a series of inspections are conducted as outlined in Category 2.

### **Category 2—Selective Property Fumigation and Treatment**

This treatment is similar to Category 1 except not all structures of related usage are fumigated and the fumigation is followed by at least three inspections of the entire property.

Notify the owner of the establishment in writing on the PPQ Form 523 (Emergency Action Notification) of the inspection requirement prior to fumigating any structures (see [Appendix A](#) on **page A-1-1**). To verify success of this treatment, conduct at least three inspections of the entire property within 1 year. In the Northeast and other cooler regions, inspections must extend through two summer seasons when khapra beetles are active. Allow at least 90 days to elapse between inspections. Make the last inspection within 30 days of the time the structure is to be released.

### **Category 3—Interior Fumigation**

Treat all structures on the premises or only those structures known to be infested. Use interior fumigation when conditions make the use of complete fumigation impractical. Conduct three inspections of the property after the fumigation has been completed.

This method of fumigation is less desirable because khapra beetles may crawl into cracks, crevices, and other openings on both the interior and exterior of an infested structure. Seal all openings in the structure with masking tape, putty, polyethylene, or other materials from the outside of the structure. Make the structure as airtight as possible without sealing out any areas that may harbor khapra beetle.

Spray the area surrounding the structures or the structures within the confines of the property at least twice with a registered malathion formulation. Make the last application after sealing the structure prior to fumigation. Free the surface area of all debris by raking or sweeping all debris toward the building. Include the debris in the fumigated structure.

Notify the owner of the establishment in writing on the PPQ Form 523 (Emergency Action Notification) of the inspection requirement prior to fumigating any structures (see [Appendix A](#) on **page A-1-1**). To verify success of this treatment, conduct at least three inspections of the entire property within 1 year. In the Northeast and other cooler regions, inspections must extend through two summer seasons when

khapra beetles are active. Allow at least 90 days to elapse between inspections. Make the last inspection within 30 days of the time the structure is to be released.

#### **Category 4—Alternative Treatment**

Use alternative treatments in infested properties where little or no regulatory hazard exists (little or no chance for the pest to escape and spread). Typically, such properties may include unused structures or buildings, facilities that do not handle commodities or materials of regulatory significance, or facilities that by the nature or type of operation or for other reasons do not pose a regulatory hazard as a result of the commerce conducted there.

Alternative treatments include either a crack and crevice or broadcast application of a registered or exempt pesticide (including approved cleaning and sanitation prior to treatment) and may include one or more of the following procedures:

- ◆ Extensive trapping program utilizing adult and larval traps treated with both an attractant and an insecticide
- ◆ Insecticide-treated bait
- ◆ Intensive, repeated inspection program augmented by intensive larval and adult trapping
- ◆ Specified sanitation program

Apply one or more of the above treatments when the Port Director, Plant Health Programs in Riverdale, and the responsible State regulatory official believe treatment will result in eradication and no regulatory hazard.

#### **Category 5—Selective Property Fumigation Plus Alternative Treatments**

Fumigate selected structures with related usage on a single, infested property. Apply one or more alternative treatments to all structures which are on the property and are not fumigated.

#### **Step 2—Issuing a PPQ Form 523 (Emergency Action Notification)**

Once an infestation of khapra beetle is identified and confirmed by a PPQ area identifier, issue a PPQ Form 523 (Emergency Action Notification) to the owner of the premises, except when treatment is ordered under State or county regulations. Follow instructions in Appendix 1 for completing and distributing PPQ Form 523 (Emergency Action Notification).

Be sure to document the treatment selected plus any alternative treatments, inspections, and safeguards to be applied.



### Step 3—Conducting Prefumigation Conference

Fumigating a structure presents problems not usually encountered in other types of fumigations. The quantity of fumigant, supplies, equipment needed, and the variations in building configurations make it essential that experienced commercial fumigators and PPQ officers conduct structure fumigations.

Arrange a meeting with the fumigator to discuss the conditions of the treatment. Discuss the following items:

- ◆ Accurate cubic capacity (volume) measurement of the enclosure
- ◆ Fumigation schedule to be used
- ◆ Adequate tarpaulin material—polyethylene or equivalent tarpaulin of 6 mil or greater thickness
- ◆ Electrical power source sufficient to operate circulation fans and gas detection device
- ◆ Gas sampling tubes—types and number
- ◆ Auxiliary air pump—to quickly draw samples through gas sampling tubes
- ◆ Pedestal-type fans for fumigant distribution and aeration
- ◆ Sufficient quantity of fumigant for initial dosage plus an additional amount of fumigant in case gas must be added
- ◆ Commodities involved and identification of materials that may be adversely affected by the fumigant (see **Fumigants • Methyl Bromide** on **page 2-3-1** for a list of commodities). Advise the property owner of any possible adverse effects. Articles or materials that may be damaged should be subjected to an alternate treatment if possible. Office furniture and equipment with foam rubber can be affected and should be removed. Computer equipment may have to be completely sealed with polyethylene and a positive pressure maintained within the sealed enclosure during the exposure period
- ◆ Provide a sheltered area for taking gas concentration readings. The area should be located a safe distance (30 feet or more) from the enclosure. All gas sampling tubes and the electrical source should be located within the sheltered area
- ◆ Structure and commodities aeration
- ◆ Final release—this is the responsibility of the fumigator unless the structure contains commodities requiring a Section 18 Exemption

In addition to the above, explain to the fumigator that it is the fumigator's responsibility to perform the fumigation in a manner which meets required treatment schedule, treatment procedures, and

pest safeguards prescribed by the PPQ officer. The fumigator is also responsible for meeting all Federal, State, and local regulations. The fumigator must notify local fire, police, and health officials as required. The fumigator is also responsible for making arrangements for utility services such as electricity, telephone, and water.

Your responsibility is to determine that the prescribed procedures are followed, actually checking volume and dosage calculations, dosage applications, and that the required gas concentrations are maintained. When food commodities are involved, you must notify the local Food and Drug Administration (FDA) office so they can collect residue samples if they deem it necessary.

#### **Step 4—Preparing Areas for Fumigation**

In order to ensure uniform gas distribution and penetration, you may require commodities within the structure to be restacked. Place dense commodities such as flour and similar bagged commodities on pallets or other supports to improve gas circulation.

In the outside surrounding area, rake the surface area of all debris by raking the debris toward the structure.

#### **Step 5—Arranging and Operating Fans**

Use fans capable of 2,500 cfm or greater during gas introduction and for 30 minutes following gas introduction. Extend fan operation only if gas distribution is inadequate (concentration readings vary more than 4 oz.), or you need to add gas. If you must operate fans after the 30-minute reading, do so for the least amount of time required to get equal gas distribution.

Placing fans is largely determined by the configuration of the structure and the absence or presence of cargo, its nature, and quantity. Pedestal fans are preferred for large structures. Direct fan air movement upward to complement other fans and assure even gas distribution in every area of the enclosure. There is no definitive rule for determining the proper number of fans, but both you and the commercial fumigator must be satisfied that circulation will be adequate for both gas introduction and recirculation. Extremely tall buildings may require fans at several levels to ensure gas distribution to the top of the structure. Arrange the electrical source and extension cords of the fan system so the fans can be turned on and off individually from the outside of the enclosure.

#### **Step 6—Placing Gas Sampling Tubes**

Place gas sampling tubes in areas and commodities which will give representative samples of the gas concentration within the fumigated area. All gas sampling tubes must be 0.25 inch interior diameter polyethylene tubing.

The recommended number of sampling tubes is as follows:

**TABLE 2-7-1: Determine the Number of Sampling Tubes**

If the size of the enclosure is:	Then use:
500,000 ft <sup>3</sup> or less	Six sampling tubes for the first 100,000 ft <sup>3</sup> , and Add one tube for each additional 50,000 ft <sup>3</sup>
Greater than 500,000 ft <sup>3</sup>	Fourteen sampling tubes for the first 500,000 ft <sup>3</sup> , and Add one tube for each additional 200,000 ft <sup>3</sup>

In addition to the number of sampling tubes described above, you must place sampling tubes within commodities stored in the structure. Place the sampling tube as near as practical to the center of the packaging (e.g., boxes, bags, or bins). Before placing the sampling tube in the commodity, wrap a piece of burlap over the end of the sampling tube and secure the burlap to the tube with tape.

Use a minimum of three tubes for the first 10,000 ft<sup>3</sup> of commodity. Use additional tubes to assure sampling of all types of tightly packed and difficult to penetrate commodities. Take care in placing sampling tubes to avoid clogging or pinching. Label each sampling tube with the location. Indicate if tube is in a commodity prior to fumigation and at the point where the concentration readings will be taken. For safety purposes, the gas sampling tubes should extend a minimum of 30 feet upwind from the enclosure. You should have extra tubing on hand to extend beyond 30 feet if necessary.

### Step 7—Measuring the Temperature

Using a calibrated thermometer, take temperature readings of the air (space) and of the commodity. Record the temperatures in Block 22 on the PPQ Form 429.

If using the electronic 429 database, record the temperatures in the space and commodity fields in the Treatment form.

If the temperature is below the minimum listed for the treatment schedule, then you will have to heat the space to be fumigated or wait until the temperature rises to the level required by the schedule treatment.

### Step 8—Sealing the Structure

Depending on the method of fumigation, interior fumigation or tarpaulin fumigation, the effort required in this step will vary greatly.

## Tarpaulin Fumigation

Locate and seal all openings which have the potential to leak gas. Since the entire structure will be tarped, do not cover openings to the exterior of the structure such as doors, windows, and air vents. Look for and seal all openings which may lead outside the structure such as manhole covers, drain pipes, and vent pipes. Seal these types of

openings with polyethylene, tape, putty, or a combination of these materials. Do **not** seal out recessed areas, ducts, or similar areas which may harbor an infestation.

The structure or portion to be fumigated must be transformed into a gastight fumigation enclosure. This is accomplished by covering the entire structure with a 6 mil or greater, polyethylene tarpaulin. Tarpaulins may be joined together with mastic and tape or rolled and clamped together.

Have padding, such as burlap, placed on all corners of the structure and in any area where the tarpaulin may rub against rough or sharp edges of the structure.

## Interior Fumigation

One of the most important steps in preparing for a structure interior fumigation is sealing all openings and areas which have the potential to leak gas. Consider the entire area to be fumigated as a natural atmospheric chamber and make the area as gastight as possible. The most important task is to locate all openings (e.g., drain pipes, or air ducts) and seal them.

Do **not** seal out or make gastight recessed areas, ducts, or similar apertures which may harbor infestations. In some cases, it is better to seal sources of leaks from the outside of the area to be fumigated. Use caulk compound or tape for sealing small spaces. For sealing larger areas, use polyethylene or similar material secured with tape or adhesive spray. Seal doors and other openings with either polyethylene or spray with vinylite plastic. When practical, seal air ventilation ducts on the outside of the space being fumigated so sealing tape can be removed when you get ready to evacuate the gas and begin aeration. Large openings should be covered with polyethylene and securely taped.

### Step 9—Measuring Volume

For rectangular and square shaped buildings, multiply the length, width, and height. If the buildings are irregular, the volume of each unit can best be calculated separately and then added together.

### Step 10—Calculating Dosage

The formula for calculating dosage is:

$$\begin{aligned} \text{dosage(lbs.)} &= \text{volume(ft}^3\text{)} \times \text{dosage rate(lbs./1,000 ft}^3\text{)} \\ &= \frac{\text{volume(ft}^3\text{)} \times \text{dosage rate(lbs.)}}{1,000 \text{ ft}^3} \end{aligned}$$

---

EXAMPLE: A structure infested with khapra beetle has a volume of 100,000 ft<sup>3</sup>. The space and commodity temperature is 65°F. The treatment schedule requires 6 lbs. MB/1,000 ft<sup>3</sup> at 65°F. To calculate the dosage multiply the volume (100,000 ft) by the dosage rate (6 lbs. MB/1,000 ft). This equals 600 lbs. of MB needed for the dosage.

---

### Step 11—Placing the Gas Introduction Line(s)

Introduce MB from the outside of the building with the introduction line going under the tarpaulin and directly into the airstream in front of a fan. Use the “hot gas” method of gas introduction by passing the fumigant through volatilizers after it leaves the cylinders. Depending upon the size of the structure being fumigated, you may want to have several gas introduction lines going into the structure to shorten the time required for gas introduction. Attach introduction lines to the top of the fans to prevent movement of the hose. Place a piece of nonpermeable sheeting (e.g., plastic or rubberized canvas) over the commodity in front of and below each gas introduction line. The sheet will prevent any liquid MB from coming in contact with the cargo and will prevent damage.

The other option of gas introduction is to release MB from inside the building. If this option is selected, cylinders should be placed by a team of two people and the location of each cylinder in the building should be mapped. The cylinders should be arranged so that fumigators can walk away from the released gas as they open each subsequent cylinder.

Because MB is heavier than air, it is advisable to increase slightly the amount of gas released on the top floor. Cylinders should be placed within a room for best distribution into all areas. Cylinders should be placed in an upright position and the shipping caps removed.

Because MB is heavier than air, it is advisable to attach standpipes (or curved pipes directed slightly upward) to the cylinder valves in order to reduce stratification at lower levels in the structure. If standpipes are used, they should be equipped with “T” fittings to direct the gas laterally and to prevent direct contact with the ceiling.

If the “inside release” option is used, provision must be made to have equipment in place to use the gas method of hot gas introduction to add fumigants as necessary to all areas of the structure.

You must be present during the introduction of the fumigant to ensure that the correct dosage is introduced into the enclosure.

### Step 12—Making a Final Check

Just before introducing the gas, you and the fumigator must do the following:

- ◆ Make sure building is clear of all personnel and animals
- ◆ Make sure all areas requiring sealing are sealed
- ◆ Check the placement and identification of gas introduction lines and gas sampling tubes
- ◆ Turn on all fans and gas detection device to make sure they work

- ◆ Check that the tarpaulin is placarded with warning signs on all sides of the building
- ◆ Take gas readings to determine if any contaminant gases are present (contaminant gases may affect concentration readings)
- ◆ Check that all gas sampling tubes are labelled and not crimped or crushed by attaching to gas detection device and watch the air flow meter to ensure that air is getting through
- ◆ Check that there is enough gas for dosage and additional gas in case you need to add gas
- ◆ Start volatilizer and heat water to at least 200 °F or above
- ◆ Place fumigant cylinders with gas introduction line on scale and take initial weight reading. Make sure the gas introduction line is attached to the cylinder. After obtaining the correct weight, subtract the dosage to be introduced into the enclosure. When you have introduced the proper amount of gas, the scale will be balanced
- ◆ Check gas introduction line connections to make sure they are tight
- ◆ If using a T/C, install Drierite<sup>®</sup> tube on gas sampling lines of T/C unit making sure the Drierite<sup>®</sup> granules are blue in color and have not turned pink
- ◆ Make sure all safety equipment is present and in working order

---

## Conducting the Fumigation

### Step 1—Introducing the Gas



You and the fumigator must wear the SCBA whenever:

- ◆ Concentration exceeds 5 ppm
- ◆ The concentration level is unknown, as with spills, leaks, and other emergencies
- ◆ Introducing gas
- ◆ Checking for leaks
- ◆ Taking aeration readings

In addition, the PPQ Officer must wear SCBA when they are within 30 feet of the enclosure.

Turn on all fans before introducing the gas. When using large cylinders of MB, have the fumigator slightly open the cylinder valve then close the valve. Using an APHIS-approved leak detection device, check all connections on the gas introduction line for leaks. If leaks

are found, have the fumigator tighten the connections and repeat the test. Also, check all areas which are sealed. If you find a leak and it cannot be readily corrected, evacuate this partial dosage and reseal the area. If no leaks are found, then open the valve to the point where 3 to 4 pounds of MB are being introduced per minute. The gas introduction line should always be hot and the volatilizer should read at least 150°F.



Do not touch the introduction line with your bare hands—you may get burned! Close the cylinder valve once the proper dosage has been introduced.

The fumigation time begins once all the gas has been introduced. Record the time gas introduction was started and completed in Block 32 on the PPQ Form 429.

If using the electronic 429 database, record the fumigation date, gas introduction start and finish time in the corresponding fields under the "GAS INTRODUCTION" heading in the Treatment form.

Run the fans for 30 minutes after all gas has been introduced. You will take the initial concentration reading 30 minutes after all the gas has been introduced.

When using large cylinders, getting the final amount of gas out of the cylinder may take a long time. Using a pressurized cylinder will shorten the time. Consider taking a gas reading 30 minutes after the gas was first introduced. If the gas distribution is even (all readings within 4 oz. of each other) and at a sufficiently high concentration, then turn off the fans. Running the fans longer may contribute to gas leakage. Allow the remainder of the gas to discharge at its slow rate with intermittent running of the fans for dispersal.

### Step 2—Testing for Leaks

Wear the SCBA while checking for leaks. Use an APHIS-approved leak detection device to test for leaks before the 30-minute reading. Test around the perimeter of the tarpaulin on the ground, corners, and especially where electric cords, gas sampling tubes, or gas introduction lines are present. If you detect leaks, be sure they are sealed by using more sand or water snakes for floor leaks and tape for small holes in the tarpaulin.

### Step 3—Taking Concentration Readings

Take concentration readings with a gas detection device to determine the gas concentration and distribution within the enclosure. Check Drierite® tubes before each reading and change Drierite® if its color is pink. Depending on the length of exposure period, take concentration readings at the following times after the introduction of the fumigant:

- ◆ 30 minutes
- ◆ 2 hours
- ◆ 4 hours
- ◆ 6 hours
- ◆ 12 hours
- ◆ 24 hours
- ◆ 36 hours
- ◆ 48 hours
- ◆ 72 hours

All times are after gas introduction is completed.

Use an auxiliary air pump when there are many gas sampling tubes or the gas sampling tubes are very long. The auxiliary air pump will lessen the time required to draw gas to the gas detection device.

You may start the final reading 30 minutes to 1 hour prior to completion of the exposure period. If final gas concentration levels meet minimum levels, start aeration immediately at the end of the exposure period.

### Additional Readings

Adverse weather conditions may indicate the need for additional readings. Sorptive commodities and indications of a steady decline in gas concentration also indicate the need to take additional concentration readings.

#### Step 4—Adding Gas

For concentration readings below minimum levels, add gas at the following rate:

$$1.6 \times \text{number of oz. below} \times \text{volume}/1,000 = \text{oz. of fumigant to add}$$

Once you've determined that you need to add gas, follow the same procedures as introducing the gas (Step 1). That is—

1. Heat water in the volatilizer to at least 200 °F.
2. Turn on the fans.
3. Weigh the cylinder.
4. Use your SCBA.
5. Open valve on cylinder and introduce the gas.
6. Close valve when the weight of the cylinder indicates that the needed amount of gas has been added.



7. Record quantity of fumigant added in Block 34 on the PPQ Form 429.
8. If using the electronic 429, record the amount of additional gas added in the "Additional Gas Recommended" field and the additional fan time in the "TIME FANS OPERATED" field in the Treatment form.

Note the time you started introducing additional gas and the time you finished introducing gas and record in Block 40 (Remarks) on the PPQ Form 429 or in the "Remarks" form in the electronic 429 database. Run the fans until you get even gas distribution throughout the enclosure. Turn off the fans, then take a concentration reading 30 minutes after you complete introducing the gas. If all readings are above minimum concentration levels, then proceed as usual with the remainder of the concentration readings. If gas is not evenly distributed (readings not within 4 oz. of each other), then run fans until you get gas evenly distributed.

### Step 5—Exhausting the Gas

Exhaust the gas at the completion of the exposure period. The aeration of the structure and the final release to the owner is the responsibility of the commercial fumigator unless under a Section 18 Exemption. Exhausting the fumigant is facilitated by partially removing the tarpaulin and the use of suction fans which are supplied with ducts leading from the enclosure to the outside. The fumigant should be evacuated to the outside, downwind areas of the enclosure. The fumigator must be certain that the removal of the covers and ventilation is done in a manner that minimizes the hazard from the released gas.

## Aerating the Enclosure

**TABLE 2-7-2: Determine the Responsibility for Monitoring the Aeration**

If the treatment schedule is:	Then:
A FIFRA Section 18 Exemption	MONITOR the aeration of the commodity. FOLLOW "Aerating the Enclosure" steps which follow.
A labelled treatment	RELEASE the commodity and RELEASE the fumigation to the fumigator.

### Step 1—Securing the Area

Assuming that you've already restricted access and secured the fumigation area, you now must restrict access to the area where the exhaust duct extends beyond the enclosure. During the first 10 minutes of aeration, there should be no people within 200 feet of the exhaust duct outlet. When securing the duct outlet area, consider the

direction of the wind. Face the duct outlet toward an open area and away from people. Point the duct outlet upward to aid in dispersing the exhaust gas.

Have the fumigator use a physical barrier such as ropes, barricades, or walls to secure the area.

Placard the secure area near the exhaust outlet with the appropriate DANGER/PELIGRO signs. Make sure the placards meet the appropriate fumigant label or labeling requirements. The skull and crossbones should be present as well as “AREA UNDER FUMIGATION, DO NOT ENTER/NO ENTRE”; date of the fumigation; name of the fumigant used; and the name, address, and telephone number of the fumigator.

Unless you authorize their use, do **not** allow motorized vehicles to operate within the secure area.

### Step 2—Aerating the Structure

Wearing the SCBA, have the fumigator open slightly the opposite end of the enclosure to allow entry of fresh air. The fumigator may open doors, tarpaulins, and areas to facilitate aeration. Start the exhaust system (minimum 2,500 cfm exhaust fan connected to an exhaust duct) and aerate the structure.



The PPQ officer is not required to be continuously onsite during the entire aeration unless specified by the label, Section 18 Exemption, or State or local regulations. The officer must verify the gas concentration levels before removal of the tarpaulin and final release of the structure.

### Step 3—Taking Concentration Readings

Stop the aeration fans. Take a concentration reading with a colorimetric tube in the exhaust duct within the enclosure. If the concentration is above 5 ppm but less than 100 ppm (for MB), the fumigator may remove the tarpaulin while wearing the SCBA. Release the structure when the concentration is 5 ppm or less. Record the date, concentration reading, and time on PPQ Form 429. If using the electronic 429 database, record the time and detector reading (in ppm) in the corresponding "Detector Readings" form.

# 2

Treatment Manual

## Chemical Treatments

*Fumigants • Methyl Bromide • Special Procedures for Container Fumigations Without a Tarpaulin*



**Important**

Effective February 25, 2008, tarpless container fumigations for quarantine purposes conducted under APHIS supervision are no longer authorized. This suspension remains in effect until further notice from the APHIS-PPQ Quarantine Policy and Analysis Support Staff (QPAS.) All container fumigations must be conducted under tarpaulin.



# 2

Treatment Manual

## Chemical Treatments

### *Fumigants • Sulfuryl Fluoride*

#### Contents

Properties and Use	page-2-9-1
Leak Detection	page-2-9-2
Tarpaulin Fumigation	page-2-9-2
Sealing	page-2-9-2
Circulation	page-2-9-3
Prevention of Condensation	page-2-9-3
Gas Sampling Lines	page-2-9-3
Gas Introduction	page-2-9-4
Dosage Rate	page-2-9-5
Measure Gas Concentrations	page-2-9-5
Replacing Lost Gas	page-2-9-5
Aeration	page-2-9-5
Structural Fumigation	page-2-9-6
Chamber Fumigation	page-2-9-6
Shipboard Fumigation	page-2-9-6
Safety and First Aid	page-2-9-7
Protective Clothing	page-2-9-7
If SF Is Inhaled	page-2-9-7
If Liquid SF Is Spilled on the Skin	page-2-9-7
If Liquid SF Is in the Eyes	page-2-9-7

Consult the Vikane<sup>1</sup> Gas Fumigant label and Structural Fumigation Manual for more detailed instructions and additional supportive information.

#### Properties and Use

Sulfuryl fluoride (SF) is a compressed-gas fumigant which is used primarily against insects that attack wood. The following characteristics make this fumigant especially desirable:

- ◆ 2.88 times heavier than air
- ◆ High vapor pressure — 13,442 mm Hg @ 770°F
- ◆ Low solubility in water and low sorption by soil or commodity
- ◆ Odorless, colorless, and nonflammable
- ◆ Penetrates wood better than any other commercial fumigants, including methyl bromide
- ◆ Relatively nonreactive

1 Trademark of Dow Agro Sciences

- ◆ Very low loss through plastic tarpaulins

SF boils at minus 67°F. SF is not registered for use on foodstuffs or on living plant material.

SF is effective at very low dosages on Drywood termites where control of the adult stage is the only concern (typically 0.5 to 1.0 lbs/1,000<sup>2</sup>). Higher dosages are required for control of the egg stage of other insects (typically 3 to 5 lbs/1,000<sup>2</sup>). Consult treatment schedules in this manual for specific dosages.

---

## Leak Detection

Interscan (Model GF 1900) or Miran gas analyzers (these units are portable) may be used to detect SF in the range of 0 to 150 ppm respectively. Consult the Vikane Structural Fumigation Manual for further instructions. Colorimetric (“detector”) tubes are not available for detecting SF gas leaks around tarpaulins, chambers, and application equipment.

---

## Tarpaulin Fumigation



Refer to the section for tarpaulin fumigation with methyl bromide for additional information on the following:

- selecting fumigation sites
- placing gas sampling lines
- sealing tarpaulins
- taking concentration readings
- securing fumigation areas



Refer to the PPQ Treatment Manual section on **Fumigants • Methyl Bromide • Tarpaulin Fumigation** on **page 2-4-1** (and aeration), the Vikane label, and Vikane Structural Fumigation Manual for a detailed discussion of proper procedures.

### Sealing

The commodity to be fumigated should be placed onto a relatively even and non-porous surface, such as concrete, asphalt, or macadam. Special attention should be given to the seal along the ground or floor. The inspector should have tape, sand, or water snakes properly positioned.

### **Circulation**

Fans are necessary to distribute SF and to help prevent condensation. The number of fans depends upon the cubic volume of the enclosure being treated, and the arrangement of cargo. Axial fans of approximately 5,000 cfm have proven effective. Usually 2 fans are used, one on either end facing the lower center and upper center of the load. If the enclosure is over 35 feet long, additional fans should be used. It is usually not necessary to run fans longer than 15 minutes after the gas has been introduced.

### **Prevention of Condensation**

In cool weather, moisture may condense under tarpaulins if the sun is shining directly on the load. Continuous air circulation can prevent this from occurring. Do not tarp or seal any item while it is wet.

### **Gas Sampling Lines**

A thermal conductivity unit calibrated for Vikane must be available for readings. Sampling lines should be arranged so that gas samples are drawn from representative parts of the fumigation area and lead to a common point.

A minimum of 3 sampling lines should be placed in enclosures of up to 10,000 ft<sup>3</sup> at the following locations:

- ◆ Front of the load, 3 inches from the floor
- ◆ Center of the load, midway from the bottom to the top of the load
- ◆ Rear of the load, at the top.

When 10,000 to 15,000 ft<sup>3</sup> are being treated, 2 additional lines should be appropriately deployed.

## Gas Introduction

Unlike methyl bromide, SF does not require the use of a volatilizer to speed up its conversion from a liquid to a gas. The gas introduction tube should be placed directly in the air flow of a fan away from the cargo. Also, place a drip cloth under the tube. The introduction rate is controlled by the introduction line length and diameter. A 1/8 inch inside diameter by 100 ft long hose will allow a flow rate of approximately 2 lbs per minute while a 25 ft long hose will allow approximately 4 lbs per minute.

**TABLE 2-0-30: Effect of Hose Inside Diameter on Rate of Gas Introduction through a 25 Foot Hose**

Inside Diameter (in inches)	Pounds Vikane Per Minute
1/8	4
1/4	20
1/2	45

Approximate; dependent on pressure in cylinder.

**TABLE 2-9-1: Effect of Hose Length on Rate of Gas Introduction through a 1/8 inch Inside Diameter Hose**

Hose Length (in feet)	Pounds Vikane Per Minute
25 ft	4.0
50 ft	2.8
100 ft	2.0 <sup>1</sup>

- 1 Where fumigant introduction rates lower than 2 lbs/min are needed, a longer hose can be used, e.g., 200 ft.

It is important not to overshoot the ability of the fan to rapidly disperse the cool air near the fumigant introduction site. Fan capacity should be at least 1,000 cfm for each lb of Vikane introduced per minute. In addition, a volatilizer (heat exchanger) may be used in fumigating containers or small chambers to prevent a “fog-out” (condensation) which could cause corrosion or damage to the contents. The last few pounds of fumigant will turn to gas within the cylinder before moving out, and the flow rate will be reduced. The cylinder and tubing will often become frosted. Be certain that no open flame or glowing hot surfaces above 400°C are present since corrosive substances (mainly hydrofluoric acid) are formed when SF is exposed to such conditions. To avoid possible damage, do not apply the fumigant directly to any surface.



## Dosage Rate

To control a particular pest, locate the proper fumigation schedule to be followed in the Treatment Manual. The three variables in these schedules are temperature, dosage, and exposure duration. Treatment is not recommended below 50°F. Dosages are in pounds per 1,000 feet<sup>3</sup> of space. To determine the total amount of fumigant required by weight in pounds, divide the total volume of space by 1,000. Then multiply the resulting figure by the dosage rate schedule expressed in pounds (per 1,000 feet<sup>3</sup>). The cylinder should be placed on a scale, and the flow of gas is controlled by the valve and introduction line until the desired cylinder end-weight is obtained. The valve should be turned fully open to fill the fumigant introduction hose with liquid SF. Initially, the valve should be opened slightly until flow has begun and then opened about one full turn which should give full flow through the 1/8" fumigant introduction hose.

## Measure Gas Concentrations

During the course of fumigation, minimum concentrations must be maintained according to the schedules used. Readings on the T/C unit (Fumiscope or Gow-Mac) if not calibrated for Vikane must be multiplied by a factor to obtain the actual ounces per 1,000 feet<sup>3</sup> present. Contact the Center for Plant Health Science & Technology (CPHST) in Raleigh, North Carolina, for calibration information. Be certain that the reading without the multiplied factor is also registered on PPQ Form 429, however. Do not use filters containing sodium hydroxide (Ascarite) with SF. Fresh desiccant (Drierite) should be used with the T/C unit. Desiccant should be changed at appropriate intervals to insure accurate readings.

## Replacing Lost Gas

When it appears that additional SF will be needed, the inspector should use his best judgment to determine the amount of gas to add, according to the prevailing conditions of tarpaulin tightness or wind conditions. Usually, 1.6 oz of gas should be added for every ounce of deficiency in the minimum concentration required.

## Aeration

For detailed guidelines, consult the "Aeration" discussion elsewhere in this manual, **Fumigants • Methyl Bromide • Tarpaulin Fumigation** on **page 2-4-1**, the Vikane Gas Fumigant label, and Structural Fumigation Manual. The threshold limit value for SF is 5 ppm (20 mg/cubic meter), the same as for MB. Since no colorimetric ("detector") tubes are available for SF, a suitable instrument must be used, such as the Interscan GF 1900 or Miran (calibrated for SF).

## Structural Fumigation

Refer to the section on MB structural fumigation (or aeration) in this manual, the Vikane label, and Vikane Structural Fumigation Manual for a detailed discussion of proper procedures.

When preparing a structure for fumigation with SF, the surrounding soil should be watered thoroughly at the base of trees, shrubs, and other ornamental plants around the perimeter of the structure to prevent loss of fumigant into the soil. Watering around the plants will protect the roots; however, plants and grass closer than 1 ft may die even if this precaution is taken.

Before placing the tarpaulin over the structure, be sure to remove items for which the use of SF is not registered. These include food, feed, drugs, and medicines. Extinguish all flames (including pilot lights), unplug all heating elements, and turn off all lights. Open all internal doors.

---

## Chamber Fumigation

Refer to the section on MB chamber fumigation (and aeration) in this manual, the Vikane label, and Vikane Structural Fumigation Manual for a detailed discussion of proper procedures.



Trying to measure out a small quantity of SF in a graduated glass tube (sight gauge)—which is common practice with MB chamber fumigations—should never be attempted with SF because the cylinder pressure is much greater, and the glass gauge may explode and shatter.

The gas will generally be introduced through a volatilizer or heat exchanger in order to prevent a “fog-out” which could damage the contents. Introducing a very small amount of gas into a small chamber, however, is difficult to do with precise accuracy because the amount introduced must be calculated by weight loss from the cylinder. The scale used beneath the cylinder must be readable in ounces or grams, not just in pounds or kilograms.

---

## Shipboard Fumigation

Refer to the section on MB ship fumigation (and aeration) in this manual, the Vikane label, and Vikane Structural Fumigation Manual for a detailed discussion of proper procedures. Surface ships (only those in port) must be fumigated at dock side, and not when the vessels are underway. Shipboard fumigation is also regulated by the U.S. Coast Guard (Department of Transportation). That regulation appears as 46CFR 147A.

## Safety and First Aid

Read and understand all directions and safety precautions on Vikane label before applying. Additional information is presented in Vikane Structural Fumigation Manual. There is no known antidote for SF. Vikane is odorless. However, the chance of lethal exposure is not probable unless an individual actually enters the fumigation space. An SCBA must be worn by anyone in the fumigated areas when the level exceeds 5 ppm.

### Protective Clothing

Wear goggles or full face shield for eye protection during introduction of the fumigant. Do not wear gloves or rubber boots. Do not reuse clothing or shoes that have become contaminated with liquid SF until thoroughly aerated and cleaned.

### If SF Is Inhaled

An individual who has inhaled high concentrations of SF may exhibit the following symptoms:

- ◆ Difficulty breathing
- ◆ Dulled awareness
- ◆ Nausea
- ◆ Numbness in the extremities
- ◆ Slowed body movements
- ◆ Slowed or garbled speech

If any of the above symptoms appear, immediately do the following:

- ◆ Remove the victim to fresh air
- ◆ Put victim at complete rest
- ◆ Keep the victim warm and see that breathing is normal and unhampered; if breathing has stopped, give artificial respiration
- ◆ Do not give anything by mouth to an unconscious person
- ◆ Obtain medical assistance

### If Liquid SF Is Spilled on the Skin

Immediately apply water to the contaminated area of clothing before removing. Wash contaminated skin thoroughly or shower.

### If Liquid SF Is in the Eyes

Flush with plenty of water for at least 20 minutes, and get medical attention. Damage to the eye may result from cold or freezing temperatures.



# 2

Treatment Manual

## Chemical Treatments

### *Fumigants, Phosphine*

---

#### Contents

Properties and Use	<a href="#">page-2-10-1</a>
Phosphine	<a href="#">page-2-10-3</a>
Carbon Dioxide	<a href="#">page-2-10-4</a>
Leak Detection: Gas Analysis	<a href="#">page-2-10-4</a>
Safety	<a href="#">page-2-10-4</a>
Applicator Requirements	<a href="#">page-2-10-4</a>
Storage and Handling	<a href="#">page-2-10-5</a>
First Aid Treatment	<a href="#">page-2-10-7</a>
Respiratory Protection	<a href="#">page-2-10-7</a>
MP, AP, ECO2FUME® and VAPORPH3OS®	<a href="#">page-2-10-9</a>
Packaging	<a href="#">page-2-10-9</a>
Dispensing ECO2FUME® Fumigant Gas	<a href="#">page-2-10-11</a>
Blending VAPORPH3OS® Fumigant Gas	<a href="#">page-2-10-15</a>
Dosage	<a href="#">page-2-10-18</a>
Preparing to Fumigate Break Bulk Cargo	<a href="#">page-2-10-21</a>
Preparing to Fumigate Containerized Cargo	<a href="#">page-2-10-29</a>
Probing	<a href="#">page-2-10-30</a>
In Transit Ship Board Fumigation	<a href="#">page-2-10-32</a>
In Transit Fumigation of Wood Chips	<a href="#">page-2-10-32</a>
Aeration Requirements	<a href="#">page-2-10-37</a>
Disposal of AP and MP Residue	<a href="#">page-2-10-37</a>
Contacts	<a href="#">page-2-10-38</a>

---

#### Properties and Use

There are a number of phosphine formulations registered with the United States Environmental Protection Agency (EPA) to control a variety of insects currently infesting raw agricultural commodities, processed foods, animal feed, feed ingredients, and nonfood commodities, including tobacco. Aluminum phosphine (AP), magnesium phosphide (MP), ECO<sub>2</sub>FUME® and VAPORPH<sub>3</sub>OS® are phosphine formulations that are currently approved for use by the Plant Protection and Quarantine (PPQ). Always refer to the PPQ *Treatment Manual* to determine if there is an available treatment. There are commodities and pests listed on the labels that are not authorized for treatment by the United States Department of Agriculture (USDA), PPQ.

AP and MP are solid products and are available under various trade names (**Figure 2-10-2** on **page 2-10-9**) as tablets, pellets, prepacks, bags, or plates. In the presence of moisture, phosphine (hydrogen phosphide, PH<sub>3</sub>), a colorless gas, is emitted from the solid product

The flash point of PH is 212°F. Direct contact with a liquid could cause spontaneous combustion. In case of fire, a CO<sub>2</sub> dry chemical fire extinguisher should be used. *Never use water to extinguish a PH-ignited fire.* PH has an odor somewhat like garlic, which enables the gas to serve as its own warning agent. However, under some conditions, the odor can be lost, even at high toxic concentrations.

ECO<sub>2</sub>FUME<sup>®</sup> fumigant gas is a nonflammable, premixed mixture of phosphine and carbon dioxide. The phosphine is liquefied and mixed with carbon dioxide in high-pressure cylinders for shipment. Phosphine, the active ingredient, makes up 2% by weight (2.6% by volume) of the product. The carbon dioxide is used as a propellant and a flame inhibitor, making the product nonflammable in air. Do not store the fumigant near heat or open flame. Do not drop, puncture, or incinerate the cylinder.

Under pressure, ECO<sub>2</sub>FUME<sup>®</sup> is a poisonous liquefied gas. The product is withdrawn from the cylinder as a liquid, but dispensed as a gas. When expanding from a liquid to a gas, ECO<sub>2</sub>FUME's volume is multiplied by hundreds. Proper dispensing equipment (See [Dispensing ECO<sub>2</sub>FUME<sup>®</sup> Fumigant Gas](#) on [page 2-10-11](#)) is necessary to ensure a safe and effective fumigation; therefore, always contact the manufacturer concerning proper dispensing equipment for the fumigant. Fumigators should provide PPQ with all [Cytec<sup>®</sup>](#) equipment authorization documentation. The documentation should be on file and available for periodic audits by the USDA.

The rate at which phosphine is dispensed is not dependant on temperature or humidity, but on the dispensing equipment used. Unlike metal phosphide fumigants, the phosphine is not generated through a chemical reaction and its release is instantaneous. The choice of dispensing methods will depend on the type and duration of the fumigation planned.

VAPORPH<sub>3</sub>OS<sup>®</sup> consists of 100% phosphine gas packaged in high-pressure gas cylinders. Unlike solid phosphide fumigants, the phosphine is not generated through a chemical reaction and its release is instantaneous. Phosphine is pyrophoric and will spontaneously ignite in air. Phosphine is dispensed as a gas from the cylinder and can be safely blended with carbon dioxide to less than 3% volume (30,000 ppm) or diluted with the surrounding air to 1% volume (10,000 ppm) to eliminate the flammability hazard. Contact the manufacturer for approved blending equipment necessary to ensure a safe and effective fumigation. Never store the cylinders where the temperature will exceed 125°F. Fumigators should provide PPQ with all [Cytec<sup>®</sup>](#) equipment authorization documentation. The documentation should be on file and available for periodic audits by the USDA.

## Phosphine

Phosphine (PH) is highly toxic to humans and other animals. Avoid exposure to nontarget organisms. The current U.S. OSHA Permissible Exposure Limit (PEL) for phosphine is 0.3 ppm as an 8-hour time weighted average. The Short Term Exposure Limit (STEL) for phosphine is 1 ppm as a 15-minute time weighted average.

Phosphine is colorless and, at concentrations below the OSHA PEL, has the odor of decaying fish or garlic. Intermittent low concentration exposure may cause headaches, malaise, ringing of ears, fatigue, nausea, and chest pressure. Moderate exposure causes weakness, vomiting, and pain in the stomach and chest with difficult breathing. Phosphine gas reacts with moisture to form phosphoric acid, which causes pulmonary edema.

Phosphine may spontaneously ignite in air at levels above its lower flammability limit of 1.8% v/v (18,000 ppm). Do not exceed this concentration because, under these conditions, explosions can occur that could cause severe personal injury. Never allow the buildup of phosphine to exceed explosive concentrations.

Under high vacuum conditions, phosphine gas can cause an explosive hazard. **Do not apply either fumigant in vacuum chambers.**

Phosphine can react with certain metals and cause corrosion (especially at higher temperatures and lower relative humidity). **Gold, silver, copper, brass, and other copper alloys are susceptible to corrosion.**



### Remove or protect the following items prior to fumigation:

- ◆ Batteries and battery chargers
- ◆ Brass sprinkler heads
- ◆ Communication devices
- ◆ Computers
- ◆ Electric motors
- ◆ Electronic or electrical equipment
- ◆ Fork lifts
- ◆ Smoke detectors
- ◆ Switching gears
- ◆ Temperature monitoring systems

Fans and blowers used with phosphine products should be manufactured from materials resistant to the fumigant. Aluminum or plastic wheels and housings are preferred. For phosphine fumigations, always contact the manufacturer for recommended fan and blower types.

### **Carbon Dioxide**

In a liquefied state and when contact is made with exposed areas of the body, carbon dioxide can cause frostbite and freeze burns. Overexposure to carbon dioxide at low levels can cause headache, nausea, weakness, confusion, and labored breathing. Overexposure to higher concentrations can cause excitation, dizziness, euphoria, loss of consciousness, coma, and death.

The current U.S. OSHA PEL for carbon dioxide is 5,000 ppm as an 8-hour time weighted average.

---

## **Leak Detection: Gas Analysis**

Phosphine levels can be detected using either colorimetric detector tubes or any approved electronic instrument such as the “Porta-Sens” detector. (See **Equipment** on **page 8-1-1** for instructions on how to use the Porta-Sens.) This equipment is used to determine both the high (fumigation concentration) and low (personnel safety) levels of PH. **Do not use** thermal conductivity (T/C) units (e.g., Gow-Mac or fumiscope) for PH.

---

## **Safety**

### **Applicator Requirements**

Before using ECO<sub>2</sub>FUME<sup>®</sup> and VAPORPH<sub>3</sub>OS<sup>®</sup>, all users (fumigators) are required to attend the fumigant gas product stewardship course offered by **Cytec**<sup>®</sup> Industries. PPQ Officers are not required to attend the stewardship courses, but attendance is recommended.

It is a violation of federal law to use AP, MP, ECO<sub>2</sub>FUME<sup>®</sup> and VAPORPH<sub>3</sub>OS<sup>®</sup> fumigants in a manner inconsistent with their labeling. These fumigants are **Restricted Use Pesticides** that can only be used by certified applicators. Prior to using the fumigants, submit to PPQ all documentation concerning applicator certification and stewardship program completion by personnel working for the fumigation company. The documentation should be on file and available for periodic audits by the USDA.



A certified applicator must be physically present, responsible for, and maintain visual and/or voice contact with all fumigation workers during the application of the fumigants and during the initial opening of the fumigation structure for aeration.

### Storage and Handling

Although PH is flammable and can ignite when exposed to excessive moisture, the commercial precautions of AP and MP are considered fire safe and explosion safe when used in accordance with the manufacturer's instruction. Place no more than 10 pellets of Phostoxin in a single envelope, which is supplied by the manufacturer. A Fumi-Cel plate should not contact another Fumi-Cel plate or the commodity.

Store containers of AP and MP in a cool, dry, locked, ventilated, protected area not subject to extremes of temperature. Never allow water to come in contact with AP or MP. The shelf life of unopened containers is virtually unlimited. When a tube or container is first opened, the odor of PH (garlic) and ammonia will be noticeable and a blue flame sometimes occurs. However, the quantity of free PH present within that container should not be considered dangerous.

When planning a storage area for ECO<sub>2</sub>FUME<sup>®</sup> and VAPORPH<sub>3</sub>OS<sup>®</sup> cylinders, consider the needs of the local authorities. Provide all emergency response personnel with Material Safety Data Sheets (MSDS) and detailed information regarding the quantities of product stored and the nature and location of the storage area.

Develop an Emergency Response Plan that defines procedures and outlines responsibilities in the event of an accident. Train all site personnel in the plan. Store all cylinders with the valve discharge cap securely in place.

In addition to instructions and precautions found on the label, be certain to:

- ◆ Study and follow the recommended application procedure
- ◆ Comply with all regulations
- ◆ Allow only properly trained personnel to conduct fumigations under the supervision of certified pesticide applicator(s)
- ◆ Ensure that first aid equipment, MSDS sheets, and fumigant labels are readily available at the fumigation site
- ◆ Placard the area to be fumigated and an area extending 30 feet from the fumigation enclosure—refer to the fumigation label for appropriate wording on all placards

- ◆ Always work in pairs, never alone—a minimum of two people must be present during the introduction, sampling, and aeration of the fumigant
- ◆ Never eat, drink, or smoke when handling PH products
- ◆ Remove placards when aeration is complete and concentrations are below the TLV
  - ❖ Only certified pesticide applicators or individuals under the direct supervision of the certified applicator should remove placards
- ◆ Do not apply either PH fumigant in vacuum chambers
- ◆ Wear leather or leather-faced cotton gloves when connecting or disconnecting ECO<sub>2</sub>FUME and VAPORPH<sub>3</sub>OS<sup>®</sup> cylinders from the dispensing or blending equipment
- ◆ Wear dry cloth gloves when handling AP or MP products
- ◆ Wear steel-toed shoes
- ◆ Always wear safety glasses when handling pressurized equipment
- ◆ Read and understand sections XI. STORAGE OF CYLINDERS and XII. TRANSPORT in the ECO<sub>2</sub>FUME<sup>®</sup> and VAPORPH<sub>3</sub>OS<sup>®</sup> Application Manual

## First Aid Treatment

**Mild** inhalation exposure causes:

- ◆ Malaise
- ◆ Ringing of the ears
- ◆ Fatigue
- ◆ Nausea
- ◆ Pressure in chest

**Moderate** inhalation exposure causes:

- ◆ Weakness
- ◆ Vomiting
- ◆ Epigastric pain
- ◆ Chest pain
- ◆ Diarrhea
- ◆ Dyspnea (difficulty breathing)

**Severe** inhalation poisoning can occur within a few hours or up to several days—symptoms may be:

- ◆ Pulmonary edema (fluid in lungs)
- ◆ Dizziness
- ◆ Cyanosis (blue or purple skin color)
- ◆ Unconsciousness
- ◆ Death



Get the victim to fresh air, treat for shock, and call a physician.

## Respiratory Protection

When applying AP, MP, ECO<sub>2</sub>FUME<sup>®</sup> and VAPORPH<sub>3</sub>OS<sup>®</sup>, respiratory protection must be available at the site. An adequate number of NIOSH-approved self-contained breathing apparatus (SCBA) with full face piece and operated in pressure-demand mode must be available.

The slow evolution of PH from the AP or MP enables the operator to dispense the tablets, pellets, packets, plates, or pre-pack ropes safely, usually without the need for wearing an SCBA.

However, wear SCBA during exposure to concentrations in excess of permitted limits (**Figure 2-10-1** on **page 2-10-8**) or when concentrations are unknown. If the concentration of phosphine is unknown or known to exceed the STELs for phosphine and/or carbon dioxide, wear SCBA during troubleshooting for leaks. Use respiratory protection according to local regulations, including regular worker training in using respiratory protection equipment properly, medical clearance for respirator use, fit testing, inspection, maintenance, and cleaning and storage of respiratory protection equipment.

Phosphine Gas (ppm)	Minimum Respiratory Protection
0.3 - 3.0	Supplied-air respirator
3.1 - 7.5	Supplied-air respirator operated in a continuous-flow mode
7.6 - 15	1. SCBA with full face piece OR 2. Supplied-air respirator with full face piece OR 3. Air-purifying full face piece respirator (gas mask) with chin style front or back-mounted canister
16 - 50	1. Supplied-air respirator with a full face piece and operated in pressure-demand mode OR 2. SCBA with a full face piece and operated in pressure-demand mode

**FIGURE 2-10-1: : NIOSH-Recommended Respiratory Protection**

## MP, AP, ECO<sub>2</sub>FUME® and VAPORPH<sub>3</sub>OS®

### Packaging

AP and MP are packaged in a variety of ways, depending on the manufacturer. Use [Figure 2-10-2](#) on [page 2-10-9](#) to determine the amount of phosphine liberated by each product.

Product	Type	Unit and weight in grams	Grams of phosphine
Degesch Fumi-Cel	MP	1 plate; 117.0	33.0
Degesch Fumi-Strip	MP	20 plates; 2340.0	660.0
Degesch Phostoxin	AP	1 tablet; 3.0	1.0
Degesch Phostoxin Tablet Prepac Rope	AP	1 prepac; 99.0 (strip or rope of 33 tablets)	33.0
Detia	AP	1 tablet; 3.0	1.0
Detia Rotox AP	AP	1 pellet; 0.6	0.2
Detia Gas EX-B	AP	1 bag or sachet; 34.0	11.4
Fumiphos tablets	AP	1 tablet; 3.0	1.0
Fumiphos pellets	AP	1 pellet; 0.6	0.2
Fumiphos bags	AP	1 bag; 34.0	11.0
Fumitoxin	AP	1 tablet; 3.0	1.0
Fumitoxin	AP	1 pellet; 0.6	0.2
Fumitoxin	AP	1 bag; 34.0	11.0
Gastoxin	AP	1 tablet; 3.0	1.0
Gastoxin	AP	1 pellet; 0.6	0.2
"L" Fume	AP	1 pellet; 0.5	0.18
	AP	1 pellet; 0.6	0.22
Phos-Kill	AP	1 tablet; 3.0	1.1
Phos-Kill	AP	1 pellet; 0.6	0.22
Phos-Kill	AP	1 bag; 34.0	12.0

**FIGURE 2-10-2: Amount of Phosphine Liberated by Various Products**

ECO<sub>2</sub>FUME® fumigant gas is packaged in a steel compressed gas cylinder designed, manufactured, maintained, and filled in compliance with regulations established by the United States Department of Transportation (DOT). (**Figure 2-10-3** on **page 2-10-10**) The product flows to the dispensing equipment through the cylinder outlet valve, which is equipped with a "dip tube." This tube extends to the bottom of the cylinder to facilitate the withdrawal of the liquefied gas mixture. As liquid is withdrawn from the cylinder, some of the product vaporizes to fill the remaining space in the cylinder. Through this vaporization, the cylinder pressure is maintained.

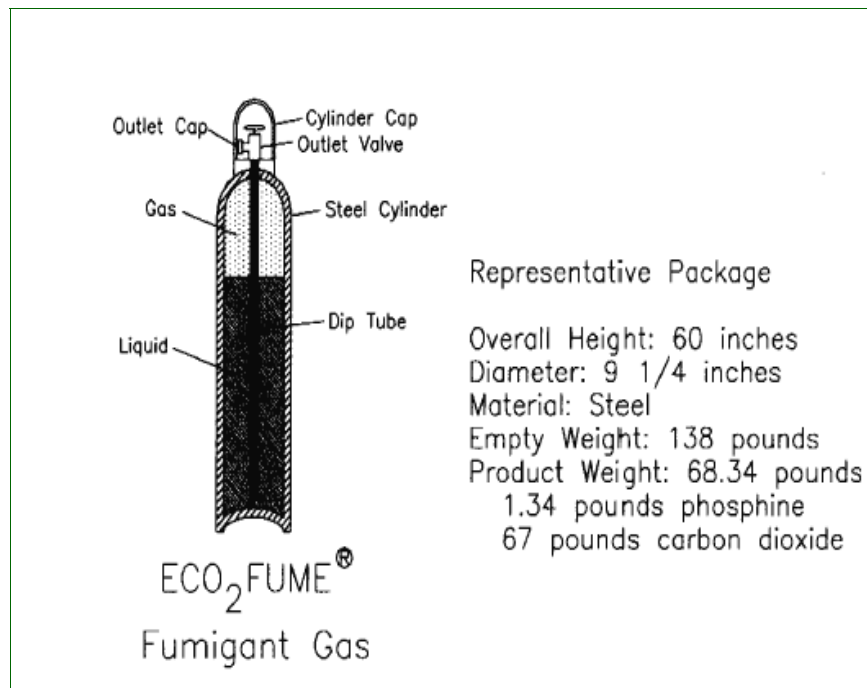

**FIGURE 2-10-3: Diagram of ECO<sub>2</sub>FUME® Gas Cylinder**

The capacity of one ECO<sub>2</sub>FUME® cylinder at 200 and 500 ppm is 78,000 and 31,100 ft<sup>3</sup> respectively. With the volume of ECO<sub>2</sub>FUME® at 500 ft<sup>3</sup>, the internal volume of the cylinder is 49 liters. The maximum cylinder pressure is 2,400 psig.

The Compressed Gas Association (CGA) established the valve outlet fitting as a CGA350. The valve outlet is protected by a threaded gas tight outlet cap, which must be secured whenever the cylinder is not in use. To dispense ECO<sub>2</sub>FUME® fumigant gas at the time of fumigation, attach only **Cytec®**-provided (or approved) dispensing equipment to the cylinder valve outlet. Using any other dispensing equipment is prohibited.

Most compressed gas cylinder valves are equipped with a safety device that releases the cylinder contents due to fire exposure or over-pressurization. Because ECO<sub>2</sub>FUME® and VAPORPH<sub>3</sub>OS® fumigant gases are poisonous, Hazard Class A, the DOT regulations prohibit using such a device.

Each cylinder is supplied with a cylinder cap designed to protect the outlet valve. Secure this cap whenever a cylinder is not in use. It is unlawful to transport an ECO<sub>2</sub>FUME® or VAPORPH<sub>3</sub>OS® fumigant gas cylinder without the valve outlet cap and the cylinder cap securely in place.

ECO<sub>2</sub>FUME® and VAPORPH<sub>3</sub>OS® fumigant gas cylinders can only be refilled by authorized distributors. They can be filled countless times within a five-year period. Every five years, however, the cylinder is required, by law, to be tested by a qualified facility.

VAPORPH<sub>3</sub>OS® is packaged in much the same way as ECO<sub>2</sub>FUME® with two critical exceptions. First, VAPORPH<sub>3</sub>OS® does **not** contain a dip tube, which means the fumigant is withdrawn from the cylinder directly through the outlet valve. Second, the capacity of one VAPORPH<sub>3</sub>OS® cylinder at 200 and 500 ppm is 2.25M and 900,000 ft<sup>3</sup> respectively. With the volume of VAPORPH<sub>3</sub>OS® at 500 ft<sup>3</sup>, the internal volume of the cylinder is 49 liters. The maximum cylinder pressure is 2,400 psig. One VAPORPH<sub>3</sub>OS® cylinder contains 18,000 grams of phosphine and is capable of fumigating 2.25M ft<sup>3</sup>.



ECO<sub>2</sub>FUME® cylinders are painted yellow with a dark green shoulder and cap. If you receive a cylinder of a different color or without a **Cytec®** ECO<sub>2</sub>FUME® label, do not use the cylinder. Contact your distributor or **Cytec®** with the cylinder serial number.



VAPORPH<sub>3</sub>OS® cylinders are painted silver with a red shoulder. If you receive a cylinder of a different color or without a VAPORPH<sub>3</sub>OS® label, do not use the cylinder. Contact your distributor or **CYTEC** with the cylinder serial number.

### Dispensing ECO<sub>2</sub>FUME® Fumigant Gas

The following instructions are intended to provide general guidelines for typical ECO<sub>2</sub>FUME® fumigation. There are a number of critical factors involved in the design of dispensing equipment. (See **Figure 2-10-4** on **page 2-10-12**) As such, dispensing equipment must meet both high-pressure standards and chemical compatibility requirements. Improper or inappropriate use of dispensing equipment can result in severe injury or death. Application inconsistent with the

labeling and Application Manual is a violation of federal law. Buyer assumes all risk should the product be used contrary to label or Application Manual instructions.

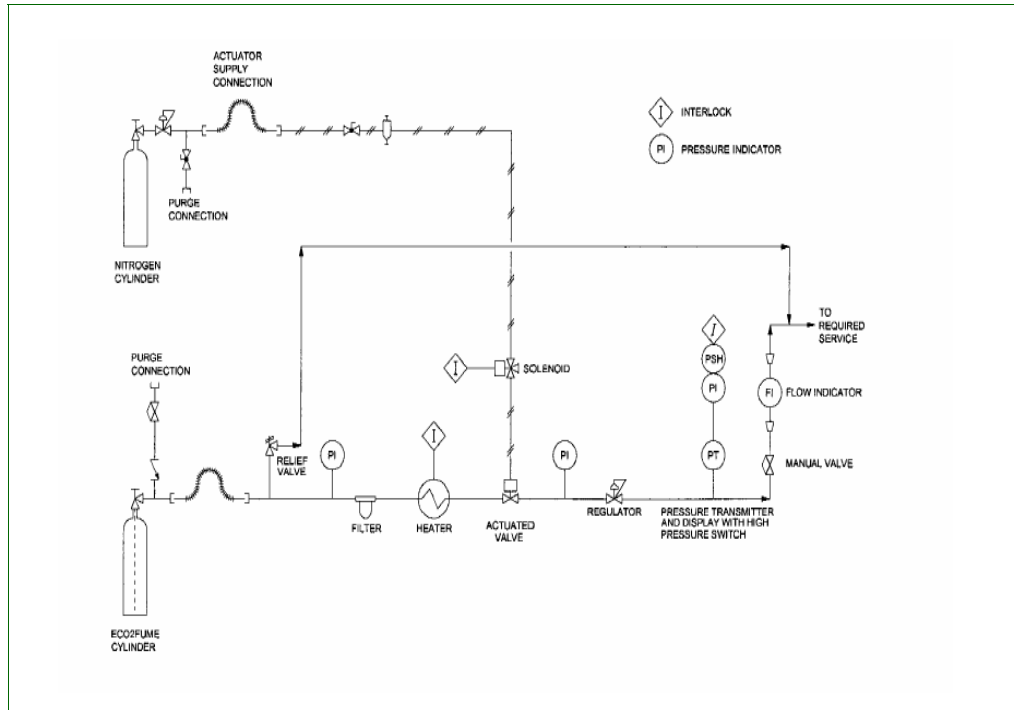

FIGURE 2-10-4: Diagram of One Type of Dispensing Equipment

### Equipment Specification and Use

The equipment used to dispense ECO<sub>2</sub>FUME® provides a means of containing the gas during the fumigation and controlling the release of the product into the desired space. While some dispensing equipment has been developed and used to date, it cannot be expected to cover all possible fumigation scenarios. The development of suitable dispensing equipment is an ongoing process based on the needs of the users and available technology.

The design of dispensing equipment must account for a number of technical issues including pressure rating, material compatibility, temperature limitations and operator safety. For this reason, use only appropriate equipment when dispensing ECO<sub>2</sub>FUME®. Only persons trained in the proper use of ECO<sub>2</sub>FUME® and the dispensing equipment shall be permitted to use ECO<sub>2</sub>FUME® for fumigation. Consult the instruction materials provided with the dispensing equipment for their proper use and maintenance.

### Unapproved Dispensing Methods

It has been common practice, with other cylinderized fumigants, to place the cylinder in the space to be fumigated and the cylinder outlet valve opened to allow the fumigant to release. This is **not** an approved dispensing method and should **not** be used with ECO<sub>2</sub>FUME®.



## Approved Dispensing Methods

The approved dispensing methods for ECO<sub>2</sub>FUME® include using pressure-reducing regulators for slow release and selected piping components for quick release. The slow release of ECO<sub>2</sub>FUME® is generally used for fumigating bulk storage facilities such as silos or bins, or for small fumigation chambers or spaces and for fumigating stacked materials under tarpaulins. The quick release method is used for space fumigation, or where the commodity to be treated is warehoused. The selection of the dispensing method will depend on the size of the fumigation, the time required, and facility limitations.

Two gas regulators, ambient and heated, have been developed for use with ECO<sub>2</sub>FUME®. Each of the regulators is designed to reduce the high cylinder pressure (less than 30 psig) and provide the heat necessary to vaporize the fumigant. Once reduced to this lower pressure, the fumigant can be distributed to the desired dispensing points using inexpensive and easy-to-use materials, such as plastic tubing. Flow indicators are used with regulated dispensers to measure and set the dispensing rate.

### **Ambient Heater Regulated Dispenser**

The slower of the two dispensers relies on ambient heat to vaporize the fumigant and is limited to a dispensing rate of about one-half pound of ECO<sub>2</sub>FUME® per hour.

### **Heated Regulated Dispenser**

The heated regulator uses an external heating vaporizer to provide the energy required to vaporize the liquid fumigant at a much higher rate than the ambient heat regulator. This regulator is limited to a dispensing rate of about 24 pounds of ECO<sub>2</sub>FUME® per hour. The equipment is designed for a service pressure up to 3,000 psig. From the cylinder, the liquid mixture flows down a flexible hose or pigtail through a filter and into a heater. The heater is thermostatically controlled and the temperature setting can be adjusted. Exiting the heater, ECO<sub>2</sub>FUME® gas flows through an actuated valve that can be used for emergency shutdown purposes. ECO<sub>2</sub>FUME® gas then flows through a gas regulator that drops the pressure to 30 psig. A diaphragm valve is used to control the gas flow at any desired value up to 100 liters/minute as indicated by the flow rotameter. The heater provides 1,000 watts of power that can vaporize a maximum of 100 ppm. Lower rotameter ranges are possible. ECO<sub>2</sub>FUME® regulator assemblies, equipped with basic features, are available through authorized ECO<sub>2</sub>FUME® distributors. Multiple regulators may be used together to achieve higher fumigant flows than available through a single regulator and custom equipment can be developed for specific types of applications.

## Quick Release Dispensing Equipment

When the fumigation space is very large, such as a mill, warehouse, or large fumigation chamber, using a number of cylinders is anticipated, a quick means of dispensing ECO<sub>2</sub>FUME® is available. Specially selected components can be used to direct the cylinder discharge into the fumigation space, without the need to enter the space during the fumigation. Using this method, a single cylinder can be completely discharged in as little as 15 minutes. Unlike the regulated dispensing methods, the dispensing rate is not adjustable and generally, entire cylinders are emptied using this process. If partial cylinder contents are needed, the ECO<sub>2</sub>FUME® cylinder can be placed on a weight scale and the amount of released fumigant can be measured. The quick release method must **not** be used for fumigation of small-sized stacked materials under tarpaulins, however, the quick dispensing method will be used for most applications. Three techniques of quick dispensing are presented in this section, with the major difference being the tubing size.

1. One technique uses high pressure tubing (stainless steel or hydraulic hose with a nylon core) connected directly to the cylinder valve. The tubing is then routed into the fumigation space. When the cylinder valve is opened the majority of the liquid will be dispensed in four to five minutes. The last few pounds below the cylinder internal dip pipe will require several additional minutes to vaporize and be dispensed. When the cylinder is empty of liquid, approximately 18 pounds of gas will remain in the cylinder. For larger fumigations, manifolds may be used with the cylinders to make the dispensing faster. Always leak test the dispensing piping and cylinder connection before opening the cylinder valve.
2. When a slower dispensing rate is desired, use smaller tubing (stainless steel or hydraulic hose with a nylon core). The fumigator must not throttle the cylinder valve to slow the dispensing rate; to do so will cause a high pressure drop through the valve. The pressure drop will result in cooling and dry ice formation. This solid dry ice formation will plug the dispensing pipe and possibly the cylinder valve. Attaching a short section of 1/8 inch tubing to the end of the 1/4 inch tubing will slow the dispensing rate to approximately 5 pounds/min. Use a calibrated scale to ensure the proper amount of product dispensed.
3. If a dispensing rate of less than 5 pounds/min is required, a small section of 1/16 inch tubing, 0.04 inch internal diameter (stainless steel or hydraulic hose with a nylon core) can be attached to the end of the 1/4 inch tubing to slow the dispensing rate to approximately 1.6 pounds/min. Use a scale to ensure the proper amount of product is dispensed. The tubing is also available in smaller internal diameters (I.D.) for reduced

dispensing rates. When 1/8 inch tubing or 1/16 inch tubing is used a filter is recommended to prevent plugging of the smaller tubing.

### Blending VAPORPH<sub>3</sub>OS® Fumigant Gas

The following instructions are intended to provide general guidelines for typical fumigations. There are a number of critical factors involved in the design of blending equipment. As such, blending equipment must meet both high-pressure standards and chemical compatibility requirements. Improper or inappropriate use of blending equipment may result in severe injury or death. Application inconsistent with the labeling and Application Manual is a violation of federal law. Buyer assumes all risk should the product be used contrary to label or Application Manual instructions.

### Equipment Specification and Use

The equipment used to blend VAPORPH<sub>3</sub>OS® on site with carbon dioxide or surrounding air into a nonflammable gas mixture provides a means of containing the gas during the application and controlling the release of the product into the desired space. While some blending equipment has been developed and used to date, they cannot be expected to cover all possible fumigations scenarios. The development of suitable blending equipment is an ongoing process based on the needs of the users and available technology.

Blending equipment design must account for a number of technical issues, including pressure rating, material compatibility, temperature limitations and operator safety, and controlling the phosphine concentration between 2.0 and 2.9% volume for carbon dioxide blending and less than 10,000 ppm (1% volume) for dilution with air. For this reason, use only **Cytec**®-approved equipment in VAPORPH<sub>3</sub>OS® blending. Only persons trained in the proper use of VAPORPH<sub>3</sub>OS® and the dispensing equipment shall be permitted to use VAPORPH<sub>3</sub>OS® for fumigation. These persons must also be licensed pesticide applicators.

Consult the instruction materials provided with the blending equipment or dilution equipment for their proper use and maintenance. FOSFOQUIM, the authorized manufacturer of the phosphine air blending equipment, will provide training and written instructions for the use and maintenance of its HDS equipment.

### Unapproved Dispensing Methods

It has been common practice, with other cylinderized fumigants, to place the cylinder in the space to be fumigated and the cylinder outlet valve opened to allow the fumigant to release. This is **not** an approved dispensing method and should **not** be used with VAPORPH<sub>3</sub>OS®. VAPORPH<sub>3</sub>OS® phosphine fumigant is pyrophoric and will spontaneously ignite in air. VAPORPH<sub>3</sub>OS® must be properly blended with carbon dioxide or diluted with air to eliminate the flammability hazard.

## Blending Equipment for VAPORPH<sub>3</sub>OS® and Carbon Dioxide

Phosphine gas (VAPORPH<sub>3</sub>OS®) from high-pressure cylinders flows into the blender unit where it combines with carbon dioxide gas sourced from bulk storage, mobile bulk truck, semibulk, or cylinders. Various models of on-site blending equipment have been designed, built, and tested. All of the designs have incorporated engineering safeguards to ensure that the blended product is a nonflammable mixture.

One design uses a pressure regulator and flow control orifice on both the VAPORPH<sub>3</sub>OS® and carbon dioxide gases to control the flow rate and to properly blend VAPORPH<sub>3</sub>OS® with carbon dioxide. The size of each orifice is engineered for a specific fixed flow rate and, therefore, the blending rate cannot be adjusted. By controlling the pressure drop across the orifice plates, the phosphine concentration can be controlled around 2.5% v/v.

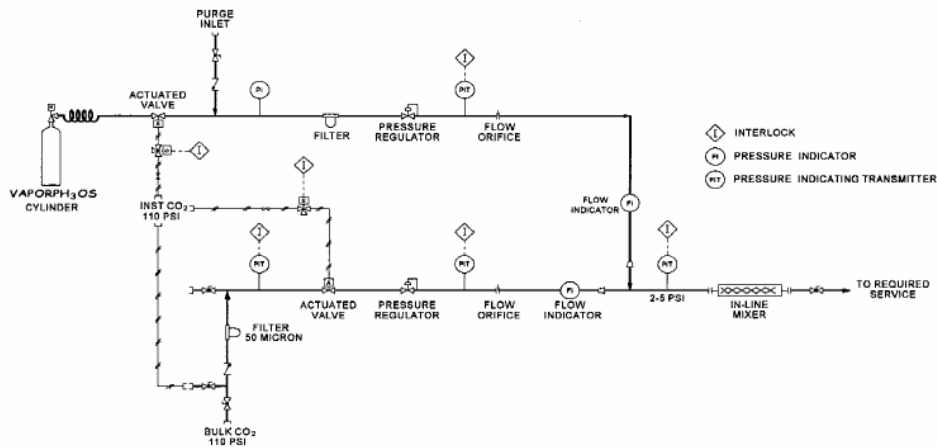

**FIGURE 2-10-5: Diagram of One Type of Blending Equipment**

A more sophisticated design uses mass meters, control valves, and the electronics to allow an adjustable blending rate while maintaining the proper blend of phosphine concentration from going outside the range of 2.0 to 2.9% volume (1.6 to 2.2% weight). The product from this equipment is equivalent to ECO<sub>2</sub>FUME® fumigant gas. Blending equipment is intended for large facilities that have on-site carbon dioxide bulk storage and vaporizing equipment or facilities where it is feasible to bring in bulk carbon dioxide and vaporizing equipment for the fumigation. The blending equipment is designed for use only with carbon dioxide gas; therefore, a bulk supply of liquid carbon dioxide must be equipped with suitable vaporizing equipment. Contact [Cyttec® Industries Incorporated](#) for blending equipment design specifications and recommendations. For smaller fumigation jobs, it is recommended that preblended

**Blending  
Equipment for  
VAPORPH<sub>3</sub>OS®  
and Forced Air**

ECO<sub>2</sub>FUME® cylinders be used. VAPORPH<sub>3</sub>OS® fumigant gas can only be blended with registered carbon dioxide products. Never allow the buildup of phosphine to exceed explosive concentrations. When phosphine is blended with carbon dioxide, the LFL is raised to 3% v/v. The fumigator should always check with **Cytec®** for approved blending equipment. Fumigators should provide PPQ with all **Cytec®** equipment authorization documentation. The documentation should be on file and available for periodic audits by the USDA.

Phosphine gas (VAPORPH<sub>3</sub>OS®) can spontaneously ignite in air if the concentration is greater than 1.8% (18,000 ppm). With specialized equipment, pure phosphine can be safely blended with a forced air stream to ensure the final concentration does not exceed 10,000 ppm (55% of the Lower Flammability Limit of 18,000 ppm). The equipment has incorporated engineering safeguards to ensure the flammable concentration is never exceeded.

Various models of phosphine/forced air blending equipment have been designed, built, and tested. The Horn Diluphos System (HDS) from FOSFOQUIM is approved by **Cytec®** and the **Treatment Quality Assurance Unit** to blend VAPORPH<sub>3</sub>OS® with forced air (see section on HDS80 and HDS200 Blending Equipment). One design uses inert gas (nitrogen or carbon dioxide) to prepurge the phosphine lines and equipment. Once purged, phosphine flows through a pressure regulator and flow controller to the mixing point. Here, phosphine is safely blended into the forced air stream. The forced air can be supplied by various fans, blowers, or compressors. The air flow is measured and the phosphine flow will stop if the air flow is insufficient.

If the phosphine flow is stopped for any reason, post-purging of the phosphine lines and equipment is automatic.

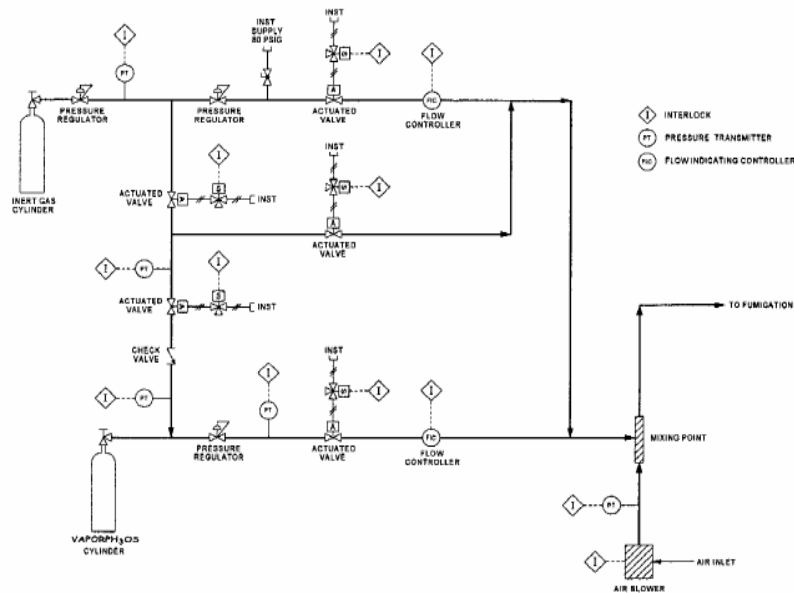

**FIGURE 2-10-6: Diagram of VAPORPH<sub>3</sub>OS® and Forced Air Blending Equipment**

### Dosage

The dosage rate for AP, MP, ECO<sub>2</sub>FUME® and VAPORPH<sub>3</sub>OS® is measured in grams per 1,000 cubic feet or grams per cubic meter and varies with the commodity, treatment temperature, and type of enclosure. The initial fumigant dose is determined by the volume of the space to be fumigated and the required phosphine dose rate needed to kill the target pest. ECO<sub>2</sub>FUME® and VAPORPH<sub>3</sub>OS® fumigant gas and carbon dioxide/forced air can be added if the desired target concentration changes due to a loss of the fumigant through leaks in the fumigation enclosure.

### AP and MP

To calculate the number of tablets or pellets of AP or MP required for the fumigation:

Dosage Rate = the dosage rate from the treatment schedule (grams)  
 Volume of enclosure = Length \* Width \* Height (ft<sup>3</sup>)  
 Grams of phosphine liberated = **Figure 2-10-2** on **page 2-10-9**

**Step 1: Grams of PH<sub>3</sub>** = (Dosage Rate\* Volume of enclosure)/1,000 ft<sup>3</sup>

**Step 2: Number of Tablets or Pellets needed =**  
 Grams of PH<sub>3</sub> / Grams of phosphine liberated

EXAMPLE: **T308-b-2**. Tobacco for Export in a warehouse requires 20 grams of phosphine per 1000 ft<sup>3</sup>. The size of the warehouse is 100' \* 75' \* 50'. To determine the number of Fumiphos tablets and pellets to introduce, use the following procedure:

$$100 * 75 * 50 = 375,000 \text{ ft}^3$$

$$\text{Step 1: } (20 \text{ g} * 375,000 \text{ ft}^3) / 1000 \text{ ft}^3 = 7500 \text{ g}$$

**Step 2:**

$$\text{Tablets: } 7500 / 1.0 = 7500 \text{ tablets}$$

$$\text{Pellets: } 7500 / 0.2 = 37,500 \text{ pellets}$$

---

## ECO<sub>2</sub>FUME®

### Method 1:

$$\blacklozenge \text{ 1 gram of phosphine (PH3) = 25 ppm PH3/1000 ft}^3$$

To calculate the total amount of ECO<sub>2</sub>FUME® required for each treatment:

$$\blacklozenge \text{ Target concentration in ppm = } \\ \text{(Dosage rate in grams from Treatment schedule} * 25 \text{ ppm)}$$

$$\blacklozenge \text{ Grams of PH3 = } \\ \text{(Target concentration} * \text{Volume of enclosure)} / 25,000$$

$$\blacklozenge \text{ Pounds of ECO}_2\text{FUME}^\circledR = \\ \text{(Target concentration} * \text{Volume)} / 226,800$$

---

EXAMPLE: **T301-d-1-2** on **page 5-4-5**. Cotton and cotton products infested with boll weevil requires 36 g of phosphine per 1000 ft<sup>3</sup>. The volume of this enclosure is 10\*10\*10\*. To determine the pounds of ECO<sub>2</sub>FUME® gas to introduce, follow these steps.

**Step 1:** Convert grams of phosphine to ppm:

$$36\text{g} * 25 = 900 \text{ ppm}/1000 \text{ ft}^3$$

**Step 2:** Determine total volume of the enclosure

$$10 * 10 * 10 = 1000 \text{ ft}^3$$

**Step 3:** Apply the formula to determine the amount of ECO<sub>2</sub>FUME® to introduce  $(900 \text{ ppm} * 1000 \text{ ft}^3) / 226,800 = 3.97 \text{ pounds}$

Therefore, 3.97 pounds of ECO<sub>2</sub>FUME® will be introduced into the structure.

---

**Method 2:**

- ◆ **1 pound of ECO<sub>2</sub>FUME® = 9.07 grams PH<sub>3</sub>**
- ◆ Divide the dosage rate from the treatment schedule (in grams) by 9.07.

---

EXAMPLE:

Assuming the same treatment schedule as the previous example (**T301-d-1-2** on **page 5-4-5**):

$$36 / 9.07 = 3.97 \text{ pounds}$$

---

NOTE: When the amount of gas introduced is less than 68 pounds, use a calibrated scale to determine when the proper amount of gas has been introduced into the space.

**VAPORPH<sub>3</sub>OS®**

To calculate the amount of VAPORPH<sub>3</sub>OS® required for the fumigation:

- ◆ **1 pound of VAPORPH<sub>3</sub>OS® = 454 grams PH<sub>3</sub>**

**Target concentration** = the desired phosphine concentration (ppm) from the treatment schedule

**Step 1:**

$$\text{Grams of PH}_3 = (\text{Target concentration} * \text{Volume of enclosure}) / 25,000$$

**Blending with CO<sub>2</sub>**

Once the amount of phosphine has been determined, the appropriate amount of carbon dioxide must be calculated. It is recommended that twice the amount of carbon dioxide be available to ensure an adequate supply for the initial dose, the addition of gas, and equipment purging.

To calculate the amount of carbon dioxide required for the fumigation:

**Step 2:**

$$\text{Pounds of CO}_2 = (\text{Grams of PH}_3 / 454) * 105.3$$

---

EXAMPLE: **T301-d-1-2** on **page 5-4-5**. Cotton and cotton products infested with Boll weevil requires 36 g of phosphine per 1000 ft<sup>3</sup>. The volume of the enclosure is 75,000 ft<sup>3</sup>. To determine the amount of VAPORPH<sub>3</sub>OS® gas to introduce, follow these steps:

**Step 1:**  $(36\text{g} * 75,000 \text{ ft}^3) / 25,000 = 108 \text{ grams PH}_3$

**Step 2:**  $(108 / 454) * 105.3 = 25 \text{ pounds CO}_2$

---



### **Blending with Forced Air**

When blending with forced air, only the amount of phosphine needs to be calculated. A closed circulation system is created if the air supply is sourced from inside the fumigation enclosure. This will prevent a positive pressure from developing within the fumigation space. If recirculation is not used the perimeter of the fumigation site will need to be monitored because the air will be displaced from the fumigation space. The HDS 80 blending equipment used with forced air dispenses at 50g/min. If the minimum air flow is not maintained, the blending equipment will automatically shut down and phosphine will no longer be dispensed.

### **Adding ECO<sub>2</sub>FUME® and VAPORPH<sub>3</sub>OS® Gas to an Enclosure**

Depending on the sealability of the type of space to be fumigated, it may be necessary to add additional gas to the structure in order to maintain the target concentration required by the treatment schedule.

To calculate the amount of ECO<sub>2</sub>FUME®/VAPORPH<sub>3</sub>OS® to be added:

$$\text{Grams of PH}_3 = (\text{Target Concentration} - \text{Actual Concentration}) * \text{Volume} / 25,000$$

The target and actual concentrations are measured in ppm and must be monitored with a device approved by CPHST, TQAU.

### **Preparing to Fumigate Break Bulk Cargo**

Break bulk cargo has been unloaded from a ship hold, a container, or rail car. This cargo can be fumigated by covering the pallets, boxes, or raw cargo with an impervious tarpaulin.

Always check the PPQ *Treatment Manual* to determine if there is an approved treatment schedule using either AP, MP, ECO<sub>2</sub>FUME® or VAPORPH<sub>3</sub>OS® fumigant for the infested commodity. Treatment schedules typically list the commodity to fumigate with its associated pest(s). If the commodity in question does not have a treatment schedule, contact the **Treatment Quality Assurance Unit** on **page 2-10-38** to determine if there is an alternative treatment available.

### Step 1: Site Selection

- ◆ Select sites that are well ventilated and in a sheltered area
  - ❖ Well-ventilated site is required for exhausting gas before and when the tarpaulin is removed from the stack
  - ❖ When applying ECO<sub>2</sub>FUME® or VAPORPH<sub>3</sub>OS®, a sealed fumigation enclosure will typically see an increase of eight inches water pressure
  - ❖ It is advisable to have a vent area in one or more of the openings to the space to allow air to escape as ECO<sub>2</sub>FUME® or VAPORPH<sub>3</sub>OS® fumigant gas is applied
  - ❖ Seal the space after the target concentration is obtained
- ◆ Use portable or permanent fans to decrease the amount of time required for aeration
  - ❖ To ensure the exhausted gas does not reenter the building where the fumigation is being conducted nor endanger people working outdoors, monitor gas levels at the property lines and near inhabited structures adjacent to the fumigation site
- ◆ If fumigations are conducted outside, select a site that is semisheltered such as the leeward side of a warehouse, pier, or building that offers some protection from strong winds

### Ability to Heat Area

- ◆ When cool temperatures (below 40°F) are expected, heat the site to maintain commodity temperatures above 40°F; take the ambient temperature 12 inches above the floor
- ◆ Because phosphoric acid will be produced if phosphine is burned, never use flame or exposed electrical element heaters during treatment
  - ❖ Contact the **Treatment Quality Assurance Unit** on **page 2-10-38** for appropriate heating sources

### **An Impervious Surface**

- ◆ To fumigate on a porous surface, cover the surface with asphalt (tar) paper or plastic tarpaulins
  - ❖ For large fumigations, covering the surface is not usually practical because pallets must be rearranged and heavy equipment used to move the commodity
  - ❖ On docks, wharfs, and piers, check for cracks, holes, and manhole covers that will allow the phosphine gas to escape through the floor
  - ❖ Seal all cracks, holes, and manhole covers with plastic or asphalt paper

### **A Nonwork Area**

- ◆ Select a secure nonwork area where traffic and people are restricted from entering
  - ❖ The fumigation area is considered either the entire structure area or an area that extends 30 feet from the tarpaulin and is separated by a physical barrier such as ropes, barricades, or walls
  - ❖ If a wall of gas-impervious material is less than 30 feet from the tarpaulin, the wall may serve as the edge of the secured area
  - ❖ Additional guidelines may be required by some states Department of Agriculture. Some states, California, for example, require a 100-foot buffer zone

- ◆ Place placards clearly in sight of all who come near
  - ❖ Placards must meet label requirements regarding specific warnings, information, and language
  - ❖ Placards generally include the name of the fumigant, the fumigation date, time, and the name of the company conducting the fumigation
  - ❖ Restrict access to the fumigation area to the fumigator's employees and PPQ employees monitoring the treatment
  - ❖ Use rope or marker tape to limit access within 30 feet of the enclosure
  - ❖ Do not allow motor vehicles (including forklifts) to operate within 30 feet of the enclosure during fumigation and aeration periods
  - ❖ The area outside the 30-foot perimeter is usually regarded as a safe distance from the tarpaulin
  - ❖ The 30-foot perimeter is not specifically mentioned on the AP, MP, ECO<sub>2</sub>FUME® and VAPORPH<sub>3</sub>OS® labels, but is required for safety to PPQ Officers



**Important**

Gas concentrations should never exceed 0.3 ppm phosphine and 5,000 ppm carbon dioxide in the safety zone (30 feet from the enclosure where officers are taking gas concentration readings).

Use colorimetric tubes or other approved devices to measure gas concentrations.

### **Electrical Power Supply**

- ◆ An adequate electrical source must be available to run the dispensing equipment (ECO<sub>2</sub>FUME® and VAPORPH<sub>3</sub>OS® only)
  - ❖ A separate line should be available for the dispensing and blending units
  - ❖ Electrical outlets must be grounded and conveniently located in relation to the fumigation area
  - ❖ Except under emergency conditions, do not use generators as a power source

### **Water Supply**

- ◆ A water supply is necessary for safety purposes; if no permanent water source is present on site, the fumigator must provide a portable, five-gallon supply of clean water

### **Well-Lighted Areas**

- ◆ The area should have adequate lighting for safety purposes and for ease in reading the gas monitoring devices, thermometers, and for determining whether a tarpaulin has holes or tears

### **Step 2: Arranging the Stack**

- ◆ Arrange the cargo in a square or rectangular shape, if possible, to make it easy to cover and to calculate the volume of the stack
  - ❖ An even-shaped stack is easier to tarp
  - ❖ The height of the stack should be uniform so dosage can be calculated accurately
  - ❖ By arranging the stack evenly and with space between pallets or cartons, the fumigant will be effectively distributed
- ◆ The maximum size for an enclosure is 25,000 ft<sup>3</sup>
  - ❖ Contact the **Treatment Quality Assurance Unit** on **page 2-10-38** to get approval for any enclosures larger than 25,000 ft<sup>3</sup>
  - ❖ For very large enclosures it may be necessary to add more sampling leads or introduce the fumigant at several sites
- ◆ When the fumigation involves multiple stacks, allow 10 feet of space between each uncovered stack; after the stack is tarped, there should be approximately five feet between enclosures

### **Step 3: Padding the Corners**

Examine all areas that typically tear tarpaulins, e.g., corners and sharp angles. If the sharp angles or corners cannot be eliminated, they must be covered with burlap or other suitable padding (e.g., old tires or cloth).

#### **Step 4: Covering the Stack**

After covering the stack, check the tarpaulin for rips, tears, and holes. Look at the taped areas and verify they are properly sealed. Have the fumigator repair all holes.

The tarpaulin must be made of a tough material such as vinyl, polyethylene plastic, or coated nylon. The tarpaulins should be a minimum of 2-mil thickness, however, it is recommended to use 6 mil tarpaulins whenever possible.

The tarpaulin must be large enough to provide a floor overlap of at least 18 inches around all sides of the stack. Carefully lay the tarpaulin out to prevent excess folds or wrinkles along the floor, especially around corners.

#### **Step 5: Sealing the Tarp**

The goal in sealing the tarpaulin is to get it to lay flat against the floor to prevent gas from leaking out. Seal the tarpaulin with loose, wet sand, sand snakes, water snakes, adhesives, or a combination. If there is danger of crushing or crimping the gas sampling or introduction tubes, use the loose, wet sand. If using snakes, use two rows of snakes along the sides and three rows on the corners. The snakes should overlap each other by approximately one foot. Seal corners by laying two sand snakes around the corner and working the tarpaulin until it is flat. To force the tarpaulin against the floor, place a third snake on top of the two other snakes to provide additional weight. Loose, wet sand can be used in the area where the gas introduction line, electrical cords, and gas sampling tubes extend from under the tarpaulin.

#### **Step 6: Introducing the Gas**

Depending upon the type of AP or MP formulation used, the gas may be dispensed in a variety of methods. Follow the Application Procedures from the manufacturer's label for detailed instructions on gas introduction.

For ECO<sub>2</sub>FUME® and VAPORPH<sub>3</sub>OS®, install the gas introduction line(s) at ground level on the floor or secured onto a pallet. These lines should not be located in or attached to commodity package and should be secured to eliminate the movement of the line(s). Direct the discharge toward the center of the space being treated and away from equipment if possible. For tarpaulin enclosures, control the dispensing rate of the gas. The tarpaulin can become damaged and sealing undone if the fumigant is dispensed at high speeds. For small enclosures, a cylinder pressure less than 100 psig is recommended. A regulated dispenser with a pressure regulator and flow restricting nozzles are options to control the rate of the fumigant.

Place the fumigant cylinder with gas introduction line on a calibrated scale and take an initial weight reading. Ensure the gas introduction line is attached to the cylinder. After obtaining the correct weight, subtract the dosage to be introduced into the enclosure. After introducing the proper amount of gas, the scale will be balanced.

When no further fumigant is required to maintain target concentration levels, close all cylinder valves, depressurize the dispensing equipment, and disconnect all ECO<sub>2</sub>FUME® or VAPORPH<sub>3</sub>OS® cylinders. Replace the cylinder cap after the valve discharge cap is securely installed.

### Step 7: Placing Gas Sampling Lines

Place a minimum of 3 gas sampling leads for fumigations up to 10,000 ft<sup>3</sup>. Position the gas sampling tubes in the following locations:

- ◆ Front—low and front of the load, 3 inches above the floor
- ◆ Middle—center of the load (inside the box with the commodity), midway from bottom to top of load
- ◆ Rear—high and rear of the load, at the extreme top of the load

For fumigations from 10,001 to 25,000 ft<sup>3</sup>, use 6 gas sampling leads. Position the gas sampling leads in the following locations:

- ◆ Front—low and front of the load, 3 inches above the floor
- ◆ Upper front quarter section (inside the box with the commodity)
- ◆ Middle—center of the stack (inside the box with the commodity), midway from bottom to top
- ◆ Upper rear quarter section
- ◆ Lower rear quarter section (inside the box with the commodity)
- ◆ Rear—high and rear of the stack, at the extreme top of the load

For approval of fumigations larger than 25,000 ft<sup>3</sup>, contact the **Treatment Quality Assurance Unit** on **page 2-10-38** for instructions regarding the number of gas sampling leads, and for other technical information.

Before inserting into the commodity, cover the end of the gas sampling lines with burlap or wire gauze taped to the tube.

Use gas sampling lines of sufficient length to extend from the sampling position inside the enclosure to at least 30 feet beyond the tarpaulin. Connect all the gas sampling lines in one area for ease and safety in recording gas concentration readings. Do not splice gas sampling lines. Fix all gas sampling lines securely in place under the tarpaulin

and label each one where the gas concentration readings will be recorded. By labeling each gas sampling line, concentration readings can be easily recorded.

### **Step 8: Testing For Leaks**

To ensure they are within acceptable levels outside the fumigation area, monitor phosphine and carbon dioxide levels at the fumigation site and 30 feet from the fumigation enclosure. Phosphine and carbon dioxide levels can be detected using chemical-specific colorimetric tubes or electronic monitor's, e.g., Draeger and PortaSens detection kits. Do not use a Gow-Mac or Fumiscope to record gas readings.

The fumigator should leak test all connections and fittings before opening the cylinder valve. Instructions concerning cylinder leak detection can be found under the section "Poison Gas Hazards-Leak Detection and Repair" of the ECO<sub>2</sub>FUME® and VAPORPH<sub>3</sub>OS® fumigant Application Manuals.

### **Step 9: Monitoring Gas Concentrations**

Take concentration readings within the enclosure using sampling lines connected to an APHIS-approved phosphine monitoring device. The fumigation does not begin until all of the gas has been introduced. Monitoring must take place 30 feet or more from the enclosure.

Phosphine and carbon dioxide levels can be detected using chemical-specific colorimetric tubes or approved electronic monitor's, e.g., Draeger and PortaSens detection kits. To determine if additional gas is needed, check gas concentration levels 30 minutes after the fumigant is added and periodically throughout the fumigation. Record gas concentration readings on PPQ Form 429 at the time intervals prescribed by the treatment schedule in the PPQ *Treatment Manual*.

The 30-minute reading shows the initial concentration and distribution of gas and can indicate leakage, incorrect dosage calculation, or error in fumigant introduction.

If the desired phosphine concentration is met before all of the gas is introduced, stop the addition of ECO<sub>2</sub>FUME® or VAPORPH<sub>3</sub>OS® and check all calculations. When fumigating with ECO<sub>2</sub>FUME®, 200 ppm of phosphine will release 7,700 ppm of carbon dioxide.



NOTICE

Erroneous readings can occur if the monitoring leads become blocked or crimped. It would be impossible to install a new monitoring lead during a fumigation treatment; therefore, always test monitoring leads before the treatment begins.

In order to detect blocked monitoring leads, follow the procedure below using a Mityvac hand-held pump (for supplier see Vacuum Pump, Appendix H).

- Prior to fumigant introduction, connect the Mityvac hand-held vacuum pump to a monitoring lead
- Squeeze the handle on the Mityvac unit. If the lead is blocked, a vacuum will be indicated on the vacuum gauge of the Mityvac unit. For monitoring leads longer than 25 feet, squeeze the handle two or three times. The Mityvac hand-held pump has the capacity to attain and hold 25 inches of Hg vacuum and a minimum of 7 psig pressure
- Disconnect the Mityvac hand-held pump from the monitoring lead, and repeat this procedure for each monitoring lead. Connect monitoring leads to the gas analyzer prior to fumigant introduction

### Preparing to Fumigate Containerized Cargo

Containers require small amounts of phosphine, therefore, AP, MP, or ECO<sub>2</sub>FUME® fumigant gas (not VAPORPH<sub>3</sub>OS®) is recommended for all container fumigations for which an approved treatment exists.

PPQ **does allow** the fumigation of nontarped containers provided the container can be completely sealed in order to prevent gas loss.

To fumigate containerized cargo, follow Steps 1 through 9 in the previous section **Preparing to Fumigate Break Bulk Cargo** on **page 2-10-21**.

#### Additional Considerations for Fumigating Containerized Cargo

If fumigating a **nontarped** container:

- ◆ Close and secure one of the doors
  - ❖ Seal all openings and joints
  - ❖ If possible, caulk all joints and drape entire doorway with polyethylene sheeting, securing the edges to the inner walls, floor, and ceiling with duct tape
- ◆ Inspect the roof, floor, and walls for holes and cracks
  - ❖ Seal all openings with either duct tape or caulking compound
  - ❖ Containers require close inspection and a great deal of sealing to prevent fumigant leakage

- ◆ If possible, drape **remaining** doorway with polyethylene sheeting before the door is closed
  - ❖ Secure edges to door jambs and floor
  - ❖ Close door and secure
  - ❖ If doorway is draped with polyethylene, it may **not** be necessary to seal the door from the outside
  - ❖ If doorway is **not** draped, seal all cracks, openings, and joints with masking tape and caulking compound from the outside
- ◆ Placard all doors of the container with the appropriate warnings before fumigation begins

If fumigating a **tarped** container:

- ◆ If unable to completely seal the container, use a tarpaulin to cover the entire container
- ◆ Use a 4, 6, 10, or 12 mil vinyl, polyethylene plastic, or coated nylon tarpaulin
- ◆ After covering the container with a tarpaulin check for rips, tears, and holes
  - ❖ Examine all taped areas and verify they are properly sealed
  - ❖ Have the fumigator repair all holes
- ◆ The tarpaulin must be large enough to provide a floor overlap of at least 18 inches around all sides of the container—carefully lay the tarpaulin out to prevent excess folds or wrinkles along the floor, especially around corners

### Preparing to Fumigate Bulk Commodities

AP, MP, ECO<sub>2</sub>FUME® and VAPORPH<sub>3</sub>OS® can be used to fumigate any type of bulk commodity storage for which there is an approved treatment in the PPQ *Treatment Manual*. These include, but are not limited to bins, tanks, flat storage, and bunkers. The most important aspects of a successful fumigation, as with any fumigant, are the degree to which the space is sealed and the assurance that the minimum fumigant concentrations are maintained for the required time.

To fumigate bulk commodities, use the procedures outlined in the section, ***Preparing to Fumigate Break Bulk Cargo*** on **page 2-10-21**.

### AP and MP Fumigation

#### Probing

When large quantities of grain or other commodity in bulk are to be treated, it will be necessary to “probe” tablets or pellets into the mass of the commodity for adequate distribution. Specially constructed probes made of steel tubing one and one-quarter inch in diameter are generally available as described below:

- ◆ **Head Piece**—Dosing device and numerical counter to indicate number of tablets used
- ◆ **Tubing**—Usually in three-foot sections that can be added to one another to provide the desired length
- ◆ **End Piece**—Cut obliquely and provided with a hinged flap, closing the entrance to the tube
  - ❖ When the tube is inserted into the commodity, the flap is closed and prevents the commodity from entering
  - ❖ When the probe is withdrawn, the flap opens due to the slightly larger diameter on the flap
    - ▶ The tablets or pellets are then released one at a time as the probe is withdrawn

Grain or other bulk or loose commodities up to 30 feet deep can be probed. Best results are obtained by probing twice every square foot and as regularly as possible. Penetration of phosphine is up to 10 feet below the area in which the tablets are placed. When large bulk grain stores are treated, many probes can be placed prior to treatment. One head piece can be moved from probe to probe, or pellets or tablets can be placed in the tubes by hand (use surgical or disposable thin rubber or polyethylene gloves).

Gas generation starts within four hours of placing the pellets or tablets (depending on relative humidity). Therefore, the whole procedure of pellet or tablet placement or tarpaulin covering must be accomplished within this time frame. It is possible to work in a probed area if the area is covered with a gas-proof tarpaulin. Monitor gas concentrations to determine if toxic levels are approached take corrective action to prevent exposure.

**Additional  
Considerations  
for Fumigating  
Bulk  
Commodities**

- ◆ For large storage facilities (>25,000 ft<sup>3</sup>), consider multiple dispensing points to assist in fumigant distribution
  - ❖ Contact the **Treatment Quality Assurance Unit** on **page 2-10-38** for a determination on the number of sampling lines for large fumigations
- ◆ Based on the size of the structure being fumigated, refer to the ECO<sub>2</sub>FUME® and VAPORPH<sub>3</sub>OS® Application Manuals for acceptable dispensing equipment
- ◆ If it is known ahead of time that grain or cottonseed will require treatment prior to placement in a means of conveyance or storage, the space should be properly sealed before loading—tarpaulins of at least 6 mm thickness should be used if walls are permeable since lighter tarpaulins may tear

- ◆ If a bulk shipment is in a large storage facility with a high roof, it may be better to tarp on top of the grain rather than seal the roof
  - ❖ When side walls of the facility are not gas impervious, tarpaulins (minimum 6 mm thickness) can be placed around the outside of the facility to the height of the commodity

### In Transit Ship Board Fumigation

Until further studies provide the appropriate efficacy data, the **Treatment Quality Assurance Unit** on page 2-10-38 **does not allow** the use of ECO<sub>2</sub>FUME® or VAPORPH<sub>3</sub>OS® fumigant aboard vessels.

However, the solid formulations of AP and MP are approved for use on wood chips for export in ship holds. For guidelines on how to conduct this type of fumigation, refer to the section below, **In Transit Fumigation of Wood Chips** on page 2-10-32.

### In Transit Fumigation of Wood Chips

The TQAU has approved the use of a low-flow recirculation system for the fumigation of coniferous wood chips within ship holds. The technique is based on a patented system for recirculation of phosphine gas in commodity storages such as silos, ship holds, flat storages and other structures. The recirculation system facilitates the rapid and even distribution of phosphine throughout the stored commodity. Phosphine gas is pumped through ductwork using specially designed low volume fans which operate either continuously or intermittently. The gas is drawn from the head space of the ship hold and is blown, via ducting, to the bottom of the hold where it moves upwards through the wood chips to the top of the hold. This recirculation system is a critical component of the fumigation process and is required for all in-transit wood chip fumigations.

### Pest of Concern

Coniferous wood chips exported from the United States of America are fumigated to eliminate the pinewood nematode (*Bursaphelenchus xylophilus*) which is a concern to certain importing countries. Heat generated from oxidative processes in the center of the wood chip pile is typically sufficient to kill the pinewood nematode. However, those nematodes that inhabit the wood chips in the outermost layers of the piles and at the bottom of the hold where temperatures are optimal for their survival are the targets of the fumigation. The incorporation of a recirculation system guarantees phosphine gas will reach all areas of the ship hold to eliminate the pinewood nematode.

## Fumigant

Prior to fumigation, the fumigator must verify that the certified applicator follows the EPA-registered label requirements for aluminum phosphide tablet fumigants and the U.S. Coast Guard regulations regarding shipboard fumigation (See Coast Guard Regulations in Appendix B regarding 46 CFR 147A) and applicable State and local laws and regulations.

Aluminum phosphide tablets are preferred over pellets because tablets release the phosphine gas at a slower rate, thus minimizing peak gas concentrations and slowing gas leakage rates. Fumigate with phosphine at 115-145 tablets per 1000 cubic feet (ft<sup>3</sup>) according to the label requirements, however, verify the amount of phosphine to use from the EXCERPT database. Refer to **Figure 2-10-2** on **page 2-10-9** for the amount of phosphine liberated by various products. A PPQ officer must be present during the application of the tablets to verify the proper dosage has been dispensed. For exports, document the treatment in the treatment section of the Phytosanitary Certificate. Record all information regarding the fumigation in the electronic 429 database.

To determine the length of time to fumigate the wood chips while in-transit, refer to **Figure 2-10-7** on **page 2-10-33**.

Temperature of Commodity	Exposure Period
Below 40°F	Do not fumigate
40-53°F	10 days (240 hours)
54-59°F	5 days (120 hours)
60-68°F	4 days (96 hours)
Above 68°F	3 days (72 hours)

**FIGURE 2-10-7: Commodity temperature and exposure period**

The temperature should be taken from the surface of the wood chip pile after the commodity is loaded into the ship hold. Insert a calibrated long-stem thermometer to a minimum depth of 6 inches. Measure the ambient air of the ship hold with a calibrated thermometer. It must be a minimum of 40°F. When the hatch is closed, air temperature will equilibrate to the commodity temperature rather quickly if the hold is filled to capacity. If the commodity and/or ship hold temperatures are below 40°F the treatment must be postponed until the minimum requirement of 40°F is met.

## Equipment

### Fans

The recirculation system must consist of one fan per ship hold. The type of fan used depends on the total volume of the hold. Fans used in recirculation fumigation systems are typically rated in bushels per minute.



**Important**

To determine the appropriate fan capacity to be used, convert bushels to cubic feet (1 bushel is equal to 1.24 cubic feet) and then refer to [Figure 2-10-8](#) on [page 2-10-34](#).

Volume of Hold (ft <sup>3</sup> )	Fan Capacity (cfm)
62,000 - 248,000	199
248,000 - 372,000	343
372,000 - 744,000	490

**FIGURE 2-10-8: Fan sizes required based on volume of the hold**

**EXAMPLE:** 124,000 bushels of wood chips are to be fumigated for export. Calculate the total fan capacity (cfm) to be used in the ship hold.

$$124,000 * 1.24 = 124,000 \text{ ft}^3$$

Therefore, use a fan that has the capacity of 199 cfm.

---

The fans are secured in the headspace, either to a man way ladder or to a platform inside the hold (**Figure 2-10-9** on **page 2-10-35**). After the fan is installed, connect it to a data logger that has the ability to record the amount of time the fan is operational and when the fan motor was turned on or off during the fumigation. Contact the **Treatment Quality Assurance Unit** on **page 2-10-38** for approved data loggers. The information must be presented to the importing country upon arrival to verify the fan was operational for a minimum of 48 hours during the fumigation process. If the records indicate the fan was not operational for a minimum of 48 hours, the treatment should be documented as incomplete and the **Treatment Quality Assurance Unit** on **page 2-10-38** should be contacted immediately. Record the initial time the fan was turned on in the comments section of the electronic 429 database.

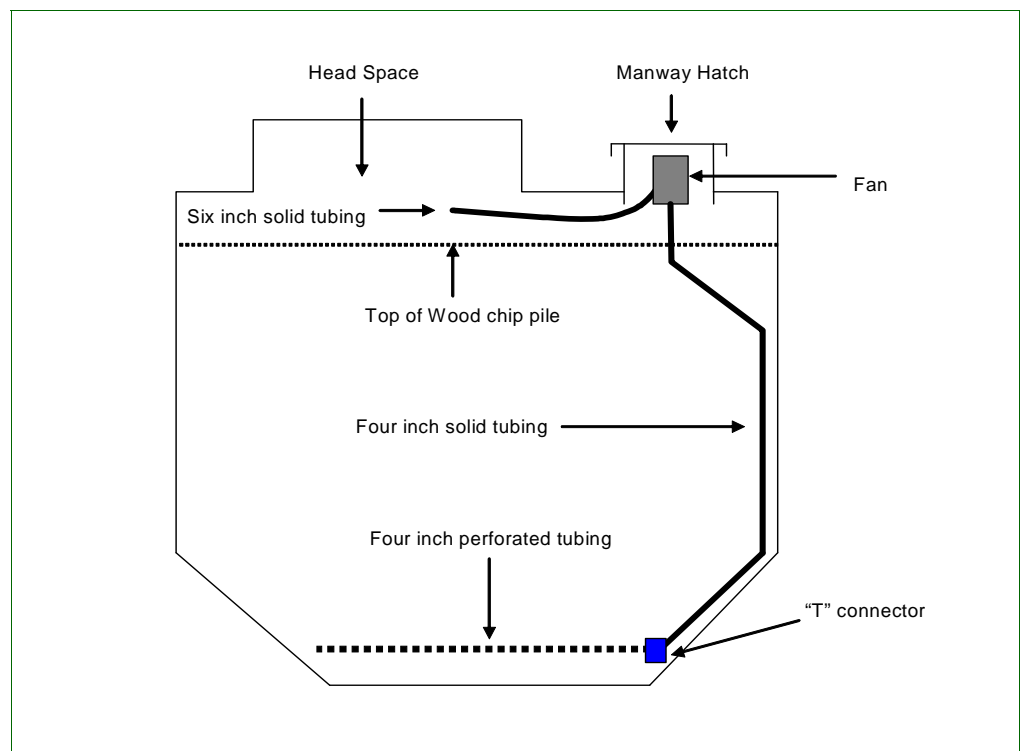
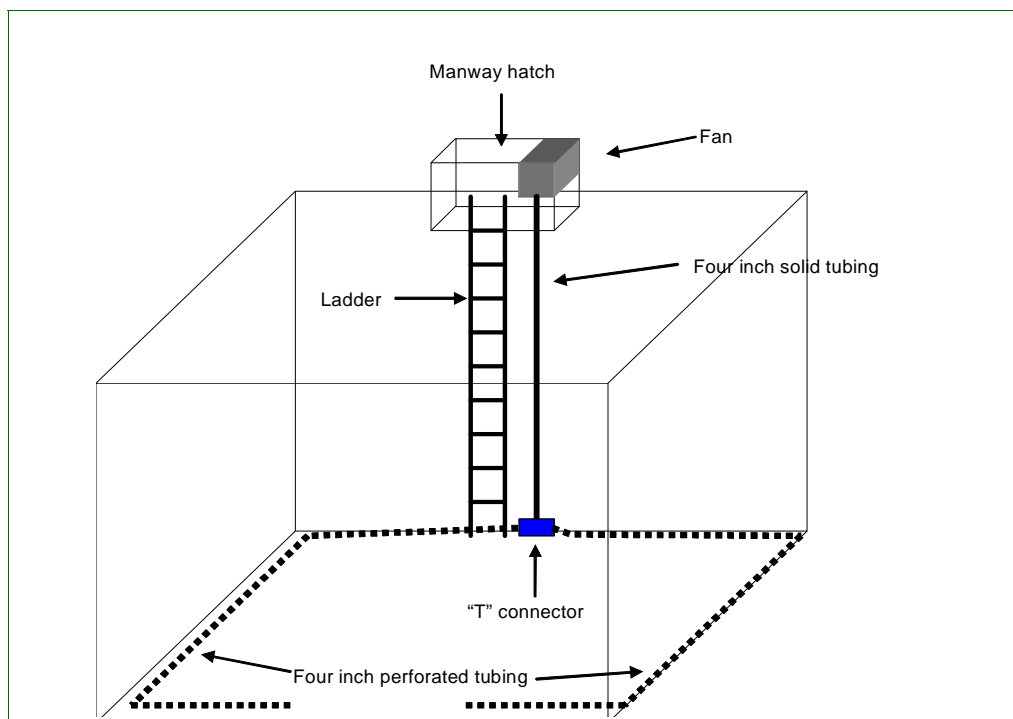

**FIGURE 2-10-9: Side view of a recirculation system**

## Tubing

Different types of high density corrugated polyethylene tubing are used for the recirculation system (**Figure 2-10-10** on **page 2-10-36**). Connect 6" diameter solid tubing to the intake side of the fan and place on the surface of the wood chips in the headspace. Connect 4" diameter solid tubing to the exhaust side of the fan and attach behind or beside the man way ladder that runs to the bottom of the hold. Attach a polyethylene "T" connector to the bottom of the 4" diameter, solid tubing at the bottom of the hold. Each side of the "T" connector is attached to 4" diameter perforated tubing which runs in opposite directions around the perimeter of the hold along a minimum of three walls of the hold.

All of the tubing should be taped and/or glued in place before the commodity is loaded into the hold. Conduct a visual inspection of the recirculation system prior to the loading of wood chips. If the recirculation system is not installed properly, the fumigation will be delayed until necessary corrections are made to the system.



**FIGURE 2-10-10: Three-dimensional view of a recirculation system**



**Break Bulk,  
Containers, and  
Bulk  
Fumigations**

**Aeration Requirements**

Following completion of treatment, phosphine-treated commodities must be aerated using either electric exhaust fans or by passive aeration in the open air. Personnel are **not** allowed to enter or reenter fumigated areas until gas concentrations are determined to be below the Threshold Limit Values (TLV) for phosphine and carbon dioxide. Check ambient air and the air inside the box, carton, bin etc. of the commodity during aeration. Measure gas concentration levels with a sensitive gas detection device. Aerate all commodities to acceptable tolerance levels (**Figure 2-10-11** on **page 2-10-37**). Because they can continue to release gas after the initial gas levels have dropped to acceptable levels, continue to monitor densely packed commodities. A certified applicator must be physically present, responsible for, and maintain visual and/or voice contact with all fumigation workers during the initial opening of the fumigation structure for aeration. Always follow the aeration instructions provided with the fumigant label.

Commodity	Tolerance of Phosphine Residues (ppm)	Minimum Aeration Period (hours)
Animal Feeds, Grains, Nuts, and Dates	0.1	48
Processed Foods	0.01	48
Fresh fruits and Vegetables	0.01	48
Nonfood Commodities	<0.3	None
Tobacco	<0.3	48

**FIGURE 2-10-11: Tolerance Levels and Minimum Aeration Periods**

**Disposal of AP  
and MP Residue**

Following treatment with AP, a powdery residue, essentially aluminum hydroxide, will remain. Collect this material and mix it in a container of water to which liquid detergent has been added (two tablespoons of detergent per gallon of water). The liquid should then be buried or deposited in an approved pesticide disposal landfill.

Following treatment with MP, dispose of the plates by burial in an approved landfill or by burning where approved by local ordinances.

Follow the manufacturer’s label instructions for detailed disposal guidelines.

---

## Contacts

### **Cytec®**

Cytec Industries  
5 Garret Mountain Plaza  
West Patterson, NJ 07242  
Phone: 973-357-3100  
email: INFO@CYTEC.COM

<http://www.cytec.com/business/phosphine/products/phosphinegas.shtm>

### **Treatment Quality Assurance Unit**

USDA-APHIS-PPQ-CPHST  
1730 Varsity Drive  
Suite 400  
Raleigh, NC 27606  
Phone: 919-855-7450  
FAX: 919-855-7493

# 2

Treatment Manual

## Chemical Treatments

### *Aerosols and Micronized Dusts*

---

#### Contents

Introduction	<a href="#">page-2-11-1</a>
Aerosols	<a href="#">page-2-11-1</a>
Micronized Dusts	<a href="#">page-2-11-2</a>
Cartridges	<a href="#">page-2-11-2</a>
Equipment	<a href="#">page-2-11-2</a>
Methods and Procedures for Application	<a href="#">page-2-11-2</a>
Treatment of Passenger Compartments and Cargo Aircraft	<a href="#">page-2-11-2</a>
Treatment of Separate Cargo Compartments and Containerized or Palletized Cargo	<a href="#">page-2-11-3</a>
Precautions for Both Aerosols and Micronized Dusts	<a href="#">page-2-11-4</a>
Precautions in Use of CO <sub>2</sub> Fire Extinguishers	<a href="#">page-2-11-4</a>

---

#### Introduction

This section includes information about aerosols and micronized dusts. Use this information with the treatments from **T409—Aircraft** on [page 5-5-28](#), and with [Table 5-5-1](#) on [page 5-5-30](#), to conduct a safe and effective aerosol disinfestation.

---

#### Aerosols

When applying an aerosol, the dispenser nozzle(s) should be directed upward at a 45° angle and moved from side to side in order to get uniform distribution of the material. During discharge, the dispensing valve should be depressed fully, and the nozzle held 45 cm (18 inches) or more from all surfaces. Devices are available for depressing the valve and expending all the aerosol in the can or a trigger mechanism for ease in dispensing the material. Aerosol dosages are based on a dispensing rate of 1 g per second, unless otherwise noted. The applicator should use a dust mask, or face mask (with filter) for personal protection. The PPQ quarantine dosage shall not be applied in the presence of passengers, crew, or animals, except as noted in the schedules.

## Micronized Dusts

Both domestic and foreign quarantine programs use dust to kill pests such as the Japanese beetle and pests of foreign origin. This method may be used in treating aircraft, railroad cars, trucks, and palletized or containerized cargo. Specific instructions for domestic quarantine use are included in Program Manuals.

### Cartridges

Prefilled cartridges are used (available as follows: green–1 g; yellow–3 g; red–5 g; and blue–13 g). Combinations of these sizes will give the correct amount and the dust may be combined into a single cartridge to reduce the number of individual “shots” required. Care must be taken in combining the material to insure no exposure to the dust occurs through dermal contact or inhalation.

Store filled pesticide cartridges in a cool, dry, protected location. Damaged cartridges and empty cartridges should be disposed of by placing them in refuse containers in accordance with recommendations for the safe disposal of pesticide containers. When treating aircraft, refer to **T409—Aircraft** on **page 5-5-28** which lists the cubic capacity and application schedules for most commercial and military aircraft. Do not deduct the space occupied by cargo in computing the required treatment rate.

### Equipment

Compressed CO<sub>2</sub> or compressed air is used to expel the dust. A modified CO<sub>2</sub> fire extinguisher with a standard release valve may be used. The 10-lb. CO<sub>2</sub> capacity extinguisher, which weighs 35 to 40 pounds when full, is convenient and safe for use. Sufficient gas for 25 to 30 releases is contained in this size. Smaller modified extinguishers are also satisfactory. Compressed air units must be specifically designed for expelling dust and are not readily available.

Specifically developed micronized dust guns with proper connections may be available through the Program Support Staff in Riverdale, MD.

---

## Methods and Procedures for Application

### Treatment of Passenger Compartments and Cargo Aircraft

All entry doors and other openings should be closed and all ventilation systems stopped before discharge of dust. The door to the pilot's compartment must be closed. On aircraft with a baggage compartment immediately behind the pilot's and no door to separate these compartments, place a screen of plastic or other suitable material

between the baggage compartment and the pilot's compartment. Galleys shall be closed off by means of doors or a screen of plastic, etc., which will prevent the entry of the pesticide.

The single nozzle gun recoils or kicks back when discharged. Therefore, it must be held firmly with one hand while the other hand is used to trigger the release of the CO<sub>2</sub>. Keep the host between the extinguisher and the gun as straight as possible to reduce kickback. A position should be taken much like that used when firing a large caliber pistol. Rest the bottom of the gun on a solid object if possible. Kneeling on one knee may be necessary if the host to gun is short. A 1-second blast is sufficient. The discharge nozzle should be directed above the top of the seats or cargo to assure unimpeded flow of the dust cloud from the release point.

On smaller types of aircraft, stand behind the first seat to discharge the dust. Leave the aircraft immediately after release; close the door quickly to avoid disturbing proper dust distribution.

In larger aircraft, discharge the dust from the front behind the pilot's compartment or from the rear depending on location of exit doors. Remain in the craft only long enough for the dust cloud to appear to have reached the other end of the craft—about 1 minute. The dust cloud may not return from the opposite end of the large aircraft. Judgment should be used by the inspector as to the best location for firing if partitions are present.

A recently designed gun has 2 nozzles facing in opposite directions. Since the gas and dust are expelled from both nozzles, no "kick" results. The operator should stand in the middle of the large compartment when firing the charge.

After dust has been discharged, the officer will leave the aircraft, close the door, and hold the aircraft closed for 10 minutes.

Unless responsible personnel remain near the craft to prevent inadvertent entry by others, place a treatment notice, PPQ Form 468, on the entry door. Cargo or passenger area ventilation systems shall not be in operation during the application and settling periods. After a 15-minute aeration period, the aircraft may be reentered.

### **Treatment of Separate Cargo Compartments and Containerized or Palletized Cargo**

Cargo compartments in bellies of aircraft will be treated by opening the doors sufficiently to insert the applicator nozzle. After firing, close the door quickly and do not open for at least 10 minutes. Treatment of such compartments may require two people, one to operate the doors

and the other to operate the gun. Containerized cargo is treated by lifting the cover or otherwise inserting the nozzle in the container. After discharge, the cover should be quickly closed.

---

## Precautions for Both Aerosols and Micronized Dusts

1. Treatment shall not be applied when animals or people are present.
2. Food should be removed or covered prior to treatment.
3. Food preparation surfaces and equipment shall be covered to prevent contamination.
4. A suitable respirator, approved by the National Institute of Safety and Health (NIOSH) shall be worn by the person applying the pesticide. **EXCEPTION:** A respirator is not required when the pesticide label or this manual specifies that use in the presence of people is acceptable.
5. Goggles are optional equipment and should be worn if the person applying the pesticide experiences any eye irritation.
6. Do not smoke or eat during application and not until after washing. Wash as soon as possible after application of pesticides.
7. Any pesticide residue noted on smooth surfaces after treatment should be wiped away using a clean damp cloth. (If a deposit of dust is noted on the floor immediately after discharge, a blast of compressed air or CO<sub>2</sub> will usually clear the area.)

---

## Precautions in Use of CO<sub>2</sub> Fire Extinguishers

1. Discharging CO<sub>2</sub> chills metal and can cause freezing injury to bare hands. Do not touch the nozzle immediately after discharge. It may be advantageous to wear a glove on the gun hand if several discharges are to be made in close succession. Do not hold the release valve open longer than necessary to expel the dust (about a second).
2. Replace the safety pin in the CO<sub>2</sub> tank valve after each use and secure with wire or tape. Accidental release could result in severe injury.
3. Keep the face away from openings when applying material in a luggage compartment or to containerized cargo to avoid dust backlash.
4. Check the flexible hose between the CO<sub>2</sub> tank and dust gun. Pay particular attention to the areas near the connections. Replace the hose when it shows wear.

# 2

Treatment Manual

# Chemical Treatments

## *Dips*

---

### Contents

Overview	<a href="#">page-2-12-1</a>
Safety and Dip Treatment Equipment and Materials	<a href="#">page-2-12-1</a>
Dip Treatment Procedures	<a href="#">page-2-12-3</a>
Safety Responsibilities	<a href="#">page-2-12-5</a>

---

### Overview

As with other treatments, chemical dips require careful planning and preparation. Make sure you have all the necessary safety and treatment equipment and materials ready before you start the dip treatment procedure. When you handle pesticides, always comply with the pesticide Label instructions, and State and local regulations.

---

### Safety and Dip Treatment Equipment and Materials

The following lists include safety equipment (Personal Protective Equipment, PPE) and basic material that you will need for dip treatments. However, other materials may be required by additional Label requirements that are specific to chemical being used.

#### **Personal Protective Equipment (PPE)**

Always check the Label and Material Safety and Data Sheet (MSDS) for additional requirements of personal protective equipment. The following is a basic list of PPE that you will need for dip treatments:

- ◆ chemical-resistant footwear (rubber or neoprene boots)
- ◆ chemical-resistant gloves (neoprene)
- ◆ chemical-resistant headgear for overhead exposure
- ◆ chemical-resistant rain suit with hood
- ◆ protective eye wear (goggles)
- ◆ respirator (per Label and MSDS requirements)

#### **Dip Treatment Equipment and Materials**

Always check the Label for additional requirements for equipment and materials. The following is a basic list of equipment and materials you will need for dip treatments:

◆ Newspaper or any other absorbent paper



**Important**

Place plastic backed paper on pallets prior to covering with paper and/or absorbent paper to preclude the pesticide being absorbed onto the wood.

◆ Pesticides



**Important**

Pesticides should be fresh (not over 1 year old). Labels and MSDS must be attached to the pesticide container and all instructions must be followed.

- ◆ Mixing containers and dipping containers must be provided with lids to prevent spills during transportation and storage.
- ◆ New boxes (when reconditioning or excess contamination of original boxes is not possible)
- ◆ Fans<sup>1</sup>



**Important**

A mechanical exhaust is the preferred method of aeration when it is specifically installed to remove chemical fumes from the treatment area. Fans may be used if they do not cause airborne pesticides to contaminate the treatment facility or the breathable air. The flow of air should be across the dip vat/container and away from people in the treatment area.

◆ Pallets<sup>1</sup>



**Important**

Place plastic backed paper on pallets prior to covering with paper and/or absorbent paper to preclude the pesticide being absorbed onto the wood.

- ◆ Plastic bags (4 to 6 mil plastic)<sup>1</sup>
- ◆ Shear scissors
- ◆ Sponges
- ◆ Liquid soap<sup>2</sup>
- ◆ Packing material<sup>1</sup>

---

1 This equipment will be provided by USDA when available.  
2 This equipment will be provided by USDA when available.



## Dip Treatment Procedures

### Step 1—Plan for the Dip Treatment

Before you start the dip treatment, inform the customer (Broker/Importer) of the specific material and personal protective equipment (PPE) that will be needed to perform the dip treatment procedure. All required materials and equipment must be available at the time of treatment.

### Step 2—Designate Restricted Use Areas

Designate the following restricted use areas:

- ◆ **Measuring and mixing area-** The measuring and mixing area for the specific pesticide(s) must be in a well ventilated area away from food preparation, eating areas, and offices. Areas that contain mechanical exhaust systems are preferred.
- ◆ **Plant material dipping area-** The plant material dipping area must be an area where access is limited by a barricade or warning signs. Areas that contain mechanical exhaust systems are preferred.
- ◆ **Plant material drying area-** The plant material drying area must have proper air circulation and exhaust ventilation. These areas should be closed to the dipping area. The route from the plant dripping area to the drying area should be lined with plastic backed absorbent paper or plastic and paper to catch excess pesticide solution.

### Step 3—Prepare Plant Material

Prepare the plant material for the dip treatment according to the PPQ Treatment Manual and pesticide Label requirements.

### Step 4—Prepare the Pesticide Solution



Wear personal protective equipment (PPE) and keep the exhaust system running when you are preparing pesticide solutions. To minimize your exposure to the pesticide dust or airborne particles, keep the pesticide between you and the exhaust.

1. Measure the amount of water required for the treatment.
2. Measure the amount of pesticide required for the treatment.



It is important to use fresh chemicals for every solution. If questions arise during this procedure, stop and seek assistance from the Center for Plant Health Science & Technology (CPHST) (Tel: 919-855-7450).

3. Prepare a pesticide paste as follows:

- A. Add the previously measured amount of water into a clean and empty container, for example, an empty can or plastic container.
  - B. Form a paste (with dry pesticides) by adding the measured pesticide to the small amount of water and mix gently
  - C. Dilute the paste by slowly adding more water from the previously measured water
  - D. Slowly add the concentrated solution(s) to the rest of the measured water
4. Add some drops of liquid soap to the solution (soap is used as a sticking agent).
  5. Mix the final solution by stirring it gently.

### **Step 5—Dip the Plants in the Pesticide Solution**

Dip the plants in the solution for the time required by the PPQ Treatment Manual.

### **Step 6—Remove the Plants from the Pesticide Solution**

Remove the plants from the solution and allow excess solution to drip into the dipping container.

### **Step 7—Dry the Plants**

Place the plants on newspaper covered pallets and allow them to dry (make sure to space the plants out for maximum drying).



Plants should be dried thoroughly before releasing them to the customer.

### **Step 8—Disinfect Original Shipping Containers**

Disinfect the original shipping containers with a sponge containing the pesticide solution. The plant material may be packed with new packing material in a previously used container that has been disinfected.

### **Step 9—Clean Up the Treatment Area and Equipment**

Discard all empty containers, excess pesticides, packing materials, plastic bags/backing materials, and newspaper/absorbent paper in compliance with instructions on the Label and State/Local regulations. Decontaminate all treatment areas and equipment while you are wearing your PPE.

### **Step 10—Release the Cargo**

After the plant material is dry, release it to the customer or broker if agreed to by the airline and if it has been released by Customs.

## Safety Responsibilities

The PPQ Officer is responsible for the following safety issues:

- ◆ Make the broker/importer aware of his or her responsibilities as it pertains to:
  - ❖ materials
  - ❖ Personal Protective Equipment (PPE)
  - ❖ health hazard and safety concerns when performing the dip treatment process
- ◆ All personnel involved in the dip treatment process are required to wear the appropriate and Label required PPE while performing the treatment. PPQ Officers may need to wear PPE if the dip treatment process area prevents them from observing the process from outside the restricted area.
- ◆ Designated dip treatment process areas must be located away from food preparation, eating areas, and offices. All efforts should be made to place dip treatment processes in an area containing a mechanical exhaust.
- ◆ The broker/importer personnel involved with treatments must be aware and briefed on the location of the emergency eyewash and all other required safety equipment. They also need to be aware of the areas that they will be limited to working within and any other specific restrictions determined by the PPQ Officer in charge of the process. The PPQ Officer monitoring the process should be aware of procedures to be followed in the event of an accidental release of the pesticide or an injury to one of the broker/importer's personnel.
- ◆ The broker/importer's personnel should shower as soon as possible after performing a dip treatment. The PPQ Officer should ensure that personnel are aware of the location and route to the shower. Guidance should also include instruction on how to disrobe and dispose of clothing used during dip treatment processes. All contaminated clothing and PPE must be removed before entering the shower room. Contaminated clothing should be placed in plastic bags and PPE in Separate plastic bags.
- ◆ Broker/importer personnel should be informed that clothes worn during treatment must be washed in hot water with detergent and that they should be washed separately from other clothes
- ◆ The plant material should be released to the Broker/importer only if they are using/provide a vehicle that has a compartment physically separated from the cab, for example, a pick-up truck or tractor trailer.



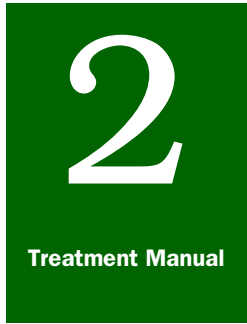

# Chemical Treatments

## *Dusts*

---

### Contents

This section for future development.



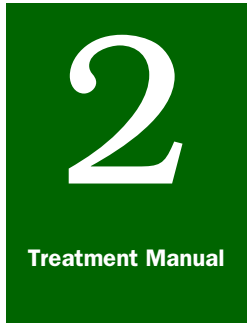

# Chemical Treatments

## *Sprays*

---

### Contents

This section for future development.





# 3

Treatment Manual

# Nonchemical Treatments

## *Overview*

---

### Contents

Overview [page-3-1-1](#)  
Heat [page-3-2-1](#)  
Cold Treatment (CT) [page-3-7-1](#)  
Irradiation [page-3-8-1](#)

The Nonchemical Treatment section of this manual is organized by the following nonchemical categories:

- ◆ Heat
- ◆ Cold
- ◆ Irradiation

Use the Table of Contents that follows each tab to quickly find the information you need. If the Table of Contents is not specific enough, then turn to the Index to find the topic and its page number.



# 3

Treatment Manual

# Nonchemical Treatments

## *Heat*

---

### Contents

- Introduction [page-3-2-1](#)
- Heat, Hot Water Immersion Treatment [page-3-3-1](#)
- Heat • Steam Treatments [page-3-4-1](#)
- Heat • Vapor Heat and Forced Hot Air Treatment [page-3-5-1](#)
- Heat • Forced Hot Air • Niger Seed [page-3-6-1](#)

---

### Introduction

Heat treatments are generally based on maintaining the plant material at a specific temperature for a specified time. Heat treatments, as other quarantine treatments, are designed to kill plant pests without destroying or appreciably devaluing the infested commodity. The following heat treatments are described in this section:

- ◆ Hot Water Immersion Treatment
- ◆ Steam Treatments
- ◆ Vapor Heat and Forced Hot Air Treatment
- ◆ Forced Hot Air - Niger Seed



# 3

Treatment Manual

## Nonchemical Treatments

### *Heat, Hot Water Immersion Treatment*

#### Contents

Hot Water Immersion Treatment (in General)	<b>page 3-3-2</b>
Principle	<b>page 3-3-2</b>
Schedules	<b>page 3-3-2</b>
Procedures	<b>page 3-3-2</b>
Checklist of USDA-APHIS Minimum Requirements for Hot Water Immersion Treatment Facilities: General Requirements	<b>page 3-3-3</b>
Proposal Submission	<b>page 3-3-3</b>
On-Site Inspection Option	<b>page 3-3-3</b>
Facility Design	<b>page 3-3-3</b>
Electrical and Electronic Components	<b>page 3-3-5</b>
Wiring	<b>page 3-3-5</b>
Computers and Microprocessors	<b>page 3-3-5</b>
Commercial Line Conditioner (Surge Protector)	<b>page 3-3-5</b>
Electrical Generator	<b>page 3-3-5</b>
Fruit Sizing Equipment	<b>page 3-3-6</b>
Boilers and Thermostatic Controls	<b>page 3-3-6</b>
Adequate Water Heating Capacity	<b>page 3-3-6</b>
Thermostatic Controls (Set Point)	<b>page 3-3-6</b>
Multiple Set Point Option	<b>page 3-3-6</b>
Water Circulation	<b>page 3-3-7</b>
Temperature Sensors	<b>page 3-3-7</b>
Type of Sensor	<b>page 3-3-7</b>
Number of Sensors Required and Their Placement	<b>page 3-3-7</b>
Tank Access for Temporary Placement of Portable Sensors	<b>page 3-3-8</b>
Certified Glass-Mercury, Non-mercury and Digital Thermometer	<b>page 3-3-8</b>
Temperature Recorder	<b>page 3-3-8</b>
Automatic Operation	<b>page 3-3-8</b>
Long-Term Recording	<b>page 3-3-8</b>
Recording Frequency	<b>page 3-3-8</b>
Accuracy	<b>page 3-3-9</b>
Repeatability	<b>page 3-3-9</b>
Calibration	<b>page 3-3-9</b>
Range	<b>page 3-3-9</b>
APHIS-Approved Recorder Models	<b>page 3-3-9</b>
Approved Strip Chart (Pen) Recorder Models	<b>page 3-3-10</b>
Approved Data Logger Recorder Models	<b>page 3-3-10</b>
Chart Paper Specifications	<b>page 3-3-11</b>
Alarm System	<b>page 3-3-11</b>
Safeguarding the Treated Fruit	<b>page 3-3-12</b>
Layout and Flow Pattern	<b>page 3-3-12</b>
Garbage Disposal	<b>page 3-3-12</b>
Quarantine Area	<b>page 3-3-12</b>
Pre-treatment Warming Options	<b>page 3-3-13</b>
Post-Treatment Cooling Options	<b>page 3-3-13</b>
Refrigerated Room	<b>page 3-3-13</b>

Fans [page 3-3-13](#)  
Hydrocooling [page 3-3-13](#)  
Facility Changes [page 3-3-14](#)  
Safety and Health Checklist [page 3-3-14](#)  
Work Plan [page 3-3-15](#)  
Address for Technical Contact [page 3-3-15](#)

---

## Hot Water Immersion Treatment (in General)

### Principle

Hot water immersion treatment (also called hydrothermal treatment) uses heated water to raise the temperature of the commodity to the required temperature for a specified period of time. This is used primarily for certain fruits that are hosts of fruit flies, but may also be used for nursery stock for a variety of pests.

### Schedules

Refer to the appropriate section in the Treatment Manual for Treatment Schedules. The time/temperature relationship varies with the commodity and pest. Typically, the pulp temperature is raised using water heated to between 115°F and 118°F for a prescribed period of time.

### Procedures

- ◆ Before the start of each treatment, examine the facility for proper operation of the heating, circulation, and recording equipment. Examine continuous flow equipment (submerged conveyor belt) at the start of each day or run
- ◆ Commodities subject to size restrictions require a preliminary culling procedure to eliminate oversized items prior to treatment
- ◆ Conduct all treatments in an approved tank
- ◆ Entire treatment will be under the general monitoring of APHIS, and may be further governed by a signed Work Plan (for foreign facilities) or Compliance Agreement (for domestic facilities)
- ◆ Load immersion tanks in a manner approved by the U.S. Department of Agriculture (USDA), usually using baskets with perforations that allow adequate water circulation and heat exchange
- ◆ Number each treatment container or lot before placing in the immersion tank

- ◆ Record the temperature and duration of each hot water dip with an automatic temperature recording system
  - ❖ A responsible employee of the packing company must indicate on the printed temperature record the starting time, lot number, duration of each treatment, and initial each entry
  - ❖ An alternative recording system can be used only with prior APHIS approval
  - ❖ During certification, the average pulp temperature becomes the minimum commercial treatment pulp temperature
  - ❖ During commercial treatments, the "Adjusted Tank Sensor Temperature" in is used as the lowest treatment temperature. Refer to **Figure 6-1-1** on **page 6-5-3** for more information.
- ◆ Stamp all boxes of hot water-treated fruit, *Treated with Hot Water, APHIS-USDA*, together with the numerical designation APHIS has assigned to the particular treatment facility
- ◆ When treatment is complete, promptly move commodities treated at origin to an insect-free enclosure
  - ❖ Maintain the insect-free commodities throughout the shipping process, this can be accomplished by using insect-proof containers, screened or enclosed rooms, doors with air-curtains, or some combination of the above

---

## Checklist of USDA-APHIS Minimum Requirements for Hot Water Immersion Treatment Facilities: General Requirements

### Proposal Submission

Follow the accepted protocol when submitting proposals for new hot water facilities. (In the chapter ***Certifying Facilities*** on **page 6-1-1**, see the discussion titled, ***Protocols for Foreign Treatment Facilities*** on **page 6-5-7**).

### On-Site Inspection Option

When the construction is 75% complete, the firm can request APHIS to make an on-site inspection. This interim inspection is optional. However, a final inspection is required as well as performance tests of the equipment. All costs involved must be prepaid by the requesting firm.

### Facility Design

APHIS does not provide construction details, but only this list of minimum requirements. Design and construction of the hot water facility is the responsibility of the owner, in consultation with an engineering firm. (Engineering firms and sources of supply are

provided in ***Reference Guide to Commercial Suppliers of Treatment and Related Safety Equipment*** on **page H-1-1.**) To take into account variations in facility size, availability of materials, economic feasibility, and individual preference, APHIS allows a wide range of design flexibility.

Although each facility is somewhat unique, there are two basic designs for hot water facilities. The two types are referred to as the *batch system* and the *continuous flow system*.

### **Batch System (Sometimes Called “Jacuzzi System”)**

Most hot water immersion treatment facilities are the batch system type. In this system, baskets of fruit are loaded onto a platform, which is then lowered into the hot water immersion tank where the fruit remain at the prescribed temperature for a certain length of time, then are taken out, usually by means of an overhead hoist. In this system, the treatment chart must indicate (by an identifiable marking) when a fruit basket is prematurely removed from the tank. Other alternatives include a solenoid switch, sensor, or similar device that disengages whenever a basket is removed from the treatment tank, or a locking device to make it physically impossible to remove the fruit until the treatment is fully complete.

### **Continuous Flow System**

In the continuous flow type of system, the fruit are submerged (either loosely or in wire or plastic mesh baskets) on a conveyor belt, which moves slowly from one end of the hot water tank to the other. Belt speed is set to ensure the fruits are submerged for the required length of time. This system requires an instrument to monitor the speed of the conveyor belt. This can be accomplished by attaching a speed indicator (encoder) to the gear mechanism. The belt speed is recorded on the same chart as the time and temperature, and also indicates whether the belt is moving or stopped during the treatment cycle. Smaller fruits require less treatment time than larger fruits. Therefore, conveyor belt speed should be adjustable to accommodate treatments of different lengths of time. As an alternative, the belt speed may remain constant, but the length of the submerged portion of the belt is adjusted according to the length of treatment time required for the particular size of fruit. The conveyor must prohibit either forward or backward movement of the fruit during treatment (due to flotation).

Some operators believe that treating fruit while it passes through the system on a conveyor belt is an advantage. Few new systems of this type were built after 1990, presumably because mechanical fruit damage (scratching of the peel) often occurs if the fruit are not in baskets. The system also occupies much more floor space in the plant than a batch system.



## Water Quality

The water used for washing, dipping, hydrocooling or showering the fruit should be chlorinated at a level not to exceed 200 parts per million (ppm). This level is easier to maintain if the water is first filtered and run through a flocculation process to remove organic material that would otherwise bind with the chlorine.

The facility should check the water for microbial contamination on a regular basis. To maintain sanitary conditions, change water as necessary. Implement standard operating procedures to include water change schedules for all processes that use water. To ensure the safety of the fruit, the facility must clean and sanitize surfaces that come into contact with water, such as wash tanks, hot water tanks, and hydrocooling tanks as often as necessary. To ensure efficient operation, routinely inspect and maintain equipment designed to assist in maintaining water quality, such as chlorine injectors, filtration systems, and backflow devices.



Periodic monitoring by the facility is critical, because chlorine levels above 300 ppm can result in metal corrosion.

---

## Electrical and Electronic Components

### Wiring

Electrical wiring throughout the facility must meet both international as well as local safety code requirements. To eliminate shock hazard, earth grounding is required for all electrical wiring located in the vicinity of water. To prevent damage, shield wires inside metal or PVC conduit.

### Computers and Microprocessors

To maintain accuracy and reliability, place computers and microprocessors in a climate-controlled (air-conditioned) room. This room should be above tank level, provide a clear view of the treatment tank(s), and be lockable. This room can also serve as an office for the inspector.

### Commercial Line Conditioner (Surge Protector)

A commercial line conditioner is recommended for use with computers and microprocessors to provide protection from voltage irregularity (power surges), noise reduction, and harmonic distortion.

### Electrical Generator

In the event of a power outage and to provide a secondary source of electricity to enable continued plant operation, an electrical generator is recommended as a backup power supply.

### **Fruit Sizing Equipment**

In the Treatment Schedule, the duration of hot water immersion depends on the particular weight class and variety of the fruit being processed. The inspector must visually inspect and weigh the largest fruit until the inspector is satisfied that all of the fruit is within the weight class, with no more than three fruit over the weight class. The weight inspection must occur for each lot change (orchard or variety) to ensure the accuracy of the sizing equipment. No mangoes will be accepted that are over the weight class.

It is very important to have accurate sizing equipment that sorts the fruit into groups, either by diameter or by weight. (Weight sorting is the preferred method.) If the weight range is too broad, recalibrate the equipment.

---

## **Boilers and Thermostatic Controls**

### **Adequate Water Heating Capacity**

The hot water facility must have adequate water heating capacity (i.e., a powerful enough boiler), and accurate enough thermostatic controls to hold the water temperature at or above the temperatures prescribed in the Treatment Schedule for the given length of time.

### **Thermostatic Controls (Set Point)**

APHIS requires that the thermostatic controls be automatic. The temperature set point(s) are determined and approved during the official performance test, and must be high enough to ensure the water in the treatment tank will meet or exceed the minimum treatment temperature prescribed for the fruit. Once approved, do not tamper with the temperature set points. Temperature set points must remain constant for the entire shipping season. However, if the operator of the facility requests a change in set points, the inspector should conduct a new performance test. If this test is unsuccessful, revert the tanks to their prior set points.

### **Multiple Set Point Option**

Managers of some facilities use multiple set points for each tank. The initial set point is higher than the other set points. All set points will be selected by the facility manager or systems engineer based on results of the preliminary performance test.

Verify the set points during the official performance test, and the same procedure must be repeated on each subsequent commercial treatment. This system works only for tanks that treat only one cage (basket) of fruit at a time.



Tanks are not allowed to have any set point that is lower than the standard treatment temperature for the commodity being treated (115°F in the case of mangoes).

---

## Water Circulation

Install a water circulation system in the tank to provide uniform water temperatures throughout the treatment process and to avoid the formation of cool pockets during treatment. To guarantee that the equipment is not turned off during the treatment process, the controls for the circulation pumps or propellers must be tamper resistant. For the safety of personnel working in the area, shield pulleys on all pumps located within six feet of the floor.

After the first five minutes of treatment (with the tank sensor at "lowest temperature permitted at that set point"), differences in the lowest and highest actual temperature sensor readings of more than 1.8°F may be accepted on a case-by-case basis.

Using a flotation barrier, keep the fruit at least 4 inches (10.2cm) below the water surface during the treatment.

---

## Temperature Sensors

### Type of Sensor

Permanently install platinum 100-ohm resistive thermal detectors (RTD sensors) in the lower third of the tank. The resistance of an RTD sensor linearly changes with temperature, whereas thermistors and thermocouples are nonlinear and less stable. Major advantages of RTD sensors include long-term stability, high signal levels, and overall accuracy of the system. Place the sensor unit within the distal 1 inch (2.54cm) of the sensor rod. The sensor must have an outer sheath of 0.25 inch (6.4mm) or less in diameter.

### Number of Sensors Required and Their Placement

For continuous flow systems, the minimum number of sensors required is at least 10 per tank, which must be spaced throughout the length of the conveyor. For batch systems, the requirement is at least 2 sensors per tank. However, in tanks that treat multiple baskets (cages) of fruit, there must be at least 1 sensor per basket position. (A tank with 4 basket positions, for example, would require at least 4 sensors). In both the batch and continuous flow systems, install sensors in the lower third of the tank.

### **Tank Access for Temporary Placement of Portable Sensors**

The hot water tank must be designed to accommodate the temporary placement of numerous portable sensors or probes to be used during the performance testing procedure required for certification or recertification. During the testing procedure and at the direction of the inspector who conducts the performance test, position the temporary sensors throughout the load of fruit. The facility is required to purchase and have available 24 portable thermistor or thermocouple sensors (each with its own flexible cord at least 10 feet in length), and a portable temperature monitor that reads to the nearest one-tenth of a degree.

### **Certified Glass-Mercury, Non-mercury and Digital Thermometer**

The treatment facility is required to have at least 1 high-accuracy, water-immersible, certified mercury, non-mercury or digital thermometer on the premises at all times. This thermometer must be accurate to 0.1°F (or C) and will cover the range between 113°F and 118°F (45°C to 47.8°C). It will be used as the standard against which all sensors are calibrated.

---

## **Temperature Recorder**

Use an automatic temperature recorder (strip chart or data logger) to record the time and temperature during each treatment.

### **Automatic Operation**

The instrument used for recording the time and temperature must be capable of automatic operation whenever the hot water treatment system is activated.

### **Long-Term Recording**

The recording equipment must be capable of nonstop recording for an extended period of time. Continuous flow systems require recording equipment capable of operating for up to 12 consecutive hours.

### **Recording Frequency**

The time interval between prints will be no less than once every two minutes. Alternatively, a strip chart system can be used that gives continuous color pen lines. The numerical print or pen line representing each temperature channel (sensor) must be uniquely identified by color, number, or symbol. It is not necessary to record temperatures from sensors located in portions of the tank not in use.

### Accuracy

The accuracy of the temperature recording system (i.e., sensors and recorders) must be within 0.5°F (0.3°C) of the true temperature (as verified by a certified mercury, non-mercury, or digital thermometer). The temperature variation for the control sensors should be as close to zero as possible.

### Repeatability

When used under field conditions over an extended period of time, the recording equipment must be capable of repeatability to within 0.1°F (or C) of the true calibrated readings. Failure to maintain reliability, accuracy, and readability in a previously approved instrument will result in cancelling approval. The design construction and materials must be such that the typical environmental conditions (including vibration) will not affect performance.

### Calibration

Individually calibrate channels (sensors) against a certified mercury, non-mercury or digital thermometer reading in one-tenth or two-tenths of a degree Fahrenheit or one-tenth of a degree Centigrade, within the range of 113 °F to 118 °F (45 °C to 47.8 °C). The engineering firm that installs the recording equipment must also calibrate it. (Calibration equipment often used for this purpose includes, for example, a Decade instrument and relay range cards.) Calibrate the sensors at or near the fruit treatment temperature (around 115°F), not at 32°F.

### Range

The recorder must be programmed to cover the entire range between 113°F to 118°F (45°C to 47.8°C), with a resolution of one-tenth of a degree. The range should not extend below 100°F (37.8°C) nor above 130°F (54.4°C). If the range band of the recorder is wider than this, restrict it (narrowed) with proper programming.

### APHIS-Approved Recorder Models

Some recorder models currently on the market are not approved by APHIS for various reasons. For example, if the recorder only displays the sensor numbers and temperatures without making a printout on paper; or if it prints out the temperature data only after the treatment has been completed it is not approved by APHIS. (These are known as "memory loggers.") These two types of recorder models do not provide an adequate level of monitoring during treatment. *Also, revolving circular charts are not acceptable because of the difficulty in reading fractions of one degree.*

Temperature recorder models presently approved by APHIS are listed below. They can be either of the strip chart or data logger type. Some have adjustable chart speeds. Additional temperature recorder models may be added to this list upon petition to the [TQAU](#). To seek APHIS approval for recorder models not listed, submit the manufacturer's technical brochure to the [TQAU](#) for evaluation.

### Approved Strip Chart (Pen) Recorder Models



**Important**

**Strip chart recorders are no longer approved for installation in new facilities or used to replace any style of recorder.**

- ◆ Chessel 346
- ◆ Honeywell DPR 100A (3-channel capability)
- ◆ Honeywell DPR 100B (6-channel capability)
- ◆ Honeywell DPR 100C (3-channel capability)
- ◆ Honeywell DPR 100D (6-channel capability)
- ◆ Honeywell DPR 180 (36-channel capability)
- ◆ Honeywell DPR 1000 (6-channel capability)
- ◆ Honeywell DPR-3000, version D4 (32-channel capability)
- ◆ Molytek 2702
- ◆ Neuberger P1Y
- ◆ Toshiba AR201
- ◆ Tracor 3000

### Approved Data Logger Recorder Models

- ◆ ASICS Systems B & C
- ◆ Chino AA Series
- ◆ Cole Parmer (32-channel capability)
- ◆ Contech (10- and 16-channel capability)
  - ❖ Model: Smart Seda
- ◆ Flotek (must be attached to a printer)
- ◆ HACCP Warrior PTR- 4 (4-channel capability)
- ◆ HAACP Warrior PTR- 10 (10-channel capability)
- ◆ Honeywell DPR I00B (6-channel capability)
- ◆ Honeywell DPR-1500 (30-channel capability)
- ◆ Honeywell DPR-3000, version D4 (32-channel capability)

- ◆ HyThsoft v2
- ◆ IBM-PC (must be attached to a printer)
- ◆ Koyo, Model Direct Logic DL 350, with Hidro Soft
- ◆ Nanmac H30-1
- ◆ National Instruments (hardware + software) (64-channel capability)
- ◆ Omega OM-205
- ◆ Omega OM-503
- ◆ Ryan Data Mentor (12-channel capability)
- ◆ Tracor Westronics DDR10

### Chart Paper Specifications

#### Celsius or Fahrenheit Scale

Temperature can be recorded either in Fahrenheit or Celsius, although Fahrenheit is preferred by APHIS.

#### Scale Deflection

Scale deflection on the strip chart paper must be at least 0.10 inches for each degree Fahrenheit, or at least 5mm for each degree Celsius. Greater width between whole degrees, however, is preferred. Between each line representing one degree, there must also be finer lines, each representing subdivisions of one-tenth or two-tenths of a degree, in the range of 113°F to 118°F (45°C to 47.8°C).

#### Sample Required

Submit a sample of the strip chart or numerical printout made by the recording equipment to [TQAU](#). It should be in the exact format to be used at the facility during the treatment cycle. Each symbol on the print wheel (or ink color, in the case of strip charts) must correspond to and identify the particular sensor that it represents.

#### Chart Speed

Chart speed for strip chart recorders must be no less than 1 inch for every 5 minutes of treatment time.

#### Chart Length

The chart paper must be long enough to display at least 1 entire treatment. Continuous flow systems must contain enough chart paper to continuously record temperatures for up to 12 consecutive hours.

---

## Alarm System

An alarm is required for all batch (Jacuzzi) systems, in order to notify packinghouse employees that a treatment has been completed for a particular basket (cage). This system can be an audible noise (such as a horn, buzzer, or bell) or a highly visible light attached to a timing device located on the equipment that indicates time and temperature.

Some facilities use both a noise and a light. To avoid “overcooking,” the alarm system alerts the operator of the hoist to remove a basket from the tank at the end of treatment.

---

## Safeguarding the Treated Fruit

### Layout and Flow Pattern

Design the flow pattern of the fruit moving through the hot water treatment process to ensure that fruit waiting to be loaded into the hot water immersion tank cannot become mixed with fruit that has already completed treatment. Submit a drawing showing the proposed layout of the packinghouse to **TQAU** for approval.

### Garbage Disposal

In order not to attract fruit flies, place cut fruit, culled fruit, rotting fruit, and miscellaneous garbage into covered containers and remove from the premises daily.

### Quarantine Area

Bring treated fruit to an insect-free enclosure immediately after treatment. The treated fruit must remain there until loading into insect-proof shipping containers. The designated enclosure is usually a screened room. Packing line equipment, hydrocooling equipment, and a cool storage room (if any), should be located in this area, but this equipment is not a requirement. To prevent the movement of untreated fruit (accidentally or intentionally) into the insect-free quarantine area enforce effective procedures.

### Screening and Other Materials

Ordinary window screen or mosquito netting (at least 100 mesh per square inch) is sufficient to exclude fruit flies. Inspect it regularly and repair it as often as needed. Solid glass, concrete, drywall, or wooden walls are also acceptable.

### Air Curtain

Place on the wall or ceiling prior to entering any quarantine area an apparatus that generates a high-velocity wind barrier or air curtain (such as fans or blowers and associated air-directing chambers or enclosures such as baffles, boxes, etc.). This device must exclude the possible entry of fruit flies into the insect-free enclosure. (For facilities approved prior to July 1, 1997, vertically hang clear plastic flaps, as minimally required, at the doors to the insect-free enclosure.

### Loading of Treated Fruit

When not in use, close doors leading from the quarantine area to the loading dock. When loading, truck vans and containers must form a fly-proof seal with the exterior wall. Prior to loading, inspect and disinfect truck vans and containers. If wooden pallets are used, they must be completely free of wood-infesting insects and bark. Apply a numbered APHIS seal to each container before its departure.



---

## Pre-treatment Warming Options

Prewarming the fruit is sometimes desirable in order to meet the APHIS requirement that all fruit pulp temperatures be at least 70°F before start of the certification performance test. At the very least, the fruit pulp temperature must reach the minimum pulp temperature stabilized during the certification test for commercial treatment. After prewarming, take pulp temperatures from the mangoes located at the coldest part of the crates and/or baskets. Do not take the pulp temperatures from the mangoes that are located on the outside of the basket or crate.

---

## Post-Treatment Cooling Options

Cooling the fruit after hot water treatment is not an APHIS requirement. However, from the standpoint of fruit quality, many facilities choose to install a system to cool the fruit after removal from the hot water.

Hydrocooling of the treated mangoes is allowed after a waiting period of 30 minutes following treatment unless the original dip times indicated in the treatment schedule are extended for 10 minutes. Allowing the fruit to simply stand for at least 30 minutes after being removed from the hot water tank is thought to be helpful in killing immature stages of fruit flies because the mangoes complete their “cooking” process during that time.

### Refrigerated Room

The recommended storage temperature for mangoes is between 55°F and 57°F (12.8°C and 13.9°C) at 85% to 90% relative humidity. These temperatures delay softening and prolong storage life to approximately 2 to 3 weeks.

### Fans

APHIS allows the use of fans in the screen room to blow air over the fruit as soon as they are removed from the hot water tank (if desired). However, the ambient air cannot be less than 70°F.

### Hydrocooling

APHIS allows the use of a cool water tank or shower system, but with the following provisions:

- ◆ During the waiting period and hydrocooling period, safeguard the mangoes in a room or tunnel, separate from the hot water tanks
- ◆ Water temperature used during hydrocooling must be 70°F or above

- ◆ Water used for hydrocooling should be chlorinated (not to exceed 200 ppm)
  - ❖ Any other chemicals, such as fungicides, are optional, but must be approved in advance by the FDA

---

## Facility Changes

Hot water immersion treatment facilities whose construction was approved under earlier guidelines can continue to operate with APHIS approval. Newer facilities, however, are required to meet the current requirements outlined in this checklist, which in most cases are more strict.

Once **TQAU** has formally approved the plans and drawings for a hot water immersion treatment facility, the facility can make no further changes in the equipment without APHIS approval. Any proposed changes or improvements must be described in writing (with accompanying drawings, if necessary) and must be approved by APHIS in writing. Examples of proposed changes include adding additional treatment tanks, adding a cold storage room, and changing the model of the temperature recorder.

---

## Safety and Health Checklist

- ◆ Adequate lavatory
- ◆ Admission of children or unauthorized persons into the treatment and packing areas prohibited if not accompanied by a responsible employee
- ◆ Approved safety ladders or walkways (catwalks, etc.) for observing treatment tank operations
- ◆ Electric power meets safety code requirements
  - ❖ Electrical wiring, including switches and other connections, contained in metal or PVC conduit and grounded to prevent electrical shock
- ◆ Engines, pulleys, drive belts, and other hazardous moving parts, if located within six feet of floor level, guarded with a safety shield or barrier
- ◆ Fire extinguisher located near the boiler
- ◆ First-aid kit located near moving machinery
- ◆ Hard hats for workers and visitors in the treatment and loading areas must wear (this is optional if not required by local regulations)

- ◆ Steam and hot water pipes insulated or otherwise protected
- ◆ Sufficient lighting provided in working areas

---

## Work Plan

A Work Plan is a formal agreement signed by a representative of each treatment facility in a particular country, the Agriculture Ministry of the host government, and by USDA-APHIS. Work Plans govern the day-to-day operations of each facility and can be improved from one year to the next. Work Plans usually contain additional provisions not included in this checklist.

Fruit exporters are required to operate under general APHIS monitoring and to be in full compliance with all APHIS regulations as outlined in detail in the current Work Plan. The operator of the facility, as well as the inspector assigned to the facility, should each keep a copy available to resolve any disputes.

---

## Address for Technical Contact

### TQAU

Center for Plant Health Science & Technology  
USDA, APHIS, PPQ, CHPST  
Treatment Quality Assurance Unit  
1730 Varsity Drive, Suite 400  
Raleigh, NC 27606  
Tel: 919-855-7450  
Fax: 919-855-7493



# 3

Treatment Manual

## Nonchemical Treatments

### Heat • Steam Treatments

#### Contents

- Principle [page-3-4-1](#)
- Steam Pressure Sterilization [page-3-4-1](#)
  - Loose Masses of Material [page-3-4-2](#)
  - Closely Packed Material [page-3-4-2](#)
- Steam Jet Method [page-3-4-2](#)



This section includes information from the old Treatment Manual and is for future development.

#### Principle

Steam at a temperature of 212°F will destroy most pathogenic microorganisms of the common vegetative forms or the spore types when in the growing or vegetative state in a short period of exposure. Some spores, however, are much more resistant and will withstand prolonged periods of exposure to steam at atmospheric pressure. Saturated steam at temperatures of 240°F to 248°F (10 to 15 lbs. pure steam pressure) will destroy the most resistant spores in a brief interval of exposure. However, near-complete air discharge from the autoclave or steam chamber is necessary. When steam is admitted to a chamber from which the air is completely evacuated, the temperature of the steam throughout the chamber will advance at once to the maximum range that can be attained for the pressure carried. If air remains in the chamber, the ultimate temperature will be reduced dependent upon the quantity of air remaining. Refer to a recording or indicating thermometer for correct chamber temperature-pressure relationships.

#### Steam Pressure Sterilization

Live steam is introduced into a closed chamber containing the material to be treated until the required temperature and pressure are indicated. The temperature/pressure relationship is maintained at or above this point for the required exposure period. The exposure period will depend on the nature of the material, quantity, and its penetrable condition.

### Loose Masses of Material

For loose masses of material, which permit rapid and complete penetration of steam to all parts of the mass, no initial vacuum is needed, but air must be released until steam vapor escapes, and exposure at 20 pounds pressure for 10 minutes, 15 lbs. for 15 minutes, or 10 lbs. for 20 minutes is sufficient.

### Closely Packed Material

For closely packed material, such as soil or baled straw, special measures are needed to ensure rapid heat penetration to all parts of the material. Baled rice straw, for example, is required to have a density of less than 30 lbs. per cubic foot since penetration at higher densities is too slow to be practical. Soil, if in large containers, will not allow adequate treatment under normal sterilization exposure periods. Quicker penetration of the steam is obtained by first exhausting the air in the chamber to a high vacuum and then introducing live steam until the required positive pressure is reached.

Examples of the pressure-temperature relationships are listed below. The gauge pressure in pounds per square inch corresponds to the temperature of saturated steam in degrees Fahrenheit. Zero gauge pressure corresponds to an absolute pressure of 14.7 lbs. per square inch. The figures are based upon the complete replacement of air by steam. If air replacement is not complete the temperature for any given pressure will be less than the corresponding temperature.

Gauge Pressure (lbs. per sq. in.)	Temperature °F
10	239.4
15	249.8
20	258.8
30	274.1
40	286.7
50	297.7
60	307.4

---

### Steam Jet Method

Live steam from a jet or nozzle is forced into or through a more or less loose and open mass of material in such amount and for such period required to raise the temperature of all parts of the mass to approximately 212°F. This method takes advantage of the considerable latent heat liberated when steam condenses into water. This process does not effect complete sterilization since spore-forming bacteria are not always destroyed. Since no spore-forming bacteria are known that cause plant diseases, however, and fungi are readily killed by the

temperatures reached, this process is effective for quarantine purposes if the necessary degree of heat is generated in all parts of the material.





# 3

Treatment Manual

## Nonchemical Treatments

### *Heat • Vapor Heat and Forced Hot Air Treatment*

---

#### Contents

Introduction	<a href="#">page-3-5-1</a>
Procedures	<a href="#">page-3-5-1</a>
Pretreatment	<a href="#">page-3-5-2</a>
Loading	<a href="#">page-3-5-2</a>
Conducting the Treatment	<a href="#">page-3-5-3</a>
Verifying the Treatment	<a href="#">page-3-5-3</a>
Post Treatment Handling	<a href="#">page-3-5-4</a>
Record Keeping	<a href="#">page-3-5-4</a>
Common Problems and Failure Points	<a href="#">page-3-5-4</a>

---

#### Introduction

Vapor Heat (VH) and Forced Hot Air (FHA) treatments use heated air to warm fruit to temperatures that are lethal to target pests, primarily fruit flies. Generally, VH treatment differs from FHA only in the relative humidity of the air in the treatment chamber; higher humidity levels may preserve fruit quality. Unless otherwise noted, information in this chapter applies to both VH and FHA treatments for fruits and vegetables.

This chapter describes processes for routine (commercial) treatments for fresh fruits and vegetables at VH and FHA facilities. **See “Certification of Forced Hot Air and Vapor Heat Treatment Facilities” on [page-6-6-1](#)** for VH and FHA certification and equipment requirements.

VH treatment schedules can be found in “[T106—Vapor Heat](#)” on [page-5-2-65](#). FHA treatment schedules can be found in “[T103—High Temperature Forced Air](#)” on [page-5-2-55](#).

---

#### Procedures

Before any treatments are conducted at a facility, the authorized PPQ official should familiarize themselves with the facility and the way the chamber functions. The official should also carefully review the treatment schedule for the commodity(ies) that will be treated, and any special requirements specified during certification, in the workplan or in the compliance agreement.

## Pretreatment

Prior to treatment, the PPQ official must ensure that the facility and the chamber are in good working order and the permanent temperature sensors are functioning properly. Conduct a brief facility inspection before any other steps in the treatment process are taken. During this inspection, the official verifies that all safeguarding and quarantine measures are in place and that there are no obvious problems that may affect the treatment. If any deficiencies are found, correct them prior to treatment. After the inspection, the official will assist facility personnel in the calibration of the permanent temperature sensors. Refer to the section “[Calibrating the Permanent Temperature Sensors](#)” on [page-6-6-4](#) " for calibration procedures.

Before treatment, the PPQ official ensures that the commodity meets the requirements specified in the Treatment Manual, the certification conditions, the workplan and/or the compliance agreement. These requirements generally include:

- ◆ Fruit size and weight requirements: The process and/or equipment used to sort the fruit should be verified by measuring or weighing the fruit that is to be treated. Sampling rates may be provided in the workplan, compliance agreement or certification conditions. If no rates are provided, weigh and measure 30 suspect fruit per treatment lot. If fruit are found that do not meet the size and weight requirements, the sorting process and/or equipment should be evaluated and the fruit resorted.
- ◆ Fruit pulp temperature: There are no specific pretreatment fruit pulp temperature requirements. However, the temperature of the fruit pulps within the treatment lot should not vary by more than 3.0°C (5.0°F). The PPQ official verifies that the pulp temperatures meet this requirement prior to treatment.
- ◆ Pest inspection: The PPQ official conducts pest inspections required by the workplan and/or compliance agreement.

## Loading

Load the fruit into containers (crates, lugs, or bins) according to the requirements in the certification conditions or workplan. Generally, these requirements will indicate whether or not the fruit must be sorted and the volume of fruit allowed in each container.

Load the containers onto pallets or into cabinets according to the requirements in the certification conditions or workplan. These requirements may specify that containers with larger fruit must be located in the colder areas of the stack or that certain layers of containers are left empty when partial loads are treated.

The permanent temperature sensors are placed in the largest fruit in the treatment lot as it is being loaded into the containers. Insert the tip of the sensor into an area of the fruit pulp that will take the longest to reach treatment temperature. The PPQ official monitors the placement of the permanent sensors and verifies that the probes are placed in the locations required by the certification conditions.

### Conducting the Treatment

After all the fruit is loaded into the containers and onto the pallets, and the permanent probes are properly installed, load the fruit into the chamber. The chamber doors should be closed and locked to prevent accidental openings. The PPQ official (and the NPPO official, if required by the work plan or compliance agreement) must initial the treatment temperature record and the chamber operator can then initiate the treatment.

During the treatment, the PPQ official must monitor the permanent temperature sensor data to ensure the treatment is proceeding in the approved manner. The PPQ official must also check the chamber for leaks or other problems during the treatment.

### Verifying the Treatment

The PPQ official must review the treatment temperature record after the treatment is complete. The official must ensure that the temperature and recording interval requirements have been met. Additionally, the official must verify that the requirements for the duration of the run up and dwell times are conducted according to the treatment schedule. Time requirements for the run up and dwell time are continuous. Once the PPQ official determines that all the treatment requirements are met, the PPQ official must sign and date the treatment record.

### Important Treatment Terminology

The following terms are referred to in the treatment schedules:

- ◆ **Heat up time:** the minimum time allowed for all the temperature probes to reach the prescribed minimum pulp temperature (may also be referred to as the approach or run-up time)
- ◆ **Heat up recording interval:** the time interval required for recording temperatures during the heat up time
- ◆ **Minimum air temperature:** the minimum temperature required for the air in the chamber
- ◆ **Minimum pulp temperature at end of heat up:** the minimum temperature required for all fruit pulp temperature probes
- ◆ **Dwell time:** the length of time all pulp temperature probes must maintain the minimum pulp temperature

- ◆ **Dwell recording interval:** the time interval required for recording temperatures during the dwell time
- ◆ **Cooling method:** optional and may be either hydrocooling or air cooling

**TABLE 3-5-1 Example of a Treatment Schedule**

Heat Up Time:	4 hours
Heat Up Recording Interval:	5 minutes
Minimum Air Temperature:	N/A
Minimum Pulp Temperature at End of Heat Up:	47.2 °C/117.0 °F
Dwell Time:	5 minutes
Dwell Recording Interval:	5 minutes
Cooling Method:	Forced air or Hydrocooling



"N/A" in any of the requirements in the Treatment Schedule indicates that PPQ has no requirement.

### Post Treatment Handling

After the treatment is complete, move the fruit from the chamber into the quarantine area. Cool the fruit according to the requirements listed in the treatment schedule.

## Record Keeping

Keep all treatment records at the treatment facility for one year after treatment. The facility must also maintain a record of all problems and/or breakdowns and any maintenance performed on the chamber. All the records listed above must be made available to the PPQ official upon request.

## Common Problems and Failure Points

If the temperature recording intervals and minimum temperature requirements are not met, the treatment fails. The only exception to this is that a probe may record no data for a single recording interval during the treatment. (Note: This does not mean the temperature may be out of range, only that the data may be missing). After reviewing the treatment data, the official should sign and date the data.

If a problem arises during treatment, such as a probe stops recording data or the temperature drops below the required temperature, the treatment will fail. The facility manager must determine if the fruit will be re-treated or will be removed from the chamber into the non-quarantine area.

# 3

Treatment Manual

## Nonchemical Treatments

*Heat • Forced Hot Air • Niger Seed*

### Contents

- Dry Heat Treatment Facilities for Niger (*Guizotia abyssinica*) [page-3-6-1](#)
- Location of Treatment Facilities in the US [page-3-6-1](#)
- Checklist of USDA-APHIS Minimum Requirements for Dry Heat Treatment Facilities for Niger seed Treatment [page-3-6-1](#)
- Requirements for a valid treatment [page-3-6-2](#)
- Sanitation and Pest Control [page-3-6-3](#)

### Dry Heat Treatment Facilities for Niger (*Guizotia abyssinica*)

Niger seed is grown as a marginal crop mainly in India, Ethiopia and Burma and is imported into the United States for bird feed. Since Niger seed from India, Ethiopia and Burma is frequently contaminated with Federal Noxious Weed seeds, it is required to be heat treated in accordance with T412 treatment schedule.

#### Location of Treatment Facilities in the US

Construct the proposed niger treatment facility near the port environs; not exceeding 10 miles from the port.

#### Checklist of USDA-APHIS Minimum Requirements for Dry Heat Treatment Facilities for Niger seed Treatment

#### Minimum Requirements for Dry Heat Treatment

- ◆ Accuracy of the total temperature recording system must be within plus or minus 0.5°F. (0.3°C) of actual temperatures as recorded by a certified calibrated thermometer
- ◆ Action plan is be established to address any pests that may be associated with the storage, treatment, or shipment of niger seed
- ◆ All the valves and controls that affect heat flow to the treatment system are secured to avoid manipulation by unauthorized personnel during the treatment process
- ◆ Audible alarm or highly visible light is installed on burners or other equipment to indicate system failure and/or when not operating properly
- ◆ Gear systems used to control the niger seed conveyor (if applicable) are capable of being adjusted as necessary to meet treatment requirements

- ◆ Heating controls are automatic and run continuously throughout the treatment process. Manual adjustments are allowed, if necessary.
- ◆ Minimum of two temperature probes are situated in the heat-treating equipment in such a way as to determine that all niger seed being treated reaches the target temperature
- ◆ Proper sanitation measures are implemented to ensure there are no potential breeding grounds for pests on the premises, and therefore, little risk of reinfestation or cross-contamination
- ◆ Seed processing equipment has the capability to divert for retreatment any nontreated or treated seeds that do not meet treatment standards
- ◆ Speed indicator is present for continuous flow systems.
- ◆ Temperature readings are recorded on the chart at time intervals not exceeding 4 minutes between each reading
- ◆ Temperature recording chart is showing changes in temperature in increments of not less than 0.1 inch for each degree Fahrenheit (°F) or 5 mm for each degree Celsius (°C)
- ◆ Treated seeds are stored in a location separate from nontreated seeds-the treated and nontreated seeds must be handled in a manner to prevent cross-contamination

### Requirements for a valid treatment

#### Facility Requirements

- ◆ Facility operators or managers must record the following information on each treatment chart:
  - ❖ Date
  - ❖ Lot number
  - ❖ Operator signature
- ◆ Minimum number of temperature recording elements is two fixed temperature probes-accurate time/temperature records will also be maintained for any additional probes
- ◆ Treatment must be in a Niger seed facility maintaining current valid approval in good operating order so as to be capable of providing an acceptable treatment

#### Treatment Requirements

The Niger seed heat treatment schedule will be for at least 15 minutes at 120°C (248°F) and the following procedures will be used by operators to determine if treatment standards are met.

- ◆ Examine treatment records for completion of treatment
- ◆ If any temperature reading falls below 120°C (248°F), nullify the treatment for that specific lot of seed and retreat the seed

### Documentation Requirements

- ◆ If, for any reason records indicate that the niger seed was not held at the target temperature for the required time, retreat the niger seed and correct the reason for the faulty treatment before continuing any niger seed treatment
- ◆ Verify that the niger seed was kept at the target temperature for the required time
- ◆ Maintain a logbook of all niger seed treatments
- ◆ Maintain records of equipment breakdowns and repairs and changes or modifications to the treatment process

### Sanitation and Pest Control

#### The Plant and Warehouse premises

The premises must have a cleaning and control program. The facility manager will ensure that there are no potential breeding grounds for pests in the premises, and therefore little risk of reinfestation or cross-contamination.

#### Containers and Packaging

The facility manager will ensure that packaging, whether used or new, is checked and cleaned for pests so that the packages are not a source of pests and contamination

#### Waste Disposal

To minimize contamination risk and eliminate pest breeding sites, the facility manager will implement a regular waste program for waste and for nonconforming or infested produce.

#### Post Treatment Requirements

- ◆ After treatment and cooling, immediately place the niger seed in new bags-treat or dispose the old bags in a manner that will eliminate regulated pests.
- ◆ PPQ will monitor (by sampling the treated seeds periodically) for actionable contaminants
  - ❖ Some time in the middles of the bagging process, sample every 25th lot after treatment
  - ❖ Perform random inspections and viability tests as needed by PPQ at the Port of Entry

Label each sample with the following information:

- ◆ Bill of lading number
- ◆ Container and lot number
- ◆ Date the sample was taken
- ◆ Date the seeds were treated
- ◆ Origin of seed
- ◆ Vessel name and nationality

Send laboratory results with the above information to:

USDA-APHIS-PPQ-CPHST  
Treatment Quality Assurance Unit  
1730 Varsity Drive  
Suite 400, Raleigh, NC 27606



# 3

Treatment Manual

# Nonchemical Treatments

## *Cold Treatment (CT)*

---

### Contents

Intransit Cold Treatment in Conventional Vessels, Self-Refrigerated (Integral) Containers, and Warehouses	<b>page-3-7-2</b>
Precooling Procedures	<b>page-3-7-2</b>
Initiating Intransit Cold Treatment in Vessels and Containers	<b>page-3-7-3</b>
Verification of Temperature Recording Equipment	<b>page-3-7-3</b>
Verification of Temperature Sensors	<b>page-3-7-4</b>
Calibration of Temperature Sensors	<b>page-3-7-5</b>
Loading of Commodity in Conventional Vessels and Self-Refrigerated (Integral) Containers—General	<b>page-3-7-7</b>
Placement of Temperature Sensors	<b>page-3-7-10</b>
Treatment Requirements	<b>page-3-7-13</b>
Prepare Documents	<b>page-3-7-14</b>
Distribution of Documents	<b>page-3-7-14</b>
Clearance of Cold Treated Shipments	<b>page-3-7-15</b>
Conventional Vessels	<b>page-3-7-15</b>
Self-Refrigerated (Integral) Containers	<b>page-3-7-18</b>
Cold Treatment in Refrigerated Warehouses	<b>page-3-7-20</b>
Initiating the Cold Treatment	<b>page-3-7-20</b>
Placement of Temperature Sensors:	<b>page-3-7-20</b>
Contact Information	<b>page-3-7-21</b>
TQAU	<b>page-3-7-21</b>

---

## **Intransit Cold Treatment in Conventional Vessels, Self-Refrigerated (Integral) Containers, and Warehouses**

The use of sustained cold temperatures as a means of insect control has been employed for many years. Rigid adherence to specified temperatures and time periods effectively eliminates certain insect infestations. Treatments may be conducted in warehouses, refrigerated compartments of transporting vessels (Conventional Vessels), containers cooled by the ship's refrigeration system (Container Vessels) or by individually refrigerated containers (Self-Refrigerated/Integral Containers). Information concerning conventional vessels, self-refrigerated containers, and warehouses is found in this chapter.

Only certified USDA representatives have permission to conduct warehouse, vessel and/or container approval tests under the general guidance of TQAU. The following website provides information for the testing of specific vessels and/or containers:

<https://treatments.cphst.org/vessels>

---

## **Precooling Procedures**

Experience with in-transit cold treatments and Computational Fluid Dynamics (CFD) modeling of refrigerated vessel compartments show that the fruit must be precooled at or below the prescribed cold treatment temperature before loading. Otherwise, a large quantity of fruit in the middle of large pallet groups may require a week or more to reach the cold treatment temperature.

Fruit intended for intransit cold treatment must be precooled to the temperature at which the fruit will be treated prior to beginning treatment.

**Precooling cannot be conducted in the conveyance in which the commodity is loaded unless authorized by the APHIS official.**

Conduct random fruit pulp sampling in the precooling location prior to loading in order to verify that the commodity has completed precooling.

Use the following general guidelines for fruit pulp sampling in the precooling location:

- ◆ Pulp temperatures will be taken by personnel authorized by APHIS, which includes industry representatives

- ◆ Take pulp temperatures by probing the fruit on the periphery of the pallet
  - ❖ If pulp temperatures are 0.28 °C (0.5 °F) or more above the temperature at which the fruit will be treated, the pallet will remain in the precooling location for further precooling

Also, sample fruit pulp temperatures **immediately** before the fruit is loaded on the intransit cold treatment conveyance. Take fruit pulp temperatures by probing fruit in the **top** of the pallet. An official authorized by APHIS will sample the fruit pulp temperatures in all sections of the load to verify temperatures have not risen appreciably. If the pulp temperatures for the sample are 0.28 °C (0.5 °F) or more above the temperature at which the fruit will be treated, the pallet will be rejected and returned to the precooling location for further precooling until the fruit reaches the treatment temperature.

---

## Initiating Intransit Cold Treatment in Vessels and Containers

For cold treatments conducted in approved vessels and containers, the ship's officers will have already received instructions on the APHIS requirements from their owners. However, a discussion by the authorized APHIS official with these individuals will provide for better understanding and cooperation. Such a discussion should include:

- ◆ General treatment procedures in accordance with 7CFR 305.15
- ◆ Stowage arrangement
- ◆ Temperature sensor and instrument calibration testing
- ◆ Treatment conditions

Ensure that there is an adequate communication system in place between personnel in the compartments and the recording room.

### Verification of Temperature Recording Equipment

Approved vessels and containers must be capable of maintaining fruit pulp temperatures within the specified CT schedules. To monitor these treatments, they must be equipped with a temperature recording device which meets the approval of **TQAU**. All approved temperature recording devices must be password protected and tamperproof and have the ability to record the date, time, sensor number, and temperature during all calibrations and actual treatments.

If APHIS determines that the records and calibrations can be manipulated, the vessel and/or container will be suspended from conducting cold treatments until proper equipment is installed. Submit any changes to the temperature recording and monitoring equipment to **TQAU** for approval before installation in the vessel or

container. Compare the existing equipment with the equipment listed at <http://treatments.cphst.org/vessels/> to determine if new equipment has been installed that was not approved by TQAU.

Specifications for temperature recording installations and other requirements for approval are discussed in [Chapter 6-4: Certifying Cold Treatment-Standards for Temperature Recording Systems](#). Refer to [Appendix H](#) for a list of approved temperature recorders.

### Strip Chart Recorder



**Important**

Since December 31, 2005, strip chart recorders were no longer acceptable temperature recording devices. Consequently, by December 31, 2008, there should be no strip chart recorders in use for APHIS cold treatment.

Contact TQAU for approved temperature recording instrumentation.

### Data Logger

A sufficient supply of log sheets must be available to provide a continuous record of calibration and treatment temperatures. The instrument should be in operation for at least 30 minutes prior to calibration tests. Examine a completed log sheet printout and the functioning of the visual scanner, the printer, and the high limit setting. Check the logsheets for proper format and serialization. Activate the temperature set-point for an alarm printout to verify that this function is operational.



**Important**

Data logger installations are utilized to record various components of the vessel's operating systems. Temperature recording is only a part of the record produced. Under TQAU approval requirements, the logsheets upon which the intransit cold treatment is recorded are generally more detailed in design than the standard commercial logsheet. They are prepared and serialized to facilitate scanning and to provide a level of security against fraudulent records. The USDA log should be printed on separate sheets with no other ship data interspersed. Data loggers are programmed to print out the temperatures above a set limit in a contrasting color. Some instruments print a symbol to indicate this. The limit is set at the time of loading to a temperature level that coincides with the projected treatment schedule.

### Verification of Temperature Sensors

Check individual sensors to verify that they are properly labeled and correctly connected to the temperature recorder. This can be accomplished by hand warming each sensor when its' number appears on the visual display panel of the recording instrument. A temperature change, which can be observed at the instrument, should occur. If the instrument fails to react, the sensor is incorrectly connected or malfunctioning and should be corrected by the instrument representative.

## **Calibration of Temperature Sensors**

Calibrate all air and pulp temperature sensors in a clean ice water slurry mixture that is at 0 °C (32 °F), the freezing/melting point of freshwater.

1. Prepare a mixture of clean ice and fresh water in a clean insulated container.
2. Crush or chip the ice and completely fill the container.
3. Add enough water to stir the mixture.
4. Stir the ice and water for a minimum of 2 minutes to ensure the water is completely cooled and good mixing has occurred.
  - ❖ The percentage of ice is estimated at 80 to 85 percent while the water fills the air voids (15 to 20 percent).
5. Add more ice as the ice melts.
6. Prepare and stir the ice water slurry to maintain a temperature of 0 °C (32 °F).
7. Submerge the sensors in the ice water slurry without touching the sides or bottom of the container.
8. Stir the mixture.
9. Continue testing of each sensor in the ice water slurry until the temperature reading stabilizes.
10. Record two consecutive readings of the stabilized temperature on the temperature chart or logsheet.
  - ❖ The temperature recording device should be in manual mode to provide an instantaneous readout.
11. Allow at least a 1 minute interval between two consecutive readings for any one sensor; however, the interval should not exceed 5 minutes.
  - ❖ The variance between the two readings should not exceed 0.1°.
12. Contact an instrument company representative immediately if the time interval exceeds the normal amount of time required to verify the reading and accuracy of the sensor and recorder system
  - ❖ The recorder used with the sensors must be capable of printing or displaying on demand and not just at hourly intervals.
13. Correct any deficiencies in the equipment before certification.
14. Replace any sensor that reads more than plus or minus 0.3 °C (0.5 °F) from the standard 0 °C (32 °F).
15. Replace and recalibrate any sensors that malfunction.

- 16.** Document the recalibration and replacement of the sensor(s).
- 17.** Determine the calibrations to the nearest tenth of one degree.

## Loading of Commodity in Conventional Vessels and Self-Refrigerated (Integral) Containers—General



In countries with which USDA-APHIS has a cooperative agreement, these activities can be conducted by qualified officials from that country. Contact the [TQAU](#) for a list of qualified officials.

1. Each compartment or container must contain only one type of fruit loaded in one type of carton.
2. Load fruit directly from the precooling area so fruit temperatures do not rise significantly after loading and during the transfer of the container to the vessel.
3. Open the cartons in which the sensors will be located and insert the sensors well into the fruit ([Figure 3-7-1](#)). The tip of the sensor must not extend through the fruit.

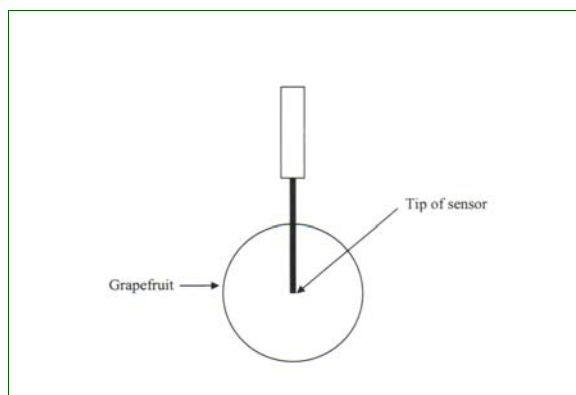

**FIGURE 3-7-1 Proper Placement of Pulp Sensor within Larger Fruit**

In the case of small fruit, cover a minimum of two thirds of the tip of the sensor using multiple fruit. If, for example, the fruit is grapes, insert the sensor directly into the grapes in a shis-ka-bob fashion (**Figure 3-7-2**). Completely cover the probe with the top layer of fruit in the top of the box or carton located in the middle of the pallet.

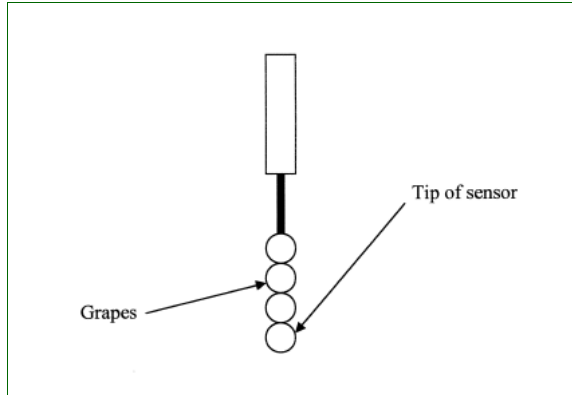

**FIGURE 3-7-2 Proper Placement of Pulp Sensor within Smaller Fruit**

4. Securely close the cartons following insertion of the sensors. If the fruit is palletized, it may be necessary to insert the sensor into the fruit from the side of the carton. If the side of the carton or box is opened to insert a sensor, reseal the opened side of the carton or box using tape.



## Conventional Vessels



**Hanging decks, hatch coamings within vessels and double-stacking of pallets are not approved for intransit cold treatment.** The treatment will not begin until all double-stacked pallets are reconfigured into a single-stack pallet arrangement and any pallets located in hanging decks or hatch coamings are removed.

Contact **TQAU** for more information regarding hatch coamings or hanging decks for particular vessels.

There are two sensor types used for the compartments during cold treatment.

- ◆ Ambient air sensors—the cables which are attached to the ceiling of the compartment, should be long enough to extend from the ceiling to the floor. Place the sensors on the center line of the vessel approximately 30 centimeters from the ceiling. Attach the sensors in such a way that they do not touch the bulkhead and are protected from damage from the cargo. One sensor must be located on the fore and aft bulkheads of each compartment.

In the case of twin deck compartments, two sensors are required in the upper compartment plus one sensor in the lower compartment. Place the lower sensor on the bulkhead furthest from the cooling unit. Ensure that all sensors are readily detachable and stowed in compartments to protect from damage when not in use.

- ◆ Fruit pulp sensors—the cables which are attached to the side walls of the compartment must be distributed throughout the compartment so that all areas of the compartment can be reached. The cables should be long enough to extend from the hold walls to three meters beyond the center line of the ship hold.

### Placement of Temperature Sensors

All of the sensors for conventional vessels must be located at the mid level of the pallets as depicted in **Figure 3-7-3**. The black circles represent pulp sensors.

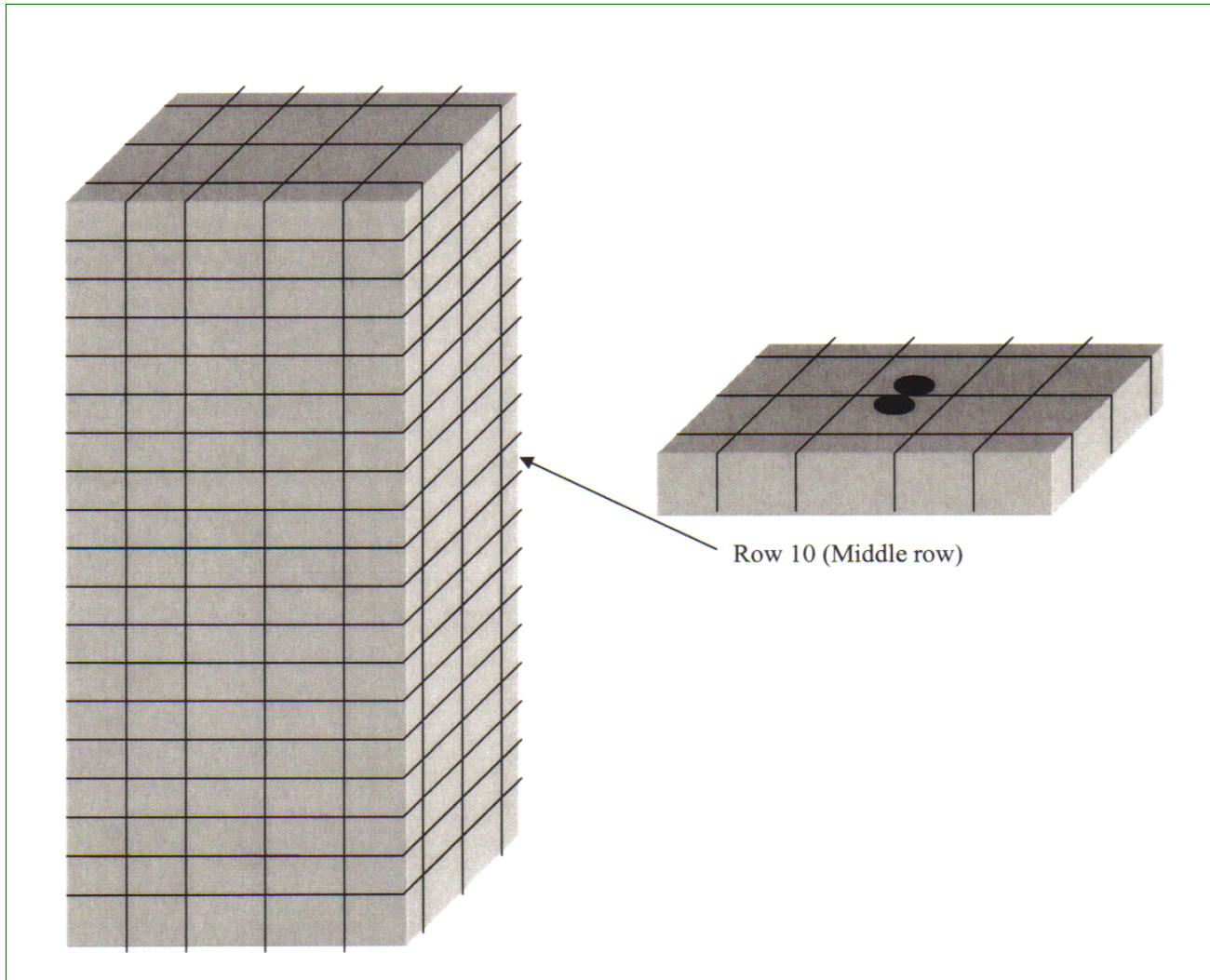

**FIGURE 3-7-3 Fruit stack with middle row temperature probe placement**



It is highly recommended that more temperature sensors be installed than the minimum number required for each refrigerated compartment. If a sensor malfunctions during a treatment, the certified USDA representative has the option of disregarding it, providing that an additional working sensor is present, and the functional sensors were appropriately placed, certified, and calibrated. Otherwise, the entire treatment must be repeated for the fruit in that compartment.

### Self-Refrigerated (Integral) Containers

When loading refrigerated containers, place the warmest fruit in the last quarter of the load (near the back doors of the container), completely cover the floor and ensure that the load is of uniform height.

Place a numbered seal on the loaded container. This must not be removed until the load has been cleared at the port of destination.

Use a minimum of three pulp sensors. Place all sensors as far into a box of fruit as possible. Use [Figure 3-7-4](#) as a general guideline for sensor placement.

- ◆ Place the first sensor, labeled USDA1, in a box at the top of the stack of fruit nearest to the air return intake.
- ◆ Place the second sensor, labeled USDA2, slightly aft of the middle of the container, halfway between the top and bottom of the stack.
- ◆ Place the third sensor, labeled USDA3, one pallet stack in from the doors of the container, halfway between the top and bottom of the stack.

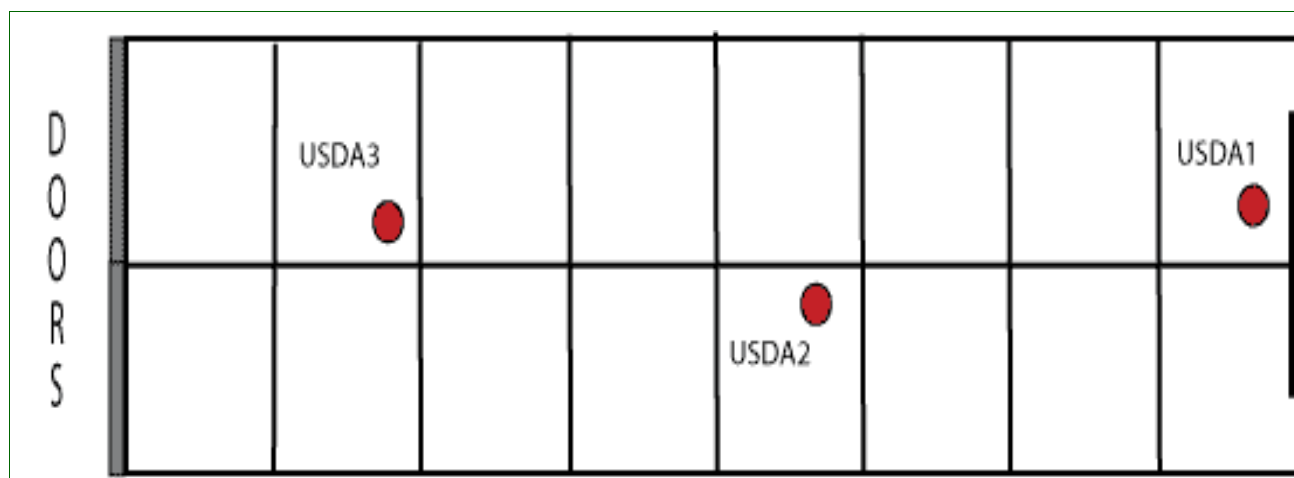

FIGURE 3-7-4 40 foot Refrigerated Container with 18 Pallets of Fruit (not drawn to scale)

### Secure the Load

Place a piece of cardboard that extends from the front edge of the second-to-last pallet row to the back doors on the container floor before the last pallet row is loaded. Once the cardboard is installed properly, load the last pallet row so the pallets rest on top of the cardboard. Place a second piece of cardboard perpendicular to the first piece of cardboard and staple to the cartons in the last pallet row (**Figure 3-7-5**). The placement of the cardboard between the back doors of the container and the last row of pallets aids in maximizing air flow through the pallets. Complete this procedure for all pallets in the last pallet row of the container.



**FIGURE 3-7-5** Proper placement of cardboard between the last pallet row of fruit and the back doors of the container

### Treatment Requirements

Temperatures must be recorded at intervals no longer than 1 hour apart. Gaps of longer than 1 hour may invalidate the treatment or cause treatment failure.

Fruit pulp temperatures must be maintained at the temperature specified in the treatment schedule with no more than **0.39 °C (0.7 °F)** variation in temperature between two consecutive hourly readings. Failure to comply with this requirement may result in treatment failure.

The time required to complete the treatment begins when all temperature probes reach the prescribed treatment schedule temperature.

## Prepare Documents

Complete the following PPQ forms and worksheets:

- ◆ "Calibration of Temperature Probes" record showing the temperature readings as taken from the temperature chart or log sheet during the calibration testing. Record readings to the nearest tenth of one degree. When the loading of each compartment has been completed, obtain the temperature reading of each fruit probe from the temperature recorder and record on this form.
- ◆ "Instructions to Captain" form letter.
- ◆ "Location of Temperature Sensors" record to show the actual position of each fruit temperature sensor. (See sample form in Appendix A.) This can be accomplished by a written description or by a diagrammatic sketch. Include compartment loading start and end times and dates on the form.
- ◆ PPQ Form 203, Foreign Site Certificate (for APHIS pre-inspected fruit)
- ◆ Shipper's manifest containing the quantity and kind of commodity.

### Distribution of Documents

Place the following documents in a sealed envelope and give to the Captain for presentation to the clearance official at the port of arrival.

- ◆ Original "Calibration of Temperature Probes"
- ◆ Original "Location of Temperature Sensors"
- ◆ Copy of the "Instructions to Captain"

For reference purposes, present the Captain with the following documents:

- ◆ Original "Instructions to Captain"
- ◆ Copy of the "Calibration of Temperature Probes"
- ◆ Copy of the "Location of Temperature Sensors"

Send copies of all documents to the clearance official at the port of arrival and to **TQAU**.

### Conventional Vessels and Self Refrigerated (Integral) Containers

---

## Clearance of Cold Treated Shipments

The TQAU is in the process of designing electronic versions of all required cold treatment documentation. In the future the forms that are filled out overseas (excluding the preclearance forms) will be entered on-line through a secured website so that the port of arrival will be able to view all required documentation before the certified vessel or container undergoing intransit cold treatment arrives at a U.S. port of entry. Until the new database and electronic forms are finished, continue following the instructions listed below.

Off-loading of self-refrigerated containerized fruit that is under treatment must be accomplished rapidly. Containers must be off-loaded and treatment reconvened within 2 or 3 hours from the time the container was disconnected from the refrigerating unit. The pulp sensors should never exceed the maximum allowable treatment temperature.

Observe the stacking pattern. Double stacking is not permitted. Do not release the shipment if the pallets have been double stacked.

### Conventional Vessels

The "Calibration of Temperature Sensors" and "Location of Portable Sensors" documents from the country of origin should have been received at the port of entry prior to the arrival of the carrying vessel.

The document, "Calibration of Temperature Sensors", is required for all shipments and includes information regarding the loading date and location of temperature sensors within the commodity, as well as calibration correction factors for every sensor.

Check the TQAU web site (<http://treatments.cphst.org/vessels/>) to familiarize yourself with the compartment layout.

Check the documents, and any accompanying correspondence for comments relating to deficiencies noted at origin. The documents must bear the signature of an APHIS-approved official or of an authorized official of the exporting country. A list of authorized names and signatures for each country is on file at TQAU and is available upon request.

Inform shipping line officials and pier supervisors of the quarantine safeguards to be observed pending clearance. The authorized APHIS official boarding the vessel must have several calibrated thermometers.

### **PPQ Form 556, In Transit Cold Treatment Report**

Complete PPQ Form 556, In Transit Cold Treatment Report. Record the date and time of completion of each compartment and the officer's signature on the temperature chart or log sheet. Do not add fruit to the compartment after loading has been completed.

Complete the entries on the PPQ Form 556 during the actual performance of each step of the clearance procedure. The PPQ Form 556 instructions provide for a progressive clearance in the event that treatments are not completed before a vessel sails for a second U.S. port.

The Officer responsible for a U.S. vessel is typically the Chief Engineer or Reefer Engineer. The Officer responsible for a Foreign Flag vessel is typically the Chief Officer or Captain.

Inform the ship's officer to withhold discharging the treated commodity until clearance has been completed.

Obtain the clearance officer's copy of the calibration documents from ship's officer (Record in blocks 1-6, and 10).

Proceed to the data logger with the ship's officer and retrieve a temperature printout.



Review the temperature chart.



If the initial treatment period is broken because of excessive temperatures, failure of the recorder, or improper procedure, and the treatment is later restarted, enter the date and time of restart on the second line of item 28. Air temperatures may occasionally exceed treatment temperatures during defrost cycles; however, fruit temperatures should not rise appreciably during this time and must not exceed the temperature listed in the schedule. During non defrost times, the temperatures of the air sensors should never exceed the maximum allowable treatment temperature. For each compartment of a hold, the hourly sensor printouts will be examined by a PPQ Officer at the port of entry. Based on these records, the PPQ Official will make a determination as to whether to accept the treatment as satisfactory. In case of dispute, the ultimate decision will be made by the Officer in Charge (PPQ), who will take all factors into consideration. Occasionally, for example, there are cases in which one or two sensors in a compartment mechanically malfunctioned during the voyage, due to situations beyond the ship's control (e.g., rough seas). This is generally excusable, as long as the other sensors in the same compartment showed no readings higher than the cold treatment schedule allows. If, however, the ship stopped at another port while in route to the discharge destination in the U.S., but failed to have the facility sensor(s) repaired and recalibrated, it may be considered negligence on the part of the shipping line. The fruit from such refrigerated compartments would have to be retreated (in a cold warehouse) to be eligible for entry.

If a sensor is reading consistently high, it should be tested by using the ice-water bath technique. If this sensor proves to be accurate (i.e., readings within plus or minus 0.3 °C from zero) then it must be assumed that the high readings obtained in the fruit were indeed accurate, which would be sufficient grounds for rejection. For additional evidence, the PPQ Official can also obtain independent fruit pulp readings from a hand-held portable temperature-sensing instrument in the area of the load where high readings were obtained from the ship's sensor(s).

The vessel is permitted to store logged temperatures on magnetic media instead of printed on paper. However, the stored data must be printed in the presence of the authorized APHIS official.

Assemble logsheets so that a review can be made starting at the beginning of the temperature record. Check the calibration record; compare the actual calibration readings on logsheets with the calibration data on the calibration document (Record in block 23).



Many data logger installations are programmed to record temperature variations to one-hundredth of a degree centigrade (0.01°C). With this high resolution of temperature readings, a deviation of up to three-hundredths of a degree can be expected from consecutive readings in a standard ice water test. Accordingly, calibration certifications that are acceptable under our accuracy requirements show either the average of two consecutive calibration readings or two consecutive readings that are within three-hundredths of a degree centigrade of each other. Report deviations beyond this standard.

Review the logsheets up to when the loading of the compartment was complete. Determine the maximum and minimum fruit temperature at the time the sensors were inserted (Record in blocks 24, 25, and 26).

Continue reviewing the logsheets through the precooling period to the time when treatment commenced. Note abnormalities in the temperature readings that could indicate an irregularity in the treatment process (Record in block 27).

Review the treatment portion of the logsheets for irregularities and excessive temperatures (Record in block 28).

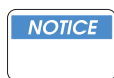

If the initial treatment period is broken because of excessive temperatures, failure of the data logger, or improper procedure, and the treatment is later restarted, enter the date and time of restart on the second line of item 28.

### **Clearance Action by Authorized APHIS Official**

The authorized APHIS official will:

- ◆ Release shipment for discharge if all requirements have been met and notify ship's officers, pier superintendents, and Customs and Border Protection Agriculture Inspector(s).
- ◆ Hold shipment pending further evaluation if total effects of irregularities are not consistent with treatment requirements (Contact the supervisor regarding the reasons for holding the shipment).
- ◆ Record all exceptions in narrative form and attach to the clearance report.

### **Inspection of Load and Compartments**

Time permitting, examine the load and compartments during and after unloading. Observe sensor locations, labeling, and physical condition and report irregularities.

### **Distribution of Clearance Documents**

After final clearance, the completed PPQ Form 556 with supporting documents are to be distributed as follows:

- ◆ Keep copies of the PPQ Form 556 and the chart printouts at the port of arrival.
- ◆ Send copies of the PPQ Form 556 to **TQAU**.

### **Self-Refrigerated (Integral) Containers**

Obtain the temperature printout and match it with the corresponding "Location of Temperature Sensors" and "Calibration of Temperature Probes" documents by using the container or recorder number. Check the documents and any accompanying correspondence for comments relating to deficiencies noted at origin. They must bear the signature of a PPQ Official or of an authorized official of the exporting country.

Compare the printout with the loading document to ensure the calibration factors, recorder start time, recorder serial number and recorder start date are the same. If the information is not the same, there must be proof that the equipment was exchanged and calibrated at the country of origin. Undocumented discrepancies will be cause for treatment failure.

Using PPQ Form 556, complete blocks 1-6 and 10. Record the container number in block 24. Six containers can be cleared per form.

Record the maximum and minimum fruit temperatures from the printout at time of loading (Blocks 25 and 26).

Review the temperatures and mark the printout where treatment commences at each temperature according to the appropriate treatment schedule. Determine date and time each treatment commenced (Block 27).

Review the treatment portion of the printout for irregularities and excessive temperatures (Block 28). If necessary, subtract or add correction factors to obtain the true temperature.

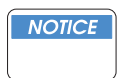

If the initial treatment period is broken because of excessive temperatures, failure of the data logger, or improper procedure, and the treatment is restarted, enter the date and time of restart on the second line of Block 27.

Determine the amount of time needed to complete the treatment if the treatment has not been completed, and report this to the persons responsible for the container. Check the temperature recordings to determine if the treatment has been completed at the end of the predicted completion period.

Record the last readings of the printout in Block 30. Investigate discrepancies.

Submit documentation even if the treatment was negated.

---

## Cold Treatment in Refrigerated Warehouses

The warehouse must be approved by PPQ (see Certifying Facilities).

The shipment must move directly from the port of entry to the cold storage warehouse with no diversion or delay.

The warehouse must provide the necessary security for safeguarding each shipment.

The unloading of containers which arrive at the warehouse under seal must be conducted under PPQ supervision.

### Initiating the Cold Treatment

The procedures for the verification of recording equipment and calibration of temperature sensors are the same as those outlined for vessels in [“Intransit Cold Treatment in Conventional Vessels, Self-Refrigerated \(Integral\) Containers, and Warehouses” on page-3-7-2](#), [“Initiating Intransit Cold Treatment in Vessels and Containers” on page-3-7-3](#), [“Verification of Temperature Recording Equipment” on page-3-7-3](#) and [“Calibration of Temperature Sensors” on page-3-7-5](#). These activities must be performed under the direction of an authorized APHIS official.

Arrange stowage to provide for adequate air distribution throughout the shipment, and to allow for the sampling of pulp temperatures in any desired location. To accomplish this, leave aisles between rows of pallets, with the aisles parallel to the air flow. Allow space between pallets. Double stacking of pallets is not allowed; therefore treatments will not begin until pallets are reconfigured to a single stacked pallet arrangement. However, rack systems are acceptable provided they have been approved by TQAU.

### Placement of Temperature Sensors:

After loading is completed, take fruit temperatures at various locations throughout the load to determine the location of the warmest fruit. Place temperature sensors throughout the load, being sure to place sensors in the warmest areas. Under some conditions, additional air circulation will be required to cool the shipment uniformly. The use of additional fans or blowers will depend on the particular circumstances at the time of treatment.

Placement of sensors should be under the direction of an authorized APHIS official. Insert the sensor well into the fruit. The tip of the sensor must not extend through the fruit ([Figure 3-7-1 on page-3-7-7](#)). If necessary (in the case of small fruit), the sensor should

penetrate multiple fruit (**Figure 3-7-2 on page-3-7-8**). The number and location of the temperature sensors are determined during warehouse certification (**Figure 3-7-6**).

Number of Pallets	Number of Air Sensors	Number of Pulp Sensors	Total Number of Sensors
1 - 100	1	2	3
101 - 200	1	3	4
201 - 300	1	4	5
301 - 400	1	5	6
401 - 500	1	6	7
501 - 600	1	7	8
601 - 700	1	8	9
701 - 800	1	9	10
801 - 900	1	10	11
901 - 1000	1	11	12
1000 +	Must be approved by TQAU		

**FIGURE 3-7-6 Number of Sensors in a Warehouse**

## Contact Information

### TQAU

USDA, APHIS, PPQ, CPHST  
Treatment Quality Assurance Unit  
1730 Varsity Drive, Suite 400  
Raleigh, NC 27606-5202  
Email: [CPHST\\_TQAU@aphis.usda.gov](mailto:CPHST_TQAU@aphis.usda.gov)  
Phone: 919-855-7450  
Fax: 919-855-7493



# 3

Treatment Manual

# Nonchemical Treatments

## *Irradiation*

---

### Contents

Introduction	page 3-8-1
Authorities and Other Responsible Parties	page 3-8-2
Treatment Objectives	page 3-8-2
Efficacy	page 3-8-2
Treatment	page 3-8-3
Dosimetry	page 3-8-5
Dose Mapping	page 3-8-5
Facility Approval	page 3-8-5
Documentation	page 3-8-5
Terminology	page 3-8-6

---

### Introduction

This chapter provides background and general information for the use of irradiation as a phytosanitary treatment of plant pests. Irradiation was first approved by APHIS in 1997 for use on papayas from Hawaii for export to the U.S. mainland, Guam, Puerto Rico, and the U.S. Virgin Islands. In 2002, irradiation was approved as a phytosanitary treatment for all admissible fresh fruits and vegetables from all countries.

---

## Authorities and Other Responsible Parties

- ◆ 7CFR 305.31 through 305.34
- ◆ Food and Drug Administration (FDA)

The FDA is responsible for determining the labelling requirements for irradiated food.

- ◆ National nuclear regulatory authority of the country where the facility is located
- ◆ International Standard for Phytosanitary Measures #18 (ISPM)

This International Standard provides technical guidance on the specific procedures for the application of ionizing radiation as a phytosanitary treatment for regulated pests or articles.

---

## Treatment Objectives

The objective of phytosanitary treatments is to prevent the introduction or spread of regulated pests. As a phytosanitary treatment, irradiation may reduce the risk of introduction by achieving certain responses, known as "endpoints," in the targeted pest(s). These endpoints are:

- ◆ Inability to emerge or fly
- ◆ Inactivation or devitalization (seeds may germinate but seedlings do not grow; or tubers, bulbs or cuttings do not sprout)
- ◆ Mortality
- ◆ Sterility (inability to reproduce)

### Efficacy

Unlike the Probit 9 mortality required for many chemical and nonchemical quarantine treatments, the use of irradiation as a phytosanitary measure presents a new paradigm to PPQ. The officer inspecting the treated consignment upon arrival in the U.S. may encounter living insects. However, this is to be expected since the treatment endpoint may not necessarily be mortality.



## Treatment

There are three types of ionizing radiation:

- ◆ Electrons generated from machine sources up to 10 MeV (eBeam)
- ◆ Radioactive isotopes (gamma rays from cobalt-60 or cesium-137)
- ◆ X-rays (up to 5 MeV)

The unit of measure for absorbed dose from any type of radiation is gray (Gy).

Modified atmospheres, such as low oxygen, may reduce treatment efficacy at a prescribed dose. Do not treat commodities that are in an oxygen-deficient environment.

Treatment procedures should also ensure that the minimum absorbed dose (Dmin) is fully attained throughout the commodity to provide the prescribed level of efficacy. Owing to the differences in the configuration of lots being treated, higher doses than the Dmin may be received by some of the commodities to ensure that the Dmin is achieved throughout the configured commodity. All treatments must be certified by verifying Dmin with approved dosimetry systems.

The minimum absorbed dose for the most-tolerant unmitigated pest is required if more than one pest is present. Refer to [Table 3-8-1](#) on [page 3-8-4](#) to determine the required minimum absorbed dose. For example, if a shipment of grapes is infested with both Mediterranean fruit fly and codling moth, the commodity would be irradiated using a minimum dose of 200 Gy.

There may be additional treatment requirements specific to the pest/host complex. Refer to the treatment schedules listed in [T105-a-1](#) on [page 5-2-63](#) for detailed information.

**Table 3-8-1** on **page 3-8-4** summarizes the minimum required doses required for effective treatment of specific pests.:

**TABLE 3-8-1 Pest-Specific Minimum absorbed dose (Gy)**

Scientific Name	Common Name	Minimum Absorbed Dose (Gy)
<i>Anastrepha ludens</i>	Mexican fruit fly	70
<i>Anastrepha obliqua</i>	West Indian fruit fly	70
<i>Anastrepha serpentina</i>	Sapote fruit fly	100
<i>Anastrepha suspensa</i>	Caribbean fruit fly	70
<i>Bactrocera cucurbitae</i>	Melon fruit fly	150
<i>Bactrocera dorsalis</i>	Oriental fruit fly	150
<i>Bactrocera jarvisi</i>	Jarvis fruit fly	100
<i>Bactrocera tryoni</i>	Queensland fruit fly	100
<i>Brevipalpus chilensis</i>	False red spider mite	300
<i>Ceratitis capitata</i>	Mediterranean fruit fly	150
<i>Conotrachelus nenuphar</i>	Plum curculio	92
<i>Cryptophlebia ombrodelta</i>	Litchi fruit moth	250
<i>Cryptophlebia illepida</i>	Koa seed worm	250
<i>Cylas formicarius elegantulus</i>	Sweet potato weevil	150
<i>Cydia pomonella</i>	Codling moth	200
<i>Euscepes postfasciatus</i>	West Indian sweet potato weevil	150
<i>Grapholita molesta</i>	Oriental fruit moth	200
<i>Omphisa anastomosalis</i>	Sweet potato vine borer	150
<i>Rhagoletis pomonella</i>	Apple maggot	60
<i>Sternochetus mangiferae</i>	Mango seed weevil	300
	All other fruit flies of the family Tephritidae which are not listed above	150
	Plant pests of the class Insecta not listed above, except pupae and adults of the order Lepidoptera	400

## Dosimetry

Dosimetry is the system used by the facility to determine absorbed dose. The absorbed dose is a quantity of radiation energy (measured in Gray (Gy)) absorbed per unit of mass of the commodity.

The dosimetry system should be calibrated in accordance with international standards or appropriate national standards (e.g. Standard ISO/ASTM 51261 *Guide for Selection and Calibration of Dosimetry Systems for Radiation Processing*).

### Dose Mapping

Prior to routine treatments, the region(s) of lowest and highest dose absorbance must be mapped for each treatment configuration. Configurations may be defined by a variety of criteria which may vary by facility. Factors that affect dose mapping commonly include:

- ◆ Density and composition of the material treated
- ◆ Orientation of the product, stacking, volume and packaging
- ◆ Shape and/or size

Dose mapping of the product in each geometric packing configuration, arrangement and product density that will be used during routine treatments should be required by APHIS prior to the approval of a facility for the treatment application. Only the configurations approved by the APHIS should be used for actual treatments.

The data obtained from the dose mapping is used to determine the proper number and placement of dosimeters during routine operations.

---

## Facility Approval

Chapter 6-8 of this manual covers the requirements for Irradiation facility approval ([Certifying Irradiation Treatment Facilities](#) on [page 6-8-1](#)).

---

## Documentation

The tracking and reporting of an irradiation treatment is critical to the integrity of the entire irradiation process. Treatment failure is linked to non-compliance, not pest detection. Consequently, an electronic database is being developed to standardize data entry, accurately and quickly produce data summaries and analysis, and allow access to a geographically diverse group of people.

Until this electronic database is fully operational, documentation requirements include the completion of the PPQ Form 203, Foreign Site Certificate of Inspection and/or Treatment.



The Irradiation Reporting and Accountability Database (IRAD) is a component of the Commodity Treatment Information System (CTIS) developed by USDA-APHIS-PPQ-CPHST Treatment Quality Assurance Unit (TQAU). Access to this web-based system will be permitted depending on the user's specific role or function in the irradiation process. TQAU will assign individual usernames and passwords.

The ITRS is scheduled for release by late 2007, with full implementation by mid-2008.

---

## Terminology

**absorbed dose**—Quantity of radiation energy (in gray) absorbed per unit of mass of a specified target [ISPM No. 18]

**dose mapping**—Measurement of the absorbed dose distribution within a process load through the use of dosimeters placed at specific locations within the process load [ISPM No. 18]

**dosimeter**—A device that, when irradiated, exhibits a quantifiable change in some property of the device which can be related to absorbed dose in a given material using appropriate analytical instrumentation and techniques [ISPM No. 18]

**dosimetry**—A system used for determining absorbed dose, consisting of dosimeters, measurement instruments and their associated reference standards, and procedures for the system's use [ISPM No. 18]

**gray (Gy)**—Unit of absorbed dose where 1 Gy is equivalent to the absorption of 1 joule per kilogram (1 Gy = 1 J.kg<sup>-1</sup>) [ISPM No. 18]

**ionizing radiation**—Charged particles and electromagnetic waves that as a result of physical interaction create ions by either primary or secondary processes [ISPM No. 18]

**irradiation**—Treatment with any type of ionizing radiation [ISPM No. 18]

**minimum absorbed dose**—The localized minimum absorbed dose within the process load [ISPM No. 18] (D<sub>min</sub>)

**radura**—internationally recognized symbol used to indicate when a food product has been irradiated





# 4

Treatment Manual

# Residue Monitoring

## Overview

### Contents

Overview [page-4-1-1](#)

### Overview

Methyl bromide fumigants, except those with “Q” labels, are subject to requirements of the FIFRA Section 18 Quarantine Exemption. When commodities intended for food or feed are fumigated with methyl bromide under the FIFRA Section 18 Quarantine Exemption, one additional EPA requirement must be met: PPQ must monitor aeration by sampling the gas concentration to determine when a commodity may be released.

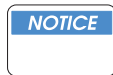

Currently, Plant Protection and Quarantine (PPQ) is *not* taking samples of commodities for residue monitoring. However, if residue monitoring becomes necessary, this section provides guidelines for taking samples that will be used for monitoring fumigant residues.

In the past, PPQ used residue monitoring to comply with the Environmental Protection Agency’s (EPA’s) guidelines for fumigation of edible food or feed products conducted under a Section 18 Quarantine Exemption. PPQ took and analyzed samples of fumigated commodities, and they reported the resulting data yearly to EPA. When a fumigation was conducted under a Section 18 Quarantine Exemption, samples were taken only when the commodity would be eaten by people or fed to animals. When the commodity would *not* be used for food or feed, PPQ did *not* take samples.

For example, if thyme would be used as an herb and fumigated under the schedule (T101-n-2), PPQ would sample the commodity because it would be eaten. On the other hand, if that same thyme were treated but imported as a cut flower, sampling would be unnecessary because it would be used for decoration—not eating.





# 4

Treatment Manual

## Residue Monitoring

### *Instructions for Collecting, Packaging, and Shipping Residue Monitoring Samples*

---

#### Contents

Safety	<a href="#">page-4-2-1</a>
Collecting the Sample	<a href="#">page-4-2-2</a>
Pretreatment Sample	<a href="#">page-4-2-2</a>
Post-Treatment Samples	<a href="#">page-4-2-2</a>
Labeling the Sample	<a href="#">page-4-2-2</a>
Storing the Sample	<a href="#">page-4-2-3</a>
Shipping Samples	<a href="#">page-4-2-3</a>
Quarantine Requirements	<a href="#">page-4-2-3</a>



Currently, Plant Protection and Quarantine (PPQ) is *not* taking samples of commodities for residue monitoring. However, if residue monitoring becomes necessary, this section provides guidelines for taking samples that will be used for monitoring fumigant residues.

---

#### Safety

Pretreatment samples will be shipped with dry ice. Be sure to store dry ice in well-ventilated areas and to transport dry ice and samples packed in dry ice in well-ventilated containers. Wear gloves when handling dry ice. For detailed information, see [Hazard Communication and Material Safety Data Sheets](#) on [page 7-4-1](#).

The Department of Transportation (DOT) considers dry ice a hazardous material and requires that aircraft record the amount of dry ice carried in the cargo hold. Amounts of 5 pounds or less are not stringently regulated; however, include the weight of dry ice on the shipping label. In addition, some overnight delivery companies have restrictions on shipping dry ice. Equip shipping containers with loose-fitting lids to prevent an explosive release of sublimating carbon dioxide. Identify dry ice as ORM-A on the shipping label. Also indicate on the label that the package contains diagnostic specimens.

## Collecting the Sample

You must take a sample prior to treatment (pretreatment) and after aeration is completed (post-treatment). To avoid contaminating the sample, handle it as little as possible. Take pretreatment and post-treatment samples from the same general location within a given lot (i.e., the same bags, boxes, or other containers).

Some ports receive commodities several times a month. For example, the port of Ft. Lauderdale received 20 shipments of chayote in October 1992. These shipments need not be sampled each time. For frequently received commodities, ports should develop a routine sample collection plan, such as one sample collected per week. However, when a new commodity is received or a commodity is received infrequently (once a week or less), collect a sample each time the commodity is treated.

### Pretreatment Sample

1. Collect a minimum of 450g (approximately 1 lb.) except for herbs of which you need to collect 150 grams (approximately one-third pound). If you are collecting fruits or vegetables that are heavy (for example grapefruit or yams), be sure to collect at least two pieces of produce that weigh 450g.
2. Place these samples in containers with dry ice.
3. Ship the pretreatment samples separately from post-treatment samples.

### Post-Treatment Samples

1. Collect a minimum of 450g (approximately 1 lb.) except for herbs of which you need to collect 150g (approximately one-third pound). If you are collecting fruits or vegetables that are heavy (for example grapefruit or yams), be sure to collect at least two pieces of produce that weigh 450g.
2. Ship the post-treatment samples separately from the pretreatment samples and in accordance with standard shipping practices. If the samples require refrigeration, then ship the samples with wet ice or ice packs. If the samples are normally shipped at ambient temperature (e.g., yams), ship them without ice.

---

## Labeling the Sample

Label each sample container with the State, county, date, and name of contents and whether the sample is “pre” or “post” treatment. For this label, use waterproof ink on a strip of masking tape or other label

material. Be sure to attach the label before leaving the sampling site. Securely fasten a plastic envelope containing the yellow copy of the APHIS Form 2061 to the side of the sampling container. Label this envelope with the same information that you placed on the sample container (State, county, date, and name of contents and whether sample was “pre” or “post” treatment).

---

## Storing the Sample

Immediately place the samples in a freezer or refrigerator until ready to package the samples for shipping.

---

## Shipping Samples

### Quarantine Requirements

Contact the State Plant Health Director to determine where to ship the samples. Ship all samples in leakproof, double sealed containers. Ensure the pretreatment sample is secure since it does not meet entry requirements for the United States.

Ship samples in coolers with dry ice packed above the samples. The lid of the cooler should be loose fitting to allow gasses to escape. Ship the samples using the contract overnight delivery service or the U.S. Postal Service Overnight Delivery.



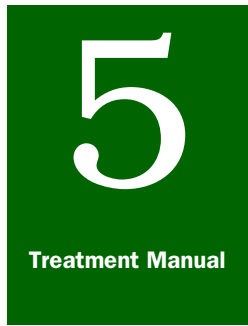

# Treatment Schedules

## *Index to Schedules*

---

### Contents

- T100 - Schedules for Fruit, Nuts, and Vegetables **page-5-2-1**
  - T200 - Schedules for Propagative Plant Material **page-5-3-1**
  - T300 - Schedules for Miscellaneous Plant Products **page-5-4-1**
  - T400 - Schedules for Miscellaneous Products **page-5-5-1**
  - T500 - Schedules for Plant Pests or Pathogens **page-5-6-1**
-



# 5

Treatment Manual

## Treatment Schedules

### *T100 - Schedules for Fruit, Nuts, and Vegetables*

---

#### Contents

T101—Methyl Bromide Fumigation	<a href="#">page-5-2-3</a>
T102—Water Treatment	<a href="#">page-5-2-49</a>
T103—High Temperature Forced Air	<a href="#">page-5-2-55</a>
T104—Pest Specific/Host Variable	<a href="#">page-5-2-58</a>
T105—Irradiation	<a href="#">page-5-2-61</a>
T106—Vapor Heat	<a href="#">page-5-2-65</a>
T107—Cold Treatment	<a href="#">page-5-2-69</a>
T108—Fumigation Plus Refrigeration of Fruits	<a href="#">page-5-2-74</a>
T109—Cold Treatment Plus Fumigation of Fruits	<a href="#">page-5-2-78</a>
T110—Quick Freeze	<a href="#">page-5-2-80</a>

---

#### Reporting Commodity Injury

Record any new or unusual observations relating to injury of commodity and report them to Quarantine Policy, Analysis and Support (QPAS) in Riverdale. Give pertinent details of the treatment and conditions regarding its application. In appraising the effect of a particular treatment, take care to distinguish between the actual or apparent effects directly attributable to the treatment and those relating to factors or conditions not subject to PPQ control.

Commodities in the T100 series are intended for consumption as food or feed. These commodities may have to be treated with methyl bromide to control a pest.

---

#### FIFRA Section 18 Exemption

Methyl bromide fumigants, except those with “Q” labels, are subject to requirements of the Federal Insecticide, Fungicide, and Rodenticide Act (FIFRA), Section 18 Quarantine Exemption. When commodities intended for food or feed are fumigated with methyl bromide under the FIFRA Section 18 Quarantine Exemption, one additional EPA requirement must be met: PPQ must monitor aeration by sampling the gas concentration to determine when a commodity may be released.

In this manual, fumigation schedules under the FIFRA Section 18 Quarantine Exemption are identified by the following note:



Do not use this treatment schedule if its FIFRA Section 18 Exemption has expired. For the current exemption status, call your local State Plant Health Director (SPHD).

---

## Determine the Correct Label for Fumigation

Always use the label of the fumigant to determine if the commodity can be treated. Fumigation schedules in this publication are intended to clarify and expand commercial labels for methyl bromide. The EPA only authorizes fumigation for commodities that are listed on the label of the gas being used for the fumigation. Also, to comply with State regulations, a fumigant must be registered in the State where it is being used.

Although the EPA only authorizes the use of a pesticide on a crop, animal, or site that is listed on the label of a pesticide, specific pests do not have to be listed on the label to use the pesticide. An amendment to FIFRA in 1978 permits the use of a pesticide to control a pest not on the label if the application is to a crop, animal, or site specified on the label, unless mentioned otherwise.

---

## How Fruits and Vegetables Are Listed

Fruits and vegetables that are to be fumigated with methyl bromide (T101s) will be listed in alphabetical order. Each schedule will have an assigned letter, e.g., Apples T101-a-1, Zucchini T101-h-3. For fruits and vegetables that require treatment as a condition of entry, refer to the Fruits and Vegetables Manual (Nonpropagative) for the specific treatment. Also, monitor aeration. see [page 2-4-36](#). However, if treatment is required as a condition of entry for a fruit or vegetable, monitoring the aeration is **not** required. On the other hand, if the fruit or vegetable is being treated under a Section 18 Exemption, monitoring aeration is required.



## T101—Methyl Bromide Fumigation

### T101-a-1 Apple and Pear<sup>1</sup>

Pest: External feeders

Treatment: **T101-a-1** MB at NAP—tarpaulin or chamber

Temperature	Dosage Rate (lb/1000 ft <sup>3</sup> )	Minimum Concentration Readings (ounces) At:	
		0.5 hr	2 hrs
80 °F or above	1.5 lbs	19	14
70-79 °F	2 lbs	26	19
60-69 °F	2.5 lbs	32	24
50-59 °F	3 lbs	38	29
40-49 °F	4 lbs	48	38

### T101-a-3 Apricot<sup>2</sup>, Peach, Plum<sup>2</sup>, Nectarine

Pest: External feeders

Treatment: **T101-a-3** MB at NAP—tarpaulin or chamber

Temperature	Dosage Rate (lb/1,000 ft <sup>3</sup> )	Minimum Concentration Readings (ounces) At:	
		0.5 hr	2 hrs
80 °F or above	1.5 lbs	19	14
70-79 °F	2 lbs	26	19
60-69 °F	2.5 lbs	32	24
50-59 °F	3 lbs	38	29
40-49 °F	4 lbs	48	38

### T101-b-1 Asparagus

Pest: External feeders such as Noctuidae spp., *Thrips* spp.  
(except *Scirtothrips dorsalis* from Thailand), *Copitarsia* spp.

Treatment: **T101-b-1** MB (“Q” label only) at NAP—tarpaulin or chamber

Temperature	Dosage Rate (lb/1000 ft <sup>3</sup> )	Minimum Concentration Readings (ounces) At:	
		0.5 hr	2 hrs
80 °F or above	1.5 lbs	19	14
70-79 °F	2 lbs	26	19
60-69 °F	2.5 lbs	32	24
50-59 °F	3 lbs	38	29
40-49 °F	4 lbs	48	38

- 1 Fumigation may cause **severe** damage to Chinese, Japanese, Asian and Sand Pears. Obtain the importer’s consent before fumigation.
- 2 **Pluots** and **plumcots** are considered hybrids of plums and apricots and can be treated using T101-a-3 provided they are treated as a **Section 18 Crisis Exemption**.

### T101-b-1-1 Asparagus from Thailand, Australia, and New Zealand

Pest: *Scirtothrips dorsalis* (Thailand), *Halotydeus destructor* (Australia) (New Zealand)

Treatment: **T101-b-1-1** MB (“Q” label only) at NAP—tarpaulin or chamber

Temperature	Dosage Rate (lb/1000 ft <sup>3</sup> )	Minimum Concentration Readings (ounces) At:	
		0.5 hr	2 hrs
80 °F or above	2.5 lbs	32	24
70-79 °F	3 lbs	38	29
60-69 °F	4 lbs	48	38

### T101-c-1 Avocado (from Hawaii, Israel, or the Philippines)

Pest: *Ceratitidis capitata* (Mediterranean fruit fly), *Bactrocera dorsalis* (Oriental fruit fly), and *Bactrocera cucurbitae* (melon fly)

Treatment: **T101-c-1** MB at NAP—tarpaulin or chamber

This treatment is marginal as to host tolerance and shipper should be warned of possible injury. Treatment approved for issuance of 318.13-4e certification.

Temperature	Dosage Rate (lb/1000 ft <sup>3</sup> )	Minimum Concentration Readings (ounces) At:		
		0.5 hr	2 hrs	4 hrs
70 °F or above	2 lbs	26	16	14



**Important**

Do not use this treatment schedule if its FIFRA Section 18 Exemption has expired. For the current exemption status, call your local State Plant Health Director (SPHD).

**Alternate Treatment**—Fumigation plus refrigeration T108

### T101-d-1

### Banana

Pest: External feeders such as Noctuidae, *Thrips* spp.,  
*Copitarsia* spp.

Treatment: **T101-d-1** MB at NAP—tarpaulin or chamber

This treatment is marginal as to host tolerance and shipper should be warned of possible injury.

Temperature	Dosage Rate (lb/1,000 ft <sup>3</sup> )	Minimum Concentration Readings (ounces) At:	
		0.5 hr	2 hrs
80 °F or above	1.5 lbs	19	14
70-79 °F	2 lbs	26	19
60-69 °F	2.5 lbs	32	24
50-59 °F	3 lbs	38	29
40-49 °F	4 lbs	48	38



**Important**

Do not use this treatment schedule if its FIFRA Section 18 Exemption has expired. For the current exemption status, call your local State Plant Health Director (SPHD).

### T101-e-1

### Bean (except for fava bean), dry

Pest: Bruchidae (seed beetles)

Treatment: **T101-e-1** MB at NAP—tarpaulin or chamber

Temperature	Dosage Rate (lb/1,000 ft <sup>3</sup> )	Minimum Concentration Readings (ounces) At:					
		0.5 hr	2 hrs	2.5 hrs	3 hrs	3.5 hrs	4 hrs
70 °F or above	3 lbs	38	—	24	—	—	—
60-69 °F	3 lbs	38	29	—	24	—	—
50-59 °F	3 lbs	38	29	—	—	24	—
40-49 °F	3 lbs	38	29	—	—	—	24

see also T101-k-2 or T101-K-2-1 for fresh beans

### T101-g-1

### Beet

Pest: Internal feeders

Treatment: **T101-g-1** MB chamber, 15" vacuum—chamber

Temperature	Dosage Rate (lb/1,000 ft <sup>3</sup> )	Exposure Period
90 °F or above	2 lbs	2 hrs
80-89 °F	2.5 lbs	2 hrs
70-79 °F	3 lbs	2 hrs
60-69 °F	3 lbs	2.5 hrs
50-59 °F	3 lbs	3 hrs
40-49 °F	3 lbs	3.5 hrs



As of October 2008, no **commercial** chambers in the United States are approved for the vacuum fumigation of imported commodities. If vacuum treatment is required as a **condition of entry**, the consignment must be destroyed, reexported or returned to country of origin.

### Beet

### T101-g-1-1

Pest: External feeders

Treatment: **T101-g-1-1** MB at NAP—tarpaulin or chamber

Temperature	Dosage Rate (lb/1,000 ft <sup>3</sup> )	Minimum Concentration Readings (ounces) At:				
		0.5 hr	2 hrs	3 hrs	3.5 hrs	4 hrs
90 °F and above	2 lbs	26	19	19	—	—
80-89 °F	2.5 lbs	32	24	24	—	—
70-79 °F	3 lbs	38	29	24	—	—
60-69 °F	3 lbs	38	29	—	24	—
50-59 °F	3 lbs	38	29	—	—	24

### T101-h-1

### Blackberry

Pest: External feeders such as Noctuidae, *Thrips* spp., *Copitarsia* spp., Pentatomidae, and *Tarsonemus* spp.

Treatment: **T101-h-1** MB at NAP—tarpaulin or chamber

Temperature	Dosage Rate (lb/1,000 ft <sup>3</sup> )	Minimum Concentration Readings (ounces) At:	
		0.5 hr	2 hrs
80 °F or above	1.5 lbs	19	14
70-79 °F	2 lbs	26	19
60-69 °F	2.5 lbs	32	24
50-59 °F	3 lbs	38	29
40-49 °F	4 lbs	48	38



Do not use this treatment schedule if its FIFRA Section 18 Exemption has expired. For the current exemption status, call your local State Plant Health Director (SPHD).

### T101-i-1

### Blueberry

Pest: External feeders

Treatment: **T101-i-1** MB at NAP—tarpaulin or chamber

Temperature	Dosage Rate (lb/1,000 ft <sup>3</sup> )	Minimum Concentration Readings (ounces) At:	
		0.5 hr	2 hrs
80 °F or above	1.5 lbs	19	14
70-79 °F	2 lbs	26	19

### T101-i-1-1

### Blueberry

Pest: *Ceratitidis capitata* (Mediterranean fruit fly) and *Anastrepha fraterculus* (South American fruit fly)

Treatment: **T101-i-1-1** MB at NAP—tarpaulin or chamber

Temperature	Dosage Rate (lb/1,000 ft <sup>3</sup> )	Minimum Concentration Readings (ounces) At:		
		0.5 hr	2 hrs	3.5 hrs
70 °F or above	2 lbs	26	22	21

**T101-n-2 Broccoli (*Brassica oleracea* var. *botrytis*)**

Pest: External feeders and leaf miners

Treatment: **T101-n-2** MB at NAP—tarpaulin or chamber

Temperature	Dosage Rate (lb/1,000 ft <sup>3</sup> )	Minimum Concentration Readings (ounces) At:	
		0.5 hr	2 hrs
70 °F or above	2 lbs	26	14
60-69 °F	2.5 lbs	32	24
50-59 °F	3 lbs	38	29
45-49 °F	3.5 lbs	43	34
40-44 °F	4 lbs	48	38



**Important**

Do not use this treatment schedule if its FIFRA Section 18 Exemption has expired. For the current exemption status, call your local State Plant Health Director (SPHD).

**T101-n-2 Broccoli, Chinese (gai lon) (*Brassica alboglabra*)**

Pest: External feeders and leaf miners

Treatment: **T101-n-2** MB at NAP—tarpaulin or chamber

Temperature	Dosage Rate (lb/1,000 ft <sup>3</sup> )	Minimum Concentration Readings (ounces) At:	
		0.5 hr	2 hrs
70 °F or above	2 lbs	26	14
60-69 °F	2.5 lbs	32	24
50-59 °F	3 lbs	38	29
45-49 °F	3.5 lbs	43	34
40-44 °F	4 lbs	48	38



**Important**

Do not use this treatment schedule if its FIFRA Section 18 Exemption has expired. For the current exemption status, call your local State Plant Health Director (SPHD).

## T101-n-2

### Broccoli raap (rapini) (*Brassica campestris*)

Pest: External feeders and leaf miners

Treatment: **T101-n-2** MB at NAP—tarpaulin or chamber

Temperature	Dosage Rate (lb/1,000 ft <sup>3</sup> )	Minimum Concentration Readings (ounces) At:	
		0.5 hr	2 hrs
70 °F or above	2 lbs	26	14
60-69 °F	2.5 lbs	32	24
50-59 °F	3 lbs	38	29
45-49 °F	3.5 lbs	43	34
40-44 °F	4 lbs	48	38



**Important**

Do not use this treatment schedule if its FIFRA Section 18 Exemption has expired. For the current exemption status, call your local State Plant Health Director (SPHD).

## T101-n-2

### Brussels sprouts (*Brassica oleracea* var. *gemmifera*)

Pest: External feeders and leaf miners

Treatment: **T101-n-2** MB at NAP—tarpaulin or chamber

Temperature	Dosage Rate (lb/1,000 ft <sup>3</sup> )	Minimum Concentration Readings (ounces) At:	
		0.5 hr	2 hrs
70 °F or above	2 lbs	26	14
60-69 °F	2.5 lbs	32	24
50-59 °F	3 lbs	38	29
45-49 °F	3.5 lbs	43	34
40-44 °F	4 lbs	48	38



**Important**

Do not use this treatment schedule if its FIFRA Section 18 Exemption has expired. For the current exemption status, call your local State Plant Health Director (SPHD).

### T101-j-1

### Cabbage

Includes both European and Chinese cabbage

Pest: External feeders

Treatment: **T101-j-1** MB at NAP—tarpaulin or chamber

Temperature	Dosage Rate (lb/1,000 ft <sup>3</sup> )	Minimum Concentration Readings (ounces) At:	
		0.5 hr	2 hrs
70 °F or above	2 lbs	26	14
60-69 °F	2.5 lbs	32	24
50-59 °F	3 lbs	38	29
45-49 °F	3.5 lbs	43	34
40-44 °F	4 lbs	48	38

For other *Brassica* spp., use the leafy vegetable schedule  
 T101-n-2

### T101-n-2

### Cabbage (*Brassica oleracea*)

Pest: External feeders and leaf miners

Treatment: **T101-n-2** MB at NAP—tarpaulin or chamber

Temperature	Dosage Rate (lb/1,000 ft <sup>3</sup> )	Minimum Concentration Readings (ounces) At:	
		0.5 hr	2 hrs
70 °F or above	2 lbs	26	14
60-69 °F	2.5 lbs	32	24
50-59 °F	3 lbs	38	29
45-49 °F	3.5 lbs	43	34
40-44 °F	4 lbs	48	38



Do not use this treatment schedule if its FIFRA Section 18 Exemption has expired. For the current exemption status, call your local State Plant Health Director (SPHD).



### T101-n-2

### Cabbage, Chinese (bok choy) (*Brassica chinensis*)

Pest: External feeders and leaf miners

Treatment: **T101-n-2** MB at NAP—tarpaulin or chamber

Temperature	Dosage Rate (lb/1,000 ft <sup>3</sup> )	Minimum Concentration Readings (ounces) At:	
		0.5 hr	2 hrs
70 °F or above	2 lbs	26	14
60-69 °F	2.5 lbs	32	24
50-59 °F	3 lbs	38	29
45-49 °F	3.5 lbs	43	34
40-44 °F	4 lbs	48	38



**Important**

Do not use this treatment schedule if its FIFRA Section 18 Exemption has expired. For the current exemption status, call your local State Plant Health Director (SPHD).

### T101-n-2

### Cabbage, Chinese (napa) (*Brassica pekinensis*)

Pest: External feeders and leaf miners

Treatment: **T101-n-2** MB at NAP—tarpaulin or chamber

Temperature	Dosage Rate (lb/1,000 ft <sup>3</sup> )	Minimum Concentration Readings (ounces) At:	
		0.5 hr	2 hrs
70 °F or above	2 lbs	26	14
60-69 °F	2.5 lbs	32	24
50-59 °F	3 lbs	38	29
45-49 °F	3.5 lbs	43	34
40-44 °F	4 lbs	48	38



**Important**

Do not use this treatment schedule if its FIFRA Section 18 Exemption has expired. For the current exemption status, call your local State Plant Health Director (SPHD).

## T101-n-2 Cabbage, Chinese mustard (gai choy) (*Brassica campestris*)

Pest: External feeders and leaf miners

Treatment: **T101-n-2** MB at NAP—tarpaulin or chamber

Temperature	Dosage Rate (lb/1,000 ft <sup>3</sup> )	Minimum Concentration Readings (ounces) At:	
		0.5 hr	2 hrs
70 °F or above	2 lbs	26	14
60-69 °F	2.5 lbs	32	24
50-59 °F	3 lbs	38	29
45-49 °F	3.5 lbs	43	34
40-44 °F	4 lbs	48	38



**Important**

Do not use this treatment schedule if its FIFRA Section 18 Exemption has expired. For the current exemption status, call your local State Plant Health Director (SPHD).

## T101-k-1 Cantaloupe

Pest: External feeders

Treatment: **T101-k-1** MB at NAP—tarpaulin or chamber

Temperature	Dosage Rate (lb/1,000 ft <sup>3</sup> )	Minimum Concentration Readings (ounces) At:	
		0.5 hr	2 hrs
80 °F or above*	1.5 lbs	19	14
70-79 °F*	2 lbs	26	19
60-69 °F	2.5 lbs	32	24
50-59 °F	3 lbs	38	29
40-49 °F	4 lbs	48	38

\* Use “MB 100” at 70 °F or above, use MB “Q” label at 40 °F or above.

For other melons, see T101-o-2

**T101-I-1**

**Carrot**

Pest: External feeders

Treatment: **T101-I-1** MB at NAP—tarpaulin or chamber—chamber

Temperature	Dosage Rate (lb/1,000 ft <sup>3</sup> )	Minimum Concentration Readings (ounces) At:				
		0.5 hr	2 hrs	3 hrs	3.5 hrs	4 hrs
90 °F and above	2 lbs	26	19	19	—	—
80-89 °F	2.5 lbs	32	24	24	—	—
70-79 °F	3 lbs	38	29	24	—	—
60-69 °F	3 lbs	38	29	—	24	—
50-59 °F	3 lbs	38	29	—	—	24

**T101-m-1**

**Carrot**

Pest: Internal feeders

Treatment: **T101-m-1** MB, chamber, 15" vacuum

Temperature	Dosage Rate (lb/1,000 ft <sup>3</sup> )	Exposure Period
90 °F or above	2 lbs	2 hrs
80-89 °F	2.5 lbs	2 hrs
70-79 °F	3 lbs	2 hrs
60-69 °F	3 lbs	2.5 hrs
50-59 °F	3 lbs	3 hrs
40-49 °F	3 lbs	3.5 hrs

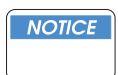

As of October 2008, no **commercial** chambers in the United States are approved for the vacuum fumigation of imported commodities. If vacuum treatment is required as a **condition of entry**, the consignment must be destroyed, reexported or returned to country of origin.

### T101-n-1 Cassava (*manihot and yuca*)

Pest: External feeders and hitchhikers<sup>3</sup>

Treatment: **T101-n-1** MB at NAP—tarpaulin or chamber

Temperature	Dosage Rate (lb/1,000 ft <sup>3</sup> )	Minimum Concentration Readings (ounces) At:			
		0.5 hr	2 hrs	3 hrs	3.5 hrs
90 °F or above	2 lbs	26	19	19	—
80-89 °F	2.5 lbs	32	24	24	—
70-79 °F	3 lbs	38	29	24	—
60-69 °F	3 lbs	38	29	—	24



**Important**

Do not use this treatment schedule if its FIFRA Section 18 Exemption has expired. For the current exemption status, call your local State Plant Health Director (SPHD).

### T101-n-2 Cauliflower (*Brassica oleracea var. botrytis*)

Pest: External feeders and leaf miners

Treatment: **T101-n-2** MB at NAP—tarpaulin or chamber

Temperature	Dosage Rate (lb/1,000 ft <sup>3</sup> )	Minimum Concentration Readings (ounces) At:	
		0.5 hr	2 hrs
70 °F or above	2 lbs	26	14
60-69 °F	2.5 lbs	32	24
50-59 °F	3 lbs	38	29
45-49 °F	3.5 lbs	43	34
40-44 °F	4 lbs	48	38



**Important**

Do not use this treatment schedule if its FIFRA Section 18 Exemption has expired. For the current exemption status, call your local State Plant Health Director (SPHD).

<sup>3</sup> This treatment should NOT be used for snails, but can be used for slugs.

## T101-n-2

### Cavalo broccolo (*Brassica oleracea* var. *botrytis*)

Pest: External feeders and leaf miners

Treatment: **T101-n-2** MB at NAP—tarpaulin or chamber

Temperature	Dosage Rate (lb/1,000 ft <sup>3</sup> )	Minimum Concentration Readings (ounces) At:	
		0.5 hr	2 hrs
70 °F or above	2 lbs	26	14
60-69 °F	2.5 lbs	32	24
50-59 °F	3 lbs	38	29
45-49 °F	3.5 lbs	43	34
40-44 °F	4 lbs	48	38



**Important**

Do not use this treatment schedule if its FIFRA Section 18 Exemption has expired. For the current exemption status, call your local State Plant Health Director (SPHD).

## T101-n-1

### Celeriac (celery root)

Pest: External feeders

Treatment: **T101-n-1** MB at NAP—tarpaulin or chamber

Temperature	Dosage Rate (lb/1,000 ft <sup>3</sup> )	Minimum Concentration Readings (ounces) At:			
		0.5 hr	2 hrs	3 hrs	3.5 hrs
90 °F or above	2 lbs	26	19	19	—
80-89 °F	2.5 lbs	32	24	24	—
70-79 °F	3 lbs	38	29	24	—
60-69 °F	3 lbs	38	29	—	24



**Important**

Do not use this treatment schedule if its FIFRA Section 18 Exemption has expired. For the current exemption status, call your local State Plant Health Director (SPHD).

### T101-o-1 Celery (above-ground parts)

Pest: External feeders

Treatment: **T101-o-1** MB at NAP—tarpaulin or chamber

Temperature	Dosage Rate (lb/ 1,000 ft <sup>3</sup> )	Minimum Concentration Readings (ounces) At:	
		0.5 hr	2 hrs
80 °F or above	1.5 lbs	19	14
70-79 °F	2 lbs	26	19
60-69 °F	2.5 lbs	32	24
50-59 °F	3 lbs	38	29
40-49 °F	4 lbs	48	38



Do not use this treatment schedule if its FIFRA Section 18 Exemption has expired. For the current exemption status, call your local State Plant Health Director (SPHD).

For below ground parts, use T101-n-1

### T101-p-1 Chayote (fruit only)

Pest: External feeders

Treatment: **T101-p-1** MB at NAP—tarpaulin or chamber

Temperature	Dosage Rate (lb/ 1,000 ft <sup>3</sup> )	Minimum Concentration Readings (ounces) At:	
		0.5 hr	2 hrs
80 °F or above	1.5 lbs	19	14
70-79 °F	2 lbs	26	19
60-69 °F	2.5 lbs	32	24
50-59 °F	3 lbs	38	29
40-49 °F	4 lbs	48	38

For below ground parts, use T101-a-2 (Dasheen)

### T101-r-1 Cherry

Pest: Insects other than fruit flies

Treatment: **T101-r-1** MB at NAP—tarpaulin or chamber

Temperature	Dosage Rate (lb/ 1,000 ft <sup>3</sup> )	Minimum Concentration Readings (ounces) At:	
		0.5 hr	2 hrs
80 °F or above	1.5 lbs	19	14
70-79 °F	2 lbs	26	19
60-69 °F	2.5 lbs	32	24
50-59 °F	3 lbs	38	29
40-49 °F	4 lbs	48	38

### T101-s-1

#### Cherry

Pest: *Rhagoletis indifferens* (Western cherry fruit fly) and *Cydia pomonella* (codling moth)

Treatment: **T101-s-1** MB at NAP—chamber only

Temperature	Dosage Rate (lb/1,000 ft <sup>3</sup> )	Exposure Period
70 °F or above	2 lbs	2 hrs
60-69 °F	2.5 lbs	2 hrs
50-59 °F	3 lbs	2 hrs
40-49 °F	4 lbs	2 hrs

### T101-t-1

#### Chestnut

Pest: *Cydia splendana* (nut fruit tortrix) and *Curculio* spp.

Treatment: **T101-t-1** MB at NAP—tarpaulin or chamber

Temperature	Dosage Rate (lb/1,000 ft <sup>3</sup> )	Minimum Concentration Readings (ounces) At:					
		0.5 hr	2 hrs	3 hrs	4 hrs	5 hrs	6 hrs
90 °F and above	4 lbs	58	34	34	—	—	—
80-89 °F	4 lbs	58	32	—	32	—	—
70-79 °F	5 lbs	72	42	—	42	—	—
60-69 °F	5 lbs	72	40	—	—	40	—
50-59 °F	6 lbs	85	50	—	—	50	—
40-49 °F	6 lbs	85	48	—	—	—	48

see also T101-u-1

Does not include water chestnut

### T101-u-1

#### Chestnut

Pest: *Cydia splendana* (nut fruit tortrix) and *Curculio* spp.

Treatment: **T101-u-1** MB in 26" vacuum—chamber

Temperature	Dosage Rate (lb/1,000 ft <sup>3</sup> )	Exposure Period
80 °F or above	3 lbs	2 hrs
70-79 °F	4 lbs	2 hrs
60-69 °F	4 lbs	3 hrs
50-59 °F	4 lbs	4 hrs
40-49 °F	4 lbs	5 hrs

Does not include water chestnut

## T101-v-1 Chicory (above-ground parts)

Pest: External feeders

Treatment: **T101-v-1** MB at NAP—tarpaulin or chamber

Temperature	Dosage Rate (lb/1,000 ft <sup>3</sup> )	Minimum Concentration Readings (ounces) At:	
		0.5 hr	2 hrs
70 °F or above	2 lbs	26	14
60-69 °F	2.5 lbs	32	24
50-59 °F	3 lbs	38	29
45-49 °F	3.5 lbs	43	34
40-44 °F	4 lbs	48	38



**Important**

Do not use this treatment schedule if its FIFRA Section 18 Exemption has expired. For the current exemption status, call your local State Plant Health Director (SPHD).

see T101-n-1 for below-ground parts

see T101-z-1 for below-ground parts

see T101-a-2 for below-ground parts

## T101-n-1 Chicory root

Pest: External feeders

Treatment: **T101-n-1** MB at NAP—tarpaulin or chamber

Temperature	Dosage Rate (lb/1,000 ft <sup>3</sup> )	Minimum Concentration Readings (ounces) At:			
		0.5 hr	2 hrs	3 hrs	3.5 hrs
90 °F or above	2 lbs	26	19	19	—
80-89 °F	2.5 lbs	32	24	24	—
70-79 °F	3 lbs	38	29	24	—
60-69 °F	3 lbs	38	29	—	24



**Important**

Do not use this treatment schedule if its FIFRA Section 18 Exemption has expired. For the current exemption status, call your local State Plant Health Director (SPHD)..



### T101-w-1

### Cipollini (bulbs)

Pest: *Exosoma lusitanica* (chrysomelid beetle)

Treatment: **T101-w-1** MB in 15" vacuum—chamber

Temperature	Dosage Rate (lb/1,000 ft <sup>3</sup> )	Exposure Period
80 °F or above	2 lbs.	2 hrs
70-79 °F	3 lbs.	2 hrs
60-69 °F	4 lbs.	2 hrs
50-59 °F	4 lbs.	3 hrs
40-49 °F	4 lbs.	4 hrs



As of October 2008, no **commercial** chambers in the United States are approved for the vacuum fumigation of imported commodities. If vacuum treatment is required as a **condition of entry**, the consignment must be destroyed, reexported or returned to country of origin.

### T101-w-1-2

### Citrus from U.S. (interstate movement)

Pest: *Ceratitis capitata* (Mediterranean fruit fly)

Treatment: **T101-w-1-2** MB at NAP—tarpaulin or chamber

Temperature	Dosage Rate (lb/1000 ft <sup>3</sup> )	Minimum Concentration Readings (ounces) At:	
		0.5 hr	2 hrs
70 °F or above	2 lbs	26	22

Includes only kumquats, lemons, limes, oranges, tangelos, and tangerines for interstate movement

### T101-n-2-1

### Clementine, Lemon, Lime, Mandarin, and Tangerine from Chile

Pest: External feeders and *Brevipalpus chilensis* (Chilean false spider mite of grapes)

Treatment: **T101-n-2-1** MB at NAP—tarpaulin or chamber

Temperature	Dosage Rate (lb/1,000 ft <sup>3</sup> )	Minimum Concentration Readings (ounces) At:	
		0.5 hr	2 hrs
80 °F or above	1.5 lbs	19	14
70-79 °F	2 lbs	26	19
60-69 °F	2.5 lbs	32	24
50-59 °F	3 lbs	38	29

### T101-j-2-1 **Clementines (Tangerines) from Mexico and quarantine areas of the U.S.**

Pest: *Anastrepha* spp.

Treatment: **T101-j-2-1** MB at NAP—chamber

Temperature	Dosage Rate (lb/1,000 ft <sup>3</sup> )	Exposure Period
80 °F or above	2.5 lbs	2 hrs

Load limit not to exceed 80 percent of chamber capacity

Inspect a representative sample of the fruit. If the level of infestation with fruit flies is more than 0.5% for the lot, then the fruit is ineligible for fumigation.

### T101-n-2 **Coles (Brassica spp.)\***

Pest: External feeders and leaf miners

Treatment: **T101-n-2** MB at NAP—tarpaulin or chamber

Temperature	Dosage Rate (lb/1,000 ft <sup>3</sup> )	Minimum Concentration Readings (ounces) At:	
		0.5 hr	2 hrs
70 °F or above	2 lbs	26	14
60-69 °F	2.5 lbs	32	24
50-59 °F	3 lbs	38	29
45-49 °F	3.5 lbs	43	34
40-44 °F	4 lbs	48	38



**Important**

Do not use this treatment schedule if its FIFRA Section 18 Exemption has expired. For the current exemption status, call your local State Plant Health Director (SPHD).



**Important**

\*Coles (Brassica spp.), EPA Crop Group 5, are restricted to broccoli (Brassica oleracea var. botrytis); broccoli, Chinese (gai lon) (Brassica alboglabra); broccoli raap (rapini) (Brassica campestris); brussels sprouts (Brassica oleracea var. gemmifera); cabbage (Brassica oleracea); Cabbage, Chinese (bok choy) (Brassica chinensis); Cabbage, Chinese (napa) (Brassica pekinensis); cabbage, Chinese mustard (gai choy) (Brassica campestris); cauliflower (Brassica oleracea var. botrytis); cavalo broccolo (Brassica oleracea var. botrytis); collards (Brassica oleracea var. acephala); kale (Brassica oleracea var. acephala); kohlrabi (Brassica oleracea var. gongyiodes); mizuna (Brassica rapa Japonica Group); mustard greens (Brassica juncea); mustard spinach (Brassica rapa Perviridis Group); rape greens (Brassica napus)

Of these, cabbage (Brassica oleracea) (labeled treatment T101-j-1) is the only vegetable in this group not covered by a FIFRA Section 18 Exemption.

## T101-n-2

### Collard Greens (*Brassica oleracea* var. *acephala*)

Pest: External feeders and leaf miners

Treatment: **T101-n-2** MB at NAP—tarpaulin or chamber

Temperature	Dosage Rate (lb/1,000 ft <sup>3</sup> )	Minimum Concentration Readings (ounces) At:	
		0.5 hr	2 hrs
70 °F or above	2 lbs	26	14
60-69 °F	2.5 lbs	32	24
50-59 °F	3 lbs	38	29
45-49 °F	3.5 lbs	43	34
40-44 °F	4 lbs	48	38



Important

Do not use this treatment schedule if its FIFRA Section 18 Exemption has expired. For the current exemption status, call your local State Plant Health Director (SPHD).

## T101-x-1

### Copra

(Dried coconuts and whole coconuts without the husk)

Pest: External feeders

Treatment: **T101-x-1** MB (“Q” label only) at NAP—tarpaulin or chamber

Temperature	Dosage Rate (lb/1,000 ft <sup>3</sup> )	Minimum Concentration Readings (ounces) At:	
		0.5 hr	2 hrs
80 °F or above	1.5 lbs	19	14
70-79 °F	2 lbs	26	19
60-69 °F	2.5 lbs	32	24

## T101-x-1-1

### Corn-on-the-cob

(Green corn, sweet corn)

Pest: *Ostrinia nubilalis* (European corn borer)

Treatment: **T101-x-1-1** MB at NAP—tarpaulin or chamber

Temperature	Dosage Rate (lb/1000 ft <sup>3</sup> )	Minimum Concentration Readings (ounces) At:	
		0.5 hr	2.5 hrs
70 °F or above	2.5 lbs	32	24

### T101-y-1

### Cucumber

Pest: External feeders

Treatment: **T101-y-1** MB at NAP—tarpaulin or chamber

Temperature	Dosage Rate (lb/1,000 ft <sup>3</sup> )	Minimum Concentration Readings (ounces) At:	
		0.5 hr	2 hrs
80 °F or above	1.5 lbs	19	14
70-79 °F	2 lbs	26	19
60-69 °F	2.5 lbs	32	24
50-59 °F	3 lbs	38	29

### T101-z-1

### Dasheen

(Eddoe, malanga, tannia, tanya, taro, and yautia)

Pest: External feeders

Treatment: **T101-z-1** MB at NAP—tarpaulin or chamber

Temperature	Dosage Rate (lb/1,000 ft <sup>3</sup> )	Minimum Concentration Readings (ounces) At:				
		0.5 hr	2 hrs	3 hrs	3.5 hrs	4 hrs
90 °F or above	2 lbs	26	19	19	—	—
80-89 °F	2.5 lbs	32	24	24	—	—
70-79 °F	3 lbs	38	29	24	—	—
60-69 °F	3 lbs	38	29	—	24	—
50-59 °F	3 lbs	38	29	—	—	24
40-49°F	4 lbs	48	40	—	—	32



**Important**

Do not use this treatment schedule if its FIFRA Section 18 Exemption has expired. For the current exemption status, call your local State Plant Health Director (SPHD).

## T101-a-2

### Dasheen

Pest: Internal feeders

Treatment: **T101-a-2** MB chamber, 15" vacuum—chamber

Temperature	Dosage Rate (lb/1,000 ft <sup>3</sup> )	Exposure Period
90 °F or above	2 lbs	2 hrs
80-89 °F	2.5 lbs	2 hrs
70-79 °F	3 lbs	2 hrs
60-69 °F	3 lbs	2.5 hrs
50-59 °F	3 lbs	3 hrs
40-49 °F	3 lbs	3.5 hrs



**Important**

Do not use this treatment schedule if its FIFRA Section 18 Exemption has expired. For the current exemption status, call your local State Plant Health Director (SPHD).



As of October 2008, no **commercial** chambers in the United States are approved for the vacuum fumigation of imported commodities. If vacuum treatment is required as a **condition of entry**, the consignment must be destroyed, reexported or returned to country of origin.

## T101-b-2

### Endive

Pest: External feeders

Treatment: **T101-b-2** MB at NAP—tarpaulin or chamber

Temperature	Dosage Rate (lb/1,000 ft <sup>3</sup> )	Minimum Concentration Readings (ounces) At:	
		0.5 hr	2 hrs
70 °F or above	2 lbs	26	14
60-69 °F	2.5 lbs	32	24
50-59 °F	3 lbs	38	29
45-49 °F	3.5 lbs	43	34
40-44 °F	4 lbs	48	38



**Important**

Do not use this treatment schedule if its FIFRA Section 18 Exemption has expired. For the current exemption status, call your local State Plant Health Director (SPHD).

**T101-c-2 Fava bean (dried)**

Pest: Bruchidae (seed beetles)

Treatment: **T101-c-2** MB in 26" vacuum—chamber

Temperature	Dosage Rate (lb/1,000 ft <sup>3</sup> )	Exposure Period
70 °F or above	3 lbs	3.5 hrs
60-69 °F	3 lbs	4 hrs
50-59 °F	3 lbs	4.5 hrs
40-49 °F	3 lbs	5 hrs

**T101-d-2 Fava bean (dried)**

Pest: Bruchidae (seed beetles)

Treatment: **T101-d-2** MB at NAP—tarpaulin or chamber

Temperature	Dosage Rate (lb/1,000 ft <sup>3</sup> )	Minimum Concentration Readings (ounces) At:					
		0.5 hr	2 hrs	11 hrs	12hrs	13 hrs	14 hrs
70 °F and above	3.5 lbs	46	28	27	—	—	—
60-69 °F	3.5 lbs	46	28		27		
50-59 °F	3.5 lbs	46	28			27	
40-49 °F	3.5 lbs	46	28				27

If fresh, see Green Pod Vegetables

## T101-e-2

### Garlic

Pest: *Brachymerus* spp. (garlic beetles) and *Dyspessa ulula* (garlic carpenterworm)

Treatment: **T101-e-2** MB in 15" vacuum—chamber

Temperature	Dosage Rate (lb/1,000 ft <sup>3</sup> )	Exposure Period
90 °F or above	2 lbs	1.5 hrs
80-89 °F	2 lbs	2 hrs
70-79 °F	2.5 lbs	2 hrs
60-69 °F	3 lbs	2 hrs
50-59 °F	3 lbs	3 hrs
40-49 °F	3 lbs	4 hrs



As of October 2008, no **commercial** chambers in the United States are approved for the vacuum fumigation of imported commodities. If vacuum treatment is required as a **condition of entry**, the consignment must be destroyed, reexported or returned to country of origin.

Load limit not to exceed 80 percent of chamber capacity

Treatment is waived for shipments of garlic for food purposes from Italy and Spain when accompanied by an official phytosanitary certificate stating freedom from *Brachymerus* spp. and *Dyspessa ulula* and inspection at port of entry discloses no pests. This exemption from treatment only applies to garlic for food purposes.

## T101-f-2

### Ginger (rhizome)

Pest: Internal feeders

Treatment: **T101-f-2** MB in 15" vacuum—chamber

Temperature	Dosage Rate (lb/1,000 ft <sup>3</sup> )	Exposure Period
90 °F or above	2 lbs	3 hrs
80-89 °F	2.5 lbs	3 hrs
70-79 °F	3 lbs	3 hrs
60-69 °F	3 lbs	3.5 hrs



Do not use this treatment schedule if its FIFRA Section 18 Exemption has expired. For the current exemption status, call your local State Plant Health Director (SPHD).

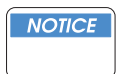

As of October 2008, no **commercial** chambers in the United States are approved for the vacuum fumigation of imported commodities. If vacuum treatment is required as a **condition of entry**, the consignment must be destroyed, reexported or returned to country of origin.

## T101-g-2

### Ginger (rhizome)

Pest: External feeders

Treatment: **T101-g-2** MB at NAP—tarpaulin or chamber

Temperature	Dosage Rate (lb/1,000 ft <sup>3</sup> )	Minimum Concentration Readings (ounces) At:			
		0.5 hr	2 hrs	3 hrs	3.5 hrs
90 °F or above	2 lbs	26	19	19	—
80-89 °F	2.5 lbs	32	24	24	—
70-79 °F	3 lbs	38	29	24	—
60-69 °F	3 lbs	38	29	—	24



Important

Do not use this treatment schedule if its FIFRA Section 18 Exemption has expired. For the current exemption status, call your local State Plant Health Director (SPHD).

## T101-h-2

### Grape

Pest: *Lobesia botrana* (vine moth)

Treatment: **T101-h-2** MB at NAP—tarpaulin or chamber

Temperature	Dosage Rate (lb/1,000 ft <sup>3</sup> )	Minimum Concentration Readings (ounces) At:	
		0.5 hr	2 hrs
80 °F or above	1.5 lbs	19	14
70-79 °F	2 lbs	26	19
60-69 °F	2.5 lbs	32	24
50-59 °F	3 lbs	38	29
40-49 °F	4 lbs	48	38

## T101-h-2-1

### Grape

Pest: *Ceratitis capitata* (Mediterranean fruit fly) or *Ceratitis capitata* and *Lobesia botrana* (vine moth)

Treatment: **T101-h-2-1** MB at NAP—tarpaulin or chamber

Temperature	Dosage Rate (lb/1,000 ft <sup>3</sup> )	Minimum Concentration Readings (ounces) At:					
		0.5 hr	2 hrs	2.5 hrs	3 hrs	3.5 hrs	4 hrs
70 °F or above	2 lbs	26	22	22	—	21	—
65-69 °F	2 lbs	26	22	22	—	—	19



### T101-i-2

#### Grape

Pest: Insects other than *Ceratitis capitata* (Mediterranean fruit fly) and *Lobesia botrana* (vine moth)

Treatment: **T101-i-2** MB at NAP—tarpaulin or chamber

Temperature	Dosage Rate (lb/1,000 ft <sup>3</sup> )	Minimum Concentration Readings (ounces) At:	
		0.5 hr	2 hrs
80 °F or above	1.5 lbs	19	14
70-79 °F	2 lbs	26	19
60-69 °F	2.5 lbs	32	24
50-59 °F	3 lbs	38	29
40-49 °F	4 lbs	48	38

If mealybugs are found, use treatment schedule T104-a-2.

### T101-i-2-1

#### Grapes from Chile

Pest: External feeders

Treatment: **T101-i-2-1** MB at NAP—tarpaulin or chamber

Temperature	Dosage Rate (lb/1,000 ft <sup>3</sup> )	Minimum Concentration Readings (ounces) At:	
		0.5 hr	2 hrs
80 °F or above	1.5 lbs	19	14
70-79 °F	2 lbs	26	19
60-69 °F	2.5 lbs	32	24
50-59 °F	3 lbs	38	29
40-49 °F	4 lbs	48	38

If mealybugs are found, use treatment schedule T104-a-2.

### T101-j-2

#### Grapefruit and other kinds of citrus

Pest: *Aleurocanthus woglumi* (citrus blackfly)

Treatment: **T101-j-2** MB at NAP—tarpaulin or chamber

Temperature	Dosage Rate (lb/1,000 ft <sup>3</sup> )	Minimum Concentration Readings (ounces) At:	
		0.5 hr	2 hrs
80 °F or above	1.5 lbs	16	12
70-79 °F	1.5 lbs	19	15
65-69 °F	1.75 lbs	23	17

### T101-j-2-1 Grapefruit from Mexico and quarantine areas of the U.S.

Pest: *Anastrepha* spp.

Treatment: **T101-j-2-1** MB at NAP—chamber (load limit not to exceed 80 percent of chamber capacity)

Temperature	Dosage Rate (lb/1,000 ft <sup>3</sup> )	Exposure Period
80 °F or above	2.5 lbs	2 hrs

Inspect a representative sample of the fruit. If the level of infestation with fruit flies is more than 0.5% for the lot, then the fruit is ineligible for fumigation.

### T101-k-2 Green pod vegetables (legumes)

Snap, string, yard-long beans, peas<sup>4</sup>, and pigeon peas, lablab beans

Pest: *Cydia fabivora*, *Epinotia aporema*, and *Maruca testulalis* (exotic legume pod borers) and leaf miners

Treatment: **T101-k-2** MB in 15" vacuum—chamber

Temperature	Dosage Rate (lb/1,000 ft <sup>3</sup> )	Exposure Period
90 °F or above	0.5 lb	1.5 hrs
80-89 °F	1 lb	1.5 hrs
70-79 °F	1.5 lbs	1.5 hrs
60-69 °F	2 lbs	1.5 hrs
50-59 °F	2.5 lbs	1.5 hrs
40-49 °F	3 lbs	1.5 hrs

### T101-k-2-1 Green pod vegetables (legumes)

Snap, string, yard-long beans, peas<sup>4</sup>, and pigeon peas, lablab beans

Pest: *Cydia fabivora*, *Epinotia aporema*, and *Maruca testulalis* (exotic legume pod borers) and leaf miners

Alternative treatment: **T101-k-2-1** MB at NAP—tarpaulin or chamber

Temperature	Dosage Rate (lb/1,000 ft <sup>3</sup> )	Minimum Concentration Readings (ounces) At:	
		0.5 hr	2 hrs
80 °F or above	1.5 lbs	19	14
70-79 °F	2 lbs	26	19
60-69 °F	2.5 lbs	32	24
50-59 °F	3 lbs	38	29

4 Do not treat snow peas from Guatemala for Agromyzid leaf miners UNLESS destined to Florida. (refer to [Pea Leaf Miner DA2008-76](#))

## T101-n-2-1-1

### Herbs and Spices, Dried\*

Pest: Various stored product pests, not including khapra beetle

Treatment: T101-n-2-1-1 MB (“Q” label only) at NAP

Temperature	Dosage Rate (lb/1,000 ft <sup>3</sup> )	Minimum Concentration Readings (ounces) At:			
		0.5 hr	4 hrs	16 hrs	24 hrs
70 °F or above	2 lbs	24	16	10	—
60-69 °F	2 lbs	24	16	—	10
50-59 °F	3 lbs	36	24	15	—
40-49 °F	3 lbs	36	24	—	15

\*Includes all dried plant parts, as well as seeds.



If khapra beetle is intercepted on herbs and spices (dried), do not use this schedule. Contact the Center for Plant Health Science & Technology (CPHST), tel: 1-919-855-7450.



Dried herbs and spices are restricted to Allspice, (*pimenta dioica*), Angelica (*Angelica archangelica*), Anise (Anise seed) (*Pimpinella anisum*), Anise star (*Illicium verum*), Annatto (seed), Balm (Lemon balm) (*Melissa officinalis*), Basil (*Ocimum basilicum*), Borage (*Borago officinalis*), Bumet (*Sanguisorba minor*), Camomile (*Anthemis nobilis*), Caper buds (*Capparis spinosa*), Caraway (*Carum carvi*), Curaway, black (*Nigelia sativa*), Cardamom (*Elettaria cardamomum*), Cassia bark (*Cinnamomum aromaticum*), Cassia buds (*Cinnamomum aromaticum*), Catnip (*Nepeta cataria*), Celery seed (*Apium graveolens*), Chervil (dried) (*Anthriscus cerefolium*), Chive (*Allium schoenoprasum*), Chive, Chinese (*Allium tuberosum*), Cinnamon (*Cinnamomum verum*), Clary (*Salvia sciarea*), Clove buds (*Eugenia caryophyllata*), Coriander (cilantro or Chinese parsley) (leaf) (*Coriandrum sativum*), Coriander (cilantro) (seed) (*Coriandrum sativum*), Costmary (*Chrysanthemum balsamita*), Culantro (leaf) (*Eryngium foetidum*), Culantro (seed) (*Eryngium foetidum*), Cumin (*Cuminum cyminum*), Curry (leaf) (*Murraya koenigii*), Dill (dillweed) (*Anthemum graveolens*), Dill (seed) (*Anthemum graveolens*), Fennel (common) (*Foeniculum vulgare*), Fennel, Floronce (seed) (*Foeniculum vulgare* Azoricum group), Fenugreek (*Trigonella foenumgraecum*), Grains of paradise (*Aframomum melgueta*), Horehound (*Marrubium vulgare*), Hyssop (*Hyssopus officinalis*), Juniper berry (*Juniperus communis*), Lavender (*Lavandula officinalis*), Lemongrass (*Cymbopogon citratus*), Lovage (leaf) (*Levisticum officinale*), Lovage (seed) (*Levisticum officinale*), Mace (*Myristica fragrans*), Marigold (*Calendula officinalis*), Marjoram (*Origanum* spp.) (includes sweet or annual marjoram, wild marjoram, or oregano, and pot marjoram), Mustard (seed) (*Brassica juncea*, *B. hirta*, *B. nigra*), Nasturtium (*Tropaeolum majus*), Nutmeg (*Myristica fragrans*) Parsley (dried) (*Pestroselinum crispum*), Pennyroyal (*Mentha pulegium*), Pepper, black (*Piper nigrum*), Poppy (seed) (*Papaver somniferum*), Rosemary (*Rosemarinus officinalis*), Rue (*Ruta graveolens*), Saffron (*Crocus sativus*), Sage (*Salvia officinalis*), Savory summer and winter (*Saturegia* spp.), Sweet bay (bay leaf) (*Laurus nobilis*), Tansy (*Tanacetum vulgare*), Tarragan (*Artemisia dracuncululus*), Thyme (*Thymus* spp.), Vanilla (*Vanillia planifolia*), Wintergreen (*Gaultheria procumbens*), Woodruff (*Galium odorata*), Wormwood (*Artemisia absinthium*).

## T101-n-2

### Herbs, fresh (Includes all fresh plant parts except seeds)

Pest: External feeders and leaf miners

Treatment: T101-n-2 MB at NAP-tarpaulin or chamber

Temperature	Dosage Rate (lb/1,000 ft <sup>3</sup> )	Minimum Concentration Readings (ounces) At:	
		0.5 hr	2 hrs
70 °F or above	2 lbs	25	14
60-69 °F	2.5 lbs	32	24
50-59 °F	3 lbs	38	29
45-49 ° F	3.5 lbs	43	34
40-44 ° F	4 lbs	48	38



**Important**

Do not use this treatment schedule if its FIFRA Section 18 Exemption has expired. For the current exemption status, call your local State Plant Health Director (SPHD).



**Important**

Fresh herbs and spices are restricted to Allspice, (*pimenta dioica*), Angelica (*Angelica archangelica*), Anise (Anise seed) (*Pimpinella anisum*), Anise star (*Illicium verum*), Annatto (seed), Balm (Lemon balm) (*Melissa officinalis*), Basil (*Ocimum basilicum*), Borage (*Borago officinalis*), Bumet (*Sanguisorba minor*), Camomile (*Anthemis nobilis*), Caper buds (*Capparis spinosa*), Caraway (*Carum carvi*), Curaway, black (*Nigelia sativa*), Cardamom (*Elettaria cardamomum*), Cassia bark (*Cinnamomum aromaticum*), Cassia buds (*Cinnamomum aromaticum*), Catnip (*Nepeta cataria*), Celery seed (*Apium graveolens*), Chervil (dried) (*Anthriscus cerefolium*), Chive (*Allium schoenoprasum*), Chive, Chinese (*Allium tuberosum*), Cinnamon (*Cinnamomum verum*), Clary (*Salvia sciarea*), Clove buds (*Eugenia caryophyllata*), Coriander (cilantro or Chinese parsley) (leaf) (*Coriandrum sativum*), Coriander (cilantro) (seed) (*Coriandrum sativum*), Costmary (*Chrysanthemum balsamita*), Culantro (leaf) (*Eryngium foetidum*), Culantro (seed) (*Eryngium foetidum*), Cumin (*Cuminum cyminum*), Curry (leaf) (*Murraya koenigii*), Dill (dillweed) (*Anthemum graveolens*), Dill (seed) (*Anthmum graveolens*), Fennel (common) (*Foeniculum vulgare*), Fennel, Floronce (seed) (*Foeniculum vulgare* Azoricum group), Fenugreek (*Trigonella foenumgraecum*), Grains of paradise (*Afromomum melgueta*), Horehound (*Marribium vulgare*), Hyssop (*Hyssopus officinalis*), Juniper berry (*Juniperus communis*), Lavender (*Lavendula offinalis*), Lemongrass (*Cymbopogon citratus*), Lovage (leaf) (*Levisticum officinale*), Lovage (seed) (*Levisticum officinale*), Mace (*Myristica fragrans*), Marigold (*Calendula officinalis*), Marjoram (*Origanum* spp.) (includes sweet or annual marjoram, wild marjoram, or oregano, and pot marjoram), Mustard (seed) (*Brassica junceca*, *B. hirta*, *B. nigra*), Nasturtium (*Tropaeolum majus*), Nutmeg (*Myristica fragrans*) Parsley (dried) (*Pestroselinum crispum*), Pennyroyal (*Mentha pulegium*), Pepper, black (*Piper nigrum*), Poppy (seed) (*Papaver somniferum*), Rosemary (*Rosemarinus officinalis*), Rue (*Ruta graveolens*), Saffron (*Crocus sativus*), Sage (*Salvia officinalis*), Savory summer and winter (*Saturega* spp.), Sweet bay (bay leaf) (*Laurus nobilis*), Tansy (*Tanacetum vulgare*), Tarragan (*Artemisia dracunculus*), Thyme (*Thymus* spp.), Vanilla (*Vanillia planifolia*), Wintergreen (*Gaultheria procumbens*), Woodruff (*Galium odorata*), Wormwood (*Artemisia absinthium*).

## T101-I-2

### Horseradish

Pest: *Baris lepidii* (imported crucifer weevil)

Treatment: **T101-I-2** MB in 15" vacuum—chamber

Temperature	Dosage Rate (lb/1,000 ft <sup>3</sup> )	Exposure Period
90 °F or above	2 lbs	2 hrs
80-89 °F	2.5 lbs	2 hrs
70-79 °F	3 lbs	2 hrs



As of October 2008, no **commercial** chambers in the United States are approved for the vacuum fumigation of imported commodities. If vacuum treatment is required as a **condition of entry**, the consignment must be destroyed, reexported or returned to country of origin.

## T101-n-2

### Kale (*Brassica oleracea* var. *acephala*)

Pest: External feeders and leaf miners

Treatment: **T101-n-2** MB at NAP—tarpaulin or chamber

Temperature	Dosage Rate (lb/1,000 ft <sup>3</sup> )	Minimum Concentration Readings (ounces) At:	
		0.5 hr	2 hrs
70 °F or above	2 lbs	26	14
60-69 °F	2.5 lbs	32	24
50-59 °F	3 lbs	38	29
45-49 °F	3.5 lbs	43	34
40-44 °F	4 lbs	48	38



Do not use this treatment schedule if its FIFRA Section 18 Exemption has expired. For the current exemption status, call your local State Plant Health Director (SPHD).

## T101-m-2

### Kiwi

Pest: External feeders, *Nysius huttoni* (wheat bug)

Treatment: **T101-m-2** MB at NAP—tarpaulin or chamber

Temperature	Dosage Rate (lb/1,000 ft <sup>3</sup> )	Minimum Concentration Readings (ounces) At:	
		0.5 hr	2 hrs
80 °F or above	1.5 lbs	19	14
70-79 °F	2 lbs	26	19
60-69 °F	2.5 lbs	32	24
50-59 °F	3 lbs	38	29
40-49 °F	4 lbs	48	38



Do not use this treatment schedule if its FIFRA Section 18 Exemption has expired. For the current exemption status, call your local State Plant Health Director (SPHD).

### T101-m-2-1

#### Kiwi

Pest: *Ceratitus capitata* (Mediterranean fruit fly)

Treatment: **T101-m-2-1** MB at NAP—tarpaulin or chamber

Temperature	Dosage Rate (lb/1,000 ft <sup>3</sup> )	Minimum Concentration Readings (ounces) At:			
		0.5 hr	2 hrs	3.5 hrs	4 hrs
70 °F or above	2 lbs	26	22	21	—
65-69 °F	2 lbs	26	22	—	19



Do not use this treatment schedule if its FIFRA Section 18 Exemption has expired. For the current exemption status, call your local State Plant Health Director (SPHD).

### T101-n-2

#### Kohlrabi (*Brassica oleracea* var. *gongyiodes*)

Pest: External feeders and leaf miners

Treatment: **T101-n-2** MB at NAP—tarpaulin or chamber

Temperature	Dosage Rate (lb/1,000 ft <sup>3</sup> )	Minimum Concentration Readings (ounces) At:	
		0.5 hr	2 hrs
70 °F or above	2 lbs	26	14
60-69 °F	2.5 lbs	32	24
50-59 °F	3 lbs	38	29
45-49 °F	3.5 lbs	43	34
40-44 °F	4 lbs	48	38



Do not use this treatment schedule if its FIFRA Section 18 Exemption has expired. For the current exemption status, call your local State Plant Health Director (SPHD).

## T101-n-2

### Leafy vegetables

Pest: External feeders and leaf miners

Treatment: **T101-n-2** MB at NAP—tarpaulin or chamber

Temperature	Dosage Rate (lb/1,000 ft <sup>3</sup> )	Minimum Concentration Readings (ounces) At:	
		0.5 hr	2 hrs
70 °F or above	2 lbs	26	14
60-69 °F	2.5 lbs	32	24
50-59 °F	3 lbs	38	29
45-49 °F	3.5 lbs	43	34
40-44 °F	4 lbs	48	38



**Important**

Do not use this treatment schedule if its FIFRA Section 18 Exemption has expired. For the current exemption status, call your local State Plant Health Director (SPHD).



**Important**

Leafy vegetables, EPA Crop Group 4, (Except *Brassica* Vegetables) are restricted to amaranth (leafy amaranth, Chinese spinach, tampala) (*Amaranthus* spp.); arugula (Roquette) (*Eruca sativa*); cardoon (*Cyanara cardunculus*); celery (*Apium graveolens* var. *dulcea*); celery, Chinese (*Apium graveolens* var. *secalinum*); celtuce (*Lactuca sativa* var. *angustana*); chervil (*Anthriscus cerefolium*); chrysanthemum, edible-leaved (*Chrysanthemum coronarium* var. *coronarium*); chrysanthemum, garland (*Chrysanthemum coronarium* var. *spatiosum*); corn salad (*Valerianella locusta*); cress garden (*Lepidium sativum*); cress upland (yellow rocket, winter cress) (*Barbarea vulgaris*); dandelion (*Taraxacum officinale*); dock (sorrel) (*Rumex* spp.); endive (escarole) (*Cichorium endivia*); fennel, Florence (finocchio) (*Foeniculum vulgare* Azoricum Group); lettuce, head and leaf (*Lactuca sativa*); Orach (*Atriplex hortensis*); parsley (*Petroselinum crispum*); purslane, garden (*Portulaca oleracea*); purslane, winter (*Montia perfoliata*); radicchio (red chicory) (*Cichorium intybus*); rhubarb (*Rheum rhabarbarum*); spinach (*Spinacia oleracea*); spinach, New Zealand (*Tetragonia tetragonioides*, *T. expansa*); spinach, vine (Malabar spinach, Indian spinach) (*Basella alba*); swiss chard (*Beta vulgaris* var. *cicia*). Reference 40 CFR 180.34 (f)(a)(iv)(A)

### T101-q-2

#### Leeks

Pest: Internal feeders (including leafminers)

Treatment: **T101-q-2** MB at NAP—tarpaulin or chamber

Temperature	Dosage Rate (lb/1,000 ft <sup>3</sup> )	Minimum Concentration Readings (ounces) At:				
		0.5 hr	2 hrs	2.5 hrs	3 hrs	3.5 hrs
90 °F or above	2 lbs	26	19	—	—	—
80-89 °F	2.5 lbs	32	24	—	—	—
70-79 °F	3 lbs	38	29	—	—	—
60-69 °F	3 lbs	38	26	26	—	—
50-59 °F	3 lbs	38	26	—	26	—
40-49 °F	3 lbs	38	26	—	—	26

### T101-e-1

#### Lentils (Dry)

Pest: Bruchidae (seed beetles)

Treatment: **T101-e-1** MB at NAP—tarpaulin or chamber

Temperature	Dosage Rate (lb/1,000 ft <sup>3</sup> )	Minimum Concentration Readings (ounces) At:					
		0.5 hr	2 hrs	2.5 hrs	3 hrs	3.5 hrs	4 hrs
70 °F or above	3 lbs	38	—	24	—	—	—
60-69 °F	3 lbs	38	29	—	24	—	—
50-59 °F	3 lbs	38	29	—	—	24	—
40-49 °F	3 lbs	38	29	—	—	—	24

### T101-n-2

#### Lettuce from Spain

Pest: *Autographa gamma*, *Helicoverpa armigera*, *Mamestra brassicae*, *Spodoptera littoralis*

Treatment: **T101-n-2** MB at NAP—tarpaulin or chamber (see Leafy vegetables for treatment schedule)

### T101-b-1-1

#### Lychee (Litchi)

Pest: Mealybugs (Pseudococcidae)

Treatment: **T101-b-1-1** MB (“Q” label only) at NAP—tarpaulin or chamber

Temperature	Dosage Rate (lb/1000 ft <sup>3</sup> )	Minimum Concentration Readings (ounces) At:	
		0.5 hr	2 hrs
80 °F or above	2.5 lbs	32	24
70-79 °F	3 lbs	38	29
60-69 °F	4 lbs	48	38





T101-b-1-1 is not a substitute for the mandatory cold treatment of lychee from China and Taiwan, T107-h, which targets the pests *Bactrocera dorsalis* (Oriental fruit fly), *Bactrocera curubitae* (melon fly) and *Conopomorpha sinensis* (lychee fruit borer). Because mealybugs are not controlled by T107-h, T101-b-1-1 can be used as a follow-up treatment if mealybugs are found.

## T101-o-2

### Melons

(Including honeydew, muskmelon, and watermelon)

Pest: External feeders such as Noctuidae spp., *Thrips* spp., *Copitarsia* spp.

Treatment: **T101-o-2** MB at NAP—tarpaulin or chamber

Temperature	Dosage Rate (lb/1,000 ft <sup>3</sup> )	Minimum Concentration Readings (ounces) At:	
		0.5 hr	2 hrs
80 °F or above*	1.5 lbs	19	14
70-79 °F*	2 lbs	26	19
60-69 °F*	2.5 lbs	32	24
50-59 °F	3 lbs	38	29
40-49 °F	4 lbs	48	38

\* Use “MB 100” at 60 °F or above, use MB “Q” label at 40 °F or above

For cantaloupe, see T101-k-1

## T101-n-2

### Mizuna (*Brassica rapa Japonica* Group)

Pest: External feeders and leaf miners

Treatment: **T101-n-2** MB at NAP—tarpaulin or chamber

Temperature	Dosage Rate (lb/1,000 ft <sup>3</sup> )	Minimum Concentration Readings (ounces) At:	
		0.5 hr	2 hrs
70 °F or above	2 lbs	26	14
60-69 °F	2.5 lbs	32	24
50-59 °F	3 lbs	38	29
45-49 °F	3.5 lbs	43	34
40-44 °F	4 lbs	48	38



Do not use this treatment schedule if its FIFRA Section 18 Exemption has expired. For the current exemption status, call your local State Plant Health Director (SPHD).

### T101-n-2 Mustard greens (*Brassica juncea*)

Pest: External feeders and leaf miners

Treatment: **T101-n-2** MB at NAP—tarpaulin or chamber

Temperature	Dosage Rate (lb/1,000 ft <sup>3</sup> )	Minimum Concentration Readings (ounces) At:	
		0.5 hr	2 hrs
70 °F or above	2 lbs	26	14
60-69 °F	2.5 lbs	32	24
50-59 °F	3 lbs	38	29
45-49 °F	3.5 lbs	43	34
40-44 °F	4 lbs	48	38



**Important**

Do not use this treatment schedule if its FIFRA Section 18 Exemption has expired. For the current exemption status, call your local State Plant Health Director (SPHD).

### T101-n-2 Mustard spinach (*Brassica rapa Perviridis* Group)

Pest: External feeders and leaf miners

Treatment: **T101-n-2** MB at NAP—tarpaulin or chamber

Temperature	Dosage Rate (lb/1,000 ft <sup>3</sup> )	Minimum Concentration Readings (ounces) At:	
		0.5 hr	2 hrs
70 °F or above	2 lbs	26	14
60-69 °F	2.5 lbs	32	24
50-59 °F	3 lbs	38	29
45-49 °F	3.5 lbs	43	34
40-44 °F	4 lbs	48	38



**Important**

Do not use this treatment schedule if its FIFRA Section 18 Exemption has expired. For the current exemption status, call your local State Plant Health Director (SPHD).

### T101-a-3

### Nectarine

Pest: External feeders

Treatment: **T101-a-3** MB at NAP—tarpaulin or chamber

Temperature	Dosage Rate (lb/1,000 ft <sup>3</sup> )	Minimum Concentration Readings (ounces) At:	
		0.5 hr	2 hrs
80 °F or above	1.5 lbs	19	14
70-79 °F	2 lbs	26	19
60-69 °F	2.5 lbs	32	24
50-59 °F	3 lbs	38	29
40-49 °F	4 lbs	48	38

### T101-p-2

### Okra

Pest: *Pectinophora gossypiella* (pink bollworm)

Treatment: **T101-p-2** MB at NAP—chamber only

Temperature	Dosage Rate (lb/1,000 ft <sup>3</sup> )	Exposure Period
90 °F or above	1 lb	2 hrs
80-89 °F	1.5 lbs	2 hrs
70-79 °F	2 lbs	2 hrs
60-69 °F	2.5 lbs	2 hrs
50-59 °F	3 lbs	2 hrs
40-49 °F	3.5 lbs	2 hrs

Okra may be injured by fumigation if moisture is present.

The term “okra” does **not** include Chinese okra (*Luffa* spp.), which is a cucurbit.

### T101-q-2

### Onion\*

Pest: Internal feeders (and leafminers)

Treatment: **T101-q-2** MB at NAP—tarpaulin or chamber

Temperature	Dosage Rate (lb/1,000 ft <sup>3</sup> )	Minimum Concentration Readings (ounces) At:				
		0.5 hr	2 hrs	2.5 hrs	3 hrs	3.5 hrs
90 °F or above	2 lbs	26	19	—	—	—
80-89 °F	2.5 lbs	32	24	—	—	—
70-79 °F	3 lbs	38	29	—	—	—
60-69 °F	3 lbs	38	26	26	—	—
50-59 °F	3 lbs	38	26	—	26	—
40-49 °F	3 lbs	38	26	—	—	26

\*The term “onion” includes dry bulbs. It also includes leeks, shallots and chives for both above ground and below ground parts.

### T101-j-2-1 Oranges from Mexico and quarantine areas of the U.S.

Pest: *Anastrepha* spp.

Treatment: **T101-j-2-1** MB at NAP—chamber

Temperature	Dosage Rate (lb/1,000 ft <sup>3</sup> )	Exposure Period
80 °F or above	2.5 lbs	2 hrs

Load limit not to exceed 80 percent of chamber capacity

Inspect a representative sample of the fruit. If the level of infestation with fruit flies is more than 0.5 percent for the lot, then the fruit is ineligible for fumigation.

### T101-g-1 Parsnip

Pest: Internal feeders

Treatment: **T101-g-1** MB chamber, 15" vacuum—chamber

Temperature	Dosage Rate (lb/1,000 ft <sup>3</sup> )	Exposure Period
90 °F or above	2 lbs	2 hrs
80-89 °F	2.5 lbs	2 hrs
70-79 °F	3 lbs	2 hrs
60-69 °F	3 lbs	2.5 hrs
50-59 °F	3 lbs	3 hrs
40-49 °F	3 lbs	3.5 hrs



As of October 2008, no **commercial** chambers in the United States are approved for the vacuum fumigation of imported commodities. If vacuum treatment is required as a **condition of entry**, the consignment must be destroyed, reexported or returned to country of origin.

### T101-a-3 Peach

Pest: External feeders

Treatment: **T101-a-3** MB at NAP—tarpaulin or chamber

Temperature	Dosage Rate (lb/1,000 ft <sup>3</sup> )	Minimum Concentration Readings (ounces) At:	
		0.5 hr	2 hrs
80 °F or above	1.5 lbs	19	14
70-79 °F	2 lbs	26	19
60-69 °F	2.5 lbs	32	24
50-59 °F	3 lbs	38	29
40-49 °F	4 lbs	48	38

### T101-a-1

### Pear<sup>5</sup>

Pest: External feeders

Treatment: T101-a-1 MB at NAP-tarpaulin or chamber

Temperature	Dosage Rate (lb/1,000 ft <sup>3</sup> )	Minimum Concentration Readings (ounces) At:	
		0.5 hr	2 hrs
80 °F or above	1.5 lbs	19	14
70-79 °F	2 lbs	26	19
60-69 °F	2.5 lbs	32	24
50-59 °F	3 lbs	38	29
40-49 °F	4 lbs	48	38

### T101-e-1

### Peas (Dry)

Pest: Bruchidae (seed beetles)

Treatment: **T101-e-1** MB at NAP—tarpaulin or chamber

Temperature	Dosage Rate (lb/1,000 ft <sup>3</sup> )	Minimum Concentration Readings (ounces) At:					
		0.5 hr	2 hrs	2.5 hrs	3 hrs	3.5 hrs	4 hrs
70 °F or above	3 lbs	38	—	24	—	—	—
60-69 °F	3 lbs	38	29	—	24	—	—
50-59 °F	3 lbs	38	29	—	—	24	—
40-49 °F	3 lbs	38	29	—	—	—	24

see also T101-K-2 or T101-K-1 for fresh peas

### T101-a-3

### Peppers

Pest: Internal Pests (except fruit flies) and External Pests (except mealy bugs)

Treatment: T101-a-3 MB at NAP—tarpaulin or chamber

Temperature	Dosage Rate (lb/1,000 ft <sup>3</sup> )	Minimum Concentration Readings (ounces) At:	
		0.5 hr	2 hrs
80 °F or above	1.5 lbs	19	14
70-79 °F	2 lbs	26	19
60-69 °F	2.5 lbs	32	24
50-59 °F	3 lbs	38	29
40-49 °F	4 lbs	48	38

<sup>5</sup> Fumigation may cause **severe** damage to Chinese, Japanese, Asian and Sand Pears. Obtain the importer's consent before fumigation.



This treatment is not effective against fruit flies or mealy bugs. For fruit flies, use T106-b (vapor heat). For mealy bugs, use T104-a-2 (fumigation). Certain varieties of peppers are sensitive to methyl bromide and may develop darkening of the seed cavity.

### T101-r-2

#### Pineapple

Pest: Internal feeders

Treatment: **T101-r-2** MB (“Q” label only) at NAP—tarpaulin or chamber

Temperature	Dosage Rate (lb/1,000 ft <sup>3</sup> )	Minimum Concentration Readings (ounces) At:		
		0.5 hr	2 hrs	6 hrs
70 °F or above	2 lbs	26	22	16

### T101-s-2

#### Pineapple

Pest: External feeders

Treatment: **T101-s-2** MB (“Q” label only if under 70 °F, 21.1 °C) at NAP—tarpaulin or chamber

Temperature	Dosage Rate (lb/1,000 ft <sup>3</sup> )	Minimum Concentration Readings (ounces) At:	
		0.5 hr	2 hrs
80 °F or above*	1.5 lbs	19	14
70-79 °F*	2 lbs	26	19
60-69 °F	2.5 lbs	32	24
50-59 °F	3 lbs	38	29
40-49 °F**	4 lbs	48	38

\* Use “MB 100” at 70 °F or above, use MB “Q” label at 40 °F or above

\*\* 40–49°F temperature range may cause pineapple core to turn purple.

### T101-t-2

#### Plantain

Pest: External feeders such as Noctuidae spp., *Thrips* spp., *Copitarsia* spp.

Treatment: **T101-t-2** MB at NAP—tarpaulin or chamber

Temperature	Dosage Rate (lb/1,000 ft <sup>3</sup> )	Minimum Concentration Readings (ounces) At:	
		0.5 hr	2 hrs
80 °F or above	1.5 lbs	19	14
70-79 °F	2 lbs	26	19
60-69 °F	2.5 lbs	32	24
50-59 °F	3 lbs	38	29
40-49 °F	4 lbs	48	38



Do not use this treatment schedule if its FIFRA Section 18 Exemption has expired. For the current exemption status, call your local State Plant Health Director (SPHD).

### T101-a-3

#### Plum

Pest: External feeders

Treatment: **T101-a-3** MB at NAP—tarpaulin or chamber

Temperature	Dosage Rate (lb/1,000 ft <sup>3</sup> )	Minimum Concentration Readings (ounces) At:	
		0.5 hr	2 hrs
80 °F or above	1.5 lbs	19	14
70-79 °F	2 lbs	26	19
60-69 °F	2.5 lbs	32	24
50-59 °F	3 lbs	38	29
40-49 °F	4 lbs	48	38

### T101-u-2

#### Potato (white or Irish)

Pest: *Graphognathus* spp. (whitefringed beetles)

Treatment: **T101-u-2** MB at NAP—tarpaulin or chamber

Temperature	Dosage Rate (lb/1,000 ft <sup>3</sup> )	Minimum Concentration Readings (ounces) At:	
		0.5 hr	2 hrs
80 °F or above	2.5 lbs	30	20
70-79 °F	3 lbs	36	24

### T101-v-2

#### Potato (white or Irish)

Pest: *Ostrinia nubilalis* (European corn borer) and *Phthorimaea operculella* (potato tuberworm)

Treatment: **T101-v-2** MB at NAP—tarpaulin or chamber

Temperature	Dosage Rate (lb/1,000 ft <sup>3</sup> )	Minimum Concentration Readings (ounces) At:	
		0.5 hr	2 hrs
70 °F or above	2.75 lbs	33	22

### T101-e-1 Pulses, dried

Pest: Bruchidae (seed beetles)

Treatment: **T101-e-1** MB at NAP—tarpaulin or chamber

Temperature	Dosage Rate (lb/1,000 ft <sup>3</sup> )	Minimum Concentration Readings (ounces) At:					
		0.5 hr	2 hrs	2.5 hrs	3 hrs	3.5 hrs	4 hrs
70 °F or above	3 lbs	38	—	24	—	—	—
60-69 °F	3 lbs	38	29	—	24	—	—
50-59 °F	3 lbs	38	29	—	—	24	—
40-49 °F	3 lbs	38	29	—	—	—	24

### T101-w-2 Pumpkin

Includes calabaza varieties

Pest: External feeders

Treatment: **T101-w-2** MB at NAP—tarpaulin or chamber

Temperature	Dosage Rate (lb/1,000 ft <sup>3</sup> )	Minimum Concentration Readings (ounces) At:	
		0.5 hr	2 hrs
80 °F or above	1.5 lbs	19	14
70-79 °F	2 lbs	26	19
60-69 °F	2.5 lbs	32	24

### T101-g-1 Radish

Pest: Internal feeders

Treatment: **T101-g-1** MB chamber, 15" vacuum—chamber

Temperature	Dosage Rate (lb/1,000 ft <sup>3</sup> )	Exposure Period
90 °F or above	2 lbs	2 hrs
80-89 °F	2.5 lbs	2 hrs
70-79 °F	3 lbs	2 hrs
60-69 °F	3 lbs	2.5 hrs
50-59 °F	3 lbs	3 hrs
40-49 °F	3 lbs	3.5 hrs



As of October 2008, no **commercial** chambers in the United States are approved for the vacuum fumigation of imported commodities. If vacuum treatment is required as a **condition of entry**, the consignment must be destroyed, reexported or returned to country of origin.



## T101-n-2

### Rape greens (*Brassica napus*)

Pest: External feeders and leaf miners

Treatment: **T101-n-2** MB at NAP—tarpaulin or chamber

Temperature	Dosage Rate (lb/1,000 ft <sup>3</sup> )	Minimum Concentration Readings (ounces) At:	
		0.5 hr	2 hrs
70 °F or above	2 lbs	26	14
60-69 °F	2.5 lbs	32	24
50-59 °F	3 lbs	38	29
45-49 °F	3.5 lbs	43	34
40-44 °F	4 lbs	48	38



**Important**

Do not use this treatment schedule if its FIFRA Section 18 Exemption has expired. For the current exemption status, call your local State Plant Health Director (SPHD).

Of these, cabbage (*Brassica oleracea*) (labeled treatment T101-j-1) is the only vegetable in this group not covered by a FIFRA Section 18 Exemption.

## T101-x-2

### Raspberry

Pest: External feeders such as Noctuidae spp., *Thrips* spp.,  
*Copitarsia* spp., Pentatomidae spp.

Treatment: **T101-x-2** MB at NAP—tarpaulin or chamber

Temperature	Dosage Rate (lb/1,000 ft <sup>3</sup> )	Minimum Concentration Readings (ounces) At:	
		0.5 hr	2 hrs
80 °F or above	1.5 lbs	19	14
70-79 °F	2 lbs	26	19
60-69 °F	2.5 lbs	32	24
50-59 °F	3 lbs	38	29
40-49 °F	4 lbs	48	38



**Important**

Do not use this treatment schedule if its FIFRA Section 18 Exemption has expired. For the current exemption status, call your local State Plant Health Director (SPHD).

### T101-q-2

### Shallots

Pest: Internal feeders (including leafminers)

Treatment: **T101-q-2** MB at NAP—tarpaulin or chamber

Temperature	Dosage Rate (lb/1,000 ft <sup>3</sup> )	Minimum Concentration Readings (ounces) At:				
		0.5 hr	2 hrs	2.5 hrs	3 hrs	3.5 hrs
90 °F or above	2 lbs	26	19	—	—	—
80-89 °F	2.5 lbs	32	24	—	—	—
70-79 °F	3 lbs	38	29	—	—	—
60-69 °F	3 lbs	38	26	26	—	—
50-59 °F	3 lbs	38	26	—	26	—
40-49 °F	3 lbs	38	26	—	—	26

### T101-y-2

### Squash (winter, summer, and chayote)

Pest: External feeders

Treatment: **T101-y-2** MB at NAP—tarpaulin or chamber

Temperature	Dosage Rate (lb/1,000 ft <sup>3</sup> )	Minimum Concentration Readings (ounces) At:	
		0.5 hr	2 hrs
80 °F or above	1.5 lbs	19	14
70-79 °F	2 lbs	26	19
60-69 °F	2.5 lbs	32	24
50-59 °F	3 lbs	38	29
40-49 °F	4 lbs	48	38

If zucchini, see [T101-h-3](#)

If pumpkin, see [T101-w-2](#)

### T101-z-2

### Strawberry

Pest: External feeders

Treatment: **T101-z-2** MB at NAP—tarpaulin or chamber

Temperature	Dosage Rate (lb/1,000 ft <sup>3</sup> )	Minimum Concentration Readings (ounces) At:	
		0.5 hr	2 hrs
80 °F or above	1.5 lbs	19	14
70-79 °F	2 lbs	26	19
60-69 °F	2.5 lbs	32	24
50-59 °F	3 lbs	38	29

### T101-b-3-1 Sweet Potato (*Ipomoea*)

Pest: External and internal feeders

Treatment: **T101-b-3-1** MB at NAP—tarpaulin or chamber

This treatment is also required for the interstate movement from Hawaii.

Temperature	Dosage Rate (lb/1,000 ft <sup>3</sup> )	Minimum Concentration Readings (ounces) At:		
		0.5 hr	2 hrs	4.0 hrs
90 °F or above*	2.5 lbs	32	20	20
80-89 °F*	3 lbs	38	24	24
70-79 °F*	3.5 lbs	44	28	28
60-69 °F	4 lbs	50	32	32

\* Use “MB 100” at 70°F or above, use MB “Q” label at 60 °F or above



Temperatures below 70°F may cause injury to sweet potatoes. Fumigation below 70 °F is to be made only on specific request from the importer.

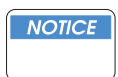

Sweet potatoes should be cured, free from surface moisture, and held at the fumigation temperature for 24 hours following treatment. This is not mandatory; however, following this advise will help maintain the quality of the fumigated product.

### T101-c-3 Tomato (from Hawaii)

Pest: *Ceratitis capitata* (Mediterranean fruit fly)

Treatment: **T101-c-3** MB at NAP—tarpaulin or chamber

Temperature	Dosage Rate (lb/1,000 ft <sup>3</sup> )	Minimum Concentration Readings (ounces) At:			
		0.5 hr	2 hrs	3.5 hrs	4 hrs
70 °F or above	2 lbs	26	21	21	—
65-69 °F	2 lbs	26	21	—	19

Treatment is marginal as to host tolerance and shipper should be warned of possible injury.

### T101-c-3-1 Tomato (from Chile)

Pest: *Tuta absoluta* (tomato fruit moth) and *Rhagoletis tomatis* (tomato fruit fly)

Treatment: **T101-c-3-1** MB at NAP—tarpaulin or chamber

Temperature	Dosage Rate (lb/1,000 ft <sup>3</sup> )	Minimum Concentration Readings (ounces) At:	
		0.5 hr	2 hrs
70 °F or above	3 lbs	43	33

**T101-d-3 Tuna (Opuntia) and all other fruits from cacti (prickly pear, pitahaya)**

Pest: *Ceratitidis capitata* (Mediterranean fruit fly)

Treatment: **T101-d-3** MB at NAP—tarpaulin or chamber

Temperature	Dosage Rate (lb/1,000 ft <sup>3</sup> )	Minimum Concentration Readings (ounces) At:		
		0.5 hr	2 hrs	3.5 hrs
70 °F or above	2 lbs	26	21	21



Do not use this treatment schedule if its FIFRA Section 18 Exemption has expired. For the current exemption status, call your local State Plant Health Director (SPHD).

**T101-e-3 Tuna (Opuntia) and all other fruits from cacti (prickly pear, pitahaya)**

Pest: External feeders and leaf miners

Treatment: **T101-e-3** MB at NAP—tarpaulin or chamber

Temperature	Dosage Rate (lb/1,000 ft <sup>3</sup> )	Minimum Concentration Readings (ounces) At:	
		0.5 hr	2 hrs
80 °F or above	1.5 lbs	19	14
70-79 °F	2 lbs	26	19
60-69 °F	2.5 lbs	32	24
50-59 °F	3 lbs	38	29
40-49 °F	4 lbs	48	38



Do not use this treatment schedule if its FIFRA Section 18 Exemption has expired. For the current exemption status, call your local State Plant Health Director (SPHD).

### T101-g-1

### Turnip

Pest: Internal feeders

Treatment: **T101-g-1** MB chamber, 15" vacuum—chamber

Temperature	Dosage Rate (lb/1,000 ft <sup>3</sup> )	Exposure Period
90 °F or above	2 lbs	2 hrs
80-89 °F	2.5 lbs	2 hrs
70-79 °F	3 lbs	2 hrs
60-69 °F	3 lbs	2.5 hrs
50-59 °F	3 lbs	3 hrs
40-49 °F	3 lbs	3.5 hrs



As of October 2008, no **commercial** chambers in the United States are approved for the vacuum fumigation of imported commodities. If vacuum treatment is required as a **condition of entry**, the consignment must be destroyed, reexported or returned to country of origin.

### T101-f-3

### Yam (Dioscorea)

Pest: Internal and external feeders

Treatment: **T101-f-3** MB at NAP—tarpaulin or chamber

Temperature	Dosage Rate (lb/1,000 ft <sup>3</sup> )	Minimum Concentration Readings (ounces) At:		
		0.5 hr	2 hrs	4 hrs
90 °F or above	2.5 lbs	32	20	20
80-89 °F	3 lbs	38	24	24
70-79 °F	3.5 lbs	44	28	28
60-69 °F	4 lbs	50	32	32

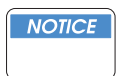

Temperatures below 70°F may cause injury to yams. Fumigation below 70 °F is to be made only on specific request from the importer.



Sweet potatoes and yams should be cured, free from surface moisture, and held at the fumigation temperature for 24 hours following treatment. This is not mandatory; however, following this advise will help maintain the quality of the fumigated product.

### T101-h-3

### Zucchini

Pest: External feeders

Treatment: **T101-h-3** MB at NAP—tarpaulin or chamber

Temperature	Dosage Rate (lb/1,000 ft')	Minimum Concentration Readings (ounces) At:	
		0.5 hr	2 hrs
80 °F or above	1.5 lbs	19	14
70-79 °F	2 lbs	26	19
60-69 °F	2.5 lbs	32	24

If another variety of squash, see T101-y-2

## T102—Water Treatment



Whenever water comes into contact with fresh produce, the water's quality dictates the potential for pathogen contamination. To reduce the risk of food-borne illnesses, the water used for washing, treatments, and cooling must be fortified with sodium hypochlorite (household bleach), and constantly maintained at a chlorine level not to exceed 200 ppm.

### T102-b

#### Cherimoya from Chile

Pest: *Brevipalpus chilensis* (Chilean false spider mite of grapes)

Treatment: **T102-b** Soapy water and wax

1. Immerse fruit for 20 seconds in soapy water bath of one part soap solution (such as Deterfruit) to 3,000 parts water.
2. Follow the soapy bath with a pressure shower rinse to remove all the soapy excess.
3. Immerse fruit for 20 seconds in an undiluted wax coating (such as Johnson's Wax Primafresh 31 Kosher fruit coating). The wax coating should cover the entire surface of the fruit.



At the port of entry, the PPQ Officer should check to make sure the wax coating covers the entire surface of the fruit.

### T102-c

#### Durian and other large fruits such as breadfruit

Pest: External Feeders

Treatment: **T102-c** Warm, soapy water and brushing

1. Add detergent (such as Deterfruit) to warm water (110° to 120°F) at the rate of one part detergent or soap to 3,000 parts water.
2. Immerse the fruit for at least 1 minute in the warm detergent water.
3. Using a brush with stiff bristles, have the importer or the importer's agent scrub each fruit to remove any insects.
4. Using a pressure shower, have the importer or the importer's agent rinse the fruit free from residue (detergent and dead insects).
5. Inspect each brushed and cleaned fruit. Pay particular attention to external feeders such as mealybugs and scales. If any insects remain, have the fruit retreated or have it destroyed.

## T102-e

### Limes

Pest: Mealybugs (Pseudococcidae) and other surface pests

Treatment: **T102-e** Hot water immersion

1. Fruit must be treated in a certified hot water immersion treatment tank, and the treatment must be monitored by an inspector.
  - A. Fruit must be submerged at least 4 inches below the water's surface.
  - B. Water must circulate continually and be kept at 120.2°F (or above) for 20 minutes. Treatment time begins when the water temperature reaches at least 120.2°F in all locations of the tank.
2. Cooling and waxing the fruit are both optional, and are the sole responsibility of the processor.

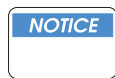

Phytotoxic damage (increased yellowing) may occur if the temperature reaches 125.6°F or if the treatment duration significantly exceeds 20 minutes.

## T102-b-1

### Limes from Chile

Pest: *Brevipalpus chilensis* (Chilean false spider mite of grapes)

Treatment: **T102-b-1** Soapy water and wax

1. Immerse fruit for 20 seconds in soapy water bath of one part soap solution (such as Deterfruit) to 3,000 parts water.
2. Follow the soapy bath with a pressure shower rinse to remove all the soapy excess.
3. Immerse fruit for 20 seconds in an undiluted wax coating (such as Johnson's Wax Primafresh 31 Kosher fruit coating). The wax coating should cover the entire surface of the fruit.



At the port of entry, the PPQ Officer should check to make sure the wax coating covers the entire surface of the fruit.



## T102-d-1

### Longan fruit from Hawaii

Pest: *Ceratitis capitata* (Mediterranean fruit fly) and  
*Bactrocera dorsalis* (Oriental fruit fly)

Treatment: **T102-d-1** Hot water immersion



Fruit must be at ambient temperature before the treatment begins

1. Submerge the fruit at least 4 inches below the water's surface in a hot water immersion treatment tank certified by APHIS.
2. Keep the fruit submerged for 20 minutes after the water temperature reaches at least 120.2°F in all locations of the tank. The water must circulate continually and be kept at 120.2°F (or above) for the duration of the treatment.



Phytotoxic damage (increased yellowing) may occur if the temperature exceeds 121.1°F.

3. Cool the fruit to ambient temperature. Hydrocooling for 20 minutes at 75.2°F is recommended, though not required, to prevent injury to the fruit from the hot water immersion treatment.

## T102-d

### Lychee (litchi) fruit from Hawaii

Pest: *Ceratitis capitata* (Mediterranean fruit fly) and *Bactrocera dorsalis* (Oriental fruit fly)

Treatment: T102-d Hot water immersion

1. Lychees must be thoroughly examined at the packinghouse by an inspector and found free of ***Cryptophlebia spp.*** (Lychee fruit moth) and other plant pests<sup>6</sup>
2. Fruit must be grown and treated in Hawaii, under monitoring of an inspector, in a certified hot water immersion treatment tank.<sup>7</sup>
  - A. Fruit must be submerged at least 4 inches below the water's surface.

<sup>6</sup> Because ***Eriophyes litchii*** (lychee mite) cannot be effectively detected by inspection, and would not be effectively eliminated by hot water immersion, the lychees may not be shipped into Florida. Each carton must be stamped "Not for importation into or distribution in Florida."

<sup>7</sup> Use of Treatment T102D is at the risk of the shipper. Limited research on fruit quality after treatment application indicated that fruit quality varies among cultivars. 'Kaimana' and 'Kwai Mi' ('Tai So') tolerate the treatment better than 'Brewster' and 'Groff'; no other cultivars were tested.

- B.** Water must circulate constantly, and be kept at 120.2°F (or above) for 20 minutes. Treatment time begins when the water temperature reaches at least 120.2°F in all locations throughout the tank.<sup>8</sup>

Temperatures exceeding 121.1°F can cause phytotoxic damage.

- 3.** Hydrocooling for 20 minutes at 75.2°F is recommended, though not required, to prevent injury to the fruit from the hot water treatment.

## T102-a

### Mango

Pest: *Ceratitidis capitata* (Mediterranean fruit fly), *Anastrepha spp.*, *Anastrepha ludens* (Mexican fruit fly)

Treatment: **T102-a** Hot water immersion

Fruit must be treated in country of origin at a certified facility and under the monitoring of APHIS personnel.

- 1.** Mangoes must be pre-sorted by weight class. Treatment of mixed loads is not allowed.
- 2.** Pulp temperature must be 70°F or above before start of treatment.
- 3.** Fruit must be submerged at least 4 inches below the water's surface.
- 4.** Water must circulate constantly and be kept at least 115°F throughout the treatment with the following tolerances:
  - ◆ **During the first 5 minutes of a treatment**—Adjusted Tank Temperatures from [Figure 6-1-1](#) on [page 6-5-3](#) that are below 113.7°F are allowed during the first 5 minutes of a treatment only if the temperature is at least 115°F at the end of the 5 minute period.
  - ◆ **For treatments lasting 65 to 75 minutes**—Adjusted Tank Temperatures from [Figure 6-1-1](#) on [page 6-5-3](#) may fall as low as 113.7°F for no more than 10 minutes under emergency conditions.
  - ◆ **For treatments lasting 90 to 110 minutes**—Adjusted Tank Temperatures from [Figure 6-1-1](#) on [page 6-5-3](#) may fall as low as 113.7°F for no more than 15 minutes under emergency conditions.

---

<sup>8</sup> Treatment does not begin until after the fruit is immersed and the water temperature recovers to 120.2°F (or above). Therefore, before the start of the treatment, fruit pulp temperatures of 70°F (or above) are recommended to minimize water temperature recovery time and the overall time fruit are immersed in heated water. Fruit quality of treated lychees with initial pulp temperatures below 68°F has not been studied.

5. Determine the dip time from Tables **Table 5-2-1** on page 5-2-53, **Table 5-2-2** on page 5-2-53, or **Table 5-2-3** on page 5-2-54.



Dip times for T102-a are valid if the fruit is not hydrocooled within 30 minutes of removal from the hot water immersion tank.

However, if hydrocooling starts immediately after the hot water immersion treatment, then the original dip time must be extended for an additional 10 minutes.

(Hydrocooling is optional and may be done only at temperatures of 70°F or above, for any length of time, or not at all.)

**TABLE 5-2-1: Determine Dip Time Based on Origin of Fruit<sup>1</sup>**

If the origin of the fruit is:	And the shape of the fruit is:	And the weight is (grams):	Then dip:
Puerto Rico, U.S. Virgin Islands, or West Indies (excluding Aruba, Bonaire, Curacao, Margarita, Tortuga or Trinidad and Tobago)	Flat, elongated varieties <sup>2</sup>	Up to 400 grams	65 minutes
		401 to 570 grams	75 minutes
	Rounded varieties <sup>3</sup>	Up to 500 grams	75 minutes
		501 to 700 grams	90 minutes
		701 to 900 grams	110 minutes

- 1 Valid if the fruit is not hydrocooled within 30 minutes of removal from the hot water immersion tank.
- 2 Such as 'Frances,' 'Carrot,' 'Zill,' 'Ataulfo,' 'Carabao,' 'Irwin', and Manila.
- 3 Such as 'Tommy Atkins,' 'Kent,' 'Hayden,' and 'Keitt.'

**TABLE 5-2-2: Determine Dip Time Based on Origin of Fruit<sup>1</sup>**

If the origin of the fruit is:	And the shape of the fruit is:	And the weight is (grams):	Then dip:
Mexico or Central America (north of and including Costa Rica)	Flat, elongated varieties <sup>2</sup>	Up to 375 grams	65 minutes
		376 to 570 grams	75 minutes
	Rounded varieties <sup>3</sup>	Up to 500 grams	75 minutes
		501 to 700 grams	90 minutes
		701 to 900 grams	110 minutes

- 1 Valid if the fruit is not hydrocooled within 30 minutes of removal from the hot water immersion tank
- 2 Such as 'Frances,' 'Carrot,' 'Zill,' 'Ataulfo,' 'Carabao,' 'Irwin.', and Manila.
- 3 Such as 'Tommy Atkins,' 'Kent,' 'Hayden,' and 'Keitt.'

**TABLE 5-2-3: Determine Dip Time Based on Origin of Fruit<sup>1</sup>**

If the origin of the fruit is:	And the shape of the fruit is:	And the weight is (grams):	Then dip:
Panama, South America or West Indies islands of Aruba, Bonaire, Curacao, Margarita, Tortuga, or Trinidad and Tobago	Flat, elongated varieties <sup>2</sup>	Up to 375 grams	65 minutes
		376 to 570 grams	75 minutes
	Rounded varieties <sup>3</sup>	Up to 425 grams	75 minutes
		426 to 650 grams	90 minutes

- 1 Valid if the fruit is not hydrocooled within 30 minutes of removal from the hot water immersion tank
- 2 Such as 'Frances,' 'Carrot,' 'Zill,' 'Ataulfo,' 'Carabao,' 'Irwin.', and Manila.
- 3 Such as 'Tommy Atkins,' 'Kent,' 'Hayden,' and 'Keitt.'

## T102-b-2

### Passion Fruit from Chile

Pest: *Brevipalpus chilensis* (Chilean false spider mite of grapes)

Treatment: **T102-b-2** Soapy water and wax

1. Immerse fruit for 20 seconds in soapy water bath of one part soap solution (such as Deterfruit) to 3,000 parts water.
2. Follow the soapy bath with a pressure shower rinse to remove all the soapy excess.
3. Immerse fruit for 20 seconds in an undiluted wax coating (such as Johnson's Wax Primafresh 31 Kosher fruit coating). The wax coating should cover the entire surface of the fruit.



**Important**

At the port of entry, the PPQ Officer should check to make sure the wax coating covers the entire surface of the fruit.

## T103—High Temperature Forced Air

### T103-a-1 Citrus from Mexico and infested areas in the United States

Pest: *Anastrepha* spp.

Treatment: T103-a-1 High temperature forced air

Heat Up Time:	90 minutes
Heat Up Recording Interval:	2 minutes
Minimum Air Temperature:	N/A
Minimum Pulp Temperature at End of Heat Up:	44 °C/111.2 °F
Dwell Time:	100 minutes
Dwell Recording Interval:	2 minutes
Cooling Method:	Hydrocooling optional

Size Restrictions	Standard Count	Max. Weight/Fruit		Max. Diameter
	bushel	grams	ounces	inches
Navel Orange	100 per 1 2/5	450	15.9	3 3/16
Orange (other than Navel)	100 per 1 2/5	468	16.4	3 13/16
Tangerine	120 per 4/5	245	8.6	—
Grapefruit	70 per 1 2/5	536	18.8	4 5/16

### T103-b-1 Citrus from Hawaii

Pest: *Ceratitis capitata* (Mediterranean fruit fly), *B. dorsalis* (Oriental fruit fly), and *B. cucurbitae* (melon fly)

Treatment: T103-b-1 High temperature forced air

Heat Up Time:	4 hours
Heat Up Recording Interval:	5 minutes
Minimum Air Temperature:	N/A
Minimum Pulp Temperature at End of Heat Up:	47.2 °C/117.0 °F
Dwell Time:	5 minutes
Dwell Recording Interval:	5 minutes
Cooling Method:	Forced air or Hydrocooling



Tolerance of Citrus to Treatment—Users of this treatment for citrus should test the specific cultivar to determine how well it will tolerate the required heat treatment. Of all citrus species tested to date, grapefruit showed the highest tolerance to this treatment. The tolerance of citrus treated in excess of 7 hours has not been determined. Although the method of cooling fruit after treatment is optional, research indicated that forced air cooling using ambient air temperature produced the least fruit injury.

### T103-c-1

### Mango from Mexico

Pest: *Anastrepha ludens* (Mexican fruit fly), *Anastrepha obliqua* (West Indian fruit fly), and *Anastrepha serpentina* (black fruit fly)

Treatment: T103-c-1 High temperature forced air

Heat Up Time:	N/A
Heat Up Recording Interval:	2 minutes
Minimum Air Temperature:	50.0 °C/122.0 °F
Minimum Pulp Temperature at End of Heat Up:	48.0 °C/118.0 °F
Dwell Time:	2 minutes
Dwell Recording Interval:	2 minutes
Cooling Method:	Forced air or Hydrocooling
Size Restrictions:	Fruit weight must not exceed 1 1/2 lbs. (700 grams)

**T103-d**

**Mountain Papaya from Chile (T103-d-1) and Papaya from Belize and Hawaii (T103-d-2)**

Pest: *Ceratitidis capitata* (Mediterranean fruit fly), *B. dorsalis* (Oriental fruit fly), and *B. cucurbitae* (melon fly)

Treatment: T103-d High temperature forced air

Heat Up Time:	4 hours
Heat Up Recording Interval:	5 minutes
Minimum Air Temperature:	N/A
Minimum Pulp Temperature at End of Heat Up:	47.2 °C/117.0 °F
Dwell Time:	5 minutes
Dwell Recording Interval:	5 minutes
Cooling Method:	Forced air or Hydrocooling (If papayas are hydrocooled with water lower than 54.5 °F (12.5° C), the fruit may be damaged.)



Tolerance of Papayas to Treatment—To enable the papayas to tolerate the treatment, the fruit may first have to be conditioned. Such conditioning is the responsibility of the shipper and at the shipper’s risk.

**T103-e**

**Rambutan from Hawaii**

Pest: *Ceratitidis capitata* (Mediterranean fruit fly), and *Bactrocera dorsalis* (Oriental fruit fly)

Treatment: T103-e High temperature forced air

Heat Up Time:	1 hour
Heat Up Recording Interval:	5 minutes
Minimum Air Temperature:	N/A
Minimum Pulp Temperature at End of Heat Up:	47.2 °C/117.0 °F
Dwell Time:	20 minutes
Dwell Recording Interval:	5 minutes
Cooling Method:	Optional

---

## **T104—Pest Specific/Host Variable**

For the treatments that follow, never exceed the labeled or Section 18 dosage and time for the specific commodity at the given temperature. Moreover, the specific commodity being treated determines if the schedule is a labeled treatment or one authorized under a Section 18 exemption. For example, oranges cannot be treated for hitchhikers using T104-a-1 at 40-49°F because this schedule requires 4 lbs. of methyl bromide/1,000 ft<sup>3</sup>. Whereas, the methyl bromide “Q” label allows a maximum of only 3 lbs. at this temperature range. Therefore, the oranges would have to be heated to at least 50°F before fumigation because at 50°F a dosage of only 3 lbs./1,000 ft<sup>3</sup> is required.

Although the following treatments are pest specific, the treatment schedule for the associated host will determine if and when a pest specific treatment can be used. Always check the schedule for the host before selecting the proper treatment schedule. Also, consult the methyl bromide labeling brochure, and do not exceed the restrictions on dosage and exposure time.



## T104-a-1

### Various Commodities\*

Pest: Hitchhikers and surface pests such as: thrips, aphids, scale insects, leafminers, spider mites, lygaeid bugs, ants, earwigs, surface feeding caterpillars and slugs<sup>9</sup>

Treatment: **T104-a-1** MB at NAP—tarpaulin or chamber

Temperature	Dosage Rate (lb/1,000 ft <sup>3</sup> )	Minimum Concentration Readings (ounces) At:	
		0.5 hr	2 hrs
80 °F or above	1.5 lbs	19	14
70-79 °F	2 lbs	26	19
60-69 °F	2.5 lbs	32	24
50-59 °F	3 lbs	38	29
40-49 °F	4 lbs	48	38



**Important**

\* To comply with dosage restrictions imposed by the methyl bromide “Q” label, these fruits and vegetables may be fumigated only at the following temperatures (the items bolded are under FIFRA Section 18 Exemption.) For the current exemption status, call your local State Plant Health Director:

40°F or above (maximum dosage, 4 pounds/1,000 ft<sup>3</sup>):

Apple, apricot<sup>1</sup>, asparagus, **banana**, **blackberry**, cabbage, **cactus fruit (tuna)**, cantaloupe, **celery**, chayote, cherry, chestnut, **chicory**, cippollino, cucumber, **Dasheen**, **endive**, fava bean (dried), **fresh herbs**<sup>2</sup>, grape, honeydew melon, **kiwi**, **leafy vegetables**, muskmelon, nectarine, peach, pear<sup>3</sup>, pepper, pineapple, **plantain**, plum<sup>1</sup>, **raspberry**, **snow peas**<sup>4</sup>, squash (summer, winter), stone fruit, sweet potato, watermelon, yam

50°F or above (maximum dosage, 3 pounds/1,000 ft<sup>3</sup>):

Bean, beet, carrot, citron (Ethrog), clementine, coconut, corn-on-the-cob (Sweet corn), eggplant, garlic, **ginger**, grapefruit, green pod vegetables, horseradish, Jerusalem artichoke, kumquat, lemon, lime, mandarin, okra, onion, orange, parsnip, pea, potato, radish, rutabaga, salsify, strawberry, sugar beet, tangelo, tangerine, tomato, turnip.

60°F or above (maximum dosage, 2.5 pounds/1,000 ft<sup>3</sup>):

Pimento, pumpkin, zucchini.

70°F or above (maximum dosage, 2 pounds/1,000 ft<sup>3</sup>):

**Avocado**, blueberry, cocoa bean.

- Pluots** and **plumcots** are considered hybrids of plums and apricots and can be treated using T104-a-1 provided they are treated as a **Section 18 Crisis Exemption**.
- Refer to list of approved herbs on [page 5-2-30](#).
- Fumigation may cause **severe** damage to Chinese, Japanese, Asian and Sand Pears. Obtain the importer's consent before fumigation.
- Snow peas may be damaged at dosages higher than 3 lbs. Obtain the importers consent before fumigating at 4 lbs.

<sup>9</sup> Quarantine-significant slugs of the families Agriolimacidae, Arionidae, Limacidae, Milacidae, Philomycidae, and Veronicellidae, including the following genera: *Agriolimax*, *Arion*, *Colosius*, *Deroceras*, *Diplosolenodes*, *Leidyula*, *Limax*, *Meghimatium*, *Milax*, *Pallifera*, *Pseudoveronicella*, *Sarasinula*, *Semperula*, *Vaginulus*, *Veronicella*. **Slugs must be treated at 60°F (2.5 lbs.) or above.**

## T104-a-2

### Various Commodities\*

Pest: Mealybugs (Pseudococcidae)

Treatment: **T104-a-2** MB at NAP—tarpaulin or chamber

Temperature	Dosage Rate (lb/1,000 ft <sup>3</sup> )	Minimum Concentration Readings (ounces) At:	
		0.5 hr	2 hrs
80°F or above	2.5 lbs	32	24
70-79°F	3 lbs	38	29
60-69°F	4 lbs	48	38



**Important**

\* To comply with dosage restrictions imposed by the methyl bromide “Q” label, the following fruits and vegetables may be fumigated only at the following temperatures (the items bolded are under Section 18 Exemption. FIFRA Section 18 Exemption. For the current exemption status, call your local State Plant Health Director (SPHD):

60 °F or above (maximum dosage, 4 pounds/1,000 ft<sup>3</sup>):

Apple, apricot<sup>1</sup>, asparagus, **banana, blackberry**, cabbage, cantaloupe, **celery**, chayote, cherry, chestnut, **chicory**, cipolini, cucumber, **dasheen, endive**, fava bean (dried), grape, **fresh herbs**<sup>2</sup>, honeydew melon, **kiwi, leafy vegetables, lychee (litchi)**, muskmelon, nectarine, peach, pear<sup>3</sup>, pepper, pineapple, **plantain**, plum<sup>1</sup>, rambutan, **raspberry, snow peas**<sup>4</sup>, squash (summer, winter), stone fruit, sweet potato, watermelon.

70 °F or above (maximum dosage, 3 pounds/1,000 ft<sup>3</sup>):

Bean, beet, carrot, clementine, citron (ethrog), coconut, corn-on-the-cob (sweet corn), eggplant, garlic, **ginger root**, grapefruit, green pod vegetables, horseradish, Jerusalem artichoke, kumquat, lemon, lime, mandarin, okra, onion, orange, parsnip, potato, radish, rutabaga, salsify, scallion, shallot, strawberry, sugar beet, tangelo, tangerine, tomato, turnip.

80 °F or above (maximum dosage, 2.5 pounds/1,000 ft<sup>3</sup>):

Peppers, pimento, pumpkin, zucchini.

- 1 **Pluots** and **plumcots** are considered hybrids of plums and apricots and can be treated using T104-a-2 provided they are treated as a **Section 18 Crisis Exemption**.
- 2 Refer to list of approved herbs on [page 5-2-30](#).
- 3 Fumigation may cause **severe** damage to Chinese, Japanese, Asian and Sand Pears. Obtain the importer’s consent before fumigation.
- 4 Snow peas may be damaged at dosages higher than 3 lbs. Obtain the importers consent before fumigating at 4 lbs.

## T105—Irradiation

Irradiation (IR) is an approved treatment for all imported fruits and vegetables and for fruits and vegetables moved interstate from Hawaii, Puerto Rico, and the U.S. Virgin Islands. In addition, irradiation can be used against particular pests (Refer to [Table 5-2-4](#) on [page 5-2-62](#)) of cut flowers and foliage, however, some damage may occur.

Treatment must be conducted at approved facilities in a foreign country, Hawaii, Puerto Rico, US Virgin Islands or any area in the US mainland that does not support fruit flies (any state except AL, AZ, CA, FL, GA<sup>10</sup>, KY, LA, MS<sup>8</sup>, NV, NM, NC<sup>8</sup>, SC, TN, TX, or VA).

Refer to chapter [Certifying Irradiation Treatment Facilities](#) on [page 6-8-1](#) of this manual for facility certification requirements.



When designing the facility's dosimetry system and procedures for its operation, the facility operator must address guidance and principles from American Society for Testing Materials (ASTM) standards or an equivalent standard recognized by the Administrator of APHIS.

(The American Society for Testing and Materials (ASTM) publication, ISO/ASTM 51261-2002 (E), "**Standard Guide for Selection and Calibration of Dosimetry Systems for Radiation Processing**" is available from: ASTM, 100 Barr Harbor Drive, West Conshohocken, Pennsylvania, USA 19428-2959).

---

<sup>10</sup> IR facilities may be located at the airport of Atlanta, GA, maritime ports of Gulfport, MS, and Wilmington, NC, provided the conditions listed in CFR 305.31(b) are met.

The following table lists pest-specific minimum absorbed doses for use on any fruit, vegetable, cut flower or foliage:

**TABLE 5-2-4 Pest-Specific Minimum absorbed dose (Gy)**

Scientific Name	Common Name	Minimum Absorbed Dose (Gy)
<i>Anastrepha ludens</i>	Mexican fruit fly	70
<i>Anastrepha obliqua</i>	West Indian fruit fly	70
<i>Anastrepha serpentina</i>	Sapote fruit fly	100
<i>Anastrepha suspensa</i>	Caribbean fruit fly	70
<i>Bactrocera cucurbitae</i>	Melon fruit fly	150
<i>Bactrocera dorsalis</i>	Oriental fruit fly	150
<i>Bactrocera jarvisi</i>	Jarvis fruit fly	100
<i>Bactrocera tryoni</i>	Queensland fruit fly	100
<i>Brevipalpus chilensis</i>	False red spider mite	300
<i>Ceratitis capitata</i>	Mediterranean fruit fly	150
<i>Conotrachelus nenuphar</i>	Plum curculio	92
<i>Cryptophlebia ombrodelta</i>	Litchi fruit moth	250
<i>Cryptophlebia illepida</i>	Koa seed worm	250
<i>Cylas formicarius elegantulus</i>	Sweet potato weevil	150
<i>Cydia pomonella</i>	Codling moth	200
<i>Euscepes postfasciatus</i>	West Indian sweet potato weevil	150
<i>Grapholita molesta</i>	Oriental fruit moth	200
<i>Omphisa anastomosalis</i>	Sweet potato vine borer	150
<i>Rhagoletis pomonella</i>	Apple maggot	60
<i>Sternochetus mangiferae</i>	Mango seed weevil	300
	All other fruit flies of the family Tephritidae which are not listed above	150
	Plant pests of the class Insecta not listed above, except pupae and adults of the order Lepidoptera	400

The minimum absorbed dose for the most-tolerant unmitigated pest is required if more than one pest is present. Refer to [Table 5-2-4](#) on [page 5-2-62](#) to determine the required minimum absorbed dose. For example, if a shipment of grapes is infested with both Mediterranean fruit fly and codling moth, the commodity would be irradiated using a minimum dose of 200 Gy.

## T105-a-1

### Various Commodities

Treatment:T105-a-1 (IR @ 150 Gy)

Pests: All fruit flies from the family Tephritidae  
(Refer to [Table 5-2-4](#) for other pests that can be treated at 150 Gy or less.) Treat using a minimum absorbed dose of 150 Gy, not to exceed 1000 Gy.



Refer to the [Hawaii/CNMI Manual](#) for detailed inspection procedures and additional entry requirements for pests not managed by 150 Gy or when a 400 Gy dose may be used instead.

**TABLE 5-2-5 Origin and Approved Commodity List for 150 Gy**

Origin	Commodity
Hawaii	Abiu, Atemoya, Banana, Breadfruit, <i>Capsicum</i> spp., Carambola, <i>Cucurbita</i> spp., Curry Leaf, Dragon fruit, Eggplant, Jackfruit, Litchi, Longan, Mangosteen, Melon, Moringa pods (Drumstick), Papaya, Pineapple, Rambutan, Sapodilla, Sweet Potato, and Tomato <sup>1</sup>
Mexico	Carambola, Mango, Manzano Pepper ( <i>Capsicum pubescens</i> )

- 1 In addition to these commodities, commodities that are currently admissable with a treatment or systems approach could also use irradiation as an alternative treatment, provided all the pests targeted by the treatment or systems approach are neutralized by the irradiation dose.

### T105-a-2 Various Commodities

Treatment: T105-a-2 (IR @ 400 Gy)

Pests: Fruit flies from the family Tephritidae and all insect pests **except** adults and pupae of the order Lepidoptera

Treat using a minimum absorbed dose of 400 Gy, not to exceed 1000 Gy.

**TABLE 5-2-6 Origin and Approved Commodity List for 400 Gy**

Origin	Commodity
Ghana	Eggplant, Okra, Pepper
Hawaii	Banana, Breadfruit, Cowpea (pod), Dragon fruit, Jackfruit, Mangosteen, Melon, Moringa pods (Drumstick), and Sweet Potato
India	Mango
Mexico	Guava
Thailand	Litchi, Longan, Mango, Mangosteen, Pineapple, Rambutan
Viet Nam	Dragon Fruit

### T105-a-3 Various Commodities

Treatment: T105-a-3 (IR @ 300 Gy)

Pests: *Sternochetus mangiferae* (Mango seed weevil), and all fruit flies from the family Tephritidae

Treat using a minimum absorbed dose of 300 Gy, not to exceed 1000 Gy.

**TABLE 5-2-7 Origin and Approved Commodity List for 300 Gy**

Origin	Commodity
Hawaii	Mango

## T106—Vapor Heat

### T106-a **Various Commodities from Mexico: Clementine (T106-a-1), Grapefruit (T106-a-2), Mango (Manilla variety only; T106-a-3), Orange (T106-a-4)**

Pest: *Anastrepha* spp. (includes Mexican fruit fly, *A. ludens*)

Treatment: T106-a Vapor heat

Heat Up Time:	8 hours
Heat Up Recording Interval:	5 minutes
Minimum Air Temperature:	N/A
Minimum Pulp Temperature at End of Heat Up:	43.3 °C/110.0 °F
Dwell Time:	6 hours
Dwell Recording Interval:	5 minutes
Cooling Method:	N/A

### T106-b **Bell Pepper (T106-b-1), Eggplant (T106-b-2), Mountain papaya (T106-b-3), Papaya (T106-b-4), Pineapple (T106-b-5), Squash (T106-b-6), Tomato (T106-b-7), Zucchini (T106-b-8)**

Pest: *Ceratitis capitata* (Mediterranean fruit fly), *Bactrocera dorsalis* (Oriental fruit fly), and *B. cucurbitae* (melon fly)

Treatment: T106-b Vapor heat

Heat Up Time:	N/A
Heat Up Recording Interval:	N/A
Minimum Air Temperature:	112.0 F
Minimum Pulp Temperature at End of Heat Up:	44.4 °C/112.0 °F
Dwell Time:	8.75 hours
Dwell Recording Interval:	5 minutes
Cooling Method:	Optional



Commodities should be exposed at 112°F to determine tolerance to the treatment before commercial shipments are attempted.

### T106-a-1-1 Clementine or Orange from Mexico

Treatment: T106-a-1-1 Vapor heat

Heat Up Time:	6 hours <sup>1</sup>
Heat Up Recording Interval:	5 minutes
Minimum Air Temperature:	N/A
Minimum Pulp Temperature at End of Heat Up:	43.3 °C/110.0 °F
Dwell Time:	4 hours
Dwell Recording Interval:	5 minutes
Cooling Method:	N/A

- 1 During the initial raising of fruit temperature, the temperature should be raised rapidly in the first 2 hours; the increase over the next 4 hours should be gradual.

### T106-f Litchi from Hawaii

Pest: *Ceratitis capitata* (Mediterranean fruit fly), and *Bactrocera dorsalis* (Oriental fruit fly)

Treatment: T106-f Vapor heat

Heat Up Time:	1 hour
Heat Up Recording Interval:	5 minutes
Minimum Air Temperature:	N/A
Minimum Pulp Temperature at End of Heat Up:	47.2 °C/117.0 °F
Dwell Time:	20 minutes
Dwell Recording Interval:	5 minutes
Cooling Method:	Cool water spray

### T106-d-1 Mango from the Philippines (the island of Guimaras only)

Pest: *Bactrocera occipitalis*, *B. cucurbitae* and *B. philippinensis*

Treatment: T106-d-1 Vapor heat

Heat Up Time:	4 hours
Heat Up Recording Interval:	5 minutes
Minimum Air Temperature:	N/A
Minimum Pulp Temperature at End of Heat Up:	46.0 °C/114.8 °F
Dwell Time:	10 minutes
Dwell Recording Interval:	1 minute
Cooling Method:	Hydrocooling optional



### T106-d

### Mango from Taiwan

Pest: *Bactrocera dorsalis* (Oriental fruit fly) and *B. cucurbitae*

Treatment: T106-d Vapor heat

Heat Up Time:	N/A
Heat Up Recording Interval:	N/A
Minimum Air Temperature:	N/A
Minimum Pulp Temperature at End of Heat Up:	47.5 °C/115.7 °F
Dwell Time:	30 minutes
Dwell Recording Interval:	5 minute
Cooling Method:	Cooling required

### T106-c

### Papaya

Pest: *Ceratitis capitata* (Mediterranean fruit fly), *Bactrocera dorsalis* (Oriental fruit fly), and *B. cucurbitae* (melon fly)

Treatment: T106-c Vapor heat

Heat Up Time:	4 hours
Heat Up Recording Interval:	5 minutes
Minimum Air Temperature:	N/A
Minimum Pulp Temperature at End of Heat Up:	47.2 °C/117.0 °F
Dwell Time:	N/A
Dwell Recording Interval:	N/A
Cooling Method:	Optional

### T106-e Yellow Pitaya (*Selenicereus megalanthus*) from Colombia

Pest: *Ceratitis capitata* (Mediterranean fruit fly), *Anastrepha fraterculus* (South American fruit fly)

Treatment: T106-e Vapor heat

Heat Up Time:	4 hours
Heat Up Recording Interval:	5 minutes
Minimum Air Temperature:	N/A
Minimum Pulp Temperature at End of Heat Up:	46.0 °C/114.8 °F
Dwell Time:	20 minutes
Dwell Recording Interval:	5 minutes
Cooling Method:	Hydrocooling optional <sup>1</sup>

<sup>1</sup> If post-treatment cooling is conducted, wait 30 minutes after the treatment to start the forced cooling process.

### T106-g Rambutan from Hawaii

Pest: *Ceratitis capitata* (Mediterranean fruit fly), and *Bactrocera dorsalis* (Oriental fruit fly)

Treatment: T106-g Vapor heat

Heat Up Time:	1 hour
Heat Up Recording Interval:	5 minutes
Minimum Air Temperature:	N/A
Minimum Pulp Temperature at End of Heat Up:	47.2 °C/117.0 °F
Dwell Time:	20 minutes
Dwell Recording Interval:	5 minutes
Cooling Method:	Optional

---

## T107—Cold Treatment

### Pulp of the Fruit

The pulp of the fruit must be at or below the indicated temperature at time of beginning treatment for all cold treatments.

---

### Fruits for Which Cold Treatment Is Authorized

The following cold treatment schedules are authorized by Plant Protection and Quarantine (PPQ) for the control of specific pests associated with shipments of fruit. The cold treatment schedule that must be used for a specific commodity from a specific country is listed in the Fruits and Vegetables Section of the PPQ Nonpropagative Manual. These cold treatment schedules indicate the specific pests for which they are designed to control.

Treatment upon arrival may be accomplished at authorized ports as named in the permits.

Treatment in transit may be authorized for specifically equipped and approved vessels or containers and from approved countries, for entry at ports named in the permits. Intransit cold treatment authorization must be preceded by a visit to the country of origin by a PPQ Official to explain loading, inspection, and certification procedures to designated certifying officials of country of origin. Refrigerated compartments on carrying vessels and cold storage warehouse must have prior certification by PPQ. Authorization of cold treatments from countries with direct sailing time less than the number of days prescribed for intransit refrigeration treatment must be contingent on importer understanding that prescribed intransit refrigeration period must be met before arrival of vessel at the approved U.S. port.

Gaps in the cold treatment data print-out for pulp sensors and air sensors shall be allowed or disallowed on a case-by-case basis, taking into account the number of gaps, the length of each gap, and the temperatures before and after. Air temperatures may occasionally exceed treatment temperatures during defrost cycles; however, fruit temperatures should not rise appreciably during this time. During non-defrost times, the temperatures of the air sensors should never exceed the maximum allowable treatment temperature.



The fruit must be precooled at or below the target treatment temperature prior to loading. A certified USDA representative must sample the fruit pulp temperatures during loading in all sections of the lot until precooling has been accomplished.

**T107-a**

**Apple, Apricot<sup>11</sup>, Avocado, Blueberry, Cape Gooseberry, Cherry, Ethrog, Grape, Grapefruit, Kiwi, Lemon, Loquat, Litchi (Lychee), Nectarine, Orange, Ortanique, Peach, Pear, Persimmon, Plum<sup>11</sup>, Plumcot, Pomegranate, Pummelo, Quince, Sand Pear, Tangerine (includes Clementine)**

Pest: *Ceratitis capitata* (Mediterranean fruit fly) and *Ceratitis rosa* (Natal fruit fly)

Treatment: T107-a Cold treatment

Temperature	Exposure Period
34°F (1.11°C) or below	14 days
35°F ( 1.67°C) or below	16 days
36°F (2.22°C) or below	18 days



Pretreatment conditioning for avocado (heat shock or 100.4°F (38°C) for 10 to 12 hours) is optional and is the responsibility of the shipper. The pretreatment conditioning, which may improve fruit quality, is described in HortScience 29 (10): 1166-1168. 1994. and 30(5): 1052-1053 (1995)

**T107-a-1**

**Apple, Apricot<sup>12</sup>, Blueberry, Cherry, Grape, Grapefruit, Kiwi, Mandarin, Nectaine, Orange, Peach, Pear, Plum<sup>12</sup>, Pomegranate, Quince, Sweet Orange, Tangelo, Tangerine (includes Clementine)**

Pest: *Ceratitis capitata* (Mediterranean fruit fly) and species of *Anastrepha* (other than *Anastrepha ludens*)

Treatment: T107-a-1 Cold treatment

Temperature	Exposure Period
34°F (1.11°C) or below	15 days
35°F ( 1.67°C) or below	17 days

11 **Pluots** and **plumcots** are considered hybrids of plums and apricots and can be treated using T107-a.

12 **Pluots** and **plumcots** are considered hybrids of plums and apricots and can be treated using T107-a-1.

**T107-b**

**Apple, Apricot<sup>13</sup>, Cherry, Ethrog, Grapefruit, Litchi, Longan, Orange, Peach, Persimmon, Plum<sup>13</sup>, Pomegranate, Tangerine (includes Clementine), White Zapote**

Pest: *Anastrepha ludens* (Mexican fruit fly)

Treatment: **T107-b** Cold treatment

Temperature	Exposure Period
33°F (0.56°C) or below	18 days
34°F (1.11°C) or below	20 days
35°F ( 1.67°C) or below	22 days

**T107-c**

**Apple, Apricot<sup>14</sup>, Carambola, Cherry, Grape, Grapefruit, Orange, Pomegranate, Tangerine (includes Clemetine)**

Pest: Species of *Anastrepha* (other than *Anastrepha ludens*)

Treatment: **T107-c** Cold treatment

Temperature	Exposure Period
32°F (0°C) or below	11 days
33°F (0.56°C) or below	13 days
34°F (1.11°C) or below	15 days
35°F ( 1.67°C) or below	17 days

**T107-d**

**Apple, Grapefruit, Kiwi, Orange, Pear, Tangerine (includes Clementine)**

Pest: *Bactrocera tryoni* (Queensland fruit fly)

Treatment: **T107-d** Cold treatment

Temperature	Exposure Period
32°F (0°C) or below	13 days
33°F (0.56°C) or below	14 days
34°F (1.11°C) or below	18 days
35°F ( 1.67°C) or below	20 days
36°F (2.22°C) or below	22 days

13 **Puots** and **plumcots** are considered hybrids of plums and apricots and can be treated using T107-b.

14 **Puots** and **plumcots** are considered hybrids of plums and apricots and can be treated using T107-c.

## T107-e

### Apricot<sup>15</sup>, Grape, Nectarine, Peach, Plum<sup>15</sup>

Pest: *Thaumatotibia leucotreta* (false codling moth) and *Ceratitis rosa* (Natal fruit fly)

Treatment: **T107-e** Cold treatment

Temperature	Exposure Period
31°F ( -0.55°C) or below <sup>1</sup>	22 days

- 1 The treatment shall not commence until all sensors are reading 31°F (-0.55°C) or below. If the temperature exceeds 31.5°F (-0.27°C), the treatment shall be extended one-third of a day for each day or part of a day the temperature is above 31.5°F (-0.27°C). If the exposure period is extended, the temperature during the extension period must be 34° F (1.11°C) or below. If the temperature exceeds 34°F (1.11°C) at any time, the treatment is nullified. Also, some freeze damage to the fruit may occur if the pulp temperature is allowed to drop below approximately 29.5°F (-1.38°C) (This varies with the commodity.)

## T107-k

### Citrus

Pest: *Thaumatotibia leucotreta* (false codling moth) and *Ceratitis rosa* (Natal fruit fly)

Treatment: **T107-k** Cold treatment

Temperature	Exposure Period
31°F ( -0.55°C) or below <sup>1</sup>	24 days

- 1 The treatment shall not commence until all sensors are reading 31°F (-0.55°C) or below. If the temperature exceeds 31.5°F (-0.27°C), the treatment shall be extended one-third of a day for each day or part of a day the temperature is above 31.5°F (-0.27°C). If the exposure period is extended, the temperature during the extension period must be 34° F (1.11°C) or below. If the temperature exceeds 34°F (1.11°C) at any time, the treatment is nullified. Also, some freeze damage to the fruit may occur if the pulp temperature is allowed to drop below approximately 29.5°F (-1.38°C) (This varies with the commodity.)

## T107-h

### Carambola, Litchi (Lychee), Longan, Sand Pear

Pest: *Bactrocera dorsalis* (Oriental fruit fly), *Bactrocera curcubitae* (melon fly) and *Conopomorpha sinensis* (lychee fruit borer)

Treatment: **T107-h** Cold treatment

Temperature	Exposure Period
33.8°F ( 0.99°C) or below	17 days
34.5°F ( 1.38°C) or below	20 days

<sup>15</sup> **Pluots** and **plumcots** are considered hybrids of plums and apricots and can be treated using T107-e.

### T107-j

### Carambola, Litchi (Lychee), Longan, Sand Pear

Pest: *Bactrocera dorsalis* (Oriental fruit fly)

Treatment: **T107-j** Cold treatment

Temperature	Exposure Period
33.8°F ( 0.99°C) or below	15 days
34.5°F ( 1.38°C) or below	18 days

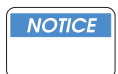

Use T107-j when *Bactrocera dorsalis* is the **ONLY** pest of concern that is identified by APHIS PPQ import requirements.

### T107-g

### Pecans and Hickory Nuts

Pest: *Curculio caryae* (Pecan weevil)

Treatment: **T107-g** Cold treatment

Temperature	Exposure Period
0°F (-17.78°C) or below	7 days

### T107-f

### Ya Pear from China

Treatment: **T107-f** Cold treatment

Temperature	Exposure Period
32°F (0°C) or below	10 days
33°F (0.56°C) or below	11 days
34°F (1.11°C) or below	12 days
35°F ( 1.67°C) or below	14 days

---

## T108—Fumigation Plus Refrigeration of Fruits

### Fruits for Which Fumigation Followed by Cold Treatment Is Authorized

The following treatment schedules (fumigation followed by cold treatment) are authorized by Plant Protection and Quarantine (PPQ) for the control of specific pests associated with shipments of fruit. The treatment schedule that must be used for a specific commodity from a specific country is listed in the Fruits and Vegetables Section of the PPQ Nonpropagative Manual. These treatment schedules indicate the specific pests for which they are designed to control.



For Hawaiian-grown avocados, research has shown that, during the process of cold treatment (T108-a), a single transient heat spike of no greater than 39.6°F (4.2°C) and no longer than 2 hours, during or after 6 days of cold treatment, does not affect the efficacy of the treatment. However, in the absence of supporting research, such a tolerance for heat spikes shall not be extended to other fruits.



Cold treatment in break-bulk vessels must be initiated by an APHIS Officer when shipments are from Italy, and Taiwan. However, cold treatment in containers may be initiated by treatment technicians from these countries only because they have been trained to initiate cold treatments for containers and not break-bulk vessels



Some varieties of fruit may be injured by exposure to MB. Importers should be encouraged to treat small samples of fruit to determine tolerance levels before shipping commercial quantities. The USDA is not liable for damages caused by quarantine.



## T108-a

### Apple, Apricot<sup>16</sup>, Avocado, Cherry, Grape, Kiwi, Nectarine, Peach, Pear<sup>17</sup>, Plum<sup>16</sup>, Quince

Pest: *Bactrocera cucurbitae* (melon fly), *Bactrocera dorsalis* (Oriental fruit fly), *Bactrocera tryoni* (Queensland fruit fly), *Brevipalpus chiliensis* (false red mite), *Ceratitis capitata* (Mediterranean fruit fly), *Lobesia botrana* (grapevine moth)

Treatment: **T108-a** Fumigation plus Cold treatment  
Three alternative schedules based upon the fumigation exposure time



Pretreatment conditioning for avocado (heat shock or 100.4°F (38°C) for 10 to 12 hours) is optional and is the responsibility of the shipper. The pretreatment conditioning, which may improve fruit quality, is described in HortScience 29 (10): 1166-1168. 1994. and 30(5): 1052-1053 (1995)



Check the PPQ Nonpropagative Manual to determine the required treatments for a commodity from a specific country.



Some varieties of fruit may be injured by the 3-hour exposure. Importers should be encouraged to test treat small quantities to determine tolerance before shipping commercial quantities



Time lapse between fumigation and start of cooling not to exceed 24 hours.

<sup>16</sup> **Plumcot** and **pluot** are considered hybrids of plums and apricots and may also be treated using T108-a provided they are treated under a **Section 18 Crisis exemption**.

<sup>17</sup> Fumigation may cause **severe** damage to Chinese, Japanese, Asian and Sand Pears. Obtain the importer's consent before fumigation.

**T108-a-1**

Treatment: **T108-a-1** MB at NAP—tarpaulin or chamber followed by cold treatment

Temperature	Dosage Rate (lb/1,000 ft <sup>3</sup> )	Minimum Concentration Readings (ounces) At:	
		0.5 hr	2 hrs
70°F ( 21.11°C) or above	2 lbs	25	18
<b>Followed by cold treatment</b>			

Refrigeration	
Temperature	Exposure Period
33 to 37°F ( 0.56 to 2.77°C)	4 days
OR 38 to 47°F ( 3.33 to 8.33°C)	11 days

**T108-a-2**

Treatment: **T108-a-2** MB at NAP—tarpaulin or chamber followed by cold treatment

Temperature	Dosage Rate (lb/1,000 ft <sup>3</sup> )	Minimum Concentration Readings (ounces) At:		
		0.5 hr	2 hrs	2.5 hrs
70°F ( 21.11°C) or above	2 lbs	25	18	18
<b>Followed by cold treatment</b>				

Refrigeration	
Temperature	Exposure Period
34 to 40°F (1.11 to 4.44°C)	4 days
OR 41 to 47°F (5.0 to 8.33°C)	6 days
OR 48 to 56°F (8.88 to 13.33°C)	10 days

**T108-a-3**

Treatment: **T108-a-3** MB at NAP—tarpaulin or chamber followed by cold treatment

Temperature	Dosage Rate (lb/1,000 ft <sup>3</sup> )	Minimum Concentration Readings (ounces) At:			
		0.5 hr	2 hrs*	2.5 hrs	3 hrs
70°F (21.11°C) or above	2 lbs	25	18	18	17
<b>Followed by cold treatment</b>					

Refrigeration	
Temperature	Exposure Period
43°F to 47°F (6.11 to 8.33°C)	3 days
OR 48°F to 56°F (8.88 to 13.33°C)	6 days

## T108-b

### Apple, Grape, and Pear<sup>18</sup>

Pest: *Austrotortrix* spp. and *Epiphyas* spp. (light brown apple moth complex), *Bactrocera tryoni* (Queensland fruit fly), *Ceratitidis capitata* (Mediterranean fruit fly) and other fruit flies

Treatment: T108-b MB at NAP—tarpaulin or chamber followed by cold treatment

Temperature	Dosage Rate (lb/1,000 ft <sup>3</sup> )	Minimum Concentration Readings (ounces) At:	
		0.5 hr	2 hrs
50°F (10 °C) or above	1.5 lbs	23	20
40-49°F (4.44 to 9.44°C)	2 lbs	30	25
<b>Followed by cold treatment</b>			

Temperature	Exposure Period
33°F (0.56°C) or below	21 days



Load not to exceed 80 percent of chamber capacity. Time lapse between fumigation and start of cooling not to exceed 24 hours.

<sup>18</sup> Fumigation may cause **severe** damage to Chinese, Japanese, Asian and Sand Pears. Obtain the importer's consent before fumigation.

## T109—Cold Treatment Plus Fumigation of Fruits

### T109-d-1 Apple, Grape, and Pear<sup>19</sup> from Australia

Pest: *Austrotortrix* spp. and *Epiphyas* spp. (light brown apple moth complex), *Bactrocera tryoni* (Queensland fruit fly), *Ceratitidis capitata* (Mediterranean fruit fly) and other fruit flies

Treatment: T109-d-1 Cold treatment followed by MB at NAP—tarpaulin or chamber

Temperature	Exposure Period
33°F (0.56°C) or below	21 days
Followed by MB at NAP—tarpaulin or chamber	

Temperature	Dosage Rate (lb/1,000 ft <sup>3</sup> )	Minimum Concentration Readings (ounces) At:	
		0.5 hr	2 hrs
70°F (21.11°C) or above	2 lbs	30	25
60 to 69°F (15.55 to 20.55°C)	2.5 lbs	36	28
40 to 59°F (4.44 to 15°C)	3 lbs	44	36

Alternate treatment for *Austrotortrix* and *Epiphyas* is fumigation plus refrigeration (**T108-b** on page 5-2-77).

Alternate treatment for grapes from Australia as a fruit fly precautionary treatment for *Bactrocera tryoni* and *Ceratitidis capitata* is fumigation plus refrigeration (**T108-a** on page 5-2-75 and **T108-b** on page 5-2-77).



Load not to exceed 80% of capacity.

<sup>19</sup> Fumigation may cause **severe** damage to Chinese, Japanese, Asian and Sand Pears. Obtain the importer's consent before fumigation.

**T109a**

**Apple ('Fuji' Apple from Japan and Korea)**

Pest: *Carposina niponensis* (peach fruit moth), *Conogethes punctiferalis* (yellow peach moth), *Tetranychus viennensis* (fruit tree spider mite), *Tetranychus kanzawai* (Kanzawa mite)

Two alternative schedules based on type of container

**T109-a-1**

Treatment: **T109-a-1** (apples in plastic field bins at maximum load factor 50% or less) Cold treatment followed by MB at NAP—tarpaulin or chamber

Temperature	Exposure Period
34°F (1.11°C) or below	40 days
<b>Followed by MB at NAP—tarpaulin or chamber</b>	

Temperature	Dosage Rate (lb/1,000 ft <sup>3</sup> )	Minimum Concentration Readings (ounces) At:	
		0.5 hr	2 hrs
50°F or (10°C) above	3 lbs	44	36

**T109-a-2**

Treatment: **T109-a-2** (apples in only cardboard cartons at maximum load factor 40% or less) Cold treatment followed by MB at NAP—tarpaulin or chamber

Temperature	Exposure Period
34°F (1.11°C) or below	40 days
<b>Followed by MB at NAP—tarpaulin or chamber</b>	

Temperature	Dosage Rate (lb/1,000 ft <sup>3</sup> )	Minimum Concentration Readings (ounces) At:	
		0.5 hr	2 hrs
59°F (15°C) above	2 lbs 6 oz	35	29

## T110—Quick Freeze

There are two alternative Quick Freeze treatments, depending on whether the commodity is to be treated and released or destroyed. The commodities listed in [Figure 5-2-1](#) below are not eligible for this treatment:



Important

**Avocados with seeds** are prohibited from South America, Central America, or Mexico; **Citrus with peel** is prohibited from Afghanistan, Andaman Islands, Argentina, Bangladesh, Brazil, Cambodia, China (People's Republic of), Comoros, Côte d'Ivoire, Federated States of Micronesia, Fiji Islands, Home Island in Cocos (Keeling) Islands, Hong Kong, India, Indonesia, Japan and adjacent islands, Korea, Laos, Madagascar, Malaysia, Maldives, Mauritius, Mozambique, Myanmar, Nepal, Oman, Pakistan, Papua New Guinea, Paraguay, Philippines, Reunion Islands, Rodrigues Islands, Ryukyu Islands, Saudi Arabia, Seychelles, Sri Lanka, Taiwan, Thailand, Thursday Island, United Arab Emirates, Uruguay, Vietnam, Yemen, and Zaire. **Mangoes with seeds** are prohibited from Barbados, Dominica, French Guiana, Guadeloupe, Martinique, St. Lucia, and all countries outside of North, Central, and South America and their adjacent islands (which include the Caribbean Islands and Bermuda). **Black currants** are enterable only to areas specified in the import permit. **Corn-on-the-cob** is prohibited from Albania, Algeria, Bosnia and Hercegovina, Croatia, Cyprus, Egypt, France, Greece, Israel, Italy, Lebanon, Libya, Malta, Macadonia, Morocco, Sardinia, Slovenia, Spain, Syria, Tunisia, and Turkey.

**Never** use this treatment for the control of bruchid beetles in dried beans. Research has shown that a treatment of -18°C (-0.4°F) for 14 days would be needed to be efficacious.

**FIGURE 5-2-1 Commodities Ineligible for Quick Freeze Treatment**

### T110-a

Treatment: T110-a — Quick Freeze

1. Initially, lower the commodity's temperature to 0°F (-17.77°C) or below.
2. Hold the commodity's temperature at 20°F (-6.66°C) or below for at least 48 hours.

The commodity may be transported during the 48-hour treatment period, but at no time may the commodity's temperature rise above 20°F (-6.66°C) prior to release.

All fruits and vegetables (except for the commodities listed in [Figure 5-2-1](#)) are enterable from all foreign countries after receiving this treatment in accordance with 7CFR 319.56-2c. Also, interstate movement of all fruits and vegetables from offshore areas of the United States (except mango from Hawaii) is authorized in the frozen state after being quick frozen.

Freezing will ruin the market quality of most fresh fruits and vegetables, except for thick-skinned items such as durian and coconut. Generally, this treatment is used on fruits and vegetables that will be processed into another form (e.g., for puree, juice, or mashed vegetables).

## T110-b

Treatment: **T110-b** — Quick Freeze for Destruction



T110-b may ONLY be used with permission from CPHST Treatment Quality Assurance Unit.

Contact 919-855-7457 for official approval.

1. Initially, lower the commodity's temperature to 0°F (-17.77°C) or below.
2. Hold the commodity's temperature at 20°F (-6.66°C) or below for at least 48 hours.

The commodity may be transported during the 48-hour treatment period, but at no time may the commodity's temperature rise above 20°F (-6.66°C) prior to release.

3. After treatment, transport the commodity to a landfill for deep burial.

This treatment is considered an acceptable method of destroying most commodities in lieu of returning them to the country of origin, with the exceptions listed in the **Figure 5-2-1 on page-5-2-80** at the beginning of this treatment schedule.





# 5

Treatment Manual

## Treatment Schedules

### *T200 - Schedules for Propagative Plant Material*

#### Contents

The following schedules of the T200 series are arranged by category such as a specifically named plant, type of plant, character of growth, or pest.



Plant and plant parts treated under the T200 series schedules are not to be used for food or feed purposes.

#### **T201—Plants**

- T201-q**—Aquatic plants infested with freshwater snails **page 5-3-3**  
**T201-e-1** and **T201-e-2**—Bromeliads **page 5-3-3**  
**T201-f-1** and **T201-f-2**—Cacti and other succulents **page 5-3-4**  
**T201-g-1**, **T201-g-2** and **T201-g-3**—Chrysanthemum spp., rooted and unrooted cuttings **page 5-3-5**  
**T201-l**—Commodities infested with quarantine significant slugs **page 5-3-6**  
**T201-h-1**—Cycads—excluding *Dioon edule* (chestnut dioon) **page 5-3-6**  
**T201-a-1** and **T201-a-2**—Deciduous woody plants (dormant) **page 5-3-6**  
**T201-h-2**—*Dioon edule* (chestnut dioon) **page 5-3-8**  
**T201-i-1** and **T201-i-2**—*Dieffenbachia* spp., *Dracaena* spp., *Philodendron* spp. (plants and cuttings) **page 5-3-8**  
**T201-b-1**—Evergreens\*, (Broadleaved genera, such as *Azalea*, *Berberis*, *Camellia*, *Ilex*, and *Photinia*) **page 5-3-9**  
**T201-k-1**—Foliated hosts plants of *Dialeurodes citri* (citrus whitefly), excluding *Osmanthus americanus* **page 5-3-10**  
**T201-c-1** and **T201-c-2**—Greenhouse-grown plants, herbaceous plants and cuttings, and greenwood cuttings of woody plants **page 5-3-10**  
**T201-n**—Host plants of *Aleurocanthus woglumi* (citrus blackfly) **page 5-3-12**  
**T201-o-1** and **T201-o-2**—Host plants of *Omalonyx unguis* and *Succinea* spp. (snails) **page 5-3-12**  
**T201-k-2**—Nonfoliated hosts plants of *Dialeurodes citri* (citrus whitefly), excluding *Osmanthus americanus* **page 5-3-13**  
**T201-d-1**, **T201-d-2**, **T201-d-3**, **T201-d-4**, and **T201-d-5**—Orchids, plants, and cuttings **page 5-3-13**  
**T201-e-3-1** and **T201-e-3-2**—Pineapple slips **page 5-3-15**  
**T201-j**—Pines (*Pinus* spp.) from Canada **page 5-3-16**  
**T201-m-1**—Plant cuttings (Scion wood)\* **page 5-3-16**  
**T201-m-2**—Plant cuttings (greenwood cuttings of woody plants and herbaceous plant cuttings)\* **page 5-3-17**  
**T201-m-3** and **T201-m-4**—Plant cuttings (root cuttings)\* **page 5-3-17**  
**T201-p**—Plant material not tolerant to fumigation **page 5-3-18**

## **T202—Bulbs, Corms, Tubers, Rhizomes, and Roots**

- T202-b**—Astilbe roots [page-5-3-20](#)
- T202-c**—Banana roots [page-5-3-20](#)
- T202-j**—Garlic [page-5-3-20](#)
- T202-e-1**—Gladiolus spp. [page-5-3-21](#)
- T202-f**—Horseradish roots [page-5-3-22](#)
- T202-g**—Lily bulbs packed in subsoil [page-5-3-23](#)
- T202-h**—**Lycoris** [page-5-3-23](#)
- T202-i-1**—**Narcissus** [page-5-3-23](#)
- T202-a-1**—Selaginella spp. (Resurrection plants) [page-5-3-24](#)
- T202-d**—Yams (Dioscorea spp.) and Sweet Potatoes (Ipomoea spp.) [page-5-3-25](#)

## **T203—seeds**

- T203-m**—Avocado (seeds only, without pulp) [page-5-3-26](#)
- T203-e**—Chestnuts (does not include water chestnuts) and Acorns [page-5-3-26](#)
- T203-i-1**—Conifer seeds (species with small seeds, such as Picea spp., Pinus sylvestris, and Pinus mugo) [page-5-3-26](#)
- T203-f-1**—Cottonseed—bagged, packaged, or in bulk [page-5-3-28](#)
- T203-k**—Macadamia nuts (as seeds) [page-5-3-30](#)
- T203-g-1**—Pods and seed of Kenaf, Hibiscus, and Okra [page-5-3-29](#)
- T203-h**—Rosmarinus seeds [page-5-3-30](#)
- T203-l**—seeds [page-5-3-30](#)
- T203-b**—seeds excluding seeds of Vicia spp. [page-5-3-31](#)
- T203-o-1**—Seeds of Casuarina [page 5-3-32](#)
- T203-p**—Seeds of Citrus (Rutaceae family) [page 5-3-33](#)
- T203-j**—Seeds of Hevea brasiliensis (rubber tree) [page-5-3-32](#)
- T203-o-3**—Seeds of Leguminosae = Fabaceae, etc. [page-5-3-33](#)
- T203-o-5**—Seeds of Lonicera and Other seeds [page 5-3-33](#)
- T203-o-2**—Seeds of Umbelliferae [page 5-3-34](#)
- T203-d-1**—Seeds of Vicia spp. (vetch seeds) excluding seeds of Vicia faba [page 5-3-34](#)
- T203-l**—Seeds of Vicia spp. (vetch seeds) including seeds of Vicia faba [page-5-3-34](#)
- T203-a-1**—Seeds not specifically listed in the T203 Schedules [page-5-3-31](#)
- T203-n**—Seeds with infested pulp [page-5-3-35](#)



**Plant Tolerance.** In general, nursery stock should be fumigated in a normal atmospheric pressure (NAP) chamber. Damage may occur when treatment is performed under a tarpaulin. When selecting a treatment for a particular pest, consider the tolerance of the plant material to the treatment. Refer to the “Handbook of Plant Tolerances to Quarantine Treatments” to determine if a genus or species is tolerant to treatment.

The condition of the plants at the time of treatment may have a bearing on reaction to treatment.

Any new or unusual observations relating to treatment tolerance of treated material should be recorded and reported to the Center for Plant Health Science & Technology (CPHST), giving details of the treatment and the conditions of application. In appraising the effects of a particular treatment, take care to distinguish between the actual or apparent effects attributable to the treatment and those not related to the treatment.



**Seeds for Propagation.** Precautionary treatment for small lots of seeds (1 lb or less) is **not** required if you can inspect 100% of the seeds and you do not find any pests.



**Containers.** Give boxes, crates, and other propagative containers the same treatment as the propagative material with which they are associated. Exceptions are necessary, however, when significant pests are found infesting containers or packing materials that would not be controlled by the treatment required for the contents.



**Dipping.** In lieu of fumigation, an approved chemical dip may be recommended for those plants known to be intolerant to fumigants. Plants, including the roots, should be entirely submerged in the chemical dip for 30 seconds. Agitating the plants while immersed in the solution will eliminate air pockets and aid in obtaining complete coverage of the plants with the pesticide. For approved fungicidal dips, see the appropriate section in the T500 Treatment Schedules.



Use fresh chemicals in preparing the dip solution for same day use. Wear rubber gloves while dipping plants to prevent pesticides from coming in contact with skin. Wash the gloves in soap and water before removing. Also, thoroughly wash hands and arms in soap and water after removing the gloves. Do **not** eat or smoke while working with pesticides.

## T201—Plants

### T201-q

#### Aquatic plants infested with freshwater snails

**Pest:** Snails of the following families: Amphulariidae, Bulinidae, Limnaeidae, Planorbidae, Viviparidae

**Treatment:** T201-q—Hot water treatment 112°F for 10 minutes. *Elodea Danes* and *Cabomba caroliniana* plants not tolerant to this treatment. Inspection stations should refer to their reference report guide for host tolerances to the hot water treatment.

### T201-e-1

#### Bromeliads

**Pest:** External feeders

**Treatment:** T201-e-1 MB (“Q” label only) at NAP—tarpaulin or chamber

Temperature	Dosage Rate (lb/1,000 ft <sup>3</sup> )	Exposure Period
90-96°F	2 lbs	1.5 hrs
80-89°F	2 lbs	2 hrs
70-79°F	3 lbs	2 hrs
60-69°F	3 lbs	2.5 hrs
50-59°F	3 lbs	3 hrs

### T201-e-2

#### Bromeliads

Pest: Internal feeders such as borers and miners

Treatment: T201-e-2 MB (“Q” label only) at 15" vacuum

Temperature	Dosage Rate (lb/1,000 ft <sup>3</sup> )	Exposure Period
90-96 °F	2 lbs	1.5 hrs
80-89 °F	2 lbs	2 hrs
70-79 °F	3 lbs	2 hrs
60-69 °F	3 lbs	2.5 hrs
50-59 °F	3 lbs	3 hrs

### T201-f-1

#### Cacti and other succulents

Two schedules based on type of pest

Pest: External feeders (other than soft scales) infesting collected dormant and nondormant plant material

Treatment: T201-f-1 MB (“Q” label only) at NAP—tarpaulin or chamber)

Temperature	Dosage Rate (lb/1,000 ft <sup>3</sup> )	Exposure Period:	
		<i>Brachyrhinus</i> larvae	All others
90-96°F	2 lbs	2.5 hrs	2 hrs
80-89°F	2.5 lbs	2.5 hrs	2 hrs
70-79°F	3 lbs	2.5 hrs	2 hrs
60-69°F	3 lbs	3 hrs	2.5 hrs
50-59°F	3 lbs	3.5 hrs	3 hrs
40-49°F	3 lbs	4 hrs	3.5 hrs

### T201-f-2

#### Cacti and other succulents

Two schedules based on type of pest

Pest: Borers and soft scales

Treatment: T201-f-2 MB (“Q” label only) in 15" vacuum

Temperature	Dosage Rate (lb/1,000 ft <sup>3</sup> )	Exposure Period:	
		<i>Brachyrhinus</i> larvae	All others
90-96°F	2 lbs	2.5 hrs	2 hrs
80-89°F	2.5 lbs	2.5 hrs	2 hrs
70-79°F	3 lbs	2.5 hrs	2 hrs
60-69°F	3 lbs	3 hrs	2.5 hrs
50-59°F	3 lbs	3.5 hrs	3 hrs
40-49°F	3 lbs	4 hrs	3.5 hrs



Vacuum fumigation requires prior consent of the importer. If consent is denied, entry should be refused unless hand removal plus 100% inspection is feasible.



Obtain consent of the importer prior to treatment of the following plants since some damage may occur:

- Bromeliads, see [T201-e-3-1](#) on [page 5-3-15](#)
- Kalenchoe synsepala**, see [T201-p](#) on [page 5-3-18](#)
- Sedum adolphi**, see [T201-p](#) on [page 5-3-18](#)

### T201-g-1

#### ***Chrysanthemum* spp., rooted and unrooted cuttings**

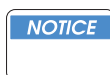

Obtain consent of the importer prior to fumigation since some damage may occur.

Pest: Aphids

Treatment: T201-g-1 MB (“Q” label only) at NAP—tarpaulin or chamber

Temperature	Dosage Rate (lb/1,000 ft <sup>3</sup> )	Exposure Period
70°F or above	0.75 lb	2 hrs

### T201-g-2

#### ***Chrysanthemum* spp., rooted and unrooted cuttings**

Pest: External feeders

Treatment: T201-g-2 Malathion-carbaryl chemical dip—Hand removal of pests of infested parts *plus* a malathion-carbaryl chemical dip. Solution prepared by adding 3 level tablespoons of 25% malathion wettable powder and 3 level tablespoons of 50% carbaryl wettable powder to each gallon of water. The addition of a sticker-spreader formulation may be required for hard to wet plants. Use fresh chemicals and prepare dip for the same day use. Plants, including the roots, should be entirely submerged in the chemical dip for 30 seconds.

### T201-g-3

#### ***Chrysanthemum* spp., rooted and unrooted cuttings**

Pest: Leafminers, aphids, mites, etc.\*

Treatment: T201-g-3—Hot water at 110-111°F for 20 minutes

\*This treatment is marginal as to host tolerance.



*Chrysanthemum* spp. from the Dominican Republic and Colombia when infested with Agromyzid leafminers requires no treatment unless destined to Florida.

## T201-I Commodities infested with quarantine significant slugs

Pest: Quarantine significant slugs of the families Agriolimacidae, Arionidae, Limacidae, Milacidae, Philomycidae, and Veronicellidae, including the following genera:

<b><i>Agriolimax</i></b>	<b><i>Leidyula</i></b>	<b><i>Pseudoveronicella</i></b>
<b><i>Arion</i></b>	<b><i>Limax</i></b>	<b><i>Sarasinula</i></b>
<b><i>Colosius</i></b>	<b><i>Meghimatium</i></b>	<b><i>Semperula</i></b>
<b><i>Deroceras</i></b>	<b><i>Milax</i></b>	<b><i>Vaginulus</i></b>
<b><i>Diplosolenodes</i></b>	<b><i>Pallifera</i></b>	<b><i>Veronicella</i></b>

Treatment: T201-I MB (“Q” label only) at NAP—tarpaulin or chamber

Temperature	Dosage Rate (lb/1000 ft <sup>3</sup> )	Minimum Concentration Readings (ounces) At:	
		0.5 hr	2 hrs
90-96°F	1 lb	12	9
80-89°F	1.25 lbs	15	12
70-79°F	1.5 lbs	18	15
60-69°F	1.75 lbs	22	19

## T201-h-1 Cycads—excluding *Dioon edule* (chestnut dion)

Pest: External feeders

Treatment: T201-h-1 MB (“Q” label only) in 15" vacuum

Temperature	Dosage Rate (lb/1,000 ft <sup>3</sup> )	Exposure Period
90-96°F	2 lbs	2 hrs
80-89°F	2.5 lbs	2 hrs
60-79°F	3 lbs	2 hrs
40-59°F	3 lbs	2.5 hrs

## T201-a-1 Deciduous woody plants (dormant)

Pest: External feeders

Treatment: T201-a-1 MB (“Q” label only) at NAP

Temperature	Dosage Rate (lb/1,000 ft <sup>3</sup> )	Exposure Period:	
		<i>Brachyrhinus</i> larvae	All others
90-96°F	2 lbs	2.5 hrs	2 hrs
80-89°F	2.5 lbs	2.5 hrs	2 hrs
70-79°F	3 lbs	2.5 hrs	2 hrs
60-69°F	3 lbs	3 hrs	2.5 hrs
50-59°F	3 lbs	3.5 hrs	3 hrs
40-49°F	3 lbs	4 hrs	3.5 hrs

For gypsy moth egg masses, use **T313-a** on page 5-4-36 or **T313-b** on page 5-4-36.



If treating for mealybugs, use **T305-c** on page 5-4-18.



Residue samples are not required on FIFRA Section 18 materials that are inedible.



This schedule is not entirely satisfactory for use against egg masses of *Yponomeuta malinellus* (apple ermine moth).

## T201-a-2

### Deciduous woody plants (dormant)

root cuttings, scion wood cuttings, and nonfoliated citrus whitefly host—such as *Acer*, *Berberis*, *Fraxinus*, *Philadelphus*, *Rosa*, *Spiraea*, and *Syringa*

Pest: Borers

Treatment: T201-a-2 MB (“Q” label only) in 26" vacuum

Temperature	Dosage Rate (lb/1,000 ft <sup>3</sup> )	Exposure Period:	
		<i>Brachyrhinus</i> larvae	All others
90-96°F	2 lbs	2.5 hrs	2 hrs
80-89°F	2.5 lbs	2.5 hrs	2 hrs
70-79°F	3 lbs	2.5 hrs	2 hrs
60-69°F	3 lbs	3 hrs	2.5 hrs
50-59°F	3 lbs	3.5 hrs	3 hrs
40-49°F	3 lbs	4 hrs	3.5 hrs



Citrus whitefly hosts, see **T201-k-1** on page 5-3-10 Evergreens\* broadleaved genera

**T201-h-2** **Dioon edule (chestnut dion)**

For other cycads see cycads

Pest: External feeders

Treatment: T201-h-2 MB (“Q” label only) in 26" vacuum

Temperature	Dosage Rate (lb/1,000 ft <sup>3</sup> )	Exposure Period
90-96°F	2 lbs	2 hrs
80-89°F	2.5 lbs	2 hrs
60-79°F	3 lbs	2 hrs
40-59°F	3 lbs	2.5 hrs

**T201-i-1** **Dieffenbachia spp., Dracaena spp., Philodendron spp. (plants and cuttings)**

Pest: External feeders

Treatment: T201-i-1 MB (“Q” label only) at NAP—chamber

Temperature	Dosage Rate (lb/1,000 ft <sup>3</sup> )	Exposure Period
90-96°F	2 lbs	1.5 hrs
80-89°F	2 lbs	2 hrs
70-79°F	3 lbs	2 hrs
60-69°F	3 lbs	2.5 hrs
50-59°F	3 lbs	3 hrs



This treatment may cause leaf tip burn in *Dieffenbachia* (dumbcane).

**T201-i-2** **Dieffenbachia spp., Dracaena spp., Philodendron spp. (plants and cuttings)**

Pest: Internal feeders

Treatment: T201-i-2 MB (“Q” label only) in 26" vacuum

Temperature	Dosage Rate (lb/1,000 ft <sup>3</sup> )	Exposure Period
90-96°F	2 lbs	1.5 hrs
80-89°F	2 lbs	2 hrs
70-79°F	3 lbs	2 hrs
60-69°F	3 lbs	2.5 hrs
50-59°F	3 lbs	3 hrs



Immature and tender plants and cuttings, and species and varieties known or considered to be affected by MB, should not be fumigated without consent of the importer. Without such consent, entry should be denied.

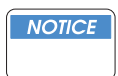

This schedule may cause leaf tip burn in *Dieffenbachia* (dumbcane).

### T201-b-1

### Evergreens\*, (Broadleaved genera, such as *Azalea*, *Berberis*, *Camellia*, *Ilex*, and *Photinia*)

(Coniferous genera, such as *Cedrus*, *Cupressus*, *Juniperus*, *Podocarpus*, *Thuja*, and *Taxus*)

Pest: External feeder

Treatment: T201-b-1 MB (“Q” label only) at NAP—tarpaulin or chamber

Temperature	Dosage Rate (lb/1,000 ft <sup>3</sup> ):		Exposure Period:	
	<i>Brachyrhinus</i> larvae	All others	<i>Brachyrhinus</i> larvae	All others
90-96°F	2 lbs	1.5 lbs	2.5 hrs	2 hrs
80-89°F	2.5 lbs	2 lbs	2.5 hrs	2 hrs
70-79°F	3 lbs	2.5 lbs	2.5 hrs	2 hrs
60-69°F	3 lbs	2.5 lbs	3 hrs	2.5 hrs
50-59°F	3 lbs	2.5 lbs	3.5 hrs	3 hrs
40-49°F	3 lbs	2.5 lbs	4 hrs	3.5 hrs



Important

\*If treating for mealybugs, fumigate at 60 °F or above.

**Exceptions:**

*Araucaria* spp., see [T201-c-1](#) on page 5-3-10

*Azalea indica*, see [T201-c-2](#) on page 5-3-11

Cycads, see [T201-l](#) on page 5-3-6

Citrus whitefly hosts, see [T201-k-1](#) on page 5-3-10

*Daphne* spp., see [T201-c-1](#) on page 5-3-10

*Lavandula* spp., see [T201-p-1](#) on page 5-3-19

*Osmanthus americanus*, see [T201-p-2](#) on page 5-3-19

*Pinus* from Canada to certain States, see [T201-j](#) on page 5-3-16

Peanuts with gypsy moth egg masses, see [T313-a](#) on page 5-4-36



Some species and varieties of evergreens, particularly in *Azalea* and *Juniperus* have low tolerances and should be fumigated as in schedule T201-c; those known or believed to be intolerant should be handled under T201-p. For tolerance data, see Handbook of Plant Tolerances to Quarantine Treatments.

**T201-k-1 Foliated hosts plants of *Dialeurodes citri* (citrus whitefly), excluding *Osmathus americanus***

For *Osmathus americanus*, see T201-p

Pest: *Dialeurodes citri* (citrus whitefly)

Treatment: T201-k-1 MB (“Q” label only) at NAP

Temperature	Dosage Rate (lb/1,000 ft <sup>3</sup> ):		Exposure Period:
	<i>Brachyrhinus</i> larvae	All others	
85-96°F	1.5 lbs	1 lb	4 hrs
80-84°F	2.5 lbs	2 lbs	2.5 hrs
70-79°F	2 lbs	2 lbs	3.5 hrs

**T201-c-1 Greenhouse-grown plants, herbaceous plants and cuttings, and greenwood cuttings of woody plants**

For cut flowers and greenery, use T305-a, which is identical to this schedule).

Pest: External feeders, leaf miners, thrips\*

Treatment: T201-c-1 MB (“Q” label only) at NAP—tarpaulin or chamber

Temperature	Dosage Rate (lb/1000 ft <sup>3</sup> )	Minimum Concentration Readings (ounces) At:	
		0.5 hr	2 hrs
80-90°F	1.5 lbs	19	12
70-79°F	2 lbs	24	16
60-69°F	2.5 lbs	30	20
50-59°F	3 lbs	36	24
40-49 F	3.5 lbs	41	27



If treating for mealybugs, fumigate at 60°F or above.

## T201-c-2

### Greenhouse-grown plants, herbaceous plants and cuttings, and greenwood cuttings of woody plants

Pest: Borers, soft scales



For cut flowers and greenery, use [T305-b](#) on [page 5-4-17](#), which is identical to this schedule.

Treatment: T201-c-2 MB (“Q” label only) in 15" vacuum

Temperature	Dosage Rate (lb/1,000 ft <sup>3</sup> )	Exposure Period
80-90°F	2.5 lbs	2 hrs
70-79°F	3 lbs	2 hrs
60-69°F	3 lbs	2.5 hrs
50-59°F	3 lbs	3 hrs
40-49°F	3 lbs	3.5 hrs

Vacuum fumigation requires prior consent of the importer. If consent is denied, refuse entry unless T201-c-1, plus hand removal of these pests is feasible. For shipments of a size to permit 100% inspection, plants with these pests may be handled separately. Vacuum fumigation is not required for soft scales known to be widely distributed in the United States.



Exceptions to Schedules T201-c-1 and 2

Bromeliads, see [T201-e-3-1](#) on [page 5-3-15](#)

Cacti and other succulents, see [T201-j](#) on [page 5-3-16](#)

*Chrysanthemum* spp., see [T201-g-1](#) on [page 5-3-5](#)

Cycads, see [T201-l](#) on [page 5-3-6](#)

Cyclamen mites, [T201-a-2](#) on [page 5-3-7](#)

*Dieffenbachia* spp., *Dracaena* spp., and *Philodendron* spp., see [T201-i-1](#) on [page 5-3-8](#)

*Kalanchoe synsepala*, see [T201-p-1](#) on [page 5-3-19](#)

*Lavandula* spp., see [T201-p-2](#) on [page 5-3-19](#)

Orchids, see [T201-d-1](#) on [page 5-3-13](#)

*Osmanthus americanus*, see [T201-p](#) on [page 5-3-18](#)

*Pelargonium* spp., see [T201-p](#) on [page 5-3-18](#)

*Sedum adolphi*, see [T201-p](#) on [page 5-3-18](#)

Plants infested with *Succinea horticola*, see [T201-o-1](#) on [page 5-3-12](#)

Plants infested with *Veronicella* or other slugs, see [T201-l](#) on [page 5-3-6](#)

## T201-n

### Host plants of *Aleurocanthus woglumi* (citrus blackfly)

Pest: *Aleurocanthus woglumi* (citrus blackfly)

Treatment: T201-n MB (“Q” label only) at NAP—tarpaulin or chamber

Temperature	Dosage Rate (lb/1000 ft <sup>3</sup> )	Minimum Concentration Readings (ounces) At:	
		0.5 hr	2 hrs
85°F or above	1 lb	13	9
80-85°F	1.25 lbs	16	12
70-79°F	1.5 lbs	19	15
65-69°F	1.75 lbs	23	17

Precautions within citrus blackfly quarantine areas:

- ◆ Conduct tarpaulin fumigations in shaded areas, if possible, to prevent the development of high space temperatures within the tarpaulin enclosure.
- ◆ Fumigate 4 to 5 days after plants are dug, balled, and burlapped, if possible.
- ◆ Roots and soil should be moist prior to fumigation. Watering should be deferred for 12 hours after fumigation unless there is wilting, in which case, water as needed.
- ◆ Avoid excessive air circulation during fumigation or during the post-treatment aeration period.
- ◆ Avoid placing plants in direct sunlight after fumigation.

## T201-o-1

### Host plants of *Omalonyx unguis* and *Succinea spp.* (snails)



These treatments are for use on plants that may not tolerate fumigation. Use either of the following treatments.

Pest: *Omalonyx unguis* and *Succinea spp.* (snails)

Treatment: T201-o-1 Water Spray—Use a high-pressure water spray on the foliage to flush snails from the plants. Care should be taken not to spray the root systems of conifers since they will be damaged. The run-off drain must be screened to catch snails before drainage into the sewer system. Reinspect plants after wash.

**T201-o-2 Host plants of *Omalonyx unguis* and *Succinea* spp. (snails)**

Treatment: **T201-o-2** Chemical Dip—Dip plants with a Malathion-carbaryl chemical dip. Solution prepared by adding 3 level tablespoons of 25 percent Malathion wettable powder and 6 level teaspoons of 50 percent carbaryl wettable powder per gallon of water with a sticker-spreader formulation.

**T201-k-2 Nonfoliated hosts plants of *Dialeurodes citri* (citrus whitefly), excluding *Osmanthus americanus***

Pest: *Dialeurodes citri* (citrus whitefly)

Treatment: T201-k-2 MB (“Q” label at NAP)

Temperature	Dosage Rate (lb/1,000 ft <sup>3</sup> )	Exposure Period:	
		<i>Brachyrhinus</i> larvae	All others
90-96°F	2 lbs	2.5 hrs	2 hrs
80-89°F	2.5 lbs	2.5 hrs	2 hrs
70-79°F	3 lbs	2.5 hrs	2 hrs
60-69°F	3 lbs	3 hrs	2.5 hrs
50-59°F	3 lbs	3.5 hrs	3 hrs
40-49°F	3 lbs	4 hrs	3.5 hrs

**T201-d-1 Orchids, plants, and cuttings**

Pest: External feeders, other than soft scales

Collected: Dormant or nondormant

Treatment: T201-d-1 MB (“Q” label only) at NAP tarpaulin or chamber,

Temperature	Dosage Rate (lb/1,000 ft <sup>3</sup> )	Exposure Period:	
		<i>Brachyrhinus</i> larvae	All others
90-96°F	2 lbs	2.5 hrs	2 hrs
80-89°F	2.5 lbs	2.5 hrs	2 hrs
70-79°F	3 lbs	2.5 hrs	2 hrs
60-69°F	3 lbs	3 hrs	2.5 hrs
50-59°F	3 lbs	3.5 hrs	3 hrs
40-49°F	3 lbs	4 hrs	3.5 hrs



If treating for mealybugs, use [T305-c](#) on page 5-4-18.

### T201-d-2 Orchids, plants, and cuttings

Pest: External feeders (other than soft scales) infesting greenhouse grown plant material

Treatment: T201-d-2 MB (“Q” label only) at NAP tarpaulin or chamber

Temperature	Dosage Rate (lb/1,000 ft <sup>3</sup> )	Exposure Period
90-96°F	1 lb	2 hrs
80-89°F	1.5 lbs	2 hrs
70-79°F	2 lbs	2 hrs
60-69°F	2.5 lbs	2 hrs
50-59°F	3 lbs	2 hrs
40-49°F	3.5 lbs	2 hrs

### T201-d-3 Orchids, plants, and cuttings

Pest: Borers, cattleya fly, *Mordellistena* spp., soft scales, *Vinsonia* spp.

Treatment: T201-d-3 MB (“Q” label only) in 15" vacuum

Temperature	Dosage Rate (lb/1,000 ft <sup>3</sup> )	Exposure Period
90-96°F	3 lbs	1 hr
80-89°F	3 lbs	1.5 hrs
70-79°F	3 lbs	2 hrs
60-69°F	3 lbs	2.5 hrs
50-59°F	3 lbs	3 hrs
40-49°F	3 lbs	3.5 hrs

For nondormant plants, collected or greenhouse grown, vacuum fumigation requires prior consent of the importer. If consent denied, entry should be refused unless T201-a-1 plus hand removal of these pests is feasible. Plant shipments of a size to permit 100% inspection and pest removal may be handled separately.

### T201-d-4 Orchids, plants, and cuttings

Pest: Cecidomyid galls

Treatment: **T201-d-4** Excised in all cases

### T201-d-5 Orchids, plants, and cuttings

Pest: Leaf miner, *Eurytoma* spp., infesting *Rhynchosstylis*

Treatment: T201-d-5 Hot water—118°F for 0.5 hour followed by a cool water bath

**NOTICE**

Some varieties of Orchids may be sensitive to methyl bromide (MB) treatments. These varieties include *Cymbidium*, *Cypripedium*, and *Phalaenopsis*. As an alternative to MB treatments that may damage orchids, see [T201-p](#) on page 5-3-18

**T201-e-3-1**

**Pineapple slips**

Two alternative schedules

Pest: Various

Treatment: T201-e-3-1 MB (“Q” label only) at NAP

Temperature	Dosage Rate (lb/1,000 ft <sup>3</sup> )	Exposure Period
90-96°F	1.5 lbs	2 hrs
80-89°F	2 lbs	2 hrs
70-79°F	2.5 lbs	2 hrs
60-69°F	3 lbs	2 hrs

**T201-e-3-2**

**Pineapple slips**

Alternative schedule

Treatment: T201-e-3-2 MB (“Q” label only) in 26" vacuum

Temperature	Dosage Rate (lb/1,000 ft <sup>3</sup> )	Exposure Period
90-96°F	1.5 lbs	1.5 hrs
80-89°F	2 lbs	1.5 hrs
70-79°F	2.5 lbs	1.5 hrs
60-69°F	3 lbs	1.5 hrs

**NOTICE**

Some varieties of bromeliads may be sensitive to methyl bromide (MB) treatments. These varieties include *Aechmea* spp., *Billbergia* spp., *Guzmania* spp., *Nidularium* spp., *Vriesia* spp., and other broad shiny-leafed types, and thin-leafed types. As an alternative to MB treatments that may damage bromeliads, see [T201-p](#) on page 5-3-18.

## T201-j

### Pines (*Pinus* spp.) from Canada

Destined to California, Idaho, Oregon, and Utah

Pest: *Rhyacionia buoliana* (European pine shoot moth)

Treatment: T201-j MB (“Q” label only) at NAP

Dosage rate for all schedules is 4 lbs MB (51 oz. minimum concentration)

Temperature	Exposure Period	Temperature	Exposure Period
75°F	2 hrs	59°F	2 hrs 41 min
74°F	2 hrs 1 min	58°F	2 hrs 43 min
73°F	2 hrs 2 min	57°F	2 hrs 46 min
72°F	2 hrs 4 min	56°F	2 hrs 49 min
71°F	2 hrs 7 min	55°F	2 hrs 52 min
70°F	2 hrs 9 min	54°F	2 hrs 55 min
69°F	2 hrs 11 min	53°F	2 hrs 58 min
68°F	2 hrs 14 min	52°F	3 hrs 1 min
67°F	2 hrs 16 min	51°F	3 hrs 5 min
66°F	2 hrs 19 min	50°F	3 hrs 8 min
65°F	2 hrs 22 min	49°F	3 hrs 12 min
64°F	2 hrs 25 min	48°F	3 hrs 15 min
63°F	2 hrs 28 min	47°F	3 hrs 19 min
62°F	2 hrs 31 min	46°F	3 hrs 24 min
61°F	2 hrs 35 min	45°F	3 hrs 28 min
60°F	2 hrs 38 min		



**Important**

This is a precautionary treatment for pine trees with or without roots and twigs and branches of all *Pinus* species except that Christmas trees and other pine decorative materials are exempt from the fumigation requirement during the period November 1 through December 31.

Prior consent of the importer is required for fumigation at temperatures above 65°F or below 50°F and also for all bare-rooted pines, since some damage may occur.

## T201-m-1

### Plant cuttings (Scion wood)\*

Pest: External feeders

Treatment: T201-m-1 MB (“Q” label only) at NAP—tarpaulin or chamber



**Important**

\*See exceptions to plant cuttings commodity



Temperature	Dosage Rate (lb/1,000 ft <sup>3</sup> )	Exposure Period:	
		<i>Brachyrhinus</i> larvae	All others
90-96°F	2 lbs	2.5 hrs	2 hrs
80-89°F	2.5 lbs	2.5 hrs	2 hrs
70-79°F	3 lbs	2.5 hrs	2 hrs
60-69°F	3 lbs	3 hrs	2.5 hrs
50-59°F	3 lbs	3.5 hrs	3 hrs
40-49°F	3 lbs	4 hrs	3.5 hrs

### T201-m-2

### Plant cuttings (greenwood cuttings of woody plants and herbaceous plant cuttings)\*

Pest: External feeders

Treatment: T201-m-2 MB (“Q” label only) at NAP—tarpaulin or chamber



\*See exceptions to plant cuttings commodity.

Temperature	Dosage Rate (lb/1000 ft <sup>3</sup> )	Minimum Concentration Readings (ounces) At:	
		0.5 hr	2 hrs
80-90°F	1.5 lbs	19	12
70-79°F	2 lbs	24	16
60-69°F	2.5 lbs	30	20
50-59°F	3 lbs	36	24
40-49°F	3.5 lbs	41	27

### T201-m-3

### Plant cuttings (root cuttings)\*

Pest: External feeders

Treatment: T201-m-3 MB (“Q” label only) at NAP—chamber



\*See exceptions to plant cuttings commodity.

Temperature	Dosage Rate (lb/1,000 ft <sup>3</sup> )	Exposure Period:	
		<i>Brachyrhinus</i> larvae	All others
90-96°F	2 lbs	2.5 hrs	2 hrs
80-89°F	2.5 lbs	2.5 hrs	2 hrs
70-79°F	3 lbs	2.5 hrs	2 hrs
60-69°F	3 lbs	3 hrs	2.5 hrs
50-59°F	3 lbs	3.5 hrs	3 hrs
40-49°F	3 lbs	4 hrs	3.5 hrs

### T201-m-4 Plant cuttings (root cuttings)\*

Pest: External feeders

Treatment: T201-m-4 MB (“Q” label only) at NAP—tarpaulin

Temperature	Dosage Rate (lb/1000 ft <sup>3</sup> )	Minimum Concentration Readings (ounces) At:				
		0.5 hr	2.5 hrs	3 hrs	3.5 hrs	4 hrs
90-96°F	2 lbs	24	16	—	—	—
80-89°F	2.5 lbs	30	20	—	—	—
70-79°F	3 lbs	36	24	—	—	—
60-69°F	3 lbs	36	—	24	—	—
50-59°F	3 lbs	36	—	—	24	—
40-49°F	3 lbs	36	—	—	—	24



Important

\*See exceptions to plant cuttings commodity.



Important

Exceptions to Plant Cutting Commodities Treated with T201-m-1, T201-m-2, T201-m-3, and T201-m-4:

- Avocado, see [T201-p](#) on page 5-3-18
- Chrysanthemum, see [T201-g-1](#) on page 5-3-5
- Dieffenbachia, see [T201-i-1](#) on page 5-3-8
- Dracaena, see [T201-i-2](#) on page 5-3-8
- Lavandula, see [T201-p](#) on page 5-3-18
- Orchids, see [T201-k-2](#) on page 5-3-13
- Philodendron, see [T201-i-1](#) on page 5-3-8

### T201-p Plant material not tolerant to fumigation

Three treatments based on pest

Propagative material known to be sensitive to fumigation (see Handbook of Plant Tolerance to Quarantine Treatments) should be handled by the following methods for “quarantine action” pests. The selection of the method will depend upon the character of the plant material and the type of pests that may be found.

## T201-p-1

### Plant material not tolerant to fumigation

Pest: Actionable Pests Excluding Scale Insects

Treatment: **T201-p-1** Hand removal—With the exception of scale insects, hand removal of pests or infested parts and detailed inspection to ensure plants are pest free. If the characteristics of the plant growth, volume, or the type of pest are such that hand removal plus inspection may not provide a pest free shipment, then see **T201-p-2** on page 5-3-19 or **T201-p-3** on page 5-3-20, which follows.

## T201-p-2

### Plant material not tolerant to fumigation

Pest: Actionable Pests

Treatment: **T201-p-2** Hand removal plus chemical dip—Hand removal of pests of infested parts *plus* a malathion-carbaryl chemical dip. Solution prepared by adding 3 level tablespoons of 25% malathion wettable powder and 3 level tablespoons of 50% carbaryl wettable powder to each gallon of water. The addition of a sticker-spreader formulation may be required for hard to wet plants. Use fresh chemicals and prepare dip for the same day use. Plants, including the roots, should be entirely submerged in the chemical dip for 30 seconds.



Important

When the actionable pests are scale insects or their immature crawlers, prepare the solution by adding 4 level tablespoons of 25% malathion wettable powder (if the label allows) and 3 level tablespoons of 50% carbaryl wettable powder to each gallon of water. Labels registered for this concentration are currently available from the following companies:

Micro-Flo Company LLC  
Memphis, TN  
Product: Malathion 25-WP  
EPA Registration No. 051036-00033  
(Tel 901-432-5131)

Cheminova Inc.  
Oak Hill Park  
1700 Route 23, Suite 210  
Wayne, NJ 07470  
Product Fyfanon 25 WP  
EPA Registration No. 067760-00016  
(Tel 201-305-6600)



Methoxychlor (50% wettable powder) may be substituted for carbaryl. Do *not* use methoxychlor on chrysanthemums. Other formulations of malathion, carbaryl, and methoxychlor may be substituted for the ones mentioned in this treatment, provided that the final dilution of the acting ingredients in the dip are the same, by weight. For example, you would need to use twice as much carbaryl wettable powder if the active ingredient were 25% instead of 50%.

### T201-p-3

#### Plant material not tolerant to fumigation

Pest: Actionable Pests

Treatment: **T201-p-3** Hot water treatment—Hot water at 112 °F for 20 minutes. Not effective against all insects. Some plants may not be tolerant.



This treatment is authorized in lieu of fumigation as a precautionary treatment following the hand removal of the visible “action” pests or infected plant parts. This alternative treatment is not recommended for mature scale insects. (Schedule **T201-c-1** on page **5-3-10** is recommended for armored scales and schedule **T201-c-2** on page **5-3-11** is recommended for soft scales.) If hand removal is not feasible or complete, or insecticidal coverage cannot be assured because of volume or nature of the plant material, the importer should be given the options of either fumigating at his own risk or returning shipment to origin.

## T202—Bulbs, Corms, Tubers, Rhizomes, and Roots

### T202-b

#### Astilbe roots

Pest: *Brachyrhinus* larvae

Treatment: T202-b MB (“Q” label only) in 26" vacuum

Temperature	Dosage Rate (lb/1,000 ft <sup>3</sup> )	Exposure Period
70-96°F	4 lbs	2 hrs
60-69°F	4 lbs	2.5 hrs
50-59°F	4 lbs	3 hrs
40-49°F	4 lbs	4 hrs

For roots received in large cases packed in peat moss, temperatures apply to packing materials, if lower than root temperatures.

### T202-c

#### Banana roots

Pest: External feeders

Treatment: T202-c Hot water 110°F for 30 minutes as pretreatment followed by 120°F for 60 minutes. Requires consent of importer. Deny entry without consent unless 100% inspection plus pest removal is feasible.

### T202-j

#### Garlic

For shipments from Algeria, Armenia, Austria, Azerbaijan, Belarus, Bosnia and Hercegovina, Croatia, Czech Republic, Egypt, Estonia, France, Germany, Georgia, Greece, Hungary, Iran, Israel, Italy,

Kazakhstan, Kyrgyzstan, Latvia, Lebanon, Lithuania, Macedonia, Moldova, Morocco, Portugal, Slovakia, Slovenia, Republic of South Africa, Russia, Spain, Switzerland, Syria, Tajikistan, Turkey, Turkmenistan, Ukraine, Uzbekistan, and Yugoslavia.

Pest: ***Brachycerus*** spp. (garlic beetles) and *Dyspessa ulula* (Bkh.) (onion/garlic carpenterworm)

Treatment: T202-j MB (“Q” label only) at 15" vacuum

Temperature	Dosage Rate (lb/1,000 ft <sup>3</sup> )	Exposure Period
90-96°F	2 lbs	1.5 hrs
80-89°F	2 lbs	2 hrs
70-79°F	2.5 lbs	2 hrs
60-69°F	3 lbs	2 hrs
50-59°F	3 lbs	3 hrs
40-49°F	3 lbs	4 hrs



Load limit not to exceed 80% of chamber.



This treatment is a precautionary requirement for *Brachycerus* spp. (garlic beetles) and *Dyspessa ulula* (Bkh.) (onion/garlic carpenterworm).

### T202-e-1

#### ***Gladiolus* spp.**

Two alternative schedules

Pest: *Taeniothrips simplex* (gladiolus thrips)

Treatment: T202-e-1 MB (“Q” label only) at NAP

Temperature	Dosage Rate (lb/1,000 ft <sup>3</sup> )	Exposure Period
90-96°F	2 lbs	3 hrs
80-89°F	2.5 lbs	3 hrs
70-79°F	3 lbs	3 hrs
60-69°F	3 lbs	3.5 hrs
50-59°F	3 lbs	4 hrs
40-49°F	3 lbs	4.5 hrs

**T202-e-2**

***Gladiolus* spp.**

Pest: *Taeniothrips simplex* (gladiolus thrips)

Treatment: T202-e-2 MB (“Q” label only) in 26" vacuum

Temperature	Dosage Rate (lb/1,000 ft <sup>3</sup> )	Exposure Period
90-96°F	2 lbs	2 hrs
80-89°F	2.5 lbs	2 hrs
70-79°F	3 lbs	2 hrs
60-69°F	3 lbs	2.5 hrs
50-59°F	3 lbs	3 hrs
40-49°F	3 lbs	3.5 hrs

**T202-f**

**Horseradish roots**

Mandatory from the following countries:

Armenia, Azerbaijan, Belarus, Bosnia and Hercegovina, Croatia, Czech Republic, Estonia, Georgia, Germany, Hungary, Italy, Kazakhstan, Kyrgyzstan, Latvia, Lithuania, Macedonia, Moldova, Poland, Russia, Slovakia, Slovenia, Tajikistan, Turkmenistan, Ukraine, Uzbekistan, and Yugoslavia

Pest: External feeders

Treatment: T202-f MB in 15" vacuum

Temperature	Dosage Rate (lb/1,000 ft <sup>3</sup> )	Exposure Period:	
		<i>Brachyrhinus</i> larvae	All others
90-96°F	2 lbs	2.5 hrs	2 hrs
80-89°F	2.5 lbs	2.5 hrs	2 hrs
70-79°F	3 lbs	2.5 hrs	2 hrs
60-69°F	3 lbs	3 hrs	2.5 hrs
50-59°F	3 lbs	3.5 hrs	3 hrs
40-49°F	3 lbs	4 hrs	3.5 hrs

## T202-g

### Lily bulbs packed in subsoil

Pest: Internal feeders

Treatment: T202-g MB ("Q" label only) at NAP

Temperature	Dosage Rate (lb/1,000 ft <sup>3</sup> )	Exposure Period
90-96°F	2 lbs	3 hrs
80-89°F	2.5 lbs	3 hrs
70-79°F	3 lbs	3 hrs
60-69°F	3 lbs	3.5 hrs
50-59°F	3 lbs	4 hrs
40-49°F	3 lbs	4.5 hrs

Load limit 50% of chamber volume. Remove all wooden case covers. Overnight or longer aeration advisable.

## T202-h

### Lycoris

Pest: *Taeniothrips eucharii*

Treatment: T202-h MB in 26" vacuum

Temperature	Dosage Rate (lb/1,000 ft <sup>3</sup> )	Exposure Period:	
		<i>Brachyrhinus</i> larvae	All others
90-96°F	2 lbs	2.5 hrs	2 hrs
80-89°F	2.5 lbs	2.5 hrs	2 hrs
70-79°F	3 lbs	2.5 hrs	2 hrs
60-69°F	3 lbs	3 hrs	2.5 hrs
50-59°F	3 lbs	3.5 hrs	3 hrs
40-49°F	3 lbs	4 hrs	3.5 hrs

## T202-i-1

### Narcissus

Pest: *Steneotarsonemus laticeps* (bulb scale mite)

Treatment: T202-i-1 MB ("Q" label only) at NAP

Temperature	Dosage Rate (lb/1,000 ft <sup>3</sup> )	Exposure Period
90-96°F	3 lbs	2 hrs
80-89°F	3.5 lbs	2 hrs
70-79°F	4 lbs	2 hrs
60-69°F	4 lbs	2.5 hrs
50-59°F	4 lbs	3 hrs
40-49°F	4 lbs	3.5 hrs

### T202-i-2

#### *Narcissus*

Pest: *Steneotarsonemus laticeps* (bulb scale mite)

Treatment: T202-i-2 MB (“Q” label only) in 26" vacuum chamber

Temperature	Dosage Rate (lb/1,000 ft <sup>3</sup> )	Exposure Period
90-96°F	2 lbs	2 hrs
80-89°F	2.5 lbs	2 hrs
70-79°F	3 lbs	2 hrs
60-69°F	3 lbs	2.5 hrs
50-59°F	3 lbs	3 hrs
40-49°F	3 lbs	3.5 hrs

### T202-i-3

#### *Narcissus*

Pest: *Steneotarsonemus laticeps* (bulb scale mite)

Treatment: T202-i-3 Hot water, 110-111°F for 1 hour



Exposure measured from time bulbs reach 110°F pulp temperature. Hot water should be applied *within 1 month after normal harvest*, or flower bud injury may develop.

### T202-a-1

#### *Selaginella* spp. (Resurrection plants)

Pest: External feeders

Treatment: T202-a-1 MB (“Q” label only) at NAP—Chamber

Temperature	Dosage Rate (lb/1,000 ft <sup>3</sup> )	Exposure Period:	
		<i>Brachyrhinus</i> larvae	All others
90-96°F	2 lbs	2.5 hrs	2 hrs
80-89°F	2.5 lbs	2.5 hrs	2 hrs
70-79°F	3 lbs	2.5 hrs	2 hrs
60-69°F	3 lbs	3 hrs	2.5 hrs
50-59°F	3 lbs	3.5 hrs	3 hrs
40-49°F	3 lbs	4 hrs	3.5 hrs



### T202-a-2

### *Selaginella* spp. (Resurrection plants)

Pest: External feeders

Treatment: T202-a-2 MB (“Q” label only) at NAP—Tarpaulin

Temperature	Dosage Rate (lb/1000 ft <sup>3</sup> )	Minimum Concentration Readings (ounces) At:				
		0.5 hr	2.5 hrs	3 hrs	3.5 hrs	4 hrs
90-96°F	2 lbs	24	16	—	—	—
80-89°F	2.5 lbs	30	20	—	—	—
70-79°F	3 lbs	36	24	—	—	—
60-69°F	3 lbs	36	—	24	—	—
50-59°F	3 lbs	36	—	—	24	—
40-49°F	3 lbs	36	—	—	—	24

### T202-a-3

### *Selaginella* spp. (Resurrection plants)

Pest: Internal feeders

Treatment: T202-a-3 MB (“Q” label only) in 26" vacuum—chamber

Temperature	Dosage Rate (lb/1,000 ft <sup>3</sup> )	Exposure Period:	
		<i>Brachyrhinus</i> larvae	All others
90-96°F	2 lbs	2.5 hrs	2 hrs
80-89°F	2.5 lbs	2.5 hrs	2 hrs
70-79°F	3 lbs	2.5 hrs	2 hrs
60-69°F	3 lbs	3 hrs	2.5 hrs
50-59°F	3 lbs	3.5 hrs	3 hrs
40-49°F	3 lbs	4 hrs	3.5 hrs

### T202-d

### Yams (*Dioscorea* spp.) and Sweet Potatoes (*Ipomoea* spp.)

Pest:

Treatment: T202-d MB (“Q” label only) at NAP

Temperature	Dosage Rate (lb/1,000 ft <sup>3</sup> )	Exposure Period
90-96°F	2.5 lbs	4 hrs
80-89°F	3 lbs	4 hrs
70-79°F	3.5 lbs	4 hrs
60-69°F	4 lbs	4 hrs

**NOTICE**

Temperatures below 70°F may cause injury to yams. Fumigations below 70°F should only be made with consent of importer. The tuberous roots should be cured, free from surface moisture, and held at fumigation temperatures for 24 hours following treatment. Mandatory for yams for all foreign countries except Japan, Dominican Republic into Puerto Rico, and all of the West Indies into the U.S. Virgin Islands. Also, for interstate movement of sweet potatoes from Hawaii.

## T203—seeds

### T203-m

#### Avocado (seeds only, without pulp)

Pest: Avocado seed weevils (*Conotrachelus* spp., *Heilipus lauri*, and *Caulophilus latusus*); avocado stem weevil (*Copturus aguacatae*), and avocado seed moth (*Stenomoma catenifer*)

Treatment: T203-m MB (“Q” label only) at 26" vacuum

Temperature	Dosage Rate (lb/1,000 ft <sup>3</sup> )	Exposure Period
90-96°F	2 lbs	2 hrs
80-89°F	3 lbs	2 hrs
70-79°F	4 lbs	2 hrs
60-69°F	4 lbs	3 hrs
50-59°F	4 lbs	4 hrs
40-49°F	4 lbs	5 hrs

### T203-e

#### Chestnuts (does not include water chestnuts) and Acorns

From all countries except Canada and Mexico

Pest: Internal feeders

Treatment: T203-e (mandatory treatment) MB (“Q” label only) at 26" vacuum

Temperature	Dosage Rate (lb/1,000 ft <sup>3</sup> )	Exposure Period
80-96°F	3 lbs	2 hrs
70-79°F	4 lbs	2 hrs
60-69°F	4 lbs	3 hrs
50-59°F	4 lbs	4 hrs
40-49°F	4 lbs	5 hrs

### T203-i-1

#### Conifer seeds (species with small seeds, such as *Picea* spp., *Pinus sylvestris*, and *Pinus mugo*)

Two schedules based on type of pest

For species with small seeds, such as *Picea* spp., *Pinus sylvestris*, and *Pinus mugo*, in bags containing 75 lbs. draw an initial vacuum of at least 24 inches. Once the MB is introduced, then reduce the vacuum to NAP. This procedure is necessary for efficient penetration and distribution of the fumigant. Conifer seeds in bags of more than 75 lbs. each should be aerated in a well ventilated area for 24 hours, small seeds should be aerated for 48 hours.

Pest: External feeders

Treatment: T203-i-1 MB (“Q” label only) at NAP

Temperature	Dosage Rate (lb/1,000 ft <sup>3</sup> )	Exposure Period
80-96°F	2.5 lbs	2.5 hrs
70-79°F	3 lbs	2.5 hrs
60-69°F	3 lbs	3 hrs
50-59°F	3 lbs	3.5 hrs
40-49°F	3 lbs	4 hrs



**Important**

Load limit is 30% of chamber space. Moisture should not be added in fumigation of dry seeds.

## T203-i-2

### Conifer seeds (species with small seeds, such as *Picea* spp., *Pinus sylvestris*, and *Pinus mugo*)

Pest: Internal feeders, nutlike seeds, or when seeds are tightly packed so as to make fumigant penetration questionable.

Treatment: T203-i-2 MB (“Q” label only) in 26" vacuum

Temperature	Dosage Rate (lb/1,000 ft <sup>3</sup> )	Exposure Period
80-96°F	2.5 lbs	2.5 hrs
70-79°F	3 lbs	2.5 hrs
60-69°F	3 lbs	3 hrs
50-59°F	3 lbs	3.5 hrs
40-49°F	3 lbs	4 hrs



**Important**

Load limit is 50% of chamber space. Plastic or impermeable liners should be removed or well perforated. This schedule is not entirely effective against some species of Chalcid wasps.

### T203-f-1 Cottonseed—bagged, packaged, or in bulk

Four alternative schedules

Pest: External feeders

Treatment: T203-f-1 MB ("Q" label only) at NAP—chamber

Temperature	Dosage Rate (lb/1,000 ft <sup>3</sup> )	Exposure Period
60°F or above	6 lbs	12 hrs
OR	3 lbs	24 hrs
40-59°F	7 lbs	12 hrs
OR	4 lbs	24 hrs



Important

Load limit is 50% of chamber volume.

### T203-f-2 Cottonseed—bagged, packaged, or in bulk

Pest: External feeders

Treatment: T203-f-2 MB ("Q" label only) at NAP—tarpaulin

Temperature	Dosage Rate (lb/1000 ft <sup>3</sup> )	Minimum Concentration Readings (ounces) At:			
		0.5 hr	2 hrs	12 hrs	24 hrs
60°F or above	7 lbs	54	56	27	—
OR	5 lbs	40	40	—	20
40-59°F	8 lbs	64	64	32	—
OR	6 lbs	48	48	—	24

### T203-f-3 Cottonseed—bagged, packaged, or in bulk

Pest: External feeders

Treatment: T203-f-3 MB ("Q" label only) at 26" vacuum—chamber

Temperature	Dosage Rate (lb/1,000 ft <sup>3</sup> )	Exposure Period
40°F or above	4 lbs	2 hrs



Important

Load limit is 50% of chamber volume.

### T203-f-4

### Cottonseed—bagged, packaged, or in bulk

Pest: External feeders

Treatment: T203-f-4 Phosphine at NAP

Temperature	Dosage Rate (gms/cu meter)	Minimum Concentration Readings (ppm) At:	
		72 hrs	120 hrs
50°F or above	2.1 g	225 <sup>1</sup>	50 or above

<sup>1</sup> An average reading with no reading less than 50 ppm.

Relative humidity must be 40% or higher when commodity enclosed.

Aerate minimum of 24 hours.

### T203-g-1

### Pods and seed of Kenaf, Hibiscus, and Okra

Three alternative schedules

Pest: Internal feeders

Treatment: T203-g-1 MB (“Q” label only) at NAP—tarpaulin or chamber

Temperature	Dosage Rate (lb/1000 ft <sup>3</sup> )	Minimum Concentration Readings (ounces) At:		
		0.5 hr	12 hrs	24 hrs
60-96°F	2 lbs	24	12	—
OR	1 lb	12	—	5
40-59°F	3 lbs	36	17	—
OR	2 lbs	24	—	10

### T203-g-2

### Pods and seed of Kenaf, Hibiscus, and Okra

Pest: Internal feeders

Treatment: T203-g-2 MB (“Q” label only) in 26" vacuum—chamber  
(kenaf and okra seed only)

Temperature	Dosage Rate (lb/1,000 ft <sup>3</sup> )	Exposure Period
40°F or above	4 lbs	2 hrs



**Important**

Load limit is 50% of chamber volume.

### T203-g-3

### Pods and seed of Kenaf, Hibiscus, and Okra

Pest: Internal feeders

Treatment: T203-g-3 Phosphine at NAP

Temperature	Dosage Rate (gms/cu meter)	Minimum Concentration Readings (ppm) At:	
		72 hrs	120 hrs
50°F or above	2.1 g	225*	50



\*An average reading with no reading less than 50 ppm.

Relative humidity must be 40% or higher when commodity enclosed.

Aerate minimum of 24 hours.

### T203-k

### Macadamia nuts (as seeds)

Pest: *Cryptophlebia illepidia* (koa seedworm)

Treatment: T203-k MB (“Q” label only) at NAP

Temperature	Dosage Rate (lb/1,000 ft <sup>3</sup> )	Exposure Period
70°F or above	2 lbs	2 hrs
60-69°F	2.5 lbs	2 hrs
50-59°F	3 lbs	2 hrs
40-49°F	3.5 lbs	2 hrs

### T203-h

### Rosmarinus seeds

Pest: Juvenile *Helicella* spp. (snails) or Internal Feeders

Treatment: T203-h MB (“Q” label only) at 26" vacuum

Temperature	Dosage Rate (lb/1,000 ft <sup>3</sup> )	Exposure Period
70°F or above	4 lbs	4 hrs

### T203-l

### seeds

Pest: *Trogoderma granarium* (khapra beetle)

Treatment: T203-l MB (“Q” label only) at NAP—tarpaulin or chamber

Temperature	Dosage Rate (lb/1000 ft <sup>3</sup> )	Minimum Concentration Readings (ounces) At:			
		0.5 hr	2 hrs	4 hrs	12 hrs
90°F or above	2.5 lbs	30	20	20	15
80-89°F	3.5 lbs	42	30	30	20



If seed is intended for propagation, this dosage rate may damage seed by sterilization.

**T203-b seeds excluding seeds of *Vicia* spp.**

Pest: Bruchidae (seed beetles) excluding the beetles of *Caryedon* spp.

Treatment: T203-b MB (“Q” label only) in 26" vacuum

Temperature	Dosage Rate (lb/1,000 ft <sup>3</sup> ):		Exposure Period:	
	<i>Caryedon</i> spp.	All others	<i>Caryedon</i> spp.	All others
70-96°F	5 lbs	3 lbs	2 hrs	2.5 hrs
60-69°F	—	3 lbs	—	3 hrs
50-59°F	—	3 lbs	—	3.5 hrs
40-49°F	—	3 lbs	—	4 hrs

**T203-o** (deleted)

**T203-a-1 Seeds not specifically listed in the T203 Schedules**

Pest: External feeders

Treatment: T203-a-1 MB (“Q” label only) at NAP

Temperature	Dosage Rate (lb/1,000 ft <sup>3</sup> )	Exposure Period
80-96°F	2.5 lbs	2.5 hrs
70-79°F	3 lbs	2.5 hrs
60-69°F	3 lbs	3 hrs
50-59°F	3 lbs	3.5 hrs
40-49°F	3 lbs	4 hrs

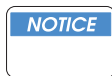

Load limit is 30% of chamber space. Moisture should *not* be added in fumigation of dry seeds. Normally, dry seed shipments arriving in wet or damp condition may be injured. This schedule may scald coconut husks. (Some tropical or nutlike seeds are usually shipped damp.)

## T203-a-2 Seeds not specifically listed in the T203 Schedules

Pest: Internal feeders

Treatment: T203-a-2 MB (“Q” label only) in 26" vacuum

Temperature	Dosage Rate (lb/1,000 ft <sup>3</sup> )	Exposure Period
80-96°F	2.5 lbs	2.5 hrs
70-79°F	3 lbs	2.5 hrs
60-69°F	3 lbs	3 hrs
50-59°F	3 lbs	3.5 hrs
40-49°F	3 lbs	4 hrs



**Important**

Load limit is 50% of chamber space. Plastic or impermeable liners should be removed or well perforated.

## T203-o-1 Seeds of *Casuarina*

Pest: *Bootanomyia* spp. (in *Casuarina*)

Treatment: T203-o-1 MB (“Q” label only) in 26" vacuum

Temperature	Dosage Rate (lb/1,000 ft <sup>3</sup> )	Exposure Period
70°F or above	3.5 lbs	6 hrs

## T203-j Seeds of *Hevea brasiliensis* (rubber tree)

Pest: seed-boring insects

Treatment: T203-j MB (“Q” label only) at NAP

Temperature	Dosage Rate (lb/1,000 ft <sup>3</sup> )	Exposure Period
80-96°F	2.5 lbs	2 hrs
70-79°F	3 lbs	2 hrs
60-69°F	3 lbs	2.5 hrs

## T203-o-3 Seeds of *Leguminosae = Fabaceae*

Pest: *Bruchophagus* spp., *Eurytoma* spp.

Treatment: T203-o-3 MB (“Q” label only) in 26" vacuum

Temperature	Dosage Rate (lb/1,000 ft <sup>3</sup> )	Exposure Period
70°F or above	4 lbs	4 hrs



Two alternative schedules

**T203-c**

**Seeds of Leguminosae = Fabaceae, etc.**

Pest: *Caryedon* spp.

Treatment: T203-c MB (“Q” label only) at NAP

Temperature	Dosage Rate (lb/1,000 ft <sup>3</sup> )	Exposure Period
50°F or above	2 lbs	24 hrs

Alternative treatment: T203-a-2 (under 26" vacuum)

**T203-o-4-1**

**Seeds of Leguminosae = Fabaceae**

Pest: *Caryedon* spp. (in or with, etc.)

Treatment: T203-o-4-1 MB (“Q” label only) in 26" vacuum

Temperature	Dosage Rate (lb/1,000 ft <sup>3</sup> )	Exposure Period
50°F or above	2 lbs	24 hrs

**T203-o-4-2**

**Seeds of Leguminosae = Fabaceae**

Pest: *Caryedon* spp. (in or with, etc.)

Treatment: T203-o-4-2 MB (“Q” label only) in 26" vacuum

Temperature	Dosage Rate (lb/1,000 ft <sup>3</sup> )	Exposure Period
70°F or above	3.5 lbs*	3 hrs

**T203-o-5**

**Seeds of *Lonicera* and Other seeds**

Pest: *Rhagoletis cerasi* (European cherry fruit fly) pupae (Diptera: Tephritidae)

Treatment: T203-o-5 MB (“Q” label only) at NAP

Temperature	Dosage Rate (lb/1,000 ft <sup>3</sup> )	Exposure Period
70°F or above	4 lbs*	8 hrs



\*If seed is intended for propagation, the dosage rate may damage seed by sterilization.

**T203-p**

**Seeds of Citrus (Rutaceae family)**

Pest: Citrus Canker (*Xanthomonas citri*)

Treatment: T203-p Hot water plus Chemical Dip

1. Wash the seed if any mucilaginous material, such as pulp, is adhering to the seed.
2. Immerse the seed in water heated to 125°F (51.6°C) or higher for 10 minutes.
3. Then, immerse the seed in a solution containing 200 parts per million sodium hypochlorite at a pH of 6.0 to 7.5 for at least 2 minutes.

### T203-o-2

#### Seeds of *Umbelliferae*

Pest: *Systole* spp. (in Umbelliferae)

Treatment: T203-o-2 MB (“Q” label only) in 26" vacuum

Temperature	Dosage Rate (lb/1,000 ft <sup>3</sup> )	Exposure Period
80-86°F	2.5 lbs	3.5 hrs
70-79°F	3 lbs	3.5 hrs
60-69°F	3 lbs	4 hrs
50-59°F	3 lbs	4.5 hrs
40-49°F	3 lbs	5 hrs

### T203-d-1

#### Seeds of *Vicia* spp. (vetch seeds) excluding seeds of *Vicia faba*

Pest: Bruchidae (seed beetles)

Treatment: T203-d-1 MB (“Q” label only) at NAP

Temperature	Dosage Rate (lb/1000 ft <sup>3</sup> )	Minimum Concentration Readings (ounces) At:					
		0.5 hr	2 hrs	11 hrs	12 hrs	13 hrs	14 hrs
70°F or above	3.5 lbs	46	28	27	—	—	—
60-69°F	3.5 lbs	46	28	—	27	—	—
50-59°F	3.5 lbs	46	28	—	—	27	—
40-49°F	3.5 lbs	46	28	—	—	—	27

### T203-d-2

#### Seeds of *Vicia* spp. (vetch seeds) including seeds of *Vicia faba*

Pest: Bruchidae (seed beetles)

Treatment: T203-d-2 MB (“Q” label only) in 26" vacuum

Temperature	Dosage Rate (lb/1,000 ft <sup>3</sup> )	Exposure Period:	
		<i>Vicia faba</i>	All others
70-96°F	3 lbs	3.5 hrs	2.5 hrs
60-69°F	3 lbs	4 hrs	3 hrs
50-59°F	3 lbs	4.5 hrs	3.5 hrs
40-49°F	3 lbs	5 hrs	4 hrs



Seed shipments arriving wet or damp may be injured.

## T203-n

### Seeds with infested pulp

Pest: Fruit flies and other pulp infesting insects

Treatment: T203-n Depulping

1. Place seed in wire basket.
2. Immerse in water at 118-125°F for 25 minutes.
3. Remove pulp from seed under running tap water.



This treatment is effective only for fruit flies, as well as some other pulp infesting insects. Fumigation may also be required for seed weevils and other internal and external feeding insects.



# 5

Treatment Manual

## Treatment Schedules

### *T300 - Schedules for Miscellaneous Plant Products*

#### Contents

The following schedules are listed by product.

- T301—Cotton and Cotton Products [page-5-4-2](#)
- T302—Grains and Seeds Not Intended for Propagation [page-5-4-8](#)
- T303—Rice [page-5-4-13](#)
- T304—Alpha (alfa) Grass and Handicrafts (*Stipa tenacissima*, *Ampelodesma mauritanicus*) [page-5-4-16](#)
- T305—Cut Flowers and Greenery [page-5-4-16](#)
- T306—Bags and Bagging Material, Covers [page-5-4-18](#)
- T307—Khapra Beetle Infested Material [page-5-4-21](#)
- T308—Tobacco, for Export [page-5-4-21](#)
- T309—Broomcorn and Broomcorn Articles [page-5-4-25](#)
- T310—Tick-Infested Materials (Nonfood) [page-5-4-26](#)
- T311—Hay, Baled [page-5-4-27](#)
- T312—Oak Logs and Lumber [page-5-4-28](#)
- T313—Christmas Trees [page-5-4-36](#)
- T314—Logs and Firewood [page-5-4-37](#)



Exposure period may be extended for any commodity which *cannot* be used for food or propagation. This extension is only a matter of convenience for the importer and is intended only for the purpose of reducing treatment costs. The request for extension must come from the importer or his authorized representative and should be confirmed in writing. A letter is not required for each treatment. A single blanket request should be considered as acceptable and renewed each year as required.

During the extended exposure period, the concentrations must remain stable and the prescribed minimums be met at the end of the extension. Otherwise, the treatment may be voided and retreatment required. Examples of commodities for which extended exposure periods may be approved include: cotton piece goods, baled cotton, bagging, wood, marble, soil as such, etc. Examples of commodities for which *no* extension may be approved include: cottonseed, grain, tobacco, etc. An extension of exposure period for other purposes is not permitted except as may be prescribed in various schedules for concentration readings below minimum.

Additional safety precautions, including additional aeration, may be required because of the extended exposure period. The PPQ officer or the commercial fumigator will specify any needed precautions.

## T301—Cotton and Cotton Products

### T301-a-3 Baled lint or linters

Pest: *Pectinophora* spp.

Treatment: T301-a-3—MB (“Q” label only) at NAP—tarpaulin

Temperature	Dosage Rate (lb/1,000 ft <sup>3</sup> )	Minimum Concentration Readings (ounces) At:			
		0.5 hr	2 hrs	12 hrs	24 hrs
40°F or above	7 lbs	84	60	30	—
OR	4 lbs	60	40	—	20

### T301-b-1-1 Baled lint, linters, waste, piece goods, gin trash

Two alternative treatments

Pest: *Trogoderma granarium* (khapra beetle)

Treatment: T301-b-1-1—MB (“Q” label only) at NAP—tarpaulin

Temperature	Dosage Rate (lb/1,000 ft <sup>3</sup> )	Minimum Concentration Readings (ounces) At:		
		0.5 hr	2 hrs	24 hrs*
60°F or above	8 lbs	96	64	35
40-59°F	11 lbs	132	88	50

\*In addition to the space concentration readings, you must take a commodity concentration reading. The minimum concentration reading for commodity reading is as follows: For 60°F or above—25 oz.; for 40-59°F—30 oz.



Load limit is 50% of chamber volume. Concentration readings may be omitted for chamber fumigations.

### T301-b-1-2 Baled lint, linters, waste, piece goods, gin trash

Pest: *Trogoderma granarium* (khapra beetle)

Treatment: T301-b-1-2—MB (“Q” label only) at NAP—chamber

Temperature	Dosage Rate (lb/1,000 ft <sup>3</sup> )	Exposure Period
60°F or above	8 lbs	3 hrs
40-59°F	9 lbs	3 hrs

### T301-a-7 Cottonseed (samples and bulk)

Pest: *Pectinophora* spp.

Treatment: T301-a-7—Acid delinting and heat treatment (alternative treatment)

Cottonseed delinting is primarily intended for the elimination of surface-borne disease organisms. It is also effective against insects. To be completely effective against insects, this treatment must be carried out at approximately 145°F (by the application of sufficient heat to the seed, or acid, or both) or by raising the temperature of the delinted seed during the subsequent drying process to 145°F for a period of not less than 45 seconds or at least 140°F for a period of not less than 8 minutes.



This treatment schedule is not applicable to cottonseed infested with boll weevil, *Anthonomus grandis*.

Also, this treatment largely destroys the cottonseed's ability to germinate.

### T301-b-2

### Cottonseed, cottonseed products, or samples

Pest: *Trogoderma granarium* (khapra beetle)

Treatment: T301-b-2—MB ("Q" label only) at NAP—tarpaulin

Temperature	Dosage Rate (lb/1,000 ft <sup>3</sup> )	Minimum Concentration Readings (ounces) At:		
		0.5 hr	2 hrs	12 hrs
90°F or above	2.5 lbs	30	20	15
80-89°F	3.5 lbs	42	30	20

The sorptive rates of commodities vary. When a commodity is known or suspected to be sorptive, take more gas readings than normal. Additional fumigant is added as prescribed on [Special Procedures for Adding Gas and Extending Exposure Period](#) on [page 2-4-24](#).



Items known to be sorptive or items whose sorptive properties are unknown are not to be fumigated in chambers at NAP unless gas readings are taken.

When both woodborers and khapra beetles are involved, use schedule [T404-d](#) on [page 5-5-19](#).



Cottonseed products (other than cottonseed) treated under this schedule are not to be used for food or feed.

### T301-b-3

### Cottonseed meal

Pest: *Trogoderma granarium* (khapra beetle)

Treatment: T301-b-3—MB ("Q" label only) at NAP



Concentration readings should be obtained within the commodity.  
 Concentration readings not required for chamber fumigations.

Temperature	Dosage Rate (lb/1,000 ft <sup>3</sup> )	Minimum Concentration Readings (ounces) At:				
		0.5 hr	2 hrs	24* hrs	28* hrs	32* hrs
90°F or above	4 lbs	48	32	25	—	—
80-89°F	6 lbs	72	48	30	—	—
70-79°F	8 lbs	96	64	35	—	—

\*In addition to the space concentration readings, you must take a commodity concentration reading. The minimum concentration reading for commodity reading is as follows: For 90-96°F—10 oz.; for 80-89°F—15 oz.; and for 70-79°F—20 oz.

\*\*Optional



Cottonseed meal treated with this schedule is not to be used for food or feed.

### T301-c Cotton and cotton products

Pest: *Globodera rostochiensis* (golden nematode)

Treatment: T301-c—MB (“Q” label) at NAP—chamber

Temperature	Dosage Rate (lb/1,000 ft <sup>3</sup> )	Exposure Period
40°F or above	8 lbs	16 hrs
	10.5 lbs	12 hrs

### T301-d-1-1 Cotton and cotton products

Two alternative treatments

Pest: *Anthonomus grandis* (boll weevil)

Treatment: T301-d-1-1—MB (“Q” label only) at NAP—tarpaulin

Temperature	Dosage Rate (lb/1,000 ft <sup>3</sup> )	Minimum Concentration Readings (ounces) At:				
		0.5 hr	2 hrs	3 hrs	4 hrs	8 hrs
90°F or above	2.5 lbs	30	20	—	—	—
80-89°F	3 lbs	36	28	—	—	—
70-79°F	4 lbs	48	36	—	—	—
60-69°F	4 lbs	50	—	34	—	—
55-59°F	5 lbs	64	—	48	—	—
50-54°F	5.5 lbs	70	—	—	50	—
40-49°F	6 lbs	80	—	—	54	40



### T301-d-1-2

### Cotton and cotton products

Pest: *Anthonomus grandis* (boll weevil)

Treatment: T301-d-1-2—Phosphine at NAP—tarpaulin or chamber

Temperature	Dosage Rate (g/1,000 ft <sup>3</sup> )	Minimum Concentration Readings (ppm) At 72 hours:
50°F or above	36 g*	225**

\*36g/1,000ft<sup>3</sup> (28.3m<sup>3</sup>) is equivalent to 1.27 g/m<sup>3</sup>.

\*\*An average reading with no reading less than 50 ppm.



Refer to the Equipment Section for a description of the MityVac pump and the Port-a-sens phosphine detector.



Refer to [Table 5-4-3](#) on [page 5-4-38](#) for data on amount of phosphine liberated by various products.

### T301-a-1-1

### Lint, linters, cottonseed, cottonseed hulls, gin trash, waste, cottonseed meal, or other baled or bulk commodities (except samples)

Pest: *Pectinophora* spp.

Treatment: T301-a-1-1—MB (“Q” label only) at NAP—chamber

Temperature	Dosage Rate (lb/1,000 ft <sup>3</sup> ) for:		Exposure Period
	Bulk shipments	Other than bulk shipments	
60°F or above	6 lbs	6 lbs	12 hrs
OR	4 lbs	3 lbs	24 hrs
40-59°F	7 lbs	7 lbs	12 hrs
OR	5 lbs	4 lbs	24 hrs

**T301-a-1-2 Lint, linters, cottonseed, cottonseed hulls, gin trash, waste, cottonseed meal, or other baled or bulk commodities (except samples)**

Pest: *Pectinophora* spp.

Treatment: T301-a-1-2—MB (“Q” label only) in 26” vacuum—chamber

Temperature	Dosage Rate (lb/1,000 ft <sup>3</sup> )	Exposure Period
60°F or above	8 lbs	3 hrs
40-59°F	9 lbs	3 hrs

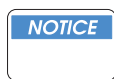

For propagative seed cotton, refer to [T203-f1](#) on page 5-3-28 through [T203-f4](#) on page 5-3-29.

**T301-a-6 Lint, linters, and cottonseed (bulk, sacked, or packaged cottonseed, lint or linters, cottonseed hulls, gin trash, and all other baled or bulk cotton commodities)**

Pest: *Pectinophora* spp.

Treatment: T301-a-6—Phosphine at NAP

Temperature	Dosage Rate (g/1,000 ft <sup>3</sup> )	Minimum Concentration Readings (ppm) At:	
		72 hrs	120 hrs
50°F or above	60 g*	225**	50***

\* 60 g/1,000ft<sup>3</sup> (28.3m<sup>3</sup>) is equivalent to 2.1g/m<sup>3</sup>.  
\*\* An average reading with no reading less than 50 ppm.  
\*\*\*An average of 50 PPM or more.

Aerate commodity 24 hours and/or make appropriate tests for presence of gas.



Refer to [Table 5-4-3](#) on page 5-4-38 for data on amount of phosphine liberated by various products.  
Refer to [Equipment](#) on page 8-1-1 for a description of the MityVac pump and the Port-a-sens phosphine detector.

**T301-a-2 Lint (except baled lint or linters), cottonseed (except packaged cottonseed), cottonseed hulls, gin trash, waste, cottonseed meal, or other baled or bulk commodities (excluding samples)**

Pest: *Pectinophora* spp.

Treatment: T301-a-2—MB (“Q” label only) at NAP—tarpaulin

Temperature	Dosage Rate (lb/1,000 ft <sup>3</sup> )	Minimum Concentration Readings (ounces) At:			
		0.5 hr	2 hrs	12 hrs	24 hrs
40°F or above	7 lbs	84	60	30	—
OR	5 lbs	60	40	—	20

**T301-a-4 Packaged cottonseed**

Pest: *Pectinophora* spp.

Treatment: T301-a-4—MB (“Q” label only) at NAP—tarpaulin

Temperature	Dosage Rate (lb/1,000 ft <sup>3</sup> )	Minimum Concentration Readings (ounces) At:			
		0.5 hr	2 hrs	12 hrs	24 hrs
40°F or above	7 lbs	84	60	30	—
OR	5 lbs	60	40	—	20

**T301-a-5-1 Samples of cotton and cotton products**

Two alternative treatments

Pest: *Pectinophora* spp.

Treatment: T301-a-5-1—MB at NAP—chamber

Temperature	Dosage Rate (lb/1,000 ft <sup>3</sup> )	Exposure Period
40°F or above	3 lbs	24 hrs

**T301-a-5-2 Samples of cotton and cotton products**

Pest: *Pectinophora* spp.

Treatment: T301-a-5-2—MB in 26" vacuum—chamber

Temperature	Dosage Rate (lb/1,000 ft <sup>3</sup> )	Exposure Period
40°F or above	4 lbs	2 hrs

## T302—Grains and Seeds Not Intended for Propagation



**Important**

If grain and seeds for propagation, use appropriate treatment in T203 schedules

### T302-g-1

#### Acorns not intended for propagation

Two alternative treatments

Pest: *Cydia splendana* (nut fruit tortrix) and *Curculio* spp. (weevils)

Treatment: T302-g-1—MB at NAP—tarpaulin, chamber, or van container

Temperature	Dosage Rate (lb/1,000 ft <sup>3</sup> )	Minimum Concentration Readings (ounces) At:					
		0.5 hr	2 hrs	3 hrs	4 hrs	5 hrs	6 hrs
90-95°F	4 lbs	58	32	34	—	—	—
80-89°F	4 lbs	58	32	—	34	—	—
70-79°F	5 lbs	72	40	—	42	—	—
60-69°F	5 lbs	72	40	—	—	40	—
50-59°F	6 lbs	85	48	—	—	50	—
40-49°F	6 lbs	85	48	—	—	—	48

### T302-g-2

#### Acorns not intended for propagation

Pest: *Cydia splendana* (nut fruit tortrix) and *Curculio* spp. (weevils)

Treatment: T302-g-2—MB in 26" vacuum—chamber

Temperature	Dosage Rate (lb/1,000 ft <sup>3</sup> )	Exposure Period
80-96°F	3 lbs	2 hrs
70-79°F	4 lbs	2 hrs
60-69°F	4 lbs	3 hrs
50-59°F	4 lbs	4 hrs
40-49°F	4 lbs	5 hrs



**Important**

Either T302-g-1 or T302-g-2 required from all countries except Canada and Mexico. Treated commodity not to be used for food or feed.

### T302-a-1-1

#### Ear corn

Two alternative treatments

Pest: Borers

Treatment: T302-a-1-1—MB at NAP—chamber only

Temperature	Dosage Rate (lb/1,000 ft <sup>3</sup> )	Exposure Period
70°F or above	2 lbs	6 hrs

### T302-a-1-2

#### Ear corn

Pest: Borers

Treatment: T302-a-1-2—Dry heat

168°F minimum air temperature for not less than 2 hours; ears spread in single layers on slats or wire shelves.

### T302-c-1

#### Grains and seeds not intended for propagation (e.g., guar “gum”)

Pest: *Trogoderma granarium* (Khapra beetle)

Treatment: T302-c-1—MB (“Q” gas only) at NAP—tarpaulin.

Temperature	Dosage Rate (lb/1,000 ft <sup>3</sup> )	Minimum Concentration Readings (ounces) At:		
		0.5 hr	2 hrs	12 hrs
90°F or above	2.5 lbs	30	20	15
80-89°F	3.5 lbs	42	30	20
70-79°F	4.5 lbs	54	40	25
60-69°F	6 lbs	72	50	30
50-59°F	7.5 lbs	90	60	35
40-49°F	9 lbs	108	70	40

The sorptive rates of commodities vary. When a commodity is known or suspected to be sorptive (see [T307-a](#) on [page 5-4-21](#)), take more gas readings than normal. Additional fumigant is added as prescribed on [Aerating Sorptive Commodities in Containers—Indoors and Outdoors](#) on [page 2-4-45](#).



Important

Items known to be sorptive or items whose sorptive properties are unknown are not to be fumigated in chambers at NAP unless gas readings are taken.

When both woodborers and khapra beetles are involved, use schedule [T404-d](#) on [page 5-5-19](#).

### T302-c-2

#### Grains and seeds not intended for propagation(e.g., guar “gum”)

NOTE: Load limit is 75% of chamber volume.

Pest: *Trogoderma granarium* (Khapra beetle)  
Treatment: T302-c-2—MB (“Q” label gas) in 26” vacuum—chamber

Temperature	Dosage Rate (lb/1,000 ft <sup>3</sup> )	Exposure Period
60°F or above	8 lbs	3 hrs
40-59°F	9 lbs	3 hrs

### T302-c-3

#### Grains and seeds not intended for propagation (e.g., guar “gum”)

Pest: *Trogoderma granarium* (Khapra beetle)  
Treatment: T302-c-3—MB (“Q” gas only) in 26” NAP—chamber

Temperature	Dosage Rate (lb/1,000 ft <sup>3</sup> )	Exposure Period
90-96°F	2.5 lbs	12 hrs
80-89°F	3.5 lbs	12 hrs
70-79°F	4.5 lbs	12 hrs
60-69°F	6 lbs	12 hrs
50-59°F	10 lbs	12 hrs
40-49°F	12 lbs	12 hrs

The sorptive rates of commodities vary. When a commodity is known or suspected to be sorptive (see [T307-a](#) on [page 5-4-21](#)), take more gas readings than normal. Additional fumigant is added as prescribed on [Special Procedures for Adding Gas and Extending Exposure Period](#) on [page 2-4-24](#).



Items known to be sorptive or items whose sorptive properties are unknown are not to be fumigated in chambers at NAP unless gas readings are taken.

When both woodborers and khapra beetles are involved, use schedule T404-d.

### T302-d

#### Grains and seeds not intended for propagation and contaminated with cotton seed

Pest: *Pectinophora* spp.  
Treatment: See Cotton and Cotton Products, [T301-a-1-1](#) on [page 5-4-5](#) or [T301-a-1-2](#) on [page 5-4-6](#).



Alternate method—screening for removal of cotton seed contamination.

### T302-e-1 Grains and seeds not intended for propagation

Two alternative treatments

Pest: Insects other than *Trogoderma granarium* (khapra beetle)

Treatment: T302-e-1—MB (“Q” label only) at NAP—chamber

Temperature	Dosage Rate (lb/1,000 ft <sup>3</sup> )	Exposure Period
80-96°F	2.5 lbs	2.5 hrs
70-79°F	3 lbs	2.5 hrs
60-69°F	3 lbs	3 hrs
50-59°F	3 lbs	3.5 hrs
40-49°F	3 lbs	4 hrs

### T302-e-2 Grains and seeds not intended for propagation

Pest: Insects other than *Trogoderma granarium* (khapra beetle)

Treatment: T302-e-2—MB (“Q” label only) at 26" vacuum—chamber

Temperature	Dosage Rate (lb/1,000 ft <sup>3</sup> )	Exposure Period
80-96°F	2.5 lbs	2.5 hrs
70-79°F	3 lbs	2.5 hrs
60-69°F	3 lbs	3 hrs
50-59°F	3 lbs	3.5 hrs
40-49°F	3 lbs	4 hrs



Load limit is 50% of chamber volume. This vacuum treatment primarily for material so packed or packaged as to make fumigant penetration questionable.

### T302-f Grains and seeds (excluding Rosmarinus seed) not intended for propagation

Pest: Snails

Treatment: T302-f—Mechanical separation by screening or hand removal. If not feasible, entry should be denied when snails are of agricultural or public health significance, or treat using appropriate schedule as listed in T403-a.



For *Rosmarinus* seed use [T203-h](#) on [page 5-3-30](#)

**T302-b-1-1 Shelled corn**

Treatment: T302-b-1-1 **Reserved**

**T302-b-1-2 Shelled corn contaminated with cottonseed**

Pest: *Pectinophora* spp.

Treatment: T302-b-1-2



See [T301-a-1-1](#) on page 5-4-5 or [T301-a-1-2](#) on page 5-4-6



Shelled corn treated with T301 is not to be used for food or feed.



## T303—Rice

### T303-a-1

#### Rice (*Oryza spp.*)<sup>1</sup> seed



**Important**

T303-a-1,-2,-3 are to be used for:

- ◆ Rice seed moving interstate from Puerto Rico
- ◆ Rice seed harvested from greenhouses under Emergency Action Notice for Panicle Rice Mite

The yellow color of these three alternative treatments indicates that the authority to conduct the treatment comes from the Federal Order for Panicle Rice Mite DA-2008-29.

Treatment: T303-a-1 Phosphine

Pest: Panicle Rice Mite (*Steneotarsonemus spinki*)

Temperature	Dosage Rate (g/1,000 ft <sup>3</sup> )	Minimum Concentration Readings (ppm) At:		
		24 hrs	48 hrs	72 hrs
68 °F or above	30-90 <sup>1</sup> g	350	350	350

1 25 ppm = 1 g/1000 ft<sup>3</sup> of phosphine liberated



**Important**

If any of the required minimum concentration readings are not met, the treatment must be ABORTED. However, phosphine gas may be added to prevent failure if a previous successful reading indicates the minimum will most likely NOT be met for a subsequent reading. Any addition of gas MUST occur immediately after a successful reading is recorded. DO NOT add time.

### T303-a-2

#### Rice (*Oryza spp.*)<sup>1</sup> seed

Treatment: T303-a-2 MB at NAP

Pest: Panicle Rice Mite (*Steneotarsonemus spinki*)

Temperature	Dosage Rate (lb/1,000 ft <sup>3</sup> )	Minimum Concentration Readings (ounces) At:		
		0.5 hr	2 hrs	12 hrs
80 °F or above	1.25 lbs	15	12	10



**Important**

Depending on seed moisture content, fumigation with methyl bromide will result in reduced seed germination. Inform the importer and obtain a waiver of PPQ liability if MB treatment is used.

1 Including, but not limited to, *O.sativa* (cultivated paddy rice) and *O.latifolia* (weedy red rice) and *Cyperus iria*.

### T303-a-3 Rice (*Oryza spp.*)<sup>2</sup> seed

Treatment: T303-a-3 Cold treatment

Pest: Panicle Rice Mite (*Steneotarsonemus spinki*)

Temperature	Time (hrs)
17.6 °F (-8 °C)	72

Treat rice seed at 17.6 °F (-8 °C) for a minimum of 72 hours. This treatment is feasible for small-scale seed treatments.

### T303-d-1 Articles made with rice straw

Two alternative treatments

Pest: Fungous diseases of rice or internal feeders

Treatment: T303-d-1—Dry heat at 180-200°F for 2 hours

### T303-d-2 Articles made with rice straw

Pest: Fungous diseases of rice or internal feeders

Treatment: T303-d-2—Steam sterilization

Temperature	Pressure	Exposure Period
260°F	20 lbs	15 minutes
250°F	15 lbs	20 minutes

### T303-d-2-1 Articles made with rice straw

Pest: Fungous diseases of rice or internal feeders

Treatment: T303-d-2-1—Steam sterilization, use **T303-b-1** on page **5-4-15**

### T303-d-2-3 Articles made with rice straw for indoor use only

Pest: Internal feeders

Treatment: T303-d-2-3—MB (“Q” label only) at NAP—tarpaulin or chamber

Temperature	Dosage Rate (lb/1,000 ft <sup>3</sup> )	Minimum Concentration Readings (ounces) At:			
		0.5 hr	2 hrs	4 hrs	24 hrs
60°F or above	2.5 lbs	30	20	20	15
50-59°F	3 lbs	36	25	24	20
40-49°F	4 lbs	48	35	32	25

2 Including, but not limited to, *O. sativa* (cultivated paddy rice) and *O. latifolia* (weedy red rice) and *Cyperus iria*.

**T303-d-2-2**

**Articles made with rice straw for indoor use only**

Pest: Internal feeders

Treatment: T303-d-2-2—MB (“Q” label only) in 26" vacuum

Temperature	Dosage Rate (lb/1,000 ft <sup>3</sup> )	Exposure Period
60°F or above	2.5 lbs	2.5 hrs
50-59°F	3.5 lbs	2.5 hrs
40-49°F	5 lbs	2.5 hrs

**T303-b-1**

**Rice straw and hulls imported for purposes other than approved processing**

Two alternative treatments based on how commodity is packed

Pest: Fungous diseases of rice

Treatment: T303-b-1—Steam sterilization, for closely packed commodity

Introduce the live steam into a 28" vacuum until pressure reaches 10 lbs and hold for 20 minutes. (Steam sterilization is not practical for the treatment of bales having a density greater than 30 lbs. per cubic foot.)

**T303-b-2**

**Rice straw and hulls imported for purposes other than approved processing**

Pest: Fungous diseases of rice

Treatment: T303-b-2—Steam sterilization, for commodity packed as loose masses

Use **T303-b-1** on **page 5-4-15** or, if without initial vacuum, bleed air until steam vapor escapes.

**T303-c-1**

**Rice straw and hulls imported in small lots of 25 lbs. or less**



T303-c-1 is suspended until further notice. (01-14-08)

Pest: Fungous diseases of rice

Treatment: T303-c-1—Dry heat at 212 °F for 1 hour

## T304—Alpha (alfa) Grass and Handicrafts (*Stipa tenacissima*, *Ampelodesma mauritanicus*)

### T304-a Alpha (alfa) grass and handicrafts (*Stipa tenacissima*, *Ampelodesma mauritanicus*)

Two alternative treatments

Pest: Infested with *Harmolita* spp. (jointworms)

Treatment: T304-a—MB at NAP—chamber only

Temperature	Dosage Rate (lb/1,000 ft <sup>3</sup> )	Exposure Period
60°F or above	2.5 lbs	32 hrs
50-59°F	3.5 lbs	32 hrs
40-49°F	4.5 lbs	32 hrs

### T304-b Alpha (alfa) grass and handicrafts (*Stipa tenacissima*, *Ampelodesma mauritanicus*)

Treatment: T304-b—MB in 26" vacuum

Temperature	Dosage Rate (lb/1,000 ft <sup>3</sup> )	Exposure Period
60°F or above	2.5 lbs	2.5 hrs
50-59°F	3.5 lbs	2.5 hrs
40-49°F	5 lbs	2.5 hrs

## T305—Cut Flowers and Greenery

### T305-a Cut flowers and greenery



The “external pests” controlled by this schedule do not include dormant snails. Refer to [T201-o-1](#) on [page 5-3-12](#) through [T201-p-3](#) on [page 5-3-20](#).

Pest: External feeders, leafminers, hitch-hikers, surface pests, and slugs<sup>3</sup>

Treatment: T305-a—MB (“Q” label only) at NAP—tarpaulin or chamber

Temperature	Dosage Rate (lb/1,000 ft <sup>3</sup> )	Minimum Concentration Readings (ounces) At:	
		0.5 hr	2 hrs
80-89°F	1.5 lbs	19	12
70-79°F	2 lbs	24	16
60-69°F	2.5 lbs	30	20
50-59°F	3 lbs	36	24
40-49°F*	3.5 lbs	41	27

\* For leafminers, use the initial dosage rate of 4 lbs/1,000 ft<sup>3</sup>.

### T305-b

#### Cut flowers and greenery

Pest: Borers or soft scales

Treatment: T305-b—MB (“Q” label only) in 15" vacuum



Vacuum fumigation requires prior consent of the importer. If consent denied, refuse entry unless T305-a plus hand removal of these pests is feasible. Vacuum fumigation is not required for soft scales known to be widely distributed in the U.S.

Temperature	Dosage Rate (lb/1,000 ft <sup>3</sup> )	Exposure Period
80-90°F	2.5 lbs	2 hrs
70-79°F	3 lbs	2 hrs
60-69°F	3 lbs	2.5 hrs
50-59°F	3 lbs	3 hrs
40-49°F	3 lbs	3.5 hrs

<sup>3</sup> Quarantine significant slugs of the families Agriolimacidae, Arionidae, Limacidae, Milacidae, Philomycidae, and Veronicellidae, including the following genera: Agriolimax, Arion, Colosius, Deroceras, Diplosolenodes, Leidyula, Limax, Meghimatium, Milax, Pallifera, Pseudoveronicella, Sarasinula, Semperula, Vaginulus, Veronicella  
Slugs must be treated at 60°F or above (2.5 lbs. or greater)

**T305-c Cut flowers and greenery**

Pest: Mealybugs

Treatment: T305-c—MB (“Q” label only) at NAP—tarpaulin or chamber

Temperature	Dosage Rate (lb/1,000 ft <sup>3</sup> )	Minimum Concentration Readings (ounces) At:	
		0.5 hr	2 hrs
80°F or above	2.5 lbs	32	24
70-79°F	3 lbs	38	29
60-69°F	4 lbs	48	38

**T306—Bags and Bagging Material, Covers**

**T306-a Bags and bagging material or covers used to contain root crops**

Pest: *Globodera rostochiensis* (golden nematode)

Treatment: T306-a—MB (“Q” label only) in 26" vacuum

Temperature	Dosage Rate (lb/1,000 ft <sup>3</sup> )	Exposure Period
40°F or above	8 lbs	16 hrs
	10.5 lbs	12 hrs
	16 lbs	8 hrs

**T306-b Bags and bagging material or covers used for cotton only**

Pest: *Pectinophora* spp.

Treatment: T306-b—MB at NAP—chamber

Temperature	Dosage Rate (lb/1,000 ft <sup>3</sup> ) for:		Exposure Period
	Bulk shipments	Other than bulk shipments	
60°F or above	6 lbs	6 lbs	12 hrs
60°F or above	4 lbs	3 lbs	24 hrs
40-59°F	7 lbs	7 lbs	12 hrs
40-59°F	5 lbs	4 lbs	24 hrs

**T306-c-1 Bags and bagging material or covers**

Two alternative treatments

Pest: *Trogoderma granarium* (khapra beetle)

Treatment: T306-c-1—MB (“Q” label only) at NAP



Concentration readings should be obtained within the commodity.  
Concentration readings not required for chamber fumigations.

Temperature	Dosage Rate (lb/1,000 ft <sup>3</sup> )	Minimum Concentration Readings (ounces) At:				
		0.5 hr	2 hrs	24 <sup>1</sup> hrs	28 <sup>1</sup> hrs	32 <sup>1</sup> hrs
90°F or above	4 lbs	48	32	25	—	—
80-89°F	6 lbs	72	48	30	—	—
70-79°F	8 lbs	96	64	35	—	—
60-69°F	12 lbs	144	96	50	—	—
50-59°F	12 lbs	144	96	50	50	—
40-49°F	12 lbs	144	96	50	50 <sup>2</sup>	50

- 1 In addition to the space concentration readings, commodity concentration reading must be taken. The minimum concentration reading for commodity reading is as follows: For 90-96°F—10 oz.; for 80-89°F—15 oz.; and for 70-79°F—20 oz.
- 2 Optional

### T306-c-2

#### Bags and bagging material or covers

Pest: *Trogoderma granarium* (khapra beetle)

Treatment: T306-c-2—MB (“Q” label only) in 26" vacuum

Temperature	Dosage Rate (lb/1,000 ft <sup>3</sup> )	Exposure Period
60°F or above	8 lbs	3 hrs
40-59°F	9 lbs	3 hrs

### T306-d-1

#### Bagging from unroasted coffee beans

Two alternative treatments

Pest: Various

Treatment: T306-d-1—MB (“Q” label only) at NAP



Concentration readings should be obtained within the commodity.  
Concentration readings not required for chamber fumigations.

Temperature	Dosage Rate (lb/1,000 ft <sup>3</sup> )	Minimum Concentration Readings (ounces) At:				
		0.5 hr	2 hrs	24* hrs	28* hrs	32* hrs
90°F or above	4 lbs	48	32	25	—	—
80-89°F	6 lbs	72	48	30	—	—
70-79°F	8 lbs	96	64	35	—	—
60-69°F	12 lbs	144	96	50	—	—
50-59°F	12 lbs	144	96	50	50	—
40-49°F	12 lbs	144	96	50	50	50

\*In addition to the space concentration readings, you must take a commodity concentration reading. The minimum concentration reading for commodity reading is as follows: For 90-96°F—10 oz.; for 80-89°F—15 oz.; and for 70-79°F—20 oz.

### T306-d-2

### Bagging from unroasted coffee beans

Two alternative treatments

Pest: Various

Treatment: T306-d-2—MB (“Q” label only) in 26" vacuum

Temperature	Dosage Rate (lb/1,000 ft <sup>3</sup> )	Exposure Period
60°F or above	8 lbs	3 hrs
40-59°F	9 lbs	3 hrs



**Important**

Load limit maximum 75% of chamber volume.



## T307—Khapra Beetle Infested Material

### T307-a

#### Feeds and milled products heated as a part of the processing procedure, or other commodities that can be subjected to heat

Pest: Khapra beetle

Treatment: T307-a—Heat treatment



This treatment should not be used except when specifically authorized in each case by the Quarantine Policy, Analysis and Support (QPAS), Riverdale, MD, office.

180°F in any part of a processing procedure or at 150°F for a total of 7 minutes, the commodity being moved through or manipulated in the heated area in a manner to ensure that all parts meet the time and temperature requirements.

#### Miscellaneous products infested with Khapra beetle

Pest: Khapra beetle

Treatment: Summary of fumigation treatments for infested material



Bags and bagging, see [T306-c-1](#) on [page 5-4-18](#)  
Cotton products, see [T301-b-1-1](#) on [page 5-4-2](#)  
Finely ground oily meals, see [T306-c-1](#) on [page 5-4-18](#)  
Grains and seeds, see [T302-c-1](#) on [page 5-4-9](#)  
Flour, see [T306-c-1](#) on [page 5-4-18](#)  
Sorptive materials, see [T302-g-1](#) on [page 5-4-8](#).  
Goatskins, lambskins, sheepskins (skins and hides), see “T416” on [T416—Goatskins, Lambskins, Sheepskins \(Skins and Hides\)](#) on [page 5-5-45](#)



The following commodities have shown relatively high sorption:  
Carpet backing, Cinnamon quill, Cocoa mats, Cocoa powder, Lumber, Myrobalan, Pistachio nuts, Polymide waste, Potato starch, Rubber (crepe or crude) Vermiculite, Wool (raw, except pulled)

All other commodities, see [T302-g-1](#) on [page 5-4-8](#)

## T308—Tobacco, for Export

### T308-e

#### Blended strip tobacco for export

Pest: *Lasioderma serricorne* (Cigarette beetle) and *Ephestia elutella* (Tobacco moth)

Treatment: T308-e—Vacuum-steam flow method

1. Evacuate the chamber to the wet bulb temperature of 35°F (0.2 in. Hg. absolute or 29.8 in. Hg. vacuum) to remove air from the tobacco mass and facilitate steam penetration.
2. Introduce steam until 160°F is reached while maintaining vacuum to evacuate gases pushed ahead of the steam. Hold at 160°F for 3 minutes to allow the steam to condense within the tobacco mass for the temperature to equilibrate.
3. Re-evacuate to 110°F.
4. Introduce steam to 135°F for 3 minutes to allow the steam to condense within the tobacco mass and for the temperature to equilibrate.

### T308-c

#### Leaf tobacco for export

Pest: *Lasioderma serricorne* (Cigarette beetle) and *Ephestia elutella* (Tobacco moth)

Treatment: T308-c—Vacuum-steam flow process followed by reconditioning

For leaf tobacco—flowing steam at 170°F for 15 minutes in 23" vacuum. Followed by reconditioning of the tobacco to 12 to 13% moisture content.

### T308-d

#### Stored tobacco for export

Pest: *Lasioderma serricorne* (Cigarette beetle) and *Ephestia elutella* (Tobacco moth)

Treatment: T308-d—Kabat<sup>®</sup> (active ingredient—methoprene) is an insect growth regulator applied at the rate of 0.2 lbs. (3.9 fluid oz.) per 1,000 lbs. of tobacco.

Application should be made directly to tobacco immediately prior to compaction in hogsheads. Assure complete coverage by using multi-directional sprays and tumbling. Kabat<sup>®</sup> may be applied by use of a proportional dilution apparatus or by preparation of a dilute spray solution. Follow mixing and application instructions on the label. Zoecon Corporation will be responsible for ensuring that receivers in foreign countries will accept this treatment in lieu of fumigation.

In most cases, indication of Kabat<sup>®</sup> treatment need not be shown on the phytosanitary certificate. PPQ prefers that tobacco exporting firms utilize the letterhead certification of treatment rather than relying on the phytosanitary certificate to convey this information to foreign receivers. However, if requested, an additional declaration may be made showing application rates as supplied by the exporter if it has been determined through periodic inspection of a firm's facilities that application of the protectant is an integral part of the processing procedure.

**T308-a-1 Tobacco for export (flue-cured and burley in hogshead and cases; turkish in bales; cigar filler/binder in cases or bales; and cigar wrappers in bales)**

Four alternative treatments

Pest: *Lasioderma serricorne* (Cigarette beetle) and *Ephestia elutella* (Tobacco moth)

Treatment: T308-a-1—MB in 28" vacuum

Flue-cured and burley in hogshead and cases; Turkish in bales; cigar filler/binder in cases or bales; and cigar wrappers in bales

Temperature	Dosage Rate (lb/1,000 ft <sup>3</sup> )	Exposure Period
70°F or above	4 lbs	4 hrs

**T308-a-2 Tobacco for export (flue-cured and burley in hogshead and cases; turkish in bales; cigar filler/binder in cases or bales; and cigar wrappers in bales)**

Treatment: T308-a-2—MB at NAP—tarpaulin or chamber

Temperature	Dosage Rate (lb/1,000 ft <sup>3</sup> )	Exposure Period
70°F or above	1.25 lbs	72 hours
45-69°F	2 lbs	72 hrs

**T308-b-1 Tobacco for export (flue-cured and burley in hogshead and cases; turkish in bales; cigar filler/binder in cases or bales; and cigar wrappers in bales)**

Treatment: T308-b-1—Phosphine at NAP—Tarpaulin or freight containers

Temperature	Dosage Rate (g/1,000 ft <sup>3</sup> )	Minimum Concentration Readings (ppm) At:	
		96 hrs	144 hours
Greater than 68°F	33 g*	200	—
61-68°F	33 g*	—	300

\* 33g/1,000 ft<sup>3</sup> is equivalent to 1.17 g/m<sup>3</sup>.



The tobacco industry's Sanitation Committee wants to consider "starting time" as the time when the minimum concentration reading is reached. It is recommended that concentration monitoring be done every 6 hours leading up to "starting time," then again at completion (96 or 120 hours later). [Note that this concept differs from the "starting time" in other phosphine fumigation schedules. In those cases, "starting time" starts when the aluminum phosphide or magnesium phosphide are first introduced.]



Gas concentration readings and temperature readings must be taken in the middle of a tightly packed bale. The fumigation does not begin until the gas concentration readings reach minimum required levels.



Refer to the Equipment Section of this manual for a discussion of the MityVac hand-operated gas sampling pump and the Port-a-sens phosphine monitor. See [Table 5-4-3](#) on [page 5-4-38](#) for data on amount of phosphine liberated by various products.

**T308-b-2**

**Tobacco for export (flue-cured and burley in hogshead and cases; turkish in bales; cigar filler/binder in cases or bales; and cigar wrappers in bales)**

Treatment: T308-b-2—Phosphine at NAP—Warehouses

Temperature	Dosage Rate (g/1,000 ft <sup>3</sup> )	Minimum Concentration Readings (ppm) At:	
		96 hrs	144 hours
Greater than 68°F	20 g*	200	—
61-68°F	20 g*	—	300

\* 20g/1,000 ft<sup>3</sup> is equivalent to 0.71 g/m<sup>3</sup>.



The tobacco industry's Sanitation Committee wants to consider "starting time" as the time when the minimum concentration reading is reached. It is recommended that concentration monitoring be done every 6 hours leading up to "starting time," then again at completion (96 or 120 hours later). [Note that this concept differs from the "starting time" in other phosphine fumigation schedules. In those cases, "starting time" starts when the aluminum phosphide or magnesium phosphide are first introduced.]



Gas concentration readings and temperature readings must be taken in the middle of a tightly packed bale. The fumigation does not begin until the gas concentration readings reach minimum required levels.



Refer to [Table 5-4-3](#) on [page 5-4-38](#) for the amount of phosphine liberated by various products

## T309—Broomcorn and Broomcorn Articles

### T309-a Broomcorn and broomcorn articles

Four alternative schedules

Pest: *Ostrinia nubilalis* (European corn borers), ticks, and saw flies

Treatment: T309-a—MB in 26" vacuum

Temperature	Dosage Rate (lb/1,000 ft <sup>3</sup> )	Exposure Period for:	
		Sawflies	Other than sawflies
60°F or above	2.5 lbs	5 hrs	2.5 hrs
50-59°F	3.5 lbs	5 hrs	2.5 hrs
40-49°F	5 lbs	5 hrs	2.5 hrs

### T309-b-1 Broomcorn and broomcorn articles

Pest: *Ostrinia nubilalis* (European corn borers), ticks, and saw flies

Treatment: T309-b-1—MB at NAP—chamber

Temperature	Dosage Rate (lb/1,000 ft <sup>3</sup> )	Exposure Period
60°F or above	2.5 lbs	16 hrs
50-59°F	3.5 lbs	16 hrs
40-49°F	4.5 lbs	16 hrs

### T309-b-2 Broomcorn and broomcorn articles

Pest: *Ostrinia nubilalis* (European corn borers), ticks, and saw flies

Treatment: T309-b-2—MB at NAP—Railroad car, reefer, highway van, tarpaulin

Temperature	Dosage Rate (lb/1,000 ft <sup>3</sup> )	Minimum Concentration Readings (ounces) At:			
		0.5 hr	2 hrs	4 hrs	24 hrs
60°F or above	3 lbs	36	24	20	15
50-59°F	5 lbs	60	40	30	20
40-49°F	7 lbs	84	56	40	25

### T309-c Broomcorn and broomcorn articles

Pest: *Ostrinia nubilalis* (European corn borers), ticks, and saw flies

Treatment: T309-c—Steam sterilization (alternate treatment)

Introduce live steam into 25" vacuum until pressure reaches 10 psi and 240°F, then hold for 20 minutes.

## T310—Tick-Infested Materials (Nonfood)

### T310-a

#### Nonfood materials

Three alternative treatments

Pest: Ticks

Treatment: T310-a—MB (“Q” label only) at NAP

Temperature	Dosage Rate (lb/1,000 ft <sup>3</sup> )	Minimum Concentration Readings (ounces) At:							
		0.5 hr	2 hrs	3 hrs	4 hrs	5 hrs	7 hrs	8 hrs	16 hrs
90°F or above	4 lbs	55	32	45	—	—	—	—	—
80-89°F	5 lbs	65	40	52	—	—	—	—	—
70-79°F	6 lbs	75	48	—	50	—	—	—	—
60-69°F	7 lbs	88	56	—	—	60	—	—	—
50-59°F	8 lbs	100	64	—	—	—	70	—	—
40-49°F	8 lbs	100	—	—	—	—	—	65	50



Always check the fumigant label for the proper dosage used on the commodity being treated.

### T310-b

#### Nonfood materials

Treatment: T310-b—MB (“Q” label only) in 26" vacuum

Temperature	Dosage Rate (lb/1,000 ft <sup>3</sup> )	Exposure Period
80°F or above	3 lbs	2.5 hrs
70-79°F	3 lbs	3.5 hrs
60-69°F	4 lbs	4 hrs
50-59°F	5.5 lbs	5 hrs



For all fumigations with MB, if commodity temperature is known or considered to have been below the temperature range during the previous 48 hours, use the next lower range to calculate dosage.

### T310-c

#### Nonfood materials

Treatment: T310-c (*Vacant*)

## T310-d

### Nonfood materials

Treatment: T310-d—Sulfuryl fluoride at NAP

Temperature	Dosage Rate (lb/1,000 ft <sup>3</sup> )	Minimum Concentration Readings (ounces) At:		
		0.5 hr	2 hrs	24 hrs
70°F or above	2 lbs	25	16	20
50-69°F	2.5 lbs	32	20	24
40-49°F	3 lbs	40	24	28



Fumigations below 50°F to be used only on an emergency basis and specifically authorized by Quarantine Policy, Analysis and Support (QPAS) in Riverdale MD.

## T311—Hay, Baled

### T311

#### Baled hay

Pest: *Mayetiola destructor* (Hessian fly), *Oulema melanopus* (cereal leaf beetle)

Treatment: T311 Phosphine at NAP

Temperature	Dosage Rate (g/1,000 ft <sup>3</sup> )	Minimum Concentration Readings (ounces) At:			
		0.5 hr	2 hrs	24 hrs	168 hrs
50°F or above	60	45	30	15	15

Aerate 24 hours or until a level at or below 0.3 ppm is determined.

See [Table 5-4-3](#) on [page 5-4-38](#) for data on amount of phosphine liberated by various products.

## T312—Oak Logs and Lumber

There are two alternative treatments for the MB fumigation of Oak logs, T312-a and T312-a-Alternative. Do not combine the schedules.

**“Special Procedures for Adding Gas to Oak Logs Using T312 or T312-a-Alternative” on page-2-4-30** provides specific instructions for the correct actions to take at each gas concentration reading. Refer to this section (specifically **Table 2-4-8 on page-2-4-31** and **Table 2-4-9 on page-2-4-34**) for every reading.

The following is a list of IMPORTANT items to remember when conducting either of these treatments:

- ◆ Take gas concentration readings 30 minutes after adding gas and record the readings in the CPHST-TQAU electronic 429 Fumigation database.
  - ❖ To access the 429 database go to:  
<http://cphst.aphis.usda.gov/tqau/>
- ◆ Run the fans for 30 minutes and take gas concentration readings whenever additional gas is added.
- ◆ Ensure that the gas concentration readings **do not differ more than 4 ounces among the sampling lines**. If they do, run the fans for 30 more minutes to equalize the gas.
- ◆ Use DriRite® and Ascarite® during the fumigation. Replace the DriRite® when it changes color from blue to pink. Replace the Ascarite® when the granules become hard or moist.
- ◆ Aerate the logs for a minimum of 48 hours. Follow aeration procedures under sections **Aerating Sorptive Commodities in Containers—Indoors and Outdoors** on **page 2-4-45** and **Aerating Sorptive, Noncontainerized Cargo—Indoors and Outdoors** on **page 2-4-43**.
- ◆ Add additional time onto the end of the fumigation and record the gas concentration reading in the electronic 429 database. Explain the reason the treatment was extended in the Remarks section of the 429.



The 72 hour reading MUST be taken even if the fumigation has been extended. Take the 72 hour reading and then take the extra reading as required by **Table 2-4-8 on page-2-4-31** or **Table 2-4-9 on page-2-4-34** in the section “Special Procedures for Adding Gas to Oak Logs Using T312 or T312-a-Alternative” on **page-2-4-30**.



## T312-a

### Oak logs

Pest: Oak Wilt Disease

Treatment T312-a—MB (“Q” label only) at NAP

Temperature	Dosage Rate (lb/1,000 ft <sup>3</sup> )	Minimum Concentration Readings (ounces) At: <sup>1</sup>						
		0.5 hr	2 hrs	12 hrs	24 hrs	36 hrs	48 hrs	72 hrs
40°F or above	15 lbs	240	240	200	120	160	120	80

1 Refer to [Table 5-4-1](#) for adding gas at each reading.

## T312-a- Alternative

### Oak logs-Alternative

Pest: Oak Wilt Disease

Treatment T312-a-Alternative—MB (“Q” label only) at NAP

Temperature	Dosage Rate (lb/1,000 ft <sup>3</sup> )	Minimum Concentration Readings (ounces) At: <sup>1</sup>				
		0.5 hr	2 hrs	24 hrs	48 hrs	72 hrs
40°F or above	15 lbs	240	240	140	140	100

1 Refer to [Table 5-4-2](#) for adding gas at each reading.

## T312-b

### Oak lumber

Pest: Oak Wilt Disease

Treatment T312-b—MB (“Q” label only) at NAP

Temperature	Dosage Rate (lb/1,000 ft <sup>3</sup> )	Minimum Concentration Readings (ounces) At:					
		0.5 hrs	2 hrs	12 hrs	24 <sup>1</sup> hrs	36 hrs	48 hrs
40°F or above	15 lbs	240	160	100	40	120	80

1 After 24 hours, add enough fumigant to bring the concentration up to 240 oz.

### Special Procedures for Adding Gas to Oak Logs Using T312 or T312-a-Alternative

There are two alternative treatments for the MB fumigation of Oak logs. Refer to **Table 5-4-1** and **Table 5-4-2** for actions to take during the fumigation of Oak Logs using T312-a or T312-a-Alternative.

Use the following formula to calculate the amount of gas to add to the enclosure:

$1.6 \times (\text{number of oz. below the required minimum}) \times (\text{volume in ft}^3) / 1,000 \text{ ft}^3 = \text{oz. of gas to add}$ . To convert ounces to pounds, use the formula:

$$\frac{\text{oz. of gas to add}}{16 \frac{\text{oz.}}{\text{lbs.}}} = \text{pounds (lbs.) of gas to add}$$

After adding gas, run the fans for 30 minutes and take additional gas concentration readings.

Refer to **Table 5-4-1** if using T312-a and **Table 5-4-2** if using T312-a-Alternative to determine how much additional time must be added to the fumigation to compensate for the low gas concentrations.

---

**EXAMPLE:** The treatment schedule is T312-a-Alternative. The size of the enclosure is 2400 ft<sup>3</sup>. The required reading at 48 hours must be a minimum of 140 ounces. The actual lowest reading is 132 ounces. Calculate the amount of gas to add to the enclosure using the formula:  $1.6 \times (\text{the number of ounces below 140}) \times (\text{volume in ft}^3) / 1000 \text{ ft}^3$

**ANSWER:**  
 $140 - 132 = 8$   
 $1.6 \times 8 \times 2400 = 30,720 / 1000 = 30.72$  ounces of gas to add  
 $30.72 / 16 = 1.92$  pounds of gas to add

Determine the amount of time to add by referring to **Table 5-4-2**. In this example, 1 hour will be added to the total fumigation time. Take the regularly scheduled reading at 72 hours (the minimum should be 100 ounces.) Take another reading at 73 hours (the minimum should be 100 ounces.) If the minimum is not 100 ounces, add more gas and time according to **Table 5-4-2**.

---

### Instructions for Adding Gas and Time to schedule T312-a

Do not combine schedules T312-a and T312-a-Alternative. The treatment must be aborted if any individual gas concentration reading is 50% or more below the minimum required concentration.

**TABLE 5-4-1 Determine Gas Concentration Values and Corrections for Oak Log Fumigations using schedule T312-a**

If the Reading is Taken At:	And the lowest individual concentration reading is:	Then:
0.5 hour	121-239	1. ADD gas, and 2. EXTEND exposure by 0.5 hour
	0-120	<b>ABORT</b>
2 hours	160-239	1. ADD gas, and 2. EXTEND exposure by 0.5 hour
	121-159	1. ADD gas, and 2. EXTEND exposure by 1.0 hour
	0-120	<b>ABORT</b>
12 hours	190-199	1. ADD gas, and 2. EXTEND exposure by 0.5 hour
	180-189	1. ADD gas, and 2. EXTEND exposure by 1.0 hour
	170-179	1. ADD gas, and 2. EXTEND exposure by 1.5 hours
	160-169	1. ADD gas, and 2. EXTEND exposure by 2.0 hours
	150-159	1. ADD gas, and 2. EXTEND exposure by 2.5 hours
	140-149	1. ADD gas, and 2. EXTEND exposure by 3.0 hours
	130-139	1. ADD gas, and 2. EXTEND exposure by 3.5 hours
	120-129	1. ADD gas, and 2. EXTEND exposure by 4.0 hours
	110-119	1. ADD gas, and 2. EXTEND exposure by 4.5 hours
	101-109	1. ADD gas, and 2. EXTEND exposure by 5.0 hours
	0-100	<b>ABORT</b>

**TABLE 5-4-1 Determine Gas Concentration Values and Corrections for Oak Log Fumigations using schedule T312-a (continued)**

<b>If the Reading is Taken At:</b>	<b>And the lowest individual concentration reading is:</b>	<b>Then:</b>
24 hours	120-239	1. Add gas to bring the total concentration to 240 ounces. 2. DO NOT ADD TIME.
	110-119	1. ADD gas, and 2. EXTEND exposure by 1.0 hour
	100-109	1. ADD gas, and 2. EXTEND exposure by 2.0 hours
	90-99	1. ADD gas, and 2. EXTEND exposure by 3.0 hours
	80-89	1. ADD gas, and 2. EXTEND exposure by 4.0 hours
	70-79	1. ADD gas, and 2. EXTEND exposure by 5.0 hours
	61-69	1. ADD gas, and 2. EXTEND exposure by 6.0 hours
	0-60	<b>ABORT</b>
36 hours	150-159	1. ADD gas, and 2. EXTEND exposure by 1.0 hour
	140-149	1. ADD gas, and 2. EXTEND exposure by 1.5 hours
	130-139	1. ADD gas, and 2. EXTEND exposure by 2.5 hours
	120-129	1. ADD gas, and 2. EXTEND exposure by 3.0 hours
	110-119	1. ADD gas, and 2. EXTEND exposure by 4.0 hours
	100-109	1. ADD gas, and 2. EXTEND exposure by 4.5 hours
	90-99	1. ADD gas, and 2. EXTEND exposure by 5.5 hours
	81-89	1. ADD gas, and 2. EXTEND exposure by 6.0 hours
	0-80	<b>ABORT</b>

**TABLE 5-4-1 Determine Gas Concentration Values and Corrections for Oak Log Fumigations using schedule T312-a (continued)**

<b>If the Reading is Taken At:</b>	<b>And the lowest individual concentration reading is:</b>	<b>Then:</b>
48 hours	110-119	1. ADD gas, and 2. EXTEND exposure by 1.0 hour
	100-109	1. ADD gas, and 2. EXTEND exposure by 2.0 hours
	90-99	1. ADD gas, and 2. EXTEND exposure by 3.0 hours
	80-89	1. ADD gas, and 2. EXTEND exposure by 4.0 hours
	70-79	1. ADD gas, and 2. EXTEND exposure by 5.0 hours
	61-69	1. ADD gas, and 2. EXTEND exposure by 6.0 hours
	0-60	<b>ABORT</b>
72 hours	70-79	1. ADD gas, and 2. EXTEND exposure by 3.0 hours
	60-69	1. ADD gas, and 2. EXTEND exposure by 6.0 hours
	50-59	1. ADD gas, and 2. EXTEND exposure by 9.0 hours
	41-49	1. ADD gas, and 2. EXTEND exposure by 12.0 hours
	0-40	<b>ABORT</b>
 <p><b>Important</b></p>		<p>If additional time has been added to the treatment, the 72 hour reading AND the extended time reading MUST be taken. If the minimum of 80 ounces is not met, time and gas MUST be added according to this Table.</p>

## Instructions for Adding Gas and Time to schedule T312-a-Alternative

Do not combine schedules T312-a and T312-a-Alternative.

**TABLE 5-4-2 Determine Gas Concentration Values and Corrections for Oak Log Fumigations using schedule T312-a-Alternative**

If the Reading is Taken At:	And the any individual concentration reading is:	Then:
0.5 hours	121-239	1. ADD gas, and 2. DO NOT EXTEND exposure.
	0-120	ABORT
2 hours	160-239	1. ADD gas, and 2. DO NOT EXTEND exposure
	121-159	1. ADD gas, and 2. EXTEND exposure by 1.0 hour
	0-120	ABORT
24 hours	140-239	1. Add gas to bring the total concentration to <span style="color: red;">240</span> ounces. 2. DO NOT ADD TIME.
	130-139	1. ADD gas, and 2. EXTEND exposure by 1.0 hour
	120-129	1. ADD gas, and 2. EXTEND exposure by 2.5 hours
	110-119	1. ADD gas, and 2. EXTEND exposure by 4.0 hours
	100-109	1. ADD gas, and 2. EXTEND exposure by 5.5 hours
	90-99	1. ADD gas, and 2. EXTEND exposure by 7.0 hours
	80-89	1. ADD gas, and 2. EXTEND exposure by 8.5 hours
	71-79	1. ADD gas, and 2. EXTEND exposure by 10.0 hours
	0-70	ABORT

**TABLE 5-4-2 Determine Gas Concentration Values and Corrections for Oak Log Fumigations using schedule T312-a-Alternative (continued)**

If the Reading is Taken At:	And the any individual concentration reading is:	Then:
48 hours	130-139	1. ADD gas, and 2. EXTEND exposure by 1.0 hour
	120-129	1. ADD gas, and 2. EXTEND exposure by 2.5 hours
	110-119	1. ADD gas, and 2. EXTEND exposure by 4.5 hours
	100-109	1. ADD gas, and 2. EXTEND exposure by 6.0 hours
	90-99	1. ADD gas, and 2. EXTEND exposure by 8.5 hours
	80-89	1. ADD gas, and 2. EXTEND exposure by 9.5 hours
	71-79	1. ADD gas, and 2. EXTEND exposure by 11 hours
	0-70	<b>ABORT</b>
72 hours	90-99	1. ADD gas, and 2. EXTEND exposure by 1.5 hours
	80-89	1. ADD gas, and 2. EXTEND exposure by 4.0 hours
	70-79	1. ADD gas, and 2. EXTEND exposure by 7.5 hours
	60-69	1. ADD gas, and 2. EXTEND exposure by 8.5 hours
	51-59	1. ADD gas, and 2. EXTEND exposure by 11.0 hours
		0-50
<div style="display: flex; align-items: center;">  <div style="background-color: #e0f2f1; padding: 10px; border: 1px solid #ccc;"> <p>If additional time has been added to the treatment, the 72 hour reading AND the extended time reading MUST be taken. If the minimum of 100 ounces is not met, time and gas MUST be added according to this Table.</p> </div> </div> <p><b>Important</b></p>		

## T313—Christmas Trees



Cut trees at least 2 weeks prior to treatment in order to reduce possible damage by the fumigant to the trees.

### T313-a Cut conifer Christmas trees

Pest: *Lymantria dispar* (gypsy moth) egg masses

Treatment: T313-a—MB (“Q” label only) at NAP—tarpaulin or chamber

Temperature	Dosage Rate (lb/1,000 ft <sup>3</sup> )	Minimum Concentration Readings (ounces) At:				
		0.5 hr	2.5 hrs	3 hrs	4 hrs	4.5 hrs
75°F or above	1.5 lbs	18	12	—	—	—
70-74°F	2 lbs	24	16	—	—	—
60-69°F	2.5 lbs	30	—	24	—	—
60-69°F	3 lbs	36	24	—	—	—
50-59°F	3 lbs	36	—	—	24	—
50-59°F	4 lbs	48	32	—	—	—
40-49°F	3.5 lbs	42	—	—	—	28
40-49°F	5 lbs	60	40	—	—	—

### T313-b Cut pine Christmas trees and pine logs

Pest: *Tomicus piniperda* (pine shoot beetle)

Treatment: T313-b—MB (“Q” label only) at NAP—chamber or tarpaulin

Temperature	Dosage Rate (lb/1,000 ft <sup>3</sup> )	Minimum Concentration Readings (ounces) At:			
		2 hrs	3 hrs	3.5 hrs	4 hrs
60°F or above	3 lbs	43	—	—	36
60°F or above	4 lbs	57	48	—	—
50-59°F	3.5 lbs	50	—	—	42
50-59°F	4 lbs	57	—	48	—
40-49°F	4 lbs	57	—	—	48



If treating pine Christmas trees for both gypsy moth egg masses and the pine shoot beetle, use the schedule for the pine shoot beetle since it is more potent.



## T314—Logs and Firewood

These heat treatment procedures may employ steam, hot water, kilns, or any other method that raises the temperature of the **center** of the log to the minimum required temperature for the time specified. Procedures for obtaining internal log temperature can be found in the chapter "Methyl Bromide-Tarpaulin", section "[Logs and Lumber](#)" on [page-2-4-15](#).

The heat treatment must be performed at an approved facility that maintains a current compliance agreement. The PPQ official will review facility treatment records to ensure the treatment temperature and duration requirements have been met.

Contact USDA-APHIS-CPHST-PPQ Pest Survey Detection and Exclusion Laboratory at 508-563-9303 ext. 259 for a list of approved facilities, temperature monitoring equipment and operational guidelines.



For annual facility certification guidelines, follow the procedures in "[Certifying Facilities for the Heat Treatment of Firewood](#)" on [page-6-9-1](#).

### T314-a

#### **Fraxinus (Ash Logs, including firewood) and all Hardwood Firewood from Emerald Ash Borer quarantine areas**

Pest: *Agrilus planipennis* (Emerald Ash Borer)

Treatment: T314-a—Heat treatment

Unit	Temperature	Time (minutes)
°F	160.0	75
°C	71.1	75

### T314-b

#### **All logs (including firewood) from Gypsy Moth quarantine areas**

Pest: *Lymantria dispar* (Gypsy Moth egg masses)

Treatment: T314-b

Unit	Temperature	Time (minutes)
°F	132.8	30
°C	56.0	30

**TABLE 5-4-3: Amount of Phosphine Liberated by various Products. Calculate amount of product needed by using the amount of phosphine released as shown in the right column.**

Product	Type	Unit and weight in grams	Grams of phosphine *
Degesch Fumi-Cel®	MP	1 plate; 117.0	33.0
Degesch Fumi-Strip®	MP	16 plates; 1872.0	528.0
Degesch Phostoxin®	AP	1 tablet; 3.0	1.0
Degesch Phostoxin® Tablet Prepac Rope	AP	1 prepac; 99.0 (strip or rope of 33 tablets)	33.0
Detia	AP	1 tablet; 3.0	1.0
Detia Rotox AP	AP	1 pellet; 0.6	0.2
Detia Gas EX-B	AP	1 bag or sachet; 34.0	11.4
Fumiphos tablets	AP	1 tablet; 3.0	1.0
Fumiphos pellets	AP	1 pellet; 0.6	0.2
Fumiphos bags	AP	1 bag; 34.0	11.0
Fumitoxin	AP	1 tablet; 3.0	1.0
Fumitoxin	AP	1 pellet; 0.6	0.2
Fumitoxin	AP	1 bag; 34.0	11.0
Gastoxin	AP	1 tablet; 3.0	1.0
Gastoxin	AP	1 pellet; 0.6	0.2
“L” Fume	AP	1 pellet; 0.5	0.18
	AP	1 pellet; 0.6	0.22
Phos-Kill	AP	1 tablet; 3.0	1.1
Phos-Kill	AP	1 pellet; 0.6	0.22
Phos-Kill	AP	1 bag; 34.0	12.0

\* Reacts with moisture in the air to yield grams of phosphine.

# 5

Treatment Manual

## Treatment Schedules

### *T400 - Schedules for Miscellaneous Products*

#### Contents

Commodities treated with the following schedules are not to be used for food or feed.

- T401—Railroad Cars (Empty) [page-5-5-2](#)
- T402—Ships, Containers, and Surrounding Area [page-5-5-3](#)
- T403—Miscellaneous Cargo (Nonfood, Nonfeed Commodities) [page-5-5-7](#)
- T404—Wood Products Including Containers [page-5-5-13](#)
- T405—Bags and Bagging Materials [page-5-5-21](#)
- T406—Golden Nematode Contaminations [page-5-5-21](#)
- T407—Mechanical Cotton Pickers and Other Cotton Equipment [page-5-5-24](#)
- T408—Soil as Such and Soil Contaminating Durable Commodities [page-5-5-25](#)
- T409—Aircraft [page-5-5-28](#)
- T410—Tick Infestations [page-5-5-40](#)
- T411—Ant Infestations—Nonplant Products [page-5-5-41](#)
- T412—Noxious Weed Seeds (Devitalization Treatment) [page-5-5-41](#)
- T413—Brassware from Mumbai (Bombay), India [page-5-5-42](#)
- T415— Garbage [page-5-5-44](#)
- T414—Inanimate, Nonfood Articles with Gypsy Moth Egg Masses [page-5-5-43](#)
- T416—Goatskins, Lambskins, Sheepskins (Skins and Hides) [page-5-5-45](#)



Exposure period may be extended for any commodity which *cannot* be used for food or propagation. This extension is only a matter of convenience for the importer and is intended only for the purpose of reducing treatment costs. The request for extension must come from the importer or his authorized representative and should be confirmed in writing. A letter is not required for each treatment. A single blanket request should be considered as acceptable and renewed each year as required.

During the extended exposure period, the concentrations must remain stable and the prescribed minimums be met at the end of the extension. Otherwise, the treatment may be voided and retreatment required. Examples of commodities for which extended exposure periods may be approved include cotton piece goods, baled cotton, bagging, wood, marble, soil as such, etc. Examples of commodities for which *no* extension may be approved include cottonseed, grain, tobacco, etc. An extension of exposure period for other purposes is not permitted except as may be prescribed in various schedules for concentration readings below minimum.

Additional safety precautions, including additional aeration, may be required because of the extended exposure period. The PPQ officer or the commercial fumigator will specify any needed safety precautions.

## T401—Railroad Cars (Empty)

### T401-a Railroad cars (empty)

Pest: *Pectinophora gossypiella* (pink bollworm) and fruit flies

Treatment: T401-a—MB (“Q” label only) at NAP

Temperature	Dosage Rate (lb/1,000 ft <sup>3</sup> )	Exposure Period
40°F or above	4 lbs	12 hrs
OR	8 lbs	3 hrs

### T401-b Railroad cars (empty)

Pest: *Trogoderma granarium* (khapra beetle)

Treatment: T401-b—MB (“Q” label only) at NAP—tarpaulin covered car

Temperature	Dosage Rate (lb/1,000 ft <sup>3</sup> )	Minimum Concentration Readings (ounces) At:		
		0.5 hr	2 hrs	12 hrs
90°F or above	2.5 lbs	30	20	15
80-89°F	3.5 lbs	42	30	20
70-79°F	4.5 lbs	54	40	25
60-69°F	6 lbs	72	50	30
50-59°F	7.5 lbs	90	60	35
40-49°F	9 lbs	108	70	40

### T401-c Railroad cars (empty)

Pest: For nematode cysts

Treatment: T401-c—High pressure steam cleaning *or* formaldehyde wetting spray (1 part 40% commercial formalin to 9 parts water).



Under FIFRA Section 2(ee), it is permissible to use a method of application not prohibited by the labeling unless the labeling specifically states that the product may be applied only by the methods specified on the labeling. Therefore, a wetting spray may be used in this case if the label refers to the application of formaldehyde as a fumigant and does not specifically restrict the method of application to fumigation."

The debris and/or runoff from the cleaning procedure must be handled in a manner approved by local and port authority guidelines.

## T402—Ships, Containers, and Surrounding Area

### T402-b-3-2 Asphalt surfaces and asphalt-base painted surfaces

Pest: *Trogoderma granarium* (khapra beetle)

Treatment: T402-b-3-2—Malathion spray at 2 gal/1,000 ft<sup>2</sup> or to the point of runoff.

Asphalt surface, asphalt-base paint—3% spray prepared by adding 1 lb. of 25% malathion wettable powder to each gal. of water.

### T402-c Empty holds (precautionary treatment for grain exports)

Pest: Without khapra beetle infestation

Treatment: T402-b—MB at NAP

Temperature	Dosage Rate (lb/1,000 ft <sup>3</sup> )	Exposure Period
60°F or above	1 lb	10 hrs
50-59°F	1 lb	12 hrs
40-59°F	1.5 lbs	12 hrs



Operate fans during gas introduction and for 30 minutes thereafter. During exposure period, operate fans for 30 minutes every 3 hours.



If khapra beetle is present, see [T401-b](#) on page 5-5-2.

### T402-b-3-1 Metal and wood surfaces such as decks, bulkheads, piers, and other areas not subject to fumigation

Pest: *Trogoderma granarium* (khapra beetle)

Treatment: T402-b-3-1—Malathion spray at 2 gal/1,000 ft<sup>2</sup> or to the point of runoff.

Metal and wood surfaces—3% spray prepared by mixing 1/2 pt. emulsifiable concentrate (57% premium grade malathion) per gal. of water.

Malathion is toxic to fish, birds, and other wildlife. Keep out of lakes, streams, ponds, tidal marshes, and estuaries. Do **not** apply where fish and other aquatic life are important resources or where water is used for irrigational purposes, recreational purposes, or domestic purposes. Do **not** apply where runoff is likely to occur.

## T402-d

### Ship decks (metal, concrete, asphalt, or wood)

Pest: Miscellaneous hitchhiking insects (e.g., crickets, scarab beetles, ants, Africanized honey bee swarms)

Treatment: T402-d—Residual insecticidal spray (1% to 5% strength, according to label directions), using malathion, chlorpyrifos, or cyfluthrin (Tempo)

Apply the insecticide to dry surfaces as a fine spray or mist, according to the manufacturer's label. Direct the spray to areas on the decks where the insects congregate, with special attention to corners, cracks, and crevices.



Do not treat freshly painted surfaces.

Avoid pooling or runoff. If rain is imminent, use a spreader-sticker in the spray mixture, or postpone spraying weather-exposed decks until the storm has passed and the decks have thoroughly dried. Submarines are exempt from treatment.



Do not release the ship from quarantine until the application has dried, and no live insects are seen.

If the insects are capable of flight (e.g., scarab beetles), the ship must move offshore for at least one mile (which is beyond the normal flight range of most insects) while the insecticide is being applied.

### T402-a-1 Ship holds and any nonplant cargo material within holds

Pest: Quarantine significant snails of the family Achatinidea, including the following genera:

*Achatina*                      *Lignus*  
*Archachatina*              *Limicolaria*

Treatment: T402-a-1—MB (“Q” label only) at NAP

Temperature	Dosage Rate (lb/1,000 ft <sup>3</sup> )	Minimum Concentration Readings (ounces) At:		
		0.5 hr	2 hrs	24 hrs
55°F or above	8 lbs	96	65	35

### T402-a-2 Ship holds and any nonplant cargo material within holds

Pest: Quarantine significant snails of the family Hygromiidae, including the following genera:

*Canidula*                      *Monacha*                      *Xeropicta*  
*Cernuella*                      *Platytheba*                      *Xerosecta*  
*Cochlicella*                      *Pseudotrichia*                      *Xerotricha*  
*Helicella*                      *Trochoidea*  
*Helicopsis*                      *Xerolenta*

Treatment: T402-a-2—MB (“Q” label only) at NAP

Temperature	Dosage Rate (lb/1,000 ft <sup>3</sup> )	Minimum Concentration Readings (ounces) At:				
		0.5 hr	2 hrs	24 hrs	48 hrs	72 hrs
55°F or above	8 lbs	95	64	62	60	40

### T402-a-3 Ship holds and any nonplant cargo material within holds

Pest: Quarantine significant snails of the families Helicidae and Succineidae, including the following genera:

*Caracollina*                      *Omalonyx*  
*Cepaea*                      *Otala*  
*Cryptomphalus*                      *Succinea*  
*Helix*                      *Theba*

Treatment: T402-a-3—MB (“Q” label only) at NAP

Temperature	Dosage Rate (lb/1,000 ft <sup>3</sup> )	Minimum Concentration Readings (ounces) At:					
		0.5 hr	2 hrs	10 hrs	12 hrs	16 hrs	24 hrs
80°F or above	6 lbs	70	48	40	—	—	—
55-79°F	6 lbs	70	48	—	—	40	—
40-54°F	8 lbs	96	64	—	—	—	39

**T402-b-1**

**Ship holds and storerooms that do not contain finely milled products such as flour or appreciable quantities of tightly packed cargo such as baled materials**

Pest: *Trogoderma granarium* (khapra beetle)

Treatment: T402-b-1—MB (“Q” label only) at NAP—tarpaulin covered car

Temperature	Dosage Rate (lb/1,000 ft <sup>3</sup> )	Minimum Concentration Readings (ounces) At:		
		0.5 hr	2 hrs	12 hrs
90°F or above	2.5 lbs	30	20	15
80-89°F	3.5 lbs	42	30	20
70-79°F	4.5 lbs	54	40	25
60-69°F	6 lbs	72	50	30
50-59°F	7.5 lbs	90	60	35
40-49°F	9 lbs	108	70	40

**T402-b-2**

**Ship holds and storerooms that contain milled products, or with appreciable quantities of tightly packed or baled material**

Pest: *Trogoderma granarium* (khapra beetle)

Treatment: T402-b-2—MB (“Q” label only) at NAP

Temperature	Dosage Rate (lb/1,000 ft <sup>3</sup> )	Minimum Concentration Readings (ounces) At:		
		0.5 hr	4 hrs	24* hrs
90-96°F	4 lbs	48	35	25
80-89°F	6 lbs	72	50	30
70-79°F	8 lbs	96	65	35

\*In addition to the space concentration readings, you must take a commodity concentration reading. The minimum concentration reading for commodity reading is as follows: For 90-96°F—10 oz.; for 80-89°F—15 oz.; for 70-79°F—20 oz.;



Concentration readings not required for chamber fumigation.



Some ships’ masters or agents prefer to abandon flour or other finely milled products to qualify for the 12 hours schedule ([T401-b](#) on [page 5-5-2](#)). This practice should not be discouraged if PPQ approved incineration or steam sterilization facilities are available within the port city. Small quantities may be burned or boiled on board the vessel, but in no case should the material be removed from treatment in PPQ facilities. Such articles must be left in the storeroom during the 12-hour fumigation and then removed under PPQ safeguards. This will serve to reduce the possibility of pest dispersal when the articles are removed under PPQ supervision.



## T403—Miscellaneous Cargo (Nonfood, Nonfeed Commodities)

### T403-a-1 Miscellaneous cargo (non-food, non-feed commodities)

Pest: Quarantine significant snails of the family Achatinidae, including the following genera:

*Achatina*                      *Lignus*  
*Archachatina*              *Limicolaria*

Treatment: T403-a-1—use T402-a-1 for temperatures of 55°F and above, use T403-a-6 for temperatures below 55°F



Important

Commodity or product temperature must reach treatment temperature before exposure time begins.

### T403-a-2-1 Miscellaneous cargo (nonfood, nonfeed commodities)

Three alternative treatments

Pest: Quarantine significant snails of the family Hygromiidae, including the following genera:

*Candidula*                      *Monacha*                      *Xeropicta*  
*Cernuella*                      *Platytheba*                      *Xerosecta*  
*Cochlicella*                      *Pseudotrachia*                      *Xerotricha*  
*Helicella*                      *Trochoidea*  
*Helicopsis*                      *Xerolenta*

Treatment: T403-a-2-1—MB (“Q” label only) at NAP

Temperature	Dosage Rate (lb/1,000 ft <sup>3</sup> )	Minimum Concentration Readings (ounces) At:			
		0.5 hr	2 hrs	48 hrs	72 hrs
55°F or above	8 lbs	95	64	60	40

### T403-a-2-2 Miscellaneous cargo (nonfood, nonfeed commodities)

Treatment: T403-a-2-2—MB in 26" vacuum

Temperature	Dosage Rate (lb/1,000 ft <sup>3</sup> )	Exposure Period
70°F or above	8 lbs	16 hrs

### T403-a-2-3 Miscellaneous cargo (nonfood, nonfeed commodities)

Treatment: T403-a-2-3—Cold treatment (for temperatures below 55°F)

Temperature	Exposure Period
0°F	48 hrs

### T403-a-3 Miscellaneous cargo (nonfood, nonfeed commodities)

Pest: Quarantine significant slugs of the families Agriolimacidae, Arionidae, Limacidae, Milacidae, Philomycidae, and Veronicellidae, including the following genera:

<i>Agriolimax</i>	<i>Leidyula</i>	<i>Pseudoveronicella</i>
<i>Arion</i>	<i>Limax</i>	<i>Sarasinula</i>
<i>Colosius</i>	<i>Meghimatium</i>	<i>Semperula</i>
<i>Deroceras</i>	<i>Milax</i>	<i>Vaginulus</i>
<i>Diplosolenodes</i>	<i>Pallifera</i>	<i>Veronicella</i>

Treatment: T403-a-3—MB at NAP

Temperature	Dosage Rate (lb/1000 ft <sup>3</sup> )	Minimum Concentration Readings (ounces) At:	
		0.5 hr	2 hrs
90-96°F	1 lb	12	9
80-89°F	1.25 lbs	15	12
70-79°F	1.5 lbs	18	15
60-69°F	1.75 lbs	22	19

### T403-a-4-1 Miscellaneous cargo (nonfood, nonfeed commodities)

Three alternative schedules

Pest: Quarantine significant snails of the family Helicidae, including the following genera:

<i>Caracollina</i>	<i>Helix</i>
<i>Cepaea</i>	<i>Otala</i>
<i>Cryptomphalus</i>	<i>Theba</i>

Treatment: T403-a-4-1—MB at NAP

Temperature	Dosage Rate (lb/1,000 ft <sup>3</sup> )	Minimum Concentration Readings (ounces) At:					
		0.5 hr	2 hrs	10 hrs	12 hrs	16 hrs	24 hrs
80°F or above	6 lbs	70	48	40	—	—	—
55-79°F	6 lbs	70	48	—	—	40	—
40-54°F	8 lbs	96	64	—	—	—	39



If the fumigation is done at a temperature range of 40 to 54°F, use Methyl Bromide Q gas only.

**T403-a-4-2 Miscellaneous cargo (nonfood, nonfeed commodities)**

Treatment: T403-a-4-2—MB (“Q” label only) in 26" vacuum

Temperature	Dosage Rate (lb/1,000 ft <sup>3</sup> )	Exposure Period
70°F or above	6 lbs	6 hrs

**T403-a-4-3 Miscellaneous cargo (nonfood, nonfeed commodities)**

Treatment: T403-a-4-3—Cold treatment, use [T403-a-6-1](#) on page **5-5-10** for temperatures below 55°F

**T403-a-5-1 Miscellaneous cargo (nonfood, nonfeed commodities)**

Three alternative treatments

Pest: Quarantine significant snails of the families Bradybaenidae and Succineidae, including the following genera:

*Bradybaena*                      *Omalonyx*  
*Cathaica*                        *Succinea*  
*Helicostyla*                      *Trishoplita*

Treatment: T403-a-5-1—MB (“Q” label only) at NAP

Temperature	Dosage Rate (lb/1,000 ft <sup>3</sup> )	Minimum Concentration Readings (ounces) At:			
		0.5 hr	2 hrs	10 hrs	16 hrs
80°F or above	6 lbs	72	48	40	—
40-79°F	6 lbs	70	48	—	40

**T403-a-5-2 Miscellaneous cargo (nonfood, nonfeed commodities)**

Treatment: T403-a-5-2—MB (“Q” label only) in 26" vacuum

Temperature	Dosage Rate (lb/1,000 ft <sup>3</sup> )	Exposure Period
40°F or above	6 lbs	6 hrs

**T403-a-5-3 Miscellaneous cargo (nonfood, nonfeed commodities)**

Treatment: T403-a-5-3—Cold Treatment, use [T403-a-6-1](#) on page **5-5-10** for temperatures below 40°F



Commodity or product must reach treatment temperature before exposure time begins.

**T403-a-6-1 Miscellaneous cargo (nonfood, nonfeed commodities)**

Three alternative treatments

Pest: Quarantine significant snails sensitive to Cold Treatment, members of the families Bradybaenidae, Helicidae, Helicellidae, Hygromiidae, and Succineidae, including the following genera:

<i>Bradybaena</i>	<i>Cochlicella</i>	<i>Trochoidea</i>
<i>Candidula</i>	<i>Helicella</i>	<i>Xerolenta</i>
<i>Cepaea</i>	<i>Helicostyla</i>	<i>Xeropicta</i>
<i>Cathaica</i>	<i>Theba</i>	<i>Xerosecta</i>
<i>Cernuella</i>	<i>Trishoplita</i>	<i>Xerotricha</i>

Treatment: T403-a-6-1—Cold Treatment

Temperature	Exposure Period
0°F	48 hrs

**T403-a-6-2 Miscellaneous cargo (nonfood, nonfeed commodities)**

Pest: Quarantine-significant snails sensitive to Cold Treatment, certain members of the family Helicidae, including the following genera:

<i>Helix</i>	<i>Otala</i>
--------------	--------------

Treatment: T403-a-6-2—Cold Treatment

Temperature	Exposure Period
0°F	32 hrs
10°F	48 hrs

**T403-a-6-3 Miscellaneous cargo (nonfood, nonfeed commodities)**

Pest: Quarantine-significant snails sensitive to Cold Treatment, of the family Achatinidae, including the following genera:

<i>Achatina</i>	<i>Lignus</i>
<i>Archachatina</i>	<i>Limicolaria</i>

Treatment: T403-a-6-3—Cold Treatment

Temperature	Exposure Period
0°F	8 hrs
10°F	16 hrs
20°F	24 hrs

**T403-b Miscellaneous cargo (nonfood, nonfeed commodities)**

Pest: *Trogoderma granarium* (khapra beetle)

Treatment: T403-b—MB at NAP, use T401-b or T402-b-2

**T403-c Miscellaneous cargo (nonfood, nonfeed commodities)**

Pest: *Globodera rostochiensis* (golden nematode)

Treatment: T403-c—MB (“Q” label only) in 26" vacuum

Temperature	Dosage Rate (lb/1,000 ft <sup>3</sup> )	Exposure Period
40°F or above	8 lbs	16 hrs
	10.5 lbs	12 hrs
	16 lbs	8 hrs

**T403-d Miscellaneous cargo (nonfood, nonfeed commodities)**

Pest: Wood Borers or termites

Treatment: T403-d see T404 schedules

**T403-e-1-1 Miscellaneous cargo (nonfood, nonfeed commodities) that is not sorptive or difficult to penetrate**

Pest: Quarantine-significant insects not specifically provided for elsewhere in non-food or non-feed commodities

Treatment: T403-e-1-1—MB (“Q” label only) at NAP—tarpaulin

Temperature	Dosage Rate (lb/1,000 ft <sup>3</sup> )	Minimum Concentration Readings (ounces) At:		
		0.5 hr	2 hrs	12 hrs
90°F or above	2.5 lbs	30	20	15
80-89°F	3.5 lbs	42	30	20
70-79°F	4.5 lbs	54	40	25
60-69°F	6 lbs	72	50	30
50-59°F	7.5 lbs	90	60	35
40-49°F	9 lbs	108	70	40

**T403-e-1-2**      **Miscellaneous cargo (nonfood, nonfeed commodities) that is sorptive or difficult to penetrate**

Pest:            Quarantine-significant insects not specifically provided for elsewhere in nonfood or nonfeed commodities

Treatment: T403-e-1-2—MB (“Q” label only) at NAP

Temperature	Dosage Rate (lb/1,000 ft <sup>3</sup> )	Minimum Concentration Readings (ounces) At:				
		0.5 hr	4 hrs	24 hrs	28 hrs	32 hrs
90-96°F	4 lbs	48	35	25*	—	—
80-89°F	6 lbs	72	50	30*	—	—
70-79°F	8 lbs	96	65	35*	—	—
60-69°F	12 lbs	144	95	50*	—	—
50-59°F	12 lbs	144	95	—	50*	—
40-49°F	12 lbs	144	95	—	—	50*

\*In addition to the space concentration readings, you must take a commodity concentration reading. The minimum concentration reading for commodity reading is as follows: For 90-96°F—10 oz.; for 80-89°F—15 oz.; for 70-79°F—20 oz.; for 60-69°F—30 oz; for 50-59°F—30 oz; and 40-49°F—30 oz.

This fumigation schedule may be used, for example, on finely milled products and on material that is tightly packed or baled.

**T403-e-2**      **Miscellaneous cargo (nonfood, nonfeed commodities) that is not sorptive or difficult to penetrate**

Pest:            Quarantine-significant pests other than insects



This would include quarantine-significant snails of the families Helicarionidae, Streptacidae, Subulinidae, and Zontidae, as well as other noninsect pests.

Treatment: T403-e-2—MB (“Q” label only) at NAP tarpaulin or chamber

Temperature	Dosage Rate (lb/1,000 ft <sup>3</sup> )	Minimum Concentration Readings (ounces) At:			
		0.5 hr	2 hrs	24 hrs	48 hrs
40°F or above	10 lbs	140	130	120	80

## T403-f

### Miscellaneous cargo (nonfood, nonfeed commodities)

Pest: *Pieris* spp. (cabbageworms—all life stages) and all other *Lepidoptera*\*. Also hitchiking insects, including non-*Lepidoptera*.

Treatment: T403-f—MB at NAP

Temperature	Dosage Rate (lb/1,000 ft <sup>3</sup> )	Minimum Concentration Readings (ounces) At:	
		0.5 hr	3 hrs
70°F or above	3 lbs	36	16
60-69°F	3.5 lbs	40	19
50-59°F	4 lbs	45	21
45-49°F	4.5 lbs	49	24
40-44°F	5 lbs	54	27



\*A 3-hour exposure easily kills all Lepidopterous hitchhikers, including gypsy moth, and is preferred over using the much longer schedules that are aimed more at khapra beetles (T404-b-1 and T402-b-2). This schedule should not be used for mollusks (snails and slugs) or for any insect with cryptic habits (e.g., ants or borers), or for insects in diapause.

## T404—Wood Products Including Containers<sup>1</sup>

### T404-b-5-1

#### Metal, wood, concrete, or other surfaces not subject to fumigation

Pest: Borers (wood wasps, Cerambycids, and Dinoderus)

Treatment: T404-b-5-1—Chlorpyrifos spray

Use Dursban 4E as a 1% chlorpyrifos spray using suitable hand- or power-operated ground spray equipment. To be applied only by or under the supervision of pest control operators or other trained personnel responsible for inspect control programs.

To prepare the spray, thoroughly mix 79 ml (2-2/3 fl oz) of Dursban 4E with water to make up a total of 1 gal. of mixture (equivalent to 2.1 gal. in 100 gal. of water) and spray to the point of runoff.

**1 Use Treatment Schedule [T404-d](#) on page 5-5-19 for the fumigation of any bamboo products.**

## T404-c-2 Wood products including containers

Pest: Termites (for borers see T404-b-1-1 and T404-b-1-2)

Treatment: T404-c-2—SF at NAP

Temperature	Dosage Rate (lb/1,000 ft <sup>3</sup> )	Minimum Concentration Readings (ounces) At:			
		0.5 hr	2 hrs	16 hrs	24 hrs
70°F or above	1 lb	12	8	8	—
60-69°F	1.5 lbs	18	12	—	8
50-59°F	2.5 lbs	32	20	—	20

Do not use filters containing sodium hydroxide (Ascarite®) with this fumigant.

## T404-a Wood products including containers

Pest: *Globodera rostochiensis* (golden nematode)

Treatment: T404-a—MB (“Q” label only) in 26" vacuum

Temperature	Dosage Rate (lb/1,000 ft <sup>3</sup> )	Exposure Period
40°F or above	8 lbs	16 hrs
	10.5 lbs	12 hrs
	16 lbs	8 hrs

## T404-b-1-1 Wood products including containers



If using a T/C, an Ascarite® filter must be mounted when taking concentration readings for the following MB-NAP treatments.

Four alternative treatments

Pest: See following pest list for T404-b-1-1, T404-b-1-2, and T404-b-4

Treatment: T404-b-1-1—MB at NAP—tarpaulin or chamber

Temperature	Dosage Rate (lb/1,000 ft <sup>3</sup> )	Minimum Concentration Readings (ounces) At:			
		0.5 hr	2 hrs	4 hrs	16 hrs <sup>1</sup>
70°F or above	3 lbs	36	30	27	25
40-69°F	5 lbs	60	51	46	42

- 1 If the 4- and 16-hour readings would occur outside of normal working hours, then the fumigation may be extended to a total of 24 hours, instead of 16. In that case, the 24-hr minimum concentration reading would be 25 (for the initial 3-lb dosage), or 42 (for the initial 5-lb dosage).





For termites use T404-c schedules.



1. Minimum concentration must be met in chamber fumigations of sorptive materials.
2. For fumigating of hardboard (Masonite), an initial dosage of 10 lb/1,000 ft<sup>3</sup> is recommended. Inspector should be prepared to provide extra attention to maintaining minimum concentrations when fumigating this commodity.
3. If both termites and borers are present at 40-69°F, use the schedule for borers with exposure extended to 20 hours. Use same minimum concentrations.
4. Use an Ascarite filter (in addition to a Drierite filter) if any of the following conditions apply:
  - The wood is uncured (“green”).
  - The wood is manifested as guatamba wood.In the two cases above, water vapor or other gases may be evolved during the fumigation, which give false (additive) readings on the T/C gas analyzer.
5. If the 4- and 16-hour readings would occur outside of normal working hours, then the fumigation may be extended to a total of 24 hours, instead of 16. In that case, the 24-hr minimum concentration reading would be 25 (for the initial 3-lb dosage), or 42 (for the initial 5-lb dosage).
6. Resume use of fans anytime a difference of 4 oz. or more occurs between the highest and lowest reading.
7. Readings more than 5 oz. below minimum at end of exposure negates treatment. For readings less than 5 oz. below minimum at the end of exposure period, add 2 oz/1,000ft<sup>3</sup> for each ounce below minimum and extend exposure for 4 hours.
8. A reduction in dosage is allowed when fumigating nonsorptive commodities such as marble, shells, metal containers, etc., which have infested crating associated with them providing the following additional conditions are met:
  - Use only new 4-mil or 6-mil tarpaulins.
  - No truck trailer, van, or railroad car fumigations are permitted unless the carrier is covered with a 6-mil tarpaulin which is then sealed to the ground.
  - Use five or more sampling leads to determine minimum concentrations.
9. When fumigating wood commodities (e.g., dunnage, crating, logs) the proper fumigation temperature may be determined by inserting the tip of a dial thermometer or other temperature probe in a hole in the wood. A hole can be made with an electric or hand-powered drill or an awl. The hole diameter should be just large enough to insert the probe shaft (to lessen the influence of surrounding air). The depth should be 2 inches or half the thickness of the wood. Different areas of the load should be probed and the lowest temperature used in determining fumigation temperature. Determine the wood temperature 5 to 10 minutes after drilling the hole to allow the heat generated during drilling to dissipate.

### T404-b-1-2 Wood products including containers

Pest: See following pest list for T404-b-1-1, T404-b-1-2, and T404-b-4

Treatment: T404-b-1-2—MB in 26" vacuum

Temperature	Dosage Rate (lb/1,000 ft <sup>3</sup> )	Exposure Period
70°F or above	4 lbs	4 hrs
40-69°F	4 lbs	5 hrs

### T404-b-2 Wood products including containers

Pest: Borers (wood wasps, carpenter ants, carpenter bees, and termites )

Treatment: T404-b-2—SF at NAP

Temperature	Dosage Rate (lb/1,000 ft <sup>3</sup> )	Minimum Concentration Readings (ounces) At:						
		0.5 hr	2 hrs	4 hrs	12 hrs	16 hrs	24 hrs	32 hrs
70°F or above	4 lbs	48	45	40	—	32	—	—
60-69°F	4 lbs	48	45	40	36	—	32	—
50-59°F	5 lbs	60	56	52	48	—	40	—
40-49°F	6.5 lbs	76	71	66	60	—	52	—
OR	5 lbs	60	57	53	49	—	44	40



Do not use a filter containing sodium hydroxide (Ascarite<sup>®</sup>) with this fumigant.

Sulfuryl Fluoride (SF) is **NOT** an approved quarantine treatment for wood-boring beetles because SF has difficulty in penetrating insect eggs; therefore, many eggs will still hatch following fumigation. SF treatment of wood should be authorized only for brood-tending species of insects such as termites, bees, wasps, and ants. Even if all eggs are not killed, the hatching larvae will die of starvation, due to lack of care.

## T404-b-4

### Wood products including containers

Pest: See following pest list for T404-b-1-1, T404-b-1-2, and T404-b-4

Treatment: T404-b-4—Kiln Sterilization

Dry bulb temperature	Wet bulb depression	Relative humidity	Moisture content	Thickness of lumber	Exposure*
140°F	7°F	82%	13.8%	1 inch 2 inches 3 inches	3 hrs 5 hrs 7 hrs
130°F	16°F	60%	9.4%	1 inch 2 inches 3 inches	10 hrs 12 hrs 14 hrs
125°F	15°F	61%	9.7%	1 inch 2 inches 3 inches	46 hrs 48 hrs 50 hrs



Use this pest list for T404-b-1-1, T404-b-1-2, and T404-b-4

Coleoptera (beetles):

Bostrichidae (branch and twig borers)  
 Buprestidae (metallic or flat-headed borers)  
 Cerambycidae (long-horned or round-headed borers)  
 Curculionidae (wood-boring and root-feeding weevils)  
 Lyctidae (powder-post beetles)  
 Lymexylonidae (ship timber beetles)  
 Passalidae (bess beetles)  
 Platypodidae (pin-hole borers)  
 Rhizophagidae (root-eating beetles)  
 Salpingidae (narrow-wasted bark beetles)  
 Scolytidae (bark/engraver beetles; also ambrosia/timber beetles)  
 Trogositidae (Bark-gnawing beetles)

Hymenoptera (bees, wasps, and ants):

Formicidae (carpenter ants)  
 Orussidae (parasitic wood wasps)  
 Siricidae (wood wasps)  
 Syntexicae (incense-cedar wood wasps)  
 Xylocopidae (carpenter bees)  
 Xyphydriidae (wood wasps)

Isoptera (termites)

Lepidoptera (moths):

Cossidae (carpenter worms)  
 Sesiidae (clear-winged moths)

### T404-c-1-1

### Wood products including containers



If using a T/C analyzer, an Ascarite<sup>®</sup> filter must be mounted when taking concentration readings for the following MB-NAP treatments.

Two alternative treatments

Pest: Termites



Important

For borers, see [T404-b-1-1](#) on [page 5-5-14](#).

Treatment: T404-c-1-1—MB at NAP—tarpaulin or chamber

Temperature	Dosage Rate (lb/1,000 ft <sup>3</sup> )	Minimum Concentration Readings (ounces) At:				
		0.5 hr	2 hrs	4 hrs	16 hrs	24 hrs
40°F or above	3 lbs	36	30	27	25	24



Important

1. Minimum concentration must be met in NAP chamber fumigations of sorptive materials. (see [Sorption](#) on [page 2-3-6](#) for a list of sorptive materials.)
2. If both termites and borers are present at 40°F–60°F, use the schedule for borers with exposure extended to 20 hours. Use same minimum concentrations.
3. Guatamba wood squares and green wood may emit a gas which gives a reading additive to MB on the fumiscope. Use of a filter containing sodium hydroxide (Ascarite<sup>®</sup>) will eliminate this contaminative gas.

### T404-c-1-2

### Wood products including containers

Treatment: T404-c-1-2—MB in 26" vacuum

Temperature	Dosage Rate (lb/1,000 ft <sup>3</sup> )	Exposure Period
70°F or above	4 lbs	3 hrs
40-69°F	4 lbs	4 hrs

## T404-d

### Wood products including containers



If using a T/C Analyzer, an Ascarite® filter must be mounted when taking concentration readings for the following MB-NAP treatments.

Pest: Borers and *Trogoderma granarium* (khapra beetle)

Treatment: T404-d—MB at NAP—tarpaulin or chamber

Temperature	Dosage Rate (lb/1,000 ft <sup>3</sup> )	Minimum Concentration Readings (ounces) At:				
		0.5 hr	2 hrs	4 hrs	16 hrs <sup>1</sup>	24 hrs
80°F or above	3.5 lbs	36	33	30	25	17
70-79°F	4.5 lbs	50	45	40	25	22
60-69°F <sup>2</sup>	6 lbs	65	55	50	42	29
50-59°F	7.5 lbs	80	70	60	42	36
40-49°F <sup>3</sup>	9 lbs	85	76	70	42	42

- 1 If the 16-hour reading is **not** performed, the 24-hour reading **must** have the following minimum concentrations: For 80°F or above—25 oz.; for 70-79°F—25 oz.; for 60-69°F—42 oz; for 50-59°F—42 oz; and 40-49°F—42 oz.
- 2 Due to label restrictions, use MB-100 gas may not be used at 60°F or below.
- 3 MB Q-gas may be used at any temperature above 40°F.

## T404-e - Approved marking for regulated wood packing material

The wood packing material<sup>2</sup> must be stamped in a visible location on each article, with a legible and permanent mark that indicates the article has met the treatment required. The mark must be approved by the International Plant Protection Convention (IPPC). The currently approved mark shown in **Figure 5-5-1** below. XX would be replaced by the country code, 000 by the producer number, and YY by the treatment type (HT or MB).

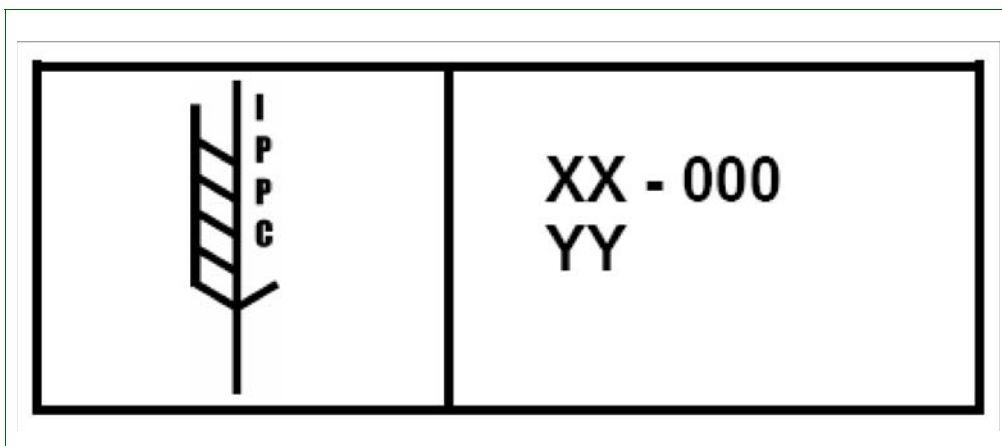

**FIGURE 5-5-1 Example of International Plant Protection Convention Marking**

### T404-e-1

#### Regulated wood packing material (WPM)

Two alternative treatments

Pest: Various

Treatment: T404-e-1—MB at NAP—tarpaulin

Temperature	Dosage Rate (lb/1,000 ft <sup>3</sup> )	Minimum Concentration Readings (ounces) At:				
		0.5 hr	2 hrs	4 hrs	16 hrs	24 hrs
69.8°F or above	3 lbs	36	36	31	28	24
61°-69.8°F	3.5 lbs	42	42	36	32	28
51.8°-61°F	4 lbs	48	48	42	36	32

<sup>2</sup> Regulated wood packing material is defined as all types of wood packaging materials used for or for use with cargo to prevent damage, including, but not limited to, dunnage, crating, pallets, packing blocks, drums, cases, and skids. Excluded from the definition of wood packaging materials are:

- ◆ Pieces of wood that are less than 6mm or 0.24 inches in any dimension
- ◆ Loose wood packing materials, such as wood shavings, excelsior, etc.
- ◆ Processed wood packing materials that have received more than primary processing, such as plywood, corrugated board, fiberboard, veneer, whiskey and wine barrels, oriented strand boards, etc.

**T404-e-2 Regulated wood packing material (WPM)**

Pest: Various  
Treatment: T404-e-2

Heat treatment to achieve a minimum core temperature of 56°C (132.8°F) for a minimum of 30 minutes. Treatments must be conducted in USDA-approved facilities. Contact CPHST in Raleigh, NC for facility specifications.

**T405—Bags and Bagging Materials**

See T306 schedules

**T406—Golden Nematode Contaminations**

**T406-a Miscellaneous cargo (nonfood, nonfeed commodities)**

Pest: *Globodera rostochiensis* (golden nematode)  
Treatment: T406-a—MB in 26" vacuum, use T403-c

**T406-c Piers, barges, railroad cars, automobiles, used farm equipment, etc.**

Pest: ***Globodera rostochiensis*** (golden nematode)  
Treatment: T406-c—Steam Cleaning

Steam at high pressure until all soil is removed. Treated surfaces should be thoroughly wet and heated. The debris and/or runoff from the cleaning procedure must be handled in a manner approved by local and port authority guidelines.

**T406-b Used farm equipment, construction equipment, containers, etc.**

Pest: *Globodera rostochiensis* (golden nematode)  
Treatment: T406-b—MB (“Q” label only) at NAP—tarpaulin or chamber

Temperature	Dosage Rate (lb/ 1,000 ft <sup>3</sup> )	Minimum Concentration Readings (ounces) At:		
		0.5 hr	2 hrs	24 hrs
60°F or above	15 lbs	180	120	120



Soil should be easily crumbled but not wet. The soil should not exceed 12 inches in the smallest dimension.

## T406-d

### Used farm equipment (without cabs), construction equipment (without cabs), and used containers

Pest: *Globodera rostochiensis* (golden nematode)

Treatment: T406-d—Steam at NAP—tarpaulin, or tent

Steam heat for 60 minutes after all temperature sensors reach 140°F (60°C). (see sensor placement and other requirements below)



This treatment must be conducted under the following minimum ambient air temperatures, which will vary with the volume of the treatment enclosure:

—For treatment enclosures of 4,000 ft<sup>3</sup> or less, the minimum air temperature is 40°F.

—For treatment enclosures greater than 4,000 ft<sup>3</sup> and less than or equal to 6,000 ft<sup>3</sup>, the minimum air temperature is 60°F.

This treatment is not recommended for treatment enclosures greater than 6,000 ft<sup>3</sup>.

#### Step 1—Determine if the temperature and volume requirements can be met

If you cannot meet the temperature and enclosure volume requirements, do not use this treatment.

#### Step 2—Assemble articles to be treated

Articles to be treated should be placed as close together as possible. Arrange articles to allow space for placement of the steam distribution manifold.

#### Step 3—Place the steam distribution manifold pipe beneath articles to be treated

The steam distribution manifold should be assembled and placed beneath the articles to be treated in order to facilitate steam distribution. A flexible steam introduction hose, approximately 20 feet in length, connects the steam generator to a 10 foot long U-shaped pipe capped at the ends, with 0.5 inch holes every 12 inches. This pipe serves as the steam distribution manifold.

#### Step 4—Place temperature recording sensors on the article to be treated

#### Enclosures of 4,000 ft<sup>3</sup> or less

When the treatment is being conducted in enclosures 4,000 ft<sup>3</sup> or less, use at least four temperature recording sensors in addition to the sensor on the steam generator. Place sensors in hard-to-treat cracks or crevices on the equipment or containers. Position sensors in the following locations:



1. Front high—near the top of the front of the equipment or load
2. Center middle—midway from the top and bottom of the center of the equipment or load
3. Center bottom—bottom of the center of the equipment or load, but at least 3 inches above the floor if the equipment is flush with the floor
4. Rear bottom—bottom of the rear of the equipment, but at least 3 inches above the floor if the equipment is flush with the floor

**Enclosures  
greater than  
4,000 ft<sup>3</sup> and  
less than or  
equal to 6,000  
ft<sup>3</sup>**

When the treatment is being conducted in enclosures greater than 4,000 ft<sup>3</sup> and less than or equal to 6,000 ft<sup>3</sup>, use at least eight temperature recording sensors in addition to the sensor on the steam generator. Again, place sensors in hard-to-treat cracks or crevices on the equipment or containers. Position probes in the following locations:

1. Front high—near the top of the left side of the front of the equipment or load
2. Front low—bottom of the right side of the front of the equipment or load, but at least 3 inches above the floor if the equipment is flush with the floor
3. Center high—near the top of the center of the equipment or load on the right side
4. Center middle—midway from the top and bottom of the center of the equipment or load
5. Center low—bottom of the center of the equipment or load on the left side, but at least 3 inches above the floor if the equipment is flush with the floor
6. Rear high—near the top of the rear of the equipment on the right side
7. Rear middle—midway from the top and bottom of the rear of the equipment
8. Rear low—bottom of the rear of the equipment or load on the left side, but at least 3 inches above the floor if the equipment is flush with the floor.

**Step 5—Enclose the article to be treated with a tarpaulin or tent**

If a tarpaulin (6 mil plastic) is used instead of a tent, pad sharp edges of the equipment or containers before covering with the tarp.

If the equipment or containers will be moved into an enclosure, such as a tent, it may be more practical to place the temperature sensors after this step. In either case, the front of the equipment or load and the front of the enclosure should face in the same direction.

**Step 6—Place the steam generator at an open end of the enclosure and seal the enclosure**

The steam generator is placed approximately 20 feet from the front of the enclosure and connected to a steam introduction line (hose.) The steam introduction line is connected to the steam distribution manifold pipe which is situated under the articles to be treated. The enclosure is sealed at the base including the point at which the introduction line enters the enclosure. An airtight seal is not essential for steam treatment; therefore small pinholes are acceptable.

**Step 7—Steam heat the enclosure for 60 minutes after all temperature sensors reach a minimum 140°F (60°C)**



**Important**

Use only a steam generator approved by APHIS.

The maximum temperature in the enclosure should not exceed 160°F (71°C).

The temperature should be recorded once every 2 minutes during the treatment.

**T407—Mechanical Cotton Pickers and Other Cotton Equipment**

**T407**

**Mechanical cotton pickers and other cotton equipment**

Pest: *Pectinophora gossypiella* (pink bollworm)

Treatment: T407—MB (“Q” label only) at NAP—tarpaulin, chamber, railroad car, or van

Temperature	Dosage Rate (lb/1,000 ft <sup>3</sup> )	Minimum Concentration Readings (ounces) At:				
		0.5 hr	2 hrs	3 hrs	4 hrs	12 hrs
40°F or above	4 lbs	48	—	—	—	21
	8 lbs	96	—	64	—	—



**Important**

This treatment is designed to kill exposed larvae, larvae within green cotton bolls or single locks of seed cotton, or loose trash. Any materials such as sacked or bulked seed, cotton waste, lint, linters, or any packaged commodity shall be treated in accordance with T301.

## T408—Soil as Such and Soil Contaminating Durable Commodities

### T408-e-1 Herbarium specimens of mosses and liverworts in soil and originating in golden nematode free countries

Pest: (Precautionary)

Treatment: T408-e-1—MB (“Q” label only) in 26" vacuum (Precautionary fumigation)

Temperature	Dosage Rate (lb/1,000 ft <sup>3</sup> )	Exposure Period
70°F or above	2 lbs	3.5 hrs

### T408-e-2 Herbarium specimens of mosses and liverworts in soil and originating in golden nematode free countries

Pest: *Globodera rostochiensis* (golden nematode)

Treatment: T408-e-2—MB (“Q” label only) in 26" vacuum

Temperature	Dosage Rate (lb/1,000 ft <sup>3</sup> )	Exposure Period
40°F or above	8 lbs	16 hrs
	10.5 lbs	12 hrs
	16 lbs	8 hrs

### T408-a Soil as such

Two alternative treatments

Pest: Various pests and pathogens found in soil (including striga)

Treatment: T408-a—Dry heat—

Temperature	Exposure Period
230°F to 249°F	16 hours
250°F to 309°F	2 hours
310°F to 379°F	30 minutes
380°F to 429°F	4 minutes
430°F to 450°F	2 minutes

Soil to be spread in layers 0.5 inches in depth to ensure uniform heat penetration. The exposure period does not begin until the entire mass reaches 250°F.

### T408-b Soil as such

Pest: Various pest and pathogens found in soil

Treatment: T408-b—Steam—250°F at 15 lbs pressure (p.s.i.) for 0.5 hour

Preheat laboratory autoclaves. Restrict soil depth to 2 inches when treating quantities of soil in trays. Restrict each package weight to 5 lbs. or less when treating individual packages. Load with adequate spacing. Large commercial steam facilities which operate at pressures up to 60 lbs. psi will permit treatment of greater soil depth.

**T408-b-1 Soil contaminating durable commodities (e.g., equipment, cobblestone, marble)**

Pest: Various pests and pathogens found in soil

Treatment: Steam Cleaning

Steam at high pressure until all soil is removed. Treated surfaces should be thoroughly wet and heated. The debris and/or runoff from the cleaning procedure must be handled in a manner approved by local and port authority guidelines.

**T408-c-1 Soil as such**

Two alternative treatments

Pest: *Globodera rostochiensis* (golden nematode)

Treatment: T408-c-1—MB (“Q” label only) in 26" vacuum, see **T403-c** on **page 5-5-11** for loose and friable material only.

Soil to be fumigated in containers—no dimensions of which can exceed 24 inches.

**T408-c-2 Soil as such**

Pest: *Globodera rostochiensis* (golden nematode)

Treatment: T408-c-2—MB (“Q” label only) at NAP—tarpaulin or chamber

Temperature	Dosage Rate (lb/1,000 ft <sup>3</sup> )	Minimum Concentration Readings (ounces)		
		At: 0.5 hr	2 hrs	24 hrs
60°F or above	15 lbs	180	120	72



Soil should be friable, moist, but not wet. Soil must not be more than 12 inches in depth. If stacked in containers, 12 inches of space must be left between levels.

**T408-d-1**

**Soil as such**

Two alternative treatments

Pest: Insects

Treatment: T408-d-1—Screening through 16 mesh screens will remove most larvae and pupae, except smaller types.

**T408-d-2**

Treatment: T408-d-2—Freezing—0°F for 5 days

**T408-f**

**Soil contaminated durable commodities (e.g., equipment, cobblestone, marble)(precautionary treatment)**

Pest: Soil fungi, nematodes, and certain soil insects

Treatment: T408-f—Steam Cleaning

Steam at high pressure until all soil is removed. Treated surfaces should be thoroughly wet and heated.

The debris and/or runoff from the cleaning procedure must be handled in a manner approved by local and port authority guidelines.

**T408-g-1**

**Soil contaminated nonfood or nonfeed commodities**

Two alternative treatments

Pest: *Striga* spp. (witchweed)

Treatment: T408-g-1—MB (“Q” label only) (tarpaulin)

Temperature	Dosage Rate (lb/1,000 ft <sup>3</sup> )	Exposure Period
60°F or above	10 lbs	24 hrs
	20 lbs	15.5 hrs

**T408-g-2**

**Soil contaminated nonfood or nonfeed commodities**

Pest: *Striga* spp. (witchweed)

Treatment: T408-g-2—MB (“Q” label only) (tarpaulin)

Temperature	Dosage Rate (lb/1,000 ft <sup>3</sup> )	Minimum Concentration Readings (ounces) At:		
		0.5 hr	2 hrs	24 hrs
60°F or above	15 lbs	164	120	72



Soil must be friable, moist, but not wet. The soil shall not exceed 12 inches in least dimension.

## T409—Aircraft

### T409-a

#### Aircraft

Pest: *Trogoderma granarium* (khapra beetle)

Treatment: T409-a



Contact Regional Director for specific instructions.

### T409-b

#### Aircraft

Pest: Hitchhiking pests other than khapra beetle, fruit flies, and soft-bodied insects

Treatment: T409-b—d-phenothrin aerosols (10%)—apply at rate of 8g/1,000 ft<sup>3</sup>



Aerosol disinfestation of U.S. military aircraft must conform to requirements in the latest edition of “Quarantine Regulations of the Armed Forces” (Army Reg. 40-12; SECNAVINST 6210.2A; AFR 161-4).

Currently, d-phenothrin aerosol (10%) is available from Sumitomo Chemical Company LTD, 5-33, Kitahama 4-Chrome, Chuo-ku, Osaka 541-8550, Japan (EPA Reg. No. 10308-21)

### Determine the number of seconds to spray the aerosol

The time needed to spray the aerosol is a function the following three things:

- ◆ Volume of the aircraft (in 1000 cubic feet)
- ◆ Spray rate of the nozzle (in grams per second)
- ◆ Required application rate for the pesticide (in grams per 1000 cubic feet)

This relationship is shown in the following formula:

$$\text{Volume of Aircraft} \times \left( \frac{\text{Required Application Rate}}{\text{Spray Rate of Nozzel}} \right) = \text{Time Needed to Spray Aersol}$$

Use **Table 5-5-1** on **page 5-5-30** through **Table 5-5-23** on **page 5-5-40** to determine the spray time when using 10 percent d-phenothrin, which requires an application rate of 8 grams per 1000 cubic feet, and a nozzle with a spray rate of 5 gram per second.



Currently, d-phenothrin aerosol (10 percent) is available from Sumitomo Chemical Company LTD, 5-33, Kitahama 4-Chrome, Chuo-ku, Osaka 541-8550, Japan (EPA Reg. No. 10308-21). The labeled application rate is 8 grams per 1000 cubic feet, and the spray rate of the aerosol can is 5 grams per second. Calculations for spray times beginning with **Table 5-5-1** on **page 5-5-30** are based on the spray rate of 5 gram per second. To have better control of spray times of one second or less, you can use an extender tube on the nozzle of the aerosol can. The extender tube can cut the spray rate in half. For example, if a can of d-phenothrin normally sprays at a rate of 5 grams per second, the extender tube would reduce this rate to 2.5 grams per second and the correct spraying time would then be twice the time listed beginning with **Table 5-5-1** on **page 5-5-30**.

Also, the aircraft volumes in Table 5-5-1 represent standard configurations of aircraft. Check with the captain or contact the follow manufacturers to determine if the aircraft has been modified from the standard configuration, and determine the actual volume.

### **Airbus Industries of North America, Inc.**

593 Herndon Parkway  
Herndon, VA 20170  
Telephone: (703) 834-3400  
Fax: (703) 834-3550  
Website: <http://www.airbus.com/body.html>

### **Boeing Commercial Aeroplane Group**

P.O. Box 3707, Mail Stop 74-31  
Seattle, WA 98124-2207  
Telephone: (425) 237-3657  
Website: <http://www.boeing.com/commercial.com>

### **Fairchild Aerospace Corp.**

P.O. Box 790490  
San Antonio, TX 78279-0490  
Telephone: (210) 824-2313

### **McDonald-Douglas Corporation**

Military Aircraft Section  
P.O. Box 516  
St. Louis, MO 63166  
Telephone: (314) 233-5360  
Fax: (314) 232-7528

## Aerospatiale

Website: <http://www.aerospatiale.fr/products/avions>

## Casa

Website: <http://www.casa.es252>

Determine the Spray Time for 10% d-phenothrin with a labeled application rate of 8 grams per 1000 cu. ft. and nozzle dispersion rate of 5 grams per second

**TABLE 5-5-1: Airbus Industries**

Aircraft, model, and series	Area	Volume ft <sup>3</sup>	Aerosol Calculations		
			1,000 ft <sup>3</sup> Units	Grams/ 1,000 ft <sup>3</sup>	Spray Time in Seconds
A300	Cabin	27,100	27.1	8	43.5
	Pit-#1	3,722	3.7	8	6.0
	Pit-#2	1,265	1.3	8	2.0
	Pit-#3	565	.6	8	1.0
A300-600R (passenger) (long-range)	Cabin	?			?
	Forward	1,134	1.1	8	2.0
	Aft	1,134	1.1	8	2.0
	Bulk	400	.4	8	0.5
A300-600 (freighter)	Main	9,950	10.0	8	16.0
	Pit-Fwd	1,900	1.9	8	3.0
	Pit-Aft	2,250	2.2	8	3.5
A300-600 (FEDEX)	Main	19,069	19.1	8	30.5
	Pit-Fwd	2,684	2.7	8	4.5
	Pit-Aft	2,154	2.2	8	3.5
	Pit-Back	742	.7	8	1.0
A300 (convertible)	Main	11,943	11.9	8	19.0
A300B4 (freighter)	Main	9,950	10.0	8	16.0
	Pit-Fwd	1,900	1.9	8	3.0
	Pit-Aft	1,850	1.9	8	3.0
A310 (freighter)	Main	7,950	8.0	8	13.0
	Pit-Fwd	1,260	1.3	8	2.0
	Pit-Aft	1,550	1.6	8	2.5
A310 (FEDEX)	Main	14,650	14.7	8	23.5
	Pit-Fwd	1,942	1.9	8	3.0
	Pit-Aft	1,271	1.3	8	2.0
	Pit-Back	742	.7	8	1.0
A320-200 (passenger)	N/A	982	.9	8	1.5



**TABLE 5-5-2: Antonov**

Aircraft, model, and series	Area	Volume ft <sup>3</sup>	Aerosol Calculations		
			1,000 ft <sup>3</sup> Units	Grams/ 1,000 ft <sup>3</sup>	Spray Time in Seconds
AN 124 and 126	N/A	26,485	26.5	8	42.5

**TABLE 5-5-3: ATR**

Aircraft, model, and series	Area	Volume ft <sup>3</sup>	Aerosol Calculations		
			1,000 ft <sup>3</sup> Units	Grams/ 1,000 ft <sup>3</sup>	Spray Time in Seconds
ATR 42 (CTO) (Container Transport Option)	Bulk	890	.9	8	1.5
ATR 72 (CTO)	Bulk	1,285	1.3	8	2.0

**TABLE 5-5-4: BAC (British Aircraft Corp)**

Aircraft, model, and series	Area	Volume ft <sup>3</sup>	Aerosol Calculations		
			1,000 ft <sup>3</sup> Units	Grams/ 1,000 ft <sup>3</sup>	Spray Time in Seconds
111-200, 300, and 400	Cabin	4,056	4.1	8	6.5
	Pit-Fwd	380	.4	8	0.5
	Pit-Aft	154	.2	8	0.5
111-500	Cabin	5,094	5.1	8	8.0
	Pit-Fwd	451	.5	8	1.0
	Pit-Aft	260	.3	8	0.5
VC 10	Cabin	6,750	6.8	8	11.0
	Pit-Fwd	744	.7	8	1.0
	Pit-Aft	820	.8	8	1.5
Super VC 10	Cabin	7,850	7.9	8	12.5
	Pit-Fwd	744	.7	8	1.0
	Pit-Aft	820	.8	8	1.5

**TABLE 5-5-5: BAC (Aerospatiale)**

Aircraft, model, and series	Area	Volume ft <sup>3</sup>	Aerosol Calculations		
			1,000 ft <sup>3</sup> Units	Grams/ 1,000 ft <sup>3</sup>	Spray Time in Seconds
Concorde	Cabin	5,100	5.1	8	8.0
	Pit-Fwd	241	.2	8	0.5
	Pit-Aft	468	.5	8	1.0

**TABLE 5-5-6: Boeing**

Aircraft, model, and series	Area	Volume ft <sup>3</sup>	Aerosol Calculations		
			1,000 ft <sup>3</sup> Units	Grams/ 1,000 ft <sup>3</sup>	Spray Time in Seconds
707-120, 120B, and 220	Cabin	7,484	7.5	8	12.0
	Pit-Fwd	755	.8	8	1.5
	Pit-Aft	910	.9	8	1.5
	Fl.Deck	451	.5		1.0
707-320C	Bulk	7,548	7.5	8	12.0
707-320, 420	Cabin	8,074	8.0	8	13.0
	Pit-Fwd	870	.9	8	1.5
	Pit-Aft	905	.9	8	1.5
	Fl. Deck	451	.5	8	1.0
720	Cabin	6,860	6.9	8	11.0
	Pit-Fwd	688	.7	8	1.0
	Pit-Aft	690	.7	8	1.0
	Fl. Deck	451	.5	8	1.0
727-100C	Bulk	4,168	4.2	8	7.0
727-100 (passenger)	Cabin	4,560	4.6	8	7.5
	Pit-Fwd	900	.9	8	1.5
	Pit-Aft	425	.4	8	0.5
	Fl. Deck	451	.5	8	1.0
727-200C	Bulk	8,032	8.0	8	13.0
727-200 (passenger)	Cabin	6,561	6.6	8	10.5
	Pit-Fwd	690	.7	8	1.0
	Pit-Aft	760	.8	8	1.5
	Fl. Deck	451	.5	8	1.0
737-100	Cabin	4,636	4.6	8	7.5
	Pit-Fwd	280	.3	8	0.5
	Pit-Aft	406	.4	8	0.5
737-200 (passenger)	Cabin	4,636	4.6	8	7.5
	Pit-Fwd	370	.4	8	0.5
	Pit-Aft	505	.5	8	1.0
737-200C	Bulk	3,602	3.6	8	6.0
737-300	Cabin	4,900	4.9	8	8.0
	Pit-Fwd	425	.4	8	1.0
	Pit-Aft	650	.7	8	1.0
	Fl. Deck	225	.3	8	0.5
737-400	Cabin	5,600	5.6	8	9.0
	Pit-Fwd	600	0.6	8	1.0
	Pit-Aft	770	0.8	8	1.5
	Fl. Deck	225	0.2	8	0.5
737-500	Cabin	4,340	4.3	8	7.0
	Pit-Fwd	290	.3	8	0.5
	Pit-Aft	535	.5	8	1.0
	Fl. Deck	255	.3	8	0.5
747 Combi	—	6,886	6.9	8	11.0
747F	—	22,952	23.0	8	37.0

**TABLE 5-5-6: Boeing (continued)**

Aircraft, model, and series	Area	Volume ft <sup>3</sup>	Aerosol Calculations		
			1,000 ft <sup>3</sup> Units	Grams/ 1,000 ft <sup>3</sup>	Spray Time in Seconds
747-100, 200	Cabin	27,650	27.7	8	44.5
	Pit-Fwd	3,485	3.5	8	6.0
	Pit-Aft	3,015	3.0	8	5.0
	Fl. Deck	920	.9	8	1.5
	U. Deck	1,370	1.4	8	2.0
	Belly	1,000	1.0	8	1.5
747-300,400	Cabin	27,650	27.7	8	44.5
	Pit-Fwd	3,485	3.5	8	5.5
	Pit-Aft	3,015	3.0	8	5.0
	Fl. Deck	920	.9	8	1.5
	U. Deck	2,800	2.8	8	4.5
	Belly	1,000	1.0	8	1.5
757-200 (passenger)	Pit-Fwd	652	.6	8	1.0
	Pit-Aft	1,086	1.1	8	2.0
757-200PF	Bulk	8,405	8.4	8	13.5
767-200	Main	14,255	14.3	8	23.0
	Pit-Fwd	1,470	1.5	8	2.5
	Pit-Aft	1,470	1.5	8	2.5
767-300 (passenger)	Cabin	10,497	10.5	8	17.0
	Pit-Fwd	1,920	1.9	8	3.0
	Pit-Aft	1,680	1.7	8	2.5
	Aft+Bulk	430	.4	8	0.5
777-200	Cabin	20,700	20.7	8	33.0
	Pit-Fwd	280	.3	8	0.5
	Pit-Aft	4,630	4.6	8	7.5
	Aft+Bulk	4,220	4.2	8	6.5

**TABLE 5-5-7: Canadair**

Aircraft, model, and series	Area	Volume ft <sup>3</sup>	Aerosol Calculations		
			1,000 ft <sup>3</sup> Units	Grams/ 1,000 ft <sup>3</sup>	Spray Time in Seconds
CL-44	Bulk	6,235	6.2	8	10.0
CL-440	Bulk	13,798	13.8	8	22.0

**TABLE 5-5-8: Casa**

Aircraft, model, and series	Area	Volume ft <sup>3</sup>	Aerosol Calculations		
			1,000 ft <sup>3</sup> Units	Grams/ 1,000 ft <sup>3</sup>	Spray Time in Seconds
C-212	N/A	777	.8	8	1.5
ATR 72 (CTO)	N/A	1,528	1.5	8	2.5

**TABLE 5-5-9: Cessna**

Aircraft, model, and series	Area	Volume ft <sup>3</sup>	Aerosol Calculations		
			1,000 ft <sup>3</sup> Units	Grams/ 1,000 ft <sup>3</sup>	Spray Time in Seconds
Caravan	N/A	452	.5	8	1.0

**TABLE 5-5-10: Convair**

Aircraft, model, and series	Area	Volume ft <sup>3</sup>	Aerosol Calculations		
			1,000 ft <sup>3</sup> Units	Grams/ 1,000 ft <sup>3</sup>	Spray Time in Seconds
240	Cabin	1,650	1.7	8	2.5
	Pit-Fwd	193	.2	8	0.5
	Belly	88	.1	8	— <sup>1</sup>
340 & 44-	Cabin	1,816	1.8	8	3.0
	Pit-Fwd	158	.2	8	0.5
	Pit-Aft	193	.2	8	0.5
	Belly	78	.1	8	— <sup>1</sup>
880 & 800M	Cabin	5,802	5.8	8	9.5
	Pit-Fwd	415	.4	8	0.5
	Pit-Aft	488	.5	8	1.0
990	Cabin	6,336	6.3	8	10.0
	Pit-Fwd	488	.5	8	1.0
	Pit-Aft	497	.5	8	1.0

1 In these small volume spaces, use the extender and calculate the application time using a rate of 2.5 grams per second. At a rate of 2.5 grams per second, the following table will give the spray time:

1,000 ft<sup>3</sup> Units Spray Time in Seconds

0.10.5  
0.20.5  
0.31.0  
0.41.5

**TABLE 5-5-11: de Havilland**

Aircraft, model, and series	Area	Volume ft <sup>3</sup>	Aerosol Calculations		
			1,000 ft <sup>3</sup> Units	Grams/ 1,000 ft <sup>3</sup>	Spray Time in Seconds
Dash 7, Series 100 (all cargo)	N/A	240	.2	8	0.5
DHC-6 Twin	Fwd	38	.1	8	— <sup>1</sup>
Otter, Series 300 (cargo version)	Aft Bulk	88 384	.1 .4	8 8	— <sup>1</sup> 0.5
Dash 7, Series 100, Combi (50 passengers)	N/A	240	.2	8	0.5

**TABLE 5-5-11: de Havilland**

Aircraft, model, and series	Area	Volume ft <sup>3</sup>	Aerosol Calculations		
			1,000 ft <sup>3</sup> Units	Grams/ 1,000 ft <sup>3</sup>	Spray Time in Seconds
Dash 7, Series 100, Combi (18 passengers)	N/A	240	.2	8	0.5
Dash 8, Series 300, Combi (49 passengers)	N/A	400	.4	8	0.5
Dash 8, Series 100, Combi (37 passengers)	N/A	300	.3	8	0.5
Dash 8, Series 100, Combi (20 passengers)	N/A	775	.8	8	1.5

- 1 In these small volume spaces, use the extender and calculate the application time using a rate of 2.5 grams per second. At a rate of 2.5 grams per second, the following table will give the spray time:

1,000 ft<sup>3</sup> Units Spray Time in Seconds

0.10.5  
0.20.5  
0.31.0  
0.41.5

**TABLE 5-5-12: Dornier**

Aircraft, model, and series	Area	Volume ft <sup>3</sup>	Aerosol Calculations		
			1,000 ft <sup>3</sup> Units	Grams/ 1,000 ft <sup>3</sup>	Spray Time in Seconds
228-212	N/A	642	.6	8	1.0

**TABLE 5-5-13: Embraer**

Aircraft, model, and series	Area	Volume ft <sup>3</sup>	Aerosol Calculations		
			1,000 ft <sup>3</sup> Units	Grams/ 1,000 ft <sup>3</sup>	Spray Time in Seconds
EMB-120 Brasilia	N/A	1,193	1.2	8	2.0
EMB-110 Brasilia	N/A	523	.5	8	1.0

**TABLE 5-5-14: Fairchild**

Aircraft, model, and series	Area	Volume ft <sup>3</sup>	Aerosol Calculations		
			1,000 ft <sup>3</sup> Units	Grams/ 1,000 ft <sup>3</sup>	Spray Time in Seconds
Expediter	NA	580	.6	8	1.0
Metro II & IIA	NA	580	.6	8	1.0
F27	Cabin	2,900	2.9	8	4.5
	Pit	192	.2	8	0.5
FH11227	Cabin	3,200	3.2	8	5.0
	Pit	192	.2	8	0.5

**TABLE 5-5-15: Fokker**

Aircraft, model, and series	Area	Volume ft <sup>3</sup>	Aerosol Calculations		
			1,000 ft <sup>3</sup> Units	Grams/ 1,000 ft <sup>3</sup>	Spray Time in Seconds
F27	N/A	198	.2	8	0.5
F28	N/A	290	.3	8	0.5
F100C	Bulk	2,070	2.0	8	3.0

**TABLE 5-5-16: Lockheed**

Aircraft, model, and series	Area	Volume ft <sup>3</sup>	Aerosol Calculations		
			1,000 ft <sup>3</sup> Units	Grams/ 1,000 ft <sup>3</sup>	Spray Time in Seconds
Electra	Cabin	5,160	5.2	8	8.5
	Pit-Fwd	254	.3	8	0.5
	Pit-Aft	274	.3	8	0.5
L1011 (100) (200) (250)	Cabin	23,100	23.1	8	37.0
	Pit-Fwd	1,600	1.6	8	2.5
	Pit-Ctr	1,600	1.6	8	2.5
	Pit-Aft	700	.7	8	1.0
	Galley	1,380	1.4	8	2.0
L-1011-1	Cargo Holds	3,900	3.9	8	6.0
L-100-30	N/A	6,057	6.1	8	10.0

**TABLE 5-5-17: McDonnell-Douglas**

Aircraft, model, and series	Area	Volume ft <sup>3</sup>	Aerosol Calculations		
			1,000 ft <sup>3</sup> Units	Grams/ 1,000 ft <sup>3</sup>	Spray Time in Seconds
DC-3	Bulk	1,300	1.3	8	2.0
DC-6 (cargo)	Bulk	3,354	3.4	8	5.5
DC-6 (passengers)	Cabin	4,332	1.3	8	7.0
	Pit-Fwd	200	.2	8	0.5
	Pit-Aft	173	.2	8	0.5

**TABLE 5-5-17: McDonnell-Douglas (continued)**

Aircraft, model, and series	Area	Volume ft <sup>3</sup>	Aerosol Calculations		
			1,000 ft <sup>3</sup> Units	Grams/ 1,000 ft <sup>3</sup>	Spray Time in Seconds
DC-6A	Cabin	4,375	4.4	8	7.0
	Pit-Fwd	267	.3	8	0.5
	Pit-Aft	300	.3	8	0.5
DC-6B	Cabin	4,375	4.4	8	7.0
	Pit-Fwd	276	.3	8	0.5
	Pit-Aft	242	.2	8	0.5
DC-7B	Cabin	4,612	4.6	8	7.0
	Pit-Fwd	267	.3	8	0.5
	Pit-Aft	364	.4	8	0.5
DC-7C	Cabin	4,778	4.8	8	7.5
	Pit-Fwd	312	.3	8	0.5
	Pit-Aft	339	.3	8	0.5
DC-8-50	Cabin	12,911	12.9	8	20.5
	Pit-Fwd	690	.7	8	1.0
	Pit-Aft	700	.7	8	1.0
DC-8-54F	Main	5,984	6.0	8	9.5
	Pit-Fwd	690	.7	8	1.0
	Pit-Aft	700	.7	8	1.0
DC-8-55F	Main	5,878	5.9	8	9.5
	Pit-Fwd	690	.7	8	1.0
	Pit-Aft	700	.7	8	1.0
DC-8-61 & 63	Cabin	15,955	16.0	8	25.5
	Pit-Fwd	1,290	1.3	8	2.0
	Pit-Aft	1,210	1.2	8	2.0
DC-8-62	Cabin	13,739	13.7	8	22.0
	Pit-Fwd	799	.8	8	1.5
	Pit-Aft	816	.8	8	1.5
DC-8-62CF	Main	6,442	6.4	8	10.0
	Pit-Fwd	800	.8	8	1.5
	Pit-Aft	815	.8	8	1.5
DC-8-63F and DC-8-73F	Main	10,350	10.4	8	16.5
	Pit-Fwd	1,290	1.3	8	2.0
	Pit-Aft	1,210	1.2	8	2.0
DC-8-71CF	Main	8,148	8.1	8	13.0
	Pit-Fwd	1,290	1.3	8	2.0
	Pit-Aft	1,210	1.2	8	2.0
DC-8-61CF & 71CF	Main	15,472	15.5	8	25.0
	Pit-Fwd	1,290	1.3	8	2.0
	Pit-Aft	1,210	1.2	8	2.0
DC-9-10	Cabin	4,056	4.1	8	6.5
	Pit-Fwd	1,000	1.0	8	1.5
	Pit-Aft	619	0.6	8	1.0
DC-9-10AF	Main	2,386	2.4	8	4.0
	Pit-Fwd	373	.4	8	0.5
	Pit-Aft	327	.3	8	0.5

**TABLE 5-5-17: McDonnell-Douglas (continued)**

Aircraft, model, and series	Area	Volume ft <sup>3</sup>	Aerosol Calculations		
			1,000 ft <sup>3</sup> Units	Grams/ 1,000 ft <sup>3</sup>	Spray Time in Seconds
DC-9-30	Cabin	5,094	5.1	8	8.0
	Pit-Fwd	1,386	1.4	8	2.0
	Pit-Aft	832	.8	8	1.5
DC-9-32AF	Main	3,300	3.3	8	5.5
	Pit-Fwd	562	.6	8	1.0
	Pit-Aft	333	.3	8	0.5
DC-9-33CF	Main	2,944	2.9	8	4.5
	Pit-Fwd	562	.6	8	1.0
	Pit-Aft	333	.3	8	0.5
DC-40	Cabin	5,535	5.5	8	9.0
	Pit-Fwd	1,290	1.3	8	2.0
	Pit-Aft	1,040	1.0	8	1.5
DC-10-10CF & 10F, also DC-10-30CF & 30F	Main	12,236	12.2	8	19.5
	Pit-Fwd	3,020	3.0	8	5.0
	Pit-Ctr	1,935	1.9	8	3.0
	Pit-Aft	510	.5	8	1.0
	Fl. Deck	400	.4	8	0.5
MD 8-61/63	Main	11,173	11.2	8	18.0
	Pit-Fwd	1,290	1.3	8	2.0
	Pit-Aft	1,210	1.2	8	2.0
MD8-62	Main	8,862	8.9	8	14.0
	Pit-Fwd	800	.8	8	1.5
	Pit-Aft	815	.8	8	1.5
MD9-10	Main	3,582	3.6	8	6.0
	Pit-Fwd	393	.4	8	0.5
	Pit-Aft	254	.3	8	0.5
MD9-30	Main	4,525	4.5	8	7.0
	Pit-Fwd	562	.6	8	1.0
	Pit-Aft	333	.3	8	0.5
MD9-40	Main	4,926	4.9	8	8.0
	Pit-Fwd	618	.6	8	1.0
	Pit-Aft	350	.4	8	0.5
MD-11F	Main Deck	15,530	15.5	8	25.0
	Lower Deck	4,976	5.0	8	8.0
MD-11 Combi	Main	5,822	5.8	8	9.5
	Pit-Fwd	3,655	3.7	8	6.0
	Pit-Ctr	2,685	2.7	8	4.5
	Pit-Aft	510	.5	8	1.0
MD-80 JT8D-217	Lower Hold	1,253	1.3	8	2.0
MD-80 JT8D-219	Lower Hold	1,013	1.0	8	1.5
MD 81 & 82	Cargo	1,253	1.3	8	2.0
MD-83	Cargo	1,013	1.0	8	1.5



**TABLE 5-5-17: McDonnell-Douglas (continued)**

Aircraft, model, and series	Area	Volume ft <sup>3</sup>	Aerosol Calculations		
			1,000 ft <sup>3</sup> Units	Grams/ 1,000 ft <sup>3</sup>	Spray Time in Seconds
MD-87	Cargo	938	.9	8	1.5
		or 697	.7	8	1.0
MD-88	Cargo	1,013	1.0	8	1.5
		or 1,253	1.3	8	2.0

**TABLE 5-5-18: SAAB**

Aircraft, model, and series	Area	Volume ft <sup>3</sup>	Aerosol Calculations		
			1,000 ft <sup>3</sup> Units	Grams/ 1,000 ft <sup>3</sup>	Spray Time in Seconds
340 B/QC	N/A	1,303	1.3	8	2.0

**TABLE 5-5-19: Shorts**

Aircraft, model, and series	Area	Volume ft <sup>3</sup>	Aerosol Calculations		
			1,000 ft <sup>3</sup> Units	Grams/ 1,000 ft <sup>3</sup>	Spray Time in Seconds
330	N/A	1,230	1.2	8	2.0
360 and 360-F	N/A	1,450	1.5	8	2.5

**TABLE 5-5-20: Sidely**

Aircraft, model, and series	Area	Volume ft <sup>3</sup>	Aerosol Calculations		
			1,000 ft <sup>3</sup> Units	Grams/ 1,000 ft <sup>3</sup>	Spray Time in Seconds
Carvelle	Cabin	5,600	5.6	8	9.0
	Pit-Fwd	258	.3	8	0.5
	Pit-Aft	116	.1	8	. <sup>1</sup>

1 In these small volume spaces, use the extender and calculate the application time using a rate of 2.5 grams per second. At a rate of 2.5 grams per second, the following table will give the spray time:

1,000 ft<sup>3</sup> Units Spray Time in Seconds

- 0.10.5
- 0.20.5
- 0.31.0
- 0.41.5

**TABLE 5-5-21: Tupolev**

Aircraft, model, and series	Area	Volume ft <sup>3</sup>	Aerosol Calculations		
			1,000 ft <sup>3</sup> Units	Grams/ 1,000 ft <sup>3</sup>	Spray Time in Seconds
TU-154	Bulk	5,000	5.0	8	8.0

**TABLE 5-5-22: Vickers**

Aircraft, model, and series	Area	Volume ft <sup>3</sup>	Aerosol Calculations		
			1,000 ft <sup>3</sup> Units	Grams/1,000 ft <sup>3</sup>	Spray Time in Seconds
Merchantman	Bulk	5,040	5.0	8	8.0
Viscount	Bulk	3,000	3.0	8	5.0

**TABLE 5-5-23: Military Aircraft**

Aircraft, model, and series	Area	Volume ft <sup>3</sup>	Aerosol Calculations		
			1,000 ft <sup>3</sup> Units	Grams/1,000 ft <sup>3</sup>	Spray Time in Seconds
C-5A	Main	46,651	46.7	8	74.5
	U. Deck	6,147	6.1	8	10.0
	Fwd. & Fl. Deck	5,147	5.1	8	8.0
	U. Floor	6,294	6.3	8	10.0
C-17	Main	20,875	20.9	8	33.5
C-26	Cabin	500	.5	8	1.0
	Pit	198	.2	8	0.5
C-130	Main	8,340	8.3	8	13.5
C-130 LG382		4,737	4.7	8	7.5
C-130 LG385-G		6,057	6.1	8	10.0
C-135	Cabin	6,000	6.0	8	9.5
C-141	Main	12,000	12.0	8	19.0
C-141B	Main	13,701	13.7	8	22.0
KC-10	Cabin	4,056	4.1	8	6.5
	Pit-Fwd	1,000	1.0	8	1.5
	Pit-Aft	619	.6	8	1.0

## T410—Tick Infestations

### Nonplant articles (i.e., bat guano, fence posts, etc.)

Pest: Ticks

Treatment: Use T310 schedules, Tick-infested materials (nonfood)

## T411—Ant Infestations—Nonplant Products

### T411

Pest: Ants

Treatment: T411—MB at NAP

Temperature	Dosage Rate (lb/1,000 ft <sup>3</sup> )	Minimum Concentration Readings (ounces) At:				
		0.5 hr	2.5 hrs	3 hrs	3.5 hrs	4 hrs
90-96°F	2 lbs	24	16	—	—	—
80-89°F	2.5 lbs	30	24	—	—	—
70-79°F	3 lbs	36	24	—	—	—
60-69°F	3 lbs	36	—	24	—	—
50-59°F	3 lbs	36	—	—	24	—
40-49°F	3 lbs	36	—	—	—	24

## T412—Noxious Weed Seeds (Devitalization Treatment)

### T412-a

#### *Guizotia abyssinica* (niger seed)

Pest: Weed seeds of the following genera:  
*Asphodelus fistulosus* (onionweed)  
*Digitaria* spp. (includes African couchgrass)  
*Oryza* spp. (red rice)  
*Paspalum scrobiculatum* (Kodo-millet)  
*Prosopis* spp. (includes mesquites)  
*Solanum viarum* (tropical soda apple)  
*Striga* spp. (witchweed)  
*Urochloa panicoides* (liver-seed grass)

Treatment: T412-a—Dry Heat Treatment at 248°F (120°C) for 15 minutes



Important

Do not start counting time until the entire mass reaches the required temperature.

### T412-b-1

#### Noxious weed seeds (devitalization treatment)

Pest: *Cuscuta* spp.

Two alternative treatments

Treatment: T412-b-1—Dry heat—commodity heated to 212°F (100°C) for 15 minutes

### T412-b-2 Noxious weed seeds (devitalization treatment)

Pest: *Cuscuta* spp.

Treatment: T412-b-2—Steam heat—commodity heated to 212°F (100°C) for 15 minutes

T412-b-3 Deleted

## T413—Brassware from Mumbai (Bombay), India

### T413-a Brassware from Mumbai (Bombay), India

Two alternative treatments

Pest: *Trogoderma granarium* (khapra beetle)

Treatment: T413-a—MB at NAP—tarpaulin or chamber

Temperature	Dosage Rate (lb/1,000 ft <sup>3</sup> )	Minimum Concentration Readings (ounces) At:		
		0.5 hr	2 hrs	12 hrs
90°F or above	2.5 lbs	30	20	15
80-89°F	3.5 lbs	42	30	20
70-79°F	4.5 lbs	54	40	25
60-69°F <sup>1</sup>	6 lbs	72	50	30
50-59°F	7.5 lbs	90	60	35
40-49°F <sup>2</sup>	9 lbs	108	70	40

- 1 Use MB 100 gas at 60°F or above.
- 2 Use MB "Q" gas at 40°F or above.



When both woodborers and khapra beetles are involved, use schedule [T404-d](#) on [page 5-5-19](#).

### T413-b Brassware from Mumbai (Bombay), India

Treatment: T413-b—MB in 26" vacuum

Temperature	Dosage Rate (lb/1,000 ft <sup>3</sup> )	Exposure Period
60°F or above <sup>1</sup>	8 lbs	3 hrs
40-59°F <sup>2</sup>	9 lbs	3 hrs

- 1 Use MB 100 gas at 60°F or above.
- 2 Use MB "Q" gas at 40°F or above.



Load limit is 75% of chamber volume.

## T414—Inanimate, Nonfood Articles with Gypsy Moth Egg Masses

### T414 Inanimate, nonfood articles with Gypsy Moth egg masses

Pest: Gypsy Moth egg masses

Treatment: T414—MB at NAP—tarpaulin or chamber

Temperature	Dosage Rate (lb/1,000 ft <sup>3</sup> )	Minimum Concentration Readings (ounces) At:				
		0.5 hr	4 hrs	8 hrs	12 hrs	16 hrs
50°F or above	3.5 lbs	42	28	—	—	—
	2.5 lbs	30	20	14	—	—
	2 lbs	24	16	12	12	10
40-49°F	4.5 lbs	54	36	—	—	—
	3.25 lbs	38	26	18	—	—
	2.25 lbs	30	20	14	14	12



For *Lymantria dispar* (gypsy moth) egg masses on such items as outdoor household articles, quarry products, lumber, logs, and timber products.

## T415— Garbage

Three alternative treatments are approved. The treatments can be used for commodity destruction.

### T415-a Garbage

Pest: Insect pest and pathogens

Treatment: T415-a—Heat Treatment- Incinerate to ash.



Caterers under compliance agreement using an incinerator for garbage must comply with the following conditions:

- Incinerator must be capable of reducing garbage to ash
- Incinerator must be maintained adequately to assure continued operation

### T415-b Garbage

Pest: Insect pest and pathogens

Treatment: T415-b—Dry heat or Steam- commonly heated to internal temperature of 212°F (100°C) for 30 minutes followed by burial in a landfill.



Caterers under compliance agreement using a sterilizer must comply with the following conditions:

The sterilizer must be capable of heating garbage to an internal temperature of 212° F and maintaining it at that temperature for a minimum of 30 minutes.

Reevaluate and adjust the sterilization cycle twice a year using a thermocouple to recalibrate the temperature recording device. Adjusting the sterilization cycle semiannually will assure that all garbage processed is heated to a minimum internal temperature of 212° F for at least 30 minutes, and that the temperature recording device accurately reflects the internal temperature of the sterilizer.



Observe all reevaluations and adjustments.

The operator is to date and initial time/temperature records for each batch of garbage sterilized. The supervisor is to review and sign each time/temperature record. The facility must retain records for 6 months for review by PPQ.

Clean the drain in the bottom of the sterilizer between each cycle to assure proper heat circulation

## T415-C

### Garbage

Pest: Insect pest and pathogens

Treatment: T415-c—Grinding and discharge into an approved sewage system



Important

Grinding and discharging is allowed into an approved sewage system. An approved sewage system is designed and operated in such a way as to preclude the discharge of sewage effluents onto land surfaces or into lagoons or other stationary waters, is adequate to prevent the dissemination of plant pests and livestock or poultry diseases, and is certified by an appropriate government official as currently complying with the applicable laws for environmental protection.

## T416—Goatskins, Lambskins, Sheepskins (Skins and Hides)

Three alternative treatments



Important

Fur, horsehair articles, and leather goods (skins and hides), may cause off-odors that may be unacceptable when exposed to methyl bromide (MB).



Important

Items known to be sorptive or items whose sorptive properties are unknown are not to be fumigated in chambers at NAP unless gas readings are taken.

### T416-a-1

#### Goatskins, lambskins, sheepskins (skins and hides)

Pest *Trogoderma granarium* (Khapra beetle)

Treatment MB (“Q” gas only) at NAP—tarpaulin

Temperature	Dosage Rate (lb/ 1,000 ft <sup>3</sup> )	Minimum Concentration Readings (ounces) At:		
		0.5 hr	2 hrs	12 hrs
90°F or above	2.5 lbs	30	20	15
80-89°F	3.5 lbs	42	30	20
70-79°F	4.5 lbs	54	40	25
60-69°F	6 lbs	72	50	30
50-59°F	7.5 lbs	908	60	35
40-49°F	9 lbs	108	70	40

The sorptive rates of commodities vary. When a commodity is known or suspected to be sorptive (see **T307-a** on **page 5-4-21**), take more gas readings than normal. Additional fumigant is added as prescribed on **Additional Readings** on **page 2-4-23**.

When both woodborers and khapra beetles are involved, use schedule **T404-d** on **page 5-5-19**.

**T416-a-2 Goatskins, lambskins, sheepskins (skins and hides)**

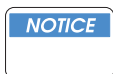

Load limit is 75% of chamber volume.

Pest *Trogoderma granarium* (Khapra beetle)  
Treatment MB (“Q” label gas) in 26” vacuum

Temperature	Dosage Rate (lb/1,000 ft <sup>3</sup> )	Exposure Period
60°F or above	8 lbs	3 hrs
40-59°F	9 lbs	3 hrs

**T416-a-3 Goatskins, lambskins, sheepskins (skins and hides)**

Pest *Trogoderma granarium* (Khapra beetle)  
Treatment MB (“Q” gas only) in 26” vacuum—chamber

Temperature	Dosage Rate (lb/1,000 ft <sup>3</sup> )	Exposure Period
90-96°F	2.5 lbs	12 hrs
80-89°F	3.5 lbs	12 hrs
70-79°F	4.5 lbs	12 hrs
60-69°F	6 lbs	12 hrs
50-59°F	10 lbs	12 hrs
40-49°F	12 lbs	12 hrs



### Amount of Phosphine liberated by various products

Calculate amount of product needed by using the amount of phosphine released as shown in the right column.

**TABLE 5-5-24: Amount of Phosphine Liberated by Various Products**

Product	Type	Unit and weight in grams	Grams of phosphine*
Degesch Fumi-Cel®	MP	1 plate; 117.0	33.0
Degesch Fumi-Strip®	MP	16 plates; 1872.0	528.0
Degesch Phostoxin®	AP	1 tablet; 3.0	1.0
Degesch Phostoxin® Tablet Prepac Rope	AP	1 prepac; 99.0 (strip or rope of 33 tablets)	33.0
Detia	AP	1 tablet; 3.0	1.0
Detia Rotox AP	AP	1 pellet; 0.6	0.2
Detia Gas EX-B	AP	1 bag or sachet; 34.0	11.4
Fumiphos tablets	AP	1 tablet; 3.0	1.0
Fumiphos pellets	AP	1 pellet; 0.6	0.2
Fumiphos bags	AP	1 bag; 34.0	11.0
Fumitoxin	AP	1 tablet; 3.0	1.0
Fumitoxin	AP	1 pellet; 0.6	0.2
Fumitoxin	AP	1 bag; 34.0	11.0
Gastoxin	AP	1 tablet; 3.0	1.0
Gastoxin	AP	1 pellet; 0.6	0.2
"L" Fume	AP	1 pellet; 0.5	0.18
	AP	1 pellet; 0.6	0.22
Phos-Kill	AP	1 tablet; 3.0	1.1
Phos-Kill	AP	1 pellet; 0.6	0.22
Phos-Kill	AP	1 bag; 34.0	12.0

\*Reacts with moisture in the air to yield grams of phosphine.



# 5

Treatment Manual

## Treatment Schedules

### *T500 - Schedules for Plant Pests or Pathogens*

#### Contents

The following Schedules are listed by plant pest or pathogen

#### General Schedules

- T501—Pest: *Chrysomyxa* spp. [page-5-6-3](#)  
Pest: *Cercospora* spp. [page-5-6-3](#).  
Pest: *Phoma chrysanthemi* [page-5-6-3](#)
- T502—Pest: Potato cyst nematode [page-5-6-4](#)
- T503—Pest: Diseases listed in 7CFR 319.24: Downy Mildews and Physoderma diseases of Maize [page-5-6-5](#)
- T504—Pest: Flag smut [page-5-6-5](#)
- T505—T505—Treatment for Infestation of *Chrysomyxa* spp. on various commodities [page-5-6-6](#)
- T506—Pest: Potato cyst nematode [page-5-6-7](#)
- T507—Pest: *Phyllosticta bromeliae*, *Uredo* spp. (when destined to Florida, refuse entry) [page-5-6-8](#).  
Pest: *Septoria gentianae* [page-5-6-8](#)
- T508—Pest: Rusts [page-5-6-9](#)
- T509—Pest: *Cylindrosporium camalliae* [page-5-6-9](#)  
Pest: *Hemileia* spp. *Leptosphaeria* spp. *Mycosphaerella* spp. *Opiodothella orchidearum* *Phomopsis orchidophila* *Phyllachora* spp. *Phyllosticta* spp. *Sphenospora* spp. *Sphaerodothis* spp. *Uredo* spp. (except *U. scabies*) [page-5-6-9](#)
- T510—Pest: Various corn-related diseases [page-5-6-10](#)
- T511—Pest: *Xanthomonas axonopodis*, pv. *citri* (citrus canker) [page-5-6-10](#)
- T512—(Deleted) [page-5-6-11](#)
- T513—Pest: *Ascochyta* spp. [page-5-6-11](#)
- T514—Pest: *Xanthomonas albilineans* and *X. vasculorum* [page-5-6-11](#)
- T515—Pest: Various sugarcane-related diseases [page-5-6-12](#)
- T516 (Deleted) [page-5-6-12](#)
- TT517 (Deleted) [page-5-6-12](#)
- T518—Pest: Various rice-related diseases [page-5-6-12](#)
- T519—Pest: Various rice-related diseases [page-5-6-12](#)
- T520—Pest: *Verticillium albo-atrum* [page-5-6-14](#)

#### Hot Water Treatments

- T551—Pest: *Globodera rostochiensis*, *G. pallida* [page-5-6-14](#)
- T552—Pest: Bulb nematodes: *Ditylenchus dipsaci*, *D. destructor* [page-5-6-14](#)
- T553—Pest: Root-knot nematodes (*Meloidogyne* spp.) [page-5-6-15](#)  
Pest: Lesion nematodes (*Pratylenchus* spp.) [page-5-6-15](#)  
Pest: Golden nematodes (*Globodera rostochiensis* and *G. pallida*) [page-5-6-15](#)  
Pest: Foliar nematodes (*Aphelenchoides fragariae*) [page-5-6-15](#)  
Pest: Cyst nematodes (*Heterodera humuli*) [page-5-6-15](#)

- T554—Pest: Bulb nematodes—*Ditylenchus dipsaci* and *D. destructor* [page-5-6-16](#)  
T555—Pest: Bulb nematodes—*Ditylenchus dipsaci* [page-5-6-16](#)  
T556—Pest: Root-knot nematodes (*Meloidogyne* spp.) [page-5-6-16](#)  
T557—Pest: *Meloidogyne* spp. and *Pratylenchus* spp. [page-5-6-16](#)  
T558—Pest: *Pratylenchus* spp. (surface diseases) [page-5-6-17](#)  
T559—Pest: White tip nematode (*Aphelenchoides besseyi*) [page-5-6-17](#)  
T560—Pest: *Meloidogyne* spp. [page-5-6-17](#).  
T561—Treatment for Infestations of *Cercospora mamaonis* and *Phomopsis carica-papayae* on Papayas [page-5-6-17](#)  
T562—(deleted) [page-5-6-18](#)  
T563—(deleted) [page-5-6-18](#)  
T564—Pest: Foliar nematodes (*Aphelenchoides fragariae*) [page-5-6-20](#)  
T565—**Pest: *Ditylenchus destructor*** [page-5-6-18](#)  
**Pest: *Ditylenchus dipsaci*** [page-5-6-19i](#)  
**Pest: *Aphelenchoides subtenuis*, *Ditylenchus destructor*** [page-5-6-18](#)  
**Pest: *Globodera rostochiensis*, *G. pallida*** [page-5-6-19](#)  
T566—Pest: Precautionary treatment for corn-related diseases [page-5-6-19](#)  
Pest: *Aphelenchoides fragariae* [page-5-6-19](#)  
T567—Pest: Bulb nematodes (*Ditylenchus dipsaci*) [page-5-6-19](#)  
T568—Pest: Foliar nematodes (*Aphelenchoides fragariae*) [page-5-6-19](#)  
T569—Pest: Foliar nematodes (*Aphelenchoides fragariae*) [page-5-6-20](#)  
T570—Pest: *Pratylenchus* spp. [page-5-6-20](#).  
Pest: *Aphelenchoides fragariae* spp. [page-5-6-20](#)  
T571—(Deleted) [page-5-6-20](#)

The following section lists the recommended treatments or actions to be applied to items or commodities found infected with various diseases, or infested with various plant pests including nematodes. Commodities may include cut flowers and greenery, propagative plant materials, as well as entire plants. Due to recent restrictions and prohibitions on the use of certain chemicals, every effort has been made to substitute the best alternative treatment available to us. The diseases and commodities for which these treatments are recommended are listed in the Index to Schedules and with the following treatment schedules. Ports should endeavor to make post-treatment examinations or arrange to have the consignee or importer submit data concerning the material following the treatment. Ports should forward any information of this nature to:

Center for Plant Health Science & Technology  
USDA-APHIS-PPQ-CPHST  
Treatment Quality Assurance Unit  
1730 Varsity Drive, Suite 400  
Raleigh, NC 27606

## General Schedules

---

### T501—Treatment for infestation of *Chrysomyxa* spp., *Cercospora* spp., and *Phoma chrysanthemi* on various commodities

#### T501-1 Azalea

Pest: *Chrysomyxa* spp.

Treatment: T501-1 Remove infected parts and treat all plants of same species in shipment with 4-4-50 Bordeaux dip or spray.



see alternative treatment [T501-1](#) for *Chrysomyxa* spp.

#### T501-2 Azaleodendron

Pest: *Chrysomyxa* spp.

Treatment: T501-2 Remove infected parts and treat all plants of same species in shipment with 4-4-50 Bordeaux dip or spray.



see alternative treatment [T501-1](#) for *Chrysomyxa* spp.

#### T501-4 Chrysanthemum

Pest: ***Phoma chrysanthemi***

Treatment: T501-4 Remove infected parts and treat all plants of same species in shipment with 4-4-50 Bordeaux dip or spray.

#### T501-5 Christmas trees

Pest: ***Phoma chrysanthemi***

Treatment: T501-5 Remove infected parts and treat all plants of same species in shipment with 4-4-50 Bordeaux dip or spray.

#### T501-3 Orchid

Pest: *Cercospora* spp.

Treatment: T501-3 Remove infected parts and treat all plants of same species in shipment with 4-4-50 Bordeaux dip or spray.

### **T501-6 Rhododendron**

Pest: *Chrysomyxa* spp.

Treatment: T501-6 Remove infected parts and treat all plants of same species in shipment with 4-4-50 Bordeaux dip or spray.



see alternative treatment [T501-2](#) for *Chrysomyxa* spp.

---

## **T502—Treatment for infestation of Potato cyst nematode on various commodities**

### **T502-1 Bags and bagging used for commodities grown in soil**

Pest: Potato cyst nematode

Treatment: T502-1 Methyl bromide—8 lbs/1,000 ft<sup>3</sup> for 16 hours in 26" vacuum at 40°F or above.

### **T502-2 Covers used for commodities grown in soil**

Pest: Potato cyst nematode

Treatment: T502-2 Methyl bromide—8 lbs/1,000 ft<sup>3</sup> for 16 hours in 26" vacuum at 40°F or above.

### **T502-3 Soil**

Pest: Potato cyst nematode

Treatment: T502-3 Methyl bromide—8 lbs/1,000 ft<sup>3</sup> for 16 hours in 26" vacuum at 40°F or above.



**T504-2**                    **Covers used for wheat**

Pest:            Flag smut

Alternative treatments:

Treatment: T504-2-1 Dry heat at 212°F for 1 hour. Treat small bales only.

Treatment: T504-2-2 Steam at 10 pounds pressure at 242°F (114°C) for 20 minutes.

---

**T505—Treatment for Infestation of *Chrysomyxa* spp. on various commodities**

**T505-1**                    **Azaleodendron**

Pest: *Chrysomyxa* spp.

Alternative treatments:

Treatment: T505-1-1 Treat with mancozeb or other approved fungicide of equal effectiveness. (Use label instructions for treatment.)

Treatment: T505-1-2 see alternative treatment T501

**T505-2**                    **Rhododendron**

Pest: *Chrysomyxa* spp.

Alternative treatments:

Treatment: T505-2-1 Treat with mancozeb or other approved fungicide of equal effectiveness. (Use label instructions for treatment.)

Treatment: T505-2-2 see alternative treatment T501-1.



## T506—Treatment for Infestation of Potato Cyst Nematode on various commodities

### T506-1 Containers

Pest: Potato cyst nematode

Alternative treatments:

Treatment: T506-1-1 MB (“Q” label only) in 26" vacuum

Temperature	Dosage Rate (lb/1,000 ft <sup>3</sup> )	Exposure Period
40°F or above	8 lbs	16 hrs
OR	10.5 lbs	12 hrs
OR	16 lbs	8 hrs

### T506-2-1 Nonplant articles

Pest: Potato cyst nematode

Alternative treatments:

Treatment: T506-2-1 MB (“Q” label only) in 26" vacuum

Temperature	Dosage Rate (lb/1,000 ft <sup>3</sup> )	Exposure Period
40°F or above	8 lbs	16 hrs
OR	10.5 lbs	12 hrs
OR	16 lbs	8 hrs

### T506-2-3 Nonplant articles

Pest: Potato cyst nematode

Treatment: T506-2-3 High pressure steam.

Live steam is introduced into a closed chamber containing the material to be treated until the required temperature and pressure are indicated. The temperature/pressure relationship is maintained at or above this point for the required exposure period. The exposure period will depend on the nature of the material, quantity, and its penetrable condition.

For loose masses of material which permit rapid and complete penetration of steam to all parts of the mass, no initial vacuum is needed but air must be released until steam vapor escapes, and exposure at 20 pounds pressure for 10 minutes, 15 pounds for 15 minutes, or 10 pounds for 20 minutes is sufficient.

For closely packed material, such as soil, special measures are needed to ensure rapid heat penetration to all parts of the material. Soil, if in large containers, will not allow adequate treatment under normal sterilization exposure periods. Quicker penetration of the steam is obtained by first exhausting the air in the chamber to a high vacuum and then introducing live steam until the required positive pressure is reached.

---

## **T507—Treatment for Infestation of *Phyllostictia bromeliae*, *Uredo* and *Septoria gentianae* on various commodities**

### **T507-1 Bromeliads**

Pest: ***Phyllosticta bromeliae*, *Uredo*** spp. (when destined to Florida, refuse entry)

Treatment: T507-1 Remove infected leaves and treat all plants of same species in shipment with Captan following label directions.



Advise importer or consignee that treatment may cause commodity damage.

### **T507-2 Gentiana**

Pest: ***Septoria gentianae***

Treatment: T507-2 Remove infected leaves and treat all plants of same species in shipment with Captan following label directions.



Advise importer or consignee that treatment may cause commodity damage.

---

## T508—Treatment for Infestation of Rusts on various commodities

### T508-1 Orchids (to Florida)

Pest: Rusts

Treatment: T508-1 **For rust-infected shipments to Florida:** Refuse entry to all infected plants and all other plants of the same species or variety in the shipment. Treat other orchid species in the shipment (which may have become contaminated) with Captan. Repackage treated orchids in clean shipping containers. For rusts on orchids to States other than Florida, follow the procedures in T509.

---

## T509—Treatment for Infestation of Various Plant Pests of Camellia and Orchids

### T509-1 Camellia

Pest: ***Cylindrosporium camelliae***

Alternative treatments:

Treatment: T509-1-1 **Light infection:** Remove infected leaves and dip or spray plant with 4-4-50 Bordeaux. Dry quickly and thoroughly before release.

Treatment: T509-1-2 **Heavy infection:** Refuse entry.

### T509-2 Orchids

Pest: ***Hemileia* spp.**  
***Leptosphaeria* spp.**  
***Mycosphaerella* spp.**  
***Opiodothella orchidearum***  
***Phomopsis orchidophila***  
***Phyllachora* spp.**  
***Phyllosticta* spp.**  
***Sphenospora* spp.**  
***Sphaerodothis* spp.**  
***Uredo* spp. (except *U. scabies*)**

Alternative treatments:

Treatment: T509-2-1 **Light infection:** Remove infected leaves and dip or spray plant with 4-4-50 Bordeaux. Dry quickly and thoroughly before release.

Treatment: T509-2-2 **Heavy infection:** Refuse entry.

---

## T510—Treatment for Infestation of various Corn-Related diseases

### T510-1 Corn (seed) (Commercial lots (not for propagation))

Pest: Various corn-related diseases

Treatment: T510-1 Live steam from jet or nozzle into loose masses of material until all parts reach 212°F.

### T510-2 Corn (seed) (Small lots for propagation but not for food, feed, or oil purposes)

Pest: Various corn-related diseases

Treatment: T510-2 Treat seeds with a dry application of Mancozeb in combination with Captan. Disinfect bags by: 1) Dry heat at 212°F for 1 hour. Treat small bales only; or 2) Steam at 10 pounds pressure at 40°F for 20 minutes.

---

## T511—Precautionary treatment for Infestations of *Xanthomonas axonopodis*, pv. *citri* (citrus canker)

### T511-1 Citrus and other Rutaceous seeds from citrus canker countries

Pest: ***Xanthomonas axonopodis***, pv. ***citri*** (citrus canker)

Treatment: T511-1 seeds shall be treated for possible infection with citrus canker bacteria by first washing the seeds if any mucilaginous materials is adhering. Next, immerse the seeds in water at 125 degree F or higher for 10 minutes. Then immerse seed for a period of at least 2 minutes in a 0.525% sodium hypochlorite (Clorox) solution at a pH of 6.0 to 7.5. Drain, dry and repack near original moisture content.



**A 0.525% sodium hypochlorite solution is prepared by diluting 1 part Clorox (containing 5.25% sodium hypochlorite) in 9 parts of water. If using "ultra strength" chlorine bleach, use only 3/4 as much bleach.**

---

## T512—(Deleted)

---

### T513—Treatment for Infestations of *Ascochyta* on various commodities

#### T513-1 Orchids

Pest: ***Ascochyta* spp.**

Treatment: T513-1 Defoliate if leaf-borne only; refuse entry if pseudo-bulbs infected.

---

### T514—Treatment for Infestations of *Xanthomonas albilineans* and *X. vasculorum*

#### T514-1 Saccharum (sugarcane) (seed pieces)

Pest: ***Xanthomonas albilineans* and *X. vasculorum***

Treatment: T514-1 Presoak in water at room temperature for 24 hours then immerse in water at 122°F for 3 hours.

This treatment may damage sprouted cane.

#### T514-2 Saccharum (sugarcane) (True seed (fuzz))

Pest: ***Xanthomonas albilineans* and *X. vasculorum***

Treatment: T514-2 Immerse in 0.525 percent sodium hypochlorite solution for 30 minutes followed by at least 8 hours air drying before packaging. (Dilute 1 part Clorox or similar solution containing 5.25 percent sodium hypochlorite; if using “ultra strength” chlorine bleach, use only 3/4 as much bleach).

#### T514-3 Saccharum (sugarcane) (Bagasse)

Pest: ***Xanthomonas albilineans* and *X. vasculorum***

Treatment: T514-3 Dry heat treatment for 2 hours at 158°F.

#### T514-4 Saccharum (sugarcane) (Field and processing equipment)

Pest: ***Xanthomonas albilineans* and *X. vasculorum***

Treatment: T514-4 Remove all debris and soil from equipment with water at high pressure (300 pounds per square inch minimum) or with steam.

---

## **T515—Treatment for Infestations of various Sugarcane-Related diseases**

### **T515-1 Sugarcane (Baled)**

Pest: Various sugarcane-related diseases

Alternative treatments:

Treatment: T515-1 Introduce live steam into 25" vacuum until pressure reaches 15 to 20 pounds. Hold until center of bale is 220°F-230°F and maintain for 30 minutes.

### **T515-2-1 Sugarcane (Loose Sugarcane)**

Treatment: T515-2-1 Introduce steam into 25" vacuum (or if with initial vacuum, "bleed" air until steam vapor fills chamber).

### **T515-2-3 Sugarcane (Loose Sugarcane)**

Treatment: T515-2-3 Dry heat—212°F for 1 hour.

### **T515-2-4 Sugarcane (Loose Sugarcane)**

Treatment: T515-2-4 Pulped in water at 190°F–205°F, followed by drying at 212°F for 1 hour.

### **T515-2-5 Sugarcane (Loose Sugarcane)**

Treatment: T515-2-5 Flash heated to 1,000°F (Arnold dryer).

---

## **T516 (Deleted)**

---

## **T517 (Deleted)**

---

## **T518—Treatment for Infestations of Various Rice-Related diseases**

### **T518-1 Brooms made of rice straw**

Pest: Various rice-related diseases

Treatment: T518-1 Dry heat at 170°F for 4.5 hours—may take 2 hours to reach this temperature.

### **T518-2-1 Novelties made of rice straw**

Two alternative treatments

Pest: Various rice-related diseases

Treatment: T518-2-1 Dry heat at 180°F–200°F for 2 hours

## T518-2-2      **Novelties made with rice straw**

Pest:            Various rice-related diseases

Treatment: T518-2-2 Steam sterilization

Temperature	Pressure	Exposure Period
260°F	20 lbs	15 minutes
250°F	15 lbs	20 minutes

## T519—Treatment for Infestations of Various Rice-Related diseases

### T519-1      **Closely packed rice straw and hulls**

Pest:            Various rice-related diseases

Treatment: T519-1 Introduce steam into 28" vacuum until pressure reaches 10 pounds and hold for 20 minutes.

### T519-2      **Loose rice straw and hulls**

Pest:            Various rice-related diseases

Treatment: T519-2 Introduce steam into 28" vacuum (or if without initial vacuum, "bleed" air until steam vapor escapes) until pressure reaches 20 pounds AND temperature 259°F and hold for 10 minutes (OR 10 pounds and 240°F for 20 minutes).



see also [T518-1](#).

---

## T520—Treatment for Infestation of *Verticillium albo-atrum* on various commodities

### T520-1 seeds of alfalfa (*Medicago falcata*, *M. gaetula*, *M. glutinosa*, *M. media*, and *M. sativa*) from Europe

Pest: ***Verticillium albo-atrum***

Alternative treatments:

Treatment: T520-1-1 Dust with 75 percent Thiram at the rate of 166 grams per 50 kilograms of seed (3.3g/kg).

Treatment: T520-1-2 Treat with a slurry of Thiram 75 WP at a rate of 166 grams per 360 milliliters of water per 50 kilograms of seed (3.3g pesticide/7.2ml water/kg seed).

## Hot Water Treatments

---

## T551—Treatment for Infestation of *Globodera rostochiensis* and *G. pallida* (Nematodes) on *Convallaria* (pips)

### T551-1 *Convallaria* (pips)

Pest: ***Globodera rostochiensis*, *G. pallida***

Treatment: T551-1 Keep pips frozen until time for treatment, then thaw enough to separate bundles one from another just before treatment begins. Without preliminary warm-up, immerse in hot water at 118°F for 30 minutes, following with a 5 minute drain, finishing with 5 minutes cooling dip or hosing with tap water.

---

## T552—Treatment for Infestation of *Ditylenchus dipsaci* and *D. destructor*

### T552-1 *Allium*, *Amaryllis*, and Bulbs (NSPF)

Pest: Bulb nematodes: *Ditylenchus dipsaci*, *D. destructor*

Treatment: T552-1 Presoak bulbs in water at 75°F for 2 hours, then at 110°F–111°F for 4 hours.



---

## **T553—Treatment for Infestations of Nematodes on various plant commodities**

- T553-1**            **Achimenes, Actinidia, Agapanthus, Aloe, Amorphophallus (bulbs), Ampelopsis, Anchuse, Anemone, Astilbe, Begonia (tubers), Bletilla hyacinthina (bulbs) (NSPF), Cactus, Calliopsis, Campanula, Cestrum, Cimicifuga, Cissus, Clematis, Convolvulus japonicus, Corytholoma, Curcuma (turmeric), Cyclamen, Cytisus, Dahlia (tubers), Dracaena, Epimedium pinnatum (only; other spp. not tolerant), Euonymus alata (only), Eupatorium, Euphorbia, Fragaria (strawberry), Gardenia, Gentiana, Gerbera, Gesneria, Geum, Gladiolus, Heliopsis, Helleborus, Hibiscus, Hosta, Hoya, Iris, Jasminum, Kaempferia, Kohleria, Naegelia, Orchid, Ornithogalum, Paeonia, Passiflora, Polyanthes (tuberose), Primula, Reichsteineria, Sansevieria, Scabiosa, Sedum, Senecio (Lingularis), Thompsonia nepalensis, Tydaea, Verbena, Vitis (grape), Weigela, Zantedeschia, Zingiberaceae**
- Pest:            Root-knot nematodes (*Meloidogyne* spp.)
- Treatment: T553-1 Hot water at 118°F for 30 minutes.
- T553-2**            **Anchusa, Astilbe, Clematis, Dicentra, Gardenia, Helleborus, Hibiscus, Kniphofia, Primula**
- Pest:            Lesion nematodes (*Pratylenchus* spp.)
- Treatment: T553-2 Hot water at 118°F for 30 minutes.
- T553-3**            **Armoracea (horseradish roots), bulbs (NSPF)**
- Pest:            Golden nematodes (*Globodera rostochiensis* and *G. pallida*)
- Treatment: T553-3 Hot water at 118°F for 30 minutes.
- T553-4**            **Bletilla hyacinthina (alternate treatment: T564)**
- Pest:            Foliar nematodes (*Aphelenchoides fragariae*)
- Treatment: T553-4 Hot water at 118°F for 30 minutes.
- T553-5**            **Humulus**
- Pest:            Cyst nematodes (*Heterodera humuli*)
- Treatment: T553-5 Hot water at 118°F for 30 minutes.

---

## **T554—Treatment for Infestations of *Ditylenchus dipsaci* and *D. destructor* on Hyacinthus**

### **T554-1            *Hyacinthus* (bulbs), *Iris* (bulbs and rhizomes), *Tigridia***

Pest:            Bulb nematodes—*Ditylenchus dipsaci* and *D. destructor*  
Alternative treatments

Treatment: T554-1-1 Presoak in water at 70°F–80°F for 2.5 hours, followed by hot water immersion at 110°F–111°F for 1 hour.

Treatment: T554-1-2 Hot water immersion at 110°F–111°F for 3 hours with no presoaking.

---

## **T555—Treatment for Infestations of *Ditylenchus dipsaci* on *Narcissus***

### **T555-1            *Narcissus* (bulbs)**

Pest:            Bulb nematodes—*Ditylenchus dipsaci*

Treatment: T555-1 Presoak in water at 70°F–80°F for 2 hours, then at 110°F–111°F until all bulbs reach that temperature and hold for 4 hours.

---

## **T556—Treatment for Infestations of Root-knot nematodes (*Meloidogyne* spp.) on *Calla***

### **T556-1            *Calla* (rhizomes)**

Pest:            Root-knot nematodes (*Meloidogyne* spp.)

Treatment: T556-1 Dip in hot water at 122°F for 30 minutes.

---

## **T557—Treatment for Infestations of *Meloidogyne* spp. and *Pratylenchus* spp. on *Chrysanthemum* (not including *Pyrethrum*)**

### **T557-1            *Chrysanthemum* (not including *Pyrethrum*)**

Pest:            *Meloidogyne* spp. and *Pratylenchus* spp.

Treatment: T557-1 Dip in hot water at 118°F for 25 minutes.

---

### **T558—Treatment for Infestations of *Pratylenchus* surface diseases on *Fragaria* (strawberry)**

#### **T558-1 *Fragaria* (strawberry)**

Pest: *Pratylenchus* spp. (surface diseases)

Treatment: T558-1 Dip in hot water at 127°F for 2 minutes.

---

### **T559—Treatment for Infestations of Foliar Nematodes on *Begonia* and *Oryza* (paddy rice)**

#### **T559-1 *Begonia***

Pest: White tip nematode (*Aphelenchoides besseyi*)

Treatment: T559-1 Dip in hot water at 118°F for 5 minutes.

#### **T559-2 *Oryza* (paddy rice)**

Pest: White tip nematode (*Aphelenchoides besseyi*)

Treatment: T559-2 Dip in hot water at 132.8°F (56°F) for 15 minutes.

---

### **T560—Treatment for Infestations of *Meloidogyne* spp. on *Rosa***

#### **T560-1 *Rosa* spp. (except *multiflora*, which is not tolerant)**

Pest: *Meloidogyne* spp.

Treatment: T560-1 Dip in hot water at 123°F for 10 minutes.

---

### **T561—Treatment for Infestations of *Cercospora mamaonis* and *Phomopsis carica-papayae* on Papayas**

#### **T561 Papayas**

Pest: *Cercospora mamaonis* and *Phomopsis carica-papayae*

Treatment: T561-1 Dip in hot water at 120.2°F (49°C) for 20 minutes.

---

---

## T562—(deleted)

---

## T563—(deleted)

---

## T564—Treatment for Infestations of Foliar Nematodes on various commodities

### T564-1 *Astilbe, Bletilla hyacinthina, Cimicifuga, Epimedium pinnatum* (only; other spp. not tolerant), *Hosta, Paeonia*

Pest: Foliar nematode (*Aphelenchoides besseyi*)

Treatment: T564-1 Presoak in water at 68°F for 1 hour followed by hot water soak at 110°F for 1 hour. Then dip in cold water and let dry.



see Alternative treatment for **Bletilla hyacinthina**: [T553-1](#)

---

## T565—Treatment for Infestations of Nematodes on various commodities

### T565-1 **Amaryllis**

Pest: *Ditylenchus destructor*

Treatment: T565-1 Hot water at 110°F for 4 hours. (Should be done immediately after digging.)

### T565-2 **Crocus**

Pest: *Aphelenchoides subtenuis, Ditylenchus destructor*

Treatment: T565-2 Hot water at 110°F for 4 hours. (Should be done immediately after digging.)

### T565-3 **Gladiolus**

Pest: *Ditylenchus destructor*

Treatment: T565-3 Hot water at 110°F for 4 hours. (Should be done immediately after digging.)

**T565-4**

**Scilla**

Pest: ***Ditylenchus dipsaci***

Treatment: T565-4 Hot water at 110°F for 4 hours. (Should be done immediately after digging.)

**T565-5**

***Solanum* (potato tubers)**

(see Restricted Entry Orders, Part 321)

Pest: ***Globodera rostochiensis*, *G. pallida***

Treatment: T565-5 Hot water at 110°F for 4 hours. (Should be done immediately after digging.)

---

**T566—Treatment for Infestations of various diseases on Broomcorn, Broomcorn Articles, and Liliium (bulbs)**

**T566-1**

**Broomcorn**

Pest: Precautionary treatment for corn-related diseases

Treatment: T566-1 Hot water at 102°F.

**T566-2**

**Broomcorn Articles**

Pest: Precautionary treatment for corn-related diseases

Treatment: T566-2 Hot water at 102°F.

**T566-3**

**Liliium (bulbs)**

Pest: *Aphelenchoides fragariae*

Treatment: T566-3 Hot water at 102°F.

---

**T567—Treatment for Infestations of Bulb nematodes on various commodities**

**T567-1**

***Muscari*, *Ornithogalum*, *Polyanthes* (tuberose)**

Pest: Bulb nematodes (*Ditylenchus dipsaci*)

Treatment: T567-1 Dip in hot water at 113°F for 4 hours.

---

**T568—Treatment for Infestations of Foliar nematodes on Senecio**

**T568-1**

**Senecio (Lingularis)**

Pest: Foliar nematodes (*Aphelenchoides fragariae*)

Treatment: T568-1 Treat with hot water at 110°F for 1 hour.

---

## **T569—Treatment for Infestations of Foliar nematodes on *Fragaria* (strawberry)**

### **T569-1                    *Fragaria* (strawberry)**

Pest:            Foliar nematodes (*Aphelenchoides fragariae*)

Treatment: T569-1 Hot water at 121°F for 7 minutes. (National Plant Board Conference, Tennessee, 1968)

---

## **T570—Treatment for Infestations of various diseases *Acalypha* and *Aconitum***

### **T570-1                    *Acalypha***

Pest:            *Pratylenchus* spp.

Treatment: T570-1 Hot water dip at 110°F for 50 minutes. (Tolerance not established.)

### **T570-2                    *Aconitum***

Pest:            *Aphelenchoides fragariae* spp.

Treatment: T570-2 Hot water dip at 110°F for 50 minutes. (Tolerance not established.)

---

## **T571—(Deleted)**

# 5

Treatment Manual

## Treatment Schedules

### *T600-Controlled Atmosphere Temperature Treatment System*

#### Contents

- Controlled Atmosphere Temperature Treatment System(CATTS) [page-5-7-1](#)  
Nectarines and Peaches [page-5-7-2](#)  
Apples [page-5-7-3](#)  
Sweet Cherries [page-5-7-3](#)

#### Controlled Atmosphere Temperature Treatment System(CATTS)

Controlled atmosphere temperature treatment system (CATTS) combines forced moist or vapor hot air with controlled atmosphere (i.e. low oxygen, high carbon dioxide).

The treatments are conducted in a chamber similar to a vapor heat or forced hot air chamber that has the capability of introducing nitrogen and carbon dioxide. Once this atmosphere is established, temperature ramp-up begins. When the treatment target temperature is reached, it is sustained for a minimum treatment time.



All fruit must be at or above room temperature before treatment begins. Treating cold fruit will cause phytotoxicity.

All of the following treatments share several common factors:

- ◆ Air speed equivalent to 1.3—2.0 meters per second as measured by an anemometer
- ◆ Modified atmosphere equivalent to 1% O<sub>2</sub> and 15% CO<sub>2</sub>
- ◆ Relative humidity greater than or equal to 90%



CATTS treatments are currently approved for commodities exported from the U.S. into certain countries. The treatments have **not** yet been approved for imported commodities or domestic movement of these commodities. Regulatory approval is pending.

For more information, contact PPQ Phytosanitary Issues Management Import Specialist, Paul Gadh at 301-734-5210.

## T601-a

### Nectarines and Peaches

Two alternative treatments.

Pest: *Cydia pomonella* (Codling moth) and *Grapholita molesta* (Oriental fruit moth)

Treatment: T601-a-1—CATTS

Units	Ramp-Up Rate (per hour) <sup>1</sup>	Final Temperature	Internal fruit (core) Temperature within 2.5 hours <sup>2</sup>	Time at Core Temperature (minutes)	Total Treatment Time (hours)
°F	53.6	114.8	109.4	30	3
°C	12.0	46.0	43.0	30	3

- 1 The temperature ramp-up rate is the rate (in hours) at which the temperature changes in the chamber. Add 10 minutes to the total treatment time for every 10 minute increase in ramp-up time.
- 2 The core of the fruit must reach 109.4°F (43.0°C) within 2.5 hours.

Treatment: T601-a-2—CATTS

Units	Ramp-Up Rate (per hour) <sup>1</sup>	Final Temperature	Internal fruit (core) Temperature within 2.25 hours <sup>2</sup>	Time at Core Temperature (minutes)	Total Treatment Time (hours)
°F	75.2	114.8	110.3	15	2.5
°C	24.0	46.0	43.5	15	2.5

- 1 The temperature ramp-up rate is the rate (in hours) at which the temperature changes in the chamber. Add 10 minutes to the total treatment time for every 10 minute increase in ramp-up time.
- 2 The core of the fruit must reach 110.3°F (43.5°C) within 2.25 hours.



## T601-b

### Apples

Pest: *Cydia pomonella* (Codling moth) and *Grapholita molesta* (Oriental fruit moth)

Treatment: T601-b—CATTS

Units	Ramp-Up Rate (per hour) <sup>1</sup>	Final Temperature	Internal fruit (core) Temperature within 2.5 hours <sup>2</sup>		Time at Core Temperature (minutes)	Total Treatment Time (hours)
°F	53.6	114.8	112.3		15	3
°C	12.0	46.0	44.6		15	3

- 1 The temperature ramp-up rate is the rate (in hours) at which the temperature changes in the chamber. Add 10 minutes to the total treatment time for every 10 minute increase in ramp-up time.
- 2 The core of the fruit must reach 112.3°F (44.6°C) within 2.5 hours.

## T601-c

### Sweet Cherries

Two alternative treatments

Pest: *Cydia pomonella* (Codling moth) and *Rhagoletis indifferens* (Western Cherry Fruit Fly)

Treatment: T601-c-1—CATTS

Units	Ramp-Up Rate (per hour)	Final Chamber Temperature	Internal fruit (core) Temperature within (minutes):		Total Treatment Time (minutes)
			9 <sup>1</sup>	22–24 <sup>2</sup>	
°F	None	113.0	107.6	112.1	45
°C	None	45.0	42.0	44.5	45

- 1 The internal fruit temperature must reach the 107.6°F (42.0°C) within 9 minutes.
- 2 After the internal fruit temperature reaches 107.6°F (42.0°C) in 9 minutes, the internal fruit temperature must then continue to increase to 112.1°F (44.5°C) within 22-24 more minutes.

Treatment: T601-c-2—CATTS

Units	Ramp-Up Rate (per hour)	Final Chamber Temperature	Internal fruit (core) Temperature within (minutes):		Total Treatment Time (minutes)
			9 <sup>1</sup>	12-14 <sup>2</sup>	
°F	None	116.6	107.6	113.9	25
°C	None	47.0	42.0	45.5	25

- 1 The internal fruit temperature must reach the 107.6°F (42.0°C) within 9 minutes.
- 2 After the internal fruit temperature reaches 107.6°F (42.0°C) in 9 minutes, the internal fruit temperature must continue to increase to 113.9°F (45.5°C) within 12-14 more minutes.

**TABLE 5-7-1 Summary of CATTS treatments**

<b>Treatment Schedule</b>	<b>Commodity</b>	<b>Pest</b>	<b>Ramp-up Rate (per hour)</b>	<b>Final Chamber Temperature</b>	<b>Total Treatment Time</b>	<b>Core Temperature</b>	<b>Time at Core Temperature</b>
T601-a-1	Nectarine and Peach	<i>Cydia pomonella</i> (Codling moth) and <i>Grapholita molesta</i> (Oriental fruit moth)	53.6°F (12°C)	114.8°F (46°C)	3 hours	109.4°F (43°C) within 2.5 hours	30 minutes
T601-a-2	Nectarine and Peach	<i>Cydia pomonella</i> (Codling moth) and <i>Grapholita molesta</i> (Oriental fruit moth)	75.2°F (24°C)	114.8°F (46°C)	2.5 hours	110.3°F (43.5°C) within 2.25 hours	15 minutes
T601-b	Apple	<i>Cydia pomonella</i> (Codling moth) and <i>Grapholita molesta</i> (Oriental fruit moth)	53.6°F (12°C)	114.8°F (46°C)	3 hours	112.3°F (44.6°C) within 2.5 hours	15 minutes
T601-c-1	Cherry	<i>Cydia pomonella</i> (Codling moth) and <i>Rhagoletis indifferens</i> (Western Cherry Fruit Fly)	None	113°F (45°C)	45 minutes	107.6°F (42°C) within 9 minutes	112.1°F (44.5°C) within 22-24 minutes
T601-c-2	Cherry	<i>Cydia pomonella</i> (Codling moth) and <i>Rhagoletis indifferens</i> (Western Cherry Fruit Fly)	None	116.6°F (47°C)	25 minutes	107.6°F (42°C) within 9 minutes	113.9°F (45.5°C) within 12-14 minutes



# 6

Treatment Manual

# Certifying Facilities

## Overview

### Contents

Certification of Vacuum Fumigation Chambers	<a href="#">page-6-2-1</a>
Certifying Atmospheric Fumigation Chambers	<a href="#">page-6-3-1</a>
Certification of Cold Treatment	<a href="#">page-6-4-1</a>
Certification of Hot Water Immersion Facilities	<a href="#">page-6-5-1</a>
Certification of Forced Hot Air and Vapor Heat Treatment Facilities	<a href="#">page-6-6-1</a>
Certification of Niger seed Treatment Facilities	<a href="#">page-6-7-1</a>
Certifying Irradiation Treatment Facilities	<a href="#">page-6-8-1</a>
Certifying Facilities for the Heat Treatment of Firewood	<a href="#">page-6-9-1</a>

The Certification of Facilities section of this manual is organized by the following categories:

- ◆ Vacuum Fumigation Chambers
- ◆ Atmospheric Fumigation Chambers
- ◆ Cold Treatment Facilities
- ◆ Hot Water Immersion Facilities
- ◆ Forced Hot Air and Vapor Heat Treatment Facilities
- ◆ Niger seed Treatment Facilities
- ◆ Irradiation Treatment Facilities
- ◆ Firewood Heat Treatment Facilities

Domestic and foreign treatment facilities must be certified by APHIS before they can perform treatments to meet United States quarantine requirements. Specific requirements for each type of facility are included in this section.

After the Center for Plant Health Science and Technology (CPHST) has approved blueprints or drawings of a treatment facility, the treatment facility can request certification from Plant Protection and Quarantine at local ports or State Plant Health Directors.



Blueprints or drawings of **domestic** treatment facilities should be sent to:

USDA-APHIS-PPQ-CPHST  
Treatment Quality Assurance Unit  
1730 Varsity Drive, Suite 400  
Raleigh, NC 27606  
tel: 919-855-7450

Request for certification can be sent to State Plant Directors listed at the following URL:

[http://www.aphis.usda.gov/services/report\\_pest\\_disease/report\\_pest\\_disease.shtml](http://www.aphis.usda.gov/services/report_pest_disease/report_pest_disease.shtml)



Blueprints or drawings and request for certification of **foreign** treatment facilities should be sent to:

Director, Preclearance Programs  
USDA, APHIS, PPQ  
4700 River Road, Unit 60  
Riverdale, MD 20737  
tel: 301-734-8295  
fax: 301-734-8318

For foreign treatment facilities, the company requesting certification is responsible for paying money into a trust fund account to pay the salary, travel costs, and per diem of a PPQ Officer to be sent on temporary duty.

Sea-going vessels that participate in the APHIS cold treatment program for fresh fruit may be certified at a port in the USA or at a foreign port. Also, if the certification is to be carried out overseas, a trust fund account will be needed to cover the costs. (For details call PPQ Quarantine Policy, Analysis and Support (QPAS), tel: 301-734-6404.

# 6

Treatment Manual

## Certifying Facilities

### *Certification of Vacuum Fumigation Chambers*

---

#### Contents

Construction and Performance Standards	<a href="#">page-6-2-1</a>
Vacuum Chamber	<a href="#">page-6-2-1</a>
Vacuum Pump	<a href="#">page-6-2-2</a>
Fumigant Introduction Systems	<a href="#">page-6-2-2</a>
Circulation and Exhaust System	<a href="#">page-6-2-2</a>
Accessories	<a href="#">page-6-2-3</a>
Certification Standards	<a href="#">page-6-2-3</a>

---

#### Construction and Performance Standards

Vacuum fumigation consists of placing the commodity in a gastight metal chamber, removing most of the air, and replacing a small portion of it with a gas which is lethal to insects and other pests. Vacuum fumigation provides a more rapid penetration of commodities undergoing treatment than is obtained in normal atmospheric fumigations.

##### **Vacuum Chamber**

Vacuum chambers are usually of welded steel construction. A rectangular chamber might be preferred for more effective use of space. Reinforcement of the chamber body by means of steel ribs, or other supports, is usually required to enable the chamber to withstand the difference in pressures when the vacuum is drawn. Doors can be provided at one or both ends of the chamber. In cylindrical chambers, the doors can be either concave or convex, but in rectangular chambers flat doors are commonly used with suitable reinforcements. The doors can be hinged at the side, or at the top and counterbalanced. Many doors are fitted with special mechanisms for rapid closing. Door gaskets should be durable and at the same time provide gastight seal. To a large extent, the efficiency of a chamber depends upon the tightness with which the door or doors will seal. All other chamber openings must be equally tight to sustain the prescribed vacuum over a specified period of time.

To permit circulation beneath the load, the chamber must be designed to enable the stacking of commodities on pallets, skids, or small trucks. Small chambers that are usually hand loaded have removable floors.

### **Vacuum Pump**

Each installation required a high quality, high capacity vacuum pump. The vacuum pump should have the capacity to reduce the chamber pressure to 1 to 2 inches (25 to 51 millimeters) of mercury (28 to 29 inches or 711 to 737 millimeters vacuum) in 15 minutes or less.

### **Fumigant Introduction Systems**

The size of the chamber will determine the introduction system needed. For small chambers and for introducing fumigants in small quantities, measure the fumigant by volume using a graduated dispenser. For larger chambers place the gas supply cylinder on a platform scale and measure the amount of fumigant by weight.

For methyl bromide, a volatilizing unit is required to ensure fumigant introduction in a gaseous state. The volatilizer is located outside of the chamber between the gas cylinder or dispenser and the introduction port of the chamber. Essentially, the volatilizer consists of a metal coil submerged in water hot enough to vaporize the fumigant. The volatilizer must maintain the water temperature to at least 150°F throughout the entire gas introduction period.

Within the chamber the gas introduction system should consist of tubing with multiple, graduated openings that will provide uniform distribution of the fumigant throughout the length of the chamber. Ensure that the fumigant enters the chamber from multiple points along the ceiling.

### **Circulation and Exhaust System**

Adequate gas distribution is often hindered by the cargo placed in the chamber. To overcome this, equip vacuum chambers with a circulation system. If fans are employed, the number of fans required would depend upon the chamber design, volume, and loading arrangements. A minimum of 2 fans is normally required for chambers of over 1,000 cubic feet capacity (28.31 m<sup>3</sup>). Place the fans at opposite ends of the chamber facing each other—one high, one low. Additional fans might be required for larger chambers. The fans should be capable of circulating air at the rate of at least one-third the volume of the chamber per minute. Some fumigants require nonsparking, explosion-proof-type circulation systems.

In most installations, the vacuum pump is used to remove the fumigant following the exposure period. The air-gas mixture is pumped out of the chamber through exhaust ducts or stacks installed for that purpose. The actual height of these stacks will vary with the location of the chamber, and may be regulated by local, state or federal safety ordinances.



### Accessories

Equip chambers with a vacuum gauge and an instrument for measuring and recording the vacuum drawn and maintained during the exposure period. Install a temperature monitoring device in chambers used for quarantine treatments that are six or more hours in length. Combination temperature and vacuum recorders are available.

### Certification Standards

To qualify for program approval, vacuum chambers must be able to meet or exceed specified vacuum leakage tests. There are four classification levels in which a chamber may be certified. The tests are listed below and determine the classification under which the chamber qualified.



There should be no commodity in the chamber during the certification procedure.

**TABLE 6-1-1 Vacuum Chamber Classification Table**

Classification	Initial vacuum (inches)	Allowable vacuum loss			
		4 hr	6 hr	16 hr	24 hr
Superior	28 1/2	—	1/2"	—	1"
A	28 1/2	1/2"	—	1"	2"
B	28 1/2	1"	—	2 1/2"	3"
C	26	1"	—	2 1/2"	3"

In addition to the classification tests in **Table 6-1-1**, **ALL** chambers must be capable of meeting the following requirement: A vacuum equivalent to 26 inches (660 mm) of mercury is drawn. The vacuum is then reduced to 5 inches (127 mm) and held for a period of 4 hours. A vacuum of 2 inches (55 mm) or more after 4 hours is considered adequate for this test.

- ◆ Chambers classified “Superior” or “A” are approved for all vacuum treatments. These chambers are to be tested annually.
- ◆ Chambers classified “B” are approved for all vacuum schedules up to and including 28-inch (711 mm) sustained vacuum. These chambers are to be tested semiannually.
- ◆ Chambers classified “C” are approved for all vacuum schedules up to and including 26-inch (711 mm) sustained vacuum. These chambers are to be tested semiannually.

Once the chamber has met the requirements in **Table 6-1-1**, the approving APHIS official must complete PPQ Form 480, Treatment Facility Construction, Operation and Test Data, and PPQ Form 482, Certificate of Approval. A copy of each of the forms should be given to the owner/operator of the chamber and also mailed to :

USDA-APHIS-PPQ-CPHST  
Treatment Quality Assurance Unit  
1730 Varsity Drive, Suite 400  
Raleigh, NC 27606

Approving a chamber for vacuum fumigation does not include approving atmospheric (NAP) fumigations. If the vacuum chamber will also be used as a normal atmospheric pressure chamber, it must also pass a pressure leakage test (see **page-2-5-6**).

Actual detailed instructions for constructing a vacuum chamber are not included in this discussion. The information presented is designed to list the component parts needed and the function of each. Instructions and additional information can be obtained from the following list of vacuum chamber manufacturers. In furnishing the names of these dealers, no discrimination is intended against any firm whose name may have been omitted. Neither does this program endorse the firms mentioned nor guarantee the reliability of their products. The list is furnished solely for information and convenience.

### **Partial List of Manufacturers of Vacuum Chambers**

Slack Associates, Inc.  
540 South Longwood Street  
Baltimore, MD 21223

Vacudyne Altair  
375 East Joe Orr Road  
Chicago Heights, IL. 60411

CosMed Group  
28 Narragansett Avenue  
Jamestown, RI 02835  
401-423-2003

The following three companies (SFS, ETO and BQA) are subsidiaries of the CosMed Group.

Sterilization and Fumigation Services, Inc. (SFS)  
3500 Shiells Road  
Newman, CA 95360  
Plant Manager, Peter Baker

Phone: 209-862-4074  
Bill Lanning  
Phone: 208-880-0746

ETO Sterilization  
2500 Brunswick Avenue  
Linden, NJ 07036-2432  
Vice President of Operations, Karen Burns  
Phone: 908-862-7077  
FAX: 908-862-7168

Baltimore Quality Associates, Inc. (BQA)  
4200 Boston Street  
Baltimore, MD 21224  
Ellen Heath  
Phone: 410-327-0916



# 6

Treatment Manual

## Certifying Facilities

### *Certifying Atmospheric Fumigation Chambers*

---

#### Contents

Construction and Performance Standards	<a href="#">page-6-3-1</a>
Basic Elements for Design and Construction of Chambers	<a href="#">page-6-3-2</a>
Gastight Construction	<a href="#">page-6-3-3</a>
Circulation and Exhaust Systems	<a href="#">page-6-3-3</a>
Fumigant Dispensing System	<a href="#">page-6-3-4</a>
Pressure-Leakage Test for NAP Fumigation Chambers	<a href="#">page-6-3-4</a>
Other Auxiliary Equipment	<a href="#">page-6-3-5</a>

---

#### Construction and Performance Standards

The primary purpose of a program fumigation is to obtain quarantine control of the pests in all stages of development in or on the product being fumigated. A properly constructed fumigation chamber will provide an enclosure into which the product can be loaded and where the fumigant will be maintained at the prescribed concentration for the required exposure period.

When constructing an atmospheric fumigation chamber, the primary consideration is making it as gastight as possible. In addition, install circulation equipment to properly distribute the fumigant throughout the chamber. The chamber must retain these qualities of tightness and fumigant circulation during every fumigation.

Although chamber sizes are not restricted to specific dimensions, size chambers according to the volume of material to be fumigated. Experience has shown that two moderately sized chambers is preferable to one large chamber.

Select the construction material according to the type of product to be fumigated and the method of operation involved. Wood frame construction with light metal sheathing could be used if the products to be fumigated are lightweight and are to be hand loaded. Heavy products, often loaded by machinery or handtrucks, require heavy-gauge sheet metal, masonry, or metal plate construction. It is advisable to construct the chamber in the most durable manner consistent with its intended use.

Auxiliary equipment is required to measure, vaporize, circulate, and exhaust the fumigant. Size such equipment according to the volume of the chamber. When a relatively small amount of methyl bromide is used, it is often measured by volume in graduated dispensers. When larger amounts are used, the fumigant is most often measured by weight.

Equip chambers with heating or refrigeration units depending on the climatic environment and the products to be fumigated. Product injury or an ineffective fumigation can occur within certain temperature ranges. Although provisions for temperature control are not generally mandatory, in certain fumigation operations, temperature control is necessary and therefore must be considered in the design and construction of fumigation chambers.

While complete construction details for an atmospheric fumigation chamber are not contained in the following narrative, sufficient information is available to develop specifications for a proposed structure. Firms considering chambers for approval by the U.S. Department of Agriculture (USDA) should submit drawings to:

USDA-APHIS-PPQ-CPHST  
1730 Varsity Drive, Suite 400  
Raleigh, NC 27606

### **Basic Elements for Design and Construction of Chambers**

- ◆ Equipped with removable, slatted floors unless all material placed in the chamber is on pallets or carts
- ◆ Gastight and remains so during every use
- ◆ Provides an efficient system for circulating and exhausting the fumigant
- ◆ Provides an efficient system of dispensing the fumigant
- ◆ Provides heating or refrigeration units when required for fumigation efficiency or to prevent product injury
- ◆ Provides a recording thermometer when product temperatures are critical or treatments are of such duration that temperature variations could affect the efficiency of the fumigation
- ◆ Provides suitable fittings to facilitate a pressure-leakage test and gas concentration sampling

The criteria listed above deal primarily with the efficiency of the fumigation chamber itself. In determining the ultimate design and construction, it is essential to give consideration to the safe and practical operation of the facility.

## Gastight Construction

Interior surfaces must be impervious to the fumigant. Seal joints with proper compound, solders, or welds. Provide all doors and vents with proper gaskets. Make all openings for wiring, thermometer, tubing, and ports for pressure-leakage tests, etc. gastight.

Paint interior surfaces—whether metal (except for stainless steel), cement, concrete block, tile, or plywood—with epoxy resin, vinyl plastic, or asphalt base paints. Such paint coverings make the surfaces less sorptive, an important factor in maintaining gas concentrations.



Aluminum base paints are **not** acceptable because of the corrosive effect caused by a reaction between such paints and the fumigant.

When wood or wood and sheet metal are used in construction, it is critical to seal all joints and seams with a nonhardening material. This makes a gastight seal and allows for expansion and contraction without leakage. In masonry construction, joint the mortar between all courses of cement blocks to produce a smooth, compact surface. Poured concrete structures should also have smooth, compact surfaces.

The construction and fastening of chamber doors is most critical. Hinge the doors from the top or side. A chamber door hinged at the top is less apt to sag. If the door is hinged at the side, use refrigerator hinges. Install a high-quality gasket around the entire perimeter of the chamber opening. To obtain maximum tightness, uniformly fasten the doors against the gaskets.

## Circulation and Exhaust Systems

Fans or blowers delivering the prescribed minimum air movement are essential to proper fumigant distribution.

Various methods can be used to circulate the fumigant within the chamber. Equipment should be capable of circulating air at the rate of at least one-third the volume of the chamber per minute. For smaller chambers, a suitable circulating fan will usually provide the necessary air movement. For larger chambers, obtain effective gas distributions by using a circulating or squirrel cage fan that picks up the air/gas mixture from a duct reaching near the floor and blows it across the top of the load. A blower located outside the chamber can also be used, but this method considerably increases the possibilities of leakage.

Size exhaust blowers according to the volume of the chamber. Volume of enclosure (in cubic feet) divided by the sum of cubic feet per minute (cfm) of the exhaust fan(s) or exhaust blower equals the number of minutes required per complete gas volume exchange. Sixty minutes divided by the number of minutes per gas volume exchange equals the number of complete gas exchanges per hour. The result should be in the range of four to fifteen. The faster the rate of aeration, the better, particularly for perishable commodities. If the exhaust flow is connected to a MB recovery system, it must not impede the flow rate to less than four volumes per hour. Frequently, circulation and exhaust systems are designed to utilize the same blower. Extend the exhaust stack well above all nearby structures. Venting to the outside and complying with local safety ordinances are both essential.

### **Fumigant Dispensing System**

The dispensing system needed will vary with the types of fumigants being used. The fumigant MB is usually introduced into the chamber through a tube extending from the volatilizer. Within the chamber, provide this tube with properly spaced openings through which the fumigant is dispersed. Fumigants in small quantities are generally measured by volume using a graduated dispenser. Place the dispenser in the introduction line between the supply cylinder and the volatilizer. For larger quantities, place the supply cylinder on a platform scale and weigh the fumigant used. The measured amount of fumigant must pass through a volatilizer where it is converted from a liquid to a vapor. The volatilizer consists of a metal coil submerged in 150°F degree water. The water temperature must remain at or above 150°F throughout the entire gas introduction.

For the fumigant sulfuryl fluoride (SF), do not use a volatilizer or graduated dispenser. For the fumigant phosphine (PH), a chamber is generally not used because PH will corrode copper and brass (including tubing, fans, and electrical wiring).

### **Pressure-Leakage Test for NAP Fumigation Chambers**

Before a chamber is used for fumigation, it must be checked for tightness using an open-arm manometer. [See Open-Arm Manometer](#) on **page- 8-1-30** for a detailed description of this type of manometer. (If a digital manometer is used, contact CPHST for accurate conversion factors.)

The procedure for conducting a pressure leakage test is as follows:

- 1.** Create an opening (usually one-inch diameter) in the chamber for the use of a blower or other means for the introduction of air to create a positive pressure in the chamber.
- 2.** Create an additional opening, such as a gas sampling line opening, for the manometer.



3. Close chamber as for fumigation.
4. Attach one end of the manometer to the chamber opening.
5. Use vacuum cleaner blower or similar apparatus to create a total pressure (as measured on an open arm manometer) of either 25 or 50 mm depending on chamber construction.

For a chamber constructed of materials such as cement or cinder blocks, create a total pressure of 50 mm. The time lapse for the chamber pressure to recede from 25 mm to 2.5 mm in **each** arm must be:

- ❖ 22 to 29 seconds; reinspect chambers every 6 months
- ❖ 30 seconds or longer; reinspect chambers annually

A **reduced** pressure test is acceptable for plywood chambers. Create a total pressure of 25 mm (12.5 in each arm of the manometer.) The time lapse for the chamber pressure to recede from 12.5 mm to 1.25 mm in each arm must be:

- ❖ 60 seconds or longer; reinspect chambers annually

6. Discontinue blower and close its opening.
7. Observe time for pressure to recede.

The inability to develop or maintain adequate pressure indicates considerable leakage. In such cases, the chamber operator can use a smoke bomb or other device in an effort to determine the areas of leakage.

The approving APHIS official must complete PPQ Form 480, Treatment Facility Construction, Operation and Test Data, and PPQ Form 482, Certificate of Approval. A copy of each of the forms should be given to the owner/operator of the chamber and also mailed to:

USDA-APHIS-PPQ-CPHST  
1730 Varsity Drive, Suite 400  
Raleigh, NC 27606

### Other Auxiliary Equipment

According to the needs of the operation, other auxiliary equipment may be necessary. When heat is required, steam pipes or low-temperature electric strip heaters are generally recommended. Do not use open flame or exposed electric coils as they tend to break down the gas and form undesirable compounds. Size refrigeration units to the volume of the chamber and the type and amount of commodity involved. Temperature recording thermometers are usually attached to the outside of the chamber with a remote sensing unit attached to the inside wall or inserted into the product.



# 6

Treatment Manual

# Certifying Facilities

## *Certification of Cold Treatment*

### Contents

Introduction	<a href="#">page-6-4-1</a>
Standards for Temperature Recording Systems	<a href="#">page-6-4-2</a>
Temperature Recording System	<a href="#">page-6-4-2</a>
Temperature Sensors	<a href="#">page-6-4-3</a>
Certification of Vessels Used for Intransit Cold Treatment	<a href="#">page-6-4-4</a>
Plan and Specification Approval	<a href="#">page-6-4-4</a>
Certification Testing	<a href="#">page-6-4-5</a>
Documentation	<a href="#">page-6-4-8</a>
Certificate of Approval	<a href="#">page-6-4-8</a>
Application for USDA Vessel Approval	<a href="#">page-6-4-9</a>
Certification of Self Refrigerated Containers Used for Intransit Cold Treatment	<a href="#">page-6-4-12</a>
Certification Requirements	<a href="#">page-6-4-12</a>
Letter of Certification	<a href="#">page-6-4-12</a>
Application for USDA Container Certification	<a href="#">page-6-4-13</a>
Certification of Warehouses Used for Cold Treatment	<a href="#">page-6-4-15</a>
Plan and Specification Approval	<a href="#">page-6-4-15</a>
Certification Testing	<a href="#">page-6-4-15</a>
Calibration of Temperature Sensors	<a href="#">page-6-4-16</a>
Frequency of Certification Testing	<a href="#">page-6-4-18</a>
Application for USDA Warehouse Approval	<a href="#">page-6-4-19</a>
Contact Information	<a href="#">page-6-4-22</a>

### Introduction

Since the early 1900s, sustained cold temperature has been employed as an effective post-harvest method for the control of the Mediterranean and certain other tropical fruit flies. Exposing infested fruit to temperatures of 2.2 °C (36 °F) or below for specific periods of time results in the mortality of the various life stages of this group of notoriously injurious insects. Procedures were developed to effectively apply cold treatment (CT) to fruit while in transport in refrigerated holds of ships, in refrigerated containers, and in warehouses located in the country of origin or in the United States.

Self-refrigerated (Integral) containers, conventional vessels, and warehouses utilized for regulatory cold treatment are subject to approval by the USDA. Approval is needed only when treating fruit under USDA regulations and does not constitute an endorsement for the carrying or storage of refrigerated cargo.

Only officials authorized by APHIS have permission to conduct warehouse, vessel or container certification under the general guidance of TQAU. Refer to the following web site for a complete list of USDA-certified vessels and containers for intransit cold treatment:

<https://treatments.cphst.org/vessels/>

---

## Standards for Temperature Recording Systems

Temperature recording systems may consist of various electronic components such as temperature sensors, computers, printers, and cables and are required for temperature recording installations in cold treatment vessels, refrigerated containers, or warehouses. Submit plans and specifications of the temperature recording system to **TQAU** for review and approval before installation.

### Temperature Recording System

- ◆ **Accuracy**—The accuracy of the system must be within plus or minus 0.3 °C (0.5 °F) of the true temperature in the range of minus 3 °C (27 °F) to plus 3 °C (37 °F).
  - ❖ Ensure the instrument is capable of repeatability in the range of minus 3 °C to plus 3 °C (27 °F to 37 °F.)
- ◆ **Automatic Operation**—The system must be capable of automatic operation whenever the treatment system is activated.
- ◆ **Long-Term Recording**—The system must be capable of continuous recording of date, time, sensor number, and temperature during all calibrations and for the duration of a voyage and/or treatment period.
- ◆ **Password Protection**—All approved temperature recording devices must be password protected and tamperproof.
- ◆ **Recording Frequency**—The time interval between prints will be no less than **once every hour**. For each sensor, the temperature value, location/identification, time and date must print **once per hour**.
- ◆ **Repeatability**—When used under treatment conditions over an extended period of time, the system must be capable of repeatability in the range of minus 3 °C to plus 3 °C (27 °F to 37 °F.) The design, construction and materials must be such that the typical environmental conditions (including vibration) will not affect performance.
- ◆ **Range**—The recorder must be programmed to cover the entire range between minus 3 °C to plus 3 °C (27 °F to 37 °F), with a resolution of 0.1 (°C or °F.)

- ◆ **Visual Display**—The system must have a visual display so the temperature can be reviewed manually during the treatment and calibrations.

### Temperature Sensors

- ◆ **Construction Standards**—Sensors should have an outer sheath diameter of 0.25 inches (6.4 millimeters) or less. The sensing unit must be in the first inch of the sensor.
- ◆ **Identification**—Identify all sensors to distinguish the sensors in one compartment from those in other compartments.
  - ❖ Place an identifying number on the box where the sensor originates and on a permanent tag where the cable joins the sensor.
  - ❖ Identify the sensors for each compartment so the air sensors are numbered first (e.g., A1, A2—air; A3, A4, ..., etc.,—fruit pulp.)
- ◆ **Location**—Post a diagram next to the recording instrument that shows the location and identification of each sensor by compartment.
  - ❖ Air sensors—Place sensors on the center line of the vessel, fore and aft, approximately 30 centimeters from the ceiling and connected to cables at least 3 meters in length
  - ❖ Fruit sensors—Distribute fruit sensors throughout the compartment so all areas of the compartment can be reached (5- to 15-meter cable lengths are usually sufficient.) The number and location is dependent upon cubic capacity of the compartment. Refer to **Figure 6-1-1 on page-6-4-6** for guidance for vessels and **Figure 6-1-7 on page-6-4-16** for guidance for warehouses. Three temperature sensors are required for refrigerated containers. These are labeled USDA1, USDA2, and USDA3.

Contact **TGAU** for a complete list of approved temperature recording systems.

---

## Certification of Vessels Used for Intransit Cold Treatment

Vessels used in cold treatment must be certified by a qualified APHIS-PPQ employee or a designated representative before treating fruit under USDA regulations. Refrigeration (reefer) vessels presented for approval must be classified under the rules of the American Bureau of Shipping or a comparable internationally recognized ship classification society.

Submit plans, drawings and specifications to **TQAU** prior to the first vessel certification. Conduct certification tests prior to the vessel receiving final approval to conduct a cold treatment. Certification will be performed every **three** years or sooner if APHIS determines that a malfunction or alteration of the system warrants a recertification.

### Plan and Specification Approval

Prior to the start of vessel construction, an application for vessel approval, detailed drawings of the vessel's physical characteristics and a written description of the all the equipment related to treatment must be reviewed and approved by **TQAU** (all plans and supporting materials must be submitted in Standard English.)

Plans and specifications must include the following information:

- ◆ Completed Application for Vessel Approval (an example of a completed Application is provided on **page-6-4-9**)
- ◆ Drawings showing the dimensions of the refrigerated compartments
- ◆ Example of an hourly printout from the recording system (must include date, time, temperature unit, vessel name)
- ◆ Number and location of air and pulp sensors in each compartment (see **Figure 6-1-1 on page-6-4-6**)
- ◆ Specifications of the recording system
- ◆ Specifications of refrigeration equipment (including air circulation)

The review of plans and process descriptions may take up to sixty days and subsequent requests for additional information may further extend this time.

Vessel owners will receive a letter granting plan approval or describing plan deficiencies and necessary remedial measures.

Following plan approval, the vessel should be built according to the plans. If deviations from the plans are necessary, TQAU must approve the changes (changes should be submitted in a manner similar to that described in "Plan and Specification Approval".)

### **Certification Testing**

Make the vessel available for an on-site certification visit by a PPQ official when all documents and a completed Application have been submitted and approved by the **TQAU**.

Contact the State Plant Health Director or Officer-In-Charge at the port of call to arrange vessel certification at a US port.

Establish a cooperative agreement and other arrangements as needed with USDA for vessel certification inspections made at a foreign location. This will require a 60-day notification before the inspection can be scheduled. For specific information on the required procedure, contact:

Quarantine Policy, Analysis and Support (QPAS)  
Preclearance Programs  
USDA-APHIS-PPQ  
4700 River Road, Unit 67  
Riverdale, MD 20737  
Phone: 301-734-4910

A representative from the temperature recorder company who is familiar with the installation, should be on hand to correct any deficiencies in the system.

Before requesting final inspection, the vessel's owner must complete all arrangements. Calibration and identification tests will be made during the inspection. Clean containers filled with crushed ice and fresh water must be made available for the immersion of the temperature sensors.

## Determining the Number of Temperature Sensors

The number and location of temperature sensors is based on the cubic capacity of the compartment. Refer to **Figure 6-1-1** to determine the number and location of sensors. Always place the **air** sensors on the fore and aft bulkheads. Always distribute the **pulp** sensors throughout the compartment so that all areas can be reached.

Cubic Feet	Cubic Meters	Number of Air Sensors <sup>1</sup>	Number of Pulp Sensors	Total Number of Sensors
0 to 10,000	0 to 283	2 or 3	2	4 or 5
10,001 to 15,000	284 to 425	2 or 3	3	5 or 6
15,001 to 25,000	426 to 708	2 or 3	4	6 or 7
25,001 to 45,000	709 to 1,274	2 or 3	5	7 or 8
45,001 to 70,000	1,275 to 1,980	2 or 3	6	8 or 9
70,001 to 100,000	1,981 to 2,830	2 or 3	8	10 or 11
> 100,000	> 2,830	Contact TQAU		

**FIGURE 6-1-1 Number of Temperature Sensors per compartment**

- 1 In the case of twin deck compartments, two air sensors are required in the upper deck plus one air sensor in the lower compartment. This sensor should be located on the bulkhead farthest from the cooling unit.



It is highly recommended that more temperature sensors be installed than the minimum number required for each refrigerated compartment. If a sensor malfunctions during a treatment, the Port Director has the option of disregarding it, providing that an additional working sensor is present, and the functional sensors were uniformly distributed. Otherwise, the entire treatment must be repeated for the fruit in that compartment.

Designate two of the sensors as air sensors, and the others as pulp sensors. Any sensors above the required minimum may be either pulp or air sensors.

For compartments exceeding 100,000 cubic feet, contact the **TQAU** for the minimum number of required sensors.

## Calibration of Temperature Sensors

Calibrate all temperature sensors using a clean ice water slurry at 0 °C (32 °F).



It is APHIS policy to use the standard "rounding rule". In determining calibration factors, if the reading is .05 or higher, round to the next higher number in tenths. If it is .04 or lower, round to the lower number. For example: If the calibration factor was .15, round to .2. If it was .32, round to .3. Similar rounding can be used in actual treatment readings. If an actual reading was 34.04, round to 34.0, add or subtract the calibration factor, if necessary. If it was 34.07, round to 34.1, add or subtract the calibration factor, if necessary.

Use the following steps to make the ice water slurry:

1. Prepare a mixture of clean ice and fresh water in a clean insulated container.



- 2.** Crush or chip the ice and completely fill the container.
- 3.** Add enough water to stir the mixture.
- 4.** Stir the ice and water for a minimum of 2 minutes to ensure the water is completely cooled and good mixing has occurred.
  - ❖ The percentage of ice is estimated at 80 to 85 percent while the water fills the air voids (15 to 20 percent).
- 5.** Add more ice as the ice melts.
- 6.** Prepare and stir the ice water slurry to maintain a temperature of 0 °C (32 °F).
- 7.** Submerge the sensors in the ice water slurry without touching the sides or bottom of the container.
- 8.** Stir the slurry.
- 9.** Continue testing of each sensor in the ice water slurry until the temperature reading stabilizes.
- 10.** Record two consecutive readings of the stabilized temperature on the temperature chart or logsheet.
  - ❖ The temperature recording device should be in manual mode to provide an instantaneous readout.
- 11.** Allow at least a 1 minute interval between two consecutive readings for any one sensor; however, the interval should not exceed 5 minutes.
  - ❖ The variance between the two readings should not exceed 0.1°.
- 12.** Contact an instrument company representative immediately if the time interval exceeds the normal amount of time required to verify the reading and accuracy of the sensor and recorder system
  - ❖ The recorder used with the sensors must be capable of printing or displaying on demand and not just at hourly intervals.
- 13.** Correct any deficiencies in the equipment before certification.
- 14.** Replace any sensor that reads more than plus or minus 0.3 °C (0.5 °F) from the standard 0 °C (32 °F).
- 15.** Replace and recalibrate any sensors that malfunction.
- 16.** Document the recalibration and replacement of the sensor(s) on the PPQ Form 449-R, Temperature Recording Calibration Report.
- 17.** Determine the calibrations to the nearest tenth of one degree.

### **Frequency of Certification Testing**

A certification test is required every three years. No extensions to this three year requirement will be granted. Make requests for renewal at least 60 days before expiration to the TQAU or USDA PPQ Preclearance programs. Certification testing is also required anytime a malfunction, breakdown or other failure occurs (excluding temperature sensors) that requires modifications to the recording and monitoring system(s).

### **Documentation**

The APHIS official will document all tests during certification. Send a copy of the signed PPQ Form 449-R, Temperature Recording Calibration Report, copies of all charts and/or printouts, and any other pertinent addenda or appendices to the [TQAU](#) for final approval.

### **Certificate of Approval**

Upon meeting all requirements, the vessel will be designated as approved to conduct intransit cold treatments under the provisions of the PPQ's Fruit and Vegetable Quarantine 56. A PPQ Form 482, Certificate of Approval, listing the approved refrigerated compartments will be issued to the vessel. This approval is for equipment only, and each shipment of fruit must satisfy all requirements as described in Section 319.56 and 305.15 of the Code of Federal Regulations as a condition of entry into the United States.

## Application for USDA Vessel Approval

Visit the [Commodity Treatment Information System](#) web site or  
contact [TQAU](#) for a fillable, electronic Vessel Approval Application.

APPLICATION FOR USDA VESSEL APPROVAL FOR USE IN CONDUCTING QUARANTINE COLD TREATMENTS UNDER USDA REGULATIONS	
<p>Instructions:</p> <p>(1) Use one application for each vessel.</p> <p>(2) Review the regulatory requirements in Chapter 6 of the Plant Protection and Quarantine (PPQ) Treatment Manual. An electronic PDF document of the manual is available at the following website: <a href="http://www.aphis.usda.gov/import_export/plants/manuals/ports/downloads/treatment.pdf">http://www.aphis.usda.gov/import_export/plants/manuals/ports/downloads/treatment.pdf</a></p> <p>(3) A list of approved and certified vessels can be found at: <a href="https://treatments.cphst.org/vessels/">https://treatments.cphst.org/vessels/</a></p> <p>(4) Each application must include technical documents that support the information supplied.</p> <p>(5) Fill in each field of the application completely. Review of the application will not begin until all information is received. If a field is not applicable, please put "N/A" in the space provided. In the column labeled "Reference", indicate the page number(s) or specific location where the information can be found in the supporting technical documents.</p> <p>(6) Send the completed application and required additional information (manuals, technical sheets) to the following office:</p> <p align="center"><b>Treatment Quality Assurance Unit USDA-APHIS-PPQ-CPHST 1730 Varsity Drive, Suite 400 Raleigh, North Carolina 27606 USA</b></p> <p align="center">E-mail: <a href="mailto:cphst.tgau@aphis.usda.gov">cphst.tgau@aphis.usda.gov</a> / Fax: (919) 855-7493 / Telephone: (919) 855-7450</p>	
1. Contact Information (Please type or print)	
<b>Requestor Information: This information will be used by USDA as the official contact information for this vessel.</b>	
Name of Company: Golden Management	
Name and Title of Requestor: Ben Charles, Owner	
Address of Requestor: 111 Executive Drive Washington, DC 30943	
Telephone: 444-123-1234	FAX: 444-123-1235
E-Mail Address: bcharles@goldenmanage.com	
Agent Responsible for the Vessel (if different from Requestor)	
Name of Agent: N/A	
Address of Agent:	
Telephone:	Fax:
E-Mail Address:	
2. Vessel Information	
Shipyards: Shikoku	Hull number: 3456
IMO number: 99991111	Vessel name: Golden Swan

Form T-CT-V-A-124 Approved on 3/24/2009 Revision: 01  
Page 1 of 3

*The USDA is an equal opportunity provider and employer.*

**FIGURE 6-1-2 Example of a Completed Application for USDA Vessel Approval, page 1 of 3**

<b>Attach vessel schematic(s) to include the following:</b> <i>All information must be clearly referenced in supporting technical documents.</i>		
<b>Requirement</b>	<b>Reference Page or Section</b>	
<b>(a) Sensor location</b>	Page 6	
<b>(b) Sensor number</b>	Page 2	
<b>(c) Sensor type (air or pulp)</b>	Page 3	
<b>(d) Compartment identifiers</b>	Page 4	
<b>(e) Airflow direction</b>	Page 6	
<b>(f) Refrigeration Unit locations</b>	Page 6	
<b>(g) Recorder location</b>	Page 7	
<b>Ensure that a list of compartment identifiers with corresponding cubic capacity is attached to this application.</b>		
<b>3. Refrigeration Unit</b>		
Make of Refrigeration Unit: Saab	Model of Refrigeration Unit: 687Vn123	
Location of Refrigeration Unit: Power plant	Model Year: 2001	
Airflow maximum rate (cfm): 3000	Airflow direction: aft	
<b>4. Temperature Recorder</b>		
Manufacturer: Mycom	Model: Marcs	Model Year: 2003
Serial number(s): 554987, 965896	Quantity of recorders: 2	Is this a USDA approved recorder: Yes: <input checked="" type="checkbox"/> No: <input type="checkbox"/>
Accuracy: Recorder (Must be accurate to within +/- 0.15 C in the range of +/- 3.0 C): yes Recorder plus Sensor (Must be accurate to within +/- 0.30 C in the range of +/- 3.0 C): yes		
<b>5. Temperature Sensors</b>		
Accuracy (Must be accurate to within +/- 0.15 C in the range of +/- 3.0 C): yes		
Are these USDA approved temperature sensors: Yes: <input checked="" type="checkbox"/> No: <input type="checkbox"/>		
Do sensors numbers match the numbers on the recorder: Yes: <input checked="" type="checkbox"/> No: <input type="checkbox"/>		
<b>Description</b>	<b>Air Sensors</b>	<b>Pulp Sensors</b>
<b>Manufacturer</b>	Mycom	Mycom
<b>Model</b>	RM105	RM115
<b>Length of sensor cable</b>	3 meters (Must extend from ceiling to floor)	15 meters (Must extend beyond centerline of the vessel compartment)

X \_\_\_\_\_ 8-16-2008  
**Requestor's Signature** **Date (mm-dd-yyyy)**

**FIGURE 6-1-3 Example of a Completed Application for USDA Vessel Approval, page 2 of 3**



---

## **Certification of Self Refrigerated Containers Used for Intransit Cold Treatment**

Certify refrigerated containers used as cold treatment facilities before carrying treated fruit under USDA regulations. Classify refrigerated containers under the rules of the American Bureau of Shipping or a comparable internationally recognized classification society.

### **Certification Requirements**

Complete an Application for Container Certification and submit to **TQAU**. All plans and supporting materials must be submitted in Standard English. Refer to **Figure 6-1-5 on page-6-4-13** for an example of a completed Application for Container Certification.

Include the following specifications in the application:

- ◆ Air flow rate
- ◆ Container size
- ◆ Make and model of refrigeration unit
- ◆ Make and model of temperature recorder/control unit
- ◆ Type of sensor
  - ❖ At least 3 sensors are necessary for each container and must be labeled USDA1, USDA2 and USDA3

### **Letter of Certification**

Upon meeting all requirements, the container(s) will be certified to conduct intransit cold treatments under the provisions of the PPQ Fruit and Vegetable Quarantine 56. A Letter of Certification listing the refrigerated container(s) will be issued to the owner. This certification is for container(s) only, and each shipment of fruit must satisfy all requirements as described in Section 319.56 and 305.15 of the Code of Federal Regulations as a condition of entry for importation into the United States.

## Application for USDA Container Certification

Visit the [Commodity Treatment Information System](#) web site or contact **TQAU** for a fillable, electronic Vessel Approval Application.

APPLICATION FOR USDA CONTAINER CERTIFICATION TO CONDUCT COLD TREATMENT UNDER USDA REGULATIONS	
<p>Instructions:</p> <p>(1) Prior to submitting your Application for USDA Container Certification please verify that the containers are <b>not</b> already approved by going to the USDA Certified Containers Website: <a href="https://treatments.cphst.org/vessels/containers.cfm">https://treatments.cphst.org/vessels/containers.cfm</a></p> <p>(2) Review the regulatory requirements in Chapters 3-7 and 6-4 of the PPQ Treatment Manual. An electronic PDF document of the manual is available at the following website: <a href="http://www.aphis.usda.gov/import_export/plants/manuals/ports/downloads/treatment.pdf">http://www.aphis.usda.gov/import_export/plants/manuals/ports/downloads/treatment.pdf</a></p> <p>(3) Fill in each field on the application completely. Review for certification will not begin until all information is received. If a field is not applicable, please put "N/A" in the space provided.</p> <p>(4) Send the completed application via electronic mail, fax, or postal mail to the following office:</p>	
<p><b>USDA-APHIS-PPQ-CPHST-TQAU</b> 1730 Varsity Drive, Suite 400 Raleigh, North Carolina 27606 USA E-mail: <a href="mailto:cphst.tgau@aphis.usda.gov">cphst.tgau@aphis.usda.gov</a> / Fax: (919) 855-7493</p>	
1. Name and Address of Requestor (Please type or print)	
(First) (Last) John Johnson	Company Name: Cold World
Job Title: Manager	
Company Address: 1356 Westshore Drive, Miami, Florida 60188	
Country: USA	E-Mail Address: jjohnson@coldworld.com
Telephone: 901-564-5555	FAX: 901-565-5556
2. Name and Address of Container Series Owner (Different from Leasing Company)	
Container Series Owner: Maersk LTD	
Owner Address: Kiel, New Jersey	
Country: USA	E-Mail Address: manage@maersk.com
Telephone: 605-545-8974	FAX: 605-545-8965
3. Name and Address of Container Manufacturer (Fill out ONLY if different from 1)	
Container Manufacturer: Belding Reefer Company	
Manufacturer Address: 2565 East River Drive, New York, NY	
Country: USA	E-Mail Address: bdrcompany@belding.com
Telephone: 565-509-5698	FAX: 565-509-5699
<p><i>The USDA is an equal opportunity provider and employer.</i></p>	
Form T-CT-C-C-107	Approved 4/9/2009
	Revision: 02 Page 1 of 2

**FIGURE 6-1-5 Example of a Completed Application for USDA Container Certification, page 1 of 2**

4. Container Information			
Container Code and Numbers:	BIC: APRU	Begin: 904954	End: 905154
Total Number of Containers in Series: 200		Date of Construction (mm/yyyy): 06/2009	
External Dimensions (feet):	Length: 40	Width: 8'	Height: 9'6"
5. Refrigeration Unit			
Make: Carrier		Model: 69NT40-551-509	
Year of Manufacture: 2008		Location of the Unit: Inside the container <input checked="" type="checkbox"/> Outside the container <input type="checkbox"/>	
Airflow Maximum Rate (cubic feet per minute): 1400		Bottom Air Delivery? Yes <input checked="" type="checkbox"/> No <input type="checkbox"/>	
6. Temperature Controller			
Make: Carrier		Model: MicroLink 2	
Year of Manufacture: 2008			
Is a modem connected to the controller / recorder? Yes <input type="checkbox"/> No <input checked="" type="checkbox"/>		If Yes, specify model:	
7. Temperature Sensors: Indicate which approved sensors will be used with the temperature monitoring and control system:			
Thermistor <input checked="" type="checkbox"/>	ST9702 <input type="checkbox"/>	PT100 <input type="checkbox"/>	NTC <input type="checkbox"/>

X John Johnson 06/01/2009  
 Requestor's Name/Signature Date (mm/dd/yyyy)

\*\*\*\*\*DO NOT WRITE BELOW – FOR USDA PURPOSES ONLY – DO NOT WRITE BELOW\*\*\*\*\*

Reviewer \_\_\_\_\_

Date Application Received \_\_\_\_\_

Approved \_\_\_\_\_ Not Approved \_\_\_\_\_ Date \_\_\_\_\_

Reviewer's Signature \_\_\_\_\_

Container ID # \_\_\_\_\_ Document File Name \_\_\_\_\_

Comments:

*The USDA is an equal opportunity provider and employer.*

**FIGURE 6-1-6 Example of a Completed Application for USDA Container Certification, page 2 of 2**



## Certification of Warehouses Used for Cold Treatment

The local APHIS-PPQ inspector will certify refrigerated warehouses for use as cold treatment facilities before treating fruit under USDA regulations. In addition to the general requirements, warehouse approval is subject to specific geographical pest-risk considerations as outlined in Title 7, Section 305.15 of the Code of Federal Regulations.

**TQAU** will approve plans and specifications prior to the initial warehouse certification. Conduct a performance survey prior to the warehouse receiving approval to conduct cold treatments under USDA regulations.

### Plan and Specification Approval

Prior to the start of warehouse construction, submit a completed Application for Warehouse Approval, detailed drawings of the physical characteristics, and a written description of the all the treatment related equipment to **TQAU**. All plans and supporting materials must be submitted in Standard English. An example of a completed Application is provided in **Figure 6-1-8 on page-6-4-19**.

Include the following information in the Application:

- ◆ Address of the warehouse location
- ◆ Drawings showing the dimensions, cubic capacity and door locations



Drawings may be hand-drawn, but must clearly show location of refrigeration units, circulation fans, temperature recorder, and sensors.

- ◆ Make and model of the refrigeration equipment
- ◆ Name and address of the firm owning the warehouse chamber
- ◆ Number and location of sensors (**Figure 6-1-7 on page-6-4-16**)
- ◆ Method for segregating fruit under treatment and securing it from other foreign or domestic articles
- ◆ Specification of the air circulation system; must indicate the number of air changes and direction of air flow
- ◆ Specifications of the recording system

### Certification Testing

When all documents and a completed Application have been submitted and approved by the **TQAU**, the warehouse owner should make the warehouse available for an on-site certification visit by a local PPQ official. To arrange warehouse certification, contact the State Plant Health Director or Officer-In-Charge for the port. Before

requesting final inspection, the warehouse owner must complete all arrangements as directed by the PPQ officer. The PPQ official will conduct calibration and identification tests during the inspection.

**Determining the Number of Temperature Sensors**

The number and location of temperature sensors is based on the cubic capacity. Refer to **Figure 6-1-7** to determine the number and location of sensors. The minimum requirement is three sensors—one air sensor and two pulp sensors. Sensor cables must be long enough to reach all areas of the load.

Cubic Feet	Cubic Meters	Number of Air Sensors	Number of Pulp Sensors	Total Number of Sensors
0 to 10,000	0 to 283	1	2	3
10,001 to 20,000	284 to 566	1	3	4
20,001 to 30,000	567 to 849	1	4	5
30,001 to 40,000	850 to 1132	1	5	6
40,001 to 50,000	1133 to 1415	1	6	7
50,001 to 60,000	1416 to 1698	1	7	8
60,000 to 70,000	1699 to 1981	1	8	9
70,001 to 80,000	1982 to 2264	1	9	10
80,001 to 90,000	2265 to 2547	1	10	11
90,001 to 100,000	2548 to 2830	1	11	12
Over 100,000	>2830	Must be Approved by TQAU		

**FIGURE 6-1-7 Number of Temperature Sensors**



If a refrigerated room is equipped according to the cubic capacity of the storage area (rather than of the load itself), the same criteria apply.

It is highly recommended that additional sensors beyond the required minimum be installed.

**Calibration of Temperature Sensors**

Calibrate all temperature sensors using a freshwater ice water slurry at 0 °C (32 °F).



It is APHIS policy to use the standard "rounding rule". In determining calibration factors, if the reading is .05 or higher, round to the next higher number in tenths. If it is .04 or lower, round to the lower number. For example: If the calibration factor was .15, round to .2. If it was .32, round to .3. Similar rounding can be used in actual treatment readings. If an actual reading was 34.04, round to 34.0, add or subtract the calibration factor, if necessary. If it was 34.07, round to 34.1, add or subtract the calibration factor, if necessary.

Use the following steps to make the ice water slurry:

- 1.** Prepare a mixture of clean ice and fresh water in a clean insulated container.
- 2.** Crush or chip the ice and completely fill the container.
- 3.** Add enough water to stir the mixture.
- 4.** Stir the ice and water for a minimum of 2 minutes to ensure the water is completely cooled and good mixing has occurred.
  - ❖ The percentage of ice is estimated at 80 to 85 percent while the water fills the air voids (15 to 20 percent).
- 5.** Add more ice as the ice melts.
- 6.** Prepare and stir the ice water slurry to maintain a temperature of 32 °F. (0 °C)
- 7.** Submerge the sensors in the ice water slurry without touching the sides or bottom of the container.
- 8.** Stir the mixture.
- 9.** Continue testing of each sensor in the ice water slurry until the temperature reading stabilizes.
- 10.** Record two consecutive readings of the stabilized temperature on the temperature chart or logsheet.
  - ❖ The temperature recording device should be in manual mode to provide an instantaneous readout.
- 11.** Allow at least a 1 minute interval between two consecutive readings for any one sensor; however, the interval should not exceed 5 minutes.
  - ❖ The variance between the two readings should not exceed 0.1°.
- 12.** Contact an instrument company representative immediately if the time interval exceeds the normal amount of time required to verify the reading and accuracy of the sensor and recorder system
  - ❖ The recorder used with the sensors must be capable of printing or displaying on demand and not just at hourly intervals.
- 13.** Correct any deficiencies in the equipment before certification.
- 14.** Replace any sensor that reads more than plus or minus 0.3 °C (0.5 °F) from the standard 0 °C (32 °F).
- 15.** Replace and recalibrate any sensors that malfunction.
- 16.** Document the recalibration and replacement of the sensor(s) on the PPQ Form 449-R, Temperature Recording Calibration Report.
- 17.** Determine the calibrations to the nearest tenth of one degree.

**Frequency of  
Certification  
Testing**

A certification test is required every year. Summit requests for recertification to the local PPQ office at least 60 days before expiration. Certification testing is also required anytime a malfunction, breakdown or other failure occurs (excluding temperature sensors) that requires modifications to the recording and monitoring system(s).

## Application for USDA Warehouse Approval

Visit the [Commodity Treatment Information System](#) web site or  
contact [TQAU](#) for a fillable, electronic Vessel Approval Application.

**APPLICATION FOR USDA WAREHOUSE APPROVAL**  
FOR USE IN CONDUCTING QUARANTINE COLD TREATMENTS UNDER USDA REGULATIONS

**Instructions:**

- (1) Use one application for each warehouse.
- (2) Review the regulatory requirements in Chapter 6 of the Plant Protection and Quarantine (PPQ) Treatment Manual. An electronic PDF document of the manual is available at the following website:  
[http://www.aphis.usda.gov/import\\_export/plants/manuals/ports/downloads/treatment.pdf](http://www.aphis.usda.gov/import_export/plants/manuals/ports/downloads/treatment.pdf)
- (3) Each application must include technical documents that support the information supplied.
- (4) Fill in each field of the application completely. Review of the application will not begin until all information is received. If a field is not applicable, please put "N/A" in the space provided. In the column labeled "Reference", indicate the page number(s) or specific location where the information can be found in the supporting technical documents.
- (5) Send the completed application and required additional information (manuals, technical sheets) to the following office:

**Treatment Quality Assurance Unit**  
**USDA-APHIS-PPQ-CPHST**  
**1730 Varsity Drive, Suite 400**  
**Raleigh, North Carolina 27606 USA**  
E-mail: [cphst.tqau@aphis.usda.gov](mailto:cphst.tqau@aphis.usda.gov)  
Fax: (919) 855-7493 / Telephone: (919) 855-7450

1. Contact Information	
<b>Requestor Information: This information will be used by USDA as the official contact information for this warehouse.</b>	
Name (First) (Last): John Smith	Company Name: Bilco Cold Products
Job Title: Manager	E-Mail Address: jsmith@bcp.com
Company Address: 1700 Dock Street Philadelphia, PA 12345	
Telephone: 800-555-5555	FAX: 800-555-5556
Agent Responsible for the Warehouse (if different from Requestor)	
Name (First) (Last):	E-Mail Address:
Address of Agent:	
Telephone:	FAX:
2. Warehouse Information	
Name of Warehouse: Bilco Building 14	
Address: 123 Harbour Street Gloucester City, NJ 13456	
E-Mail Address: jsmith@bcp.com	Company Website: www.bcp.com
Telephone: 800-565-1234	FAX: 800-565-1236

*The USDA is an equal opportunity provider and employer.*

Form T-CT-W-A-123

Approved on 3/23/2009

Revision: 01  
Page 1 of 3

**FIGURE 6-1-8 Example of a Completed Application for USDA Warehouse Approval, page 1 of 3**

Requirement		Reference Page or Section
<b>Attach a warehouse schematic(s) that includes the following: All information must be clearly referenced in supporting technical documents.</b>		
(a) Delineations of treatment areas to be certified		See page 5
(b) Cubic capacity of each treatment area to be certified		See page 3
(c) Total cubic capacity of warehouse		See page 2
(d) Sensor location		See page 4
(e) Sensor number		See page 4
(f) Sensor type (air or pulp)		See page 1
(g) Treatment area identifiers		See page 2
(h) Airflow direction		See page 1
(i) Refrigeration unit location		See page 1
(j) Recorder location		See page 1
<b>Also attach a description of the method used to segregate fruit under PPQ treatment from other foreign or domestic articles.</b>		
<b>3. Refrigeration Unit</b>		
Make of Refrigeration Unit: Carrier	Model of Refrigeration Unit: GSE	
Location of Refrigeration Unit: Equipment Room 1	Model Year: 1998	
Airflow maximum rate (cfm): 1250	Airflow direction: East to West	
<b>4. Temperature Recorder</b>		
Manufacturer: ACR	Model: Smart Recorder	Model Year: 2005
Serial number(s): 12513541111, 123569858, 125456852		Quantity of recorders: 3/25/2009
Location of unit(s): Portable		
Accuracy of Recorder (Must be accurate to within +/- 0.15 C in the range of +/- 3.0 C): 0.1		
Accuracy of Recorder plus Sensor (Must be accurate to within +/- 0.30 C in the range of +/- 3.0 C): 0.3		
Is this a USDA approved recorder? Yes		
<b>5. Temperature Sensors</b>		
Manufacturer: ACR	Model: 105	Model Year: 2005
Accuracy (Must be accurate to within +/- 0.15 C in the range of +/- 3.0 C): 0.1		
Length of sensor cable (must be long enough to reach fruit in all parts of the stack): 15 meters		
Do sensor numbers match the numbers on the recorder: Yes <input checked="" type="checkbox"/> No <input type="checkbox"/>		

X \_\_\_\_\_ 03/23/2009  
**Requestor's Signature** **Date (mm-dd-yyyy)**  
*The USDA is an equal opportunity provider and employer.*

**FIGURE 6-1-9 Example of a Completed Application for USDA Warehouse Approval, page 2 of 3**



---

## Contact Information

### **TQAU**

USDA-APHIS-PPQ-CPHST  
Treatment Quality Assurance Unit  
1730 Varsity Drive  
Suite 400  
Raleigh, NC 27606  
Phone: 919-855-7450  
FAX: 919-855-7493  
Email: [cphst.tqau@aphis.usda.gov](mailto:cphst.tqau@aphis.usda.gov)



# 6

Treatment Manual

## Certifying Facilities

### *Certification of Hot Water Immersion Facilities*

---

#### Contents

Introduction	<a href="#">page-6-5-1</a>
Preliminary Performance Testing	<a href="#">page-6-5-1</a>
New Procedures for Hot Water Facility Certification and Commercial Testing	<a href="#">page-6-5-2</a>
Procedures for Conducting the Annual APHIS Performance Test	<a href="#">page-6-5-4</a>
Protocols for Foreign Treatment Facilities	<a href="#">page-6-5-7</a>
Address for Technical Contact	<a href="#">page-6-5-7</a>

---

#### Introduction

Quarantine treatment by immersion in hot water is used primarily for fruits that are hosts of tropical fruit flies. Exposing the fruit to a temperature of at least 115°F (46.1°C) for specific periods of time (depending upon the specific pest, type of fruit, and size of fruit) constitutes a quarantine treatment. The U.S. Department of Agriculture (USDA), Animal and Plant Health Inspection Service (APHIS) incorporates this principle of insect control into its regulations to facilitate the importation or interstate movement of certain fruits from areas where tropical fruit flies are the significant pests of concern.

Commercial facilities using hot water immersion treatment are subject to USDA-APHIS, certification on an annual basis. More frequent tests may be required at the option of APHIS. APHIS certification is given solely in conjunction with quarantine treatment requirements.



The certifying official shall check with the manager of the facility to be sure that he is aware of the requirement for using potable water. Whenever water comes into contact with fresh produce, the water's quality dictates the potential for pathogen contamination. To reduce the risk of food-borne illnesses, the water used for washing, treatments, and cooling must be fortified with sodium hypochlorite (household bleach), and constantly maintained at a chlorine level not to exceed 200 ppm.

---

#### Preliminary Performance Testing

If the facility has not been previously certified by APHIS, the operators should conduct preliminary, informal performance tests on their own (together with an engineer, if needed), to assure themselves that their equipment is in good working order.

By trial and error, the manager of the facility should decide on a tentative temperature set point for their tanks. This should be done by immersing one or more full baskets of fruit into each tank, to be certain that the water temperature (nearest the fruit) reaches at least 115.0°F (46.1°C) within 5 minutes. A thermostatic set point for each tank is typically in the range of 115.8°F to 116.9°F (46.6°C to 47.2°C).

As an option, some hot water immersion systems use an initial higher set point for the first several minutes, then automatically drop to a lower set point for the remainder of the treatment. (If this programming option is used, the change to the second set point must be done automatically, not manually.)

Data from the preliminary tests need not be recorded on official forms. These data, however, must be presented to APHIS, as evidence that the facility is ready for the official performance test.

Once the facility has been officially certified, APHIS does not require the facility to present preliminary performance test data in subsequent years, except when there have been major engineering changes to the equipment.

---

## **New Procedures for Hot Water Facility Certification and Commercial Testing**

These guidelines have been issued to provide a more accurate reflection of the tank's coldest temperatures. They are not intended to replace existing procedures, but to be used in conjunction with the current operational framework. These guidelines are only needed for facilities **not** capturing interior probe temperatures with actual sensors and are **only** in place until each facility begins capturing interior temperatures with actual sensors. Furthermore, these guidelines will be in effect until each facility develops a procedure for placing probes in the coldest locations of the tank. Facilities already using temporary probes as a routine part of commercial testing can disregard the procedures outlined below. All new equipment and procedures must be approved by the Treatment Quality Assurance Unit (**TQAU**) before implementation.

Refer to the following Figure for information regarding adjusted temperatures and set points:

1	2	3	4	5	6
Tank Sensor (Lowest) (F)	Portable Sensor (Lowest) (F)	Adjusted Tank Sensor Temperature <sup>1</sup> (F)	Set Point (F)	Treatment Interval (minutes)	Pulp Temperature (F)
116.0	115.9	115.1	117.0	5	78
115.5	115.4	115.1	116.0	6 - 30	78
115.3	115.2	115.1	115.5	31 - 60	78
115.1	115.0	115.1	115.3	61 - 75	78
115.0	115.0	115.0	115.0	76 - 90	78

**FIGURE 6-1-1 Hypothetical Certification Results: Treatment Tank with Multiple Set Points**

1 Adjusted Tank Sensor Temperature Equation:

Take the amount of temperature exceeding 115.0 from Portable Sensor (Lowest) in column 2, and subtract it from Tank Sensor (Lowest) in column 1 ( $116.0 - 0.9 = 115.1$ ).

1. Average minimum pulp temperatures must be taken from a minimum of 5 fruit extracted from the coldest fruit before treatment. On certification day, this average pulp temperature becomes the minimum commercial treatment pulp temperature permitted. All fruit must be at or above 70°F to be hot water treated.
2. The "adjusted tank sensor temperature" is determined by taking the amount of temperature exceeding 115.0 from Portable Sensor (Lowest) in column 2, and subtract it from Tank Sensor (Lowest) in column 1.
3. During certification, establish the set point with its lowest corresponding charted temperature. Document these values on the PPQ Form 482, Certificate of Approval and an attachment in the format of **Figure 6-1-1**.
4. The **Figure 6-1-1** attachment and PPQ Form 482 must be displayed in a prominent location at the facility.
5. During commercial treatments, the "Adjusted Tank Sensor Temperature" is used as the lowest treatment temperature. The commercial treatment fails if the tank temperature is below the "Adjusted Tank Sensor Temperature"

### **Mango temperatures prior to treatment**

During certification, determine and record an average pulp temperature (prior to treatment). Calculate this averaged pulp temperature by averaging pulp temperatures from the 5 "coldest" mangoes before treatment (mangoes extracted from the coldest

locations). This temperature becomes the minimum pretreatment pulp temperature allowable for commercial treatments. Therefore, during subsequent commercial treatments, mangoes must be at or above this minimum temperature before beginning treatment. (Any fruit below 70°F cannot be treated per manual requirements).

### **Permanent probe temperatures**

During certification, record from the printout/chart each set point with its lowest corresponding charted (permanent probe) temperature. A treatment tank may have one set point or multiple set points. If the tank has multiple set points, these set points are for a fixed length of treatment time. Refer to **Figure 6-1-1** for a detailed explanation. This "adjusted tank temperature sensor" (always above 115.0°F) becomes the lowest temperature permitted for that set point, or the "standard" at that set point. Commercial temperatures (permanent probe temperatures from the chart/printout) must be equal to or greater than the set point standard for each length of time. Document each "adjusted tank sensor temperature" determined during certification, on the PPQ Form 482, Certificate of Approval and on the attachment to the Certificate.

---

## **Procedures for Conducting the Annual APHIS Performance Test**

To approve the facility, the APHIS officer (or designated representative) shall take the following steps:

- 1.** If the facility has not been previously certified, or if modifications have been made since the last performance test, compare the plans and drawings with the actual installation.

Clearly show dimensions, water circulation, temperature sensing and recording systems, and safeguarding precautions in the plans and specifications.

- 2.** Conduct a performance test (at least annually), during an actual treatment (as described below), to determine (or verify) a temperature "set point" for the system, and to determine the minimum duration of time required between the immersion of successive baskets of fruit within the same tank.
- 3.** Inspect the heating, water circulation, and alarm systems, and check to see that all necessary safeguards (including screens, fans, locks, and air curtains) are secure and operational.
- 4.** Calibrate the portable sensors, recording the results on APHIS form 205 (or a plain sheet of paper).

- A.** Using a factory-calibrated, mercury, non-mercury or digital thermometer as the standard, compare the reading of each portable sensor to the standard, and record any deviation.
  - B.** To facilitate this process, a specially designed, portable temperature calibrator may be used, which uses either hot air or a swirling hot water bath, set at approximately the temperature at which treatments will take place; a treatment tank can also be used for this purpose, provided that the water is kept in motion.
- 5.** Examine the calibration of the tank's permanent RTD sensors, and record the results on APHIS form 206.
- 6.** Tape the cords of three or four portable "water temperature sensors" to the skins of three or four selected fruits in each basket. (Do not cover the end of the sensor with tape.)
- 7.** Insert a portable "pulp temperature sensor" approximately one centimeter into the flesh of one or more fruits in the tank.
  - A.** Hold the sensor in place with tape.
  - B.** *It is not necessary to have a pulp temperature sensor in each basket.*
- 8.** Set the fruit at ambient temperature (70°F or above) immediately prior to the performance test.

If the fruit is pre-warmed by artificial means, note this routine as a condition of approval that should be followed for each commercial treatment.

- 9.** On the location diagram (APHIS form 207), show the relative position of each portable sensor used in the test, and indicate whether it is a "water" or a "pulp" sensor. Number each sensor.
- 10.** While the fruit are immersed in water, use an electronic thermometer to monitor the temperatures of each portable sensor at various times throughout the test. (record this information on APHIS form 208 for each tank.)

As a second option, a portable, automatic recording instrument can be used; it must, however, operate independently from the temperature recording system installed at the facility.

- 11.** During the performance test, lower the baskets of fruit into the hot water immersion tank.
  - A.** Closely monitor the "water temperature sensors" during the first five minutes of treatment.

APHIS requires that the temperatures of all “water temperature sensors” must reach at least 115°F (46.1°C) within 5 minutes; if not, in order to achieve the 5-minute temperature recovery requirement, repeat the test using other fruit, using a slightly higher water temperature set point, and/or a slightly longer time interval between subsequent basket immersions.

- B.** Run the test for the full duration (up to 90 minutes, depending upon fruit size).

During that time, all “water temperature sensors” must read at least 115°F (46.1°C) at the 5 minute point and beyond; in addition, the “pulp temperature sensor” (or sensors) must read at least 113°F (45°C) *by the end of the test*.



It should be noted that APHIS standards for passing the official performance test are higher than the standards accepted for commercial treatments. This is intentional. *During commercial treatments* of mangoes, the water in the tank is allowed up to 5 minutes to reach the minimum treatment temperature of 115°F after the fruit have been submerged.



The mango hot water schedules also have a built-in tolerance for subnormal temperatures in the range of 113.7°F to 114.9°F for up to 10 minutes (in the case of 65 or 75-minute treatments), or 15 minutes (in the case of 90-minute treatments). This tolerance was designed to “save” an ongoing treatment during an emergency situation such as an electrical power outage. However, *for purposes of the official performance test*, all water temperature sensors are required to read at least 115.0°F within the first 5 minutes, and to maintain temperatures at or above that threshold during the remainder of the treatment.

- 12.** For issuance of a Certificate of Approval (PPQ form 482), submit all supporting documents to the APHIS-Regional Office (or to another APHIS office delegated by the Region).
- 13.** APHIS will certify the facility only when all requirements are met, including *two* successful hot water immersion treatments in each tank, using standard fruit loads.

For annual recertification, however, only *one* successful performance test is required per tank, unless the Work Plan requires additional tests. Submit a copy of PPQ Form 482, the corresponding attachment (**Figure 6-1-1**), all forms used in the certification or recertification and printouts from the temperature recorder to **TQAU**.

---

## **Protocols for Foreign Treatment Facilities**

This section has been moved to the [Commodity Preclearance Program Management Guidelines](#).

---

## **Address for Technical Contact**

### **TQAU**

Center for Plant Health Science & Technology  
USDA, APHIS, PPQ, CHPST  
Treatment Quality Assurance Unit  
1730 Varsity Drive, Suite 400  
Raleigh, NC 27606

Tel: 919-855-7450  
Fax: 919-855-7493





# 6

Treatment Manual

## Certifying Facilities

### *Certification of Forced Hot Air and Vapor Heat Treatment Facilities*

---

#### Contents

Introduction	<a href="#">page-6-6-1</a>
Plan and Process Approval	<a href="#">page-6-6-2</a>
Preliminary Performance Testing	<a href="#">page-6-6-3</a>
Official Certification Testing	<a href="#">page-6-6-3</a>
Calibrating the Portable Temperature Sensors	<a href="#">page-6-6-4</a>
Calibrating the Permanent Temperature Sensors	<a href="#">page-6-6-4</a>
Permanent Sensor Heat-up Test	<a href="#">page-6-6-5</a>
Thermal Mapping	<a href="#">page-6-6-5</a>
Conducting a Test Treatment	<a href="#">page-6-6-7</a>
Frequency of Certification	<a href="#">page-6-6-7</a>
Frequency of Permanent Temperature Sensor Calibration	<a href="#">page-6-6-7</a>
Documentation	<a href="#">page-6-6-8</a>
Contact Information	<a href="#">page-6-6-8</a>

---

#### Introduction

Forced hot air (FHA) and vapor heat (VH) treatment facilities must be certified by a qualified APHIS inspector. For brevity, "certification" and "re-certification" will both be referred to as "certification" in this chapter.

Prior to the first certification at a facility, the facility plan and process description must be approved by the Treatment Quality Assurance Unit (TQAU) ([TQAU](#) contact information can be found at the end of the chapter). Certification tests must be carried out prior to treatment at the beginning of the shipping season or whenever APHIS determines that a malfunction or alteration in the system warrants a certification test.

Certification will be granted on the basis of the ability of the chamber to meet treatment requirements, extent and condition of phytosanitary safeguards, sanitary (human health) conditions, and safety conditions. Facilities must be certified for each species (in some cases each variety or subspecies) of fruit, each chamber load configuration (half full, quarter full, etc....), and, for some species, each size class of fruit treated.

Facilities should be aware that certification may not be the only condition under which they may treat fruit for shipment to or within the US. In addition to certification, there are other requirements such

as agreeing to an operational workplan, signing compliance agreements, and obtaining import permits that must be satisfied prior to treatment. Treatment facility managers outside the US should contact APHIS International Services (IS) and managers of facilities in the US or its territories should contact their local PPQ office for a complete list of requirements.

---

## Plan and Process Approval

Prior to the start of facility construction, a detailed plan of the facility's physical characteristics and a written, step by step, description of the all the processes related to treatment must be approved by **TQAU** (all plans and supporting materials must be submitted in Standard English). Plans and process descriptions for facilities within the US and its territories must be submitted through the local PPQ office, facilities outside the US should consult APHIS IS for the appropriate plan submission procedure.

At a minimum, plans must include the following information as diagrams and/or written descriptions:

1. Physical location of facility.
2. Areas designated for fruit arrival.
3. Areas for storage of untreated fruit.
4. Pre-treatment sorting and grading areas.
5. Crates, lugs, bins, etc.... that will be used to hold fruit during treatment, including total volume and projected fruit capacity.
6. Delineations of area(s) for storage of treated and untreated fruit.
7. Treatment chamber including heating system, crate arrangement within the chamber, and air flow.
8. Post-treatment cooling system.
9. Post-treatment packing.
10. Areas designated for loading of treated fruit.
11. Systems designed to ensure phytosanitary security of the treated fruit.
12. Systems designed to ensure water which comes into contact with fruit is free of microbial or any other contaminants that may adversely affect human health.
13. Description of all processes related to treatment of fruit. These descriptions should reference diagrams with numbers where appropriate.

The process of reviewing the plans and process descriptions may take as long as sixty days and subsequent requests for additional information may further extend this time. Facilities should take this time constraint into account when developing a project timeline. Facilities will receive a letter granting plan approval or describing plan deficiencies. Plan approvals expire one year from the approval date if the facility has not been certified.

---

## **Preliminary Performance Testing**

Following plan approval, the facility should be built according to the plans. If deviations from the plans are necessary, **TGAU** must approve these changes (changes should be submitted in a manner similar to that described in "Plan and Process Approval"). After construction is completed, the facility must be tested to be sure it can meet all treatment requirements. These trials should test the ability of the treatment chambers to heat a full (maximum) load of fruit to according the treatment guidelines. Any problems or deficiencies found in the facility must be corrected and the preliminary tests must be re-run until all treatment requirements are met. After the facility representative is satisfied that the treatment system is running properly and can fully meet treatment requirements, they must submit results of the test to **TGAU** for review.

General requirements for test result submission are in the list below, facilities will be provided with specific requirements as part of the plan approval letter.

1. Amount, type, and size of fruit in load and in each crate.
2. A diagram of chamber that shows location of each permanent sensor.
3. Time and temperature data from the test run(s).

The process of reviewing results from preliminary performance tests may take as long as 30 days. After **TGAU** reviews the results from the preliminary performance test, they will issue a letter either approving or rejecting the results. If approval is granted, the facility representative can then schedule an official certification test.

---

## **Official Certification Testing**

The official certification test has four main components: (i) calibrating the portable and permanent sensors, (ii) permanent sensor heat up test (iii) thermal mapping (cold spot mapping), and (iv) conducting an actual test treatment. These steps are discussed below in detail. A

certification test must be completed for each combination of fruit species, chamber load configuration, and, in some cases, fruit size class.

### Calibrating the Portable Temperature Sensors

If the facility is outside the US, it is the responsibility of the exporter to provide portable temperature sensors for the certification procedure.



Only portable sensors approved by **TQAU** may be used. Contact **TQAU** for a list of approved temperature sensors.

### Permanent sensors may not be substituted for portable sensors.

Portable temperature sensors must be calibrated in a swirling hot water bath with a factory calibrated certified mercury, non-mercury or digital thermometer with 0.1°C (0.2°F) graduations as a standard. The temperature of the swirling hot water bath must consistently read the treatment temperature on the certified thermometer. Portable temperature sensors must be inserted into the hot water bath and must remain until the certified thermometer reads the treatment temperature for ten consecutive minutes. After the 10 minute calibration period, the portable sensors may be removed and their data read. Any sensor that deviates by more than +/- 0.3°C (0.5°F) from the treatment temperature may not be used. The greatest deviation for each portable sensor should be recorded as the correction factor for that portable sensor.



If using a glass mercury thermometer, carefully inspect the calibrated certified glass mercury thermometers for bubbles in the mercury or other defects prior to each use.

### Calibrating the Permanent Temperature Sensors

The permanent temperature recording system should be calibrated in the same manner described for portable sensors described in "Calibrating the Portable Temperature Sensors".

However, it should be noted that this calibration is not just for the sensor portion of the temperature recording system, but applies to the sensors, the wires that attach the sensors to the recording instruments, the recording instruments, and any other devices used to measure, transmit, or record the temperature. Failure of the permanent temperature recording system to read within +/- 0.3°C (0.5°F) of the treatment temperature may indicate that a portion of or the entire permanent temperature recording system needs to be

repaired or replaced. If any part or portion of the permanent temperature recording system is repaired or replaced, the entire permanent temperature recording system must be recalibrated.



Calibration of permanent and portable temperature sensors must be completed before the permanent sensor heat-up test, thermal mapping, and or test treatment is performed.

### Permanent Sensor Heat-up Test

The permanent temperature sensor system must be tested against the portable temperature sensors to verify that the permanent temperature sensors correctly respond to changes in temperature within the chamber.

This test is performed by arranging permanent temperature sensors and portable temperature sensors in close proximity within the treatment chamber. A maximum ratio of 2 permanent sensors to one portable sensor is allowed for this test. Sensors should be placed in locations within the chamber that are expected to have relatively uniform heating patterns. After all sensors are secured within the chamber, conduct the treatment as usual. When the test is complete, review the data. All data collected from the permanent temperature sensors must be within  $\pm 0.3^{\circ}\text{C}$  ( $0.5^{\circ}\text{F}$ ) of the corresponding portable temperature sensor.

### Thermal Mapping

Thermal mapping determines the placement of permanent temperature sensors in the chamber. Because the permanent temperature sensors will be placed in the coldest areas of the chamber, this process is also referred to as cold spot mapping or cold spot testing. The process of thermal mapping is relatively simple, portable temperature sensors are placed throughout the chamber and the treatment is conducted. The sensors that took the longest time to record treatment temperature represent colder areas of the chamber. Thermal mapping can be time consuming and resource intensive. The procedure is as follows:

1. Based on basic thermodynamics and data from the preliminary performance test, develop hypotheses about which regions of the chamber are most likely to have cold spots. This will be based primarily on the direction of the air flow in the chamber. Chambers in which air flows in a single vertical direction will generally have cold regions in portions of the load that come into contact with the heated air last. For example, if the chamber delivers hot air from the bottom, the top of the load is likely to take longer to heat up because the fruit at the bottom absorbs heat first. In chambers where the air flow changes direction or the air delivery is horizontal, it may be more difficult to form these types of hypotheses.

2. Inspect fruit to be used in test to be sure it is similar in size, ripeness, and variety to the fruit that will be routinely treated. Fruit should be sorted and a subset totaling the number of portable temperature sensors plus 20% should be selected. The difference between the heaviest and lightest fruit must not be more than 5% of the heaviest fruit's weight.
3. Each sensor must be placed in one of the fruit in the subset collected in #2 above. The most sensitive portion of the temperature sensor must be placed in the area of the fruit pulp most resistant to temperature change, usually the center of the fruit or close to the pit.
4. Based on the hypotheses formed in #1 above, place the majority of the portable temperature sensors in the areas thought to be cold regions. In order to verify the hypothesis, place a portion of the portable temperature sensors in the areas thought to be warmer. If no hypotheses were formed in #1 above, portable temperature sensors must be placed in a systematic pattern that can provide a complete thermal map of the entire load. If necessary, contact **TQAU** for assistance developing a thermal mapping sampling scheme.



Each chamber may require a different number of portable sensors depending on factors such as the chamber size, chamber dimensions, air flow patterns, and size and species of the fruit. Typically, a chamber approximately the size of a standard 40 ft. shipping container will require about 60 sensors. Contact **TQAU** for help in determining the number of sensors required.

5. Create a map of the chamber that shows the relative horizontal and vertical location of each portable temperature sensor.
6. Conduct the treatment.
7. Remove the portable temperature sensors and read their data.
8. Determine the amount of time each portable temperature sensor took to reach treatment temperature. The portable temperature sensors which required the longest time to reach treatment temperature indicate cold spots.

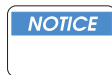

All portable temperature sensors must reach treatment temperature.

9. Create a map of the cold spots based on the map created in step #5 and the analysis completed in step #8.
10. Repeat this process at least twice for each load / volume configuration to ensure that correct and consistent cold spots are found.

11. Based on the thermal maps created in step #9, create a map showing the location of each permanent temperature sensor for each load/ volume configuration.



If thermal mapping shows that difference in the time required to reach treatment temperature between any two sensors is greater than 2 hours, the chamber will not be certified.

### Conducting a Test Treatment

A test treatment must be performed to verify that the chamber is capable of meeting treatment requirements. Test treatments are only required for the maximum load/volume configuration that the facility will be certified for and may be done in conjunction with the thermal mapping described above. The procedure for conducting a test treatment is as follows:

1. Place permanent temperature sensors in areas of the load that are thought to be cold spots (based on thermal mapping data).
2. Conduct the treatment.
3. During treatment, inspect the outside of the chamber to be sure it is free of leaks, is operating smoothly, and generally is in good working order.
4. After treatment is completed, review the temperature logs from the permanent temperature sensors. All permanent temperature sensors must have reached the treatment temperature.

### Frequency of Certification

A certification test is required once a year, usually at the beginning of the shipping season, and whenever the system has a malfunction, breakdown, or other failure (excluding malfunction of temperature sensors) that require modifications that alter the manner in which the system functions.

### Frequency of Permanent Temperature Sensor Calibration

Permanent temperature sensors must be calibrated using the process described in [“Calibrating the Permanent Temperature Sensors” on page-6-6-4](#). Calibration of permanent temperature sensors must be performed every 14 days. However, calibration can also occur whenever any part of the permanent temperature recording system fails or is replaced, or at the discretion of the APHIS inspector.

---

## Documentation

All tests performed during certification must be documented by the APHIS official. A copy of the signed APHIS Form 482, copies of all thermal maps, description of load size limitations, description of any other special limitations placed on the treatment, and any other pertinent addenda or appendices, must be sent to [TQAU](#) for final approval.

---

## Contact Information

### **TQAU**

Center for Plant Health Science & Technology  
USDA, APHIS, PPQ, CHPST  
Treatment Quality Assurance Unit  
1730 Varsity Drive, Suite 400  
Raleigh, NC 27606

Tel: 919-855-7450  
Fax: 919-855-7493



# 6

Treatment Manual

## Certifying Facilities

### *Certification of Niger seed Treatment Facilities*

---

#### Contents

PPQ Regulation Policies Governing the Entry of Niger seeds into the United States	<a href="#">page-6-7-1</a>
The Certification Process	<a href="#">page-6-7-1</a>
Approval of engineering construction plan	<a href="#">page-6-7-1</a>
Requesting certification for a treatment plant.	<a href="#">page-6-7-2</a>
Performance test for a Niger seed treatment facility.	<a href="#">page-6-7-2</a>
Minimum standards and specifications	<a href="#">page-6-7-3</a>
Actions Required During Plant Certification	<a href="#">page-6-7-4</a>
Certification (approval) of a Treatment Facility.	<a href="#">page-6-7-4</a>
Quality Assurance	<a href="#">page-6-7-5</a>

---

#### PPQ Regulation Policies Governing the Entry of Niger seeds into the United States

Seeds of *Guizotia abyssinica* (Niger seed) from any foreign place, at or before the time of arrival at the port of first arrival, shall be heat treated for possible infestation with noxious weeds or prohibited pathogens in accordance with the applicable provisions of PPQ's Treatment Manual.

#### The Certification Process

Certification of a niger seed treatment facilities includes the following steps:

1. The facility submits an engineering construction plan
2. APHIS approves the engineering construction plan
3. The facility formally requests certification
4. APHIS conducts a performance test for certification
5. APHIS makes final approval for certification and issues a Certificate of Approval (PPQ Form 482)

#### Approval of engineering construction plan

Plans and specifications showing dimensions, capacity, heating units and temperature time recording system must be sent for approval through the appropriate State officials and through:

USDA-APHIS-PPQ-CPHST  
Treatment Quality Assurance Unit (TQAU)  
1730 Varsity Drive, Suite 400  
Raleigh, NC 27606

Foreign treatment facilities must be constructed to meet foreign standards. The equipment must be designed in a manner to hold the temperature at or above temperatures prescribed in the treatment schedule for heat treatment of niger seed (T412-a). When the engineering plans are approved, the treatment plant will be constructed accordingly. Any modification of the original plans, will require advanced approval in writing from PPQ.

### **Requesting certification for a treatment plant.**

To obtain certification from APHIS, a Niger seed treatment plant should submit a written request to the APHIS. The request should include the following:

- ◆ Listing of names, addresses and phone numbers of the facility, facility manager or supervisor and plant construction engineer,
- ◆ Assurance that the facility manager accepts responsibility for facility operations
- ◆ Assurance that required equipment is on-site
- ◆ Data from at least two preliminary performance tests indicating that the plant meets performance requirements for certification, including copies of completed treatment sheets and related temperature printout sheets for test treatments.



The appropriate permits and approval to import niger seeds for tests must be approved by PPQ Permit Unit prior to shipment of the commodity to the United States.

### **Performance test for a Niger seed treatment facility.**

Initial certification/performance testing will be conducted by CPHST-TQAU in conjunction with PPQ. CPHST may delegate this responsibility to others for the purpose recertification.

### **Equipment/materials needed by APHIS or its designee to conduct facility performance tests for certification.**

The facility must supply the following equipment and materials to conduct a performance test for certification:

- ◆ Copy of plans and specifications showing dimensions and other details of heating and temperature recording systems.

- ◆ Certified calibrated thermometer (temperature range to at least 270° F (132.2° C))
- ◆ Stop watch and tape measure
- ◆ Temperature recording system to record temperature and processing time.

---

## Minimum standards and specifications

To qualify for certification/recertification, the facility must meet the following minimum standards and specifications:

- ◆ Temperature probes (a minimum of 2) situated in the heat treating equipment in such a way as to determine when the niger seeds reaches the target temperature. Probes or sensors shall be placed in the commodity in order accurately record commodity temperature.
- ◆ Temperature recording chart shall be in increments of not less than 0.10 inch for each degree F. (or 5mm for each degree C)
- ◆ Temperature readings shall be recorded on a chart in time intervals not to exceed four minutes between each reading.
- ◆ Accuracy of the total temperature recording system shall be within plus or minus 0.5 degree F. (0.3 degree C.) of actual temperatures as measured with a certified calibrated thermometer.
- ◆ Speed indicator shall be present for continuous flow systems.
- ◆ All the valves and controls that affect heat flow to the treatment system shall be secured to avoid manipulation during the treatment process by unauthorized personnel.
- ◆ Heating controls shall be automatic and run continuously throughout the treatment process, manual adjustments are allowed.
- ◆ Gear systems used to control the niger seed conveyor (if applicable) shall be capable of being adjusted as needed to meet treatment requirements.
- ◆ An audible alarm or highly visible light shall be installed on burners or other equipment to indicate system failure and/or when not operating properly.
- ◆ A system shall be in place to divert any untreated niger seeds for treatment.
- ◆ An action plan shall be available to address any pests which may be associated with the storage, treatment and shipment of niger seeds.

- ◆ Proper sanitation measures shall be implemented to ensure that there are no potential breeding grounds for pests on the premises and therefore, little risk of re-infestation or cross-contamination.
- ◆ Treated seeds shall be stored in a location separate from the non-treated seeds. The treated and non-treated seeds shall be handled in a manner to prevent cross-contamination.
- ◆ Seed processing equipment shall have the capability to divert for re-treatment any non-treated, or treated seeds which do not meet treatment standards.

---

### **Actions Required During Plant Certification**

Also, the facility must conform to the following operating procedures:

- ◆ Sufficient niger seeds for two (2) test runs at the maximum load for one (1) hour must be on hand for APHIS personnel overseeing the tests.
- ◆ All temperature sensing probes must be verified during the test runs or evidence provided that the probes have been calibrated by an official calibration company within a 12 month period.
- ◆ The temperature and conveyer speed must be verified to coincide with the readings taken during manual testing and calculation.
- ◆ Check the continuity of the system to verify the lack of any cross-contamination.
- ◆ Ensure that after treatment and cooling, the niger seeds are immediately bagged in new bags. The old bags must be treated or disposed of in a manner that will preclude regulated pests.

---

### **Certification (approval) of a Treatment Facility.**

If treatment standards are not met during performance testing, APHIS will record the test as not acceptable for certification. A copy of the data sheet with explanation as to why the test was not acceptable, should be provided to the facility operator for corrective action.

Final approval of niger heat treating equipment will be given after two (2) consecutive successful runs of maximum capacity at the longest treating period consecutive successful runs of maximum capacity at the longest treating period (at least 15 minutes at 248 degrees F. minimum or 120 degrees C). Upon approval, APHIS will issue a Certificate of Approval (PPQ form 482).



Any compliance agreement/workplans or standards developed by APHIS for the facility must be adhered to. (see Dry heat Treatment Facilities for Niger seeds.)

---

## Quality Assurance

PPQ will monitor by sampling the treated seeds periodically to find actionable contaminants. Every 25th lot after treatment is to be sampled according to PPQ sampling protocol.



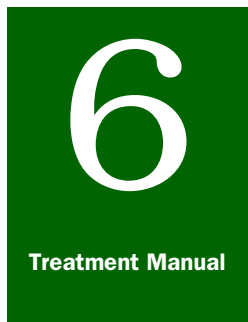

# Certifying Facilities

## *Certifying Irradiation Treatment Facilities*

---

### Contents

Introduction	<a href="#">page-6-8-1</a>
Certification Requirements	<a href="#">page-6-8-1</a>
Recertification	<a href="#">page-6-8-3</a>
Audits	<a href="#">page-6-8-3</a>
Certificate of Approval	<a href="#">page-6-8-3</a>

---

### Introduction

In order to receive authorization to conduct approved phytosanitary irradiation treatments, an irradiation facility must obtain a PPQ Form 482, Certificate of Approval from the USDA-APHIS-PPQ Treatment Quality Assurance Unit (TQAU).

The purpose of this chapter is to provide basic guidelines for facility certification, recertification and audits. Approved facilities must be able to demonstrate that their equipment and personnel are able to safely, accurately, and consistently administer the minimum dose (D<sub>min</sub>) to all components of the commodity over the range of conditions expected for commodities treated.

---

### Certification Requirements

The facility must be certified by the national nuclear regulatory authority of the country where the facility is located prior to involvement from USDA.

In order to receive a Certificate of Approval for treating commodities to mitigate regulated pests, a facility must complete the following in numerical order:

- 1. Operational Workplan (OWP)**

An Operational Workplan (OWP) must be established prior to a Cooperative Agreement. The OWP provides general guidelines for safeguarding procedures.

- 2. Addenda to the Workplan**

The addenda to the OWP identifies specific information not covered in the OWP, such as the commodity(ies) and pest(s) that will be irradiated and details pertinent to facility operation.

### **3. Cooperative Agreement**

The Cooperative Agreement establishes a trust fund between the importing and exporting countries.

### **4. Plan Approval Application**

The Plan Approval Application must be completed in its entirety and submitted to CPHST-TQAU. For electronic, fillable copies of the Application, contact CPHST-TQAU at the following address:

USDA-APHIS-PPQ-CPHST  
Treatment Quality Assurance Unit  
1730 Varsity Drive  
Raleigh, NC 27606-5202  
Phone: 919-855-7450

### **5. On-site certification**

When all documents have been approved, an official on-site visit will be scheduled. During this visit, the certifying official will verify the accuracy of the information submitted in the Plan Approval Application, review the Standard Operating Procedures (SOP), inspect the dosimetry equipment and verify that the personnel are proficient in its use. The on-site certification will also include inspection of the segregation structures to ensure misidentification or cross-contamination of treated and untreated commodities does not occur. Phytosanitary measures must be in place to guard against pest infestation from the perimeter of the facility. The certifying official will also review the dose mapping procedures and records and verify that data management procedures are acceptable.

### **6. Compliance Agreement**

The Compliance Agreement serves as the legal notice to the treatment facility to follow the OWP. The Compliance Agreement defines what the facility must do before, during and after receipt of the fruit (i.e. segregation, inspection, safeguarding, record keeping, and labelling) and any additional requirements specific to the facility.



## Recertification

Recertification will be conducted when at least one of the major non-compliances described below have been detected:

- ◆ A problem with the treatment process has been identified by APHIS or the NPPO (i.e. unmitigated pest interception)
- ◆ Change in management which substantially affects any aspect of the treatment process
- ◆ Operational or structural changes of the facility
- ◆ Replenishment, rearrangement or change of the radiation-producing source



Annual recertification is NOT necessary.

---

## Audits

Audits will be performed at the discretion of the Director of APHIS-PPQ-CPHST-TQAU. On-site audits will include review of the dosimetry, dose mapping, safeguarding measures, record keeping, and the treatment process and system integrity as a whole.

Electronic audits will also be performed by TQAU to review routine dosimetry data and dose mapping data.

---

## Certificate of Approval

Upon facility approval, the USDA will issue a PPQ Form 482, Certificate of Approval, outlining the terms, conditions, and restrictions of the approval. The USDA approval status of all irradiation treatment facilities, both domestic and foreign, treating commodities to mitigate regulated agricultural pests will be tracked by USDA-APHIS-PPQ-CPHST-TQAU.

The Certificate of Approval can be revoked if major non-compliances are detected.



# 6

Treatment Manual

## Certifying Facilities

### *Certifying Facilities for the Heat Treatment of Firewood*

---

#### Contents

Introduction	page-6-9-1
Plan and Process Approval	page-6-9-2
Official Certification Testing	page-6-9-3
Calibrating the Temperature Sensors	page-6-9-3
Thermal Mapping	page-6-9-3
Conducting a Test Treatment	page-6-9-5
Frequency of Certification and Temperature Sensor Calibration	page-6-9-6
Documentation	page-6-9-6
Contact Information	page-6-9-6

---

#### Introduction

*Agrilus planipennis* Fairmaire (Coleoptera: Buprestidae), commonly known as the Emerald Ash Borer (EAB, ) is a wood-boring insect that infests firewood. This destructive beetle attacks all North American species of Ash trees and has been detected in Illinois, Indiana, Ohio, Pennsylvania, Maryland, Michigan, and Windsor, Ontario, Canada.

The European Gypsy moth (*Lymantria dispar* L.) feeds on over 500 species of trees and shrubs. Quarantined areas include the District of Columbia, the entire States of Connecticut, Delaware, Maryland, Massachusetts, Michigan, New Hampshire, New Jersey, New York, Pennsylvania, Rhode Island, and Vermont. Additionally these states, portions of the following states are quarantined: Indiana, Illinois, Maine, North Carolina, Ohio, Virginia, West Virginia, and Wisconsin.

Heat treatment is an approved treatment for these two common wood pests. The treatment must occur in a certified heat treatment facility. The purpose of this chapter is to provide guidelines for the certification of a heat treatment facility.

Heat treatment facilities must be certified by a qualified PPQ official. For brevity, "certification" and "re-certification" will both be referred to as "certification" in this chapter.

Certification tests must be carried out prior to treatment to allow movement of wood from the current quarantine areas, or whenever a malfunction or alteration in the system warrants a certification test.

Certification will be granted on the basis of the ability of the chamber to meet treatment requirements, extent and condition of phytosanitary safeguards, and safety conditions.

Facilities should be aware that certification may **not** be the only condition under which firewood for shipment can be moved from quarantine areas. In addition to certification, there are other requirements that must be satisfied prior to treatment:

- ◆ An operational workplan
- ◆ A compliance agreement
- ◆ Appropriate federal, state or local permits

Treatment facility managers should contact their local PPQ office and/or local state departments of agriculture for state-specific requirements.

---

## Plan and Process Approval

Prior to the start of the certification process for a new or existing facility, a detailed plan of the facility's physical characteristics and a written, step by step, description of all the processes related to treatment must be approved by USDA-APHIS. Plans and process descriptions must be submitted through the local PPQ office.

At a minimum, plans must include a description of all processes related to the heat treatment of firewood. These descriptions should reference diagrams with numbers where appropriate. Submit the following information as diagrams and/or written descriptions:

- ◆ Areas designated for:
  - ❖ Arrival and storage of untreated firewood
  - ❖ Loading of untreated and treated firewood
  - ❖ Storage of untreated and treated firewood
- ◆ Crates, bins, racks etc. used to hold firewood during treatment, including total volume and projected capacity
- ◆ Physical location of facility
- ◆ Post-treatment cooling system
- ◆ Post-treatment packaging
- ◆ Pre-treatment sorting and grading areas
- ◆ Systems to ensure phytosanitary security of the treated wood
- ◆ Treatment chamber including heating system, arrangement within the chamber, and air flow

The process of reviewing the plans and process descriptions may take as long as sixty days and subsequent requests for additional information may further extend this time. Facilities should take this time constraint into account when developing a project timeline. Facilities will receive a letter granting plan approval or describing plan deficiencies. Plan approvals expire one year from the approval date if the facility has not been certified.

---

## Official Certification Testing

Following plan approval, facilities seeking certification must be tested to ensure they can meet all treatment requirements. If deviations from the plans are necessary, PPQ must approve these changes prior to testing (changes should be submitted in a manner similar to that described in "Plan and Process Approval").

The official certification test has three main components: (i) calibrating the temperature sensors, (ii) thermal mapping (cold spot mapping), and (iii) conducting an actual test treatment. These steps are discussed below in detail. A certification test must be completed for each chamber load configuration.

### Calibrating the Temperature Sensors



Only temperature sensors approved by USDA-APHIS may be used. Contact the PPQ personnel listed in "Contact Information" on [page-6-9-6](#).

Calibrate all temperature sensors prior to facility certification tests and a minimum of once annually thereafter. In addition, if a permanent temperature recording system is used, the system must be recalibrated when any part or portion of the system is repaired or replaced. Calibrations must be performed by the temperature sensor manufacturer or by manufacturer trained technicians. All temperature sensors must read within  $\pm 0.5^{\circ}\text{C}$  ( $0.9^{\circ}\text{F}$ ) of the treatment temperature.

### Thermal Mapping

Thermal mapping determines the placement of permanent temperature sensors in the chamber. Because the permanent temperature sensors will be placed in the coldest areas of the chamber, this process is also referred to as cold spot mapping or cold spot testing. The process of thermal mapping is relatively simple;

portable temperature sensors are placed throughout the chamber and the treatment is conducted. The sensors that took the longest time to record treatment temperature represent colder areas of the chamber.



Each facility may require a different number of portable sensors depending on factors such as the chamber size, chamber dimensions, and air flow patterns. A facility that is less than or equal to 10,000 ft<sup>3</sup> will require about 20 sensors for thorough temperature mapping. Contact the PPQ personnel listed at the end of this chapter for help in determining the number of sensors required for a facility larger than 10,000 ft<sup>3</sup>.

The thermal mapping procedure is as follows:

1. Drill holes a minimum of 4 inches deep into the ends of the largest pieces of wood. The diameter of the hole should be equivalent to the outer diameter of the sensor.
2. Place the sensors in the wood and in various locations throughout the entire chamber.
3. Create a diagram of the chamber that shows the relative horizontal and vertical location of each temperature sensor.
4. Conduct the treatment.
5. Remove the temperature sensors and analyze the temperature data.
6. Determine the amount of time each temperature sensor took to reach the treatment temperature. The temperature sensors that required the longest time to reach treatment temperatures indicate cold spots.
7. Create a map of the cold spots based on the map created in step #3.
8. Repeat this process for each load and volume configuration to ensure that correct and consistent cold spots are found.
9. Based on the thermal maps created in step #7, create a map to indicate where temperature sensors should be placed for each load and volume configuration during daily operational treatments.

### **Conducting a Test Treatment**

A test treatment must be performed to verify that the chamber is capable of meeting treatment requirements. Test treatments are only required for the maximum load/volume configuration that the facility will be certified for and may be done in conjunction with the thermal mapping described above. The procedure for conducting a test treatment is as follows:

1. Place permanent temperature sensors in areas of the load that are thought to be cold spots (based on thermal mapping data).
2. Conduct the treatment.
3. After treatment is completed, review the temperature data from the temperature sensors. All temperature sensors must have reached the treatment temperature.

These trials should test the ability of the treatment chambers to heat a full (maximum) load of wood according to the treatment guidelines. Any problems or deficiencies found in the facility or with the treatment must be corrected and the tests run again until all treatment requirements are met. After the facility representative is satisfied the

treatment system is running properly and can fully meet treatment requirements, test results must be submitted to USDA-APHIS for review.

The process of reviewing results from preliminary performance tests may take as long as 30 days. After USDA-APHIS-PPQ reviews the results from the preliminary performance test, a letter will be issued either approving or rejecting the results. Once the facility is approved, treatment and shipment may begin.

---

## Frequency of Certification and Temperature Sensor Calibration

A certification test is required once a year, and/or whenever the system has a malfunction, breakdown, or other failure that requires modifications that alter the manner in which the system functions. This excludes the replacement of a faulty temperature sensor.

All temperature sensors must be calibrated at the discretion of the PPQ official, annually, or whenever any part of the temperature recording system fails or is replaced. Use the process described in the "Calibrating the Permanent Temperature Sensors" section of this chapter.

---

## Documentation

All tests performed during certification must be documented by the PPQ official. A copy of the signed APHIS Form 482, copies of all thermal maps, description of load size limitations, description of any other special limitations placed on the treatment, and any other pertinent addenda or appendices, must be sent to USDA-APHIS-PPQ for final approval.

---

## Contact Information

USDA-APHIS-PPQ  
Federal Program Manager, Philip Bell  
920 Main Campus Dr. Ste 200  
Raleigh, NC 27606-5210  
Phone: 919 855-7300  
Philip.D.Bell@aphis.usda.gov

USDA-APHIS-PPQ  
National Program Coordinator, Deborah McPartlan  
4700 River Road, Unit 137  
5C-03.41



Riverdale, MD 20737  
Phone: 301-734-5356  
Deborah.L.McPartlan@aphis.usda.gov

USDA-APHIS-PPQ-EAB  
Ken Witt  
5936 Ford Court  
Ste. 200  
Brighton, MI 48116  
Phone: 810-844-2716  
FAX: 810-844-0583  
Kenneth.A.Witt@aphis.usda.gov



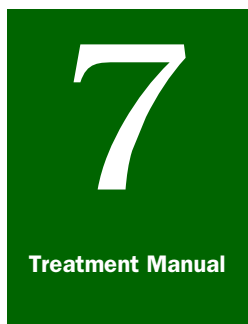

# Emergency Aid and Safety

## *Fumigation Exposure*

---

### Contents

Emergency Action—DO NOT HESITATE	page-7-1-1
You	page-7-1-1
Coworker	page-7-1-1
First Aid With Rescue Breathing	page-7-1-2
Signs, Symptoms, Emergency Aid, and Medical Treatment for Poisoning by Some Fumigants Used by APHIS	page-7-1-3
Chloropicrin	page-7-1-3
Methyl Bromide	page-7-1-3
Phosphine (From Aluminum Phosphide)	page-7-1-3
Sulfuryl Fluoride	page-7-1-3
Fumigant Safety	page-7-1-4
Guidelines for Using Fumigants Safely	page-7-1-6

---

### Emergency Action—DO NOT HESITATE

#### You

If exposed to fumigant, immediately move well away from the contaminated area. Notify your coworkers of the danger and that you have been exposed. Onset of symptoms may be delayed in some fumigants. Promptly notify your supervisor of all details.

If liquid fumigants have spilled on skin or clothing—immediately remove contaminated clothing and gently wash the skin with large quantities of water and soap. Do not use abrasive cloths or brushes. Be sure to include areas under finger and toenails. Contaminated skin may also be rinsed with rubbing alcohol.

Contaminated clothing must not be used again until thoroughly aired, washed, and dried. Dangerous vapors will be produced by the liquid fumigant as it evaporates from skin or clothing.

#### Coworker

If chemical intoxication due to exposure is at any time suspected:

1. Immediately move the victim out of the area to fresh air.



Do not enter contaminated areas without a proper respirator, even to effect rescue.

2. If there is evidence of respiratory weakness, give artificial respiration. Oxygen can be beneficial. **Artificial respiration takes precedence over all other first aid.** (see next page.)
3. Call a physician when symptoms suggest immediate care is needed.
4. Keep patient warm, comfortable, and as quiet as possible.
5. If convulsions occur, use gentle restraint and prevent injury.

---

## First Aid With Rescue Breathing

If you think a person has stopped breathing, don't delay. Give first aid immediately. Ask someone else to get medical help.

1. Is the person breathing?



To find out if the person is breathing, place him flat on his back and put your ear close to his mouth. If he is breathing, you will feel his breath and see his chest rise and fall.

2. Open the airway.



If the person has stopped breathing, lift up his neck with one hand and push down on his forehead with the other. This opens the airway and the person may start to breathe. If he doesn't, begin RESCUE BREATHING at once.

3. Rescue Breathing. Keep one hand under the person's neck so that his head is tilted backward with his chin up. Pinch his nostrils shut with the fingers of your other hand.

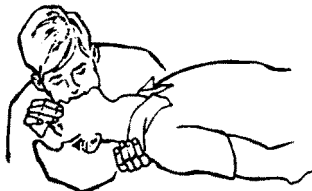

Take a deep breath and cover his mouth completely with yours. Blow air into his mouth. When his chest moves up, take your mouth away and let his chest go down by itself.

Repeat this procedure every 5 seconds. Do not stop until the person starts breathing or medical help comes.

---

## Signs, Symptoms, Emergency Aid, and Medical Treatment for Poisoning by Some Fumigants Used by APHIS

### Chloropicrin

#### Signs and Symptoms

Powerful irritant; affects all body surfaces, lacrimation, vomiting, bronchitis, pulmonary edema. Inhalation causes anemia, weak and irregular heart beat, recurrent asthmatic attacks.

#### Emergency Aid

Artificial respiration. Oxygen if available.

#### Medical Treatment

Symptomatic—oxygen. Sample analysis might be helpful in diagnosis and prognosis.

### Methyl Bromide

#### Signs and Symptoms

Central nervous system depression, nausea, fever, dizziness, confusion, delirium, staggering, visual disturbances, abdominal pain, mania, tremors, pulmonary edema, convulsions, coma. **Onset may be delayed 4-12 hours.** On skin, severe irritations, skin blisters, dermatitis.

#### Emergency Aid

Artificial respiration. Oxygen if available. No mechanical resuscitation. If on skin, wash 15 minutes with large amounts of water. If on clothing, vapors may be released in toxic quantities.

#### Medical Treatment

Symptomatic—Artificial respiration, oxygen without mechanical resuscitator. Analysis of breath and blood may help in diagnosis and prognosis. Nausea, accompanied by vomiting. Give intravenous, glucose-bearing vehicles.

### Phosphine (From Aluminum Phosphide)

#### Signs and Symptoms

2,000 ppm in air, rapidly fatal. Chest pain, headache, dyspnea, restlessness, vomiting, diarrhea, convulsions, coma, paralysis, low blood pressure, slow heart, death may be delayed several days.

#### Emergency Aid

Artificial respiration. Oxygen if available.

#### Medical Treatment

Symptomatic—oxygen; control convulsions with sedatives, restore fluid balance with glucose and saline.

### Sulfuryl Fluoride

#### Signs and Symptoms

Central nervous system depression, excitation may follow.

**Emergency Aid** Place patient in fresh air, face downward, with head slightly below level of lungs. Keep warm. If breathing stops, give artificial respiration.

**Medical Treatment** First symptoms expected are those of respiratory irritation and central nervous system depression. Treat symptomatically.

---

## **Fumigant Safety**

Specific precautions to be followed when using each of the fumigants are listed on the label and labelling. However, the following general safety procedures can be applied to most applications.

- 1.** Hazards vary with:
  - A.** Relative toxicity of each fumigant
  - B.** Dosage rate (concentration)
  - C.** Size of enclosure
  - D.** Tightness of enclosure
  - E.** Physical condition of employee (allergies, heart condition, respiratory ailments, etc.)
- 2.** It is important to:
  - A.** Know the characteristics of the fumigants you are working with
  - B.** Have the proper equipment to carry out the fumigation
  - C.** Be familiar with the emergency aid required should an accident occur
- 3.** Wear protective equipment if there is a chance of exposure to highly toxic liquid fumigants.
  - A.** Gloves should be impermeable to liquid fumigant being used
  - B.** Rubber aprons should be long enough to prevent legs from being exposed
  - C.** A face shield or respirator should be worn when liquids are being transferred and there is a possibility of splattering
- 4.** Dispensers for measuring the amount of fumigant should have shatter-proof shields.
- 5.** The area surrounding the fumigation enclosure should be well-aerated. Operators should be located upwind from treatment.
- 6.** If it is necessary to stay in the area of a treatment, the air should be monitored to determine if harmful levels of the fumigant are present.

- 7.** Under no circumstances should an inspector be exposed to concentrations above minimum safe standards. A self-contained breathing apparatus (SCBA) should always be readily available should an emergency develop.
- 8.** A SCBA is required at all fumigation sites. Use of such respirators is mandatory for PPQ Officers when within 30 feet of tarpaulin fumigation or whenever TLV is exceeded (5 ppm for methyl bromide).. You must have a medical evaluation and clearance to use SCBA equipment. The evaluation must be performed by a physician or licensed health care professional. Also, you must follow OSHA standards for respirator use. (see APHIS Safety and Health Manual, Chapter 11, Section 3)
- 9.** Wash hands and face after leaving area where toxic amounts of fumigants are being used.
- 10.** Do not eat, drink, smoke, or carry tobacco in areas where fumigants are being used.
- 11.** A first-aid kit equipped with the proper materials should be readily available at the treatment site.
- 12.** Persons working regularly with toxic fumigants should have blood tests and physical examinations if warranted by supervisor's consultation with local medical authorities.
- 13.** Have telephone numbers of local hospitals, doctors, and poison control centers prominently displayed.
- 14.** Learn to recognize the signs and symptoms of fumigant poisoning. Training should be given to each inspector.
- 15.** Supervisors should be aware of signs of fatigue. Risk of accidents increases in tired employees.

## Guidelines for Using Fumigants Safely

Emergency-Rescue and respirator<sup>1</sup> for each of the fumigants is a SCBA.

**TABLE 7-1-1: Fumigant Monitoring Devices and Sources of Exposure**

Fumigant/Routes of Entry	Detector Unit or Monitoring Device	Sources of Exposure
Methyl bromide: Inhalation, skin	Gas detector tubes, Electronic detector, Thermal Conductivity Unit, Infrared Spectroscopy	Cylinder connection, leaks in tarpaulin, applicators, aeration
Phosphine (from aluminum phosphide): Inhalation	Gas detector tubes, Electronic detector	Application of pellets, leakage from enclosure, aeration
Sulfuryl fluoride (Vikane®): Inhalation	Thermal Conductivity Unit, Electronic detector	Applicator and cylinder connections, leakage from enclosure, aeration

<sup>1</sup> For use outside of enclosure only.



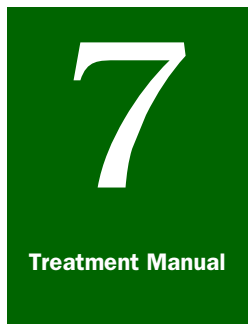

# Emergency Aid and Safety

## *Pesticide Exposure*

---

### Contents

Emergency Action—DO NOT HESITATE	page-7-2-1
You	page-7-2-1
Coworker	page-7-2-1
First Aid With Rescue Breathing	page-7-2-2
General Symptoms	page-7-2-3
Mild Poisoning	page-7-2-3
Moderate Poisoning	page-7-2-3
Severe Poisoning	page-7-2-3
Pesticide Safety	page-7-2-3

---

### Emergency Action—DO NOT HESITATE

#### You

If your clothing is soaked with pesticide, remove the contaminated articles quickly. Then gently wash the skin with large quantities of soap and water. Do not scrub the skin or use an abrasive cloth or brush. Include areas under your fingernails and toenails. Contaminated skin can also be rinsed with rubbing alcohol. Call or notify your supervisor or coworker immediately, giving full details of the incident.

#### Coworker

Move the victim well away from the contaminated area.

1. If there is respiratory weakness or **if breathing ceases, give artificial respiration immediately.** (see next page.)
2. Call a physician as quickly as possible. If you are alone, do not abandon the first-aid treatment.
3. Keep the patient as quiet as possible, warm, and comfortable.
4. When symptoms are moderate or severe and caused by organophosphate or carbamate poisoning, and if the patient is conscious, immediately give two atropine tablets (1/100 grain each). (see number 13 under Pesticide Safety, [page-7-2-3](#)). Then immediately contact the nearest medical help and request assistance, even if symptoms disappear.
5. If pesticide is splashed in the eyes, immediately wash with large volumes of clean water. Continue for at least 15 minutes.

6. If medical help cannot be obtained or is delayed, transport the patient to the nearest hospital, physician's office, or urgent medical clinic. If possible, use a radio or other means of communication to alert authorities and the hospital. Drive safely if you must transport a patient. Take the pesticide label or any available records of pesticides used and any other information which may aid in diagnosis and treatment.

---

## First Aid With Rescue Breathing

If you think a person has stopped breathing, don't delay. Give first aid immediately. Ask someone else to get medical help.

1. Is the person breathing?



To find out if the person is breathing, place him flat on his back and put your ear close to his mouth. If he is breathing, you will feel his breath and see his chest rise and fall.

2. Open the airway.



If the person has stopped breathing, lift up his neck with one hand and push down on his forehead with the other. This opens the airway and the person may start to breathe. If he doesn't, begin RESCUE BREATHING at once.

3. Rescue Breathing. Keep one hand under the person's neck so that his head is tilted backward with his chin up. Pinch his nostrils shut with the fingers of your other hand.

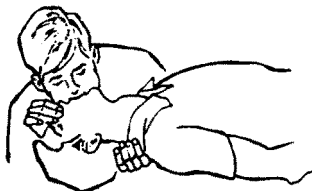

Take a deep breath and cover his mouth completely with yours. Blow air into his mouth. When his chest moves up, take your mouth away and let his chest go down by itself.

Repeat this procedure every 5 seconds. Do not stop until the person starts breathing or medical help comes.

## General Symptoms

### Mild Poisoning

Any discomfort can be an indication of mild poisoning or some other sickness. Individuals who are exposed to poison and who experience the following symptoms should be aware that more serious indications may follow.

Headache, fatigue, skin irritation, loss of appetite, dizziness, weakness, nervousness, nausea, perspiration, diarrhea, eye irritation, insomnia, thirst, restlessness, irritation of nose and throat, loss of weight, soreness of joints, changes of mood.

### Moderate Poisoning

May be the beginning of severe symptoms. Nausea, trembling, muscular incoordination, excessive saliva, blurring of vision, feeling of constriction in the throat and chest, difficulty in breathing, flushed or yellow skin, abdominal cramps, vomiting, diarrhea, mental confusion, twitching of muscles, weeping, excessive perspiration, profound weakness, rapid pulse, cough.

### Severe Poisoning

Vomiting, loss of reflexes, inability to breathe, uncontrollable muscular twitching, constriction of pupils (to pinpoint pupils), convulsions, unconsciousness, severe secretion from respiratory tract, fever, intense thirst, increased rate of breathing.

---

## Pesticide Safety

1. Read the label before using any pesticide and follow precautions. If material is transferred to another container for application, a copy of the label should be kept near the dispersing point.
2. Use only proper tools for opening containers. Carefully open bags and use the proper tools to prevent pesticide from spilling onto your face or hands.
3. Pesticides should be opened in an area where any spills can be cleaned up properly. Mixing and pouring should be done in a well-ventilated place removed from other personnel. If there is a breeze, personnel should be upwind of any transfer of pesticides.
4. Pour pesticides properly. If an air vent is provided, use it.
5. A good supply of lime, coarse clay, sand, sawdust, or other absorbent material should be readily available.
6. Do not allow any person to work alone, especially when handling highly toxic materials.

- 7.** Wear clean, dry, long-sleeved shirts and trousers made of cotton or any protective clothing as directed by the label.
- 8.** Wear rubber gloves, well-fitted goggles, a rubber apron, and rubber boots when handling concentrates. Be certain the equipment is adequate for the task. Thin rubber gloves (disposable) should only be used once. An apron or gloves made of permeable material may be hazardous.
- 9.** Be careful not to spill toxic chemicals on skin or clothing. If this happens, remove contaminated clothing at once and wash skin and clothing thoroughly. All operators should have available one change of clean clothes in case of accidental spillage.
- 10.** Wash hands and face immediately after applying pesticide, before using toilet, and before eating, drinking, or smoking. Do not eat, drink, or carry tobacco in areas where pesticides are present.
- 11.** Do not use mouth to siphon or to blow out nozzles or clogged lines, etc. on equipment. Do not put fingers in mouth or rub eyes while working with pesticides.
- 12.** Never use arms to stir or to reach into a container of pesticides to retrieve tools or other accidentally dropped items.
- 13.** When applying the more toxic organophosphates and carbamate insecticides, be prepared to contact a physician. In case of poisoning, the physician can prescribe atropine tablets. Also, read the label to learn what additional actions to take in case of poisoning—like giving liquids or inducing vomiting.
  - A.** If symptoms from poisoning include blurred vision, abdominal cramps, or tightness in the chest, and if a physician is not readily available, then immediately have the patient transported to the nearest doctor, hospital, poison control center, or urgent care clinic, even if symptoms subside.
  - B.** Further symptoms may include nausea, vomiting, diarrhea, pinpoint pupils, bronchial edema, muscle twitches, giddiness, drowsiness, confusion, difficulty in speech, and finally, coma.
  - C.** The acute emergency lasts 24 to 48 hours. The patient should be under the observation of a physician during this period. Illness caused by carbamate poisoning does not last as long as organophosphate poisoning symptoms.
- 14.** A supply of detergent soap, clean water, rubbing alcohol, skin lotion, and a nail file (if possible) should be readily available.
- 15.** Persons working regularly with or frequently exposed to the more toxic organophosphate pesticides should have periodic cholinesterase level checks and physical examinations if warranted by supervisor in consultation with local authorities, and Chapter 7, APHIS Safety and Health Manual.

- 16.** Respirators or filter masks with proper canisters approved or the particular type exposure noted in the label directions should be used when such pesticides are handled. Rubber boots may be needed in an area drenched with pesticides.
- 17.** Know the limitation of the protective clothing and equipment, especially respirators.
- 18.** Learn to recognize the symptoms of pesticide poisoning and know the first-aid measure to be taken in case of accident. Training in emergency measures should be given to all employees who work with pesticides.
- 19.** Have the telephone numbers of local hospitals, doctors, or poison control centers prominently displayed.
- 20.** Fatigue lowers the standards of pesticide safety. Key personnel should be aware that risk increases after long hours of work.
- 21.** If an employee feels any sign of illness suspected as being due to poisoning, he should contact a doctor immediately. However, certain circumstances such as consuming large amounts of liquids following excessive heat exposure may cause nausea, vomiting, dizziness, and cramps. Such signs mimic pesticide poisoning.



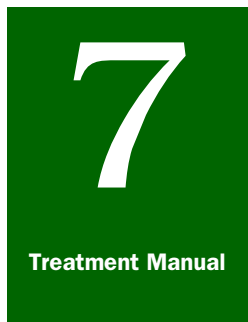

# Emergency Aid and Safety

## *Guidelines for Managing Pesticide Spills*

---

### Contents

Guidelines for Managing Pesticide Spills	page-7-3-1
Introduction	page-7-3-1
Emergency Spill Procedures	page-7-3-2
Identify Contacts and Telephone Numbers	page-7-3-3
Evaluate the Situation (Take care of people first!!!)	page-7-3-3
Safety and First Aid	page-7-3-3
Crash Notification	page-7-3-5
Contamination Control	page-7-3-5
Notification	page-7-3-6
Site Security	page-7-3-7
Cleanup Techniques	page-7-3-7
Decontamination	page-7-3-8
Post-Spill Procedures	page-7-3-10
Disposal of Contaminated Material	page-7-3-10
Environmental Monitoring	page-7-3-10
Reporting	page-7-3-10
Planning for Pesticide Spills	page-7-3-11
State Hazardous Waste Management Agencies	page-7-3-12
Accident or Spill Emergency Kit	page-7-3-17
Safety	page-7-3-17
Cleanup	page-7-3-17

---

### Introduction

This document provides instructions for dealing with pesticide spills during program operations. “Pesticide spill” refers to any unplanned spill or leakage into the environment that occurs during storage, use, transport, or disposal of pesticide. Examples include aircraft and surface vehicular crashes, jettisoning pesticide cargoes from the air, and leaks or other equipment failures. After a pesticide spill, the responsible program person should evaluate the situation and begin appropriate corrective measures. (Use **Figure 7-3-2** to identify your responsible program contact.)

The Officer-in-Charge (OIC), Contracting Officer’s Representative (COR), or other responsible program official should prepare a site-specific plan based on the generic plan, **Emergency Spill Procedures**. (see **Figure 7.4.1** for an abbreviated plan. Make a copy of this figure, and keep it for your pocket reference.) Prepare the plan

before program operations begin by filling in the names, telephone numbers, and other required information. Specific objectives of each plan include:

- ◆ Protecting people working in the spill area.
- ◆ Preventing or minimizing the risk of further pesticide exposure to people, animals, and the environment.
- ◆ Cleanup of the area and disposal or detoxification of residual material.
- ◆ Notifying Federal, State, and local government officials of the magnitude and details of the pesticide spill.
- ◆ Evaluation of the potential impact to the environment based on chemical residues found in environmental components.

_____
Responsible Program Contact (Name)
_____
(Work telephone number)
_____
(Home telephone number)
IF A PESTICIDE SPILLS TAKE THE FOLLOWING STEPS:
1. <b>Evaluate.</b> (Take care of people first!!!)
2. <b>Safety and First Aid.</b> The most immediate concern is for the health and well-being of persons in and around the area.
3. <b>Call 911</b> for fire/rescue squad to obtain medical assistance for injured or contaminated persons.
4. <b>Contamination Control.</b> Consult pesticide label & MSDS for appropriate protective clothing and hazards (or <b>CHEMTREC Emergency Hotline (800) 424-9300</b> ).

**FIGURE 7-3-1: Abbreviated Spill Plan, Personal Reference Card (Wallet-size)**

---

## Emergency Spill Procedures

Use this section as your guide to prepare a site-specific plan for pesticide spills. (Please, complete the blanks for your specific program.) The following is a summary of factors you must consider when a pesticide spill occurs (details follow this summary):

- ◆ Identify Contacts and Telephone Numbers
- ◆ Evaluate the Situation
- ◆ Safety and First Aid
- ◆ Crash Notification



- ◆ Contamination Control
- ◆ Notification
- ◆ Site Security
- ◆ Cleanup Techniques
- ◆ Decontamination

### Identify Contacts and Telephone Numbers

You must know who to contact and where to call if a pesticide spill occurs. **Figure 7.4.2** identifies preliminary information that you will need in case of an emergency. Fill in the blanks for your site-specific plan.

_____ (Program name)
_____ Responsible Program Contact (Name)
_____ (Work telephone number)
_____ (Home telephone number)
_____ <b>Alternative</b> Program Contact (Name)
_____ (Work telephone number)
_____ (Home telephone number)

**FIGURE 7-3-2: Emergency Contacts for Pesticide Spills**

### Evaluate the Situation (Take care of people first!!!)

1. Injury/pesticide exposure. Go to **Safety and First Aid** (below).
2. Vehicle or aircraft crash. Go to **Crash Notification** (below).
3. Spill containment. Go to **Contamination Control** (below).

### Safety and First Aid

The most immediate concern is for the health and well-being of persons in and around the area.

1. Call **911** for fire/rescue squad to obtain medical assistance for injured or contaminated persons.

2. Evacuate the immediate area, if necessary get upwind.
3. Remove injured people from the area. (Do not move a seriously injured person unless absolutely essential because of the risk of further injury.)
4. Consult the pesticide label and/or MSDS for appropriate protective equipment and hazards.
5. Administer first aid as necessary. see the pesticide's MSDS or contact the nearest poison control center. **Figure 7-3-3** identifies information that you will need in case of an emergency. Fill in the blanks for your site-specific plan.

_____
(Center Name)
_____
(Telephone)

**FIGURE 7-3-3: Poison Control Center**

6. Remove contaminated clothing and wash affected area with soap and water. If eyes are contaminated, flush with clean water.
7. If individuals experience pesticide poisoning symptoms (blurred vision, trembling, nausea, etc.) then transport them to the nearest medical emergency facility. **Figure 7-3-4** identifies information that you will need in case of an emergency. Fill in the blanks for your site-specific plan.

_____
(Address)
_____
(How to get there)

**FIGURE 7-3-4: Medical Emergency Facility**

8. Eliminate sources of ignition (e.g., pilot lights, electric motors, gasoline engines, or smoking) to prevent the threat of fire or explosion from flammable vapors.

## Crash Notification

1. If the spill involved a vehicle or aircraft crash, contact the local police (911) as soon as practical.
2. If the spill involved an aircraft crash, notify the nearest Federal Aviation Administration (FAA) office. **Figure 7.4.5** identifies information that you will need in case of an emergency. Fill in the blank for your site-specific plan.

<hr/> <p>(Telephone number)</p>
---------------------------------

**FIGURE 7-3-5: Federal Aviation Administration (FAA) Office**

## Contamination Control

1. Consult the pesticide label and/or MSDS for appropriate protective clothing and hazards (**or call the CHEMTREC Emergency Hotline at (800) 424-9300**).
2. Try to contain the spilled pesticide at the original site, and prevent it from entering streams, rivers, ponds, storm drains, wells, and water systems as follows:
  - A. If possible, reposition the pesticide container to stop further leakage.
  - B. Prevent the spill from spreading by trenching or encircling the area with a dike of sand, sand snakes, absorbent material, soil or rags.
  - C. If a liquid formulation spills, cover it with absorbent material; however, use absorbent sparingly, since it also becomes hazardous waste. Use no more than necessary.
  - D. If a dry formulation spills, securely cover it with polyethylene or plastic tarpaulin to prevent tracking or airborne spreading of dust.

## Notification

1. Notify by telephone state officials and the PPQ regional office. Headquarters management will be notified through normal channels.
2. Contact the local Community-Right-To-Know or Emergency Planning Coordinator (often the Fire Marshall). **Figure 7.4.6** identifies information that you will need in case of an emergency. Fill in the blanks for your site-specific plan.

_____
(Name)
_____
(Telephone number)

**FIGURE 7-3-6: Community-Right-To-Know or Emergency Planning Coordinator (Fire Marshall)**

3. Call the CHEMTREC Emergency Hotline at **(800) 424-9300**.
4. Notify by telephone the National Monitoring and Residue Analysis Laboratory (NMRAL) in Gulfport, Mississippi, Area Code (601) 863-8124 or (601) 863-1813. NMRAL will provide any supplies needed for sampling environmental components.
5. If the spill involves a large area (4 hectares (10 acres) or more) or you judge that it could affect a large area through runoff or other movement, notify the State Fish and Game Department or equivalent through appropriate channels. **Figure 7.4.7** identifies information that you will need in case of an emergency. Fill in the blank for your site-specific plan.

_____
(Telephone number)

**FIGURE 7-3-7: Fish and Game Department**

6. If animal poisoning may occur, notify the Regional Veterinary Services (RVS) Office. **Figure 7.4.8** identifies information that you will need in case of an emergency. Fill in the blank for your site-specific plan.

_____
(Telephone number)

**FIGURE 7-3-8: Regional Veterinary Services (VS) Office**

7. If the spilled product is a Comprehensive Environmental Response, Compensation, and Liability Act (CERCLA) classified hazardous substance or a Superfund Amendments and Reauthorization Act of 1986 (SARA) Title III classified extremely hazardous substance, spills of active ingredient exceeding the reportable quantities may be reportable (see Appendix 8 for information on determining whether to report).
8. If you are unsure as to reporting under CERCLA or SARA look at the product's MSDS or call the National Response Center **(800) 424-8802** for CERCLA, and for SARA call the at **(800) 535-0202**.
9. Notify your Regional Safety and Health Coordinator. **Figure 7.4.9** identifies information that you will need in case of an emergency. Fill in the blank for your site-specific plan.

<hr/> <p>(Telephone number)</p>
---------------------------------

**FIGURE 7-3-9: Regional Safety and Health Coordinator**

### Site Security

Secure the spill site from unauthorized entry by roping off the area and posting warning signs. If necessary, request assistance from local police. **Figure 7.4.10** identifies information that you will need in case of an emergency. Fill in the blank for your site-specific plan.

<hr/> <p>(Telephone number)</p>
---------------------------------

**FIGURE 7-3-10: Local Police**

### Cleanup Techniques

The following are general techniques. You should consult local hazardous waste officials, the pesticide's label, or its MSDS to determine specific cleanup and disposal techniques. (see State Hazardous Waste Management Agencies for a list of local hazardous waste officials.) **Figure 7.4.11** identifies information that you will need in case of an emergency. Fill in the blanks for your site-specific plan.

--------------

**FIGURE 7-3-11: Local Hazardous Waste Official**

(Name)
(Telephone)

**FIGURE 7-3-11: Local Hazardous Waste Official**

Adequate cleanup of spilled pesticides is essential to minimize health or environmental hazards. When cleaning pesticide spills, **NEVER WORK ALONE**. Be sure to ventilate the area and use appropriate protective equipment. Clean up dry spills (dusts, wettable powders, granular formulations) as follows:

- ◆ Immediately cover powders, dusts, or granular materials with polyethylene or plastic tarpaulin to prevent them from becoming airborne. If outside, weight the tarp ends, especially the end facing into the wind. Begin cleanup operations by rolling up the tarp while simultaneously sweeping up the spilled pesticide using a broom and shovel or dust pan. Avoid brisk movements to keep the dry pesticide from becoming airborne. When practical, lightly sprinkle the material with water to minimize dust. Always use an approved dust mask or respirator when working with dry pesticide materials.
- ◆ Collect the pesticide and place it in heavy-duty plastic bags. Secure and label the bags, properly identifying the pesticide and possible hazards. Set the bags aside in a secured area for disposal.
- ◆ Clean up liquid spills by placing an appropriate absorbent material (floor-sweeping compound, sawdust, sand, etc.) over the spilled pesticide. Work the absorbent into the spill using a broom or other tool to force the absorbent material into contact with the pesticide. Collect all spent absorbent material and place into a properly labeled metal drum for disposal.

Depending upon the pesticide, the size of the spill, and local conditions, you may need to remove the top ½-inch layer of contaminated soil with a shovel and dispose of it.

### **Decontamination**

As soon as practical, decontaminate crashed aircraft, wrecked vehicles, and pavements. see the pesticide's MSDS or label for specific instructions. For aircraft, coordinate with investigating officials and FAA authorities. For automobile wrecks, coordinate with appropriate law enforcement agencies or investigative bodies.

Chlorine bleach, caustic soda (lye, sodium hydroxide) detergents, or burnt or hydrated lime effectively decontaminate most spill areas (see attached MSDS sheets for precautions when using these substances).



Use bleach or lye, but never both together since this combination may liberate poisonous chlorine gas. Lye or lime readily decomposes many pesticides, especially the organophosphates, and carbamates. Clean up and remove as much of the spilled pesticide as possible prior to applying any decontaminate. Allow 1 to 6 hours reaction with the decontaminate before using an absorbent material.

Spread decontaminates thinly and evenly over the spill area. Then, lightly sprinkle the area with water to activate the decontaminate. Repeat the cleanup procedures until all the spilled pesticide is removed.

Clean all equipment used for spill cleanup with detergent and appropriate decontaminates. Collect all used decontaminates and rinse water and place them in labeled metal drums. Place clothing and gloves that cannot be decontaminated in the drums for proper disposal.

It may also be necessary to completely remove and dispose of contaminated porous materials.

If pesticides have leaked or spilled on the soil, removal of the visibly contaminated soil (top 1-inch) may be required using a shovel. In such cases, place the contaminated soil in metal drums for disposal. Chemical analysis of monitoring samples may govern removal of additional soil.

---

## Post-Spill Procedures

### Disposal of Contaminated Material

You may contact the pesticide's manufacturers for specific instructions regarding their product. Also contact the State or Federal EPA office with jurisdiction over the pesticide spill location about disposal, and consult with the U.S. Department of Transportation (DOT) prior to shipping/transporting across state lines. Shipping by licensed transporters may be required.

In general, place contaminated materials in sealed leak-proof metal disposal drums. Label all drums properly and dispose of in an approved hazardous waste disposal facility (incinerator, landfill site, etc.) under current EPA or State permit. The pesticide's labeling and MSDS contain specific information concerning disposal.

### Environmental Monitoring

After cleanup and disposal, if the pesticide spilled into the environment, collect environmental monitoring samples. see M390.1403, **Collecting Environmental Monitoring Samples** for specific instructions. Contact the Region and request an Environmental Monitoring Coordinator if you need help with sample collection.

### Reporting

Report information regarding pesticide spills in accordance with the program's specific monitoring plan, and as required by state and federal law. In general, reports should include:

1. Detailed map with the site of the pesticide spill clearly marked.
2. Information on location, time, spill area, terrain, pesticide spilled, how spill occurred, and how managed.
3. Any other information the writer deems pertinent to the pesticide spill.

Upon completion of the chemical analyses NMRAL will report its findings to Technical and Scientific Services (TSS). TSS will include the spill residue data in its programmatic environmental monitoring report and distribute as appropriate.



## Planning for Pesticide Spills

Pesticides vary in toxicity as described in the pesticide's labeling and MSDS. Actions taken following an accidental spill will depend upon the pesticide toxicity involved. Always consult the labeling and MSDS for your program's pesticides when planning for spills. Check the telephone book for the telephone number of the local poison control center and enter it on your plan.

The Environmental Protection Agency (EPA) under the Federal Insecticide, Fungicide, and Rodenticide Act (FIFRA); Resource Conservation and Recovery Act (RCRA); and CERCLA or Superfund assigned the primary responsibility for enforcing safe pesticide use and disposal to most States. States may therefore acquire primary responsibility for determining pesticide spill, cleanup, and disposal procedures.

Not all States will perform or react to pesticide spills in the same way. Therefore the Port Director or COR should assist with cleanup, sample collection, sample analysis, securing affected area, etc. The Port Director or COR must monitor such activities to assure PPQ that the responsible parties take proper actions during and after a spill. Keep in mind that legal actions as a result of a pesticide spill may place liability on the cooperating Federal Agency.

Program Managers should inform the PPQ Assistant Regional Director's office of procedures to follow when pesticide spills occur within their jurisdictions so they may support field operations when needed. The Port Director, COR, or Senior Staff Officer for any given PPQ operation, is responsible for implementing pesticide spill procedures. These officers must be familiar with these guidelines and should make contingency plans for such pesticide spills in advance of field operations.

Useful information for completing your spill plan is found in the appendices to these guidelines. Copies of the MSDS (obtainable from the manufacturer) for your program's pesticides should be included in your spill plan.

---

## State Hazardous Waste Management Agencies

When a pesticide spill occurs, you should consult local hazardous waste officials, the pesticide's label, and its MSDS to determine specific cleanup and disposal techniques. The following is a list of State Hazardous Waste Management Agencies:

### **ALABAMA**

Land Division  
Alabama Department of Environmental  
Management  
1751 Congressman W. L. Dickinson Drive  
Montgomery, Alabama 36130  
(205) 271-7730

### **AMERICAN SAMOA**

Solid Waste Division  
Environmental Quality Commission  
Government of American Samoa  
Pago Pago, American Samoa 96799  
Overseas Operator (Commercial call  
(684) 663-2304)

### **ARKANSAS**

Hazardous Waste Division  
Arkansas Department of Pollution Control  
and Ecology  
8001 National Drive, P.O. Box 8913  
Little Rock, Arkansas 72219  
(501) 570-2858

### **COLORADO**

Waste Management Division  
Colorado Department of Health  
4210 East 11th Avenue  
Denver, Colorado 80220  
(303) 331-4830  
Emergency Response: (303) 377-6326

### **DELAWARE**

Division of Air and Waste Management  
Department of Natural Resources and  
Environmental Control  
P.O. Box 1401, 89 Kings Highway  
Dover, Delaware 19903  
(302) 739-3672

### **ALASKA**

Division of Environmental Quality  
Alaska Department of Environmental  
Conservation  
P.O. Box 0  
Juneau, Alaska 99811-1800  
Program Manager: (907) 465-2666  
Northern Regional Office (Fairbanks):  
(907) 452-1714  
South-Central Regional Office  
(Anchorage): (907) 563-6529  
Southeast Regional Office (Juneau):  
(907) 789-3151

### **ARIZONA**

Office of Waste and Water Quality  
Management  
Arizona Department of Environmental  
Quality  
2005 North Central Avenue, Room 304  
Phoenix, Arizona 85004  
Hazardous Waste Management:  
(602) 257-6829

### **CALIFORNIA**

Toxic Substances Control Division  
Department of Health Services  
400 P Street, P.O. Box 806  
Sacramento, California 95812-0806  
(916) 324-1826

### **CONNECTICUT**

Hazardous Material Management Unit  
Department of Environmental Protection  
State Office Building  
165 Capitol Avenue  
Hartford, Connecticut 06106  
(203) 566-5148

### **DISTRICT OF COLUMBIA**

Pesticides and Hazardous Waste  
Management Branch  
Department of Consumer and Regulatory  
Affairs  
Room 505  
614 H Street, NW  
Washington, D.C. 20001  
(202) 404-1167

### **FLORIDA**

Solid and Hazardous Waste Section  
Department of Environmental Regulation  
Twin Towers Office Building  
2600 Blair Stone Road  
Tallahassee, Florida 32399-2400  
(904) 488-0190

### **GUAM**

Hazardous Waste Management Program  
Guam Environmental Protection Agency  
P.O. Box 2999  
Agana, Guam 96910  
Overseas Operator [Commercial Call  
(671) 646-8863]

### **IDAHO**

Hazardous Materials Bureau  
Department of Health and Welfare  
1410 North Hilton Street  
Boise, Idaho 83706  
(208) 334-5879

### **INDIANA**

Office of Solid and Hazardous Waste  
Indiana Department of Environmental  
Management  
105 South Meridian, P. O. Box 6015  
Indianapolis, Indiana 46204  
(317) 232-7959

### **KANSAS**

Hazardous Waste Section  
Department of Health and Environment  
Forbes Field, Building 740  
Topeka, Kansas 66620  
(913) 862-1607

### **GEORGIA**

Land Protection Branch  
Industrial and Hazardous Waste  
Management Program  
Georgia Environmental Protection Division  
Floyd Towers East, Suite 1154  
205 Butler Street, S.E.  
Atlanta, Georgia 30334  
(404) 656-2833

### **HAWAII**

Environmental Management Division  
Department of Health  
Five Waterfront Plaza  
500 Ala Moana Boulevard, Suite 250  
Honolulu, Hawaii 96813  
(808) 543-8225

### **ILLINOIS**

Division of Land Pollution Control  
Illinois Environmental Protection Agency  
2200 Churchill Road,  
P. O. Box 19276  
Springfield, Illinois 62794-9276  
(217) 782-6760

### **IOWA**

Air Quality and Solid Waste Protection  
Department of Water, Air, and Waste  
Management  
Henry A. Wallace Bldg.  
900 East Grand Ave.  
Des Moines, Iowa 50319-0034  
(515) 281-8852  
(contact EPA Region VII, below, for Iowa  
generator ID#)  
— or —  
U.S. EPA Region VII  
Hazardous Materials Branch  
726 Minnesota Avenue  
Kansas City, Kansas 66101  
(913) 236-2888  
Spills: (913) 236-3778  
Iowa RCRA Questions, Toll Free:  
(800) 223-0425

### **KENTUCKY**

Division of Waste Management  
Department of Environmental Protection  
Frankfort Office Park  
18 Reilly Road  
Frankfort, Kentucky 40601  
(502) 564-6716

**LOUISIANA**

Hazardous Waste Division  
Office of Solid Waste and Hazardous  
Waste  
Louisiana Department of Environmental  
Quality  
P.O. Box 44307  
Baton Rouge, Louisiana 70804-4307  
(504) 342-1354

**MARYLAND**

Hazardous and Solid Waste Management  
Administration  
Maryland Department of the Environment  
2500 Broening Highway  
Baltimore, Maryland 21224  
(301) 631-3343  
Emergency:  
(301) 225-5700 [Business Hours]  
(301) 243-8700 [After Hours]

**MICHIGAN**

Waste Management Division  
Hazardous Waste Program  
Michigan Department of Natural  
Resources  
Box 30038  
Lansing, Michigan 48909  
(517) 373-2730  
Emergency Response: (800) 292-4706

**MISSISSIPPI**

Hazardous Waste Division  
Bureau of Pollution Control  
Department of Natural Resources  
P.O. Box 10385  
Jackson, Mississippi 39289  
(601) 961-5062  
Emergency Response: (800) 222-6362

**MONTANA**

Solid and Hazardous Waste Bureau  
Department of Health and Environmental  
Sciences  
Cogswell Building, Room B-201  
Helena, Montana 59620  
(406) 444-2821  
Emergency Response: (406) 444-6911

**NEVADA**

Bureau of Waste Management  
Division of Environmental Protection  
123 West Nye Lane  
Room 120  
Carson City, Nevada 89710  
(702) 687-5872  
Emergency Response:  
(702) 687-4240 [Business Hours]  
(702) 885-5300 [Weekends]

**MAINE**

Bureau of Oil and Hazardous Materials  
Control  
Department of Environmental Protection  
State House Station #17  
Augusta, Maine 04333  
(207) 289-2651  
Spills, Toll Free: (800) 482-0777

**MASSACHUSETTS**

Division of Hazardous Waste  
Department of Environmental Protection  
One Winter Street, 5th Floor  
Boston, Massachusetts 02108  
(617) 292-5589,-5851  
Emergency Response:  
(617) 292-5649 [Business Hours]  
(617) 566-4500 [After Hours]

**MINNESOTA**

Ground Water and Solid Waste Division  
Minnesota Pollution Control Agency  
520 Lafayette Road, North  
St. Paul, Minnesota 55155-3898  
(612) 296-7282  
Emergency Response: (612) 296-8100

**MISSOURI**

Waste Management Program  
Missouri Department of Natural Resources  
205 Jefferson Street  
Jefferson City, Missouri 65102  
(314) 751-3176  
Missouri Hotline: 1 (800) 334-6946

**NEBRASKA**

Hazardous Waste Section  
Department of Environmental Control  
P.O. Box 98922  
Lincoln, Nebraska 68509  
(402) 471-2186

**NEW HAMPSHIRE**

Waste Management Division  
Department of Environmental Services  
6 Hazen Drive  
Concord, New Hampshire 03301-6509  
(603) 271-2942

### **NEW JERSEY**

Hazardous Waste Management Programs  
Department of Environmental Protection  
CN-028  
Trenton, New Jersey 08625  
Hazardous Waste Advisement Program:  
(609) 292-8341  
Emergency Response: (609) 292-7172

### **NEW YORK**

Division of Hazardous Substance  
Regulation  
Department of Environmental  
Conservation  
50 Wolfe Road, Room 209  
Albany, New York 12233-7250

### **NORTH DAKOTA**

Division of Waste Management  
Department of Health  
1200 Missouri Avenue  
P. O. Box 5520  
Bismarck, North Dakota 58502-5520  
(701) 221-5166  
Emergency Response: 1 (800) 472-2121

### **OHIO**

Division of Solid and Hazardous Waste  
Management  
Ohio Environmental Protection Agency  
1800 Watermark Drive/P.O. Box 1049  
Columbus, Ohio 43266  
(614) 644-2934  
Emergency: 1 (800) 282-9378

### **OREGON**

Hazardous and Solid Waste Division  
Department of Environmental Quality  
811 S.W. 6th Avenue  
Portland, Oregon 97204  
(503) 229-5356  
Emergency Management Response,  
Toll Free: (800) 452-0311

### **PUERTO RICO**

Environmental Quality Board  
P.O. Box 11488  
Santurce, Puerto Rico 00910-1488  
(809) 725-0439  
— or —  
EPA Region II  
Air and Waste Management Division  
26 Federal Plaza  
New York, New York 10278  
(212) 264-5175

### **NEW MEXICO**

Ground Water and Hazardous Waste  
Bureau  
Environmental Improvement Division  
New Mexico Health and Environment Dept.  
1190 St. Francis Drive  
Santa Fe, New Mexico 87503  
(505) 827-2714  
Emergency: (505) 827-9329

### **NORTH CAROLINA**

Hazardous Waste Section  
Division of Solid Waste Management  
Department of Environment, Health, and  
Natural Resources  
P.O. Box 27687  
Raleigh, North Carolina 27611-7687  
(919) 733-2178  
Emergency Response: 1 (800) 662-7956

### **NORTHERN MARIANA ISLANDS, COMMONWEALTH OF**

Division of Environmental Quality  
Department of Public Health and  
Environmental Services  
Commonwealth of the Northern Mariana  
Islands  
Office of the Governor  
Saipan, Mariana Islands 96950  
Overseas Operator 6984

### **OKLAHOMA**

Waste Management Service  
Oklahoma State Department of Health  
P.O. Box 53551  
Oklahoma City, Oklahoma 73152  
(405) 271-5338  
Emergency Response: (405) 271-8056

### **PENNSYLVANIA**

Bureau of Waste Management  
Pennsylvania Department of Environmental  
Resources  
P.O. Box 2063  
Harrisburg, Pennsylvania 17105-2063  
(717) 787-9870

### **RHODE ISLAND**

Division of Air and Hazardous Management  
Department of Environmental Management  
291 Promenade Street  
Providence, Rhode Island 02908  
(401) 277-2797

**SOUTH CAROLINA**

Bureau of Solid and Hazardous Waste  
Management  
Department of Health and Environmental  
Control  
2600 Bull Street  
Columbia, South Carolina 29201  
(803) 734-5200  
Emergency Response: (803) 253-6488

**TENNESSEE**

Division of Solid Waste Management  
Tennessee Department of Health and  
Environment  
701 Broadway  
Customs House, 4th Floor  
Nashville, Tennessee 37247-3530  
(615) 741-3424  
Emergency Response: (800) 262-3300

**UTAH**

Bureau of Solid and Hazardous Waste  
Department of Health  
P.O. Box 16690  
Salt Lake City, Utah 84116-0690  
(801) 538-6170  
Emergency: (801) 538-6333 [After Hours]

**VIRGIN ISLANDS**

Department of Conservation and Cultural  
Affairs  
P.O. Box 4399, Charlotte Amalie  
St. Thomas, Virgin Islands 00801  
(809) 774-6420  
— or —  
EPA Region II  
Air and Waste Management Division  
26 Federal Plaza  
New York, New York 10278  
(212) 264-5175

**SOUTH DAKOTA**

Division of Environmental Regulation  
Department of Water and Natural  
Resources  
523 East Capitol  
Foss Building  
Pierre, South Dakota 57501  
(605) 773-3153  
Emergency Response: (605) 773-3231

**TEXAS**

Hazardous and Solid Waste Division  
Texas Natural Resources Conservation  
Commission  
P.O. Box 13087, Capitol Station  
Austin, Texas 78711  
(512) 463-7760  
Emergency Response: (512) 463-7727

**VERMONT**

Hazardous Materials Management Division  
Department of Environmental  
Conservation  
103 South Main Street  
Waterbury, Vermont 05676  
(802) 244-8702  
Emergency: (800) 424-8802

**VIRGINIA**

Division of Technical Services  
Virginia Department of Waste Management  
Monroe Building, 11th Floor  
101 North 14th Street  
Richmond, Virginia 23219  
(804) 225-2667  
Hazardous Waste Hotline:  
1 (800) 552-2075

#### **WASHINGTON**

Waste Management Programs  
Department of Ecology  
Mail Stop PV-11  
Olympia, Washington 98504-8711  
(206) 459-6316  
Hazardous Substance Hotline,  
In State: 1 (800) 633-7585  
24 Hour Spill Hotline,  
In State: 1 (800) 262-5990

#### **WISCONSIN**

Bureau of Solid and Hazardous Waste  
Management  
Department of Natural Resources  
P.O. Box 7921  
Madison, Wisconsin 53707  
(608) 266-1327  
Hazardous Substances Hotline:  
(608) 266-3232

#### **WEST VIRGINIA**

Waste Management Section  
Division of Natural Resources  
Department of Commerce, Labor, and  
Environmental Resources  
1356 Hansford Street  
Charleston, West Virginia 25301  
(304) 348-5393  
24 Hour Spill Hotline: (800) 642-3074

#### **WYOMING**

Division of Solid Waste  
State of Wyoming Department of  
Environmental Quality  
122 West 25th Street  
Cheyenne, Wyoming 82002  
(307) 777-7752  
Emergency: (307) 777-7781

---

## **Accident or Spill Emergency Kit**

The Port Director, COR, or their designee should have available a fully supplied pesticide emergency spill cleanup/decontamination kit with instructions for its use. The kit will have the label designation “For Use in Handling and Cleanup of Accident Pesticide Spills Only.”

Responsible officials should use their discretion as to what items will be stored in vehicles for immediate use. The following items should be immediately available for responding to a pesticide spill:

### **Safety**

- ◆ First aid kit—bus and truck kit, (GSA #6545-00-664-5312, or equivalent)
- ◆ Fire extinguisher, 5-lb. size for class A, B, C fires

### **Cleanup**

- ◆ One shovel, square-point, “D” handle (GSA 5120-00-224-9326, or equivalent)
- ◆ Twenty-five large, heavy-duty plastic bags with ties (GSA 8105-00-848-9631, or equivalent)
- ◆ Two pair, unlined vinyl rubber boots
- ◆ Four pair, disposable coveralls
- ◆ One 5-gallon water container
- ◆ Four pair, unlined vinyl rubber gloves

- ◆ Two approved respirators with approved pesticide canisters (Self-contained breathing apparatus must also be available in operations where methyl bromide is utilized.)
- ◆ One broom and dust pan
- ◆ One pint bottle of liquid detergent
- ◆ Two scrub brushes (GSA 7920-00-068-7903 or equivalent)
- ◆ One plastic cover or tarpaulin (to cover dry spills) (GSA 8135-00-529-6487, or equivalent)
- ◆ Twenty-five pound bag, absorbent material (GSA 7930-00-269-1272), or sweeping compound, sawdust, “kitty litter”, or other absorbent materials
- ◆ One large metal or heavy duty plastic garbage can with removable cover for storing contaminated materials for later disposal



Use this can to store the spill kit materials during transport.

- ◆ Several sand snakes should be kept in storage areas

Obtain many of these items through the GSA Federal Supply System or from a local hardware store. NMRAL will assist in obtaining items not readily available.



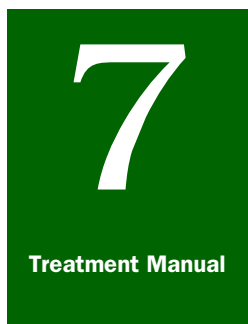

# Emergency Aid and Safety

## *Hazard Communication and Material Safety Data Sheets*

---

### Contents

Overview [page-7-4-1](#)  
OSHA Requirements [page-7-4-1](#)  
Guidelines on Opening Containers Containing Commodities Under Controlled Atmosphere (CA) Storage [page-7-4-9](#)  
    Oxygen (O<sup>2</sup>) [page-7-4-9](#)  
    Carbon dioxide (CO<sup>2</sup>) [page-7-4-9](#)  
Acronyms and Abbreviations Used in This Section [page-7-4-10](#)

---

### Overview

Material safety data sheets (MSDS) provide information about hazardous chemicals that are used in the workplace. This information is necessary to safely handle hazardous chemicals.

---

### OSHA Requirements

The Occupational Safety and Health Administration (OSHA) requires that the hazards of all chemicals produced or imported be evaluated, and information concerning chemical hazards is communicated to employers and employees by means of a comprehensive hazard communication program. A hazard communication program should include, but not be limited to, the following:

- ◆ Developing and maintaining a written hazard communication program for the workplace, including lists of hazardous chemicals present at the workplace.
- ◆ Labeling of containers of chemicals in the workplace, as well as containers of chemicals being shipped to other workplaces.
- ◆ Preparation and distribution of MSDS to employees and downstream employers.
- ◆ Development and implementation of employee training programs regarding hazards of chemicals and protective measures.

Employers who do not produce or import chemicals need only focus on those parts of 29CFR 1910.1200 that deal with establishing a workplace program and communicating information to their workers.

Appendix E of 29CFR 1910.1200 is a general guide for such employers to help them determine the compliance obligations under this rule, and includes the following topics:

- ◆ Becoming Familiar With the Rule
- ◆ Identify Responsible Staff
- ◆ Identify Hazardous Chemicals in the Workplace
- ◆ Preparing and Implementing a Hazard Communication Program
  - ❖ Labels and Other Forms of Warning
  - ❖ Material Safety Data Sheets (MSDS's)
  - ❖ Employee Information and Training
  - ❖ Other Requirements
- ◆ Checklist for Compliance
- ◆ Further Assistance

A copy of **Appendix E** is included in **Figure 7-4-1—Guidelines for Employer Compliance**.

The Hazard Communication Standard (HCS) is based on a simple concept—that employees have both a need and a right to know the hazards and identities of the chemicals they are exposed to when working. They also need to know what protective measures are available to prevent adverse effects from occurring. The HCS is designed to provide employees with the information they need.

Knowledge acquired under the HCS will help employers provide safer workplaces for their employees. When employers have information about the chemicals being used, they can take steps to reduce exposures, substitute less hazardous materials, and establish proper work practices. These efforts will help prevent the occurrence of work-related illnesses and injuries caused by chemicals.

The HCS addresses the issues of evaluating and communicating hazards to workers. Evaluation of chemical hazards involves a number of technical concepts, and is a process that requires the professional judgment of experienced experts. That's why the HCS is designed so that employers who simply use chemicals, rather than produce or import them, are not required to evaluate the hazards of those chemicals. Hazard determination is the responsibility of the producers and importers of the materials. Producers and importers of chemicals are then required to provide the hazard information to employers that purchase their products.

Employers that don't produce or import chemicals need only focus on those parts of the rule that deal with establishing a workplace program and communicating information to their workers. This appendix is a general guide for such employers to help them determine what's required under the rule. It does not supplant or substitute for the regulatory provisions, but rather provides a simplified outline of the steps an average employer would follow to meet those requirements.

### **1. Becoming Familiar With the Rule**

OSHA has provided a simple summary of the HCS in a pamphlet entitled "Chemical Hazard Communication." OSHA Publication Number 3084. Some employers prefer to begin to become familiar with the rule's requirements by reading this pamphlet. A copy may be obtained from your local OSHA Area Office, or by contacting the OSHA Publications Office at (202) 523-9667.

**FIGURE 7-4-1: Appendix E—Guidelines for Employer Compliance**

The standard is long, and some parts of it are technical, but the basic concepts are simple. In fact, the requirements reflect what many employers have been doing for years. You may find that you are already largely in compliance with many of the provisions, and will simply have to modify your existing programs somewhat. If you are operating in an OSHA-approved State Plan State, you must comply with the State's requirements, which may be different than those of the Federal rule. Many of the State Plan States had hazard communication or "right-to-know" laws prior to promulgation of the Federal rule. Employers in State Plan States should contact their State OSHA offices for more information regarding applicable requirements.

The HCS requires information to be prepared and transmitted regarding all hazardous chemicals. The HCS covers both physical hazards (such as flammability), and health hazards (such as irritation, lung damage, and cancer). Most chemicals used in the workplace have some hazard potential, and thus will be covered by the rule.

One difference between this rule and many others adopted by OSHA is that this one is performance-oriented. That means that you have the flexibility to adapt the rule to the needs of your workplace, rather than having to follow specific, rigid requirements. It also means that you have to exercise more judgment to implement an appropriate and effective program.

The standard's design is simple. Chemical manufacturers and importers must evaluate the hazards of the chemicals they produce or import. Using that information, they must then prepare labels for containers, and more detailed technical bulletins called material safety data sheets (MSDS).

Chemical manufacturers, importers, and distributors of hazardous chemicals are all required to provide the appropriate labels and material safety data sheets to the employers to which they ship the chemicals. The information is to be provided automatically. Every container of hazardous chemicals you receive must be labeled, tagged, or marked with the required information. Your suppliers must also send you a properly completed material safety data sheet (MSDS) at the time of the first shipment of the chemical, and with the next shipment after the MSDS is updated with new and significant information about the hazards.

You can rely on the information received from your suppliers. You have no independent duty to analyze the chemical or evaluate the hazards of it.

Employers that "use" hazardous chemicals must have a program to ensure the information is provided to exposed employees. "Use" means to package, handle, react, or transfer. This is an intentionally broad scope, and includes any situation where a chemical is present in such a way that employees may be exposed under normal conditions of use or in a foreseeable emergency.

The requirements of the rule that deal specifically with the hazard communication program are found in this section in paragraph (e), written hazard communication program; (f), labels and other forms of warning; (g) material safety data sheets; and (h) employee information and training. The requirements of these paragraphs should be the focus of your attention. Concentrate on becoming familiar with them, using paragraphs (b) scope and application, and (c) definitions, as references when needed to help explain the provisions.

There are two types of work operations where the coverage of the rule is limited. These are laboratories and operations where chemicals are only handled in sealed containers (e.g., a warehouse). The limited provisions for these workplaces can be found in paragraph (b) of this section, scope and application. Basically, employers having these types of work operations need only keep labels on containers as they are received; maintain material safety data sheets that are received, and give employees access to them; and provide information and training for employees. Employers do not have to have written hazard communication programs and lists of chemicals for these types of operations.

The limited coverage of laboratories and sealed container operations addresses the obligation of an employer to the workers in the operations involved, and does not affect the employer's duties as a distributor of chemicals. For example, a distributor may have warehouse operations where employees would be protected under the limited sealed container provisions. In this situation, requirements for obtaining and maintaining MSDSs are limited to providing access to those received with containers while the substance is in the workplace, and requesting MSDSs when employees request access for those not received with the containers. However, as a distributor of hazardous chemicals, that employer will still have responsibilities for providing MSDSs to downstream customers at the time of the first shipment and when the MSDS is updated. Therefore, although they may not be required for the employees in the work operation, the distributor may, nevertheless, have to have MSDSs to satisfy other requirements of the rule.

**FIGURE 7-4-1: Appendix E—Guidelines for Employer Compliance (continued)**

## 2. Identify Responsible Staff

Hazard communication is going to be a continuing program in your facility. Compliance with the HCS is not a “one shot deal.” In order to have a successful program, it will be necessary to assign responsibility for both the initial and ongoing activities that have to be undertaken to comply with the rule. In some cases, these activities may already be part of current job assignments. For example, site supervisors are frequently responsible for on-the-job training sessions. Early identification of the responsible employees, and involvement of them in the development of your plan of action, will result in a more effective program design. Evaluation of the effectiveness of your program will also be enhanced by involvement of affected employees.

For any safety and health program, success depends on commitment of every level of the organization. This is particularly true for hazard communication, where success requires a change in behavior. This will only occur if employers understand the program, and are committed to its success, and if employees are motivated by the people presenting the information to them.

## 3. Identify Hazardous Chemicals in the Workplace

The standard requires a list of hazardous chemicals in the workplace as part of the written hazard communication program. The list will eventually serve as an inventory of everything for which an MSDS must be maintained. At this point, however, preparing the list will help you complete the rest of the program since it will give you some idea of the scope of the program required for compliance in your facility.

The best way to prepare a comprehensive list is to survey the workplace. Purchasing records may also help, and certainly employers should establish procedures to ensure that in the future purchasing procedures result in MSDSs being received before a material is used in the workplace.

The broadest possible perspective should be taken when doing the survey. Sometimes people think of “chemicals” as being only liquids in containers. The HCS covers chemicals in all physical forms—liquids, solids, gases, vapors, fumes, and mists—whether they are “contained” or not. The hazardous nature of the chemical and the potential for exposure are the factors which determine whether a chemical is covered. If it’s not hazardous, it’s not covered. If there is no potential for exposure (e.g., the chemical is inextricably bound and cannot be released), the rule does not cover the chemical.

Look around. Identify chemicals in containers, including pipes, but also think about chemicals generated in the work operations. For example, welding fumes, dusts, and exhaust fumes are all sources of chemical exposures. Read labels provided by suppliers for hazard information. Make a list of all chemicals in the workplace that are potentially hazardous. For your own information and planning, you may also want to note on the list the location(s) of the products within the workplace, and an indication of the hazards as found on the label. This will help you as you prepare the rest of your program.

Paragraph (b) of this section, scope and application, includes exemptions for various chemicals or workplace situations. After compiling the complete list of chemicals, you should review paragraph (b) of this section to determine if any of the items can be eliminated from the list because they are exempted materials. For example, food, drugs, and cosmetics brought into the workplace for employee consumption are exempt. So rubbing alcohol in the first aid kit would not be covered.

Once you have compiled as complete a list as possible of the potentially hazardous chemicals in the workplace, the next step is to determine if you have received material safety data sheets for all of them. Check your files against the inventory you have just compiled. If any are missing, contact your supplier and request one. It is a good idea to document these requests, either by copy of a letter or a note regarding telephone conversations. If you have MSDSs for chemicals that are not on your list, figure out why. Maybe you don’t use the chemical anymore. Or maybe you missed it in your survey. Some suppliers do provide MSDSs for products that are not hazardous. These do not have to be maintained by you.

You should not allow employees to use any chemicals for which you have not received an MSDS. The MSDS provides information you need to ensure proper protective measures are implemented prior to exposure.

**FIGURE 7-4-1: Appendix E—Guidelines for Employer Compliance (continued)**

#### 4. Preparing and Implementing a Hazard Communication Program

All workplaces where employees are exposed to hazardous chemicals must have a written plan which describes how the standard will be implemented in the facility. Preparation of a plan is not just a paper exercise—all of the elements must be implemented in the workplace in order to be in compliance with the rule. see paragraph (e) of this section for the specific requirements regarding written hazard communication programs. The only work operations which do not have to comply with the written plan requirements are laboratories and work operations where employees only handle chemicals in sealed containers. see paragraph (b) of this section, scope and application, for the specific requirements for these two types of workplaces.

The plan does not have to be lengthy or complicated. It is intended to be a blueprint for implementation of your program—an assurance that all aspects of the requirements have been addressed.

Many trade associations and other professional groups have provided sample programs and other assistance materials to affected employers. These have been very helpful to many employers since they tend to be tailored to the particular industry involved. You may wish to investigate whether your industry trade groups have developed such materials.

Although such general guidance may be helpful, you must remember that the written program has to reflect what you are doing in your workplace. Therefore, if you use a generic program it must be adapted to address the facility it covers. For example, the written plan must list the chemicals present at the site, indicate who is to be responsible for the various aspects of the program in your facility, and indicate where written materials will be made available to employees.

If OSHA inspects your workplace for compliance with the HCS, the OSHA compliance officer will ask to see your written plan at the outset of the inspection. In general, the following items will be considered in evaluating your program.

The written program must describe how the requirements for labels and other forms of warning, material safety data sheets, and employee information and training, are going to be met in your facility. The following discussion provides the type of information compliance officers will be looking for to decide whether these elements of the hazard communication program have been properly addressed.

In-plant containers of hazardous chemicals must be labeled, tagged, or marked with the identity of the material and appropriate hazard warnings. Chemical manufacturers, importers, and distributors are required to assure that every container of hazardous chemicals they ship is appropriately labeled with such information and with the name and address of the producer or other responsible party. Employers purchasing chemicals can rely on the labels provided by their suppliers. If the material is subsequently transferred by the employer from a labeled container to another container, the employer will have to label that container unless it is subject to the portable container exemption. see paragraph (f) of this section for specific labeling requirements.

The primary information to be obtained from an OSHA-required label is an identity for the material, and appropriate hazard warnings. The identity is any term which appears on the label, the MSDS, and the list of chemicals, and thus links these three sources of information. The identity used by the supplier may be a common or trade name (“Black Magic Formula”), or a chemical name (1,1,1,—trichloroethane). The hazard warning is a brief statement of the hazardous effects of the chemical (“flammable,” “causes lung damage”). Labels frequently contain other information, such as precautionary measures (“do not use near open flame”), but this information is provided voluntarily and is not required by the rule. Labels must be legible, and prominently displayed. There are no specific requirements for size or color, or any specified text.

With these requirements in mind, the compliance officer will be looking for the following types of information to ensure that labeling will be properly implemented in your facility.

1. Designation of person(s) responsible for ensuring labeling of in-plant containers;
2. Designation of person(s) responsible for ensuring labeling of any shipped containers;
3. Description of labeling system(s) used;
4. Description of written alternatives to labeling of in-plant containers (is used); and
5. Procedures to review and update label information when necessary.

**FIGURE 7-4-1: Appendix E—Guidelines for Employer Compliance (continued)**

Employers that are purchasing and using hazardous chemicals—rather than producing or distributing them—will primarily be concerned with ensuring that every purchased container is labeled. If materials are transferred into other containers, the employer must ensure that these are labeled as well, unless they fall under the portable container exemption (paragraph (f)(7) of this section). In terms of labeling systems, you can simply choose to use the labels provided by your suppliers on the containers. These will generally be verbal text labels, and do not usually include numerical rating systems or symbols that require special training. The most important thing to remember is that this is a continuing duty—all in-plant containers of hazardous chemicals must always be labeled. Therefore, it is important to designate someone to be responsible for ensuring that the labels are maintained as required on the containers in your facility, and that newly purchased materials are checked for labels prior to use.

Chemical manufacturers and importers are required to obtain or develop a material safety data sheet for each hazardous chemical they produce or import. Distributors are responsible for ensuring that their customers are provided a copy of these MSDSs. Employers must have an MSDS for each hazardous chemical which they use. Employers may rely on the information received from their suppliers. The specific requirements for material safety data sheets are in paragraph (g) of this section.

There is no specified format for the MSDS under the rule, although there are specific information requirements. OSHA has developed a non-mandatory format, OSHA Form 174, which may be used by chemical manufacturers and importers to comply with the rule. The MSDS must be in English. You are entitled to receive from your supplier a data sheet which includes all of the information required under the rule. If you do not receive one automatically, you should request one. If you receive one that is obviously inadequate, with, for example, blank spaces that are not completed, you should request an appropriately completed one. If your request for a data sheet or for a corrected data sheet does not produce the information needed, you should contact your local OSHA Area Office for assistance in obtaining the MSDS.

The role of MSDSs under the rule is to provide detailed information on each hazardous chemical, including its potential hazardous effects, its physical and chemical characteristics, and recommendations for appropriate protective measures. This information should be useful to you as the employer responsible for designing protective programs, as well as to the workers. If you are not familiar with material safety data sheets and with chemical terminology, you may need to learn to use them yourself. A glossary of MSDS terms may be helpful in this regard. Generally speaking, most employers using hazardous chemicals will primarily be concerned with MSDS information regarding hazardous effects and recommended protective measures. Focus on the sections of the MSDS that are applicable to your situation.

MSDSs must be readily accessible to employees when they are in their work areas during their workshifts. This may be accomplished in many different ways. You must decide what is appropriate for your particular workplace. Some employers keep the MSDSs in a binder in a central location (e.g., in the pick-up truck on a construction site). Others, particularly in workplaces with large numbers of chemicals, computerize the information and provide access through terminals. As long as employees can get the information when they need it, any approach may be used. The employees must have access to the MSDSs themselves—simply having a system where the information can be read to them over the phone is only permitted under the mobile worksite provision, paragraph (g)(9) of this section, when employees must travel between workplaces during the shift. In this situation, they have access to the MSDSs prior to leaving the primary worksite, and when they return, so the telephone system is simply an emergency arrangement.

In order to ensure that you have a current MSDS for each chemical in the plant as required, and that employee access is provided, the compliance officers will be looking for the following types of information in your written program:

1. Designation of person(s) responsible for obtaining and maintaining the MSDSs;
2. How such sheets are to be maintained in the workplace (e.g., in notebooks in the work area(s) or in a computer with terminal access), and how employees can obtain access to them when they are in their work area during the work shift;
3. Procedures to follow when the MSDS is not received at the time of the first shipment;
4. For producers, procedures to update the MSDS when new and significant health information is found; and
5. Description of alternatives to actual data sheets in the workplace, if used.

For employers using hazardous chemicals, the most important aspect of the written program in terms of MSDSs is to ensure that someone is responsible for obtaining and maintaining the MSDSs for every hazardous chemical in the workplace. The list of hazardous chemicals required to be maintained as part of the written program will serve as an inventory. As new chemicals are purchased, the list should be updated. Many companies have found it convenient to include on their purchase orders the name and address of the person designated in their company to receive MSDSs.

**FIGURE 7-4-1: Appendix E—Guidelines for Employer Compliance (continued)**

Each employee who may be “exposed” to hazardous chemicals when working must be provided information and trained prior to initial assignment to work with a hazardous chemical, and whenever the hazard changes. “Exposure” or “exposed” under the rule means that “an employee is subjected to a hazardous chemical in the course of employment through any route of entry (inhalation, ingestion, skin contact or absorption, etc.) and includes potential (e.g., accidental or possible) exposure.” see paragraph (h) of this section for specific requirements. Information and training may be done either by individual chemical, or by categories of hazards (such as flammability or carcinogenicity). If there are only a few chemicals in the workplace, then you may want to discuss each one individually. Where there are large numbers of chemicals, or the chemicals change frequently, you will probably want to train generally based on the hazard categories (e.g., flammable liquids, corrosive materials, carcinogens). Employees will have access to the substance-specific information on the labels and MSDSs.

Information and training is a critical part of the hazard communication program. Information regarding hazards and protective measures are provided to workers through written labels and material safety data sheets. However, through effective information and training, workers will learn to read and understand such information, determine how it can be obtained and used in their own workplaces, and understand the risks of exposure to the chemicals in their workplaces as well as the ways to protect themselves. A properly conducted training program will ensure comprehension and understanding. It is not sufficient to either just read material to the workers, or simply hand them material to read. You want to create a climate where workers feel free to ask questions. This will help you to ensure that the information is understood. You must always remember that the underlying purpose of the HCS is to reduce the incidence of chemical source illnesses and injuries. This will be accomplished by modifying behavior through the provision of hazard information and information about protective measures. If your program works, you and your workers will better understand the chemical hazards within the workplace. The procedures you establish regarding, for example, purchasing, storage, and handling of these chemicals will improve, and thereby reduce the risks posed to employees exposed to the chemical hazards involved. Furthermore, your workers’ comprehension will also be increased, and proper work practices will be followed to your workplace.

If you are going to do the training yourself, you will have to understand the material and be prepared to motivate the workers to learn. This is not always an easy task, but the benefits are worth the effort. More information regarding appropriate training can be found in OSHA Publication No. 2254 which contains voluntary training guidelines prepared by OSHA’s Training Institute. A copy of this document is available from OSHA’s Publications Office at (202) 219-4667.

In reviewing your written program with regard to information and training, the following items need to be considered:

1. Designation of person(s) responsible for conducting training;
2. Format of the program to be used (audiovisuals, classroom instruction, etc.);
3. Elements of the training program (should be consistent with the elements in paragraph (h) of this section); and
4. Procedure to train new employees at the time of their initial assignment to work with a hazardous chemical, and to train employees when a new hazard is introduced into the workplace.

The written program should provide enough details about the employer’s plans in this area to assess whether or not a good faith effort is being made to train employees. OSHA does not expect that every worker will be able to recite all of the information about each chemical in the workplace. In general, the most important aspects of training under the HCS are to ensure that employees are aware that they are exposed to hazardous chemicals, that they know how to read and use labels and material safety data sheets, and that, as a consequence of learning this information, they are following the appropriate protective measures established by the employer. OSHA compliance officers will be talking to employees to determine if they have received training. If they know they are exposed to hazardous chemicals, and if they know where to obtain substance-specific information on labels and MSDSs.

The rule does not require employers to maintain records of employee training, but many employers choose to do so. This may help employers choose to do so. This may help you monitor your own program to ensure that all employees are appropriately trained. If you already have a training program, you may simply have to supplement it with whatever additional information is required under the HCS. For example, construction employers that are already in compliance with the construction training standard (29CFR 1926.21) will have little extra training to do.

**FIGURE 7-4-1: Appendix E—Guidelines for Employer Compliance (continued)**

An employer can provide employees information and training through whatever means are found appropriate and protective. Although there would always have to be some training on-site (such as informing employees of the location and availability of the written program and MSDSs), employee training may be satisfied in part by general training about the requirements of the HCS and about chemical hazards on the job which is provided by, for example, trade associations, unions, colleges, and professional schools. In addition, previous training, education and experience of a worker may relieve the employer of some of the burdens of informing and training that worker. Regardless of the method relied upon, however, the employer is always ultimately responsible for ensuring that employees are adequately trained. If the compliance officer finds that the training is deficient, the employer will be cited for the deficiency regardless of who actually provided the training on behalf of the employer.

In addition to these specific items, compliance officers will also be asking the following questions in assessing the adequacy of the program:

Does a list of the hazardous chemicals exist in each work area or at a central location?

Are methods the employer will use to inform employees of the hazards of non-routine tasks outlined?

Are employees informed of the hazards associated with chemicals contained in unlabeled pipes in their work areas?

On multi-employer worksites, has the employer provided other employers with information about labeling systems and precautionary measures where the other employers have employees exposed to the initial employer's chemicals?

Is the written program made available to employees and their designated representatives?

If your program adequately addresses the means of communicating information to employees in your workplace, and provides answers to the basic questions outlined above, it will be found to be in compliance with the rule.

### 5. Checklist for Compliance

The following checklist will help to ensure you are in compliance with the rule:

- Obtained a copy of the rule.
- Read and understood the requirements.
- Assigned responsibility for tasks.
- Prepared an inventory of chemicals.
- Ensured containers are labeled.
- Obtained MSDS for each chemical.
- Prepared written program.
- Made MSDSs available to workers.
- Conducted training of workers.
- Established procedures to maintain current program.
- Established procedures to evaluate effectiveness.

### 6. Further Assistance

If you have a question regarding compliance with the HCS, you should contact your local OSHA Area Office for assistance. In addition, each OSHA Regional Office has a Hazard Communication Coordinator who can answer your questions. Free consultation services are also available to assist employers, and information regarding these services can be obtained through the Area and Regional offices as well.

The telephone number for the OSHA office closest to you should be listed in your local telephone directory. If you are not able to obtain this information, you may contact OSHA's Office of Information and Consumer Affairs at (202) 219-8151 for further assistance in identifying the appropriate contacts.

[59 FR 6170, Feb. 9, 1994, as amended at 59 FR 17479, Apr. 13, 1994; 59 FR 65948, Dec. 22, 1994; 61 FR 9245, Mar. 7, 1996]

**FIGURE 7-4-1: Appendix E—Guidelines for Employer Compliance (continued)**



## Guidelines on Opening Containers Containing Commodities Under Controlled Atmosphere (CA) Storage

Controlled atmosphere (CA) is being used more and more commonly to preserve the quality of fresh produce during and shipment, especially during long voyages. It also has the advantage of reducing the number of many of the pests that may be present. In most cases, however, insufficient research has been done on enough pest species for APHIS to accept CA as a stand-alone quarantine treatment, although this could change in the future.

Opening and inspecting a container known or suspected to be under CA poses a safety risk to the inspector, and to others in the immediate vicinity. A placard is usually posted on the doors of the container prior to shipment, stating that the fresh produce is being shipped under CA. Also, a monitoring device, indicating the kinds and levels of gases in the mixture, should be present. If the monitor is not functioning properly, it is possible to use gas detector tubes specific for oxygen and carbon dioxide. If the nitrogen or carbon dioxide levels are high, or the oxygen level is low, the inspector must not enter the container immediately, because of the high risk of asphyxiation. This risk is very insidious, because the potential victim usually does not recognize the danger signs.



It should be noted that normal air contains 78% nitrogen, 21% oxygen, and 0.03 to 0.04% carbon dioxide (CO<sup>2</sup>). Health risk to the inspector occurs when the oxygen level is too low, or the levels of nitrogen or CO<sup>2</sup> are too high.

### Oxygen (O<sup>2</sup>)

Gases within a CA space normally contain only 3% oxygen or less. The lowest oxygen level considered safe is 19.5%. A personal oxygen monitor (worn by the inspector) would set off an alarm at that level.

An oxygen level of 6% or less causes loss of consciousness within 45 seconds. Breathing is in gasps, followed by convulsive movements, then breathing stops. The heart may continue beating for a few minutes, then stops. If the person attempting to rescue is not equipped with a SCBA, there is a high probability that this person will also become a victim of asphyxiation.

### Carbon dioxide (CO<sup>2</sup>)

Gases within a CA space often contain high levels of CO<sub>2</sub>. Although this is a common compound, it can also be deadly--a fact often overlooked. Breathing pure CO<sub>2</sub> will cause immediate death. Even at concentrations over 15%, death can be rapid. Above 10%, CO<sub>2</sub> causes unconsciousness (coma). At 8%, CO<sub>2</sub> causes headache, nausea, vomiting, and may lead to unconsciousness. Concentrations as low as

4 to 5% cause rapid, labored breathing, slight choking, and headache. The threshold limit value (TLV), the highest level at which a person can work without adverse effect, is 0.05% or 5 ppm.

If dangerous gas levels are determined to be present, then the container must be aerated prior to inspection, preferably by using the container's own recirculation system, set in "exhaust" mode. Aeration may also be done passively, or by the use of fans, or by means of a fan-assisted aeration duct.



Do not attempt to aerate while the container is parked at a loading dock, because the gases may asphyxiate workers in the area. Have the container moved to an open area. While opening doors and placing fans or a fan-assisted exhaust duct, wear SCBA for personal protection.

Aerate for at least one hour, then recheck gas levels. Proceed with cargo inspection only when safe levels have been reached. The safe waiting time (to achieve at least 19.5% oxygen in the accessible portion of the container) depends upon several factors:

- ◆ The type of produce and how it is packed
- ◆ The extent of holes in the boxes
- ◆ Packing density of the boxes
- ◆ Pallet spacing, and return-flow ribs in the floor of the container
- ◆ Amount of head-space above the load
- ◆ Whether the recirculation blower is on or off
- ◆ Percentage of oxygen in the controlled atmosphere

At ports receiving CA containers, periodic training/awareness sessions are needed, and policies clearly spelled out.

---

## Acronyms and Abbreviations Used in This Section

a.i.	active ingredient
ACGIH	American Conference of Governmental Industrial Hygienists
ADI	Acceptable Daily Intake
APHIS	Animal and Plant Health Inspection Service
BBEP	Biotechnology, Biologics, and Environmental Protection
bw	body weight
CAS	Chemical Abstracts Service
cc	cubic centimeters
CERCLA	Comprehensive Environmental Response, Compensation, and Liability Act
ChE	cholinesterase
CHEMTREC	24-hour emergency telephone service for spills

CNS	central nervous system
COR	Contracting Officer's Representative
CPK	creatin phosphokinase
cu.m	cubic meter
CWA	Clean Water Act
DHEW	U.S. Department of Health, Education, and Welfare
DNA	deoxyribonucleic acid
DOT	U.S. Department of Transportation
DW	drinking water
EPA	Environmental Protection Agency
FAA	Federal Aviation Administration
FIFRA	Federal Insecticide, Fungicide, and Rodenticide Act
g	grams
GI	gastrointestinal
HDT	highest dose tested
Hgb	hemoglobin
HHS	U.S. Department of Health and Human Services
i.m.	intramuscular
i.p.	intraperitoneal
i.v.	intravenous
kg	kilogram
L	liter
LC50	Lethal Concentration 50; dose lethal to 50% of the animals
LCLO	Lethal Concentration Low; the lowest concentration causing death
LD50	Lethal Dose 50; dose lethal to 50% of the animals
LDLO	Lethal Dose Low; the lowest dose at which death occurred
LDT	lowest dose tested
LEL	lower exposure limit, or lowest-effect level
LOAEL	lowest-observed-adverse-effect-level
m	meter
MED	minimum effective dose
mg	milligram
mg/kg	milligrams per kilogram
mg/L	milligrams per liter
mmHg	millimeters of mercury; a measure of pressure
MOE	Margin of Exposure
MOS	Margin of Safety
MSDS	Material Safety Data Sheet
MTD	maximum tolerated dose
MTL	median threshold limit
NFPA	National Fire Prevention Association
ng	nanogram

NIOSH	National Institute for Occupational Safety and Health
NMRAL	National Monitoring and Residue Analysis Laboratory
NOAEL	no-observed-adverse-effect level
NOEL	no-observed-effect level
NTP	National Toxicology Program
OIC	Officer-in-Charge
OSHA	U.S. Occupational Safety and Health Administration
PEL	permissible exposure limit
PHS	U.S. Public Health Service
p.o.	per os (by mouth)
ppb	parts per billion
ppm	parts per million
PPQ	Plant Protection and Quarantine
RBC	red blood cell(s)
RfD	Reference Dose
RfDi	Inhalation Reference Dose
RfDo	Oral Reference Dose
s.c.	subcutaneous
STEL	short-term exposure limit
TLV	threshold limit value
TSS	Technical and Scientific Services
TWA	time-weighted average
UCL	upper confidence limit
UEL	upper exposure limit
UF	uncertainty factor
ug	microgram
ug/cu.	micrograms per cubic meter
ug/L	micrograms per liter
USDA	United States Department of Agriculture

# 8

Treatment Manual

# Equipment

## Contents

Thermal Conductivity Gas Analyzers	<b>page 8-1-2</b>
Instrument Description	<b>page 8-1-2</b>
Instrument Standardization	<b>page 8-1-5</b>
Maintenance	<b>page 8-1-7</b>
Operation Procedures	<b>page 8-1-6</b>
Maintenance	<b>page 8-1-7</b>
Infrared Spectroscopy Gas Monitoring Device	<b>page 8-1-9</b>
General Operation	<b>page 8-1-10</b>
Calibration and Service	<b>page 8-1-12</b>
Respiratory Protection	<b>page 8-1-13</b>
Responsibility	<b>page 8-1-13</b>
Fumigants	<b>page 8-1-14</b>
Pesticides Other Than Fumigants	<b>page 8-1-14</b>
Air Purifying Respirators	<b>page 8-1-14</b>
Dust Masks	<b>page 8-1-14</b>
Employee Acceptance	<b>page 8-1-14</b>
Capabilities and Limitations	<b>page 8-1-15</b>
Respirator Protection Use	<b>page 8-1-16</b>
Use in Dangerous Atmospheres	<b>page 8-1-17</b>
Facepiece Fitting	<b>page 8-1-17</b>
Facepiece Fit Tests	<b>page 8-1-18</b>
Corrective Lenses With Full Facepiece	<b>page 8-1-18</b>
Eyeglasses With Half Facepiece	<b>page 8-1-19</b>
Use in Low Temperatures	<b>page 8-1-19</b>
Communications	<b>page 8-1-19</b>
Maintenance and Care	<b>page 8-1-20</b>
Cleaning and Disinfecting	<b>page 8-1-20</b>
Inspection for Defects (Including Leak Checks)	<b>page 8-1-21</b>
Repairs	<b>page 8-1-22</b>
Respirable Air for Self-Contained Breathing Apparatus	<b>page 8-1-22</b>
Storage	<b>page 8-1-22</b>
Detector Kits or Gas Samples	<b>page 8-1-23</b>
Principles of Operations	<b>page 8-1-23</b>
Volatilizer	<b>page 8-1-25</b>
Air Velocity Measuring Instruments	<b>page 8-1-27</b>
Anemometer	<b>page 8-1-27</b>
Velometer®	<b>page 8-1-27</b>
Auxiliary Pump	<b>page 8-1-28</b>
Open-Arm Manometer	<b>page 8-1-30</b>
Mityvac Hand-held Vacuum Pump	<b>page 8-1-33</b>
Usage	<b>page 8-1-33</b>
Phosphine Detector	<b>page 8-1-33</b>
PortaSens Phosphine Detector	<b>page 8-1-33</b>
Photo Ionization Detector	<b>page 8-1-35</b>
Certified Precision Thermometers: Calibration Guidelines	<b>page 8-1-35</b>

## Thermal Conductivity Gas Analyzers

The thermal conductivity gas analyzer (T/C) is a portable instrument specifically designed to determine the concentration of gases under a tarpaulin or within a chamber during a fumigation. These fumigation gases include methyl bromide (MB) and sulfuryl fluoride (SF).

### Instrument Description

There are two instrument brands approved for use during a PPQ-supervised fumigation:

- ◆ Fumiscopes® (**Figure 8-1-1**)
- ◆ Gow-Mac® (**Figure 8-1-2**)

These instruments are lightweight, portable, and completely contained in a compact metal case. They contain a thermal conductivity cell, scale, gas pump, range switch, and gas flow meter. A gas drying tube is also included. For large enclosures, an auxiliary pump may be needed.



**FIGURE 8-1-1: Fumiscopes®**



**FIGURE 8-1-2: GowMac®**

- Inlet** The inlet tube connector is the gas inlet for the instrument. The sampling lines are 1/4" inner diameter (I.D.) and are connected to the inlet through the drying tube.
- Flow Rate Meter** The flow rate meter indicates the gas flow rate in “simulated cubic feet per hour (SCFH).” Note: The flow rate should always be read at the middle of the ball.
- Flow Rate Adjustment** The flow rate adjustment dial controls the air or gas flow rate by adjusting the pump. After connecting to the gas sampling line, adjust the flow rate upward until it reads exactly 1.0 SCFH.
- Scale or Digital Display** The scale or digital display indicates the concentration of the fumigant in ounces per 1,000 cubic feet (milligrams per liter or grams per cubic meter). Record the gas concentration reading only after this meter stabilizes, which may take a minute or more (depending on the length of the tubing and whether an auxiliary pump is being used). Digital Fumiscope® models can indicate a range from 0 to 2999 ounces per 1,000 cubic feet. When using the GowMac® for sulfuryl fluoride, the concentration is calculated as the reading multiplied by a specific factor.
- Zero Adjustment** The zero adjustment dial is used to adjust the display to zero after the instrument has warmed up.
- 

**Important**
- The instrument should be set to **zero** before taking concentration readings at each required time interval and **reset to zero** after each reading.
- Line Switches** Line switches control the electrical supply to the pump and scale.
- Fumigant Selector Switch** The fumigant selector switch (Fumiscope® only) changes the display to register either methyl bromide or sulfuryl fluoride (Vikane®.)
- Range Switch** The range switch (GowMac® only) regulates the scale indicating the concentrations of fumigant measured, for example, 0 to 100 ounces per 1,000 cubic foot or 101 to 200 ounces per 1,000 cubic foot (some models).
- Exhaust Outlet** Always connect an exhaust line to the exhaust outlet to carry gas away from the instrument and operator. When using the T/C unit in confined or poorly ventilated areas, recirculate the exhaust gas back to the fumigation space or exhaust it to the outside.
- Drying Tube** Use drying tubes (filter tube) with a prepared chemical for removing certain contaminant gases or vapors that interfere with correct fumigant concentration readings. The tubes will contain a desiccant

such as Drierite<sup>®</sup> (granules of anhydrous calcium sulfate), or Ascarite<sup>®</sup> (sodium hydroxide). Both are available from scientific supply houses. **Never mix Drierite<sup>®</sup> and Ascarite<sup>®</sup> in the same tube.**

When a drying tube is used, place a thin layer of glass wool or aquarium filter wool at the bottom and top of the tube to prevent small particles from sifting into the T/C unit. Using absorbent cotton or similar materials is not recommended. Cotton tends to pick up moisture and to become matted, and once matted, the cotton may restrict normal air flow, thus, adversely affecting the T/C unit's operation.

Mount the drying tube *vertically* so the gas mixture moves through the drying material and does not pass over the top. The gas mixture will pass over the top of the drying tube when the tube is mounted horizontally (lengthwise).

### Drierite<sup>®</sup>

Always use anhydrous calcium sulfate (Drierite<sup>®</sup>) to remove moisture from the gas sample. Insert the drying tubes in the gas sampling line just before the inlet connection. Drierite<sup>®</sup> should be fresh and frequently changed to ensure correct readings. Drierite<sup>®</sup>, blue in color when dry, turns pink when moisture is absorbed. Replace the Drierite<sup>®</sup> when most of it has turned pink. In extremely high moisture conditions, two Drierite<sup>®</sup> tubes can be connected in tandem. Close drying tube openings when not in use.

### Ascarite<sup>®</sup>

T/C gas analyzers are sensitive to a number of gases other than MB. For example, CO<sub>2</sub> may be troublesome when fumigating fruit where kerosene heaters are placed under the tarpaulin to raise pulp temperatures, or with plant material packed in peat moss or subsoil. Correct MB gas concentration readings may be obtained if a CO<sub>2</sub> absorbent is used in the gas sampling line before the air-gas mixture enters the T/C unit. A CO<sub>2</sub> absorbent that can be used is Ascarite<sup>®</sup>. Observe the poison warning labels on the containers when using Ascarite<sup>®</sup>. **Tubes containing Ascarite<sup>®</sup> should be clearly labeled, "Warning—Avoid contact with skin, eyes, and clothing."**



During a fumigation of living plant products, such as plants, plant material, logs, wood and wood products, tubes containing Ascarite<sup>®</sup> **must** be used to remove carbon dioxide from gas samples. Used Ascarite<sup>®</sup> should be discarded per label instructions. The Ascarite<sup>®</sup> tube should be connected between the Drierite<sup>®</sup> tube and the sample inlet. **Never mix Drierite<sup>®</sup> and Ascarite<sup>®</sup> in the same tube.** Ascarite<sup>®</sup> should be replaced when the granules begin to aggregate or become moist.

Because a chemical reaction will occur, **never** use Ascarite<sup>®</sup> when taking readings of SF.



## Instrument Standardization

Instrument standardization is the first and basic operation. In order to standardize the instrument, do the following:

1. Connect the instrument to an electrical outlet with proper voltage and set the pump and meter switches to “on”; if inoperable, check fuse (replacements—Little Fuse or Buss #3AG 1/2 Amp.—should be kept on hand).
2. Attach the drying tube to the inlet port.
  - A. Give the instrument a tightness test.
  - B. A tightness test can be accomplished by placing a finger over the inlet of the drying tube; if the tubing and connections are tight, the flow ball in the flow meter should then fall to zero.
3. Warm up the instrument for 15 to 30 minutes.



The manufacturer recommends that the analyzer be kept at the same temperature as the fumigated site. It may take up to two hours for the analyzer to acclimate if moved from extreme temperatures.

4. Adjust the gas flow rate to one SCFH by adjusting the flow rate knob.
  - A. If the flow rate knob is turned counterclockwise too far, the pump will emit noises and cease to operate properly.
  - B. When properly adjusted, the flow ball should float at the center mark, or slightly below it, on the calibrated glass cylinder.
  - C. The pump now draws dry, fresh air through the T/C cell; the air enters via the inlet on the face of the instrument, passes through the cell, and leaves through the exhaust outlet.
5. Turn the zero adjustment knob to obtain a zero reading on the meter.
  - A. To obtain a stable zero reading, several additional adjustments during the first few minutes may be necessary.

Standardization is now complete and readings can be made of fumigant-air mixture drawn through the unit. At this point, it may be necessary to replace the desiccant.

The difference in the thermal conductivity of the fumigant-air mixture as compared with fresh air is measured electrically and indicated on the meter as concentration readings in ounces of gas per 1,000 cubic feet. T/C units used in PPQ must be calibrated for MB and/or SF by

the manufacturer or an approved outside contractor prior to use. When fumigations are under even a small vacuum, readings will not be accurate.

### **Operation Procedures**

Because of the variety of fumigation situations, some adjustments may be necessary to meet specific needs. Nevertheless, this outline should be helpful in establishing correct operational procedures.

The proper use of the T/C unit is discussed under two headings:

- ◆ Selecting operational site
- ◆ Measuring gas concentrations

### **Selecting Operational Site for T/C Unit**

The T/C unit should be at least 30 feet upwind from the fumigation site to allow the operator to function without the fear of accidental exposure to gas and to allow for easy exit in an emergency. It should be close enough to the fumigation site to avoid using unreasonable lengths of sampling lines, to allow for constant surveillance of the fumigation during testing, and to avoid interference with other activities in the area. Avoid excessive wiring length. When T/C unit readings in multiple locations are necessary, see that each location is the best available.

The T/C unit should be supported on a sturdy, level surface, outside the traffic pattern, and protected from wind, rain, excessive cold, and, in hot weather, sun. In some cases, temporary shelter such as a tarpaulin cover may be adequate. The gas concentration readings indicated by the T/C unit may be inaccurate unless the unit is placed in an area that is approximately the same temperature as the gas mixture in the enclosure being fumigated. If the temperature of the gas mixture within the fumigated enclosure is approximately equal to that of the ambient air outside the enclosure, the gas concentration readings indicated by the T/C unit's meter will be generally more accurate. If there are great differences between the two temperatures, water vapor may condense inside the gas sampling leads. Such condensation, if desiccant is saturated, can result in a lower than normal T/C meter reading, thus leading to the unnecessary addition of fumigant to compensate for the apparent shortage. Therefore, if vapor condensation appears inside the gas sampling leads, purge the line and move the T/C unit to a new location where the ambient temperature approximates that of the enclosure.

Most T/C units operate on 110 to 120 volts alternating current (AC). T/C units operating on 210 to 220 volts AC on direct current (DC) are available for overseas or other assignments as necessary. A converter is required to use DC. Keep extension wiring and gas sampling line length to a practical minimum and raise extension wiring above floor level when feasible.

## Measuring Gas Concentrations With the Standardized Unit

As a protection for the cell and the pump of T/C units, **use a drying tube filled with Drierite® at all times.**

When taking gas concentration readings, first warm up the unit for at least 15 to 30 minutes depending on ambient temperatures. Then turn on the pump and adjust the gas flow meter to a 1.0 SCFH flow. Turn the zero adjustment knob to obtain a zero reading on the meter.

The unit is now ready to measure gas samples drawn through position tagged tubes from the area being treated. The meter will indicate gas concentrations in ounces per 1,000 cubic feet (grams per cubic meter).

Connect the gas sampling line to the Drierite tube using 1/4 inch ID polyethylene tubing. Allow sufficient time to draw a true sample. With 150 to 200 feet of 1/4 inch ID tubing and a temperature of 70°F, a sufficient amount of time will be approximately 7 minutes. Stations equipped with small, auxiliary pumps can draw a sample through the same length of tubing in 12 to 15 seconds.

Wait until the analyzer reaches the maximum reading (at least thirty seconds) and does not move for thirty seconds. Ensure the flow meter still reads 1.0 SCFH. This is the gas reading. Record this reading on the PPQ Form 429.

Disconnect the sampling line and allow the pump to draw uncontaminated air through the T/C cell. The instrument should return to zero, however it may be necessary to re-zero the analyzer. Again, ensure that the flow meter reads 1.0 SCFH. **Always re-zero the analyzer before taking the next reading.**

After taking the final reading at the end of the fumigation, thoroughly purge the unit by disconnecting it from the gas sampling line and allowing the pump to draw fresh air through the instrument for several minutes.

## Maintenance

If it is to function properly, the T/C unit requires the same attention as any other equipment. While the instrument is designed specifically for field use, the components, particularly the meter, may be damaged easily. To maintain an instrument capable of accurate gas concentration readings, careful handling is essential. If repairs are needed and are extensive, or the parts are not readily available, there will be a delay in returning the instrument. Should the need for a substitute T/C unit occur, the port should be prepared to obtain one from another source.

### Repair and Calibration

Under normal service, the T/C unit will hold its calibration for a considerable length of time. To ensure all units are providing accurate gas concentration readings, recalibrate T/C units at least annually; calibrate more often if use is frequent.

Send the instrument by insured delivery service (ie. Federal Express, United Parcel Service, U.S. postal priority mail) to one of the contractors listed below. To prevent damage, the unit must be well-packed and shipped in a durable, tamper-proof box.

Prepare a memorandum to accompany each instrument explaining the need for sending the unit. Ensure all instruments are shipped with a proper return address, name of a contact person, and telephone number. The T/C unit will be calibrated for MB only, unless the PPQ office requests calibration for SF. **Notify the contractor if Ascarite® will be utilized during the readings, as the T/C must be calibrated using this type of absorbent.** All port locations will be responsible for payments to contractors.

Use one of the following contractors for repair and calibration:

Key Chemical and Equipment Co. (BPA# 45-6395-3-2872)  
13195 49th St. North  
Unit A  
Clearwater, FL 33762  
tel (727) 572-1159  
fax (727) 572-4595  
<http://www.fumiscope.com/>

Cardinal Professional Products (BPA# 45-6395-3-2871)  
2641 W. Woodland Drive  
Anaheim, CA 92801-2628  
tel (714) 761-3292  
fax (714) 761-2095  
<http://www.cardinalproproducts.com/>

## Infrared Spectroscopy Gas Monitoring Device

Infrared spectroscopy is an accurate and efficient method for measuring methyl bromide gas concentrations. There is one unit currently approved for use by PPQ. The MB-ContainIR™ is manufactured by Spectros Instruments Inc., Hopedale, MA, and will be referred to in this document as the "Spectros." The Spectros is light-weight (9 pounds; 4 kg) and battery operated.



**FIGURE 8-1-3 Spectros Methyl Bromide Monitor**

The Spectros uses a technology known as "non-dispersive infrared technology" (NDIR.) NDIR is based on Beer's Law (also known as Lambert-Beer Law or Beer-Lambert-Bouguer Law) that relates the absorption of light to the properties of the material through which the light is traveling. The Spectros is not affected by other volatile organic compounds such as carbon dioxide, eliminating the need for Ascarite™. Other benefits of the unit include:

- ◆ Audible and visible programmable alarm
- ◆ Battery powered and portable
- ◆ Measuring range for methyl bromide 0-240 oz./1000 ft<sup>3</sup> (g/m<sup>3</sup>)
  - ❖ Sensitivity 0.16 oz./1000 ft<sup>3</sup> (g/m<sup>3</sup>)
  - ❖ Accuracy 0.08 oz./1000 ft<sup>3</sup> (g/m<sup>3</sup>)
- ◆ Operating temperature 32 °F - 122 °F (0 °C - 50 °C)
- ◆ Variable temperature compensation

The information and guidelines in this chapter are based on the Spectros Inc. Operation and Maintenance Guide. Contact [Spectros](#) for more detailed operating instructions or technical assistance.

## Important points to remember:



- ◆ This monitor **is not** and **should not** be used as a worker safety clearance device.
- ◆ This monitor is **not** set up to evaluate, test, or determine readings for other approved fumigants that PPQ uses, such as **phosphine** or **sulfuryl fluoride**.
- ◆ Do not operate the monitor in the presence of flammable liquids, vapors, or aerosols.
- ◆ Do not use soap and water to clean the monitor; use a dry cloth to clean the monitor.
- ◆ Maintain proper care and storage of the monitor when not in use.
- ◆ Use only batteries supplied by the factory.
- ◆ Operate the monitor at all times in a horizontal position. Operating the monitor in a vertical position may cause inaccurate measurements.
- ◆ Never operate this unit at or above 6,562 feet. (2,000 meters.)
- ◆ The monitor must be maintained free of moisture or other contaminants.
- ◆ Always place supplied filter on the gas sample line between the monitor and the sampling line.
- ◆ Always ensure that the direction of flow is correct for the supplied filter before using the monitor.
- ◆ Cap the ends of the gas sample lines to prevent the possibility of mists, aerosol, oil, water, dust, or other contaminants being drawn into the monitor.
- ◆ The maximum length of the gas sample line is 1000 feet.
- ◆ The monitor does not require Drierite if the measuring range is greater than 2 oz./1000 ft<sup>3</sup>.
- ◆ Return the monitor to the manufacturer for calibration every 6 months.

### General Operation

Prior to taking gas concentration readings, follow the guidelines in Chapter 2-4 Methyl Bromide Tarpaulin Fumigation, Conducting a Fumigation, to ensure proper installation of gas sampling lines and circulation fans.

If not using direct current, ensure that the battery for the Spectros is fully charged before the fumigation begins. When using the Spectros in battery mode, press the "test" button and observe the number of LEDs that light up.

- Four green LEDs on the battery indicate that the unit is fully charged and monitoring can begin. A fully charged battery pack will power the monitor for 8-10 hours.
- A red flashing LED on the battery indicates a low battery. Recharge the battery per manufacturer instructions before using for gas monitoring. Charging time is 3-4 hours for a fully discharged battery pack.

**Gas Sample Line** Using 1/4-inch flex tubing, connect the gas sample line to the monitor by pushing the tubing onto the gas sample port on the front of the monitor. The gas sample line can be up to 50 feet in length and should be free of kinks or obstructions. If the gas sample line is longer than 300 feet, the instrument will display "FAULT" on the display screen. Ensure that the end of the line is positioned to prevent moisture or water intake, or utilize the filter element.

**Purge Air Line** Connect the purge air line to the monitor by pushing the tubing onto the purge air port on the left side of the monitor. The purge line can be up to 100 feet maximum in length and should be in an area of fresh air. Ensure that the end of the line is positioned to prevent moisture or water intake, or utilize the filter element.

**Exhaust Line** Connect the exhaust line to the monitor by pushing the tubing onto the exhaust port's barbed fitting. The exhaust line can be up to 50 feet in length and should terminate outside the building. Ensure that the end of the tube is positioned to prevent moisture or water intake.

### Measuring Gas Concentration

To turn on the monitor lift the shield in front of the handle and press the red power ON/OFF toggle switch. Allow the monitor to warm up for 15 minutes.

The WARM UP screen is displayed and the ON light (green) will blink. After 15 minutes the ON light will stop blinking and glows steady.

The data display screen will show:

ZONETEMP - enter temperature of the area being monitored in °C. The zone is the area where the monitor is being operated, rather than the temperature of the commodity undergoing fumigation

The factory default temperature setting is 25 °C.



If the monitor is turned off at any time during operation, the monitor will run through an entire 15 minute WARM UP cycle, regardless of how long the monitor has been running.

After the warm up period, the Data Display Screen will read either MEASURE or PURGE in the upper left corner of the screen.

MEASURE indicates the monitor is actively measuring gas. The measurement is shown in the lower section of the screen. The monitor measures up to 240 g/m<sup>3</sup> with a sensitivity of 0.16g/m<sup>3</sup>.

The measurement (reading) should stabilize (stop) before recording the reading. This may take one or more purge cycles depending on the length of the gas sample line.

## Equipment

Infrared Spectroscopy Gas Monitoring Device

---

The measurement cycle will run for 4 minutes before the purge cycle begins. When the display shows "PURGE", the monitor is resetting its infrared detector to baseline. The PURGE cycle runs for 10 seconds.

A zero reading indicates the concentration measured is below the lower limit of detection of 0.77g/m<sup>3</sup> (200ppm approximately).



If kinks or obstructions occur in the line, the monitor may not function properly.

Check for crimped sampling lines. Make sure nothing is restricting the flow of either the inlet sample air, purge air, or the exhaust (return sample line).

## Calibration and Service

Return the Spectros to the manufacturer every 6 months for a calibration check and service. Contact Spectros to obtain a Service Request Form and Return Materials Authorization Number (RMA). Ship the unit using an insured carrier.

## Contact Information

### Spectros

Spectros Instruments, Inc.  
4 Evergreen Lane, #12A  
Hopedale, MA 01747  
Phone: 508-478-1648  
FAX: 508-478-1652  
Website: [www.spectrosinstruments.com](http://www.spectrosinstruments.com)  
Email: [info@spectrosinstruments.com](mailto:info@spectrosinstruments.com)

### Treatment Quality Assurance Unit

USDA-APHIS-PPQ-CPHST  
Treatment Quality Assurance Unit  
1730 Varsity Drive  
Suite 400  
Raleigh, NC 27606  
Phone: 919-855-7450  
FAX: 919-855-7493  
Email: [cphst.tqau@aphis.usda.gov](mailto:cphst.tqau@aphis.usda.gov)



## Respiratory Protection

Fumigation or other treatments conducted under the monitored conditions stated in this manual and other program manuals, are safe operations. The Occupational Safety and Health Administration (OSHA) has ruled that employees with possible exposure to pesticides (including fumigants) shall be provided adequate respiratory protection from such exposure. This section discusses the types, capabilities, limitations, and uses of different respiratory protection available.

### Responsibility

#### Management's Responsibilities

1. Provide respiratory protective equipment when such equipment is necessary to protect the health of the individual.
2. Provide equipment that is applicable and suitable for the purpose intended.
3. Establish a maintenance program for respiratory devices used.
4. Initiate and maintain a regular training program to inform personnel of basic and current information.

#### Officer's Responsibilities

1. Use and maintain respiratory equipment in accordance with instructions written in this manual and other instructions issued.
  - A. Adherence or nonadherence to prescribed instructions for the proper use of protective devices and equipment will be a factor in evaluating the quality of an employee's performance.
  - B. Gross disregard for safety measures may result in disciplinary action.
  - C. Proper respiratory protection unit is required at the treatment site.
2. Report any damage or malfunction of the device to management.
3. Carry out routine cleaning and care in accordance with instructions in this manual or instructions provided by the manufacturer.

**TABLE 8-1-1: Threshold Limit Values of Fumigants**

Toxicity	Threshold limit value
Methyl bromide (MB)	5 ppm (skin)* STEL** and ceiling
Sulfuryl fluoride (SF)	10 ppm STEL**; 5 ppm TWA***
Phosphine (PH)	1 ppm STEL**; 0.3 ppm TWA***

\*Skin means the potential overall exposure includes absorption through the skin and mucous membranes.

\*\*Short term exposure limit

\*\*\*Time-weighted average

### **Fumigants**

Every effort will be made by management and workers to prevent exposing PPQ personnel to atmospheres containing dangerous concentrations of toxic fumigants or other pesticides, or to atmospheres where there is an oxygen deficiency. However, if an emergency situation develops in which personnel may be exposed, use only respiratory protective equipment with a pressure-demand regulator. This equipment includes self-contained breathing apparatus (SCBA), air-supplied respirators, and units combining these two types. (In this manual, the term, "SCBA" may be read to include all three of these types.) Because positive air pressure is maintained in the full face mask at all times, the pressure-demand respirator affords the best protection currently available.

### **Pesticides Other Than Fumigants**

When there is doubt selecting proper respiratory protection in either of the following categories, use the device that offers the best protection. Consulting this manual, the pesticide label, and the supervisor can help determine the most effective respiratory protection.

### **Air Purifying Respirators**

Air purifying respirators using either a full face mask or half face mask are acceptable in areas where concentrations below maximums designated on the canisters can be expected. They may also be used during pesticide application with a pesticide toxicity or concentration known to pose little or no danger when correctly applied.

### **Dust Masks**

Dust masks may be used when particulate matter such as dust, insect scales, aerosol, spray, or other particles are a nuisance and are of low or moderate toxicity.

### **Employee Acceptance**

The wearer's acceptance of respiratory protection depends on facepiece comfort, clear and full vision, device weight, breathing resistance, individual physical condition, and personal preference. If more than one device with the proper facepiece seal is approved for the conditions, then the most comfortable device may be used by the individual. PPQ will use only respiratory protective equipment tested and certified by the National Institute for Occupational Safety and Health (NIOSH) and carrying an approval number prefixed by "TC."

## Capabilities and Limitations

### Self-Contained Breathing Apparatus (SCBA)

Breathing air is carried in a tank by the user. When properly fitted and used according to instructions, the positive pressure-demand system will prevent harmful contaminants from entering and will provide breathing air in low oxygen areas. A warning device indicates when the air supply is low and allows adequate time to leave the area. The individual must know that only 5 to 7 minutes of air remain at the alarm and that a proper evacuation route must be planned in advance. Test each unit to determine the time remaining at the sound of the alarm.

### Limitations

The time that the device will provide respiratory protection is limited by the amount of air in the tank. Rapid breathing due to stress will use the air supply more quickly. There is no protection against skin irritation from toxic gases with the self-contained breathing apparatus. Because some chemicals such as HCN or pesticide groups like the organo-phosphates can be absorbed through the skin, avoid splashes of liquid fumigants or other pesticides and wear protective clothing to protect against accidental exposure.

### Gas- and Vapor-Removing Respirators

Canisters and cartridges can be used as protection from most pesticides *other than fumigants*. Select the type of canister for a specific gas or vapor or combinations of gases or vapors. Canisters and cartridges have the advantage of being small, light, and simple in operation.

### Limitations

Canisters and cartridges are not effective in oxygen-deficient atmospheres. There is no protection from skin irritations or pesticide absorption through the skin. The capacity of the cartridge or canister determines the maximum contaminant concentration against which a purifying respirator will protect. The maximum concentration for which a canister is designed is printed on the label. Cartridges do not have this information. Unless specified on the canister or cartridge label, no protection is provided against particulate contaminants.

The unit will not provide full protection unless the facepiece is carefully fitted to the wearer's face. Protection is provided dependent on the canister- or cartridge-type concentration of the contaminant and the wearer's respiratory rate.

A rise in canister or cartridge temperature indicates that a gas or vapor is being removed from the inspired air. However, do not rely on this characteristic as an indicator of canister performance. An uncomfortably high canister temperature usually indicates a high concentration of gas or vapor and requires an immediate return to fresh air.

## **Particulate-Removing Respirators**

Particulate-removing respirators can be used only to protect against nonvolatile particles. Unless a special combination filter and chemical cartridge (canister) system is used, no protection is afforded against gases and vapors. When retained particles plug the filter or cartridge, breathing becomes difficult and the filter or cartridge must be replaced. Combination respirators using both chemical and mechanical filtering systems are used for dual or multiple exposures to dust and vapors. Normally, filters used for removing dust, mist, or other particulates plug up before the chemical cartridge is exhausted. Replace both filter and chemical cartridge at the same time.

### **Respiratory Protection Selection**

Work time, including the time necessary to enter or leave a contaminated area, determines the length of time for which respiratory protection is needed. Selecting respirators must be based on all hazards to which the wearer may be exposed.

The only unit with an adequate warning device is the SCBA. The SCBA is equipped with a pressure gauge and audible alarm device. Canisters may have a window indicator that indicates only the presence of moisture. Because canister and cartridge respirators have no indication of remaining service life, replace used canisters and cartridges after each use.

The more active the wearer is, the more rapid his or her breathing. This rapid breathing shortens the usable working time of all types of respirators. High breathing resistance of air-purifying respirators under conditions of heavy work can result in distressed breathing.

### **Respirator Protection Use**

Every effort will be made to avoid the need for respirators. The supervisor issuing respirators must be adequately trained to ensure the correct respirator is issued for each type of possible pesticide exposure. Unless more rigid standards are specified by PPQ, follow pesticide labels regarding respirator use.

If a PPQ Officer will use a respirator, the supervisor must ensure a physician or other licensed health care professional apply one or more of the following tests to determine the officer's fitness to use a respirator:

- ◆ Chest x-ray
- ◆ EKG (Echocardiogram)
- ◆ Examination of nasal passages
- ◆ Pulmonary function test

Any such examination should be requested and reported as outlined in Section 7.2.8 of the Animal and Plant Health Inspection Service (APHIS) Safety and Health Manual. Use APHIS Form 29 for this purpose. Only a physician or other licensed health care professional can judge whether an officer is physically able to wear a respirator.

Supervisors must ensure employees who use respirators complete a medical review every two years, or more frequently if there is a significant change in the medical or physical condition of the officer. Procedures for conducting this review are outlined in Change No. 5 of the APHIS Safety and Health Manual, **dated 2/7/86**.

### **Use in Dangerous Atmospheres**

For situations in which employees may be overcome by a toxic or oxygen-deficient atmosphere, at least one additional person qualified in using respirators (such as the commercial applicator) must be present. The commercial applicator and the employee should cooperate to limit the likelihood of exposure to both individuals at one time. To prevent exposure to any individual at a treatment site, all precautions must be followed. Should exposure occur and an employee be overcome by a toxic atmosphere, do not attempt rescue without the SCBA.

### **Facepiece Fitting**

All respirator or SCBA wearers must receive prior fitting instructions from their supervisors, fumigation trainers, or others experienced in these procedures. By demonstrations and practice, the wearer will know how to wear the respirator, how to make adjustments, and how to determine correct fit.

The same individual fit can vary over time due to weight loss or gain, hair, and scars. Supervisors will schedule periodic fittings to ensure officers are diligent in observing these conditions. With ideal wearing conditions, leakage may be as low as one percent. The wearer must check facepiece fit according to manufacturer's facepiece fitting instructions each time respiratory protection is worn.

Inward leakage is one of the most important considerations in selecting a facepiece. Because conditions such as beard growth, sideburns, a skull cap that projects under the facepiece, temple pieces of eyeglasses, or the absence of one or both dentures can prevent obtaining an effective face seal, these conditions must be corrected so an effective seal can be obtained. Having a clean shaven area for an effective seal, removal or repositioning of a skull cap, using an eyeglass adapter kit (contact lenses cannot be worn during fumigations), or inserting dentures are some ways to correct these conditions. Long sideburns, beards, and other facial hair in the sealing area prevents an effective seal even for positive pressure masks, and is in violation of the Occupational Safety and Health

Administration (OSHA) regulations. Because the presence of facial hair in the sealing area is in direct violation of the OSHA regulations and also creates a significant safety hazard for the employees and their coworkers, cleanly shave the sealing area of the face to permit an effective seal. All supervisors and employees must be advised of this policy.



The proper seal can also be attained with a hooded pressure demand SCBA designed to fit over beards and glasses, such as Survivair's Puma™, which is NIOSH-certified and OSHA-compliant.

All personnel assigned fumigation and/or pesticide duties wear SCBAs during critical portions of treatment procedures and must not have any condition(s) that prevent obtaining an effective face seal. Individual face masks, available in small, medium, and large sizes, will be assigned.

### **Facepiece Fit Tests**

By following the manufacturer's facepiece-fitting instructions, examine the facepiece fit each time the respiratory protection is used. Two simple field tests are described below.

#### **Negative Pressure Test**

Close off the inlet opening of the facepiece or the canister or cartridges by covering with the palm of the hand(s). Gently inhale so the facepiece slightly collapses and hold your breath for 10 seconds. If the facepiece remains in a slightly collapsed condition and no inward air leakage is detected, the tightness of the respirator is probably satisfactory.

Also, detect leakage by crushing an ampoule of isoamyl acetate and passing it one to two inches around the seal area and exhalation valve. In this case, leakage will be noted by a "banana-like" odor in the facepiece. (See Isoamyl acetate in Appendix H, Reference Guide to Commercial Suppliers of Treatment and Related Safety Equipment.)

#### **Positive Pressure Test**

Close the exhalation valve and exhale gently into the facepiece. The face fit is considered satisfactory if a slightly positive pressure can be built up inside the facepiece without any evidence of outward air leakage along the seal. For most respirators, this method of leak testing requires that the wearer remove the exhalation valve cover, examine it, and then carefully replace it after the test. To prevent affecting the rubber valve, replace the exhalation valve cover the correct way.

### **Corrective Lenses With Full Facepiece**

All facepieces will restrict, to some degree, the wearer's vision. This will increase accident potential. If the temple bars of eyeglasses extend through the sealing edge of the full facepiece, a proper seal cannot be

established. A prescription spectacle kit for respirators is available to correct this problem. All personnel who must wear prescription eyeglasses must use this kit when wearing equipment with a full facepiece.

It is APHIS policy to supply this adapter kit to all personnel requiring one.



Wearing of contact lenses in contaminated atmospheres with a respiratory protection device is prohibited.

### **Eyeglasses With Half Facepiece**

If corrective eyeglasses or goggles are required, they must be worn so as not to affect the fit of the facepiece. Proper equipment selection will minimize or avoid this problem.

### **Use in Low Temperatures**

The use of full facepieces at low temperatures presents problems such as poor visibility and freezing exhalation valves. All full facepieces are designed so the incoming fresh air sweeps over the inside of the lens to reduce fogging. This makes it possible to wear a full facepiece in ordinary room temperatures without severe fogging. Antifog compounds can be used to coat the inside of the lens to prevent fogging at room temperatures and down to temperatures approaching 32°F. However, below 0°F, antifog compounds will not prevent severe fogging.

Although such instances are not usually encountered, the employee should be aware that it is dangerous to work at temperatures near and below freezing when using respirators not designed for such use.

When using air supplied respirators, the high-pressure connections may leak because of metal contraction at low temperatures. Because they may break when temperatures return to normal, it is important to remember that high-pressure connections should not be overtightened.

### **Communications**

The conventional respirator exhalation valve will provide a pathway for some speech transmission over short distances in relatively quiet areas. Talking can induce facepiece or component leakage and, therefore, should be limited while wearing a respirator, especially those wearing half-facepieces.

## Maintenance and Care

To retain its effectiveness, properly maintain equipment. A program for maintenance and care include the following basic services:

- ◆ Cleaning and disinfecting
- ◆ Inspection for defects (including leak checks)
- ◆ Repairs
- ◆ Respirable air for self-contained breathing apparatus
- ◆ Storage

## Cleaning and Disinfecting

To ensure proper protection is provided for the wearer, routinely clean and disinfect used equipment after each use and those not routinely used as necessary. The following is recommended for cleaning and disinfecting respiratory protection devices.

1. Remove any filters, cartridges, or canisters.
2. Wash facepiece and breathing tube with a cleaner-disinfectant or detergent solution (see following paragraphs); use a hand brush to facilitate removal of dirt.
3. Rinse completely in clean, warm water.
4. Air dry in a clean area.
5. Clean other parts as recommended by manufacturer.
6. Inspect valves, headstraps, and other parts; replace with new parts when defective.
  - A. Stretching and manipulating rubber elastomer parts with a massaging action will keep them pliable and flexible and prevent them from warping or sticking during storage.
7. Insert new filter, cartridge, or canister in the unit; ensure seal is tight.

Cleaner-disinfectant solutions containing a bactericidal agent (generally a quaternary ammonium compound) are available.

To obtain the proper solution, use commercial products according to the label. However, different concentrations of the quaternary ammonium salt are required for various hardness of water to obtain a satisfactory disinfectant solution. Dermatitis can occur if the quaternary ammonium compounds are not completely rinsed from the facepiece and associated parts.

Strong cleaning and disinfecting can damage parts. Avoid temperatures above 120°F and vigorous mechanical agitation. Solvents that affect elastomer or rubber parts must be used with caution.



Respiratory protective equipment can be contaminated with toxic materials such as organo-phosphates or other pesticides. If the contamination is light, normal cleaning procedures should provide satisfactory decontamination. If contamination is heavy, a separate decontamination step may be required before cleaning. For complete decontamination of phosphate pesticide residues, wash with alkaline soap, rinse with clean warm water, and then rinse with 50 percent alcohol (ethyl or isopropyl).

If commercial materials are not available, respiratory equipment may be washed in a liquid detergent solution, then immersed in one of the following:

- ◆ Sodium hypochlorite solution (50 parts per million of chlorine) for 2 minutes; **OR**
- ◆ Aqueous iodine solution (50 parts per million of iodine) for 2 minutes; **OR**
- ◆ Quaternary ammonium solution with 200 parts per million of quaternary ammonium compounds in water of less than 500 parts per million total hardness (see Quaternary Ammonium in Appendix H, Reference Guide to Commercial Suppliers of Treatment and Related Safety Equipment)

The sodium hypochlorite and iodine solutions are not stable. Prepare fresh solution for each use. These solutions age rubber parts and are corrosive to metallic parts, therefore, do not extend immersion times and thoroughly rinse the disinfectants from all parts with clean, warm water.

### **Inspection for Defects (Including Leak Checks)**

The user must inspect the respiratory equipment before and after each use. Respiratory equipment that is not routinely used, but is kept ready for emergency use, must be inspected at least monthly to ensure it is in satisfactory working condition. SCBA air cylinders must be fully charged according to the manufacturer's instructions.

Inspection must include the following.

1. Examine the tightness of connections.
2. Examine the condition of the facepiece, headbands, valves, connecting tube, and any canisters or cartridges.
3. Examine rubber or other elastic parts for pliability and signs of deterioration.
4. Examine the regulator and the warning device to determine proper functioning before each use.
5. Examine for leaks.

Keep a record of inspection dates and findings in the unit carrying case.

### **Repairs**

Only experienced persons should handle replacements or repairs using only those parts specifically designed for the equipment. Make no attempt to replace components or to make adjustments or repairs beyond the manufacturer's recommendations. Send reducing or inlet valves and regulators to the manufacturer or to a trained technician for adjustment or repair.

### **Respirable Air for Self-Contained Breathing Apparatus**

Compressed air must be of high purity. Breathing air must meet the requirements for Grade D breathing air as described in Compressed Gas Association Commodity Specification G-7.1-1966. Air tanks can be refilled at most SCUBA diving stores or where local fire departments or rescue squads obtain air for their units. Test data denoting the quality of the compressed air should be available from the air supplier.

There is no need to change the air in the units, even after extended periods of time.



**Never** use compressed oxygen! (Compressed air may contain a low concentration of oil. When high-pressure oxygen passes through an oil or grease-coated orifice, an explosion or fire may occur.)

Have breathing air cylinders inspected and hydrostatically tested as required by the type of cylinder being used. Refer to the manufacturer's recommendations and comply with the Department of Transportation (DOT) or Interstate Commerce Commission Specifications for shipping containers.

Breathing air cylinders must be marked in accordance with American National Standard Method of Marking Portable Compressed Gas Containers to Identify the Material Contained.

### **Storage**

After inspection, cleaning, and necessary repair, store equipment to protect against dust, sunlight, heat, extreme cold, excessive moisture, or damaging chemicals. Store respiratory equipment located at stations and work areas for emergency use in compartments built for that purpose. The compartments should be clearly marked and quickly accessible at all times. Under no circumstances shall a motor vehicle be used for respiratory protective equipment storage. The excessive and uncontrollable changes in temperature are bad for this equipment.

Routinely used respirators, such as dust respirators, may be placed in resealable plastic bags or heat-sealed plastic. Do not store respirators in such places as lockers or toolboxes unless they are in carrying cases or cartons and plainly marked. To prevent function impairment by the elastomer taking a permanent set in an abnormal position, pack or store respirators so the facepiece and exhalation valve will rest in a normal position. It is advisable to rotate the respirator face up, or face down at monthly inspections. Instructions for proper emergency respirators, or self-contained breathing apparatus storage are found in “use and care” instructions usually mounted inside the carrying case lid. Should the case not have such instructions, obtain them from the manufacturer and place in the case cover.

---

## **Detector Kits or Gas Samples**

Although thermal conductivity (T/C) and infrared spectroscopy units are used to measure concentrations of MB and SF in ounces per 1,000 cubic feet (milligrams per liter), concentrations of phosphine and some other fumigants cannot be measured with these units. However, they may be measured with detector tubes. Residual gas concentrations during commodities or enclosures aeration can also be determined for most fumigants with detector tubes.

### **Principles of Operations**

Special pumps are used to draw a measured sample (usually 100 milliliters) of an air-gas mixture. The sample is drawn through 1 or 2 detector tubes where a chemical reaction with the tube reagent takes place, creating a stain. The length of the stain is proportional to the concentration of the gas. Measure the length of the stain by using a calibrated chart or by simply reading the number from a scale printed on the glass tube.

Gas detector tubes are manufactured with a constant reagent weight with corrections for variations in the diameter of each tube. Detailed operational instructions accompany the equipment.

The detector tubes are specific for each fumigant and are usually available from several manufacturers. However, it is advisable to use the pump supplied by the manufacturer of the tube used. In an emergency, detector tubes available under the trade names Auer, Draeger, Gastec, Kitagawa, and Mine Safety Appliances can be used with pumps manufactured by any of these companies provided they draw 100 milliliters. Because of the different diameters of the tubes sold by each manufacturer, adapters may be necessary. The Kitagawa pump uses a removable, stainless-steel micro-orifice to reduce the rate

## Equipment

### Detector Kits or Gas Samples

---

of air flow through many of its detector tubes. This provides greater accuracy in the chemical reaction within the tube. Remove the orifice when using tubes manufactured by other companies.

To increase shelf life, store tubes under refrigeration. Before each day's use, test pumps as provided by instructions with each kit and make repairs as necessary. Keep spare parts and operational instructions with each kit for use as needed.

When many samples must be drawn to a common point during a large fumigation, an auxiliary pump can be used. If only one sample lead is involved, it may be necessary to pull the fumigant through the line by pumping several times. A used tube can be inserted in the pump to determine when the fumigant has reached the pump.

## Volatilizer

Methyl bromide must pass through a volatilizer (vaporizer) to ensure adequate conversion of liquid MB to gaseous MB. The volatilized fumigant should be introduced into or near the air flow of the gas introduction fan. When 5 pounds or less of MB are used, a simple volatilizer can be made with a 25-foot coil of 3/8 inch O.D. (outer diameter) coiled copper tubing immersed in a container of hot water.

When amounts greater than 5 pounds are to be used, the copper tubing used in the volatilizer must consist of a minimum of 50 feet of 1/2 inch O.D. coiled copper tubing immersed in a container of hot water.

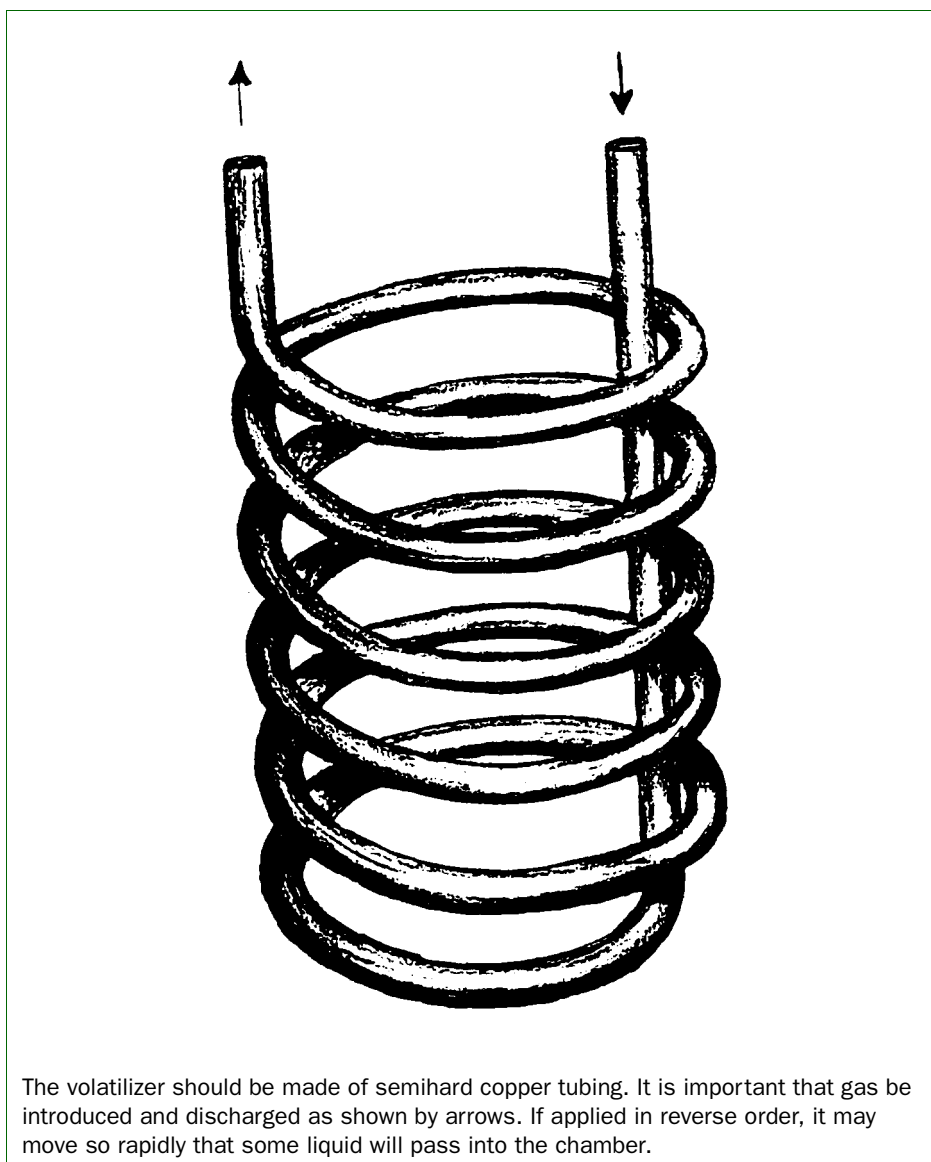

**FIGURE 8-1-4: Methyl Bromide Volatilizer Coil**

The water in all sizes of volatilizers must be heated to temperatures of 200°F or above with a minimum of 150°F during the gas introduction process. A calibrated thermometer must be used to determine the water temperature. The thermometer must be calibrated once per year by an approved calibration company or by the fumigator under the supervision of PPQ. Written documentation of calibration must be present at the time of fumigation.

The line that runs from the MB cylinder to the copper tubing in the volatilizer must be a 3000 PSI hydraulic high pressure hose with a 3/8 inch diameter ID (inner diameter) or larger. The line that exits the volatilizer and runs into the enclosure must be a 350 PSI tubing with a 1/2 inch diameter ID or greater.

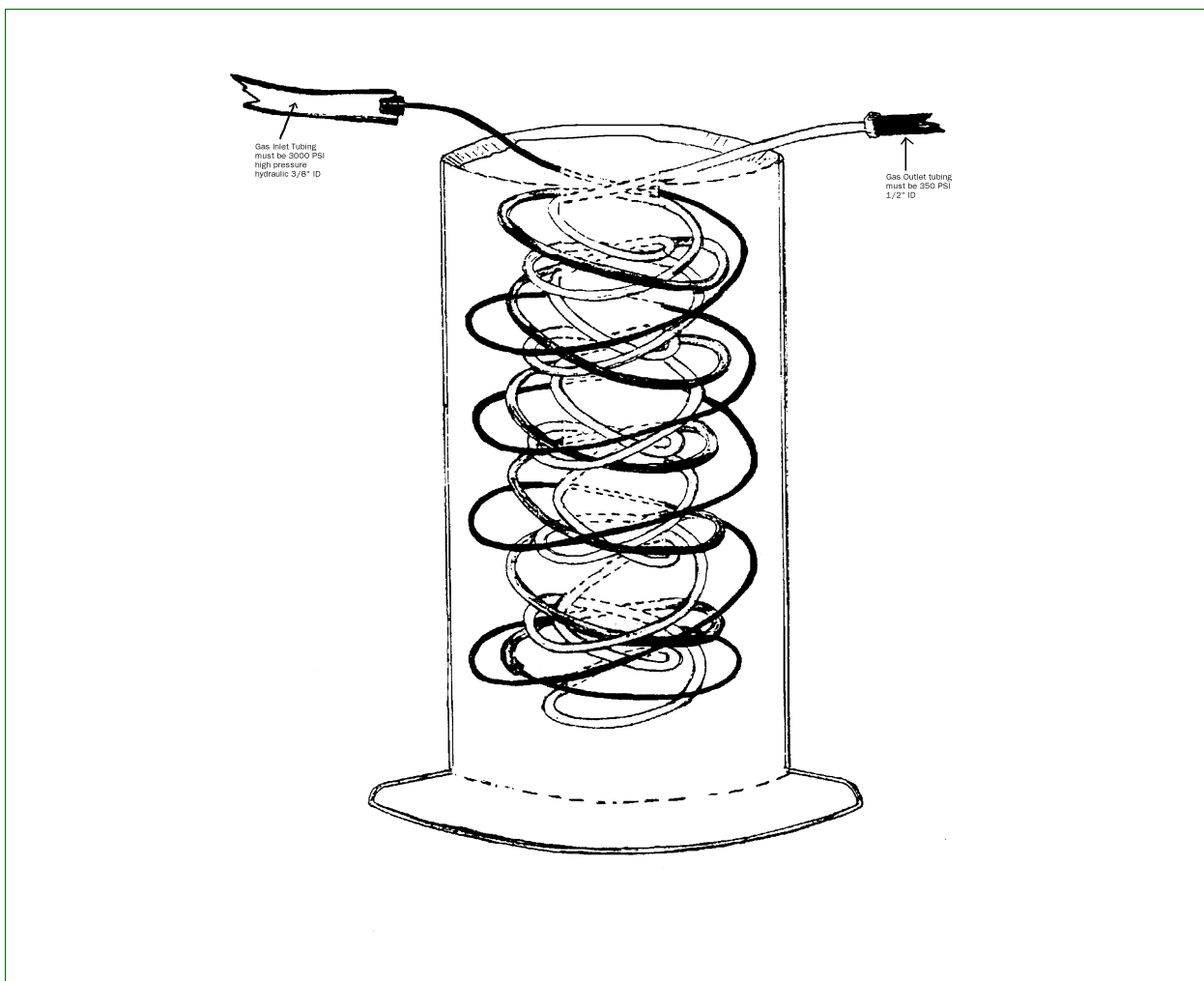

**FIGURE 8-1-5: Tubing Specifications**

The fumigant should be introduced through the tubing at the rate of 3 to 4 pounds of gas per minute. The gas introduction tube should feel hot to the touch as a good measure of satisfactory vaporization.

## Air Velocity Measuring Instruments

### Anemometer

Anemometers (wind meters) are used for measuring the air velocity of circulation fans and air curtains. Wind meters must be approved by the Treatment Quality Assurance Unit (TQAU). Submit specifications of unapproved wind meters to TQAU for approval.

### Fan Velocity

The cubic feet per minute (cfm) of a fan can be measured by placing the anemometer 12 inches from the face of the fan to be tested. Take a minimum of 3 readings; 1 from the center and the others from points toward the outside of the fan. Average the readings. If an anemometer is used, each measurement should be for 1 minute, thereby giving the result in feet per minute. If a wind speed indicator is used, the reading in miles per hour should be converted to feet per minute by multiplying the miles per hour by 5,280 and dividing by 60.

Area of the fan is calculated by first measuring the radius (R)—distance from the center of the fan to the end of a blade. Formula for area is  $\text{Pi} \times R^2$  where Pi is equivalent to 3.1416 (22/7). The final answer should be given in cfm. Therefore, if the radius of the blade is given in inches and not feet, the factor 1/144 must be multiplied in to convert square inches to square feet. The full formula would be: Feet per minute  $\times R^2$  (in inches)  $\times 3.14 \times 1/144 = \text{cfm}$ .

**EXAMPLE:** If average air movement is 1,600 feet for 1 minute from a fan having a 7 inch radius (14 inch diameter), the calculations are as follows:

$$1,600 \times 7^2 \times 3.1416 \times 1/144 = 1,700 \text{ cfm (approximate)}$$

### Velometer®

The Velometer® is one approved anemometer that can be used to measure fan velocity. It is manufactured by TSI Inc., Alnor Products. Take readings by either holding the instrument itself or jets (probes) in front of the air stream. Velocities are rapidly determined in units of feet per minute without timing or calculations.

### Air Curtain Velocity

The velocity of air curtains is also measured with an anemometer. Anemometers used in this capacity must meet the following specifications:

- ◆ Hand held
- ◆ Digital
- ◆ +/- 3% accuracy
- ◆ Minimum operating speed of 0.4 m/s

- ◆ Record in at least one of the following units with the resolution in parenthesis:
  - ❖ m/s (0.1)
  - ❖ ft/min (1)
  - ❖ km/h (0.1)
  - ❖ mph (1)
  - ❖ knots (0.1)
  - ❖ Beaufort (0.1)
- ◆ CE certified with a certificate of conformity
- ◆ Tested to NIST-Traceable standards with a written certificate of tests
- ◆ Calibrated once a year to NIST calibration and certification

### **Kestrel® Pock Wind Meter**

All models of Kestrel® Pocket Wind Meters are approved for use by TQAU. Refer to Appendix H for ordering information.

---

## **Auxiliary Pump**

During large-enclosure fumigations, it is necessary to take numerous gas concentration readings from various locations throughout the enclosure. Thus, some sample leads may be over 200 feet long. Pump the fumigant to the sampling point before making an accurate concentration reading using an auxiliary pump. If the inspector must rely on the pump provided with the gas sampler to pull the fumigant, a great deal of time may be needed between readings.

Because it pumps the fumigant from many areas and keeps a constant pull, the auxiliary pump will reduce sampling time to only the reading time. Constructing a unit is relatively simple. Petcocks capable of accepting sample leads are tapped and soldered to a short length of pipe. This pipe is connected to the suction side of the pump. The pipe acts as a manifold. Opening or closing the petcocks allows the gas samples to be drawn as required. Connect an exhaust line of sufficient length to the pump to ensure the fumigant is removed from the sample area.

It is important that all soldering be done in such a manner as to provide gastight construction of the petcocks. The pump should be of sufficient size to pull one cubic foot per minute through all of the leads on the manifold. Therefore, the more leads, the higher the required capacity of the pump. Mount the whole unit on a board large enough to keep vibration to a minimum. Keep the unit weight down to allow easy transport.



Disconnect each sampling line from the auxiliary pump in turn, and close the petcock. Attach the line to the gas detector. Obtain a reading and reconnect the line to the auxiliary pump and open the petcock.

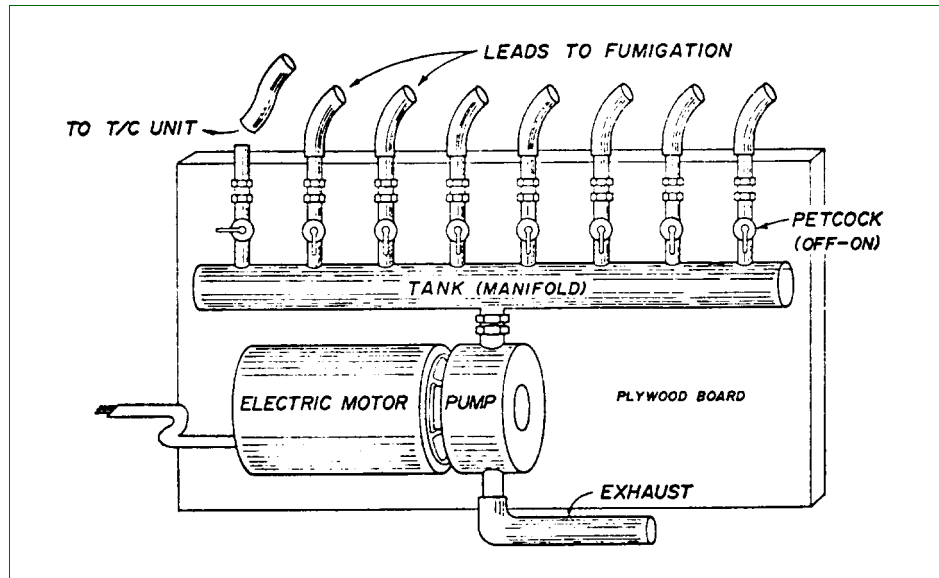

FIGURE 8-1-6: Auxiliary Pump

## Open-Arm Manometer

This information has been extracted from the following web site <http://www.dwyer-inst.com/htdocs/pressure/ManometerIntroduction.cfm>

A manometer is used during a leakage test of a fumigation chamber and is a device used to measure pressure. Pressure is defined as a force per unit area. The most accurate way to measure low air pressure is to balance a column of liquid of known weight against it and measure the height of the liquid column so balanced. The units of measure commonly used are inches of mercury (in. Hg), using mercury as the fluid and inches of water (in. w.c.), using water or oil as the fluid.

A simple manometer is typically a U-shaped tube partially filled with liquid. The tube may be of glass or transparent plastic tubing. A ruler calibrated in millimeter (mm) divisions or carefully measured lines on a background is used to measure the difference in level of the liquid in the two arms (or the level in one arm).

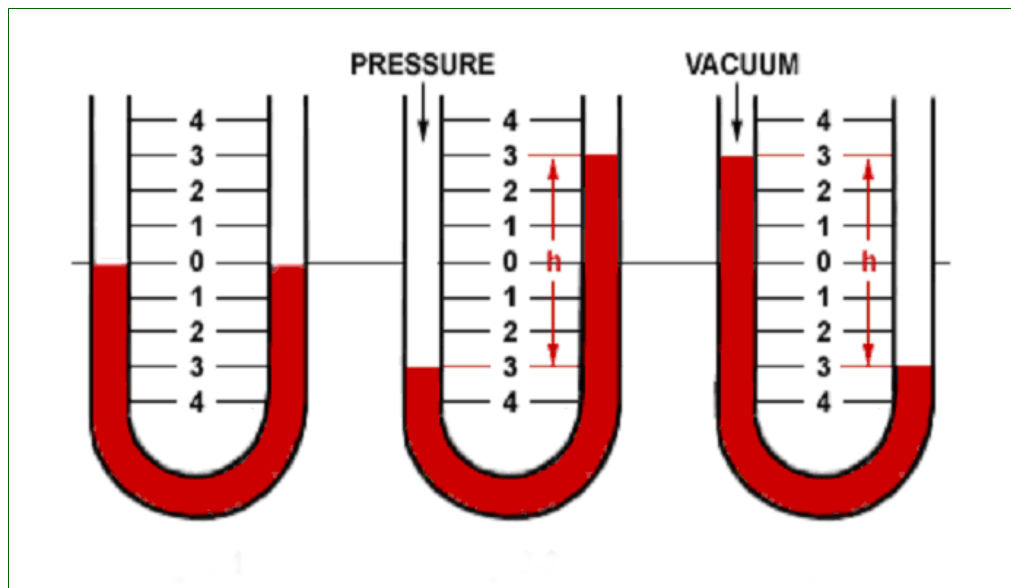

**FIGURE 8-1-7: Example of Pressure Measurement in an Open-arm Manometer**

As displayed by the middle picture in Figure 8-1-5, when positive pressure is applied to one arm, the liquid is forced down in that arm and up in the other. The difference in height, "h," which is the sum of the readings above and below zero, indicates the pressure.

The picture of the manometer on the right in Figure 8-1-5 shows that when a vacuum is applied to one arm, the liquid rises in that arm and falls in the other. The difference in height, "h," which is the sum of the readings above and below zero, indicates the amount of vacuum.

No manometer can be read more accurately than the accuracy with which the specific gravity of the liquid inside the manometer is known. The liquid must also have good "wetting" characteristics and be capable of forming a consistent, well shaped meniscus in the indicating tube to facilitate accurate, repeatable readings.

The liquid used also affects the operating range of the manometer. Mercury being 13.6 times the weight of water will move 1/13.6th the distance water will move in response to a given pressure. Red gage oil, having a specific gravity of .826, which is lighter than water, will move about 1.2 times farther than water in response to a given pressure. This, obviously, expands the scale for easier, more precise reading.

Red gage oil is a stable petroleum base oil with carefully controlled specific gravity which gives an excellent, consistent high visibility meniscus. Manometers for use with water are furnished with a fluorescent green concentrate which when added to water serves as a setting agent and a dye to improve the consistency and visibility of the meniscus for easier more accurate readability. Because of increased accuracy and consistency, CPHST recommends the use of red gage oil manometers.

### **Operating Procedures**

When a fumigant is volatilized in a chamber at atmospheric pressure, a positive pressure is created, which may then be continuously reduced by leakage of the air-fumigant mixture. PPQ-approved chambers must be sufficiently tight to retain the fumigant during the exposure period. The manometer is used during the pressure leakage test for NAP chamber certification and the vacuum leakage test for vacuum chamber certification. (See "**Pressure-Leakage Test for NAP Fumigation Chambers**" on **page-6-3-4** and **Certification Standards** on **page 6-2-3** for detailed descriptions of the certification processes.)

## Equipment

### Open-Arm Manometer

---

Use the following example for the most accurate way to determine the pressure measurement from a manometer.

**EXAMPLE:** Referencing Figure 8-1-6, the left arm of the open-arm manometer measures 8 mm below zero. The right arm measures 7 above zero. The sum of the two measurements equals 15 mm. Therefore, in this example, 15 mm is the actual reading.

---

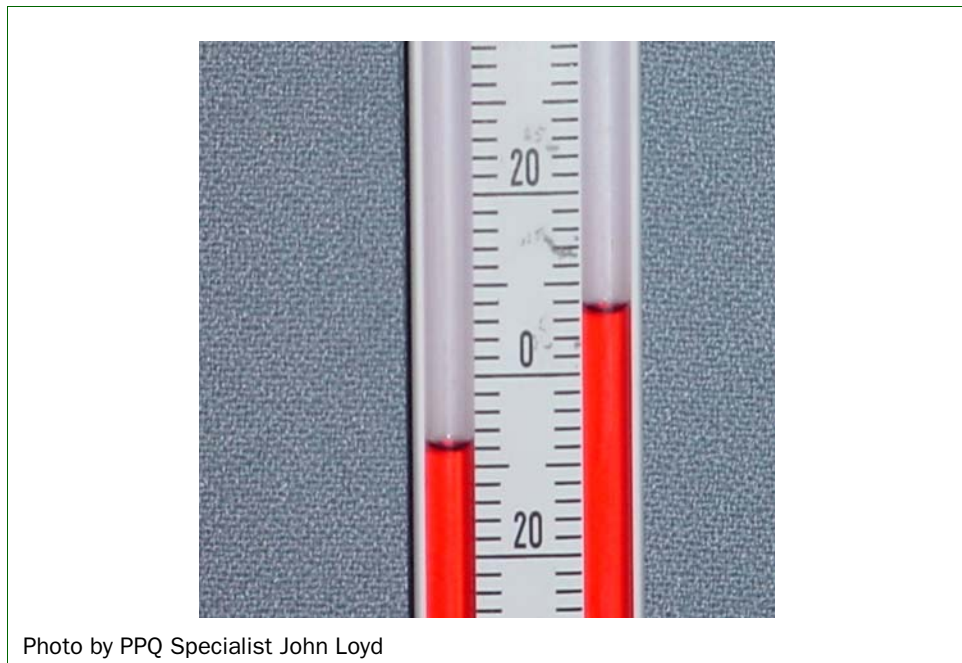

**FIGURE 8-1-8: Example of U Tube Manometer**

## Mityvac Hand-held Vacuum Pump

The Center for Plant Health Science and Technology (CPHST) has developed the following procedure to detect blocked monitoring leads by using a Mityvac hand-held vacuum pump (for supplier, see [Vacuum Pump](#) on [page H-1-65](#)).

### Usage

1. Prior to introducing fumigant, connect the Mityvac hand-held vacuum pump to a monitoring lead.
2. Squeeze the handle on the Mityvac Unit; if the lead is blocked, a vacuum will be indicated on the vacuum gauge of the Mityvac unit (squeeze the handle 2 or 3 times for monitoring leads longer than 25 feet; the Mityvac hand-held pump has the capacity to attain and hold 25 inches of Hg vacuum and a minimum of 7 psi pressure).
3. Disconnect the Mityvac hand-held pump from the monitoring lead, and repeat this procedure for each monitoring lead (connect monitoring leads to the gas analyzer prior to fumigant introduction).

---

## Phosphine Detector

### PortaSens Phosphine Detector

#### Description

Historically, measuring phosphine has been done using detector tubes specific for phosphine (see [Detector Kits or Gas Samples](#) on [page 8-1-23](#)). The high cost associated with these tubes has been a deterrent for many ports.

A more accurate, portable unit has been recommended for use during phosphine fumigations. The Series B16 PortaSens is a portable, battery-operated instrument for measuring various gas concentrations in ambient air. The instrument can be ordered specifically for phosphine in the 0 to 1,000 ppm range. Ranges from 0 to 1 ppm are available also, along with other configurations. The PortaSens is a complete measuring instrument containing an electrochemical sensor, sampling pump, flow cell assembly, microprocessor electronics, and a two-line, backlit LCD display. The unit is powered by a rechargeable NiCad battery located in the handle, with the charger connection located at the bottom of the handle.

#### Operation

The PortaSens needs to be calibrated by the Center for Plant Health Science & Technology (CPHST) before use. After calibration, the instrument is ready to use directly out of the box. Simply remove the instrument from the storage case and press and release the button

(instrument switch) on the front of the handle. The LCD display on the front will immediately be activated and the internal pump will begin to pull sample into the flow cell.

The unit comes with a flexible extension wand that screws into the standard inlet fitting. Connect the extension wand and a length of flexible tubing that will reach safely from the item(s) being fumigated to the PortaSens.

### **Response Time**

Response time will vary depending on the gas concentration and ambient temperature. The LCD readout will stabilize when maximum concentration is reached. Readings will be more timely when the monitoring leads are purged using the Mityvac hand-held vacuum pump (refer to *Mityvac Hand-held Vacuum Pump* on **page 8-1-33**).

### **Alarm Function**

The PortaSens contains both visual and audible gas concentration alarm functions that are preset at the factory. Refer to B16 PortaSens Operation and Maintenance Manual for specific instructions. For instruments in the 0 to 1,000 ppm range, the alarm has been disabled to allow for more efficient use.

### **Battery Power Supply**

The instrument is powered by a rechargeable NiCad battery. With a fully charged battery, the unit will continuously operate for 12 hours at 20°C. Battery capacity will drop with decreasing temperature. Should the battery become weak during operation, the lower line of the LCD display will indicate "LOW BATT." An audible beeper will begin to sound. At this point, there will be 1 hour of operating time left. When the voltage reaches a level where reliable measurements are no longer possible, the unit will turn itself off. If emergency use is anticipated, it is good practice to leave the instrument on charge at all times.

### **Flow Verification**

#### **Verify proper flow before using the PortaSens for leak detection.**

When the unit is turned on, a pump continuously delivers an air sample to the flow cell. In normal operation, the flow rate is approximately 300 cc/min. In order to allow quick verification of proper flow, a flowmeter is included in the PortaSens kit. Turn the instrument on and connect the sampling wand. Place the tip of the sampling wand into the tubing adapter attached to the flowmeter. Hold the flowmeter in the vertical position and verify that the flow rate is above 150 cc/min.

### **Power Down**

In order to turn the unit off, press and hold the switch for approximately three seconds, until the "POWER DOWN" message appears on the display and then release.

## Photo Ionization Detector

The Photo Ionization Detector (PID) is a portable vapor and gas detector that detects a variety of organic compounds. For methyl bromide, the PID has been used both as a leak detector to locate fumigant leakage around chambers, application equipment, temporary enclosures, and as a safety device around fumigation sites.

### Principles of Operations

The PID is used to indicate the presence and approximate concentration of methyl bromide or other volatile organic compounds (VOCs) present. This is accomplished by photo ionization that occurs when an atom or molecule absorbs light of sufficient energy to cause an electron to leave and create a positive ion. Because PIDs measure all VOCs, careful attention must be paid to the presence of other VOCs in the air. Other VOCs include but are not limited to cigarette smoke, perfume, soap, and exhaust fumes from vehicles.

### Description

All PIDs have the same basic construction, differing only in detail by the various manufacturers. Each has an ultraviolet lamp that emits photons that are absorbed by the compound in an ionization chamber. Electrodes collect the ions that are produced. The current that is generated provides a measure of the concentration.

### Calibration

PIDs are typically calibrated using isobutylene, a stable gas with a slightly pungent odor. This gas is easy to handle and can be stored at high pressure, allowing calibration bottles to be used for calibrations many times. The PID manufacturer supplies a reference manual that describes calibration procedures and provides a list of correction factors.

For a partial list of manufacturers refer to [Photo Ionization Detector](#) on **page H-1-36**.

---

## Certified Precision Thermometers: Calibration Guidelines

Before a thermometer can be used as a calibration standard, it must meet the following requirements from an approved facility. All calibration facilities must be approved by TQAU, 1730 Varsity Drive, Suite 400, Raleigh, NC 27606 USA.

A list of current approved facilities is located in [Appendix H](#), Section: [Thermometers, Certified Precision, Approved Calibration Companies](#).

## Equipment

### Certified Precision Thermometers: Calibration Guidelines

---

- ◆ Accuracy must be 0.1°C or less for Centigrade thermometer or 0.1 °F or less for Fahrenheit thermometer.
- ◆ Thermometer must be calibrated against standards that are approved by National Institute of Standards and Technology (NIST).
- ◆ The calibration certificate issued by calibration facility lists one to five calibration points, tabulated corrections for each calibration point, serial and test identification number of the NIST standard, and explanatory notes defining the conditions under which the test results were made.
- ◆ The thermometer must be calibrated annually. Thermometers with expired calibration certificates cannot be used in quarantine treatments.
- ◆ ASTM thermometers must have 5 or more calibration points. Non-ASTM (precision) thermometers must have calibration points at the treatment temperature.



# 9

Treatment Manual

## Glossary

### Acronyms, Abbreviations, and Terms

a.i.	active ingredient
ACGIH	American Conference of Governmental Industrial Hygienists
ADI	Acceptable Daily Intake
APHIS	Animal and Plant Health Inspection Service
BBEP	Biotechnology, Biologics, and Environmental Protection
bw	body weight
CAS	Chemical Abstracts Service
cc	cubic centimeters
CERCLA	Comprehensive Environmental Response, Compensation, and Liability Act
ChE	cholinesterase
CHEMTREC	24-hour emergency telephone service for spills
CNS	central nervous system
copra	dried coconuts and whole coconuts without the husk
COR	Contracting Officer's Representative
CPK	creatine phosphokinase
cu.m	cubic meter
CWA	Clean Water Act
DHEW	U.S. Department of Health, Education, and Welfare
DNA	deoxyribonucleic acid
DOT	U.S. Department of Transportation
DW	drinking water
EPA	Environmental Protection Agency
External Feeder	A pest that normally inhabits the outside or outer part of its host. Contrast with hitchhiker and internal feeder.
FAA	Federal Aviation Administration
FIFRA	Federal Insecticide, Fungicide, and Rodenticide Act
g	grams
GI	gastrointestinal
HDT	highest dose tested
Hgb	hemoglobin
HHS	U.S. Department of Health and Human Services
Hitchhiker	A pest transported by chance and not found inhabiting its host. Contrast with external feeder.
i.m.	intramuscular
Internal Feeder	A pest that normally inhabits the inside or inner part of its host. Contrast with external feeder.
i.p.	intraperitoneal

## Glossary

### Acronyms, Abbreviations, and Terms

---

i.v.	intravenous
kg	kilogram
L	liter
LC50	Lethal Concentration 50; dose lethal to 50% of the animals
LCLO	Lethal Concentration Low; the lowest concentration causing death
LD50	Lethal Dose 50; dose lethal to 50% of the animals
LDLO	Lethal Dose Low; the lowest dose at which death occurred
LDT	lowest dose tested
LEL	lower exposure limit, or lowest-effect level
LOAEL	lowest-observed-adverse-effect-level
m	meter
MED	minimum effective dose
mg	milligram
mg/kg	milligrams per kilogram
mg/L	milligrams per liter
mmHg	millimeters of mercury; a measure of pressure
MOE	Margin of Exposure
MOS	Margin of Safety
MSDS	Material Safety Data Sheet
MTD	maximum tolerated dose
MTL	median threshold limit
NFPA	National Fire Prevention Association
ng	nanogram
NIOSH	National Institute for Occupational Safety and Health
NMRAL	National Monitoring and Residue Analysis Laboratory
NOAEL	no-observed-adverse-effect level
NOEL	no-observed-effect level
NTP	National Toxicology Program
OIC	Officer-in-Charge
OSHA	U.S. Occupational Safety and Health Administration
p.o.	per os (by mouth)
PEL	permissible exposure limit
PHS	U.S. Public Health Service
ppb	parts per billion
ppm	parts per million
PPQ	Plant Protection and Quarantine
RBC	red blood cell(s)
RfD	Reference Dose
RfDi	Inhalation Reference Dose
RfDo	Oral Reference Dose
s.c.	subcutaneous
STEL	short-term exposure limit

TLV	threshold limit value
TSS	Technical and Scientific Services
TWA	time-weighted average
UCL	upper confidence limit
UEL	upper exposure limit
UF	uncertainty factor
ug	microgram
ug/cu.	micrograms per cubic meter
ug/L	micrograms per liter
USDA	United States Department of Agriculture

**Glossary**

Acronyms, Abbreviations, and Terms

---



# Appendix A

## Forms

---

### Contents

APHIS Form 2061 (Residue Sample for Food or Feed Product) **page-A-1-2**  
APHIS Form 205-R, Instructions and Worksheet for Calibrating Portable Temperature Sensors **page-A-1-3**  
APHIS Form 206-R, Test of the Accuracy of the Permanent RTD Sensors Installed in Hot Water Tanks **page-A-1-4**  
APHIS Form 207-R, Sensor Location Diagram Fruit Weights and Pulp Temperatures **page-A-1-5**  
APHIS Form 208, Performance Test for Mango Hot Water Immersion Tank Calibration of Temperature Probes (Cold Treatment) **page-A-1-6**  
Location of Temperature Sensors in Containerized Cargo (Cold Treatment) **page-A-1-8**  
PPQ Form 429, Fumigation Record **page-A-1-9**  
PPQ Form 519, Compliance Agreement **page-A-1-14**  
PPQ Form 523, Emergency Action Notification **page-A-1-17**  
PPQ Form 449-R, Temperature Recording Calibration Report **page-A-1-27**  
PPQ Form 203, Foreign Site Certificate of Inspection and/or Treatment **page-A-1-29**  
PPQ Form 556, In Transit Cold Treatment Clearance Report **page-A-1-32**

This Appendix contains example forms and instructions for completing the forms you may need when conducting or monitoring a fumigation.

---

**APHIS Form 2061 (Residue Sample for Food or Feed Product)**

The APHIS Form 2061 has been removed from this manual. Contact the Manuals Unit to obtain a copy and instructions for use.





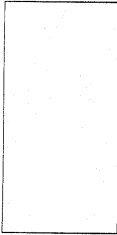
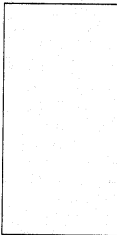
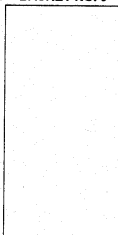
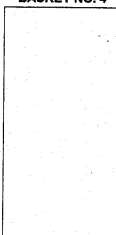
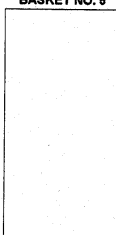

## APHIS Form 207-R, Sensor Location Diagram Fruit Weights and Pulp Temperatures

SENSOR LOCATION DIAGRAM FRUIT WEIGHTS AND PULP TEMPERATURES			USDA-APHIS	1. DATE
2. NAME OF FACILITY		3. TANK NUMBER		4. TEST NUMBER
<b>INSTRUCTIONS</b>				
<p>Show sensor numbers, and their approximate location within each basket. (Use three or four sensors per basket.) Place an asterisk (*) beside fruit pulp sensors. (Use one or two per test.) Indicate, by arrow, the direction of water flow in the tank. (If the tank is of an unusual shape (e.g., round) please use the reverse side of this form to draw a diagram, showing position of baskets and sensors.)</p>				
BASKET NO. 1	BASKET NO. 2	BASKET NO. 3	BASKET NO. 4	BASKET NO. 5
				
5. WEIGHT (g) OF 10 FRUITS SELECTED AT RANDOM		6. WEIGHT (g) OF 6 LARGEST FRUITS	7. FRUIT PULP TEMPERATURES (Taken at random)	8. NET WEIGHT OF A TYPICAL FIELD CRATE OF MANGOES
				9. NUMBER OF FIELD CRATES PER LOADED BASKET
MEAN WT. =		MEAN WT. =	MEAN TEMP. =	
(g)				
10. REMARKS				

APHIS FORM 207-R (OCT 95) (Previous edition is obsolete)

**FIGURE A-1-3: APHIS Form 207-R, Sensor Location Diagram Fruit Weights and Pulp Temperatures**

## APHIS Form 208, Performance Test for Mango Hot Water Immersion Tank

<b>PERFORMANCE TEST FOR MANGO HOT WATER IMMERSION TANK</b>		<small>USDA-APHIS</small>	<small>1. DATE OF TEST</small>
<b>2. NAME OF FACILITY</b>		<b>3. LOCATION</b>	
<b>4. NAME OF FACILITY MANAGER (Type or print)</b>			
<b>5. TELEPHONE NUMBER</b> ( )		<b>6. FAX NUMBER</b> ( )	
<b>7. FRUIT VARIETY</b>		<b>8. STAGE OF RIPENESS</b>	
<b>9. TEMPERATURES AT START OF TEST</b>			
<b>9A. THERMOSTATIC SET POINT</b>	<b>9B. WATER IN THE TANK</b>	<b>9C. FRUIT PULP (Average)</b>	<b>9D. AMBIENT AIR</b>
<b>10. SIGNATURE OF INSPECTOR</b>		<b>11. NAME OF INSPECTOR (Type or print)</b>	
<b>12. NOTES</b>			

BASKET NO.: \_\_\_\_\_ TANK NO.: \_\_\_\_\_ TEST NO.: \_\_\_\_\_

Readings taken at specific times (minutes) before calibration adjustment (if any). Use 1 or 2 pulp sensors per tank. Indicate pulp sensors with an asterisk (\*).

PORTABLE SENSOR NO. <small>(Use at least 3)</small>	CALIBRATION ADJUSTMENT		0-1	1-2	2-3	3-4	5	30	60	75	90
		TIME									
		TEMP.									
		TIME									
		TEMP.									
		TIME									
		TEMP.									
		TIME									
		TEMP.									



## Location of Temperature Sensors in Containerized Cargo (Cold Treatment)

LOCATION OF TEMPERATURE SENSORS IN CONTAINERIZED CARGO

NAME OF VESSEL \_\_\_\_\_

CONTAINER NUMBER \_\_\_\_\_

PROBE 1 \_\_\_\_\_  
\_\_\_\_\_  
\_\_\_\_\_

PROBE 2 \_\_\_\_\_  
\_\_\_\_\_  
\_\_\_\_\_

PROBE 3 \_\_\_\_\_  
\_\_\_\_\_  
\_\_\_\_\_

SIGNATURE: \_\_\_\_\_ DATE: \_\_\_\_\_

TITLE: \_\_\_\_\_

**FIGURE A-1-5: Location of Temperature Sensors in Containerized Cargo (Cold Treatment)**

## PPQ Form 429, Fumigation Record

### Example

FUMIGATION RECORD		USDA-APHIS		1. STATION REPORTING		2. PEST AND INTERCEPTION NUMBER				
3. CARRIER		4. DATE OF ARRIVAL		5. DATE INTERCEPTED		6. ORIGIN				
7. PLACE OF ARRIVAL		8. DATE CONFIRMED		9. PORT OF LADING						
10. FUMIGATION CONTRACTOR		11. DATE FUMIGATION ORDERED		12. COMMODITY						
13. FUMIGATION SITE		14. DATE FUMIGATED		15. QUANTITY						
16. MARKS	17. BL. NO.	18. ENTRY NO.	19. SHIPPER		20. CONSIGNEE					
21. FUMIGANT AND TREATMENT SCHEDULE		22. TEMPERATURE		23. GAS ANALYZER (Type and Ser. No.)						
24. ENCLOSURE		25. WEATHER CONDITIONS		26. CUBIC CAPACITY		27. TREATMENT UNDER SECTION 18 EXEMPTION				
28. NO. OF FANS		29. TOTAL CFM'S FANS		30. TIME FANS OPERATED		<input type="checkbox"/> Yes <input type="checkbox"/> No <input type="checkbox"/> Yes <input type="checkbox"/> No				
32. GAS INTRODUCTION		33. AMT. GAS INTRODUCED		34. GAS ADDED		35. RESIDUE SAMPLE TAKEN				
a. Start		b. Finish				<input type="checkbox"/> Yes <input type="checkbox"/> No Sample No.				
<b>GAS CONCENTRATIONS</b> (grams per cubic meter (g/m <sup>3</sup> )/1000 cu. ft.) <i>(To be prepared for fumigations when gas concentration readings are required while treatment is in progress.)</i>										
36. DATE-TIME	37. PLACEMENT OF TEST LINES							38. TIME INTERVAL (FROM 32. B)	INSPECTOR'S INITIALS	
	FRONT	CENTER	REAR	COMMODITY						
	A	B	C	D	E	F	G	H	I	J
39. DETECTOR TUBE READINGS (PPM)										
40. REMARKS										
41. CALCULATIONS										
42. SIGNATURE OF INSPECTOR				DATE		43. SIGNATURE OF REVIEWER				DATE

PPQ FORM 429 (MAR 92) *Replaces APHIS FORM 8030 (JUL 89), which may be used*

FIGURE A-1-6: Example of PPQ Form 429, Fumigation Record (Front)

**Example (Back)**

TARPAULIN FUMIGATION			
NOTE: <i>In preparation for the fumigation and prior to site selection the officer should have determined (1) the immediate pest risk associated with the infested commodity, (2) the temperature requirements for the fumigation, and (3) the permeability of the packaging.</i>			
CHECKLIST OF MATERIALS AND PROCEDURES (Consider each of the listed items when performing a fumigation.)			
MATERIALS			
FUMIGATOR			PPO
Tarpaulin	Tarpaulin Supports	Volatilizer	Gas Analyzer
Sand Snakes	Fans	Heat Supply	Driente
Water Snakes	Extension Cords	Exhaust Fans	
Loose Sand	2-3 Prong Plug Adapters	Sampling Tubes	Self Contained (SCBA) Breathing Apparatus
Burlap / Padding	Fumigant	Scale	Halide Detector
Masking Tape	Gas Introduction Line	Fumigation Placards	Tape Measure
Pesticide & Spray Equipment	T/C Gas Analyzer	SCBA - Self Contained Breathing Apparatus	Thermometer
			Gas Detector Kit and Detector Tubes
PROCEDURES (SECTION III TREATMENT MANUAL)			
PREPARATION		FUMIGATION	
<b>1. SITE SELECTION</b> Ventilated Area Sheltered Area Impervious Surface Non-work Area Proximity to Electrical Source Proximity to Commodity	<b>3. TARPAULIN ENCLOSURE</b> <b>A. COVER</b> Condition Air Space, Above Load Floor Area 30 cm (12") Space Around Load Overlap 45 cm (18") Border <b>B. SNAKES</b> Contact Along Sides Contact Around Corners Overlap 15 cm (6") Minimum <b>C. SAND</b> Perimeter <b>D. ADHESIVE</b> Perimeter	<b>4. TREATMENT SCHEDULE DETERMINATION</b> Plant Pest Commodity Temperature Space Temperature Volume Determination Sorptive Commodity Amount of Fumigant <b>5. FUMIGANT INTRODUCTION</b> Area Clear of Unauthorized Personnel Cover condition Fan Operation Contaminant Gases Fumigant Cylinder Weight Gas Line Connections Volatilizer Heated	Introduction Rate Check for Leaks <b>6. SAFETY</b> Gas Detection Tests <b>7. CONCENTRATION READINGS</b> T/C Gas Analyzer Standardization Time Intervals Gas Distribution Maximum / Minimum <b>8. AERATION (MULTIPLE STACKS)</b> Exhaust Fan(s) Exhaust Tube(s) Exhausted in a Non-fumigation Area Negligible Gas Readings Before Tarpaulin Removal Halide or Other Detector Tests
PPQ FORM 429 (Reverse)		* U.S. GOVERNMENT PRINTING OFFICE: 1997 417-294/60024	

**FIGURE A-1-7: Example of PPQ Form 429, Fumigation Record (Back)**

### Purpose

This form is to be used as a station record for all treatments conducted in approved chambers or in temporary enclosures (tarpaulin, in containers, truck vans, railroad cars, ships, warehouses, or other enclosures). Treatments conducted under temporary enclosures require minimum gas concentration readings be reported.



Aircraft fumigation is not authorized.

Block	Instruction
1	Fill in.
2	Fill in scientific name(s) of pest or simply “precautionary” when fumigation is mandatory as a condition of entry or movement. Include station interception number(s) if fumigation is based on pest findings.
3-20	Fill in. In completing Block 12, if the commodity is a fruit or vegetable, enter the common name. The common name is more descriptive. If available, include the variety. By using common names and names of varieties, tolerances to the fumigant can be better predicted.
21	Fill in fumigant (for example, MB, CB, PH, EO, or SF), schedule number, dosage rate, and exposure period (4 lbs/1,000 ft <sup>3</sup> for 12 hours).
22	Fill in beginning temperatures in space under enclosure (a) and commodity temperature (b). Specify Centigrade or Fahrenheit.
23	Fill in type of thermal conductivity unit used (Fumiscope® or Gow-Mac®) and the serial number of the conductivity unit.
24	Fill in chamber, tarpaulin, structure, or type of carrier such as truck van, railroad car, or ship. If a container was used, indicate if covered by tarpaulin. Fill in type of tarpaulin used—single or multiple-use and the thickness (4 mil or 6 mil).
25	If treatment is conducted outside, fill in the weather conditions.
26	Fill in.
27	If commodity is treated under APHIS Section 18 Exemption, check “yes.” If commodity is treated at label dosage or less, check “no.”
28-30	Fill in.
31	If food or feed, check “yes.” If nonfood/nonfeed, check “no.”
32	Record time gas introduction started (a) and finished (b). Treatment does not start until gas is completely introduced in the chamber or enclosure.
33	When the fumigant dosage is calculated by weight, fill in the dosage to the nearest quarter pound. If liquid measures are needed, convert from weight to volume by using the conversion table in Appendix D.
34	If additional gas is required, note under Remarks (Block 40) and show calculations (Block 41).
35	Check appropriate box. Sample number refers to Block 7 on APHIS Form 2061 (Residue Sample for Food or Feed Product).
36	Record the date and time you take concentration readings. Treatment schedules specify when to take concentration readings.
37	Fumigants such as methyl bromide may be read and recorded directly from the gas analyzer. However, readings for fumigants such as sulfuryl fluoride must be corrected to get the true concentration reading. Each gas analyzer used for fumigants other than methyl bromide is calibrated with a correction factor. The factor is multiplied times the reading, to give the actual concentration. Record phosphine gas concentrations as ppm as determined by detector tubes. Specify where the gas sampling line was placed: space or commodity. Use at least three lines. Use additional lines as needed.
38	Fill in.
39	Fill in time as well as the reading. Refer to the section in the manual that is tabbed “Aeration” for guidelines.
40	Note any unusual events that occurred during the treatment. When it is necessary to abort a fumigation, details concerning the termination of the treatment should be reported in this block.



Block	Instruction
41	Show all calculations used in determining the volume of temporary enclosures. Also show calculations when additional gas is added.
42-43	Sign and date.
Reverse Side	Use as a check list.

### Distribution

Give the original and one copy to your supervisor for review. The supervisor should keep the original for port files and send one copy to:

USDA, APHIS, PPQ, CPHST  
Treatment Quality Assurance Unit  
1730 Varsity Drive, Suite 400  
Raleigh, NC 27606

## PPQ Form 519, Compliance Agreement

UNITED STATES DEPARTMENT OF AGRICULTURE ANIMAL AND PLANT HEALTH INSPECTION SERVICE PLANT PROTECTION AND QUARANTINE  <b>COMPLIANCE AGREEMENT</b>		FORM APPROVED OMB NUMBER 0578-0064
According to the Paperwork Reduction Act of 1995, no persons are required to respond to a collection of information unless it displays a valid OMB control number. The valid OMB control number for this information collection is 0578-0064. The time required to complete this information collection is estimated to average 1.25 hours per response, including the time for reviewing instructions, searching existing data sources, gathering and maintaining the data needed, and completing and reviewing the collection of information.		
<b>1. NAME AND MAILING ADDRESS OF PERSON OR FIRM</b>		<b>2. LOCATION</b>
<b>3. REGULATED ARTICLE(S)</b>		
<b>4. APPLICABLE FEDERAL QUARANTINE(S) OR REGULATIONS</b>		
<b>5. I/We agree to the following:</b>		
<b>6. SIGNATURE</b>	<b>7. TITLE</b>	<b>8. DATE SIGNED</b>
The affixing of the signatures below will validate this agreement which shall remain in effect until canceled, but may be revised as necessary or revoked for noncompliance.		<b>9. AGREEMENT NO.</b>
		<b>10. DATE OF AGREEMENT</b>
<b>11. PPQ OFFICIAL (Name and Title)</b>		<b>12. ADDRESS</b>
<b>13. SIGNATURE</b>		
<b>14. STATE AGENCY OFFICIAL (Name and Title)</b>		<b>16. ADDRESS</b>
<b>15. SIGNATURE</b>		
PPQ FORM 519 (FEB 2002)		

**FIGURE A-1-8: Example of PPQ Form 519, Compliance Agreement**

### **Purpose**

The PPQ Form 519 is a form that provides a signed, written agreement with fumigators to indicate their understanding of methods, conditions, and procedures necessary for compliance with regulations.

The PPQ Form 519 is also available as an electronic form. Click on the following link to access a fillable version of the form:

[PPQ Form 519](#)

### **Instructions**

Many PPQ ports maintain Compliance Agreements with commercial pesticide applicators. PPQ may maintain compliance agreements, however if they cancel an agreement, PPQ should not ban an exterminator from doing business, or applying regulatory treatments. PPQ may however, discontinue certification of a particular treatment that did not meet the required time, temperature, and concentration levels indicated in the treatment schedule. Similarly, PPQ may not want to begin monitoring a fumigation if the tarp appears inadequate and excessive leakage may lead to a safety problem.

Review compliance agreements at least annually, but preferably twice a year. Amend compliance agreements as appropriate.

If the establishment fails to abide by the conditions of the agreement, then the Port Director may cancel that agreement orally or in writing.

If you make an oral cancellation, confirm it in writing as soon as possible. The establishment has 10 days to appeal the cancellation. Appeals must be made to the Deputy Administrator.

**TABLE 1-1-1: Instructions for Completing PPQ Form 519, Compliance Agreement**

<b>Block</b>	<b>Instructions</b>
1,8,9, 10-12	Fill in.
2	Fill in the location of the specific property(s) for which the agreement is signed.
3	Fill in the specific regulated articles to which the agreement applies.
4	Fill in the titles, parts, and subparts.
5	Outline stipulations which apply to the fumigator for each quarantine or regulation affecting the fumigator. Make clear to the fumigator that stipulations in the compliance agreement do not preclude compliance with other sections of the quarantine or regulations. If space in Block 6 is inadequate for listing the stipulations, then write "see Attached Sheets."
6	Have a responsible official of the fumigator's sign.
9	Assign a compliance agreement number.

**TABLE 1-1-1: Instructions for Completing PPQ Form 519, Compliance Agreement**

Block	Instructions
13	Have the PPQ Port Director sign.
14-16	Complete only when State is involved in cooperating with enforcing Federal quarantines.

**Distribution**

If:	Then:
Compliance agreement affects one work unit	GIVE original to the fumigator, and KEEP a copy for port files in the area where the fumigator is located
Compliance agreement affects more than one work unit	GIVE original to the fumigator, and GIVE copies to all work units affected by the compliance agreement, and KEEP a copy for port files in the area where the fumigator is located

## PPQ Form 523, Emergency Action Notification

According to the Paperwork Reduction Act of 1995, no persons are required to respond to a collection of information unless it displays a valid OMB control number. The valid OMB control number for this information is 0579-0102. The time required to complete this information collection is estimated to average 1 hour per response, including the time for reviewing instructions, searching existing data sources, gathering and maintaining the data needed, and completing and reviewing the collection of information.

**FORM APPROVED - OMB NO. 0579-0102**

U.S. DEPARTMENT OF AGRICULTURE ANIMAL AND PLANT HEALTH INSPECTION SERVICE PLANT PROTECTION AND QUARANTINE  <b>EMERGENCY ACTION NOTIFICATION</b>	SERIAL NO. <hr/> 1. PPQ LOCATION <span style="float: right;">2. DATE ISSUED</span> <hr/> 4. LOCATION OF ARTICLES <hr/> 5. DESTINATION OF ARTICLES <hr/> 6. SHIPPER <span style="float: right;">7. NAME OF CARRIER</span> <hr/> 8. SHIPMENT ID NO.(S) <hr/> 9. OWNER/CONSIGNEE OF ARTICLES <span style="float: right;">10. PORT OF LADING</span> <span style="float: right;">11. DATE OF ARRIVAL</span> Name: _____ Address: _____ _____ _____ PHONE NO. _____ FAX NO. _____ SS NO. _____ TAX ID NO. _____ 12. ID OF PEST(S), NOXIOUS WEEDS, OR ARTICLE(S) <hr/> 12a. PEST ID NO. <span style="float: right;">12b. DATE INTERCEPTED</span> <hr/> 13. COUNTRY OF ORIGIN <span style="float: right;">14. GROWER NO.</span> <hr/> 15. FOREIGN CERTIFICATE NO. <hr/> 15a. PLACE ISSUED <span style="float: right;">15b. DATE</span>
---	---

Under Sections 411, 412, and 414 of the Plant Protection Act (7 USC 7711, 7712, and 7714) and Sections 10404 through 10407 of the Animal Health Protection Act (7 USC 8303 through 8306), you are hereby notified, as owner or agent of the owner of said carrier, premises, and/or articles, to apply remedial measures for the pest(s), noxious weeds, and or article(s) specified in Item 12, in a manner satisfactory to and under the supervision of an Agriculture Officer. Remedial measures shall be in accordance with the action specified in Item 16 and shall be completed within the time specified in Item 17.

**AFTER RECEIPT OF THIS NOTIFICATION, ARTICLES AND/OR CARRIERS HEREIN DESIGNATED MUST NOT BE MOVED EXCEPT AS DIRECTED BY AN AGRICULTURE OFFICER. THE LOCAL OFFICER MAY BE CONTACTED AT:**

16. ACTION REQUIRED

TREATMENT: \_\_\_\_\_

RE-EXPORTATION: \_\_\_\_\_

DESTRUCTION: \_\_\_\_\_

OTHER: \_\_\_\_\_

**Should the owner or owner's agent fail to comply with this order within the time specified below, USDA is authorized to recover from the owner or agent cost of any care, handling, application of remedial measures, disposal, or other action incurred in connection with the remedial action, destruction, or removal.**

17. AFTER RECEIPT OF THIS NOTIFICATION COMPLETE SPECIFIED ACTION WITHIN (Specify No. Hours or No. Days): _____	18. SIGNATURE OF OFFICER: _____
--	---------------------------------

ACKNOWLEDGMENT OF RECEIPT OF EMERGENCY ACTION NOTIFICATION  
*I hereby acknowledge receipt of the foregoing notification.*

SIGNATURE AND TITLE: _____	DATE AND TIME: _____
----------------------------	----------------------

19. REVOCATION OF NOTIFICATION

ACTION TAKEN: \_\_\_\_\_

SIGNATURE OF OFFICER: _____	DATE: _____
-----------------------------	-------------

PPQ FORM 523 (JULY 2002) Previous editions are obsolete.

**FIGURE A-1-9: Example of PPQ Form 523, Emergency Action Notification**

## Purpose

The Emergency Action Notification (EAN) is a document that serves purposes for APHIS regulations. When an emergency action must be taken on a shipment, this form allows Customs and Border Protection - Agriculture Inspection (CBPAI) and/or Plant Protection and Quarantine (PPQ) to communicate the need for a specific action on a shipment to the interested parties. The EAN specifies to the broker, shipper, market owner, or other stakeholder the reason(s) why the shipment is being refused and basic explanation(s) as to what action is necessary.

The document also serves other critical needs. Use of the EAN information assists in determining risks and identifying trends. Through data compilation and analysis PPQ will use the information to update regulations, inform trade partners of areas of concern in foreign countries, and help with domestic emergencies. Targeting is another use for the information. CBPAI will be better able to determine which shipments may need closer inspection.

An EAN **must be issued from the National AQAS EAN Database** every time an emergency action is ordered for an agricultural purpose in the cargo or express courier environment. Agricultural purposes would be those that relate back to a violation of a regulation within the 7 CFR or 9 CFR chapters.



EANs **MAY NOT** be issued as a hand written document, typed on a manual typewriter, from any local database, or any means of issuance other than the **National AQAS** system.<sup>1</sup>

<sup>1</sup> The only acceptable reason for issuing an EAN from a source other than the AQAS National EAN Database is if the AQAS system is not in operation. In this instance, the EAN issued in another format must be entered into the AQAS National EAN Database within 24 hours.

### Issue an EAN when:

- ◆ The Agriculture Specialist finds an actionable pest, potential quarantine pest, a contaminant, or prohibited product
- ◆ The Agriculture Specialist needs to record a commercial seizure
- ◆ The shipment lacks proper documentation
- ◆ The shipment contains non-compliant WPM
- ◆ The shipment is in the express courier environment (i.e. FedEx, UPS, DHL, etc.).

An EAN must **not** be issued for the following reasons:

- ◆ Condition of Entry/Precautionary Treatments - An EAN is **not** to be issued for a shipment requiring treatment as a condition of entry.
- ◆ Holding a Shipment - An EAN is only for taking immediate action. Do **not** use an EAN as a hold or supplemental hold for a shipment for any other reason than immediate treatment.
- ◆ Quality Issues - An EAN is **not** to be issued for the quality of a shipment. If the shipment does not pose a pest risk do not write an EAN.
- ◆ No inspection - An EAN is only to be issued if a shipment has been inspected (either a physical inspection of the goods or a paperwork inspection when that is the requirement) and an agricultural problem has been found. Do **not** write an EAN in lieu of inspection.
- ◆ Mail - Do **not** issue an EAN for any USPS mail. A Mail Interception Notification (PPQ 287) must be used for these shipments.
- ◆ Selected Animal Products - EANs are **not** to be issued on shipments of live animals or live animal products. Refer to the Animal Products Manual for instructions on these products.
- ◆ Other Agencies' regulations - EANs are **not** to be issued for a violation of other agencies regulations. The only regulations that may be cited on an EAN are chapters 7 CFR and 9 CFR.

### Instructions

The instructions in **Table A-1-2** are for initiating an EAN. The electronic version of PPQ Form 523 which is located in the National Agricultural Quarantine Activity System (AQAS) at <https://moks14.aphis.usda.gov/aqas/login.jsp> is the only method by which an Emergency Action Notification may be initiated. **Emergency Action Notifications MAY NOT be issued in any other format, either manual or electronic.**

**TABLE A-1-2: Instructions for Initiating an EAN**

Block Number	Field Name	Instructions
1	Issuing Port	Select the port in which the EAN is being issued. Please note that some users will have multiple locations. If the user is assigned to multiple locations, be sure to select the correct location. If the user is not assigned to a port to which he/she requires access, contact the help desk.
2	Date Issued	Enter the date that the EAN was issued.

**TABLE A-1-2: Instructions for Initiating an EAN**

Block Number	Field Name	Instructions
3 Name and Quantity of Manifested Article	Article Category* Article Name*	<p>This block is to determine the commodity of the shipment. <b>Only one commodity is allowed to be listed per EAN. Do NOT</b> list pallets, crates, dunnage, etc. as the Name of Article unless they are the actual <b>commodity</b> being shipped.</p> <p><b>Article Category</b> - Select a category (Animal Product, Plant Product, or Miscellaneous). The user must select the appropriate category as the other fields in this block are dependent upon it.</p> <p><b>Animal Products</b></p> <p>Animal Classification - Select the classification of the shipment. The classification selected will determine the drop down list for the classification category in the next field. See the Animal Products Manual (APM) contents page for further clarification.</p> <p>Classification Category - Select the classification category. The classification category will determine if a classification subcategory is required. To decide on a classification category see the APM classification selected in the previous field.</p> <p>Classification Subcategory - Select the classification subcategory. This information can be found in shipment documentation.</p> <p>* The drop down lists in this category have come directly from the Animal Products manual. If you need assistance with this menu, see the APM.</p> <p><b>Plant Products</b></p> <p>This selection is for fresh cut flowers, fresh fruits and vegetables, logs, lumber, and propagative materials only. Any processed plant products (mulch, handicrafts, potpourri, Chinese Teas, etc.) will be found in the Miscellaneous Category.</p> <p><b>Miscellaneous Products</b></p> <p>This category is for all products that do not fit into either Animal Products or Plant products as defined above. Select the category that best fits the commodity. If there is not a category that fits your item please contact the help desk, National Coordinator, or Regional Coordinators before continuing. If the user selects miscellaneous, a description of the article must be entered. The description should be as accurate as the information available. For example, brake pads, bolt screws, linen fabric, stuffed toys, etc. If the product is agricultural but processed, the user must give an exact description of the article. For example, wooden birdhouses with grass roofs, dried whole apricots, wood carvings with bark edging, etc.</p> <p><b>Article Name</b> - This drop down list has been determined by the user's previous selections. If the user does not find the article name in the drop down list please contact the help desk.</p>



**TABLE A-1-2: Instructions for Initiating an EAN**

Block Number	Field Name	Instructions
<b>3</b> Name and Quantity of Manifested Article (continued)	Quantity* Unit of Measure*	Enter the numerical quantity of the shipment. When determining the article quantity, use the most specific number. For example, kilograms is a better selection than box count when dealing with most produce or meat products, but square meter is a better selection for veneer. <b>“Boxes/Crates” may not be used if another option is available.</b>
	APHIS Permit Number	<b>APHIS Permit Number</b> - If the shipment has any kind of APHIS permit, enter the number here.
	Wood Packing Material*	Check the appropriate boxes. If the user selects none or non-compliant only one box may be selected, but if the wood is non-compliant the user may chose both non-compliant for timber pest and no markings. <b>If wood is not marked with an acceptable symbol, then it is considered unmarked.</b>
<b>4</b>	Location of Articles*	The location of articles is the place where the shipment is located when it is inspected. For example, US Air Warehouse, 123 Airplane Way, Butte, MT 12345. Each port will have a local drop down list so that users will not have to type addresses that have already been added to the system. If using the drop down list, ensure that the correct location has been selected. If the location that the user needs to select is not on the default list, it may be added by port users and supervisors by selecting "Set Defaults". All locations must contain the name of the facility, the physical address, city, state, and zip code.
<b>5</b> Delivery Address of Articles	Name*	Enter the name of the company/individual accepting the goods as destination of the articles (delivery address). Do <b>not</b> use the broker as destination. Do <b>not</b> automatically assume that the consignee address and delivery address is the same.
	Address where the articles will be delivered*	Enter the address where the goods are intended to be delivered including street address, city, state (within the US), country, and zip/postal code.  If the shipment has multiple destinations, the officer should include the destination to which the majority of the shipment is being delivered. If the shipments will be distributed evenly then choose the location to which the product could potentially cause the greatest risk. When determining the address to select the officer should use his/her best judgment. Additional delivery addresses should be entered into the “Comments” field on page 4 of the data entry screens. Questions regarding this should be directed to the officer’s first line supervisor.
<b>6</b> Shipper	Name*	Enter the name of the shipper.
	Address of Shipper*	Enter the address of the shipper including street address, city, and country. Enter state/province and postal code if known. <b>This must be a foreign address.</b>

**TABLE A-1-2: Instructions for Initiating an EAN**

Block Number	Field Name	Instructions
<b>7</b> Name of Carrier	Name*	Enter the name of the carrier company. For example, Northwest Airlines, M/V Panama, Canadian Pacific, Yellow Freight. On the land borders independent trucks frequently cross. If the truck is independent use the name of the owner of the tractor. Do <b>not</b> enter vehicle numbers in this field. <b>Do NOT enter abbreviations for the name of carrier including airline codes.</b>
	Flight/Voyage/Trip Number*	Enter the appropriate number based on pathway. For trucks use the trailer license number.
<b>8</b> Shipment Identification Numbers	Airway Bill, Bill of Lading, PAPS Code*	Enter the bill of lading number. If the cargo is border cargo and does not have a bill number, use the PAPS code. <b>This is a mandatory field. Every shipment will have this number at the time that shipment is presented for inspection.</b>
	Tariff Number*	Enter the 10 character tariff number as provided in ACS or ATS. This is indicated in ATS as the HTS number. Do not add any punctuation, numbers only. If the user cannot find the tariff number in ATS or ACS then use this link to look up the number: <a href="http://dataweb.usitc.gov/scripts/tariff_current.asp">http://dataweb.usitc.gov/scripts/tariff_current.asp</a>
	Customs Entry Number*	Enter the Customs Entry Number. Do not add any punctuation, numbers only.  *If the entry has not yet been filed at the time of inspection, enter "Not Yet Filed"  *If the shipment is of low value (under \$2000 as of 09/2006) it is considered informal and no entry number will ever be processed, enter "Informal"  <b>Do not enter N/A or Not Available. If the user doesn't have an entry number other than listed above, describe why.</b>
	Container Number	Enter the complete container number. This is usually a 4-letter code followed by 5 or 6 numbers. Include the check digit.
	ISPM Markings	Enter the complete information from the ISPM Marking (IPPC wood marking). If the officer finds a pest in <b>marked</b> wood, this is a required field.
	Other Identifying Number	This field is available to include another number that there is either not a field for or can be used for a number collected for port policy. Examples include invoice number, shipment number, etc. <b>If the pathway is air cargo, the House Airway Bill must be entered here.</b>
	Other Identifying Number Description	If the user enters an "Other Identifying Number" then this field must be completed. The entry should clearly identify what the "Other Identifying Number" is. Do not use abbreviations in the description other than HAWB for "House Airway Bill."

**TABLE A-1-2: Instructions for Initiating an EAN**

Block Number	Field Name	Instructions
9	Consignee of Articles	Name*
		Address of Consignee*
		Phone and Fax Numbers
10	Port of Lading	City*
		Country*
11		Date of Arrival*
12		Reason for EAN*

Enter the name of the Consignee. This will be a company name most of the time. If the shipment owner is an individual, enter the name of the individual.

The Consignee is the owner of the shipment. The broker is usually not the consignee.

Enter the street address of the consignee. Street address, city, and country must be entered. Enter the state/province and postal code if known.

Enter the phone and fax numbers of consignee if known

Enter the foreign city where the shipment was last loaded onto a vessel, plane, railcar, or vehicle.

Enter the foreign country where the shipment was last loaded onto a vessel, plane, railcar, or vehicle.

Enter the date that the shipment entered the port.

Select the reason(s) that the EAN is being issued. The following is a guideline to help determine the reason.

**Pest** - If a pest or disease is found on, in, or with a shipment. Do **not** to enter a tentative ID. A national AQAS Pest ID number will be required.

**Lacks Documentation or Certification** - Shipment is missing documentation or the documentation is not acceptable. Documents may include but are not limited to health certificates, FSIS paperwork, permits, phytosanitary certificates, etc.

**Contaminant- Seed** - Shipment is found to have seed or seed heads that are contaminants, but not part of the manifested commodity. A national AQAS Pest ID number is required.

**Contaminant-Other** - Shipment is found to have any contaminant that does not need to be sent to an identifier. Examples include blood, soil, manure, etc.

**Lacking ISPM15 Marking** - Shipment was found to have unmarked or improperly marked WPM.

**Prohibited Animal Product** - Shipment was found to be prohibited by a 9 CFR.

**Prohibited Product** - Shipment was found to be prohibited by 7 CFR regulation.

**TABLE A-1-2: Instructions for Initiating an EAN**

Block Number	Field Name	Instructions
<b>12a</b>	Pest ID Number*	Enter the Pest ID number generated by the Pest ID system. This number must be provided by the identifier or an APHIS employee acting on behalf of an identifier. If pest or seed contaminant is selected as the reason for the EAN then the user will have to enter the 17 digit Pest ID number. If the user does not have the Pest ID number the EAN may be saved and printed, however the EAN can not be closed in the system until this information has been added. The system will not accept local pest ID numbers in any form.
<b>12b</b>	Date Intercepted*	Enter the date that the reason for writing the EAN was found. This date must match the date that is entered on the Pest ID record (309A).
<b>13</b>	Country of Origin	Enter country of origin. The country of origin is not necessarily the country from which it is being shipped. The country of origin is the location where the commodity was grown, manufactured, or produced. For example, a shipment of handicrafts might be shipped from Canada, but were made in China. China is the country of origin. Canada is the country of lading.
<b>14</b>	Grower/Facility Number	Enter the number of the foreign facility in which the product was processed or the foreign grower number. This number is frequently found on the invoice. It may also be available in ATS.
<b>15</b>	Foreign Sanitary Certificate Status*	Select the status of the certificate. If a certificate is not required continue to Block 16.
<b>15a</b>	Foreign Sanitary Certificate Number	Enter the certificate number.
<b>15b</b>	Place Issued	Enter City/Country where the certificate was issued. This will be a foreign address.
	Date Issued	Enter the date on which the certificate was issued.
<b>Contact Number</b>	Phone Number*	Enter the phone number at which the user issuing the EAN can be reached.
<b>16</b>	Treatment Schedule	Using the drop down menu, <b>if treatment is available</b> , select the appropriate treatment schedule. The treatment schedule <b>MUST</b> be provided by a PPQ Identifier or PPQ Employee acting on behalf of an Identifier. CBP AI should <b>not</b> select a treatment schedule that has not been approved by a PPQ Identifier or PPQ Employee acting on behalf of an Identifier.
	Explanation Text*	Select the explanation text that best matches the scenario for this EAN. This explanation tells the acceptor of the EAN two things: 1) what the problem is and 2) how to correct the situation. <b>This is where the options are given. DO NOT use the "check boxes" printed on the form.</b>
	Phyto-Fumigation Disclaimer	If fumigation is an option, the phyto disclaimer must be selected.

**TABLE A-1-2: Instructions for Initiating an EAN**

Block Number	Field Name	Instructions
16 (continued)	CFR Regulation*	Select the CFR under which the shipment is being regulated. More than one CFR can be selected. To look up a CFR use this link: <a href="http://ecfr.gpoaccess.gov">http://ecfr.gpoaccess.gov</a>
	Seal Text	If the shipment must be transferred to another location under seal, select the text that is appropriate to scenario. If the shipment is being sent for treatment by PPQ the quantity of the shipment being transferred (preferably in box count) <b>must</b> be included.  <b>NOTE:</b> If the PPQ Officer supervising the treatment does not know the quantity to be treated the shipment will not be treated until that information is provided from CBP.
	Comments	If the user has any additional comments to make, they should be recorded in the Comment field. Do not repeat information that has previously been provided. Do not enter any pest name in this location.  It may be helpful on a local level to enter a local ID number or broker information here.  <b>NOTE:</b> These comments will print on the paper EAN.
17	After Receipt of Notification Complete Specified Action Within:	The user should select the amount of time allowed before treatment begins. For example, if the shipment is to be re-exported then the user should select the amount of time before the shipment must be on the conveyance back to country of origin.
18	Name of Inspecting Officer	Enter the name of the officer that inspected the shipment.  <b>DO NOT</b> enter the name of the data enterer unless it is the same individual.
	Acknowledgement of Receipt of Notification	Name of Recipient  Enter the first and last name of the person accepting the EAN. The user <b>MUST</b> have this person print their name next to the signature. The only acceptable entry in this field is the first and last name of the person accepting the EAN. <b>DO NOT</b> enter "On File."
		Title of Recipient  Enter the title of the person accepting and signing the EAN. Preferably enter name of their company as well. Example: Dispatcher, American Shipping
	Date Signed	Enter the date the EAN was signed and accepted.
19 Revocation Notification	Reason for Action Taken*	Enter the reason that the EAN was written. <b>This should match the data entered in block 12.</b>

**TABLE A-1-2: Instructions for Initiating an EAN**

Block Number	Field Name	Instructions
<b>19</b> Revocation Notification (continued)	Action Taken*	Enter the action that was actually taken. <b>Do not enter an action unless that action was taken.</b>  If the action was "Treatment," select the treatment type.  If the action was "Other," enter what action was taken in the "Additional Remarks" section. Be descriptive in the narrative.  Example: The WPM was separated from the shipment. The WPM was re-exported. The commodity entered commerce.
	Was the Article Mislabeled, Misrepresented, or Concealed?*	Select yes or no.
	Form 518 Reference Number	If the above answer is yes, then a 518 number must be entered.
	Additional Remarks	If the user has additional information that was not previously recorded, it should be entered here. This field is required if Action Taken-Treatment Type is equal to "Other." This field will not print at any time. These are private comments visible only to system users.
	Signature of Officer*	Enter the name of the officer that completed or supervised the treatment, received confirmation of destruction, or received confirmation of re-exportation. Do not enter the data entry clerk's name unless it is the same officer as described above. This may be a different user than originally opened the EAN.
	Date Action was Completed*	Date - Enter the date that the final action was completed.

**Special Instructions for Infested Vessels Sailing Foreign Without Treatment**

When an infested vessel is allowed to sail foreign without treatment, type the following statement in the "Comments" field on the EAN.

The requirements of the Emergency Action Notification are suspended upon condition that this vessel shall leave the territorial limits of the United States within *[list number]* of hours after receipt of this notice. This vessel shall **not** re-enter any port in the United States unless it has been treated in accordance with the notification and certified by the person who applied the treatment. If the certificate is **not** presented to the CBP officer when arriving at a port in the United States, or if the CBP officer for any other reason is **not** satisfied that the infestation has been eliminated, the notification shall immediately become effective and treatment required.

## PPQ Form 449-R, Temperature Recording Calibration Report

Use the PPQ Form 449-R to document the calibration of temperature sensors for intransit cold treatment in vessels.

TEMPERATURE RECORDING CALIBRATION REPORT (IN-TRANSIT COLD TREATMENT)											1. NAME OF VESSEL <b>Crown Emerald</b>				
2. PPQ DUTY STATION <b>Houston</b>			3. DATE OF INSPECTION <b>8-5-2008</b>			4. POINT OF INSPECTION <b>Bremerhaven, Germany</b>			5. HULL NUMBER AND DOCKYARD <b>164 - Imabari</b>						
6. IMO NUMBER <b>9128037</b>			7. FLAG (3-LETTER CODE) <b>PAN</b>			8. SHIP'S OFFICER <b>ENS Smith</b>			9. OWNER/OPERATOR <b>Wallem Management</b>						
10. RECORDING INSTRUMENT 1						11. RECORDING INSTRUMENT 2									
<b>Recorder(s) must match CPHST website – see instructions.</b>															
10a. MAKE <b>Mycom</b>						11a. MAKE									
10b. MODEL <b>MarcS</b>						11b. MODEL									
<b>TEMPERATURE SENSORS</b> (If unsatisfactory, explain in item 17.)															
12. LOCATIONS MATCH DIAGRAM Satisfactory <input checked="" type="radio"/> Unsatisfactory <input type="radio"/>			13. LABELING OF SENSORS/BOXES Satisfactory <input checked="" type="radio"/> Unsatisfactory <input type="radio"/>			14. CABLE LENGTH Satisfactory <input checked="" type="radio"/> Unsatisfactory <input type="radio"/>			15. REACTION TIME Satisfactory <input checked="" type="radio"/> Unsatisfactory <input type="radio"/>						
16. TEMPERATURE READINGS AT 0 C (32 F)															
BULB NO.	TEST			BULB NO.	TEST			BULB NO.	TEST			BULB NO.	TEST		
	I	II	III		I	II	III		I	II	III		I	II	III
1A1	0.1	0.1		1C3	0.0	0.0		2A4	0.1	0.1		2C4	0.1	0.1	
1A2	0.0	0.0		1C7	0.0	0.0		2A5	0.1	0.1		2C5	0.1	0.1	
1A3	0.1	0.1		1C8	0.0	0.1	0.0	2A6	0.1	0.1		2D1	0.1	0.1	
1A4	0.1	0.1		1C9	0.0	0.0		2A7	0.1	0.1		2D2	0.1	0.1	
1A5	0.1	0.1		1D1	0.1	0.1		2B3	0.1	0.1		2D3	0.1	0.1	
1A6	0.1	0.1		1D2	0.1	0.1		2B8	0.1	0.1		2D4	0.1	0.1	
1A7	0.1	0.1		1D3	0.1	0.1		2B9	0.1	0.1		2D5	0.1	0.1	
1B1	0.1	0.1		1D4	0.1	0.1		2B10	0.1	0.1		3A1	0.1	0.1	
1B2	0.1	0.1		1D5	-0.2	-0.2		2B11	0.1	0.1		3A2	0.1	0.1	
1B4	0.2	0.2		1D6	-0.1	-0.1		2C1	0.1	0.1		3A3	0.1	0.1	
1B5	0.0	0.0		2A1	0.2	0.2		2C2	0.1	0.1		3A4	0.1	0.1	
1B6	0.0	0.0		2A2	0.3	0.3		2C3	0.1	0.1		3A5	-0.1	-0.1	
17. REMARKS (List names of all USDA officials participating in the calibration.) <b>D. Jones, S. Wood</b>															
18. COMPANY NAME AND ADDRESS TO SEND CERTIFICATE OF APPROVAL <b>Wallem Ship Management 1799 West Street New York, NY</b>									19. COMPANY EMAIL <b>WSM@gmail.com</b>			20. COMPANY PHONE NUMBER <b>800-879-4659</b>			
21. SIGNATURE OF LEAD INSPECTOR									22. DATE <b>5-August-2008</b>						

PPQ FORM 449-R (Local Reproduction Authorized)  
(JAN 2007)

FIGURE A-1-10 Example of PPQ Form 449-R, Temperature Recording Calibration Report

## Instructions for Completing PPQ Form 449-R

Block	Instructions
1	Verify that the vessel name agrees with the name on the CPHST web site: <a href="https://treatments.cphst.org/vessels/">https://treatments.cphst.org/vessels/</a> .
2	PPQ officer's duty station.
3	Date of Inspection
4	Place of Inspection
5	Verify that the hull number and dockyard agrees with the CPHST web site: <a href="https://treatments.cphst.org/vessels/">https://treatments.cphst.org/vessels/</a> .
6	The IMO number is a unique identification number for every vessel engaged in commerce and provides a complete history of the vessel. Verify that the IMO number agrees with the CPHST web site: <a href="https://treatments.cphst.org/vessels/">https://treatments.cphst.org/vessels/</a> . If this information is not on the CPHST web site, collect the number from the ship's officer and record in this block.
7	Verify that the flag (country of registry) agrees with the 3-letter code on the CPHST web site: <a href="https://treatments.cphst.org/vessels/">https://treatments.cphst.org/vessels/</a> .
8	Name of Captain, Chief Engineer, Reefer Engineer, or First Officer
9	Name of the shipping line owner or agent. Verify with CPHST web site: <a href="https://treatments.cphst.org/vessels/">https://treatments.cphst.org/vessels/</a> .
10a, b	Verify the make and model agree with the information on the web site. If the information differs from that listed on the website, gather as much information as possible from the vessels crew regarding when (date) instrument was changed, and whether or not they have any documentation from CPHST approving the changes. Record this additional information in the remarks section.
11a, b	Multiple recorders may be used. Record the make and model.
12	Verify that the sensor and cable locations match the diagram on the CPHST web site.
13	Verify that the sensors and cables are labeled correctly and in accordance with the sensor diagram.
14	Confirm that air sensors are capable of reaching the floor and fruit sensors are capable of reaching all areas of the compartment from their location along the walls (each should reach past the center line of the compartment).
15	Do the sensors respond appropriately when hand-warmed?
16	TEST ALL AIR AND PULP SENSORS. If officer suspects a compartment to be a hanging deck, test any sensors located in the space and make a notation in this block and in the narrative.
17	Record names of all USDA officials participating in the inspection, indicating lead officer for the report. Include any other information deemed appropriate.
18	Include as much information as possible.
19	Company email.
20	Company phone number.
21	Signature of Lead Inspector.
22	Date the report is completed.





### Purpose

PPQ Form 203 verifies that PPQ has precleared the commodity it accompanies (either through inspection or treatment) at the foreign site.

An electronic copy of this form is available in the APHIS forms library at:

<http://www.aphis.usda.gov/library/forms/#ppq>

### Instructions

The Agriculture Specialist at Port of Entry (POE) examines this form when a precleared commodity arrives at the port.

The APHIS officer completes this form at the foreign site where the commodity is inspected or treated. The form may either be handwritten in ink or typed. Use **Table A-1-3** to decide what paperwork should be presented upon the arrival of a precleared commodity.

**TABLE A-1-3: Determine Paperwork to Be Presented upon Arrival of a Precleared Commodity**

If arriving from:	And by:	Then the exporter or the exporter's agent must provide the following paperwork:
Australia, Japan, Korea, or the Republic of South Africa	→	<ul style="list-style-type: none"> <li>◆ Original (yellow) PPQ Form 203 for the commodity</li> <li>◆ Copy of the master PPQ Form 203 or original Phytosanitary Certificate, specifying the number of units shipped or remaining in cold storage from the master PPQ Form 203</li> </ul>
Chile	Vessel	<ul style="list-style-type: none"> <li>◆ Original Chilean Phytosanitary Certificate</li> <li>◆ E-mail notification of the cargo on board and its status from the IS Region II office to the POE</li> </ul> <p><b>NOTE:</b> No PPQ Form 203 will accompany the commodity</p>
	Air	<ul style="list-style-type: none"> <li>◆ Original (yellow) PPQ Form 203 for the commodity</li> <li>◆ Original Chilean Phytosanitary Certificate</li> </ul>
New Zealand	→	<ul style="list-style-type: none"> <li>◆ Original (yellow) PPQ Form 203 for the commodity, <b>or</b> a copy of the master 203</li> <li>◆ Original New Zealand Ministry of Agriculture forms specifying the number of units shipped or remaining in cold storage from the master PPQ Form 203, Final Balances-Balance Sheet for USA-Passed Product in Coolstore and Details of Loading Certificate</li> </ul>
<b>Other than</b> a country listed in the three cells above	→	<ul style="list-style-type: none"> <li>◆ Original (yellow) PPQ Form 203 for the commodity</li> </ul>

Verify that any seals listed on the form are still intact. Also, confirm that the information and conditions described on the form agree with the cargo manifest, invoice, or other CBP entry documents. Contact QPAS at 301/734-8295 if **any** of the following occurs:

- ◆ PPQ Form 203 is missing
- ◆ Seals are broken
- ◆ Information on the PPQ Form 203 does **not** match the entry documents



Refer to your *Plant Import: Nonpropagative Volume of Manuals* for the commodity being shipped. The commodity may be undergoing in-transit cold treatment. If it is, you need to ensure that the commodity meets the time and temperature requirements.

### Instructions for Issuing Officer

The APHIS Issuing Officer will complete PPQ Form 203, as follows:

1. Type the form or write in ink.
2. Number the certificate using the numbering system assigned by the Area Office with responsibility for the program.
3. If the commodity was treated, mark the form with the plant's approved stamp.
4. Fill in the remaining, self-explanatory information.

### Distribution

#### Issuing Officer

The APHIS Issuing Officer will distribute PPQ Form 203 using **Table A-1-4** as a guide.

**TABLE A-1-4: Distribution of PPQ Form 203, Foreign Site Certificate of Inspection and/or Treatment**

If:	Then:
Original and first copy	GIVE to the exporter (the original must be presented at the first POE)
Copy	SEND to the Area Office, IS, with responsibility for the program
Copy	RETAIN by the certifying APHIS officer
Copy (through the office of cooperator) <sup>1</sup>	FAX a copy to the U.S. Port of Arrival
Copy	ATTACH to trip report

<sup>1</sup> This does **not** apply to all programs. Check the technical packet or with the IS Field Office in Charge.

## PPQ Form 556, In Transit Cold Treatment Clearance Report

U. S. DEPARTMENT OF AGRICULTURE Animal and Plant Health Inspection Service Plant Protection and Quarantine Programs <b>IN TRANSIT COLD TREATMENT          CLEARANCE REPORT</b>				1. NAME OF CARRIER		2. PORT OF LOADING		3. PAGE NO.				
INSTRUCTIONS: Refer to PPQ Treatment Manual Sec. III part 10 and CFR 319.56-2d.				4. PORT REPORTING		5. DATE		6. TIME				
				7. PORT REPORTING		8. DATE		9. TIME				
10. CONTENTS OF COMPARTMENTS												
COMMODITY	NO. CASES	COMMODITY	NO. CASES	COMMODITY	NO. CASES	COMMODITY	NO. CASES	COMMODITY	NO. CASES			
Apples		Nectarines		Pears		Plums						
Cherries		Oranges		OTHER (Specify)		OTHER (Specify)						
Grapes		Peaches										
INSTRUMENT EXAMINATION					INSTRUMENT EXAMINATION							
11. INSTRUMENT NO.		12. WAS INSTRUMENT LOCKED? YES <input type="checkbox"/> NO <input type="checkbox"/>			17. INSTRUMENT NO.		18. WAS INSTRUMENT LOCKED? YES <input type="checkbox"/> NO <input type="checkbox"/>					
13. PRINTING INTERVAL		14. CHART SPEED (in. or cm/24 hours)			19. PRINTING INTERVAL		20. CHART SPEED (in. or cm/24 hours)					
15. ACTUAL LENGTH OF RECORD		16. CALCULATED LENGTH OF RECORD			21. ACTUAL LENGTH OF RECORD		22. CALCULATED LENGTH OF RECORD					
23. CALIBRATION RECORD		IF NOT SATISFACTORY - WHY					SIGNED BY					
SATISFACTORY <input type="checkbox"/>												
24. IDENTIFY COMPARTMENTS												
TEMPERATURE RECORD												
25. Initial fruit temp. recorded		MAX.	MIN.	MAX.	MIN.	MAX.	MIN.	MAX.	MIN.	MAX.	MIN.	
26. Loading completed		DATE	TIME	DATE	TIME	DATE	TIME	DATE	TIME	DATE	TIME	
27. TREATMENT COMMENCED	2.2°C (36°F)											
	1.7°C (35°F)											
	1.1°C (34°F)											
	0.6°F (33°F)											
	0°C (32°F)											
28. Total No. days treatment to time of clearance		TEMP.	DAYS	TEMP.	DAYS	TEMP.	DAYS	TEMP.	DAYS	TEMP.	DAYS	
29. Pulp temperatures (manual check by PPQ officer)		MAX.	MIN.	MAX.	MIN.	MAX.	MIN.	MAX.	MIN.	MAX.	MIN.	
30. Recorded temperatures		BULB NO.	TEMP.	BULB NO.	TEMP.	BULB NO.	TEMP.	BULB NO.	TEMP.	BULB NO.	TEMP.	
31. CARGO STOWAGE		IF NOT, SPECIFY WHY					32. SIGNATURE OF OFFICER					
SATISFACTORY <input type="checkbox"/>												
PPQ FORM 556 AUG. 1977		REPLACES PPQ FORM 556(9/74) WHICH MAY BE USED										

FIGURE A-1-12: PPQ Form 556, In Transit Cold Treatment Clearance Report







# Appendix B

## *Coast Guard Regulations*

This Appendix contains information reprinted from 46CFR, October 1, 1997.

---

### **Title 46—Shipping**

### **Chapter 1—Coast Guard, Dept. of Transportation**

---

### **Part 147A—Interim Regulations For Shipboard Fumigation**

#### **MINIMUM REQUIREMENTS**

##### **General**

**Sec. 147A.1 Purpose.**

**Sec. 147A.3 Applicability..**

**Sec. 147A.5 General requirement.**

**Sec. 147A.7 Definitions..**

**Sec. 147A.9 Persons in charge of fumigation and the vessel; designation..**

**Sec. 147A.10 Notice to Captain of the Port.**

##### **Before Fumigation**

**Sec. 147A.11 Person in charge of fumigation; before fumigation..**

**Sec. 147A.13 Person in charge of the vessel; before fumigation..**

##### **During Fumigation**

**Sec. 147A.21 Person in charge of fumigation; during fumigation.**

**Sec. 147A.23 Person in charge of vessel; during fumigation..**

**Sec. 147A.25 Entry.**

##### **After Ventilation**

**Sec. 147A.31 Removal of fumigation material and warning signs..**

#### **SPECIAL REQUIREMENTS FOR FLAMMABLE FUMIGANTS**

**Sec. 147A.41 Person in charge of fumigation; flammable fumigants..**

**Sec. 147A.43 Other sources of ignition; flammable fumigants..**

AUTHORITY: 46U.S.C. 170; (49 U.S.C. 1655(b)(1)); 49CFR 1.46(b).

SOURCE: CGD 74-144, 39 FR 32998, Sept. 13, 1974, unless otherwise noted.

---

## General

### **Sec. 147A.1 Purpose.**

The purpose of this part is to prescribe the requirements for shipboard fumigation that are critical for the health and safety of the crew and any other person who is on board a vessel during fumigation. These are interim rules pending further study and promulgation of comprehensive regulations on shipboard fumigation.

### **Sec. 147A.3 Applicability.**

This part prescribes the rules for shipboard fumigation on vessels to which 49 CFR parts 171-179 apply under 49 CFR 176.5.

### **Sec. 147A.5 General requirement.**

No person may cause or authorize shipboard fumigation contrary to the rules in this part.

### **Sec. 147A.7 Definitions.**

As used in this part:

(a) Qualified person means a person who has experience with the particular fumigant or knowledge of its properties and is familiar with fumigant detection equipment and procedures, or an applicator who is certified by the Environmental Protection Agency if his certification covers the fumigant that is used.

(b) Fumigant means a substance or mixture of substances that is a gas or is rapidly or progressively transformed to the gaseous state though some nongaseous or particulate matter may remain in the space that is fumigated.

(c) Fumigation means the application of a fumigant on board a vessel to a specific treatment space.

### **Sec. 147A.9 Persons in charge of fumigation and the vessel; designation.**

(a) The person, including any individual, firm, association, partnership, or corporation, that is conducting a fumigation operation shall designate a person in charge of fumigation for each operation.

(b) The operator of each vessel shall designate a person in charge of the vessel for each fumigation operation.



### **Sec. 147A.10 Notice to Captain of the Port.**

Unless otherwise authorized by the Captain of the Port, at least 24 hours before fumigation the operator of the vessel shall notify the Coast Guard Captain of the Port, for the area where the vessel is to be fumigated, of the time and place of the fumigation, and the name of the vessel that is to be fumigated.

---

## **Before Fumigation**

### **Sec. 147A.11 Person in charge of fumigation; before fumigation.**

(a) The person in charge of fumigation shall notify the person in charge of the vessel of:

- (1) The space that is to be fumigated;
- (2) The name, address, and emergency telephone number of the fumigation company;
- (3) The dates and times of fumigation;
- (4) The characteristics of the fumigant;
- (5) The spaces that are determined to be safe for occupancy paragraph (b)(1)(i) of this section;
- (6) The maximum allowable concentration of fumigant in spaces, if any, that are determined to be safe for occupancy under paragraph (b)(1)(i) of this section;
- (7) The symptoms of exposure to the fumigant; and
- (8) Emergency first aid treatment for exposure to the fumigant.

(b) The person in charge of fumigation shall ensure that:

- (1) A marine chemist or other qualified person who has knowledge of and experience in shipboard fumigation evaluates the vessel's construction and configuration and determines:
  - (i) Which spaces, if any, are safe for occupancy during fumigation; and
  - (ii) The intervals that inspections must be made under Sec. 147A.21(a)(1);
- (2) No persons or domestic animals are in the space that is to be fumigated or the spaces that are designated as unsafe for occupancy under paragraph (b)(1)(i) of this section;

- (3) There is proper and secure sealing to confine the fumigant to the space that is to be fumigated, including blanking off and sealing any ventilation ducts and smoke detectors;
- (4) The personal protection and fumigation detection equipment for the fumigant that is to be used is on board the vessel;
- (5) Warning signs are:
  - (i) Posted upon all gangplanks, ladders, and other points of access to the vessel;
  - (ii) Posted on all entrances to the spaces that are designated as unsafe for occupancy under paragraph (b)(1)(i) of this section; and
  - (iii) In accordance with 49 CFR 173.9(c) or section 8.10 of the General Introduction of the International Maritime Dangerous Goods Code. The word "unit" on the warning sign may be replaced with "vessel," "barge," "hold," or "space," as appropriate.
- (6) Watchmen are stationed at all entrances to:
  - (i) Spaces that are not determined to be safe for occupancy under paragraph (b)(1)(i) of this section; or
  - (ii) The vessel, if no spaces are determined to be safe for occupancy under paragraph (b)(1)(i) of this section.

**Sec. 147A.13 Person in charge of the vessel; before fumigation.**

(a) After notice under Sec. 147A.11 (a)(5), the person in charge of the vessel shall notify the crew and all other persons on board the vessel who are not participating in the fumigation of the spaces that are determined to be safe for occupancy under Sec. 147A.11(b)(1)(i).

(b) If no spaces are determined to be safe for occupancy under Sec. 147A.11 (b)(1)(i), the person in charge of the vessel shall ensure that the crew and all persons who are not participating in the fumigation leave the vessel and remain away during fumigation.

---

**During Fumigation**

**Sec. 147A.21 Person in charge of fumigation; during fumigation.**

(a) Until ventilation begins, or until the vessel leaves port, the person in charge of fumigation shall ensure that a qualified person inspects the vessel as follows:

- (1) He must use detection equipment for the fumigant that is used to ensure that the fumigant is confined to:

(i) The space that is fumigated, if partial occupancy is allowed under Sec. 147A.11(b)(1)(i); or

(ii) The vessel, if no space is determined to be safe for occupancy under Sec. 147A.11(b)(1)(i).

(2) He must make inspections at the intervals that are determined to be necessary by the marine chemist or qualified person under Sec. 147A.11(b)(1)(ii).

(b) If leakage occurs, the person in charge of fumigation shall:

(1) Notify the person in charge of the vessel that there is leakage;

(2) Ensure that all necessary measures are taken for the health and safety of any person; and

(3) Notify the person in charge of the vessel when there is no danger to the health and safety of any person.

(c) After the exposure period, if the vessel is in port, the person in charge of fumigation shall ensure that fumigators or other qualified persons ventilate the space that is fumigated as follows:

(1) Hatch covers and vent seals must be removed, other routes of access to the atmosphere must be opened, and if necessary, mechanical ventilation must be used.

(2) Personal protection equipment that is appropriate for the fumigant that is used must be worn.

(d) If ventilation is completed before the vessel leaves port, the person in charge of fumigation shall:

(1) Ensure that a qualified person, who is wearing the personal protection equipment for the fumigant that is used if remote detection equipment is not used, tests the space that is fumigated and determines if there is any danger to the health and safety of any person, including a danger from fumigant that may be retained in bagged, baled, or other absorbent cargo;

(2) Notify the person in charge of the vessel of this determination; and

(3) If it is determined that there is a danger:

(i) Ensure that all measures are taken that are necessary for the health and safety of all persons; and

(ii) Notify the person in charge of the vessel when there is no danger to the health and safety of any person.

**Sec. 147A.23 Person in charge of vessel; during fumigation.**

(a) The person in charge of the vessel shall ensure that the crew and all other persons on board the vessel who are not participating in the fumigation restrict their movement during fumigation to the spaces that are determined to be safe for occupancy under Sec.

147A.11(b)(1)(i).

(b) The person in charge of the vessel shall ensure that the crew and all other persons who are not participating in the fumigation follow any instructions of the person in charge of fumigation that are issued under Sec. 147A.21(b)(2) or (d)(3)(i) and that the vessel does not leave port if he is notified under:

(1) Section 147A.21(b)(1) that there is leakage, unless the person in charge of fumigation notifies him under Sec. 147A.21(b)(3) of this subpart that there is no danger; or

(2) Section 147A.21(d)(2) that there is a danger after ventilation, unless the person in charge of the fumigation notifies him under Sec. 147A.21(d)(3)(ii) that there is no danger.

(c) If fumigation is not completed before the vessel leaves port, the person in charge of the vessel shall ensure that personal protection and fumigant detection equipment for the fumigant that is used is on board the vessel.

(d) If the vessel leaves port before fumigation is completed, the person in charge of the vessel shall ensure that a qualified person makes periodic inspections until ventilation is completed and this person shall use detection equipment for the fumigant that is used to determine if:

(1) There is leakage of fumigant; or

(2) There is a concentration of fumigant that is a danger to the health and safety of any person.

(e) If the qualified person determines under paragraph (d) of this section that there is leakage or a concentration of fumigant that is a danger to the health and safety of any person, the person in charge of the vessel shall take all measures that are, in his discretion, necessary to ensure health and safety of all persons who are on board the vessel. If the danger is due to leakage, he shall also ensure that qualified persons immediately ventilate in accordance with paragraphs (c)(1) and (2) of Sec. 147A.21.

(f) If the vessel leaves port during the exposure period, the person in charge of the vessel shall ensure that the space that is fumigated is ventilated by qualified persons after the exposure period in accordance with paragraphs (c) (1) and (2) of Sec. 147A.21.

(g) If ventilation is completed after the vessel leaves port, the person in charge of the vessel shall ensure that a qualified person, who is wearing the personal protection equipment for the fumigant that is used if remote detection equipment is not used, tests the space that is fumigated to determine if there is a danger to the health and safety of any person, including a danger from fumigant that may be retained in bagged, baled, or other absorbent cargo. If the qualified person determines that there is a danger, the person in charge of the vessel shall take all measures that are, in his discretion, necessary to ensure the health and safety of all persons who are on board the vessel.

### **Sec. 147A.25 Entry.**

(a) No person may enter the spaces that immediately adjoin the space that is fumigated during fumigation unless entry is for emergency purposes or the space is tested and declared safe for human occupancy by a marine chemist or other qualified person and is inspected under Sec. 147A.21(a)(2) or Sec. 147A.23(d).

(b) If entry is made for emergency purposes:

(1) No person may enter the space that is fumigated or any adjoining spaces during fumigation unless he wears the personal protection equipment for the fumigant that is in use;

(2) No person may enter the space that is fumigated unless the entry is made by a two person team; and

(3) No person may enter the space that is fumigated unless he wears a lifeline and safety harness and each life-line is tended by a person who is outside the space and who is wearing the personal protection equipment for the fumigant that is in use.

---

## **After Ventilation**

### **Sec. 147A.31 Removal of fumigation material and warning signs.**

After ventilation is completed and a marine chemist or other qualified person determines that there is no danger to the health and safety of any person under Sec. 147A.21(d) or Sec. 147A.23(g), the person in charge of fumigation, or, if the vessel has left port, the person in

charge of the vessel, shall ensure that all warning signs are removed and fumigation containers and materials are removed and disposed of in accordance with the manufacturer's recommendations.

---

## **Special Requirements for Flammable Fumigants**

### **Sec. 147A.41 Person in charge of fumigation; flammable fumigants.**

(a) The person in charge of fumigation shall ensure that:

- (1) Before the space that is to be fumigated is sealed, it is thoroughly cleaned, and all refuse, oily waste, and other combustible material is removed;
- (2) Before fumigation, all fire fighting equipment, including sprinklers and fire pumps, is in operating condition; and
- (3) Before and during fumigation, electrical circuits that are in the space that is fumigated are de-energized.

(b) [Reserved]

### **Sec. 147A.43 Other sources of ignition; flammable fumigants.**

While the space that is fumigated is being sealed or during fumigation, no person may use matches, smoking materials, fires, open flames, or any other source of ignition in any spaces that are not determined to be safe for occupancy under Sec. 147A.11(b)(1)(i).



# Appendix C

## *Maintenance: Supporting and Updating Manuals*

---

### Contents

Introduction	page-C-1-1
Issuing Revisions	page-C-1-1
Keeping Manuals Current	page-C-1-2
Knowing What Is Revised	page-C-1-2
Knowing Your Responsibility	page-C-1-3
Ordering Manuals	page-C-1-3
Updating Distribution Lists	page-C-1-4
Change of Address	page-C-1-5
Correcting Errors and Suggesting Improvements	page-C-1-5
Manual Order Form	page-C-1-7
Distribution Update Sheet	page-C-1-9

---

### Introduction

Just as it is cheaper and less time consuming over time to properly maintain a piece of equipment, so it is with a manual. The Agency must maintain and modify manuals properly. Without an orderly procedure for maintaining manuals, they are likely to fail, significantly reducing the effectiveness of the programs they support. So, to maintain manuals, an orderly procedure is critical. Here then is a description of how Plant Protection and Quarantine (PPQ) will support the manuals. Also, here are directions for you to follow in maintaining the integrity of the manuals issued to you.

---

### Issuing Revisions

PPQ will revise this manual by distributing immediate updates. We will schedule new editions at fixed intervals—at least every 5 years. If more than 50 percent of some section changes, we will issue a new section. We will **not** issue a new page solely to correct a minor typographical error. Errors will be corrected only when they would lead to an incorrect action.

PPQ will issue all revisions as either “add a page” or “replace a page.” However, if information in the manuals might result in an error on the job, PPQ will post an update on PPQ's electronic bulletin board. For example, if PPQ's Permit Unit issues a permit for the entry of a new

fruit or vegetable, this unit will post the information. If you do **not** have access to the PPQ Bulletin Board, you should receive a copy of the posting through your work unit.

---

## Keeping Manuals Current

There are three ways to track revisions for your manuals:

- ◆ Update Record
- ◆ Transmittal memos
- ◆ Control data

The *Update Record* is the next page after the title page of this manual. If you miss a transmittal, the *Update Record* alerts you. Also, during an audit, this record lets your supervisor know how up-to-date your manual is. Record all the transmittals you receive in the *Update Record*.

PPQ will mail all revisions with a transmittal memo. PPQ will number these consecutively—allowing you to know if you've missed a transmittal. Filing these memos to assure that you've received all the previous issuances is best. File transmittals immediately upon receiving them. If two or more transmittals accumulate, add the earliest first. PPQ Headquarters may audit how well the manuals are kept during port reviews.

Besides having numbered transmittals, each page in the manual has control data. This is positioned at the bottom of the page. The revised pages' control data alerts you to whether you have the most up-to-date version. The control data looks like this:

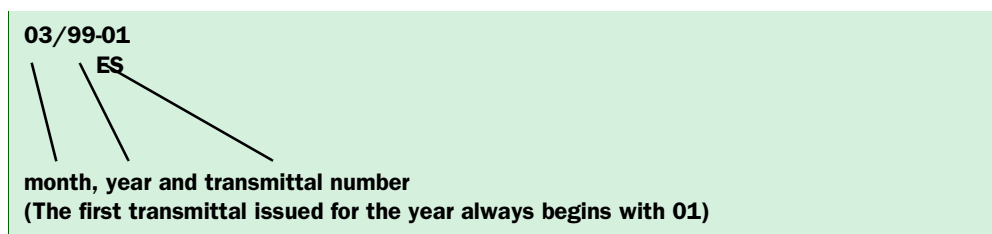

---

## Knowing What Is Revised

The transmittal will explain the revision's purpose and give you directions for making the revision—adding or replacing pages.



Except changes to the index, PPQ will mark all revisions with arrows, (—>) or change bars (|). Deleted material will be marked with angle brackets (<). If no other changes occur, material moved from the bottom of one page to the top of the next page will **not** be marked.

---

## Knowing Your Responsibility

To enhance professionalism, keep your manuals current. If you fail to update your manual, you run the risk of making a costly error. The incorrect action you take might result in the outbreak of an exotic pest or disease. Or, an error may result in additional costs to an importer.

Therefore, please do the following:

1. Read the revisions when you receive them.
2. Add or replace the revised pages the day you receive them.
3. If a practice exercise is included, complete it.
4. File transmittal memos in your manual.
5. If you miss a transmittal, order another one.
6. Let the manuals unit know when it has made an error.
7. Give the manuals unit your suggestions for improvements

---

## Ordering Manuals

Management and Budget's Printing, Distribution, and Mail Section is responsible for storing and distributing PPQ's manuals and their associated updates. Their address is as follows:

USDA, APHIS, MRP-BS, RWBS  
Printing, Distribution, and Mail Section  
4700 River Road, Suite 1A01  
Riverdale, MD 20737-1229

If you need to replace or order additional manuals, manual parts, or transmittals, use E-mail, facsimile, telephone, or use the Manual Order Form in the section.

Part Number	Date	Title	Quantity
M319.8	11/82	Foreign Cotton and Covers	10
7CFR 354.1	01/85	Overtime Services—Hourly Rate Increases	03
	03/88	Plant Import: Nonpropagative Trans.	
		No. 01/94-01	02

When ordering, include the following information (if information is missing, shipment may be delayed or order may not be filled):

- ❖ Your organization
- ❖ Your P.O. Box (if you have one)
- ❖ Your street address (include your room number)
- ❖ City, State, and Zip Code
- ❖ Contact person
- ❖ Telephone numbers

**To order by telephone**, call Area Code (301) 734-5524 (MRP-BS/RWBS, Riverdale, MD)

**To mail or send a facsimile of the Order Form**, fill out the *Mail Order Form* in this section. Please be sure to include all the necessary information. Make sure you frank or put a stamp on the form. Order by Transmittal Number (for example, 12/95-05). Never order by page number. The facsimile number for MRP-BS/RWBS is Area Code (301) 734-8455.

---

## Updating Distribution Lists

### To Change the Number of Manuals You Are Receiving or to Have Manuals:

**To change number of manuals received**, use the *Distribution Update Sheet* in this section. Follow these directions for completing the form:

1. Using M390.1120, list the distribution code(s) you want changed.
2. Enter total number of copies you need.
3. Get the Officer-in-Charge's or Operations Supervisor's signature.
4. Attach an old mailing label (it has the necessary access or organization structure code).
5. Fold and mail or send a facsimile of the *Distribution Update Sheet*



If any of the above information in 1-4 above is missing, HSB will return your request. If you don't have an old label, then wait until you get one. HSB cannot make the change without the access code. Your access code appears on every mailing label sent from HSB in Riverdale, MD.

---

## Change of Address

**To change your mailing address**, use the *Distribution Update Sheet* in this section. Follow these directions for completing the form:

1. Attach an old mailing label (it has the necessary access code).
2. Print or type the new address as it should appear.
3. Fold and mail or send a facsimile of the *Distribution Update Sheet*.

---

## Correcting Errors and Suggesting Improvements

If you detect an error, report it using a comment sheet that's included with this manual. Or, if it is easier, call, send an E-mail message, or transmit a facsimile to Josie Cooley or anyone else in the manuals unit:

Office number: (240) 529-0358

Facsimile number: (240) 529-0399

E-mail address: [josie.cooley@aphis.usda.gov](mailto:josie.cooley@aphis.usda.gov)

Do the same if you want to suggest an improvement or question a procedural change. If your improvement is substantive, you might want to submit a formal suggestion, using the required form.



## Manual Order Form

I am missing the following manuals or transmittals. (If any information is missing, orders will not be filled.)

Manual or Transmittal Number	Dated:	Title:	Quantity:

Please send to:

Name:

Organization:

PO Box or Street Address:

City/State/Zip Code:

Telephone Number:

**Fold, Staple, Affix Postage, and Drop in the Mail**

UNITED STATES DEPARTMENT OF AGRICULTURE  
ANIMAL AND PLANT HEALTH INSPECTION SERVICE

USDA, APHIS, MRP-BS, RWBS

Printing, Distribution, and Mail Section  
4700 River Road, Suite 1A01  
Riverdale MD 20737

## Distribution Update Sheet

1. List Distribution code(s) to be changed: The distribution code for the ECM is ECM. (If you are making a change to another manual, see a list of distribution codes in M390.1120, revised February 1982)

_____	_____	_____	_____
_____	_____	_____	_____
_____	_____	_____	_____

2. Number of copies you get now \_\_\_\_\_ Number of copies you want to get \_\_\_\_\_

3. New or corrected address:

\_\_\_\_\_

\_\_\_\_\_

\_\_\_\_\_

\_\_\_\_\_

4. The address on the attached label is to be deleted  Yes  No

Attach mailing label below.

**NOTE: If you do not have a mailing label, wait until you receive one. This request will be returned to you if there is no old label attached.**

This Distribution Update Sheet is to be submitted by the person at your location who is responsible for the distribution of manuals.

**FOLD, STAPLE, AFFIX POSTAGE, AND DROP IN THE MAIL.**

UNITED STATES DEPARTMENT OF AGRICULTURE  
ANIMAL AND PLANT HEALTH INSPECTION SERVICE

USDA, APHIS, MRP-BS, RWBS

Printing, Distribution, and Mail Section  
4700 River Road, Suite 1A01  
Riverdale MD 20737



# D

Treatment Manual

## Appendix D

### Conversion Tables

**TABLE D-1-1: Conversion Tables**

To convert from:	To:	Multiply by:
Acres (a)	Hectares (ha)	0.4047
Acres (a)	Square meters (m <sup>2</sup> )	4,047.0
Celsius	Fahrenheit	9/5 (then add 32)
Centimeters, cu. (cm <sup>3</sup> )	Cubic inches (in <sup>3</sup> )	0.061
Centimeters, sq. (cm <sup>2</sup> )	Square inches (in <sup>2</sup> )	0.155
Centimeters (cm)	Inches (in)	0.3937
Fahrenheit	Celsius	First, subtract 32, then multiply by <sup>5</sup> / <sub>9</sub>
Feet, cubic (ft <sup>3</sup> )	Liters (L)	28.32
Feet, cubic (ft <sup>3</sup> )	Cubic meters (m <sup>3</sup> )	0.0283
Feet, square (ft <sup>2</sup> )	Square meters (m <sup>2</sup> )	0.0929
Feet, square (ft <sup>2</sup> )	Sq. centimeters (cm <sup>2</sup> )	929.0
Feet (ft)	Centimeters (cm)	30.48
Feet (ft)	Meters (m)	0.3048
Gallons (gal)	Liters (L)	3.785
Grams (g)	Ounces (oz)	0.0353
Hectares (ha)	Acres (a)	2.471
Inches (in)	Centimeters (cm)	2.54
Inches, square (in <sup>2</sup> )	Sq. centimeters (cm <sup>2</sup> )	6.4516
Inches, cubic (in <sup>3</sup> )	Cu. centimeters (cm <sup>3</sup> )	16.387
Kilograms (kg)	Pounds (lb)	2.205
Kilograms (kg)	Ounces (oz)	35.27
Kilometers, sq. (km <sup>2</sup> )	Square miles (mi <sup>2</sup> )	0.3861
Kilometers, sq. (km <sup>2</sup> )	Acres (a)	247.1
Kilometers (km)	Miles (mi)	0.6214
Liters (L)	Gallons (gal)	0.2642
Liters (L)	Quarts (qt)	1.0567
Meters, cubic (m <sup>3</sup> )	Cubic feet (ft <sup>3</sup> )	35.314
Meters, cubic (m <sup>3</sup> )	Cubic yards (yd <sup>3</sup> )	1.308
Meters (m)	Feet (ft)	3.281
Meters (m)	Yards (yd)	1.0936
Meters, sq. (m <sup>2</sup> )	Square inches (in <sup>2</sup> )	1,550.00
Meters (m)	Inches (in)	39.37
Meters, sq. (m <sup>2</sup> )	Square feet (ft <sup>2</sup> )	10.764

**TABLE D-1-1: Conversion Tables**

To convert from:	To:	Multiply by:
Miles, square (mi <sup>2</sup> )	Hectares (ha)	258.99
Miles, square (mi <sup>2</sup> )	Sq. kilometers (km <sup>2</sup> )	2.5899
Miles, statute (mi)	Meters (m)	1,609.347
Miles, statute (mi)	Kilometers (km)	1.609
Milliliters (ml)	Liquid ounces (lq oz)	0.0338
Nautical miles	Meters (m)	1,852.00
Ounces, fluid (fl oz)	Milliliters (ml)	29.57
Ounces (oz)	Kilograms (kg)	0.0284
Ounces (oz)	Grams (g)	28.35
Pounds (lb)	Kilograms (kg)	0.4536
Pounds (lb)	Grams (g)	453.6
Quarts (qt)	Liters (L)	0.9464
Tons, short (2000 lb)	Metric tons (t)	0.9072
Tons, Metric (t)	Tons, short	1.102
Yards, cubic (yd <sup>3</sup> )	Liters (L)	764.6
Yards, cubic (yd <sup>3</sup> )	Cubic meters (m <sup>3</sup> )	0.765
Yards (yd)	Meters (m)	0.9144
Yards (yd)	Centimeters (cm)	91.44

Miscellaneous:

Ounces (weight) per 1,000 cu. ft. = grams per cu. meter (g/m<sup>3</sup>)  
Pounds per acre (lb/a) × 1.1206 = kg/ha  
Ounces (liquid) per acre × 73.14 = ml/ha  
Gallons per acre (gal/a) × 9.3527 = liters per hectare (L/ha)  
Pressure per square inch (PSI) × 6.894757 = kilopascals (kPa)  
Inches mercury × 3.38 = kilopascals (kPa)  
Grams per cu. meter (g/m<sup>3</sup>) = ounces per 1,000 cu. ft. (oz/1,000 ft<sup>3</sup>)  
Kilogram per hectare (kg/ha) × 0.8924 = pounds per acre  
Milliliters per hectare × 0.01367 = ounces (lq.) per acre  
Liters per hectare (L/ha) × 0.1069 = gallons per acre  
Kilopascals (kPa) × 0.145038 = pounds per square inch (PSI)  
Grams per liter × 0.008345 = pounds per gallon  
Kilopascals (kPa) × 0.29586 = inches mercury



# Appendix E

## *Directory of Treatment Facilities*

There are two lists of approved treatment facilities available for public viewing. They are separated by region and include facilities that are used for the treatment of **imported** commodities.

Click on the following address to access the Manuals Unit complete list of electronic manuals. Scroll down to the end of the page where "*Treatment Manual*" appears. Select either Eastern Region Facility List or Western Region Facility List.

[http://www.aphis.usda.gov/import\\_export/plants/manuals/online\\_manuals.shtml](http://www.aphis.usda.gov/import_export/plants/manuals/online_manuals.shtml)

In addition, a complete list of approved treatment facilities for both exported and imported commodities can be viewed on the PPQ Intranet site by government agencies only. Government personnel may access the list at <http://inside.aphis.usda.gov/ppq/php/manuals.shtml>



These lists are updated semi-annually. If you have any questions regarding the status of a treatment facility, contact the Regional Treatment Program Manager in your region.





# Appendix F

## *List of Integral Containers Approved for Intransit Cold Treatment*

---

A database of approved containers is maintained by the PPQ Center for Plant Health Science & Technology (CPHST) Treatment Quality Assurance Unit (TQAU.) To search for an approved container, consult the TQAU database:

<https://treatments.cphst.org/vessels/>

**NOTICE**

If you have any questions regarding the status of a self-refrigerated container, contact the Center for Plant Health Science and Technology (CPHST) at (919) 855-7450 or fax (919) 855-7493.





# Appendix G

## *List of Vessels Equipped for Intransit Cold Treatment*

---

A database of approved vessels is maintained by the PPQ-Center for Plant Health Science & Technology (CPHST) Treatment Quality Assurance Unit (TQAU.) To search for an approved vessel, consult the TQAU database:

<https://treatments.cphst.org/vessels/>

  
**NOTICE**

If you have questions regarding the status of vessels, contact CPHST at (919)855-7450 or fax (919) 855-7493 for the current status of the vessel







# Appendix H

## *Reference Guide to Commercial Suppliers of Treatment and Related Safety Equipment*

This list is not intended to be all inclusive; only domestic suppliers are shown. Many large companies have branch offices. This list is intended to be a reference guide to the availability of fumigation equipment and supplies and is furnished solely for the convenience of potential users, particularly PPQ plant inspection stations. No endorsement is intended of the particular items listed, and no discrimination is intended toward those products or companies that may not be listed.

### Products

Aeration Duct, Flexible [page-H-1-6](#)  
Aerosol Insecticides [page-H-1-7](#)  
Air Pump, Auxiliary [page-H-1-7](#)  
Air-Purifying Respirator\* [page-H-1-8](#)  
Air Velocity Measuring (Anemometer) [page-H-1-9](#)  
Aluminum Phosphide [page-H-1-10](#)  
Applicator (Dispenser) for Methyl Bromide [page-H-1-12](#)  
Ascarite II [page-H-1-13](#)  
Balances, Portable (for weighing individual fruit) [page-H-1-13](#)  
Batch Systems (complete installations, hot water immersion treatments) [page-H-1-14](#)  
Blower [page-H-1-17](#)  
Bubble Fumigation System [page-H-1-17](#)  
Cascade Air Tank Recharging System (for SCBA) [page-H-1-18](#)  
Chain Hoist (Electronic) (For hot water immersion treatments) [page-H-1-18](#)  
Consultants (For hot water immersion treatments) [page-H-1-18](#)  
Curtains (air, safeguarding) [page-H-1-20](#)  
Digital Thermister Instrument (hand-held for hot water immersion treatments) and Portable Sensors (used in Performance Test) [page-H-1-20](#)  
Drierite® (anhydrous calcium sulfate) [page-H-1-21](#)  
Exhaust Duct (Tube), Flexible [page-H-1-21](#)  
Fans [page-H-1-22](#)  
Fruit Crates, (Plastic for hot water immersion treatments) [page-H-1-22](#)  
Fruit Sizing Equipment (Automatic) [page-H-1-22](#)  
Fumigation Chamber, NAP [page-H-1-23](#)  
Fumigation Chamber, Vacuum [page-H-1-23](#)  
Fumigators, Commercial [page-H-1-24](#)  
Fungicides [page-H-1-24](#)

Gas Analyzers [page-H-1-26](#)  
Gas Detector Tube (colorimetric) and Apparatus [page-H-1-27](#)  
Gas Drying Tube (for Drierite®) [page-H-1-29](#)  
Germicides/Disinfectants [page-H-1-29](#)  
Halide Gas Leak Detector (removed) [page-H-1-30](#)  
Incinerators [page-H-1-30](#)  
Magnesium Phosphide [page-H-1-30](#)  
Manometer (used in pressure leakage test) [page-H-1-31](#)  
Metam-sodium [page-H-1-32](#)  
Methyl Bromide, 100% [page-H-1-32](#)  
Moisture Meter (for wood) [page-H-1-34](#)  
Newsletters and Trade Journals [page-H-1-34](#)  
Personal Air Sample Pump [page-H-1-35](#)  
Photo Ionization Detector [page-H-1-36](#)  
Safety Equipment [page-H-1-36](#)  
Scale (portable platform type) [page-H-1-37](#)  
Sealing Tape [page-H-1-37](#)  
Self-Contained Breathing Apparatus (SCBA) [page-H-1-38](#)  
Smoking Candle [page-H-1-39](#)  
Snakes (sand snakes, watersnakes) [page-H-1-40](#)  
Soil Fumigants [page-H-1-40](#)  
Spill Recovery Materials [page-H-1-41](#)  
Steam Boilers (For hot water immersion treatment) [page-H-1-42](#)  
Steam Generators [page-H-1-42](#)  
Steam Sterilizers/Autoclaves [page-H-1-42](#)  
Sulfuryl Fluoride (Vikane) [page-H-1-43](#)  
Supplied-Air Respirators [page-H-1-44](#)  
Tarpaulins (made to order) [page-H-1-44](#)  
Temperature Recorders and Sensors - General Use [page-H-1-46](#)  
Temperature Recorders for Hot Water Immersion Treatment [page-H-1-51](#)  
Temperature Sensors (RTD, 100 ohm) [page-H-1-54](#)  
Thermocouple Wire [page-H-1-55](#)  
Thermometers [page-H-1-55](#)  
Thermometers, Glass-Mercury, Certified Precision [page-H-1-56](#)  
Thermometers, Glass Non-Mercury, Certified Precision [page-H-1-58](#)  
Thermometers, Digital, Certified Precision [page-H-1-59](#)  
Thermometers, Certified Precision, Approved Calibration Companies [page-H-1-62](#)  
Tubing, Gas-Sampling [page-H-1-64](#)  
Vacuum Pump [page-H-1-65](#)  
Vapam [page-H-1-66](#)  
Volatilizer (heat exchanger) for Methyl Bromide [page-H-1-66](#)  
Warning Signs and Placards [page-H-1-67](#)

---

## Suppliers

Acme Protection Equipment Co. [page-H-1-8](#)  
Agri-Machinery, Inc. (A.M.I.) [page-H-1-14](#)  
Agroindustrias Integradas, S.A. de C.V. [page-H-1-14](#)  
Aldrich Chemical Company, Inc. [page-H-1-13](#)  
Allied Electronics [page-H-1-20](#)  
Alnor Instrument Co. [page-H-1-31](#)

American Optical Corporation [page-H-1-8](#)  
Analytical Technology, Inc. [page-H-1-26](#)  
Anatole J. Sipin Co., Inc. [page-H-1-35](#)  
Ansul [page-H-1-41](#)  
APHIS/NOAA Centralized Warehouse [page-H-1-27](#)  
Arlington Scale Co., Inc. [page-H-1-37](#)  
Atlantic Scale Co., Inc. [page-H-1-37](#)  
B&G Equipment Company [page-H-1-17](#)  
Barnant Company [page-H-1-7](#)  
Biesterfeld U.S. Inc. [page-H-1-6](#), [page-H-1-32](#)  
Brooklyn Thermometer Co., Inc. [page-H-1-55](#)  
Buckman Laboratories, Inc. [page-H-1-40](#)  
Burlington Scientific Corp. [page-H-1-10](#) [page-H-1-30](#)  
Calderas Astro, S.A. de C.V. [page-H-1-14](#)  
Carlton Industries, Inc. [page-H-1-67](#)  
Cesco Safety Products [page-H-1-38](#)  
Chemonics [page-H-1-18](#)  
Champion America, Inc. [page-H-1-67](#)  
Chessell Corporation [page-H-1-51](#)  
Crystal Chemical Inter-America [page-H-1-24](#)  
Cole-Parmer Instrument Co. [page-H-1-7](#), [page-H-1-55](#), [page-H-1-64](#)  
Columbus McKinnon Corp. [page-H-1-18](#)  
Electro Scientific Industries [page-H-1-52](#)  
Consolidated Plastics Co. [page-H-1-64](#)  
Consultecnia [page-H-1-14](#), [page-H-1-20](#), [page-H-1-51](#)  
Contech [page-H-1-51](#)  
Control Instrument Services, Inc. [page-H-1-52](#)  
Construcciones Pyrsa [page-H-1-14](#)  
Consultecnia [page-H-1-14](#),  
Cooper Instrument Corp. [page-H-1-21](#), [page-H-1-55](#) [page-H-1-55](#)  
Crowell Manufacturing Company [page-H-1-65](#)  
Crystal Chemical Inter-America [page-H-1-24](#)  
Davis Instruments [page-H-1-31](#), [page-H-1-39](#)  
Degesch America, Inc. [page-H-1-10](#) [page-H-1-12](#), [page-H-1-30](#), [page-H-1-32](#),  
[page-H-1-37](#), [page-H-1-66](#)  
Delmhorst Instrument Company [page-H-1-34](#)  
Dica de Mexico, S.A. [page-H-1-15](#), [page-H-1-19](#)  
Diseños y Maquinaria Jer, S.A. de C.V.(“Jersa”) [page-H-1-15](#)  
Dow Agro Sciences [page-H-1-43](#)  
Drexel Chemical Co. [page-H-1-24](#)  
Dwyer Instruments, Inc. [page-H-1-31](#)  
Eastern Scales NJ [page-H-1-37](#)  
Electro Scientific Industries [page-H-1-52](#)  
Electro Scientific Industries [page-H-1-52](#)  
Equipos Agroindustriales de Occidente, S.A. de C. V. [page-H-1-15](#)  
Equipos Industriales Guadalajara [page-H-1-52](#)  
ETC Biophysics [page-H-1-42](#)  
Fisher Scientific [page-H-1-13](#), [page-H-1-21](#), [page-H-1-31](#), [page-H-1-64](#)  
FMC Corp. AG [page-H-1-25](#)  
Fruit Technologies [page-H-1-23](#)  
Frutico International [page-H-1-15](#), [page-H-1-19](#)  
Fulton Boiler Works, Inc. [page-H-1-42](#)  
Fumigants and Pheromones [page-H-1-34](#)

Fumigation Service & Supply Inc. [page-H-1-6](#), [page-H-1-12](#), [page-H-1-30](#),  
[page-H-1-32](#), [page-H-1-40](#), [page-H-1-38](#), [page-H-1-41](#)  
Consultecnia [page-H-1-19](#)  
Gaskets, Inc. [page-H-1-21](#)  
GEC Instruments [page-H-1-46](#)  
Georgia-Pacific Corp. [page-H-1-29](#)  
Georgia Steel & Chemical Company, Inc. [page-H-1-35](#)  
Gilmore, Inc. [page-H-1-6](#), [page-H-1-10](#)  
Gow-Mac Instrument Company [page-H-1-26](#)  
Great Lakes Chemical Corp. [page-H-1-33](#),  
Griffolyn Company, Division [page-H-1-45](#)  
Guiar Industrial, S.A. de C.V. [page-H-1-15](#), [page-H-1-52](#)  
H. T. McGill Company [page-H-1-12](#)  
Helena Chemical Co. [page-H-1-10](#), [page-H-1-30](#), [page-H-1-33](#)  
Honeywell, Inc. [page-H-1-53](#)  
HSC Corporation [page-H-1-8](#)  
ICD Group, Inc. [page-H-1-10](#), [page-H-1-33](#)  
IDA, Inc. [page-H-1-11](#)  
Illinois Testing Labs, Inc. [page-H-1-66](#)  
Inchema, Inc. [page-H-1-11](#)  
Industrial Equipment & Engineering Co. [page-H-1-16](#), [page-H-1-53](#)  
Industrial Safety Company [page-H-1-36](#)  
Instrumentacion y Control Industrial [page-H-1-53](#)  
Interscan Corp. [page-H-1-26](#)  
Kerian Machines, Inc. [page-H-1-22](#)  
Key Chemical and Equipment Co., Inc. [page-H-1-26](#)  
Lab Safety Supply [page-H-1-27](#), [page-H-1-38](#)  
Lignomat [page-H-1-34](#)  
Loveland Industries, Inc. [page-H-1-11](#)  
Lurex Scientific [page-H-1-29](#)  
Marman USA, Inc. [page-H-1-6](#), [page-H-1-11](#), [page-H-1-31](#), [page-H-1-33](#),  
[page-H-1-43](#)  
Matheson Gas Products [page-H-1-27](#)  
McMaster-Carr Supply Co. [page-H-1-8](#)  
Micro Precision Calibration, Inc. [page-H-1-63](#)  
Mine Safety Appliances Co. (MSA) [page-H-1-8](#), [page-H-1-36](#)  
NK Nielson-Kellerman [page-H-1-9](#)  
Nanmac Corporation [page-H-1-53](#)  
National Draeger, Inc. [page-H-1-28](#), [page-H-1-39](#), [page-H-1-44](#)  
National Instruments, Inc. [page-H-1-54](#)  
Neal Systems, Inc. [page-H-1-27](#)  
Neotronics of North America [page-H-1-32](#)  
Neuberger Messinstrumente Gmbh [page-H-1-54](#)  
New Pig Corp. [page-H-1-41](#)  
Neward Enterprises, Inc. [page-H-1-65](#)  
Nojoxten [page-H-1-20](#)  
North Bay Produce, Inc. [page-H-1-19](#)  
Nova-Chem, Inc. [page-H-1-6](#), [page-H-1-11](#), [page-H-1-31](#), [page-H-1-33](#), [page-H-1-43](#)  
N.Z. Automacao Ltda. [page-H-1-54](#)  
Ohaus Corporation [page-H-1-13](#)  
Omega Engineering, Inc. [page-H-1-55](#), [page-H-1-55](#)  
Oregon-California Chemicals, Inc. [page-H-1-40](#)  
Center for Plant Health Science and Technology [page-H-1-19](#)

Pest Control [page-H-1-35](#)  
Pest Control Technology [page-H-1-35](#)  
Pest Fog Sales [page-H-1-12](#), [page-H-1-66](#)  
Pestcon Systems, Inc. [page-H-1-11](#), [page-H-1-33](#)  
Phifer Wire Products, Inc. [page-H-1-37](#)  
Poly-Flex, Inc. [page-H-1-45](#)  
Power Plastics [page-H-1-17](#)  
Prentiss Drug & Chem. Co., Inc. [page-H-1-7](#)  
Process Technologies, Inc. [page-H-1-54](#)  
Produce Sorters Internationale [page-H-1-16](#)  
Protech Safety Equipment [page-H-1-28](#)  
Proyect Asesoria Industrial [page-H-1-16](#)  
Rae Systems [page-H-1-36](#)  
Red Panther Chemical Co. [page-H-1-7](#)  
Rexnord Electronic Products [page-H-1-39](#)  
Rhone-Poulenc Ag Co. [page-H-1-26](#)  
Roxan, Inc. [page-H-1-28](#)  
Vacuum Research Corp. [page-H-1-54](#)  
Scott Air Aviation [page-H-1-39](#)  
Scott Aviation [page-H-1-9](#), [page-H-1-18](#), [page-H-1-44](#)  
Sensidyne, Inc. [page-H-1-28](#)  
Silsa, S.A. de C.V. [page-H-1-16](#)  
Sioux Steam Cleaner Corporation [page-H-1-42](#)  
SKC, Inc. [page-H-1-28](#)  
Slack Associates, Inc. [page-H-1-23](#)  
Southern Agricultural Insecticides, Inc. [page-H-1-7](#), [page-H-1-34](#), [page-H-1-43](#)  
Southern Mill Creek Products Co., Inc. [page-H-1-7](#), [page-H-1-34](#), [page-H-1-43](#)  
Spectrex Corp. [page-H-1-35](#)  
Spectros Instruments, Inc. [page-H-1-27](#)  
Superior Signal Co., Inc. [page-H-1-40](#)  
Survivair [page-H-1-39](#)  
TSI, Inc. Alnor Products [page-H-1-9](#)  
Thermo Electric [page-H-1-56](#)  
Thomas Scientific [page-H-1-13](#), [page-H-1-65](#)  
3M Occupational Health & Safety [page-H-1-44](#)  
UCB Chemicals Corp. [page-H-1-25](#), [page-H-1-41](#)  
Union Carbide Corp, Linde Div. [page-H-1-28](#)  
Uniroyal Chemical Co., Inc. [page-H-1-24](#)  
United Suppliers, Inc. [page-H-1-12](#)  
Upright, Inc. [page-H-1-42](#)  
Vacudyne Corporation [page-H-1-66](#)  
Vacuum Research Corp. [page-H-1-54](#)  
Vestrol Laboratories Div. of Chemed Corp. [page-H-1-29](#)  
Vuscamante North [page-H-1-12](#)  
W. A. Hammond Drierite Co. (Manufacturer) [page-H-1-21](#)  
W. W. Grainger, Inc. [page-H-1-17](#),  
Whitton Technology, Inc. [page-H-1-30](#)  
William B. Cresse, Inc. [page-H-1-16](#), [page-H-1-54](#)  
William W. Meyer & Sons, Inc. [page-H-1-17](#)  
ZENECA Ag Products [page-H-1-24](#), [page-H-1-41](#)

---

## Aeration Duct, Flexible

(specify diameter and length)

**Biesterfeld U.S. Inc.**

500 Fifth Avenue, # 4232  
New York, NY 10110  
tel (212) 782-0500 (resmethrin)

**Fumigation Service & Supply Inc.**

10540 Jessup Boulevard  
Indianapolis, IN 46280-1438  
tel (800) 992-1991  
fax (317) 867-5757

**Gilmore, Inc.**

152 Collins Street  
Memphis, TN 38112  
tel (901) 323-5870 (resmsthrin)  
fax (901) 454-0295

**Marman USA, Inc.**

500 N. Westshore Blvd., # 405  
Tampa, FL 33609  
tel (813) 286-2503 (resmethrin)

**Nova-Chem, Inc.**

P.O. Box 22685  
Tampa, FL 33622  
tel (813) 287-1348 (resmethrin)  
fax (813) 287-1348

**Niles Biological Control Laboratory**

USDA/APHIS/PPQ  
2534 S11th Street  
Niles, MI 49120  
tel:(616) 683-3563  
fax:(616) 683-9608  
(10% d-phenothrin)

**Otis Plant Protection Center**

USDA/APHIS/PPQ  
tel (508) 559-5354 or  
tel (508) 563-9303  
fax:(508) 564-4398  
(10% d-phenothrin)

**Prentiss Drug & Chem. Co., Inc.**

CB 2000  
Floral Park, NY 11001  
tel (516) 326-1919

**Red Panther Chemical Co.**

P.O. Box 530  
Clarksdale, MS 38614  
tel (662) 627-4731 (resmethrin)

**Southern Agricultural Insecticides, Inc.**

P.O. Box 218  
Palmetto, FL 34220  
tel (941) 722-3285 (resmethrin)  
fax (941) 723-2974  
e-mail [www.southernag.com](http://www.southernag.com)

---

## Aerosol Insecticides

**Southern Mill Creek Products Co., Inc.**

5414 North 59th Street  
Tampa, FL 33610  
tel (813) 635-0707 (resmethrin)  
fax (813) 630-9536

---

## Air Pump, Auxiliary

**Barnant Company**

28W092 Commercial Avenue  
Barrington, IL 60010  
tel (800) 637-3739 or  
(708) 381-7050  
fax (847) 381-7053

**Cole-Parmer Instrument Co.**

625 East Bunker Court  
Vernon Hills, IL 60061  
tel (800) 323-4340/(847) 323-4340  
fax (847) 247-2929  
e-mail [www.colepalmer.com](http://www.colepalmer.com)  
("Air Cadet" Vacuum/Pressure Pump; Single-J7530-40; Dual  
J7530-60)

**McMaster-Carr Supply Co.**

P.O. Box 740100

Atlanta, GA 30374-0100

tel (404) 346-7000

fax(404) 349-9091

(Hand-held Mityvac vacuum/pressure pump, zinc alloy, cat. no. 9963K12)

Air-Purifying Respirator\*

(gas masks with cartridge for organic vapors)

**Acme Protection Equipment Co.**

1201-99 Kalamazoo Street

South Haven, MI

**American Optical Corporation**

Safety Products Division

South Bridge, MA 01550

AO Quantifit in small (#R 4000), medium (#R 5000), or large (#R 6000) with cartridge (#R 58)

\* Gas masks are no longer used by PPQ. They are listed here for information only. When fumigating, use SCBA.

**HSC Corporation**

P.O. Box 192

Buchanan, MI 449107

H.S. Cover (H<sub>s</sub>C) model 1482 with G100 and F104 pesticide cartridge

---

**Air-Purifying Respirator**

**Mine Safety Appliances Co. (MSA)**

P.O. Box 427

600 Penn Center Boulevard

Pittsburgh, PA 15235

MSA CompII in various sizes, MSA #46968 with GMP Pesticide Combination Cartridge (MSA #464025)

MSA Belt-Mounted Respirator (MSA #461000)

MSA Chin Style Pesticide Mask (MSA #448983)

MSA Industrial Size Mask (MSA #457100)

MSA Fumigant Masks 1 —Phosphine and hydrogen sulfide (MSA #457069); hydrocyanic acid (cyanide) (MSA #457084); methyl bromide (MSA #457081); sulfuryl fluoride (MSA #457097)



**Scott Aviation**

A Division of A-T-O  
Lancaster, NY 14086  
Model 64 and 64 w/cartridge #65-OVP (full-face piece), or  
#652-L; cartridge #642-OV; filter #642-F retainer #642-FR

**Willson Division**

INCO Safety Products Co.  
P.O. Box 622  
Reading, PA 19603  
Willson Chin Style gas mask (#2100/2200 w/ 61F pesticide  
canister)  
Willson #1600 & #1700 w/#R15 filter, #R683 retainer and #R21  
organic vapor cartridges.  
Willson #1200 w/#R filter, #R683 retainer, and #R21 cartridges

---

**Air Velocity Measuring (Anemometer)**

**TSI, Inc. Alnor Products**

500 Cardigan Road  
Shoreview, MN 55126  
tel 651-490-2811  
Toll Free: 1-800-874-2811  
fax: 651-490-3824  
E-mail: [answers@tsi.com](mailto:answers@tsi.com)  
web site: [http://www.tsi.com/en-1033/products/13926/  
velometer\\_anemometers.aspx](http://www.tsi.com/en-1033/products/13926/velometer_anemometers.aspx)  
Velometer Jr.®

**NK Nielson-Kellerman**

21 Creek Circle  
Boothwyn, PA 19061  
USA  
tel: 610-447 1555  
fax: 610 447 1577  
e-mail- [info@nkhome.com](mailto:info@nkhome.com)  
web site: <http://www.nkhome.com/ww/wwindex.html>  
Kestrel® Pocket Wind Meters

---

## Aluminum Phosphide

**Burlington Scientific Corp.**

71 Carolyn Blvd.  
Farmingdale, NY 11735  
tel (631) 694-4700

**Degesch America, Inc.**

P.O. Box 116  
Weyers Cave, VA 24486  
tel (540) 234-9281  
fax (540) 234-8225

**Fumigation Service & Supply Inc.**

10540 Jessup Boulevard  
Indianapolis, IN 46280-1438  
tel (800) 992-1991  
fax (317) 867-5757

**Gilmore, Inc.**

152 Colluns Street  
Memphis, TN 38112  
tel (901) 323-5870  
fax (901) 454-0295

---

## Aluminum Phosphide (continued)

**Helena Chemical Co.**

434-T Feen Road  
P.O. Box 837  
Cordelia, GA 31015  
tel (912) 273-6243  
tel (912) 273-0837  
fax (912) 273-8293

**ICD Group, Inc.**

641 Lexington Avenue  
New York, NY 10022  
tel (212) 644-1260 or  
tel (212) 644-1500

**IDA, Inc.**

2215 West Street, 2nd Floor  
Germantown, TN 38138  
tel (901) 757-8056

**Inchema, Inc.**

213T Old appan Road  
Old Tappan, NJ 07675  
tel (201) 664-6035  
fax (201) 664-5938

**Loveland Industries, Inc.**

P.O. Box 1289  
Greeley, CO 80632-1289  
tel (303) 356-8926

**Marman USA, Inc.**

500 N. Westshore Blvd. #405  
Tampa, FL 33609  
tel (813) 287-1348

**Nova-Chem, Inc.**

P.O. Box 22685  
Tampa, FL 33622  
tel (813) 286-2503  
fax (813) 287-1348

**Pest Fog Sales Corp.**

1424 Bonita St.,  
PO Box 3703  
Corpus Christi, TX 78463  
tel (512) 884-8214 or  
tel (800) 395-2345  
fax: (512) 884-5903

**Pestcon Systems, Inc.**

P.O. Box 3510  
(3001 104th Street)  
Des Moines, IA 50322-0510  
tel (515) 284-4606

**United Suppliers, Inc.**

Box 538  
Eldora, IA 50627  
tel (515) 858-2341  
fax (515) 858-5493  
Applicator (Dispenser) for Methyl Bromide  
(sight gauges calibrated in ml, grams, or pounds)

**Degesch America, Inc.**

P.O. Box 45136  
(14802 Park Alameda Drive)  
Houston, TX 77245  
(5 lbs. applicator w/ 1/4 lb. divisions)  
tel (713) 433-4777

**Fumigation Service & Supply Inc.**

10540 Jessup Boulevard  
Indianapolis, IN 46280-1438  
tel (800) 992-1991  
fax (317) 867-5757

**H. T. McGill Company**

Box 18, 206  
Houston, TX

---

**Applicator (Dispenser) for Methyl Bromide**

**Pest Fog Sales**

P.O. Box 3703  
(1424 Bonita)  
Corpus Christi, TX 78463  
1-800-395-2345  
tel (361) 884-8214  
fax (361) 884-5903

**Vuscamante North**

(Attn.: Sr. Maurilio Plata)  
307 Montemorelos  
Neuvo Leon, Mexico  
tel 82-63-33-58

## Ascarite II

(granules of sodium hydroxide-coated silica used to remove carbon dioxide from gas samples)

### **Aldrich Chemical Company, Inc.**

1001 West Saint Paul Avenue  
Milwaukee, WI 53233  
tel (800) 558-9160 or  
tel (414) 273-3850  
fax (800) 962-9591

### **Fisher Scientific**

P.O. Box 14989  
(1241 Ambassador Boulevard)  
St. Louis, MO 63178  
tel (800) 766- 7000  
fax (800) 926-1166

### **Thomas Scientific**

P.O. Box 99  
(99 High Hill Road at I 295)  
Swedesboro, NJ 08085-0099  
tel (800) 345-2100 or  
tel (800) 345-2000  
fax: (800) 345-5232 or  
fax (856) 467-3087

---

## Balances, Portable (for weighing individual fruit)

### **Ohaus Corporation**

29 Hanover Road  
Florham Park, NJ 07932  
tel (973) 377-9000  
fax (973) 593-0359  
(Portable balance for weighing individual fruits, Model LS 2000)

---

## **Batch Systems (complete installations, hot water immersion treatments)**

### **Agri-Machinery, Inc. (A.M.I.)**

3489 American Boulevard

Orlando, FL 32810

tel (407) 299-1592

fax(407) 299-1489

(2-tank system with 4 baskets each, with Honeywell strip chart recorder)

### **Agroindustrias Integradas, S.A. de C.V.**

Calle Cernicalo, No. 590

Col. Mor, S.H.C.P. 44490

Guadalajara, Jalisco

Mexico

tel (52) 810-7422

fax(52) 810-7422

### **Calderas Astro, S.A. de C.V.**

Jose Herrera, No. 607-B

C.P. 36350

San Francisco del Rincon

Guanajuato, Guan.

Mexico

tel (474) 31274

fax(474) 32698

### **Construcciones Pyrsa**

Depto. de Ingenieria

Anil No. 100

Col. Los Pinos

Celaya, Guanajuato

Mexico

tel 91-461-20946

### **Consultecnia**

3a Calle 28-70, Zona 1

Quetzaltenango

Apartado Postal 537-1

Guatemala

tel (502)02-781-496

**Dica de Mexico, S.A.**

Corretera - Navolato, km 8  
Culiacan, Sinaloa  
Mexico  
tel (52) 4-32-23

**Diseños y Maquinaria Jer, S.A. de C.V("Jersa")**

Emiliano Zapata, No. 51-A  
Cuatitlan Izcalli  
Estado do Mexico, C.P. 54710  
Mexico  
tel (52) 5-873-84-09 or 77  
tel (52) 5-873-85-22  
fax(52) 5-871-20-02

**Equipos Agroindustriales de Occidente, S.A. de C. V.**

Avenida Washington, No. 1370  
Guadalajara, Jalisco  
Mexico  
tel (52) 11-04-66  
fax(52) 11-44-67

**Frutico International**

P.O. Box 35-A  
Avenida Vallarta 2095  
Culiacan, Sinaloa  
Mexico  
tel (52) 671-490-30  
tel (52) 671-490-80

**Guiar Industrial, S.A. de C.V.**

Rayon No 989  
Colonia Moderna, Sector Juarez  
Guadalajara, C.P. 44190, Jalisco  
Mexico  
tel (91-36) 10-10-06  
tel (91-36) 10-19-49  
fax (91-36) 10-19-52  
("System Model No. 63-89")

**Industria de Maquinas Agricolas GB Ltda.**

Via Anhanguera, Km 150  
Limeira / Sao Paulo  
Brazil CEP 13480-970-Cx. Pt. 385  
tel (55-19) 451-1811  
fax(55-19) 451-5854

**Industrial Equipment & Engineering Co.**

(I.E. & E.)  
2045 Sprint Blvd.  
Apopka, FL 32703  
tel (407) 293-9212

**Produce Sorters Internationale**

7403 West Sunnyview Avenue  
Visalia, CA 93291  
tel (559) 651-7840  
fax (559) 651-7845

**Proyect Asesoria Industrial**

Av. Los Diplomaticos 1318  
San Salvador, El Salvador  
or  
8a Avenida 33-10, Zona 11  
Guatemala, Guat.  
tel (503) 701731/707217  
tel (503) 701749/802221  
fax (503) 701731/259145  
fax (502-2) 767439

**Pyrsa de Celaya**

Calle Violeta No. 1204  
Colonia Las Flores  
Celaya, Guanajuato, Mexico  
tel:(52-4) 61-270-72

**Silsa, S.A. de C.V.**

Avenida Acueducto  
597 Planta Alta  
Colonia Tecoman  
07330 Mexico 14, D.F.  
Mexico  
fax(52) 754-32-27

**William B. Cresse, Inc.**

1091 NW 23rd Street  
Miami, FL 33127  
tel (305) 633-0977  
tel (305) 633-6508  
(Batch system with 2 tanks of 3 baskets each.)



---

## Blower

(used in pressure leakage test; may also be used to evacuate a fumigation chamber)

**W. W. Grainger, Inc.**

(e-mail [www.grainger.com](http://www.grainger.com))

(outlets in various cities, including the following:)

308 Allwood Road  
Clifton, NJ 07012  
tel (201) 777-7700

also

816 Ramseur Street  
Durham, NC 27701  
tel (919) 688-1002

also

4820 Signet Drive  
Raleigh, NC 27604  
tel (919) 790-0888

**William W. Meyer & Sons, Inc.**

P.O. Box 105  
(8261 Elmwood Avenue)  
Skokie, IL 60077  
tel (847) 673-0312

---

## Bubble Fumigation System

(inflatable tarpaulin)

**B&G Equipment Company**

6120 Route 611  
Plumsteadville, PA 18949-0130  
tel (800) 544-881 / (215) 766-8811

**Power Plastics**

Station Road  
Thirks, N. Yorkshire YO7 1P2  
England  
tel 0845-525503  
fax 0845-525483

---

## Cascade Air Tank Recharging System (for SCBA)

### **Mine Safety Appliance Co. (MSA)**

P.O. Box 427  
600 Penn Center Boulevard  
Pittsburgh, PA 15235

### **Scott Aviation**

A Division of A-T-0 Inc.  
Lancaster, NY 14086  
tel (716) 683-5100

---

## Chain Hoist (Electronic) (For hot water immersion treatments)

### **Columbus McKinnon Corp.**

Industrial Products Division  
140 John James Audubon Parkway  
Amherst, NY 14228  
tel (716) 689-5400  
(Lodestar electronic chain hoist, capacity to 3 tons)

### **Chemonics**

PROEXAG Project  
5a Av. 15-45, Zona 10  
Edificio Centro Empresarial  
Torre 1, 9 Nivel  
Guatemala, Guatemala  
tel (502) 2-33-70-82 or 83  
fax (502) 2-33-70-84  
(Post-harvest advice; international consulting)

---

## Consultants (For hot water immersion treatments)

### **C.C. Coutinho Consulting**

Av. Princess Leopddina, 238  
Ap. 101 D  
Graca - Ed Olga Pontes  
Cep 40150-080 Salvador, Bahia  
Brazil  
tel (55-81) 99-98-42-84  
fax (55-81) 8-62-29-93  
e-mail <cosam@uol.com.br>

**Center for Plant Health Science and Technology**

USDA-APHIS-PPQ-CPHST  
Treatment Quality Assurance Unit  
1730 Varsity Drive, Suite 400  
Raleigh, NC 27606  
tel (919) 855-7450  
fax(919) 513-1995

(APHIS technical contact; approval of plans and drawings)

**Consultecnia**

3a Calle 28-70, Zona 1  
Quetzaltenango  
Apartado Postal 537-1  
Guatemala  
tel (502) 02-781-496

**Dica de Mexico, S.A.**

Carretera a Navolato, Km 8  
Culiacan, Sinaloa  
Mexico  
tel (52) 4-32-23

**Frutico International**

P.O. Box 35-A  
Avenida Vallarta 2095  
Culiacan, Sinaloa  
Mexico  
tel (52) 671-490-30  
tel (52) 671-490-80

**Gaffney Engineering Co.**

5530 NW 97th Street  
Gainesville, FL 32653  
tel (352) 373-7955  
(Engineering consulting)

**North Bay Produce, Inc.**

10a Calle 1-4, Zona 9  
Guatemala, Guat.  
tel (502-2) 342-295 or 6  
fax (502-2) 344-974  
(Legal and technical advice)

**Nojoxten**

Sta. Martha No. 276-A Col. Sta.  
Margarita C.P. 45140  
Zapopan, Jalisco, Mexoci  
tel (33) 3833-1999  
fax (33) 3633-9380  
[www.nojoxten.com.mx](http://www.nojoxten.com.mx)

**Societe d'Entretien & d'Installation (SODEIN)**

Route de Carrefour #83  
(P.O. Box 995)  
Port-au-Prince, Haiti  
(Installation of temperature recording equipment, especially the  
Chessel 346)

---

**Curtains (air, safeguarding)**

**W.W. Granger, Inc.**

(branch offices in many cities)  
[www.grainger.com](http://www.grainger.com)

---

**Digital Thermister Instrument (hand-held for hot water immersion treatments)  
and Portable Sensors (used in Performance Test)**

**Allied Electronics**

5979 NW 151st Street  
Miami Lakes, FL 33014  
tel (305) 558-2511  
tel (800) 433-5700  
fax (305) 558-1130  
(Additional sales outlets in other cities) (Instruments include  
Cooper Instrument Corp's Model TM99A, and. Thermister  
sensors with submersible 10 or 20 ft. cord,  
Catalog No. 2010.)

**Cooper Instrument Corp.**

33 Reeds Gap Road  
Middlefield, CT 06455  
tel (860) 349-3473  
fax(860) 349-5155

(Note: This company manufactures the Cooper instruments sold by Allied Electronics, but does not sell directly to retail customers.)

---

**Drierite® (anhydrous calcium sulfate)**

**Aldrich Chemical Company, Inc.**

1001 West Saint Paul Avenue  
Milwaukee, WI 53233  
tel (414) 273-3850

**Fisher Scientific**

P.O. Box 14989  
St. Louis, MO 63178  
tel (314) 991-2400

**W. A. Hammond Drierite Co. (Manufacturer)**

138 Dayton Avenue  
Xenia, OH 45385  
tel (937) 376-2927

---

**Exhaust Duct (Tube), Flexible**

(stock sizes available in diameters of 12, 16, and 24 inches. Available in 10 and 20 feet lengths, which may be attached by a ring coupling.)

**Gaskets, Inc.**

301 Highway 1600  
Rio, WI 53960  
tel (920) 992-3137

**Super Vacuum Mfg. Co., Inc.**

1303 E 11  
Loveland, CO 80537  
tel (970) 667-5146

---

## Fans

**Pest Fog Sales Corp.**

1424 Bonita St.  
PO Box 3703 Corpus Christi, TX 78463  
tel (512) 884-8214 or  
tel (800) 395-2345  
fax (512) 884-5903  
(18-inch fumigation fan)

**Super Vacuum Mfg. Co., Inc.**

1303 E 11  
Loveland, CO 80537  
tel (970) 667-5146  
For use in a chamber or under tarpaulin, or during exhaust.  
Specify blade size, horsepower, and CFM.

---

## Fruit Crates, (Plastic for hot water immersion treatments)

**No listings**

---

## Fruit Sizing Equipment (Automatic)

**Hortagro International b. v.**

P.O. Box: 4050  
8901 EB Leeuwarden  
Holland  
tel: (058) 21-23-795  
fax: (058) 21-25-344  
(Mechanical weight sizer with conveyor belt)

**Kerian Machines, Inc.**

Highway 81 South  
(P.O. Box 311)  
Grafton, ND 58237  
tel (701) 352-0480  
fax(701) 352-3776  
(Roller type of sizing equipment)

---

## Fumigation Chamber, NAP

(large fumigation chambers must be custom built by engineering contractors)

### **Fruit Technologies**

Walla Walla & Wenatchee, WA  
tel (509) 662-0700  
fax(509) 664-3743

---

## Fumigation Chamber, Vacuum

### **Slack Associates, Inc.**

540 South Longwood Street  
Baltimore, MD 21223

### **Vacudyne Altair**

375 East Joe Orr Road  
Chicago Heights, IL. 60411

### **CosMed Group**

28 Narragansett Avenue  
Jamestown, RI 02835  
401-423-2003

The following three companies (SFS, ETO and BQA) are subsidiaries of the CosMed Group.

### **Sterilization and Fumigation Services, Inc. (SFS)**

3500 Shiells Road  
Newman, CA 95360  
Plant Manager, Peter Baker  
Phone: 209-862-4074  
Bill Lanning  
Phone: 208-880-0746

### **ETO Sterilization (ETO)**

2500 Brunswick Avenue  
Linden, NJ 07036-2432  
Vice President of Operations, Karen Burns  
Phone: 908-862-7077  
FAX: 908-862-7168

**Baltimore Quality Associates, Inc. (BQA)**

4200 Boston Street  
Baltimore, MD 21224  
Ellen Heath  
Phone: 410-327-0916

---

**Fumigators, Commercial**

see listings in local telephone directories (yellow pages) under the heading "Pest Control Services"

---

**Fungicides**

**Bordeaux Mixture (hydrated lime + copper sulfate)**

**Uniroyal Chemical Co., Inc.**

Benson Road  
Middlebury, CT 06762  
tel (203) 573-2000  
fax (203) 573-3394  
Product name: Nutra-Spray  
Captan

**Crystal Chemical Inter-America**

1523 N. Pest Oak Road  
Houston, TX 77055  
tel (713) 956-6196  
fax(713) 956-6835  
Product name: Captanex

**Drexel Chemical Co.**

1700 Channel Avenue  
Memphis, TN 38113  
tel (901) 774-4370  
fax(901) 774-4666  
Product name: Drexel Captan

**ZENECA Ag Products**

1800 Concord Pike  
Wilmington, DE 19897  
tel (800) 759-4500  
fax (302) 886-1552



## **Ferbam**

### **FMC Corp. AG**

Chemical Group  
1735 Market Street  
Philadelphia, PA 19103  
tel (215) 299-6661  
fax (215) 299-6256  
Product Name: Carbamate

### **UCB Chemicals Corp.**

5505-A Robin Hood Road  
Virginia Beach, VA 23513  
tel (804) 473-9775  
Product names: Carbamate WDG, Ferbam 76 WDG, Ferbam Granuflo

## **Mancozeb**

### **Elf Agrochem North America, Inc.**

Agrochemicals Group  
2000 Market Street, 21st Floor  
Philadelphia, PA 19103  
tel (215) 419-7219  
fax (215) 419-5012  
Product name: Penncozeb 80 WP

### **Rohn and Haas Co.**

100 Independence Mall W.  
Philadelphia, PA 19106  
tel (215) 592-3000  
fax (215) 592-2797  
Product name; Dithane

## **Thiram**

### **UCB Chemicals Corp**

5505-A Robin Hood Road  
Virginia Beach, VA 23513  
tel (804) 473-9775  
Product Names: Tech TMTD, Thianosan, THiLor, Thipel, Thiram Granuflo, Thiram 65, Thiram 75-WDG  
Zineb

**Rhone-Poulenc Ag Co.**

P.O. Box 12014  
Research Triangle Park, NC 27709  
tel (919) 549-2000  
Product Names: Cuprothex Super Mix

---

**Gas Analyzers**

**Analytical Technology, Inc.**

680 Hollow Road, Box 879  
Oaks, PA 19456  
tel (800) 959-0299 or  
tel (610) 917-0991  
fax (610) 917-0992  
(Porta-Sens Phosphine Detector)

**Gow-Mac Instrument Company**

Mailing Address:  
P.O. Box 25444  
Lehigh Valley, PA 18002-5441  
tel (610) 954-9000  
fax (610) 954-0599  
(Fumigant Thermal Conductivity Analyzer Model)  
Shipping/Receiving Address:  
277 Brodhead Road  
Bethlehem, PA 18017-8600

**Interscan Corp.**

21700 Nordoff Street  
(P.O. Box 2496)  
Chatsworth, CA 91313  
(Interscan Model GF 1900 pyrolysis unit, sensitive to SF at 0–50 ppm.)  
tel:(818) 882-2331  
fax:(818) 341-0642

**Key Chemical and Equipment Co., Inc.**

13195 49th Street North, #A  
Clearwater, FL 34622  
tel (727) 572-1159  
fax(727) 572-4595  
(Fumiscope, Model D)

**Neal Systems, Inc.**

122 Terry Drive  
Newtown, PA 18940  
tel (215) 968-7577  
fax (215) 968-6480  
(Porta-Sens Phosphine Detector)

**Pest Fog Sales Corp.**

1424 Bonita St.  
PO Box 3703 Corpus Christi, TX 78404  
tel: (512) 884-8214 or  
tel (800) 395-2345  
fax: (512) 884-5903

**Spectros Instruments, Inc.**

4 Evergreen Lane, #12A  
Hopedale, MA 01747  
Phone: 508-478-1648  
FAX: 508-478-1652  
Website: [www.spectrosinstruments.com](http://www.spectrosinstruments.com)  
Email: [info@spectrosinstruments.com](mailto:info@spectrosinstruments.com)

---

**Gas Detector Tube (colorimetric) and Apparatus**

**APHIS/NOAA Centralized Warehouse**

(must order by Fedstrip procedure)  
FTS: 758-6222 (Draeger tubes)

**Lab Safety Supply**

A Division of Science Related Materials, Inc.  
401 South Wright Road  
Janesville, WI 53546  
tel (800) 356-0783  
tel (608) 754-2345  
(Draeger tubes)

**Matheson Gas Products**

932 Paterson Plank Road  
East Rutherford, NJ 07073-2173  
tel (201) 933-2400 (Kitagawa tubes)

**National Draeger, Inc.**

P.O. Box 120  
Pittsburgh, PA 15230-0120  
tel (800) 922-5518 (Draeger tubes)  
fax (800) 922-5519

**Pest Fog Sales Corp.**

1424 Bonita St.  
PO Box 3703  
Corpus Christi, TX 78463  
tel (800) 395-2945 or  
tel (512) 884-8214  
fax (512) 884-5903

**Protech Safety Equipment**

37 East 21st Street  
Linden, NJ 07036  
tel (908) 862-1550 (Draeger tubes)

**Roxan, Inc.**

5425 Lockhurst Drive  
Woodland Hills, CA 91367  
tel (800) 228-5775 (except CA, AK)  
tel (818) 703-6108 (CA, AK)  
(Sensidyne/Gastec tubes and apparatus)

**Sensidyne, Inc.**

12345 Starkey Rd., Suite E  
Clearwater, FL 33543  
tel (727) 530-3602 (Sensidyne/Gastec tubes and apparatus)

**SKC, Inc.**

863 Valley View Road  
Eighty Four, PA 15330-9614  
tel (800) 752-8472  
tel (412) 941-1369  
fax (800) 752-8476

**Union Carbide Corp, Linde Div.**

National Specialty Gases Office  
40 Veronica Avenue  
Somerset, NJ 08873-3498  
tel (732) 937-4900  
(Sensidyne/Gastec tubes and apparatus)

---

## Gas Drying Tube (for Drierite®)

### **Lurex Scientific**

P.O. Box 2420  
South Vineland, NJ 08360  
tel (609) 794-2121  
(glass tube) – Catalog # 301-7501

---

## Germicides/Disinfectants

### **Vestrol Laboratories Div. of Chemed Corp.**

St. Louis, MO 63110  
Product: 1 Stroke Environ

### **Georgia-Pacific Corp.**

P.O. Box 1236  
300 W. Laurel Street (98225)  
Bellingham, WA 98227  
tel (800) 385-4348 or  
tel (360) 733-4410  
fax (206) 676-7217  
Product: Formaldehyde  
Order from GSA  
(NSN 6810-00-664-7121 or  
NSN 6810-00-664-0402)  
Product: Soda Ash  
Order from GSA  
(NSN 6810-00-270-8177)  
Product: Sodium Hydroxide  
Order from GSA (NSN 6810-00-281-254 or NSN  
6810-00-240-2121)  
Product: Sodium Hypochlorite  
Available from APHIS-VS  
Product: Sodium Orthophenate  
(Also available as bleach in almost all grocery stores. Trade  
names include Clorox and others.)

---

## Halide Gas Leak Detector (removed)

---

### Incinerators

**Whitton Technology, Inc.**

Air Burners Products Div.  
4390 Cargo Way  
Palm City, FL 34990  
tel (561) 622-9626  
fax (561) 220-7302  
e-mail info@airburners.com  
(Air Curtain Incinerators)

---

### Magnesium Phosphide

**Burlington Scientific Corp.**

222 Sherwood Avenue  
Farmingdale, NY 11735  
tel (516) 678-4414

**Degesch America, Inc.**

P.O. Box 116  
Weyers Cave, VA 24486  
tel (703) 234-9281  
fax (703) 234-8225

**Fumigation Service & Supply, Inc.**

10540 Jessup Boulevard  
Indianapolis, IN 46280-1438  
tel (800) 992-1991  
fax (317) 867-5757

**Helena Chemical Co.**

434-T Fern Road  
P.O. Box 837  
Cordelia, GA 31015  
tel (912) 273-6243 or  
tel (912) 273-0837  
fax (912) 273-8293

**Marman USA, Inc.**

500 North Westshore Blvd. #405  
Tampa, FL 33609  
tel (813) 286-2503

**Nova-Chem, Inc.**

P.O. Box 22685  
Tampa, FL 33629  
tel (813) 286-2503  
fax (813) 287-1348

---

**Manometer (used in pressure leakage test)**

**Alnor Instrument Co.**

7555 North Linder Avenue  
Skokie, IL 60077  
tel (847) 677-3500  
Model 530 (1–10 inches of water) (electronic)

**Davis Instruments**

4701 Mount Hope Drive  
Baltimore, MD 21215  
tel (410) 243-4301  
fax (410) 358-0252  
e-mail [www.davisontheweb.com](http://www.davisontheweb.com)  
(U-tube or electronic)

**Dwyer Instruments, Inc.**

102 Indiana Highway 212  
Michigan City, IN 46360  
tel (219) 879-8000  
(flex-tube type)

**Fisher Scientific**

52 Fadem Road  
Springfield, NJ 07081  
(also other locations)  
tel (800) 766-7000  
fax (800) 926-1166  
(tube or electronic)

**Neotronics of North America**

4331 Thurmond Tanner Road  
Flowery Branch, GA 30542  
tel (770) 967-2196  
Model No. 530 (0–19.99 inches of water)

---

**Metam-sodium**

**Amvac Chemical Corp.**

4100 E. Washington Blvd.  
Los Angeles, CA. 90023  
also  
2110 Davie Blvd.  
Los Angeles, CA 90040  
tel (323) 264-3910  
fax (213) 268-1028

---

**Methyl Bromide, 100%**

**Ameribrom, Inc.**

52 Vanderbilt Ave.  
New York, NY 10017  
tel: (212) 286-4000  
fax: (212) 286-2275

**Biesterfeld U.S., Inc.**

500 Fifth Avenue #4230  
New York, NY 10110-4296  
tel (212) 782-0500

**Degesch America, Inc.**

Houston Division  
P.O. Box 451036  
Houston, TX 77245  
tel (713) 433-4777  
fax (713) 433-0877

**Fumigation Serv. & Supply Inc.**

10540 Jessup Boulevard  
Indianapolis, IN 64280-1438  
tel (800) 992-1991  
fax (317) 867-5757



**Great Lakes Chemical Corp.**

P.O. Box 2200  
West Lafayette, IN 47906  
tel (765) 497-6100 (Indiana)  
tel (901) 645-2698 (Ramer, TN)  
tel (800) 428-7947

**Helena Chemical Co.**

434-T Fenn Road  
P.O. Box 837  
Cordelia, GA 31015  
tel (912) 273-6243  
tel (912) 273-0837  
fax (912) 273-8293

**ICD Group, Inc.**

61 Lexington Avenue  
New York, NY 10022  
tel (212) 644-1260  
tel (212) 644-1500

**Marman USA Inc.**

500 North Westshore Blvd. #405  
Tampa, FL 33609  
tel (813) 286-2503

**Nova-Chem, Inc.**

P.O. Box 22685  
Tampa, FL 33622  
tel (813) 286-2503  
fax (813) 287-1348

**Pest Fog Sales Corp.**

1424 Bonita St.  
PO Box 3703 Corpus Christi, TX 78463  
tel: (512) 884-8214 or (800) 395-2945  
fax: (512) 884-5903

**Pestcon System, Inc.**

P.O. Box 3510  
(3001 104th Street)  
Des Moines, IA 50322-0510  
tel (515) 284-4606

**Southern Agricultural Insecticides Inc.**

P.O. Box 218  
Palmetto, FL 34220  
tel (941) 722-3285  
fax (941) 723-2974  
e-mail [www.southernag.com](http://www.southernag.com)

**Southern Mill Creek Products Co., Inc.**

5441 North 56th Street  
Tampa, FL 33610  
tel (813) 635-0707  
fax (813) 630-9536

---

**Moisture Meter (for wood)**

**Delmhorst Instrument Company**

P.O. Box 68  
(51 Indian Lane East)  
Towaco, NJ 07082  
tel (800) 222-0638  
fax (973) 334-2657  
e-mail [www.delmhorst.com](http://www.delmhorst.com)  
Order: Moisture Meter G30  
Electrode 26ES  
Type 496 pin  
Above comes as package in carrying case.

**Lignomat**

14345 N.E. Morris Court  
Portland, OR 97230  
tel (503) 257-8957  
fax (503) 256-3844  
e-mail [lignomat.com](http://lignomat.com)

---

**Newsletters and Trade Journals**

(containing articles on fumigation)

**Fumigants and Pheromones**

(free newsletter)  
Fumigation Serv. & Supply Inc.  
10505 North College Avenue  
Indianapolis, IN 46280

### **Pest Control**

(monthly for professional pest control operators)

Advanstar Communications Inc.

P.O. Box 6215

Duluth, MN 55806-9833

tel (218) 723-9477

fax (218) 723-9417

### **Pest Control Technology**

(monthly for professional pest control operators)

4012 Bridge Avenue

Cleveland, OH 44101

tel (216) 961-4130

fax (216) 961-0364

---

## **Personal Air Sample Pump**



Important

This equipment is not for routine use at ports.

### **Anatole J. Sipin Co., Inc.**

505 8th Avenue

New York, NY 10018

tel (212) 695-5706

(Model SP-15 wide range personal sampler, pump, with charcoal tube inserts)

### **Spectrex Corp.**

3580 Haven Avenue

Redwood City, CA 94063

tel (650) 365-6567 or (800) 822-3940

fax (650) 365-5845

e-mail [www.spectrex.com](http://www.spectrex.com)

Quaternary Ammonium

### **Georgia Steel & Chemical Company, Inc.**

10810 Guilford Road, Suite 104

Annapolis Jct., MD 20701

tel (800) 296-0351

fax (301) 470-6313

e-mail [www.georgiasteelco.com](http://www.georgiasteelco.com)

(Clean-Gear, Breathing Mask Cleaning Towelette)

**Mine Safety Appliances Company (MSA)**

P.O. Box 427  
(600 Penn Center Blvd.)  
Pittsburgh, PA 15230  
(Cleaner-Sanitizer II, part no. 34337)

---

**Photo Ionization Detector**

**Mine Safety and Appliance**

MSA World Headquarters  
Customer Service Center  
P.O. Box 426  
Pittsburg, PA 15230  
1-800-MSA-2222  
Sirius Multigas Detector  
<http://www.msanorthamerica.com/>

**Rae Systems**

3775 North First Street  
San Jose, CA 95134  
408-952-8200  
MiniRAE 2000  
[http://www.raesystems.com/products/minirae\\_2000](http://www.raesystems.com/products/minirae_2000)

---

**Safety Equipment**

**Industrial Safety Company**

1390 Neubrecht Road  
Lima, OH 45801  
tel (800) 537-9721  
tel (419) 227-6030  
fax (419) 228-5034  
e-mail [www.indlsafety.com](http://www.indlsafety.com)  
(Safety guards for belt and chain drives; fan guards; fire extinguishers; safety equipment in general).

---

## Scale (portable platform type)

(for weighing gas cylinders) (in addition to the following, also see Yellow Pages)

### **Arlington Scale Co., Inc.**

P.O. Box 1058  
(47 Johnston Avenue)  
Kearny, NJ 07032  
tel (201) 998-3242

### **Atlantic Scale Co., Inc.**

136 Washington Avenue  
Nutley, NJ 07110  
tel (973) 661-7090  
fax (973) 661-3651  
e-mail [www.atlanticscale.com](http://www.atlanticscale.com)

### **Eastern Scales NJ**

1053 Pennsylvania Avenue  
Linden, NJ 07036  
tel (908) 486-4433  
tel (732) 381-8007

### **Phifer Wire Products, Inc.**

P.O. Box 1700  
Tuscaloosa, AL 35403  
tel (800) 633-5955  
tel (205) 345-2120  
fax (205) 759-4450  
e-mail [www.phifer.com](http://www.phifer.com)  
(Fiberglass insect screening of various mesh sizes and colors)

---

## Sealing Tape

### **Degesch America, Inc.**

Houston Division  
14802 Parkalmeda  
Houston, TX 77045  
tel (713) 433-4777  
fax(713) 433-0877

**Fumigation Serv. & Supply Inc.**

16950 Westfield Park Road  
Westfield, IN 46074  
tel (800) 992-1991  
fax (317) 867-5757  
e-mail [www.insectsltd@aol.com](mailto:www.insectsltd@aol.com)  
(ARMAK sealing tape)

---

**Self-Contained Breathing Apparatus (SCBA)**

**Cesco Safety Products**

P.O. Box 1237  
Kansas City, MO 64141  
tel (913) 814-7300

**Georgia Steel & Chemical Company, Inc.**

10810 Gilford Road  
Annapolis Jct. MD. 20701  
tel 1-800-296-0351  
(CLEAN-GEAR, Breathing mask cleaning towelette)

**Lab Safety Supply**

401 S. Wright Road  
Janesville, WI 53546-8729 (shipping address)  
or  
P.O. Box 1368  
Janesville, WI 53547-1368  
tel (608) 754-2345  
tel (800) 356-6964  
e-mail [www.labsafety.com](http://www.labsafety.com)

**Mine Safety Appliances Co. (MSA)**

P.O. Box 427  
600 Penn Center Boulevard  
Pittsburgh, PA 15235

**Pest Fog Sales Corp.**

1424 Bonita St.  
PO Box 3703 Corpus Christi, TX 78463  
tel: (512) 884-8214 or (800) 395-2945  
fax: (512) 884-5903

**National Draeger, Inc.**

Box 120  
Pittsburgh, PA 15230  
tel (412) 787-8383  
e-mail [www.draeger-usa.com](http://www.draeger-usa.com)

**Rexnord Electronic Products**

45 Great Valley Parkway  
Malvern, PA 19355  
tel (215) 647-7200

**Scott Air Aviation**

A Division of A-T-O Inc.  
225 Erie Street  
Lancaster, NY 14086  
tel (716) 683-5100  
Scott Air-Pak 11a (#900,000)  
Presur-Pak 11a (#900,014)  
Scott Air-Pak 4.5 (#900,450)  
Presur-Pak (#900,455)

**Survivair**

3001 S. Susan Street  
Santa Ana, CA 92704  
tel (888) 277-7222  
fax (714) 850-0299  
e-mail [scba@survivair.com](mailto:scba@survivair.com)  
URL [www.survivair.com](http://www.survivair.com)

---

## Smoking Candle

(Used in pressure leakage test. Candles of various sizes.)

Purchase only candles that emit white smoke. If candles that emit colored smoke are used, their residue will stain the interior walls of the fumigation chamber, skin, and clothing. Store candles in a dry, cool place.

**Davis Instruments**

4701 Mount Hope Drive  
Baltimore, MD 21215  
tel (410) 243-4301  
fax (410) 358-0252  
e-mail [www.davisontheweb.com](http://www.davisontheweb.com)

**Superior Signal Co., Inc.**

178 Greystone Road  
Spotswood, NJ 08884  
tel (732) 251-8800  
fax (732) 251-9442  
e-mail [www.superiorsignal.com](http://www.superiorsignal.com)

---

**Snakes (sand snakes, watersnakes)**

**Fumigation Serv. & Supply Inc.**

10540 Jessup Boulevard  
Indianapolis, IN 46280-1438  
tel (800) 992-1991  
fax (317) 867-5757

**Pest Fog Sales Corp.**

1424 Bonita St.  
PO Box 3703 Corpus Christi, TX 78404  
tel: (512) 884-8214 or (800) 395-2945  
fax: (512) 884-5903

---

**Soil Fumigants**

(Metam-sodium, Vapam, etc.)

**Buckman Laboratories, Inc.**

1256 N. McLean Boulevard  
Memphis, TN 38108  
tel (901) 278-0330  
fax (901) 276-5343  
Product name: Busan 1020

**Oregon-California Chemicals, Inc.**

29454 Meadowview Road  
Junction City, OR 97448  
tel (541) 689-4413  
fax (541) 689-5026  
Product name: Sectagon



**UCB Chemicals Corp.**

2000 Lake Park Drive  
Smyrna, GA 30080  
tel (800) 426-3820  
e-mail [www.ucb.be.com](http://www.ucb.be.com)  
Products: Metam 32.7, Metam 42, Ucetam

**ZENECA Ag Products**

1800 Concord Pike  
Wilmington, DE 19897  
tel (800) 759-4500  
fax (302) 886-1553  
Product name: Vapam  
e-mail [www.zenecaagproducts.com](http://www.zenecaagproducts.com)

---

**Spill Recovery Materials**

(products to absorb spills of hazardous materials)

**Ansul**

Spill Control Products Group  
One Stanton Street  
Marinette, WI 54143  
(Product: Spill-X)  
tel (800) 346-3626  
e-mail [www.ansul.com](http://www.ansul.com)

**Fumigation Service & Supply Inc.**

10540 Jessup Boulevard  
Indianapolis, IN 46280-1438  
tel (800) 992-1991  
fax (317) 867-5757

**New Pig Corp.**

One Pork Avenue  
Tipton, PA 16684-0304  
tel (800) 468-4647  
e-mail [www.newpig.com](http://www.newpig.com)

**Upright, Inc.**

10715 Kahlmayer Drive  
St. Louis, MO 66132  
(Product: absorbant pillows and socks) (Free samples available)  
tel (800) 248-7007  
email [www.uprightinc.com](http://www.uprightinc.com)  
tel (314) 961-3711

---

**Steam Boilers (For hot water immersion treatment)**

**Fulton Boiler Works, Inc.**

P.O. Box 257  
Pulaski, NY 13142  
tel (315) 298-5121  
fax (315) 298-6398  
e-mail [www.fulton.com](http://www.fulton.com)  
(oil-fired, gas-fired, or combination)

---

**Steam Generators**

**Sioux Steam Cleaner Corporation**

One Sioux Plaza  
Beresford, SD 57004-1500  
tel (605) 763-3333  
tel (888) 763-8833  
fax (605) 763-3334  
e-mail [siouxstm@bmtc.net](mailto:siouxstm@bmtc.net)

---

**Steam Sterilizers/Autoclaves**

**ETC Biophysics**

Environmental Tectonics Corp.  
125 James Way  
South Hampton, PA 18966  
tel (215) 355-9100  
e-mail [www.etcusa.com](http://www.etcusa.com)

---

## Sulfuryl Fluoride (Vikane)

### **Dow Agro Sciences**

9330 Zionsville Road  
Indianapolis, IN 46268  
tel (317) 337-4389  
fax (317) 337-4330

### **Marman USA, Inc.**

500 North Westshore Blvd. #405  
Tampa, FL 33609  
tel (813) 286-2503

### **Nova-Chem, Inc.**

P.O. Box 22685  
Tampa, FL 33622  
tel (813) 286-2503  
fax (813) 287-1348

### **Pest Fog Sales Corp.**

1424 Bonita St.  
PO Box 3703 Corpus Christi, TX 78463  
tel: (512) 884-8214 or (800) 395-2345  
fax: (512) 884-5903

### **Southern Agricultural Insecticides Inc.**

P.O. Box 218  
Palmetto, FL 34220  
tel (941) 722-3285  
fax (941) 723-2974  
e-mail [www.sothernag.com](http://www.sothernag.com)

### **Southern Mill Creek Products, Co., Inc.**

5441 North 59th Street  
Tampa, FL 33610  
tel (813) 635-0707  
fax (813) 630-9536

---

## Supplied-Air Respirators

### **Mine Safety Appliances Co (MSA).**

600 Penn Center Boulevard  
P.O. Box 427  
Pittsburgh, PA 15235  
(Airline respirator)

### **National Draeger, Inc.**

Box 120  
Pittsburgh, PA 15230-0120  
tel (800) 922-5518  
fax (800) 922-5519  
(Airline respirator)

### **Scott Aviation**

A Division of A-T-O, Inc.  
Lancaster, NY 14086  
Scott #900,034 Supplied Airline respirator with self-contained air supply  
Scott #801, 548 Type C Supplied-air pressure demand respirator

### **3M Occupational Health & Safety**

Products Division  
220-7W 3M Center  
St. Paul, MN 55101  
3M #W-2804 pesticide helmet and other Whitecap systems

### **Willson Division**

INCO Safety Products Company  
P.O. Box 622  
Reading, PA 19603  
Willson #1810 and #1820 half-mask respirator  
Willson #1850 and #1860 full-face piece respirator

---

## Tarpaulins (made to order)

Tarpaulins for fumigation are made by many companies. Consult the Yellow Pages.

**Elastec**

401 Shearer Blvd  
Cocoa, FL 32922  
tel:(321) 636-5783  
fax:(321) 636-5787  
e-mail [www.elastec.com](http://www.elastec.com)

**Griffolyn Company, Division**

Division of Reed Industries, Inc.  
P.O. Box 33248  
(10020 Mykawa Road)  
Houston, TX 77233  
tel (713) 507-4200  
Inflatable tarpaulin: see “Bubble Fumigation System”

**Poly-Flex, Inc.**

2000 West Marshall Drive  
Grand Prairie, TX 75051-9983  
tel (800) 527-3322, Ext. 308

**Raven Industries**

PO box 5107  
Sioux Falls, SD 57117-5107  
tel: (605) 335-0174  
fax: (605)331-0333  
e-mail [www.ravenind.com](http://www.ravenind.com)

---

## Temperature Recorders and Sensors - General Use

### **Cole-Parmer**

Web site: <http://www.coleparmer.com>  
1-888-358-4717

### **GEC Instruments**

5530 NW 97th Street  
Gainesville, FL 32653  
352-373-7955  
Web site: <http://www.gecinstruments.com>  
email: [info@gecinstruments.com](mailto:info@gecinstruments.com)  
Model S16TC Type T Thermocouple  
Model S4TC Type T Thermocouple

### **Madge Tech**

201 Route 103 West  
P.O. Box 50  
Warner, NH 03278  
Phone: 603-456-2011  
FAX: 603-456-2012  
Web site: <http://www.madgetech.com>  
email: General Information: [info@madgetech.com](mailto:info@madgetech.com)  
Customer Support: [support@madgetech.com](mailto:support@madgetech.com)  
Model: HITEMP 150A

### **Mesa Laboratories, Inc.**

Data Trace Division  
12100 West 6th Avenue  
Lakewood, CO 80228  
Phone: 303-987-8989  
FAX: 303-987-8989  
Web site: <http://www.mesalabs.com>  
Email:  
Technical Support and Service:  
[datatracetechical@mesalabs.com](mailto:datatracetechical@mesalabs.com)  
Product Sales and Customer Service:  
[datatracesales@mesalabs.com](mailto:datatracesales@mesalabs.com)

Models: Data Tracers, STO, LTO, and Micropack III

**Nanmac Corporation USA**

11 Mayhew Street  
Framingham, MA 01702  
Web site: <http://www.nanmac.com>  
1-800-789-4669

**National Instruments**

11500 N. Mopac Expwy.  
Austin, TX 78759-3504  
Web site: <http://www.ni.com>  
1-888-280-7645

**NSI**

Web site: <http://www.nordicsensors.com>  
email: [info@nordicsensors.com](mailto:info@nordicsensors.com)  
1-888-667-3421

**Omega Engineering Inc.**

Web site: <http://www.omega.com>  
1-800-622-2378

---

## Temperature Recorders (Portable Type) for Cold Treatment in Self-regulated Containers

**Remonsys Limited**

The Stables, Church Hanborough  
Witney, OXON OX29 8AB  
United Kingdom  
tel (44) 1993 886996  
fax (44) 1993 886997  
(Autolog Time/Temperature Monitor,  
AUTOLOG 2000 Data Logger)

**Control One**

26 Lafayette Street  
Stamford, CT 06902  
tel (203) 359-0909  
fax (203) 327-7295  
(Control One)

**Controlyne, Inc.**

25 North Fullerton Ave.  
Montclair, NJ 07042-3412  
tel (800) 766-5737  
fax (973) 746-2286  
(ACR SmartReader 8 Logger)

**Cox Recorders**

69 McAdenville Road  
Belmont, NC 28012  
tel (704) 825-8146  
fax (704) 825-4498  
(Cox/Escort (Memory Logger))  
(Cox Tracer temp. logger)

**Sensitech, Inc. (formerly Ryan Instr.)**

707 Drew Avenue  
Lanoka Harbor, NJ 08734  
tel (609) 971-7176  
fax (732) 946-0533  
(Data Mentor, RTM 2000 CTU)

**Wescor Environ. (Omnidata)**

P. O. Box 361  
Logan, UT 84323-0361  
tel (435) 753-8311  
fax (435) 753-8177  
(Datapod)

**DeltaTrak**

9260 Isaac Street, Suite D  
Santee, CA 92171  
tel (925) 467-5940  
fax (800) 962-6776  
(DeltaTrak T-8, DeltaTrak CDX-100, CDX-300, CDX-22000)

**Metrosonics, Inc.**

P. O. Box 23075  
Rochester, NY 14692  
Tel. (716) 334-7300  
Fax- 716-334-2635  
(DocuTemp 714A)



**Science/Electronics**

521 Kiser Street  
Dayton, OH 45404-1641  
Tel. (937) 224-4444  
Fax (937) 224-4434  
(Grant Squirrel Meter/Logger)

**Kaye Instruments**

15 DeAngelo Drive  
Bedford, MA 01730  
Tel. (781) 275-0300  
Fax -781-275-9024  
(Model DR-2B Digistrip II)

---

**Temperature Recorders (Built-in Type) for Cold Treatment in Self-Regulated Containers**

**Matrix Dynamics**

501 Doylestown Road  
Lansdale, PA 19446  
tel (215) 393-9780  
fax (215) 393-9783  
(Road Warrior 1, HACCP Warrior)

**Carrier Transicold Division**

Carrier Corporation  
United Technologies  
P. O. Box 4805  
Syracuse, NY 13221  
tel (315) 432-6000  
fax (315) 432-7583  
(Micro Link 2 DataCorder, Micro Link 2i Controller/DataCorder,  
Micro Link 3 DataCorder, 69NT40-541, 69NT40-551, and  
69NT20-551)

**Daikin Industries Ltd.**

Sakai Plant, Kanaoka Factory  
1304, Kanaoka-Cho.  
Sakai, Osaka 591-8511  
Japan  
tel (81) 722 59-9724  
fax (81) 722 51-6833  
(Decos III Microproc. Temp Controller, Decos III A, Decos III B,  
Decos III C, and Decos IIID)

**Mitsubishi Heavy Industries**

3-1 Asahimachi  
Nishibiwgima-Cho  
Nishikasugai-Gun, Aichi,  
452-8561 Japan  
tel (81) 52 503 9312  
fax (81) 52 503 2638  
(MMCCIII & MMCC IIIA, MMCC IIIA-47B)

**Klinge Corporation**

4075 E. Market Street  
P. O. Box 3608  
York, PA 17402  
tel (717) 840-4500  
fax (717) 840-4501  
(ThermLogger II)

**Brandstedt Controls Corporation**

8990 NW 105 Way  
Medly, FL 33178  
tel (305) 885-0099  
fax (305)885-1499  
(WR 1095 Data Recorder)

**Sabroe Reefer Cooling Inc.**

524B South Walnut Street  
Wilmington, DE 19901  
tel (302) 426-0700  
fax (302) 426-0701  
(MP-2000, MP-3000)

**Thermo King Corporation**

314 West 90th Street  
Minneapolis, MN 55420  
tel (612) 887-2307  
fax (612)-885-3581  
(Thermoguard PA Microprocessor Temperature Controller,  
MP-D Microprocessor Controller, Thermoguard PA+  
Microprocessor Controllers)

---

## Temperature Recorders for Hot Water Immersion Treatment

### **Agri-Machinery, Inc. (A.M.I.)**

3489 All American Boulevard  
Orlando, FL 32810  
tel (407) 299-1592  
fax (407) 299-1489  
(Honeywell strip chart recorders)

### **Chessell Corporation**

One Pleasant Run  
Newton, PA 18940  
tel (215) 968-0660  
fax (215) 968-0662  
e-mail [www.chessel.com](http://www.chessel.com)  
(Chessell strip-unit recorder,  
Model 346)

### **Conax Buffalo Corp.**

2300 Walden Avenue  
Buffalo, NY 14225  
tel (716) 684-4500  
fax (716) 684-7433  
e-mail [www.conaxbuffalo.com](http://www.conaxbuffalo.com)

### **Consultecnia**

3a Calle 28-70, Zona 1  
Quetzaltenango  
Apartado Postal 537-1  
Guatemala  
tel (502) 02-781-496  
(ASICS temperature recorder)

### **Contech**

Avenida Circunvalacion #1590  
Jardines del Country, C.P. 44210  
Guadalajara, Jalisco  
Mexico  
tel (523) 823-2831  
fax (523) 823-2831  
(contech data logger)

**Control Instrument Services, Inc.**

3607 Ventura Drive East  
Lakeland, FL 33811  
tel (863) 644-9838  
fax (863) 644-8608  
e-mail [www.cisinc.org](http://www.cisinc.org)  
(Honeywell strip chart recorders)

**Electro Scientific Industries**

139 N.W. Science Park Drive  
Portland, OR 97229  
tel (503) 641-4141  
fax (503) 671-5551  
(Dekabox Delade Resister instrument, Model No. DB62, which  
may be used in the calibration of RTD sensors)

**Enterprise S.A. de C.V.**

Rodriguez Saro 424  
Colonia del Valle  
03100 Mexico D.F.  
Mexico  
tel (905) 534-6028  
fax (905) 524-6426  
(Honeywell and Molytek 2702 temperature recorders)

**Equipos Industriales Guadalajara**

Aguador No. 3959-A  
Int. 5 Fracc. La Calma  
C.P. 45070, Zapopan, Jalisco  
Mexico  
tel (52-3) 634-52-64  
fax (52-3) 632-35-20  
(Honeywell instruments)

**Guiar Industrial, S.A. de C.V.**

Rayon No. 989  
Colonia Moderna  
Sector Juarez  
Guadalajara, C.P. 44190, Jalisco  
Mexico  
tel (91-36) 10-10-06  
tel (91-36) 10-19-49  
fax (91-36) 10-10-52  
(Honeywell instruments)

**Honeywell, Inc.**

Industrial Automation & Control Div.  
1100 Virginia Drive  
Ft. Washington, PA 19034  
tel (215) 641-3000  
fax (215) 641-4428  
e-mail [www.honeywell.com](http://www.honeywell.com)  
(Honeywell instruments)

**Industrial Equipment & Engineering Co.**

(I.E. & E.)  
2045 Sprint Blvd.  
Apopka, FL 32703  
tel (407) 293-9212  
(Honeywell instruments)

**Instrumentacion y Control Industrial**

Santa Martha No. 269  
Zapopan, Jalisco  
Mexico  
tel/fax (52-3) 636-5145  
(National and Honeywell Instruments)

**Laboratorios Jael**

Automation Division  
Calle 2 Norte #7, Parque Industrial Francisco I. Madero  
Puerto Chiapas, Tapachula, Chiapas, Mexico  
C.P 30830  
tel: 962-620-4147  
fax: 962-620-4148  
web: <http://labjael.com>  
(HyThsoft v 2)

**Measurement Dynamics LLC**

125 Titus Ave.  
Warrington PA 18976  
tel: (800) 656-1114  
fax: (215) 343-4670

**Nanmac Corporation**

9 Mayhew Street  
Framingham, MA 01702  
tel (508) 872-4811  
fax (508) 879-5450  
e-mail [www.nanmac.com](http://www.nanmac.com)  
(Nanmac data logger, Model H30-1)

**National Instruments, Inc.**

P.O. Box 840909  
Dallas, TX 75284-0909  
tel (512) 794-0100  
fax (512) 683-5794  
e-mail [www.ni.com](http://www.ni.com)  
(National Instruments)

**Neuberger Messinstrumente GmbH**

Steinerstr 16, D-8000  
Munchen, Germany  
tel (089) 72402-0  
(Neuberger strip chart recorder)

**N.Z. Automacao Ltda.**

Rua do Areal  
Bom Retiro  
Sao Paulo SP  
tel: 5511 3223 6594  
Web site: <http://www.mercosulbordados.com.br/mercosulbordados/placas.htm>

**Process Technologies, Inc.**

P.O. Box 82070  
Tampa, FL 33682  
tel (813) 949-9553  
fax (813) 949-8108

**Vacuum Research Corp.**

2419 Smallman Street  
Pittsburgh, PA 15222  
tel (412) 261-9030  
fax(412) 261-7220  
e-mail [www.vacuumresearchcorp.com](http://www.vacuumresearchcorp.com)  
(Molytek temperature recorder, Model 2702)

**William B. Cresse, Inc.**

1091 NW 23rd Street  
Miami, FL 33127  
tel (305) 633-0977  
fax (305) 633-6508  
(Honeywell strip chart recorder)  
Temperature Sensors (RTD, 100 ohm)

---

## Thermocouple Wire

**Omega Engineering, Inc.**

Box 4047  
(1 Omega Drive)  
Stamford, CT 06907-0047  
tel (203) 359-1660  
fax (877) 329-6634  
e-mail [www.omega.com](http://www.omega.com)  
(Type "T" thermocouple wire)  
Catalog No. PR-T-24

---

## Thermometers

**Brooklyn Thermometer Co., Inc.**

(Out of Business, October, 2007)

**Cole-Parmer Instrument Co.**

625 East Bunker Court  
Vernon Hills, IL 60061  
tel (800) 323-4340 or  
tel (847) 323-4340  
fax(847) 247-2929  
e-mail [www.colepalmer.com](http://www.colepalmer.com)  
(digital thermometers, hand-held)

**Cooper Instrument Corp.**

33 Reeds Gap Road  
Middlefield, CT 06455-0450  
tel (860) 347-2256  
fax (860) 349-8994  
e-mail [www.cooperinstrument.com](http://www.cooperinstrument.com)  
Electro-Therm hand-held digital thermometer. Instrument model  
Tm-99a (Electro Therm), general purpose air/surface probes, 12  
feet in length, cat # 20-10, puncture probe #1075

**Omega Engineering, Inc.**

Box 4047  
1 Omega Drive  
Stamford, CT 06907-0047  
tel (203) 359-1660  
fax (877) 329-6634  
e-mail [www.omega.com](http://www.omega.com)

**Thermo Electric**

Saddle Brook, NJ 07662  
tel (201) 843-5800  
Micromite indicator/calibrator;  
Model 3115-1-T-0-1-0-0  
Probe for Micromite;  
Model T-18-G-304-0-36-4M1

---

**Thermometers, Glass-Mercury, Certified Precision**

These thermometers are used as calibration standards in cold treatment, hot water dip treatment and hot air treatment.

Thermometers from other sources may be considered as long as they meet the specifications outlined in **Chapter 8: Certified Precision Thermometers: Calibration Guidelines**.

Request approval for thermometers from:

USDA-APHIS-PPQ-CPHST-TQAU  
1730 Varsity Drive, Suite 400  
Raleigh, NC 27606

**DC Scientific Glass**

PO Box 1099  
Pasadena, MD 21123 USA  
tel (800)379-8493  
fax (410)863-1700  
web site: <http://www.dcglass.com/>



Catalog Number	Type	Range	Scale Division	Calibration Points	Length (mm)	Immersion
210-624	Extreme Precision	30 to 124 °F	0.1 °F	Minimum of one at the treatment temperature	610	Total
210-626	Extreme Precision	30 to 124 °F	0.1 °F	Minimum of one at the treatment temperature	610	3 inches
10064F-C	ASTM	77 to 131 °F	0.2 °F	5 calibration points (32, 80, 05, 115, 130 °F)	379	Total
10064C-C	ASTM	25 to 55 °C	0.1 °C	5 calibration points (0, 25, 35, 45, 55 °C)	379	Total
67C-100MM-C	ASTM	95 to 155 °C	0.2 °C	5 calibration points (0, 100, 110, 130, 150 °C)	379	100 mm

**FIGURE H-1-1 DC Scientific Glass - Approved Thermometers**

**Fisher Scientific**

P.O. Box 14989  
 St. Louis, MO 61378  
 tel (800)766-7000  
 fax (800)926-1166  
 web site: [www.fishersci.com](http://www.fishersci.com)

Catalog Number	Type	Range	Scale Division	Calibration Points	Length (mm)	Immersion
15-142C	ASTM Mercury	77 to 131 °F	0.2 °F	5 calibration points (32, 80, 95, 115, 130 °F)	379	Total
15-140C	ASTM Mercury	25 to 55 °C	0.1 °C	5 calibration points (0, 25, 35, 45, 55 °C)	379	Total
15-169-120	ASTM Mercury	95 to 155 °C	0.2 °C	5 calibration points (0, 100, 110, 130, 150 °C)	379	Total

**FIGURE H-1-2 Fisher Scientific - Approved Thermometers**

**VWR**

1310 Goshen Parkway  
West Chester, PA 19380  
Tel 800-932 5000  
610 431 1700  
Fax 610 431 9174  
web site: [www.VWR.com](http://www.VWR.com)

Catalog Number	Type	Range	Scale Division	Calibration Points	Length (mm)	Immersion
61099-068	ASTM Mercury	77 to 131 °F	0.2 °F	5 calibration points (32, 80, 95, 115, 130 °F)	379	Total
15-61099-057	ASTM Mercury	25 to 55 °C	0.1 °C	5 calibration points (0, 25, 35, 45, 55 °C)	379	Total

**FIGURE H-1-3 VWR - Approved Thermometers**

---

### Thermometers, Glass Non-Mercury, Certified Precision

These thermometers are used as a calibration standard in cold treatment, hot water dip treatment and hot air treatment.

Thermometers from other sources may be considered as long as they meet the specifications outlined in **Chapter 8: Certified Precision Thermometers: Calibration Guidelines**.

Request approval for thermometers from:

USDA-APHIS-PPQ-CPHST-TQAU  
1730 Varsity Drive, Suite 400  
Raleigh, NC 27606

**Cole-Parmer Instrument Co.**

625 East Bunker Court  
Veron Hills, IL 60061-1844  
Tel 800 323 4340  
847 549 7600  
Fax 847 247 2929  
e-mail [techinfo@coleparmer.com](mailto:techinfo@coleparmer.com)  
website: [www.coleparmer.com](http://www.coleparmer.com)

Catalog Number	Type	Range	Scale Division	Calibration Points	Length (mm)	Immersion
K-08007-15	Thermo Scientific ERTCO®	77 to 131 °F	0.2 °F	5 calibration points (32, 80, 95, 115, 130 °F)	379	Total
K-08007-14	Thermo Scientific ERTCO®	25 to 55 °C	0.1 °C	5 calibration points (0, 25, 35, 45, 55 °C)	379	Total
EW-08007-20	Thermo Scientific ERTCO®	95 to 155 °C	0.2 °C	5 calibration points (0, 100, 110, 130, 150 °C)	379	100 mm

**FIGURE H-1-4 Cole Parmer - Approved Thermometers**

## Thermometers, Digital, Certified Precision

These thermometers are used as a calibration standard and can be substituted for mercury and non-mercury thermometers in cold treatment, hot water dip treatment and hot air treatment.

Thermometers from other sources may be considered as long as they meet the specifications outlined in **Chapter 8: Certified Precision Thermometers: Calibration Guidelines**.

Request approval for thermometers from:

USDA-APHIS-PPQ-CPHST-TQAU  
1730 Varsity Drive, Suite 400  
Raleigh, NC 27606

### **Tech Instrumentation, Inc.**

160 W Kiowa Ave  
PO Box 2029  
Elizabeth, CO 80107  
USA  
Toll Free: (USA & Canada only) 800-390-0004  
Telephone: 303-841-7567  
Fax: 303-840-8568  
e-mail: [sales@techinstrument.com](mailto:sales@techinstrument.com)  
web site: [www.techinstrument.com](http://www.techinstrument.com)

**Catalog #TL-1W:** Digital thermometer with range -44 to 600 °F and -43 to 315 °C; Resolution 0.01 degrees; Accuracy -/+0.1 F below 300 °F; Various stem lengths; 4 point NIST traceable calibration included (request 5 or more calibration points and a certificate); 1 year warranty.

### **EUTECH Instruments**

For Africa, Asia, Middle East and Pacific Rim:  
Eutech Instruments Pte Ltd  
Blk 55, Ayer Rajah Crescent, #04-16/24, Singapore 139949  
Tel: (65) 6778-6876  
Fax: (65) 6773-0836  
e-mail: [eutech@thermofisher.com](mailto:eutech@thermofisher.com)  
web site: [www.eutechinst.com](http://www.eutechinst.com)

For Europe:  
Eutech Instruments Europe B.V.  
P.O. Box 254, 3860 AG Nijkerk  
The Netherlands  
Tel: (31) 033-2463887  
Fax: (31) 033-2460832  
e-mail: [info@eutech.nl](mailto:info@eutech.nl)  
web site: [www.eutech.nl](http://www.eutech.nl)

For North and South America:  
OAKTON Instruments  
P.O. Box 5136, Vernon Hills, IL 60061, USA  
Tel: 1-888-4OAKTON (1-888-462-5866)  
Fax: 1-847-247-2984  
e-mail: [info@4oakton.com](mailto:info@4oakton.com)  
web site: [www.4oakton.com](http://www.4oakton.com)

Cole-Parmer Instrument Company  
625, East Bunker Court, Vernon Hills,  
Illinois, 60061-1844, USA  
Tel: 1-800-323-4340 (or 1-847-549-7600)  
Fax: 1-847-247-2929  
e-mail: [info@coleparmer.com](mailto:info@coleparmer.com)  
web site: [www.coleparmer.com](http://www.coleparmer.com)

For China:  
Thermo Fisher Scientific  
Building 6, No.27 Xin Jinqiao Rd.,  
Shanghai 201206, China  
Tel: (86) 021 6865 4588

Fax (86) 021 6445 7909  
e-mail: [candy.tian@thermofisher.com](mailto:candy.tian@thermofisher.com)  
web site: [www.eutech.cn](http://www.eutech.cn)

For India:  
Thermo Fisher Scientific  
102, 104 Delphi 'C' wing  
Hiranandani Business Park  
Powai, Mumbai - 400 076  
Tel : 022 - 6742 94 94 (Board No.)  
Fax: 022 - 6742 94 95  
e-mail: [prasanna.pandit@thermofisher.com](mailto:prasanna.pandit@thermofisher.com)  
website: [www.eutechinst.com](http://www.eutechinst.com)

**Catalog # 60010-85:** Digital thermometer with range -330 to 2210 °F or -201 to 1210 °C; Resolution 0.1 °C/°F at 100.0 to 999.9 C/F; Accuracy +/- 0.1 °C/°F at 100 to 999.9 °C/°F; various probe lengths; Request NIST traceable calibration with 5 temperature points or more and a certificate.

**OpticsPlanet, Inc.**

3150CommercialAve  
Northbrook, IL 60062  
Toll-Free Phone:(800) 504-5897  
Intl. Calls.(847) 513-6201  
Fax:(847) 919-3003  
e-mail:[Sales@OpticsPlanet.com](mailto:Sales@OpticsPlanet.com)  
web site: <http://www.opticsplanet.net/control-company-vwr-digital-data-logger-thermometers-4000.html>

**Catalog # C1-LB-4000:** Control Company Digital Data Logger Thermometer with Probe 4000/61220-601; Accuracy- +/-0.05 °C; Request NIST calibration and certificate with 5 or more temperature points in treatment range.

**Thermco Products, Inc.**

10 Millpond Drive  
Lafayette, New Jersey 07848  
Tel. 973 300 9100  
Fax 973 940 112  
e-mail: [paul@thermcoproductsinc.com](mailto:paul@thermcoproductsinc.com)  
No website

Catalog #ACCD650P: High Precision Digital Pt100 Platinum Thermometer; Range- Pt100: -200 °C to +850 °C: Accuracy- Pt 100 +/- 0.03 from -50 °C to + 199.99 °C; with Certificate of calibration. Request NIST calibration and certificate with 5 or more temperature points in treatment range; ACCD1019 High Precision Probe Pt100 Platinum 12" (405mm)

**ThermoWorks**

165 N. 1330 W., #A1  
Orem, UT 84057  
Tel. 801 756 7705  
Fax 801 756 8948  
e-mail: [info@thermoworks.com](mailto:info@thermoworks.com)  
web site: <http://www.thermoworks.com>

Model P600 series; Precision handheld reference thermometer: Range; -328 F to 842 F; Accuracy 0.05 F from -148 to 302 F: w/Certificate of calibration. Request NIST calibration and certificate with temperature points in treatment range; choice of temperature sensors.

---

**Thermometers, Certified Precision, Approved Calibration Companies**

Conduct thermometer calibration by USDA-approved calibration companies. Follow the procedures for calibration summarized in Chapter 8-1, "[Certified Precision Thermometers: Calibration Guidelines](#)" on [page-8-1-35](#) .

**DC Scientific Glass**

PO Box 1099  
Pasadena, Maryland 21123,USA  
Tel 800 379 8493  
410 863 1700  
web site: [www.dcglass.com](http://www.dcglass.com)

**ERTCO**

2555 Kerper Blvd  
Dubuque, IA 52001  
Tel 800 553 0039  
563 556 2241  
e-mail: [ertco&thermofisher.com](mailto:ertco&thermofisher.com)  
web site: [www.ertco.com](http://www.ertco.com)

**ICL Calibration Laboratories, INC.**

1501 Decker Ave, Suite 118  
Stuart, FL 34994 USA  
Tel 772 286 7710  
1 800 713 6647  
e-mail: [sales@iclcalibration.com](mailto:sales@iclcalibration.com)  
web site: [www.icllabs.com](http://www.icllabs.com)

**INNOCAL**

625 East Bunker St.  
M/S14  
Vernon Hills, IL 60061-1844  
Tel 866 466 6225  
Fax 847 247 2984  
e-mail: [infor@innocalsolutions.com](mailto:infor@innocalsolutions.com)  
web site: [www.innocalsolution.com](http://www.innocalsolution.com)

**Instrumentation Technical Services INC (ITS)**

20 Hagerty Bld  
Suite 1  
West Chester, PA 19380  
Tel 610 436 973  
e-mail: [general@calservice.net](mailto:general@calservice.net)  
[sales@calservice.net](mailto:sales@calservice.net)  
web site: [www.calservice.com](http://www.calservice.com)

**Measurement Assurance Technology**

2109 Luna Rd. Suite 240  
Carrollton, TX75006  
tel 866 678 8420  
972 241 2167  
fax 972 241 2167  
e-mail: [calibration@mattestusa.com](mailto:calibration@mattestusa.com)  
[sales@mattestusa.com](mailto:sales@mattestusa.com)  
web site: [www.mattestusda.com](http://www.mattestusda.com)

**Micro Precision Calibration, Inc.**

Sacramento USA Corporate Headquarters  
Labs in the U.S., Mexico, and Asia  
21331 Adamson Drive  
Grass Valley, CA 95949  
tel 530-268-1860  
fax 530-268-1203  
e-mail: [gv-contact@microprecision.com](mailto:gv-contact@microprecision.com)  
web site: <http://www.microprecision.com/index.php>

**Phoenix Calibration DR**

Parque Industrial Excel  
Los Tanquecitos  
Andres Boca Chica  
Santo Domingo, D.R.  
tel 809 563 0457  
fax 809 540 2320  
e-mail: [dweil@phoenixcalibrationdr.com](mailto:dweil@phoenixcalibrationdr.com)

web site: [www.phoenixcalibrationdr.com](http://www.phoenixcalibrationdr.com)

**VWR**

1310 Goshen Parkway  
West Chester, PA 19380  
Tel 800-932 5000  
610 431 1700  
Fax 610 431 9174  
web site: [www.VWR.com](http://www.VWR.com)

---

**Tubing, Gas-Sampling**

(polyethylene or polypropylene)

**Cole-Parmer Instrument Co.**

625 East Bunker Court  
Vernon Hills, IL 60061  
tel (800) 323-4340  
fax (847) 247-2929  
e-mail: [www.coleparmar.com](http://www.coleparmar.com)

**Consolidated Plastics Co.**

8181 Darrow Road  
Twinsburg, OH 44087  
tel (800) 321-1980  
fax (330) 425-3333

**Fisher Scientific**

P.O. Box 14989  
St. Louis, MO 61378  
tel (800) 766-7000  
fax (800) 926-1166



**Pest Fog Sales Corp.**

1424 Bonita St.  
PO Box 3703 Corpus Christi, TX 78463  
tel: (512) 884-8214 or (800) 395-2945  
fax: (512) 884-5903

**Thomas Scientific**

P.O. Box 99  
Swedesboro, NJ 07085  
tel (800) 345-2100  
tel (800) 345-2000  
fax (800) 345-5232  
fax (856) 467-3087

---

**Vacuum Pump**

(air compressor) (for use with vacuum fumigation chambers)

**Central Scientific Co.**

Sargent Walsh  
911 Commerce Court  
Buffalo Grove, IL 60080  
tel (847) 451-0524  
fax (800) 676-2540  
e-mail [www.sargentwalsh.com](http://www.sargentwalsh.com)

**Crowell Manufacturing Company**

318-319 Franklin Avenue  
Brooklyn, NY

**Neward Enterprises, Inc.**

Distributor: McMaster-Carr  
P.O. Box 740100  
Atlanta, GA 30374-0100  
tel(404) 346-7000  
(Mityvac hand-held vacuum pump)  
Cost: \$69 (zinc-alloy pump #9963K12)

## Vapam

(see Metam-sodium)

---

## Volatilizer

(for volatilizing liquid methyl bromide into a fumigant gas)

### **Illinois Testing Labs, Inc.**

420 North LaSalle Street

Chicago, IL

Volatilizer (heat exchanger) for Methyl Bromide

(coiled copper tube in hot water bath)

### **Degesch America, Inc.**

Houston Division

14802 Parkalmeda

Houston, TX 77045

tel (713) 433-4777

fax (713) 433-0877

### **Pest Fog Sales**

P.O. Box 3703

(1424 Bonita)

Corpus Christi, TX 78463

tel (512) 884-8214

tel (800) 395-2345

fax (512) 884-5903

### **Vacudyne Corporation**

375 East Joe Orr Road

Chicago Heights, IL 60441

tel (708) 757-5200

fax (708) 757-7180

e-mail [www.vacudyne.com](http://www.vacudyne.com)

---

## Warning Signs and Placards

**Carlton Industries, Inc.**

Highway 71 West  
P.O. Box 280  
La Grange, TX 78945  
tel (979) 242-5055  
fax (979) 242-5058

**Champion America, Inc.**

P.O. Box 3092  
Stroney Creek, CT 06405  
tel (203) 315-1181  
fax (800) 336-3707  
e-mail [www.champion-america.com](http://www.champion-america.com)

**Pest Fog Sales Corp.**

1424 Bonita St.  
PO Box 3703 Corpus Christi, TX 78463  
tel: (512) 884-8214 or (800) 395-2945  
fax: (512) 884-5903



# Comment Sheet

**Directions:** Use this sheet to suggest an improvement or to identify a problem in the content of the manual. **Do not use this sheet to order manuals and manual parts—see Appendix C for ordering manuals and manual parts, or for changing the number of manuals you receive.** To mail, please follow the directions on the next page.

Description of problem (error, inconsistency, missing or insufficient information, etc.)

--

Description of improvement or recommended change (add attachments if necessary)

--

Reason for improvement or change

--

---

After completion:

- 1.** Fold on the dotted lines with the address side outward.
- 2.** Staple or tape to close.
- 3.** Affix postage.
- 4.** Drop in the mail.

---

USDA-APHIS-PPQ  
Manuals Unit  
92 Thomas Johnson Drive, Suite 200  
Frederick, MD 21702-4301

Attn: Josie Cooley

# Index

A  
B  
C  
D  
E  
F  
G  
H  
I  
J  
K  
L  
M  
N  
O  
P  
Q  
R  
S  
T  
U  
V  
W  
X  
Y  
Z

## A

### *Acalypha*

Accident or spill emergency kit [7-3-17](#)  
treatment schedule, see also Pesticide spills

*Acalypha*, treatment T570-1 [5-6-20](#)

*Achimenes*, treatment T553-1 [5-6-15](#)

*Aconitum*, treatment T570-2 [5-6-20](#)

Acorns, treatment T302-g-1 [5-4-8](#)

Acronyms and abbreviations [9-1-1 to 9-1-3](#)

### *Actinidia*

treatment T553-1 [5-6-15](#)

### Aeration

chamber fumigation [2-5-3 to 2-5-7](#)  
determining when to release the  
commodity [2-4-39 to 2-4-47](#), ?? to [2-5-7](#)  
materials needed [2-4-37](#)  
normal atmospheric pressure chambers ?? to  
[2-5-6](#)  
of fruits, vegetables, and cut flowers [2-4-42 to 2-4-43](#)  
of nonsorptive, noncontainerized cargo [2-4-40 to 2-4-41](#)  
of sorptive, containerized commodities [2-4-45 to 2-4-47](#)  
of sorptive, noncontainerized cargo [2-4-43 to 2-4-45](#)  
procedure determination [2-5-4](#)  
requirements for [2-4-6](#)  
responsibility for  
ship fumigation [2-6-12](#)  
tarpaulin fumigation [2-4-36](#)  
ship fumigation [2-6-13 to ??](#)  
structure fumigation [2-7-15 to ??](#)  
tarpaulin fumigation  
methyl bromide [2-4-36 to 2-4-47](#)  
vacuum fumigation chambers [2-5-6](#)  
wearing respiratory protection [2-4-38](#)

### Aerosols

application of [2-11-1](#)  
safety precautions [2-11-4](#)

*Agapanthus*, treatment T553-1 [5-6-15](#)

*Agriolimacidae*, treatment T201-l [5-3-6](#)

Air velocity measuring instruments  
anemometer [8-1-27](#)  
velometer [8-1-27](#)

Aircraft, application of micronized dusts [2-11-2 to ??](#)

Aircraft, treatment T409-a [5-5-28 to 5-5-30](#)

Alarm systems  
requirements for hot water immersion  
treatment [3-3-11](#)

*Aleurocanthus woglumi*, fruit treatment  
schedule [5-2-25](#)

Alfalfa, treatment T520-1-1 [5-6-14](#)

### *Allium*

treatment T552-1 [5-6-14](#)

Aloe, treatment T553-1 [5-6-15](#)

Aluminum phosphide  
measurement of phosphine [8-1-23](#)  
See also Phosphine  
threshold limit value for phosphine [8-1-13](#)

Amaryllis, treatment T552-1 [5-6-14](#), [5-6-18](#)

American Bureau of Shipping [6-4-4](#)

### *Amorphophallus*

treatment T553-1 [5-6-15](#)

*Ampelodesma mauriticus* [5-4-14](#)

*Ampelopsis*, treatment T553-1 [5-6-15](#)

*Amphulariidae*, treatment T201-q [5-3-3](#)

*Anastrepha ludens*, treatment T106-a-1 [5-2-64](#)

*Anastrepha* spp. [5-2-18](#), [5-2-26](#)

### *Anastrepha* spp.

methyl bromide fumigation treatment  
schedule [5-2-36](#)

- vapor heat treatment schedules 5-2-64
- Anchusa*, treatment T553-2 5-6-15
- Anemometer 8-1-27
- Anemone*, treatment T553-1 5-6-15
- Animal and Plant Health Inspection Service 3-3-3  
 financing of commercial ventures 6-5-12  
 preclearance program for foreign treatment facilities 6-5-8 to 6-5-12  
 preclearance program for vessels used for intran-  
 sit cold treatment 6-4-2 to ??
- Anthonomus grandis*  
 treatment T301-d-1-1, 301-d-1-2 5-4-4
- Ants  
 treatment schedules for nonplant products 5-5-41
- Aphelenchoides besseyi*  
 treatment T564-1 5-6-18
- Aphelenchoides subtenuis*  
 treatment T565-2 5-6-18
- Aphids  
 treatment T201-g-1, T201-g-3 ?? to 5-3-5
- APHIS, **see** Animal and Plant Health Inspection Service
- Apple  
 T101-a-1 methyl bromide fumigation treatment schedule 5-2-3
- Application of manual 1-1-3
- Apricot  
 T107-e cold treatment schedule 5-2-71  
 treatment T101-a-3 5-2-3
- Aquatic plants  
 treatment T201-q 5-3-3
- Armoracea  
 treatment T553-3 5-6-15
- Ascochyta  
 treatment T513-1 5-6-11
- Ash Logs  
 heat treatment 5-4-29  
 emerald ash borer 5-4-29
- Asparagus 5-2-3, 5-2-4, 5-2-33
- Asphalt surfaces  
 effect of malathion sprays 2-6-4
- Astilbe roots, treatment T202-b 5-3-20
- Astilbe spp.  
 treatment T553-1 5-6-15  
 treatment T553-2 5-6-15  
 treatment T564-1 5-6-18
- Atmospheric fumigation chambers  
 auxiliary equipment 6-3-5  
 chamber 6-3-2  
 circulation and exhaust systems 6-3-3  
 fumigant dispensing system 6-3-4  
 gas-tight construction 6-3-3  
 pressure-leakage test 6-3-4 to ??  
 U tube manometer 8-1-29 to ??, 8-1-31
- Australia  
 asparagus treatment schedule 5-2-4
- Automobiles  
 treatment schedule for golden nematode contamination 5-5-21
- Auxiliary pump 8-1-27 to 8-1-28
- Avocado  
 countries prohibited from exporting to the United States 5-2-80  
 treatment T101-c-1 5-2-4  
 treatment T203-m 5-3-26
- Azalea  
 treatment T201-a-2 5-3-7  
 treatment T501-1 5-6-3
- Azaleodendron*  
 treatment T501-2  
 Remove infected parts and treat all plants of same species in shipment with 4-4-50 Bordeaux dip or spray. 5-6-3
- 
- B**
- Bactrocera cucurbitae*  
 methyl bromide fumigation treatment schedule 5-2-4
- Bactrocera dorsalis*  
 methyl bromide fumigation treatment schedule 5-2-4  
 vapor heat treatment schedules 5-2-64 to ??  
 water treatment schedule 5-2-50
- Bactrocera tryoni*  
 fumigation followed by cold treatment schedule 5-2-75
- Bags and bagging material  
 treatment T306  
 Bags and Bagging Material, Covers 5-4-16 to 5-4-18  
 treatment T503-1-1



- Soak in formaldehyde for 1 hour, 1 pint of commercial formaldehyde to 10 gallons of water. 5-6-5
- Baled hay**  
treatment T311  
Phosphine at NAP 5-4-25
- Baled straw**  
treatment schedule 3-4-2
- Banana roots**  
treatment T202-c 5-3-20
- Bananas**  
treatment T101-d-1 5-2-4
- Baris lepidii**  
treatment T101-f-2 5-2-29
- Beans**  
methyl bromide fumigation treatment  
schedule 5-2-26 to 5-2-27  
treatment T101-e-1 5-2-5
- Beets**  
treatment T101-g-1 5-2-5
- Begonia**  
treatment T553-1 5-6-15  
treatment T559-1 5-6-17
- Bell peppers**  
treatment T106-b-1  
Vapor heat 5-2-64
- Berberis**  
treatment T201-a-2 5-3-7
- Blackberries**  
treatment T101-h-1  
MB at NAP—tarpaulin or chamber 5-2-6
- Bletilla hyacinthina**  
treatment T553-1 5-6-15
- Bletilla hyacinthina**  
treatment T564-1 5-6-18
- Blueberries**  
treatment T101-i-1 5-2-6
- Boilers**  
requirements for hot water immersion  
treatment 3-3-6
- Boll weevil**  
treatment T301-a-3  
MB (“Q” label only) at NAP—tarpaulin 5-4-4
- Bombay, India**  
treatment schedules for brassware ?? to 5-5-42
- Bootanomyia spp.**  
treatment T203-o-1  
MB (“Q” label only) in 26" vacuum 5-3-32
- Borers**  
plant material treatment schedule 5-3-7, ?? to 5-3-14  
wood products treatment schedules 5-5-15
- Brachycerus spp.**  
garlic treatment schedule 5-2-23  
plants treatment schedule 5-3-20
- Brachyrhinus larvae**  
treatment T202-b  
MB (“Q” label only) in 26" vacuum 5-3-20
- Brassica spp.**  
treatment T101-n-2  
MB at NAP—tarpaulin or chamber 5-2-7, 5-2-19
- Brassware**  
treatment schedule ?? to 5-5-42
- Breadfruit**  
treatment T102-c  
Warm, soapy water and brushing 5-2-48
- Break bulk cargo**  
arranging for fumigation 2-3-8  
fan arrangement 2-3-8  
gas introduction line placement 2-3-8  
gas sampling tube placement 2-3-8
- Brevipalpus chilensis**  
methyl bromide fumigation treatment  
schedule 5-2-18  
water treatment schedule 5-2-48 to 5-2-49, 5-2-53
- Bribery** 6-5-12
- Broccoli**  
treatment T101-n-2  
MB at NAP—tarpaulin or chamber 5-2-7
- Bromeliads**  
treatment T507-1  
Remove infected leaves and treat all plants of same species in shipment with Ferbam or Captan following label directions. 5-6-8
- Broomcorn**  
treatment T566-1 5-6-19
- Bruchidae**  
vegetable treatment schedule 5-2-22 to ??, 5-2-32, 5-2-38, 5-2-41
- Brussels sprouts**  
treatment T101-n-2 5-2-8
- Bulb nematodes**

treatment T552-1 [5-6-14](#)  
treatment T567-1 [5-6-19](#)

**Bulb scale mite**  
treatment T202-i-1 [5-3-23](#)

**Bulbs**  
treatment schedules [?? to 5-3-21](#)  
treatment T552-1 [5-6-14](#)

**Bulinidae**  
treatment T201-q [5-3-3](#)

**Bulk fumigation** [2-10-21 to ??](#)

## C

**Cabbage**  
T101-n-2 treatment T101-j-1 [5-2-9](#)

**Cacti**  
treatment T201-f-1 [?? to 5-3-5](#)  
treatment T553-1 [5-6-15](#)

**Cacti fruits**  
treatment T101-d-3 [5-2-45](#)

**Calla**  
treatment T556-1 [5-6-16](#)

**Calliopsis**  
treatment T553-1 [5-6-15](#)

**Camellia**  
treatment T509-1-1 [5-6-9](#)

**Campanula**  
treatment T553-1 [5-6-15](#)

**Canada**  
treatment schedule for pines [5-3-16](#)

**Cantaloupe**  
treatment T101-k-1 [5-2-11](#)

**Cargo**  
non-food, non-feed commodities treatment  
schedules [?? to 5-5-13](#)

**Cargo compartments**  
application of micronized dusts [2-11-3](#)

**Carrots**  
treatment T101-l-1, T101-m-1 [5-2-12](#)

**Cassava**  
treatment T101-n-1 [5-2-12](#)

**Cauliflower**  
treatment T101-n-2 [5-2-13](#)

**Celeriac**  
treatment T101-n-1 [5-2-14](#)

**Celery and celery root**  
treatment T101-n-1 [5-2-14](#)

**Ceratitis capitata**  
fumigation followed by cold treatment  
schedule [?? to 5-2-75](#)  
methyl bromide fumigation treatment  
schedule [?? to 5-2-53](#)  
water treatment schedule [?? to 5-2-53](#)

**Cercospora spp.**  
treatment T501-3 [5-6-3](#)

**Certified glass-mercury thermometer** [3-3-8](#)

**Certifying facilities**  
hot water immersion facilities [6-5-1 to 6-5-12](#)  
vacuum fumigation chambers [6-2-4, H-1-22](#)

**Cestrum**  
treatment T553-1 [5-6-15](#)

**Chamber fumigation**  
methyl bromide  
aerating the chamber [2-5-3 to ??](#)  
conducting the fumigation [2-5-2 to ??](#)  
materials needed [2-5-1](#)

**Chart recorders**  
APHIS approved models [3-3-10](#)  
specifications [3-3-11](#)

**Chayote**  
treatment T101-p-1  
MB at NAP—tarpaulin or chamber [5-2-15](#)

**Chemical treatments**  
aerosols [2-11-1](#)  
dips [5-3-13 to 5-3-19](#)  
dusts [2-13-1](#)  
fumigants  
methyl bromide [2-3-1 to 2-3-8](#)  
physical properties [2-2-4](#)  
supervision of quarantine treatments [2-2-2 to 2-2-4](#)  
micronized dusts [2-11-2 to ??](#)  
overview [2-1-1](#)  
sprays [2-14-1](#)

**Cherimoya**  
treatment T102-b  
Soapy water and wax [5-2-48, 5-2-53](#)

**Cherries**  
treatment schedule [5-2-15](#)  
treatment T101-r-1  
MB at NAP—tarpaulin or chamber [5-2-15](#)

**Chestnut**  
treatment T101-u-1, T101-t-1 [5-2-16](#)

- treatment T203-e (mandatory treatment)  
MB ("Q" label only) at 26" vacuum [5-3-26](#)
- Chicory and chicory root**  
treatment T101-v-1 [5-2-16 to 5-2-17](#)
- Chile**  
cherimoya treatment schedule [5-2-53](#)  
grapes treatment schedule [5-2-25](#)  
lemons treatment schedule [5-2-18](#)  
limes treatment schedule [5-2-49](#)  
mountain papaya treatment schedule [5-2-56](#)  
tomato treatment schedule [5-2-44](#)
- Chilean false spider mite**  
water treatment schedule [?? to 5-2-49](#)
- Chinese**  
cabbage  
treatment T101-n-2  
MB at NAP—tarpaulin or chamber [5-2-10](#)  
mustard  
treatment T101-n-2  
MB at NAP—tarpaulin or chamber [5-2-11](#)
- Christmas trees**  
treatment T501-5 [5-6-3](#)
- Chrysanthemum* spp.**  
treatment T201-g-1 [?? to 5-3-5](#)  
treatment T501-4 [5-6-3](#)  
treatment T557-1 [5-6-16](#)
- Chrysomya* spp.**  
treatment T501-1 [5-6-3](#)  
treatment T501-6 [5-6-4](#)
- Cimicifuga**  
treatment T553-1 [5-6-15](#)  
treatment T564-1 [5-6-18](#)
- Cipollini**  
treatment T101-w-1  
MB in 15" vacuum—chamber [5-2-17](#)
- Circulation and exhaust systems**  
atmospheric fumigation chambers [6-3-3](#)  
vacuum fumigation chambers [6-2-2](#)
- Cissus**  
treatment T553-1  
Hot water at 118°F for 30 minutes. [5-6-15](#)
- Citrus**  
methyl bromide fumigation treatment  
schedule [5-2-18](#)
- Citrus blackfly**  
plant treatment schedule [?? to 5-3-12](#)
- Citrus canker**  
treatment T511-1 [5-6-10](#)
- Clematis**  
treatment T553-2 [5-6-15](#)
- Clementine**  
methyl bromide fumigation treatment [5-2-18](#)  
vapor heat treatment schedules [5-2-64](#)
- CO2 fire extinguishers**  
safety precautions [2-11-4](#)
- Coast Guard Regulations** [B-1-1 to B-1-8](#)
- Coconuts**  
treatment T101-x-1 [5-2-20](#)
- Cold treatment**  
fumigation followed by cold treatment  
schedules [5-2-73](#)  
fumigation plus refrigeration treatment schedules  
for fruits [?? to 5-2-73](#)  
integral containers used for cold  
treatment [6-4-11 to ??](#)  
list of approved [F-1-1](#)  
temperature recording instruments  
standards [6-4-14 to ??](#)  
vessels used for intransit cold treatment [6-4-2 to ??](#)  
approval requirements [6-4-4 to ??](#)  
list of approved [G-1-1](#)  
temperature recording systems standards [6-4-2 to ??](#)  
warehouses used for [6-4-14 to ??](#)
- Coles**  
treatment T101-n-2  
MB at NAP—tarpaulin or chamber [5-2-7, 5-2-19](#)
- Collard greens, treatment schedule**  
T101-n-2 [5-2-19](#)
- Commercial line conditioner**  
requirements for hot water immersion  
treatment [3-3-5](#)
- Computers**  
requirements for hot water immersion  
treatment [3-3-5](#)
- Concentration readings**  
chamber fumigation [2-5-5, 2-5-6](#)  
ship fumigation [2-6-13 to ??](#)  
structure fumigation [2-7-16 to ??](#)  
tarpaulin fumigation  
methyl bromide [2-4-20 to ??](#)
- Concrete surfaces**  
treatment T404-b-5-1  
Chlorpyrifos spray [?? to 5-5-14](#)
- Conifer seeds**  
treatment T203-i-1  
MB ("Q" label only) at NAP [5-3-26](#)

- Containerized cargo  
 aeration of 2-4-38, ?? to 2-5-6  
 arrangement for fumigation 2-4-7 to 2-4-8  
 fan arrangement 2-4-10  
 gas introduction line placement 2-4-11  
 gas sampling tube placement 2-4-12
- Containers  
 potato cyst nematode treatment schedule 5-6-7
- Controlled Atmosphere Temperature Treatment System(CATTS) 5-7-1  
 apples 5-7-3  
 nectarines and peaches 5-7-2  
 sweet cherries 5-7-3
- Convallaria (pips)  
 treatment T551-1 5-6-14
- Conventions 1-1-4
- Conversion factors 2-2-3
- Conversion Tables D-1-1 to D-1-2
- Convolvulus japonicus* 5-6-15
- Copra  
 treatment T101-x-1  
 MB ("Q" label only) at NAP—tarpaulin or chamber 5-2-20
- Corms  
 treatment T202-a-1  
 MB ("Q" label only) at NAP—Chamber ?? to 5-3-21
- Corn  
 treatment schedules 5-6-10
- Corn-on-the-cob  
 methyl bromide fumigation treatment schedule 5-2-20
- Corrective lenses and respiratory protection 8-1-18, 8-1-19
- Corytholoma*  
 treatment T553-1 5-6-15
- Cotton and cotton products  
 treatment schedules ?? to 5-4-5, 5-5-20 to ??
- Cottonseed  
 treatment T203-f-1  
 MB ("Q" label only) at NAP—chamber 5-3-28 to 5-3-29  
 treatment T301-a-1-1  
 MB ("Q" label only) at NAP—chamber ?? to 5-4-7
- Covers  
 treatment schedules ?? to 5-4-17
- treatment T503-2-1 5-6-5
- Crocus  
 treatment T565-2 5-6-18
- Cucumbers  
 treatment schedule 5-2-20
- Curculio* spp.  
 treatment T101-t-1  
 MB at NAP—tarpaulin or chamber ?? to 5-2-16  
 treatment T302-g-1  
 MB at NAP—tarpaulin, chamber, or van container ?? to 5-4-8
- Curcuma  
 treatment T553-1 5-6-15
- Cuttings  
 plants  
 treatment T201-d-1  
 MB ("Q" label only) at NAP tarpaulin or chamber, see T201-a-1 ?? to 5-3-15  
 treatment T201-m-1  
 MB ("Q" label only) at NAP—tarpaulin or chamber 5-3-16 to 5-3-18
- Cyclamen  
 treatment T553-1 5-6-15
- Cydia splendana*  
 treatment T101-t-1  
 MB at NAP—tarpaulin or chamber ?? to 5-2-16  
 treatment T302-g-1  
 MB at NAP—tarpaulin, chamber, or van containe ?? to 5-4-8
- Cylindrosporium camalliae*  
 treatment T509-1-1  
 Light infection  
 Remove infected leaves and dip or spray plant with 4-4-50 Bordeaux. Dry quickly and thoroughly before release. 5-6-9
- Cyst nematodes  
 treatment T553-5 5-6-15
- Cytisus  
 treatment T553-1 5-6-15
- 
- D**
- Dahlia  
 treatment T553-1 5-6-15
- Dasheen  
 treatment T102-a-2  
 MB chamber, 15" vacuum-chamber 5-2-21
- Data logger recorders

APHIS approved models 3-3-10

Decontamination  
of respiratory protection 8-1-20 to 8-1-22

Desiccants 8-1-7

Detector kits or gas samples  
operations 8-1-23 to 8-1-24

Dicentra  
treatment T553-1 5-6-15

*Dieffenbachia* spp.  
treatment T201-i-1  
MB ("Q" label only) at NAP ?? to 5-3-9

Dioon edule  
treatment T201-h-2  
MB ("Q" label only) in 26" vacuum 5-3-8

Dips ?? to 5-3-19

Directory of commercial suppliers H-1-1 to H-1-65

*Ditylenchus destructor*  
treatment T552-1 5-6-14  
treatment T554-1-1 5-6-16  
treatment T565-1 5-6-18

*Ditylenchus dipsaci*  
treatment T552-1 5-6-14  
treatment T554-1-2 5-6-16  
treatment T565-4 5-6-19

Documentation 1-1-3

Dosage rates  
methyl bromide  
chamber fumigation 2-5-3  
determining temperature for 2-4-14  
guidelines 2-2-3  
tarpaulin fumigation 2-4-1  
phosphine 2-10-1  
using commodity or air temperature 2-5-3

Downy mildews  
treatment schedules 5-6-5

*Dracaena* spp.  
treatment T201-i-1  
MB ("Q" label only) at NAP ?? to 5-3-9  
treatment T553-1  
Hot water at 118°F for 30 minutes. 5-6-15

Dry ice  
safety precautions 4-2-1

Durian  
water treatment schedule 5-2-48

Dust Masks 8-1-14  
See also Respiratory protection

Dusts 2-13-1

## E

Electrical wiring  
requirements for hot water immersion  
treatment 3-3-5

Electronic manometer 8-1-31

Emerald ash borer  
ash log heat treatment T314-a 5-4-29

Endive  
treatment T101-b-2  
MB at NAP—tarpaulin or chamber 5-2-22

*Epimendium pinnatum*  
treatment T553-1 5-6-15  
treatment T564-1 5-6-18

*Epinotia aporema*  
treatment T101-k-2  
MB in 15" vacuum—chamber ?? to 5-2-27

Equipment 8-1-1 to 8-1-33  
air velocity measuring instruments 8-1-27  
auxiliary pump 8-1-27 to 8-1-28  
detector kits or gas samples 8-1-23 to 8-1-24  
open arm manometer 8-1-29 to ??  
phosphine detector 8-1-32 to 8-1-33  
reference guide to commercial suppliers H-1-1 to  
H-1-65  
respiratory protection ?? to 8-1-22  
See also *specific pieces of equipment*  
thermal conductivity gas analyzers 8-1-2 to ??,  
8-1-2 to ??  
vacuum pump 8-1-32  
volatilizer 8-1-25 to 8-1-26

*Euonymus alata*  
treatment T553-1 5-6-15

*Eupatorium*  
treatment T553-1 5-6-15

*Euphorbia*  
treatment T553-1 5-6-15

Europe  
treatment schedule for alfalfa 5-6-14

Exhaust system  
installation of ?? to 2-4-43

Exotic legume pod borers  
treatment T101-k-2  
MB in 15" vacuum—chamber ?? to 5-2-27

Exposure periods

adjusting  
 for miscellaneous products [5-5-1](#)  
 for plant products [5-4-1](#)  
 ship fumigation [2-6-11](#)  
 tarpaulin fumigation [2-4-40](#) to [2-4-47](#)

## F

### Fans

arranging and operating  
 guidelines [??](#) to [2-2-4](#)  
 ship fumigation [2-6-5](#) to [??](#)  
 structure fumigation [2-7-8](#)  
 tarpaulin fumigation [2-4-10](#)  
 determining number of [2-4-40](#)

### Fava bean (dried)

treatment schedule [5-2-22](#) to [??](#)

### Financing [6-5-12](#)

### Flag smut

treatment T504-1-1  
 Dry heat at 212°F for 1 hour. Treat small bales  
 only. [5-6-5](#)

### Florida

treatment schedule for orchids shipped to [5-6-9](#)

### Flowers

aerating [2-4-40](#)  
 treatment schedules for cut flowers [??](#) to [5-4-16](#)

### Foliar nematodes

treatment T553-4  
 Hot water at 118°F for 30 minutes. [5-6-15](#)  
 treatment T559-1  
 Dip in hot water at 118°F for 5 minutes. [5-6-17](#)  
 treatment T564-1 [5-6-18](#)

### Foreign treatment facilities protocols [6-5-8](#) to [6-5-12](#)

### Forms [A-1-1](#) to [A-1-6](#)

APHIS Form 2061 (Residue Sample for Food or  
 Feed Product) [A-1-2](#) to [??](#)  
 Calibration of Temperature Probes (Cold  
 Treatment) [A-1-4](#)  
 Certificate of Loading and Calibration for Cold  
 Treatment in Self Refrigerated Containers (Cold  
 Treatment) [A-1-9](#)  
 Instructions to Captain (Cold Treatment) [A-1-7](#)  
 Location of Temperature Sensors in Containerized  
 Cargo (Cold Treatment) [A-1-8](#)  
 PPQ Form 203 (Foreign Site Certificate of Inspec-  
 tion and/or Treatment) [A-1-29](#)  
 PPQ Form 429 (Fumigation Record) [A-1-9](#) to [??](#)  
 PPQ Form 519 (Compliance Agreement) [A-1-14](#)  
 PPQ Form 523 (Emergency Action  
 Notification) [A-1-17](#) to [??](#)

PPQ Form 556 (In Transit Cold Treatment Clear-  
 ance Report) [A-1-30](#), [A-1-32](#)  
**see also specific forms by title**

### *Fragaria*

treatment T553-1 [5-6-15](#)  
 treatment T558-1 [5-6-17](#)  
 treatment T569-1  
 Hot water at 121°F for 7 minutes. (National  
 Plant Board Conference, Tennessee,  
 1968) [5-6-20](#)

### Fruit

adjusting exposure period [2-4-24](#) to [2-4-26](#)  
 aerating [2-4-40](#) to [2-4-42](#)  
 determining temperature for proper dosage  
 rate [2-4-14](#)  
 fumigation plus refrigeration treatment  
 schedules [??](#) to [5-2-73](#)  
 hot water immersion treatment  
 flow pattern [3-3-12](#)  
 garbage disposal [3-3-12](#)  
 post-treatment cooling options [3-3-13](#) to [??](#)  
 pre-warming options [3-3-13](#)  
 quarantine area [3-3-12](#)  
 methyl bromide fumigation [??](#) to [5-2-47](#)  
 quick freeze treatment schedules [5-2-79](#)  
 reporting commodity injury [5-2-1](#)  
 water treatment schedules [5-2-48](#) to [5-2-53](#)

### Fruit flies

cold treatment schedule [??](#) to [5-2-71](#), [??](#) to  
[5-2-72](#)  
 fumigation followed by cold treatment  
 schedule [??](#) to [5-2-78](#)  
 hot water immersion treatment for [6-5-1](#)  
 seeds treatment schedule [5-3-35](#)

### Fruit, imported

foreign treatment facilities protocols [6-5-8](#) to  
[6-5-12](#)  
 hot water immersion treatment [6-5-1](#) to [6-5-7](#)

### Fumigants

methyl bromide [2-3-1](#) to [2-3-8](#), [2-4-1](#) to [2-4-47](#), [??](#)  
 to [2-5-7](#)  
 physical properties [2-2-4](#)  
 respiratory protection for [8-1-14](#)  
**see also specific fumigants**  
 supervision of quarantine treatments [2-2-2](#) to  
[2-2-4](#)  
 threshold limit values [8-1-13](#)

### Fumigation

Coast Guard regulations [B-1-1](#) to [B-1-8](#)  
 conducting the fumigation [2-4-20](#) to [??](#)  
 container arrangement [2-4-7](#)  
 followed by cold treatment schedules [??](#) to  
[5-2-78](#)  
 guidelines for safe use [2-2-3](#) to [2-2-4](#)  
 items not to fumigate [2-3-8](#)  
 preparing to fumigate [2-4-3](#) to [2-4-20](#)  
 site selection [2-4-4](#) to [2-4-7](#)

vacuum fumigation chambers ?? to 6-2-4, ?? to H-1-22

#### Fumiscopes

description ?? to 8-1-4  
operational procedures ?? to 8-1-7, 8-1-7 to ??  
repair and calibration 8-1-7  
standardizing the instrument 8-1-5 to ??

## G

#### Gardenia

treatment T553-1 5-6-15

#### Garlic

treatment T101-e-2  
MB in 15" vacuum—chamber 5-2-23  
treatment T202-j  
MB ("Q" label only) at 15" vacuum 5-3-20

#### Gas and vapor removing respirators 8-1-15

See also Respiratory Protection

#### Gas introduction lines

methyl bromide  
ship fumigation 2-6-6  
structure fumigation 2-7-11  
tarpaulin fumigation 2-4-20

#### Gas sampling tubes

determining number of 2-7-9  
methyl bromide  
tarpaulin fumigation 2-4-12 to 2-4-13  
placement of 2-4-12 to 2-4-13

#### Generators

requirements for hot water immersion  
treatment 3-3-5

#### Gentiana

treatment T553-1 5-6-15

#### Gentiana

treatment T507-2 5-6-8

#### Gerbera

treatment T553-1 5-6-15

#### Gesneria

treatment T553-1 5-6-15

#### Geum

treatment T553-1 5-6-15

#### Gin trash

treatment T301-a-6  
Phosphine at NAP ?? to 5-4-2

#### Ginger

treatment T101-f-2  
MB in 15" vacuum—chamber 5-2-23

#### Gladiolus spp.

treatment T202-e-1  
MB ("Q" label only) at NAP 5-3-21  
treatment T553-1 5-6-15  
treatment T565-3 5-6-18

#### Globodera

campestris, pv. citri  
treatment T511-1 5-6-10  
pallida  
Armoracea treatment schedule 5-6-15  
Solanum treatment schedule 5-6-19  
rostochiensis  
Armoracea treatment schedule 5-6-15  
Convallaria (pips) treatment schedule 5-6-14  
infestation treatment schedule 5-6-15  
Solanum treatment schedule 5-6-19

#### Glossary 9-1-1 to 9-1-3

#### Golden nematode

plants treatment schedule 5-6-15  
soil treatment schedule ?? to 5-5-26

#### Gow-Mac

operational procedures ?? to 8-1-6, 8-1-7 to ??  
repair and calibration 8-1-7  
standardizing the instrument 8-1-5 to ??

#### Grains

treatment schedules ?? to 5-4-11, 5-6-5 to 5-6-6

#### Grapefruit

methyl bromide fumigation treatment  
schedule 5-2-25

#### Grapes

methyl bromide fumigation treatment  
schedule 5-2-24 to 5-2-25

#### Green pod vegetables

treatment T101-k-2  
MB in 15" vacuum—chamber 5-2-26

#### Greenery

treatment schedules ?? to 5-4-16

#### Greenhouse-grown plants

treatment T201-c-1  
MB ("Q" label only) at NAP—tarpaulin or  
chamber ?? to 5-3-11

#### Gypsy moth egg masses

heat treatment T314-b 5-4-29  
MB treatment T313-a 5-4-28



---

**H****H. pallida**

Convallaria (pips) treatment schedule 5-6-14

**Haiti**

supervision of hot water immersion treatments 6-5-12

**Hawaii**avacado treatment schedule 5-2-4  
citrus treatment schedule 5-2-54 to ??  
lychee fruit treatment schedules 5-2-50  
tomato treatment schedule 5-2-44**Heat**steam treatments 3-4-1 to ??  
vapor heat treatment 3-5-1 to ??**Heliopsis**

treatment T553-1 5-6-15

**Helleborus**

treatment T553-1 5-6-15

**Herbaceous plants**treatment T201-c-2  
MB ("Q" label only) in 15" vacuum ?? to 5-3-11  
treatment T201-m-2  
MB ("Q" label only) at NAP—tarpaulin or chamber 5-3-17**Hibiscus**

treatment T553-1 5-6-15

**Horseradish**treatment T101-l-2  
MB in 15" vacuum—chamber 5-2-29**Horseradish roots**treatment T202-f  
MB in 15" vacuum 5-3-22  
treatment T553-3 5-6-15**Hosta**treatment T553-1 5-6-15  
treatment T564-1 5-6-18**Hot water immersion facilities**address for technical contact 6-5-8  
annual APHIS performance test procedures 6-5-4 to 6-5-6  
description 6-5-1  
foreign treatment facilities protocols 6-5-8 to 6-5-12  
list of ideas if tank fails performance test 6-5-7  
preliminary performance testing 6-5-2**Hot water immersion treatment**alarm system 3-3-11  
boilers 3-3-6  
changes 3-3-14

electrical and electronic components 3-3-5

post-treatment cooling 3-3-13  
pre-treatment warming 3-3-13  
principle 3-3-2  
procedures 3-3-2  
safeguarding treated fruit 3-3-12  
safety precautions 3-3-14  
schedules 3-3-2  
temperature recorder 3-3-8 to ??  
temperature sensors 3-3-7 to ??  
water circulation 3-3-7  
Work Plans 3-3-15**Hot water treatment**

schedules for 5-6-14 to 5-6-20, ?? to 5-7-1

**Hoya**

treatment T553-1. 5-6-15

**Humulus**

treatment T553-5 5-6-15

**Hyacinthus**

treatment T554-1-1 5-6-16

**Hydrocooling fruit 3-3-13 to ??**

---

**I****India**

treatment schedules for brassware ?? to 5-5-42

**Indoor fumigation 2-4-38 to 2-4-47****Infrared Spectroscopy Gas Monitoring Device 8-1-9**

Spectros 8-1-9

**Inspections on-site 3-3-3****Inspectors**bribery 6-5-12  
foreign treatment facilities protocols 6-5-8 to 6-5-12  
withdrawal from foreign facilities 6-5-12**Interior Fumigation**

methyl bromide 2-7-10

**Iris**treatment T553-1 5-6-15  
treatment T554-1-1 5-6-16

---

**J****Jasminum**

treatment T553-1 5-6-15





---

## K

- Kaempferia**  
treatment T553-1 [5-6-15](#)
- Kale**  
treatment T101-n-2  
MB at NAP—tarpaulin or chamber [5-2-30](#)
- Khapra beetle**  
cotton treatment schedules [?? to 5-4-4](#)  
ships treatment schedule [?? to 5-5-3](#)
- Kiwi**  
treatment T101-m-2  
MB at NAP—tarpaulin or chamber [5-2-30](#)
- Kniphofia**  
treatment T553-2 [5-6-15](#)
- Kohleria**  
treatment T553-1 [5-6-15](#)
- Kohlrabi**  
treatment T101-n-2  
MB at NAP—tarpaulin or chamber [5-2-31](#)

---

## L

- Leaf miners**  
methyl bromide fumigation treatment  
schedule [?? to 5-2-26](#)
- Leafy vegetables**  
treatment T101-n-2  
MB at NAP—tarpaulin or chamber [5-2-31](#),  
[5-2-33](#)
- Leak detection**  
methyl bromide  
structure fumigation [2-7-13](#)  
tarpaulin fumigation [2-4-21](#)  
phosphine [2-10-4](#)
- Leeks**  
treatment T101-q-2  
MB at NAP—tarpaulin or chamber [5-2-32](#)
- Lemon**  
treatment T101-n-2-1  
MB at NAP—tarpaulin or chamber [5-2-18](#)
- Lentils**  
treatment T101-e-1  
MB at NAP—tarpaulin or chamber [5-2-32](#)
- Lesion nematodes**  
treatment T553-2 [5-6-15](#)

- Libium**  
treatment schedule [5-6-19](#)
- Lily bulbs**  
treatment T202-g  
MB (“Q” label only) at NAP [5-3-23](#)

- Limes**  
water treatment schedule [5-2-49](#)

- Lingularis**  
treatment T568-1 [5-6-19](#)

- Lint and linters**  
treatment T301-a-6  
Phosphine at NAP [?? to 5-4-2](#)

- Liquid measure conversion** [2-2-3](#)

- Litchi, *see* Lychee**

- Liverworts**  
treatment schedule for soil [?? to 5-5-25](#)

- Lobesia botrana**  
methyl bromide fumigation treatment  
schedule [?? to 5-2-25](#)

- Logs**  
from gypsy moth quarantine areas [5-4-29](#)

- Logs and lumber**  
adjusting exposure period [2-4-30](#)  
determining temperature for proper dosage  
rate [2-4-15](#)

- Lychee**  
treatment T102-d  
Hot water immersion [5-2-50](#)

- Lycoris**  
treatment T202-h  
MB in 26" vacuum [5-3-23](#)

---

## M

- Macadamia nuts**  
treatment T203-k  
MB (“Q” label only) at NA [5-3-30](#)

- Maintaining**  
the manual [C-1-1 to C-1-5](#)

- Maintenance**  
respiratory protection [8-1-20 to 8-1-23](#)  
Supporting and Updating the Export Certification  
Manual (ECM) and Its Summaries  
Appendix 10 [C-1-1 to C-1-5](#)

- Maintenance- Supporting and Updating the Export Certification Manual ?? to C-1-5, D-1-1 to D-1-2, E-1-1 to ??, F-1-1, G-1-1, H-1-1 to H-1-66
- Maize  
treatment schedules 5-6-5
- Malathion spray  
effect asphalt surfaces 2-6-4
- Mango seed weevils 6-5-8
- Mangoes  
high temperature forced air treatment schedule 5-2-55  
hot water immersion standards 6-5-6  
water treatment schedule 5-2-51 to 5-2-53
- Manometer  
electronic 8-1-31  
open arm 8-1-29 to ??  
use in pressure-leakage testing 6-3-4 to 8-1-32
- Manuals  
distributing C-1-9  
ordering additional copies C-1-7, C-1-7
- Maruca testulalis*  
treatment T101-k-2  
MB in 15" vacuum—chamber ?? to 5-2-27
- MB  
**see** Methyl bromide
- Medicago  
treatment T520-1-1  
Dust with 75 percent Thiram at the rate of 166 grams per 50 kilograms of seed (3.3g/kg). 5-6-14
- Mediterranean fruit fly  
fumigation followed by cold treatment schedule ?? to 5-2-75  
water treatment schedule ?? to 5-2-53
- Meloidogyne* spp.  
treatment schedules 5-6-16 to 5-6-17
- Melons  
treatment T101-o-2  
MB at NAP—tarpaulin or chamber 5-2-33
- Metal surfaces  
treatment schedules ?? to 5-5-14
- Meth-O-Gas Q 2-3-2 to 2-3-4
- Methyl bromide  
acceptable air concentration level 2-4-20  
chamber fumigation  
aerating the chamber 2-5-3 to ??  
conducting the fumigation 2-5-2 to ??  
materials needed 2-5-1  
items not to fumigate ?? to 2-3-8  
leak detection 2-3-5  
Meth-O-Gas Q 2-3-2 to 2-3-4  
properties of 2-3-1 to 2-3-2  
residual effect 2-3-7 to 2-3-8  
residue monitoring 4-1-1, 4-2-1  
Section 18 Exemptions 5-2-1 to ??  
**see also** Treatment schedules  
ship fumigation  
aeration 2-6-13 to ??  
conducting the fumigation 2-6-10 to 2-6-12  
materials needed 2-6-1 to ??  
preparing to fumigate 2-6-3 to ??  
safety measures 2-6-3  
sorption 2-3-6 to 2-3-7  
structure fumigation  
aerating the enclosure 2-7-15 to ??  
conducting the fumigation 2-7-12 to 2-7-13  
materials needed 2-7-1 to 2-7-2  
preparing to fumigate 2-7-3 to ??  
safety precautions 2-7-3  
tarpaulin fumigation  
aerating the enclosure 2-4-36 to 2-4-47  
conducting the fumigation 2-4-20 to ??  
materials needed 2-4-1 to 2-4-3  
preparing to fumigate 2-4-3 to 2-4-20  
threshold limit value 8-1-13  
use of ?? to 2-3-2
- Mexico  
clementines  
methyl bromide treatment schedule 5-2-18  
vapor heat treatment schedules 5-2-64  
grapefruit  
methyl bromide treatment schedule 5-2-26  
mangoes  
high temperature forced air treatment schedule 5-2-55  
oranges  
methyl bromide treatment schedule 5-2-36  
supervision of hot water immersion treatments 6-5-12
- Micronized dusts  
application of 2-11-2 to ??  
cartridges 2-11-2  
equipment 2-11-2  
safety precautions 2-11-4
- Monitoring leads  
blocked or crimped 2-4-19
- Mosses  
treatment schedule for soil ?? to 5-5-25
- Mountain papaya  
high temperature forced air treatment schedule 5-2-56 to ??
- Muscari*  
treatment T567-1 5-6-19
- Mustard

greens  
treatment T101-n-2  
MB at NAP—tarpaulin or chamber 5-2-34

## N

*Naegelia*  
treatment T553-1 5-6-15

*Narcissus*  
treatment T202-i-1  
MB (“Q” label only) at NAP 5-3-23 to 5-3-24  
treatment T555-1 5-6-16

National Monitoring and Residue Monitoring Analysis Laboratory 4-2-3

*Nectarines*  
treatment T101-a-3  
MB at NAP—tarpaulin or chamber 5-2-35

*Nematodes*  
treatment schedules 5-6-15, 5-6-18

### Nonchemical treatments

heat  
Cold Treatment (CT) 3-7-1 to ??  
Forces Hot Air 3-6-1 to ??  
Hot Water Immersion Treatment 3-3-1 to ??  
hot water immersion treatment 3-3-2 to ??  
Irradiation 3-8-1 to ??  
overview 3-2-1 to ??  
Steam Treatments 3-4-1 to ??  
steam treatments 3-4-1 to ??  
Vapor Heat Treatment 3-5-1 to ??  
vapor heat treatment 3-5-1 to ??  
irradiation 3-8-1  
overview 3-1-1, 6-1-1

Normal atmospheric pressure chamber  
aeration of ?? to 2-5-6

*Nut fruit tortrix*  
treatment schedules ?? to 5-2-16, ?? to 5-4-8

*Nuts*  
methyl bromide fumigation treatment  
schedules 5-2-16  
reporting commodity injury 5-2-1

## O

*Oak Logs and Lumber* 5-4-26  
oak lumber 5-4-27  
oak wilt disease 5-4-27  
oak wilt disease alternative treatment 5-4-27

Occupational Safety and Health Administration  
respiratory protection requirements 8-1-14

Off-odors  
effect of methyl bromide ?? to 2-3-8

*Okra*  
treatment schedules ?? to 5-3-30  
treatment T101-p-2 5-2-35

*Onions*  
treatment T101-q-2  
MB at NAP—tarpaulin or chamber 5-2-36

On-site inspections 3-3-3

Open arm manometer  
illustrations 8-1-31  
use in pressure-leakage testing 6-3-4

OPPC  
**see** Oxford Plant Protection Center

*Orange*  
methyl bromide fumigation treatment  
schedule 5-2-36

*Orchid*  
bordeaux spray treatment schedules 5-6-3, 5-6-9  
defoliation treatment schedules 5-6-11  
hot-water treatment schedules 5-6-15  
rusts treatment schedules 5-6-9

Ordering additional manuals, summaries or  
revisions C-1-7 to C-1-9

*Ornithogalum*  
treatment T553-1 5-6-15  
treatment T567-1 5-6-19

*Oryza*  
treatment schedules 5-6-17

Outdoor fumigation ?? to 2-4-7

Oxford Plant Protection Center  
procedures to detect blocked monitoring leads  
with use of Mitivac vacuum pump 8-1-32

## P

*Paddy rice*  
**see also** Rice straw and hulls treatment schedule  
treatment schedule 5-6-17

*Paeonia*  
treatment T553-1 5-6-15  
treatment T564-1 5-6-18

*Papaya*

- high temperature forced air treatment  
schedule 5-2-56 to ??
- Parsnip**  
treatment T101-g-1  
MB chamber, 15" vacuum—chamber 5-2-36
- Particulate removing respirators** 8-1-16  
See also Respiratory protection
- Passiflora**  
treatment T553-1  
Hot water at 118°F for 30 minutes. 5-6-15
- Peach**  
treatment T101-a-3  
MB at NAP—tarpaulin or chamber 5-2-37
- Pear**  
MB treatment schedule T101-a-1 5-2-3
- Peas**  
treatment schedules 5-2-26 to 5-2-27  
treatment T101-e-1  
MB at NAP—tarpaulin or chamber 5-2-38
- Pectinophora spp.**  
treatment schedules ?? to 5-5-20
- Pectinophora* spp.**  
treatment schedule T301-a-7 ?? to 5-4-3  
treatment schedules T301-a-1-1, ?? to 5-4-10  
treatment schedules T301-a-1-1, T301-a-1-2,  
T301-a-6, T301-a-2, ?? to 5-4-7
- Pen recorders**  
APHIS approved models 3-3-10
- Perishable commodities**  
supervision of quarantine treatments 2-2-2
- Pest risk analysis** 6-5-8
- Phoma chrysanthemi***  
treatment T501-4  
Remove infected parts and treat all plants of  
same species in shipment with 4-4-50 Bor-  
deaux dip or spray. 5-6-3
- Phosphine**  
bulk fumigations 2-10-21 to ??  
dosage rates ?? to 2-10-9, 2-10-15 to ??  
leak detection 2-10-4  
properties of 2-10-1 to ??  
safety precautions 2-10-4 to ??  
threshold limit value 8-1-13  
treatment schedule for seeds 5-3-29, 5-3-30
- Phyllosticia bromeliae***  
treatment schedules 5-6-8
- Physoderma diseases**  
treatment schedules 5-6-5
- Pine Christmas trees**  
treatment T313-b  
MB ("Q" label only) at NAP—chamber or  
tarpaulin 5-4-28
- Pineapple**  
methyl bromide fumigation treatment  
schedule 5-2-39
- Pines**  
treatment T201-j  
MB ("Q" label only) at NAP 5-3-16
- Pinus***  
*sylvestris* spp.  
treatment T203-i-1  
MB ("Q" label only) at NAP 5-3-26
- Pitaya from Colombia** 5-2-67
- Plant pests and pathogens**  
treatment schedules 5-6-1 to 5-6-20, ?? to 5-7-1
- Plantain**  
treatment T101-t-2  
MB at NAP—tarpaulin or chamber 5-2-39
- Plants**  
treatment schedules ?? to 5-3-3, 5-4-1 to 5-4-30
- Plants in Growing Media** E-1-1, F-1-1, G-1-1, H-1-1
- Plum**  
treatment schedule 5-2-40
- Poisoning**  
see Emergency aid and safety
- Polyanthes***  
treatment schedules 5-6-15, 5-6-19
- Post-treatment cooling** 3-3-13 to ??
- Potato**  
treatment T101-u-2  
MB at NAP—tarpaulin or chamber 5-2-40
- Potato cyst nematode**  
treatment schedules 5-6-4, 5-6-7 to 5-6-8
- Potato tubers**  
treatment T565-5 5-6-19
- Pratylenchus* spp.**  
treatment schedules 5-6-15, 5-6-16, 5-6-20
- Preclearance programs**  
See Certifying facilities  
see Certifying facilities
- Pre-fumigation**  
procedures 2-6-6

Pre-warming treatment 3-3-13

#### Primula

treatment T553-1  
Hot water at 118°F for 30 minutes. 5-6-15

#### Propagative plant material

treatment schedules ?? to 5-3-33

#### Puerto Rico

supervision of hot water immersion  
treatments 6-5-12

#### Pulp

fruit  
treatment schedules 5-2-68 to 5-2-71, ?? to 5-2-72

#### Pulses

treatment T101-e-1  
MB at NAP—tarpaulin or chamber 5-2-41

#### Pumpkins

treatment schedule 5-2-41

Purpose of manual 1-1-1

## Q

Q labels 2-3-2 to 2-3-4

#### Quarantine

fumigants  
supervision of ?? to 2-2-4  
requirements  
samples for residue monitoring 4-2-3

#### Queensland fruit fly

fumigation followed by cold treatment  
schedule ?? to 5-2-75

Quick freeze treatment schedules 5-2-79

## R

#### Radishes

treatment T101-g-1  
MB chamber, 15" vacuum—chamber 5-2-41

#### Rape greens

treatment T101-n-2  
MB at NAP—tarpaulin or chamber 5-2-42

#### Raspberries

treatment T101-x-2  
MB at NAP—tarpaulin or chamber 5-2-42

Reference documents 1-1-3

#### Refrigerated transport

*See also* Cold treatment  
vessels used for intransit cold treatments 6-4-2 to ??, G-1-1

#### Refrigerated warehouses

used for cold treatment 6-4-14 to ??

#### *Reichsteineria*

treatment T553-1 5-6-15

Reporting problems 1-1-4

#### Residual effect

of methyl bromide 2-3-7 to 2-3-8

#### Residue monitoring

collecting samples 4-2-2  
labeling samples 4-2-2  
overview 4-1-1  
safety precautions 4-2-1  
shipping samples 4-2-3  
storing samples 4-2-3

Respirators 2-4-20, 2-4-38, 2-10-7

#### Respiratory protection

capabilities and limitations 8-1-15  
communication and 8-1-19  
corrective lenses and 8-1-18  
employee acceptance 8-1-14  
facepiece fit and testing 8-1-17 to 8-1-18  
for fumigants 8-1-14  
for pesticides other than fumigants 8-1-14  
maintenance and care 8-1-20 to 8-1-23  
responsibility for 8-1-13  
*See also specific types or respiratory protection*  
selection of 8-1-16  
use of 8-1-16 to 8-1-19

Restrictions of manual 1-1-1

#### Rhizomes

treatment schedules ?? to 5-3-21

#### *Rhododendron*

treatment T501-6  
Remove infected parts and treat all plants of same species in shipment with 4-4-50 Bordeaux dip or spray. 5-6-4

#### Rice straw and hulls

steam treatment schedules 5-6-13

#### Root cuttings

treatment schedule ?? to 5-3-18

#### Root-knot nematodes

treatment T553-1 5-6-15  
treatment T556-1 5-6-16

- Roots**  
treatment schedule ?? to 5-3-21
- Rosa spp.**  
treatment T560-1 5-6-17
- Rosmarinus seeds**  
treatment T203-h  
MB ("Q" label only) at 26" vacuum 5-3-30
- Rusts**  
treatment T508-1  
For rust-infected shipments to Florida  
Refuse entry to all infected plants and all other plants of the same species or variety in the shipment. 5-6-9
- 
- S**
- Saccharum**  
treatment T514-1 5-6-11
- Safety precautions**  
aerosols 2-11-4  
CO2 fire extinguishers 2-11-4  
hot water immersion treatment 3-3-14  
phosphine 2-10-21 to ??  
residue monitoring 4-2-1  
**see also** Emergency aid and safety
- Sansevieria**  
treatment T553-1 5-6-15
- Scabiosa**  
treatment T553-1 5-6-15
- Schedules**  
**see** Treatment schedules
- Scilla**  
treatment T565-4 5-6-19
- Scope of manual** 1-1-2
- Section 18 Exemptions**  
for fruits nuts and vegetables 5-2-1 to ??  
methyl bromide fumigants ?? to 2-3-4
- Sedum**  
treatment T553-1 5-6-15
- seeds**  
treatment schedules 5-3-26 to 5-3-33, ?? to 5-4-8
- Selaginella spp.**  
treatment T202-a-1  
MB ("Q" label only) at NAP—Chamber 5-3-24
- Self-contained breathing apparatus** 8-1-15, 8-1-23
- Senecio**  
treatment T553-1 5-6-15  
treatment T568-1 5-6-19
- Septoria gentinae**  
treatment T507-2  
Remove infected leaves and treat all plants of same species in shipment with Ferbam or Captan following label directions. 5-6-8
- Shallots**  
treatment T101-q-2  
MB at NAP—tarpaulin or chamber 5-2-43
- Shelf life**  
effect of methyl bromide ?? to 2-3-8
- Ship fumigation**  
aeration 2-6-13 to ??  
conducting the fumigation 2-6-10 to 2-6-12  
materials needed 2-6-1 to ??  
preparing to fumigate 2-6-3 to ??
- Ship holds**  
treatment schedules ?? to 5-5-3
- Ships**  
treatment schedules ?? to 5-5-6
- Snails**  
cargo treatment schedules ?? to 5-5-10
- Soil**  
pests and pathogens treatment schedule ?? to 5-5-27  
potato cyst nematode treatment schedule 5-6-4  
steam pressure sterilization 3-4-1
- Solanum**  
treatment T565-5 5-6-19
- Sorption**  
of methyl bromide 2-3-6 to 2-3-7
- Sprays** 2-14-1
- Squash**  
methyl bromide fumigation treatment schedule 5-2-43
- Steam treatments**  
principle 3-4-1  
steam jet method 3-4-2  
steam pressure sterilization 3-4-1 to 3-4-2
- Stenotarsonemus laticeps**  
treatment T202-i-1  
MB ("Q" label only) at NAP ?? to 5-3-24
- Strawberries**  
hot water treatment schedule 5-6-17, 5-6-20  
methyl bromide fumigation treatment schedule 5-2-43

**Strip chart recorders**

APHIS approved models 3-3-9

**Structure fumigation**

aerating the enclosure 2-7-15 to ??  
 conducting the fumigation 2-7-12 to ??  
 materials needed 2-7-1 to 2-7-2  
 preparing to fumigate 2-7-3 to ??  
 safety precautions 2-7-3

**Succulents**

treatment T201-f-1  
 MB ("Q" label only) at NAP—tarpaulin or chamber ?? to 5-3-5

**Sugarcane**

treatment schedules 5-6-11 to 5-6-12

**Sulfuryl Fluoride**

threshold limit value 8-1-13

**Suppliers**

reference guide to commercial suppliers H-1-1 to H-1-65

**Sweet**

potatoes  
 treatment T101-b-3-1  
 MB at NAP—tarpaulin or chamber 5-2-43

**T****T/C units****see**Thermal conductivity gas analyzers**Tarpaulin fumigation**

arranging the stack 2-4-7 to 2-4-10  
 covering the stack 2-4-16  
 methyl bromide  
 aerating the enclosure 2-4-36 to 2-4-47  
 conducting the fumigation 2-4-20 to ??  
 materials needed 2-4-1 to 2-4-3  
 preparing to fumigate 2-4-3 to 2-4-20  
 of structures 2-7-9  
 padding corners 2-4-13  
 phosphine 2-10-21 to ??  
 rate of sorption 2-3-6  
 sealing 2-4-17

**Temperature**

effect on methyl bromide 2-3-5  
 measurement of  
 ship fumigation 2-6-6  
 tarpaulin fumigation 2-4-14  
 using commodity or air temperature 2-5-3

**Temperature recorders**

for hot water immersion treatment 3-3-8 to ??

**Temperature recording systems**

standards for integral containers used for cold treatment 6-4-14 to ??  
 standards for vessels used for intransit cold treatment 6-4-2 to ??

**Temperature sensors**

for hot water immersion treatment 3-3-7 to ??

**Terms and conventions 1-1-4****Thermal conductivity gas analyzers**

Fumiscope and Grow-Mac  
 description 8-1-2, 8-1-2 to 8-1-4  
 operational procedures 8-1-7 to ??  
 repair and calibration 8-1-7  
 standardizing the instrument 8-1-5 to ??

**Thermal conductivity units 2-4-21****Thermistors 3-3-8****Thermometers 8-1-35**

certified glass-mercury 3-3-8

**Thermostatic controls**

requirements for hot water immersion treatment 3-3-6

***Thomsonia nepalensis***

treatment T553-1 5-6-15

**Tick-infested materials**

non-food treatment schedules ?? to 5-4-25

**Tigridia**

treatment T554-1-1 5-6-16

**Tobacco, for export**

treatment schedules ?? to 5-4-20

**Tomatoes**

methyl bromide fumigation treatment schedule 5-2-44

**Treatment facilities**

certifying 6-2-1, 6-3-1 to ??, 6-4-1, 6-5-1, 6-6-1, 6-7-1, 6-8-1 to ??, 6-9-1 to ??

**Treatment schedules**

adjusting exposure period 2-4-24 to 2-4-26  
 cold treatment ?? to 5-2-71, ?? to 5-2-72  
 determining label for fumigation 5-2-2  
 for miscellaneous plant products 5-4-1 to 5-4-30, ?? to 5-5-47  
 for miscellaneous products ?? to 5-5-47  
 for plant pests or pathogens 5-6-1 to 5-6-20, ?? to 5-7-1  
 for propagative plant material ?? to 5-3-33  
 fruits, nuts and vegetables 2-4-26 to 2-4-29  
 fumigation plus refrigeration of fruits ?? to 5-2-73  
 hot water treatments 5-6-14 to 5-6-20, ?? to 5-7-1  
 methyl bromide fumigation ?? to 5-2-47

pest specific/host variable 5-2-57 to ??, 5-2-64 to ??  
 quick freeze 5-2-79  
 reporting commodity injury 5-2-1  
 Section 18 Exemptions 5-2-1 to ??  
 T100 5-2-1 to ??  
 T200 5-3-1 to 5-3-33  
 T300 5-4-1 to 5-4-30  
 T400 5-5-1 to 5-5-47  
 T500 5-6-1 to 5-6-20, 5-7-1  
 water treatment schedules 5-2-48 to 5-2-53

#### Trees, Christmas

treatment T501-5  
 Remove infected parts and treat all plants of same species in shipment with 4-4-50 Bordeaux dip or spray. 5-6-3

#### Trogoderma granarium

cottonseed treatment schedules 5-5-20 to ??

#### Trogoderma granarium

cottonseed treatment schedules ?? to 5-4-4  
 ships treatment schedule T402-b-3-2 5-5-3

#### Tuberose

treatment T565-5 5-6-19

#### Tubers

treatment schedules ?? to 5-3-21

#### Tuna

Opuntia  
 treatment T101-e-3  
 MB at NAP—tarpaulin or chamber 5-2-45

#### Turnips

treatment T101-g-1  
 MB chamber, 15" vacuum—chamber 5-2-46

#### Tydaea

treatment T553-1 5-6-15

## U

#### United States

citrus treatment schedule 5-2-18

#### Updating the manual

Appendix 10 C-1-1 to C-1-5

#### Use of manual 1-1-3

#### U-tube manometer

See Open arm manometer

## V

#### Vacuum Fumigation chambers

accessories 6-2-3  
 aeration of 2-5-3  
 chamber 6-2-1  
 circulation and exhaust system 6-2-2  
 fumigant introduction systems 6-2-2  
 manufacturers 6-2-4  
 performance standards 6-2-3  
 vacuum pump 6-2-2

#### Vacuum Pump 8-1-32

#### Vegetables

adjusting exposure period 2-4-26 to 2-4-29  
 aerating 2-4-36 to 2-4-37  
 determining temperature for proper dosage rate 2-4-15  
 methyl bromide fumigation treatment schedules ?? to 5-2-47  
 quick freeze treatment schedules 5-2-79  
 reporting commodity injury 5-2-1  
**see also specific vegetables by name**  
 water treatment schedules 5-2-48 to 5-2-53

#### Velometer 8-1-27

#### Verbena

treatment T553-1  
 Hot water at 118°F for 30 minutes. 5-6-15

#### Verticillium albo-atrum

treatment T520-1-1  
 Dust with 75 percent Thiram at the rate of 166 grams per 50 kilograms of seed (3.3g/kg). 5-6-14

#### Vessels

used for intransit cold treatment 6-4-2 to ??

#### Vine moth

treatment schedule ?? to 5-2-25

#### Vitis

treatment T553-1 5-6-15

#### Volatilizer

description and use 8-1-25  
 liquid fumigant vaporizer 8-1-26  
 methyl bromide volatilizer coil 8-1-25

#### Volume measurement

tarpaulin fumigation 2-4-17

## W

#### Warehouses





used for cold treatment [6-4-14 to ??](#)

**Water circulation system**  
 requirements for hot water immersion  
 treatment [3-3-7 to ??](#)

**Water treatment schedules** [5-2-48 to 5-2-53](#)

**Weevils**  
 treatment T302-g-1  
 MB at NAP—tarpaulin, chamber, or van  
 container [?? to 5-4-8](#)

**Weigela**  
 treatment T553-1 [5-6-15](#)

**Wheat**  
 treatment schedules for flag smut [5-6-6](#)

**Wiring**  
 requirements for hot water immersion  
 treatment [3-3-5](#)

**Wood products**  
 treatment schedules [?? to 5-5-19](#)

**Wood surfaces**  
 treatment schedules [?? to 5-5-14](#)

**Work plans**  
 hot water immersion treatment [3-3-15](#)

---

**X**

*Xanthomona*  
 albilineans  
 treatment schedules [5-6-11](#)  
 vasculorum  
 treatment schedules [5-6-11](#)

---

**Y**

**Yams**  
 treatment schedules [5-2-46, 5-3-25](#)

---

**Z**

*Zantedeschia*  
 treatment T553-1 [5-6-15](#)

*Zingiberaceae*  
 treatment T553-1 [5-6-15](#)

**Zucchini**  
 methyl bromide fumigation [5-2-46](#)



