

# **National Scale Modeling of Air Toxics for the Final Mobile Source Air Toxics Rule**

## **Technical Support Document**

EPA454/R-07-002  
February 2007

# **National Scale Modeling of Air Toxics for the Final Mobile Source Air Toxics Rule**

Technical Support Document

Emissions, Monitoring and Analysis Division  
Office of Air Quality Planning and Standards  
U.S. Environmental Protection Agency  
Research Triangle Park, North Carolina

## **Disclaimer**

The information in this document has been reviewed in accordance with the U.S. EPA administrative review policies and approved for publication. Mention of trade names or commercial products does not constitute endorsement or recommendation for their use.

The following trademarks appear in this document:

UNIX is a registered trademark of AT&T Bell Laboratories.

Linux is a registered trademark of Red Hat

SAS<sup>®</sup> is a registered trademark of SAS Institute

SUN is a registered trademark of Sun Microsystems, Inc.

## Table of Contents

1. Purpose of Work .....	1
2. 1999 base inventories .....	5
2.1 1999 HAP inventories.....	5
2.2 1999 Precursor inventories .....	8
3. Development of Future Year Mobile and Mobile-Related Emissions .....	11
3.1 Locomotive and commercial marine vessels .....	11
3.2 Aircraft and Aviation gasoline.....	19
3.3 Projection of onroad and nonroad categories using NMIM.....	24
3.3.1 Description of NMIM .....	24
3.3.2 Onroad projections using NMIM.....	25
3.3.2.1 Calculation of refueling emissions for light-duty gasoline vehicles.....	26
3.3.3 Nonroad projections using NMIM (excluding aircraft, locomotives, and commercial marine vessels).....	36
3.3.4 Portable Fuel Containers (PFC) emission inventories .....	48
3.3.4.1 VOC allocation .....	48
3.3.4.2 Creation of HAP PFC inventories .....	52
4. Creation of stationary inventories.....	57
4.1 Growth factors .....	57
4.1.1 MACT based growth factors.....	58
4.1.2 SIC based growth factors .....	61
4.1.3 SCC based growth factors.....	62
4.2 Reduction factors .....	62
4.3 Other inventory adjustments .....	65
4.3.1 Calculation of gasoline distribution adjustment factors.....	65
4.3.2 Calculation of benzene controls.....	72
4.3.3 Removal of vehicle refueling emissions .....	75
4.4 Application of growth and reductions to project stationary source emissions .....	76
4.4.1 Point and airport nonpoint sources .....	76
4.4.2 Nonpoint sources .....	78
5. EMS-HAP Processing for HAPs .....	85
5.1 Spatial surrogates and temporal factors for PFC SCC codes.....	85
5.2 Inventory scenarios .....	87
5.3 Point sources .....	87
5.4 Nonpoint sources .....	88
5.5 Onroad sources.....	89
5.6 Nonroad sources.....	89
5.6.1 Aircraft sources.....	89
5.6.2 Airport Support Equipment.....	89
5.6.3 Remaining nonroad sources.....	89
6. ASPEN Processing .....	91
6.1 ASPEN modeling.....	91
6.2 Post-processing of ASPEN concentrations .....	96
6.2.1 Secondary contributions.....	97
7. HAPEM6 Model and Post-Processing.....	119
7.1 HAPEM6 Model .....	119

## Table of Contents

7.2 Air quality input files .....	120
7.3 HAPEM6 output .....	120
8. Cancer and non-cancer risk calculations .....	147
8.1 Cancer risk calculations .....	148
8.2 Non-cancer calculations .....	168
8.3 Cancer and non-cancer population bin calculations .....	182
8.3.1 Using 30 replicates per tract .....	182
8.3.2 Comparison of risk methods .....	190
9. References.....	193

## List of Tables

Table 1. Pollutants of interest in MSAT study. CAS numbers in italics are in the stationary inventories only; otherwise they are in mobile and stationary inventories.....	3
Table 2. Changes made to the 1999 NEI HAP inventories prior to processing for 1999 NATA or projections for MSAT.....	6
Table 3. Emissions (tons) for MSAT HAPs in the 1999 inventories. Totals are for the 50 states and District of Columbia.....	7
Table 4. Non-HAP precursors for the MSAT secondary HAPs with source sector emissions for 1999. Totals are for the 50 states and District of Columbia. ....	9
Table 5. Locomotive SCC codes in the 1999 NEI nonroad inventory. ....	11
Table 6. Locomotive 50-State annual emissions trends (tons per year) and future year ratios. ..	12
Table 7. Locomotive MSAT HAPs. ....	13
Table 8. Commercial marine vessel 50-State annual emissions trends (tons per year) and future year ratios used as projection factors. ....	14
Table 9. Commercial marine vessel SCC codes, HAPs, and basis of projection factors. ....	15
Table 10. National locomotive emissions by SCC for selected HAPs and across all HAPs. ....	17
Table 11. National commercial marine vessel emissions by SCC for selected HAPs and across all HAPs.....	18
Table 12. TAF landing and take-off data for 1999, 2010, 2015, and 2020. ....	19
Table 13. Airport related SCC codes, assigned growth factor basis, and growth factors for MSAT study years. ....	20
Table 14. Aircraft and aviation gasoline distribution emissions for selected HAPs and all HAPs by SCC. Aviation gasoline distribution emissions for 2030 are set equal to 2020.....	23
Table 15. Calculated refueling emissions by HAP for base and controlled strategies. ....	30
Table 16. Base inventory emissions by vehicle type and total onroad for selected HAPs and all HAPs. ....	31
Table 17. Fuels control inventory emissions by vehicle type and total onroad for selected HAPs and all HAPs. Total onroad includes diesel emissions. ....	33
Table 18. Vehicle control inventory emissions by vehicle type and total onroad for selected HAPs and all HAPs. Total onroad includes diesel. ....	34
Table 19. Cumulative fuels and vehicle control inventory emissions by vehicle type and total onroad for selected HAPs and all HAPs. Total onroad includes diesel.....	35
Table 20. Nonroad gasoline equipment SCC codes refueled by portable fuel containers (PFC) and percentage of refueling from PFCs. ....	38
Table 21. Factors used to allocate Adams County emissions to surrounding counties. ....	38
Table 22. Nonroad refueling emissions before and after subtracting the refueling emissions due to portable fuel containers (PFC).....	41
Table 23. Base nonroad emissions by engine type. ....	42
Table 24. Base nonroad emissions by equipment type.....	43
Table 25. Controlled gasoline engine emissions for 2015, 2020, and 2030. ....	45
Table 26. Controlled gasoline engine equipment emissions for 2015, 2020, and 2030. ....	46
Table 27. Base engine and equipment for all HAPs. ....	47
Table 28. Controlled gasoline engine emissions by engine and equipment type for all HAPs. ..	48
Table 29. PFC categories with national level residential and commercial emissions. ....	51
Table 30. SCC codes of PFC categories.....	51
Table 31. PFC and benzene fuel control inventory scenarios.....	52

## List of Tables

Table 32. PFC emissions with and without controls for no benzene fuel controls.....	55
Table 33. PFC emissions with and without controls for benzene fuel controls.....	56
Table 34. National level MACT growth factors for 2015 and 2020.....	59
Table 35. Utility Boilers: Coal (MACT=1808-1) state level growth factors for 2015 and 2020.	60
Table 36. SIC codes changed due to unrealistic growth factors.....	61
Table 37. Summary of Categories for which reductions were applied in EMS-HAP. ....	64
Table 38. Gasoline distribution SCC codes used in calculation of adjustment factors. ....	67
Table 39. National gasoline distribution adjustment factors for each HAP. ....	72
Table 40. Change in Average Fuel Benzene Level (Volume Percent) by PADD with Implementation of Proposed Fuel Benzene Standard (CG – Conventional Gasoline; RFG – Reformulated Gasoline).....	74
Table 41. Vehicle refueling SCC codes.....	75
Table 42. 1999, 2015, and 2020, pre-adjusted, adjusted, and controlled adjusted gasoline distribution emissions. ....	82
Table 43. Vehicle refueling emissions removed from stationary inventories. ....	82
Table 44. PFC SCC codes and assigned surrogates.....	86
Table 45. Emission scenarios to be processed in EMS-HAP and ASPEN. Base inventory applies to all years and control inventory applies to 2015, 2020, and 2030.....	87
Table 46. ASPEN emission groups.....	90
Table 47. Reactivity classes for MSAT HAPs and precursors.....	92
Table 48. Base background and ASPEN stationary and mobile concentrations ( $\mu\text{g m}^{-3}$ ) for 1999, 2015, 2020, and 2030.....	103
Table 49. Controlled ASPEN stationary and mobile concentrations ( $\mu\text{g m}^{-3}$ ) for 2015, 2020, and 2030.....	104
Table 50. Concentration replacement strategy for controlled HAPEM concentrations. ....	127
Table 51. HAPEM national average concentrations (based on median tract concentrations) for 1999,2015, 2020, and 2030.....	128
Table 52. HAPEM national average concentrations (based on 90 <sup>th</sup> percentile tract concentrations) for 1999,2015, 2020, and 2030. ....	129
Table 53. HAPEM national average controlled concentrations (based on median tract concentrations) for 2015, 2020, and 2030. ....	130
Table 54. HAPEM national average controlled concentrations (based on 90 <sup>th</sup> percentile tract concentrations) for 2015, 2020, and 2030. ....	130
Table 55. MSAT HAPs carcinogenic class, URE, non-cancer target organ systems, and RfC. N/A denotes HAP is not a cancer or non-cancer HAP. ....	147
Table 56. Base national average risks for 1999, 2015, 2020, and 2030 by HAP, carcinogen class and across all HAPs. HAPs are grouped by carcinogen class. Total includes background risks.....	153
Table 57. Control national average risks for 2015, 2020, and 2030 by HAP, carcinogen class and across all HAPs. HAPs are grouped by carcinogen class. Total includes background. ...	154
Table 58. National total risk incidences (all sources) by HAP, carcinogen class, and across all HAPs.....	167
Table 59. Base national average hazard quotients (HAPs) and hazard indices (organ systems) for 1999, 2015, 2020, and 2030. Total includes background. ....	170

List of Tables

Table 60. Control national average hazard quotients (HAPs) and hazard indices (organ systems) for 2015, 2020, and 2030. Total includes background. .... 171

Table 61. Populations by source category, year, and inventory scenario for total risk (all HAPs). .... 184

Table 62. Populations by source category, year, and inventory scenario for the respiratory system. .... 185

Table 63. Populations and percent differences (MSAT-NATA) of risk bins using the MSAT method and NATA method for 1999, 2015, 2020, and 2030. .... 191

Table 64. Populations and percent differences (MSAT-NATA) of respiratory HI bins using the MSAT method and NATA method for 1999, 2015, 2020, and 2030. .... 192



This page intentionally blank

## List of Figures

Figure 1. General steps in flow of emissions to cancer risk and non-cancer hazard quotient estimates.....	2
Figure 2. Steps in projecting 1999 locomotive and commercial marine vessel emissions to future years.....	16
Figure 3. Format of the aircraft growth factor file. 2010 growth factors shown as example. ....	21
Figure 4. Flowchart of a) aircraft and b) aviation gasoline distribution emissions projections...	22
Figure 5. General steps in processing of onroad NMIM emissions for EMS-HAP input. ....	26
Figure 6. Refueling calculations for a) benzene 1999 and 2010, and b) other HAPs.....	29
Figure 7. 1999 and 2010 nonroad processing steps. ....	39
Figure 8. 2015, 2020, and 2030 nonroad processing steps. ....	40
Figure 9. Steps in allocation of state VOC PFC emissions to counties. ....	50
Figure 10. Steps in creating HAP PFC emissions.....	54
Figure 11. PADD regions for the U.S.....	73
Figure 12. RFG counties (dark gray) for the U.S. ....	74
Figure 13. Steps in adjustment of 1999 and 2015 and 2020 projected point and airport nonpoint inventories.....	77
Figure 14. Steps in used in developing controlled 2015 and 2020 point and airport nonpoint inventories.....	78
Figure 15. Adjustment of: a) 1999 nonpoint inventory with MWI emissions included and b) 1999 nonpoint inventory without MWI emissions for projection to 2015, 2020, and 2030. 80	
Figure 16. Development of nonpoint base and controlled inventories for projection for 2015, 2020, and 2030.....	81
Figure 17. Major, area & other, nonroad and onroad emissions for 1999, 2015, 2020, and 2030 for base and controlled inventories for a) sum of all HAPs, and b) benzene only. ....	83
Figure 18. Temporal profile assigned to PFC SCC codes. ....	85
Figure 19. Reactivity class 1 ASPEN inputs and outputs. Output is the final output from ASPENA and ASPENB.....	93
Figure 20. Reactivity class 2 ASPEN inputs and outputs. Output is the final output from ASPENA and ASPENB.....	94
Figure 21. Reactivity classes 3 and 4 ASPEN inputs and outputs. Output is the final output from ASPENA and ASPENB.....	95
Figure 22. Reactivity classes 5 and 7 ASPEN inputs and outputs. Output is the final output from ASPENA and ASPENB.....	95
Figure 23. Reactivity class 9 ASPEN inputs and outputs. Output is the final output from ASPENA and ASPENB.....	96
Figure 24. Box and whisker plots of ratios of stationary secondary contributions to total concentrations (white boxes) and ratios of mobile secondary contributions to total concentrations (gray boxes) for 1999 acetaldehyde and formaldehyde concentrations. Dots represent the national mean ratios.....	98
Figure 25. Secondary onroad concentrations calculated from modeled precursors (white boxes) and calculated from 1999 ratios of secondary to primary modeled concentrations (gray boxes) for 2015, 2020, and 2030 for a) acetaldehyde, b) formaldehyde, and c) propionaldehyde.....	100
Figure 26. Secondary nonroad concentrations calculated from modeled precursors (white boxes) and calculated from 1999 ratios of secondary to primary modeled concentrations (gray	

## List of Figures

boxes) for 2015, 2020, and 2030 for a) acetaldehyde, b) formaldehyde, and c) propionaldehyde.....	101
Figure 27. 1999 base ASPEN concentration distributions.....	105
Figure 28. 2015 base and controlled ASPEN concentration distributions.....	106
Figure 29. 2020 base and controlled ASPEN concentration distributions.....	107
Figure 30. 2030 base and controlled ASPEN concentration distributions.....	108
Figure 31. Distributions of the ratio of 2015 controlled annual average total concentrations to 2015 base annual average total concentrations by HAP. Totals include background concentration.....	109
Figure 32. Distributions of the ratio of 2020 controlled annual average total concentrations to 2020 base annual average total concentrations by HAP. Totals include background concentration.....	110
Figure 33. Distributions of the ratio of 2030 controlled annual average total concentrations to 2030 base annual average total concentrations by HAP. Totals include background concentration.....	111
Figure 34. 1999 county level median total (all sources and background) concentrations ( $\mu\text{g m}^{-3}$ ) for benzene.....	112
Figure 35. 2015 base county level median total (all sources and background) concentrations ( $\mu\text{g m}^{-3}$ ) for benzene. ....	113
Figure 36. 2015 control county level median total (all sources and background) concentrations ( $\mu\text{g m}^{-3}$ ) for benzene. ....	114
Figure 37. 2020 base county level median total (all sources and background) concentrations ( $\mu\text{g m}^{-3}$ ) for benzene. ....	115
Figure 38. 2020 control county level median total (all sources and background) concentrations ( $\mu\text{g m}^{-3}$ ) for benzene. ....	116
Figure 39. 2030 base county level median total (all sources and background) concentrations ( $\mu\text{g m}^{-3}$ ) for benzene. ....	117
Figure 40. 2030 control county level median total (all sources and background) concentrations ( $\mu\text{g m}^{-3}$ ) for benzene. ....	118
Figure 41. Modification of 2015 and 2020 HAPEM6 controlled concentrations for a) all HAPs excluding benzene, metals, naphthalene, POM, propionaldehyde, and styrene and b) propionaldehyde and styrene. ....	122
Figure 42. Modification of 2015 and 2020 HAPEM6 controlled concentrations for a) metals, naphthalene, and POM and b) benzene.....	123
Figure 43. Modification of 2030 base HAPEM6 concentrations for all HAPs. ....	124
Figure 44. Modification of 2030 HAPEM6 controlled concentrations for a) all HAPs excluding benzene, metals, naphthalene, POM, propionaldehyde, and styrene and b) propionaldehyde and styrene. ....	125
Figure 45. Modification of 2030 HAPEM6 controlled concentrations for a) metals, naphthalene, and POM and b) benzene.....	126
Figure 46. 1999 base HAPEM6 tract concentration distributions for a) tract median exposure concentration and b) tract 90 <sup>th</sup> percentile exposure concentration. ....	132
Figure 47. 2015 base and controlled HAPEM6 tract concentration distributions for a) tract median exposure concentration and b) tract 90 <sup>th</sup> percentile exposure concentration. ....	133

## List of Figures

Figure 48. 2020 base and controlled HAPEM6 tract concentration distributions for a) tract median exposure concentration and b) tract 90 <sup>th</sup> percentile exposure concentration. ....	134
Figure 49. 2030 base and controlled HAPEM6 tract concentration distributions for a) tract median exposure concentration and b) tract 90 <sup>th</sup> percentile exposure concentration. ....	135
Figure 50. Distributions of the ratio of 2015 HAPEM6 controlled annual average total concentrations to 2015 HAPEM6 base annual average total concentrations by HAP for a) tract median exposure concentration and b) tract 90 <sup>th</sup> percentile exposure concentration. Totals include background concentration. ....	136
Figure 51. Distributions of the ratio of 2020 HAPEM6 controlled annual average total concentrations to 2020 HAPEM6 base annual average total concentrations by HAP for a) tract median exposure concentration and b) tract 90 <sup>th</sup> percentile exposure concentration. Totals include background concentration. ....	137
Figure 52. Distributions of the ratio of 2030 HAPEM6 controlled annual average total concentrations to 2030 HAPEM6 base annual average total concentrations by HAP for a) tract median exposure concentration and b) tract 90 <sup>th</sup> percentile exposure concentration. Totals include background concentration. ....	138
Figure 53. 1999 HAPEM6 county level median total (all sources and background) concentrations ( $\mu\text{g m}^{-3}$ ) for benzene. Median concentration based on tract median exposure concentrations. ....	139
Figure 54. 2015 base HAPEM6 county level median total (all sources and background) concentrations ( $\mu\text{g m}^{-3}$ ) for benzene. Median concentration based on tract median exposure concentrations. ....	140
Figure 55. 2015 controlled HAPEM6 county level median total (all sources and background) concentrations ( $\mu\text{g m}^{-3}$ ) for benzene. Median concentration based on tract median exposure concentrations. ....	141
Figure 56. 2020 base HAPEM6 county level median total (all sources and background) concentrations ( $\mu\text{g m}^{-3}$ ) for benzene. Median concentration based on tract median exposure concentrations. ....	142
Figure 57. 2020 controlled HAPEM6 county level median total (all sources and background) concentrations ( $\mu\text{g m}^{-3}$ ) for benzene. Median concentration based on tract median exposure concentrations. ....	143
Figure 58. 2030 base HAPEM6 county level median total (all sources and background) concentrations ( $\mu\text{g m}^{-3}$ ) for benzene. Median concentration based on tract median exposure concentrations. ....	144
Figure 59. 2030 controlled HAPEM6 county level median total (all sources and background) concentrations ( $\mu\text{g m}^{-3}$ ) for benzene. Median concentration based on tract median exposure concentrations. ....	145
Figure 60. Example output of HAPEM6 calculated risks for one tract for 1999 benzene. ....	149
Figure 61. 1999 base national HAPEM6 risk distributions. ....	155
Figure 62. 2015 base (white) and control (gray) national HAPEM6 risk distributions. ....	156
Figure 63. 2020 base (white) and control (gray) national HAPEM6 risk distributions. ....	157
Figure 64. 2030 base (white) and control (gray) national HAPEM6 risk distributions. ....	158
Figure 65. 1999 base county level median total (all sources and background) risk for benzene. ....	159

## List of Figures

Figure 66. 2015 base county level median total (all sources and background) risk for benzene. .....	160
Figure 67. 2015 control county level median total (all sources and background) risk for benzene. .....	161
Figure 68. 2020 base county level median total (all sources and background) risk for benzene. .....	162
Figure 69. 2020 control county level median total (all sources and background) risk for benzene. .....	163
Figure 70. 2030 base county level median total (all sources and background) risk for benzene. .....	164
Figure 71. 2030 control county level median total (all sources and background) risk for benzene. .....	165
Figure 72. Total risk for each year and control strategy with HAP contributions.....	166
Figure 73. Contribution of individual HAP incidences (70 year lifetime) to total risk (all HAPs and all sources). .....	168
Figure 74. 1999 base national HAPEM6 hazard quotient (HAPs) and hazard index (respiratory system) distributions. ....	172
Figure 75. 2015 base (white) and control (gray) national HAPEM6 hazard quotient (HAPs) and hazard index (respiratory system) distributions.....	173
Figure 76. 2020 base (white) and control (gray) national HAPEM6 hazard quotient (HAPs) and hazard index (respiratory system) distributions.....	174
Figure 77. 2030 base (white) and control (gray) national HAPEM6 hazard quotient (HAPs) and hazard index (respiratory system) distributions.....	175
Figure 78. 1999 base county level median total (all sources and background) hazard quotient for benzene. ....	176
Figure 79. 2015 base county level median total (all sources and background) hazard quotient for benzene. ....	177
Figure 80. 2015 control county level median total (all sources and background) hazard quotient for benzene.....	178
Figure 81. 2020 base county level median total (all sources and background) hazard quotient for benzene. ....	179
Figure 82. 2020 control county level median total (all sources and background) hazard quotient for benzene.....	180
Figure 83. 2030 base county level median total (all sources and background) hazard quotient for benzene. ....	181
Figure 84. 2030 control county level median total (all sources and background) hazard quotient for benzene.....	182
Figure 85. Populations of risk bins for total risk (all HAPs) by year and scenario for a) major sources, b) area & other sources, c) onroad sources and d) nonroad sources.....	186
Figure 86. Populations of risk bins for total risk (all HAPs) by year and scenario for a) background sources and b) all sources.....	187
Figure 87. Populations of non-cancer HI bins for the respiratory system by year and scenario for a) major sources, b) area & other sources, c) onroad sources and d) nonroad sources. ....	188
Figure 88. Populations of non-cancer HI bins for the respiratory system by year and scenario for a) background sources and b) all sources. ....	189

## Acronyms

AEO	Annual Energy Outlook
ASPEN	Assessment System for Population Exposure Nationwide
BEA	Bureau of Economic Analysis
BenMAP	Environmental Benefits Mapping and Analysis Program
CAS	Chemical Abstract Service
EGAS	Economic Growth Analysis System
EMS-HAP	The Emissions Modeling System for Hazardous Air Pollutants
EPA	United States Environmental Protection Agency
HAP	Hazardous Air Pollutant
HAPEM5	Hazardous Air Pollutant Exposure Model, Version 5
HAPEM6	Hazardous Air Pollutant Exposure Model, Version 6
HI	non-cancer Hazard Index for a target organ system
HQ	non-cancer Hazard Quotient for an individual HAP
MACT	Maximum Available Control Technology standards for HAP, established under Section 112 of the Clean Air Act
MSAT	Mobile Source Air Toxics
NATA	National Air Toxics Assessment
NEI	EPA's National Emission Inventory
NMIM	National Mobile Inventory Model
OAQPS	EPA's Office of Air Quality Planning and Standards
OTAQ	EPA's Office of Transportation and Air Quality
PFC	Portable Fuel Containers
REMI	Regional Economic Model, Inc.
SAROAD	Air pollution chemical species classification system used in EPA's initial data base for "Storage and Retrieval of Aerometric Data"
SCC	Source Classification Code
SIC	Standard Industrial Classification code used for Federal economic statistics
TAF	Terminal Area Forecast
URE	Unit risk estimate for cancer risk

## List of files referenced in document

File	Description	Section
onroad_0906.xls	Excel workbook of onroad emissions by vehicle type for state and national level	3.3.2
onroad_pivot_0905.xls	Excel workbook containing pivot table of onroad emissions by vehicle type for state and national	3.3.2
nonroad_1009.xls	Excel workbook of nonroad emissions by engine, equipment, and engine/equipment type for state and national level	3.3.3
nonroad_pivot_1009.xls	Excel workbook containing pivot table of nonroad emissions by engine, equipment, and engine/equipment type for state and national level	3.3.3
pfc_summaries.xls	National and state PFC emission summaries	3.3.4
mwi.sas	SAS <sup>®</sup> program to substitute 2002 MWI point emissions in the 1999 point inventory	4.3
aspen_concentrations.xls	Excel workbook of national and state mean concentrations and concentration distribution for ASPEN results	6.2
acetaldehyde_aspen.ppt	PowerPoint file containing national maps of county median total ASPEN concentrations for acetaldehyde	6.2
acrolein_aspen.ppt	PowerPoint file containing national maps of county median total ASPEN concentrations for acrolein	6.2
benzene_aspen.ppt	PowerPoint file containing national maps of county median total ASPEN concentrations for benzene	6.2
butadiene_aspen.ppt	PowerPoint file containing national maps of county median total ASPEN concentrations for 1,3-butadiene	6.2
formaldehyde_aspen.ppt	PowerPoint file containing national maps of county median total ASPEN concentrations for formaldehyde	6.2
naphthalene_aspen.ppt	PowerPoint file containing national maps of county median total ASPEN concentrations for naphthalene	6.2
hapem_concentrations_50.xls	Excel workbook of national and state mean concentrations and concentration distribution for HAPEM tract median concentrations	7.3
hapem_concentrations_90.xls	Excel workbook of national and state mean concentrations and concentration distribution for HAPEM tract 90 <sup>th</sup> percentile concentrations	7.3
acetaldehyde_hapem.ppt	PowerPoint file containing national maps of acetaldehyde county median total HAPEM concentrations	7.3
acrolein_hapem.ppt	PowerPoint file containing national maps of acrolein county median total HAPEM concentrations	7.3
benzene_hapem.ppt	PowerPoint file containing national maps of benzene county median total HAPEM concentrations	7.3
butadiene_hapem.ppt	PowerPoint file containing national maps of 1,3-bbutadiene county median total HAPEM concentrations	7.3
formaldehyde_hapem.ppt	PowerPoint file containing national maps of formaldehyde county median total HAPEM concentrations	7.3
naphthalene_hapem.ppt	PowerPoint file containing national maps of naphthalene county median total HAPEM concentrations	7.3
risks.xls	Excel workbook of national and state mean risks and risk distribution for HAPEM based results	8.1
acetaldehyde_risk.ppt	PowerPoint file containing national maps of acetaldehyde county median total HAPEM based risks	8.1
benzene_risk.ppt	PowerPoint file containing national maps of benzene county median total HAPEM based risks	8.1

### List of files referenced in document

File	Description	Section
butadiene_risk.ppt	PowerPoint file containing national maps of 1,3-butadiene county median total HAPEM based risks	8.1
total_risk.ppt	PowerPoint file containing national maps of county median total (all HAPs and sources) HAPEM based risks	8.1
risk_incidences.xls	Excel workbook of national and state cancer total risk incidences	8.1
noncancer.xls	Excel workbook of national and state mean HQ and HI distribution for HAPEM based results	8.2
acetaldehyde_hq.ppt	PowerPoint file containing national maps of acetaldehyde county median total HAPEM based risks	8.2
acrolein_hq.ppt	PowerPoint file containing national maps of acrolein county median total HAPEM based risks	8.2
benzene_hq.ppt	PowerPoint file containing national maps of benzene county median total HAPEM based risks	8.2
butadiene_hq.ppt	PowerPoint file containing national maps of 1,3-butadiene county median total HAPEM based risks	8.2
formaldehyde_hq.ppt	PowerPoint file containing national maps of formaldehyde county median total HAPEM based risks	8.2
naphthalene_hq.ppt	PowerPoint file containing national maps of naphthalene county median total HAPEM based risks	8.2
risk_bins_benzene.xls	Excel workbook of population of risk categories by source category for benzene	8.3
risk_bins_total.xls	Excel workbook of population of risk categories by source category for total risk	8.3.1
hq_bins_benzene.xls	Excel workbook of population of non-cancer HQ categories by source category for benzene	8.3.1
hi_bins_respiratory.xls	Excel workbook of population of non-cancer HI categories by source category for the respiratory system	8.3.1
risk_bins_comp_1999_base.xls	Excel workbook of risk bin comparisons for 1999.	8.3.2
risk_bins_comp_2015_base.xls	Excel workbook of risk bin comparisons for 2015 base	8.3.2
risk_bins_comp_2015_con.xls	Excel workbook of risk bin comparisons for 2015 control	8.3.2
risk_bins_comp_2020_base.xls	Excel workbook of risk bin comparisons for 2020 base	8.3.2
risk_bins_comp_2020_con.xls	Excel workbook of risk bin comparisons for 2020 control	8.3.2
risk_bins_comp_2030_base.xls	Excel workbook of risk bin comparisons for 2030 base	8.3.2
risk_bins_comp_2030_con.xls	Excel workbook of risk bin comparisons for 2030 control	8.3.2
hi_bins_comp_1999_base.xls	Excel workbook of respiratory HI bin comparisons for 1999.	8.3.2
hi_bins_comp_2015_base.xls	Excel workbook of respiratory HI bin comparisons for 2015 base	8.3.2
hi_bins_comp_2015_con.xls	Excel workbook of respiratory HI bin comparisons for 2015 control	8.3.2
hi_bins_comp_2020_base.xls	Excel workbook of respiratory HI bin comparisons for 2020 base	8.3.2
hi_bins_comp_2020_con.xls	Excel workbook of respiratory HI bin comparisons for 2020 control	8.3.2
hi_bins_comp_2030_base.xls	Excel workbook of respiratory HI bin comparisons for 2030 base	8.3.2
hi_bins_comp_2030_con.xls	Excel workbook of respiratory HI bin comparisons for 2030 control	8.3.2



This page intentionally blank

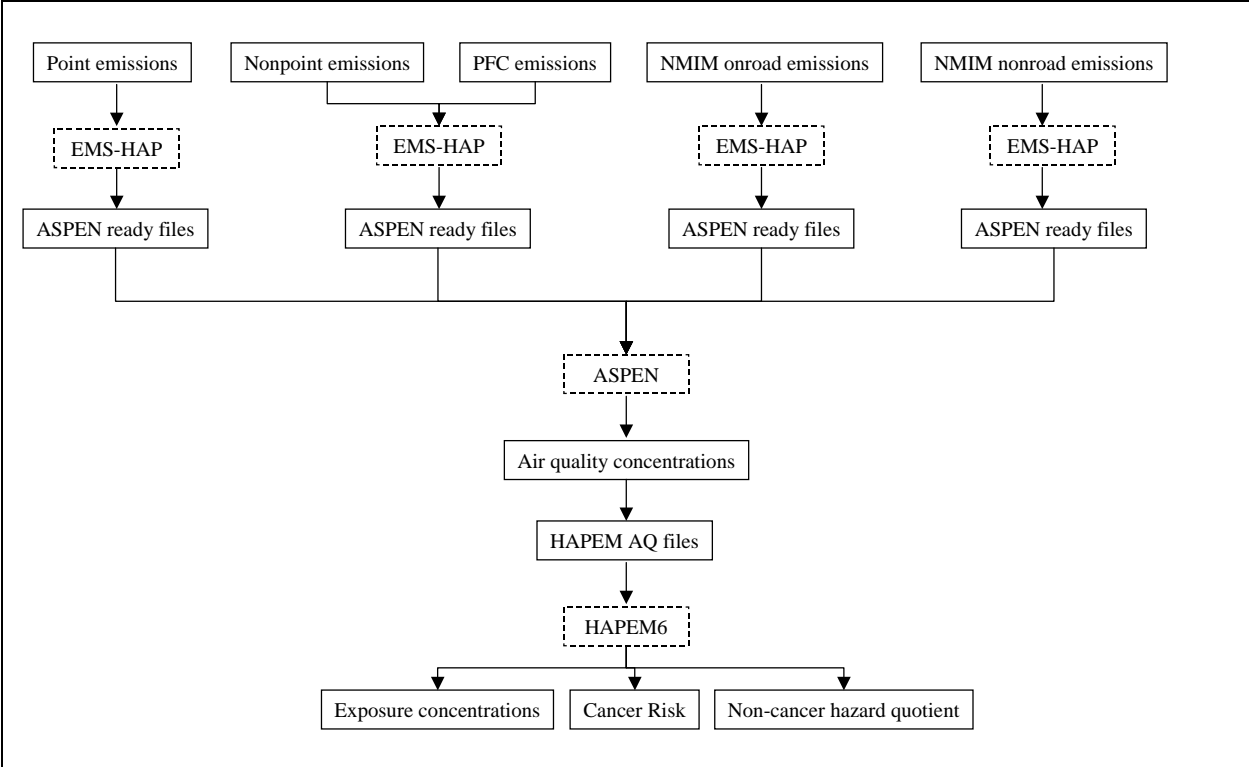
## 1. Purpose of Work

The purpose of the work described in this technical document was to project emissions for mobile source hazardous air pollutants (HAPs) to 2010, 2015, 2020, and 2030 from the 1999 National Emissions Inventory Version 3 (NEI) (U. S. EPA, 2004a), conduct air quality and exposure modeling, and estimate cancer and non-cancer risk for select future years. Air quality modeling utilized the Assessment System for Population Exposure Nationwide (ASPEN) model (U. S. EPA, 2000). Exposure modeling utilized the Hazardous Air Pollutant Exposure Model, Version 6 (HAPEM6) (U.S. EPA, 2007). Cancer risk and non-cancer risk were estimated for 1999, 2015, 2020, and 2030. Modeling was done for reference cases, which included programs currently planned and in place, as well as control scenarios that evaluated impacts of additional control programs being finalized in this rule. This work was done to support regulatory needs related to the 2007 final mobile source air toxics rule.

The pollutants modeled in this study, in support of the mobile source air toxics rule, are shown in Table 1. They are referenced in the document as MSAT HAPs. These pollutants are all included in the NEI and are on EPA's list of hazardous pollutants in Section 112 of the Clean Air Act. They are also emitted by mobile sources. In this assessment, projected inventories were developed for both the mobile and stationary emission sources in the 1999 NEI. There are additional hazardous air pollutants in the 1999 NEI with a mobile source emissions estimate that are not included in Table 1. Some of these were pollutants found only in data submitted by individual States. EPA generated others through the use of speciation factors obtained from a non-mobile source process (e.g., commercial marine vessels, residual oil). More information on the 1999 NEI development can be found at [www.epa.gov/ttn/chief/](http://www.epa.gov/ttn/chief/).

After inventory development, these pollutants were modeled in ASPEN and HAPEM6, following the same general methods used in the 1999 National Air Toxics Assessment (U.S. EPA, 2006a) ([www.epa.gov/ttn/nata99](http://www.epa.gov/ttn/nata99)).

The remainder of this document describes the methodology used for the inventory projections and subsequent air quality modeling. Section 2 describes the 1999 base HAP and precursor inventories, Section 3 describes the development of the projected mobile inventories including portable fuel containers. Section 4 describes the development of the projected stationary inventories. Sections 5, 6, and 7 describe the emissions processing, air quality modeling and exposure modeling. Section 8 describes the calculation of cancer risk and non-cancer risk (hazard quotients and hazard indices). A flowchart of the general steps is shown in Figure 1.



**Figure 1.** General steps in flow of emissions to cancer risk and non-cancer hazard quotient estimates.

**Table 1.** Pollutants of interest in MSAT study. CAS numbers in italics are in the stationary inventories only; otherwise they are in mobile and stationary inventories.

HAP	CAS or pollutant code in 1999 NEI	SAROAD(s)
<b>Organic gaseous HAPs (excluding those assessed as POM group)</b>		
1,3-Butadiene	106990	43218
2,2,4-Trimethylpentane	540841	43250
Acetaldehyde	75070	43503
Acrolein	107028	43505
Benzene	71432	45201
Ethyl Benzene	100414	45203
Formaldehyde	50000	43502
Hexane	110543	43231
Methyl tert-butyl ether (MTBE)	1634044	43376
Naphthalene	91203	46701, 46702
Propionaldehyde	123386	43504
Styrene	100425	45220
Toluene	108883	45202
Xylenes	106423, 108383, 1330207, 95476	45102
<b>Metal HAPs</b>		
Chromium III	<i>10060125, 12018018, 1308389, 136, 16065831, 21679312, 7440473</i>	59992, 59993
Chromium VI	<i>10294403, 10588019, 11103869, 11115745, 1308130, 1333820, 13530659, 136, 13765190, 14307358, 18454121, 18540299, 7440473, 7738945, 7758976, 7775113, 7778509, 7789006, 7789062</i>	69992, 69993
Manganese	<i>10101505, 1313139, 1317346, 1317357, 198, 7439965, 7722647, 7783166, 7785877</i>	80196, 80396
Nickel	<i>10101970, 12054487, 13138459, 1313991, 1314063, 13462889, 13463393, 13770893, 226, 373024, 7440020, 7718549, 7786814, NY059280</i>	80216, 80316
<b>HAPs grouped as POM</b>		
Acenaphthene	83329	72002
Acenaphthylene	208968	72002
Anthracene	120127	72002
Benzo(g,h,i)perylene	191242	72002
Fluoranthene	206440	72002
Fluorene	86737	72002
Phenanthrene	85018	72002
Pyrene	129000	72002
Benzo(a)pyrene	50328	75002
Dibenzo(a,h)anthracene	53703	75002
Benz(a)anthracene	56553	76002
Benzo(b)fluoranthene	205992	76002
Benzo(k)fluoranthene	207089	76002
Indeno(1,2,3,c,d)-pyrene	193395	76002
Chrysene	218019	77002
<b>Description of POM groups by SAROAD</b>		
72002: POM, Group 2: no URE data		
75002: POM, Group 5: $5.0E-4 < URE \leq 5.0E-3$		
76002: POM, Group 6: $5.0E-5 < URE \leq 5.0E-4$		
77002: POM, Group 7: $5.0E-6 < URE \leq 5.0E-5$		

The following notes apply to Table 1:

- Although designated as SAROAD code in the EMS-HAP User's Guide (U.S. EPA, 2004b) and ASPEN User's Guide (U.S. EPA, 2000), the SAROAD code value in Table 1 is not the actual SAROAD code for the HAP. Rather, it is a 5-digit code used by ASPEN and EMS-HAP to represent the specific pollutant or pollutant group that is modeled in ASPEN.
- For HAPs with two SAROAD codes, the lower numbered code represents the fine particle mode and the higher number represents the coarse particle mode. For naphthalene, the lower numbered code represents the gas mode while the higher number represents the fine particle mode. For chromium III and chromium VI, CAS numbers 136 and 7440473 are used for both HAPs. These two CAS numbers represent non-speciated chromium. During emissions processing, the non-speciated chromium is speciated to chromium III and chromium VI. For mobile sources not modeled in NMIM (aircraft, locomotives, and commercial marine vessels), eighteen percent of the chromium was assumed to be hexavalent, based on combustion data from stationary combustion turbines that burn diesel fuel (Taylor, 2003).
- The 1999 stationary NEI contains additional POM pollutants including unspciated POM groups such as 7-PAH or other specific POM that are not on the MSAT list but are emitted from stationary sources and were thus modeled as a POM group. These other POM pollutants, with CAS in parentheses, are listed below along with the POM group that they fall in.
  - POM group 71002: total PAH (234), POM (246), 16-PAH – 7-PAH (75040)<sup>1</sup>, 16-PAH (40), Benz(a)Anthracene/Chrysene (103)
  - POM group 72002: Benzo(e)pyrene (192972), Perylene (198550), 2-Methylnaphthalene (91576), Benzofluoranthenes (56832736), 2-Chloronaphthalene (91587), Methylanthracene (26914181), Methylchrysene (248), 12-Methylbenz(a)Anthracene (2422799), 1-Methylpyrene (2381217), 1-Methylphenanthrene (832699), Methylbenzopyrenes (247), 9-Methylbenz(a)Anthracene (779022), Benzo(a)fluoranthene (203338), Benzo(g,h,i)Fluoranthene (203123), Benzo(c)phenanthrene (195197)
  - POM group 73002: 7,12-Dimethylbenz(a)anthracene (57976)
  - POM group 74002: Dibenz(a,i)pyrene (189559), D(a,h)pyrene (189640), 3-Methylcholanthrene (56495)
  - POM group 75002: D(a,e)pyrene (192654), 5-Methylchrysene (3697243)
  - POM group 76002: B(j)fluoranthene (205823), D(a,j)acridine (224420), Benzo(b+k)fluoranthene (102)
  - POM group 78002: 7-PAH (75)

---

<sup>1</sup> See Table 2 for explanation of CAS 75040.

## **2. 1999 base inventories**

### **2.1 1999 HAP inventories**

The inventories used in development of the future locomotive, commercial marine vessel, aircraft, and stationary inventories were from the 1999 National Emissions Inventory (NEI) Version 3 (<http://www.epa.gov/ttn/chief/net/1999inventory.html>). This was the inventory used for the 1999 NATA. The HAP emissions were provided for the following four inventory sectors: point, non-point, onroad mobile, and nonroad mobile. Point and non-point inventories contained the stationary source emissions, and onroad and nonroad contained the mobile emissions. For details about each inventory see <http://www.epa.gov/ttn/chief/net/1999inventory.html>. However for this study, onroad and nonroad (excluding aircraft, locomotives, and commercial marine vessels) were provided via the NMIM2005 model, rather than taken from the 1999 NEI.

For the 1999 NATA, emissions, concentrations and risks were also summarized by emission source sector: major, area & other, onroad and nonroad. The inventory sectors onroad and nonroad mapped directly to the corresponding NATA source sectors. The stationary sources (point and non-point) map was as follows: point sources contained both major and area sources; non-point sources contained area & other sources.

Some changes (or fixes) were made to the inventories before processing in EMS-HAP. Table 2 lists these changes. Onroad is not listed since onroad emissions for the rule will come from NMIM.

**Table 2.** Changes made to the 1999 NEI HAP inventories prior to processing for 1999 NATA or projections for MSAT.

Inventory	Change	Reason (NATA or projections)
Point	Changed stack diameter for siteid 4200300899 to 0.67 ft	Both
	Corrected emissions from pounds to tons for siteid 31109-0217 for methylene chloride	Both
	Converted stack parameters from English units to metric units	Both
	Removed dashes from SCC code and convert all lowercase characters in SCC code to uppercase. Also if SCC was 0, 00000000, "NONE", or "N/A" make SCC blank	Both
	If SIC code was "NONE" or "XXXX" make SIC blank	Both
	If Maximum Achievable Control Technology (MACT) code was "NONE" made MACT blank	Both
	For sources defaulted to county centroids (DEFAULT_LOC_FLAG='CNTYCENT') made the location coordinates equal to missing so that EMS-HAP would default location to tracts.	Both
	If MACT code = 723 then MACT = 0723	Projections
	If MACT code = 724 then MACT = 0724	Projections
	Removed all emissions for Puerto Rico and Virgin Islands since we conducted the MSAT analysis for the 50 states	Projections
	Replaced 1999 MACT 1801 emissions with 2002 draft 1801 emissions	Projections
Non-point	Removed all emissions for Puerto Rico and Virgin Islands since we conducted the MSAT analysis for the 50 states.	Projections
	Changed MACT 1801 emissions to 0 for projections.	Projections
	For FIPS/SCC/ combinations where there were both 16-PAH emissions (CAS=40) and 7-PAH emissions (CAS=75) and the 16-PAH emissions were larger than the 7-PAH emissions, subtracted the 7-PAH emissions from the 16-PAH emissions and assigned the CAS 75040 to the emissions. For the FIPS/SCC combinations being changed deleted the 16-PAH emissions but retained the 7-PAH emissions. For FIPS/SCC combinations that had both 16-PAH and 7-PAH, but 7-PAH emissions were larger than 16-PAH emissions, made no changes. Also made no changes where there were 7-PAH emissions but no 16-PAH and vice versa.	Both
Nonroad	Remove all emissions for Puerto Rico and Virgin Islands since we conducted the MSAT analysis for the 50 states	Projections
	For FIPS/SCC/ combinations where there were both 16-PAH emissions (CAS=40) and 7-PAH emissions (CAS=75) and the 16-PAH emissions are larger than the 7-PAH emissions, subtract the 7-PAH emissions from the 16-PAH emissions and assign the CAS 75040 to the emissions. For the FIPS/SCC combinations being changed delete the 16-PAH emissions but retain the 7-PAH emissions. For FIPS/SCC combinations that have both 16-PAH and 7-PAH, but 7-PAH emissions are larger than 16-PAH emissions, make no changes. Also make no changes where there are 7-PAH emissions but no 16-PAH and vice versa.	Both
	Change Chromium III and Chromium VI CAS numbers to the unspeciated Chromium CAS (7440473). Once making the change, sum up the chromium emissions by FIPS/SCC. The chromium was summed so that EMS-HAP would use an 82/18 chromium III/chromium VI split. Before the summation, the chromium III/chromium VI split was not 82/18% as desired.	Both
	Corrected FIPS for aircraft emissions in a few counties in which we found the underlying NEI geographic data to be erroneous. Section C.2.1 of the EMS-HAP V3 User's Guide provides details, in particular, see Table C-4.	Both

Table 3 lists the inventory emissions for each of the MSAT HAPs prior to EMS-HAP processing.

**Table 3.** Emissions (tons) for MSAT HAPs in the 1999 inventories<sup>2</sup>. Totals are for the 50 states and District of Columbia.

HAP	Inventory				Total
	Point	Non-point	Onroad	Nonroad	
1,3-Butadiene	2.06x10 <sup>3</sup>	2.21x10 <sup>4</sup>	2.22x10 <sup>4</sup>	1.03x10 <sup>4</sup>	5.67x10 <sup>4</sup>
2,2,4-Trimethylpentane	7.02x10 <sup>3</sup>	7.02x10 <sup>3</sup>	1.77x10 <sup>5</sup>	1.11x10 <sup>5</sup>	3.02x10 <sup>5</sup>
Acetaldehyde	1.21x10 <sup>4</sup>	2.64x10 <sup>4</sup>	2.26x10 <sup>4</sup>	2.20x10 <sup>4</sup>	8.31x10 <sup>4</sup>
Acrolein	9.59x10 <sup>2</sup>	2.10x10 <sup>4</sup>	2.94x10 <sup>3</sup>	2.75x10 <sup>3</sup>	2.77x10 <sup>4</sup>
Benzene	1.24x10 <sup>4</sup>	9.88x10 <sup>4</sup>	1.78x10 <sup>5</sup>	7.59x10 <sup>4</sup>	3.66x10 <sup>5</sup>
Ethyl Benzene	1.20x10 <sup>4</sup>	2.76x10 <sup>4</sup>	7.07x10 <sup>4</sup>	4.64x10 <sup>4</sup>	1.57x10 <sup>5</sup>
Formaldehyde	3.55x10 <sup>4</sup>	1.21x10 <sup>5</sup>	6.08x10 <sup>4</sup>	5.21x10 <sup>4</sup>	2.70x10 <sup>5</sup>
Hexane	4.62x10 <sup>4</sup>	9.37x10 <sup>4</sup>	5.86x10 <sup>4</sup>	3.78x10 <sup>4</sup>	2.36x10 <sup>5</sup>
MTBE	4.31x10 <sup>3</sup>	1.38x10 <sup>4</sup>	5.43x10 <sup>4</sup>	8.14x10 <sup>4</sup>	1.54x10 <sup>5</sup>
Naphthalene	2.64x10 <sup>3</sup>	1.14x10 <sup>4</sup>	3.75x10 <sup>3</sup>	1.21x10 <sup>3</sup>	1.90x10 <sup>4</sup>
Propionaldehyde	1.96x10 <sup>3</sup>	3.48x10 <sup>3</sup>	2.57x10 <sup>3</sup>	4.97x10 <sup>3</sup>	1.30x10 <sup>4</sup>
Styrene	4.07x10 <sup>4</sup>	9.67x10 <sup>3</sup>	1.38x10 <sup>4</sup>	3.06x10 <sup>3</sup>	6.71x10 <sup>4</sup>
Toluene	9.31x10 <sup>4</sup>	2.29x10 <sup>5</sup>	4.78x10 <sup>5</sup>	2.36x10 <sup>5</sup>	1.04x10 <sup>6</sup>
Xylenes	6.23x10 <sup>4</sup>	1.80x10 <sup>5</sup>	2.70x10 <sup>5</sup>	2.10x10 <sup>5</sup>	7.22x10 <sup>5</sup>
Chromium (total)	8.45x10 <sup>2</sup>	4.58x10 <sup>1</sup>	1.34x10 <sup>1</sup>	1.81x10 <sup>1</sup>	9.22x10 <sup>2</sup>
Manganese	2.84x10 <sup>3</sup>	3.56x10 <sup>2</sup>	4.49x10 <sup>0</sup>	1.76x10 <sup>0</sup>	3.20x10 <sup>3</sup>
Nickel	1.24x10 <sup>3</sup>	1.75x10 <sup>2</sup>	9.75x10 <sup>0</sup>	3.11x10 <sup>1</sup>	1.45x10 <sup>3</sup>
Acenaphthene	3.98x10 <sup>1</sup>	3.10x10 <sup>2</sup>	2.50x10 <sup>1</sup>	2.68x10 <sup>1</sup>	4.01x10 <sup>2</sup>
Acenaphthylene	1.41x10 <sup>0</sup>	1.74x10 <sup>3</sup>	1.41x10 <sup>2</sup>	6.89x10 <sup>1</sup>	1.96x10 <sup>3</sup>
Anthracene	3.81x10 <sup>1</sup>	3.33x10 <sup>2</sup>	2.90x10 <sup>1</sup>	1.50x10 <sup>1</sup>	4.15x10 <sup>2</sup>
Benzo(g,h,i)perylene	2.04x10 <sup>0</sup>	2.84x10 <sup>2</sup>	8.79x10 <sup>0</sup>	8.50x10 <sup>0</sup>	3.03x10 <sup>2</sup>
Fluoranthene	2.32x10 <sup>2</sup>	5.24x10 <sup>2</sup>	3.12x10 <sup>1</sup>	2.76x10 <sup>1</sup>	8.14x10 <sup>2</sup>
Fluorene	5.97x10 <sup>1</sup>	2.54x10 <sup>2</sup>	5.19x10 <sup>1</sup>	4.97x10 <sup>1</sup>	4.15x10 <sup>2</sup>
Phenanthrene	1.75x10 <sup>2</sup>	1.09x10 <sup>3</sup>	8.70x10 <sup>1</sup>	1.01x10 <sup>2</sup>	1.45x10 <sup>3</sup>
Pyrene	3.99x10 <sup>2</sup>	6.17x10 <sup>2</sup>	4.26x10 <sup>1</sup>	3.18x10 <sup>1</sup>	1.09x10 <sup>3</sup>
Benzo(a)pyrene	1.57x10 <sup>1</sup>	1.07x10 <sup>3</sup>	3.51x10 <sup>0</sup>	2.87x10 <sup>0</sup>	1.10x10 <sup>3</sup>
Dibenzo(a,h)anthracene	8.73x10 <sup>-1</sup>	7.12x10 <sup>0</sup>	0.00x10 <sup>0</sup>	5.16x10 <sup>-2</sup>	8.05x10 <sup>0</sup>
Benz(a)anthracene	1.09x10 <sup>2</sup>	4.34x10 <sup>2</sup>	3.51x10 <sup>0</sup>	4.45x10 <sup>0</sup>	5.51x10 <sup>2</sup>
Benzo(b)fluoranthene	4.95x10 <sup>0</sup>	8.59x10 <sup>1</sup>	4.17x10 <sup>0</sup>	2.45x10 <sup>0</sup>	9.75x10 <sup>1</sup>
Benzo(k)fluoranthene	2.07x10 <sup>0</sup>	1.44x10 <sup>2</sup>	4.17x10 <sup>0</sup>	2.28x10 <sup>0</sup>	1.52x10 <sup>2</sup>
Indeno(1,2,3,c,d)-pyrene	4.34x10 <sup>-1</sup>	1.78x10 <sup>2</sup>	2.64x10 <sup>0</sup>	2.58x10 <sup>0</sup>	1.84x10 <sup>2</sup>
Chrysene	3.02x10 <sup>1</sup>	3.88x10 <sup>2</sup>	3.51x10 <sup>0</sup>	2.87x10 <sup>0</sup>	4.25x10 <sup>2</sup>
7-PAH*	6.63x10 <sup>1</sup>	3.82x10 <sup>1</sup>	0.00x10 <sup>0</sup>	4.77x10 <sup>-4</sup>	1.04x10 <sup>2</sup>
16-PAH*	1.25x10 <sup>1</sup>	2.23x10 <sup>2</sup>	0.00x10 <sup>0</sup>	0.00x10 <sup>0</sup>	2.35x10 <sup>2</sup>
16-PAH – 7-PAH*	0.00x10 <sup>0</sup>	1.29x10 <sup>2</sup>	0.00x10 <sup>0</sup>	4.78x10 <sup>-2</sup>	1.29x10 <sup>2</sup>
Total PAH*	5.48x10 <sup>1</sup>	9.77x10 <sup>2</sup>	0.00x10 <sup>0</sup>	0.00x10 <sup>0</sup>	1.03x10 <sup>3</sup>
Total POM*	3.31x10 <sup>3</sup>	6.40x10 <sup>2</sup>	0.00x10 <sup>0</sup>	0.00x10 <sup>0</sup>	3.95x10 <sup>3</sup>
Non-MSAT POM#	1.29x10 <sup>1</sup>	1.82x10 <sup>3</sup>	0.00x10 <sup>0</sup>	0.00x10 <sup>0</sup>	1.83x10 <sup>3</sup>

\*Some portion of these could be MSAT HAPs but are not sufficiently speciated in the inventory to determine what portion is MSAT POM HAP.

<sup>2</sup> Onroad emissions are from NMIM. Nonroad aircraft, locomotive, and commercial marine vessel emissions are from the 1999 NEI and all other other nonroad emissions are from NMIM. Onroad and nonroad emissions shown are before any processing to create EMS-HAP ready inventories. Point and nonpoint emissions are from the 1999 NEI.



Note that HAPs in the non-MSAT POM were included in the same groups as MSAT POM and were included in emissions input into ASPEN as part of those groups.

One change made to modeled concentrations for NATA (and this effort) after EMS-HAP and ASPEN was to the POM group 75002 concentrations for Oregon for area & other sources. The area & other emissions for benzo(a)pyrene were incorrect in the 1999 NEI for Oregon. In order to alleviate the problem, the national median area & other concentration (excluding Oregon) was substituted for Oregon's area & other tract level concentrations.

## **2.2 1999 Precursor inventories**

In order to calculate secondary concentrations for acetaldehyde, acrolein, formaldehyde, and propionaldehyde after ASPEN simulations for the primary concentrations, the emissions for the precursors also had to be processed through EMS-HAP and subsequently ASPEN for later secondary contribution calculations. For those precursors that were not HAPs themselves (non-HAP precursors) a separate precursor inventory was used. The precursor inventory used was the same as that used for the 1999 NATA and was Version 2 of the NEI for VOC. Precursor emissions were obtained by speciating VOC emissions from Version 2 of the NEI. The speciation profiles are the same as those used for the 1996 NATA (see Section D.1.2 in EMS-HAP Version 2 User's Guide, [U.S. EPA, 2002a]). Table 4 lists the non-HAP precursors for acetaldehyde, formaldehyde, and propionaldehyde. Precursors for acrolein are not listed because the precursors for acrolein were inert and reactive 1,3-butadiene, an MSAT HAP already being modeled.

**Table 4.** Non-HAP precursors for the MSAT secondary HAPs with source sector emissions for 1999. Totals are for the 50 states and District of Columbia.

Precursor	Precursor for	Inventory				Total
		Point	Non-point	Onroad	Nonroad	
1-Butene	Formaldehyde, Propionaldehyde	5.34x10 <sup>3</sup>	2.42x10 <sup>4</sup>	4.15x10 <sup>4</sup>	1.25x10 <sup>4</sup>	8.36x10 <sup>4</sup>
1-2,3-Dimethyl butene	Formaldehyde	1.10x10 <sup>2</sup>	3.00x10 <sup>3</sup>	1.90x10 <sup>3</sup>	0.00x10 <sup>0</sup>	5.02x10 <sup>3</sup>
1-2-Ethyl butene	Formaldehyde	5.40x10 <sup>-4</sup>	0.00x10 <sup>0</sup>	0.00x10 <sup>0</sup>	2.55x10 <sup>2</sup>	2.55x10 <sup>2</sup>
1-2-Methyl butene	Formaldehyde	1.04x10 <sup>2</sup>	4.75x10 <sup>3</sup>	3.06x10 <sup>4</sup>	1.19x10 <sup>4</sup>	4.74x10 <sup>4</sup>
1-3-Methyl butene	Formaldehyde	8.15x10 <sup>1</sup>	7.53x10 <sup>3</sup>	4.63x10 <sup>3</sup>	2.95x10 <sup>3</sup>	1.52x10 <sup>4</sup>
2-Butene	Acetaldehyde	2.17x10 <sup>3</sup>	7.50x10 <sup>3</sup>	4.23x10 <sup>4</sup>	7.52x10 <sup>3</sup>	5.95x10 <sup>4</sup>
2-2-Methyl butene	Acetaldehyde	7.81x10 <sup>1</sup>	4.75x10 <sup>3</sup>	8.97x10 <sup>4</sup>	1.97x10 <sup>4</sup>	1.14x10 <sup>5</sup>
1-Decene	Formaldehyde	7.62x10 <sup>2</sup>	0.00x10 <sup>0</sup>	0.00x10 <sup>0</sup>	1.65x10 <sup>2</sup>	9.27x10 <sup>2</sup>
Ethanol	Acetaldehyde	4.39x10 <sup>4</sup>	2.02x10 <sup>5</sup>	2.28x10 <sup>4</sup>	3.30x10 <sup>2</sup>	2.69x10 <sup>5</sup>
Ethene	Formaldehyde	2.45x10 <sup>4</sup>	3.50x10 <sup>5</sup>	4.11x10 <sup>5</sup>	1.65x10 <sup>5</sup>	9.50x10 <sup>5</sup>
1-Heptene	Formaldehyde	6.02x10 <sup>2</sup>	1.77x10 <sup>2</sup>	1.52x10 <sup>3</sup>	1.80x10 <sup>3</sup>	4.11x10 <sup>3</sup>
2-Heptene	Acetaldehyde	5.79x10 <sup>2</sup>	1.77x10 <sup>2</sup>	2.82x10 <sup>3</sup>	2.19x10 <sup>3</sup>	5.77x10 <sup>3</sup>
1-Hexene	Formaldehyde	1.25x10 <sup>3</sup>	1.33x10 <sup>3</sup>	1.55x10 <sup>4</sup>	6.50x10 <sup>3</sup>	2.46x10 <sup>4</sup>
2-Hexene	Acetaldehyde	9.38x10 <sup>1</sup>	1.33x10 <sup>3</sup>	1.34x10 <sup>4</sup>	1.01x10 <sup>4</sup>	2.49x10 <sup>4</sup>
3-Hexene	Propionaldehyde	5.16x10 <sup>2</sup>	1.33x10 <sup>3</sup>	5.37x10 <sup>3</sup>	4.37x10 <sup>3</sup>	1.16x10 <sup>4</sup>
Isoprene	Formaldehyde	3.16x10 <sup>2</sup>	4.01x10 <sup>2</sup>	6.28x10 <sup>3</sup>	5.29x10 <sup>3</sup>	1.23x10 <sup>4</sup>
1-Nonene	Formaldehyde	5.59x10 <sup>1</sup>	3.01x10 <sup>2</sup>	3.58x10 <sup>4</sup>	7.08x10 <sup>3</sup>	4.32x10 <sup>4</sup>
2-Nonene	Acetaldehyde	2.32x10 <sup>0</sup>	0.00x10 <sup>0</sup>	0.00x10 <sup>0</sup>	8.25x10 <sup>1</sup>	8.48x10 <sup>1</sup>
1-Octene	Formaldehyde	3.72x10 <sup>1</sup>	3.29x10 <sup>-1</sup>	1.96x10 <sup>3</sup>	1.83x10 <sup>3</sup>	3.83x10 <sup>3</sup>
2-Octene	Acetaldehyde	1.76x10 <sup>1</sup>	3.29x10 <sup>-1</sup>	1.96x10 <sup>3</sup>	8.36x10 <sup>2</sup>	2.82x10 <sup>3</sup>
1-Pentene	Formaldehyde	2.69x10 <sup>3</sup>	1.82x10 <sup>4</sup>	3.23x10 <sup>4</sup>	8.95x10 <sup>3</sup>	6.22x10 <sup>4</sup>
1-2,4,4-Trimethyl Pentene	Formaldehyde	2.72x10 <sup>1</sup>	0.00x10 <sup>0</sup>	2.11x10 <sup>4</sup>	0.00x10 <sup>0</sup>	2.11x10 <sup>4</sup>
1-2-Methyl pentene	Formaldehyde	1.24x10 <sup>2</sup>	1.78x10 <sup>3</sup>	3.79x10 <sup>4</sup>	4.78x10 <sup>3</sup>	4.46x10 <sup>4</sup>
1-3-Methyl pentene	Formaldehyde	8.65x10 <sup>1</sup>	1.78x10 <sup>3</sup>	5.52x10 <sup>4</sup>	4.13x10 <sup>3</sup>	6.12x10 <sup>4</sup>
1-4-Methyl pentene	Formaldehyde	9.63x10 <sup>1</sup>	1.78x10 <sup>3</sup>	6.07x10 <sup>3</sup>	2.27x10 <sup>3</sup>	1.02x10 <sup>4</sup>
2-Pentene	Acetaldehyde, Propionaldehyde	2.70x10 <sup>3</sup>	4.55x10 <sup>3</sup>	7.08x10 <sup>4</sup>	2.22x10 <sup>4</sup>	1.00x10 <sup>5</sup>
2-3-Methyl pentene	Acetaldehyde	6.56x10 <sup>1</sup>	1.78x10 <sup>3</sup>	1.43x10 <sup>4</sup>	1.09x10 <sup>4</sup>	2.71x10 <sup>4</sup>
2-4-Methyl pentene	Acetaldehyde	1.32x10 <sup>2</sup>	1.78x10 <sup>3</sup>	3.79x10 <sup>4</sup>	8.95x10 <sup>3</sup>	4.88x10 <sup>4</sup>
Propene	Acetaldehyde, Formaldehyde	1.57x10 <sup>4</sup>	6.49x10 <sup>4</sup>	1.71x10 <sup>5</sup>	6.60x10 <sup>4</sup>	3.18x10 <sup>5</sup>
2-Methyl propene	Formaldehyde	6.02x10 <sup>2</sup>	8.90x10 <sup>3</sup>	9.39x10 <sup>4</sup>	1.92x10 <sup>4</sup>	1.23x10 <sup>5</sup>

This page intentionally blank

### 3. Development of Future Year Mobile and Mobile-Related Emissions

#### 3.1 Locomotive and commercial marine vessels

Emissions from locomotive and commercial marine vessels were projected similarly using ratios computed from previously projected, multi-year, national-level, criteria pollutant emission data. Because these previously projected emissions account for both activity growth and reductions due to control programs, the term “projection factor” is used rather than “growth factor” to describe the factor used to multiply base year emissions to obtain future year emissions. Table 5 shows the eight locomotive SCC codes in the 1999 NEI.

**Table 5.** Locomotive SCC codes in the 1999 NEI nonroad inventory.

SCC	Description
2285000000	Mobile Sources, Railroad Equipment, All Fuels, Total
2285002000	Mobile Sources, Railroad Equipment, Diesel, Total
2285002005	Mobile Sources, Railroad Equipment, Diesel, Line Haul Locomotives
2285002006	Mobile Sources, Railroad Equipment, Diesel, Line Haul Locomotives: Class I operations
2285002007	Mobile Sources, Railroad Equipment, Diesel, Line Haul Locomotives: Class II/III operations
2285002008	Mobile Sources, Railroad Equipment, Diesel, Line Haul Locomotives: Passenger Trains (Amtrak)
2285002009	Mobile Sources, Railroad Equipment, Diesel, Line Haul Locomotives: Commuter lines
2285002010	Mobile Sources, Railroad Equipment, Diesel, Yard Locomotives

Projection factors for the locomotive emissions, which account for both growth and reductions due to control programs, were developed from the VOC and PM10 projected emissions shown in Table 6. These were derived as part of the EPA’s 2004 Clean Air Nonroad Diesel Rule (U.S. EPA, 2004d).

**Table 6.** Locomotive 50-State annual emissions trends (tons per year) and future year ratios.

Year	VOC emissions	VOC ratio (future year/1999)	PM10 emissions	PM10 ratio (future year/1999)
1999	3.46x10 <sup>4</sup>	1.0000	2.09x10 <sup>4</sup>	1.0000
2010	3.16x10 <sup>4</sup>	0.9127	1.51x10 <sup>4</sup>	0.7240
2015	3.11x10 <sup>4</sup>	0.8986	1.45x10 <sup>4</sup>	0.6929
2020	3.02x10 <sup>4</sup>	0.8725	1.37x10 <sup>4</sup>	0.6542
2030	2.86x10 <sup>4</sup>	0.8277	1.21x10 <sup>4</sup>	0.5779

The projection factors were national level, in that they were computed using 50-state total emission sums. In addition, they were applied to each pollutant across all SCC codes. That is, all locomotive SCC codes with pollutants deemed VOC received the same projection factor. The pollutants associated with locomotive emissions are shown in Table 7 with their assigned projection factor for locomotives.

**Table 7.** Locomotive MSAT HAPs.

HAP	Growth factor basis
1,3-Butadiene	VOC ratios
2,2,4-Trimethylpentane	VOC ratios
Acetaldehyde	VOC ratios
Acrolein	VOC ratios
Benzene	VOC ratios
Chromium	Metals (projection factors = 1.0)
Ethyl benzene	VOC ratios
Formaldehyde	VOC ratios
Hexane	VOC ratios
Manganese	Metals (growth factors = 1.0)
Naphthalene	PM ratios
Nickel	Metals (projection factors = 1.0)
POM (excluding Naphthalene)	PM ratios
Propionaldehyde	VOC ratios
Styrene	VOC ratios
Toluene	VOC ratios
Xylene	VOC ratios

Metals were set to no growth (projection factor = 1.0, metals remain at 1999 levels) because little activity change was expected in locomotives in the future. This is because metal emissions were most likely the result of impurities in fuel and engine oil, and from engine wear, and it is not known how these emissions would be impacted by controls, if it all. Several of the metals were estimated using emission factor (EF) x Activity, and several were estimated as fractions of PM emissions.

Projection factors for commercial marine vessels (CMV) were computed similarly to locomotive projection factors, using 50-state emission summaries for various future years that were developed as part of the EPA's 2004 Clean Air Nonroad Diesel Rule (U.S. EPA, 2004d). These emissions summaries are shown in Table 8.

One difference, however, is that the projection factors for CMV were specific to both SCC (diesel, residual, or no fuel information) and pollutant specific (VOC or PM). The SCC

dependence on the projection factor was based on whether the SCC was related to diesel emissions or residual emissions. There were three SCC codes used to assign the basis of the projection factor for the SCC. Within the SCC, the projection factor used was dependent on whether the HAP was VOC or PM. Table 8 lists the projection factors computed from the 50-state total emission summaries commercial marine vessels.

Projection factors computed for the SCC codes in Table 8 were assigned to the five SCC codes corresponding to the commercial marine vessels in the 1999 NEI. Each HAP within the SCC category was then assigned the projection factor for VOC or PM. Table 9 lists the SCC codes and HAPs associated with the commercial marine vessel emissions in the 1999 NEI.

**Table 8.** Commercial marine vessel 50-State annual emissions trends (tons per year) and future year ratios used as projection factors.

SCC	Description	Year	VOC emissions	VOC ratio (year/ 1999)	PM10 emissions	PM10 ratio (year/ 1999)
2280000000	Mobile Sources, Marine Vessels, Commercial, All Fuels, Total, All Vessel Types	1999	3.21x10 <sup>4</sup>	1.0000	3.90x10 <sup>4</sup>	1.0000
		2010	3.70x10 <sup>4</sup>	1.1511	4.37x10 <sup>4</sup>	1.1206
		2015	3.95x10 <sup>4</sup>	1.2306	4.75x10 <sup>4</sup>	1.2165
		2020	4.34x10 <sup>4</sup>	1.3505	5.35x10 <sup>4</sup>	1.3713
		2030	5.51x10 <sup>4</sup>	1.7142	7.25x10 <sup>4</sup>	1.8581
2280002000	Mobile Sources, Marine Vessels, Commercial, Diesel, Total, All Vessel Types	1999	2.34x10 <sup>4</sup>	1.0000	1.99x10 <sup>4</sup>	1.0000
		2010	2.46x10 <sup>4</sup>	1.0498	1.77x10 <sup>4</sup>	0.8893
		2015	2.47x10 <sup>4</sup>	1.0552	1.69x10 <sup>4</sup>	0.8481
		2020	2.53x10 <sup>4</sup>	1.0797	1.68x10 <sup>4</sup>	0.8428
		2030	2.75x10 <sup>4</sup>	1.7700	1.83x10 <sup>4</sup>	1.9162
228003000	Mobile Sources, Marine Vessels, Commercial, Residual, Total, All Vessel Types	1999	8.73x10 <sup>3</sup>	1.0000	1.91x10 <sup>4</sup>	1.0000
		2010	1.24x10 <sup>4</sup>	1.4229	2.60x10 <sup>4</sup>	1.3621
		2015	1.48x10 <sup>4</sup>	1.7009	3.06x10 <sup>4</sup>	1.6011
		2020	1.81x10 <sup>4</sup>	2.0765	3.67x10 <sup>4</sup>	1.9230
		2030	2.75x10 <sup>4</sup>	3.1544	5.42x10 <sup>4</sup>	2.8416

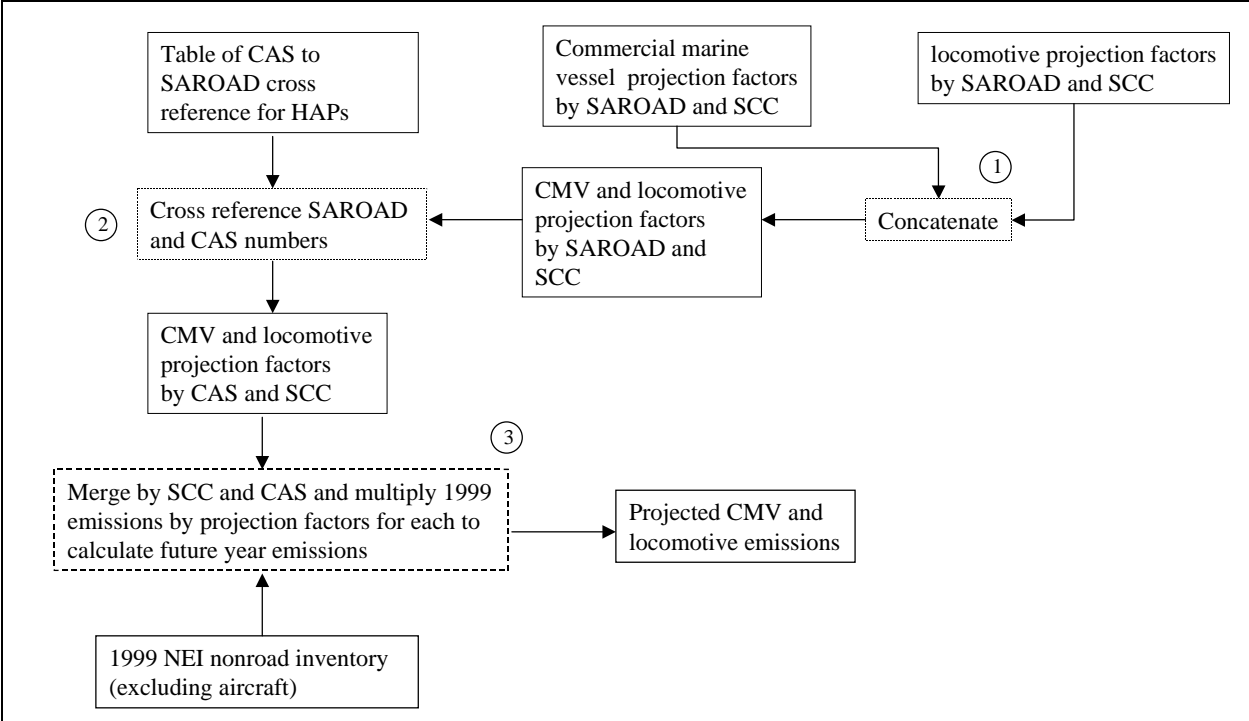
**Table 9.** Commercial marine vessel SCC codes, HAPs, and basis of projection factors.

SCC	Description	HAPs	Projection factor basis
2280000000	Mobile Sources, Marine Vessels, Commercial, All Fuels, Total, All Vessel Types	1,3-Butadiene, 2,2,4-Trimethylpentane, Acetaldehyde, Benzene, Ethyl Benzene, Formaldehyde, Hexane, Propionaldehyde, Styrene, Toluene, Xylenes	VOC ratios for 2280000000 (all fuels)
		Chromium, Manganese, Naphthalene, Nickel	PM ratios for 2280000000 (all fuels)
2280002100	Mobile Sources, Marine Vessels, Commercial, Diesel, Diesel- port emissions	1,3-Butadiene, 2,2,4-Trimethylpentane, Acetaldehyde, Acrolein, Benzene, Ethyl Benzene, Formaldehyde, Hexane, Propionaldehyde, Styrene, Toluene, Xylenes	VOC ratios for 2280002000 (diesel)
		Chromium, Manganese, Naphthalene, Nickel, POM	PM ratios for 2280002000 (diesel)
2280002200	Mobile Sources, Marine Vessels, Commercial, Diesel, Diesel- underway emissions	2,2,4-Trimethylpentane, Acetaldehyde, Acrolein, Benzene, Ethyl Benzene, Formaldehyde, Hexane, Propionaldehyde, Styrene, Toluene, Xylenes	VOC ratios for 2280002000 (diesel)
		Chromium, Manganese, Naphthalene, Nickel, POM	PM ratios for 2280002000 (diesel)
2280003100	Mobile Sources, Marine Vessels, Commercial, Residual, Residual - port emissions	2,2,4-Trimethylpentane, Acetaldehyde, Acrolein, Benzene, Ethyl Benzene, Formaldehyde, Hexane, Propionaldehyde, Styrene, Toluene, Xylenes	VOC ratios for 2280003000 (residual)
		Chromium, Manganese, Naphthalene, Nickel, POM	PM ratios for 2280003000 (residual)
2280003200	Mobile Sources, Marine Vessels, Commercial, Residual, Residual - underway emissions	2,2,4-Trimethylpentane, Acetaldehyde, Acrolein, Benzene, Ethyl Benzene, Formaldehyde, Hexane, Propionaldehyde, Styrene, Toluene, Xylenes	VOC ratios for 2280003000 (residual)
		Chromium, Manganese, Naphthalene, Nickel, POM	PM ratios for 2280003000 (residual)

The general methodology used in applying the projection factors for locomotives and commercial marine vessels are shown in Figure 2. Tables 10 and 11 present the nationwide 1999 and projected emissions for locomotives and commercial marine vessels, respectively. “All HAPs” refers to all MSAT HAPs<sup>3</sup>.

<sup>3</sup> Throughout this document, “All HAPs” refers to MSAT HAPs in all summary tables.





**Figure 2.** Steps in projecting 1999 locomotive and commercial marine vessel emissions to future years.

**Table 10.** National locomotive emissions by SCC for selected HAPs and across all HAPs.

SCC	HAP	Emissions (tons/yr)				
		1999	2010	2015	2020	2030
2285000000	Acrolein	2.44x10 <sup>1</sup>	2.23x10 <sup>1</sup>	2.19x10 <sup>1</sup>	2.13x10 <sup>1</sup>	2.02x10 <sup>1</sup>
	All HAPs	1.51x10 <sup>2</sup>	1.38x10 <sup>2</sup>	1.36x10 <sup>2</sup>	1.32x10 <sup>2</sup>	1.25x10 <sup>2</sup>
2285002000	Acetaldehyde	6.05x10 <sup>-1</sup>	5.52x10 <sup>-1</sup>	5.44x10 <sup>-1</sup>	5.28x10 <sup>-1</sup>	5.01x10 <sup>-1</sup>
	Acrolein	3.13x10 <sup>-1</sup>	2.86x10 <sup>-1</sup>	2.82x10 <sup>-1</sup>	2.73x10 <sup>-1</sup>	2.59x10 <sup>-1</sup>
	Formaldehyde	1.79x10 <sup>0</sup>	1.63x10 <sup>0</sup>	1.61x10 <sup>0</sup>	1.56x10 <sup>0</sup>	1.48x10 <sup>0</sup>
	All HAPs	5.20x10 <sup>0</sup>	4.75x10 <sup>0</sup>	4.67x10 <sup>0</sup>	4.54x10 <sup>0</sup>	4.30x10 <sup>0</sup>
2285002005	1,3-Butadiene	4.51x10 <sup>0</sup>	4.12x10 <sup>0</sup>	4.05x10 <sup>0</sup>	3.94x10 <sup>0</sup>	3.73x10 <sup>0</sup>
	Acetaldehyde	1.74x10 <sup>2</sup>	1.59x10 <sup>2</sup>	1.57x10 <sup>2</sup>	1.52x10 <sup>2</sup>	1.44x10 <sup>2</sup>
	Benzene	4.75x10 <sup>1</sup>	4.33x10 <sup>1</sup>	4.27x10 <sup>1</sup>	4.14x10 <sup>1</sup>	3.93x10 <sup>1</sup>
	Formaldehyde	3.49x10 <sup>2</sup>	3.19x10 <sup>2</sup>	3.14x10 <sup>2</sup>	3.05x10 <sup>2</sup>	2.89x10 <sup>2</sup>
	Naphthalene	2.14x10 <sup>0</sup>	1.55x10 <sup>0</sup>	1.48x10 <sup>0</sup>	1.40x10 <sup>0</sup>	1.23x10 <sup>0</sup>
	All HAPs	6.80x10 <sup>2</sup>	6.21x10 <sup>2</sup>	6.11x10 <sup>2</sup>	5.93x10 <sup>2</sup>	5.63x10 <sup>2</sup>
2285002006	1,3-Butadiene	8.97x10 <sup>1</sup>	8.19x10 <sup>1</sup>	8.06x10 <sup>1</sup>	7.83x10 <sup>1</sup>	7.43x10 <sup>1</sup>
	Acetaldehyde	5.19x10 <sup>2</sup>	4.74x10 <sup>2</sup>	4.66x10 <sup>2</sup>	4.53x10 <sup>2</sup>	4.29x10 <sup>2</sup>
	Acrolein	8.74x10 <sup>1</sup>	7.98x10 <sup>1</sup>	7.85x10 <sup>1</sup>	7.62x10 <sup>1</sup>	7.23x10 <sup>1</sup>
	Benzene	7.15x10 <sup>1</sup>	6.52x10 <sup>1</sup>	6.42x10 <sup>1</sup>	6.24x10 <sup>1</sup>	5.92x10 <sup>1</sup>
	Formaldehyde	1.20x10 <sup>3</sup>	1.09x10 <sup>3</sup>	1.07x10 <sup>3</sup>	1.04x10 <sup>3</sup>	9.90x10 <sup>2</sup>
	Naphthalene	4.77x10 <sup>1</sup>	3.45x10 <sup>1</sup>	3.31x10 <sup>1</sup>	3.12x10 <sup>1</sup>	2.76x10 <sup>1</sup>
	All HAPs	2.71x10 <sup>3</sup>	2.45x10 <sup>3</sup>	2.42x10 <sup>3</sup>	2.34x10 <sup>3</sup>	2.22x10 <sup>3</sup>
2285002007	1,3-Butadiene	6.00x10 <sup>0</sup>	5.47x10 <sup>0</sup>	5.39x10 <sup>0</sup>	5.23x10 <sup>0</sup>	4.96x10 <sup>0</sup>
	Acetaldehyde	3.47x10 <sup>1</sup>	3.17x10 <sup>1</sup>	3.12x10 <sup>1</sup>	3.03x10 <sup>1</sup>	2.87x10 <sup>1</sup>
	Acrolein	6.19x10 <sup>0</sup>	5.65x10 <sup>0</sup>	5.56x10 <sup>0</sup>	5.40x10 <sup>0</sup>	5.12x10 <sup>0</sup>
	Benzene	4.78x10 <sup>0</sup>	4.36x10 <sup>0</sup>	4.29x10 <sup>0</sup>	4.17x10 <sup>0</sup>	3.95x10 <sup>0</sup>
	Formaldehyde	8.00x10 <sup>1</sup>	7.30x10 <sup>1</sup>	7.18x10 <sup>1</sup>	6.98x10 <sup>1</sup>	6.62x10 <sup>1</sup>
	Naphthalene	3.19x10 <sup>0</sup>	2.31x10 <sup>0</sup>	2.21x10 <sup>0</sup>	2.09x10 <sup>0</sup>	1.84x10 <sup>0</sup>
	All HAPs	1.84x10 <sup>2</sup>	1.67x10 <sup>2</sup>	1.64x10 <sup>2</sup>	1.59x10 <sup>2</sup>	1.51x10 <sup>2</sup>
2285002008	1,3-Butadiene	1.94x10 <sup>0</sup>	1.77x10 <sup>0</sup>	1.74x10 <sup>0</sup>	1.69x10 <sup>0</sup>	1.61x10 <sup>0</sup>
	Acetaldehyde	1.12x10 <sup>1</sup>	1.03x10 <sup>1</sup>	1.01x10 <sup>1</sup>	9.80x10 <sup>0</sup>	9.30x10 <sup>0</sup>
	Acrolein	1.91x10 <sup>0</sup>	1.75x10 <sup>0</sup>	1.72x10 <sup>0</sup>	1.67x10 <sup>0</sup>	1.58x10 <sup>0</sup>
	Benzene	1.55x10 <sup>0</sup>	1.41x10 <sup>0</sup>	1.39x10 <sup>0</sup>	1.35x10 <sup>0</sup>	1.28x10 <sup>0</sup>
	Formaldehyde	2.59x10 <sup>1</sup>	2.36x10 <sup>1</sup>	2.33x10 <sup>1</sup>	2.26x10 <sup>1</sup>	2.14x10 <sup>1</sup>
	Naphthalene	1.03x10 <sup>0</sup>	7.47x10 <sup>-1</sup>	7.15x10 <sup>-1</sup>	6.75x10 <sup>-1</sup>	5.96x10 <sup>-1</sup>
	All HAPs	5.88x10 <sup>1</sup>	5.33x10 <sup>1</sup>	5.25x10 <sup>1</sup>	5.09x10 <sup>1</sup>	4.82x10 <sup>1</sup>
2285002009	1,3-Butadiene	1.68x10 <sup>0</sup>	1.53x10 <sup>0</sup>	1.51x10 <sup>0</sup>	1.47x10 <sup>0</sup>	1.39x10 <sup>0</sup>
	Acetaldehyde	9.73x10 <sup>0</sup>	8.88x10 <sup>0</sup>	8.75x10 <sup>0</sup>	8.49x10 <sup>0</sup>	8.06x10 <sup>0</sup>
	Acrolein	1.46x10 <sup>0</sup>	1.33x10 <sup>0</sup>	1.31x10 <sup>0</sup>	1.27x10 <sup>0</sup>	1.21x10 <sup>0</sup>
	Benzene	1.34x10 <sup>0</sup>	1.22x10 <sup>0</sup>	1.20x10 <sup>0</sup>	1.17x10 <sup>0</sup>	1.11x10 <sup>0</sup>
	Formaldehyde	2.24x10 <sup>1</sup>	2.05x10 <sup>1</sup>	2.02x10 <sup>1</sup>	1.96x10 <sup>1</sup>	1.86x10 <sup>1</sup>
	All HAPs	8.94x10 <sup>-1</sup>	6.47x10 <sup>-1</sup>	6.20x10 <sup>-1</sup>	5.85x10 <sup>-1</sup>	5.17x10 <sup>-1</sup>
2285002010	1,3-Butadiene	7.55x10 <sup>0</sup>	6.89x10 <sup>0</sup>	6.79x10 <sup>0</sup>	6.59x10 <sup>0</sup>	6.25x10 <sup>0</sup>
	Acetaldehyde	6.55x10 <sup>1</sup>	5.98x10 <sup>1</sup>	5.89x10 <sup>1</sup>	5.72x10 <sup>1</sup>	5.43x10 <sup>1</sup>
	Acrolein	6.57x10 <sup>0</sup>	6.00x10 <sup>0</sup>	5.91x10 <sup>0</sup>	5.74x10 <sup>0</sup>	5.44x10 <sup>0</sup>
	Benzene	1.25x10 <sup>1</sup>	1.14x10 <sup>1</sup>	1.12x10 <sup>1</sup>	1.09x10 <sup>1</sup>	1.03x10 <sup>1</sup>
	Formaldehyde	1.43x10 <sup>2</sup>	1.31x10 <sup>2</sup>	1.29x10 <sup>2</sup>	1.25x10 <sup>2</sup>	1.18x10 <sup>2</sup>
	Naphthalene	5.33x10 <sup>0</sup>	3.86x10 <sup>0</sup>	3.69x10 <sup>0</sup>	3.49x10 <sup>0</sup>	3.08x10 <sup>0</sup>
	All HAPs	3.66x10 <sup>2</sup>	3.32x10 <sup>2</sup>	3.27x10 <sup>2</sup>	3.17x10 <sup>2</sup>	3.00x10 <sup>2</sup>
Total Locomotive	1,3-Butadiene	1.11x10 <sup>2</sup>	1.02x10 <sup>2</sup>	1.00x10 <sup>2</sup>	9.72x10 <sup>1</sup>	9.22x10 <sup>1</sup>
	Acetaldehyde	8.15x10 <sup>2</sup>	7.44x10 <sup>2</sup>	7.32x10 <sup>2</sup>	7.11x10 <sup>2</sup>	6.75x10 <sup>2</sup>
	Acrolein	1.28x10 <sup>2</sup>	1.17x10 <sup>2</sup>	1.15x10 <sup>2</sup>	1.12x10 <sup>2</sup>	1.06x10 <sup>2</sup>
	Benzene	1.39x10 <sup>2</sup>	1.27x10 <sup>2</sup>	1.25x10 <sup>2</sup>	1.21x10 <sup>2</sup>	1.15x10 <sup>2</sup>
	Formaldehyde	1.82x10 <sup>3</sup>	1.66x10 <sup>3</sup>	1.63x10 <sup>3</sup>	1.59x10 <sup>3</sup>	1.50x10 <sup>3</sup>
	Naphthalene	6.03x10 <sup>1</sup>	4.37x10 <sup>1</sup>	4.18x10 <sup>1</sup>	3.94x10 <sup>1</sup>	3.48x10 <sup>1</sup>
	All HAPs	4.20x10 <sup>3</sup>	3.82x10 <sup>3</sup>	3.75x10 <sup>3</sup>	3.64x10 <sup>3</sup>	3.45x10 <sup>3</sup>

**Table 11.** National commercial marine vessel emissions by SCC for selected HAPs and across all HAPs.

SCC	HAP	Emissions (tons/yr)				
		1999	2010	2015	2020	2030
2280000000	1,3-Butadiene	1.35x10 <sup>-1</sup>	1.55x10 <sup>-1</sup>	1.66x10 <sup>-1</sup>	1.82x10 <sup>-1</sup>	2.31x10 <sup>-1</sup>
	Acetaldehyde	5.21x10 <sup>0</sup>	6.00x10 <sup>0</sup>	6.41x10 <sup>0</sup>	7.04x10 <sup>0</sup>	8.94x10 <sup>0</sup>
	Benzene	1.42x10 <sup>0</sup>	1.63x10 <sup>0</sup>	1.75x10 <sup>0</sup>	1.92x10 <sup>0</sup>	2.43x10 <sup>0</sup>
	Formaldehyde	1.04x10 <sup>1</sup>	1.20x10 <sup>1</sup>	1.28x10 <sup>1</sup>	1.41x10 <sup>1</sup>	1.79x10 <sup>1</sup>
	Naphthalene	6.38x10 <sup>-2</sup>	6.70x10 <sup>-2</sup>	6.74x10 <sup>-2</sup>	6.89x10 <sup>-2</sup>	7.51x10 <sup>-2</sup>
	All HAPs	2.03x10 <sup>1</sup>	2.34x10 <sup>1</sup>	2.50x10 <sup>1</sup>	2.74x10 <sup>1</sup>	3.48x10 <sup>1</sup>
2280002100	1,3-Butadiene	5.56x10 <sup>0</sup>	5.83x10 <sup>0</sup>	5.86x10 <sup>0</sup>	6.00x10 <sup>0</sup>	6.54x10 <sup>0</sup>
	Acetaldehyde	1.48x10 <sup>3</sup>	1.55x10 <sup>3</sup>	1.56x10 <sup>3</sup>	1.60x10 <sup>3</sup>	1.74x10 <sup>3</sup>
	Acrolein	5.37x10 <sup>1</sup>	5.64x10 <sup>1</sup>	5.66x10 <sup>1</sup>	5.80x10 <sup>1</sup>	6.32x10 <sup>1</sup>
	Benzene	4.04x10 <sup>2</sup>	4.24x10 <sup>2</sup>	4.27x10 <sup>2</sup>	4.36x10 <sup>2</sup>	4.76x10 <sup>2</sup>
	Formaldehyde	2.97x10 <sup>3</sup>	3.12x10 <sup>3</sup>	3.14x10 <sup>3</sup>	3.21x10 <sup>3</sup>	3.50x10 <sup>3</sup>
	Naphthalene	3.26x10 <sup>1</sup>	2.90x10 <sup>1</sup>	2.76x10 <sup>1</sup>	2.75x10 <sup>1</sup>	2.99x10 <sup>1</sup>
	All HAPs	5.43x10 <sup>3</sup>	5.69x10 <sup>3</sup>	5.72x10 <sup>3</sup>	5.85x10 <sup>3</sup>	6.37x10 <sup>3</sup>
2280002200	Acetaldehyde	4.59x10 <sup>2</sup>	4.82x10 <sup>2</sup>	4.85x10 <sup>2</sup>	4.96x10 <sup>2</sup>	5.40x10 <sup>2</sup>
	Acrolein	2.16x10 <sup>1</sup>	2.27x10 <sup>1</sup>	2.28x10 <sup>1</sup>	2.34x10 <sup>1</sup>	2.55x10 <sup>1</sup>
	Benzene	1.26x10 <sup>2</sup>	1.32x10 <sup>2</sup>	1.33x10 <sup>2</sup>	1.36x10 <sup>2</sup>	1.48x10 <sup>2</sup>
	Formaldehyde	9.25x10 <sup>2</sup>	9.71x10 <sup>2</sup>	9.76x10 <sup>2</sup>	9.98x10 <sup>2</sup>	1.09x10 <sup>3</sup>
	Naphthalene	1.07x10 <sup>1</sup>	9.53x10 <sup>0</sup>	9.09x10 <sup>0</sup>	9.03x10 <sup>0</sup>	9.82x10 <sup>0</sup>
	All HAPs	1.69x10 <sup>3</sup>	1.78x10 <sup>3</sup>	1.78x10 <sup>3</sup>	1.83x10 <sup>3</sup>	1.99x10 <sup>3</sup>
2280003100	Acetaldehyde	3.00x10 <sup>2</sup>	4.26x10 <sup>2</sup>	5.10x10 <sup>2</sup>	6.22x10 <sup>2</sup>	9.45x10 <sup>2</sup>
	Acrolein	1.71x10 <sup>1</sup>	2.43x10 <sup>1</sup>	2.91x10 <sup>1</sup>	3.55x10 <sup>1</sup>	5.40x10 <sup>1</sup>
	Benzene	7.95x10 <sup>1</sup>	1.13x10 <sup>2</sup>	1.35x10 <sup>2</sup>	1.65x10 <sup>2</sup>	2.51x10 <sup>2</sup>
	Formaldehyde	5.61x10 <sup>2</sup>	7.98x10 <sup>2</sup>	9.54x10 <sup>2</sup>	1.16x10 <sup>3</sup>	1.77x10 <sup>3</sup>
	Naphthalene	1.61x10 <sup>1</sup>	2.20x10 <sup>1</sup>	2.58x10 <sup>1</sup>	3.10x10 <sup>1</sup>	4.58x10 <sup>1</sup>
	All HAPs	1.13x10 <sup>3</sup>	1.59x10 <sup>3</sup>	1.90x10 <sup>3</sup>	2.32x10 <sup>3</sup>	3.50x10 <sup>3</sup>
2280003200	Acetaldehyde	1.22x10 <sup>2</sup>	1.74x10 <sup>2</sup>	2.08x10 <sup>2</sup>	2.54x10 <sup>2</sup>	3.86x10 <sup>2</sup>
	Acrolein	5.75x10 <sup>0</sup>	8.18x10 <sup>0</sup>	9.78x10 <sup>0</sup>	1.19x10 <sup>1</sup>	1.81x10 <sup>1</sup>
	Benzene	3.34x10 <sup>1</sup>	4.76x10 <sup>1</sup>	5.69x10 <sup>1</sup>	6.94x10 <sup>1</sup>	1.05x10 <sup>2</sup>
	Formaldehyde	2.47x10 <sup>2</sup>	3.51x10 <sup>2</sup>	4.20x10 <sup>2</sup>	5.13x10 <sup>2</sup>	7.79x10 <sup>2</sup>
	Naphthalene	5.72x10 <sup>0</sup>	7.79x10 <sup>0</sup>	9.16x10 <sup>0</sup>	1.10x10 <sup>1</sup>	1.63x10 <sup>1</sup>
	All HAPs	4.66x10 <sup>2</sup>	6.59x10 <sup>2</sup>	7.87x10 <sup>2</sup>	9.58x10 <sup>2</sup>	1.45x10 <sup>3</sup>
Total CMV	1,3-Butadiene	5.69x10 <sup>0</sup>	5.99x10 <sup>0</sup>	6.03x10 <sup>0</sup>	6.18x10 <sup>0</sup>	6.77x10 <sup>0</sup>
	Acetaldehyde	2.36x10 <sup>3</sup>	2.64x10 <sup>3</sup>	2.77x10 <sup>3</sup>	2.97x10 <sup>3</sup>	3.62x10 <sup>3</sup>
	Acrolein	9.82x10 <sup>1</sup>	1.12x10 <sup>2</sup>	1.18x10 <sup>2</sup>	1.29x10 <sup>2</sup>	1.61x10 <sup>2</sup>
	Benzene	6.44x10 <sup>2</sup>	7.19x10 <sup>2</sup>	7.53x10 <sup>2</sup>	8.09x10 <sup>2</sup>	9.82x10 <sup>2</sup>
	Formaldehyde	4.72x10 <sup>3</sup>	5.25x10 <sup>3</sup>	5.50x10 <sup>3</sup>	5.90x10 <sup>3</sup>	7.15x10 <sup>3</sup>
	Naphthalene	6.52x10 <sup>1</sup>	6.83x10 <sup>1</sup>	7.18x10 <sup>1</sup>	7.86x10 <sup>1</sup>	1.02x10 <sup>2</sup>
	All HAPs	8.74x10 <sup>3</sup>	9.74x10 <sup>3</sup>	1.02x10 <sup>4</sup>	1.10x10 <sup>4</sup>	1.34x10 <sup>4</sup>

### 3.2 Aircraft and Aviation gasoline

Aircraft emissions were projected by using growth factors based on activity growth. These growth factors were also used to project aviation gasoline source categories that were inventoried in the NEI as stationary sources. Note that the projection of airport support equipment source categories did not use this approach; they were projected using the National Mobile Inventory Model (NMIM) as described in Section 3.3.3.

Aircraft growth factors were developed using data on itinerant (landing and take-off) operations from the Terminal Area Forecast System (TAF) (FAA, 2004), <http://www.apo.data.faa.gov/>. These data were accessed from the website in February 2004.

The TAF model provides itinerant activity for commercial aircraft, general aviation, air taxis, and military aircraft. The four categories map directly to inventory categories for aircraft emissions. We used the growth factors for general aviation for aviation gasoline emissions since most aircraft gasoline is used with general aviation aircraft. Although the TAF model provides activity at individual airports, the TAF data were summed to create growth factors at the national level. This was done to smooth out the large-scale year-to-year changes in individual airport itinerant data that were questionable. The same approach was used in the modeling for the Clean Air Interstate (CAIR) rule (EPA, 2005a). Table 12 provides the nationally aggregated TAF itinerant data for 1999, 2010, 2015 and 2020. Note that the “all operations” data is simply the sum of commercial aircraft, air taxi, general aviation, and military operations.

**Table 12.** TAF landing and take-off data for 1999, 2010, 2015, and 2020.

Year	Commercial	Air Taxi	General Aviation	Military	All Operations
1999	14,769,055	14,177,496	44,413,777	3,977,646	77,337,974
2010	15,199,253	17,566,653	45,516,733	4,157,730	82,440,369
2015	16,844,216	18,943,304	47,366,817	4,159,893	87,314,230
2020	18,584,876	20,347,985	49,223,017	4,162,058	92,317,936

Growth factors were computed for 2010, 2015 and 2020 by dividing each year’s TAF data by the TAF data for 1999. The TAF data did not cover 2030; growth factor for 2030 was calculated by using the same rate of growth between 2015 and 2020 and extrapolating to 2030 using Equation 1:

$$GF_{2030} = GF_{2020} + ((2030 - 2020) \times (GF_{2020} - GF_{2015}) \div (2020 - 2015)) \quad (1)$$

where GF is the growth factor for the respective years.

The growth factor assignments and growth factors for each of the airport related SCC codes are shown in Table 13.

**Table 13.** Airport related SCC codes, assigned growth factor basis, and growth factors for MSAT study years.

SCC	Description	Aviation type (Growth factor basis)	Growth Factor			
			2010	2015	2020	2030
2265008000	Airport Support Equipment, Total, Off-highway 4-stroke	No factor. Projected emissions in NMIM (see 3.3.3)	No factor	No factor	No factor	No factor
2265008005	Airport Support Equipment, Off-highway 4-stroke	No factor. Projected emissions in NMIM (see 3.3.3)	No factor	No factor	No factor	No factor
2267008000	Airport Ground Support Equipment, All, LPG	No factor. Projected emissions in NMIM (see 3.3.3)	No factor	No factor	No factor	No factor
2267008005	Airport Ground Support Equipment, LPG	No factor. Projected emissions in NMIM (see 3.3.3)	No factor	No factor	No factor	No factor
2268008000	Airport Ground Support Equipment, CNG, All	No factor. Projected emissions in NMIM (see 3.3.3)	No factor	No factor	No factor	No factor
2270008000	Airport Service Equipment, Total, Off-highway Diesel	No factor. Projected emissions in NMIM (see 3.3.3)	No factor	No factor	No factor	No factor
2270008005	Airport Service Equipment, Airport Support Equipment, Off-highway Diesel	No factor. Projected emissions in NMIM (see 3.3.3)	No factor	No factor	No factor	No factor
2275000000	All Aircraft Types and Operations	All operations	1.0660	1.1290	1.1937	1.3231
2275060000	Air Taxi, Total	Air Taxi	1.2391	1.3362	1.4352	1.6334
2275020000	Commercial Aircraft, Total	Commercial Aviation	1.0291	1.1405	1.2584	1.4941
2275070000	Aircraft Auxiliary Power Units, Total	Commercial Aviation	1.0291	1.1405	1.2584	1.4941
2275050000	General Aircraft, Total	General Aviation	1.0248	1.0665	1.1083	1.1919
2275900000	Aircraft Refueling: All Fuels, All Processes	General Aviation	1.0248	1.0665	1.1083	1.1919
2501080000 <sup>#</sup>	Aviation Gasoline Distribution: Stage 1 & II	General Aviation	1.0248	1.0665	1.1083	1.1919
2501080050 <sup>#</sup>	Aviation Gasoline Storage -Stage I	General Aviation	1.0248	1.0665	1.1083	1.1919
2501080100 <sup>#</sup>	Aviation Gasoline Storage -Stage II	General Aviation	1.0248	1.0665	1.1083	1.1919
2275001000	Military Aircraft, Total	Military Aviation	1.0453	1.0458	1.0464	1.0475

<sup>#</sup> Stationary sources in the non-point inventory. All others are nonroad sources.

Growth factor files were created for each year, 2010, 2015, 2020, and 2030, using the SCC growth factor file format for EMS-HAP Version 3.0 described in Appendix B of the EMS-HAP Version 3.0 User's Guide (U.S. EPA, 2004b). For this format, each SCC was assigned a code describing its growth method, basically the "growth factor basis" column in Table 14. The format of the file is shown in Figure 3. The naming convention of the aircraft and aviation gasoline growth factor files is gf99scca\_XX.txt where XX is the two-digit year for 2010, 2015, 2020, and 2030.

```

1999 Base Year EGAS SCC Growth Factors for 2010, Created 12APRIL04 BEGIN SCC-REMI XREF on line 3.
GROWTH FACTORS BEGIN ON LINE 18.
2265008000 N/A projected emissions will be supplied with NMIM
2265008005 N/A projected emissions will be supplied with NMIM
2267008000 N/A projected emissions will be supplied with NMIM
2267008005 N/A projected emissions will be supplied with NMIM
2268008000 N/A projected emissions will be supplied with NMIM
2270008000 N/A projected emissions will be supplied with NMIM
2270008005 N/A projected emissions will be supplied with NMIM
2275000000 TAF for ALL OPERATIONS (p_tot)
2275060000 TAF for Air Taxi
2275020000 TAF for Commercial Aviation
2275070000 TAF for Commercial Aviation
2275050000 TAF for General Aviation
2275900000 TAF for General Aviation
2501080000 TAF for General Aviation
2501080050 TAF for General Aviation
2501080100 TAF for General Aviation
2275001000 TAF for Military Aviation
00 000 1.0000 N/A projected emissions will be supplied with NMIM
00 000 1.0660 TAF for ALL OPERATIONS (p_tot)
00 000 1.2391 TAF for Air Taxi
00 000 1.0291 TAF for Commercial Aviation
00 000 1.0248 TAF for General Aviation
00 000 1.0453 TAF for Military Aviation

```

**Figure 3.** Format of the aircraft growth factor file. 2010 growth factors shown as example.

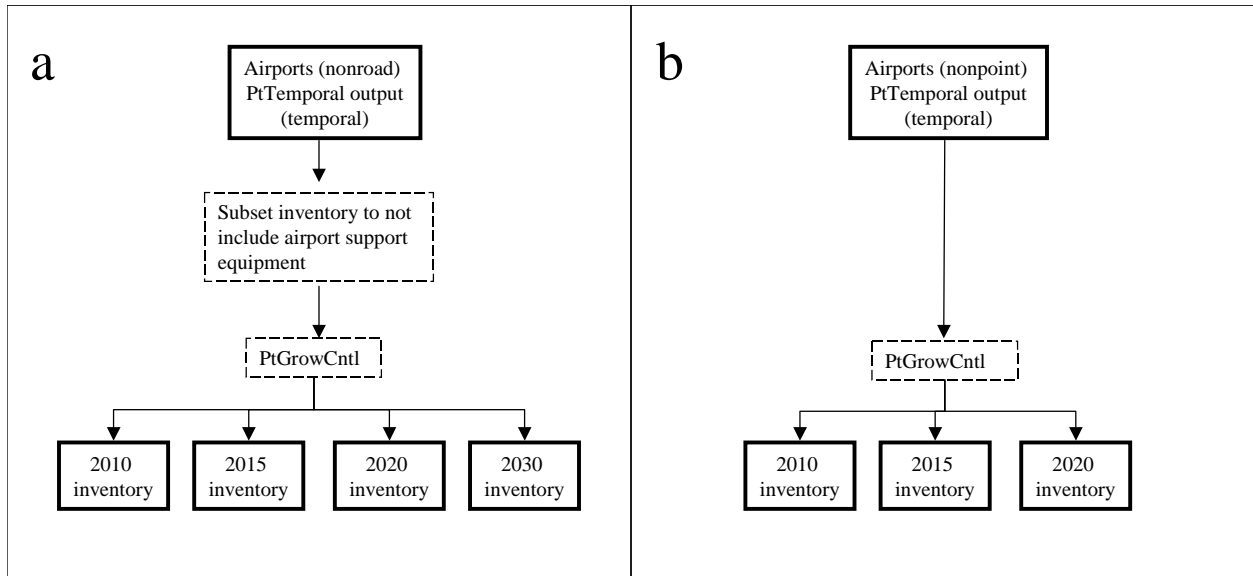
EMS-HAP V3 was used to apply the growth factors to the aircraft and aviation gasoline sources.

Aircraft emissions were projected by first reducing the nonroad airport-related emissions to exclude the airport support equipment emissions, which were projected using NMIM future emissions data as described in Section 3.3.3. The reduction of the data was done on the temporally allocated 1999 NEI emissions for NATA (National Air Toxics Assessment). These emissions had previously been processed through the appropriate EMS-HAP programs, COPAX, PtDataProc, PtModelProc, and PtTemporal for the 1999 NATA [see EMS-HAP User's Guide for details, (U.S. EPA, 2004b)]. After reduction was completed, the emissions were processed through the EMS-HAP program PtGrowCntl for 2010, 2015, 2020, and 2030, using the TAF-derived growth factors described above.

Aviation gasoline emissions (SCCs shown in Table 13 with # footnotes) that had been processed through the appropriate EMS-HAP programs for the 1999 NATA, were projected using the

EMS-HAP program PtGrowCntl for 2010, 2015 and 2020, using the TAF-derived growth factors described above. Aviation gasoline emissions were not projected to 2030 but it was decided to use 2020 projected emissions for 2030 for all stationary sources because of uncertainty in the 2030 projection and growth factors. Aviation gasoline emissions were also adjusted after projection for 2015 and 2020, as well as for 1999 as part of an adjustment of gasoline distribution emissions. This adjustment process is discussed in Section 4.3.

A flowchart of the projection processing is shown in Figure 4.



**Figure 4.** Flowchart of a) aircraft and b) aviation gasoline distribution emissions projections.

Projected aircraft and aviation gasoline distribution emissions by SCC are shown in Table 14.

**Table 14.** Aircraft and aviation gasoline distribution emissions for selected HAPs and all HAPs by SCC. Aviation gasoline distribution emissions for 2030 are set equal to 2020.

SCC	HAP	Emissions (tons/yr)				
		1999	2010	2015	2020	2030
2275000000	1,3-Butadiene	5.59x10 <sup>0</sup>	5.96x10 <sup>0</sup>	6.31x10 <sup>0</sup>	6.68x10 <sup>0</sup>	7.40x10 <sup>0</sup>
	Acetaldehyde	1.21x10 <sup>1</sup>	1.29x10 <sup>1</sup>	1.37x10 <sup>1</sup>	1.45x10 <sup>1</sup>	1.60x10 <sup>1</sup>
	Acrolein	5.53x10 <sup>0</sup>	5.90x10 <sup>0</sup>	6.24x10 <sup>0</sup>	6.60x10 <sup>0</sup>	7.32x10 <sup>0</sup>
	Benzene	9.76x10 <sup>0</sup>	1.04x10 <sup>1</sup>	1.10x10 <sup>1</sup>	1.16x10 <sup>1</sup>	1.29x10 <sup>1</sup>
	Formaldehyde	3.99x10 <sup>1</sup>	4.25x10 <sup>1</sup>	4.51x10 <sup>1</sup>	4.76x10 <sup>1</sup>	5.28x10 <sup>1</sup>
	Naphthalene	1.32x10 <sup>0</sup>	1.41x10 <sup>0</sup>	1.49x10 <sup>0</sup>	1.58x10 <sup>0</sup>	1.75x10 <sup>0</sup>
	All HAPs	1.04x10 <sup>2</sup>	1.11x10 <sup>2</sup>	1.17x10 <sup>2</sup>	1.24x10 <sup>2</sup>	1.37x10 <sup>2</sup>
2275001000	1,3-Butadiene	1.93x10 <sup>2</sup>	2.02x10 <sup>2</sup>	2.02x10 <sup>2</sup>	2.02x10 <sup>2</sup>	2.02x10 <sup>2</sup>
	Acetaldehyde	5.06x10 <sup>2</sup>	5.29x10 <sup>2</sup>	5.29x10 <sup>2</sup>	5.30x10 <sup>2</sup>	5.30x10 <sup>2</sup>
	Acrolein	2.47x10 <sup>2</sup>	2.58x10 <sup>2</sup>	2.58x10 <sup>2</sup>	2.58x10 <sup>2</sup>	2.58x10 <sup>2</sup>
	Benzene	2.13x10 <sup>2</sup>	2.23x10 <sup>2</sup>	2.23x10 <sup>2</sup>	2.23x10 <sup>2</sup>	2.23x10 <sup>2</sup>
	Formaldehyde	1.63x10 <sup>3</sup>	1.71x10 <sup>3</sup>	1.71x10 <sup>3</sup>	1.71x10 <sup>3</sup>	1.71x10 <sup>3</sup>
	Naphthalene	6.15x10 <sup>1</sup>	6.43x10 <sup>1</sup>	6.43x10 <sup>1</sup>	6.44x10 <sup>1</sup>	6.44x10 <sup>1</sup>
	All HAPs	3.13x10 <sup>3</sup>	3.27x10 <sup>3</sup>	3.27x10 <sup>3</sup>	3.27x10 <sup>3</sup>	3.27x10 <sup>3</sup>
2275020000	1,3-Butadiene	5.25x10 <sup>2</sup>	5.40x10 <sup>2</sup>	5.99x10 <sup>2</sup>	6.61x10 <sup>2</sup>	7.84x10 <sup>2</sup>
	Acetaldehyde	1.36x10 <sup>3</sup>	1.40x10 <sup>3</sup>	1.55x10 <sup>3</sup>	1.71x10 <sup>3</sup>	2.03x10 <sup>3</sup>
	Acrolein	6.62x10 <sup>2</sup>	6.81x10 <sup>2</sup>	7.54x10 <sup>2</sup>	8.32x10 <sup>2</sup>	9.88x10 <sup>2</sup>
	Benzene	5.74x10 <sup>2</sup>	5.91x10 <sup>2</sup>	6.55x10 <sup>2</sup>	7.22x10 <sup>2</sup>	8.58x10 <sup>2</sup>
	Formaldehyde	4.38x10 <sup>3</sup>	4.51x10 <sup>3</sup>	5.00x10 <sup>3</sup>	5.52x10 <sup>3</sup>	6.55x10 <sup>3</sup>
	Naphthalene	1.64x10 <sup>2</sup>	1.69x10 <sup>2</sup>	1.87x10 <sup>2</sup>	2.06x10 <sup>2</sup>	2.45x10 <sup>2</sup>
	All HAPs	8.44x10 <sup>3</sup>	8.68x10 <sup>3</sup>	9.62x10 <sup>3</sup>	1.06x10 <sup>4</sup>	1.26x10 <sup>4</sup>
2275050000	1,3-Butadiene	5.98x10 <sup>1</sup>	6.12x10 <sup>1</sup>	6.37x10 <sup>1</sup>	6.62x10 <sup>1</sup>	7.12x10 <sup>1</sup>
	Acetaldehyde	8.53x10 <sup>1</sup>	8.74x10 <sup>1</sup>	9.10x10 <sup>1</sup>	9.46x10 <sup>1</sup>	1.02x10 <sup>2</sup>
	Acrolein	3.29x10 <sup>1</sup>	3.37x10 <sup>1</sup>	3.51x10 <sup>1</sup>	3.64x10 <sup>1</sup>	3.92x10 <sup>1</sup>
	Benzene	1.86x10 <sup>2</sup>	1.91x10 <sup>2</sup>	1.99x10 <sup>2</sup>	2.06x10 <sup>2</sup>	2.22x10 <sup>2</sup>
	Formaldehyde	2.85x10 <sup>2</sup>	2.93x10 <sup>2</sup>	3.04x10 <sup>2</sup>	3.16x10 <sup>2</sup>	3.40x10 <sup>2</sup>
	Naphthalene	1.09x10 <sup>2</sup>	1.11x10 <sup>2</sup>	1.16x10 <sup>2</sup>	1.20x10 <sup>2</sup>	1.29x10 <sup>2</sup>
	All HAPs	1.53x10 <sup>3</sup>	1.57x10 <sup>3</sup>	1.63x10 <sup>3</sup>	1.70x10 <sup>3</sup>	1.83x10 <sup>3</sup>
2275060000	1,3-Butadiene	3.99x10 <sup>1</sup>	4.95x10 <sup>1</sup>	5.34x10 <sup>1</sup>	5.73x10 <sup>1</sup>	6.52x10 <sup>1</sup>
	Acetaldehyde	5.79x10 <sup>1</sup>	7.17x10 <sup>1</sup>	7.73x10 <sup>1</sup>	8.30x10 <sup>1</sup>	9.45x10 <sup>1</sup>
	Acrolein	2.17x10 <sup>1</sup>	2.69x10 <sup>1</sup>	2.90x10 <sup>1</sup>	3.11x10 <sup>1</sup>	3.54x10 <sup>1</sup>
	Benzene	1.19x10 <sup>2</sup>	1.47x10 <sup>2</sup>	1.59x10 <sup>2</sup>	1.71x10 <sup>2</sup>	1.94x10 <sup>2</sup>
	Formaldehyde	2.06x10 <sup>2</sup>	2.55x10 <sup>2</sup>	2.75x10 <sup>2</sup>	2.96x10 <sup>2</sup>	3.36x10 <sup>2</sup>
	Benzene	1.21x10 <sup>2</sup>	1.50x10 <sup>2</sup>	1.62x10 <sup>2</sup>	1.74x10 <sup>2</sup>	1.98x10 <sup>2</sup>
	All HAPs	1.08x10 <sup>3</sup>	1.33x10 <sup>3</sup>	1.44x10 <sup>3</sup>	1.55x10 <sup>3</sup>	1.76x10 <sup>3</sup>
2501080000 <sup>#</sup>	Benzene	4.15x10 <sup>-2</sup>	4.25x10 <sup>-2</sup>	4.43x10 <sup>-2</sup>	4.60x10 <sup>-2</sup>	4.60x10 <sup>-2</sup>
	Naphthalene	7.98x10 <sup>-3</sup>	8.18x10 <sup>-3</sup>	8.51x10 <sup>-3</sup>	8.84x10 <sup>-3</sup>	8.84x10 <sup>-3</sup>
	All HAPs	1.13x10 <sup>0</sup>	1.15x10 <sup>0</sup>	1.20x10 <sup>0</sup>	1.25x10 <sup>0</sup>	1.25x10 <sup>0</sup>
2501080050 <sup>#</sup>	Benzene	2.87x10 <sup>2</sup>	2.94x10 <sup>2</sup>	3.06x10 <sup>2</sup>	3.18x10 <sup>2</sup>	3.18x10 <sup>2</sup>
	Naphthalene	1.59x10 <sup>1</sup>	1.63x10 <sup>1</sup>	1.70x10 <sup>1</sup>	1.77x10 <sup>1</sup>	1.77x10 <sup>1</sup>
	All HAPs	1.67x10 <sup>3</sup>	1.71x10 <sup>3</sup>	1.78x10 <sup>3</sup>	1.85x10 <sup>3</sup>	1.85x10 <sup>3</sup>
2501080100 <sup>#</sup>	Benzene	1.99x10 <sup>1</sup>	2.04x10 <sup>1</sup>	2.12x10 <sup>1</sup>	2.20x10 <sup>1</sup>	2.20x10 <sup>1</sup>
	Naphthalene	1.10x10 <sup>0</sup>	1.13x10 <sup>0</sup>	1.18x10 <sup>0</sup>	1.22x10 <sup>0</sup>	1.22x10 <sup>0</sup>
	All HAPs	1.16x10 <sup>2</sup>	1.19x10 <sup>2</sup>	1.24x10 <sup>2</sup>	1.29x10 <sup>2</sup>	1.29x10 <sup>2</sup>
Total	1,3-Butadiene	8.24x10 <sup>2</sup>	8.59x10 <sup>2</sup>	9.24x10 <sup>2</sup>	9.93x10 <sup>2</sup>	1.13x10 <sup>3</sup>
	Acetaldehyde	2.02x10 <sup>3</sup>	2.10x10 <sup>3</sup>	2.26x10 <sup>3</sup>	2.43x10 <sup>3</sup>	2.77x10 <sup>3</sup>
	Acrolein	9.68x10 <sup>2</sup>	1.01x10 <sup>3</sup>	1.08x10 <sup>3</sup>	1.16x10 <sup>3</sup>	1.33x10 <sup>3</sup>
	Benzene	1.41x10 <sup>3</sup>	1.48x10 <sup>3</sup>	1.57x10 <sup>3</sup>	1.67x10 <sup>3</sup>	1.85x10 <sup>3</sup>
	Formaldehyde	6.55x10 <sup>3</sup>	6.81x10 <sup>3</sup>	7.33x10 <sup>3</sup>	7.89x10 <sup>3</sup>	8.99x10 <sup>3</sup>
	Naphthalene	4.73x10 <sup>2</sup>	5.13x10 <sup>2</sup>	5.48x10 <sup>2</sup>	5.85x10 <sup>2</sup>	6.57x10 <sup>2</sup>
	All HAPs	1.61x10 <sup>4</sup>	1.68x10 <sup>4</sup>	1.80x10 <sup>4</sup>	1.92x10 <sup>4</sup>	2.16x10 <sup>4</sup>

<sup>#</sup>emissions reflect pre-adjustment levels



### 3.3 Projection of onroad and nonroad categories using NMIM

#### 3.3.1 Description of NMIM

For all mobile source categories except commercial marine vessels, locomotives, and aircraft (Sections 3.1 and 3.2), EPA's Office of Transportation and Air Quality's (OTAQ) new emissions inventory modeling system for highway and nonroad sources, the National Mobile Inventory Model (NMIM2005) (U. S. EPA, 2005b; Cook et al. 2004) was used to generate emission data for projections. NMIM2005 develops county level inventories using MOBILE6.2, NONROAD2005, and model inputs stored in data files. NONROAD2005 includes a number of improvements over NONROAD 2004, which was used in the proposed rule. These improvements include new evaporative categories for tank permeation, hose permeation, hot soak, and running loss emissions, a revised methodology for calculating diurnal emissions, and improvements to allocation of emissions from recreational marine and construction equipment. NMIM2005 was also modified to include the hydrocarbon start emission adjustment factors discussed in Section 2.1.1.1 of the Regulatory Impact Analysis for the final Mobile Source Air Toxics Rule. Since the algorithms used to calculate toxic to hydrocarbon emission ratios in MOBILE6.2 do not vary with temperature, reductions in hydrocarbon emissions result in proportional reductions in air toxic emissions. In addition to criteria pollutants, NMIM can currently produce 13 gaseous hydrocarbons, 16 polycyclic aromatic hydrocarbons, 4 metal compounds and 17 dioxin and furan congeners, for any calendar year 1999 through 2050.

Future year MOBILE6.2 and NONROAD inputs include future year vehicle miles traveled (VMT) and fuel parameters, and future year equipment populations. Future year VMT for years 2010, 2020 and 2030 were developed at the county-level using data from the Energy Information Administration's National Energy Modeling System (NEMS) Transportation Model and Regional Economic Models Inc. population growth (Mullen and Neumann, 2004). VMT for intermediate years were interpolated, using 1999 as the base year. This same approach and projected VMT were used for the CAIR rule. Projection year fuel parameters were developed using results of several refinery modeling analyses conducted to assess impacts of fuel control programs on fuel properties (MathPro, 1998; 1999a, 1999b). The projection year fuel parameters were calculated by applying adjustment factors to the base year parameters (Eastern Research Group, 2003). In addition, NMIM uses monthly rather than seasonal fuel parameters, and parameters for spring and fall months were estimated by interpolating from summer and winter data. Documentation of the fuel parameters used in NMIM was compiled in 2003 (Eastern Research Group, 2003) and then subsequently, a number of changes were made, based on comments from States. These changes are documented in the change log for NMIM, dated May 14, 2004. This change log is included in the docket for this rule (EPA-HQ-OAR-2005-0036), along with the original documentation. In general, multiplicative adjustment factors were used to calculate future year gasoline parameters (i.e., future year parameter = base year parameter x adjustment factor). However, additive adjustment factors were used to calculate future year parameters for E200, E300, and oxygenate market shares (i.e., future year parameter = base year parameter + adjustment factor). The database used for this assessment assumes no Federal ban on MTBE, but does include State bans. Also, it did not include the renewable fuels mandate in the recent Energy Policy Act.

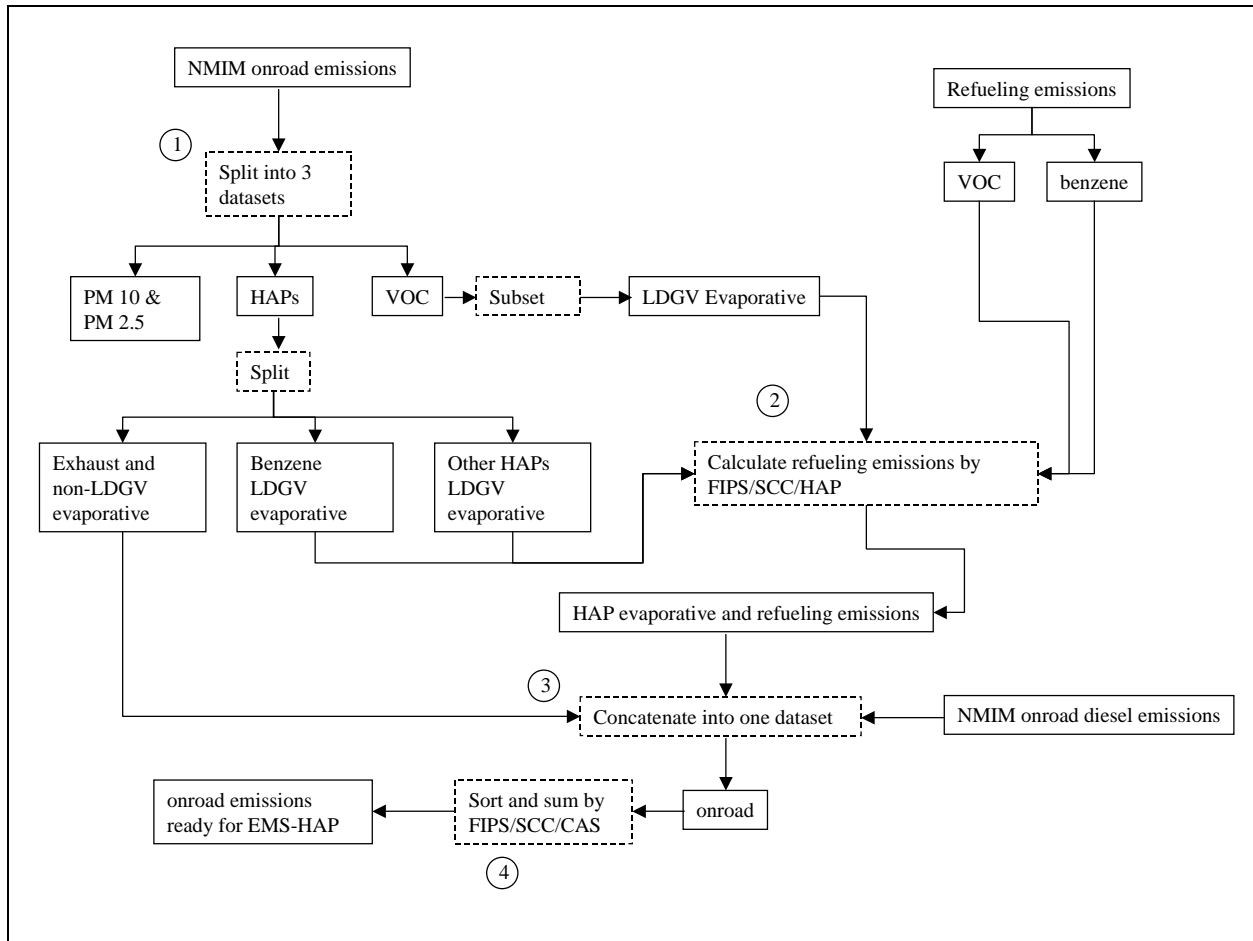
### ***3.3.2 Onroad projections using NMIM***

Before the creation of ASPEN ready emissions files, the NMIM emissions had to be formatted for input into EMS-HAP. The NMIM emissions were initially in SQL databases. SQL was used to create tab delimited ASCII text files that could be easily read into SAS<sup>®</sup>. The creation of SAS<sup>®</sup> datasets were created for each year: 1999, 2010, 2015, 2020, and 2030. These datasets were also ready for input into EMS-HAP. However, 2010 would not be processed through EMS-HAP since it was not an air quality modeling year.

For 1999 and 2010, there was only one inventory to process, the base year emissions. For the other years, 2015, 2020, and 2030, there were four inventories to process: 1) base case, 2) fuels control case, 3) vehicle controls, and 4) cumulative controls from fuels and vehicle controls. For the purposes of air quality and exposure modeling, only the base and cumulative controls emissions would be processed through EMS-HAP to create ASPEN ready emissions. Emissions processing comprised of the following steps.

- Imported the NMIM emissions into SAS<sup>®</sup>. The NMIM emissions were for gasoline vehicles and were broken out by exhaust and evaporative type for each FIPS, SCC, and pollutant
- Added refueling emissions for light duty gasoline vehicles (LDGV). This step is described in detail below
- Appended diesel vehicle emissions from the NMIM emissions from the proposed MSAT rule
- Summed across the emissions types, exhaust, evaporative, and refueling, to get emissions for each FIPS, SCC, and CAS combination

A general flow of the processing is shown in Figure 5.



**Figure 5.** General steps in processing of onroad NMIM emissions for EMS-HAP input.

### 3.3.2.1 Calculation of refueling emissions for light-duty gasoline vehicles

Refueling emissions were calculated for each of the inventories, 1999 base, future year reference, future year fuels controls, future year vehicle controls, and future year cumulative controls. For each of the vehicle control inventories, the refueling emissions were the same as the reference case since they were affected by only fuel controls. For 1999 base and the future year reference inventories, reference (no controls) refueling emissions were used. For the fuel and cumulative control inventories, controlled refueling emissions were used. For benzene, county specific benzene refueling emissions were used for 2015, 2020, and 2030. For 1999 and 2010, benzene refueling emissions were not available. Therefore, 2015 benzene refueling emissions were backcast to 1999 and 2010 by multiplying the county specific 2015 benzene refueling emissions by the ratio of the 1999 or 2010 county specific VOC refueling emissions to the county specific 2015 VOC refueling emissions. This calculation is shown in Equation 2.

$$Benzene_{XXXX,FIPSYYYYY} = Benzene_{2015,FIPSYYYYY} \times \left( \frac{VOC_{XXXX,FIPSYYYYY}}{VOC_{2015,FIPSYYYYY}} \right) \quad (2)$$

where XXXX is 1999 or 2010, and YYYY represents the FIPS code of a county. Equation 2 represents reference refueling emissions. Benzene processing steps for 1999 and 2010 are shown in Figure 6a.

For each year and control scenario, the county level reference or control benzene refueling emissions were merged with the LDGV non-refueling emissions. To add the appropriate tonnage of the county level benzene refueling emissions, a ratio of each LDGV SCC code's evaporative emissions to the county total LDGV evaporative emissions was calculated and then multiplied with the benzene refueling emissions,

$$Benzene_{refuel, XXXX, YYYY, 2201001ZZZ} = Benzene_{refuel, XXXX, YYYY} \times \left( \frac{Benzene_{evap, XXXX, YYYY, 2201001ZZZ}}{Benzene_{evap, XXXX, YYYY, LDGV}} \right) \quad (3)$$

where XXXX is the year, YYYY is the FIPS code, 2201001ZZZ is an LDGV SCC, and LDGV represents total LDGV emissions for the county for benzene.

For all other HAPs, VOC refueling emissions were scaled using the ratio of the HAP specific LDGV evaporative emissions to the VOC LDGV evaporative emissions for each SCC. The following steps were employed to calculate the HAP specific refueling emissions for LDGV SCC emissions:

1. Calculated the ratio of VOC evaporative emissions for a particular LDGV SCC code to the total county VOC LDGV evaporative emissions.

$$Ratio_{refuel, XXXX, YYYY, 2201001ZZZ} = \left( \frac{VOC_{evap, XXXX, YYYY, 2201001ZZZ}}{VOC_{evap, XXXX, YYYY, LDGV}} \right) \quad (4)$$

2. Multiplied the ratio calculated in step 1 by the county VOC refueling emissions to yield SCC specific VOC refueling emissions.

$$VOC_{refuel, XXXX, YYYY, 2201001ZZZ} = VOC_{refuel, XXXX, YYYY} \times Ratio_{refuel, XXXX, YYYY, SCC2201001ZZZ} \quad (5)$$

3. Multiplied the SCC specific VOC refueling emissions by the ratio of HAP evaporative emissions to VOC evaporative emissions for the SCC code.

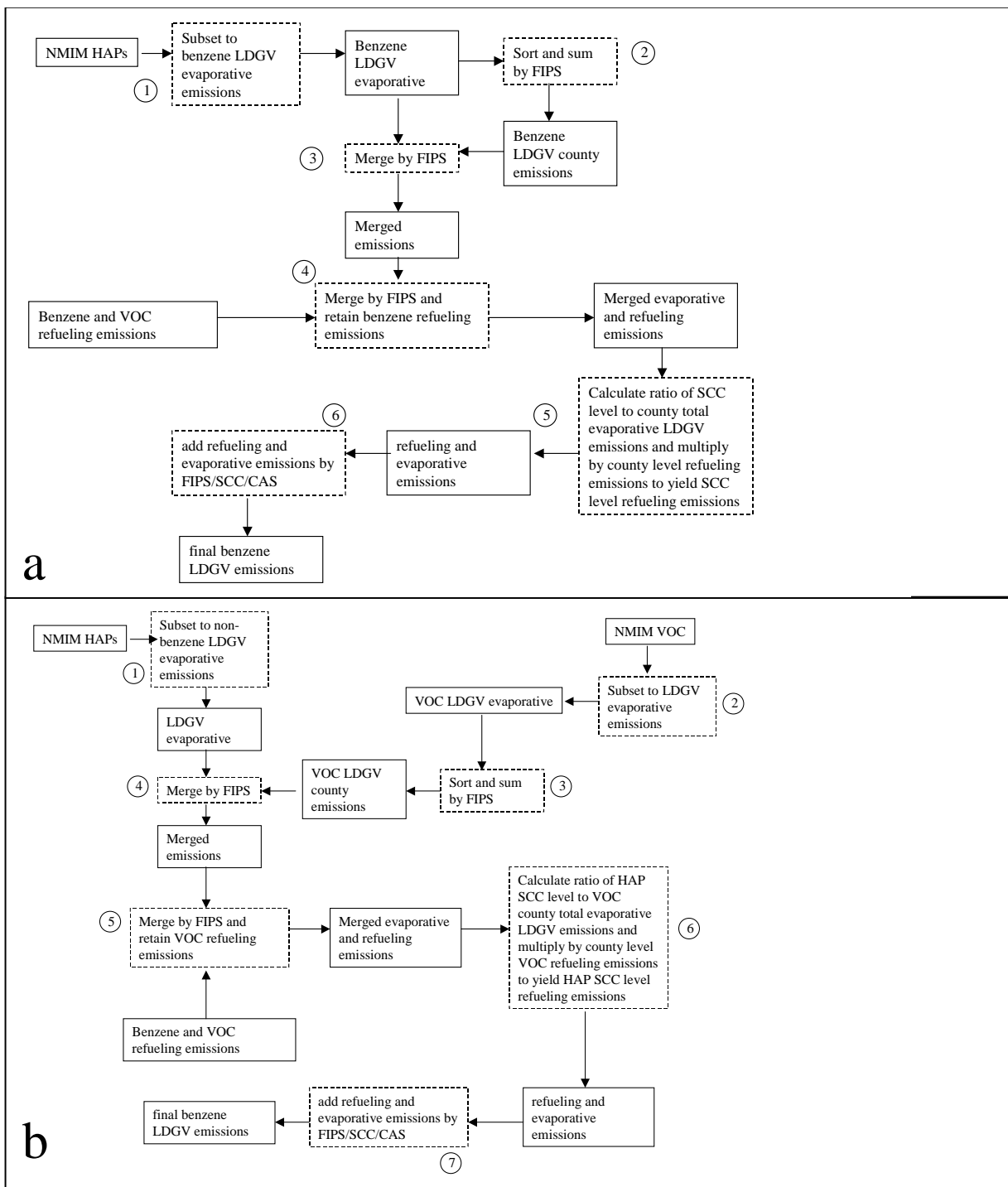
$$HAP_{refuel, XXXX, YYYY, 2201001ZZZ} = VOC_{refuel, XXXX, YYYY, 2201001ZZZ} \times \left( \frac{HAP_{evap, XXXX, YYYY, 2201001ZZZ}}{VOC_{evap, XXXX, YYYY, 2201001ZZZ}} \right) \quad (6)$$

where XXXX is the year, YYYY is the FIPS code, 2201001ZZZ is an LDGV SCC, and LDGV represents total LDGV emissions for the county for VOC. However, if the right hand side of Equation 4 is substituted into Equation 5 for the ratio, and the right hand side of Equation 5 is substituted for the VOC refueling emissions, the final calculation becomes

$$HAP_{refuel,XXXX,YYYY,2201001ZZZ} = VOC_{refuel,XXXX,YYYY} \times \left( \frac{HAP_{evap,XXXX,YYYY,2201001ZZZ}}{VOC_{evap,XXXX,YYYY,LDGV}} \right) \quad (7)$$

Other HAP refueling calculations are shown in Figure 6b.

Once refueling emissions were calculated for all HAPs with LDGV evaporative emissions, the refueling emissions were added to the exhaust and evaporative emissions by FIPS, SCC and CAS. This resulted in a total emissions for each FIPS, SCC, and CAS combination. The emissions were then ready for EMS-HAP processing. Summaries of the refueling emissions are shown in Table 15 and summaries of onroad emissions are shown in Tables 16 through 19. Diesel emissions are shown only in the base inventories as they do not change with controls but they are included in the total onroad emissions for the control emissions. In the tables, LDGV emissions include the refueling emissions. Full emission summaries can be found in onroad\_0906.xls and onroad\_pivot\_0905.xls in the MSAT rule docket, EPA-HQ-OAR-2005-0036.



**Figure 6.** Refueling calculations for a) benzene 1999 and 2010, and b) other HAPs.

**Table 15.** Calculated refueling emissions by HAP for base and controlled strategies.

HAP	Year								
	1999	2010		2015		2020		2030	
	Base	Base	Control	Base	Control	Base	Control	Base	Control
2,2,4-Trimethylpentane	4.88x10 <sup>3</sup>	2.18x10 <sup>3</sup>	2.18x10 <sup>3</sup>	1.53x10 <sup>3</sup>	1.53x10 <sup>3</sup>	1.38x10 <sup>3</sup>	1.38x10 <sup>3</sup>	1.39x10 <sup>3</sup>	1.39x10 <sup>3</sup>
Benzene	2.32x10 <sup>3</sup>	1.02x10 <sup>3</sup>	6.05x10 <sup>2</sup>	7.01x10 <sup>2</sup>	4.22x10 <sup>2</sup>	6.22x10 <sup>2</sup>	3.76x10 <sup>2</sup>	6.18x10 <sup>2</sup>	3.77x10 <sup>2</sup>
Ethyl Benzene	2.21x10 <sup>3</sup>	9.60x10 <sup>2</sup>	9.60x10 <sup>2</sup>	6.67x10 <sup>2</sup>	6.67x10 <sup>2</sup>	5.94x10 <sup>2</sup>	5.94x10 <sup>2</sup>	5.93x10 <sup>2</sup>	5.93x10 <sup>2</sup>
Hexane	6.30x10 <sup>3</sup>	2.71x10 <sup>3</sup>	2.71x10 <sup>3</sup>	1.86x10 <sup>3</sup>	1.86x10 <sup>3</sup>	1.64x10 <sup>3</sup>	1.64x10 <sup>3</sup>	1.62x10 <sup>3</sup>	1.62x10 <sup>3</sup>
MTBE	3.53x10 <sup>3</sup>	2.16x10 <sup>3</sup>	2.16x10 <sup>3</sup>	1.55x10 <sup>3</sup>	1.55x10 <sup>3</sup>	1.34x10 <sup>3</sup>	1.34x10 <sup>3</sup>	1.34x10 <sup>3</sup>	1.34x10 <sup>3</sup>
Naphthalene	1.24x10 <sup>2</sup>	5.52x10 <sup>1</sup>	5.52x10 <sup>1</sup>	3.89x10 <sup>1</sup>	3.89x10 <sup>1</sup>	3.49x10 <sup>1</sup>	3.49x10 <sup>1</sup>	3.52x10 <sup>1</sup>	3.52x10 <sup>1</sup>
Toluene	1.15x10 <sup>4</sup>	4.97x10 <sup>3</sup>	4.97x10 <sup>3</sup>	3.43x10 <sup>3</sup>	3.43x10 <sup>3</sup>	3.04x10 <sup>3</sup>	3.04x10 <sup>3</sup>	3.02x10 <sup>3</sup>	3.02x10 <sup>3</sup>
Xylenes	6.36x10 <sup>3</sup>	2.75x10 <sup>3</sup>	2.75x10 <sup>3</sup>	1.91x10 <sup>3</sup>	1.91x10 <sup>3</sup>	1.70x10 <sup>3</sup>	1.70x10 <sup>3</sup>	1.70x10 <sup>3</sup>	1.70x10 <sup>3</sup>

**Table 16.** Base inventory emissions by vehicle type and total onroad for selected HAPs and all HAPs.

Year	HAP	Vehicle Type								
		HDDV	HDGV	LDDT	LDDV	LDGT1	LDGT2	LDGV	MC	Total onroad
1999	1,3-Butadiene	1.49x10 <sup>3</sup>	1.18x10 <sup>3</sup>	8.99x10 <sup>1</sup>	5.05x10 <sup>1</sup>	5.31x10 <sup>3</sup>	3.53x10 <sup>3</sup>	1.20x10 <sup>4</sup>	2.02x10 <sup>2</sup>	2.39x10 <sup>4</sup>
	Acetaldehyde	7.03x10 <sup>3</sup>	1.41x10 <sup>3</sup>	1.23x10 <sup>2</sup>	6.90x10 <sup>1</sup>	6.05x10 <sup>3</sup>	3.43x10 <sup>3</sup>	1.16x10 <sup>4</sup>	1.52x10 <sup>2</sup>	2.98x10 <sup>4</sup>
	Acrolein	8.55x10 <sup>2</sup>	6.89x10 <sup>2</sup>	3.50x10 <sup>1</sup>	1.96x10 <sup>1</sup>	6.23x10 <sup>2</sup>	3.26x10 <sup>2</sup>	1.29x10 <sup>3</sup>	1.26x10 <sup>1</sup>	3.84x10 <sup>3</sup>
	Benzene	2.56x10 <sup>3</sup>	6.67x10 <sup>3</sup>	2.00x10 <sup>2</sup>	1.12x10 <sup>2</sup>	4.64x10 <sup>4</sup>	2.14x10 <sup>4</sup>	1.06x10 <sup>5</sup>	6.46x10 <sup>2</sup>	1.84x10 <sup>5</sup>
	Formaldehyde	1.91x10 <sup>4</sup>	6.14x10 <sup>3</sup>	3.86x10 <sup>2</sup>	2.17x10 <sup>2</sup>	1.57x10 <sup>4</sup>	9.92x10 <sup>3</sup>	2.85x10 <sup>4</sup>	5.16x10 <sup>2</sup>	8.05x10 <sup>4</sup>
	Naphthalene	1.67x10 <sup>2</sup>	7.73x10 <sup>2</sup>	7.00x10 <sup>0</sup>	6.92x10 <sup>0</sup>	7.60x10 <sup>2</sup>	4.89x10 <sup>2</sup>	1.83x10 <sup>3</sup>	2.34x10 <sup>1</sup>	4.06x10 <sup>3</sup>
	All HAPs	3.70x10 <sup>4</sup>	6.67x10 <sup>4</sup>	1.21x10 <sup>3</sup>	6.88x10 <sup>2</sup>	3.54x10 <sup>5</sup>	1.88x10 <sup>5</sup>	8.37x10 <sup>5</sup>	7.27x10 <sup>3</sup>	1.49x10 <sup>6</sup>
2010	1,3-Butadiene	9.15x10 <sup>2</sup>	1.97x10 <sup>2</sup>	4.37x10 <sup>1</sup>	3.03x10 <sup>0</sup>	3.82x10 <sup>3</sup>	1.99x10 <sup>3</sup>	4.28x10 <sup>3</sup>	2.24x10 <sup>2</sup>	1.15x10 <sup>4</sup>
	Acetaldehyde	4.32x10 <sup>3</sup>	3.90x10 <sup>2</sup>	5.98x10 <sup>1</sup>	4.15x10 <sup>0</sup>	4.81x10 <sup>3</sup>	2.37x10 <sup>3</sup>	5.04x10 <sup>3</sup>	1.80x10 <sup>2</sup>	1.72x10 <sup>4</sup>
	Acrolein	5.25x10 <sup>2</sup>	7.59x10 <sup>1</sup>	1.70x10 <sup>1</sup>	1.18x10 <sup>0</sup>	4.57x10 <sup>2</sup>	2.31x10 <sup>2</sup>	5.03x10 <sup>2</sup>	1.38x10 <sup>1</sup>	1.82x10 <sup>3</sup>
	Benzene	1.57x10 <sup>3</sup>	2.38x10 <sup>3</sup>	9.72x10 <sup>1</sup>	6.74x10 <sup>0</sup>	3.95x10 <sup>4</sup>	1.97x10 <sup>4</sup>	4.66x10 <sup>4</sup>	6.69x10 <sup>2</sup>	1.11x10 <sup>5</sup>
	Formaldehyde	1.17x10 <sup>4</sup>	1.21x10 <sup>3</sup>	1.88x10 <sup>2</sup>	1.30x10 <sup>1</sup>	9.70x10 <sup>3</sup>	4.85x10 <sup>3</sup>	1.06x10 <sup>4</sup>	5.67x10 <sup>2</sup>	3.89x10 <sup>4</sup>
	Naphthalene	6.46x10 <sup>1</sup>	4.00x10 <sup>2</sup>	2.17x10 <sup>0</sup>	3.47x10 <sup>-1</sup>	6.40x10 <sup>2</sup>	2.67x10 <sup>2</sup>	8.61x10 <sup>2</sup>	2.46x10 <sup>1</sup>	2.26x10 <sup>3</sup>
	All HAPs	2.26x10 <sup>4</sup>	2.13x10 <sup>4</sup>	5.89x10 <sup>2</sup>	4.13x10 <sup>1</sup>	2.80x10 <sup>5</sup>	1.44x10 <sup>5</sup>	3.49x10 <sup>5</sup>	7.90x10 <sup>3</sup>	8.26x10 <sup>5</sup>
2015	1,3-Butadiene	7.94x10 <sup>2</sup>	9.90x10 <sup>1</sup>	3.93x10 <sup>1</sup>	1.72x10 <sup>0</sup>	3.93x10 <sup>3</sup>	1.91x10 <sup>3</sup>	3.74x10 <sup>3</sup>	2.43x10 <sup>2</sup>	1.08x10 <sup>4</sup>
	Acetaldehyde	3.75x10 <sup>3</sup>	2.48x10 <sup>2</sup>	5.37x10 <sup>1</sup>	2.36x10 <sup>0</sup>	5.07x10 <sup>3</sup>	2.33x10 <sup>3</sup>	4.50x10 <sup>3</sup>	1.96x10 <sup>2</sup>	1.61x10 <sup>4</sup>
	Acrolein	4.55x10 <sup>2</sup>	2.41x10 <sup>1</sup>	1.53x10 <sup>1</sup>	6.70x10 <sup>-1</sup>	4.72x10 <sup>2</sup>	2.26x10 <sup>2</sup>	4.42x10 <sup>2</sup>	1.51x10 <sup>1</sup>	1.65x10 <sup>3</sup>
	Benzene	1.37x10 <sup>3</sup>	1.72x10 <sup>3</sup>	8.73x10 <sup>1</sup>	3.83x10 <sup>0</sup>	4.18x10 <sup>4</sup>	2.01x10 <sup>4</sup>	4.02x10 <sup>4</sup>	7.28x10 <sup>2</sup>	1.06x10 <sup>5</sup>
	Formaldehyde	1.02x10 <sup>4</sup>	6.88x10 <sup>2</sup>	1.68x10 <sup>2</sup>	7.39x10 <sup>0</sup>	1.00x10 <sup>4</sup>	4.66x10 <sup>3</sup>	9.52x10 <sup>3</sup>	6.17x10 <sup>2</sup>	3.59x10 <sup>4</sup>
	Naphthalene	3.18x10 <sup>1</sup>	2.48x10 <sup>2</sup>	1.40x10 <sup>0</sup>	1.57x10 <sup>-1</sup>	6.97x10 <sup>2</sup>	2.73x10 <sup>2</sup>	7.43x10 <sup>2</sup>	2.67x10 <sup>1</sup>	2.02x10 <sup>3</sup>
	All HAPs	1.96x10 <sup>4</sup>	1.48x10 <sup>4</sup>	5.28x10 <sup>2</sup>	2.34x10 <sup>1</sup>	2.88x10 <sup>5</sup>	1.41x10 <sup>5</sup>	2.91x10 <sup>5</sup>	8.59x10 <sup>3</sup>	7.63x10 <sup>5</sup>
2020	1,3-Butadiene	7.89x10 <sup>2</sup>	7.84x10 <sup>1</sup>	3.50x10 <sup>1</sup>	1.20x10 <sup>0</sup>	4.52x10 <sup>3</sup>	2.06x10 <sup>3</sup>	3.60x10 <sup>3</sup>	2.63x10 <sup>2</sup>	1.14x10 <sup>4</sup>
	Acetaldehyde	3.72x10 <sup>3</sup>	2.04x10 <sup>2</sup>	4.79x10 <sup>1</sup>	1.63x10 <sup>0</sup>	5.84x10 <sup>3</sup>	2.50x10 <sup>3</sup>	4.36x10 <sup>3</sup>	2.13x10 <sup>2</sup>	1.69x10 <sup>4</sup>
	Acrolein	4.53x10 <sup>2</sup>	1.71x10 <sup>1</sup>	1.36x10 <sup>1</sup>	4.65x10 <sup>-1</sup>	5.38x10 <sup>2</sup>	2.40x10 <sup>2</sup>	4.25x10 <sup>2</sup>	1.63x10 <sup>1</sup>	1.70x10 <sup>3</sup>
	Benzene	1.36x10 <sup>3</sup>	1.40x10 <sup>3</sup>	7.79x10 <sup>1</sup>	2.66x10 <sup>0</sup>	4.74x10 <sup>4</sup>	2.11x10 <sup>4</sup>	3.83x10 <sup>4</sup>	7.87x10 <sup>2</sup>	1.10x10 <sup>5</sup>
	Formaldehyde	1.01x10 <sup>4</sup>	5.56x10 <sup>2</sup>	1.50x10 <sup>2</sup>	5.13x10 <sup>0</sup>	1.15x10 <sup>4</sup>	4.96x10 <sup>3</sup>	9.21x10 <sup>3</sup>	6.67x10 <sup>2</sup>	3.72x10 <sup>4</sup>
	Naphthalene	1.92x10 <sup>1</sup>	1.95x10 <sup>2</sup>	8.86x10 <sup>-1</sup>	8.47x10 <sup>-2</sup>	7.69x10 <sup>2</sup>	2.81x10 <sup>2</sup>	6.93x10 <sup>2</sup>	2.89x10 <sup>1</sup>	1.99x10 <sup>3</sup>
	All HAPs	1.95x10 <sup>4</sup>	1.16x10 <sup>4</sup>	4.70x10 <sup>2</sup>	1.62x10 <sup>1</sup>	3.20x10 <sup>5</sup>	1.44x10 <sup>5</sup>	2.71x10 <sup>5</sup>	9.29x10 <sup>3</sup>	7.76x10 <sup>5</sup>



**Table 16. Continued.**

Year	HAP	Vehicle Type								
		HDDV	HDGV	LDDT	LDDV	LDGT1	LDGT2	LDGV	MC	Total onroad
2030	1,3-Butadiene	8.99x10 <sup>-2</sup>	6.34x10 <sup>1</sup>	2.90x10 <sup>1</sup>	1.17x10 <sup>0</sup>	5.41x10 <sup>3</sup>	2.34x10 <sup>3</sup>	4.31x10 <sup>3</sup>	3.18x10 <sup>2</sup>	1.34x10 <sup>4</sup>
	Acetaldehyde	4.24x10 <sup>3</sup>	1.73x10 <sup>2</sup>	3.96x10 <sup>1</sup>	1.60x10 <sup>0</sup>	7.04x10 <sup>3</sup>	2.88x10 <sup>3</sup>	5.25x10 <sup>3</sup>	2.58x10 <sup>2</sup>	1.99x10 <sup>4</sup>
	Acrolein	5.16x10 <sup>-2</sup>	1.19x10 <sup>1</sup>	1.13x10 <sup>1</sup>	4.54x10 <sup>-1</sup>	6.44x10 <sup>2</sup>	2.71x10 <sup>2</sup>	5.08x10 <sup>2</sup>	1.97x10 <sup>1</sup>	1.98x10 <sup>3</sup>
	Benzene	1.55x10 <sup>3</sup>	1.21x10 <sup>3</sup>	6.44x10 <sup>1</sup>	2.60x10 <sup>0</sup>	5.63x10 <sup>4</sup>	2.37x10 <sup>4</sup>	4.55x10 <sup>4</sup>	9.47x10 <sup>2</sup>	1.29x10 <sup>5</sup>
	Formaldehyde	1.15x10 <sup>4</sup>	4.60x10 <sup>2</sup>	1.24x10 <sup>2</sup>	5.01x10 <sup>0</sup>	1.38x10 <sup>4</sup>	5.65x10 <sup>3</sup>	1.10x10 <sup>4</sup>	8.06x10 <sup>2</sup>	4.34x10 <sup>4</sup>
	Naphthalene	1.57x10 <sup>1</sup>	1.76x10 <sup>2</sup>	5.96x10 <sup>-1</sup>	7.46x10 <sup>-2</sup>	9.00x10 <sup>2</sup>	3.15x10 <sup>2</sup>	8.17x10 <sup>2</sup>	3.49x10 <sup>1</sup>	2.26x10 <sup>3</sup>
	All HAPs	2.22x10 <sup>4</sup>	1.02x10 <sup>4</sup>	3.89x10 <sup>2</sup>	1.58x10 <sup>1</sup>	3.76x10 <sup>5</sup>	1.60x10 <sup>5</sup>	3.19x10 <sup>5</sup>	1.12x10 <sup>4</sup>	8.99x10 <sup>5</sup>
HDDV: Heavy Duty Diesel Vehicles HDGV: Heavy Duty Gasoline Vehicles LDDT: Light Duty Diesel Trucks LDDV: Light Duty Diesel Vehicles LDGT1: Light Duty Gasoline Trucks 1 LDGT2: Light Duty Gasoline Trucks 2 LDGV: Light Duty Gasoline Vehicles MC: Motorcycles										

**Table 17.** Fuels control inventory emissions by vehicle type and total onroad for selected HAPs and all HAPs. Total onroad includes diesel emissions.

Year	HAP	Vehicle Type					Total onroad
		HDTV	LDGT1	LDGT2	LDGV	MC	
2015	1,3-Butadiene	9.90x10 <sup>1</sup>	3.94x10 <sup>3</sup>	1.92x10 <sup>3</sup>	3.75x10 <sup>3</sup>	2.43x10 <sup>2</sup>	1.08x10 <sup>4</sup>
	Acetaldehyde	2.48x10 <sup>2</sup>	5.08x10 <sup>3</sup>	2.34x10 <sup>3</sup>	4.52x10 <sup>3</sup>	1.96x10 <sup>2</sup>	1.62x10 <sup>4</sup>
	Acrolein	2.41x10 <sup>1</sup>	4.72x10 <sup>2</sup>	2.26x10 <sup>2</sup>	4.42x10 <sup>2</sup>	1.51x10 <sup>1</sup>	1.65x10 <sup>3</sup>
	Benzene	1.50x10 <sup>3</sup>	3.73x10 <sup>4</sup>	1.78x10 <sup>4</sup>	3.57x10 <sup>4</sup>	6.26x10 <sup>2</sup>	9.44x10 <sup>4</sup>
	Formaldehyde	6.88x10 <sup>2</sup>	1.01x10 <sup>4</sup>	4.67x10 <sup>3</sup>	9.55x10 <sup>3</sup>	6.17x10 <sup>2</sup>	3.59x10 <sup>4</sup>
	Naphthalene	2.48x10 <sup>2</sup>	6.97x10 <sup>2</sup>	2.73x10 <sup>2</sup>	7.43x10 <sup>2</sup>	2.67x10 <sup>1</sup>	2.02x10 <sup>3</sup>
	All HAPs	1.46x10 <sup>4</sup>	2.83x10 <sup>5</sup>	1.39x10 <sup>5</sup>	2.86x10 <sup>5</sup>	8.49x10 <sup>3</sup>	7.52x10 <sup>5</sup>
2020	1,3-Butadiene	7.84x10 <sup>1</sup>	4.53x10 <sup>3</sup>	2.07x10 <sup>3</sup>	3.61x10 <sup>3</sup>	2.63x10 <sup>2</sup>	1.14x10 <sup>4</sup>
	Acetaldehyde	2.04x10 <sup>2</sup>	5.85x10 <sup>3</sup>	2.51x10 <sup>3</sup>	4.38x10 <sup>3</sup>	2.13x10 <sup>2</sup>	1.69x10 <sup>4</sup>
	Acrolein	1.71x10 <sup>1</sup>	5.38x10 <sup>2</sup>	2.40x10 <sup>2</sup>	4.25x10 <sup>2</sup>	1.63x10 <sup>1</sup>	1.70x10 <sup>3</sup>
	Benzene	1.23x10 <sup>3</sup>	4.24x10 <sup>4</sup>	1.88x10 <sup>4</sup>	3.41x10 <sup>4</sup>	6.77x10 <sup>2</sup>	9.87x10 <sup>4</sup>
	Formaldehyde	5.56x10 <sup>2</sup>	1.15x10 <sup>4</sup>	4.98x10 <sup>3</sup>	9.24x10 <sup>3</sup>	6.67x10 <sup>2</sup>	3.72x10 <sup>4</sup>
	Naphthalene	1.95x10 <sup>2</sup>	7.69x10 <sup>2</sup>	2.81x10 <sup>2</sup>	6.93x10 <sup>2</sup>	2.89x10 <sup>1</sup>	1.99x10 <sup>3</sup>
	All HAPs	1.15x10 <sup>4</sup>	3.15x10 <sup>5</sup>	1.42x10 <sup>5</sup>	2.67x10 <sup>5</sup>	9.18x10 <sup>3</sup>	7.65x10 <sup>5</sup>
2030	1,3-Butadiene	6.34x10 <sup>1</sup>	5.42x10 <sup>3</sup>	2.35x10 <sup>3</sup>	4.32x10 <sup>3</sup>	3.18x10 <sup>2</sup>	1.34x10 <sup>4</sup>
	Acetaldehyde	1.73x10 <sup>2</sup>	7.06x10 <sup>3</sup>	2.89x10 <sup>3</sup>	5.26x10 <sup>3</sup>	2.58x10 <sup>2</sup>	1.99x10 <sup>4</sup>
	Acrolein	1.19x10 <sup>1</sup>	6.44x10 <sup>2</sup>	2.71x10 <sup>2</sup>	5.08x10 <sup>2</sup>	1.97x10 <sup>1</sup>	1.98x10 <sup>3</sup>
	Benzene	1.07x10 <sup>3</sup>	5.05x10 <sup>4</sup>	2.12x10 <sup>4</sup>	4.06x10 <sup>4</sup>	8.16x10 <sup>2</sup>	1.16x10 <sup>5</sup>
	Formaldehyde	4.60x10 <sup>2</sup>	1.38x10 <sup>4</sup>	5.67x10 <sup>3</sup>	1.11x10 <sup>4</sup>	8.06x10 <sup>2</sup>	4.35x10 <sup>4</sup>
	Naphthalene	1.76x10 <sup>2</sup>	9.00x10 <sup>2</sup>	3.15x10 <sup>2</sup>	8.17x10 <sup>2</sup>	3.49x10 <sup>1</sup>	2.26x10 <sup>3</sup>
	All HAPs	1.00x10 <sup>4</sup>	3.70x10 <sup>5</sup>	1.57x10 <sup>5</sup>	3.15x10 <sup>5</sup>	1.11x10 <sup>4</sup>	8.85x10 <sup>5</sup>

**Table 18.** Vehicle control inventory emissions by vehicle type and total onroad for selected HAPs and all HAPs. Total onroad includes diesel.

Year	HAP	Vehicle Type					
		HDGV	LDGT1	LDGT2	LDGV	MC	Total onroad
2010	1,3-Butadiene	1.97x10 <sup>2</sup>	3.53x10 <sup>3</sup>	1.98x10 <sup>3</sup>	3.89x10 <sup>3</sup>	2.24x10 <sup>2</sup>	1.08x10 <sup>4</sup>
	Acetaldehyde	3.90x10 <sup>2</sup>	4.41x10 <sup>3</sup>	2.34x10 <sup>3</sup>	4.54x10 <sup>3</sup>	1.80x10 <sup>2</sup>	1.62x10 <sup>4</sup>
	Acrolein	7.59x10 <sup>1</sup>	4.23x10 <sup>2</sup>	2.30x10 <sup>2</sup>	4.58x10 <sup>2</sup>	1.38x10 <sup>1</sup>	1.74x10 <sup>3</sup>
	Benzene	2.38x10 <sup>3</sup>	3.64x10 <sup>4</sup>	1.95x10 <sup>4</sup>	4.21x10 <sup>4</sup>	6.69x10 <sup>2</sup>	1.03x10 <sup>5</sup>
	Formaldehyde	1.21x10 <sup>3</sup>	8.90x10 <sup>3</sup>	4.81x10 <sup>3</sup>	9.55x10 <sup>3</sup>	5.67x10 <sup>2</sup>	3.70x10 <sup>4</sup>
	Naphthalene	4.00x10 <sup>2</sup>	6.40x10 <sup>2</sup>	2.67x10 <sup>2</sup>	8.60x10 <sup>2</sup>	2.46x10 <sup>1</sup>	2.26x10 <sup>3</sup>
	All HAPs	2.13x10 <sup>4</sup>	2.61x10 <sup>5</sup>	1.43x10 <sup>5</sup>	3.23x10 <sup>5</sup>	7.90x10 <sup>3</sup>	7.79x10 <sup>5</sup>
2015	1,3-Butadiene	9.90x10 <sup>1</sup>	3.25x10 <sup>3</sup>	1.75x10 <sup>3</sup>	2.97x10 <sup>3</sup>	2.43x10 <sup>2</sup>	9.14x10 <sup>3</sup>
	Acetaldehyde	2.48x10 <sup>2</sup>	4.09x10 <sup>3</sup>	2.10x10 <sup>3</sup>	3.50x10 <sup>3</sup>	1.96x10 <sup>2</sup>	1.39x10 <sup>4</sup>
	Acrolein	2.41x10 <sup>1</sup>	3.90x10 <sup>2</sup>	2.07x10 <sup>2</sup>	3.51x10 <sup>2</sup>	1.51x10 <sup>1</sup>	1.46x10 <sup>3</sup>
	Benzene	1.72x10 <sup>3</sup>	3.46x10 <sup>4</sup>	1.84x10 <sup>4</sup>	3.19x10 <sup>4</sup>	7.28x10 <sup>2</sup>	8.88x10 <sup>4</sup>
	Formaldehyde	6.88x10 <sup>2</sup>	8.14x10 <sup>3</sup>	4.21x10 <sup>3</sup>	7.40x10 <sup>3</sup>	6.17x10 <sup>2</sup>	3.14x10 <sup>4</sup>
	Naphthalene	2.48x10 <sup>2</sup>	6.97x10 <sup>2</sup>	2.73x10 <sup>2</sup>	7.43x10 <sup>2</sup>	2.67x10 <sup>1</sup>	2.02x10 <sup>3</sup>
	All HAPs	1.48x10 <sup>4</sup>	2.42x10 <sup>5</sup>	1.30x10 <sup>5</sup>	2.39x10 <sup>5</sup>	8.59x10 <sup>3</sup>	6.54x10 <sup>5</sup>
2020	1,3-Butadiene	7.84x10 <sup>1</sup>	3.28x10 <sup>3</sup>	1.76x10 <sup>3</sup>	2.43x10 <sup>3</sup>	2.63x10 <sup>2</sup>	8.64x10 <sup>3</sup>
	Acetaldehyde	2.04x10 <sup>2</sup>	4.07x10 <sup>3</sup>	2.09x10 <sup>3</sup>	2.85x10 <sup>3</sup>	2.13x10 <sup>2</sup>	1.32x10 <sup>4</sup>
	Acrolein	1.71x10 <sup>1</sup>	3.90x10 <sup>2</sup>	2.05x10 <sup>2</sup>	2.87x10 <sup>2</sup>	1.63x10 <sup>1</sup>	1.38x10 <sup>3</sup>
	Benzene	1.40x10 <sup>3</sup>	3.44x10 <sup>4</sup>	1.80x10 <sup>4</sup>	2.60x10 <sup>4</sup>	7.87x10 <sup>2</sup>	8.20x10 <sup>4</sup>
	Formaldehyde	5.56x10 <sup>2</sup>	8.11x10 <sup>3</sup>	4.15x10 <sup>3</sup>	6.06x10 <sup>3</sup>	6.67x10 <sup>2</sup>	2.98x10 <sup>4</sup>
	Naphthalene	1.95x10 <sup>2</sup>	7.69x10 <sup>2</sup>	2.81x10 <sup>2</sup>	6.93x10 <sup>2</sup>	2.89x10 <sup>1</sup>	1.99x10 <sup>3</sup>
	All HAPs	1.16x10 <sup>4</sup>	2.37x10 <sup>5</sup>	1.24x10 <sup>5</sup>	1.92x10 <sup>5</sup>	9.29x10 <sup>3</sup>	5.94x10 <sup>5</sup>
2030	1,3-Butadiene	6.34x10 <sup>1</sup>	3.32x10 <sup>3</sup>	1.72x10 <sup>3</sup>	2.34x10 <sup>3</sup>	3.18x10 <sup>2</sup>	8.69x10 <sup>3</sup>
	Acetaldehyde	1.73x10 <sup>2</sup>	4.13x10 <sup>3</sup>	2.06x10 <sup>3</sup>	2.75x10 <sup>3</sup>	2.58x10 <sup>2</sup>	1.37x10 <sup>4</sup>
	Acrolein	1.19x10 <sup>1</sup>	3.97x10 <sup>2</sup>	2.00x10 <sup>2</sup>	2.77x10 <sup>2</sup>	1.97x10 <sup>1</sup>	1.43x10 <sup>3</sup>
	Benzene	1.21x10 <sup>3</sup>	3.48x10 <sup>4</sup>	1.75x10 <sup>4</sup>	2.53x10 <sup>4</sup>	9.47x10 <sup>2</sup>	8.14x10 <sup>4</sup>
	Formaldehyde	4.60x10 <sup>2</sup>	8.27x10 <sup>3</sup>	4.08x10 <sup>3</sup>	5.87x10 <sup>3</sup>	8.06x10 <sup>2</sup>	3.11x10 <sup>4</sup>
	Naphthalene	1.76x10 <sup>2</sup>	9.00x10 <sup>2</sup>	3.15x10 <sup>2</sup>	8.17x10 <sup>2</sup>	3.49x10 <sup>1</sup>	2.26x10 <sup>3</sup>
	All HAPs	1.02x10 <sup>4</sup>	2.38x10 <sup>5</sup>	1.20x10 <sup>5</sup>	1.88x10 <sup>5</sup>	1.12x10 <sup>4</sup>	5.90x10 <sup>5</sup>

**Table 19.** Cumulative fuels and vehicle control inventory emissions by vehicle type and total onroad for selected HAPs and all HAPs. Total onroad includes diesel.

Year	HAP	Vehicle Type					Total onroad
		HDBGV	LDGT1	LDGT2	LDGV	MC	
2015	1,3-Butadiene	9.90x10 <sup>1</sup>	3.25x10 <sup>3</sup>	1.75x10 <sup>3</sup>	2.97x10 <sup>3</sup>	2.43x10 <sup>2</sup>	9.16x10 <sup>3</sup>
	Acetaldehyde	2.48x10 <sup>2</sup>	4.10x10 <sup>3</sup>	2.11x10 <sup>3</sup>	3.51x10 <sup>3</sup>	1.96x10 <sup>2</sup>	1.40x10 <sup>4</sup>
	Acrolein	2.41x10 <sup>1</sup>	3.90x10 <sup>2</sup>	2.07x10 <sup>2</sup>	3.51x10 <sup>2</sup>	1.51x10 <sup>1</sup>	1.46x10 <sup>3</sup>
	Benzene	1.50x10 <sup>3</sup>	3.08x10 <sup>4</sup>	1.63x10 <sup>4</sup>	2.84x10 <sup>4</sup>	6.26x10 <sup>2</sup>	7.90x10 <sup>4</sup>
	Formaldehyde	6.88x10 <sup>2</sup>	8.16x10 <sup>3</sup>	4.23x10 <sup>3</sup>	7.43x10 <sup>3</sup>	6.17x10 <sup>2</sup>	3.15x10 <sup>4</sup>
	Naphthalene	2.48x10 <sup>2</sup>	6.97x10 <sup>2</sup>	2.73x10 <sup>2</sup>	7.43x10 <sup>2</sup>	2.67x10 <sup>1</sup>	2.02x10 <sup>3</sup>
	All HAPs	1.46x10 <sup>4</sup>	2.38x10 <sup>5</sup>	1.28x10 <sup>5</sup>	2.35x10 <sup>5</sup>	8.49x10 <sup>3</sup>	6.45x10 <sup>5</sup>
2020	1,3-Butadiene	7.84x10 <sup>1</sup>	3.29x10 <sup>3</sup>	1.77x10 <sup>3</sup>	2.44x10 <sup>3</sup>	2.63x10 <sup>2</sup>	8.66x10 <sup>3</sup>
	Acetaldehyde	2.04x10 <sup>2</sup>	4.08x10 <sup>3</sup>	2.09x10 <sup>3</sup>	2.86x10 <sup>3</sup>	2.13x10 <sup>2</sup>	1.32x10 <sup>4</sup>
	Acrolein	1.71x10 <sup>1</sup>	3.90x10 <sup>2</sup>	2.05x10 <sup>2</sup>	2.87x10 <sup>2</sup>	1.63x10 <sup>1</sup>	1.38x10 <sup>3</sup>
	Benzene	1.23x10 <sup>3</sup>	3.06x10 <sup>4</sup>	1.60x10 <sup>4</sup>	2.32x10 <sup>4</sup>	6.77x10 <sup>2</sup>	7.31x10 <sup>4</sup>
	Formaldehyde	5.56x10 <sup>2</sup>	8.14x10 <sup>3</sup>	4.17x10 <sup>3</sup>	6.08x10 <sup>3</sup>	6.67x10 <sup>2</sup>	2.99x10 <sup>4</sup>
	Naphthalene	1.95x10 <sup>2</sup>	7.69x10 <sup>2</sup>	2.81x10 <sup>2</sup>	6.93x10 <sup>2</sup>	2.89x10 <sup>1</sup>	1.99x10 <sup>3</sup>
	All HAPs	1.15x10 <sup>4</sup>	2.33x10 <sup>5</sup>	1.23x10 <sup>5</sup>	1.89x10 <sup>5</sup>	9.18x10 <sup>3</sup>	5.86x10 <sup>5</sup>
2030	1,3-Butadiene	6.34x10 <sup>1</sup>	3.32x10 <sup>3</sup>	1.73x10 <sup>3</sup>	2.34x10 <sup>3</sup>	3.18x10 <sup>2</sup>	8.71x10 <sup>3</sup>
	Acetaldehyde	1.73x10 <sup>2</sup>	4.14x10 <sup>3</sup>	2.06x10 <sup>3</sup>	2.76x10 <sup>3</sup>	2.58x10 <sup>2</sup>	1.37x10 <sup>4</sup>
	Acrolein	1.19x10 <sup>1</sup>	3.97x10 <sup>2</sup>	2.00x10 <sup>2</sup>	2.77x10 <sup>2</sup>	1.97x10 <sup>1</sup>	1.43x10 <sup>3</sup>
	Benzene	1.07x10 <sup>3</sup>	3.11x10 <sup>4</sup>	1.56x10 <sup>4</sup>	2.25x10 <sup>4</sup>	8.16x10 <sup>2</sup>	7.27x10 <sup>4</sup>
	Formaldehyde	4.60x10 <sup>2</sup>	8.30x10 <sup>3</sup>	4.09x10 <sup>3</sup>	5.89x10 <sup>3</sup>	8.06x10 <sup>2</sup>	3.12x10 <sup>4</sup>
	Naphthalene	1.76x10 <sup>2</sup>	9.00x10 <sup>2</sup>	3.15x10 <sup>2</sup>	8.17x10 <sup>2</sup>	3.49x10 <sup>1</sup>	2.26x10 <sup>3</sup>
	All HAPs	1.00x10 <sup>4</sup>	2.34x10 <sup>5</sup>	1.18x10 <sup>5</sup>	1.85x10 <sup>5</sup>	1.11x10 <sup>4</sup>	5.81x10 <sup>5</sup>

### 3.3.3 Nonroad projections using NMIM (excluding aircraft, locomotives, and commercial marine vessels)

EMS-HAP inventories were created from the NMIM output for nonroad sources, excluding aircraft, locomotives and commercial marine vessels. In addition to reading the NMIM output and converting to an EMS-HAP ready inventory in similar fashion as done for the onroad inventories, refueling emissions were adjusted to account for portable fuel container (PFC) emissions and to create controlled inventories for 2015, 2020, and 2030. The general methodology was:

- A file containing nonroad gasoline fueled equipment SCC codes and the fraction of refueling emissions by PFCs was read into SAS<sup>®</sup>. The SCC codes and fractions are shown in Table 20.
- For each year, 1999, 2010, 2015, 2020, or 2030, the NMIM output was read into SAS<sup>®</sup>, separating the HAP emissions from VOC, PM, and other non-HAP pollutants.
- For 2010, 2015, 2020, and 2030, reallocated the emissions of Broomfield County CO (FIPS = 08014) to surrounding counties and recalculated the county emissions by FIPS, SCC, and CAS. This step is done because Broomfield County was created after the 2000 census and therefore is not in any of the EMS-HAP ancillary files, such as spatial allocation factor files. The allocation factors used to reallocate the emissions are shown in Table 21. Broomfield County emissions were multiplied by the factors in Table 21 to allocate to the other counties.
- Merged the PFC fractions with the nonroad emissions and recalculated the refueling emissions of the SCC codes in Table 20 to subtract out the PFC equipment refueling emissions by using the equation:

$$E_{refuel} = E_{refuel} \times (1 - Fraction) \quad (8)$$

where Fraction is the fractional form of the PFC refueling percentage in Table 20. Table 22 shows the refueling emissions before and after the calculations. This step was done because refueling PFC emissions were processed separately from other nonroad emissions and were subtracted from the nonroad inventory to avoid double counting.

- After recalculating the refueling emissions, the inventory was considered the base or reference inventory.
- For 2015, 2020, or 2030, the base onroad NMIM emissions and fuel control onroad NMIM emissions were read into SAS<sup>®</sup>, retaining emissions for 1,3-butadiene, acetaldehyde, benzene, and formaldehyde for light duty gasoline vehicles.

- Merged the base and fuel control LDGV emissions by FIPS, SCC, emissions type (evaporative or exhaust) and pollutant. Summed the emissions by FIPS, pollutant, and emissions type across the LDGV SCC codes.
- Calculated a ratio of fuel control to base emissions for each FIPS, CAS, and emissions type.
- Merged with the reference nonroad inventory and if a gasoline engine (2-stroke or 4-stroke) SCC code and the pollutant was 1,3-butadiene, acetaldehyde, benzene, or formaldehyde and the emissions type was exhaust or evaporative, multiplied the nonroad emissions by the appropriate ratio (exhaust or evaporative). There was exhaust for all HAPs and evaporative for benzene only. Thus, the change in exhaust and evaporative emissions for nonroad equipment due to fuel benzene control was assumed to be proportional to the change for LDGV. This was the controlled inventory.
- Appended MSAT HAP emissions from the projected locomotive and commercial marine vessel inventory to the reference and controlled inventories for the appropriate year.
- Summed up emissions by FIPS/SCC/CAS for the reference and control inventories. The inventory was ready for input into EMS-HAP.

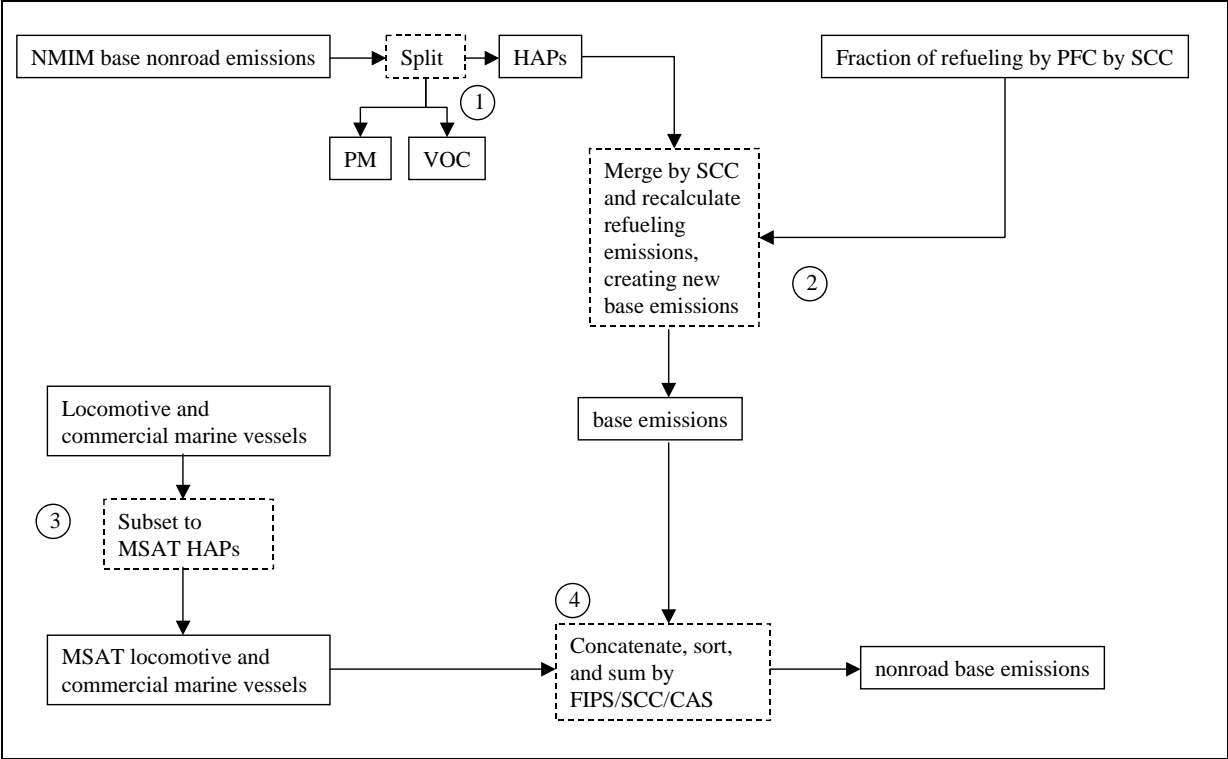
Note that aircraft emissions were not appended to the inventories. They were processed separately in EMS-HAP and had their own set of ASPEN emissions files. The methodology for nonroad emissions for 1999 and 2010 processing is shown in Figure 7 and for the other years, including control calculations are shown in Figure 8.

**Table 20.** Nonroad gasoline equipment SCC codes refueled by portable fuel containers (PFC) and percentage of refueling from PFCs.

SCC	Description	PFC refueling percentage
2260003030	2-Stroke, Industrial Equipment, Sweepers/Scrubbers	100
2260003040	2-Stroke, Industrial Equipment, Other General Industrial Equipment	100
2260004016	2-Stroke, Lawn and Garden Equipment, Rotary Tillers < 6 HP (Commercial)	100
2260004021	2-Stroke, Lawn and Garden Equipment, Chain Saws < 6 HP (Commercial)	100
2260004026	2-Stroke, Lawn and Garden Equipment, Trimmers/Edgers/Brush Cutters (Commercial)	100
2260004031	2-Stroke, Lawn and Garden Equipment, Leafblowers/Vacuums (Commercial)	100
2260004071	2-Stroke, Lawn and Garden Equipment, Turf Equipment (Commercial)	100
2260006005	2-Stroke, Commercial Equipment, Generator Sets	100
2260006010	2-Stroke, Commercial Equipment, Pumps	98.459
2260006015	2-Stroke, Commercial Equipment, Air Compressors	100
2260007005	2-Stroke, Logging Equipment, Chain Saws > 6 HP	100
2265001060	4-Stroke, Recreational Equipment, Specialty Vehicles/Carts	0.021
2265003010	4-Stroke, Industrial Equipment, Aerial Lifts	1.587
2265003030	4-Stroke, Industrial Equipment, Sweepers/Scrubbers	18.803
2265003040	4-Stroke, Industrial Equipment, Other General Industrial Equipment	63.058
2265003050	4-Stroke, Industrial Equipment, Other Material Handling Equipment	0.156
2265004011	4-Stroke, Lawn and Garden Equipment, Lawn Mowers (Commercial)	100
2265004016	4-Stroke, Lawn and Garden Equipment, Rotary Tillers < 6 HP (Commercial)	100
2265004026	4-Stroke, Lawn and Garden Equipment, Trimmers/Edgers/Brush Cutters (Commercial)	100
2265004031	4-Stroke, Lawn and Garden Equipment, Leafblowers/Vacuums (Commercial)	100
2265004036	4-Stroke, Lawn and Garden Equipment, Snowblowers (Commercial)	100
2265004041	4-Stroke, Lawn and Garden Equipment, Rear Engine Riding Mowers (Commercial)	100
2265004046	4-Stroke, Lawn and Garden Equipment, Front Mowers (Commercial)	100
2265004051	4-Stroke, Lawn and Garden Equipment, Shredders < 6 HP (Commercial)	100
2265004056	4-Stroke, Lawn and Garden Equipment, Lawn and Garden Tractors (Commercial)	100
2265004066	4-Stroke, Lawn and Garden Equipment, Chippers/Stump Grinders (Commercial)	100
2265004071	4-Stroke, Lawn and Garden Equipment, Turf Equipment (Commercial)	100
2265004076	4-Stroke, Lawn and Garden Equipment, Other Lawn and Garden Equipment (Commercial)	100
2265006005	4-Stroke, Commercial Equipment, Generator Sets	52.297
2265006010	4-Stroke, Commercial Equipment, Pumps	76.737
2265006015	4-Stroke, Commercial Equipment, Air Compressors	57.208
2265006025	4-Stroke, Commercial Equipment, Welders	10.29
2265006030	4-Stroke, Commercial Equipment, Pressure Washers	77.253

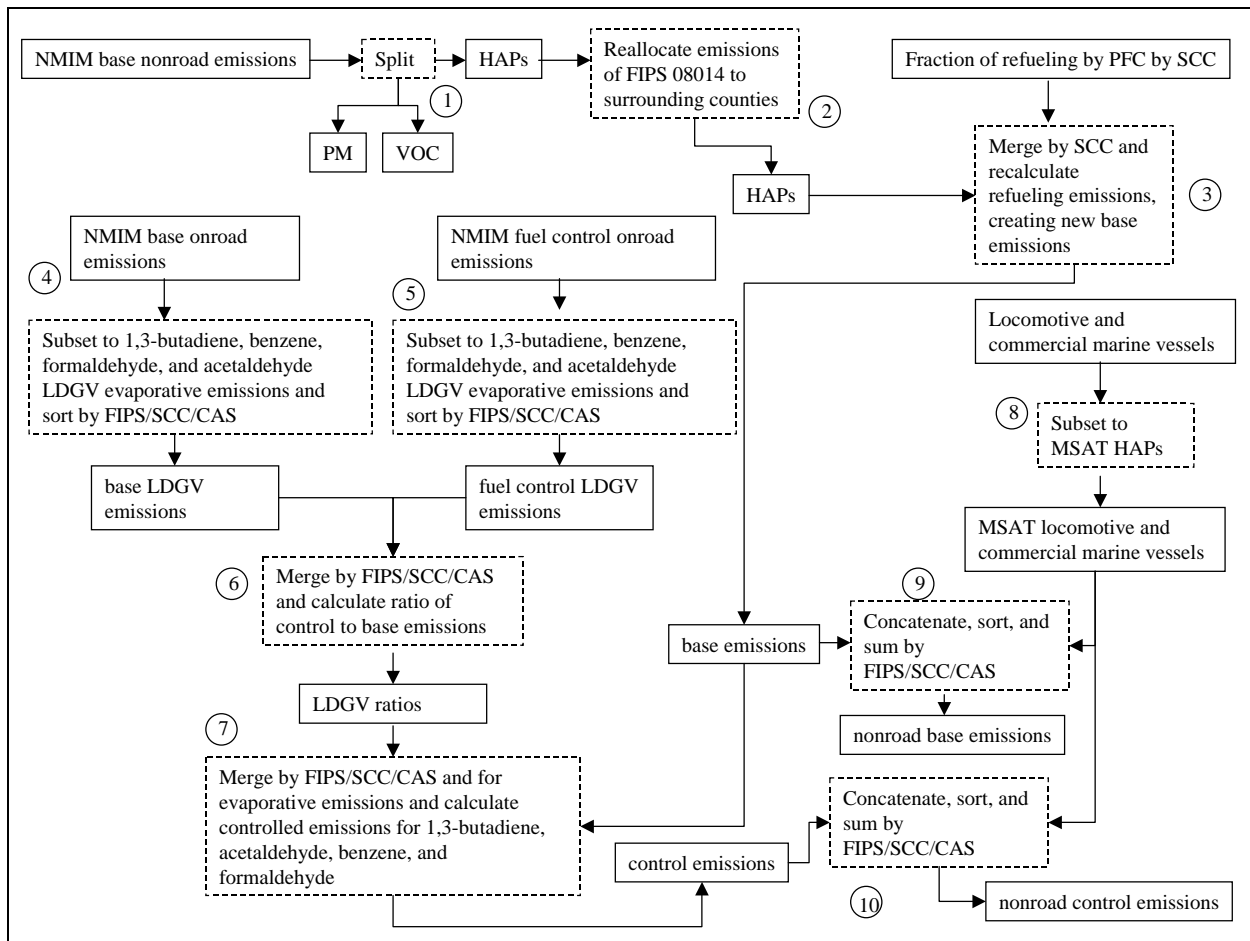
**Table 21.** Factors used to allocate Adams County emissions to surrounding counties.

County	FIPS code	Factor
Adams County	08001	0.352807188
Boulder County	08013	0.62193445
Jefferson County	08059	0.024794365
Weld County	08123	0.000463998



**Figure 7.** 1999 and 2010 nonroad processing steps.





**Figure 8.** 2015, 2020, and 2030 nonroad processing steps.

Emissions summaries are shown in Tables 23 through 28. Table 23 lists the base emissions by engine type, Table 24 lists base emissions by equipment type, Table 25 lists the controlled emissions by gasoline engine type, Table 26 lists controlled emissions by equipment type (only those with gasoline engine emissions), Table 27 lists the base emissions by engine and equipment type combinations, and Table 28 lists the controlled gasoline engine and equipment combination emissions. Tables 25, 26, and 28 are for 2015, 2020, and 2030 only. Full summaries can be found in nonroad\_1009.xls and nonroad\_pivot\_1009.xls in the MSAT rule docket EPA-HQ-OAR-2005-0036.

**Table 22.** Nonroad refueling emissions before and after subtracting the refueling emissions due to portable fuel containers (PFC).

Year	Emissions	Pollutant							
		2,2,4-Trimethylpentane	Benzene	Ethyl Benzene	Hexane	MTBE	Toluene	Xylenes	All HAPs
1999	NMIM refueling	1.57x10 <sup>3</sup>	1.88x10 <sup>3</sup>	6.83x10 <sup>2</sup>	1.70x10 <sup>3</sup>	4.58x10 <sup>3</sup>	3.41x10 <sup>3</sup>	1.98x10 <sup>3</sup>	1.58x10 <sup>4</sup>
	PFC refueling	8.46x10 <sup>2</sup>	1.00x10 <sup>3</sup>	3.66x10 <sup>2</sup>	8.85x10 <sup>2</sup>	2.81x10 <sup>3</sup>	1.81x10 <sup>3</sup>	1.06x10 <sup>3</sup>	8.78x10 <sup>3</sup>
	New refueling	7.26x10 <sup>2</sup>	8.80x10 <sup>2</sup>	3.18x10 <sup>2</sup>	8.15x10 <sup>2</sup>	1.77x10 <sup>3</sup>	1.60x10 <sup>3</sup>	9.19x10 <sup>2</sup>	7.03x10 <sup>3</sup>
2010	NMIM refueling	1.59x10 <sup>3</sup>	1.83x10 <sup>3</sup>	6.54x10 <sup>2</sup>	1.70x10 <sup>3</sup>	2.24x10 <sup>3</sup>	3.27x10 <sup>3</sup>	1.87x10 <sup>3</sup>	1.31x10 <sup>4</sup>
	PFC refueling	8.31x10 <sup>2</sup>	9.31x10 <sup>2</sup>	3.35x10 <sup>2</sup>	8.48x10 <sup>2</sup>	1.36x10 <sup>3</sup>	1.66x10 <sup>3</sup>	9.54x10 <sup>2</sup>	6.91x10 <sup>3</sup>
	New refueling	7.58x10 <sup>2</sup>	8.95x10 <sup>2</sup>	3.19x10 <sup>2</sup>	8.53x10 <sup>2</sup>	8.84x10 <sup>2</sup>	1.61x10 <sup>3</sup>	9.12x10 <sup>2</sup>	6.23x10 <sup>3</sup>
2015	NMIM refueling	1.70x10 <sup>3</sup>	1.95x10 <sup>3</sup>	7.00x10 <sup>2</sup>	1.82x10 <sup>3</sup>	2.41x10 <sup>3</sup>	3.50x10 <sup>3</sup>	2.00x10 <sup>3</sup>	1.41x10 <sup>4</sup>
	PFC refueling	9.01x10 <sup>2</sup>	1.01x10 <sup>3</sup>	3.63x10 <sup>2</sup>	9.18x10 <sup>2</sup>	1.47x10 <sup>3</sup>	1.79x10 <sup>3</sup>	1.03x10 <sup>3</sup>	7.49x10 <sup>3</sup>
	New refueling	8.01x10 <sup>2</sup>	9.45x10 <sup>2</sup>	3.37x10 <sup>2</sup>	9.01x10 <sup>2</sup>	9.36x10 <sup>2</sup>	1.70x10 <sup>3</sup>	9.64x10 <sup>2</sup>	6.59x10 <sup>3</sup>
2020	NMIM refueling	1.83x10 <sup>3</sup>	2.10x10 <sup>3</sup>	7.52x10 <sup>2</sup>	1.95x10 <sup>3</sup>	2.60x10 <sup>3</sup>	3.76x10 <sup>3</sup>	2.15x10 <sup>3</sup>	1.51x10 <sup>4</sup>
	PFC refueling	9.77x10 <sup>2</sup>	1.09x10 <sup>3</sup>	3.94x10 <sup>2</sup>	9.97x10 <sup>2</sup>	1.60x10 <sup>3</sup>	1.95x10 <sup>3</sup>	1.12x10 <sup>3</sup>	8.13x10 <sup>3</sup>
	New refueling	8.52x10 <sup>2</sup>	1.00x10 <sup>3</sup>	3.58x10 <sup>2</sup>	9.56x10 <sup>2</sup>	1.00x10 <sup>3</sup>	1.81x10 <sup>3</sup>	1.02x10 <sup>3</sup>	7.01x10 <sup>3</sup>
2030	NMIM refueling	2.09x10 <sup>3</sup>	2.39x10 <sup>3</sup>	8.58x10 <sup>2</sup>	2.23x10 <sup>3</sup>	3.00x10 <sup>3</sup>	4.28x10 <sup>3</sup>	2.45x10 <sup>3</sup>	1.73x10 <sup>4</sup>
	PFC refueling	1.13x10 <sup>3</sup>	1.27x10 <sup>3</sup>	4.56x10 <sup>2</sup>	1.15x10 <sup>3</sup>	1.85x10 <sup>3</sup>	2.25x10 <sup>3</sup>	1.30x10 <sup>3</sup>	9.42x10 <sup>3</sup>
	New refueling	9.56x10 <sup>2</sup>	1.13x10 <sup>3</sup>	4.02x10 <sup>2</sup>	1.07x10 <sup>3</sup>	1.14x10 <sup>3</sup>	2.03x10 <sup>3</sup>	1.15x10 <sup>3</sup>	7.87x10 <sup>3</sup>

**Table 23.** Base nonroad emissions by engine type.

Year	Engine	Pollutant						
		1,3-Butadiene	Acetaldehyde	Acrolein	Benzene	Formaldehyde	Naphthalene	All HAPs
1999	2-Stroke	3.25x10 <sup>3</sup>	2.21x10 <sup>3</sup>	4.80x10 <sup>2</sup>	3.41x10 <sup>4</sup>	5.30x10 <sup>3</sup>	2.04x10 <sup>-1</sup>	5.85x10 <sup>5</sup>
	4-Stroke	5.73x10 <sup>3</sup>	3.00x10 <sup>3</sup>	4.19x10 <sup>2</sup>	3.45x10 <sup>4</sup>	7.99x10 <sup>3</sup>	5.43x10 <sup>2</sup>	2.22x10 <sup>5</sup>
	Aircraft	8.24x10 <sup>2</sup>	2.02x10 <sup>3</sup>	9.68x10 <sup>2</sup>	1.10x10 <sup>3</sup>	6.55x10 <sup>3</sup>	4.56x10 <sup>2</sup>	1.43x10 <sup>4</sup>
	Diesel	5.22x10 <sup>2</sup>	1.43x10 <sup>4</sup>	8.39x10 <sup>2</sup>	5.10x10 <sup>3</sup>	3.14x10 <sup>4</sup>	1.90x10 <sup>2</sup>	6.36x10 <sup>4</sup>
	Miscellaneous	1.35x10 <sup>-1</sup>	5.21x10 <sup>0</sup>	2.44x10 <sup>1</sup>	1.42x10 <sup>0</sup>	1.04x10 <sup>1</sup>	6.38x10 <sup>-2</sup>	1.72x10 <sup>2</sup>
	Residual	0.00x10 <sup>0</sup>	4.22x10 <sup>2</sup>	2.29x10 <sup>1</sup>	1.13x10 <sup>2</sup>	8.07x10 <sup>2</sup>	2.18x10 <sup>1</sup>	1.59x10 <sup>3</sup>
2010	2-Stroke	2.30x10 <sup>3</sup>	1.53x10 <sup>3</sup>	3.71x10 <sup>2</sup>	2.50x10 <sup>4</sup>	3.94x10 <sup>3</sup>	2.18x10 <sup>-1</sup>	4.27x10 <sup>5</sup>
	4-Stroke	3.62x10 <sup>3</sup>	2.23x10 <sup>3</sup>	2.62x10 <sup>2</sup>	2.51x10 <sup>4</sup>	5.06x10 <sup>3</sup>	5.21x10 <sup>2</sup>	1.51x10 <sup>5</sup>
	Aircraft	8.59x10 <sup>2</sup>	2.10x10 <sup>3</sup>	1.01x10 <sup>3</sup>	1.16x10 <sup>3</sup>	6.81x10 <sup>3</sup>	4.96x10 <sup>2</sup>	1.50x10 <sup>4</sup>
	Diesel	3.52x10 <sup>2</sup>	9.74x10 <sup>3</sup>	5.71x10 <sup>2</sup>	3.35x10 <sup>3</sup>	2.12x10 <sup>4</sup>	1.35x10 <sup>2</sup>	4.27x10 <sup>4</sup>
	Miscellaneous	1.55x10 <sup>-1</sup>	6.00x10 <sup>0</sup>	2.23x10 <sup>1</sup>	1.63x10 <sup>0</sup>	1.20x10 <sup>1</sup>	6.70x10 <sup>-2</sup>	1.62x10 <sup>2</sup>
	Residual	0.00x10 <sup>0</sup>	6.00x10 <sup>2</sup>	3.25x10 <sup>1</sup>	1.61x10 <sup>2</sup>	1.15x10 <sup>3</sup>	2.97x10 <sup>1</sup>	2.25x10 <sup>3</sup>
2015	2-Stroke	1.94x10 <sup>3</sup>	1.31x10 <sup>3</sup>	3.13x10 <sup>2</sup>	2.13x10 <sup>4</sup>	3.40x10 <sup>3</sup>	2.03x10 <sup>-1</sup>	3.59x10 <sup>5</sup>
	4-Stroke	3.43x10 <sup>3</sup>	2.11x10 <sup>3</sup>	2.48x10 <sup>2</sup>	2.45x10 <sup>4</sup>	4.79x10 <sup>3</sup>	5.48x10 <sup>2</sup>	1.49x10 <sup>5</sup>
	Aircraft	9.24x10 <sup>2</sup>	2.26x10 <sup>3</sup>	1.08x10 <sup>3</sup>	1.25x10 <sup>3</sup>	7.33x10 <sup>3</sup>	5.30x10 <sup>2</sup>	1.61x10 <sup>4</sup>
	Diesel	2.91x10 <sup>2</sup>	8.06x10 <sup>3</sup>	4.74x10 <sup>2</sup>	2.71x10 <sup>3</sup>	1.75x10 <sup>4</sup>	1.15x10 <sup>2</sup>	3.51x10 <sup>4</sup>
	Miscellaneous	1.66x10 <sup>-1</sup>	6.41x10 <sup>0</sup>	2.19x10 <sup>1</sup>	1.75x10 <sup>0</sup>	1.28x10 <sup>1</sup>	6.74x10 <sup>-2</sup>	1.61x10 <sup>2</sup>
	Residual	0.00x10 <sup>0</sup>	7.17x10 <sup>2</sup>	3.89x10 <sup>1</sup>	1.92x10 <sup>2</sup>	1.37x10 <sup>3</sup>	3.50x10 <sup>1</sup>	2.69x10 <sup>3</sup>
2020	2-Stroke	1.69x10 <sup>3</sup>	1.16x10 <sup>3</sup>	2.63x10 <sup>2</sup>	1.89x10 <sup>4</sup>	2.94x10 <sup>3</sup>	1.90x10 <sup>-1</sup>	3.06x10 <sup>5</sup>
	4-Stroke	3.58x10 <sup>3</sup>	2.19x10 <sup>3</sup>	2.60x10 <sup>2</sup>	2.57x10 <sup>4</sup>	5.02x10 <sup>3</sup>	5.85x10 <sup>2</sup>	1.56x10 <sup>5</sup>
	Aircraft	9.93x10 <sup>2</sup>	2.43x10 <sup>3</sup>	1.16x10 <sup>3</sup>	1.33x10 <sup>3</sup>	7.89x10 <sup>3</sup>	5.66x10 <sup>2</sup>	1.73x10 <sup>4</sup>
	Diesel	2.50x10 <sup>2</sup>	7.00x10 <sup>3</sup>	4.12x10 <sup>2</sup>	2.30x10 <sup>3</sup>	1.51x10 <sup>4</sup>	9.80x10 <sup>1</sup>	3.02x10 <sup>4</sup>
	Miscellaneous	1.82x10 <sup>-1</sup>	7.04x10 <sup>0</sup>	2.13x10 <sup>1</sup>	1.92x10 <sup>0</sup>	1.41x10 <sup>1</sup>	6.89x10 <sup>-2</sup>	1.60x10 <sup>2</sup>
	Residual	0.00x10 <sup>1</sup>	8.76x10 <sup>2</sup>	4.75x10 <sup>1</sup>	2.35x10 <sup>2</sup>	1.68x10 <sup>3</sup>	4.20x10 <sup>1</sup>	3.27x10 <sup>3</sup>
2030	2-Stroke	1.61x10 <sup>3</sup>	1.12x10 <sup>3</sup>	2.51x10 <sup>2</sup>	1.88x10 <sup>4</sup>	2.84x10 <sup>3</sup>	1.99x10 <sup>-1</sup>	2.97x10 <sup>5</sup>
	4-Stroke	4.04x10 <sup>3</sup>	2.45x10 <sup>3</sup>	2.93x10 <sup>2</sup>	2.89x10 <sup>4</sup>	5.68x10 <sup>3</sup>	6.56x10 <sup>2</sup>	1.76x10 <sup>5</sup>
	Aircraft	1.13x10 <sup>3</sup>	2.77x10 <sup>3</sup>	1.33x10 <sup>3</sup>	1.51x10 <sup>3</sup>	8.99x10 <sup>3</sup>	6.38x10 <sup>2</sup>	1.96x10 <sup>4</sup>
	Diesel	2.22x10 <sup>2</sup>	6.47x10 <sup>3</sup>	3.76x10 <sup>2</sup>	2.09x10 <sup>3</sup>	1.39x10 <sup>4</sup>	8.33x10 <sup>1</sup>	2.76x10 <sup>4</sup>
	Miscellaneous	2.31x10 <sup>-1</sup>	8.94x10 <sup>0</sup>	2.02x10 <sup>1</sup>	2.43x10 <sup>0</sup>	1.79x10 <sup>1</sup>	7.51x10 <sup>-2</sup>	1.60x10 <sup>2</sup>
	Residual	0.00x10 <sup>0</sup>	1.33x10 <sup>3</sup>	7.21x10 <sup>1</sup>	3.56x10 <sup>2</sup>	2.55x10 <sup>3</sup>	6.20x10 <sup>1</sup>	4.96x10 <sup>3</sup>

**Table 24.** Base nonroad emissions by equipment type.

Year	Equipment	Pollutant						
		1,3-Butadiene	Acetaldehyde	Acrolein	Benzene	Formaldehyde	Naphthalene	All HAPs
1999	Agriculture	2.36x10 <sup>2</sup>	3.99x10 <sup>3</sup>	2.32x10 <sup>2</sup>	2.10x10 <sup>3</sup>	8.89x10 <sup>3</sup>	4.17x10 <sup>1</sup>	2.14x10 <sup>4</sup>
	Aircraft	8.24x10 <sup>2</sup>	2.02x10 <sup>3</sup>	9.68x10 <sup>2</sup>	1.10x10 <sup>3</sup>	6.55x10 <sup>3</sup>	4.56x10 <sup>2</sup>	1.43x10 <sup>4</sup>
	Airport Support	4.27x10 <sup>0</sup>	5.49x10 <sup>1</sup>	3.25x10 <sup>0</sup>	3.32x10 <sup>1</sup>	1.23x10 <sup>2</sup>	6.56x10 <sup>-1</sup>	3.25x10 <sup>2</sup>
	Commercial	1.32x10 <sup>3</sup>	1.39x10 <sup>3</sup>	1.43x10 <sup>2</sup>	7.93x10 <sup>3</sup>	3.52x10 <sup>3</sup>	1.04x10 <sup>2</sup>	5.93x10 <sup>4</sup>
	Commercial Marine Vessel	5.69x10 <sup>0</sup>	2.36x10 <sup>3</sup>	9.82x10 <sup>1</sup>	6.44x10 <sup>2</sup>	4.72x10 <sup>3</sup>	6.52x10 <sup>1</sup>	8.74x10 <sup>3</sup>
	Construction	4.55x10 <sup>2</sup>	5.43x10 <sup>3</sup>	3.26x10 <sup>2</sup>	3.95x10 <sup>3</sup>	1.21x10 <sup>4</sup>	5.58x10 <sup>1</sup>	4.25x10 <sup>4</sup>
	Industrial	2.42x10 <sup>2</sup>	1.09x10 <sup>3</sup>	7.18x10 <sup>1</sup>	1.50x10 <sup>3</sup>	2.49x10 <sup>3</sup>	2.63x10 <sup>1</sup>	1.14x10 <sup>4</sup>
	Lawn/Garden	4.03x10 <sup>3</sup>	2.38x10 <sup>3</sup>	3.98x10 <sup>2</sup>	2.58x10 <sup>4</sup>	7.05x10 <sup>3</sup>	3.05x10 <sup>2</sup>	2.62x10 <sup>5</sup>
	Logging	3.48x10 <sup>1</sup>	1.33x10 <sup>2</sup>	1.10x10 <sup>1</sup>	2.02x10 <sup>2</sup>	3.34x10 <sup>2</sup>	1.95x10 <sup>0</sup>	3.58x10 <sup>3</sup>
	Pleasure Craft	2.07x10 <sup>3</sup>	1.62x10 <sup>3</sup>	2.18x10 <sup>2</sup>	2.50x10 <sup>4</sup>	2.34x10 <sup>3</sup>	3.40x10 <sup>1</sup>	3.33x10 <sup>5</sup>
	Railroad	1.14x10 <sup>2</sup>	8.50x10 <sup>2</sup>	1.30x10 <sup>2</sup>	1.62x10 <sup>2</sup>	1.89x10 <sup>3</sup>	6.07x10 <sup>1</sup>	4.41x10 <sup>3</sup>
	Recreational	9.90x10 <sup>2</sup>	5.99x10 <sup>2</sup>	1.51x10 <sup>2</sup>	6.55x10 <sup>3</sup>	1.99x10 <sup>3</sup>	5.93x10 <sup>1</sup>	1.26x10 <sup>5</sup>
Underground Mining	1.37x10 <sup>0</sup>	3.90x10 <sup>1</sup>	2.23x10 <sup>0</sup>	1.49x10 <sup>1</sup>	8.68x10 <sup>1</sup>	2.36x10 <sup>-1</sup>	1.77x10 <sup>2</sup>	
2010	Agriculture	1.45x10 <sup>2</sup>	2.26x10 <sup>3</sup>	1.32x10 <sup>2</sup>	1.28x10 <sup>3</sup>	5.05x10 <sup>3</sup>	2.60x10 <sup>1</sup>	1.25x10 <sup>4</sup>
	Aircraft	8.59x10 <sup>2</sup>	2.10x10 <sup>3</sup>	1.01x10 <sup>3</sup>	1.16x10 <sup>3</sup>	6.81x10 <sup>3</sup>	4.96x10 <sup>2</sup>	1.50x10 <sup>4</sup>
	Airport Support	2.24x10 <sup>0</sup>	3.70x10 <sup>1</sup>	2.15x10 <sup>0</sup>	1.93x10 <sup>1</sup>	8.25x10 <sup>1</sup>	5.03x10 <sup>-1</sup>	1.98x10 <sup>2</sup>
	Commercial	7.74x10 <sup>2</sup>	9.99x10 <sup>2</sup>	8.85x10 <sup>1</sup>	5.14x10 <sup>3</sup>	2.33x10 <sup>3</sup>	1.03x10 <sup>2</sup>	3.40x10 <sup>4</sup>
	Commercial Marine Vessel	5.99x10 <sup>0</sup>	2.64x10 <sup>3</sup>	1.12x10 <sup>2</sup>	7.19x10 <sup>2</sup>	5.25x10 <sup>3</sup>	6.83x10 <sup>1</sup>	9.74x10 <sup>3</sup>
	Construction	2.31x10 <sup>2</sup>	3.31x10 <sup>3</sup>	1.95x10 <sup>2</sup>	2.11x10 <sup>3</sup>	7.35x10 <sup>3</sup>	3.68x10 <sup>1</sup>	2.23x10 <sup>4</sup>
	Industrial	7.61x10 <sup>1</sup>	5.39x10 <sup>2</sup>	3.33x10 <sup>1</sup>	5.24x10 <sup>2</sup>	1.21x10 <sup>3</sup>	1.33x10 <sup>1</sup>	4.25x10 <sup>3</sup>
	Lawn/Garden	2.24x10 <sup>3</sup>	1.52x10 <sup>3</sup>	2.06x10 <sup>2</sup>	1.60x10 <sup>4</sup>	3.90x10 <sup>3</sup>	2.45x10 <sup>2</sup>	1.30x10 <sup>5</sup>
	Logging	2.11x10 <sup>1</sup>	5.89x10 <sup>1</sup>	5.40x10 <sup>0</sup>	1.31x10 <sup>2</sup>	1.53x10 <sup>2</sup>	1.64x10 <sup>0</sup>	2.09x10 <sup>3</sup>
	Pleasure Craft	1.29x10 <sup>3</sup>	1.10x10 <sup>3</sup>	1.34x10 <sup>2</sup>	1.67x10 <sup>4</sup>	1.55x10 <sup>3</sup>	3.61x10 <sup>1</sup>	2.03x10 <sup>5</sup>
	Railroad	1.04x10 <sup>2</sup>	7.72x10 <sup>2</sup>	1.19x10 <sup>2</sup>	1.43x10 <sup>2</sup>	1.72x10 <sup>3</sup>	4.39x10 <sup>1</sup>	3.97x10 <sup>3</sup>
	Recreational	1.39x10 <sup>3</sup>	8.43x10 <sup>2</sup>	2.31x10 <sup>2</sup>	1.08x10 <sup>4</sup>	2.73x10 <sup>3</sup>	1.12x10 <sup>2</sup>	2.01x10 <sup>5</sup>
Underground Mining	1.07x10 <sup>0</sup>	3.04x10 <sup>1</sup>	1.74x10 <sup>0</sup>	1.17x10 <sup>1</sup>	6.77x10 <sup>1</sup>	1.59x10 <sup>-1</sup>	1.38x10 <sup>2</sup>	

**Table 24.** Continued.

Year	Equipment	Pollutant						
		1,3-Butadiene	Acetaldehyde	Acrolein	Benzene	Formaldehyde	Naphthalene	All HAPs
2015	Agriculture	1.16x10 <sup>2</sup>	1.68x10 <sup>3</sup>	9.87x10 <sup>1</sup>	1.02x10 <sup>3</sup>	3.76x10 <sup>3</sup>	2.07x10 <sup>1</sup>	9.69x10 <sup>3</sup>
	Aircraft	9.24x10 <sup>2</sup>	2.26x10 <sup>3</sup>	1.08x10 <sup>3</sup>	1.25x10 <sup>3</sup>	7.33x10 <sup>3</sup>	5.30x10 <sup>2</sup>	1.61x10 <sup>4</sup>
	Airport Support	1.71x10 <sup>0</sup>	2.95x10 <sup>1</sup>	1.71x10 <sup>0</sup>	1.51x10 <sup>1</sup>	6.59x10 <sup>1</sup>	4.28x10 <sup>-1</sup>	1.57x10 <sup>2</sup>
	Commercial	8.20x10 <sup>2</sup>	9.02x10 <sup>2</sup>	8.51x10 <sup>1</sup>	5.48x10 <sup>3</sup>	2.12x10 <sup>3</sup>	1.13x10 <sup>2</sup>	3.60x10 <sup>4</sup>
	Commercial Marine Vessel	6.03x10 <sup>0</sup>	2.77x10 <sup>3</sup>	1.18x10 <sup>2</sup>	7.53x10 <sup>2</sup>	5.50x10 <sup>3</sup>	7.18x10 <sup>1</sup>	1.02x10 <sup>4</sup>
	Construction	1.98x10 <sup>2</sup>	2.55x10 <sup>3</sup>	1.51x10 <sup>2</sup>	1.79x10 <sup>3</sup>	5.66x10 <sup>3</sup>	2.95x10 <sup>1</sup>	1.87x10 <sup>4</sup>
	Industrial	4.73x10 <sup>1</sup>	3.72x10 <sup>2</sup>	2.28x10 <sup>1</sup>	3.35x10 <sup>2</sup>	8.37x10 <sup>2</sup>	8.80x10 <sup>0</sup>	2.79x10 <sup>3</sup>
	Lawn/Garden	2.08x10 <sup>3</sup>	1.41x10 <sup>3</sup>	1.95x10 <sup>2</sup>	1.55x10 <sup>4</sup>	3.63x10 <sup>3</sup>	2.46x10 <sup>2</sup>	1.30x10 <sup>5</sup>
	Logging	2.15x10 <sup>1</sup>	4.13x10 <sup>1</sup>	4.61x10 <sup>0</sup>	1.30x10 <sup>2</sup>	1.17x10 <sup>2</sup>	1.51x10 <sup>0</sup>	2.23x10 <sup>3</sup>
	Pleasure Craft	1.03x10 <sup>3</sup>	9.20x10 <sup>2</sup>	1.06x10 <sup>2</sup>	1.41x10 <sup>4</sup>	1.27x10 <sup>3</sup>	3.73x10 <sup>1</sup>	1.64x10 <sup>5</sup>
	Railroad	1.02x10 <sup>2</sup>	7.55x10 <sup>2</sup>	1.17x10 <sup>2</sup>	1.39x10 <sup>2</sup>	1.68x10 <sup>3</sup>	4.20x10 <sup>1</sup>	3.89x10 <sup>3</sup>
	Recreational	1.23x10 <sup>3</sup>	7.43x10 <sup>2</sup>	1.94x10 <sup>2</sup>	9.43x10 <sup>3</sup>	2.36x10 <sup>3</sup>	1.27x10 <sup>2</sup>	1.67x10 <sup>5</sup>
Underground Mining	8.85x10 <sup>-1</sup>	2.52x10 <sup>1</sup>	1.44x10 <sup>0</sup>	9.68x10 <sup>0</sup>	5.62x10 <sup>1</sup>	1.30x10 <sup>-1</sup>	1.14x10 <sup>2</sup>	
2020	Agriculture	9.83x10 <sup>1</sup>	1.31x10 <sup>3</sup>	7.69x10 <sup>1</sup>	8.55x10 <sup>2</sup>	2.92x10 <sup>3</sup>	1.69x10 <sup>1</sup>	7.88x10 <sup>3</sup>
	Aircraft	9.93x10 <sup>2</sup>	2.43x10 <sup>3</sup>	1.16x10 <sup>3</sup>	1.33x10 <sup>3</sup>	7.89x10 <sup>3</sup>	5.66x10 <sup>2</sup>	1.73x10 <sup>4</sup>
	Airport Support	1.58x10 <sup>0</sup>	2.61x10 <sup>1</sup>	1.52x10 <sup>0</sup>	1.37x10 <sup>1</sup>	5.82x10 <sup>1</sup>	3.46x10 <sup>-1</sup>	1.41x10 <sup>2</sup>
	Commercial	9.01x10 <sup>2</sup>	8.50x10 <sup>2</sup>	8.57x10 <sup>1</sup>	6.01x10 <sup>3</sup>	2.02x10 <sup>3</sup>	1.25x10 <sup>2</sup>	3.92x10 <sup>4</sup>
	Commercial Marine Vessel	6.18x10 <sup>0</sup>	2.97x10 <sup>3</sup>	1.29x10 <sup>2</sup>	8.09x10 <sup>2</sup>	5.90x10 <sup>3</sup>	7.86x10 <sup>1</sup>	1.10x10 <sup>4</sup>
	Construction	1.80x10 <sup>2</sup>	2.05x10 <sup>3</sup>	1.23x10 <sup>2</sup>	1.59x10 <sup>3</sup>	4.54x10 <sup>3</sup>	2.24x10 <sup>1</sup>	1.64x10 <sup>4</sup>
	Industrial	3.67x10 <sup>1</sup>	3.10x10 <sup>2</sup>	1.89x10 <sup>1</sup>	2.63x10 <sup>2</sup>	6.97x10 <sup>2</sup>	5.63x10 <sup>0</sup>	2.24x10 <sup>3</sup>
	Lawn/Garden	2.23x10 <sup>3</sup>	1.48x10 <sup>3</sup>	2.07x10 <sup>2</sup>	1.66x10 <sup>4</sup>	3.82x10 <sup>3</sup>	2.64x10 <sup>2</sup>	1.40x10 <sup>5</sup>
	Logging	2.34x10 <sup>1</sup>	3.66x10 <sup>1</sup>	4.60x10 <sup>0</sup>	1.40x10 <sup>2</sup>	1.09x10 <sup>2</sup>	1.49x10 <sup>0</sup>	2.45x10 <sup>3</sup>
	Pleasure Craft	9.28x10 <sup>2</sup>	8.44x10 <sup>2</sup>	9.45x10 <sup>1</sup>	1.31x10 <sup>4</sup>	1.16x10 <sup>3</sup>	3.88x10 <sup>1</sup>	1.49x10 <sup>5</sup>
	Railroad	9.88x10 <sup>1</sup>	7.28x10 <sup>2</sup>	1.13x10 <sup>2</sup>	1.34x10 <sup>2</sup>	1.62x10 <sup>3</sup>	3.97x10 <sup>1</sup>	3.75x10 <sup>3</sup>
	Recreational	1.03x10 <sup>3</sup>	6.13x10 <sup>2</sup>	1.48x10 <sup>2</sup>	7.50x10 <sup>3</sup>	1.90x10 <sup>3</sup>	1.32x10 <sup>2</sup>	1.25x10 <sup>5</sup>
Underground Mining	7.81x10 <sup>-1</sup>	2.23x10 <sup>1</sup>	1.27x10 <sup>0</sup>	8.54x10 <sup>0</sup>	4.96x10 <sup>1</sup>	1.13x10 <sup>-1</sup>	1.01x10 <sup>2</sup>	

**Table 24.** Continued.

Year	Equipment	Pollutant						
		1,3-Butadiene	Acetaldehyde	Acrolein	Benzene	Formaldehyde	Naphthalene	All HAPs
2030	Agriculture	8.50x10 <sup>1</sup>	1.03x10 <sup>3</sup>	6.09x10 <sup>1</sup>	7.36x10 <sup>2</sup>	2.30x10 <sup>3</sup>	1.25x10 <sup>1</sup>	6.57x10 <sup>3</sup>
	Aircraft	1.13x10 <sup>3</sup>	2.77x10 <sup>3</sup>	1.33x10 <sup>3</sup>	1.51x10 <sup>3</sup>	8.99x10 <sup>3</sup>	6.38x10 <sup>2</sup>	1.96x10 <sup>4</sup>
	Airport Support	1.72x10 <sup>0</sup>	2.81x10 <sup>1</sup>	1.64x10 <sup>0</sup>	1.49x10 <sup>1</sup>	6.28x10 <sup>1</sup>	2.72x10 <sup>-1</sup>	1.52x10 <sup>2</sup>
	Commercial	1.08x10 <sup>3</sup>	8.66x10 <sup>2</sup>	9.42x10 <sup>1</sup>	7.18x10 <sup>3</sup>	2.08x10 <sup>3</sup>	1.49x10 <sup>2</sup>	4.65x10 <sup>4</sup>
	Commercial Marine Vessel	6.77x10 <sup>0</sup>	3.62x10 <sup>3</sup>	1.61x10 <sup>2</sup>	9.82x10 <sup>2</sup>	7.15x10 <sup>3</sup>	1.02x10 <sup>2</sup>	1.34x10 <sup>4</sup>
	Construction	1.71x10 <sup>2</sup>	1.74x10 <sup>3</sup>	1.05x10 <sup>2</sup>	1.49x10 <sup>3</sup>	3.86x10 <sup>3</sup>	1.68x10 <sup>1</sup>	1.52x10 <sup>4</sup>
	Industrial	3.13x10 <sup>1</sup>	3.20x10 <sup>2</sup>	1.92x10 <sup>1</sup>	2.33x10 <sup>2</sup>	7.18x10 <sup>2</sup>	3.58x10 <sup>0</sup>	2.09x10 <sup>3</sup>
	Lawn/Garden	2.56x10 <sup>3</sup>	1.67x10 <sup>3</sup>	2.36x10 <sup>2</sup>	1.91x10 <sup>4</sup>	4.33x10 <sup>3</sup>	3.03x10 <sup>2</sup>	1.61x10 <sup>5</sup>
	Logging	2.83x10 <sup>1</sup>	3.66x10 <sup>1</sup>	5.16x10 <sup>0</sup>	1.68x10 <sup>2</sup>	1.16x10 <sup>2</sup>	1.80x10 <sup>0</sup>	2.96x10 <sup>3</sup>
	Pleasure Craft	9.09x10 <sup>2</sup>	8.34x10 <sup>2</sup>	9.27x10 <sup>1</sup>	1.33x10 <sup>4</sup>	1.15x10 <sup>3</sup>	4.18x10 <sup>1</sup>	1.48x10 <sup>5</sup>
	Railroad	9.36x10 <sup>1</sup>	6.85x10 <sup>2</sup>	1.07x10 <sup>2</sup>	1.26x10 <sup>2</sup>	1.53x10 <sup>3</sup>	3.50x10 <sup>1</sup>	3.53x10 <sup>3</sup>
	Recreational	9.07x10 <sup>2</sup>	5.33x10 <sup>2</sup>	1.28x10 <sup>2</sup>	6.80x10 <sup>3</sup>	1.67x10 <sup>3</sup>	1.36x10 <sup>2</sup>	1.07x10 <sup>5</sup>
Underground Mining	7.91x10 <sup>-1</sup>	2.25x10 <sup>1</sup>	1.29x10 <sup>0</sup>	8.64x10 <sup>0</sup>	5.02x10 <sup>1</sup>	1.16x10 <sup>-1</sup>	1.02x10 <sup>2</sup>	

**Table 25.** Controlled gasoline engine emissions for 2015, 2020, and 2030.

Year	Engine	Pollutant					
		1,3-Butadiene	Acetaldehyde	Benzene	Formaldehyde	Naphthalene	All HAPs
2015	2-Stroke	1.95x10 <sup>3</sup>	1.32x10 <sup>3</sup>	1.83x10 <sup>4</sup>	3.41x10 <sup>3</sup>	2.03x10 <sup>-1</sup>	3.56x10 <sup>5</sup>
	4-Stroke	3.44x10 <sup>3</sup>	2.12x10 <sup>3</sup>	2.08x10 <sup>4</sup>	4.81x10 <sup>3</sup>	5.48x10 <sup>2</sup>	1.45x10 <sup>5</sup>
2020	2-Stroke	1.69x10 <sup>3</sup>	1.16x10 <sup>3</sup>	1.60x10 <sup>4</sup>	2.95x10 <sup>3</sup>	1.90x10 <sup>-1</sup>	3.03x10 <sup>5</sup>
	4-Stroke	3.59x10 <sup>3</sup>	2.20x10 <sup>3</sup>	2.18x10 <sup>4</sup>	5.04x10 <sup>3</sup>	5.85x10 <sup>2</sup>	1.53x10 <sup>5</sup>
2030	2-Stroke	1.62x10 <sup>3</sup>	1.13x10 <sup>3</sup>	1.59x10 <sup>4</sup>	2.85x10 <sup>3</sup>	1.99x10 <sup>-1</sup>	2.94x10 <sup>5</sup>
	4-Stroke	4.05x10 <sup>3</sup>	2.45x10 <sup>3</sup>	2.46x10 <sup>4</sup>	5.70x10 <sup>3</sup>	6.56x10 <sup>2</sup>	1.72x10 <sup>5</sup>

**Table 26.** Controlled gasoline engine equipment emissions for 2015, 2020, and 2030.

Year	Equipment	Pollutant					
		1,3-Butadiene	Acetaldehyde	Benzene	Formaldehyde	Naphthalene	All HAPs
2015	Agriculture	1.16x10 <sup>2</sup>	1.69x10 <sup>3</sup>	9.58x10 <sup>2</sup>	3.76x10 <sup>3</sup>	2.07x10 <sup>1</sup>	9.62x10 <sup>3</sup>
	Airport Support	1.72x10 <sup>0</sup>	2.95x10 <sup>1</sup>	1.48x10 <sup>1</sup>	6.59x10 <sup>1</sup>	4.28x10 <sup>-1</sup>	1.56x10 <sup>2</sup>
	Commercial	8.21x10 <sup>2</sup>	9.03x10 <sup>2</sup>	4.82x10 <sup>3</sup>	2.12x10 <sup>3</sup>	1.13x10 <sup>2</sup>	3.53x10 <sup>4</sup>
	Construction	1.98x10 <sup>2</sup>	2.55x10 <sup>3</sup>	1.70x10 <sup>3</sup>	5.66x10 <sup>3</sup>	2.95x10 <sup>1</sup>	1.86x10 <sup>4</sup>
	Industrial	4.74x10 <sup>1</sup>	3.72x10 <sup>2</sup>	3.14x10 <sup>2</sup>	8.37x10 <sup>2</sup>	8.80x10 <sup>0</sup>	2.77x10 <sup>3</sup>
	Lawn/Garden	2.09x10 <sup>3</sup>	1.41x10 <sup>3</sup>	1.35x10 <sup>4</sup>	3.64x10 <sup>3</sup>	2.46x10 <sup>2</sup>	1.28x10 <sup>5</sup>
	Logging	2.15x10 <sup>1</sup>	4.14x10 <sup>1</sup>	1.14x10 <sup>2</sup>	1.17x10 <sup>2</sup>	1.51x10 <sup>0</sup>	2.21x10 <sup>3</sup>
	Pleasure Craft	1.04x10 <sup>3</sup>	9.23x10 <sup>2</sup>	1.16x10 <sup>4</sup>	1.28x10 <sup>3</sup>	3.73x10 <sup>1</sup>	1.61x10 <sup>5</sup>
	Railroad	1.02x10 <sup>2</sup>	7.55x10 <sup>2</sup>	1.38x10 <sup>2</sup>	1.68x10 <sup>3</sup>	4.20x10 <sup>1</sup>	3.89x10 <sup>3</sup>
	Recreational	1.23x10 <sup>3</sup>	7.45x10 <sup>2</sup>	8.06x10 <sup>3</sup>	2.38x10 <sup>3</sup>	1.27x10 <sup>2</sup>	1.66x10 <sup>5</sup>
2020	Agriculture	9.85x10 <sup>1</sup>	1.31x10 <sup>3</sup>	7.95x10 <sup>2</sup>	2.92x10 <sup>3</sup>	1.69x10 <sup>1</sup>	7.82x10 <sup>3</sup>
	Airport Support	1.58x10 <sup>0</sup>	2.61x10 <sup>1</sup>	1.34x10 <sup>1</sup>	5.82x10 <sup>1</sup>	3.46x10 <sup>-1</sup>	1.40x10 <sup>2</sup>
	Commercial	9.03x10 <sup>2</sup>	8.52x10 <sup>2</sup>	5.28x10 <sup>3</sup>	2.02x10 <sup>3</sup>	1.25x10 <sup>2</sup>	3.85x10 <sup>4</sup>
	Construction	1.80x10 <sup>2</sup>	2.05x10 <sup>3</sup>	1.51x10 <sup>3</sup>	4.54x10 <sup>3</sup>	2.24x10 <sup>1</sup>	1.64x10 <sup>4</sup>
	Industrial	3.67x10 <sup>1</sup>	3.10x10 <sup>2</sup>	2.47x10 <sup>2</sup>	6.97x10 <sup>2</sup>	5.63x10 <sup>0</sup>	2.22x10 <sup>3</sup>
	Lawn/Garden	2.23x10 <sup>3</sup>	1.48x10 <sup>3</sup>	1.44x10 <sup>4</sup>	3.83x10 <sup>3</sup>	2.64x10 <sup>2</sup>	1.38x10 <sup>5</sup>
	Logging	2.35x10 <sup>1</sup>	3.66x10 <sup>1</sup>	1.22x10 <sup>2</sup>	1.10x10 <sup>2</sup>	1.49x10 <sup>0</sup>	2.43x10 <sup>3</sup>
	Pleasure Craft	9.30x10 <sup>2</sup>	8.46x10 <sup>2</sup>	1.07x10 <sup>4</sup>	1.16x10 <sup>3</sup>	3.88x10 <sup>1</sup>	1.46x10 <sup>5</sup>
	Railroad	9.88x10 <sup>1</sup>	7.28x10 <sup>2</sup>	1.33x10 <sup>2</sup>	1.62x10 <sup>3</sup>	3.97x10 <sup>1</sup>	3.75x10 <sup>3</sup>
	Recreational	1.03x10 <sup>3</sup>	6.15x10 <sup>2</sup>	6.36x10 <sup>3</sup>	1.91x10 <sup>3</sup>	1.32x10 <sup>2</sup>	1.24x10 <sup>5</sup>
2030	Agriculture	8.51x10 <sup>1</sup>	1.03x10 <sup>3</sup>	6.77x10 <sup>2</sup>	2.30x10 <sup>3</sup>	1.25x10 <sup>1</sup>	6.51x10 <sup>3</sup>
	Airport Support	1.72x10 <sup>0</sup>	2.81x10 <sup>1</sup>	1.45x10 <sup>1</sup>	6.28x10 <sup>1</sup>	2.72x10 <sup>-1</sup>	1.52x10 <sup>2</sup>
	Commercial	1.08x10 <sup>3</sup>	8.67x10 <sup>2</sup>	6.30x10 <sup>3</sup>	2.08x10 <sup>3</sup>	1.49x10 <sup>2</sup>	4.56x10 <sup>4</sup>
	Construction	1.71x10 <sup>2</sup>	1.74x10 <sup>3</sup>	1.41x10 <sup>3</sup>	3.86x10 <sup>3</sup>	1.68x10 <sup>1</sup>	1.51x10 <sup>4</sup>
	Industrial	3.13x10 <sup>1</sup>	3.20x10 <sup>2</sup>	2.21x10 <sup>2</sup>	7.19x10 <sup>2</sup>	3.58x10 <sup>0</sup>	2.08x10 <sup>3</sup>
	Lawn/Garden	2.56x10 <sup>3</sup>	1.67x10 <sup>3</sup>	1.66x10 <sup>4</sup>	4.34x10 <sup>3</sup>	3.03x10 <sup>2</sup>	1.58x10 <sup>5</sup>
	Logging	2.84x10 <sup>1</sup>	3.67x10 <sup>1</sup>	1.46x10 <sup>2</sup>	1.16x10 <sup>2</sup>	1.80x10 <sup>0</sup>	2.94x10 <sup>3</sup>
	Pleasure Craft	9.12x10 <sup>2</sup>	8.37x10 <sup>2</sup>	1.07x10 <sup>4</sup>	1.15x10 <sup>3</sup>	4.18x10 <sup>1</sup>	1.45x10 <sup>5</sup>
	Railroad	9.36x10 <sup>1</sup>	6.85x10 <sup>2</sup>	1.25x10 <sup>2</sup>	1.53x10 <sup>3</sup>	3.50x10 <sup>1</sup>	3.53x10 <sup>3</sup>
	Recreational	9.10x10 <sup>2</sup>	5.35x10 <sup>2</sup>	5.74x10 <sup>3</sup>	1.68x10 <sup>3</sup>	1.36x10 <sup>2</sup>	1.06x10 <sup>5</sup>

**Table 27.** Base engine and equipment for all HAPs.

Engine	Equipment	Year				
		1999	2010	2015	2020	2030
2-Stroke	Agriculture	3.86x10 <sup>2</sup>	9.18x10 <sup>1</sup>	9.93x10 <sup>1</sup>	1.07x10 <sup>2</sup>	1.22x10 <sup>2</sup>
	Commercial	1.00x10 <sup>4</sup>	2.72x10 <sup>3</sup>	3.02x10 <sup>3</sup>	3.35x10 <sup>3</sup>	4.03x10 <sup>3</sup>
	Construction	1.20x10 <sup>4</sup>	4.47x10 <sup>3</sup>	4.53x10 <sup>3</sup>	4.59x10 <sup>3</sup>	4.71x10 <sup>3</sup>
	Industrial	1.39x10 <sup>2</sup>	1.46x10 <sup>1</sup>	8.04x10 <sup>0</sup>	4.02x10 <sup>0</sup>	0.00x10 <sup>0</sup>
	Lawn/Garden	1.33x10 <sup>5</sup>	4.87x10 <sup>4</sup>	5.22x10 <sup>4</sup>	5.65x10 <sup>4</sup>	6.50x10 <sup>4</sup>
	Logging	2.55x10 <sup>3</sup>	1.47x10 <sup>3</sup>	1.69x10 <sup>3</sup>	1.90x10 <sup>3</sup>	2.32x10 <sup>3</sup>
	Pleasure Craft	3.16x10 <sup>5</sup>	1.88x10 <sup>5</sup>	1.49x10 <sup>5</sup>	1.34x10 <sup>5</sup>	1.32x10 <sup>5</sup>
	Recreational	1.11x10 <sup>5</sup>	1.82x10 <sup>5</sup>	1.48x10 <sup>5</sup>	1.06x10 <sup>5</sup>	8.84x10 <sup>4</sup>
4-Stroke	Agriculture	3.16x10 <sup>3</sup>	2.31x10 <sup>3</sup>	2.09x10 <sup>3</sup>	1.98x10 <sup>3</sup>	1.92x10 <sup>3</sup>
	Airport Support	8.14x10 <sup>1</sup>	3.30x10 <sup>1</sup>	2.46x10 <sup>1</sup>	2.42x10 <sup>1</sup>	2.67x10 <sup>1</sup>
	Commercial	4.59x10 <sup>4</sup>	2.87x10 <sup>4</sup>	3.10x10 <sup>4</sup>	3.44x10 <sup>4</sup>	4.14x10 <sup>4</sup>
	Construction	6.64x10 <sup>3</sup>	3.17x10 <sup>3</sup>	2.95x10 <sup>3</sup>	2.93x10 <sup>3</sup>	2.98x10 <sup>3</sup>
	Industrial	6.81x10 <sup>3</sup>	1.93x10 <sup>3</sup>	1.18x10 <sup>3</sup>	8.91x10 <sup>2</sup>	6.90x10 <sup>2</sup>
	Lawn/Garden	1.27x10 <sup>5</sup>	8.04x10 <sup>4</sup>	7.72x10 <sup>4</sup>	8.27x10 <sup>4</sup>	9.51x10 <sup>4</sup>
	Logging	5.05x10 <sup>2</sup>	4.03x10 <sup>2</sup>	4.08x10 <sup>2</sup>	4.48x10 <sup>2</sup>	5.45x10 <sup>2</sup>
	Pleasure Craft	1.66x10 <sup>4</sup>	1.48x10 <sup>4</sup>	1.45x10 <sup>4</sup>	1.45x10 <sup>4</sup>	1.50x10 <sup>4</sup>
	Railroad	5.94x10 <sup>1</sup>	3.26x10 <sup>1</sup>	3.35x10 <sup>1</sup>	3.49x10 <sup>1</sup>	3.81x10 <sup>1</sup>
Recreational	1.50x10 <sup>4</sup>	1.95x10 <sup>4</sup>	1.94x10 <sup>4</sup>	1.85x10 <sup>4</sup>	1.84x10 <sup>4</sup>	
Aircraft	Aircraft	1.43x10 <sup>4</sup>	1.50x10 <sup>4</sup>	1.61x10 <sup>4</sup>	1.73x10 <sup>4</sup>	1.96x10 <sup>4</sup>
Diesel	Agriculture	1.79x10 <sup>4</sup>	1.01x10 <sup>4</sup>	7.50x10 <sup>3</sup>	5.79x10 <sup>3</sup>	4.53x10 <sup>3</sup>
	Airport Support	2.44x10 <sup>2</sup>	1.65x10 <sup>2</sup>	1.32x10 <sup>2</sup>	1.16x10 <sup>2</sup>	1.25x10 <sup>2</sup>
	Commercial	3.37x10 <sup>3</sup>	2.52x10 <sup>3</sup>	1.95x10 <sup>3</sup>	1.49x10 <sup>3</sup>	1.08x10 <sup>3</sup>
	Commercial Marine Vessel	7.12x10 <sup>3</sup>	7.47x10 <sup>3</sup>	7.50x10 <sup>3</sup>	7.67x10 <sup>3</sup>	8.36x10 <sup>3</sup>
	Construction	2.39x10 <sup>4</sup>	1.46x10 <sup>4</sup>	1.12x10 <sup>4</sup>	8.92x10 <sup>3</sup>	7.51x10 <sup>3</sup>
	Industrial	4.48x10 <sup>3</sup>	2.30x10 <sup>3</sup>	1.61x10 <sup>3</sup>	1.34x10 <sup>3</sup>	1.40x10 <sup>3</sup>
	Lawn/Garden	1.21x10 <sup>3</sup>	8.55x10 <sup>2</sup>	7.11x10 <sup>2</sup>	6.20x10 <sup>2</sup>	5.88x10 <sup>2</sup>
	Logging	5.26x10 <sup>2</sup>	2.17x10 <sup>2</sup>	1.34x10 <sup>2</sup>	1.07x10 <sup>2</sup>	9.40x10 <sup>1</sup>
	Pleasure Craft	3.59x10 <sup>2</sup>	4.04x10 <sup>2</sup>	4.00x10 <sup>2</sup>	3.96x10 <sup>2</sup>	4.10x10 <sup>2</sup>
	Railroad	4.20x10 <sup>3</sup>	3.80x10 <sup>3</sup>	3.72x10 <sup>3</sup>	3.59x10 <sup>3</sup>	3.37x10 <sup>3</sup>
	Recreational	1.29x10 <sup>2</sup>	9.94x10 <sup>1</sup>	7.90x10 <sup>1</sup>	5.90x10 <sup>1</sup>	3.24x10 <sup>1</sup>
Underground Mining	1.77x10 <sup>2</sup>	1.38x10 <sup>2</sup>	1.14x10 <sup>2</sup>	1.01x10 <sup>2</sup>	1.02x10 <sup>2</sup>	
Miscellaneous	Commercial Marine Vessel	2.03x10 <sup>1</sup>	2.34x10 <sup>1</sup>	2.50x10 <sup>1</sup>	2.74x10 <sup>1</sup>	3.48x10 <sup>1</sup>
	Railroad	1.51x10 <sup>2</sup>	1.38x10 <sup>2</sup>	1.36x10 <sup>2</sup>	1.32x10 <sup>2</sup>	1.25x10 <sup>2</sup>
Residual	Commercial Marine Vessel	1.59x10 <sup>3</sup>	2.25x10 <sup>3</sup>	2.69x10 <sup>3</sup>	3.27x10 <sup>3</sup>	4.96x10 <sup>3</sup>
<b>Total nonroad</b>		8.86x10 <sup>5</sup>	6.38x10 <sup>5</sup>	5.61x10 <sup>5</sup>	5.14x10 <sup>5</sup>	5.25x10 <sup>5</sup>



**Table 28.** Controlled gasoline engine emissions by engine and equipment type for all HAPs.

Engine	Equipment	Year		
		2015	2020	2030
2-Stroke	Agriculture	9.80x10 <sup>1</sup>	1.06x10 <sup>2</sup>	1.20x10 <sup>2</sup>
	Commercial	3.00x10 <sup>3</sup>	3.33x10 <sup>3</sup>	4.00x10 <sup>3</sup>
	Construction	4.50x10 <sup>3</sup>	4.56x10 <sup>3</sup>	4.68x10 <sup>3</sup>
	Industrial	7.98x10 <sup>0</sup>	3.99x10 <sup>0</sup>	0.00x10 <sup>0</sup>
	Lawn/Garden	5.19x10 <sup>4</sup>	5.61x10 <sup>4</sup>	6.46x10 <sup>4</sup>
	Logging	1.68x10 <sup>3</sup>	1.89x10 <sup>3</sup>	2.32x10 <sup>3</sup>
	Pleasure Craft	1.47x10 <sup>5</sup>	1.32x10 <sup>5</sup>	1.30x10 <sup>5</sup>
	Recreational	1.47x10 <sup>5</sup>	1.05x10 <sup>5</sup>	8.79x10 <sup>4</sup>
4-Stroke	Agriculture	2.03x10 <sup>3</sup>	1.92x10 <sup>3</sup>	1.86x10 <sup>3</sup>
	Airport Support	2.42x10 <sup>1</sup>	2.39x10 <sup>1</sup>	2.63x10 <sup>1</sup>
	Commercial	3.04x10 <sup>4</sup>	3.37x10 <sup>4</sup>	4.06x10 <sup>4</sup>
	Construction	2.89x10 <sup>3</sup>	2.87x10 <sup>3</sup>	2.93x10 <sup>3</sup>
	Industrial	1.16x10 <sup>3</sup>	8.76x10 <sup>2</sup>	6.78x10 <sup>2</sup>
	Lawn/Garden	7.55x10 <sup>4</sup>	8.08x10 <sup>4</sup>	9.29x10 <sup>4</sup>
	Logging	3.97x10 <sup>2</sup>	4.35x10 <sup>2</sup>	5.30x10 <sup>2</sup>
	Pleasure Craft	1.40x10 <sup>4</sup>	1.39x10 <sup>4</sup>	1.44x10 <sup>4</sup>
	Railroad	3.27x10 <sup>1</sup>	3.40x10 <sup>1</sup>	3.71x10 <sup>1</sup>
Recreational	1.89x10 <sup>4</sup>	1.80x10 <sup>4</sup>	1.78x10 <sup>4</sup>	

### 3.3.4 Portable Fuel Containers (PFC) emission inventories

As part of the MSAT rule, emissions for portable fuel containers (PFC) would be processed in EMS-HAP, ASPEN, and subsequent HAPEM exposure modeling. In order to create the emissions inventories for the MSAT HAPs, two main steps were taken. First, state level VOC PFC emissions were allocated to counties and to several SCC codes. Secondly, after allocation of the VOC emissions, HAP specific emissions were developed. This section describes the processes in both steps.

#### 3.3.4.1 VOC allocation

VOC total PFC reference (uncontrolled) emissions were available for 1990, 2005, 2010, 2015, 2020, and 2030 by state. In addition to the reference inventories, there were control inventories for 2010, 2015, 2020, and 2030. In addition to the years listed, a 1999 reference inventory was needed. The 1999 inventory would be created based on linear interpolation between the 1990 and 2005 inventories.

For both the reference and control inventories, the state VOC emissions needed to be allocated to counties and to SCC codes related to PFC emissions. The following steps were used to allocate the VOC emissions:

- For each year, the reference inventories were read into SAS<sup>®</sup>. For 2010, 2015, 2020, and 2030, the control inventories were read into SAS<sup>®</sup>.

- The state level VOC emissions for each year and emissions scenario, reference or control, were allocated to residential and commercial components for six categories: 1) vapor displacement while refilling containers at the pump, 2) spillage while refilling at the pump, 3) spillage during transport, 4) vapor displacement while refueling equipment, 5) spillage while refueling equipment, and 6) permeation and evaporation. Total state level PFC emissions were allocated to the categories by using national level residential and commercial emissions (Table 29) for each of the categories using the following equations:

$$E_{residential,XXXX,YY} = E \times \left( \frac{Res}{Res + Com} \right) \quad (9)$$

$$E_{commercial,XXXX,YY} = E \times \left( \frac{Com}{Res + Com} \right) \quad (10)$$

where E was the emissions of the category being split, XXXX was year, YY was state, and Res and Com were the emissions shown in Table 29.

- After allocating the VOC emissions to the six categories, the commercial and residential permeation and evaporation categories were split into commercial permeation, commercial evaporation, residential permeation, and residential evaporation by

$$E_{AAA,XXXX,YY,perm} = E_{AAA,XXXX,YY,perm\&evap} \times 0.3387 \quad (11)$$

$$E_{AAA,XXXX,YY,evap} = E_{AAA,XXXX,YY,perm\&evap} \times (1 - 0.3387) \quad (12)$$

The fraction 0.3387 represents the fraction of combined permeation and evaporative emissions attributable to permeation, based on data from the California Air Resources Board.

- Once the state VOC emissions were allocated to the residential and commercial components of the categories, they were assigned SCC codes for later processing in EMS-HAP. These codes are shown in Table 30.
- After creating the SCC level state emissions for the years and emission scenarios, a 1999 reference inventory was created by interpolating from the 1990 to 2005 emissions. The interpolation was done for each state and SCC combination and the equation was:

$$E_{1999,YY,SCC} = E_{1990,YY,SCC} + \left( 9 \times \left( \frac{E_{2005,YY,SCC} - E_{1990,YY,SCC}}{15} \right) \right) \quad (13)$$

where  $E_{1999,YY,SCC}$ ,  $E_{1990,YY,SCC}$ , and  $E_{2005,YY,SCC}$  were the 1999, 1990, and 2005 emissions for state YY and SCC shown in Table 30.

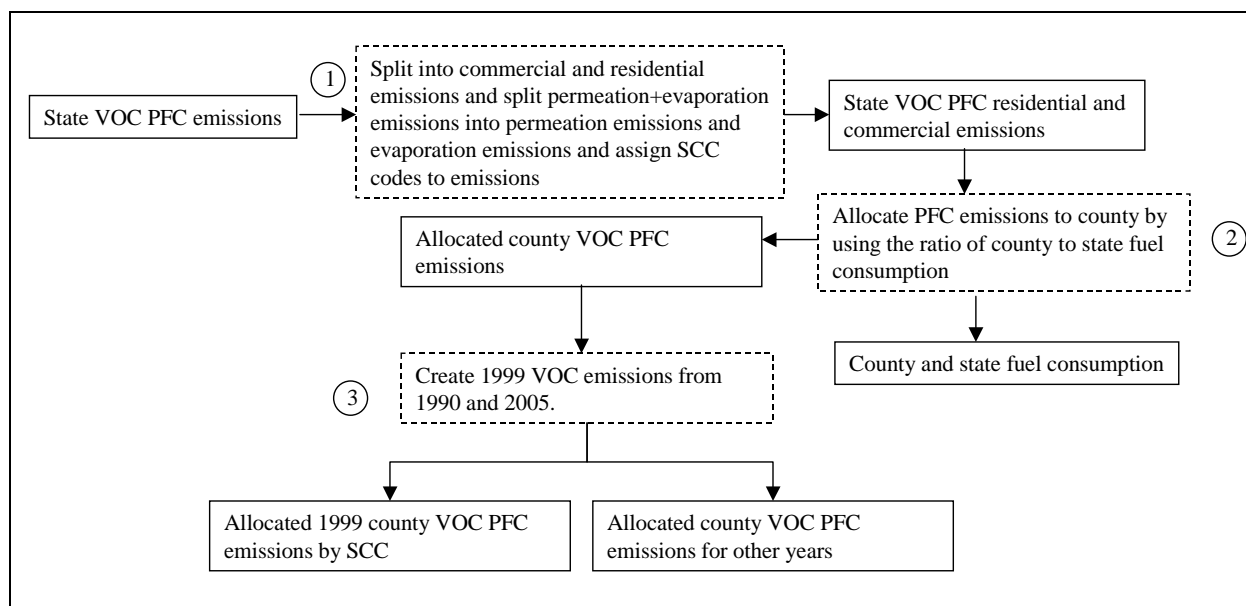
- After creating the 1999 state VOC inventory, the state emissions were allocated to the counties by using the ratio of county to state fuel consumption. State emissions were multiplied by the county specific ratio to yield a county specific VOC emissions number for each SCC. This equation is shown as Equation 14.

$$E_{XXXX,YYYY,AAA,SCC} = E_{XXXX,YY,AAA,SCC} \times \left( \frac{Consumption_{YYYY}}{Consumption_{YY}} \right) \quad (14)$$

where  $E_{XXXX,YYYY,AAA,SCC}$  were the emissions for year XXXX, county with FIPS code YYYYY, emission scenario AAA (reference or control) and SCC shown in Table 30,  $E_{XXXX,YY,AAA,SCC}$  were the state level emissions for year XXXX, state YY, emission scenario AAA, and SCC in Table 30,  $Consumption_{YYYY}$  was the county fuel consumption and  $Consumption_{YY}$  was the state fuel consumption.

- As for the nonroad emissions, Broomfield County emissions were allocated to surrounding counties.

Figure 9 shows the flow of steps for allocation of VOC emissions.



**Figure 9.** Steps in allocation of state VOC PFC emissions to counties.

**Table 29.** PFC categories with national level residential and commercial emissions.

Category	Residential Emissions	Commercial Emissions
Vapor displacement while refilling at the pump	4,328	8,341
Spillage displacement while refilling at the pump	382	735
Spillage during transport	13,519	18,442
Vapor displacement while refueling equipment	4,328	8,341
Spillage while refueling equipment	21,340	41,747
Permeation and evaporation	187,757	5,997

**Table 30.** SCC codes of PFC categories.

SCC code	Description
2501011011	Storage and Transport; Petroleum and Petroleum Product Storage; Residential Portable Gas Cans; Permeation
2501011012	Storage and Transport; Petroleum and Petroleum Product Storage; Residential Portable Gas Cans; Evaporation
2501011013	Storage and Transport; Petroleum and Petroleum Product Storage; Residential Portable Gas Cans; Spillage During Transport
2501011014	Storage and Transport; Petroleum and Petroleum Product Storage; Residential Portable Gas Cans; Refilling at the Pump - Vapor Displacement
2501011015	Storage and Transport; Petroleum and Petroleum Product Storage; Residential Portable Gas Cans; Refilling at the Pump - Spillage
2501011016	Storage and Transport; Petroleum and Petroleum Product Storage; Residential Portable Gas Cans; Refueling Equipment - Vapor Displacement
2501011017	Storage and Transport; Petroleum and Petroleum Product Storage; Residential Portable Gas Cans; Refueling Equipment - Spillage
2501012011	Storage and Transport; Petroleum and Petroleum Product Storage; Commercial Portable Gas Cans; Permeation
2501012012	Storage and Transport; Petroleum and Petroleum Product Storage; Commercial Portable Gas Cans; Evaporation
2501012013	Storage and Transport; Petroleum and Petroleum Product Storage; Commercial Portable Gas Cans; Spillage During Transport
2501012014	Storage and Transport; Petroleum and Petroleum Product Storage; Commercial Portable Gas Cans; Refilling at the Pump - Vapor Displacement
2501012015	Storage and Transport; Petroleum and Petroleum Product Storage; Commercial Portable Gas Cans; Refilling at the Pump - Spillage
2501012016	Storage and Transport; Petroleum and Petroleum Product Storage; Commercial Portable Gas Cans; Refueling Equipment - Vapor Displacement
2501012017	Storage and Transport; Petroleum and Petroleum Product Storage; Commercial Portable Gas Cans; Refueling Equipment - Spillage

### 3.3.4.2 Creation of HAP PFC inventories

Once the state VOC PFC emissions were allocated to counties and SCC codes, PFC emissions for MSAT HAPs could be developed. Two methods were used to create the emissions, one for benzene, and the second for other HAPs. For benzene, the county level light duty gasoline vehicle (LDGV) refueling emissions for benzene and VOC were used to create the PFC emissions. At the county level, the benzene refueling emissions were divided by the VOC refueling emissions, to yield a ratio that would be multiplied with the PFC VOC emissions. Benzene fuel control refueling emissions would be used for refueling control emissions while no fuel controls would be used for 1999 and all the future year reference inventories. Several combinations of PFC and benzene fuel control refueling ratios would be used. These combinations were composed of the PFC emissions with no controls, with controls, and with benzene refueling emissions with and without controls. Table 31 lists the combinations and years for which they were used.

**Table 31.** PFC and benzene fuel control inventory scenarios.

PFC emissions	Benzene refueling emissions	Years
No controls	No controls	1999, 2010, 2015, 2020, 2030
Controls	Controls	2015, 2020, 2030
No controls	Controls	2015, 2020, 2030
Controls	No controls	2010, 2015, 2020, 2030

To calculate the benzene emissions for each PFC SCC in each county the following equations were used. For all SCC emissions except for permeation (residential and commercial) the benzene emissions were calculated as:

$$Benzene_{AAA,XXXX,YYYY,SCC} = VOC_{AAA,XXXX,YYYY,SCC} \times \left( \frac{Benzene_{refuel,XXXX,YYYY,BBB}}{VOC_{refuel,XXXX,YYYY,BBB}} \right) \times 0.36 \quad (15)$$

For permeation emissions, the equation was

$$Benzene_{AAA,XXXX,YYYY,SCC} = VOC_{AAA,XXXX,YYYY,SCC} \times \left( \frac{Benzene_{refuel,XXXX,YYYY,BBB}}{VOC_{refuel,XXXX,YYYY,BBB}} \right) \times 0.36 \times 1.77 \quad (16)$$

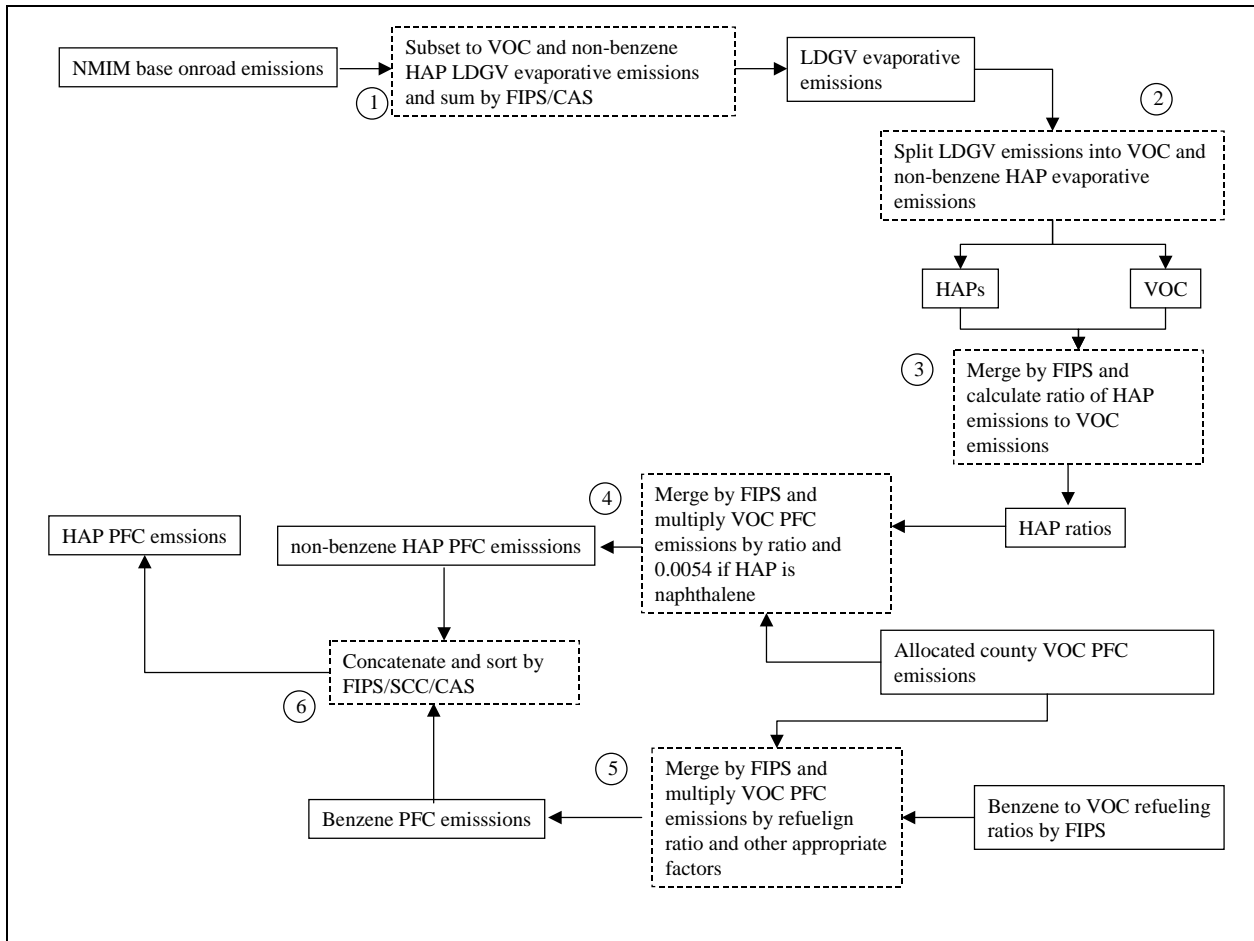
where XXXX was the year, YYYYY was the FIPS code of the county, and SCC was an SCC code shown in Table 30. AAA represents no controls or controls for PFC emissions, and BBB represents whether refueling emissions are control or uncontrolled as in Table 31. Note that 1999 and 2010 uncontrolled benzene refueling emissions were calculated from 2015, as done in the onroad emissions processing.

In the equations the factor 0.36 represents an adjustment based on the nationwide percentage of benzene in gasoline vapor from gasoline distribution with an RVP of 10 psi at 60°F (Hester, 2006). The percentage is 0.27%, in contrast to 0.74% benzene in vehicle refueling emissions from highway vehicles. The ratio or factor of 0.36 was applied to the refueling emissions. A second ratio was used for permeation emissions since recent research suggests that the ratio of benzene from permeation is higher than for evaporation, vapor displacement or spillage. A recent study (Haskew et al., 2004) suggests that the ratio of benzene from permeation to total VOC from permeation is about 1.7727 times higher than the ratio associated with evaporation.

For all other HAPs, the PFC emissions were created by multiplying the PFC VOC emissions by the county level ratio of HAP LDGV evaporative emissions by the VOC LDGV evaporative emissions for the county or:

$$HAP_{AAA,XXXX,YYYY,SCC} = VOC_{AAA,XXXX,YYYY,SCC} \times \left( \frac{HAP_{LDGV,XXXX,YYYY}}{VOC_{LDGV,XXXX,YYYY}} \right) \quad (17)$$

where the subscripts are as denoted previously. Using the LDGV evaporative emissions means only HAPs in the onroad inventory with LDGV evaporative emissions would have PFC emissions. For all other HAPs, the same equation was used for all SCC codes. An adjustment of 0.0054 was also applied to naphthalene emissions with and without fuel benzene control, based on a recent analysis of average nationwide percentage of naphthalene in gasoline vapor from gasoline distribution with an RVP of 10 psi at 60 degrees Fahrenheit (Hester, 2006; U. S. EPA, 2006b). Table 32 lists the emissions summaries for the no controls inventories and Table 33 lists the emissions summaries for the controlled inventories. Steps used in creating the HAP inventories are shown in Figure 10. Full emission summaries can be found in pfc\_summaries.xls in the MSAT rule docket, EPA-HQ-OAR-2005-0036.



**Figure 10.** Steps in creating HAP PFC emissions.

**Table 32.** PFC emissions with and without controls for no benzene fuel controls.

PFC type	HAP	Year								
		1999	2010		2015		2020		2030	
		PFC: no controls	PFC: no controls	PFC: with controls	PFC: no controls	PFC: with controls	PFC: no controls	PFC: with controls	PFC: no controls	PFC: with controls
Commercial PFC: Evaporation	Benzene	9.30x10 <sup>0</sup>	9.03x10 <sup>0</sup>	8.62x10 <sup>0</sup>	9.55x10 <sup>0</sup>	7.72x10 <sup>-1</sup>	1.02x10 <sup>1</sup>	8.24x10 <sup>-1</sup>	1.15x10 <sup>1</sup>	9.33x10 <sup>-1</sup>
	All HAPs	4.61x10 <sup>2</sup>	3.92x10 <sup>2</sup>	3.71x10 <sup>2</sup>	4.13x10 <sup>2</sup>	3.93x10 <sup>1</sup>	4.37x10 <sup>2</sup>	4.14x10 <sup>1</sup>	4.92x10 <sup>2</sup>	4.65x10 <sup>1</sup>
Commercial PFC: Permeation	Benzene	8.43x10 <sup>0</sup>	8.18x10 <sup>0</sup>	7.82x10 <sup>0</sup>	8.66x10 <sup>0</sup>	7.00x10 <sup>-1</sup>	9.25x10 <sup>0</sup>	7.47x10 <sup>-1</sup>	1.05x10 <sup>1</sup>	8.46x10 <sup>-1</sup>
	All HAPs	2.40x10 <sup>2</sup>	2.04x10 <sup>2</sup>	1.94x10 <sup>2</sup>	2.15x10 <sup>2</sup>	2.04x10 <sup>1</sup>	2.28x10 <sup>2</sup>	2.15x10 <sup>1</sup>	2.57x10 <sup>2</sup>	2.42x10 <sup>1</sup>
Commercial PFC: Refilling at the Pump: Spillage	Benzene	1.61x10 <sup>0</sup>	1.80x10 <sup>0</sup>	1.80x10 <sup>0</sup>	1.96x10 <sup>0</sup>	1.96x10 <sup>0</sup>	2.12x10 <sup>0</sup>	2.12x10 <sup>0</sup>	2.45x10 <sup>0</sup>	2.45x10 <sup>0</sup>
	All HAPs	8.42x10 <sup>1</sup>	8.73x10 <sup>1</sup>	8.73x10 <sup>1</sup>	9.44x10 <sup>1</sup>	9.44x10 <sup>1</sup>	1.01x10 <sup>2</sup>	1.01x10 <sup>2</sup>	1.16x10 <sup>2</sup>	1.16x10 <sup>2</sup>
Commercial PFC: Refilling at the Pump: Vapor Displacement	Benzene	1.83x10 <sup>1</sup>	2.05x10 <sup>1</sup>	2.05x10 <sup>1</sup>	2.23x10 <sup>1</sup>	2.23x10 <sup>1</sup>	2.41x10 <sup>1</sup>	2.41x10 <sup>1</sup>	2.79x10 <sup>1</sup>	2.79x10 <sup>1</sup>
	All HAPs	9.57x10 <sup>2</sup>	9.90x10 <sup>2</sup>	9.90x10 <sup>2</sup>	1.07x10 <sup>3</sup>	1.07x10 <sup>3</sup>	1.14x10 <sup>3</sup>	1.14x10 <sup>3</sup>	1.31x10 <sup>3</sup>	1.31x10 <sup>3</sup>
Commercial PFC: Refueling Equipment: Spillage	Benzene	1.00x10 <sup>2</sup>	8.95x10 <sup>1</sup>	5.30x10 <sup>1</sup>	9.66x10 <sup>1</sup>	5.72x10 <sup>1</sup>	1.05x10 <sup>2</sup>	6.20x10 <sup>1</sup>	1.21x10 <sup>2</sup>	7.16x10 <sup>1</sup>
	All HAPs	5.17x10 <sup>3</sup>	4.09x10 <sup>3</sup>	2.58x10 <sup>3</sup>	4.40x10 <sup>3</sup>	2.78x10 <sup>3</sup>	4.72x10 <sup>3</sup>	2.97x10 <sup>3</sup>	5.41x10 <sup>3</sup>	3.41x10 <sup>3</sup>
Commercial PFC: Refueling Equipment: Vapor Displacement	Benzene	1.83x10 <sup>1</sup>	2.05x10 <sup>1</sup>	2.05x10 <sup>1</sup>	2.23x10 <sup>1</sup>	2.23x10 <sup>1</sup>	2.41x10 <sup>1</sup>	2.41x10 <sup>1</sup>	2.79x10 <sup>1</sup>	2.79x10 <sup>1</sup>
	All HAPs	9.57x10 <sup>2</sup>	9.90x10 <sup>2</sup>	9.90x10 <sup>2</sup>	1.07x10 <sup>3</sup>	1.07x10 <sup>3</sup>	1.14x10 <sup>3</sup>	1.14x10 <sup>3</sup>	1.31x10 <sup>3</sup>	1.31x10 <sup>3</sup>
Commercial PFC: Spillage During Transport	Benzene	4.10x10 <sup>1</sup>	4.44x10 <sup>1</sup>	4.35x10 <sup>1</sup>	4.81x10 <sup>1</sup>	4.29x10 <sup>1</sup>	5.20x10 <sup>1</sup>	4.64x10 <sup>1</sup>	5.99x10 <sup>1</sup>	5.34x10 <sup>1</sup>
	All HAPs	2.12x10 <sup>3</sup>	2.11x10 <sup>3</sup>	2.07x10 <sup>3</sup>	2.28x10 <sup>3</sup>	2.06x10 <sup>3</sup>	2.43x10 <sup>3</sup>	2.20x10 <sup>3</sup>	2.78x10 <sup>3</sup>	2.52x10 <sup>3</sup>
Residential PFC: Evaporation	Benzene	2.91x10 <sup>2</sup>	2.83x10 <sup>2</sup>	2.70x10 <sup>2</sup>	2.99x10 <sup>2</sup>	2.42x10 <sup>1</sup>	3.19x10 <sup>2</sup>	2.58x10 <sup>1</sup>	3.62x10 <sup>2</sup>	2.92x10 <sup>1</sup>
	All HAPs	1.44x10 <sup>4</sup>	1.23x10 <sup>4</sup>	1.16x10 <sup>4</sup>	1.29x10 <sup>4</sup>	1.23x10 <sup>3</sup>	1.37x10 <sup>4</sup>	1.30x10 <sup>3</sup>	1.54x10 <sup>4</sup>	1.46x10 <sup>3</sup>
Residential PFC: Permeation	Benzene	2.64x10 <sup>2</sup>	2.56x10 <sup>2</sup>	2.45x10 <sup>2</sup>	2.71x10 <sup>2</sup>	2.19x10 <sup>1</sup>	2.90x10 <sup>2</sup>	2.34x10 <sup>1</sup>	3.28x10 <sup>2</sup>	2.65x10 <sup>1</sup>
	All HAPs	7.50x10 <sup>3</sup>	6.39x10 <sup>3</sup>	6.06x10 <sup>3</sup>	6.75x10 <sup>3</sup>	6.40x10 <sup>2</sup>	7.14x10 <sup>3</sup>	6.75x10 <sup>2</sup>	8.04x10 <sup>3</sup>	7.58x10 <sup>2</sup>
Residential PFC: Refilling at the Pump: Spillage	Benzene	8.37x10 <sup>-1</sup>	9.37x10 <sup>-1</sup>	9.37x10 <sup>-1</sup>	1.02x10 <sup>0</sup>	1.02x10 <sup>0</sup>	1.10x10 <sup>0</sup>	1.10x10 <sup>0</sup>	1.27x10 <sup>0</sup>	1.27x10 <sup>0</sup>
	All HAPs	4.38x10 <sup>1</sup>	4.54x10 <sup>1</sup>	4.54x10 <sup>1</sup>	4.91x10 <sup>1</sup>	4.91x10 <sup>1</sup>	5.25x10 <sup>1</sup>	5.25x10 <sup>1</sup>	6.02x10 <sup>1</sup>	6.02x10 <sup>1</sup>
Residential PFC: Refilling at the Pump: Vapor Displacement	Benzene	9.51x10 <sup>0</sup>	1.07x10 <sup>1</sup>	1.07x10 <sup>1</sup>	1.16x10 <sup>1</sup>	1.16x10 <sup>1</sup>	1.25x10 <sup>1</sup>	1.25x10 <sup>1</sup>	1.45x10 <sup>1</sup>	1.45x10 <sup>1</sup>
	All HAPs	4.97x10 <sup>2</sup>	5.14x10 <sup>2</sup>	5.14x10 <sup>2</sup>	5.55x10 <sup>2</sup>	5.55x10 <sup>2</sup>	5.94x10 <sup>2</sup>	5.94x10 <sup>2</sup>	6.82x10 <sup>2</sup>	6.82x10 <sup>2</sup>
Residential PFC: Refueling Equipment: Spillage	Benzene	5.11x10 <sup>1</sup>	4.57x10 <sup>1</sup>	2.71x10 <sup>1</sup>	4.94x10 <sup>1</sup>	2.93x10 <sup>1</sup>	5.35x10 <sup>1</sup>	3.17x10 <sup>1</sup>	6.18x10 <sup>1</sup>	3.66x10 <sup>1</sup>
	All HAPs	2.64x10 <sup>3</sup>	2.09x10 <sup>3</sup>	1.32x10 <sup>3</sup>	2.25x10 <sup>3</sup>	1.42x10 <sup>3</sup>	2.41x10 <sup>3</sup>	1.52x10 <sup>3</sup>	2.77x10 <sup>3</sup>	1.74x10 <sup>3</sup>
Residential PFC: Refueling Equipment: Vapor Displacement	Benzene	9.51x10 <sup>0</sup>	1.07x10 <sup>1</sup>	1.07x10 <sup>1</sup>	1.16x10 <sup>1</sup>	1.16x10 <sup>1</sup>	1.25x10 <sup>1</sup>	1.25x10 <sup>1</sup>	1.45x10 <sup>1</sup>	1.45x10 <sup>1</sup>
	All HAPs	4.97x10 <sup>2</sup>	5.14x10 <sup>2</sup>	5.14x10 <sup>2</sup>	5.55x10 <sup>2</sup>	5.55x10 <sup>2</sup>	5.94x10 <sup>2</sup>	5.94x10 <sup>2</sup>	6.82x10 <sup>2</sup>	6.82x10 <sup>2</sup>
Residential PFC: Spillage During Transport	Benzene	3.00x10 <sup>1</sup>	3.26x10 <sup>1</sup>	3.19x10 <sup>1</sup>	3.53x10 <sup>1</sup>	3.15x10 <sup>1</sup>	3.81x10 <sup>1</sup>	3.40x10 <sup>1</sup>	4.39x10 <sup>1</sup>	3.92x10 <sup>1</sup>
	All HAPs	1.56x10 <sup>3</sup>	1.55x10 <sup>3</sup>	1.52x10 <sup>3</sup>	1.67x10 <sup>3</sup>	1.51x10 <sup>3</sup>	1.78x10 <sup>3</sup>	1.62x10 <sup>3</sup>	2.04x10 <sup>3</sup>	1.85x10 <sup>3</sup>



**Table 33.** PFC emissions with and without controls for benzene fuel controls.

PFC type	HAP	Year					
		2015		2020		2030	
		PFC: no controls	PFC: with controls	PFC: no controls	PFC: with controls	PFC: no controls	PFC: with controls
Commercial PFC: Evaporation	Benzene	5.79x10 <sup>0</sup>	5.05x10 <sup>-1</sup>	6.19x10 <sup>0</sup>	5.39x10 <sup>-1</sup>	7.00x10 <sup>0</sup>	6.10x10 <sup>-1</sup>
	All HAPs	4.10x10 <sup>2</sup>	3.91x10 <sup>1</sup>	4.33x10 <sup>2</sup>	4.12x10 <sup>1</sup>	4.88x10 <sup>2</sup>	4.62x10 <sup>1</sup>
Commercial PFC: Permeation	Benzene	5.25x10 <sup>0</sup>	4.58x10 <sup>-1</sup>	5.61x10 <sup>0</sup>	4.89x10 <sup>-1</sup>	6.35x10 <sup>0</sup>	5.53x10 <sup>-1</sup>
	All HAPs	2.12x10 <sup>2</sup>	2.02x10 <sup>1</sup>	2.24x10 <sup>2</sup>	2.13x10 <sup>1</sup>	2.53x10 <sup>2</sup>	2.39x10 <sup>1</sup>
Commercial PFC: Refilling at the Pump: Spillage	Benzene	1.25x10 <sup>0</sup>	1.25x10 <sup>0</sup>	1.35x10 <sup>0</sup>	1.35x10 <sup>0</sup>	1.56x10 <sup>0</sup>	1.56x10 <sup>0</sup>
	All HAPs	9.37x10 <sup>1</sup>	9.37x10 <sup>1</sup>	1.00x10 <sup>2</sup>	1.00x10 <sup>2</sup>	1.15x10 <sup>2</sup>	1.15x10 <sup>2</sup>
Commercial PFC: Refilling at the Pump: Vapor Displacement	Benzene	1.42x10 <sup>1</sup>	1.42x10 <sup>1</sup>	1.54x10 <sup>1</sup>	1.54x10 <sup>1</sup>	1.77x10 <sup>1</sup>	1.77x10 <sup>1</sup>
	All HAPs	1.06x10 <sup>3</sup>	1.06x10 <sup>3</sup>	1.14x10 <sup>3</sup>	1.14x10 <sup>3</sup>	1.30x10 <sup>3</sup>	1.30x10 <sup>3</sup>
Commercial PFC: Refueling Equipment: Spillage	Benzene	6.02x10 <sup>1</sup>	3.66x10 <sup>1</sup>	6.52x10 <sup>1</sup>	3.97x10 <sup>1</sup>	7.53x10 <sup>1</sup>	4.58x10 <sup>1</sup>
	All HAPs	4.36x10 <sup>3</sup>	2.76x10 <sup>3</sup>	4.68x10 <sup>3</sup>	2.95x10 <sup>3</sup>	5.37x10 <sup>3</sup>	3.38x10 <sup>3</sup>
Commercial PFC: Refueling Equipment: Vapor Displacement	Benzene	1.42x10 <sup>1</sup>	1.42x10 <sup>1</sup>	1.54x10 <sup>1</sup>	1.54x10 <sup>1</sup>	1.77x10 <sup>1</sup>	1.77x10 <sup>1</sup>
	All HAPs	1.06x10 <sup>3</sup>	1.06x10 <sup>3</sup>	1.14x10 <sup>3</sup>	1.14x10 <sup>3</sup>	1.30x10 <sup>3</sup>	1.30x10 <sup>3</sup>
Commercial PFC: Spillage During Transport	Benzene	3.05x10 <sup>1</sup>	2.74x10 <sup>1</sup>	3.30x10 <sup>1</sup>	2.96x10 <sup>1</sup>	3.80x10 <sup>1</sup>	3.41x10 <sup>1</sup>
	All HAPs	2.26x10 <sup>3</sup>	2.05x10 <sup>3</sup>	2.41x10 <sup>3</sup>	2.19x10 <sup>3</sup>	2.76x10 <sup>3</sup>	2.50x10 <sup>3</sup>
Residential PFC: Evaporation	Benzene	1.81x10 <sup>2</sup>	1.58x10 <sup>1</sup>	1.94x10 <sup>2</sup>	1.69x10 <sup>1</sup>	2.19x10 <sup>2</sup>	1.91x10 <sup>1</sup>
	All HAPs	1.28x10 <sup>4</sup>	1.22x10 <sup>3</sup>	1.36x10 <sup>4</sup>	1.29x10 <sup>3</sup>	1.53x10 <sup>4</sup>	1.45x10 <sup>3</sup>
Residential PFC: Permeation	Benzene	1.64x10 <sup>2</sup>	1.43x10 <sup>1</sup>	1.76x10 <sup>2</sup>	1.53x10 <sup>1</sup>	1.99x10 <sup>2</sup>	1.73x10 <sup>1</sup>
	All HAPs	6.64x10 <sup>3</sup>	6.33x10 <sup>2</sup>	7.02x10 <sup>3</sup>	6.67x10 <sup>2</sup>	7.91x10 <sup>3</sup>	7.49x10 <sup>2</sup>
Residential PFC: Refilling at the Pump: Spillage	Benzene	6.50x10 <sup>-1</sup>	6.50x10 <sup>-1</sup>	7.03x10 <sup>-1</sup>	7.03x10 <sup>-1</sup>	8.13x10 <sup>-1</sup>	8.13x10 <sup>-1</sup>
	All HAPs	4.87x10 <sup>1</sup>	4.87x10 <sup>1</sup>	5.21x10 <sup>1</sup>	5.21x10 <sup>1</sup>	5.97x10 <sup>1</sup>	5.97x10 <sup>1</sup>
Residential PFC: Refilling at the Pump: Vapor Displacement	Benzene	7.36x10 <sup>0</sup>	7.36x10 <sup>0</sup>	7.97x10 <sup>0</sup>	7.97x10 <sup>0</sup>	9.20x10 <sup>0</sup>	9.20x10 <sup>0</sup>
	All HAPs	5.51x10 <sup>2</sup>	5.51x10 <sup>2</sup>	5.90x10 <sup>2</sup>	5.90x10 <sup>2</sup>	6.76x10 <sup>2</sup>	6.76x10 <sup>2</sup>
Residential PFC: Refueling Equipment: Spillage	Benzene	3.08x10 <sup>1</sup>	1.87x10 <sup>1</sup>	3.33x10 <sup>1</sup>	2.03x10 <sup>1</sup>	3.85x10 <sup>1</sup>	2.34x10 <sup>1</sup>
	All HAPs	2.23x10 <sup>3</sup>	1.41x10 <sup>3</sup>	2.39x10 <sup>3</sup>	1.51x10 <sup>3</sup>	2.74x10 <sup>3</sup>	1.73x10 <sup>3</sup>
Residential PFC: Refueling Equipment: Vapor Displacement	Benzene	7.36x10 <sup>0</sup>	7.36x10 <sup>0</sup>	7.97x10 <sup>0</sup>	7.97x10 <sup>0</sup>	9.20x10 <sup>0</sup>	9.20x10 <sup>0</sup>
	All HAPs	5.51x10 <sup>2</sup>	5.51x10 <sup>2</sup>	5.90x10 <sup>2</sup>	5.90x10 <sup>2</sup>	6.76x10 <sup>2</sup>	6.76x10 <sup>2</sup>
Residential PFC: Spillage During Transport	Benzene	2.24x10 <sup>1</sup>	2.01x10 <sup>1</sup>	2.42x10 <sup>1</sup>	2.17x10 <sup>1</sup>	2.78x10 <sup>1</sup>	2.50x10 <sup>1</sup>
	All HAPs	1.66x10 <sup>3</sup>	1.50x10 <sup>3</sup>	1.77x10 <sup>3</sup>	1.60x10 <sup>3</sup>	2.02x10 <sup>3</sup>	1.83x10 <sup>3</sup>

## 4. Creation of stationary inventories

This section describes the methodology used to develop growth factors, reduction factors, and other inventory changes used to project the stationary (point and non-point inventories) to various future years, including 2015 and 2020, which are the MSAT years of interest by Strum et al. (2006). As previously noted, 1999 stationary source emissions were not projected to 2030 because of uncertainty in 2030 projection information; 2020 stationary emissions were used for both 2020 and 2030 with the exception of PFC emissions.

The general approach was to develop growth and reduction factors, and apply them using EMS-HAP Version 3.0. For one category (medical waste incineration), however, a draft 2002 emission inventory was used to represent emissions for all future years (Section 4.3).

### 4.1 Growth factors

Three sets of growth factors (GFs) were developed for input into EMS-HAP for use in growing stationary source emissions: Maximum Achievable Control Technology (MACT)-based GFs, Standard Industrial Classification (SIC)-based GFs and SCC-based GFs. Depending upon the particular code (i.e., MACT, SCC, SIC), the GFs were national, state-level or county level.

EMS-HAP uses the most specific level of data (county) available within a particular GF file. Thus, if a SIC-based GF file contained state and county GFs for the same SIC, and if the county in the GF file matched the county in the inventory, EMS-HAP would apply the county SIC-based GF. Also, in EMS-HAP, if an inventory record matches to GFs in multiple files, the MACT-based GF overrides the SIC-based GF, which overrides the SCC-based one.

For stationary sources, growth factors were developed using three sources of information:

- Regional Economic Model, Inc. (REMI) Policy Insight<sup>®</sup> model, version 5.5 (REMI, 2004; Fan et al., 2000),
- Regional and National fuel-use forecast data from the U.S. Department of Energy, Annual Energy Outlook for the years 2004, 2001 and 2002 (Energy Information Administration, 2005), and
- Rule development leads or economists who had obtained economic information in the process of rule development.

The first two sources of information were also used in projecting criteria pollutant emissions for the Clean Air Interstate Rule (U.S. EPA, 2005a). Earlier versions of REMI and AEO were used to develop the EGAS 4.0, which provides growth factors from 1996 up to 2020 (E.H. Pechan and Associates, 2001).

#### 4.1.1 MACT based growth factors

The MACT-based growth factors used in the projections are shown in Table 34 (national level growth factors) and Table 35 (state level growth factors for utility boilers, coal, which is MACT=1808-1). Most growth factors were based on data from rule development project leads. Some leads estimated that particular categories were not expected to experience any growth, and were assigned growth factors of 1.0. Some leads provided a per year rate, which resulted in a formula of raising a percent growth to a power, where the power was the number of years between the future year and 1999. In one case, for primary aluminum production (MACT=0201), year-specific growth factors based on a 1996 base year were provided; we determined the 1999 base year growth factors as the ratio of the future year's growth factor and 1999 growth factor from the 1996 base year information (Table 34). All MACT-based growth factors in the files were national level growth factors with the exception of 1808-1 (coal burning utility boilers). These growth factors were developed at the state level, using Integrated Planning Model (IPM) run results from the IAQR proposal (<http://www.epa.gov/airmarkets/epa-ipm/iaqr.html>) (U. S. EPA, 2004c). The IPM data were available for 2010 and 2015; thus growth factors for 1808-1 for other years were computed using interpolation, with 2020 being set equal to 2015. For years prior to 2010 the interpolation equation was:

$$GF_X = 1 + ((X - 1999) \times (GF_{2010} - 1) / (2010 - 1999)) \quad (18)$$

where X is 2015 or 2020.

**Table 34.** National level MACT growth factors for 2015 and 2020.

MACT	Description	Methodology*	Equation	Growth Factors	
				2015	2020
0101-2	Rocket Engine Test Firing	no growth	$GF = 1$	1.0000	1.0000
0105	Stationary RICE	5% growth per year	$GF=1.05^{(year-1999)}$	2.1829	2.7860
0108	Stationary Combustion Turbines	0.8% growth per year	$GF=1.008^{(year-1999)}$	1.1360	1.1821
0201	Primary Aluminum Production	Future year's 1996 based growth factor divided by 1999 growth factor based on 1996	$GF=GF_{1996}/(1999 GF_{1996})$ 1999 $GF_{1996} = 0.832$ 2015 $GF_{1996} = 1.025$ 2020 $GF_{1996} = 1.11$	1.2320	1.3341
0302	Coke Ovens: Charging, Top Side, and Door Leaks	4% decline per year	$GF=0.96^{(year-1999)}$	0.5204	0.4243
0303	Coke Ovens: Pushing, Quenching, & Battery Stacks	4% decline per year	$GF=0.96^{(year-1999)}$	0.5204	0.4243
0409	Mineral Wool Production	no growth	$GF = 1$	1.0000	1.0000
0412	Wool Fiberglass Manufacturing	no growth	$GF = 1$	1.0000	1.0000
0415	Clay Ceramics Manufacturing	no growth	$GF = 1$	1.0000	1.0000
0705	Magnetic Tapes (Surface Coating)	no growth	$GF = 1$	1.0000	1.0000
0707	Metal Can (Surface Coating)	no growth	$GF = 1$	1.0000	1.0000
0802	Municipal Landfills	no growth	$GF = 1$	1.0000	1.0000
1001	Acrylic/Modacrylic Fibers Production	no growth before 2007, 1% growth after 2007	$GF=1$ before 2007 $GF=1.01^{(year-2007)}$	1.0829	1.1381
1101	Manufacture of Nutritional Yeast	growth factors based on 2020 $GF=1.14$	$1.006258947^{(year-1999)}$	1.1045	1.1400
1609	Commercial Sterilization Facilities	0.5% growth per year	$1.005^{(year-1999)}$	1.0831	1.1104
1614	Halogenated Solvent Cleaners	no growth	$GF = 1$	1.0000	1.0000
1621	Paint Stripping Operations	decline by 40% from 1999 to 2010 Keep same growth factor as 2010 for all future years thereafter.	$GF=0.954623^{(year-1999)}$ $GF=0.6$ for 2010 and beyond	0.6	0.6
1631	Rubber Tire Production	increase by 2% per year from 1999 to 2020.	$1.02^{(year-1999)}$	1.3728	1.5157
1643	Dry Cleaning: Perchloroethylene	no growth	$GF = 1$	1.0000	1.0000
1801	Medical Waste Incinerators	no growth; future set to 2002 emissions. See Section 4.3	$GF = 1$	1.0000	1.0000
1802	Municipal Waste Combustors	no growth	$GF = 1$	1.0000	1.0000
1808-2	Utility Boilers: Natural Gas	no growth	$GF = 1$	1.0000	1.0000
1808-3	Utility Boilers: Oil	no growth	$GF = 1$	1.0000	1.0000

\* growth factor methodologies provided by project leads

**Table 35.** Utility Boilers: Coal (MACT=1808-1) state level growth factors for 2015 and 2020.

State FIPS	State	Growth Factor	State FIPS	State	Growth Factor	State FIPS	State	Growth Factor
01	Alabama	1.0124	21	Kentucky	1.0061	38	North Dakota	0.8446
02	Alaska	1.0291	22	Louisiana	0.7512	39	Ohio	1.1332
04	Arizona	0.8722	23	Maine	0.8222	40	Oklahoma	0.9677
05	Arkansas	1.0505	24	Maryland	0.8925	41	Oregon	0.9657
06	California	1.1607	25	Massachusetts	0.6548	42	Pennsylvania	1.1294
08	Colorado	0.9969	26	Michigan	1.0635	44	Rhode Island	1.0000
09	Connecticut	2.9294	27	Minnesota	1.0894	45	South Carolina	1.1315
10	Delaware	1.1898	28	Mississippi	1.1299	46	South Dakota	0.9049
11	District of Columbia	1.0000	29	Missouri	1.1095	47	Tennessee	1.0324
12	Florida	0.9407	30	Montana	0.9568	48	Texas	0.8056
13	Georgia	1.1779	31	Nebraska	1.1353	49	Utah	0.8566
15	Hawaii	1.0291	32	Nevada	1.1310	50	Vermont	1.0000
16	Idaho	1.0000	33	New Hampshire	0.9262	51	Virginia	0.9378
17	Illinois	1.1783	34	New Jersey	1.3554	53	Washington	1.0034
18	Indiana	1.0211	35	New Mexico	0.9538	54	West Virginia	1.0764
19	Iowa	0.9547	36	New York	1.1976	55	Wisconsin	1.2966
20	Kansas	1.1285	37	North Carolina	1.1753	56	Wyoming	0.8366

In Table 35, Alaska and Hawaii were set equal to the average 48 state growth factor.

Note, MACT codes in the NEI that are not listed in Tables 34 and 35 were not assigned a MACT-based growth factor. Instead growth for sources with those MACT codes were grown using the SIC or SCC based growth factors, described in the next sections.

The actual MACT-based growth factors files containing the data described above are provided with the EMS-HAP version 3.0 projection-related ancillary files, at <http://www.epa.gov/ttn/chief/emch/projection/emshap30.html> and also in the MSAT rule docket (EPA-HQ-OAR-2005-0036).

#### 4.1.2 SIC based growth factors

State-specific SIC-based growth factors, for specific standard industrial codes (SIC) were developed using the Regional Economic Model, Inc. (REMI) Policy Insight<sup>®</sup> model, version 5.5 (being used in the development of the Economic Growth Analysis System (EGAS), version 5.0, (U.S. EPA, 2005c)). The REMI model forecasts economic activity by region and for individual sectors of the economy. By making assumptions about which economic indicators can represent emissions growth, growth factors can be developed for projecting emission inventories. A review of these growth factors for the development of the Clean Air Interstate Rule (U.S. EPA, 2005a) projected inventories, led to changes to about thirty SIC-based growth factors where they were unrealistic or highly uncertain (U.S. EPA 2005a). They were replaced with data (national-level) from industry forecasts, bureau of labor statistics (BLS) projections and Bureau of Economic Analysis (BEA) historical growth from 1986 – 2002 (U. S. EPA, 2005a). These SIC codes are shown in Table 36. Also SIC 1041 (Mining of gold ores) was set to no growth (GF=1.0). Growth factors for 3322 (Malleable iron foundries) and 3324 (Steel investment foundries) were set equal to the growth factors for SIC 3321.

**Table 36.** SIC codes changed due to unrealistic growth factors.

SIC	Description
1311	Oil And Gas Extraction, Crude Petroleum And Natural Gas, Crude petroleum and natural gas
1321	Oil And Gas Extraction, Natural Gas Liquids, Natural gas liquids
2821	Chemicals And Allied Products, Plastics Materials and Synthetics, Plastics materials and resins
2822	Chemicals And Allied Products, Plastics Materials and Synthetics, Synthetic rubber
2823	Chemicals And Allied Products, Plastics Materials and Synthetics, Cellulosic manmade fibers
2851	Chemicals And Allied Products, Paints and Allied Products, Paints and allied products
2873	Chemicals And Allied Products, Agricultural Chemicals, Nitrogenous fertilizers
2874	Chemicals And Allied Products, Agricultural Chemicals, Phosphatic fertilizers
2895	Chemicals And Allied Products, Miscellaneous Chemical Products, Carbon black
3011	Rubber And Misc. Plastics Products, Tires and Inner Tubes, Tires and inner tubes
3211	Stone, Clay, And Glass Products, Flat Glass, Flat glass
3221	Stone, Clay, And Glass Products, Glass and Glassware, Pressed Or Blown, Glass containers
3229	Stone, Clay, And Glass Products, Glass and Glassware, Pressed Or Blown, Pressed and blown glass, nec
3241	Stone, Clay, And Glass Products, Cement, Hydraulic, Cement, hydraulic
3321	Primary Metal Industries, Iron and Steel Foundries, Gray and ductile iron foundries
3325	Primary Metal Industries, Iron and Steel Foundries, Steel foundries, nec
3331	Primary Metal Industries, Primary Nonferrous Metals, Primary copper
3334	Primary Metal Industries, Primary Nonferrous Metals, Primary aluminum
3339	Primary Metal Industries, Primary Nonferrous Metals, Primary nonferrous metals, nec
3411	Fabricated Metal Products, Metal Cans and Shipping Containers, Metal cans
3441	Fabricated Metal Products, Fabricated Structural Metal Products, Fabricated structural metal
3471	Fabricated Metal Products, Metal Services, Nec, Plating and polishing
3479	Fabricated Metal Products, Metal Services, Nec, Metal coating and allied services
3497	Fabricated Metal Products, Misc. Fabricated Metal Products, Metal foil & leaf
3499	Fabricated Metal Products, Misc. Fabricated Metal Products, Fabricated metal products, nec
3711	Transportation Equipment, Motor Vehicles and Equipment, Motor vehicles and car bodies
3713	Transportation Equipment, Motor Vehicles and Equipment, Truck and bus bodies
3714	Transportation Equipment, Motor Vehicles and Equipment, Motor vehicle parts and accessories
3715	Transportation Equipment, Motor Vehicles and Equipment, Truck trailers

The actual SIC-based growth factors files containing the data described above are provided with the EMS-HAP version 3.0 projection-related ancillary files, at <http://www.epa.gov/ttn/chief/emch/projection/emshap30.html> and in the MSAT rule docket (EPA-HQ-OAR-2005-0036).

#### ***4.1.3 SCC based growth factors***

SCC based growth factors for stationary sources were derived from four sources: 1) REMI model (discussed in Section 4.1.2), 2) Energy Information Administration's National Energy Modeling System (Energy Information Administration, 2005), and 3) aviation gasoline emissions (discussed in Section 3.2). The National Energy Modeling system was used to calculate growth factors for emission sources related to energy use such as residential heating. The data are provided at a division level, with the country divided into nine divisions, for some sectors (e.g., residential fuel use), and at the national level for more detailed industrial sectors (e.g., paper). Growth factors were developed at the most detailed geographic scale (e.g., developed State-level growth factors from the division information) and sectors available. The AEO data were then mapped to SCC codes (Bollman, 2004). In addition to the three sources of data above, emissions for fires (wild and prescribed) were assumed to remain flat, i.e. no growth. For all SCC codes, growth factors were at national or state level.

In the growth factor files that are input into EMS-HAP, instead of listing growth factors by SCC, each SCC is assigned a growth indicator group. These groups consist of related SCC codes that shared common growth factors. For example, for the aviation gasoline distribution SCC codes, instead of listing the growth factor for each of the individual SCC codes, the aviation gasoline distribution SCC codes are assigned the growth indicator group "TAF for General Aviation" and the growth factors cross-referenced by growth indicator group instead of SCC. This cuts down on the number of records in the SCC-based growth factor files. Example records showing the SCC based growth factor file format are shown in Figure 3 in Section 3.2.

The actual SCC-based growth factors files containing the data described above are provided with the EMS-HAP version 3.0 projection-related ancillary files, at <http://www.epa.gov/ttn/chief/emch/projection/emshap30.html> and in the MSAT rule docket (EPA-HQ-OAR-2005-0036).

## **4.2 Reduction factors**

Not only does EMS-HAP allow the user to specify the growth factors for emissions sources, EMS-HAP also allows for reduction of emissions. Reduction factors were applied to the grown stationary source emissions to account for regulatory impacts and plant closures.

The percent reductions were primarily based on estimates of national average reductions for specific HAPs or for groups of HAPs from a source category or subcategory as a result of regulatory efforts. These efforts are primarily the MACT and Section 129 standards, mandated in Title III of the 1990 Clean Air Act Amendments. Percent reductions were determined by, as well as information on applicability and compliance dates, whether they apply to "major" only or

both “major” and “area” sources. With regards to applicability it was necessary to gather information for the various rules from rule preambles, fact sheets and through the project leads (questionnaire and phone calls). A major source is defined as any stationary source or group of stationary sources located within a contiguous area and under common control that has the potential to emit, considering controls, in the aggregate, 10 tons per year or more of any hazardous air pollutant or 25 tons per year or more of any combination of hazardous air pollutants; the status of a point source as “major” is indicated in the NEI by the field called “FACILITY CATEGORY”. For some rules, percent reductions were provided for specific HAPs or groups of HAPs (e.g., all metals, or all volatiles) rather than a single number for all HAPs in the categories. Information was also received on plant closures for several categories such as coke ovens and municipal waste combustors. For the “utility boilers coal” category, it was assumed that the acid gases (hydrochloric acid, hydrogen fluoride and chlorine) would be reduced by the same amount as SO<sub>2</sub> due to co-benefits of potential controls. State-level SO<sub>2</sub> reductions were calculated using SO<sub>2</sub> projected emissions from the Integrated Planning Model (IPM) runs done for proposed CAIR (U. S. EPA, 2004c) and applied these reductions to the acid gas emissions. At the time of the projections, the IPM runs for the final CAIR rule were not available.

Emission reductions were applied in EMS-HAP by MACT code; some were HAP and MACT specific, some were SCC and MACT specific. Site specific reductions such as plant closures or estimations of reductions expected from particular facilities in the source category, were applied by the EMS-HAP site id; process specific, site specific reductions used the SCC as well.

A list of the source categories to which reductions were applied in EMS-HAP, either to facilities in the category or the entire category, is presented in Table 37. Note that this does not include the impacts of all of the rules, only those for which HAP emission reductions could be estimated and for which the compliance date was later than 1999, or for which information on closures was obtained. In addition, if the inventory did not have emissions for which the rule was expected to impact, then that was also left out of the table. It also does not include reductions from MWI, as discussed in the next section.

The actual reduction information for these source categories is provided with the EMS-HAP version 3.0 projection-related ancillary files, at <http://www.epa.gov/ttn/chief/emch/projection/emshap30.html> along with more detailed descriptions and summaries of the data. The reduction information and detailed summaries and descriptions can also be found in the MSAT rule docket (EPA-HQ-OAR-2005-0036).



**Table 37.** Summary of Categories for which reductions were applied in EMS-HAP.

Category	Category
<p>Amino/Phenolic Resins Production: POLYMERS &amp; RESINS III                      Ammonium Sulfate - Caprolactam By-Product Plants: THE MON                      Asphalt roofing and Processing                      Boat Manufacturing                      Brick and Structural Clay Products Manufacturing                      Carbon Black Production                      Carbonyl Sulfide (COS) Production                      Cellulose products manufacturing                      Commercial/Industrial Solid Waste Incineration (CISWI)                      Coke Ovens: Charging, Topside and Door Leaks                      Coke Ovens: Pushing, Quenching, &amp; Battery Stacks                      Cyanide Chemicals Manufacturing                      Ethylene Processes                      Flexible Polyurethane Foam Production                      Friction Products Manufacturing                      Hazardous Waste Incineration and its subcategories: Commercial Haz. Waste Incinerators, On-Site Haz. Waste Incinerators, Cement Kilns, Lightweight Aggregate Kilns                      Industrial/Commercial/ Institutional Boilers &amp; Process Heaters                      Industrial/Commercial/ Institutional Boilers &amp; Process Heaters (Coal)                      Integrated Iron &amp; Steel Manufacturing                      Iron Foundries                      Leather Tanning &amp; Finishing Operations                      Lime Manufacturing                      Manufacturing of Nutritional Yeast                      Mineral Wool Production                      Municipal Solid Waste Landfills                      Miscellaneous Organic Chemical Products &amp; Processes                      Miscellaneous Coatings Manufacturing                      Municipal Waste Combustors                      Primary Aluminum Production                      Primary Copper Smelting                      Primary Magnesium Refining                      Secondary Aluminum Production                      Stationary Reciprocating Internal Combustion Engines                      Natural Gas Transmission &amp; Storage                      Off-Site Waste and Recovery Operations                      Oil &amp; Natural Gas Production</p>	<p>Organic Liquids Distribution (Non-Gasoline)                      Pesticide Active Ingredient Production                      Petroleum Refineries - Catalytic Cracking, Catalytic Reforming, &amp; Sulfur Plant Units (10 yr)                      Petroleum Refineries - Other Sources Not Distinctly Listed (4yr)                      Pharmaceuticals Production                      Reinforced Plastic Composites Production                      Phosphate Fertilizers Production &amp; Phosphoric Acid Manufacturing                      Plywood and Composite Wood Products                      Polyether Polyols Production                      Portland Cement Manufacturing                      Pulp &amp; Paper Production – Combustion &amp; Noncombustion.                      Refractories Products Manufacturing                      Rubber Tire Production                      Secondary Aluminum Production                      Secondary Lead Smelting                      Site Remediation                      Solvent Extraction for Vegetable Oil Production                      Stationary Reciprocating Internal Combustion Engines                      Surface coating related categories:                     <ul style="list-style-type: none"> <li>• Auto &amp; Light Duty Truck</li> <li>• Wood Building Products</li> <li>• Large Appliances</li> <li>• Metal Can</li> <li>• Metal Coil</li> <li>• Metal Furniture</li> <li>• Miscellaneous Metal Parts</li> <li>• Paper &amp; Other Webs</li> <li>• Plastic Parts &amp; Products</li> <li>• Fabric Coating Dying and Printing</li> <li>• Printing/Publishing</li> </ul>                     Steel Pickling - HCL Process                      Taconite Iron Ore Processing                      Viscose Process Manufacturing                      Wet-Formed Fiberglass Mat Production                      Wool Fiberglass Manufacturing                      Utility Boilers: Coal</p>

### 4.3 Other inventory adjustments

In addition to the growth and reduction factors, several other adjustments were made to the stationary inventories. This included:

- the adjustment of gasoline distribution emissions
- control of adjusted benzene gasoline distribution emissions
- the removal of vehicle refueling emissions
- inclusion of PFC emissions (reference and controlled) to the inventories for EMS-HAP processing

The vehicle refueling emissions, which were part of the stationary inventories for the 1999 NEI were included in the onroad inventories described in Section 3.2, so they were removed from the stationary inventories to avoid double counting. For 2015, 2020 and 2030, two stationary inventories were developed:

1. a reference inventory of:
  - a. adjusted gasoline distribution emissions without benzene controls
  - b. uncontrolled PFC emissions (no PFC controls or benzene fuel controls)
  - c. other stationary sources, excluding vehicle refueling
2. a controlled inventory of:
  - a. the adjusted gasoline distribution emissions with benzene controls
  - b. controlled PFC emissions (PFC controls and benzene fuel controls applied)
  - c. other stationary sources, excluding vehicle refueling.

It should be noted that for 2030, with the exception of the PFC emissions, the remaining stationary emissions, including gasoline distribution emissions were the 2020 stationary emissions. This is due to 2030 not being initially projected for stationary sources.

#### *4.3.1 Calculation of gasoline distribution adjustment factors*

The current gasoline marketing projections for 2015 and 2020 developed by Strum et al. (2006) were based on projection information (growth factors, closures, reductions, etc.) from the 1999 NEI. With the recent availability of the 2002 NEI, the current projected emissions for gasoline distribution were to be adjusted using adjustment factors based on the 2002 NEI and the projected 2002 emissions for benzene, toluene, xylenes, naphthalene, ethyl benzene, n-hexane, MTBE, 2,2,4-trimethylpentane.

For calculation of the adjustment factors, emissions of the SCC codes in Table 38 were included in the calculations. There was one additional gasoline distribution SCC code, 2501995120 (Storage and Transport; Petroleum and Petroleum Product Storage; All Storage Types: Working Loss; Gasoline) that was not included in the adjustments. This SCC code was not included in the draft 2002 NEI so it was not included in the adjustments.

**Table 38.** Gasoline distribution SCC codes used in calculation of adjustment factors.

SCC	Description	SCC	Description
2501000000	Storage and Transport; Petroleum and Petroleum Product Storage; All Storage Types: Breathing Loss; Total: All Products	2501050120	Storage and Transport; Petroleum and Petroleum Product Storage; Bulk Stations/Terminals: Breathing Loss; Gasoline
2501060050	Storage and Transport; Petroleum and Petroleum Product Storage; Gasoline Service Stations; Stage 1: Total	2501060051	Storage and Transport; Petroleum and Petroleum Product Storage; Gasoline Service Stations; Stage 1: Submerged Filling
2501060052	Storage and Transport; Petroleum and Petroleum Product Storage; Gasoline Service Stations; Stage 1: Splash Filling	2501060053	Storage and Transport; Petroleum and Petroleum Product Storage; Gasoline Service Stations; Stage 1: Balanced Submerged Filling
2501060200	Storage and Transport; Petroleum and Petroleum Product Storage; Gasoline Service Stations; Underground Tank: Total	2501060201	Storage and Transport; Petroleum and Petroleum Product Storage; Gasoline Service Stations; Underground Tank: Breathing and Emptying
2501080000	Aviation Gasoline Distribution: Stage 1 & II	2501080050	Aviation Gasoline Storage -Stage I
2501080100	Aviation Gasoline Storage -Stage II	2505000000	Storage and Transport; Petroleum and Petroleum Product Transport; All Transport Types; Total: All Products
2505000120	Storage and Transport; Petroleum and Petroleum Product Transport; All Transport Types; Gasoline	2505010000	Storage and Transport; Petroleum and Petroleum Product Transport; Rail Tank Car; Total: All Products
2505020000	Storage and Transport; Petroleum and Petroleum Product Transport; Marine Vessel; Total: All Products	2505020120	Storage and Transport; Petroleum and Petroleum Product Transport; Marine Vessel; Gasoline
2505020121	Marine Vessel Operations - Barge Handling of Gasoline	2505030120	Storage and Transport; Petroleum and Petroleum Product Transport; Truck; Gasoline
40400101	Petroleum and Solvent Evaporation; Petroleum Liquids Storage (non-Refinery); Bulk Terminals; Gasoline RVP 13: Breathing Loss (67000 Bbl Capacity) - Fixed Roof Tank	40400102	Petroleum and Solvent Evaporation; Petroleum Liquids Storage (non-Refinery); Bulk Terminals; Gasoline RVP 10: Breathing Loss (67000 Bbl Capacity) - Fixed Roof Tank
40400103	Petroleum and Solvent Evaporation; Petroleum Liquids Storage (non-Refinery); Bulk Terminals; Gasoline RVP 7: Breathing Loss (67000 Bbl. Capacity) - Fixed Roof Tank	40400104	Petroleum and Solvent Evaporation; Petroleum Liquids Storage (non-Refinery); Bulk Terminals; Gasoline RVP 13: Breathing Loss (250000 Bbl Capacity)-Fixed Roof Tank
40400105	Petroleum and Solvent Evaporation; Petroleum Liquids Storage (non-Refinery); Bulk Terminals; Gasoline RVP 10: Breathing Loss (250000 Bbl Capacity)-Fixed Roof Tank	40400106	Petroleum and Solvent Evaporation; Petroleum Liquids Storage (non-Refinery); Bulk Terminals; Gasoline RVP 7: Breathing Loss (250000 Bbl Capacity) - Fixed Roof Tank
40400107	Petroleum and Solvent Evaporation; Petroleum Liquids Storage (non-Refinery); Bulk Terminals; Gasoline RVP 13: Working Loss (Diam. Independent) - Fixed Roof Tank	40400108	Petroleum and Solvent Evaporation; Petroleum Liquids Storage (non-Refinery); Bulk Terminals; Gasoline RVP 10: Working Loss (Diameter Independent) - Fixed Roof Tank
40400109	Petroleum and Solvent Evaporation; Petroleum Liquids Storage (non-Refinery); Bulk Terminals; Gasoline RVP 7: Working Loss (Diameter Independent) - Fixed Roof Tank	40400110	Petroleum and Solvent Evaporation; Petroleum Liquids Storage (non-Refinery); Bulk Terminals; Gasoline RVP 13: Standing Loss (67000 Bbl Capacity)-Floating Roof Tank

**Table 38. Continued.**

SCC	Description	SCC	Description
40400111	Petroleum and Solvent Evaporation; Petroleum Liquids Storage (non-Refinery); Bulk Terminals; Gasoline RVP 10: Standing Loss (67000 Bbl Capacity)-Floating Roof Tank	40400112	Petroleum and Solvent Evaporation; Petroleum Liquids Storage (non-Refinery); Bulk Terminals; Gasoline RVP 7: Standing Loss (67000 Bbl Capacity)- Floating Roof Tank
40400113	Petroleum and Solvent Evaporation; Petroleum Liquids Storage (non-Refinery); Bulk Terminals; Gasoline RVP 13: Standing Loss (250000 Bbl Cap.) - Floating Roof Tank	40400114	Petroleum and Solvent Evaporation; Petroleum Liquids Storage (non-Refinery); Bulk Terminals; Gasoline RVP 10: Standing Loss (250000 Bbl Cap.) - Floating Roof Tank
40400115	Petroleum and Solvent Evaporation; Petroleum Liquids Storage (non-Refinery); Bulk Terminals; Gasoline RVP 7: Standing Loss (250000 Bbl Cap.) - Floating Roof Tank	40400116	Petroleum and Solvent Evaporation; Petroleum Liquids Storage (non-Refinery); Bulk Terminals; Gasoline RVP 13/10/7: Withdrawal Loss (67000 Bbl Cap.) - Float Rf Tnk
40400117	Petroleum and Solvent Evaporation; Petroleum Liquids Storage (non-Refinery); Bulk Terminals; Gasoline RVP 13/10/7: Withdrawal Loss (250000 Bbl Cap.) - Float Rf Tnk	40400118	Petroleum and Solvent Evaporation; Petroleum Liquids Storage (non-Refinery); Bulk Terminals; Gasoline RVP 13: Filling Loss (10500 Bbl Cap.) - Variable Vapor Space
40400119	Petroleum and Solvent Evaporation; Petroleum Liquids Storage (non-Refinery); Bulk Terminals; Gasoline RVP 10: Filling Loss (10500 Bbl Cap.) - Variable Vapor Space	40400120	Petroleum and Solvent Evaporation; Petroleum Liquids Storage (non-Refinery); Bulk Terminals; Gasoline RVP 7: Filling Loss (10500 Bbl Cap.) - Variable Vapor Space
40400131	Petroleum and Solvent Evaporation; Petroleum Liquids Storage (non-Refinery); Bulk Terminals; Gasoline RVP 13: Standing Loss - Ext. Floating Roof w/ Primary Seal	40400132	Petroleum and Solvent Evaporation; Petroleum Liquids Storage (non-Refinery); Bulk Terminals; Gasoline RVP 10: Standing Loss - Ext. Floating Roof w/ Primary Seal
40400141	Petroleum and Solvent Evaporation; Petroleum Liquids Storage (non-Refinery); Bulk Terminals; Gasoline RVP 13: Standing Loss - Ext. Floating Roof w/ Secondary Seal	40400142	Petroleum and Solvent Evaporation; Petroleum Liquids Storage (non-Refinery); Bulk Terminals; Gasoline RVP 10: Standing Loss - Ext. Floating Roof w/ Secondary Seal
40400143	Petroleum and Solvent Evaporation; Petroleum Liquids Storage (non-Refinery); Bulk Terminals; Gasoline RVP 7: Standing Loss - Ext. Floating Roof w/ Secondary Seal	40400148	Petroleum and Solvent Evaporation; Petroleum Liquids Storage (non-Refinery); Bulk Terminals; Gasoline RVP 13/10/7: Withdrawal Loss - Ext. Float Roof (Pri/Sec Seal)
40400150	Petroleum and Solvent Evaporation; Petroleum Liquids Storage (non-Refinery); Bulk Terminals; Miscellaneous Losses/Leaks: Loading Racks	40400151	Petroleum and Solvent Evaporation; Petroleum Liquids Storage (non-Refinery); Bulk Terminals; Valves, Flanges, and Pumps
40400152	Petroleum and Solvent Evaporation; Petroleum Liquids Storage (non-Refinery); Bulk Terminals; Vapor Collection Losses	40400153	Petroleum and Solvent Evaporation; Petroleum Liquids Storage (non-Refinery); Bulk Terminals; Vapor Control Unit Losses
40400154	Petroleum and Solvent Evaporation; Petroleum Liquids Storage (non-Refinery); Bulk Terminals; Tank Truck Vapor Leaks	40400161	Petroleum and Solvent Evaporation; Petroleum Liquids Storage (non-Refinery); Bulk Terminals; Gasoline RVP 13: Standing Loss - Int. Floating Roof w/ Primary Seal
40400162	Petroleum and Solvent Evaporation; Petroleum Liquids Storage (non-Refinery); Bulk Terminals; Gasoline RVP 10: Standing Loss - Int. Floating Roof w/ Primary Seal	40400163	Petroleum and Solvent Evaporation; Petroleum Liquids Storage (non-Refinery); Bulk Terminals; Gasoline RVP 7: Standing Loss - Internal Floating Roof w/ Primary Seal

**Table 38.** Continued.

SCC	Description	SCC	Description
40400171	Petroleum and Solvent Evaporation; Petroleum Liquids Storage (non-Refinery); Bulk Terminals; Gasoline RVP 13: Standing Loss - Int. Floating Roof w/ Secondary Seal	40400172	Petroleum and Solvent Evaporation; Petroleum Liquids Storage (non-Refinery); Bulk Terminals; Gasoline RVP 10: Standing Loss - Int. Floating Roof w/ Secondary Seal
40400173	Petroleum and Solvent Evaporation; Petroleum Liquids Storage (non-Refinery); Bulk Terminals; Gasoline RVP 7: Standing Loss - Int. Floating Roof w/ Secondary Seal	40400178	Petroleum and Solvent Evaporation; Petroleum Liquids Storage (non-Refinery); Bulk Terminals; Gasoline RVP 13/10/7: Withdrawal Loss - Int. Float Roof (Pri/Sec Seal)
40400201	Petroleum and Solvent Evaporation; Petroleum Liquids Storage (non-Refinery); Bulk Plants; Gasoline RVP 13: Breathing Loss (67000 Bbl Capacity) - Fixed Roof Tank	40400202	Petroleum and Solvent Evaporation; Petroleum Liquids Storage (non-Refinery); Bulk Plants; Gasoline RVP 10: Breathing Loss (67000 Bbl Capacity) - Fixed Roof Tank
40400203	Petroleum and Solvent Evaporation; Petroleum Liquids Storage (non-Refinery); Bulk Plants; Gasoline RVP 7: Breathing Loss (67000 Bbl. Capacity) - Fixed Roof Tank	40400204	Petroleum and Solvent Evaporation; Petroleum Liquids Storage (non-Refinery); Bulk Plants; Gasoline RVP 13: Working Loss (67000 Bbl. Capacity) - Fixed Roof Tank
40400205	Petroleum and Solvent Evaporation; Petroleum Liquids Storage (non-Refinery); Bulk Plants; Gasoline RVP 10: Working Loss (67000 Bbl. Capacity) - Fixed Roof Tank	40400206	Petroleum and Solvent Evaporation; Petroleum Liquids Storage (non-Refinery); Bulk Plants; Gasoline RVP 7: Working Loss (67000 Bbl. Capacity) - Fixed Roof Tank
40400207	Petroleum and Solvent Evaporation; Petroleum Liquids Storage (non-Refinery); Bulk Plants; Gasoline RVP 13: Standing Loss (67000 Bbl Cap.) - Floating Roof Tank	40400208	Petroleum and Solvent Evaporation; Petroleum Liquids Storage (non-Refinery); Bulk Plants; Gasoline RVP 10: Standing Loss (67000 Bbl Cap.) - Floating Roof Tank
40400209	Petroleum and Solvent Evaporation; Petroleum Liquids Storage (non-Refinery); Bulk Plants; Gasoline RVP 7: Standing Loss (67000 Bbl Cap.) - Floating Roof Tank	40400210	Petroleum and Solvent Evaporation; Petroleum Liquids Storage (non-Refinery); Bulk Plants; Gasoline RVP 13/10/7: Withdrawal Loss (67000 Bbl Cap.) - Float Rf Tnk
40400212	Petroleum and Solvent Evaporation; Petroleum Liquids Storage (non-Refinery); Bulk Plants; Gasoline RVP 10: Filling Loss (10500 Bbl Cap.) - Variable Vapor Space	40400213	Petroleum and Solvent Evaporation; Petroleum Liquids Storage (non-Refinery); Bulk Plants; Gasoline RVP 7: Filling Loss (10500 Bbl Cap.) - Variable Vapor Space
40400231	Petroleum and Solvent Evaporation; Petroleum Liquids Storage (non-Refinery); Bulk Plants; Gasoline RVP 13: Standing Loss - Ext. Floating Roof w/ Primary Seal	40400241	Petroleum and Solvent Evaporation; Petroleum Liquids Storage (non-Refinery); Bulk Plants; Gasoline RVP 13: Standing Loss - Ext. Floating Roof w/ Secondary Seal
40400242	Petroleum and Solvent Evaporation; Petroleum Liquids Storage (non-Refinery); Bulk Plants; Gasoline RVP 10: Standing Loss - Ext. Floating Roof w/ Secondary Seal	40400250	Petroleum and Solvent Evaporation; Petroleum Liquids Storage (non-Refinery); Bulk Plants; Loading Racks
40400251	Petroleum and Solvent Evaporation; Petroleum Liquids Storage (non-Refinery); Bulk Plants; Valves, Flanges, and Pumps	40400252	Petroleum and Solvent Evaporation; Petroleum Liquids Storage (non-Refinery); Bulk Plants; Miscellaneous Losses/Leaks: Vapor Collection Losses
40400253	Petroleum and Solvent Evaporation; Petroleum Liquids Storage (non-Refinery); Bulk Plants; Miscellaneous Losses/Leaks: Vapor Control Unit Losses	40400254	Petroleum and Solvent Evaporation; Petroleum Liquids Storage (non-Refinery); Bulk Plants; Tank Truck Vapor Losses

**Table 38. Continued.**

SCC	Description	SCC	Description
40400261	Petroleum and Solvent Evaporation; Petroleum Liquids Storage (non-Refinery); Bulk Plants; Gasoline RVP 13: Standing Loss - Int. Floating Roof w/ Primary Seal	40400262	Petroleum and Solvent Evaporation; Petroleum Liquids Storage (non-Refinery); Bulk Plants; Gasoline RVP 10: Standing Loss - Int. Floating Roof w/ Primary Seal
40400263	Petroleum and Solvent Evaporation; Petroleum Liquids Storage (non-Refinery); Bulk Plants; Gasoline RVP 7: Standing Loss - Internal Floating Roof w/ Primary Seal	40400278	Petroleum and Solvent Evaporation; Petroleum Liquids Storage (non-Refinery); Bulk Plants; Gasoline RVP 10/13/7: Withdrawal Loss - Int. Float Roof (Pri/Sec Seal)
40400401	Petroleum and Solvent Evaporation; Petroleum Liquids Storage (non-Refinery); Petroleum Products - Underground Tanks; Gasoline RVP 13: Breathing Loss	40400402	Petroleum and Solvent Evaporation; Petroleum Liquids Storage (non-Refinery); Petroleum Products - Underground Tanks; Gasoline RVP 13: Working Loss
40400403	Petroleum and Solvent Evaporation; Petroleum Liquids Storage (non-Refinery); Petroleum Products - Underground Tanks; Gasoline RVP 10: Breathing Loss	40400404	Petroleum and Solvent Evaporation; Petroleum Liquids Storage (non-Refinery); Petroleum Products - Underground Tanks; Gasoline RVP 10: Working Loss
40400405	Petroleum and Solvent Evaporation; Petroleum Liquids Storage (non-Refinery); Petroleum Products - Underground Tanks; Gasoline RVP 7: Breathing Loss	40400406	Petroleum and Solvent Evaporation; Petroleum Liquids Storage (non-Refinery); Petroleum Products - Underground Tanks; Gasoline RVP 7: Working Loss
40400497	Petroleum and Solvent Evaporation; Petroleum Liquids Storage (non-Refinery); Petroleum Products - Underground Tanks; Specify Liquid: Breathing Loss	40400498	Petroleum and Solvent Evaporation; Petroleum Liquids Storage (non-Refinery); Petroleum Products - Underground Tanks; Specify Liquid: Working Loss
406001	Petroleum and Solvent Evaporation; Transportation and Marketing of Petroleum Products; Tank Cars and Trucks	40600101	Petroleum and Solvent Evaporation; Transportation and Marketing of Petroleum Products; Tank Cars and Trucks; Gasoline: Splash Loading **
40600126	Petroleum and Solvent Evaporation; Transportation and Marketing of Petroleum Products; Tank Cars and Trucks; Gasoline: Submerged Loading **	40600131	Petroleum and Solvent Evaporation; Transportation and Marketing of Petroleum Products; Tank Cars and Trucks; Gasoline: Submerged Loading (Normal Service)
40600136	Petroleum and Solvent Evaporation; Transportation and Marketing of Petroleum Products; Tank Cars and Trucks; Gasoline: Splash Loading (Normal Service)	40600141	Petroleum and Solvent Evaporation; Transportation and Marketing of Petroleum Products; Tank Cars and Trucks; Gasoline: Submerged Loading (Balanced Service)
40600144	Petroleum and Solvent Evaporation; Transportation and Marketing of Petroleum Products; Tank Cars and Trucks; Gasoline: Splash Loading (Balanced Service)	40600147	Petroleum and Solvent Evaporation; Transportation and Marketing of Petroleum Products; Tank Cars and Trucks; Gasoline: Submerged Loading (Clean Tanks)
40600162	Petroleum and Solvent Evaporation; Transportation and Marketing of Petroleum Products; Tank Cars and Trucks; Gasoline: Loaded with Fuel (Transit Losses)	40600163	Petroleum and Solvent Evaporation; Transportation and Marketing of Petroleum Products; Tank Cars and Trucks; Gasoline: Return with Vapor (Transit Losses)
406002	Petroleum and Solvent Evaporation; Transportation and Marketing of Petroleum Products; Marine Vessels	40600231	Petroleum and Solvent Evaporation; Transportation and Marketing of Petroleum Products; Marine Vessels; Gasoline: Ship Loading - Cleaned and Vapor Free Tanks

**Table 38. Continued.**

<b>SCC</b>	<b>Description</b>	<b>SCC</b>	<b>Description</b>
40600232	Petroleum and Solvent Evaporation; Transportation and Marketing of Petroleum Products; Marine Vessels; Gasoline: Ocean Barges Loading	40600233	Petroleum and Solvent Evaporation; Transportation and Marketing of Petroleum Products; Marine Vessels; Gasoline: Barge Loading - Cleaned and Vapor Free Tanks
40600234	Petroleum and Solvent Evaporation; Transportation and Marketing of Petroleum Products; Marine Vessels; Gasoline: Ship Loading - Ballasted Tank	40600236	Petroleum and Solvent Evaporation; Transportation and Marketing of Petroleum Products; Marine Vessels; Gasoline: Ship Loading - Uncleaned Tanks
40600237	Petroleum and Solvent Evaporation; Transportation and Marketing of Petroleum Products; Marine Vessels; Gasoline: Ocean Barges Loading - Uncleaned Tanks	40600238	Petroleum and Solvent Evaporation; Transportation and Marketing of Petroleum Products; Marine Vessels; Gasoline: Barges Loading - Uncleaned Tanks
40600239	Petroleum and Solvent Evaporation; Transportation and Marketing of Petroleum Products; Marine Vessels; Gasoline: Tanker Ship - Ballasted Tank Condition	40600240	Petroleum and Solvent Evaporation; Transportation and Marketing of Petroleum Products; Marine Vessels; Gasoline: Barge Loading - Average Tank Condition
40600241	Petroleum and Solvent Evaporation; Transportation and Marketing of Petroleum Products; Marine Vessels; Gasoline: Tanker Ship - Ballasting	40600242	Petroleum and Solvent Evaporation; Transportation and Marketing of Petroleum Products; Marine Vessels; Gasoline: Transit Loss
40600301	Petroleum and Solvent Evaporation; Transportation and Marketing of Petroleum Products; Gasoline Retail Operations - Stage I; Splash Filling	40600302	Petroleum and Solvent Evaporation; Transportation and Marketing of Petroleum Products; Gasoline Retail Operations - Stage I; Submerged Filling w/o Controls
40600305	Petroleum and Solvent Evaporation; Transportation and Marketing of Petroleum Products; Gasoline Retail Operations - Stage I; Unloading **	40600306	Petroleum and Solvent Evaporation; Transportation and Marketing of Petroleum Products; Gasoline Retail Operations - Stage I; Balanced Submerged Filling
40600307	Petroleum and Solvent Evaporation; Transportation and Marketing of Petroleum Products; Gasoline Retail Operations - Stage I; Underground Tank Breathing and Emptying	40600399	Petroleum and Solvent Evaporation; Transportation and Marketing of Petroleum Products; Gasoline Retail Operations - Stage I; Not Classified **
40600706	Petroleum and Solvent Evaporation; Transportation and Marketing of Petroleum Products; Consumer (Corporate) Fleet Refueling - Stage I; Balanced Submerged Filling	40600707	Petroleum and Solvent Evaporation; Transportation and Marketing of Petroleum Products; Consumer (Corporate) Fleet Refueling - Stage I; Underground Tank Breathing and Emptying
40688801	Petroleum and Solvent Evaporation; Transportation and Marketing of Petroleum Products; Fugitive Emissions; Specify in Comments Field	40688802	Petroleum and Solvent Evaporation; Transportation and Marketing of Petroleum Products; Fugitive Emissions; Specify in Comments Field



To calculate the adjustment factors, the emissions of the SCC codes from Table 38 were summed across the country for each HAP for the projected 2002 inventory and the 2002 draft NEI. The HAP specific adjustment factor was then calculated as the ratio of the 2002 NEI emissions to the 2002 projected emissions.

The 2002 draft NEI emissions, 2002 projected emissions, and adjustment factors are shown in Table 39.

**Table 39.** National gasoline distribution adjustment factors for each HAP.

HAP	2002 NEI emissions	2002 projected emissions	National adjustment factor
2,2,4-trimethylpentane	5,466.99	4,877.25	1.12092
Benzene	5,530.95	4,993.05	1.10773
Ethyl benzene	1,471.76	1,093.31	1.34615
Hexane	10,674.11	11,929.36	0.89478
MTBE	16,847.54	9,318.57	1.80795
Naphthalene	432.47	526.33	0.82167
Toluene	10,778.90	9,372.60	1.15004
Xylenes	6,570.87	7,034.62	0.93408

In addition to the factors in Table 39, additional nationwide adjustments of 0.36 and 0.0054, respectively, were applied to emissions of benzene and naphthalene. The basis for these adjustments is discussed in the Section 3.3.4.

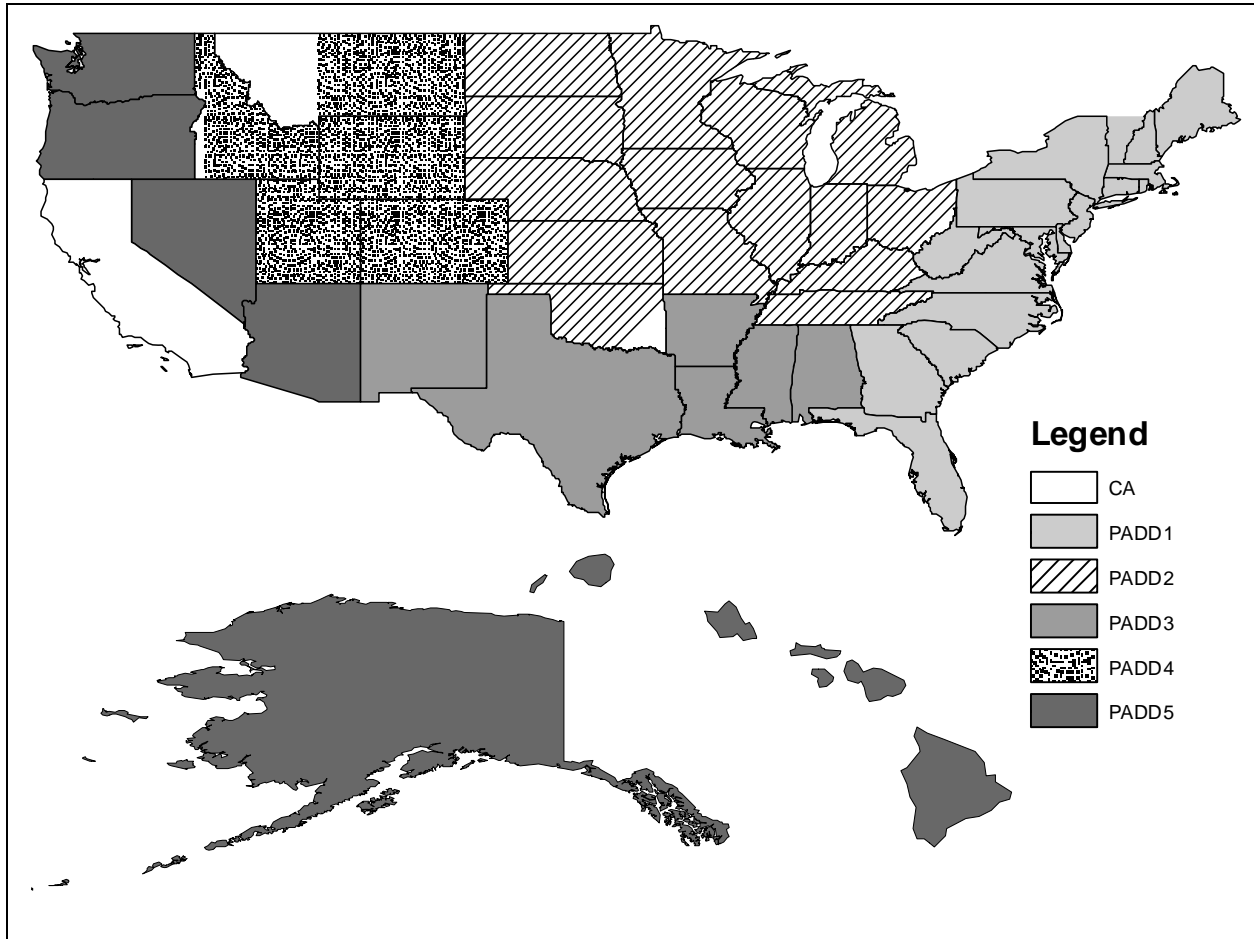
#### **4.3.2 Calculation of benzene controls**

After adjusting the gasoline marketing and distribution emissions, controls were applied to benzene gasoline distribution emissions. In the application of the benzene controls, SCC code 2501995120 was included in the list of SCC codes to be controlled.

Gasoline marketing and distribution emissions were estimated for the control scenario by applying a county specific control ratio based on the change in average fuel benzene level for the control and reference case. Average fuel benzene level for the control case was determined from refinery modeling done for the proposed rule. As part of the refinery modeling, average fuel properties for each Petroleum Administration for Defense District (PADD) under the new standards were estimated. Average fuel benzene levels for conventional gasoline (CG) and reformulated gasoline (RFG) in each PADD before and after implementation of the proposed standards were used to develop multiplicative factors. These multiplicative factors were used as control ratios for estimating the controlled gasoline marketing and distribution emissions.

The multiplicative factors (control ratios for gasoline marketing and distribution emissions) are shown in Table 40. Although California is part of PADD5, it was treated separately since California has its own reformulated gasoline program. PADD regions are shown in Figure 11.

To apply the control ratios to the gasoline marketing and distribution SCCs, it was necessary to distinguish between the counties in each PADD using RFG versus CG. Figure 12 shows which counties are RFG counties.



**Figure 11.** PADD regions for the U.S.



**Figure 12.** RFG counties (dark gray) for the U.S.

**Table 40.** Change in Average Fuel Benzene Level (Volume Percent) by PADD with Implementation of Proposed Fuel Benzene Standard (CG – Conventional Gasoline; RFG – Reformulated Gasoline).

	Gasoline Type	Region					
		PADD 1	PADD 2	PADD 3	PADD 4	PADD 5	Calif.
Reference Case	CG	0.91 %	1.26%	0.95%	1.47%	1.42%	0.62%
	RFG	0.59%	0.80%	0.57%	1.05%	0.65%	0.62%
Control Case	CG	0.55%	0.68%	0.54%	0.93%	0.85%	0.61%
	RFG	0.54%	0.71%	0.55%	0.62%	0.60%	0.61%
Multiplicative Factor	CG	0.60	0.54	0.57	0.63	0.60	0.98
	RFG	0.92	0.89	0.96	0.59	0.92	0.98

### 4.3.3 Removal of vehicle refueling emissions

In addition to adjusting the gasoline marketing and distribution emissions and controlling the benzene gasoline marketing and distribution emissions, emissions associated with vehicle refueling were removed from the stationary inventories since they were now part of the onroad inventories. Table 41 lists the SCC codes associated with vehicle refueling that were removed.

**Table 41.** Vehicle refueling SCC codes.

SCC	Description
2501060000	Storage and Transport, Petroleum and Petroleum Product Storage, Gasoline Service Stations, Total: All Gasoline/All Processes
2501060100	Storage and Transport, Petroleum and Petroleum Product Storage, Gasoline Service Stations, Stage 2: Total
2501060101	Storage and Transport, Petroleum and Petroleum Product Storage, Gasoline Service Stations, Stage 2: Displacement Loss/Uncontrolled
2501060102	Storage and Transport, Petroleum and Petroleum Product Storage, Gasoline Service Stations, Stage 2: Displacement Loss/Controlled
2501060103	Storage and Transport, Petroleum and Petroleum Product Storage, Gasoline Service Stations, Stage 2: Spillage
40600401	Petroleum and Solvent Evaporation, Transportation and Marketing of Petroleum Products, Filling Vehicle Gas Tanks - Stage II, Vapor Loss w/o Controls
40600402	Petroleum and Solvent Evaporation, Transportation and Marketing of Petroleum Products, Filling Vehicle Gas Tanks - Stage II, Liquid Spill Loss w/o Controls
40600403	Petroleum and Solvent Evaporation, Transportation and Marketing of Petroleum Products, Filling Vehicle Gas Tanks - Stage II, Vapor Loss w/o Controls
40600499	Petroleum and Solvent Evaporation, Transportation and Marketing of Petroleum Products, Filling Vehicle Gas Tanks - Stage II, Not Classified
40600601	Petroleum and Solvent Evaporation, Transportation and Marketing of Petroleum Products, Consumer (Corporate) Fleet Refueling - Stage II, Vapor Loss w/o Controls
40600602	Petroleum and Solvent Evaporation, Transportation and Marketing of Petroleum Products, Consumer (Corporate) Fleet Refueling - Stage II, Liquid Spill Loss w/o Controls
40600603	Petroleum and Solvent Evaporation, Transportation and Marketing of Petroleum Products, Consumer (Corporate) Fleet Refueling - Stage II, Vapor Loss w/controls

#### **4.4 Application of growth and reductions to project stationary source emissions**

For stationary sources, EMS-HAP was used to project the emissions with the lone exception of Medical Waste Incinerator (MWI, MACT=1801) emissions which utilized draft 2002 MWI emissions as advised by the MWI project lead. For this category, it was expected that emissions would remain at 2002 levels into the future.

##### ***4.4.1 Point and airport nonpoint sources***

For point sources, the PtTemporal output from the 1999 NATA EMS-HAP run was adjusted (via a program called mwi.sas, which is available in the docket for this rule [EPA-HQ-OAR-2005-0036] to change the 1999 medical waste incineration (MWI) emissions to 2002 emissions (U.S. EPA, 2005d). The new emissions were then processed through PtGrowCntl, using the growth and reduction factors described in Sections 3.3.5, 4.1 and 4.2, to project the inventory to 2015 and 2020

The substitution of the 2002 MWI emissions for the 1999 emissions resulted in a change from 727 tons to 31.5 tons.

Note that the aviation gasoline point sources were run separately through EMS-HAP, using the aircraft growth factors as described in Section 3.2.

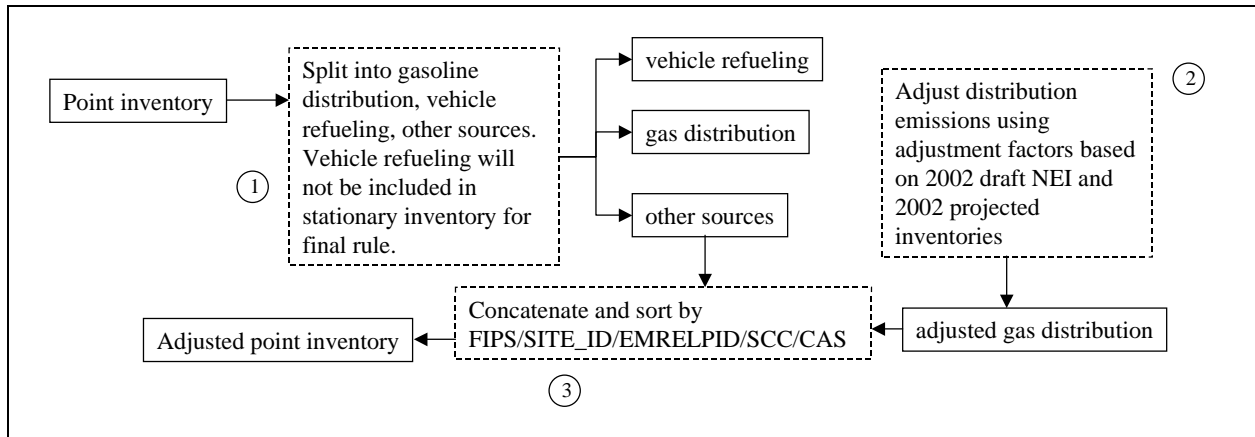
After projecting the emissions to 2015 and 2020, the gasoline distribution emissions were adjusted and controlled for benzene and removal of any vehicle refueling emissions. Note that gasoline distribution emissions were only adjusted for those HAPs listed in Table 39. The general methodology in modifying the projected emissions was:

- For each of the years, the emissions were split into three subsets: gasoline distribution, vehicle refueling, and other point sources, i.e. those that are not gasoline distribution or vehicle refueling. The gasoline distribution emissions included the emissions of SCC codes from Table 38. Vehicle refueling emissions were those of SCC codes from Table 41.
- For each of the HAPs shown in Table 39, applied the national adjustment factor to each gasoline distribution emission source. For HAPs not listed in Table 39, the emissions were not adjusted, i.e. an adjustment factor of 1.0 was applied to the emissions.
- After adjusting the gasoline distribution emissions, the adjusted emissions were concatenated with the other point source emissions. Vehicle refueling emissions were not appended to the new inventory.

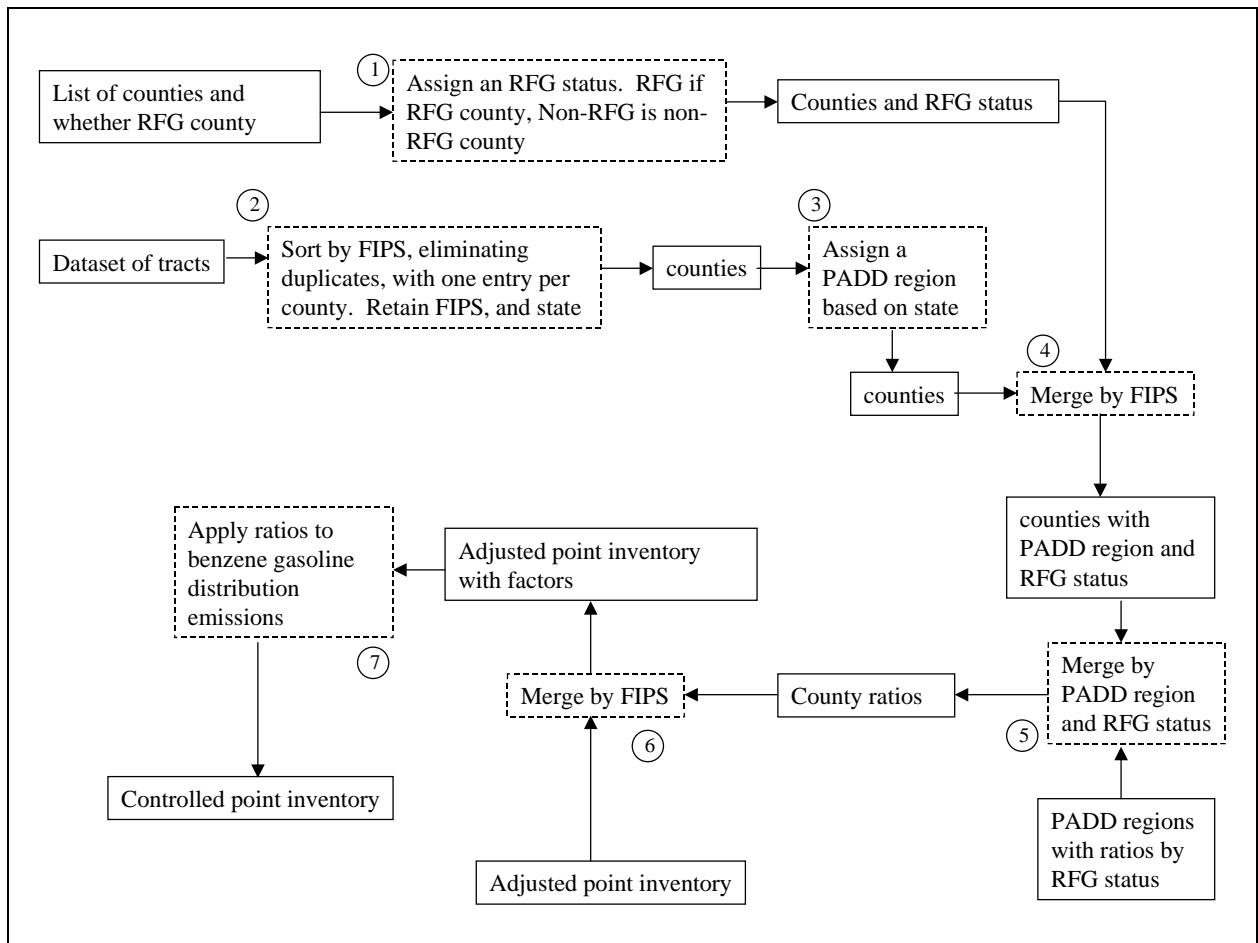
Figure 13 shows the steps in adjusting the 1999 and projected inventories and Figure 14 shows the development of the controlled adjusted inventories for 2015 and 2020.

The inventories were then ready for input into EMS-HAP module PtFinal\_ASPEN to create ASPEN ready emissions files.

Airport nonpoint emissions consisted entirely of aviation gasoline distribution and were adjusted in the same manner as the point sources and Figures 13 and 14 are valid for airport nonpoint emissions. As with the point sources, the output of PtTemporal was used for 1999 and the output of PtGrowCntl was used for 2015 and 2020. After adjustment of emissions, the inventories were ready for input into PtFinal\_ASPEN in order to create ASPEN ready emission files.



**Figure 13.** Steps in adjustment of 1999 and 2015 and 2020 projected point and airport nonpoint inventories.



**Figure 14.** Steps in used in developing controlled 2015 and 2020 point and airport nonpoint inventories.

#### 4.4.2 Nonpoint sources

The adjustments of the nonpoint sources were more complex than the point sources. This is because the nonpoint sources would include the PFC emissions as well. For the nonpoint inventories the approach was to modify the gasoline distribution emissions and vehicle refueling emissions before projection, i.e. the 1999 emissions, because the EMS-HAP module CountyProc, which projects the emissions, also creates the ASPEN ready files. There was no intermediate step as in the point processing to allow for modification of emissions. Emissions had to be modified before input into EMS-HAP. Since the PFC emissions were already projected to 2015, 2020, and 2030, the pre-CountyProc inventories for 2015, 2020, and 2030 would consist of 1999 emissions for all sources except the PFC, which would already be the year specific emissions. Additionally, there were no growth factors in the growth factor files for the PFC emissions, so they would remain unchanged. Following is the methodology in creating the pre-EMS-HAP inventories for 2015, 2020, and 2030:

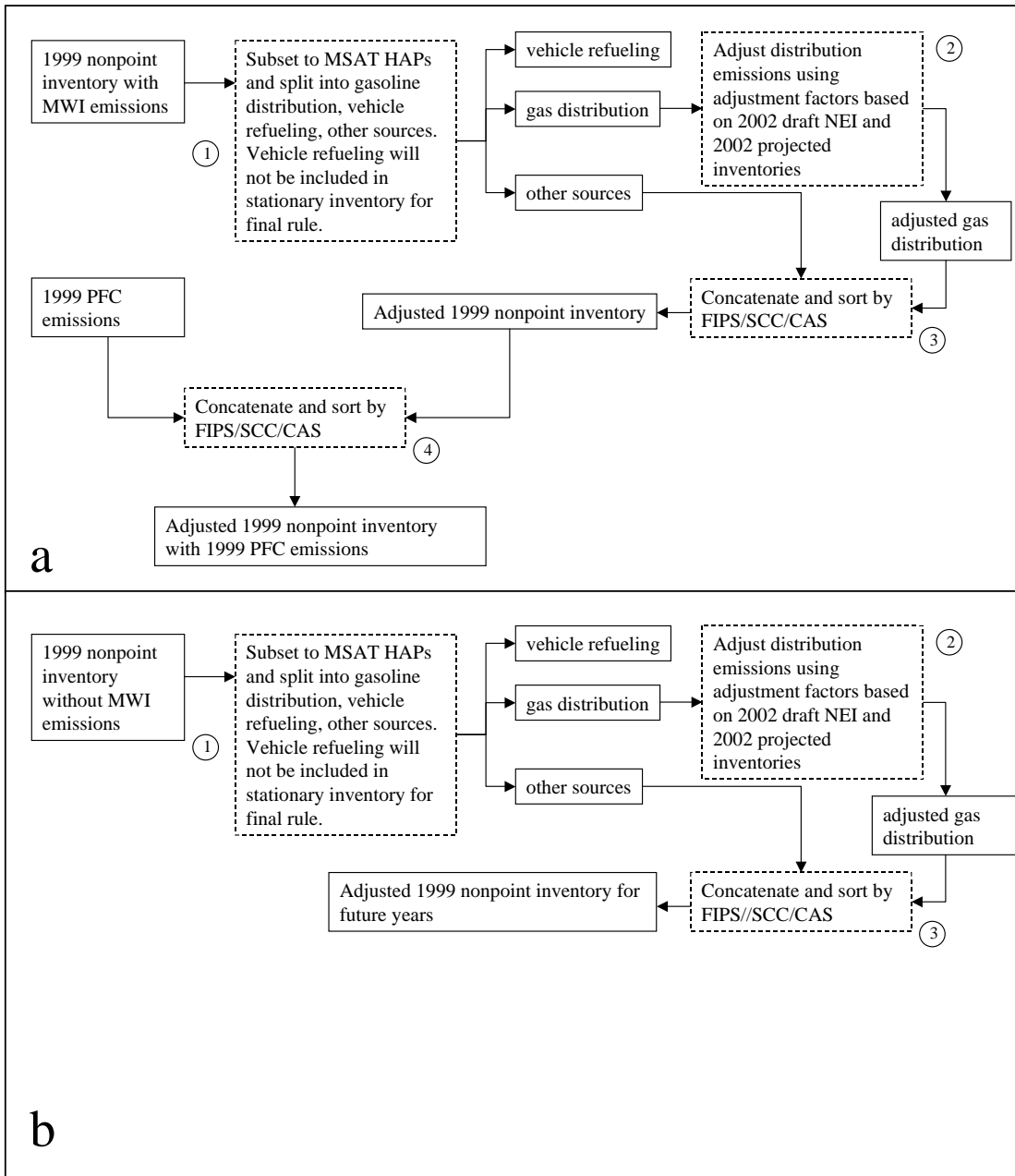
- From the 1999 NEI nonpoint inventory, reduced the emissions to MSAT HAPs, and adjusted the gasoline distribution emissions as done for the point sources. Also, benzene controls were applied to the gasoline distribution emissions.
- Removed vehicle refueling emissions
- As with point sources, the MWI emissions were modified. There were no non-point MWI emissions in 2002, so the 1999 MWI emissions were set to zero.
- For the reference case inventories for 2015, 2020, or 2030, appended the county level base PFC emissions (no PFC or benzene fuel controls) to the 1999 modified emissions.
- For the control case inventories, appended the county level controlled PFC emissions (PFC controls and benzene fuel controls) to the 1999 modified inventories

For 1999 processing for 1999 ASPEN modeling, the following steps were taken:

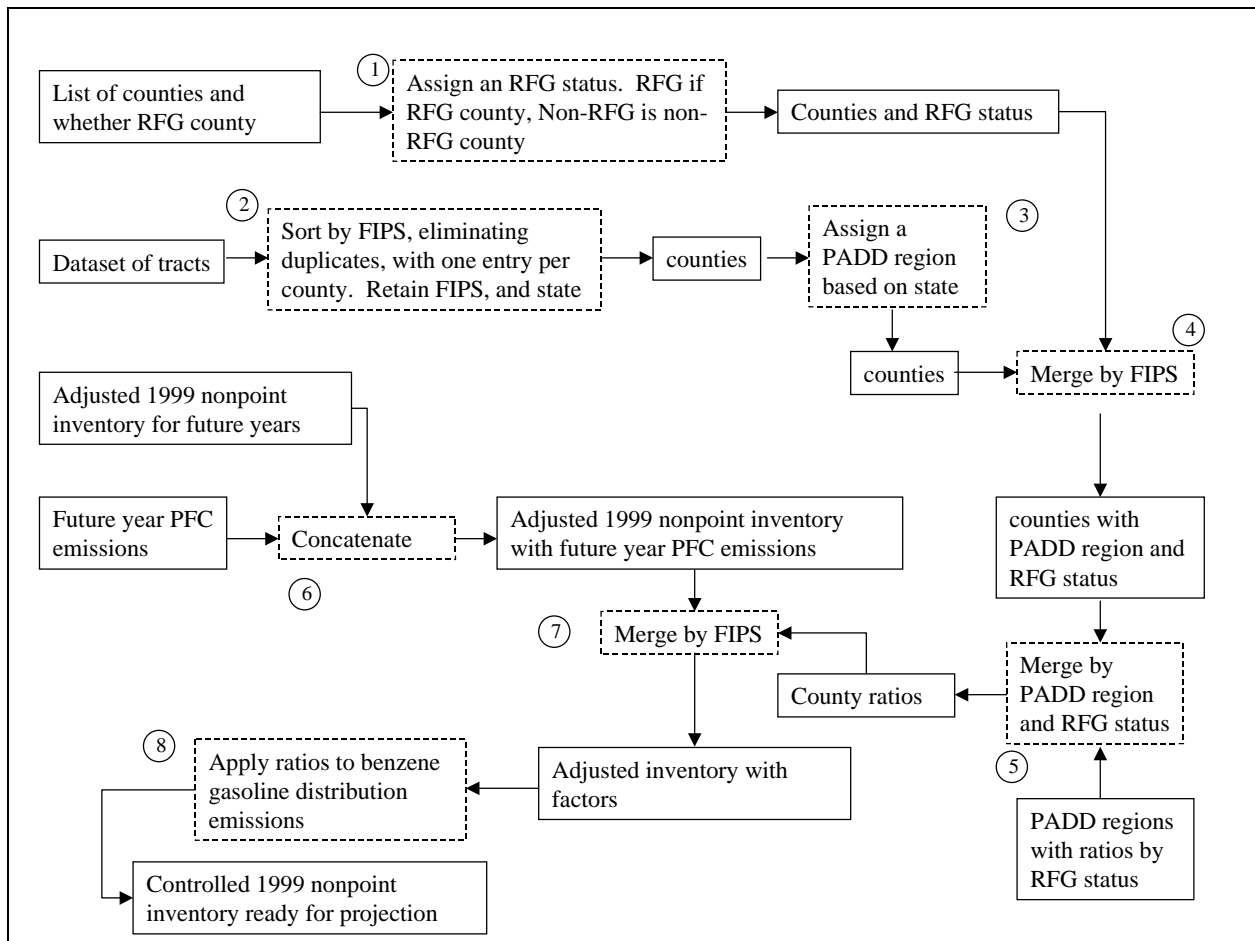
- From the 1999 NEI nonpoint inventory, reduced the emissions to MSAT HAPs, and adjusted the gasoline distribution emissions as done for the point sources.
- Removed vehicle refueling emissions
- MWI emissions were not changed to zero. They were left unchanged.
- Appended the county level base 1999 PFC emissions (no PFC or benzene fuel controls) to the 1999 modified emissions.

Figure 15 shows the adjustment of the 1999 inventories with and without MWI emissions and Figure 16 shows the development of the controlled inventories for projection for 2015, 2020, and 2030.





**Figure 15.** Adjustment of: a) 1999 nonpoint inventory with MWI emissions included and b) 1999 nonpoint inventory without MWI emissions for projection to 2015, 2020, and 2030.



**Figure 16.** Development of nonpoint base and controlled inventories for projection for 2015, 2020, and 2030.

Once the inventories were created, they were ready for input into CountyProc, which would project the emissions using the growth and reduction factors described in Sections 3.3.4, 4.1 and 4.2, to project the inventory to 2015, and 2020, and 2030. The PFC SCC codes were not in any growth or reduction factor files, so they would remain unchanged and at their already projected levels. CountyProc would also speciate, temporally allocate, and spatially allocate the county-level emissions and create ASPEN ready files.

A summary of the gasoline distribution and vehicle refueling adjustments can be found in Tables 42 and 43 respectively.

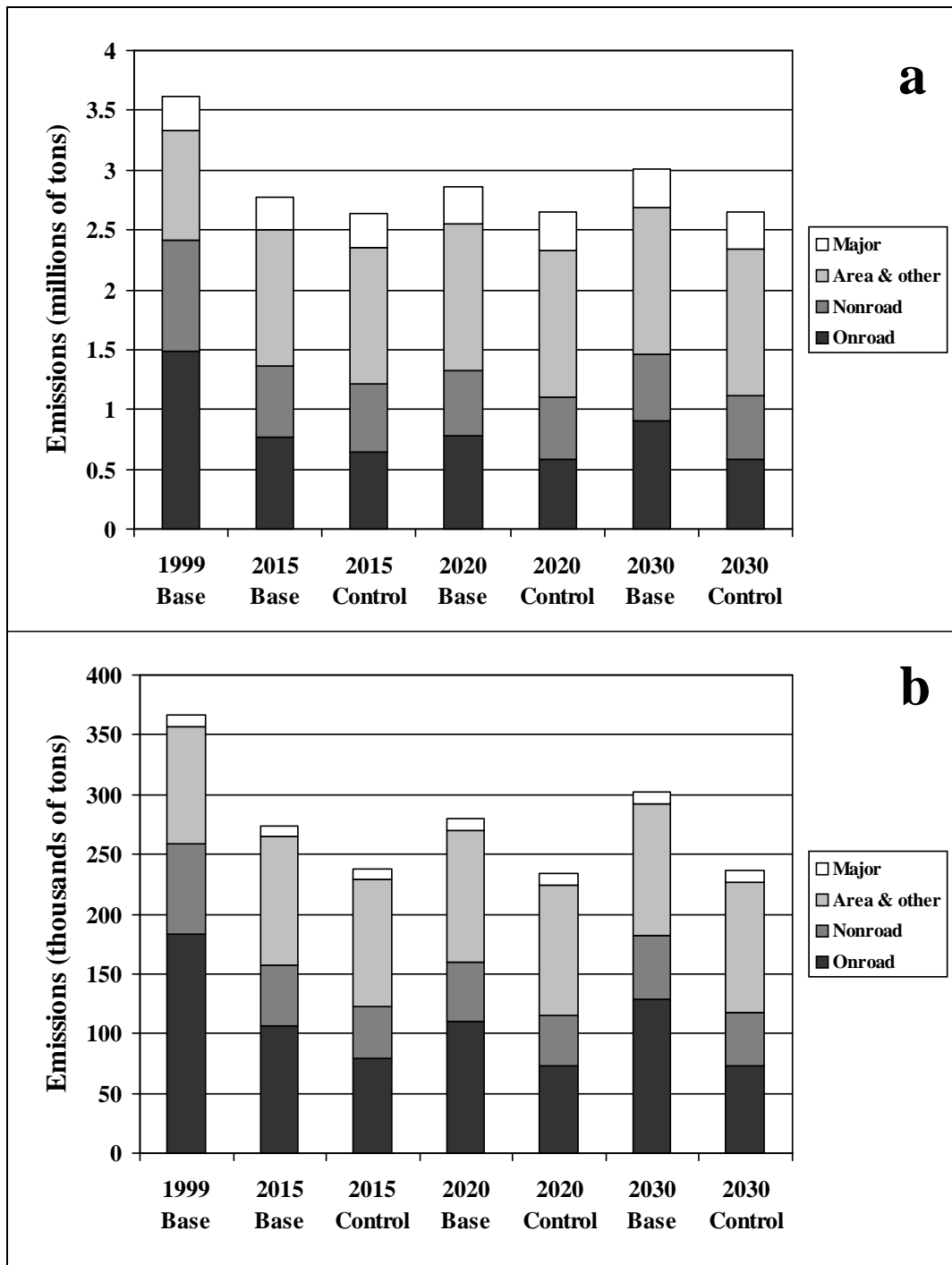
**Table 42.** 1999, 2015, and 2020, pre-adjusted, adjusted, and controlled adjusted gasoline distribution emissions.

HAP	Year							
	1999		2015			2020		
	Pre-adjusted	Adjusted	Pre-adjusted	Adjusted	Controlled	Pre-adjusted	Adjusted	Controlled
2,2,4-Trimethylpentane	4.88x10 <sup>3</sup>	5.47x10 <sup>3</sup>	5.34x10 <sup>3</sup>	5.98x10 <sup>3</sup>	5.98x10 <sup>3</sup>	5.51x10 <sup>3</sup>	6.17x10 <sup>3</sup>	6.17x10 <sup>3</sup>
Benzene	4.97x10 <sup>3</sup>	1.98x10 <sup>3</sup>	5.42x10 <sup>3</sup>	2.16x10 <sup>3</sup>	1.46x10 <sup>3</sup>	5.60x10 <sup>3</sup>	2.23x10 <sup>3</sup>	1.52x10 <sup>3</sup>
Ethyl Benzene	1.07x10 <sup>3</sup>	1.44x10 <sup>3</sup>	1.27x10 <sup>3</sup>	1.71x10 <sup>3</sup>	1.71x10 <sup>3</sup>	1.36x10 <sup>3</sup>	1.82x10 <sup>3</sup>	1.82x10 <sup>3</sup>
Hexane	1.20x10 <sup>4</sup>	1.07x10 <sup>4</sup>	1.26x10 <sup>4</sup>	1.13x10 <sup>4</sup>	1.13x10 <sup>4</sup>	1.30x10 <sup>4</sup>	1.16x10 <sup>4</sup>	1.16x10 <sup>4</sup>
MTBE	9.37x10 <sup>3</sup>	1.69x10 <sup>4</sup>	1.00x10 <sup>4</sup>	1.81x10 <sup>4</sup>	1.81x10 <sup>4</sup>	1.03x10 <sup>4</sup>	1.85x10 <sup>4</sup>	1.85x10 <sup>4</sup>
Naphthalene	2.81x10 <sup>0</sup>	2.31x10 <sup>0</sup>	3.10x10 <sup>0</sup>	2.55x10 <sup>0</sup>	2.55x10 <sup>0</sup>	3.21x10 <sup>0</sup>	2.64x10 <sup>0</sup>	2.64x10 <sup>0</sup>
Toluene	9.30x10 <sup>3</sup>	1.07x10 <sup>4</sup>	1.02x10 <sup>4</sup>	1.18x10 <sup>4</sup>	1.18x10 <sup>4</sup>	1.06x10 <sup>4</sup>	1.22x10 <sup>4</sup>	1.22x10 <sup>4</sup>
Xylenes	6.91x10 <sup>3</sup>	6.45x10 <sup>3</sup>	7.97x10 <sup>3</sup>	7.45x10 <sup>3</sup>	7.45x10 <sup>3</sup>	8.43x10 <sup>3</sup>	7.87x10 <sup>3</sup>	7.87x10 <sup>3</sup>

**Table 43.** Vehicle refueling emissions removed from stationary inventories.

HAP	Year								
	1999			2015			2020		
	Major	Area & Other	Total	Major	Area & Other	Total	Major	Area & Other	Total
1,3-Butadiene	0.00x10 <sup>0</sup>	3.05x10 <sup>0</sup>	3.05x10 <sup>0</sup>	0.00x10 <sup>0</sup>	1.18x10 <sup>0</sup>	1.18x10 <sup>0</sup>	0.00x10 <sup>0</sup>	1.12x10 <sup>0</sup>	1.12x10 <sup>0</sup>
2,2,4-Trimethylpentane	2.00x10 <sup>-1</sup>	1.97x10 <sup>3</sup>	1.97x10 <sup>3</sup>	3.05x10 <sup>-1</sup>	1.00x10 <sup>3</sup>	1.00x10 <sup>3</sup>	3.33x10 <sup>-1</sup>	1.01x10 <sup>3</sup>	1.01x10 <sup>3</sup>
Benzene	4.51x10 <sup>-1</sup>	1.57x10 <sup>3</sup>	1.57x10 <sup>3</sup>	6.73x10 <sup>-1</sup>	7.24x10 <sup>2</sup>	7.24x10 <sup>2</sup>	7.53x10 <sup>-1</sup>	7.19x10 <sup>2</sup>	7.20x10 <sup>2</sup>
Ethyl Benzene	9.37x10 <sup>-2</sup>	4.69x10 <sup>2</sup>	4.69x10 <sup>2</sup>	1.42x10 <sup>-1</sup>	2.89x10 <sup>2</sup>	2.89x10 <sup>2</sup>	1.56x10 <sup>-1</sup>	3.01x10 <sup>2</sup>	3.01x10 <sup>2</sup>
Hexane	5.02x10 <sup>-1</sup>	3.52x10 <sup>3</sup>	3.52x10 <sup>3</sup>	7.53x10 <sup>-1</sup>	1.35x10 <sup>3</sup>	1.36x10 <sup>3</sup>	8.27x10 <sup>-1</sup>	1.29x10 <sup>3</sup>	1.29x10 <sup>3</sup>
MTBE	3.31x10 <sup>0</sup>	5.38x10 <sup>3</sup>	5.38x10 <sup>3</sup>	5.02x10 <sup>0</sup>	3.22x10 <sup>3</sup>	3.22x10 <sup>3</sup>	5.48x10 <sup>0</sup>	3.34x10 <sup>3</sup>	3.34x10 <sup>3</sup>
Naphthalene	2.00x10 <sup>-3</sup>	1.86x10 <sup>2</sup>	1.86x10 <sup>2</sup>	2.18x10 <sup>-3</sup>	7.88x10 <sup>1</sup>	7.88x10 <sup>1</sup>	2.28x10 <sup>-3</sup>	7.70x10 <sup>1</sup>	7.70x10 <sup>1</sup>
POM	0.00x10 <sup>0</sup>	4.71x10 <sup>1</sup>	4.71x10 <sup>1</sup>	0.00x10 <sup>0</sup>	2.58x10 <sup>1</sup>	2.58x10 <sup>1</sup>	0.00x10 <sup>0</sup>	2.63x10 <sup>1</sup>	2.63x10 <sup>1</sup>
Styrene	0.00x10 <sup>0</sup>	3.46x10 <sup>1</sup>	3.46x10 <sup>1</sup>	0.00x10 <sup>0</sup>	1.32x10 <sup>1</sup>	1.32x10 <sup>1</sup>	0.00x10 <sup>0</sup>	1.26x10 <sup>1</sup>	1.26x10 <sup>1</sup>

Figure 17 shows the base and controlled stationary and mobile emissions after all emissions processing, prior to EMS-HAP. The nonroad emissions include the PFC emissions.



**Figure 17.** Major, area & other, nonroad and onroad emissions for 1999, 2015, 2020, and 2030 for base and controlled inventories for a) sum of all HAPs, and b) benzene only.

This page intentionally blank

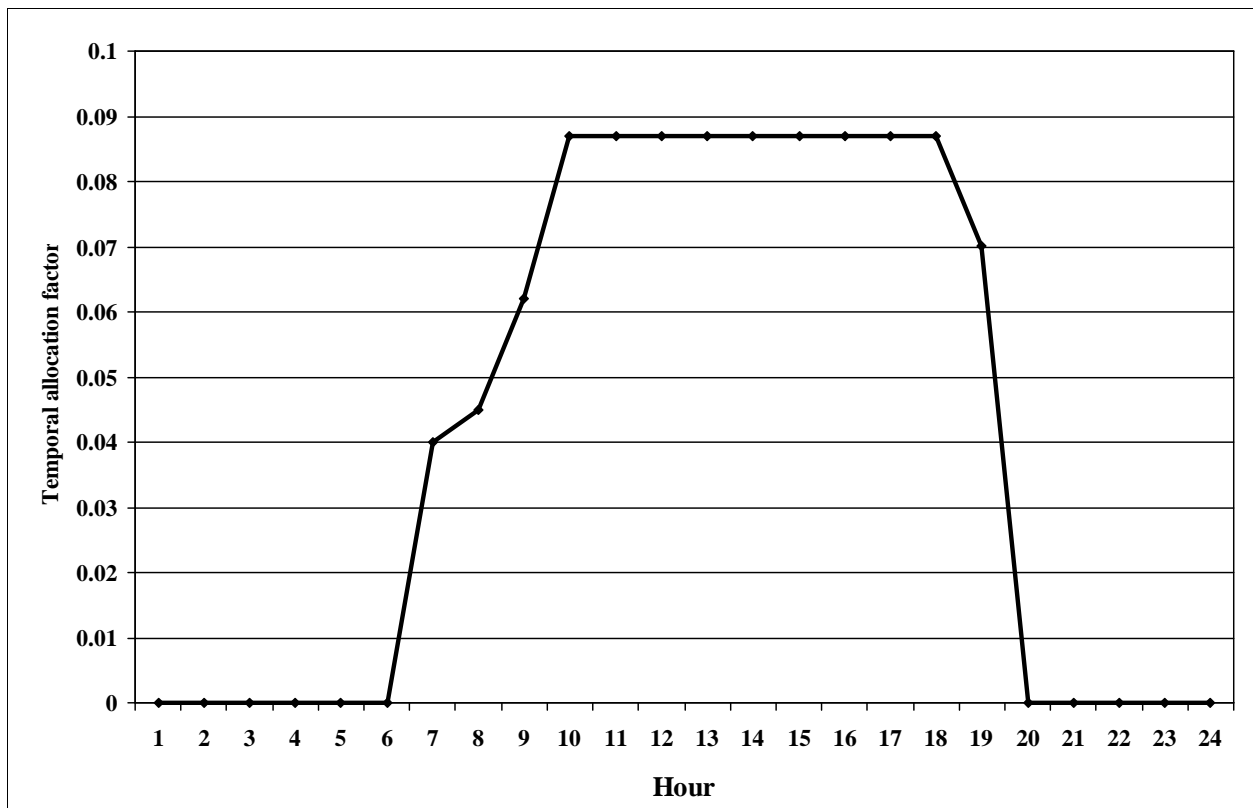
## 5. EMS-HAP Processing for HAPs

Prior to conducting air quality modeling using the ASPEN model, the emissions were processed in the Emissions Modeling System for Hazardous Air Pollutants (EMS-HAP) Version 3 (U.S. EPA, 2004b). EMS-HAP creates the emissions input files that are used by ASPEN to calculate the air quality concentrations. Following are brief descriptions of the EMS-HAP processing. The reader is referred to the EMS-HAP User's Guide (U.S. EPA, 2004b) for more details.

### 5.1 Spatial surrogates and temporal factors for PFC SCC codes

As a new addition to the inventories, the PFC SCC codes needed temporal profiles and spatial surrogate assignments in order to allocate the county-level annual emissions to eight 3-hour time blocks and census tracts. For the temporal profiles, temporal profiles of nonroad gasoline equipment were used, as the fuel containers would be used to fuel the equipment and refueling would take place at the same times as when the equipment was being used. Also, equipment refueling accounted for over 60% of MSAT emissions from PFCs. The nonroad SCC codes all had the same profile, so the same profile was assigned to each of the PFC SCC codes.

The temporal profile for the PFC SCC codes is shown in Figure 18.



**Figure 18.** Temporal profile assigned to PFC SCC codes.

Table 44 lists the PFC SCC codes with the spatial surrogate assignments. Residential SCC codes for permeation, evaporation, and refueling were assigned the single family dwelling surrogate. The spillage during transport SCC codes (residential and commercial) were assigned total road miles as the surrogate since the spillage would occur while the containers were transported on the roads. Refilling at the pump SCC codes (residential and commercial) were assigned the gasoline station surrogates. Other commercial SCC codes were assigned the golf courses plus commercial, industrial, and institutional area surrogate.

**Table 44. PFC SCC codes and assigned surrogates.**

SCC	Description	Surrogate
2501011011	Residential Portable Fuel Containers: Permeation	Single family dwelling
2501011012	Residential Portable Fuel Containers: Evaporation	Single family dwelling
2501011013	Residential Portable Fuel Containers: Spillage During Transport	Total road miles
2501011014	Residential Portable Fuel Containers: Refilling at the Pump: Vapor Displacement	Gasoline stations
2501011015	Residential Portable Fuel Containers: Refilling at the Pump: Spillage	Gasoline stations
2501011016	Residential Portable Fuel Containers: Refueling Equipment: Vapor Displacement	Single family dwelling
2501011017	Residential Portable Fuel Containers: Refueling Equipment: Spillage	Single family dwelling
2501012011	Commercial Portable Fuel Containers: Permeation	golf courses + commercial + industrial + institutional area
2501012012	Commercial Portable Fuel Containers: Evaporation	golf courses + commercial + industrial + institutional area
2501012013	Commercial Portable Fuel Containers: Spillage During Transport	Total road miles
2501012014	Commercial Portable Fuel Containers: Refilling at the Pump: Vapor Displacement	Gasoline stations
2501012015	Commercial Portable Fuel Containers: Refilling at the Pump: Spillage	Gasoline stations
2501012016	Commercial Portable Fuel Containers: Refueling Equipment: Vapor Displacement	golf courses + commercial + industrial + institutional area
2501012017	Commercial Portable Fuel Containers: Refueling Equipment: Spillage	golf courses + commercial + industrial + institutional area

## 5.2 Inventory scenarios

For the years 2015, 2020 and 2030, there were two basic scenarios for each inventory to model, the base inventory and the control inventory, which included cumulative impacts of all controls being finalized in this rule. The exception to this is 1999, which is base case only. Table 45 summarizes the base and control inventories to model for point, nonpoint, onroad, and the nonroad inventories.

**Table 45.** Emission scenarios to be processed in EMS-HAP and ASPEN. Base inventory applies to all years and control inventory applies to 2015, 2020, and 2030.

Inventory	Base inventory	Control inventory
Point	Adjusted gasoline distribution; no vehicle refueling; other sources unchanged.	Base inventory with benzene controls applied to gasoline distribution emissions
Nonpoint	Adjusted gasoline distribution, including aviation gasoline; no vehicle refueling; PFC emissions with no PFC controls or benzene fuel controls; other sources unchanged	Base inventory with benzene controls applied to gasoline distribution emissions and PFC and benzene fuel controls applied to PFC emissions
Onroad	Base NMIM emissions for onroad gasoline and onroad diesel with vehicle refueling added to light duty gasoline vehicles	Fuel and vehicle controls applied to gasoline engine emissions, diesel emissions same as base inventory
Nonroad	Projected diesel locomotive, commercial marine vessel, and aircraft emissions <sup>1</sup> ; NMIM emissions with subtracted PFC refueling emissions for nonroad gasoline; diesel emissions	Controls applied to nonroad gasoline emissions, all other emissions unchanged.

<sup>1</sup> For 1999, diesel locomotive, commercial marine vessel, and aircraft emissions are the same as those used in NATA.

## 5.3 Point sources

Point sources (including major and area sources) are processed through four EMS-HAP programs to create ASPEN ready files: PtDataProc, PtModelProc, PtTemporal, and PtFinal\_ASPEN. A fifth point source program, PtGrowCntl is used to apply growth factors and reduction information to a base year inventory to develop future year emissions inventories. This program is run between PtTemporal and PtFinal\_ASPEN.

For the MSAT study, the point inventory had already been processed through PtDataProc, PtModelProc and PtTemporal for the 1999 National Air Toxics Assessment (NATA). Geographic locations and stack parameters' quality assurance was done in PtDataProc. See Ch. 3, EMS-HAP User's Guide for details.

In PtModelProc, the individual POM HAPs were grouped into eight POM groups, based on cancer risk (See Section C.4.2 in Appendix C of the EMS-HAP User's Guide for POM groupings). Also in PtModelProc, the metals (chromium, nickel, and manganese) were split into fine and coarse particle emissions. Also, unspciated chromium was speciated into chromium III and chromium VI based on MACT codes. For naphthalene, emissions were split into gaseous and particle mode. For descriptions of these two processes see Ch. 4, EMS-HAP User's Guide.



Urban/rural dispersion parameters, vent type, and building parameters were also assigned in PtModelProc.

PtTemporal allocated the annual emissions to eight 3-hour time blocks based on the category of the emissions. PtTemporal output was adjusted to change the 1999 medical waste incineration (MWI) emissions to 2002 emissions (see Section 4.3) which were used as the projected MWI emissions for all future years.

As discussed in Section 4.4.1, PtGrowCntl was run to project the inventory to 2015 and 2020. For 2015 and 2020, the PtGrowCntl output was subset to MSAT HAPs, the output adjusted for gasoline distribution and vehicle refueling, and then processed through PtFinal\_ASPEN to create ASPEN ready emissions files (including reactivity/particle size information) for the base and controlled point inventories. EMS-HAP also allows for grouping of the emissions so that the contribution of different source groups can be quantified when calculating concentrations in ASPEN. As for the 1999 NATA, the point sources were binned into two groups, major (group=0) and area & other sources (group=1). Source groupings for stationary and mobile sources can be seen in Table 46.

#### **5.4 Nonpoint sources**

For the 1999 NATA, the non-point emissions inventory was first processed through the EMS-HAP COPAX program to separate the airport related emissions from other non-point emissions (see Table 14 for airport related SCC codes). COPAX allocated the airport related emissions to point source locations at the airports (See Ch. 2 in the EMS-HAP User's Guide). The airport related emissions were then processed through the same programs as the point source inventory. The growth factors used for PtGrowCntl are documented in Section 3.2.

For the remaining non-point inventory for 1999, the gasoline distribution emissions were adjusted and vehicle refueling emissions were removed. The 1999 inventory was then processed through CountyProc to create the ASPEN ready files. CountyProc spatially allocated county level emissions to census tracts, temporally allocated emissions to 3-hour time blocks, assigned urban/rural dispersion parameters, assigned reactivity classes/particle size information for ASPEN, and grouped certain pollutants together such as the POM groups, and metals (See Ch. 9 of EMS-HAP User's Guide).

For the remaining non-point inventory, after removing the MWI (MACT=1801) emissions and performing the other adjustments discussed in Section 4.4.2, the emissions were projected to 2015, 2020, and 2030 using the EMS-HAP program CountyProc. This program also spatially allocated county level emissions to census tracts, temporally allocated emissions to 3-hour time blocks, assigned urban/rural dispersion parameters, assigned reactivity classes/particle size information for ASPEN, and grouped certain pollutants together such as the POM groups, and metals as done for 1999.

For the non-point airport related emissions, the emissions were grouped into area & other sources (group=1). For the remaining nonpoint sources, the PFC emissions were grouped into

the non-gasoline nonroad emissions (group=3). The remaining nonpoint emissions were grouped into the area & other sources (group=1).

## **5.5 Onroad sources**

The emission inventories for 2015, 2020, and 2030 were projected outside of EMS-HAP using the methodology in Section 3.3.3. Therefore, EMS-HAP was only used to create the ASPEN ready files. For the onroad inventory, the CountyProc program was used to create the ASPEN ready files. As with the non-point inventory, CountyProc spatially allocated county level emissions to census tracts, temporally allocated emissions to 3-hour time blocks, assigned urban/rural dispersion parameters, assigned reactivity classes/particle size information for ASPEN, and grouped certain pollutants together such as the POM groups, and metals (See Ch. 9 of EMS-HAP User's Guide for details). Onroad emissions were grouped into two onroad groups: onroad gasoline emissions (group=2) and onroad diesel emissions (group=4). SCC codes beginning with 2201 were assigned to group 2 and SCC codes beginning with 2230 were assigned to group 4.

## **5.6 Nonroad sources**

### ***5.6.1 Aircraft sources***

Aircraft emissions had been previously extracted from the 1999 inventory for NATA using COPAX in order to be modeled in ASPEN as point sources and processed as discussed in Section 3.2. The projected aircraft emissions were processed in PtFinal\_ASPEN to create ASPEN ready files. Aircraft emissions, SCC codes beginning with 2275, were grouped into non-gasoline nonroad emissions (group=3).

### ***5.6.2 Airport Support Equipment***

The projected nonroad inventories discussed in Section 3.3.3 contained emissions related to airport support equipment. Therefore, the projected nonroad inventories were processed through COPAX to separate the airport related emissions from the remaining nonroad emissions. See Table 14 for airport support equipment SCC codes (those denoted as being projected in NMIM). After the COPAX program, the airport support equipment emissions were processed through the point source programs PtDataProc, PtModelProc, PtTemporal, and PtFinal\_ASPEN. Note that unlike the non-point airport emissions and aircraft emissions, the airport support equipment emissions were not processed through the PtGrowCntl program since emissions had already been projected outside of EMS-HAP.

### ***5.6.3 Remaining nonroad sources***

The remaining nonroad emissions were processed through CountyProc in a similar fashion to the onroad emissions. Both airport support equipment emissions and remaining nonroad emissions were binned into two groups, non-gasoline nonroad emissions (group=3) and nonroad gasoline (group=5) (Table 30).

**Table 46. ASPEN emission groups<sup>4</sup>.**

<b>Group</b>	<b>Source Sector</b>	<b>Description</b>	<b>Inventories<sup>#</sup></b>
0	Major sources	Any stationary source or group of stationary sources located within a contiguous area and under common control that emits or has the potential to emit considering controls, in the aggregate, 10 tons per year or more of any hazardous air pollutant or 25 tons per year or more of any combination of hazardous air pollutants	Point
1	Area & other sources	Any stationary source of hazardous air pollutants that is not a major source. Does not include motor vehicles or nonroad vehicles.	Point, and non-point
2	Onroad gasoline sources	Onroad vehicles burning gasoline	Onroad
3	Non-gasoline nonroad sources	Nonroad vehicles burning fuels other than gasoline such as diesel, natural gas, aviation fuel, LP gas, residual oils, and miscellaneous fuel sources; PFC emissions	Nonroad, non-point
4	Onroad diesel sources	Onroad vehicles burning diesel	Onroad
5	Nonroad gasoline sources	Nonroad vehicles burning gasoline	Nonroad

<sup>#</sup>Non-point and nonroad include airport related emissions.

---

<sup>4</sup> During ASPEN post-processing and subsequent exposure modeling and risk assessments, onroad diesel and onroad gasoline were summed into total onroad and nonroad gasoline and other nonroad were grouped into total nonroad. The groupings shown in the table are carried over from the modeling for the proposed rule.

## **6. ASPEN Processing**

### **6.1 ASPEN modeling**

Once the emissions were processed, they were input into ASPEN (U.S. EPA, 2000) to calculate ambient air quality concentrations. In addition to the emissions, ASPEN needs meteorological parameters, and census tract centroid locations for concentration calculations. For the MSAT years, 2015, 2020, and 2030, the 1999 meteorology and year 2000 census tract locations were used as for the 1999 NATA.

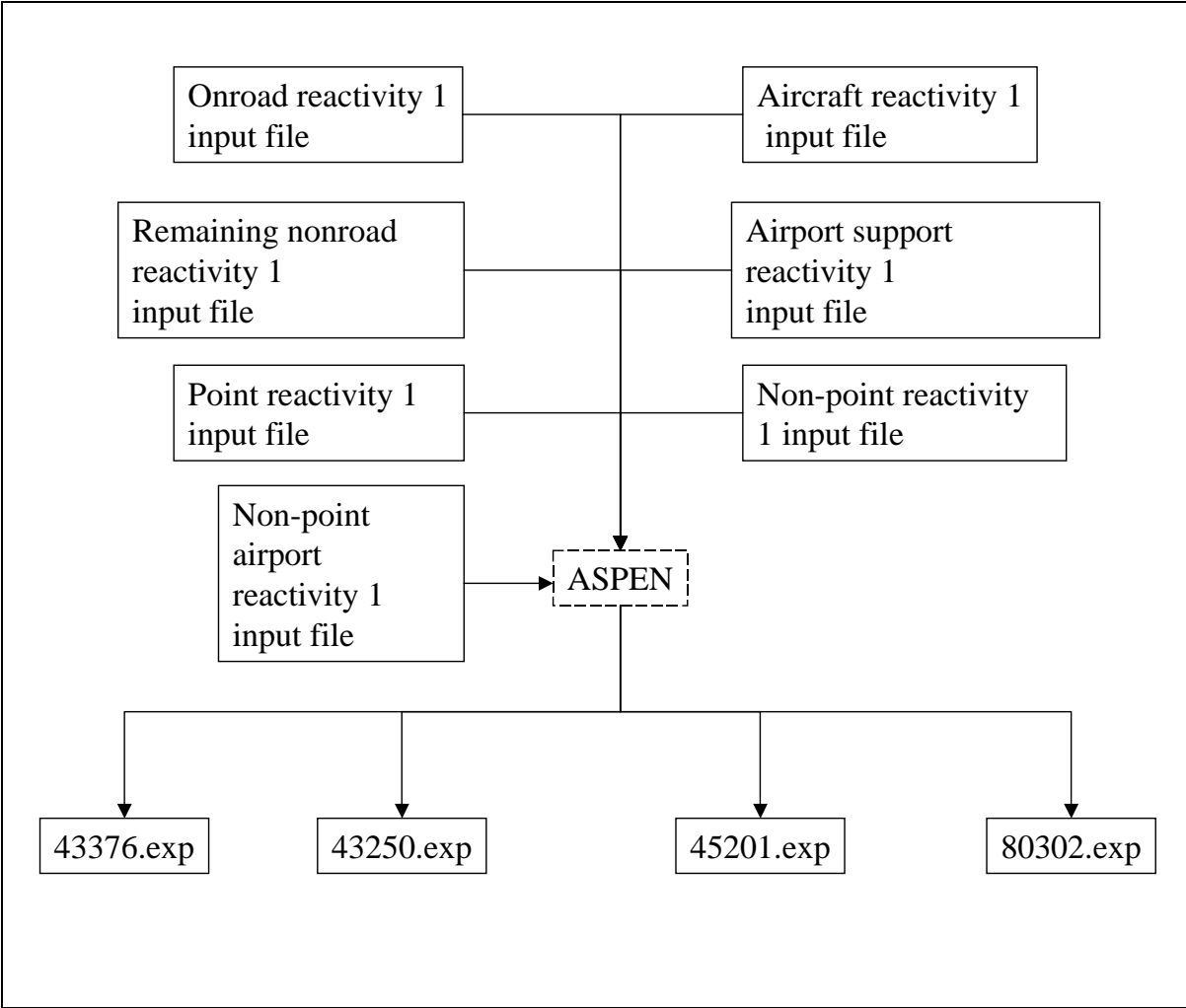
In EMS-HAP, emissions are divided into nine files, one for each HAP reactivity class, 1-9, as defined for ASPEN (Reactivity classes 6 and 8 are not used for HAPs) based on decay rates or particulate sizes (See ASPEN User's Guide [U.S. EPA, 2000] for details). For example, the emissions file for reactivity class 1 would contain the emissions information (location, emissions, stack parameters, etc.) for all of the HAPs processed through EMS-HAP with reactivity class 1. The reactivity classes for each MSAT HAP are listed in Table 47.

**Table 47.** Reactivity classes for MSAT HAPs and precursors.

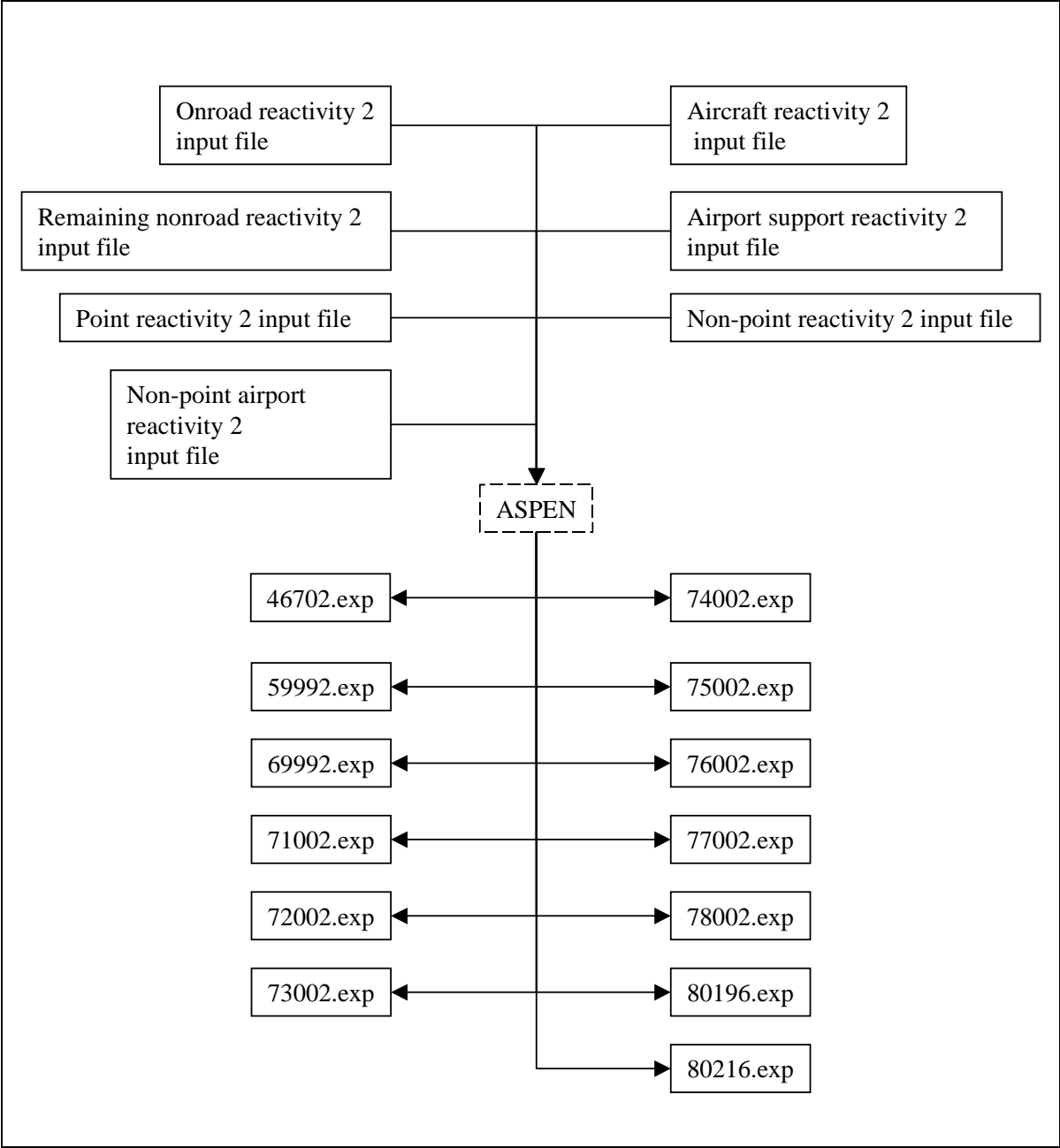
Pollutant	SAROAD	Reactivity	Pollutant	SAROAD	Reactivity
1,3-Butadiene	43218	7	Naphthalene, fine PM	46702	2
2,2,4-Trimethylpentane	43250	1	Nickel, fine	80216	2
Acetaldehyde, primary	43503	5	Nickel, coarse	80316	3
Acrolein, primary	43505	5	Propionaldehyde, primary	43505	5
Benzene	45201	1	Styrene	45220	7
Chromium III, fine	59992	2	Toluene	45202	4
Chromium III, coarse	59993	3	Xylenes	45102	5
Chromium VI, fine	69992	2	POM 1	71002	2
Chromium VI, coarse	69993	3	POM 2	72002	2
Ethyl Benzene	45203	4	POM 3	73002	2
Formaldehyde, primary	43502	5	POM 4	74002	2
Hexane	43231	9	POM 5	75002	2
Manganese, fine	80196	2	POM 6	76002	2
Manganese, coarse	80396	3	POM 7	77002	2
MTBE	43376	1	POM 8	78002	2
Naphthalene, gas	46701	5	Acrolein precursor, inert	80302	1
POM 1: POM, Group 1: Unspecified POM 2: POM, Group 2: no URE data POM 3: POM, Group 3: $5.0E-2 < URE \leq 5.0E-1$ POM 4: POM, Group 4: $5.0E-3 < URE \leq 5.0E-2$ POM 5: POM, Group 5: $5.0E-4 < URE \leq 5.0E-3$ POM 6: POM, Group 6: $5.0E-5 < URE \leq 5.0E-4$ POM 7: POM, Group 7: $5.0E-6 < URE \leq 5.0E-5$ POM 8: POM, Group 8: Unspecified (7-PAH only)					
REACTIVITY CLASSES: 1 non reactive 2 fine particulate (2.5 microns and less) 3 coarse particulate (2.5 to 10 microns) 4 medium low reactivity 5 medium reactivity 6 medium high reactivity 7 very high reactivity 8 high reactivity 9 low reactivity					

ASPEN is composed of two modules, ASPENA and ASPENB. ASPENA calculates concentrations at receptors arranged in rings around an emission source up to 50 km away. ASPENB then reads the ASPENA output and interpolates the concentrations to census tract centroids. ASPEN is run for each reactivity class for mobile sources and stationary sources. The output from ASPEN is a binary file for each SAROAD code in the emissions input file (see Table 1 for MSAT HAPs' SAROAD codes). Figures 19 through 23 graphically show the input/output for each reactivity class, including which HAPS are in each reactivity class.

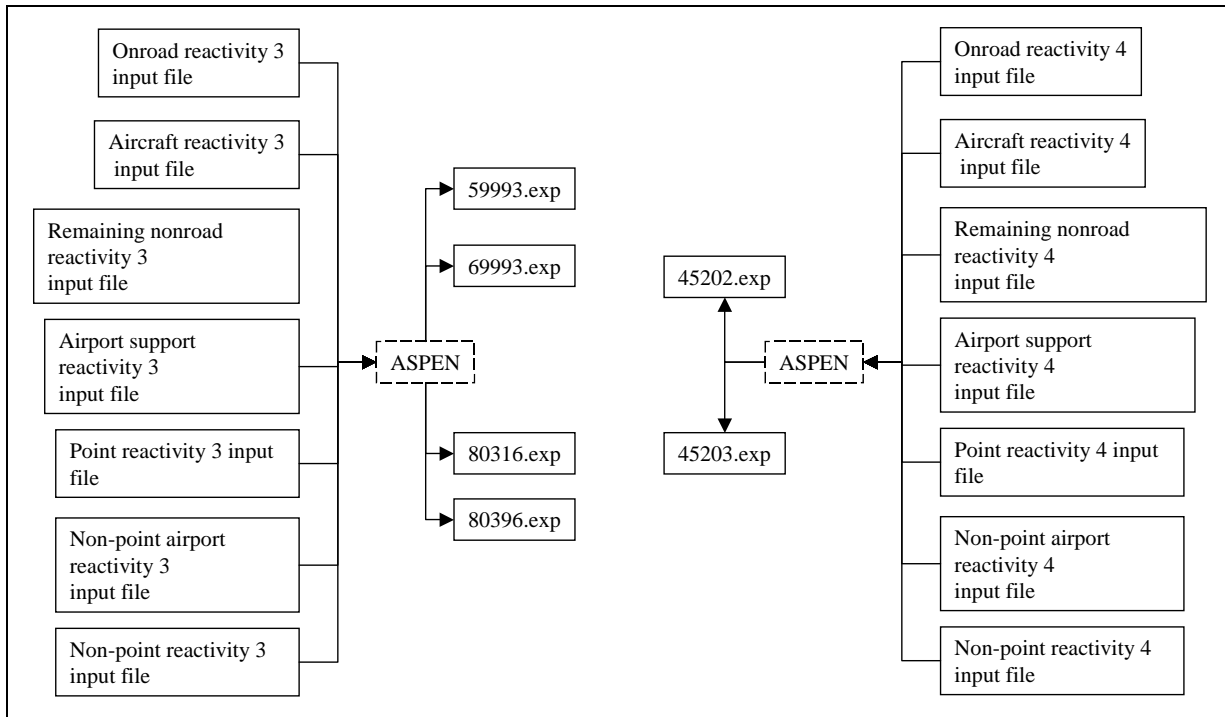
Once ASPEN has been run, the programs AVGDAT and EXTRAVG were used to convert the binary output from ASPEN to ASCII text. Concentrations are annual average concentrations for each source sector and are at the census tract level. For details of the two programs see the ASPEN User's Guide (U.S. EPA, 2000).



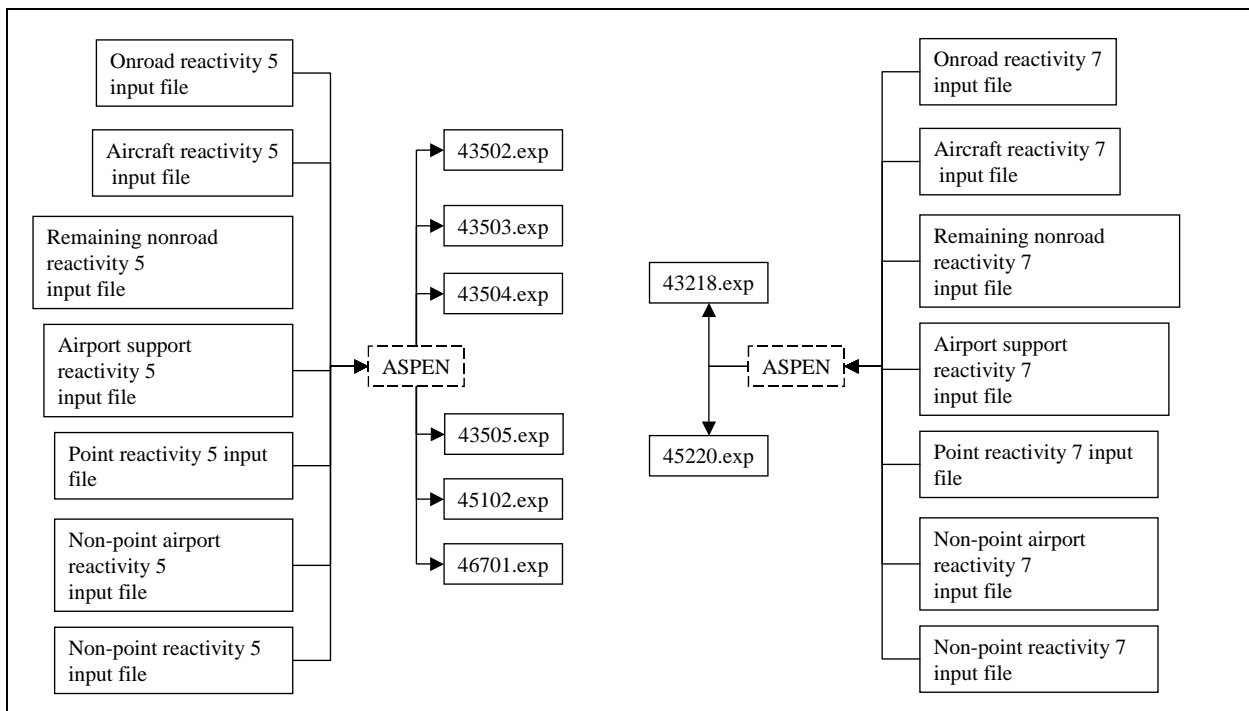
**Figure 19.** Reactivity class 1 ASPEN inputs and outputs. Output is the final output from ASPENA and ASPENB.



**Figure 20.** Reactivity class 2 ASPEN inputs and outputs. Output is the final output from ASPENA and ASPENB.

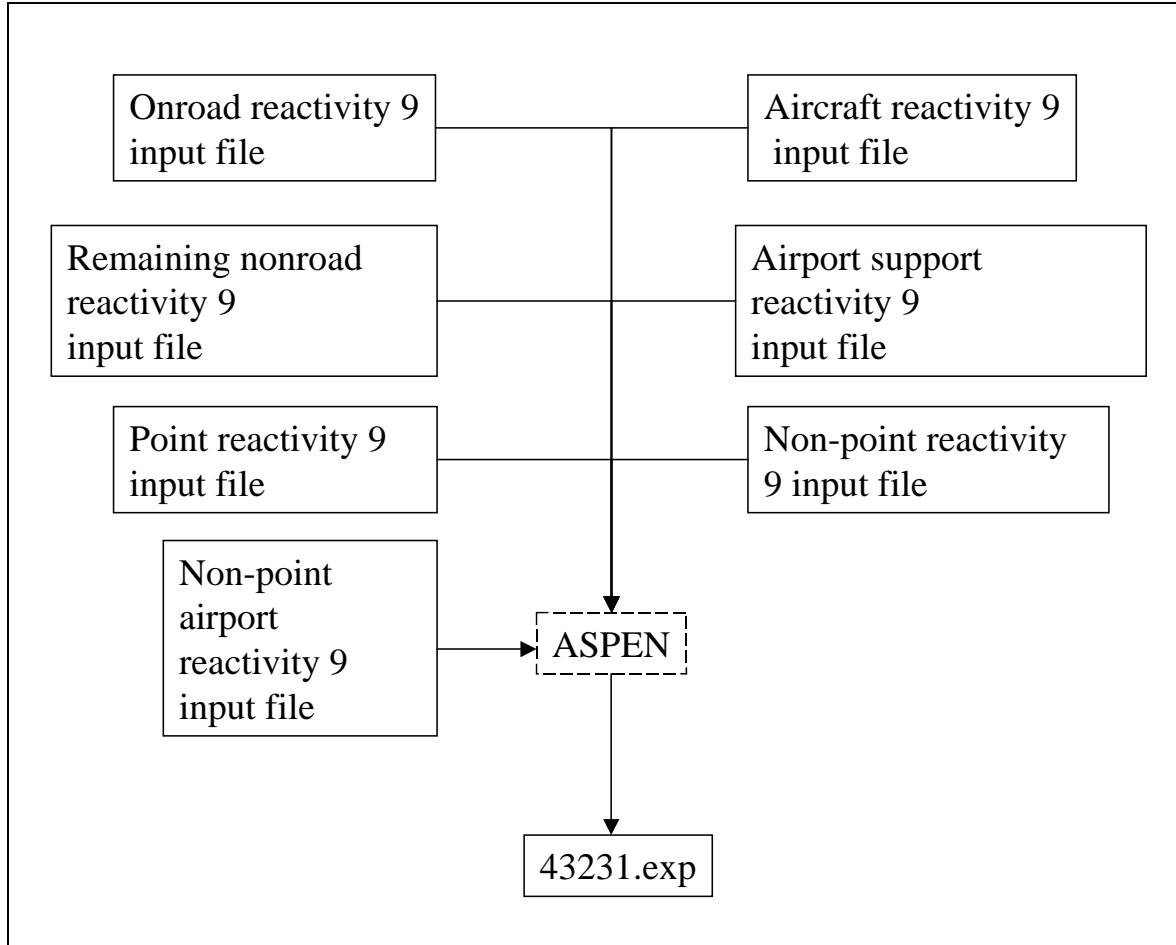


**Figure 21.** Reactivity classes 3 and 4 ASPEN inputs and outputs. Output is the final output from ASPENA and ASPENB.



**Figure 22.** Reactivity classes 5 and 7 ASPEN inputs and outputs. Output is the final output from ASPENA and ASPENB.





**Figure 23.** Reactivity class 9 ASPEN inputs and outputs. Output is the final output from ASPENA and ASPENB.

## 6.2 Post-processing of ASPEN concentrations

ASPEN output concentrations were calculated for each SAROAD associated with the MSAT HAPs (see Table 1 for SAROADs). Post-processing of the ASPEN concentrations for each year included the following:

- Adjusted the SAROAD 75002 (POM Group 5) area & other concentrations in Oregon as described in Section 2.1.
- Summed the fine and coarse metal concentrations (i.e., fine and coarse nickel) at census tract level for each source sector.

- Summed the particle and gas modes of naphthalene at census tract level for each source category.
- Summed onroad gasoline and onroad diesel to total onroad and summed the nonroad gasoline and other nonroad concentrations to total nonroad.
- Added county level background concentrations to total concentrations (all sources) for HAPs with background. The MSAT HAPs with nonzero background were: 1,3-butadiene, acetaldehyde, benzene, formaldehyde, and xylenes. Each of the three model years used 1999 background. For details about the 1999 background see <http://www.epa.gov/ttn/atw/nata1999/background.html> or Battelle (2003).
- Calculated secondary contributions for acetaldehyde, acrolein, formaldehyde, and propionaldehyde. The methodology is detailed in Section 6.2.1.

### 6.2.1 Secondary contributions

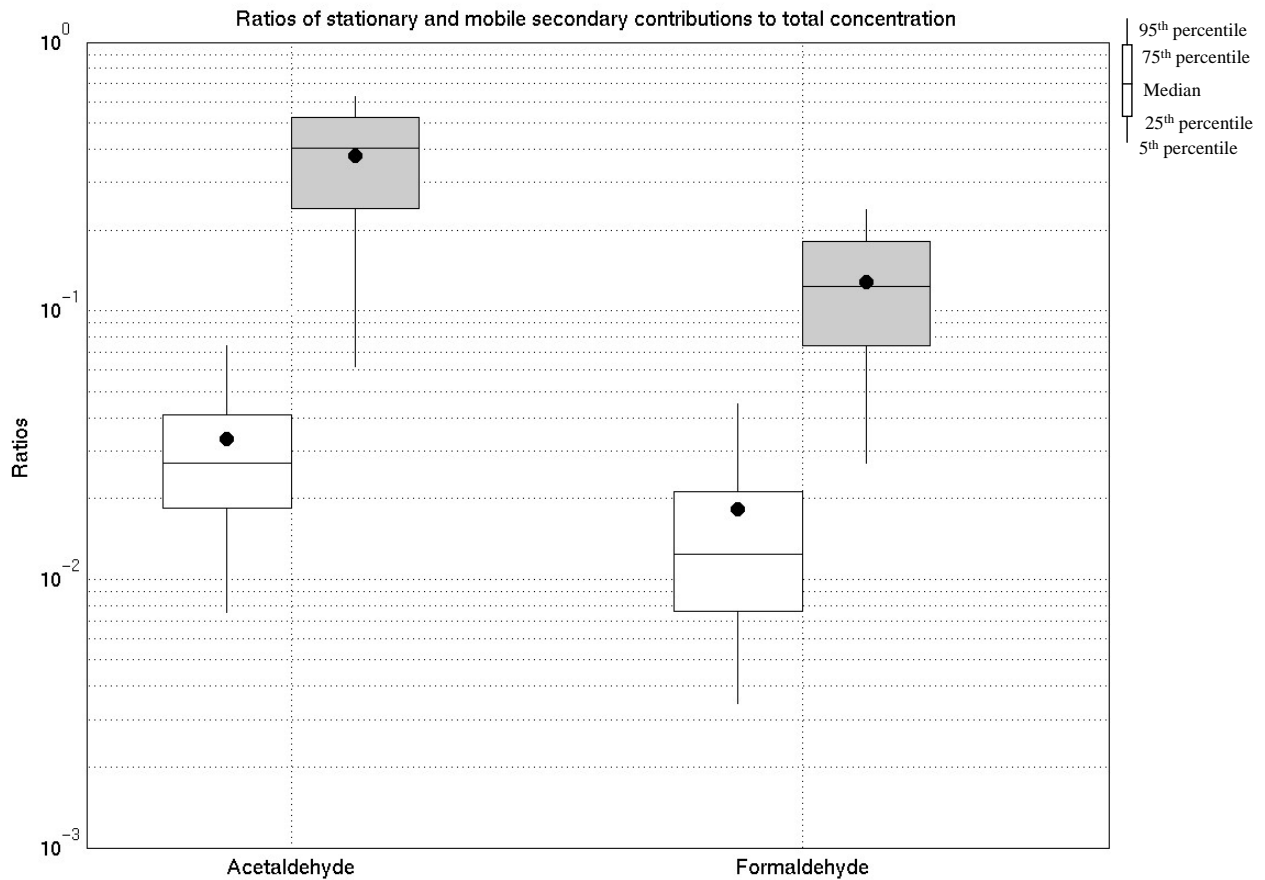
Four HAPs, acetaldehyde, acrolein, formaldehyde, and propionaldehyde needed secondary concentrations added to the modeled concentrations. Two different strategies were used. For acrolein, the precursor pollutants were inert and reactive 1,3-butadiene, an MSAT HAP. Therefore, acrolein's precursors were already projected to the future years. The secondary contribution for acrolein for each source category was calculated as the difference between the inert and reactive components added to the primary modeled concentration at each. Before the difference could be calculated, the inert and react components were multiplied by 1.04 which was a correction factor as used for the 1996 NATA (U.S. EPA, 2002b) and 1999 NATA (U.S. EPA, 2006a). The equation to calculate the secondary contributions was:

$$X_{acrolein} = X_{43505} + 1.04(X_{80302} - X_{43218}) \quad (19)$$

where  $X_{43505}$  was the primary modeled acrolein concentration,  $X_{80302}$  was the modeled inert 1,3-butadiene concentration,  $X_{43218}$  was the modeled reactive 1,3-butadiene concentration, and  $X_{acrolein}$  was the secondarily formed acrolein concentration.

For the other secondary pollutants, acetaldehyde, formaldehyde, and propionaldehyde, the 1999 secondary concentrations for the 1999 NATA were used for the major and area & other source sectors. Stationary precursors were not projected due to the small contribution of stationary secondary contributions to the total concentrations for acetaldehyde and formaldehyde. An analysis of the secondary contributions of the 1999 NATA precursor concentrations for acetaldehyde and formaldehyde revealed that stationary secondary contributions were small when compared to the total concentrations (secondary and background included). Figure 24 shows box and whisker plots for acetaldehyde and formaldehyde for ratios of tract level stationary secondary concentrations to total concentrations (white boxes) and ratios of tract level mobile secondary concentrations to total concentrations (gray boxes) for 1999. The ratios for the stationary secondary contributions are much less than the mobile ratios, since acetaldehyde and formaldehyde are mobile dominant. Note that even though propionaldehyde is an MSAT

HAP, it has no cancer or non-cancer risks associated with it and was not included in the analysis of the secondary concentrations.



**Figure 24.** Box and whisker plots of ratios of stationary secondary contributions to total concentrations (white boxes) and ratios of mobile secondary contributions to total concentrations (gray boxes) for 1999 acetaldehyde and formaldehyde concentrations. Dots represent the national mean ratios.

For the mobile sources, which have a larger contribution to overall concentration for the secondary HAPs, the ratio of the 1999 secondary to primary concentrations were used to calculate secondary contributions for the projected concentrations. The calculation is:

$$X_{HAP,SRC} = \left[ X_{HAP,SRC,PRIMARY} \times \left( \frac{X_{SRC,SECONDARY,1999}}{X_{HAP,SRC,PRIMARY,1999}} \right) \right] + X_{HAP,SRC,PRIMARY} \quad (20)$$

where  $X_{HAP,SRC}$  was the secondarily formed concentration for SRC (major, area & other, onroad, or nonroad), for HAP (formaldehyde, acetaldehyde, or propionaldehyde) for one of the modeling years (1999, 2015, 2020, or 2030),  $X_{HAP,SRC,PRIMARY}$  was the primary or directly emitted and modeled concentration for the HAP,  $X_{HAP,SRC,SECONDARY,1999}$  was the secondary contribution for

the HAP and SRC for 1999, and  $X_{\text{HAP,SRC,PRIMARY,1999}}$  was the directly emitted and modeled concentration for the HAP,SRC for 1999.

In the proposed MSAT rule, the secondarily formed concentrations for acetaldehyde, formaldehyde, and propionaldehyde were calculated using the following equations:

$$X_{\text{acetaldehyde}} = X_{43503} + X_{80301} - X_{80100} \quad (21)$$

$$X_{\text{formaldehyde}} = X_{43502} + X_{80303} - X_{80180} \quad (22)$$

$$X_{\text{propionaldehyde}} = X_{43504} + X_{80305} - X_{80234} \quad (23)$$

Where:

$X_{\text{acetaldehyde}}$  = Acetaldehyde concentrations with secondary contributions included.

$X_{43503}$  = Primary acetaldehyde concentrations due to directly emitted acetaldehyde.

$X_{80301}$  = Inert precursor concentrations for acetaldehyde (reactivity class 1).

$X_{80100}$  = Reactive precursor concentrations for acetaldehyde (reactivity class 7).

$X_{\text{formaldehyde}}$  = Formaldehyde concentrations with secondary contributions included.

$X_{43502}$  = Primary formaldehyde concentrations due to directly emitted formaldehyde.

$X_{80303}$  = Inert precursor concentrations for formaldehyde (reactivity class 1).

$X_{80180}$  = Reactive precursor concentrations for formaldehyde (reactivity class 6).

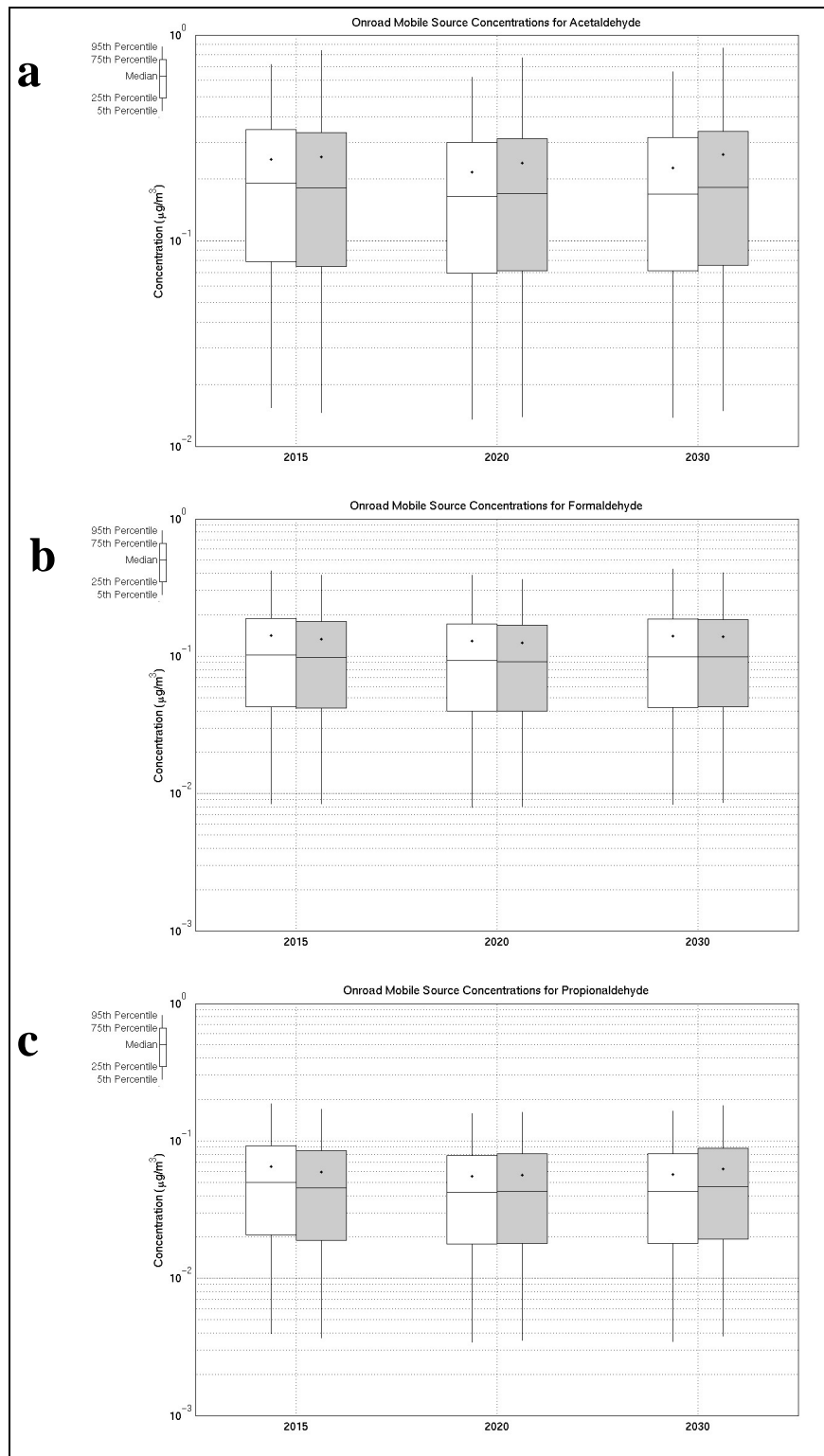
$X_{\text{propionaldehyde}}$  = Propionaldehyde concentrations with secondary contributions included.

$X_{43504}$  = Primary propionaldehyde concentrations due to directly emitted propionaldehyde.

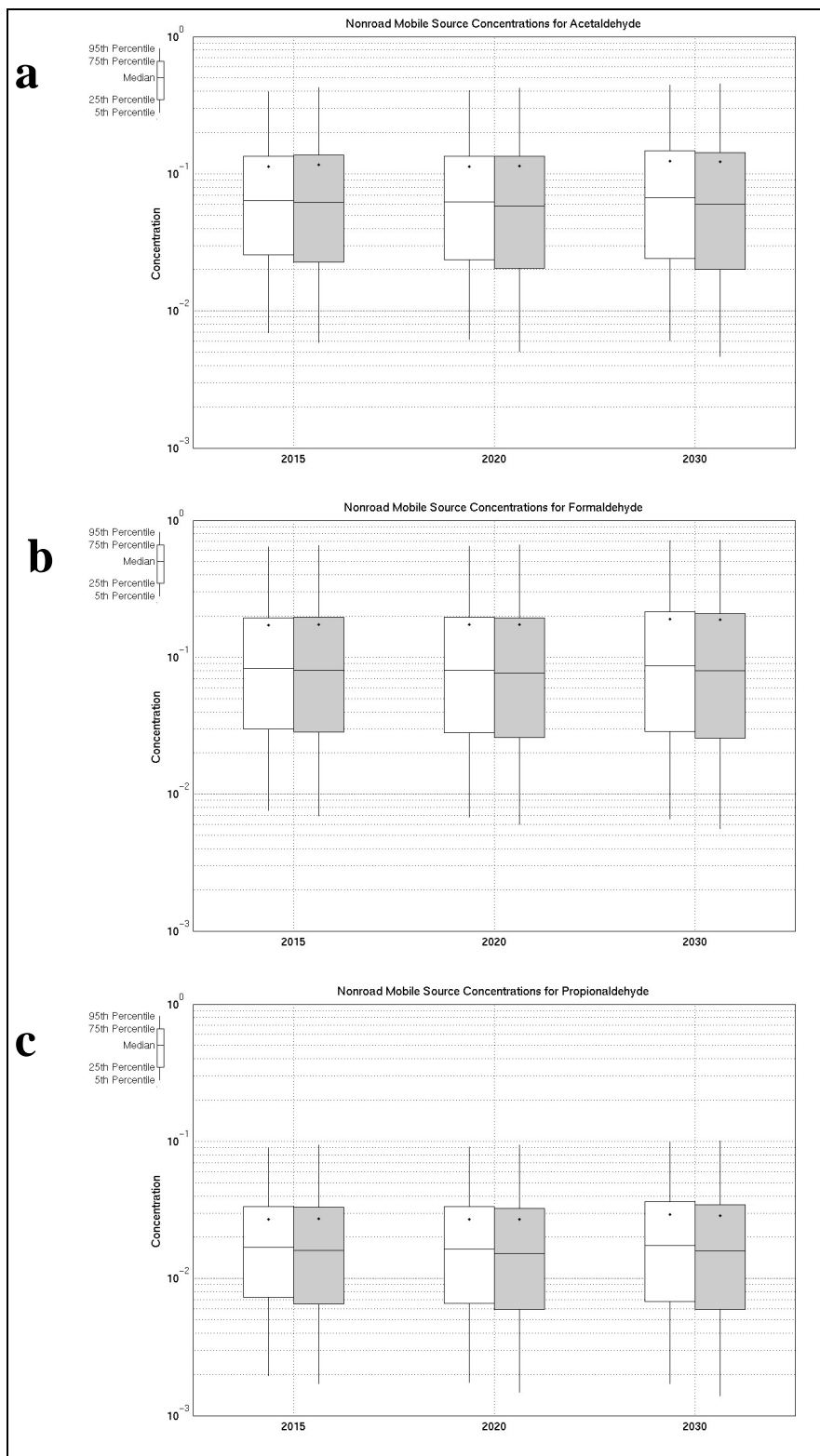
$X_{80305}$  = Inert precursor concentrations for propionaldehyde (reactivity class 1).

$X_{80234}$  = Reactive precursor concentrations for propionaldehyde (reactivity class 6).

To ensure the ratio method shown in Equation 20 would be acceptable, the secondary concentrations for the proposed MSAT rule concentrations were calculated using Equation 20 and Equations 24 through 26 for 2015, 2020, and 2030 for onroad and nonroad sources. Figures 25 and 26 show the results of the comparisons. From the results, it appeared that the ratio approach would be adequate for the secondary concentrations since the differences were not large between the two methods.



**Figure 25.** Secondary onroad concentrations calculated from modeled precursors (white boxes) and calculated from 1999 ratios of secondary to primary modeled concentrations (gray boxes) for 2015, 2020, and 2030 for a) acetaldehyde, b) formaldehyde, and c) propionaldehyde.



**Figure 26.** Secondary nonroad concentrations calculated from modeled precursors (white boxes) and calculated from 1999 ratios of secondary to primary modeled concentrations (gray boxes) for 2015, 2020, and 2030 for a) acetaldehyde, b) formaldehyde, and c) propionaldehyde.

After post-processing of the concentrations, summary statistics for the concentrations for each year, including 1999 were calculated for base and controlled concentrations. They included:

- Average concentrations for major, area & other, total onroad, total nonroad background, and total at the county, state, state urban/rural, state RFG/non-RFG, national, national urban/rural, and national RFG/non-RFG levels.
- Distributions (5<sup>th</sup>, 10<sup>th</sup>, 25<sup>th</sup>, 50<sup>th</sup>, 75<sup>th</sup>, 90<sup>th</sup>, and 95<sup>th</sup> percentiles) for total concentrations at the county, state, state urban/rural, state RFG/non-RFG levels.
- Maps of county median concentrations for 1,3-butadiene, acetaldehyde, acrolein, benzene, formaldehyde, and naphthalene were generated for 1999, 2015, 2020, and 2030.

Tables 48 and 49 list the national average concentrations for selected HAPs for base and control strategies

**Table 48.** Base background and ASPEN stationary and mobile concentrations ( $\mu\text{g m}^{-3}$ ) for 1999, 2015, 2020, and 2030.

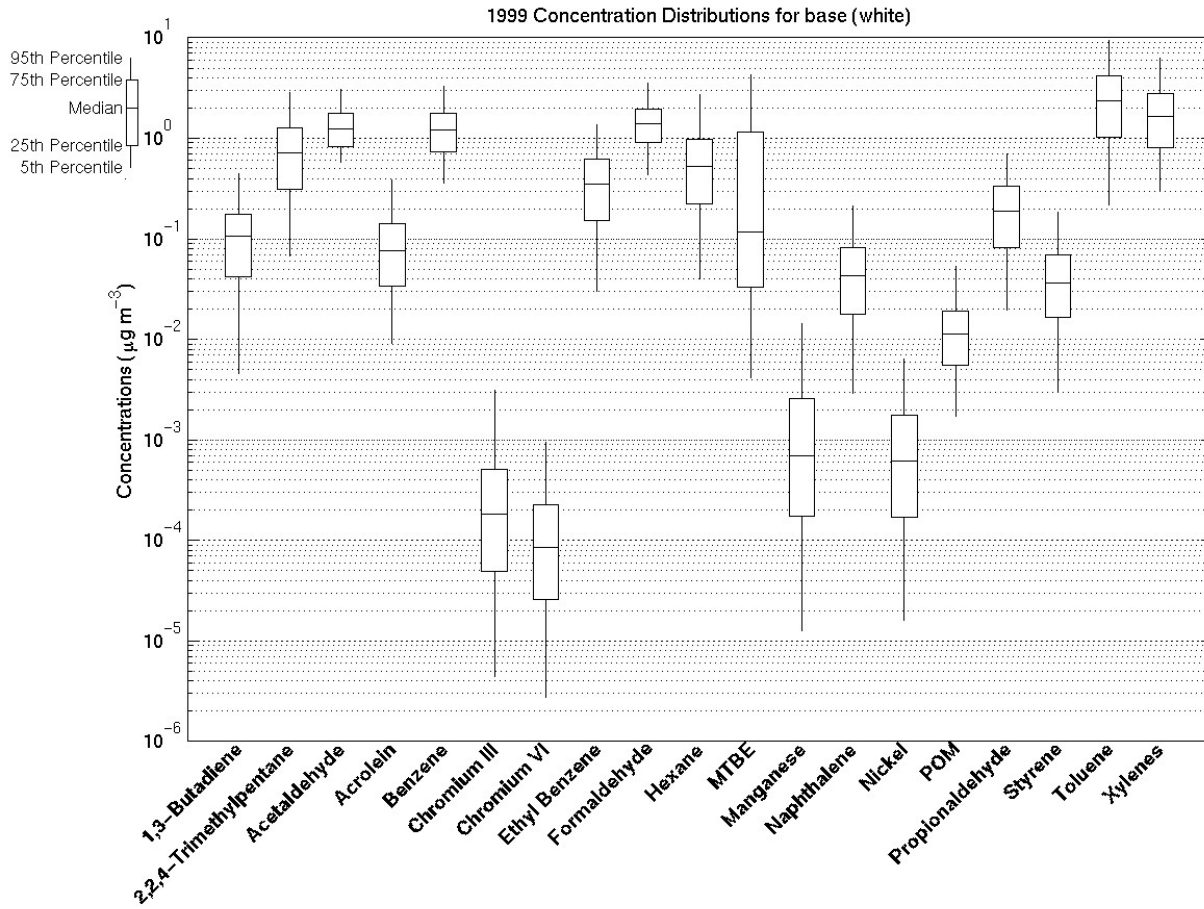
HAP	Background	Year							
		1999		2015		2020		2030	
		Stationary	Mobile	Stationary	Mobile	Stationary	Mobile	Stationary	Mobile
1,3-Butadiene	$5.10 \times 10^{-2}$	$2.24 \times 10^{-2}$	$7.01 \times 10^{-2}$	$2.27 \times 10^{-2}$	$3.36 \times 10^{-2}$	$2.28 \times 10^{-2}$	$3.50 \times 10^{-2}$	$2.28 \times 10^{-2}$	$4.08 \times 10^{-2}$
2,2,4-Trimethylpentane	$0.00 \times 10^0$	$4.49 \times 10^{-2}$	$9.25 \times 10^{-1}$	$3.78 \times 10^{-2}$	$4.81 \times 10^{-1}$	$4.01 \times 10^{-2}$	$4.80 \times 10^{-1}$	$4.01 \times 10^{-2}$	$5.48 \times 10^{-1}$
Acetaldehyde	$5.17 \times 10^{-1}$	$8.43 \times 10^{-2}$	$8.25 \times 10^{-1}$	$8.67 \times 10^{-2}$	$4.96 \times 10^{-1}$	$8.93 \times 10^{-2}$	$5.07 \times 10^{-1}$	$8.93 \times 10^{-2}$	$5.88 \times 10^{-1}$
Acrolein	$0.00 \times 10^0$	$3.25 \times 10^{-2}$	$7.90 \times 10^{-2}$	$2.97 \times 10^{-2}$	$4.23 \times 10^{-2}$	$2.93 \times 10^{-2}$	$4.41 \times 10^{-2}$	$2.93 \times 10^{-2}$	$5.12 \times 10^{-2}$
Benzene	$3.94 \times 10^{-1}$	$1.62 \times 10^{-1}$	$8.66 \times 10^{-1}$	$1.79 \times 10^{-1}$	$4.93 \times 10^{-1}$	$1.86 \times 10^{-1}$	$5.05 \times 10^{-1}$	$1.86 \times 10^{-1}$	$5.86 \times 10^{-1}$
Chromium III	$0.00 \times 10^0$	$1.28 \times 10^{-3}$	$8.75 \times 10^{-5}$	$1.66 \times 10^{-3}$	$1.03 \times 10^{-4}$	$1.86 \times 10^{-3}$	$1.07 \times 10^{-4}$	$1.86 \times 10^{-3}$	$1.20 \times 10^{-4}$
Chromium VI	$0.00 \times 10^0$	$3.06 \times 10^{-4}$	$3.39 \times 10^{-5}$	$4.08 \times 10^{-4}$	$4.26 \times 10^{-5}$	$4.61 \times 10^{-4}$	$4.56 \times 10^{-5}$	$4.61 \times 10^{-4}$	$5.33 \times 10^{-5}$
Ethyl Benzene	$0.00 \times 10^0$	$1.08 \times 10^{-1}$	$3.70 \times 10^{-1}$	$1.32 \times 10^{-1}$	$1.92 \times 10^{-1}$	$1.45 \times 10^{-1}$	$1.93 \times 10^{-1}$	$1.45 \times 10^{-1}$	$2.21 \times 10^{-1}$
Formaldehyde	$7.62 \times 10^{-1}$	$1.28 \times 10^{-1}$	$6.86 \times 10^{-1}$	$1.48 \times 10^{-1}$	$3.55 \times 10^{-1}$	$1.60 \times 10^{-1}$	$3.61 \times 10^{-1}$	$1.60 \times 10^{-1}$	$4.11 \times 10^{-1}$
Hexane	$0.00 \times 10^0$	$4.97 \times 10^{-1}$	$3.20 \times 10^{-1}$	$5.80 \times 10^{-1}$	$1.76 \times 10^{-1}$	$6.27 \times 10^{-1}$	$1.68 \times 10^{-1}$	$6.27 \times 10^{-1}$	$1.86 \times 10^{-1}$
MTBE	$0.00 \times 10^0$	$7.35 \times 10^{-2}$	$8.04 \times 10^{-1}$	$7.90 \times 10^{-2}$	$2.14 \times 10^{-1}$	$8.22 \times 10^{-2}$	$1.96 \times 10^{-1}$	$8.22 \times 10^{-2}$	$2.09 \times 10^{-1}$
Manganese	$0.00 \times 10^0$	$4.92 \times 10^{-3}$	$2.27 \times 10^{-5}$	$6.14 \times 10^{-3}$	$3.01 \times 10^{-5}$	$6.80 \times 10^{-3}$	$3.28 \times 10^{-5}$	$6.80 \times 10^{-3}$	$3.95 \times 10^{-5}$
Naphthalene	$0.00 \times 10^0$	$4.57 \times 10^{-2}$	$1.89 \times 10^{-2}$	$5.41 \times 10^{-2}$	$1.24 \times 10^{-2}$	$5.77 \times 10^{-2}$	$1.27 \times 10^{-2}$	$5.77 \times 10^{-2}$	$1.46 \times 10^{-2}$
Nickel	$0.00 \times 10^0$	$2.19 \times 10^{-3}$	$1.39 \times 10^{-4}$	$2.50 \times 10^{-3}$	$1.69 \times 10^{-4}$	$2.74 \times 10^{-3}$	$1.80 \times 10^{-4}$	$2.74 \times 10^{-3}$	$2.04 \times 10^{-4}$
POM	$0.00 \times 10^0$	$2.11 \times 10^{-2}$	$2.59 \times 10^{-3}$	$2.23 \times 10^{-2}$	$1.68 \times 10^{-3}$	$2.32 \times 10^{-2}$	$1.72 \times 10^{-3}$	$2.32 \times 10^{-2}$	$1.98 \times 10^{-3}$
Propionaldehyde	$0.00 \times 10^0$	$3.34 \times 10^{-2}$	$2.11 \times 10^{-1}$	$3.32 \times 10^{-2}$	$1.11 \times 10^{-1}$	$3.39 \times 10^{-2}$	$1.12 \times 10^{-1}$	$3.39 \times 10^{-2}$	$1.28 \times 10^{-1}$
Styrene	$0.00 \times 10^0$	$3.92 \times 10^{-2}$	$3.35 \times 10^{-2}$	$4.89 \times 10^{-2}$	$1.72 \times 10^{-2}$	$5.53 \times 10^{-2}$	$1.79 \times 10^{-2}$	$5.53 \times 10^{-2}$	$2.10 \times 10^{-2}$
Toluene	$0.00 \times 10^0$	$1.01 \times 10^0$	$2.23 \times 10^0$	$1.20 \times 10^0$	$1.15 \times 10^0$	$1.32 \times 10^0$	$1.16 \times 10^0$	$1.32 \times 10^0$	$1.34 \times 10^0$
Xylenes	$1.70 \times 10^{-1}$	$6.59 \times 10^{-1}$	$1.40 \times 10^0$	$8.42 \times 10^{-1}$	$7.16 \times 10^{-1}$	$9.30 \times 10^{-1}$	$7.22 \times 10^{-1}$	$9.30 \times 10^{-1}$	$8.27 \times 10^{-1}$



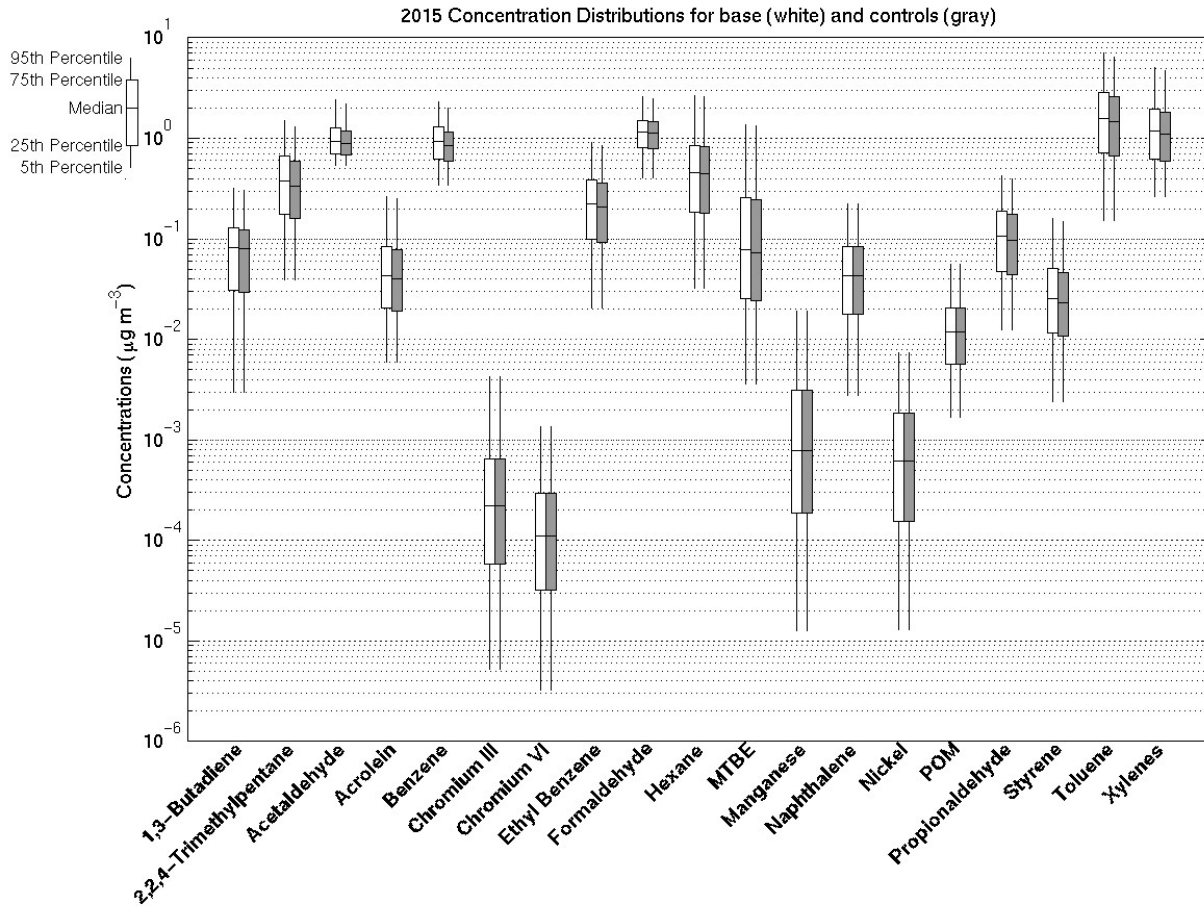
**Table 49.** Controlled ASPEN stationary and mobile concentrations ( $\mu\text{g m}^{-3}$ ) for 2015, 2020, and 2030.

HAP	Year					
	2015		2020		2030	
	Stationary	Mobile	Stationary	Mobile	Stationary	Mobile
1,3-Butadiene	$2.27 \times 10^{-2}$	$2.97 \times 10^{-2}$	$2.28 \times 10^{-2}$	$2.88 \times 10^{-2}$	$2.28 \times 10^{-2}$	$3.05 \times 10^{-2}$
2,2,4-Trimethylpentane	$3.78 \times 10^{-2}$	$4.15 \times 10^{-1}$	$4.01 \times 10^{-2}$	$3.78 \times 10^{-1}$	$4.01 \times 10^{-2}$	$3.86 \times 10^{-1}$
Acetaldehyde	$8.67 \times 10^{-2}$	$4.32 \times 10^{-1}$	$8.93 \times 10^{-2}$	$4.06 \times 10^{-1}$	$8.93 \times 10^{-2}$	$4.24 \times 10^{-1}$
Acrolein	$2.97 \times 10^{-2}$	$3.82 \times 10^{-2}$	$2.93 \times 10^{-2}$	$3.76 \times 10^{-2}$	$2.93 \times 10^{-2}$	$4.04 \times 10^{-2}$
Benzene	$1.76 \times 10^{-1}$	$3.85 \times 10^{-1}$	$1.84 \times 10^{-1}$	$3.60 \times 10^{-1}$	$1.84 \times 10^{-1}$	$3.72 \times 10^{-1}$
Chromium III	$1.66 \times 10^{-3}$	$1.03 \times 10^{-4}$	$1.86 \times 10^{-3}$	$1.07 \times 10^{-4}$	$1.86 \times 10^{-3}$	$1.20 \times 10^{-4}$
Chromium VI	$4.08 \times 10^{-4}$	$4.26 \times 10^{-5}$	$4.61 \times 10^{-4}$	$4.56 \times 10^{-5}$	$4.61 \times 10^{-4}$	$5.33 \times 10^{-5}$
Ethyl Benzene	$1.32 \times 10^{-1}$	$1.68 \times 10^{-1}$	$1.45 \times 10^{-1}$	$1.56 \times 10^{-1}$	$1.45 \times 10^{-1}$	$1.61 \times 10^{-1}$
Formaldehyde	$1.48 \times 10^{-1}$	$3.26 \times 10^{-1}$	$1.60 \times 10^{-1}$	$3.15 \times 10^{-1}$	$1.60 \times 10^{-1}$	$3.37 \times 10^{-1}$
Hexane	$5.80 \times 10^{-1}$	$1.57 \times 10^{-1}$	$6.27 \times 10^{-1}$	$1.42 \times 10^{-1}$	$6.27 \times 10^{-1}$	$1.48 \times 10^{-1}$
MTBE	$7.90 \times 10^{-2}$	$2.03 \times 10^{-1}$	$8.22 \times 10^{-2}$	$1.84 \times 10^{-1}$	$8.22 \times 10^{-2}$	$1.92 \times 10^{-1}$
Manganese	$6.14 \times 10^{-3}$	$3.01 \times 10^{-5}$	$6.80 \times 10^{-3}$	$3.28 \times 10^{-5}$	$6.80 \times 10^{-3}$	$3.95 \times 10^{-5}$
Naphthalene	$5.41 \times 10^{-2}$	$1.24 \times 10^{-2}$	$5.77 \times 10^{-2}$	$1.27 \times 10^{-2}$	$5.77 \times 10^{-2}$	$1.46 \times 10^{-2}$
Nickel	$2.50 \times 10^{-3}$	$1.69 \times 10^{-4}$	$2.74 \times 10^{-3}$	$1.80 \times 10^{-4}$	$2.74 \times 10^{-3}$	$2.04 \times 10^{-4}$
POM	$2.23 \times 10^{-2}$	$1.68 \times 10^{-3}$	$2.32 \times 10^{-2}$	$1.72 \times 10^{-3}$	$2.32 \times 10^{-2}$	$1.98 \times 10^{-3}$
Propionaldehyde	$3.32 \times 10^{-2}$	$9.95 \times 10^{-2}$	$3.39 \times 10^{-2}$	$9.44 \times 10^{-2}$	$3.39 \times 10^{-2}$	$9.91 \times 10^{-2}$
Styrene	$4.89 \times 10^{-2}$	$1.44 \times 10^{-2}$	$5.53 \times 10^{-2}$	$1.34 \times 10^{-2}$	$5.53 \times 10^{-2}$	$1.36 \times 10^{-2}$
Toluene	$1.20 \times 10^0$	$9.83 \times 10^{-1}$	$1.32 \times 10^0$	$9.03 \times 10^{-1}$	$1.32 \times 10^0$	$9.20 \times 10^{-1}$
Xylenes	$8.42 \times 10^{-1}$	$6.25 \times 10^{-1}$	$9.30 \times 10^{-1}$	$5.80 \times 10^{-1}$	$9.30 \times 10^{-1}$	$5.98 \times 10^{-1}$

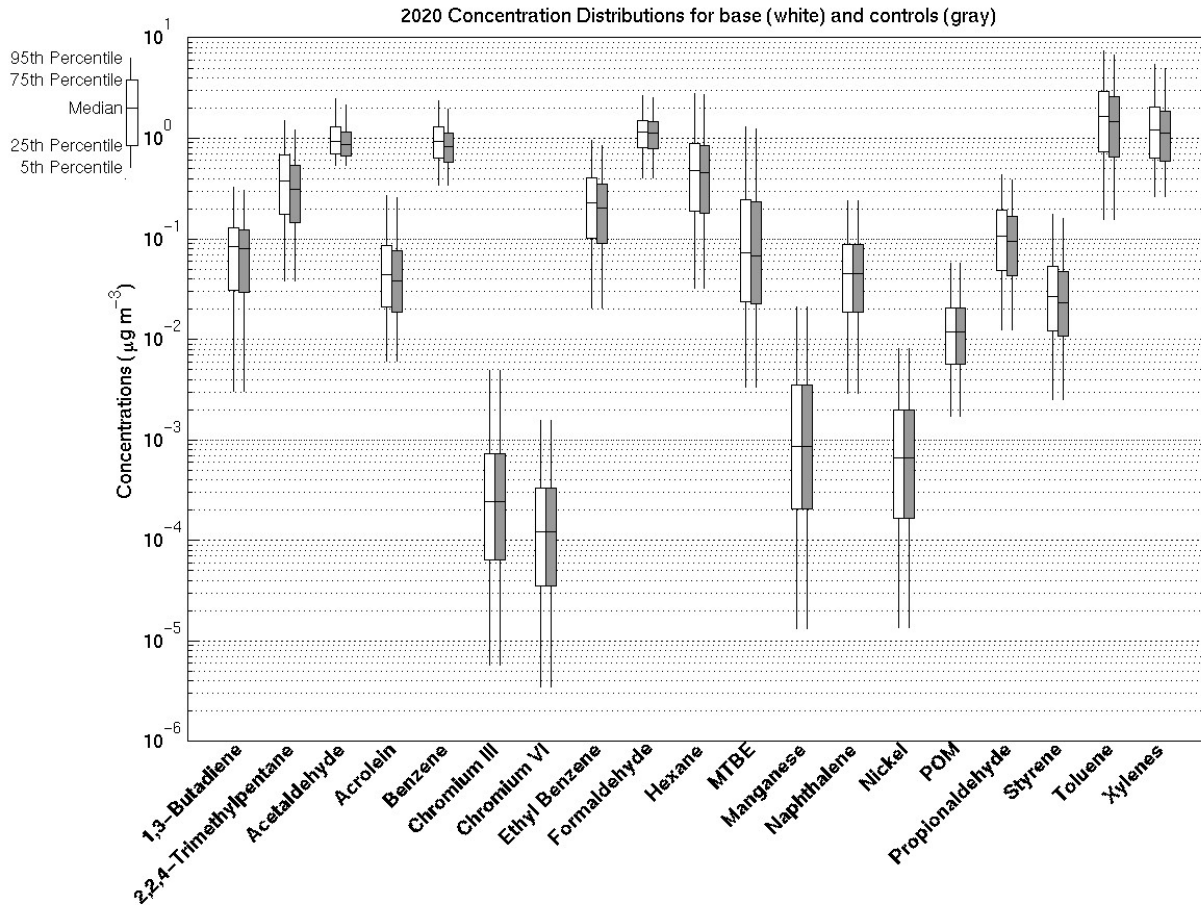
Figures 27 through 30 show the distributions of the base and controlled average concentrations for total concentrations (all sources and background) by HAP. For each HAP, the concentration distributions for base and controlled cases are very similar. Figures 31 through 33 show the distributions (dots represent mean ratios) of the ratio of controlled to base concentrations for total concentrations for each HAP. Metals and total POM have ratios of 1.0 as the inventories did not change between base and control for those HAPs. The spatial distribution of county median total concentrations for benzene for the base and control cases are shown in Figures 34 through 40. Full concentration summaries can be found in aspen\_concentrations.xls. Maps for acetaldehyde, acrolein, benzene, 1,3-butadiene, formaldehyde, and naphthalene can be found in acetaldehyde\_aspen.ppt, acrolein\_aspen.ppt, benzene\_aspen.ppt, butadiene\_aspen.ppt, formaldehyde\_aspen.ppt, and naphthalene\_aspen.ppt. All summaries and maps can be found in the MSAT rule docket, EPA-HQ-OAR-2005-0036.



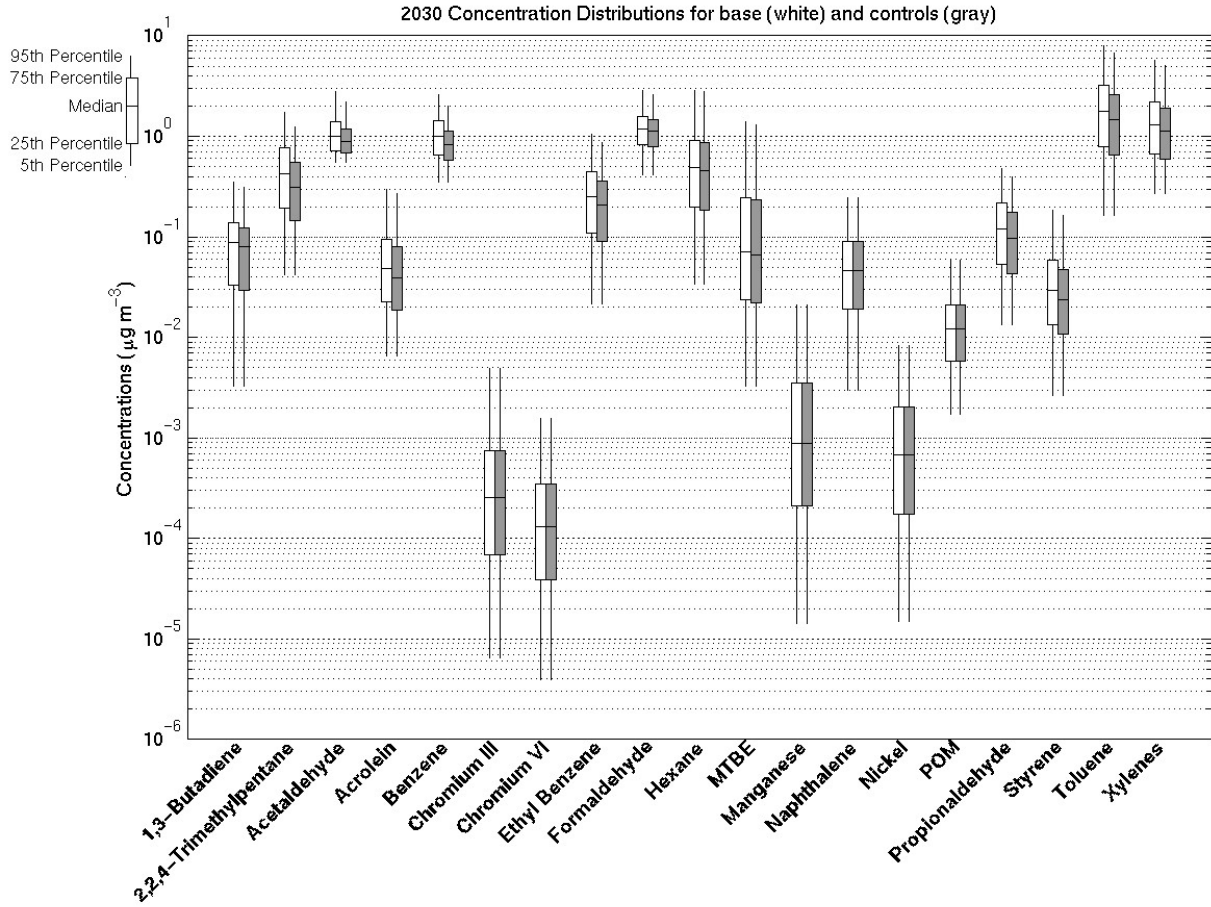
**Figure 27.** 1999 base ASPEN concentration distributions.



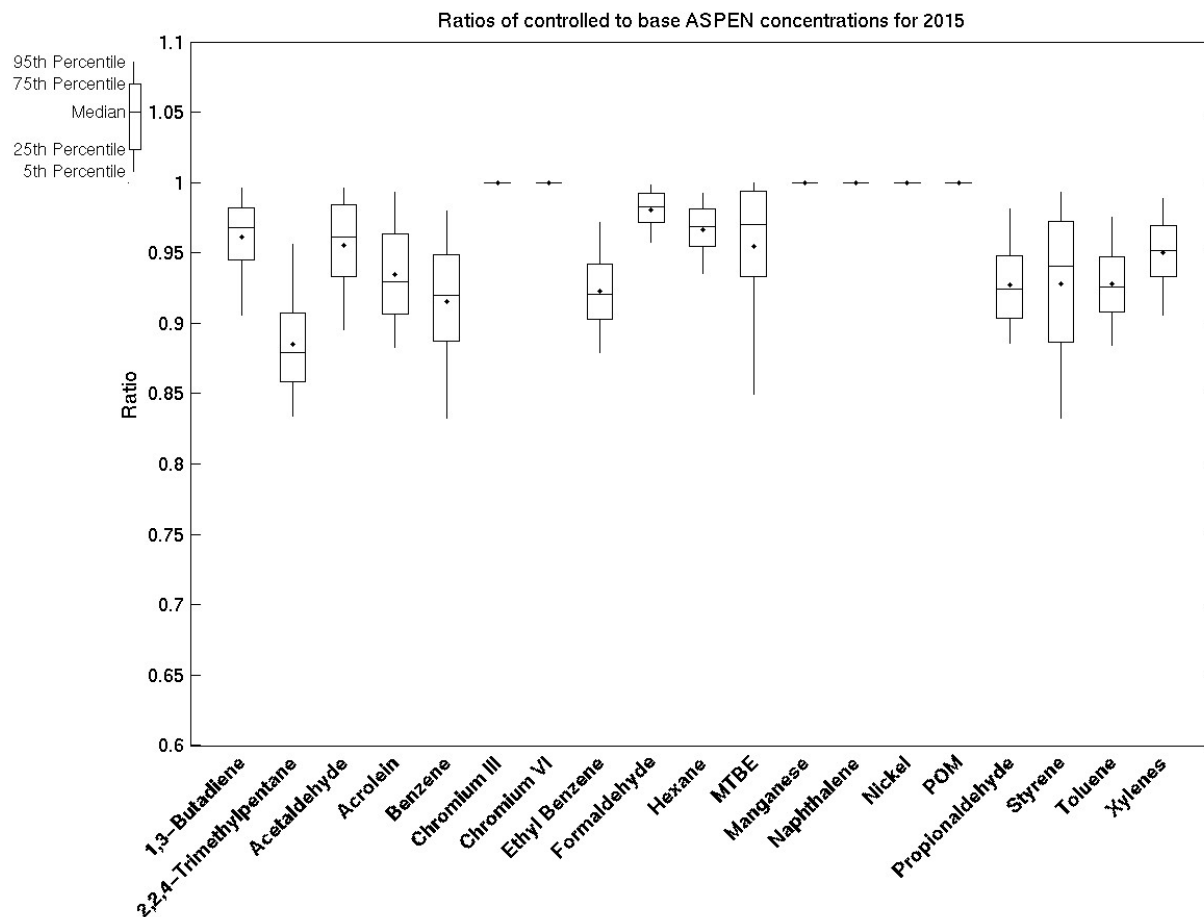
**Figure 28.** 2015 base and controlled ASPEN concentration distributions.



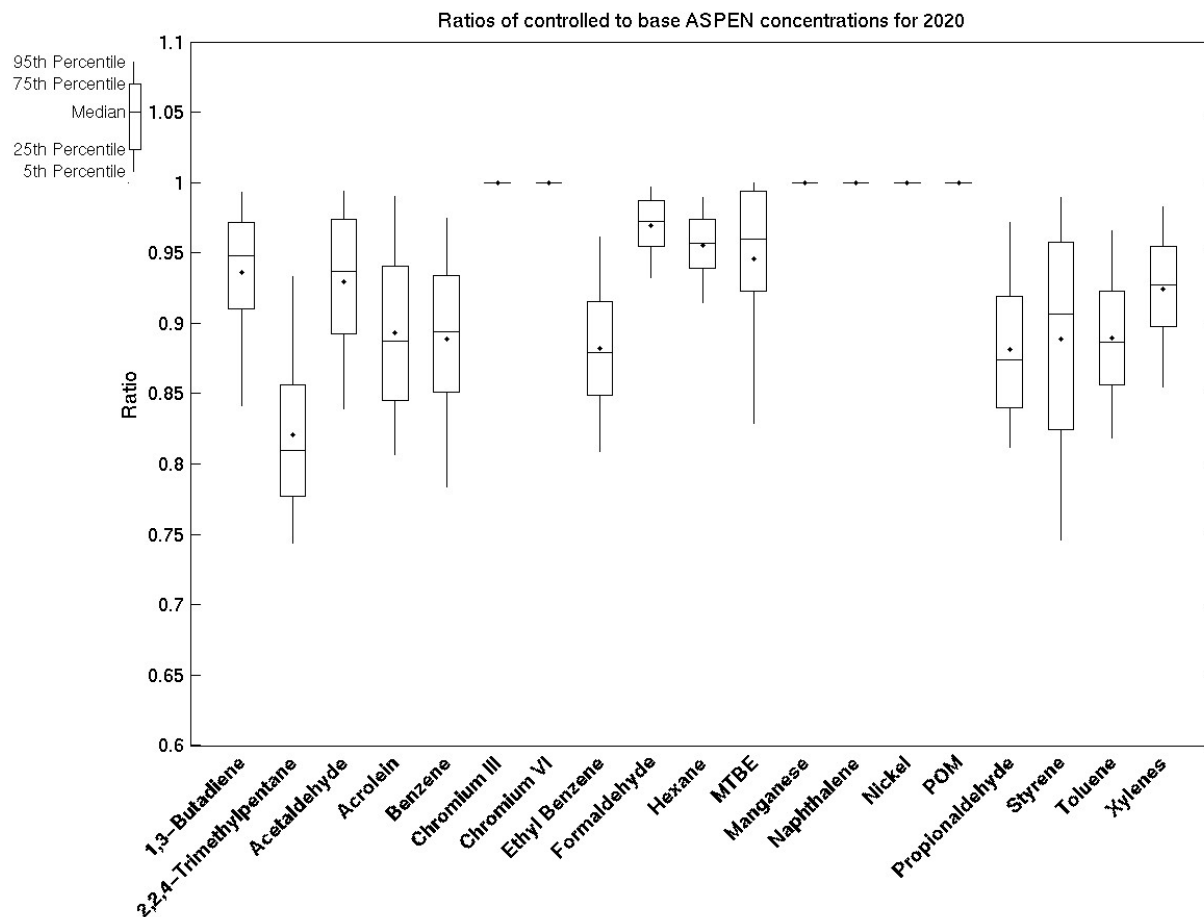
**Figure 29.** 2020 base and controlled ASPEN concentration distributions.



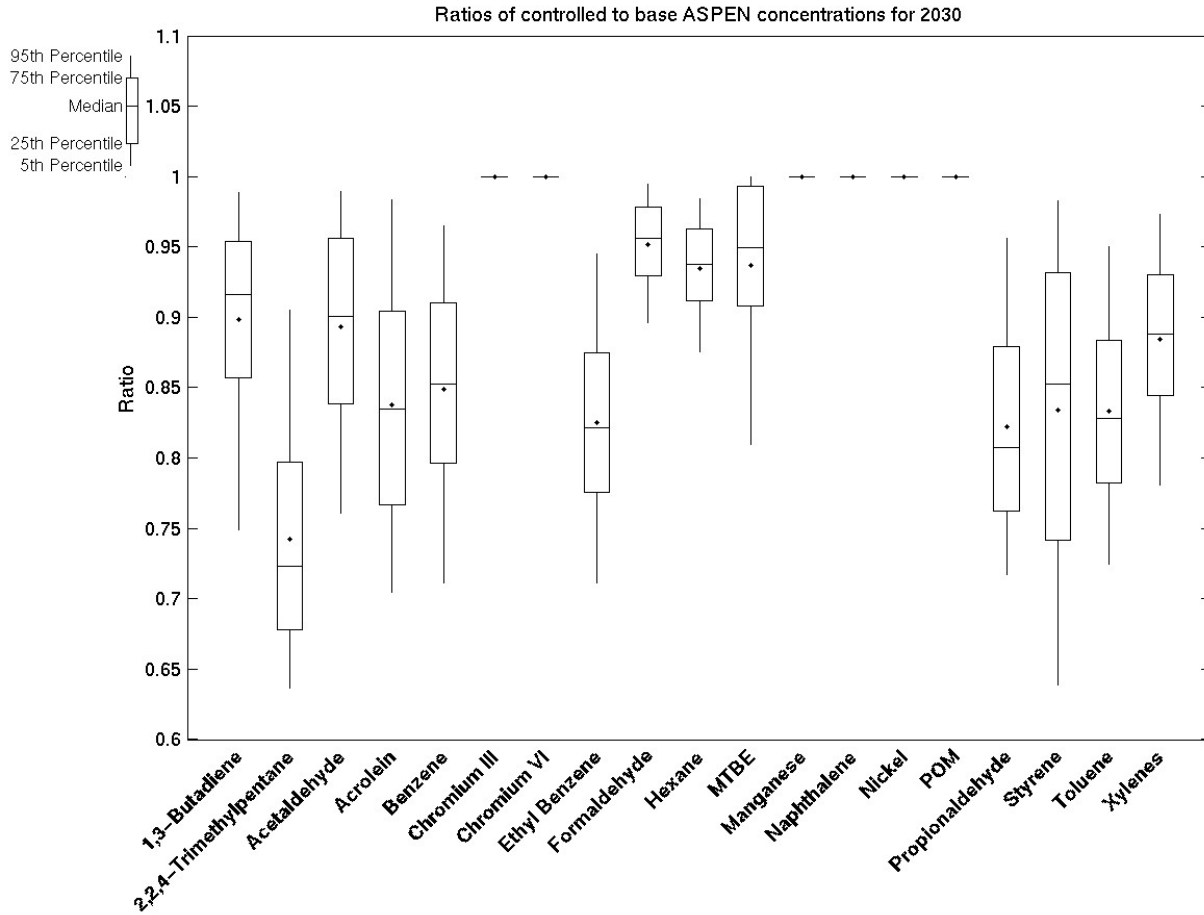
**Figure 30.** 2030 base and controlled ASPEN concentration distributions.



**Figure 31.** Distributions of the ratio of 2015 controlled annual average total concentrations to 2015 base annual average total concentrations by HAP. Totals include background concentration.

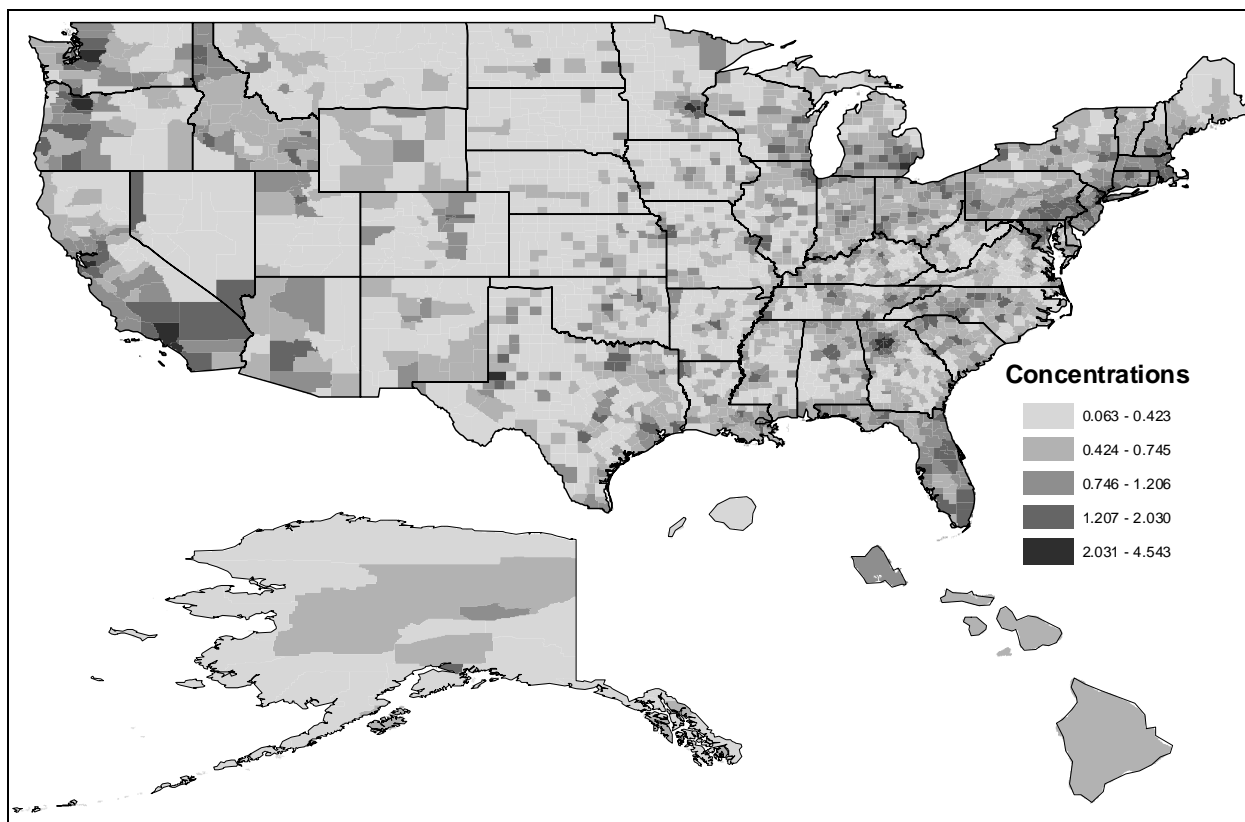


**Figure 32.** Distributions of the ratio of 2020 controlled annual average total concentrations to 2020 base annual average total concentrations by HAP. Totals include background concentration.

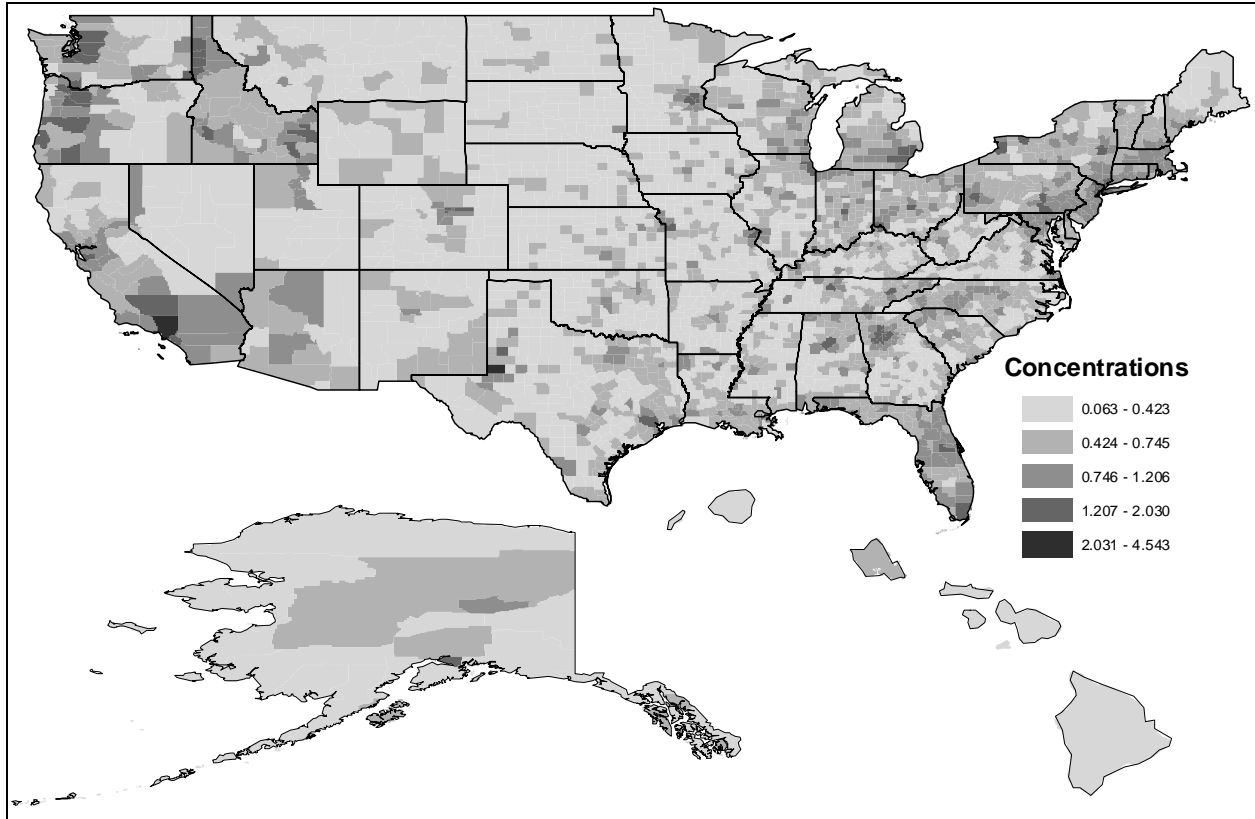


**Figure 33.** Distributions of the ratio of 2030 controlled annual average total concentrations to 2030 base annual average total concentrations by HAP. Totals include background concentration.

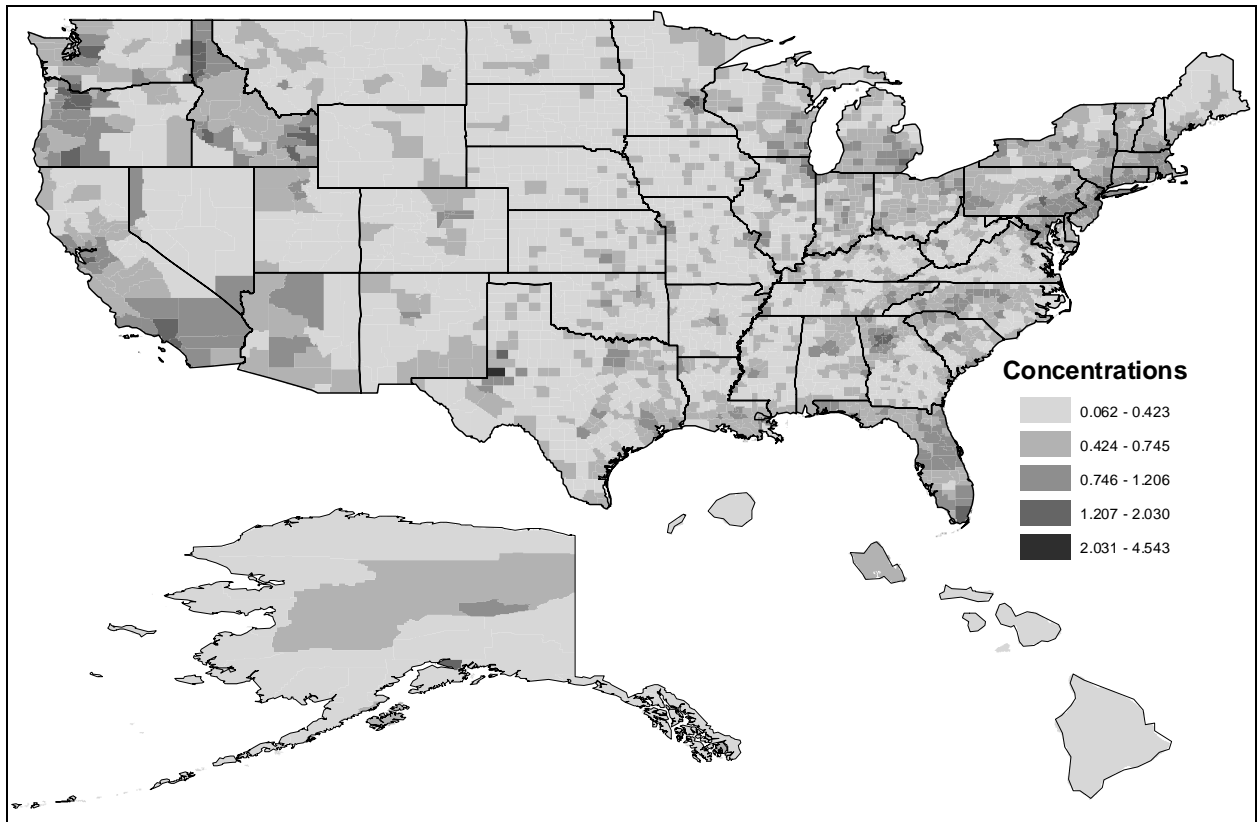




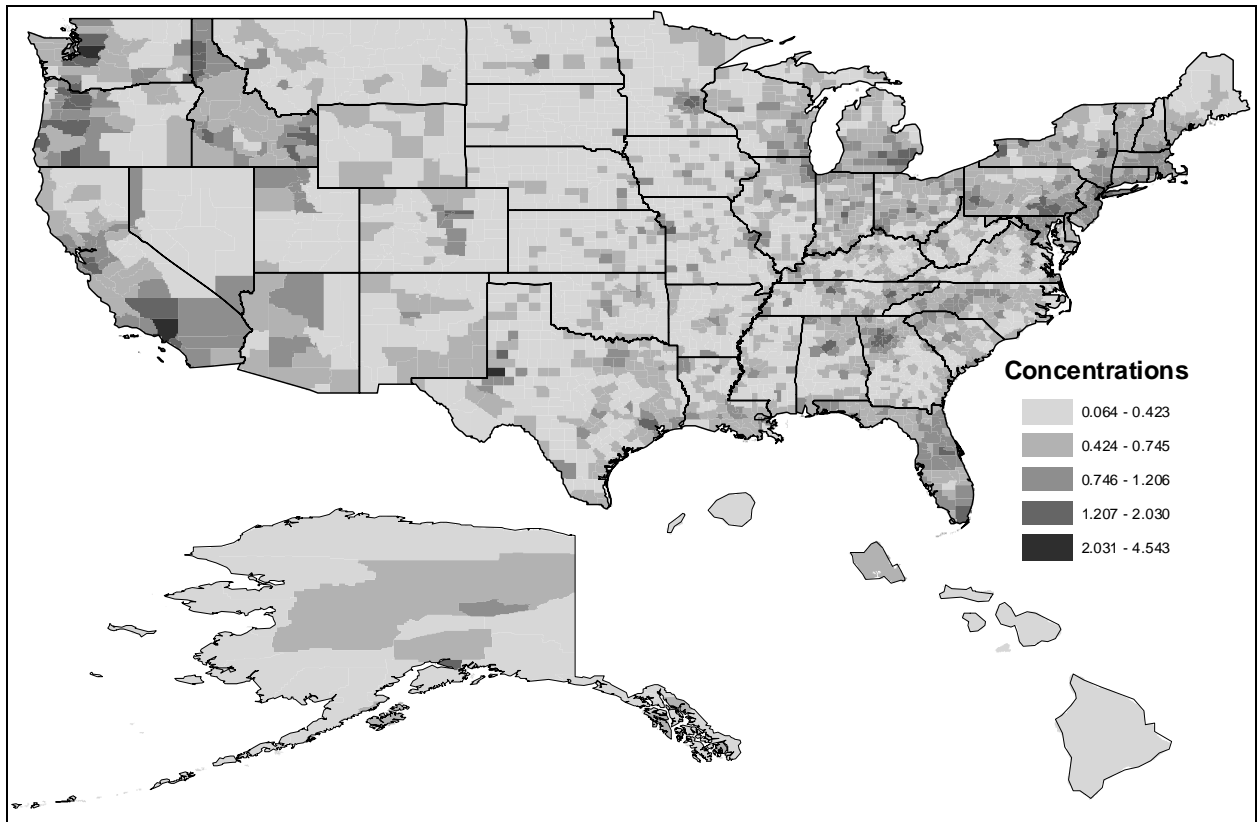
**Figure 34.** 1999 county level median total (all sources and background) concentrations ( $\mu\text{g m}^{-3}$ ) for benzene.



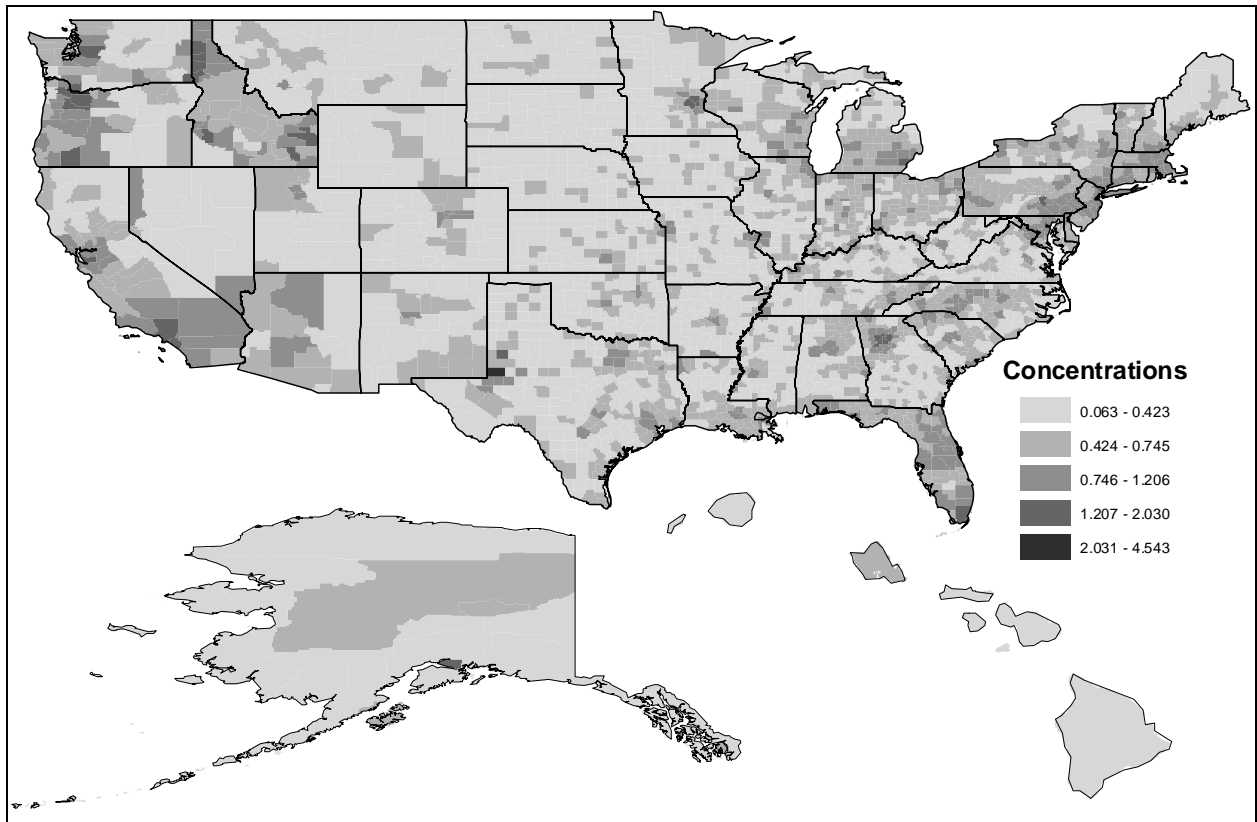
**Figure 35.** 2015 base county level median total (all sources and background) concentrations ( $\mu\text{g m}^{-3}$ ) for benzene.



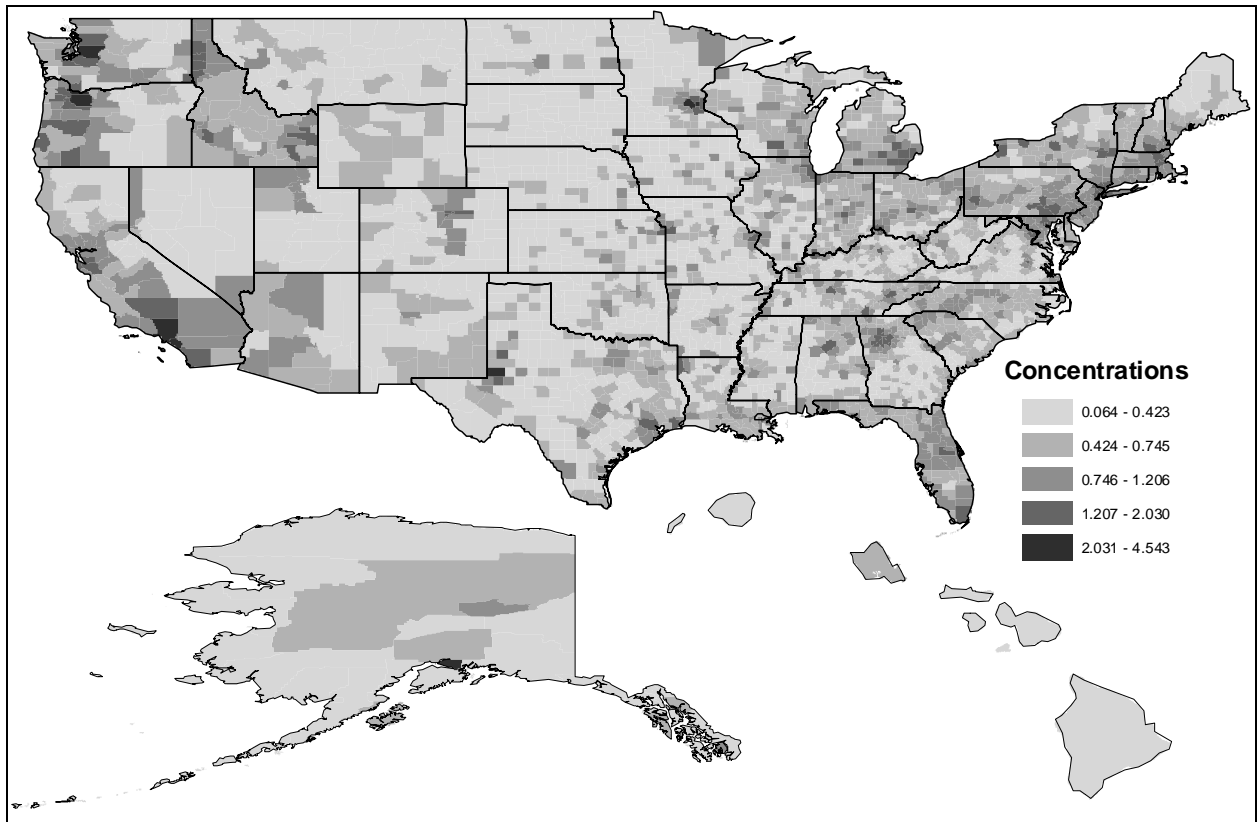
**Figure 36.** 2015 control county level median total (all sources and background) concentrations ( $\mu\text{g m}^{-3}$ ) for benzene.



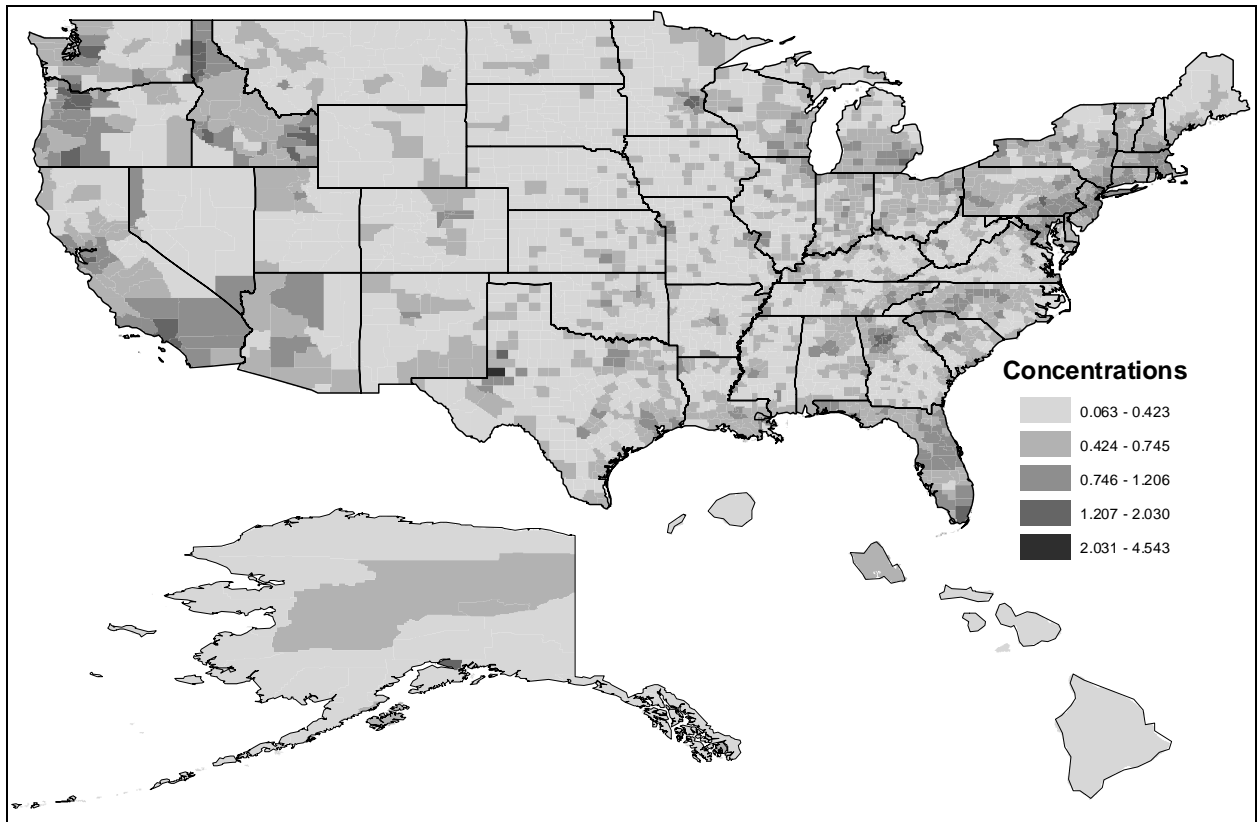
**Figure 37.** 2020 base county level median total (all sources and background) concentrations ( $\mu\text{g m}^{-3}$ ) for benzene.



**Figure 38.** 2020 control county level median total (all sources and background) concentrations ( $\mu\text{g m}^{-3}$ ) for benzene.



**Figure 39.** 2030 base county level median total (all sources and background) concentrations ( $\mu\text{g m}^{-3}$ ) for benzene.



**Figure 40.** 2030 control county level median total (all sources and background) concentrations ( $\mu\text{g m}^{-3}$ ) for benzene.

## 7. HAPEM6 Model and Post-Processing

### 7.1 HAPEM6 Model

Exposure modeling was done using the HAPEM6 model, which is based on the HAPEM5 model (U.S. EPA, 2007). One of the main differences between HAPEM6 and HAPEM5 is that HAPEM6 accounts for near roadway concentrations.

The HAPEM6 exposure model used in this assessment is the most recent version in a series of models that the EPA has used to model population exposures and risks at the urban and national scale in a number of assessments (U.S. EPA, 1993; U.S. EPA, 1999; U.S. EPA, 2002b). HAPEM6 is designed to assess average long-term inhalation exposures of the general population, or a specific sub-population, over spatial scales ranging from urban to national. HAPEM6 uses the general approach of tracking representatives of specified demographic groups as they move among indoor and outdoor microenvironments and among geographic locations. The estimated pollutant concentrations in each microenvironment visited are combined into a time-weighted average concentration, which is assigned to members of the demographic group. HAPEM6 calculates 30 replicates with different exposures for each demographic group. These data can be used to develop a distribution of exposures for the entire U. S. population.

HAPEM6 uses five primary sources of information: population data from the U.S. Census, population activity data, air quality data, roadway locations, and microenvironmental data. The population data used is obtained from the U.S. Census. Two kinds of activity data are used: activity pattern data and commuting pattern data. The activity pattern data quantify the amount of time individuals spend in a variety of microenvironments and come from EPA's Consolidated Human Activity Database (CHAD) (Glen et al., 1997). The commuting data contained in the HAPEM6 default file were derived from the year 2000 U.S. Census, and includes the number of residents of each tract that work in that tract and every other U.S. Census tract, as well as data on commuting times and distances. The air quality data come from ASPEN (after background has been added). The road locations are determined from geographic information system files from the U.S. Census. The microenvironmental data consist of factors that estimate air toxic concentrations in specific microenvironments, based on penetration of outdoor air into the microenvironment, proximity of the microenvironment to the emission source, and emission sources within the microenvironment. These factors vary among pollutants (Long et al., 2004).

New to HAPEM6 are algorithms, which account for the gradient in concentrations of primary (directly emitted) mobile source air toxics within 200 meters of major roadways (U.S. EPA, 2007). HAPEM6 adjusts ambient concentrations generated by ASPEN for each census tract using concentration gradients developed using the CALPUFF dispersion model (Cohen et al., 2005). For locations within 75 meters and from 75 to 200 meters from major roads, ambient concentrations are adjusted upward, while locations further from major roadways are adjusted downward. These adjustments are consistent with results from prior modeling studies that explicitly accounted for concentration gradients around major roads within census tracts (Pratt et al, 2004). These adjusted concentrations are then employed in microenvironmental concentration calculations.



HAPEM6 has a number of other technical improvements over the previous version of HAPEM5. These improvements, along with other details of the model, are described in the HAPEM6 User's Guide (U.S. EPA 2007). The HAPEM6 runs used year 2000 census data. Average lifetime exposure for an individual in a census tract was calculated from data for individual demographic groups using a post-processing routine. We estimated the contributions to ambient concentrations for the following source sectors: major, area and other, onroad, nonroad, and background.

## **7.2 Air quality input files**

ASPEN results were also processed for input to HAPEM6. ASPEN outputs annual average tract-level concentrations for eight 3-hour time blocks. The concentrations were extracted from the binary ASPEN output, .exp files, using the AVGDAT program and written to an ASCII text file. The concentrations were then processed in a similar fashion as for the annual average concentrations: fine and coarse components of the metals added together, gas and particulate phases of naphthalene added together and secondary concentrations added to the secondary HAPs using the approach described in Section 6.3.1. Once these steps were done there were eight 3-hour concentrations for major, area & other, total onroad, total nonroad. Background was also added for each tract.

## **7.3 HAPEM6 output**

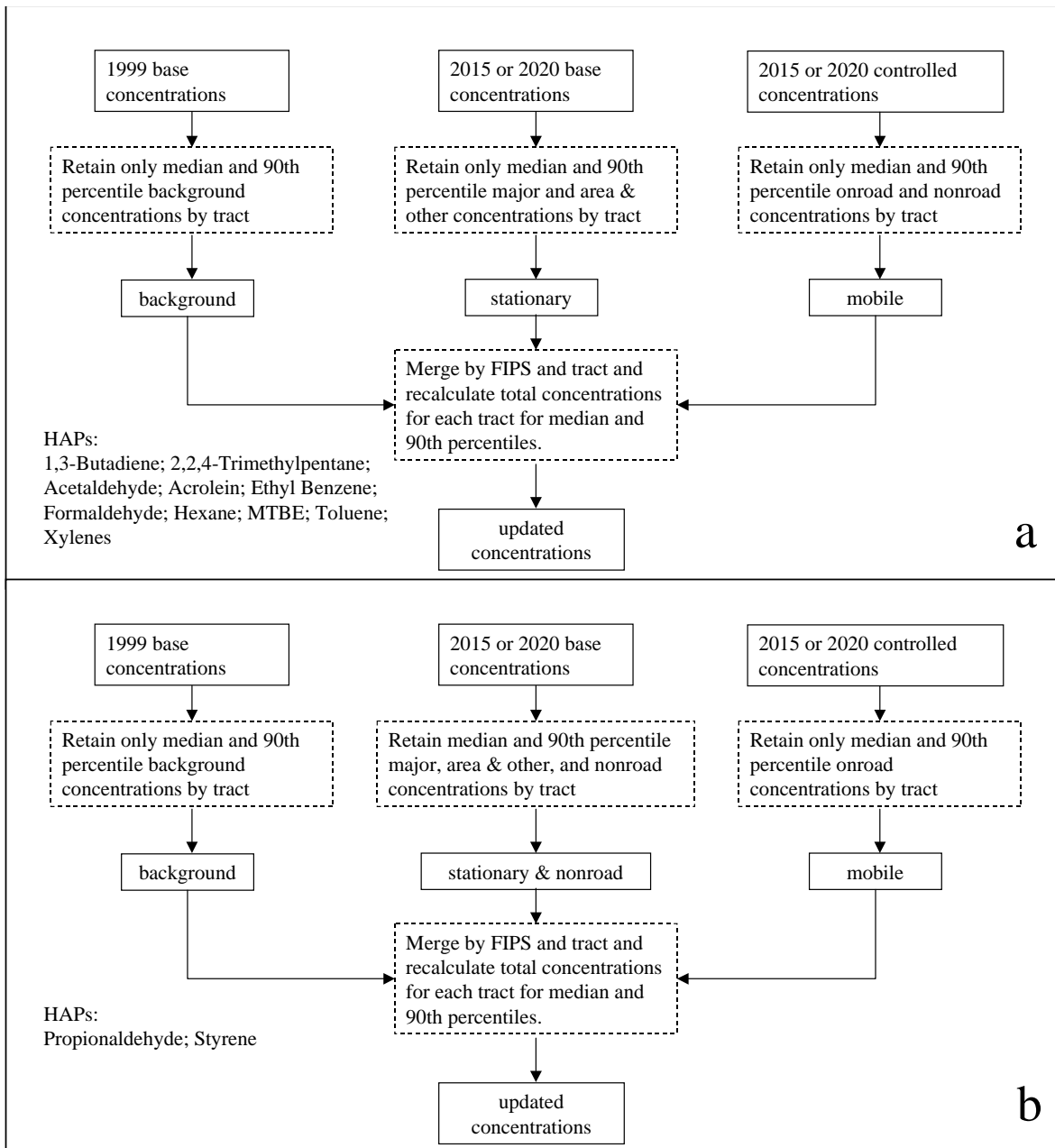
For each HAP, the HAPEM6 output file consisted of a series of concentrations for each tract. For each tract, the 1<sup>st</sup>, 5<sup>th</sup>, 10<sup>th</sup>, 25<sup>th</sup>, 50<sup>th</sup>, 75<sup>th</sup>, 90<sup>th</sup>, 95<sup>th</sup>, and 99<sup>th</sup> percentile concentrations for the total concentrations were listed along with the individual source category concentrations for each total concentration. For summary purposes, the 50<sup>th</sup>, or median, and 90<sup>th</sup> percentiles were summarized.

For all pollutants, with the exception of benzene, the base and control stationary ASPEN concentrations were identical for a given year, such as 2015. Additionally, for the metals (chromium III, chromium VI, manganese, and nickel), POM and naphthalene, the base and control mobile ASPEN concentrations were identical. For all years and cases, the background concentrations added to the ASPEN results were the same. Finally, for 2030, for all HAPs, the stationary concentrations were equal to the 2020 ASPEN concentrations for either base or control cases. However, in the HAPEM output, the base and stationary concentrations, mobile concentrations, and background were not equal as they were in ASPEN. This is due to the post-processing of the raw HAPEM output. The tract-level source category concentrations associated with each of the percentiles above are adjusted by multiplying by the tract-level median total concentration by the ratio of the average source category concentration (major, area & other, etc.) by the tract average total concentration. For a given year, while the stationary concentrations and background may remain the same for base and control cases for ASPEN, the total concentration changes due to changes in mobile concentrations between base and control. Therefore, the total concentrations change, which will affect the stationary and background

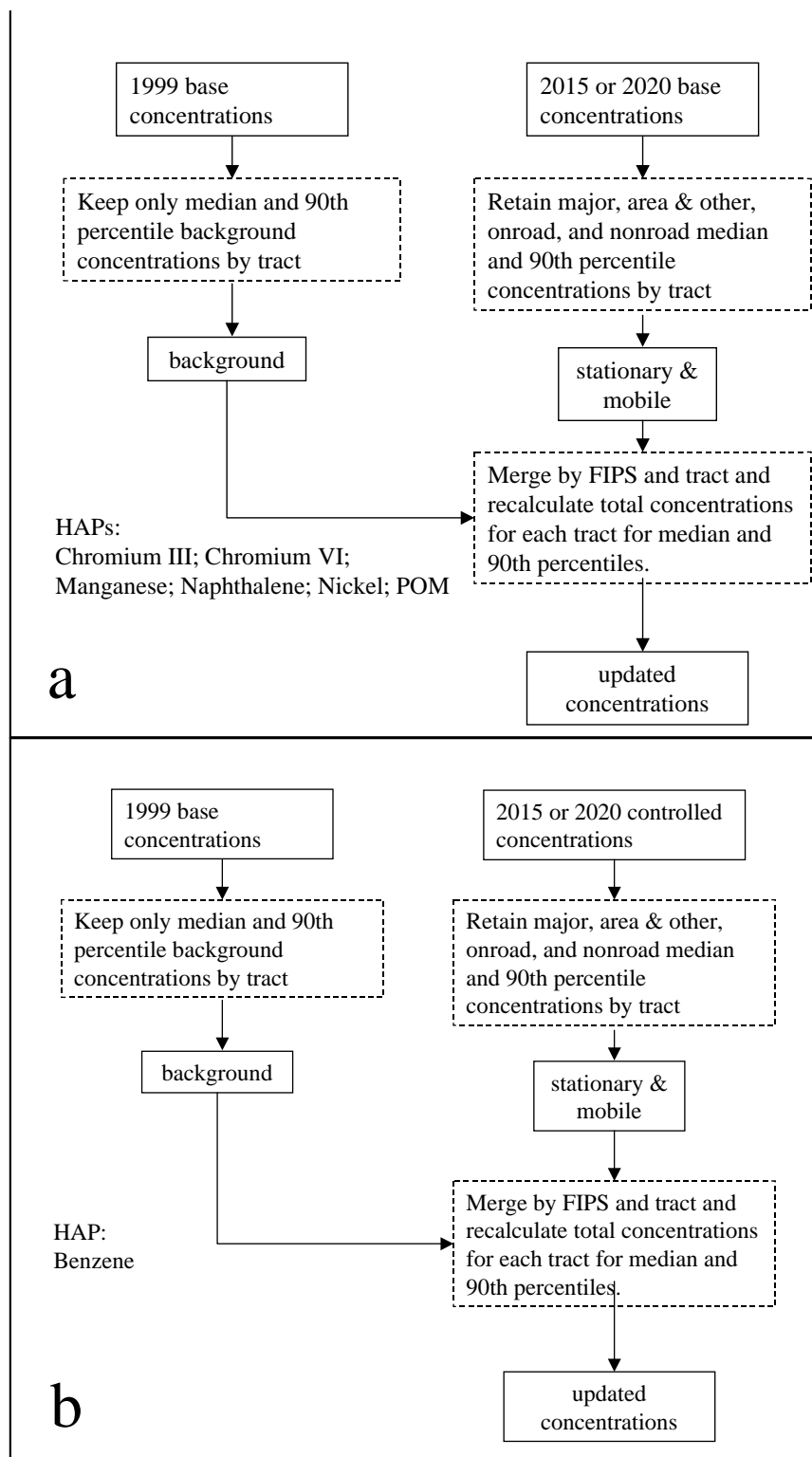
concentrations in the final HAPEM6 output. To alleviate this the following steps were taken in creating the concentration summaries of HAPEM6 output:

- For 2015, 2020, and 2030 for base and control concentrations, the background concentrations were set equal to the 1999 background concentrations at the census tract level.
- For a given year, for each HAP, except benzene, the control case stationary concentrations were set equal to the corresponding year and HAP's base stationary concentrations at the census tract level.
- For a given year, for propionaldehyde and styrene, the control case nonroad concentrations were set equal to the base nonroad concentrations.
- For all HAPs for 2030, the stationary concentrations for the base case were set equal to the 2020 stationary base concentrations. For all HAPs except benzene, the 2030 stationary control concentrations were set equal to the 2020 base stationary concentrations. For benzene for 2030, the stationary control concentrations were set equal to the 2020 stationary control concentrations. All substitutions were at the census tract level.
- For a given year, for the metals, POM, and naphthalene, the control case onroad and nonroad concentrations were set equal to the corresponding year and HAP's base onroad and nonroad concentrations at the census tract level.

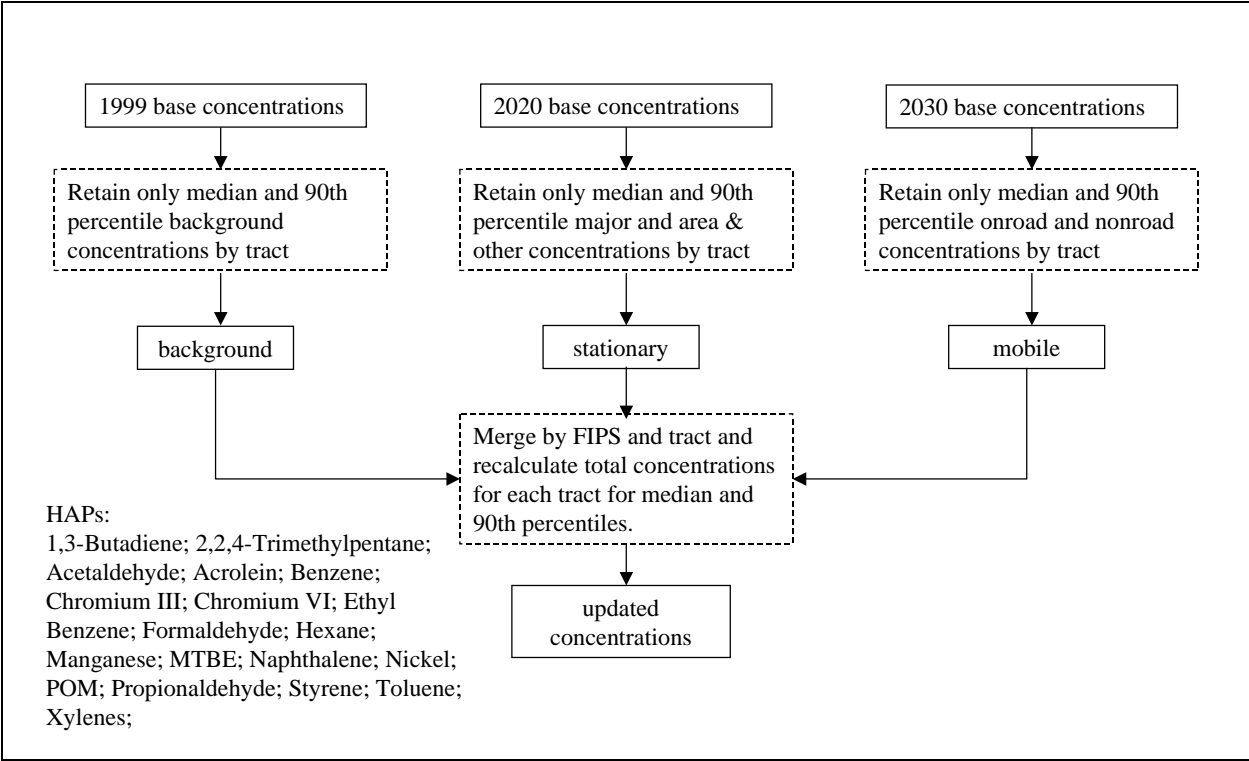
Figures 41 through 45 show the above steps in diagram form and a summarization of the steps is listed in Table 50.



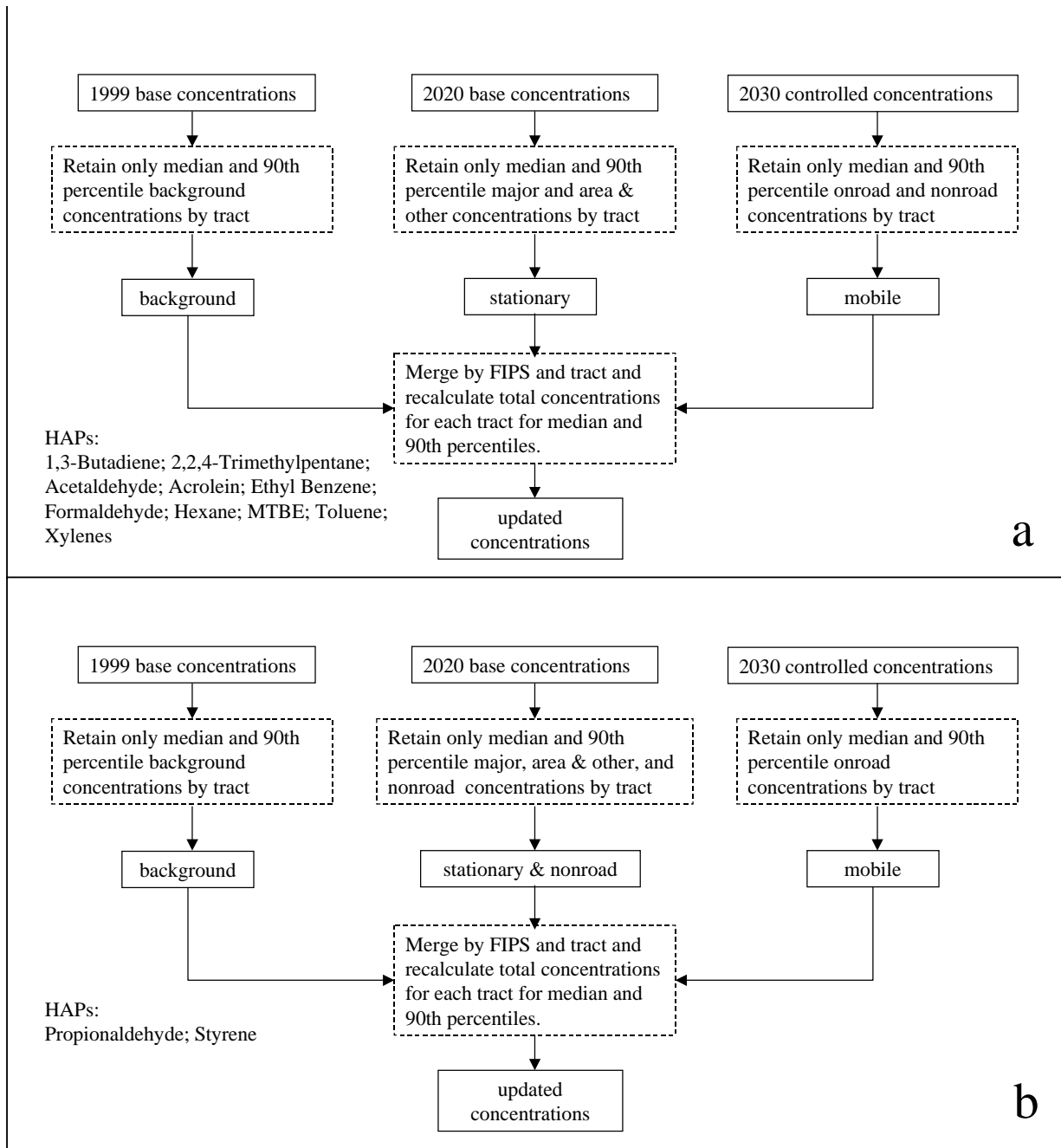
**Figure 41.** Modification of 2015 and 2020 HAPEM6 controlled concentrations for a) all HAPs excluding benzene, metals, naphthalene, POM, propionaldehyde, and styrene and b) propionaldehyde and styrene.



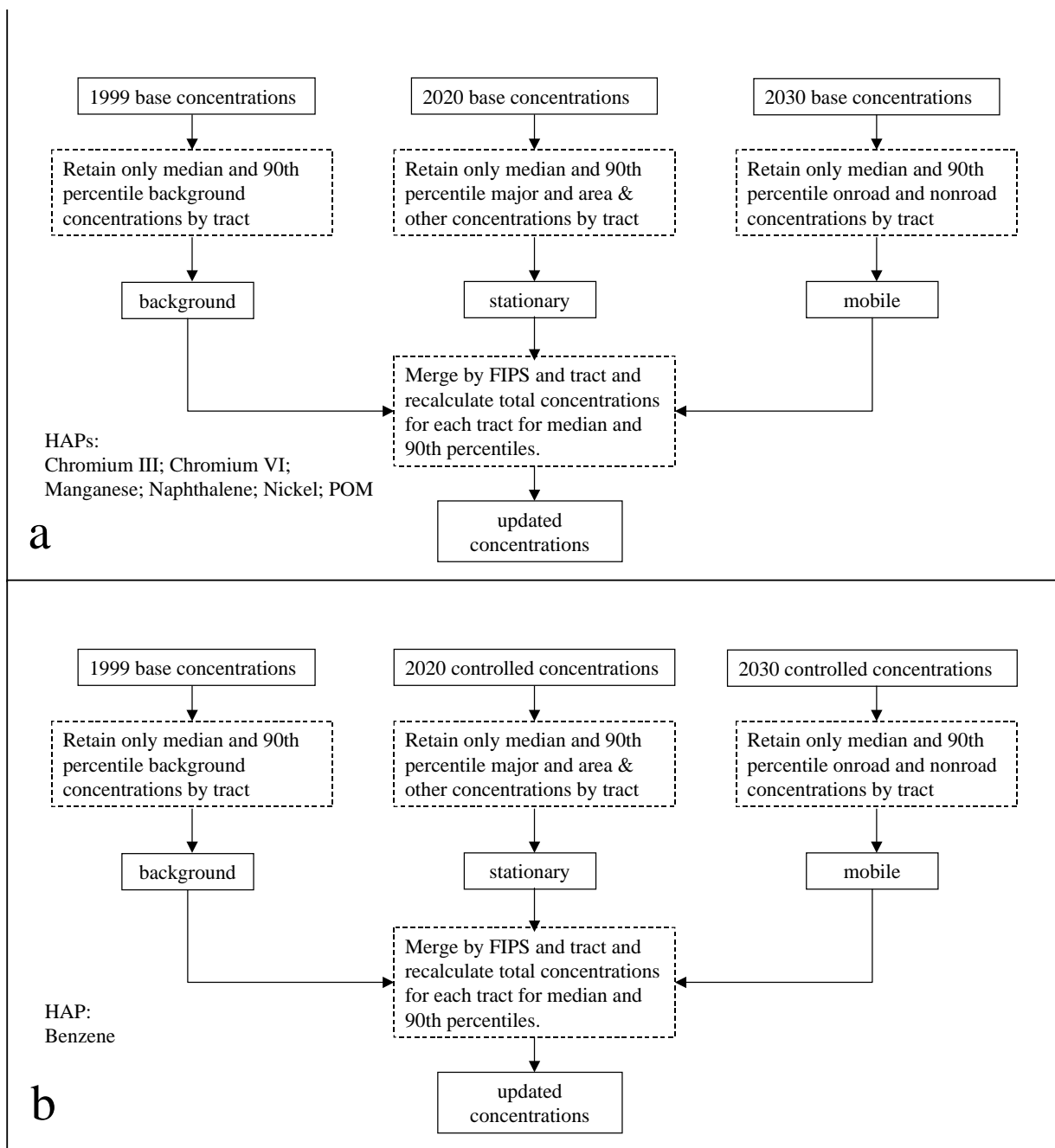
**Figure 42.** Modification of 2015 and 2020 HAPEM6 controlled concentrations for a) metals, naphthalene, and POM and b) benzene.



**Figure 43.** Modification of 2030 base HAP concentrations for all HAPs.



**Figure 44.** Modification of 2030 HAPEM6 controlled concentrations for a) all HAPs excluding benzene, metals, naphthalene, POM, propionaldehyde, and styrene and b) propionaldehyde and styrene.



**Figure 45.** Modification of 2030 HAPEM6 controlled concentrations for a) metals, naphthalene, and POM and b) benzene.

**Table 50.** Concentration replacement strategy for controlled HAPEM concentrations.

Source category	Strategy	HAP(s)
Background	Replace all future years (base and control) with 1999 background.	All
Major source base	For 2030 base, replace all concentrations with 2020 base.	All
Area & other source base	For 2030 base, replace all concentrations with 2020 base.	All
Major source controlled	For 2015 and 2020 replace controlled concentrations with base concentrations	1,3-Butadiene; 2,2,4-Trimethylpentane; Acetaldehyde; Acrolein; Chromium III; Chromium VI; Ethyl Benzene; Formaldehyde; Hexane; Manganese; MTBE; Naphthalene; Nickel; POM; Propionaldehyde; Styrene; Toluene; Xylenes;
	For 2015 and 2020 leave controlled concentrations unchanged.	Benzene
	For 2030 controlled, replace the concentrations with 2020 base concentrations.	1,3-Butadiene; 2,2,4-Trimethylpentane; Acetaldehyde; Acrolein; Chromium III; Chromium VI; Ethyl Benzene; Formaldehyde; Hexane; Manganese; MTBE; Naphthalene; Nickel; POM; Propionaldehyde; Styrene; Toluene; Xylenes;
	For 2030 controlled, replace with 2020 controlled concentrations.	Benzene
Area & other source controlled	For 2015 and 2020 replace controlled concentrations with base concentrations	1,3-Butadiene; 2,2,4-Trimethylpentane; Acetaldehyde; Acrolein; Chromium III; Chromium VI; Ethyl Benzene; Formaldehyde; Hexane; Manganese; MTBE; Naphthalene; Nickel; POM; Propionaldehyde; Styrene; Toluene; Xylenes;
	For 2015 and 2020 leave controlled concentrations unchanged.	Benzene
	For 2030 controlled, replace the concentrations with 2020 base concentrations.	1,3-Butadiene; 2,2,4-Trimethylpentane; Acetaldehyde; Acrolein; Chromium III; Chromium VI; Ethyl Benzene; Formaldehyde; Hexane; Manganese; MTBE; Naphthalene; Nickel; POM; Propionaldehyde; Styrene; Toluene; Xylenes;
	For 2030 controlled, replace with 2020 controlled concentrations.	Benzene
Onroad controlled	For a given year, replace the controlled concentrations with base concentrations for the same year.	Chromium III; Chromium VI; Manganese; Naphthalene; Nickel; POM;
Nonroad controlled	For a given year, replace the controlled concentrations with base concentrations for the same year.	Chromium III; Chromium VI; Manganese; Naphthalene; Nickel; POM; Propionaldehyde; Styrene

National summaries by year for base HAPEM6 concentrations are shown in Table 51 and Table 52 with controlled concentrations shown in Table 53 and Table 54.



**Table 51.** HAPEM national average concentrations (based on median tract concentrations) for 1999,2015, 2020, and 2030.

HAP	Background	Year							
		1999		2015		2020		2030	
		Stationary	Mobile	Stationary	Mobile	Stationary	Mobile	Stationary	Mobile
1,3-Butadiene	3.96x10 <sup>-2</sup>	1.82x10 <sup>-2</sup>	8.03x10 <sup>-2</sup>	1.86x10 <sup>-2</sup>	3.89x10 <sup>-2</sup>	1.87x10 <sup>-2</sup>	4.05x10 <sup>-2</sup>	1.87x10 <sup>-2</sup>	4.71x10 <sup>-2</sup>
2,2,4-Trimethylpentane	0.00x10 <sup>0</sup>	3.56x10 <sup>-2</sup>	9.81x10 <sup>-1</sup>	3.05x10 <sup>-2</sup>	5.08x10 <sup>-1</sup>	3.24x10 <sup>-2</sup>	5.08x10 <sup>-1</sup>	3.24x10 <sup>-2</sup>	5.82x10 <sup>-1</sup>
Acetaldehyde	4.00x10 <sup>-1</sup>	6.67x10 <sup>-2</sup>	9.26x10 <sup>-1</sup>	7.02x10 <sup>-2</sup>	5.61x10 <sup>-1</sup>	7.22x10 <sup>-2</sup>	5.75x10 <sup>-1</sup>	7.22x10 <sup>-2</sup>	6.66x10 <sup>-1</sup>
Acrolein	0.00x10 <sup>0</sup>	2.60x10 <sup>-2</sup>	8.44x10 <sup>-2</sup>	2.43x10 <sup>-2</sup>	4.40x10 <sup>-2</sup>	2.40x10 <sup>-2</sup>	4.57x10 <sup>-2</sup>	2.40x10 <sup>-2</sup>	5.30x10 <sup>-2</sup>
Benzene	3.05x10 <sup>-1</sup>	1.33x10 <sup>-1</sup>	9.59x10 <sup>-1</sup>	1.50x10 <sup>-1</sup>	5.52x10 <sup>-1</sup>	1.56x10 <sup>-1</sup>	5.66x10 <sup>-1</sup>	1.56x10 <sup>-1</sup>	6.55x10 <sup>-1</sup>
Chromium III	0.00x10 <sup>0</sup>	5.02x10 <sup>-4</sup>	4.15x10 <sup>-5</sup>	6.53x10 <sup>-4</sup>	4.99x10 <sup>-5</sup>	7.34x10 <sup>-4</sup>	5.27x10 <sup>-5</sup>	7.34x10 <sup>-4</sup>	5.99x10 <sup>-5</sup>
Chromium VI	0.00x10 <sup>0</sup>	1.22x10 <sup>-4</sup>	1.80x10 <sup>-5</sup>	1.63x10 <sup>-4</sup>	2.32x10 <sup>-5</sup>	1.84x10 <sup>-4</sup>	2.50x10 <sup>-5</sup>	1.84x10 <sup>-4</sup>	2.96x10 <sup>-5</sup>
Ethyl Benzene	0.00x10 <sup>0</sup>	8.94x10 <sup>-2</sup>	4.02x10 <sup>-1</sup>	1.10x10 <sup>-1</sup>	2.09x10 <sup>-1</sup>	1.21x10 <sup>-1</sup>	2.10x10 <sup>-1</sup>	1.21x10 <sup>-1</sup>	2.41x10 <sup>-1</sup>
Formaldehyde	6.12x10 <sup>-1</sup>	1.05x10 <sup>-1</sup>	7.66x10 <sup>-1</sup>	1.24x10 <sup>-1</sup>	3.84x10 <sup>-1</sup>	1.34x10 <sup>-1</sup>	3.90x10 <sup>-1</sup>	1.34x10 <sup>-1</sup>	4.45x10 <sup>-1</sup>
Hexane	0.00x10 <sup>0</sup>	4.15x10 <sup>-1</sup>	3.56x10 <sup>-1</sup>	4.91x10 <sup>-1</sup>	1.94x10 <sup>-1</sup>	5.32x10 <sup>-1</sup>	1.85x10 <sup>-1</sup>	5.32x10 <sup>-1</sup>	2.05x10 <sup>-1</sup>
MTBE	0.00x10 <sup>0</sup>	5.89x10 <sup>-2</sup>	8.00x10 <sup>-1</sup>	6.48x10 <sup>-2</sup>	2.13x10 <sup>-1</sup>	6.75x10 <sup>-2</sup>	1.93x10 <sup>-1</sup>	6.75x10 <sup>-2</sup>	2.04x10 <sup>-1</sup>
Manganese	0.00x10 <sup>0</sup>	1.95x10 <sup>-3</sup>	1.32x10 <sup>-5</sup>	2.43x10 <sup>-3</sup>	1.76x10 <sup>-5</sup>	2.69x10 <sup>-3</sup>	1.92x10 <sup>-5</sup>	2.69x10 <sup>-3</sup>	2.33x10 <sup>-5</sup>
Naphthalene	0.00x10 <sup>0</sup>	3.75x10 <sup>-2</sup>	2.17x10 <sup>-2</sup>	4.52x10 <sup>-2</sup>	1.39x10 <sup>-2</sup>	4.82x10 <sup>-2</sup>	1.41x10 <sup>-2</sup>	4.82x10 <sup>-2</sup>	1.63x10 <sup>-2</sup>
Nickel	0.00x10 <sup>0</sup>	8.81x10 <sup>-4</sup>	6.55x10 <sup>-5</sup>	9.97x10 <sup>-4</sup>	8.09x10 <sup>-5</sup>	1.09x10 <sup>-3</sup>	8.64x10 <sup>-5</sup>	1.09x10 <sup>-3</sup>	9.92x10 <sup>-5</sup>
POM	0.00x10 <sup>0</sup>	1.29x10 <sup>-2</sup>	2.11x10 <sup>-3</sup>	1.38x10 <sup>-2</sup>	1.33x10 <sup>-3</sup>	1.43x10 <sup>-2</sup>	1.36x10 <sup>-3</sup>	1.43x10 <sup>-2</sup>	1.58x10 <sup>-3</sup>
Propionaldehyde	0.00x10 <sup>0</sup>	2.57x10 <sup>-2</sup>	2.26x10 <sup>-1</sup>	2.61x10 <sup>-2</sup>	1.18x10 <sup>-1</sup>	2.66x10 <sup>-2</sup>	1.21x10 <sup>-1</sup>	2.66x10 <sup>-2</sup>	1.38x10 <sup>-1</sup>
Styrene	0.00x10 <sup>0</sup>	3.18x10 <sup>-2</sup>	3.70x10 <sup>-2</sup>	3.95x10 <sup>-2</sup>	1.91x10 <sup>-2</sup>	4.46x10 <sup>-2</sup>	1.99x10 <sup>-2</sup>	4.46x10 <sup>-2</sup>	2.34x10 <sup>-2</sup>
Toluene	0.00x10 <sup>0</sup>	8.18x10 <sup>-1</sup>	2.49x10 <sup>0</sup>	9.96x10 <sup>-1</sup>	1.29x10 <sup>0</sup>	1.10x10 <sup>0</sup>	1.31x10 <sup>0</sup>	1.10x10 <sup>0</sup>	1.51x10 <sup>0</sup>
Xylenes	1.28x10 <sup>-1</sup>	5.47x10 <sup>-1</sup>	1.54x10 <sup>0</sup>	7.11x10 <sup>-1</sup>	7.96x10 <sup>-1</sup>	7.87x10 <sup>-1</sup>	8.05x10 <sup>-1</sup>	7.87x10 <sup>-1</sup>	9.23x10 <sup>-1</sup>

**Table 52.** HAPEM national average concentrations (based on 90<sup>th</sup> percentile tract concentrations) for 1999,2015, 2020, and 2030.

HAP	Background	Year							
		1999		2015		2020		2030	
		Stationary	Mobile	Stationary	Mobile	Stationary	Mobile	Stationary	Mobile
1,3-Butadiene	5.88x10 <sup>-2</sup>	2.43x10 <sup>-2</sup>	1.25x10 <sup>-1</sup>	2.37x10 <sup>-2</sup>	5.50x10 <sup>-2</sup>	2.39x10 <sup>-2</sup>	5.76x10 <sup>-2</sup>	2.39x10 <sup>-2</sup>	6.82x10 <sup>-2</sup>
2,2,4-Trimethylpentane	0.00x10 <sup>0</sup>	5.77x10 <sup>-2</sup>	1.69x10 <sup>0</sup>	4.86x10 <sup>-2</sup>	8.62x10 <sup>-1</sup>	5.14x10 <sup>-2</sup>	8.63x10 <sup>-1</sup>	5.14x10 <sup>-2</sup>	9.94x10 <sup>-1</sup>
Acetaldehyde	5.82x10 <sup>-1</sup>	9.82x10 <sup>-2</sup>	1.45x10 <sup>0</sup>	9.59x10 <sup>-2</sup>	8.17x10 <sup>-1</sup>	9.89x10 <sup>-2</sup>	8.42x10 <sup>-1</sup>	9.89x10 <sup>-2</sup>	9.96x10 <sup>-1</sup>
Acrolein	0.00x10 <sup>0</sup>	3.73x10 <sup>-2</sup>	1.35x10 <sup>-1</sup>	3.16x10 <sup>-2</sup>	6.48x10 <sup>-2</sup>	3.12x10 <sup>-2</sup>	6.76x10 <sup>-2</sup>	3.12x10 <sup>-2</sup>	7.93x10 <sup>-2</sup>
Benzene	4.50x10 <sup>-1</sup>	1.97x10 <sup>-1</sup>	1.47x10 <sup>0</sup>	2.08x10 <sup>-1</sup>	7.91x10 <sup>-1</sup>	2.18x10 <sup>-1</sup>	8.12x10 <sup>-1</sup>	2.18x10 <sup>-1</sup>	9.58x10 <sup>-1</sup>
Chromium III	0.00x10 <sup>0</sup>	7.14x10 <sup>-4</sup>	6.03x10 <sup>-5</sup>	9.32x10 <sup>-4</sup>	7.32x10 <sup>-5</sup>	1.05x10 <sup>-3</sup>	7.76x10 <sup>-5</sup>	1.05x10 <sup>-3</sup>	8.88x10 <sup>-5</sup>
Chromium VI	0.00x10 <sup>0</sup>	1.77x10 <sup>-4</sup>	2.64x10 <sup>-5</sup>	2.36x10 <sup>-4</sup>	3.40x10 <sup>-5</sup>	2.67x10 <sup>-4</sup>	3.67x10 <sup>-5</sup>	2.67x10 <sup>-4</sup>	4.38x10 <sup>-5</sup>
Ethyl Benzene	0.00x10 <sup>0</sup>	1.42x10 <sup>-1</sup>	6.84x10 <sup>-1</sup>	1.66x10 <sup>-1</sup>	3.38x10 <sup>-1</sup>	1.82x10 <sup>-1</sup>	3.39x10 <sup>-1</sup>	1.82x10 <sup>-1</sup>	3.93x10 <sup>-1</sup>
Formaldehyde	8.03x10 <sup>-1</sup>	1.34x10 <sup>-1</sup>	1.04x10 <sup>0</sup>	1.47x10 <sup>-1</sup>	4.70x10 <sup>-1</sup>	1.58x10 <sup>-1</sup>	4.79x10 <sup>-1</sup>	1.58x10 <sup>-1</sup>	5.55x10 <sup>-1</sup>
Hexane	0.00x10 <sup>0</sup>	5.86x10 <sup>-1</sup>	5.39x10 <sup>-1</sup>	6.60x10 <sup>-1</sup>	2.75x10 <sup>-1</sup>	7.10x10 <sup>-1</sup>	2.59x10 <sup>-1</sup>	7.10x10 <sup>-1</sup>	2.88x10 <sup>-1</sup>
MTBE	0.00x10 <sup>0</sup>	8.59x10 <sup>-2</sup>	1.24x10 <sup>0</sup>	8.69x10 <sup>-2</sup>	3.26x10 <sup>-1</sup>	8.95x10 <sup>-2</sup>	2.89x10 <sup>-1</sup>	8.95x10 <sup>-2</sup>	3.04x10 <sup>-1</sup>
Manganese	0.00x10 <sup>0</sup>	2.62x10 <sup>-3</sup>	1.79x10 <sup>-5</sup>	3.27x10 <sup>-3</sup>	2.39x10 <sup>-5</sup>	3.63x10 <sup>-3</sup>	2.62x10 <sup>-5</sup>	3.63x10 <sup>-3</sup>	3.17x10 <sup>-5</sup>
Naphthalene	0.00x10 <sup>0</sup>	4.87x10 <sup>-2</sup>	2.95x10 <sup>-2</sup>	5.54x10 <sup>-2</sup>	1.75x10 <sup>-2</sup>	5.89x10 <sup>-2</sup>	1.77x10 <sup>-2</sup>	5.89x10 <sup>-2</sup>	2.06x10 <sup>-2</sup>
Nickel	0.00x10 <sup>0</sup>	1.25x10 <sup>-3</sup>	9.56x10 <sup>-5</sup>	1.40x10 <sup>-3</sup>	1.17x10 <sup>-4</sup>	1.54x10 <sup>-3</sup>	1.24x10 <sup>-4</sup>	1.54x10 <sup>-3</sup>	1.43x10 <sup>-4</sup>
POM	0.00x10 <sup>0</sup>	1.58x10 <sup>-2</sup>	2.74x10 <sup>-3</sup>	1.67x10 <sup>-2</sup>	1.65x10 <sup>-3</sup>	1.74x10 <sup>-2</sup>	1.70x10 <sup>-3</sup>	1.74x10 <sup>-2</sup>	1.99x10 <sup>-3</sup>
Propionaldehyde	0.00x10 <sup>0</sup>	4.09x10 <sup>-2</sup>	3.92x10 <sup>-1</sup>	3.87x10 <sup>-2</sup>	1.95x10 <sup>-1</sup>	3.94x10 <sup>-2</sup>	2.00x10 <sup>-1</sup>	3.94x10 <sup>-2</sup>	2.32x10 <sup>-1</sup>
Styrene	0.00x10 <sup>0</sup>	4.65x10 <sup>-2</sup>	6.42x10 <sup>-2</sup>	5.62x10 <sup>-2</sup>	3.18x10 <sup>-2</sup>	6.33x10 <sup>-2</sup>	3.30x10 <sup>-2</sup>	6.33x10 <sup>-2</sup>	3.92x10 <sup>-2</sup>
Toluene	0.00x10 <sup>0</sup>	1.30x10 <sup>0</sup>	4.18x10 <sup>0</sup>	1.48x10 <sup>0</sup>	2.04x10 <sup>0</sup>	1.63x10 <sup>0</sup>	2.05x10 <sup>0</sup>	1.63x10 <sup>0</sup>	2.40x10 <sup>0</sup>
Xylenes	2.04x10 <sup>-1</sup>	8.28x10 <sup>-1</sup>	2.47x10 <sup>0</sup>	1.01x10 <sup>0</sup>	1.19x10 <sup>0</sup>	1.12x10 <sup>0</sup>	1.20x10 <sup>0</sup>	1.12x10 <sup>0</sup>	1.39x10 <sup>0</sup>

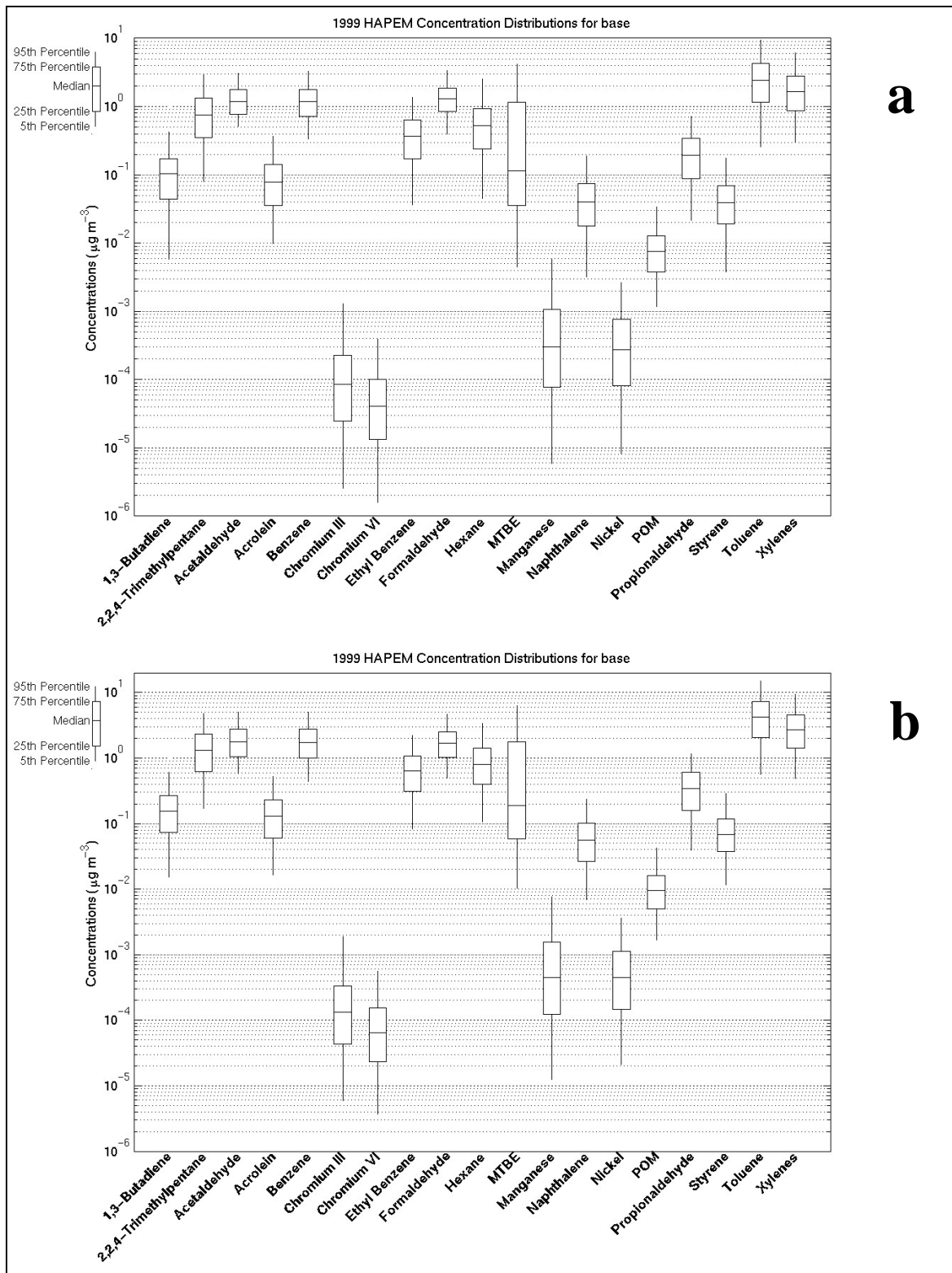
**Table 53.** HAPEM national average controlled concentrations (based on median tract concentrations) for 2015, 2020, and 2030.

HAP	Year					
	2015		2020		2030	
	Stationary	Mobile	Stationary	Mobile	Stationary	Mobile
1,3-Butadiene	1.86x10 <sup>-2</sup>	3.42x10 <sup>-2</sup>	1.87x10 <sup>-2</sup>	3.29x10 <sup>-2</sup>	1.87x10 <sup>-2</sup>	3.46x10 <sup>-2</sup>
2,2,4-Trimethylpentane	3.05x10 <sup>-2</sup>	4.37x10 <sup>-1</sup>	3.24x10 <sup>-2</sup>	3.97x10 <sup>-1</sup>	3.24x10 <sup>-2</sup>	4.04x10 <sup>-1</sup>
Acetaldehyde	7.02x10 <sup>-2</sup>	4.84x10 <sup>-1</sup>	7.22x10 <sup>-2</sup>	4.54x10 <sup>-1</sup>	7.22x10 <sup>-2</sup>	4.71x10 <sup>-1</sup>
Acrolein	2.43x10 <sup>-2</sup>	3.93x10 <sup>-2</sup>	2.40x10 <sup>-2</sup>	3.82x10 <sup>-2</sup>	2.40x10 <sup>-2</sup>	4.07x10 <sup>-2</sup>
Benzene	1.49x10 <sup>-1</sup>	4.31x10 <sup>-1</sup>	1.55x10 <sup>-1</sup>	4.02x10 <sup>-1</sup>	1.55x10 <sup>-1</sup>	4.13x10 <sup>-1</sup>
Chromium III	6.53x10 <sup>-4</sup>	4.99x10 <sup>-5</sup>	7.34x10 <sup>-4</sup>	5.27x10 <sup>-5</sup>	7.34x10 <sup>-4</sup>	5.99x10 <sup>-5</sup>
Chromium VI	1.63x10 <sup>-4</sup>	2.32x10 <sup>-5</sup>	1.84x10 <sup>-4</sup>	2.50x10 <sup>-5</sup>	1.84x10 <sup>-4</sup>	2.96x10 <sup>-5</sup>
Ethyl Benzene	1.10x10 <sup>-1</sup>	1.81x10 <sup>-1</sup>	1.21x10 <sup>-1</sup>	1.68x10 <sup>-1</sup>	1.21x10 <sup>-1</sup>	1.73x10 <sup>-1</sup>
Formaldehyde	1.24x10 <sup>-1</sup>	3.49x10 <sup>-1</sup>	1.34x10 <sup>-1</sup>	3.35x10 <sup>-1</sup>	1.34x10 <sup>-1</sup>	3.56x10 <sup>-1</sup>
Hexane	4.91x10 <sup>-1</sup>	1.75x10 <sup>-1</sup>	5.32x10 <sup>-1</sup>	1.57x10 <sup>-1</sup>	5.32x10 <sup>-1</sup>	1.62x10 <sup>-1</sup>
MTBE	6.48x10 <sup>-2</sup>	2.03x10 <sup>-1</sup>	6.75x10 <sup>-2</sup>	1.80x10 <sup>-1</sup>	6.75x10 <sup>-2</sup>	1.86x10 <sup>-1</sup>
Manganese	2.43x10 <sup>-3</sup>	1.76x10 <sup>-5</sup>	2.69x10 <sup>-3</sup>	1.92x10 <sup>-5</sup>	2.69x10 <sup>-3</sup>	2.33x10 <sup>-5</sup>
Naphthalene	4.52x10 <sup>-2</sup>	1.39x10 <sup>-2</sup>	4.82x10 <sup>-2</sup>	1.41x10 <sup>-2</sup>	4.82x10 <sup>-2</sup>	1.63x10 <sup>-2</sup>
Nickel	9.97x10 <sup>-4</sup>	8.09x10 <sup>-5</sup>	1.09x10 <sup>-3</sup>	8.64x10 <sup>-5</sup>	1.09x10 <sup>-3</sup>	9.92x10 <sup>-5</sup>
POM	1.38x10 <sup>-2</sup>	1.33x10 <sup>-3</sup>	1.43x10 <sup>-2</sup>	1.36x10 <sup>-3</sup>	1.43x10 <sup>-2</sup>	1.58x10 <sup>-3</sup>
Propionaldehyde	2.61x10 <sup>-2</sup>	1.05x10 <sup>-1</sup>	2.66x10 <sup>-2</sup>	9.91x10 <sup>-2</sup>	2.66x10 <sup>-2</sup>	1.03x10 <sup>-1</sup>
Styrene	3.95x10 <sup>-2</sup>	1.59x10 <sup>-2</sup>	4.46x10 <sup>-2</sup>	1.48x10 <sup>-2</sup>	4.46x10 <sup>-2</sup>	1.50x10 <sup>-2</sup>
Toluene	9.96x10 <sup>-1</sup>	1.10x10 <sup>0</sup>	1.10x10 <sup>0</sup>	1.01x10 <sup>0</sup>	1.10x10 <sup>0</sup>	1.03x10 <sup>0</sup>
Xylenes	7.11x10 <sup>-1</sup>	6.90x10 <sup>-1</sup>	7.87x10 <sup>-1</sup>	6.39x10 <sup>-1</sup>	7.87x10 <sup>-1</sup>	6.54x10 <sup>-1</sup>

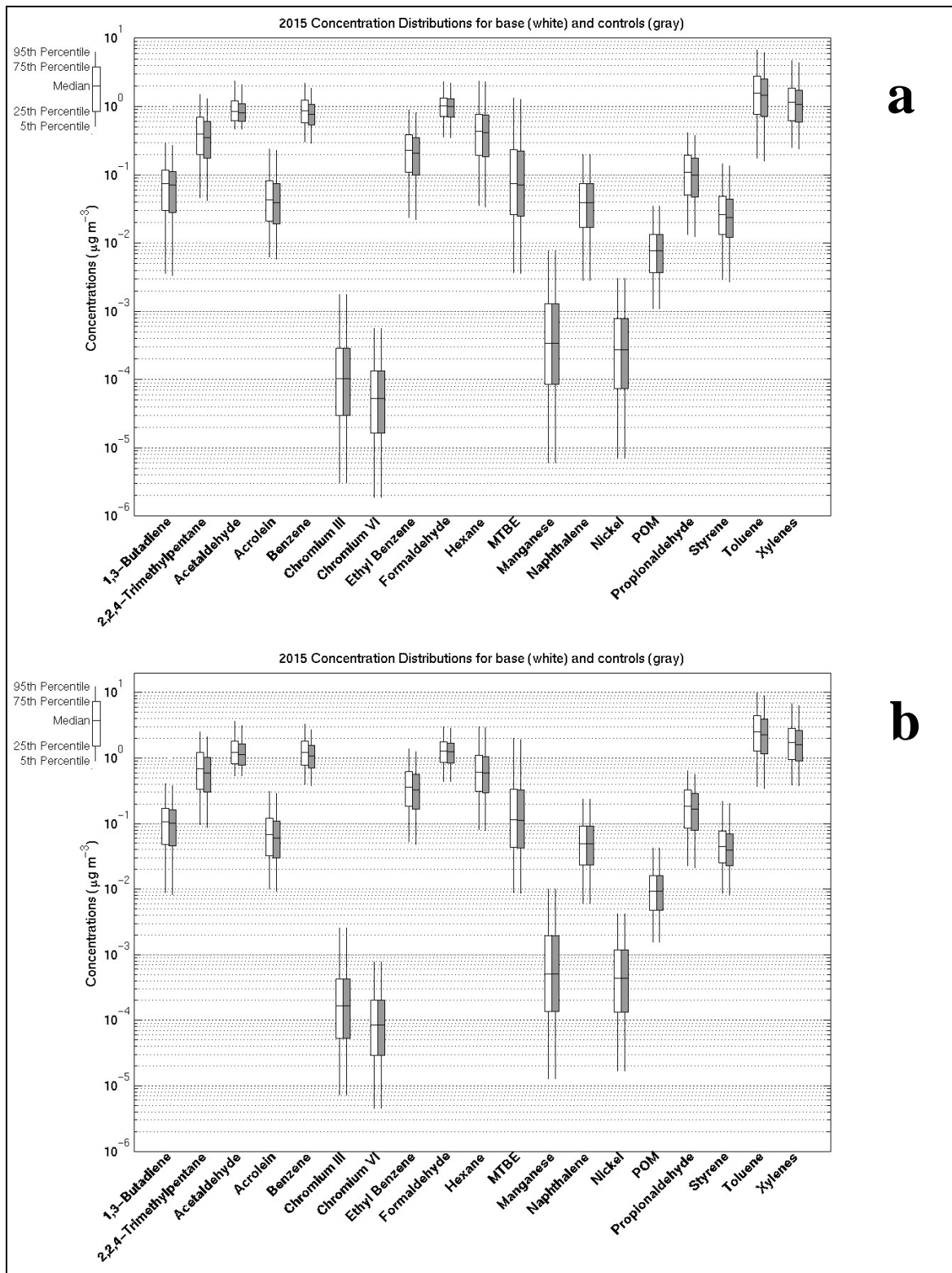
**Table 54.** HAPEM national average controlled concentrations (based on 90<sup>th</sup> percentile tract concentrations) for 2015, 2020, and 2030.

HAP	Year					
	2015		2020		2030	
	Stationary	Mobile	Stationary	Mobile	Stationary	Mobile
1,3-Butadiene	2.37x10 <sup>-2</sup>	4.73x10 <sup>-2</sup>	2.39x10 <sup>-2</sup>	4.52x10 <sup>-2</sup>	2.39x10 <sup>-2</sup>	4.76x10 <sup>-2</sup>
2,2,4-Trimethylpentane	4.86x10 <sup>-2</sup>	7.34x10 <sup>-1</sup>	5.14x10 <sup>-2</sup>	6.62x10 <sup>-1</sup>	5.14x10 <sup>-2</sup>	6.69x10 <sup>-1</sup>
Acetaldehyde	9.59x10 <sup>-2</sup>	6.84x10 <sup>-1</sup>	9.89x10 <sup>-2</sup>	6.32x10 <sup>-1</sup>	9.89x10 <sup>-2</sup>	6.56x10 <sup>-1</sup>
Acrolein	3.16x10 <sup>-2</sup>	5.64x10 <sup>-2</sup>	3.12x10 <sup>-2</sup>	5.43x10 <sup>-2</sup>	3.12x10 <sup>-2</sup>	5.73x10 <sup>-2</sup>
Benzene	2.01x10 <sup>-1</sup>	5.95x10 <sup>-1</sup>	2.08x10 <sup>-1</sup>	5.47x10 <sup>-1</sup>	2.08x10 <sup>-1</sup>	5.62x10 <sup>-1</sup>
Chromium III	9.32x10 <sup>-4</sup>	7.32x10 <sup>-5</sup>	1.05x10 <sup>-3</sup>	7.76x10 <sup>-5</sup>	1.05x10 <sup>-3</sup>	8.88x10 <sup>-5</sup>
Chromium VI	2.36x10 <sup>-4</sup>	3.40x10 <sup>-5</sup>	2.67x10 <sup>-4</sup>	3.67x10 <sup>-5</sup>	2.67x10 <sup>-4</sup>	4.38x10 <sup>-5</sup>
Ethyl Benzene	1.66x10 <sup>-1</sup>	2.90x10 <sup>-1</sup>	1.82x10 <sup>-1</sup>	2.64x10 <sup>-1</sup>	1.82x10 <sup>-1</sup>	2.71x10 <sup>-1</sup>
Formaldehyde	1.47x10 <sup>-1</sup>	4.20x10 <sup>-1</sup>	1.58x10 <sup>-1</sup>	4.00x10 <sup>-1</sup>	1.58x10 <sup>-1</sup>	4.27x10 <sup>-1</sup>
Hexane	6.60x10 <sup>-1</sup>	2.46x10 <sup>-1</sup>	7.10x10 <sup>-1</sup>	2.17x10 <sup>-1</sup>	7.10x10 <sup>-1</sup>	2.24x10 <sup>-1</sup>
MTBE	8.69x10 <sup>-2</sup>	3.11x10 <sup>-1</sup>	8.95x10 <sup>-2</sup>	2.69x10 <sup>-1</sup>	8.95x10 <sup>-2</sup>	2.75x10 <sup>-1</sup>
Manganese	3.27x10 <sup>-3</sup>	2.39x10 <sup>-5</sup>	3.63x10 <sup>-3</sup>	2.62x10 <sup>-5</sup>	3.63x10 <sup>-3</sup>	3.17x10 <sup>-5</sup>
Naphthalene	5.54x10 <sup>-2</sup>	1.75x10 <sup>-2</sup>	5.89x10 <sup>-2</sup>	1.77x10 <sup>-2</sup>	5.89x10 <sup>-2</sup>	2.06x10 <sup>-2</sup>
Nickel	1.40x10 <sup>-3</sup>	1.17x10 <sup>-4</sup>	1.54x10 <sup>-3</sup>	1.24x10 <sup>-4</sup>	1.54x10 <sup>-3</sup>	1.43x10 <sup>-4</sup>
POM	1.67x10 <sup>-2</sup>	1.65x10 <sup>-3</sup>	1.74x10 <sup>-2</sup>	1.70x10 <sup>-3</sup>	1.74x10 <sup>-2</sup>	1.99x10 <sup>-3</sup>
Propionaldehyde	3.87x10 <sup>-2</sup>	1.70x10 <sup>-1</sup>	3.94x10 <sup>-2</sup>	1.60x10 <sup>-1</sup>	3.94x10 <sup>-2</sup>	1.66x10 <sup>-1</sup>
Styrene	5.62x10 <sup>-2</sup>	2.61x10 <sup>-2</sup>	6.33x10 <sup>-2</sup>	2.40x10 <sup>-2</sup>	6.33x10 <sup>-2</sup>	2.43x10 <sup>-2</sup>
Toluene	1.48x10 <sup>0</sup>	1.71x10 <sup>0</sup>	1.63x10 <sup>0</sup>	1.54x10 <sup>0</sup>	1.63x10 <sup>0</sup>	1.56x10 <sup>0</sup>
Xylenes	1.01x10 <sup>0</sup>	1.01x10 <sup>0</sup>	1.12x10 <sup>0</sup>	9.20x10 <sup>-1</sup>	1.12x10 <sup>0</sup>	9.42x10 <sup>-1</sup>

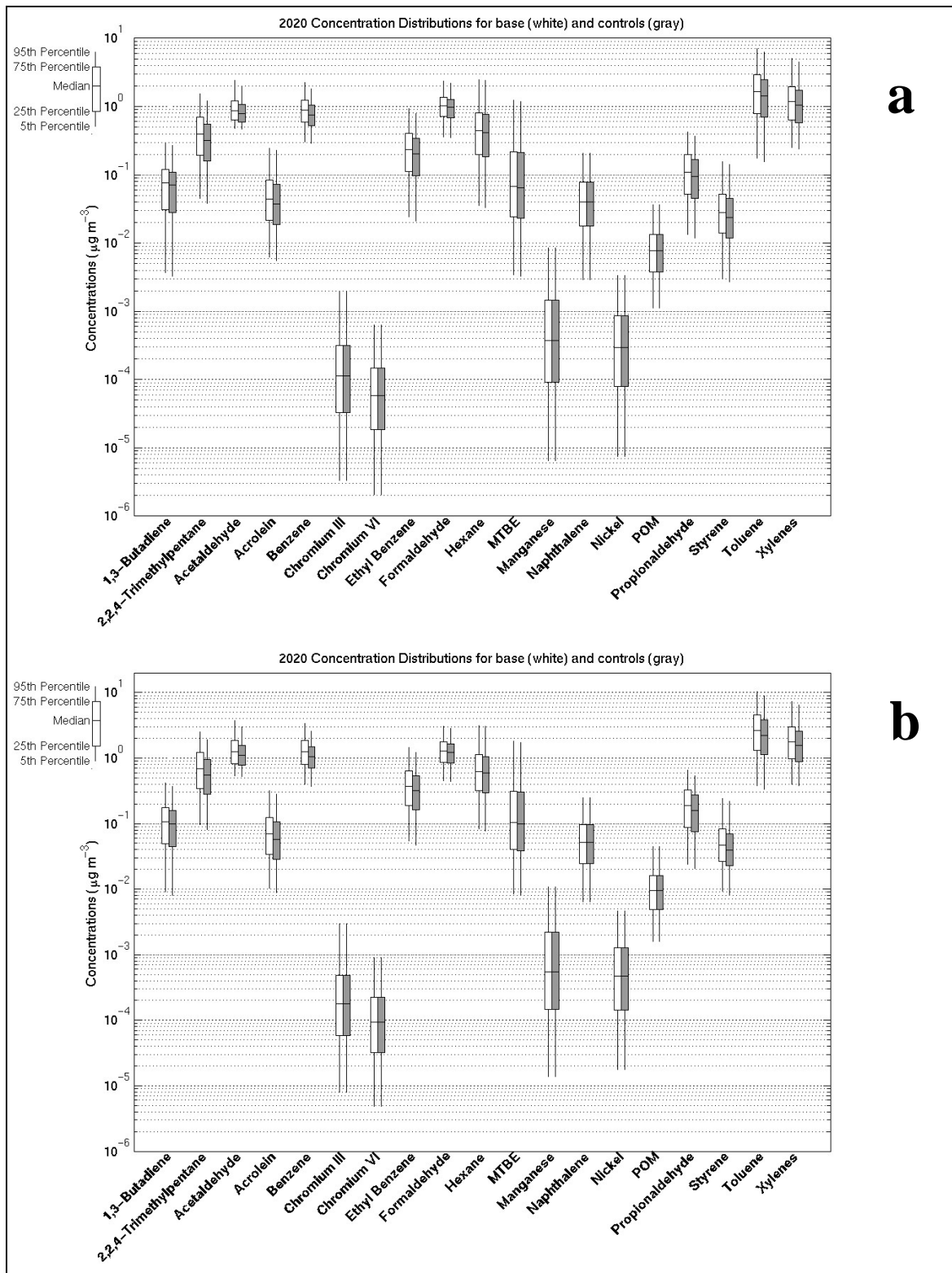
Figures 46 through 49 show the concentration distributions for 1999 base, 2015, 2020, and 2030 HAPEM concentrations. Figures 50-52 show the ratio of controlled to base HAPEM6 concentrations for 2015, 2020, and 2030. In those figures, the dots represent the mean ratio. Figures 53-59 show the spatial distribution of county median HAPEM6 concentrations (based on median tract exposure) for 1999, 2015, 2020, and 2030. Full concentration summaries can be found in hapem\_concentrations\_50.xls and hapem\_concentrations\_90.xls for median and 90<sup>th</sup> percentile tract concentrations. Maps for acetaldehyde, acrolein, benzene, 1,3-butadiene, formaldehyde, and naphthalene can be found in acetaldehyde\_hapem.ppt, acrolein\_hapem.ppt, benzene\_hapem.ppt, butadiene\_hapem.ppt, formaldehyde\_hapem.ppt, and naphthalene\_hapem.ppt. All summaries and maps can be found in the MSAT rule docket, EPA-HQ-OAR-2005-0036.



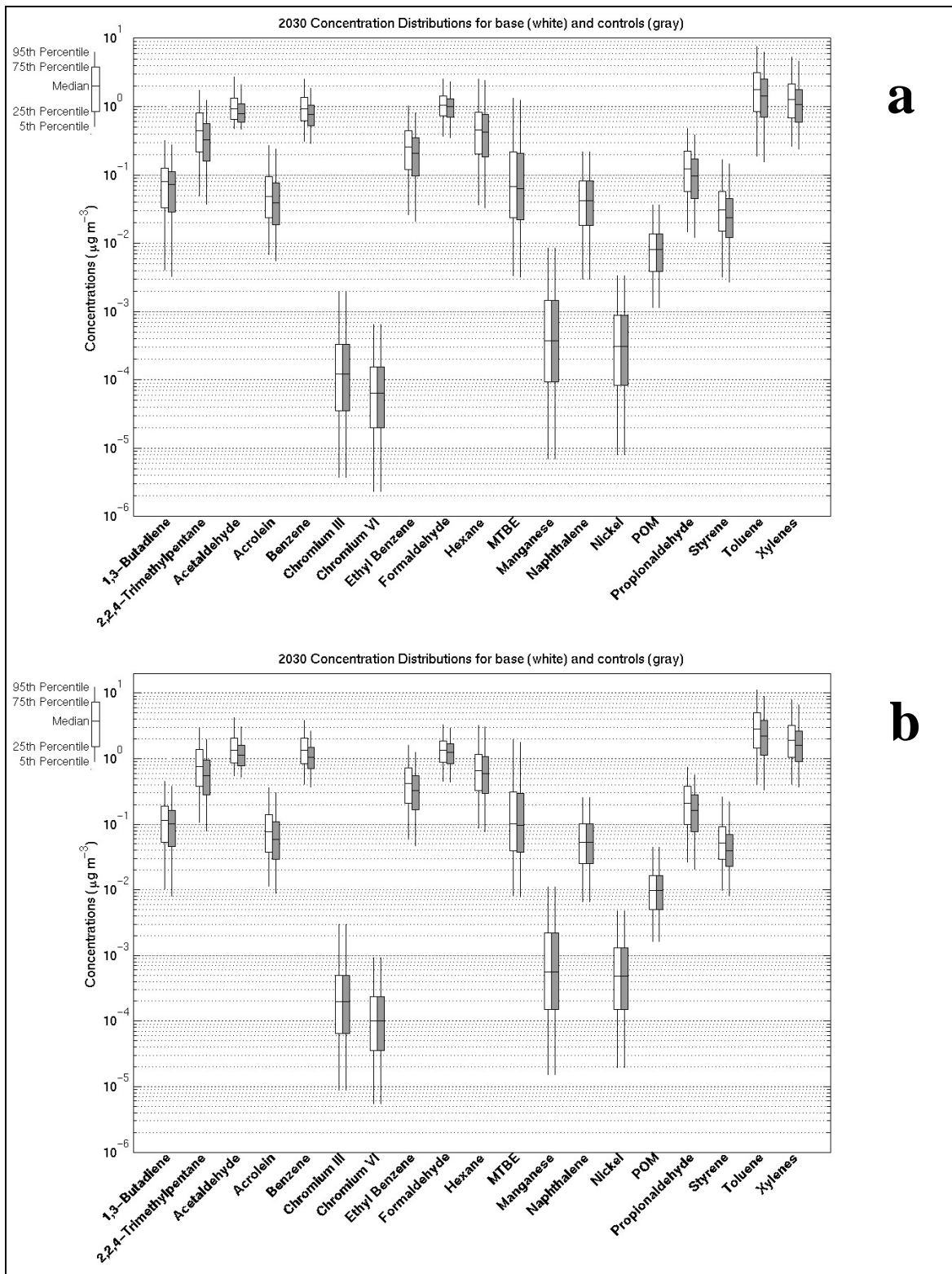
**Figure 46.** 1999 base HAPEM6 tract concentration distributions for a) tract median exposure concentration and b) tract 90<sup>th</sup> percentile exposure concentration.



**Figure 47.** 2015 base and controlled HAPEM6 tract concentration distributions for a) tract median exposure concentration and b) tract 90<sup>th</sup> percentile exposure concentration.

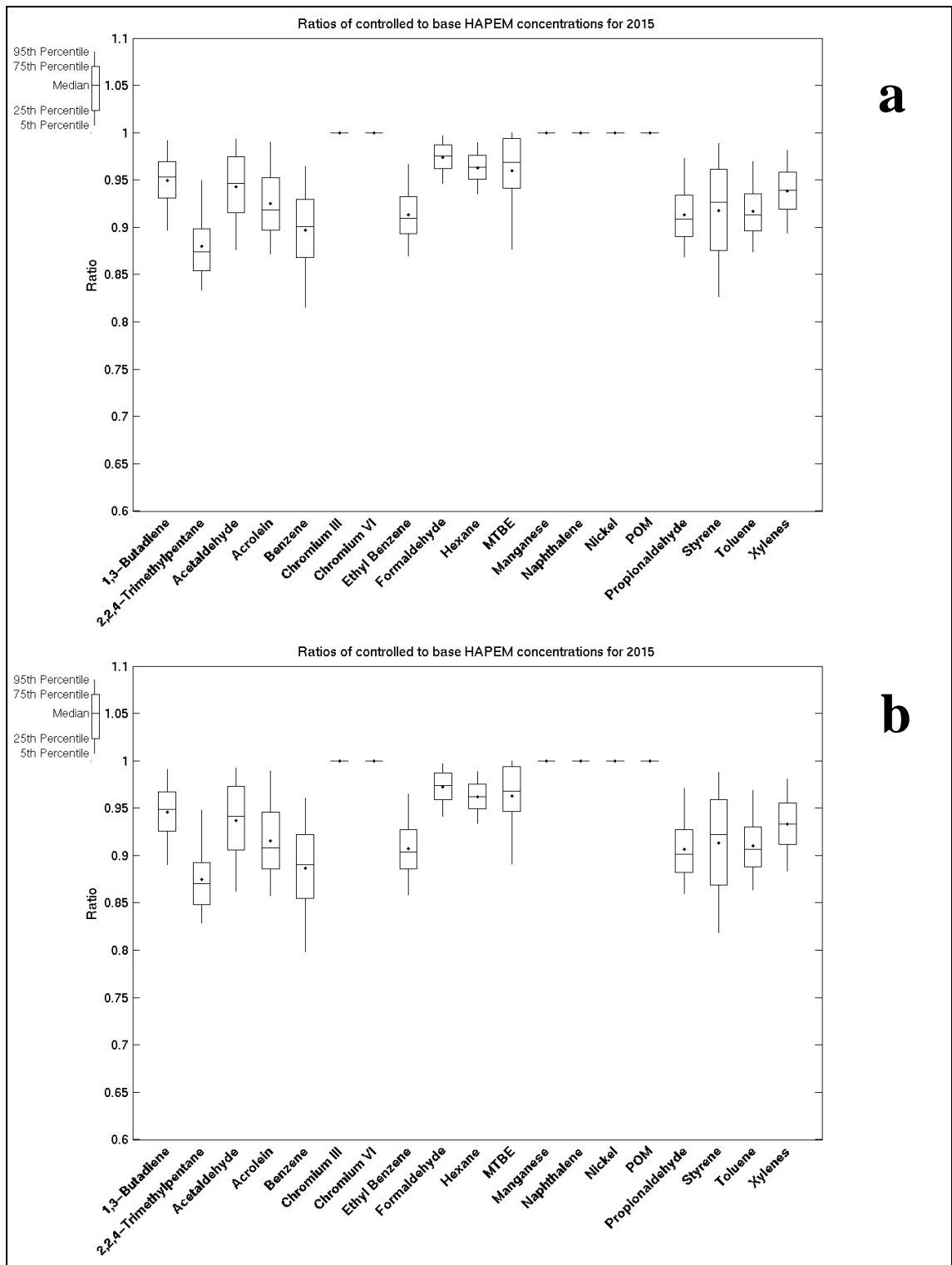


**Figure 48.** 2020 base and controlled HAPEM6 tract concentration distributions for a) tract median exposure concentration and b) tract 90<sup>th</sup> percentile exposure concentration.

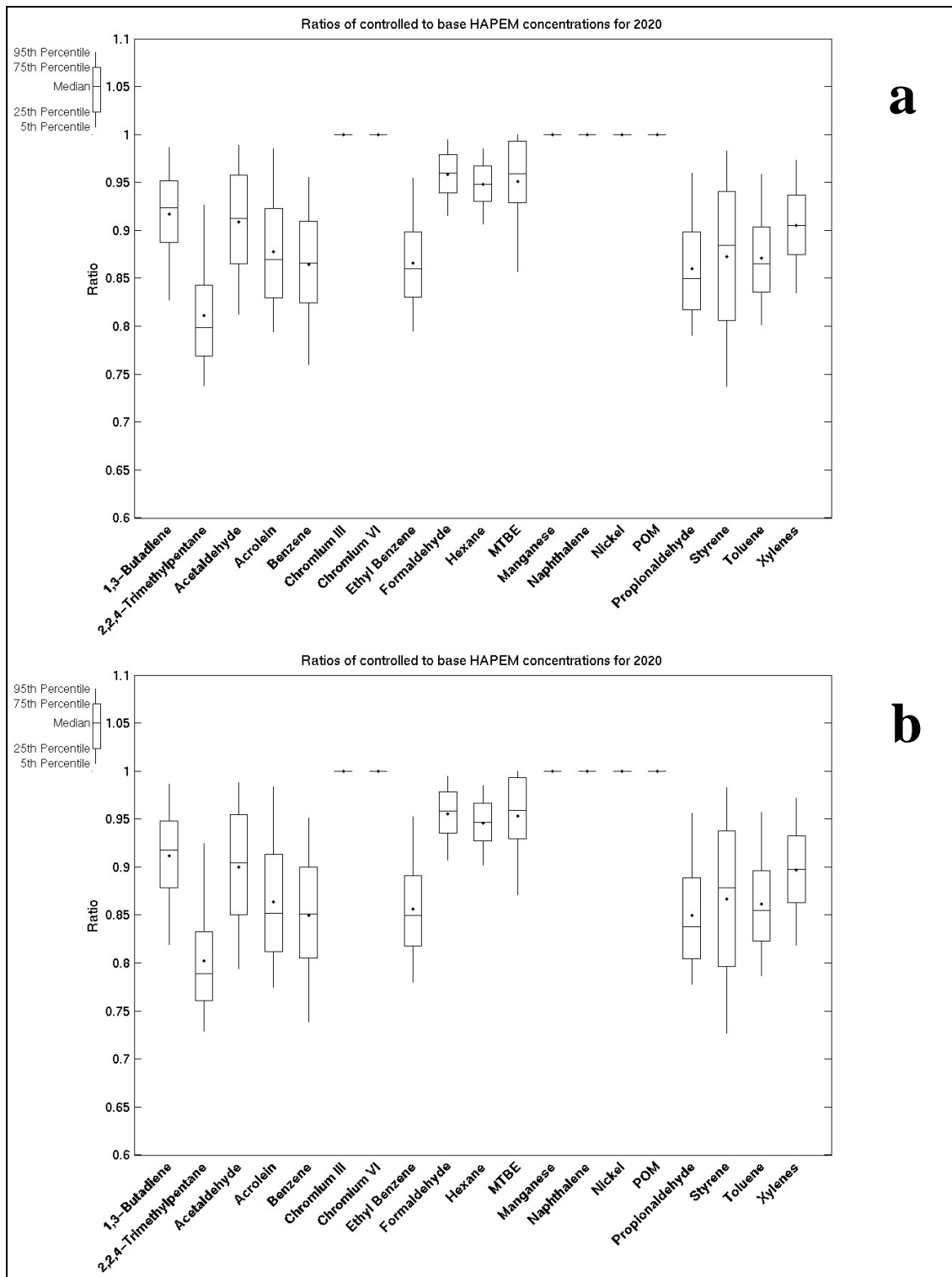


**Figure 49.** 2030 base and controlled HAPEM6 tract concentration distributions for a) tract median exposure concentration and b) tract 90<sup>th</sup> percentile exposure concentration.

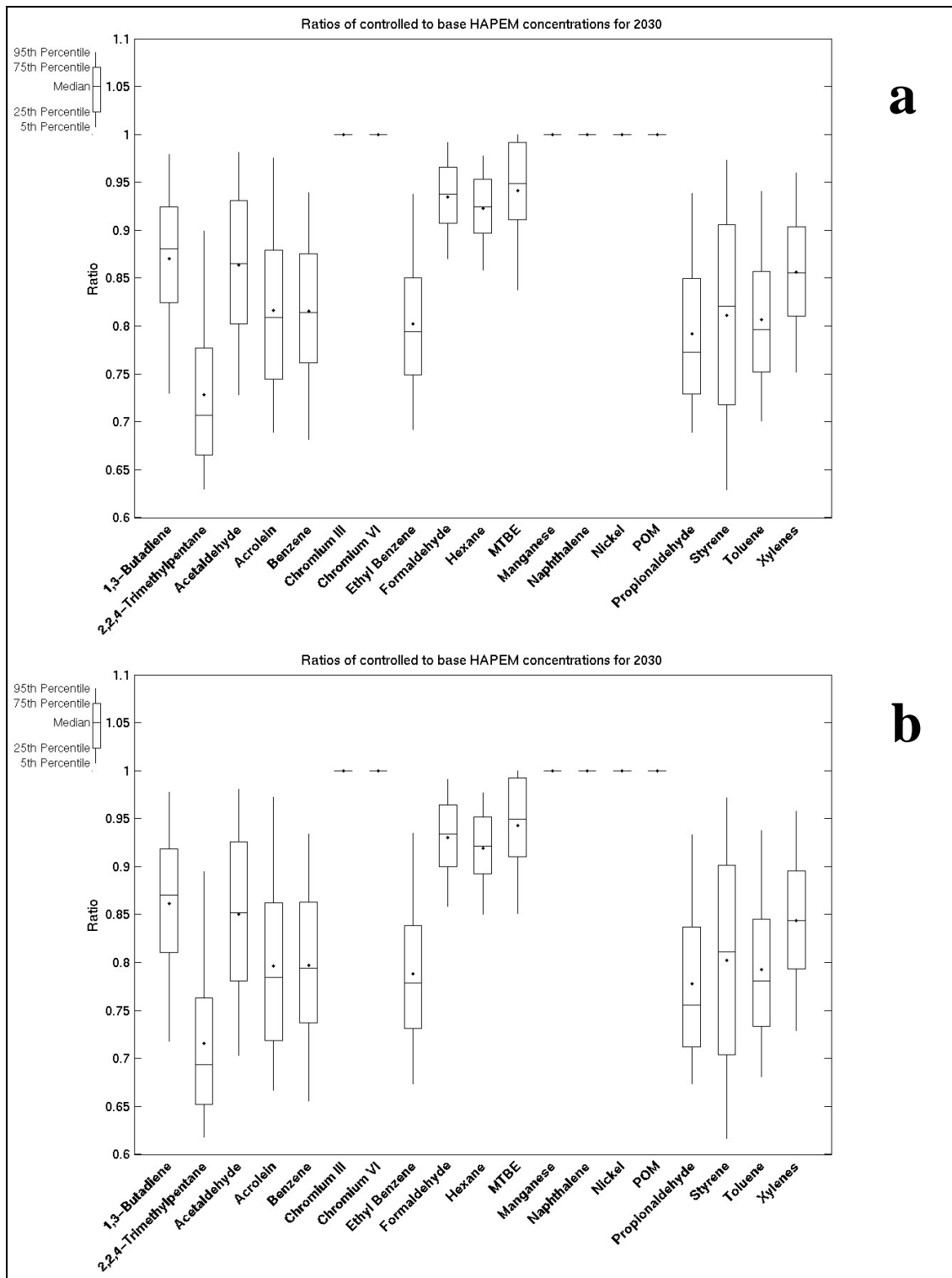




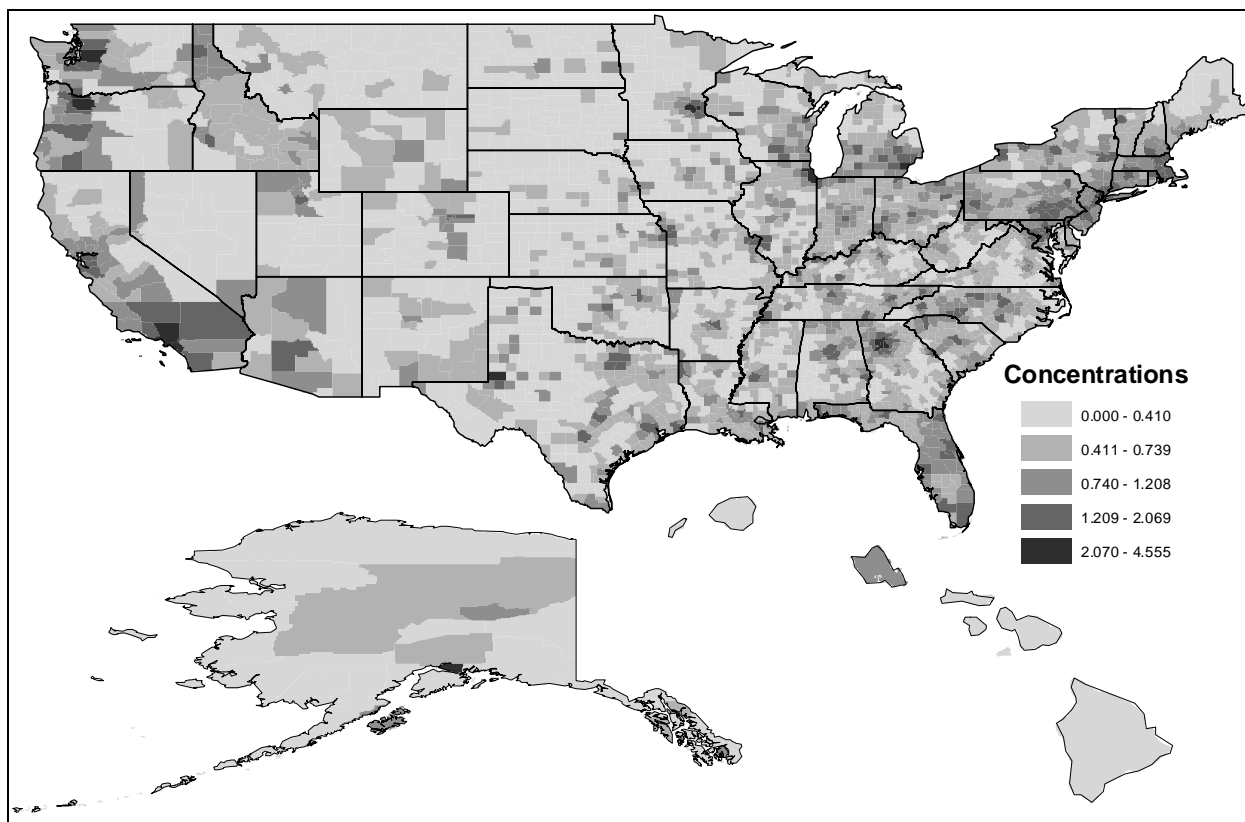
**Figure 50.** Distributions of the ratio of 2015 HAPEM6 controlled annual average total concentrations to 2015 HAPEM6 base annual average total concentrations by HAP for a) tract median exposure concentration and b) tract 90<sup>th</sup> percentile exposure concentration. Totals include background concentration.



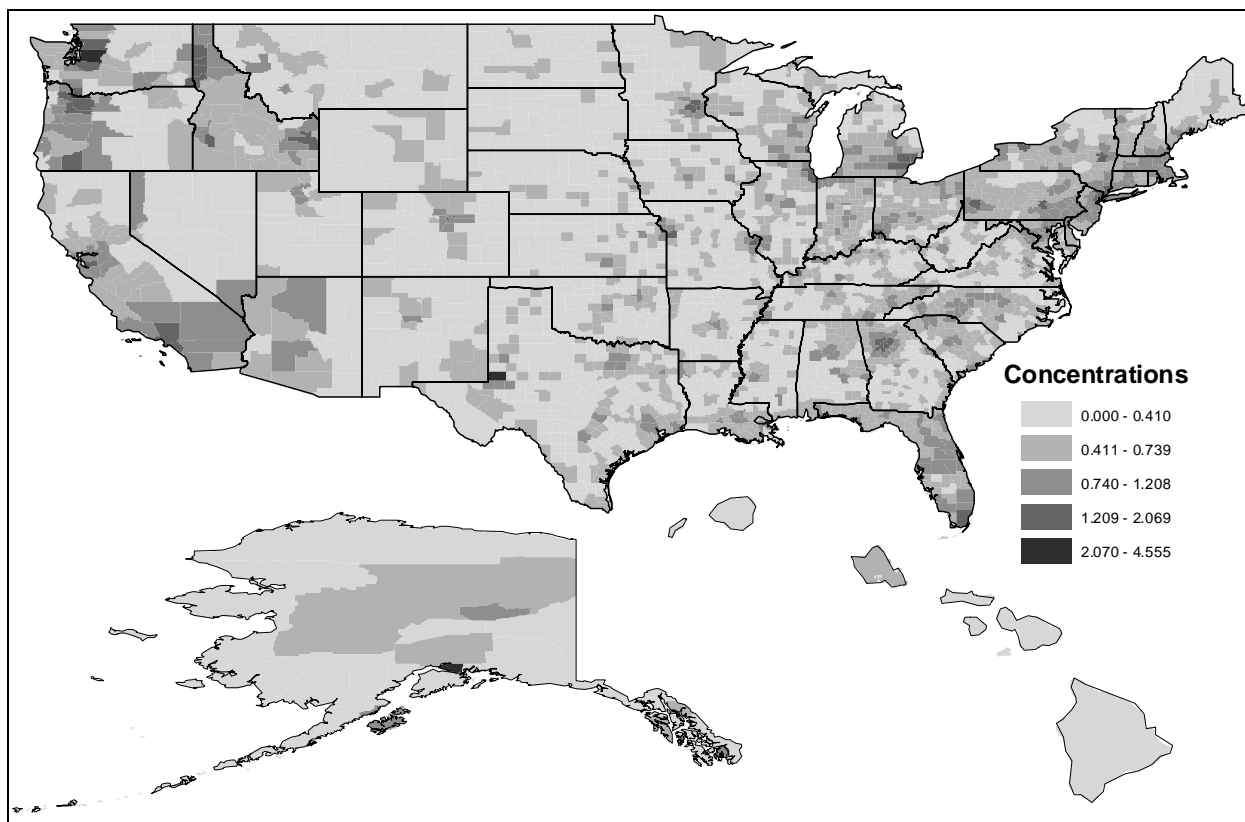
**Figure 51.** Distributions of the ratio of 2020 HAPEM6 controlled annual average total concentrations to 2020 HAPEM6 base annual average total concentrations by HAP for a) tract median exposure concentration and b) tract 90<sup>th</sup> percentile exposure concentration. Totals include background concentration.



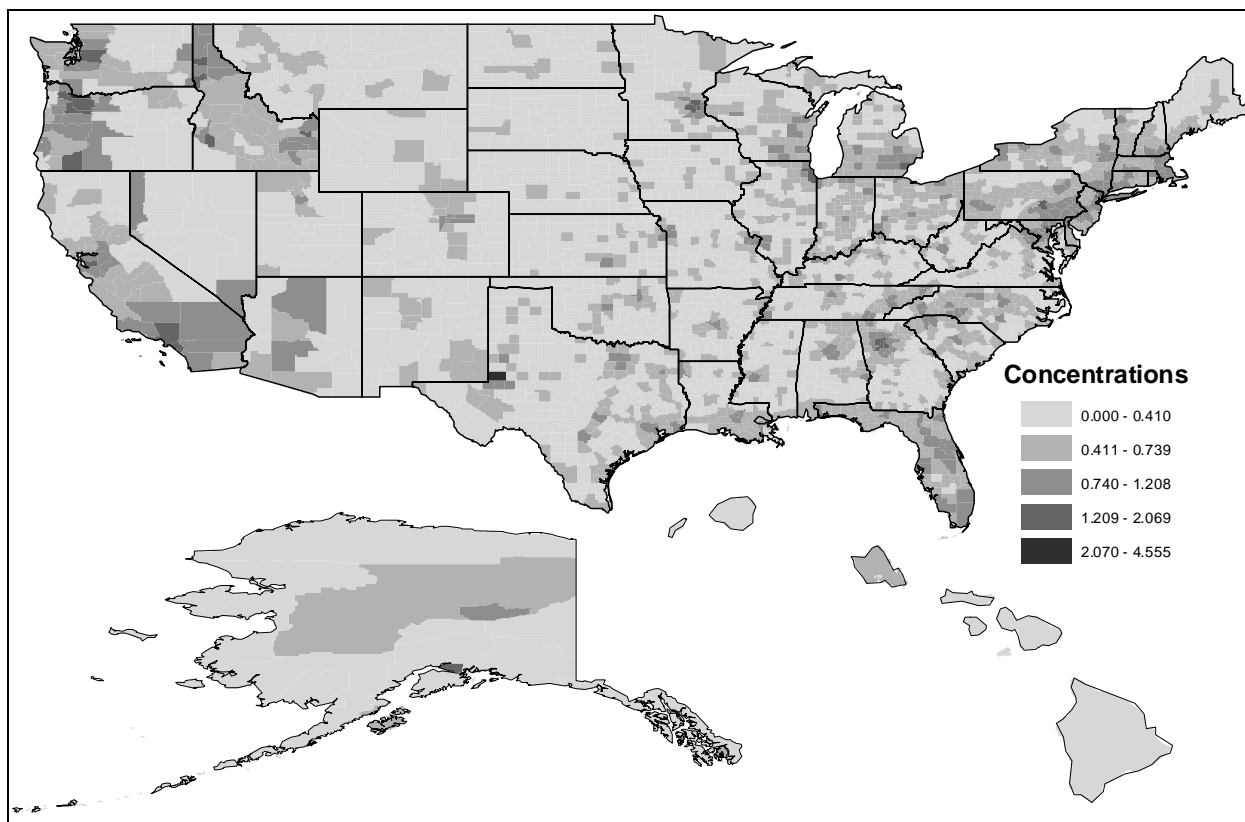
**Figure 52.** Distributions of the ratio of 2030 HAPEM6 controlled annual average total concentrations to 2030 HAPEM6 base annual average total concentrations by HAP for a) tract median exposure concentration and b) tract 90<sup>th</sup> percentile exposure concentration. Totals include background concentration.



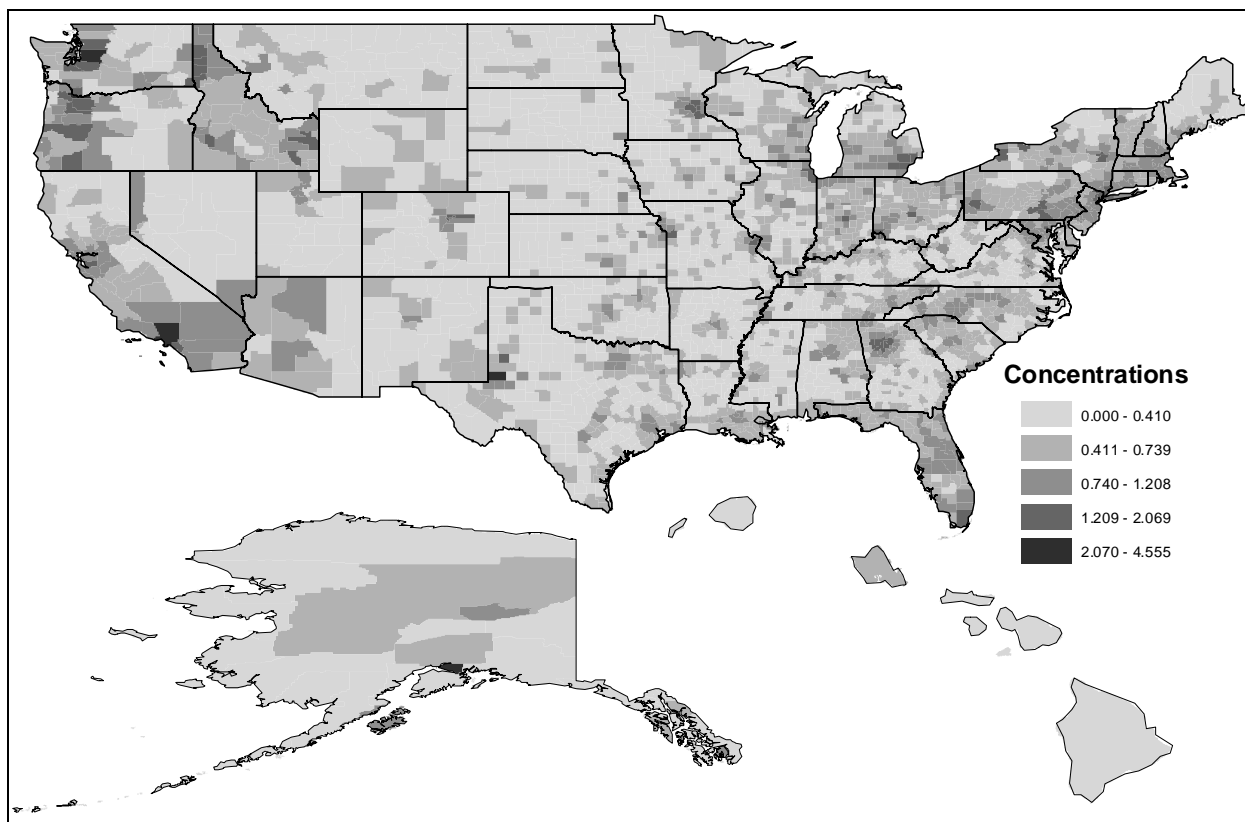
**Figure 53.** 1999 HAPEM6 county level median total (all sources and background) concentrations ( $\mu\text{g m}^{-3}$ ) for benzene. Median concentration based on tract median exposure concentrations.



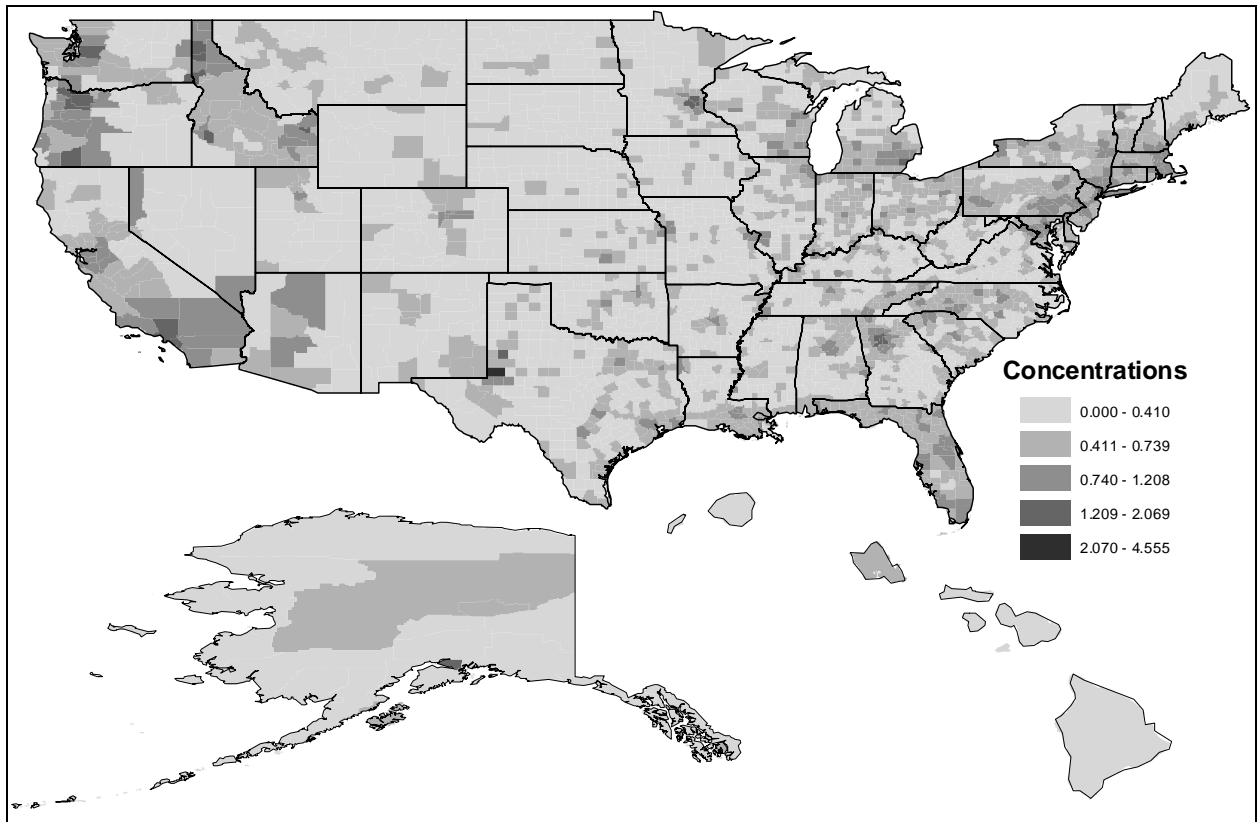
**Figure 54.** 2015 base HAPEM6 county level median total (all sources and background) concentrations ( $\mu\text{g m}^{-3}$ ) for benzene. Median concentration based on tract median exposure concentrations.



**Figure 55.** 2015 controlled HAPEM6 county level median total (all sources and background) concentrations ( $\mu\text{g m}^{-3}$ ) for benzene. Median concentration based on tract median exposure concentrations.

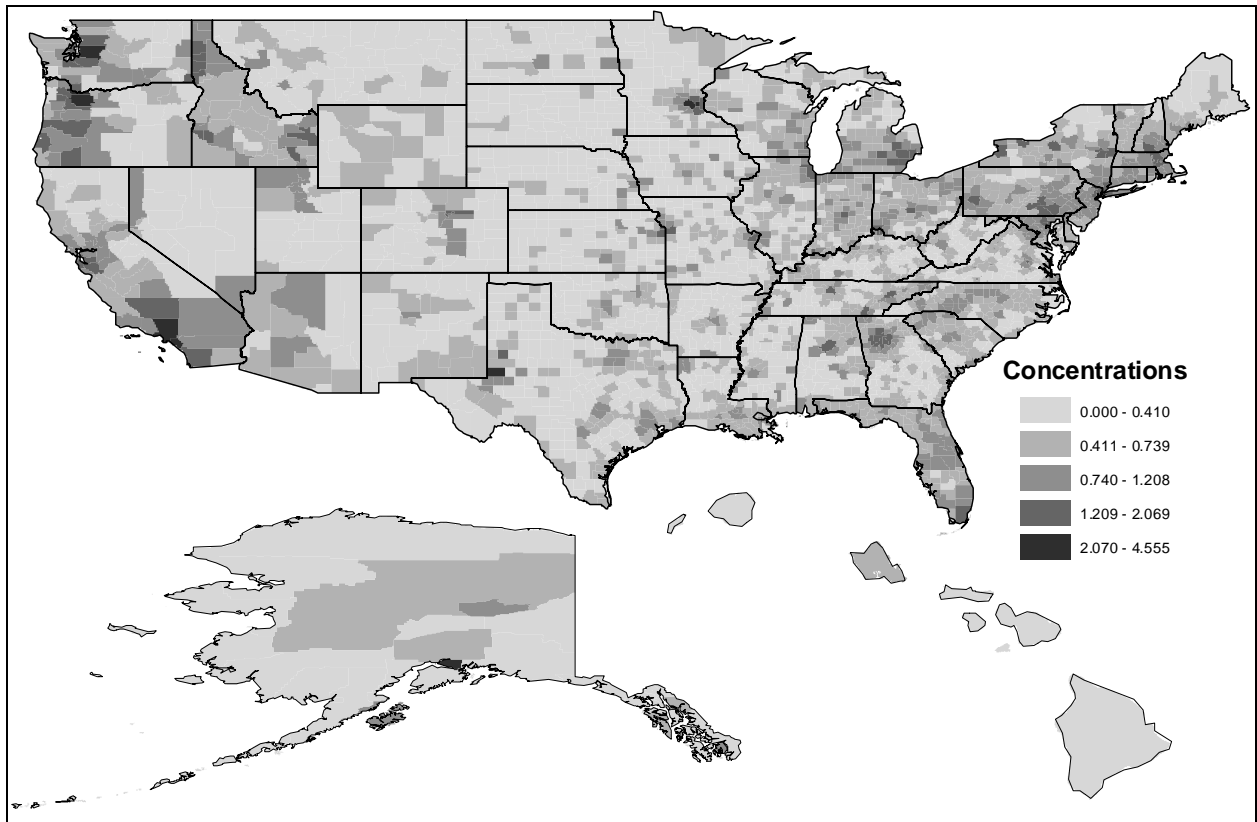


**Figure 56.** 2020 base HAPEM6 county level median total (all sources and background) concentrations ( $\mu\text{g m}^{-3}$ ) for benzene. Median concentration based on tract median exposure concentrations.

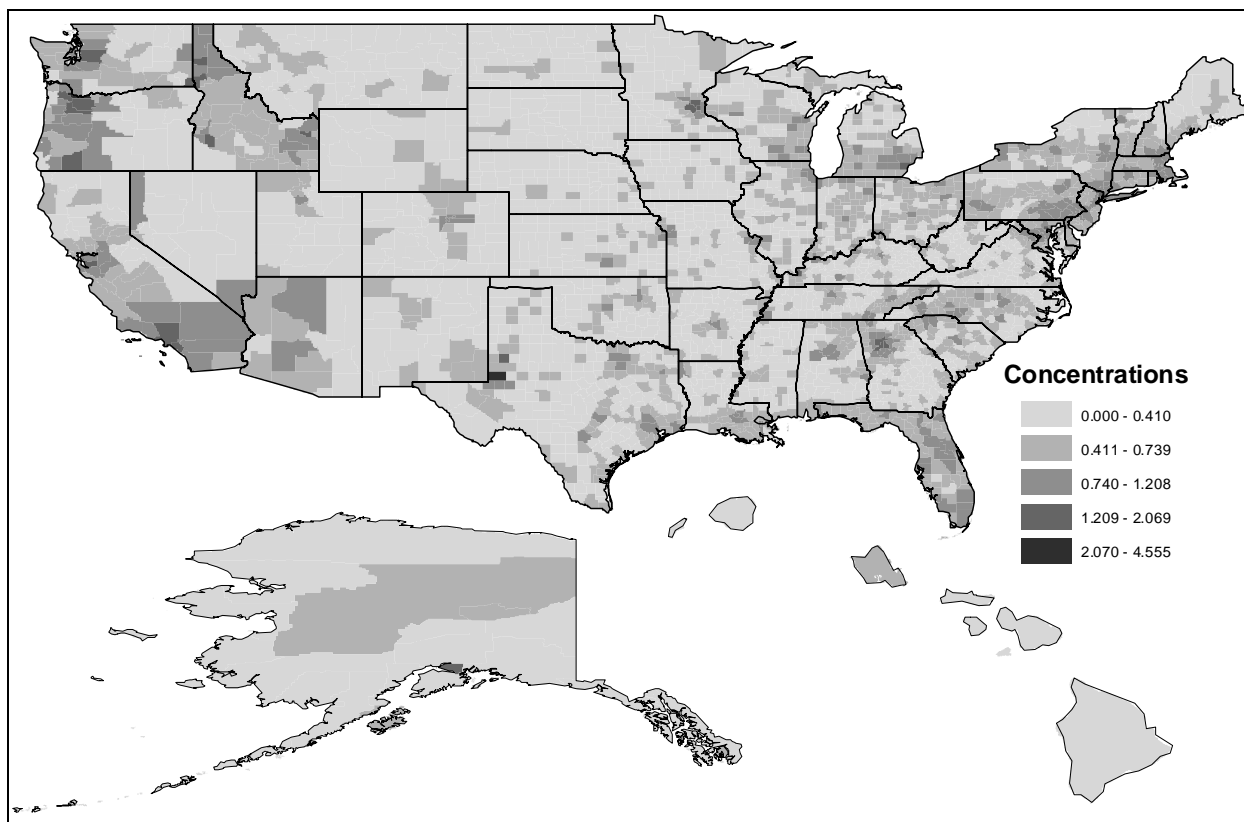


**Figure 57.** 2020 controlled HAPEM6 county level median total (all sources and background) concentrations ( $\mu\text{g m}^{-3}$ ) for benzene. Median concentration based on tract median exposure concentrations.





**Figure 58.** 2030 base HAPEM6 county level median total (all sources and background) concentrations ( $\mu\text{g m}^{-3}$ ) for benzene. Median concentration based on tract median exposure concentrations.



**Figure 59.** 2030 controlled HAPEM6 county level median total (all sources and background) concentrations ( $\mu\text{g m}^{-3}$ ) for benzene. Median concentration based on tract median exposure concentrations.

This page intentionally blank

## 8. Cancer and non-cancer risk calculations

Cancer risk and non-cancer hazard quotients (HQ) were calculated in HAPEM6 post-processing for each tract. Table 55 lists the MSAT HAPS with their respective unit risk estimates (URE) for cancer calculations and non-cancer reference concentrations (RfC) for non-cancer calculations, resulting from long term (chronic) inhalation exposure to these HAPS. Also listed are the HAPS appropriate carcinogenic class and target organ system(s) for non-cancer effects.

**Table 55.** MSAT HAPs carcinogenic class, URE, non-cancer target organ systems, and RfC. N/A denotes HAP is not a cancer or non-cancer HAP.

HAP	Carcinogen Class	URE	Organ systems	RfC
1,3-Butadiene	A	3.0x10 <sup>-5</sup>	Reproductive	2.0x10 <sup>-3</sup>
2,2,4-Trimethylpentane	N/A	N/A	N/A	N/A
Acetaldehyde	B2	2.2x10 <sup>-6</sup>	Respiratory	9.0x10 <sup>-3</sup>
Acrolein		N/A	Respiratory	2.0x10 <sup>-5</sup>
Benzene	A	7.8x10 <sup>-6</sup>	Immune	3.0x10 <sup>-2</sup>
Chromium III	N/A	N/A	N/A	N/A
Chromium VI	A	1.2x10 <sup>-2</sup>	Respiratory	1.0x10 <sup>-4</sup>
Ethyl Benzene		N/A	Developmental	1.0
Formaldehyde	B1	5.5x10 <sup>-9</sup>	Respiratory	9.8x10 <sup>-3</sup>
Hexane		N/A	Respiratory, Neurological	2.0x10 <sup>-1</sup>
Manganese		N/A	Neurological	5.0x10 <sup>-5</sup>
MTBE		N/A	Liver, Kidney, Ocular	3.0
Naphthalene	C	3.4x10 <sup>-5</sup>	Respiratory	3.0x10 <sup>-3</sup>
Nickel	A	1.6x10 <sup>-4</sup>	Respiratory, Immune	6.5x10 <sup>-5</sup>
Propionaldehyde	N/A	N/A	N/A	N/A
POM1	B2	5.5x10 <sup>-5</sup>		N/A
POM2	B2	5.5x10 <sup>-5</sup>		N/A
POM3	B2	1.0x10 <sup>-1</sup>		N/A
POM4	B2	1.0x10 <sup>-2</sup>		N/A
POM5	B2	1.0x10 <sup>-3</sup>		N/A
POM6	B2	1.0x10 <sup>-4</sup>		N/A
POM7	B2	1.0x10 <sup>-5</sup>		N/A
POM8	B2	2.0x10 <sup>-4</sup>		N/A
Styrene		N/A	Neurological	1.0
Toluene		N/A	Respiratory, Neurological	4.0x10 <sup>-1</sup>
Xylenes		N/A	Neurological	1.0x10 <sup>-1</sup>
Carcinogen classes: A: Known carcinogens B1: Probable carcinogens, based on incomplete human data B2: Probable carcinogens, based on adequate animal data C: Possible carcinogens				

URE and RfC estimates were obtained from hazard and dose-response information that EPA's Office of Air Quality Planning and Standards posts on the internet ("OAQPS Toxicity Values") at the following link: [www.epa.gov/ttn/fera](http://www.epa.gov/ttn/fera). This information is updated as new data become available; the version of the table used for this paper is the same as used for the 1999 NATA (U. S. EPA, 2005e).

## 8.1 Cancer risk calculations

In the HAPEM6 output, for each source group, there are 30 replicate exposure concentrations for each of the six demographic groups (180 concentrations per tract for each source group). For each source category and each of the 30 replicates, a lifetime exposure concentration was calculated as shown in brackets in Equation 24 below. The lifetime exposure concentration was then multiplied by the HAP's URE to yield a lifetime risk for each of the 30 replicates as shown below:

$$Risk_i = \left[ \frac{\left( (X_{i,1} \times 2) + (X_{i,2} \times 3) + (X_{i,3} \times 11) + (X_{i,4} \times 2) + (X_{i,5} \times 47) + (X_{i,6} \times 5) \right)}{70} \right] \times URE \quad (24)$$

where  $X_{i,1}$  is the concentration for demographic group 1 (ages 0-1) for replicate  $i$  ( $i = 1$  to 30),  $X_{i,2}$  is the concentration for demographic group 2 (ages 2-4) for replicate  $i$ ,  $X_{i,3}$  is the concentration for demographic group 3 (ages 5-15) for replicate  $i$ ,  $X_{i,4}$  is the concentration for demographic group 4 (ages 16-17) for replicate  $i$ ,  $X_{i,5}$  is the concentration for demographic group 5 (ages 18-64) for replicate  $i$ , and  $X_{i,6}$  is the concentration for demographic group 6 (ages 65-70) for replicate  $i$ . For each demographic group, the replicate  $i$  concentrations are multiplied by the number of years for each demographic group. For example for replicate 1 for major sources, each of the demographic groups' replicate 1 major source exposure concentrations would be inserted into Equation 24 to yield a lifetime risk for major sources for replicate 1. Similar steps would be used for other source categories and replicates.

The result was 30 lifetime exposure replicate risks for each tract and source category. An example output file for benzene is shown in Figure 60. In Figure 60, the first tract for the country is shown. There are 30 replicates among the demographic groups, each with a population, variable POP and six source category risks (SC1 = major, SC2 = area & other, SC3 = onroad, SC4 = nonroad, SC5 = background, and SC6 = total).

SAROD: 45201										
URE: 7.8000E-06										
ST	CTY	TRACT	POP	SC1	SC2	SC3	SC4	SC5	SC6	
01	001	020100	64.	4.138E-08	5.250E-07	2.101E-06	3.951E-07	1.990E-06	5.053E-06	
01	001	020100	64.	4.555E-08	6.957E-07	2.590E-06	5.227E-07	2.157E-06	6.011E-06	
01	001	020100	64.	4.046E-08	5.612E-07	2.937E-06	4.697E-07	2.182E-06	6.191E-06	
01	001	020100	64.	5.048E-08	7.003E-07	2.951E-06	5.363E-07	2.161E-06	6.399E-06	
01	001	020100	64.	4.475E-08	6.665E-07	3.174E-06	5.116E-07	2.103E-06	6.499E-06	
01	001	020100	64.	4.562E-08	6.827E-07	3.321E-06	5.161E-07	2.132E-06	6.697E-06	
01	001	020100	64.	4.667E-08	7.022E-07	3.431E-06	5.411E-07	2.213E-06	6.934E-06	
01	001	020100	64.	3.947E-08	5.435E-07	3.763E-06	5.542E-07	2.069E-06	6.968E-06	
01	001	020100	64.	4.443E-08	6.723E-07	3.680E-06	5.076E-07	2.096E-06	7.000E-06	
01	001	020100	64.	4.523E-08	5.613E-07	3.553E-06	5.966E-07	2.311E-06	7.067E-06	
01	001	020100	64.	4.074E-08	5.780E-07	3.717E-06	1.168E-06	2.212E-06	7.718E-06	
01	001	020100	64.	4.471E-08	6.714E-07	4.429E-06	5.179E-07	2.128E-06	7.790E-06	
01	001	020100	64.	4.780E-08	7.123E-07	4.327E-06	5.488E-07	2.253E-06	7.888E-06	
01	001	020100	64.	5.378E-08	8.249E-07	4.333E-06	6.338E-07	2.169E-06	8.013E-06	
01	001	020100	64.	4.444E-08	6.792E-07	4.738E-06	5.349E-07	2.109E-06	8.105E-06	
01	001	020100	64.	4.585E-08	6.816E-07	4.718E-06	5.714E-07	2.162E-06	8.176E-06	
01	001	020100	64.	3.965E-08	5.646E-07	4.944E-06	7.081E-07	2.096E-06	8.350E-06	
01	001	020100	64.	3.658E-08	5.838E-07	5.156E-06	5.129E-07	2.137E-06	8.426E-06	
01	001	020100	64.	4.369E-08	5.232E-07	5.496E-06	4.528E-07	2.206E-06	8.725E-06	
01	001	020100	64.	5.469E-08	7.289E-07	5.792E-06	5.587E-07	2.179E-06	9.314E-06	
01	001	020100	64.	4.060E-08	5.755E-07	5.550E-06	1.146E-06	2.127E-06	9.438E-06	
01	001	020100	64.	4.108E-08	5.834E-07	5.656E-06	1.217E-06	2.156E-06	9.656E-06	
01	001	020100	64.	1.229E-07	6.785E-07	6.440E-06	5.382E-07	2.179E-06	9.959E-06	
01	001	020100	64.	3.945E-08	5.227E-07	6.572E-06	6.752E-07	2.271E-06	1.008E-05	
01	001	020100	64.	8.885E-08	6.372E-07	6.835E-06	5.040E-07	2.104E-06	1.017E-05	
01	001	020100	64.	4.507E-08	6.892E-07	6.891E-06	5.365E-07	2.162E-06	1.033E-05	
01	001	020100	64.	4.452E-08	6.700E-07	7.401E-06	5.111E-07	2.092E-06	1.072E-05	
01	001	020100	64.	5.223E-08	1.059E-06	7.195E-06	8.441E-07	2.101E-06	1.125E-05	
01	001	020100	64.	4.960E-08	7.572E-07	8.390E-06	6.169E-07	2.273E-06	1.209E-05	
01	001	020100	64.	4.687E-08	7.045E-07	9.575E-06	5.377E-07	2.177E-06	1.304E-05	

**Figure 60.** Example output of HAPEM6 calculated risks for one tract for 1999 benzene.

After calculating the risks, the tract level risks for each HAP, risk for each carcinogen class, and risk across all HAPs were summarized at the same levels as done for the ASPEN and HAPEM5 outputs. To calculate the average risks at a particular summary level (national, state, or county), the following steps were done:

- Substitute risk estimates in a similar manner as done for HAPEM concentrations (see Table 50):
  - For 2015, 2020, and 2030 for base and control risks, the background risks were set equal to the 1999 background risks at the census tract level.

- For a given year, for each HAP, except benzene, the control case stationary risks were set equal to the corresponding year and HAP's base stationary risks at the census tract level.
- For all HAPs for 2030, the stationary risks for the base case were set equal to the 2020 stationary base risks. For all HAPs except benzene, the 2030 stationary control concentrations were set equal to the 2020 base stationary risks. For benzene for 2030, the stationary control risks were set equal to the 2020 stationary control risks. All substitutions were at the census tract level.
- For a given year, for the metals, POM, and naphthalene, the control case onroad and nonroad risks were set equal to the corresponding year and HAP's base onroad and nonroad risks at the census tract level.
- Merged the tract populations for HAPEM6 with the original risk data (as shown in Figure 60) and recalculate the 30 replicate populations for each tract. This was done because of formatting or rounding in HAPEM6 that resulted in replicates with a population less than one being shown as zero population. Only tracts with nonzero populations were merged. All tracts with total population of zero were dropped since they would not impact the average risk calculations.
- After merging in the unrounded tract populations and recalculating the replicate populations, each source category risk (SC1, SC2, etc.) was multiplied by the replicate population for each tract.
- After multiplying risks by populations, the products were summed together for each source category for the appropriate summary level (national, state, county, etc.) and divided by the total population for the summary level:

$$Avg. Risk_{SC\#,YEAR,LEVEL,CON} = \frac{\sum_{i=1}^n \sum_{j=1}^{30} (Risk_{i,j,SC\#,YEAR,CON} \times Population_{i,j,YEAR})}{\sum_{i=1}^n \sum_{j=1}^{30} Population_{i,j,YEAR}} \quad (25)$$

where  $Avg.Risk_{SC\#,YEAR,LEVEL,CON}$  is the average risk for source category # (1 through 6), year (1999, 2015, 2020, or 2030), LEVEL (national, national urban/rural, national RFG/non-RFG, state, state urban/rural, state RFG/non-RFG, or county), n=number of tracts for the average level, j represents the number of replicates (30), and CON is base or controlled risk.

$Risk_{i,j,SC\#,YEAR,LEVEL,CON}$  is the jth replicate risk for tract i and  $Population_{i,j,YEAR}$  is the jth replicate population for tract i for year YEAR.

Note that the populations were year specific. HAPEM6 used a year 2000 population in processing and post-processing. Projected populations for 2015, 2020, and 2030 were available at the county level from Woods and Poole ([www.woodsandpoole.com](http://www.woodsandpoole.com)) for the contiguous 48 states for BenMAP (Abt, 2005). National populations were:

- 1) 1999: 281,371,447
- 2) 2015: 318,742,833
- 3) 2020: 331,530,902
- 4) 2030: 357,733,724

The population for 1999 was calculated from the HAPEM6 population file while the other years' populations were from the Woods and Poole data. For Alaska and Hawaii, where no projected populations were available, the future year populations were set equal to the HAPEM6 populations.

To allocate the projected county emissions to tract level for use in calculations, the ratio of the tract to county population for the original 2000 populations was calculated and multiplied by the projected county level population to give a projected tract population. This method assumes growth of population but that the proportion of county population contained by a tract remained unchanged.

Populations were also used in calculating the distribution of risks for each summary level. In theory, the distributions could be calculated on assigning a risk for each individual in a summary level (all people for national summaries for example). However, this was not practical within SAS<sup>®</sup> as this resulted in large datasets and long computing times. A methodology to approximate the “brute force” approach was developed:

- For a summary level, i.e. national level, the percentile levels for the population were calculated as:

$$Population_{5th} = Population_{YEAR,LEVEL} * 0.05 \quad (26)$$

$$Population_{10th} = Population_{YEAR,LEVEL} * 0.10 \quad (27)$$

$$Population_{25th} = Population_{YEAR,LEVEL} * 0.25 \quad (28)$$

$$Population_{50th} = Population_{YEAR,LEVEL} * 0.50 \quad (29)$$

$$Population_{75th} = Population_{YEAR,LEVEL} * 0.75 \quad (30)$$

$$Population_{90th} = Population_{YEAR,LEVEL} * 0.90 \quad (31)$$

$$Population_{95th} = Population_{YEAR,LEVEL} * 0.95 \quad (32)$$



where YEAR and LEVEL are as defined above. Note that each population was rounded to the nearest whole number for counting purposes.

- After calculating the percentile populations, the replicate tract populations were rounded up to the next whole number. This was done for counting purposes.
- If the replicate population was less than one, i.e. tracts with less than 30 people, the replicate population was reset to one person. This is because the distributions are assumed to be based on individuals, not portions of an individual.
- Next for each replicate, a loop was executed within SAS<sup>®</sup>, starting at one and ending at the rounded replicate population. Within the loop, a running total of population was calculated. As the loop executed, the running population was incremented by one person.
- If the running total equaled any of the percentile population, the risk associated with the tract replicate being processed was output to a dataset. The distributions were then merged with the average risks for the appropriate summary level.

All calculations above, average and distributions, were done for each HAP, each carcinogen class, and total risk (all HAPs). Once statistics were calculated for each year and level (county, state, etc.) they were merged together. Maps of county median risk were generated for several HAPs and total risk. National average risks by HAP, carcinogen class, and across all HAPs are shown in Table 56 for base risks and Table 57 for control risks. Box and whisker plots for 1999, 2015, 2020, and 2030 are shown in Figures 61, 62, 63, and 64 respectively. Maps of county median benzene risk are shown in Figures 65 through 71. Figure 72 shows the trend of total risk (all HAPs and sources, including background) with the relative contributions of each cancer HAP.

Full risk summaries can be found in risks.xls. Maps for acetaldehyde, benzene, 1,3-butadiene, and total risk can be found in acetaldehyde\_risk.ppt, benzene\_risk.ppt, butadiene\_risk.ppt, and total\_risk.ppt. All summaries and maps can be found in the MSAT rule docket, EPA-HQ-OAR-2005-0036.

**Table 56.** Base national average risks for 1999, 2015, 2020, and 2030 by HAP, carcinogen class and across all HAPs. HAPs are grouped by carcinogen class. Total includes background risks.

HAP	Year											
	1999			2015			2020			2030		
	Stationary	Mobile	Total	Stationary	Mobile	Total	Stationary	Mobile	Total	Stationary	Mobile	Total
1,3-Butadiene	5.29x10 <sup>-7</sup>	2.59x10 <sup>-6</sup>	4.43x10 <sup>-6</sup>	4.96x10 <sup>-7</sup>	1.19x10 <sup>-6</sup>	2.97x10 <sup>-6</sup>	4.88x10 <sup>-7</sup>	1.23x10 <sup>-6</sup>	3.00x10 <sup>-6</sup>	4.67x10 <sup>-7</sup>	1.42x10 <sup>-6</sup>	3.16x10 <sup>-6</sup>
Benzene	1.13x10 <sup>-6</sup>	8.09x10 <sup>-6</sup>	1.18x10 <sup>-5</sup>	1.23x10 <sup>-6</sup>	4.48x10 <sup>-6</sup>	8.33x10 <sup>-6</sup>	1.28x10 <sup>-6</sup>	4.56x10 <sup>-6</sup>	8.45x10 <sup>-6</sup>	1.27x10 <sup>-6</sup>	5.24x10 <sup>-6</sup>	9.13x10 <sup>-6</sup>
Chromium VI	1.48x10 <sup>-6</sup>	2.41x10 <sup>-7</sup>	1.72x10 <sup>-6</sup>	1.92x10 <sup>-6</sup>	3.10x10 <sup>-7</sup>	2.23x10 <sup>-6</sup>	2.15x10 <sup>-6</sup>	3.34x10 <sup>-7</sup>	2.49x10 <sup>-6</sup>	2.13x10 <sup>-6</sup>	3.93x10 <sup>-7</sup>	2.52x10 <sup>-6</sup>
Nickel	1.46x10 <sup>-7</sup>	1.04x10 <sup>-8</sup>	1.56x10 <sup>-7</sup>	1.62x10 <sup>-7</sup>	1.25x10 <sup>-8</sup>	1.75x10 <sup>-7</sup>	1.77x10 <sup>-7</sup>	1.33x10 <sup>-8</sup>	1.90x10 <sup>-7</sup>	1.75x10 <sup>-7</sup>	1.51x10 <sup>-8</sup>	1.90x10 <sup>-7</sup>
<b>A Class</b>	3.28x10 <sup>-6</sup>	1.09x10 <sup>-5</sup>	1.82x10 <sup>-5</sup>	3.80x10 <sup>-6</sup>	5.99x10 <sup>-6</sup>	1.37x10 <sup>-5</sup>	4.09x10 <sup>-6</sup>	6.14x10 <sup>-6</sup>	1.41x10 <sup>-5</sup>	4.04x10 <sup>-6</sup>	7.07x10 <sup>-6</sup>	1.50x10 <sup>-5</sup>
Formaldehyde	6.32x10 <sup>-10</sup>	4.46x10 <sup>-9</sup>	8.69x10 <sup>-9</sup>	7.29x10 <sup>-10</sup>	2.12x10 <sup>-9</sup>	6.43x10 <sup>-9</sup>	7.82x10 <sup>-10</sup>	2.14x10 <sup>-9</sup>	6.49x10 <sup>-9</sup>	7.82x10 <sup>-10</sup>	2.41x10 <sup>-9</sup>	6.76x10 <sup>-9</sup>
<b>B1 Class</b>	6.32x10 <sup>-10</sup>	4.46x10 <sup>-9</sup>	8.69x10 <sup>-9</sup>	7.29x10 <sup>-10</sup>	2.12x10 <sup>-9</sup>	6.43x10 <sup>-9</sup>	7.82x10 <sup>-10</sup>	2.14x10 <sup>-9</sup>	6.49x10 <sup>-9</sup>	7.82x10 <sup>-10</sup>	2.41x10 <sup>-9</sup>	6.76x10 <sup>-9</sup>
Acetaldehyde	1.66x10 <sup>-7</sup>	2.25x10 <sup>-6</sup>	3.39x10 <sup>-6</sup>	1.71x10 <sup>-7</sup>	1.29x10 <sup>-6</sup>	2.43x10 <sup>-6</sup>	1.77x10 <sup>-7</sup>	1.31x10 <sup>-6</sup>	2.46x10 <sup>-6</sup>	1.77x10 <sup>-7</sup>	1.50x10 <sup>-6</sup>	2.65x10 <sup>-6</sup>
POM	1.24x10 <sup>-6</sup>	1.41x10 <sup>-7</sup>	1.38x10 <sup>-6</sup>	1.40x10 <sup>-6</sup>	8.63x10 <sup>-8</sup>	1.48x10 <sup>-6</sup>	1.46x10 <sup>-6</sup>	8.81x10 <sup>-8</sup>	1.55x10 <sup>-6</sup>	1.47x10 <sup>-6</sup>	1.01x10 <sup>-7</sup>	1.57x10 <sup>-6</sup>
<b>B2 Class</b>	1.41x10 <sup>-6</sup>	2.39x10 <sup>-6</sup>	4.77x10 <sup>-6</sup>	1.57x10 <sup>-6</sup>	1.38x10 <sup>-6</sup>	3.91x10 <sup>-6</sup>	1.63x10 <sup>-6</sup>	1.40x10 <sup>-6</sup>	4.00x10 <sup>-6</sup>	1.65x10 <sup>-6</sup>	1.60x10 <sup>-6</sup>	4.22x10 <sup>-6</sup>
Naphthalene	1.34x10 <sup>-6</sup>	7.75x10 <sup>-7</sup>	2.11x10 <sup>-6</sup>	1.56x10 <sup>-6</sup>	4.82x10 <sup>-7</sup>	2.04x10 <sup>-6</sup>	1.65x10 <sup>-6</sup>	4.88x10 <sup>-7</sup>	2.14x10 <sup>-6</sup>	1.63x10 <sup>-6</sup>	5.59x10 <sup>-7</sup>	2.19x10 <sup>-6</sup>
C Class	1.34x10 <sup>-6</sup>	7.75x10 <sup>-7</sup>	2.11x10 <sup>-6</sup>	1.56x10 <sup>-6</sup>	4.82x10 <sup>-7</sup>	2.04x10 <sup>-6</sup>	1.65x10 <sup>-6</sup>	4.88x10 <sup>-7</sup>	2.14x10 <sup>-6</sup>	1.63x10 <sup>-6</sup>	5.59x10 <sup>-7</sup>	2.19x10 <sup>-6</sup>
<b>Total Risk: All HAPs</b>	6.03x10 <sup>-6</sup>	1.41x10 <sup>-5</sup>	2.50x10 <sup>-5</sup>	6.93x10 <sup>-6</sup>	7.86x10 <sup>-6</sup>	1.97x10 <sup>-5</sup>	7.38x10 <sup>-6</sup>	8.03x10 <sup>-6</sup>	2.03x10 <sup>-5</sup>	7.32x10 <sup>-6</sup>	9.24x10 <sup>-6</sup>	2.14x10 <sup>-5</sup>

**Table 57.** Control national average risks for 2015, 2020, and 2030 by HAP, carcinogen class and across all HAPs. HAPs are grouped by carcinogen class. Total includes background.

HAP	Year								
	2015			2020			2030		
	Stationary	Mobile	Total	Stationary	Mobile	Total	Stationary	Mobile	Total
1,3-Butadiene	4.96x10 <sup>-7</sup>	1.04x10 <sup>-6</sup>	2.83x10 <sup>-6</sup>	4.88x10 <sup>-7</sup>	1.00x10 <sup>-6</sup>	2.77x10 <sup>-6</sup>	4.67x10 <sup>-7</sup>	1.05x10 <sup>-6</sup>	2.78x10 <sup>-6</sup>
Benzene	1.22x10 <sup>-6</sup>	3.47x10 <sup>-6</sup>	7.30x10 <sup>-6</sup>	1.26x10 <sup>-6</sup>	3.21x10 <sup>-6</sup>	7.09x10 <sup>-6</sup>	1.25x10 <sup>-6</sup>	3.28x10 <sup>-6</sup>	7.15x10 <sup>-6</sup>
Chromium VI	1.92x10 <sup>-6</sup>	3.10x10 <sup>-7</sup>	2.23x10 <sup>-6</sup>	2.15x10 <sup>-6</sup>	3.34x10 <sup>-7</sup>	2.49x10 <sup>-6</sup>	2.13x10 <sup>-6</sup>	3.93x10 <sup>-7</sup>	2.52x10 <sup>-6</sup>
Nickel	1.62x10 <sup>-7</sup>	1.25x10 <sup>-8</sup>	1.75x10 <sup>-7</sup>	1.77x10 <sup>-7</sup>	1.33x10 <sup>-8</sup>	1.90x10 <sup>-7</sup>	1.75x10 <sup>-7</sup>	1.51x10 <sup>-8</sup>	1.90x10 <sup>-7</sup>
<b>A Class</b>	3.79x10 <sup>-6</sup>	4.83x10 <sup>-6</sup>	1.25x10 <sup>-5</sup>	4.08x10 <sup>-6</sup>	4.56x10 <sup>-6</sup>	1.25x10 <sup>-5</sup>	4.02x10 <sup>-6</sup>	4.74x10 <sup>-6</sup>	1.26x10 <sup>-5</sup>
Formaldehyde	7.29x10 <sup>-10</sup>	1.93x10 <sup>-9</sup>	6.23x10 <sup>-9</sup>	7.82x10 <sup>-10</sup>	1.83x10 <sup>-9</sup>	6.19x10 <sup>-9</sup>	7.82x10 <sup>-10</sup>	1.93x10 <sup>-9</sup>	6.28x10 <sup>-9</sup>
<b>B1 Class</b>	7.29x10 <sup>-10</sup>	1.93x10 <sup>-9</sup>	6.23x10 <sup>-9</sup>	7.82x10 <sup>-10</sup>	1.83x10 <sup>-9</sup>	6.19x10 <sup>-9</sup>	7.82x10 <sup>-10</sup>	1.93x10 <sup>-9</sup>	6.28x10 <sup>-9</sup>
Acetaldehyde	1.71x10 <sup>-7</sup>	1.11x10 <sup>-6</sup>	2.25x10 <sup>-6</sup>	1.77x10 <sup>-7</sup>	1.03x10 <sup>-6</sup>	2.17x10 <sup>-6</sup>	1.77x10 <sup>-7</sup>	1.06x10 <sup>-6</sup>	2.20x10 <sup>-6</sup>
POM	1.40x10 <sup>-6</sup>	8.63x10 <sup>-8</sup>	1.48x10 <sup>-6</sup>	1.46x10 <sup>-6</sup>	8.81x10 <sup>-8</sup>	1.55x10 <sup>-6</sup>	1.47x10 <sup>-6</sup>	1.01x10 <sup>-7</sup>	1.57x10 <sup>-6</sup>
<b>B2 Class</b>	1.57x10 <sup>-6</sup>	1.20x10 <sup>-6</sup>	3.73x10 <sup>-6</sup>	1.63x10 <sup>-6</sup>	1.12x10 <sup>-6</sup>	3.72x10 <sup>-6</sup>	1.65x10 <sup>-6</sup>	1.16x10 <sup>-6</sup>	3.77x10 <sup>-6</sup>
Naphthalene	1.56x10 <sup>-6</sup>	4.82x10 <sup>-7</sup>	2.04x10 <sup>-6</sup>	1.65x10 <sup>-6</sup>	4.88x10 <sup>-7</sup>	2.14x10 <sup>-6</sup>	1.63x10 <sup>-6</sup>	5.59x10 <sup>-7</sup>	2.19x10 <sup>-6</sup>
<b>C Class</b>	1.56x10 <sup>-6</sup>	4.82x10 <sup>-7</sup>	2.04x10 <sup>-6</sup>	1.65x10 <sup>-6</sup>	4.88x10 <sup>-7</sup>	2.14x10 <sup>-6</sup>	1.63x10 <sup>-6</sup>	5.59x10 <sup>-7</sup>	2.19x10 <sup>-6</sup>
<b>Total Risk: All HAPs</b>	6.92x10 <sup>-6</sup>	6.51x10 <sup>-6</sup>	1.83x10 <sup>-5</sup>	7.36x10 <sup>-6</sup>	6.16x10 <sup>-6</sup>	1.84x10 <sup>-5</sup>	7.30x10 <sup>-6</sup>	6.45x10 <sup>-6</sup>	1.86x10 <sup>-5</sup>

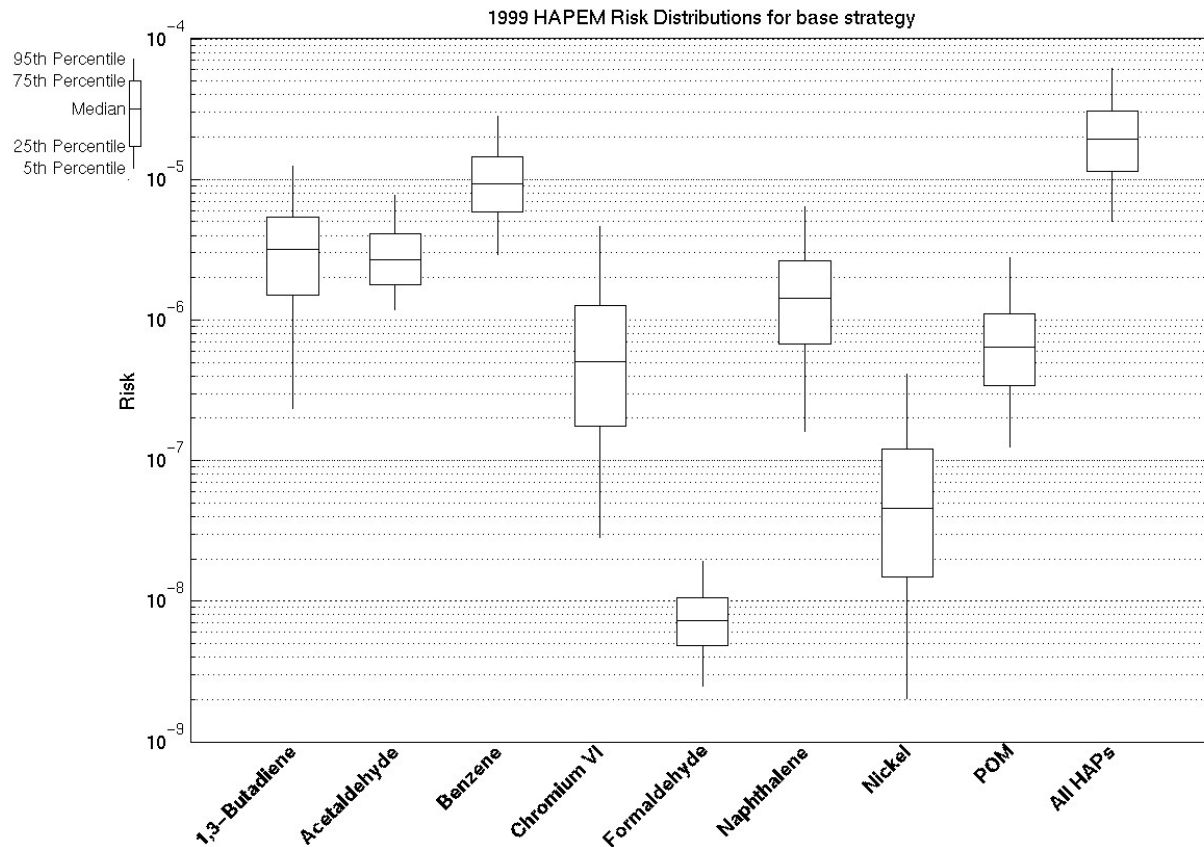
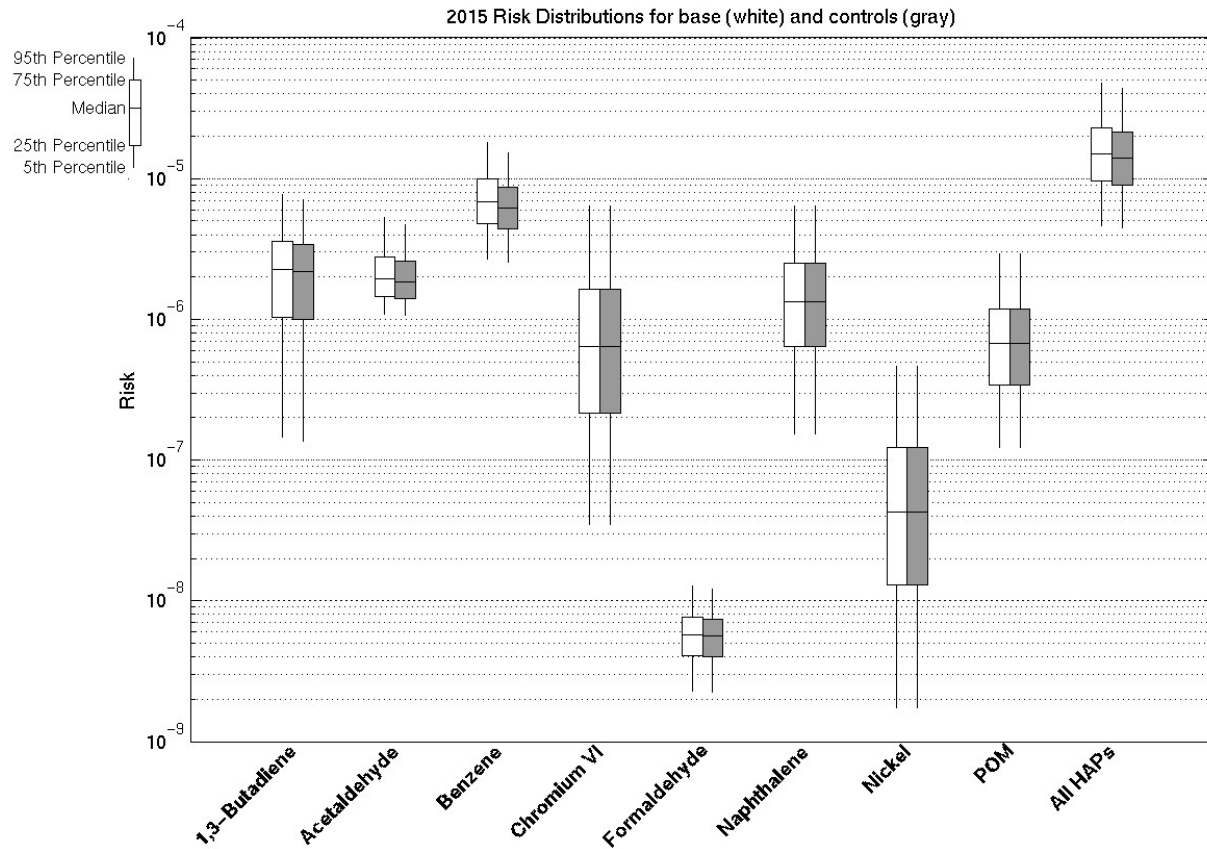
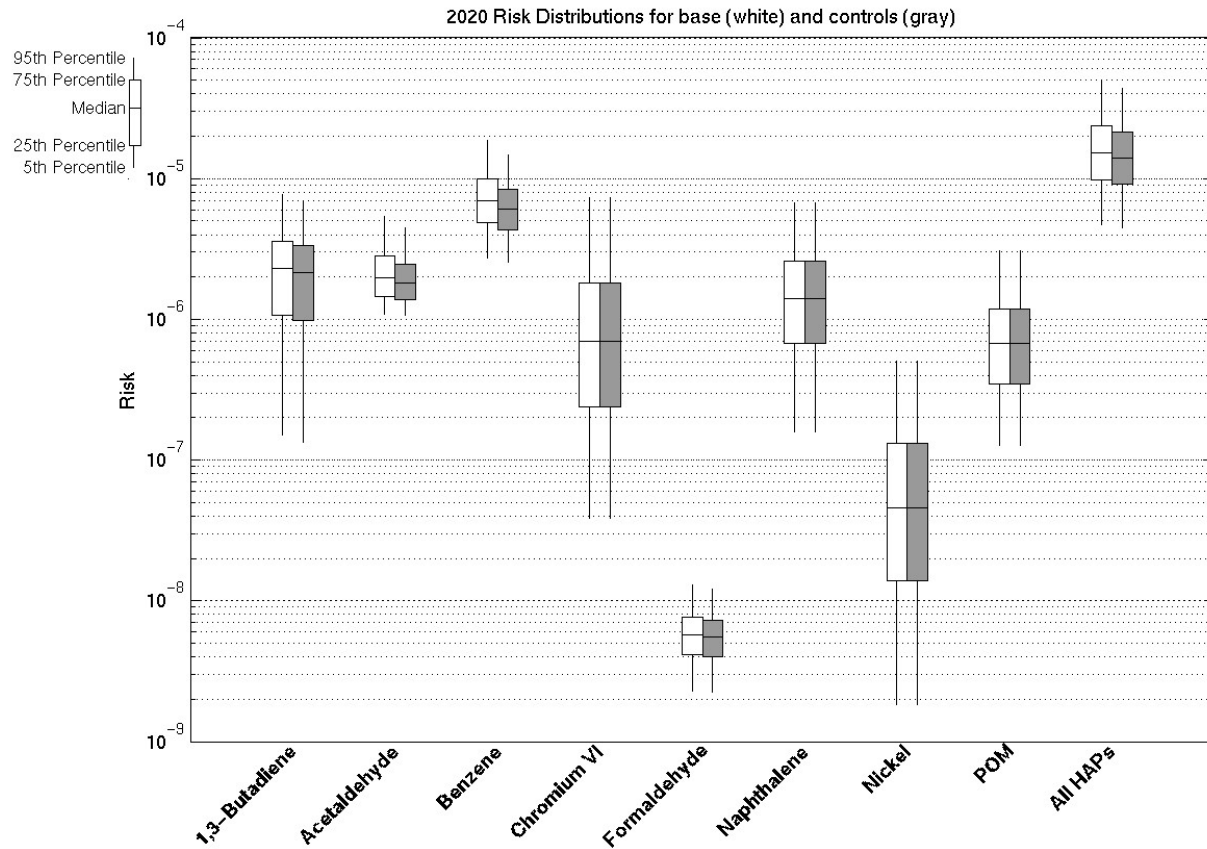


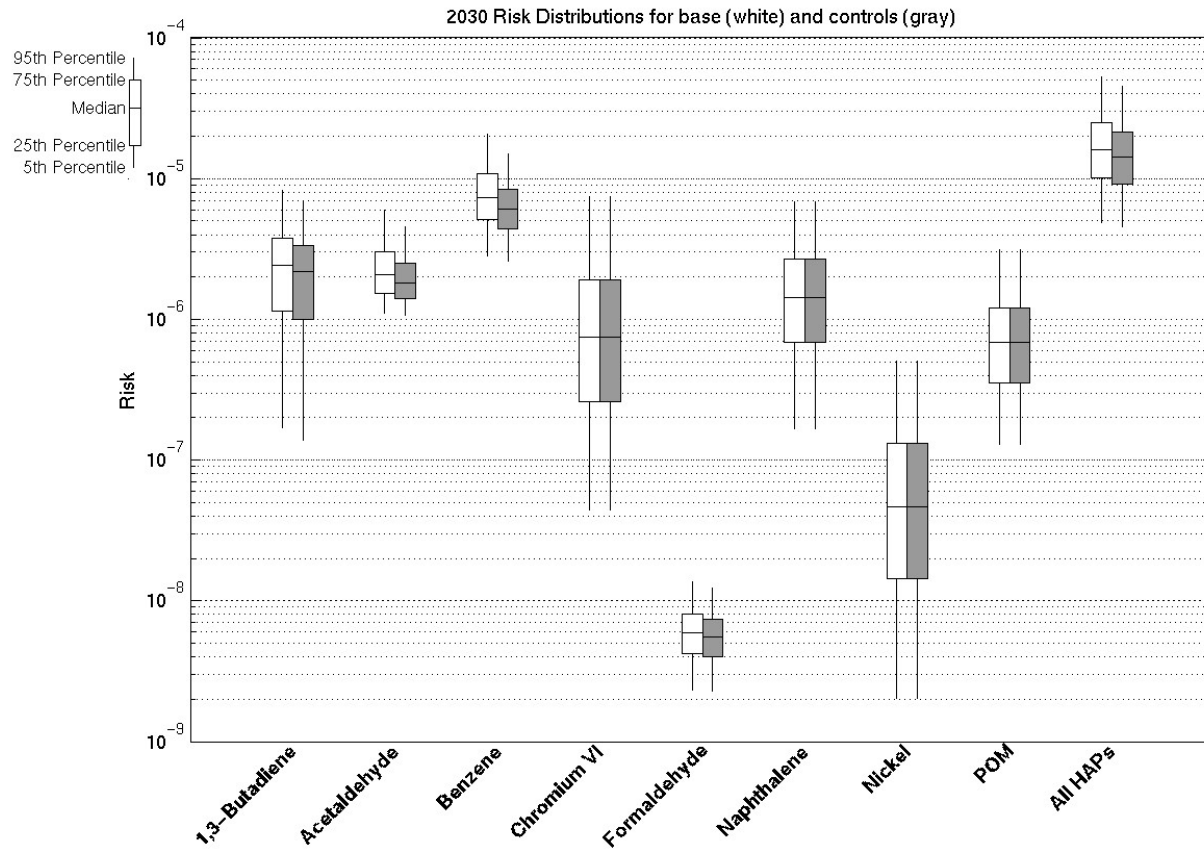
Figure 61. 1999 base national HAPEM6 risk distributions.



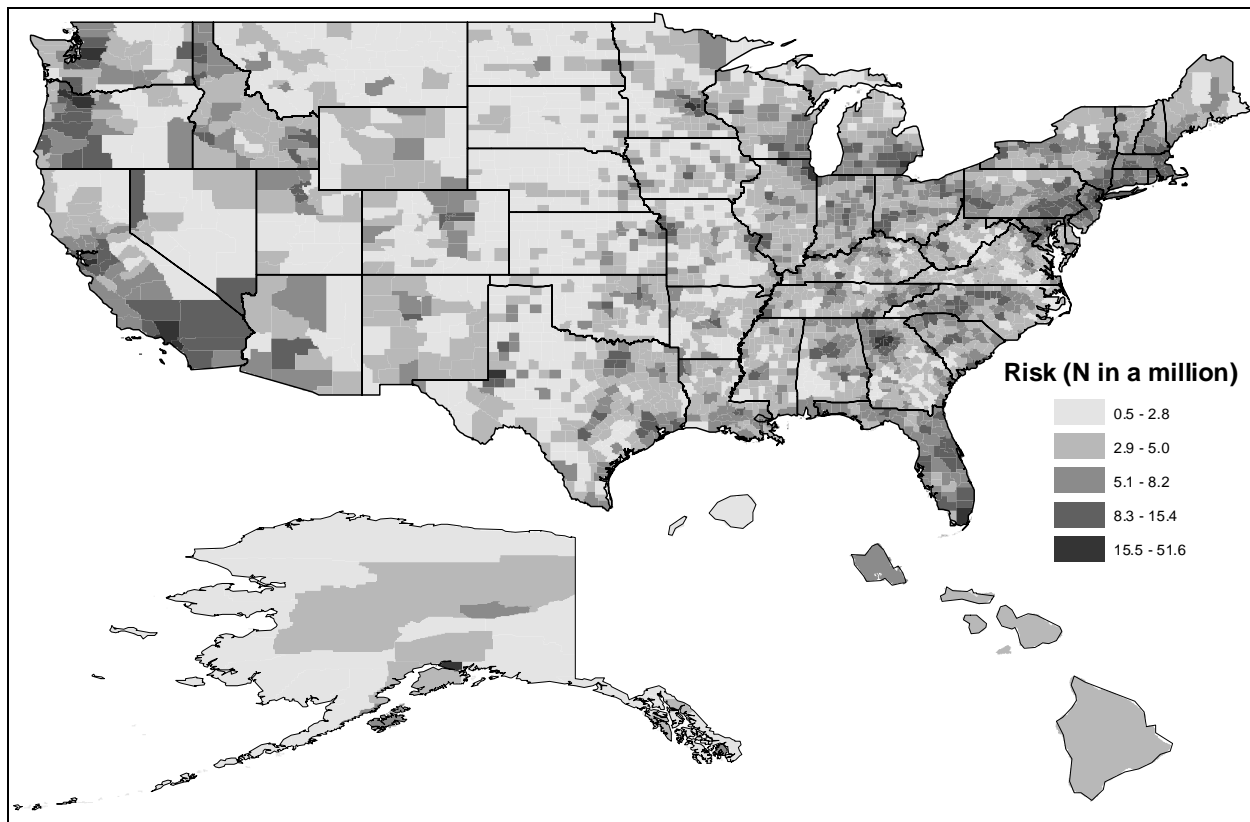
**Figure 62.** 2015 base (white) and control (gray) national HAPEM6 risk distributions.



**Figure 63.** 2020 base (white) and control (gray) national HAPEM6 risk distributions.

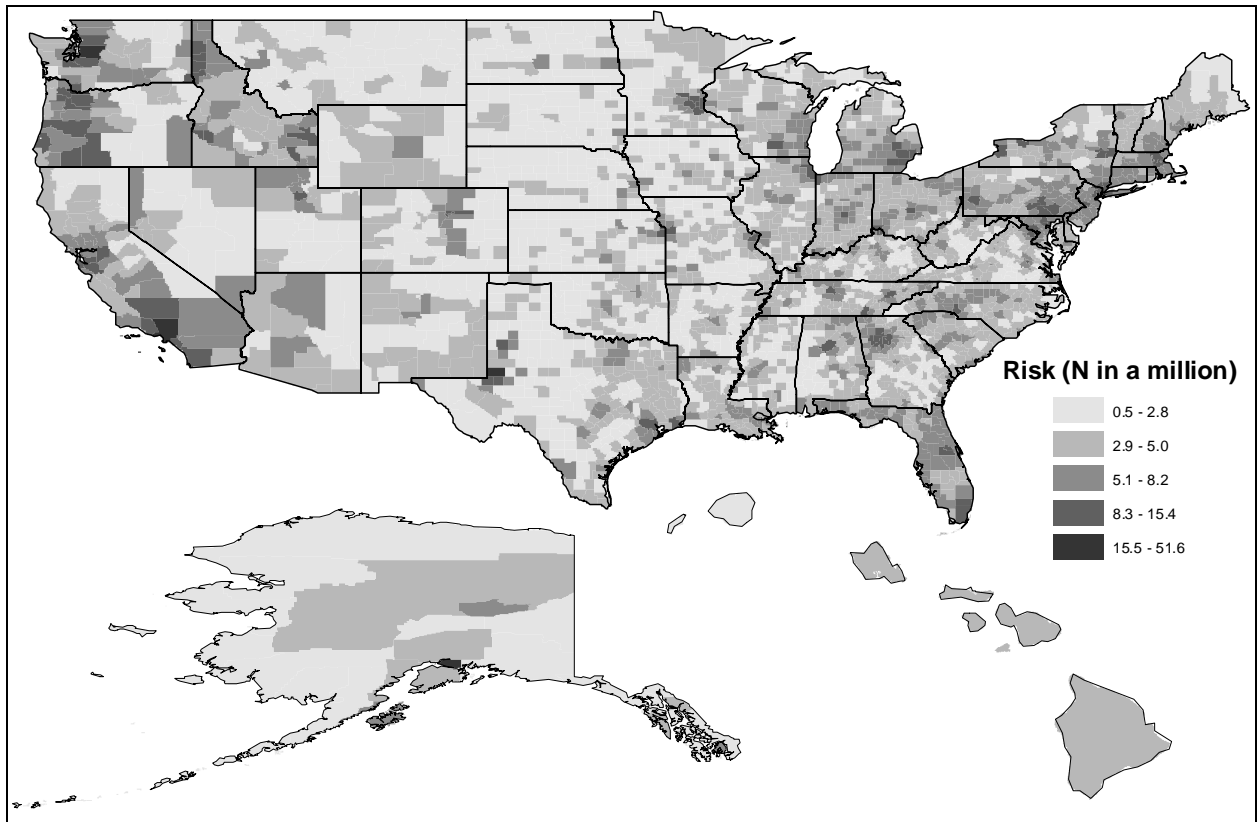


**Figure 64.** 2030 base (white) and control (gray) national HAPEM6 risk distributions.

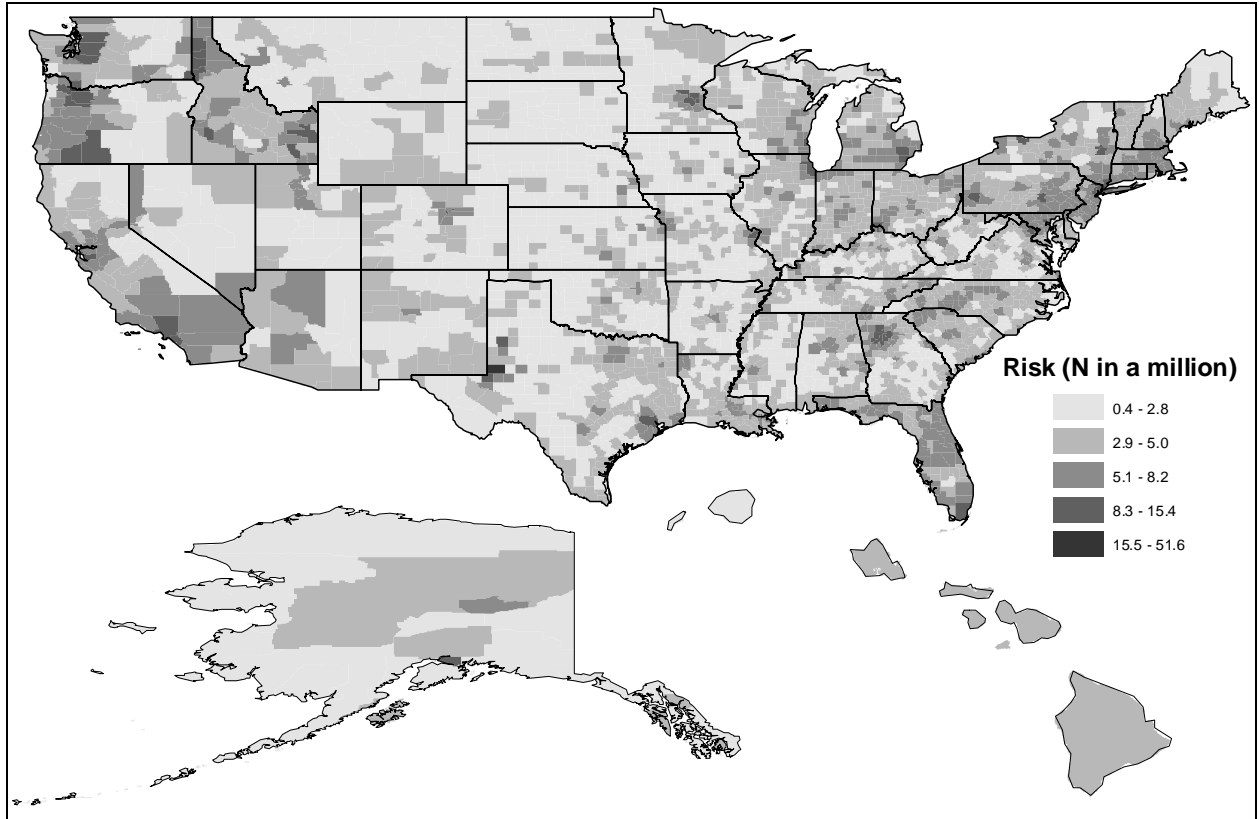


**Figure 65.** 1999 base county level median total (all sources and background) risk for benzene.

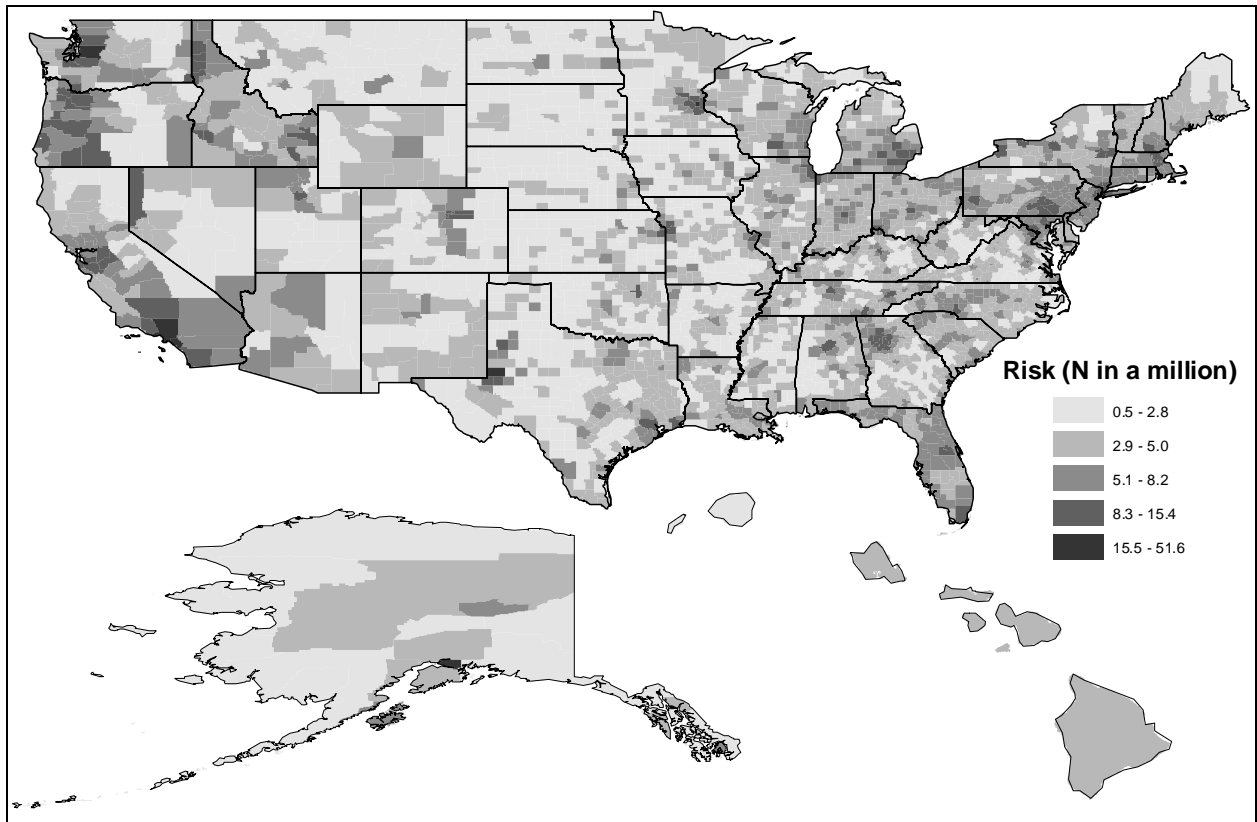




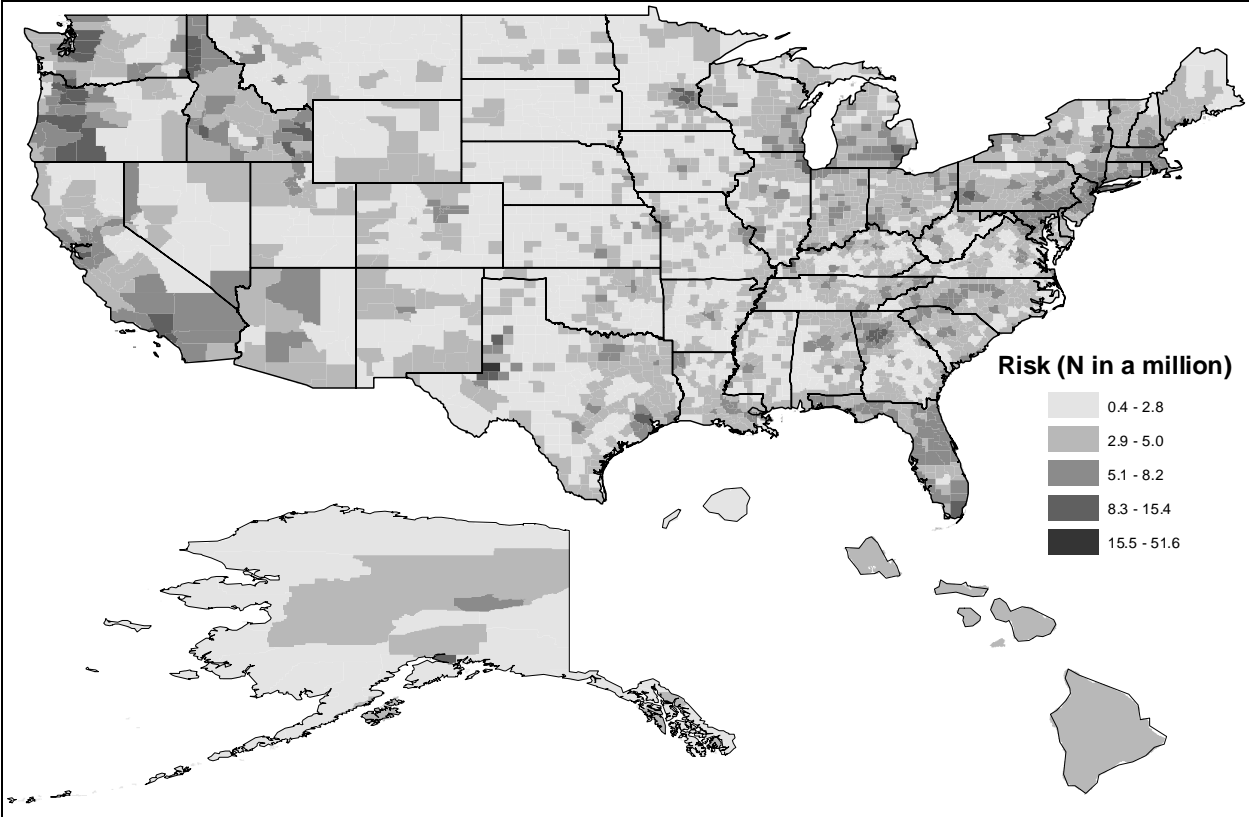
**Figure 66.** 2015 base county level median total (all sources and background) risk for benzene.



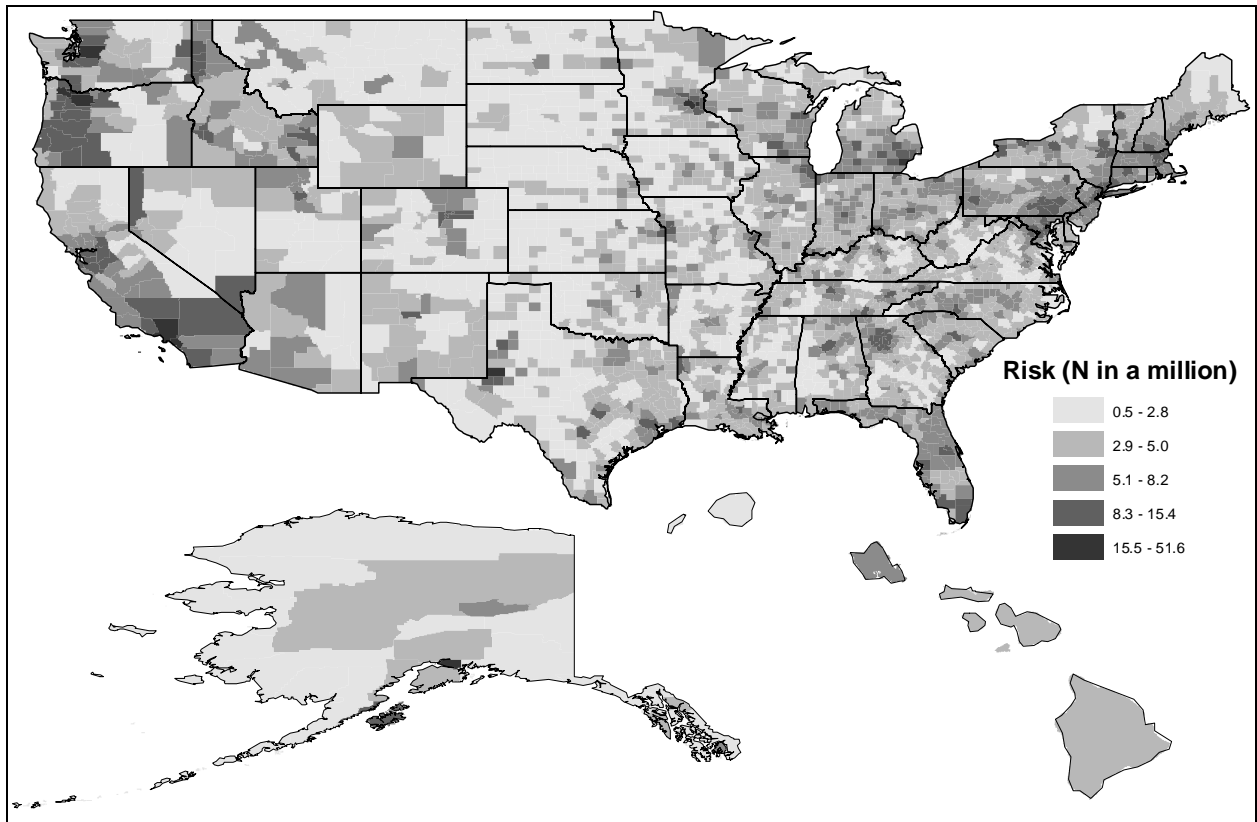
**Figure 67.** 2015 control county level median total (all sources and background) risk for benzene.



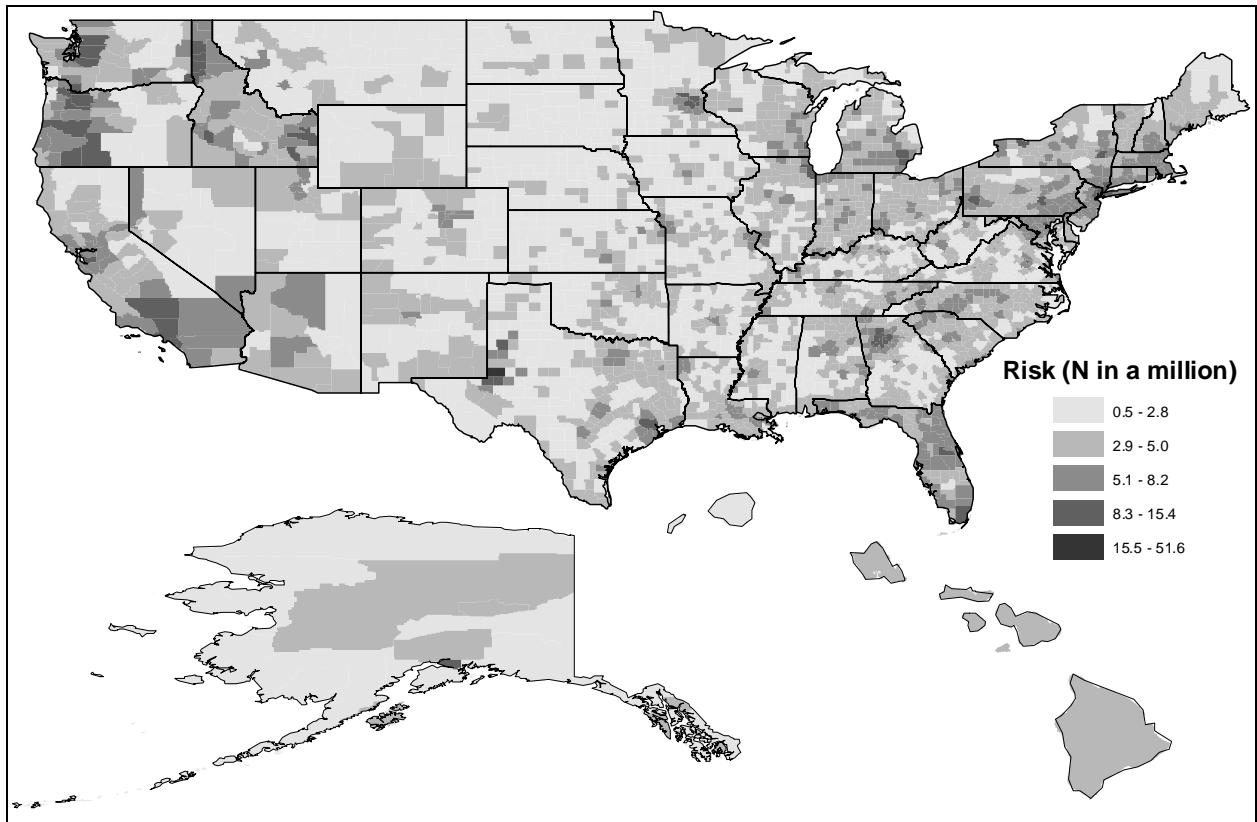
**Figure 68.** 2020 base county level median total (all sources and background) risk for benzene.



**Figure 69.** 2020 control county level median total (all sources and background) risk for benzene.



**Figure 70.** 2030 base county level median total (all sources and background) risk for benzene.



**Figure 71.** 2030 control county level median total (all sources and background) risk for benzene.

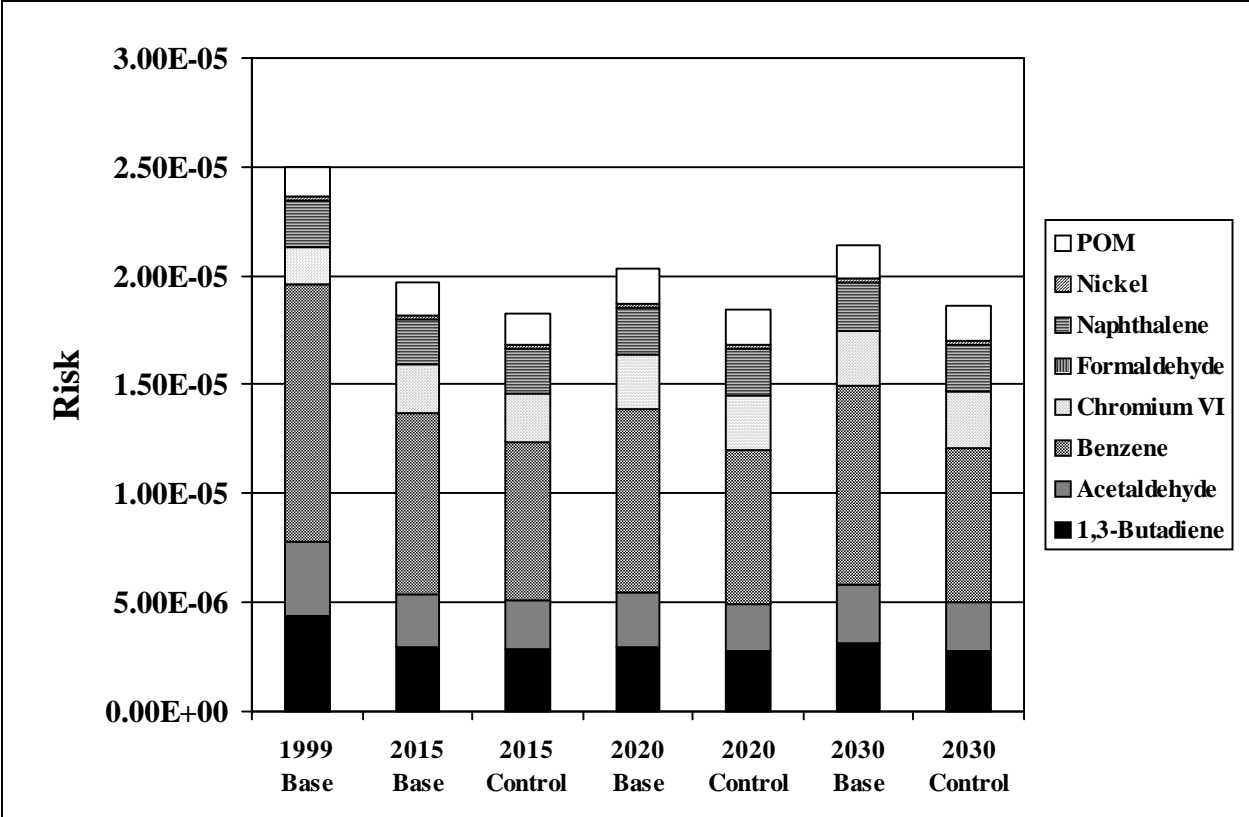


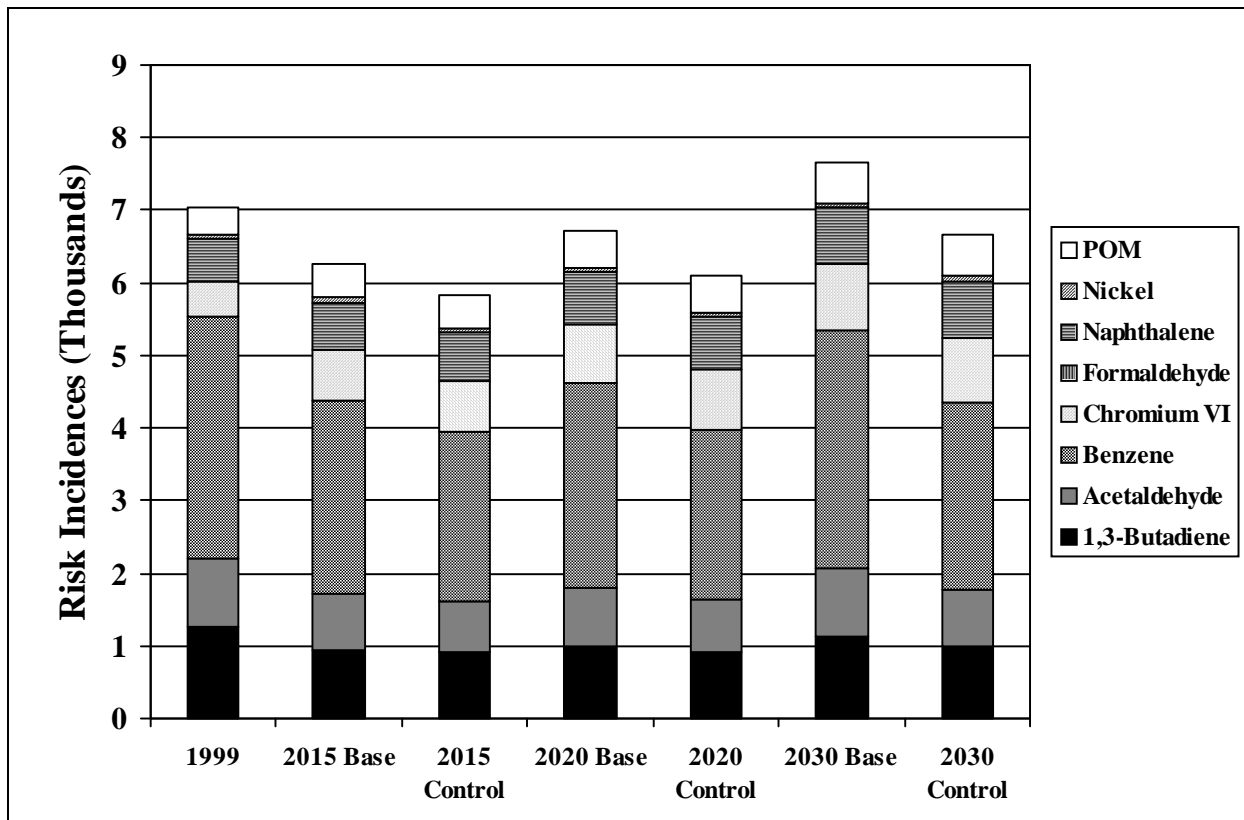
Figure 72. Total risk for each year and control strategy with HAP contributions.

In addition to calculating averages and distributions, the national and state risk incidences were calculated for each HAP, carcinogen class, and total risk. Incidences were the sum of all individual risks across the country or state. The incidences were calculated by multiplying the tract populations by the risks calculated in HAPEM6 post-processing. Basically, the incidences were the sums calculated in the numerator of Equation 25. Table 58 shows the national incidences for each HAP, carcinogen class, and across all HAPs for total risk (all sources) for 1999, 2015, 2020, and 2030 for base and controlled results. Figure 73 shows the contribution of each HAP to the total (all HAPs) risk for all source categories. Full incidence summaries can be found in risk\_incidences.xls in the MSAT rule docket, EPA-HQ-OAR-2005-0036.

**Table 58.** National total risk incidences (all sources) by HAP, carcinogen class, and across all HAPs.

Pollutant	Year						
	1999	2015		2020		2030	
	Base	Base	Control	Base	Control	Base	Control
1,3-Butadiene	1.25x10 <sup>3</sup>	9.48x10 <sup>2</sup>	9.01x10 <sup>2</sup>	9.95x10 <sup>2</sup>	9.19x10 <sup>2</sup>	1.13x10 <sup>3</sup>	9.96x10 <sup>2</sup>
Benzene	3.33x10 <sup>3</sup>	2.65x10 <sup>3</sup>	2.33x10 <sup>3</sup>	2.80x10 <sup>3</sup>	2.35x10 <sup>3</sup>	3.27x10 <sup>3</sup>	2.56x10 <sup>3</sup>
Chromium VI	4.83x10 <sup>2</sup>	7.10x10 <sup>2</sup>	7.10x10 <sup>2</sup>	8.24x10 <sup>2</sup>	8.24x10 <sup>2</sup>	9.02x10 <sup>2</sup>	9.02x10 <sup>2</sup>
Nickel	4.40x10 <sup>1</sup>	5.56x10 <sup>1</sup>	5.56x10 <sup>1</sup>	6.29x10 <sup>1</sup>	6.29x10 <sup>1</sup>	6.80x10 <sup>1</sup>	6.80x10 <sup>1</sup>
<b>A Class</b>	5.11x10 <sup>3</sup>	4.37x10 <sup>3</sup>	3.99x10 <sup>3</sup>	4.68x10 <sup>3</sup>	4.16x10 <sup>3</sup>	5.36x10 <sup>3</sup>	4.52x10 <sup>3</sup>
Formaldehyde	2.44x10 <sup>0</sup>	2.05x10 <sup>0</sup>	1.99x10 <sup>0</sup>	2.15x10 <sup>0</sup>	2.05x10 <sup>0</sup>	2.42x10 <sup>0</sup>	2.25x10 <sup>0</sup>
<b>B Class</b>	2.44x10 <sup>0</sup>	2.05x10 <sup>0</sup>	1.99x10 <sup>0</sup>	2.15x10 <sup>0</sup>	2.05x10 <sup>0</sup>	2.42x10 <sup>0</sup>	2.25x10 <sup>0</sup>
Acetaldehyde	9.53x10 <sup>2</sup>	7.75x10 <sup>2</sup>	7.17x10 <sup>2</sup>	8.14x10 <sup>2</sup>	7.20x10 <sup>2</sup>	9.47x10 <sup>2</sup>	7.87x10 <sup>2</sup>
POM	3.88x10 <sup>2</sup>	4.73x10 <sup>2</sup>	4.73x10 <sup>2</sup>	5.13x10 <sup>2</sup>	5.13x10 <sup>2</sup>	5.62x10 <sup>2</sup>	5.62x10 <sup>2</sup>
<b>B2 Class</b>	1.34x10 <sup>3</sup>	1.25x10 <sup>3</sup>	1.19x10 <sup>3</sup>	1.33x10 <sup>3</sup>	1.23x10 <sup>3</sup>	1.51x10 <sup>3</sup>	1.35x10 <sup>3</sup>
Naphthalene	5.95x10 <sup>2</sup>	6.50x10 <sup>2</sup>	6.50x10 <sup>2</sup>	7.09x10 <sup>2</sup>	7.09x10 <sup>2</sup>	7.82x10 <sup>2</sup>	7.82x10 <sup>2</sup>
<b>C Class</b>	5.95x10 <sup>2</sup>	6.50x10 <sup>2</sup>	6.50x10 <sup>2</sup>	7.09x10 <sup>2</sup>	7.09x10 <sup>2</sup>	7.82x10 <sup>2</sup>	7.82x10 <sup>2</sup>
Total Risk: All HAPs	7.05x10 <sup>3</sup>	6.27x10 <sup>3</sup>	5.84x10 <sup>3</sup>	6.72x10 <sup>3</sup>	6.10x10 <sup>3</sup>	7.66x10 <sup>3</sup>	6.66x10 <sup>3</sup>





**Figure 73.** Contribution of individual HAP incidences (70 year lifetime) to total risk (all HAPs and all sources).

## 8.2 Non-cancer calculations

Tract level non-cancer hazard quotients (HQ) for each HAP were calculated by dividing, for each HAP and each source sector, the exposure concentration by the RfC. The output was similar in format to the risk as shown in Figure 60, except for hazard quotients instead of risk. The methodology in calculating distributions and averages was exactly the same as for cancer risks with substitutions as done for exposure concentrations and risks. Statistics for individual HAPs were calculated, as well as for hazard indices (HI, sum of individual HAP HQ) for organ systems shown in Table 55.

National average hazard quotients for HAPs and hazard indices for organ systems for the base scenarios are shown in Table 59. Controlled hazard quotients and hazard indices are shown in Table 60. Box and whisker plots of the distributions for HAPs and the respiratory system are shown in Figures 74 through 77 for 1999, 2015, 2020, and 2030 respectively. Figures 78-84 show the county median hazard quotients for benzene for 1999, 2015, 2020, and 2030. Finally, in Figure 84, the HAP contributions to the respiratory hazard indices for each year are shown.

Full non-cancer summaries can be found in noncancer.xls. Maps for acetaldehyde, acrolein, benzene, 1,3-butadiene, formaldehyde, and respiratory HI can be found in acetaldehyde\_hq.ppt,

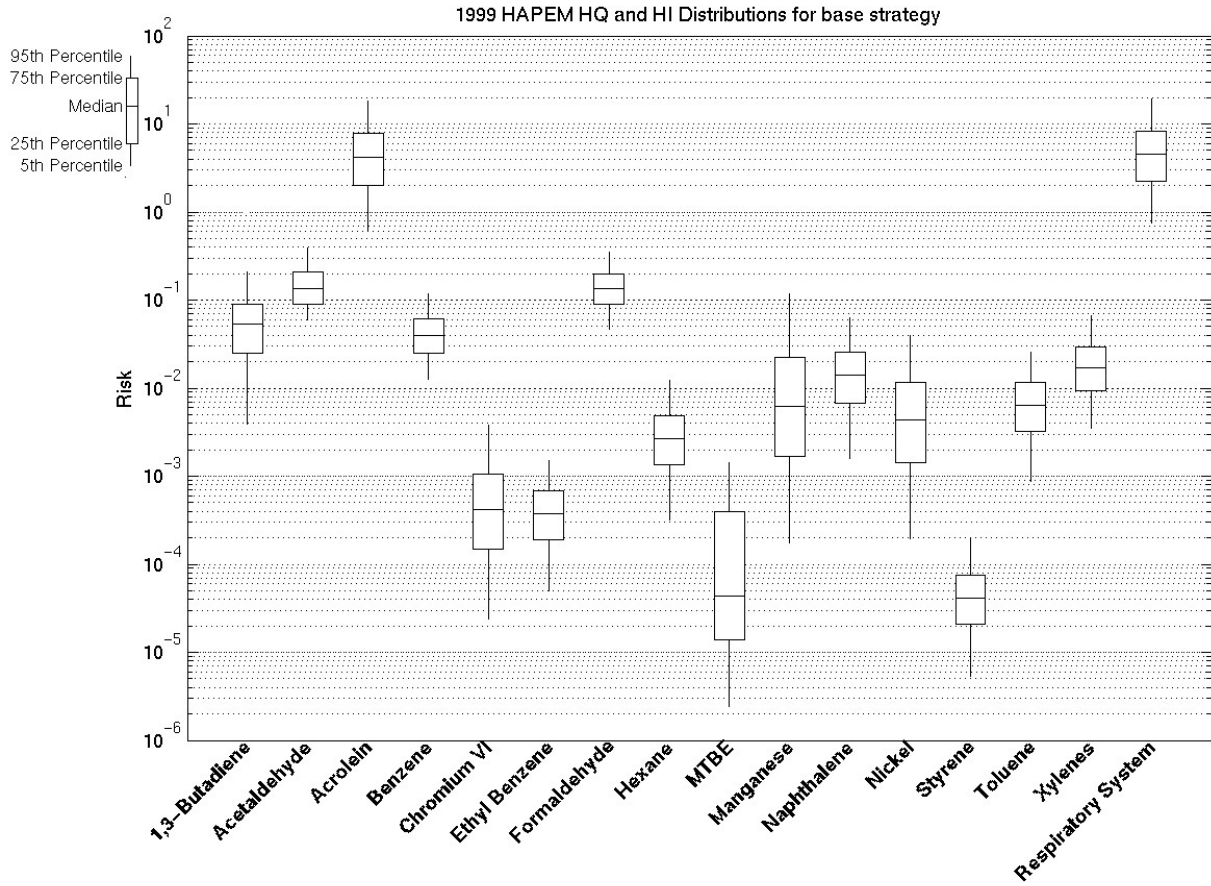
acrolein\_hq.ppt, benzene\_hq.ppt, butadiene\_hq.ppt, formaldehyde\_hq.ppt, and resp\_hq.ppt. All summaries and maps can be found in the MSAT rule docket, EPA-HQ-OAR-2005-0036.

**Table 59.** Base national average hazard quotients (HAPs) and hazard indices (organ systems) for 1999, 2015, 2020, and 2030. Total includes background.

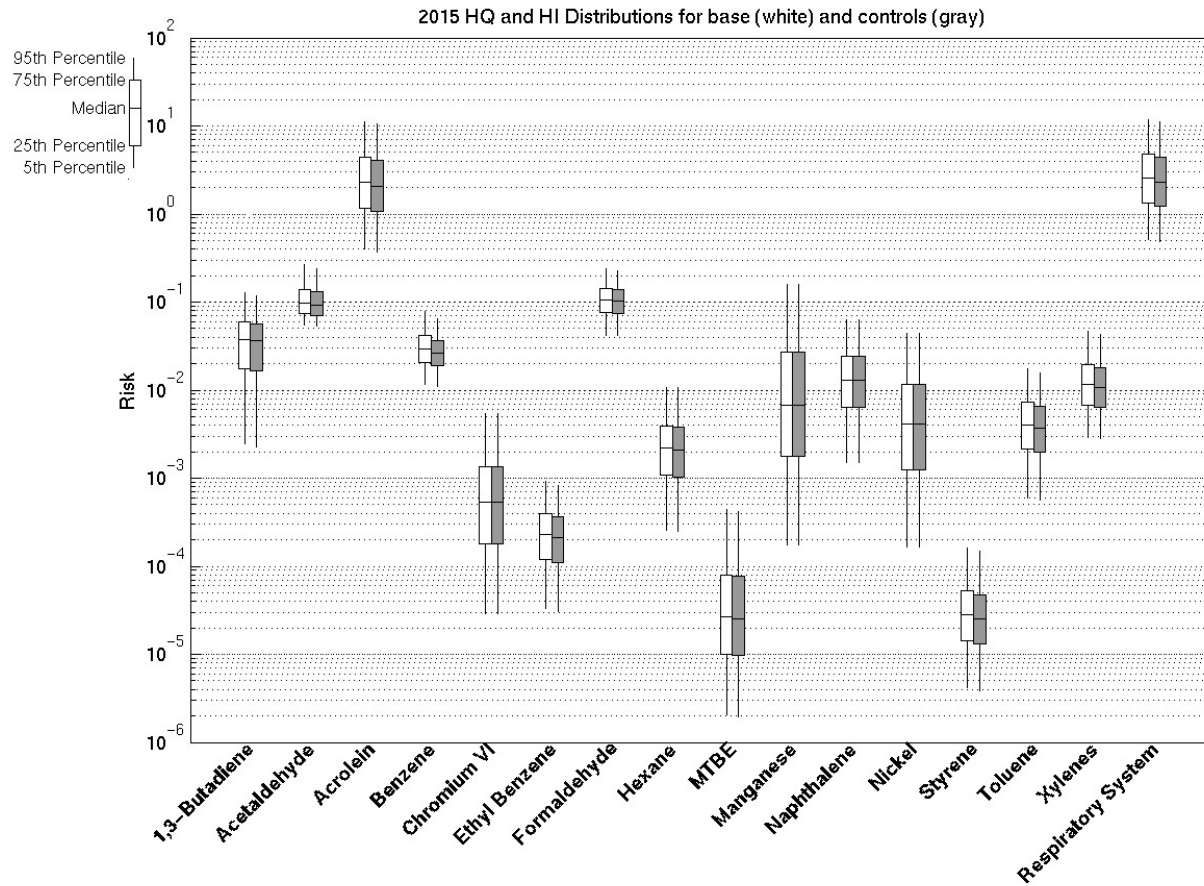
HAP	Year											
	1999			2015			2020			2030		
	Stationary	Mobile	Total	Stationary	Mobile	Total	Stationary	Mobile	Total	Stationary	Mobile	Total
1,3-Butadiene	8.81x10 <sup>-3</sup>	4.32x10 <sup>-2</sup>	7.39x10 <sup>-2</sup>	8.26x10 <sup>-3</sup>	1.98x10 <sup>-2</sup>	4.96x10 <sup>-2</sup>	8.13x10 <sup>-3</sup>	2.05x10 <sup>-2</sup>	5.00x10 <sup>-2</sup>	7.78x10 <sup>-3</sup>	2.36x10 <sup>-2</sup>	5.26x10 <sup>-2</sup>
Acetaldehyde	8.40x10 <sup>-3</sup>	1.14x10 <sup>-1</sup>	1.71x10 <sup>-1</sup>	8.66x10 <sup>-3</sup>	6.53x10 <sup>-2</sup>	1.23x10 <sup>-1</sup>	8.91x10 <sup>-3</sup>	6.63x10 <sup>-2</sup>	1.24x10 <sup>-1</sup>	8.93x10 <sup>-3</sup>	7.59x10 <sup>-2</sup>	1.34x10 <sup>-1</sup>
Acrolein	1.43x10 <sup>0</sup>	4.73x10 <sup>0</sup>	6.16x10 <sup>0</sup>	1.28x10 <sup>0</sup>	2.35x10 <sup>0</sup>	3.63x10 <sup>0</sup>	1.27x10 <sup>0</sup>	2.43x10 <sup>0</sup>	3.69x10 <sup>0</sup>	1.26x10 <sup>0</sup>	2.78x10 <sup>0</sup>	4.04x10 <sup>0</sup>
Benzene	4.83x10 <sup>-3</sup>	3.46x10 <sup>-2</sup>	5.06x10 <sup>-2</sup>	5.26x10 <sup>-3</sup>	1.91x10 <sup>-2</sup>	3.56x10 <sup>-2</sup>	5.46x10 <sup>-3</sup>	1.95x10 <sup>-2</sup>	3.61x10 <sup>-2</sup>	5.43x10 <sup>-3</sup>	2.24x10 <sup>-2</sup>	3.90x10 <sup>-2</sup>
Chromium VI	1.23x10 <sup>-3</sup>	2.01x10 <sup>-4</sup>	1.43x10 <sup>-3</sup>	1.60x10 <sup>-3</sup>	2.58x10 <sup>-4</sup>	1.86x10 <sup>-3</sup>	1.79x10 <sup>-3</sup>	2.78x10 <sup>-4</sup>	2.07x10 <sup>-3</sup>	1.77x10 <sup>-3</sup>	3.27x10 <sup>-4</sup>	2.10x10 <sup>-3</sup>
Ethyl Benzene	9.69x10 <sup>-5</sup>	4.51x10 <sup>-4</sup>	5.48x10 <sup>-4</sup>	1.15x10 <sup>-4</sup>	2.27x10 <sup>-4</sup>	3.42x10 <sup>-4</sup>	1.26x10 <sup>-4</sup>	2.26x10 <sup>-4</sup>	3.52x10 <sup>-4</sup>	1.24x10 <sup>-4</sup>	2.57x10 <sup>-4</sup>	3.81x10 <sup>-4</sup>
Formaldehyde	1.17x10 <sup>-2</sup>	8.28x10 <sup>-2</sup>	1.61x10 <sup>-1</sup>	1.35x10 <sup>-2</sup>	3.94x10 <sup>-2</sup>	1.19x10 <sup>-1</sup>	1.45x10 <sup>-2</sup>	3.97x10 <sup>-2</sup>	1.20x10 <sup>-1</sup>	1.45x10 <sup>-2</sup>	4.48x10 <sup>-2</sup>	1.25x10 <sup>-1</sup>
Hexane	2.17x10 <sup>-3</sup>	1.94x10 <sup>-3</sup>	4.11x10 <sup>-3</sup>	2.45x10 <sup>-3</sup>	1.03x10 <sup>-3</sup>	3.48x10 <sup>-3</sup>	2.63x10 <sup>-3</sup>	9.73x10 <sup>-4</sup>	3.61x10 <sup>-3</sup>	2.59x10 <sup>-3</sup>	1.07x10 <sup>-3</sup>	3.66x10 <sup>-3</sup>
MTBE	2.14x10 <sup>-5</sup>	3.00x10 <sup>-4</sup>	3.21x10 <sup>-4</sup>	2.27x10 <sup>-5</sup>	7.63x10 <sup>-5</sup>	9.90x10 <sup>-5</sup>	2.35x10 <sup>-5</sup>	6.81x10 <sup>-5</sup>	9.16x10 <sup>-5</sup>	2.32x10 <sup>-5</sup>	7.06x10 <sup>-5</sup>	9.38x10 <sup>-5</sup>
Manganese	3.96x10 <sup>-2</sup>	2.73x10 <sup>-4</sup>	3.99x10 <sup>-2</sup>	5.20x10 <sup>-2</sup>	3.61x10 <sup>-4</sup>	5.24x10 <sup>-2</sup>	5.79x10 <sup>-2</sup>	3.93x10 <sup>-4</sup>	5.83x10 <sup>-2</sup>	5.89x10 <sup>-2</sup>	4.72x10 <sup>-4</sup>	5.94x10 <sup>-2</sup>
Naphthalene	1.31x10 <sup>-2</sup>	7.60x10 <sup>-3</sup>	2.07x10 <sup>-2</sup>	1.53x10 <sup>-2</sup>	4.73x10 <sup>-3</sup>	2.00x10 <sup>-2</sup>	1.62x10 <sup>-2</sup>	4.78x10 <sup>-3</sup>	2.10x10 <sup>-2</sup>	1.60x10 <sup>-2</sup>	5.48x10 <sup>-3</sup>	2.14x10 <sup>-2</sup>
Nickel	1.40x10 <sup>-2</sup>	9.97x10 <sup>-4</sup>	1.50x10 <sup>-2</sup>	1.56x10 <sup>-2</sup>	1.20x10 <sup>-3</sup>	1.68x10 <sup>-2</sup>	1.70x10 <sup>-2</sup>	1.28x10 <sup>-3</sup>	1.83x10 <sup>-2</sup>	1.68x10 <sup>-2</sup>	1.46x10 <sup>-3</sup>	1.83x10 <sup>-2</sup>
Styrene	3.66x10 <sup>-5</sup>	4.12x10 <sup>-5</sup>	7.78x10 <sup>-5</sup>	4.62x10 <sup>-5</sup>	2.05x10 <sup>-5</sup>	6.66x10 <sup>-5</sup>	5.25x10 <sup>-5</sup>	2.11x10 <sup>-5</sup>	7.36x10 <sup>-5</sup>	5.30x10 <sup>-5</sup>	2.45x10 <sup>-5</sup>	7.74x10 <sup>-5</sup>
Toluene	2.27x10 <sup>-3</sup>	6.93x10 <sup>-3</sup>	9.20x10 <sup>-3</sup>	2.71x10 <sup>-3</sup>	3.45x10 <sup>-3</sup>	6.16x10 <sup>-3</sup>	2.98x10 <sup>-3</sup>	3.47x10 <sup>-3</sup>	6.45x10 <sup>-3</sup>	2.97x10 <sup>-3</sup>	3.95x10 <sup>-3</sup>	6.93x10 <sup>-3</sup>
Xylenes	5.85x10 <sup>-3</sup>	1.70x10 <sup>-2</sup>	2.43x10 <sup>-2</sup>	7.37x10 <sup>-3</sup>	8.41x10 <sup>-3</sup>	1.72x10 <sup>-2</sup>	8.11x10 <sup>-3</sup>	8.43x10 <sup>-3</sup>	1.80x10 <sup>-2</sup>	8.02x10 <sup>-3</sup>	9.58x10 <sup>-3</sup>	1.90x10 <sup>-2</sup>
<b>Organ Systems</b>												
Developmental	9.69x10 <sup>-5</sup>	4.51x10 <sup>-4</sup>	5.48x10 <sup>-4</sup>	1.15x10 <sup>-4</sup>	2.27x10 <sup>-4</sup>	3.42x10 <sup>-4</sup>	1.26x10 <sup>-4</sup>	2.26x10 <sup>-4</sup>	3.52x10 <sup>-4</sup>	1.24x10 <sup>-4</sup>	2.57x10 <sup>-4</sup>	3.81x10 <sup>-4</sup>
Immune	1.89x10 <sup>-2</sup>	3.56x10 <sup>-2</sup>	6.57x10 <sup>-2</sup>	2.08x10 <sup>-2</sup>	2.03x10 <sup>-2</sup>	5.24x10 <sup>-2</sup>	2.24x10 <sup>-2</sup>	2.08x10 <sup>-2</sup>	5.44x10 <sup>-2</sup>	2.22x10 <sup>-2</sup>	2.39x10 <sup>-2</sup>	5.73x10 <sup>-2</sup>
Kidney	2.14x10 <sup>-5</sup>	3.00x10 <sup>-4</sup>	3.21x10 <sup>-4</sup>	2.27x10 <sup>-5</sup>	7.63x10 <sup>-5</sup>	9.90x10 <sup>-5</sup>	2.35x10 <sup>-5</sup>	6.81x10 <sup>-5</sup>	9.16x10 <sup>-5</sup>	2.32x10 <sup>-5</sup>	7.06x10 <sup>-5</sup>	9.38x10 <sup>-5</sup>
Liver System	2.14x10 <sup>-5</sup>	3.00x10 <sup>-4</sup>	3.21x10 <sup>-4</sup>	2.27x10 <sup>-5</sup>	7.63x10 <sup>-5</sup>	9.90x10 <sup>-5</sup>	2.35x10 <sup>-5</sup>	6.81x10 <sup>-5</sup>	9.16x10 <sup>-5</sup>	2.32x10 <sup>-5</sup>	7.06x10 <sup>-5</sup>	9.38x10 <sup>-5</sup>
Neurological	4.99x10 <sup>-2</sup>	2.62x10 <sup>-2</sup>	7.75x10 <sup>-2</sup>	6.46x10 <sup>-2</sup>	1.33x10 <sup>-2</sup>	7.93x10 <sup>-2</sup>	7.17x10 <sup>-2</sup>	1.33x10 <sup>-2</sup>	8.64x10 <sup>-2</sup>	7.26x10 <sup>-2</sup>	1.51x10 <sup>-2</sup>	8.91x10 <sup>-2</sup>
Ocular	2.14x10 <sup>-5</sup>	3.00x10 <sup>-4</sup>	3.21x10 <sup>-4</sup>	2.27x10 <sup>-5</sup>	7.63x10 <sup>-5</sup>	9.90x10 <sup>-5</sup>	2.35x10 <sup>-5</sup>	6.81x10 <sup>-5</sup>	9.16x10 <sup>-5</sup>	2.32x10 <sup>-5</sup>	7.06x10 <sup>-5</sup>	9.38x10 <sup>-5</sup>
Reproductive	8.81x10 <sup>-3</sup>	4.32x10 <sup>-2</sup>	7.39x10 <sup>-2</sup>	8.26x10 <sup>-3</sup>	1.98x10 <sup>-2</sup>	4.96x10 <sup>-2</sup>	8.13x10 <sup>-3</sup>	2.05x10 <sup>-2</sup>	5.00x10 <sup>-2</sup>	7.78x10 <sup>-3</sup>	2.36x10 <sup>-2</sup>	5.26x10 <sup>-2</sup>
Respiratory	1.48x10 <sup>0</sup>	4.94x10 <sup>0</sup>	6.54x10 <sup>0</sup>	1.34x10 <sup>0</sup>	2.46x10 <sup>0</sup>	3.92x10 <sup>0</sup>	1.33x10 <sup>0</sup>	2.54x10 <sup>0</sup>	3.99x10 <sup>0</sup>	1.32x10 <sup>0</sup>	2.92x10 <sup>0</sup>	4.35x10 <sup>0</sup>

**Table 60.** Control national average hazard quotients (HAPs) and hazard indices (organ systems) for 2015, 2020, and 2030. Total includes background.

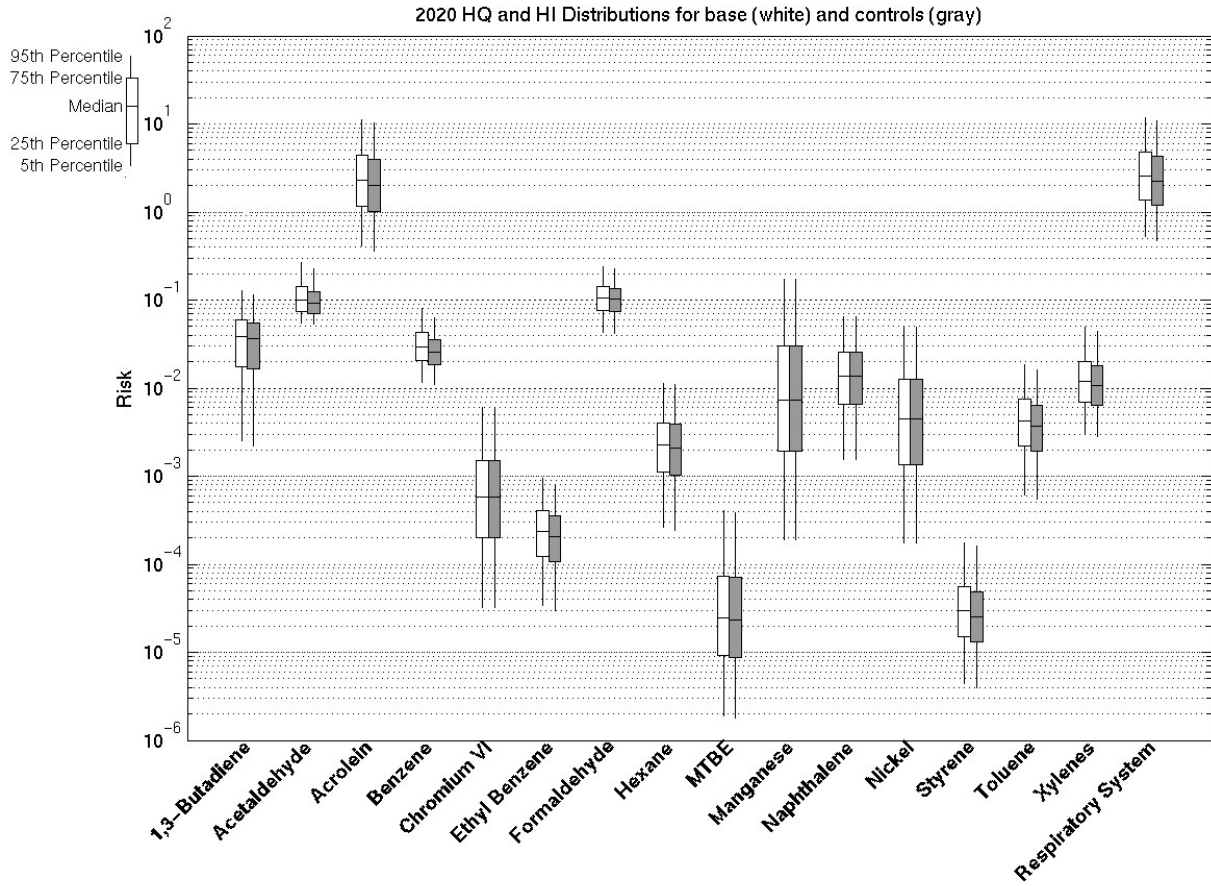
HAP	Year								
	2015			2020			2030		
	Stationary	Mobile	Total	Stationary	Mobile	Total	Stationary	Mobile	Total
1,3-Butadiene	8.26x10 <sup>-3</sup>	1.74x10 <sup>-2</sup>	4.71x10 <sup>-2</sup>	8.13x10 <sup>-3</sup>	1.67x10 <sup>-2</sup>	4.62x10 <sup>-2</sup>	7.78x10 <sup>-3</sup>	1.74x10 <sup>-2</sup>	4.64x10 <sup>-2</sup>
Acetaldehyde	8.66x10 <sup>-3</sup>	5.60x10 <sup>-2</sup>	1.14x10 <sup>-1</sup>	8.91x10 <sup>-3</sup>	5.19x10 <sup>-2</sup>	1.10x10 <sup>-1</sup>	8.93x10 <sup>-3</sup>	5.34x10 <sup>-2</sup>	1.11x10 <sup>-1</sup>
Acrolein	1.28x10 <sup>0</sup>	2.09x10 <sup>0</sup>	3.38x10 <sup>0</sup>	1.27x10 <sup>0</sup>	2.02x10 <sup>0</sup>	3.29x10 <sup>0</sup>	1.26x10 <sup>0</sup>	2.13x10 <sup>0</sup>	3.39x10 <sup>0</sup>
Benzene	5.19x10 <sup>-3</sup>	1.48x10 <sup>-2</sup>	3.12x10 <sup>-2</sup>	5.39x10 <sup>-3</sup>	1.37x10 <sup>-2</sup>	3.03x10 <sup>-2</sup>	5.36x10 <sup>-3</sup>	1.40x10 <sup>-2</sup>	3.05x10 <sup>-2</sup>
Chromium VI	1.60x10 <sup>-3</sup>	2.58x10 <sup>-4</sup>	1.86x10 <sup>-3</sup>	1.79x10 <sup>-3</sup>	2.78x10 <sup>-4</sup>	2.07x10 <sup>-3</sup>	1.77x10 <sup>-3</sup>	3.27x10 <sup>-4</sup>	2.10x10 <sup>-3</sup>
Ethyl Benzene	1.15x10 <sup>-4</sup>	1.97x10 <sup>-4</sup>	3.12x10 <sup>-4</sup>	1.26x10 <sup>-4</sup>	1.81x10 <sup>-4</sup>	3.07x10 <sup>-4</sup>	1.24x10 <sup>-4</sup>	1.86x10 <sup>-4</sup>	3.09x10 <sup>-4</sup>
Formaldehyde	1.35x10 <sup>-2</sup>	3.57x10 <sup>-2</sup>	1.16x10 <sup>-1</sup>	1.45x10 <sup>-2</sup>	3.40x10 <sup>-2</sup>	1.15x10 <sup>-1</sup>	1.45x10 <sup>-2</sup>	3.58x10 <sup>-2</sup>	1.17x10 <sup>-1</sup>
Hexane	2.45x10 <sup>-3</sup>	9.26x10 <sup>-4</sup>	3.38x10 <sup>-3</sup>	2.63x10 <sup>-3</sup>	8.27x10 <sup>-4</sup>	3.46x10 <sup>-3</sup>	2.59x10 <sup>-3</sup>	8.52x10 <sup>-4</sup>	3.44x10 <sup>-3</sup>
MTBE	2.27x10 <sup>-5</sup>	7.28x10 <sup>-5</sup>	9.55x10 <sup>-5</sup>	2.35x10 <sup>-5</sup>	6.36x10 <sup>-5</sup>	8.71x10 <sup>-5</sup>	2.32x10 <sup>-5</sup>	6.45x10 <sup>-5</sup>	8.77x10 <sup>-5</sup>
Manganese	5.20x10 <sup>-2</sup>	3.61x10 <sup>-4</sup>	5.24x10 <sup>-2</sup>	5.79x10 <sup>-2</sup>	3.93x10 <sup>-4</sup>	5.83x10 <sup>-2</sup>	5.89x10 <sup>-2</sup>	4.72x10 <sup>-4</sup>	5.94x10 <sup>-2</sup>
Naphthalene	1.53x10 <sup>-2</sup>	4.73x10 <sup>-3</sup>	2.00x10 <sup>-2</sup>	1.62x10 <sup>-2</sup>	4.78x10 <sup>-3</sup>	2.10x10 <sup>-2</sup>	1.60x10 <sup>-2</sup>	5.48x10 <sup>-3</sup>	2.14x10 <sup>-2</sup>
Nickel	1.56x10 <sup>-2</sup>	1.20x10 <sup>-3</sup>	1.68x10 <sup>-2</sup>	1.70x10 <sup>-2</sup>	1.28x10 <sup>-3</sup>	1.83x10 <sup>-2</sup>	1.68x10 <sup>-2</sup>	1.46x10 <sup>-3</sup>	1.83x10 <sup>-2</sup>
Styrene	4.62x10 <sup>-5</sup>	1.70x10 <sup>-5</sup>	6.32x10 <sup>-5</sup>	5.25x10 <sup>-5</sup>	1.57x10 <sup>-5</sup>	6.82x10 <sup>-5</sup>	5.30x10 <sup>-5</sup>	1.58x10 <sup>-5</sup>	6.88x10 <sup>-5</sup>
Toluene	2.71x10 <sup>-3</sup>	2.94x10 <sup>-3</sup>	5.65x10 <sup>-3</sup>	2.98x10 <sup>-3</sup>	2.67x10 <sup>-3</sup>	5.65x10 <sup>-3</sup>	2.97x10 <sup>-3</sup>	2.70x10 <sup>-3</sup>	5.67x10 <sup>-3</sup>
Xylenes	7.37x10 <sup>-3</sup>	7.27x10 <sup>-3</sup>	1.61x10 <sup>-2</sup>	8.11x10 <sup>-3</sup>	6.68x10 <sup>-3</sup>	1.62x10 <sup>-2</sup>	8.02x10 <sup>-3</sup>	6.83x10 <sup>-3</sup>	1.63x10 <sup>-2</sup>
<b>Organ Systems</b>									
Developmental	1.15x10 <sup>-4</sup>	1.97x10 <sup>-4</sup>	3.12x10 <sup>-4</sup>	1.26x10 <sup>-4</sup>	1.81x10 <sup>-4</sup>	3.07x10 <sup>-4</sup>	1.24x10 <sup>-4</sup>	1.86x10 <sup>-4</sup>	3.09x10 <sup>-4</sup>
Immune	2.08x10 <sup>-2</sup>	1.60x10 <sup>-2</sup>	4.80x10 <sup>-2</sup>	2.24x10 <sup>-2</sup>	1.50x10 <sup>-2</sup>	4.85x10 <sup>-2</sup>	2.22x10 <sup>-2</sup>	1.55x10 <sup>-2</sup>	4.88x10 <sup>-2</sup>
Kidney	2.27x10 <sup>-5</sup>	7.28x10 <sup>-5</sup>	9.55x10 <sup>-5</sup>	2.35x10 <sup>-5</sup>	6.36x10 <sup>-5</sup>	8.71x10 <sup>-5</sup>	2.32x10 <sup>-5</sup>	6.45x10 <sup>-5</sup>	8.77x10 <sup>-5</sup>
Liver System	2.27x10 <sup>-5</sup>	7.28x10 <sup>-5</sup>	9.55x10 <sup>-5</sup>	2.35x10 <sup>-5</sup>	6.36x10 <sup>-5</sup>	8.71x10 <sup>-5</sup>	2.32x10 <sup>-5</sup>	6.45x10 <sup>-5</sup>	8.77x10 <sup>-5</sup>
Neurological	6.46x10 <sup>-2</sup>	1.15x10 <sup>-2</sup>	7.76x10 <sup>-2</sup>	7.17x10 <sup>-2</sup>	1.06x10 <sup>-2</sup>	8.37x10 <sup>-2</sup>	7.26x10 <sup>-2</sup>	1.09x10 <sup>-2</sup>	8.49x10 <sup>-2</sup>
Ocular System	2.27x10 <sup>-5</sup>	7.28x10 <sup>-5</sup>	9.55x10 <sup>-5</sup>	2.35x10 <sup>-5</sup>	6.36x10 <sup>-5</sup>	8.71x10 <sup>-5</sup>	2.32x10 <sup>-5</sup>	6.45x10 <sup>-5</sup>	8.77x10 <sup>-5</sup>
Reproductive	8.26x10 <sup>-3</sup>	1.74x10 <sup>-2</sup>	4.71x10 <sup>-2</sup>	8.13x10 <sup>-3</sup>	1.67x10 <sup>-2</sup>	4.62x10 <sup>-2</sup>	7.78x10 <sup>-3</sup>	1.74x10 <sup>-2</sup>	4.64x10 <sup>-2</sup>
Respiratory	1.34x10 <sup>0</sup>	2.19x10 <sup>0</sup>	3.65x10 <sup>0</sup>	1.33x10 <sup>0</sup>	2.12x10 <sup>0</sup>	3.56x10 <sup>0</sup>	1.32x10 <sup>0</sup>	2.23x10 <sup>0</sup>	3.67x10 <sup>0</sup>



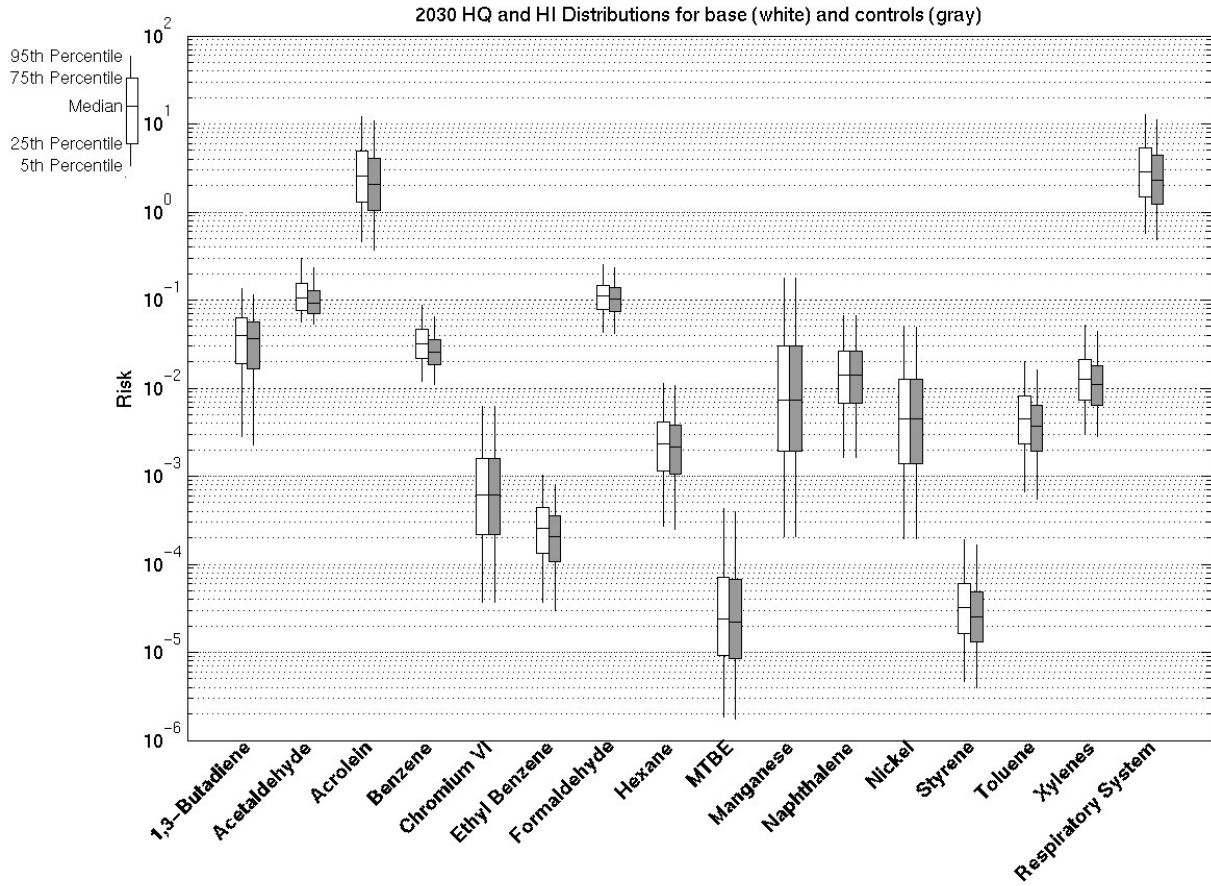
**Figure 74.** 1999 base national HAPEM6 hazard quotient (HAPs) and hazard index (respiratory system) distributions.



**Figure 75.** 2015 base (white) and control (gray) national HAPEM6 hazard quotient (HAPs) and hazard index (respiratory system) distributions.

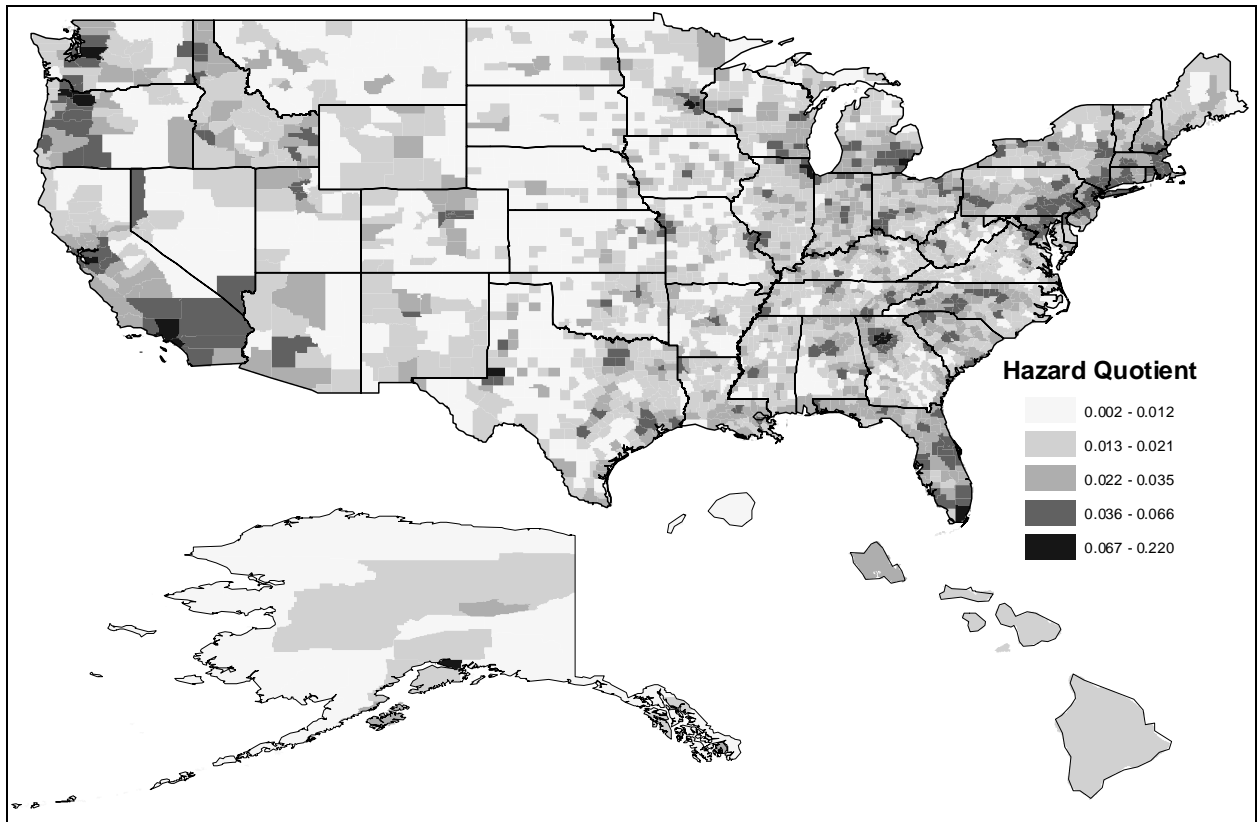


**Figure 76.** 2020 base (white) and control (gray) national HAPEM6 hazard quotient (HAPs) and hazard index (respiratory system) distributions.

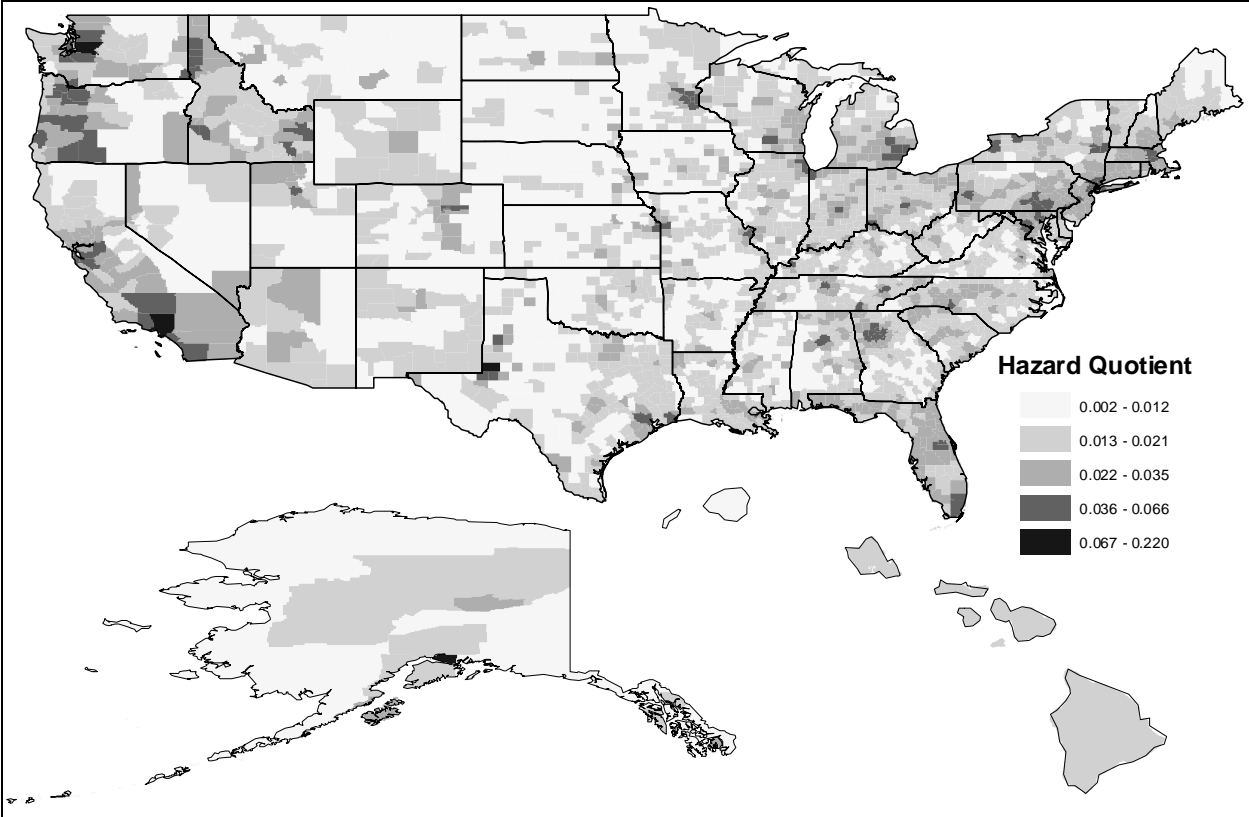


**Figure 77.** 2030 base (white) and control (gray) national HAPEM6 hazard quotient (HAPs) and hazard index (respiratory system) distributions.

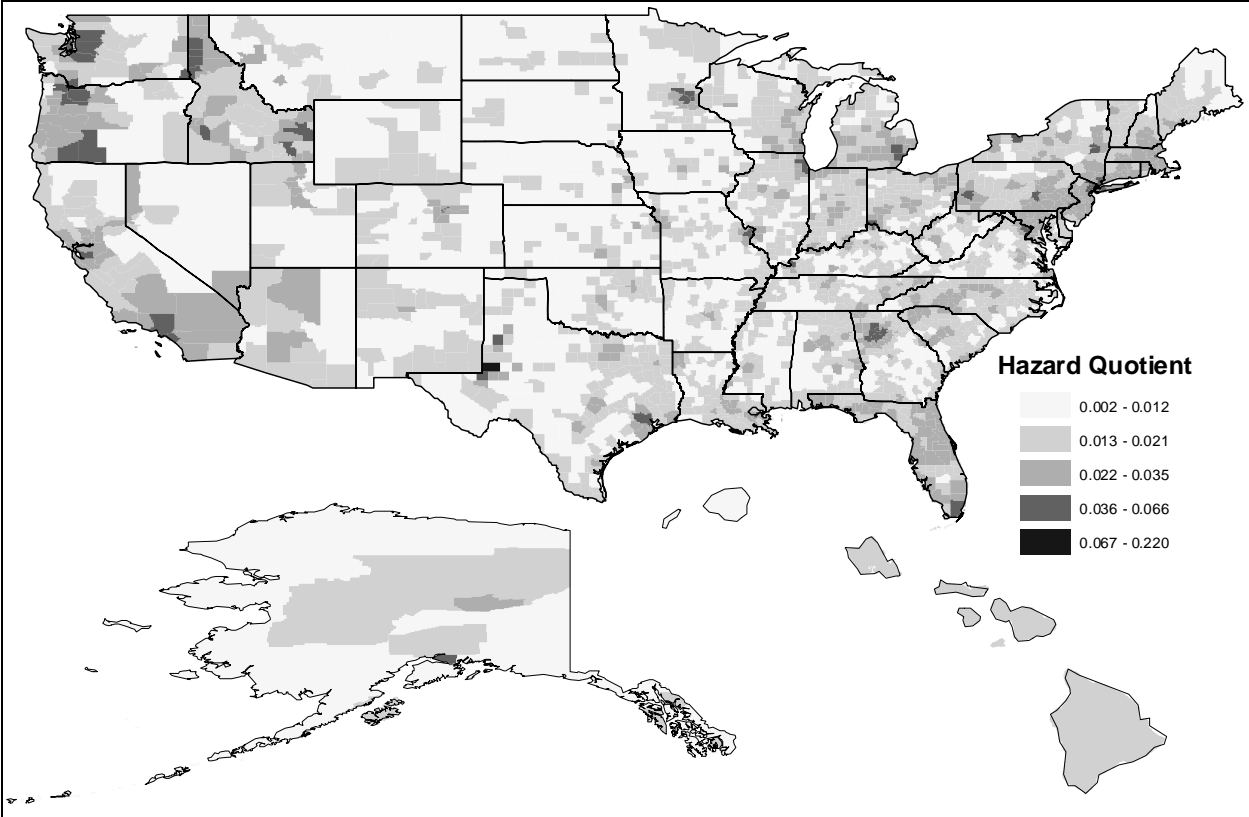




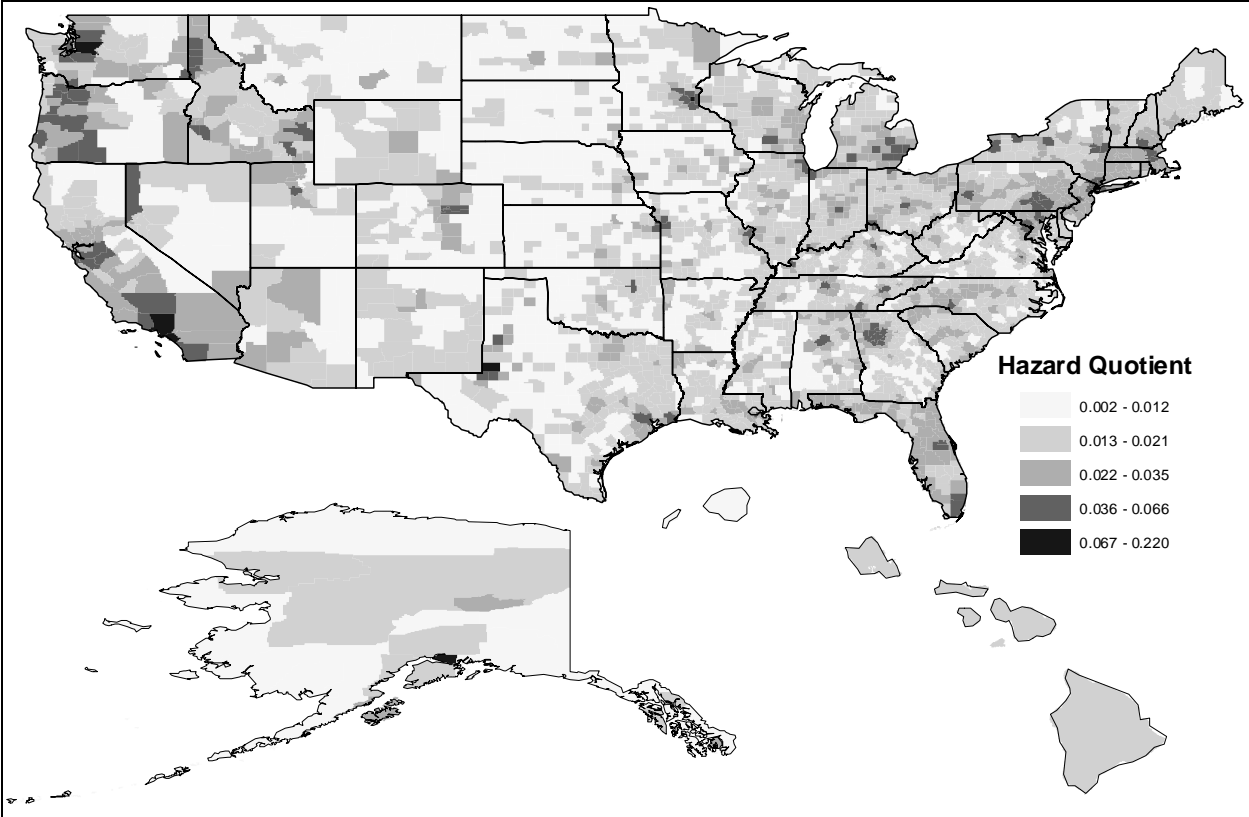
**Figure 78.** 1999 base county level median total (all sources and background) hazard quotient for benzene.



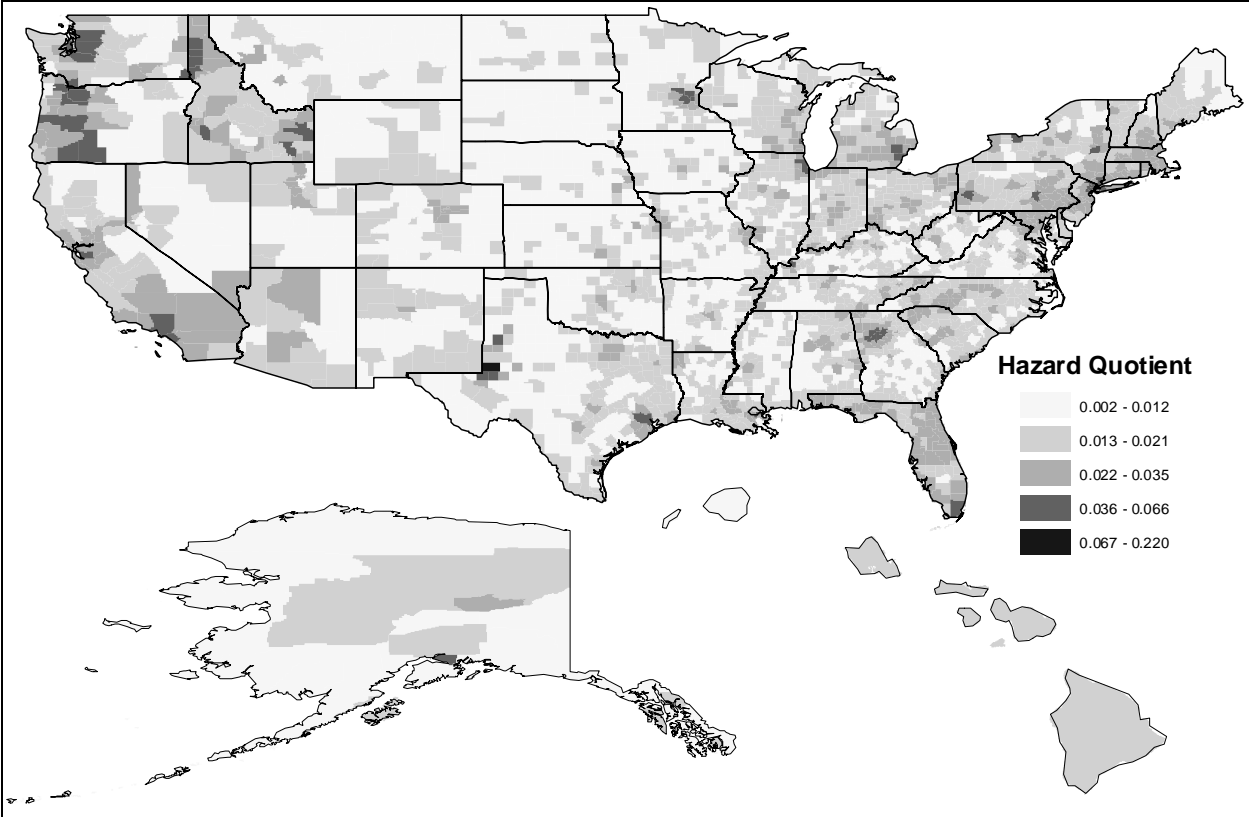
**Figure 79.** 2015 base county level median total (all sources and background) hazard quotient for benzene.



**Figure 80.** 2015 control county level median total (all sources and background) hazard quotient for benzene.



**Figure 81.** 2020 base county level median total (all sources and background) hazard quotient for benzene.



**Figure 82.** 2020 control county level median total (all sources and background) hazard quotient for benzene.

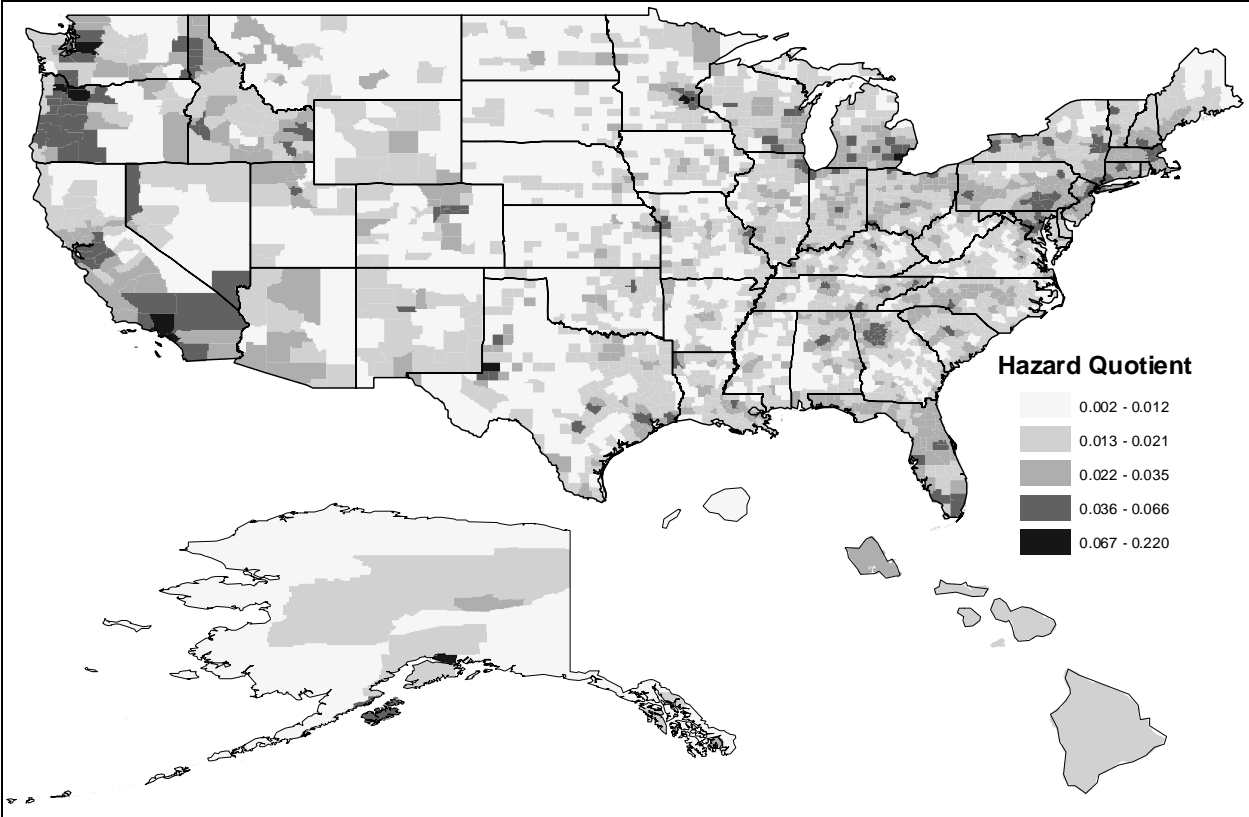
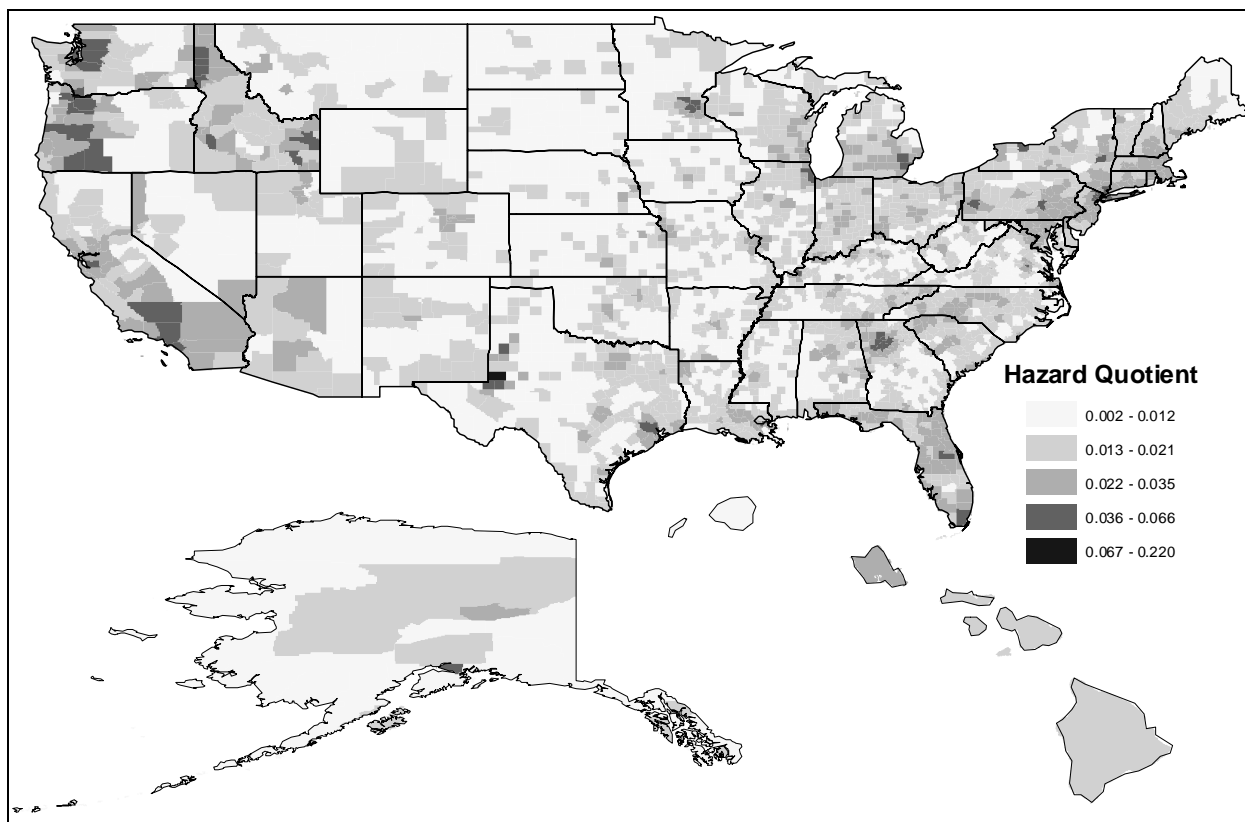


Figure 83. 2030 base county level median total (all sources and background) hazard quotient for benzene.



**Figure 84.** 2030 control county level median total (all sources and background) hazard quotient for benzene.

### 8.3 Cancer and non-cancer population bin calculations

#### 8.3.1 Using 30 replicates per tract

In addition to calculating cancer risk and hazard quotients and indices, population totals for several cancer risk bins for total risk and benzene were calculated as were hazard quotient bins for benzene and hazard index bins for the respiratory system. Populations were calculated for each source category and year. For 1999, the population file used for HAPEM6 was used. For 2015, 2020, and 2030, projected populations as described in Section 8.1 were used, using the same methodology as for risk and non-cancer calculations. Each tract population was divided by 30 and assigned to each of the 30 replicates per tract. Next each risk or hazard quotient or index was assigned a bin as listed below. For risk, four bins were used:

- Risk  $\geq 1 \times 10^{-4}$
- $1 \times 10^{-5} \leq \text{Risk} < 1 \times 10^{-4}$
- $1 \times 10^{-6} \leq \text{Risk} < 1 \times 10^{-5}$
- Risk  $< 1 \times 10^{-6}$

For hazard quotients or hazard index, four bins were used as well:

- $HQ \text{ or } HI \geq 10$
- $1 \leq HQ \text{ or } HI < 10$
- $\leq HQ \text{ or } HI < 1$
- $HQ \text{ or } HI < 0.1$

After assigning the bins, populations were totaled for each bin. Results for total risk are shown in Table 61 and the respiratory system in Table 62. Figures 85 and 86 show the contribution to total population of each risk bin for total risk and Figures 87 and 88 show the contribution to total population for each HI bin for the respiratory system. Full cancer results can be found in `risk_bins_benzene.xls` for benzene and `risk_bins_total.xls`, and full non-cancer results can be found in `hq_bins_benzene.xls` for benzene and `hi_bins_respiratory.xls` for respiratory HI in the MSAT docket, EPA-HQ-OAR-2005-0036.

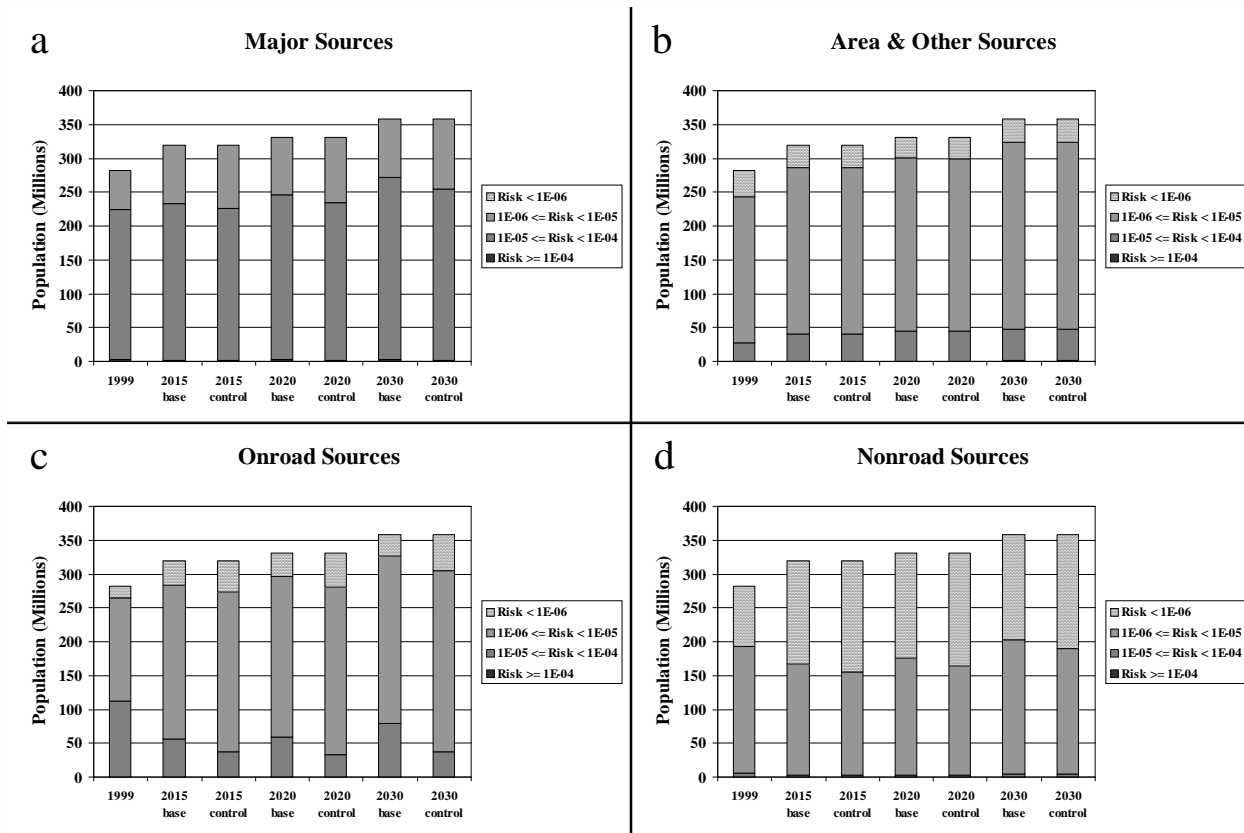


**Table 61.** Populations by source category, year, and inventory scenario for total risk (all HAPs).

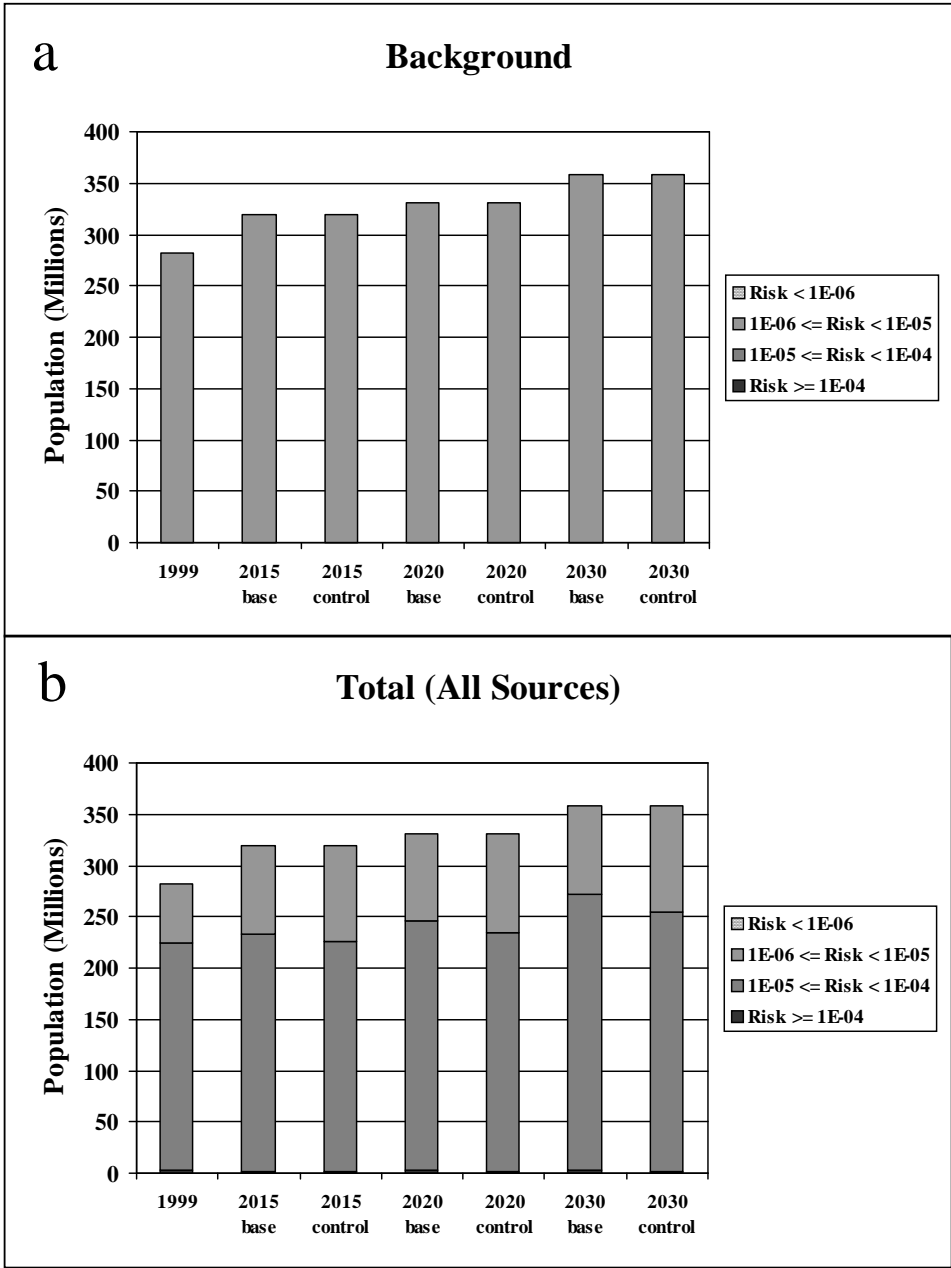
Source Category	Risk Bin	Year						
		1999	2015		2020		2030	
		Base	Base	Control	Base	Control	Base	Control
Major	Risk $\geq 1 \times 10^{-4}$	177,427	235,655	235,655	294,703	294,647	319,267	319,206
	$1 \times 10^{-5} \leq$ Risk $< 1 \times 10^{-4}$	3,653,632	4,580,463	4,580,680	5,602,975	5,601,950	5,978,093	5,976,982
	$1 \times 10^{-6} \leq$ Risk $< 1 \times 10^{-5}$	52,124,755	52,956,519	52,909,970	58,287,730	58,220,563	62,207,167	62,136,898
	Risk $< 1 \times 10^{-6}$	225,415,633	260,970,190	261,016,522	267,345,488	267,413,735	289,229,189	289,300,631
	<b>Total Population</b>	<b>281,371,447</b>	<b>318,742,826</b>	<b>318,742,826</b>	<b>331,530,896</b>	<b>331,530,896</b>	<b>357,733,717</b>	<b>357,733,717</b>
Area & Other	Risk $\geq 1 \times 10^{-4}$	353,339	569,243	569,629	686,688	686,152	727,560	727,064
	$1 \times 10^{-5} \leq$ Risk $< 1 \times 10^{-4}$	27,605,534	39,136,624	39,039,809	43,883,767	43,759,448	46,345,212	46,212,312
	$1 \times 10^{-6} \leq$ Risk $< 1 \times 10^{-5}$	215,434,769	246,412,050	246,176,063	255,458,853	255,243,345	276,938,226	276,703,915
	Risk $< 1 \times 10^{-6}$	37,977,806	32,624,910	32,957,326	31,501,587	31,841,950	33,722,718	34,090,426
	<b>Total Population</b>	<b>281,371,447</b>	<b>318,742,826</b>	<b>318,742,826</b>	<b>331,530,896</b>	<b>331,530,896</b>	<b>357,733,717</b>	<b>357,733,717</b>
Onroad	Risk $\geq 1 \times 10^{-4}$	610,144	88,442	41,322	97,548	30,927	183,677	37,643
	$1 \times 10^{-5} \leq$ Risk $< 1 \times 10^{-4}$	112,200,362	55,685,221	37,672,407	59,409,983	32,943,892	79,320,335	37,123,184
	$1 \times 10^{-6} \leq$ Risk $< 1 \times 10^{-5}$	152,471,535	227,109,654	235,058,031	236,627,982	247,933,400	246,809,753	267,807,157
	Risk $< 1 \times 10^{-6}$	16,089,406	35,859,509	45,971,066	35,395,383	50,622,677	31,419,951	52,765,733
	<b>Total Population</b>	<b>281,371,447</b>	<b>318,742,826</b>	<b>318,742,826</b>	<b>331,530,896</b>	<b>331,530,896</b>	<b>357,733,717</b>	<b>357,733,717</b>
Nonroad	Risk $\geq 1 \times 10^{-4}$	21,732	27,925	28,045	30,288	30,292	35,376	35,450
	$1 \times 10^{-5} \leq$ Risk $< 1 \times 10^{-4}$	5,143,886	2,356,284	2,188,411	2,851,960	2,658,457	4,366,467	4,080,827
	$1 \times 10^{-6} \leq$ Risk $< 1 \times 10^{-5}$	187,310,440	164,408,077	153,869,921	172,560,496	161,415,357	198,712,690	186,459,218
	Risk $< 1 \times 10^{-6}$	88,895,390	151,950,541	162,656,449	156,088,153	167,426,790	154,619,184	167,158,223
	<b>Total Population</b>	<b>281,371,447</b>	<b>318,742,826</b>	<b>318,742,826</b>	<b>331,530,896</b>	<b>331,530,896</b>	<b>357,733,717</b>	<b>357,733,717</b>
Background	Risk $\geq 1 \times 10^{-4}$	0	0	0	0	0	0	0
	$1 \times 10^{-5} \leq$ Risk $< 1 \times 10^{-4}$	0	0	0	0	0	0	0
	$1 \times 10^{-6} \leq$ Risk $< 1 \times 10^{-5}$	281,371,104	318,742,482	318,742,482	331,530,551	331,530,551	357,733,371	357,733,371
	Risk $< 1 \times 10^{-6}$	343	345	345	345	345	346	346
	<b>Total Population</b>	<b>281,371,447</b>	<b>318,742,826</b>	<b>318,742,826</b>	<b>331,530,896</b>	<b>331,530,896</b>	<b>357,733,717</b>	<b>357,733,717</b>
Total	Risk $\geq 1 \times 10^{-4}$	3,345,788	1,884,453	1,542,694	2,290,317	1,772,847	2,955,506	1,960,343
	$1 \times 10^{-5} \leq$ Risk $< 1 \times 10^{-4}$	220,583,326	231,598,109	223,791,213	243,699,842	232,960,339	268,745,425	253,003,857
	$1 \times 10^{-6} \leq$ Risk $< 1 \times 10^{-5}$	57,442,329	85,260,257	93,408,911	85,540,729	96,797,701	86,032,777	102,769,508
	Risk $< 1 \times 10^{-6}$	5	8	8	8	8	9	10
	<b>Total Population</b>	<b>281,371,447</b>	<b>318,742,826</b>	<b>318,742,826</b>	<b>331,530,896</b>	<b>331,530,896</b>	<b>357,733,717</b>	<b>357,733,717</b>

**Table 62.** Populations by source category, year, and inventory scenario for the respiratory system.

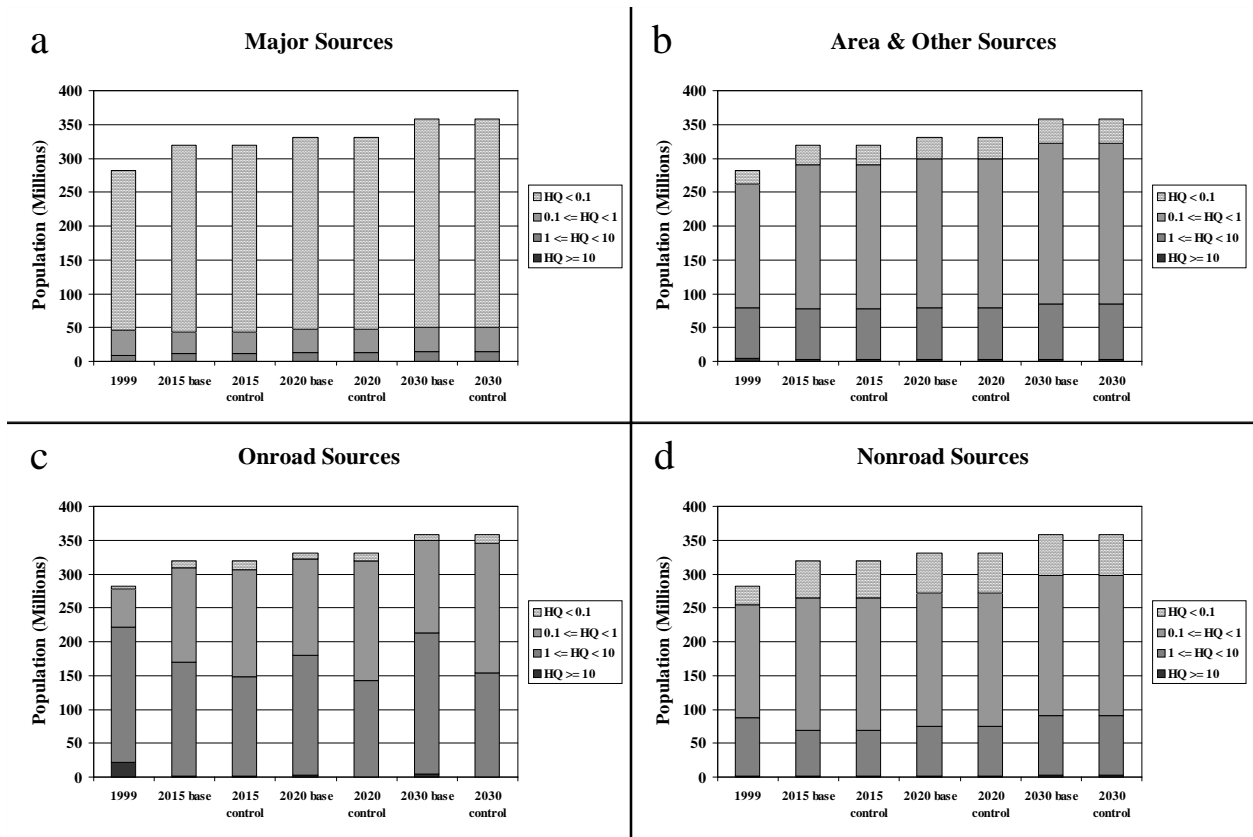
Source Category	HI Bin	Year						
		1999	2015		2020		2030	
		Base	Base	Control	Base	Control	Base	Control
Major	HI ≥ 10	250,650	481,602	481,602	653,239	653,239	707,599	707,599
	1 ≤ HI < 10	8,701,133	11,237,253	11,237,253	12,853,515	12,853,515	13,840,575	13,840,575
	0.1 ≤ HI < 1	37,350,955	31,834,691	31,834,691	33,873,444	33,873,444	36,026,687	36,026,687
	HI < 0.1	235,068,708	275,189,280	275,189,280	284,150,698	284,150,698	307,158,856	307,158,856
	<b>Total Population</b>	<b>281,371,447</b>	<b>318,742,826</b>	<b>318,742,826</b>	<b>331,530,896</b>	<b>331,530,896</b>	<b>357,733,717</b>	<b>357,733,717</b>
Area & Other	HI ≥ 10	4,810,434	2,877,705	2,877,705	2,459,707	2,459,707	2,677,429	2,677,429
	1 ≤ HI < 10	74,837,165	74,861,202	74,861,202	76,107,039	76,107,039	82,108,831	82,108,831
	0.1 ≤ HI < 1	181,704,642	212,856,140	212,856,140	220,062,054	220,062,054	237,882,484	237,882,484
	HI < 0.1	20,019,206	28,147,780	28,147,780	32,902,096	32,902,096	35,064,973	35,064,973
	<b>Total Population</b>	<b>281,371,447</b>	<b>318,742,826</b>	<b>318,742,826</b>	<b>331,530,896</b>	<b>331,530,896</b>	<b>357,733,717</b>	<b>357,733,717</b>
Onroad	HI ≥ 10	21,346,190	2,033,906	846,455	2,254,408	541,515	4,156,080	618,861
	1 ≤ HI < 10	200,491,851	167,339,959	147,315,692	177,081,890	141,801,606	208,374,099	153,586,546
	0.1 ≤ HI < 1	56,116,605	139,706,192	159,016,750	143,018,058	176,692,701	137,392,182	190,557,803
	HI < 0.1	3,416,801	9,662,769	11,563,929	9,176,539	12,495,075	7,811,357	12,970,508
	<b>Total Population</b>	<b>281,371,447</b>	<b>318,742,826</b>	<b>318,742,826</b>	<b>331,530,896</b>	<b>331,530,896</b>	<b>357,733,717</b>	<b>357,733,717</b>
Nonroad	HI ≥ 10	1,263,955	1,510,114	1,510,214	1,806,374	1,805,919	2,502,691	2,503,287
	1 ≤ HI < 10	86,416,125	67,994,457	68,017,130	73,648,016	73,663,085	88,826,632	88,815,090
	0.1 ≤ HI < 1	166,963,366	195,089,909	195,140,711	196,944,463	197,003,022	205,830,365	205,880,524
	HI < 0.1	26,728,001	54,148,347	54,074,772	59,132,043	59,058,869	60,574,030	60,534,816
	<b>Total Population</b>	<b>281,371,447</b>	<b>318,742,826</b>	<b>318,742,826</b>	<b>331,530,896</b>	<b>331,530,896</b>	<b>357,733,717</b>	<b>357,733,717</b>
Background	HI ≥ 10	0	0	0	0	0	0	0
	1 ≤ HI < 10	0	0	0	0	0	0	0
	0.1 ≤ HI < 1	218,595,138	247,677,369	247,677,369	257,623,739	257,623,739	278,003,622	278,003,622
	HI < 0.1	62,776,309	71,065,457	71,065,457	73,907,157	73,907,157	79,730,095	79,730,095
	<b>Total Population</b>	<b>281,371,447</b>	<b>318,742,826</b>	<b>318,742,826</b>	<b>331,530,896</b>	<b>331,530,896</b>	<b>357,733,717</b>	<b>357,733,717</b>
Total	HI ≥ 10	52,982,383	24,540,632	21,830,744	26,156,624	21,990,016	32,709,422	25,261,964
	1 ≤ HI < 10	205,143,419	240,724,948	237,796,107	251,566,896	245,506,348	274,525,452	265,054,379
	0.1 ≤ HI < 1	23,160,783	53,295,211	58,912,537	53,628,384	63,816,593	50,341,709	67,195,938
	HI < 0.1	84,862	182,035	203,439	178,992	217,939	157,135	221,435
	<b>Total Population</b>	<b>281,371,447</b>	<b>318,742,826</b>	<b>318,742,826</b>	<b>331,530,896</b>	<b>331,530,896</b>	<b>357,733,717</b>	<b>357,733,717</b>



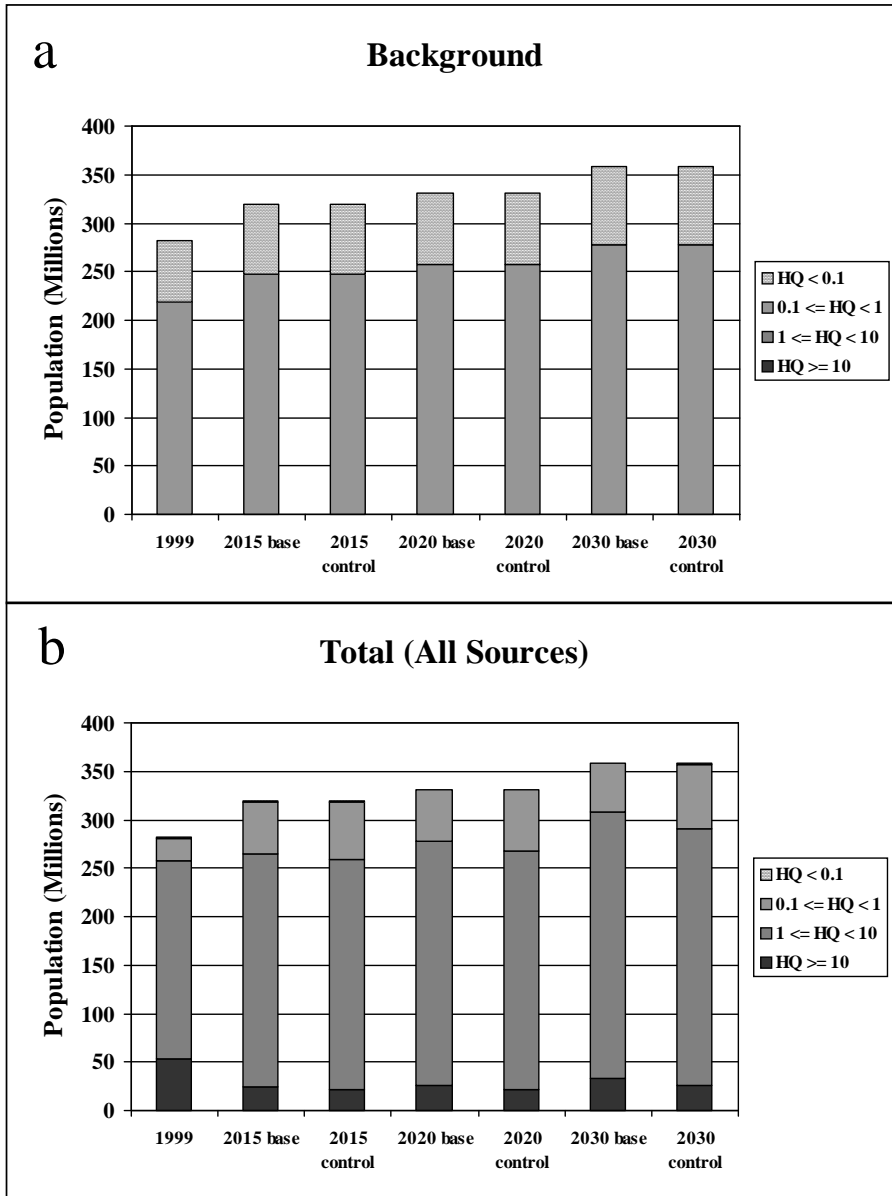
**Figure 85.** Populations of risk bins for total risk (all HAPs) by year and scenario for a) major sources, b) area & other sources, c) onroad sources and d) nonroad sources.



**Figure 86.** Populations of risk bins for total risk (all HAPs) by year and scenario for a) background sources and b) all sources.



**Figure 87.** Populations of non-cancer HI bins for the respiratory system by year and scenario for a) major sources, b) area & other sources, c) onroad sources and d) nonroad sources.



**Figure 88.** Populations of non-cancer HI bins for the respiratory system by year and scenario for a) background sources and b) all sources.

### ***8.3.2 Comparison of risk methods***

The current method to calculate risk and hazard quotients, is to use the 30 replicate risks and HQ and associated populations to calculate statistics and population bins. Using this method allows for intra-tract variations. That is, not all people in the tract are exposed to the same risk. In the past, the method of calculating risk was to use the tract median HAP concentration and calculate risk or HQ by applying the URE or RfC for each HAP. In this method, all the people in the tract are assumed to be exposed to the same risk. That is, there is no intra-tract variability. This method was the method used for the 1996 NATA (U.S. EPA, 2002b) and 1999 NATA (U.S. EPA, 2006a).

Comparisons were made between the two methods, using 30 replicates and using the tract median concentration for toxic calculations. Table 63 shows the populations for each year and inventory scenario for total risk (all HAPs and sources) using the current method (denoted as MSAT approach) and the past method (NATA approach) along with percent differences. Table 64 shows the same for respiratory hazard indices. Full summaries with charts can be found for each year in risk\_bins\_comp\_1999\_base.xls, risk\_bins\_comp\_2015\_base.xls, risk\_bins\_comp\_2015\_con.xls, risk\_bins\_comp\_2020\_base.xls, risk\_bins\_comp\_2020\_con.xls, risk\_bins\_comp\_2030\_base.xls, risk\_bins\_comp\_2030\_con.xls, hi\_bins\_comp\_1999\_base.xls, hi\_bins\_comp\_2015\_base.xls, hi\_bins\_comp\_2015\_con.xls, hi\_bins\_comp\_2020\_base.xls, hi\_bins\_comp\_2020\_con.xls, hi\_bins\_comp\_2030\_base.xls, and hi\_bins\_comp\_2030\_con.xls in the MSAT docket, EPA-HQ-OAR-2005-0036.

**Table 63.** Populations and percent differences (MSAT-NATA) of risk bins using the MSAT method and NATA method for 1999, 2015, 2020, and 2030.

Year	Scenario	Bin	MSAT	NATA	Percent Difference
1999	Base	Risk $\geq 1 \times 10^{-4}$	3,345,787.83	1,667,155.00	100.69%
		$1 \times 10^{-5} \leq$ Risk $< 1 \times 10^{-4}$	220,583,325.53	218,961,073.00	0.74%
		$1 \times 10^{-6} \leq$ Risk $< 1 \times 10^{-5}$	57,442,328.63	60,743,214.00	-5.43%
		Risk $< 1 \times 10^{-6}$	5.00	5.00	0.00%
		<b>Total Population</b>	281,371,447.00	281,371,447.00	0.00%
2015	Base	Risk $\geq 1 \times 10^{-4}$	235,654.93	189,821.11	24.15%
		$1 \times 10^{-5} \leq$ Risk $< 1 \times 10^{-4}$	4,580,462.61	4,043,640.10	13.28%
		$1 \times 10^{-6} \leq$ Risk $< 1 \times 10^{-5}$	52,956,519.03	50,776,300.04	4.29%
		Risk $< 1 \times 10^{-6}$	260,970,189.88	263,733,065.20	-1.05%
		<b>Total Population</b>	318,742,826.45	318,742,826.45	0.00%
	Control	Risk $\geq 1 \times 10^{-4}$	1,542,694.34	1,127,608.72	36.81%
		$1 \times 10^{-5} \leq$ Risk $< 1 \times 10^{-4}$	223,791,213.09	218,520,091.57	2.41%
		$1 \times 10^{-6} \leq$ Risk $< 1 \times 10^{-5}$	93,408,911.32	99,095,118.28	-5.74%
		Risk $< 1 \times 10^{-6}$	7.69	7.88	-2.36%
		<b>Total Population</b>	318,742,826.45	318,742,826.45	0.00%
2020	Base	Risk $\geq 1 \times 10^{-4}$	294,703.33	235,864.00	24.95%
		$1 \times 10^{-5} \leq$ Risk $< 1 \times 10^{-4}$	5,602,974.97	5,026,985.60	11.46%
		$1 \times 10^{-6} \leq$ Risk $< 1 \times 10^{-5}$	58,287,729.68	55,295,768.82	5.41%
		Risk $< 1 \times 10^{-6}$	267,345,488.04	270,972,277.60	-1.34%
		<b>Total Population</b>	331,530,896.01	331,530,896.01	0.00%
	Control	Risk $\geq 1 \times 10^{-4}$	1,772,847.03	1,329,433.25	33.35%
		$1 \times 10^{-5} \leq$ Risk $< 1 \times 10^{-4}$	232,960,339.33	227,323,672.28	2.48%
		$1 \times 10^{-6} \leq$ Risk $< 1 \times 10^{-5}$	96,797,701.33	102,877,781.97	-5.91%
		Risk $< 1 \times 10^{-6}$	8.31	8.51	-2.26%
		<b>Total Population</b>	331,530,896.01	331,530,896.01	0.00%
2030	Base	Risk $\geq 1 \times 10^{-4}$	2,955,505.68	1,940,474.63	52.31%
		$1 \times 10^{-5} \leq$ Risk $< 1 \times 10^{-4}$	268,745,424.90	264,520,973.18	1.60%
		$1 \times 10^{-6} \leq$ Risk $< 1 \times 10^{-5}$	86,032,777.07	91,272,259.46	-5.74%
		Risk $< 1 \times 10^{-6}$	9.40	9.78	-3.80%
		<b>Total Population</b>	357,733,717.05	357,733,717.05	0.00%
	Control	Risk $\geq 1 \times 10^{-4}$	1,960,342.84	1,434,886.23	36.62%
		$1 \times 10^{-5} \leq$ Risk $< 1 \times 10^{-4}$	253,003,856.51	246,926,052.64	2.46%
		$1 \times 10^{-6} \leq$ Risk $< 1 \times 10^{-5}$	102,769,508.12	109,372,768.40	-6.04%
		Risk $< 1 \times 10^{-6}$	9.57	9.78	-2.11%
		<b>Total Population</b>	357,733,717.05	357,733,717.05	0.00%



**Table 64.** Populations and percent differences (MSAT-NATA) of respiratory HI bins using the MSAT method and NATA method for 1999, 2015, 2020, and 2030.

Year	Scenario	Bin	MSAT	NATA	Percent Difference
1999	Base	HI ≥ 10	52,982,382.53	41,599,343.00	27.36%
		1 ≤ HI < 10	205,143,419.33	215,552,678.00	-4.83%
		0.1 ≤ HI < 1	23,160,782.97	24,129,542.00	-4.01%
		HI < 0.1	84,862.17	89,884.00	-5.59%
		<b>Total Population</b>	281,371,447.00	281,371,447.00	0.00%
2015	Base	HI ≥ 10	24,540,632.08	21,277,323.15	15.34%
		1 ≤ HI < 10	240,724,948.29	240,898,595.27	-0.07%
		0.1 ≤ HI < 1	53,295,211.49	56,374,338.32	-5.46%
		HI < 0.1	182,034.59	192,569.72	-5.47%
		<b>Total Population</b>	318,742,826.45	318,742,826.45	0.00%
	Control	HI ≥ 10	21,830,744.00	19,377,623.40	12.66%
		1 ≤ HI < 10	237,796,107.04	236,413,926.13	0.58%
		0.1 ≤ HI < 1	58,912,536.85	62,741,556.26	-6.10%
		HI < 0.1	203,438.57	209,720.67	-3.00%
		<b>Total Population</b>	318,742,826.45	318,742,826.45	0.00%
2020	Base	HI ≥ 10	26,156,623.68	22,544,762.23	16.02%
		1 ≤ HI < 10	251,566,896.07	252,022,794.44	-0.18%
		0.1 ≤ HI < 1	53,628,384.14	56,776,470.22	-5.54%
		HI < 0.1	178,992.13	186,869.12	-4.22%
		<b>Total Population</b>	331,530,896.01	331,530,896.01	0.00%
	Control	HI ≥ 10	21,990,016.31	19,676,310.28	11.76%
		1 ≤ HI < 10	245,506,347.73	243,569,802.65	0.80%
		0.1 ≤ HI < 1	63,816,593.32	68,061,006.22	-6.24%
		HI < 0.1	217,938.64	223,776.86	-2.61%
		<b>Total Population</b>	331,530,896.01	331,530,896.01	0.00%
2030	Base	HI ≥ 10	32,709,421.65	27,543,697.32	18.75%
		1 ≤ HI < 10	274,525,451.75	276,929,036.47	-0.87%
		0.1 ≤ HI < 1	50,341,708.76	53,105,249.27	-5.20%
		HI < 0.1	157,134.89	155,733.99	0.90%
		<b>Total Population</b>	357,733,717.05	357,733,717.05	0.00%
	Control	HI ≥ 10	25,261,964.46	22,675,246.45	11.41%
		1 ≤ HI < 10	265,054,379.05	263,203,086.00	0.70%
		0.1 ≤ HI < 1	67,195,938.37	71,626,733.45	-6.19%
		HI < 0.1	221,435.17	228,651.15	-3.16%
		<b>Total Population</b>	357,733,717.05	357,733,717.05	0.00%

## 9. References

- Abt Associates, Inc., 2005: BenMAP (Environmental Benefits Mapping and Analysis Program) User's Manual, June 2005. Bethesda, MD.  
<http://www.epa.gov/ttn/ecas/models/BenMAPUserManualTextJune2005.pdf>
- Battelle, 2003: Estimate background concentrations for the National-Scale Air Toxics Assessment. Technical Report. Contract No. 68-D-02-061. Work Assignment 1-03.
- Bollman A. Technical Memorandum: Development of Growth Factors for Future Year Modeling Inventories, Prepared by E. H. Pechan and Associates for Marc Houyoux, U.S. EPA, Contract Number 68-D-00-265, Work Assignment 3-31, April 30, 2004.  
[http://www.epa.gov/air/interstateairquality/pdfs/Non-EGU\\_nonpoint\\_Growth\\_Development.pdf](http://www.epa.gov/air/interstateairquality/pdfs/Non-EGU_nonpoint_Growth_Development.pdf)
- Cohen, J., R. Cook, C.R. Bailey, E. Carr, 2005. Relationship between motor vehicle emissions of hazardous pollutants, roadway proximity, and ambient concentrations in Portland, Oregon. *Environ Modeling & Software* 20: 7-12.
- Cook, R.; Glover, E.; Michaels, H.; Brzezinski, D. "Modeling of Mobile Source Air Toxics Using EPA's National Mobile Inventory Model. Proceedings, 2004 Emission Inventory Conference, Clearwater Beach, Fl.  
<http://www.epa.gov/ttn/chief/conference/ei13/poster/cook.pdf>
- Eastern Research Group. National Mobile Inventory Model (NMIM) Base and Future Year County Database Documentation and Quality Assurance Procedures. Prepared by Eastern Research Group, Inc., for U.S. Environmental Protection Agency, Office of Transportation and Air Quality, Ann Arbor, MI, 2003.
- E.H. Pechan and Associates. Economic Growth and Analysis System Reference Manual, EGAS 4.0. Prepared for U. S. EPA, Emission Factor and Inventory Group, Emissions Monitoring and Analysis Division, Office of Air Quality Planning and Standards, EPA, January 6, 2001. [http://www.epa.gov/ttn/chief/emch/projection/egas40/ref\\_man\\_4.pdf](http://www.epa.gov/ttn/chief/emch/projection/egas40/ref_man_4.pdf)
- Energy Information Administration. Annual Energy Outlook 2005 with Projections to 2025. 2005, Report No. DOE/EIA-0383. <http://www.eia.doe.gov/oiaf/aeo/index.html>.
- Fan W, Treyz F, Treyz G. An evolutionary new economic geography model. *J Regional Sci* 2000 40: 671- 696.
- Federal Aviation Administration, 2004. Terminal Area Forecast System.

- Glen, G., Y. Lakkadi, J. A. Tippet, M. del Valle-Torres. 1997. Development of NERL/CHAD: The National Exposure Research Laboratory Consolidated Human Activity Database. Prepared by ManTech Environmental Technology, Inc. EPA Contract No. 68-D5-0049.
- Haskew, H. M.; Liberty, T. F.; McClement, D. 2004. Fuel Permeation from Automotive Systems. Prepared for the Coordinating Research Council by Harold Haskew and Associates and Automotive Testing Laboratories, Inc. September 2004. CRC Project No. E-65. <http://www.crcao.com>.
- Hester, Charles. 2006. Review of Data on HAP Content in Gasoline. Memorandum from MACTEC to Steve Shedd, U. S. EPA, March 23, 2006.
- Long, T, T. Johnson, J. Laurensen, A. Rosenbaum 2004. Development of Penetration and Proximity Microenvironment Factor Distributions for the HAPEM5 in Support of the 1999 National-Scale Air Toxics Assessment (NATA). Memorandum from TRJ Consulting and ICF Consulting, Inc. to Ted Palma, U. S. EPA, Office of Air Quality Planning and Standards, RTP, NC, April 5, 2004. [http://www.epa.gov/ttn/fera/human\\_hapem.html](http://www.epa.gov/ttn/fera/human_hapem.html)
- MathPro, 1998. Costs of Alternative Sulfur Content Standards for Gasoline in PADD IV. Final Report. Prepared for the National Petrochemical and Refiners Association. December 30 1998.
- Mathpro, 1999a. Costs of meeting 40 ppm Sulfur Content Standard for Gasoline in PADDs 1-3, Via MOBIL and CD Tech Desulfurization Processes. Final Report. Prepared for the American Petroleum Institute. February 26 1999.
- MathPro, 1999b. Analysis of California Phase 3 RFG Standards. Prepared for the California Energy Commission. December 7 1999.
- Mullen M, Neumann J. Technical Memorandum: Documentation of 2003 VMT Projection Methodology, Prepared by E. H. Pechan and Associates and Industrial Economics, Inc. for James DeMocker, Office of Air and Radiation, Office of Policy Analysis and Review, U. S. EPA, Contract No. 68-W-02-048, WA B-41, March 2004.
- Pratt, G. C., C. Y. Wu, D. Bock, et al., 2004. Comparing air dispersion model predictions with measured concentrations of VOCs in urban communities. Environ. Sci. Technol. 38: 1949-1959.
- Regional Economic Models, Inc. REMI Policy Insight, 2004. <http://www.remi.com>
- Strum M. R. Cook, J. Thurman, D. Ensley, A. Pope, T. Palma, R. Mason, H. Michaels, and S. Shedd, 2006. Projection of hazardous air pollutant emissions to future years. Science of the Total Environment, 590-601.

- Taylor, M. Memorandum: Revised HAP Emission Factors for Stationary Combustion Turbines, Prepared by Alpha-Gamma Technologies, Inc for Sims Roy, EPA OAQPS ESD Combustion Group. August, 2003. Docket ID: OAR-2002-0060-0649. Access via <http://www.regulations.gov>
- U. S. Environmental Protection Agency, 1993. Motor Vehicle-Related Air Toxics Study. Office of Mobile Sources, Ann Arbor, MI. Report No. EPA 420-R-93-005. [http://www.epa.gov/otaq/regs/toxics/tox\\_archive.htm](http://www.epa.gov/otaq/regs/toxics/tox_archive.htm)
- U.S Environmental Protection Agency, 1999. Analysis of the Impacts of Control Programs on Motor Vehicle Toxics Emissions and Exposure in Urban Areas and Nationwide. Prepared for U. S. EPA, Office of Transportation and Air Quality, by Sierra Research, Inc., and Radian International Corporation/Eastern Research Group. Report No. EPA 420 –R-99-029/030. [http://www.epa.gov/otaq/regs/toxics/tox\\_archive.htm](http://www.epa.gov/otaq/regs/toxics/tox_archive.htm)
- U.S. Environmental Protection Agency, 2000. User’s Guide for the Assessment System for Population Exposure Nationwide (ASPEN, Version 1.1) Model. Office of Air Quality Planning and Standards, Research Triangle Park, NC, Report No. EPA-454/R-00-017. [http://www.epa.gov/scram001/dispersion\\_alt.htm#aspen](http://www.epa.gov/scram001/dispersion_alt.htm#aspen)
- U. S. Environmental Protection Agency, 2002a. User’s Guide for the Emissions Modeling System for Hazardous Air Pollutants (EMS-HAP, Version 2.0), Office of Air Quality Planning and Standards, Research Triangle Park, NC, Report No. EPA-454/B-02-001. <http://www.epa.gov/scram001/userg/other/emshapv2ug.pdf>
- U. S. EPA. 2002b. 1996 National-Scale Air Toxics Assessment. <http://www.epa.gov/ttn/atw/nata/>
- U. S. Environmental Protection Agency, 2004a. 1999 Final National Emissions Inventory Data and Documentation. <http://www.epa.gov/ttn/chief/net/1999inventory.html>
- U. S. Environmental Protection Agency, 2004b. User’s Guide for the Emissions Modeling System for Hazardous Air Pollutants (EMS-HAP, Version 3.0), Office of Air Quality Planning and Standards, Research Triangle Park, NC, Report No. EPA-454/B-03-006. [http://www.epa.gov/scram001/dispersion\\_related.htm#ems-hap](http://www.epa.gov/scram001/dispersion_related.htm#ems-hap)
- U. S. Environmental Protection Agency, 2004c. IPM Analysis for the Clean Air Interstate Rule (CAIR) – Formerly known as the Interstate Air Quality Rule (IAQR). <http://www.epa.gov/airmarkets/epa-ipm/iaqr.html>
- U. S. Environmental Protection Agency, 2004d. Regulatory Impact Analysis: Clean Air Nonroad Diesel Rule. Office of Transportation and Air Quality, Ann Arbor, MI, Report No. EPA420-R-04-007. <http://www.epa.gov/nonroad-diesel/2004fr.htm#ria>

- U. S. Environmental Protection Agency, 2005a. Clean Air Interstate Rule Emissions Inventory Technical Support Document, March 4 2005. <http://www.epa.gov/cair/pdfs/finaltech01.pdf>
- U. S. EPA, 2005b. EPA's National Mobile Inventory Model (NMIM), A Consolidated Emissions Modeling System for MOBILE6 and NONROAD. U. S. Environmental Protection Agency, Office of Transportation and Air Quality, Assessment and Standards Division, Ann Arbor, MI, December 2005; Report No. EPA-R-05-024.
- U. S. Environmental Protection Agency, 2005c. EGAS Version 5.0 Beta, 2005. <http://www.epa.gov/ttn/ecas/egas5.htm>.
- U. S. Environmental Protection Agency, 2005d. 2002 National Emissions Inventory Data and Documentation. <http://www.epa.gov/ttn/chief/net/2002inventory.html>
- U. S. Environmental Protection Agency, 2005e. Risk - Air Toxics Risk Assessment. 2005. [http://www.epa.gov/ttn/fera/risk\\_atoxic.html](http://www.epa.gov/ttn/fera/risk_atoxic.html).
- U. S. EPA. 2006a. 1999 National-Scale Air Toxics Assessment. <http://www.epa.gov/ttn/atw/nata1999/>
- U. S. EPA. 2006b. Determination that Gasoline Distribution Stage 1 Area Source (GD AS) Category Does Not Need to Be Regulated Under Section 112(c) 6. Memorandum from Stephen Shedd to Kent Hustvedt, May 9, 2006. This document is available in Docket EPA-HQ-OAR-2005-0036.
- U. S. Environmental Protection Agency, 2007: The HAPEM6 User's Guide - Hazardous Air Pollutant Exposure Model, Version 6; January 2007, Available at: [http://www.epa.gov/ttn/fera/hapem6/hapem6\\_guide.pdf](http://www.epa.gov/ttn/fera/hapem6/hapem6_guide.pdf) ; RTP, NC



---

United States  
Environmental Protection  
Agency

Office of Air Quality Planning and Standards  
Air Quality Strategies and Standards Division  
Research Triangle Park, NC

Publication No. EPA 454/R-07-002  
Month Year

---