

**BARATARIA PLAQUEMINES BARRIER ISLAND COMPLEX PROJECT  
CWPPRA PROJECT Fed No./BA-38  
PASS LA MER TO CHALAND PASS AND PELICAN ISLAND  
ENVIRONMENTAL ASSESSMENT  
Plaquemines Parish, Louisiana**

*Prepared for:*

**U.S. Department of Commerce  
National Oceanic and Atmospheric Administration  
National Marine Fisheries Service**



*Prepared in Cooperation with:*

**U.S. Department of the Interior  
Minerals Management Service**



*Prepared by:*

**Tetra Tech EM Inc.  
11955 Lakeland Park Blvd. Suite 100  
Baton Rouge, LA 70809  
(225) 753-4949**

**December 22, 2003**

## CONTENTS (Continued)

<u>Section</u>	<u>Page</u>
3.2.2.1 Beach and Intertidal Habitats.....	39
3.2.2.2 Open-Water Habitats .....	39
3.2.2.3 Benthic Habitats.....	40
3.2.3 Fish Resources.....	40
3.2.3.1 Essential Fish Habitat .....	41
3.2.3.2 Wildlife Resources.....	46
3.2.3.3 Threatened and Endangered Species.....	48
3.3 CULTURAL RESOURCES.....	50
3.3.1 Historic, Prehistoric, and Native American Resources .....	50
3.3.1.1 Terrestrial Archeological Cultural Resources.....	50
3.3.1.2 Offshore Archeological Cultural Resources .....	52
3.3.2 Land Use and Recreation .....	54
3.3.3 Infrastructure .....	54
3.3.4 Socioeconomics.....	59
4.0 ENVIRONMENTAL CONSEQUENCES .....	60
4.1 IMPACT-PRODUCING FACTORS .....	67
4.1.1 Dredge Operating Characteristics .....	67
4.1.2 Effluent Discharge at Sea .....	70
4.1.3 Total Depth of Cut Expected Within the Borrow Area.....	70
4.1.4 Emplacement on the Beach .....	70
4.2 PHYSICAL RESOURCES .....	70
4.2.1 Impacts on Geology, Topography, and Physical Oceanographic Processes .....	70
4.2.2 Impacts on Climate and Weather .....	71
4.2.3 Impacts on Air Quality .....	71
4.2.4 Impacts on Water Resources .....	72
4.3 BIOLOGICAL ENVIRONMENT .....	73
4.3.1 Impacts on Vegetative Communities .....	73
4.3.2 Impacts on Fisheries and Aquatic Resources .....	74
4.3.3 Impacts on Essential Fish Habitat .....	75
4.3.4 Impacts on Wildlife Resources.....	75
4.3.5 Impacts on Threatened and Endangered Species .....	76
4.4 CULTURAL RESROUCES.....	77

## CONTENTS (Continued)

<u>Section</u>	<u>Page</u>
4.4.1	Impacts on Historic, Prehistoric, and Native American Resources.....77
4.4.1.1	Impacts on Terrestrial Cultural Resources.....77
4.4.1.2	Impacts on Offshore Cultural Resources .....77
4.4.2	Impacts on Land Use/Recreation .....79
4.4.3	Impacts on Infrastructure.....79
4.4.4	Impacts on Socioeconomics .....79
4.5	ENVIRONMENTAL JUSTICE.....79
4.6	CUMULATIVE IMPACTS .....80
4.7	THE PROTECTION OF CHILDREN .....80
5.0	OTHER CONSIDERATIONS REQUIRED BY THE NATIONAL ENVIRONMENTAL POLICY ACT.....81
5.1	COORDINATION AMONG AGENCIES.....81
5.2	PUBLIC PARTICIPATION.....81
5.3	COMPLIANCE.....81
6.0	CONCLUSIONS .....83
7.0	PREPARERS.....84
8.0	FINDING OF NO SIGNIFICANT IMPACT.....85
9.0	LITERATURE CITED.....86
 <u>Appendices</u>	
A	AGENCY COORDINATION LETTERS

## FIGURES

<u>Figure</u>	<u>Page</u>
1A	LOCATION OF PELICAN ISLAND PROJECT SITE, INCLUDING EMPIRE AND SANDY POINT BORROW AREAS.....2
1B	LOCATION OF CHALAND HEADLAND PROJECT SITE, INCLUDING QUATRE BAYOU BORROW AREA.....3
2A	PELICAN ISLAND PREFERRED ALTERNATIVE PLAN VIEW (WESTERN HALF OF ISLAND).....9
2B	PELICAN ISLAND PREFERRED ALTERNATIVE PLAN VIEW (EASTERN HALF OF ISLAND).....10
2C	PELICAN ISLAND PREFERRED ALTERNATIVE PLAN VIEW (WESTERN THIRD OF ISLAND).....11
2D	PELICAN ISLAND PREFERRED ALTERNATIVE CROSS SECTION (MIDDLE THIRD OF ISLAND).....12
2E	PELICAN ISLAND PREFERRED ALTERNATIVE CROSS SECTION (EASTERN THIRD OF ISLAND).....13
3A	CHALAND HEADLAND PREFERRED ALTERNATIVE PLAN VIEW (WESTERN HALF OF ISLAND).....14
3B	CHALAND HEADLAND PREFERRED ALTERNATIVE PLAN VIEW (EASTERN HALF OF ISLAND).....15
3C	CHALAND HEADLAND PREFERRED ALTERNATIVE CROSS SECTION (WESTERN THIRD OF ISLAND).....16
3D	CHALAND HEADLAND PREFERRED ALTERNATIVE CROSS SECTION (MIDDLE THIRD OF ISLAND).....17
3E	CHALAND HEADLAND PREFERRED ALTERNATIVE CROSS SECTION (EASTERN THIRD OF ISLAND).....18
4	LOCATION OF PREFERRED BORROW AREAS .....21
5	EMPIRE BORROW AREA.....22
6	DETAILS OF NORTHWEST SANDY POINT BORROW AREA.....24
7	DETAILS OF SOUTHEAST SANDY POINT BORROW AREA.....25
8	QUATRE BAYOU BORROW AREA .....28
9	CHALAND HEADLAND CULTURAL RESOURCES INVESTIGATION .....51



**FIGURES (Continued)**

<b><u>Figure</u></b>		<b><u>Page</u></b>
10	OIL AND GAS INFRASTRUCTURE: PELICAN ISLAND .....	55
11	OIL AND GAS INFRASTRUCTURE: CHALAND HEADLAND.....	56
12	OIL AND GAS INFRASTRUCTURE: EMPIRE AND SANDY POINT BORROW AREAS ...	57
13	OIL AND GAS INFRASTRUCTURE: QUATRE BAYOU BORROW AREA.....	58
14	DREDGE OPERATION .....	68

## TABLES

<b><u>Table</u></b>		<b><u>Page</u></b>
1	RESULTS OF PLAQUEMINES SHORELINE FRAGMENTATION ANALYSIS (COASTAL RESEARCH LABORATORY 2000).....	5
2	PREDICTED DISAPPEARANCE RATES AND DATES BY SUB-REACH (COASTAL RESEARCH LABORATORY 2000).....	6
3	MAJOR FEATURES OF PELICAN ISLAND ALTERNATIVES.....	19
4	CHARACTERISTICS OF BORROW AREAS.....	20
5	DECISION MATRIX.....	30
6	OFFSHORE WAVE STATISTICS, 1976-1995 BARATARIA BARRIER COMPLEX, GRAND ISLE, LA.....	34
7	OFFSHORE GULF WAVES BARATARIA BARRIER COMPLEX, GRAND ISLE, LA.....	34
8	STWAVE WAVE CASES WIS STATION GU1058 BARATARIA BAY COMPLEX, LA.....	35
9	HABITAT AREA INVENTORY FOR PROJECT SITES.....	38
10	ESSENTIAL FISH HABITAT (EFH) FOR MANAGED SPECIES IN THE BARATARIA BARRIER ISLAND COMPLEX PROJECT AREA, INCLUDING BORROW AREAS.....	42
11	THREATENED AND ENDANGERED SPECIES OF PLAQUEMINES PARISH / BARATARIA BAY.....	48
12	OVERVIEW OF CONSTRUCTION PLANS FOR PREFERRED ALTERNATIVES.....	61
13	SUMMARY OF ENVIRONMENTAL CONSEQUENCES AND AVOIDANCE, MINIMIZATION AND MITIGATION MEASURES OF PROPOSED ACTION.....	62
14	COMPLIANCE WITH ENVIRONMENTAL STATUTES.....	82

## ACRONYMS

CASC	Central Administrative Support Center
CEQ	Council of Environmental Quality
CFR	Code of Federal Regulations
cfs	Cubic foot per second
COE	U.S. Army Corps of Engineers
CPE	Coastal Planning Engineers
CWPPRA	Coastal Wetlands Planning, Protection and Restoration Act
cy	Cubic yard(s)
DOI	Department of Interior
EA	Environmental Assessment
EFH	Essential Fish Habitat
EIS	Environmental Impact Statement
EO	Executive order
EPA	U.S. Environmental Protection Agency
FONSI	Finding of No Significant Impact
ft	Foot
FWS	U.S. Fish and Wildlife Service
GEC	Gulf Engineers and Consultants
GMFMC	Gulf of Mexico Fisheries Management Council
in	Inch(es)
LCWCRTF	Louisiana Coastal Wetlands Conservation and Restoration Task Force
LDNR	Louisiana Department of Natural Resources
m	Meter(s)
mm	Millimeter(s)
MMS	Minerals Management Service, U.S. Department of Interior
NAVD	North American Vertical Datum
NEPA	National Environmental Policy Act
NOAA	National Oceanic and Atmospheric Administration, U.S. Department of Commerce
NRCS	Natural Resources Conservation Service, U.S. Department of Agriculture
NW	Northwest
SAV	Submerged aquatic vegetation
SE	Southeast
USGS	U.S. Geological Survey, U.S. Department of Interior
WCRA	Wetlands Conservation and Restoration Authority

## EXECUTIVE SUMMARY

This Environmental Assessment (EA) was prepared to assess impacts related to implementation of the Barataria Barrier Island Complex Project: Pelican Island and Pass La Mer to Chaland Pass (BA-38), in Plaquemines Parish, Louisiana. The intent of the project is to protect and create habitat along a barrier island complex.

The EA was prepared in accordance with all applicable statutes and regulations, including the National Environmental Policy Act (NEPA) (Public Law 91-190, as amended), the Council of Environmental Quality (CEQ) regulations (Code of Federal Regulations 1500 – 1508), and the National Oceanic and Atmospheric Administration (NOAA) Administrative Order. This EA augments an Environmental Impact Statement (EIS) for the Louisiana Coastal Wetlands Restoration Plan prepared by the Coastal Wetlands Planning, Protection and Restoration Act (CWPPRA) Task Force (Louisiana Coastal Wetlands Conservation and Restoration Task Force [LCWCRTF] 1993). Information on existing conditions and potential impacts came from documents prepared recently by the Department of Interior (DOI) Minerals Management Service (MMS) — including the final EIS for the Gulf of Mexico OCS oil and gas lease sales (DOI MMS 2002) and the final EA for issuance of non-competitive leases for the use of sand resources from Ship Shoal (DOI MMS 2003).

The project area encompasses 868 acres (351 hectares) dominated by shallow open water, salt marsh, and barrier islands with beach and dune habitats. The purpose of the project is to: (1) prevent breaching of the barrier shoreline by increasing its width and average height; and (2) protect and create dune, swale, and intertidal marsh habitat along the Plaquemines barrier island and shoreline complex. Most of Chaland Headland, Pelican Island, and the area between them are erosional. Shoreline changes were documented by analyzing historical data, reviewing digitized topographic maps, and conducting beach surveys in 2000 and 2002.

Three alternatives to no action were considered for each of the two project areas. All construction alternatives involve moving sand from offshore borrow areas into the project areas. The alternatives vary in construction alignment from landward of the existing island to primarily seaward of the existing island. Borrow areas were identified for each design alternative. The project will confine fill material with containment dikes. Subsequent monitoring will determine the long-term necessity of containment dikes. Containment dikes will be gapped or degraded following appropriate dewatering and consolidation of fill material. Although structures at the terminal ends of islands often are used to retain sand in the project area and to reduce shoaling of the adjacent passes, use of terminal structures is not recommended for this project. Areas of newly created landward or seaward habitat would be planted with vegetation and protected with sand fencing.

All three alternatives for Pelican Island call for about 28,000 cubic yards (21,406 cubic meters) of constructed tidal features and include 25,000 linear feet (7620 m) of sand fencing to reduce Aeolian loss and maintain target island topography. Two sources of fill material have been identified for Pelican Island restoration. The Empire borrow area contains relatively fine-grained material suitable for marsh creation. The Sandy Point borrow area contains slightly coarser material suitable for building the island. In the preferred alternative, the island cross-section would be constructed primarily landward of the existing berm and dune features. Approximately 12,400 linear feet (3779 m) of dikes would be constructed, and about 1.13 million cy (0.8 million cubic meters) of wetland fill would be placed in the project area. About 254 acres (102.8 hectares) of marsh would be constructed using fill material from the Empire borrow area. Island fill would be dredged from the Sandy Point borrow area. The island component for this alternative would consist of a berm height +6 feet (1.8 m) NAVD with a nominal width of 200 feet (60.9 m). The berm would extend both landward and seaward at a 1:45 slope to the existing grade. This landward shift would reduce construction on the gulf side and thus decrease the

shoreline erosion rate. However, this alternative calls for construction over more of the existing island and marsh. Vegetative planting would occur on about 446 acres (180.6 hectares).

Three alternatives, in addition to the no action alternative, were considered for the Chaland Headland project area. Components of the three construction alternatives include the following features, as in the Pelican Island project: (1) Marsh creation and nourishment behind the island, with associated containment; (2) beach nourishment and dune construction on the Gulf side of the island; (3) sand fencing; and (4) vegetative planting. Major differences among the construction alternatives are the alignment (landward or seaward) of the construction template. The preferred borrow area for the Chaland Headlands project area is the Quatre Bayou borrow area, located offshore Quatre Bayou Pass and Pass Ronquille to the west of Chaland Island. In this preferred alternative, island construction would occur primarily landward of the existing berm and dike feature. The island component for this alternative would consist of a berm height +6 feet (1.8 m) NAVD with a nominal width of 200 feet (60.9 m). The berm would extend both landward and seaward at a 1:45 slope to the existing grade. About 1.49 million cy (1.1 million cubic meters) of sand from the Quatre Bayou borrow area would be used for the island component, and about 1.03 million cy (0.8 million cubic meters) of finer material for the marsh component of the project. About 12,400 linear feet (3779 m) of containment dikes would be constructed. Vegetative planting would occur on about 477 acres (193 hectares). Sufficient room is available to position the island cross-section in front of existing infrastructure.

This EA finds that no significant long-term adverse environmental impacts are anticipated from implementing the preferred Barataria Barrier Island Complex project. Short-term impacts related to construction activities are considered reversible. This conclusion is based on a comprehensive review of relevant literature, site-specific data, and project-specific engineering reports related to biological, physical, and cultural resources. The natural resource benefits anticipated from implementing this project would enhance and sustain dune, swale, and intertidal habitat within the project area. The increase in both quality and acreage of fisheries habitat is expected to have long-term beneficial impacts on the local economy, as more people visit the area to take advantage of recreational and commercial fishing opportunities. In addition, the preferred project would result in increased protection for infrastructure on and behind the barrier islands to be restored.

## 1.0 INTRODUCTION

This Environmental Assessment (EA) was prepared to assess impacts related to implementation of the Barataria Barrier Island Complex Project: Pelican Island and Pass La Mer to Chalant Pass (BA-38), in Plaquemines Parish, Louisiana (see Figures 1a and 1b). The intent of the project is to protect and create habitat along a barrier island complex.

The EA was prepared in accordance with all applicable statutes and regulations, including the National Environmental Policy Act (NEPA) (Public Law 91-190, as amended), the Council of Environmental Quality (CEQ) regulations (Code of Federal Regulations 1500 – 1508), and the National Oceanic and Atmospheric Administration (NOAA) Administrative Order. This EA augments an Environmental Impact Statement (EIS) for the Louisiana Coastal Wetlands Restoration Plan prepared by the Coastal Wetlands Planning, Protection and Restoration Act (CWPPRA) Task Force (Louisiana Coastal Wetlands Conservation and Restoration Task Force [LCWCRTF] 1993). Information on existing conditions and potential impacts came from documents prepared recently by the Department of Interior (DOI) Minerals Management Service (MMS) — including the final EIS for the Gulf of Mexico OCS oil and gas lease sales (DOI MMS 2002) and the final EA for issuance of non-competitive leases for the use of sand resources from Ship Shoal (DOI MMS 2003).

FIGURE 1A  
LOCATION OF PELICAN ISLAND PROJECT SITE, INCLUDING EMPIRE AND SANDY POINT BORROW AREAS

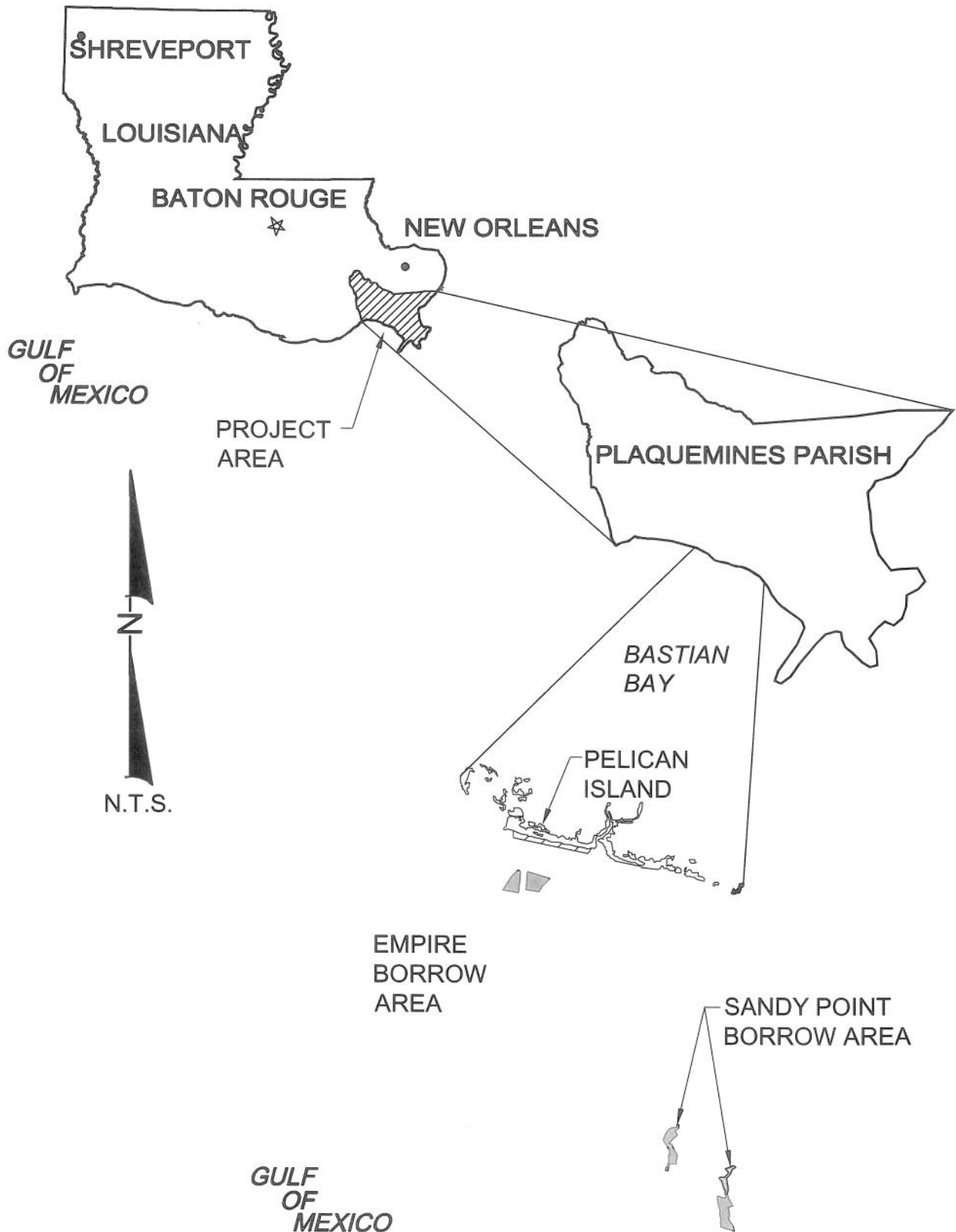
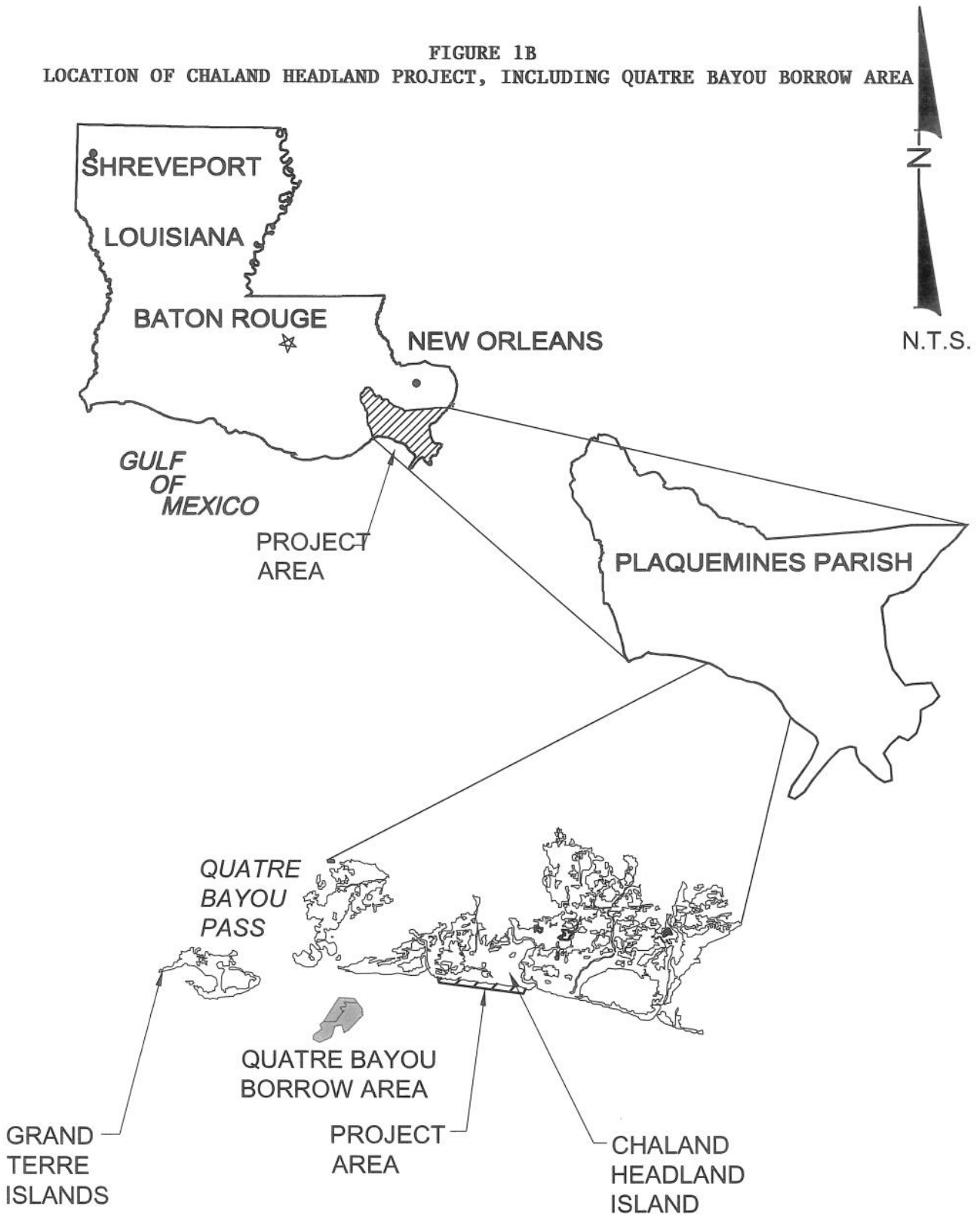

Figure 1a

FIGURE 1B  
LOCATION OF CHALAND HEADLAND PROJECT, INCLUDING QUATRE BAYOU BORROW AREA





## 1.1 PROJECT LOCATION AND SETTING

The Barataria Barrier Island Complex Project proposes restoration efforts in two reaches of the Barataria-Plaquemines shoreline: Pelican Island (see Figures 2a through 2e) and Pass La Mer to Chalant Pass (Chalant Headland) (see Figures 3a through 3e). The project area encompasses 868 acres (351 hectares) dominated by shallow open water, salt marsh, and barrier islands with beach and dune habitats. The project area is southwest of Empire, Louisiana, in the barrier island-shoreline system of Plaquemines Parish on the eastern side of Barataria Bay. The area is included in the Barataria Barrier Shorelines Mapping Unit that extends from Quatre Bayou Pass along the Plaquemines parish shoreline to Sandy Point of Region 2 of the Coast 2050 Restoration Plan (LCWCRTF and WCRA 1998 and 1999). The project area is bound by Bay Joe Wise, Bastian Bay, and associated wetlands to the north; the Gulf of Mexico to the south; Sandy Point to the east; and Chenier Ronquille to the west. The Pelican Island segment lies between Scofield Pass and Fontanelle Pass, approximately 8 miles south of Sunrise, Louisiana. The Chalant Headland segment lies between Pass La Mer and Chalant Pass. The Barataria Barrier Shorelines Mapping Unit consists of a narrow strip along Louisiana's Gulf of Mexico coastline that includes barrier islands and shoreline (12% of total area); forest and shrub cover (10%); and saline marsh to the north (78%) (LCWCRTF and WCRA 1999).

Most of Chalant Headland, Pelican Island, and the area between them are erosional. Shoreline changes are evident from the analysis of Williams and others (1992), review of digitized topographic maps (U.S. Geological Survey [USGS] 2002), and beach surveys performed in 2000 and 2002 (Tetra Tech and Coastal Planning and Engineering [CPE] 2003a). On Chalant Headland, the Gulf beaches generally were erosional between 1884 and 1973, with mild accretion between 1973 and 1988. The retreat rate since 1988 has been about 19 feet (5.8 m) per year. The contribution of relative sea-level rise to the net erosion between 1884 and the present is roughly 20 percent. Recent aerial photos show a buildup of sandy beach near Pass La Mer, suggesting that some past erosion and recent accretion may be due to inlet effects (Tetra Tech and CPE 2003a). Wetlands and bay environments behind the barrier islands are becoming more directly connected and exposed to the Gulf of Mexico as the barrier islands fragment and narrow; this increases salinity and wave action in these fragile environments.

## 1.2 PURPOSE AND NEED FOR ACTION

The purpose of the project is to: (1) prevent breaching of the barrier shoreline by increasing its width and average height; and (2) protect and create dune, swale, and intertidal marsh habitat along the Plaquemines barrier island and shoreline complex (<http://www.lacoast.gov/reports>). The project addresses a strategy in the plan to restore the Louisiana coastline for the Plaquemines region to "restore/maintain barrier headlands, islands, and shorelines" (LCWCRTF and Wetlands Conservation and Restoration Authority [WCRA] 1998). As authorized under CWPPRA, project objectives include the following:

- Nourish and rebuild the shoreline with sand.
- Create a beach berm and dune.
- Create a back-barrier marsh platform with unrestricted tidal exchange.
- Create tidal creeks and tidal ponds.
- Reduce erosion rates in the project area.
- Prevent breaching of the gulf shoreline.

During the last 50 years, land loss rates in Louisiana have at times exceeded 40 square miles per year (103.6 square kilometers) (LCWCRTF and WCRA 1998). In the 1990s, the rate was estimated at 25 to 35 square miles (64 to 90 square kilometers) each year (LCWCRTF and WCRA 1998). A healthy coastal marsh provides rearing habitat for shellfish and finfish; furnishes habitat for waterfowl, wading birds, small mammals, and numerous amphibians and reptiles; protects interior lands from storm surges; helps maintain water quality; and provides other services. Louisiana's coastal wetlands are essential to sustain renewable fisheries resources integral to the local, state, and national economies. Of the 1.7 billion pounds of fisheries landings reported for the Gulf Coast in 2000, more than 75% were caught in Louisiana (NOAA 2001). Barrier island wetlands, flats, and subtidal habitat provide unique nursery, foraging, and spawning habitat for numerous marine and estuarine species of commercial and recreational importance. Many species prefer back-barrier beaches (Thompson 1988) and intra-island ponds and tidal creeks (Williams 1998). Island fragmentation results in loss of habitat, as more area is exposed to storm surges and erosion. As the islands break up, both habitat and infrastructure behind the islands become increasingly vulnerable to damage from high energy Gulf waves (Kindinger and others 2001).

The Barataria barrier shoreline and associated wetlands are the most rapidly eroding areas in Louisiana (Coastal Research Laboratory 2000; Boesch and others 1994). Erosion and deterioration of the shoreline and back-bay wetlands result from increased relative sea-level rise; diminished sediment supply; repeated storm events; construction of canals and navigation channels; and high rates of subsidence (Kulp and Penland 2001; Boesch and others 1994). The barrier islands on the southern margin of Barataria Bay have decreased in size 47% from the 1890s to the late 1980s (Williams and others 1992). Shoreline in the project area has receded to a critical width susceptible to breaching during storm events that can remove up to 100 feet (30.5 M) of shoreline; average storm return frequency is 8.3 years along the Barataria shoreline. As the Barataria barrier shoreline degrades, the infrastructure and interior marshes of Barataria Bay in Plaquemines, Lafourche, and Jefferson Parishes become more vulnerable to erosion. A fragmentation analysis compared percentages of water and land in 1988 and 2000 for project areas within sub-reaches of the Plaquemines shoreline. Fragmentation indicates extent of disintegration of the barrier islands and therefore serves as a measure of Gulf connectivity to the back-bay marshes. The results of this analysis (Table 1) show loss of land in the project areas (Coastal Research Laboratory 2000). Coastal Research Laboratory also conducted a shoreline change analysis and predicted rates and timetables for loss of different sub-reaches of the Barataria shoreline (Table 2). This study estimated that the Barataria shoreline is retreating at a rate of 1.9 to 100 feet (0.6 to 30.5 m) per year, averaging 18 feet (5.5 m) per year over the last 100 years (Coastal Research Laboratory 2000).

**TABLE 1**

**RESULTS OF PLAQUEMINES SHORELINE FRAGMENTATION ANALYSIS (COASTAL RESEARCH LABORATORY 2000)**

<b>Sub-reach</b>	<b>Year</b>	<b>% Land (acres)</b>	<b>% Water (acres)</b>
Pass La Mer to Chalant Pass	1988	52.8	47.2
	2000	31.47	68.53
Pelican Island / Empire Jetties	1988	19.51	80.49
	2000	9.26	90.74

**TABLE 2****PREDICTED DISAPPEARANCE RATES AND DATES BY SUB-REACH (COASTAL RESEARCH LABORATORY 2000)**

Sub-reach	Area in acres (2000)	Loss Rate (acres/year)	Short-term year of disappearance
Pass La Mer to Chalant Pass	826.15	46.61	2018
Pelican Island / Empire Jetties	225.31	20.79	2011

Surveys conducted by Tetra Tech and CPE in October 2000 and September 2002 were the first to allow assessment of volumetric changes in both project areas (Tetra Tech and CPE 2003f). In the 30% design report, volumetric changes were analyzed from the landward dune toe (at +1.5 feet [0.46 m] North American Vertical Datum [NAVD]) to the depth of closure. The report excluded apparent changes due to inlet shoaling, mechanically placed fill, and survey errors. Between October 2000 and September 2002, Chalant Headland gained 8,000 cubic yards (6116 cubic meters), excluding fill placed near the mouth of Robinson Canal to close breaches in the barrier island. This gain represents a short-term change, likely due to shoaling at Pass La Mer. Historically, however, the area has eroded. Inlet channel shifting explains much of the sediment loss near Chalant Pass. Between October 2000 and September 2002, Pelican Island lost 157,000 cubic yards (120,026 cubic meters) — a loss more typical of the project area. Gains on the western half of the island result from impoundment at the Empire Waterway east jetty. Losses on the eastern half of the island derive from channel shifting at Scofield Pass and a rapid landward migration of the eastern end of the island. Chalant Headland and Pelican Island have been losing approximately 30 and 42 acres (12 and 17 hectares) of land per year, respectively. Land areas were evaluated from USGS (2002) georeferenced quad maps for the years 1981-83 and 1989. The September 2002 land areas were estimated by locating the mean high-water contour (+1.5 feet [0.46 m] NAVD) based on the survey data. Much of what appears to be land in the aerial photographs is actually intertidal marsh. Along both project areas, most remaining land area is concentrated near the dune. The rate of land loss along Chalant Headland has been uniform, while the land-loss rate at Pelican Island has slowed since 1989 (Tetra Tech and CPE 2003a).

**1.3 AUTHORITY**

This project is authorized under CWPPRA of 1990 (16 U.S.C. §777c, 3951-3956), which stipulates that five Federal agencies and the State of Louisiana jointly develop and implement a plan to reduce the loss of coastal wetlands in Louisiana (16 U.S.C. §3952 (b) (2)).

As Federal sponsor for the implementation of the Barataria Barrier Island Complex Project (Pelican Island and Pass La Mer to Chalant Pass, BA-38) the National Marine Fisheries Service (NOAA Fisheries), Department of Commerce is responsible NEPA compliance. The Louisiana Department of Natural Resources (LDNR) is the non-Federal local project sponsor. The MMS is a Federal cooperating agency. Other participating Federal agencies include the U.S. Army Corps of Engineers (COE); the U.S. Fish and Wildlife Service (FWS), Department of the Interior; Natural Resources Conservation Service (NRCS), Department of Agriculture; and the U.S. Environmental Protection Agency (EPA). The CWPPRA Task Force approved the Barataria Barrier Island Complex Project (Pelican Island and Pass La Mer to Chalant Pass, BA-38), in January 2002 as part of the 11<sup>th</sup> Priority Project List. The LCWCRTF chooses projects for this annual list by conducting a careful technical and public evaluation of numerous candidate projects. Under CWPPRA guidelines the Federal sponsor provides 85% of the project cost and

LDNR contributes the rest. A cooperative agreement between LDNR and NOAA Fisheries documents cost sharing details.

A portion of the proposed Barataria Barrier Island Complex project will involve the use of sand resources located on the Outer Continental Shelf (OCS). The United States Government, and specifically, the Minerals Management Service (MMS), a bureau within the U. S. Department of the Interior, has jurisdiction over all mineral resources on the Federal OCS. Public Law 103-426, enacted October 31, 1994, gave MMS the authority to convey, on a noncompetitive basis, the rights to OCS sand, gravel, or shell resources for shore protection, beach or wetlands restoration projects, or for use in construction projects funded in whole or part or authorized by the Federal government. Those resources fall under the purview of the Secretary of the Interior who oversees the use of OCS sand and gravel resources, and the MMS as the agency charged with this oversight by the Secretary. After an evaluation required by the NEPA, the MMS may issue non-competitive leases for the use of OCS sand to the requesting agencies. Accordingly, this EA is prepared in cooperation with the MMS and will examine (1) the physical, biological, and socioeconomic resources affected by dredging OCS sand from one of the proposed borrow sites and emplacement of sand on a barrier island, (2) the impact-producing factors caused by dredging or emplacement, and (3) the potential impacts from dredging or emplacement on the affected environmental resources.

## 2.0 ALTERNATIVES, INCLUDING PREFERRED ACTION

The no action alternative and three construction alternatives have been considered for each of the two project areas. All construction alternatives involve moving sand from offshore borrow areas onto project areas. The alternatives vary in construction alignment. The alignments considered range from landward of the existing island to primarily seaward of the existing island. Borrow areas have been identified for each design alternative. This section briefly describes the all alternatives and includes a decision matrix (Section 2.3) that summarizes the rationale for selecting the preferred alternative. Figures 2a through 2e, and Figures 3a through 3e illustrate the preferred alternatives.

The landward construction alternatives specify construction north of the existing gulf shoreline. Landward alignments are expected to maintain their structural integrity longer and create more habitat than would seaward alternatives. However, landward construction would result in conversion of existing wetlands to supratidal habitats (Tetra Tech and CPE 2003a). Seaward construction alignments would be more susceptible to storm impacts and loss of material to longshore transport. The hybrid construction alternative would construct both marsh and island components—a compromise between landward and seaward construction alignments.

Project fill material will be confined with containment dikes. Subsequent monitoring will determine the long-term necessity of containment dikes. Containment dikes will be gapped or degraded following appropriate dewatering and consolidation of fill material. Although structures at the terminal ends of islands often are used to retain sand in the project area and to reduce shoaling of the adjacent passes, use of terminal structures is not recommended for this project—the cost-benefit analysis is unfavorable, and terminal structures would abruptly change existing ebb shoal systems while failing to address long-term losses from relative sea-level rise (Tetra Tech and CPE 2003a). Areas of newly created landward or seaward habitat would be planted with vegetation, and protected with sand fencing (Tetra Tech and CPE 2003a). The 30% Design Report presents construction alternatives in detail (Tetra Tech and CPE 2003a); they are summarized below.



H:\Louisiana\1726107\PERMITS\PELICAN\PELICAN PERMIT PV.DWG

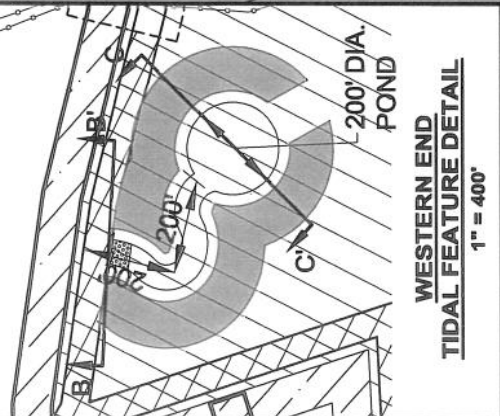
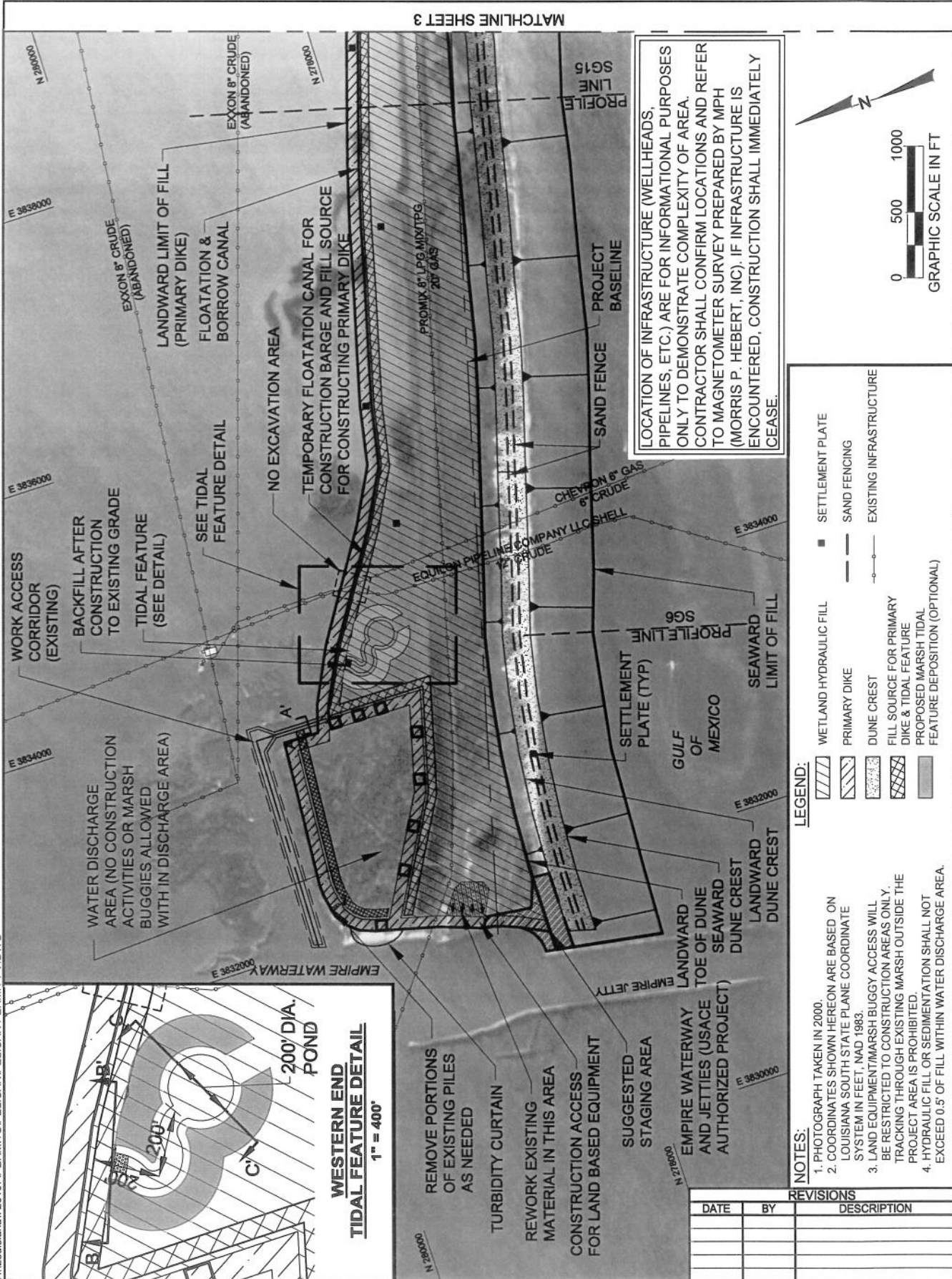

**WESTERN END TIDAL FEATURE DETAIL**  
1" = 400'

REMOVE PORTIONS OF EXISTING PILES AS NEEDED

TURBIDITY CURTAIN

REWORK EXISTING MATERIAL IN THIS AREA

CONSTRUCTION ACCESS FOR LAND BASED EQUIPMENT

SUGGESTED STAGING AREA

EMPIRE WATERWAY LANDWARD TOE OF DUNE

EMPIRE JETTY SEAWARD TOE OF DUNE

LANDWARD DUNE CREST

SEAWARD DUNE CREST

LOCATION OF INFRASTRUCTURE (WELLHEADS, PIPELINES, ETC.) ARE FOR INFORMATIONAL PURPOSES ONLY TO DEMONSTRATE COMPLEXITY OF AREA. CONTRACTOR SHALL CONFIRM LOCATIONS AND REFER TO MAGNETOMETER SURVEY PREPARED BY MPH (MORRIS P. HEBERT, INC). IF INFRASTRUCTURE IS ENCOUNTERED, CONSTRUCTION SHALL IMMEDIATELY CEASE.

- LEGEND:**
- WETLAND HYDRAULIC FILL
  - PRIMARY DIKE
  - DUNE CREST
  - FILL SOURCE FOR PRIMARY DIKE & TIDAL FEATURE
  - PROPOSED MARSH TIDAL FEATURE DEPOSITION (OPTIONAL)
  - SETTLEMENT PLATE
  - SAND FENCING
  - EXISTING INFRASTRUCTURE

- NOTES:**
1. PHOTOGRAPH TAKEN IN 2000.
  2. COORDINATES SHOWN HEREON ARE BASED ON LOUISIANA SOUTH STATE PLANE COORDINATE SYSTEM IN FEET, NAD 1983.
  3. LAND EQUIPMENT/MARSH BUGGY ACCESS WILL BE RESTRICTED TO CONSTRUCTION AREAS ONLY. TRACKING THROUGH EXISTING MARSH OUTSIDE THE PROJECT AREA IS PROHIBITED.
  4. HYDRAULIC FILL OR SEDIMENTATION SHALL NOT EXCEED 0.5' OF FILL WITHIN WATER DISCHARGE AREA.

**REVISIONS**

DATE	BY	DESCRIPTION

DATE:	11/17/03
BY:	JRC
COMM NO.:	7261.07
SHEET:	2

**COASTAL PLANNING & ENGINEERING, INC.**  
www.CoastalPlanning.net

2481 N.W. BOCA RATON BLVD.  
BOCA RATON, FL 33431  
PH. (561) 391-8102 FAX (561) 391-8116

**PELICAN ISLAND RESTORATION (BA-38-1) CWP/PRA PROJECT**  
**PLAN VIEW**

Figure 2a

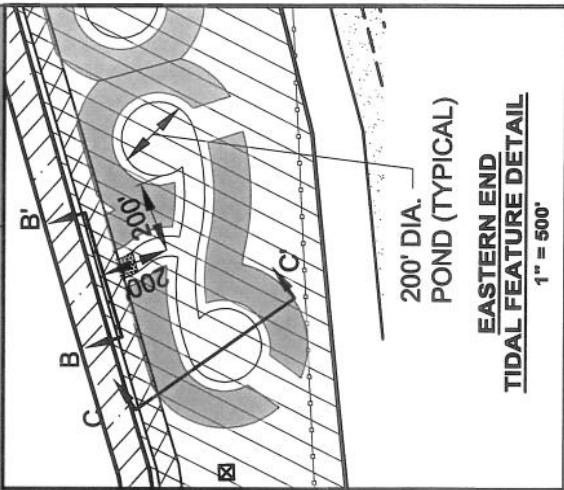
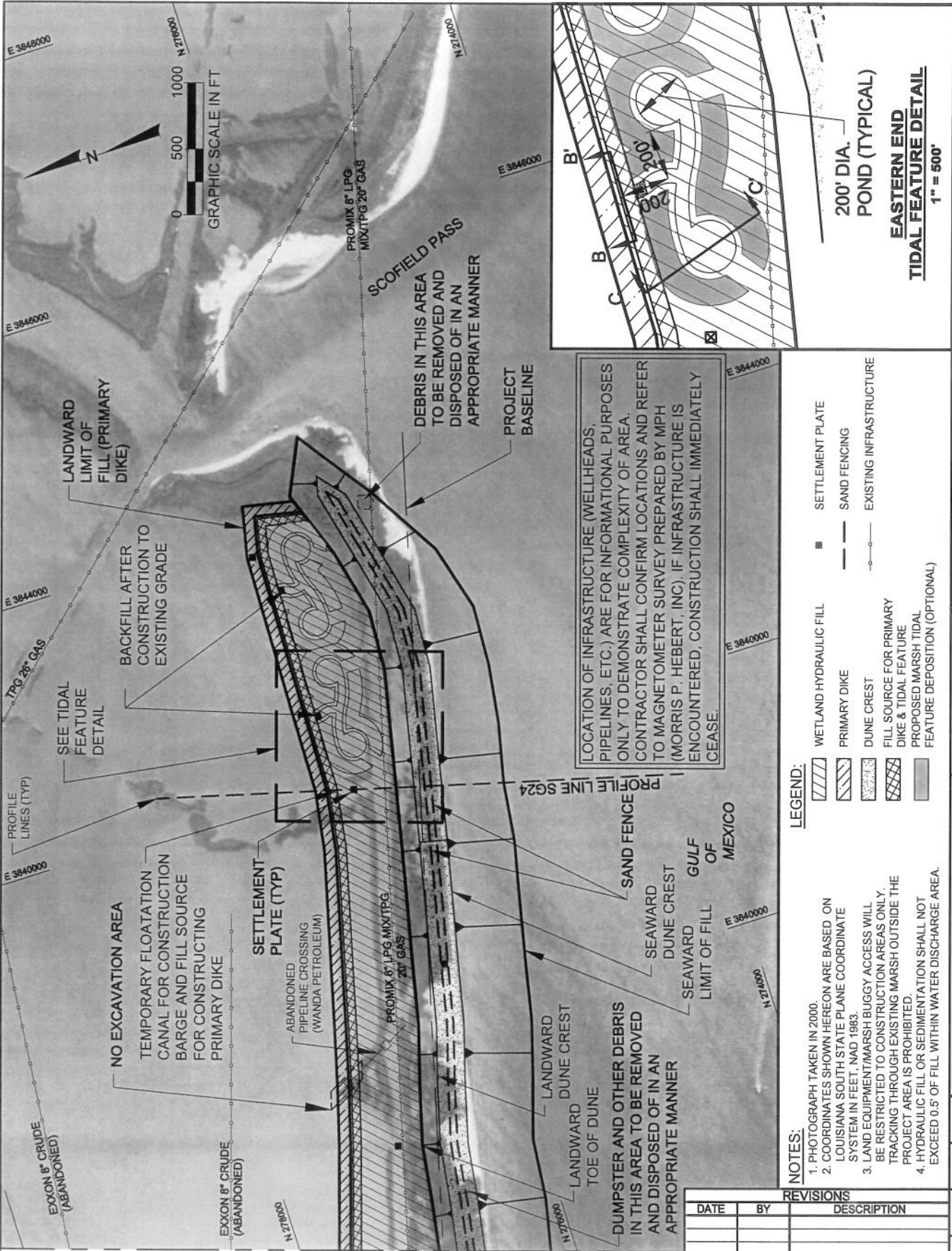

LOCATION OF INFRASTRUCTURE (WELLHEADS, PIPELINES, ETC.) ARE FOR INFORMATIONAL PURPOSES ONLY TO DEMONSTRATE COMPLEXITY OF AREA. CONTRACTOR SHALL CONFIRM LOCATIONS AND REFER TO MAGNETOMETER SURVEY PREPARED BY MPH (MORRIS P. HEBERT, INC). IF INFRASTRUCTURE IS ENCOUNTERED, CONSTRUCTION SHALL IMMEDIATELY CEASE.

- LEGEND:**
- WETLAND HYDRAULIC FILL
  - PRIMARY DIKE
  - DUNE CREST
  - FILL SOURCE FOR PRIMARY DIKE & TIDAL FEATURE
  - PROPOSED MARSH TIDAL FEATURE DEPOSITION (OPTIONAL)
  - SETTLEMENT PLATE
  - SAND FENCING
  - EXISTING INFRASTRUCTURE

- NOTES:**
- PHOTOGRAPH TAKEN IN 2000.
  - COORDINATES SHOWN HEREON ARE BASED ON LOUISIANA SOUTH STATE PLANE COORDINATE SYSTEM IN FEET, NAD 1983.
  - LAND EQUIPMENT/MARSH BUGGY ACCESS WILL BE RESTRICTED TO CONSTRUCTION AREAS ONLY. TRACKING THROUGH EXISTING MARSH OUTSIDE THE PROJECT AREA IS PROHIBITED.
  - HYDRAULIC FILL OR SEDIMENTATION SHALL NOT EXCEED 0.5' OF FILL WITHIN WATER DISCHARGE AREA.

REVISIONS		
DATE	BY	DESCRIPTION

**COASTAL PLANNING & ENGINEERING, INC.**  
[www.CoastalPlanning.net](http://www.CoastalPlanning.net)

**DATE:** 11/17/03  
**BY:** JRC

**COMM NO.:** 7261.07  
**SHEET:**

**2481 N.W. BOCA RATON BLVD.**  
**BOCA RATON, FL 33431**  
**PH. (561) 391-8102 FAX (561) 391-9116**

**TITLE:** PELICAN ISLAND RESTORATION (BA-38-1) CWP/PPRA PROJECT PLAN VIEW

Figure 2b

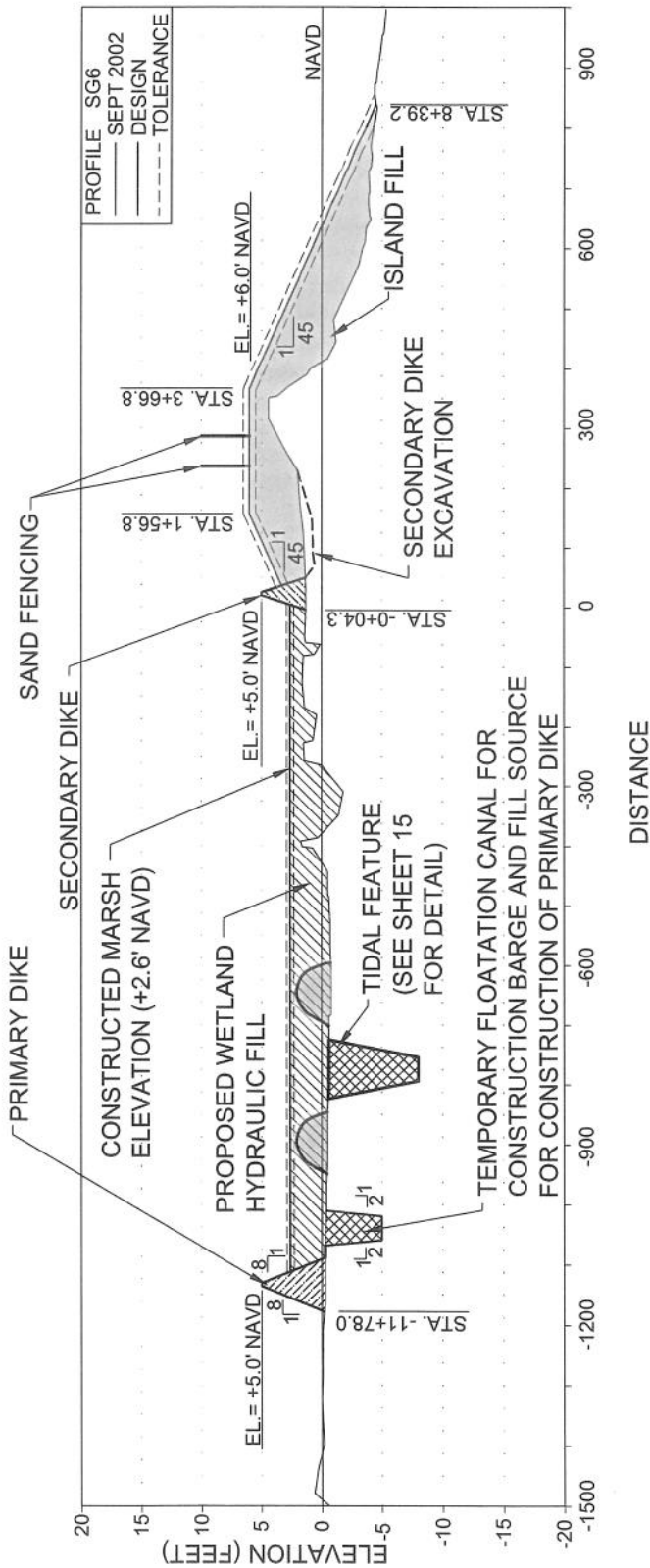

**NOTE:**  
 ELEVATIONS SHOWN HEREON ARE IN FEET  
 BASED ON NAVD 1988.

- LEGEND:**
- DENOTES WETLAND FILL
  - DENOTES ISLAND FILL
  - DENOTES CONTAINMENT DIKE
  - DENOTES EXCAVATED MARSH MATERIAL TO BE USED FOR CONTAINMENT DIKE

SCALE: 1"= 300' HORIZONTAL  
 1"=15' VERTICAL

REVISIONS		
DATE	BY	DESCRIPTION

**COASTAL PLANNING & ENGINEERING, INC.**  
 www.CoastalPlanning.net

DATE: 11/17/03

BY: RC

COMM NO.: 7261.07

SHEET: 11

2481 N.W. BOCA RATON BLVD.  
 BOCA RATON, FL 33431  
 PH. (561) 391-8102 FAX (561) 391-9116

**TITLE:** PELICAN ISLAND RESTORATION  
 (BA-38-1) CWPRA PROJECT  
 FILL CROSS SECTION SG6

Figure 2c



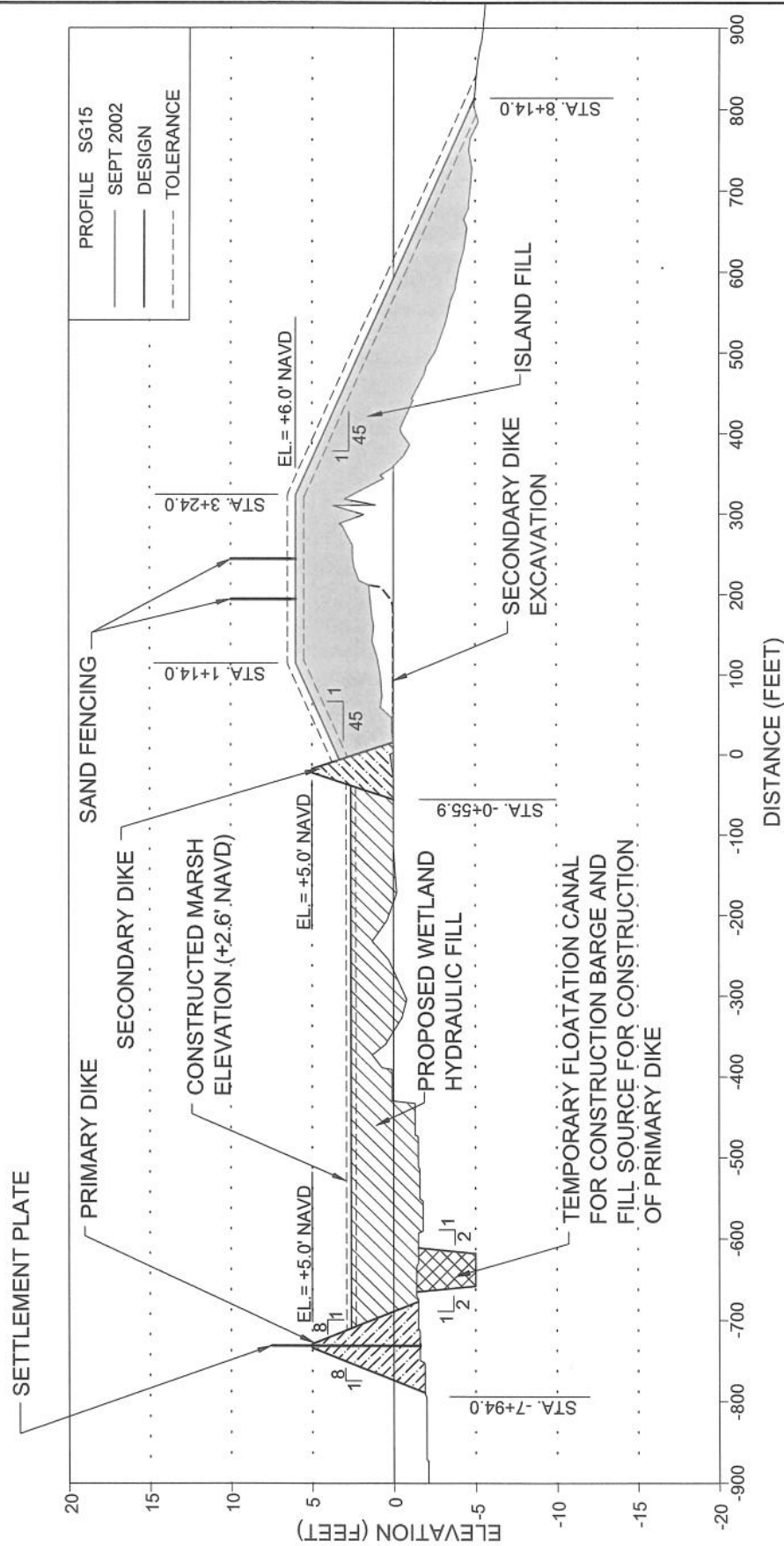

PROFILE SG15  
 SEPT 2002  
 DESIGN  
 TOLERANCE

**NOTE:**  
 ELEVATIONS SHOWN HEREON ARE IN FEET  
 BASED ON NAVD 1988.

**LEGEND:**

- DENOTES WETLANDS FILL
- DENOTES ISLAND FILL
- DENOTES CONTAINMENT DIKE
- DENOTES EXCAVATED MARSH MATERIAL TO BE USED FOR CONTAINMENT DIKE

REVISIONS		
DATE	BY	DESCRIPTION

SCALE: 1"= 200' HORIZONTAL  
 1"= 10' VERTICAL

<b>COASTAL PLANNING &amp; ENGINEERING, INC.</b> 2481 N.W. BOCA RATON BLVD. BOCA RATON, FL 33431 PH. (561) 391-8102 FAX (561) 391-9116 www.CoastalPlanning.net		TITLE: <b>PELICAN ISLAND RESTORATION                  (BA-38-1) CWPRA PROJECT                  FILL CROSS SECTION SG15</b>
DATE:	11/17/03	COMM NO.:
BY:	RC	7261.07
SHEET:	12	

Figure 2d

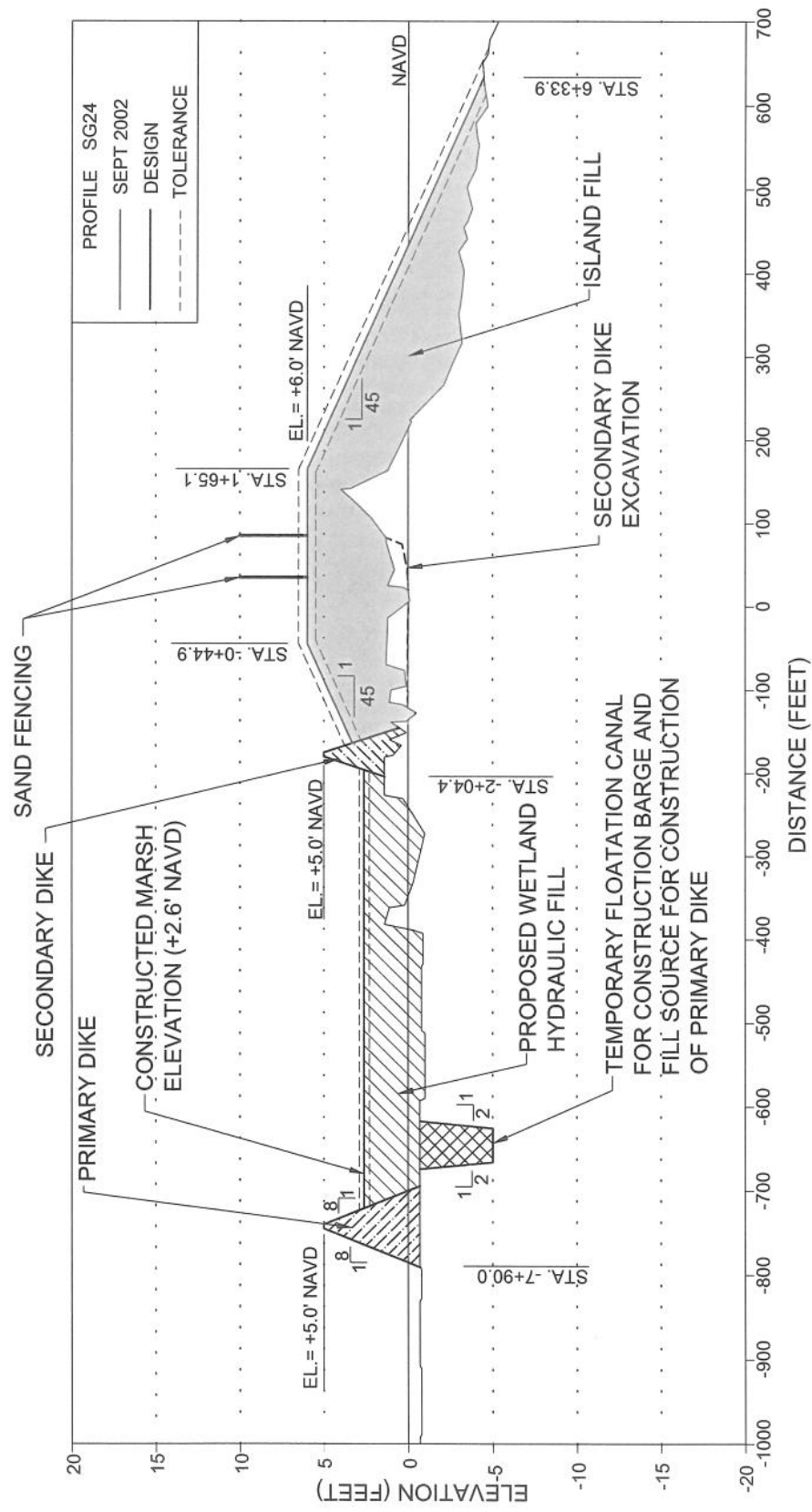

**NOTE:**  
ELEVATIONS SHOWN HEREON ARE IN FEET  
BASED ON NAVD 1988.

**LEGEND:**

- DENOTES WETLAND FILL
- DENOTES ISLAND FILL
- DENOTES CONTAINMENT DIKE
- DENOTES EXCAVATED MARSH MATERIAL TO BE USED FOR CONTAINMENT DIKE

**NOTE:**  
1. ELEVATIONS SHOWN HEREON ARE IN FEET  
BASED ON NAVD 1988.

SCALE: 1"= 200' HORIZONTAL  
1"=10' VERTICAL

REVISIONS		
DATE	BY	DESCRIPTION

<b>Coastal Planning &amp; Engineering, Inc.</b> <small>www.CoastalPlanning.net</small>	2481 N.W. BOCA RATON BLVD. BOCA RATON, FL 33431 PH. (561) 391-8102 FAX (561) 391-9116	TITLE: <b>PELICAN ISLAND RESTORATION (BA-38-1) CWPRA PROJECT FILL CROSS SECTION SG24</b>
DATE:	11/17/03	COMM NO.:
BY:	RC	7261.07
		SHEET:
		13

Figure 2e

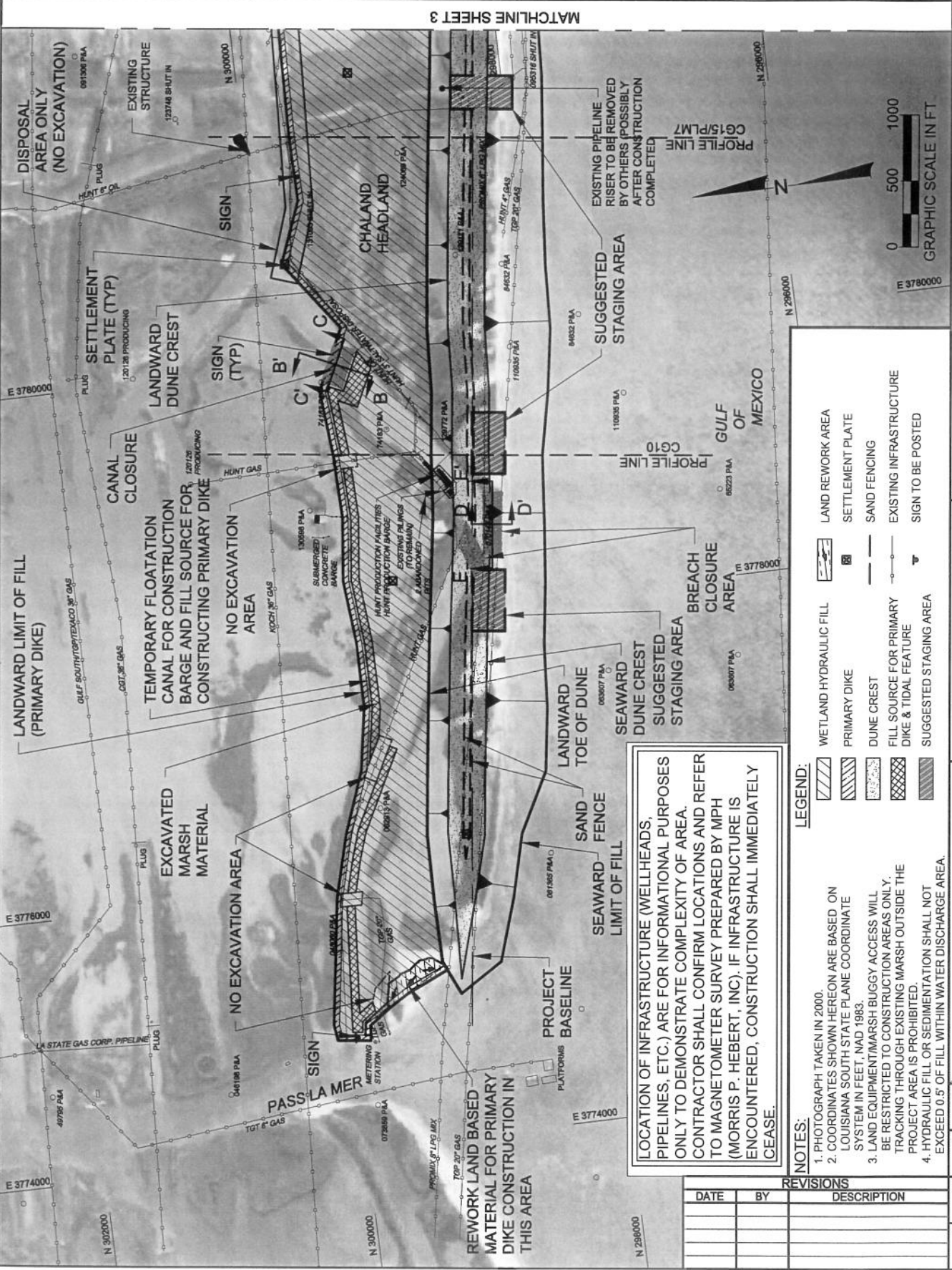

MATCHLINE SHEET 3

LOCATION OF INFRASTRUCTURE (WELLHEADS, PIPELINES, ETC.) ARE FOR INFORMATIONAL PURPOSES ONLY TO DEMONSTRATE COMPLEXITY OF AREA. CONTRACTOR SHALL CONFIRM LOCATIONS AND REFER TO MAGNETOMETER SURVEY PREPARED BY MPH (MORRIS P. HEBERT, INC.) IF INFRASTRUCTURE IS ENCOUNTERED, CONSTRUCTION SHALL IMMEDIATELY CEASE.

**LEGEND:**

- WETLAND HYDRAULIC FILL
- PRIMARY DIKE
- DUNE CREST
- FILL SOURCE FOR PRIMARY DIKE & TIDAL FEATURE
- SUGGESTED STAGING AREA
- LAND REWORK AREA
- SETTLEMENT PLATE
- SAND FENCING
- EXISTING INFRASTRUCTURE
- SIGN TO BE POSTED

**NOTES:**

1. PHOTOGRAPH TAKEN IN 2000.
2. COORDINATES SHOWN HEREON ARE BASED ON LOUISIANA SOUTH STATE PLANE COORDINATE SYSTEM IN FEET, NAD 1983.
3. LAND EQUIPMENT/MARSH BUGGY ACCESS WILL BE RESTRICTED TO CONSTRUCTION AREAS ONLY. TRACKING THROUGH EXISTING MARSH OUTSIDE THE PROJECT AREA IS PROHIBITED.
4. HYDRAULIC FILL OR SEDIMENTATION SHALL NOT EXCEED 0.5' OF FILL WITHIN WATER DISCHARGE AREA.

REVISIONS		
DATE	BY	DESCRIPTION

**CHALAND HEADLAND RESTORATION (BA-38-2) CWPRA PROJECT PLAN VIEW**

TITLE: 2481 N.W. BOCA RATON BLVD. BOCA RATON, FL 33431 PH. (561) 391-8102 FAX (561) 391-9116

**COASTAL PLANNING & ENGINEERING, INC.**  
www.CoastalPlanning.net

DATE: 11/17/03  
BY: JRC  
COMM NO.: 7261.07  
SHEET: 2

Figure 3a

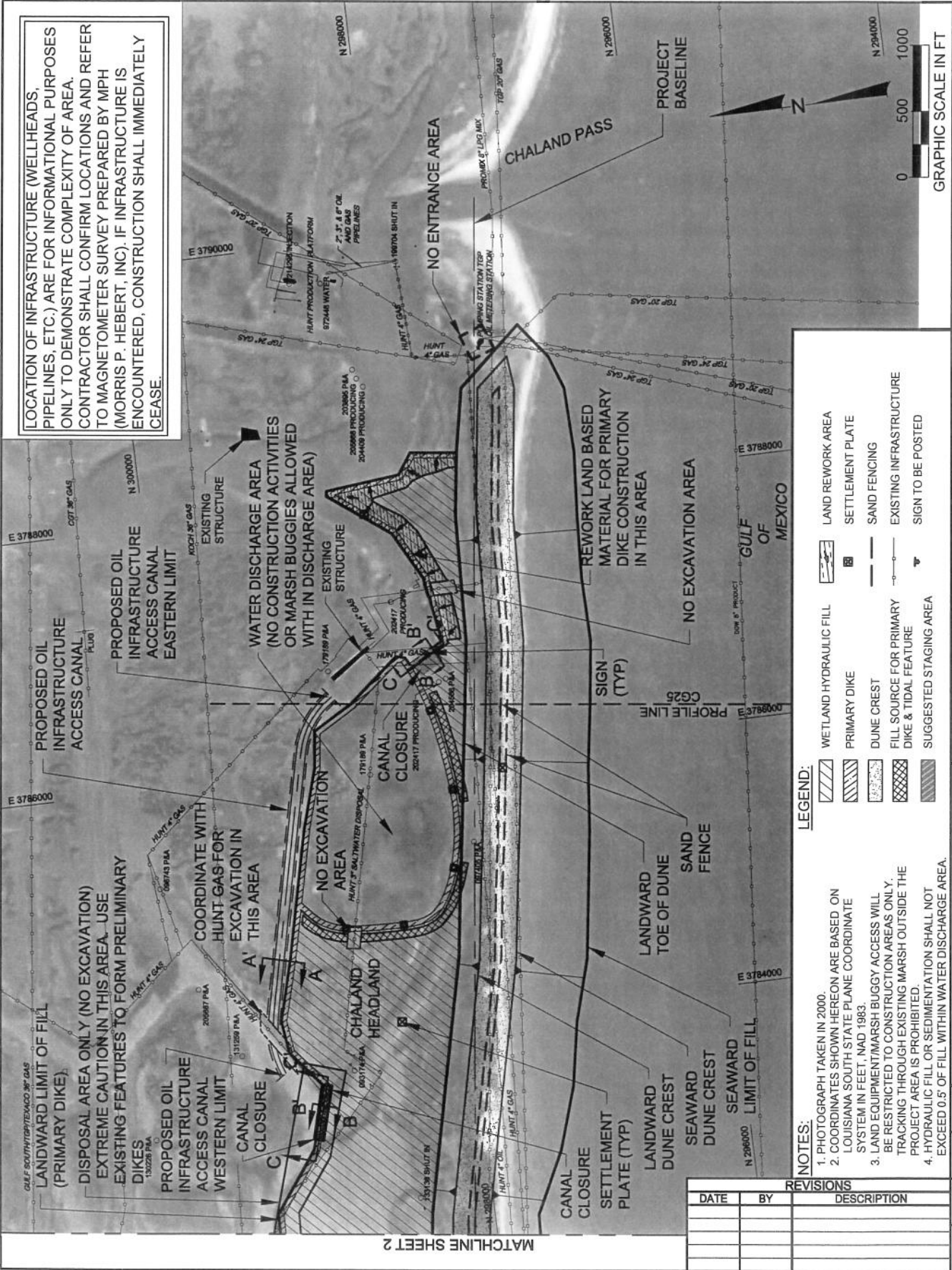
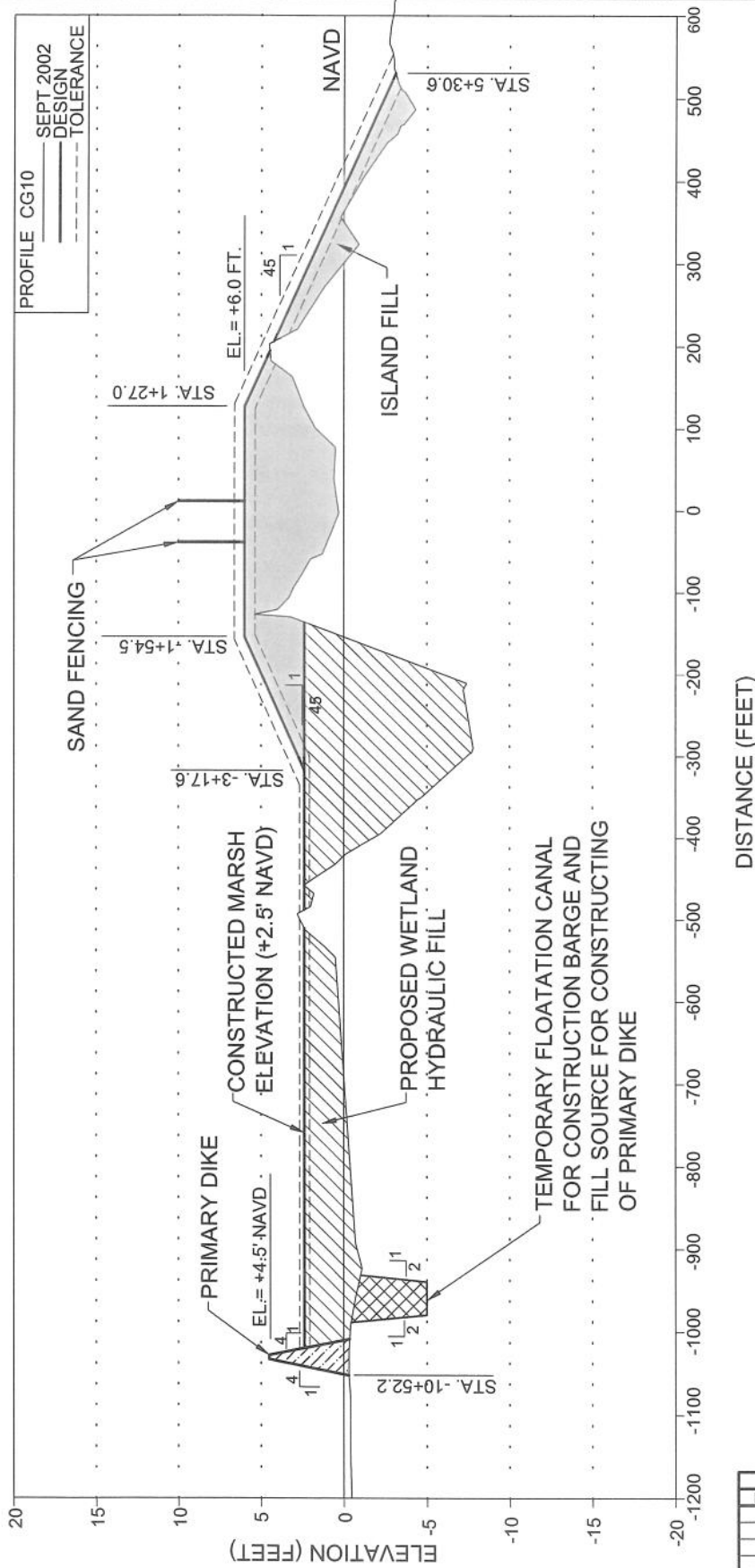

Figure 3b





REVISIONS		
DATE	BY	DESCRIPTION

- LEGEND:**
- DENOTES WETLAND HYDRAULIC FILL
  - DENOTES ISLAND FILL
  - DENOTES PRIMARY DIKE
  - DENOTES EXCAVATED MARSH MATERIAL TO BE USED FOR PRIMARY DIKE

**NOTE:**  
1. ELEVATIONS SHOWN HEREON ARE IN FEET BASED ON NAVD 1988.

SCALE: 1"= 200' HORIZONTAL  
1"=10' VERTICAL

<b>COASTAL PLANNING &amp; ENGINEERING, INC.</b> www.CoastalPlanning.net	DATE: 11/17/03	<b>CHALAND HEADLAND RESTORATION (BA-38-2) CWPBRA PROJECT</b> FILL CROSS SECTION CG10
BY: TW	COMM NO.:	TITLE:
SHEET: 7	7261.07	2481 N.W. BOCA RATON BLVD. BOCA RATON, FL 33431 PH. (561) 391-8102 FAX (561) 391-9116

Figure 3c

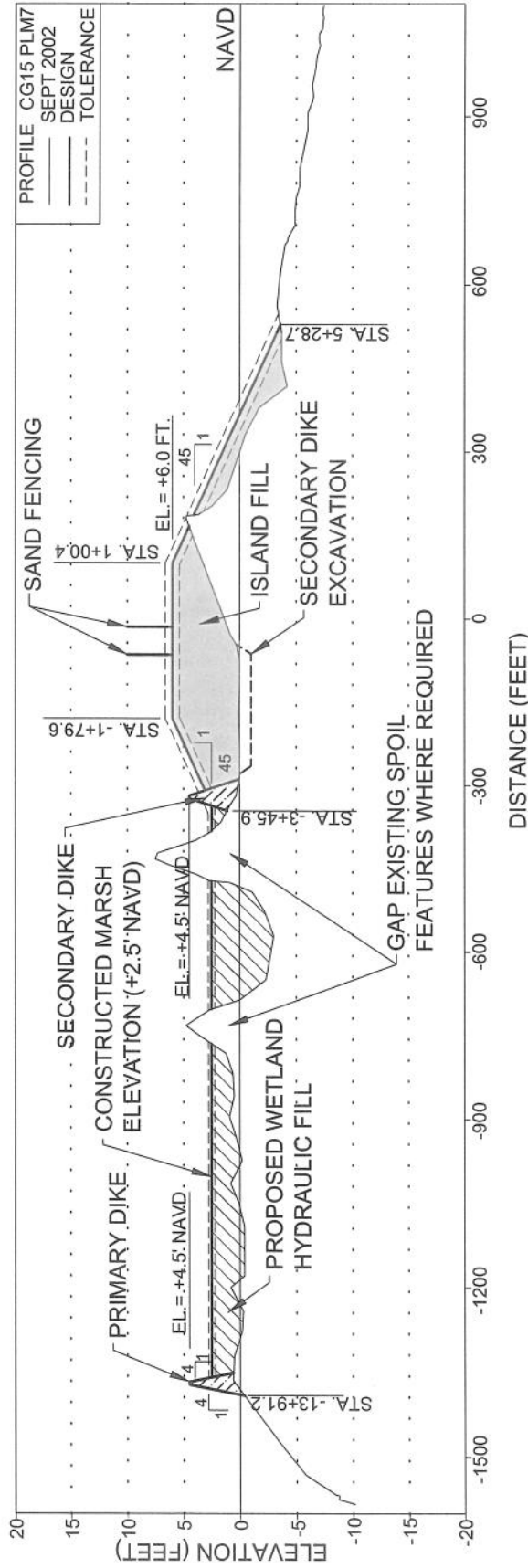

REVISIONS		
DATE	BY	DESCRIPTION

- LEGEND:**
- DENOTES WETLAND HYDRAULIC FILL
  - DENOTES ISLAND FILL
  - DENOTES PRIMARY DIKE

**NOTE:**  
1. ELEVATIONS SHOWN HEREON ARE IN FEET  
BASED ON NAVD 1988.

SCALE: 1"= 300' HORIZONTAL  
1"=15' VERTICAL

<p><b>COASTAL PLANNING &amp; ENGINEERING, INC.</b> www.CoastalPlanning.net</p>	<p>DATE: 10/17/03</p>	<p><b>CHALAND HEADLAND RESTORATION</b> (BA-38-2) CWPRA PROJECT FILL CROSS SECTION CG15 PLM7</p>
	<p>BY: TW</p>	<p>2481 N.W. BOCA RATON BLVD. BOCA RATON, FL 33431 PH. (561) 391-8102 FAX (561) 391-9116</p>
<p>COMM NO.: 7261.07</p>	<p>SHEET: 8</p>	<p>TITLE:</p>

Figure 3d

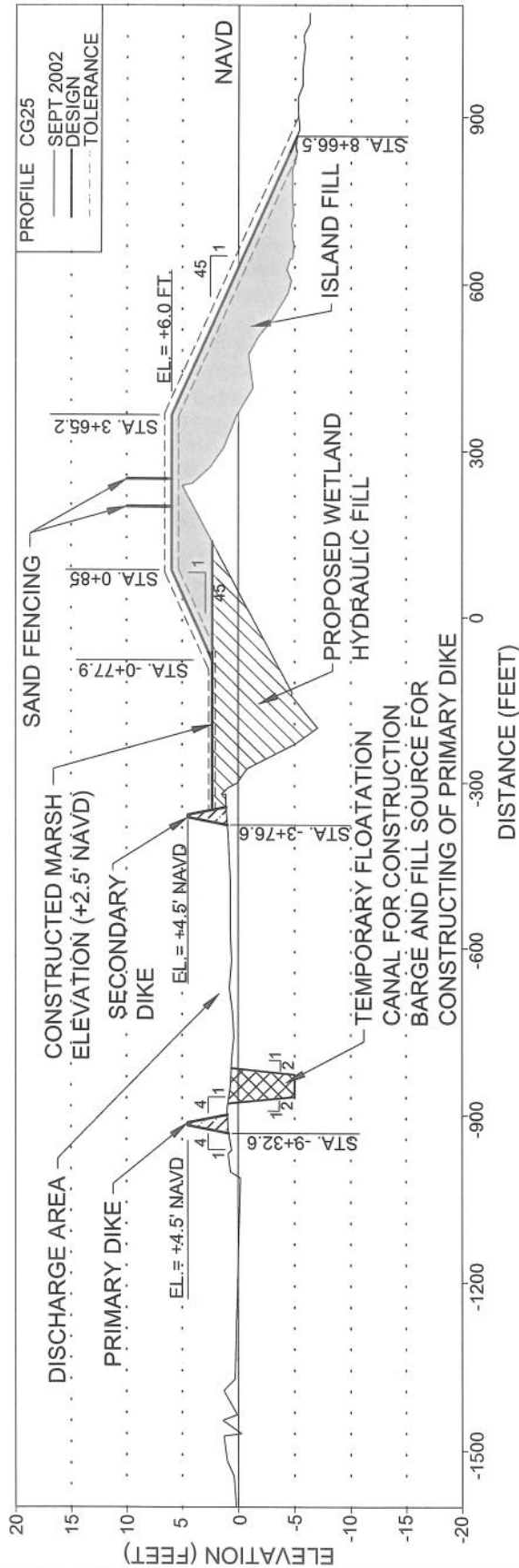

**LEGEND:**

-  DENOTES WETLAND HYDRAULIC FILL
-  DENOTES ISLAND FILL
-  DENOTES PRIMARY DIKE
-  DENOTES EXCAVATED MARSH MATERIAL TO BE USED FOR PRIMARY DIKE

**NOTE:**

1. ELEVATIONS SHOWN HEREON ARE IN FEET BASED ON NAVD 1988.

SCALE: 1" = 300' HORIZONTAL  
1" = 15' VERTICAL

REVISIONS		
DATE	BY	DESCRIPTION

DATE:	10/17/03
BY:	TW
COMM NO.:	7261.07
SHEET:	9

**Coastal Planning & Engineering, Inc.**  
www.CoastalPlanning.net

2481 N.W. BOCA RATON BLVD.  
BOCA RATON, FL 33431  
PH. (561) 391-8102 FAX (561) 391-9116

TITLE:

**CHALAND HEADLAND RESTORATION  
(BA-38-2) CWPRA PROJECT  
FILL CROSS SECTION CG25**

Figure 3e

## 2.1 PELICAN ISLAND ALTERNATIVES

Three alternatives, in addition to the no action alternative, were considered for the Pelican Island project area. The major features of the alternatives and, where applicable, the associated borrow are summarized in Table 3. Components of the three construction alternatives include the following:

- Marsh creation and nourishment behind the island, with associated containment
- Beach nourishment and dune construction on the Gulf side of the island
- Constructed tidal features in the marsh (channels and ponds)
- Sand fencing
- Vegetative planting

**TABLE 3**

**MAJOR FEATURES OF PELICAN ISLAND ALTERNATIVES**

<b>Pelican Island Restoration Alternatives</b>	<b>Features</b>	<b>Borrow Area</b>
No Action	None	None
Alternative 1	<ul style="list-style-type: none"> <li>- Creation and restoration of back-barrier marsh</li> <li>- Vegetative planting</li> </ul>	Empire
Alternative 2; Hybrid	<ul style="list-style-type: none"> <li>- Beach nourishment and dune creation</li> <li>- Creation and restoration of back-barrier marsh</li> <li>- Vegetative planting</li> <li>- Sand fencing</li> <li>- Tidal features</li> </ul>	Sandy Point and possibly Empire
Alternative 3; Seaward	<ul style="list-style-type: none"> <li>- Beach nourishment and dune creation</li> <li>- Creation and restoration of back-barrier marsh</li> <li>- Vegetative planting</li> <li>- Sand fencing</li> <li>- Tidal features</li> </ul>	Sandy Point and possibly Empire

### 2.1.1 No Action

This alternative considers not constructing shoreline or marsh. With no action, the shoreline of Pelican Island will retreat an average 17.9 feet (5.5 meters [m]) per year, and the island will lose approximately 5.2 acres per year. The shoreline position 20 years after construction will be -358 feet (109 m) with respect to its current position. Total acreage above zero feet 20 years after construction will be 70 acres (Tetra Tech and CPE 2003a).

### 2.1.2 Construction Alternatives

Three alternatives, in addition to no action, were considered for the Pelican Island project area.



Two sources of fill material have been identified for Pelican Island restoration. The Empire borrow area contains relatively fine-grained material suitable for marsh creation. The Sandy Point borrow area contains slightly coarser material suitable for building the island. These two borrow areas are shown in Figure 4 and described briefly below. Table 4 summarizes physical characteristics of the borrow areas.

**TABLE 4**  
**CHARACTERISTICS OF BORROW AREAS**

	Pelican Island			Chaland Headland
	Empire	Sandy Point		Quatre Bayou
		Southeast	Northwest	
Distance from Shore (miles)	1.3	11	9	4
Water Depth (feet)	-18	-35	-35.5	-14.5
Area (square miles)	0.40	0.18	0.13	0.71
Depth of Cut (feet)	-27	-55	-55	-30
Volume of Sand and Silt (cubic yards)	304,600	2,421,800	1,583,500	4,775,900
Mean Grain Size (mm)	0.11	0.12	0.11	0.09
Sand Percent	84	91	86	78

#### **Empire Borrow Area**

The Empire borrow area—divided by three oil and gas pipelines—has a highly variable sediment and stratified structure (Figure 5). Areas that contain workable volumes of clean sandy sediments are limited because of undesirable textural properties (such as high silt content in the sandy layers and predominance of silt and clay beds), limited spatial distribution of the sand deposits (such as sand distributed in small, isolated pockets or buried mounds), and seabed infrastructure (such as presence of oil and gas pipelines). Therefore, the Empire borrow area is suitable only for back barrier and marsh restoration on Pelican Island (Tetra Tech and CPE 2003b) (Table 4).

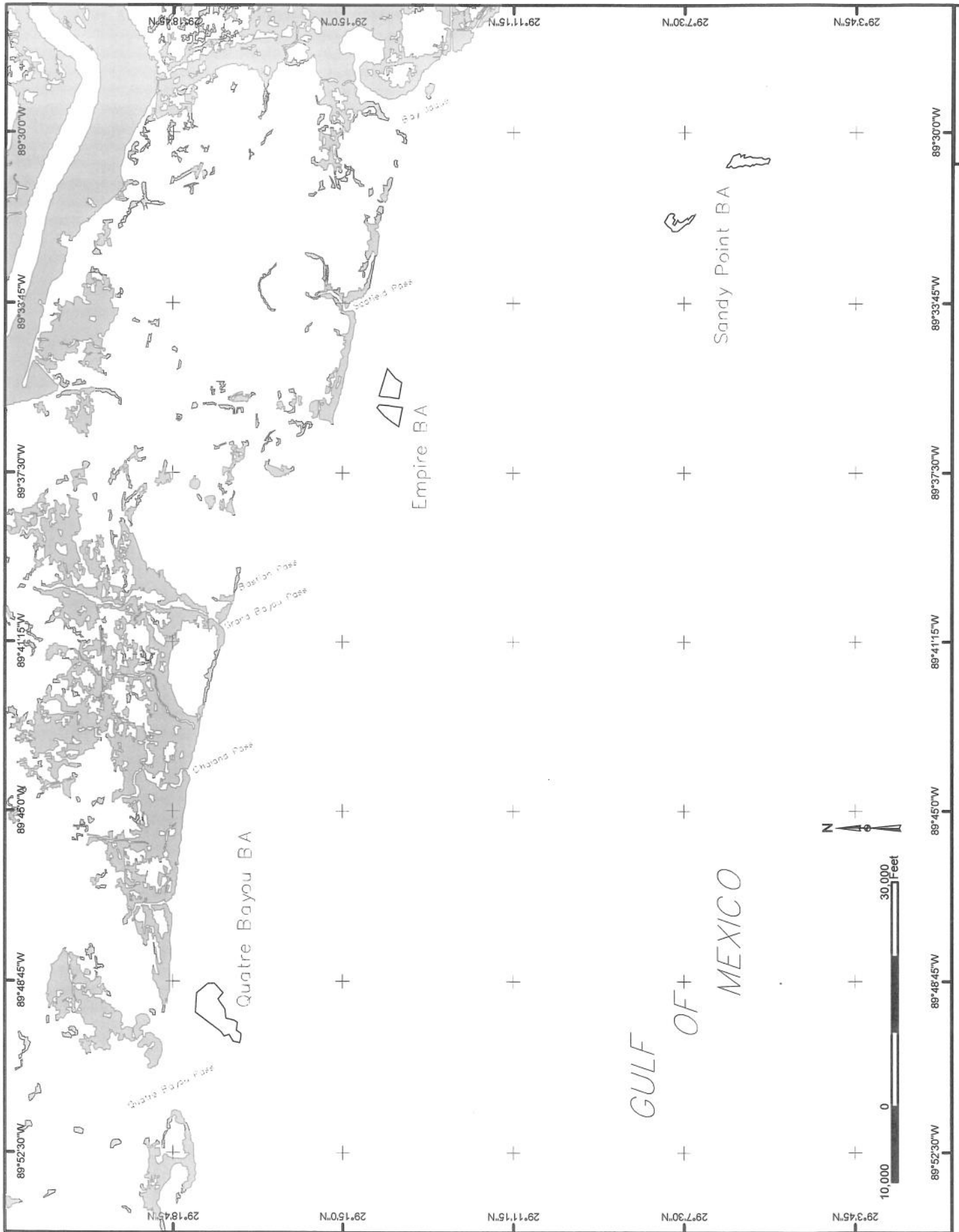
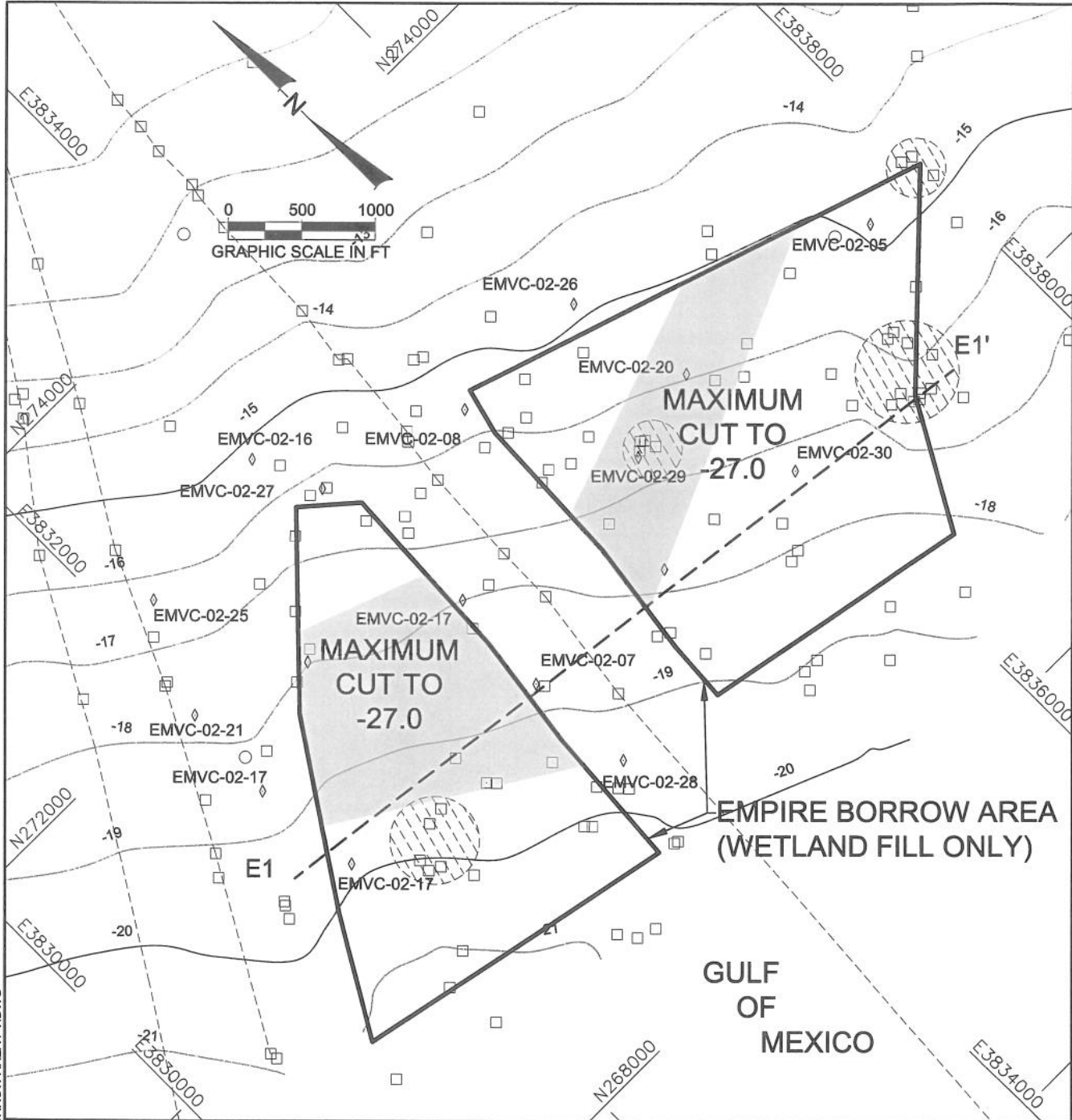

FIGURE 4



**PELICAN ISLAND RESTORATION  
(BA-38-1) CWPRA PROJECT  
EMPIRE BORROW AREA BATHYMETRY**

TITLE:  
2481 N.W. BOCA RATON BLVD.  
BOCA RATON, FL 33431  
PH. (561) 391-8102 FAX (561) 391-9116

**COASTAL PLANNING & ENGINEERING, INC.**  
www.CoastalPlanning.net

**NOTES:**

- COORDINATES SHOWN HEREON ARE BASED ON LOUISIANA SOUTH STATE PLANE COORDINATE SYSTEM IN FEET, NAD 1983.
- ELEVATIONS SHOWN HEREON ARE IN FEET BASED ON NAVD 1988.
- CONTOURS SHOWN HEREON ARE IN FEET AND DERIVED FROM THE BATHYMETRIC SURVEY CONDUCTED BY CPE ON 8/6/02 - 8/15/02.

**LEGEND:**

- EMVC-02-17 CPE 2002 VIBRACORE LOCATION
- 2002 MAGNETOMETER HIT
- BSS CORE LOCATIONS (FROM USGS FILE REPORT NO. 01-384, DATED SEPTEMBER 2001, APPENDIX B CD ROM)
- MAGNETIC ANOMALY WITH BUFFER RECOMMENDED FOR INVESTIGATION OR AVOIDANCE
- PIPELINE LOCATION
- PRIMARY DREDGE AREA (SILT/CLAY/SAND)

REVISIONS		
DATE	BY	DESCRIPTION

DATE: 11/17/03  
BY: JRC  
COMM NO.: 7261.07  
SHEET: 4

H:\Louisiana\726107\PERMITS\PELICAN BORROW AREA PV.DWG

Figure 5

## **Sandy Point Borrow Area**

The Sandy Point borrow area contains sufficient sand volumes to meet the volumetric requirements of the Pelican Island restoration project (Tetra Tech and CPE 2003c). The Sandy Point borrow area lies in the Gulf of Mexico from 5.5 to 7 nautical miles (10.2 to 12.9 kilometers) south-southwest of Sandy Point in Plaquemines Parish, Louisiana (Tetra Tech and CPE 2003c). Within the Sandy Point borrow area, two potential sand deposits (northwest [NW] and southeast [SE]) were identified, surveyed, mapped, and cored (Tetra Tech and CPE 2003c) (Figures 6 and 7). These areas were found to contain 3.6 million cubic yards (cy) (2.7 million cubic meters) of clean sand and 4 million cy [3.2 million cubic meters] of sand and silt (Table 4). Oil and gas pipelines somewhat limit the areas that contain workable volumes of clean sandy sediments.

### **NW Point**

The NW Sandy Point borrow area is 6 nautical miles (11.1 kilometers) south-southwest of Sandy Point in the south half of Block 27, West Delta Area. Water depths in the NW Borrow area range from 34 to 37 feet (10.4 to 11.3 m) NAVD. The NW Sandy Point borrow area contains approximately 1,846,700 cy (1.4 million cubic meters) of sandy sediment. The average mean grain size of the sand deposits is 0.11 millimeter (mm), and the average percent silt is 13.7%.

### **SE Point**

The SE Sandy Point borrow area is 7 nautical miles (12.9 kilometers) south of Sandy Point in the northwestern corner of Block 49 and the southwestern edge of Block 26, West Delta Area. Water depths in the SE borrow area range from 33 to 36 feet (9.9 to 10.8 m) NAVD. The SE borrow area contains approximately 2,220,100 cy (1.7 million cubic meters) of sandy sediment. The average mean grain size of the sand deposits is 0.12 mm, and the average percent silt is 9.0%.

Approximately 3 million cy (2.3 million cubic meters) of overburden cover the total extent of sand deposits within the two Sandy Point borrow areas (Tetra Tech and CPE 2003c). To access the sand deposits, the overburden must be removed. The overburden will be excavated and transported to underwater disposal sites that will not interfere with future excavation of material from the Sandy Point borrow area. The NW Sandy Point dump area is 5 nautical miles (9.3 kilometers) south-southwest of Sandy Point in the west central portion of Block 27, West Delta Area. Water depths in the NW dump area range from to 35 feet (10.0 to 10.6 m) NAVD. The SE Sandy Point Dump area is 7 nautical miles (12.9 kilometers) south of Sandy Point in the north central part of Block 49 and southern edge of Block 26, West Delta Area. Water depths in the SE Dump area range from 34 to 35 feet (10.4 to 10.5 m) NAVD (Tetra Tech and CPE 2003c).

Overburden material will be extracted through dredging, and mixed with water to form a slurry. The slurry will be transported through pipelines and deposited underwater. The disposal pipeline will likely be suspended under the surface of the water, but well above bottom, depending on water depth of disposal. The placement under water will help to further mix and spread the material, which should prevent the creation of undesirable shallow areas. To avoid formation of shallow areas hazardous to navigation, specifications will require the contractor to periodically survey the disposal site and to relocate the discharge pipe whenever a critical minimum water depth occurs (Tetra Tech and CPE 2003a). In this way, the overburden can be spread well away from the borrow area without creating a hazard to navigation.

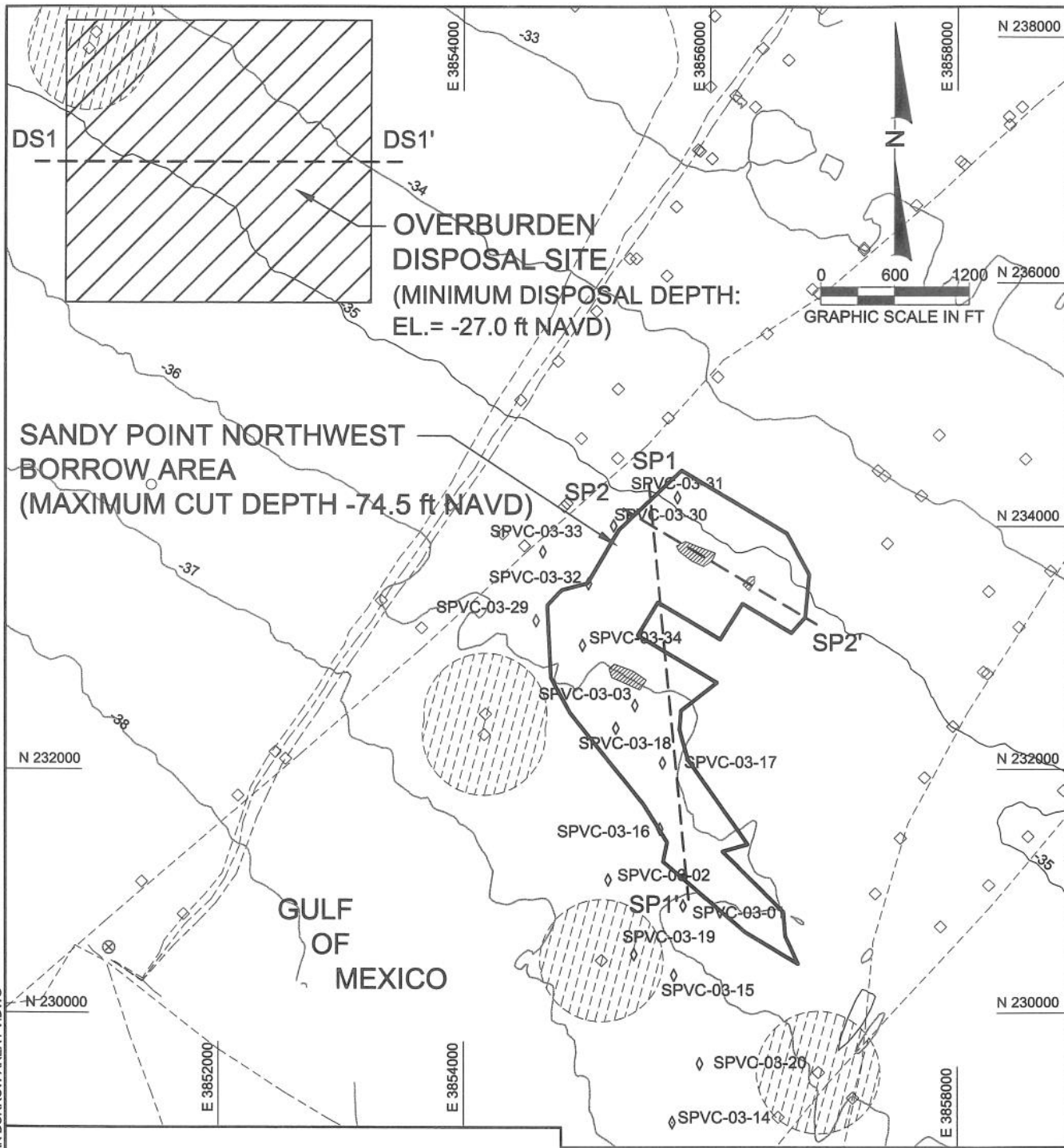

**PELICAN ISLAND RESTORATION  
(BA-38-1) CWPRA PROJECT  
SANDY POINT NW BORROW AREA BATHYMETRY**

TITLE:  
2481 N.W. BOCA RATON BLVD.  
BOCA RATON, FL 33431  
PH. (561) 391-8102 FAX (561) 391-9116

**COASTAL PLANNING & ENGINEERING, INC.**  
www.CoastalPlanning.net

**NOTES:**

1. COORDINATES SHOWN HEREON ARE BASED ON LOUISIANA SOUTH STATE PLANE COORDINATE SYSTEM IN FEET, NAD 1983.
2. CONTOURS SHOWN HEREON ARE IN FEET AND DERIVED FROM THE BATHYMETRIC SURVEY CONDUCTED BY CPE JULY, 2003.
3. PIPELINE LAYOUTS FROM: THE GULF OF MEXICO GIS MAP VIEWER CD, BY OILFIELD PUBLICATIONS LIMITED (OPL); THE LOUISIANA GIS CD: A DIGITAL MAP OF THE STATE, 2 CD SET; AND SOME GROUND TRUTHING BY CPE.
4. ELEVATIONS SHOWN HEREON ARE IN FEET BASED ON NAVD 1988.

**LEGEND:**

- ◇ CPE 2003 VIBRACORE LOCATION
- MAGNETIC ANOMALY
- UNIDENTIFIED MAG. ANOMALY RECOMMENDED FOR INVESTIGATION OR AVOIDANCE
- ▨ AREA DEVOID OF SAND
- PIPELINES

REVISIONS		
DATE	BY	DESCRIPTION
12/17/03	STR	REVISED CUTS

DATE:  
11/17/03  
BY:  
JRC  
COMM NO.:  
7261.07  
SHEET:  
6

H:\Louisiana\726107\PERMITS\PELICAN BORROW AREA.PV.DWG

Figure 6



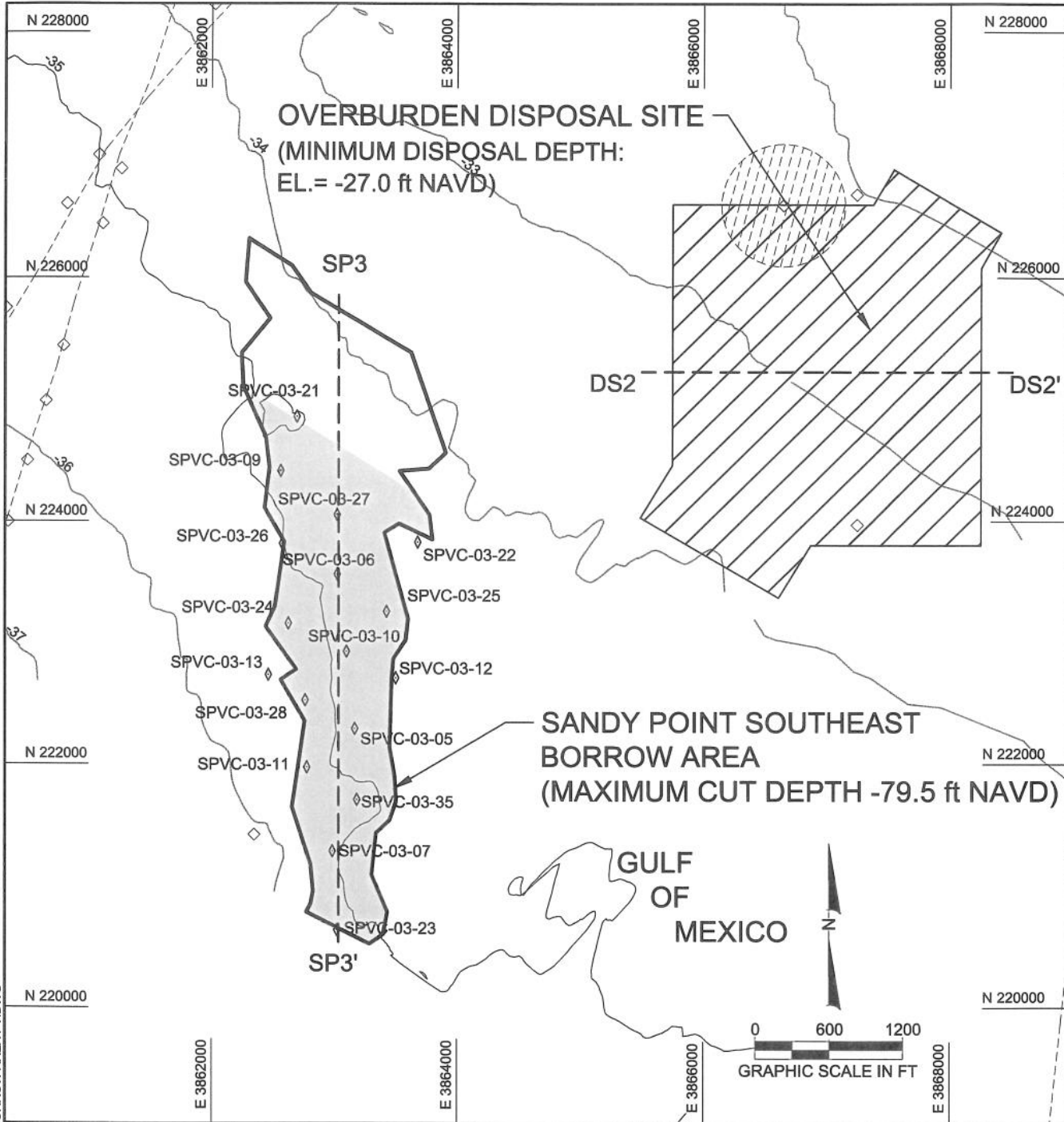

**TITLE:**  
 PELICAN ISLAND RESTORATION  
 (BA-38-1) CWP/PRA PROJECT  
 SANDY POINT SE BORROW AREA BATHYMETRY

2481 N.W. BOCA RATON BLVD.  
 BOCA RATON, FL 33431  
 PH. (561) 391-8102 FAX (561) 391-9116

**COASTAL PLANNING & ENGINEERING, INC.**  
 www.CoastalPlanning.net

DATE:  
 11/17/03  
 BY:  
 JRC  
 COMM NO.:  
 7261.07  
 SHEET:  
 8

- NOTES:**
- COORDINATES SHOWN HEREON ARE BASED ON LOUISIANA SOUTH STATE PLANE COORDINATE SYSTEM IN FEET, NAD 1983.
  - CONTOURS SHOWN HEREON ARE IN FEET AND DERIVED FROM THE BATHYMETRIC SURVEY CONDUCTED BY CPE JULY, 2003.
  - PIPELINE LAYOUTS FROM: THE GULF OF MEXICO GIS MAP VIEWER CD, BY OILFIELD PUBLICATIONS LIMITED (OPL); THE LOUISIANA GIS CD: A DIGITAL MAP OF THE STATE, 2 CD SET; AND SOME GROUND TRUTHING BY CPE.
  - ELEVATIONS SHOWN HEREON ARE IN FEET BASED ON NAVD 1988.

- LEGEND:**
- DENOTES CPE 2003 VIBRACORE LOCATION
  - DENOTES MAGNETIC ANOMALY
  - DENOTES MAGNETIC ANOMALY WITH BUFFER (NO DREDGE AREA)
  - PRIMARY DREDGE AREA TO BE DREDGED FIRST (LOWER SILT AND OVERBURDEN)
  - PIPELINES

REVISIONS		
DATE	BY	DESCRIPTION
12/17/03	STR	REVISED CUTS

H:\Louisiana\726107\PERMIT\PELICAN\BORROW AREA P.V.DWG

Figure 7

In addition, disposal will occur away from any oil infrastructure that placement of sediment might adversely affect. An alternative to disposal on the undredged gulf bottom is to dispose of the material in areas that have been used as borrow areas. But how much material actually will remain in the borrow pit is unknown because of uncertainty about the nature of the material as it is dredged and further affected by water mixing. Furthermore, the overburden would be transported a sufficient distance to avoid creating additional overburden over sand resources yet to be excavated (Tetra Tech and CPE 2003a).

#### **2.1.2.1 Design Alternative 1: Marsh-Only Construction (Landward)**

The marsh-only alternative would place available marsh-compatible material from the nearshore Empire borrow area to construct a marsh platform of 254 acres (102.8 hectares) behind the existing island. No additional beach or island construction is included within this alternative. This alternative would require construction of approximately 12,000 linear feet (3657 m) of new dikes to contain about 1.64 million cy of fill material (Tetra Tech and CPE 2003a). Planting about 365 acres of intertidal vegetation in the newly constructed marsh would control turbidity and increase habitat value. This alternative would nourish approximately 150 acres of marsh and restore 154 additional acres.

#### **2.1.2.2 Design Alternative 2: Seaward Island Construction**

The seaward alternative would retain the 254 acres (102.8 hectares) of marsh construction using fill material from the Empire borrow area described in Alternative 1 (Section 2.1.2). Island components (increased berm height and beach fill) would be added, using material from the Sandy Point borrow area. The island cross-section would be constructed primarily seaward of the existing beach berm and dune features. The island component for this alternative would consist of a berm height +6 feet (1.8 m) NAVD with a nominal width of 200 feet (60.9 m). The berm would extend both landward and seaward at a 1:45 slope to the existing grade. Since erosion rate increases with seaward construction, the island would not be constructed beyond -5 feet (1.5 m) NAVD. The fill would be tapered substantially at the eastern portion of the island (Tetra Tech and CPE 2003a).

Approximately 17,000 linear feet (5181 m) of dikes would be constructed to contain about 1.58 million cy (1.2 million cubic meters) of wetland fill. Planting 537 acres (217 hectares) of supratidal and intertidal vegetation would increase immediate habitat value and control turbidity in the adjacent water.

#### **2.1.2.3 Design Alternative 3 (Preferred): Hybrid Island Construction**

In the hybrid island alignment, the dike locations and marsh creation would be further landward (Figures 2a through 2e). Approximately 12,400 linear feet (3779 m) of dikes would be constructed, and about 1.13 million cy (0.8 million cubic meters) of wetland fill would be placed in the project area. About 254 acres (102.8 hectares) of marsh would be constructed using fill material from the Empire borrow area. The island cross-section would be constructed primarily landward of the existing berm and dune feature. As described in Alternative 2, island fill would be dredged from the Sandy Point borrow area. The island component for this alternative would consist of a berm height +6 feet (1.8 m) NAVD with a nominal width of 200 feet (60.9 m). The berm would extend both landward and seaward at a 1:45 slope to the existing grade. This landward shift would reduce construction on the gulf side and thus decrease the shoreline erosion rate. However, this alternative calls for construction over more of the existing island and marsh (Tetra Tech and CPE 2003a). Vegetative planting would occur on about 446 acres (180.6 hectares).

## **2.2 CHALAND HEADLAND ALTERNATIVES**

### **2.2.1 No Action**

Under the no-action alternative, no island or marsh construction will occur. With no action, the shoreline of Chaland Headland will retreat an average 16.4 feet (5 m) per year, and the island will lose approximately 5.6 acres per year. The shoreline position 20 years after construction will be -328 feet (100 m), and the total acres above zero feet will be 26 acres (Tetra Tech and CPE 2003a).

### **2.2.2 Action, Design or Construction Alternatives**

Three alternatives, in addition to the no action alternative, were considered for the Chaland Headland project area. The process of selecting the preferred alternative is further discussed in Section 2.3. Components of the three construction alternatives include the following features:

- Marsh creation and nourishment behind the island, with associated containment
- Beach nourishment and dune construction on the Gulf side of the island
- Sand fencing
- Vegetative planting

All construction alternatives are similar in that beach nourishment, dune construction, and back-barrier marsh restoration are components of all alternatives. Major differences between the construction alternatives are the alignment (i.e., landward or seaward) of the construction template.

The preferred borrow area for the Chaland Headlands project area is the Quatre Bayou borrow area, located offshore Quatre Bayou Pass and Pass Ronquille to the west of Chaland Island (Figure 8 and Table 4). This area contains ancient distributary channel fill and channel-mouth bar deposits, both of which show great lateral and vertical variability. These deposits are overlain by a mixture of silts, clays, and organic material (Tetra Tech and CPE 2003b). Overburden material would be sidecast during excavation of the desired material. The area meets the volumetric requirements of this project. Although the Quatre Bayou borrow area contains highly variable beds with silt-clay laminates (10-40% silt), sufficient volumes in clean sand beds (<10% silt) are also present. More than 3.6 million cy (2.7 million cubic meters) of sand without silt are present. Mean grain size of the sand resource is 0.09 mm, and deposits average about 78% sand (Tetra Tech and CPE 2003b).



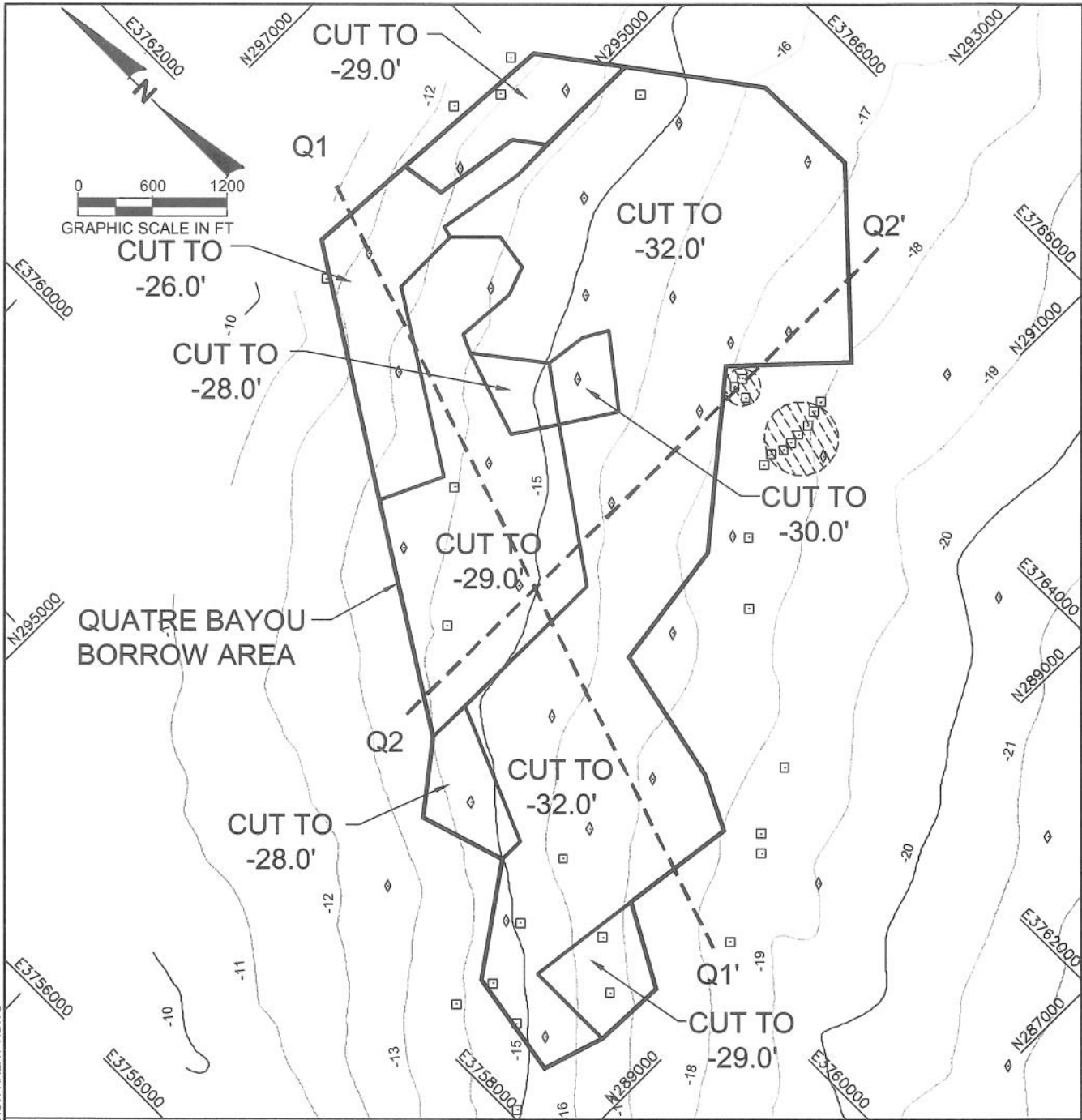

**CHALAND HEADLAND RESTORATION  
(BA-38-2) CWPRA PROJECT  
QUATRE BAYOU BORROW AREA BATHYMETRY**

**TITLE**

**2481 N.W. BOCA RATON BLVD.  
BOCA RATON, FL 33431  
PH. (561) 391-8102 FAX (561) 391-8116**

**COASTAL PLANNING & ENGINEERING, INC.**  
www.CoastalPlanning.net

**DATE:**  
11/17/03

**BY:**  
JRC

**COMM NO.:**  
7281.07

**SHEET:**  
4

**Figure 8**

**NOTES:**

1. COORDINATES SHOWN HEREON ARE BASED ON LOUISIANA SOUTH STATE PLANE COORDINATE SYSTEM IN FEET, NAD 1983.
  2. ELEVATIONS SHOWN HEREON ARE IN FEET BASED ON NAVD 1988.
- CONTOURS SHOWN HEREON ARE IN FEET AND DERIVED FROM THE BATHYMETRIC SURVEY CONDUCTED BY CPE ON 8/6/02 - 8/15/02.

**LEGEND:**

- ◇ DENOTES CPE 2002 VIBRACORE LOCATION
- DENOTES 2002 MAGNETOMETER HIT
- DENOTES BSS CORE LOCATIONS (FROM USGS FILE REPORT NO. 01-384, DATED SEPTEMBER 2001, APPENDIX B CD ROM)
- ⊙ DENOTES MAGNETIC ANOMALY WITH BUFFER

REVISIONS		
DATE	BY	DESCRIPTION

H:\Louisiana\7281.07\PERMITS\CHALAND\BORROW AREA PV.DWG

### **2.2.2.1 Design Alternative 1: Seaward Island Construction**

Under this alternative, island construction would be primarily seaward of the existing island berm and dune features, and marsh construction would be behind the existing island between existing marsh and canal features. Material from the Quatre Bayou borrow area would serve for both marsh and island construction. The island component for this alternative would consist of a berm height +6 feet (1.8 m) NAVD with a nominal width of 200 feet (60.9 m). The berm would extend both landward and seaward at a 1:45 slope to the existing grade. Since the erosion rate increases with seaward construction, the island would not be constructed beyond -5 feet (1.5 m) NAVD. The fill would be tapered at both the east and west boundary (Tetra Tech and CPE 2003a).

About 1.4 million cy (1.07 million cubic meters) of wetland fill would be placed in the project area. Marsh construction would exploit the existing dike around the 'W' canal (see Figures 3a and 3b), and about 11,700 linear feet (3566 m) of containment dikes would be constructed. An additional 1.3 million cy (0.99 million cubic meters) of island fill would be used. About 526 acres (213 hectares) would be planted with vegetation to control erosion, reduce turbidity, and maintain target topography (Tetra Tech and CPE 2003a).

### **2.2.2.2 Design Alternative 2 (Preferred): Landward Island Construction**

In this alternative, island construction would occur primarily landward of the existing berm and dike feature (Figures 3a and 3b). The island component for this alternative would consist of a berm height +6 feet (1.8 m) NAVD with a nominal width of 200 feet (60.9 m). The berm would extend both landward and seaward at a 1:45 slope to the existing grade. About 1.49 million cy (1.1 million cubic meters) of sand from the Quatre Bayou borrow area would be used for the island component, and about 1.03 million cy (0.8 million cubic meters) of finer material for the marsh component of the project. About 12,400 linear feet (3779 m) of containment dikes would be constructed. Vegetative planting would occur on about 477 acres (193 hectares). Sufficient room is available to position the island cross-section in front of existing infrastructure. This alternative seems to be the most constructible of the three (Tetra Tech and CPE 2003a).

### **2.2.2.3 Design Alternative 3: Hybrid Island Construction**

This alternative falls between the seaward (Alternative 1) and landward (Alternative 2) alternatives, and specifies island construction over the existing island berm and dune feature. The island component for this alternative would consist of a berm height +6 feet (1.8 m) NAVD with a nominal width of 200 feet (60.9 m). The berm would extend both landward and seaward at a 1:45 slope to the existing grade.

## **2.3 RATIONALE FOR SELECTING THE PREFERRED ALTERNATIVE**

Table 5 presents a decision matrix of factors considered in selecting the preferred alternative: construction costs, constructability, various performance criteria, and construction impacts. Constructability of the design—a measure of the engineering feasibility of construction—was the primary factor influencing selection of the preferred alternative. Costs were similar across most alternatives (except for Alternative #1 for Pelican Island) and thus not heavily weighed in the selection process. The following sections describe the selection process.

**TABLE 5**  
**DECISION MATRIX**

	Pelican Island				Chaland Headland			
	Without	Alt. 1	Alt. 2	Alt. 3*	Without	Alt. 1	Alt. 2*	Alt. 3
	Project	Marsh only	Seaward	Hybrid	Project	Seaward	Landward	Hybrid
<i>Construction Costs</i>	-	\$13.6M	\$27.1M	\$24.2M	-	\$23.8M	\$22.9M	\$23.9M
<i>Constructability</i>	-	1	6	4	-	5	2	3
<i>Performance Criteria</i>								
Shoreline Position at TY20 (feet)	-358	-358	-65	-133	-328	-64	-148	-95
Island Vol. Remaining at TY20 (cy)	-	-1,076,900	217,400	224,600	-	122,400	107,900	284,000
Marsh Vol. Remaining at TY20 (cy)	-	-133,800	-29,500	51,300	-	62,800	80,000	81,500
Average Recession (feet/year)	17.9	17.9	14.7	14.0	16.4	13.8	12.8	13.3
Island Acreage Loss Rate (acres/year)	5.2	5.2	4.3	4.1	5.6	4.8	4.4	4.6
Total Acreage above 0' at TY20 (acres)	70	293	372	297	26	344	314	333
<i>Construction Impacts</i>								
Wetland Converted to Supratidal Habitat (acres)	-	0	+	+++	-	+	+++	++

Notes:

- \* Preferred alternative
- Alt. Alternative
- cy Cubic yards
- M Million
- TY20 20 years after construction

Metric Conversions:

- 1 foot = 0.3 meters
- 1 cubic yard = 0.7654 cubic meters
- 1 acre = 0.405 hectare

- Construction Impacts ranked as follows: 0 = no impact on wetland; + = low impact; ++ = medium impact; +++ = high impact
- Constructability is based on ranking from 1 (most constructible) to 6 (least constructible) of the alternatives. All alternatives are constructible.
- Shoreline position at TY20 is relative to existing average island shoreline position.
- Without project recession values based on measured recession rates from 1973-2002.
- Pelican Island Alternative 1 recession is assumed the same as the without condition due to no island construction.
- Project recession rates are based on GENESIS shoreline modeling of each alternative and include relative sea-level rise and construction adjustment.

### 2.3.1 Pelican Island Design Alternatives

Design Alternative 1 (marsh-only construction) does not significantly improve island shoreline performance as evidenced by shoreline position 20 years after construction, shoreline retreat rate, and island acreage loss rate that are identical to the no-action option. As a result, the island volume and marsh volume remaining 20 years after construction would be 1,076,900 and 133,800 cy (823,000 and 102,000 cubic meters) less, respectively, than volumes at the time of construction (Table 5). Marsh construction may provide some resistance to island disintegration from the bay side—20 years after construction, 293 acres (118.6 hectares) would be above zero feet. On a scale of 1 to 6 (1 is most constructible and 6 is least constructible), both beach and marsh construction for this alternative rate as 1. Construction cost for this alternative is about \$13.6 million (Tetra Tech and CPE 2003a).

Although the marsh-only alternative scores well in constructability and cost, it fares poorly when evaluated for long-term project performance. In fact, this alternative fails to meet the project goal of preventing breaching and maintaining shoreline integrity. Constructed marsh acreage would be lost as the island migrates landward into the marsh. Future predictions for this alternative (such as shoreline position 20 years following construction, shoreline retreat rate, and acreage loss rate) assume a stable island throughout project life. But because the current condition of the island is poor, disintegration could occur without reinforcing the existing island platform and volume. This potential scenario is the primary reason that Alternative 1 was eliminated (Tetra Tech and CPE 2003a).

Alternative 2 (seaward construction) provides the greatest extent of marsh creation and seaward construction (Table 5). Twenty years after construction, Alternative 2 would perform better than Alternative 1 in terms of shoreline position (-65 feet [19.8 m]) and total acres above zero feet (372 acres [150 hectares]). Average recession would be 14.7 feet (4.5 m) per year, and island acreage loss rate would be 4.3 acres (1.7 hectares) per year—both values slightly higher than those expected with Alternative 3 (hybrid island construction). Island volume and marsh volume 20 years after construction (217,400 cy and -29,500 cy [166,202 and -22,552 cubic meters], respectively) would be less than those expected under Alternative 3. Alternative 2 is the least constructible (score of 6). At a cost of about \$27.1 million, Alternative 2 is more expensive to construct than Alternative 3 (Tetra Tech and CPE 2003a).

Though Alternative 2 promises high project performance, it does not offer the most constructible alternative for this project reach—and constructability of design has been identified as the primary factor to differentiate between Alternatives 2 and 3. Therefore, Alternative 2 has not been chosen as the preferred alternative (Tetra Tech and CPE 2003a).

Alternative 3 values of shoreline position and total acres above zero feet 20 years after construction are 133 feet (40.5 m) and 297 acres (120 hectares), respectively (Table 5). Average recession is expected at 14.0 feet (4.3 m) per year, and island acreage loss rate would be 4.1 acres (1.7 hectares) per year. Both of these values are close to those expected with Alternative 2, but island volume and marsh volume remaining 20 years after construction are greater (224,600 cy and 51,300 cy [171,706 and 39,218 cubic meters, respectively]). Alternative 3 is more constructible than Alternative 2. At a cost of about \$24.2 million, Alternative 3 is less expensive to construct than Alternative 2 (Tetra Tech and CPE 2003a).

Alternative 3 promises sufficient project performance. Because constructability of design has been identified as the primary factor differentiating among alternatives, Alternative 3 is the preferred alternative. Alternatives 1 and 2 were considered but eliminated.

### 2.3.2 Chaland Headland Alternatives

Alternative 1 (seaward construction) provides the most seaward island orientation. It thus results in the most seaward shoreline position (-64 feet [19.5 m]) and the greatest amount of total acreage above zero feet (344 acres) (139 hectares) at the end of the project life. Average recession would be 13.8 feet (4.2 m) per year, and island acreage loss rate would be 4.8 acres (1.9 hectares) per year. Island volume and marsh volume remaining 20 years after construction would be 122,400 cy and 62,800 cy (93,574 and 48,000 cubic meters), respectively. On a scale of 1 to 6 (1 the most constructible and 6 the least constructible), beach construction rates as 5 and marsh construction rates as 4 (Table 5). Construction cost for this alternative is about \$23.8 million. While the seaward alternative has the greatest potential benefit, it also poses the greatest technical and engineering challenges (Tetra Tech and CPE 2003a). Moreover, it may influence longshore sediment transport in unexpected ways.

Alternative 2 (landward construction) would pose the most landward shoreline position (-148 feet [45.1 m]) and least amount of island acreage retained. At the end of the project life, total acreage above zero feet would be 314 acres (127 hectares) (Table 5). Average recession would be 12.8 feet (3.9 m) per year, and island acreage loss rate would be 4.4 acres (1.78 hectares) per year. Island volume and marsh volume remaining 20 years after construction would be 107,900 cy and 80,000 cy (82,489 and 61,160 cubic meters), respectively. On a scale of 1 to 6 (1 the most constructible and 6 the least constructible), both beach and marsh constructions rate as 2. Construction cost for this alternative is about \$22.9 million (Tetra Tech and CPE 2003a).

Under Alternative 3 (hybrid island construction), total acreage above zero feet at the end of project life would be 333 acres (135 hectares) (Table 5). Average recession would be 13.3 feet (4.0 m) per year, and island acreage loss rate would be 4.6 acres (1.86 hectares) per year. Island volume and marsh volume remaining 20 years after construction would be 284,000 cy and 81,500 cy (217,000 and 62,306 cubic meters), respectively. On a scale of 1 to 6 (1 the most constructible and 6 the least constructible), both beach and marsh constructions rate as 3. Construction cost for this alternative is about \$23.9 million (Tetra Tech and CPE 2003a).

Though each alternative would perform differently, the range in performance values is minimal. Therefore, constructability of the project alternatives is key for determining a preferred alternative. Alternative 2 is the preferred alternative given the greater constructability of the landward construction orientation. Alternatives 1 and 3 were considered but eliminated (Tetra Tech and CPE 2003a).



### 3.0 SIGNIFICANT RESOURCES IN AFFECTED ENVIRONMENT

The following sections describe resources in the project area that may be impacted by the proposed action. Regional or parishwide conditions are described when site-specific information is lacking.

#### 3.1 PHYSICAL RESOURCES

##### 3.1.1 Geology, Topography, and Physical Oceanographic Processes

The Barataria shoreline has resulted from fluvial and marine depositional processes over the last 7,000 years. The Mississippi River has been the primary source of sediment to the shoreline system as deltaic headlands formed and the coastline progressed seaward. However, by 1956, three human influences significantly affected natural sedimentary processes in the area: (1) construction of the Mississippi levee system to the north that disrupted sediment inputs and flow; (2) extensive dredging of canal systems in the back-barrier environment that converted barrier marsh to open water; and (3) construction of the Fontanelle Pass (Empire Jetties) that blocked longshore sediment movement (Coastal Research Laboratory 2000). Subsidence poses serious risk for coastal areas only a few feet above sea level (Gulf Engineers and Consultants [GEC] 2001). Subsidence rates in the Barataria barrier shoreline complex are among the highest in southern Louisiana at 3.5 feet (1.1 m) per century (LCWCRTF and WCRA 1998, 1999). Decreased sediment supply and reworking of the coastline by marine processes has retreated the shoreline landward rapidly, increased the size of Barataria Bay (due to wetland loss in the back-bay area), and increased tidal prism and storm impacts. As a result of these factors, tidal inlets have formed, and the barrier shoreline has breached and fragmented. Once virtually continuous, the now fragmented shoreline migrates landward as sediment is redistributed and erosional processes predominate (Kulp and Penland 2001; Kindinger and others 2001). Tidal passes opened in the barrier islands during storm events have not resealed during calm weather (Kindinger and others 2001).

As the USGS and the Coastal Research Laboratory at the University of New Orleans assessed potential offshore sand resources to identify potential borrow areas for coastal restoration of barrier islands and back-bay wetlands for the entire Barataria barrier shoreline (Kindinger and others 2001), and more specifically for the Cheniere Ronquille area (Kulp and Penland 2001). More site-specific investigations of sand resources of the Quatre Bayou Borrow Area and Empire Borrow Area were completed in early 2003 (Tetra Tech and CPE 2003b). A detailed geotechnical investigation of Sandy Point was completed in the summer of 2003 (Tetra Tech and CPE 2003c). These assessments provided information on grain size and geomorphology that were used to design and evaluate restoration alternatives, as described in Section 2.0.

In the project vicinity, bottom sediments are deltaic in origin. Coring indicates that the Sandy Point borrow areas are covered by an average of 8 feet (2.4 m) of mud over an average of 8 feet (2.4 m) of sand. In the Northwest Borrow Area, mud depths range from 5 feet (1.5 m) in the northwest to 15 feet (4.6 m) in the northeast, and sand deposits range from 0 to 25 (7.6 m) feet in thickness. In the Southeast Borrow Area, mud depths range from 0 feet along the western margin to as much as 20 feet in the northwest and central-west. Below the mud, sand deposits range from 5 to 25 feet (1.5 to 7.6 m) in thickness (Tetra Tech and CPE 2003c).

Primary coastal physical processes affecting project areas include gulf and back-bay waves and storm surge. Waves impacting the project areas are generated primarily by local winds, although significant wave events may occur due to distant storms. The restricted fetch of the Gulf of Mexico basin, however, limits the size and associated period of significant storm events.

Annual wave statistics generated for the project areas utilize the 1976-1995 hindcast data at WIS Node G1058 (WIS, 1997) and are summarized in Table 6. The average wave height is 2.6 feet, with a corresponding period and direction of 4.6 seconds and 131° (SE). Approximately 66 percent of the waves propagate from the offshore direction band, 101° to 281°. Within this band, the average height is 2.5 feet, with a corresponding period and direction of 5.0 seconds and 157° (SSE). The largest storm waves occur in August and October during hurricane season. With the exception of tropical storm events, the highest waves under normal conditions occur in March, and the lowest in July and August. The wave direction varies from 76° (ENE) in January to 178° (S) in July. However, within the onshore direction band, the wave direction is relatively constant throughout the year. The largest and longest waves under normal conditions come from the south to south-southeasterly direction band.

**TABLE 6**  
**OFFSHORE WAVE STATISTICS, 1976-1995**  
**BARATARIA BARRIER COMPLEX, GRAND ISLE, LA**

ALL WAVES				ONSHORE WAVES (101-281 degrees)			
Height $H_{mo}$ (feet)		Per.	Dir.	Height $H_{mo}$ (feet)		Per.	Dir.
Mean	Max	$T_p$ (sec.)	(deg.)	Mean	Max	$T_p$ (sec.)	(deg)
2.6	25.3	4.6	131	2.5	25.3	5.0	157

Location: WIS Station G1058, 29.00° N, 89.75° W, depth 37 M (121').

Waves under storm conditions are summarized in Table 7. The extremal wave statistics account for hurricanes, tropical storms, and extratropical storms. Offshore wave heights for the 5, 10, and 20 year conditions range from 18 to 23 feet, with a corresponding period of 12 to 13 seconds, and a corresponding direction near 173°.

**TABLE 7**  
**OFFSHORE GULF WAVES**  
**BARATARIA BARRIER COMPLEX, GRAND ISLE, LA**

Return Period (Years)	Wave Height $H_{mo}$		Wave Period $T_p$	
	(Feet)	+/- std.	(Seconds)	+/- std.
1	12.4	0.8	10.0	0.2
2	14.8	1.2	10.7	0.4
3	16.2	1.5	11.1	0.5
4	17.2	1.7	11.5	0.5
5	18.0	1.9	11.7	0.6
10	20.5	2.5	12.4	0.8
20	22.9	3.7	13.2	1.2
30	24.4	4.7	13.6	1.6
40	25.5	5.5	14.0	1.7
50	26.3	6.2	14.2	2.0

Location: WIS Station G1058, 29.00° N, 89.75° W, depth 37 M (121').

The existing wave refraction characteristics for the study area were assessed utilizing the STWAVE model (Smith 2001). STWAVE is a spectral wave model that evaluates the refracted wave height and wave angle based on spectrum of waves instead of a single, monochromatic wave. The model utilizes linear wave theory, assuming negligible bottom friction and steady-state waves, winds, and currents. Inputs to the STWAVE model include the bathymetry, the wave spectra, and the water levels. Bathymetric data was split into two grids, corresponding to the two domains utilized in the STWAVE model. The western domain extends from Pass Abel to Shell Island. The eastern domain extends from Shell Island to Bayou Trouve. Offshore contours generally form an elliptical arc, with the major axis running from west-northwest to east-southeast. Due south of the Empire Waterway, the contours protrude about 1 mile seaward. A similar protrusion is located about 5 ½ miles to the east. The average distance between the Gulf shoreline and the -7 foot NAVD depth of closure is about ½ mile. The average distance between the shoreline and the -15 foot NAVD contour is about 1.4 miles.

Input wave cases appear in Table 8, and are based on the 1975-1995 wave hindcast at WIS Station G1058. Five cases during average conditions were considered, along with four storm wave cases. Waves during the average conditions govern the long-term erosion and sediment transport. These cases include the average wave and the average onshore wave, both of which fall within the two most common direction bands, southeast and south-southeast.

**TABLE 8**  
**STWAVE WAVE CASES**  
**WIS STATION GU1058**  
**BARATARIA BAY COMPLEX, LA**

Wave Case	Height***		Period (Sec.)	Direction		NAVD Stage	
	(Feet)	(m)		Compass (Deg.)	STWAVE (Deg.)*	(Feet)	(m)
<b>Average Conditions:</b>							
Mean Of All Waves	2.5	0.78	5.0	123	57	1.0	0.31
	2.6	0.78	4.6	131	49	1.0	0.31
Mean Of Onshore Waves	2.5	0.78	5.0	157	23	1.0	0.31
	2.6	0.78	4.6	165	15	1.0	0.31
	2.5	0.78	5.0	191	-11	1.0	0.31
<b>Storm Conditions:</b>							
H <sub>e</sub> , T <sub>e</sub>	17.4	5.31	11.0	177	3	1.6	0.48
5-Year	18.0	5.49	11.7	173**	7	3.0	0.91
10-Year	20.5	6.25	12.4	173**	7	4.9	1.48
20-Year	22.9	6.98	13.2	173**	7	6.7	2.04

Notes:

\* STWAVE direction = 180 deg. - Compass Direction.

\*\* Wave angles for 5, 10, 20 year events based on Jan. 1979 storm, Hurricane Andrew (1992), and Hurricane Juan (1985).

\*\*\*Reported wave heights are offshore wave conditions.



Waves during storm conditions can result in periods of elevated erosion and sediment transport. The 20 year wave corresponds to the design conditions upon which the dune dimensions are based. The 5 and 10 year waves are severe events which may occur over the project life. Wave directions during these conditions are based on historic storms. The wave height  $H_e$  and wave period  $T_e$  correspond to the wave exceeded 12 hours per year, representing the conditions during frequent storms. This wave case governs the depth of closure, the elevation below which there is no significant sediment motion (Birkemeier 1985). Given the water depths in the vicinity of the borrow areas (on the order of -20 ft NAVD or shallower), the borrow areas are within the influence of wave breaking for storm conditions.

STWAVE results given the existing conditions demonstrate that in general, waves propagating from the southeast during average conditions maintain their height and direction until reaching the -7 foot NAVD depth of closure. Along the depth of closure, these waves assume a south-southeasterly direction and subsequently break. East of Pelican Island, broken waves decrease to 0.5 feet or less at the shoreline, under the influence of the nearby ebb shoals. Along Pelican Island, broken waves vary from 1.5 feet near Scofield Pass to 2.0 feet near the Empire jetties. Along Chaland Headland, broken waves at the shoreline vary from 0.5 foot near Chaland Pass to 1.8 feet near Pass La Mer. Towards the west, ebb shoals tend to focus wave energy along the islands adjacent to Quatre Bayou and inside Pass Abel. The resulting sediment transport is generally from east to west.

Waves propagating from the south-southeast during average conditions also maintain their height and direction until reaching the -7 foot NAVD depth of closure. Along the depth of closure, these waves assume a southerly direction and subsequently break, except between Quatre Bayou and Pass Abel. Along this section, the wave direction is south-southeasterly all the way to the shoreline. East of Pelican Island, broken waves decrease to 0.5 feet or less at the shoreline, under the influence of the nearby ebb shoals. Along Pelican Island, broken waves at the shoreline vary from 2.0 feet near Scofield Pass to 2.5 feet near the Empire jetties. Along Chaland Headland, broken waves at the shoreline vary from 0.5 foot near Chaland Pass to 2.3 feet near Pass La Mer. Towards the west, ebb shoals tend to focus wave energy along the islands adjacent to Quatre Bayou and inside Pass Abel. The resulting sediment transport is generally from east to west.

Waves propagating from the south to south-southwest under average conditions exhibit similar variations in wave height. After crossing the depth of closure, the waves assume a southerly direction near Pass Abel and a south-southwesterly direction elsewhere. In most locations, this wave direction is perpendicular to the shoreline. As a result, the corresponding sediment transport can occur in either direction between Quatre Bayou and Scofield Pass.

Under storm conditions, waves break before reaching the depth of closure. The depth at which the waves break is approximately equal to their height. Wave focusing occurs where the offshore contours protrude seaward south of Pelican Island. However, after breaking, the waves are depth limited. As a result, waves along a given contour landward of the breaking point are uniform.

### **3.1.2 Climate and Weather**

The subtropical climate of coastal Louisiana is characterized by long hot summers and short mild winters, with high humidity year round. Over the past 40 years, air temperature ranged from 14 to 102°F; average winter and summer temperatures are 55.3 and 82.4° F (12.9 to 28 °C), respectively. In a typical year, more than 60 inches (1.5 m) of rain falls, mostly in the spring and summer months. In the fall and winter, winds tend to be from the north-northeast; in spring and summer, winds are generally from the south-southeast.

The weather patterns controlling precipitation in Barataria Basin include Frontal Overrunning, Gulf Return, Frontal Gulf Return, and Gulf Tropical Disturbances (responsible for most of the precipitation). Freshwater inputs from rain are greatest in the late winter and spring, and least in the fall (GEC 2001).

### **3.1.3 Air Quality**

The project area lies in the Southern Louisiana-Southeast Texas Interstate Air Quality Control Region (GEC 2001). Plaquemines Parish meets all national ambient air quality standards, according to the Louisiana Department of Environmental Quality Office of Environmental Assessment. No significant point sources of air-borne pollutants occur in the vicinity of the preferred project, and air quality is generally good. The most prominent source of air-borne pollutants in the area is the exhaust from boats. Offshore breezes mix and freshen the air, and frequent precipitation prevents accumulation of particulates. Plaquemines Parish reduced its overall toxic air pollutant emissions from over 4 million pounds (1.8 million kilograms) per year in 1991 to less than 700,000 pounds (317,000 kilograms) per year in 2000 (<http://www.deq.state.la.us/evaluation/airmon/tedi.htm>).

### **3.1.4 Water Resources**

No fresh water (groundwater) is found in the subsurface of Barataria Basin and no specific groundwater information is available for the project areas (GEC 2001).

Tidal influences and precipitation are the primary factors affecting surface water in Barataria Basin; riverine inputs are minimal, and the freshwater aquifer present in much of Louisiana is not present in the basin.

Until recently, freshwater input to the Basin was minimal due to construction of the levee system along the Mississippi River and closure of Bayou Lafourche at Donaldsonville. However, the newly constructed Davis Pond Freshwater Diversion Structure is expected to divert up to 10,650 cubic feet per second (cfs) (298 cubic meters per second) of fresh water into the Barataria Basin. Diversions through the structure, located on the west bank of St. Charles Parish near Luling, will occur under regulated conditions determined by monitoring basin salinities and fish and wildlife resources. Contributions of freshwater to the Basin from the Naomi and West Point a la Hache siphons are negligible (GEC 2001).

Tides in Barataria Basin are diurnal, with the tidal range decreasing with increasing distance from the coast. Depth and volume of water in the basin are affected by tides, winds, and precipitation. In the northern Gulf of Mexico, tidal range is relatively small (about 1 foot [0.3 m] in the Gulf and 0.1 foot [0.03 m] in the upper basin), according to LCWCRTF (1993). Daily water-level fluctuations in the basin are strongly influenced by storm tides, which can cause significant fluctuations in water levels. Little Lake, Bayou Perot, and Lake Salvador provide the principal water exchange routes between the upper and lower basin.

No long-term trends in salinity occur in the basin; however, salinity does vary seasonally and decreases landward from the coast (GEC 2001). Salinity in coastal areas is highest from October through November and lowest in February and March. Designated uses of the coastal bays of the Barataria Basin and nearshore waters of the Gulf of Mexico include recreational activities (such as swimming, fishing, and boating), as well as support of commercially and ecologically valuable biological systems (GEC 2001).

### 3.2 BIOLOGICAL ENVIRONMENT

#### 3.2.1 Vegetative Resources

In 2000, before selecting sub-reaches of the Plaquemines shoreline to be restored, the Coastal Research Laboratory assessed the types and areas of habitats present in the general area (Table 9). Natural and man-made areas are described separately in Table 9. Spoil banks are areas created by the disposal of dredged materials; they often form the banks of canals. The regional habitat types are considered generally representative of the preferred project areas.

TABLE 9

HABITAT AREA INVENTORY FOR PROJECT SITES

Project Area	Marsh	Upland	Shrub/ Scrub	Forest	Bare	Beach	Inter- tidal	Total Land	Water
<b>Habitat other than Spoil Bank (acres)</b>									
Pass La Mer to Chaland Pass	523.48	27.53	193.14	23.24	0.48	36.66	21.62	826.15	1796.44
Pelican Island / Empire Jetties	133.24	17.22	43.88	NA	NA	30.97	NA	225.31	2207.69
<b>Habitat classified as Spoil Bank (acres)</b>									
Pass La Mer to Chaland Pass	9.26	1.53	188.20	22.59	NA	NA	NA	221.58	NA
Pelican Island / Empire Jetties	0.44	NA	41.35	NA	NA	NA	NA	NA	41.79

Source: Coastal Research Laboratory 2000

#### Marsh Habitat

In their habitat assessment, Coastal Research Laboratory (2000) defined marsh as any unforested vegetated area normally subject to inundation or tidal action that can occur at any time and is sufficient to support wetland-dependent, emergent vegetation. Marsh habitat occurs in the back-bay environment of both Pelican Island and Chaland Headland, where a favorable balance exists between sedimentation and vegetative growth that allows vegetation to colonize intertidal mudflats. The back-bay environment is characterized by saline marshes (GEC 2001). Salt marsh occurs behind the barrier islands in areas with salinity between 18 and 30 parts per thousand (ppt) (GEC 2001). Salt-marsh vegetation is dominated by smooth cordgrass (*Spartina alterniflora*) and wiregrass (*S. patens*), with needlerush (*Juncus roemerianus*), saltgrass (*Distichlis spicata*), and salt wort (*Batis maritima*) as subdominant species (Gosselink 1984).

#### Upland Habitats

In their habitat assessment, Coastal Research Laboratory (2000) defined upland as an elevated natural area or dredged material deposition area not subject to tidal action or inundation under normal circumstances so that upland species (non-marsh species) thrive. For Pelican Island and Chaland Headland, this includes barrier island habitats and inland habitats, and usually denotes a grassland, dune, barrier flat, swale, or elevated area within a marsh that is artificially altered (such as a spoil bank); the upland habitat designation does not include significant shrub or tree coverage. Dominant dune plants (in

terms of frequency of occurrence) are wiregrass/marshhay cordgrass, seashore dropseed/coast dropseed (*Sporobolus virginicus*), bitter panicum, and beach morning-glory (*Ipomea stolonifera*) (Mendelssohn 1987). Dune plants that occur less frequently include sea oats, beach tea (*Croton punctatus*), seashore paspalum/jointgrass (*Paspalum vaginatum*), dune elder (*Iva imbricata*), seaside goldenrod (*Solidago sempervirens*), and pennywort (*Hydrocotyle bonariensis*) (Mendelssohn 1987). Barrier flats normally are inhabited by wiregrass/marshhay cordgrass (Mendelssohn 1987). Swales are dominated by three-square bulrush (*Scirpus americanus*), fimbry (*Fimbristylis castanea*), broom sedges (*Andropogon scoparius* and *A. glomeratus*), and wiregrass/marshhay cordgrass (Mendelssohn 1987).

Other upland habitats include shrub/scrub, defined as shrubs or trees less than 20 feet (6.1 m) tall. This habitat may occur within an upland area or within a marsh area. Shrub/scrub vegetation typical on barrier islands includes wax myrtle (*Myrica cerifera*) and grousel bush (*Baccharis halimifolia*) (Mendelssohn 1987).

In their habitat assessment, Coastal Research Laboratory (2000) also identified some upland "forest" on Chaland Headland but not on Pelican Island. Trees on Chaland Headland occur mostly along older, protected, artificially elevated ridges (spoil banks) (Coastal Research Laboratory 2000).

### **3.2.2 Aquatic Resources and Communities**

The project areas include beach, intertidal, open-water, and benthic habitats. Each is described briefly below.

#### **3.2.2.1 Beach and Intertidal Habitats**

Beach habitat occurs as unvegetated areas adjacent to open water that are subject to direct wave action at some time during the daily tidal cycle or during average storm surges, and therefore do not typically support vegetation. Beaches consist of sand, shell, organic matter, rock, or a mixture of sediment types. The beach may extend from the high-tide line to the upper extent of unvegetated washover sediments (Coastal Research Laboratory (2000). Intertidal habitat is an indistinct shallow area that does not support emergent vegetation

#### **3.2.2.2 Open-Water Habitats**

Open-water habitat in the project areas includes the Gulf of Mexico to the south, Barataria Bay to the north, and small tidal sloughs and manmade canals running laterally and perpendicular to the islands on the back-bay side. The pelagic offshore water-column biota contains: (1) primary producers—phytoplankton and bacteria, with 90 percent of the phytoplankton in the northern Gulf of Mexico constituted by diatoms; (2) secondary producers—zooplankton; and (3) consumers—larger marine species including fish, reptiles, cephalopods, crustaceans, and marine mammals. The zooplankton consists of holoplankton (organisms for which all life stages are spent in the water column—including protozoans, gelatinous zooplankton, copepods, chaetognaths, polychaetes, and euphausiids) and meroplankton (mostly invertebrate and vertebrate organisms for which larval stages are spent in the water column—including polychaetes, echinoderms, gastropods, bivalves, and fish larvae and eggs). Planktonic primary producers drift with currents, whereas zooplankton move by swimming (DOI MMS 2002).

According to DOI MMS (2002), floating *Sargassum* in the Gulf can support more than 100 animal species. Hydroids and copepods dominate the assemblage, which also includes fish, crabs, gastropods, polychaetes, bryozoans, anemones, and sea spiders. Most of these species depend on the *Sargassum*



algae. During their early years of life, sea turtles drift with the *Sargassum* and feed off their living organisms.

Tidal ponds are present on the eastern end of Pelican Island. Bays, lakes, and sounds are abundant near the seaward edge of the deltaic lobe; these increase in size and generally become more saline as land loss occurs and the saltwater margin moves landward (GEC 2001). Although open water is EFH to several managed species, the trend toward increasing amount of open water habitat generally is considered a problem to be addressed by the preferred project. Potential impacts are discussed in Section 4.0.

### **3.2.2.3 Benthic Habitats**

The description of benthic resources primarily derives from a recent Environmental Impact Statement prepared for the Gulf of Mexico OCS Oil and Gas Lease Sales (DOI MMS 2002). The most typical bottom substrate in the Central Gulf of Mexico is soft muddy bottom where polychaetes are the dominant benthic organism. Benthic habitats near the project sites support bacteria, algae, and seagrasses; abundances are controlled by scarcity of suitable substrates and limited light penetration. When turbidity is low, coralline red algae and other benthic algae grow in water depths to at least 180 m (DOI MMS 2002). Offshore seagrasses are uncommon in the Central Gulf but are more common in the estuaries behind barrier islands. Dominant groups of benthic fauna are: (1) infauna (animals that live in the substrate, such as burrowing worms, crustaceans, and mollusks) and (2) epifauna (animals closely associated with the substrate, such as crustaceans, echinoderms, mollusks, hydroids, sponges, and soft and hard corals). The benthic community supports higher levels of the food chain, such as shrimp and demersal fish. Substrate quality strongly influences the distribution of benthic fauna. For example, infaunal organisms increase in number as sediment particle size increases (DOI MMS 2002). Other variables affecting the distribution of benthic organisms include water depth, distance from shore, illumination, food availability, currents, tides, and wave shock (DOI MMS 2002).

The prevalence of opportunistic species on the Louisiana shelf is an indication that the region is regularly disturbed, stressed, and a highly unpredictable environment (Baker and others 1981, as cited in EPA 2003). The variable benthic environment causes the inner shelf macroinfaunal community to be dynamic and unstable, and to remain at immature levels of development (EPA 2003).

### **3.2.3 Fish Resources**

The nearest port, at Empire-Venice, Louisiana, ranks third in the nation for quantity of commercial fisheries landings and sixth in the nation for value of landings (NOAA 2001).

The Barataria Bay estuary supports a variety of invertebrate and fish species of ecological, commercial, and recreational value. This area is considered typical of Louisiana coastal estuaries, which are characterized by extensive marshes and open-water habitats representing a salinity continuum from fresh to saline. Rich in finfish and shellfish, Barataria Bay is one of the most productive estuaries in the nation for seafood (<http://www.btneq.org/>). The Barataria and Terrebonne basins were nominated for participation in the National Estuary Program in 1989 in recognition of their significance for ecological and economic sustainability of estuarine resources (<http://www.btneq.org/>). Highly abundant or abundant harvested species include brown shrimp, white shrimp, sand sea trout, black drum, southern flounder, blue crab, gulf menhaden, and anchovies (Patillo and others 1997). Important forage species in the area include hardhead catfish, sheepshead minnow, gulf killifish, spot, Atlantic croaker, southern kingfish, silver perch, white mullet, striped mullet, scaled sardine, Florida pompano, and silversides (Patillo and others 1997).

Other species that occur in the project area during some portion of their life history include the ecologically important grass shrimp (Pattillo and others 1997). Many other non-game species of finfish and shellfish are important links in the food chain to commercially and recreationally harvested species. Some species shown in Table 10 are prey for species such as red drum, mackerels, snappers, and groupers that the Gulf of Mexico Fisheries Management Council (GMFMC) Federally manages under the Magnuson-Stevens Fishery Conservation and Management Act, P.L. 104-297; 16 U.S.C. 1801 et seq. (Magnuson-Stevens Act). The NOAA Fisheries also manage highly migratory predatory species such as billfish and sharks. In addition, project area wetlands produce nutrients and detritus that contribute to the overall productivity of the Barataria estuary as important components of the aquatic food web.

Approximately 24 million pounds (10 million kilograms) of oysters were harvested in Louisiana in 1999. Most of Louisiana's oyster beds are located in Barataria Basin; as of 2000, 3,875 oyster leases covered 157,707 acres (63,821 hectares) in Plaquemines Parish (Louisiana Department of Wildlife and Fisheries 2001, as cited in GEC 2001). More than 40 oyster leases occur in the two project areas, particularly on the bay side of Pelican Island. The LNR now is surveying existing leases near the project site to determine if they remain functional and to assess their values.

In the Barataria Barrier Shorelines Mapping Unit, estuarine-dependent species such as blue crab, black drum, Gulf menhaden, southern flounder, and spotted seatrout have shown decreasing trends over the last 10-20 years, as has the estuarine resident, American oyster (LCWCRTF and WCRA 1999).

The role of barrier islands in protecting important fisheries habitat within the back-barrier region is well documented. Perhaps less appreciated is the value of habitat of the barrier islands themselves—in the surf zone on the Gulf side of the islands as well as the intra-island tidal creeks and ponds (Williams 1998). For example, fishes that dominate the surf zone of barrier islands throughout the Gulf of Mexico are among the most important forage species in the ecosystem (such as menhaden, anchovies, and silversides) (Ross 1983, as cited in Williams 1998). The surf zone is used extensively by larval and juvenile fish, and it provides an essential staging area for fish awaiting tides favorable for transport into back-barrier marshes through tidal passes. Intra-island ponds and creeks provide more protected habitat for resident and transient fishes, many of which exhibit a marked preference for intra-island habitats (Williams 1998). A detailed study of species assemblages of intra-island habitats of East Timbalier, LA, showed tremendous seasonal variability—likely due to changes in water level, temperature, and tidal action. Overall species diversity was greater in intra-island habitats than in mainland marshes, suggesting that barrier island restoration has value beyond protecting back-barrier marshes (Williams 1998).

Fisheries resources in the borrow areas are difficult to describe and quantify, since seismic and sub-bottom data geomorphologically define the borrow areas. The Quatre Bayou and Empire borrow areas differ from the Sandy Point borrow area primarily in distance from shore and water depth (Table 4); though buried sand resources in these locations are of particular value to the restoration project, they are not necessarily relevant to fisheries resources occupying the overlying water column, nor to benthic species associated with surficial sediments in the area. Section 3.2.2 describes typical benthic resources of the continental shelf in the Gulf of Mexico. Section 3.2.3.2 describes important fisheries species expected to associate with the borrow areas.

### **3.2.3.1 Essential Fish Habitat**

The project is located in an area containing EFH as designated by the GMFMC for species that are Federally managed under the Magnuson-Stevens Act. EFH is defined as areas in the estuaries where species are considered “common,” “abundant,” and “highly abundant.” Detailed information on Federally managed fisheries and their EFH is provided in the 1998 generic amendment of the Fishery



Management Plans for the Gulf of Mexico prepared as required by the Magnuson-Stevens Act (GMFMC 1998). In the Barataria Barrier Shorelines Mapping Unit, the estuarine-dependent assemblage, including white and brown shrimp and red drum, have shown decreasing trends over the last 10-20 years (LCWCRTF and WCRA 1999). Table 10 lists the EFH, Federally managed species, and their life stages expected to occur in the project area and borrow areas.

Brown shrimp and white shrimp are estuarine-dependent species. Habitats within the estuary are considered EFH for certain life stages of these species. In addition, these species migrate through tidal passes during their planktonic life stage. These species also depend on the marine environment for survival and reproduction; brown and white shrimp are associated with offshore zones characterized by different types of sediment all considered essential habitat for shrimp. As well, shrimp play an important role as prey species for other Federally managed fish and crustaceans (GMFMC 1998). All estuaries and marine habitats of the Gulf where red drum are known to occur are considered essential habitat (GMFMC 1998).

**TABLE 10**

**ESSENTIAL FISH HABITAT (EFH) FOR MANAGED SPECIES IN THE BARATARIA BARRIER ISLAND COMPLEX PROJECT AREA, INCLUDING BORROW AREAS**

Common Name	Latin Name	Life Stage	System	EFH
Brown shrimp (Estuarine-dependent)	<i>Farfante penaeus aztecus</i>	eggs	Marine (M)	<110 m, demersal
		larvae	M	<100 m, planktonic
		postlarvae/juvenile	Estuarine (E)	marsh edge, submerged aquatic vegetation (SAV), tidal creeks, inner marsh
		subadults	E	mud bottoms, marsh edge
		adults	M	<110 m silt sand, muddy sand
White shrimp (Estuarine-dependent)	<i>Litopenaeus setiferus</i>	eggs	M	<40 m, demersal
		larvae	M	<40 m, planktonic
		postlarvae/juvenile	E	marsh edge, SAV, marsh ponds, inner marsh, oyster reefs
		subadults	E	same as postlarvae/juvenile
		adults	M	<35 m, silt, soft mud
Red drum (Estuarine-dependent)	<i>Sciaenops ocellatus</i>	eggs	M	planktonic
		larvae	M	planktonic
		postlarvae/juvenile	M/E	SAV, estuarine mud bottoms, marsh/water interface
		subadults	E	mud bottoms, oyster reefs
		adults	M/E	Gulf of Mexico and estuarine mud bottoms, oyster reef

TABLE 10 (Continued)

**ESSENTIAL FISH HABITAT (EFH) FOR MANAGED SPECIES IN THE BARATARIA  
BARRIER ISLAND COMPLEX PROJECT AREA, INCLUDING BORROW AREAS**

Common Name	Latin Name	Life Stage	System	EFH
Red snapper		eggs	M	Over shelf in summer/fall
		larvae	M	17 – 183 m
		postlarvae/juvenile	M	17 – 183 m
		subadults	M	20 – 46 m; over sand and mud
		adults	M	7- 146 m
Gray snapper	<i>Lutjanus griseus</i>	juvenile	E	SAV, mangrove, mud
		adult	M/E	SAV, mangrove, sand, mud
Lane snapper	<i>Lutjanus synagris</i>	eggs	M	Quatre Bayou borrow area
		adult	M	Reefs, sand, 4-132 m (Sandy Point borrow area only)
Spanish mackerel	<i>Scomberomorus maculatus</i>	juvenile	M/E	offshore, beach, estuarine
		adult	M	pelagic
King mackerel	<i>Scomberomorus cavalla</i>	juvenile	M	pelagic
		adult	M	pelagic
Bluefish	<i>Pomatomus saltatrix</i>	juvenile	M/E	beaches, estuaries, inlets
		adult	M/E	Gulf and estuaries, pelagic
Cobia	<i>Rachycentron canadum</i>	eggs	M	pelagic
		larvae	M/E	estuarine & shelf
		postlarvae/juvenile	M	coastal & shelf
		adult	M	coastal & shelf
Dolphin	<i>Corypheana hippurus</i>	juvenile	M	Epipelagic (Sandy Point borrow area only)
		adult	M	Epipelagic (Sandy Point borrow area only)
Bonnethead shark	<i>Sphyrna tiburo</i>	juvenile	M	inlet, estuaries, coastal waters <25 m
		adult	M	<25 m deep
Atlantic sharpnose shark	<i>Rhizoprionodon terraenovae</i>	juvenile	M	<25 m deep

Source: GMFMC (1998)

**Brown shrimp:** Brown shrimp are present in both the marsh and borrow areas of the project. The brown shrimp fishery comprises 57% of the Gulf of Mexico shrimp landings (NOAA 1993, as cited in Patillo and others 1997). Brown shrimp are consumed by many finfish predators and, therefore, large juvenile stocks are considered important for supporting other fish species. Brown shrimp are estuarine-dependent, which means that they require estuarine habitat to complete their lives. The eggs of brown shrimp are demersal and occur offshore, probably in proposed project borrow areas. Larval stages are planktonic and postlarvae move into the estuary through the passes on flood tides at night. The peak recruitment of postlarvae into estuaries occurs in the spring (February to April) with a minor peak in the fall (Cook and Lindner 1970 cited in GMFMC 1998). Larvae are highly abundant in Barataria Bay during February and

March (Patillo and others 1997). The postlarval and juvenile stages are highly abundant in Barataria Bay, especially in low salinity months. The abundance of postlarvae and juveniles is highest in marsh-edge habitat and near submerged vegetation; tidal creeks, inner marsh, shallow open water, and oyster reefs also are used. In unvegetated areas, muddy bottoms are preferred. Juveniles and subadults are found in estuarine channels, shallow marsh areas, and estuarine bays; they prefer vegetated habitats. Subadults move into coastal waters and at the adult stage emigrate to offshore spawning grounds; adults are associated with silt, muddy sand, and sandy substrates. Subadults and adults are likely to be found in preferred project borrow areas. Spawning occurs mainly during spring to late fall in water greater than 59 feet (18 m) deep (generally 151 to 298 feet [46-91 m]). In deeper water (210 to 361 feet [64-110 m]), spawning appears to occur throughout the year (Patillo and others 1997; GMFMC 1998).

**White Shrimp:** White shrimp are present in both the marsh and borrow areas of the preferred project areas. White shrimp comprise 31 percent of the Gulf of Mexico shrimp landings; maximum catches are along the Louisiana coast west of the Mississippi delta (NOAA 1993, as cited in Patillo and others 1997). White shrimp are estuarine-dependent. Within Barataria Bay, adults are abundant during March-April and August-November; larvae are highly abundant during May-June, August-September, and abundant during June-August; juveniles are highly abundant during June-November. White shrimp stay in the estuary longer than brown shrimp, but brown shrimp may displace white shrimp from *Spartina* marshes to nearby mud substrates in areas where their distributions overlap. White shrimp eggs are demersal in marine waters and possibly occur in the borrow area locations. Larval stages are planktonic, and postlarvae migrate through the passes during May-November, peaking in June and September, and become benthic when they reach the estuarine nursery. Postlarvae and juveniles prefer shallow estuarine waters with mud and sand bottoms that have high organic debris or vegetative cover; densities are highest along the marsh edge and among submerged aquatic vegetation, though they also occur in marsh ponds and channels, inner marsh, and oyster reefs. Juveniles and adults are demersal; juveniles prefer lower salinity waters of tidal rivers but move through and out of the estuary into coastal waters when they mature. Adults inhabit nearshore Gulf waters on bottoms of soft mud or silt. Due to the habitat preferences of juveniles and adults, they are likely to be found in borrow area locations. White shrimp are euryhaline and are not as affected as brown shrimp by sudden salinity drops (Patillo and others 1997; GMFMC 1998). Spawning occurs from spring to late fall, peaking in the summer months of June and July (Linder and Anderson 1956, as cited in GMFMC 1998). Spawning occurs offshore in water 29 to 111 feet (9 to 34 m) deep with most spawning occurring in water less than 88.6 feet (27 m) deep. Limited spawning may occur in bays and estuaries (Renfro and Brusher 1982, as cited in GMFMC 1998).

**Red Drum:** The red drum is present in both marsh and borrow areas of the preferred project sites. The commercial harvest of red drum caused significant declines in numbers that resulted in restriction of the harvest in Louisiana and a moratorium in Federal waters. Juveniles are common in Barataria Bay throughout the year, and adults are common in the high salinity season. Red drum is an estuarine-dependent species. Eggs are spawned in nearshore waters close to barrier islands and passes from June to October. Therefore, eggs are likely to occur in borrow areas. Spawning habitats include seagrass, muddy, or hard bottom areas with little or no current. Eggs, larvae, and early juveniles are planktonic. Larvae enter estuarine waters July to November through passes and seek quiet cover, tidal flats, and lagoons with vegetation that offer protection; larvae prefer muddy bottoms. Young of the year exhibit a strong affinity for tidal ponds and creeks. As they mature, juveniles disperse through the bay and estuarine waters and may be found in tidal passes, marshes, shallow shorelines, back bays and other sheltered areas; they can be found over mud to sand bottoms. Older juveniles move into primary bays and open-water habitats. Estuarine wetlands are important to larvae, juveniles, and subadults; juveniles are abundant around the perimeters of marshes. Subadults and adults prefer shallow bay bottoms or oyster reefs. The FWS developed a habitat suitability index model for larval and juvenile red drum which indicated that shallow water (5 to 8.2 feet [1.5 to 2.5 m]) deep) with 50 to 75 percent submerged vegetation cover over mud bottoms and fringed emergent vegetation is optimum (Buckley 1984, as cited

in GMFMC 1998). Subadults are common or more abundant to both estuarine and marine environments, and exhibit both solitary and schooling behavior. Adults are often solitary except for large aggregations during spawning periods in early fall months. Adults may be found in the estuary but tend to move into shallow nearshore waters off beaches and up to 13.5 mi (25 kilometers) from shore; they prefer mud to sand or oyster-reef bottoms with little or no seagrass (Patillo and others 1997; GMFMC 1998), as well as artificial reef habitats such as oil and gas platforms. Due to the habitat preferences of adults, they are likely to occur in the borrow areas.

**Gray Snapper:** Gray snapper is likely to be found in both the marsh and borrow areas. The fishery for gray snapper has recently grown in Louisiana, supplementing other fisheries. Juvenile gray snapper are common in Barataria Bay during the high salinity season. Eggs and larvae occur in offshore marine waters, possibly in the borrow areas. Postlarvae move into estuarine habitats—including estuaries, tidal ponds, channels, marshes, mangroves—and up into freshwater creeks. Juveniles, which generally occupy inshore grassy areas, are common in Barataria Bay from March to October. Juvenile gray snapper exhibit habitat selection of back-barrier ponds and streams. Within these back-barrier areas, juveniles have high affinity for mangroves and other structures (such as rip-rap and navigational aids) (Milan in press). Juveniles and adults are considered marine, estuarine, and riverine (Patillo and others 1997; GMFMC 1998). Because juveniles and adults are known to occupy marine habitats, both of these life stages of gray snapper may be present in borrow areas.

**Lane Snapper:** Lane snapper is expected to be present only in the preferred borrow areas of the project. Adults are found offshore over sandy bottoms, natural channels, banks, and man-made reefs and structures (Bullis and Jones 1976, as cited in GMFMC 1998) in water depths of 13 to 433 feet (4 to 132 m) (Starck 1971, as cited in GMFMC 1998). Spawning occurs some distance offshore (Reid 1952, as cited in GMFMC 1998) from March to September with a peak between July and August. Eggs are present offshore on the continental shelf during these spawning periods (Starck 1971, as cited in GMFMC 1998). Juveniles are present inshore during the late summer or early fall, and are associated with grass flats, back reefs, and soft bottoms.

**Spanish Mackerel:** The Spanish mackerel is expected to occur in the marsh and borrow areas of the proposed project. In 1992, 26.3 metric tons were landed in Louisiana. Spanish mackerel is a migratory species, and adults are present in the northern Gulf during the spring, near south Florida during the summer, and in the western Gulf during the fall. Juveniles are not considered estuarine-dependent; however, Spanish mackerel tolerate brackish to marine waters and often inhabit estuaries that offer nursery habitat. Spawning grounds are offshore, and spawning occurs April to October with a peak in August and September; eggs and larvae occur in the water column. Juveniles are found offshore and in beach surf, and sometimes in estuaries. Juvenile Spanish mackerel are considered common in Barataria Bay in the high and declining salinity periods. Juveniles are not considered estuarine-dependent, and prefer marine salinity and clean sand substrates. Adults occur in large schools offshore and in nearshore waters, particularly near barrier islands and tidal passes. In Barataria Bay, adults are common from May to October and juveniles are common March to October (Patillo and others 1997; GMFMC 1998). Juveniles and adults are expected to occur in borrow areas. Spawning activities and eggs also are likely to occur in the borrow areas.

**King Mackerel:** King mackerel is expected to be present only in the preferred borrow areas of the project. Adults migrate throughout the Gulf of Mexico. They are present in the northern Gulf during the spring, near southern Florida in the summer, and in the western Gulf in fall (Nakamura 1987; Sutherland and Fable 1980, both cited in GMFMC 1998). Adults can be found in both coastal and offshore waters up to depths of 656 feet (200 m). Spawning occurs May to October on the outer continental shelf in the northwestern and northeastern Gulf of Mexico (Nakamura 1987, as cited in GMFMC 1998). Young juveniles occur May-October, peaking in July and October, and can be found ranging from the inshore to



the midshelf. Older juveniles occur within the nearshore and innershelf (Grimes and others 1990, as cited in GMFMC 1998). While juveniles are not estuarine-dependent, they prey upon estuarine dependent fishes (Naughton and Saloman 1981, as cited in GMFMC 1998). Growth of larval and juvenile king mackerel is enhanced in the north-central and northwestern Gulf due to the nutrient-rich Mississippi River plume (DeVries and others 1990; Grimes and others 1990, both cited in GMFMC 1998).

**Cobia:** The cobia is expected to be present only in the preferred borrow areas of the project. Eggs are pelagic and occur during the summer (Shaffer and Nakamura 1989, as cited in GMFMC 1998) in the top meter of the water column (Ditty and Shaw 1992, as cited in GMFMC 1998). Larvae are present from May to September in estuarine and offshore shelf waters from the surface up to 984 feet (300 m) deep (Shaffer and Nakamura 1989, as cited in GMFMC 1998). Juveniles occur in coastal water and the offshore shelf from April to October (Dawson 1971, as cited in GMFMC 1998). In the northern Gulf, seasonal migration of adults occurs from March to October. Cobia can be found from 3.3 to 230 feet (1 to 70 m) depths ranging from shallow coastal waters to continental shelf waters (Christmas and Walker 1974, as cited in GMFMC 1998). Spawning occurs April to September in continental shelf waters (Joseph and others 1964, as cited in GMFMC 1998).

**Dolphin:** The dolphin is expected to be present only in the preferred borrow areas of the project. Juveniles are present in inshore and offshore waters throughout the year, peaking in the summer (Palko and others 1982, as cited in GMFMC 1998). They are closely associated with *Sargassum* communities in the Gulf (Rose 1965; Johnson 1978, both cited in GMFMC 1998).

**Bonnethead shark:** The bonnethead is expected to be present only in the preferred borrow areas of the project, often in schools in inshore waters less than 82 feet (25 m) deep. Spawning occurs spring through fall (Hoese and Moore 1998).

**Atlantic sharpnose shark:** This species is expected to be present only in the preferred borrow areas of the project. The Atlantic sharpnose shark is an inshore species that occurs in depths of less than 131 feet (40 m). Juveniles appear in the surf zone and saltier estuaries in the summer (Hoese and Moore 1998).

**Bluefish:** The bluefish is expected to be present in both the marsh and borrow areas of the preferred project areas. The recreational importance of bluefish outweighs its commercial value. The bluefish is considered only an incidental commercial species, and in 1992 Louisiana landed just 12.2 metric tons. This species occurs in continental shelf waters less than 328 feet (100 m) deep. Larvae move more inshore during their first growing season and are likely to be found in borrow areas. Juveniles and adults are pelagic, nektonic, and migratory. However, juveniles and adults school separately. Juveniles are common in Barataria Bay from April to October (Patillo and others 1997).

### 3.2.3.2 Wildlife Resources

In the Barataria Barrier Shorelines Mapping Unit, brown pelican populations have exhibited increasing trends over the last 10 to 20 years; however, populations of most other wildlife species such as seabirds, shorebirds, wading birds, ducks, and furbearers, have exhibited decreasing trends as the area is experiencing rapid erosion, leading to loss of habitat (LCWCRTF and WCRA 1999). The following sections present more details on these general trends.

#### Coastal Birds

Birds that use the project area can be divided functionally into swimmers, sea birds, waders, shore birds, birds of prey, and passerine birds. Ducks are part of the swimmer functional group. Though most ducks

prefer freshwater marshes and rarely use saline marsh, the marshes near the project area may provide habitat for the mottled duck (*Anas fulvigula*), the only duck that breeds in large numbers in the coastal marshes of Louisiana (Wicker and others 1982). The most frequently encountered (and harvested) dabbling ducks are gadwall (*Anas strepera*), blue-winged teal (*A. discors*), and green-winged teal (*A. crecca*) (Wicker and others 1982). Open water in brackish marsh is favored by the lesser scaup (*Aythya affinis*), the most commonly harvested diving duck in the area. Except for the mottled duck, all the game birds are migratory winter residents. Other ducks that occur in saline habitats and thus possibly could occur in the project area include: fulvous whistling-duck (*Dendrocygna bicolor*), American widgeon (*Anas americana*), ring-necked duck (*Aythya collaris*), bufflehead (*Bucephala albeola*), ruddy duck (*Oxyura jamaicensis*), American black duck (*Anas rubripes*), mallard (*Anas platyrhynchos*), northern pintail (*Anas acuta*), and northern shoveler (*Anas clypeata*). Other swimming birds that occur in saline habitats include: pied-billed grebe (*Podilymbus podiceps*), eared grebe (*Podiceps nigricollis*), snow goose (*Chen caerulescens*), and Canada goose (*Branta canadensis*) (American Ornithologists' Union 1983, as cited in Gosselink 1984).

Seabirds are most common along the barrier islands and inland bays of Barataria Bay (Conner and Day 1987). Within the Barataria Barrier Island system in Plaquemines Parish, 10 seabird colonies have been identified (GEC 2001). A survey published in 1984 noted that colonies of black skimmers (*Rynchops niger*) and least terns (*Sterna albifrons*) were present (Keller and others 1984, as cited in Gosselink 1984).

Several wading birds occur in saline habitats and thus could occur in the project area. The clapper rail (*Rallus longirostris*) is a wading bird common in brackish and salt marsh. The yellow rail (*Coturnicops noveboracensis*), black rail (*Laterallus jamaicensis*), and Virginia rail (*Rallus limicola*) also occur in saline habitats. Other wading species include least bittern (*Ixobrychus exilis*), great blue heron (*Ardea herodias*), great egret (*Casmerodius albus*), snowy egret (*Egretta thula*), little blue heron (*Egretta caerulea*), tricolored heron (*Egretta tricolor*), reddish egret (*Egretta rufescens*), cattle egret (*Bubulcus ibis*), green-backed heron (*Butorides striatus*), black-crowned night-heron (*Nycticorax nycticorax*), yellow-crowned night heron (*Nycticorax violaceus*), white ibis (*Eudocimus albus*), white-faced ibis (*Plegadis chihi*), and glossy ibis (*Plegadis falcinellus*) (American Ornithologists' Union 1983, as cited in Gosselink 1984).

Shore birds are primarily winter visitors and occur on sand beaches and tidal mud flats in large numbers (Conner and Day 1987). Shore birds likely to occur in the project area include black-bellied plover (*Pluvialis squatarola*), semipalmated plover (*Charadrius semipalmatus*), black-necked stilt (*Himantopus mexicanus*), American avocet (*Recurvirostra americana*), greater yellowlegs (*Tringa melanoleuca*), lesser yellowlegs (*Tringa flavipes*), solitary sandpiper (*Tringa solitaria*), willet (*Catoptrophorus semipalmatus*), spotted sandpiper (*Actitis macularia*), wimbrel (*Numenius phaeopus*), hudsonian godwit (*Limosa haemastica*), semipalmated sandpiper (*Calidris pusilla*), western sandpiper (*Calidris mauri*), least sandpiper (*Calidris minutilla*), baird's sandpiper (*Calidris bairdii*), dunlin (*Calidris alpina*), stilt sandpiper (*Calidris himantopus*), short-billed dowitcher (*Limnodromus griseus*), long-billed dowitcher (*Limnodromus scolopaceus*), common snipe (*Gallinago gallinago*), and Wilson's phalarope (*Phalaropus tricolor*) (American Ornithologists' Union 1983, as cited in Gosselink 1984).

Birds of prey that occur in saline habitats and are thus likely to be present in the project area include northern harrier (*Circus cyaneus*), American kestrel (*Falco sparverius*), merlin (*Falco columbarius*), peregrine falcon (*Falco peregrinus*) and short-eared owl (*Asio flammeus*) (American Ornithologists' Union 1983, as cited in Gosselink 1984).

Passerine birds that occur in saline habitats and are thus likely to occur in the project area include tree swallow (*Tachycineta bicolor*), bank swallow (*Riparia riparia*), cliff swallow (*Hirundo pyrrhonota*), barn swallow (*Hirundo rustica*), sedge wren (*Cistothorus platensis*), marsh wren (*Cistothorus palustris*),



savannah sparrow (*Passerculus sandwichensis*), sharp-tailed sparrow (*Ammodramus caudacutus*), and seaside sparrow (*Ammodramus maritimus*) (American Ornithologists' Union 1983, as cited in Gosselink 1984).

The project area is located at the bottom of the Mississippi Flyway, and birds from central and northern North America start to converge in the fall. Shorebirds begin arriving in mid-July and peak in September. Waterfowl migration begins in mid-August, and populations peak in December. Birds of prey and passerine birds also converge in Louisiana. Some stay all winter, but many stay only a few days before departing southward. The spring return of migrants starts in late February or early March and peaks in late April and early May. Most wading birds do not migrate from Louisiana (Conner and Day 1987).

### **Mammals and Reptiles**

No wildlife surveys have been conducted in the project areas; however, based on the types of habitat present in the preferred project areas, many furbearing species may be present. The swamp rabbit is the only species of mammal harvested as game from the saline marshes typical of the project area (GEC 2001). Fur-bearing mammals that may also occur in the project area include muskrat, nutria, mink, raccoon, and otter, although trapping is not common in the area (GEC 2001). Non-game mammals that may occur in or near the project area include red fox, nine-banded armadillo, and marsh rice rat (GEC 2001).

Reptiles and amphibians that could occur within the project area include treefrogs, bullfrogs, salamanders, newts, diamondback terrapins, six-lined racerunners, mole skinks, and island glass lizards (GEC 2001).

### **3.2.3.3 Threatened and Endangered Species**

No critical habitat for any threatened or endangered species occurs in the project area. Several vertebrate species listed as Federally threatened or endangered occur at least occasionally in Plaquemines Parish, although none are known to breed in the immediate vicinity of the project areas (<http://www.wlf.state.la.us>). The Latin name, legal status, and likelihood of occurrence in the project area are listed for each threatened or endangered species (Table 11).

In response to a request for information on threatened and endangered species in the Barataria Basin, FWS supplied a summary of concerns regarding restoration projects in this area as they relate to threatened and endangered species (USFWS 2003a, USFWS 2003b). The endangered brown pelican nests on several barrier islands in the vicinity, and is known to change nesting sites as habitat change occurs. They feed along the Louisiana coast in shallow estuarine waters, using sand spits and offshore sand bars as rest and roost areas. The pelican is considered likely to use the project area at some time in the future.

The threatened piping plover may spend the majority of the year in coastal Louisiana, including the project area, from late July to late March or April. This species feeds in intertidal beaches and other sparsely unvegetated habitats (e.g. mudflats, sandflats, algal flats, wash-over passes), and roosts on barrier islands as well. Although exact locations of use shift annually and seasonally as environmental conditions change, the piping plover is expected to occur at or near the project site (USFWS 2003a, USFWS 2003b).

The threatened Bald Eagle nests in Louisiana from October to Mid-May usually in bald cypress trees near fresh to intermediate marshes or open water (USFWS 2003a, USFWS 2003b). Since bald cypress trees do not occur in the project area, bald eagles are not likely to be found in the project area.

Five species of sea turtles occur in the Gulf of Mexico off the Louisiana coast. All are considered either threatened or endangered. The draft biological Assessment prepared by NMFS (2003) lists additional details about the various species of sea turtles that may occur in the area. The loggerhead and the green turtle are somewhat common in nearshore waters. Nesting and hatching dates for the loggerhead in the northern gulf are from May to November (USFWS 2003a, USFWS 2003b). The Kemp's Ridley is an uncommon visitor, and the hawksbill turtle and the leatherback are rarely encountered in Louisiana (Dundee and Rossman 1989). Kemp's Ridley juveniles and sub-adults occupy shallow, coastal regions and are often associated with crab-laden, sandy, or muddy water bottoms. If present, small Kemp's Ridley turtles are generally found in inshore areas of the Louisiana coast from May to October. Adult Kemp's Ridley may be abundant near the mouth of the Mississippi River in spring and summer. Adults and juveniles move to offshore waters during the winter months. Kemp's Ridley have been observed in Sabine and Calcasieu Lakes and use nearshore waters, ocean sides of jetties, small boat passageways through jetties, and dredged and non-dredged channels (USFWS 2003a, USFWS 2003b).

The threatened gulf sturgeon is an anadromous fish that occurs in rivers, streams, and estuarine waters of the gulf coast between the Atchafalaya River and Suwanee River, Florida. In the late 19th and early 20th century, the Gulf sturgeon supported an important commercial fishery, providing eggs for caviar, flesh for smoked fish, and swim bladders for isinglass. Gulf sturgeon numbers declined due to overfishing during most of the 20th century. Gulf sturgeon adults would most likely occur in the estuarine and marine waters of the project area from November to March when they are not spawning (USFWS 2003a, USFWS 2003b). Various riverine, estuarine, and marine habitats in FL, AL, MS, and LA have been designated as critical habitat for Gulf Sturgeon. Critical habitat for Gulf Sturgeon in Louisiana includes portions of the Bogue Chitto River, the Pearl River, Lake Pontchartrain, Lake Catherine, Little Lake, The Rigolets, Lake Borgne, Pascagoula Bay & Mississippi Sound Systems, as well as sections of the adjacent State waters within the Gulf of Mexico. No critical habitat occurs in the project area.

The endangered pallid sturgeon is found in both the Mississippi and Atchafalaya USFWS 2003a, USFWS 2003b). Since this species requires riverine habitat, it is not thought to occur in the estuarine and marine waters of the project site.

The West Indian manatee is the only mammal listed as threatened or endangered that may be present in the project area (USFWS 2003a, USFWS 2003b). Manatees have occasionally been sighted in coastal marshes along the Louisiana Gulf coast. The West Indian manatee is known to occur in Plaquemines Parish, and manatees typically frequent protected inshore waters such as bays and coastal streams.

**TABLE 11**  
**THREATENED AND ENDANGERED SPECIES OF PLAQUEMINES**  
**PARISH / BARATARIA BAY**

Common Name	Latin Name	Federal Legal Status
West Indian manatee	<i>Trichechus manatus</i>	E
Brown Pelican	<i>Pelecanus occidentalis</i>	E
Piping Plover	<i>Charadrius melodus</i>	T/E
Bald Eagle	<i>Haliaeetus leucocephalus</i>	T

**TABLE 11 (Continued)**

**THREATENED AND ENDANGERED SPECIES OF PLAQUEMINES  
PARISH / BARATARIA BAY**

<b>Common Name</b>	<b>Latin Name</b>	<b>Federal Legal Status</b>
Loggerhead sea turtle	<i>Caretta caretta</i>	T
Green sea turtle	<i>Chelonia mydas</i>	T
Kemp's Ridley sea turtle	<i>Lepidochelys kempii</i>	E
Hawksbill sea turtle	<i>Eretmochelys imbricata</i>	E
Leatherback sea turtle	<i>Dermochelys coriacea</i>	E
West Indian Manatee	<i>Trichechus manatus</i>	E
Gulf Sturgeon	<i>Acipenser oxyrinchus desotoi</i>	T
Pallid Sturgeon	<i>Scaphirhynchus albus</i>	E

Notes:

E = Endangered

T = Threatened

### 3.3 CULTURAL RESOURCES

#### 3.3.1 Historic, Prehistoric, and Native American Resources

Prehistoric and historic archeological sites are common along the coast of Louisiana, reflecting the long history of human habitation. The French established the first fortification along the Mississippi River in 1700 at Fort de la Boulaye. The Spanish constructed more fortifications after gaining possession in 1769. Lack of arable land limited early European colonization of Plaquemines Parish, but following establishment of plantations by the mid-eighteenth century, sugar became the major industry. Agriculture was the primary industry after the Civil War, and oyster farming became important in the early twentieth century. Consultation with the State Historic Preservation Officer (SHPO) has occurred in compliance with Section 106 of the National Historic Preservation Act.

##### 3.3.1.1 Terrestrial Archeological Cultural Resources

The project vicinity encompasses Chaland Headland portion of the Barataria barrier island shoreline system, as well as the open waters of the Barataria Bay region and the Gulf of Mexico. The preferred project area lies within Management Unit V, as defined in Louisiana's Comprehensive Archaeological Plan (Smith and others 1983). That Management Unit is composed of 14 parishes located in the southeast portion of the state, including Plaquemines Parish. The entire management unit falls within the Holocene period alluvial deposits of the four major deltaic lobes that have shaped southeastern Louisiana.

A review of the Louisiana site files located at the Louisiana Department of Culture, Recreation and Tourism identified two previously recorded archeological sites within 1.5 mi (2.4 km) of the preferred project area (Figure 9). Site 16PL30 was found in 1952 at the mouth of Bayou Robinson based on a scatter of prehistoric materials positioned on a beach deposit. Later investigation resulted in collection of 145 prehistoric ceramic sherds. This site was not found during recent cultural resources survey and is assumed to have eroded into the Gulf of Mexico (Tetra Tech and Goodwin 2003).

Site 16PL31, also recorded in 1952, was a prehistoric shell midden and beach deposit. While this site is within 1.5 mi (2.4 km) of the current project area, it is not situated within the currently preferred project area.

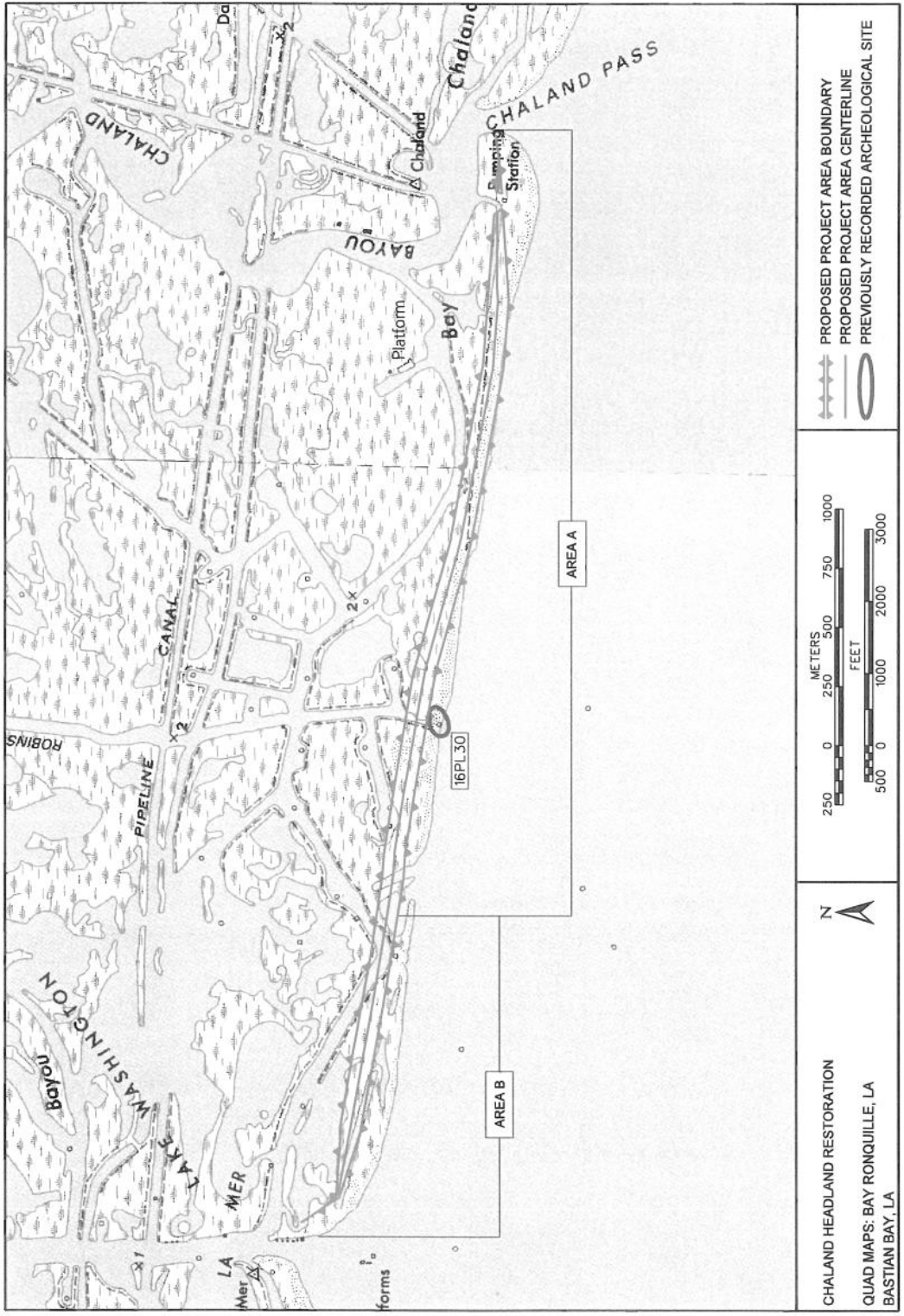

Figure 9 Excerpt from the 1983 7.5' series topographical quadrangles, Bay Ronquille and Bastian Bay, Louisiana, depicting the location of the proposed Chaland Headland Restoration Project Area and previously recorded sites.



### 3.3.1.2 Offshore Archeological Cultural Resources

Few archaeological sites have been located that pre-date the Tchula period in the coastal zone south of New Orleans. Those sites are on salt dome structures and remnant natural levees of the Teche complex. The oldest landforms in or near the current project area consist of barrier islands and cheniers, which are estimated less than 1,000 years old, but more likely are less than 700 years old (Conaster 1971; Kniffen 1988; Spearing 1995). A survey of historical and archaeological literature and archival background research confirmed considerable evidence of maritime activity in the northern Gulf of Mexico. Maritime activity in the vicinity of the preferred project was associated with colonization, development, agriculture, industry, trade, shipbuilding, commerce, warfare, transportation, and fishing. Because of those international, national, and regional maritime activities, the Gulf Coast of Louisiana has been identified as a high probability area for shipwreck resources. Human error, storms, and warfare have caused ship losses in every period of Gulf Coast history. Statistical probability suggests that most shipwrecks in the project area date from the post-World War II period and were associated with the coastal trade, fishing, or oil and gas industry (Garrison and others 1989). Wrecks from earlier periods possibly are in the area, though earlier historical records are limited.

The Quatre Bayou borrow area is approximately 1.5 nautical miles (2.12 kilometers) southeast of Quatre Bayou Pass (see Figure 8). Water depths in the Quatre Bayou borrow area range from 12 to 18 feet (3.6 to 5.5 m) NAVD. The Empire borrow area is approximately 1 nautical mile (1.85 kilometers) south of Pelican Island (see Figure 5). Water depths in the Empire borrow area range from 15 to 20 feet (4.6 to 6.1 m) NAVD. The Sandy Point Borrow and Dump Sites lie in the Gulf of Mexico from 5.5 to 7 nautical miles (10.2 to 12.9 kilometers) south-southwest to south of the Plaquemines Parish shoreline (see Figures 6 and 7).

Recent cultural resource surveys were conducted for the Quatre Bayou borrow area, the Empire borrow area, and the Sandy Point borrow area. The surveys and assessments included acquisition and analyses of magnetometer, seismic, fathometer, and side scan sonar data. The survey encompassed the entire area proposed for potential borrow, as well as a 250-foot buffer zone around each site. Fifty-meter line spacing was surveyed at Sandy Point, and 30-meter spacing at Empire and Quatre Bayou, based on Federal and State requirements. Additional, more tightly spaced transects were conducted over all potentially significant anomalies to provide more detail on site configuration and complexity.

In the marine environment, geologic features and man-made objects can create an external magnetic field which disturbs the earth's primary magnetic field. A cesium magnetometer provided a scalar measurement of the earth's magnetic field intensity, expressed in gammas, to indicate potential cultural resources composed of magnetic material. Seismic surveys of unconsolidated sediments were accomplished by sending an acoustic signal through the seafloor and receiving reflected acoustic signals in the form of a recording chart signature. The seismic record identified the sediment surface and other layers or features within the sediment column. A side-scan sonar system with a dual frequency measuring device was used to map the seafloor. A data acquisition system digitized, stored and processed the side scan sonar signals and combined the sonar imagery with navigational inputs to georeference the data in real-time.

Magnetic anomalies were interpreted by comparing field data with expectations of the character (or signature) of cultural resources derived from the available literature. Interpretation of anomalies also considered the potential for natural and modern sources of magnetic anomalies. Results of the surveys are summarized below.

**Quatre Bayou Borrow Area Findings:** Current NOAA chart 11358 identifies five shipwreck and/or derelict sites in the vicinity of the Quatre Bayou borrow site. One of the wrecks lies within the preferred borrow site. That wreck has been identified as the F/V *Last Chance*.

The draft submerged cultural resources survey identified several targets in the Quatre Bayou borrow area as potentially significant (Tetra Tech and CPE 2003d) (Figure 8). The low intensity, moderate-duration, monopolar nature of the signatures from material generating targets 4 and 7 suggest the possibility of more complex concentrations of small ferrous objects such as fittings, equipment, and some types of ballast associated with vessel remains. Target 15 is low in intensity but long in duration. In addition, the complex multi-component nature of the signature suggests concentrations of material associated with shipwreck sites. Target 21—dipolar, of moderate intensity, and of moderate duration—is approximately 500 feet (152 m) from the F/V *Last Chance*.

**Empire Borrow Area Findings:** Only one documented shipwreck was identified in the Empire survey area, although the potential for other submerged cultural resources is high. In the vicinity of the Empire borrow area, an additional three shipwreck and/or derelict sites have been charted by NOAA. The presence of charted wrecks in the vicinity of the Barataria borrow sites reinforces the high potential for shipwrecks established by MMS (Garrison and others 1989).

Analysis of the magnetic and acoustic data generated by the remote sensing survey of the Empire survey area identified 89 unidentified magnetic anomalies (Figure 5). No sonar signatures were identified in conjunction with those targets, and there were no unrelated sonar targets. Most targets were dipolar or monopolar signatures of limited intensity and duration or moderate intensity and limited duration. As such, they likely represent single ferrous objects. While they could be generated by small anchors, ordnance, or other historic material, their characteristics do not reflect the complex signatures associated with more complex shipwreck sites. Modern materials such as anchors, pipe, cable, vessel equipment, trawl gear, and other debris is frequently the source of such signatures. Several are clustered together to produce linear signatures such as pipe or cable.

Targets 7 and 8 form a complex multi-component signature in the northern extremity of the western dredge site in the Empire survey area. Targets 9, 11, 12, and 16 form a cluster in the southern half of the western dredge site in the Empire survey area. The signature of target 9 is multi-component and complex, while the others suggest single objects that could be associated. Targets 32 and 33 form a multi-component signature near the southeastern corner of the western dredge site in the Empire survey area. The combination of signature intensity, duration, and complex multi-component nature of these signatures may well suggest concentrations of material associated with shipwreck remains. Each of these target sites has potential association with significant submerged cultural resources.

**Sandy Point Findings:** Although no documentation exists of shipwrecks or small vessel losses in the Sandy Point borrow and dump areas, the potential for these submerged cultural resources is high. Current NOAA charts 11358 and 11361 identify 10 shipwreck and derelict sites in the vicinity of the Sandy Point borrow and dredge sites. One of the wrecks lies 1.15 nautical miles (2.12 kilometers) northeast of the Southeast Dump site, and a second is identified 1.55 miles west-northwest of the Northwest Dump site. The wrecks of two modern fishing vessels, the *James Lee* and *First Tim*, are identified west of the Sandy Point project areas at 29 05.5781 North and 89 34.0109 West, and 29 08.0272 North and 89 36.0020 West, respectively. Their presence and that of other wrecks in the vicinity of the dump and borrow sites reinforces the high potential for shipwrecks established by MMS (Garrison and others 1989).

A number of buried channels were documented during the geotechnical and cultural resource investigation of the Sandy Point area. These channels appear to be tributary systems of the St. Bernard and Belize Delta Complexes of the Mississippi River, formed approximately 4000 to 2000 years before



present BP and 1000 years BP to present. Because the confluence of streams and rivers, river levees, and river and coastal terraces have proven to be high probability areas for Native American sites, relict channels and other submerged geological features are potential markers of submerged cultural resources.

However, in the Sandy Point area, marine transgression within the last 4,000 years appears to have destroyed most if not all prehistoric land surfaces. Three of the four areas surveyed in Sandy Point (SE Borrow, NW Borrow, and NW Dump) show evidence of buried channels. No cultural features likely survived intact in the areas associated with the buried channels. Consequently, no relict channel features are recommended for avoidance or additional investigation.

Analysis of the remote sensing data revealed four acoustic and nine magnetic anomalies within the four survey areas (Figures 6 and 7). None appear to be significant cultural resources that warrant investigation or avoidance, based on the characteristics of the signature (Tetra Tech and CPE 2003d).

### **3.3.2 Land Use and Recreation**

Plaquemines Parish is predominantly rural with widespread croplands and undeveloped areas. Agriculture is the primary land use and more than 1000 acres are planted in food crops valued at \$4 million annually. The Parish also supports a citrus industry dating back to the 1700s; currently, more than 100,000 citrus trees produce 400,000 boxes of fruit per year. In addition, growers sell young citrus trees ([www.plaqueminesparish.com](http://www.plaqueminesparish.com)). Hunting and fishing are the primary sources of recreation in the preferred project area.

In the Chalant Headlands project area, oil and gas production is the primary land use. In the Pelican Island project area, oyster harvesting predominates. Plaquemines Parish has some of the best waterfowl hunting in the U.S. ([www.plaqueminesparish.com](http://www.plaqueminesparish.com)), with millions of resident or migratory waterfowl present in the wetlands and open water habitats. The closest residential communities, Sunrise and Diamond, are 8 and 15 miles from the project site, respectively.

### **3.3.3 Infrastructure**

No major roadways or railways are within the project area (LCWCRTF and WCRA 1999). The major roadway closest to the project area is LA highway 23, which parallels the Mississippi River down to Venice, LA. The Barataria Barrier Shoreline Mapping Unit includes 12 miles of oil and gas pipelines and 45 oil or gas wells (LCWCRTF and WCRA 1999). The Naval Air Station-Joint Reserve base is located in Plaquemines Parish at Belle Chasse (Plaquemines Parish Economic Development Office; <http://www.plaqueminesparish.com>).

The Pelican Island project area is dominated by the Empire waterway, which is 12 feet (3.6 m) deep and 80 feet (24.4 m) wide, and enters the Gulf through Fontanelle Pass (LCWCRTF and WCRA 1999). The waterway is protected by the Empire Jetties, which the COE maintains.

A recent investigation documented locations of oil and gas infrastructure on Pelican Island (Figure 10) and Chalant Headland (Figure 11) (Tetra Tech 2003). Magnetometer and hazard identification surveys are under way in areas that construction of the restoration projects may affect. To support the final engineering design and construction, the surveys will identify, precisely locate, and map oil and gas facilities (active and potentially abandoned)—including pipelines, flowlines, meter stations, injection wells, and other facilities and hazards. Figures 12 and 13 show oil and gas pipelines in the preferred borrow areas.



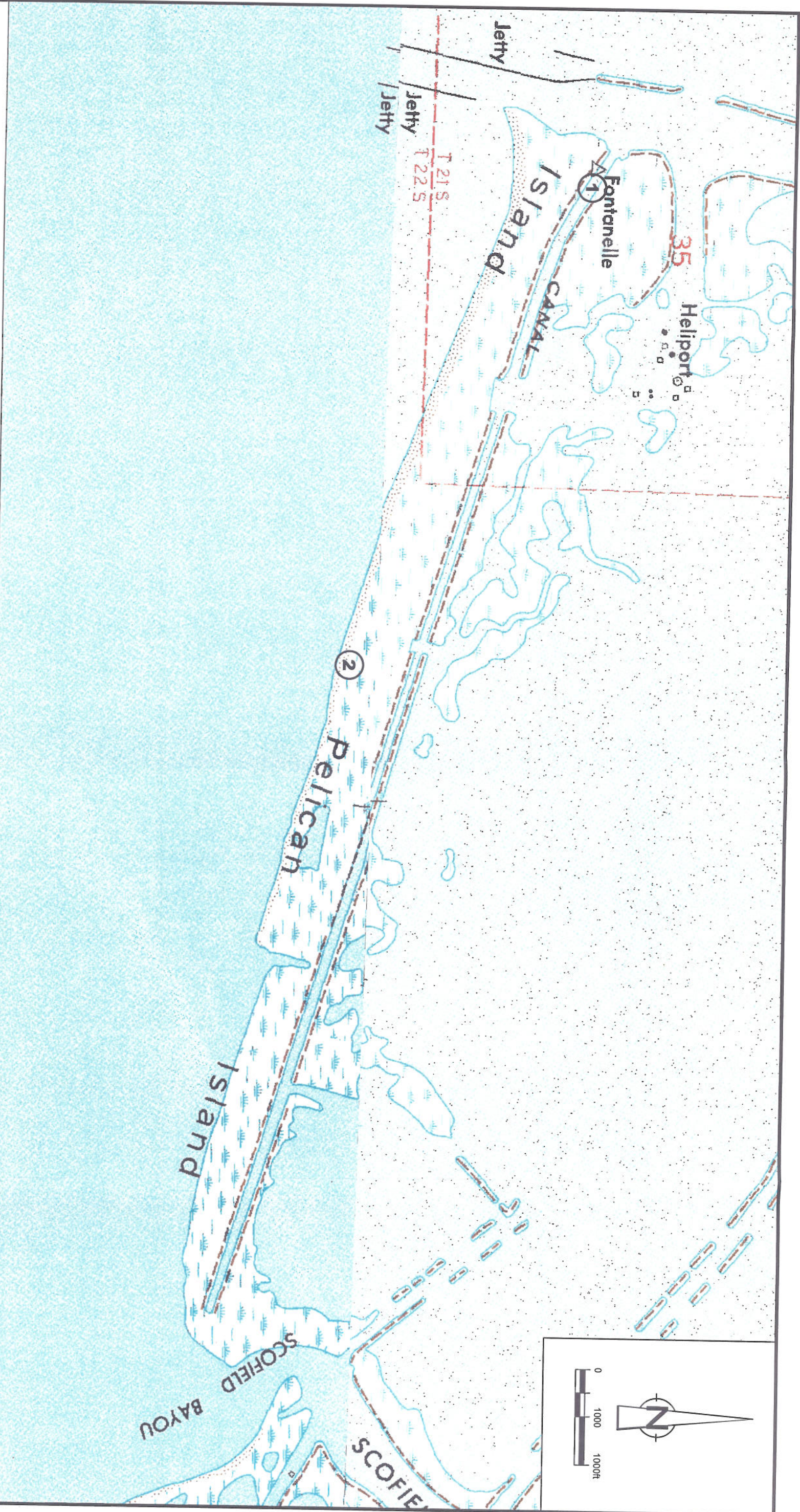

RE: U.S.G.S. 7.5-MINUTE SERIES TOPOGRAPHIC MAP,  
 "BAY COQUETTE, LOUISIANA" AND "BURAS, LOUISIANA."

- LEGEND**
- ① TGP VALVE PLATFORM STATION
  - ② ABANDONED WASTE CONTAINER

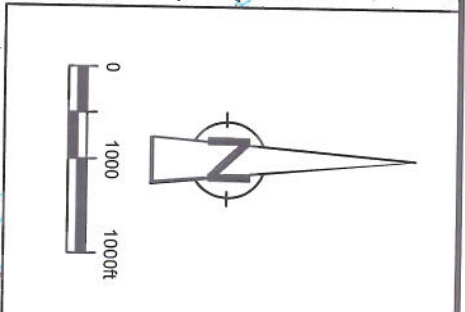

Tetra Tech EM INC.

**NATIONAL OCEANIC AND  
 ATMOSPHERIC ADMINISTRATION**  
 KANSAS CITY, MISSOURI  
 Client

**ENVIRONMENTAL ASSESSMENT**  
 BARATARIA PLAQUEMINES BARRIER ISLAND COMPLEX PROJECT  
 PLAQUEMINES PARISH, LOUISIANA  
 Project Location

**OIL AND GAS  
 INFRASTRUCTURE:  
 PELICAN ISLAND**

DATE	NO.	REVISION	BY

DESIGNED BY:	
DRAWN BY:	
CHECKED BY:	
APPROVED BY:	

1" = 1000' SCALE	
G106300680503 REPORT NO.	0 REV.
FIG./SHEET No.	10



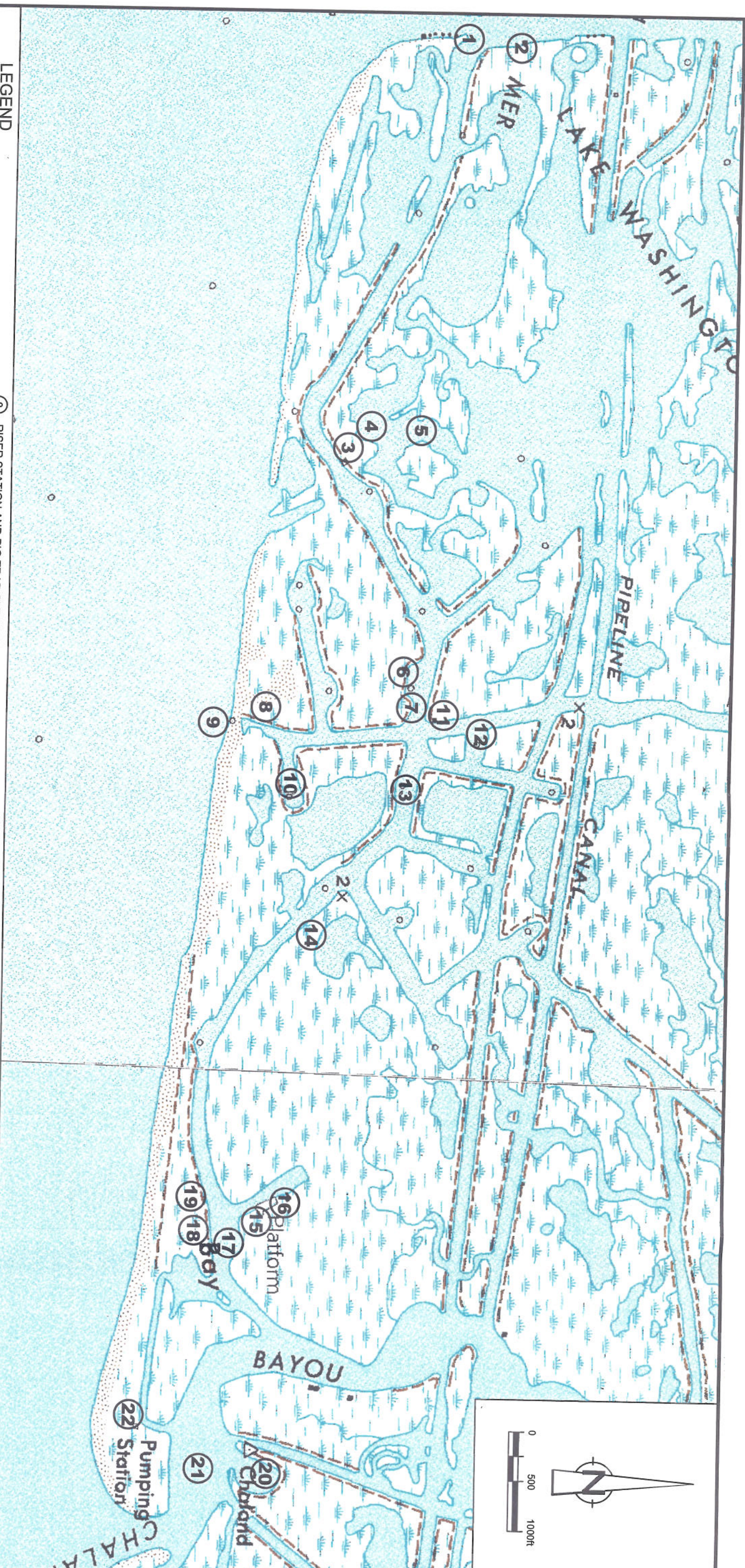

- LEGEND**
- ① ABANDONED PRODUCT FLOW LINES
  - ② GAS PIPELINE CROSSING STATION
  - ③ SOUTH END PRODUCTION FACILITY
  - ④ FORMER PIT LOCATION
  - ⑤ INACTIVE COMPRESSOR STATION
  - ⑥ LEAKING PRODUCT FLOW LINE
  - ⑦ HUNT PETROLEUM CORPORATION WELL NUMBER 15

- ⑧ RISER STATION AND PIG TRAP CLEAN OUT
- ⑨ GULFSIDE ABANDONED OIL PRODUCTION WELL AND EQUIPMENT
- ⑩ HUNT PETROLEUM CORPORATION WELL NUMBER 16
- ⑪ PRIVATE CAMP
- ⑫ ABANDONED OIL PRODUCTION WELL
- ⑬ HUNT PETROLEUM CORPORATION WELL NUMBER 4
- ⑭ REPAIRED PRODUCT FLOW LINE
- ⑮ UNIDENTIFIED DISCHARGE PIPE

- ⑯ SOUTHEAST PRODUCTION FACILITY
- ⑰ HUNT PETROLEUM CORPORATION WELL NUMBER 001
- ⑱ SEPARATOR STATION
- ⑲ DISPOSAL AREA
- ⑳ BAY CHALAND PRODUCTION AREA
- ㉑ BAY CHALAND OIL PRODUCTION WELL
- ㉒ PIPELINE STATION AND HELIPORT

RE: U.S.G.S. 7.5-MINUTE SERIES TOPOGRAPHIC MAP,  
 "BAY RONQUILLE, LOUISIANA" AND "BAY BASTIAN,  
 LOUISIANA."



DATE	NO.	REVISION	BY	DESIGNED BY:	DRAWN BY:	CHECKED BY:	APPROVED BY:

**NATIONAL OCEANIC AND ATMOSPHERIC ADMINISTRATION**  
 KANSAS CITY, MISSOURI  
 Client

**ENVIRONMENTAL ASSESSMENT**  
 BARATARIA PLAQUEMINES BARRIER ISLAND COMPLEX PROJECT  
 PLAQUEMINES PARISH, LOUISIANA  
 Project Location

**OIL AND GAS INFRASTRUCTURE: CHALAND HEADLAND**

1" = 1000'	SCALE
G106300690503	REPORT NO.
0	REV.
11	FIG./SHEET NO.



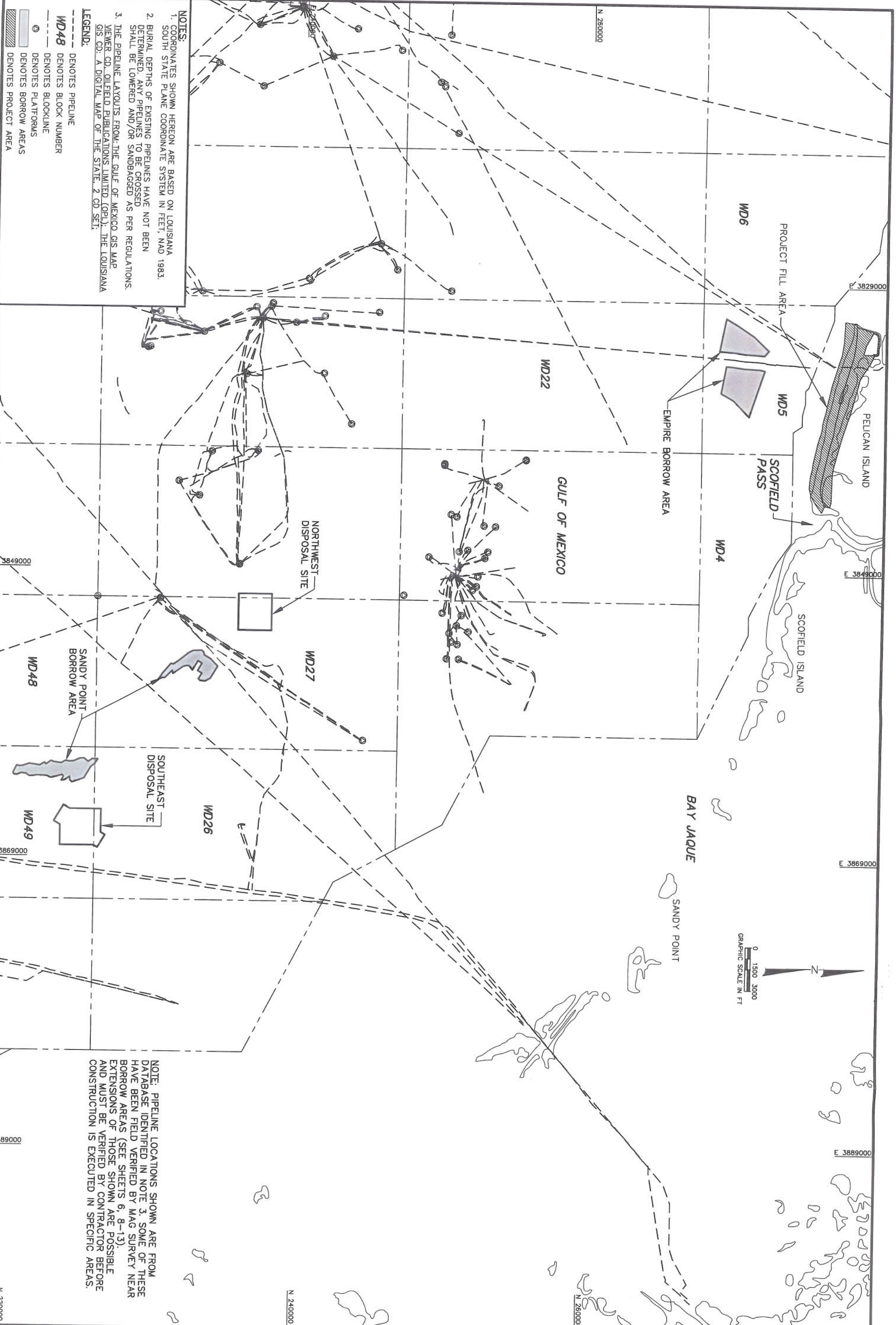

**NOTES:**

1. COORDINATES SHOWN HEREON ARE BASED ON LOUISIANA SOUTH STATE PLANE COORDINATE SYSTEM IN FEET, NAD 1983.
2. BURIAL DEPTHS OF EXISTING PIPELINES HAVE NOT BEEN DETERMINED. ANY PIPELINES TO BE CROSSED SHALL BE LOWERED AND/OR SANDBAGGED AS PER REGULATIONS.
3. THE PIPELINE LAYOUTS FROM THE GULF OF MEXICO VIEWER CD, OILFIELD PUBLICATIONS LIMITED (OPL), THE LOUISIANA GIS CD; A DIGITAL MAP OF THE STATE, 2 CD SET.

**LEGEND:**

- DENOTES PIPELINE
- DENOTES BLOCKLINE
- WD48 DENOTES BLOCK NUMBER
- DENOTES PLATFORMS
- DENOTES BORROW AREAS
- ▨ DENOTES PROJECT AREA

**NOTE:** PIPELINE LOCATIONS SHOWN ARE FROM DATABASE IDENTIFIED IN NOTE 3. SOME OF THESE BORROW AREAS (SEE SHEETS 6, 8-13) EXTENSIONS OF THOSE SHOWN ARE POSSIBLE AND MUST BE VERIFIED BY CONTRACTOR BEFORE CONSTRUCTION IS EXECUTED IN SPECIFIC AREAS.

Reference Files: BORDERPELICAN.DWG Pelisma.DWG	Designed by: MJ	Checked by: AB
	Drawn by: TW	Reviewed by: CD
	Date: 11/7/03	Submitted by: MJ
	Plot Scale: 1"=3000'	Comm. No.: 7261.00
	No.	Date
		Description

PELICAN ISLAND RESTORATION  
(BA-38-1)  
CWPPRA PROJECT  
OFFSHORE INFRASTRUCTURE  
PLAN VIEW

DRAWING NO.  
**LO-1**

**COASTAL PLANNING & ENGINEERING, INC.**  
2481 N.W. BOCA RATON BOULEVARD  
BOCA RATON, FLORIDA 33431  
PH. (561) 391-8102  
FAX (561) 391-9116  
FLA. #COA 4028

www.CoastalPlanning.net



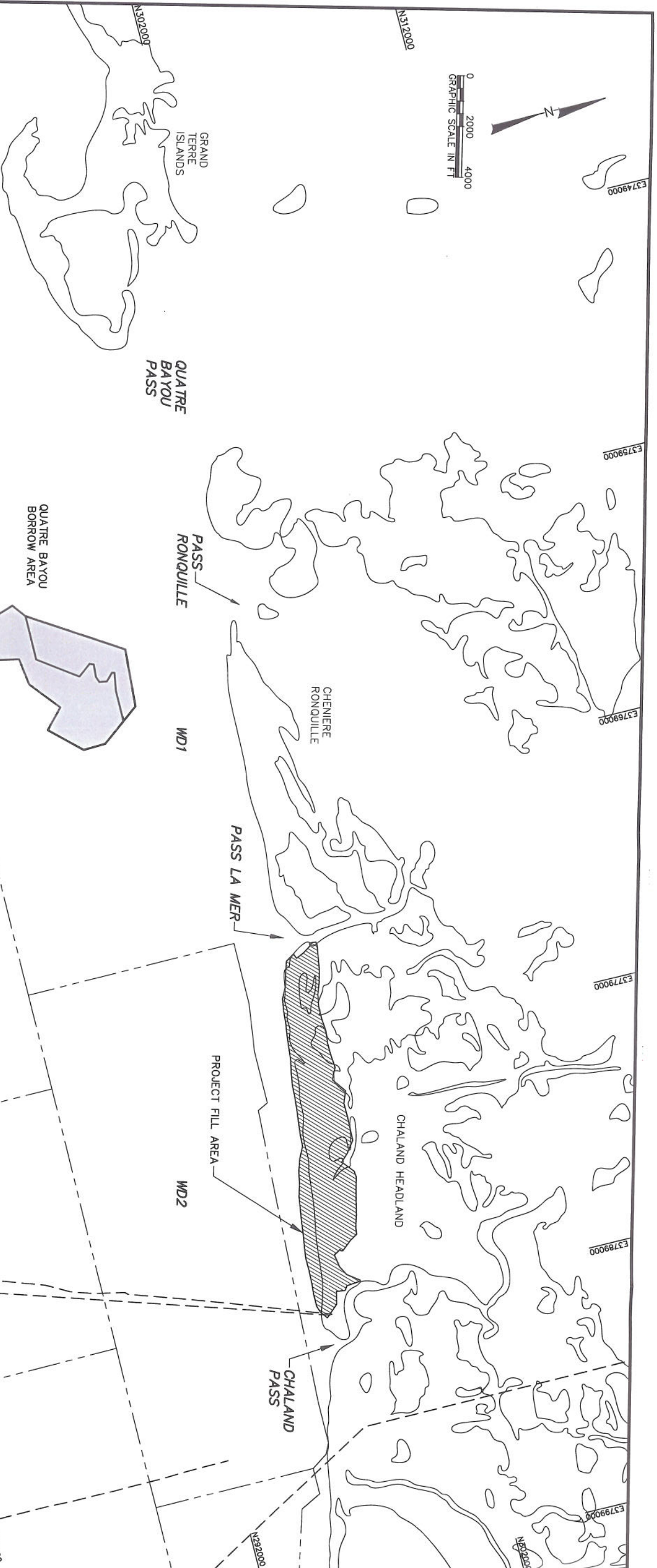
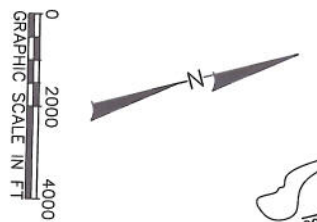

N292000

N312000

N302000

E3749000

E3759000

E3769000

E3779000

E3789000

E3799000

N320000

N332000

N282000

N272000

**NOTES:**

1. COORDINATES SHOWN HEREON ARE BASED ON LOUISIANA SOUTH STATE PLANE COORDINATE SYSTEM IN FEET, NAD 1983.
2. IF CONTRACTOR PLANS TO CROSS EXISTING INFRASTRUCTURE WITH SUBMERGED LINES, THE CONTRACTOR WILL LOCATE AND COORDINATE WITH PIPELINE OWNER & DEVELOP CROSSING PLAN ACCEPTABLE TO THE OWNER BEFORE LAYING HIS PIPELINE.
3. THE PIPELINE LAYOUTS FROM: THE GULF OF MEXICO GIS MAP VIEWER CD, OIL FIELD PUBLICATIONS LIMITED (OFL); THE LOUISIANA GIS CD: A DIGITAL MAP OF THE STATE, 2 CD SET.

**LEGEND:**

- DENOTES PIPELINE
- MD48 DENOTES BLOCK NUMBER
- DENOTES BLOCKLINE
- DENOTES BORROW AREA
- ▨ DENOTES PROJECT AREA

MD12

MD1

MD2

MD11

**NOTE:**  
PIPELINE LOCATIONS SHOWN ARE FROM DATABASE IDENTIFIED IN NOTE 3. SOME OF THESE HAVE BEEN FIELD VERIFIED BY MAG SURVEY NEAR BORROW AREA (SEE SHEETS 6-8). EXTENSIONS OF THOSE SHOWN ARE POSSIBLE AND MUST BE VERIFIED BY CONTRACTOR BEFORE CONSTRUCTION IS EXECUTED IN SPECIFIC AREAS.

Reference Files: BDR\CHALAND.dwg Bdhy.DWG	Designed by: MJ	Checked by: AB			
	Drawn by: TW	Reviewed by: CD			
	Date: 11/07/03	Submitted by: MJ			
	Plot Scale: 1"=2000'	Comm. No.:	7261.00	No.	Date
				Description	

CHALAND HEADLAND RESTORATION  
(BA-38-2)  
CWPPRA PROJECT)  
  
OFFSHORE INFRASTRUCTURE  
PLAN VIEW

DRAWING NO.  
**LO-1**

**COASTAL PLANNING & ENGINEERING, INC.**  
2481 N.W. BOCA RATON BOULEVARD  
BOCA RATON, FLORIDA 33431  
PH. (561) 391-8102  
FAX (561) 391-9116  
FLA. #COA 4028

[www.CoastalPlanning.net](http://www.CoastalPlanning.net)



### 3.3.4 Socioeconomics

The 2000 census reported 26,757 people living in Plaquemines Parish, with an average population density of 31.7 persons per square mile (U.S. Census 2000). The total area of the parish is 2,428 square miles (6288 square kilometers), with only 34% characterized as land and the remainder as “water area.” There are 10,481 housing units, with an average of 12.4 housing units per square mile of land area, and an average household size of 3 persons (U.S. Census 2000).

People of Acadian, Croatian, Creole, German, Filipino, Spanish, and Vietnamese descent are in Plaquemines Parish (Plaquemines Parish Economic Development Office; <http://www.plaqueminesparish.com>). The majority of residents of Plaquemines Parish identify as white (70%), 23% as African American, 2.6% as Asian (predominantly Vietnamese), 2.1% as Native American, and the remainder as other races or combination of races (U.S. Census 2000). The median age reported for Plaquemines Parish residents is 33.7 years; 32% of the population is below 19 years of age, while almost 50% of the population is 20-54 years of age.

Industry, manufacturing, and retail trade have become increasingly important to the local economy. However, fisheries and agriculture continue to be the primary industries. Plaquemines Parish supports agricultural activities along the Mississippi River; crops include citrus (the main cash crop), melons, and tomatoes. Numerous small vegetable stands and truck farms are in the parish (Plaquemines Parish Economic Development Office; <http://www.plaqueminesparish.com>)

Plaquemines Parish exports \$60 million dollars of commercial seafood annually—including oysters, shrimp, crabs, snapper, menhaden, bluefin and yellowfin tuna, and crawfish (Plaquemines Parish Economic Development Office; <http://www.plaqueminesparish.com>).

Four small marinas and a large commercial port are at Empire (Plaquemines Parish Economic Development Office; <http://www.plaqueminesparish.com>). The Plaquemines Parish Port Authority provides safe anchorage for supertankers, cargo vessels, and other ships at several locations. The port imports primarily steel, crude oil, and iron ore. Major exports are coal, coke, and grains. Large sulphur and salt deposits that yield millions of tons per year are in Plaquemines Parish, including a sulphur mining area near Chaland Headland (Plaquemines Parish Economic Development Office; <http://www.plaqueminesparish.com>). In addition, oil and natural gas reserves are present along with an extensive infrastructure to support the oil industry. The Plaquemines Parish Economic Development Office is promoting industries such as coal and fuel storage, metals, manufacturing, and aquaculture.

The unemployment rate in 2000 in Plaquemines Parish was 5.8% (Plaquemines Parish Economic Development Office; <http://www.plaqueminesparish.com>)

#### 4.0 ENVIRONMENTAL CONSEQUENCES

This section of the EA presents an evaluation of the anticipated environmental impacts that would result from implementation of the preferred alternative.

A qualitative assessment was conducted for direct and indirect short-term (i.e. occurring during construction) and long-term (i.e. occurring during operation) impacts. The qualitative impact assessments used were "no impact", "not significant", or "significant". The impacts that were found not significant were further defined by the terms minor and moderate impacts, and the significant impacts were defined further by the terms major and severe impacts. The qualitative assessment is based on a review of the available and relevant reference material and on professional judgment, which includes consideration of the permanence of an impact or the potential for natural attenuation of an impact, the uniqueness of the resource, the abundance or scarcity of the resource, and the potential that mitigation measures can offset the anticipated impact. A quantitative assessment is included when sufficient data are available to conduct such an analysis.

Adverse environmental consequences of the no-action alternative contrast with benefits of the preferred alternatives. With no action, continued loss of these habitats likely will occur along with associated declines in fish and wildlife resources. But the preferred alternative can offset adverse impacts to these habitats.

Table 12 summarizes general construction plans for each preferred alternative. Table 13 presents a summary of environmental consequences and mitigation measures of the preferred actions, as presented below.

TABLE 12

OVERVIEW OF CONSTRUCTION PLANS FOR PREFERRED ALTERNATIVES

	Project Start Date	Duration of Project	Total Dredge Time	Onshore Construction Time	Onshore Construction Equipment Deployed	Bottom Area Disturbed	Depth of Dredging Cut	Quantity of Dredged Sediment	Net Acres Benefited
Chaland Headlands	4/2004	203 Days	173 Days	203 Days	Bulldozers Cranes Pipes Barge	544 Acres	20 Feet	2.5 Million Cubic Yards	246 (Yr 3) 197 (Yr 20)
Pelican Island	4/2004	223 Days	193 Days	223 Days	Bulldozers Cranes Pipes Barge	909 Acres	45 feet	2.4 Million Cubic Yards	264 (Yr 3) 203 (Yr 20)

Notes:

Bottom Area Disturbed includes total borrow area acreages and overburden disposal sites.

Depth of Dredging Cut is the maximum depth below existing grade for plan.

Quantity of Dredged Sediment includes both island and marsh fill.

Net Acres Benefited based on WVA projections at 3 years and 20 years, respectively, post-construction

TABLE 13

SUMMARY OF ENVIRONMENTAL CONSEQUENCES AND AVOIDANCE, MINIMIZATION AND MITIGATION MEASURES OF PROPOSED ACTION

Resource	Potential Environmental Consequences	Potential Avoidance, Minimization and Mitigation Measures	Level of Significance
<p>Geology, Topography, and Physical Oceanographic Processes</p>	<ul style="list-style-type: none"> <li>Emplaced materials would result in long-term, direct, beneficial impacts in the proposed project area by protecting marshes from storm surge, reducing erosion rates, and increasing seaward position at the 20-year mark</li> <li>Island construction would result in coverage of existing marsh in both proposed project locations</li> <li>Short-term, direct, moderate, adverse effects would occur in the proposed borrow areas associated with suspension of sediments and disturbance to natural sediment sorting and layering within the borrow areas.</li> </ul>	<ul style="list-style-type: none"> <li>Construction of marshes would replace marsh covered during island construction</li> <li>Containment dikes would contain employed materials to allow for consolidation and stabilization</li> <li>Vegetative plantings and revegetation of disturbed areas would stabilize soil, reduce resuspension of recently deposited sediment, and enhance sedimentation.</li> </ul>	<ul style="list-style-type: none"> <li>No significant adverse impacts</li> </ul>
<p>Air Quality</p>	<ul style="list-style-type: none"> <li>Construction and dredging activities would result in adverse direct short-term minor impacts from exhaust diesel fumes and fugitive dust generated by dredging equipment, earthmoving equipment, tugs, and barges</li> </ul>	<ul style="list-style-type: none"> <li>Adhere to Best Management Practices, including sand fencing and revegetation to minimize exhaust fumes and fugitive dust</li> </ul>	<ul style="list-style-type: none"> <li>No significant adverse impacts</li> </ul>

TABLE 13 (Continued)

SUMMARY OF ENVIRONMENTAL CONSEQUENCES AND AVOIDANCE, MINIMIZATION AND MITIGATION MEASURES OF PROPOSED ACTION

Resource	Potential Environmental Consequences	Potential Avoidance, Minimization and Mitigation Measures	Level of Significance
Surface Water and Water Column Resources	<ul style="list-style-type: none"> <li>Dredging and emplacement activities would result in adverse direct short-term minor impacts on surface water quality associated with (1) increased turbidity in the water column at the dredge site (dredge plume) and at the construction location; (2) exhumation of buried trash and debris; and (3) discharges from the dredge vessel.</li> </ul>	<ul style="list-style-type: none"> <li>Use Best Management Practices to prevent soil erosion</li> <li>Adhere to the Clean Water Act and other regulations</li> </ul>	<ul style="list-style-type: none"> <li>No significant adverse impacts</li> </ul>
Wetlands	<ul style="list-style-type: none"> <li>Emplacement activities would result in adverse direct short-term minor impacts on wetlands</li> <li>Long-term benefits of wetlands on water resources and wildlife</li> </ul>	<ul style="list-style-type: none"> <li>Use Best Management Practices</li> <li>Creation of wetlands in excess of that converted to supratidal area</li> <li>Adhere to the Clean Water Act, Section 404 and Section 301</li> </ul>	<ul style="list-style-type: none"> <li>No significant adverse impacts</li> <li>Significant positive impacts</li> </ul>
Vegetation	<ul style="list-style-type: none"> <li>The proposed action would result in short-term adverse direct minor and long-term direct moderate beneficial impacts on vegetation</li> <li>Long-term improvement in vegetation and available habitat</li> </ul>	<ul style="list-style-type: none"> <li>Project specific evaluations and coordination with appropriate Federal, state, and local agencies</li> <li>Use Best Management Practices to reduce scour, erosion, and sedimentation</li> <li>Habitat restoration activities</li> </ul>	<ul style="list-style-type: none"> <li>No significant adverse impacts</li> <li>Moderate positive impacts</li> </ul>



TABLE 13 (Continued)

SUMMARY OF ENVIRONMENTAL CONSEQUENCES AND AVOIDANCE, MINIMIZATION AND MITIGATION MEASURES OF PROPOSED ACTION

Resource	Potential Environmental Consequences	Potential Avoidance, Minimization and Mitigation Measures	Level of Significance
Aquatic Biota, LMR, Fisheries, and Essential Fish Habitat	<ul style="list-style-type: none"> <li>Construction and dredging activities would result in localized adverse direct short-term minor impacts on fisheries and EFH</li> <li>Entrapment and death of slow-moving and benthic organisms (including oysters), and possible suffocation or injury to sessile organisms in emplacement and borrow areas</li> <li>The proposed action would have long-term, significant, direct and indirect beneficial impacts to EFH through re-establishment of marsh and protection of existing marsh habitat from erosion</li> <li>Long-term benefits of improved habitat, surf zone stability, increased resources, and improved water quality; improved access to interior island locations during storm or high-water events</li> </ul>	<ul style="list-style-type: none"> <li>Timing of dredging activities to avoid peak infaunal periods (spring and summer months)</li> <li>Preservation of adjacent non-dredged areas to facilitate rapid recovery</li> <li>Best Management plans to minimize soil erosion</li> <li>Project specific evaluations and coordination with appropriate Federal, state, and local agencies</li> <li>Habitat restoration activities</li> <li>Creation of tidal features</li> <li>Gapping of retention dikes after construction to provide tidal connection</li> </ul>	<ul style="list-style-type: none"> <li>No significant adverse impacts</li> <li>Moderate to significant positive impacts</li> </ul>
Terrestrial Wildlife	<ul style="list-style-type: none"> <li>Construction and dredging activities would result in localized adverse direct short-term minor impacts on seabird habitat through covering of existing beach</li> <li>The proposed action would result in adverse direct short-term minor impacts on terrestrial wildlife</li> </ul>	<ul style="list-style-type: none"> <li>Project specific evaluations and coordination with appropriate Federal, state, and local agencies</li> <li>Habitat restoration activities</li> </ul>	<ul style="list-style-type: none"> <li>No significant adverse impacts</li> <li>Moderate to significant positive impacts</li> </ul>

TABLE 13 (Continued)

SUMMARY OF ENVIRONMENTAL CONSEQUENCES AND AVOIDANCE, MINIMIZATION AND MITIGATION MEASURES OF PROPOSED ACTION

Resource	Potential Environmental Consequences	Potential Avoidance, Minimization and Mitigation Measures	Level of Significance
Threatened, Endangered, and Sensitive Species	<ul style="list-style-type: none"> <li>Excavation activities could result in localized adverse direct short-term minor impacts on sea turtles and sturgeon in the borrow areas, which could be caught in dragheads</li> <li>The proposed action would result in positive indirect long-term moderate impacts on threatened and endangered species</li> </ul>	<ul style="list-style-type: none"> <li>Timing of excavation activities to avoid times of year when sturgeon are present</li> <li>Use of observers, relocation trawling, inflow-overflow screening, and draghead deflectors to avoid adverse impacts to turtles</li> <li>Coordination with the U.S. Fish and Wildlife Service, NOAA Protected Resources, and state agencies on state and Federally listed species</li> </ul>	<ul style="list-style-type: none"> <li>No significant adverse impacts</li> <li>Long-term moderate positive impacts</li> </ul>
Cultural and Historic Resources	<ul style="list-style-type: none"> <li>The proposed action would have no adverse impacts to terrestrial cultural resources</li> <li>Long-term significant adverse effects are possible to offshore cultural resources such as shipwrecks during dredging activities</li> <li>Long-term benefits to historic structures through the beneficial restoration of surrounding areas</li> </ul>	<ul style="list-style-type: none"> <li>Careful evaluation of magnetic and acoustic anomalies identified during the cultural resources survey</li> <li>Avoidance of potentially significant anomalies during dredging operations</li> <li>If artifacts of potential cultural or historical significance are unearthed, those construction or excavation activities would be immediately halted and the Louisiana SHPO consulted</li> <li>Appropriate Section 106 Consultation with the Louisiana SHPO would be completed if necessary</li> <li>MMS archaeologist would be contacted if a potential cultural material is detected during project activities</li> </ul>	<ul style="list-style-type: none"> <li>Significant adverse impacts are possible to offshore cultural resources</li> </ul>

TABLE 13 (Continued)

SUMMARY OF ENVIRONMENTAL CONSEQUENCES AND AVOIDANCE, MINIMIZATION AND MITIGATION MEASURES OF PROPOSED ACTION

Resource	Potential Environmental Consequences	Potential Avoidance, Minimization and Mitigation Measures	Level of Significance
Land Use/Recreation	<ul style="list-style-type: none"> <li>Construction of new facilities would result in adverse direct short-term minor impacts on land use, including minor localized disruption of hunting and fishing</li> <li>Long-term, direct beneficial impacts to recreation, including improved waterfowl habitat and oyster leases</li> </ul>	<ul style="list-style-type: none"> <li>Coordination with appropriate Federal, state, and local agencies</li> <li>All staging areas used for construction materials or debris would be restored to pre-construction conditions (or better)</li> </ul>	<ul style="list-style-type: none"> <li>No significant adverse impacts</li> <li>Long-term beneficial impacts</li> </ul>
Infrastructure	<ul style="list-style-type: none"> <li>Long-term beneficial impacts would be expected for oil and gas leases and infrastructure, as pipelines would be better protected from problems associated with erosion</li> <li>Short-term significant adverse impacts are possible in the event that a pipeline is damaged during dredging activities</li> </ul>	<ul style="list-style-type: none"> <li>Construction activities would avoid pipelines and other oil and gas equipment</li> <li>Compliance with MMS regulations and regarding burial depth of pipelines and associated equipment and removal of wellheads and associated fixtures within one year of lease termination</li> <li>Extensive magnetometer surveys of proposed borrow areas</li> </ul>	<ul style="list-style-type: none"> <li>Significant adverse impacts associated with pipeline damage are possible, though unlikely</li> <li>Long-term beneficial impacts are anticipated</li> </ul>
Socioeconomics	<ul style="list-style-type: none"> <li>No adverse impacts to socioeconomics are expected</li> <li>Long-term moderate beneficial impacts to socioeconomics by improving fisheries, recreational opportunities, commercial fishing outfits, and pipelines, among others</li> </ul>	<ul style="list-style-type: none"> <li>Coordination with appropriate Federal, state, and local agencies.</li> </ul>	<ul style="list-style-type: none"> <li>Beneficial impacts</li> </ul>

## 4.1 IMPACT-PRODUCING FACTORS

Several features of offshore dredging generate expected environmental impacts, as a recent EA prepared by MMS for a large dredging project at Ship Shoal, Louisiana, described in detail (DOI MMS 2003). This section summarizes information from that report. Impacts from offshore dredging stem from: (1) dredge operating characteristics, (2) effluent discharge at sea, (3) total depth of cut expected within the borrow area, and (4) emplacement of sandy material on the island.

### 4.1.1 Dredge Operating Characteristics

Offshore dredging operations for beach nourishment projects generally involve hydraulic dredges. Along with other considerations (including practicality and costs), the distance from borrow site to beach determines the dredging and sand transport method. One of two dredging methods commonly is used: a hydraulic cutter-suction dredge with pipeline or a trailing suction hopper (TSH) dredge.

Generally, cutter suction and pipeline are appropriate when the borrow area is less than 2.7 to 3.2 miles (5 to 6 km) from the beach. A TSH dredge often is used when the distance exceeds 2.7 to 3.2 miles (5 to 6 km). Pipeline deployment over greater distances is possible, but depends on prevailing sea conditions at the site. A cutter-suction dredge is more productive than a large hopper dredge because the latter cannot approach close to the beach at prevailing water depths. Most modern high-capacity dredges are hydraulic—employing suction produced by high-speed centrifugal pumps to excavate sediment and dispose of it into a pipeline to a storage hopper. Material dislodged from the ocean floor by the suction is suspended in water in the form of a slurry and then passed through the centrifugal pump and discharge pipeline to the nourishment or disposal site. Hydraulic dredges perform at high production rates when the dredged materials are relatively soft and contain a high ratio of water to sediment.

Brief discussions follow about the two dredge types and operations likely to remove and transport sand from Sandy Point and Empire borrow areas to Pelican Island, and from Quatre Bayou borrow area to the Chaland Headland project site. Figure 14 is a drawing illustrating how material is removed from the seabed.

**FIGURE 14**  
**DREDGE OPERATION**

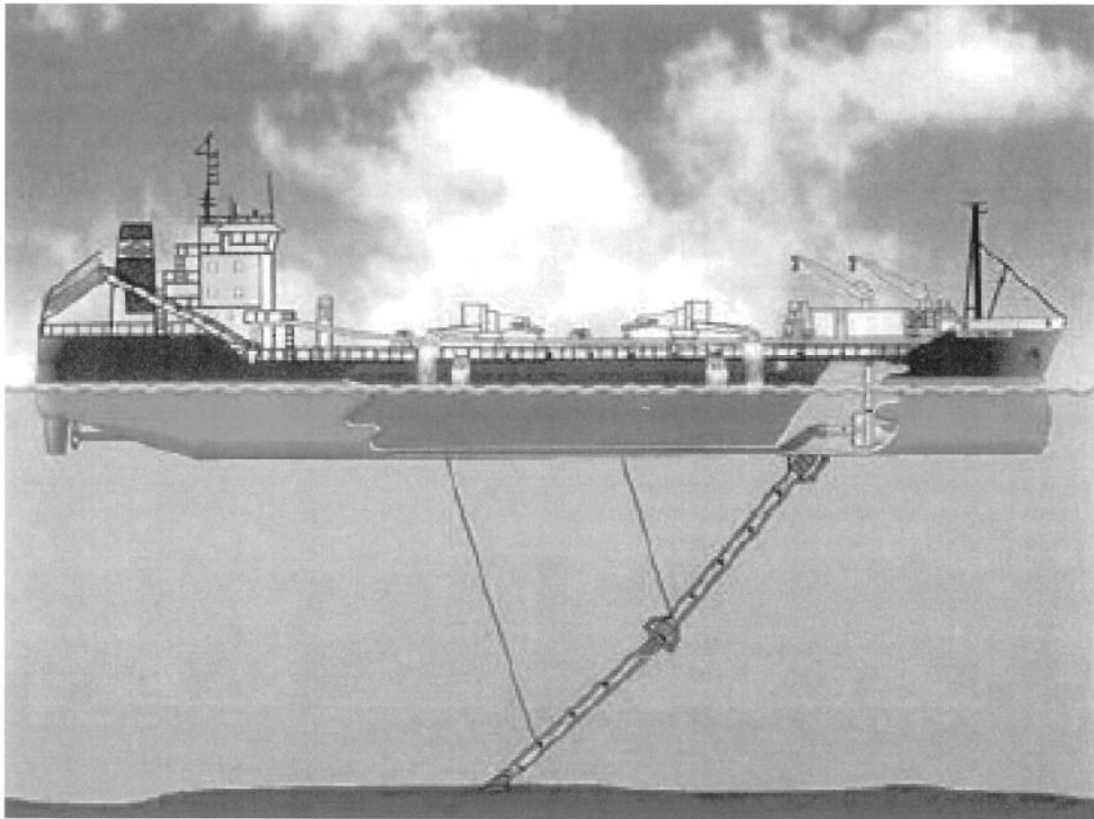



**Cutter-Suction Dredge and Pipeline:** This dredge pumps and excavates material as a fluidized mass (slurry) through a pipeline deployed on the seabed; the slurry then is discharged onto the beach. The cutter-suction dredge is the most widely used dredge in the industry. It can efficiently excavate all types of compacted sediments such as dense sands, gravel, clay, and soft rock. It is equipped with a rotating cutter that surrounds the intake end of the suction pipe. The dredge uses a rotating cutterhead, usually an open basket with hardened teeth or cutting edges. In standard practice, the dredge swings back and forth in an arc pivoted from a large post or spud attached to the stern. The cutterhead cuts downward a short distance with each swing. Because the cutterhead rotates in one direction only, the bite is much stronger on one swing than the other.

Around 90 to 95 percent of excavated sand reaches the beach via the pipeline discharge. In most beach nourishment projects, suction dredges circulate large quantities of slurry that is pumped ashore by pipeline along with the sand. A significant amount of water containing fine particulate materials thus may discharge at the end point. Treatment of the decanted solids normally is unnecessary for beach nourishment activities.

The cutter-suction dredge continually excavates and pumps sand through a pipeline previously laid on the seabed from the borrow area to the beach. A pipeline with >1.17 foot (0.36 m) diameter may be floated into position when sealed. The dredge is deployed on a 5-anchor spread (referred to as a Christmas Tree). Operational uptime generally is between 50 percent and 70 percent of total time—downtime results from weather conditions (5 to 10 percent in summer) and need for repairs.

**Trailing Suction Hopper (TSH) Dredge:** TSH dredges are self-propelled ships suitable for operations in an ocean environment. They can mine sand and load a self-contained hopper while the ship is underway. Most TSH dredges are twin-screw with bow thrusters that provide excellent maneuverability. Loading occurs as the ship moves ahead at a speed of 2-3 knots. Unloading can be by bottom discharge (bottom doors or split hull), pump discharge, or discharge by mechanical means. TSH dredges frequently are used in beach nourishment projects, especially where distance of borrow area to shore is significant.

A TSH dredge uses a pump to draw a slurry of bottom water and sediment into a riser or pipe leading to the mining vessel. As the sediment accumulates in the hopper, much of the water decants overboard. As its name implies, the trailing-suction hopper dredge mines while in motion, creating numerous shallow trenches commonly about 1 m wide and 0.3 m deep as dragheads traverse the seabed. The dredge uses one of several dragheads, each with a coarse-grid steel framework positioned across the opening of the suction head to prevent large rocks from entering the suction pipe.

When the hopper is full, the dredge transits to the pump-out mooring (usually located not less than 2500 feet [762 m] seaward of the mean low water line). The borrow material then is transported via a submerged pipeline directly onto the beach. Approximately 96% of the excavated sand is discharged onto the beach from the transfer pipeline. The number of daily trips to and from the offloading area depends on several factors. Loading times are variable and depend on the physical characteristics of the dredged material; the mechanical properties and efficiency of the dredging plant and vessel; and sea conditions at the dredging site. Coarse material with a fast settling rate requires long overflow times to fill the hoppers. These times diminish with decreasing particle size, because a greater proportion of the solids remain in suspension—the density of overflow mixture nearly equals the density of the mixture proceeding to the hopper.

A typical hopper dredge has a capacity of 3,060 cubic meters with two dragheads, each of 746 kilowatts, and pump-out power of 3,282 kilowatts. The dredge operates 24 hours per day; the typical cycle time is around 5 hours, excluding lost time due to repairs and maintenance. Time lost due to repairs may amount to as much as 3 hours daily. The disadvantage is that although the dredging rate is about 1,988 cubic

meters per hour (higher than that of the cutter suction dredge), only about 20 percent of the TSH dredge's available working time is devoted to excavating.

#### **4.1.2 Effluent Discharge at Sea**

With beach nourishment dredging using either type of dredge, resuspended materials are localized in the vicinity of the excavation tool. At Sandy Point, fine-grained overburden will be removed and disposed of in dump areas (see Figures 6 and 7). Overburden at the Empire and Quatre Bayou sites will be sidecast.

#### **4.1.3 Total Depth of Cut Expected Within the Borrow Area**

The total depths of cut expected in the three borrow areas are shown on Figures 5, 6, 7, and 8, and listed in Table 12. Regardless of the depth of cut, construction solicitation and specifications documents normally stipulate that dredge cuts in the borrow area shall not have side slopes steeper than 1 on 2.

#### **4.1.4 Emplacement on the Beach**

Where excavated material comes ashore through a pipeline, bulldozers and graders will distribute and smooth out the material. Expectations are that 2-4 bulldozers and an equal number of graders will be necessary. The work likely will proceed in segment lengths of approximately 500 feet (152.4 m).

### **4.2 PHYSICAL RESOURCES**

This section describes potential impacts to geology, topography, and physical oceanographic processes; air quality; and surface water and water column resources for all alternatives.

#### **4.2.1 Impacts on Geology, Topography, and Physical Oceanographic Processes**

Under the preferred alternative, materials dredged from offshore borrow areas would stabilize the islands and create marsh habitat. Dune elevation in both project areas would increase +6 NAVD, creating more upland habitat and better protect marshes from storm surge. Average annual recession rates would decrease to 12.8 feet (3.9 m) per year on Chaland Headland and 14.0 feet (4.3 m) per year on Pelican Island.

Island construction would result in coverage of existing marsh in both project locations (Tetra Tech and CPE 2003a). At both Pelican Island and Chaland Headland, marsh would be constructed at an elevation of +3 feet (0.91 m) NAVD to account for relative sea-level rise, high marsh loss rate, high subsidence rate, and material desiccation and consolidation. Currently, Pelican Island has an average marsh elevation of +1.34 feet (0.41 m) NAVD, and Chaland Headland has an average marsh elevation of +1.01 feet (0.31 m) NAVD. On Pelican Island, marsh construction would result in filling a pipeline canal. Since marsh would be constructed in currently exposed shallow open water (-1 to -2 NAVD), extensive containment diking would be built. Diking also would ensure that bayside erosion of the constructed marsh does not occur. Breaches would be placed in strategic places along the dike to return tidal influence to the marsh and thus increase its habitat value. For Chaland Headland, marsh construction would result in filling many canals. Since many dikes already exist, additional construction of containment dikes would not be as extensive as on Pelican Island (Tetra Tech and CPE 2003a).

The dredged material used in both island and marsh construction consists of naturally occurring material deposited in the Gulf over time by riverine processes. Dredged materials would be sorted according to

grain size, with coarser sand used for island construction and finer sand used for marsh construction (Tetra Tech and CPE 2003a). Potential for contamination of dredged material may exist, since oil and gas pipelines, waste pits, and abandoned barges are present in the area (GEC 2001). Sand fencing would protect and build dunes by capturing fine grains transported by the wind. Vegetative plantings would stabilize soil, reduce resuspension of recently deposited sediment, and encourage sedimentation. Vegetative plantings will not occur in the project's initial construction phase, but will proceed approximately a year after construction (Louisiana Department of Natural Resources [LDNR] 2003).

The STWAVE model (Smith 2001) was used to determine physical impacts on the shoreline resulting from dredging borrow areas. During average conditions, wave energy near the Quatre Bayou borrow area may be redirected to the shoreline east of the inlet. Changes to the nearshore wave height (-7 NAVD) never exceed 0.4 feet (0.12 m), and changes to the wave angle are within 5 to 10 degrees. During storm conditions, the largest wave height changes at -15 feet (4.6 m) NAVD are reductions that never exceed 2 feet (0.61 m). Landward of the -15 feet (4.6 m) contour, the waves are depth limited, and changes to the waves diminish. Given the uncertainty associated with the 1975-1995 hindcast data and the STWAVE model, these changes fall within an acceptable margin of error. Accordingly, changes to littoral drift and resulting erosion patterns are expected to be negligible (Tetra Tech and CPE 2003a).

In the short term, dredging will result in suspension of sediments and disturbance to natural sediment sorting and layering within the borrow area. Impacts to biological resources are discussed in Section 4.3. Water depth will increase in the area as sediments are removed. Over the long-term, dredged materials removed from the borrow areas are expected to rearrange by natural processes, and pre-dredging bathymetric contours will return to the dredged areas.

The long-term benefits of the preferred alternative include a reduction of erosion rates and a greater seaward position at the 20-year mark compared to no action. Based on the SBEACH model, the primary impact of a severe storm, given year-zero conditions, would be a minor lowering of the dunes (<1 foot [0.3 m]) (Tetra Tech and CPE 2003a).

#### **4.2.2 Impacts on Climate and Weather**

Present information on possible carbon sink due to marsh creation and/or the added protection against hurricanes.

#### **4.2.3 Impacts on Air Quality**

Impacts to air quality from the preferred action would be associated with emissions from diesel engines powering the dredging activities, propulsion between the dredge site and mooring buoy, and pump-out operations. Additional emissions would result from tugs and barges used to place and relocate the mooring buoys. On the beach, impacts from diesel emissions would result from bulldozers, graders, and trucks. Emissions would occur over a period of about four months, with most emissions occurring at the dredge site and the mooring buoy just off the beach. The emissions would consist predominantly of nitrogen oxides, with smaller amounts of carbon monoxide, sulfur dioxide, particulate matter, and volatile organic compounds.

Prevailing winds would dissipate airborne pollutants and limit them to the project's construction phase. In addition, newly placed, unconsolidated, dredged material is subject to drying and blowing during high wind events—adding particulates to the air. Sand fencing would minimize the speed and range of blowing sand in the short term, and revegetation would hold sand in place over the long term. Because the project area is removed from any residential area, the impact to human health would be negligible.

Other sources of air emissions in the preferred project area are mainly associated with the oil and gas industry, commercial vessel traffic, and commercial fishing activities. Emission amounts would vary depending on the amount of activity in these sectors. Overall, it is expected that there will be decreasing emissions in the future as a result of more stringent control technologies applied to marine vessels, on-road vehicles, and off-road vehicles. Air quality in the area, therefore, is expected to be the same as now or better.

In summary, air quality impacts from any individual project would be low.

#### **4.2.4 Impacts on Water Resources**

Impacts associated with the offshore dredging required for implementation of the preferred alternative would include: (1) increased turbidity in the water column at the dredge site (dredge plume) and at the construction location; (2) exhumation of buried trash and debris; and (3) discharges from the dredge vessel. Two phases of operation would impact water quality—the dredging phase and the emplacement phase.

During dredging, sand would be collected from the dredge site with a cutterhead or hopper dredge. When a hopper dredge is used, a turbidity plume (or dredge plume) results as water is decanted overboard onto the sea surface from the dredge vessel and the vessel hopper fills with sand. Silt or clay that may be present in the sandy substrate remains suspended in the water that is discharged overboard. The discharge would occur in water ranging from approximately 26 to 105 ft (8 to 32 m) in depth, and would settle in a matter of hours to days (depending on current activity). If the disturbed sediments were anoxic, the biological oxygen demand in the water column would increase.

Turbidity and suspended particulate levels in the water column above the preferred borrow areas normally fluctuate due to seasonal riverine inputs and discharge rate. The increased turbidity is expected to impact water quality only in the immediate area of dredging (DOI MMS 2003).

During emplacement, sand slurry will be pumped onto the beach through a temporary pipeline approximately 30 inches (in) (0.76 m) in diameter. Fine-grained sand will settle out rapidly; water will separate from the slurry and drain off of the beach into the surf zone or percolate into the sand. If silt- or clay-sized sediments are part of the slurry, the settling velocity of these suspended solids will control the amount of silt and clay that is emplaced on the beach or that remains in suspension to drain into the surf zone. Drilling mud discharge from offshore operations, exhumed contaminants, or trash and debris present in the dredged sand also could be deposited on the beach. The emplacement area for dredged sand is expected to total hundreds of acres, but only an area of 5 to 10 acres is active at any one time—as the sand slurry discharges and bulldozers create and grade a new beach and dune platform area. Though suspended particulate matter levels in the receiving water could increase temporarily, this would occur in a limited emplacement area and would affect water quality minimally (DOI MMS 2003).

A wave impact analysis using the STWAVE numerical model (Smith 2001) was conducted to evaluate potential modification of the wave climate due to the Sandy Point borrow area excavation. This study indicated no significant impact to the nearshore wave climate or sediment transport patterns. Dredging of the Sandy Point borrow areas is not expected to change the beach erosion patterns near Pelican Island, Scofield Pass, and Bayou Trouve, LA. Noticeable changes to the wave patterns near the borrow areas during storms may occur after excavation. However, due to large distances between the borrow areas and the shoreline, changes to the nearshore waves and sediment transport patterns will be negligible during



storms and average conditions. Accordingly, utilizing the Sandy Point borrow areas will not result in any noticeable changes to the long-term and storm erosion patterns along the nearby shorelines.

### 4.3 BIOLOGICAL ENVIRONMENT

#### 4.3.1 Impacts on Vegetative Communities

The preferred alternatives would exert positive long-term impacts on vegetative communities of Pelican Island and Chaland Headland. Because the accumulation of organic material is a primary factor influencing the vertical accretion of marshes, protecting marshes from excessive erosion and tidal scour would increase the overall health and stability of both Pelican Island and Chaland Headland.

<b>PELICAN ISLAND 2003 WVA</b>			
	<b>Dune</b>	<b>Supratidal</b>	<b>Intertidal</b>
As-build acres	73	338	61
TY3 acres	57	77	264
TY20 acres	0	51	203
<b>CHALAND HEADLAND 2003 WVA</b>			
	<b>Dune</b>	<b>Supratidal</b>	<b>Intertidal</b>
As-build acres	111	276	65
TY3 acres	90	90	246
TY20 acres	0	82	197
<b>CHALAND AND PELICAN SUB-REACHES</b>			
TY3 Acres Total	147	167	510

Implementing the preferred alternatives would unavoidably impact beach, marsh, and shallow open water areas and their associated vegetative communities. Traffic areas (paths for construction materials, dikes, access canals) and construction areas would be adversely impacted.

The preferred alternative for Pelican Island would adversely impact about 62 acres of intertidal saline marsh by converting those acres to supratidal (i.e., dune, swale and berm) habitats. However, that conversion of wetland habitat is offset by the creation of about 168 acres of saline marsh in existing open water areas and the nourishment and enhancement of about 40 acres of existing saline marsh. Additional habitat benefits result from the restoration of dune, swale, and berm habitats.

As evaluated under CWPPRA's Wetland Value Assessment, the preferred alternative for Pelican Island is anticipated to result in the creation and restoration of about 57 acres of dune, 77 acres of swale, beach and berm, and 264 acres of intertidal saline marsh after initial project construction and post-construction consolidation and settlement. The preferred alternative for Pelican Island is also anticipated to result in a long term, net benefit of about 203 acres of barrier island habitats.

The preferred alternative for Chaland Headland would adversely impact about 53 acres of intertidal saline marsh by conversion to supratidal (i.e., dune, swale and berm) habitats. However, that conversion of wetland habitat is offset by the creation of about 120 acres of saline marsh in existing open water areas and the nourishment and enhancement of about 57 acres of existing saline marsh. Additional habitat benefits result from the restoration of dune, swale and berm habitats.

As evaluated under CWPPRA's Wetland Value Assessment, the preferred alternative for Chaland Headland is anticipated to result in the creation and restoration of about 90 acres of dune, 90 acres of



swale, beach and berm, and 246 acres of intertidal saline marsh after initial project construction and post-construction consolidation and settlement. The preferred alternative for Pelican Island is also anticipated to result in a long term, net benefit of about 197 acres of barrier island habitats.

#### **4.3.2 Impacts on Fisheries and Aquatic Resources**

Under the preferred alternative, short-term, local, adverse impacts to fisheries resources would occur during the construction phase of the project. The immediate effect of dredging is the removal of sediment along with the organisms living in the sediment. In addition to direct removal of organisms, impacts could include entrapment and likely death of slow-moving organisms (such as crabs) and benthic organisms (such as polychaetes) during dredging in the borrow areas and canals, and smothering of benthic organisms and more sessile fish species in the deposition sites. Mobile aquatic animals would be expected to move away from the project area during construction and return following completion of construction. Invertebrates and fish that do not move out of the area would likely be injured as suspended particulates cause gill clogging. Short term severe effects on pelagic fish eggs and larvae in the immediate area may occur. Dredging would change substrate topography, re-assorting benthic and other aquatic organisms using this habitat.

Benthic organisms would likely recolonize borrow areas and dredged canals, but increased competition likely would ensue for more suitable waterbottom habitat (DOI MMS 2003). Early stage recruitment of defaunated sediments has been found to occur rapidly in coastal systems (Grassle and Grassle, 1974; McCall, 1977; Simon and Dauer, 1977; Ruth et al., 1994, as cited in EPA 2003). Dredged sites would be rapidly colonized by opportunistic infauna (EPA 2003). Later stages of colonization would be more gradual, and depend on environmental conditions after cessation of dredging.

The impacts of dredging on benthic resources can be mitigated by considering temporal and spatial elements. For example, timing to avoid dredging during the peak infaunal recruitment periods (spring and summer months) would facilitate more rapid faunal recovery. Also, preservation of non-dredged areas throughout an offshore borrow site can potentially contribute to more rapid community recovery after dredging, presumably due to immigration of fauna from adjacent non-dredged areas (EPA 2003). It is important to note that the nature of the reestablished community would not necessarily be similar to the pre-dredged species composition. While levels of diversity and abundance may be reached or exceeded within a relatively short time after dredging, the pertinent goal of recovery success is for infaunal assemblages to become equivalent to nearby non-dredged areas within a relatively brief interval after dredging (about 1 to 2 years). Because assemblages vary over time, efforts to ascertain recovery success can be confounded by natural variability, and so overall temporal changes in community parameters of nondredged areas must be taken into account (EPA 2003).

Several oyster leases occur in deposition sites. Construction activities would impact some oyster leases by burying and killing oysters with dredged material. Oysters not completely buried could be stressed by suspended particulates clogging their gills. Construction specifications would require best management practices to control turbidity. Oyster lease holders would be compensated under a program administered by the LDNR. Over the long term, however, project impacts are expected to benefit oyster leases in the area by limiting increases in salinity and tidal scour. Fish and invertebrates are expected to recover as turbidity returns to pre-construction levels.

Neither the total volume of sand to be dredged nor the estimated area of sea bottom disturbed is significant. Nearshore benthic communities in the preferred borrow areas already inhabit a dynamic environment subject to perturbations and disturbances, such as high turbidity from river discharge,

tropical storms, and hypoxia, which have the potential to degrade benthic community structure to an equivalent and greater degree (DOI MMS 2003)

Over the 20-year life of the preferred alternative, the quality and quantity of fish habitat would increase. The surf zone would stabilize. Species that use intra-island habitats during some or all life stages would benefit from tidal features created post-construction (Williams 1998). Further access to interior portions of the island for aquatic organisms would occur during high-water or storm events. Access to the Gulf would still be possible through existing passes.

#### **4.3.3 Impacts on Essential Fish Habitat**

In the long term, the preferred alternatives would improve EFH by re-establishing marsh and protecting marsh habitat from erosion. Marsh, inner marsh, and marsh edge habitat would increase with the vegetative plantings and hydrological features added post-construction. Detrital material, formed by the breakdown of emergent vegetation, would contribute to the aquatic food web of Barataria Bay and near-shore Gulf of Mexico ecosystems. Decreases in erosion rates and tidal scour also would protect SAV, estuarine mud bottoms, and marsh ponds. Thus, the preferred alternatives would benefit greatly brown shrimp, white shrimp, red drum, gray snapper, and Spanish mackerel. King mackerel, blue fish, cobia, bonnethead, sharpnose, and lane snapper also likely would benefit since these species depend on various types of estuarine features during their life cycles.

Short-term, unavoidable, adverse impacts to brown shrimp, white shrimp, red drum, gray snapper, and Spanish mackerel would occur during the construction phase of the project as marsh is filled. Approximately 152 acres and 161 acres of marsh at Pelican Island and Chaland Headland, respectively, would be covered by fill (Tetra Tech and CPE 2003a), and turbidity would increase. However, post-construction increases in quality and quantity of the marsh would offset these impacts. Turbidity would return to ambient conditions post-construction.

Short-term adverse minor impacts to EFH could result from dredging the preferred borrow areas. Turbidity of the water column would increase during dredging activities, affecting pelagic and shallow EFHs of brown shrimp, white shrimp, red drum, king mackerel, bluefish, cobia, dolphin, bonnethead, sharpnose, and lane snapper. Turbidity would be expected to return to ambient conditions once dredging is complete (DOI MMS 2003). EFH for adult brown shrimp, adult white shrimp, adult red drum, adult grey snapper, and adult lane snapper include either sand and/or mud substrates located in marine waters; therefore, dredging of the borrow areas could negatively impact these species for a short time. Due to natural sedimentation rates, borrow areas are expected to fill quickly to pre-dredging bathymetric contours. Other potential short-term impacts to EFH include movement of prey species away from the construction area, interruption of feeding or spawning by some species, and other effects on behavioral patterns. Because hundreds of thousands of acres of similar substrate are available to organisms outside of the small areas to be dredged, no significant effects on EFH are expected.

#### **4.3.4 Impacts on Wildlife Resources**

With no action, the continued conversion of marsh to open water may increase the foraging area for the lesser scaup. Over time though, the habitat would become less suitable for this species as aquatic vegetation declines. Since most ducks prefer freshwater marshes, the increase in salinity due to fragmentation and the resulting increase in connectivity with the gulf will most likely deter mottled duck, gadwall, blue-winged teal, and green winged teal from using the marshes on Pelican Island and Chaland Headland. Clapper rail numbers in the project areas will also probably decline due to deterioration of brackish and salt marsh habitats.

Seabird colonies have been identified within the Barataria Barrier Island System. Occasionally these birds construct nests in marshes or on the ground. Therefore with no-action the loss of these habitats on Pelican Island and Chaland Headland would negatively impact these colonies.

Mammals, reptiles, and amphibians within the project area would likely decline due to the loss of habitat if no action is taken.

During construction of the proposed alternatives, wildlife may vacate or avoid the project area or suffer mortality if they do not vacate fill sites quickly enough. Those individuals that avoid the area during construction are expected to return once construction is complete. The most significant wildlife resource likely to be affected by the covering of existing beach and marsh with fill are the seabird colonies. However, in the long-term, nesting habitat for seabirds would be protected by decreasing the erosion rate of Pelican Island and Chaland Headland. Project modifications to avoid impacts to colonial nesting birds during the nesting season will be coordinated with the USFWS.

Over the twenty year life of the proposed alternatives, the quantity and quality of habitat for wildlife would increase. Many bird species are migratory or permanent residents and depend on marsh and shore areas within and surrounding the project area. Population numbers of bird species are expected to increase in response to the implementation of proposed alternatives. Mammals, reptiles, and amphibians will also most likely increase in the project area as habitat improves in quantity and quality.

#### **4.3.5 Impacts on Threatened and Endangered Species**

Without action, existing habitat would continue to be lost, reducing available resources for the brown pelican, piping plover, manatee, various sea turtle species, and the gulf sturgeon. In the long-term, the preferred alternatives will increase the longevity and enhance the quality and quantity of available habitat for protected species. The preferred alternatives will result in more stable islands in an area adjacent to habitat critical to piping plover. It is reasonable to expect that at some time during the 20-year life of the projects, overwintering piping plover will use the newly created island habitat in the project sites. Brown pelican would also benefit from the increased acreage and stability of the restored project areas. The increase in fisheries habitat associated with the preferred alternatives would improve foraging success for both of these avian species.

During construction activities, it is anticipated that any brown pelicans or piping plovers which may be in the area will be temporarily displaced to nearby suitable habitats. Also during construction, contract personnel associated with the project shall be informed of the potential presence of manatees and the need to avoid collisions with manatees. All construction personnel are responsible for observing water-related activities for the presence of manatee(s). Temporary signs will be posted prior to and during all construction/dredging activities to remind personnel to be observant for manatees within the active construction/dredging operations or vessel movement (i.e., work zone), and at least one sign should be placed visible to the vessel operator. In the event that a manatee is sighted within 100 yards of the active work zone, special operating conditions would be implemented, including: no operation of moving equipment within 50 feet of a manatee; all vessels shall operate at no wake/idle speeds within 100 yards of the work zone; and siltation barriers, if used, should be re-secured and monitored. Once the manatee has left the 100 yard buffer around the work zone on its own accord, special operating conditions are no longer necessary. Also, if a manatee is sighted, sightings will be reported to appropriate Federal and State agencies.

Based on the longterm benefits of the preferred alternatives, and the conservation measures during construction activities, the preferred alternatives are not expected to adversely affect the brown pelican, piping plover, manatee, sturgeon or bald eagle.

On-going consultation regarding the potential for adverse impacts to protected sea turtles managed by NOAA Fisheries suggests that the preferred alternative is not likely to adversely affect Leatherback sea turtles. Potential species-specific adverse effects to protected Green Sea Turtles, Hawksbill Sea Turtles, Loggerhead Sea Turtles, and Kemp's Ridley Sea Turtles which may result from the project are detailed in the Biological Assessment (BA) prepared by NMFS (2003). That BA will be transmitted to the respective agencies for concurrence. Excavation of the borrow areas to obtain sand and mud for the restoration has the potential to cause direct effects on turtles, as these large animals can become trapped in dragheads. Impacts to turtles will be avoided and minimized by use of observers, relocation trawling, inflow/overflow screening, and draghead deflectors. Although dredging can result in habitat destruction, no critical habitat occurs in the project area. Dredging may temporarily disrupt a small area of foraging habitat, but food sources are abundant and turtles and sturgeon are mobile.

#### **4.4 CULTURAL RESOURCES**

##### **4.4.1 Impacts on Historic, Prehistoric, and Native American Resources**

Terrestrial and offshore cultural resource investigations were conducted as described in Section 3.1. Potential effects resulting from preferred activities in onshore and offshore areas are evaluated in Sections 4.4.1.1 and 4.4.1.2, respectively.

###### **4.4.1.1 Impacts on Terrestrial Cultural Resources**

The preferred alternatives would have no adverse effect on any cultural resources listed on or eligible for listing in the National Register of Historic Places. No significant terrestrial cultural resources are known to exist in either project site.

###### **4.4.1.2 Impacts on Offshore Cultural Resources**

Offshore cultural resources in the three borrow areas were considered in this EA. Twenty-three anomalies in the Quatre Bayou borrow area and eighty-nine anomalies in the Empire borrow area were suggested by magnetic and acoustic data collected in Summer, 2003. While 53 of those anomalies appear to be associated with modern debris, 25 have signature characteristics suggesting potentially significant submerged cultural resources. Those anomalies have been recommended for identification and assessment if avoidance is not an option (Tetra Tech and CPE 2003d). No magnetic anomalies were identified in the Sandy Point borrow or dump areas.

Because the Barataria project area has a high documented potential for shipwreck sites, magnetic and acoustic anomalies identified during the survey should be considered carefully. The patterns of navigation identified by historical research confirm that the spectrum of vessels employed in the vicinity of the project includes everything from small coastal craft to international merchant and warships. While larger and more modern vessels generate a more readily detectable magnetic and acoustic signature, small coastal craft can be very difficult, if not impossible, to detect. For that reason, each anomaly must be considered seriously. Complicating signature analysis further, the bottom of the northern Gulf of Mexico is littered with modern debris. Determining whether an anomaly represents a shipwreck or modern debris can be difficult, if not impossible. While many pipelines and wells can be identified using charts and



geographic information systems, much bottom surface debris is undocumented. The complexity of signature analysis has been addressed by Saltus (1982), and Garrison and others (1989).

**Quatre Bayou Borrow Area:** Analysis of the magnetic and acoustic data generated by the remote sensing survey of the Quatre Bayou survey area identified 23 unidentified magnetic anomalies. One sonar signature was identified in conjunction with a cluster of magnetic anomalies that generated the largest magnetic signature (Tetra Tech and CPE 2003d). That feature was identified as the remains of a well head and a scatter of associated debris.

On the basis of the data available, targets 4, 7, 8, 15, and 21 are considered potentially significant. The low intensity, moderate duration, monopolar nature of the signatures from material generating targets 4 and 7 suggest the possibility of more complex concentrations of small ferrous objects such as fittings, equipment, and some types of ballast associated with vessel remains. Target 15 is low in intensity but long in duration. In addition, the complex multi-component nature of the signature suggests concentrations of material associated with shipwreck sites. Target 21 is dipolar of moderate intensity and duration. In addition, it is approximately 500 feet (152.4 m) from a shipwreck on NOAA Chart 11358 identified as the F/V *Last Chance*. These four targets would be avoided during borrow area excavation, and a no-impact zone with a radius of 150 feet (45.7 m) would be established around each anomaly. The dredge contractor would be required to stop work if any cultural resources are encountered during construction.

**Empire Borrow Area:** On the basis of the data available, several targets are considered potentially significant. Those targets combine to reflect complex signatures or fall into groups or clusters that suggest scatters of associated material. Because of the location of a Chevron pipeline (Figure 12), the Empire survey area was divided into two separate dredge sites. One lies to the west of the pipeline and the other is situated to its east. Each of these target sites is considered to have a potential association with significant submerged cultural resources. Avoidance of these targets is specified in the design of the preferred alternative.

**Sandy Point:** In the Sandy point area, none of the nine documented magnetic anomalies lie within the designated borrow areas (see Figures 6 and 7) (Tetra Tech and CPE 2003f). Though four anomalies were found in the two dump areas, none are expected to be impacted by the preferred alternative that would deposit overburden material. Consequently, none of the targets would be recommended for avoidance or additional investigation in conjunction with the preferred project. However, if construction plans change and the magnetic anomalies are included in the area of potential effect, six of the nine anomaly locations would be avoided, because their signatures exhibit characteristics consistent with shipwreck material. In the SE Dump site, anomaly 2 (24 gammas, 247-foot [75.3 m] duration) would be recommended for avoidance. In the NW Borrow area, anomalies 1 (16 gammas, 286-foot [87.2 m] duration), 2 (74 gammas, 286-foot [87.2 m] duration) and 3 (166 gammas, 456-foot [139 m] duration) would be recommended for avoidance. Anomalies 2 and 3 also appear to be spatially associated. In the NW Dump site, anomalies 1 (14 gammas, 134 feet [40.8 m]) and 2 (6 gammas, 92 feet [28 m]) would be recommended for avoidance.

Possibly, shipwreck remains may lie undetected within the survey areas. If any potentially significant cultural material is detected during project activities, the MMS archaeologist would be contacted for immediate assessment of the material.



#### **4.4.2 Impacts on Land Use/Recreation**

Over the long term, the preferred action would have direct, long-term beneficial impacts to waterfowl habitats and oyster leases, and provide buffers during storm activity. Short-term reversible impacts on fishing would occur during construction. However, habitat suitable for fishing is common in the region, and the temporary loss of opportunity for fishing in the project sides is considered minimal.

#### **4.4.3 Impacts on Infrastructure**

The preferred alternative would have long-term beneficial impacts on oil and gas infrastructure in the project sites. Pipelines within and north of the project areas would be better protected, reducing the likelihood of exposure due to erosion. Construction activity would avoid pipelines and other oil and gas infrastructure in the borrow areas. Dredging and other associated activities can impact pipelines if the dredge draghead crosses a buried pipeline. The MMS's regulation 30 CFR 250.1003(a)(1) requires all pipelines under water depth <200 ft (61 m) be buried to a depth of 3 ft (1 m); all pipelines that border or cross the borrow areas are expected to be buried in sediment to a depth of 1 m. Dredging can exhume a pipeline segment or damage a pipeline already exposed (by, for example, storm activity).

The most serious accident scenario from the dredging operation would be a pipeline rupture followed by an oil spill. This event is not very likely, but it warrants consideration because positions of pipelines have been known to shift as a result of strong wave activity and currents during storms or hurricanes. The borrow areas identified in the preferred alternative were surveyed extensively using magnetometers to identify locations of pipelines. In addition, construction specifications include requirements of a setback distance from all known pipelines.

The MMS's regulations require removal of wellhead structures such as casing stubs to a depth below mudline up to or exceeding 15 ft (4.6 m) within one year of lease termination. No PA wells and no temporarily abandoned wellhead structures are within any of the borrow areas. Therefore, no hazards to dredging equipment from buried casing or exposed casing stubs are present, and no potential exists for the dredge draghead to damage wellhead structures.

#### **4.4.4 Impacts on Socioeconomics**

The preferred projects would not be expected to affect economic resources adversely. Under the preferred alternative, marshes created in the Pelican Island and Chaland Headland project areas would provide forage, nursery, and grow-out sites for a variety of commercially and recreationally important fisheries species. Improvements to barrier-island and marsh habitats would affect fisheries resources positively and indirectly support nearby businesses that provide services to recreational and commercial fishing parties. Pipelines would be protected better, and economic activity in the area would continue at present levels or increase. During the period of construction, a small increase in employment of dredge operators, crew members, and other construction-related technicians would occur.

#### **4.5 ENVIRONMENTAL JUSTICE**

Executive Order (EO) 12898 requires that each Federal agency evaluating the impacts of a preferred action identify and address, as appropriate, disproportionately high and adverse human health or environmental effects of its programs, policies, and activities on minority and low-income populations. The preferred action would include protecting and creating dune, swale, and intertidal habitat along Pelican Island and Chaland Headland. Impacts to human health are minor and include increased noise and exhaust emissions during the construction phase of the project. In the long term, positive economic

impacts would result, as discussed in Section 4.3.4. Significant adverse impacts to the environment will not occur as a result of this project. Therefore, no disproportionately high impacts to minority or low-income populations will occur.

#### **4.6 CUMULATIVE IMPACTS**

The Council on Environmental Quality (CEQ) regulations (40 Code of Federal Regulations [CFR] § 1500-1508) implementing the procedural provisions of NEPA, as amended (42 U.S. Code § 4321 and following sections) define cumulative effects as follows: “The impact on the environment which results from the incremental impact of the action when added to other past, present, and reasonably foreseeable future actions regardless of what agency (Federal or non-Federal) or person undertakes such other actions.” (40 CFR § 1508.7).

The preferred project was conceived under CWPPRA to meet immediate needs of the project area. However, the value of Louisiana’s coastal wetland ecosystem derives in part from the physical expanse of interconnected habitats. Though CWPPRA projects are nominated and implemented one at a time, and must have individual merit, the cumulative value of all wetland restoration and protection projects in an area can far exceed the summed values of the individual projects. Other barrier island restoration projects in the vicinity, such as Bay Joe Wise, will add to the ultimate value of the Chaland Headlands and Pelican Island restoration projects.

The negative effects of the no-action alternative also are appropriately considered in the context of cumulative impacts. An overview of the Barataria Basin, of which the Chaland Headlands and Pelican Island reaches are a part, predicts that without intervention, barrier island retreat and disintegration will continue—decreasing protection of the marsh and mainland from Gulf waters.

#### **4.7 THE PROTECTION OF CHILDREN**

Protection of Children-Executive Order 13045 requires that each Federal agency evaluating the impacts of a preferred action identify and assess environmental health and safety risks that may disproportionately affect children, and ensure that its policies, programs, activities, and standards address disproportionate risks to children that result from environmental health or safety risks. Implementation of the preferred alternatives would not result in any additional health or safety risks to children, because all activities would occur well away from Sunrise and Diamond Louisiana, the nearest communities with populations of children.

## **5.0 OTHER CONSIDERATIONS REQUIRED BY THE NATIONAL ENVIRONMENTAL POLICY ACT**

This section addresses topics that NEPA requires and includes a discussion of cumulative impacts, unavoidable adverse impacts, environmental justice, and protection of children from environmental health risks. Issues related to environmental justice and protection of children are in accordance with Executive Orders (EO) 12898 and 13045, respectively.

### **5.1 COORDINATION AMONG AGENCIES**

Coordination of the preferred project has been maintained with each CWPPRA Task Force agency and LDNR. Contents of this draft EA and the draft Finding of No Significant Impact (FONSI) were discussed with appropriate congressional, Federal, state, and local agencies and other interested parties. Comments from all reviewers on the preferred action are in Appendix A. The final EA and the draft FONSI will be available to the following agencies:

- U.S. Department of the Interior, FWS
- U.S. Environmental Protection Agency, Region VI
- U.S. Department of Commerce, NOAA Fisheries
- U.S. Natural Resources Conservation Service
- U.S. Army Corps of Engineers
- Louisiana State Historic Preservation Officer
- Louisiana Department of Natural Resources
- Louisiana Department of Wildlife and Fisheries

### **5.2 PUBLIC PARTICIPATION**

The preferred project was nominated by Plaquemines Parish during public meetings held in New Orleans, Louisiana. These meetings are part of the standard Priority Project List development procedure used to nominate, evaluate, and select projects for CWPPRA implementation. The Barataria Barrier Shoreline Complex project was evaluated during several CWPPRA working meetings between 1999 and the present. Additionally, the Plaquemines Parish Council and its Coastal Advisory Committee have been briefed on the preferred project. All meetings are open to the public, and meeting announcements are circulated through a standard mailing list. Additional coordination meetings have been held with land owners, private companies with oil and gas operations in the project areas.

### **5.3 COMPLIANCE**

The status of compliance of the preferred restoration project with applicable laws and regulations is presented in Table 14. Regulations require coordination of the EA and draft FONSI with appropriate

agencies, organizations, and individuals for their review and comments. The preferred project is not expected to cause adverse environmental impacts requiring compensatory mitigation.

**TABLE 14**

**COMPLIANCE WITH ENVIRONMENTAL STATUTES**

<i>Federal Statutes</i>	<i>Status</i>
Archaeological and Historic Preservation Act of 1974	In Progress
Clean Water Act of 1977, as amended	In Progress
Coastal Zone Management Act of 1972, as amended	In Progress
Endangered Species Act of 1973, as amended	In Progress
Estuary Protection Act	In Progress
Fish and Wildlife Coordination Act of 1958, as amended	In Progress
Magnuson-Stevens Fishery Conservation and Management Act of 1976, as amended	In Progress
National Environmental Policy Act of 1969, as amended	In Progress
National Historic Preservation Act of 1966, as amended	In Progress
<i>State Statutes</i>	
Archaeological Treasury Act of 1974, as revised	In Progress
Louisiana State and Local Coastal Resources Management Act of 1978	In Progress

## 6.0 CONCLUSIONS

This EA finds that no significant long-term adverse environmental impacts are anticipated from implementing the preferred Baratavia Barrier Island Complex project. Short-term impacts related to construction activities are considered reversible. This conclusion is based on a comprehensive review of relevant literature, site-specific data, and project-specific engineering reports related to biological, physical, and cultural resources. The natural resource benefits anticipated from implementing this project would enhance and sustain dune, swale, and intertidal habitat within the project area. The increase in both quality and acreage of fisheries habitat is expected to have long-term beneficial impacts on the local economy, as more people visit the area to take advantage of recreational and commercial fishing opportunities. In addition, the preferred project would result in increased protection for infrastructure on and behind the barrier islands to be restored.



## 7.0 PREPARERS

This EA was prepared by Tetra Tech under contract to the Central Administrative Support Center (CASC) of NOAA. It was written by June Mire, Ph.D., under the guidance of Rachel Sweeney and Joy Merino of NOAA Fisheries.

## 8.0 FINDING OF NO SIGNIFICANT IMPACT

Based on the conclusion of this document and the available information relative to the Barataria Barrier Island Complex project, no significant adverse environmental impacts would result from implementing the preferred alternatives. Furthermore, preparation of an Environmental Impact Statement on this action is not required by the NEPA or its implementing regulations.

\_\_\_\_\_  
William T. Hogarth, Ph.D.  
Assistant Administrator for Fisheries  
National Marine Fisheries Service

\_\_\_\_\_  
Date

## 9.0 LITERATURE CITED

- Boesch, D. F., M. N. Josselyn, A. J. Mehta, J. T. Morris, W. K. Nuttle, C. A. Simenstad, and D. J. P. Swift. 1994. *Scientific Assessment of Coastal Wetland Loss, Restoration and Management in Louisiana*. Journal of Coastal Research. Specific Issue No. 20. 103 pp.
- Coastal Research Laboratory. 2000. *Barataria Barrier Island Restoration: Shoreline Change Analysis*. Coastal Research Laboratory, Department of Geology and Geophysics, University of New Orleans. New Orleans, LA. September. 36 pp.
- Conaster, W. E. 1971. *The Grand Isle Barrier Island Complex*. Ph.D. dissertation. Tulane University. New Orleans.
- Conner, W. H. and J. W. Day, Jr. (editors). 1987. *The Ecology of Barataria Basin, Louisiana: An Estuarine Profile*. Fish and Wildlife Service. Biological Report 85(7.13). July. 166 pp.
- Dingler, J. R. and T. E. Reiss. 1990. *Cold-Front Driven Storm Erosion and Overwash in the Central Part of the Isles Dernieres, a Louisiana Barrier-Island Arc*. Marine Geology. 91: 195-206.
- Dundee, H. A. and D. A. Rossman. 1989. *The Amphibians and Reptiles of Louisiana*. Louisiana University Press. Baton Rouge. 300 pp.
- Garrison, E. G., C. P. Giammona, F. J. Kelly, A. R. Tripp, and G. A. Wolff. 1989. *Historic Shipwrecks and Magnetic Anomalies of the Northern Gulf of Mexico: Reevaluation of Archaeological Resource Management Zone 1*. Texas A&M Research Foundation. OCS Study MMS 89-0023. Published by the U. S. Department of the Interior, Minerals Management Service, Gulf of Mexico OCS Region Office.
- Gosselink, J. G. 1984. *The Ecology of Delta Marshes Of Coastal Louisiana: A Community Profile*. U.S. Fish and Wildlife Service.
- Gulf Engineers and Consultants (GEC). 2001. *Hazardous, Toxic, and Radioactive Waste (HTRW) Investigation for Barataria Island Restoration Project*. Submitted to U.S. Army Corps of Engineers, New Orleans District. October.
- Gulf of Mexico Fishery Management Council (GMFMC). 1998. *Generic Amendment for Addressing Habitat Requirements in the following Fishery Management Plans of the Gulf of Mexico*. October.
- Hoese, H. D. And R. H. Moore. 1998. *Fishes of the Gulf of Mexico - Texas, Louisiana, and Adjacent Waters*. Second Edition. Texas A&M University Press. College Station. 422 pp.
- Kindinger, J., J. Flocks, M. Kulp, S. Penland, L. Britsch. 2001. *Sand Resources, Regional Geology, and Coastal Processes for the Restoration of the Barataria Barrier shoreline*. Report to the U.S. Army Corps of Engineers, New Orleans District. U.S. Geological Survey Open File Report 01-384. September. 70 pp.

- Kniffen, Fred B. 1988. *Louisiana: Its Land and its People* (Revised edition). Louisiana State University Press. Baton Rouge, Louisiana.
- Kulp M. and S. Penland. 2001. *Offshore Sand Resources Between Quatre Bayou and Sandy Point: Plaquemines Parish, Louisiana*. Coastal Research Laboratory, Department of Geology and Geophysics, University of New Orleans, New Orleans, LA. Submitted to Tetra Tech EM, Inc. April. 35 pp.
- LCWCRTF and the Wetlands Conservation and Restoration Authority (WCRA). 1998. *Coast 2050: Towards a Sustainable Coastal Louisiana*. Louisiana Department of Natural Resources. Baton Rouge, Louisiana. 161 pp.
- LCWCRTF and WCRA 1999. *Coast 2050: Towards a Sustainable Coastal Louisiana, The Appendices. Appendix D – Region 2 Supplemental Information*. Louisiana Department of Natural Resources. Baton Rouge, Louisiana. 260 pp.
- Louisiana Coastal Wetlands Conservation and Restoration Task Force (LCWCRTF). 1993. *Louisiana Coastal Wetlands Restoration Plan: Main Report and Environmental Impact Statement*. 163 pp.
- Louisiana Department of Natural Resources. 2003. Ecological Review: Pelican Island and Pass la Mer to Chalant Pass Restoration.
- McBride, R. A. and M. R. Byrnes. 1995. *A Megascale Systems Approach for Shoreline Change Analysis and Coastal Management Along the Northern Gulf of Mexico*. Gulf Coast Association of Geological Societies Transactions. Vol XLV: 405-414.
- Mendelssohn, I. A. 1987. *Chapter 3: Vegetational Communities of Louisiana's Barrier Islands. In: Barrier Islands and Beaches of the Louisiana Deltaic Plain*. Prepared by I. A. Mendelssohn, S. Penland, and W. H. Are these authors? Patrick, Jr. Laboratory for Wetland Soils and Sediments – Center for Wetland Resources. Federal grant: NA-79-AAD-C20-29. State Project number: 21920-31C-79-06. Pages 197-266.
- Milan, B.J. (in press). Comparison of fish and decapod crustacean distribution between smooth cordgrass (*Spartina alterniflora*) and black mangrove (*Avicennia germinans*), marsh edge located in southcentral Louisiana. JOURNAL?
- Neuman, Robert W. 1984. *An Introduction to Louisiana Archaeology*. Louisiana State University Press. Baton Rouge, Louisiana.
- NOAA. 2001. *Fisheries of the United States: 2000*. B. K. O'Bannon, editor. Office of Science and Technology, Fisheries Statistics and Economics Division. Silver Spring, MD. August.
- NOAA. 2003. *Biological Assessment for the Barataria Barrier Islands*. Baton Rouge Field Office, Habitat Conservation Division, Southeast Regional Office. November 2003.
- Patillo, M., T. E. Czaplak, D.M. Nelson, and M.E. Monaco. 1997. *Distribution and Abundance of Fishes and Invertebrates in Gulf of Mexico Estuaries*. Rockville, MD. NOAA/NOS Strategic Environmental Assessments Division. II. Species Life History Summaries: 377.



- Penland, S. and J. R. Suter. 1984. *Low-Profile Barrier Island Overwash and Breaching in the Gulf of Mexico*. 19<sup>th</sup> Coastal Engineering Conference Proceedings. Pages 2339-2345.
- Saltus, Allen R., Jr.. 1982. *Cultural Resources Survey of a Portion of the Northeast Cape Fear River and Report on the Test Excavation to Evaluate the Steamship "Spray"*. Archaeological Research and Survey. Prepared for Atlantic Salvesen, Scotland.
- Smith, J. M. 2001. *Modeling Nearshore Wave Transformation with STWAVE*. Coastal and Hydraulics Engineering Technical Note I-64, Coastal and Hydraulics Laboratory. Vicksburg, Mississippi. <http://chl.wes.army.mil/library/publications/chetn/pdf/chetn-i64.pdf>.
- Smith, S. D., P. G. Rivet, K. M. Byrd, and N. W. Hawkins. 1983. *Louisiana's Comprehensive Archaeological Plan*. State of Louisiana, Department of Culture, Recreation and Tourism, Office of Cultural Development, Division of Archaeology. Baton Rouge.
- Spearing, Darwin. 1995. *Roadside Geology of Louisiana*. Mountain Press Publishing Company. Missoula, Montana.
- Tetra Tech. 2003. *Final Phase I Environmental Site Assessment: Chaland Headlands*. August.
- Tetra Tech and CPE. 2003a. *Final 30% Design Review. Chaland Headland and Pelican Island Barrier Shoreline Restoration*. June.
- Tetra Tech and CPE. 2003b. *Final Geotechnical Investigation and Analysis Report. Barataria Barrier Island Complex Project*. April.
- Tetra Tech and CPE. 2003c. *Final Sandy Point Geotechnical Report. Barataria Barrier Island Complex Project*. October.
- Tetra Tech and CPE. 2003d. *Draft Submerged Cultural Resources Assessment of Empire and Quatre Borrow Areas*. September.
- Tetra Tech and CPE. 2003e. *Sandy Point Borrow and Dump Areas, Blocks 26, 27 & 49 West Delta Submerged Cultural Resources Assessment*. September.
- Tetra Tech and CPE 2003f. *Final Survey Report. Barataria Barrier Island Complex Project*. April.
- Tetra Tech and Goodwin. 2003. *Draft Phase I Cultural Resources Survey and Archeological Inventory of the Chaland Headland Restoration Project, Plaquemines Parish, Louisiana*. September.
- Thompson, B. A. 1988. "Fish and Shellfish." In: *Isles Dernieres Barrier Island Stabilization Project*. State Project Number 750-55-01. Draft Environmental Assessment submitted to State of Louisiana Department of Transportation and Development. Pages 31-38.
- United States Census. 2000. As cited on <http://www.census.gov/census2000/states/la.html>

U.S. Department of the Interior, Minerals Management Service. 2002. *Gulf of Mexico OCS Oil and Gas Lease Sales: 2003-2007, Central and Western Planning Areas — Final Environmental Impact Statement*. 2 vols. U.S. Department of the Interior, Minerals Management Service, Gulf of Mexico OCS Region, New Orleans, LA. OCS EIS/EA MMS 2002-052.

U.S. Department of the Interior, Minerals Management Service. 2003. *Issuance of Non-Competitive Leases for the Use of Sand Resources from Ship Shoal, Outer Continental Shelf, Offshore Central Louisiana for Coastal and Barrier Island Nourishment*. PUBLISHER and location? November.

U.S. Environmental Protection Agency. 2003. *New Cut / Marsh Restoration and Whiskey Island West flank Restoration Projects Using Ship Shoal Sediment: Survey, Data Collection, and Analysis for Use by EPA in Determination of Impacts from Use of Ship Shoal Sand: Benthic Impacts – Sampling and Analysis*.

U.S. Fish and Wildlife Service, Lafayette Field Office. 2003. *Threatened and Endangered Species of Louisiana*. Lafayette, LA.

U.S. Geological Survey (2002), "USGS Digital Backyard, MSN Terraserver,"  
<http://terraserver.homeadvisor.msn.com/default.aspx>.

Wicker, K.M., G.C. Castille, D.J. Davis, S.M. Gagliano, D.W. Roberts, D.S. Sabins, and R.A. Weinstein. 1982. *St. Bernard Parish: A Study in Wetland Management*. Prepared for St. Bernard Parish Police Jury, Chalmette, Louisiana. 132 pages.

Williams, J., S. Penland, and A.H. Sallenger, Asbury H. 1992. *Atlas of Shoreline Changes in Louisiana from 1853 to 1995*. U.S. Geological Survey, Denver.

Williams, P. R. 1998. *Nekton Assemblages Associated with the Barrier Island Aquatic Habitats of East Timbalier Island, Louisiana*. M.S. Thesis. Louisiana State University. 120 pages.

---

### Personal Communications

Sweeney, Rachel. (2002). PowerPoint presentation at Barataria Barrier Island Complex Project kickoff meeting, August 9.

---

### Websites

<http://www.lacoast.gov/reports/>

<http://www.deq.state.la.us/evaluation/airmon/tedi.htm>

<http://www.plaqueminesparish.com>

<http://www.btnep.org/>