

Intel Pollution Rose Acetaldehyde - Intel Meteorology

Intel SE CUB 2-24 to 3-12-04

Wind.m.s: 0.0 to 1.0

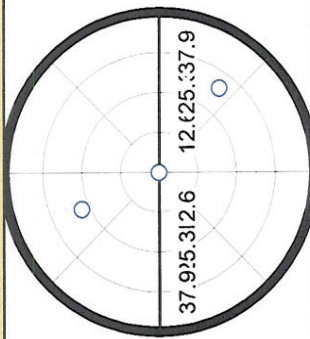

Wind.m.s: 1.0 to 2.0

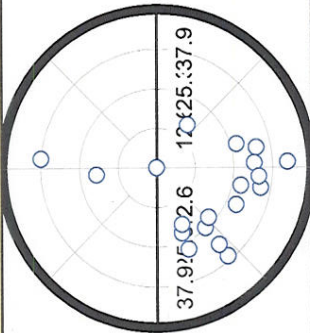

Wind.m.s: 2.0 to 3.0

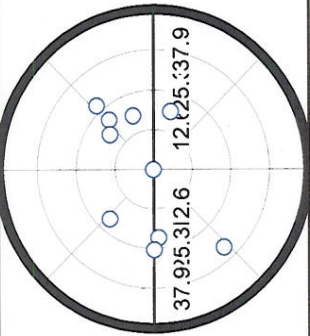

Wind.m.s: 3.0 to 4.0

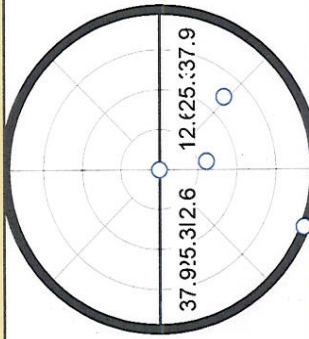

Wind.m.s: 4.0 to 5.0

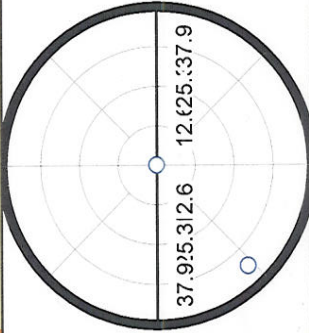

Wind.m.s: 5.0 to 6.0

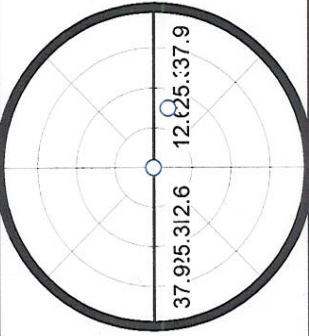

Wind.m.s: 6.0 to 7.0

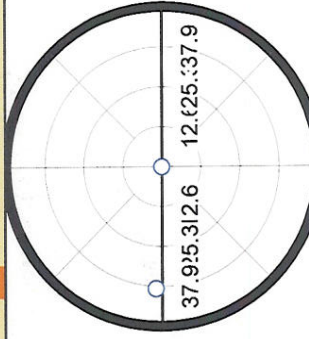

Wind.m.s: 7.0 to 8.0

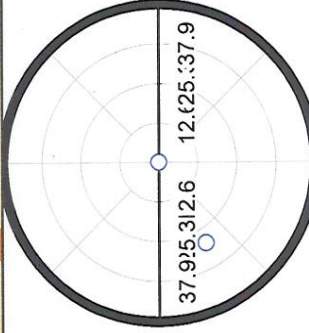

Wind.m.s: 8.0 to 20.0

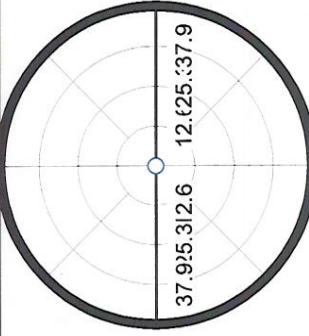

Intel Pollution Rose Acetaldehyde - Intel Meteorology

Intel SE CUB 2-24 to 3-12-04

Wind.m.s.converted: 0.0 to 1.0

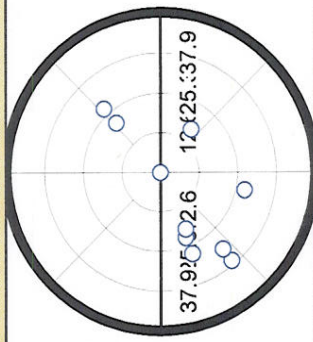

Wind.m.s.converted: 1.0 to 2.0

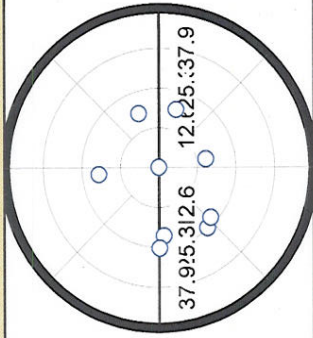

Wind.m.s.converted: 2.0 to 3.0

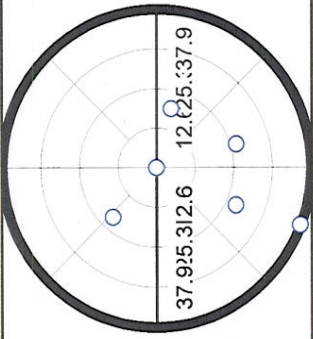

Wind.m.s.converted: 3.0 to 4.0

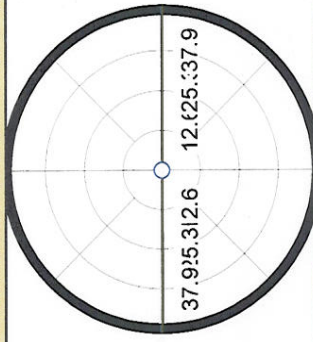

Wind.m.s.converted: 4.0 to 5.0

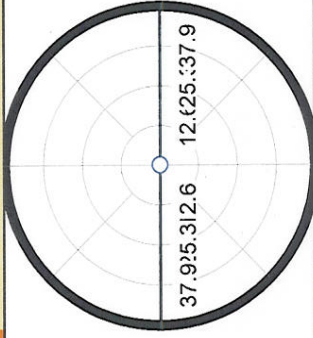

Wind.m.s.converted: 5.0 to 6.0

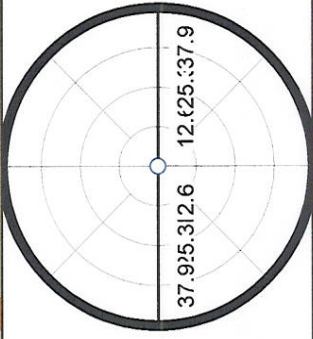

Wind.m.s.converted: 6.0 to 7.0

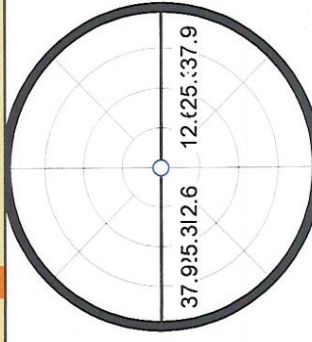

Wind.m.s.converted: 7.0 to 8.0

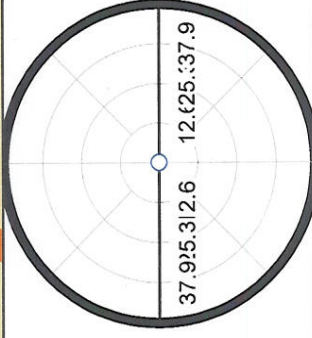

Wind.m.s.converted: 8.0 to 20.0

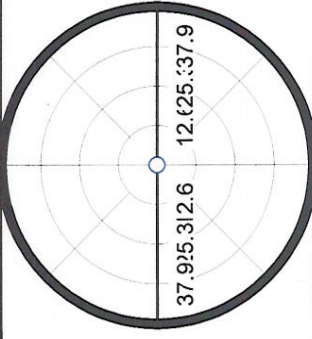

Intel Pollution Rose Acetone - Intel Meteorology

Intel SE CUB 2-24 to 3-12-04

Wind.m.s: 0.0 to 1.0

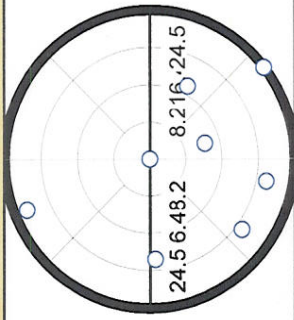

Wind.m.s: 1.0 to 2.0

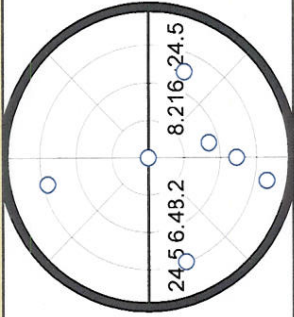

Wind.m.s: 2.0 to 3.0

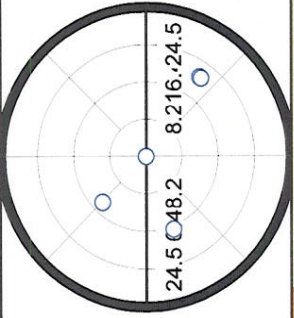

Wind.m.s: 3.0 to 4.0

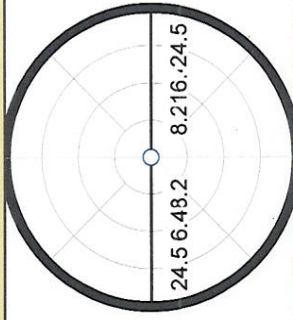

Wind.m.s: 4.0 to 5.0

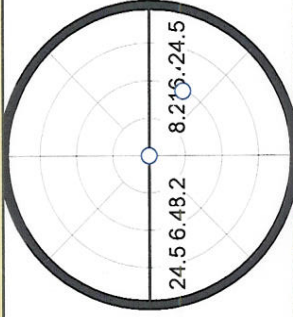

Wind.m.s: 5.0 to 6.0

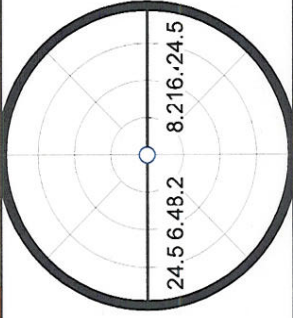

Wind.m.s: 6.0 to 7.0

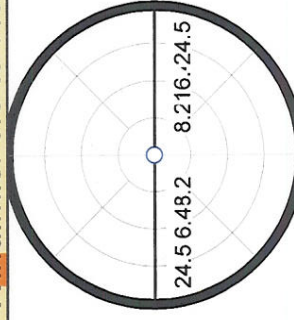

Wind.m.s: 7.0 to 8.0

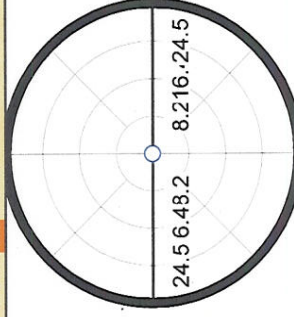

Wind.m.s: 8.0 to 20.0

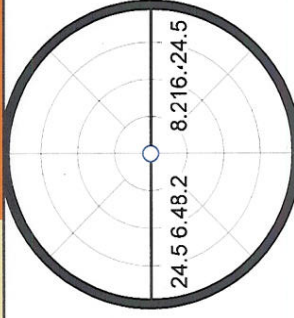

Intel Pollution Rose Acetone - Intel Meteorology

Intel SE CUB 2-24 to 3-12-04

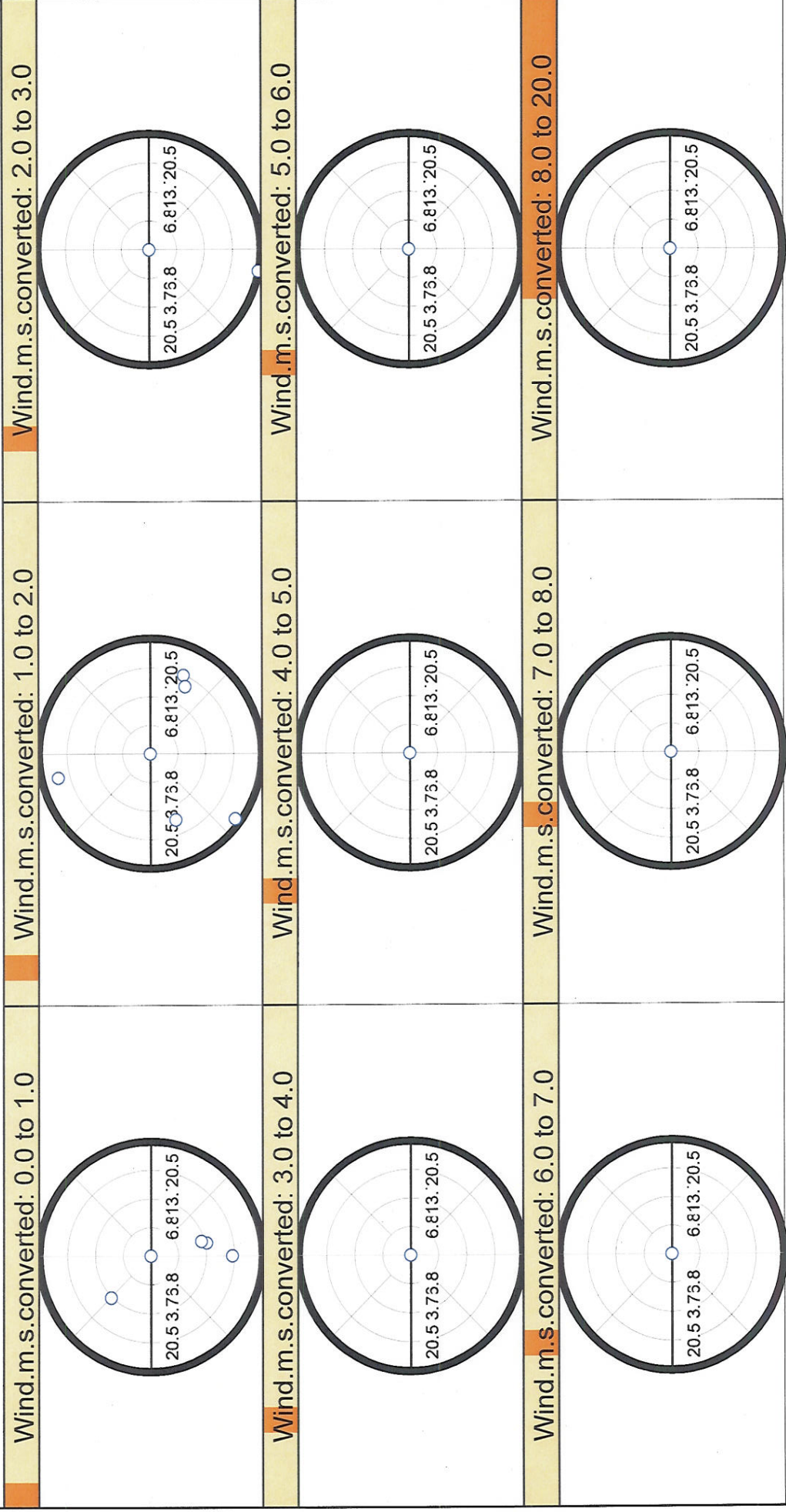

Intel Pollution Rose Benzene - Intel Meteorology

Intel SE CUB 2-24 to 3-12-04

Wind.m.s: 0.0 to 1.0

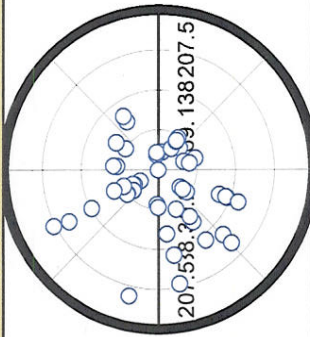

Wind.m.s: 1.0 to 2.0

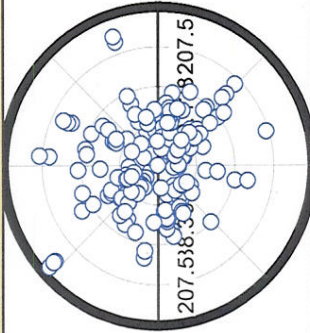

Wind.m.s: 2.0 to 3.0

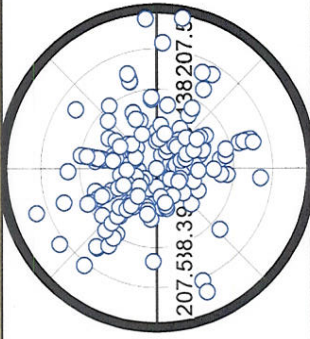

Wind.m.s: 3.0 to 4.0

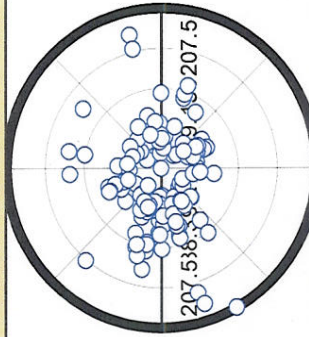

Wind.m.s: 4.0 to 5.0

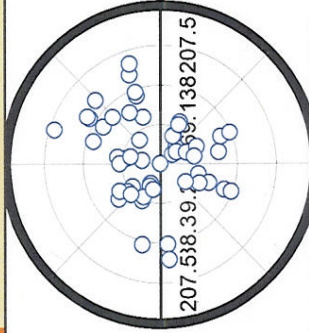

Wind.m.s: 5.0 to 6.0



Wind.m.s: 6.0 to 7.0

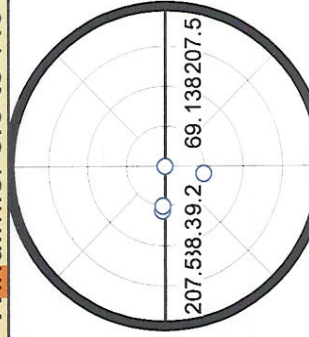

Wind.m.s: 7.0 to 8.0

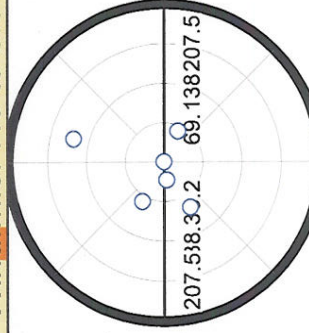

Wind.m.s: 8.0 to 20.0

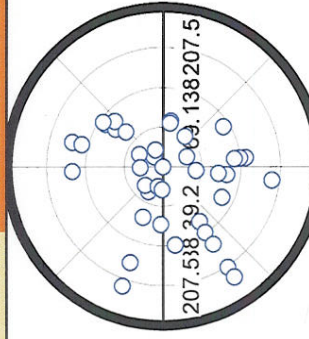

Intel Pollution Rose Benzene - Intel Meteorology

Intel SE CUB 2-24 to 3-12-04

Wind.m.s. converted: 0.0 to 1.0

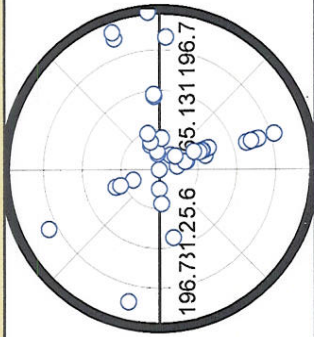

Wind.m.s. converted: 1.0 to 2.0

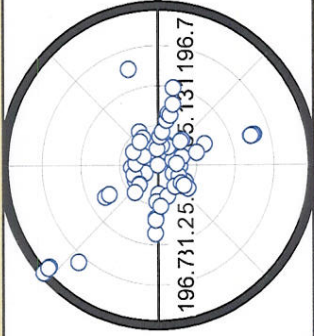

Wind.m.s. converted: 2.0 to 3.0

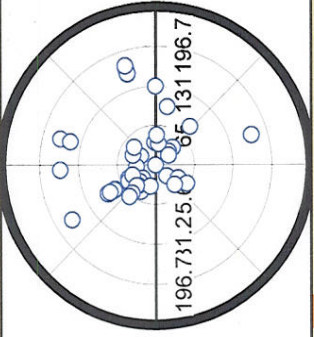

Wind.m.s. converted: 3.0 to 4.0

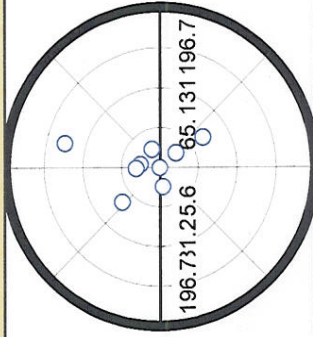

Wind.m.s. converted: 4.0 to 5.0

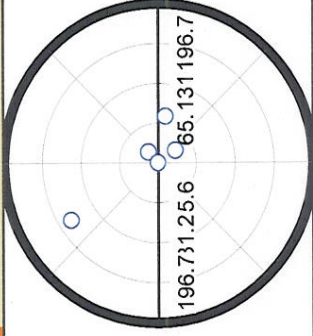

Wind.m.s. converted: 5.0 to 6.0

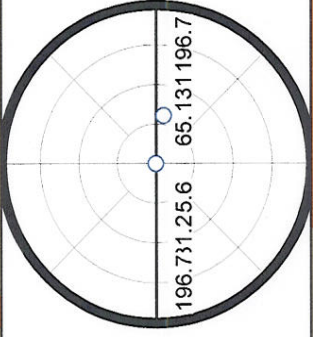

Wind.m.s. converted: 6.0 to 7.0

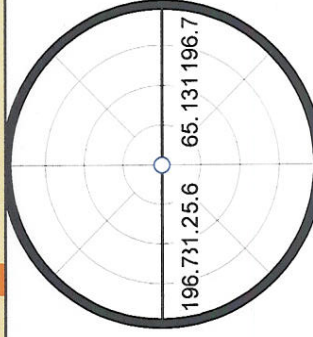

Wind.m.s. converted: 7.0 to 8.0

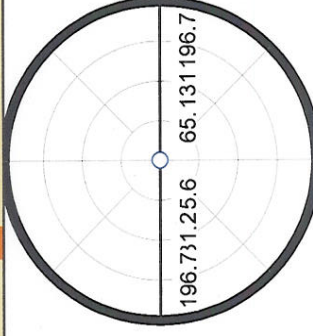

Wind.m.s. converted: 8.0 to 20.0

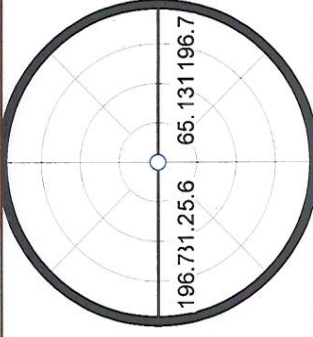

Intel Pollution Rose CCL4 - Intel Meteorology

Intel SE CUB 2-24 to 3-12-04

Wind.m.s: 0.0 to 1.0



Wind.m.s: 1.0 to 2.0

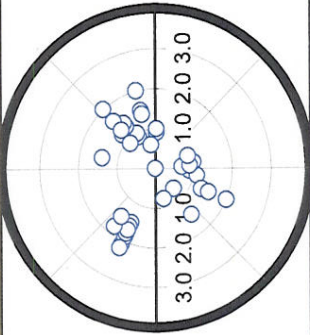

Wind.m.s: 2.0 to 3.0

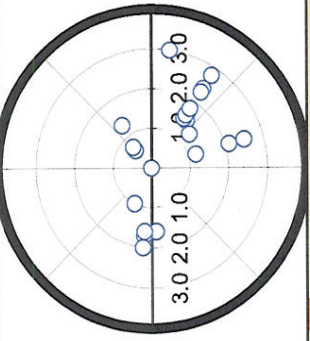

Wind.m.s: 3.0 to 4.0

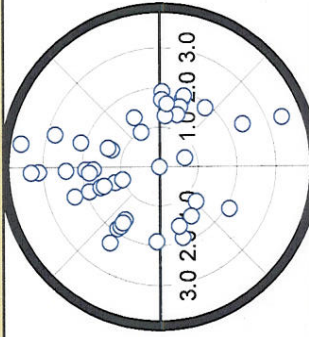

Wind.m.s: 4.0 to 5.0

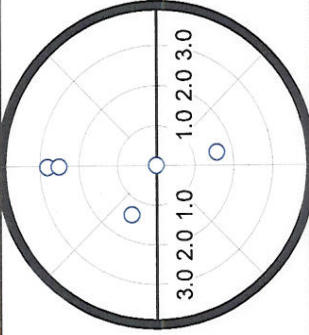

Wind.m.s: 5.0 to 6.0

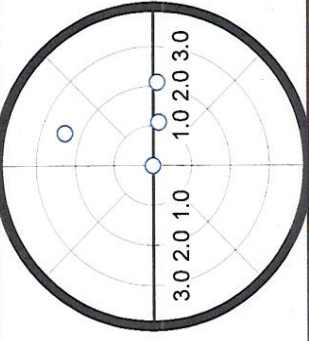

Wind.m.s: 6.0 to 7.0

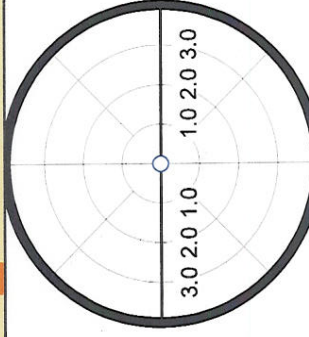

Wind.m.s: 7.0 to 8.0

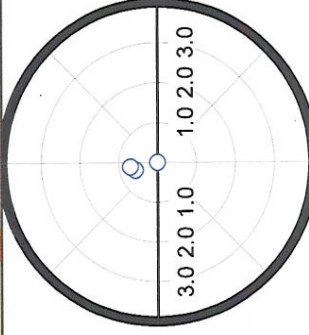

Wind.m.s: 8.0 to 20.0

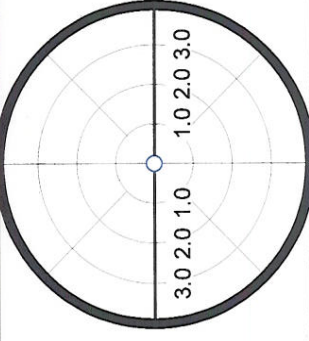

Intel Pollution Rose CCL4 - Intel Meteorology

Intel SE CUB 2-24 to 3-12-04

Wind.m.s. converted: 0.0 to 1.0

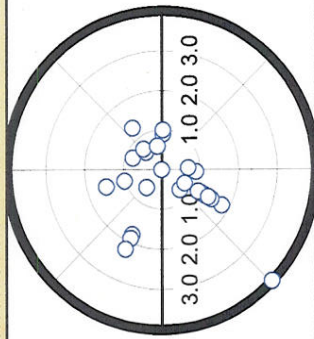

Wind.m.s. converted: 1.0 to 2.0

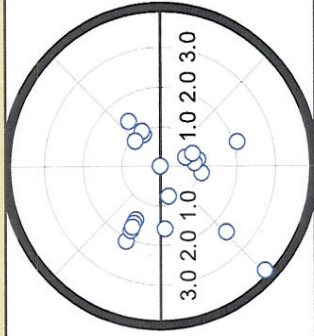

Wind.m.s. converted: 2.0 to 3.0

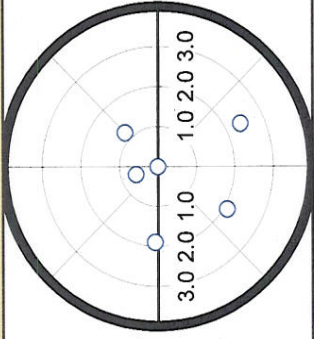

Wind.m.s. converted: 3.0 to 4.0

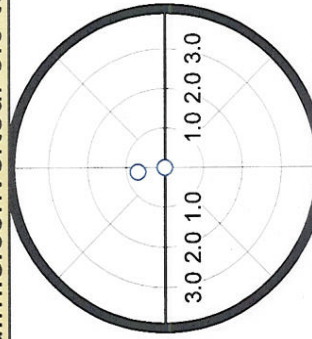

Wind.m.s. converted: 4.0 to 5.0

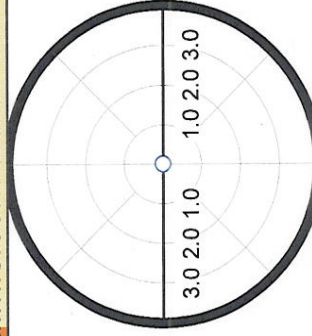

Wind.m.s. converted: 5.0 to 6.0

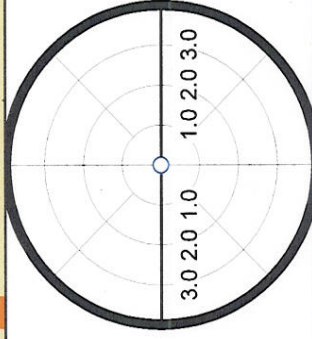

Wind.m.s. converted: 6.0 to 7.0

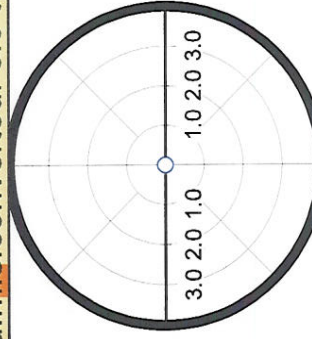

Wind.m.s. converted: 7.0 to 8.0

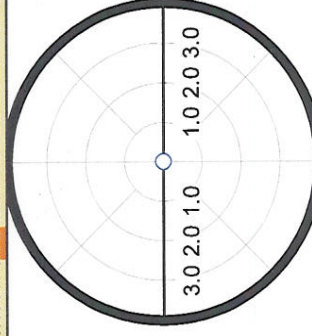

Wind.m.s. converted: 8.0 to 20.0

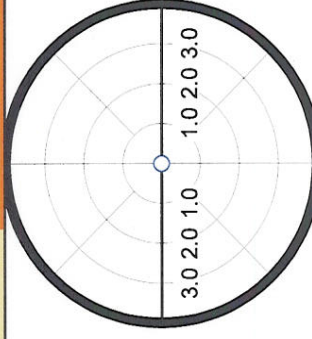

Intel Pollution Rose Chloroform - Intel Meteorology

Intel SE CUB 2-24 to 3-12-04

Wind.m.s: 0.0 to 1.0

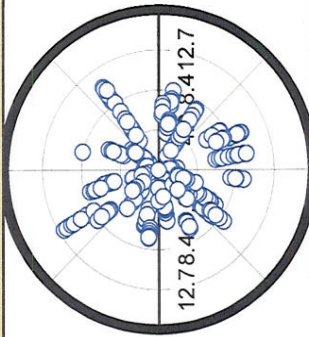

Wind.m.s: 1.0 to 2.0

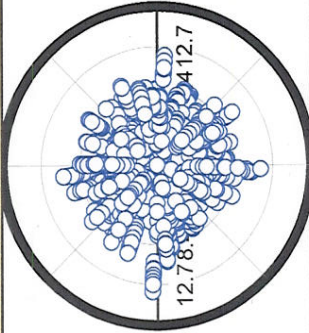

Wind.m.s: 2.0 to 3.0

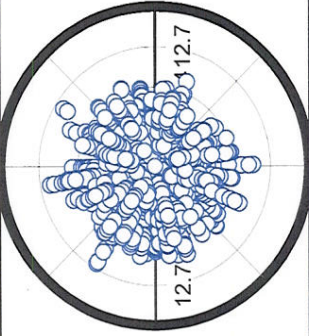

Wind.m.s: 3.0 to 4.0

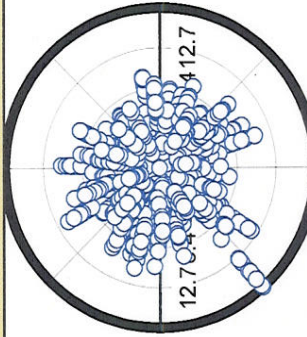

Wind.m.s: 4.0 to 5.0

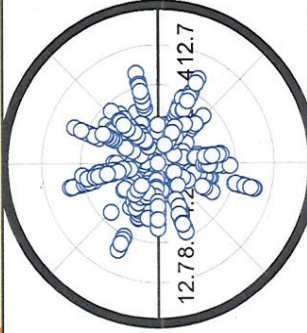

Wind.m.s: 5.0 to 6.0

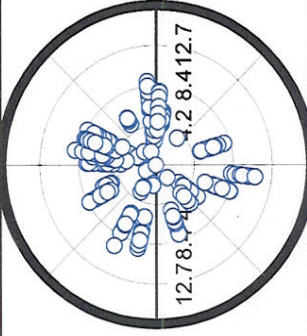

Wind.m.s: 6.0 to 7.0

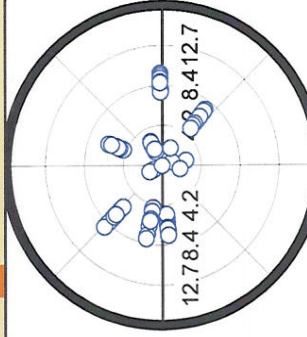

Wind.m.s: 7.0 to 8.0

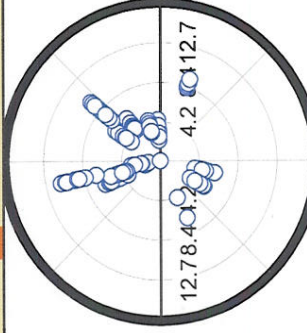

Wind.m.s: 8.0 to 20.0

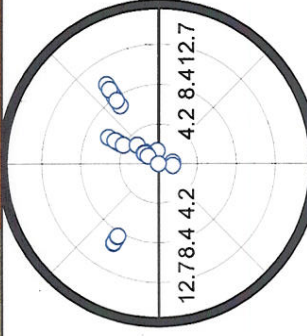

Intel Pollution Rose Chloroform - Intel Meteorology

Intel SE CUB 2-24 to 3-12-04

Wind.m.s. converted: 0.0 to 1.0

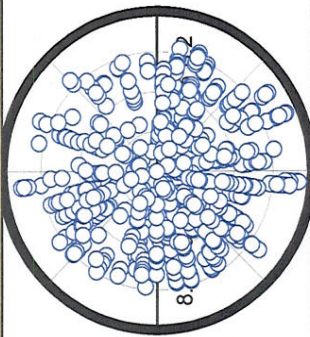

Wind.m.s. converted: 1.0 to 2.0

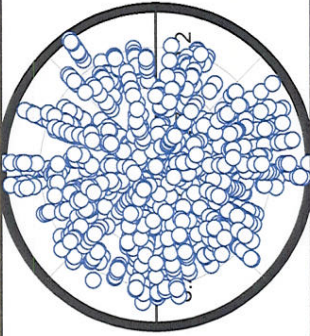

Wind.m.s. converted: 2.0 to 3.0

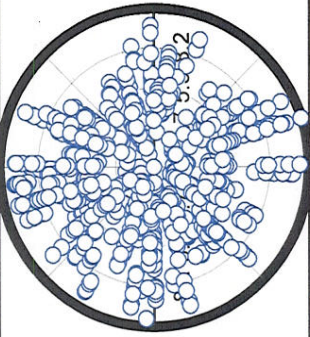

Wind.m.s. converted: 3.0 to 4.0

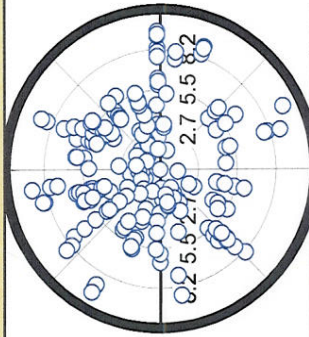

Wind.m.s. converted: 4.0 to 5.0

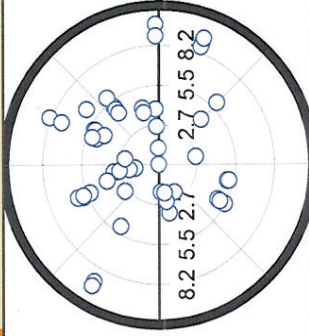

Wind.m.s. converted: 5.0 to 6.0

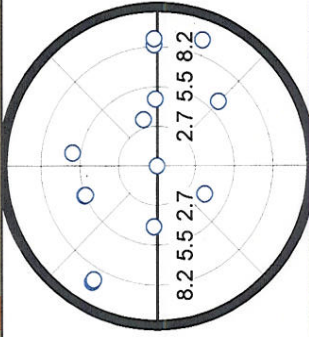

Wind.m.s. converted: 6.0 to 7.0

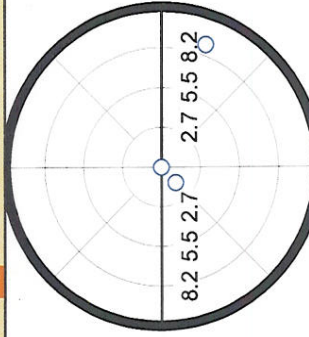

Wind.m.s. converted: 7.0 to 8.0

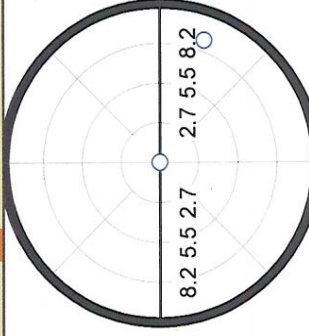

Wind.m.s. converted: 8.0 to 20.0

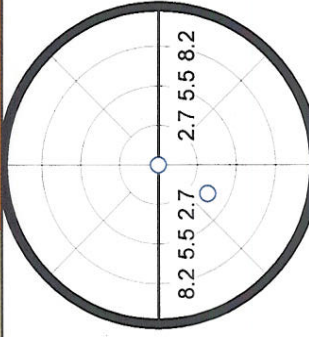

Intel Pollution Rose CO - Intel Meteorology

Intel SE CUB 2-24 to 3-12-04

Wind.m.s: 0.0 to 1.0

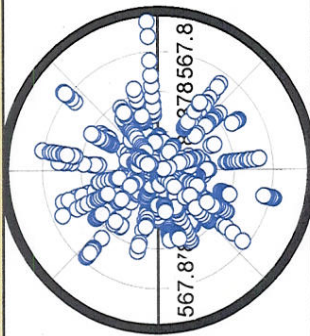

Wind.m.s: 1.0 to 2.0

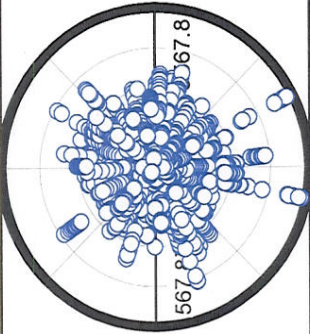

Wind.m.s: 2.0 to 3.0

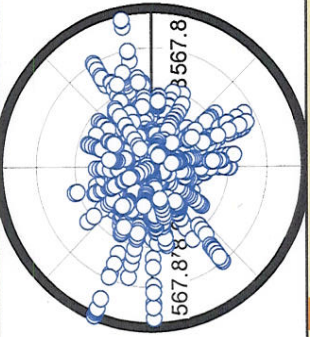

Wind.m.s: 3.0 to 4.0

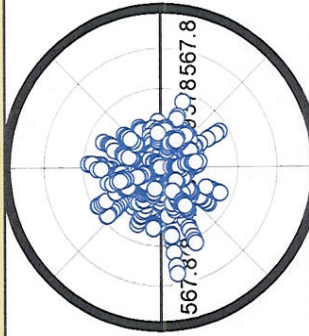

Wind.m.s: 4.0 to 5.0

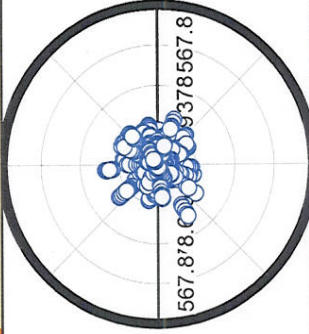

Wind.m.s: 5.0 to 6.0

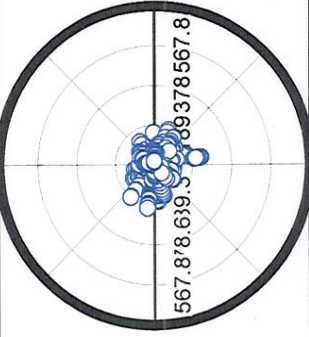

Wind.m.s: 6.0 to 7.0

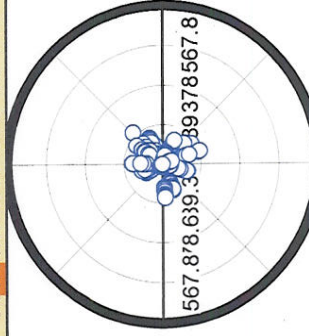

Wind.m.s: 7.0 to 8.0

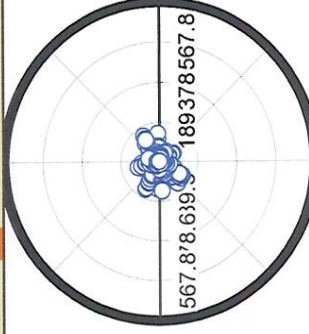

Wind.m.s: 8.0 to 20.0

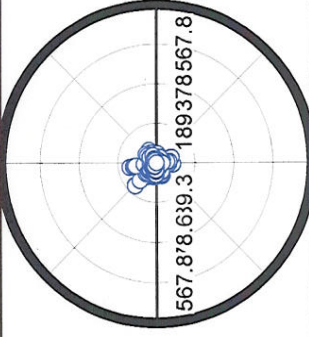

Intel Pollution Rose CO - Intel Meteorology

Intel SE CUB 2-24 to 3-12-04

Wind.m.s. converted: 0.0 to 1.0

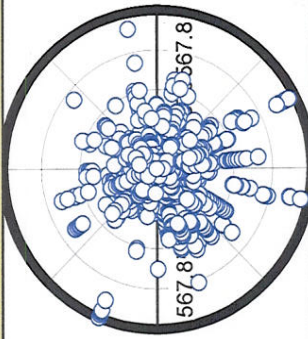

Wind.m.s. converted: 1.0 to 2.0

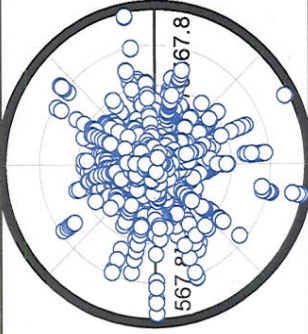

Wind.m.s. converted: 2.0 to 3.0

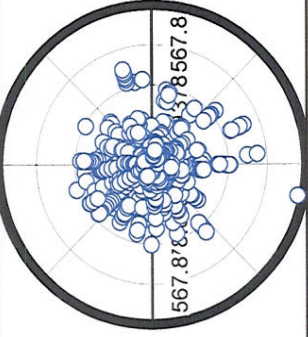

Wind.m.s. converted: 3.0 to 4.0

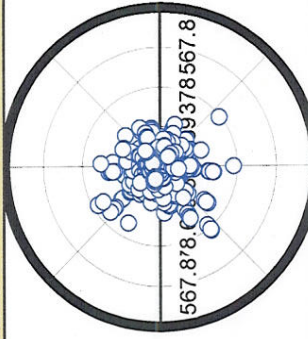

Wind.m.s. converted: 4.0 to 5.0

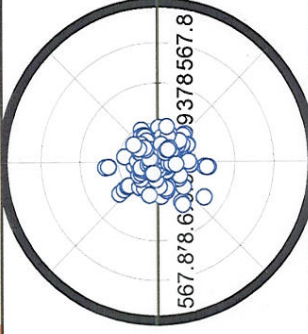

Wind.m.s. converted: 5.0 to 6.0

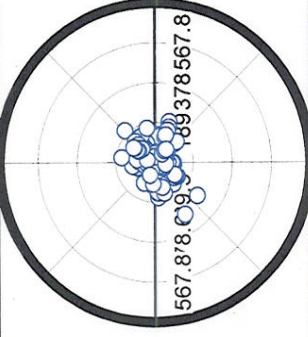

Wind.m.s. converted: 6.0 to 7.0

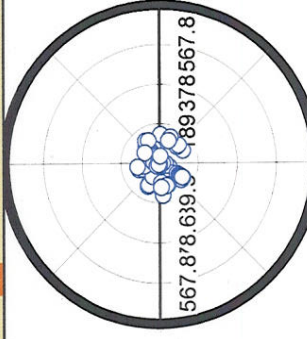

Wind.m.s. converted: 7.0 to 8.0

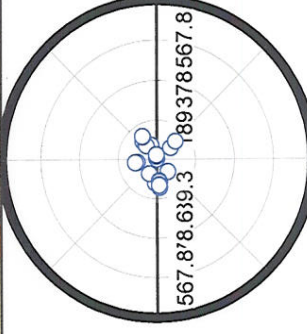

Wind.m.s. converted: 8.0 to 20.0

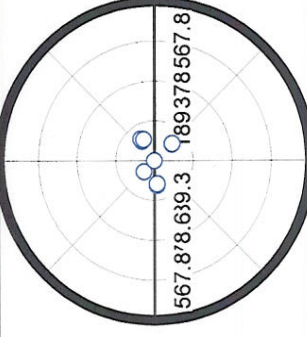

Intel Pollution Rose Formaldehyde - Intel Meteorology

Intel SE CUB 2-24 to 3-12-04

Wind.m.s: 0.0 to 1.0

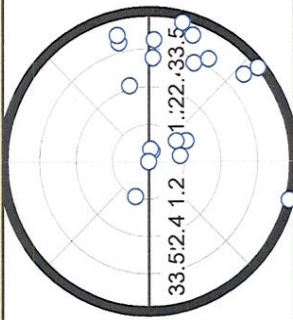

Wind.m.s: 1.0 to 2.0

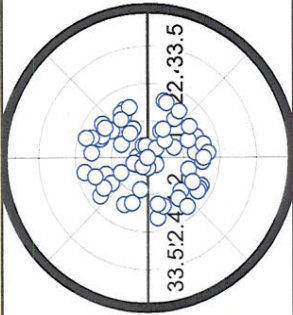

Wind.m.s: 2.0 to 3.0

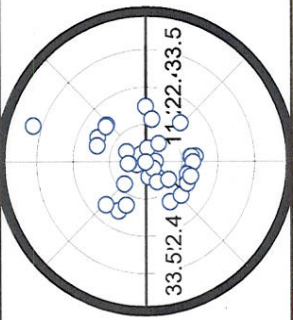

Wind.m.s: 3.0 to 4.0

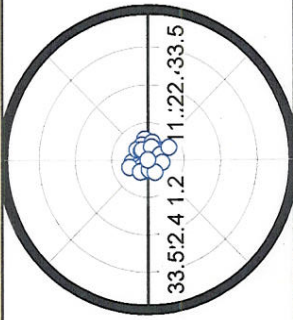

Wind.m.s: 4.0 to 5.0

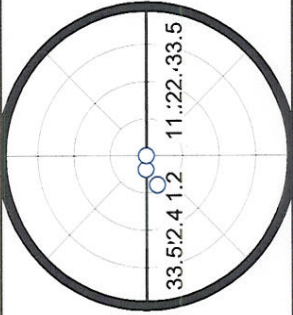

Wind.m.s: 5.0 to 6.0

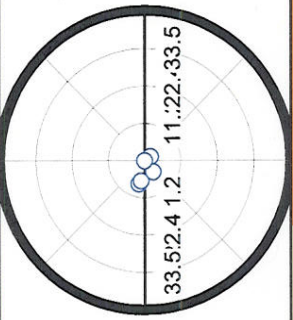

Wind.m.s: 6.0 to 7.0

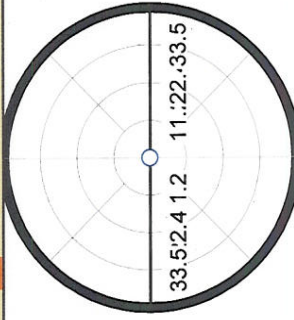

Wind.m.s: 7.0 to 8.0

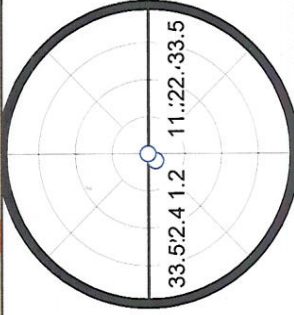

Wind.m.s: 8.0 to 20.0

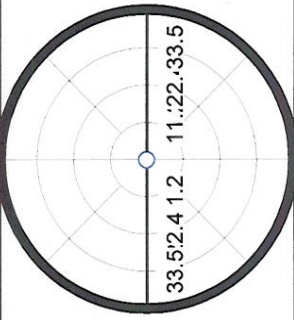

Intel Pollution Rose Formaldehyde - Intel Meteorology

Intel SE CUB 2-24 to 3-12-04

Wind.m.s.converted: 0.0 to 1.0

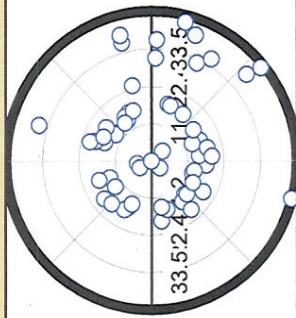

Wind.m.s.converted: 1.0 to 2.0

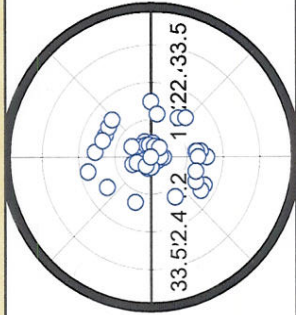

Wind.m.s.converted: 2.0 to 3.0



Wind.m.s.converted: 3.0 to 4.0

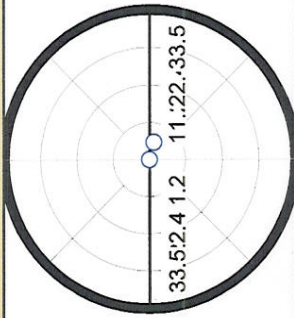

Wind.m.s.converted: 4.0 to 5.0

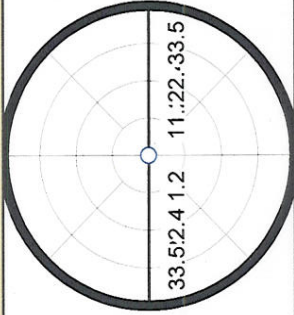

Wind.m.s.converted: 5.0 to 6.0



Wind.m.s.converted: 6.0 to 7.0

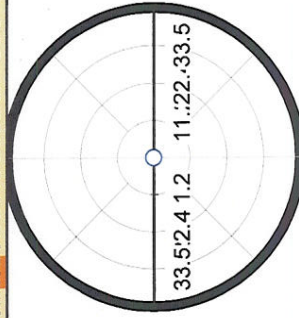

Wind.m.s.converted: 7.0 to 8.0

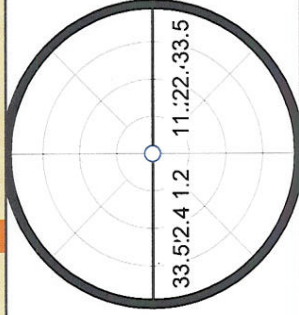

Wind.m.s.converted: 8.0 to 20.0

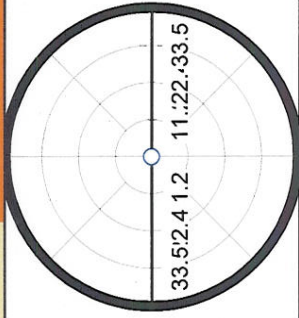

Intel Pollution Rose Isopropyl Alcohol - Intel Meteorology

Intel SE CUB 2-24 to 3-12-04

Wind.m.s: 0.0 to 1.0

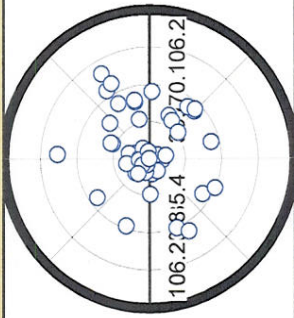

Wind.m.s: 1.0 to 2.0

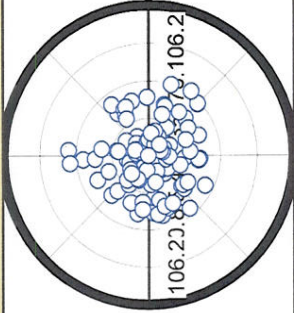

Wind.m.s: 2.0 to 3.0

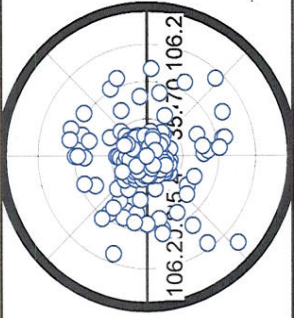

Wind.m.s: 3.0 to 4.0

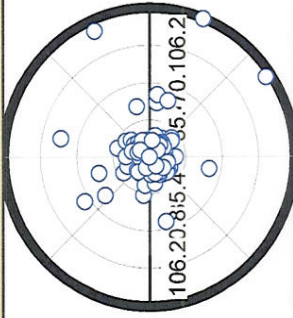

Wind.m.s: 4.0 to 5.0

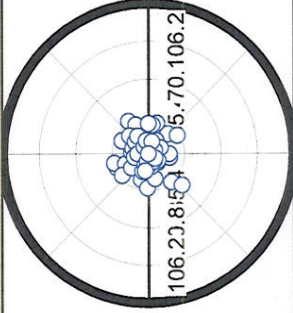

Wind.m.s: 5.0 to 6.0

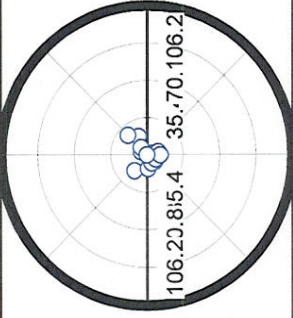

Wind.m.s: 6.0 to 7.0

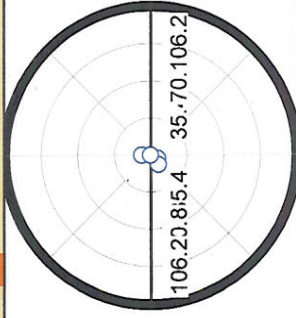

Wind.m.s: 7.0 to 8.0

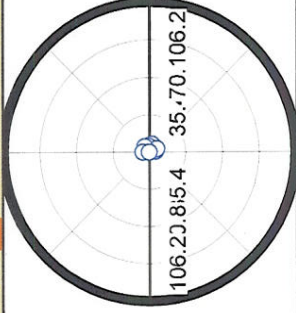

Wind.m.s: 8.0 to 20.0

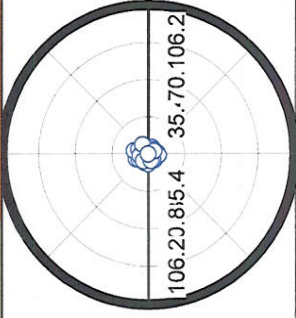

Intel Pollution Rose Isopropyl Alcohol - Intel Meteorology

Intel SE CUB 2-24 to 3-12-04

Wind.m.s. converted: 0.0 to 1.0

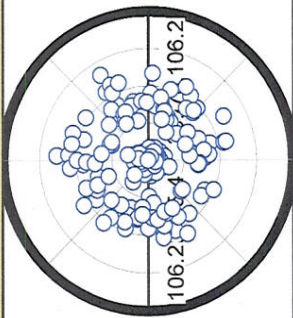

Wind.m.s. converted: 1.0 to 2.0

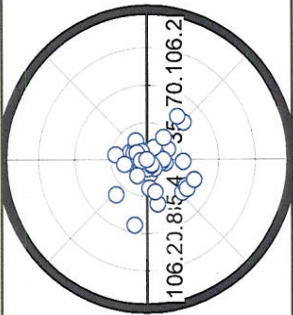

Wind.m.s. converted: 2.0 to 3.0

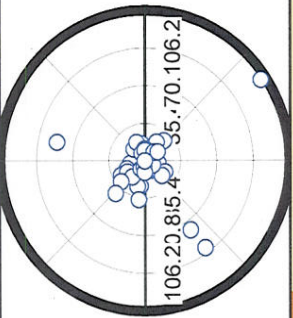

Wind.m.s. converted: 3.0 to 4.0

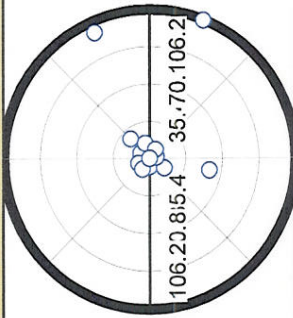

Wind.m.s. converted: 4.0 to 5.0

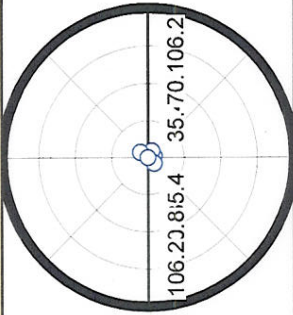

Wind.m.s. converted: 5.0 to 6.0

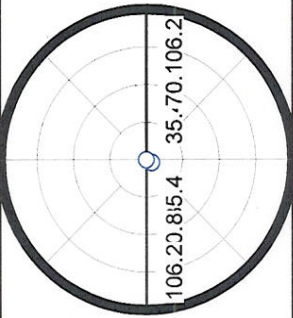

Wind.m.s. converted: 6.0 to 7.0

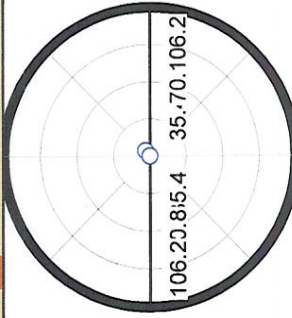

Wind.m.s. converted: 7.0 to 8.0

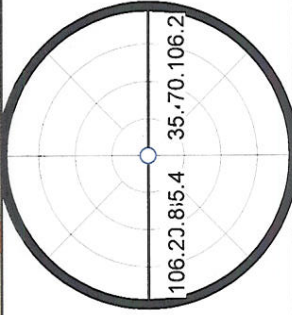

Wind.m.s. converted: 8.0 to 20.0

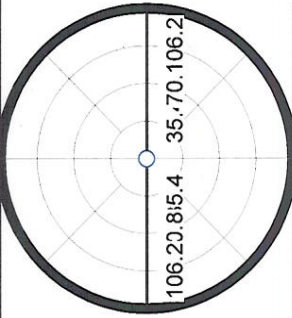

Intel Pollution Rose Methanol - Intel Meteorology

Intel SE CUB 2-24 to 3-12-04

Wind.m.s: 0.0 to 1.0

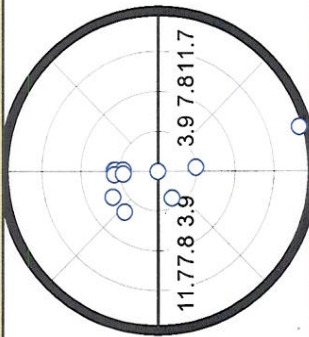

Wind.m.s: 1.0 to 2.0

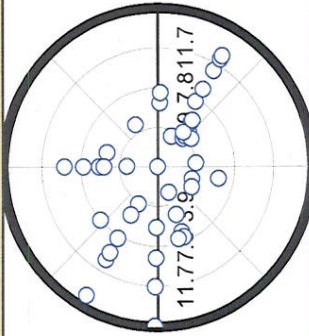

Wind.m.s: 2.0 to 3.0

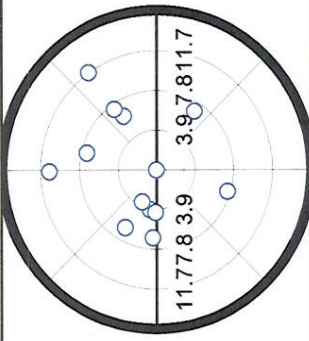

Wind.m.s: 3.0 to 4.0

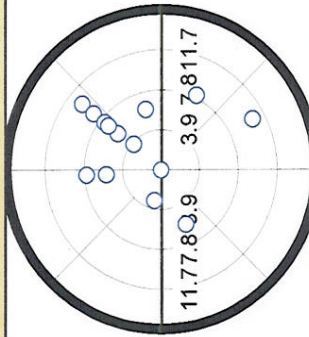

Wind.m.s: 4.0 to 5.0

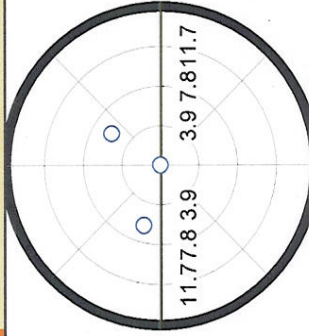

Wind.m.s: 5.0 to 6.0

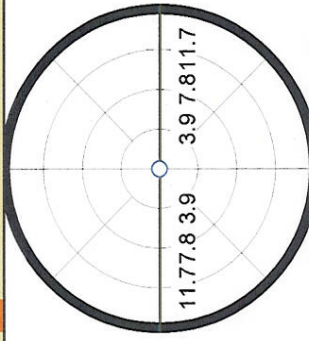

Wind.m.s: 6.0 to 7.0

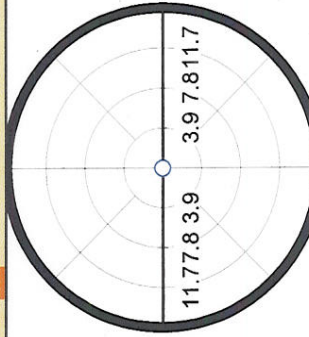

Wind.m.s: 7.0 to 8.0



Wind.m.s: 8.0 to 20.0

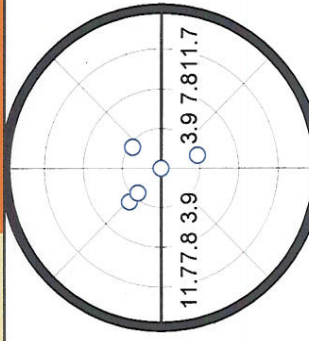

Intel Pollution Rose Methanol - Intel Meteorology

Intel SE CUB 2-24 to 3-12-04

Wind.m.s. converted: 0.0 to 1.0

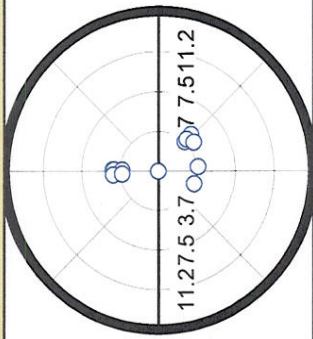

Wind.m.s. converted: 1.0 to 2.0

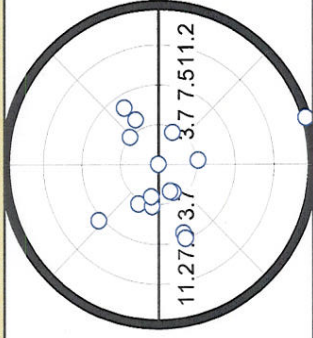

Wind.m.s. converted: 2.0 to 3.0

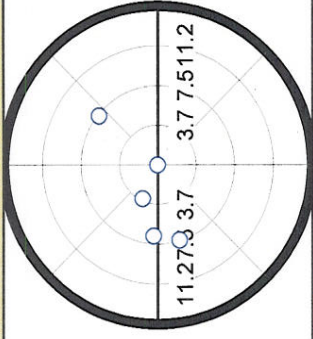

Wind.m.s. converted: 3.0 to 4.0

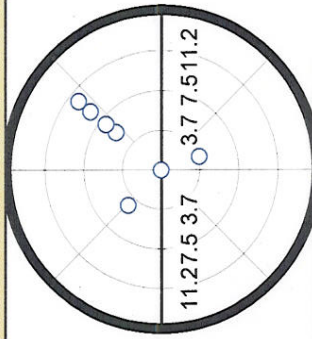

Wind.m.s. converted: 4.0 to 5.0

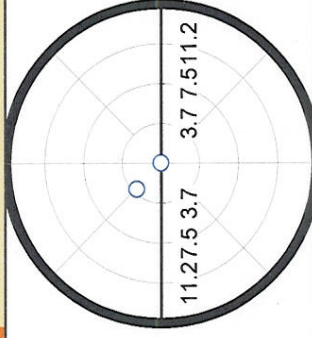

Wind.m.s. converted: 5.0 to 6.0

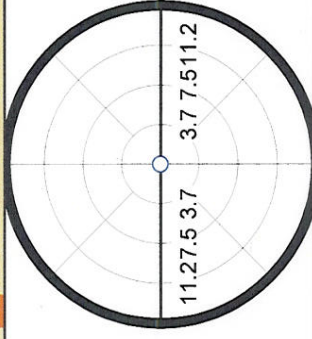

Wind.m.s. converted: 6.0 to 7.0

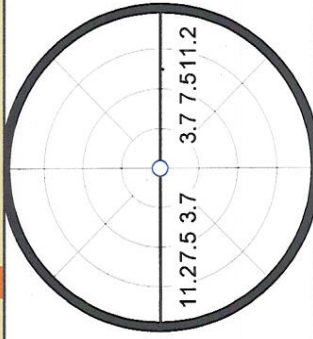

Wind.m.s. converted: 7.0 to 8.0

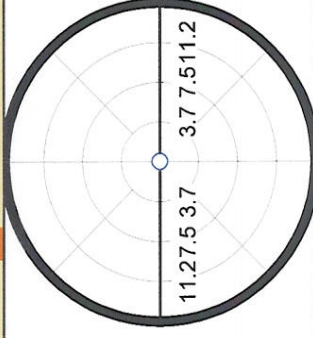

Wind.m.s. converted: 8.0 to 20.0

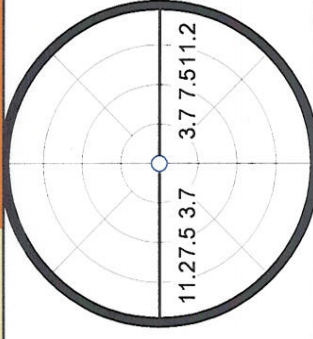

Intel Pollution Rose NH3 - Intel Meteorology

Intel SE CUB 2-24 to 3-12-04

Wind.m.s: 0.0 to 1.0

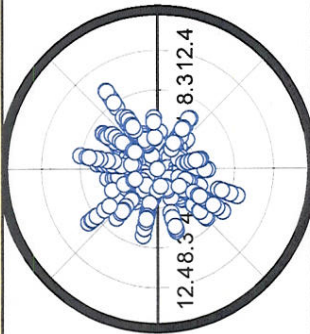

Wind.m.s: 1.0 to 2.0

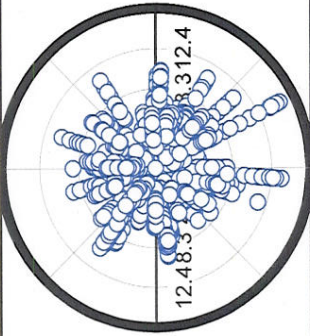

Wind.m.s: 2.0 to 3.0

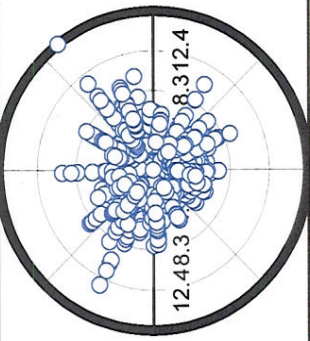

Wind.m.s: 3.0 to 4.0

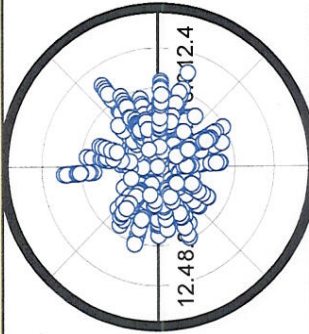

Wind.m.s: 4.0 to 5.0

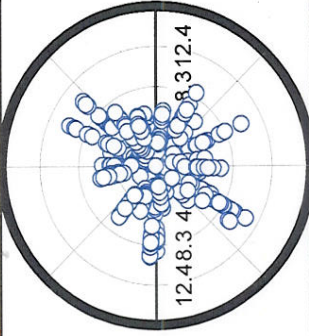

Wind.m.s: 5.0 to 6.0

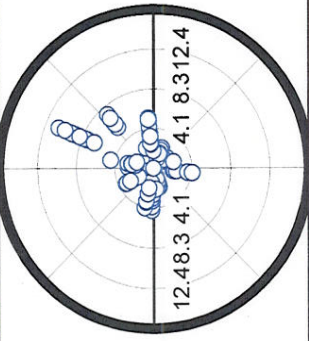

Wind.m.s: 6.0 to 7.0

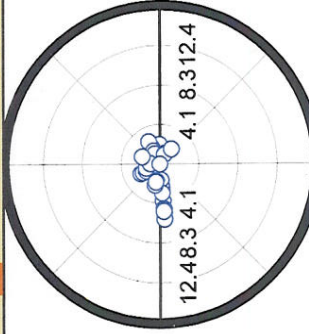

Wind.m.s: 7.0 to 8.0

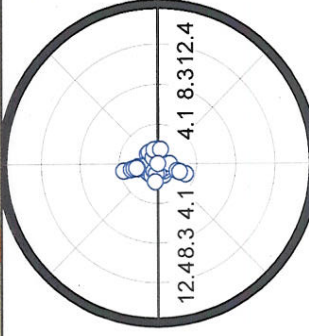

Wind.m.s: 8.0 to 20.0

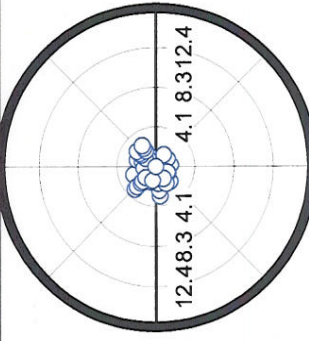

Intel Pollution Rose NH3 - Intel Meteorology

Intel SE CUB 2-24 to 3-12-04

Wind.m.s. converted: 0.0 to 1.0

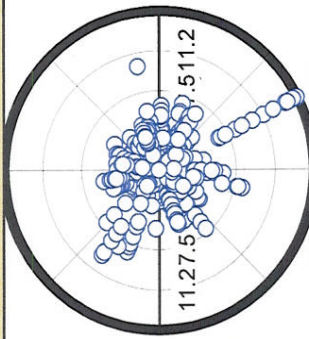

Wind.m.s. converted: 1.0 to 2.0

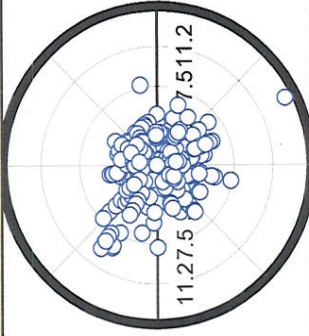

Wind.m.s. converted: 2.0 to 3.0

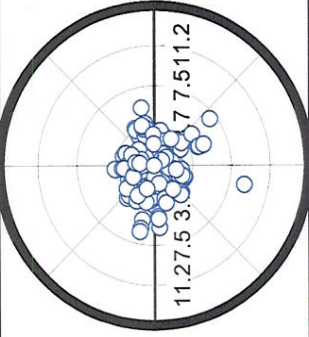

Wind.m.s. converted: 3.0 to 4.0



Wind.m.s. converted: 4.0 to 5.0



Wind.m.s. converted: 5.0 to 6.0

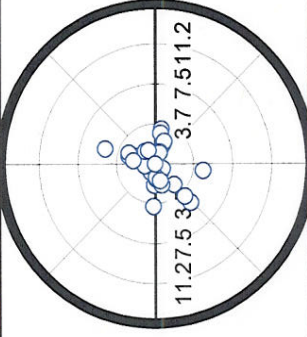

Wind.m.s. converted: 6.0 to 7.0



Wind.m.s. converted: 7.0 to 8.0

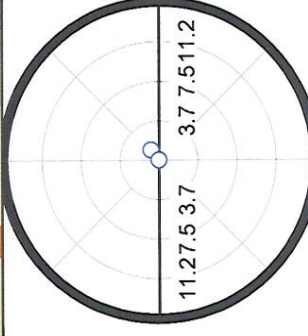

Wind.m.s. converted: 8.0 to 20.0

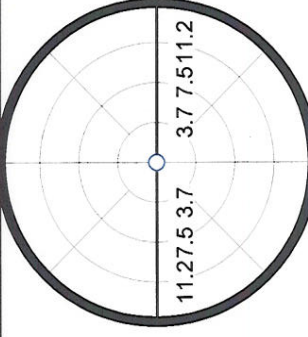

Intel Pollution Rose n-Hexane - Intel Meteorology

Intel SE CUB 2-24 to 3-12-04

Wind.m.s: 0.0 to 1.0

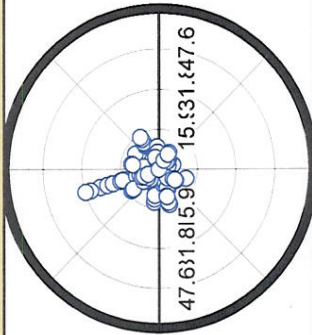

Wind.m.s: 1.0 to 2.0

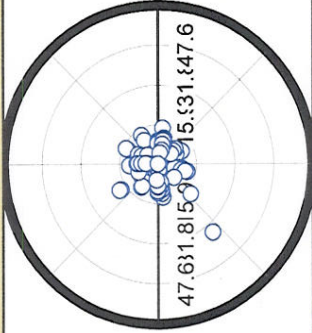

Wind.m.s: 2.0 to 3.0

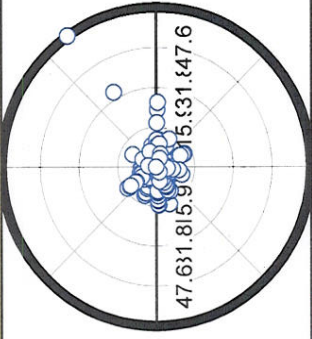

Wind.m.s: 3.0 to 4.0

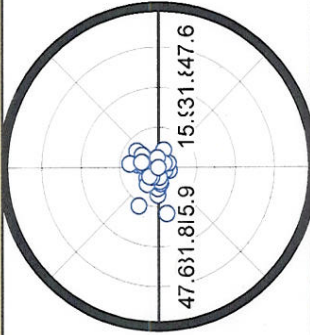

Wind.m.s: 4.0 to 5.0

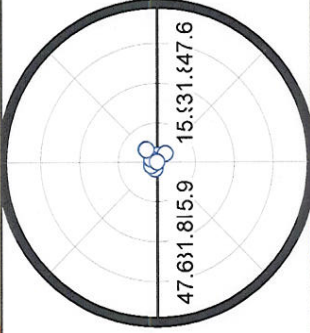

Wind.m.s: 5.0 to 6.0

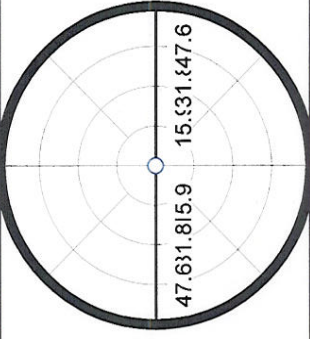

Wind.m.s: 6.0 to 7.0

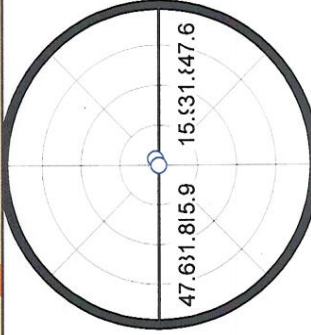

Wind.m.s: 7.0 to 8.0

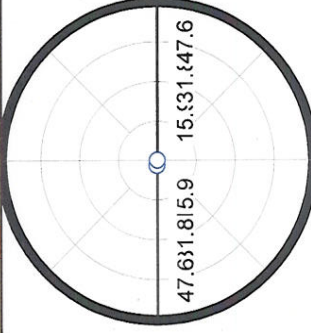

Wind.m.s: 8.0 to 20.0

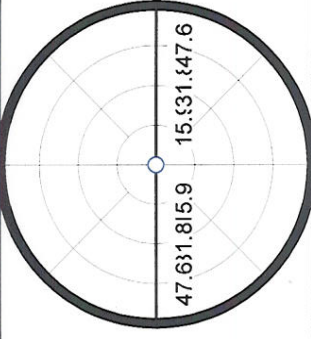

Intel Pollution Rose n-Hexane - Intel Meteorology

Intel SE CUB 2-24 to 3-12-04

Wind.m.s. converted: 0.0 to 1.0

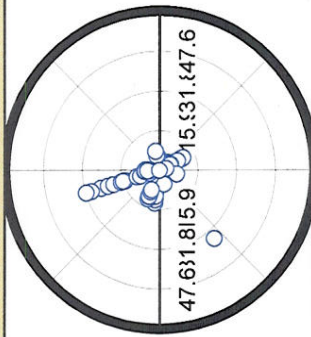

Wind.m.s. converted: 1.0 to 2.0

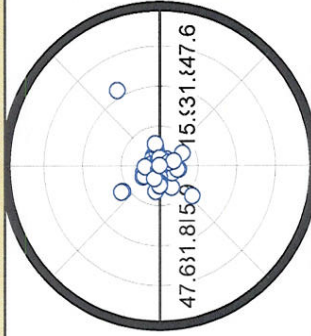

Wind.m.s. converted: 2.0 to 3.0

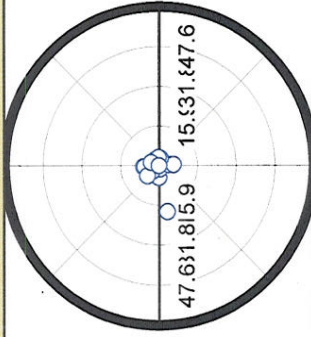

Wind.m.s. converted: 3.0 to 4.0



Wind.m.s. converted: 4.0 to 5.0

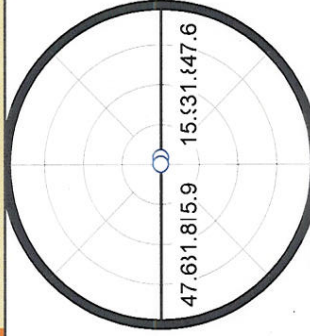

Wind.m.s. converted: 5.0 to 6.0

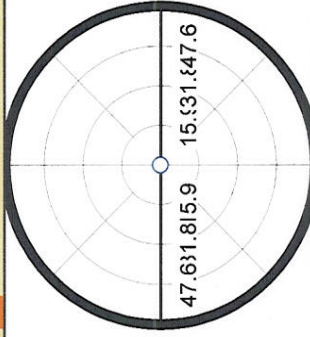

Wind.m.s. converted: 6.0 to 7.0

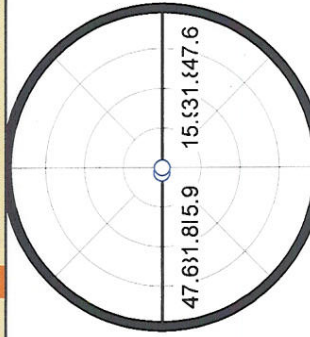

Wind.m.s. converted: 7.0 to 8.0



Wind.m.s. converted: 8.0 to 20.0

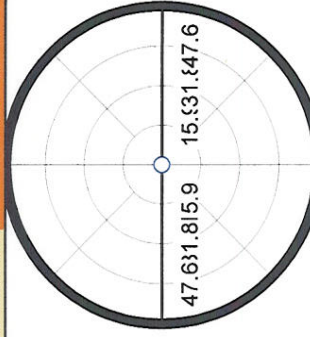

Intel Pollution Rose o-Xylene - Intel Meteorology

Intel SE CUB 2-24 to 3-12-04

Wind.m.s: 0.0 to 1.0

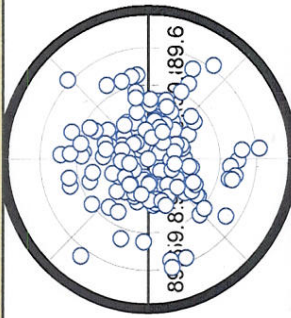

Wind.m.s: 1.0 to 2.0

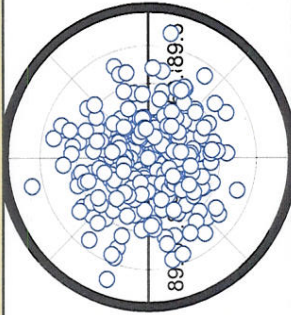

Wind.m.s: 2.0 to 3.0

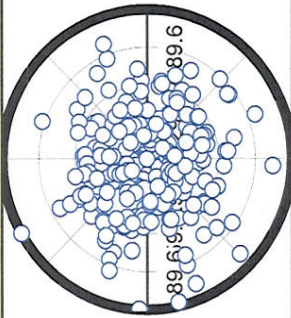

Wind.m.s: 3.0 to 4.0

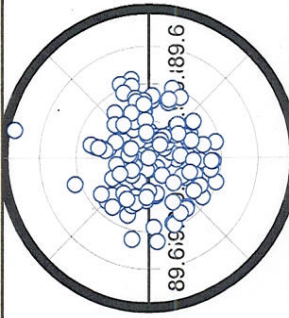

Wind.m.s: 4.0 to 5.0

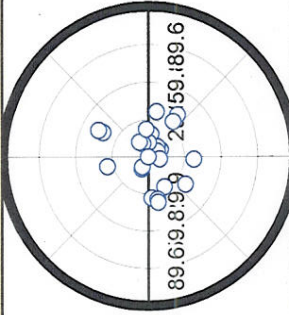

Wind.m.s: 5.0 to 6.0

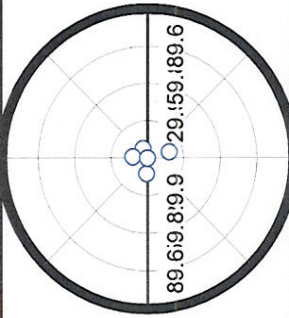

Wind.m.s: 6.0 to 7.0



Wind.m.s: 7.0 to 8.0



Wind.m.s: 8.0 to 20.0



Intel Pollution Rose o-Xylene - Intel Meteorology

Intel SE CUB 2-24 to 3-12-04

Wind.m.s. converted: 0.0 to 1.0

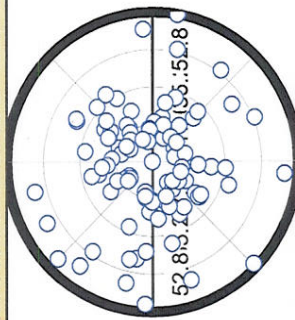

Wind.m.s. converted: 1.0 to 2.0

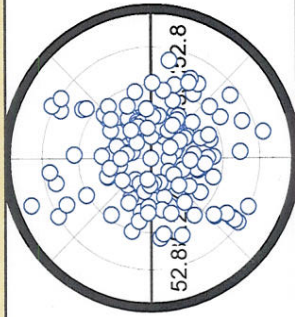

Wind.m.s. converted: 2.0 to 3.0

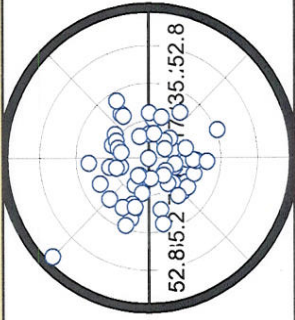

Wind.m.s. converted: 3.0 to 4.0



Wind.m.s. converted: 4.0 to 5.0

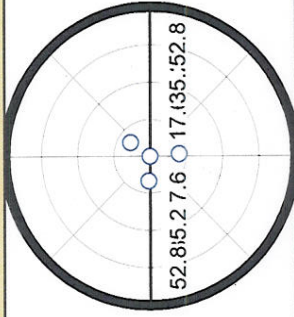

Wind.m.s. converted: 5.0 to 6.0

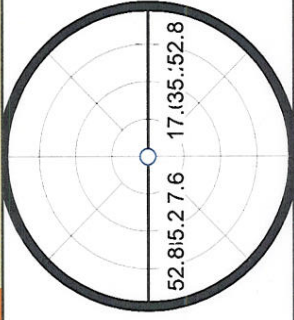

Wind.m.s. converted: 6.0 to 7.0

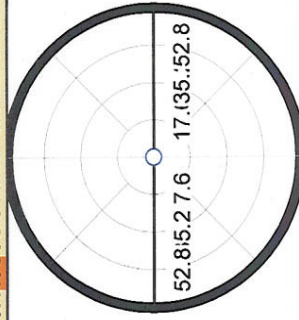

Wind.m.s. converted: 7.0 to 8.0

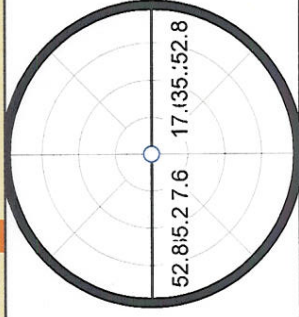

Wind.m.s. converted: 8.0 to 20.0

