

OMB NO. 1505-0146
Approval Expires: August 31, 2009

ANNUAL REPORT TO THE FEDERAL RESERVE BANK OF NEW YORK

**REPORT OF U.S. OWNERSHIP OF
FOREIGN SECURITIES, INCLUDING
SELECTED MONEY MARKET
INSTRUMENTS (SHCA)**

**Mandatory Report
Response Required By Law
(22 U.S.C. 3101 et seq.)**



**Department of the Treasury
Federal Reserve Bank of New York
Board of Governors of the Federal Reserve System**

TABLE OF CONTENTS

	Page
I. INTRODUCTION	
A. Purpose	1
B. Authority	1
C. Confidentiality of Data Reported	1
D. Penalties for Failure to Report	1
E. Paperwork Reduction Act Notice	2
II. GENERAL INSTRUCTIONS	
A. Who Must Report	2
B. Which Schedules to Report	3
C. Exemptions	4
D. Reporting Dates	4
E. Submission Instructions and Contact Information	4
III. WHAT SECURITIES MUST BE REPORTED	
A. Reportable Foreign Securities	6
B. Do Not Report	8
C. Funds and Related Equity Holdings	8
D. Securities Involved in Repurchase and Securities Lending Arrangements	9
E. Depositary Receipts/Shares	9
F. Stripped Securities	10
G. Direct Investment	10
H. Securities Held by Central Securities Depositories	10
I. Country Attribution	10
J. Limited Partnerships	11
K. Accounting Rules, Valuation of Securities, and Calculation of U.S. Dollar Values	11
L. Data Retention Period	12
M. Review of Data and Requests For Revised Data	12
IV. INSTRUCTIONS FOR COMPLETING REPORTING SCHEDULES	
A. Schedule 1 - Reporter Contact Identification and Summary of Financial Information	13
B. Schedule 2 - Details of Securities	16
C. Schedule 3 - Custodians Used	20
APPENDICES	
A. Sample Reporting Schedules	22
Reporter Contact Identification and Summary Financial Information	Schedule 1, Page 1 of 3
Details of Securities	Schedule 2, Page 1 of 2
Custodians Used	Schedule 3, Page 1 of 1
B. Reporting Requirement Flowcharts	28
C. List of Security Identification Systems	34
D. List of Country Codes	36
E. List of International and Regional Organizations	37
F. List of Currency Codes	38
G. List of Custodian Codes	40
H. Glossary	42
I. Technical Information for Electronic Submission	47

NOTE: Vertical bars in the left hand margin indicate significant changes from the reporting instructions for the SHC benchmark report as of December 31, 2006.

I. INTRODUCTION

A. PURPOSE

The Department of the Treasury, with the assistance of the Board of Governors of the Federal Reserve System and the Federal Reserve Bank of New York (FRBNY), is conducting a mandatory survey of the ownership of foreign securities, including selected money market instruments, by U.S. residents as of December 31. The data will be collected by the FRBNY, acting as fiscal agent for the Department of the Treasury. The data collected will be used by the U.S. Government in the computation of the U.S. balance of payments accounts and the U.S. international investment position, and in the formulation of international economic and financial policies. This report also is part of the Coordinated Portfolio Investment Survey (CPIS), an internationally coordinated effort under the auspices of the IMF, to improve the statistics on the holdings of foreign securities by major investing countries.

In order to reduce reporting burden and costs to the government, there will be a substantial reduction in the number of reporters in four out of every five years. A benchmark survey (Form SHC) of all significant U.S.-resident custodians and end-investors will continue to be held approximately every five years. In non-benchmark years, the annual survey (Form SHCA) will require reports from only the very largest U.S.-resident custodians and end-investors. The data reported under these annual surveys (Form SHCA) will be used in conjunction with the results of the previous benchmark survey to compute economy-wide estimates for the non-benchmark years.

The determination of who must report on the annual reports (Form SHCA) will be based upon the data submitted during the previous benchmark survey. Certain U.S.-resident custodians and end-investors (including fund managers) will be designated to file detailed foreign security data on Schedule 2 and data on foreign securities entrusted to U.S.-resident custodians on Schedule 3, i.e., they will be required to file in the same manner as they did on the December 31, 2006 benchmark survey.

B. AUTHORITY

This survey is conducted under the authority of the *International Investment and Trade in Services Survey Act* (22 U.S.C. 3101 et seq., [the Act]) and *Executive Order 11961* of January 19, 1977. The Act specifies that the President has the authority to conduct a regular data collection program, including such studies and reports as may be necessary and feasible, to secure current information on international investment, including (but not limited to) such information as may be necessary for computing and analyzing the balance of payments and the international investment position of the United States (22 U.S.C. 3103). In *Executive Order 11961* §2, the President designated the Secretary of the Treasury to be responsible for collecting data on portfolio investment required by the Act.

C. CONFIDENTIALITY OF DATA REPORTED

The information collected by this survey may be used only for analytical and statistical purposes and to enforce the Act. Access to the information is available only to officials and employees (including consultants and contractors and their employees) designated to perform functions under the Act. Persons having access to individual company information submitted pursuant to the Act are subject to penalties for unauthorized disclosure (22 U.S.C. §3104 and 18 U.S.C. §1905). The results of this survey will be made available to the general public at an aggregated level so that neither the U.S. persons or organizations providing information nor individual or organizational ownership of foreign securities can be identified.

D. PENALTIES FOR FAILURE TO REPORT

Reporting as directed in this package is mandatory for any U.S. person or organization subject to the reporting requirements set forth in the report instructions. Failure by an organization to provide timely and accurate data can result in a civil penalty of not less than \$2,500 and not more than \$25,000, or injunctive relief ordering such person to comply, or both (22 U.S.C. §3105(a)).

Willfully failing to submit any required information under the Act can result in a fine of not more than \$10,000; and, if an individual, may result in imprisonment for not more than a year, or both. Any officer, director, employee or agent who knowingly participates in such violation, upon conviction, may be punished by a like fine, imprisonment, or both (22 U.S.C. §3105(c)).

E. PAPERWORK REDUCTION ACT NOTICE

This report has been reviewed and approved by the Office of Management and Budget in accordance with the *Paperwork Reduction Act of 1995* and assigned OMB Control Number 1505-0146. The purpose is to collect accurate and complete data that will enable the Treasury Department to fulfill its responsibility under the Act. The estimated annual average preparation time per respondent (over five years) is about 84 hours, but this will vary widely from respondent to respondent. (a) In the year of a benchmark survey (using Form SHC), it is estimated that exempt SHC reporters will require an average of 16 hours; custodians of securities providing security-by-security information will require an average of 360 hours, but this figure will vary widely for individual custodians; end-investors providing security-by-security information will require an average of 120 hours; and end-investors and custodians employing U.S. custodians will require an average of 40 hours. (b) In a non-benchmark year (using Form SHCA), custodians of securities providing security-by-security information will require an average of 700 hours (because only the largest U.S.-resident custodians will report), end-investors providing security-by-security information will require an average of 145 hours; and SHCA reporters entrusting their foreign securities to U.S. custodians will require an average of 48 hours. Comments concerning the accuracy of this burden estimate and suggestions for reducing the burden should be directed to:

Administrator, International Portfolio Investment Data Systems
U.S. Department of the Treasury
1500 Pennsylvania Avenue NW, Room 4410-1440NYA
Washington, DC 20220, or

The Office of Management and Budget
Paperwork Reduction Project (1505-0146)
Washington, DC 20503

No person is required to respond to any U.S. Government collection of information unless it displays a currently valid OMB control number.

II. GENERAL INSTRUCTIONS

A. WHO MUST REPORT

All U.S.-resident custodians and end-investors that receive a copy of this SHCA booklet of forms and instructions from the Federal Reserve Bank of New York or are notified by the Federal Reserve Bank of New York that they are required to file must report. (See Section II.C, Exemptions.) All other entities are exempt from reporting.

1) **Custodians** are all organizations that hold securities in safekeeping for other organizations. Most U.S.-resident custodians also invest in foreign securities for their own account, i.e., are also U.S.-resident end-investors for purposes of this report. U.S.-resident custodians should report both the foreign securities held in safekeeping for other U.S. residents and their own foreign securities.

2) **End-Investors** are U.S. resident organizations that invest in foreign securities for their own portfolio. This includes securities that are held-for-trading, available-for-sale, held-for-maturity, or which have been invested on behalf of others by managers of mutual funds, insurance companies, and pension funds. Collectively such investors are referred to as “end-investors” throughout these instructions. U.S.-resident end-investors include, but are not limited to:

Financial and non-financial organizations
Managers of private and public pension funds
Managers of mutual funds, country funds, unit-investment funds, exchange-traded funds, collective-investment trusts, or any other similarly pooled, commingled fund
Insurance companies
Foundations
Institutions of higher learning (e.g., university endowments)
Trusts and estates

Reports should include all reportable securities held or managed by all U.S.-resident parts of your organization, including all U.S.-resident branches, offices, and subsidiaries. U.S. residents include organizations located in the Commonwealth of Puerto Rico and U.S. territories and possessions. Please see Appendix H for the complete definition of United States. It is the responsibility of the parent entity in each organization to ensure that its report covers all applicable entities within the organization.

If any of the following conditions apply, please contact the FRBNY staff:

- Your organization is not the top parent U.S.-resident entity in your organization and has received the forms and instructions from, or has been notified of its obligation to report by, the Federal Reserve Bank of New York.
- Your organization cannot submit a single report for the entire organization.

Additional copies of the reporting forms and instructions may be printed from the Internet at:

<http://www.treas.gov/tic/forms.html#benchmark>

B. WHICH SCHEDULES TO REPORT

- **Schedule 1**

Schedule 1 must be filed by all entities that 1) receive a copy of the SHCA forms and instructions from the Federal Reserve Bank of New York, or 2) are notified by the Federal Reserve Bank of New York that they are required to file the SHCA report.

Schedule 1 requests information that identifies the reporter. It also provides contact information, indicates the reporting status, and summarizes the data, if any, reported on Schedule 2 and/or Schedule 3.

- **Schedule 2:**

Schedule 2 is used to report detailed information on foreign securities (1) that the reporter safekeeps for itself or for its U.S.-resident clients or (2) for which the reporter directly employs foreign-resident sub-custodians or U.S.-resident or foreign-resident central securities depositories to manage the safekeeping of those securities (See Section III.H.).

- **Schedule 3:**

Schedule 3 is used to report summary amounts for all foreign securities entrusted to the safekeeping of a U.S.-resident custodian (excluding U.S.-resident central securities depositories) (See Section III.H.).

C. EXEMPTIONS

- **Schedule 1**

If you have received these forms and instructions from the Federal Reserve Bank of New York, there is NO exemption level for **Schedule 1**. You must submit the reporter identification, the contact and certifying information parts of **Schedule 1**. However, items requesting aggregate data on foreign securities on Schedule 1 should be left blank if you are not required to report data on Schedule 2 or Schedule 3.

- **Schedule 2**

SHCA reporters are exempt from reporting on Schedule 2 if the total fair (market) value of foreign securities whose safekeeping they manage for themselves and for other U.S. residents or whose safekeeping the reporter has entrusted directly to foreign-resident custodians or U.S. or foreign-resident central securities depositories **is less than US\$ 100 million** (aggregated over all accounts) as of December 31.

- **Schedule 3**

SHCA reporters are exempt from reporting on a Schedule 3 holdings entrusted to another U.S.-resident custodian if the total fair (market) value of the foreign securities entrusted to that U.S.-resident custodian – aggregated over all accounts they own and all accounts they manage for other U.S. residents - **is less than US\$ 100 million** as of December 31.

D. REPORTING DATES

Report data as of December 31. Data should be submitted to the Federal Reserve Bank of New York (FRBNY) no later than the first Friday of March.

E. SUBMISSION INSTRUCTIONS AND CONTACT INFORMATION

Schedule 1 must be submitted on paper, unless you are submitting Schedule 2 data via the IESUB application (see below). If you are submitting Schedule 2 data via the IESUB application, you must submit Schedule 1 via IESUB.

Schedule 2 reports consisting of **200 or more** records, must be submitted electronically on diskette(s) or compact disk(s) (CDs) or via IESUB using the format specified in Appendix I.

Schedule 2 reports consisting of **less than 200** records may be submitted electronically on diskette(s) or compact disk(s) (CDs) or via IESUB using the format specified in Appendix I, or on paper, using the form contained in Appendix A.

Schedule 3 reports must always be submitted on paper using the form in Appendix A.

Reports can be mailed or sent by courier to:

**Federal Reserve Bank of New York
Statistics Function, 4th Floor
33 Liberty Street
New York, NY 10045-0001**

IESUB

The Federal Reserve System's Internet Electronic Submission (IESUB) System is fast, easy to use and secure. IESUB provides a confirmation of the receipt of the data at the Federal Reserve Bank of New York and performs a number of validity checks of your file format.

For more information on how to submit data using the IESUB system, contact the SHC staff at 212-720-6300 or 646-720-6300 or at SHC.Help@ny.frb.org. Alternatively, additional information and an application to register for IESUB can be obtained at:

<http://www.treas.gov/tic/forms.htm#benchmark>.

Completed applications should be sent to:

Federal Reserve Bank of New York
Statistics Function, 4th Floor
33 Liberty Street
New York, New York 10045-0001

or faxed to 1-212-720-5030.

If your business or technical contact information changes after submission of your Schedule 1 or if you have any questions pertaining to the report, please contact the FRBNY staff:

Phone: (212) 720-6300
(646) 720-6300

Email: SHC.Help@ny.frb.org

III. WHAT SECURITIES MUST BE REPORTED

This report collects information on U.S. resident holdings of foreign securities, including foreign equities, short-term debt securities (including selected money market instruments), and long-term debt securities. Asset-backed securities are to be reported separately from other debt securities. Foreign securities include all securities issued by entities that are established under the laws of a foreign country (i.e., any entity that is legally incorporated, otherwise legally organized, or licensed (such as branches) in a foreign country) and all securities issued by international organizations, such as the International Bank for Reconstruction and Development (IBRD or World Bank), and the Inter-American Development Bank (IADB), even if these organizations are located in the United States.

Reportable securities may be traded or issued in the United States and in foreign countries, and may be denominated in any currency, including euros and U.S. dollars. Neither the country in which the securities are traded or issued, nor the currency in which the securities are denominated, is relevant in determining whether the securities are reportable.

As an exception, foreign securities held by a U.S. depository to back depository receipts/shares should not be reported. Instead, the holders of the depository receipts/shares should report the receipts/shares. This exception is necessary to identify the portion of depository receipts/shares actually held by U.S. residents, because many depository receipts/shares are held by foreign residents.

A. REPORTABLE FOREIGN SECURITIES

Reportable securities include:

- Securities issued by international and regional organizations, such as the International Bank for Reconstruction and Development (IBRD or World Bank) or the Inter-American Development Bank (IDB).
- Securities issued in the United States by foreign-resident organizations (e.g., Canadian or Mexican firms), even if they are denominated in U.S. dollars and trade on U.S. securities exchanges.
- Securities issued by foreign-resident subsidiaries of U.S.-resident organizations (e.g., GMAC Canada) and foreign-resident offices of U.S. banks or U.S. broker/dealers, even if they are guaranteed by the U.S. parent company, or issued in the United States.
- Depository receipts/shares, including American Depositary Receipts (ADRs), American Depositary Shares (ADS), Global Depositary Receipts (GDRs), and International Depositary Receipts (IDRs), if the underlying securities are issued by foreign residents— (See Section III.E.).
- Securities issued by foreign-resident entities under Section 144A of the SEC Act.
- Money market instruments, including negotiable certificates of deposit (CDs), issued by foreign-resident entities.

Equity securities represent an ownership interest in foreign-resident organizations.

Include as equities:

- Common stock (ordinary shares);
- Preferred stock (participating and nonparticipating preference shares);
- Restricted stock;
- Depository receipts/shares (e.g., ADRs, ADSs, GDRs, IDRs) **provided** the underlying securities used to collateralize the receipts/shares **are** foreign securities (See Section III.E.);
- Shares/units in foreign-resident funds, investment trusts, and similar investment vehicles (including mutual funds and money market funds— (See Section III.C.);
- U.S.-resident limited partner ownership in foreign-resident limited partnerships (general partner ownership is excluded – (See Section III.J.); and
- Other equity securities.

Short-Term Debt Securities include bills, commercial paper, and other money market instruments specified below with an **original maturity of one year or less** that give the holder the unconditional right to financial assets. (Asset-backed short-term debt securities should be reported as asset-backed securities (see below).)

Include as short-term debt securities:

- Short-term foreign government securities;
- Short-term bankers' acceptances and trade acceptances;
- Short-term commercial and financial paper, including asset-backed commercial paper;
- Short-term **negotiable** certificates of deposit, bank notes, and deposit notes;
- Short-term notes issued under note issuance facilities and revolving underwriting facilities, even though the underlying facility may be for more than one year;
- Short-term medium-term notes;
- Short-term promissory notes;
- Stripped securities with an original maturity of one year or less; and
- Other short-term debt securities.

Long-Term Debt Securities (excluding asset-backed securities) include bonds and notes, with an **original maturity of over one year**, that usually give the holder the unconditional right to financial assets.

Include as long-term debt securities:

- Bonds such as foreign treasury, zero coupon, stripped, deep-discounted, currency-linked (e.g., dual-currency), floating rate, equity-related (e.g., convertible bonds) bonds and Eurobonds;
- Long-term index-linked debt securities;
- Long-term floating rate notes (FRN), such as perpetual notes (PRN), variable rate notes (VRN), structured FRN, reverse FRN, collared FRN, step up recovery FR (SURF), and range/corridor/accrual notes;
- Long-term medium-term notes;
- Bonds with multiple call options, the last of which is more than one year after issue;
- Long-term debentures;
- Long-term negotiable certificates of deposit, bank notes, and deposit notes;
- Long-term bearer depositary receipts denoting ownership of debt securities issued by nonresidents;
- Brady bonds;
- Covered bonds (e.g., Pfandbriefe);
- Long-term securities backed by a sinking fund; and
- Other long-term debt securities.

Asset-Backed Securities are securitized interests in a pool of assets, which give the purchaser a claim against the cash flows generated by the underlying assets. In many cases, the security's outstanding principal is reduced over time as principal repayments are received and passed on to the holders of the security. Securities backed by revolving credits, such as pools of credit card receivables, do not meet this criterion, but are still classified as ABS if the return to the holder is based upon these credits, (i.e., the credits do not merely serve as collateral). The ABS is reported if the **issuer securitizing the assets** is a foreign resident. The underlying asset should not be used to determine if the securities are reportable. Asset-backed commercial paper should be reported as commercial paper with other short-term debt.

Include as asset-backed securities all collateralized mortgage obligations (CMOs), collateralized bond obligations (CBOs), collateralized loan obligations (CLOs), collateralized debt obligations (CDOs), and other securities which give the purchaser a claim against the cash flows generated by pools of:

- Mortgages;
- Credit card receivables;
- Automobile loans;
- Consumer and personal loans;
- Commercial and industrial loans and other whole loans; and
- Other assets.

B. DO NOT REPORT

Do not report any:

- Derivative contracts (including futures, forwards, swaps, options, and warrants) meeting the definition of a derivative under FAS 133. If the embedded derivative has not been bifurcated from the host contract under FAS 133, then the security should be reported without separating the embedded derivative from the host contract. However, if the embedded derivative is bifurcated from the host contract, then the derivative should be excluded from the report and the host security should be included on the report.
- Loans and loan participation certificates;
- Letters of credit;
- Non-negotiable certificates of deposit ;
- Bank deposits, including time deposits (except for negotiable CDs) and demand deposits;
- Foreign securities temporarily acquired under reverse repurchase, borrowing, or lending arrangements (See Section III.D.);
- The underlying security of a depositary receipt, even if a foreign security (See Section III.E.);
- Direct investments (See Section III.G.), including investments in real estate and general partner ownership in limited partnerships (however, limited partner ownership are reportable investments);and
- All U.S. securities, including:
 1. Securities issued by U.S.-resident organizations, even if they are denominated in foreign currencies or traded on foreign securities exchanges;
 2. Securities issued by U.S.-resident subsidiaries of foreign-resident organizations and U.S.-resident offices of foreign banks or foreign broker/dealers, even if they are guaranteed by the foreign parent company, or issued outside of the United States;
 3. Securities issued by U.S.-resident entities under Section 144A of the SEC Act;
 4. Ownership of shares of U.S.-resident funds, even if the fund invests in foreign securities (See Section III.C.); and
 5. Stripped securities issued by a U.S.-resident financial institution, even if the underlying security is a foreign security (See Section III.F.).

C. FUNDS AND RELATED EQUITY HOLDINGS

1. Report U.S. residents' ownership of shares/units of funds legally established outside of the United States (foreign-resident funds) as equity securities. All U.S. residents' holdings of foreign-resident funds should be assigned security type 3 (fund shares), and not categorized as a debt security, regardless of the types of securities held by the fund.

For purposes of this report, funds include all investment vehicles that pool investors' money and invest the pooled money in one or more of a variety of assets. Funds include, but are not limited to:

- Mutual funds (including both closed-end and open-end mutual funds);
- Money market funds;
- Investment trusts;
- Index-linked funds;
- Exchange traded funds (ETFs); and
- Common trust funds.

The determination of whether fund shares are foreign securities is based on the country in which the fund is legally established, not on the type of securities the fund purchases. For example, a share in a fund organized in

Bermuda that purchases U.S. Treasury securities is a reportable foreign equity security. Likewise, a share in a fund established in the United States is a U.S. security and should be excluded from the report, even if the U.S.-resident fund invests in foreign securities.

Many funds established outside the United States have names that are similar to U.S.-resident fund names. This often occurs when the fund is managed by a group that manages many U.S.-resident funds and therefore may be thought of as managing only U.S.-resident funds. If there is doubt as to whether the investment should be classified as a fund or whether a fund is U.S. or foreign, please contact FRBNY report staff at (212) 720-6300 or (646) 720-6300.

2. Report U.S.-resident funds' ownership of foreign securities.

Although ownership of shares of U.S.-resident funds is excluded from this report, the foreign securities owned by U.S.-resident funds are reportable. These are distinct holdings and, therefore, are not duplicate reporting. Foreign securities owned by U.S.-resident funds should be classified as equity, debt, or asset-backed securities, as indicated in Section III.A.

D. SECURITIES INVOLVED IN REPURCHASE AND SECURITIES LENDING ARRANGEMENTS

A repurchase agreement (repo) is an arrangement involving the sale of securities at a specified price for cash with a commitment to repurchase the same or similar securities at a specified price on a future date. A reverse repo is an agreement whereby a security is purchased at a specified price with a commitment to resell the same or similar securities at a specified price on a specified future date. Securities lending/borrowing arrangements are agreements whereby the ownership of a security is transferred in return for collateral, usually another security or cash, under condition that the security or similar security will revert to its original owner at a future date. All of these arrangements, as well as buy/sell agreements, should be treated as follows:

- Securities sold under repurchase agreements or lent under securities lending arrangements, or collateral provided, should be reported by the original owner of the securities (or their U.S.-resident custodian) as if the securities were continuously held; that is, as if the repurchase or security lending agreement did not exist. Thus, if a U.S. resident transferred a foreign security under a repurchase or securities lending arrangement, the U.S. resident (or their U.S.-resident custodian) transferring the security should include it in its Schedule 2 or Schedule 3 records. The country reported should be the country of the issuer of the security and not the country of the counterparty to the repo or other agreement.
- Securities, including collateral, temporarily acquired by U.S. residents under reverse repurchase or borrowing or lending arrangements should not be reported.
- However, if cash was temporarily received as collateral and was used to purchase securities, those securities should be reported.

E. DEPOSITARY RECEIPTS/SHARES

Depositary receipts/shares, including American depositary receipts (ADRs) or bearer depositary receipts, should be attributed to the country of residence of the issuer of the security underlying the depositary receipt/share. Issuers of depositary receipts/shares should **not** report their holdings of the actual foreign securities. Only U.S. residents' holdings of depositary receipts/shares should be reported.

In addition, the security type reported should be determined based on the security underlying the depositary receipt/share. For example, if the underlying security is foreign common stock then the security type reported in Item 7 of the Schedule 2 should be 1 (common stock).

F. STRIPPED SECURITIES

Stripped securities are securities that have been transformed from a principal amount with periodic interest coupons into a series of zero coupon securities, with the range of maturities matching the coupon payment dates and the redemption date of the principal amount.

The country of residence of a stripped security is the country of residence of the entity that issued the stripped security, not the country of residence of the entity that issued the underlying security. Stripped securities issued by foreign residents, (the interest-only (IO) component, the principal-only (PO) component and tranches of stripped asset-backed securities), and held by U.S. residents are reportable. If a U.S.-resident financial institution issued the stripped securities, the issuer of the stripped securities should report its ownership of the underlying foreign securities. Exclude U.S. residents' holdings of stripped securities issued by a U.S.-resident financial institution.

G. DIRECT INVESTMENT

All holdings known to be direct investment should be excluded from the survey.

A direct investment relationship exists when a U.S. company owns 10% or more of the voting equity securities of an incorporated foreign business (or an equivalent interest in an unincorporated foreign business or branch. (See Section III.K.) If a direct investment relationship exists, then, in general, all securities held by the parent entity that were issued by the affiliate of the parent are considered to be direct investment. **However, if one of the entities is a banking or securities brokerage firm, then inter-company holdings are considered to be direct investment only if they provide permanent capital.** All holdings known to be direct investment should be excluded from this report.

H. SECURITIES HELD BY CENTRAL SECURITIES DEPOSITORIES

Foreign securities entrusted to U.S.-resident custodians that are in turn held at a U.S.-resident central securities depository (such as the Depository Trust Company or the Federal Reserve Bank of New York), or a foreign-resident central securities depository (such as Euroclear or Clearstream), must be reported by the U.S.-resident custodian, not by the U.S. or foreign-resident central securities depository. Likewise, foreign securities held by a U.S.-resident end-investor directly with a U.S.-resident or foreign-resident central securities depository must be reported by the U.S.-resident end-investor, not by the central securities depository.

Foreign securities provided to the Federal Reserve Bank of New York (FRBNY) for discount window loan collateral must be reported by the "lender" of the securities, not by the FRBNY.

I. COUNTRY ATTRIBUTION

Except for international and regional organizations, and depository receipts, securities should be reported based upon **the country of residence of the issuer of the securities**. The country of residence of any entity is where it is legally incorporated or otherwise legally organized, with the exception of bank branches, which are reported by where they are licensed. In cases where a foreign subsidiary of a U.S.-resident organization issues a reportable security, report these securities in the country where the foreign subsidiary is resident if the security is the direct legal obligation of the foreign subsidiary.

Securities issued by international and regional organizations are not allocated to the country in which the international or regional organization is located but rather to the separate code for international and regional organizations (79995). (Refer to Appendix E for a list of international and regional organizations.) Depository receipts should be attributed to the country of residence of the issuer of the security underlying the depository receipt.

Attribution of country of residence of the issuer should **not** be affected by the currency of issue or by the country of a guarantor.

J. LIMITED PARTNERSHIPS

U.S.-resident limited partner ownership of foreign-resident limited partnerships should be reported as Other Equity (Schedule 2, Item 7 = 4). Limited partners' ownership does not carry voting rights; therefore, such ownership, even if greater than 10%, is reportable. The Number of Shares Held field on the Schedule 2 (Item 16) should be defaulted to the value reported in the US\$ Market Value field (Item 14a) because limited partnerships do not issue shares.

U.S.-resident general partner ownership of foreign-resident limited partnerships is always considered to be direct investment and is excluded from this report.

K. ACCOUNTING RULES, VALUATION OF SECURITIES, AND CALCULATION OF U.S. DOLLAR VALUES

Accounting Rules

All securities should be reported using settlement date accounting. Gross long positions should be reported. Do not net any short positions from long positions. Do not enter decimals or negative values in any cells.

Valuation of Securities

Report the fair (market) value of securities as December 31. The fair (market) value follows the definition of FAS 157. Fair value is the amount at which an asset could be bought or sold in a current transaction between willing parties, other than in a forced or liquidation sale. If a quoted market price is available for an instrument, the fair (market) value is the product of the number of trading units times that market price. For securities that do not regularly trade, the estimate of fair value should be based on the best information available in the circumstances. The estimate of fair value should consider prices for similar assets and the results of valuation techniques to the extent available in the circumstances. Examples of valuation techniques include discounted cash flow, matrix pricing, option-adjusted spread models and fundamental analysis.

For asset-backed securities, the fair (market) value of the unpaid principal amount outstanding on December 31 should be reported; if principal has been repaid, this fair (market) value will **not** be the same as the original face value revalued at end-period market prices.

U.S.-resident custodians should, at a minimum, report the fair (market) value to the extent that it is available as part of their normal services provided to customers, even if the price available is prior to December 31. If there is doubt as to whether to report the available fair (market) value or to report a fair (market) value of zero, please contact FRBNY report staff at (212) 720-6300 or (646) 720-6300.

Foreign Currency Denominated Securities – Calculation Of U.S. Dollar Values

If the security is not denominated in U.S. dollars (US\$) and a US\$ fair (market) value is not available in your system, convert the foreign currency denominated fair (market) value into US\$ using the spot exchange rate as of December 31. If you need assistance locating an exchange rate, please contact FRBNY staff at (212) 720-6300 or (646) 720-6300.

If the exchange rate is normally quoted in units of foreign currency per US\$, such as ¥105.75/US\$, divide foreign currency values by the foreign exchange rate to obtain the US\$ values. For example, if the value of a security issued in Japan is ¥ 200,000, divide ¥ 200,000 by 105.75 to obtain US\$ 1,891.

If the exchange rate is normally quoted in US\$ per units of the foreign currency, such as US\$1.75/UK£, then multiply foreign currency values by the US\$ exchange rate value of the foreign currency to obtain US\$ values.

For example, if the value of a security issued in the United Kingdom is UK £1,000, multiply UK £1,000 by 1.75 to obtain US\$ 1,750.

L. DATA RETENTION PERIOD

The reporter must retain all data used to create this report for a period of 36 months from the date of the report's submission.

M. REVIEW OF DATA AND REQUESTS FOR REVISED DATA

Data submitted on the reporting schedules are reviewed by FRBNY staff. As a result of this review, the reporter may be asked by FRBNY staff to provide supplemental information, including reasons for significant data changes between reporting periods, or corrected data. In addition, FRBNY staff may request: (1) information to ensure that all reportable foreign securities have been reported; (2) information to ensure that all reported foreign securities are held by U.S. residents; or (3) other information that helps to explain or corroborate the submitted data.

Entities filing data on electronic media that are not formatted per the specifications in Appendix I will be required to re-submit the data in the proper format.

IV. INSTRUCTIONS FOR COMPLETING REPORTING SCHEDULES

A. SCHEDULE 1 - REPORTER CONTACT IDENTIFICATION AND SUMMARY OF FINANCIAL INFORMATION

Schedule 1 must be completed by all organizations that meet the survey reporting requirements as specified in Section II.A. This schedule is used to provide basic identifying information and provide summaries of data reported on Schedule 2 and Schedule 3 records. Please type or print all information.

1. Reporter Identification Number - Enter your organization's ten-digit Reporter Identification Number. If you do not know the Reporter Identification Number for your organization, please contact FRBNY staff at (212) 720-6300 or (646) 720-6300.

(Please enter your ten-digit Reporter Identification number at the top of each page of Schedule 1.)

2. Organization Name and Address - Include the full legal name and mailing address of the reporting entity.

3. Reporting Status

Select **1** if your organization is Exempt from reporting on both Schedules 2 and 3 as defined in Section II.C
OR if your organization's reportable foreign securities are included in the report of its U.S.-resident parent.

Select **2** if your organization is filing only Schedule 2 records.

Select **3** if your organization is filing only Schedule 3 records.

Select **4** if your organization is filing both Schedule 2 and Schedule 3.

4. Industrial Classification Code - Enter one of the following that best describes your organization.

1 = Bank	4 = Insurance Company	7 = Foundation, Trust, or Estate
2 = Mutual Fund or Investment Trust	5 = Other Financial Organization	8 = Institution of Higher Learning (e.g., university)
3 = Pension Fund	6 = Non-Financial Organization	9 = Other (not listed above)

A Bank is any depository institution (i.e., an institution that takes deposits), a bank holding company, or a financial holding company organized under Regulation Y of the Federal Reserve Act.

An Other Financial Organization is any other organization that acts as a financial intermediary, such as a finance company or a broker/dealer, which is operated separately from an organization in one of the other categories listed above.

A Non-Financial Organization is an organization that conducts commercial, industrial or trade activities.

5. Name of Contact - Enter the name of the person who will be the primary contact for this report and can answer questions about the data reported.

6. Title - Enter the job title of the contact identified in item 5.

7. Telephone Number - Enter the telephone number of the contact identified in item 5.

8. Fax Number - Enter the fax number of the contact identified in item 5.

9. Email Address - Enter the email address of the contact identified in item 5.

10. Name of Service Provider or Vendor Used - If a service provider or vendor was used to prepare the data reported, enter the name of the service provider.

- 11. Name of Technical Contact** - Enter the name of a person who will serve as a contact should any technical issues, such as incorrect file formats, arise. If a service provider was used to prepare the data reported, the technical contact may be a vendor employee.
- 12. Title** - Enter the job title of the technical contact identified in item 11.
- 13. Telephone Number** - Enter the telephone number of the technical contact identified in item 11.
- 14. Email Address** - Enter the email address of the technical contact identified in item 11.
- 15. Valuation Technique** - For each reporting unit, describe the valuation technique(s) used to calculate the reported market values. If securities are automatically valued at zero after a specified time period of inactivity, please specify the time period and whether this applies to the market value of the security or to the client's holdings (quantity) of the security. Also, please specify how securities not actively traded on the report date and those with internally generated security identification numbers are valued. If your organization has more than four reporting units, please attach additional copies of Schedule 1, page 2, with item 15 completed.

SUMMARY OF SCHEDULE 2 INFORMATION

This section contains summary data for the information reported on **Schedule 2** records. If your organization submits Schedule 2 data on multiple media, the summary Schedule 2 data should represent aggregate data across all media submitted for the same reporter identification number.

- 16. Total Number of Schedule 2s Submitted** - Enter the total number of Schedule 2 records submitted.
- 17. Total US\$ Fair (Market) Value of All Equity Securities** - Enter the sum of the US\$ fair (market) value of all equity security records (records with Schedule 2, Item 7 = 1, 2, 3, or 4), rounded to the nearest U.S. dollar.
- 18. Total US\$ Fair (Market) Value of All Short-Term Debt Securities** (excluding asset-backed securities) - Enter the sum of the US\$ fair (market) value of all short-term debt security (including asset-backed commercial paper) records (records with Schedule 2, Item 7 = 5, 6, 7, 8, or 9 and Item 10 = 1), rounded to the nearest U.S. dollar.
- 19. Total US\$ Fair (Market) Value of All Long-Term Debt Securities** (excluding asset-backed securities) - Enter the sum of the US\$ fair (market) value of all long-term debt security (excluding asset-backed securities) records (records with Schedule 2, Item 7 = 6, 7, 8, or 9 and Item 10 = 2), rounded to the nearest U.S. dollar.
- 20. Total US\$ Fair (Market) Value of All Asset-Backed Securities** - Enter the sum of the US\$ fair (market) value of all asset-backed security records (records with Schedule 2, Item 7 = 10), rounded to the nearest U.S. dollar.

SUMMARY OF SCHEDULE 3 INFORMATION

This section contains summary data for the information reported on **Schedule 3** records.

- 21. Total Number of Schedule 3s Submitted** - Enter the total number of Schedule 3 records submitted.
- 22. Total US\$ Fair (Market) Value of All Equity Securities** - Enter the sum of all Schedule 3 records, item 4.
- 23. Total US\$ Fair (Market) Value of All Short-Term Debt Securities** (excluding asset-backed securities) - Enter the sum of all Schedule 3 records, item 5.

24. Total US\$ Fair (Market) Value of All Long-Term Debt Securities (excluding asset-backed securities) - Enter the sum of all Schedule 3 records, item 6.

25. Total US\$ Fair (Market) Value of All Asset-Backed Securities - Enter the sum of all Schedule 3 records, item 7.

CERTIFYING INFORMATION

All reporters must complete this section.

By signing and dating the certification, the Certifier acknowledges that:

- He/she has read and understood the reporting requirements of this report;
- He/she is aware that both civil and criminal penalties may be imposed for filing a false report; and
- He/she is sufficiently knowledgeable about the activities and functions of this organization that he/she can knowingly and with reasonable confidence certify that the information provided in this report is both accurate and complete.

26 - 30 - Enter the name, job title, telephone number, and email address of the person in your organization who certifies that the information provided is complete and accurate, as well as the date and signature.

B. SCHEDULE 2 - DETAILS OF SECURITIES

(Please enter your ten-digit Reporter Identification Number at the top of each page of Schedule 2.)

1. Reporter Identification Number - Enter your organization's ten-digit Reporter Identification Number. If you do not know the Reporter Identification Number for your organization, please contact FRBNY staff at (212) 720-6300 or (646) 720-6300.

2. Sequence Number - Enter the sequence number of this detail record, right justified. The first detail record should be assigned sequence number 1, and each succeeding Schedule 2 should be assigned a sequence number one higher than the previous record.

3a. Reporting Unit Code - If data being submitted are collected from multiple databases or reporting systems, please report the internal code used in your organization to identify the database or system from which the information on this Schedule 2 came. This information may greatly reduce the costs of identifying and fixing reporting errors that occur.

3b. Name of Reporting Unit - Enter a description or name of the reporting unit or area that corresponds to the code reported in item 3a.

4. Security ID - Enter the security ID code used to identify the security reported on this Schedule 2. ISIN codes are strongly preferred. If the ISIN code is not available, please use a code listed as "Primary" in Appendix C. If no "primary" code is available, please use a "secondary" code listed in Appendix C other than "internally generated." **Do not use internally generated codes unless this security has not been assigned a code by any recognized numbering agency (e.g., limited partnerships).** However, all records for securities for which a portion is restricted and a portion is not restricted should be reported with the numbering agency code assigned to the unrestricted portion. If excessive internal codes are used, we may have to contact you to help identify characteristics of certain individual securities. **Please include the security id's check digit and exclude any internal coding characters added to the ISIN, CUSIP, or other numbering agency code.**

5. Security Description - Briefly describe the security, providing any relevant descriptive information available. Ideally, this would include, but is not restricted to: (a) for preferred stock, the annual dividend; (b) for debt securities, the interest rate; (c) for floating rate notes, how the interest is calculated (e.g., Libor plus 1.5); and (d) for depositary receipts, the underlying security.

6. Security ID System - Select the appropriate number from the list provided in Appendix C. For example, if the Security ID Number entered in Item 4 was an ISIN number, enter "01"; if it was a CINS, enter "33." If the security ID system used is not listed, enter a code of 99 (other) and provide the name of the organization generating the code in item 6a. If the code is internally generated, enter a code of 98 and explain how your internal coding system assigns numbers in item 6a.

6a. Comment Line - If you entered a code of 99 (other) in item 6 you must provide the name of the organization generating the security ID code. If you entered a code of 98 (internally generated) in item 6 please explain how your internal coding system assigns numbers.

7. Security Type - Enter the appropriate Security Type code from the listed options below:

Equity	Non-asset-backed Debt	Asset-backed Securities
1 = Common stock	5 = Commercial paper	9 = Unstripped note or bond
2 = Preferred stock	6 = Negotiable CD	& all other
3 = Fund shares	7 = Convertible debt security	non-asset-backed debt
4 = All other equity	8 = Zero coupon & stripped security	10 = Asset-backed security

Common stock includes securities representing equity ownership in a foreign corporation. All foreign common stock, including restricted common stock and depositary receipts where the underlying security is common stock should be reported as security type 1.

Preferred stock includes securities representing equity ownership in a foreign corporation where the holder's claim is given priority over common shares. Preference shares, non-participating preference shares, convertible preferred stock, restricted preferred stock, and depositary receipts where the underlying security is preferred stock should be reported as security type 2.

Funds include all investment vehicles that pool investors' money and invest the pooled money in one or more of a variety of assets. All ownership interests in funds should be reported as security type 3, regardless of the securities held by the fund. (See Section III.C.)

All other equity includes U.S.-resident limited partner ownership of foreign-resident limited partnerships and any other form of equity not specified in Security Types 1, 2, and 3 and should be reported as security type 4.

Commercial paper, security type 5, includes **all** commercial paper, including asset-backed commercial paper.

Negotiable certificates of deposit, security type 6, includes negotiable bank notes and negotiable deposit notes.

Convertible debt securities, security type 7, includes all convertible debt such as convertible bonds and zero-coupon convertible debt. Note that non-convertible debt securities with embedded warrants or options should be reported as either security type 8, if a zero coupon bond or note, or as security type 9, if **straight debt**.

Zero coupon & stripped securities, security type 8, includes bonds and notes that do not provide explicit interest payments, such as discount notes and stripped, non-asset-backed securities (both the interest-only (IO) and principal-only (PO) components) **except** zero-coupon convertible debt, which should be reported as security type 7, and stripped asset-backed securities, (including their tranches, and all IO and PO components) which should be reported as security type 10.

Unstripped notes, bonds, and all other non-asset-backed debt, security type 9, includes non-asset-backed debt that is not covered in security types 5 through 8. These are bonds or notes that : (1) cannot be converted to equity securities; (2) provide explicit interest payments; (3) have not been stripped; and (4) do not give the owner a claim on cash flows generated by the underlying assets (i.e., are not asset-backed). These bonds and notes are commonly referred to as "straight debt."

Asset-backed securities, security type 10, includes securities that represent securitized interests in a pool of assets and that give the investor a claim against the cash flows generated by the underlying assets, **except** for asset-backed commercial paper, which should be reported as security type 5. All tranches of stripped asset-backed securities, as well as unstripped asset-backed securities, should be reported as security type 10. Debt which is collateralized by assets (real or financial), but only give the investor a claim against the underlying interest if the issuer defaults, should reported as security types 5 through 9, as appropriate.

8. Depositary Receipt/Share - Enter **1** if the security is a depositary receipt/share. Enter **2** otherwise.

9. Name of Issuer - Enter the name of the organization that issued the security. Please try to provide the full legal name of the issuer. For branches of banks, please provide the location of the branch.

10. Term Indicator (based on original maturity) – Enter **1** (short-term) if the period from the issue date to the maturity date is one year or less, regardless if a leap year; enter **2** (long-term), if the period from the issue date to the maturity date is greater than one year. Term indicator only applies to debt, including asset-backed debt. If there are multiple issue dates or redemption dates, term should be determined by the length of the period between the initial/first issue date and the latest redemption date. Perpetual debt should be classified as long-term debt.

11. Country of Issuer - Enter the country code from Appendix D that corresponds to the country of residence of the entity that issued the security. (Refer to Section III.I, Country Attribution.)

12. Currency of Denomination - Enter the ISO code from Appendix F that corresponds to the currency in which the security being reported is denominated.

13. Ownership Code - Enter the appropriate code from the list below:

- 1 = if your organization is reporting as the owner of this security
- 2 = if your organization is reporting as the custodian for a U.S.-resident mutual fund for this security
- 3 = if your organization is reporting as the custodian for a U.S.-resident pension fund for this security
- 4 = if your organization is reporting as the custodian for a U.S.-resident insurance company for this security
- 5 = if your organization is reporting as the custodian for any other U.S. residents for this security
- 6 = if your organization is the custodian and the entity type of the beneficial owner is unknown

Ownership code 1 should be used if your organization is the owner of this security and either holds the security or uses a foreign-resident custodian or a U.S.-resident or foreign-resident central securities depository.

Ownership code 2 should be used if your organization is the custodian and the beneficial owner is identified as a U.S.-resident that is a mutual fund.

Ownership code 3 should be used if your organization is the custodian and the beneficial owner is identified as a U.S.-resident that is a pension fund.

Ownership code 4 should be used if your organization is the custodian and the beneficial owner is identified as a U.S.-resident that is an insurance company.

Ownership code 5 should be used if your organization is the custodian and the beneficial owner is identified as a U.S.-resident that is not a mutual fund, pension fund, or insurance company (which are reported as ownership codes 2 through 4). When your organization is the custodian and cannot identify the entity type of the beneficial owner, the ownership code should be reported as ownership code 6.

Ownership code 6 should be used if your organization is the custodian and the entity type of the beneficial owner is unknown.

14a. US\$ Fair (Market) Value of Security Held - Enter the US\$ fair (market) value of the security being reported, rounded to the nearest U.S. dollar. (See Section III.K, Accounting Rules, Valuation of Securities, and Calculation of U.S. Dollar Values, for more information on how to calculate the US\$ fair (market) value.)

14b. Fair (Market) Value of Security Held Denominated in Currency of Issue - Enter the fair (market) value of the security being reported, rounded to the nearest currency of issue unit. If the currency of issue is US\$, report the same value as in item 14a. (See Section III.K, Accounting Rules, Valuation of Securities, and Calculation of U.S. Dollar Values, for more information on how to calculate the fair (market) value.)

15. Intentionally left blank. Leave this field null or enter a blank space for each record.

FOR EQUITY SECURITIES ONLY

16. Number of Shares Held - Enter the number of shares held, rounded to the nearest share. Securities for which the amount of shares held is zero should not be reported.

FOR SHORT-TERM AND LONG-TERM DEBT SECURITIES EXCLUDING ASSET-BACKED SECURITIES ONLY

17. Face Value in Currency of Denomination - For both short-term and long-term securities, enter the face value held in the currency of denomination, rounded to the nearest whole currency unit. If a security is traded in units, then calculate the face value as: (face value of each unit) * (the number of units held) and report the result in this field. Securities for which the amount held is zero should not be reported.

18. Issue Date - Enter the issue date of this security in MMDDYYYY format. For example, if the security was issued on October 4, 1985, enter 10041985. If there are multiple issue dates, enter the first such issue date.

19. Maturity Date - Enter the final maturity date (when all remaining principal and interest is due) of this security in MMDDYYYY format. For example, if the security's final maturity date is January 5, 2010, enter 01052010.

FOR SHORT-TERM AND LONG-TERM ASSET-BACKED SECURITIES ONLY

20. Original Face Value in Currency of Denomination - Enter the original face value in the currency of denomination, rounded to the nearest whole currency unit. This is the value that is (would have been) outstanding if no principal has been (had been) repaid. If a security is traded in units, then calculate the original face value as: (original face value of each unit) * (the number of units held) and report the result in this field.

21. Remaining Principal Outstanding in Currency of Denomination - Enter the remaining principal outstanding as of December 31, in the currency of denomination, rounded to the nearest whole currency unit. This will equal the original face value if no principal has been repaid. If a security is traded in units, then calculate the remaining face value as: (remaining face value of each unit) * (the number of units held) and report the result in this field. Securities for which the amount held is zero should not be reported.

22. Issue Date - Enter the issue date of this security in MMDDYYYY format. For example, if the security was issued on October 4, 1985, enter 10041985. If there are multiple issue dates, enter the first such issue date.

23. Maturity Date - Enter the final maturity date of this security in MMDDYYYY format. For example, if the security's final maturity date is January 5, 2010, enter 01052010.

C. SCHEDULE 3 - CUSTODIANS USED

(Please enter your ten-digit Reporter Identification Number at the top of each page of Schedule 3.)

- 1. Reporter Identification Number** - Enter your organization's ten-digit Reporter Identification Number. If you do not know the Reporter Identification Number for your organization, please contact FRBNY staff at (212) 720-6300 or (646) 720-6300.
- 2. Sequence Number** - Enter the sequence number of this detail record, right justified. The first detail record should be assigned sequence number 1, and each succeeding Schedule 3 should be assigned a sequence number one higher than the previous record.
- 3. Custodian Code** - Please refer to Appendix G for a list of the major U.S.-resident custodians. If you do not see your U.S.-resident custodian listed in Appendix G, please enter 99 and complete items 9 through 14. (Items 4 through 8 should be completed on all Schedule 3s)
- 4. Total US\$ Fair (Market) Value of Equities Entrusted** - Enter the aggregate US\$ fair (market) value for all foreign equities that you entrusted to the organization(s) reported in the custodian code field, rounded to the nearest U.S. dollar.
- 5. Total US\$ Fair (Market) Value of Short-Term Debt (excluding asset-backed securities) Entrusted** - Enter the aggregate US\$ fair (market) value for all foreign short-term debt securities (excluding asset-backed securities) that you entrusted to the organization(s) reported in the custodian code field, rounded to the nearest U.S. dollar.
- 6. Total US\$ Fair (Market) Value of Long-Term Debt (excluding asset-backed securities) Entrusted** - Enter the aggregate US\$ fair (market) value for all foreign long-term debt securities (excluding asset-backed securities) that you entrusted to the organization(s) reported in the custodian code field, rounded to the nearest U.S. dollar.
- 7. Total US\$ Fair (Market) Value of Asset-Backed Securities Entrusted** - Enter the aggregate US\$ fair (market) value for all foreign asset-backed securities that you entrusted to the organization(s) reported in the custodian code field, rounded to the nearest U.S. dollar.
- 8. Reporting As** - Enter 1 if you are the U.S.-resident end-investor or fund manager or 2 if you are the U.S.-resident custodian that is entrusting foreign securities to the organization reported in the custodian code field. (See Appendix H for the definitions of end-investor and custodian.)

COMPLETE ITEMS 9 THROUGH 14 ONLY IF THE CUSTODIAN CODE (ITEM 3) IS 99

- 9. Name of U.S.-Resident Custodian** - Enter the full legal name of the U.S.-resident custodian to which you entrusted the securities.
- 10. Street Address of U.S.-Resident Custodian** - Enter the mailing address of the U.S.-resident custodian identified in item 9.
- 11. City** - Enter the city in which the U.S.-resident custodian identified in item 9 is located.
- 12. State** - Enter the state in which the U.S.-resident custodian identified in item 9 is located.
- 13. Zip Code** - Enter the zip code for the address of the U.S.-resident custodian identified in item 9.
- 14. Telephone Number of U.S.-Resident Custodian** - Enter the telephone number of the U.S.-resident custodian identified in item 9.

APPENDIX A: SAMPLE REPORTING SCHEDULES

Please enter your 10-digit Reporter Identification Number.....

--	--	--	--	--	--	--	--	--	--

15. Valuation Technique(s) Used to Determine Market Values

For each reporting unit, please describe the valuation technique(s) used to determine reported market values. If securities are automatically valued at zero after a specified time period of inactivity, please specify the time period and whether this applies to the security or to the client's holdings of the security. Also, please specify how securities not actively traded on the report date and those with internally generated security identification numbers are valued.

Reporting Unit Valuation Description

--	--	--

--	--	--

--	--	--

--	--	--

Please enter your 10-digit Reporter Identification Number.....

SUMMARY OF SCHEDULE 2 INFORMATION

- 16. Total Number of Schedule 2s Submitted.....
- 17. Total US\$ Fair (Market) Value of All Equity Securities , , , ,
Reported on Schedule 2(s)
- 18. Total US\$ Fair (Market) Value of All Short-Term Debt Securities... , , , ,
(excluding asset-backed securities) Reported on Schedule 2(s)
- 19. Total US\$ Fair (Market) Value of All Long-Term Debt Securities... , , , ,
(excluding asset-backed securities) Reported on Schedule 2(s)
- 20. Total US\$ Fair (Market) Value of All Asset-Backed..... , , , ,
Securities Reported on Schedule 2(s)

SUMMARY OF SCHEDULE 3 INFORMATION

- 21. Total Number of Schedule 3s Submitted..... ,
- 22. Total US\$ Fair (Market) Value of All Equity Securities , , , ,
Reported on Schedule 3(s)
- 23. Total US\$ Fair (Market) Value of All Short-Term Debt Securities... , , , ,
(excluding asset-backed securities) Reported on Schedule 3(s)
- 24. Total US\$ Fair (Market) Value of All Long-Term Debt Securities... , , , ,
(excluding asset-backed securities) Reported on Schedule 3(s)
- 25. Total US\$ Fair (Market) Value of All Asset-Backed..... , , , ,
Securities Reported on Schedule 3(s)

CERTIFYING INFORMATION

By signing the certification below you acknowledge that:

- You have read and understood the reporting requirements of this survey.
- You are aware that both civil and criminal penalties may be imposed for filing a false report; and
- You are sufficiently knowledgeable about the activities and functions of your organization that you can knowingly and with reasonable confidence certify that the information provided in this report is both accurate and complete.

Certifier's Signature: _____

26. Certifier's Name: _____

27. Certifier's Title: _____

28. Certifier's Telephone Number: _____ 29. Date Signed: _____

30. Certifier's Email Address: _____

Reporter Identification Number: Enter your 10-digit identification number.....

14a. US\$ Fair (Market) Value of Security Held..... , , ,

14b. Fair (Market) Value of Security Held Denominated in the
Currency of Issue (If US\$ is the currency of issue, then enter the
same value as item 14a.)..... , , ,

15. Intentionally Left Blank.

FOR EQUITY TYPE SECURITIES ONLY

(Security Types 1, 2, 3 or 4)

16. Number of Shares Held: Enter the number of shares held
rounded to the nearest share..... , , ,

**FOR SHORT-TERM AND LONG-TERM DEBT SECURITIES EXCLUDING
ASSET-BACKED SECURITIES**

(Security Types 5, 6, 7, 8, or 9)

17. Face Value in Currency of Denomination: Enter the face value in the
currency of denomination..... , , ,

18. Issue Date: MMDDYYYY format.....

19. Maturity Date: MMDDYYYY format.....

FOR SHORT-TERM AND LONG-TERM ASSET-BACKED SECURITIES

(Security Type 10)

20. Original Face Value in Currency of Denomination: Enter the face value.....
in the currency of denomination that would have been outstanding if no
principal had been repaid. , , ,

21. Remaining Principal Outstanding in Currency of Denomination: Enter
the remaining principal outstanding as of December 31 in the
currency of denomination. , , ,

22. Issue Date: MMDDYYYY format.....

23. Maturity Date: MMDDYYYY format.....

SCHEDULE 3: CUSTODIANS USED

- 1. Reporter Identification Number: Enter your 10-digit identification number.....
- 2. Sequence Number: From 1 to the number of Schedule 3 records submitted:
- 3. Custodian Code: Please see Appendix G for a list of custodians. If the U.S.-resident custodian used is not on the list, please enter 99 and complete items 9 through 14.
- 4. Total US\$ Fair (Market) Value of Foreign Equity Securities Entrusted to this Custodian as of December 31.....
- 5. Total US\$ Fair (Market) Value of Foreign Short-Term Debt Securities (excluding asset-backed securities) Entrusted to this Custodian as of December 31
- 6. Total US\$ Fair (Market) Value of Foreign Long-Term Debt Securities (excluding asset-backed securities) Entrusted to this Custodian as of December 31
- 7. Total US\$ Fair (Market) Value of Foreign Asset-Backed Securities Entrusted to this Custodian as of December 31
- 8. Reporting As: Please enter one of the following.....
 - 1 = U.S.-resident end-investor (as defined in Appendix H)
 - 2 = U.S.-resident custodian (as defined in Appendix H), who is in turn entrusting these securities to another U.S.-resident custodian

Complete only if the U.S.-Resident Custodian Code in Item 3 is 99:

- 9. Name of U.S.-Resident Custodian: _____
- 10. Street Address of U.S.-Resident Custodian: _____

- 11. City: _____ 12. State: _____ 13. Zip Code: _____
- 14. Telephone Number of U.S.-Resident Custodian: _____

APPENDIX B: REPORTING REQUIREMENT FLOWCHARTS

1. Reporting Requirements for Reporters that are U.S.-Resident Custodians (See Section II.A.)

Flowchart 1a - Foreign securities held in custody for your own organization or for your U.S.-resident clients that are not in turn entrusted to any other organization

Flowchart 1b - Foreign securities entrusted to the safekeeping of a U.S.-resident central securities depository

Flowchart 1c - Foreign securities held abroad, either by employing a foreign-resident custodian or by directly entrusting to a foreign-resident central securities depository

Flowchart 1d - Foreign securities entrusted to the safekeeping of another U.S.-resident custodian (excluding U.S.-resident central securities depositories)

2. Reporting Requirements for Reporters that are U.S.-Resident End-Investors (See Section II.A.)

Flowchart 2a - Foreign securities held for your own organization or for your U.S.-resident clients that are not in turn entrusted to any other organization (held in self-custody)

Flowchart 2b - Foreign securities entrusted to the safekeeping of a U.S.-resident central securities depository

Flowchart 2c - Foreign securities held abroad, either by employing a foreign-resident custodian or by directly entrusting to a foreign-resident central securities depository

Flowchart 2d - Foreign securities entrusted to the safekeeping of a U.S.-resident custodian (excluding U.S.-resident central securities depositories)

3. Determining Reportable Securities

Reporting Requirements for Reporters that are U.S.-Resident Custodians (See Section II.A.)

Flowchart 1a - Foreign securities held in custody for your own organization or for your U.S.-resident clients that are not in turn entrusted to any other organization

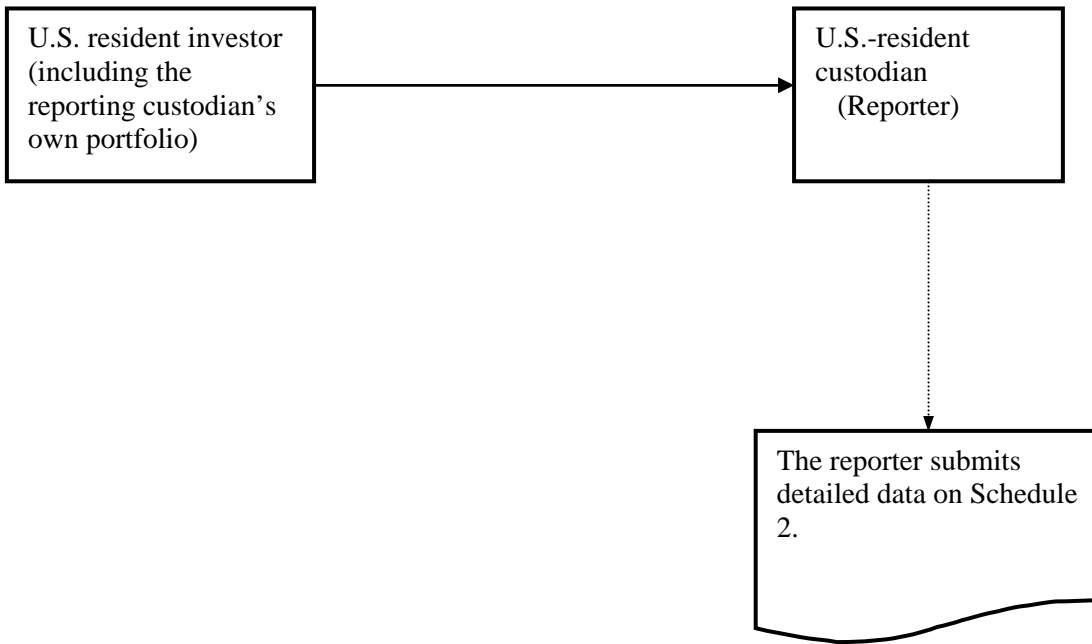

Flowchart 1b - Foreign securities entrusted to the safekeeping of a U.S.-resident central securities depository

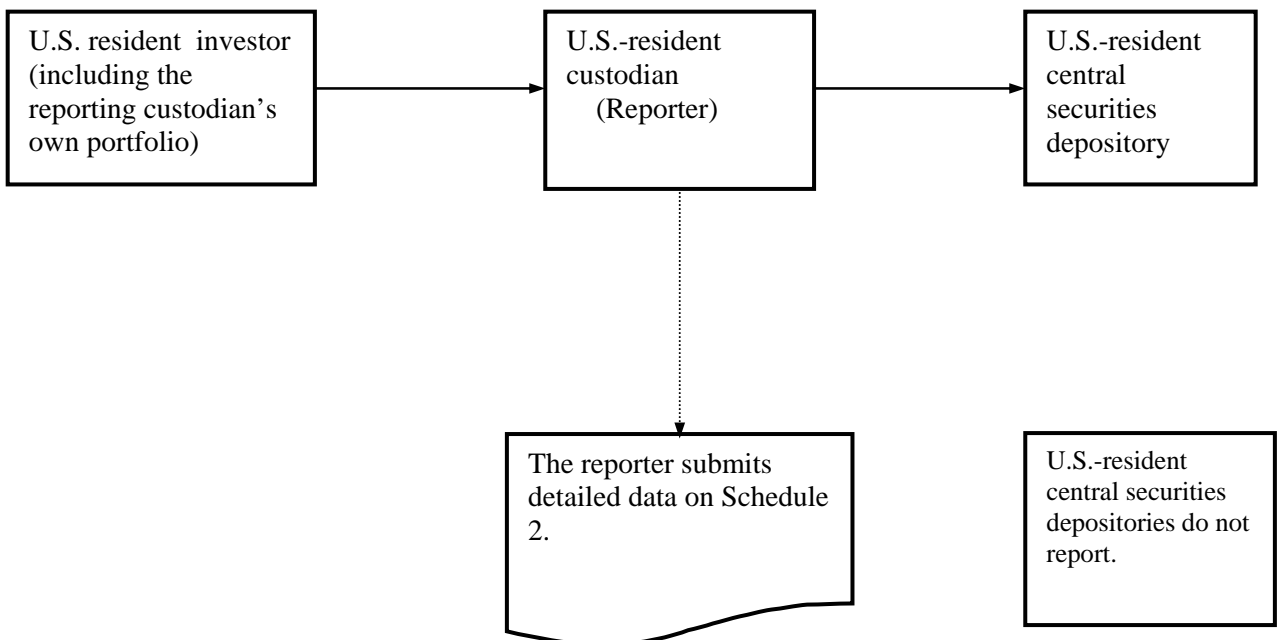

**Reporting Requirements for Reporters that are
U.S.-Resident Custodians (See Section II.A.)**

Flowchart 1c - Foreign securities held abroad, either by employing a foreign-resident custodian or by directly entrusting to a foreign-resident central securities depository

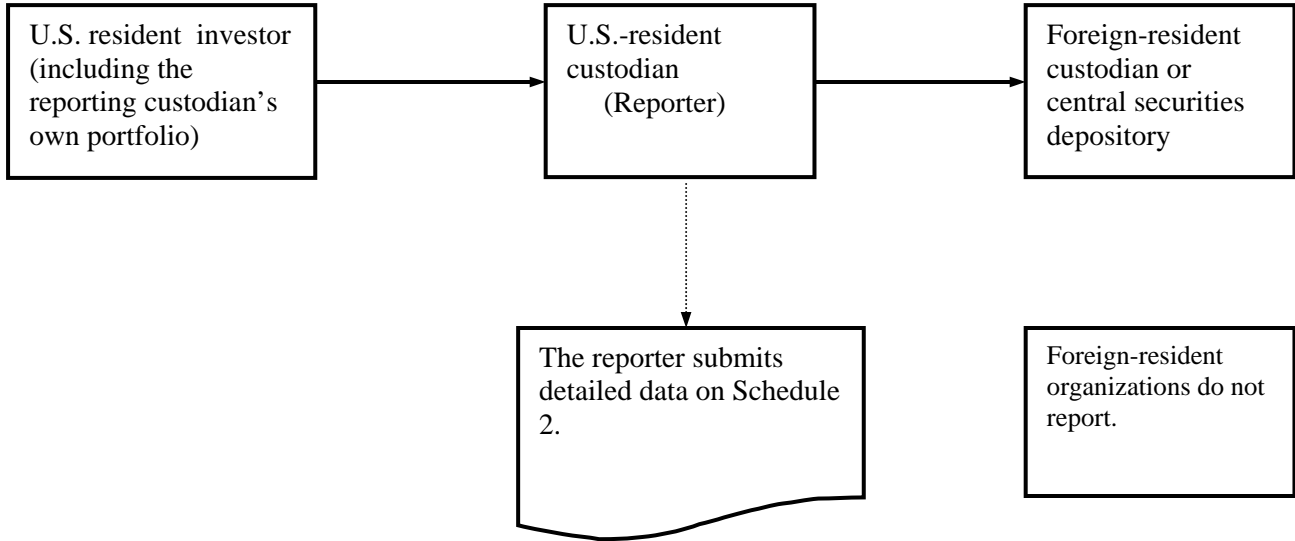

Flowchart 1d - Foreign securities entrusted to the safekeeping of another U.S.-resident custodian (excluding U.S.-resident central securities depositories)

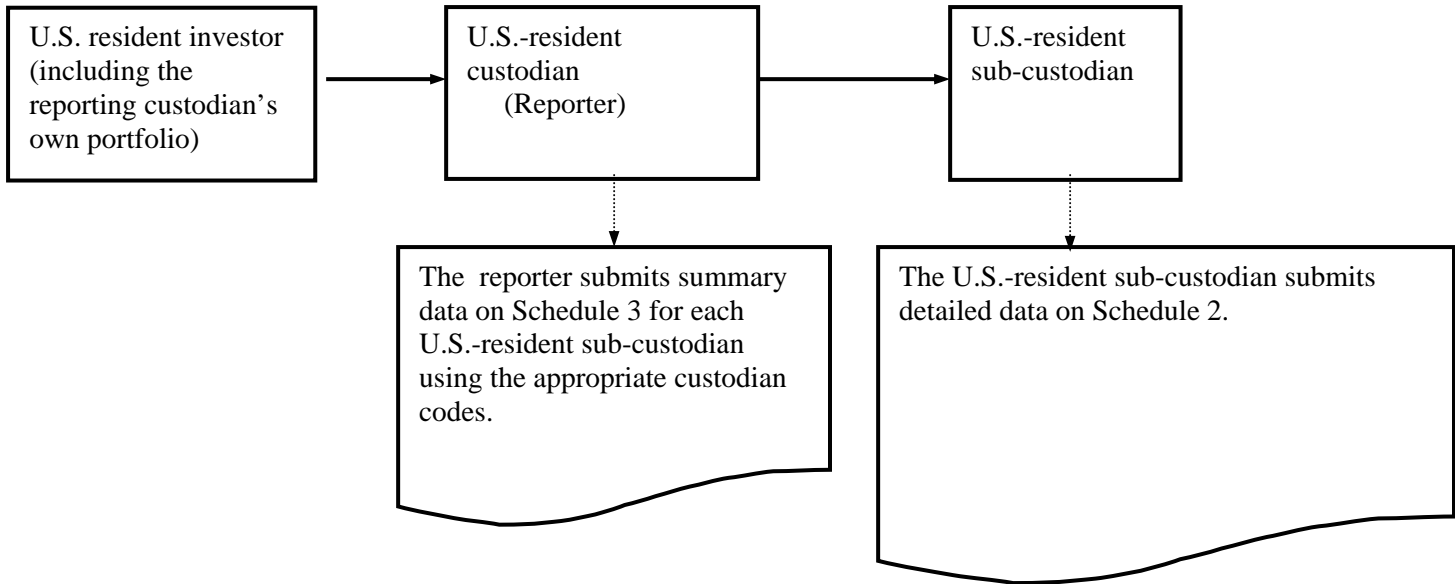

**Reporting Requirements for Reporters that are
U.S.-Resident End-Investors, including Investment Managers (See Section
II.A.)**

Flowchart 2a - Foreign securities held for your own organization or for your U.S.-resident clients that are not in turn entrusted to any organization

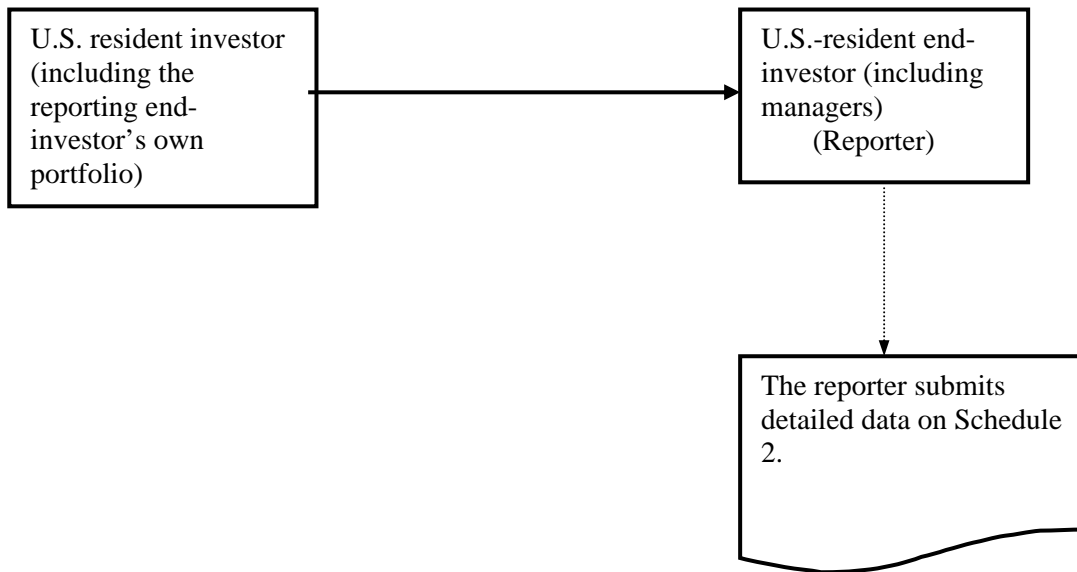

Flowchart 2b - Foreign securities entrusted to the safekeeping of a U.S.-resident central securities depository

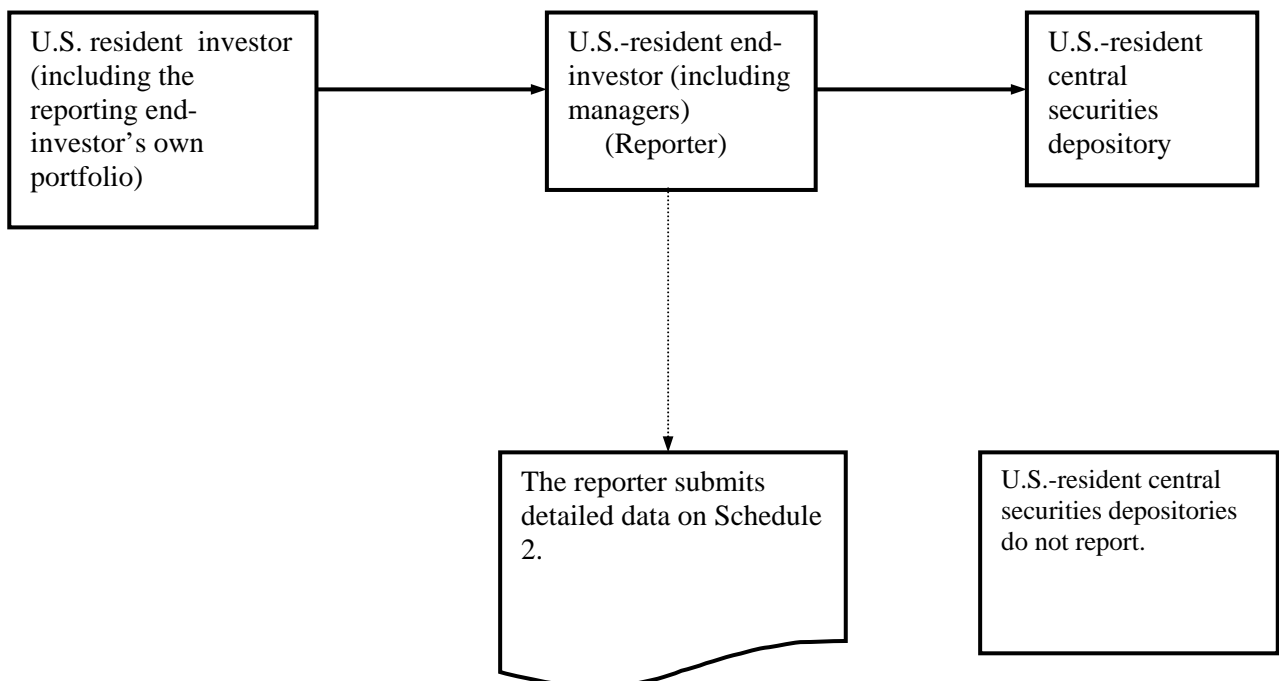

**Reporting Requirements for Reporters that are
U.S.-Resident End-Investors (See Section II.A.) (cont'd)**

Flowchart 2c - Foreign securities held abroad, either by employing a foreign-resident custodian or by directly entrusting to a foreign-resident central securities depository

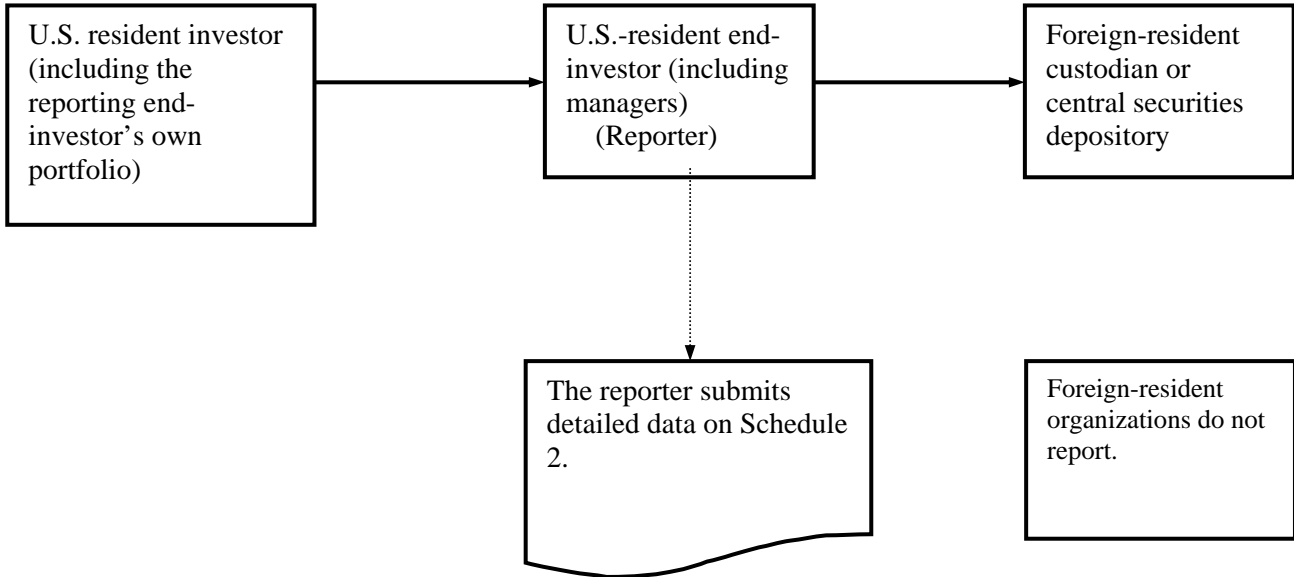

Flowchart 2d - Foreign securities entrusted to the safekeeping of a U.S.-resident custodian (excluding U.S.-resident central securities depositories)

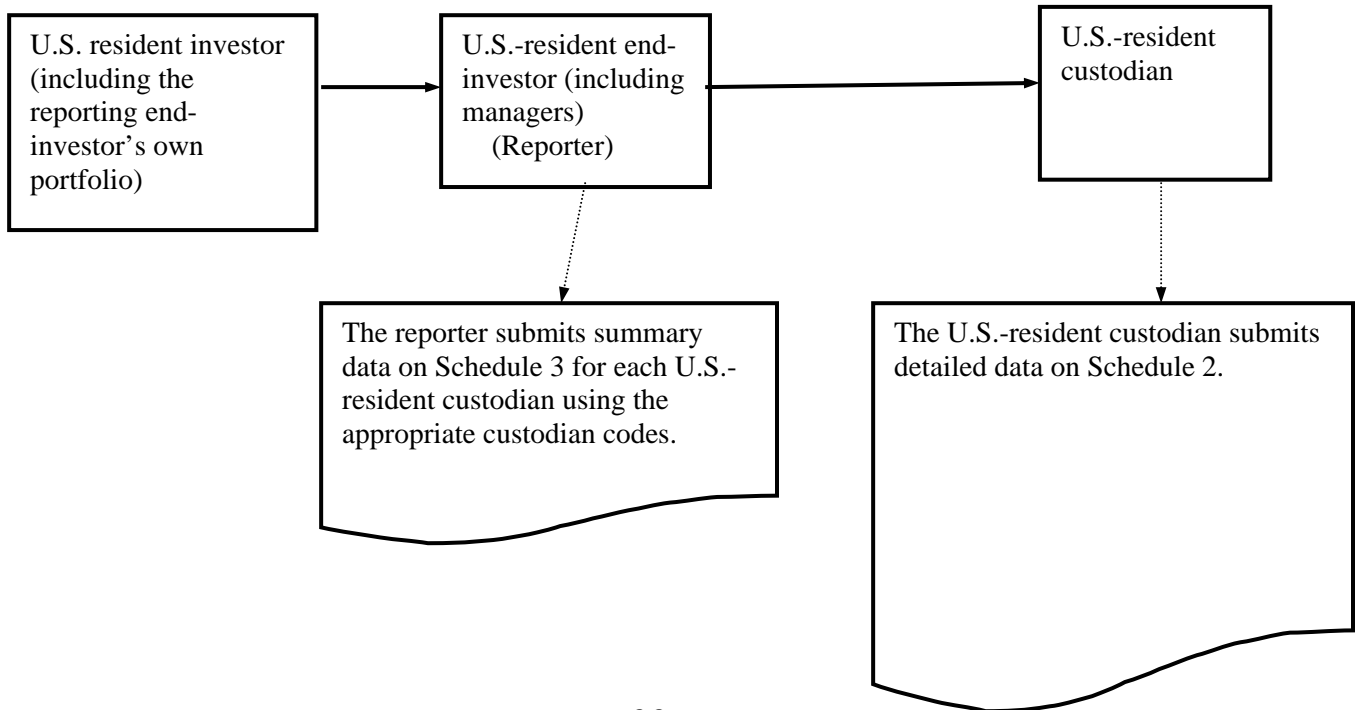

Flowchart 3 Determining Reportable Securities

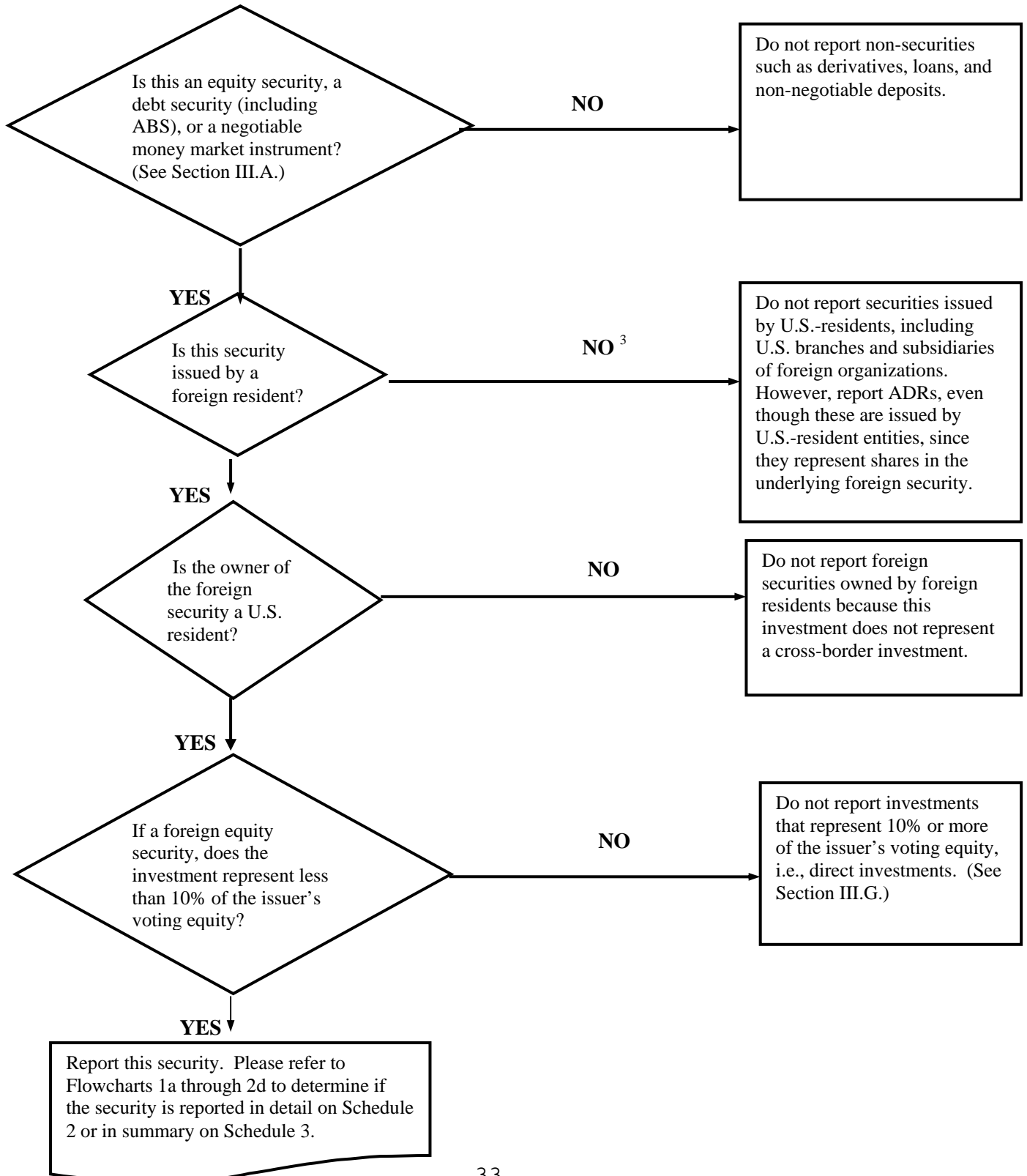

APPENDIX C: LIST OF SECURITY IDENTIFICATION SYSTEMS

Code	Issuing Country/Agency	Security Identification Coding System
Primary Codes-These codes are required; however, if they are not applicable use the secondary codes listed below.		
01	International Organization for Standardization (ISO)	ISIN (International Securities Identification Number)
02	Common Code	"European" Common Code (Clearstream/CedeUEuroclear)
31	United Kingdom	SEDOL (Stock Exchange Daily Official List)
33	United States American Securities)	CINS (CUSIP International Numbering System for Non-North
Secondary Codes — Only use these codes if none of the primary codes listed above are available.		
03	Euroclear	Euroclear Code (old)
04	Cedel	Cedel Code (old)
05	Australia	ASX Security Code (Australian Stock Exchange)
06	Austria	WPK Nummer (Wertpapier Kenn-Nummer)
07	Belgium	SVM Code (Secretariat des Valeurs Mobilieres)
08	Brazil	National Stock Exchange Association Code (Comissao Nacional de Bolsas de Valores)
09	Brazil	Rio de Janeiro Stock Exchange Code
10	Brazil	Sao Paulo Stock Exchange Code
11	Denmark	Fondskode
12	France	SICOVAM (Societe Interprofessionnelle pour la Compensation des Valeurs Mobilieres)
13	Germany	WKN Nummer (Wertpapier Kenn-Nummer)
14	Hong Kong	Stock Exchange of Hong Kong Code
15	Italy	UIC Code (Ufficio Italiano dei Cambi)
16	Italy	ABI Code (Codice Associazione Bancaria Italiana)
17	Japan	SICC Code (Security Identification Code Conference)
18	Japan	TSE Code (Tokyo Stock Exchange Code) (Toushou Code)
19	Korea	Clearing Code (Korean Stock Exchange Code)
20	Mexico	Mexican Stock Exchange Code (Clave de pizarra de la Bolsa Mexicana de Valores)
21	Netherlands	Clearing Code (Amsterdam Stock Exchange Code)
22	New Zealand	New Zealand Stock Exchange Code
23	Norway	Modified ISIN (Verdipapirsentralen) (VPS)
24	Portugal	Lisbon Stock Exchange Code
25	Portugal	Oporto Stock Exchange Code
26	South Africa	Clearing House Code (Johannesburg Stock Exchange Code)
27	Spain	CNMV Code (Comision Nacional del Mercado de Valores)
28	Sweden	VPC Number (Vardepapperscentralen)
29	Switzerland	VALOR (Valoren-Nummer)
30	Thailand	Stock Exchange of Thailand Code
32	United States	CUSIP Number (for North American Securities)
40	BB	Bloomberg security identification code issued by Bloomberg
50	RIC	Reuters Identification Code issued by Reuters

98	Your Company	Internally-Generated Code
99	Other	Other Coding System Not Specified Above

APPENDIX D

DEPARTMENT OF THE TREASURY

COUNTRY/AREA CODES

**CODES FOR COUNTRIES & AREAS TO BE USED FOR PURPOSES OF REPORTING ON TREASURY
INTERNATIONAL CAPITAL FORMS**

**The most recent version of this appendix is now a separate document.
A copy is on the TIC website, next to these instructions, at:
<http://www.treas.gov/tic/forms-sh.shtml#shc>**

APPENDIX E

DEPARTMENT OF THE TREASURY

INTERNATIONAL & REGIONAL ORGANIZATIONS

**CODES FOR INTERNATIONAL & REGIONAL ORGANIZATIONS TO BE USED FOR PURPOSES OF
REPORTING ON TREASURY INTERNATIONAL CAPITAL FORMS**

**The most recent version of this appendix is now a separate document.
A copy is on the TIC website, next to these instructions, at:
<http://www.treas.gov/tic/forms-sh.shtml#shc>**

APPENDIX F: LIST OF CURRENCY CODES (updated 10-27-08)

Code	Currency	Code	Currency
AFN	Afghanistan Afghani	CYP	Cyprus Pound
ALL	Albanian Lek	CZK	Czech Koruna
DZD	Algerian Dinar	DKK	Danish Krone
ADP	Andorran Peseta	DJF	Djibouti Franc
AOR	Angolan Kwanza Reajustado	DOP	Dominican Peso
ARS	Argentine Peso	XCD	East Caribbean Dollar
AMD	Armenian Dram	EGP	Egyptian Pound
AWG	Aruban Guilder	SVC	El Salvador Colon
AUD	Australian Dollar	ERN	Eritrea Nakfa
I AZM	Azerbaijani New Manat	EEK	Estonia Kroon
BSD	Bahamian Dollar	ETB	Ethiopian Birr
BHD	Bahraini Dinar	EUR	European Union Euro
BDT	Bangladeshi Taka	FKP	Falkland Islands Pound
BBD	Barbados Dollar	FJD	Fiji Dollar
BYR	Belarussian Ruble	GMD	Gambia Dalasi
BZD	Belize Dollar	GEL	Georgia Lari
BMD	Bermudian Dollar	GHS	Ghana Cedi
BTN	Bhutan Ngultrum	GIP	Gibraltar Pound
BOB	Bolivian Boliviano	GTQ	Guatemala Quetzal
BWP	Botswana Pula	GWP	Guinea-Bissau Peso
I BAM	Bosnia & Herzegovina Convertible Marks	GNF	Guinea Franc
BRL	Brazilian Real	GYD	Guyana Dollar
BND	Brunei Dollar	HTG	Haitian Gourde
BGN	Bulgarian Lev	HNL	Honduras Lempira
BIF	Burundi Franc	HKD	Hong Kong Dollar
KHR	Cambodian Riel	HUF	Hungarian Forint
CAD	Canadian Dollar	I SK	Iceland Krona
CVE	Cape Verde Escudo	INR	Indian Rupee
KYD	Cayman Islands Dollar	IDR	Indonesian Rupiah
XOF	CFA Franc BCEAO	IRR	Iranian Rial
XAF	CFA Franc BEAC	IQD	Iraqi Dinar
XPF	CFP Franc	JMD	Jamaican Dollar
CLP	Chilean Peso	JPY	Japanese Yen
CNY	Chinese Yuan Renminbi	JOD	Jordanian Dinar
COP	Colombian Peso	KZT	Kazakhstan Tenge
KMF	Comoro Franc	KES	Kenyan Shilling
CDF	Congolais Franc	KWD	Kuwaiti Dinar
CRC	Costa Rican Colon	KGS	Kyrgyzstan Som
HRK	Croatian Kuna	LAK	Laos Kip
CUP	Cuban Peso	LVL	Latvian Lats

Deleted: C

Code	Currency	Code	Currency
LBP	Lebanese Pound	STD	Sao Tome & Principe Dora
LSL	Lesotho Lote	SAR	Saudi Arabian Riyal
LRD	Liberian Dollar	SCR	Seychelles Rupee
LYD	Libyan Dinar	SLL	Sierra Leone Leone
LTL	Lithuanian Litas	SGD	Singapore Dollar
MOP	Macau SAR Pataca	SKK	Slovak Koruna
MKD	Macedonian Denar	SIT	Slovenia Tolar
MGF	Malagasy Franc	SBD	Solomon Islands Dollar
MWK	Malawi Kwacha	SOS	Somali Shilling
MYR	Malaysian Ringgit	ZAR	South African Rand
MVR	Maldives Rufiyaa	KRW	South Korean Won
MTL	Maltese Lira	LKR	Sri Lanka Rupee
MRO	Mauritania Oguiya	SDD	Sudanese Dinar
MUR	Mauritius Rupee	SRG	Suriname Guilder
MXN	Mexican Peso	SZL	Swziland Lilangeni
MDL	Moldovan Leu	SEK	Swedish Krona
MNT	Mongolian Tugrik	CHF	Swiss Franc
MAD	Moroccan Dirham	SYP	Syrian Pound
I MZM	Mozambique New Metical	TWD	Taiwan New Dollar
MMK	Myanmar Kyat	TJS	Tajikistan Somoni
NAD	Namibia Dollar	TZS	Tanzanian Shilling
NPR	Nepalese Rupee	THB	Thailand Baht
ANG	Netherlands Antillean Guilder	TOP	Tongan Pa'anga
ILS	New Israeli Shekel	TTD	Trinidad and Tobago
TWD	New Taiwan Dollar	TND	Tunisian Dinar
NZD	New Zealand Dollar	TRY	Turkish Yani
NIO	Nicaraguan Cordoba Oro	TMM	Turkmenistan Manat
NGN	Nigerian Naira	UGX	Uganda New Shilling
KPW	North Korean Won	UAH	Ukrainian Hryvnia
NOK	Norwegian Krone	AED	United Arab Emirates
OMR	Omani Rial	USD	United States Dollar
PKR	Pakistani Rupee	UYU	Uruguayo Peso
PAB	Panamanian Balboa	UZS	Uzbekistan Sum
PGK	Papua New Guinea Kina	VUV	Vanuatu Vatu
PYG	Paraguay Guarani	VEB	Venezuelan Bolivar
PEN	Peruvian New Sol	VND	Vietnamese Dong
PHP	Philippine Peso	YER	Yemeni Rial
PLN	Polish Zloty	YUM	Yugoslavian Dinar
GBP	Pound Sterling	ZMK	Zambian Kwacha
QAR	Qatari Rial		
RON	Romanian Leu		
RUB	Russian Ruble		
RWF	Rwanda Franc		
SHP	Saint Helena Pound		
WST	Samoan Tala		

1

Deleted: L

APPENDIX G: LIST OF CUSTODIAN CODES

If your securities are held by any U.S. affiliate of one of these custodians listed below, please use the custodian code of that firm

THE FOLLOWING CODES SHOULD BE USED BY ALL REPORTERS

<u>Name of U.S.-Resident Custodian</u>	<u>Custodian Code</u>
ABN-Amro Bank N.V. (U.S.-resident branches)	01
Bank Julius Baer & Co. Ltd (U.S.-resident branch)	02
Bank of Bermuda Limited, The	03
Bank of New York Mellon Corporation (including but not limited to Bank of New York , The and affiliates of the former Mellon Financial Corporation)	04
Barclays Global Investors Services	24
BNP Paribas (U.S.-resident branches)	07
Brown Brothers Harriman & Co.	08
Citigroup Inc./Citibank, N.A. (including but not limited to Salomon Smith Barney)	09
Credit Agricole Indosuez North America Inc.	10
Credit Lyonnais (U.S.-resident branches)	11
Deutsche Bank Aktiengesellschaft (U.S.-resident branches)	12
Dresdner Bank Aktiengesellschaft (U.S.-resident branches)	13
Fidelity Management and Research Corp.(FMR Corp.) (including but not limited to Fidelity Investments, Fidelity Management Trust Company, and National Financial Services Corporation)	26
Fifth Third Bancorp/Fifth Third Bank	25
Goldman Sachs Group L.P.	27
HSBC North America Inc./HSBC Bank USA, N.A.	14

<u>Name of U.S.-Resident Custodian</u>	<u>Custodian Code</u>
JPMorgan Chase & Co./JPMorgan Chase Bank	16
Merrill Lynch & Company, Inc.	28
Morgan Stanley, Dean Witter & Co.	29
Northern Trust Company, The	18
PNC Financial Services Group, Inc., The (including but not limited to PNC Bank, N.A., PFPC)	30
Societe Generale (U.S.-resident branches)	19
State Street Bank and Trust Company (including but not limited to International Fund Services, Investors Financial Services Corporation, Investors Bank and Trust , and Investors Trust Company)	20
Taunus Corporation/Deutsche Bank Trust Company Americas (including but not limited to Deutsche Bank Securities Inc.)	6
UBS AG (U.S.-resident branches)	21
UBS Financial Services Inc.	59
UBS Securities LLC	60
Union Bancorp/Union Bank of California, N.A.	22
UMB Financial Corporation/UMB Bank N.A.	33
U.S. Bancorp/U.S. Bank N.A.	32
Wachovia Corporation /Wachovia Bank N.A. (including but not limited to A.G. Edwards & Sons, Inc.)	34
Wells Fargo & Co./Wells Fargo Bank, N.A.	35
U.S.-Resident custodian that is not listed above	99

APPENDIX H: GLOSSARY

AMERICAN DEPOSITARY RECEIPT (ADR) – Negotiable certificates, typically issued by a U.S.-resident company, for shares of stock issued by a foreign corporation. The securities are held in a custodial account, either at the issuing bank or by an agent. The ADR should be reported, not the foreign securities held by the depository. Report the ADR as common stock (security type=1) if the underlying foreign security is common stock or as preferred stock (security type =2) if the underlying foreign security is preferred stock. (See Section III.E for more information on the correct reporting of these securities.)

AMERICAN DEPOSITARY SHARE (ADS) – Negotiable securities certificate issued in the United States by transfer agents acting on behalf of foreign issuers, where the foreign issuers absorb part or all of the handling costs involved. The ADS should be reported, not the foreign securities held in custody. Report the ADS as common stock (security type =1) if the underlying foreign security is common stock or as preferred stock (security type =2) if the underlying foreign security is preferred stock. (See Section III.E for more information on the correct reporting of these securities.)

ASSET-BACKED SECURITIES – Securitized interests in a pool of assets, which give the purchaser a claim against the cash flows generated by the underlying assets. These pools may be derived from mortgage loans, auto loans, credit card receivables, vehicle and equipment leases, consumer loans, commercial loans or other assets. Include as asset-backed securities (ABS): CMOs, CLOs, CBOs and CDOs. ABS give the holder an undivided interest in the securitized assets and payments made from the cash flows received by the issuer from the payments of principal and interest from the borrowers. (ABS do not include securities, such as covered bonds or pfandbriefes, where the security is collateralized, but the holder of the security does not have a claim of the cash flows generated by the collateral.) ABS, including stripped ABS, are reported as security type 10 (asset-backed security), **except** for asset-backed commercial paper, which is reported as security type 5 (commercial paper).

BEARER BOND – Securities that are not registered in the name of their owner. The owner collects interest and dividends upon presentation of detachable coupons to a bank or fiduciary agent. These securities are reported as security type 9 (unstripped bond or note and all other long-term debt).

BRADY BONDS – Collateralized dollar-denominated bonds issued by a foreign government or central bank in exchange for loans under the Brady Plan. These securities are reported as all other long-term debt (security type = 9).

COMMERCIAL PAPER – A promissory note, either unsecured or backed by assets such as loans or mortgages. They are usually sold at a discount and customarily have a fixed maturity of 270 days or less. All commercial paper should be reported as security type = 5 (commercial paper)

COMMINGLED ACCOUNT – An account in which the investment funds of individual clients are pooled, with each client owning portions of the pooled account. Foreign securities held in commingled accounts should be reported.

CONVERTIBLE BOND – A bond that can be exchanged at a set price for equity securities by the holder under certain conditions. These securities are reported as convertible debt (security type = 7).

COVERED BOND – Also known as Mortgage Bond or Pfandbriefe. A bond that is backed by loans, typically mortgages, but does not give the purchaser a claim against the cash flows generated by the

underlying assets. These securities are reported as security type 9 (unstripped bond or note and all other long-term debt).

CUSTODIAN – A bank or other organization that manages or administers the custody or safekeeping of stock certificates, debt securities, or other assets for institutional and private investors.

DEPOSITARY RECEIPTS – See American Depositary Receipts (ADR). Related types of depositary receipts, such as Global Depositary Receipts, are reported in the same manner as ADRs.

DEPOSITORY – An entity that holds securities, either in certificated or uncertificated (dematerialized) form, to enable the transfer of ownership of securities. Depositories are not necessarily custodians, since they may be responsible only for registering and settling security transactions.

DERIVATIVE CONTRACT – Financial instrument or other contract with all three of the following characteristics:

1. (a) One or more underlyings; (b) one or more notional amounts; and (c) payment provisions. These terms determine the amount of the settlement or settlements, and, in some cases, whether or not a settlement is required.
2. Requires no initial investment, or an initial net investment that is much smaller than would be required for other types of contracts that would be expected to have a similar response to changes in market factors.
3. The terms require or permit net settlement, it can readily be settled net by a means outside the contract, or it provides for delivery of an asset that puts the recipient in a position not substantially different from net settlement.

Derivative contracts are excluded from the report. Embedded derivatives that are not bifurcated under FAS 133 should be reported without separating the embedded derivative from the host contract. However, if the embedded derivative is bifurcated from the host contract, then the derivative should be excluded from the report and the host security should be included on the report.

DEVELOPMENT BANKS – Entities owned by national governments and established to promote economic development of sectors of the economy, such as trade, housing, agriculture, finance and industry. Securities issued by foreign development banks should be reported.

DIRECT INVESTMENT – The beneficial ownership or control, by one person or by a group of affiliated persons, of 10 percent or more of the voting securities of another incorporated business, or an equivalent interest in an unincorporated business, including a branch. If a direct investment relationship exists, then generally, all financial flows between the firms are considered direct investment. However, for banking institutions, direct investment is limited to intercompany holdings that are permanent investment. Direct investment positions are excluded from this report.

END-INVESTOR – An entity that invests in foreign securities for its own account (for trading, investment, or any other purpose) or invests on behalf of others, including asset pools, such as managers of mutual funds, managers of insurance company policyholder assets, and pension fund managers. (See Section II.A for examples of end-investors.)

FOREIGN RESIDENT - Any individual, corporation, or other organization located outside the United States. A corporation incorporated outside the United States is a foreign resident even if it has no physical presence outside the United States. Foreigners/foreign residents include:

1. Individuals, including citizens of the United States, residing outside the United States.
2. Entities that have filed an IRS Form W-8, indicating that the individual or entity is a nonresident alien or foreign entity not subject to certain United States information return reporting or to backup withholding rules.
3. Any corporation or other organization located outside the United States, including branches, subsidiaries and other affiliates of U. S. entities located abroad.
4. Foreign governments and any subdivision, agency or instrumentality thereof, including all foreign official nonbanking institutions, even if located in the United States (e.g., an embassy, consulate, or other diplomatic establishment of a foreign country). (However, all U.S.-resident subsidiaries of foreign corporations, including government-owned foreign corporations, are U.S. residents.)
5. International or regional organizations or subordinate or affiliated agencies thereof, created by treaty or convention between sovereign states, even if located in the United States, including the International Bank for Reconstruction and Development (IBRD or World Bank), the International Monetary Fund (IMF), and the United Nations (UN). (See Appendix E for a list of international and regional organizations.)

FOREIGN-RESIDENT CUSTODIAN – A custodian located outside the United States, including a foreign affiliate of a U.S. custodian. Reporters should determine the location of a custodian according to the country in which the custodian is incorporated, or otherwise legally established, not according to the country of the custodian's parent firm, and not according to the location of the custodian's operations center.

FOREIGN SUB CUSTODIAN – A foreign institution that holds in safekeeping foreign securities for a U.S.-resident custodian.

FUNDS – Pooled, separate and general investment accounts of one or more of the following institutional and private investors: private and public pension funds; mutual funds, country funds, exchange traded funds, unit investment trusts, collective-investment trusts, and any other similarly pooled, commingled investment funds; insurance companies; foundations; institutions of higher learning; government-sponsored enterprises and other independently acting government agencies; financial and nonfinancial corporations; investment advisors; trusts and estates; and private individuals. U.S. ownership of shares of foreign-resident funds are reported as funds (security type= 3), regardless of the types of securities held by the fund. Foreign securities held in U.S.-resident funds should also be reported. (See Section III.0 for the correct reporting of funds.)

INVESTMENT TRUST SHARE – A share of a company bound by a trust deed issued in registered form, formed to invest in specific types of securities. Shares in an investment trust can usually be bought and sold only through the stock exchange. Sometimes referred to as a 'closed-end' fund. Investment trust shares are reported as fund shares (security type =3), regardless of the types of securities held by the trust.

LONG-TERM – No contractual maturity or an original maturity of more than one year.

LONG-TERM DEBT SECURITY – Debt security with no contractual maturity or with an original maturity of more than one year.

NATIONALIZED BANK – Institution owned by a foreign central government that is classified as a bank in its own country. A nationalized bank is considered to be an official organization only if it also performs the functions of a central bank.

NEGOTIABLE CERTIFICATES OF DEPOSIT – A negotiable (transferable) instrument or deposit in book entry form evidenced by a receipt or similar acknowledgement issued by a bank, which provides on its face that the amount of such deposit is payable to bearer or any specified person (e.g., deposit notes, bank notes). These negotiable money market instruments should be reported as security type 6.

SECURITY – Any bill, note, bond, debenture, equity, negotiable money market instrument, or similar instrument that is commonly referred to as a security, whether or not it is tradeable. Do not include loans, even if tradeable. See Section III.A for a list of reportable foreign securities.

SETTLEMENT DATE – The date a security is delivered to the purchaser.

SETTLEMENT DATE ACCOUNTING – Under settlement date accounting, the purchase and sale of assets are not recorded until the settlement date. Settlement date accounting should be used for purposes of this report.

SHORT-TERM – Original maturity of one year or less.

SHORT-TERM DEBT SECURITY – Debt security, including negotiable money market instruments, with an original maturity of one year or less.

STRUCTURED NOTE OR BOND – An over-the-counter financial instrument created specifically to meet the needs of one or a small number of investors. Some of the more common structures include: step-up bonds, index amortizing notes, dual index notes, deleveraged bonds, range bonds, and inverse floaters. These securities are reportable debt securities.

SUBORDINATED DEBT – A security evidencing debt that the holder agrees to rank after senior creditors, but before shareholders, in a bankruptcy.

SUBSIDIARY – A company in which another company (parent) owns 50 percent or more of the voting securities, or an equivalent interest.

TREASURY BILL – a common form of sovereign debt issued by many governments. Foreign treasury bills should be reported as security type 9 (unstripped bond or note and all other non-asset-backed debt).

UNITED STATES – The fifty (50) States of the United States, the District of Columbia, the Commonwealth of Puerto Rico, the Commonwealth of the Northern Mariana Islands, and the following: American Samoa, Baker Island, Guam, Howland Island, Jarvis Island, Johnston Atoll, Kingman Reef, Midway Islands, Navassa Island, Palmyra Atoll, the U.S. Virgin Islands, and Wake Island.

UNIT INVESTMENT TRUST – A fixed portfolio of securities that are assembled by an underwriter sponsor and upon completion of the underwriting, are deposited with an independent trustee. Unit investment trusts have a definite termination date, usually between 6 months and 10 years. U.S. ownership of shares of foreign-resident unit investment trusts are reported as fund shares (security type = 3), regardless of the types

of securities in held by the trust. Foreign securities held in U.S.-resident unit investment trusts should also be reported. (See Section III.0 for the correct reporting of unit investment trusts.)

U.S. RESIDENT – Any individual, corporation, or other organization located in the United States, including branches, subsidiaries and affiliates of foreign entities located in the United States. Corporations incorporated in the United States are considered to be U.S. residents even if they have no "physical presence" in the United States.

U.S.-RESIDENT CUSTODIAN – A custodian located in the United States, including a U.S.-resident affiliate of a foreign custodian.

U.S.-RESIDENT END-INVESTOR – An entity located in the United States, including a U.S. affiliate of a foreign end-investor, that either invests for its own account (for trading, investment and other purposes) or on behalf of others, including assets pools. U.S.-resident end-investors include managers of a mutual fund, managers of assets held for insurance company policyholders, and managers of pension and endowment funds.

ZERO-COUPON BOND – Bonds that do not provide interest payments. Zero coupon bonds usually have an issue price well below 100% of the face value with repayment on maturity at face value or par. The investors' return is the difference between the issue price and redemption value. These securities are reported as security type **8** (zero coupon & stripped security).

APPENDIX I: TECHNICAL INFORMATION FOR ELECTRONIC SUBMISSION

Included in this appendix are instructions for how to properly prepare data in a file for submission. Your entity must retain a copy of the data for a period of 36 months from the date of the report's submission.

I. Requirements for submitting data via IESUB

- ✓ Each file should contain data for only one Reporter Identification Number. If your entity will be reporting using multiple Reporter Identification Numbers, the data pertaining to each Reporter Identification Number must be reported in a separate file.
- ✓ Your entity must agree to the Terms and Use for Internet Reporting. This information can be found at: <http://www.treas.gov/tic/forms-sh.html>
- ✓ Your entity must have a connection to the Internet that supports the World Wide Web (WWW). Your connection must not block or disable JavaScript.
- ✓ Your entity must have a web browser program (e.g., Microsoft Internet Explorer 5.5 or higher) that supports 128-bit Secure Sockets Layer (SSL) encryption. 128-bit encryption is used for all communication between you and the Federal Reserve System.
- ✓ All Schedule 1 information must be data entered before Schedule 2 data can be submitted.
- ✓ All files must be text files and have file names ending with .TXT (e.g., Schedue_2_Company_Name.TXT)

II. Requirements for submitting data via Diskette/CD

- ✓ Each diskette/CD (media) should contain data for only one Reporter Identification Number. If your entity will be reporting using multiple Reporter Identification Numbers, the data pertaining to each Reporter Identification Number must be reported on separate media.
- ✓ Each media for a particular Reporter Identification Number must be accompanied by a paper format Schedule 1.

- ✓ A dump or print out that includes at least the first ten detail records should accompany each media.
- ✓ Include a printout of the command string used to create the file if the file was created directly from the mainframe.
- ✓ Include any special instructions on how to unload the file.
- ✓ All Schedule 2 data must be provided in a standard DOS, ASCII flat file on one of the following media:
 - High density, IBM PC-compatible diskette(s)
 - Standard 700 MB CD(s)

Data must be submitted to:

Federal Reserve Bank of New York
Statistics Function, 4th Floor
33 Liberty Street
New York, NY 10045-0001

Should you have any questions concerning the instructions in this appendix, please contact the FRBNY automation staff at 212-720-1989 or 646-720-1989.

III. Electronic File Formats for both IESUB and Diskette/CD Submissions for Schedule 2(s).

Reporters must use either a semicolon-delimited format or positional format. The layouts and examples of each follows.

Semicolon Delimited Format

Data Field and Instructions	Field Format	Schedule 2 Item Number
Reporter Identification Number	N10	1
Delimiter	Semi-colon	
Sequence Number (value from 1 - maximum number of records)	N7	2
Delimiter	Semi-colon	
Reporting Unit	N3	3a
Delimiter	Semi-colon	
Name of Reporting Unit	A80	3b
Delimiter	Semi-colon	
Security ID	A12	4
Delimiter	Semi-colon	
Security Description	A80	5
Delimiter	Semi-colon	
Security ID System (Refer to Appendix C)	N2	6
Delimiter	Semi-colon	
Security ID System Description	A80	6a
Delimiter	Semi-colon	
Security Type (Refer to Schedule 2, Page1)	N2	7
Delimiter	Semi-colon	
Depository Receipt/Share (Refer to Schedule 2, Page1)	N1	8
Delimiter	Semi-colon	
Name of Issuer	A80	9
Delimiter	Semi-colon	
Term Indicator (Refer to Schedule 2, Page1)	N1	10
Delimiter	Semi-colon	
Country of Issuer (Refer to Appendix D)	N5	11
Delimiter	Semi-colon	
Currency of Denomination (Refer to Appendix F)	A3	12
Delimiter	Semi-colon	
Ownership Code (Refer to Schedule 2, Page1)	N1	13
Delimiter	Semi-colon	
US\$ Fair (Market) Value of Security Held	N12	14a
Delimiter	Semi-colon	
Fair (Market) Value of Security Held Denominated in the Currency of Issue	N12	14b
Delimiter	Semi-colon	

Intentionally Left Blank	N1	15
Delimiter	Semi-colon	
Number of Shares Held	N11	16
Delimiter	Semi-colon	
Face Value in Currency of Denomination (non-ABS debt only)	N12	17
Delimiter	Semi-colon	
Issue Date (MMDDYYYY) (non-ABS debt only)	N8	18
Delimiter	Semi-colon	
Maturity Date (MMDDYYYY) (non-ABS debt only)	N8	19
Delimiter	Semi-colon	
Original Face Value in Currency of Denomination (ABS only)	N12	20
Delimiter	Semi-colon	
Remaining Principal Outstanding in Currency of Denomination (ABS only)	N12	21
Delimiter	Semi-colon	
Issue Date (MMDDYYYY) (ABS only)	N8	22
Delimiter	Semi-colon	
Maturity Date (MMDDYYYY) (ABS only)	N8	23

Data Specifications

In addition to the instructions in the above table, follow these instructions:

- Semi-colons must be used as space-delimiters between fields.
- No special characters should be present in numeric fields (e.g. currency signs, commas, negative signs, slashes, etc.).
- All numeric fields should be unpacked, unsigned and with leading zeros.
- A format specification of N12 is numeric, with length of up to 12.
- A format specification of A80 is alphanumeric, with length of up to 80.
- Issue Date and Maturity Date fields should be in the format of MMDDYYYY with leading zero for months January-September and for the 1st to the 9th day of the month (e.g. 01092004 = January 9, 2004).

External Label for Diskette/CD submissions (affix to media, not to cover)

Company Name

Reporter Identification Number as assigned by the FRBNY

Data Processing Contact Name and Telephone Number

Diskette/CD Identification Number (as identified in your records)

Total Number of Diskette/CD: 1 of __

Creation Date

Contents: Report of U.S. Ownership of Foreign Securities, Including Selected Money Market Instruments
(SHC(A))

Sample Equity Record

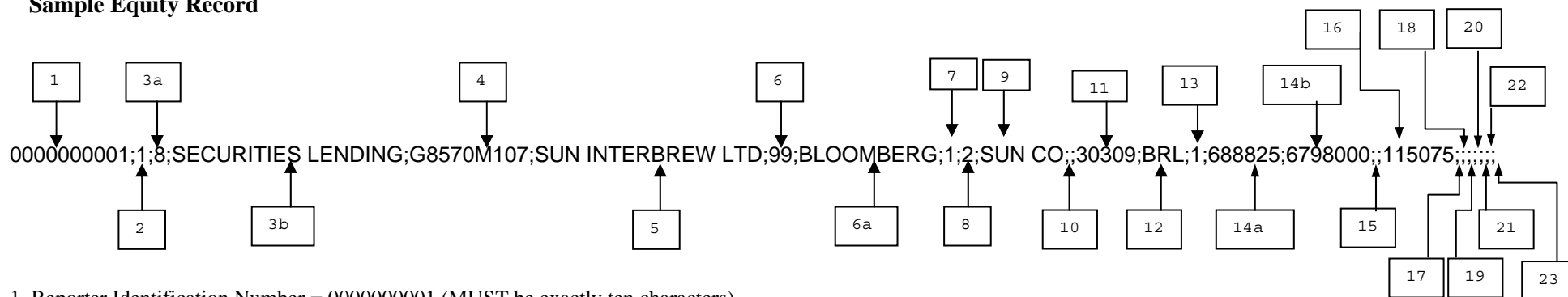

1. Reporter Identification Number = 0000000001 (MUST be exactly ten characters)
2. Sequence Number (can also be of format: 0000001)
- 3a. Reporting Unit (internal code to identify the area within your organization that the data came from)
- 3b. Name of Reporting Unit (can be up to 80 characters in length)
4. Security ID (can be up to 12 characters in length)
5. Security Description (can be up to 80 characters in length)
6. Security ID System (use security ID system codes from Appendix C)
- 6a. Security ID System "Other" (name of the organization or system that assigned the security ID)
7. Security Type (use security types listed on Schedule 2, Page 1)
8. Depository Receipt/Share (refer to Schedule 2, Page 1 for codes)
9. Name of Issuer (can be up to 80 characters in length)
10. Term Indicator – must be null for an equity record
11. Country of Issuer (use country codes listed in Appendix D)
12. Currency of Denomination (use currency codes listed in Appendix F)
13. Ownership Code (refer to Schedule 2, Page 1 for codes)
- 14a. US\$ Fair (Market) Value of Security Held (can be up to 12 characters in length)
- 14b. Fair (Market) Value of Security Held Denominated in the Currency of Issue (can be up to 12 characters in length)
15. Intentionally Left Blank
16. Number of shares held – (can be up to 11 characters in length) **Must have a value greater than zero for an equity record.**
17. Face Value in Currency of Denomination – must be null for an equity record
18. Issue Date – must be null for an equity record
19. Maturity Date – must be null for an equity record
20. Original Face Value in Currency of Denomination – must be null for an equity record
21. Remaining Principal Outstanding in Currency of Denomination – must be null for an equity record
22. Issue Date – must be null for an equity record
23. Maturity Date – must be null for an equity record

Null

Note: Null fields are to be included. They are represented by the inclusion of a delimiter as if a value were present. E.g. - ;desc;;

Sample Short-term/Long-term Debt Record (excluding Asset-Backed securities)

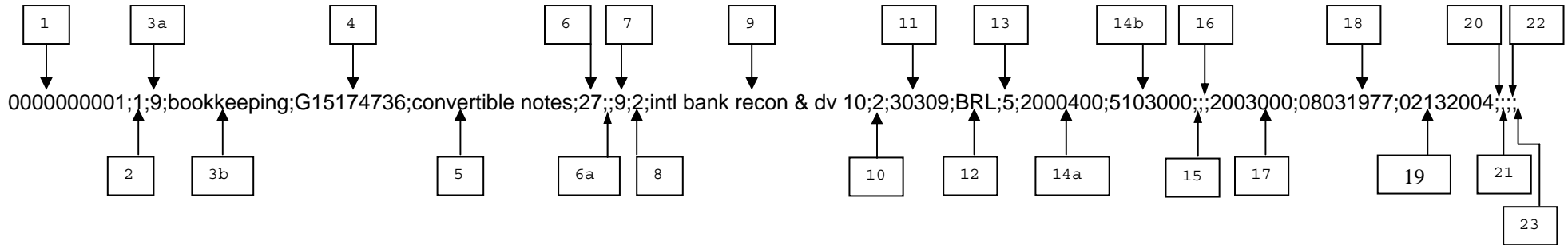

1. Reporter Identification Number = 0000000001 (MUST be exactly ten characters)
2. Sequence Number (can also be of format: 0000001)
- 3a. Reporting Unit (internal code to identify the area within your organization that the data came from)
- 3b. Name of Reporting Unit (can be up to 80 characters in length)
4. Security ID (can be up to 12 characters in length)
5. Security Description (can be up to 80 characters in length)
6. Security ID System (use security ID system codes from Appendix C)
- 6a. Security ID System "Other" (name of the organization or system that assigned the security ID)
7. Security Type (use security types listed on Schedule 2, Page 1)
8. Depository Receipt/Share (refer to Schedule 2, Page 1 for codes)
9. Name of Issuer (can be up to 80 characters in length)
10. Term Indicator (refer to Schedule 2, Page 1 for codes)
11. Country of Issuer (use country codes listed in Appendix D)
12. Currency of Denomination (use currency codes listed in Appendix F)
13. Ownership Code (refer to Schedule 2, Page 1 for codes)
- 14a. US\$ Fair (Market) Value of Security Held (can be up to 12 characters in length)
- 14b. Fair (Market) Value of Security Held Denominated in the Currency of Issue (can be up to 12 characters in length)
15. Intentionally Left Blank
16. Number of shares held – must be null for short-term/long-term debt record (excluding asset-backed securities)
17. Face Value in Currency of Denomination - (can be up to 12 characters in length). **Must have a value greater than zero for a short-term/long-term debt record (excluding asset-backed securities).**
18. Issue Date – MMDDYYYY format (08031977 = August 3, 1977)
19. Maturity Date – MMDDYYYY format (02132004 = February 13, 2004)
20. Original Face Value in Currency of Denomination – must be null for short-term/long-term debt record (excluding asset-backed securities)
21. Remaining Principal Outstanding in Currency of Denomination – must be null for short-term/long-term debt record (excluding asset-backed securities)
22. Issue Date – must be null for short-term/long-term debt record (excluding asset-backed securities)
23. Maturity Date – must be null for short-term/long-term debt record (excluding asset-backed securities)

Sample Asset-Backed Long-term Debt Record

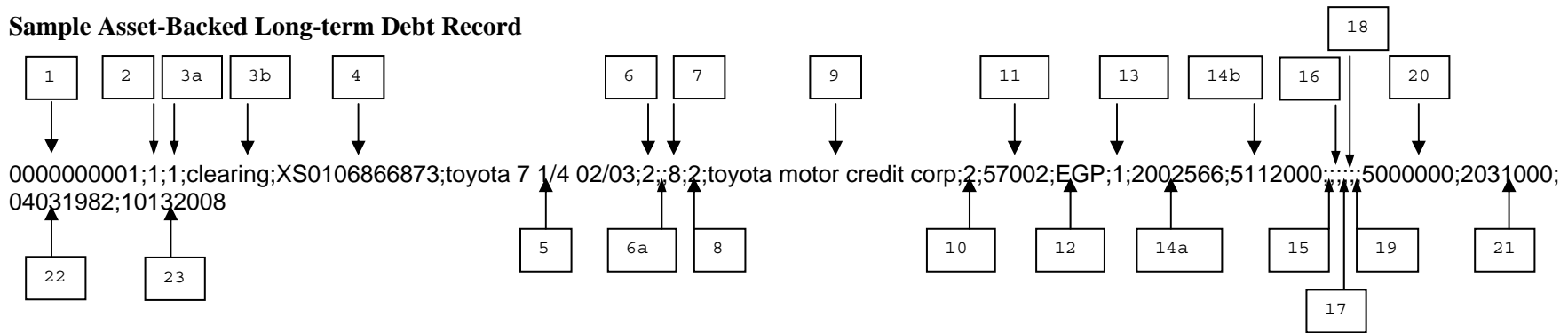

1. Reporter Identification Number = 0000000001 (MUST be exactly ten characters)
2. Sequence Number (can also be of format: 0000001)
- 3a. Reporting Unit (internal code to identify the area within your organization that the data came from)
- 3b. Name of Reporting Unit (can be up to 80 characters in length)
4. Security ID (can be up to 12 characters in length)
5. Security Description (can be up to 80 characters in length)
6. Security ID System (use security ID system codes from Appendix C)
- 6a. Security ID System "Other" (name of the organization or system that assigned the security ID)
7. Security Type (use security types listed on Schedule 2, Page 1)
- 8 Depository Receipt/Share (refer to Schedule 2, Page 1 for codes)
9. Name of Issuer (can be up to 80 characters in length)
10. Term Indicator (refer to Schedule 2, Page 1 for codes)
11. Country of Issuer (use country codes listed in Appendix D)
12. Currency of Denomination (use currency codes listed in Appendix F)
13. Ownership Code (refer to Schedule 2, Page 1 for codes)
- 14a. US\$ Fair (Market) Value of Security Held (can be up to 12 characters in length)
- 14b. Fair (Market) Value of Security Held Denominated in the Currency of Issue (can be up to 12 characters in length)
15. Intentionally Left Blank
16. Number of shares held – must be null for an asset-backed long-term debt record
17. Face Value in Currency of Denomination - must be null for an asset-backed long-term debt record
18. Issue Date – must be null for an asset-backed long-term debt record
19. Maturity Date – must be null for an asset-backed long-term debt record
20. Original Face Value in Currency of Denomination – for ABS debt only (can be up to 12 characters in length). **Must have a value greater than zero for an asset-backed long-term debt record.**
21. Remaining Principal Outstanding in Currency of Denomination – for ABS debt only (can be up to 12 characters in length). **Must have a value greater than zero for an asset-backed long-term debt record.**
22. Issue Date – MMDDYYYY format (04031982 = April 3, 1982)
23. Maturity Date – MMDDYYYY format (10132008 = October 13, 2008)

Positional Format (Record length = 496 characters)

Position	Data Field and Instructions	Field Format	Schedule 2 Item Number
1-10	Reporter Identification Number	N10	1
11	Filler (space)	Space	
12-18	Sequence Number (value from 1 - maximum number of records)	N7	2
19	Filler (space)	Space	
20-22	Reporting Unit	N3	3a
23	Filler (space)	Space	
24-103	Name of Reporting Unit	A80	3b
104	Filler (space)	Space	
105-116	Security ID	A12	4
117	Filler (space)	Space	
118-197	Security Description	A80	5
198	Filler (space)	Space	
199-200	Security ID System (Refer to Appendix C)	N2	6
201	Filler (space)	Space	
202-281	Security ID System Description	A80	6a
282	Filler (space)	Space	
283-284	Security Type (Refer to Schedule 2, Page1)	N2	7
285	Filler (space)	Space	
286	Depository Receipt/Share (Refer to Schedule 2, Page1)	N1	8
287	Filler (space)	Space	
288-367	Name of Issuer	A80	9
368	Filler (space)	Space	
369	Term Indicator (Refer to Schedule 2, Page1)	N1	10
370	Filler (space)	Space	
371-375	Country of Issuer (Refer to Appendix D)	N5	11
376	Filler (space)	Space	
377-379	Currency of Denomination (Refer to Appendix F)	A3	12
380	Filler (space)	Space	
381	Ownership Code (Refer to Schedule 2, Page1)	N1	13
382	Filler (space)	Space	
383-394	US\$ Fair (Market) Value of Security Held	N12	14a
395	Filler (space)	Space	
396-407	Fair (Market) Value of Security Held Denominated in the Currency of Issue	N12	14b
408	Filler (space)	Space	
409	Intentionally Left Blank	N1	15
410	Filler (space)	Space	
411-421	Number of Shares Held	N11	16
422	Filler (space)	Space	
423-434	Face Value in Currency of Denomination (non-ABS debt only)	N12	17
435	Filler (space)	Space	

436-443	Issue Date (MMDDYYYY) (non-ABS debt only)	N8	18
444	Filler (space)	Space	
445-452	Maturity Date (MMDDYYYY) (non-ABS debt only)	N8	19
453	Filler (space)	Space	
454-465	Original Face Value in Currency of Denomination (ABS only)	N12	20
466	Filler (space)	Space	
467-478	Remaining Principal Outstanding in Currency of Denomination(ABS only)	N12	21
479	Filler (space)	Space	
480-487	Issue Date (MMDDYYYY) (ABS only)	N8	22
488	Filler (space)	Space	
489-496	Maturity Date (MMDDYYYY) (ABS only)	N8	23

496 character logical records blocked at 60 logical records or a block size of 29,760 bytes.

Data Specifications

In addition to the instructions in the above table, follow these instructions:

- No special characters should be present in numeric fields (e.g. currency signs, commas, negative signs, slashes, etc.).
- All numeric fields should be unpacked, unsigned, **right** justified with leading zeros, e.g., COBOL PIC 9(12). A format specification of N12 is numeric, with length of up to 12.
- Alphanumeric data should be **left** justified and blank filled, e.g., COBOL PIC X(50). A format specification of A80 is alphanumeric, with length of up to 80.
- Issue Date and Maturity Date fields should be in the format of MMDDYYYY with leading zero for months January-September and for the 1st to the 9th day of the month (e.g., 01092004 = January 9, 2004)
- The filler should be a space, e.g., in COBOL PIC X value spaces.
- Columns corresponding to null or not applicable items should be space filled

External Label for Diskette/CD submissions (affix to media, not to cover)

Company Name

Reporter Identification Number as assigned by the FRBNY

Data Processing Contact Name and Telephone Number

Diskette/CD Identification Number (as identified in your records)

Total Number of Diskette/CD: 1 of __

Creation Date

Contents: Report of U.S. Ownership of Foreign Securities, Including Selected Money Market Instruments
(SHC(A))

Below are sample equity, short-term/long-term debt (excluding asset-backed securities), and asset-backed debt records for the positional file layout. For purposes of *illustration only*, a darkened circle (●) represents the filler referred to on pages [\[enter pages\]](#) between fields and an open square () represents a field position where information can be entered.

Equity:

0000000001•0000001•008•SECURITIES
 LENDING
 ●G8570M107 ●SUN INTERBREW LIMITED COMMON ●99•BLOOMBERG ●01
 STOCK
 ●2•SUN
 COMPANYINCORPORATED
 ●30309•BRL•1•000000688825•000006798000• ●00000115075•
 ● ● ● ● ● ● ● ●

Short-term/Long-term Debt Record (excluding Asset-Backed securities):

0000000001•0000002•009•BOOKKEEPING ●G15174736 ●CONVERTIBLE
 NOTES
 ●27●
 ●09•2•INTERNATIONAL BANK FOR RECONSTRUCTION
 ANDDEVELOPMENT ●2•30309•BRL•5•000002000400•000005103000●
 ● ●000002003000•08031977•02132004● ● ● ● ● ● ● ●

Asset-Backed Long-term Debt Record:

0000000001•0000003•010•CLEARING•XS0106866873 ●TOYOTA7
 1/402/03
 ●02●
 ●08•2•TOYOTA MOTOR ●2•838
 CREDITCORPORATION ●000 ●000 ● ●000
 44•EGP•1•000002002566•000005112000● ● ● ● ●000
 005000000•000002031000•04031982•10132008

436-443	Issue Date (MMDDYYYY) (non-ABS debt only)	N8	18
444	Filler (space)	Space	
445-452	Maturity Date (MMDDYYYY) (non-ABS debt only)	N8	19
453	Filler (space)	Space	
454-465	Original Face Value in Currency of Denomination (ABS only)	N12	20
466	Filler (space)	Space	
467-478	Remaining Principal Outstanding in Currency of Denomination(ABS only)	N12	21
479	Filler (space)	Space	
480-487	Issue Date (MMDDYYYY) (ABS only)	N8	22
488	Filler (space)	Space	
489-496	Maturity Date (MMDDYYYY) (ABS only)	N8	23

496 character logical records blocked at 60 logical records or a block size of 29,760 bytes.

Data Specifications

In addition to the instructions in the above table, follow these instructions:

- No special characters should be present in numeric fields (e.g. currency signs, commas, negative signs, slashes, etc.).
- All numeric fields should be unpacked, unsigned, **right** justified with leading zeros, e.g., COBOL PIC 9(12). A format specification of N12 is numeric, with length of up to 12.
- Alphanumeric data should be **left** justified and blank filled, e.g., COBOL PIC X(50). A format specification of A80 is alphanumeric, with length of up to 80.
- Issue Date and Maturity Date fields should be in the format of MMDDYYYY with leading zero for months January-September and for the 1st to the 9th day of the month (e.g., 01092004 = January 9, 2004)
- The filler should be a space, e.g., in COBOL PIC X value spaces.
- Columns corresponding to null or not applicable items should be space filled

External Label for Diskette/CD submissions (affix to media, not to cover)

Company Name

Reporter Identification Number as assigned by the FRBNY

Data Processing Contact Name and Telephone Number

Diskette/CD Identification Number (as identified in your records)

Total Number of Diskette/CD: 1 of __

Creation Date

Contents: Report of U.S. Ownership of Foreign Securities, Including Selected Money Market Instruments
(SHC(A))

Below are sample equity, short-term/long-term debt (excluding asset-backed securities), and asset-backed debt records for the positional file layout. For purposes of *illustration only*, a darkened circle (●) represents the filler referred to on pages [\[enter pages\]](#) between fields and an open square () represents a field position where information can be entered.

Equity:

0000000001•0000001•008•SECURITIES
 LENDING
 ●G8570M107 ●SUN INTERBREW LIMITED COMMON ●99•BLOOMBERG ●01
 STOCK
 ●2•SUN
 COMPANYINCORPORATED
 ●30309•BRL•1•000000688825•000006798000• ●00000115075•
 ● ● ● ● ● ● ● ●

Short-term/Long-term Debt Record (excluding Asset-Backed securities):

0000000001•0000002•009•BOOKKEEPING ●G15174736 ●CONVERTIBLE
 NOTES
 ●27●
 ●09•2•INTERNATIONAL BANK FOR RECONSTRUCTION
 ANDDEVELOPMENT ●2•30309•BRL•5•000002000400•000005103000●
 ● ●000002003000•08031977•02132004● ● ● ● ●

Asset-Backed Long-term Debt Record:

0000000001•0000003•010•CLEARING•XS0106866873 ●TOYOTA7
 1/402/03
 ●02●
 ●08•2•TOYOTA MOTOR ●2•838
 CREDITCORPORATION ●000 ●000 ●000 ●000
 44•EGP•1•000002002566•000005112000● ● ● ● ●000
 005000000•000002031000•04031982•10132008