

**Report on
U.S. Portfolio Holdings of
Foreign Securities**

as of December 31, 2007

**Department of the Treasury
Federal Reserve Bank of New York
Board of Governors of the Federal Reserve System**

October 2008

Table of Contents

Introduction	1
Chapter 1. Results of the December 30, 2007 Survey	3
<i>U.S. Holdings over Time by Type of Security</i>	3
Table 1. Market value of U.S. holdings of foreign securities, by type of security, as of the survey dates.....	3
<i>U.S. Portfolio Investment by Country</i>	4
Table 2. Market value of U.S. holdings of foreign securities, by country and type of security, for the countries attracting the most U.S. investment, as of December 31, 2007.....	4
Table 3. Market value of U.S. holdings of foreign long-term securities, for the countries attracting the most U.S. investment, as of the survey dates.....	6
<i>Measured and Estimated Values of U.S. Holdings of Foreign Long-Term Securities</i>	6
Table 4. Measured and estimated market values of U.S. holdings of foreign long-term securities, by type of security, as of December 31, 2007.....	7
<i>U.S. Portfolio Investment Abroad Compared with Foreign Portfolio Investment in the United States</i>	7
Table 5. Market value of U.S. holdings of foreign long-term securities and foreign holdings of U.S. long-term securities, selected dates, 1994-2007.....	8
<i>Details of U.S. Equity Investment by Country</i>	9
Table 6. Market value of U.S. holdings of foreign equities, by country, and type of equity, for the countries attracting the most U.S. investment, as of December 31, 2007.....	9
Table 7. Market value of U.S. holdings of foreign equities, by country, size of domestic equity markets, and share of each market that is U.S. held, for selected countries and regions, as of December 31, 2007.....	11
Table 8. Market value of U.S. holdings of foreign equities, by country and amount held in depositary receipts, for the countries attracting the most U.S. investment, as of December 31, 2007.....	12
<i>U.S. Investment in Foreign Debt Securities by Currency of Denomination</i>	13
Table 9. Market value of U.S. holdings of foreign debt securities, by currency of denomination, as of December 31, 2006 and December 31, 2007.....	13

Table 10. Market value of U.S. holdings of foreign long-term debt securities, by currency, for selected regions and countries, as of December 31, 2007	14
<i>U.S. Holdings of Foreign Private and Government Debt</i>	15
Table 11. Market value of U.S. holdings of foreign debt securities, by country and sector of issuer, as of December 31, 2007	15
Table 12. Market value of U.S. holdings of foreign long-term debt securities, by country and sector of issuer, denominated in U.S. dollars and in local currency, as of December 31, 2007	16
<i>U.S. Holdings of Asset-backed Securities</i>	17
Table 13. Market value of U.S. holdings of foreign long-term asset-backed securities, for the countries attracting the most U.S. investment, as of December 31, 2006 and December 31, 2007	17
<i>Maturity Structure of U.S. Foreign Debt Holdings</i>	18
Table 14. Maturity structure of U.S. holdings of foreign long-term debt securities, by remaining maturity, as of December 31, 2006 and December 31, 2007	18
<i>U.S. Portfolio Investment Abroad by Type of Market and Geographic Region</i>	18
Table 15. Market value of U.S. holdings of foreign securities in advanced economies, Caribbean financial centers, and developing countries, as of December 31, 2006 and December 31, 2007	19
Table 16. Market value of U.S. holdings of foreign securities, by geographic region, as of December 31, 2006 and December 31, 2007.....	20
<i>U.S. Ownership of Foreign Securities by Industry</i>	20
Table 17. Market value of U.S. holdings of foreign securities, by industry, as of December 31, 2007.....	21
<i>Comparison of different types of U.S. portfolio investment abroad as of selected dates</i>	21
Table 18. Forms of U.S. portfolio investment abroad, as of selected survey dates.....	22
Chapter 2. Data Collection Methodology	23
Statistical Appendix	26
Table 19. Market value of U.S. holdings of foreign securities, by country and type of security, as of December 31, 2007	27
Table 20. Market value of U.S. holdings of foreign long-term securities, by country, as of selected survey dates.....	31

Table 21. Market value of U.S. holdings of foreign equities, by country, as of selected survey dates	36
Table 22. Market value of U.S. holdings of foreign long-term debt securities, by country, as of selected survey dates.....	41
Table 23. Market value of U.S. holdings of foreign short-term debt securities, by country, as of the survey dates.....	46
Table 24. Market value of U.S. holdings of foreign long-term debt securities, by country and currency, as of December 31, 2007	51
Table 25. Market value of U.S. holdings of foreign short-term debt securities, by country and currency, as of December 31, 2007	54
Table 26. Market value of U.S. holdings of foreign long-debt securities, by country and type of security, as of December 31, 2007	56
Table 27. Market value of U.S. holdings of foreign short-debt securities, by country and type of security, as of December 31, 2007	59
Table 28. Market value of U.S. holdings of foreign debt securities, by country and sector of issuer, as of December 31, 2007	61
Table 29. Market value of U.S. holdings of foreign long-term debt securities, by country and sector of issuer, denominated in U.S. dollars and in local currency, as of December 31, 2007	64
Table 30. Market value of U.S. holdings of foreign equities, by country and type of security, as of December 31, 2007	66
Table 31. Market value of U.S. holdings of foreign equities, by country and amounts held as Depositary Receipts, as of December 31, 2007	70
Table 32. Market value of U.S. holdings of foreign equities, by country, size of domestic equity markets, and percentage of each market that is U.S.-held, as of December 31, 2007	74
Table 33. Market value of U.S. holdings of foreign securities, by industry, as of December 31, 2007	78
Forms and Instructions	80

Introduction

This report presents data and analyses regarding U.S. portfolio investment in foreign equity and debt securities.¹ The data are drawn primarily from the latest survey of U.S. holdings of foreign securities as of December 31, 2007. The survey was a joint undertaking of the U.S. Treasury Department, the Federal Reserve Bank of New York, and the Board of Governors of the Federal Reserve System. The 2007 survey was the eighth survey of U.S. ownership of foreign securities conducted by the United States. Prior surveys were conducted as of March 31, 1994, December 31, 1997, December 31, 2001, December 31, 2003, December 31, 2004, December 31, 2005, and December 31, 2006.²

The surveys were initiated as the level of U.S. investment in foreign securities began to grow significantly in the 1990s. The first two U.S. surveys measured only holdings of foreign long-term securities. However, beginning with the 2001 survey, information has been collected on U.S. holdings of both foreign long-term and short-term securities.³ The first three surveys were conducted at widely-spaced intervals and were “benchmark” surveys; that is, they collected data from a large number of institutions in an attempt to measure total U.S. holdings as comprehensively as practical. Beginning with the December 2003 survey, surveys have been conducted annually. Full benchmark surveys continue to be conducted at five-year intervals. In the four years following each benchmark survey, annual data are collected from only the largest respondents in the preceding benchmark survey, with results grossed up to account for unmeasured holdings. The last full benchmark survey was the December 2006 survey. For the 2007 survey, data were collected from the respondents who collectively accounted for about 99 percent of the 2006 survey holdings, and thus results presented in this report are grossed up to be comparable to the more comprehensive benchmark results. Details of the gross-up procedure are described in Chapter 2.

This report contains three tables not contained in the 2006 report. New Table 6 reports the market value of U.S. holdings of foreign equity by type of equity, with information provided on U.S. holdings of common stock as well as fund shares and preferred stock and other forms of equity. This table is introduced to provide information on the growing amounts of fund shares that U.S. investors hold in some countries. Table 12 provides additional information on the amounts of long-term debt securities issued by foreign government and foreign private sectors denominated in U.S. dollars and in the issuing country’s own currency. This table is included

¹ U.S. portfolio investment in foreign securities, for the purposes of this report, includes all foreign securities owned by U.S. residents except those in which the owner has a direct investment relationship with the foreign issuer of the securities. Direct investment means the ownership or control, directly or indirectly, by one person or by a group of affiliated persons, of 10 percent or more of the voting stock of an incorporated business enterprise, or an equivalent interest in an unincorporated enterprise. Data on direct investment are collected by the Bureau of Economic Analysis (BEA), Department of Commerce, and published in the Survey of Current Business and on the BEA web site.

² The Treasury Department conducted a survey during World War II of all foreign assets owned by U.S. residents as of May 1943. That survey measured portfolio investment as well as other forms of investment, but it is removed in time and in purpose from the modern survey program that began with the 1994 survey.

³ Long-term securities are defined as all equity securities and all debt securities with an original term-to-maturity of more than one year. Short-term securities are debt securities with an original term-to-maturity of one year or less.

because of the growing interest in local currency bond markets in developing countries and the degree to which U.S. investors are participating in these markets. Table 18 provides a comprehensive historical perspective of total U.S. portfolio investment abroad for each of the survey dates.

The surveys collect information at the individual security level, making possible both detailed analysis and the presentation of data in a wide variety of ways, such as by country, security type, currency, remaining term-to-maturity, and industry. Experience has shown that collecting security level data produces far more accurate survey results than can be obtained by collecting aggregate information. Significant errors are detected in the security-level data that may otherwise go undetected. In addition, the collection of security level data is efficient because survey respondents need to report data in only one format, instead of aggregating and reporting their holdings in different ways, such as those shown in the tables in this report.

The U.S. surveys are part of an internationally coordinated effort under the auspices of the International Monetary Fund (IMF) to improve the measurement of portfolio asset holdings.⁴ The IMF Coordinated Portfolio Investment Surveys (CPIS) were initiated primarily because there has been a wide discrepancy between worldwide measured portfolio assets and worldwide measured portfolio liabilities, with reported liabilities exceeding reported assets. Sixty seven countries or geographic regions, including most of the industrial and financial center countries, participated in the most recent CPIS survey (measuring holdings as of December 2006). Future U.S. asset surveys will also be part of IMF-coordinated efforts and will continue to measure U.S. holdings of both long-term and short-term foreign securities.

Chapter 1 of this report presents the 2007 survey findings. Chapter 2 discusses data collection methodology. Appendix A presents a variety of statistics not included elsewhere in the report. Appendix B contains a copy of the forms and instructions used by the survey.

The Treasury Department, the Federal Reserve Bank of New York, and the Federal Reserve Board wish to express their appreciation to all survey respondents whose efforts and information have made this report possible.

⁴ International Monetary Fund, Portfolio Investment: CPIS Data Results, which can be found on the web at <http://www.imf.org/external/np/sta/pi/datarstl.htm>. Also, see the discussion regarding the CPIS following Table 1 below.

Chapter 1. Results of the December 30, 2007 Survey

The data presented in this report are drawn primarily from the survey of U.S. ownership of foreign securities conducted as of December 31, 2007. Data from previous surveys – conducted as of March 31, 1994; December 31, 1997; December 31, 2001; December 31, 2003; December 31, 2004; December 31, 2005, and December 31, 2006 – are also included in many of the tables. In all tables, components may not sum to totals because of rounding. All data are presented, to the extent possible, at market value as of the date of the survey. With the exception of zero-coupon securities, the market value of U.S. holdings of foreign securities in this report are given using “clean prices”; that is, values are computed exclusive of accrued and unpaid interest. The value of accrued and unpaid interest for U.S. holdings of foreign long-term debt securities was not estimated for the most recent survey but was calculated at approximately \$12 billion as of the December 31, 2004, survey.

U.S. Holdings over Time by Type of Security

Table 1 shows total U.S. holdings of foreign securities, by type of security held, as measured by the eight surveys conducted. U.S. holdings of foreign short-term securities were not measured in the first two surveys.

Table 1. Market value of U.S. holdings of foreign securities, by type of security, as of the survey dates

Billions of dollars

Type of security	March 1994	Dec. 1997	Dec. 2001	Dec. 2003	Dec. 2004	Dec. 2005	Dec. 2006	Dec. 2007
Long-term securities¹	870	1,755	2,170	2,954	3,553	4,346	5,623	6,855
Equity	567	1,208	1,613	2,079	2,560	3,318	4,329	5,248
Long-term debt	304	547	557	874	993	1,028	1,294	1,607
Short-term debt	n.a.	n.a.	147	199	233	263	368	357
Total	n.a.	n.a.	2,317	3,152	3,787	4,609	5,991	7,212

n.a. Not available.

1. Long-term securities are defined as those without a stated maturity date (such as equities) or with an original term-to-maturity in excess of one year.

U.S. holdings of foreign securities increased by about \$1.2 trillion in 2007, an increase of more than 20 percent, bringing the level of holdings to \$7.2 trillion. Most of U.S. holdings continued to be in the form of foreign equities, which increased by \$919 billion to reach \$5.2 trillion. As was the case in 2006, much of the increase in holdings of foreign equities was attributable to equity price gains rather than to net purchases of foreign shares. U.S. holdings of foreign long-term debt securities also increased significantly (by \$313 billion) during the year to reach \$1.6 trillion at year-end. A more complete discussion of the factors affecting the change in U.S. holdings during 2007 accompanies Table 4.

The U.S. preference for cross-border equities (as opposed to debt) is not generally shared by other major cross-border investing countries. The IMF's most recently completed Coordinated Portfolio Investment Survey (which measured each participating country's holdings of foreign

securities as of end-December 2006) shows that of the ten countries with the largest private sector holdings of foreign securities (United States, United Kingdom, Luxembourg, France, Japan, Germany, Ireland, Netherlands, Italy, and Switzerland, respectively), only the United States held more foreign equity than foreign debt.⁵

U.S. Portfolio Investment by Country

The United Kingdom was by far the first choice of U.S. international investors at the end of 2007, attracting almost twice as much U.S. investment as did Japan, the country with the next highest level of U.S. investment. The United Kingdom also attracted the highest level of investment into each type of security (equity, long-term debt, and short-term debt).

Table 2. Market value of U.S. holdings of foreign securities, by country and type of security, for the countries attracting the most U.S. investment, as of December 31, 2007

Billions of dollars					
Country or category	Total	Equity	Debt		
			Total	Long-term	Short-term
United Kingdom	1,142	715	427	286	141
Japan	594	529	65	60	4
Canada	586	379	207	185	22
Cayman Islands	544	232	312	271	41
France	448	348	100	83	17
Germany	426	329	97	89	8
Switzerland	288	281	7	4	3
Bermuda	273	256	17	17	*
Netherlands	235	154	81	76	5
Australia	223	138	84	73	11
Brazil	189	173	16	16	*
Spain	146	107	40	38	2
Rest of world	2,118	1,608	510	408	102
Total	7,212	5,248	1,964	1,607	357

* Greater than zero but less than \$500 million.

Table 19 in the Statistical Appendix shows the data in Table 2 above for an expanded list of countries.

Japan was a close second in terms of attracting U.S. equity investment, followed by Canada and France. The pattern for investment in long-term debt securities is a bit different, with the

⁵ International Monetary Fund, Portfolio Investment: CPIS Data Results, table 9, found on the web at <http://www.imf.org/external/np/sta/pi/06/Table09.pdf>.

Cayman Islands and Canada following the United Kingdom in rank order. Combined, the United Kingdom, Japan, Canada, France, and the Cayman Islands attracted nearly half of total U.S. investment in foreign long-term securities. Short-term debt securities issued by U.K.-resident issuers account for about 40 percent of all U.S. holdings of foreign short-term debt securities. The high percentage of short-term debt holdings attributed to the United Kingdom may reflect a tendency of internationally active financial firms to issue short-term debt through their United Kingdom offices.

The country attribution of U.S. holdings of foreign securities presented in this report should be very accurate. This is because information is collected at the individual security level, and in most cases it is a relatively straightforward matter to determine the country of residence of the issuer of the security. This point is made because in the companion surveys of foreign ownership of U.S. securities, chains of intermediaries involved in the custody or management of these securities can make it difficult to determine the country of residence of the ultimate beneficial owners of U.S. securities. An additional difficulty in determining ownership of U.S. securities is that ownership information typically is not available for U.S.-issued bearer (unregistered) securities.

Table 3 shows the countries attracting the most U.S. portfolio investment in their long-term securities as of the eight survey dates. Only data on long-term securities are presented because the 1994 and 1997 surveys did not collect information on short-term securities. Table 23 in the Statistical Appendix shows U.S. holdings of foreign short-term securities by country in the six most recent surveys.

By a clear margin, the United Kingdom, Japan, and Canada have occupied the top three positions in each survey. In the 1994 survey U.S. investment in these three countries was roughly equal, with Japan attracting the most U.S. investment by a small margin. But since the 1994 survey, U.S. holdings of United Kingdom securities have grown much more rapidly than have holdings of Japanese or Canadian securities.

The countries with the greatest growth rates for the 1994-2007 period are the Cayman Islands and Bermuda. The rapid growth in holdings of Bermudan securities over the period in large part reflects the fact that several large corporations changed their country of incorporation from the United States to Bermuda, which had the effect of changing what had been U.S. investment in U.S. securities into U.S. investment in Bermudan securities. The bulk of investment attributed to the Cayman Islands represents ownership of securities issued by companies that are incorporated in the Cayman Islands (a so-called “offshore financial center”) for tax or regulatory reasons but whose center of economic activity is elsewhere.

Table 3. Market value of U.S. holdings of foreign long-term securities, for the countries attracting the most U.S. investment, as of the survey dates

Billions of dollars								
Country or category	March 1994	Dec. 1997	Dec. 2001	Dec. 2003	Dec. 2004	Dec. 2005	Dec. 2006	Dec. 2007
United Kingdom	120	272	431	564	627	723	919	1,001
Japan	131	167	197	293	367	528	590	589
Canada	108	177	205	289	332	405	460	564
Cayman Islands	11	19	70	121	184	221	338	503
France	42	100	138	174	206	253	370	431
Germany	48	108	118	175	192	207	282	418
Switzerland	21	63	76	119	140	194	264	284
Bermuda	9	27	125	116	163	185	205	273
Netherlands	48	120	143	174	192	185	229	230
Australia	27	47	53	86	97	120	164	211
Rest of world	305	655	614	843	1,053	1,325	1,801	2,349
Total	870	1,755	2,170	2,954	3,553	4,346	5,623	6,855

Tables 20-23 in the Statistical Appendix show, respectively, historical data by country on U.S. ownership of total foreign long-term securities, equities, long-term debt, and short-term debt. In these tables there are some patterns of holdings that may be explained by factors other than U.S. investor sentiment. For instance, a sharp rise or decline in the level of U.S. investment could be caused by a company in country A having been acquired by a company in country B, causing what had been U.S. investment in country A to become U.S. investment in country B.

Measured and Estimated Values of U.S. Holdings of Foreign Long-Term Securities

The United States has a two-part system for measuring cross-border securities activity. In addition to annual direct surveys of *positions* discussed in this report, the system also collects monthly data on cross-border *transactions* in long-term securities.⁶ The monthly data are available with a lag of approximately 45 days and can be combined with the most recent position data to form more timely estimates of positions. The estimation procedure involves adjusting data from the preceding survey for price and exchange rate changes, adding price-adjusted transactions data, and making adjustments for estimated stock swaps and for transactions costs. It should be noted that there are inherent inaccuracies in such estimates. For example, it is not possible to know precisely which foreign securities U.S. residents buy or sell or the exact timing of the transactions. Table 4 presents both the estimated and directly measured positions. Errors are possible in all parts of such computations: the previous survey, the transactions data, the adjustments, and the current survey.

⁶ For a detailed discussion on the U.S. system for measuring cross-border financial flows, see C. Bertaut, W. Grier, and R. Tryon, "Understanding U.S. Cross-Border Securities Data", Federal Reserve Bulletin, May 2006, 59-75, available online at http://www.federalreserve.gov/pubs/bulletin/2006/cross_border_securities.pdf.

Table 4. Measured and estimated market values of U.S. holdings of foreign long-term securities, by type of security, as of December 31, 2007

Billions of dollars

Type of security	December 2006	January 2007 - December 2007				December 2007		
	Measured (1)	Net purchases (2)	Transaction costs ¹ (3)	Stock swaps ¹ (4)	Valuation adjustments ¹ (5)	Estimated (1)+(2)+ (3)+(4)+(5)	Measured (7)	Measured less estimated (8)
Debt	1,294	129	-15	n.a.	17	1,425	1,607	183
Equity	4,329	95	-26	11	692	5,101	5,248	147
Total	5,623	224	-41	11	709	6,526	6,855	329

1. Staff estimates.

n.a. Not applicable.

U.S. holdings of foreign long-term securities, as measured by the two most recent portfolio asset surveys, increased by \$1,232 billion during 2007, from \$5,623 at end-2006 to \$6,855 at end-2007. The total estimated increase during the year is \$903 billion, composed of \$224 billion in net purchases of foreign long-term securities as measured by the TIC monthly transactions systems (column 2), estimated valuation gains of \$709 billion (column 5), and -\$30 billion in other adjustments (columns 3 and 4). Thus, the survey measured U.S. foreign holdings to be \$329 billion higher than estimated by the method shown above. This difference between the estimated and the measured position is not unusual, as the surveys of U.S. holdings of foreign securities have tended to measure U.S. holdings higher than estimates, and in the past, such discrepancies have sometimes led to improved reporting of net purchases and to improved estimates of valuation adjustments.

U.S. Portfolio Investment Abroad Compared with Foreign Portfolio Investment in the United States

The following table shows both U.S. holdings of foreign long-term securities and foreign holdings of U.S. long-term securities over time. The dates chosen are those that correspond to the surveys of U.S. holdings of foreign securities. Because surveys of foreign holdings of U.S. securities were conducted on different dates, the figures reported for foreign holdings are estimates.

Foreign holdings of U.S. long-term securities increased considerably more rapidly than did U.S. holdings of foreign securities during the 1994-2004 period, and as a result the ratio of U.S. holdings to foreign holdings decreased from nearly 0.75 to less than 0.60 by 2001. However, between December 2004 and December 2007 both U.S. and foreign cross-border holdings increased by roughly the same amount, and the ratio of U.S. holdings to foreign holdings has increased over this period, reaching 0.72 by December 2007. This reversal of trend might be considered surprising, given that foreign net purchases of U.S. long-term securities were much larger than U.S. net purchases of foreign securities during the period: for example, during the calendar year 2007, foreign net acquisitions of U.S. long-term securities amounted to \$792

billion, whereas U.S. net acquisitions of foreign securities (including stock swaps) amounted to only \$235 billion.⁷

Table 5. Market value of U.S. holdings of foreign long-term securities and foreign holdings of U.S. long-term securities, selected dates, 1994-2007

Billions of dollars except as noted

Date	U.S. holdings of foreign long-term securities	Foreign holdings of U.S. long-term securities ¹	Ratio of U.S. holdings to foreign holdings	Net foreign holdings of long-term securities
Mar. 1994	870	1,181	0.74	311
Dec. 1997	1,755	2,561	0.69	806
Dec. 2001	2,170	3,932	0.55	1,763
Dec. 2003	2,954	4,977	0.59	2,024
Dec. 2004	3,553	5,967	0.60	2,413
Dec. 2005	4,346	6,777	0.64	2,432
Dec. 2006	5,623	8,255	0.68	2,632
Dec. 2007	6,855	9,506	0.72	2,651

1. Staff estimates. Because surveys of foreign holdings of U.S. long-term securities were collected on different dates from the surveys of U.S. holdings of foreign securities, estimated positions are shown for the between-survey values of foreign holdings. These estimates are subject to revision.

This seeming contradiction results in large part from differences in portfolio composition and valuation gains. Although foreign investors' total holdings of U.S. securities continue to exceed U.S. investors' total holdings of foreign securities, U.S. residents' cross-border portfolios are heavily weighted towards holdings of equities (73 percent) whereas only 32 percent of foreign residents' holdings consist of equities. As a result, U.S. holdings of foreign equity (\$5.2 trillion) exceed foreign holdings of U.S. equity (\$3.1 trillion). In dollar terms, U.S. holdings of foreign equity increased in value over this period by far more than did the value of foreign holdings of U.S. equity – both because of the higher level of U.S. holdings, and because foreign equity prices rose faster over this period than did U.S. equity prices, resulting in large valuation gains for U.S. residents. In addition, the depreciation of the dollar increased further the dollar value of U.S. investors' holdings of equity abroad.

The difference in the composition of U.S. and foreign holdings is explained in part by the makeup of cross-border investors: almost all U.S. holdings represent investments made by U.S. private investors (both institutions and individuals), whereas approximately 29 percent of foreign holdings are owned by foreign official institutions, such as central banks and other governmental

⁷ Foreign net acquisitions of U.S. securities are net purchases adjusted for ABS repayment flows and acquisitions and for stock swaps, and are available on the Treasury International Capital System website at <http://www.treas.gov/tic/>.

entities. Because roughly 90 percent of foreign official holdings are in the form of debt securities, their holdings help to explain the overall foreign preference for U.S. debt securities.⁸

Details of U.S. Equity Investment by Country

Table 6 ranks countries based on the level of U.S. investment in their equity securities, and additionally shows holdings by type of equity (common stock shares, fund shares, and preferred stock and other forms of equity).

Table 6. Market value of U.S. holdings of foreign equities, by country, and type of equity, for the countries attracting the most U.S. investment, as of December 31, 2007

Billions of dollars except as noted

Country or region	Total Equity	Common Stock	Fund Shares	Preferred Stock and Other
United Kingdom	715	683	14	17
Japan	529	526	3	0
Canada	379	344	33	2
France	348	346	1	1
Germany	329	318	0	11
Switzerland	281	280	0	0
Bermuda	256	248	4	5
Cayman Islands	232	159	48	25
Brazil	173	111	2	60
Netherlands	154	147	2	5
Australia	138	134	4	0
Korea, South	129	125	0	4
Hong Kong	120	118	2	0
Spain	107	105	0	2
Rest of world	1,359	1,313	34	12
Total	5,248	4,956	147	145

Most of the foreign equity held by U.S. investors is held in the form of common stock (about 94 percent). Holdings of fund shares account for only about 3 percent of U.S. holdings of foreign equity. In contrast, foreign investors hold about 85 percent of U.S. equity in the form of common stock and a much larger share (13 percent) in the form of fund shares.⁹ However, the amount of U.S. investment in foreign fund shares has grown; holdings in 2007 (\$147 billion) were more than twice the amount held in 2006. And for some countries, fund shares account for a considerably larger share of equity held: 21 percent of Cayman Island equity is held in the

⁸ See Table 6 in the "Report on Foreign Portfolio Holdings of U.S. Securities as of June 30, 2007" at www.treas.gov/tic/shl2007r.pdf.

⁹ See table 8 in the "Report on Foreign Portfolio Holdings of U.S. Securities as of June 30, 2007" at www.treas.gov/tic/shl2007r.pdf.

form of fund shares. Other countries (not shown in the table) where a sizable share of U.S. equity investment is held in fund shares are the British Virgin Islands (58 percent) and Ireland and Luxembourg (each 23 percent). Table 30 in the appendix shows the detail of U.S. holdings by type of equity for these and additional countries.

Table 7 shows the common stock shares for the same countries, the relative size of each country's equity market, and the share that is owned by U.S. investors. The share that is U.S.-owned can be misleading because in some instances companies are incorporated in one country but their securities primarily trade in another country. This practice can lead to odd results, such as those shown for Bermuda and the Cayman Islands, where U.S. investors' holdings exceed the size of the country's domestic equity market. Of the countries that account for the most U.S. equity investment (excluding the offshore financial centers of Bermuda and the Cayman Islands), U.S. investors typically held between 6 percent (Spain) and 22 percent (Switzerland) of each country's equity market; one exception was that U.S. investors held only 2 percent of the market capitalization of China, which in 2007 had the largest foreign equity market capitalization. Overall, U.S. investors held approximately 11 percent of the common stock included in total foreign equities outstanding. By comparison, foreign investors also held just over 11 percent of total U.S. equities outstanding as of June 2007.¹⁰

The table also shows that U.S. investors held relatively more of the market capitalization of advanced economies (13 percent) than they did of other countries excluding the Caribbean financial centers (4 percent). By region, U.S. investors held 13 percent of European equity market capitalization. They held smaller shares of the market capitalization of Asian and African countries (6 percent and 5 percent, respectively) than they did of Latin American and Caribbean market capitalization excluding the Caribbean financial centers (9 percent). The somewhat higher share for the Latin American and Caribbean region in large part reflects that U.S. investors held a sizable 21 percent of Mexican market capitalization. U.S. investors also held an-above average share of Canadian market capitalization (16 percent).

¹⁰ See Table 2 in the "Report on Foreign Portfolio Holdings of U.S. Securities as of June 30, 2007" at www.treas.gov/tic/shl2007r.pdf. This figure includes all forms of equity held by foreigners, including U.S. fund shares, but also includes a more comprehensive measure of U.S. market capitalization that accounts for fund shares outstanding.

Table 7. Market value of U.S. holdings of foreign equities, by country, size of domestic equity markets, and share of each market that is U.S. held, for selected countries and regions, as of December 31, 2007

Billions of dollars except as noted

Country or region	U.S. holdings of common stock	Country rank according to domestic market capitalization ¹	Percent of domestic market capitalization ²
United Kingdom	683	3	18
Japan	526	2	12
France	346	4	12
Canada	344	5	16
Germany	318	6	15
Switzerland	280	12	22
Bermuda	248	84	> 100
Cayman Islands	159	97	> 100
Netherlands	147	16	15
Australia	134	11	10
Korea, South	125	14	11
Hong Kong	118	13	10
Brazil	111	10	8
Spain	105	8	6
Italy	96	15	9
China	96	1	2
Rest of world	1,121	n.a.	9
Total	4,956	n.a.	11
By type of market			
Advanced economies ³	3,775	n.a.	13
Caribbean financial centers ⁴	525	n.a.	> 100
Other countries	656	n.a.	4
By selected region			
Europe	2,484	n.a.	13
<i>of which: euro currency countries⁵</i>	<i>1,250</i>	<i>n.a.</i>	<i>12</i>
Latin America and Caribbean, excluding Caribbean financial centers	205	n.a.	9
Asia	1,182	n.a.	6
Africa	64	n.a.	5

1. Market capitalization data are from Standard & Poor's Global Stock Markets Factbook 2008 and are based on year-end 2007 total market values of domestic exchanges. Rank order excludes the United States, which has the largest equity market capitalization.

2. U.S. holdings include securities of companies registered in each country, some of which may not trade on domestic exchanges, thus U.S. holdings can exceed the total size of a country's domestically-traded securities.

3. Australia, Austria, Belgium, Canada, Cyprus, Denmark, Finland, France, Germany, Greece, Hong Kong, Iceland, Ireland, Israel, Italy, Japan, Luxembourg, the Netherlands, New Zealand, Norway, Portugal, Singapore, Slovenia, South Korea, Spain, Sweden, Switzerland, Taiwan, and the United Kingdom.

4. Bahamas, Bermuda, British Virgin Islands, Cayman Islands, Netherlands Antilles, and Panama.

5. Austria, Belgium, Finland, France, Germany, Greece, Ireland, Italy, Luxembourg, Netherlands, Portugal, Slovenia, and Spain.

n.a. Not applicable.

Table 32 in the Statistical Appendix shows the information contained in Table 7 for an expanded list of countries.

Table 8 ranks countries based on the level of U.S. investment in their equity securities as in Table 6 and presents the amounts of these investments that are represented by holdings of depositary receipts (DRs), primarily American Depositary Receipts (ADRs). Depositary receipts are negotiable certificates held in a bank in one country that represent a specific number of shares of a stock that trades on an exchange in another country. They entitle their owners to all dividends, capital gains or losses, and voting rights, just as if the underlying shares were directly owned. ADRs are depositary receipts that trade on U.S. exchanges in U.S. dollars and that facilitate the holding and trading of foreign securities by U.S. residents. Overall, 17 percent of foreign equity held by U.S. investors in 2007 was in the form of DRs. However, the share is notably larger for some countries and regions: for example, 59 percent of Brazilian equity is held as DRs, and overall, 56 percent of Latin American equity is held as DRs.

Table 8. Market value of U.S. holdings of foreign equities, by country and amount held in depositary receipts, for the countries attracting the most U.S. investment, as of December 31, 2007

Billions of dollars except as noted

Country or region	Equity	Depositary Receipts	Percentage Depositary Receipts
United Kingdom	715	187	26
Japan	529	53	10
Canada	379	1	0
France	348	45	13
Germany	329	30	9
Switzerland	281	46	17
Bermuda	256	2	1
Cayman Islands	232	35	15
Brazil	173	102	59
Netherlands	154	36	24
Australia	138	12	8
Korea, South	129	24	19
Hong Kong	120	12	10
Spain	107	12	12
Rest of world	1,359	309	23
Total	5,248	907	17

Table 31 in the Statistical Appendix shows the information contained in the above table for an expanded list of countries.

U.S. Investment in Foreign Debt Securities by Currency of Denomination

U.S. investors continue to have a strong preference for foreign debt securities denominated in U.S. dollars, although the 2007 survey showed a slight decrease in the percentage of dollar-denominated holdings from the previous year. As of year-end 2007, 76 percent of U.S.-owned foreign debt securities were denominated in U.S. dollars, compared with 79 percent at year-end 2006, 78 percent at year-end 2005, 74 percent at year-end 2004, and 69 percent at year-end 2003. The preference for U.S. dollar-denominated debt is strongest in short-term securities, with 92 percent of all such holdings denominated in U.S. dollars, while 73 percent of long-term debt was U.S. dollar-denominated. Of debt held in foreign currency, almost all was denominated in one of the world's other major currencies (euro, yen, British pounds, and Canadian dollars), with only 3 percent of U.S. holdings denominated in other currencies (Table 9).

Table 9. Market value of U.S. holdings of foreign debt securities, by currency of denomination, as of December 31, 2006 and December 31, 2007

Billions of dollars except as noted

Currency	2007		2006	
	Amount	Percentage	Amount	Percentage
U.S. dollar	1,499	76	1,314	79
Euro	199	10	149	9
Canadian dollar	58	3	50	3
Yen	67	3	46	3
U.K. pound	62	3	43	3
Other currencies	67	3	60	4
Total	1,964	100	1,662	100

Table 24 in the Statistical Appendix shows U.S. holdings of foreign long-term debt securities by country and currency for an expanded list of countries. Table 25 shows the same data for holdings of foreign short-term debt securities.

Table 10 presents the currency distribution of U.S. holdings of foreign long-term debt securities by type of market (advanced economies, Caribbean financial centers, and developing countries excluding Caribbean financial centers). The table also shows the currency distribution of U.S. long-term debt holdings in the developing countries attracting the highest level of U.S. investment. Only long-term debt is shown because almost all U.S.-held foreign short-term debt is U.S.-dollar-denominated.

For U.S. holdings of long-term debt securities issued by advanced economies, 66 percent was denominated in U.S. dollars, a share a bit smaller than in 2006, while the share denominated in euro was nearly 16 percent, slightly larger than in 2006. A much larger fraction (98 percent) of long-term debt issued by Caribbean financial centers was dollar-denominated, as was also the case in 2006. For U.S. investors' holdings of emerging market debt, a notable factor has been the decline in the share of dollar-denominated debt and a corresponding increase in the share of own-currency denominated debt. The U.S.-dollar-denominated share declined from 90 percent in 2005 to 81 percent in 2006, and declined further to 76 percent in 2007, while the share of local

currency denominated debt increased from 15 percent in December 2006 (the first date for which this information is available) to approximately 19 percent by December 2007. For Brazil, the percentage of debt held that was denominated in local currency in December 2007 was much higher (38 percent), comparable to the share for long-term debt issued by the advanced economies (31 percent).

The amounts in each row for Table 10 may not sum to the total. U.S. holdings will in some cases be counted in two columns, such as when U.S. residents own a French debt security denominated in euro, because holdings will be counted under both the “euro” column and the “own currency” column. Further, holdings denominated in currencies other than U.S. dollars, euro, yen, U.K. pounds, and the country’s own currency are not shown.

Table 10. Market value of U.S. holdings of foreign long-term debt securities, by currency, for selected regions and countries, as of December 31, 2007

Billions of dollars except as noted

Country or region	Total	\$U.S.	Euro	Japanese Yen	U.K. Pound	Own Currency
Advanced economies ¹	1,135	747	176	60	57	356
Caribbean financial centers ²	298	292	2	3	1	4
Developing countries ³	152	116	6	*	1	29
Of which:						
Mexico	24	20	*	0	*	4
Brazil	16	9	1	0	0	6
Argentina	8	6	1	*	*	1
International organizations	22	14	3	1	1	0
Total	1,607	1,169	187	64	59	389

n.a. Not applicable.

1. Australia, Austria, Belgium, Canada, Cyprus, Denmark, Finland, France, Germany, Greece, Hong Kong, Iceland, Ireland, Israel, Italy, Japan, Luxembourg, the Netherlands, New Zealand, Norway, Portugal, Singapore, South Korea, Slovenia, Spain, Sweden, Switzerland, Taiwan, and the United Kingdom.
2. Bahamas, Bermuda, British Virgin Islands, Cayman Islands, Netherlands Antilles, and Panama.
3. Excludes Caribbean financial centers.

Table 24 in the Statistical Appendix shows the information presented above for all countries.

U.S. Holdings of Foreign Private and Government Debt

In the most recent survey, U.S. investors' holdings of foreign long-term debt were primarily those issued by foreign private institutions, with such holdings accounting for nearly 76 percent of total long-term debt holdings, a share slightly higher than in 2006 (Table 11). This pattern represents a significant shift from the first asset survey conducted in 1994, when about three-quarters of U.S. investors' holdings of long-term debt were in the form of foreign government debt. The percentage of U.S. holdings of foreign long-term debt invested in private sector securities has increased with every survey (in 1994, 25 percent was private-sector issued; in 1997: 48 percent; in 2001: 56 percent; in 2003: 62 percent; in 2004: 66 percent; in 2005: 70 percent; in 2006: 74 percent). U.S. holdings of short-term debt are highly concentrated in private sector issues.

Table 11. Market value of U.S. holdings of foreign debt securities, by country and sector of issuer, as of December 31, 2007

Billions of dollars

Country	Total	Long-term		Short-term	
		Private	Government ¹	Private	Government ¹
United Kingdom	427	246	41	139	2
Cayman Islands	312	271	*	41	0
Canada	207	138	47	19	3
France	100	48	35	17	1
Germany	97	32	57	6	2
Australia	84	67	7	11	*
Ireland	83	50	*	33	0
Netherlands	81	72	4	5	*
Japan	65	11	50	3	1
Luxembourg	55	44	*	11	0
Sweden	55	22	7	26	0
Spain	40	35	3	2	*
Rest of world	358	180	142	32	4
Total	1,964	1,214	393	344	13

* Greater than zero but less than \$500 million.

1. "Government" includes central, local, and provincial governments, and government-sponsored or guaranteed corporations. Debt issued by international and regional organizations is classified as "private".

Table 28 in the Statistical Appendix shows the information contained in the above table for an expanded list of countries.

Table 12 provides additional detail on the portions of U.S. holdings of foreign long-term government and private sector debt that are denominated in dollars and denominated in the issuing country's "own" currency. Although about three quarters of total foreign long-term debt held by U.S. investors was dollar-denominated, the shares are notably different for government-issued and private-issued debt. Only 25 percent of foreign government debt held by U.S. investors is dollar-denominated, whereas 88 percent of foreign private sector debt held is dollar-denominated. For government debt issued by advanced economies, an even smaller percentage held by U.S. investors is dollar-denominated (14 percent), while 85 percent is denominated in the currency of the issuing country; a notable exception to this pattern is Canada, where 40 percent of the government debt held by U.S. investors is denominated in U.S. dollars. The table also shows that most of the long-term debt issued by emerging market economies that is denominated in "own" currency and held by U.S. investors is government-issued debt. Table 29 in the Statistical Appendix provides information on dollar and "own currency" holdings of government-issued and private-issued debt for a larger group of countries.

Table 12. Market value of U.S. holdings of foreign long-term debt securities, by country and sector of issuer, denominated in U.S. dollars and in local currency, as of December 31, 2007

Billions of dollars							
Country	Total Long-Term Debt	Government ¹			Private		
		Total	U.S. dollars	Own currency	Total	U.S. dollars	Own currency
United Kingdom	286	41	*	40	246	224	12
Cayman Islands	271	*	*	0	271	266	*
Canada	185	47	19	27	138	114	24
Germany	89	57	1	56	32	20	7
France	83	35	*	35	48	41	6
Netherlands	76	4	*	4	72	59	10
Australia	73	7	*	7	67	62	2
Japan	60	50	1	49	11	5	5
Ireland	50	*	*	*	50	41	7
Luxembourg	44	*	*	0	44	37	7
Spain	38	3	*	2	35	33	1
Sweden	29	7	*	7	22	21	*
Mexico	24	12	8	4	12	12	*
International organizations	22	0	0	0	22	14	0
Rest of world	276	130	69	55	146	123	19
Total	1,607	393	99	287	1,214	1,070	102
Total Advanced economies ²	1,135	306	42	261	829	705	94
Total Caribbean financial centers ³	298	2	2	0	296	289	4
Developing countries ⁴	175	84	55	26	90	75	4

* Greater than zero but less than \$500 million.

1. "Government" includes central, local, and provincial governments, and government-sponsored or guaranteed corporations. Debt issued by international organizations is classified as "private".

2. Australia, Austria, Belgium, Canada, Cyprus, Denmark, Finland, France, Germany, Greece, Hong Kong, Iceland, Ireland, Israel, Italy, Japan, Luxembourg, the Netherlands, New Zealand, Norway, Portugal, Singapore, South Korea, Slovenia, Spain, Sweden, Switzerland, Taiwan, and the United Kingdom.

3. Bahamas, Bermuda, British Virgin Islands, Cayman Islands, Netherlands Antilles, and Panama.

4. Excludes Caribbean financial centers.

U.S. Holdings of Asset-backed Securities

Foreign-issued asset-backed securities (ABS) continued to gain importance in U.S. portfolios in 2007, accounting for about 21 percent of U.S. investors' holdings of foreign long-term debt securities, an increase from 18 percent in 2006 (Table 13). As of December 2007, ABS accounted for nearly three-quarters of U.S. investors' holdings of long-term debt issued through the Cayman Islands and increasing shares of debt securities issued by several other countries.

Table 13. Market value of U.S. holdings of foreign long-term asset-backed securities, for the countries attracting the most U.S. investment, as of December 31, 2006 and December 31, 2007

Billions of dollars except as noted

Country	2007			2006		
	Total long-term debt	ABS	ABS as percent of total	Total long-term debt	ABS	ABS as percent of total
United Kingdom	286	81	28	245	75	31
Cayman Islands	271	199	73	178	119	67
Netherlands	76	9	12	68	8	12
Australia	73	14	19	62	13	21
Ireland	50	14	27	38	6	16
Jersey	12	4	36	10	3	27
Rest of world	837	9	52	693	9	54
Total	1,607	330	21	1,294	233	18

Table 26 in the Statistical Appendix shows U.S. holdings of long-term asset-backed securities as of December 31, 2007 for all countries.

U.S. investors also hold foreign-issued short-term ABS but it is more difficult to document the extent and growth of such holdings. Table 27 in the statistical appendix reports that U.S. investors held \$5.4 billion in short-term ABS in 2007, but it should be noted this figure excludes holdings of foreign asset-backed commercial paper, which are instead included with holdings of conventional commercial paper. Total holdings of foreign commercial paper amounted to \$178 billion in 2007. This figure was about unchanged from the amount held in 2006, and compares with \$149 billion held in 2005. In part the increase in holdings of foreign commercial paper from 2005 to 2006 and the subsequent leveling-off of holdings in 2007 reflects changes in holdings of foreign asset-backed commercial paper.

Maturity Structure of U.S. Foreign Debt Holdings

Table 14 presents the maturity structure of U.S.-owned foreign long-term debt securities. In both the 2006 and 2007 surveys the median time-to-maturity, or remaining maturity, for long-term securities (those issued with an original time-to-maturity in excess of one year) was about 7 years. There was no appreciable difference in the maturity structure of U.S.-owned securities issued by foreign governments and those issued by the private sector.

Table 14. Maturity structure of U.S. holdings of foreign long-term debt securities, by remaining maturity, as of December 31, 2006 and December 31, 2007

Remaining years to maturity ¹	2007 Percent of total ²	2006 Percent of total ^{2,3}
One or less	14.7	8.8
1 - 2	7.1	9.9
2 - 3	6.1	6.9
3 - 4	6.2	7.0
4 - 5	6.4	10.0
5 - 6	5.5	4.4
6 - 7	4.8	5.6
7 - 8	4.8	4.8
8 - 9	5.4	5.5
9 - 10	5.8	6.0
10 - 15	7.5	7.1
15 - 20	3.8	4.0
20 - 25	5.3	5.5
25 - 30	8.3	7.8
30 - 40	8.3	6.7
Total	100.0	100.0

1. Inclusive of the higher figure in the range

2. Excludes perpetual bonds and securities with unknown maturity dates that together amounted to approximately \$70 billion in 2006 and \$116 billion in 2007, or about 7 percent of total foreign long-term debt securities held by U.S. residents.

3. Maturity distributions for 2006 are very slightly revised from those published in the previous survey report.

U.S. Portfolio Investment Abroad by Type of Market and Geographic Region

Table 15 presents U.S. foreign portfolio investment by type of foreign market: advanced economies, Caribbean financial centers, international organizations, and developing countries for the two most recent surveys.

Investment in the twenty-nine advanced economies continued to account for the bulk of U.S. foreign investment in 2007, although the share in 2007 (74 percent) was slightly lower than in 2006 (78 percent). The shares invested in developing countries and in Caribbean financial centers were each slightly higher in 2007.

Table 15. Market value of U.S. holdings of foreign securities in advanced economies, Caribbean financial centers, and developing countries, as of December 31, 2006 and December 31, 2007

Billions of dollars except as noted

Market	2007				2006			
	Total	Percent of Total	Equity	Debt	Total	Percent of Total	Equity	Debt
Advanced economies ¹	5,339	74	3,905	1,434	4,644	78	3,397	1,248
Caribbean financial centers ²	953	13	614	339	681	11	439	242
International organizations	24	0	*	24	22	0	*	22
Developing countries ³	896	12	729	167	644	11	493	151
Total	7,212	100	5,248	1,964	5,991	100	4,329	1,662

* Greater than zero but less than \$500 million.

1. Australia, Austria, Belgium, Canada, Cyprus, Denmark, Finland, France, Germany, Greece, Hong Kong, Iceland, Ireland, Israel, Italy, Japan, Luxembourg, the Netherlands, New Zealand, Norway, Portugal, Singapore, Slovenia, South Korea, Spain, Sweden, Switzerland, Taiwan, and the United Kingdom.

2. Bahamas, Bermuda, British Virgin Islands, Cayman Islands, Netherlands Antilles, and Panama.

3. Excludes Caribbean financial centers.

U.S. holdings of securities issued by the advanced economies have been consistently weighted towards holdings of equity securities: equities accounted for about 73 percent of holdings of all securities issued by the advanced economies in each of the past three surveys. Recently, a preference for equities has also been a feature of U.S. holdings of securities issued by developing countries, and in 2007 equities accounted for more than 80 percent of U.S. investment in developing country securities, an increase from 77 percent in 2006 and from 68 percent in 2005.

Table 16 shows the distribution of U.S. portfolio investment by geographic region rather than by type of economy. Europe continued to attract a little more than half of all U.S. cross-border portfolio investment in 2007; holdings of securities issued by the euro-currency countries in turn account for nearly half of all European securities held by U.S. investors. U.S. investors' holdings of equity increased for every region during 2007, and U.S. investors also increased their holdings of debt securities in all regions except Central and South America.

Total U.S. investment in African securities remained fairly small, and of those holdings, a large share continued to be directed to South Africa, which attracted \$53 billion of the \$76 billion invested in the continent. U.S. portfolio investment in the Australia and Oceania region is composed primarily of investment in Australia and New Zealand.

Table 16. Market value of U.S. holdings of foreign securities, by geographic region, as of December 31, 2006 and December 31, 2007

Billions of dollars

Region/category	2007				2006			
	Total	Percent of total	Equity	Debt	Total	Percent of total	Equity	Debt
Europe	3,652	51	2,569	1,083	3,129	52	2,190	939
<i>Of which: euro currency countries¹</i>	<i>1,798</i>	<i>25</i>	<i>1,295</i>	<i>503</i>	<i>1,470</i>	<i>25</i>	<i>1,054</i>	<i>416</i>
Asia	1,325	18	1,194	132	1,166	19	1,053	113
Caribbean ²	928	13	589	339	658	11	418	240
Canada	586	8	379	207	478	8	298	180
Australia and Oceania	248	3	158	91	192	3	113	79
South America	231	3	183	48	152	3	101	51
Central America ³	141	2	111	30	136	2	106	30
Africa	76	1	66	10	57	1	49	8
International organizations	24	0	*	24	22	0	*	22
Total	7,212	100	5,248	1,964	5,991	100	4,329	1,662

* Greater than zero but less than \$500 million.

1. Austria, Belgium, Finland, France, Germany, Greece, Ireland, Italy, Luxembourg, Netherlands, Portugal, Slovenia (effective 2007), and Spain.
2. Includes Bermuda and the Bahamas as well as all Caribbean nations. This grouping is different than the Caribbean financial centers shown in Table 15.
3. Excludes Caribbean financial centers.

U.S. Ownership of Foreign Securities by Industry

Table 17 provides information on U.S. holdings of securities by broad industry sector of the issuer. Combining equity and debt investments, the foreign economic industrial sector attracting the highest level of U.S. investment (based on the GICS¹¹ classification system) was by far the financial sector, with holdings of \$2,167 billion, accounting for 30 percent of all U.S. holdings. Within the financial sector, U.S. holdings were especially large in commercial banking (\$744 billion) and capital markets, which includes mutual funds (\$543 billion). Though U.S. investors overall hold considerably more foreign equity than debt, only a little more than half of financial sector investment was held in the form of equity (\$1,165 billion). Total holdings of financial sector debt securities (\$719 billion in long-term debt and \$284 billion in short-term debt) accounted for a little more than half of all U.S. holdings of foreign debt securities. U.S. investors also had sizable holdings in the industrial sector (\$749 billion), the energy sector (\$704 billion), the materials sector (\$578 billion), and the consumer discretionary sector (\$570 billion). In each of these sectors, U.S. investments were concentrated in equity, with equity accounting for about 90 percent of total holdings within each broad sector.

¹¹ The Global Industry Classification Standard (GICS) system, developed by Morgan Stanley Capital International and Standard & Poor's, was selected because it can be used to categorize security issuers worldwide, enabling both foreign holdings of U.S. securities and U.S. holdings of foreign securities to be shown using the same classification system.

Table 17. Market value of U.S. holdings of foreign securities, by industry, as of December 31, 2007

Billions of dollars

GICS Code		Total	Equity	Debt	
				Long-term	Short-term
1010	Total Energy	704	655	47	3
1510	Total Materials	578	514	62	2
2000	Total Industrial	749	693	48	7
2500	Total Consumer Discretionary	570	528	41	1
3000	Total Consumer Staples	328	297	22	9
3500	Total Health Care	372	355	11	6
4000	Total Financial	2,167	1,165	719	284
4500	Total Information Technology	354	323	31	0
5010	Total Telecommunication Services	410	344	65	1
5510	Total Utilities	286	220	60	5
	Government ¹	427	1	411	15
	Industry unknown	269	154	90	24
	Total	7,212	5,248	1,607	357

1. Includes securities issued by local governments as well as government-sponsored or guaranteed corporations.

Table 33 in the Statistical Appendix provides information on holdings by detailed industry as well as broad industry sector.

Comparison of different types of U.S. portfolio investment abroad as of selected dates

Table 18 presents a more comprehensive time-series picture of U.S. portfolio investment abroad and compares U.S. holdings of foreign securities with U.S. holdings of deposits, loans, and other investments reported by U.S. bank and non-bank institutions. The table shows the growing importance of securities holdings in U.S. portfolio investment abroad. In 1994, holdings of foreign securities accounted for a little less than 60 percent of U.S. foreign portfolio investment, but that share has grown to 67 percent by 2007, and at \$7,212 billion, holdings of securities were more than twice the amount in deposits, loans, and other forms of investment (\$3,520 billion)

Table 18. Forms of U.S. portfolio investment abroad, as of selected survey dates.

Billions of dollars

Date	Total Investment	Securities			Deposits, Loans, and Other ¹		
		Total	Long-term	Short-term	Total	Reported by banks	Reported by nonbanks
Mar. 1994	1,549	905	870	35	644	622	21
Dec. 1997	2,730	1,809	1,755	54	921	890	31
Dec. 2001	3,586	2,317	2,170	147	1,269	1,237	32
Dec. 2003	4,803	3,152	2,954	199	1,650	1,553	98
Dec. 2004	5,884	3,787	3,553	233	2,098	1,964	133
Dec. 2005	6,968	4,608	4,346	262	2,360	2,228	132
Dec. 2006	8,857	5,991	5,623	368	2,866	2,743	123
Dec. 2007	10,732	7,212	6,855	357	3,520	3,385	135

1. Includes deposits, brokerage balances, loans, resale agreements, and trade receivables and advance payments.

Sources. Data on securities are from the surveys (except for short-term securities in 1994 and 1997); data on deposits, loans, and other are from the Department of the Treasury, Treasury Bulletin, various issues. Short-term securities for 1994 and 1997 are from the Treasury Bulletin. Numbers for prior years may be revised from those published in earlier survey reports.

Chapter 2. Data Collection Methodology

The U.S. system for measuring U.S. holdings of foreign securities consists of “benchmark” surveys conducted at five-year intervals and smaller surveys conducted annually in non-benchmark years. The benchmark surveys collect data from a large number of institutions in an attempt to measure total U.S. holdings as comprehensively as practical. In the four years following each benchmark survey, data are collected from only the largest respondents who collectively reported a very large share of data in the preceding benchmark survey.

The 2007 survey was a non-benchmark year. Data were collected primarily from U.S.-resident custodians, but also from some end-investors, who were required to report holdings of foreign securities at the individual security level. In total, 101 firms reported data. Reporting was quite concentrated: The ten largest custodians reported 84 percent of the total market value of security-by-security data submitted. In total, some 945,595 records were submitted by respondents, of which 736,715 were equity records and 208,880 were debt security records. Banks were the leading custodians, though broker-dealers also reported significant amounts of custodial holdings.

This survey was conducted under the authority of the International Investment and Trade in Services Survey Act (22 U.S.C. 3101 et seq.). Reporting was mandatory, and subject to penalties for noncompliance. Data were collected for holdings as of December 31, 2007, and were to be reported to the Federal Reserve Bank of New York, acting as agent for the Department of the Treasury, no later than March 7, 2008. A copy of the forms and instructions is included in Appendix B.

Data Analysis and Editing

The detailed security level data submitted by respondents were subjected to extensive analysis and editing. The first step in the process was to analyze respondent data to identify systematic errors within each respondent’s submission. Each respondent’s data were analyzed individually and compared with the data submitted in the previous year’s submission. Reported securities with the largest market values were analyzed in detail, and the other reported securities were analyzed in the aggregate to identify common types of reporting errors.

Once the analysis of the data for each respondent was completed, the data were analyzed on a security-by-security basis, across all reporters. Securities subject to particular attention included those with either a large quantity or market value reported, those with particularly high or low prices, or those securities comprising a large percentage of the total amount outstanding.

The data were also examined by categories, such as country of issuer, type of security, and type of issuer. This review was especially useful in eliminating cases in which the mis-coding of a security with a small market value could have a large relative impact upon a small category. Additionally, the data was compared to various TIC and regulatory reports to identify possible systemic issues.

Avoidance of Data Gaps and Double Counting

Respondent's reports were examined to ensure that frequently omitted securities were included, such as those of international organizations resident in the United States, those issued by foreign conduits of U.S. entities, and those of former U.S. corporations that have re-incorporated outside of the United States. Checks were also made to detect and exclude securities issued by U.S.-resident entities. In addition, the security-by-security data provided by end-investors were examined to ensure that only securities that were held either directly by the end-investor or through foreign custodians were reported on a security-by-security basis.

In some cases, foreign securities may be entrusted to a U.S.-resident custodian who, in turn, entrusts the securities to another U.S.-resident custodian. To avoid double-counting in these instances, U.S.-resident custodians who passed the foreign securities to other U.S.-resident custodians were instructed not to provide security-by-security information on these securities, but instead only to identify the custodian(s) involved and the amount(s) entrusted. The reports provided by end-investors and U.S.-resident custodians using U.S.-resident sub-custodians were examined to ensure that all significant U.S.-resident custodians were included on the panel and to provide a crude check on the aggregate amounts reported by each custodian. Special analyses were performed to ensure that respondents excluded their foreign operations and foreign customers and that they included all of their U.S. organizational units.

Estimate of Unreported Data and Calculation of Total U.S. Holdings of Foreign Securities

The December 2007 survey collected data from the largest U.S.-resident custodians and end-investors, based on the data reported in the 2006 Benchmark survey. These respondents accounted for over 99 percent of the reported 2006 Benchmark data and will continue to report annually through the December 2010 survey. The remaining 1 percent was accounted for in the December 2007 data by adding the securities reported in the 2006 Benchmark survey by the respondents who were not part of the annual panel to the securities reported annually. The data added were adjusted to maintain the years to maturity that were originally reported for debt instruments.

Acknowledgments

The Department of the Treasury, the Federal Reserve Bank of New York and the Federal Reserve Board of Governors wish to express their appreciation to the Securities Reports Division of the Federal Reserve Bank of New York for preparation of the U.S. portfolio data. Under the direction of Kenneth Aberbach, staff responsible for data analysis were: Michael Ball, Lois Burns, Evelyn Castillo, Aamna Farooq, Caroline Fernandez, Hansy Hernandez, David Hubbs, Nigel Jones, Aaron Gononsky, Brian Goodwin, Jason Nuccio, Philip Papaelias, Marc Plotsker, Gillian Stowe, and Paula Webster. Automation staff, working under the direction of Howard Brickman, responsible for obtaining properly formatted data files and for facilitating data loads and updates were: Amador Castelo, Melissa Harris, Frank Innocenti, and Sharon McKenzie. Business Systems Development staff, working under the direction of Jean Stoloff and Pamela Zaiontz, who developed and enhanced the database and reports, were: Yee Ying Chan and Aswin Subramaniam. Staff who provided timely data entry and file loading support, working

U.S. Holdings of Foreign Securities

under the direction of Laura Iannolino, were: Mary Ann Campano, Natasha Fair, and Rita Cek-Dagostin, and Ada Hernandez.

Statistical Appendix

Table 19. Market value of U.S. holdings of foreign securities, by country and type of security, as of December 31, 2007

Millions of dollars except as noted

Country or region	Total	Equity	Debt	
			Long-term	Short-term
Albania	13	*	13	0
Andorra	14	14	0	0
Anguilla	15	15	0	0
Antigua and Barbuda	127	127	0	0
Argentina	9,827	1,922	7,860	44
Aruba	1,102	0	1,102	0
Australia	222,570	138,096	73,257	11,217
Austria	28,998	20,069	6,443	2,486
Bahamas	2,263	1,302	908	52
Bangladesh	167	163	0	4
Barbados	423	56	367	0
Belgium	37,874	31,642	5,105	1,127
Belize	88	56	32	0
Bermuda	272,969	256,111	16,708	149
Bolivia	10	0	10	0
Bosnia and Herzegovina	90	0	90	0
Botswana	6	5	1	0
Brazil	188,808	172,599	16,165	44
British Virgin Islands	14,844	11,156	3,687	*
Bulgaria	561	387	174	0
Burundi	4	0	4	0
Canada	586,454	378,965	185,217	22,272
Cayman Islands	543,887	231,886	271,328	40,673
Chile	12,774	5,205	7,564	5
China, mainland ¹	97,241	95,658	1,457	125
Colombia	6,794	1,193	5,567	35
Comoros	*	*	0	0
Cook Islands	*	*	0	0
Costa Rica	376	*	370	6
Cote d'Ivoire	158	1	158	0
Croatia	467	164	304	0
Cuba	*	*	0	0
Cyprus	2,968	2,305	338	325
Czech Republic	5,352	5,155	196	0
Denmark	47,157	32,971	12,830	1,356
Dominican Republic	849	*	848	1
Ecuador	709	*	707	2
Egypt	11,868	8,865	1,758	1,245
El Salvador	835	5	822	8
Estonia	174	135	38	1

* Greater than zero but less than \$500,000.

1. Excludes Hong Kong and Macau, which are reported separately.

Table 19. Market value of U.S. holdings of foreign securities, by country and type of security, as of December 31, 2007 (continued)

Millions of dollars except as noted

Country or region	Total	Equity	Debt	
			Long-term	Short-term
Falkland Islands	4	4	0	0
Faroe Islands	14	14	0	0
Fiji	29	0	29	0
Finland	94,174	90,158	3,587	428
France	448,189	347,795	82,929	17,466
French Guiana	*	*	0	0
Gambia	*	*	0	0
Georgia	150	147	3	0
Germany	426,020	329,164	88,938	7,919
Ghana	192	20	173	0
Gibraltar	96	96	0	0
Greece	25,485	23,722	1,763	0
Grenada	14	0	14	0
Guatemala	224	0	224	0
Guernsey	15,830	13,229	2,572	29
Guinea	3	3	0	0
Honduras	27	*	6	21
Hong Kong	121,276	119,522	1,736	18
Hungary	9,226	7,309	1,785	131
Iceland	7,268	32	7,219	17
India	85,149	81,755	3,294	100
Indonesia	18,350	15,077	3,271	1
Ireland	131,854	48,969	50,153	32,732
Isle of Man	1,306	1,144	149	13
Israel	54,250	38,892	15,255	103
Italy	119,962	96,927	21,885	1,151
Jamaica	662	*	662	0
Japan	593,764	529,219	60,218	4,326
Jersey	28,633	5,414	12,237	10,982
Jordan	110	83	28	0
Kazakhstan	1,341	812	504	25
Kenya	32	24	8	0
Korea, South	139,554	129,234	9,845	476
Latvia	18	18	*	0
Lebanon	432	141	291	0
Lesotho	*	*	0	0
Liberia	6,763	5,053	1,710	0
Liechtenstein	263	253	10	0
Lithuania	74	29	45	0
Luxembourg	95,121	40,071	43,820	11,230

* Greater than zero but less than \$500,000.

Table 19. Market value of U.S. holdings of foreign securities, by country and type of security, as of December 31, 2007 (continued)

Millions of dollars except as noted

Country or region	Total	Equity	Debt	
			Long-term	Short-term
Malaysia	25,209	17,670	6,360	1,179
Malta	127	50	71	5
Marshall Islands	13,586	13,096	490	0
Mauritania	*	0	*	0
Mauritius	1,657	1,568	87	2
Mexico	109,731	85,417	23,882	432
Moldova	*	*	0	0
Monaco	16	16	0	0
Mongolia	*	0	*	0
Morocco	455	394	61	0
Namibia	3	3	0	0
Nauru	*	*	0	0
Netherlands	235,059	153,976	76,411	4,672
Netherlands Antilles	89,288	87,994	1,287	8
New Caledonia	*	*	0	0
New Zealand	9,799	3,940	3,900	1,958
Nicaragua	29	0	29	0
Norway	67,909	46,383	15,232	6,294
Pakistan	1,757	1,444	313	*
Panama	29,435	25,296	4,136	3
Papua New Guinea	2,429	2,429	0	0
Paraguay	*	0	0	*
Peru	4,605	1,679	2,651	274
Philippines	14,461	9,909	4,550	2
Poland	13,860	9,078	4,782	0
Portugal	8,711	6,109	2,232	370
Romania	622	612	1	9
Russia	80,919	74,386	6,520	13
Saint Kitts and Nevis	*	*	0	0
Saint Lucia	62	0	62	0
Senegal	2	2	0	0
Serbia and Montenegro	272	201	71	0
Seychelles	58	0	58	0
Singapore	64,710	55,584	9,061	65
Slovakia	71	*	70	0
Slovenia	351	318	34	0
South Africa	53,141	49,138	3,908	95
Spain	146,413	106,648	37,823	1,942
Sri Lanka	285	166	115	4
Sweden	112,057	57,393	29,110	25,554

* Greater than zero but less than \$500,000.

Table 19. Market value of U.S. holdings of foreign securities, by country and type of security, as of December 31, 2007 (continued)

Millions of dollars except as noted

Country or region	Total	Equity	Debt	
			Long-term	Short-term
Switzerland	287,675	280,767	3,618	3,290
Taiwan	81,191	81,024	168	0
Thailand	16,842	15,998	834	10
Trinidad and Tobago	1,472	*	1,472	0
Tunisia	501	4	497	0
Turkey	25,086	19,705	5,381	0
Turks and Caicos Islands	*	*	0	0
Uganda	1	0	0	1
Ukraine	2,137	643	1,495	0
United Kingdom	1,142,380	714,928	286,488	140,964
Uruguay	1,957	0	1,957	*
Venezuela	5,416	416	5,000	0
Vietnam	248	11	237	0
Zambia	78	75	2	2
Zimbabwe	200	157	43	0
International Organizations	24,015	366	22,130	1,520
Middle East oil-exporters ²	10,463	2,184	8,276	3
African oil-exporters ³	772	251	519	1
Total	7,212,217	5,247,990	1,607,211	357,016
Totals by Region:				
Total Africa	75,895	65,564	8,985	1,346
Total Asia	1,325,459	1,193,733	125,309	6,417
Total Caribbean	927,977	588,650	298,444	40,884
Total Europe	3,652,357	2,569,361	812,467	270,529
<i>Of which: Euro Area Countries⁴</i>	1,797,861	1,295,250	421,089	81,522
Total Latin America	371,650	293,794	76,983	874
Canada	586,454	378,965	185,217	22,272
Total Other Countries	248,410	157,559	77,677	13,174
International Organizations	24,015	366	22,130	1,520

* Greater than zero but less than \$500,000.

2. Bahrain, Iran, Iraq, Kuwait, Oman, Qatar, Saudi Arabia, United Arab Emirates.

3. Algeria, Gabon, Libya, Nigeria.

4. Austria, Belgium, Finland, France, Germany, Greece, Ireland, Italy, Luxembourg, Netherlands, Portugal, Slovenia, Spain.

Table 20. Market value of U.S. holdings of foreign long-term securities, by country, as of selected survey dates

Millions of dollars

Country or category	December 1997	December 2001	December 2003	December 2004	December 2005	December 2006	December 2007
Albania	32	10	4	5	6	12	13
Andorra	14	0	0	2	5	9	14
Anguilla	0	0	0	2	3	4	15
Antigua and Barbuda	0	0	1	12	33	33	127
Argentina	38,567	4,379	4,304	4,826	6,841	10,980	9,783
Aruba	22	271	906	1,114	1,189	1,272	1,102
Australia	46,999	53,111	85,672	97,418	119,701	163,624	211,353
Austria	5,662	3,510	9,170	13,659	15,836	23,144	26,512
Bahamas	910	1,640	2,889	2,650	3,257	1,522	2,211
Bangladesh	7	4	*	0	*	4	163
Barbados	17	54	253	256	272	323	423
Belarus	3	0	*	0	0	0	0
Belgium	9,169	12,140	15,764	23,297	24,162	34,459	36,747
Belize	34	8	77	60	50	52	88
Bermuda	26,607	125,207	116,206	163,411	185,074	205,419	272,819
Bolivia	12	0	2	0	*	0	10
Bosnia and Herzegovina	3	11	50	149	114	72	90
Botswana	147	22	4	7	5	4	6
Brazil	51,656	33,453	50,146	62,989	90,257	110,257	188,764
British Virgin Islands	1,138	2,011	3,599	4,463	8,348	10,996	14,844
Bulgaria	1,310	1,763	1,443	1,173	428	312	561
Burma	142	0	0	0	0	0	0
Burundi	0	0	0	0	0	0	4
Cambodia	1	0	0	0	0	0	0
Cameroon	4	0	0	0	0	0	0
Canada	177,473	205,209	288,700	332,249	405,332	460,210	564,182
Cayman Islands	19,247	70,081	120,954	184,128	221,003	338,444	503,214
Central African Republic	0	1	0	0	0	0	0
Chile	8,126	5,947	9,697	11,598	12,097	12,539	12,769
China, mainland ¹	5,434	3,004	13,731	12,710	28,432	75,217	97,115
Colombia	4,163	2,760	3,488	4,455	5,018	5,827	6,759
Comoros	21	0	*	0	0	0	*
Congo (Brazzaville)	13	0	0	0	0	0	0
Congo (Kinshasa)	*	0	0	0	0	0	0
Cook Islands	1	0	0	*	73	0	*
Costa Rica	165	158	319	241	420	317	370
Cote d'Ivoire	458	162	96	98	92	95	158
Croatia	496	763	676	716	703	400	467
Cuba	*	0	*	1	*	*	*
Cyprus	322	110	101	103	208	820	2,643

* Greater than zero but less than \$500,000. n.a. Not available.

1. Excludes Hong Kong and Macau, which are reported separately.

Table 20. Market value of U.S. holdings of foreign long-term securities, by country, as of selected survey dates (continued)

Millions of dollars

Country or category	December 1997	December 2001	December 2003	December 2004	December 2005	December 2006	December 2007
Czech Republic	808	481	1,293	1,876	1,742	3,070	5,352
Denmark	16,758	11,551	20,416	22,780	24,623	33,042	45,801
Dominica	2	0	0	0	0	0	0
Dominican Republic	87	164	512	472	662	792	848
Ecuador	2,032	774	902	1,091	984	550	707
Egypt	832	603	571	1,149	3,549	5,651	10,623
El Salvador	51	51	582	658	822	932	827
Estonia	27	44	174	343	97	98	173
Ethiopia	*	0	0	0	0	0	0
Falkland Islands	0	0	0	*	1	2	4
Faroe Islands	0	0	0	0	0	*	14
Fiji	0	0	0	0	0	7	29
Finland	20,715	54,604	40,705	38,353	48,403	59,659	93,745
France	99,752	138,291	173,716	206,465	252,914	369,822	430,724
French Guiana	*	0	*	*	*	8	*
Gambia	32	22	30	0	0	*	*
Georgia	*	4	*	0	*	30	150
Germany	108,414	118,319	174,641	191,604	207,010	282,409	418,101
Ghana	358	208	350	4	3	3	192
Gibraltar	*	22	11	64	211	135	96
Greece	2,741	4,563	5,935	8,290	10,555	16,006	25,485
Grenada	*	8	6	2	2	16	14
Guadeloupe	1	0	0	0	0	0	0
Guatemala	193	58	109	173	206	206	224
Guernsey	450	4,645	5,348	5,941	6,394	12,487	15,801
Guinea	0	0	0	0	0	0	3
Guyana	*	0	5	0	0	0	0
Haiti	*	0	0	0	0	0	0
Honduras	17	17	22	15	17	8	6
Hong Kong	31,628	32,047	37,628	37,328	46,197	87,493	121,259
Hungary	4,846	2,026	3,064	5,104	5,634	8,382	9,094
Iceland	309	224	133	243	3,229	6,051	7,251
India	8,138	7,173	18,683	23,515	33,226	48,957	85,049
Indonesia	4,345	1,841	5,072	6,985	9,001	14,072	18,348
Ireland	17,666	31,384	30,642	46,244	49,920	86,268	99,122
Isle of Man	9	1	0	15	61	569	1,293
Israel	12,298	21,180	28,653	34,308	44,308	41,506	54,147
Italy	59,171	46,985	63,927	74,845	75,953	104,678	118,811
Jamaica	329	268	40	195	442	591	662
Japan	166,758	196,866	292,668	366,860	528,415	589,677	589,437

* Greater than zero but less than \$500,000. n.a. Not available.

Table 20. Market value of U.S. holdings of foreign long-term securities, by country, as of selected survey dates (continued)

Millions of dollars

Country or category	December 1997	December 2001	December 2003	December 2004	December 2005	December 2006	December 2007
Jersey	1,554	1,615	5,197	7,074	9,140	12,747	17,652
Jordan	219	98	57	41	72	61	110
Kazakhstan	121	140	102	346	336	1,281	1,316
Kenya	36	16	22	17	21	15	32
Kiribati	24	0	0	0	0	0	0
Korea, South	15,262	34,475	53,338	73,544	118,507	123,663	139,079
Kyrgyzstan	0	0	*	11	0	0	0
Latvia	4	13	*	8	12	13	18
Lebanon	813	87	151	223	408	375	432
Lesotho	73	2	2	26	0	0	*
Liberia	1,400	1,359	4,328	7,829	6,749	5,786	6,763
Liechtenstein	5	59	19	35	66	244	263
Lithuania	41	51	28	5	52	41	74
Luxembourg	8,289	10,941	21,069	34,181	40,463	52,697	83,892
Macedonia	20	34	42	40	53	0	0
Madagascar	2	3	0	0	0	0	0
Malawi	0	19	0	0	0	0	0
Malaysia	9,078	4,258	7,954	10,684	11,282	15,386	24,029
Maldives	*	0	0	0	0	0	0
Mali	0	4	0	0	0	0	0
Malta	148	93	19	17	96	155	122
Marshall Islands	35	66	942	4,475	5,546	7,462	13,586
Mauritania	0	0	0	0	*	*	*
Mauritius	731	149	174	325	237	638	1,655
Mexico	63,751	48,772	56,145	66,121	86,074	108,432	109,299
Moldova	39	29	0	0	0	*	*
Monaco	0	2	3	8	9	10	16
Mongolia	0	0	1	0	0	0	*
Morocco	561	369	162	228	440	415	455
Mozambique	0	3	0	0	0	0	0
Namibia	132	1	3	1	1	2	3
Nauru	0	0	0	0	0	*	*
Netherlands	120,150	143,375	173,780	191,544	184,530	229,364	230,387
Netherlands Antilles	17,002	15,871	24,727	30,252	47,223	58,171	89,280
New Caledonia	1	0	0	0	0	0	*
New Zealand	8,817	4,056	8,905	10,439	9,871	8,677	7,841
Nicaragua	76	19	0	37	30	28	29
Norway	14,267	13,831	20,168	28,422	31,478	46,728	61,615
Pakistan	1,521	180	133	147	389	1,026	1,757
Palau	1	0	0	0	0	0	0

* Greater than zero but less than \$500,000. n.a. Not available.

Table 20. Market value of U.S. holdings of foreign long-term securities, by country, as of selected survey dates (continued)

Millions of dollars

Country or category	December 1997	December 2001	December 2003	December 2004	December 2005	December 2006	December 2007
Panama	6,595	9,868	18,583	24,279	25,938	26,068	29,432
Papua New Guinea	174	155	235	314	782	1,298	2,429
Paraguay	81	0	0	0	0	0	0
Peru	3,544	1,673	3,999	3,874	4,588	3,763	4,331
Philippines	7,327	4,015	5,037	5,690	7,179	10,989	14,459
Poland	4,495	3,098	3,480	5,624	7,536	11,816	13,860
Portugal	8,233	4,350	5,077	6,313	5,966	6,442	8,342
Romania	211	13	151	172	251	380	613
Russia	12,153	10,208	21,554	21,314	28,764	48,421	80,906
Rwanda	*	0	0	0	0	0	0
Saint Kitts and Nevis	*	0	*	*	3	3	*
Saint Lucia	0	0	0	49	98	66	62
Saint Vincent and Grenadine	0	0	0	0	0	0	0
Sao Tome and Principe	33	0	0	0	0	0	0
Senegal	7	0	*	*	*	*	2
Serbia and Montenegro	13	1	15	1	108	205	272
Seychelles	52	0	1	0	0	2	58
Sierra Leone	1	0	*	0	0	0	0
Singapore	10,735	22,818	24,883	29,081	36,047	52,428	64,644
Slovakia	184	133	88	190	309	299	71
Slovenia	224	14	87	37	79	144	351
Solomon Islands	*	0	0	0	0	0	0
Somalia	6	0	*	0	0	0	0
South Africa	12,541	7,861	17,849	24,647	34,211	42,546	53,046
Spain	32,146	39,825	50,094	68,074	69,226	109,773	144,471
Sri Lanka	193	158	87	79	93	183	281
Sudan	*	0	0	0	0	0	0
Suriname	46	0	0	0	0	0	0
Swaziland	3	5	3	0	0	0	0
Sweden	51,886	33,606	40,284	52,862	57,011	83,261	86,503
Switzerland	63,140	76,354	119,000	139,738	193,999	263,828	284,385
Taiwan	6,227	19,860	27,228	34,885	57,877	74,449	81,191
Tanzania	*	7	0	0	0	0	0
Thailand	5,624	2,698	7,312	7,097	10,392	12,756	16,832
Tokelau Islands	20	0	*	0	0	0	0
Tonga	50	0	0	0	0	0	0
Trinidad and Tobago	464	469	606	477	490	711	1,472
Tunisia	280	168	1,280	588	639	607	501
Turkey	7,010	3,525	5,713	8,137	14,179	15,225	25,086
Turks and Caicos Islands	419	32	57	*	*	*	*

* Greater than zero but less than \$500,000. n.a. Not available.

Table 20. Market value of U.S. holdings of foreign long-term securities, by country, as of selected survey dates (continued)

Millions of dollars

Country or category	December 1997	December 2001	December 2003	December 2004	December 2005	December 2006	December 2007
Uganda	1	5	*	0	0	0	0
Ukraine	90	203	603	1,548	1,276	1,506	2,137
United Kingdom	271,680	430,882	563,955	627,365	722,849	919,343	1,001,416
Uruguay	613	603	603	1,303	1,073	1,694	1,957
Uzbekistan	0	1	4	0	0	0	0
Venezuela	7,827	3,655	5,303	6,863	6,003	6,097	5,416
Vietnam	37	21	81	113	306	238	248
Zambia	9	5	5	2	12	16	76
Zimbabwe	169	88	61	68	79	203	200
Country Unknown	870	40	35	*	*	0	0
International Organizations	16,975	11,878	17,552	18,162	18,986	19,369	22,495
Middle East oil-exporters ²	458	602	990	1,454	2,693	5,829	10,460
African oil-exporters ³	843	636	320	191	222	97	771
Total	1,755,015	2,169,735	2,953,781	3,553,387	4,345,891	5,623,019	6,855,201

* Greater than zero but less than \$500,000. n.a. Not available.

2. Bahrain, Iran, Iraq, Kuwait, Oman, Qatar, Saudi Arabia, United Arab Emirates.

3. Algeria, Gabon, Libya, Nigeria.

Table 21. Market value of U.S. holdings of foreign equities, by country, as of selected survey dates

Millions of dollars

Country or category	December 1997	December 2001	December 2003	December 2004	December 2005	December 2006	December 2007
Albania	0	0	0	0	0	0	*
Andorra	5	0	0	2	5	9	14
Anguilla	0	0	0	2	3	4	15
Antigua and Barbuda	0	0	1	12	32	33	127
Argentina	12,892	744	846	1,161	1,144	1,844	1,922
Aruba	11	*	0	*	0	0	0
Australia	31,120	37,112	56,454	57,052	71,141	101,990	138,096
Austria	3,707	1,204	3,925	8,976	10,724	18,144	20,069
Bahamas	568	1,162	1,819	1,779	2,327	1,064	1,302
Bangladesh	7	4	0	0	*	4	163
Barbados	1	1	2	10	*	25	56
Belarus	1	0	0	0	0	0	0
Belgium	6,099	8,415	10,621	18,083	19,947	28,805	31,642
Belize	29	7	25	26	41	27	56
Bermuda	22,617	118,878	107,538	153,549	173,842	191,853	256,111
Bolivia	*	*	2	0	0	0	0
Bosnia and Herzegovina	0	1	0	4	0	0	0
Botswana	131	20	3	3	3	4	5
Brazil	31,338	21,801	31,781	43,104	68,560	92,045	172,599
British Virgin Islands	698	1,774	2,269	3,716	5,899	8,178	11,156
Bulgaria	*	*	5	6	78	95	387
Burma	3	0	0	0	0	0	0
Burundi	0	0	0	0	0	0	0
Cambodia	1	0	0	0	0	0	0
Cameroon	0	0	0	0	0	0	0
Canada	70,798	89,591	149,267	180,398	247,823	298,137	378,965
Cayman Islands	5,612	35,764	45,287	69,750	102,603	160,555	231,886
Central African Republic	0	0	0	0	0	0	0
Chile	4,555	1,917	2,102	2,564	3,520	4,447	5,205
China, mainland ¹	2,256	2,370	13,064	11,645	26,888	73,912	95,658
Colombia	704	150	133	270	753	732	1,193
Comoros	2	0	*	0	0	0	*
Congo (Brazzaville)	0	0	0	0	0	0	0
Congo (Kinshasa)	*	0	0	0	0	0	0
Cook Islands	1	0	0	0	73	*	*
Costa Rica	*	5	5	5	20	2	*
Cote d'Ivoire	2	6	0	2	0	0	1
Croatia	126	255	270	234	189	74	164
Cuba	*	0	*	*	*	*	*
Cyprus	120	59	17	3	105	726	2,305

* Greater than zero but less than \$500,000.

1. Excludes Hong Kong and Macau, which are reported separately.

Table 21. Market value of U.S. holdings of foreign equities, by country, as of selected survey dates (continued)

Millions of dollars

Country or category	December 1997	December 2001	December 2003	December 2004	December 2005	December 2006	December 2007
Czech Republic	763	444	1,249	1,843	1,727	3,045	5,155
Denmark	8,917	7,533	10,429	14,488	15,652	21,236	32,971
Dominica	2	0	0	0	0	0	0
Dominican Republic	*	13	4	*	*	1	*
Ecuador	98	18	5	25	41	*	*
Egypt	763	340	523	1,093	2,567	4,377	8,865
El Salvador	39	2	0	*	*	0	5
Estonia	17	39	138	304	62	63	135
Falkland Islands	0	0	0	*	1	2	4
Faroe Islands	0	0	0	0	0	*	14
Fiji	0	0	0	0	0	0	0
Finland	14,785	51,307	35,162	33,860	44,393	55,852	90,158
France	85,019	112,205	130,761	164,634	205,113	306,861	347,795
French Guiana	*	0	*	*	*	8	*
Gambia	*	1	0	0	0	*	*
Georgia	*	3	*	0	0	27	147
Germany	64,965	72,200	103,239	123,685	158,013	220,397	329,164
Ghana	358	207	349	3	2	2	20
Gibraltar	*	22	1	64	211	135	96
Greece	1,513	2,810	3,957	6,980	9,529	14,448	23,722
Grenada	*	*	0	0	0	0	0
Guadeloupe	0	0	0	0	0	0	0
Guatemala	2	0	0	0	*	*	0
Guernsey	378	4,576	4,636	5,399	5,797	11,715	13,229
Guinea	0	0	0	0	0	0	3
Guyana	*	0	0	0	0	0	0
Haiti	0	0	0	0	0	0	0
Honduras	*	0	*	0	0	0	*
Hong Kong	28,102	30,154	36,210	35,395	44,465	85,833	119,522
Hungary	3,483	1,702	2,412	4,503	4,880	7,619	7,309
Iceland	3	41	3	2	14	29	32
India	6,176	6,897	18,500	23,152	32,753	47,932	81,755
Indonesia	2,488	1,526	4,406	6,116	7,127	11,490	15,077
Ireland	14,147	28,374	22,191	32,422	33,027	47,943	48,969
Isle of Man	9	1	0	*	36	541	1,144
Israel	7,036	13,333	16,361	19,054	29,125	26,019	38,892
Italy	41,547	33,686	38,971	57,494	63,915	92,733	96,927
Jamaica	3	1	1	2	2	2	*
Japan	136,404	170,714	255,494	330,427	493,343	543,506	529,219

* Greater than zero but less than \$500,000.

Table 21. Market value of U.S. holdings of foreign equities, by country, as of selected survey dates (continued)

Millions of dollars

Country or category	December 1997	December 2001	December 2003	December 2004	December 2005	December 2006	December 2007
Jersey	1,517	29	867	436	824	2,848	5,414
Jordan	40	61	40	19	40	28	83
Kazakhstan	1	2	*	*	6	953	812
Kenya	19	5	6	2	3	7	24
Kiribati	*	0	0	0	0	0	0
Korea, South	4,428	29,537	49,121	66,639	110,264	114,155	129,234
Kyrgyzstan	0	0	0	*	0	0	0
Latvia	4	13	*	4	10	13	18
Lebanon	133	38	23	49	100	87	141
Lesotho	70	2	2	25	0	0	*
Liberia	924	701	2,589	5,866	5,172	4,253	5,053
Liechtenstein	5	59	19	35	66	241	253
Lithuania	14	3	3	3	20	9	29
Luxembourg	5,345	2,357	6,026	7,634	11,134	15,590	40,071
Macedonia	0	0	0	0	0	0	0
Madagascar	1	3	0	0	0	0	0
Malawi	0	19	0	0	0	0	0
Malaysia	4,713	2,578	4,075	6,474	6,934	10,781	17,670
Maldives	0	0	0	0	0	0	0
Mali	0	4	0	0	0	0	0
Malta	0	*	*	*	*	82	50
Marshall Islands	0	65	705	3,727	5,047	6,781	13,096
Mauritania	0	0	0	0	0	0	0
Mauritius	65	71	62	143	188	619	1,568
Mexico	34,965	26,279	28,529	37,516	57,876	84,620	85,417
Moldova	*	*	0	0	0	*	*
Monaco	0	2	3	8	9	10	16
Mongolia	0	0	0	0	0	0	0
Morocco	217	37	16	89	299	337	394
Mozambique	0	3	0	0	0	0	0
Namibia	130	1	*	1	1	2	3
Nauru	0	0	0	0	0	*	*
Netherlands	106,984	112,751	115,792	136,467	132,769	161,493	153,976
Netherlands Antilles	15,809	14,544	23,359	28,730	45,378	56,368	87,994
New Caledonia	1	0	0	0	0	0	*
New Zealand	5,311	2,004	3,861	4,720	4,633	4,671	3,940
Nicaragua	0	0	0	0	0	0	0
Norway	9,494	7,906	11,972	18,153	22,023	32,096	46,383
Pakistan	1,180	86	85	111	364	780	1,444
Palau	*	0	0	0	0	0	0

* Greater than zero but less than \$500,000.

Table 21. Market value of U.S. holdings of foreign equities, by country, as of selected survey dates (continued)

Millions of dollars

Country or category	December 1997	December 2001	December 2003	December 2004	December 2005	December 2006	December 2007
Panama	3,556	7,450	14,822	19,450	20,998	21,340	25,296
Papua New Guinea	165	155	235	314	782	1,298	2,429
Paraguay	*	0	0	0	0	0	0
Peru	2,341	452	1,087	666	870	925	1,679
Philippines	2,848	1,344	1,634	2,222	3,068	6,050	9,909
Poland	1,618	1,197	1,671	3,072	4,562	7,384	9,078
Portugal	6,993	3,819	3,949	5,505	5,323	5,982	6,109
Romania	4	3	24	120	249	372	612
Russia	8,457	4,613	13,259	10,775	18,631	40,291	74,386
Rwanda	0	0	0	0	0	0	0
Saint Kitts and Nevis	*	0	*	*	3	3	*
Saint Lucia	0	0	0	0	0	0	0
Saint Vincent and Grenadine	0	0	0	0	0	0	0
Sao Tome and Principe	0	0	0	0	0	0	0
Senegal	4	0	*	*	*	0	2
Serbia and Montenegro	*	0	0	0	7	105	201
Seychelles	6	0	1	0	0	0	0
Sierra Leone	1	0	*	0	0	0	0
Singapore	10,185	21,376	21,932	23,968	29,109	43,911	55,584
Slovakia	87	3	14	*	1	*	*
Slovenia	56	4	13	1	48	116	318
Solomon Islands	0	0	0	0	0	0	0
Somalia	3	0	*	0	0	0	0
South Africa	9,937	6,714	15,101	21,600	31,605	39,586	49,138
Spain	25,223	32,455	43,801	63,002	63,514	85,600	106,648
Sri Lanka	133	35	33	31	74	152	166
Sudan	0	0	0	0	0	0	0
Suriname	46	0	0	0	0	0	0
Swaziland	1	*	0	*	0	0	0
Sweden	38,784	24,274	27,529	38,284	40,530	59,433	57,393
Switzerland	61,897	75,587	117,910	138,187	191,812	262,620	280,767
Taiwan	4,939	19,607	26,970	34,554	57,088	74,228	81,024
Tanzania	*	7	0	0	0	0	0
Thailand	2,158	1,916	6,477	5,961	8,992	11,054	15,998
Tokelau Islands	*	0	*	0	0	0	0
Tonga	0	0	0	0	0	0	0
Trinidad and Tobago	1	158	*	5	2	*	*
Tunisia	0	4	*	*	*	4	4
Turkey	6,005	2,269	3,781	5,561	11,122	11,180	19,705
Turks and Caicos Islands	384	32	57	*	*	*	*

* Greater than zero but less than \$500,000.

Table 21. Market value of U.S. holdings of foreign equities, by country, as of selected survey dates (continued)

Millions of dollars

Country or category	December 1997	December 2001	December 2003	December 2004	December 2005	December 2006	December 2007
Uganda	1	5	0	0	0	0	0
Ukraine	61	2	17	25	50	235	643
United Kingdom	217,525	350,014	420,675	455,919	537,891	673,978	714,928
Uruguay	15	4	3	6	3	*	0
Uzbekistan	0	1	0	0	0	0	0
Venezuela	1,975	348	405	636	483	971	416
Vietnam	*	0	*	*	*	0	11
Zambia	7	5	5	2	11	16	75
Zimbabwe	133	47	13	14	32	135	157
Country Unknown	337	38	11	*	*	0	0
International Organizations	10	147	365	373	21	327	366
Middle East oil-exporters ²	28	14	1	1	138	299	2,184
African oil-exporters ³	61	23	34	12	11	18	251
Total	1,207,787	1,612,673	2,079,424	2,560,418	3,317,712	4,328,960	5,247,990

* Greater than zero but less than \$500,000.

2. Bahrain, Iran, Iraq, Kuwait, Oman, Qatar, Saudi Arabia, United Arab Emirates.

3. Algeria, Gabon, Libya, Nigeria.

Table 22. Market value of U.S. holdings of foreign long-term debt securities, by country, as of selected survey dates

Millions of dollars

Country or category	December 1997	December 2001	December 2003	December 2004	December 2005	December 2006	December 2007
Albania	32	10	4	5	6	12	13
Andorra	0	0	0	0	0	0	0
Anguilla	0	0	0	0	0	0	0
Antigua and Barbuda	0	0	*	*	2	0	0
Argentina	25,675	3,635	3,458	3,664	5,696	9,135	7,860
Aruba	11	271	906	1,114	1,189	1,272	1,102
Australia	15,879	15,999	29,218	40,366	48,560	61,634	73,257
Austria	1,954	2,306	5,244	4,682	5,113	5,001	6,443
Bahamas	342	478	1,070	872	930	458	908
Bangladesh	0	0	*	0	0	0	0
Barbados	16	53	251	246	272	298	367
Belarus	2	0	*	0	0	0	0
Belgium	3,070	3,725	5,143	5,213	4,215	5,654	5,105
Belize	5	1	52	34	9	25	32
Bermuda	3,989	6,329	8,668	9,862	11,232	13,566	16,708
Bolivia	12	*	*	0	*	*	10
Bosnia and Herzegovina	3	10	50	145	114	72	90
Botswana	16	2	2	4	1	1	1
Brazil	20,318	11,652	18,365	19,885	21,697	18,211	16,165
British Virgin Islands	440	237	1,330	747	2,449	2,818	3,687
Bulgaria	1,310	1,763	1,438	1,167	350	217	174
Burma	139	0	0	0	0	0	0
Burundi	0	0	0	0	0	0	4
Cambodia	0	0	0	0	0	0	0
Cameroon	4	0	0	0	0	0	0
Canada	106,675	115,618	139,433	151,852	157,509	162,074	185,217
Cayman Islands	13,635	34,317	75,668	114,378	118,399	177,889	271,328
Central African Republic	0	1	0	0	0	0	0
Chile	3,571	4,030	7,595	9,034	8,577	8,092	7,564
China, mainland ¹	3,178	634	667	1,065	1,544	1,305	1,457
Colombia	3,458	2,610	3,354	4,185	4,266	5,096	5,567
Comoros	19	0	0	0	0	0	0
Congo (Brazzaville)	13	0	0	0	0	0	0
Congo (Kinshasa)	*	0	0	0	0	0	0
Cook Islands	0	0	0	0	0	0	0
Costa Rica	165	153	313	236	400	315	370
Cote d'Ivoire	456	156	96	95	92	95	158
Croatia	370	508	406	482	514	326	304
Cuba	*	0	0	1	0	0	0
Cyprus	202	51	83	100	103	93	338

* Greater than zero but less than \$500,000.

1. Excludes Hong Kong and Macau, which are reported separately.

Table 22. Market value of U.S. holdings of foreign long-term debt securities, by country, as of selected survey dates (continued)

Millions of dollars

Country or category	December 1997	December 2001	December 2003	December 2004	December 2005	December 2006	December 2007
Czech Republic	45	37	44	33	15	26	196
Denmark	7,841	4,018	9,987	8,292	8,970	11,806	12,830
Dominica	0	0	0	0	0	0	0
Dominican Republic	87	151	508	472	662	791	848
Ecuador	1,934	756	897	1,066	942	550	707
Egypt	69	263	48	56	983	1,274	1,758
El Salvador	12	49	582	658	822	932	822
Estonia	10	5	36	39	35	35	38
Falkland Islands	0	0	0	0	0	0	0
Faroe Islands	0	0	0	0	0	0	0
Fiji	0	0	0	0	0	7	29
Finland	5,930	3,297	5,542	4,493	4,010	3,807	3,587
France	14,733	26,086	42,955	41,831	47,801	62,961	82,929
French Guiana	0	0	0	0	0	0	0
Gambia	32	21	30	0	0	0	0
Georgia	0	1	*	0	*	3	3
Germany	43,449	46,119	71,403	67,918	48,997	62,012	88,938
Ghana	0	1	1	1	1	1	173
Gibraltar	0	0	10	0	0	*	0
Greece	1,228	1,753	1,978	1,310	1,025	1,559	1,763
Grenada	0	8	6	2	2	16	14
Guadeloupe	1	0	0	0	0	0	0
Guatemala	191	58	109	173	206	206	224
Guernsey	72	69	713	542	597	772	2,572
Guinea	0	0	0	0	0	0	0
Guyana	0	0	5	0	0	0	0
Haiti	0	0	0	0	0	0	0
Honduras	17	17	22	15	17	8	6
Hong Kong	3,526	1,893	1,419	1,933	1,731	1,660	1,736
Hungary	1,363	324	651	601	754	764	1,785
Iceland	306	183	130	241	3,215	6,022	7,219
India	1,962	276	183	363	473	1,025	3,294
Indonesia	1,857	315	666	869	1,874	2,582	3,271
Ireland	3,519	3,010	8,452	13,821	16,893	38,326	50,153
Isle of Man	0	0	0	15	26	28	149
Israel	5,262	7,847	12,292	15,254	15,183	15,487	15,255
Italy	17,624	13,299	24,956	17,352	12,038	11,945	21,885
Jamaica	326	267	39	193	440	590	662
Japan	30,354	26,152	37,175	36,433	35,072	46,171	60,218

* Greater than zero but less than \$500,000.

Table 22. Market value of U.S. holdings of foreign long-term debt securities, by country, as of selected survey dates (continued)

Millions of dollars

Country or category	December 1997	December 2001	December 2003	December 2004	December 2005	December 2006	December 2007
Jersey	37	1,586	4,329	6,638	8,316	9,899	12,237
Jordan	179	37	17	22	32	33	28
Kazakhstan	120	138	102	346	330	328	504
Kenya	17	11	15	15	17	8	8
Kiribati	24	0	0	0	0	0	0
Korea, South	10,834	4,938	4,217	6,905	8,243	9,507	9,845
Kyrgyzstan	0	0	*	11	0	0	0
Latvia	0	0	0	4	3	*	*
Lebanon	680	49	127	174	308	288	291
Lesotho	3	0	0	1	0	0	0
Liberia	476	658	1,739	1,964	1,576	1,533	1,710
Liechtenstein	0	0	0	0	*	2	10
Lithuania	27	48	25	1	33	32	45
Luxembourg	2,944	8,584	15,043	26,547	29,329	37,108	43,820
Macedonia	20	34	42	40	53	0	0
Madagascar	1	0	0	0	0	0	0
Malawi	0	0	0	0	0	0	0
Malaysia	4,365	1,680	3,878	4,209	4,348	4,605	6,360
Maldives	0	0	0	0	0	0	0
Mali	0	0	0	0	0	0	0
Malta	148	93	19	17	96	73	71
Marshall Islands	35	1	237	748	498	680	490
Mauritania	0	0	0	0	*	*	*
Mauritius	666	78	112	183	48	19	87
Mexico	28,786	22,493	27,615	28,606	28,198	23,812	23,882
Moldova	39	29	0	0	0	0	0
Monaco	0	0	0	0	0	0	0
Mongolia	0	0	1	0	0	0	*
Morocco	344	332	147	139	141	79	61
Mozambique	0	0	0	0	0	0	0
Namibia	2	*	3	0	0	0	0
Nauru	0	0	0	0	0	0	0
Netherlands	13,166	30,624	57,988	55,077	51,760	67,871	76,411
Netherlands Antilles	1,193	1,327	1,369	1,522	1,844	1,803	1,287
New Caledonia	0	0	0	0	0	0	0
New Zealand	3,506	2,052	5,045	5,719	5,238	4,006	3,900
Nicaragua	76	19	0	37	30	28	29
Norway	4,773	5,925	8,195	10,270	9,455	14,632	15,232
Pakistan	341	94	48	36	25	246	313
Palau	1	0	0	0	0	0	0

* Greater than zero but less than \$500,000.

Table 22. Market value of U.S. holdings of foreign long-term debt securities, by country, as of selected survey dates (continued)

Millions of dollars

Country or category	December 1997	December 2001	December 2003	December 2004	December 2005	December 2006	December 2007
Panama	3,039	2,418	3,761	4,830	4,940	4,728	4,136
Papua New Guinea	9	0	0	0	0	0	0
Paraguay	81	0	0	0	0	0	0
Peru	1,203	1,221	2,912	3,208	3,718	2,838	2,651
Philippines	4,479	2,671	3,403	3,468	4,111	4,939	4,550
Poland	2,877	1,901	1,809	2,552	2,974	4,432	4,782
Portugal	1,240	531	1,128	807	643	460	2,232
Romania	207	10	127	52	2	9	1
Russia	3,696	5,595	8,296	10,540	10,133	8,130	6,520
Rwanda	0	0	0	0	0	0	0
Saint Kitts and Nevis	0	0	0	0	0	0	0
Saint Lucia	0	0	0	49	98	66	62
Saint Vincent and Grenadine	0	0	0	0	0	0	0
Sao Tome and Principe	33	0	0	0	0	0	0
Senegal	3	0	0	0	0	*	0
Serbia and Montenegro	13	1	15	1	101	100	71
Seychelles	46	0	0	0	0	2	58
Sierra Leone	0	0	0	0	0	0	0
Singapore	550	1,442	2,951	5,113	6,938	8,518	9,061
Slovakia	97	130	74	190	309	299	70
Slovenia	168	10	74	36	31	28	34
Solomon Islands	0	0	0	0	0	0	0
Somalia	3	0	0	0	0	0	0
South Africa	2,604	1,147	2,748	3,047	2,607	2,960	3,908
Spain	6,922	7,370	6,293	5,072	5,712	24,172	37,823
Sri Lanka	60	123	55	49	19	30	115
Sudan	0	0	0	0	0	0	0
Suriname	0	0	0	0	0	0	0
Swaziland	0	3	5	3	0	0	0
Sweden	13,102	9,332	12,755	14,577	16,481	23,829	29,110
Switzerland	1,243	767	1,090	1,551	2,187	1,208	3,618
Taiwan	1,288	253	258	331	789	220	168
Tanzania	0	0	0	0	0	0	0
Thailand	3,466	782	835	1,136	1,400	1,702	834
Tokelau Islands	20	0	0	0	0	0	0
Tonga	50	0	0	0	0	0	0
Trinidad and Tobago	463	311	606	472	488	711	1,472
Tunisia	280	164	1,280	588	639	604	497
Turkey	1,005	1,256	1,932	2,577	3,056	4,045	5,381
Turks and Caicos Islands	35	0	0	0	0	0	0

* Greater than zero but less than \$500,000.

Table 22. Market value of U.S. holdings of foreign long-term debt securities, by country, as of selected survey dates (continued)

Millions of dollars

Country or category	December 1997	December 2001	December 2003	December 2004	December 2005	December 2006	December 2007
Uganda	0	0	0	0	0	0	0
Ukraine	29	201	586	1,524	1,266	1,272	1,495
United Kingdom	54,155	80,868	143,280	171,446	184,958	245,365	286,488
Uruguay	598	599	600	1,297	1,070	1,694	1,957
Uzbekistan	0	0	4	0	0	0	0
Venezuela	5,852	3,307	4,898	6,226	5,520	5,125	5,000
Vietnam	37	21	81	113	306	238	237
Zambia	2	*	0	0	1	0	2
Zimbabwe	36	41	48	54	47	68	43
Country Unknown	533	2	24	*	*	0	0
International Organizations	16,965	11,731	17,187	17,789	18,965	19,042	22,130
Middle East oil-exporters ²	430	588	989	1,453	2,555	5,530	8,276
African oil-exporters ³	782	613	286	180	211	79	519
Total	547,228	557,062	874,357	992,969	1,028,179	1,294,059	1,607,211

* Greater than zero but less than \$500,000.

2. Bahrain, Iran, Iraq, Kuwait, Oman, Qatar, Saudi Arabia, United Arab Emirates.

3. Algeria, Gabon, Libya, Nigeria.

Table 23. Market value of U.S. holdings of foreign short-term debt securities, by country, as of the survey dates

Millions of dollars

Country or category	December 2001	December 2003	December 2004	December 2005	December 2006	December 2007
Albania	0	0	0	0	0	0
Andorra	0	0	0	0	0	0
Anguilla	0	0	0	0	0	0
Antigua and Barbuda	0	0	0	0	*	0
Argentina	334	11	1	12	39	44
Aruba	0	0	0	0	0	0
Australia	2,072	4,830	5,994	8,501	9,529	11,217
Austria	826	1,201	1,591	1,444	3,424	2,486
Bahamas	7	23	1	9	152	52
Bangladesh	0	0	0	0	0	4
Barbados	0	0	0	0	0	0
Belarus	0	0	0	0	0	0
Belgium	588	1,223	677	502	1,509	1,127
Belize	0	0	0	0	0	0
Bermuda	271	89	663	1,588	2,631	149
Bolivia	3	1	0	0	0	0
Bosnia and Herzegovina	0	0	0	0	0	0
Botswana	1	0	0	0	0	0
Brazil	677	83	10	28	38	44
British Virgin Islands	0	*	4	34	0	*
Bulgaria	0	0	0	0	0	0
Burma	0	0	0	0	0	0
Burundi	0	0	0	0	0	0
Cambodia	0	0	0	0	0	0
Cameroon	0	0	0	0	0	0
Canada	6,235	12,278	12,419	13,593	17,678	22,272
Cayman Islands	958	4,017	11,549	27,768	37,098	40,673
Central African Republic	0	0	0	0	0	0
Chile	1	*	*	2	0	5
China, mainland ¹	0	7	12	11	97	125
Colombia	*	*	*	*	0	35
Comoros	0	0	0	0	0	0
Congo (Brazzaville)	0	0	0	0	0	0
Congo Kinshasa	0	0	0	0	0	0
Cook Islands	0	0	0	0	0	0
Costa Rica	33	19	19	19	23	6
Cote D'Ivoire	0	0	0	0	0	0
Croatia	0	0	0	0	0	0
Cuba	0	0	0	0	0	0
Cyprus	0	*	*	2	304	325

* Greater than zero but less than \$500,000.

1. Excludes Hong Kong and Macau, which are reported separately.

Table 23. Market value of U.S. holdings of foreign short-term debt securities, by country, as of the survey dates (continued)

Millions of dollars

Country or category	December 2001	December 2003	December 2004	December 2005	December 2006	December 2007
Czech Republic	0	0	0	0	0	0
Denmark	570	1,725	1,103	653	936	1,356
Dominica	0	0	0	0	0	0
Dominican Republic	*	*	31	101	25	1
Ecuador	*	*	24	*	2	2
Egypt	0	0	3	205	1,035	1,245
El Salvador	19	19	16	16	3	8
Estonia	0	0	0	0	0	1
Falkland Islands	0	0	0	0	0	0
Faroe Islands	0	0	0	0	0	0
Fiji	0	0	0	0	0	0
Finland	535	422	543	375	275	428
France	5,281	11,243	10,142	20,965	31,566	17,466
French Guiana	0	0	0	0	0	0
Gambia	0	0	0	0	0	0
Georgia	0	0	0	0	0	0
Germany	18,174	14,662	9,772	9,717	9,694	7,919
Ghana	0	0	*	0	0	0
Gibraltar	0	20	0	0	0	0
Greece	*	*	0	0	6	0
Grenada	0	0	0	0	0	0
Guadeloupe	2	0	0	0	0	0
Guatemala	2	0	0	0	0	0
Guernsey	0	1	*	2	6	29
Guinea	0	0	0	0	0	0
Guyana	0	0	0	0	0	0
Haiti	0	0	0	0	0	0
Honduras	28	28	28	28	21	21
Hong Kong	0	32	22	29	25	18
Hungary	0	28	*	1	27	131
Iceland	0	10	*	0	1,777	17
India	25	16	10	0	274	100
Indonesia	0	0	3	24	*	1
Ireland	1,047	2,827	9,020	25,448	34,244	32,732
Isle of Man	0	0	0	0	0	13
Israel	53	11	7	5	11	103
Italy	1,223	3,004	2,864	3,440	1,215	1,151
Jamaica	11	0	9	4	0	0
Japan	11,603	13,861	17,240	2,470	6,562	4,326

* Greater than zero but less than \$500,000.

Table 23. Market value of U.S. holdings of foreign short-term debt securities, by country, as of the survey dates (continued)

Millions of dollars

Country or category	December 2001	December 2003	December 2004	December 2005	December 2006	December 2007
Jersey	833	5,262	5,278	9,917	8,703	10,982
Jordan	0	0	*	0	0	0
Kazakhstan	0	0	0	0	7	25
Kenya	0	0	0	0	0	0
Kirabati	0	0	0	0	0	0
Korea, South	0	91	70	0	213	476
Kyrgyzstan	0	0	0	0	0	0
Latvia	0	0	0	0	0	0
Lebanon	0	0	0	*	0	0
Lesotho	0	0	0	0	0	0
Liberia	0	0	0	0	0	0
Liechtenstein	0	0	0	0	0	0
Lithuania	0	0	0	0	0	0
Luxembourg	2,094	2,314	3,868	5,824	7,404	11,230
Macedonia	0	0	0	0	0	0
Madagascar	0	0	0	0	0	0
Malawi	0	0	0	0	0	0
Malaysia	0	*	6	0	18	1,179
Maldives	0	0	0	0	0	0
Mali	0	0	0	0	0	0
Malta	0	0	0	0	0	5
Marshall Islands	0	0	0	0	0	0
Mauritania	0	0	0	0	0	0
Mauritius	0	0	0	1	1	2
Mexico	132	96	195	34	18	432
Moldova	0	0	0	0	0	0
Monaco	0	0	0	0	0	0
Mongolia	0	0	0	0	0	0
Morocco	0	0	0	0	0	0
Mozambique	0	0	0	0	0	0
Namibia	0	0	0	0	0	0
Nauru	0	0	0	0	0	0
Netherlands	5,707	8,413	10,817	7,353	4,701	4,672
Netherlands Antilles	175	9	25	*	2	8
New Caledonia	0	0	0	0	0	0
New Zealand	73	1,652	1,595	2,064	2,695	1,958
Nicaragua	3	1	1	1	0	0
Norway	810	1,076	2,055	4,856	3,845	6,294
Pakistan	0	0	0	0	0	*
Palau	0	0	0	0	0	0

* Greater than zero but less than \$500,000.

Table 23. Market value of U.S. holdings of foreign short-term debt securities, by country, as of the survey dates (continued)

Millions of dollars

Country or category	December 2001	December 2003	December 2004	December 2005	December 2006	December 2007
Panama	88	65	24	213	1	3
Papua New Guinea	0	0	0	0	0	0
Paraguay	0	0	0	0	0	*
Peru	0	0	1	0	0	274
Philippines	0	9	0	0	*	2
Poland	1	1	1	1	0	0
Portugal	156	199	73	87	43	370
Romania	0	0	0	0	0	9
Russia	0	0	0	0	20	13
Rwanda	0	0	0	0	0	0
Saint Kitts and Nevis	0	0	0	0	0	0
Saint Lucia	0	0	0	0	0	0
Saint Vincent and the Grenadines	0	0	0	0	0	0
Sao Tome and Principe	0	0	0	0	0	0
Senegal	0	0	0	0	1	0
Serbia and Montenegro	0	0	0	0	0	0
Seychelles	0	0	0	0	0	0
Sierra Leone	0	0	0	0	0	0
Singapore	0	118	114	314	302	65
Slovakia	0	0	0	0	0	0
Slovenia	0	0	0	0	0	0
Solomon Islands	0	0	0	0	0	0
Somalia	0	0	0	0	0	0
South Africa	0	0	*	0	141	95
Spain	97	1,453	831	595	1,184	1,942
Sri Lanka	0	0	*	0	0	4
Sudan	0	0	0	0	0	0
Suriname	0	0	0	0	0	0
Swaziland	0	0	0	0	0	0
Sweden	3,224	4,973	9,537	17,608	18,805	25,554
Switzerland	273	715	2,274	2,139	415	3,290
Taiwan	0	2	2	*	0	0
Tanzania	0	0	0	0	0	0
Thailand	0	27	16	145	290	10
Tokelau Islands	0	0	0	0	0	0
Tonga	0	0	0	0	0	0
Trinidad and Tobago	26	26	26	26	0	0
Tunisia	0	0	0	0	0	0
Turkey	14	3	87	22	59	0
Turks and Caicos Islands	0	0	0	0	0	0

* Greater than zero but less than \$500,000.

Table 23. Market value of U.S. holdings of foreign short-term debt securities, by country, as of the survey dates (continued)

Millions of dollars

Country or category	December 2001	December 2003	December 2004	December 2005	December 2006	December 2007
Uganda	0	*	0	0	0	1
Ukraine	0	0	3	0	0	0
United Kingdom	82,093	99,155	110,390	91,935	156,236	140,964
Uruguay	0	5	0	0	0	*
Uzbekistan	0	0	0	0	0	0
Venezuela	*	18	0	111	0	0
Vietnam	0	0	0	0	0	0
Zambia	0	0	0	0	3	2
Zimbabwe	0	0	0	0	*	0
Country Unknown	2	31	0	0	0	0
International Organizations	482	1,087	2,177	2,976	2,542	1,520
Middle East oil-exporters ²	0	4	3	3	3	3
African oil-exporters ³	0	0	0	0	0	1
Total	146,860	198,502	233,248	263,221	367,877	357,016

* Greater than zero but less than \$500,000.

2. Bahrain, Iran, Iraq, Kuwait, Oman, Qatar, Saudi Arabia, United Arab Emirates.

3. Algeria, Gabon, Libya, Nigeria.

Table 24. Market value of U.S. holdings of foreign long-term debt securities, by country and currency, as of December 31, 2007

Millions of dollars

Country or region	Total	\$U.S.	Euro	Japanese Yen	U.K. Pound	Own Currency
Albania	13	13	0	0	0	0
Argentina	7,860	5,783	704	1	*	1,328
Aruba	1,102	1,080	0	17	0	4
Australia	73,257	62,139	1,489	0	352	8,933
Austria	6,443	3,589	2,007	511	77	2,007
Bahamas	908	751	0	0	0	*
Barbados	367	367	0	0	0	0
Belgium	5,105	2,117	2,920	0	68	2,920
Belize	32	32	0	0	0	0
Bermuda	16,708	16,526	25	0	67	10
Bolivia	10	10	0	0	0	0
Bosnia and Herzegovina	90	0	50	0	0	0
Botswana	1	1	0	0	0	0
Brazil	16,165	9,442	522	0	0	6,201
British Virgin Islands	3,687	3,423	219	0	0	3,423
Bulgaria	174	171	3	0	0	0
Burundi	4	4	0	0	0	0
Canada	185,217	132,258	400	619	412	51,151
Cayman Islands	271,328	265,525	1,801	2,874	782	141
Chile	7,564	7,557	0	0	0	7
China, mainland ¹	1,457	1,389	2	0	0	5
Colombia	5,567	2,971	65	0	1	2,530
Costa Rica	370	348	0	0	0	22
Cote d'Ivoire	158	103	54	0	0	0
Croatia	304	291	12	0	0	*
Cyprus	338	288	46	0	0	0
Czech Republic	196	11	5	0	0	180
Denmark	12,830	3,139	556	0	78	8,687
Dominican Republic	848	848	0	0	0	*
Ecuador	707	707	0	0	0	707
Egypt	1,758	1,272	0	2	0	484
El Salvador	822	821	0	0	0	1
Estonia	38	0	38	0	0	0
Fiji	29	29	0	0	0	0
Finland	3,587	2,684	828	0	65	828
France	82,929	40,869	41,213	130	440	41,213
Georgia	3	0	3	0	0	0
Germany	88,938	21,224	63,280	2,525	749	63,280
Ghana	173	160	0	0	0	8
Greece	1,763	139	1,476	148	0	1,476
Grenada	14	14	0	0	0	0
Guatemala	224	224	0	0	0	*
Guernsey	2,572	2,231	338	0	1	1

* Greater than zero but less than \$500,000.

1. Excludes Hong Kong and Macau, which are reported separately.

Table 24. Market value of U.S. holdings of foreign long-term debt securities, by country and currency, as of December 31, 2007 (continued)

Millions of dollars

Country or region	Total	\$U.S.	Euro	Japanese Yen	U.K. Pound	Own Currency
Honduras	6	6	0	0	0	*
Hong Kong	1,736	1,361	1	2	*	372
Hungary	1,785	106	104	0	3	1,572
Iceland	7,219	6,904	83	0	52	180
India	3,294	3,265	3	9	0	15
Indonesia	3,271	1,721	0	0	0	1,550
Ireland	50,153	40,727	7,318	233	895	7,318
Isle of Man	149	119	30	0	0	0
Israel	15,255	13,836	50	0	*	1,353
Italy	21,885	4,758	16,497	358	255	16,497
Jamaica	662	543	118	0	0	2
Japan	60,218	5,713	645	53,760	44	53,760
Jersey	12,237	9,189	2,367	42	582	582
Jordan	28	28	0	0	0	0
Kazakhstan	504	503	0	0	0	1
Kenya	8	8	0	0	0	*
Korea, South	9,845	7,689	84	18	0	2,052
Latvia	*	0	*	0	0	0
Lebanon	291	289	1	0	0	0
Liberia	1,710	1,570	139	0	0	0
Liechtenstein	10	0	0	0	0	10
Lithuania	45	0	45	0	0	0
Luxembourg	43,820	36,548	6,911	3	281	6,911
Malaysia	6,360	3,803	36	0	0	2,521
Malta	71	71	0	0	0	0
Marshall Islands	490	490	0	0	0	490
Mauritania	*	*	0	0	0	0
Mauritius	87	83	4	0	0	0
Mexico	23,882	19,659	132	0	111	3,980
Mongolia	*	*	0	0	0	0
Morocco	61	56	5	0	0	0
Netherlands	76,411	59,051	14,754	489	1,234	14,754
Netherlands Antilles	1,287	1,223	26	30	7	0
New Zealand	3,900	2,150	0	0	37	1,589
Nicaragua	29	29	0	0	0	0
Norway	15,232	11,923	293	223	28	2,679
Pakistan	313	313	0	0	0	0
Panama	4,136	4,121	0	0	0	16
Peru	2,651	2,422	44	0	0	186
Philippines	4,550	4,336	120	0	*	94
Poland	4,782	537	36	0	2	4,206
Portugal	2,232	1,427	805	0	0	805
Romania	1	0	1	0	0	0

* Greater than zero but less than \$500,000.

Table 24. Market value of U.S. holdings of foreign long-term debt securities, by country and currency, as of December 31, 2007 (continued)

Millions of dollars

Country or region	Total	\$U.S.	Euro	Japanese Yen	U.K. Pound	Own Currency
Russia	6,520	6,474	2	0	0	44
Saint Lucia	62	62	0	0	0	0
Senegal	0	0	0	0	0	0
Serbia and Montenegro	71	71	0	0	0	0
Seychelles	58	3	55	0	0	0
Singapore	9,061	6,150	49	9	0	2,844
Slovakia	70	28	30	0	0	12
Slovenia	34	0	34	0	0	0
South Africa	3,908	1,760	619	0	0	1,529
Spain	37,823	33,487	3,895	215	99	3,895
Sri Lanka	115	110	0	0	0	5
Sweden	29,110	20,731	650	72	42	7,388
Switzerland	3,618	2,179	50	89	7	1,219
Taiwan	168	103	0	0	0	65
Thailand	834	728	0	0	0	106
Trinidad and Tobago	1,472	1,472	0	0	0	*
Tunisia	497	340	147	10	0	0
Turkey	5,381	3,279	77	0	0	65
Ukraine	1,495	1,243	32	0	0	6
United Kingdom	286,488	224,254	9,249	100	51,731	51,731
Uruguay	1,957	1,324	84	11	0	537
Venezuela	5,000	4,783	170	0	0	48
Vietnam	237	236	0	0	0	1
Zambia	2	1	0	0	0	1
Zimbabwe	43	43	0	0	0	0
International Organizations	22,130	14,199	2,836	1,439	770	0
Middle East oil-exporters ²	8,276	8,205	23	0	24	24
African oil-exporters ³	519	371	0	0	0	148
Total	1,607,211	1,168,761	186,710	63,939	59,298	388,709

Totals by Region:

Total Africa	8,985	5,776	1,023	12	0	2,169
Total Asia	125,309	59,275	1,014	53,798	69	64,767
Total Caribbean	298,444	291,833	2,189	2,921	856	3,581
Total Europe	812,467	540,375	176,038	5,138	56,689	240,468
<i>Of which: Euro Area Countries⁴</i>	<i>421,089</i>	<i>246,620</i>	<i>161,905</i>	<i>4,612</i>	<i>4,162</i>	<i>161,905</i>
Total Latin America	76,983	60,237	1,720	13	112	15,562
Canada	185,217	132,258	400	619	412	51,151
Total Other Countries	77,677	64,808	1,489	0	389	11,012
International Organizations	22,130	14,199	2,836	1,439	770	0

* Greater than zero but less than \$500,000.

2. Bahrain, Iran, Iraq, Kuwait, Oman, Qatar, Saudi Arabia, United Arab Emirates.

3. Algeria, Gabon, Libya, Nigeria.

4. Austria, Belgium, Finland, France, Germany, Greece, Ireland, Italy, Luxembourg, Netherlands, Portugal, Slovenia, Spain.

Table 25. Market value of U.S. holdings of foreign short-term debt securities, by country and currency, as of December 31, 2007

Millions of dollars

Country or region	Total	\$U.S.	Euro	Japanese Yen	U.K. Pound	Own Currency
Argentina	44	3	0	0	0	41
Australia	11,217	10,892	320	0	0	0
Austria	2,486	2,485	0	0	0	0
Bahamas	52	31	0	0	0	0
Bangladesh	4	4	0	0	0	0
Belgium	1,127	994	133	0	0	133
Bermuda	149	149	0	0	0	0
Brazil	44	44	0	0	0	0
British Virgin Islands	*	*	0	0	0	0
Canada	22,272	17,109	0	0	0	5,163
Cayman Islands	40,673	38,426	322	1,925	0	0
Chile	5	0	0	0	0	5
China, mainland ¹	125	120	0	0	0	5
Colombia	35	0	0	0	0	35
Costa Rica	6	0	0	0	0	6
Cyprus	325	325	0	0	0	0
Denmark	1,356	1,355	0	0	0	1
Dominican Republic	1	1	0	0	0	0
Ecuador	2	2	0	0	0	2
Egypt	1,245	3	0	0	0	1,243
El Salvador	8	8	0	0	0	0
Estonia	1	1	0	0	0	0
Finland	428	317	109	0	2	109
France	17,466	15,991	1,454	0	19	1,454
Germany	7,919	5,270	2,637	0	8	2,637
Guernsey	29	13	*	0	16	16
Honduras	21	*	0	0	0	21
Hong Kong	18	0	0	0	0	18
Hungary	131	0	0	0	0	131
Iceland	17	17	0	0	0	0
India	100	100	0	0	0	0
Indonesia	1	1	0	0	0	0
Ireland	32,732	31,226	1,481	0	24	1,481
Isle of Man	13	13	0	0	0	0
Israel	103	103	0	0	0	0
Italy	1,151	1,132	19	0	0	20
Japan	4,326	3,264	0	1,063	0	1,063
Jersey	10,982	10,734	237	0	10	10
Kazakhstan	25	25	0	0	0	0
Korea, South	476	394	0	0	49	32
Luxembourg	11,230	7,943	2,670	0	470	2,670
Malaysia	1,179	11	0	0	0	1,168

* Greater than zero but less than \$500,000.

1. Excludes Hong Kong and Macau, which are reported separately.

Table 25. Market value of U.S. holdings of foreign short-term debt securities, by country and currency, as of December 31, 2007 (continued)

Millions of dollars

Country or region	Total	\$U.S.	Euro	Japanese Yen	U.K. Pound	Own Currency
Malta	5	5	0	0	0	0
Mauritius	2	1	0	0	0	*
Mexico	432	400	0	0	0	31
Netherlands	4,672	4,343	327	0	0	327
Netherlands Antilles	8	8	0	0	0	0
New Zealand	1,958	1,957	0	0	0	1
Norway	6,294	5,934	0	0	0	359
Pakistan	*	*	0	0	0	0
Panama	3	3	0	0	0	0
Paraguay	*	*	0	0	0	0
Peru	274	0	0	0	0	274
Philippines	2	2	0	0	0	0
Portugal	370	370	0	0	0	0
Romania	9	0	0	0	0	0
Russia	13	13	0	0	0	0
Singapore	65	51	0	0	0	14
South Africa	95	94	0	0	0	1
Spain	1,942	1,664	259	0	19	259
Sri Lanka	4	4	0	0	0	0
Sweden	25,554	24,820	734	0	0	0
Switzerland	3,290	3,285	0	0	0	0
Thailand	10	0	0	0	0	10
Uganda	1	0	0	0	0	1
United Kingdom	140,964	137,084	1,401	0	2,425	2,425
Uruguay	*	0	0	0	0	*
Zambia	2	0	0	0	0	2
International Organizations	1,520	1,360	0	0	0	0
Middle East oil-exporters ²	3	3	0	0	0	0
African oil-exporters ³	1	0	0	0	0	1
Total	357,016	329,910	12,104	2,987	3,042	21,168
Totals by Region:						
Total Africa	1,346	98	0	0	0	1,248
Total Asia	6,417	4,058	0	1,063	49	2,310
Total Caribbean	40,884	38,616	322	1,925	0	0
Total Europe	270,529	255,361	11,461	0	2,993	12,031
<i>Of which: Euro Area Countries⁴</i>	<i>81,522</i>	<i>71,735</i>	<i>9,090</i>	<i>0</i>	<i>543</i>	<i>9,089</i>
Total Latin America	874	461	0	0	0	415
Canada	22,272	17,109	0	0	0	5,163
Total Other Countries	13,174	12,848	320	0	0	1
International Organizations	1,520	1,360	0	0	0	0

* Greater than zero but less than \$500,000.

2. Bahrain, Iran, Iraq, Kuwait, Oman, Qatar, Saudi Arabia, and the United Arab Emirates.

3. Algeria, Gabon, Libya, Nigeria.

4. Austria, Belgium, Finland, France, Germany, Greece, Ireland, Italy, Luxembourg, Netherlands, Portugal, Slovenia, Spain.

Table 26. Market value of U.S. holdings of foreign long-debt securities, by country and type of security, as of December 31, 2007

Millions of dollars

Country or category	Total	Straight debt	Zero-coupon	Convertible	Asset-backed
Albania	13	1	12	0	0
Argentina	7,860	7,808	26	1	25
Aruba	1,102	1,102	0	0	0
Australia	73,257	58,533	713	25	13,986
Austria	6,443	6,387	19	22	15
Bahamas	908	893	14	1	0
Barbados	367	253	0	0	114
Belgium	5,105	4,767	239	42	56
Belize	32	32	0	0	0
Bermuda	16,708	15,567	54	268	819
Bolivia	10	10	0	0	0
Bosnia and Herzegovina	90	50	39	0	0
Botswana	1	1	0	0	0
Brazil	16,165	16,027	123	9	6
British Virgin Islands	3,687	3,320	69	7	291
Bulgaria	174	174	0	0	0
Burundi	4	4	0	0	0
Canada	185,217	179,494	2,204	1,422	2,097
Cayman Islands	271,328	70,125	813	1,519	198,871
Chile	7,564	7,555	0	9	0
China, mainland ¹	1,457	1,342	1	114	*
Colombia	5,567	5,499	31	0	37
Costa Rica	370	361	0	0	9
Cote d'Ivoire	158	156	0	0	2
Croatia	304	304	0	0	0
Cyprus	338	338	0	0	0
Czech Republic	196	196	0	0	0
Denmark	12,830	11,614	6	1,114	97
Dominican Republic	848	847	0	0	1
Ecuador	707	672	*	0	34
Egypt	1,758	1,706	52	0	0
El Salvador	822	822	0	0	0
Estonia	38	38	0	0	0
Fiji	29	29	0	0	0
Finland	3,587	3,532	1	53	0
France	82,929	80,227	380	1,228	1,094
Georgia	3	3	0	0	0
Germany	88,938	85,980	1,924	196	838
Ghana	173	173	0	0	0
Greece	1,763	1,762	*	1	0
Grenada	14	14	0	0	0
Guatemala	224	224	0	0	0
Guernsey	2,572	2,179	71	318	4

* Greater than zero but less than \$500,000.

1. Excludes Hong Kong and Macau, which are reported separately.

Table 26. Market value of U.S. holdings of foreign long-debt securities, by country and type of security, as of December 31, 2007 (continued)

Millions of dollars

Country or category	Total	Straight debt	Zero-coupon	Convertible	Asset-backed
Honduras	6	6	0	0	0
Hong Kong	1,736	1,708	19	9	0
Hungary	1,785	1,776	0	9	0
Iceland	7,219	7,112	44	*	63
India	3,294	2,479	80	734	0
Indonesia	3,271	3,269	1	0	2
Ireland	50,153	36,134	381	69	13,568
Isle of Man	149	19	0	119	11
Israel	15,255	8,580	6,649	26	0
Italy	21,885	20,878	207	51	748
Jamaica	662	662	0	0	0
Japan	60,218	59,279	332	222	386
Jersey	12,237	6,788	235	863	4,351
Jordan	28	28	0	0	0
Kazakhstan	504	357	0	0	147
Kenya	8	8	0	0	0
Korea, South	9,845	9,579	115	92	58
Latvia	*	*	0	0	0
Lebanon	291	283	8	0	0
Liberia	1,710	1,683	0	26	0
Liechtenstein	10	8	0	2	0
Lithuania	45	45	0	0	0
Luxembourg	43,820	41,295	46	1,399	1,080
Malaysia	6,360	5,964	21	375	0
Malta	71	70	0	0	1
Marshall Islands	490	490	0	0	0
Mauritania	*	*	0	0	0
Mauritius	87	83	3	*	1
Mexico	23,882	23,544	1	2	335
Mongolia	*	*	0	0	0
Morocco	61	61	0	0	0
Netherlands	76,411	64,249	1,398	1,400	9,363
Netherlands Antilles	1,287	641	5	631	10
New Zealand	3,900	3,769	0	6	125
Nicaragua	29	29	0	0	0
Norway	15,232	14,612	523	88	10
Pakistan	313	308	0	0	5
Panama	4,136	3,609	40	487	0
Peru	2,651	2,649	2	0	*
Philippines	4,550	4,474	31	12	34
Poland	4,782	4,773	9	0	0
Portugal	2,232	2,190	*	25	17
Romania	1	1	0	0	0

* Greater than zero but less than \$500,000.

Table 26. Market value of U.S. holdings of foreign long-debt securities, by country and type of security, as of December 31, 2007 (continued)

Millions of dollars

Country or category	Total	Straight debt	Zero-coupon	Convertible	Asset-backed
Russia	6,520	6,490	20	10	0
Saint Lucia	62	62	0	0	0
Serbia and Montenegro	71	71	0	0	0
Seychelles	58	58	0	0	0
Singapore	9,061	8,682	25	314	39
Slovakia	70	70	0	0	0
Slovenia	34	34	0	0	0
South Africa	3,908	3,900	*	8	0
Spain	37,823	37,556	36	2	229
Sri Lanka	115	115	0	0	0
Sweden	29,110	28,000	1,052	5	53
Switzerland	3,618	3,384	77	156	2
Taiwan	168	127	13	27	0
Thailand	834	822	7	5	0
Trinidad and Tobago	1,472	1,472	0	0	0
Tunisia	497	494	0	0	3
Turkey	5,381	4,796	458	0	127
Ukraine	1,495	1,494	0	0	1
United Kingdom	286,488	202,040	3,377	497	80,574
Uruguay	1,957	1,940	2	0	15
Venezuela	5,000	4,988	*	*	12
Vietnam	237	237	0	0	0
Zambia	2	1	0	1	0
Zimbabwe	43	43	0	0	0
International Organizations	22,130	21,031	1,098	0	*
Middle East oil-exporters ²	8,276	8,248	28	*	0
African oil-exporters ³	519	519	*	0	0
Total	1,607,211	1,240,283	23,140	14,023	329,765
Totals by Region:					
Total Africa	8,985	8,890	55	35	5
Total Asia	125,309	115,523	7,331	1,931	524
Total Caribbean	298,444	94,956	956	2,425	200,107
Total Europe	812,467	681,793	10,556	7,670	112,449
<i>Of which: Euro Area Countries⁴</i>	<i>421,089</i>	<i>384,958</i>	<i>4,632</i>	<i>4,490</i>	<i>27,009</i>
Total Latin America	76,983	75,774	227	509	473
Canada	185,217	179,494	2,204	1,422	2,097
Total Other Countries	77,677	62,822	713	31	14,110
International Organizations	22,130	21,031	1,098	0	*

* Greater than zero but less than \$500,000.

2. Bahrain, Iran, Iraq, Kuwait, Oman, Qatar, Saudi Arabia, United Arab Emirates.

3. Algeria, Gabon, Libya, Nigeria.

4. Austria, Belgium, Finland, France, Germany, Greece, Ireland, Italy, Luxembourg, Netherlands, Portugal, Slovenia, Spain.

Table 27. Market value of U.S. holdings of foreign short-debt securities, by country and type of security, as of December 31, 2007

Millions of dollars

Country or category	Total	Commercial Paper	Negotiable CDs	Asset-backed	Other
Argentina	44	0	3	0	41
Australia	11,217	7,048	3,363	0	806
Austria	2,486	1,888	595	0	2
Bahamas	52	0	17	0	35
Bangladesh	4	0	0	0	4
Belgium	1,127	55	990	0	82
Bermuda	149	136	0	0	14
Brazil	44	0	28	0	16
British Virgin Islands	*	0	*	0	0
Canada	22,272	8,072	10,136	0	4,064
Cayman Islands	40,673	34,472	74	1,870	4,257
Chile	5	0	0	0	5
China, mainland ¹	125	105	21	0	0
Colombia	35	0	*	0	35
Costa Rica	6	0	0	0	6
Cyprus	325	25	0	0	300
Denmark	1,356	0	0	0	1,356
Dominican Republic	1	0	0	0	1
Ecuador	2	1	0	0	1
Egypt	1,245	0	0	0	1,245
El Salvador	8	0	0	0	8
Estonia	1	0	0	0	1
Finland	428	0	390	0	38
France	17,466	4,736	9,328	0	3,402
Germany	7,919	3,150	2,231	0	2,538
Guernsey	29	0	*	0	29
Honduras	21	0	0	0	21
Hong Kong	18	0	0	0	18
Hungary	131	0	0	0	131
Iceland	17	0	0	0	17
India	100	46	47	0	6
Indonesia	1	0	0	0	1
Ireland	32,732	24,655	4,237	0	3,840
Isle of Man	13	0	0	0	13
Israel	103	0	41	0	61
Italy	1,151	19	1,131	0	1
Japan	4,326	293	2,971	0	1,063
Jersey	10,982	10,269	0	0	713
Kazakhstan	25	0	0	0	25
Korea, South	476	444	0	0	32
Luxembourg	11,230	10,463	386	0	381
Malaysia	1,179	0	0	0	1,179

* Greater than zero but less than \$500,000.

1. Excludes Hong Kong and Macau, which are reported separately.

Table 27. Market value of U.S. holdings of foreign short-debt securities, by country and type of security, as of December 31, 2007 (continued)

Millions of dollars

Country or category	Total	Commercial Paper	Negotiable CDs	Asset-backed	Other
Malta	5	0	0	0	5
Mauritius	2	0	0	0	2
Mexico	432	*	0	0	432
Netherlands	4,672	1,830	2,074	0	769
Netherlands Antilles	8	8	0	0	*
New Zealand	1,958	1,482	0	0	476
Norway	6,294	5,632	114	0	548
Pakistan	*	0	0	0	*
Panama	3	0	0	0	3
Paraguay	*	0	0	0	*
Peru	274	0	3	0	271
Philippines	2	0	0	0	2
Portugal	370	0	100	0	270
Romania	9	0	0	0	9
Russia	13	0	0	0	13
Singapore	65	51	0	0	14
South Africa	95	94	0	0	1
Spain	1,942	0	1,312	0	630
Sri Lanka	4	0	0	0	4
Sweden	25,554	18,363	5,581	0	1,610
Switzerland	3,290	183	3,071	0	36
Thailand	10	0	0	0	10
Uganda	1	0	0	0	1
United Kingdom	140,964	44,136	84,026	3,559	9,243
Uruguay	*	0	0	0	*
Zambia	2	0	0	0	2
International and Reg.	1,520	714	0	0	805
Middle East oil-exporters ²	3	0	0	0	3
African oil-exporters ³	1	0	0	0	1
Total	357,016	178,368	132,268	5,429	40,951
Totals by Region:					
Total Africa	1,346	94	0	0	1,252
Total Asia	6,417	939	3,080	0	2,398
Total Caribbean	40,884	34,616	91	1,870	4,308
Total Europe	270,529	125,402	115,564	3,559	26,004
<i>Of which: Euro Area Countries⁴</i>	<i>81,522</i>	<i>46,795</i>	<i>22,772</i>	<i>0</i>	<i>11,954</i>
Total Latin America	874	1	35	0	839
Canada	22,272	8,072	10,136	0	4,064
Total Other Countries	13,174	8,529	3,362	*	1,282
International Organizations	1,520	714	0	0	805

* Greater than zero but less than \$500,000.

2. Bahrain, Iran, Iraq, Kuwait, Oman, Qatar, Saudi Arabia, and the United Arab Emirates.

3. Algeria, Gabon, Libya, Nigeria.

4. Austria, Belgium, Finland, France, Germany, Greece, Ireland, Italy, Luxembourg, Netherlands, Portugal, Slovenia, Spain.

Table 28. Market value of U.S. holdings of foreign debt securities, by country and sector of issuer, as of December 31, 2007

Millions of dollars

Country	Total	Long-term		Short-term	
		Government ¹	Private	Government ¹	Private
Albania	13	12	1	0	0
Argentina	7,904	6,079	1,781	10	34
Aruba	1,102	208	893	0	0
Australia	84,474	6,697	66,560	220	10,996
Austria	8,929	2,781	3,662	0	2,486
Bahamas	960	176	732	0	52
Bangladesh	4	0	0	0	4
Barbados	367	211	156	0	0
Belgium	6,232	2,710	2,395	74	1,053
Belize	32	27	5	0	0
Bermuda	16,857	76	16,632	0	149
Bolivia	10	0	10	0	0
Bosnia and Herzegovina	90	90	*	0	0
Botswana	1	0	1	0	0
Brazil	16,209	12,580	3,585	0	44
British Virgin Is.	3,688	0	3,687	0	*
Bulgaria	174	169	5	0	0
Burundi	4	0	4	0	0
Canada	207,489	47,046	138,171	3,467	18,805
Cayman Islands	312,002	4	271,325	0	40,673
Chile	7,569	827	6,737	0	5
China, mainland ²	1,583	332	1,126	0	125
Colombia	5,601	5,059	508	*	34
Costa Rica	376	289	81	6	0
Cote d'Ivoire	158	153	4	0	0
Croatia	304	290	14	0	0
Cyprus	663	46	292	0	325
Czech Republic	196	150	46	0	0
Denmark	14,186	1,306	11,524	3	1,353
Dominican Republic	849	562	286	0	1
Ecuador	709	663	44	0	2
Egypt	3,003	1,632	125	1,240	5
El Salvador	830	788	33	0	8
Estonia	39	0	38	1	0
Fiji	29	29	*	0	0
Finland	4,015	654	2,933	0	428
France	100,394	35,192	47,736	799	16,667
Georgia	3	0	3	0	0
Germany	96,856	57,175	31,763	1,827	6,091
Ghana	173	168	5	0	0
Greece	1,763	1,573	190	0	0
Grenada	14	14	0	0	0
Guatemala	224	215	9	0	0
Guernsey	2,601	0	2,572	0	29

* Greater than zero but less than \$500,000.

1. "Government" includes central, local, and provincial governments, and government-sponsored or guaranteed corporations. Debt issued by international organizations is classified as "private".

2. Excludes Hong Kong and Macau, which are reported separately.

Table 28. Market value of U.S. holdings of foreign debt securities, by country and sector of issuer, as of December 31, 2007 (continued)

Millions of dollars

Country	Total	Long-term		Short-term	
		Government ¹	Private	Government ¹	Private
Honduras	27	3	3	0	21
Hong Kong	1,754	465	1,271	17	*
Hungary	1,916	1,370	415	131	0
Iceland	7,236	176	7,043	0	17
India	3,394	*	3,294	0	100
Indonesia	3,272	2,876	395	0	1
Ireland	82,885	495	49,658	0	32,732
Isle of Man	162	0	149	0	13
Israel	15,358	13,976	1,279	61	41
Italy	23,036	18,155	3,730	0	1,151
Jamaica	662	463	199	0	0
Japan	64,544	49,699	10,518	1,063	3,264
Jersey	23,219	*	12,237	0	10,982
Jordan	28	25	3	0	0
Kazakhstan	529	0	504	0	25
Kenya	8	8	*	0	0
Korea, South	10,320	4,089	5,756	325	151
Latvia	*	0	*	0	0
Lebanon	291	272	19	0	0
Liberia	1,710	0	1,710	0	0
Liechtenstein	10	0	10	0	0
Lithuania	45	35	11	0	0
Luxembourg	55,050	19	43,801	0	11,230
Malaysia	7,539	2,981	3,379	1,168	11
Malta	77	0	71	0	5
Marshall Islands	490	0	490	0	0
Mauritania	*	0	*	0	0
Mauritius	89	*	87	*	1
Mexico	24,314	11,949	11,934	32	400
Mongolia	*	0	*	0	0
Morocco	61	46	15	0	0
Netherlands	81,083	4,388	72,023	62	4,610
Netherlands Antilles	1,295	0	1,287	0	8
New Zealand	5,858	1,567	2,333	0	1,958
Nicaragua	29	29	*	0	0
Norway	21,526	2,663	12,570	358	5,935
Pakistan	313	255	58	0	*
Panama	4,139	2,211	1,926	0	3
Paraguay	*	0	0	0	*
Peru	2,926	2,353	298	269	5
Philippines	4,552	3,404	1,146	0	2
Poland	4,782	4,737	45	0	0
Portugal	2,602	608	1,624	0	370
Romania	10	1	*	9	0

* Greater than zero but less than \$500,000.

1. "Government" includes central, local, and provincial governments, and government-sponsored or guaranteed corporations. Debt issued by international organizations is classified as "private".

Table 28. Market value of U.S. holdings of foreign debt securities, by country and sector of issuer, as of December 31, 2007 (continued)

Millions of dollars

Country	Total	Long-term		Short-term	
		Government ¹	Private	Government ¹	Private
Russia	6,533	5,729	791	0	13
Saint Lucia	62	0	62	0	0
Serbia and Montenegro	71	59	11	0	0
Seychelles	58	55	3	0	0
Singapore	9,126	2,723	6,338	14	51
Slovakia	70	4	66	0	0
Slovenia	34	34	0	0	0
South Africa	4,003	2,998	910	1	95
Spain	39,765	2,640	35,183	259	1,683
Sri Lanka	119	95	19	0	4
Sweden	54,664	7,312	21,798	0	25,554
Switzerland	6,908	1,129	2,489	1	3,289
Taiwan	168	63	104	0	0
Thailand	844	65	769	3	7
Trinidad and Tobago	1,472	405	1,066	0	0
Tunisia	497	265	233	0	0
Turkey	5,381	5,107	274	0	0
Uganda	1	0	0	1	0
Ukraine	1,495	1,337	157	0	0
United Kingdom	427,452	40,632	245,856	1,741	139,223
Uruguay	1,957	1,711	246	*	0
Venezuela	5,000	3,946	1,054	0	0
Vietnam	237	233	3	0	0
Zambia	3	0	2	2	0
Zimbabwe	43	20	23	0	0
International Organizations	23,649	0	22,130	0	1,520
Middle East oil-exporters ³	8,279	538	7,737	0	3
African oil-exporters ⁴	521	430	90	1	0
Total	1,964,227	392,833	1,214,378	13,165	343,851
Totals by Region:					
Total Africa	10,331	5,774	3,211	1,244	101
Total Asia	131,726	82,094	43,215	2,651	3,766
Total Caribbean	339,328	2,119	296,325	0	40,884
Total Europe	1,082,996	198,779	613,689	5,265	265,264
<i>Of which: Euro Area Countries⁵</i>	<i>502,610</i>	<i>126,391</i>	<i>294,698</i>	<i>3,020</i>	<i>78,501</i>
Total Latin America	77,857	48,729	28,254	317	557
Canada	207,489	47,046	138,171	3,467	18,805
Total Other Countries	90,851	8,293	69,384	220	12,954
International Organizations	23,649	0	22,130	0	1,520

* Greater than zero but less than \$500,000.

1. "Government" includes central, local, and provincial governments, and government-sponsored or guaranteed corporations. Debt issued by international organizations is classified as "private".

3. Bahrain, Iran, Iraq, Kuwait, Oman, Qatar, Saudi Arabia, and the United Arab Emirates.

4. Algeria, Gabon, Libya, Nigeria.

5. Austria, Belgium, Finland, France, Germany, Greece, Ireland, Italy, Luxembourg, Netherlands, Portugal, Slovenia, Spain.

Table 29. Market value of U.S. holdings of foreign long-term debt securities, by country and sector of issuer, denominated in U.S. dollars and in local currency, as of December 31, 2007

Billions of dollars

Country	Total Long-Term Debt	Government ¹			Private		
		Total	U.S. Dollars	Own Currency	Total	U.S. Dollars	Own Currency
Argentina	8	6	4	1	2	2	*
Australia	73	7	*	7	67	62	2
Austria	6	3	1	2	4	2	*
Belgium	5	3	*	3	2	2	*
Bermuda	17	*	*	0	17	16	*
Brazil	16	13	7	6	4	3	1
British Virgin Islands	4	0	0	0	4	3	3
Canada	185	47	19	27	138	114	24
Cayman Islands	271	*	*	0	271	266	*
Chile	8	1	1	0	7	7	*
Colombia	6	5	3	2	1	*	*
Denmark	13	1	0	1	12	3	8
Egypt	2	2	1	*	*	*	*
Finland	4	1	*	1	3	3	*
France	83	35	*	35	48	41	6
Germany	89	57	1	56	32	20	7
Greece	2	2	*	1	*	*	*
Guernsey	3	0	0	0	3	2	*
Hong Kong	2	*	*	*	1	1	*
Hungary	2	1	*	1	*	*	*
Iceland	7	*	*	*	7	7	*
India	3	*	0	*	3	3	*
Indonesia	3	3	1	1	*	*	*
Ireland	50	*	*	*	50	41	7
Israel	15	14	13	1	1	1	*
Italy	22	18	4	14	4	1	3
Japan	60	50	1	49	11	5	5
Jersey	12	*	0	0	12	9	1
Korea, South	10	4	2	2	6	5	*
Liberia	2	0	0	0	2	2	0
Luxembourg	44	*	*	0	44	37	7
Malaysia	6	3	1	2	3	3	*
Mexico	24	12	8	4	12	12	*
Netherlands	76	4	*	4	72	59	10
New Zealand	4	2	*	2	2	2	*
Norway	15	3	*	3	13	12	*
Panama	4	2	2	0	2	2	*
Peru	3	2	2	*	*	*	*
Philippines	5	3	3	*	1	1	*
Poland	5	5	1	4	*	*	*
Portugal	2	1	*	1	2	1	*
Russia	7	6	6	0	1	1	*
Singapore	9	3	0	3	6	6	*
South Africa	4	3	1	1	1	*	*
Spain	38	3	*	2	35	33	1
Sweden	29	7	*	7	22	21	*

1. "Government" includes central, local, and provincial governments, and government-sponsored or guaranteed corporations. Debt issued by international organizations is classified as "private".

Table 29. Market value of U.S. holdings of foreign long-term debt securities, by country and sector of issuer, denominated in U.S. dollars and in local currency, as of December 31, 2007

Billions of dollars

Country	Total Long-Term Debt	Government ¹			Private		
		Total	U.S. Dollars	Own Currency	Total	U.S. Dollars	Own Currency
Switzerland	4	1	0	1	2	2	*
Turkey	5	5	3	*	*	*	0
United Kingdom	286	41	*	40	246	224	12
Uruguay	2	2	1	*	*	*	*
Venezuela	5	4	4	*	1	1	*
International Organizations	22	0	0	0	22	14	0
Middle East oil-exporters ²	8	1	1	0	8	8	*
Total	1,607	393	99	287	1,214	1,070	102
Totals by Region:							
Total Africa	9	6	3	2	3	2	*
Total Asia	125	82	23	59	43	36	6
Total Caribbean	298	2	2	*	296	290	4
Total Europe	812	199	18	177	614	522	64
<i>Of which: Euro Area Countries³</i>	<i>421</i>	<i>126</i>	<i>7</i>	<i>119</i>	<i>295</i>	<i>240</i>	<i>43</i>
Total Latin America	77	49	34	14	28	27	2
Canada	185	47	19	27	138	114	24
Total Other Countries	78	8	*	8	69	65	3
International Organizations	22	0	0	0	22	14	0

* Greater than zero but less than \$500 million.

1. "Government" includes central, local, and provincial governments, and government-sponsored or guaranteed corporations. Debt issued by international organizations is classified as "private".

2. Bahrain, Iran, Iraq, Kuwait, Oman, Qatar, Saudi Arabia, United Arab Emirates.

3. Austria, Belgium, Finland, France, Germany, Greece, Ireland, Italy, Luxembourg, Netherlands, Portugal, Slovenia, Spain.

Table 30. Market value of U.S. holdings of foreign equities, by country and type of security, as of December 31, 2007

Millions of dollars

Country or category	Total	Common Stock	Funds	Preferred & Other
Albania	*	0	0	0
Andorra	14	0	0	14
Anguilla	15	12	0	3
Antigua and Barbuda	127	127	0	0
Argentina	1,922	1,890	*	32
Australia	138,096	133,971	3,892	233
Austria	20,069	19,999	1	69
Bahamas	1,302	1,047	124	132
Bangladesh	163	163	*	0
Barbados	56	56	0	0
Belgium	31,642	31,425	205	12
Belize	56	56	0	1
Bermuda	256,111	247,784	3,714	4,614
Botswana	5	5	0	0
Brazil	172,599	110,704	1,720	60,174
British Virgin Islands	11,156	4,263	6,493	400
Bulgaria	387	381	6	*
Canada	378,965	343,634	33,144	2,187
Cayman Islands	231,886	158,802	47,745	25,339
Chile	5,205	4,342	9	854
China, mainland ¹	95,658	95,598	21	39
Colombia	1,193	351	*	841
Comoros	*	0	0	0
Cook Islands	*	0	0	0
Costa Rica	*	0	0	0
Cote D'Ivoire	1	1	0	0
Croatia	164	152	0	12
Cuba	*	0	0	0
Cyprus	2,305	2,305	0	1
Czech Republic	5,155	5,121	1	34
Denmark	32,971	32,971	0	*
Dominican Republic	*	0	0	0
Ecuador	*	0	0	0
Egypt	8,865	8,864	1	0
El Salvador	5	5	0	*
Estonia	135	127	3	5
Falkland Islands	4	3	0	2
Faroe Islands	14	14	0	0
Finland	90,158	90,154	*	4
France	347,795	345,813	1,386	596

* Greater than zero but less than \$500,000.

1. Excludes Hong Kong and Macau, which are reported separately.

Table 30. Market value of U.S. holdings of foreign equities, by country and type of security, as of December 31, 2007 (continued)

Millions of dollars

Country or category	Total	Common Stock	Funds	Preferred & Other
French Guiana	*	0	0	0
Gambia	*	0	0	0
Georgia	147	148	0	0
Germany	329,164	317,653	320	11,190
Ghana	20	20	0	0
Gibraltar	96	95	0	*
Greece	23,722	23,669	32	21
Guernsey	13,229	9,526	2,601	1,102
Guinea	3	*	0	3
Honduras	*	0	0	0
Hong Kong	119,522	117,827	1,502	194
Hungary	7,309	7,307	2	*
Iceland	32	26	1	5
India	81,755	81,379	273	104
Indonesia	15,077	15,075	2	*
Ireland	48,969	36,759	11,480	730
Isle of Man	1,144	1,139	2	3
Israel	38,892	38,800	8	85
Italy	96,927	96,466	6	455
Jamaica	*	*	0	0
Japan	529,219	525,725	3,165	329
Jersey	5,414	4,391	106	918
Jordan	83	83	*	0
Kazakhstan	812	812	0	0
Kenya	24	24	0	0
Korea, South	129,234	125,458	41	3,735
Latvia	18	18	0	0
Lebanon	141	141	0	0
Lesotho	*	*	0	0
Liberia	5,053	5,053	0	0
Liechtenstein	253	253	0	0
Lithuania	29	29	0	0
Luxembourg	40,071	30,332	9,003	736
Malaysia	17,670	17,637	25	7
Malta	50	50	0	0
Marshall Islands	13,096	12,163	30	903
Mauritius	1,568	410	514	644
Mexico	85,417	85,269	21	128
Moldova	*	0	0	0
Monaco	16	16	0	0

* Greater than zero but less than \$500,000.

Table 30. Market value of U.S. holdings of foreign equities, by country and type of security, as of December 31, 2007 (continued)

Millions of dollars

Country or category	Total	Common Stock	Funds	Preferred & Other
Morocco	394	331	62	2
Namibia	3	3	0	0
Nauru	*	*	0	0
Netherlands	153,976	146,914	1,589	5,474
Netherlands Antilles	87,994	87,646	319	28
New Caledonia	*	0	0	0
New Zealand	3,940	3,823	116	1
Norway	46,383	45,191	452	740
Pakistan	1,444	1,428	16	0
Panama	25,296	25,285	11	0
Papua New Guinea	2,429	2,429	0	0
Peru	1,679	1,678	1	1
Philippines	9,909	9,869	0	40
Poland	9,078	9,060	1	18
Portugal	6,109	6,104	*	5
Romania	612	551	60	0
Russia	74,386	73,096	28	1,262
Saint Kitts and Nevis	*	0	0	0
Senegal	2	2	0	*
Serbia and Montenegro	201	201	0	0
Singapore	55,584	53,827	1,708	50
Slovakia	*	*	0	0
Slovenia	318	317	1	0
South Africa	49,138	48,893	8	237
Spain	106,648	104,915	67	1,666
Sri Lanka	166	166	0	0
Sweden	57,393	56,516	19	858
Switzerland	280,767	280,303	65	399
Taiwan	81,024	80,891	27	107
Thailand	15,998	15,748	199	51
Trinidad and Tobago	*	0	0	0
Tunisia	4	4	0	0
Turkey	19,705	19,654	46	5
Turks and Caicos Islands	*	0	0	0
Ukraine	643	633	10	0
United Kingdom	714,928	683,316	14,151	17,462
Venezuela	416	416	0	*
Vietnam	11	11	0	0
Zambia	75	75	0	0
Zimbabwe	157	157	0	0

* Greater than zero but less than \$500,000.

Table 30. Market value of U.S. holdings of foreign equities, by country and type of security, as of December 31, 2007 (continued)

Millions of dollars

Country or category	Total	Common Stock	Funds	Preferred & Other
International Organizations	366	366	0	0
Middle East oil-exporters ²	2,184	2,176	6	1
African oil-exporters ³	251	248	0	4
Total	5,247,990	4,956,132	146,560	145,297
Totals by Region:				
Total Africa	65,564	64,089	586	889
Total Asia	1,193,733	1,182,001	6,992	4,740
Total Caribbean	588,650	499,738	58,394	30,516
Total Europe	2,569,361	2,483,922	41,643	43,795
<i>Of which: Euro Area Countries⁴</i>	<i>1,295,250</i>	<i>1,250,204</i>	<i>24,089</i>	<i>20,958</i>
Total Latin America	293,794	229,998	1,763	62,032
Canada	378,965	343,634	33,144	2,187
Total Other Countries	157,559	152,386	4,038	1,137
International Organizations	366	366	0	0

* Greater than zero but less than \$500,000.

2. Bahrain, Iran, Iraq, Kuwait, Oman, Qatar, Saudi Arabia, and the United Arab Emirates.

3. Algeria, Gabon, Libya, Nigeria.

4. Austria, Belgium, Finland, France, Germany, Greece, Ireland, Italy, Luxembourg, Netherlands, Portugal, Slovenia, Spain.

Table 31. Market value of U.S. holdings of foreign equities, by country and amounts held as Depository Receipts, as of December 31, 2007

Millions of dollars except as noted

Country	Equity	Depository Receipts	Percentage Depository Receipts
Albania	*	0	0
Andorra	14	0	0
Anguilla	15	0	0
Antigua and Barbuda	127	0	0
Argentina	1,922	1,546	80
Australia	138,096	11,689	8
Austria	20,069	398	2
Bahamas	1,302	2	0
Bangladesh	163	*	0
Barbados	56	0	0
Belgium	31,642	1,515	5
Belize	56	3	6
Bermuda	256,111	1,840	1
Botswana	5	*	5
Brazil	172,599	101,538	59
British Virgin Islands	11,156	16	0
Bulgaria	387	0	0
Canada	378,965	551	0
Cayman Islands	231,886	35,329	15
Chile	5,205	2,883	55
China, mainland ¹	95,658	7,953	8
Colombia	1,193	908	76
Comoros	*	0	0
Cook Islands	*	0	0
Costa Rica	*	0	0
Cote D'Ivoire	1	1	100
Croatia	164	54	33
Cuba	*	0	0
Cyprus	2,305	111	5
Czech Republic	5,155	67	1
Denmark	32,971	2,519	8
Dominican Republic	*	*	100
Ecuador	*	*	100
Egypt	8,865	3,573	40
El Salvador	5	5	92
Estonia	135	12	9
Falkland Islands	4	0	0
Faroe Islands	14	0	0
Finland	90,158	36,447	40
France	347,795	45,381	13

* Greater than zero but less than \$500,000.

1. Excludes Hong Kong and Macau, which are reported separately.

Table 31. Market value of U.S. holdings of foreign equities, by country and amounts held as Depositary Receipts, as of December 31, 2007 (continued)

Millions of dollars except as noted

Country	Equity	Depositary Receipts	Percentage Depositary Receipts
French Guiana	*	0	0
Gambia	*	0	0
Georgia	147	147	100
Germany	329,164	30,207	9
Ghana	20	*	1
Gibraltar	96	0	0
Greece	23,722	1,516	6
Guernsey	13,229	2	0
Guinea	3	*	8
Honduras	*	0	0
Hong Kong	119,522	12,495	10
Hungary	7,309	466	6
Iceland	32	18	59
India	81,755	18,194	22
Indonesia	15,077	1,311	9
Ireland	48,969	15,916	33
Isle of Man	1,144	64	6
Israel	38,892	22,772	59
Italy	96,927	7,784	8
Jamaica	*	*	100
Japan	529,219	52,926	10
Jersey	5,414	1,665	31
Jordan	83	0	0
Kazakhstan	812	810	100
Kenya	24	0	0
Korea, South	129,234	24,468	19
Latvia	18	0	0
Lebanon	141	116	82
Lesotho	*	0	0
Liberia	5,053	2	0
Liechtenstein	253	0	0
Lithuania	29	1	3
Luxembourg	40,071	13,705	34
Malaysia	17,670	41	0
Malta	50	50	100
Marshall Islands	13,096	8	0
Mauritius	1,568	0	0
Mexico	85,417	57,346	67
Moldova	*	0	0
Monaco	16	0	0

* Greater than zero but less than \$500,000.

Table 31. Market value of U.S. holdings of foreign equities, by country and amounts held as Depositary Receipts, as of December 31, 2007 (continued)

Millions of dollars except as noted

Country	Equity	Depositary Receipts	Percentage Depositary Receipts
Morocco	394	*	0
Namibia	3	0	0
Nauru	*	0	0
Netherlands	153,976	36,312	24
Netherlands Antilles	87,994	13	0
New Caledonia	*	0	0
New Zealand	3,940	841	21
Norway	46,383	4,425	10
Pakistan	1,444	119	8
Panama	25,296	1	0
Papua New Guinea	2,429	495	20
Peru	1,679	1,465	87
Philippines	9,909	1,714	17
Poland	9,078	204	2
Portugal	6,109	650	11
Romania	612	0	0
Russia	74,386	63,513	85
Saint Kitts and Nevis	*	0	0
Senegal	2	*	14
Serbia and Montenegro	201	0	0
Singapore	55,584	1,676	3
Slovakia	*	0	0
Slovenia	318	*	0
South Africa	49,138	9,411	19
Spain	106,648	12,276	12
Sri Lanka	166	*	0
Sweden	57,393	4,024	7
Switzerland	280,767	46,388	17
Taiwan	81,024	16,424	20
Thailand	15,998	1,034	6
Trinidad and Tobago	*	0	0
Tunisia	4	*	6
Turkey	19,705	1,232	6
Turks and Caicos Islands	*	0	0
Ukraine	643	160	25
United Kingdom	714,928	186,635	26
Venezuela	416	277	67
Zambia	11	0	0
Zambia	75	27	36
Zimbabwe	157	0	0

* Greater than zero but less than \$500,000.

Table 31. Market value of U.S. holdings of foreign equities, by country and amounts held as Depository Receipts, as of December 31, 2007 (continued)

Millions of dollars except as noted

Country	Equity	Depository Receipts	Percentage Depository Receipts
International Organizations	366	*	0
Middle East oil-exporters ²	2,184	838	38
African oil-exporters ³	251	160	64
Total	5,247,990	906,688	17
Totals by Region:			
Total Africa	65,564	13,175	20
Total Asia	1,193,733	162,081	14
Total Caribbean	588,650	37,201	6
Total Europe	2,569,361	514,675	20
<i>Of which: Euro Area Countries⁴</i>	<i>1,295,250</i>	<i>202,106</i>	<i>16</i>
Total Latin America	293,794	165,973	56
Canada	378,965	551	0
Total Other Countries	157,559	13,032	8
International Organizations	366	*	0

* Greater than zero but less than \$500,000.

2. Bahrain, Iran, Iraq, Kuwait, Oman, Qatar, Saudi Arabia, and the United Arab Emirates.

3. Algeria, Gabon, Libya, Nigeria.

4. Austria, Belgium, Finland, France, Germany, Greece, Ireland, Italy, Luxembourg, Netherlands, Portugal, Slovenia, Spain.

Table 32. Market value of U.S. holdings of foreign equities, by country, size of domestic equity markets, and percentage of each market that is U.S.-held, as of December 31, 2007

Millions of dollars except as noted

Country or category	Common Stock	Country rank according to domestic market capitalization ¹	Percent of domestic market capitalization ¹
Anguilla	12	n.a.	n.a.
Antigua and Barbuda	127	n.a.	n.a.
Argentina	1,890	47	2
Australia	133,971	11	10
Austria	19,999	31	9
Bahamas	1,047	n.a.	n.a.
Bangladesh	163	71	2
Barbados	56	78	1
Belgium	31,425	22	8
Belize	56	n.a.	n.a.
Bermuda	247,784	84	>100
Botswana	5	75	0
Brazil	110,704	10	8
British Virgin Islands	4,263	n.a.	n.a.
Bulgaria	381	64	2
Canada	343,634	n.a.	16
Cayman Islands	158,802	97	>100
Chile	4,342	33	2
China, mainland ²	95,598	1	2
Colombia	351	45	0
Cote d'Ivoire	1	n.a.	n.a.
Croatia	152	52	0
Cyprus	2,305	60	8
Czech Republic	5,121	50	7
Denmark	32,971	28	12
Egypt	8,864	40	6
El Salvador	5	72	0
Estonia	127	74	2
Falkland Islands	3	n.a.	n.a.
Faroe Islands	14	n.a.	n.a.
Finland	90,154	23	24
France	345,813	4	12

* Greater than zero but less than \$500,000. n.a. Not available.

1. Market capitalization data are from Standard & Poor's Global Stock Markets Factbook 2008. Market capitalization based on year-end 2007 total market values of listed domestic companies. U.S. holdings include securities of companies registered in each country that may not trade on domestic exchanges, thus U.S. holdings can exceed the total size of a countries' total domestic market capitalization. Rank order excludes the United States, which has the largest equity market capitalization.

2. Excludes Hong Kong and Macau, which are reported separately.

Table 32. Market value of U.S. holdings of foreign equities, by country, size of domestic equity markets, and percentage of each market that is U.S.-held, as of December 31, 2007 (continued)

Millions of dollars except as noted

Country or category	Common Stock	Country rank according to domestic market capitalization ¹	Percent of domestic market capitalization ¹
Georgia	148	91	11
Germany	317,653	6	15
Ghana	20	87	1
Gibraltar	95	n.a.	n.a.
Greece	23,669	29	9
Guernsey	9,526	n.a.	n.a.
Guinea	*	n.a.	n.a.
Hong Kong	117,827	13	10
Hungary	7,307	53	15
Iceland	26	59	0
India	81,379	7	4
Indonesia	15,075	34	7
Ireland	36,759	39	26
Isle of Man	1,139	n.a.	n.a.
Israel	38,800	30	16
Italy	96,466	15	9
Jamaica	*	67	0
Japan	525,725	2	12
Jersey	4,391	n.a.	n.a.
Jordan	83	58	0
Kazakhstan	812	57	2
Kenya	24	66	0
Korea, South	125,458	14	11
Latvia	18	83	1
Lebanon	141	68	1
Lesotho	*	n.a.	n.a.
Liberia	5,053	n.a.	n.a.
Liechtenstein	253	n.a.	n.a.
Lithuania	29	69	0
Luxembourg	30,332	38	18
Malaysia	17,637	26	5
Malta	50	77	1
Marshall Islands	12,163	n.a.	n.a.
Mauritius	410	76	7
Mexico	85,269	21	21
Monaco	16	n.a.	n.a.

* Greater than zero but less than \$500,000. n.a. Not available.

1. Market capitalization data are from Standard & Poor's Global Stock Markets Factbook 2008. Market capitalization based on year-end 2007 total market values of listed domestic companies. U.S. holdings include securities of companies registered in each country that may not trade on domestic exchanges, thus U.S. holdings can exceed the total size of a countries' total domestic market capitalization. Rank order excludes the United States, which has the largest equity market capitalization.

Table 32. Market value of U.S. holdings of foreign equities, by country, size of domestic equity markets, and percentage of each market that is U.S.-held, as of December 31, 2007 (continued)

Millions of dollars except as noted

Country or category	Common Stock	Country rank according to domestic market capitalization ¹	Percent of domestic market capitalization ¹
Morocco	331	49	0
Namibia	3	92	0
Nauru	*	n.a.	n.a.
Netherlands	146,914	16	15
Netherlands Antilles	87,646	n.a.	n.a.
New Zealand	3,823	54	8
Norway	45,191	24	13
Pakistan	1,428	51	2
Panama	25,285	73	>100
Papua New Guinea	2,429	n.a.	n.a.
Peru	1,678	43	2
Philippines	9,869	44	10
Poland	9,060	35	4
Portugal	6,104	41	5
Romania	551	56	1
Russia	73,096	9	5
Senegal	2	n.a.	n.a.
Serbia and Montenegro	201	n.a.	n.a.
Singapore	53,827	25	15
Slovakia	*	n.a.	n.a.
Slovenia	317	61	1
South Africa	48,893	17	6
Spain	104,915	8	6
Sri Lanka	166	70	2
Sweden	56,516	19	9
Switzerland	280,303	12	22
Taiwan	80,891	18	11
Thailand	15,748	36	8
Tunisia	4	79	0
Turkey	19,654	27	7
Ukraine	633	42	1
United Kingdom	683,316	3	18
Venezuela	416	n.a.	n.a.
Vietnam	11	65	0
Zambia	75	88	3
Zimbabwe	157	80	3

* Greater than zero but less than \$500,000. n.a. Not available.

1. Market capitalization data are from Standard & Poor's Global Stock Markets Factbook 2008. Market capitalization based on year-end 2007 total market values of listed domestic companies. U.S. holdings include securities of companies registered in each country that may not trade on domestic exchanges, thus U.S. holdings can exceed the total size of a countries' total domestic market capitalization. Rank order excludes the United States, which has the largest equity market capitalization.

Table 32. Market value of U.S. holdings of foreign equities, by country, size of domestic equity markets, and percentage of each market that is U.S.-held, as of December 31, 2007 (continued)

Millions of dollars except as noted

Country or category	Common Stock	Country rank according to domestic market capitalization ¹	Percent of domestic market capitalization ¹
International Organizations	366	n.a.	n.a.
Middle East oil-exporters ³	2,176	n.a.	0
African oil-exporters ⁴	248	n.a.	0
Total	4,956,133	n.a.	11
Totals by Region:			
Total Africa	64,089	n.a.	5
Total Asia	1,182,001	n.a.	6
Total Caribbean	499,738	n.a.	>100
Total Europe	2,483,923	n.a.	13
<i>Of which: Euro Area Countries⁵</i>	<i>1,250,204</i>	<i>n.a.</i>	<i>12</i>
Total Latin America	229,998	n.a.	10
Canada	343,634	n.a.	16
Total Other Countries	152,386	n.a.	11
International Organizations	366	n.a.	n.a.

* Greater than zero but less than \$500,000. n.a. Not available.

1. Market capitalization data are from Standard & Poor's Global Stock Markets Factbook 2008. Market capitalization based on year-end 2007 total market values of listed domestic companies. U.S. holdings include securities of companies registered in each country that may not trade on domestic exchanges, thus U.S. holdings can exceed the total size of a countries' total domestic market capitalization. Rank order excludes the United States, which has the largest equity market capitalization.

3. Bahrain, Iran, Iraq, Kuwait, Oman, Qatar, Saudi Arabia, United Arab Emirates.

4. Algeria, Gabon, Libya, Nigeria.

5. Austria, Belgium, Finland, France, Germany, Greece, Ireland, Italy, Luxembourg, Netherlands, Portugal, Slovenia, Spain.

Table 33. Market value of U.S. holdings of foreign securities, by industry, as of December 31, 2007

Millions of dollars

GICS Code		Total	Equity	Debt	
				Long-term	Short-term
1010	Total Energy	704,327	654,891	46,815	2,621
101010	Energy Equipment & Services	211,012	200,349	10,594	69
101020	Oil & Gas	493,315	454,542	36,221	2,552
1510	Total Materials	577,659	513,659	61,712	2,288
151010	Chemicals	142,563	129,515	11,288	1,760
151020	Construction Materials	59,135	52,598	6,410	128
151030	Containers & Packaging	3,844	2,689	1,156	0
151040	Metals & Mining	337,636	307,951	29,286	399
151050	Paper & Forest Products	34,481	20,907	13,573	1
2000	Total Industrial	748,842	693,187	48,397	7,259
201010	Aerospace & Defense	34,109	29,763	4,346	0
201020	Building Products	6,165	5,771	394	0
201030	Construction & Engineering	77,645	74,222	3,423	0
201040	Electrical Equipment	112,672	111,777	896	0
201050	Industrial Conglomerates	148,274	138,164	10,110	0
201060	Machinery	105,483	101,400	4,083	0
201070	Trading Companies & Distributors	24,236	16,885	92	7,259
202010	Commercial Services & Supplies	115,531	105,799	9,732	0
203010	Air Freight & Logistics	17,816	17,561	255	0
203020	Airlines	21,066	19,375	1,691	0
203030	Marine	38,088	35,480	2,608	0
203040	Road & Rail	36,437	27,797	8,640	0
203050	Transportation Infrastructure	11,320	9,193	2,127	0
2500	Total Consumer Discretionary	569,750	527,938	40,854	959
251010	Auto Components	24,294	14,086	10,209	0
251020	Automobiles	110,192	108,133	1,762	297
252010	Household Durables	73,954	70,455	3,326	173
252020	Leisure Equipment & Products	42,596	42,425	171	0
252030	Textiles, Apparel & Luxury Goods	55,943	54,517	1,427	0
253010	Hotels, Restaurants & Leisure	58,599	54,385	4,214	0
254010	Media	100,617	85,119	15,109	389
255010	Distributors	13,711	13,160	551	0
255020	Internet & Catalog Retail	13,119	12,856	263	0
255030	Multiline Retail	22,883	21,960	924	0
255040	Specialty Retail	53,842	50,843	2,899	100
3000	Total Consumer Staples	327,584	297,034	22,046	8,504
301010	Food & Staples Retailing	46,282	43,843	2,222	218
302010	Beverages	83,300	67,774	14,703	822
302020	Food Products	90,276	85,373	3,349	1,554
302030	Tobacco	35,092	34,401	691	0
303010	Household Products	56,166	49,175	1,082	5,909
303020	Personal Products	16,468	16,468	0	0

Table 33. Market value of U.S. holdings of foreign securities, by industry, as of December 31, 2007 (continued)

Millions of dollars

GICS Code		Total	Equity	Debt	
				Long-term	Short-term
3500	Total Health Care	371,657	354,986	10,652	6,019
351010	Health Care Equipment & Supplies	114,182	112,732	1,450	0
351020	Health Care Providers & Services	19,516	19,422	88	6
352010	Biotechnology	1,334	1,331	3	0
352020	Pharmaceuticals	236,625	221,500	9,111	6,013
4000	Total Financial	2,167,348	1,164,814	718,789	283,745
401010	Commercial Banks	744,270	394,517	206,085	143,668
401020	Thrifts & Mortgage Finance	166,812	18,931	118,050	29,830
402010	Diversified Financial Services	300,109	151,973	113,667	34,469
402020	Consumer Finance	17,905	7,869	4,739	5,297
402030	Capital Markets (including Funds)	543,398	226,072	250,041	67,286
403010	Insurance	268,306	246,234	19,074	2,997
404010	Real Estate	126,548	119,218	7,132	198
4500	Total Information Technology	353,955	322,907	30,999	50
451010	Internet Software & Services	3,130	3,130	0	0
451020	IT Services	36,437	35,177	1,261	0
451030	Software	14,666	14,429	237	0
452010	Communications Equipment	113,507	98,735	14,722	50
452020	Computers & Peripherals	28,855	27,257	1,598	0
452030	Electronic Equipment & Instruments	118,516	106,107	12,409	0
452040	Office Electronics	14,108	14,101	7	0
453010	Semiconductors & Semiconductor Equipment	24,736	23,971	765	0
5010	Total Telecommunication Services	409,876	343,733	65,327	817
501010	Diversified Telecommunication Services	247,326	196,034	50,859	434
501020	Wireless Telecommunication Services	162,550	147,699	14,469	382
5510	Total Utilities	285,877	220,191	60,238	5,448
551010	Utilities - Electric	135,472	112,929	20,170	2,373
551020	Utilities - Gas	100,652	62,438	35,140	3,075
551030	Utilities - Multi- & Unregulated Power	40,786	38,735	2,052	0
551040	Utilities - Water	8,967	6,090	2,877	0
	Government¹	426,629	829	410,772	15,029
	Industry unknown	268,596	153,821	90,497	24,278
	Total	7,212,105	5,247,990	1,607,099	357,016

1. Includes securities issued by local governments as well as government-sponsored or guaranteed corporations.

Forms and Instructions

OMB NO. 1505-0146
Approval Expires: August 31, 2009

ANNUAL REPORT TO THE FEDERAL RESERVE BANK OF NEW YORK

**REPORT OF U.S. OWNERSHIP OF
FOREIGN SECURITIES, INCLUDING
SELECTED MONEY MARKET
INSTRUMENTS (SHCA)**

**Mandatory Report
Response Required By Law
(22 U.S.C. 3101 et seq.)**



**Department of the Treasury
Federal Reserve Bank of New York
Board of Governors of the Federal Reserve System**

TABLE OF CONTENTS

	Page
I. INTRODUCTION	
A. Purpose	1
B. Authority	1
C. Confidentiality of Data Reported	1
D. Penalties for Failure to Report	1
E. Paperwork Reduction Act Notice	2
II. GENERAL INSTRUCTIONS	
A. Who Must Report	2
B. Which Schedules to Report	3
C. Exemptions	4
D. Reporting Dates	4
E. Submission Instructions and Contact Information	4
III. WHAT SECURITIES MUST BE REPORTED	
A. Reportable Foreign Securities	6
B. Do Not Report	8
C. Funds and Related Equity Holdings	8
D. Securities Involved in Repurchase and Securities Lending Arrangements	9
E. Depositary Receipts/Shares	9
F. Stripped Securities	10
G. Direct Investment	10
H. Securities Held by Central Securities Depositories	10
I. Country Attribution	10
J. Limited Partnerships	11
K. Accounting Rules, Valuation of Securities, and Calculation of U.S. Dollar Values	11
L. Data Retention Period	12
M. Review of Data and Requests For Revised Data	12
IV. INSTRUCTIONS FOR COMPLETING REPORTING SCHEDULES	
A. Schedule 1 - Reporter Contact Identification and Summary of Financial Information	13
B. Schedule 2 - Details of Securities	16
C. Schedule 3 - Custodians Used	20
APPENDICES	
A. Sample Reporting Schedules	22
Reporter Contact Identification and Summary Financial Information	Schedule 1, Page 1 of 3
Details of Securities	Schedule 2, Page 1 of 2
Custodians Used	Schedule 3, Page 1 of 1
B. Reporting Requirement Flowcharts	28
C. List of Security Identification Systems	34
D. List of Country Codes	36
E. List of International and Regional Organizations	37
F. List of Currency Codes	38
G. List of Custodian Codes	40
H. Glossary	42
I. Technical Information for Electronic Submission	47

NOTE: Vertical bars in the left hand margin indicate significant changes from the reporting instructions for the SHC benchmark report as of December 31, 2006.

I. INTRODUCTION

A. PURPOSE

The Department of the Treasury, with the assistance of the Board of Governors of the Federal Reserve System and the Federal Reserve Bank of New York (FRBNY), is conducting a mandatory survey of the ownership of foreign securities, including selected money market instruments, by U.S. residents as of December 31. The data will be collected by the FRBNY, acting as fiscal agent for the Department of the Treasury. The data collected will be used by the U.S. Government in the computation of the U.S. balance of payments accounts and the U.S. international investment position, and in the formulation of international economic and financial policies. This report also is part of the Coordinated Portfolio Investment Survey (CPIS), an internationally coordinated effort under the auspices of the IMF, to improve the statistics on the holdings of foreign securities by major investing countries.

In order to reduce reporting burden and costs to the government, there will be a substantial reduction in the number of reporters in four out of every five years. A benchmark survey (Form SHC) of all significant U.S.-resident custodians and end-investors will continue to be held approximately every five years. In non-benchmark years, the annual survey (Form SHCA) will require reports from only the very largest U.S.-resident custodians and end-investors. The data reported under these annual surveys (Form SHCA) will be used in conjunction with the results of the previous benchmark survey to compute economy-wide estimates for the non-benchmark years.

The determination of who must report on the annual reports (Form SHCA) will be based upon the data submitted during the previous benchmark survey. Certain U.S.-resident custodians and end-investors (including fund managers) will be designated to file detailed foreign security data on Schedule 2 and data on foreign securities entrusted to U.S.-resident custodians on Schedule 3, i.e., they will be required to file in the same manner as they did on the December 31, 2006 benchmark survey.

B. AUTHORITY

This survey is conducted under the authority of the *International Investment and Trade in Services Survey Act* (22 U.S.C. 3101 et seq., [the Act]) and *Executive Order 11961* of January 19, 1977. The Act specifies that the President has the authority to conduct a regular data collection program, including such studies and reports as may be necessary and feasible, to secure current information on international investment, including (but not limited to) such information as may be necessary for computing and analyzing the balance of payments and the international investment position of the United States (22 U.S.C. 3103). In *Executive Order 11961* §2, the President designated the Secretary of the Treasury to be responsible for collecting data on portfolio investment required by the Act.

C. CONFIDENTIALITY OF DATA REPORTED

The information collected by this survey may be used only for analytical and statistical purposes and to enforce the Act. Access to the information is available only to officials and employees (including consultants and contractors and their employees) designated to perform functions under the Act. Persons having access to individual company information submitted pursuant to the Act are subject to penalties for unauthorized disclosure (22 U.S.C. §3104 and 18 U.S.C. §1905). The results of this survey will be made available to the general public at an aggregated level so that neither the U.S. persons or organizations providing information nor individual or organizational ownership of foreign securities can be identified.

D. PENALTIES FOR FAILURE TO REPORT

Reporting as directed in this package is mandatory for any U.S. person or organization subject to the reporting requirements set forth in the report instructions. Failure by an organization to provide timely and accurate data can result in a civil penalty of not less than \$2,500 and not more than \$25,000, or injunctive relief ordering such person to comply, or both (22 U.S.C. §3105(a)).

Willfully failing to submit any required information under the Act can result in a fine of not more than \$10,000; and, if an individual, may result in imprisonment for not more than a year, or both. Any officer, director, employee or agent who knowingly participates in such violation, upon conviction, may be punished by a like fine, imprisonment, or both (22 U.S.C. §3105(c)).

E. PAPERWORK REDUCTION ACT NOTICE

This report has been reviewed and approved by the Office of Management and Budget in accordance with the *Paperwork Reduction Act of 1995* and assigned OMB Control Number 1505-0146. The purpose is to collect accurate and complete data that will enable the Treasury Department to fulfill its responsibility under the Act. The estimated annual average preparation time per respondent (over five years) is about 84 hours, but this will vary widely from respondent to respondent. (a) In the year of a benchmark survey (using Form SHC), it is estimated that exempt SHC reporters will require an average of 16 hours; custodians of securities providing security-by-security information will require an average of 360 hours, but this figure will vary widely for individual custodians; end-investors providing security-by-security information will require an average of 120 hours; and end-investors and custodians employing U.S. custodians will require an average of 40 hours. (b) In a non-benchmark year (using Form SHCA), custodians of securities providing security-by-security information will require an average of 700 hours (because only the largest U.S.-resident custodians will report), end-investors providing security-by-security information will require an average of 145 hours; and SHCA reporters entrusting their foreign securities to U.S. custodians will require an average of 48 hours. Comments concerning the accuracy of this burden estimate and suggestions for reducing the burden should be directed to:

Administrator, International Portfolio Investment Data Systems
U.S. Department of the Treasury
1500 Pennsylvania Avenue NW, Room 4410-1440NYA
Washington, DC 20220, or

The Office of Management and Budget
Paperwork Reduction Project (1505-0146)
Washington, DC 20503

No person is required to respond to any U.S. Government collection of information unless it displays a currently valid OMB control number.

II. GENERAL INSTRUCTIONS

A. WHO MUST REPORT

All U.S.-resident custodians and end-investors that receive a copy of this SHCA booklet of forms and instructions from the Federal Reserve Bank of New York or are notified by the Federal Reserve Bank of New York that they are required to file must report. (See Section II.C, Exemptions.) All other entities are exempt from reporting.

1) **Custodians** are all organizations that hold securities in safekeeping for other organizations. Most U.S.-resident custodians also invest in foreign securities for their own account, i.e., are also U.S.-resident end-investors for purposes of this report. U.S.-resident custodians should report both the foreign securities held in safekeeping for other U.S. residents and their own foreign securities.

2) **End-Investors** are U.S. resident organizations that invest in foreign securities for their own portfolio. This includes securities that are held-for-trading, available-for-sale, held-for-maturity, or which have been invested on behalf of others by managers of mutual funds, insurance companies, and pension funds. Collectively such investors are referred to as “end-investors” throughout these instructions. U.S.-resident end-investors include, but are not limited to:

Financial and non-financial organizations
Managers of private and public pension funds
Managers of mutual funds, country funds, unit-investment funds, exchange-traded funds, collective-investment trusts, or any other similarly pooled, commingled fund
Insurance companies
Foundations
Institutions of higher learning (e.g., university endowments)
Trusts and estates

Reports should include all reportable securities held or managed by all U.S.-resident parts of your organization, including all U.S.-resident branches, offices, and subsidiaries. U.S. residents include organizations located in the Commonwealth of Puerto Rico and U.S. territories and possessions. Please see Appendix H for the complete definition of United States. It is the responsibility of the parent entity in each organization to ensure that its report covers all applicable entities within the organization.

If any of the following conditions apply, please contact the FRBNY staff:

- Your organization is not the top parent U.S.-resident entity in your organization and has received the forms and instructions from, or has been notified of its obligation to report by, the Federal Reserve Bank of New York.
- Your organization cannot submit a single report for the entire organization.

Additional copies of the reporting forms and instructions may be printed from the Internet at:

<http://www.treas.gov/tic/forms.html#benchmark>

B. WHICH SCHEDULES TO REPORT

- **Schedule 1**

Schedule 1 must be filed by all entities that 1) receive a copy of the SHCA forms and instructions from the Federal Reserve Bank of New York, or 2) are notified by the Federal Reserve Bank of New York that they are required to file the SHCA report.

Schedule 1 requests information that identifies the reporter. It also provides contact information, indicates the reporting status, and summarizes the data, if any, reported on Schedule 2 and/or Schedule 3.

- **Schedule 2:**

Schedule 2 is used to report detailed information on foreign securities (1) that the reporter safekeeps for itself or for its U.S.-resident clients or (2) for which the reporter directly employs foreign-resident sub-custodians or U.S.-resident or foreign-resident central securities depositories to manage the safekeeping of those securities (See Section III.H.).

- **Schedule 3:**

Schedule 3 is used to report summary amounts for all foreign securities entrusted to the safekeeping of a U.S.-resident custodian (excluding U.S.-resident central securities depositories) (See Section III.H.).

C. EXEMPTIONS

- **Schedule 1**

If you have received these forms and instructions from the Federal Reserve Bank of New York, there is NO exemption level for **Schedule 1**. You must submit the reporter identification, the contact and certifying information parts of **Schedule 1**. However, items requesting aggregate data on foreign securities on Schedule 1 should be left blank if you are not required to report data on Schedule 2 or Schedule 3.

- **Schedule 2**

SHCA reporters are exempt from reporting on Schedule 2 if the total fair (market) value of foreign securities whose safekeeping they manage for themselves and for other U.S. residents or whose safekeeping the reporter has entrusted directly to foreign-resident custodians or U.S. or foreign-resident central securities depositories is **less than US\$ 100 million** (aggregated over all accounts) as of December 31.

- **Schedule 3**

SHCA reporters are exempt from reporting on a Schedule 3 holdings entrusted to another U.S.-resident custodian if the total fair (market) value of the foreign securities entrusted to that U.S.-resident custodian – aggregated over all accounts they own and all accounts they manage for other U.S. residents - **is less than US\$ 100 million** as of December 31.

D. REPORTING DATES

Report data as of December 31. Data should be submitted to the Federal Reserve Bank of New York (FRBNY) no later than the first Friday of March.

E. SUBMISSION INSTRUCTIONS AND CONTACT INFORMATION

Schedule 1 must be submitted on paper, unless you are submitting Schedule 2 data via the IESUB application (see below). If you are submitting Schedule 2 data via the IESUB application, you must submit Schedule 1 via IESUB.

Schedule 2 reports consisting of **200 or more** records, must be submitted electronically on diskette(s) or compact disk(s) (CDs) or via IESUB using the format specified in Appendix I.

Schedule 2 reports consisting of **less than 200** records may be submitted electronically on diskette(s) or compact disk(s) (CDs) or via IESUB using the format specified in Appendix I, or on paper, using the form contained in Appendix A.

Schedule 3 reports must always be submitted on paper using the form in Appendix A.

Reports can be mailed or sent by courier to:

**Federal Reserve Bank of New York
Statistics Function, 4th Floor
33 Liberty Street
New York, NY 10045-0001**

IESUB

The Federal Reserve System's Internet Electronic Submission (IESUB) System is fast, easy to use and secure. IESUB provides a confirmation of the receipt of the data at the Federal Reserve Bank of New York and performs a number of validity checks of your file format.

For more information on how to submit data using the IESUB system, contact the SHC staff at 212-720-6300 or 646-720-6300 or at SHC.Help@ny.frb.org. Alternatively, additional information and an application to register for IESUB can be obtained at:

<http://www.treas.gov/tic/forms.htm#benchmark>.

Completed applications should be sent to:

Federal Reserve Bank of New York
Statistics Function, 4th Floor
33 Liberty Street
New York, New York 10045-0001

or faxed to 1-212-720-5030.

If your business or technical contact information changes after submission of your Schedule 1 or if you have any questions pertaining to the report, please contact the FRBNY staff:

Phone: (212) 720-6300
(646) 720-6300

Email: SHC.Help@ny.frb.org

III. WHAT SECURITIES MUST BE REPORTED

This report collects information on U.S. resident holdings of foreign securities, including foreign equities, short-term debt securities (including selected money market instruments), and long-term debt securities. Asset-backed securities are to be reported separately from other debt securities. Foreign securities include all securities issued by entities that are established under the laws of a foreign country (i.e., any entity that is legally incorporated, otherwise legally organized, or licensed (such as branches) in a foreign country) and all securities issued by international organizations, such as the International Bank for Reconstruction and Development (IBRD or World Bank), and the Inter-American Development Bank (IADB), even if these organizations are located in the United States.

Reportable securities may be traded or issued in the United States and in foreign countries, and may be denominated in any currency, including euros and U.S. dollars. Neither the country in which the securities are traded or issued, nor the currency in which the securities are denominated, is relevant in determining whether the securities are reportable.

As an exception, foreign securities held by a U.S. depository to back depository receipts/shares should not be reported. Instead, the holders of the depository receipts/shares should report the receipts/shares. This exception is necessary to identify the portion of depository receipts/shares actually held by U.S. residents, because many depository receipts/shares are held by foreign residents.

A. REPORTABLE FOREIGN SECURITIES

Reportable securities include:

- Securities issued by international and regional organizations, such as the International Bank for Reconstruction and Development (IBRD or World Bank) or the Inter-American Development Bank (IDB).
- Securities issued in the United States by foreign-resident organizations (e.g., Canadian or Mexican firms), even if they are denominated in U.S. dollars and trade on U.S. securities exchanges.
- Securities issued by foreign-resident subsidiaries of U.S.-resident organizations (e.g., GMAC Canada) and foreign-resident offices of U.S. banks or U.S. broker/dealers, even if they are guaranteed by the U.S. parent company, or issued in the United States.
- Depository receipts/shares, including American Depositary Receipts (ADRs), American Depositary Shares (ADS), Global Depositary Receipts (GDRs), and International Depositary Receipts (IDRs), if the underlying securities are issued by foreign residents— (See Section III.E.).
- Securities issued by foreign-resident entities under Section 144A of the SEC Act.
- Money market instruments, including negotiable certificates of deposit (CDs), issued by foreign-resident entities.

Equity securities represent an ownership interest in foreign-resident organizations.

Include as equities:

- Common stock (ordinary shares);
- Preferred stock (participating and nonparticipating preference shares);
- Restricted stock;
- Depository receipts/shares (e.g., ADRs, ADSs, GDRs, IDRs) **provided** the underlying securities used to collateralize the receipts/shares **are** foreign securities (See Section III.E.);
- Shares/units in foreign-resident funds, investment trusts, and similar investment vehicles (including mutual funds and money market funds— (See Section III.C.);
- U.S.-resident limited partner ownership in foreign-resident limited partnerships (general partner ownership is excluded – (See Section III.J.); and
- Other equity securities.

Short-Term Debt Securities include bills, commercial paper, and other money market instruments specified below with an **original maturity of one year or less** that give the holder the unconditional right to financial assets. (Asset-backed short-term debt securities should be reported as asset-backed securities (see below).)

Include as short-term debt securities:

- Short-term foreign government securities;
- Short-term bankers' acceptances and trade acceptances;
- Short-term commercial and financial paper, including asset-backed commercial paper;
- Short-term **negotiable** certificates of deposit, bank notes, and deposit notes;
- Short-term notes issued under note issuance facilities and revolving underwriting facilities, even though the underlying facility may be for more than one year;
- Short-term medium-term notes;
- Short-term promissory notes;
- Stripped securities with an original maturity of one year or less; and
- Other short-term debt securities.

Long-Term Debt Securities (excluding asset-backed securities) include bonds and notes, with an **original maturity of over one year**, that usually give the holder the unconditional right to financial assets.

Include as long-term debt securities:

- Bonds such as foreign treasury, zero coupon, stripped, deep-discounted, currency-linked (e.g., dual-currency), floating rate, equity-related (e.g., convertible bonds) bonds and Eurobonds;
- Long-term index-linked debt securities;
- Long-term floating rate notes (FRN), such as perpetual notes (PRN), variable rate notes (VRN), structured FRN, reverse FRN, collared FRN, step up recovery FR (SURF), and range/corridor/accrual notes;
- Long-term medium-term notes;
- Bonds with multiple call options, the last of which is more than one year after issue;
- Long-term debentures;
- Long-term negotiable certificates of deposit, bank notes, and deposit notes;
- Long-term bearer depositary receipts denoting ownership of debt securities issued by nonresidents;
- Brady bonds;
- Covered bonds (e.g., Pfandbriefe);
- Long-term securities backed by a sinking fund; and
- Other long-term debt securities.

Asset-Backed Securities are securitized interests in a pool of assets, which give the purchaser a claim against the cash flows generated by the underlying assets. In many cases, the security's outstanding principal is reduced over time as principal repayments are received and passed on to the holders of the security. Securities backed by revolving credits, such as pools of credit card receivables, do not meet this criterion, but are still classified as ABS if the return to the holder is based upon these credits, (i.e., the credits do not merely serve as collateral). The ABS is reported if the **issuer securitizing the assets** is a foreign resident. The underlying asset should not be used to determine if the securities are reportable. Asset-backed commercial paper should be reported as commercial paper with other short-term debt.

Include as asset-backed securities all collateralized mortgage obligations (CMOs), collateralized bond obligations (CBOs), collateralized loan obligations (CLOs), collateralized debt obligations (CDOs), and other securities which give the purchaser a claim against the cash flows generated by pools of:

- Mortgages;
- Credit card receivables;
- Automobile loans;
- Consumer and personal loans;
- Commercial and industrial loans and other whole loans; and
- Other assets.

B. DO NOT REPORT

Do not report any:

- Derivative contracts (including futures, forwards, swaps, options, and warrants) meeting the definition of a derivative under FAS 133. If the embedded derivative has not been bifurcated from the host contract under FAS 133, then the security should be reported without separating the embedded derivative from the host contract. However, if the embedded derivative is bifurcated from the host contract, then the derivative should be excluded from the report and the host security should be included on the report.
- Loans and loan participation certificates;
- Letters of credit;
- Non-negotiable certificates of deposit ;
- Bank deposits, including time deposits (except for negotiable CDs) and demand deposits;
- Foreign securities temporarily acquired under reverse repurchase, borrowing, or lending arrangements (See Section III.D.);
- The underlying security of a depositary receipt, even if a foreign security (See Section III.E.);
- Direct investments (See Section III.G.), including investments in real estate and general partner ownership in limited partnerships (however, limited partner ownership are reportable investments);and
- All U.S. securities, including:
 1. Securities issued by U.S.-resident organizations, even if they are denominated in foreign currencies or traded on foreign securities exchanges;
 2. Securities issued by U.S.-resident subsidiaries of foreign-resident organizations and U.S.-resident offices of foreign banks or foreign broker/dealers, even if they are guaranteed by the foreign parent company, or issued outside of the United States;
 3. Securities issued by U.S.-resident entities under Section 144A of the SEC Act;
 4. Ownership of shares of U.S.-resident funds, even if the fund invests in foreign securities (See Section III.C.); and
 5. Stripped securities issued by a U.S.-resident financial institution, even if the underlying security is a foreign security (See Section III.F.).

C. FUNDS AND RELATED EQUITY HOLDINGS

1. Report U.S. residents' ownership of shares/units of funds legally established outside of the United States (foreign-resident funds) as equity securities. All U.S. residents' holdings of foreign-resident funds should be assigned security type 3 (fund shares), and not categorized as a debt security, regardless of the types of securities held by the fund.

For purposes of this report, funds include all investment vehicles that pool investors' money and invest the pooled money in one or more of a variety of assets. Funds include, but are not limited to:

- Mutual funds (including both closed-end and open-end mutual funds);
- Money market funds;
- Investment trusts;
- Index-linked funds;
- Exchange traded funds (ETFs); and
- Common trust funds.

The determination of whether fund shares are foreign securities is based on the country in which the fund is legally established, not on the type of securities the fund purchases. For example, a share in a fund organized in

Bermuda that purchases U.S. Treasury securities is a reportable foreign equity security. Likewise, a share in a fund established in the United States is a U.S. security and should be excluded from the report, even if the U.S.-resident fund invests in foreign securities.

Many funds established outside the United States have names that are similar to U.S.-resident fund names. This often occurs when the fund is managed by a group that manages many U.S.-resident funds and therefore may be thought of as managing only U.S.-resident funds. If there is doubt as to whether the investment should be classified as a fund or whether a fund is U.S. or foreign, please contact FRBNY report staff at (212) 720-6300 or (646) 720-6300.

2. Report U.S.-resident funds' ownership of foreign securities.

Although ownership of shares of U.S.-resident funds is excluded from this report, the foreign securities owned by U.S.-resident funds are reportable. These are distinct holdings and, therefore, are not duplicate reporting. Foreign securities owned by U.S.-resident funds should be classified as equity, debt, or asset-backed securities, as indicated in Section III.A.

D. SECURITIES INVOLVED IN REPURCHASE AND SECURITIES LENDING ARRANGEMENTS

A repurchase agreement (repo) is an arrangement involving the sale of securities at a specified price for cash with a commitment to repurchase the same or similar securities at a specified price on a future date. A reverse repo is an agreement whereby a security is purchased at a specified price with a commitment to resell the same or similar securities at a specified price on a specified future date. Securities lending/borrowing arrangements are agreements whereby the ownership of a security is transferred in return for collateral, usually another security or cash, under condition that the security or similar security will revert to its original owner at a future date. All of these arrangements, as well as buy/sell agreements, should be treated as follows:

- Securities sold under repurchase agreements or lent under securities lending arrangements, or collateral provided, should be reported by the original owner of the securities (or their U.S.-resident custodian) as if the securities were continuously held; that is, as if the repurchase or security lending agreement did not exist. Thus, if a U.S. resident transferred a foreign security under a repurchase or securities lending arrangement, the U.S. resident (or their U.S.-resident custodian) transferring the security should include it in its Schedule 2 or Schedule 3 records. The country reported should be the country of the issuer of the security and not the country of the counterparty to the repo or other agreement.
- Securities, including collateral, temporarily acquired by U.S. residents under reverse repurchase or borrowing or lending arrangements should not be reported.
- However, if cash was temporarily received as collateral and was used to purchase securities, those securities should be reported.

E. DEPOSITARY RECEIPTS/SHARES

Depositary receipts/shares, including American depositary receipts (ADRs) or bearer depositary receipts, should be attributed to the country of residence of the issuer of the security underlying the depositary receipt/share. Issuers of depositary receipts/shares should **not** report their holdings of the actual foreign securities. Only U.S. residents' holdings of depositary receipts/shares should be reported.

In addition, the security type reported should be determined based on the security underlying the depositary receipt/share. For example, if the underlying security is foreign common stock then the security type reported in Item 7 of the Schedule 2 should be 1 (common stock).

F. STRIPPED SECURITIES

Stripped securities are securities that have been transformed from a principal amount with periodic interest coupons into a series of zero coupon securities, with the range of maturities matching the coupon payment dates and the redemption date of the principal amount.

The country of residence of a stripped security is the country of residence of the entity that issued the stripped security, not the country of residence of the entity that issued the underlying security. Stripped securities issued by foreign residents, (the interest-only (IO) component, the principal-only (PO) component and tranches of stripped asset-backed securities), and held by U.S. residents are reportable. If a U.S.-resident financial institution issued the stripped securities, the issuer of the stripped securities should report its ownership of the underlying foreign securities. Exclude U.S. residents' holdings of stripped securities issued by a U.S.-resident financial institution.

G. DIRECT INVESTMENT

All holdings known to be direct investment should be excluded from the survey.

A direct investment relationship exists when a U.S. company owns 10% or more of the voting equity securities of an incorporated foreign business (or an equivalent interest in an unincorporated foreign business or branch. (See Section III.K.) If a direct investment relationship exists, then, in general, all securities held by the parent entity that were issued by the affiliate of the parent are considered to be direct investment. **However, if one of the entities is a banking or securities brokerage firm, then inter-company holdings are considered to be direct investment only if they provide permanent capital.** All holdings known to be direct investment should be excluded from this report.

H. SECURITIES HELD BY CENTRAL SECURITIES DEPOSITORIES

Foreign securities entrusted to U.S.-resident custodians that are in turn held at a U.S.-resident central securities depository (such as the Depository Trust Company or the Federal Reserve Bank of New York), or a foreign-resident central securities depository (such as Euroclear or Clearstream), must be reported by the U.S.-resident custodian, not by the U.S. or foreign-resident central securities depository. Likewise, foreign securities held by a U.S.-resident end-investor directly with a U.S.-resident or foreign-resident central securities depository must be reported by the U.S.-resident end-investor, not by the central securities depository.

Foreign securities provided to the Federal Reserve Bank of New York (FRBNY) for discount window loan collateral must be reported by the "lender" of the securities, not by the FRBNY.

I. COUNTRY ATTRIBUTION

Except for international and regional organizations, and depository receipts, securities should be reported based upon **the country of residence of the issuer of the securities**. The country of residence of any entity is where it is legally incorporated or otherwise legally organized, with the exception of bank branches, which are reported by where they are licensed. In cases where a foreign subsidiary of a U.S.-resident organization issues a reportable security, report these securities in the country where the foreign subsidiary is resident if the security is the direct legal obligation of the foreign subsidiary.

Securities issued by international and regional organizations are not allocated to the country in which the international or regional organization is located but rather to the separate code for international and regional organizations (79995). (Refer to Appendix E for a list of international and regional organizations.) Depository receipts should be attributed to the country of residence of the issuer of the security underlying the depository receipt.

Attribution of country of residence of the issuer should **not** be affected by the currency of issue or by the country of a guarantor.

J. LIMITED PARTNERSHIPS

U.S.-resident limited partner ownership of foreign-resident limited partnerships should be reported as Other Equity (Schedule 2, Item 7 = 4). Limited partners' ownership does not carry voting rights; therefore, such ownership, even if greater than 10%, is reportable. The Number of Shares Held field on the Schedule 2 (Item 16) should be defaulted to the value reported in the US\$ Market Value field (Item 14a) because limited partnerships do not issue shares.

U.S.-resident general partner ownership of foreign-resident limited partnerships is always considered to be direct investment and is excluded from this report.

K. ACCOUNTING RULES, VALUATION OF SECURITIES, AND CALCULATION OF U.S. DOLLAR VALUES

Accounting Rules

All securities should be reported using settlement date accounting. Gross long positions should be reported. Do not net any short positions from long positions. Do not enter decimals or negative values in any cells.

Valuation of Securities

Report the fair (market) value of securities as December 31. The fair (market) value follows the definition of FAS 157. Fair value is the amount at which an asset could be bought or sold in a current transaction between willing parties, other than in a forced or liquidation sale. If a quoted market price is available for an instrument, the fair (market) value is the product of the number of trading units times that market price. For securities that do not regularly trade, the estimate of fair value should be based on the best information available in the circumstances. The estimate of fair value should consider prices for similar assets and the results of valuation techniques to the extent available in the circumstances. Examples of valuation techniques include discounted cash flow, matrix pricing, option-adjusted spread models and fundamental analysis.

For asset-backed securities, the fair (market) value of the unpaid principal amount outstanding on December 31 should be reported; if principal has been repaid, this fair (market) value will **not** be the same as the original face value revalued at end-period market prices.

U.S.-resident custodians should, at a minimum, report the fair (market) value to the extent that it is available as part of their normal services provided to customers, even if the price available is prior to December 31. If there is doubt as to whether to report the available fair (market) value or to report a fair (market) value of zero, please contact FRBNY report staff at (212) 720-6300 or (646) 720-6300.

Foreign Currency Denominated Securities – Calculation Of U.S. Dollar Values

If the security is not denominated in U.S. dollars (US\$) and a US\$ fair (market) value is not available in your system, convert the foreign currency denominated fair (market) value into US\$ using the spot exchange rate as of December 31. If you need assistance locating an exchange rate, please contact FRBNY staff at (212) 720-6300 or (646) 720-6300.

If the exchange rate is normally quoted in units of foreign currency per US\$, such as ¥105.75/US\$, divide foreign currency values by the foreign exchange rate to obtain the US\$ values. For example, if the value of a security issued in Japan is ¥ 200,000, divide ¥ 200,000 by 105.75 to obtain US\$ 1,891.

If the exchange rate is normally quoted in US\$ per units of the foreign currency, such as US\$1.75/UK£, then multiply foreign currency values by the US\$ exchange rate value of the foreign currency to obtain US\$ values.

For example, if the value of a security issued in the United Kingdom is UK £1,000, multiply UK £1,000 by 1.75 to obtain US\$ 1,750.

L. DATA RETENTION PERIOD

The reporter must retain all data used to create this report for a period of 36 months from the date of the report's submission.

M. REVIEW OF DATA AND REQUESTS FOR REVISED DATA

Data submitted on the reporting schedules are reviewed by FRBNY staff. As a result of this review, the reporter may be asked by FRBNY staff to provide supplemental information, including reasons for significant data changes between reporting periods, or corrected data. In addition, FRBNY staff may request: (1) information to ensure that all reportable foreign securities have been reported; (2) information to ensure that all reported foreign securities are held by U.S. residents; or (3) other information that helps to explain or corroborate the submitted data.

Entities filing data on electronic media that are not formatted per the specifications in Appendix I will be required to re-submit the data in the proper format.

IV. INSTRUCTIONS FOR COMPLETING REPORTING SCHEDULES

A. SCHEDULE 1 - REPORTER CONTACT IDENTIFICATION AND SUMMARY OF FINANCIAL INFORMATION

Schedule 1 must be completed by all organizations that meet the survey reporting requirements as specified in Section II.A. This schedule is used to provide basic identifying information and provide summaries of data reported on Schedule 2 and Schedule 3 records. Please type or print all information.

1. Reporter Identification Number - Enter your organization's ten-digit Reporter Identification Number. If you do not know the Reporter Identification Number for your organization, please contact FRBNY staff at (212) 720-6300 or (646) 720-6300.

(Please enter your ten-digit Reporter Identification number at the top of each page of Schedule 1.)

2. Organization Name and Address - Include the full legal name and mailing address of the reporting entity.

3. Reporting Status

Select **1** if your organization is Exempt from reporting on both Schedules 2 and 3 as defined in Section II.C
OR if your organization's reportable foreign securities are included in the report of its U.S.-resident parent.

Select **2** if your organization is filing only Schedule 2 records.

Select **3** if your organization is filing only Schedule 3 records.

Select **4** if your organization is filing both Schedule 2 and Schedule 3.

4. Industrial Classification Code - Enter one of the following that best describes your organization.

1 = Bank	4 = Insurance Company	7 = Foundation, Trust, or Estate
2 = Mutual Fund or Investment Trust	5 = Other Financial Organization	8 = Institution of Higher Learning (e.g., university)
3 = Pension Fund	6 = Non-Financial Organization	9 = Other (not listed above)

A Bank is any depository institution (i.e., an institution that takes deposits), a bank holding company, or a financial holding company organized under Regulation Y of the Federal Reserve Act.

An Other Financial Organization is any other organization that acts as a financial intermediary, such as a finance company or a broker/dealer, which is operated separately from an organization in one of the other categories listed above.

A Non-Financial Organization is an organization that conducts commercial, industrial or trade activities.

5. Name of Contact - Enter the name of the person who will be the primary contact for this report and can answer questions about the data reported.

6. Title - Enter the job title of the contact identified in item 5.

7. Telephone Number - Enter the telephone number of the contact identified in item 5.

8. Fax Number - Enter the fax number of the contact identified in item 5.

9. Email Address - Enter the email address of the contact identified in item 5.

10. Name of Service Provider or Vendor Used - If a service provider or vendor was used to prepare the data reported, enter the name of the service provider.

- 11. Name of Technical Contact** - Enter the name of a person who will serve as a contact should any technical issues, such as incorrect file formats, arise. If a service provider was used to prepare the data reported, the technical contact may be a vendor employee.
- 12. Title** - Enter the job title of the technical contact identified in item 11.
- 13. Telephone Number** - Enter the telephone number of the technical contact identified in item 11.
- 14. Email Address** - Enter the email address of the technical contact identified in item 11.
- 15. Valuation Technique** - For each reporting unit, describe the valuation technique(s) used to calculate the reported market values. If securities are automatically valued at zero after a specified time period of inactivity, please specify the time period and whether this applies to the market value of the security or to the client's holdings (quantity) of the security. Also, please specify how securities not actively traded on the report date and those with internally generated security identification numbers are valued. If your organization has more than four reporting units, please attach additional copies of Schedule 1, page 2, with item 15 completed.

SUMMARY OF SCHEDULE 2 INFORMATION

This section contains summary data for the information reported on **Schedule 2** records. If your organization submits Schedule 2 data on multiple media, the summary Schedule 2 data should represent aggregate data across all media submitted for the same reporter identification number.

- 16. Total Number of Schedule 2s Submitted** - Enter the total number of Schedule 2 records submitted.
- 17. Total US\$ Fair (Market) Value of All Equity Securities** - Enter the sum of the US\$ fair (market) value of all equity security records (records with Schedule 2, Item 7 = 1, 2, 3, or 4), rounded to the nearest U.S. dollar.
- 18. Total US\$ Fair (Market) Value of All Short-Term Debt Securities** (excluding asset-backed securities) - Enter the sum of the US\$ fair (market) value of all short-term debt security (including asset-backed commercial paper) records (records with Schedule 2, Item 7 = 5, 6, 7, 8, or 9 and Item 10 = 1), rounded to the nearest U.S. dollar.
- 19. Total US\$ Fair (Market) Value of All Long-Term Debt Securities** (excluding asset-backed securities) - Enter the sum of the US\$ fair (market) value of all long-term debt security (excluding asset-backed securities) records (records with Schedule 2, Item 7 = 6, 7, 8, or 9 and Item 10 = 2), rounded to the nearest U.S. dollar.
- 20. Total US\$ Fair (Market) Value of All Asset-Backed Securities** - Enter the sum of the US\$ fair (market) value of all asset-backed security records (records with Schedule 2, Item 7 = 10), rounded to the nearest U.S. dollar.

SUMMARY OF SCHEDULE 3 INFORMATION

This section contains summary data for the information reported on **Schedule 3** records.

- 21. Total Number of Schedule 3s Submitted** - Enter the total number of Schedule 3 records submitted.
- 22. Total US\$ Fair (Market) Value of All Equity Securities** - Enter the sum of all Schedule 3 records, item 4.
- 23. Total US\$ Fair (Market) Value of All Short-Term Debt Securities** (excluding asset-backed securities) - Enter the sum of all Schedule 3 records, item 5.

24. Total US\$ Fair (Market) Value of All Long-Term Debt Securities (excluding asset-backed securities) - Enter the sum of all Schedule 3 records, item 6.

25. Total US\$ Fair (Market) Value of All Asset-Backed Securities - Enter the sum of all Schedule 3 records, item 7.

CERTIFYING INFORMATION

All reporters must complete this section.

By signing and dating the certification, the Certifier acknowledges that:

- He/she has read and understood the reporting requirements of this report;
- He/she is aware that both civil and criminal penalties may be imposed for filing a false report; and
- He/she is sufficiently knowledgeable about the activities and functions of this organization that he/she can knowingly and with reasonable confidence certify that the information provided in this report is both accurate and complete.

26 - 30 - Enter the name, job title, telephone number, and email address of the person in your organization who certifies that the information provided is complete and accurate, as well as the date and signature.

B. SCHEDULE 2 - DETAILS OF SECURITIES

(Please enter your ten-digit Reporter Identification Number at the top of each page of Schedule 2.)

1. Reporter Identification Number - Enter your organization's ten-digit Reporter Identification Number. If you do not know the Reporter Identification Number for your organization, please contact FRBNY staff at (212) 720-6300 or (646) 720-6300.

2. Sequence Number - Enter the sequence number of this detail record, right justified. The first detail record should be assigned sequence number 1, and each succeeding Schedule 2 should be assigned a sequence number one higher than the previous record.

3a. Reporting Unit Code - If data being submitted are collected from multiple databases or reporting systems, please report the internal code used in your organization to identify the database or system from which the information on this Schedule 2 came. This information may greatly reduce the costs of identifying and fixing reporting errors that occur.

3b. Name of Reporting Unit - Enter a description or name of the reporting unit or area that corresponds to the code reported in item 3a.

4. Security ID - Enter the security ID code used to identify the security reported on this Schedule 2. ISIN codes are strongly preferred. If the ISIN code is not available, please use a code listed as "Primary" in Appendix C. If no "primary" code is available, please use a "secondary" code listed in Appendix C other than "internally generated." **Do not use internally generated codes unless this security has not been assigned a code by any recognized numbering agency (e.g., limited partnerships).** However, all records for securities for which a portion is restricted and a portion is not restricted should be reported with the numbering agency code assigned to the unrestricted portion. If excessive internal codes are used, we may have to contact you to help identify characteristics of certain individual securities. **Please include the security id's check digit and exclude any internal coding characters added to the ISIN, CUSIP, or other numbering agency code.**

5. Security Description - Briefly describe the security, providing any relevant descriptive information available. Ideally, this would include, but is not restricted to: (a) for preferred stock, the annual dividend; (b) for debt securities, the interest rate; (c) for floating rate notes, how the interest is calculated (e.g., Libor plus 1.5); and (d) for depositary receipts, the underlying security.

6. Security ID System - Select the appropriate number from the list provided in Appendix C. For example, if the Security ID Number entered in Item 4 was an ISIN number, enter "01"; if it was a CINS, enter "33." If the security ID system used is not listed, enter a code of 99 (other) and provide the name of the organization generating the code in item 6a. If the code is internally generated, enter a code of 98 and explain how your internal coding system assigns numbers in item 6a.

6a. Comment Line - If you entered a code of 99 (other) in item 6 you must provide the name of the organization generating the security ID code. If you entered a code of 98 (internally generated) in item 6 please explain how your internal coding system assigns numbers.

7. Security Type - Enter the appropriate Security Type code from the listed options below:

Equity	Non-asset-backed Debt	Asset-backed Securities
1 = Common stock	5 = Commercial paper	9 = Unstripped note or bond
2 = Preferred stock	6 = Negotiable CD	& all other
3 = Fund shares	7 = Convertible debt security	non-asset-backed debt
4 = All other equity	8 = Zero coupon & stripped security	10 = Asset-backed security

Common stock includes securities representing equity ownership in a foreign corporation. All foreign common stock, including restricted common stock and depositary receipts where the underlying security is common stock should be reported as security type 1.

Preferred stock includes securities representing equity ownership in a foreign corporation where the holder's claim is given priority over common shares. Preference shares, non-participating preference shares, convertible preferred stock, restricted preferred stock, and depositary receipts where the underlying security is preferred stock should be reported as security type 2.

Funds include all investment vehicles that pool investors' money and invest the pooled money in one or more of a variety of assets. All ownership interests in funds should be reported as security type 3, regardless of the securities held by the fund. (See Section III.C.)

All other equity includes U.S.-resident limited partner ownership of foreign-resident limited partnerships and any other form of equity not specified in Security Types 1, 2, and 3 and should be reported as security type 4.

Commercial paper, security type 5, includes **all** commercial paper, including asset-backed commercial paper.

Negotiable certificates of deposit, security type 6, includes negotiable bank notes and negotiable deposit notes.

Convertible debt securities, security type 7, includes all convertible debt such as convertible bonds and zero-coupon convertible debt. Note that non-convertible debt securities with embedded warrants or options should be reported as either security type 8, if a zero coupon bond or note, or as security type 9, if **straight debt**.

Zero coupon & stripped securities, security type 8, includes bonds and notes that do not provide explicit interest payments, such as discount notes and stripped, non-asset-backed securities (both the interest-only (IO) and principal-only (PO) components) **except** zero-coupon convertible debt, which should be reported as security type 7, and stripped asset-backed securities, (including their tranches, and all IO and PO components) which should be reported as security type 10.

Unstripped notes, bonds, and all other non-asset-backed debt, security type 9, includes non-asset-backed debt that is not covered in security types 5 through 8. These are bonds or notes that : (1) cannot be converted to equity securities; (2) provide explicit interest payments; (3) have not been stripped; and (4) do not give the owner a claim on cash flows generated by the underlying assets (i.e., are not asset-backed). These bonds and notes are commonly referred to as "straight debt."

Asset-backed securities, security type 10, includes securities that represent securitized interests in a pool of assets and that give the investor a claim against the cash flows generated by the underlying assets, **except** for asset-backed commercial paper, which should be reported as security type 5. All tranches of stripped asset-backed securities, as well as unstripped asset-backed securities, should be reported as security type 10. Debt which is collateralized by assets (real or financial), but only give the investor a claim against the underlying interest if the issuer defaults, should be reported as security types 5 through 9, as appropriate.

8. Depositary Receipt/Share - Enter **1** if the security is a depositary receipt/share. Enter **2** otherwise.

9. Name of Issuer - Enter the name of the organization that issued the security. Please try to provide the full legal name of the issuer. For branches of banks, please provide the location of the branch.

10. Term Indicator (based on original maturity) – Enter **1** (short-term) if the period from the issue date to the maturity date is one year or less, regardless if a leap year; enter **2** (long-term), if the period from the issue date to the maturity date is greater than one year. Term indicator only applies to debt, including asset-backed debt. If there are multiple issue dates or redemption dates, term should be determined by the length of the period between the initial/first issue date and the latest redemption date. Perpetual debt should be classified as long-term debt.

11. Country of Issuer - Enter the country code from Appendix D that corresponds to the country of residence of the entity that issued the security. (Refer to Section III.I, Country Attribution.)

12. Currency of Denomination - Enter the ISO code from Appendix F that corresponds to the currency in which the security being reported is denominated.

13. Ownership Code - Enter the appropriate code from the list below:

- 1 = if your organization is reporting as the owner of this security
- 2 = if your organization is reporting as the custodian for a U.S.-resident mutual fund for this security
- 3 = if your organization is reporting as the custodian for a U.S.-resident pension fund for this security
- 4 = if your organization is reporting as the custodian for a U.S.-resident insurance company for this security
- 5 = if your organization is reporting as the custodian for any other U.S. residents for this security
- 6 = if your organization is the custodian and the entity type of the beneficial owner is unknown

Ownership code 1 should be used if your organization is the owner of this security and either holds the security or uses a foreign-resident custodian or a U.S.-resident or foreign-resident central securities depository.

Ownership code 2 should be used if your organization is the custodian and the beneficial owner is identified as a U.S.-resident that is a mutual fund.

Ownership code 3 should be used if your organization is the custodian and the beneficial owner is identified as a U.S.-resident that is a pension fund.

Ownership code 4 should be used if your organization is the custodian and the beneficial owner is identified as a U.S.-resident that is an insurance company.

Ownership code 5 should be used if your organization is the custodian and the beneficial owner is identified as a U.S.-resident that is not a mutual fund, pension fund, or insurance company (which are reported as ownership codes 2 through 4). When your organization is the custodian and cannot identify the entity type of the beneficial owner, the ownership code should be reported as ownership code 6.

Ownership code 6 should be used if your organization is the custodian and the entity type of the beneficial owner is unknown.

14a. US\$ Fair (Market) Value of Security Held - Enter the US\$ fair (market) value of the security being reported, rounded to the nearest U.S. dollar. (See Section III.K, Accounting Rules, Valuation of Securities, and Calculation of U.S. Dollar Values, for more information on how to calculate the US\$ fair (market) value.)

14b. Fair (Market) Value of Security Held Denominated in Currency of Issue - Enter the fair (market) value of the security being reported, rounded to the nearest currency of issue unit. If the currency of issue is US\$, report the same value as in item 14a. (See Section III.K, Accounting Rules, Valuation of Securities, and Calculation of U.S. Dollar Values, for more information on how to calculate the fair (market) value.)

15. Intentionally left blank. Leave this field null or enter a blank space for each record.

FOR EQUITY SECURITIES ONLY

16. Number of Shares Held - Enter the number of shares held, rounded to the nearest share. Securities for which the amount of shares held is zero should not be reported.

FOR SHORT-TERM AND LONG-TERM DEBT SECURITIES EXCLUDING ASSET-BACKED SECURITIES ONLY

17. Face Value in Currency of Denomination - For both short-term and long-term securities, enter the face value held in the currency of denomination, rounded to the nearest whole currency unit. If a security is traded in units, then calculate the face value as: (face value of each unit) * (the number of units held) and report the result in this field. Securities for which the amount held is zero should not be reported.

18. Issue Date - Enter the issue date of this security in MMDDYYYY format. For example, if the security was issued on October 4, 1985, enter 10041985. If there are multiple issue dates, enter the first such issue date.

19. Maturity Date - Enter the final maturity date (when all remaining principal and interest is due) of this security in MMDDYYYY format. For example, if the security's final maturity date is January 5, 2010, enter 01052010.

FOR SHORT-TERM AND LONG-TERM ASSET-BACKED SECURITIES ONLY

20. Original Face Value in Currency of Denomination - Enter the original face value in the currency of denomination, rounded to the nearest whole currency unit. This is the value that is (would have been) outstanding if no principal has been (had been) repaid. If a security is traded in units, then calculate the original face value as: (original face value of each unit) * (the number of units held) and report the result in this field.

21. Remaining Principal Outstanding in Currency of Denomination - Enter the remaining principal outstanding as of December 31, in the currency of denomination, rounded to the nearest whole currency unit. This will equal the original face value if no principal has been repaid. If a security is traded in units, then calculate the remaining face value as: (remaining face value of each unit) * (the number of units held) and report the result in this field. Securities for which the amount held is zero should not be reported.

22. Issue Date - Enter the issue date of this security in MMDDYYYY format. For example, if the security was issued on October 4, 1985, enter 10041985. If there are multiple issue dates, enter the first such issue date.

23. Maturity Date - Enter the final maturity date of this security in MMDDYYYY format. For example, if the security's final maturity date is January 5, 2010, enter 01052010.

C. SCHEDULE 3 - CUSTODIANS USED

(Please enter your ten-digit Reporter Identification Number at the top of each page of Schedule 3.)

- 1. Reporter Identification Number** - Enter your organization's ten-digit Reporter Identification Number. If you do not know the Reporter Identification Number for your organization, please contact FRBNY staff at (212) 720-6300 or (646) 720-6300.
- 2. Sequence Number** - Enter the sequence number of this detail record, right justified. The first detail record should be assigned sequence number 1, and each succeeding Schedule 3 should be assigned a sequence number one higher than the previous record.
- 3. Custodian Code** - Please refer to Appendix G for a list of the major U.S.-resident custodians. If you do not see your U.S.-resident custodian listed in Appendix G, please enter 99 and complete items 9 through 14. (Items 4 through 8 should be completed on all Schedule 3s)
- 4. Total US\$ Fair (Market) Value of Equities Entrusted** - Enter the aggregate US\$ fair (market) value for all foreign equities that you entrusted to the organization(s) reported in the custodian code field, rounded to the nearest U.S. dollar.
- 5. Total US\$ Fair (Market) Value of Short-Term Debt (excluding asset-backed securities) Entrusted** - Enter the aggregate US\$ fair (market) value for all foreign short-term debt securities (excluding asset-backed securities) that you entrusted to the organization(s) reported in the custodian code field, rounded to the nearest U.S. dollar.
- 6. Total US\$ Fair (Market) Value of Long-Term Debt (excluding asset-backed securities) Entrusted** - Enter the aggregate US\$ fair (market) value for all foreign long-term debt securities (excluding asset-backed securities) that you entrusted to the organization(s) reported in the custodian code field, rounded to the nearest U.S. dollar.
- 7. Total US\$ Fair (Market) Value of Asset-Backed Securities Entrusted** - Enter the aggregate US\$ fair (market) value for all foreign asset-backed securities that you entrusted to the organization(s) reported in the custodian code field, rounded to the nearest U.S. dollar.
- 8. Reporting As** - Enter 1 if you are the U.S.-resident end-investor or fund manager or 2 if you are the U.S.-resident custodian that is entrusting foreign securities to the organization reported in the custodian code field. (See Appendix H for the definitions of end-investor and custodian.)

COMPLETE ITEMS 9 THROUGH 14 ONLY IF THE CUSTODIAN CODE (ITEM 3) IS 99

- 9. Name of U.S.-Resident Custodian** - Enter the full legal name of the U.S.-resident custodian to which you entrusted the securities.
- 10. Street Address of U.S.-Resident Custodian** - Enter the mailing address of the U.S.-resident custodian identified in item 9.
- 11. City** - Enter the city in which the U.S.-resident custodian identified in item 9 is located.
- 12. State** - Enter the state in which the U.S.-resident custodian identified in item 9 is located.
- 13. Zip Code** - Enter the zip code for the address of the U.S.-resident custodian identified in item 9.
- 14. Telephone Number of U.S.-Resident Custodian** - Enter the telephone number of the U.S.-resident custodian identified in item 9.

APPENDIX A: SAMPLE REPORTING SCHEDULES

SCHEDULE 1: REPORTER CONTACT IDENTIFICATION AND SUMMARY OF FINANCIAL INFORMATION

REPORTER CONTACT INFORMATION

1. Reporter Identification Number: Enter your 10-digit identification number.....

--	--	--	--	--	--	--	--	--	--

2. Organization Name: _____

Street Address: _____

City : _____ State: _____ Zip Code: _____

3. Reporting Status: Please enter one of the following.....

- 1 = Exempt
- 2 = Only Schedule 2(s) are being submitted
- 3 = Only Schedule 3(s) are being submitted
- 4 = Schedules 2(s) and 3(s) are being submitted

4. Industrial Classification Code: Please enter one of the following that best describes your organization.....

1 = Bank	4 = Insurance Company	7 = Foundation, Trust or Estate
2 = Mutual Fund or Investment Trust	5 = Other Financial Organization	8 = Institution of Higher Learning (e.g., university)
3 = Pension Fund	6 = Non-Financial Organization	9 = Other (not listed above)

Please provide a contact in your organization who can respond to inquiries on questions raised on the data reported. If you would like to provide more than one contact name, please attach additional copies of page 1, Schedule 1, with items 5 through 9 completed.

5. Name: _____

6. Title: _____

7. Telephone Number: _____ 8. Fax Number: _____

9. Email Address: _____

10. Name of Service Provider or Vendor Used (if applicable): _____

Please provide a technical contact at your organization or your service provider, if one is used, who can respond to inquiries on file formats or electronic transmission issues.

11. Name: _____

12. Title: _____

13. Telephone Number: _____

14. Email Address: _____

Please enter your 10-digit Reporter Identification Number.....

--	--	--	--	--	--	--	--	--	--

15. Valuation Technique(s) Used to Determine Market Values

For each reporting unit, please describe the valuation technique(s) used to determine reported market values. If securities are automatically valued at zero after a specified time period of inactivity, please specify the time period and whether this applies to the security or to the client's holdings of the security. Also, please specify how securities not actively traded on the report date and those with internally generated security identification numbers are valued.

Reporting Unit Valuation Description

--	--	--

--	--	--

--	--	--

--	--	--

Please enter your 10-digit Reporter Identification Number.....

SUMMARY OF SCHEDULE 2 INFORMATION

- 16. Total Number of Schedule 2s Submitted.....
- 17. Total US\$ Fair (Market) Value of All Equity Securities, , , ,
- 18. Total US\$ Fair (Market) Value of All Short-Term Debt Securities..., , , ,
- 19. Total US\$ Fair (Market) Value of All Long-Term Debt Securities..., , , ,
- 20. Total US\$ Fair (Market) Value of All Asset-Backed....., , , ,

SUMMARY OF SCHEDULE 3 INFORMATION

- 21. Total Number of Schedule 3s Submitted.....,
- 22. Total US\$ Fair (Market) Value of All Equity Securities, , , ,
- 23. Total US\$ Fair (Market) Value of All Short-Term Debt Securities..., , , ,
- 24. Total US\$ Fair (Market) Value of All Long-Term Debt Securities..., , , ,
- 25. Total US\$ Fair (Market) Value of All Asset-Backed....., , , ,

CERTIFYING INFORMATION

By signing the certification below you acknowledge that:

- You have read and understood the reporting requirements of this survey.
- You are aware that both civil and criminal penalties may be imposed for filing a false report; and
- You are sufficiently knowledgeable about the activities and functions of your organization that you can knowingly and with reasonable confidence certify that the information provided in this report is both accurate and complete.

Certifier's Signature: _____

26. Certifier's Name: _____

27. Certifier's Title: _____

28. Certifier's Telephone Number: _____ 29. Date Signed: _____

30. Certifier's Email Address: _____

SCHEDULE 2: DETAILS OF SECURITIES

- 1. Reporter Identification Number: Enter your 10-digit identification number...
2. Sequence Number: From 1 to the number of Schedule 2 records submitted...
3a. Reporting Unit...
3b. Name of Reporting Unit:
4. Security ID...
5. Security Description:
6. Security ID System: Please select the appropriate code from the list in Appendix C...
6a. For code of Other (99) enter the name of the organization or system that assigned the Security ID:

7. Security Type: Please enter one of the following...

Table with 3 columns: Equity, Debt (excluding asset-backed securities), and Asset-Backed Securities. Includes codes 1-10 and their corresponding security types.

8. Depository Receipt/Share: Please enter one of the following...
1 = Yes, the security is a Depository Receipt/Share
2 = No, the security is NOT a Depository Receipt/Share

9. Name of Issuer:

10. Term Indicator (debt, including ABS, only; based on original maturity)...
1 = Short Term 2 = Long Term

11. Country of Issuer:
Enter the code from Appendix D for the country of residence of the entity issuing the security.

12. Currency of Denomination:
Enter the code from Appendix F for the currency in which the security was issued.

13. Ownership Code: Please enter one of the following...
1 = If your organization is the owner of this security
2 = If your organization is the custodian for a U.S.-resident mutual fund for this security
3 = If your organization is the custodian for a U.S.-resident pension fund for this security
4 = If your organization is the custodian for a U.S.-resident insurance company for this security
5 = If your organization is the custodian for any other U.S. residents for this security
6 = If your organization is the custodian and the entity-type of the beneficial owner is unknown

Reporter Identification Number: Enter your 10-digit identification number.....

14a. US\$ Fair (Market) Value of Security Held..... , , ,

14b. Fair (Market) Value of Security Held Denominated in the
Currency of Issue (If US\$ is the currency of issue, then enter the
same value as item 14a.)..... , , ,

15. Intentionally Left Blank.

FOR EQUITY TYPE SECURITIES ONLY

(Security Types 1, 2, 3 or 4)

16. Number of Shares Held: Enter the number of shares held
rounded to the nearest share..... , , ,

**FOR SHORT-TERM AND LONG-TERM DEBT SECURITIES EXCLUDING
ASSET-BACKED SECURITIES**

(Security Types 5, 6, 7, 8, or 9)

17. Face Value in Currency of Denomination: Enter the face value in the
currency of denomination..... , , ,

18. Issue Date: MMDDYYYY format.....

19. Maturity Date: MMDDYYYY format.....

FOR SHORT-TERM AND LONG-TERM ASSET-BACKED SECURITIES

(Security Type 10)

20. Original Face Value in Currency of Denomination: Enter the face value.....
in the currency of denomination that would have been outstanding if no
principal had been repaid. , , ,

21. Remaining Principal Outstanding in Currency of Denomination: Enter
the remaining principal outstanding as of December 31 in the
currency of denomination. , , ,

22. Issue Date: MMDDYYYY format.....

23. Maturity Date: MMDDYYYY format.....

SCHEDULE 3: CUSTODIANS USED

- 1. Reporter Identification Number: Enter your 10-digit identification number.....
- 2. Sequence Number: From 1 to the number of Schedule 3 records submitted:
- 3. Custodian Code: Please see Appendix G for a list of custodians. If the U.S.-resident custodian used is not on the list, please enter 99 and complete items 9 through 14.
- 4. Total US\$ Fair (Market) Value of Foreign Equity Securities Entrusted to this Custodian as of December 31.....
- 5. Total US\$ Fair (Market) Value of Foreign Short-Term Debt Securities (excluding asset-backed securities) Entrusted to this Custodian as of December 31
- 6. Total US\$ Fair (Market) Value of Foreign Long-Term Debt Securities (excluding asset-backed securities) Entrusted to this Custodian as of December 31
- 7. Total US\$ Fair (Market) Value of Foreign Asset-Backed Securities Entrusted to this Custodian as of December 31
- 8. Reporting As: Please enter one of the following.....
 - 1 = U.S.-resident end-investor (as defined in Appendix H)
 - 2 = U.S.-resident custodian (as defined in Appendix H), who is in turn entrusting these securities to another U.S.-resident custodian

Complete only if the U.S.-Resident Custodian Code in Item 3 is 99:

- 9. Name of U.S.-Resident Custodian: _____
- 10. Street Address of U.S.-Resident Custodian: _____
- 11. City: _____ 12. State: _____ 13. Zip Code: _____
- 14. Telephone Number of U.S.-Resident Custodian: _____

APPENDIX B: REPORTING REQUIREMENT FLOWCHARTS

1. Reporting Requirements for Reporters that are U.S.-Resident Custodians (See Section II.A.)

Flowchart 1a - Foreign securities held in custody for your own organization or for your U.S.-resident clients that are not in turn entrusted to any other organization

Flowchart 1b - Foreign securities entrusted to the safekeeping of a U.S.-resident central securities depository

Flowchart 1c - Foreign securities held abroad, either by employing a foreign-resident custodian or by directly entrusting to a foreign-resident central securities depository

Flowchart 1d - Foreign securities entrusted to the safekeeping of another U.S.-resident custodian (excluding U.S.-resident central securities depositories)

2. Reporting Requirements for Reporters that are U.S.-Resident End-Investors (See Section II.A.)

Flowchart 2a - Foreign securities held for your own organization or for your U.S.-resident clients that are not in turn entrusted to any other organization (held in self-custody)

Flowchart 2b - Foreign securities entrusted to the safekeeping of a U.S.-resident central securities depository

Flowchart 2c - Foreign securities held abroad, either by employing a foreign-resident custodian or by directly entrusting to a foreign-resident central securities depository

Flowchart 2d - Foreign securities entrusted to the safekeeping of a U.S.-resident custodian (excluding U.S.-resident central securities depositories)

3. Determining Reportable Securities

Reporting Requirements for Reporters that are U.S.-Resident Custodians (See Section II.A.)

Flowchart 1a - Foreign securities held in custody for your own organization or for your U.S.-resident clients that are not in turn entrusted to any other organization

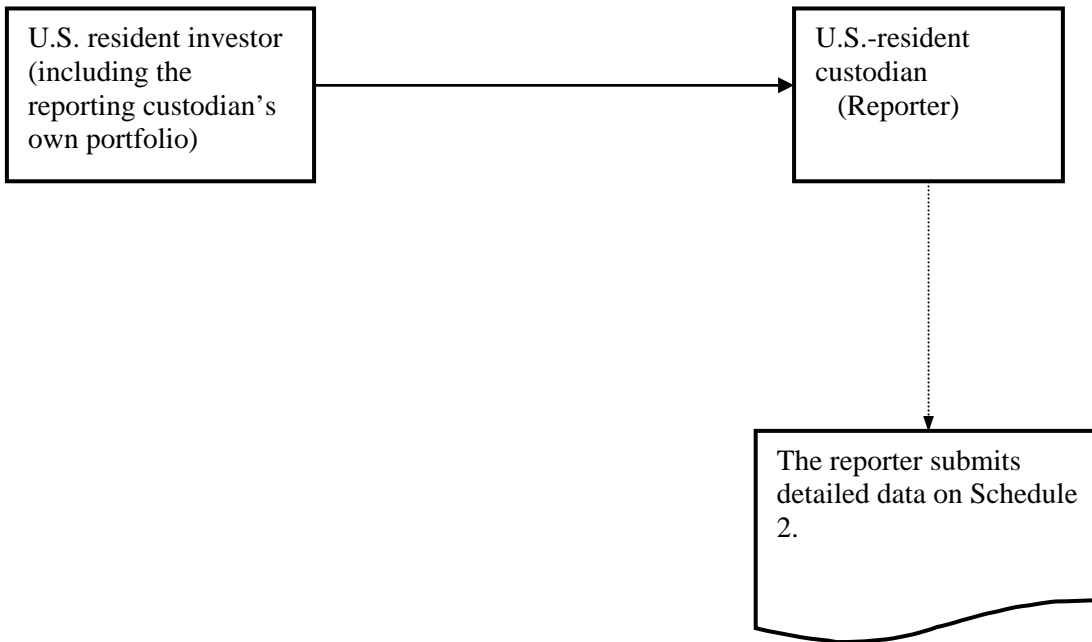

Flowchart 1b - Foreign securities entrusted to the safekeeping of a U.S.-resident central securities depository

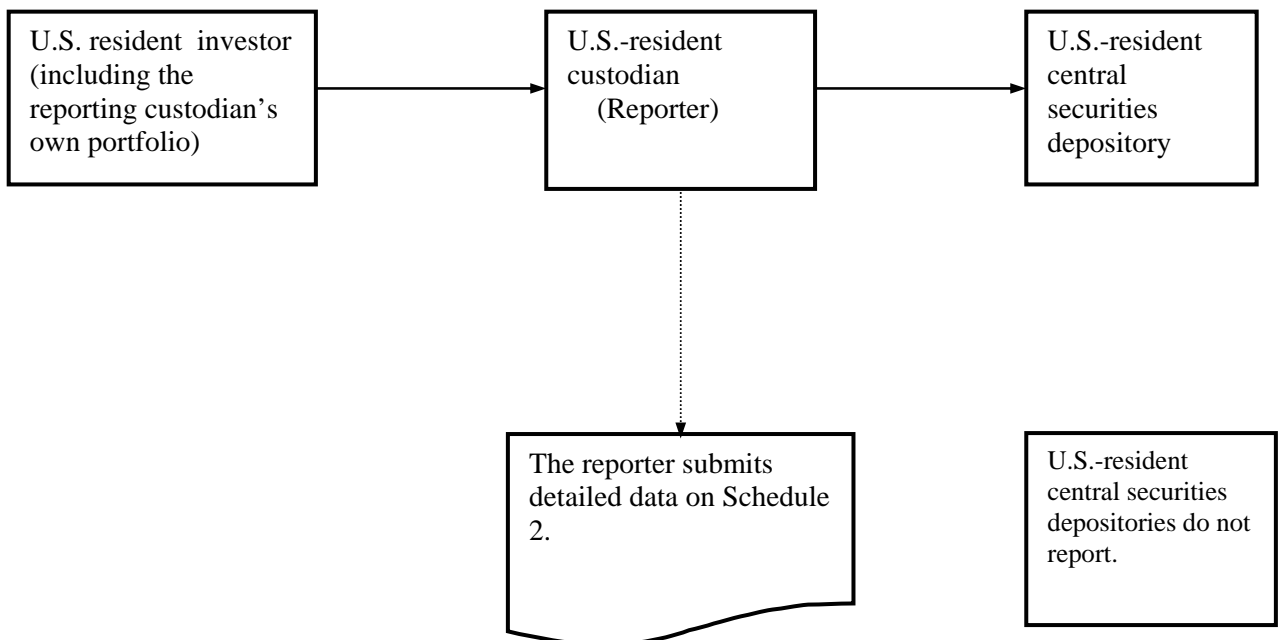

**Reporting Requirements for Reporters that are
U.S.-Resident Custodians (See Section II.A.)**

Flowchart 1c - Foreign securities held abroad, either by employing a foreign-resident custodian or by directly entrusting to a foreign-resident central securities depository

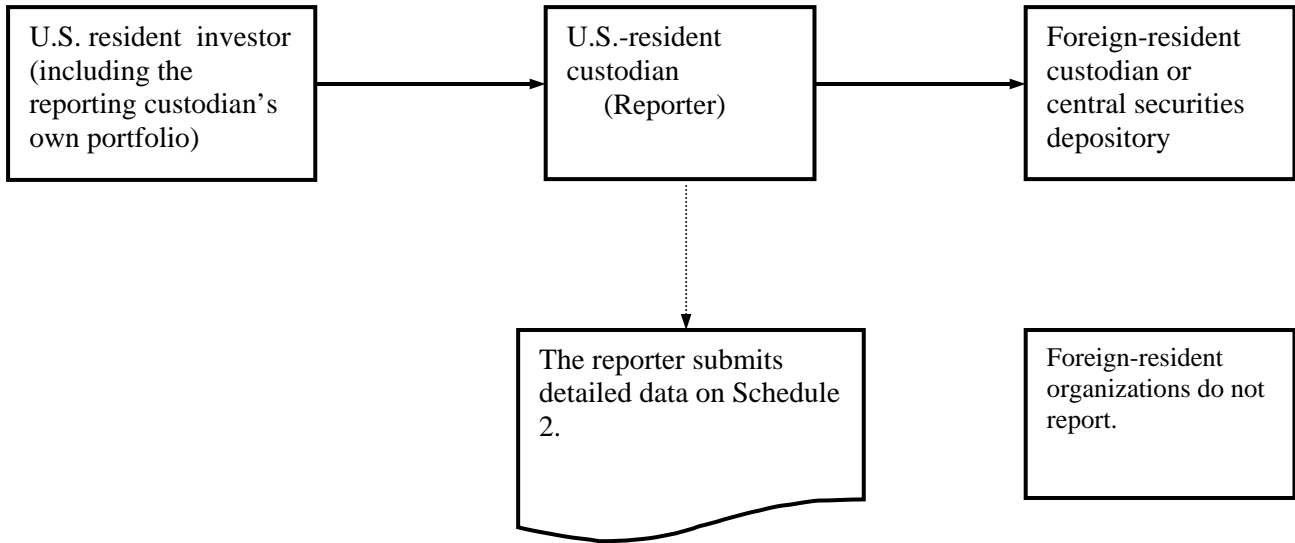

Flowchart 1d - Foreign securities entrusted to the safekeeping of another U.S.-resident custodian (excluding U.S.-resident central securities depositories)

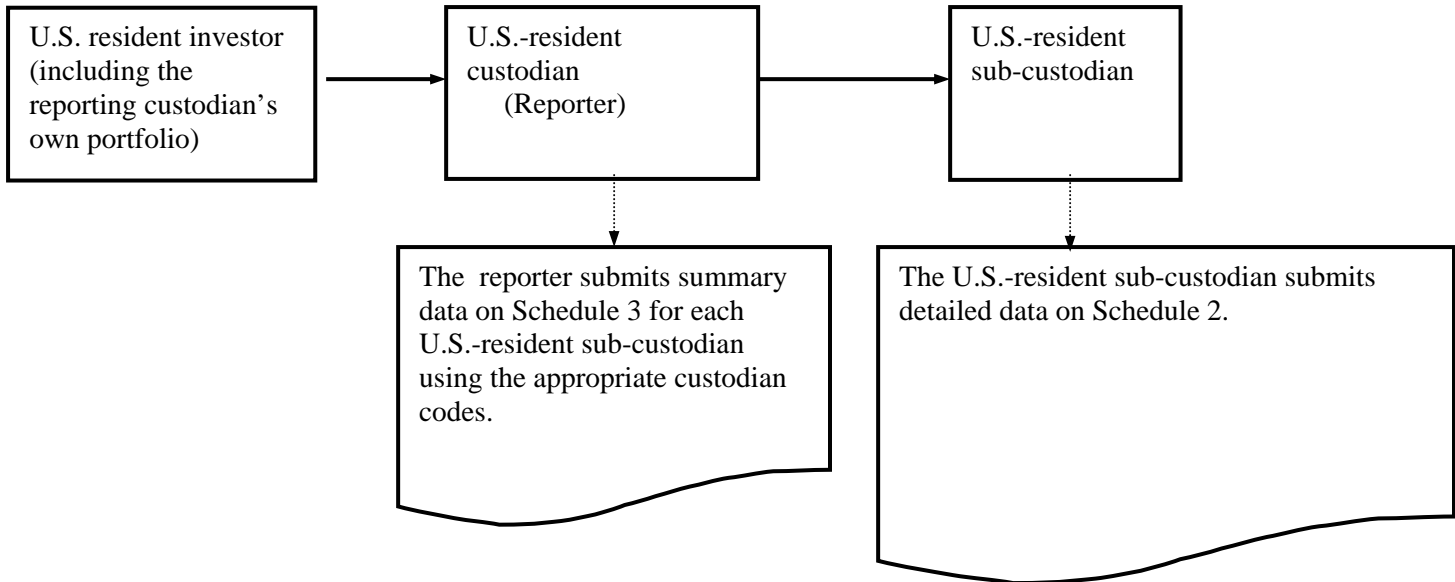

**Reporting Requirements for Reporters that are
U.S.-Resident End-Investors, including Investment Managers (See Section
II.A.)**

Flowchart 2a - Foreign securities held for your own organization or for your U.S.-resident clients that are not in turn entrusted to any organization

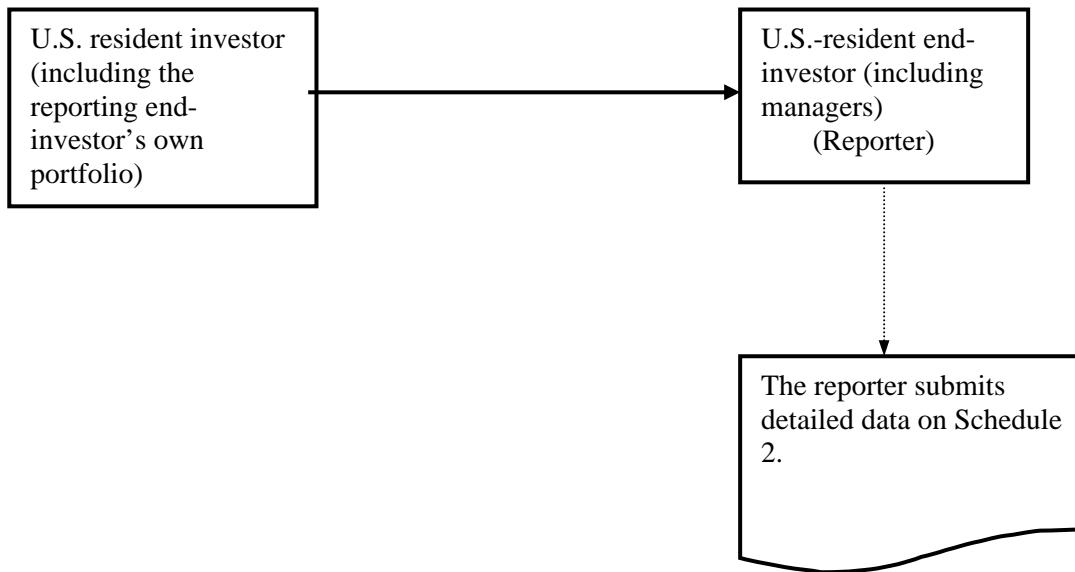

Flowchart 2b - Foreign securities entrusted to the safekeeping of a U.S.-resident central securities depository

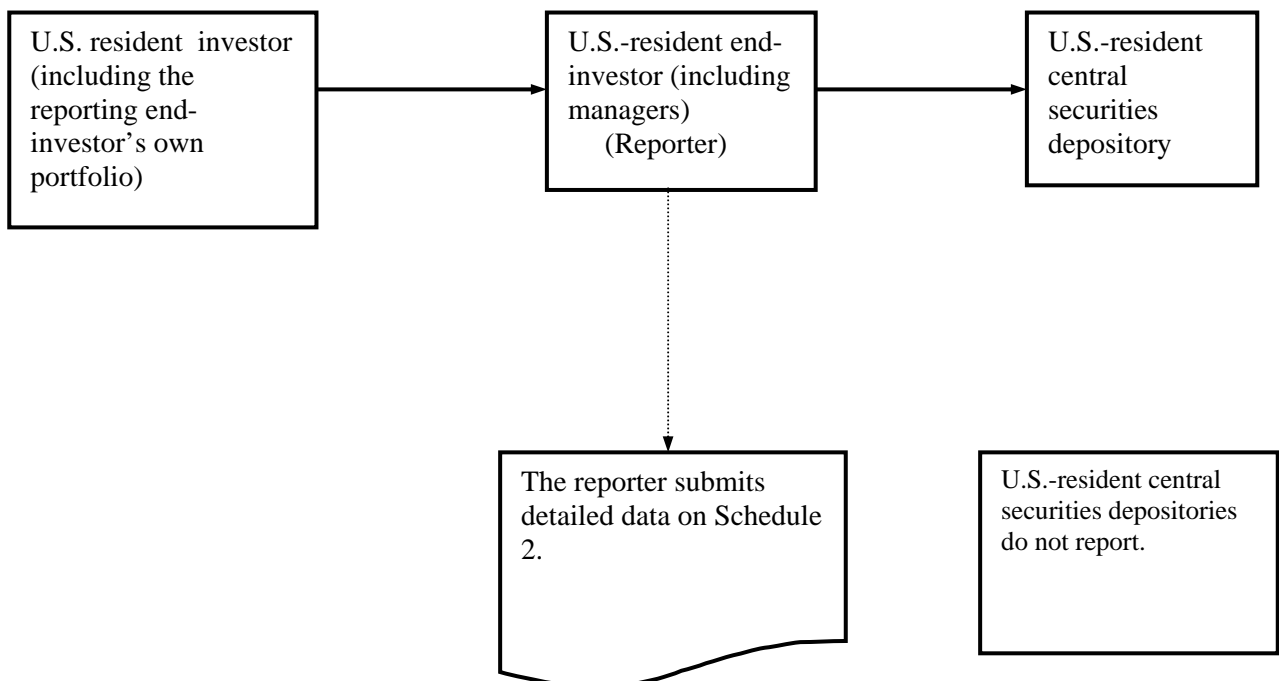

**Reporting Requirements for Reporters that are
U.S.-Resident End-Investors (See Section II.A.) (cont'd)**

Flowchart 2c - Foreign securities held abroad, either by employing a foreign-resident custodian or by directly entrusting to a foreign-resident central securities depository

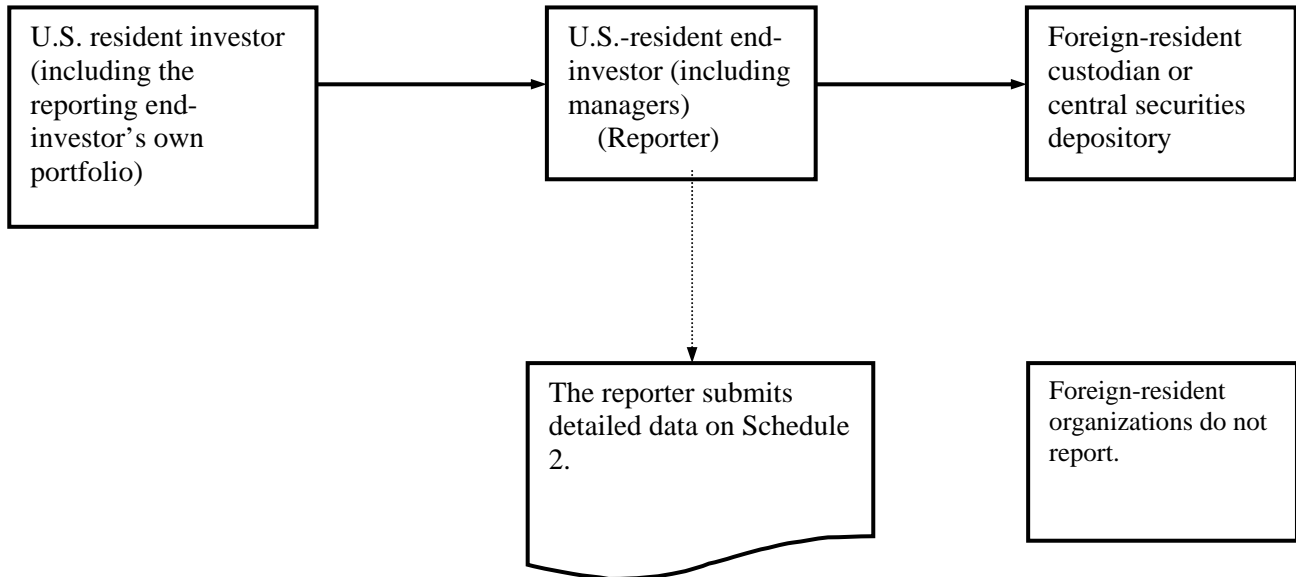

Flowchart 2d - Foreign securities entrusted to the safekeeping of a U.S.-resident custodian (excluding U.S.-resident central securities depositories)

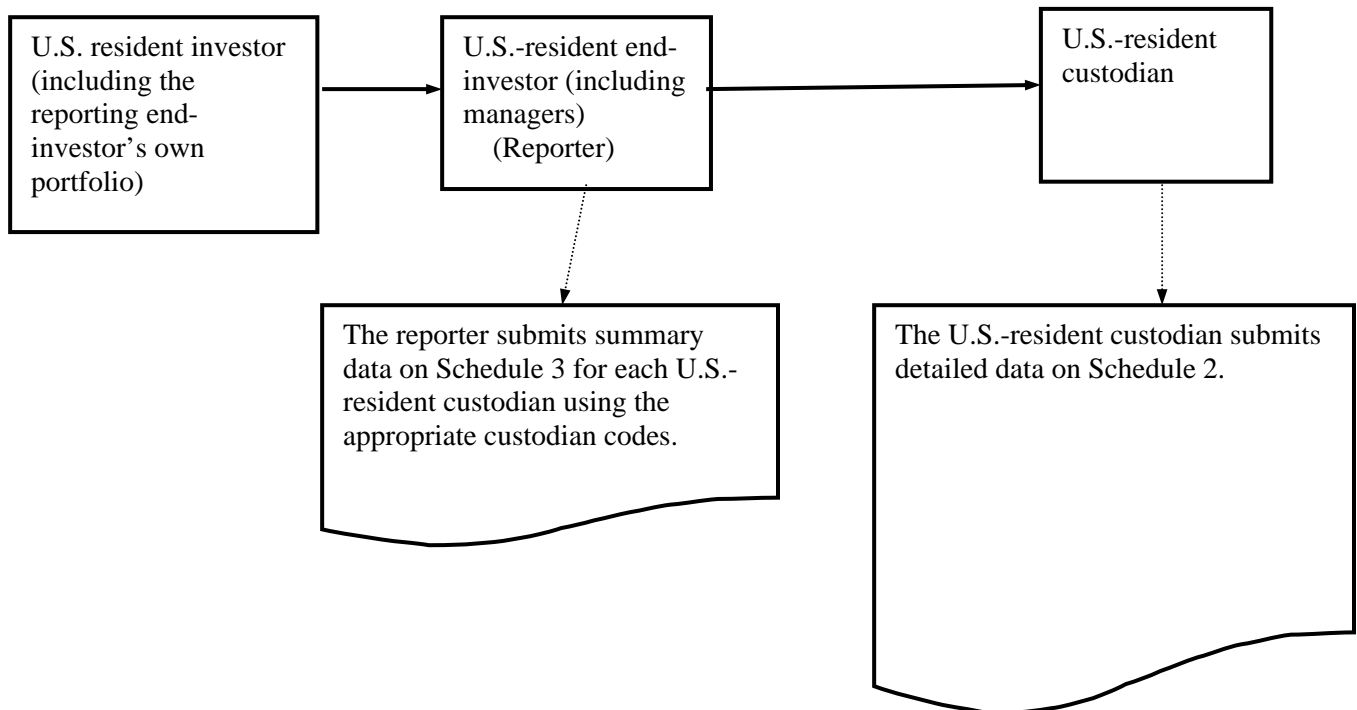

Flowchart 3 Determining Reportable Securities

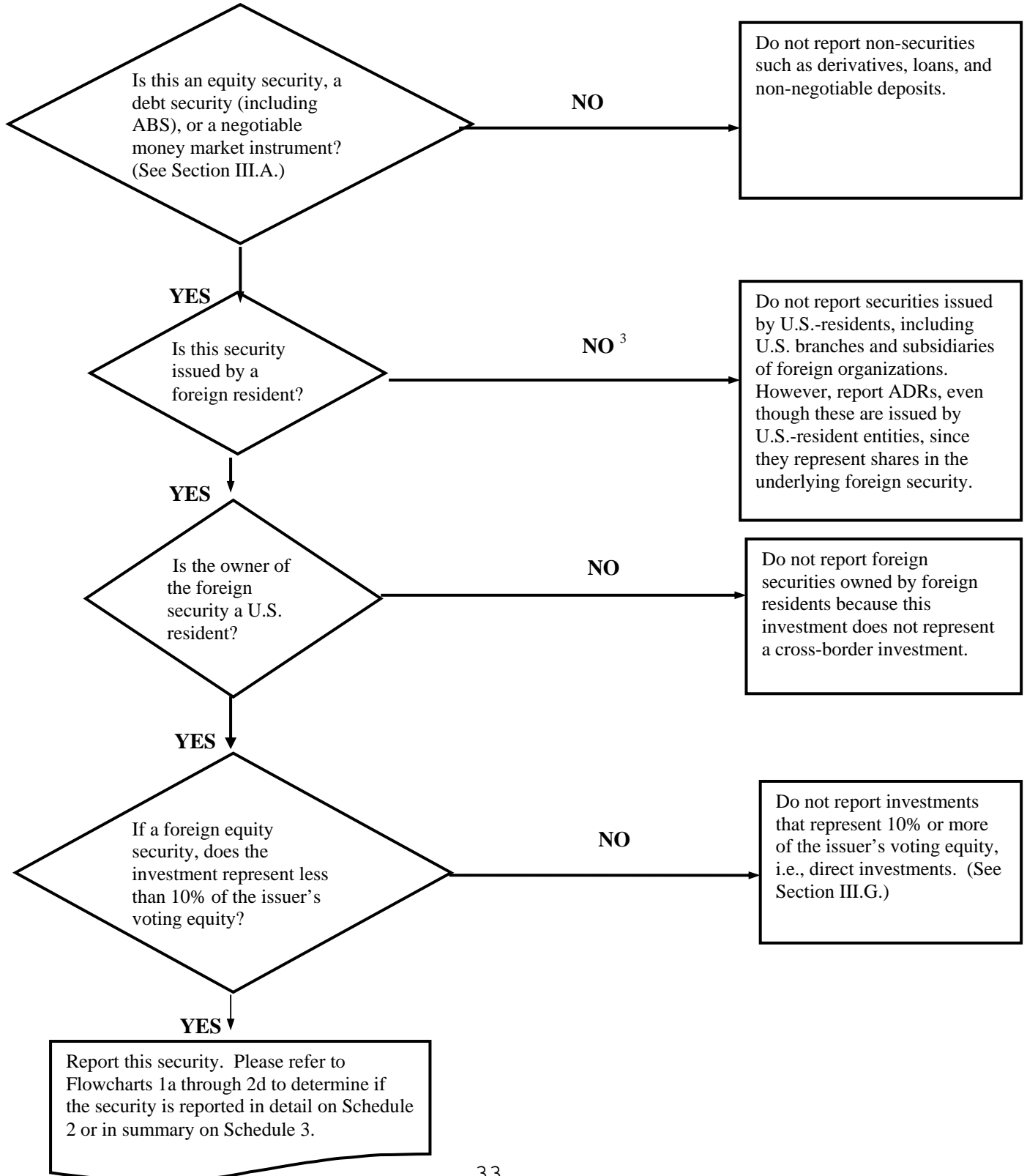

APPENDIX C: LIST OF SECURITY IDENTIFICATION SYSTEMS

Code	Issuing Country/Agency	Security Identification Coding System
Primary Codes-These codes are required; however, if they are not applicable use the secondary codes listed below.		
01	International Organization for Standardization (ISO)	ISIN (International Securities Identification Number)
02	Common Code	"European" Common Code (Clearstream/CedeUEuroclear)
31	United Kingdom	SEDOL (Stock Exchange Daily Official List)
33	United States American Securities)	CINS (CUSIP International Numbering System for Non-North
Secondary Codes — Only use these codes if none of the primary codes listed above are available.		
03	Euroclear	Euroclear Code (old)
04	Cedel	Cedel Code (old)
05	Australia	ASX Security Code (Australian Stock Exchange)
06	Austria	WPK Nummer (Wertpapier Kenn-Nummer)
07	Belgium	SVM Code (Secretariat des Valeurs Mobilieres)
08	Brazil	National Stock Exchange Association Code (Comissao Nacional de Bolsas de Valores)
09	Brazil	Rio de Janeiro Stock Exchange Code
10	Brazil	Sao Paulo Stock Exchange Code
11	Denmark	Fondskode
12	France	SICOVAM (Societe Interprofessionnelle pour la Compensation des Valeurs Mobilieres)
13	Germany	WKN Nummer (Wertpapier Kenn-Nummer)
14	Hong Kong	Stock Exchange of Hong Kong Code
15	Italy	UIC Code (Ufficio Italiano dei Cambi)
16	Italy	ABI Code (Codice Associazione Bancaria Italiana)
17	Japan	SICC Code (Security Identification Code Conference)
18	Japan	TSE Code (Tokyo Stock Exchange Code) (Toushou Code)
19	Korea	Clearing Code (Korean Stock Exchange Code)
20	Mexico	Mexican Stock Exchange Code (Clave de pizarra de la Bolsa Mexicana de Valores)
21	Netherlands	Clearing Code (Amsterdam Stock Exchange Code)
22	New Zealand	New Zealand Stock Exchange Code
23	Norway	Modified ISIN (Verdipapirsentralen) (VPS)
24	Portugal	Lisbon Stock Exchange Code
25	Portugal	Oporto Stock Exchange Code
26	South Africa	Clearing House Code (Johannesburg Stock Exchange Code)
27	Spain	CNMV Code (Comision Nacional del Mercado de Valores)
28	Sweden	VPC Number (Vardepapperscentralen)
29	Switzerland	VALOR (Valoren-Nummer)
30	Thailand	Stock Exchange of Thailand Code
32	United States	CUSIP Number (for North American Securities)
40	BB	Bloomberg security identification code issued by Bloomberg
50	RIC	Reuters Identification Code issued by Reuters

98	Your Company	Internally-Generated Code
99	Other	Other Coding System Not Specified Above

APPENDIX D

DEPARTMENT OF THE TREASURY

COUNTRY/AREA CODES

**CODES FOR COUNTRIES & AREAS TO BE USED FOR PURPOSES OF REPORTING ON TREASURY
INTERNATIONAL CAPITAL FORMS**

**The most recent version of this appendix is now a separate document.
A copy is on the TIC website, next to these instructions, at:
<http://www.treas.gov/tic/forms-sh.shtml#shc>**

APPENDIX E

DEPARTMENT OF THE TREASURY

INTERNATIONAL & REGIONAL ORGANIZATIONS

**CODES FOR INTERNATIONAL & REGIONAL ORGANIZATIONS TO BE USED FOR PURPOSES OF
REPORTING ON TREASURY INTERNATIONAL CAPITAL FORMS**

**The most recent version of this appendix is now a separate document.
A copy is on the TIC website, next to these instructions, at:
<http://www.treas.gov/tic/forms-sh.shtml#shc>**

APPENDIX F: LIST OF CURRENCY CODES

Code	Currency	Code	Currency
AFN	Afghanistan Afghani	CYP	Cyprus Pound
ALL	Albanian Lek	CZK	Czech Koruna
DZD	Algerian Dinar	DKK	Danish Krone
ADP	Andorran Peseta	DJF	Djibouti Franc
AOR	Angolan Kwanza Reajustado	DOP	Dominican Peso
ARS	Argentine Peso	XCD	East Caribbean Dollar
AMD	Armenian Dram	EGP	Egyptian Pound
AWG	Aruban Guilder	SVC	El Salvador Colon
AUD	Australian Dollar	ERN	Eritrea Nakfa
I AZM	Azerbaijani New Manat	EEK	Estonia Kroon
BSD	Bahamian Dollar	ETB	Ethiopian Birr
BHD	Bahraini Dinar	EUR	European Union Euro
BDT	Bangladeshi Taka	FKP	Falkland Islands Pound
BBD	Barbados Dollar	FJD	Fiji Dollar
BYR	Belarussian Ruble	GMD	Gambia Dalasi
BZD	Belize Dollar	GEL	Georgia Lari
BMD	Bermudian Dollar	GHC	Ghana Cedi
BTN	Bhutan Ngultrum	GIP	Gibraltar Pound
BOB	Bolivian Boliviano	GTQ	Guatemala Quetzal
BWP	Botswana Pula	GWP	Guinea-Bissau Peso
I BAM	Bosnia & Herzegovina Convertible Marks	GNF	Guinea Franc
BRL	Brazilian Real	GYD	Guyana Dollar
BND	Brunei Dollar	HTG	Haitian Gourde
BGN	Bulgarian Lev	HNL	Honduras Lempira
BIF	Burundi Franc	HKD	Hong Kong Dollar
KHR	Cambodian Riel	HUF	Hungarian Forint
CAD	Canadian Dollar	I SK	Iceland Krona
CVE	Cape Verde Escudo	INR	Indian Rupee
KYD	Cayman Islands Dollar	IDR	Indonesian Rupiah
XOF	CFA Franc BCEAO	IRR	Iranian Rial
XAF	CFA Franc BEAC	IQD	Iraqi Dinar
XPF	CFP Franc	JMD	Jamaican Dollar
CLP	Chilean Peso	JPY	Japanese Yen
CNY	Chinese Yuan Renminbi	JOD	Jordanian Dinar
COP	Colombian Peso	KZT	Kazakhstan Tenge
KMF	Comoro Franc	KES	Kenyan Shilling
CDF	Congolais Franc	KWD	Kuwaiti Dinar
CRC	Costa Rican Colon	KGS	Kyrgyzstan Som
HRK	Croatian Kuna	LAK	Laos Kip
CUP	Cuban Peso	LVL	Latvian Lats

Code	Currency	Code	Currency
LBP	Lebanese Pound	STD	Sao Tome & Principe Dora
LSL	Lesotho Lote	SAR	Saudi Arabian Riyal
LRD	Liberian Dollar	SCR	Seychelles Rupee
LYD	Libyan Dinar	SLL	Sierra Leone Leone
LTL	Lithuanian Litas	SGD	Singapore Dollar
MOP	Macau SAR Pataca	SKK	Slovak Koruna
MKD	Macedonian Denar	SIT	Slovenia Tolar
MGF	Malagasy Franc	SBD	Solomon Islands Dollar
MWK	Malawi Kwacha	SOS	Somali Shilling
MYR	Malaysian Ringgit	ZAR	South African Rand
MVR	Maldives Rufiyaa	KRW	South Korean Won
MTL	Maltese Lira	LKR	Sri Lanka Rupee
MRO	Mauritania Ouguiya	SDD	Sudanese Dinar
MUR	Mauritius Rupee	SRG	Suriname Guilder
MXN	Mexican Peso	SZL	Swziland Lilangeni
MDL	Moldovan Leu	SEK	Swedish Krona
MNT	Mongolian Tugrik	CHF	Swiss Franc
MAD	Moroccan Dirham	SYP	Syrian Pound
I MZM	Mozambique New Metical	TWD	Taiwan New Dollar
MMK	Myanmar Kyat	TJS	Tajikistan Somoni
NAD	Namibia Dollar	TZS	Tanzanian Shilling
NPR	Nepalese Rupee	THB	Thailand Baht
ANG	Netherlands Antillean Guilder	TOP	Tongan Pa'anga
ILS	New Israeli Shekel	TTD	Trinidad and Tobago
TWD	New Taiwan Dollar	TND	Tunisian Dinar
NZD	New Zealand Dollar	TRY	Turkish Yani
NIO	Nicaraguan Cordoba Oro	TMM	Turkmenistan Manat
NGN	Nigerian Naira	UGX	Uganda New Shilling
KPW	North Korean Won	UAH	UKrainian Hryvnia
NOK	Norwegian Krone	AED	United Arab Emirates
OMR	Omani Rial	USD	United States Dollar
PKR	Pakistani Rupee	UYU	Uruguayo Peso
PAB	Panamanian Balboa	UZS	Uzbekistan Sum
PGK	Papua New Guinea Kina	VUV	Vanuatu Vatu
PYG	Paraguay Guarani	VEB	Venezuelan Bolivar
PEN	Peruvian New Sol	VND	Vietnamese Dong
PHP	Philippine Peso	YER	Yemeni Rial
PLN	Polish Zloty	YUM	Yugoslavian Dinar
GBP	Pound Sterling	ZMK	Zambian Kwacha
QAR	Qatari Rial		
ROL	Romanian Leu		
RUB	Russian Ruble		
RWF	Rwanda Franc		
SHP	Saint Helena Pound		
WST	Samoan Tala		

1

APPENDIX G: LIST OF CUSTODIAN CODES

If your securities are held by any U.S. affiliate of one of these custodians listed below, please use the custodian code of that firm

THE FOLLOWING CODES SHOULD BE USED BY ALL REPORTERS

<u>Name of U.S.-Resident Custodian</u>	<u>Custodian Code</u>
ABN-Amro Bank N.V. (U.S.-resident branches)	01
Bank Julius Baer & Co. Ltd (U.S.-resident branch)	02
Bank of Bermuda Limited, The	03
Bank of New York Mellon Corporation (including but not limited to Bank of New York , The and affiliates of the former Mellon Financial Corporation)	04
Barclays Global Investors Services	24
BNP Paribas (U.S.-resident branches)	07
Brown Brothers Harriman & Co.	08
Citigroup Inc./Citibank, N.A. (including but not limited to Salomon Smith Barney)	09
Credit Agricole Indosuez North America Inc.	10
Credit Lyonnais (U.S.-resident branches)	11
Deutsche Bank Aktiengesellschaft (U.S.-resident branches)	12
Dresdner Bank Aktiengesellschaft (U.S.-resident branches)	13
Fidelity Management and Research Corp.(FMR Corp.) (including but not limited to Fidelity Investments, Fidelity Management Trust Company, and National Financial Services Corporation)	26
Fifth Third Bancorp/Fifth Third Bank	25
Goldman Sachs Group L.P.	27
HSBC North America Inc./HSBC Bank USA, N.A.	14

<u>Name of U.S.-Resident Custodian</u>	<u>Custodian Code</u>
JPMorgan Chase & Co./JPMorgan Chase Bank	16
Merrill Lynch & Company, Inc.	28
Morgan Stanley, Dean Witter & Co.	29
Northern Trust Company, The	18
PNC Financial Services Group, Inc., The (including but not limited to PNC Bank, N.A., PFPC)	30
Societe Generale (U.S.-resident branches)	19
State Street Bank and Trust Company (including but not limited to International Fund Services, Investors Financial Services Corporation, Investors Bank and Trust , and Investors Trust Company)	20
Taunus Corporation/Deutsche Bank Trust Company Americas (including but not limited to Deutsche Bank Securities Inc.)	6
UBS AG (U.S.-resident branches)	21
UBS Financial Services Inc.	59
UBS Securities LLC	60
Union Bancorp/Union Bank of California, N.A.	22
UMB Financial Corporation/UMB Bank N.A.	33
U.S. Bancorp/U.S. Bank N.A.	32
Wachovia Corporation /Wachovia Bank N.A. (including but not limited to A.G. Edwards & Sons, Inc.)	34
Wells Fargo & Co./Wells Fargo Bank, N.A.	35
U.S.-Resident custodian that is not listed above	99

APPENDIX H: GLOSSARY

AMERICAN DEPOSITARY RECEIPT (ADR) – Negotiable certificates, typically issued by a U.S.-resident company, for shares of stock issued by a foreign corporation. The securities are held in a custodial account, either at the issuing bank or by an agent. The ADR should be reported, not the foreign securities held by the depository. Report the ADR as common stock (security type=1) if the underlying foreign security is common stock or as preferred stock (security type =2) if the underlying foreign security is preferred stock. (See Section III.E for more information on the correct reporting of these securities.)

AMERICAN DEPOSITARY SHARE (ADS) – Negotiable securities certificate issued in the United States by transfer agents acting on behalf of foreign issuers, where the foreign issuers absorb part or all of the handling costs involved. The ADS should be reported, not the foreign securities held in custody. Report the ADS as common stock (security type =1) if the underlying foreign security is common stock or as preferred stock (security type =2) if the underlying foreign security is preferred stock. (See Section III.E for more information on the correct reporting of these securities.)

ASSET-BACKED SECURITIES – Securitized interests in a pool of assets, which give the purchaser a claim against the cash flows generated by the underlying assets. These pools may be derived from mortgage loans, auto loans, credit card receivables, vehicle and equipment leases, consumer loans, commercial loans or other assets. Include as asset-backed securities (ABS): CMOs, CLOs, CBOs and CDOs. ABS give the holder an undivided interest in the securitized assets and payments made from the cash flows received by the issuer from the payments of principal and interest from the borrowers. (ABS do not include securities, such as covered bonds or pfandbriefes, where the security is collateralized, but the holder of the security does not have a claim of the cash flows generated by the collateral.) ABS, including stripped ABS, are reported as security type 10 (asset-backed security), **except** for asset-backed commercial paper, which is reported as security type 5 (commercial paper).

BEARER BOND – Securities that are not registered in the name of their owner. The owner collects interest and dividends upon presentation of detachable coupons to a bank or fiduciary agent. These securities are reported as security type 9 (unstripped bond or note and all other long-term debt).

BRADY BONDS – Collateralized dollar-denominated bonds issued by a foreign government or central bank in exchange for loans under the Brady Plan. These securities are reported as all other long-term debt (security type = 9).

COMMERCIAL PAPER – A promissory note, either unsecured or backed by assets such as loans or mortgages. They are usually sold at a discount and customarily have a fixed maturity of 270 days or less. All commercial paper should be reported as security type = 5 (commercial paper)

COMMINGLED ACCOUNT – An account in which the investment funds of individual clients are pooled, with each client owning portions of the pooled account. Foreign securities held in commingled accounts should be reported.

CONVERTIBLE BOND – A bond that can be exchanged at a set price for equity securities by the holder under certain conditions. These securities are reported as convertible debt (security type = 7).

COVERED BOND – Also known as Mortgage Bond or Pfandbriefe. A bond that is backed by loans, typically mortgages, but does not give the purchaser a claim against the cash flows generated by the

underlying assets. These securities are reported as security type 9 (unstripped bond or note and all other long-term debt).

CUSTODIAN – A bank or other organization that manages or administers the custody or safekeeping of stock certificates, debt securities, or other assets for institutional and private investors.

DEPOSITARY RECEIPTS – See American Depositary Receipts (ADR). Related types of depositary receipts, such as Global Depositary Receipts, are reported in the same manner as ADRs.

DEPOSITORY – An entity that holds securities, either in certificated or uncertificated (dematerialized) form, to enable the transfer of ownership of securities. Depositories are not necessarily custodians, since they may be responsible only for registering and settling security transactions.

DERIVATIVE CONTRACT – Financial instrument or other contract with all three of the following characteristics:

1. (a) One or more underlyings; (b) one or more notional amounts; and (c) payment provisions. These terms determine the amount of the settlement or settlements, and, in some cases, whether or not a settlement is required.
2. Requires no initial investment, or an initial net investment that is much smaller than would be required for other types of contracts that would be expected to have a similar response to changes in market factors.
3. The terms require or permit net settlement, it can readily be settled net by a means outside the contract, or it provides for delivery of an asset that puts the recipient in a position not substantially different from net settlement.

Derivative contracts are excluded from the report. Embedded derivatives that are not bifurcated under FAS 133 should be reported without separating the embedded derivative from the host contract. However, if the embedded derivative is bifurcated from the host contract, then the derivative should be excluded from the report and the host security should be included on the report.

DEVELOPMENT BANKS – Entities owned by national governments and established to promote economic development of sectors of the economy, such as trade, housing, agriculture, finance and industry. Securities issued by foreign development banks should be reported.

DIRECT INVESTMENT – The beneficial ownership or control, by one person or by a group of affiliated persons, of 10 percent or more of the voting securities of another incorporated business, or an equivalent interest in an unincorporated business, including a branch. If a direct investment relationship exists, then generally, all financial flows between the firms are considered direct investment. However, for banking institutions, direct investment is limited to intercompany holdings that are permanent investment. Direct investment positions are excluded from this report.

END-INVESTOR – An entity that invests in foreign securities for its own account (for trading, investment, or any other purpose) or invests on behalf of others, including asset pools, such as managers of mutual funds, managers of insurance company policyholder assets, and pension fund managers. (See Section II.A for examples of end-investors.)

FOREIGN RESIDENT - Any individual, corporation, or other organization located outside the United States. A corporation incorporated outside the United States is a foreign resident even if it has no physical presence outside the United States. Foreigners/foreign residents include:

1. Individuals, including citizens of the United States, residing outside the United States.
2. Entities that have filed an IRS Form W-8, indicating that the individual or entity is a nonresident alien or foreign entity not subject to certain United States information return reporting or to backup withholding rules.
3. Any corporation or other organization located outside the United States, including branches, subsidiaries and other affiliates of U. S. entities located abroad.
4. Foreign governments and any subdivision, agency or instrumentality thereof, including all foreign official nonbanking institutions, even if located in the United States (e.g., an embassy, consulate, or other diplomatic establishment of a foreign country). (However, all U.S.-resident subsidiaries of foreign corporations, including government-owned foreign corporations, are U.S. residents.)
5. International or regional organizations or subordinate or affiliated agencies thereof, created by treaty or convention between sovereign states, even if located in the United States, including the International Bank for Reconstruction and Development (IBRD or World Bank), the International Monetary Fund (IMF), and the United Nations (UN). (See Appendix E for a list of international and regional organizations.)

FOREIGN-RESIDENT CUSTODIAN – A custodian located outside the United States, including a foreign affiliate of a U.S. custodian. Reporters should determine the location of a custodian according to the country in which the custodian is incorporated, or otherwise legally established, not according to the country of the custodian's parent firm, and not according to the location of the custodian's operations center.

FOREIGN SUB CUSTODIAN – A foreign institution that holds in safekeeping foreign securities for a U.S.-resident custodian.

FUNDS – Pooled, separate and general investment accounts of one or more of the following institutional and private investors: private and public pension funds; mutual funds, country funds, exchange traded funds, unit investment trusts, collective-investment trusts, and any other similarly pooled, commingled investment funds; insurance companies; foundations; institutions of higher learning; government-sponsored enterprises and other independently acting government agencies; financial and nonfinancial corporations; investment advisors; trusts and estates; and private individuals. U.S. ownership of shares of foreign-resident funds are reported as funds (security type= 3), regardless of the types of securities held by the fund. Foreign securities held in U.S.-resident funds should also be reported. (See Section III.0 for the correct reporting of funds.)

INVESTMENT TRUST SHARE – A share of a company bound by a trust deed issued in registered form, formed to invest in specific types of securities. Shares in an investment trust can usually be bought and sold only through the stock exchange. Sometimes referred to as a 'closed-end' fund. Investment trust shares are reported as fund shares (security type =3), regardless of the types of securities held by the trust.

LONG-TERM – No contractual maturity or an original maturity of more than one year.

LONG-TERM DEBT SECURITY – Debt security with no contractual maturity or with an original maturity of more than one year.

NATIONALIZED BANK – Institution owned by a foreign central government that is classified as a bank in its own country. A nationalized bank is considered to be an official organization only if it also performs the functions of a central bank.

NEGOTIABLE CERTIFICATES OF DEPOSIT – A negotiable (transferable) instrument or deposit in book entry form evidenced by a receipt or similar acknowledgement issued by a bank, which provides on its face that the amount of such deposit is payable to bearer or any specified person (e.g., deposit notes, bank notes). These negotiable money market instruments should be reported as security type 6.

SECURITY – Any bill, note, bond, debenture, equity, negotiable money market instrument, or similar instrument that is commonly referred to as a security, whether or not it is tradeable. Do not include loans, even if tradeable. See Section III.A for a list of reportable foreign securities.

SETTLEMENT DATE – The date a security is delivered to the purchaser.

SETTLEMENT DATE ACCOUNTING – Under settlement date accounting, the purchase and sale of assets are not recorded until the settlement date. Settlement date accounting should be used for purposes of this report.

SHORT-TERM – Original maturity of one year or less.

SHORT-TERM DEBT SECURITY – Debt security, including negotiable money market instruments, with an original maturity of one year or less.

STRUCTURED NOTE OR BOND – An over-the-counter financial instrument created specifically to meet the needs of one or a small number of investors. Some of the more common structures include: step-up bonds, index amortizing notes, dual index notes, deleveraged bonds, range bonds, and inverse floaters. These securities are reportable debt securities.

SUBORDINATED DEBT – A security evidencing debt that the holder agrees to rank after senior creditors, but before shareholders, in a bankruptcy.

SUBSIDIARY – A company in which another company (parent) owns 50 percent or more of the voting securities, or an equivalent interest.

TREASURY BILL – a common form of sovereign debt issued by many governments. Foreign treasury bills should be reported as security type 9 (unstripped bond or note and all other non-asset-backed debt).

UNITED STATES – The fifty (50) States of the United States, the District of Columbia, the Commonwealth of Puerto Rico, the Commonwealth of the Northern Mariana Islands, and the following: American Samoa, Baker Island, Guam, Howland Island, Jarvis Island, Johnston Atoll, Kingman Reef, Midway Islands, Navassa Island, Palmyra Atoll, the U.S. Virgin Islands, and Wake Island.

UNIT INVESTMENT TRUST – A fixed portfolio of securities that are assembled by an underwriter sponsor and upon completion of the underwriting, are deposited with an independent trustee. Unit investment trusts have a definite termination date, usually between 6 months and 10 years. U.S. ownership of shares of foreign-resident unit investment trusts are reported as fund shares (security type = 3), regardless of the types

of securities in held by the trust. Foreign securities held in U.S.-resident unit investment trusts should also be reported. (See Section III.0 for the correct reporting of unit investment trusts.)

U.S. RESIDENT – Any individual, corporation, or other organization located in the United States, including branches, subsidiaries and affiliates of foreign entities located in the United States. Corporations incorporated in the United States are considered to be U.S. residents even if they have no "physical presence" in the United States.

U.S.-RESIDENT CUSTODIAN – A custodian located in the United States, including a U.S.-resident affiliate of a foreign custodian.

U.S.-RESIDENT END-INVESTOR – An entity located in the United States, including a U.S. affiliate of a foreign end-investor, that either invests for its own account (for trading, investment and other purposes) or on behalf of others, including assets pools. U.S.-resident end-investors include managers of a mutual fund, managers of assets held for insurance company policyholders, and managers of pension and endowment funds.

ZERO-COUPON BOND – Bonds that do not provide interest payments. Zero coupon bonds usually have an issue price well below 100% of the face value with repayment on maturity at face value or par. The investors' return is the difference between the issue price and redemption value. These securities are reported as security type **8** (zero coupon & stripped security).

APPENDIX I: TECHNICAL INFORMATION FOR ELECTRONIC SUBMISSION

Included in this appendix are instructions for how to properly prepare data in a file for submission. Your entity must retain a copy of the data for a period of 36 months from the date of the report's submission.

I. Requirements for submitting data via IESUB

- ✓ Each file should contain data for only one Reporter Identification Number. If your entity will be reporting using multiple Reporter Identification Numbers, the data pertaining to each Reporter Identification Number must be reported in a separate file.
- ✓ Your entity must agree to the Terms and Use for Internet Reporting. This information can be found at: <http://www.treas.gov/tic/forms-sh.html>
- ✓ Your entity must have a connection to the Internet that supports the World Wide Web (WWW). Your connection must not block or disable JavaScript.
- ✓ Your entity must have a web browser program (e.g., Microsoft Internet Explorer 5.5 or higher) that supports 128-bit Secure Sockets Layer (SSL) encryption. 128-bit encryption is used for all communication between you and the Federal Reserve System.
- ✓ All Schedule 1 information must be data entered before Schedule 2 data can be submitted.
- ✓ All files must be text files and have file names ending with .TXT (e.g., Schedue_2_Company_Name.TXT)

II. Requirements for submitting data via Diskette/CD

- ✓ Each diskette/CD (media) should contain data for only one Reporter Identification Number. If your entity will be reporting using multiple Reporter Identification Numbers, the data pertaining to each Reporter Identification Number must be reported on separate media.
- ✓ Each media for a particular Reporter Identification Number must be accompanied by a paper format Schedule 1.

- ✓ A dump or print out that includes at least the first ten detail records should accompany each media.
- ✓ Include a printout of the command string used to create the file if the file was created directly from the mainframe.
- ✓ Include any special instructions on how to unload the file.
- ✓ All Schedule 2 data must be provided in a standard DOS, ASCII flat file on one of the following media:
 - High density, IBM PC-compatible diskette(s)
 - Standard 700 MB CD(s)

Data must be submitted to:

Federal Reserve Bank of New York
Statistics Function, 4th Floor
33 Liberty Street
New York, NY 10045-0001

Should you have any questions concerning the instructions in this appendix, please contact the FRBNY automation staff at 212-720-1989 or 646-720-1989.

III. Electronic File Formats for both IESUB and Diskette/CD Submissions for Schedule 2(s).

Reporters must use either a semicolon-delimited format or positional format. The layouts and examples of each follows.

Semicolon Delimited Format

Data Field and Instructions	Field Format	Schedule 2 Item Number
Reporter Identification Number	N10	1
Delimiter	Semi-colon	
Sequence Number (value from 1 - maximum number of records)	N7	2
Delimiter	Semi-colon	
Reporting Unit	N3	3a
Delimiter	Semi-colon	
Name of Reporting Unit	A80	3b
Delimiter	Semi-colon	
Security ID	A12	4
Delimiter	Semi-colon	
Security Description	A80	5
Delimiter	Semi-colon	
Security ID System (Refer to Appendix C)	N2	6
Delimiter	Semi-colon	
Security ID System Description	A80	6a
Delimiter	Semi-colon	
Security Type (Refer to Schedule 2, Page1)	N2	7
Delimiter	Semi-colon	
Depository Receipt/Share (Refer to Schedule 2, Page1)	N1	8
Delimiter	Semi-colon	
Name of Issuer	A80	9
Delimiter	Semi-colon	
Term Indicator (Refer to Schedule 2, Page1)	N1	10
Delimiter	Semi-colon	
Country of Issuer (Refer to Appendix D)	N5	11
Delimiter	Semi-colon	
Currency of Denomination (Refer to Appendix F)	A3	12
Delimiter	Semi-colon	
Ownership Code (Refer to Schedule 2, Page1)	N1	13
Delimiter	Semi-colon	
US\$ Fair (Market) Value of Security Held	N12	14a
Delimiter	Semi-colon	
Fair (Market) Value of Security Held Denominated in the Currency of Issue	N12	14b
Delimiter	Semi-colon	

Intentionally Left Blank	N1	15
Delimiter	Semi-colon	
Number of Shares Held	N11	16
Delimiter	Semi-colon	
Face Value in Currency of Denomination (non-ABS debt only)	N12	17
Delimiter	Semi-colon	
Issue Date (MMDDYYYY) (non-ABS debt only)	N8	18
Delimiter	Semi-colon	
Maturity Date (MMDDYYYY) (non-ABS debt only)	N8	19
Delimiter	Semi-colon	
Original Face Value in Currency of Denomination (ABS only)	N12	20
Delimiter	Semi-colon	
Remaining Principal Outstanding in Currency of Denomination (ABS only)	N12	21
Delimiter	Semi-colon	
Issue Date (MMDDYYYY) (ABS only)	N8	22
Delimiter	Semi-colon	
Maturity Date (MMDDYYYY) (ABS only)	N8	23

Data Specifications

In addition to the instructions in the above table, follow these instructions:

- Semi-colons must be used as space-delimiters between fields.
- No special characters should be present in numeric fields (e.g. currency signs, commas, negative signs, slashes, etc.).
- All numeric fields should be unpacked, unsigned and with leading zeros.
- A format specification of N12 is numeric, with length of up to 12.
- A format specification of A80 is alphanumeric, with length of up to 80.
- Issue Date and Maturity Date fields should be in the format of MMDDYYYY with leading zero for months January-September and for the 1st to the 9th day of the month (e.g. 01092004 = January 9, 2004).

External Label for Diskette/CD submissions (affix to media, not to cover)

Company Name

Reporter Identification Number as assigned by the FRBNY

Data Processing Contact Name and Telephone Number

Diskette/CD Identification Number (as identified in your records)

Total Number of Diskette/CD: 1 of __

Creation Date

Contents: Report of U.S. Ownership of Foreign Securities, Including Selected Money Market Instruments
(SHC(A))

Sample Equity Record

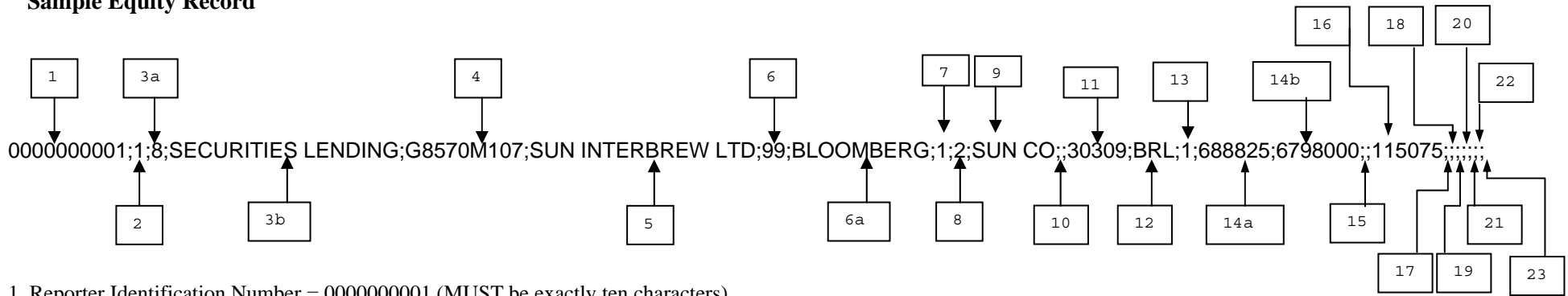

1. Reporter Identification Number = 0000000001 (MUST be exactly ten characters)
2. Sequence Number (can also be of format: 0000001)
- 3a. Reporting Unit (internal code to identify the area within your organization that the data came from)
- 3b. Name of Reporting Unit (can be up to 80 characters in length)
4. Security ID (can be up to 12 characters in length)
5. Security Description (can be up to 80 characters in length)
6. Security ID System (use security ID system codes from Appendix C)
- 6a. Security ID System "Other" (name of the organization or system that assigned the security ID)
7. Security Type (use security types listed on Schedule 2, Page 1)
- 8 Depository Receipt/Share (refer to Schedule 2, Page 1 for codes)
9. Name of Issuer (can be up to 80 characters in length)
10. Term Indicator – must be null for an equity record
11. Country of Issuer (use country codes listed in Appendix D)
12. Currency of Denomination (use currency codes listed in Appendix F)
13. Ownership Code (refer to Schedule 2, Page 1 for codes)
- 14a. US\$ Fair (Market) Value of Security Held (can be up to 12 characters in length)
- 14b. Fair (Market) Value of Security Held Denominated in the Currency of Issue (can be up to 12 characters in length)
15. Intentionally Left Blank
16. Number of shares held – (can be up to 11 characters in length) **Must have a value greater than zero for an equity record.**
17. Face Value in Currency of Denomination – must be null for an equity record
18. Issue Date – must be null for an equity record
19. Maturity Date – must be null for an equity record
20. Original Face Value in Currency of Denomination – must be null for an equity record
21. Remaining Principal Outstanding in Currency of Denomination – must be null for an equity record
22. Issue Date – must be null for an equity record
23. Maturity Date – must be null for an equity record

Null

Note: Null fields are to be included. They are represented by the inclusion of a delimiter as if a value were present. E.g. - ;desc;;

Sample Short-term/Long-term Debt Record (excluding Asset-Backed securities)

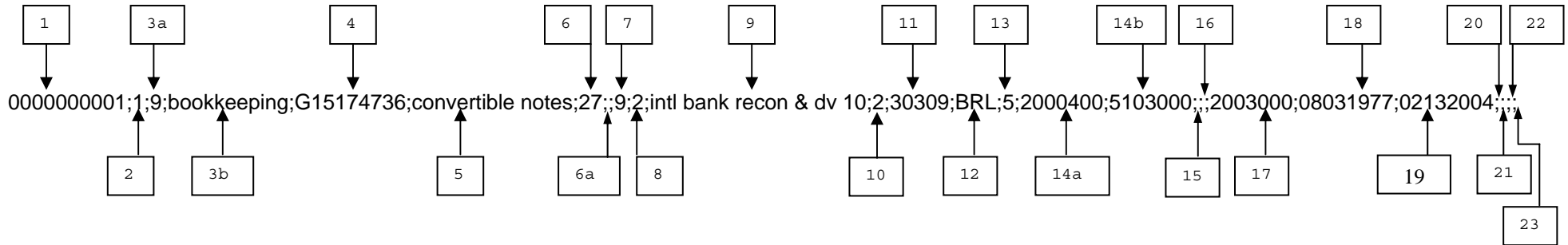

1. Reporter Identification Number = 0000000001 (MUST be exactly ten characters)
2. Sequence Number (can also be of format: 0000001)
- 3a. Reporting Unit (internal code to identify the area within your organization that the data came from)
- 3b. Name of Reporting Unit (can be up to 80 characters in length)
4. Security ID (can be up to 12 characters in length)
5. Security Description (can be up to 80 characters in length)
6. Security ID System (use security ID system codes from Appendix C)
- 6a. Security ID System "Other" (name of the organization or system that assigned the security ID)
7. Security Type (use security types listed on Schedule 2, Page 1)
8. Depository Receipt/Share (refer to Schedule 2, Page 1 for codes)
9. Name of Issuer (can be up to 80 characters in length)
10. Term Indicator (refer to Schedule 2, Page 1 for codes)
11. Country of Issuer (use country codes listed in Appendix D)
12. Currency of Denomination (use currency codes listed in Appendix F)
13. Ownership Code (refer to Schedule 2, Page 1 for codes)
- 14a. US\$ Fair (Market) Value of Security Held (can be up to 12 characters in length)
- 14b. Fair (Market) Value of Security Held Denominated in the Currency of Issue (can be up to 12 characters in length)
15. Intentionally Left Blank
16. Number of shares held – must be null for short-term/long-term debt record (excluding asset-backed securities)
17. Face Value in Currency of Denomination - (can be up to 12 characters in length). **Must have a value greater than zero for a short-term/long-term debt record (excluding asset-backed securities).**
18. Issue Date – MMDDYYYY format (08031977 = August 3, 1977)
19. Maturity Date – MMDDYYYY format (02132004 = February 13, 2004)
20. Original Face Value in Currency of Denomination – must be null for short-term/long-term debt record (excluding asset-backed securities)
21. Remaining Principal Outstanding in Currency of Denomination – must be null for short-term/long-term debt record (excluding asset-backed securities)
22. Issue Date – must be null for short-term/long-term debt record (excluding asset-backed securities)
23. Maturity Date – must be null for short-term/long-term debt record (excluding asset-backed securities)

Sample Asset-Backed Long-term Debt Record

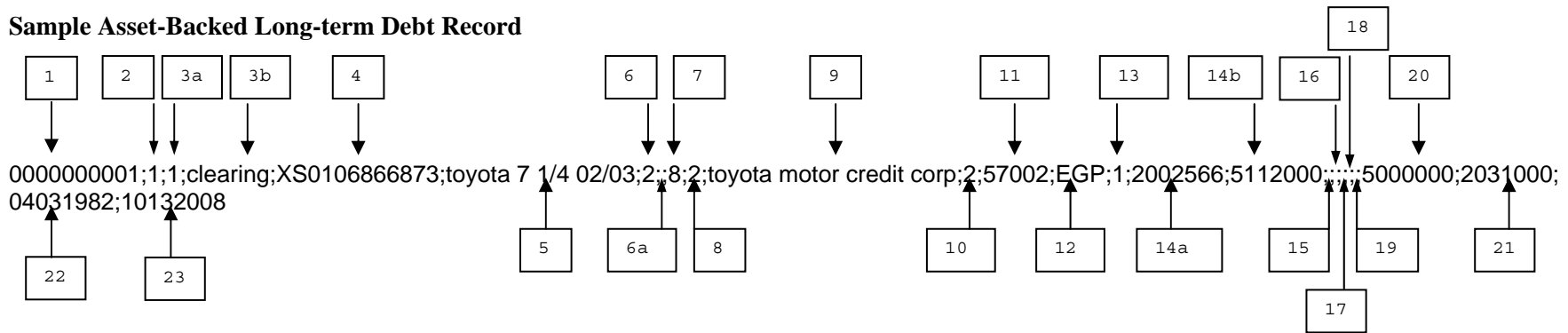

1. Reporter Identification Number = 0000000001 (MUST be exactly ten characters)
2. Sequence Number (can also be of format: 0000001)
- 3a. Reporting Unit (internal code to identify the area within your organization that the data came from)
- 3b. Name of Reporting Unit (can be up to 80 characters in length)
4. Security ID (can be up to 12 characters in length)
5. Security Description (can be up to 80 characters in length)
6. Security ID System (use security ID system codes from Appendix C)
- 6a. Security ID System "Other" (name of the organization or system that assigned the security ID)
7. Security Type (use security types listed on Schedule 2, Page 1)
8. Depository Receipt/Share (refer to Schedule 2, Page 1 for codes)
9. Name of Issuer (can be up to 80 characters in length)
10. Term Indicator (refer to Schedule 2, Page 1 for codes)
11. Country of Issuer (use country codes listed in Appendix D)
12. Currency of Denomination (use currency codes listed in Appendix F)
13. Ownership Code (refer to Schedule 2, Page 1 for codes)
- 14a. US\$ Fair (Market) Value of Security Held (can be up to 12 characters in length)
- 14b. Fair (Market) Value of Security Held Denominated in the Currency of Issue (can be up to 12 characters in length)
15. Intentionally Left Blank
16. Number of shares held – must be null for an asset-backed long-term debt record
17. Face Value in Currency of Denomination - must be null for an asset-backed long-term debt record
18. Issue Date – must be null for an asset-backed long-term debt record
19. Maturity Date – must be null for an asset-backed long-term debt record
20. Original Face Value in Currency of Denomination – for ABS debt only (can be up to 12 characters in length). **Must have a value greater than zero for an asset-backed long-term debt record.**
21. Remaining Principal Outstanding in Currency of Denomination – for ABS debt only (can be up to 12 characters in length). **Must have a value greater than zero for an asset-backed long-term debt record.**
22. Issue Date – MMDDYYYY format (04031982 = April 3, 1982)
23. Maturity Date – MMDDYYYY format (10132008 = October 13, 2008)

Positional Format (Record length = 496 characters)

Position	Data Field and Instructions	Field Format	Schedule 2 Item Number
1-10	Reporter Identification Number	N10	1
11	Filler (space)	Space	
12-18	Sequence Number (value from 1 - maximum number of records)	N7	2
19	Filler (space)	Space	
20-22	Reporting Unit	N3	3a
23	Filler (space)	Space	
24-103	Name of Reporting Unit	A80	3b
104	Filler (space)	Space	
105-116	Security ID	A12	4
117	Filler (space)	Space	
118-197	Security Description	A80	5
198	Filler (space)	Space	
199-200	Security ID System (Refer to Appendix C)	N2	6
201	Filler (space)	Space	
202-281	Security ID System Description	A80	6a
282	Filler (space)	Space	
283-284	Security Type (Refer to Schedule 2, Page1)	N2	7
285	Filler (space)	Space	
286	Depository Receipt/Share (Refer to Schedule 2, Page1)	N1	8
287	Filler (space)	Space	
288-367	Name of Issuer	A80	9
368	Filler (space)	Space	
369	Term Indicator (Refer to Schedule 2, Page1)	N1	10
370	Filler (space)	Space	
371-375	Country of Issuer (Refer to Appendix D)	N5	11
376	Filler (space)	Space	
377-379	Currency of Denomination (Refer to Appendix F)	A3	12
380	Filler (space)	Space	
381	Ownership Code (Refer to Schedule 2, Page1)	N1	13
382	Filler (space)	Space	
383-394	US\$ Fair (Market) Value of Security Held	N12	14a
395	Filler (space)	Space	
396-407	Fair (Market) Value of Security Held Denominated in the Currency of Issue	N12	14b
408	Filler (space)	Space	
409	Intentionally Left Blank	N1	15
410	Filler (space)	Space	
411-421	Number of Shares Held	N11	16
422	Filler (space)	Space	
423-434	Face Value in Currency of Denomination (non-ABS debt only)	N12	17
435	Filler (space)	Space	

436-443	Issue Date (MMDDYYYY) (non-ABS debt only)	N8	18
444	Filler (space)	Space	
445-452	Maturity Date (MMDDYYYY) (non-ABS debt only)	N8	19
453	Filler (space)	Space	
454-465	Original Face Value in Currency of Denomination (ABS only)	N12	20
466	Filler (space)	Space	
467-478	Remaining Principal Outstanding in Currency of Denomination(ABS only)	N12	21
479	Filler (space)	Space	
480-487	Issue Date (MMDDYYYY) (ABS only)	N8	22
488	Filler (space)	Space	
489-496	Maturity Date (MMDDYYYY) (ABS only)	N8	23

496 character logical records blocked at 60 logical records or a block size of 29,760 bytes.

Data Specifications

In addition to the instructions in the above table, follow these instructions:

- No special characters should be present in numeric fields (e.g. currency signs, commas, negative signs, slashes, etc.).
- All numeric fields should be unpacked, unsigned, **right** justified with leading zeros, e.g., COBOL PIC 9(12). A format specification of N12 is numeric, with length of up to 12.
- Alphanumeric data should be **left** justified and blank filled, e.g., COBOL PIC X(50). A format specification of A80 is alphanumeric, with length of up to 80.
- Issue Date and Maturity Date fields should be in the format of MMDDYYYY with leading zero for months January-September and for the 1st to the 9th day of the month (e.g., 01092004 = January 9, 2004)
- The filler should be a space, e.g., in COBOL PIC X value spaces.
- Columns corresponding to null or not applicable items should be space filled

External Label for Diskette/CD submissions (affix to media, not to cover)

Company Name

Reporter Identification Number as assigned by the FRBNY

Data Processing Contact Name and Telephone Number

Diskette/CD Identification Number (as identified in your records)

Total Number of Diskette/CD: 1 of __

Creation Date

Contents: Report of U.S. Ownership of Foreign Securities, Including Selected Money Market Instruments
(SHC(A))

Below are sample equity, short-term/long-term debt (excluding asset-backed securities), and asset-backed debt records for the positional file layout. For purposes of *illustration only*, a darkened circle (●) represents the filler referred to on pages [\[enter pages\]](#) between fields and an open square () represents a field position where information can be entered.

Equity:

0000000001•0000001•008•SECURITIES
 LENDING
 ●G8570M107 ●SUN INTERBREW LIMITED COMMON ●99•BLOOMBERG ●01
 STOCK
 ●2•SUN
 COMPANYINCORPORATED
 ●30309•BRL•1•000000688825•000006798000• ●00000115075•
 ● ● ● ● ● ● ● ●

Short-term/Long-term Debt Record (excluding Asset-Backed securities):

0000000001•0000002•009•BOOKKEEPING ●G15174736 ●CONVERTIBLE
 NOTES
 ●27●
 ●09•2•INTERNATIONAL BANK FOR RECONSTRUCTION
 ANDDEVELOPMENT ●2•30309•BRL•5•000002000400•000005103000●
 ● ●000002003000•08031977•02132004● ● ● ● ● ● ● ●

Asset-Backed Long-term Debt Record:

0000000001•0000003•010•CLEARING•XS0106866873 ●TOYOTA7
 1/402/03
 ●02●
 ●08•2•TOYOTA MOTOR ●2•838
 CREDITCORPORATION ● ● ● ● ● ● ● ●
 44•EGP•1•000002002566•000005112000● ● ● ● ● ● ● ●
 005000000•000002031000•04031982•10132008 ●000

436-443	Issue Date (MMDDYYYY) (non-ABS debt only)	N8	18
444	Filler (space)	Space	
445-452	Maturity Date (MMDDYYYY) (non-ABS debt only)	N8	19
453	Filler (space)	Space	
454-465	Original Face Value in Currency of Denomination (ABS only)	N12	20
466	Filler (space)	Space	
467-478	Remaining Principal Outstanding in Currency of Denomination(ABS only)	N12	21
479	Filler (space)	Space	
480-487	Issue Date (MMDDYYYY) (ABS only)	N8	22
488	Filler (space)	Space	
489-496	Maturity Date (MMDDYYYY) (ABS only)	N8	23

496 character logical records blocked at 60 logical records or a block size of 29,760 bytes.

Data Specifications

In addition to the instructions in the above table, follow these instructions:

- No special characters should be present in numeric fields (e.g. currency signs, commas, negative signs, slashes, etc.).
- All numeric fields should be unpacked, unsigned, **right** justified with leading zeros, e.g., COBOL PIC 9(12). A format specification of N12 is numeric, with length of up to 12.
- Alphanumeric data should be **left** justified and blank filled, e.g., COBOL PIC X(50). A format specification of A80 is alphanumeric, with length of up to 80.
- Issue Date and Maturity Date fields should be in the format of MMDDYYYY with leading zero for months January-September and for the 1st to the 9th day of the month (e.g., 01092004 = January 9, 2004)
- The filler should be a space, e.g., in COBOL PIC X value spaces.
- Columns corresponding to null or not applicable items should be space filled

External Label for Diskette/CD submissions (affix to media, not to cover)

Company Name

Reporter Identification Number as assigned by the FRBNY

Data Processing Contact Name and Telephone Number

Diskette/CD Identification Number (as identified in your records)

Total Number of Diskette/CD: 1 of __

Creation Date

Contents: Report of U.S. Ownership of Foreign Securities, Including Selected Money Market Instruments
(SHC(A))

Below are sample equity, short-term/long-term debt (excluding asset-backed securities), and asset-backed debt records for the positional file layout. For purposes of *illustration only*, a darkened circle (●) represents the filler referred to on pages [\[enter pages\]](#) between fields and an open square () represents a field position where information can be entered.

Equity:

0000000001•0000001•008•SECURITIES
 LENDING
 ●G8570M107 ●SUN INTERBREW LIMITED COMMON ●99•BLOOMBERG ●01
 STOCK
 ●2•SUN
 COMPANYINCORPORATED
 ●30309•BRL•1•000000688825•000006798000• ●00000115075•
 ● ● ● ● ● ● ● ●

Short-term/Long-term Debt Record (excluding Asset-Backed securities):

0000000001•0000002•009•BOOKKEEPING ●G15174736 ●CONVERTIBLE
 NOTES
 ●27●
 ●09•2•INTERNATIONAL BANK FOR RECONSTRUCTION
 ANDDEVELOPMENT ●2•30309•BRL•5•000002000400•000005103000●
 ● ●000002003000•08031977•02132004● ● ● ● ● ● ● ●

Asset-Backed Long-term Debt Record:

0000000001•0000003•010•CLEARING•XS0106866873 ●TOYOTA7
 1/402/03
 ●02●
 ●08•2•TOYOTA MOTOR ●2•838
 CREDITCORPORATION ●000 ●000 ●000 ●000 ●000
 44•EGP•1•000002002566•000005112000● ● ● ● ● ● ● ●
 005000000•000002031000•04031982•10132008 ●000