

Report on  
**U.S. Portfolio Holdings of  
Foreign Securities**

as of December 31, 2004

**Department of the Treasury**

**Federal Reserve Bank of New York**

**Board of Governors of the Federal Reserve System**

**December 2005**

## CONTENTS

|   |    |
|---|----|
| Introduction .....  | 1  |
| Chapter 1. Findings from the 2004 Survey .....  | 3  |
| Chapter 2. Data Collection Methodology .....  | 20 |
| Tables  |    |
| 1. Market value of U.S. holdings of foreign securities, by type of security,<br>as of the survey dates .....  | 3  |
| 2. Market value of U.S. holdings of foreign securities, by country and type of security,<br>for the countries attracting the most U.S. investment, as of December 31, 2004 .....  | 5  |
| 3. Market value of U.S. holdings of foreign long-term securities, for the countries<br>attracting the most U.S. investment, as of the survey dates .....  | 6  |
| 4. Market value of U.S. holdings of foreign long-term securities and<br>foreign holdings of U.S. long-term securities, as of selected dates, 1994-2004 .....  | 7  |
| 5. Measured and estimated market value of U.S. holdings of foreign<br>long-term securities, by type of security, as of December 31, 2004 .....  | 8  |
| 6. Market value of U.S. holdings of foreign equities, by country, size of domestic equity<br>markets, and share of each market that is U.S. held, for the countries attracting the<br>most U.S. investment, as of December 31, 2004 ..... | 9  |
| 7. Market value of U.S. holdings of foreign equities, by country and amount held in<br>depository receipts, for the countries attracting the most U.S. investment,<br>as of December 31, 2004 .....                                       | 10 |
| 8. Market value of U.S. holdings of foreign debt securities, by currency of<br>denomination, as of December 31, 2003, and December 31, 2004 .....   | 11 |
| 9. Market value of U.S. holdings of foreign long-term debt securities, by remaining<br>maturity, as of December 31, 2003, and December 31, 2004 .....   | 12 |
| 10. Market value of U.S. holdings of foreign debt securities, by country and sector of<br>issuer, as of December 31, 2004 .....   | 13 |

|   |    |
|---|----|
| 11a. Market value of U.S. holdings of foreign long-term securities in advanced economies, Caribbean financial centers, and developing countries and countries in transition, as of December 31, 2003, and December 31, 2004 . . . . .   | 14 |
| 11b. Market value of U.S. holdings of foreign equities in advanced economies, Caribbean financial centers, and developing countries and countries in transition, as a share of the total outstanding, as of December 31, 2004 . . . . . | 15 |
| 12a. Market value of U.S. holdings of foreign securities, by geographic region, as of December 31, 2003, and December 31, 2004 . . . . .  | 16 |
| 12b. Market value of U.S. holdings of foreign equities, by geographic region, as a share of the total outstanding, as of December 31, 2004 . . . . .  | 16 |
| 13. Market value of U.S. holdings of foreign securities, by industry, as of December 31, 2004 . . . . .   | 18 |
| 14. Coverage in 2001 of the Institutions Reporting in 2004 . . . . .  | 23 |
| 15. Implicit Final Gross-up Factors Used . . . . .  | 25 |

A. Statistical Appendix

|   |    |
|---|----|
| 16. Market value of U.S. holdings of foreign securities, by country and type of security, as of December 31, 2004 . . . . .         | 27 |
| 17. Market value of U.S. holdings of foreign long-term securities, by country, as of the survey dates . . . . .                     | 33 |
| 18. Market value of U.S. holdings of foreign equities, by country, as of the survey dates . . . . .                                 | 41 |
| 19. Market value of U.S. holdings of foreign long-term debt securities, by country, as of the survey dates . . . . .                | 49 |
| 20. Market value of U.S. holdings of foreign short-term debt securities, by country, as of the survey dates . . . . .               | 57 |
| 21. Market value of U.S. holdings of foreign long-term debt securities, by country and currency, as of December 31, 2004 . . . . .  | 61 |
| 22. Market value of U.S. holdings of foreign short-term debt securities, by country and currency, as of December 31, 2004 . . . . . | 67 |

|   |     |
|---|-----|
| 23. Market value of U.S. holdings of foreign long-term debt securities, by country and type of security, as of December 31, 2004 .....  | 70  |
| 24. Market value of U.S. holdings of foreign short-term debt securities, by country and type of security, as of December 31, 2004 .....                                       | 75  |
| 25. Market value of U.S. holdings of foreign debt securities, by country and sector of issuer, as of December 31, 2004 .....  | 78  |
| 26. Market value of U.S. holdings of foreign equities, by country and amounts held as Depository Receipts, as of December 31, 2004 .....                                      | 84  |
| 27. Market value of U.S. holdings of foreign equities, by country and type of security, as of December 31, 2004 .....   | 89  |
| 28. Market value of U.S. holdings of foreign equities, by country, size of domestic equity markets, and share of each market that is U.S.-held, as of December 31, 2004 ..... | 95  |
| Appendix B. Forms and Instructions .....  | 101 |

## Introduction

This report presents data and analyses regarding U.S. portfolio investment in foreign equity and debt securities.<sup>1</sup> The data are drawn primarily from the latest survey of U.S. holdings of foreign securities as of December 31, 2004. The survey was a joint undertaking of the U.S. Treasury Department, the Federal Reserve Bank of New York, and the Board of Governors of the Federal Reserve System.

The 2004 survey was the fifth survey of U.S. ownership of foreign securities conducted by the United States, with prior surveys conducted as of March 31, 1994, December 31, 1997, December 31, 2001, and December 31, 2003.<sup>2</sup> The surveys were initiated as the level of U.S. investment in foreign securities began to grow significantly in the 1990s.

The structure of the surveys has evolved over time. The first two U.S. surveys measured only holdings of foreign long-term securities; beginning with the 2001 survey information is collected on U.S. holdings of both foreign long-term and short-term securities.<sup>3</sup> Further, the first three surveys were "benchmark" surveys, that is, they collected data from a large number of institutions in an attempt to measure total U.S. holdings as comprehensively as practical. Beginning with the December 2003 survey, surveys are conducted annually. Full benchmark surveys will continue to be conducted at five-year intervals. In the four years following each benchmark survey, annual data will be collected from only the largest reporters who collectively reported approximately 90 percent of the market value of foreign holdings as measured by the preceding benchmark survey. The December 2004 survey was not a benchmark survey, thus its measured results had to be "grossed-up" to estimate total U.S. holdings. The procedures used to perform this extrapolation are described in Chapter 2, Survey Methodology.

The surveys collect information at the individual security level, making possible both detailed editing and the presentation of data in a wide variety of ways, such as by country, security type, currency, remaining term-to-maturity, and industry. Experience has shown that collecting security level data results in far more accurate survey results than can be obtained by collecting aggregate information. Many significant errors can be detected in the security-level data that would otherwise go undetected in aggregate data. In addition, the collection of security level data is efficient because survey respondents need to report data in only one format, instead of

---

1. U.S. portfolio investment in foreign securities, for the purposes of this report, includes all foreign securities owned by U.S. residents except where the owner has a direct investment relationship with the foreign issuer of the securities. Direct investment means the ownership or control, directly or indirectly, by one person or by a group of affiliated persons, of 10 percent or more of the voting stock of an incorporated business enterprise, or an equivalent interest in an unincorporated enterprise. Data on direct investment are collected by the Bureau of Economic Analysis (BEA), Department of Commerce, and published in the *Survey of Current Business* and on the BEA web site.

2. The Treasury Department conducted a survey during World War II of all foreign assets owned by U.S. residents as of May 1943. That survey measured portfolio investment as well as other forms of investment, but it is removed in time and in purpose from the modern survey program that began with the 1994 survey.

3. Long-term securities are defined as all equity securities and all debt securities with an original term-to-maturity of more than one year. Short-term securities are debt securities with an original term-to-maturity of one year or less.

aggregating and reporting their holdings in a variety of different ways, such as are shown in the tables in this report.

The surveys are part of an internationally coordinated effort under the auspices of the International Monetary Fund (IMF) to improve the measurement of portfolio asset holdings.<sup>4</sup> Seventy-three countries or geographic regions, including most of the industrial and financial center countries, participated in the 2004 survey. The Coordinated Portfolio Investment Surveys (CPIS) were initiated primarily because there has been a wide discrepancy between worldwide measured portfolio assets and worldwide measured portfolio liabilities, with reported liabilities exceeding reported assets. Future U.S. asset surveys will also be part of IMF-coordinated efforts and will continue to measure U.S. holdings of both long-term and short-term foreign securities.

Chapter 1 of this report presents the 2004 survey findings. Chapter 2 discusses data collection methodology. Appendix A presents a variety of statistics not included elsewhere in the report. Appendix B contains a copy of the forms and instructions used by the survey.

The Treasury Department, the Federal Reserve Bank of New York, and the Federal Reserve Board wish to express their appreciation to all survey respondents whose efforts and information have made this report possible.

---

4. International Monetary Fund, *Portfolio Investment: CPIS Data Results*, which can be found on the web at <http://www.imf.org/external/np/sta/pi/datars1.htm>. Also, see the discussion regarding the CPIS following Table 1 below.

## Chapter 1. Findings from the 2004 Survey

The data presented in this chapter are drawn primarily from the survey of U.S. ownership of foreign securities conducted as of December 31, 2004. Data from previous surveys -- conducted as of March 31, 1994, December 31, 1997, December 31, 2001, and December 31, 2003 -- are also frequently included. In all tables, components may not sum to totals because of rounding. All data are presented, to the extent possible, at market value as of the date of the survey.

### U.S. Holdings over Time by Type of Security

Table 1 shows total U.S. holdings of foreign securities, by type of security held, as measured by the five surveys conducted. U.S. holdings of foreign short-term securities were only measured by the three most recent surveys.

#### 1. Market value of U.S. holdings of foreign securities, by type of security, as of the survey dates

Billions of dollars except as noted

| Type of security            | March<br>1994 | December<br>1997 | December<br>2001 | December<br>2003 | December<br>2004 |
|-----------------------------|---------------|------------------|------------------|------------------|------------------|
| <b>Long-term securities</b> | 870           | 1,755            | 2,170            | 2,954            | 3,553            |
| Equity                      | 567           | 1,208            | 1,613            | 2,079            | 2,560            |
| Long-term debt              | 304           | 547              | 557              | 874              | 993              |
| <b>Short-term debt</b>      | n.a.          | n.a.             | 147              | 199              | 233              |
| <b>Total</b>                | n.a.          | n.a.             | 2,317            | 3,152            | 3,787            |

n.a. Not available.

U.S. holdings of foreign securities increased significantly between end of 2003 and end of 2004. While all types of U.S. holdings (equity, long-term debt, short-term debt) grew rapidly in the period between the past two surveys, U.S. investors show a strong and continuing preference for foreign equities, with \$2,560 billion invested in equities and only \$1,226 billion invested in debt securities. However, U.S. investors have not always preferred foreign equities to debt securities. A survey conducted by the United States during World War II found that equities accounted for only 38 percent of U.S. foreign securities holdings. By 1984 it is estimated that only 29 percent of U.S. foreign securities holdings were in equities. But after 1984, U.S. investors began to favor foreign equities over debt securities, and by 1987 the levels of debt and equity held were essentially equal.<sup>5</sup>

This increase in U.S. holdings during 2004 resulted more from equity price appreciation and the relative depreciation of the U.S. dollar (which had the effect of increasing the value of foreign currency-denominated securities) than from actual increased net acquisitions of foreign securities. A more complete discussion of the factors affecting the change in U.S. holdings during 2004 accompanies table 5.

5. These estimates were based on monthly Treasury International Capital securities transactions data.

U.S. investors' preference for foreign equities differs from the cross-border investment patterns shown by the other leading cross-border investing countries. Results from the IMF's most recently completed Coordinated Portfolio Investment Survey show that of the ten countries with the largest private sector holdings of foreign securities (U.S., Japan, U.K., France, Luxembourg, Germany, Ireland, Italy, Netherlands, and Switzerland), only the United States held more cross-border equities than debt securities.<sup>6</sup>

With the exception of zero-coupon securities, the market value of U.S. holdings of foreign securities in this report are given using "clean prices"; that is, values are computed exclusive of accrued and unpaid interest. Using commercial data sources, we estimate accrued and unpaid interest for U.S. holdings of foreign long-term debt securities at approximately \$12 billion as of December 31, 2004.

### U.S. Portfolio Investment by Country

The United Kingdom was by far the first choice of U.S. international investors at the end of 2004, as it was on the previous three surveys.

U.S. holdings of Swiss securities show an unusual pattern, with \$118 billion invested in Swiss equities and only \$2 billion invested in Swiss debt. This pattern reflects the fact that relatively little debt has been issued by Swiss firms and Swiss governmental organizations, whereas the Swiss equity market is one of the largest in the world.

The very high percentage of short-term debt holdings attributed to the United Kingdom reflects a tendency of internationally active financial firms to issue short-term debt through their United Kingdom offices.

It should be noted that the country attribution of U.S. holdings of foreign holdings presented in this report should be extremely accurate. This is because information was collected at the individual security level, and it is a relatively straightforward matter to determine the country of residence of the security issuer in most cases. This point is made because in the companion surveys of foreign ownership of U.S. securities, it is often not possible to determine the country of residence of the ultimate beneficial owners of U.S. securities, due to either chains of intermediaries involved in the custody or management of these securities or lack of ownership information on bearer (unregistered) securities.

---

6. International Monetary Fund, *Portfolio Investment: CPIS Data Results*, table 9, which can be found on the web at <http://www.imf.org/external/np/sta/pi/03/Table09.htm>.



## 2. Market value of U.S. holdings of foreign securities, by country and type of security, for the countries attracting the most U.S. investment, as of December 31, 2004

Billions of dollars except as noted

| Country or category | Total        | Equity       | Debt         |            |            |
|---------------------|--------------|--------------|--------------|------------|------------|
|                     |              |              | Total        | Long-term  | Short-term |
| United Kingdom      | 738          | 456          | 282          | 171        | 110        |
| Japan               | 384          | 330          | 54           | 36         | 17         |
| Canada              | 345          | 180          | 164          | 152        | 12         |
| France              | 217          | 165          | 52           | 42         | 10         |
| Netherlands         | 202          | 136          | 66           | 55         | 11         |
| Germany             | 201          | 124          | 78           | 68         | 10         |
| Cayman Islands      | 196          | 70           | 126          | 114        | 12         |
| Bermuda             | 164          | 154          | 11           | 10         | 1          |
| Switzerland         | 142          | 138          | 4            | 2          | 2          |
| Australia           | 103          | 57           | 46           | 40         | 6          |
| Italy               | 78           | 57           | 20           | 17         | 3          |
| Korea, South        | 74           | 67           | 7            | 7          | *          |
| Rest of world       | 943          | 626          | 317          | 278        | 39         |
| <b>Total</b>        | <b>3,787</b> | <b>2,560</b> | <b>1,226</b> | <b>993</b> | <b>233</b> |

\* Greater than zero but less than \$500 million.

Table 16 in the Statistical Appendix shows the data in table 2 for an expanded list of countries.

### Level of Portfolio Investment by Country over Time

Table 3 shows the countries attracting the most U.S. portfolio investment in their long-term securities as of the five survey dates. Only data on long-term securities are presented because the 1994 and 1997 surveys did not collect information on short-term securities.

By a clear margin, the United Kingdom, Japan, and Canada have occupied the top three positions on each survey. In the 1994 survey U.S. investment in these three countries were roughly equal. But while U.S. investment in Japanese and Canadian securities has increased at approximately the same rate, U.S. holdings of U.K. securities have grown much more rapidly and were almost equal to the combined holdings of Canadian and Japanese securities at year-end 2004. France, Germany, and the Netherlands have consistently followed the top three countries on this list.

### 3. Market value of U.S. holdings of foreign long-term securities, for the countries attracting the most U.S. investment, as of the survey dates

Billions of dollars

| Country or category | March 1994 | December 1997 | December 2001 | December 2003 | December 2004 |
|---------------------|------------|---------------|---------------|---------------|---------------|
| United Kingdom      | 120        | 272           | 431           | 564           | 627           |
| Japan               | 131        | 167           | 197           | 293           | 367           |
| Canada              | 108        | 177           | 205           | 289           | 332           |
| France              | 42         | 100           | 138           | 174           | 206           |
| Germany             | 48         | 108           | 118           | 175           | 192           |
| Netherlands         | 48         | 120           | 143           | 174           | 192           |
| Cayman Islands      | 11         | 19            | 70            | 121           | 184           |
| Bermuda             | 9          | 27            | 125           | 116           | 163           |
| Switzerland         | 21         | 63            | 76            | 119           | 140           |
| Australia           | 24         | 57            | 53            | 86            | 97            |
| Rest of world       | 308        | 645           | 614           | 843           | 1,053         |
| <b>Total</b>        | <b>870</b> | <b>1,755</b>  | <b>2,170</b>  | <b>2,954</b>  | <b>3,553</b>  |

Investment in Bermuda had the greatest percentage increase over the 1994-2004 period, but this rapid growth resulted primarily from the re-incorporation of a number of U.S. companies as Bermudan corporations rather than from a surge of U.S. investment in existing Bermudan securities. The Cayman Islands, another small island economy, also shows a high level of U.S. investment. This is because many securities are registered in the Cayman Islands (and other so-called "offshore financial centers") for tax or regulatory reasons by companies whose center of economic activity is elsewhere.

Tables 17-20 in the Statistical Appendix show U.S. ownership by country for each of the five surveys conducted, showing respectively U.S. ownership of total foreign securities, equities, long-term debt, and short-term debt. In these tables there are some figures which may be explained by factors other than U.S. investor sentiment. For instance, a sharp rise or decline in the level of U.S. investment could be caused by a company in country A having been acquired in total by a company in country B, causing what had been U.S. investment in country A to become U.S. investment in country B.

#### U.S. Foreign Portfolio Investment Compared with Foreign Portfolio Investment in the United States

The following table shows both U.S. holdings of foreign long-term securities and foreign holdings of U.S. long-term securities over time. The dates chosen are those when either a survey of foreign holdings of U.S. securities or a survey of U.S. holdings of foreign securities was conducted. Thus for each date one figure represents a survey-measured position and the other an estimated position.

#### 4. Market value of U.S. holdings of foreign long-term securities and foreign holdings of U.S. long-term securities, selected dates, 1994-2004

Billions of dollars except as noted

| Date      | U.S. holdings of foreign long-term securities | Foreign holdings of U.S. long-term securities | Ratio of U.S. holdings to foreign holdings | Net foreign holdings of long-term securities |
|-----------|---|---|--|--|
| Dec. 1994 | 870*  | 1,244   | .70  | 374  |
| Dec. 1997 | 1,755   | 2,806*  | .63  | 1,051  |
| Dec. 2001 | 2,170   | 3,944* <sup>r</sup>                           | .55 <sup>r</sup>                           | 1,774 <sup>r</sup>                           |
| Dec. 2003 | 2,954   | 4,970* <sup>r</sup>                           | .59 <sup>r</sup>                           | 2,016 <sup>r</sup>                           |
| Dec. 2004 | 3,553   | 6,010*  | .59  | 2,457  |

\* Staff estimates. r. Revised.

Foreign holdings of U.S. long-term securities have consistently exceeded U.S. holdings of foreign long-term securities. However, at year-end 2004 U.S. holdings of foreign equity (\$2,560 billion) exceeded estimated foreign holdings of U.S. equity (\$2,120 billion). Obviously, for holdings of long-term debt the situation was very different, with foreign holdings (\$3,890 billion) far exceeding U.S. holdings (\$993 billion).

A significant part of total foreign holdings of U.S. long-term debt securities at end-2004 (\$1,338 billion) are attributable to foreign official institutions; by contrast, total U.S. official holdings of foreign debt securities (both long and short-term) amounted to only \$23 billion at end-2004.<sup>7</sup> U.S. official holdings are excluded from the U.S. data on the IMF's CPIS website (<http://www.imf.org/external/np/sta/pi/cpis.htm>, discussed in the Introduction), thus those data will differ slightly from the data in this report.

#### Measured and Estimated Value of U.S. Holdings of Foreign Long-Term Securities

The United States has a two-part system for measuring cross-border securities activity. In addition to direct surveys of *positions*, such as those discussed in this report, the system also collects monthly data on cross-border *transactions* in long-term securities.<sup>8</sup> The monthly data are available with only a 45-day lag and can thus be combined with the most recent position data to

<sup>7</sup> Official institutions consist primarily of national government and multinational institutions involved in the formulation of international monetary policy, but also include national government-sponsored investment funds and other national government institutions. Data on such institutions are collected separately because the motivations behind holdings of official institutions may differ from those of other investors.

Information on U.S. official holdings at end-2004 can be found in Tables 1 and 2 in the article on foreign exchange operations of U.S. monetary authorities during the fourth quarter of 2004, which can be found on the web at <http://www.newyorkfed.org/newsevents/news/markets/2005/fxq404.pdf>.

<sup>8</sup> For a detailed discussion on the U.S. system for measuring cross-border financial flows, see W. Grier, G. Lee, and F. Warnock, "The U.S. System for Measuring Cross-Border Investment in Securities: a Primer with a Discussion of Recent Developments." *Federal Reserve Bulletin*, vol. 87 (October 2001), pp. 633-50, available online at <http://www.federalreserve.gov/pubs/bulletin/2001/1001lead.pdf>.

form more timely estimates of positions. The procedure involves adjusting data from the preceding survey for price and exchange rate changes, adding price-adjusted transactions data, and making adjustments for stock swaps and transactions costs. It should be noted that there are inherent inaccuracies in such estimates. For example, it is not possible to know precisely which foreign securities U.S. residents buy or sell or the exact timing of the transactions. Table 5 presents both the estimated and directly measured positions. There are errors possible in all parts of such computations: the previous survey, the transactions data, the adjustments, and the current survey.

### 5. Measured and estimated market value of U.S. holdings of foreign long-term securities, by type of security, as of December 31, 2004

Billions of dollars

| Type of security | December 2003 | January 2004 - December 2004 |                                    |                              |  | December 2004                 |              |                             |
|------------------|---------------|------------------------------|------------------------------------|------------------------------|--|-------------------------------|--------------|-----------------------------|
|                  | Measured (1)  | Net purchases (2)            | Transaction costs <sup>1</sup> (3) | Stock swaps <sup>1</sup> (4) | Valuation adjustments <sup>1</sup> (5) | Estimated (1)+(2)-(3)+(4)+(5) | Measured (7) | Measured less estimated (8) |
| Debt             | 874           | 68                           | 7                                  | n.a.                         | 81                                     | 1,016                         | 993          | (23)                        |
| Equity           | 2,079         | 85                           | 9                                  | (12)                         | 389                                    | 2,533                         | 2,560        | 28                          |
| <b>Total</b>     | <b>2,954</b>  | <b>153</b>                   | <b>16</b>                          | <b>(12)</b>                  | <b>470</b>                             | <b>3,549</b>                  | <b>3,553</b> | <b>5</b>                    |

n.a. Not applicable.

1. Staff estimates.

Despite the factors mentioned above, the estimated and measured levels of U.S. holdings of foreign securities were very close to each other. This may reflect the fact that both surveys and the monthly transactions system are measuring cross-border activity very accurately, or it could be the result of offsetting errors in either the measurements systems or the estimation process. It is, in any event, likely that both of the measurement systems have become more accurate in the past year.

Investigations into the reasons for the large disparity between the estimated and measured levels found by the preceding survey, combined with increasing frequency of the surveys to yearly, have resulted in improvements to each system.

The above table shows that only about a quarter (\$153 billion) of the almost \$600 billion increase in U.S. foreign holdings during 2004 resulted from increased net acquisitions of foreign long-term securities, with equity price appreciation and exchange rate gains accounting for the bulk of the net gain.

## U.S. Equity Investment by Country

Table 6 ranks countries based on the level of U.S. investment in their equity securities. Also shown is the relative size of each country's equity market based on data from Standard & Poor's *Global Stock Markets Factbook 2005*, and the ratio of U.S. holdings of the country's equities to the total market capitalization. This ratio can give a rough indication of the percentage of each country's total equities outstanding that are U.S.-owned. However, in some instances a company will incorporate in one country but have its securities trade in another. This practice can cause the ratio to yield odd results, such as those shown for Bermuda, where U.S. investors' holdings easily exceed the size of the country's domestic equity market.

For the leading countries (excluding Bermuda), U.S. investors held between 9 percent (Japan and France) and 22 percent (Netherlands) of the country's total equity markets. Overall, U.S. investors held approximately 11 percent of total foreign equities outstanding. By comparison, foreign investors held just over 9 percent of total U.S. equities as of June 2004.

### 6. Market value of U.S. holdings of foreign equities, by country, size of domestic equity markets, and share of each market that is U.S. held, for the countries attracting the most U.S. investment, as of December 31, 2004

Billions of dollars except as noted

| Country or region | Equity       | Rank according to market capitalization <sup>1</sup> | Ratio of U.S. holdings to total domestic market capitalization <sup>2</sup> |
|-------------------|--------------|--|---|
| United Kingdom    | 456          | 2  | .16   |
| Japan             | 330          | 1  | .09   |
| Canada            | 180          | 5  | .15   |
| France            | 165          | 3  | .09   |
| Bermuda           | 154          | 83   | >1  |
| Switzerland       | 138          | 8  | .17   |
| Netherlands       | 136          | 13   | .22   |
| Germany           | 124          | 4  | .10   |
| Cayman Islands    | 70           | 96   | >1  |
| Korea, South      | 67           | 16   | .16   |
| Rest of world     | 741          | n.a.   | n.a.  |
| <b>Total</b>      | <b>2,560</b> | <b>n.a.</b>  | <b>.11</b>  |

n.a. Not applicable.

1. Market capitalization data are from Standard & Poor's Global Stock Markets Factbook 2005. Market capitalizations are based on year-end 2004 total market values of domestic exchanges. Rank order excludes the United States, which has the largest equity market capitalization.

2. U.S. holdings include securities of companies registered in each country that may not trade on domestic exchanges, thus U.S. holdings can exceed the total size of a country's domestically-traded securities.

Table 28 in the Statistical Appendix shows the information contained in the above table for an expanded list of countries.

## U.S. Investment in Depositary Receipts

Table 7 again ranks countries based on the level of U.S. investment in their equity securities and in addition presents the amounts of this investment represented by holdings of depositary receipts (DRs), primarily American Depositary Receipts (ADRs). Depositary receipts are negotiable certificates held in a bank in one country that represent a specific number of shares of a stock that trades on an exchange in another country. They entitle their owners to all dividends, capital gains or losses, and voting rights, just as if the underlying shares were directly owned. ADRs are depositary receipts that trade on U.S. exchanges in U.S. dollars and that facilitate the holding and trading of foreign securities by U.S. residents.

### 7. Market value of U.S. holdings of foreign equities, by country and amount held in depositary receipts, for the countries attracting the most U.S. investment, as of December 31, 2004

Billions of dollars except as noted

| Country or region | Equity       | Depositary Receipts | Percentage<br>Depositary Receipts |
|-------------------|--------------|---------------------|-----------------------------------|
| United Kingdom    | 456          | 110                 | 24                                |
| Japan             | 330          | 20                  | 6                                 |
| Canada            | 180          | 1                   | 1                                 |
| France            | 165          | 21                  | 13                                |
| Bermuda           | 154          | 1                   | 1                                 |
| Switzerland       | 138          | 19                  | 14                                |
| Netherlands       | 136          | 36                  | 26                                |
| Germany           | 124          | 15                  | 12                                |
| Cayman Islands    | 70           | 3                   | 4                                 |
| Korea, South      | 67           | 13                  | 19                                |
| Rest of world     | 741          | 153                 | 21                                |
| <b>Total</b>      | <b>2,560</b> | <b>392</b>          | <b>15</b>                         |

Table 26 in the Statistical Appendix shows the information contained in the above table for an expanded list of countries.

### U.S. Investment in Foreign Debt Securities by Currency of Denomination

U.S. investors have a strong preference for foreign debt securities denominated in U.S. dollars. At year-end 2004, seventy-four percent of U.S.-owned foreign debt securities were denominated in U.S. dollars, compared with 69 percent at year-end 2003. During 2004, U.S. investors increased their holdings of U.S. dollar-denominated debt by \$163 billion while reducing their holdings of foreign currency-denominated debt by \$9 billion.

The preference for U.S. dollar-denominated debt was strongest in short-term securities, with 84 percent of all such holdings denominated in U.S. dollars, while 72 percent of long-term debt was dollar-denominated.

The vast majority of non-U.S. dollar-denominated foreign debt holdings are denominated in one of the world's other major currencies (Euros, Yen, British pounds, and Canadian dollars).

### 8. Market value of U.S. holdings of foreign debt securities, by currency of denomination, as of December 31, 2003, and December 31, 2004

Billions of dollars except as noted

| Currency         | 2004         |            | 2003         |            |
|------------------|--------------|------------|--------------|------------|
|                  | Amount       | Percentage | Amount       | Percentage |
| U.S. dollar      | 906          | 74         | 743          | 69         |
| Euro             | 159          | 13         | 170          | 16         |
| Yen              | 58           | 5          | 63           | 6          |
| U.K. pound       | 34           | 3          | 34           | 3          |
| Canadian dollar  | 33           | 3          | 32           | 3          |
| Other currencies | 36           | 3          | 30           | 3          |
| <b>Total</b>     | <b>1,226</b> | <b>100</b> | <b>1,073</b> | <b>100</b> |

Table 21 in the Statistical Appendix shows U.S. holdings of foreign long-term debt securities by country and currency for an expanded list of countries. Table 22 shows the same data for holdings of foreign short-term debt securities.

### Maturity Structure of U.S. Foreign Debt Holdings

Table 9 presents the maturity structure of U.S.-owned foreign long-term debt securities. In both the 2003 and 2004 surveys the median time-to-maturity, or remaining maturity, for long-term securities (those issued with an *original* time-to-maturity in excess of one year) was approximately 7 years. Securities issued by foreign governments had a slightly longer remaining time-to-maturity than those issued by the private sector.

#### 9. Market value of U.S. holdings of foreign long-term debt securities, by remaining maturity, as of December 31, 2003, and December 31, 2004

| Remaining maturity (years) | 2004 Percent of total <sup>1</sup> | 2003 percent of total <sup>1</sup> |
|----------------------------|------------------------------------|------------------------------------|
| One or less                | 7.8                                | 8.1                                |
| 1-2                        | 7.7                                | 7.4                                |
| 2-3                        | 6.5                                | 7.3                                |
| 3-4                        | 7.2                                | 7.3                                |
| 4-5                        | 7.6                                | 9.0                                |
| 5-6                        | 6.8                                | 6.3                                |
| 6-7                        | 8.7                                | 6.9                                |
| 7-8                        | 6.0                                | 7.1                                |
| 8-9                        | 6.7                                | 5.6                                |
| 9-10                       | 6.4                                | 6.7                                |
| 10-15                      | 6.9                                | 7.0                                |
| 15-20                      | 4.4                                | 4.9                                |
| 20-25                      | 3.9                                | 3.9                                |
| 25-30                      | 9.8                                | 9.7                                |
| 30-40                      | 3.7                                | 2.7                                |

1. Excludes perpetual bonds and securities with unknown maturity dates that together amounted to approximately \$30 billion in both 2003 and 2004, or about 3 percent of total foreign long-term debt securities held by U.S. residents.



## U.S. Holdings of Foreign Private and Government Debt

In the most recent survey U.S. investors held primarily long-term debt issued by private institutions. This pattern represents a significant shift from the first asset survey conducted in 1994, when U.S. investors held predominantly government debt. Each succeeding survey has shown an increasing percentage of U.S. holdings of foreign long-term debt invested in private sector securities (1994 - 25% private, 1997 - 48%, 2001 - 56%, 2003 - 62%, 2004 - 66%). U.S. holdings of short-term debt are highly concentrated in private sector issues.

### 10. Market value of U.S. holdings of foreign debt securities, by country and sector of issuer, as of December 31, 2004

Billions of dollars

| Country        | Total        | Long-term  |                         | Short-term |                         |
|----------------|--------------|------------|-------------------------|------------|-------------------------|
|                |              | Private    | Government <sup>1</sup> | Private    | Government <sup>1</sup> |
| United Kingdom | 282          | 156        | 15                      | 110        | *                       |
| Canada         | 164          | 102        | 50                      | 8          | 4                       |
| Cayman Islands | 126          | 114        | *                       | 12         | 0                       |
| Germany        | 78           | 22         | 46                      | 9          | 1                       |
| Netherlands    | 66           | 50         | 5                       | 10         | 1                       |
| Japan          | 54           | 3          | 34                      | *          | 17                      |
| France         | 52           | 24         | 18                      | 8          | 2                       |
| Australia      | 46           | 34         | 7                       | 6          | *                       |
| Luxembourg     | 30           | 27         | *                       | 4          | 0                       |
| Mexico         | 29           | 10         | 19                      | *          | *                       |
| Rest of world  | 299          | 117        | 140                     | 37         | 4                       |
| <b>Total</b>   | <b>1,226</b> | <b>659</b> | <b>334</b>              | <b>204</b> | <b>29</b>               |

\* Greater than zero but less than \$500 million.

1. "Government" refers to central, local, and provincial governments, as well as to government-sponsored or guaranteed corporations.

Table 25 in the Statistical Appendix shows the information contained in the above table for an expanded list of countries.

## U.S. Equity Investment by Type of Market

Table 11a and 11b present U.S. foreign portfolio investment by type of foreign market: advanced economies, Caribbean financial centers, and developing countries. Table 11a shows the levels of such investment in the two most recent surveys, while Table 11b compares this investment to the total size of the domestic equity markets.

Investment in the twenty-eight advanced economies accounted for the bulk of U.S. foreign investment in the two most recent surveys (Table 11a), attracting 81 percent and 79 percent of the total in 2003 and 2004, respectively. The share invested in both developing countries and Caribbean financial centers increased slightly between during 2004. Much of the investment recorded for the Caribbean financial centers results from investment in securities that are registered in these countries for tax or regulatory reasons by companies whose center of economic activity is elsewhere.

U.S. investment in the advanced economies and the Caribbean financial centers is predominantly in equity securities, whereas in the developing countries U.S. investment is split more equally between equity and debt securities.

### 11a. Market value of U.S. holdings of foreign securities in advanced economies, Caribbean financial centers, and developing countries and countries in transition, as of December 31, 2003, and December 31, 2004

Billions of dollars except as noted

| Market   | 2004         |            |              |              | 2003         |            |              |              |
|--|--------------|------------|--------------|--------------|--------------|------------|--------------|--------------|
|  | Total        | Pct.       | Equity       | Debt         | Total        | Pct.       | Equity       | Debt         |
| Advanced economies <sup>1</sup>                  | 3,003        | 79         | 2,076        | 928          | 2,564        | 81         | 1,723        | 841          |
| Caribbean financial centers <sup>2</sup>         | 421          | 11         | 277          | 144          | 291          | 9          | 195          | 96           |
| Developing countries and countries in transition | 362          | 10         | 207          | 154          | 297          | 9          | 162          | 136          |
| <b>Total</b>                                     | <b>3,787</b> | <b>100</b> | <b>2,560</b> | <b>1,226</b> | <b>3,152</b> | <b>100</b> | <b>2,079</b> | <b>1,073</b> |

1. Australia, Austria, Belgium, Canada, Cyprus, Denmark, Finland, France, Germany, Greece, Hong Kong, Iceland, Ireland, Israel, Italy, Japan, Luxembourg, the Netherlands, New Zealand, Norway, Portugal, Singapore, South Korea, Spain, Sweden, Switzerland, Taiwan, and the United Kingdom.

2. Bahamas, Bermuda, British Virgin Islands, Cayman Islands, Netherlands Antilles, and Panama.

According to the share-of-equity-markets-held criterion (Table 11b), U.S. investors show a clear preference for investment in the advanced economies compared with the developing world, holding almost twice as great a share of the advanced economies' markets. The figures for the Caribbean Financial Centers are essentially meaningless in this type of comparison, because many of the securities issued through these countries trade on exchanges outside of these countries, resulting in foreign ownership far exceeding total domestic market capitalization.

**11b. Market value of U.S. holdings of foreign equities in advanced economies, Caribbean financial centers, and developing countries and countries in transition, as a share of the total outstanding, as of December 31, 2004**

Billions of dollars except as noted

| Region/category                                  | Equity       | Ratio of U.S. holdings to total domestic market capitalization <sup>2</sup> |
|--|--------------|---|
| Advanced economies <sup>1</sup>                  | 2,076        | .110  |
| Caribbean financial centers <sup>2</sup>         | 277          | >1  |
| Developing countries and countries in transition | 207          | .056  |
| <b>Total</b>                                     | <b>2,560</b> | <b>.113</b>   |

1. Australia, Austria, Belgium, Canada, Cyprus, Denmark, Finland, France, Germany, Greece, Hong Kong, Iceland, Ireland, Israel, Italy, Japan, Luxembourg, the Netherlands, New Zealand, Norway, Portugal, Singapore, South Korea, Spain, Sweden, Switzerland, Taiwan, and the United Kingdom.

2. Bahamas, Bermuda, British Virgin Islands, Cayman Islands, Netherlands Antilles, and Panama.

**U.S. Portfolio Investment by Region**

Tables 12a and 12b show the distribution of U.S. portfolio investment by geographic region, with again the first table showing the levels of such investment in the two most recent surveys, while the following table compares this investment to the total size of the domestic equity markets.

Table 12a shows a relatively stable pattern for the two most recent surveys. In both surveys, slightly over half of all U.S. investment was in European securities and about one-sixth was in Asian securities. U.S. investment in Asia was very highly concentrated in equities (84 percent).

A large share of U.S. investment in Africa was directed to South Africa, which attracted \$25 billion of the \$35 billion invested in the continent. The Australia and Oceania line is composed primarily of investment in Australia and New Zealand. South America is the only region where U.S. investors held more debt than equity.

In Table 12b the percentage held is again not meaningful for the Caribbean region and is skewed upwards for Central America, due to the presence of offshore financial centers in these regions. The ratio for the Central American region drops to .213 (from .317) if Panama, an offshore center, is removed from the calculation.

**12a. Market value of U.S. holdings of foreign securities, by geographic region, as of December 31, 2003, and December 31, 2004**

Billions of dollars except as noted

| Region/category                                      | 2004         |            |              |              | 2003         |            |              |              |
|--|--------------|------------|--------------|--------------|--------------|------------|--------------|--------------|
|  | Total        | Percent    | Equity       | Debt         | Total        | Percent    | Equity       | Debt         |
| Europe   | 2,013        | 53         | 1,356        | 657          | 1,738        | 55         | 1,135        | 602          |
| Of which:<br>euro currency<br>countries <sup>1</sup> | 953          | 25         | 659          | 294          | 811          | 26         | 518          | 293          |
| Asia   | 664          | 18         | 566          | 98           | 538          | 17         | 454          | 83           |
| Caribbean <sup>2</sup>                               | 400          | 11         | 258          | 142          | 275          | 9          | 180          | 95           |
| Canada   | 345          | 9          | 180          | 164          | 301          | 10         | 149          | 152          |
| Australia and<br>Oceania                             | 120          | 3          | 65           | 54           | 102          | 3          | 61           | 41           |
| South America  | 97           | 3          | 48           | 49           | 79           | 3          | 36           | 42           |
| Central America <sup>3</sup>                         | 92           | 2          | 57           | 35           | 76           | 2          | 43           | 33           |
| Africa   | 35           | 1          | 29           | 6            | 25           | 1          | 19           | 7            |
| Int'l orgs.  | 20           | 1          | *            | 20           | 19           | 1          | *            | 18           |
| <b>Total</b>   | <b>3,787</b> | <b>100</b> | <b>2,560</b> | <b>1,226</b> | <b>3,152</b> | <b>100</b> | <b>2,079</b> | <b>1,073</b> |

\* Greater than zero but less than \$500 million.

1. Austria, Belgium, Finland, France, Germany, Greece, Ireland, Italy, Luxembourg, Netherlands, Portugal, and Spain.

2. Includes Bermuda and the Bahamas well as all Caribbean nations. This grouping is different than the Caribbean financial centers shown in tables 11a and 11b.

3. Includes Mexico.

**12b. Market value of U.S. holdings of foreign equities, by geographic region, as a share of the total outstanding, as of December 31, 2004**

Billions of dollars except as noted

| Region/category                                | Equity       | Ratio of U.S. holdings to total <sup>1</sup><br>domestic market capitalization <sup>1</sup> |
|--|--------------|---|
| Europe   | 1,356        | .116  |
| Of which: euro currency countries <sup>1</sup> | 659          | .097  |
| Asia   | 566          | .078  |
| Caribbean <sup>2</sup>                         | 258          | >1  |
| Canada   | 180          | .153  |
| Australia and Oceania                          | 65           | .080  |
| South America                                  | 48           | .088  |
| Central America                                | 57           | .317  |
| Africa   | 29           | .052  |
| <b>Total</b>                                   | <b>2,560</b> | <b>.113</b>   |

1. U.S. holdings include securities of companies registered in each country that may not trade on domestic exchanges, thus U.S. holdings can exceed the total market value of a country's domestically-traded securities.

2. Includes Bermuda and the Bahamas well as all Caribbean nations. This grouping is different than the Caribbean financial centers shown in tables 11a and 11b.

## **U.S. Ownership of Foreign Securities by Industry**

These data are presented using the Global Industry Classification Standard (GICS) system developed by Morgan Stanley Capital International and Standard & Poor's. This classification system was selected because it can be used to categorize security issuers worldwide, thus permitting both foreign holdings of U.S. securities and U.S. holdings of foreign securities to be presented using the same classification system.

Overall, the Commercial Banking sector (\$458 billion) attracted the highest level of U.S. portfolio investment, followed by Government (\$366 billion) and Oil and Gas (\$237 billion). These were also the sectors attracting the highest levels of U.S. investment in the preceding survey.

By security type, the sectors attracting the greatest investment were: equity - Commercial Banks (\$229 billion), Oil and Gas (\$217 billion), Insurance (\$142 billion); long-term debt - Government (\$337 billion), Commercial Banks (\$96 billion), Diversified Financial Services (\$75 billion); short-term debt - Commercial Banks (\$132 billion), Government (\$29 billion), Capital Markets (\$25 billion).

In the December 2003 survey, \$194 billion was categorized as Unknown because there was no readily available classification information. Significant resources were devoted to obtaining increased and improved industry sector information for the 2004 survey, resulting in the Unknown category being reduced to \$99 billion. This research also resulted in some securities being assigned different sector codes in the 2004 survey than they were assigned in the 2003 survey. Typically, these re-categorizations were from one sector into a related sector, as from Healthcare Equipment and Supplies to Pharmaceuticals.

**13. Market value of U.S. holdings of foreign securities, by industry, as of December 31, 2004**

Millions of dollars

| Industry                                 | Total   | Equity  | Debt      |            |
|--|---------|---------|-----------|------------|
|  |         |         | Long-term | Short-term |
| Aerospace & Defense                      | 22,453  | 15,176  | 7,277     | 0          |
| Air Freight & Logistics                  | 114     | 1       | 113       | 0          |
| Airlines                                 | 10,104  | 9,263   | 781       | 60         |
| Auto Components                          | 5,107   | 4,981   | 126       | 0          |
| Automobiles                              | 64,339  | 60,905  | 1,867     | 1,568      |
| Beverages                                | 37,516  | 30,171  | 7,033     | 311        |
| Biotechnology                            | 340     | 340     | 0         | 0          |
| Building Products                        | 1,639   | 1,388   | 251       | 0          |
| Capital Markets (including Mutual Funds) | 124,787 | 30,548  | 69,301    | 24,938     |
| Chemicals                                | 65,815  | 57,088  | 8,619     | 108        |
| Commercial Banks                         | 457,746 | 229,205 | 96,105    | 132,437    |
| Commercial Services & Supplies           | 79,222  | 70,455  | 8,767     | 0          |
| Communications Equipment                 | 111,394 | 79,086  | 32,308    | 0          |
| Computers & Peripherals                  | 10,924  | 10,457  | 467       | 0          |
| Construction & Engineering               | 29,236  | 26,371  | 2,865     | *          |
| Construction Materials                   | 40,752  | 35,397  | 5,070     | 285        |
| Consumer Finance                         | 11,317  | 9,486   | 780       | 1,052      |
| Containers & Packaging                   | 3,683   | 944     | 2,710     | 29         |
| Distributors                             | 6,359   | 6,205   | 153       | 0          |
| Diversified Financial Services           | 195,054 | 100,333 | 74,638    | 20,083     |
| Diversified Telecommunication Services   | 171,845 | 129,241 | 42,566    | 38         |
| Electric Utilities                       | 36,594  | 30,512  | 6,082     | 0          |
| Electrical Equipment                     | 69,330  | 67,802  | 1,528     | 0          |
| Electronic Equipment & Instruments       | 50,773  | 44,853  | 5,828     | 92         |
| Energy Equipment & Services              | 60,615  | 54,382  | 6,233     | 0          |
| Food & Staples Retailing                 | 30,241  | 27,112  | 3,126     | 3          |
| Food and Kindred Products                | 1,987   | 1,856   | 131       | 0          |
| Food Products                            | 13,801  | 11,478  | 1,816     | 507        |
| Gas Utilities                            | 77,067  | 48,911  | 27,702    | 454        |
| Government <sup>1</sup>                  | 365,979 | 495     | 336,597   | 28,887     |
| Health Care Equipment & Supplies         | 99,179  | 97,361  | 1,818     | 0          |
| Health Care Providers & Services         | 11,582  | 11,396  | 186       | 0          |
| Hotels, Restaurants & Leisure            | 48,098  | 43,353  | 4,672     | 73         |
| Household Durables                       | 33,752  | 32,783  | 969       | 0          |

1. Includes securities issued by local governments as well as government-sponsored or guaranteed corporations.

**13. Market value of U.S. holdings of foreign securities, by industry,  
as of December 31, 2004 (continued)**

Millions of dollars

| Industry                                 | Total            | Equity           | Debt           |                |
|--|------------------|------------------|----------------|----------------|
|  |                  |                  | Long-term      | Short-term     |
| Household Products                       | 53,289           | 51,267           | 1,734          | 287            |
| Industrial Conglomerates                 | 131,770          | 114,788          | 16,982         | 0              |
| Insurance                                | 155,232          | 141,779          | 11,559         | 1,894          |
| Internet & Catalog Retail                | 4,896            | 4,729            | 154            | 13             |
| Internet Software & Services             | 1,653            | 1,597            | 56             | 0              |
| IT Services                              | 18,842           | 16,820           | 1,002          | 1,020          |
| Leisure Equipment & Products             | 19,878           | 19,348           | 530            | 0              |
| Machinery                                | 56,843           | 53,164           | 3,679          | 0              |
| Marine                                   | 22,373           | 17,717           | 4,656          | 0              |
| Media                                    | 58,377           | 45,700           | 12,452         | 225            |
| Metals & Mining                          | 124,706          | 99,032           | 25,672         | 1              |
| Multi-utilities & Unregulated Power      | 5,450            | 3,307            | 1,337          | 806            |
| Multiline Retail                         | 9,941            | 9,461            | 480            | 0              |
| Office Electronics                       | 12,532           | 12,402           | 130            | 0              |
| Oil & Gas                                | 236,744          | 217,078          | 16,242         | 3,424          |
| Paper & Forest Products                  | 33,852           | 17,757           | 16,095         | 0              |
| Personal Products                        | 7,928            | 7,914            | 15             | 0              |
| Pharmaceuticals                          | 96,928           | 92,951           | 2,880          | 1,096          |
| Real Estate                              | 41,310           | 36,169           | 3,435          | 1,706          |
| Road & Rail                              | 23,851           | 17,259           | 6,592          | *              |
| Semiconductors & Semiconductor Equipment | 3,723            | 3,677            | 46             | 0              |
| Software                                 | 14,581           | 14,403           | 178            | 0              |
| Specialty Retail                         | 27,920           | 27,167           | 753            | 0              |
| Textiles, Apparel & Luxury Goods         | 25,328           | 24,661           | 558            | 110            |
| Thrifts & Mortgage Finance               | 83,206           | 13,903           | 60,526         | 8,777          |
| Tobacco                                  | 17,873           | 17,521           | 351            | 0              |
| Trading Companies & Distributors         | 6,182            | 6,112            | 71             | 0              |
| Transportation Infrastructure            | 4,708            | 3,681            | 615            | 412            |
| Water Utilities                          | 6,080            | 3,647            | 2,432          | 0              |
| Wireless Telecommunication Services      | 32,926           | 31,670           | 1,245          | 11             |
| Unknown                                  | 98,967           | 54,401           | 42,026         | 2,540          |
| <b>Total</b>                             | <b>3,786,635</b> | <b>2,560,418</b> | <b>992,969</b> | <b>233,248</b> |

## **Chapter 2. Data Collection Methodology**

### **Acknowledgments**

The Treasury Department, the Federal Reserve Bank of New York, and the Federal Reserve Board wish to express their appreciation to all survey respondents whose efforts and information have made this report possible.

In addition, the Department of the Treasury, the Federal Reserve Bank of New York and the Federal Reserve Board of Governors wish to express their appreciation to the Securities Reports Division of the Federal Reserve Bank of New York for preparation of the U.S. portfolio data. Under the direction of Patricia Selvaggi, divisional staff who were responsible for data analysis, for resolving often complex reporting issues, and for working with respondents to ensure comprehensive and accurate reporting, were: Kenneth Aberbach, Fiorella Bologono, Lois Burns, Evelyn Castillo, Aamna Farooq, Aaron Gononsky, Frank Innocenti, Brian Mullarkey, Dejana Neskovic, Jason Nuccio, Philip Papaalias, Marc Plotsker, Kristina Ryan and Julia Warren-Cagle. Automation staff who were responsible for working with respondents to submit properly formatted data files, and facilitating data loads and updates were: Amador Castillo, Melissa Harris and Susan Ma working under the direction of Howard Brickman. Business Systems Development staff who developed and enhanced the database and reports were: Gabriel Castillo, Yee Ying Chan, YukChong Kwan, Yuan Liu, Ashish Sharma and Aswin Subramaniam, working under the direction of Jean Stoloff and Kenneth Ruff. Staff who provided timely data entry and file loading support were: Mary Ann Campano, Jackie Charles-Gouraige, Natasha Fair and Ada Hernandez working under the direction of Laura Iannolino. Yvonne Nickens of the Board of Governors of the Federal Reserve System also provided valuable assistance in preparing this report.

### **Survey Design**

The goal of the 2004 survey was to obtain data on U.S. holdings of foreign securities in a manner that was accurate, cost-effective, and minimized burden on the public. For these reasons, data were collected only from the largest U.S.-resident custodians and end-investors, a relatively small group of institutions that collectively can report the vast majority of total U.S. holdings. Survey results were "grossed-up", as described below, to account for unmeasured data.

Custodians were required to report holdings of foreign securities at the individual security level. End-investors that did not use U.S.-resident custodians exclusively were required to report in the same manner. End-investors exclusively using U.S.-resident custodians were only required to report aggregate holdings so entrusted, by custodian and type of security.

In total, 220 firms reported data in this survey. Of these, 31 reported security-by-security data and 189 reported aggregate data entrusted to U.S. resident custodians.

A relatively small number of U.S. firms dominated the foreign securities custody business at the end of 2004. The ten largest respondents reported 90 percent of the total security-by-security data submitted on the survey. Eight institutions reported holdings in excess of \$100 billion, and



26 reported holdings in excess of \$10 billion. In total, some 513,000 records were submitted by survey respondents, of which 379,000 were equity records and 134,000 were debt security records. Banks were the leading custodians, though broker-dealers also reported significant amounts of custodial holdings.

Data provided by respondents were supplemented by data on security characteristics obtained online through Bloomberg Data Services. The collection of data on individual securities, combined with this ancillary information, made it possible for data compilers to present the data in a variety of ways without placing additional burden on survey respondents for that information.

This survey was conducted under the authority of the International Investment and Trade in Services Survey Act (22 U.S.C. 3101 et seq.). Reporting on the survey was mandatory, and penalties could have been imposed for noncompliance. Data were collected for holdings as of December 31, 2004, and were to be reported to the Federal Reserve Bank of New York, acting as agent for the Department of the Treasury, no later than the first Friday of March 2005. A copy of the survey forms and instructions is included in appendix B.

### **Data Analysis and Editing**

The detailed security level data submitted by respondents were subjected to extensive analysis and editing before they were accepted as accurate. In this process, respondents and the survey team worked together extensively to identify and resolve issues of concern. The first step in the process was to scrutinize respondent data to identify systemic errors within each respondent's submission. Each respondent's data were analyzed individually and compared with the data submitted in the previous year's survey. Reported securities with the largest market values were analyzed in detail, and the other reported securities were analyzed in the aggregate to identify common types of reporting errors.

Once the analysis of the data for each respondent was completed, the data were analyzed on a security-by-security basis, across all reporters. Securities subject to particular scrutiny included those with either a large quantity or market value reported, or with particularly high or low prices, or those securities comprising a large percentage of securities issued by a particular country.

The data were also examined by categories, such as country of issuer, type of security, and type of issuer. This review was especially useful in eliminating cases in which the mis-coding of a security with a small market value could have a large relative impact upon a small category.

The most common reporting problem was the provision of inconsistent information for the same security from different subparts of a large financial institution or from different reporting institutions. Procedures were developed to identify and resolve inconsistent reporting within a reporting institution as well as across reporting institutions.

Many securities were submitted without market values, which led to calculated prices of zero. In some cases, this presented no problem because the relevant price could be determined from commercial sources or from data submitted by other survey respondents. For the remaining

securities that were reported without market values, a great deal of time and effort was involved in attempting to determine their prices.

### **Avoidance of Data Gaps and Double Counting**

The reports of each respondent were examined to ensure that securities frequently omitted by respondents, such as those of international organizations resident in the United States and those of former U.S. corporations that had re-incorporated outside of the United States, were included. Checks were also made to detect and exclude securities of U.S.-resident entities. In addition, the security-by-security data provided by end-investors were examined to ensure that only securities held either directly or through foreign custodians were reported on a security-by-security basis.

In some cases, foreign securities may be entrusted to a U.S.-resident custodian which, in turn, entrusts the securities to another U.S.-resident custodian. To avoid double-counting in these instances, U.S.-resident custodians who passed the foreign securities to other U.S.-resident custodians were instructed not to provide security-by-security information on these securities, but instead to identify only the custodian(s) involved and the amount(s) entrusted. The reports provided by end-investors and U.S.-resident custodians who were using U.S.-resident sub-custodians were examined to ensure that all significant U.S.-resident custodians were included on the survey panel and to provide a crude check on the aggregate amounts reported by each custodian. Special analyses were performed to ensure that respondents excluded their foreign operations and foreign holders and included all of their U.S. organizational units.

## Gross-Up Factors and Calculation of Total U.S. Holdings of Foreign Securities

The December 2004 survey collected data from only the largest U.S.-resident custodians and U.S.-end-investors. Thus the data collected had to be "grossed-up" to provide an estimate for the unreported residual. The procedures used to perform this extrapolation are described below.

The December 2004 survey reporters collectively reported 94 percent of the total market value of securities reported on the December 2001 benchmark survey. However, the percentage of coverage varied significantly by type of issuer and type of security, as shown in Table 14.

### 14. Coverage in 2001 of the Institutions Reporting in 2004

Millions of dollars except as noted

| Type of security and foreign issuer<br>(a) | Total amount reported in 2001<br>(b) | Amount reported in 2001 by 2004 reporters<br>(c) | Percentage<br>(c) / (b) |
|--|--------------------------------------|--|-------------------------|
| Equity                                     |                                      |  |                         |
| Government issuers                         | 164                                  | 136  | 83                      |
| Other issuers                              | 1,611,418                            | 1,539,397  | 96                      |
| Short-Term Debt                            |                                      |  |                         |
| Government issuers                         | 15,971                               | 14,264   | 89                      |
| Other issuers                              | 130,878                              | 123,426  | 94                      |
| Long-Term Debt                             |                                      |  |                         |
| Government issuers                         | 224,944                              | 204,433  | 91                      |
| Other issuers                              | 276,322                              | 238,394  | 86                      |

One gross-up option was to extrapolate each component the 2004 data by the broad ratios (gross-up factors) in the last column in Table 14. However, extrapolating every country cell by a simple ratio (for that security type and issuer type) would lead to poor country specific results because the securities issued by entities in some countries are not uniformly likely to be held by the 2004 survey reporters. Performing the extrapolation on a country-by-country basis for each specific type of security and issuer would clearly provide more accurate country-specific results. However, in most cases, the sum of the country specific basic extrapolation will not equal the extrapolation provided by the ratios shown in Table 14. The reason, of course, is that through time there will be shifts in the relative amounts of U.S.-held securities issued by each country. The relative accuracy of the two procedures cannot be known.

The gross-up procedure used to estimate the market values for all foreign holdings was a two-step process. First, for each country and specific security type and issuer, a "first order" total market value was calculated. In almost all cases, this first order estimate was obtained by multiplying the 2004 reported market values by the corresponding 2001 gross-up factors

(obtained by dividing the 2001 reported market value for that country, type of security, and type of issuer for all reporters in 2001, by the corresponding amount reported in 2001 by the institutions on the 2004 panel). However, in some cases, mostly those in which the 2001 reported market values were small, the gross-up factor was above 2.0. In these cases (with a few exceptions for equities in which the ratio was only slightly above 2.0), it was felt that an additive process would yield, on average, more accurate results. Therefore, the 2004 estimates of total market value were obtained by adding the amount reported in 2001 by those reporters which were not on the 2004 panel to the reported 2004 data.

The first step yielded aggregate amounts, for most combinations of securities and issuers, that approximated the amounts which would have been obtained by using the gross-up factors shown in Table 14. However, where the sum of the amounts obtained using the country-specific ratios were significantly different from what would have been obtained by using the gross-up factors in Table 14, the individual country data were examined in order to determine the likely cause of the discrepancy and judgmental adjustments were applied. For example, if a country had a large increase in reported holdings by institutions in the 2004 panel and the multiplicative technique was used, the reviewers may have believed that the gross-up factor obtained from 2001 data was too high to be appropriate for 2004. If so, the factor was adjusted downward slightly. In some cases in which the additive option was used and the country experienced a major economic decline (or rapid growth), the additive amount was adjusted downward (or upward).

For security/issuer types in which U.S. residents had large holdings, these judgmental adjustments tended to be small. For security/issuer types in which the market values were small, the adjustments relied on specific information about the types of shifts observed and less effort was made to approximate the average factors shown in Table 14. In general, the judgmental adjustments made in 2004 (from 2001) were similar to those made in 2003 for two reasons: (1) the differences from 2001 observed in 2004 were similar to those observed in 2003, and (2) changing the adjustment strategy between 2003 and 2004 would have resulted in changes to the annual growth rates which were not data-based.

The final implicit gross-up factors used by type of issuer and broad security type are shown in Table 15.

**15. Implicit Final Gross-Up Factors Used**

| Type of security and foreign holder | Ratio of 2001 amount reported to amount reported in 2001 by 2004 reporters | Implicit gross-up factors actually used |
|-------------------------------------|--|---|
| <b>Equity</b>                       |  |   |
| Total                               | 1.04680  | 1.04500                                 |
| Government issuers                  | 1.20510  | 1.01715                                 |
| Other issuers                       | 1.04679  | 1.04503                                 |
| <b>Short-Term Debt</b>              |  |   |
| Total                               | 1.06653  | 1.07606                                 |
| Government issuers                  | 1.11967  | 1.07830                                 |
| Other issuers                       | 1.06038  | 1.07575                                 |
| <b>Long-Term Debt</b>               |  |   |
| Total                               | 1.13197  | 1.10698                                 |
| Government issuer                   | 1.10033  | 1.08496                                 |
| Other issuers                       | 1.15910  | 1.11849                                 |

Currency tables on a country-by-country basis also required extrapolation. The separate gross-up factors required to extrapolate these tables created minor differences in the adjusted currency totals by country when compared to the country data for each specific type of security and issuer. Realignment of these minor differences was achieved by “scaling” these tables. For each country, the grossed-up total by specific type of security was divided by the grossed-up total by currency. This ratio was then applied to the data for each currency for the specific country.

## Statistical Appendix

**16. Market value of U.S. holdings of foreign securities, by country and type of security, as of December 31, 2004**

Millions of dollars except as noted

| Country or region      | Total   | Equity  | Debt      |            |
|------------------------|---------|---------|-----------|------------|
|                        |         |         | Long-term | Short-term |
| Albania                | 5       | 0       | 5         | 0          |
| Andorra                | 2       | 2       | 0         | 0          |
| Anguilla               | 2       | 2       | 0         | 0          |
| Antigua and Barbuda    | 12      | 12      | *         | 0          |
| Argentina              | 4,827   | 1,161   | 3,664     | 1          |
| Aruba                  | 1,114   | *       | 1,114     | 0          |
| Australia              | 103,412 | 57,052  | 40,366    | 5,994      |
| Austria                | 15,249  | 8,976   | 4,682     | 1,591      |
| Bahamas                | 2,652   | 1,779   | 872       | 1          |
| Barbados               | 256     | 10      | 246       | 0          |
| Belgium                | 23,973  | 18,083  | 5,213     | 677        |
| Belize                 | 60      | 26      | 34        | 0          |
| Bermuda                | 164,074 | 153,549 | 9,862     | 663        |
| Bosnia and Herzegovina | 149     | 4       | 145       | 0          |
| Botswana               | 7       | 3       | 4         | 0          |
| Brazil                 | 62,999  | 43,104  | 19,885    | 10         |
| British Virgin Islands | 4,467   | 3,716   | 747       | 4          |
| Bulgaria               | 1,173   | 6       | 1,167     | 0          |
| Canada                 | 344,669 | 180,398 | 151,852   | 12,419     |
| Cayman Islands         | 195,677 | 69,750  | 114,378   | 11,549     |

\* Greater than zero but less than \$500,000.

**16. Market value of U.S. holdings of foreign securities, by country and type of security, as of December 31, 2004 (continued)**

Millions of dollars except as noted

| Country or region          | Total   | Equity  | Debt      |            |
|----------------------------|---------|---------|-----------|------------|
|                            |         |         | Long-term | Short-term |
| Chile                      | 11,598  | 2,564   | 9,034     | *          |
| China, Peoples Republic of | 12,723  | 11,645  | 1,065     | 12         |
| Colombia                   | 4,455   | 270     | 4,185     | *          |
| Cook Islands               | *       | *       | 0         | 0          |
| Costa Rica                 | 260     | 5       | 236       | 19         |
| Cote D'Ivoire              | 98      | 2       | 95        | 0          |
| Croatia                    | 716     | 234     | 482       | 0          |
| Cuba                       | 1       | *       | 1         | 0          |
| Cyprus                     | 103     | 3       | 100       | *          |
| Czech Republic             | 1,876   | 1,843   | 33        | 0          |
| Denmark                    | 23,882  | 14,488  | 8,292     | 1,103      |
| Dominican Republic         | 503     | *       | 472       | 31         |
| Ecuador                    | 1,115   | 25      | 1,066     | 24         |
| Egypt                      | 1,152   | 1,093   | 56        | 3          |
| El Salvador                | 674     | *       | 658       | 16         |
| Estonia                    | 343     | 304     | 39        | 0          |
| Falkland Islands           | *       | *       | 0         | 0          |
| Finland                    | 38,896  | 33,860  | 4,493     | 543        |
| France                     | 216,607 | 164,634 | 41,831    | 10,142     |
| French Guiana              | *       | *       | 0         | 0          |
| Germany                    | 201,376 | 123,685 | 67,918    | 9,772      |
| Ghana                      | 4       | 3       | 1         | *          |
| Gibraltar                  | 64      | 64      | 0         | 0          |

\* Greater than zero but less than \$500,000.



**16. Market value of U.S. holdings of foreign securities, by country and type of security, as of December 31, 2004 (continued)**

Millions of dollars except as noted

| Country or region | Total   | Equity  | Debt      |            |
|-------------------|---------|---------|-----------|------------|
|                   |         |         | Long-term | Short-term |
| Greece            | 8,290   | 6,980   | 1,310     | 0          |
| Grenada           | 2       | 0       | 2         | 0          |
| Guatemala         | 173     | 0       | 173       | 0          |
| Guernsey          | 5,941   | 5,399   | 542       | *          |
| Honduras          | 43      | 0       | 15        | 28         |
| Hong Kong         | 37,350  | 35,395  | 1,933     | 22         |
| Hungary           | 5,105   | 4,503   | 601       | *          |
| Iceland           | 243     | 2       | 241       | *          |
| India             | 23,525  | 23,152  | 363       | 10         |
| Indonesia         | 6,987   | 6,116   | 869       | 3          |
| Ireland           | 55,264  | 32,422  | 13,821    | 9,020      |
| Isle of Man       | 15      | *       | 15        | 0          |
| Israel            | 34,315  | 19,054  | 15,254    | 7          |
| Italy             | 77,710  | 57,494  | 17,352    | 2,864      |
| Jamaica           | 204     | 2       | 193       | 9          |
| Japan             | 384,099 | 330,427 | 36,433    | 17,240     |
| Jersey            | 12,352  | 436     | 6,638     | 5,278      |
| Jordan            | 41      | 19      | 22        | *          |
| Kazakhstan        | 346     | *       | 346       | 0          |
| Kenya             | 17      | 2       | 15        | 0          |
| Korea, South      | 73,613  | 66,639  | 6,905     | 70         |
| Kyrgyzstan        | 11      | *       | 11        | 0          |

\* Greater than zero but less than \$500,000.

**16. Market value of U.S. holdings of foreign securities, by country and type of security, as of December 31, 2004 (continued)**

Millions of dollars except as noted

| Country or region    | Total   | Equity  | Debt      |            |
|----------------------|---------|---------|-----------|------------|
|                      |         |         | Long-term | Short-term |
| Latvia               | 8       | 4       | 4         | 0          |
| Lebanon              | 223     | 49      | 174       | 0          |
| Lesotho              | 26      | 25      | 1         | 0          |
| Liberia              | 7,829   | 5,866   | 1,964     | 0          |
| Liechtenstein        | 35      | 35      | 0         | 0          |
| Lithuania            | 5       | 3       | 1         | 0          |
| Luxembourg           | 38,050  | 7,634   | 26,547    | 3,868      |
| Macedonia            | 40      | 0       | 40        | 0          |
| Malaysia             | 10,690  | 6,474   | 4,209     | 6          |
| Malta                | 17      | *       | 17        | 0          |
| Marshall Islands     | 4,475   | 3,727   | 748       | 0          |
| Mauritius            | 325     | 143     | 183       | 0          |
| Mexico               | 66,317  | 37,516  | 28,606    | 195        |
| Monaco               | 8       | 8       | 0         | 0          |
| Morocco              | 228     | 89      | 139       | 0          |
| Namibia              | 1       | 1       | 0         | 0          |
| Netherlands          | 202,361 | 136,467 | 55,077    | 10,817     |
| Netherlands Antilles | 30,277  | 28,730  | 1,522     | 25         |
| New Zealand          | 12,034  | 4,720   | 5,719     | 1,595      |
| Nicaragua            | 38      | 0       | 37        | 1          |

\* Greater than zero but less than \$500,000.

**16. Market value of U.S. holdings of foreign securities, by country and type of security, as of December 31, 2004 (continued)**

Millions of dollars except as noted

| Country or region     | Total   | Equity  | Debt      |            |
|-----------------------|---------|---------|-----------|------------|
|                       |         |         | Long-term | Short-term |
| Norway                | 30,477  | 18,153  | 10,270    | 2,055      |
| Pakistan              | 147     | 111     | 36        | 0          |
| Panama                | 24,303  | 19,450  | 4,830     | 24         |
| Papua New Guinea      | 314     | 314     | 0         | 0          |
| Peru                  | 3,875   | 666     | 3,208     | 1          |
| Philippines           | 5,690   | 2,222   | 3,468     | 0          |
| Poland                | 5,625   | 3,072   | 2,552     | 1          |
| Portugal              | 6,386   | 5,505   | 807       | 73         |
| Romania               | 172     | 120     | 52        | 0          |
| Russia                | 21,314  | 10,775  | 10,540    | 0          |
| Saint Kitts and Nevis | *       | *       | 0         | 0          |
| Saint Lucia           | 49      | 0       | 49        | 0          |
| Senegal               | *       | *       | 0         | 0          |
| Serbia and Montenegro | 1       | 0       | 1         | 0          |
| Singapore             | 29,195  | 23,968  | 5,113     | 114        |
| Slovakia              | 190     | *       | 190       | 0          |
| Slovenia              | 37      | 1       | 36        | 0          |
| South Africa          | 24,647  | 21,600  | 3,047     | *          |
| Spain                 | 68,905  | 63,002  | 5,072     | 831        |
| Sri Lanka             | 79      | 31      | 49        | *          |
| Swaziland             | 3       | *       | 3         | 0          |
| Sweden                | 62,398  | 38,284  | 14,577    | 9,537      |
| Switzerland           | 142,013 | 138,187 | 1,551     | 2,274      |

\* Greater than zero but less than \$500,000.

**16. Market value of U.S. holdings of foreign securities, by country and type of security, as of December 31, 2004 (continued)**

Millions of dollars except as noted

| Country or region                      | Total            | Equity           | Debt           |                |
|--|------------------|------------------|----------------|----------------|
|  |                  |                  | Long-term      | Short-term     |
| Taiwan                                 | 34,887           | 34,554           | 331            | 2              |
| Thailand                               | 7,113            | 5,961            | 1,136          | 16             |
| Trinidad and Tobago                    | 503              | 5                | 472            | 26             |
| Tunisia                                | 588              | *                | 588            | 0              |
| Turkey                                 | 8,224            | 5,561            | 2,577          | 87             |
| Turks and Caicos Islands               | *                | *                | 0              | 0              |
| Ukraine                                | 1,552            | 25               | 1,524          | 3              |
| United Kingdom                         | 737,754          | 455,919          | 171,446        | 110,390        |
| Uruguay                                | 1,303            | 6                | 1,297          | 0              |
| Venezuela                              | 6,863            | 636              | 6,226          | 0              |
| Vietnam                                | 113              | *                | 113            | 0              |
| Zambia                                 | 2                | 2                | 0              | 0              |
| Zimbabwe                               | 68               | 14               | 54             | 0              |
| Other and unknown                      | 1                | *                | *              | 0              |
| International Organizations            | 20,339           | 373              | 17,789         | 2,177          |
| Middle East oil-exporters <sup>1</sup> | 1,457            | 1                | 1,453          | 3              |
| African oil-exporters <sup>2</sup>     | 191              | 12               | 180            | 0              |
| <b>Total</b>                           | <b>3,786,635</b> | <b>2,560,418</b> | <b>992,969</b> | <b>233,248</b> |

1. Bahrain, Iran, Iraq, Kuwait, Oman, Qatar, Saudi Arabia, United Arab Emirates.

2. Algeria, Gabon, Libya, Nigeria.

\* Greater than zero but less than \$500,000.

### 17. Market value of U.S. holdings of foreign long-term securities, by country, as of the survey dates

Millions of dollars

| Country or category              | March 1994         | December 1997 | December 2001 | December 2003 | December 2004 |
|----------------------------------|--------------------|---------------|---------------|---------------|---------------|
| Albania                          | 0                  | 32            | 10            | 4             | 5             |
| Andorra                          | 0                  | 14            | 0             | 0             | 2             |
| Anguilla <sup>1</sup>            | n.a.               | 0             | 0             | 0             | 2             |
| Antigua and Barbuda              | 0                  | 0             | 0             | 1             | 12            |
| Argentina                        | 16,319             | 38,567        | 4,379         | 4,304         | 4,826         |
| Aruba                            | 0                  | 22            | 271           | 906           | 1,114         |
| Australia                        | 26,592             | 46,999        | 53,111        | 85,672        | 97,418        |
| Austria                          | 2,626              | 5,662         | 3,510         | 9,170         | 13,659        |
| Bahamas                          | 1,064              | 910           | 1,640         | 2,889         | 2,650         |
| Bangladesh                       | 5                  | 7             | 4             | *             | 0             |
| Barbados                         | 0                  | 17            | 54            | 253           | 256           |
| Belarus                          | 0                  | 3             | 0             | *             | 0             |
| Belgium-Luxembourg <sup>2</sup>  | 7,329 <sup>r</sup> | n.a.          | n.a.          | n.a.          | n.a.          |
| Belgium <sup>2</sup>             | n.a.               | 9,169         | 12,140        | 15,764        | 23,297        |
| Belize                           | 5                  | 34            | 8             | 77            | 60            |
| Bermuda                          | 9,115              | 26,607        | 125,207       | 116,206       | 163,411       |
| Bolivia                          | 1                  | 12            | 0             | 2             | 0             |
| Bosnia and Herzegovina           | 0                  | 3             | 11            | 50            | 149           |
| Botswana                         | 1                  | 147           | 22            | 4             | 7             |
| Brazil                           | 12,013             | 51,656        | 33,453        | 50,146        | 62,989        |
| British Virgin Islands           | n.a.               | 1,138         | 2,011         | 3,599         | 4,463         |
| British West Indies <sup>1</sup> | 10,803             | n.a.          | n.a.          | n.a.          | n.a.          |

\* Greater than zero but less than \$500,000. n.a. Not available r. Revised.

1. Separate reporting for Anguilla, British Virgin Islands, Cayman Islands, Montserrat, and Turks and Caicos began with the 1997 survey; previously these were reported as the British West Indies.

2. Belgium and Luxembourg were reported as a combined entity in the 1994 survey.

**17. Market value of U.S. holdings of foreign long-term securities, by country, as of the survey dates (continued)**

Millions of dollars

| Country or category         | March 1994        | December 1997 | December 2001 | December 2003 | December 2004 |
|-----------------------------|-------------------|---------------|---------------|---------------|---------------|
| Bulgaria                    | 23                | 1,310         | 1,763         | 1,443         | 1,173         |
| Burma                       | 0                 | 142           | 0             | 0             | 0             |
| Cambodia                    | 0                 | 1             | 0             | 0             | 0             |
| Cameroon                    | 0                 | 4             | 0             | 0             | 0             |
| Canada                      | 108,190           | 177,473       | 205,209       | 288,700       | 332,249       |
| Cayman Islands <sup>1</sup> | n.a. <sup>r</sup> | 19,247        | 70,081        | 120,954       | 184,128       |
| Central African Republic    | 0                 | 0             | 1             | 0             | 0             |
| Chile                       | 2,671             | 8,126         | 5,947         | 9,697         | 11,598        |
| China, Peoples Republic of  | 2,085             | 5,434         | 3,004         | 13,731        | 12,710        |
| Colombia                    | 555               | 4,163         | 2,760         | 3,488         | 4,455         |
| Comoros                     | 0                 | 21            | 0             | *             | 0             |
| Congo (Brazzaville)         | 0                 | 13            | 0             | 0             | 0             |
| Congo (Kinshasa)            | 0                 | *             | 0             | 0             | 0             |
| Cook Islands                | 0                 | 1             | 0             | 0             | *             |
| Costa Rica                  | 111               | 165           | 158           | 319           | 241           |
| Cote D'Ivoire               | 19                | 458           | 162           | 96            | 98            |
| Croatia                     | 10                | 496           | 763           | 676           | 716           |
| Cuba                        | 1 <sup>r</sup>    | *             | 0             | *             | 1             |
| Cyprus                      | 0                 | 322           | 110           | 101           | 103           |
| Czech Republic              | 453               | 808           | 481           | 1,293         | 1,876         |
| Denmark                     | 9,911             | 16,758        | 11,551        | 20,416        | 22,780        |
| Dominica                    | 0                 | 2             | 0             | 0             | 0             |

\* Greater than zero but less than \$500,000. r. Revised.

1. Separate reporting for Anguilla, British Virgin Islands, Cayman Islands, Montserrat, and Turks and Caicos began with the 1997 survey; previously these were reported as the British West Indies.

**17. Market value of U.S. holdings of foreign long-term securities, by country, as of the survey dates (continued)**

Millions of dollars

| Country or category   | March 1994          | December 1997 | December 2001 | December 2003 | December 2004 |
|-----------------------|---------------------|---------------|---------------|---------------|---------------|
| Dominican Republic    | 0                   | 87            | 164           | 512           | 472           |
| Ecuador               | 201                 | 2,032         | 774           | 902           | 1,091         |
| Egypt                 | 2                   | 832           | 603           | 571           | 1,149         |
| El Salvador           | 0                   | 51            | 51            | 582           | 658           |
| Estonia               | 0                   | 27            | 44            | 174           | 343           |
| Ethiopia              | 0                   | *             | 0             | 0             | 0             |
| Falkland Islands      | 0                   | 0             | 0             | 0             | *             |
| Finland               | 7,052 <sup>r</sup>  | 20,715        | 54,604        | 40,705        | 38,353        |
| France                | 42,412 <sup>r</sup> | 99,752        | 138,291       | 173,716       | 206,465       |
| French Guiana         | 0                   | *             | 0             | *             | *             |
| Gambia                | 0                   | 32            | 22            | 30            | 0             |
| Georgia               | 0                   | *             | 4             | *             | 0             |
| Germany               | 47,652              | 108,414       | 118,319       | 174,641       | 191,604       |
| Ghana                 | 12                  | 358           | 208           | 350           | 4             |
| Gibraltar             | 259                 | *             | 22            | 11            | 64            |
| Greece                | 676                 | 2,741         | 4,563         | 5,935         | 8,290         |
| Grenada               | 0                   | *             | 8             | 6             | 2             |
| Guadeloupe            | 0                   | 1             | 0             | 0             | 0             |
| Guatemala             | 28                  | 193           | 58            | 109           | 173           |
| Guernsey <sup>1</sup> | n.a.                | 450           | 4,645         | 5,348         | 5,941         |
| Guyana                | 0                   | *             | 0             | 5             | 0             |
| Haiti                 | 0                   | *             | 0             | 0             | 0             |

\* Greater than zero but less than \$500,000. r. Revised.

1. Separate reporting for Guernsey and Jersey began with the 1997 survey; in the 1994 survey these were included in the United Kingdom.

**17. Market value of U.S. holdings of foreign long-term securities, by country, as of the survey dates (continued)**

Millions of dollars

| Country or category | March 1994          | December 1997 | December 2001 | December 2003 | December 2004 |
|---------------------|---------------------|---------------|---------------|---------------|---------------|
| Honduras            | 0                   | 17            | 17            | 22            | 15            |
| Hong Kong           | 18,171              | 31,628        | 32,047        | 37,628        | 37,328        |
| Hungary             | 567                 | 4,846         | 2,026         | 3,064         | 5,104         |
| Iceland             | 352                 | 309           | 224           | 133           | 243           |
| India               | 1,352               | 8,138         | 7,173         | 18,683        | 23,515        |
| Indonesia           | 2,164               | 4,345         | 1,841         | 5,072         | 6,985         |
| Ireland             | 4,482               | 17,666        | 31,384        | 30,642        | 46,244        |
| Isle of Man         | 0                   | 9             | 1             | 0             | 15            |
| Israel              | 4,436               | 12,298        | 21,180        | 28,653        | 34,308        |
| Italy               | 31,587 <sup>r</sup> | 59,171        | 46,985        | 63,927        | 74,845        |
| Jamaica             | 7                   | 329           | 268           | 40            | 195           |
| Japan               | 131,198             | 166,758       | 196,866       | 292,668       | 366,860       |
| Jersey <sup>1</sup> | n.a.                | 1,554         | 1,615         | 5,197         | 7,074         |
| Jordan              | 39                  | 219           | 98            | 57            | 41            |
| Kazakhstan          | 0                   | 121           | 140           | 102           | 346           |
| Kenya               | 0                   | 36            | 16            | 22            | 17            |
| Kiribati            | 0                   | 24            | 0             | 0             | 0             |
| Korea, South        | 6,925               | 15,262        | 34,475        | 53,338        | 73,544        |
| Kyrgyzstan          | 0                   | 0             | 0             | *             | 11            |
| Latvia              | 0                   | 4             | 13            | *             | 8             |
| Lebanon             | 6                   | 813           | 87            | 151           | 223           |
| Lesotho             | 0                   | 73            | 2             | 2             | 26            |

\* Greater than zero but less than \$500,000. r. Revised.

1. Separate reporting for Guernsey and Jersey began with the 1997 survey; in the 1994 survey these were included in the United Kingdom.



**17. Market value of U.S. holdings of foreign long-term securities, by country, as of the survey dates (continued)**

Millions of dollars

| Country or category     | March<br>1994       | December<br>1997 | December<br>2001 | December<br>2003 | December<br>2004 |
|-------------------------|---------------------|------------------|------------------|------------------|------------------|
| Liberia                 | 291                 | 1,400            | 1,359            | 4,328            | 7,829            |
| Liechtenstein           | 70                  | 5                | 59               | 19               | 35               |
| Lithuania               | 0                   | 41               | 51               | 28               | 5                |
| Luxembourg <sup>1</sup> | n.a.                | 8,289            | 10,941           | 21,069           | 34,181           |
| Macedonia               | 0                   | 20               | 34               | 42               | 40               |
| Madagascar              | 0                   | 2                | 3                | 0                | 0                |
| Malawi                  | 0                   | 0                | 19               | 0                | 0                |
| Malaysia                | 9,564               | 9,078            | 4,258            | 7,954            | 10,684           |
| Maldives                | 0                   | *                | 0                | 0                | 0                |
| Mali                    | 0                   | 0                | 4                | 0                | 0                |
| Malta                   | 43                  | 148              | 93               | 19               | 17               |
| Marshall Islands        | 72                  | 35               | 66               | 942              | 4,475            |
| Mauritius               | 3                   | 731              | 149              | 174              | 325              |
| Mexico                  | 51,526              | 63,751           | 48,772           | 56,145           | 66,121           |
| Moldova                 | 0                   | 39               | 29               | 0                | 0                |
| Monaco                  | 25                  | 0                | 2                | 3                | 8                |
| Mongolia                | 0                   | 0                | 0                | 1                | 0                |
| Morocco                 | 365                 | 561              | 369              | 162              | 228              |
| Mozambique              | 0                   | 0                | 3                | 0                | 0                |
| Namibia                 | 9                   | 132              | 1                | 3                | 1                |
| Netherlands             | 47,464 <sup>r</sup> | 120,150          | 143,375          | 173,780          | 191,544          |
| Netherlands Antilles    | 10,326              | 17,002           | 15,871           | 24,727           | 30,252           |

n.a. Not available. \* Greater than zero but less than \$500,000. r. Revised.

1. Belgium and Luxembourg were reported as a combined entity in the 1994 survey.

**17. Market value of U.S. holdings of foreign long-term securities, by country, as of the survey dates (continued)**

Millions of dollars

| Country or category         | March 1994 | December 1997 | December 2001 | December 2003 | December 2004 |
|-----------------------------|------------|---------------|---------------|---------------|---------------|
| New Caledonia               | 0          | 1             | 0             | 0             | 0             |
| New Zealand                 | 6,283      | 8,817         | 4,056         | 8,905         | 10,439        |
| Nicaragua                   | 7          | 76            | 19            | 0             | 37            |
| Norway                      | 6,349      | 14,267        | 13,831        | 20,168        | 28,422        |
| Pakistan                    | 226        | 1,521         | 180           | 133           | 147           |
| Palau                       | 0          | 1             | 0             | 0             | 0             |
| Panama                      | 2,208      | 6,595         | 9,868         | 18,583        | 24,279        |
| Papua New Guinea            | 55         | 174           | 155           | 235           | 314           |
| Paraguay                    | 1          | 81            | 0             | 0             | 0             |
| Peru                        | 463        | 3,544         | 1,673         | 3,999         | 3,874         |
| Philippines                 | 2,491      | 7,327         | 4,015         | 5,037         | 5,690         |
| Poland                      | 95         | 4,495         | 3,098         | 3,480         | 5,624         |
| Portugal                    | 1,323      | 8,233         | 4,350         | 5,077         | 6,313         |
| Romania                     | 0          | 211           | 13            | 151           | 172           |
| Russia                      | 47         | 12,153        | 10,208        | 21,554        | 21,314        |
| Rwanda                      | 0          | *             | 0             | 0             | 0             |
| Saint Kitts and Nevis       | 0          | *             | 0             | *             | *             |
| Saint Lucia                 | 0          | 0             | 0             | 0             | 49            |
| Saint Vincent and Grenadine | 1          | 0             | 0             | 0             | 0             |
| Sao Tome and Principe       | 0          | 33            | 0             | 0             | 0             |
| Senegal                     | 1          | 7             | 0             | *             | *             |
| Serbia and Montenegro       | 0          | 13            | 1             | 15            | 1             |

\* Greater than zero but less than \$500,000.

**17. Market value of U.S. holdings of foreign long-term securities, by country, as of the survey dates (continued)**

Millions of dollars

| Country or category | March 1994 | December 1997 | December 2001 | December 2003 | December 2004 |
|---------------------|------------|---------------|---------------|---------------|---------------|
| Seychelles          | 0          | 52            | 0             | 1             | 0             |
| Sierra Leone        | 0          | 1             | 0             | *             | 0             |
| Singapore           | 6,838      | 10,735        | 22,818        | 24,883        | 29,081        |
| Slovakia            | 1          | 184           | 133           | 88            | 190           |
| Slovenia            | 0          | 224           | 14            | 87            | 37            |
| Solomon Islands     | 0          | *             | 0             | 0             | 0             |
| Somalia             | 0          | 6             | 0             | *             | 0             |
| South Africa        | 5,179      | 12,541        | 7,861         | 17,849        | 24,647        |
| Spain               | 24,493     | 32,146        | 39,825        | 50,094        | 68,074        |
| Sri Lanka           | 86         | 193           | 158           | 87            | 79            |
| Sudan               | 0          | *             | 0             | 0             | 0             |
| Suriname            | 0          | 46            | 0             | 0             | 0             |
| Swaziland           | 0          | 1             | 3             | 5             | 3             |
| Sweden              | 21,925     | 51,886        | 33,606        | 40,284        | 52,862        |
| Switzerland         | 21,073     | 63,140        | 76,354        | 119,000       | 139,738       |
| Taiwan              | 531        | 6,227         | 19,860        | 27,228        | 34,885        |
| Tanzania            | 0          | *             | 7             | 0             | 0             |
| Thailand            | 4,793      | 5,624         | 2,698         | 7,312         | 7,097         |
| Tokelau Islands     | 0          | 20            | 0             | *             | 0             |
| Tonga               | 0          | 50            | 0             | 0             | 0             |
| Trinidad and Tobago | 83         | 464           | 469           | 606           | 477           |
| Tunisia             | 37         | 280           | 168           | 1,280         | 588           |

\* Greater than zero but less than \$500,000.

1. Separate reporting for Anguilla, British Virgin Islands, Cayman Islands, Montserrat, and Turks and Caicos began with the 1997 survey; previously these were reported as the British West Indies.

**17. Market value of U.S. holdings of foreign long-term securities, by country, as of the survey dates (continued)**

Millions of dollars

| Country or category                    | March 1994           | December 1997    | December 2001    | December 2003    | December 2004    |
|--|----------------------|------------------|------------------|------------------|------------------|
| Turkey                                 | 963                  | 7,010            | 3,525            | 5,713            | 8,137            |
| Turks and Caicos Islands <sup>1</sup>  | n.a.                 | 419              | 32               | 57               | *                |
| Uganda                                 | 0                    | 1                | 5                | *                | 0                |
| Ukraine                                | 0                    | 90               | 203              | 603              | 1,548            |
| United Kingdom <sup>2</sup>            | 119,607 <sup>r</sup> | 271,680          | 430,882          | 563,955          | 627,365          |
| Uruguay                                | 254                  | 613              | 603              | 603              | 1,303            |
| Uzbekistan                             | 0                    | 0                | 1                | 4                | 0                |
| Venezuela                              | 5,115                | 7,827            | 3,655            | 5,303            | 6,863            |
| Vietnam                                | 0                    | 37               | 21               | 81               | 113              |
| Zambia                                 | 18                   | 9                | 5                | 5                | 2                |
| Zimbabwe                               | 75                   | 169              | 88               | 61               | 68               |
| Country Unknown                        | 180 <sup>r</sup>     | 870              | 40               | 35               | *                |
| International Organizations            | 9,854 <sup>r</sup>   | 16,975           | 11,878           | 17,552           | 18,162           |
| Middle East oil-exporters <sup>3</sup> | 0 <sup>r</sup>       | 458              | 602              | 990              | 1,454            |
| African oil-exporters <sup>4</sup>     | 361 <sup>r</sup>     | 843              | 636              | 320              | 191              |
| <b>Total</b>                           | <b>870,260</b>       | <b>1,755,015</b> | <b>2,169,735</b> | <b>2,953,781</b> | <b>3,553,387</b> |

\* Greater than zero but less than \$500,000. r. Revised.

1. Separate reporting for Anguilla, British Virgin Islands, Cayman Islands, Montserrat, and Turks and Caicos began with the 1997 survey; previously these were reported as the British West Indies.

2. Separate reporting for Guernsey and Jersey began with the 1997 survey; in the 1994 survey these were included in the United Kingdom.

3. Bahrain, Iran, Iraq, Kuwait, Oman, Qatar, Saudi Arabia, United Arab Emirates.

4. Algeria, Gabon, Libya, Nigeria.

**18. Market value of U.S. holdings of foreign equities, by country, as of the survey dates**

Millions of dollars

| Country or category                 | March<br>1994 | December<br>1997 | December<br>2001 | December<br>2003 | December<br>2004 |
|-------------------------------------|---------------|------------------|------------------|------------------|------------------|
| Albania                             | 0             | 0                | 0                | 0                | 0                |
| Andorra                             | 0             | 5                | 0                | 0                | 2                |
| Anguilla <sup>1</sup>               | n.a.          | 0                | 0                | 0                | 2                |
| Antigua and Barbuda                 | 0             | 0                | 0                | 1                | 12               |
| Argentina                           | 7,616         | 12,892           | 744              | 846              | 1,161            |
| Aruba                               | 0             | 11               | *                | 0                | *                |
| Australia                           | 16,917        | 31,120           | 37,112           | 56,454           | 57,052           |
| Austria                             | 1,223         | 3,707            | 1,204            | 3,925            | 8,976            |
| Bahamas                             | 88            | 568              | 1,162            | 1,819            | 1,779            |
| Bangladesh                          | 5             | 7                | 4                | 0                | 0                |
| Barbados                            | 0             | 1                | 1                | 2                | 10               |
| Belarus                             | 0             | 1                | 0                | 0                | 0                |
| Belgium-Luxembourg <sup>2</sup>     | 5,021         | n.a.             | n.a.             | n.a.             | n.a.             |
| Belgium <sup>2</sup>                | n.a.          | 6,099            | 8,415            | 10,621           | 18,083           |
| Belize                              | 5             | 29               | 7                | 25               | 26               |
| Bermuda                             | 8,356         | 22,617           | 118,878          | 107,538          | 153,549          |
| Bolivia                             | 0             | *                | *                | 2                | 0                |
| Bosnia and Herzegovina              | 0             | 0                | 1                | 0                | 4                |
| Botswana                            | 1             | 131              | 20               | 3                | 3                |
| Brazil                              | 8,447         | 31,338           | 21,801           | 31,781           | 43,104           |
| British Virgin Islands <sup>1</sup> | n.a.          | 698              | 1,774            | 2,269            | 3,716            |
| British West Indies <sup>1</sup>    | 6,536         | n.a.             | n.a.             | n.a.             | n.a.             |

\* Greater than zero but less than \$500,000. n.a. Not available.

1. Separate reporting for Anguilla, British Virgin Islands, Cayman Islands, Montserrat, and Turks and Caicos began with the 1997 survey; previously these were reported as the British West Indies.

2. Belgium and Luxembourg were reported as a combined entity in the 1994 survey.

**18. Market value of U.S. holdings of foreign equities, by country, as of the survey dates**  
(continued)

Millions of dollars

| Country or category         | March<br>1994 | December<br>1997 | December<br>2001 | December<br>2003 | December<br>2004 |
|-----------------------------|---------------|------------------|------------------|------------------|------------------|
| Bulgaria                    | 0             | *                | *                | 5                | 6                |
| Burma                       | 0             | 3                | 0                | 0                | 0                |
| Cambodia                    | 0             | 1                | 0                | 0                | 0                |
| Cameroon                    | 0             | 0                | 0                | 0                | 0                |
| Canada                      | 39,655        | 70,798           | 89,591           | 149,267          | 180,398          |
| Cayman Islands <sup>1</sup> | n.a.          | 5,612            | 35,764           | 45,287           | 69,750           |
| Central African Republic    | 0             | 0                | 0                | 0                | 0                |
| Chad                        | 0             | 0                | 0                | 0                | 0                |
| Chile                       | 2,492         | 4,555            | 1,917            | 2,102            | 2,564            |
| China, Peoples Republic of  | 899           | 2,256            | 2,370            | 13,064           | 11,645           |
| Colombia                    | 284           | 704              | 150              | 133              | 270              |
| Comoros                     | 0             | 2                | 0                | *                | 0                |
| Congo (Brazzaville)         | 0             | 0                | 0                | 0                | 0                |
| Congo (Kinshasa)            | 0             | *                | 0                | 0                | 0                |
| Cook Islands                | 0             | 1                | 0                | 0                | 0                |
| Costa Rica                  | 0             | *                | 5                | 5                | 5                |
| Cote D'Ivoire               | 0             | 2                | 6                | 0                | 2                |
| Croatia                     | 0             | 126              | 255              | 270              | 234              |
| Cuba                        | 0             | *                | 0                | *                | *                |
| Cyprus                      | 0             | 120              | 59               | 17               | 3                |
| Czech Republic              | 300           | 763              | 444              | 1,249            | 1,843            |
| Denmark                     | 1,819         | 8,917            | 7,533            | 10,429           | 14,488           |

\* Greater than zero but less than \$500,000.

1. Separate reporting for Anguilla, British Virgin Islands, Cayman Islands, Montserrat, and Turks and Caicos began with the 1997 survey; previously these were reported as the British West Indies.

**18. Market value of U.S. holdings of foreign equities, by country, as of the survey dates**  
(continued)

Millions of dollars

| Country or category   | March<br>1994 | December<br>1997 | December<br>2001 | December<br>2003 | December<br>2004 |
|-----------------------|---------------|------------------|------------------|------------------|------------------|
| Dominica              | 0             | 2                | 0                | 0                | 0                |
| Dominican Republic    | 0             | *                | 13               | 4                | *                |
| Ecuador               | 6             | 98               | 18               | 5                | 25               |
| Egypt                 | 2             | 763              | 340              | 523              | 1,093            |
| El Salvador           | 0             | 39               | 2                | 0                | *                |
| Estonia               | 0             | 17               | 39               | 138              | 304              |
| Falkland Islands      | 0             | 0                | 0                | 0                | *                |
| Finland               | 2,957         | 14,785           | 51,307           | 35,162           | 33,860           |
| France                | 25,647        | 85,019           | 112,205          | 130,761          | 164,634          |
| French Guiana         | 0             | *                | 0                | *                | *                |
| Gambia                | 0             | *                | 1                | 0                | 0                |
| Georgia               | 0             | *                | 3                | *                | 0                |
| Germany               | 25,580        | 64,965           | 72,200           | 103,239          | 123,685          |
| Ghana                 | 12            | 358              | 207              | 349              | 3                |
| Gibraltar             | 252           | *                | 22               | 1                | 64               |
| Greece                | 538           | 1,513            | 2,810            | 3,957            | 6,980            |
| Grenada               | 0             | *                | *                | 0                | 0                |
| Guadeloupe            | 0             | 0                | 0                | 0                | 0                |
| Guatemala             | 0             | 2                | 0                | 0                | 0                |
| Guernsey <sup>1</sup> | n.a.          | 378              | 4,576            | 4,636            | 5,399            |
| Guyana                | 0             | *                | 0                | 0                | 0                |
| Honduras              | 0             | *                | 0                | *                | 0                |

\* Greater than zero but less than \$500,000.

1. Separate reporting for Guernsey and Jersey began with the 1997 survey; in the 1994 survey these were included in the United Kingdom.

**18. Market value of U.S. holdings of foreign equities, by country, as of the survey dates**  
(continued)

Millions of dollars

| Country or category | March<br>1994 | December<br>1997 | December<br>2001 | December<br>2003 | December<br>2004 |
|---------------------|---------------|------------------|------------------|------------------|------------------|
| Hong Kong           | 17,527        | 28,102           | 30,154           | 36,210           | 35,395           |
| Hungary             | 145           | 3,483            | 1,702            | 2,412            | 4,503            |
| Iceland             | 0             | 3                | 41               | 3                | 2                |
| India               | 1,134         | 6,176            | 6,897            | 18,500           | 23,152           |
| Indonesia           | 1,935         | 2,488            | 1,526            | 4,406            | 6,116            |
| Ireland             | 2,641         | 14,147           | 28,374           | 22,191           | 32,422           |
| Isle of Man         | 0             | 9                | 1                | 0                | *                |
| Israel              | 2,581         | 7,036            | 13,333           | 16,361           | 19,054           |
| Italy               | 13,797        | 41,547           | 33,686           | 38,971           | 57,494           |
| Jamaica             | 4             | 3                | 1                | 1                | 2                |
| Japan               | 99,413        | 136,404          | 170,714          | 255,494          | 330,427          |
| Jersey <sup>1</sup> | n.a.          | 1,517            | 29               | 867              | 436              |
| Jordan              | 0             | 40               | 61               | 40               | 19               |
| Kazakhstan          | 0             | 1                | 2                | *                | *                |
| Kenya               | 0             | 19               | 5                | 6                | 2                |
| Kiribati            | 0             | *                | 0                | 0                | 0                |
| Korea, South        | 4,352         | 4,428            | 29,537           | 49,121           | 66,639           |
| Kyrgyzstan          | 0             | 0                | 0                | 0                | *                |
| Latvia              | 0             | 4                | 13               | *                | 4                |
| Lebanon             | 0             | 133              | 38               | 23               | 49               |
| Lesotho             | 0             | 70               | 2                | 2                | 25               |
| Liberia             | 100           | 924              | 701              | 2,589            | 5,866            |

\* Greater than zero but less than \$500,000. n.a. Not available.

1. Separate reporting for Guernsey and Jersey began with the 1997 survey; in the 1994 survey these were included in the United Kingdom.



**18. Market value of U.S. holdings of foreign equities, by country, as of the survey dates**  
(continued)

Millions of dollars

| Country or category     | March<br>1994 | December<br>1997 | December<br>2001 | December<br>2003 | December<br>2004 |
|-------------------------|---------------|------------------|------------------|------------------|------------------|
| Liechtenstein           | 70            | 5                | 59               | 19               | 35               |
| Lithuania               | 0             | 14               | 3                | 3                | 3                |
| Luxembourg <sup>1</sup> | n.a.          | 5,345            | 2,357            | 6,026            | 7,634            |
| Macedonia               | 0             | 0                | 0                | 0                | 0                |
| Madagascar              | 0             | 1                | 3                | 0                | 0                |
| Malawi                  | 0             | 0                | 19               | 0                | 0                |
| Malaysia                | 9,115         | 4,713            | 2,578            | 4,075            | 6,474            |
| Mali                    | 0             | 0                | 4                | 0                | 0                |
| Malta                   | 0             | 0                | *                | *                | *                |
| Marshall Islands        | 0             | 0                | 65               | 705              | 3,727            |
| Mauritius               | 3             | 65               | 71               | 62               | 143              |
| Mexico                  | 34,665        | 34,965           | 26,279           | 28,529           | 37,516           |
| Moldova                 | 0             | *                | *                | 0                | 0                |
| Monaco                  | 25            | 0                | 2                | 3                | 8                |
| Mongolia                | 0             | 0                | 0                | 0                | 0                |
| Morocco                 | 24            | 217              | 37               | 16               | 89               |
| Mozambique              | 0             | 0                | 3                | 0                | 0                |
| Namibia                 | 0             | 130              | 1                | *                | 1                |
| Netherlands             | 38,054        | 106,984          | 112,751          | 115,792          | 136,467          |
| Netherlands Antilles    | 8,096         | 15,809           | 14,544           | 23,359           | 28,730           |
| New Caledonia           | 0             | 1                | 0                | 0                | 0                |
| New Zealand             | 4,300         | 5,311            | 2,004            | 3,861            | 4,720            |

n.a. Not available. \* Greater than zero but less than \$500,000.

1. Belgium and Luxembourg were reported as a combined entity in the 1994 survey.

**18. Market value of U.S. holdings of foreign equities, by country, as of the survey dates**  
(continued)

Millions of dollars

| Country or category         | March<br>1994 | December<br>1997 | December<br>2001 | December<br>2003 | December<br>2004 |
|-----------------------------|---------------|------------------|------------------|------------------|------------------|
| Nicaragua                   | 0             | 0                | 0                | 0                | 0                |
| Norway                      | 3,929         | 9,494            | 7,906            | 11,972           | 18,153           |
| Pakistan                    | 226           | 1,180            | 86               | 85               | 111              |
| Palau                       | 0             | *                | 0                | 0                | 0                |
| Panama                      | 2,152         | 3,556            | 7,450            | 14,822           | 19,450           |
| Papua New Guinea            | 55            | 165              | 155              | 235              | 314              |
| Paraguay                    | 1             | *                | 0                | 0                | 0                |
| Peru                        | 449           | 2,341            | 452              | 1,087            | 666              |
| Philippines                 | 1,910         | 2,848            | 1,344            | 1,634            | 2,222            |
| Poland                      | 75            | 1,618            | 1,197            | 1,671            | 3,072            |
| Portugal                    | 1,106         | 6,993            | 3,819            | 3,949            | 5,505            |
| Romania                     | 0             | 4                | 3                | 24               | 120              |
| Russia                      | 16            | 8,457            | 4,613            | 13,259           | 10,775           |
| Saint Kitts and Nevis       | 0             | *                | 0                | *                | *                |
| Saint Lucia                 | 0             | 0                | 0                | 0                | 0                |
| Saint Vincent and Grenadine | 0             | 0                | 0                | 0                | 0                |
| Sao Tome and Principe       | 0             | 0                | 0                | 0                | 0                |
| Senegal                     | 1             | 4                | 0                | *                | *                |
| Serbia and Montenegro       | 0             | *                | 0                | 0                | 0                |
| Seychelles                  | 0             | 6                | 0                | 1                | 0                |
| Sierra Leone                | 0             | 1                | 0                | *                | 0                |
| Singapore                   | 6,832         | 10,185           | 21,376           | 21,932           | 23,968           |

\* Greater than zero but less than \$500,000.

**18. Market value of U.S. holdings of foreign equities, by country, as of the survey dates**  
(continued)

Millions of dollars

| Country or category                   | March<br>1994 | December<br>1997 | December<br>2001 | December<br>2003 | December<br>2004 |
|---------------------------------------|---------------|------------------|------------------|------------------|------------------|
| Slovakia                              | 1             | 87               | 3                | 14               | *                |
| Slovenia                              | 0             | 56               | 4                | 13               | 1                |
| Somalia                               | 0             | 3                | 0                | *                | 0                |
| South Africa                          | 4,438         | 9,937            | 6,714            | 15,101           | 21,600           |
| Spain                                 | 13,733        | 25,223           | 32,455           | 43,801           | 63,002           |
| Sri Lanka                             | 86            | 133              | 35               | 33               | 31               |
| Suriname                              | 0             | 46               | 0                | 0                | 0                |
| Swaziland                             | 0             | 1                | *                | 0                | *                |
| Sweden                                | 11,769        | 38,784           | 24,274           | 27,529           | 38,284           |
| Switzerland                           | 20,962        | 61,897           | 75,587           | 117,910          | 138,187          |
| Taiwan                                | 468           | 4,939            | 19,607           | 26,970           | 34,554           |
| Tanzania                              | 0             | *                | 7                | 0                | 0                |
| Thailand                              | 4,113         | 2,158            | 1,916            | 6,477            | 5,961            |
| Tokelau Islands                       | 0             | *                | 0                | *                | 0                |
| Tonga                                 | 0             | 0                | 0                | 0                | 0                |
| Trinidad and Tobago                   | 2             | 1                | 158              | *                | 5                |
| Tunisia                               | 0             | 0                | 4                | *                | *                |
| Turkey                                | 630           | 6,005            | 2,269            | 3,781            | 5,561            |
| Turks and Caicos Islands <sup>1</sup> | n.a.          | 384              | 32               | 57               | *                |
| Uganda                                | 0             | 1                | 5                | 0                | 0                |
| Ukraine                               | 0             | 61               | 2                | 17               | 25               |
| United Kingdom <sup>2</sup>           | 99,729        | 217,525          | 350,014          | 420,675          | 455,919          |

\* Greater than zero but less than \$500,000.

1. Separate reporting for Anguilla, British Virgin Islands, Cayman Islands, Montserrat, and Turks and Caicos began with the 1997 survey; previously these were reported as the British West Indies.
2. Separate reporting for Guernsey and Jersey began with the 1997 survey; in the 1994 survey these were included in the United Kingdom.

**18. Market value of U.S. holdings of foreign equities, by country, as of the survey dates**  
(continued)

Millions of dollars

| Country or category                    | March<br>1994  | December<br>1997 | December<br>2001 | December<br>2003 | December<br>2004 |
|--|----------------|------------------|------------------|------------------|------------------|
| Uruguay                                | 1              | 15               | 4                | 3                | 6                |
| Uzbekistan                             | 0              | 0                | 1                | 0                | 0                |
| Venezuela                              | 901            | 1,975            | 348              | 405              | 636              |
| Vietnam                                | 0              | *                | 0                | *                | *                |
| Zambia                                 | 18             | 7                | 5                | 5                | 2                |
| Zimbabwe                               | 15             | 133              | 47               | 13               | 14               |
| Country Unknown                        | 20             | 337              | 38               | 11               | *                |
| International Organizations            | 215            | 10               | 147              | 365              | 373              |
| Middle East oil-exporters <sup>1</sup> | 0              | 28               | 14               | 1                | 1                |
| African oil-exporters <sup>2</sup>     | 61             | 61               | 23               | 34               | 12               |
| <b>Total</b>                           | <b>566,554</b> | <b>1,207,787</b> | <b>1,612,673</b> | <b>2,079,424</b> | <b>2,560,418</b> |

\* Greater than zero but less than \$500,000.

1. Bahrain, Iran, Iraq, Kuwait, Oman, Qatar, Saudi Arabia, United Arab Emirates.
2. Algeria, Gabon, Libya, Nigeria.

### 19. Market value of U.S. holdings of foreign long-term debt securities, by country, as of the survey dates

Millions of dollars

| Country or category                 | March 1994         | December 1997 | December 2001 | December 2003 | December 2004 |
|-------------------------------------|--------------------|---------------|---------------|---------------|---------------|
| Albania                             | 0                  | 32            | 10            | 4             | 5             |
| Andorra                             | 0                  | 9             | 0             | 0             | 0             |
| Antigua and Barbuda                 | 0                  | 0             | 0             | *             | *             |
| Argentina                           | 8,703              | 25,675        | 3,635         | 3,458         | 3,664         |
| Aruba                               | 1                  | 11            | 271           | 906           | 1,114         |
| Australia                           | 9,675              | 15,879        | 15,999        | 29,218        | 40,366        |
| Austria                             | 1,403              | 1,954         | 2,306         | 5,244         | 4,682         |
| Bahamas                             | 976                | 342           | 478           | 1,070         | 872           |
| Bangladesh                          | 0                  | 0             | 0             | *             | 0             |
| Barbados                            | 0                  | 16            | 53            | 251           | 246           |
| Belarus                             | 0                  | 2             | 0             | *             | 0             |
| Belgium-Luxembourg <sup>1</sup>     | 2,308 <sup>r</sup> | n.a.          | n.a.          | n.a.          | n.a.          |
| Belgium <sup>1</sup>                | n.a.               | 3,070         | 3,725         | 5,143         | 5,213         |
| Belize                              | 0                  | 5             | 1             | 52            | 34            |
| Bermuda                             | 759                | 3,989         | 6,329         | 8,668         | 9,862         |
| Bolivia                             | 1                  | 12            | *             | *             | 0             |
| Bosnia and Herzegovina              | 0                  | 3             | 10            | 50            | 145           |
| Botswana                            | 0                  | 16            | 2             | 2             | 4             |
| Brazil                              | 3,566              | 20,318        | 11,652        | 18,365        | 19,885        |
| British Virgin Islands <sup>2</sup> | n.a.               | 440           | 237           | 1,330         | 747           |
| British West Indies <sup>2</sup>    | 4,267              | n.a.          | n.a.          | n.a.          | n.a.          |
| Bulgaria                            | 23                 | 1,310         | 1,763         | 1,438         | 1,167         |

\* Greater than zero but less than \$500,000. n.a. Not available. r. Revised.

1. Belgium and Luxembourg were reported as a combined entity in the 1994 survey.

2. Separate reporting for Anguilla, British Virgin Islands, Cayman Islands, Montserrat, and Turks and Caicos began with the 1997 survey; previously these were reported as the British West Indies.

**19. Market value of U.S. holdings of foreign long-term debt securities, by country, as of the survey dates (continued)**

Millions of dollars

| Country or category         | March 1994 | December 1997 | December 2001 | December 2003 | December 2004 |
|-----------------------------|------------|---------------|---------------|---------------|---------------|
| Burma                       | 0          | 139           | 0             | 0             | 0             |
| Cambodia                    | 0          | 0             | 0             | 0             | 0             |
| Cameroon                    | 0          | 4             | 0             | 0             | 0             |
| Canada                      | 68,535     | 106,675       | 115,618       | 139,433       | 151,852       |
| Cayman Islands <sup>1</sup> | n.a.       | 13,635        | 34,317        | 75,668        | 114,378       |
| Central African Republic    | 0          | 0             | 1             | 0             | 0             |
| Chad                        | 0          | 0             | 0             | 0             | 0             |
| Chile                       | 179        | 3,571         | 4,030         | 7,595         | 9,034         |
| China, Peoples Republic of  | 1,186      | 3,178         | 634           | 667           | 1,065         |
| Colombia                    | 271        | 3,458         | 2,610         | 3,354         | 4,185         |
| Comoros                     | 0          | 19            | 0             | 0             | 0             |
| Congo (Brazzaville)         | 0          | 13            | 0             | 0             | 0             |
| Congo (Kinshasa)            | 0          | *             | 0             | 0             | 0             |
| Cook Islands                | 0          | 0             | 0             | 0             | 0             |
| Costa Rica                  | 111        | 165           | 153           | 313           | 236           |
| Cote D'Ivoire               | 19         | 456           | 156           | 96            | 95            |
| Croatia                     | 10         | 370           | 508           | 406           | 482           |
| Cuba                        | 1          | *             | 0             | 0             | 1             |
| Cyprus                      | 0          | 202           | 51            | 83            | 100           |
| Czech Republic              | 153        | 45            | 37            | 44            | 33            |
| Denmark                     | 8,092      | 7,841         | 4,018         | 9,987         | 8,292         |
| Dominica                    | 0          | 0             | 0             | 0             | 0             |

\* Greater than zero but less than \$500,000. r. Revised.

1. Separate reporting for Anguilla, British Virgin Islands, Cayman Islands, Montserrat, and Turks and Caicos began with the 1997 survey; previously these were reported as the British West Indies.

**19. Market value of U.S. holdings of foreign long-term debt securities, by country, as of the survey dates (continued)**

Millions of dollars

| Country or category   | March 1994          | December 1997 | December 2001 | December 2003 | December 2004 |
|-----------------------|---------------------|---------------|---------------|---------------|---------------|
| Dominican Republic    | 0                   | 87            | 151           | 508           | 472           |
| Ecuador               | 195                 | 1,934         | 756           | 897           | 1,066         |
| Egypt                 | 0                   | 69            | 263           | 48            | 56            |
| El Salvador           | 0                   | 12            | 49            | 582           | 658           |
| Estonia               | 0                   | 10            | 5             | 36            | 39            |
| Finland               | 4,096 <sup>r</sup>  | 5,930         | 3,297         | 5,542         | 4,493         |
| France                | 16,765 <sup>r</sup> | 14,733        | 26,086        | 42,955        | 41,831        |
| French Guiana         | 0                   | 0             | 0             | 0             | 0             |
| Gambia                | 0                   | 32            | 21            | 30            | 0             |
| Georgia               | 0                   | 0             | 1             | *             | 0             |
| Germany               | 22,072              | 43,449        | 46,119        | 71,403        | 67,918        |
| Ghana                 | 0                   | 0             | 1             | 1             | 1             |
| Gibraltar             | 7                   | 0             | 0             | 10            | 0             |
| Greece                | 138                 | 1,228         | 1,753         | 1,978         | 1,310         |
| Grenada               | 0                   | 0             | 8             | 6             | 2             |
| Guadeloupe            | 0                   | 1             | 0             | 0             | 0             |
| Guatemala             | 28                  | 191           | 58            | 109           | 173           |
| Guernsey <sup>1</sup> | n.a.                | 72            | 69            | 713           | 542           |
| Guyana                | 0                   | 0             | 0             | 5             | 0             |
| Honduras              | 0                   | 17            | 17            | 22            | 15            |
| Hong Kong             | 644                 | 3,526         | 1,893         | 1,419         | 1,933         |
| Hungary               | 422                 | 1,363         | 324           | 651           | 601           |

\* Greater than zero but less than \$500,000. r. Revised.

1. Separate reporting for Guernsey and Jersey began with the 1997 survey; in the 1994 survey these were included in the United Kingdom.

**19. Market value of U.S. holdings of foreign long-term debt securities, by country, as of the survey dates (continued)**

Millions of dollars

| Country or category | March 1994          | December 1997 | December 2001 | December 2003 | December 2004 |
|---------------------|---------------------|---------------|---------------|---------------|---------------|
| Iceland             | 352                 | 306           | 183           | 130           | 241           |
| India               | 218                 | 1,962         | 276           | 183           | 363           |
| Indonesia           | 229                 | 1,857         | 315           | 666           | 869           |
| Ireland             | 1,841               | 3,519         | 3,010         | 8,452         | 13,821        |
| Isle of Man         | 0                   | 0             | 0             | 0             | 15            |
| Israel              | 1,855               | 5,262         | 7,847         | 12,292        | 15,254        |
| Italy               | 17,789 <sup>r</sup> | 17,624        | 13,299        | 24,956        | 17,352        |
| Jamaica             | 3                   | 326           | 267           | 39            | 193           |
| Japan               | 31,785              | 30,354        | 26,152        | 37,175        | 36,433        |
| Jersey <sup>1</sup> | n.a.                | 37            | 1,586         | 4,329         | 6,638         |
| Jordan              | 39                  | 179           | 37            | 17            | 22            |
| Kazakhstan          | 0                   | 120           | 138           | 102           | 346           |
| Kenya               | 0                   | 17            | 11            | 15            | 15            |
| Kiribati            | 0                   | 24            | 0             | 0             | 0             |
| Korea, South        | 2,573 <sup>r</sup>  | 10,834        | 4,938         | 4,217         | 6,905         |
| Kyrgyzstan          | 0                   | 0             | 0             | *             | 11            |
| Latvia              | 0                   | 0             | 0             | 0             | 4             |
| Lebanon             | 6                   | 680           | 49            | 127           | 174           |
| Lesotho             | 0                   | 3             | 0             | 0             | 1             |
| Liberia             | 191                 | 476           | 658           | 1,739         | 1,964         |
| Liechtenstein       | 0                   | 0             | 0             | 0             | 0             |
| Lithuania           | 0                   | 27            | 48            | 25            | 1             |

\* Greater than zero but less than \$500,000. n.a. Not available. r. Revised.

1. Separate reporting for Guernsey and Jersey began with the 1997 survey; in the 1994 survey these were included in the United Kingdom.



**19. Market value of U.S. holdings of foreign long-term debt securities, by country, as of the survey dates (continued)**

Millions of dollars

| Country or category     | March 1994         | December 1997 | December 2001 | December 2003 | December 2004 |
|-------------------------|--------------------|---------------|---------------|---------------|---------------|
| Luxembourg <sup>1</sup> | n.a.               | 2,944         | 8,584         | 15,043        | 26,547        |
| Macedonia               | 0                  | 20            | 34            | 42            | 40            |
| Madagascar              | 0                  | 1             | 0             | 0             | 0             |
| Malawi                  | 0                  | 0             | 0             | 0             | 0             |
| Malaysia                | 449                | 4,365         | 1,680         | 3,878         | 4,209         |
| Mali                    | 0                  | 0             | 0             | 0             | 0             |
| Malta                   | 43                 | 148           | 93            | 19            | 17            |
| Marshall Islands        | 72                 | 35            | 1             | 237           | 748           |
| Mauritius               | 0                  | 666           | 78            | 112           | 183           |
| Mexico                  | 16,861             | 28,786        | 22,493        | 27,615        | 28,606        |
| Moldova                 | 0                  | 39            | 29            | 0             | 0             |
| Monaco                  | 0                  | 0             | 0             | 0             | 0             |
| Mongolia                | 0                  | 0             | 0             | 1             | 0             |
| Morocco                 | 341                | 344           | 332           | 147           | 139           |
| Mozambique              | 0                  | 0             | 0             | 0             | 0             |
| Namibia                 | 9                  | 2             | *             | 3             | 0             |
| Netherlands             | 9,410 <sup>f</sup> | 13,166        | 30,624        | 57,988        | 55,077        |
| Netherlands Antilles    | 2,230              | 1,193         | 1,327         | 1,369         | 1,522         |
| New Caledonia           | 0                  | 0             | 0             | 0             | 0             |
| New Zealand             | 1,983              | 3,506         | 2,052         | 5,045         | 5,719         |
| Nicaragua               | 7                  | 76            | 19            | 0             | 37            |
| Norway                  | 2,420              | 4,773         | 5,925         | 8,195         | 10,270        |

n.a. Not available. \* Greater than zero but less than \$500,000.

1. Belgium and Luxembourg were reported as a combined entity in the 1994 survey.

**19. Market value of U.S. holdings of foreign long-term debt securities, by country, as of the survey dates (continued)**

Millions of dollars

| Country or category         | March<br>1994 | December<br>1997 | December<br>2001 | December<br>2003 | December<br>2004 |
|-----------------------------|---------------|------------------|------------------|------------------|------------------|
| Pakistan                    | 0             | 341              | 94               | 48               | 36               |
| Palau                       | 0             | 1                | 0                | 0                | 0                |
| Panama                      | 56            | 3,039            | 2,418            | 3,761            | 4,830            |
| Papua New Guinea            | 0             | 9                | 0                | 0                | 0                |
| Paraguay                    | 0             | 81               | 0                | 0                | 0                |
| Peru                        | 14            | 1,203            | 1,221            | 2,912            | 3,208            |
| Philippines                 | 581           | 4,479            | 2,671            | 3,403            | 3,468            |
| Poland                      | 20            | 2,877            | 1,901            | 1,809            | 2,552            |
| Portugal                    | 217           | 1,240            | 531              | 1,128            | 807              |
| Romania                     | 0             | 207              | 10               | 127              | 52               |
| Russia                      | 31            | 3,696            | 5,595            | 8,296            | 10,540           |
| Saint Kitts and Nevis       | 0             | 0                | 0                | 0                | 0                |
| Saint Lucia                 | 0             | 0                | 0                | 0                | 49               |
| Saint Vincent and Grenadine | 1             | 0                | 0                | 0                | 0                |
| Sao Tome and Principe       | 0             | 33               | 0                | 0                | 0                |
| Senegal                     | 0             | 3                | 0                | 0                | 0                |
| Serbia and Montenegro       | 0             | 13               | 1                | 15               | 1                |
| Seychelles                  | 0             | 46               | 0                | 0                | 0                |
| Sierra Leone                | 0             | 0                | 0                | 0                | 0                |
| Singapore                   | 6             | 550              | 1,442            | 2,951            | 5,113            |
| Slovakia                    | 0             | 97               | 130              | 74               | 190              |
| Slovenia                    | 0             | 168              | 10               | 74               | 36               |

\* Greater than zero but less than \$500,000.

r. Revised.

**19. Market value of U.S. holdings of foreign long-term debt securities, by country, as of the survey dates (continued)**

Millions of dollars

| Country or category                   | March<br>1994       | December<br>1997 | December<br>2001 | December<br>2003 | December<br>2004 |
|---------------------------------------|---------------------|------------------|------------------|------------------|------------------|
| Somalia                               | 0                   | 3                | 0                | 0                | 0                |
| South Africa                          | 741                 | 2,604            | 1,147            | 2,748            | 3,047            |
| Spain                                 | 10,760              | 6,922            | 7,370            | 6,293            | 5,072            |
| Sri Lanka                             | 0                   | 60               | 123              | 55               | 49               |
| Suriname                              | 0                   | 0                | 0                | 0                | 0                |
| Swaziland                             | 0                   | 0                | 3                | 5                | 3                |
| Sweden                                | 10,156              | 13,102           | 9,332            | 12,755           | 14,577           |
| Switzerland                           | 111                 | 1,243            | 767              | 1,090            | 1,551            |
| Taiwan                                | 63                  | 1,288            | 253              | 258              | 331              |
| Tanzania                              | 0                   | 0                | 0                | 0                | 0                |
| Thailand                              | 680                 | 3,466            | 782              | 835              | 1,136            |
| Tokelau Islands                       | 0                   | 20               | 0                | 0                | 0                |
| Tonga                                 | 0                   | 50               | 0                | 0                | 0                |
| Trinidad and Tobago                   | 81                  | 463              | 311              | 606              | 472              |
| Tunisia                               | 37                  | 280              | 164              | 1,280            | 588              |
| Turkey                                | 333                 | 1,005            | 1,256            | 1,932            | 2,577            |
| Turks and Caicos Islands <sup>1</sup> | n.a.                | 35               | 0                | 0                | 0                |
| Uganda                                | 0                   | 0                | 0                | 0                | 0                |
| Ukraine                               | 0                   | 29               | 201              | 586              | 1,524            |
| United Kingdom <sup>2</sup>           | 19,878 <sup>r</sup> | 54,155           | 80,868           | 143,280          | 171,446          |
| Uruguay                               | 253                 | 598              | 599              | 600              | 1,297            |

\* Greater than zero but less than \$500,000. r. Revised.

1. Separate reporting for Anguilla, British Virgin Islands, Cayman Islands, Montserrat, and Turks and Caicos began with the 1997 survey; previously these were reported as the British West Indies.

2. Separate reporting for Guernsey and Jersey began with the 1997 survey; in the 1994 survey these were included in the United Kingdom.

**19. Market value of U.S. holdings of foreign long-term debt securities, by country, as of the survey dates (continued)**

Millions of dollars

| Country or category                    | March<br>1994      | December<br>1997 | December<br>2001 | December<br>2003 | December<br>2004 |
|--|--------------------|------------------|------------------|------------------|------------------|
| Uzbekistan                             | 0                  | 0                | 0                | 4                | 0                |
| Venezuela                              | 4,214              | 5,852            | 3,307            | 4,898            | 6,226            |
| Vietnam                                | 0                  | 37               | 21               | 81               | 113              |
| Zambia                                 | 0                  | 2                | *                | 0                | 0                |
| Zimbabwe                               | 60                 | 36               | 41               | 48               | 54               |
| Country Unknown                        | 160 <sup>r</sup>   | 533              | 2                | 24               | *                |
| International Organizations            | 9,639 <sup>r</sup> | 16,965           | 11,731           | 17,187           | 17,789           |
| Middle East oil-exporters <sup>1</sup> | 0 <sup>r</sup>     | 430              | 588              | 989              | 1,453            |
| African oil-exporters <sup>2</sup>     | 300 <sup>r</sup>   | 782              | 613              | 286              | 180              |
| <b>Total</b>                           | <b>303,706</b>     | <b>547,228</b>   | <b>557,062</b>   | <b>874,357</b>   | <b>992,969</b>   |

\* Greater than zero but less than \$500,000. r. Revised.

1. Bahrain, Iran, Iraq, Kuwait, Oman, Qatar, Saudi Arabia, United Arab Emirates.

2. Algeria, Gabon, Libya, Nigeria.

**20. Market value of U.S. holdings of foreign short-term debt securities, by country, as of the survey dates**

Millions of dollars

| Country or category        | December<br>2001 | December<br>2003 | December<br>2004 |
|----------------------------|------------------|------------------|------------------|
| Argentina                  | 334              | 11               | 1                |
| Australia                  | 2,072            | 4,830            | 5,994            |
| Austria                    | 826              | 1,201            | 1,591            |
| Bahamas                    | 7                | 23               | 1                |
| Belgium                    | 588              | 1,223            | 677              |
| Bermuda                    | 271              | 89               | 663              |
| Bolivia                    | 3                | 1                | 0                |
| Botswana                   | 1                | 0                | 0                |
| Brazil                     | 677              | 83               | 10               |
| British Virgin Islands     | 0                | *                | 4                |
| Canada                     | 6,235            | 12,278           | 12,419           |
| Cayman Islands             | 958              | 4,017            | 11,549           |
| Chile                      | 1                | *                | *                |
| China, Peoples Republic of | 0                | 7                | 12               |
| Colombia                   | *                | *                | *                |
| Costa Rica                 | 33               | 19               | 19               |
| Cyprus                     | 0                | *                | *                |
| Denmark                    | 570              | 1,725            | 1,103            |
| Dominican Republic         | *                | *                | 31               |
| Ecuador                    | *                | *                | 24               |

\* Greater than zero but less than \$500,000.

**20. Market value of U.S. holdings of foreign short-term debt securities, by country, as of the survey dates (continued)**

Millions of dollars

| Country or category | December<br>2001 | December<br>2003 | December<br>2004 |
|---------------------|------------------|------------------|------------------|
| Egypt               | 0                | 0                | 3                |
| El Salvador         | 19               | 19               | 16               |
| Finland             | 535              | 422              | 543              |
| France              | 5,281            | 11,243           | 10,142           |
| Germany             | 18,174           | 14,662           | 9,772            |
| Ghana               | 0                | 0                | *                |
| Gibraltar           | 0                | 20               | 0                |
| Greece              | *                | *                | 0                |
| Guadeloupe          | 2                | 0                | 0                |
| Guatemala           | 2                | 0                | 0                |
| Guernsey            | 0                | 1                | *                |
| Honduras            | 28               | 28               | 28               |
| Hong Kong           | 0                | 32               | 22               |
| Hungary             | 0                | 28               | *                |
| Iceland             | 0                | 10               | *                |
| India               | 25               | 16               | 10               |
| Indonesia           | 0                | 0                | 3                |
| Ireland             | 1,047            | 2,827            | 9,020            |
| Israel              | 53               | 11               | 7                |
| Italy               | 1,223            | 3,004            | 2,864            |

\* Greater than zero but less than \$500,000.

**20. Market value of U.S. holdings of foreign short-term debt securities, by country, as of the survey dates (continued)**

Millions of dollars

| Country or category  | December<br>2001 | December<br>2003 | December<br>2004 |
|----------------------|------------------|------------------|------------------|
| Jamaica              | 11               | 0                | 9                |
| Japan                | 11,603           | 13,861           | 17,240           |
| Jersey               | 833              | 5,262            | 5,278            |
| Jordan               | 0                | 0                | *                |
| Korea, South         | 0                | 91               | 70               |
| Luxembourg           | 2,094            | 2,314            | 3,868            |
| Malaysia             | 0                | *                | 6                |
| Mexico               | 132              | 96               | 195              |
| Netherlands          | 5,707            | 8,413            | 10,817           |
| Netherlands Antilles | 175              | 9                | 25               |
| New Zealand          | 73               | 1,652            | 1,595            |
| Nicaragua            | 3                | 1                | 1                |
| Norway               | 810              | 1,076            | 2,055            |
| Panama               | 88               | 65               | 24               |
| Peru                 | 0                | 0                | 1                |
| Philippines          | 0                | 9                | 0                |
| Poland               | 1                | 1                | 1                |
| Portugal             | 156              | 199              | 73               |
| Singapore            | 0                | 118              | 114              |
| South Africa         | 0                | 0                | *                |

\* Greater than zero but less than \$500,000.

**20. Market value of U.S. holdings of foreign short-term debt securities, by country, as of the survey dates (continued)**

Millions of dollars

| Country or category                    | December<br>2001 | December<br>2003 | December<br>2004 |
|--|------------------|------------------|------------------|
| Spain                                  | 97               | 1,453            | 831              |
| Sri Lanka                              | 0                | 0                | *                |
| Sweden                                 | 3,224            | 4,973            | 9,537            |
| Switzerland                            | 273              | 715              | 2,274            |
| Taiwan                                 | 0                | 2                | 2                |
| Thailand                               | 0                | 27               | 16               |
| Trinidad and Tobago                    | 26               | 26               | 26               |
| Turkey                                 | 14               | 3                | 87               |
| Uganda                                 | 0                | *                | 0                |
| Ukraine                                | 0                | 0                | 3                |
| United Kingdom                         | 82,093           | 99,155           | 110,390          |
| Uruguay                                | 0                | 5                | 0                |
| Venezuela                              | *                | 18               | 0                |
| Country Unknown                        | 2                | 31               | 0                |
| International Organizations            | 482              | 1,087            | 2,177            |
| Middle East oil-exporters <sup>1</sup> | 0                | 4                | 3                |
| <b>Total</b>                           | <b>146,860</b>   | <b>198,502</b>   | <b>233,248</b>   |

\* Greater than zero but less than \$500,000.

1. Bahrain, Iran, Iraq, Kuwait, Oman, Qatar, Saudi Arabia, United Arab Emirates.



**21. Market value of U.S. holdings of foreign long-term debt securities,  
by country and currency, as of December 31, 2004**

Millions of dollars except as noted

| Country or region          | Total   | \$ U.S. | Euro  | Japanese Yen | U.K. Pound | Other  |
|----------------------------|---------|---------|-------|--------------|------------|--------|
| Albania                    | 5       | 5       | 0     | 0            | 0          | 0      |
| Antigua and Barbuda        | *       | *       | 0     | 0            | 0          | 0      |
| Argentina                  | 3,664   | 3,219   | 270   | 82           | 2          | 91     |
| Aruba                      | 1,114   | 1,111   | 0     | 3            | 0          | 0      |
| Australia                  | 40,366  | 30,993  | 1,794 | 123          | 428        | 7,027  |
| Austria                    | 4,682   | 2,834   | 1,434 | 267          | 14         | 133    |
| Bahamas                    | 872     | 871     | *     | 0            | 0          | 0      |
| Barbados                   | 246     | 246     | 0     | 0            | 0          | 0      |
| Belgium                    | 5,213   | 2,149   | 3,014 | 0            | 50         | 0      |
| Belize                     | 34      | 34      | 0     | 0            | 0          | 0      |
| Bermuda                    | 9,862   | 9,720   | 13    | 39           | 0          | 91     |
| Bosnia and Herzegovina     | 145     | 0       | 145   | 0            | 0          | 0      |
| Botswana                   | 4       | 1       | 0     | 0            | 0          | 2      |
| Brazil                     | 19,885  | 18,692  | 1,009 | 23           | *          | 161    |
| British Virgin Islands     | 747     | 745     | 1     | 0            | 0          | 0      |
| Bulgaria                   | 1,167   | 1,137   | 30    | 0            | 0          | 0      |
| Canada                     | 151,852 | 120,857 | 415   | 1,021        | 560        | 29,000 |
| Cayman Islands             | 114,378 | 110,481 | 1,174 | 1,576        | 568        | 578    |
| Chile                      | 9,034   | 8,974   | 35    | 0            | 0          | 26     |
| China, Peoples Republic of | 1,065   | 1,016   | 38    | 11           | 0          | 0      |

\* Greater than zero but less than \$500,000.

**21. Market value of U.S. holdings of foreign long-term debt securities, by country and currency, as of December 31, 2004 (continued)**

Millions of dollars except as noted

| Country or region  | Total  | \$ U.S. | Euro   | Japanese Yen | U.K. Pound | Other |
|--------------------|--------|---------|--------|--------------|------------|-------|
| Colombia           | 4,185  | 3,670   | 124    | 17           | 2          | 373   |
| Costa Rica         | 236    | 236     | 0      | 0            | 0          | 0     |
| Cote D'Ivoire      | 95     | 64      | 28     | 0            | 0          | 3     |
| Croatia            | 482    | 380     | 98     | 3            | 0          | 1     |
| Cuba               | 1      | 1       | 0      | 0            | 0          | 0     |
| Cyprus             | 100    | 2       | 98     | 0            | 0          | 0     |
| Czech Republic     | 33     | 20      | 13     | 0            | 0          | 0     |
| Denmark            | 8,292  | 2,416   | 573    | 0            | 33         | 5,270 |
| Dominican Republic | 472    | 472     | 0      | 0            | 0          | 0     |
| Ecuador            | 1,066  | 1,065   | 0      | 0            | 0          | 1     |
| Egypt              | 56     | 56      | 0      | 0            | 0          | 0     |
| El Salvador        | 658    | 658     | *      | 0            | 0          | 0     |
| Estonia            | 39     | 0       | 37     | 0            | 2          | 0     |
| Finland            | 4,493  | 3,419   | 1,023  | 0            | 41         | 11    |
| France             | 41,831 | 18,296  | 23,137 | 8            | 330        | 61    |
| Germany            | 67,918 | 14,610  | 51,900 | 414          | 793        | 200   |
| Ghana              | 1      | 1       | 0      | 0            | 0          | 0     |
| Greece             | 1,310  | 224     | 997    |              |            |       |
| Grenada            | 2      | 2       | 0      | 0            | 0          | 0     |

\* Greater than zero but less than \$500,000.

**21. Market value of U.S. holdings of foreign long-term debt securities, by country and currency, as of December 31, 2004 (continued)**

Millions of dollars except as noted

| Country or region | Total  | \$ U.S. | Euro  | Japanese Yen | U.K. Pound | Other |
|-------------------|--------|---------|-------|--------------|------------|-------|
| Guatemala         | 173    | 173     | 0     | 0            | 0          | 0     |
| Guernsey          | 542    | 304     | 160   | 6            | 13         | 59    |
| Honduras          | 15     | 6       | 0     | 0            | 0          | 9     |
| Hong Kong         | 1,933  | 1,353   | 0     | 429          | 0          | 151   |
| Hungary           | 601    | 171     | 29    | 0            | 1          | 400   |
| Iceland           | 241    | 37      | 3     | 0            | 0          | 201   |
| India             | 363    | 358     | 0     | 0            | *          | 6     |
| Indonesia         | 869    | 645     | *     | 0            | 0          | 224   |
| Ireland           | 13,821 | 7,851   | 5,702 | 31           | 125        | 112   |
| Isle of Man       | 15     | 1       | 14    | 0            | 0          | 0     |
| Israel            | 15,254 | 14,465  | 30    | 10           | 10         | 740   |
| Italy             | 17,352 | 7,008   | 9,488 | 748          | 50         | 59    |
| Jamaica           | 193    | 115     | 66    | 0            | 0          | 11    |
| Japan             | 36,433 | 2,302   | 277   | 33,810       | 28         | 16    |
| Jersey            | 6,638  | 4,485   | 1,400 | 61           | 374        | 318   |
| Jordan            | 22     | 22      | 0     | 0            | 0          | 0     |
| Kazakhstan        | 346    | 346     | 0     | 0            | 0          | 0     |
| Kenya             | 15     | 15      | 0     | 0            | 0          | 0     |
| Korea, South      | 6,905  | 6,141   | 5     | 10           | *          | 750   |
| Kyrgyzstan        | 11     | 0       | 0     | 0            | 0          | 11    |

\* Greater than zero but less than \$500,000.

**21. Market value of U.S. holdings of foreign long-term debt securities, by country and currency, as of December 31, 2004 (continued)**

Millions of dollars except as noted

| Country or region    | Total  | \$ U.S. | Euro   | Japanese Yen | U.K. Pound | Other |
|----------------------|--------|---------|--------|--------------|------------|-------|
| Latvia               | 4      | 0       | 4      | 0            | 0          | 0     |
| Lebanon              | 174    | 174     | 0      | 0            | 0          | 0     |
| Lesotho              | 1      | 0       | 1      | 0            | 0          | 0     |
| Liberia              | 1,964  | 1,964   | 0      | 0            | 0          | 0     |
| Lithuania            | 1      | 0       | 1      | 0            | 0          | 0     |
| Luxembourg           | 26,547 | 22,725  | 3,411  | 33           | 321        | 57    |
| Macedonia            | 40     | 40      | 0      | 0            | 0          | 0     |
| Malaysia             | 4,209  | 4,063   | 8      | 0            | 0          | 138   |
| Malta                | 17     | 17      | 0      | 0            | 0          | 0     |
| Marshall Islands     | 748    | 748     | 0      | 0            | 0          | 0     |
| Mauritius            | 183    | 183     | 0      | 0            | 0          | 0     |
| Mexico               | 28,606 | 27,424  | 262    | 102          | 28         | 790   |
| Morocco              | 139    | 136     | *      | 1            | 0          | 1     |
| Netherlands          | 55,077 | 35,876  | 18,261 | 107          | 644        | 189   |
| Netherlands Antilles | 1,522  | 1,429   | 2      | 0            | 53         | 39    |
| New Zealand          | 5,719  | 1,553   | 1      | 15           | 54         | 4,095 |
| Nicaragua            | 37     | 37      | 0      | 0            | 0          | 0     |
| Norway               | 10,270 | 8,626   | 40     | 93           | 21         | 1,490 |
| Pakistan             | 36     | 36      | 0      | 0            | 0          | 0     |
| Panama               | 4,830  | 4,830   | 0      | 0            | 0          | 0     |

\* Greater than zero but less than \$500,000.

**21. Market value of U.S. holdings of foreign long-term debt securities, by country and currency, as of December 31, 2004 (continued)**

Millions of dollars except as noted

| Country or region     | Total  | \$ U.S. | Euro  | Japanese Yen | U.K. Pound | Other |
|-----------------------|--------|---------|-------|--------------|------------|-------|
| Peru                  | 3,208  | 3,180   | 28    | 0            | 0          | 1     |
| Philippines           | 3,468  | 3,302   | 137   | 6            | 0          | 23    |
| Poland                | 2,552  | 683     | 16    | 19           | 0          | 1,834 |
| Portugal              | 807    | 200     | 605   | 2            | 0          | 0     |
| Romania               | 52     | 0       | 49    | 0            | 0          | 3     |
| Russia                | 10,540 | 10,507  | 22    | 0            | 0          | 11    |
| Saint Lucia           | 49     | 49      | 0     | 0            | 0          | 0     |
| Serbia and Montenegro | 1      | 1       | 0     | 0            | 0          | 0     |
| Singapore             | 5,113  | 4,380   | 97    | 0            | 0          | 636   |
| Slovakia              | 190    | 15      | 41    | 0            | 0          | 134   |
| Slovenia              | 36     | *       | 36    | 0            | 0          | 0     |
| South Africa          | 3,047  | 1,893   | 234   | 0            | 17         | 904   |
| Spain                 | 5,072  | 1,253   | 3,193 | 570          | 40         | 16    |
| Sri Lanka             | 49     | 49      | 0     | 0            | 0          | 0     |
| Swaziland             | 3      | 0       | 0     | 0            | 0          | 3     |
| Sweden                | 14,577 | 8,155   | 698   | 5            | 75         | 5,644 |
| Switzerland           | 1,551  | 1,123   | *     | 8            | 2          | 419   |
| Taiwan                | 331    | 222     | *     | 4            | 0          | 104   |
| Thailand              | 1,136  | 840     | 4     | 1            | 0          | 291   |

\* Greater than zero but less than \$500,000.

**21. Market value of U.S. holdings of foreign long-term debt securities, by country and currency, as of December 31, 2004 (continued)**

Millions of dollars except as noted

| Country or region                      | Total          | \$ U.S.        | Euro           | Japanese Yen  | U.K. Pound    | Other         |
|--|----------------|----------------|----------------|---------------|---------------|---------------|
| Trinidad and Tobago                    | 472            | 472            | 0              | 0             | 0             | 0             |
| Tunisia                                | 588            | 456            | 126            | 6             | 0             | 0             |
| Turkey                                 | 2,577          | 2,300          | 16             | 0             | 0             | 260           |
| Ukraine                                | 1,524          | 1,407          | 51             | 0             | 0             | 66            |
| United Kingdom                         | 171,446        | 132,807        | 11,365         | 132           | 27,113        | 29            |
| Uruguay                                | 1,297          | 1,201          | 1              | 2             | 0             | 93            |
| Venezuela                              | 6,226          | 5,943          | 239            | *             | 26            | 19            |
| Vietnam                                | 113            | 113            | 0              | 0             | 0             | 0             |
| Zimbabwe                               | 54             | 54             | 0              | 0             | 0             | 0             |
| Country unknown                        | *              | *              | 0              | 0             | 0             | 0             |
| International Organizations            | 17,789         | 14,197         | 1,942          | 587           | 777           | 285           |
| Middle East oil-exporters <sup>1</sup> | 1,453          | 1,453          | 0              | 0             | 0             | 0             |
| African oil-exporters <sup>2</sup>     | 180            | 167            | 0              | 12            | 0             | 0             |
| <b>Total</b>                           | <b>992,969</b> | <b>710,758</b> | <b>145,464</b> | <b>40,487</b> | <b>32,595</b> | <b>63,665</b> |

\* Greater than zero but less than \$500,000.

1. Bahrain, Iran, Iraq, Kuwait, Oman, Qatar, Saudi Arabia, United Arab Emirates.
2. Algeria, Gabon, Libya, Nigeria.

**22. Market value of U.S. holdings of foreign short-term debt securities,  
by country and currency, as of December 31, 2004**

Millions of dollars except as noted

| Country or region          | Total  | \$ U.S. | Euro  | Japanese Yen | U.K. Pound | Other |
|----------------------------|--------|---------|-------|--------------|------------|-------|
| Argentina                  | 1      | *       | 0     | 0            | 0          | 1     |
| Australia                  | 5,994  | 5,143   | 759   | 0            | 0          | 93    |
| Austria                    | 1,591  | 1,591   | 0     | 0            | 0          | 0     |
| Bahamas                    | 1      | 1       | 0     | 0            | 0          | 0     |
| Belgium                    | 677    | 176     | 202   | 0            | 0          | 298   |
| Bermuda                    | 663    | 663     | 0     | 0            | 0          | 0     |
| Brazil                     | 10     | 10      | 0     | 0            | 0          | 0     |
| British Virgin Islands     | 4      | 4       | 0     | 0            | 0          | 0     |
| Canada                     | 12,419 | 8,249   | 0     | 0            | 0          | 4,170 |
| Cayman Islands             | 11,549 | 11,430  | 118   | 0            | 1          | 0     |
| Chile                      | *      | *       | 0     | 0            | 0          | 0     |
| China, Peoples Republic of | 12     | 12      | 0     | 0            | 0          | 0     |
| Colombia                   | *      | *       | 0     | 0            | 0          | 0     |
| Costa Rica                 | 19     | 19      | 0     | 0            | 0          | 0     |
| Cyprus                     | *      | *       | 0     | 0            | 0          | 0     |
| Denmark                    | 1,103  | 948     | 128   | 0            | 0          | 26    |
| Dominican Republic         | 31     | *       | 0     | 0            | 0          | 31    |
| Ecuador                    | 24     | 24      | 0     | 0            | 0          | 0     |
| Egypt                      | 3      | 0       | 0     | 0            | 0          | 3     |
| El Salvador                | 16     | 16      | 0     | 0            | 0          | 0     |
| Finland                    | 543    | 476     | 67    | 0            | 0          | 0     |
| France                     | 10,142 | 7,535   | 2,607 | 0            | 0          | 0     |

\* Greater than zero but less than \$500,000.

**22. Market value of U.S. holdings of foreign short-term debt securities, by country and currency, as of December 31, 2004 (continued)**

Millions of dollars except as noted

| Country or region    | Total  | \$ U.S. | Euro  | Japanese Yen | U.K. Pound | Other |
|----------------------|--------|---------|-------|--------------|------------|-------|
| Germany              | 9,772  | 8,673   | 745   | 307          | 48         | 0     |
| Ghana                | *      | 0       | 0     | 0            | 0          | 0     |
| Guernsey             | *      | *       | 0     | 0            | 0          | 0     |
| Honduras             | 28     | 6       | 0     | 0            | 0          | 22    |
| Hong Kong            | 22     | 22      | 0     | 0            | 0          | 0     |
| Hungary              | *      | 0       | 0     | 0            | 0          | 0     |
| Iceland              | *      | *       | 0     | 0            | 0          | 0     |
| India                | 10     | *       | 0     | 0            | 0          | 10    |
| Indonesia            | 3      | 2       | 0     | 0            | 0          | 1     |
| Ireland              | 9,020  | 8,644   | 329   | 0            | 48         | 0     |
| Israel               | 7      | 7       | 0     | 0            | 0          | 0     |
| Italy                | 2,864  | 2,859   | 5     | 0            | 0          | 0     |
| Jamaica              | 9      | 0       | 0     | 0            | 0          | 9     |
| Japan                | 17,240 | 1       | 0     | 17,239       | 0          | 0     |
| Jersey               | 5,278  | 2,362   | 2,913 | 0            | 0          | 3     |
| Jordan               | *      | *       | 0     | 0            | 0          | 0     |
| Korea, South         | 70     | 52      | 0     | 6            | 0          | 12    |
| Luxembourg           | 3,868  | 3,539   | 208   | 0            | 22         | 99    |
| Malaysia             | 6      | 0       | 0     | 0            | 0          | 6     |
| Mexico               | 195    | 181     | 0     | 0            | 0          | 14    |
| Netherlands          | 10,817 | 8,008   | 2,808 | 0            | 2          | 0     |
| Netherlands Antilles | 25     | 25      | 0     | 0            | 0          | 0     |

\* Greater than zero but less than \$500,000.



**22. Market value of U.S. holdings of foreign short-term debt securities, by country and currency, as of December 31, 2004 (continued)**

Millions of dollars except as noted

| Country or region                      | Total          | \$ U.S.        | Euro          | Japanese Yen  | U.K. Pound   | Other        |
|--|----------------|----------------|---------------|---------------|--------------|--------------|
| New Zealand                            | 1,595          | 1,556          | 0             | 0             | 0            | 39           |
| Nicaragua                              | 1              | *              | 0             | 0             | 0            | 1            |
| Norway                                 | 2,055          | 1,920          | 64            | 0             | 0            | 71           |
| Panama                                 | 24             | 24             | 0             | 0             | 0            | 0            |
| Peru                                   | 1              | 1              | 0             | 0             | 0            | 0            |
| Poland                                 | 1              | 0              | 0             | 0             | 0            | 1            |
| Portugal                               | 73             | 60             | 13            | 0             | 0            | 0            |
| Singapore                              | 114            | 99             | 0             | 0             | 0            | 15           |
| South Africa                           | *              | *              | 0             | 0             | 0            | 0            |
| Spain                                  | 831            | 831            | 0             | 0             | 0            | 0            |
| Sri Lanka                              | *              | *              | 0             | 0             | 0            | 0            |
| Sweden                                 | 9,537          | 9,330          | 202           | 0             | 0            | 4            |
| Switzerland                            | 2,274          | 2,272          | 0             | 0             | 0            | 2            |
| Taiwan                                 | 2              | 2              | 0             | 0             | 0            | 0            |
| Thailand                               | 16             | 0              | 0             | 0             | 0            | 16           |
| Trinidad and Tobago                    | 26             | 26             | 0             | 0             | 0            | 0            |
| Turkey                                 | 87             | *              | 0             | 0             | 0            | 87           |
| Ukraine                                | 3              | 0              | 0             | 0             | 0            | 3            |
| United Kingdom                         | 110,390        | 106,559        | 2,089         | 0             | 1,499        | 243          |
| International Organizations            | 2,177          | 2,177          | 0             | 0             | 0            | 0            |
| Middle East oil-exporters <sup>1</sup> | 3              | 3              | 0             | 0             | 0            | 0            |
| <b>Total</b>                           | <b>233,248</b> | <b>195,538</b> | <b>13,258</b> | <b>17,552</b> | <b>1,618</b> | <b>5,282</b> |

\* Greater than zero but less than \$500,000.

1. Bahrain, Iran, Iraq, Kuwait, Oman, Qatar, Saudi Arabia, and the United Arab Emirates.

**23. Market value of U.S. holdings of foreign long-term debt securities,  
by country and type of security, as of December 31, 2004**

Millions of dollars

| Country or category        | Total   | "Straight" debt | Zero-coupon | Convertible | Asset-backed |
|----------------------------|---------|-----------------|-------------|-------------|--------------|
| Albania                    | 5       | 5               | 0           | 0           | 0            |
| Antigua and Barbuda        | *       | *               | 0           | 0           | 0            |
| Argentina                  | 3,664   | 3,427           | 56          | 39          | 142          |
| Aruba                      | 1,114   | 1,099           | 0           | 15          | 0            |
| Australia                  | 40,366  | 31,899          | 37          | 19          | 8,411        |
| Austria                    | 4,682   | 4,629           | 2           | 52          | 0            |
| Bahamas                    | 872     | 860             | 9           | 2           | 0            |
| Barbados                   | 246     | 184             | 0           | 0           | 62           |
| Belgium                    | 5,213   | 5,213           | *           | *           | 0            |
| Belize                     | 34      | 34              | 0           | 0           | 0            |
| Bermuda                    | 9,862   | 8,777           | 116         | 98          | 871          |
| Bosnia and Herzegovina     | 145     | 145             | *           | 0           | 0            |
| Botswana                   | 4       | 2               | 0           | 0           | 1            |
| Brazil                     | 19,885  | 19,510          | 95          | 1           | 280          |
| British Virgin Islands     | 747     | 679             | 0           | 61          | 7            |
| Bulgaria                   | 1,167   | 1,167           | 0           | 0           | 0            |
| Canada                     | 151,852 | 144,241         | 1,014       | 2,521       | 4,075        |
| Cayman Islands             | 114,378 | 46,200          | 476         | 2,043       | 65,659       |
| Chile                      | 9,034   | 8,939           | 14          | 0           | 82           |
| China, Peoples Republic of | 1,065   | 1,056           | *           | 0           | 9            |
| Colombia                   | 4,185   | 4,037           | 0           | 3           | 145          |
| Costa Rica                 | 236     | 234             | 0           | *           | 2            |
| Cote D'Ivoire              | 95      | 83              | 1           | 0           | 11           |

\* Greater than zero but less than \$500,000.

**23. Market value of U.S. holdings of foreign long-term debt securities,  
by country and type of security, as of December 31, 2004 (continued)**

Millions of dollars

| Country or category | Total  | "Straight" debt | Zero-coupon | Convertible | Asset-backed |
|---------------------|--------|-----------------|-------------|-------------|--------------|
| Croatia             | 482    | 482             | 0           | 0           | 0            |
| Cuba                | 1      | 1               | 0           | 0           | 0            |
| Cyprus              | 100    | 100             | 0           | 0           | 0            |
| Czech Republic      | 33     | 33              | 0           | 1           | 0            |
| Denmark             | 8,292  | 8,057           | 44          | 0           | 191          |
| Dominican Republic  | 472    | 472             | 0           | 0           | 0            |
| Ecuador             | 1,066  | 1,066           | 0           | 0           | *            |
| Egypt               | 56     | 56              | 0           | 0           | 0            |
| El Salvador         | 658    | 658             | 0           | *           | 0            |
| Estonia             | 39     | 39              | 0           | 0           | 0            |
| Finland             | 4,493  | 4,491           | 0           | 1           | 0            |
| France              | 41,831 | 40,378          | 38          | 434         | 982          |
| Germany             | 67,918 | 66,369          | 155         | 206         | 1,188        |
| Ghana               | 1      | 1               | 0           | 0           | 0            |
| Greece              | 1,310  | 1,270           | 0           | 0           | 40           |
| Grenada             | 2      | 2               | 0           | 0           | 0            |
| Guatemala           | 173    | 173             | 0           | 0           | 0            |
| Guernsey            | 542    | 379             | 47          | 116         | 0            |
| Honduras            | 15     | 15              | 0           | 0           | 0            |
| Hong Kong           | 1,933  | 1,867           | 16          | 49          | *            |
| Hungary             | 601    | 601             | 0           | 0           | 0            |
| Iceland             | 241    | 221             | 14          | 0           | 6            |
| India               | 363    | 248             | *           | 115         | 0            |

\* Greater than zero but less than \$500,000.

**23. Market value of U.S. holdings of foreign long-term debt securities,  
by country and type of security, as of December 31, 2004 (continued)**

Millions of dollars

| Country or category | Total  | "Straight" debt | Zero-coupon | Convertible | Asset-backed |
|---------------------|--------|-----------------|-------------|-------------|--------------|
| Indonesia           | 869    | 830             | 4           | 2           | 33           |
| Ireland             | 13,821 | 11,175          | 0           | 312         | 2,335        |
| Isle of Man         | 15     | 4               | 0           | 0           | 11           |
| Israel              | 15,254 | 10,158          | 5,033       | 38          | 26           |
| Italy               | 17,352 | 16,468          | 171         | 5           | 708          |
| Jamaica             | 193    | 193             | 0           | *           | 0            |
| Japan               | 36,433 | 35,488          | 154         | 277         | 515          |
| Jersey              | 6,638  | 5,512           | 128         | 378         | 621          |
| Jordan              | 22     | 22              | 0           | 0           | 0            |
| Kazakhstan          | 346    | 346             | 0           | 0           | 0            |
| Kenya               | 15     | 15              | 0           | 0           | 0            |
| Korea, South        | 6,905  | 6,746           | 0           | 158         | 1            |
| Kyrgyzstan          | 11     | 11              | 0           | 0           | 0            |
| Latvia              | 4      | 4               | 0           | 0           | 0            |
| Lebanon             | 174    | 166             | 0           | 0           | 7            |
| Lesotho             | 1      | 1               | 0           | 0           | 0            |
| Liberia             | 1,964  | 1,412           | 19          | 532         | 0            |
| Lithuania           | 1      | 1               | 0           | 0           | 0            |
| Luxembourg          | 26,547 | 22,752          | 131         | 2,756       | 908          |
| Macedonia           | 40     | 40              | 0           | 0           | 0            |
| Malaysia            | 4,209  | 4,159           | 9           | 42          | 0            |
| Malta               | 17     | 15              | 0           | 0           | 2            |
| Marshall Islands    | 748    | 693             | 0           | 55          | 0            |

\* Greater than zero but less than \$500,000.

**23. Market value of U.S. holdings of foreign long-term debt securities,  
by country and type of security, as of December 31, 2004 (continued)**

Millions of dollars

| Country or category   | Total  | "Straight" debt | Zero-coupon | Convertible | Asset-backed |
|-----------------------|--------|-----------------|-------------|-------------|--------------|
| Mauritius             | 183    | 180             | 2           | *           | *            |
| Mexico                | 28,606 | 28,242          | 22          | 99          | 243          |
| Morocco               | 139    | 91              | 39          | 0           | 9            |
| Netherlands           | 55,077 | 49,876          | 498         | 813         | 3,890        |
| Netherlands Antilles  | 1,522  | 608             | 11          | 902         | 0            |
| New Zealand           | 5,719  | 5,516           | 101         | 13          | 89           |
| Nicaragua             | 37     | 37              | 0           | 0           | 0            |
| Norway                | 10,270 | 10,195          | 42          | 0           | 33           |
| Pakistan              | 36     | 27              | 0           | 0           | 8            |
| Panama                | 4,830  | 4,092           | 70          | 668         | *            |
| Peru                  | 3,208  | 3,208           | 0           | 0           | 0            |
| Philippines           | 3,468  | 3,430           | 6           | 0           | 32           |
| Poland                | 2,552  | 2,549           | *           | 0           | 2            |
| Portugal              | 807    | 759             | 0           | 0           | 49           |
| Romania               | 52     | 52              | 0           | 0           | 0            |
| Russia                | 10,540 | 10,540          | 0           | *           | 0            |
| Saint Lucia           | 49     | 49              | 0           | 0           | 0            |
| Serbia and Montenegro | 1      | 1               | 0           | 0           | 0            |
| Singapore             | 5,113  | 4,780           | 2           | 287         | 44           |
| Slovakia              | 190    | 190             | 0           | 0           | 0            |
| Slovenia              | 36     | 36              | 0           | 0           | 0            |
| South Africa          | 3,047  | 3,020           | 2           | 25          | 0            |
| Spain                 | 5,072  | 4,973           | 4           | 0           | 94           |

\* Greater than zero but less than \$500,000.

**23. Market value of U.S. holdings of foreign long-term debt securities,  
by country and type of security, as of December 31, 2004 (continued)**

Millions of dollars

| Country or category                    | Total          | "Straight" debt | Zero-coupon   | Convertible   | Asset-backed   |
|--|----------------|-----------------|---------------|---------------|----------------|
| Sri Lanka                              | 49             | 49              | 0             | 0             | 0              |
| Swaziland                              | 3              | 3               | 0             | 0             | 0              |
| Sweden                                 | 14,577         | 13,816          | 695           | 22            | 44             |
| Switzerland                            | 1,551          | 1,324           | 50            | 132           | 46             |
| Taiwan                                 | 331            | 136             | 46            | 150           | 0              |
| Thailand                               | 1,136          | 1,114           | 8             | 4             | 9              |
| Trinidad and Tobago                    | 472            | 472             | 0             | 0             | 0              |
| Tunisia                                | 588            | 566             | 0             | 0             | 22             |
| Turkey                                 | 2,577          | 2,315           | 133           | 15            | 115            |
| Ukraine                                | 1,524          | 1,508           | 0             | 16            | *              |
| United Kingdom                         | 171,446        | 138,400         | 1,269         | 832           | 30,946         |
| Uruguay                                | 1,297          | 817             | 0             | 0             | 480            |
| Uzbekistan                             | 0              | 0               | 0             | 0             | 0              |
| Venezuela                              | 6,226          | 6,019           | 0             | 64            | 143            |
| Vietnam                                | 113            | 113             | 0             | 0             | 0              |
| Zimbabwe                               | 54             | 54              | 0             | 0             | 0              |
| Other and unknown                      | *              | *               | 0             | 0             | 0              |
| International Organizations            | 17,789         | 17,207          | 571           | 5             | 6              |
| Middle East oil-exporters <sup>1</sup> | 1,453          | 1,326           | 4             | 0             | 123            |
| African oil-exporters <sup>2</sup>     | 180            | 180             | 0             | 0             | 0              |
| <b>Total</b>                           | <b>992,969</b> | <b>843,483</b>  | <b>11,357</b> | <b>14,372</b> | <b>123,757</b> |

\* Greater than zero but less than \$500,000.

1. Bahrain, Iran, Iraq, Kuwait, Oman, Qatar, Saudi Arabia, United Arab Emirates.

2. Algeria, Gabon, Libya, Nigeria.

**24. Market value of U.S. holdings of foreign short-term debt securities,  
by country and type of security, as of December 31, 2004**

Millions of dollars

| Country or category        | Total  | Commercial<br>paper | Negotiable<br>CDs | Asset-backed | Other |
|----------------------------|--------|---------------------|-------------------|--------------|-------|
| Argentina                  | 1      | 0                   | 0                 | 0            | 1     |
| Australia                  | 5,994  | 4,107               | 569               | 0            | 1,317 |
| Austria                    | 1,591  | 501                 | 50                | 0            | 1,040 |
| Bahamas                    | 1      | 0                   | 1                 | 0            | 0     |
| Belgium                    | 677    | 118                 | 134               | 0            | 425   |
| Bermuda                    | 663    | 198                 | 0                 | 0            | 465   |
| Brazil                     | 10     | 1                   | 1                 | 0            | 8     |
| British Virgin Islands     | 4      | 1                   | 0                 | 0            | 3     |
| Canada                     | 12,419 | 4,741               | 4,110             | 0            | 3,568 |
| Cayman Islands             | 11,549 | 7,258               | 1,599             | 2,178        | 514   |
| Chile                      | *      | 0                   | 0                 | 0            | *     |
| China, Peoples Republic of | 12     | 0                   | 0                 | 0            | 12    |
| Colombia                   | *      | 0                   | *                 | 0            | 0     |
| Costa Rica                 | 19     | 0                   | 19                | 0            | 0     |
| Cyprus                     | *      | 0                   | 0                 | 0            | *     |
| Denmark                    | 1,103  | 64                  | 860               | 0            | 179   |
| Dominican Republic         | 31     | 0                   | *                 | 0            | 31    |
| Ecuador                    | 24     | 0                   | *                 | 0            | 24    |
| Egypt                      | 3      | *                   | 0                 | 0            | 3     |
| El Salvador                | 16     | 0                   | 16                | 0            | 0     |
| Finland                    | 543    | 87                  | 345               | 0            | 111   |
| France                     | 10,142 | 1,809               | 5,059             | 0            | 3,273 |
| Germany                    | 9,772  | 4,337               | 4,628             | 0            | 807   |

\* Greater than zero but less than \$500,000.

**24. Market value of U.S. holdings of foreign short-term debt securities,  
by country and type of security, as of December 31, 2004 (continued)**

Millions of dollars

| Country or category  | Total  | Commercial paper | Negotiable CDs | Asset-backed | Other  |
|----------------------|--------|------------------|----------------|--------------|--------|
| Ghana                | *      | *                | 0              | 0            | 0      |
| Guernsey             | *      | 0                | 0              | 0            | *      |
| Honduras             | 28     | 0                | 3              | 0            | 25     |
| Hong Kong            | 22     | 0                | 0              | 0            | 22     |
| Hungary              | *      | 0                | 0              | 0            | *      |
| Iceland              | *      | 0                | 0              | 0            | *      |
| India                | 10     | 0                | *              | 0            | 10     |
| Indonesia            | 3      | 0                | 0              | 0            | 3      |
| Ireland              | 9,020  | 8,659            | 153            | 0            | 207    |
| Isle of Man          | 0      | 0                | 0              | 0            | 0      |
| Israel               | 7      | 0                | *              | 0            | 7      |
| Italy                | 2,864  | 100              | 2,759          | 0            | 6      |
| Jamaica              | 9      | 0                | 0              | 0            | 9      |
| Japan                | 17,240 | 0                | 0              | 0            | 17,240 |
| Jersey               | 5,278  | 4,513            | 0              | 460          | 304    |
| Jordan               | *      | 0                | 0              | 0            | *      |
| Korea, South         | 70     | 0                | 0              | 0            | 70     |
| Luxembourg           | 3,868  | 3,445            | 35             | 0            | 388    |
| Malaysia             | 6      | 0                | 0              | 0            | 6      |
| Mexico               | 195    | 105              | 74             | 0            | 16     |
| Netherlands          | 10,817 | 1,533            | 4,791          | 2            | 4,492  |
| Netherlands Antilles | 25     | 0                | 25             | 0            | 0      |

\* Greater than zero but less than \$500,000.



**24. Market value of U.S. holdings of foreign short-term debt securities,  
by country and type of security, as of December 31, 2004 (continued)**

Millions of dollars

| Country or category                    | Total   | Commercial paper | Negotiable CDs | Asset-backed | Other  |
|--|---------|------------------|----------------|--------------|--------|
| New Zealand                            | 1,595   | 1,549            | *              | 0            | 46     |
| Nicaragua                              | 1       | 0                | 1              | 0            | 0      |
| Norway                                 | 2,055   | 1,458            | 149            | 0            | 448    |
| Panama                                 | 24      | 21               | 2              | 0            | 1      |
| Peru                                   | 1       | 0                | 0              | 0            | 1      |
| Poland                                 | 1       | 0                | 0              | 0            | 1      |
| Portugal                               | 73      | 52               | 0              | 0            | 21     |
| Singapore                              | 114     | 98               | 0              | 0            | 15     |
| South Africa                           | *       | 0                | 0              | 0            | *      |
| Spain                                  | 831     | 70               | 728            | 0            | 33     |
| Sri Lanka                              | *       | 0                | 0              | 0            | *      |
| Sweden                                 | 9,537   | 7,370            | 1,785          | 0            | 381    |
| Switzerland                            | 2,274   | 606              | 1,663          | 0            | 5      |
| Taiwan                                 | 2       | 0                | 0              | 0            | 2      |
| Thailand                               | 16      | 0                | 0              | 0            | 16     |
| Trinidad ana Tobago                    | 26      | 26               | 0              | 0            | 0      |
| Turkey                                 | 87      | 0                | 0              | 0            | 87     |
| Ukraine                                | 3       | 0                | 0              | 0            | 3      |
| United Kingdom                         | 110,390 | 38,221           | 65,974         | 3,619        | 2,576  |
| International and Reg.                 | 2,177   | 968              | 0              | 0            | 1,209  |
| Middle East oil-exporters <sup>1</sup> | 3       | 0                | 0              | 0            | 3      |
| Total                                  | 233,248 | 92,018           | 95,535         | 6,259        | 39,436 |

\* Greater than zero but less than \$500,000.

1. Bahrain, Iran, Iraq, Kuwait, Oman, Qatar, Saudi Arabia, United Arab Emirates.

**25. Market value of U.S. holdings of foreign debt securities, by country and sector of issuer, as of December 31, 2004**

Millions of dollars

| Country                | Total   | Long-term  |         | Short-term |         |
|------------------------|---------|------------|---------|------------|---------|
|                        |         | Government | Private | Government | Private |
| Albania                | 5       | 5          | 0       | 0          | 0       |
| Argentina              | 3,665   | 1,923      | 1,742   | 0          | 1       |
| Aruba                  | 1,114   | 97         | 1,017   | 0          | 0       |
| Australia              | 46,360  | 6,631      | 33,735  | 128        | 5,866   |
| Austria                | 6,273   | 2,029      | 2,654   | 1,215      | 375     |
| Bahamas                | 873     | 271        | 601     | 0          | 1       |
| Barbados               | 246     | 139        | 107     | 0          | 0       |
| Belgium                | 5,890   | 2,566      | 2,647   | 419        | 258     |
| Belize                 | 34      | 14         | 20      | 0          | 0       |
| Bermuda                | 10,525  | 0          | 9,862   | 0          | 663     |
| Bosnia and Herzegovina | 145     | 145        | 0       | 0          | 0       |
| Botswana               | 4       | 2          | 1       | 0          | 0       |
| Brazil                 | 19,895  | 16,611     | 3,274   | 0          | 10      |
| British Virgin Is.     | 751     | *          | 747     | 0          | 4       |
| Bulgaria               | 1,167   | 1,167      | 0       | 0          | 0       |
| Canada                 | 164,271 | 49,619     | 102,233 | 4,218      | 8,202   |
| Cayman Islands         | 125,927 | 312        | 114,066 | 0          | 11,549  |
| Chile                  | 9,034   | 1,821      | 7,213   | 0          | 0       |
| China, P.R.            | 1,077   | 481        | 584     | 0          | 12      |

\* Greater than zero but less than \$500,000.

**25. Market value of U.S. holdings of foreign debt securities, by country and sector of issuer, as of December 31, 2004 (continued)**

Millions of dollars

| Country            | Total  | Long-term  |         | Short-term |         |
|--------------------|--------|------------|---------|------------|---------|
|                    |        | Government | Private | Government | Private |
| Colombia           | 4,185  | 3,338      | 847     | 0          | 0       |
| Costa Rica         | 255    | 211        | 25      | 0          | 19      |
| Cote D'Ivoire      | 95     | 83         | 12      | 0          | 0       |
| Croatia            | 482    | 470        | 12      | 0          | 0       |
| Cuba               | 1      | 0          | 1       | 0          | 0       |
| Cyprus             | 100    | 92         | 8       | 0          | 0       |
| Czech Republic     | 33     | 10         | 23      | 0          | 0       |
| Denmark            | 9,394  | 1,392      | 6,900   | 23         | 1,080   |
| Dominican Republic | 503    | 428        | 44      | 0          | 31      |
| Ecuador            | 1,090  | 1,023      | 43      | 0          | 24      |
| Egypt              | 59     | 46         | 10      | 0          | 3       |
| El Salvador        | 674    | 626        | 32      | 0          | 16      |
| Estonia            | 39     | 0          | 39      | 0          | 0       |
| Finland            | 5,036  | 1,391      | 3,102   | 34         | 509     |
| France             | 51,973 | 17,559     | 24,273  | 2,308      | 7,834   |
| Germany            | 77,690 | 45,689     | 22,229  | 710        | 9,062   |
| Ghana              | 1      | 0          | 1       | 0          | 0       |
| Greece             | 1,310  | 1,115      | 194     | 0          | 0       |
| Grenada            | 2      | 2          | 0       | 0          | 0       |

\* Greater than zero but less than \$500,000.

**25. Market value of U.S. holdings of foreign debt securities, by country and sector of issuer, as of December 31, 2004 (continued)**

Millions of dollars

| Country      | Total  | Long-term  |         | Short-term |         |
|--------------|--------|------------|---------|------------|---------|
|              |        | Government | Private | Government | Private |
| Guatemala    | 173    | 173        | 0       | 0          | 0       |
| Guernsey     | 542    | 0          | 542     | 0          | 0       |
| Honduras     | 43     | 11         | 3       | 22         | 6       |
| Hong Kong    | 1,955  | 329        | 1,604   | *          | 22      |
| Hungary      | 601    | 575        | 26      | *          | 0       |
| Iceland      | 241    | 214        | 27      | 0          | 0       |
| India        | 373    | 33         | 330     | 10         | 0       |
| Indonesia    | 871    | 594        | 275     | 0          | 3       |
| Ireland      | 22,841 | 839        | 12,982  | 35         | 8,985   |
| Isle of Man  | 15     | 0          | 15      | 0          | 0       |
| Israel       | 15,261 | 13,853     | 1,401   | 2          | 5       |
| Italy        | 20,216 | 12,804     | 4,547   | 5          | 2,859   |
| Jamaica      | 202    | 181        | 11      | 0          | 9       |
| Japan        | 53,673 | 33,859     | 2,574   | 17,239     | 1       |
| Jersey       | 11,916 | 81         | 6,558   | 0          | 5,278   |
| Jordan       | 22     | 22         | 0       | 0          | 0       |
| Kazakhstan   | 346    | 11         | 335     | 0          | 0       |
| Kenya        | 15     | 10         | 5       | 0          | 0       |
| Korea, South | 6,975  | 3,165      | 3,740   | 10         | 60      |

\* Greater than zero but less than \$500,000.

**25. Market value of U.S. holdings of foreign debt securities, by country and sector of issuer, as of December 31, 2004 (continued)**

Millions of dollars

| Country              | Total  | Long-term  |         | Short-term |         |
|----------------------|--------|------------|---------|------------|---------|
|                      |        | Government | Private | Government | Private |
| Kyrgyzstan           | 11     | 0          | 11      | 0          | 0       |
| Latvia               | 4      | 4          | 0       | 0          | 0       |
| Lebanon              | 174    | 155        | 19      | 0          | 0       |
| Lesotho              | 1      | 0          | 1       | 0          | 0       |
| Liberia              | 1,964  | 0          | 1,964   | 0          | 0       |
| Lithuania            | 1      | 1          | 0       | 0          | 0       |
| Luxembourg           | 30,416 | 32         | 26,515  | 0          | 3,868   |
| Macedonia            | 40     | 33         | 7       | 0          | 0       |
| Malaysia             | 4,216  | 1,394      | 2,816   | 0          | 6       |
| Malta                | 17     | 0          | 17      | 0          | 0       |
| Marshall Islands     | 748    | 73         | 675     | 0          | 0       |
| Mauritius            | 183    | *          | 183     | 0          | 0       |
| Mexico               | 28,801 | 18,791     | 9,814   | 12         | 183     |
| Morocco              | 139    | 136        | 3       | 0          | 0       |
| Netherlands          | 65,894 | 5,088      | 49,989  | 720        | 10,098  |
| Netherlands Antilles | 1,547  | 6          | 1,517   | 0          | 25      |
| New Zealand          | 7,314  | 3,938      | 1,781   | 60         | 1,535   |
| Nicaragua            | 38     | 27         | 10      | 0          | 1       |

\* Greater than zero but less than \$500,000.

**25. Market value of U.S. holdings of foreign debt securities, by country and sector of issuer, as of December 31, 2004 (continued)**

Millions of dollars

| Country               | Total  | Long-term  |         | Short-term |         |
|-----------------------|--------|------------|---------|------------|---------|
|                       |        | Government | Private | Government | Private |
| Norway                | 12,324 | 1,494      | 8,775   | 63         | 1,992   |
| Pakistan              | 36     | 20         | 16      | 0          | 0       |
| Panama                | 4,853  | 2,839      | 1,991   | 0          | 24      |
| Peru                  | 3,209  | 3,196      | 12      | 0          | 1       |
| Philippines           | 3,468  | 2,638      | 829     | 0          | 0       |
| Poland                | 2,553  | 2,466      | 85      | 1          | 0       |
| Portugal              | 881    | 537        | 270     | 59         | 14      |
| Romania               | 52     | 52         | 1       | 0          | 0       |
| Russia                | 10,540 | 9,739      | 801     | 0          | 0       |
| Saint Lucia           | 49     | 0          | 49      | 0          | 0       |
| Serbia and Montenegro | 1      | 0          | 1       | 0          | 0       |
| Singapore             | 5,226  | 611        | 4,501   | 15         | 99      |
| Slovakia              | 190    | 178        | 12      | 0          | 0       |
| Slovenia              | 36     | 36         | 0       | 0          | 0       |
| South Africa          | 3,047  | 2,759      | 289     | 0          | 0       |
| Spain                 | 5,903  | 3,829      | 1,243   | 0          | 831     |
| Sri Lanka             | 49     | 19         | 30      | 0          | 0       |
| Swaziland             | 3      | 1          | 1       | 0          | 0       |
| Sweden                | 24,114 | 5,526      | 9,051   | 4          | 9,532   |

\* Greater than zero but less than \$500,000.

**25. Market value of U.S. holdings of foreign debt securities, by country and sector of issuer, as of December 31, 2004 (continued)**

Millions of dollars

| Country                                | Total            | Long-term      |                | Short-term    |                |
|--|------------------|----------------|----------------|---------------|----------------|
|  |                  | Government     | Private        | Government    | Private        |
| Switzerland                            | 3,826            | 174            | 1,378          | 26            | 2,249          |
| Taiwan                                 | 333              | 52             | 279            | 0             | 2              |
| Thailand                               | 1,152            | 503            | 632            | 15            | 1              |
| Trinidad and Tobago                    | 498              | 437            | 35             | 0             | 26             |
| Tunisia                                | 588              | 245            | 343            | 0             | 0              |
| Turkey                                 | 2,664            | 2,269          | 308            | 76            | 11             |
| Ukraine                                | 1,527            | 1,413          | 111            | 0             | 3              |
| United Kingdom                         | 281,836          | 15,029         | 156,417        | 71            | 110,318        |
| Uruguay                                | 1,297            | 717            | 580            | 0             | 0              |
| Venezuela                              | 6,226            | 5,084          | 1,142          | 0             | 0              |
| Vietnam                                | 113              | 113            | 0              | 0             | 0              |
| Zimbabwe                               | 54               | 39             | 15             | 0             | 0              |
| Other and unknown                      | *                | *              | 0              | 0             | 0              |
| International Organizations            | 19,966           | 17,657         | 132            | 1,466         | 711            |
| Middle East oil-exporters <sup>1</sup> | 1,456            | 472            | 981            | 0             | 3              |
| African oil-exporters <sup>2</sup>     | 180              | 155            | 25             | 0             | 0              |
| <b>Total</b>                           | <b>1,226,217</b> | <b>334,043</b> | <b>658,926</b> | <b>28,967</b> | <b>204,281</b> |

\* Greater than zero but less than \$500,000.

1. Bahrain, Iran, Iraq, Kuwait, Oman, Qatar, Saudi Arabia, United Arab Emirates.

2. Algeria, Gabon, Libya, Nigeria.

**26. Market value of U.S. holdings of foreign equities, by country and amounts held as Depository Receipts, as of December 31, 2004**

Millions of dollars except as noted

| Country or category        | Equity  | Depository Receipts | Percentage<br>Depository Receipts |
|----------------------------|---------|---------------------|-----------------------------------|
| Andorra                    | 2       | 0                   | 0                                 |
| Anguilla                   | 2       | 0                   | 0                                 |
| Antigua and Barbuda        | 12      | 0                   | 0                                 |
| Argentina                  | 1,161   | 860                 | 74                                |
| Australia                  | 57,052  | 4,037               | 7                                 |
| Austria                    | 8,976   | 181                 | 2                                 |
| Bahamas                    | 1,779   | 3                   | 0                                 |
| Barbados                   | 10      | 0                   | 0                                 |
| Belgium                    | 18,083  | 548                 | 3                                 |
| Belize                     | 26      | 0                   | 0                                 |
| Bermuda                    | 153,549 | 1,044               | 1                                 |
| Bosnia and Herzegovina     | 4       | 0                   | 0                                 |
| Botswana                   | 3       | 0                   | 0                                 |
| Brazil                     | 43,104  | 26,277              | 61                                |
| British Virgin Islands     | 3,716   | 2                   | 0                                 |
| Bulgaria                   | 6       | 0                   | 0                                 |
| Canada                     | 180,398 | 1,019               | 1                                 |
| Cayman Islands             | 69,750  | 2,585               | 4                                 |
| Chile                      | 2,564   | 1,965               | 77                                |
| China, Peoples Republic of | 11,645  | 2,432               | 21                                |



**26. Market value of U.S. holdings of foreign equities, by country and amounts held as Depository Receipts, as of December 31, 2004 (continued)**

Millions of dollars except as noted

| Country or category | Equity  | Depository Receipts | Percentage<br>Depository Receipts |
|---------------------|---------|---------------------|-----------------------------------|
| Colombia            | 270     | 175                 | 65                                |
| Costa Rica          | 5       | 0                   | 0                                 |
| Cote D'Ivoire       | 2       | 0                   | 0                                 |
| Croatia             | 234     | 228                 | 98                                |
| Cyprus              | 3       | *                   | 0                                 |
| Czech Republic      | 1,843   | 138                 | 8                                 |
| Denmark             | 14,488  | 862                 | 6                                 |
| Ecuador             | 25      | 24                  | 96                                |
| Egypt               | 1,093   | 192                 | 18                                |
| Estonia             | 304     | 35                  | 12                                |
| Finland             | 33,860  | 14,894              | 44                                |
| France              | 164,634 | 20,705              | 13                                |
| Germany             | 123,685 | 14,717              | 12                                |
| Ghana               | 3       | 0                   | 0                                 |
| Gibraltar           | 64      | 63                  | 99                                |
| Greece              | 6,980   | 263                 | 4                                 |
| Guernsey            | 5,399   | 0                   | 0                                 |
| Hong Kong           | 35,395  | 1,801               | 5                                 |
| Hungary             | 4,503   | 906                 | 20                                |
| Iceland             | 2       | 0                   | 0                                 |

\* Greater than zero but less than \$500,000.

**26. Market value of U.S. holdings of foreign equities, by country and amounts held as Depository Receipts, as of December 31, 2004 (continued)**

Millions of dollars except as noted

| Country or category | Equity  | Depository Receipts | Percentage<br>Depository Receipts |
|---------------------|---------|---------------------|-----------------------------------|
| India               | 23,152  | 5,637               | 24                                |
| Indonesia           | 6,116   | 861                 | 14                                |
| Ireland             | 32,422  | 11,516              | 36                                |
| Israel              | 19,054  | 9,095               | 48                                |
| Italy               | 57,494  | 4,467               | 8                                 |
| Jamaica             | 2       | *                   | 1                                 |
| Japan               | 330,427 | 20,260              | 6                                 |
| Jersey              | 436     | 250                 | 57                                |
| Jordan              | 19      | 0                   | 0                                 |
| Kenya               | 2       | 0                   | 0                                 |
| Korea, South        | 66,639  | 13,417              | 20                                |
| Latvia              | 4       | *                   | 7                                 |
| Lebanon             | 49      | 49                  | 100                               |
| Lesotho             | 25      | 0                   | 0                                 |
| Liberia             | 5,866   | 0                   | 0                                 |
| Liechtenstein       | 35      | 0                   | 0                                 |
| Lithuania           | 3       | *                   | 22                                |
| Luxembourg          | 7,634   | 1,952               | 26                                |
| Malaysia            | 6,474   | 10                  | 0                                 |

\* Greater than zero but less than \$500,000.

**26. Market value of U.S. holdings of foreign equities, by country and amounts held as Depositary Receipts, as of December 31, 2004 (continued)**

Millions of dollars except as noted

| Country or category  | Equity  | Depositary Receipts | Percentage<br>Depositary Receipts |
|----------------------|---------|---------------------|-----------------------------------|
| Marshall Islands     | 3,727   | 0                   | 0                                 |
| Mauritius            | 143     | 0                   | 0                                 |
| Mexico               | 37,516  | 25,079              | 67                                |
| Monaco               | 8       | 0                   | 0                                 |
| Morocco              | 89      | *                   | 0                                 |
| Namibia              | 1       | 0                   | 0                                 |
| Netherlands          | 136,467 | 36,373              | 27                                |
| Netherlands Antilles | 28,730  | 15                  | 0                                 |
| New Zealand          | 4,720   | 546                 | 12                                |
| Norway               | 18,153  | 1,299               | 7                                 |
| Pakistan             | 111     | 4                   | 3                                 |
| Panama               | 19,450  | *                   | 0                                 |
| Papua New Guinea     | 314     | 67                  | 21                                |
| Peru                 | 666     | 568                 | 85                                |
| Philippines          | 2,222   | 485                 | 22                                |
| Poland               | 3,072   | 284                 | 9                                 |
| Portugal             | 5,505   | 546                 | 10                                |
| Romania              | 120     | 1                   | 1                                 |
| Russia               | 10,775  | 9,791               | 91                                |
| Singapore            | 23,968  | 946                 | 4                                 |

\* Greater than zero but less than \$500,000.

**26. Market value of U.S. holdings of foreign equities, by country and amounts held as Depositary Receipts, as of December 31, 2004 (continued)**

Millions of dollars except as noted

| Country or category | Equity           | Depositary Receipts | Percentage<br>Depositary Receipts |
|---------------------|------------------|---------------------|-----------------------------------|
| Slovenia            | 1                | 0                   | 0                                 |
| South Africa        | 21,600           | 3,332               | 15                                |
| Spain               | 63,002           | 5,762               | 9                                 |
| Sri Lanka           | 31               | *                   | 0                                 |
| Sweden              | 38,284           | 5,219               | 14                                |
| Switzerland         | 138,187          | 19,378              | 14                                |
| Taiwan              | 34,554           | 7,527               | 22                                |
| Thailand            | 5,961            | 218                 | 4                                 |
| Trinidad and Tobago | 5                | 0                   | 0                                 |
| Turkey              | 5,561            | 306                 | 6                                 |
| Ukraine             | 25               | 19                  | 76                                |
| United Kingdom      | 455,919          | 110,236             | 24                                |
| Uruguay             | 6                | 0                   | 0                                 |
| Venezuela           | 636              | 567                 | 89                                |
| Zambia              | 2                | 0                   | 0                                 |
| Zimbabwe            | 14               | 0                   | 0                                 |
| <b>Total</b>        | <b>2,560,418</b> | <b>392,156</b>      | <b>15</b>                         |

**27. Market value of U.S. holdings of foreign equities, by country and type of security, as of December 31, 2004**

Millions of dollars

| Country or category        | Total   | Common  | Preferred | Funds | Other |
|----------------------------|---------|---------|-----------|-------|-------|
| Andorra                    | 2       | 0       | 0         | 0     | 2     |
| Anguilla                   | 2       | 0       | 0         | 0     | 2     |
| Antigua and Barbuda        | 12      | 12      | 0         | 0     | 0     |
| Argentina                  | 1,161   | 1,130   | 22        | 0     | 9     |
| Aruba                      | *       | 0       | 0         | 0     | *     |
| Australia                  | 57,052  | 56,016  | 563       | 69    | 404   |
| Austria                    | 8,976   | 8,917   | 16        | 26    | 18    |
| Bahamas                    | 1,779   | 1,622   | 0         | 50    | 106   |
| Barbados                   | 10      | 10      | 0         | 0     | 0     |
| Belgium                    | 18,083  | 17,948  | 52        | 79    | 3     |
| Belize                     | 26      | 26      | 0         | 0     | 0     |
| Bermuda                    | 153,549 | 151,367 | 790       | 1,209 | 183   |
| Bosnia and Herzegovina     | 4       | 4       | 0         | 0     | 0     |
| Botswana                   | 3       | 3       | 0         | 0     | 0     |
| Brazil                     | 43,104  | 27,223  | 15,801    | 5     | 74    |
| British Virgin Islands     | 3,716   | 3,054   | 0         | 650   | 13    |
| Bulgaria                   | 6       | 6       | 0         | 0     | 0     |
| Canada                     | 180,398 | 175,997 | 1,178     | 2,522 | 701   |
| Cayman Islands             | 69,750  | 55,980  | 4,298     | 8,851 | 621   |
| Chile                      | 2,564   | 2,518   | 7         | 37    | 1     |
| China, Peoples Republic of | 11,645  | 11,641  | 0         | 0     | 4     |

\* Greater than zero but less than \$500,000.

**27. Market value of U.S. holdings of foreign equities, by country and type of security, as of December 31, 2004 (continued)**

Millions of dollars

| Country or category | Total   | Common  | Preferred | Funds | Other |
|---------------------|---------|---------|-----------|-------|-------|
| Colombia            | 270     | 262     | 6         | 0     | 2     |
| Cook Islands        | *       | *       | 0         | 0     | 0     |
| Costa Rica          | 5       | 1       | 4         | 0     | 0     |
| Cote D'Ivoire       | 2       | 1       | 1         | 0     | 0     |
| Croatia             | 234     | 234     | 0         | 0     | 0     |
| Cuba                | *       | *       | 0         | 0     | 0     |
| Cyprus              | 3       | 3       | 0         | 0     | 0     |
| Czech Republic      | 1,843   | 1,842   | 0         | 0     | 0     |
| Denmark             | 14,488  | 14,475  | 12        | 1     | 0     |
| Dominican Republic  | *       | *       | 0         | 0     | 0     |
| Ecuador             | 25      | 25      | 0         | 0     | 0     |
| Egypt               | 1,093   | 1,092   | 0         | 0     | 1     |
| El Salvador         | *       | *       | 0         | 0     | 0     |
| Estonia             | 304     | 303     | 0         | 0     | 0     |
| Falkland Islands    | *       | *       | 0         | 0     | 0     |
| Finland             | 33,860  | 33,767  | 3         | 2     | 88    |
| France              | 164,634 | 164,530 | 22        | 57    | 25    |
| French Guiana       | *       | *       | 0         | 0     | 0     |
| Germany             | 123,685 | 118,213 | 5,280     | 62    | 130   |
| Ghana               | 3       | 3       | 0         | 0     | 0     |
| Gibraltar           | 64      | 64      | 0         | 0     | 0     |
| Greece              | 6,980   | 6,958   | 13        | 8     | 2     |

\* Greater than zero but less than \$500,000.

**27. Market value of U.S. holdings of foreign equities, by country and type of security, as of December 31, 2004 (continued)**

Millions of dollars

| Country or category | Total   | Common  | Preferred | Funds | Other |
|---------------------|---------|---------|-----------|-------|-------|
| Guernsey            | 5,399   | 4,993   | 16        | 283   | 106   |
| Hong Kong           | 35,395  | 35,153  | 67        | 167   | 9     |
| Hungary             | 4,503   | 4,502   | 0         | 0     | 0     |
| Iceland             | 2       | 2       | 0         | 0     | 0     |
| India               | 23,152  | 23,091  | 17        | 36    | 7     |
| Indonesia           | 6,116   | 6,096   | 0         | 1     | 18    |
| Ireland             | 32,422  | 29,911  | 245       | 1,908 | 359   |
| Isle of Man         | *       | *       | 0         | *     | 0     |
| Israel              | 19,054  | 19,030  | 15        | 0     | 8     |
| Italy               | 57,494  | 57,385  | 83        | 8     | 18    |
| Jamaica             | 2       | 2       | 0         | 0     | 0     |
| Japan               | 330,427 | 329,834 | 4         | 479   | 109   |
| Jersey              | 436     | 279     | 75        | 20    | 62    |
| Jordan              | 19      | 18      | 0         | 0     | 0     |
| Kazakhstan          | *       | *       | 0         | 0     | 0     |
| Kenya               | 2       | 2       | 0         | 0     | 0     |
| Korea, South        | 66,639  | 64,450  | 2,159     | 24    | 5     |
| Latvia              | 4       | 4       | 0         | 0     | 0     |
| Lebanon             | 49      | 49      | 0         | 0     | 0     |
| Lesotho             | 25      | 25      | 0         | 0     | 0     |

\* Greater than zero but less than \$500,000.

**27. Market value of U.S. holdings of foreign equities, by country and type of security, as of December 31, 2004 (continued)**

Millions of dollars

| Country or category  | Total   | Common  | Preferred | Funds | Other |
|----------------------|---------|---------|-----------|-------|-------|
| Liberia              | 5,866   | 5,866   | 0         | 0     | 0     |
| Liechtenstein        | 35      | 35      | 0         | 0     | 0     |
| Lithuania            | 3       | 3       | 0         | 0     | 0     |
| Luxembourg           | 7,634   | 5,469   | 126       | 1,924 | 114   |
| Malaysia             | 6,474   | 6,446   | 2         | 26    | 0     |
| Malta                | *       | *       | 0         | 0     | 0     |
| Marshall Islands     | 3,727   | 3,616   | 111       | 0     | 0     |
| Mauritius            | 143     | 15      | 1         | 81    | 47    |
| Mexico               | 37,516  | 37,464  | 2         | 16    | 34    |
| Monaco               | 8       | 8       | 0         | 0     | 0     |
| Morocco              | 89      | 89      | 1         | 0     | 0     |
| Namibia              | 1       | 1       | 0         | 0     | 0     |
| Netherlands          | 136,467 | 134,804 | 1,399     | 163   | 101   |
| Netherlands Antilles | 28,730  | 28,669  | 0         | 61    | 0     |
| New Zealand          | 4,720   | 4,611   | 48        | 4     | 57    |
| Norway               | 18,153  | 18,144  | 0         | 1     | 8     |
| Pakistan             | 111     | 111     | 0         | 0     | 0     |
| Panama               | 19,450  | 19,450  | 0         | 0     | 0     |
| Papua New Guinea     | 314     | 310     | 0         | 0     | 5     |
| Peru                 | 666     | 666     | 0         | 0     | 0     |

\* Greater than zero but less than \$500,000.



**27. Market value of U.S. holdings of foreign equities, by country and type of security, as of December 31, 2004 (continued)**

Millions of dollars

| Country or category   | Total   | Common  | Preferred | Funds | Other |
|-----------------------|---------|---------|-----------|-------|-------|
| Philippines           | 2,222   | 2,064   | 158       | 0     | 0     |
| Poland                | 3,072   | 3,067   | 2         | 1     | 2     |
| Portugal              | 5,505   | 5,496   | 0         | 0     | 9     |
| Romania               | 120     | 119     | 0         | 1     | 0     |
| Russia                | 10,775  | 10,321  | 434       | 12    | 8     |
| Saint Kitts and Nevis | *       | *       | 0         | 0     | 0     |
| Senegal               | *       | *       | 0         | 0     | 0     |
| Singapore             | 23,968  | 23,475  | 6         | 483   | 4     |
| Slovenia              | 1       | 1       | 0         | 0     | 0     |
| South Africa          | 21,600  | 21,572  | 11        | 10    | 6     |
| Spain                 | 63,002  | 62,788  | 194       | 6     | 15    |
| Sri Lanka             | 31      | 31      | 0         | 0     | 0     |
| Swaziland             | *       | *       | 0         | 0     | 0     |
| Sweden                | 38,284  | 38,114  | 152       | 14    | 5     |
| Switzerland           | 138,187 | 138,115 | 11        | 59    | 2     |
| Taiwan                | 34,554  | 34,530  | 12        | 2     | 10    |
| Tanzania              | 0       | 0       | 0         | 0     | 0     |
| Thailand              | 5,961   | 5,759   | 22        | 174   | 7     |

\* Greater than zero but less than \$500,000.

**27. Market value of U.S. holdings of foreign equities, by country and type of security, as of December 31, 2004 (continued)**

Millions of dollars

| Country or category                    | Total            | Common           | Preferred     | Funds         | Other        |
|--|------------------|------------------|---------------|---------------|--------------|
| Trinidad and Tobago                    | 5                | 5                | 0             | 0             | 0            |
| Tunisia                                | *                | *                | 0             | 0             | 0            |
| Turkey                                 | 5,561            | 5,528            | 17            | 6             | 10           |
| Turks and Caicos Islands               | *                | 0                | *             | 0             | 0            |
| Ukraine                                | 25               | 13               | 11            | 0             | 1            |
| United Kingdom                         | 455,919          | 447,456          | 4,346         | 2,848         | 1,269        |
| Uruguay                                | 6                | 0                | 6             | 0             | 0            |
| Venezuela                              | 636              | 630              | 7             | 0             | 0            |
| Vietnam                                | *                | *                | 0             | 0             | 0            |
| Zambia                                 | 2                | 2                | 0             | 0             | 0            |
| Zimbabwe                               | 14               | 14               | 0             | 0             | 0            |
| Other and unknown                      | *                | *                | 0             | 0             | 0            |
| International Organizations            | 373              | 372              | 0             | 0             | 1            |
| Middle East oil-exporters <sup>1</sup> | 1                | 1                | 0             | 0             | 0            |
| African oil-exporters <sup>2</sup>     | 12               | 12               | 0             | 0             | 0            |
| <b>Total</b>                           | <b>2,560,418</b> | <b>2,497,122</b> | <b>37,069</b> | <b>21,543</b> | <b>4,684</b> |

\* Greater than zero but less than \$500,000.

1. Bahrain, Iran, Iraq, Kuwait, Oman, Qatar, Saudi Arabia, United Arab Emirates.
2. Algeria, Gabon, Libya, Nigeria.

**28. Market value of U.S. holdings of foreign equities, by country, size of domestic equity markets, and share of each market that is U.S. held, as of December 31, 2004**

Millions of dollars except as noted

| Country or category        | Equity  | Rank according to market capitalization <sup>1</sup> | Ratio of U.S. holdings to total domestic market capitalization <sup>1</sup> |
|----------------------------|---------|--|---|
| Argentina                  | 1,161   | 39   | .025  |
| Armenia                    | 0       | 101  | .000  |
| Australia                  | 57,052  | 10   | .073  |
| Austria                    | 8,976   | 34   | .105  |
| Bangladesh                 | 0       | 67   | .000  |
| Barbados                   | 10      | 60   | .002  |
| Belgium <sup>2</sup>       | 18,083  | 11   | .024  |
| Bermuda                    | 153,549 | 83   | >1  |
| Bolivia                    | 0       | 80   | .000  |
| Botswana                   | 3       | 76   | .001  |
| Brazil                     | 43,104  | 19   | .130  |
| British Virgin Islands     | 3,716   | n.a.   | n.a.  |
| Bulgaria                   | 6       | 71   | .002  |
| Canada                     | 180,398 | 5  | .153  |
| Cayman Islands             | 69,750  | 96   | >1  |
| Chile                      | 2,564   | 29   | .022  |
| China, Peoples Republic of | 11,645  | 12   | .018  |
| Colombia                   | 270     | 46   | .011  |

1. Market capitalization data are from Standard & Poor's Global Stock Markets Factbook 2005. Market capitalization based on year-end 2004 total market values of listed domestic companies. U.S. holdings include securities of companies registered in each country that may not trade on domestic exchanges, thus U.S. holdings can exceed the total size of a countries' total domestic market capitalization. Rank order excludes the United States, which has the largest equity market capitalization.

2. The listing place of several Euronext securities changed to Brussels from Paris and Amsterdam in January 2004. This change in listing increased the market capitalization for Belgium from \$186 billion to \$768 billion and significantly lowered the percentage of Belgium securities reported as U.S. held, as U.S. holdings of these securities will still be recorded versus the country of incorporation of the relevant firms.  
n.a. Not available.

**28. Market value of U.S. holdings of foreign equities, by country, size of domestic equity markets, and share of each market that is U.S. held, as of December 31, 2004**  
(continued)

Millions of dollars except as noted

| Country or category | Equity  | Rank according to market capitalization <sup>1</sup> | Ratio of U.S. holdings to total domestic market capitalization <sup>1</sup> |
|---------------------|---------|--|---|
| Costa Rica          | 5       | 82   | .003  |
| Cote d'Ivoire       | 2       | 79   | .001  |
| Croatia             | 234     | 56   | .021  |
| Cyprus              | 3       | 6  | .001  |
| Czech Republic      | 1,843   | 42   | .060  |
| Denmark             | 14,488  | 26   | .096  |
| Ecuador             | 25      | 75   | .010  |
| Egypt               | 1,093   | 41   | .028  |
| El Salvador         | *       | 73   | .000  |
| Estonia             | 304     | 58   | .049  |
| Fiji                | 0       | 88   | .000  |
| Finland             | 33,860  | 23   | .184  |
| France              | 164,634 | 3  | .089  |
| Georgia             | 0       | 95   | .000  |
| Germany             | 123,685 | 4  | .104  |
| Ghana               | 3       | 72   | .001  |
| Greece              | 6,980   | 28   | .056  |

1. Market capitalization data are from Standard & Poor's Global Stock Markets Factbook 2005. Market capitalization based on year-end 2004 total market values of listed domestic companies. U.S. holdings include securities of companies registered in each country that may not trade on domestic exchanges, thus U.S. holdings can exceed the total size of a countries' total domestic market capitalization. Rank order excludes the United States, which has the largest equity market capitalization.

\* Greater than zero but less than \$500,000.

**28. Market value of U.S. holdings of foreign equities, by country, size of domestic equity markets, and share of each market that is U.S. held, as of December 31, 2004**  
(continued)

Millions of dollars except as noted

| Country or category | Equity  | Rank according to market capitalization <sup>1</sup> | Ratio of U.S. holdings to total domestic market capitalization <sup>1</sup> |
|---------------------|---------|--|---|
| Guernsey            | 5,399   | n.a.   | n.a.  |
| Guyana              | 0       | 97   | .000  |
| Hong Kong           | 35,395  | 7  | .041  |
| Hungary             | 4,503   | 45   | .157  |
| Iceland             | 2       | 50   | .000  |
| India               | 23,152  | 17   | .060  |
| Indonesia           | 6,116   | 36   | .083  |
| Ireland             | 32,422  | 31   | .284  |
| Israel              | 19,054  | 33   | .200  |
| Italy               | 57,494  | 9  | .073  |
| Jamaica             | 2       | 52   | .000  |
| Japan               | 330,427 | 1  | .090  |
| Jersey              | 436     | n.a.   | n.a.  |
| Jordan              | 19      | 49   | .001  |
| Kazakhstan          | *       | 63   | .000  |
| Kenya               | 2       | 64   | .001  |

1. Market capitalization data are from Standard & Poor's Global Stock Markets Factbook 2005. Market capitalization based on year-end 2004 total market values of listed domestic companies. U.S. holdings include securities of companies registered in each country that may not trade on domestic exchanges, thus U.S. holdings can exceed the total size of a countries' total domestic market capitalization. Rank order excludes the United States, which has the largest equity market capitalization.

\* Greater than zero but less than \$500,000. n.a. Not available.

**28. Market value of U.S. holdings of foreign equities, by country, size of domestic equity markets, and share of each market that is U.S. held, as of December 31, 2004**  
(continued)

Millions of dollars except as noted

| Country or category | Equity | Rank according to market capitalization <sup>1</sup> | Ratio of U.S. holdings to total domestic market capitalization <sup>1</sup> |
|---------------------|--------|--|---|
| Korea, South        | 66,639 | 16   | .155  |
| Kyrgyzstan          | *      | 99   | .002  |
| Latvia              | 4      | 84   | .002  |
| Lebanon             | 49     | 78   | .021  |
| Liberia             | 5,866  | n.a.   | n.a.  |
| Lithuania           | 3      | 57   | .001  |
| Luxembourg          | 7,634  | 38   | .152  |
| Macedonia           | 0      | 91   | .000  |
| Malaysia            | 6,474  | 22   | .034  |
| Malta               | *      | 70   | .000  |
| Marshall Islands    | 3,727  | n.a.   | n.a.  |
| Mauritius           | 143    | 77   | .060  |
| Mexico              | 37,516 | 24   | .218  |
| Mongolia            | 0      | 100  | .000  |
| Morocco             | 89     | 47   | .004  |
| Namibia             | 1      | 89   | .001  |

1. Market capitalization data are from Standard & Poor's Global Stock Markets Factbook 2005. Market capitalization based on year-end 2004 total market values of listed domestic companies. U.S. holdings include securities of companies registered in each country that may not trade on domestic exchanges, thus U.S. holdings can exceed the total size of a countries' total domestic market capitalization. Rank order excludes the United States, which has the largest equity market capitalization.

\* Greater than zero but less than \$500,000. n.a. Not available.

**28. Market value of U.S. holdings of foreign equities, by country, size of domestic equity markets, and share of each market that is U.S. held, as of December 31, 2004**  
(continued)

Millions of dollars except as noted

| Country or category   | Equity  | Rank according to market capitalization <sup>1</sup> | Ratio of U.S. holdings to total domestic market capitalization <sup>1</sup> |
|-----------------------|---------|--|---|
| Nepal                 | 0       | 86   | .000  |
| Netherlands           | 136,467 | 13   | .219  |
| Netherlands Antilles  | 28,730  | n.a.   | n.a.  |
| New Zealand           | 4,720   | 40   | .108  |
| Norway                | 18,153  | 27   | .128  |
| Pakistan              | 111     | 43   | .004  |
| Panama                | 19,450  | 66   | >1  |
| Paraguay              | 0       | 94   | .000  |
| Papua New Guinea      | 314     | 69   | .107  |
| Peru                  | 666     | 48   | .033  |
| Philippines           | 2,222   | 44   | .077  |
| Poland                | 3,072   | 37   | .043  |
| Portugal              | 5,505   | 35   | .075  |
| Romania               | 120     | 53   | .010  |
| Russia                | 10,775  | 21   | .040  |
| Saudi Arabia          | n.a.    | 20   | n.a.  |
| Serbia and Montenegro | 0       | 68   | .000  |
| Singapore             | 23,968  | 25   | .140  |
| Slovakia              | *       | 62   | .000  |
| Slovenia              | 1       | 56   | .000  |

1. Market capitalization data are from Standard & Poor's Global Stock Markets Factbook 2005. Market capitalization based on year-end 2004 total market values of listed domestic companies. U.S. holdings include securities of companies registered in each country that may not trade on domestic exchanges, thus U.S. holdings can exceed the total size of a countries' total domestic market capitalization. Rank order excludes the United States, which has the largest equity market capitalization.

\* Greater than zero but less than \$500,000. n.a. Not available.

**28. Market value of U.S. holdings of foreign equities, by country, size of domestic equity markets, and share of each market that is U.S. held, as of December 31, 2004**  
(continued)

Millions of dollars except as noted

| Country or category | Equity           | Rank according to market capitalization <sup>1</sup> | Ratio of U.S. holdings to total domestic market capitalization <sup>1</sup> |
|---------------------|------------------|--|---|
| South Africa        | 21,600           | 14   | .047  |
| Spain               | 63,002           | 6  | .067  |
| Sri Lanka           | 31               | 65   | .008  |
| Swaziland           | *                | 93   | .000  |
| Sweden              | 38,284           | 18   | .102  |
| Switzerland         | 138,187          | 8  | .167  |
| Taiwan              | 34,554           | 15   | .078  |
| Tanzania            | 0                | 85   | .000  |
| Thailand            | 5,961            | 30   | .052  |
| Trinidad and Tobago | 5                | 51   | .000  |
| Tunisia             | *                | 74   | .000  |
| Turkey              | 5,561            | 32   | .057  |
| Uganda              | 0                | 98   | .000  |
| Ukraine             | 25               | 54   | .002  |
| United Kingdom      | 455,919          | 2  | .162  |
| Uruguay             | 6                | 92   | .019  |
| Venezuela           | 636              | 59   | .104  |
| Zambia              | 2                | 90   | .004  |
| Zimbabwe            | 14               | 81   | .007  |
| <b>Total</b>        | <b>2,560,418</b> | <b>n.a.</b>  | <b>.113</b>   |

1. Market capitalization data are from Standard & Poor's Global Stock Markets Factbook 2005. Market capitalization based on year-end 2004 total market values of listed domestic companies. U.S. holdings include securities of companies registered in each country that may not trade on domestic exchanges, thus U.S. holdings can exceed the total size of a countries' total domestic market capitalization. Rank order excludes the United States, which has the largest equity market capitalization.

\* Greater than zero but less than \$500,000. n.a. Not applicable



OMB NO. 1505-0146  
Approval Expires: August 31, 2006

ANNUAL REPORT TO THE FEDERAL RESERVE BANK OF NEW YORK

**REPORT OF U.S. OWNERSHIP OF  
FOREIGN SECURITIES, INCLUDING  
SELECTED MONEY MARKET  
INSTRUMENTS (SHCA)**

**Mandatory Report  
Response Required By Law  
(22 U.S.C. 3101 et seq.)**



**Department of the Treasury  
Federal Reserve Bank of New York  
Board of Governors of the Federal Reserve System**

# TABLE OF CONTENTS

|  | <b>Page</b>             |
|--|-------------------------|
| <b>I. INTRODUCTION</b>   |                         |
| A. Purpose   | 1                       |
| B. Authority   | 1                       |
| C. Confidentiality of Data Reported  | 1                       |
| D. Penalties for Failure to Report   | 2                       |
| E. Paperwork Reduction Act Notice  | 2                       |
| <b>II. GENERAL INSTRUCTIONS</b>  |                         |
| A. Who Must Report   | 3                       |
| B. “Schedule 2 and Schedule 3” vs. “Schedule 3 only” Reporters                       | 3                       |
| C. Exemption Levels  | 4                       |
| D. Reporting Dates   | 5                       |
| E. Submission Instructions and Contact Information                                   | 5                       |
| <b>III. WHAT SECURITIES MUST BE REPORTED</b>   |                         |
| A. Reportable Foreign Securities   | 6                       |
| B. Do Not Report   | 8                       |
| C. Funds and Related Equity Holdings   | 8                       |
| D. Securities Involved in Repurchase and Securities Lending Arrangements             | 9                       |
| E. Depositary Receipts/Shares  | 9                       |
| F. Stripped Securities   | 10                      |
| G. Direct Investment   | 10                      |
| H. Securities Held by Central Securities Depositories                                | 10                      |
| I. Country Attribution   | 10                      |
| J. Limited Partnerships  | 10                      |
| K. Accounting Rules, Valuation of Securities, and Calculation of U.S. Dollar Values  | 11                      |
| L. Data Retention Period   | 12                      |
| M. Review of Data and Requests For Revised Data                                      | 12                      |
| <b>IV. INSTRUCTIONS FOR COMPLETING REPORTING SCHEDULES</b>                           |                         |
| A. Schedule 1 - Reporter Contact Identification and Summary of Financial Information | 13                      |
| B. Schedule 2 - Details of Securities  | 16                      |
| C. Schedule 3 - Custodians Used  | 20                      |
| <b>APPENDICES</b>  |                         |
| A. Sample Reporting Schedules  | 22                      |
| Reporter Contact Identification and Summary Financial Information                    | Schedule 1, Page 1 of 3 |
| Details of Securities  | Schedule 2, Page 1 of 2 |
| Custodians Used  | Schedule 3, Page 1 of 1 |
| B. Reporting Requirement Flowcharts  | 23                      |
| C. List of Security Identification Systems   | 33                      |
| D. List of Country Codes   | 34                      |
| E. List of International and Regional Organizations                                  | 37                      |
| F. List of Currency Codes  | 39                      |
| G. List of Custodian Codes   | 41                      |
| H. Glossary  | 44                      |
| I. Technical Information for Electronic Submission                                   | 49                      |

## **I. INTRODUCTION**

### **A. PURPOSE**

The Department of the Treasury, with the assistance of the Board of Governors of the Federal Reserve System and the Federal Reserve Bank of New York (FRBNY), is conducting an annual mandatory survey of the ownership of foreign securities, including selected money market instruments, by U.S. residents as of December 31 of each year. The data will be collected by the FRBNY, acting as fiscal agent for the Department of the Treasury. The data collected will be used by the U.S. Government in the computation of the U.S. balance of payments accounts and the U.S. international investment position, and in the formulation of international economic and financial policies. This report also is part of the Coordinated Portfolio Investment Survey (CPIS), an internationally coordinated effort under the auspices of the IMF, to improve the statistics on the holdings of foreign securities by major investing countries.

In order to reduce reporting burden and costs to the government, there will be a substantial reduction in the number of reporters in four out of every five years. A benchmark survey (Form SHC) of all significant U.S.-resident custodians and end-investors will continue to be held approximately every five years. In non-benchmark years, the annual survey (Form SHCA) will require reports from only the very largest U.S.-resident custodians and end-investors. The data reported under these annual surveys (Form SHCA) will be used in conjunction with the results of the previous benchmark survey to compute economy-wide estimates for the non-benchmark years.

The determination of who must report on the annual reports (Form SHCA) will be based upon the data submitted during the previous benchmark survey. Certain U.S.-resident custodians and end-investors (including fund managers) will be designated to file detailed foreign security data on Schedule 2 and data on foreign securities entrusted to U.S.-resident custodians on Schedule 3, i.e., they will be required to file in the same manner as they did on the December 31, 2001 benchmark survey. Additional U.S.-resident custodians and end-investors (including fund managers) will be required to file data on Schedule 3 only. For these reporters, reporting requirements have been changed such that data on holdings of foreign securities that are entrusted to entities other than U.S.-resident custodians are to be reported in summary on Schedule 3 instead of in detail on Schedule 2. (Please refer to Sections II.B, II.C and IV.C for information on this new reporting requirement.)

### **B. AUTHORITY**

This survey is conducted under the authority of the *International Investment and Trade in Services Survey Act* (22 U.S.C. 3101 et seq., [the Act]) and *Executive Order 11961* of January 19, 1977. The Act specifies that the President has the authority to conduct a regular data collection program, including such studies and reports as may be necessary and feasible, to secure current information on international investment, including (but not limited to) such information as may be necessary for computing and analyzing the balance of payments and the international investment position of the United States (22 U.S.C. 3103). In *Executive Order 11961* §2, the President designated the Secretary of the Treasury to be responsible for collecting data on portfolio investment required by the Act.

### **C. CONFIDENTIALITY OF DATA REPORTED**

The information collected by this survey may be used only for analytical and statistical purposes and to enforce the Act. Access to the information is available only to officials and employees (including consultants and contractors and their employees) designated to perform functions under the Act. Persons having access to individual company information submitted pursuant to the Act are subject to penalties for unauthorized disclosure (22 U.S.C. §3104 and 18 U.S.C. §1905). The results of this survey will be made available to the general public at an aggregated level so that neither the U.S. persons or organizations providing information nor individual or organizational ownership of foreign securities can be identified.

#### **D. PENALTIES FOR FAILURE TO REPORT**

Reporting as directed in this package is mandatory for any U.S. person or organization subject to the reporting requirements set forth in the report instructions. Failure by an organization to provide timely and accurate data can result in a civil penalty of not less than \$2,500 and not more than \$25,000, or injunctive relief ordering such person to comply, or both (22 U.S.C. §3105(a)).

Willfully failing to submit any required information under the Act can result in a fine of not more than \$10,000; and, if an individual, may result in imprisonment for not more than a year, or both. Any officer, director, employee or agent who knowingly participates in such violation, upon conviction, may be punished by a like fine, imprisonment, or both (22 U.S.C. §3105(c)).

#### **E. PAPERWORK REDUCTION ACT NOTICE**

This report (titled “Report of U.S. Ownership of Foreign Securities, Including Selected Money Market Instruments” in the Federal Register Notice of February 21, 2003, pages 8537-8538) has been reviewed and approved by the Office of Management and Budget in accordance with the *Paperwork Reduction Act of 1995* and assigned OMB Control Number 1505-0146. The purpose is to collect accurate and complete data that will enable the Treasury Department to fulfill its responsibility under the Act. The estimated average burden associated with this collection of information is 700 hours for U.S.-resident custodians reporting detailed information on Schedule 2, 145 hours for U.S.-resident end-investors providing detailed information on Schedule 2, and 48 hours for U.S.-resident custodians and end-investors reporting only custodian information on Schedule 3. The amount of time required to complete the report will vary depending on the amount of data to report. Comments concerning the accuracy of this burden estimate and suggestions for reducing the burden should be directed to:

Administrator, International Portfolio Investment Data Systems  
U.S. Department of the Treasury  
1500 Pennsylvania Avenue NW, Room 4410-1440NYA  
Washington, DC 20220, or

The Office of Management and Budget  
Paperwork Reduction Project (1505-0146)  
Washington, DC 20503

No person is required to respond to any U.S. Government collection of information unless it displays a currently valid OMB control number.

## II. GENERAL INSTRUCTIONS

### A. WHO MUST REPORT

All entities that receive a copy of this report booklet must report. (See Section II.C, Exemption Levels.)

U.S. resident organizations that invest in foreign securities for their own portfolio that are held-for-trading, available-for-sale, or held-for-maturity, or which invest on behalf of others, including managers of mutual funds, insurance company policyholder assets, and pension fund managers are referred to as “end-investors” throughout these instructions. U.S.-resident end-investors include, but are not limited to:

- Financial and non-financial organizations
- Managers of private and public pension funds
- Managers of mutual funds, country funds, unit-investment funds, exchange-traded funds, collective-investment trusts, or any other similarly pooled, commingled fund
- Insurance companies
- Foundations
- Institutions of higher learning (e.g., university endowments)
- Trusts and estates

Custodians<sup>1</sup> are all organizations that hold securities in safekeeping for other organizations. Most U.S.-resident custodians also invest in foreign securities for their own account, i.e., are also U.S.-resident end-investors for purposes of this report. U.S.-resident custodians should report both the foreign securities held in safekeeping for other U.S. residents and their own foreign securities.

Reports should include all reportable securities held or managed by all U.S.-resident parts of your organization, including all U.S.-resident branches, offices, and subsidiaries. U.S. residents include organizations located in the Commonwealth of Puerto Rico and U.S. territories. Please see Appendix H for the complete definition of United States. It is the responsibility of the parent entity in each organization to ensure that its report covers all applicable entities within the organization.

Additional copies of the reporting forms and instructions may be printed from the Internet at:

<http://www.treas.gov/tic/forms.html#benchmark>

### B. “SCHEDULE 2 AND SCHEDULE 3” VS. “SCHEDULE 3 ONLY” REPORTERS

“Schedule 2 and Schedule 3” reporters must report:

- On **Schedule 2**: detailed information on all foreign securities, except those reported on Schedule 3.

If the reporting institution is a U.S.-resident custodian (see Section II.A):

Detailed information must be reported on Schedule 2 if the U.S.-resident custodian safekeeps foreign securities for itself or for its U.S.-resident clients, or employs foreign-resident subcustodians (or U.S.-resident or foreign-resident central securities depositories) directly, to manage the safekeeping of these securities.

---

<sup>1</sup> Foreign-resident custodians are custodians located outside the United States, including foreign affiliates of U.S. custodians. Reporters should determine the location of a custodian according to the country in which the custodian is incorporated, or otherwise legally established, not according to the country of the custodian’s parent firm, and not according to the location of the custodian’s operations center.

If the reporting institution is a U.S.-resident end-investor (see Section II.A):

Detailed information must be reported on Schedule 2 if the U.S.-resident end-investor does not entrust the safekeeping of its foreign securities to U.S.-resident custodians; that is when it: (1) holds the foreign securities directly; or (2) entrusts the safekeeping to a foreign-resident custodian or to a U.S.-resident or foreign-resident central securities depository.

- On **Schedule 3**: summary amounts for all foreign securities entrusted to the safekeeping of a U.S.-resident custodian (excluding U.S.-resident central securities depositories, see Section III.H).

“**Schedule 3 only**” reporters must report:

- On **Schedule 3**: summary amounts for all foreign securities owned, **regardless** of where they are held in custody.

### C. EXEMPTION LEVELS

If you have received this booklet, there is NO exemption level for **Schedule 1**. You must submit the reporter contact identification and certifying information parts of **Schedule 1**. (However, securities data need not be reported on Schedule 1 if you are not required to report data on Schedule 2 or Schedule 3 records.) The cover letter that accompanies this booklet identifies your organization as either a “**Schedule 2 and Schedule 3**” reporter or as a “**Schedule 3 only**” reporter.

U.S.-resident custodians and end-investors identified as “**Schedule 2 and Schedule 3**” reporters must submit all **Schedule 2** records, regardless of the size of their holdings.

U.S.-resident custodians and end-investors identified as “**Schedule 2 and Schedule 3**” reporters are also required to report holdings entrusted to a U.S.-resident custodian on **Schedule 3** if the aggregate fair (market) value of the foreign securities entrusted to that U.S.-resident custodian for their own account or the account of other U.S. residents, aggregated over all accounts they own and all accounts that they manage, is **US\$ 100 million or more** as of the close of business on December 31.

U.S.-resident custodians and end-investors identified as “**Schedule 3 only**” reporters are exempt from reporting on Schedule 2.

U.S.-resident custodians and end-investors identified as “**Schedule 3 only**” reporters are required to report holdings entrusted to each U.S.-resident custodian on **Schedule 3** if the aggregate fair (market) value of the foreign securities entrusted to that U.S.-resident custodian, aggregated over all accounts they own and all accounts that they manage, is **US\$ 100 million or more** as of the close of business on December 31. In addition, U.S.-resident custodians and end-investors identified as “**Schedule 3 only**” reporters are required to report up to two additional **Schedule 3** reports.

- One **Schedule 3** report with summary data on foreign securities held directly with foreign-resident custodians, including foreign-resident offices of U.S. banks or U.S. broker/dealers, and foreign-resident central securities depositories if the aggregate fair (market) value of the foreign securities aggregated over all accounts they own and all accounts that they manage, is, for all foreign-resident custodians and central securities depositories used, **US\$ 100 million or more** as of the close of business on December 31.
- One **Schedule 3** report with summary data on foreign securities held directly, managed directly, or held with U.S.-resident central securities depositories, (for which no U.S.-resident custodian is used), if the aggregate fair (market) value of the foreign securities aggregated over all accounts they own

and all accounts that they manage, is, **US\$ 100 million or more** as of the close of business on December 31.

#### **D. REPORTING DATES**

Report data as of the close of business December 31. Data should be submitted to the Federal Reserve Bank of New York no later than the first Friday of March.

#### **E. SUBMISSION INSTRUCTIONS AND CONTACT INFORMATION**

**Schedule 1** and **Schedule 3** must be filed on paper. If you have 200 or more **Schedule 2** records, these records must be submitted on diskette(s) or compact disk(s) (CDs) in the format specified in Appendix I. If you have less than 200 Schedule 2 records, these records may be submitted electronically using the format specified in Appendix I or on paper, using the form contained in Appendix A.

Reports can be mailed or sent by courier to:

**Federal Reserve Bank of New York  
Statistics Function, 4<sup>th</sup> Floor  
33 Liberty Street  
New York, NY 10045-0001**

Please contact FRBNY staff with questions pertaining to the report or if the following conditions apply:

1. Your organization requires additional time to complete your report.
2. Your organization received a copy of the report booklet and is not the parent entity in your organization.
3. Your organization cannot submit a single report for its entire organization.
4. Your reporter contact information or technical contact information changed after submission of your Schedule 1.

FRBNY staff can be reached at:

Phone: (212) 720-6300  
(646) 720-6300

Email: [SHC.Help@ny.frb.org](mailto:SHC.Help@ny.frb.org)

### III. WHAT SECURITIES MUST BE REPORTED

This report collects information on U.S. resident holdings of foreign securities, including foreign equities, short-term debt securities (including selected money market instruments), and long-term debt securities. Asset-backed securities are to be reported separately from other debt securities. Foreign securities include all securities issued by entities that are established under the laws of a foreign country (i.e., any entity that is legally incorporated, otherwise legally organized, or licensed (such as branches) in a foreign country) and all securities issued by international organizations, such as the International Bank for Reconstruction and Development (IBRD or World Bank), and the Inter-American Development Bank (IADB), even if these organizations are located in the United States.

Reportable securities may be traded or issued in the United States and in foreign countries, and may be denominated in any currency, including Euros and U.S. dollars. Neither the country in which the securities are traded or issued, nor the currency in which the securities are denominated, is relevant in determining whether the securities are reportable.

As an exception, foreign securities held by a U.S. depository to back depository receipts/shares should not be reported. Instead, the holders of the depository receipts/shares should report the receipts/shares. This exception is necessary to identify the portion of depository receipts/shares actually held by U.S. residents, because many depository receipts/shares are held by foreign residents.

#### A. REPORTABLE FOREIGN SECURITIES

##### **Reportable securities include:**

- Securities issued by international and regional organizations, such as the International Bank for Reconstruction and Development (IBRD or World Bank) or the Inter-American Development Bank (IDB).
- Securities issued in the United States by foreign-resident organizations (e.g., Canadian or Mexican firms), even if they are denominated in U.S. dollars and trade on U.S. securities exchanges.
- Securities issued by foreign-resident subsidiaries of U.S.-resident organizations (e.g., GMAC Canada) and foreign-resident offices of U.S. banks or U.S. broker/dealers, even if they are guaranteed by the U.S. parent company, or issued in the United States.
- Depository receipts/shares, including American Depositary Receipts (ADRs), American Depositary Shares (ADS), Global Depositary Receipts (GDRs), and International Depositary Receipts (IDRs), if the underlying securities are issued by foreign residents – (see Section III.E).
- Securities issued by foreign-resident entities under Section 144A of the SEC Act.
- Money market instruments, including negotiable certificates of deposit (CDs), issued by foreign-resident entities.

**Equity securities** that represent an ownership interest in foreign-resident organizations.

##### *Include as equities:*

- Common stock (ordinary shares);
- Preferred stock (participating and nonparticipating preference shares);
- Restricted stock;
- Depository receipts/shares (e.g., ADRs, ADSs, GDRs, IDRs) **provided** the underlying securities used to collateralize the receipts/shares **are** foreign securities (see Section III.E);
- Shares/units in foreign-resident funds, investment trusts, and similar investment vehicles (including mutual funds and money market funds - see Section III.C);
- U.S.-resident limited partner ownership in foreign-resident limited partnerships (general partner ownership is excluded - see Section III.J); and
- Other equity securities.



**Short-Term Debt Securities** (excluding asset-backed securities) include bills, commercial paper, and other money market instruments specified below with an **original maturity of one year or less** that give the holder the unconditional right to financial assets.

*Include as short-term debt securities:*

- Short-term foreign government securities;
- Short-term bankers' acceptances and trade acceptances;
- Short-term commercial and financial paper;
- Short-term **negotiable** certificates of deposit, bank notes, and deposit notes;
- Short-term notes issued under note issuance facilities and revolving underwriting facilities, even though the underlying facility may be for more than one year;
- Short-term medium-term notes;
- Short-term promissory notes;
- STRIPS with original maturity of one year or less; and
- Other short-term debt securities.

**Long-Term Debt Securities** (excluding asset-backed securities) include bonds and notes, with an **original maturity of over one year**, that usually give the holder the unconditional right to financial assets.

*Include as long-term debt securities:*

- Bonds such as foreign treasury, zero coupon, stripped, deep-discounted, currency-linked (e.g., dual-currency), floating rate, equity-related (e.g., convertible bonds) bonds and Eurobonds;
- Long-term index-linked debt securities;
- Long-term floating rate notes (FRN), such as perpetual notes (PRN), variable rate notes (VRN), structured FRN, reverse FRN, collared FRN, step up recovery FR (SURF), and range/corridor/accrual notes;
- Long-term medium-term notes;
- Bonds with multiple call options, the last of which is more than one year after issue;
- Long-term debentures;
- Long-term negotiable certificates of deposit, bank notes, and deposit notes;
- Long-term bearer depositary receipts denoting ownership of debt securities issued by nonresidents;
- Brady bonds;
- Covered bonds (e.g., Pfandbriefe);
- Long-term securities backed by a sinking fund; and
- Other long-term debt securities.

**Asset-Backed Securities** are securitized interests in a pool of assets, which give the purchaser a claim against the cash flows generated by the underlying assets. In many cases, the security's outstanding principal is reduced over time as principal repayments are received and passed on to the holders of the security. Securities backed by revolving credits, such as pools of credit card receivables, do not meet this criterion, but are still classified as ABS if the return to the holder is based upon these credits, (i.e., the credits do not merely serve as collateral). The ABS is reported if the **issuer securitizing the assets** is a foreign resident. The underlying asset should not be used to determine if the securities are reportable.

*Include as asset-backed securities all collateralized mortgage obligations (CMOs), collateralized bond obligations (CBOs), collateralized loan obligations (CLOs), collateralized debt obligations (CDOs), and other securities backed by pools of:*

- Mortgages;
- Credit card receivables;
- Automobile loans;
- Consumer and personal loans;
- Commercial and industrial loans and other whole loans; and
- Other assets.

## **B. DO NOT REPORT**

Do not report any:

- Derivative contracts (including futures, forwards, swaps, options, and warrants) meeting the definition of a derivative under FAS 133. If the embedded derivative has not been bifurcated from the host contract under FAS 133, then the security should be reported without separating the embedded derivative from the host contract. However, if the embedded derivative is bifurcated from the host contract, then the derivative should be excluded from the report and the host security should be included on the report.
- Loans and loan participation certificates;
- Letters of credit;
- Non-negotiable certificates of deposit;
- Bank deposits, including time deposits (except for negotiable CDs) and demand deposits;
- Foreign securities temporarily acquired under reverse repurchase, borrowing, or lending arrangements (see Section III.D);
- The underlying security of a depositary receipt, even if a foreign security (see Section III.E);
- Direct investments (see Section III.G), including investments in real estate and general partner ownership in limited partnerships (however, limited partner ownership are reportable investments);and
- All U.S. securities, including:
  1. Securities issued by U.S.-resident organizations, even if they are denominated in foreign currencies or traded on foreign securities exchanges;
  2. Securities issued by U.S.-resident subsidiaries of foreign-resident organizations and U.S.-resident offices of foreign banks or foreign broker/dealers, even if they are guaranteed by the foreign parent company, or issued outside of the United States;
  3. Securities issued by U.S.-resident entities under Section 144A of the SEC Act;
  4. Ownership of shares of U.S.-resident funds, even if the fund invests in foreign securities (see Section III.C); and
  5. Stripped securities issued by a U.S.-resident financial institution, even if the underlying security is a foreign security (see Section III.F).

## **C. FUNDS AND RELATED EQUITY HOLDINGS**

1. Report U.S. residents' ownership of shares/units of funds legally established outside of the United States (foreign-resident funds) as equity securities. All U.S. residents' holdings of foreign-resident funds should be assigned Security Type 3 (funds), and not categorized as a debt security, regardless of the types of securities held by the fund.

For purposes of this report, funds include all investment vehicles that pool investors' money and invest the pooled money in one or more of a variety of assets. Funds include, but are not limited to:

- Mutual funds (including both closed-end and open-end mutual funds);
- Money market funds;
- Investment trusts;
- Index-linked funds;
- Exchange traded funds (ETFs); and
- Common trust funds.

The determination of whether funds are foreign securities is based on the country in which the fund is legally established, not based on the type of security the fund purchases. For example, a share in a fund organized in Bermuda that purchases U.S. Treasury securities is a reportable foreign equity security. Likewise, a share in a fund established in the United States is a U.S. security and should be excluded from the report, even if the U.S.-resident fund invests in foreign securities.

Many funds established outside the United States have names that are similar to U.S.-resident fund names. This often occurs when the fund is managed by a group that manages many U.S.-resident funds and therefore may be thought of as managing only U.S.-resident funds. If there is doubt as to whether the investment should be classified as a fund or whether a fund is U.S. or foreign, please contact FRBNY report staff at (212) 720-6300 or (646) 720-6300.

## 2. Report U.S.-resident funds' ownership of foreign securities.

Although ownership of shares of U.S.-resident funds is excluded from this report, the foreign securities owned by U.S.-resident funds are reportable. These are distinct holdings and, therefore, are not duplicate reporting. Foreign securities owned by U.S.-resident funds should be classified as equity, debt, or asset-backed securities, as indicated in Section III.A.

### **D. SECURITIES INVOLVED IN REPURCHASE AND SECURITIES LENDING ARRANGEMENTS**

A repurchase agreement (repo) is an arrangement involving the sale of securities at a specified price with a commitment to repurchase the same or similar securities at a specified price on a future date. A reverse repo is an agreement whereby a security is purchased at a specified price with a commitment to resell the same or similar securities at a specified price on a specified future date. Buy/sell back agreements should be treated the same as repos. Securities lending/borrowing arrangements are agreements whereby the ownership of a security is transferred in return for collateral, usually another security or cash, under condition that the security or similar security will revert to its original owner at a future date.

- Securities sold under repurchase agreements or lent under securities lending arrangements, or collateral provided, should be reported by the original owner of the securities (or their U.S.-resident custodian) as if the securities were continuously held; that is, as if the repurchase or security lending agreement did not exist. Thus, if a U.S. resident transferred a foreign security under a repurchase or securities lending arrangement, the U.S. resident (or their U.S.-resident custodian) transferring the security should include it in its Schedule 2 or Schedule 3 records. The country reported should be the country of the issuer of the security and not the country of the counterparty to the repo.
- Securities, including collateral, temporarily acquired by U.S. residents under reverse repurchase or borrowing or lending arrangements should not be reported.
- Securities acquired from cash received as collateral for securities lending programs should not be reported.

### **E. DEPOSITARY RECEIPTS/SHARES**

Depository receipts/shares, including American depository receipts (ADRs) or bearer depository receipts, should be attributed to the country of residence of the issuer of the security underlying the depository receipt/share. Issuers of depository receipts/shares should **not** report their holdings of the actual foreign securities. Only U.S. residents' holdings of depository receipts/shares should be reported.

In addition, the security type reported should be determined based on the security underlying the depository receipt/share. For example, if the underlying security is foreign common stock then the security type reported in Item 7 of the Schedule 2 should be "1" (common stock).

## F. STRIPPED SECURITIES

Separate Trading of Registered Interest and Principal Securities (STRIPS) and similar instruments are securities that have been transformed from a principal amount with periodic interest coupons into a series of zero coupon securities, with the range of maturities matching the coupon payment dates and the redemption date of the principal amount.

The residency of the STRIPS and similar instruments is the residence of the entity that issued the stripped security, not the entity that issued the underlying security. Stripped securities issued by foreign residents, (the interest-only (IO) component, the principal-only (PO) component and tranches of stripped asset-backed securities), and held by U.S. residents are reportable. If a U.S.-resident financial institution issued the stripped securities, the issuer of the stripped securities should report its ownership of the underlying foreign securities. Exclude U.S. resident holdings of stripped securities issued by a U.S.-resident financial institution.

## G. DIRECT INVESTMENT

A direct investment relationship between non-banking organizations exists when one firm or a group of affiliated firms owns 10% or more of the voting equity of another firm. If a direct investment relationship exists between non-banking organizations, all securities held by the parent organization that were issued by the direct investee are considered direct investment. If one of the organizations is a banking firm, the inter-company holdings are considered direct investment only if they provide permanent capital. **All holdings known to be direct investment should be excluded from this report.**

## H. SECURITIES HELD BY CENTRAL SECURITIES DEPOSITORIES

Foreign securities entrusted to U.S.-resident custodians that are in turn held at a U.S.-resident central securities depository (such as the Depository Trust Company or the Federal Reserve Bank of New York), or a foreign-resident central securities depository (such as Euroclear or Clearstream), must be reported by the U.S.-resident custodian, not by the U.S. or foreign-resident central securities depository. Likewise, foreign securities held by a U.S.-resident end-investor directly with a U.S.-resident or foreign-resident central securities depository must be reported by the U.S.-resident end-investor, not by the central securities depository.

Foreign securities provided to the Federal Reserve Bank of New York (FRBNY) for discount window loan collateral must be reported by the “lender” of the securities, not by the FRBNY.

## I. COUNTRY ATTRIBUTION

Except for international and regional organizations, and depository receipts, securities should be reported based upon **the country of residence of the issuer of the securities**. The country of residence of any entity is where it is legally incorporated or otherwise legally organized, with the exception of bank branches, which are reported by where they are licensed. Securities issued by international and regional organizations are not allocated to the country in which the international or regional organization is located but rather to the separate code for international and regional organizations. (Refer to Appendix E for a list of international and regional organizations.) In cases where a foreign office of a U.S.-resident organization issues a reportable security, report these securities in the country where the foreign office is resident. The only exception is that depository receipts should be attributed to the country of residence of the issuer of the security underlying the depository receipt.

Attribution of country of residence of the issuer should **not** be affected by the currency of issue or by the country of a guarantor.

## J. LIMITED PARTNERSHIPS

U.S.-resident limited partner ownership of foreign-resident limited partnerships should be reported as Other Equity (Schedule 2, Item 7 = 4). Limited partners' ownership does not carry voting rights; therefore, such

ownership, even if greater than 10%, is reportable. The Number of Shares Held field on the Schedule 2 (Item 16) should be defaulted to the value reported in the US\$ Market Value field (Item 14a) because limited partnerships do not issue shares.

U.S.-resident general partner ownership of foreign-resident limited partnerships is always considered to be direct investment and is excluded from this report.

## **K. ACCOUNTING RULES, VALUATION OF SECURITIES, AND CALCULATION OF U.S. DOLLAR VALUES**

### **Accounting Rules**

All securities should be reported using settlement date accounting. Gross long positions should be reported. Do not net any short positions from long positions. Do not enter decimals or negative values in any cells.

### **Valuation of Securities**

Report the fair (market) value of securities as of close of business December 31. The fair (market) value follows the definition of FAS 115. Fair value is the amount at which an asset could be bought or sold in a current transaction between willing parties, other than in a forced or liquidation sale. If a quoted market price is available for an instrument, the fair (market) value is the product of the number of trading units times that market price. For securities that do not regularly trade, the estimate of fair value should be based on the best information available in the circumstances. The estimate of fair value should consider prices for similar assets and the results of valuation techniques to the extent available in the circumstances. Examples of valuation techniques include discounted cash flow, matrix pricing, option-adjusted spread models and fundamental analysis.

For asset-backed securities, the fair (market) value of the unpaid principal amount outstanding at close of business on December 31, should be reported; if principal has been repaid, this fair (market) value will **not** be the same as the original face value revalued at end-period market prices.

U.S.-resident custodians should, at a minimum, report the fair (market) value to the extent that it is available as part of their normal services provided to customers, even if the price available is prior to December 31. If there is doubt as to whether to report the available fair (market) value or to report a fair (market) value of zero, please contact FRBNY report staff at (212) 720-6300 or (646) 720-6300.

If the US\$ fair (market) value is determined to be zero, please ensure that you indicate the reason for a zero value on **Schedule 2**.

### **Foreign Currency Denominated Securities – Calculation Of U.S. Dollar Values**

If the security is not denominated in U.S. dollars (US\$) and a US\$ fair (market) value is not available in your system, convert the foreign currency denominated fair (market) value into US\$ using the spot exchange rate as of the close of business on December 31. If you need assistance locating an exchange rate, please contact FRBNY staff at (212) 720-6300 or (646) 720-6300.

If the exchange rate is normally quoted in units of foreign currency per US\$, such as ¥105.75/US\$, divide foreign currency values by the foreign exchange rate to obtain the US\$ values. For example, if the value of a security issued in Japan is ¥ 200,000, divide ¥ 200,000 by 105.75 to obtain US\$ 1,891.

If the exchange rate is normally quoted in US\$ per units of the foreign currency, such as US\$1.75/UK£, then multiply foreign currency values by the US\$ exchange rate value of the foreign currency to obtain US\$ values. For example, if the value of a security issued in the United Kingdom is UK £1,000, multiply UK £1,000 by 1.75 to obtain US\$ 1,750.

## **L. DATA RETENTION PERIOD**

The reporter must retain all data used to create this report for a period of 24 months from the date of the report's submission.

## **M. REVIEW OF DATA AND REQUESTS FOR REVISED DATA**

Data submitted on the reporting schedules are reviewed by FRBNY staff. As a result of this review, the reporter may be asked by FRBNY staff to provide supplemental information, including reasons for significant data changes between reporting periods, or corrected data. In addition, FRBNY staff may request: (1) information to ensure that all reportable foreign securities have been reported; (2) information to ensure that all reported foreign securities are held by U.S. residents; or (3) other information that helps to explain or corroborate the submitted data.

Entities filing data on electronic media that are not formatted per the specifications in Appendix I will be required to re-submit the data in the proper format.

## IV. INSTRUCTIONS FOR COMPLETING REPORTING SCHEDULES

### A. SCHEDULE 1 - REPORTER CONTACT IDENTIFICATION AND SUMMARY OF FINANCIAL INFORMATION

A paper copy of a signed Schedule 1 must be completed by all organizations that receive this report booklet. This schedule is used to provide basic identifying information and provide summaries of data reported on Schedule 2 and Schedule 3 records. Please type or print all information.

**(Please enter your ten-digit Reporter Identification number at the top of each page of Schedule 1.)**

#### REPORTER CONTACT IDENTIFICATION AND SUMMARY OF FINANCIAL INFORMATION

- 1. Reporter Identification Number** - Enter your organization's ten-digit Reporter Identification Number. If you do not know the Reporter Identification Number for your organization, please contact FRBNY staff at (212) 720-6300 or (646) 720-6300.
  - 2. Organization Name and Address** - Include the full legal name and mailing address of the reporting entity.
  - 3. Reporting Status** - Select "1" only if your parent organization has received authorization to file an unconsolidated report but you are exempt (meaning you have no reportable securities in custody or do not directly own any reportable securities). Select "2" if your organization is filing only Schedule 2 records. Select "3" if your organization is filing only Schedule 3 records. Select "4" if your organization is filing both Schedule 2 and Schedule 3 records.
  - 4. Industrial Classification Code** - Enter one of the following that best describes your organization

|                                     |                                  |   |
|-------------------------------------|----------------------------------|---|
| 1 = Bank                            | 4 = Insurance Company            | 7 = Foundation, Trust, or Estate                      |
| 2 = Mutual Fund or Investment Trust | 5 = Other Financial Organization | 8 = Institution of Higher Learning (e.g., university) |
| 3 = Pension Fund                    | 6 = Non-Financial Organization   | 9 = Other (not listed above)                          |
- A Bank is any depository institution (i.e., an institution that takes deposits), a bank holding company, or a financial holding company organized under Regulation Y of the Federal Reserve Act.
- An Other Financial Organization is any other organization that acts as a financial intermediary, such as a finance company or a broker/dealer, which is operated separately from an organization in one of the other categories listed above.
- A Non-Financial Organization is an organization that conducts commercial, industrial or trade activities.
- 5. Name of Contact** - Enter the name of the person who will be the primary contact for this report and can answer questions about the data reported.
  - 6. Title** - Enter the job title of the contact identified in item 5.
  - 7. Telephone Number** - Enter the telephone number of the contact identified in item 5.
  - 8. Fax Number** - Enter the fax number of the contact identified in item 5.
  - 9. Email Address** - Enter the email address of the contact identified in item 5.
  - 10. Name of Service Provider or Vendor Used** - If a service provider or vendor was used to prepare the data reported, enter the name of the service provider.

- 11. Name of Technical Contact** - Enter the name of a person who will serve as a contact should any technical issues, such as incorrect file formats, arise. If a service provider was used to prepare the data reported, the technical contact may be a vendor employee.
- 12. Title** - Enter the job title of the technical contact identified in item 11.
- 13. Telephone Number** - Enter the telephone number of the technical contact identified in item 11.
- 14. Email Address** - Enter the email address of the technical contact identified in item 11.
- 15. Valuation Technique** - For each reporting unit, describe the valuation technique(s) used to calculate the reported market values. If securities are automatically valued at zero after a specified time period of inactivity, please specify the time period and whether this applies to the security or to the client's holdings of the security. Also, please specify how securities not actively traded on the report date and those with internally generated security identification numbers are valued. If your organization has more than four reporting units, please attach additional copies of Schedule 1, page 2, with item 15 completed.

## **SUMMARY OF SCHEDULE 2 INFORMATION**

This section contains summary data for the information reported on **Schedule 2** records. If your organization submits Schedule 2 data on multiple media, the summary Schedule 2 data should represent aggregate data across all media submitted for the same reporter identification number.

- 16. Total Number of Schedule 2s Submitted** - Enter the total number of Schedule 2 records submitted.
- 17. Total US\$ Fair (Market) Value of All Equity Securities** - Enter the sum of the US\$ fair (market) value of all equity security records (records with Schedule 2, Item 7 = 1, 2, 3, or 4), rounded to the nearest U.S. dollar.
- 18. Total US\$ Fair (Market) Value of All Short-Term Debt Securities** (excluding asset-backed securities) - Enter the sum of the US\$ fair (market) value of all short-term debt security (excluding asset-backed securities) records (records with Schedule 2, Item 7 = 5, 6, or 8), rounded to the nearest U.S. dollar.
- 19. Total US\$ Fair (Market) Value of All Long-Term Debt Securities** (excluding asset-backed securities) - Enter the sum of the US\$ fair (market) value of all long-term debt security (excluding asset-backed securities) records (records with Schedule 2, Item 7 = 9, 10, or 12), rounded to the nearest U.S. dollar.
- 20. Total US\$ Fair (Market) Value of All Asset-Backed Securities** - Enter the sum of the US\$ fair (market) value of all asset-backed security records (records with Schedule 2, Item 7 = 7 or 11), rounded to the nearest U.S. dollar.

## **SUMMARY OF SCHEDULE 3 INFORMATION**

This section contains summary data for the information reported on **Schedule 3** records.

- 21. Total Number of Schedule 3s Submitted** - Enter the total number of Schedule 3 records submitted.
- 22. Total US\$ Fair (Market) Value of All Equity Securities** - Enter the sum of all Schedule 3 records, item 4.
- 23. Total US\$ Fair (Market) Value of All Short-Term Debt Securities** (excluding asset-backed securities) - Enter the sum of all Schedule 3 records, item 5.
- 24. Total US\$ Fair (Market) Value of All Long-Term Debt Securities** (excluding asset-backed securities) - Enter the sum of all Schedule 3 records, item 6.



**25. Total US\$ Fair (Market) Value of All Asset-Backed Securities** - Enter the sum of all Schedule 3 records, item 7.

### **CERTIFYING INFORMATION**

**All reporters must complete this section.**

By signing and dating the certification, the Certifier acknowledges that:

- He/she has read and understood the reporting requirements of this report;
- He/she is aware that both civil and criminal penalties may be imposed for filing a false report; and
- He/she is sufficiently knowledgeable about the activities and functions of this organization that he/she can knowingly and with reasonable confidence certify that the information provided in this report is both accurate and complete.

**26 - 30** - Enter the name, job title, telephone number, and email address of the person in your organization who certifies that the information provided is complete and accurate, as well as the date and signature.

## B. SCHEDULE 2 - DETAILS OF SECURITIES

Please refer to Sections II.B and II.C for a description of who is required to submit data on this schedule.

**(Please enter your ten-digit Reporter Identification Number at the top of each page of Schedule 2.)**

**1. Reporter Identification Number** - Enter your organization's ten-digit Reporter Identification Number. If you do not know the Reporter Identification Number for your organization, please contact FRBNY staff at (212) 720-6300 or (646) 720-6300.

**2. Sequence Number** - Enter the sequence number of this detail record, right justified. The first detail record should be assigned sequence number 1, and each succeeding Schedule 2 should be assigned a sequence number one higher than the previous record.

**3a. Reporting Unit Code** - If data being submitted are collected from multiple databases or reporting systems, please report the internal code used in your organization to identify the database or system from which the information on this Schedule 2 came. This information may greatly reduce the costs of identifying and fixing reporting errors that occur.

**3b. Name of Reporting Unit** - Enter a description or name of the reporting unit or area that corresponds to the code reported in item 3a.

**4. Security ID** - Enter the security ID code used to identify the security reported on this Schedule 2. ISIN codes are strongly preferred. If the ISIN code is not available, please use a code listed as "Primary" in Appendix C. If no "primary" code is available, please use a "secondary" code listed in Appendix C other than "internally generated." **Do not use internally generated codes unless this security has not been assigned a code by any recognized numbering agency (e.g., limited partnerships).** However, all records for securities for which a portion is restricted and a portion is not restricted should be reported with the numbering agency code assigned to the unrestricted portion. If excessive internal codes are used, we may have to contact you to help identify characteristics of certain individual securities. **Please include the security id's check digit and exclude any internal coding characters added to the ISIN, CUSIP, or other numbering agency code.**

**5. Security Description** - Briefly describe the security, providing any relevant descriptive information available. Ideally, this would include, but is not restricted to: (a) for preferred stock, the annual dividend; (b) for debt securities, the interest rate; (c) for floating rate notes, how the interest is calculated (e.g., Libor plus 1.5); and (d) for depositary receipts, the underlying security.

**6. Security ID System** - Select the appropriate number from the list provided in Appendix C. For example, if the Security ID Number entered in Item 4 was an ISIN number, enter "01"; if it was a CINS, enter "33." If the security ID system used is not listed, enter a code of 99 (other) and provide the name of the organization generating the code in item 6a. If the code is internally generated, enter a code of 98 and explain how your internal coding system assigns numbers in item 6a.

**6a. Comment Line** - If you entered a code of 99 (other) in item 6 you must provide the name of the organization generating the security ID code. If you entered a code of 98 (internally generated) in item 6 please explain how your internal coding system assigns numbers.

**7. Security Type** - Enter the appropriate Security Type code from the listed options below:

|                             |   |   |
|-----------------------------|---|---|
| 1 = Equity, Common Stock    | 5 = Short-Term Commercial Paper                                       | 9 = Stripped and Zero Coupon Long-Term Debt |
| 2 = Equity, Preferred Stock | 6 = Short-Term Negotiable CDs   | 10 = Convertible Long-Term Debt             |
| 3 = Equity, Funds           | 7 = Short-Term Asset-Backed Securities                                | 11 = Long-Term Asset-Backed Securities      |
| 4 = Equity, All Other       | 8 = All Other Short-Term Debt or<br>Selected Money Market Instruments | 12 = All Other Long-Term Debt               |

Common stock includes securities representing equity ownership in a foreign corporation. All foreign common stock, including restricted common stock and depositary receipts where the underlying security is common stock should be reported as Security Type = 1.

Preferred stock includes securities representing equity ownership in a foreign corporation where the holder's claim is given priority over common shares. Preference shares, non-participating preference shares, convertible preferred stock, restricted preferred stock, and depositary receipts where the underlying security is preferred stock should be reported as Security Type = 2.

Funds include all investment vehicles that pool investors' money and invest the pooled money in one or more of a variety of assets. All ownership interests in funds should be reported as Security Type = 3, regardless of the securities held by the fund (see Section III.C)

All other equity includes U.S.-resident limited partner ownership of foreign-resident limited partnerships and any other form of equity not specified in security types 1, 2, and 3 and should be reported as Security Type = 4.

Short-term commercial paper, including commercial and financial paper with an original maturity of one year or less, should be reported as Security Type = 5. (Long-term commercial and financial paper should be reported as security type = 12 (all other long-term debt)).

Short-term **negotiable** certificates of deposit (CDs), including bank notes and deposit notes, with an original maturity of one year or less should be reported as Security Type = 6. (Long-term negotiable CDs, bank notes, and deposit notes should be reported as security type = 12 (all other long-term debt)).

Short-term asset-backed securities (ABS) with an original maturity of one year or less, regardless of the maturity composition of the underlying assets, should be reported as Security Type = 7.

All other short-term debt, including short-term foreign government securities, bankers' acceptances, trade acceptances, and notes, with an original maturity of one year or less should be reported as Security Type = 8.

Stripped and zero coupon long-term debt, including foreign bonds, notes, and other debt securities that do not provide interest payments, and the IO and PO component of STRIPS or other stripped securities (where the stripped security is not an asset-backed security), that have an original maturity of more than one year should be reported as Security Type = 9.

Convertible long-term debt, including debt securities that can be exchanged for common shares of the issuing corporation at a pre-stated price and zero coupon convertible debt, that have an original maturity of more than one year should be reported as Security Type = 10.

Long-term asset-backed securities (ABS) that have an original maturity of more than one year, regardless of the maturity composition of the underlying assets, including the IO or PO component of stripped asset-backed securities and the tranches of stripped asset-backed securities, should be reported as Security Type = 11.

Long-term commercial and financial paper, negotiable CDs, bank notes, deposit notes, Brady bonds, covered bonds, securities backed by a sinking fund, and all other long-term debt, (including all debt securities that provide interest payments, cannot be converted to equity securities, and do not give the holder a claim against the cash flows generated by the underlying assets (i.e., ABS)), should be reported as Security Type = 12.

**8. Depositary Receipt/Share** - Enter "1" if the security is a depositary receipt/share. Enter "2" otherwise.

**9. Name of Issuer** - Enter the name of the organization that issued the security. Please try to provide the full legal name of the issuer. For branches of banks, please provide the location of the branch.

**10. Intentionally Left Blank** - Leave this field null or enter a blank space for each record.

**11. Country of Issuer** - Enter the country code from Appendix D that corresponds to the country of residence of the entity that issued the security. (Refer to Section III.I, Country Attribution.)

**12. Currency of Denomination** - Enter the ISO code from Appendix F that corresponds to the currency in which the security being reported is denominated.

**13. Ownership Code** - Enter the appropriate code from the list below:

1 = if your organization is reporting as the owner of this security and holds the security or uses a foreign-resident custodian

2 = if your organization is reporting as the custodian for a U.S.-resident mutual fund for this security

3 = if your organization is reporting as the custodian for a U.S.-resident pension fund for this security

4 = if your organization is reporting as the custodian for a U.S.-resident insurance company for this security

5 = if your organization is reporting as the custodian for any other U.S. residents for this security

6 = if it is unknown

**14a. US\$ Fair (Market) Value of Security Held** - Enter the US\$ fair (market) value of the security being reported, rounded to the nearest U.S. dollar. (See Section III.K, Accounting Rules, Valuation of Securities, and Calculation of U.S. Dollar Values, for more information on how to calculate the US\$ fair (market) value.)

**14b. Fair (Market) Value of Security Held Denominated in Currency of Issue** - Enter the fair (market) value of the security being reported, rounded to the nearest currency of issue unit. If the currency of issue is US\$, report the same value as in item 14a. (See Section III.K, Accounting Rules, Valuation of Securities, and Calculation of U.S. Dollar Values, for more information on how to calculate the fair (market) value.)

**15. If US\$ Fair (Market) Value is Zero** - If the US\$ fair (market) value of the security being reported is calculated to be zero, please indicate the reason from the list provided.

#### **FOR EQUITY SECURITIES ONLY**

**16. Number of Shares Held** - Enter the number of shares held, rounded to the nearest share. Securities for which the amount of shares held is zero should not be reported.

#### **FOR SHORT-TERM AND LONG-TERM DEBT SECURITIES EXCLUDING ASSET-BACKED SECURITIES**

**17. Face Value in Currency of Denomination** - For both short-term and long-term securities, enter the face value held in the currency of denomination, rounded to the nearest whole currency unit. If a security is traded in units, then calculate the face value as: (face value of each unit) \* (the number of units held) and report the result in this field. Securities for which the amount held is zero should not be reported.

**18. Issue Date** - Enter the issue date of this security in MMDDYYYY format. For example, if the security was issued on October 4, 1985, enter 10041985. If there are multiple issue dates, enter the first such issue date.

**19. Maturity Date** - Enter the final maturity date (when all remaining principal and interest is due) of this security in MMDDYYYY format. For example, if the security's final maturity date is January 5, 2010, enter 01052010.

#### **FOR SHORT-TERM AND LONG-TERM ASSET-BACKED SECURITIES ONLY**

**20. Original Face Value in Currency of Denomination** - Enter the original face value in the currency of denomination, rounded to the nearest whole currency unit. This is the value that is (would have been) outstanding if no principal has been (had been) repaid. If a security is traded in units, then calculate the original face value as: (original face value of each unit) \* (the number of units held) and report the result in this field.

**21. Remaining Principal Outstanding in Currency of Denomination** - Enter the remaining principal outstanding as of December 31, in the currency of denomination, rounded to the nearest whole currency unit. This will equal the original face value if no principal has been repaid. If a security is traded in units, then calculate the remaining face value as: (remaining face value of each unit) \* (the number of units held) and report the result in this field. Securities for which the amount held is zero should not be reported.

**22. Issue Date** - Enter the issue date of this security in MMDDYYYY format. For example, if the security was issued on October 4, 1985, enter 10041985. If there are multiple issue dates, enter the first such issue date.

**23. Maturity Date** - Enter the final maturity date of this security in MMDDYYYY format. For example, if the security's final maturity date is January 5, 2010, enter 01052010.

### C. SCHEDULE 3 - CUSTODIANS USED

Please refer to Sections II.B and II.C for a description of who is required to submit data on this schedule.

**(Please enter your ten-digit Reporter Identification Number at the top of each page of Schedule 3.)**

**1. Reporter Identification Number** - Enter your organization's ten-digit Reporter Identification Number. If you do not know the Reporter Identification Number for your organization, please contact FRBNY staff at (212) 720-6300 or (646) 720-6300.

**2. Sequence Number** - Enter the sequence number of this detail record, right justified. The first detail record should be assigned sequence number 1, and each succeeding Schedule 3 should be assigned a sequence number one higher than the previous record.

**3. Custodian Code** - Please refer to Appendix G for a list of the major U.S.-resident custodians and select the code that matches your U.S.-resident custodian. If you do not see your U.S.-resident custodian listed, please enter 99 and complete items 9 through 14. If you are not required to submit **Schedule 2** records, please submit up to two additional **Schedule 3** reports:

- Using custodian code 77, submit summary data on foreign securities held directly with foreign-resident custodians, including foreign-resident offices of U.S. banks or U.S. broker/dealers, and with foreign-resident central securities depositories.
- Using custodian code 88, submit summary data on foreign securities held directly, managed directly, or held with U.S.-resident central securities depositories (and for which no U.S.-resident custodian is used).

**4. Total US\$ Fair (Market) Value of Equities Entrusted** - Enter the aggregate US\$ fair (market) value for all foreign equities that you entrusted to the organization(s) reported in the custodian code field, rounded to the nearest U.S. dollar.

**5. Total US\$ Fair (Market) Value of Short-Term Debt (excluding asset-backed securities) Entrusted** - Enter the aggregate US\$ fair (market) value for all foreign short-term debt securities (excluding asset-backed securities) that you entrusted to the organization(s) reported in the custodian code field, rounded to the nearest U.S. dollar.

**6. Total US\$ Fair (Market) Value of Long-Term Debt (excluding asset-backed securities) Entrusted** - Enter the aggregate US\$ fair (market) value for all foreign long-term debt securities (excluding asset-backed securities) that you entrusted to the organization(s) reported in the custodian code field, rounded to the nearest U.S. dollar.

**7. Total US\$ Fair (Market) Value of Asset-Backed Securities Entrusted** - Enter the aggregate US\$ fair (market) value for all foreign asset-backed securities that you entrusted to the organization(s) reported in the custodian code field, rounded to the nearest U.S. dollar.

**8. Reporting As** - Enter the code from the list provided, which indicates if you are the U.S.-resident end-investor or custodian that is entrusting foreign securities to the organization(s) reported in the custodian code field. (See Appendix H for the definitions of end-investor and custodian.)

#### **COMPLETE ITEMS 9 THROUGH 14 ONLY IF THE CUSTODIAN CODE (ITEM 3) IS 99**

**9. Name of U.S.-Resident Custodian** - Enter the full legal name of the U.S.-resident custodian to which you entrusted the securities.

**10. Street Address of U.S.-Resident Custodian** - Enter the mailing address of the U.S.-resident custodian identified in item 9.

11. **City** - Enter the city in which the U.S.-resident custodian identified in item 9 is located.
12. **State** - Enter the state in which the U.S.-resident custodian identified in item 9 is located.
13. **Zip Code** - Enter the zip code for the address of the U.S.-resident custodian identified in item 9.
14. **Telephone Number of U.S.-Resident Custodian** - Enter the telephone number of the U.S.-resident custodian identified in item 9.

## **APPENDIX A: SAMPLE REPORTING SCHEDULES**





Please enter your 10-digit Reporter Identification Number.....

|  |  |  |  |  |  |  |  |  |  |
|--|--|--|--|--|--|--|--|--|--|
|  |  |  |  |  |  |  |  |  |  |
|--|--|--|--|--|--|--|--|--|--|

15. Valuation Technique(s) Used to Determine Market Values

For each reporting unit, please describe the valuation technique(s) used to determine reported market values. If securities are automatically valued at zero after a specified time period of inactivity, please specify the time period and whether this applies to the security or to the client's holdings of the security. Also, please specify how securities not actively traded on the report date and those with internally generated security identification numbers are valued.

Reporting Unit                      Valuation Description

|  |  |  |
|--|--|--|
|  |  |  |
|--|--|--|

---

---

---

---

---

|  |  |  |
|--|--|--|
|  |  |  |
|--|--|--|

---

---

---

---

---

|  |  |  |
|--|--|--|
|  |  |  |
|--|--|--|

---

---

---

---

---

|  |  |  |
|--|--|--|
|  |  |  |
|--|--|--|

---

---

---

---

---

Please enter your 10-digit Reporter Identification Number.....

**SUMMARY OF SCHEDULE 2 INFORMATION**

- 16. Total Number of Schedule 2s Submitted....., ,
- 17. Total US\$ Fair (Market) Value of All Equity Securities ....., , , ,
- 18. Total US\$ Fair (Market) Value of All Short-Term Debt Securities..., , , ,   
(excluding asset-backed securities) Reported on Schedule 2(s)
- 19. Total US\$ Fair (Market) Value of All Long-Term Debt Securities..., , , ,   
(excluding asset-backed securities) Reported on Schedule 2(s)
- 20. Total US\$ Fair (Market) Value of All Asset-Backed....., , , ,   
Securities Reported on Schedule 2(s)

**SUMMARY OF SCHEDULE 3 INFORMATION**

- 21. Total Number of Schedule 3s Submitted.....,
- 22. Total US\$ Fair (Market) Value of All Equity Securities ....., , , ,
- 23. Total US\$ Fair (Market) Value of All Short-Term Debt Securities..., , , ,   
(excluding asset-backed securities) Reported on Schedule 3(s)
- 24. Total US\$ Fair (Market) Value of All Long-Term Debt Securities..., , , ,   
(excluding asset-backed securities) Reported on Schedule 3(s)
- 25. Total US\$ Fair (Market) Value of All Asset-Backed....., , , ,   
Securities Reported on Schedule 3(s)

**CERTIFYING INFORMATION**

By signing the certification below you acknowledge that:

- ✓ You have read and understood the reporting requirements of this survey;
- ✓ You are aware that both civil and criminal penalties may be imposed for filing a false report; and
- ✓ You are sufficiently knowledgeable about the activities and functions of your organization that you can knowingly and with reasonable confidence certify that the information provided in this report is both accurate and complete.

Certifier's Signature: \_\_\_\_\_

26. Certifier's Name: \_\_\_\_\_

27. Certifier's Title: \_\_\_\_\_

28. Certifier's Telephone Number: \_\_\_\_\_ 29. Date Signed: \_\_\_\_\_

30. Certifier's Email Address: \_\_\_\_\_

**SCHEDULE 2: DETAILS OF SECURITIES**

1. Reporter Identification Number: Enter your 10-digit identification number.....

2. Sequence Number: From 1 to the number of Schedule 2 records submitted..... , ,

3a. Reporting Unit.....

3b. Name of Reporting Unit: \_\_\_\_\_

4. Security ID.....

5. Security Description: \_\_\_\_\_

6. Security ID System: Please select the appropriate code from the list in Appendix C.....

6a. For code of Other (99) enter the name of the organization or system that assigned the Security ID:  
\_\_\_\_\_

7. Security Type: Please enter one of the following.....   
1 = Equity, Common Stock      5 = Short-Term Commercial Paper      9 = Stripped and Zero-Coupon Long-Term Debt  
2 = Equity, Preferred Stock    6 = Short-Term Negotiable CDs            10 = Convertible Long-Term Debt  
3 = Equity, Funds                7 = Short-Term Asset-Backed Securities    11 = Long-Term Asset-Backed Securities  
4 = Equity, All Other            8 = All Other Short-Term Debt or  
   Selected Money Market Instruments

8. Depository Receipt/Share: Please enter one of the following.....   
1 = Yes, the security is a Depository Receipt/Share  
2 = No, the security is NOT a Depository Receipt/Share

9. Name of Issuer: \_\_\_\_\_

10. Intentionally Left Blank

11. Country of Issuer:.....   
Enter the code from Appendix D for the country of residence of the entity issuing the security.

12. Currency of Denomination:.....   
Enter the code from Appendix F for the currency in which the security was issued.

13. Ownership Code: Please enter one of the following.....   
1 = If your organization is the owner of this security and holds the security or uses a foreign-resident custodian  
2 = If your organization is the custodian for a U.S.-resident mutual fund for this security  
3 = If your organization is the custodian for a U.S.-resident pension fund for this security  
4 = If your organization is the custodian for a U.S.-resident insurance company for this security  
5 = If your organization is the custodian for any other U.S. residents for this security  
6 = If it is unknown

Reporter Identification Number: Enter your 10-digit identification number.....

14a. US\$ Fair (Market) Value of Security Held..... , , ,

14b. Fair (Market) Value of Security Held Denominated in the  
Currency of Issue (If US\$ is the currency of issue, then enter the  
same value as item 14a.)..... , , ,

15. If US\$ Fair (Market) Value is zero, please indicate the reason from the following.....   
1 = If the organization is in receivership or the stock is impaired/security in default  
2 = If price is unknown because the security is thinly or never traded

**FOR EQUITY TYPE SECURITIES ONLY**  
(Security Type 1, 2, 3 or 4)

16. Number of Shares Held: Enter the number of shares held  
rounded to the nearest share..... , , ,

**FOR SHORT-TERM AND LONG-TERM DEBT SECURITIES EXCLUDING  
ASSET-BACKED SECURITIES**  
(Security Types 5, 6, 8, 9, 10, or 12)

17. Face Value in Currency of Denomination: Enter the face value in the  
currency of denomination..... , , ,

18. Issue Date: MMDDYYYY format.....

19. Maturity Date: MMDDYYYY format.....

**FOR SHORT-TERM AND LONG-TERM ASSET-BACKED SECURITIES**  
(Security Type 7 or 11)

20. Original Face Value in Currency of Denomination: Enter the face value.....  
in the currency of denomination that would have been outstanding if no  
principal had been repaid. , , ,

21. Remaining Principal Outstanding in Currency of Denomination: Enter .....  
the remaining principal outstanding as of December 31 in the  
currency of denomination. , , ,

22. Issue Date: MMDDYYYY format.....

23. Maturity Date: MMDDYYYY format.....

**SCHEDULE 3: CUSTODIANS USED**

Please refer to Sections II.B, II.C, and IV.C of the instructions for a description of the data that are required to be submitted on this schedule. Please note, reporting requirements are different for "Schedule 2 and Schedule 3" reporters and for "Schedule 3 only" reporters.

1. Reporter Identification Number: Enter your 10-digit identification number.....
  
2. Sequence Number: From 1 to the number of Schedule 3 records submitted: ..... ,
  
3. Custodian Code: Please see Appendix G for a list of custodians. If the U.S.-resident custodian used is not on... this list, please enter 99 and complete items 9 through 14.
  
4. Total US\$ Fair (Market) Value of Foreign Equity Securities Entrusted to this Custodian as of December 31..... ,
  
5. Total US\$ Fair (Market) Value of Foreign Short-Term Debt Securities (excluding asset-backed securities) Entrusted to this Custodian as of December 31 ..... ,
  
6. Total US\$ Fair (Market) Value of Foreign Long-Term Debt Securities (excluding asset-backed securities) Entrusted to this Custodian as of December 31 ..... ,
  
7. Total US\$ Fair (Market) Value of Foreign Asset-Backed Securities Entrusted to this Custodian as of December 31 ..... ,
  
8. Reporting As: Please enter one of the following.....   
 1 = U.S.-resident end-investor (as defined in Appendix H)  
 2 = U.S.-resident custodian (as defined in Appendix H), who is in turn entrusting these securities to another U.S.-resident custodian

**Complete only if the U.S.-Resident Custodian Code in Item 3 is 99:**

9. Name of U.S.-Resident Custodian:  
\_\_\_\_\_
  
10. Street Address of U.S.-Resident Custodian:  
\_\_\_\_\_  
\_\_\_\_\_
  
11. City: \_\_\_\_\_ 12. State: \_\_\_\_\_ 13. Zip Code: \_\_\_\_\_
  
14. Telephone Number of U.S.-Resident Custodian:  
\_\_\_\_\_

## APPENDIX B: REPORTING REQUIREMENT FLOWCHARTS

### 1. Reporting Requirements for “Schedule 2 and Schedule 3” Reporters that are U.S.-Resident Custodians (see Section II.A)

Flowchart 1a - Foreign securities held in custody for your own organization or for your U.S.-resident clients that are not in turn entrusted to any other organization

Flowchart 1b - Foreign securities entrusted to the safekeeping of a U.S.-resident central securities depository

Flowchart 1c - Foreign securities held abroad, either by employing a foreign-resident custodian or by directly entrusting to a foreign-resident central securities depository

Flowchart 1d - Foreign securities entrusted to the safekeeping of another U.S.-resident custodian (excluding U.S.-resident central securities depositories)

### 2. Reporting Requirements for “Schedule 2 and Schedule 3” Reporters that are U.S.-Resident End-Investors (see Section II.A)

Flowchart 2a - Foreign securities held for your own organization or for your U.S.-resident clients that are not in turn entrusted to any other organization (held in self-custody)

Flowchart 2b - Foreign securities entrusted to the safekeeping of a U.S.-resident central securities depository

Flowchart 2c - Foreign securities held abroad, either by employing a foreign-resident custodian or by directly entrusting to a foreign-resident central securities depository

Flowchart 2d - Foreign securities entrusted to the safekeeping of a U.S.-resident custodian (excluding U.S.-resident central securities depositories)

### 3. Reporting Requirements for “Schedule 3 only” Reporters that are U.S.-Resident Custodians (see Section II.A)

Flowchart 3a – Foreign securities held in custody for your own organization or for your U.S.-resident clients that are not in turn entrusted to any other organization

Flowchart 3b - Foreign securities entrusted to the safekeeping of a U.S.-resident central securities depository

Flowchart 3c - Foreign securities held abroad, either by employing a foreign-resident custodian or by directly entrusting to a foreign-resident central securities depository

Flowchart 3d - Foreign securities entrusted to the safekeeping of another U.S.-resident custodian (excluding U.S.-resident central securities depositories)

### 4. Reporting Requirements for “Schedule 3 only” Reporters that are U.S.-Resident End-Investors (see Section II.A)

Flowchart 4a - Foreign securities held for your own organization or for your U.S.-resident clients that are not in turn entrusted to any other organization (held in self-custody)

Flowchart 4b - Foreign securities entrusted to the safekeeping of a U.S.-resident central securities depository

Flowchart 4c - Foreign securities held abroad, either by employing a foreign-resident custodian or by directly entrusting to a foreign-resident central securities depository

Flowchart 4d - Foreign securities entrusted to the safekeeping of a U.S.-resident custodian (excluding U.S.-resident central securities depositories)

### 5. Determining Reportable Securities

## Reporting Requirements for “Schedule 2 and Schedule 3” Reporters that are U.S.-Resident Custodians (see Section II.A)

**Flowchart 1a - Foreign securities held in custody for your own organization or for your U.S.-resident clients that are not in turn entrusted to any other organization**

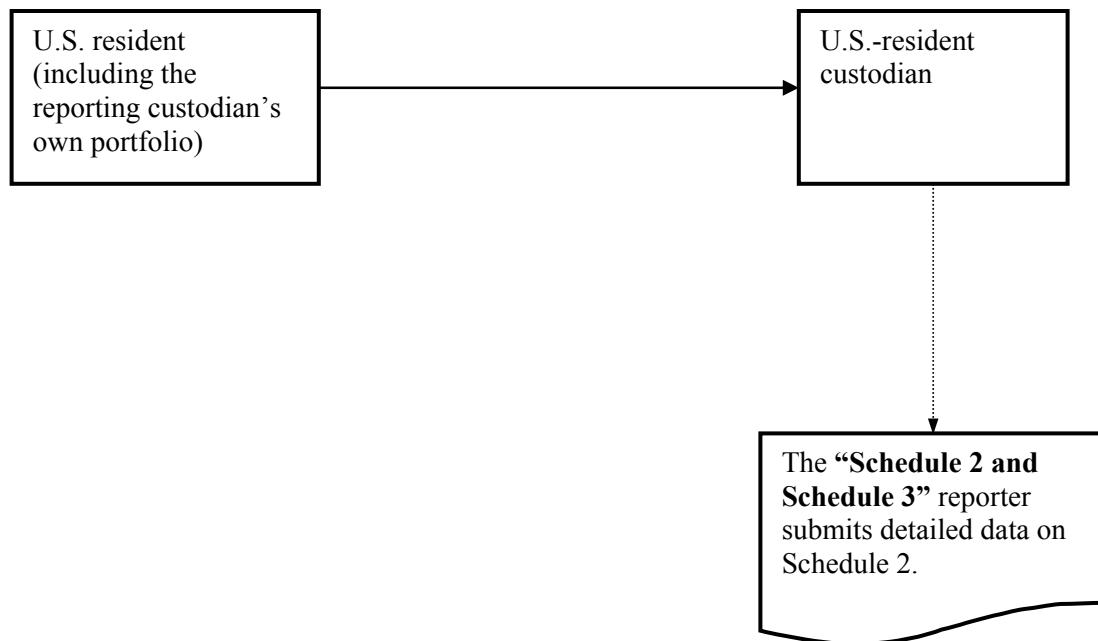

**Flowchart 1b - Foreign securities entrusted to the safekeeping of a U.S.-resident central securities depository**

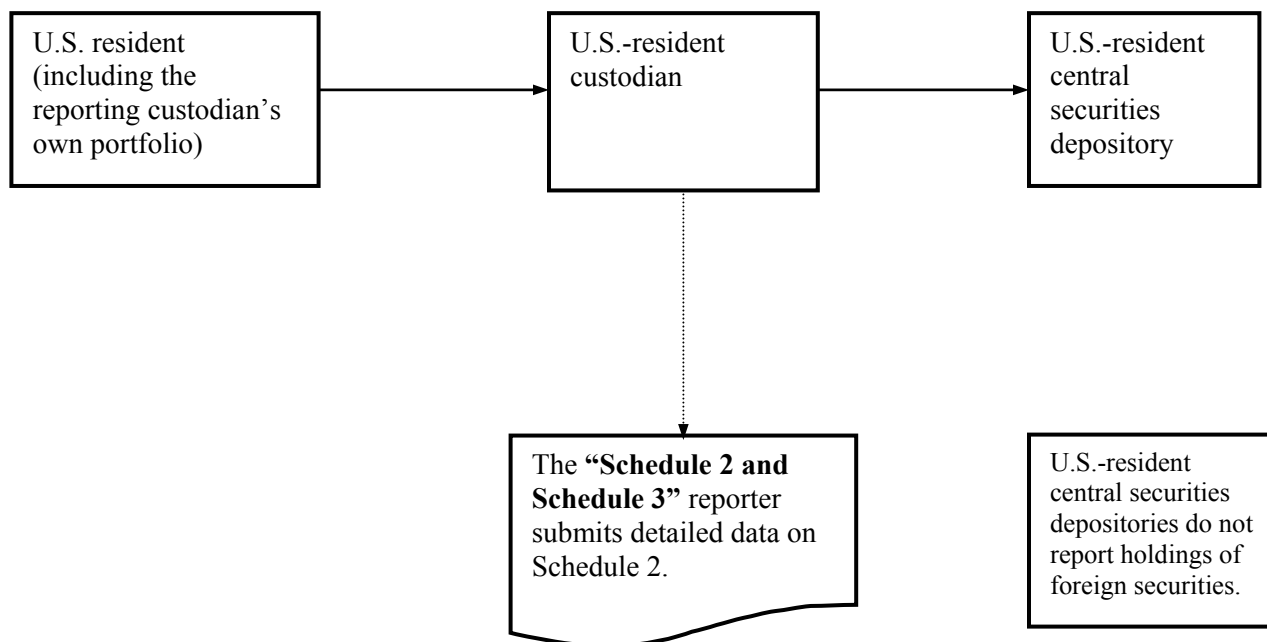



## Reporting Requirements for “Schedule 2 and Schedule 3” Reporters that are U.S.-Resident Custodians (see Section II.A)

**Flowchart 1c - Foreign securities held abroad, either by employing a foreign-resident custodian or by directly entrusting to a foreign-resident central securities depository**

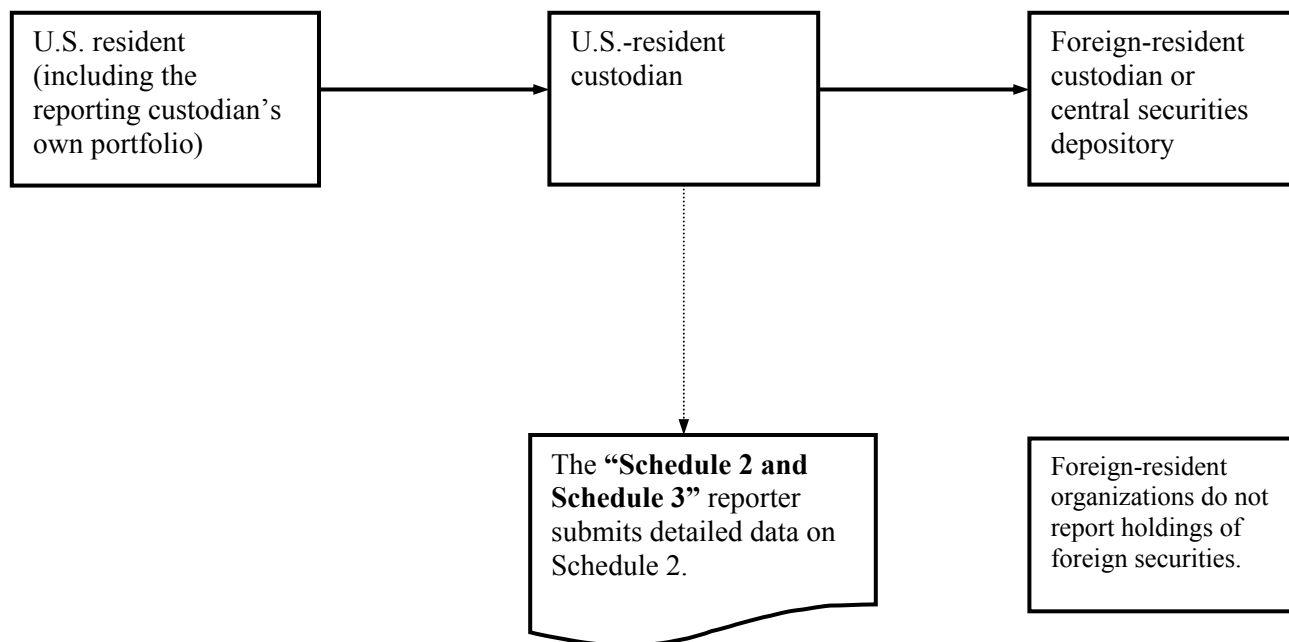

**Flowchart 1d - Foreign securities entrusted to the safekeeping of another U.S.-resident custodian (excluding U.S.-resident central securities depositories)**

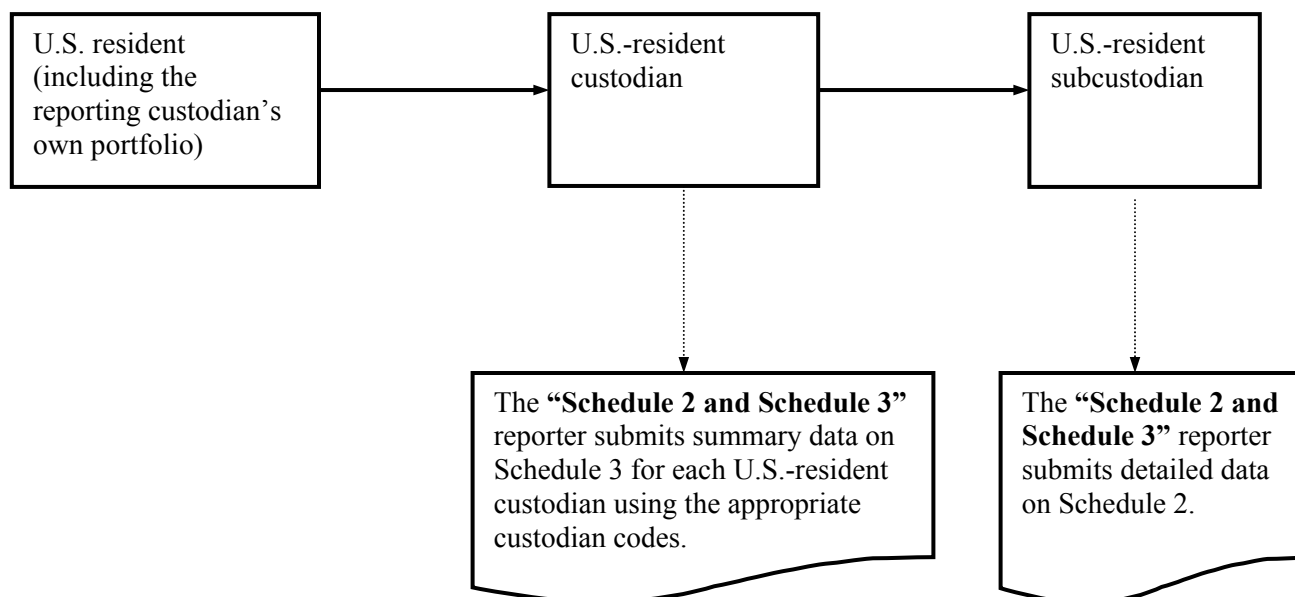

## Reporting Requirements for “Schedule 2 and Schedule 3” Reporters that are U.S.-Resident End-Investors (see Section II.A)

**Flowchart 2a - Foreign securities held for your own organization or for your U.S.-resident clients that are not in turn entrusted to any organization (held in self custody)**

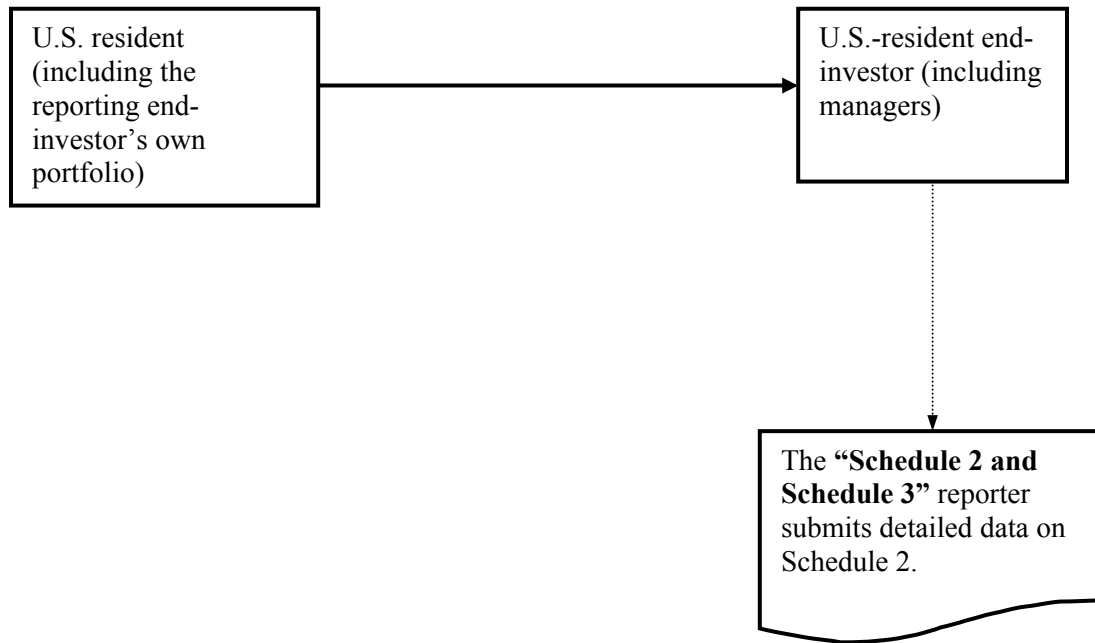

**Flowchart 2b - Foreign securities entrusted to the safekeeping of a U.S.-resident central securities depository**

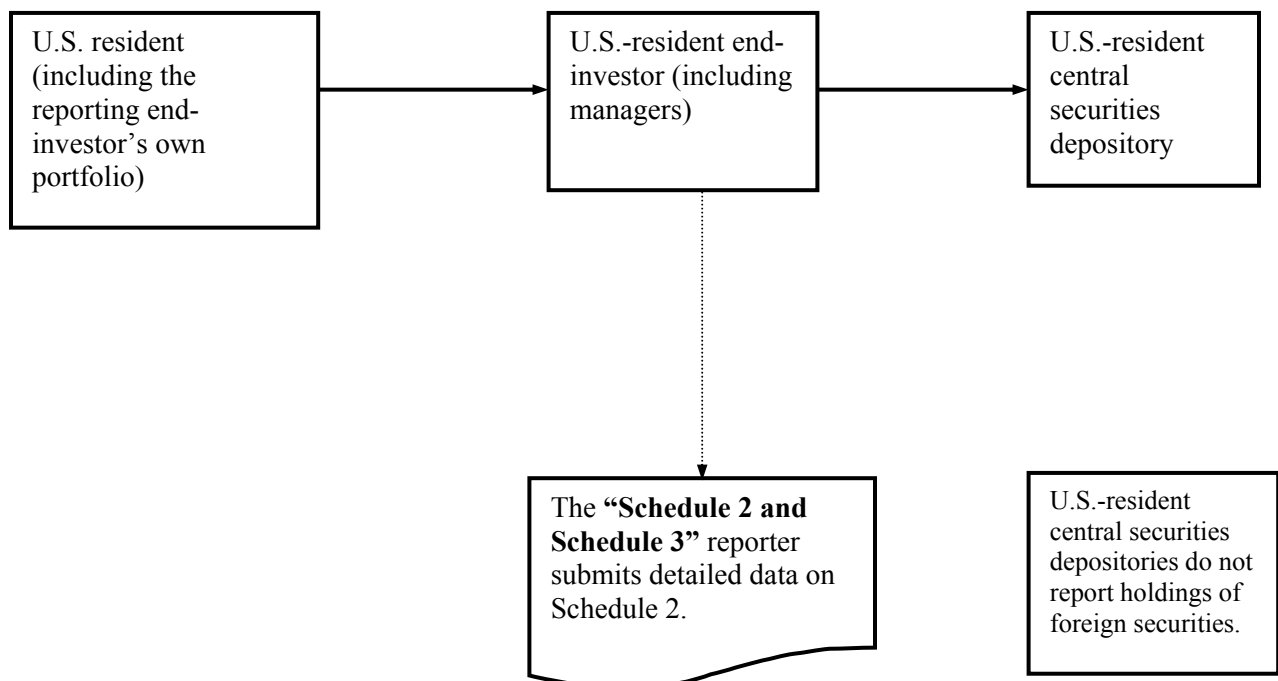

**Reporting Requirements for “Schedule 2 and Schedule 3” Reporters that are U.S.-Resident End-Investors (see Section II.A)**

**Flowchart 2c - Foreign securities held abroad, either by employing a foreign-resident custodian or by directly entrusting to a foreign-resident central securities depository**

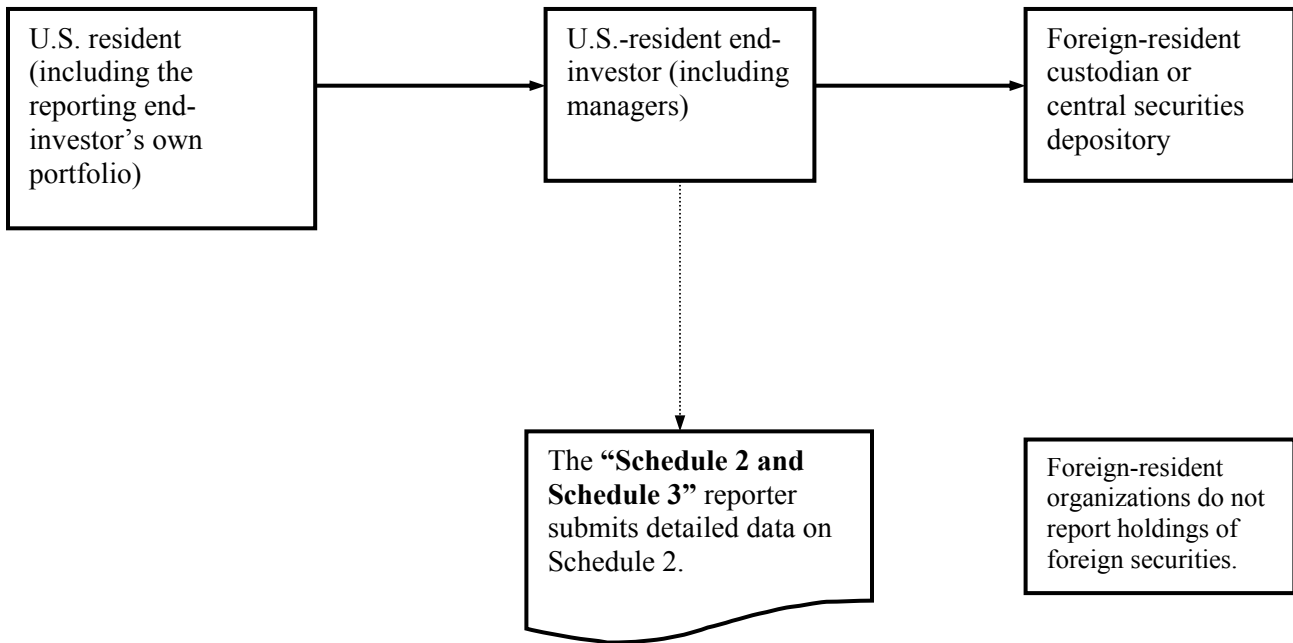

**Flowchart 2d - Foreign securities entrusted to the safekeeping of a U.S.-resident custodian (excluding U.S.-resident central securities depositories)**

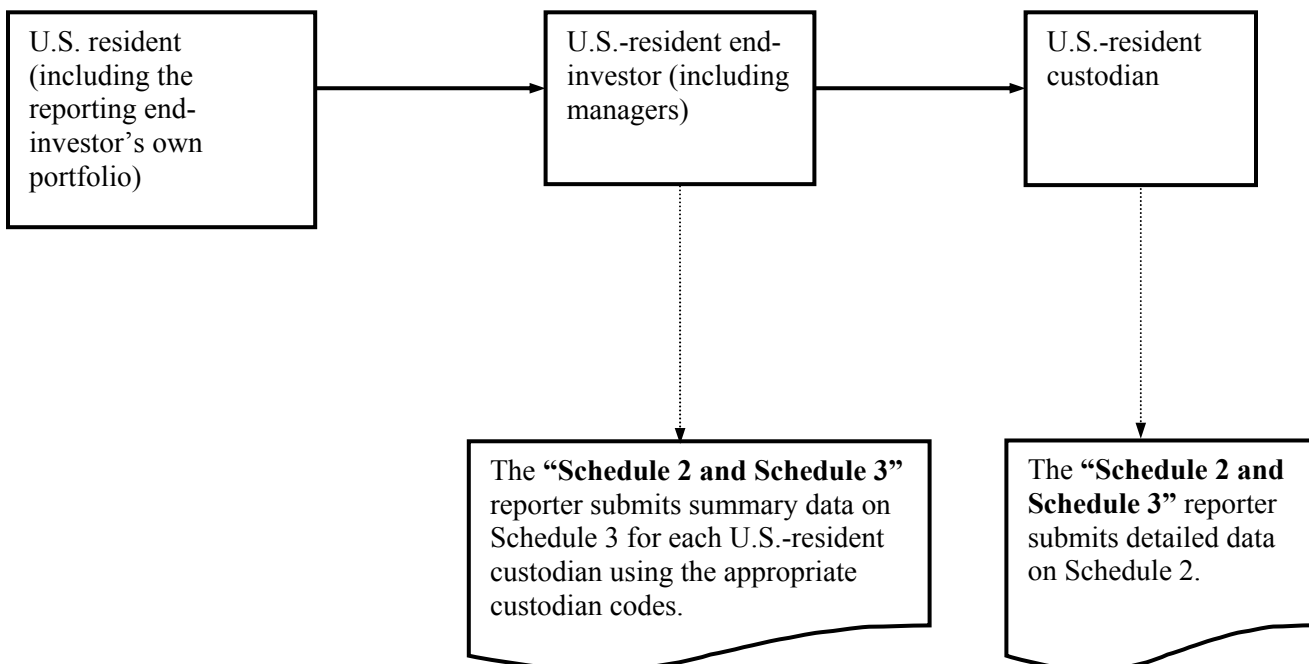

## Reporting Requirements for “Schedule 3 only” Reporters that are U.S.-Resident Custodians (see Section II.A)

**Flowchart 3a - Foreign securities held in custody for your own organization or for your U.S.-resident clients that are not in turn entrusted to any other organization**

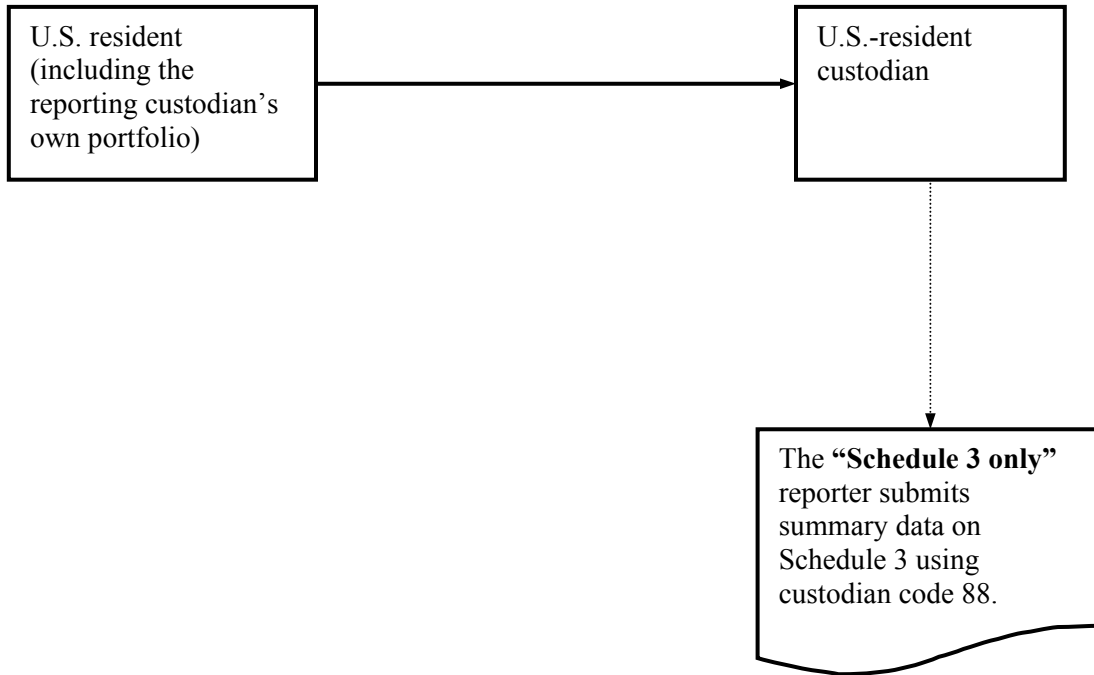

**Flowchart 3b - Foreign securities entrusted to the safekeeping of a U.S.-resident central securities depository**

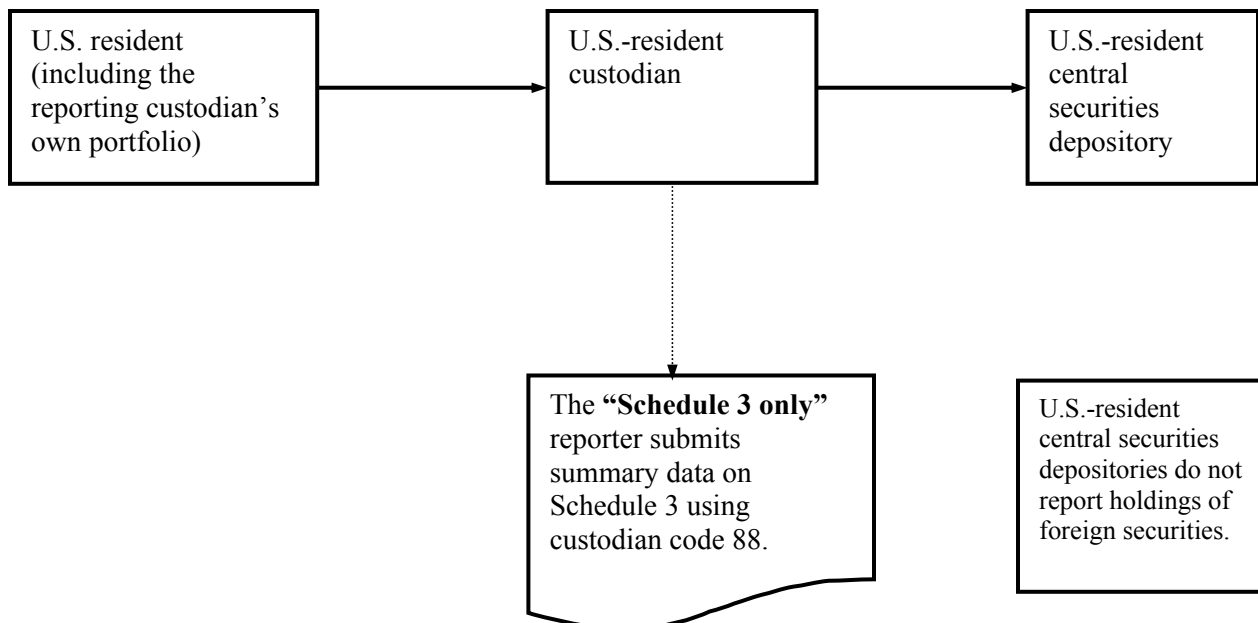

## Reporting Requirements for “Schedule 3 only” Reporters that are U.S.-Resident Custodians (see Section II.A)

**Flowchart 3c - Foreign securities held abroad, either by employing a foreign-resident custodian or by directly entrusting to a foreign-resident central securities depository**

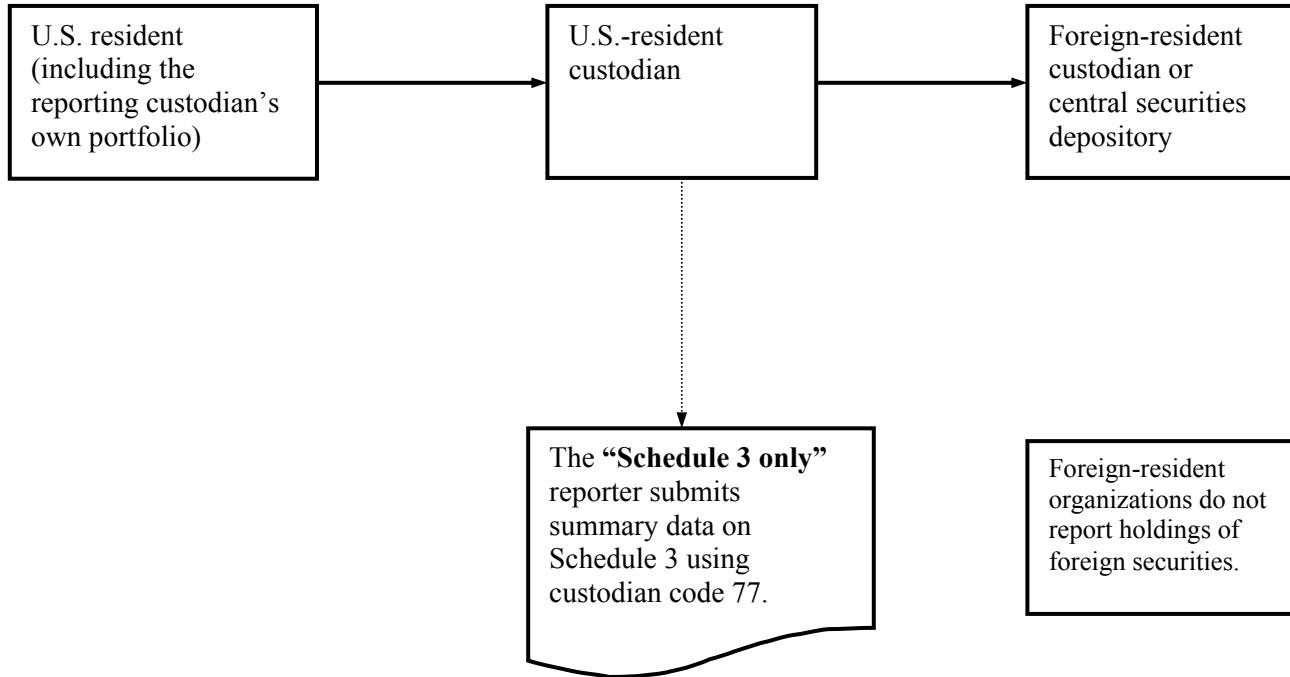

**Flowchart 3d - Foreign securities entrusted to the safekeeping of another U.S.-resident custodian (excluding U.S.-resident central securities depositories)**

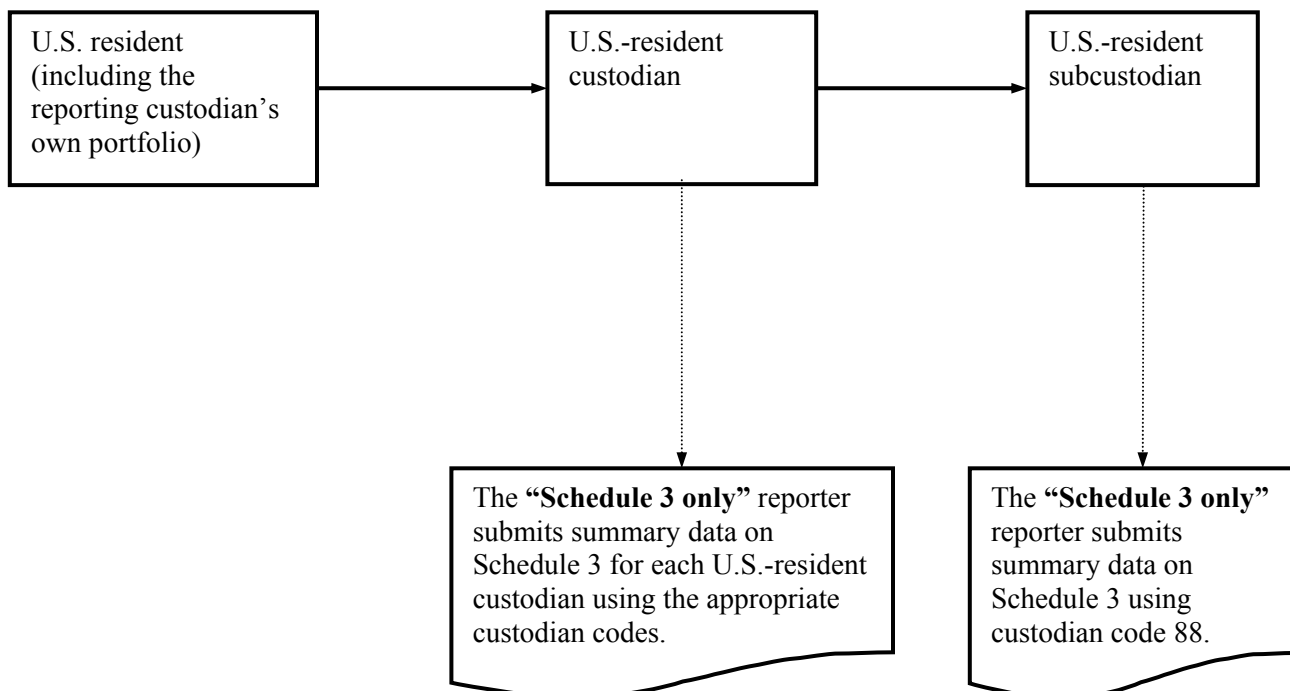

## Reporting Requirements for “Schedule 3 only” Reporters that are U.S.-Resident End-Investors (see Section II.A)

**Flowchart 4a - Foreign securities held for your own organization or for your U.S.-resident clients that are not in turn entrusted to any organization (held in self custody)**

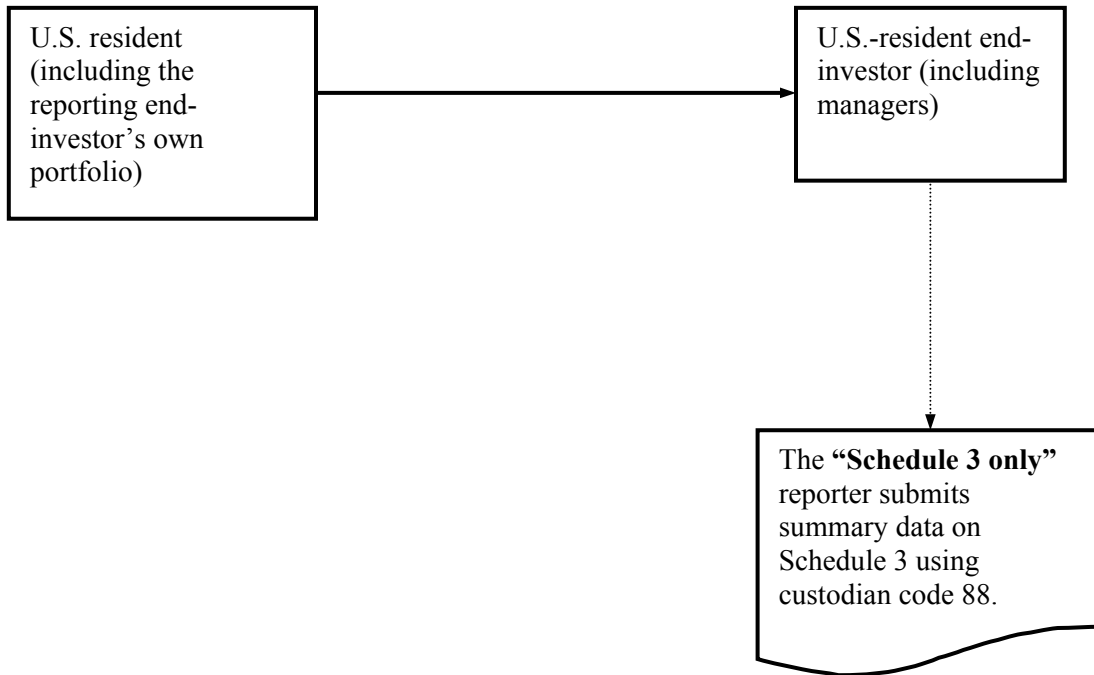

**Flowchart 4b - Foreign securities entrusted to the safekeeping of a U.S.-resident central securities depository**

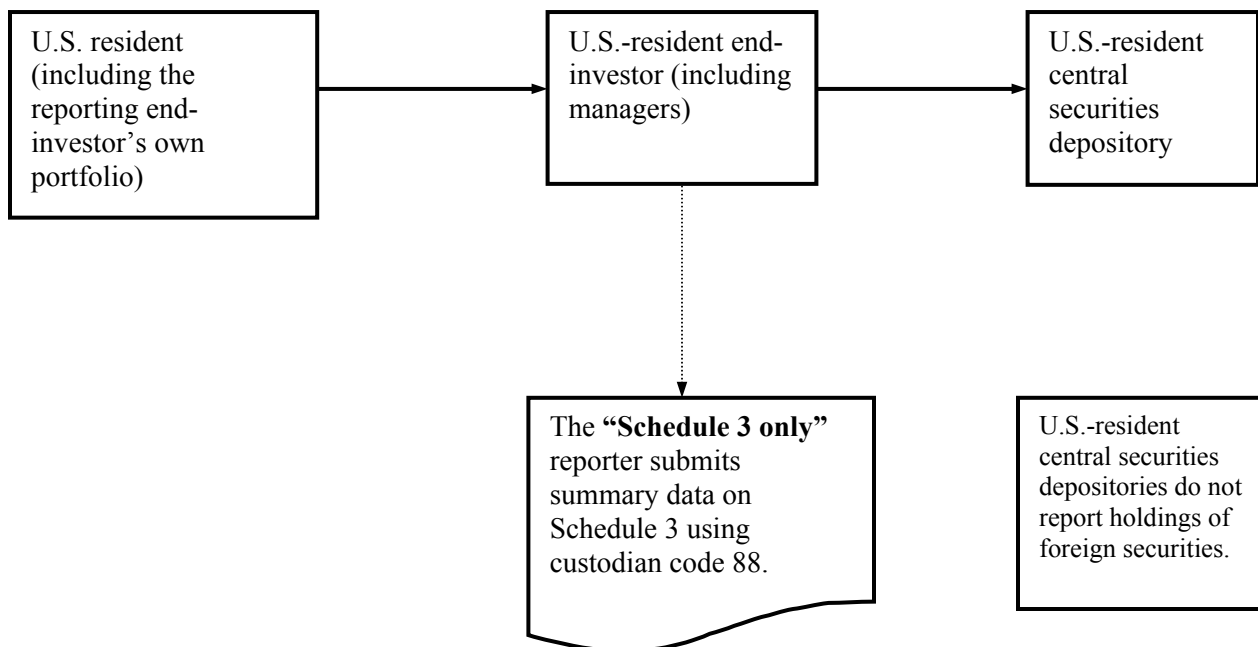

## Reporting Requirements for “Schedule 3 only” Reporters that are U.S.-Resident End-Investors (see Section II.A)

**Flowchart 4c - Foreign securities held abroad, either by employing a foreign-resident custodian or by directly entrusting to a foreign-resident central securities depository**

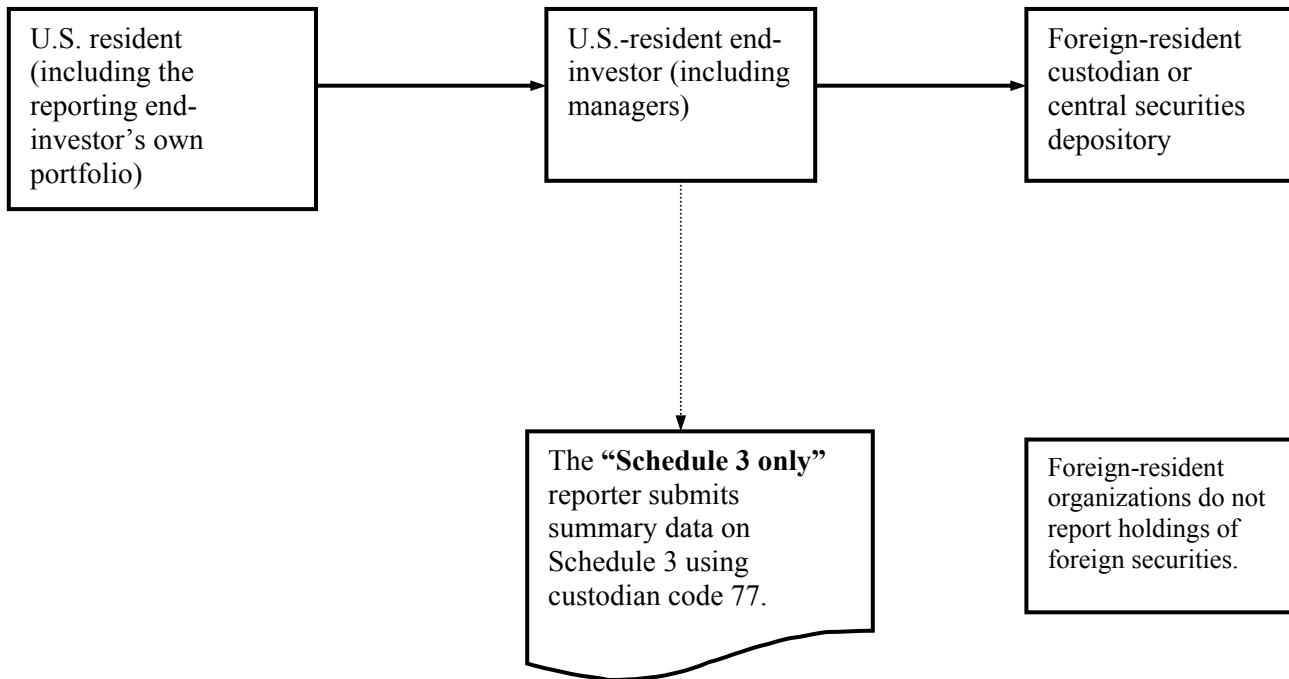

**Flowchart 4d - Foreign securities entrusted to the safekeeping of a U.S.-resident custodian (excluding U.S.-resident central securities depositories)**

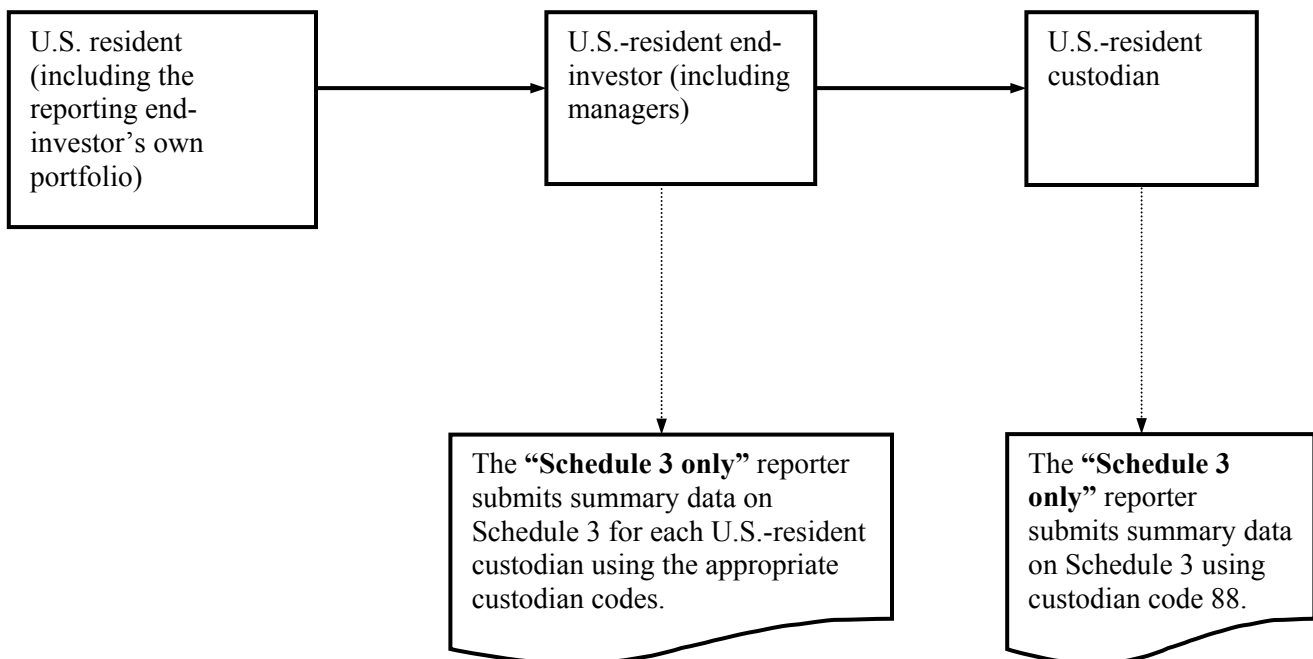

### Flowchart 5 - Determining Reportable Securities

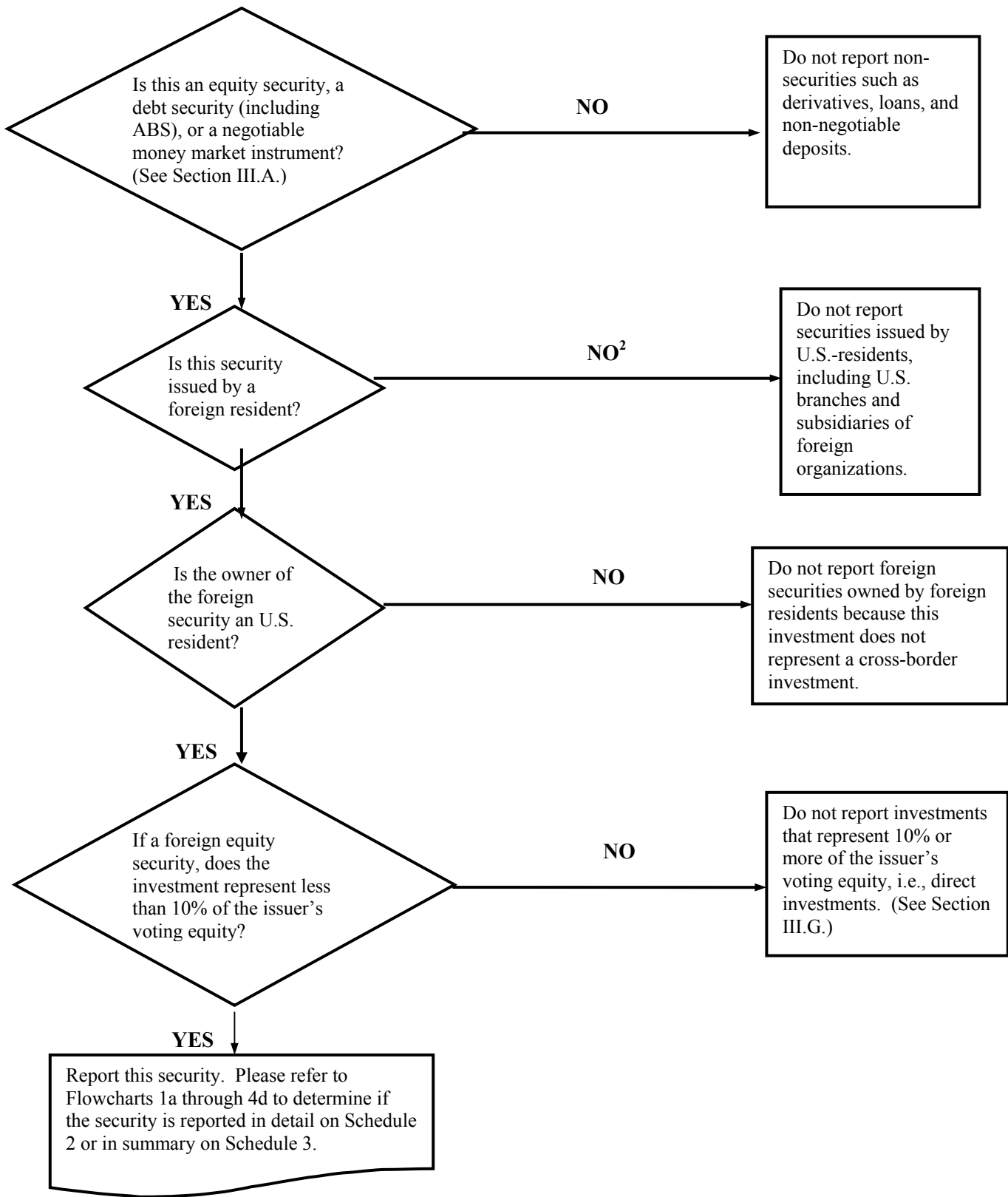

<sup>2</sup> Please see Section III.E for instructions on how to properly report depositary receipts.



## APPENDIX C: LIST OF SECURITY IDENTIFICATION SYSTEMS

| Code | Issuing Country/Agency                               | Security Identification Coding System   |
|------|--|---|
| 01   | International Organization for Standardization (ISO) | ISIN (International Securities Identification Number)                         |
| 02   | Common Code  | “European” Common Code (Clearstream/Cedel/Euroclear)                          |
| 31   | United Kingdom                                       | SEDOL (Stock Exchange Daily Official List)                                    |
| 33   | United States  | CINS (CUSIP International Numbering System for Non-North American Securities) |

**Secondary Codes - Only use these codes if none of the primary codes listed above are available.**

|    |               |  |
|----|---------------|--|
| 03 | Euroclear     | Euroclear Code (old)   |
| 04 | Cedel         | Cedel Code (old)   |
| 05 | Australia     | ASX Security Code (Australian Stock Exchange)                                      |
| 06 | Austria       | WPK Nummer (Wertpapier Kenn-Nummer)  |
| 07 | Belgium       | SVM Code (Secretariat des Valeurs Mobilieres)                                      |
| 08 | Brazil        | National Stock Exchange Association Code (Comissao Nacional de Bolsas de Valores)  |
| 09 | Brazil        | Rio de Janeiro Stock Exchange Code   |
| 10 | Brazil        | Sao Paulo Stock Exchange Code  |
| 11 | Denmark       | Fondskode  |
| 12 | France        | SICOVAM (Societe Interprofessionnelle pour la Compensation des Valeurs Mobilieres) |
| 13 | Germany       | WKN Nummer (Wertpapier Kenn-Nummer)  |
| 14 | Hong Kong     | Stock Exchange of Hong Kong Code   |
| 15 | Italy         | UIC Code (Ufficio Italiano dei Cambi)  |
| 16 | Italy         | ABI Code (Codice Associazione Bancaria Italiana)                                   |
| 17 | Japan         | SICC Code (Security Identification Code Conference)                                |
| 18 | Japan         | TSE Code (Tokyo Stock Exchange Code) (Toushou Code)                                |
| 19 | Korea         | Clearing Code (Korean Stock Exchange Code)   |
| 20 | Mexico        | Mexican Stock Exchange Code (Clave de pizarra de la Bolsa Mexicana de Valores)     |
| 21 | Netherlands   | Clearing Code (Amsterdam Stock Exchange Code)                                      |
| 22 | New Zealand   | New Zealand Stock Exchange Code  |
| 23 | Norway        | Modified ISIN (Verdipapirsentralen) (VPS)  |
| 24 | Portugal      | Lisbon Stock Exchange Code   |
| 25 | Portugal      | Oporto Stock Exchange Code   |
| 26 | South Africa  | Clearing House Code (Johannesburg Stock Exchange Code)                             |
| 27 | Spain         | CNMV Code (Comision Nacional del Mercado de Valores)                               |
| 28 | Sweden        | VPC Number (Vardepapperscentralen)   |
| 29 | Switzerland   | VALOR (Valoren-Nummer)   |
| 30 | Thailand      | Stock Exchange of Thailand Code  |
| 32 | United States | CUSIP Number (for North American Securities)                                       |
| 98 | Your Company  | Internally-Generated Code  |
| 99 | Other         | Other Coding System Not Specified Above  |

## APPENDIX D: LIST OF COUNTRY CODES

| <u>Code</u> | <u>Country</u>   | <u>Code</u> | <u>Country</u>  |
|-------------|--|-------------|---|
| 40401       | Afghanistan  | 51403       | Chad  |
| 15105       | Albania  | 30406       | Chile   |
| 50105       | Algeria  | 42005       | China, Hong Kong (including Kowloon and the New Territories)  |
| 10103       | Andorra  | 41408       | China, People's Republic of (China, Mainland) (including Inner Mongolia, Sinkiang (Chinese Turkistan), Tibet and Manchuria) |
| 50202       | Angola   | 46302       | China, Republic of (Taiwan)   |
| 30228       | Anguilla   | 30503       | Colombia  |
| 35203       | Antigua and Barbuda  | 51519       | Comoros   |
| 30104       | Argentina  | 51608       | Congo (Brazzaville)   |
| 16519       | Armenia  | 51705       | Congo (Kinshasa)  |
| 35254       | Aruba  | 60402       | Cook Islands  |
| 60089       | Australia  | 30589       | Costa Rica  |
| 10189       | Austria  | 53007       | Cote d'Ivoire (Ivory Coast)   |
| 16527       | Azerbaijan   | 14214       | Croatia   |
| 35319       | Bahamas, The   | 30708       | Cuba  |
| 40703       | Bahrain  | 10405       | Cyprus  |
| 40746       | Bangladesh   | 15288       | Czech Republic  |
| 13307       | Bank for International Settlements                           | 10502       | Denmark   |
| 30155       | Barbados   | 52302       | Djibouti  |
| 16209       | Belarus  | 36218       | Dominica  |
| 10251       | Belgium  | 30805       | Dominican Republic  |
| 35718       | Belize   | 45004       | East Timor  |
| 51802       | Benin  | 31003       | Ecuador (including the Galapagos Islands)   |
| 35602       | Bermuda  | 57002       | Egypt   |
| 40819       | Bhutan   | 31089       | El Salvador   |
| 30317       | BLADDEX (Banco Latino Americano de Exportaciones, SA)        | 51942       | Equatorial Guinea (including Fernando Po and Rio Muni)  |
| 30201       | Bolivia  | 52019       | Eritrea   |
| 14109       | Bosnia and Herzegovina                                       | 15407       | Estonia   |
| 50504       | Botswana   | 52108       | Ethiopia  |
| 30309       | Brazil   | 13501       | European Central Bank   |
| 60208       | British Oceania (also called British Indian Ocean Territory) | 36307       | Falkland Islands (Islas Malvinas)   |
| 35807       | British Virgin Islands                                       | 10618       | Faroe Islands   |
| 41009       | Brunei   | 60305       | Federated States of Micronesia  |
| 15202       | Bulgaria   | 60607       | Fiji  |
| 57118       | Burkina Faso   | 10707       | Finland (including Ahvenanamaa (Aland Islands))   |
| 41106       | Burma (Myanmar)  | 10804       | France  |
| 50806       | Burundi  | 36404       | French Guiana   |
| 41203       | Cambodia   | 60704       | French Polynesia  |
| 51004       | Cameroon   |             |   |
| 29998       | Canada   |             |   |
| 51209       | Cape Verde, Republic of                                      |             |   |
| 36137       | Cayman Islands   |             |   |
| 51306       | Central African Republic                                     |             |   |

| <u>Code</u> | <u>Country</u>  | <u>Code</u> | <u>Country</u>   |
|-------------|---|-------------|--|
| 52418       | Gabon   | 43303       | Laos   |
| 52507       | Gambia, The   | 15601       | Latvia   |
| 16535       | Georgia   | 43419       | Lebanon  |
| 11002       | Germany (Comprises the Federal Republic of Germany and the former German Democratic Republic)   | 53155       | Lesotho  |
| 52604       | Ghana   | 53201       | Liberia  |
| 11088       | Gibraltar   | 53309       | Libya  |
| 11207       | Greece (including the Aegean Islands (Khios, Kikladhes, Evvoia, Lesvos, Samos, Samothraki, etc.), the Dodecanese Islands (and Rhodes), the Ionian Islands, and Crete) | 11606       | Liechtenstein  |
| 60887       | Greenland   | 15709       | Lithuania  |
| 36706       | Grenada   | 11703       | Luxembourg   |
| 36803       | Guadeloupe  | 43508       | Macau  |
| 31208       | Guatemala   | 14419       | Macedonia, The Former Yugoslav Republic of   |
| 13006       | Guernsey (including Sark and Alderney)  | 53406       | Madagascar   |
| 52701       | Guinea  | 53503       | Malawi   |
| 54402       | Guinea-Bissau   | 43605       | Malaysia (including Sabah (North Borneo) and Sarawak and former Federation of Malaya)                              |
| 31305       | Guyana, Co-Operative Republic of  | 43702       | Maldives   |
| 31402       | Haiti   | 53589       | Mali   |
| 31488       | Honduras  | 11819       | Malta (including Gozo)   |
| 15504       | Hungary   | 61204       | Marshall Islands   |
| 11304       | Iceland   | 37001       | Martinique and smaller French Islands in the West Indies   |
| 42102       | India (including Sikkim, Andaman and Nicobar Islands, Goa, and Laccadive Islands (Union Territory of Lakshadweep))  | 53708       | Mauritania   |
| 42218       | Indonesia (including Timor (Western) and West New Guinea)   | 53805       | Mauritius  |
| 42307       | Iran  | 31704       | Mexico (including Cozumel and Revillagigedo Islands)   |
| 42404       | Iraq  | 16306       | Moldova  |
| 11401       | Ireland   | 12009       | Monaco   |
| 13008       | Isle of Man   | 43818       | Mongolia   |
| 42501       | Israel  | 37109       | Montserrat   |
| 11509       | Italy   | 54003       | Morocco (including Tangier and Ifni)   |
| 31607       | Jamaica   | 54089       | Mozambique   |
| 42609       | Japan   | 54127       | Namibia  |
| 13007       | Jersey  | 61301       | Nauru  |
| 42706       | Jordan  | 44202       | Nepal  |
| 16543       | Kazakhstan  | 12106       | Netherlands  |
| 53104       | Kenya   | 37206       | Netherlands Antilles (including Curacao and other islands (Bonaire, Saba, St. Eustatius, and southern St. Martin)) |
| 60526       | Kiribati  | 61409       | New Caledonia  |
| 44407       | Korea, North  | 61689       | New Zealand  |
| 43001       | Korea, South  | 31801       | Nicaragua  |
| 43109       | Kuwait  | 54208       | Niger  |
| 16551       | Kyrgyzstan  | 54305       | Nigeria  |
|             |   | 61808       | Niue   |
|             |   | 12203       | Norway   |
|             |   | 44105       | Oman (including Muscat)  |

| <u>Code</u> | <u>Country</u>  | <u>Code</u> | <u>Country</u>   |
|-------------|---|-------------|--|
| 44709       | Pakistan  | 16578       | Tajikistan   |
| 62502       | Palau   | 56405       | Tanzania (including Zanzibar)  |
| 31887       | Panama (including Canal Zone)   | 46418       | Thailand   |
| 61751       | Papua New Guinea  | 56502       | Togo   |
| 32107       | Paraguay  | 62405       | Tokelau  |
| 32204       | Peru  | 62448       | Tonga  |
| 44806       | Philippines   | 32409       | Trinidad and Tobago  |
| 62103       | Pitcairn Islands  | 56707       | Tunisia  |
| 15768       | Poland  | 12807       | Turkey (including Aegean Islands of Imbros and Bozcaada (Tenedos))   |
| 12319       | Portugal (including Azores and Madeira Islands)                               | 16616       | Turkmenistan   |
| 45101       | Qatar   | 37818       | Turks and Caicos Islands   |
| 54607       | Reunion   | 60518       | Tuvalu   |
| 15806       | Romania   | 56804       | Uganda   |
| 16101       | Russia  | 16403       | Ukraine  |
| 55018       | Rwanda  | 46604       | United Arab Emirates (including Abu Dhabi, Ajman, Dubai, Fujairah, Ras al Khaimah, Sharjah (including Kalbah), and Umm al Qaiwain)         |
| 55107       | Saint Helena (includes Ascension Island and Island group of Tristan de Cunha) | 13005       | United Kingdom (including England, Northern Ireland, Scotland, Wales, Hebrides, Orkney Islands, and Shetland Islands)                      |
| 37303       | Saint Kitts and Nevis   | 01007       | United States (includes American Samoa, Guam, Midway Islands, Puerto Rico, Northern Mariana Islands, U.S. Virgin Islands, and Wake Island) |
| 37508       | Saint Lucia   | 32603       | Uruguay  |
| 62219       | Saint Pierre and Miquelon   | 16705       | Uzbekistan   |
| 37605       | Saint Vincent and the Grenadines  | 61603       | Vanuatu  |
| 62618       | Samoa (formerly Western Samoa)  | 13102       | Vatican City   |
| 12408       | San Marino  | 32719       | Venezuela  |
| 55204       | Sao Tome and Principe   | 46906       | Vietnam  |
| 45608       | Saudi Arabia  | 56006       | Western Sahara   |
| 55301       | Senegal   | 47104       | Yemen (Comprises the former Yemen Arab Republic and the former People's Democratic Republic of Yemen)                                      |
| 13218       | Serbia and Montenegro (formerly Yugoslavia)                                   | 57207       | Zambia   |
| 55409       | Seychelles  | 54704       | Zimbabwe   |
| 55506       | Sierra Leone  | 79995       | International & Regional Organizations <sup>3</sup>  |
| 46019       | Singapore   | 88862       | Defunct Country  |
| 15318       | Slovakia  |             |  |
| 14338       | Slovenia  |             |  |
| 62308       | Solomon Islands   |             |  |
| 55603       | Somalia   |             |  |
| 55719       | South Africa  |             |  |
| 12505       | Spain (including Canary Islands)  |             |  |
| 41319       | Sri Lanka   |             |  |
| 56103       | Sudan   |             |  |
| 37702       | Suriname  |             |  |
| 56219       | Swaziland   |             |  |
| 12602       | Sweden  |             |  |
| 12688       | Switzerland   |             |  |
| 46205       | Syria   |             |  |

<sup>3</sup> See Appendix E for a list of International and Regional Organizations.

## APPENDIX E: LIST OF INTERNATIONAL AND REGIONAL ORGANIZATIONS

The institutions listed below should be reported with country code 79995 on item 11 of Schedule 2.

### INTERNATIONAL ORGANIZATIONS

Food and Agriculture Organization (FAO)  
Franc Zone  
Institute of International Finance (Ditchley Institute)  
Intergovernmental Committee for Migration  
International Atomic Energy Agency  
International Bank for Reconstruction and Development (IBRD) (World Bank)  
International Children's Emergency Fund  
International Civil Aviation Organization  
International Development Association (IDA)  
International Finance Corporation (IFC)  
International Fund for Agricultural Development  
International Labor Organization (ILO)  
International Monetary Fund (IMF)  
International Red Cross  
International Refugee Organization  
Multilateral Investment Guaranty Agency (MIGA)  
United Nations (UN), and Specialized Agencies and Commissions  
Universal Postal Union  
World Health Organization (WHO)

### EUROPEAN REGIONAL ORGANIZATIONS

Council of Europe  
Eurocontrol  
Eurofima  
European Atomic Energy Community (Euratom)  
European Bank for Reconstruction and Development (EBRD)  
European Coal and Steel Community (ECSC)  
European Communities (EC)  
European Development Fund (EDF)  
European Economic Community (EEC)  
European Free Trade Association (EFTA)  
European Investment Bank (EIB)  
European Investment Fund  
Nordic Investment Bank  
North Atlantic Treaty Organization (NATO)  
Organization for Economic Cooperation and Development (OECD)  
Tripartite Commission for the Restitution of Monetary Gold

### LATIN AMERICAN REGIONAL ORGANIZATIONS

Andean Development Corporation  
Andean Community of Nations (CAN) (formerly Andean Group)  
Central American Bank of Economic Integration (CABEI)  
Central American Common Market (CACM)  
Central American Development Corporation  
Central American Fund for Monetary Stabilization  
Central American Research Institute for Industry  
Inter-American Development Bank (IDB)  
Inter-American Investment Corporation  
Inter-American Savings and Loan Bank  
Latin American Integration Association  
Latin American Reserve Fund (FLAR) (formerly Andean Reserve Fund)  
North American Development Bank (NADBank)  
Organization of American States (OAS) (Pan American Union) and affiliated organizations  
Organization of Central American States (OCAS)  
Pan American Health Organization (Pan American Sanitary Bureau)  
Permanent Secretariat of the General Treaty on Central American Economic Integration  
River Plate Basin Commission  
Sistema Economico Latinoamericano (SELA) (Latin American Economic System)  
Venezuela Trust Fund

### CARIBBEAN REGIONAL ORGANIZATIONS

Caribbean Community and Common Market (CARICOM)  
Caribbean Development Bank  
Caribbean Investment Corporation  
Caribbean Regional Development Agency  
Eastern Caribbean Central Bank  
East Caribbean Development Bank  
Organization of Eastern Caribbean States (OECS)

## ASIAN REGIONAL ORGANIZATIONS

Asia and Pacific Council  
Asian Development Bank (ADB)  
Association of Southeast Asian Nations (ASEAN)  
Central Treaty Organizations (CENTO)  
Colombo Plan for Co-Operative Economic and  
Social Development in Asia and the Pacific

## AFRICAN REGIONAL ORGANIZATIONS

African Development Bank (AfDB)  
Arab Bank for Economic Development in Africa  
(BADEA)  
Banque Centrale des Etats de l'Afrique de l'Ouest  
(Central Bank of the West African States)  
Banque des Etats de l'Afrique Centrale (Bank of the  
Central African States)  
Conseil de l'Entente  
East African Common Service Organization  
East African Community  
East African Development Bank  
Organisation Commune Africaine et Mauricienne  
(OCAM)  
Organization of African Unity (OAU)  
Special Arab Fund for Africa  
Union des Etats de l'Afrique Centrale  
Union Douaniere des Etats de l'Afrique de l'Ouest  
Union Douaniere et Economique de l'Afrique  
Centrale (UDEAC) (Customs and Economic  
Union of Central Africa)  
Union Monetaire Ouest-Africaine (UMOA) (West  
African Monetary Union)

## MIDDLE EASTERN REGIONAL ORGANIZATIONS

Arab Authority for Agricultural Investment and  
Development  
Arab Fund for Economic and Social Development  
(AFESD)  
Arab Fund for Technical Assistance to Arab and  
African Countries  
Arab Investment Company  
Arab Joint Investment Company (U.A.E.- Egypt  
Investment Company)  
Arab Monetary Fund  
Arab Petroleum Investment Company  
Co-Operation Council for the Arab States of the  
Gulf, which includes Gulf Investment  
Corporation  
Inter-Arab Investment Guarantee Corporation  
Islamic Development Bank  
Islamic Solidarity Fund  
Muslim World League  
OPEC Special Fund  
Organization of Arab Petroleum Exporting  
Countries (OAPEC), which includes:  
Fund for Arab Oil Importing Countries  
OAPEC Oil Facility  
OAPEC Special Account  
Special Fund for Arab Non-oil Producers  
Organization of the Islamic Conference  
Saudi-Egyptian Industrial Investment Company  
Saudi-Egyptian Reconstruction Company  
Solidarity Fund for Economic and Social  
Development in Non-aligned Countries  
United Arab Shipping Company

## APPENDIX F: LIST OF CURRENCY CODES<sup>4</sup>

| <u>Code</u> | <u>Currency</u>          | <u>Code</u> | <u>Currency</u>        |
|-------------|--------------------------|-------------|------------------------|
| AFN         | Afghanistan Afghani      | CYP         | Cyprus Pound           |
| ALL         | Albanian Lek             | CZK         | Czech Koruna           |
| DZD         | Algerian Dinar           | DKK         | Danish Krone           |
| AOA         | Angolan Kwanza           | DJF         | Djibouti Franc         |
| ARS         | Argentine Peso           | DOP         | Dominican Peso         |
| AMD         | Armenian Dram            | XCD         | East Caribbean Dollar  |
| AWG         | Aruban Guilder           | EGP         | Egyptian Pound         |
| AUD         | Australian Dollar        | SVC         | El Salvador Colon      |
| AZM         | Azerbaijani Manat        | ERN         | Eritrea Nakfa          |
| BSD         | Bahamian Dollar          | EEK         | Estonia Kroon          |
| BHD         | Bahraini Dinar           | ETB         | Ethiopian Birr         |
| BDT         | Bangladeshi Taka         | EUR         | Euro                   |
| BBD         | Barbados Dollar          | FKP         | Falkland Islands Pound |
| BYR         | Belarussian Ruble        | FJD         | Fiji Dollar            |
| BZD         | Belize Dollar            | GMD         | Gambia Dalasi          |
| BMD         | Bermudian Dollar         | GEL         | Georgia Lari           |
| BTN         | Bhutan Ngultrum          | GHC         | Ghana Cedi             |
| BOB         | Bolivian Boliviano       | GIP         | Gibraltar Pound        |
| BWP         | Botswana Pula            | GTQ         | Guatemala Quetzal      |
| BRL         | Brazilian Real           | GWP         | Guinea-Bissau Peso     |
| BND         | Brunei Dollar            | GNF         | Guinea Franc           |
| BGN         | Bulgarian Lev            | GYD         | Guyana Dollar          |
| BIF         | Burundi Franc            | HTG         | Haitian Gourde         |
| KHR         | Cambodian Riel           | HNL         | Honduras Lempira       |
| CAD         | Canadian Dollar          | HKD         | Hong Kong Dollar       |
| CVE         | Cape Verde Escudo        | HUF         | Hungarian Forint       |
| KYD         | Cayman Islands Dollar    | ISK         | Iceland Krona          |
| XOF         | CFA Franc BCEAO          | INR         | Indian Rupee           |
| XAF         | CFA Franc BEAC           | IDR         | Indonesian Rupiah      |
| XPF         | CFP Franc                | IRR         | Iranian Rial           |
| CLP         | Chilean Peso             | IQD         | Iraqi Dinar            |
| CNY         | Chinese Yuan<br>Renminbi | JMD         | Jamaican Dollar        |
| COP         | Colombian Peso           | JPY         | Japanese Yen           |
| KMF         | Comoro Franc             | JOD         | Jordanian Dinar        |
| CDF         | Congolais Franc          | KZT         | Kazakhstan Tenge       |
| BAM         | Convertible Marks        | KES         | Kenyan Shilling        |
| CRC         | Costa Rican Colon        | KWD         | Kuwaiti Dinar          |
| HRK         | Croatian Kuna            | KGS         | Kyrgyzstan Som         |
| CUP         | Cuban Peso               | LAK         | Laos Kip               |
|             |                          | LVL         | Latvian Lats           |

---

<sup>4</sup> The currency code follows the International Organization for Standardization (ISO) Number 4217 format of a 3 alpha character code.

| <u>Code</u> | <u>Currency</u>              | <u>Code</u> | <u>Currency</u>             |
|-------------|------------------------------|-------------|-----------------------------|
| LBP         | Lebanese Pound               | SCR         | Seychelles Rupee            |
| LSL         | Lesotho Lote                 | SLL         | Sierra Leone Leone          |
| LRD         | Liberian Dollar              | SGD         | Singapore Dollar            |
| LYD         | Libyan Dinar                 | SKK         | Slovak Koruna               |
| LTL         | Lithuanian Litas             | SIT         | Slovenia Tolar              |
| MOP         | Macau Pataca                 | SBD         | Solomon Islands Dollar      |
| MKD         | Macedonian Denar             | SOS         | Somali Shilling             |
| MGF         | Malagasy Franc               | ZAR         | South African Rand          |
| MWK         | Malawi Kwacha                | KRW         | South Korean Won            |
| MYR         | Malaysian Ringgit            | LKR         | Sri Lanka Rupee             |
| MVR         | Maldives Rufiyaa             | SDD         | Sudanese Dinar              |
| MTL         | Maltese Lira                 | SRG         | Suriname Guilder            |
| MRO         | Mauritania Ouguiya           | SZL         | Swziland Lilangeni          |
| MUR         | Mauritius Rupee              | SEK         | Swedish Krona               |
| MXN         | Mexican Peso                 | CHF         | Swiss Franc                 |
| MDL         | Moldovan Leu                 | SYP         | Syrian Pound                |
| MNT         | Mongolian Tugrik             | TJS         | Tajikistan Somoni           |
| MAD         | Moroccan Dirham              | TZS         | Tanzanian Shilling          |
| MZM         | Mozambique Metical           | THB         | Thailand Baht               |
| MMK         | Myanmar Kyat                 | TOP         | Tongan Pa'anga              |
| NAD         | Namibia Dollar               | TTD         | Trinidad and Tobago Dollar  |
| NPR         | Nepalese Rupee               | TND         | Tunisian Dinar              |
| ANG         | Netherlands Antillan Guilder | TRL         | Turkish Lira                |
| ILS         | New Israeli Shekel           | TMM         | Turkmenistan Manat          |
| TWD         | New Taiwan Dollar            | UGX         | Uganda Shilling             |
| NZD         | New Zealand Dollar           | UAH         | Ukrainian Hryvnia           |
| NIO         | Nicaraguan Cordoba Oro       | AED         | United Arab Emirates Dirham |
| NGN         | Nigerian Naira               | USD         | United States Dollar        |
| KPW         | North Korean Won             | UYU         | Uruguayo Peso               |
| NOK         | Norwegian Krone              | UZS         | Uzbekistan Sum              |
| OMR         | Omani Rial                   | VUV         | Vanuatu Vatu                |
| PKR         | Pakistani Rupee              | VEB         | Venezuelan Bolivar          |
| PAB         | Panamanian Balboa            | VND         | Vietnamese Dong             |
| PGK         | Papua New Guinea Kina        | YER         | Yemeni Rial                 |
| PYG         | Paraguay Guarani             | YUM         | Yugoslavian Dinar           |
| PEN         | Peruvian New Sol             | ZMK         | Zambian Kwacha              |
| PHP         | Philippine Peso              | ZWD         | Zimbabwean Dollar           |
| PLN         | Polish Zloty                 |             |                             |
| GBP         | Pound Sterling               |             |                             |
| QAR         | Qatari Rial                  |             |                             |
| ROL         | Romanian Leu                 |             |                             |
| RUB         | Russian Ruble                |             |                             |
| RWF         | Rwanda Franc                 |             |                             |
| SHP         | Saint Helena Pound           |             |                             |
| WST         | Samoan Tala                  |             |                             |
| STD         | Sao Tome and Principe Dobra  |             |                             |
| SAR         | Saudi Arabian Riyal          |             |                             |



## APPENDIX G: LIST OF CUSTODIAN CODES

(Please note: If your securities are held by any U.S. affiliate of one of these custodians, please use the code of the bank or brokerage firm shown below.)

### THE FOLLOWING CODES SHOULD BE USED BY ALL REPORTERS

| <u>Name of U.S.-Resident Custodian</u>                       | <u>Custodian Code</u> |
|--|-----------------------|
| ABN-Amro Bank N.V.<br>(U.S.-resident branches)               | 01                    |
| Bank Julius Baer & Co. Ltd<br>(U.S.-resident branch)         | 02                    |
| Bank of Bermuda Limited, The                                 | 03                    |
| Bank of New York, The  | 04                    |
| Bank One Trust Company, National Association                 | 05                    |
| Deutsche Bank Trust Company Americas                         | 06                    |
| BNP Paribas<br>(U.S.-resident branches)                      | 07                    |
| Brown Brothers Harriman & Co.                                | 08                    |
| Citibank, N.A.   | 09                    |
| Credit Agricole Indosuez North America Inc.                  | 10                    |
| Credit Lyonnais<br>(U.S.-resident branches)                  | 11                    |
| Deutsche Bank Aktiengesellschaft<br>(U.S.-resident branches) | 12                    |
| Dresdner Bank Aktiengesellschaft<br>(U.S.-resident branches) | 13                    |
| HSBC Bank USA  | 14                    |
| Investors Bank & Trust Company                               | 15                    |
| JPMorgan Chase Bank  | 16                    |
| Mellon Trust Company of New York, LLC                        | 17                    |

| <b><u>Name of U.S.-Resident Custodian</u></b>    | <b><u>Custodian Code</u></b> |
|--|------------------------------|
| Northern Trust Company, The                      | 18                           |
| Societe Generale<br>(U.S.-resident branches)     | 19                           |
| State Street Bank and Trust Company              | 20                           |
| UBS AG<br>(U.S.-resident branches)               | 21                           |
| Union Bank of California, National Association   | 22                           |
| A.G. Edwards & Sons, Inc.                        | 23                           |
| Barclays Global Investors Services               | 24                           |
| Fifth Third Bank                                 | 25                           |
| FMR Corp.  | 26                           |
| Goldman Sachs Group L.P.                         | 27                           |
| Merrill Lynch & Company, Inc.                    | 28                           |
| Morgan Stanley, Dean Witter & Co.                | 29                           |
| PNC Financial Services Group, Inc., The          | 30                           |
| Prudential Securities                            | 31                           |
| U.S. Bank National Association                   | 32                           |
| UMB Bank National Association                    | 33                           |
| Wachovia Bank, National Association              | 34                           |
| Wells Fargo Bank, National Association           | 35                           |
| U.S.-resident custodian that is not listed above | 99                           |

**THE FOLLOWING CODES SHOULD ONLY BE USED BY “SCHEDULE 3 ONLY”  
REPORTERS**

**Custodian Code**

|   |    |
|---|----|
| Foreign securities held directly with foreign-resident custodians, including foreign-resident offices of U.S. banks or U.S. broker/dealers, and with foreign-resident central securities depositories (such as Euroclear and Clearstream) | 77 |
| Foreign securities held directly, managed directly, or held with U.S.-resident central securities depositories (such as the DTC and the FRBNY)  | 88 |

## APPENDIX H: GLOSSARY

**AMERICAN DEPOSITARY RECEIPT (ADR)** – Negotiable certificates, typically issued by a U.S.-resident company, for shares of stock issued by a foreign corporation. The securities are held in a custodial account, either at the issuing bank or by an agent. The ADR should be reported, not the foreign securities held by the depository. Report the ADR as common stock (security type = 1) if the underlying foreign security is common stock or as preferred stock (security type = 2) if the underlying foreign security is preferred stock. (See Section III.E for more information on the correct reporting of these securities.)

**AMERICAN DEPOSITARY SHARE (ADS)** – Negotiable securities certificate issued in the United States by transfer agents acting on behalf of foreign issuers, where the foreign issuers absorb part or all of the handling costs involved. The ADS should be reported, not the foreign securities held in custody. Report the ADS as common stock (security type = 1) if the underlying foreign security is common stock or as preferred stock (security type = 2) if the underlying foreign security is preferred stock. (See Section III.E for more information on the correct reporting of these securities.)

**ASSET-BACKED SECURITIES** - Securitized interests in a pool of assets, which give the purchaser a claim against the cash flows generated by the underlying assets. These pools may be derived from mortgage loans, auto loans, credit card receivables, vehicle and equipment leases, consumer loans, commercial loans or other assets. Include as asset-backed securities (ABS): CMOs, CLOs, CBOs and CDOs. ABS give the holder an undivided interest in the securitized assets and payments made from the cash flows received by the issuer from the payments of principal and interest from the borrowers. (ABS do not include securities, such as covered bonds or pfandbriefes, where the security is collateralized, but the holder of the security does not have a claim of the cash flows generated by the collateral.) ABS, including stripped ABS, are reported as security type = 7 or 11, depending on the original maturity.

**BEARER BOND** – Securities that are not registered in the name of their owner. The owner collects interest and dividends upon presentation of detachable coupons to a bank or fiduciary agent. These securities are reported as all other long-term debt (security type = 12).

**BRADY BONDS** – Collateralized dollar-denominated bonds issued by a foreign government or central bank in exchange for loans under the Brady Plan. These securities are reported as all other long-term debt (security type = 12).

**COMMERCIAL PAPER** - Unsecured negotiable promissory notes usually sold at a discount and customarily having a fixed maturity of 270 days or less. These negotiable money market instruments should be reported as security type = 5 or 12, depending on the original maturity.

**COMMINGLED ACCOUNT** – An account in which the investment funds of individual clients are pooled, with each client owning portions of the pooled account. Foreign securities held in commingled accounts should be reported.

**CONVERTIBLE BOND** – A bond that can be exchanged at a set price for equity securities by the holder under certain conditions. These securities are reported as convertible long-term debt (security type = 10).

**COVERED BOND** – Also known as Mortgage Bond or Pfandbriefe. A bond that is backed by loans, typically mortgages, but does not give the purchaser a claim against the cash flows generated by the underlying assets. These securities are reported as all other long-term debt (security type = 12).

**CUSTODIAN** – A bank or other organization that manages or administers the custody or safekeeping of stock certificates, debt securities, or other assets for institutional and private investors.

**DEPOSITARY RECEIPTS** – See American Depositary Receipts (ADR). Related types of depositary receipts, such as Global Depositary Receipts, are reported in the same manner as ADRs.

**DEPOSITARY** – An entity that holds SECURITIES, either in certificated or uncertificated (dematerialized) form, to enable the transfer of ownership of SECURITIES. DEPOSITORIES are not necessarily CUSTODIANS, since they may be responsible only for registering and settling security transactions.

**DERIVATIVE CONTRACT** - Financial instrument or other contract with all three of the following characteristics:

1. (a) One or more underlyings; (b) one or more notional amounts; and (c) payment provisions. These terms determine the amount of the settlement or settlements, and, in some cases, whether or not a settlement is required.
2. Requires no initial investment, or an initial net investment that is much smaller than would be required for other types of contracts that would be expected to have a similar response to changes in market factors.
3. The terms require or permit net settlement, it can readily be settled net by a means outside the contract, or it provides for delivery of an asset that puts the recipient in a position not substantially different from net settlement.

Derivative contracts are excluded from the SHCA report. Embedded derivatives that are not bifurcated under FAS 133 should be reported without separating the embedded derivative from the host contract. However, if the embedded derivative is bifurcated from the host contract, then the derivative should be excluded from the report and the host security should be included on the report.

**DEVELOPMENT BANKS** – Entities owned by national governments other than the United States and are established to promote economic development of sectors of the economy, such as trade, housing, agriculture, finance and industry. Securities issued by development banks should be reported.

**DIRECT INVESTMENT** – The beneficial ownership or control, by one person or by a group of affiliated persons, of 10 percent or more of the voting securities of another incorporated business, or an equivalent interest in an unincorporated business, including a branch. If a direct investment relationship exists, then generally, all financial flows between the firms are considered direct investment. However, for banking institutions direct investment is limited to intercompany holdings that are permanent investment. Direct investment positions are excluded from this report.

**END-INVESTOR** – An entity that invests in foreign securities for its own account (for trading, investment, or any other purpose) or invests on behalf of others, including asset pools, such as managers of mutual funds, managers of insurance company policyholder assets, and pension fund managers. (See Section II.A for examples of end-investors.)

**FOREIGN RESIDENT** - Any individual, corporation, or other organization located outside the United States. A corporation incorporated outside the United States is a foreign resident even if it has no physical presence outside the United States. Foreigners/foreign residents include:

1. Individuals, including citizens of the United States, residing outside the United States.

2. Entities that have filed an IRS Form W-8, indicating that the individual or entity is a nonresident alien or foreign entity not subject to certain United States information return reporting or to backup withholding rules.
3. Any corporation or other organization located outside the United States, including branches, subsidiaries and other affiliates of U. S. entities located abroad.
4. Foreign governments and any subdivision, agency or instrumentality thereof, including all foreign official nonbanking institutions, even if located in the United States (e.g., an embassy, consulate, or other diplomatic establishment of a foreign country). (However, all U.S.-resident subsidiaries of foreign corporations, including government-owned foreign corporations, are U.S. residents.)
5. Official international or regional organizations or subordinate or affiliated agencies thereof, created by treaty or convention between sovereign states, even if located in the United States, including the International Bank for Reconstruction and Development (IBRD or World Bank), the International Monetary Fund (IMF), and the United Nations (UN). (See Appendix E for a list of international and regional organizations.)

**FOREIGN-RESIDENT CUSTODIAN** – A custodian located outside the United States, including a foreign affiliate of a U.S. custodian. Reporters should determine the location of a custodian according to the country in which the custodian is incorporated, or otherwise legally established, not according to the country of the custodian’s parent firm, and not according to the location of the custodian’s operations center.

**FOREIGN SUBCUSTODIAN** – A foreign institution that holds in safekeeping foreign securities for a U.S.-resident custodian.

**FUNDS** – Pooled, separate and general investment accounts of one or more of the following institutional and private investors: private and public pension funds; mutual funds, country funds, exchange traded funds, unit investment trusts, collective-investment trusts, and any other similarly pooled, commingled investment funds; insurance companies; foundations; institutions of higher learning; government-sponsored enterprises and other independently acting government agencies; financial and nonfinancial corporations; investment advisors; trusts and estates; and private individuals. U.S. ownership of shares of foreign-resident funds are reported as funds (security type = 3), regardless of the types of securities held by the fund. Foreign securities held in U.S.-resident funds should also be reported. (See Section III.C for the correct reporting of funds.)

**INVESTMENT TRUST SHARE** – A share of a company bound by a trust deed issued in registered form, formed to invest in specific types of securities. Shares in an investment trust can usually be bought and sold only through the stock exchange. Sometimes referred to as a ‘closed-end’ fund. Investment trust shares are reported as funds (security type = 3), regardless of the types of securities held by the trust.

**LONG-TERM** – No contractual maturity or an original maturity of more than one year.

**LONG-TERM DEBT SECURITY** – Debt security with no contractual maturity or with an original maturity of more than one year. Report as security type = 9, 10, 11, or 12, depending on the specific type of long-term debt security.

**NATIONALIZED BANK** – Institution owned by a foreign central government that is classified as a bank in its own country.

**NEGOTIABLE CERTIFICATES OF DEPOSIT** – A negotiable (transferable) instrument or deposit in book entry form evidenced by a receipt or similar acknowledgement issued by a bank, which provides on its face that the amount of such deposit is payable to bearer or any specified person (e.g., deposit notes, bank notes). These negotiable money market instruments should be reported as security type = 6 or 12, depending on the original maturity.

**SECURITY** – Any bill, note, bond, debenture, equity, negotiable money market instrument, or similar instrument that is commonly referred to as a security. See Section III.A for a list of reportable foreign securities.

**SETTLEMENTDATE** – The date a security is delivered to the purchaser.

**SETTLEMENT DATE ACCOUNTING** – Under settlement date accounting the purchase and sale of assets are not recorded until the settlement date. Settlement date accounting should be used for purposes of this report.

**SHORT-TERM** – Original maturity of one year or less.

**SHORT-TERM DEBT SECURITY** – Debt security, including negotiable money market instruments, with an original maturity of one year or less.

**STRUCTURED NOTE OR BOND** – An over-the-counter financial instrument created specifically to meet the needs of one or a small number of investors. Some of the more common structures include: step-up bonds, index amortizing notes, dual index notes, deleveraged bonds, range bonds, and inverse floaters. These securities are reportable debt securities.

**SUBORDINATED DEBT** – A security evidencing debt that the holder agrees to rank after senior creditors, but before ordinary shareholders, in a bankruptcy.

**SUBSIDIARY** – A company in which another company (parent) owns 50 percent or more of the voting securities, or an equivalent interest.

**TREASURY BILL** – a common form of sovereign debt issued by many governments. Treasury bills with an original maturity of one year or less should be reported as all other short-term debt (security type = 8).

**UNITED STATES** – The fifty (50) States of the United States, the District of Columbia, the Commonwealth of Puerto Rico, the Commonwealth of the Northern Mariana Islands, and the following: American Samoa, Baker Island, Guam, Howland Island, Jarvis Island, Johnston Atoll, Kingman Reef, Midway Islands, Navassa Island, Palmyra Atoll, the U.S. Virgin Islands, and Wake Island.

**UNIT INVESTMENT TRUST** – A fixed portfolio of securities that are assembled by an underwriter sponsor and upon completion of the underwriting, are deposited with an independent trustee. Unit investment trusts have a definite termination date, usually between 6 months and 10 years. U.S. ownership of shares of foreign-resident unit investment trusts are reported as funds (security type = 3), regardless of the types of securities in the unit investment trust. Foreign securities held in U.S.-resident unit investment trusts should also be reported. (See Section III.C for the correct reporting of unit investment trusts.)

**U.S. RESIDENT** – Any individual, corporation, or other organization located in the United States, including branches, subsidiaries and affiliates of foreign entities located in the United States. Corporations incorporated in the United States are considered to be U.S. residents even if they have no “physical presence” in the United States.

**U.S.-RESIDENT CUSTODIAN** – A custodian located in the United States, including a U.S.-resident affiliate of a foreign custodian.

**U.S.-RESIDENT END-INVESTOR** - An entity located in the United States, including a U.S. affiliate of a foreign end-investor, that either invests for its own account (for trading, investment and other purposes) or on behalf of others, including assets pools. U.S.-resident end-investors include managers of a mutual fund, managers of assets held for insurance company policyholders, and managers of pension and endowment funds.

**ZERO-COUPON BOND** – Bonds that do not provide interest payments. Zero coupon bonds usually have an issue price well below 100% of the face value with repayment on maturity at face value or par. The investors' return is the difference between the issue price and redemption value. These securities are reported as zero coupon long-term debt (security type = 9).



## **APPENDIX I: TECHNICAL INFORMATION FOR ELECTRONIC SUBMISSION**

Included in this appendix are instructions for how to properly prepare data in a file for submission.

### **Requirements**

- ✓ Each diskette/CD (media) should contain data for only one Reporter Identification Number. If your organization will be reporting using multiple Reporter Identification Numbers, the data pertaining to each Reporter Identification Number must be reported on separate media.
- ✓ Each media for a particular Reporter Identification Number must be accompanied by a paper format Schedule I.
- ✓ Schedule 3 records can only be submitted in paper format.
- ✓ A dump or printout that includes at least the first ten detail records should accompany each media.
- ✓ Include a printout of the command string used to create the file if the file was created directly from the mainframe.
- ✓ Include any special instructions on how to unload the file.
- ✓ Your organization must retain a copy of the data for a period of three years from the date of the report's submission.

Data must be submitted by the first Friday in March to:

Federal Reserve Bank of New York  
Statistics Function, 4<sup>th</sup> Floor  
33 Liberty Street  
New York, NY 10045-0001

Should you have any questions concerning the instructions in this appendix, please contact the FRBNY automation staff at (212) 720-1989 or (646) 720-1989.

## Media: CD and Diskette

Please comply with the following instructions for submitting Schedule 2 data.

All data must be provided in a standard DOS, **ASCII flat file** on one of the following media:

- High density, IBM PC-compatible diskette(s)
- Standard 650 MB CD(s)

Reporters must use either a semicolon-delimited format or positional format. The layouts and examples of each follows. If data for one of the foreign currency value fields is larger than the specified field length, please contact FRBNY automation staff at (212) 720-1989 or (646) 720-1989 to discuss an alternative field format.

### Semicolon Delimited Format

| <b>Data Field and Instructions</b>                                | <b>Field Format</b> | <b>Schedule 2 Item Number</b> |
|---|---------------------|-------------------------------|
| <b>Reporter Identification Number</b>                             | <b>N10</b>          | <b>1</b>                      |
| Delimiter   | Semi-colon          |                               |
| <b>Sequence Number (value from 1 - maximum number of records)</b> | <b>N7</b>           | <b>2</b>                      |
| Delimiter   | Semi-colon          |                               |
| <b>Reporting Unit</b>   | <b>N3</b>           | <b>3a</b>                     |
| Delimiter   | Semi-colon          |                               |
| <b>Name of Reporting Unit</b>                                     | <b>A80</b>          | <b>3b</b>                     |
| Delimiter   | Semi-colon          |                               |
| <b>Security ID</b>  | <b>A12</b>          | <b>4</b>                      |
| Delimiter   | Semi-colon          |                               |
| <b>Security Description</b>                                       | <b>A80</b>          | <b>5</b>                      |
| Delimiter   | Semi-colon          |                               |
| <b>Security ID System (Refer to Appendix C)</b>                   | <b>N2</b>           | <b>6</b>                      |
| Delimiter   | Semi-colon          |                               |
| <b>Security ID System Description</b>                             | <b>A80</b>          | <b>6a</b>                     |
| Delimiter   | Semi-colon          |                               |
| <b>Security Type (Refer to Schedule 2, Page1)</b>                 | <b>N2</b>           | <b>7</b>                      |
| Delimiter   | Semi-colon          |                               |
| <b>Depository Receipt/Share (Refer to Schedule 2, Page1)</b>      | <b>N1</b>           | <b>8</b>                      |
| Delimiter   | Semi-colon          |                               |
| <b>Name of Issuer</b>   | <b>A80</b>          | <b>9</b>                      |
| Delimiter   | Semi-colon          |                               |
| <b>Intentionally Left Blank</b>                                   | <b>N1</b>           | <b>10</b>                     |
| Delimiter   | Semi-colon          |                               |
| <b>Country of Issuer (Refer to Appendix D)</b>                    | <b>N5</b>           | <b>11</b>                     |
| Delimiter   | Semi-colon          |                               |
| <b>Currency of Denomination (Refer to Appendix F)</b>             | <b>A3</b>           | <b>12</b>                     |
| Delimiter   | Semi-colon          |                               |
| <b>Ownership Code (Refer to Schedule 2, Page1)</b>                | <b>N1</b>           | <b>13</b>                     |
| Delimiter   | Semi-colon          |                               |
| <b>US\$ Fair (Market) Value of Security Held</b>                  | <b>N12</b>          | <b>14a</b>                    |
| Delimiter   | Semi-colon          |                               |

|  |            |            |
|--|------------|------------|
| <b>Fair (Market) Value of Security Held Denominated in the Currency of Issue</b> | <b>N12</b> | <b>14b</b> |
| Delimiter  | Semi-colon |            |
| <b>Zero Market Value Indicator (Refer to Schedule 2, Page2)</b>                  | <b>N1</b>  | <b>15</b>  |
| Delimiter  | Semi-colon |            |
| <b>Number of Shares Held</b>   | <b>N11</b> | <b>16</b>  |
| Delimiter  | Semi-colon |            |
| <b>Face Value in Currency of Denomination (non-ABS debt only)</b>                | <b>N12</b> | <b>17</b>  |
| Delimiter  | Semi-colon |            |
| <b>Issue Date (MMDDYYYY) (non-ABS debt only)</b>                                 | <b>N8</b>  | <b>18</b>  |
| Delimiter  | Semi-colon |            |
| <b>Maturity Date (MMDDYYYY) (non-ABS debt only)</b>                              | <b>N8</b>  | <b>19</b>  |
| Delimiter  | Semi-colon |            |
| <b>Original Face Value in Currency of Denomination (ABS only)</b>                | <b>N12</b> | <b>20</b>  |
| Delimiter  | Semi-colon |            |
| <b>Remaining Principal Outstanding in Currency of Denomination (ABS only)</b>    | <b>N12</b> | <b>21</b>  |
| Delimiter  | Semi-colon |            |
| <b>Issue Date (MMDDYYYY) (ABS only)</b>  | <b>N8</b>  | <b>22</b>  |
| Delimiter  | Semi-colon |            |
| <b>Maturity Date (MMDDYYYY) (ABS only)</b>                                       | <b>N8</b>  | <b>23</b>  |

### Data Specifications

In addition to the instructions in the above table, follow these instructions:

- No special characters should be present in numeric fields (e.g. currency signs, commas, negative signs, slashes, etc.).
- All numeric fields: unpacked, unsigned and with leading zeroes.  
A format specification of N12 is numeric, with length of up to 12.
- A format specification of A80 is an alphanumeric, with length of up to 80.
- Issue Date and Maturity Date fields should be in the format of MMDDYYYY with leading zero for months January - September and for 1<sup>st</sup> to the 9<sup>th</sup> day of the month (e.g. 01092003 = January 9, 2003).
- Semi-colons must be used as space-delimiters between fields.

### External Label (Affix to media, not to cover)

Company Name  
Reporter Identification Number as assigned by the FRBNY  
Data Processing Contact Name and Telephone Number  
Diskette/CD Identification Number (as identified in your records)  
Total Number of Diskette/CD: 1 of \_\_\_  
Creation Date  
Report and As-Of Date: SHCA December 31, XXXX

## Sample Equity Record

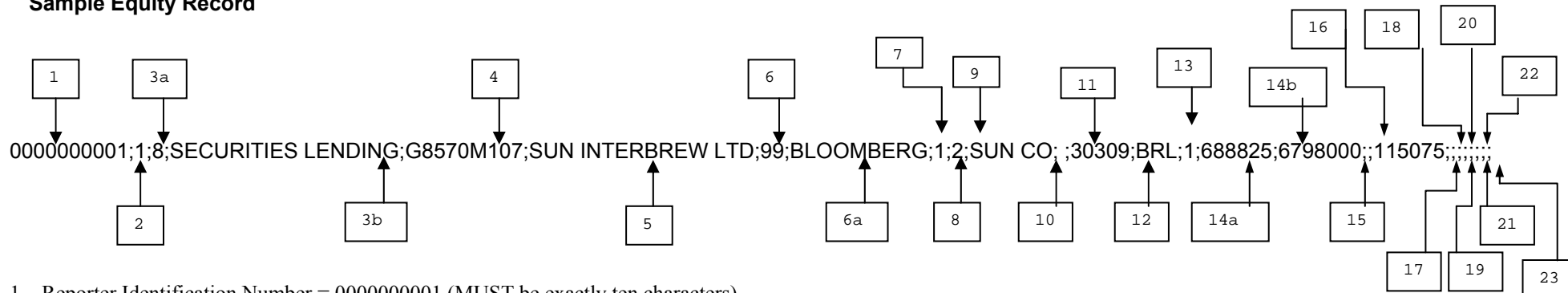

1. Reporter Identification Number = 0000000001 (MUST be exactly ten characters)
2. Sequence Number (can also be of format: 0000001)
- 3a. Reporting Unit (internal code to identify the area within your organization that the data came from)
- 3b. Name of Reporting Unit (can be up to 80 characters in length)
4. Security ID (can be up to 12 characters in length)
5. Security Description (can be up to 80 characters in length)
6. Security ID System (use security ID system codes from Appendix C)
- 6a. Security ID System "Other" (name of the organization or system that assigned the security ID)
7. Security Type (use security types listed on Schedule 2, Page 1)
8. Depositary Receipt/Share (refer to Schedule 2, Page 1 for codes)
9. Name of Issuer (can be up to 80 characters in length)
10. Intentionally Left Blank
11. Country of Issuer (use country codes listed in Appendix D)
12. Currency of Denomination (use currency codes listed in Appendix F)
13. Ownership Code (refer to Schedule 2, Page 1 for codes)
- 14a. US\$ Fair (Market) Value of Security Held (can be up to 12 characters in length)
- 14b. Fair (Market) Value of Security Held Denominated in the Currency of Issue (can be up to 12 characters in length)
15. Zero Market Value Indicator (Refer to Schedule 2, Page 2 for codes.) This item must be null if a value is entered for item 14a.
16. Number of shares held – (can be up to 11 characters in length) **Must have a value greater than zero for an equity record.**
17. Face Value in Currency of Denomination – must be null for an equity record
18. Issue Date – must be null for an equity record
19. Maturity Date – must be null for an equity record
20. Original Face Value in Currency of Denomination – must be null for an equity record
21. Remaining Principal Outstanding in Currency of Denomination – must be null for an equity record
22. Issue Date – must be null for an equity record
23. Maturity Date – must be null for an equity record

Null field

Note: Null fields are to be included. They are represented by the inclusion of a delimiter as if a value were present. E.g. - ;desc; ;

**Sample Short-term/Long-term Debt Record (excluding Asset-Backed securities)**

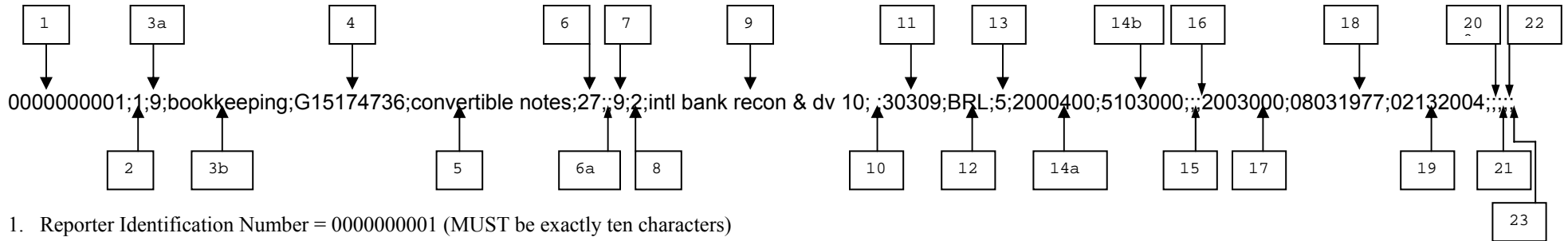

1. Reporter Identification Number = 0000000001 (MUST be exactly ten characters)
2. Sequence Number (can also be of format: 0000001)
- 3a. Reporting Unit (internal code to identify the area within your organization that the data came from)
- 3b. Name of Reporting Unit (can be up to 80 characters in length)
4. Security ID (can be up to 12 characters in length)
5. Security Description (can be up to 80 characters in length)
6. Security ID System (use security ID system codes from Appendix C)
- 6a. Security ID System "Other" (name of the organization or system that assigned the security ID)
7. Security Type (use security types listed on Schedule 2, Page 1)
8. Depository Receipt/Share (refer to Schedule 2, Page 1 for codes)
9. Name of Issuer (can be up to 80 characters in length)
10. Intentionally Left Blank
11. Country of Issuer (use country codes listed in Appendix D)
12. Currency of Denomination (use currency codes listed in Appendix F)
13. Ownership Code (refer to Schedule 2, Page 1 for codes)
- 14a. US\$ Fair (Market) Value of Security Held (can be up to 12 characters in length)
- 14b. Fair (Market) Value of Security Held Denominated in the Currency of Issue (can be up to 12 characters in length)
15. Zero Market Value Indicator (Refer to Schedule 2, Page 2 for codes.) This item must be null if a value is entered for item 14a.
16. Number of shares held – must be null for short-term/long-term debt record (excluding asset-backed securities)
17. Face Value in Currency of Denomination - (can be up to 12 characters in length). **Must have a value greater than zero for a short-term/long-term debt record (excluding asset-backed securities).**
18. Issue Date – MMDDYYYY format (08031977 = August 3, 1977)
19. Maturity Date – MMDDYYYY format (02132004 = February 13, 2004)
20. Original Face Value in Currency of Denomination – must be null for short-term/long-term debt record (excluding asset-backed securities)
21. Remaining Principal Outstanding in Currency of Denomination – must be null for short-term/long-term debt record (excluding asset-backed securities)
22. Issue Date – must be null for short-term/long-term debt record (excluding asset-backed securities)
23. Maturity Date – must be null for short-term/long-term debt record (excluding asset-backed securities)

### Sample Asset-Backed Long-term Debt Record

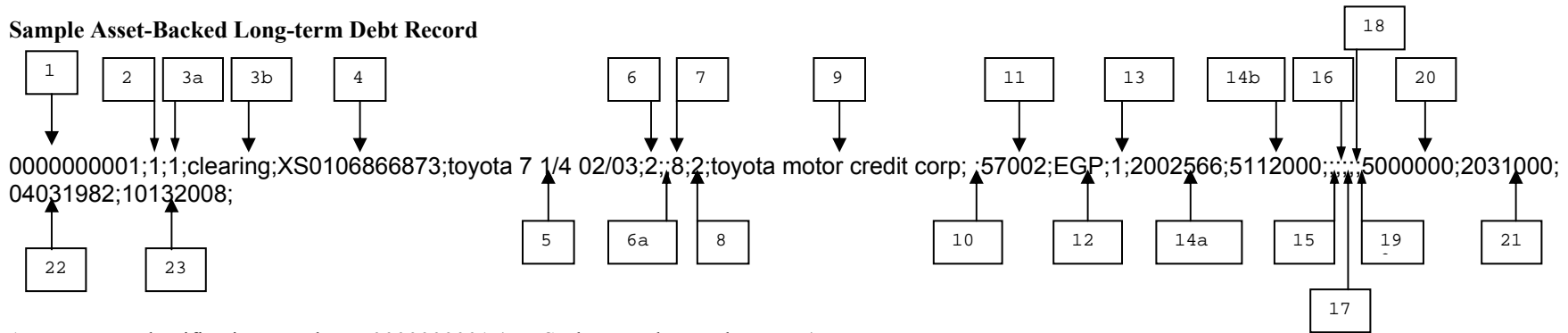

1. Reporter Identification Number = 0000000001 (MUST be exactly ten characters)
2. Sequence Number (can also be of format: 0000001)
- 3a. Reporting Unit (internal code to identify the area within your organization that the data came from)
- 3b. Name of Reporting Unit (can be up to 80 characters in length)
4. Security ID (can be up to 12 characters in length)
5. Security Description (can be up to 80 characters in length)
6. Security ID System (use security ID system codes from Appendix C)
- 6a. Security ID System "Other" (name of the organization or system that assigned the security ID)
7. Security Type (use security types listed on Schedule 2, Page 1)
8. Depository Receipt/Share (refer to Schedule 2, Page 1 for codes)
9. Name of Issuer (can be up to 80 characters in length)
10. Intentionally Left Blank
11. Country of Issuer (use country codes listed in Appendix D)
12. Currency of Denomination (use currency codes listed in Appendix F)
13. Ownership Code (refer to Schedule 2, Page 1 for codes)
- 14a. US\$ Fair (Market) Value of Security Held (can be up to 12 characters in length)
- 14b. Fair (Market) Value of Security Held Denominated in the Currency of Issue (can be up to 12 characters in length)
15. Zero Market Value Indicator (Refer to Schedule 2, Page 2 for codes.) This item must be null if a value is entered for item 14a.
16. Number of shares held – must be null for an asset-backed long-term debt record
17. Face Value in Currency of Denomination - must be null for an asset-backed long-term debt record
18. Issue Date – must be null for an asset-backed long-term debt record
19. Maturity Date – must be null for an asset-backed long-term debt record
20. Original Face Value in Currency of Denomination – for ABS debt only (can be up to 12 characters in length). **Must have a value greater than zero for an asset-backed long-term debt record.**
21. Remaining Principal Outstanding in Currency of Denomination – for ABS debt only (can be up to 12 characters in length). **Must have a value greater than zero for an asset-backed long-term debt record.**
22. Issue Date – MMDDYYYY format (04031982 = April 3, 1982)
23. Maturity Date – MMDDYYYY format (10132008 = October 13, 2008)

### Positional Format

| Position | Data Field and Instructions  | Field Format | Schedule 2 Item Number |
|----------|--|--------------|------------------------|
| 1-10     | <b>Reporter Identification Number</b>  | <b>N10</b>   | <b>1</b>               |
| 11       | Filler (space)   | Space        |                        |
| 12-18    | <b>Sequence Number (value from 1 - maximum number of records)</b>                | <b>N7</b>    | <b>2</b>               |
| 19       | Filler (space)   | Space        |                        |
| 20-22    | <b>Reporting Unit</b>  | <b>N3</b>    | <b>3a</b>              |
| 23       | Filler (space)   | Space        |                        |
| 24-103   | <b>Name of Reporting Unit</b>  | <b>A80</b>   | <b>3b</b>              |
| 104      | Filler (space)   | Space        |                        |
| 105-116  | <b>Security ID</b>   | <b>A12</b>   | <b>4</b>               |
| 117      | Filler (space)   | Space        |                        |
| 118-197  | <b>Security Description</b>  | <b>A80</b>   | <b>5</b>               |
| 198      | Filler (space)   | Space        |                        |
| 199-200  | <b>Security ID System (Refer to Appendix C)</b>                                  | <b>N2</b>    | <b>6</b>               |
| 201      | Filler (space)   | Space        |                        |
| 202-281  | <b>Security ID System Description</b>  | <b>A80</b>   | <b>6a</b>              |
| 282      | Filler (space)   | Space        |                        |
| 283-284  | <b>Security Type (Refer to Schedule 2, Page1)</b>                                | <b>N2</b>    | <b>7</b>               |
| 285      | Filler (space)   | Space        |                        |
| 286      | <b>Depository Receipt/Share (Refer to Schedule 2, Page1)</b>                     | <b>N1</b>    | <b>8</b>               |
| 287      | Filler (space)   | Space        |                        |
| 288-367  | <b>Name of Issuer</b>  | <b>A80</b>   | <b>9</b>               |
| 368      | Filler (space)   | Space        |                        |
| 369      | <b>Intentionally Left Blank</b>  | <b>N1</b>    | <b>10</b>              |
| 370      | Filler (space)   | Space        |                        |
| 371-375  | <b>Country of Issuer (Refer to Appendix D)</b>                                   | <b>N5</b>    | <b>11</b>              |
| 376      | Filler (space)   | Space        |                        |
| 377-379  | <b>Currency of Denomination (Refer to Appendix F)</b>                            | <b>A3</b>    | <b>12</b>              |
| 380      | Filler (space)   | Space        |                        |
| 381      | <b>Ownership Code (Refer to Schedule 2, Page1)</b>                               | <b>N1</b>    | <b>13</b>              |
| 382      | Filler (space)   | Space        |                        |
| 383-394  | <b>US\$ Fair (Market) Value of Security Held</b>                                 | <b>N12</b>   | <b>14a</b>             |
| 395      | Filler (space)   | Space        |                        |
| 396-407  | <b>Fair (Market) Value of Security Held Denominated in the Currency of Issue</b> | <b>N12</b>   | <b>14b</b>             |
| 408      | Filler (space)   | Space        |                        |
| 409      | <b>Zero Market Value Indicator (Refer to Schedule 2, Page2)</b>                  | <b>N1</b>    | <b>15</b>              |
| 410      | Filler (space)   | Space        |                        |
| 411-421  | <b>Number of Shares Held</b>   | <b>N11</b>   | <b>16</b>              |
| 422      | Filler (space)   | Space        |                        |
| 423-434  | <b>Face Value in Currency of Denomination (non-ABS debt only)</b>                | <b>N12</b>   | <b>17</b>              |
| 435      | Filler (space)   | Space        |                        |
| 436-443  | <b>Issue Date (MMDDYYYY) (non-ABS debt only)</b>                                 | <b>N8</b>    | <b>18</b>              |
| 444      | Filler (space)   | Space        |                        |
| 445-452  | <b>Maturity Date (MMDDYYYY) (non-ABS debt only)</b>                              | <b>N8</b>    | <b>19</b>              |
| 453      | Filler (space)   | Space        |                        |
| 454-465  | <b>Original Face Value in Currency of Denomination (ABS only)</b>                | <b>N12</b>   | <b>20</b>              |
| 466      | Filler (space)   | Space        |                        |

|         |   |            |           |
|---------|---|------------|-----------|
| 467-478 | <b>Remaining Principal Outstanding in Currency of Denomination (ABS only)</b> | <b>N12</b> | <b>21</b> |
| 479     | Filler (space)  | Space      |           |
| 480-487 | <b>Issue Date (MMDDYYYY) (ABS only)</b>                                       | <b>N8</b>  | <b>22</b> |
| 488     | Filler (space)  | Space      |           |
| 489-496 | <b>Maturity Date (MMDDYYYY) (ABS only)</b>                                    | <b>N8</b>  | <b>23</b> |

496 character logical records blocked at 60 logical records or a block size of 29,760 bytes.

### Data Specifications

In addition to the instructions in the above table, follow these instructions:

- No special characters should be present in numeric fields (e.g. currency signs, commas, negative signs, slashes, etc.).
- All numeric fields should be unpacked, unsigned, **right** justified with leading zeroes, e.g., COBOL PIC 9(12). A format specification of N11 is numeric, with length of up to 11.
- Alphanumeric data should be **left** justified and blank filled, e.g., COBOL PIC X(50). A format specification of A80 is an alphanumeric, with length of up to 80.
- Issue Date and Maturity Date fields should be in the format of MMDDYYYY with leading zero for months January - September and for 1<sup>st</sup> to the 9<sup>th</sup> day of the month (e.g. 01092003 = January 9, 2003).
- The filler should be a space, e.g., in COBOL PIC X value spaces.



