



NATIONAL AERONAUTICS AND SPACE ADMINISTRATION

FINAL

APOLLO 11 FLIGHT PLAN

AS-506/CSM-107/LM-5

JULY 1, 1969

PREPARED BY
FLIGHT PLANNING BRANCH
FLIGHT CREW SUPPORT DIVISION

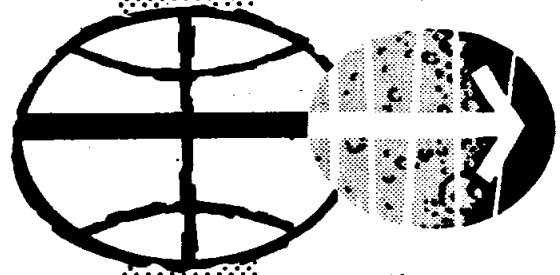

MANNED SPACECRAFT CENTER
HOUSTON, TEXAS

INDEXING DATA			T	FORM	SUBJECT	SIGNATOR	LOC
DATE	CCR	#					
7-1-69	100		1		AS-506		100-100

SECTION I

SECTION II

SECTION III

SECTION IV

SECTION V

SECTION VI

APOLLO 11
APOLLO AS-506/CSM-107/LM-5
FINAL FLIGHT PLAN

JULY 1, 1969

Submitted by: L. J. Riche
L. J. Riche
Flight Planning Branch

G. M. Colton
G. M. Colton
Flight Planning Branch

T. A. Guillory
T. A. Guillory
Flight Planning Branch

Approved by: W. J. North
W. J. North
Chief, Flight Crew Support Division

Donald K. Slayton
Donald K. Slayton
Director of Flight Crew Operations

Concurrence: George M. Low 6-27
George M. Low
Manager, Apollo Spacecraft Program

Christopher C. Kraft, Jr.
Christopher C. Kraft, Jr.
Director of Flight Operations

Any comments or questions on this document should be forwarded to T. A. Guillory, Flight Planning Branch, mail code CF34, extension 4271.

ACKNOWLEDGMENTS

Acknowledgment is made to Messrs. Richard Rogers, William Killian and Spencer Gardner for their technical support in the preparation of the Apollo 11 Flight Plan.

Views of the earth and the P52 stars shown in the Flight Plan were taken from the document, Views from the CM and LM During the Flight of Apollo 11 (Mission G).

The CSM and LM attitude information was taken from the document, Lunar Orbit Attitude Sequence for Mission G.

TABLE OF CONTENTS

Abbreviations	iii
Introduction	xi

SECTION I - GENERAL

1. Mission Description	1-1
2. Summary Flight Plan (TLC-TEC)	1-5
3. Summary Flight Plan (Lunar Orbit)	1-6
4. LM Power Descent Profile	1-7
5. CSM Burn Schedule	1-8
6. LM Burn Schedule	1-9
7. Lunar Landing Site Data	1-10
8. Landmark Tracking Data	1-10
9. Flight Plan Notes	1-13

SECTION II - UPDATE FORMS

1. Update Forms Table	2-1
2. CSM Maneuver Update Pads	2-2
3. LM Maneuver Update Pads	2-27

SECTION III - DETAILED TIMELINE

1. Launch Phase	3-1
2. TLI-T&D	3-3, 3-4
3. Translunar Coast Activities	
a. Cislunar Navigation	3-7, 3-17
b. LM Familiarization	3-35
c. Lunar Orbit Insertion	3-47
4. Lunar Orbit Activities	
a. Second LM Ingress	3-53
b. LM Activation and C/O	3-63

SECTION III CONT'D

c. Undocking	3-67
d. Touchdown	3-69
e. EVA	3-77
f. LM Liftoff	3-90
g. LM Active Docking	3-94
h. LM Jettison	3-97
5. TEI-TEC	3-101
6. Entry	3-135

SECTION IV DETAILED TEST OBJECTIVES

1. Detailed Test Objectives	4-1
2. Test Objective/Mission Activity Cross Reference	4-2
3. Test Objectives	4-6

SECTION V - CONSUMABLES

1. RCS Propellant Usage	5-2
2. SM RCS Budget	5-3
3. CM RCS Budget	5-22
4. SPS Budget	5-23
5. LM RCS Budget	5-25
6. DPS Budget	5-31
7. APS Budget	5-32
8. CSM EPS Budget	5-36
9. LM EPS Budget	5-41
10. LM ECS Budget	5-45
11. PLSS Budget	5-50

SECTION VI - SUMMARY FLIGHT PLAN

Summary Flight Plan	6-1
---------------------	-----

ABBREVIATIONS

ACCEL	Accelerometer
ACN	Ascension
ACT	Activation
ACQ	Acquisition
AEA	Abort Electronics Assembly
AGS	Abort Guidance Subsystem
AH	Ampere Hours
ALSCC	Apollo Lunar Surface Close-up Camera
ALT	Altitude
AMP or amp	Ampere
ANG	Antigua
ANT	Antenna
AOH	Apollo Operations Handbook
AOS	Acquisition of Signal or Acquisition of Site
AOT	Alignment Optical Telescope
APS	Ascent Propulsion Subsystem
ARS	Atmosphere Revitalization System
ATT	Attitude
AUX	Auxiliary
AZ	Azimuth
BAT	Battery
BDA	Bermuda
Bio	Bio-Medical Data on Voice Downlink
BP	Barber Pole
BT	Burn Time
BU	Backup
BW	Black & White
BRKT	Bracket
CAP COM	Capsule Communicator
CAL \angle	Calibration Angle
CAM	Camera
CB	Circuit Breaker
CDH	Constant Delta Altitude
CDR	Commander
CDU	Coupling Data Unit
CEX	Color External
CIN	Color Internal
CIRC	Circularization
CK	Check
CM	Command Module
CMC	Command Module Computer
CMD	Command
CMP	Command Module Pilot
CNTL	Control
C/O	Check out
COAS	Crew Optical Alignment Sight
COMM	Communications
CONFIG	Configuration

CONT	Continue
CP	Control Point
CRO	Carnarvon, Australia
CRYO	Cryogenic
CSC	Contingency Sample Collection
CSI	Coelliptic Sequence Initiation
CSM	Command Service Module
C&WS	Caution and Warning System
CYI	Grand Canary Island
DAP	Digital Auto Pilot
DB	Deadband
DCA	Digital Command Assembly
DEDA	Data Entry and Display Assembly
DEGS	Degrees
DEPL	Depletion
DET	Digital Event Timer
DIFF	Difference
DOI	Descent Orbit Insertion
DPS	Descent Propulsion System
DS	Documented Sample
DSE	Data Storage Equipment
DSKY	Display and Keyboard
DTO	Detailed Test Objective
DUA	Digital Uplink Assembly
DWN	Down
E	Erasable or Enter
EASEP	Early Apollo Scientific Experiment Package
ECS	Environmental Control System
ED	Explosive Device
EDT	Eastern Daylight Time
EFH	Earth Far Horizon
EI	Earth (atmosphere) Interface
EL	Elevation or Electric
EMS	Entry Monitor System
EMU	Extravehicular Mobility Unit
ENH	Earth Near Horizon
EPO	Earth Parking Orbit
EPS	Electrical Power Subsystem
EQUIP	Equipment
EST	Eastern Standard Time
EVA	Extravehicular Activity
EVAP	Evaporator
EVT	Extravehicular Transfer
EXT	External
f	F Stop
FC	Fuel Cell
FDAI	Flight Director Attitude Indicator

FLT	Flight
FM	Frequency Modulated
FOV	Field of View
fps or FPS	Feet per second
FT or ft	Feet
FTO	Flight Test Objective
FTP	Full Throttle Position
GBI	Grand Bahama Islands
GBM	Grand Bahama (MSFN)
GDC	Gyro Display Coupler
GDS	Goldstone, California
GET	Ground Elapsed Time
GETI	Ground Elapsed Time of Ignition
GLY	Glycol
GMT	Greenwich Mean Time
G&N	Guidance and Navigation
GNCS	Guidance Navigation Control System
GWM	Guam
GYM	Guaymas, Mexico
H2	Hydrogen
HA	Apogee Altitude
HAW	Hawaii
HBR	High Bit Rate (TLM)
HD	Highly Desirable
HGA	High Gain Antenna
HI	High
Hp	Perigee Altitude
HSK	Honeysuckle (Canberra, Australia)
HTR	Heater
HTV	USNS Huntsville
ICDU	Inertial Coupling Data Unit
ID	Identification
IGA	Inner Gimbal Angle
IGN	Ignition
IMU	Inertial Measurement Unit
INIT	Initialization
INT	Intervalometer
IP	Initial Point
ISA	Interim Storage Assembly
IU	Instrumentation Unit
IVC	Intervehicular Communications
IVT	Intravehicular Transfer
JETT	Jettison
KM	Kilometer
kwh	Kilowatt Hour

LA	Launch Azimuth
LAT	Latitude
LBR	Low Bit Rate (TLM)
LBS or lbs	Pounds
LCC	Liquid Cooled Garment
LDG	Landing
LDMK	Landmark
LEB	Lower Equipment Bay
LEC	Lunar Equipment Conveyor
LFH	Lunar Far Horizon
LGC	LM Guidance Computer
LH	Left-hand
L/H	Local Horizontal
LHEB	Left-hand Equipment Bay
LHFEB	Left-hand Forward Equipment Bay
LHSSC	Left Hand Side Storage Container
LiOH	Lithium Hydroxide
LLM	Lunar Landing Mission
LLOS	Landmark Line of Sight
LM	Lunar Module
LMP	Lunar Module Pilot
LNH	Lunar Near Horizon
LOI	Lunar Orbit Insertion
LONG	Longitude
LOS	Loss of Signal or Loss of Site
LPO	Lunar Parking Orbit
LR	Landing Radar
LRRR or LR3	Laser Ranging Retro-Reflector
LS	Landing Site
LT	Light
LTG	Lighting
LV	Launch Vehicle
L/V	Local Vertical
LVPD	Launch Vehicle Pressure Display
M	Mandatory
MAD	Madrid, Spain
MAN	Manual
MAX	Maximum
MAX Q	Maximum Dynamic Pressure
MCC	Midcourse Correction
MCC-H or MCC	Mission Control Center - Houston
MDC	Main Display Console
MEAS	Measurement
MER	USNS Mercury
MESA	Modularized Equipment Stowage Assembly
MET	Mission Event Timer

MGA	Middle Gimbal Angle
M/I	Minimum Impulse
MIN	Minimum
MLA	Merrit Island, Florida
MNVR	Maneuver
MPS	Main Propulsion System
MSFN	Manned Space Flight Network
MTVC	Manual Thrust Vector Control
N2	Nitrogen
NAV	Navigation
NM	Nautical Miles
NOM	Nominal
NXX	Noun XX
O2	Oxygen
OBS	Observation
O/F	Oxidizer to Fuel Ratio
OGA	Outer Gimbal Angle
OMNI	Omnidirectional Antenna
OPS	Oxygen Purge System
ORB	Orbital
ORDEAL	Orbit Rate Display Earth and Lunar
ORIENT	Orientation
OVHD	Overhead
P	Pitch or Program
PAD	Voice Update
PCM	Pulse Code Modulation
PC	Plane Change
PDI	Powered Descent Initiation
PGA	Pressure Garment Assembly
PGNCS	Primary Guidance Navigation Control Section
PIPA	Pulse Integrating Pendulous Accelerometer
PLSS	Personal Life Support Systems
PM	Phase Modulated
POL	Polarity or Polarizing
PRE	Pretoria, South Africa
PREF	Preferred
PREP	Preparation
PRESS	Pressure
PRIM	Primary
PROP	Proportional
PSE	Passive Seismic Experiment
PT	Point
PU	Propellant Utilization
PUGS	Propellant Utilization and Gaging System

PTC	Passive Thermal Control
PWR	Power
PXX	Program XX
Qty	Quantity
R	Roll or Range
R&B	Red & Blue
RAD	Radiator
RCDR	Recorder
RCS	Reaction Control System
RCU	Remote Control Unit
RCV	Receiver
RED	USNS Redstone
REFSMMAT	Reference Stable Member Matrix
REG	Regulator
REQD	Required
RH	Right-hand
RING	Ringsite
RLS	Radius of Landing Site
RNDZ	Rendezvous
RR	Rendezvous Radar
RSI	Roll Stability Indicator
RT	Real Time
RTC	Real Time Command
RXX	Routine XX
SA	Shaft Angle
S/C	Spacecraft
SCE	Signal Conditioning Equipment
SCS	Stabilization Control System
SCT	Scanning Telescope
SEC	Secondary
SECO	S-IVB Engine Cut-off
SECS	Sequential Events Control System
SEP	Separate
SEQ	Sequence
S-IVB	Saturn IV B(Third Stage)
SLA	Service Module LM Adapter
SLOS	Star Line-of-Sight
SM	Service Module
SPOT	Spot Meter
SPS	Service Propulsion System
SR	Sunrise
SRC	Sample Return Container
SRX	S-Band Receiver Mode No. X
SS	Sunset
STX	S-Band Transmit Mode No. X

S.V.	State Vector
SWC	Solar Wind Composition
Sw	Switch
SXT	Sextant
T EPHEM	Time of Ephemeris Update
TA	Trunnion Angle
TAN	Tananarive, Madagascar
TB	Time Base
TCA	Time of Closest Approach
TD&E	Transposition Docking & LM Ejection
TEC	Trans Earth Coast
TEI	Transearch Insertion
TEMP	Temperature
TERM	Terminate
TEX	Corpus Christi, Texas
TGT	Target
TIG	Time of Ignition
TLC	Trans Lunar Coast
TLI	Translunar Insertion
TLM or TM	Telemetry
TPF	Terminal Phase Final
TPI	Terminal Phase Initiation
TPM	Terminal Phase Midcourse
T/R	Transmitter/Receiver
TRANS	Translation
TV	Television
TVC	Thrust Vector Control
TWR	Tower
US	United States
V	Velocity
VAN	USNS Vanguard
VHF	Very High Frequency
VLV	Valve
VI	Inertial Velocity
VOX	Voice Keying
VXX	Verb XX
W/O	Without
WRT	With Respect to
WTN	USNS Watertown
XFER	Transfer
XMIT	Transmit or Transmitter
XPONDER	Transponder
Y	Yaw

ΔV	Velocity Change (Differential)
ΔVC	Velocity Change at Engine Cutoff
ΔR	Position Change (Differential)
8-balls	Flight Director Attitude Indicator (FDAI)

CAMERA NOMENCLATURE

EL/250/BW-BRKT	Electric Hasselblad/250mm Lens/ Black & White film-Camera Bracket
INT (f5.6,250,INF)	Intervalometer $\frac{1}{250}$ sec, (f-stop 5.6, shutter speed = $\frac{1}{250}$ sec, Infinity)
16mm/18/CEX-BRKT MIR (f8,250,INF) 6fps	16mm Camera/18mm Lens/Color Film External-Camera Bracket Mirror (f-stop 8, shutter speed $\frac{1}{250}$ sec, Infinity) 6 frames per sec

SYMBOL NOMENCLATURE

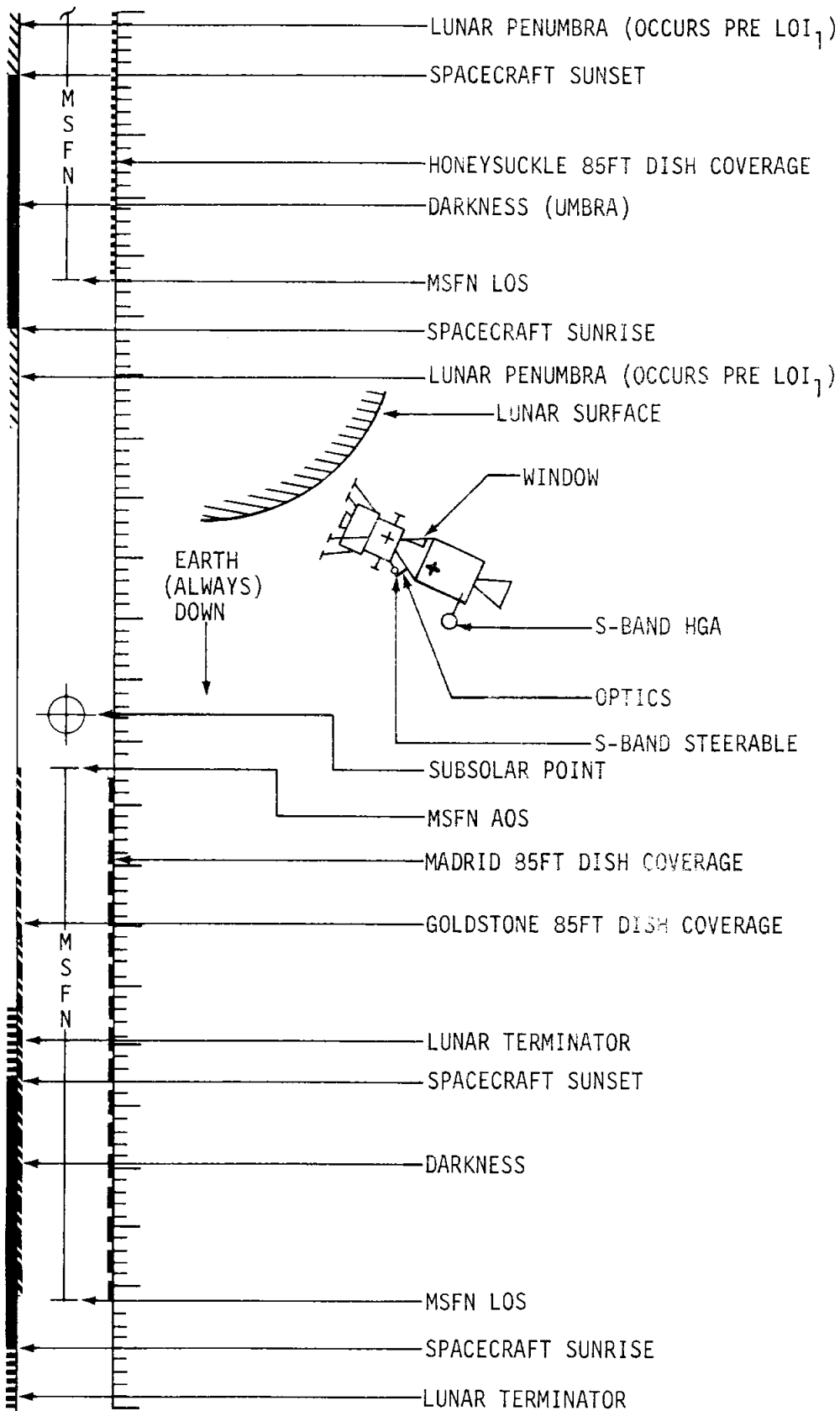

INTRODUCTION

This Flight Plan has been prepared by the Flight Planning Branch, Flight Crew Support Division, with technical support by TRW Systems.

This document schedules the AS-506/CSM-107/LM-5 operations and crew activities to fulfill, when possible, the test objectives defined in the Mission Requirements, G Type Mission Lunar Landing.

The trajectory parameters used in this Flight Plan are for July 16, 1969 launch, with a 72° launch azimuth and were supplied by Mission Planning and Analysis Division as defined by the Apollo Mission G Spacecraft Operational Trajectory.

The Apollo 11 Flight Plan is under the configuration control of the Crew Procedures Control Board (CPCB). All proposed changes to this document that fall in the following categories should be submitted to the CPCB via a Crew Procedures Change Request:

1. Items that impose additional crew training or impact crew procedures.
2. Items that impact the accomplishment of detailed test objectives.
3. Items that result in a significant RCS or EPS budget change.
4. Items that result in moving major activities to a different activity day in the Flight Plan.
5. Items that require a change to the flight data file.

The Chief, Flight Planning Branch (FCSD) will determine what proposed changes fall in the above categories.

Mr. T. A. Guillory will act as co-ordinator for all proposed changes to the Apollo 11 Flight Plan.

Any requests for additional copies or changes to the distribution lists of this document must be made in writing to Mr. W. J. North, Chief, Flight Crew Support Division, MSC, Houston, Texas.

SECTION I - GENERAL

MISSION DESCRIPTION

1. Launch and EPO (Duration 2:44) LIFT OFF - 2:44 GET
 - (a) Nominal launch time is 9:32 EDT, July 16, 1969, with a launch window duration of 4 hrs. 24 min.
 - (b) Earth orbit insertion into a 100 nm circular orbit at 11 min. 43 sec. after lift-off
 - (c) CSM systems C/O in earth orbit
 - (d) Optional IMU realign (P52) to the pad REFSMMAT during the first night period
 - (e) TLI occurs at 2:44:26 GET over the Pacific Ocean during the second revolution. (See Table 1-1 for burn data).

2. Translunar Coast (Duration 73:10) 2:44 - 75:54 GET

After TLI, which places the spacecraft in a free lunar return trajectory, the following major events occur prior to LOI:

 - (a) Transposition, docking and LM ejection, including SIVB photography
 - (b) Separation from SIVB and a CSM evasive maneuver
 - (c) SIVB propulsive venting of propellants (slingshot)
 - (d) Two series of P23 cislunar navigation sightings, star/earth horizon, consisting of five sets at 06:00 GET and five sets at 24:30 GET
 - (e) Four midcourse corrections which take place at TLI + 9, TLI + 24, LOI - 22 and LOI - 5 hours with ΔV nominally zero (See Table 1-1).

- (f) Passive thermal control (PTC) will be conducted during all periods when other activities do not require different attitudes.
- (g) LM inspection and housekeeping
- (h) LOI₁, performed at 75:54:28 GET, ends the TLC phase.

3. Lunar Orbit (Duration 59:30) 75:54 - 135:24 GET

LOI Day (Duration 25:00) 69:00 - 94:00

- (a) LOI₁
- (b) Photos of targets of opportunity
- (c) LOI₂
- (d) Post LOI₂ LM entry and inspection. S-Band/VHF B Voice tests will be conducted.
- (e) Post LOI₂ Pseudo landmark tracking (one set of sightings)
(See Table 1-4)
- (f) Rest period of 9 hours

DOI and EVA Day (Duration 28:00) 94:00 - 122:00 GET

- (a) Docked LM activation and checkout
- (b) Docked landing site landmark sighting (one set of sightings)
(See Table 1-3)
- (c) Undocking and separation
- (d) DOI thru landing (See Figure 1-3 Powered Descent)
- (e) LM post touchdown and simulated liftoff
- (f) Rest period (LM) of 4 hours
- (g) CSM plane change
- (h) Rest period (CSM) of 4 hours

- (i) EVA prep
- (j) EVA for 2 hours 40 minutes
- (k) Post EVA
- (l) Rest period (LM) 4 hours 40 minutes
- (m) Rest period (CSM) 4 hours 50 minutes

Ascent and TEI Day (Duration 25:00) 122:00 - 147:00 GET

- (a) LM Lift-Off and Insertion
- (b) LM active rendezvous
 - CSI
 - PC
 - CDH
 - TPI
 - Braking
- (c) Docking
- (d) LM jettison
- (e) TEI
- (f) Rest Period

4. Lunar Orbit Particulars (Average Values for a 60 x 60 nm orbit)

- (a) Revolutions start at 180° longitude
- (b) Revolution duration - 1 hr. 58.2 min.
- (c) S/C night period duration - 47 min.
- (d) MSFN coverage per rev. - 72 min.
- (e) Orbit inclination - 1.25° for July 16, 1969 launch

- (f) S/C orbital rate - $3^\circ/\text{min.}$ ($.05^\circ/\text{sec}$)
- (g) Lighting change at fixed ground point - $1^\circ\text{West}/\text{Rev.}$
- (h) Horizon visibility $\pm 20^\circ$ selenocentric angle on the lunar surface
- (i) One lunar degree on lunar surface is 16.35 nm
- (j) Site 2 will be visible (3° sun angle) at REV. 7
- (k) S/C subvehicle point to horizon 327 nm.

5. Transearch Coast and Entry (Duration 59:39) 131:52 - 195:03 GET

Transearch coast begins with TEI at 135:24:34 GET and consists of the following major events:

- (a) Three midcourse corrections are scheduled at TEI + 15, EI - 23 and EI - 3 hours with ΔV nominally zero.
- (b) CM/SM separation takes place at 194:51 GET and Entry Interface occurs at 195:03 GET.
- (c) Splashdown will occur in the Pacific Ocean at a longitude of about 172.4° West at 195:17 GET. This will occur approximately 25 minutes prior to sunrise local time.

FIGURE 1-1
MISSION SUMMARY FLIGHT PLAN
TRANSLUNAR COAST

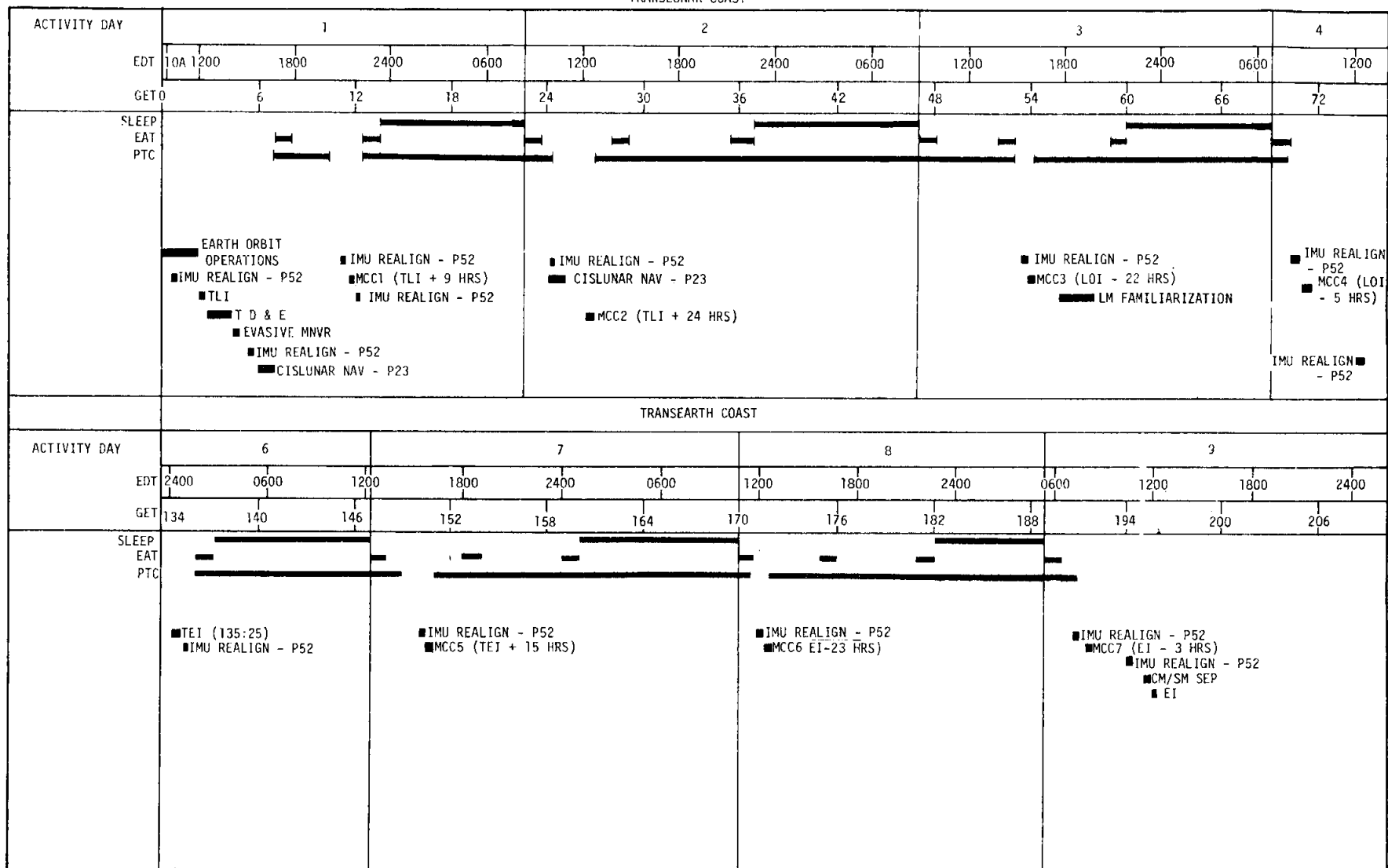

LUNAR ORBIT SUMMARY FLIGHT PLAN FIG 1-2

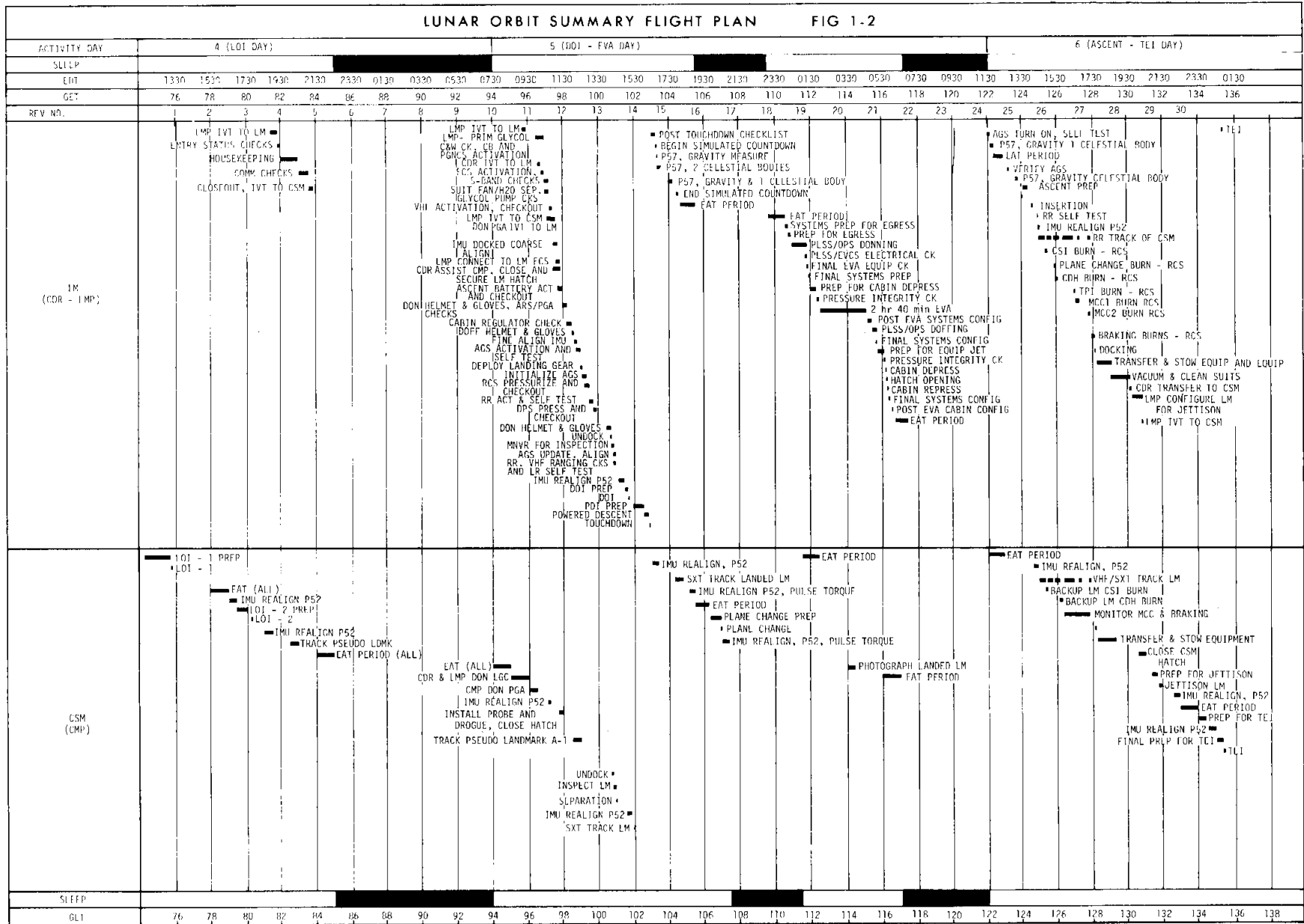

1-6

LM POWERED DESCENT

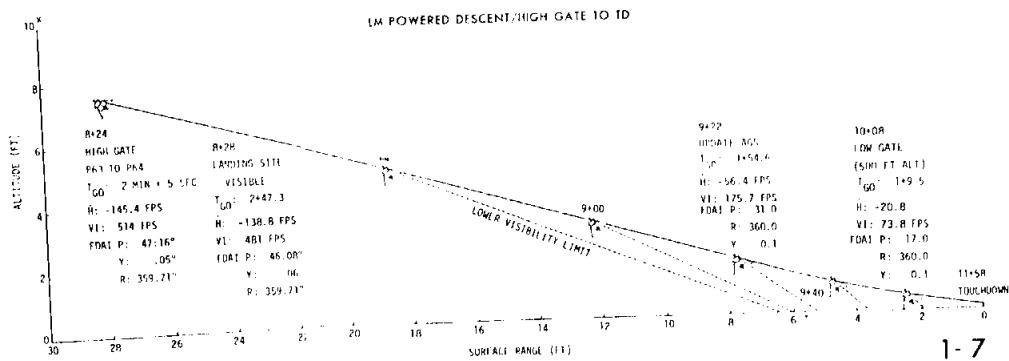
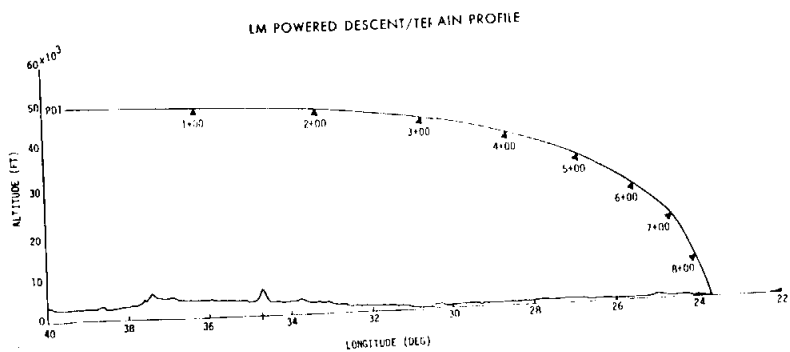
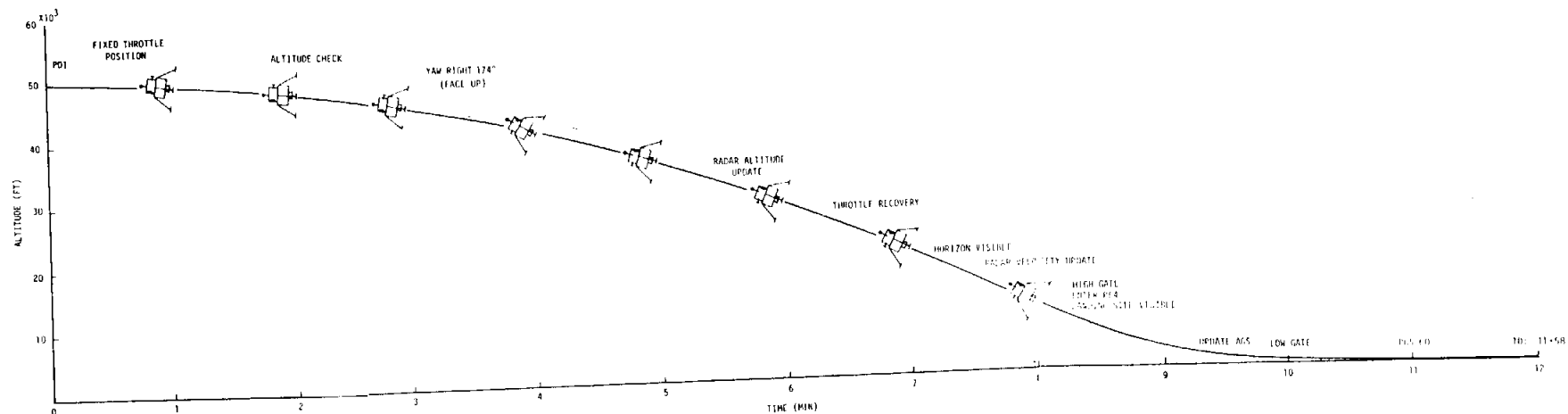

TABLE 1-1 CSM BURN SCHEDULE

BURN/MANEUVER	GETI BURN TIME ΔV_c	ATTITUDE (DEG)		LIGHTING	ΔV (FPS)	ULLAGE	TVC MODE	REFSMAT	S/C WT. RESULTANT HA, HP	REMARKS
		LH/LV	INERTIAL							
S-IVB TLI	2:44:26 5 MIN 20 SEC			BURNOUT AT SUNRISE	ΔVX : — ΔVY : — ΔVZ : — ΔV REQ: 10,451.2	—	—	PAD	WT: — HP: — HA: —	S-IVB BURN
CSM/LM S-IVB EVASIVE MNVR	04:39:44.9 2.8 SEC 15.6 FPS			DAYLIGHT	ΔVX : 5.1 ΔVY : 0.0 ΔVZ : 19.0 ΔV REQ: 19.7	NOT REQUIRED	G&N AUTO	PAD	WT: 96662.3 HP: 123.8 HA: 281953.9	SPS BURN
MIDCOURSE CORRECTIONS MCC ₇ to MCC ₄	11:45 26:45 53:55 70:55			—	ΔVX : NOMINALLY ΔVY : ZERO ΔVZ : — ΔV REQ:	NOT REQUIRED	G&N AUTO	PAD PTC PTC LDG SITE	—	TLI + 9 TLI + 24 LOI - 22 LOI - 5
LOI ₁	75:54:28.4 5 MIN 58.9 SEC 2914.8 FPS			DAYLIGHT (SS-1HR 7 MIN)	ΔVX : -2891.8 ΔVY : -433.1 ΔVZ : 20.4 ΔV RLQ: 2924.1	NOT REQUIRED	G&N AUTO	LDG SITE	WT: 95207.4 HP: 59.2 HA: 169.8	SPS BURN
LOI ₂	80:09:29.7 16.4 SEC			DAYLIGHT (SR + 9 MIN)	ΔVX : 138.3 ΔVY : 0.0 ΔVZ : 75.9 ΔV REQ: 157.8	2 JET 20 SEC	G&N AUTO	LDG SITE	WT: 71320.81bs HP: 53.6 NM HA: 65.6 NM	SPS BURN
CSM/LM SEP	100:39:50.4 8 SEC			SUNLIGHT (SS-14 MIN)	ΔVX : 0.0 ΔVY : 0.0 ΔVZ : 2.5 ΔV REQ: 2.5	—	G&N AUTO	LDG SITE	WT: 36407.9 HP: 55.6 HA: 63.1	RCS BURN
*CSM PLANE CHANGE	107:05:33.4 .8 SEC 5.7			DARKNESS (SS + 17 MIN)	ΔVX : 0.0 ΔVY : 16.6 ΔVZ : 0.0 ΔV REQ: 16.6	2 JET 20 SEC	G&N AUTO	PLANE CHANGE	WT: 36325.4 HP: NO CHANGE HA: NO CHANGE	SPS BURN
LM JETTISON	131:53:04.7 3.1 SEC 0.8 FPS			DAYLIGHT (SR + 36 MIN)	ΔVX : -1.0 ΔVY : — ΔVZ : — ΔV REQ: 1.0	—	G&N AUTO	LIFT OFF	WT: 36154.7 HP: 58.5 HA: 59.4	RCS BURN
TEI	135:24:33.8 2 MIN 29.4 SEC NOT AVAILABLE			DAYLIGHT (SR + 10 MIN)	ΔVX : 3213.3 ΔVY : 705.0 ΔVZ : -138.8 ΔV REQ: 3292.7	2 JET 16 SEC	G&N AUTO	LIFT OFF	WT: 36111.4 HP: — HA: —	SPS BURN
MIDCOURSE CORRECTIONS MCC ₅ to MCC ₇	150:24 172:00 192:06			—	ΔVX : — ΔVY : NOMINALLY ΔVZ : ZERO ΔV REQ:	—	G&N AUTO	PTC PTC ENTRY	—	TEI + 15 EI -23 ET -3

* NEW DATA INDICATES THIS BURN MAY BE NOMINALLY ZERO

TABLE 1-2 LM BURN SCHEDULE

BURN/MANEUVER	GT 11 BURN TIME	ATTITUDE (DEG)		LIGHTING	ΔV (FPS)	ULLAGE ΔV (FPS)	TVC MODE	REFSMAT	S/C Wt RESIDUAL HA, HP	REMARKS
		LH	INERTIAL							
DOI	101:38:48 28.5 SEC			DARKNESS (SR-4 MIN)	ΔVX: 67.46 ΔVY: -28.68 ΔVZ: -12.51 ΔV REQ: 70 FPS	2 JET 7.5 SEC 1.3 FPS	PGNCS AUTO	LOG SITE	WT: 33,404 HP: 8.97 HA: 57.87NM	DPS BURN
PDI	102:35:13 11MIN 58SEC			DAYLIGHT	ΔVX: - ΔVY: - ΔVZ: - ΔV REQ: 6766	2 JET 7.5 SEC 1.3 FPS	PGNCS AUTO	LOG SITE	WT: 16,569 HP: 0 HA: 0	DPS BURN
ASCENT	124:23:26 7 MIN 18 SEC			DAYLIGHT	ΔVX: - ΔVY: - ΔVZ: - ΔV REQ: 6060	---	PGNCS AUTO	LIFT OFF	WT: 5,894 AT 1NS HP: 60,000 ft HA: 45 NM	APS BURN
CSI	125:21:19.1 45.0 SEC			DARKNESS (SR - 1 MIN)	ΔVX: 49.5 ΔVY: 0.0 ΔVZ: 0.0 ΔV REQ: 49.5	---	PGNCS AUTO	LIFT OFF	WT: 5875.0 HP: 44.9 HA: 45.0	RCS BURN
PLANE CHANGE	125:50:28 0			DAYLIGHT (SR + 25 MIN)	ΔVX: 0.0 ΔVY: 0.0 ΔVZ: 0.0 ΔV REQ: 0.0	---	PGNCS AUTO	LIFT OFF	WT: - HP: - HA: -	RCS + Y 2 JET BURN NOMINALLY ZERO
CDH	126:19:37.0 1.9 SEC			DAYLIGHT (SS - 19 MIN)	ΔVX: -1.1 ΔVY: 0.0 ΔVZ: 4.1 ΔV REQ: 4.3	---	PGNCS AUTO	LIFT OFF	WT: 5842.9 (TIG) HP: 43.8 HA: 45.3	RCS BURN
TPI	126:58:08.4 22.4 SEC			DARKNESS (SR - 23 MIN)	ΔVX: 22.0 ΔVY: 0.0 ΔVZ: -11.1 ΔV REQ: 24.8	---	PGNCS AUTO	LIFT OFF	WT: 5840.1 HP: 43.3 HA: 61.7	RCS BURN
MCC ₁	127:13:08 0			DARKNESS (SR - 8 MIN)	ΔVX: 0.0 ΔVY: 0.0 ΔVZ: 0.0 ΔV REQ: 0.0	---	PGNCS AUTO	LIFT OFF	WT: - HP: - HA: -	RCS + Z 2 JET BURN NOMINALLY ZERO
MCC ₂	127:28:08 0			DAYLIGHT (SR + 7 MIN)	ΔVX: 0.0 ΔVY: 0.0 ΔVZ: 0.0 ΔV REQ: 0.0	---	PGNCS AUTO	LIFT OFF	WT: - HP: - HA: -	RCS + Z 2 JET BURN NOMINALLY ZERO
1st BRAKING MNVR	127:36:57 0			DAYLIGHT (SR + 15 MIN)	ΔVX: 0.0 ΔVY: 0.0 ΔVZ: 0.0 ΔV REQ: 0.0	---	MANUAL	LIFT OFF	WT: - HP: - HA: -	RCS -Z 2 JET BURN NOMINALLY ZERO
2nd BRAKING MNVR	127:39:24.5 10.8 SEC			DAYLIGHT (SR + 18 MIN)	ΔVX: - ΔVY: - ΔVZ: - ΔV REQ: 12.0	---	PGNCS AUTO	LIFT OFF	WT: 5824.1 HP: 49.0 HA: 60.7	RCS -Z 2 JET
3rd BRAKING MNVR	127:40:32.8 8.8 SEC			DAYLIGHT (SR + 20 MIN)	ΔVX: - ΔVY: - ΔVZ: - ΔV REQ: 9.8	---	PGNCS AUTO	LIFT OFF	WT: 5816.4 HP: 53.7 HA: 60.3	RCS -Z 2 JET
4th BRAKING MNVR	127:42:16.1 4.3 SEC			DAYLIGHT (SR + 21 MIN)	ΔVX: - ΔVY: - ΔVZ: - ΔV REQ: 4.8	---	PGNCS AUTO	LIFT OFF	WT: 5810.1 HP: 56.2 HA: 60.1	RCS -Z 2 JET
5th BRAKING MNVR	127:43:35.7 4.2 SEC			DAYLIGHT (SR + 23 MIN)	ΔVX: - ΔVY: - ΔVZ: - ΔV REQ: 4.7	---	PGNCS AUTO	LIFT OFF	WT: 5807.0 HP: 59.9 HA: 58.9	RCS -Z 2 JET

TABLE 1-3 LUNAR LANDING SITE DATA

DAY	SITE DESIG	LATITUDE	LONGITUDE	¹ LAUNCH AZIMUTH/ SUN ELEVATION	² LAUNCH AZIMUTH/ SUN ELEVATION
JULY 16 0932 EDT	2(IIP6)	00°42'50"N 00.71388889°N (00.6914°N)	23°42'28"E 23.70777778°E (23.7169°E) ³	72°/10.5°	108°/13.5°
JULY 18 1132 EDT	3(IIP8)	00°21'10"N 00.35277778°N	01°17'57"W 01.29916667°W	89.295°/11°	108°/13°
JULY 21 1409 EDT	5(IIP13)	01°40'41"N 01.67805556°N	41°53'57"W 41.89916667°W	94.6775/9.7°	108°/11.7°

Data From TJ memo, Accuracy Estimates, Landing Site Landmarks,
May 12, 1969, TJ-69-499.

- 1 Sun Elevation Angles Are For Approximately 27 Hours After LOI, 1st Opportunity TLI.
- 2 Includes 2nd Opportunity TLI.
- 3 Data From MPAD memo, landing site coordinates for G,
June 12, 1969, 69-FM41-181.

TABLE 1-4 LANDMARK TRACKING DATA

July 16 Launch

LANDMARK DESIG.	LATITUDE	LONGITUDE	DELTA ALTITUDE SUN EL (nm)	
A1(Pseudo)	2°N 2.000°N	65° 30' 60.500°E	000.00	43°
IP(130)	1°53'N 1.885°N	28°42'E 28.726°E	000.00	-
130(Prime LDG SITE 2)	01°15'56"N 01.26555556°N (01.24307°N)	23°40'44" 23.67888889°E (23.6880°E) ¹	-001.68	8.5°
123(Alternate LDG SITE 2)	00°30'19"N 00.50527778°N	24°53'20"E 24.88888889°E	-001.71	-
129(Alternate LDG SITE 2)	01°17'06"N 01.28500000°N	23°44'37"E 23.74361111°E	-001.76	-
133(Alternate LDG SITE 2)	00°47'14"N 00.78722222°N	23°30'55"E 23.51527778°E	-001.68	-

- 1 Data from MPAD memo, landing site 2 position,
June 20, 1969, 69-FM41-199.

TABLE 1-4 LANDMARK TRACKING DATA (CONT'D)

July 18 Launch

LANDMARK DESIG.	LATITUDE	LONGITUDE	DELTA ALTITUDE (nm)	SUN EL
IP(G1)	0°16'N 0.267°N	32°19'E 32.317°E	-	-
G1(129)	01°17'06"N 01.28500000°N	23°44'37"E 23.74361111°E	-001.97	26°
IP(143)	00°18'N 00.300°N	3°23'E 3.383°E	-	-
143(Prime LDG SITE 3)	00°36'51"N 00.61416667°N	01°04'39"W 01.07750000°W	-001.01	9°
150(Alternate LDG SITE 3)	00°16'59"N 00.28305556°N	01°25'43"W 01.42861111°W	-001.01	-
147(Alternate LDG SITE 3)	00°03'42"N 00.06166667°N	01°16'36"W 01.27666667°W	-000.99	-

TABLE 1-4 LANDMARK TRACKING DATA (CONT'D)

July 21 Launch

LANDMARK DESIG.	LATITUDE	LONGITUDE	DELTA ALTITUDE (nm)	SUN EL
IP(G1)	0°30'S 0.500°S	26°33'W 26.550°W	-	-
G1	1°42'N 1.696°N	32°10'W 32.162°W	-001.77	8°
IP(180)	0°36'N 0.608°N	36°34'W 36.567°W	-	-
180(PRIME LDG SITE 5)	01°30'37"N 01.51027778°N	41°49'05"W 41.81805556°W	-001.25	8.9°
171(Alternate LDG SITE 5)	01°20'04"N 01.33444444°N	40°47'34"W 40.79277778°W	-001.29	-
178(Alternate LDG SITE 5)	01°45'33"N 01.75916667°N	41°34'12"W 41.57000000°W	-001.22	-
184(Alternate LDG SITE 5)	02°03'10"N 02.05277778°N	42°13'41"W 42.22805556°W	-001.23	-

FLIGHT PLAN NOTES

A. Crew

1. Crew designations are as follows:

<u>Designation</u>	<u>Prime</u>	<u>Backup</u>
Commander (CDR)	Armstrong	Lovell
Command Module Pilot (CMP)	Collins	Anders
Lunar Module Pilot (LMP)	Aldrin	Haise

2. Crew positions during the mission are as follows:

	<u>Left</u>	<u>CSM</u> <u>Center</u>	<u>Right</u>	<u>Left</u>	<u>LM</u> <u>Right</u>
Launch thru TLI	CDR	LMP	CMP		
T&D thru Entry	CMP	CDR	LMP		
Manned LM	CMP			CDR	LMP

3. The crew will eat and sleep simultaneously throughout the mission. Eat periods will be normally 1-hour duration, with additional activities held to a minimum during this time frame. Sleep periods will normally be 8 to 10 hour duration with two 4 to 5 hour sleep periods while the LM is on the lunar surface.

4. Activity

PGA Configuration

Launch to insertion	PGA's with helmet & gloves (H&G)
Insertion to TLI	PGA's without H&G
TLI to evasive mnvr	PGA's with H&G
TLC & LOI 1&2	Constant wear garments
LM activation & checkout	PGA without H&G (CMP H&G donned for latch cocking & CDR/LMP H&G donned for pressure integrity check and cabin reg check)
Undocking through touchdown	PGA's with H&G except CMP without H&G after DOI
Touchdown through pre lift-off	PGA's without H&G except for CDR/LMP simulated count- down & EVA
Liftoff through LM jettison	PGA's with H&G (except H&G off after docking)
LM jettison through splashdown	Constant wear garmets

5. Two crew status reports via air-to-ground communications will be made by the flight crew during each activity day. The first report will be given after the first meal of the day and will concern the sleep obtained during the previous sleep period. The second report will be given following the final meal of the day and will concern the radiation dose received during the previous 24 hours and medication taken if any. The following information should be logged:
 - a. Food Consumption
 - b. Exercise
 - c. Used fecal bags marked as to crewman and GET
6. Negative reporting will be used in reporting completion of each checklist.
7. Continuous CSM biomedical data are automatically transmitted to the ground.
8. LM biomedical switching is performed manually by the LMP from undocking to docking as scheduled in the timeline.
9. All onboard gage readings will be read directly from the gages. and will not be corrected by the appropriate calibration factors.

B. Photography

Photographic requirements were derived from the following:

- a. Lunar Surface Operations Plan
- b. Photographic Operations Plan

C. Procedures

1. CSM

Crew procedures called out in the flight plan may be found in the following documents:

- a. Apollo Operations Handbook - CSM-107 (AOH), Volume 2
- b. Crew Checklist
- c. CSM Rendezvous Procedure
- d. Abort Summary Document
- e. Apollo Entry Summary Document
- f. Photographic Operations Plan
- g. Descent Procedures Document
- h. Ascent Procedures Document
- i. Lunar Landmark Tracking Attitude Studies
- j. Lunar Orbit Attitude Sequence for Mission G
- k. Data Priority Documents

2. LM

Crew procedures called out in the flight plan may be found in the following documents:

VOLUME 1

- a. Apollo Operations Handbook LM-5 Volume 2
- b. Crew Checklist
- c. LM Rendezvous Procedures
- d. LM Descent/Ascent Summary Document
- e. Lunar Landing Phase Photographic Operations Plan
- f. Data Priority Documents
- g. EVA Procedures
- h. Apollo Lunar Surface Operations Plan

D. Communications

1. General

- a. CSM and LM HBR data transmissions in lunar orbit will normally require the use of the high gain or steerable antennas
- b. During communications, the spacecraft will be referred to by name (Apollo 11) and MCC-H will be referred to as Houston.
- c. The preferred S-Band communications are:
 - (1) CSM
 - (a) Uplink Mode 6 (Voice, PRN, and Udata)
 - (b) Downlink Mode 2 (Voice, PRN, TLM-HBR)
 - (2) LM
 - (a) Uplink Mode 7 (Voice, Udata)
 - (b) Downlink Mode 1 (Voice, TLM-HBR)
- d. LM voice recorder has a maximum utilization of 10 hours. This recorder will be used during LM operations to record all LM voice data during undocked operations (27 hours 42 minutes). This recorder will be operated in the VOX mode.
- e. A small portable voice recorder will be carried in the CM to be used at the discretion of the crew as a voice recorder back-up. This recorder will not be transferred to the LM for use during undocked operations.
- f. The S-band "squelch" will be on during the sleep periods in order to prevent MSFN fade-out noise from disturbing the crew.

2. DSE Operation

- a. The DSE will normally be operated via ground command except for special cases where the operation is time limited. In these cases the crew may be asked to rewind the tape.
- b. During the earth orbit period when the CSM is not over a MSFN station, CSM TLM-LBR data will be recorded on the DSE and will be dumped during the pass over the US and over CRO prior to TLI if possible.
- c. DSE will be used for CSM HBR and voice recording during all CSM engine burns.
- d. DSE data and voice recordings will be made in CSM LBR mode whenever possible in order to minimize the DSE dump time.

- e. During PTC using the HGA REACQ communications mode the DSE will be used to record LBR data when the HGA is not in the MSFN field of view.
 - f. During lunar orbit LM operations, the DSE will be used to record LM-TLM-LBR data during all docked LM activities that occur on the lunar farside. For undocked LM activities only DOI will be recorded as VHF ranging is required.
 - g. DSE will be used to record all HBR entry data during the blackout region.
3. Launch - Earth Orbit Phase
- a. OMNI B and VHF LEFT will be selected for lift off. OMNI D will be selected by the crew during boost phase if the launch azimuth is less than 96° or OMNI C if the launch azimuth is greater than 96°. OMNI D will probably be the best antenna for earth orbit.
 - b. VHF Duplex B will be used for launch, and Simplex A for earth orbit operations.
 - c. VHF Simplex A will be used for entry to be compatible with recovery forces communications.
4. Translunar and Transearth Coast Phase
- The translunar and transearth sleep communications mode will be as follows. The CSM x-axis will be placed normal to the ecliptic plane. The CSM will be rolled at a rate of approximately three revolution per hour. During the near earth sleep periods prior to 30 hours GET (range less than 120Knm) omni antennas B and D will be used. During the other sleep periods (beyond 120Knm) the high gain antenna may be required (in the REACQ mode). The REACQ configuration will provide approximately 210 degrees of HGA coverage per CSM/LM revolution or 35 minutes of MSFN coverage per hour. The REACQ configuration will also allow MCC-H to use real time control to select TLM HBR or LBR and to dump the DSE during each spacecraft revolution.
5. Lunar Exploration Phase
- a. Normal CSM communications between MSFN/LM will be by S-Band during the lunar exploration period.
 - b. If additional communications capability is required the S-Band erectable antenna will be deployed by the EVA crewman and will be utilized for all LM/MSFN/CSM communications.
 - c. During periods when both crewmen are EVA, the "AR" position (Relay Mode) will be the normal communication mode on each of the Extravehicular Communication System (EVCS). The CDR will relay the LMP VHF voice and data to the LM which in turn will relay to MCC-H via S-Band.

E. CSM Notes

1. Electrical Power System and Water Management

- a. Spacecraft lift-off switch positions are listed in the Apollo Operations Handbook (Volume 2) for CSM 107.
- b. The CSM will remain fully powered up throughout the mission (CMC, IMU and SCS in the "operate" configuration and optics power-up as required).
- c. Fuel cell H2 and O2 purging is scheduled as follows H2 approximately every 48 hours and O2 approximately every 12 hours.
- d. The hydrogen and oxygen VAC ION pumps will be inactive throughout the mission.
- e. Potable water will be chlorinated once a day before each sleep period, starting with the First sleep period (GET 13:30). The POT H2O inlet valve will be opened prelaunch.
- f. FC purges and waste water dumps will not be scheduled within one hour prior to optical sightings.
- g. Waste H2O dumping will be managed to allow:
 - (1) Maximum QTY:85-90%
 - (2) Minimum QTY:25%
 - (3) At LOI:QTY = 75%
 - (4) At CM-SM SEP:QTY = 90% to 100%
 - (5) No dumping after MCC3 until after LOI
 - (6) Dumps will be performed (if required) within 2 hours preceding MCC maneuvers
 - (7) In lunar orbit if dumping is required, dumps will be performed immediately prior to sleep periods
 - (8) The water dump will not be operated in the automatic mode at anytime during the mission
- h. The cryogenic heaters will be in AUTO during the mission and the fans will be operated manually. The fans will be cycled for one minute before and after each sleep cycle.
- i. The batteries will be charged according to the following schedule:

<u>Time</u>	<u>Battery</u>
5:20:00	B
12:20:00	A
48:10:00	B
80:25:00	A
103:30:00	B
148:00:00	A
154:00:00	B

2. Environmental Control System and Cabin Pressurization

- a. One CO2 odor absorber filter (LiOH canister) is changed approximately every 12 hours or if CO2 partial pressure is greater than 7.6mm Hg. There are 20 filters (2 in the canisters onboard and 18 stowed).

- b. A Pre TLI/LOI ECS redundant component check including the secondary evaporator operation, is performed prior to TLI and LOI. The secondary evaporator water control valves will be turned "OFF" after the check.
- c. The evaporator operation will be as follows:
 - (1) Launch - primary loop operation
 - (2) Earth Orbit - primary loop operation and secondary loop test plus redundant operation test prior to TLI.
 - (3) Post TLI - deactivate both evaporators
 - (4) Pre LOI-ECS pre TLI/LOI redundant component check and primary evaporator activation
 - (5) Post TEI - deactivate primary evaporator
 - (6) Entry interface minus 1 hour - activate primary and secondary evaporator.

3. Guidance and Navigation

- a. During lunar orbit, the CSM and LM will utilize the same landing site REFSMMAT such that the gimbal angles would be 0,0,0 at landing with the LM sitting face forward on landing site number two and the CSM over the landing site pitched up 90° from local horizontal "heads up".
- b. During PTC the CSM/LM x-axis is pitched up 90° (North) for TLC and down 90° (South) for TEC with the Y-Z axes in the plane of the ecliptic. This change in x-axis pointing is to enable simultaneous viewing of the earth and moon through the side windows while maintaining a favorable high gain antenna position.
- c. The CSM tracking light will be on continuously from undocking to landing and from LM lift-off to docking.

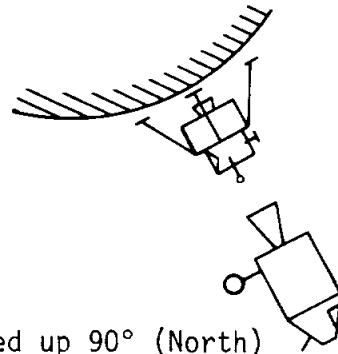

4. Landmark Tracking

- The following ground rules were used for landmark tracking.
- a. IMU to be realigned on the dark side preceding each tracking period.
 - b. MSFN is reacquired after each tracking period. The tracking data will be acquired by MSFN after all the marks have been made and while N49 ($\Delta R, \Delta V$) is displayed. MSFN will give a GO when data acquisition has been verified.
 - c. The pseudo landmark tracking (A1) will be used to determine the altitude of an area in which the LM will be making altitude checks after DOI. The data will be processed during the sleep period after the trackings and relayed to the LM prior to undocking.

- d. In the docked configuration the CSM/LM approaches the landmark in an inertial hold attitude. This inertial attitude places the spacecraft 2° below the local horizontal at the 35° elevation angle point. At 35° elevation angle a pitch down of $0.3^\circ/\text{sec}$ is initiated. Five marks are then taken with the time between marks a minimum of 25 seconds. (See tracking profile)
- e. In the undocked configuration the CSM approaches the landmark in ORB RATE and pitched down 22° from the local horizontal. At 35° elevation angle five marks are taken with the time between marks a minimum of 25 seconds. ORB RATE is continued throughout the marking period.
- f. In the undocked COAS tracking the CSM will approach the LM in ORB RATE heads up and pitched down 40° from the local horizontal. When the LM is centered in the COAS the CSM will initiate a variable pitch rate to keep the LM centered in the COAS.

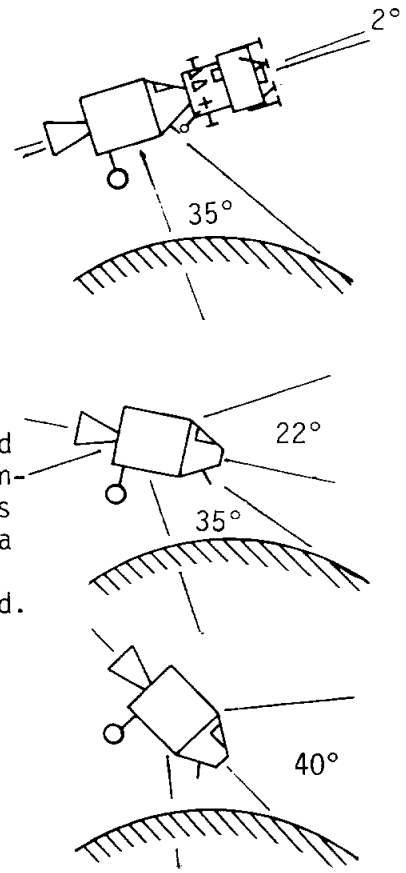

5. CSM/LM and CSM attitude maneuvers will normally be at a rate of $0.2^\circ/\text{sec}$ or $0.5^\circ/\text{sec}$, unless other rates are required.
NOTE: At $0.2^\circ/\text{sec}$, 15 minutes is required to maneuver 180° .
At $0.5^\circ/\text{sec}$, 6 minutes is required to maneuver 180° .

6. Passive thermal control mode will be initiated after MCC1 or as soon as MCC1 is scrubbed and maintained throughout the mission (except in lunar orbit) until at least three hours before entry except for interruptions for midcourse corrections, communications orientation (maximum interruption of three hours). PTC will not be initiated before approximately 7:00 GET.

7. Service Propulsion System All SPS burns will be initiated on Bank A except LOI1 which will be initiated on Bank B.

F. LM Notes

1. Entries into the LM
 - a. Three entries into the LM are scheduled in the timeline at 56:30, 81:30 and 95:52 GET respectively.

- b. The first entry (56:30 GET) will be for LM familiarization and will be performed by the CDR and LMP in the constant wear garments. During this period there will be approximately 5 minutes of VHF-B LBR data which will be recorded by the DSE in the CSM. The LM will remain on CSM power during the crew familiarization period.
 - c. The second entry (81:30 GET) will be for LM housekeeping and will be performed by the LMP in constant wear garments. During this period the LM will go to internal power for the S-Band/VHF B voice activation.
 - d. The third entry into the LM (95:52 GET) will be performed by the LMP in LCG's to prepare the LM for undocking and descent to the lunar surface. During this period the LMP and CDR initially transfer to the LM in LCG's then return to the CSM for PGA donning.
2. Environmental Control System and Cabin Pressurization
- a. The LM cabin will contain ambient air at lift off and will bleed down to zero pressure psi during the launch.
 - b. The LM will be pressurized for transposition and docking after which it will be isolated and the pressure periodically monitored.
 - c. The LM will be pressurized prior to the first entry (LM familiarization) after which it will be isolated again for the remainder of the TLC period.
 - d. Prior to the second entry (LM housekeeping) it will be pressurized again and will remain pressurized.
3. Guidance and Navigation
- a. Two LGC erasable memory dumps and MCC-H verifications will be accomplished prior to DOI. If a significant number of errors are found, memory correction and re-verification will be performed before DOI.
 - b. The LM IMU will be manually aligned to the CSM IMU during the DOI Day LM activation and checkout. P52/AOT alignments will be performed as close to DOI as possible.
 - c. All translations during the undocked manned LM operations will be under PGNCS control.
 - d. The capability for MCC-H to update the LGC via uplink will normally be blocked by the LMP UP-DATA LINK switch (panel 12).

4. RCS Operation and Interface Constraints
 - a. During CSM/LM docked checkout operations, the LM steerable and/or RR antennas will not be powered down once they have been activated. The SM B3 and C4 thrusters will be deactivated before the LM steerable and/or RR antennas have been unstowed in order to prevent SM-RCS impingement on these antennas.
 - b. The CSM roll jets and LM yaw jets will be disabled when the probe is preloaded (docking latches are cocked) and the tunnel is pressurized prior to undocking. The jets will be activated after tunnel venting.
 - c. LM RCS two jet ullage (System B) will be used for unstaged ullage maneuvers in order to prevent asymmetrical RCS thrust caused by impingement on the descent stage.
 - d. The RCS interconnect will be used during the APS lift-off and ascent, but will not be used during the rendezvous maneuvers.

5. Rendezvous
 - a. The rendezvous radar will be pointed away from the sun and will be turned off when no functional use is required to prevent overheating of the antenna.
 - b. The LM tracking light will be on continuously between separation and touchdown and between launch and docking except during PGNCS/AOT alignments. During PGNCS/AOT alignments (LM P52), the tracking light would interfere with the alignments. (dark adaption)

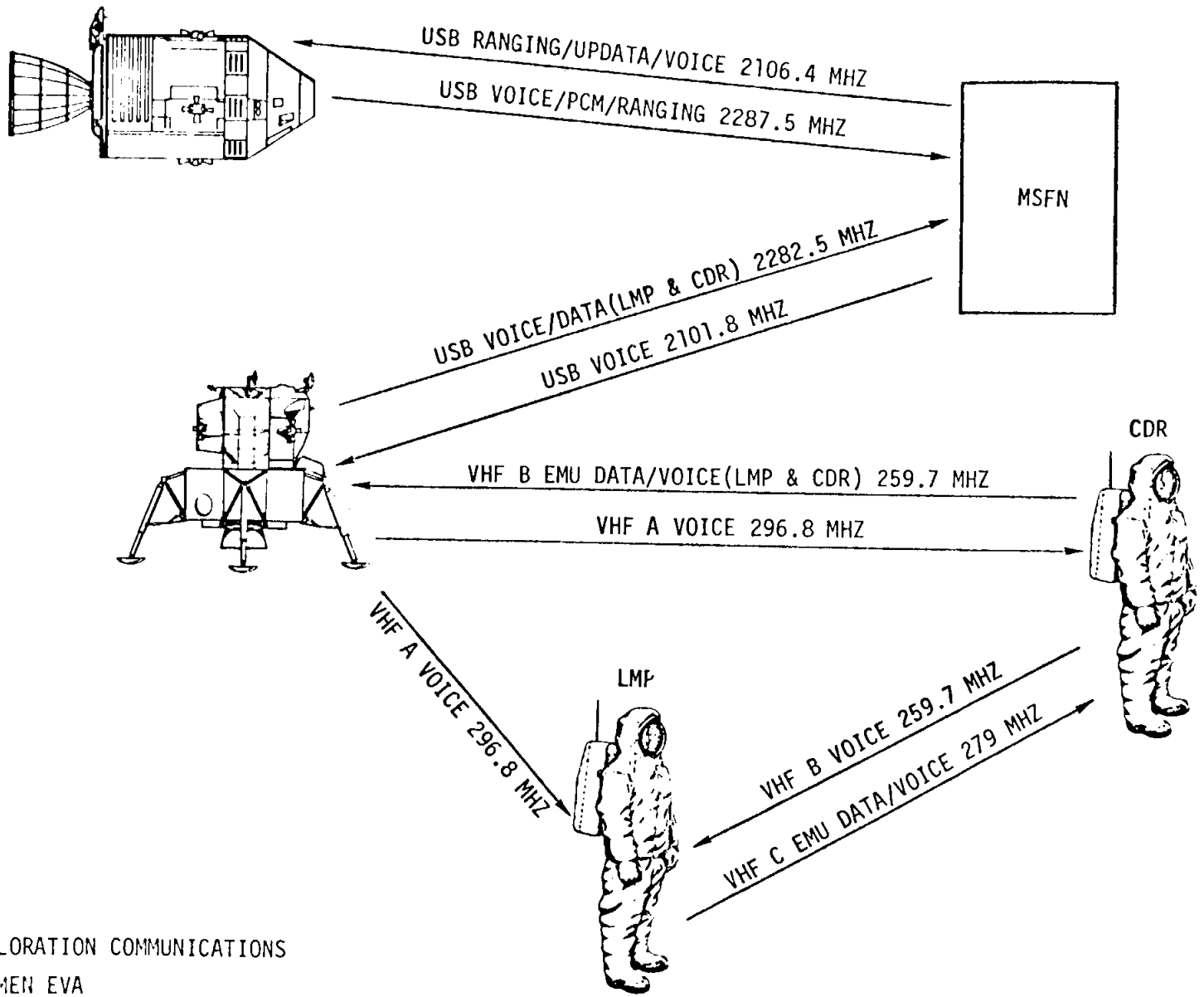

1-22

LUNAR EXPLORATION COMMUNICATIONS
 BOTH CREWMEN EVA
 EVCS DUAL MODE (RELAY)

Figure 1-4

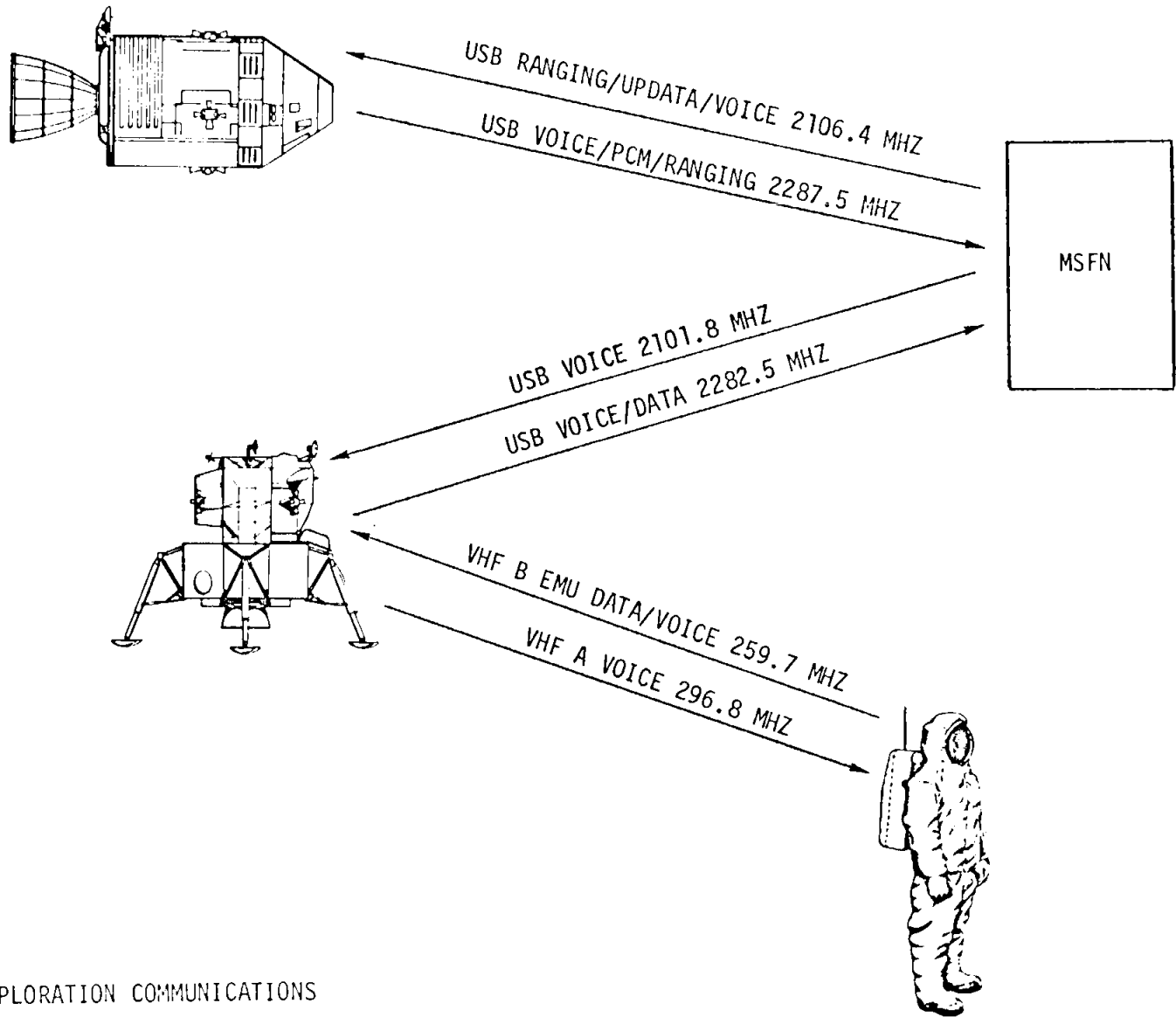

LUNAR EXPLORATION COMMUNICATIONS
ONE CREWMAN EVA
PRIMARY MODE

Figure 1-5

SECTION II - UPDATE FORMS

UPDATE FORMS

This section contains the update pads which are in the Flight Data File onboard the spacecraft.

The CSM forms are as follows:

1. TLI Maneuver
2. P37 Block Data
3. P27 Update
4. P30 Maneuver (External ΔV)
5. P76
6. CSM Rendezvous Rescue
7. Lunar Entry
8. Earth Orbit Entry
9. Earth Orbit Block Data

The LM forms are:

1. P27 Update
2. AGS State Vector Update
3. Phasing P30 LM Maneuver
4. P30 LM Maneuver
5. DOI Data
6. PDI Data
7. Lunar Surface
8. LM Ascent
9. CSI Data
10. CDH Data
11. TPI Data

APRIL 1, 1969	TLI	TLI												TLI
		X	•	•		X	•	•		TB6p				
		X	X	X		X	X	X		R				
		X	X	X		X	X	X		P				
		X	X	X		X	X	X		Y				
		X	X	X	•	X	X	X	•	BT				
					•				•	$\Delta VC'$				
		+				+				VI				
		X	X	X		X	X	X		R				
		X	X	X		X	X	X		P				
		X	X	X		X	X	X		Y				
		X				X	X	X		R				
		X				X	X	X		P				
		X				X	X	X		Y				
		EXTRACTION												

TLI PAD

TB 6p	X:XX:XX (HR:MIN:SEC)	PREDICTED TIME OF BEGINNING OF S-IVB RESTART PREPARATION FOR TLI (TB6 = TLI IGN -578.6 SEC)
R P Y	XXX (DEG) XXX (DEG) XXX (DEG)	PREDICTED SPACECRAFT IMU GIMBAL ANGLES AT TLI IGNITION
BT	X:XX (MIN:SEC)	DURATION OF TLI BURN
Δ VC	XXXX.X (FPS)	NOMINAL TLI Δ V SET INTO EMS Δ V COUNTER
VI	+XXXXXX (FPS)	NOMINAL INERTIAL VELOCITY DISPLAYED ON DSKY AT TLI CUTOFF
R SEP P SEP Y SEP	XXX (DEG) XXX (DEG) XXX (DEG)	PREDICTED SPACECRAFT IMU GIMBAL ANGLES AT COMPLETION OF S-IVB MNVR TO CSM/S-IVB SEP ATTITUDE
R EXT P EXT Y EXT	XXX (DEG) XXX (DEG) XXX (DEG)	PREDICTED SPACECRAFT IMU GIMBAL ANGLES AT TIME OF CSM EXTRACTION OF LM FROM S-IVB

P37 BLOCK DATA										P37	
X										GETI	P37
X										ΔVT	
X										LONG	
										GET 400K	
										GETI	
										ΔVT	
										LONG	
										GET 400K	
										GETI	
										ΔVT	
X										LONG	P37
X										GET 400K	
										GETI	
										ΔVT	
										LONG	
										GET 400K	
										GETI	
										ΔVT	
										LONG	
										GET 400K	
X										GETI	P37
X										ΔVT	
										LONG	
										GET 400K	
										GETI	
										ΔVT	
										LONG	
										GET 400K	
										GETI	
										ΔVT	
X										LONG	P37
X										GET 400K	
										GETI	
										ΔVT	
										LONG	
										GET 400K	
										GETI	
										ΔVT	
										LONG	
										GET 400K	
APRIL 1, 1969											P37

P37 BLOCK DATA

GETI	XXX:XX (HR:MIN)	DESIRED TIME OF IGNITION
Δ VT	XXXX (FPS)	TOTAL VELOCITY OF MNVR
LONG	+XXX (DEG)	LONGITUDE OF THE LANDING POINT FOR ENTRY GUIDANCE
GET 400K	XXX:XX (HR:MIN)	TIME OF ENTRY INTERFACE

		P27 UPDATE												
PURP		V				V				V				
GFT		:				:				:				
APRIL 1, 1969	304 01	INDEX				INDEX				INDEX				
	02													
	03													
	04													
	05													
	06													
	07													
	10													
	11													
	12													
	13													
	14													
	15													
	16													
	17													
	20													
	21													
	22													
	23													
	24													
		N34	HRS	X	X	X				X	X	X		
			MIN	X	X	X	X			X	X	X	X	
		NAV	CHECK SEC	X	X					X	X			
		N43	LAT		0						0			
		LONG												
		ALT	+	0					+	0				

P27

P27

P27 UPDATE - CSM

PURP	XXX	TYPE OF DATA TO BE RECEIVED (SUCH AS: CMC TIME)
V	XX (VERB)	TYPE OF COMMAND LOAD (70-71-72-73)
GET	XXX:XX:XX (HR:MIN:SEC)	TIME DATA RECORDED
304 01	XX (OCTAL)	INDEX NO. OF COMMAND WORDS IN LOAD
02-24	XX (OCTAL)	CORRECTION IDENTIFIERS
N34 NAV CHECK	XXX:XX:XX.XX (HR:MIN:SEC)	TIME FOR CONFIRMATION OF GROUND TRACK
N43		
LAT	XX.XX (DEG)	LATITUDE FOR GROUND TRACK CONFIRMATION
LONG	XXX.XX (DEG)	LONGITUDE FOR GROUND TRACK CONFIRMATION
ALT	XXX.X (DEG)	ALTITUDE FOR GROUND TRACK CONFIRMATION

		P30 MANEUVER						
		PURPOSE						
SET STARS		PROP/GUID						
P30	R ALIGN _____	0	0	.				P _{TRIM} N48
	P ALIGN _____	0	0	.				Y _{TRIM}
	Y ALIGN _____	+	0	0				HRS GETI
APRIL 5, 1969		+	0	0	0			MIN N33
		+	0		.			SEC
	ULLAGE _____				.			ΔV_X N81
	_____				.			ΔV_Y
	_____				.			ΔV_Z
	_____	X	X	X				R
	_____	X	X	X				P
	_____	X	X	X				Y
		+			.			H _A N42
					.			H _P
		+			.			ΔVT
	HORIZON/WINDOW _____	X	X	X	.	.		BT
	_____	X				.		ΔVC
	_____	X	X	X	X			SXTS
	_____	+			.	0		SFT
	+		.	0	0		TRN	
	X	X	X				BSS	
	X	X			.		SPA	
	X	X	X		.		SXP	
OTHER _____		0		.			LAT N61	
_____				.			LONG	
_____	+			.			RTGO EMS	
	+			.			VI0	
			GET 0.05G	

P30 MANEUVER

PURPOSE	XXXXXX	TYPE OF MNVR TO BE PERFORMED
PROP/GUID	XXX/XXX	PROPULSION SYSTEM (SPS/RCS)/ GUIDANCE (SCS/G&N)
WT	+XXXXX (lbs)	PREMANEUVER VEHICLE WEIGHT
P TRIM	+X.XX (DEG)	SPS PITCH GIMBAL OFFSET TO PLACE THRUST THROUGH THE CG
Y TRIM	+X.XX (DEG)	SPS YAW GIMBAL OFFSET TO PLACE THRUST THROUGH THE CG
GETI	XX:XX:XX.XX (HRS:MIN:SEC)	TIME OF MNVR IGNITION
ΔV_X ΔV_Y ΔV_Z	+XXXX.X (FPS) +XXXX.X (FPS) +XXXX.X (FPS)	P30 VELOCITY TO BE GAINED COMPONENTS IN LOCAL VERTICAL COORDINATES
R P Y	XXX (DEG) XXX (DEG) XXX (DEG)	IMU GIMBAL ANGLES OF MANEUVER ATTITUDE
HA	XXXX.X (NM)	PREDICTED APOGEE ALTITUDE AFTER MANEUVER
HP	+XXXX.X (NM)	PREDICTED PERIGEE ALTITUDE AFTER MANEUVER
ΔVT	+XXXX.X (FPS)	TOTAL VELOCITY OF MANEUVER
BT	X:XX (MIN:SEC)	MANEUVER DURATION
ΔVC	XXXX.X (FPS)	PREMANEUVER ΔV SETTING IN EMS ΔV COUNTER
SXTS	XX (OCTAL)	SEXTANT STAR FOR MANEUVER ATTITUDE CK
SFT	+XXX.X (DEG)	SEXTANT SHAFT SETTING FOR MANEUVER ATTITUDE CK
TRN	+XX.X (DEG)	SEXTANT TRUNNION SETTING FOR MANEUVER ATTITUDE CK
BSS	XX (OCTAL)	BORESIGHT STAR FOR MANEUVER ATTITUDE CK USING THE COAS

SPA	<u>+XX.X</u> (DEG)	BSS PITCH ANGLE ON COAS FOR MANEUVER ATTITUDE CK
SXP	<u>+X.X</u> (DEG)	BSS X POSITION ON COAS FOR MANEUVER ATTITUDE CK
LAT LONG	<u>+XX.XX</u> (DEG) <u>+XXX.XX</u> (DEG)	LATITUDE AND LONGITUDE OF THE LANDING POINT FOR ENTRY GUIDANCE
RTGO	+XXXX.X (NM)	RANGE TO GO FOR EMS INITIALIZATION
VIO	+XXXXX (FPS)	INERTIAL VELOCITY AT .05G FOR EMS INITIALIZATION
GET (.05G)	XXX:XX:XX.XX (HRS:MIN:SEC)	TIME OF .05G
SET STARS	XX (OCTAL) XX (OCTAL)	STARS FOR BACKUP GDC ALIGN
R, P, Y (ALIGN)	XXX (DEG) XXX (DEG) XXX (DEG)	ATTITUDE TO BE SET IN ATTITUDE SET TW FOR BACKUP GDC ALIGN
ULLAGE	X (JETS) XX.X (SEC)	NO. OF SM RCS JETS USED AND LENGTH OF TIME OF ULLAGE
HORIZON/WINDOW	XX.X (DEG)	WINDOW MARKING AT WHICH HORIZON IS PLACED AT A SPECIFIED TIG (ATT CK)
OTHER		ADDITIONAL REMARKS VOICED UP BY MCC-H

THIS PAGE INTENTIONALLY LEFT BLANK.

P76 UPDATE PAD												
PURPOSE												
+ 0 0			+ 0 0			HR			N33			
+ 0 0 0				+ 0 0 0				MIN		TIG		
+ 0		•		+ 0		•		SEC				
		•				•		ΔVX		N84		
		•				•		ΔVY				
		•				•		ΔVZ				
P76	PURPOSE											
	+ 0 0			+ 0 0			HR			N33		
	+ 0 0 0				+ 0 0 0				MIN		TIG	
+ 0		•		+ 0		•		SEC				
		•				•		ΔVX		N84		
		•				•		ΔVY				
		•				•		ΔVZ				
APRIL 5, 1969	PURPOSE											
	+ 0 0			+ 0 0			HR			N33		
	+ 0 0 0				+ 0 0 0				MIN		TIG	
	+ 0		•		+ 0		•		SEC			
			•				•		ΔVX		N84	
			•				•		ΔVY			
			•				•		ΔVZ			
	PURPOSE											
	+ 0 0			+ 0 0			HR			N33		
	+ 0 0 0				+ 0 0 0				MIN		TIG	
	+ 0		•		+ 0		•		SEC			
			•				•		ΔVX		N84	
		•				•		ΔVY				
		•				•		ΔVZ				

P76 UPDATE PAD

PURPOSE	XXXXX	PURPOSE OF MANEUVER
N33 TIG	XX:XX:XX.XX (HR:MIN:SEC)	TIME OF IGNITION
N84		
ΔV_X	XXXX.X (FPS)	COMPONENTS OF
ΔV_Y	XXXX.X (FPS)	ΔV APPLIED ALONG
ΔV_Z	XXXX.X (FPS)	LOCAL VERTICAL AXIS AT TIG (LM)

CSM RENDEZVOUS RESCUE PADS

CSM SEP PAD

33	00	•	000	•	0	.
81	+ 0000.0	•	+ 0000.0	•	- 0002.5	.
22	XXX	•	XXX	•	XXX	.

DOI PAD

84	•	•	•	•	•	•
33	•	•	•	•	•	•

PDI₁ +12 ABORT PAD

84	•	•	•	•	•	•
33	•	•	•	•	•	•

"CSM RESCUE" PAD

PHAS	33	00	•	000	•	0	.
TPI (PDI < 10)	37	00	•	000	•	0	.
TPI (PDI > 10)	37	00	•	000	•	0	.

"CSM RESCUE UPDATE" PAD

PHAS	33	00	•	000	•	0	.
TPI (PDI < 145)	37	00	•	000	•	0	.
TPI (T ₂)	37	00	•	000	•	0	.

RESCUE TWO PAD

47	+	•	+	00000.	•	•	•	•
48		•		•	•	•	•	•
33	00	•	000	•	0	•	•	•
81		•		•		•	•	•
22	XXX	•	XXX	•	XXX	•	•	•
ΔV _C	X	•		•		•	•	•
11	00	•	000	•	0	•	•	•
37	00	•	000	•	0	•	•	•
N		•		•		•	•	•

CSI ONE

11	•	•	000	•	0	•
81	•	•	•	•	•	•
N	•	•	•	•	•	•

P22 PAD

T1	•	•	•	•	•	•	•	•
T2	•	•	•	•	•	•	•	•
	•	•	•	•	•	•	•	•
89	NM (N OR S)	•	•	•	•	•	•	•
	LAT		LONG/2		ALT			

NOMINAL LM IGNITION TIMES

CSI	11	00	•	000	•	0	.
PC	33	00	•	000	•	0	.
TPI	37	00	•	000	•	0	.

CSI TWO

11	00	•	000	•	0	.
81	•	•	•	•	•	•
N	•	•	•	•	•	•

CSI THREE

11	00	•	000	•	0	.
81	•	•	•	•	•	•
N	•	•	•	•	•	•

CSI FOUR

11	00	•	000	•	0	.
81	•	•	•	•	•	•
N	•	•	•	•	•	•

CDH

13	00	•	000	•	0	.
81	•	•	•	•	•	•

TPI

37	00	•	000	•	0	.
81	•	•	•	•	•	•
59	•	•	•	•	•	•
LOS BT	XX	•	XX	•	XX	•

CSM SEP PAD

33	GETI	XXX:XX:XX.XX (HRS:MIN:SEC)	GET OF CSM/LM SEPARATION BURN
81	DELTA VX DELTA VY DELTA VZ	+XXXX.X (FPS) +XXXX.X (FPS) +XXXX.X (FPS)	LOCAL VERTICAL VELOCITY COMPONENTS OF SEP BURN
22	R P Y	XXX (DEG) XXX (DEG) XXX (DEG)	SEPARATION BURN INERTIAL GIMBAL ANGLES

DOI PAD

84	DELTA VX DELTA VY DELTA VZ	XXXX.X (FPS) XXXX.X (FPS) XXXX.X (FPS)	LM LOCAL VERTICAL VELOCITY COMPONENTS FOR DOI BURN
33	GETI	XXX:XX:XX.XX (HRS:MIN:SEC)	GET OF DOI BURN

PDI + 12 ABORT PAD

84	DELTA VX DELTA VY DELTA VZ	XXXX.X (FPS) XXXX.X (FPS) XXXX.X (FPS)	LM LOCAL VERTICAL VELOCITY COMPONENTS FOR FIRST OPPORTUNITY PDI PLUS 12 MIN ABORT
33	GETI	XXX:XX:XX.XX (HRS:MIN:SEC)	GET OF PDI + 12 MIN ABORT BURN

"CSM RESCUE" PAD

PHAS	33	GETI	XXX:XX:XX.XX (HRS:MIN:SEC)	GET OF CSM ABORT PHASING BURN
TPI (PDI 10)	37	GETI	XXX:XX:XX.XX (HRS:MIN:SEC)	GET OF TPI FOR LM ABORTS BETWEEN PDI AND PDI + 10 MIN
TPI (PDI 10)	37	GETI	XXX:XX:XX.XX (HRS:MIN:SEC)	GET OF TPI FOR LM ABORTS AFTER PDI + 10 MIN

"CSM RESCUE UPDATE" PAD

PHAS	33	GETI	XXX:XX:XX.XX (HRS:MIN:SEC)	GET OF CSM ABORT PHASING BURN FOR 2ND OPPORTUNITY (1 REV DELAY)
------	----	------	-------------------------------	--

TPI (PDI	14.5)	GETI	XXX:XX:XX.XX (HRS:MIN:SEC)	GET OF TPI FOR LM ABORTS BETWEEN PDI AND PDI + 14.5 MIN FOR 2ND OPPORTUNITY
TPI (T2)	37	GETI	XXX:XX:XX.XX (HRS:MIN:SEC)	GET OF PREFERRED LM LIFTOFF TIME
<u>RESCUE TWO PAD</u>				
47	WT		XXXX.X (lbs)	PREMANEUVER CSM WEIGHT
48	P TRIM		X.XX (DEG)	SPS PITCH & YAW GIMBAL OFFSET TO PLACE THRUST THROUGH THE CG
	Y TRIM		X.XX (DEG)	
33	GETI		XXX:XX:XX.XX (HRS:MIN:SEC)	GET OF RESCUE BURN
81	DELTA VX		XXXX.X (FPS)	LOCAL VERTICAL VELOCITY COMPONENTS OF RESCUE BURN
	DELTA VY		XXXX.X (FPS)	
	DELTA VZ		XXXX.X (FPS)	
22	R		XXX (DEG)	RESCUE BURN GIMBAL ANGLES
	P		XXX (DEG)	
	Y		XXX (DEG)	
ΔV_c	ΔV_c		XX.X (FPS)	VELOCITY TO BE SET IN EMS COUNTER FOR RESCUE BURN
11	GETI		XXX:XX:XX.XX (HRS:MIN:SEC)	GET OF CSI BURN BASED ON RESCUE BURN
37	GETI		XXX:XX:XX.XX (HRS:MIN:SEC)	GET OF TPI BURN BASED ON RESCUE BURN
N			X	THE FUTURE APSIDAL CROSSING (APOLUNE OR PERILUNE) OF THE ACTIVE VEHICLE AT WHICH CDH SHOULD OCCUR

CSI ONE

11	GETI	XXX:XX:XX.X (HRS:MIN:SEC)	GET OF CSI ONE BURN
81	DELTA VX DELTA VY DELTA VZ	XXXX.X (FPS) XXXX.X (FPS) XXXX.X (FPS)	LOCAL VERTICAL VELOCITY COMPONENTS OF CSI ONE BURN
N		X	THE FUTURE APSIDAL CROSSING (APOLUNE OR PERILUNE) OF THE ACTIVE VEHICLE AT WHICH CDH SHOULD OCCUR

CSI TWO, THREE, FOUR

SAME AS ABOVE EXCEPT CSI TWO, THREE, FOUR

CDH

13	GETI	XXX:XX:XX.X (HRS:MIN:SEC)	GET OF CDH BURN
81	DELTA VX DELTA VY DELTA VZ	XXXX.X (FPS) XXXX.X (FPS) XXXX.X (FPS)	LOCAL VERTICAL VELOCITY COMPONENTS OF CDH BURN

TPI

37		XXX:XX:XX.X (HRS:MIN:SEC)	GET OF LM TPI BURN
81	DELTA VX DELTA VY DELTA VZ	XXX (FPS) XXX (FPS) XXX (FPS)	LOCAL VERTICAL VELOCITY COMPONENTS OF TPI BURN
59	ΔV (LOS)	XXX (FPS)	VELOCITY COMPONENTS ALONG THE LINE OF SIGHT TO TARGET
LOS BT		X:XX MIN:SEC	BURN DURATION ALONG THE LINE OF SIGHT

P22 PAD

T1		XXX:XX:XX.XX (HRS:MIN:SEC)	GET AT WHICH LANDMARK APPEARS ON HORIZON
----	--	-------------------------------	--

T2		XXX:XX:XX.XX (HR:MIN:SEC)	GET AT WHICH LANDMARK LOS IS 35° ABOVE LOCAL HORIZONTAL
NM (N OR S)		XX.X (NM)	DISTANCE OF LANDMARK NORTH OR SOUTH OF ORBITAL TRACK
89	LAT LONG ALT	+XX.X (DEG) <u>±</u> XX (DEG)	LATITUDE OF LANDMARK LONGITUDE OF LANDMARK ALTITUDE OF LANDMARK ABOVE OR BELOW MEAN LUNAR RADIUS

NOMINAL LM IGNITION TIMES

CSI 11	GETI	XXX:XX:XX.X (HRS:MIN:SEC)	NOMINAL GET OF LM CSI BURN
PC 33	GETI	XXX:XX:XX.XX (HRS:MIN:SEC)	NOMINAL GET OF LM PLANE CHANGE BURN
TPI 37	GETI	XXX:XX:XX.XX (HRS:MIN:SEC)	NOMINAL GET OF LM TPI BURN

THIS PAGE INTENTIONALLY LEFT BLANK.

		LUNAR ENTRY																
																AREA		
		X	X	X						X	X	X				R 0.05 G		
		X	X	X						X	X	X				P 0.05G		
		X	X	X						X	X	X				Y 0.05G		
				•		•					•		•			GET HOR		
		X	X	X						X	X	X				P CK		
			0			•					0		•			LAT N61		
						•							•			LONG		
		X	X	X						X	X	X			•	MAX G		
		+								+						V _{400K} N60		
		-	0	0						-	0	0			•	Y400K		
		+								+					•	RTGO EMS		
		+								+					•	VIO		
				•		•					•		•			RRT		
		X	X			•				X	X			•		RET 0.05G		
		+	0	0						+	0	0			•	D _L MAX _{N69}		
		+	0	0						+	0	0			•	D _L MIN		
		+								+						V _L MAX		
		+								+						V _L MIN		
		X	X	X						X	X	X			•	D _O		
		X	X			•				X	X				•	RET V _{CIRC}		
		X	X			•				X	X				•	RET BBO		
		X	X			•				X	X				•	RETEBO		
		X	X			•				X	X				•	RETDRO		
		X	X	X	X					X	X	X	X			SXTS		
		+				•				+				•	0	SFT		
		+			•		0	0		+			•	0	0	TRN		
		X	X	X						X	X	X				BSS		
		X	X							X	X				•	SPA		
		X	X	X						X	X	X			•	SXP		
		X	X	X	X					X	X	X	X			LIFT VECTOR		
LUNAR ENTRY														LUNAR ENTRY				
APRIL 5, 1969																		

LUNAR ENTRY PAD

AREA	XXXXX	SPLASHDOWN AREA DEFINED BY TARGET LINE
R .05G	XXX (DEG)	SPACECRAFT IMU GIMBAL ANGLES REQUIRED FOR AERODYNAMIC TRIM AT .05G
P .05G	XXX (DEG)	
Y .05G	XXX (DEG)	
GET (HOR CK)	XXX:XX:XX (HRS:MIN:SEC)	TIME OF ENTRY ATTITUDE HORIZ CHECK AT EI -17 MIN.
P (HOR CK)	XXX (DEG)	PITCH ATTITUDE FOR HORIZON CHECK AT EI -17 MIN.
LAT	+XX.XX (DEG)	LATITUDE OF TARGET POINT
LONG	+XXX.XX (DEG)	LONGITUDE OF TARGET POINT
MAX G	XX.X (G's)	PREDICTED MAXIMUM REENTRY ACCELERATION
V400K	+XXXXX (FPS)	INERTIAL VELOCITY AT ENTRY INTERFACE
400K	-X.XX (DEG)	INERTIAL FLIGHT PATH ANGLE AT ENTRY INTERFACE
RTGO	+XXXX.X (NM)	RANGE TO GO FROM .05G TO TARGET FOR EMS INITIALIZATION
VIO	+XXXXX (fps)	INERTIAL VELOCITY AT .05G FOR EMS INITIALIZATION
RRT	XXX:XX:XX (HRS:MIN:SEC)	REENTRY REFERENCE TIME BASED ON GET OF PREDICTED 400K (DET START)
RET .05G	XX:XX (MIN:SEC)	TIME OF .05G FROM 400K (RRT)
DL MAX	+X.XX (G's)	MAXIMUM ACCEPTABLE VALUE OF PREDICTED DRAG LEVEL (FROM CMC)
DL MIN	+X.XX (G's)	MINIMUM ACCEPTABLE VALUE OF PREDICTED DRAG LEVEL (FROM CMC)
VL MAX	+XXXXX (FPS)	MAXIMUM ACCEPTABLE VALUE OF EXIT VELOCITY (FROM CMC)

VL MIN	+XXXXX (FPS)	MINIMUM ACCEPTABLE VALUE OF EXIT VELOCITY (FROM CMC)
DO	X.XX (G's)	PLANNED DRAG LEVEL DURING CONSTANT G
RET VCIRC	XX:XX (MIN:SEC)	TIME FROM EI THAT S/C VELOCITY BECOMES CIRCULAR
RETBBO	XX:XX (MIN:SEC)	TIME FROM EI TO THE BEGINNING OF BLACKOUT
RETEBO	XX:XX (MIN:SEC)	TIME FROM EI TO THE END OF BLACKOUT
RETDRO	XX:XX (MIN:SEC)	TIME FROM EI TO DROGUE DEPLOY
SXTS	XX (OCTAL)	SEXTANT STAR FOR ENTRY ATTITUDE CHECK
SFT	+XXX.X (DEG)	SEXTANT SHAFT SETTING FOR ENTRY ATTITUDE CHECK
TRN	+XX.X (DEG)	SEXTANT TRUNNION SETTING FOR ENTRY ATTITUDE CHECK
BSS	XXX (OCTAL)	BORESIGHT STAR FOR ENTRY ATTITUDE CHECK USING THE COAS
SPA	<u>+</u> XX.X (DEG)	BSS PITCH ANGLE ON COAS FOR ENTRY ATTITUDE CHECK
SXP	<u>+</u> X.X (DEG)	BSS X POSITION ON COAS FOR ENTRY ATTITUDE CHECK
LIFT VECTOR	XX (UP/DN)	LIFT VECTOR DESIRED AT .05G's BASED ON ENTRY CORRIDOR

THIS PAGE INTENTIONALLY LEFT BLANK.

EARTH ORBIT ENTRY UPDATE										
APRIL 16, 1969	X			-		X			-	AREA
	X	X	-		•	X	X	-		ΔV TO
	X	X	X			X	X	X		R 0.05G EMS
	X	X	X			X	X	X		P 0.05G
	X	X	X			X	X	X		Y 0.05G
	+				•	+				RTGO EMS
	+					+				VI0
	X	X			•	X	X			RET 0.05G
		0			•		0			LAT N61
					•					LONG
	X	X			•	X	X			RET 0.2G
					•					DRE (55°) N66
	R	R		/		R	R		/	BANK AN
	X	X			•	X	X			RET RB
	X	X			•	X	X			RETBBO
	X	X			•	X	X			RETEBO
	X	X			•	X	X			RETDROG
	X	X	X			X	X	X		(90°/fps) CHART
X	X				X	X			DRE (90°) UPDATE	
POST BURN										
X	X	X			X	X	X		P 0.05G	
+				•	+				RTGO EMS	
+					+				VI0	
X	X			•	X	X			RET 0.05G	
E.O. ENTRY	X	X			•	X	X			RET 0.2G
					•					DRE ±100 nm N66
	R	R		/		R	R		/	BANK AN
	X	X			•	X	X			RETRB
	X	X			•	X	X			RETBBO
	X	X			•	X	X			RETEBO SEC
				•	X	X			RETDROG TO MAIN	
									E.O. ENTRY	

EARTH ORBIT ENTRY UPDATE

AREA	XXX-X	RECOVERY AREA - FIRST 3 DIGITS DENOTES REV IN WHICH LANDING OCCURS. LAST DIGIT DENOTES RECOVERY AREA AND SUPPORT CAPABILITIES
ΔV TO	XX.X (FPS)	ΔV DUE TO ENGINE TAILOFF
EMS		
R 0.05G	XXX (DEG)	SPACECRAFT IMU
P 0.05G	XXX (DEG)	GIMBAL ANGLES REQUIRED
Y 0.05G	XXX (DEG)	FOR AERODYNAMIC TRIM AT 0.05G.
EMS		
RTGO	XXXX.X (NM)	RANGE TO GO FROM .05G TO TARGET
VIO	XXXXX (FPS)	INERTIAL VELOCITY AT .05G FOR EMS INITIALIZATION
RET 0.05G	XX:XX (MIN:SEC)	TIME FROM RETROFIRE TO .05G
N61		
LAT	+XX.XX (DEG)	LATITUDE OF IMPACT LANDING POINT
LONG	+XXX.XX (DEG)	LONGITUDE OF IMPACT LANDING POINT
N66		
RET .2G	XX:XX (MIN:SEC)	TIME FROM RETROFIRE TO .2G
DRE (55°)	+XXXX.X (NM)	DOWNRANGE ERROR AT .2G
BANK AN	XX/XX (DEG/DEG)	BACKUP BANK ANGLE FOR SCS ENTRY: ROLL RIGHT/ROLL LEFT

RETRB	XX:XX (MIN:SEC)	TIME FROM RETROFIRE TO REVERSE BACKUP BANK ANGLE
RETBBO	XX:XX (MIN:SEC)	TIME FROM RETROFIRE TO BEGINNING OF COMMUNICATIONS BLACKOUT
RETEBO	XX:XX (MIN:SEC)	TIME FROM RETROFIRE TO END OF COMMUNICATIONS BLACKOUT
RETDROG	XX:XX (MIN:SEC)	TIME FROM RETROFIRE TO DROGUE CHUTE DEPLOYMENT
CHART UPDATE		
90°/FPS DRE (90°)	<u>+XX</u> <u>+XXX</u>	VALUES USED TO RE-PLOT BACKUP ENTRY CHART - ΔV AND DOWN RANGE ERROR (DRE) @ 90° BANK ANGLE
<u>POST BURN</u>		
P 0.05G	XXX (DEG)	PITCH ANGLE @ ENTRY INTERFACE
EMS		
RTGO	+XXXX.X (NM)	RANGE TO GO FROM 0.05G TO TARGET FOR EMS COUNTER
VIO	+XXXXX (FPS)	INERTIAL VELOCITY @ 0.05G
RET 0.05G	XX:XX (MIN:SEC)	TIME FROM RETROFIRE TO 0.5G
RET 02G	XX:XX (MIN:SEC)	TIME FROM RETROFIRE TO 0.2G
DRE	<u>+XXXX.X (NM)</u>	DOWN RANGE ERROR
BANK AN	XX/XX (DEG/DEG)	BACKUP BANK ANGLE FOR SCS ENTRY: ROLL RIGHT/ROLL LEFT
RETRB	XX:XX (MIN:SEC)	TIME FROM RETROFIRE TO REVERSE BACKUP BANK ANGLE

RETBBO	XX:XX (MIN:SEC)	TIME FROM RETROFIRE TO BEGINNING OF COMMUNICATIONS BLACKOUT
RETEBO	XX:XX (MIN:SEC)	TIME FROM RETROFIRE TO END OF COMMUNICATIONS BLACKOUT
RETDROG	XX:XX (MIN:SEC)	TIME FROM RETROFIRE TO DROGUE CHUTE DEPLOYMENT

		EARTH ORBIT BLOCK DATA															
APRIL 1, 1969	E.O. BLOCK	X	X				-	X	X				-	AREA	E.O. BLOCK		
		X	X	X					X	X	X					LAT	
		X	X						X	X						LONG	
																GETI	
		X	X	X					X	X	X					ΔV_C	
		X	X						X	X						AREA	
		X	X	X					X	X	X					LAT	
		X	X						X	X						LONG	
																GETI	
		X	X	X					X	X	X					ΔV_C	
		X	X						X	X						AREA	
		X	X	X					X	X	X					LAT	
		X	X						X	X						LONG	
																GETI	
		E.O. BLOCK	E.O. BLOCK	X	X	X				X	X	X					ΔV_C
				X	X					X	X						AREA
X	X			X				X	X	X				LAT			
X	X							X	X					LONG			
													GETI				
													ΔV_C				
REMARKS:																	

EARTH ORBIT BLOCK DATA

AREA	XXX-X	RECOVERY AREA FIRST 3 DIGITS - LANDING REVOLUTION LAST DIGIT - RECOVERY AREA AND SUPPORT CAPABILITIES
LAT LONG	+XX.XX (DEG) <u>+XXX.X</u> (DEG)	COORDINATES OF THE DESIRED LANDING AREA
GETI	XXX:XX:XX.XX (HR:MIN:SEC)	DEORBIT IGNITION TIME FOR THE DESIRED LANDING AREA
Δ VC	XXX.X (FPS)	DEORBIT MANEUVER Δ V TO BE LOADED INTO THE EMS COUNTER.

		LM P27 UPDATE															
PURP		V				V				V							
GET		• •				• •				• •							
APRIL 16, 1969	P27	1174	01	INDEX				INDEX				INDEX				P27	
		02															
		03															
		04															
		05															
		06															
		07															
		10															
		11															
		12															
		13															
		14															
		15															
		16															
		17															
		20															
		21															
		22															
		23															
		24															
		N34		HR	X	X	X				X	X	X				
				MIN	X	X	X	X			X	X	X	X			
		NAV CHECK		SEC	X	X					X	X					
		N43		LAT		0						0					
		LONG															
		ALT	+	0					+	0							

P27 UPDATE-LM

PURP	XXX	TYPE OF DATA TO BE RECEIVED (SUCH AS: LDG TIME)
V	XX (VERB)	TYPE OF COMMAND LOAD (70-71-72-73)
GET	XXX:XX:XX (HR:MIN:SEC)	TIME DATA RECORDED
1174 01	XX (OCTAL)	INDEX NO. OF COMMAND WORDS IN LOAD
02-24	XX (OCTAL)	CORRECTION WORD IDENTIFIERS
N34 NAV CHECK TIME	XXX:XX:XX.XX (HR:MIN:SEC)	TIME FOR CONFIRMATION OF GROUND TRACK
N43		
LAT	XX.XX (DEG)	LATITUDE FOR GROUND TRACK CONFIRMATION
LONG	XXX.XX (DEG)	LONGITUDE FOR GROUND TRACK CONFIRMATION
ALT	XXX.X (NM)	ALTITUDE FOR GROUND TRACK CONFIRMATION

AGS STATE VECTOR UPDATE

										PURP	
										240	
										241	
										242	
										260	
										261	
										262	
										254	
+						+				244	
										245	
										246	
										264	
										265	
										266	
										272	

APRIL 5, 1969

REMARKS:

AGS SV

AGS SV

AGS STATE VECTOR UPDATE

PURP		PURPOSE FOR AGS STATE VECTOR UPDATE
240	<u>+XXXXX</u> (100 FT)	LM STATE VECTOR-POSITION COMPONENTS
241	<u>+XXXXX</u> (100 FT)	
242	<u>+XXXXX</u> (100 FT)	
260	<u>+XXXX.X</u> (FPS)	LM STATE VECTOR-VELOCITY COMPONENTS
261	<u>+XXXX.X</u> (FPS)	
262	<u>+XXXX.X</u> (FPS)	
254	+XXXX.X (MIN)	LM TIME FOR WHICH THE STATE VECTOR IS ACCURATE
244	<u>+XXXXX</u> (100 FT)	CSM STATE VECTOR-POSITION COMPONENTS
245	<u>+XXXXX</u> (100 FT)	
246	<u>+XXXXX</u> (100 FT)	
264	<u>+XXXX.X</u> (FPS)	CSM STATE VECTOR-VELOCITY COMPONENTS
265	<u>+XXXX.X</u> (FPS)	
266	<u>+XXXX.X</u> (FPS)	
272	+XXXX.X (MIN)	CSM TIME FOR WHICH THE STATE VECTOR IS ACCURATE

June 18, 1969

		PHASING				P30 LM MANEUVER			
HR MIN SEC	N33	+	0	0		+	0	0	
	TIG	+	0	0	0	+	0	0	0
		+	0			+	0		
ΔVX ΔVY ΔVZ	N81				•				•
	LOCAL				•				•
	VERT				•				•
H _A H _p ΔVR	N42	+			•	+			•
					•				•
		+			•	+			•
BT	X	X	X	•	X	X	X	•	
R P	FDAI	X	X	X		X	X	X	
	INER	X	X	X		X	X	X	
ΔVX ΔVY ΔVZ	AGS N86				•				•
	AGS				•				•
	AGS				•				•
BSS SPA SXP		X	X	X		X	X	X	
		X	X		•	X	X		•
		X	X	X	•	X	X	X	•

2-31

PHASING

N33 PHASING TIG	XXX:XX:XX.XX (HR:MIN:SEC)	IGNITION TIME OF LM MANEUVER
N81 LOCAL VERTICAL ΔV		
ΔVX	<u>+XXXX.X</u> (FPS)	LOCAL VERTICAL ΔV COMPONENTS OF THE MANEUVER
ΔVY	<u>+XXXX.X</u> (FPS)	
ΔVZ	<u>+XXXX.X</u> (FPS)	
N42 ORBITAL PARAMETERS		
HA	+XXXX.X (NM)	PREDICTED APOGEE RESULTING FROM MANEUVER
HP	<u>+XXXX.X</u> (NM)	PREDICTED PERIGEE RESULTING FROM MANEUVER
ΔVR	+XXXX.X (FPS)	TOTAL ΔV REQUIRED FOR THE MANEUVER
BT	X:XX (MIN:SEC)	DURATION OF THE MANEUVER
FDAI		
R	XXX (DEG)	INERTIAL FDAI ANGLES AT THE BURN ATTITUDE
P	XXX (DEG)	
AGS ΔV		
ΔVX AGS	<u>+XXXX.X</u> (FPS)	LOCAL VERTICAL ΔV COMPONENTS OF THE MANEUVER TO TARGET THE AGS
ΔVY AGS	<u>+XXXX.X</u> (FPS)	
ΔVZ AGS	<u>+XXXX.X</u> (FPS)	
BSS	XX (OCTAL)	BSS STAR FOR MANEUVER ATTITUDE CHECK
SPA	+XX.X (DEG)	BSS PITCH ANGLE ON COAS, & BSS X POSITION ON COAS FOR MANEUVER ATTITUDE CHECK
SXP	<u>+XX.X</u> (DEG)	

P30	P30 LM MANEUVER												P30			
	PURPOSE															
															HR	N33
	+	0	0												MIN	TIG
+	0	0	0										SEC			
													ΔV_X	N81		
													ΔV_Y	LOCAL		
													ΔV_Z	VERT		
+													Ha	N42		
													Hb			
+													ΔVR			
X	X	X											BT			
X	X	X											R	FDAI		
X	X	X											P	INER		
													ΔV_X AGS	N86		
													ΔV_Y AGS			
													ΔV_Z AGS			
X	X	X											BSS			
X	X												SPA			
X	X	X											SXP			
REMARKS:																

P30 LM MANEUVER

PURPOSE	XXXXX	PURPOSE OF MANEUVER (SUCH AS DOI TARGETING)
N33 TIG OF MANEUVER	XXX:XX:XX.XX (HR:MIN:SEC)	IGNITION TIME FOR THE MANEUVER
N81 LOCAL VERTICAL ΔV		
$\Delta V X$	<u>+XXXX.X</u> (FPS)	LOCAL VERTICAL ΔV COMPONENTS OF THE MANEUVER
$\Delta V Y$	<u>+XXXX.X</u> (FPS)	
$\Delta V Z$	<u>+XXXX.X</u> (FPS)	
N42 ORBITAL PARAMETERS		
HA	+XXXX.X (NM)	PREDICTED APOGEE AND PERIGEE RESULTING FROM THE MANEUVER
HP	<u>+XXXX.X</u> (NM)	
$\Delta V R$	+XXXX.X (FPS)	TOTAL ΔV REQUIRED FOR THE MANEUVER
BT	X:XX(MIN:SEC)	DURATION OF THE MANEUVER
FDAI		
R	XXX (DEG)	INERTIAL FDAI ANGLES AT THE BURN ATTITUDE
P	XXX (DEG)	
N86 AGS ΔV		
$\Delta V X$ AGS	<u>+XXXX.X</u> (FPS)	LOCAL VERTICAL ΔV COMPONENTS OF THE MANEUVER USED TO TARGET THE AGS
$\Delta V Y$ AGS	<u>+XXXX.X</u> (FPS)	
$\Delta V Z$ AGS	<u>+XXXX.X</u> (FPS)	
BSS	XX (OCTAL)	BSS STAR FOR BURN ATTITUDE CHECK
SPA	<u>+XX.X</u> (DEG)	BSS PITCH ANGLE ON COAS, & BSS X POSITION ON COAS FOR MANEUVER ATTITUDE CHECK
SXP	<u>+XX.X</u> (DEG)	

DOI DATA CARD

2-35

		P30									
HR	N33	+	0	0					+	0	0
MIN	TIG	+	0	0	0				+	0	0
SEC		+	0						+	0	
ΔV_X	N81										
ΔV_Y	LOCAL										
ΔV_Z	VERT										
H_A	N42	+									
H_p											
ΔV_R		+							+		
BT		X	X	X	:				X	X	X
R	FDAI	X	X	X					X	X	X
P	INER	X	X	X					X	X	X
ΔV_X AGS	N86										
ΔV_Y AGS											
ΔV_Z AGS											
BSS		X	X	X					X	X	X
SPA		X	X						X	X	
SXP		X	X	X					X	X	X

MANUAL SHUT-DOWN
 OR
 A. AVG NEGATIVE (PGNS)
 -AND-
 B. V_T : 2 SECONDS OVER BURN
 -AND-
 AGS VGT 2 FPS OVER
 MANUAL TAKEOVER
 ATT:5° RATE:5°/sec

LP SELF TEST
 H TM (+7994+30) _____
 H TM (-480+6) _____
 N66 SLANTING (+08275,+5.0) _____
 N67 VX (-00494,+2.0) _____
 VY (+01858,+2.0) _____
 VZ (+01329,+2.0) _____

RR/TM/VHF

P1	P2	R
----	----	---

 N78 _____
 TM _____
 CMC _____
 VHF _____

P52 STAR 1 _____ 2 _____ 3 _____
 N05 (STAR + DIFF) _____
 N93 (TORQUING) X _____
 Y _____
 Z _____
 GET _____

RESIDUALS

		PGNS			AGS		
ΔV_X					500		
ΔV_Y	N85				501		
ΔV_Z					502		

DOI DATA CARD

N33 DOI TIG	XXX:XX:XX.XX (HR:MIN:SEC)	IGNITION TIME OF LM MANEUVER
N81 LOCAL VERTICAL ΔV		LOCAL VERTICAL ΔV COMPONENTS OF THE MANEUVER
ΔVX	<u>+XXXX.X</u> (FPS)	
ΔVY	<u>+XXXX.X</u> (FPS)	
ΔVZ	<u>+XXXX.X</u> (FPS)	
N42 ORBITAL PARAMETERS		
HA	+XXXX.X (NM)	PREDICTED APOGEE RESULTING FROM MANEUVER
HP	<u>+XXXX.X</u> (NM)	PREDICTED PERIGEE RESULTING FROM MANEUVER
ΔVR	+XXXX.X (FPS)	TOTAL ΔV REQUIRED FOR THE MANEUVER
BT	X:XX (MIN:SEC)	DURATION OF THE MANEUVER
FDAI		
R	XXX (DEG)	INERTIAL FDAI ANGLES AT THE BURN ATTITUDE
P	XXX (DEG)	
N86 AGS ΔV		
ΔVX AGS	<u>+XXXX.X</u> (FPS)	LOCAL VERTICAL ΔV COMPONENTS OF THE MANEUVER TO TARGET THE AGS
ΔVY AGS	<u>+XXXX.X</u> (FPS)	
ΔVZ AGS	<u>+XXXX.X</u> (FPS)	
BSS	XXX (OCTAL)	BSS STAR FOR MANEUVER ATTITUDE CHECK
SPA	+XX.X (DEG)	BSS PITCH ANGLE ON COAS, & BSS X POSITION ON COAS FOR MANEUVER ATTITUDE CHECK
XP	<u>+XX.X</u> (DEG)	

PDI DATA CARD

PDI PAD										
HRS	TIG	+	0	0			+	0	0	
MIN	PDI	+	0	0	0		+	0	0	0
SEC		+	0				+	0		
TGO	N61	X	X				X	X		
CROSSRANGE										
R	FDAI	X	X	X			X	X	X	
P	AT TIG	X	X	X			X	X	X	
Y		X	X	X			X	X	X	
DEDA 231 IF RQD										

NO PDI + 12 ABORT										
HR	N33	+	0	0			+	0	0	
MIN	TIG	+	0	0	0		+	0	0	0
SEC		+	0				+	0		
ΔVX	N81									
ΔVY	LOCAL									
ΔVZ	VERT									
HA	N42	+								
Hp										
ΔVR		+					+			
BT		X	X	X			X	X	X	
R	FDAI	X	X	X			X	X	X	
P	INER	X	X	X			X	X	X	
ΔVX AGS	N86									
ΔVY AGS										
ΔVZ AGS										
HRS	N11	+	0	0			+	0	0	
MIN	CSI	+	0	0	0		+	0	0	0
SEC		+	0				+	0		
HRS	N37	+	0	0			+	0	0	
MIN	TPI	+	0	0	0		+	0	0	0
SEC		+	0				+	0		

PDI ABORT < 10 MIN										
LOG INSERTION SET										
5 0 0 0										
CSI TIG										
HRS	N37	+	0	0			+	0	0	
MIN	TPI	+	0	0	0		+	0	0	0
SEC		+	0				+	0		

PDI ABORT > 10 MIN										
HRS		+	0	0			+	0	0	
MIN		+	0	0	0		+	0	0	0
SEC	PHASING TIG	+	0				+	0		
HRS	N37	+	0	0			+	0	0	
MIN	TPI	+	0	0	0		+	0	0	0
SEC		+	0				+	0		

R2 SUN CHECK
 N22 _____ N20 _____

June 18, 1969

PDI DATA CARD

PDI PAD

TIG PDI	XXX:XX:XX.XX (HR:MIN:SEC)	PDI IGNITION TIME
TGO	XX:XX (MIN:SEC)	TIME TO HIGH GATE
CROSS RANGE	+XXXX.X (NM)	OUT-OF-PLANE DISTANCE BETWEEN THE INITIAL LM ORBITAL PLANE AND THE LANDING SITE (POSITIVE INDICATES LANDING SITE IS NORTH OF ORBITAL PLANE)

FDAI AT TIG

R	XXX (DEG)	INERTIAL FDAI ANGLES AT IGNITION
P	XXX (DEG)	
Y	XXX (DEG)	
DEDA 231 (IF REQ'D)	XXXXX (100 FT)	LUNAR RADIUS AT THE LANDING SITE

PDI ABORT <10 MIN

TPI TIG	XXX:XX:XX.XX (HR:MIN:SEC)	TPI IGNITION TIME
---------	------------------------------	-------------------

PDI ABORT >10 MIN

PHASING TIG	XXX:XX:XX.XX (HR:MIN:SEC)	TIME OF IGNITION OF LM PHASING MANEUVER
TPI TIG	XXX:XX:XX.XX (HR:MIN:SEC)	TPI IGNITION TIME

NO PDI +12 ABORT

N33 ABORT TIG	XXX:XX:XX.XX (HR:MIN:SEC)	IGNITION TIME FOR ABORT BURN
N81 LOCAL VERTICAL ΔV		
ΔVX	<u>+</u> XXXX.X (FPS)	LOCAL VERTICAL ΔV COMPONENTS OF THE PHASING MANEUVER
ΔVY	<u>+</u> XXXX.X (FPS)	
ΔVZ	<u>+</u> XXXX.X (FPS)	
N42 ORBITAL PARAMETERS		
HA	+XXXX.X (NM)	PREDICTED APOGEE RESULTING FROM MANEUVER
HP	<u>+</u> XXXX.X (NM)	PREDICTED PERIGEE RESULTING FROM MANEUVER
ΔVR	XXXX.X (FPS)	TOTAL ΔV REQUIRED FOR THE MANEUVER
BT	X:XX (MIN:SEC)	DURATION OF MANEUVER
FDAI		
R	XXX (DEG)	INERTIAL FDAI ANGLES AT THE BURN ATTITUDE
P	XXX (DEG)	
N86 AGS ΔV		
ΔVX AGS	<u>+</u> XXXX.X (FPS)	LOCAL VERTICAL ΔV COMPONENTS OF THE MANEUVER TO TARGET THE AGS
ΔVY AGS	<u>+</u> XXXX.X (FPS)	
ΔVZ AGS	<u>+</u> XXXX.X (FPS)	
N11 CSI TIG	XXX:XX:XX.XX (HR:MIN:SEC)	TIME OF IGNITION FOR CSI BURN
N37 TPI TIG	XXX:XX:XX.XX (HR:MIN:SEC)	TIME OF IGNITION FOR TPI BURN

THIS PAGE INTENTIONALLY LEFT BLANK.

LUNAR SURFACE DATA CARD

June 18, 1969

		T 2 ACORT							
HR	T2	+	0	0		+	0	0	
MIN	TIG	+	0	0	0	+	0	0	0
SEC		+	0			+	0		
HR	N33	+	0	0		+	0	0	
MIN	PHASING	+	0	0	0	+	0	0	0
SEC	TIG	+	0			+	0		
HRS	N11	+	0	0		+	0	0	
MIN	CSI ₁	+	0	0	0	+	0	0	0
SEC		+	0			+	0		
HRS	N37	+	0	0		+	0	0	
MIN	TPI	+	0	0	0	+	0	0	0
SEC		+	0			+	0		

		T 3 ABORT							
HRS	T3	+	0	0		+	0	0	
MIN	TIG	+	0	0	0	+	0	0	0
SEC		+	0			+	0		
HRS	CSM	+	0	0		+	0	0	
MIN	PERIOD	+	0	0	0	+	0	0	0
SEC		+	0			+	0		
HRS	P+ΔT	+	0	0		+	0	0	
MIN		+	0	0	0	+	0	0	0
SEC		+	0			+	0		
HRS	N11	+	0	0		+	0	0	
MIN	CSI TIG	+	0	0	0	+	0	0	0
SEC		+	0			+	0		
HRS	N37	+	0	0		+	0	0	
MIN	TPI	+	0	0	0	+	0	0	0
SEC		+	0			+	0		

2-40

P6B

N43 _____ LAT

_____ LONG

_____ ALT

P12

N76 _____ V (HOR) (5516.2)

_____ V (VERT) (19.5)

_____ CROSSRANGE (0.0)

NOTE: IF CROSSRANGE > 8 N.M., LOAD 8 N.M.

N74 _____ YAW

_____ PITCH

P12

N76 _____ V (HOR) (5535.6)

_____ V (VERT) (32.0)

_____ CROSSRANGE (0.0)

NOTE: IF CROSSRANGE > 8 N.M., LOAD 8 N.M.

N74 _____ YAW

_____ PITCH

LUNAR SURFACE DATA CARD

T2 ABORT

T2 TIG	XXX:XX:XX.XX (HR:MIN:SEC)	LIFTOFF TIME- SECOND PREFERRED TIME AFTER TOUCH- DOWN (~T.D. +12 MIN.)
N33 PHASING TIG	XXX:XX:XX.XX (HR:MIN:SEC)	TIME OF IGNITION FOR PHASING BURN
N11 CSI TIG	XXX:XX:XX.XX (HR:MIN:SEC)	TIME OF IGNITION FOR CSI BURN
N37 TPI TIG	XXX:XX:XX.XX (HR:MIN:SEC)	TIME OF IGNITION FOR TPI BURN

T3 ABORT

T3 TIG	XXX:XX:XX.XX (HR:MIN:SEC)	LIFT OFF TIME AFTER FIRST CSM REVOLUTION
CSM PERIOD	XXX:XX:XX.XX (HR:MIN:SEC)	CSM ORBITAL PERIOD
P + ΔT	XXX:XX:XX.XX (HR:MIN:SEC)	CSM PERIOD PLUS THE TIME INTERVAL BETWEEN CLOSEST APPROACH AND LIFTOFF TIMES
N11 CSI TIG	XXX:XX:XX.XX (HR:MIN:SEC)	TIME OF IGNITION FOR CSI BURN
N37 TPI TIG	XXX:XX:XX.XX (HR:MIN:SEC)	TIME OF IGNITION FOR TPI BURN

LM ASCENT PAD

+	0	0				+	0	0				HRS	
+	0	0	0			+	0	0	0			MIN	TIG
+	0					+	0					SEC	
+						+						V (HOR)	
+						+						V (VERT)	N76
	0						0					*CROSSRANGE	
												DEDA	047
												DEDA	053
												DEDA	225/226
												DEDA	231
*NOTE: LOAD 8 NM IF CROSSRANGE IS GREATER THAN 8 NM													
COMMENTS:													

LM ASCENT PAD

ASCENT TIG	XXX:XX:XX.XX (HR:MIN:SEC)	TIME OF APS IGNITION FOR LM ASCENT
N76 INSERTION TARGET		
V(HOR)	XXXX.X (FPS)	HORIZONTAL VELOCITY AT ORBIT INSERTION
V(VERT)	XXXX.X (FPS)	VERTICAL VELOCITY AT ORBIT INSERTION
CROSSRANGE	<u>±</u> XXX.X (NM)	CROSSRANGE DISTANCE AT ORBITAL INSERTION
DEDA 047	XXXXXX (OCTAL)	SINE OF LANDING AZIMUTH ANGLE
DEDA 053	XXXXXX (OCTAL)	COSINE OF LANDING AZIMUTH ANGLE
DEDA 225	XXXXXX (100 FT)	LOWER LIMIT OF α AT ORBIT INSERTION
DEDA 226	XXXXXX (100 FT)	UPPER LIMIT OF α AT ORBIT INSERTION
DEDA 231	XXXXXX (100 FT)	RADIAL DISTANCE OF LAUNCH SITE FROM CENTER OF MOON

CSI DATA CARD

June 19, 1969

HR	TIG	N11	+	0	0			+	0	0		
MIN	CSI		+	0	0	0		+	0	0	0	
SEC			+	0				+	0			

RESIDUALS

	PGNS	AGS
AVX		500
AVY	N85	501
AVZ		502

P52

STAR 1 _____ 2 _____ 3 _____

N85 (STAR → DIFF) _____

N93 (TORQUING →) X _____

Y _____

Z _____

N85 (+0000) (+02660) (+13000)

HR	TIG	N37	+	0	0			+	0	0		
MIN	TPI		+	0	0	0		+	0	0	0	
SEC			+	0				+	0			
ΔVX	N81		+	0				+	0			
ΔVY				0					0			
FDAI PITCH			+	X	X			+	X	X		
373	(+0321.3)		+					+				
275	(+0418.1)		+					+				

410+1, 605+00777, 416+1

ΔVX	AGS	N86		0	0				0	0		
ΔVY	AGS			0	0				0	0		
ΔVZ	AGS			0	0				0	0		

N82

AVX	CDH	AVY	CDH	AVZ	CDH
(-0.4)		(+0.0)		(+0.0)	

P
G
N
C
S
A
G
S

P	ΔH	CSI/CDH	CDH/TP1	ΔVX CSI	N81
G	(15.0)	(57.98)	(38.21)	(+60.5)	YDOT N90
N					CSI
C					(+0.0)
S					(-)
A	492	372	267	CSM SOLUTION	
G	ΔH	ΔT(CSI-CDH)	ΔVZ(CSI)	ΔVX CSI	ΔVY CSI
S					
				ΔVX	N86 (AGS)
				ΔVY	
				ΔVZ	

2-44

CSI DATA CARD (P32 LM MANEUVER)

N11 CSI TIG	XXX:XX:XX.XX (HR:MIN:SEC)	CSI IGNITION TIME
N37 TPI TIG	XXX:XX:XX.XX (HR:MIN:SEC)	TPI IGNITION TIME
N81		
ΔV_X	XXX.X (FPS)	LOCAL VERTICAL ΔV COMPONENTS OF THE CSI MANEUVER
ΔV_Y	XXX.X (FPS)	
FDAI PITCH	XXX (DEG)	FDAI INERTIAL PITCH ANGLE AT THE CSI BURN ATTITUDE
DEDA 373	XXXX.X (MIN)	AGS IGNITION TIME OF NEXT MANEUVER
DEDA 275	XXXX.X (MIN)	DESIRED TPI TIG (FOR CSI CALCULATION ONLY)
N86 AGS ΔV		
ΔV_X AGS	XX.XX (FPS)	LOCAL VERTICAL ΔV COMPONENTS OF CSI USED TO TARGET AGS EXT ΔV
ΔV_Y AGS	XX.XX (FPS)	
ΔV_Z AGS	XX.XX (FPS)	

HR	N13	+	0	0			+	0	0		
MIN	TIG	+	0	0	0		+	0	0	0	
SEC	CDH	+	0				+	0			
ΔVX			0					0			
ΔVY	N81		0					0			
ΔVZ			0					0			
PLM	FDAI	X	X	X			X	X	X		
373 (+0379.6)		+					+				
ΔVX	N86		0					0			
ΔVY	AGS		0					0			
ΔVZ			0					0			

PLANE CHANGE P30 V50 A10-1

TIG	CDH	-----

TIG	PC	-----

YDOT

CSM	N90	PGNS	N90	AGS	263
(-)		(-)		(-)	
(-)		(-)		(-)	

RESIDUALS

		PGNS	AGS
ΔVX			500
ΔVY	N85		501
ΔVZ			502

		PGNS	AGS
ΔVX			500
ΔVY	N85		501
ΔVZ			502

2-46

P C D S	N78			N81		
	ΔH (15.0)	ΔT YP1/CDH (37.31)	TPI SLIP (0.00)	ΔVX	YDOT CDH	ΔVZ N90
				(-1.1)	(+0.0)	(+4.1)
				(-)	(-)	(-)
A G S	CSM SOLUTION			CSM SOLUTION		
	402 ΔH	450 ΔVX	452 ΔVZ	ΔVX	ΔVY	ΔVZ
			N86 (AGS)			
			ΔVX	ΔVY	ΔVZ	

P
C
D
S
A
G
S

CDH DATA CARD

N13 CDH TIG	XXX:XX:XX.XX (HR:MIN:SEC)	IGNITION TIME FOR CDH MANEUVER
N81 LOCAL VERTICAL ΔV		
ΔV_X	+XXX.X (FPS)	LOCAL VERTICAL ΔV
ΔV_Y	+XXX.X (FPS)	COMPONENTS OF CDH
ΔV_Z	+XXX.X (FPS)	MANEUVER
PLM FDAI	XXX (DEG)	FDAI INERTIAL PITCH ANGLE AT CDH BURN ATTITUDE
DEDA 373	XXXX.X (MIN)	AGS IGNITION TIME OF NEXT MANEUVER
N86 AGS ΔV		
ΔV_X AGS	+XXX.X (FPS)	LOCAL VERTICAL ΔV
ΔV_Y AGS	+XXX.X (FPS)	COMPONENTS OF CDH
ΔV_Z AGS	+XXX.X (FPS)	USED TO TARGET AGS EXT ΔV

TPI DATA CARD

N37 TPI TIG

XXX:XX:XX.XX
(HR:MIN:SEC)

IGNITION TIME FOR
THE TPI MANEUVER

N81 LOCAL VERTICAL ΔV

ΔV_X
 ΔV_Y
 ΔV_Z

+XX.X (FPS)
 \mp XX.X (FPS)
 \mp XX.X (FPS)

LOCAL VERTICAL ΔV
COMPONENTS OF THE
TPI MANEUVER

N42 ΔV_R

+XX.X (FPS)

TOTAL ΔV REQUIRED
FOR THE MANEUVER

RLM
PLM

XXX (DEG)
XXX (DEG)

ROLL AND PITCH
FDAI ANGLES AT TPI
BURN ATTITUDE

N54 TIG-5

R TPI

XX.XX (FT)

RANGE AT TPI TIG - 5 MIN

\dot{R} TPI

\pm XXX.X (FPS)

RANGE RATE AT TPI TIG - 5 MIN

N59 ΔV_{LOS}

F/A
R/L
D/U

+XX.X (FPS)
 \mp XX.X (FPS)
 \mp XX.X (FPS)

LINE-OF-SIGHT ΔV
COMPONENTS OF THE
TPI MANEUVER

BT

XX:XX (MIN:SEC)

DURATION OF THE MANEUVER

SECTION III - DETAILED TIMELINE

FLIGHT PLAN

TIME	EVENT	REMARKS	
- 00:09	LCC: <u>REPORT</u> IGNITION	FIRST OPPORTUNITY LIFT-OFF JULY 16, 0932 EDT, 72° LA, TARGETED FOR LANDING SITE 2. LIFT-OFF: 1332 GMT	
00:00	LCC: CDR: <u>REPORT</u> LIFT-OFF		
00:02	CDR: <u>REPORT</u> YAW MNVR		
00:10	LCC: <u>REPORT</u> CLEAR OF TOWER		
00:15	CDR: <u>REPORT</u> ROLL AND PITCH PROGRAM INITIATE		
00:32	CDR: <u>REPORT</u> ROLL COMPLETE		
00:42	MCC: <u>REPORT</u> MARK MODE IB		PROP DUMP TO RCS CMD
00:51	LMP: <u>REPORT</u> CABIN PRESS DECREASING		ALTITUDE 14,00 ft
01:21	MAX Q		
01:56	MCC: <u>REPORT</u> MARK MODE IC		ALTITUDE 100,000 ft
02:00	MCC: CDR: <u>REPORT</u> GO/NO GO FOR STAGING		
02:15	CDR: <u>REPORT</u> INBOARD OUT		
02:41	CDR: <u>REPORT</u> OUTBOARD OUT		
02:42	CDR: <u>REPORT</u> STAGING/SII IGNITION		
03:12	CDR: <u>REPORT</u> S-II SEP LIGHT OUT		
03:17	CDR: <u>REPORT</u> TWR JETT AND MODE II		
03:21	CDR: <u>REPORT</u> GUIDANCE		
MISSION G			EDITION FINAL
			DATE JULY 1, 1969
		PAGE 3-i	

FLIGHT PLAN

TIME	EVENT	REMARKS		
04:00	MCC: <u>REPORT</u> TRAJECTORY AND GUIDANCE GO/NO GO			
04:00	CDR: <u>REPORT</u> S/C GO/NO GO			
05:00	CDR: <u>REPORT</u> S/C GO/NO GO			
05:25	MCC: <u>REPORT</u> S-IVB TO ORBIT CAPABILITY			
06:00	CDR: <u>REPORT</u> S/C GO/NO GO			
07:00	CDR: <u>REPORT</u> S/C GO/NO GO			
08:00	CDR: <u>REPORT</u> S/C GO/NO GO			
08:30	MCC: CDR: <u>REPORT</u> GO/NO GO FOR STAGING			
08:57	MCC: <u>REPORT</u> MODE IV			
	CDR: <u>REPORT</u> S/C GO/NO GO			
	MCC: <u>REPORT</u> TRAJECTORY AND GUIDANCE GO/NO GO			
09:11	CDR: <u>REPORT</u> S-II CUTOFF			
09:15	CDR: <u>REPORT</u> S-IVB IGNITION			
10:00	MCC: CDR: <u>REPORT</u> GO/NO GO FOR ORBIT			
	MCC: <u>REPORT</u> PREDICTED SECO			
11:40	CDR: <u>REPORT</u> SECO TB₅ = 0	IMU GIMBAL ANGLES @ INSERTION R 180° P 340° Y 0°		
	S-IVB MAINTAINS COMMANDED CUTOFF INERTIAL ATTITUDE			
MISSION G		EDITION FINAL	DATE JULY 1, 1969	PAGE 3-ii

MCC-H

FLIGHT PLAN

NOTES

0930 EDT

00:00

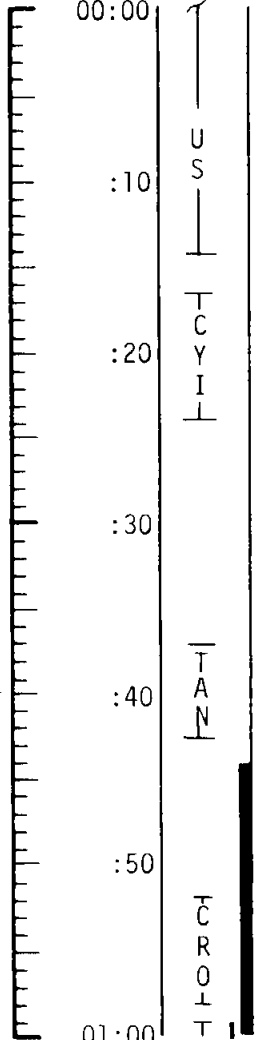

LIFTOFF

SECO-INSERTION CHECKLIST

LMP - SM RCS MON CK, CM RCS MON CK,
C&W OPERATIONAL CK

REMOVE AND STOW HELMETS AND GLOVES
UNSTOW CAMERAS

CMP - TRANS TO LEB - 02 MAIN REG CK
CMP/LMP - SEC RAD LEAK CK

CDR/CMP - ECS POST INSERTION CONFIG

LMP - FUEL CELL PURGE CK, EPS MON. CK,
FUEL CELL POWER PLANT CK, DC VOLT -
AMP CK, ECS MON CK, SPS MON CK

GDC ALIGN TO IMU - RECORD DRIFT

CDR - UNSTOW SEQ CAMERA BRACKET AND ORDEAL

INSTALL ORDEAL & COAS

MOUNT AND INITIALIZE ORDEAL SET UP CAMERA EQUIP(T&D)

CMP - ECS REDUNDANT COMPONENT
CHECK

JETTISON OPTICS COVER (DIRECT,
HIGH, SHAFT RIGHT)

RECORD Δ AZ CORRECTION

IMU REALIGN - P52
(OPTION 3 - REFSMMAT)
(OPTIONAL)

S-BAND VOL - UP FOR HSK

TWO-WAY USB VOICE CK

LIFTOFF CREW POSITIONS
LEFT COUCH - CDR
CENTER COUCH - LMP
RIGHT COUCH - CMP
INSERTION IMU GIMBAL
ANGLES P 340 R 180 Y 0
AT SECO +20 SEC, SIV-B
MNVRS TO LH AND
INITIALIZES ORB RATE
(HEADS DOWN)

COOLANT CONTROL ATTEN-
UATION PANEL NOT OPENED

UPDATE

Δ AZ CORRECTION

16mm/18/CEX-BRKT-MIR
(f8,250,7) 6 FPS
1 MAG (FOR T&D)
EL/80/CEX
(f8,250,INF)

REPORT

P52 - (PAD REFSMMAT)

N71: _____

N05: _____

N93: _____

X _____

Y _____

Z _____

GET _____:_____:

MISSION	EDITION	DATE	TIME	DAY/REV	PAGE
APOLLO 11	FINAL	JULY 1, 1969	00:00 - 01:00	1/1	3-1

MCC-H

FLIGHT PLAN

NOTES

1000 EDT

01:00

T
H
S
K

P52 - CONT'D

GDC ALIGN TO IMU
STOW OPTICS

:10

:20

:30

UPLINK CMC
CSM STATE VECTOR

U
S

SCS ATT REF COMPARISON CK
EXTEND DOCKING PROBE

UPDATE
PAD DATA

:40

V66 - TRANS CSM STATE VECTOR TO LM SLOT
RECORD PAD DATA
(TLI, TLI + 90 MIN ABORT, AND
P37 - TLI + 4 HR ABORT)
SM RCS HOT FIRE
(MIN IMPULSE - ALL JETS)

AS A GENERAL RULE
MSFN WILL ALWAYS UP-
LINK THE STATE VECTOR
TO THE CSM SLOT AND THE
CREW WILL TRANSFER
IT VIA V66 TO THE LM
SLOT

GO/NO GO

:50

C
Y
I

GO/NO GO FOR PYRO ARM
BEGIN TLI PREPARATION (CHECKLIST PG L-2-19)
DON HELMETS & GLOVES - ALL

02:00

EMS ΔV TEST

MISSION	EDITION	DATE	TIME	DAY/REV	PAGE
APOLLO 11	FINAL	JULY 1, 1969	01:00 - 02:00	1/1	3-2

THIS PAGE INTENTIONALLY LEFT BLANK.

TLI
BURN CHART

	P OR Y RATES	ATT DEVIATION	SHUTDOWN TIME	RESIDUALS
TLI	10°/SEC SHUTDOWN	+45° SHUTDOWN	BT + 6 SEC & VI = PAD VALUE	DO NOT TRIM

MCC-H

1830 EDT

FLIGHT PLAN

NOTES

09:00

:10

:20

:30

:40

:50

10:00

:10

:20

:30

:40

:50

11:00

M
S
F
N

UPLINK CMC

EARTH HORIZON
BIAS (ΔH)
(IF REQUIRED)
CSM STATE VECTOR
MCC1 TGT LOAD

UPDATE

MCC1 MNVR PAD

CO₂ FILTER CHANGE NO. 1
(3 INTO A, STORE 1 IN B5)

V66 - TRANS CSM STATE VECTOR TO LM SLOT

O₂ FUEL CELL PURGE

RECORD MCC1 MNVR PAD

CONTINUE PTC IF MCC1 IS SCRUBBED

IMU REALIGN - P52
OPTION 3 - REFSMMAT
(OPTIONAL)

PTC

THE EARTH HORIZON BIAS (ΔH) WILL BE UPDATED TO THE CMC IF THE DIFFERENCE BETWEEN THE SIGHTING ΔH & THE E-MEMORY ΔH IS ≥ 8.3 KM

REPORT:

P52 (PAD REFSMMAT)

N71: _____, _____

N05: _____

N93:

X _____

Y _____

Z _____

GET _____ : _____ :

MISSION	EDITION	DATE	TIME	DAY/REV	PAGE
APOLLO 11	FINAL	JULY 1, 1969	09:00 - 11:00	1/TLC	3-9

MCC
BURN CHART

	P OR Y RATES	ATT DEVIATION	SHUTDOWN TIME	RESIDUALS
MCC1	10°/SEC TAKEOVER	+10° TAKEOVER	BT + 1 SEC	TRIM X AXIS ONLY (UNLESS X > 2 FPS)

MCC-H

2030 EDT

FLIGHT PLAN

NOTES

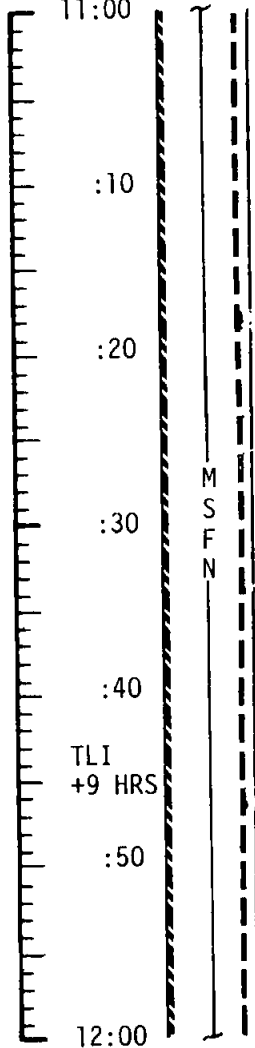

EXT ΔV - P30

SPS/RCS THRUST - P40/41

MNVR TO BURN ATT

SXT STAR CK

EMS ΔV TEST

SM RCS MON CK

GDC ALIGN TO IMU

MCC1 ΔV = NOMINALLY ZERO

SM RCS MON CK

SPS MON CK

MCC1 BURN STATUS REPORT

V66 - TRANS CSM STATE VECTOR TO LM SLOT

RECORD BLOCK DATA - (P37 - TLI + 25, 35, 44,
AND 53 HR ABORTS

BURN STATUS REPORT

X	X	<input type="checkbox"/>	•	ΔTIG
X	X	<input type="checkbox"/>	•	BT
<input type="checkbox"/>	<input type="checkbox"/>	<input type="checkbox"/>	•	V _{gx}
TRIM				
X	X	X		R
X	X	X		P
X	X	X		Y
<input type="checkbox"/>	<input type="checkbox"/>	<input type="checkbox"/>	•	V _{gx}
<input type="checkbox"/>	<input type="checkbox"/>	<input type="checkbox"/>	•	V _{gy}
<input type="checkbox"/>	<input type="checkbox"/>	<input type="checkbox"/>	•	V _{gz}
<input type="checkbox"/>	<input type="checkbox"/>	<input type="checkbox"/>	•	ΔV _c
X	X	X		FUEL
X	X	X		OX
X	X	X		UNBAL

MCC1 WIL BE PERFORMED
IF ΔV WOULD EXCEED
25 FPS IF DELAYED TO
MCC3 (LOI-22 HRS)

UPLINK CMC
DESIRED ORIENTATION (PTC)
UPDATE
BLOCK DATA

MISSION	EDITION	DATE	TIME	DAY/REV	PAGE
APOLLO 11	FINAL	JULY 1, 1969	11:00 - 12:00	1/TLC	3-10

MCC-H

2100 EDT

FLIGHT PLAN

NOTES

12:00
:10
:20
:30
:40
:50
13:00
:10
:20
:30
:40
:50
14:00

M
S
F
N

IMU REALIGN - P52
(OPTION 1 - PREFERRED)
& STAR CHECK
(IF MCC1 WAS PERFORMED)

REPORT LM/CM ΔP
BATTERY CHARGE, BATTERY A

EAT PERIOD - ALL

REST PERIOD
(9 HOURS)

WASTE STOWAGE VENT VLV - CLOSED
VENT BATTS UNTIL SYSTEM TEST
METER (4A) = 0

START PTC
P 90° Y 0°

P52 - PULSE TORQUE
TO PTC REFSMMAT.
ALIGNMENT CHECKED
WITH OPTICS
PTC ESTABLISHED IN
G&N P, Y +30°DB,
R RATE OF 0.3°/SEC

PRESLEEP CHECKLIST

CREW STATUS REPORT (RADIATION,
MEDICATION)
CYCLE O₂ & H₂ FANS
CHLORINATE POTABLE WATER
SELECT NORMAL LUNAR CONFIGURATION
EXCEPT
S-BD NORMAL MODE VOICE - OFF
S-BD SQUELCH - ENABLE
S-BD AUX TAPE - OFF
S-BD ANT - OMNI
S-BD ANT OMNI - B
TAPE RCDR FWD - OFF
VERIFY:
WASTE MNGT OVBD DRAIN - OFF
WASTE STOW VENT VLV - CLOSED
EMERG CABIN PRESS VLV - BOTH
SURGE TK O₂ VLV - ON
REPRESS PACK O₂ VLV - ON
LM TUNNEL VENT VLV - LM/CM ΔP
POT H₂O HTR - OFF
AUTO RCS JET SELECT (16) - OFF

ON BOARD READOUT

BAT C _____
PYRO BAT A _____
PYRO BAT B _____
RCS A _____
B _____
C _____
D _____

DC IND SEL TO MNA OR MNB

DURING REST PERIOD,
2 CREWMEN IN REST
STATION, 1 IN LEFT
COUCH

MISSION	EDITION	DATE	TIME	DAY/REV	PAGE
APOLLO 11	FINAL	JULY 1, 1969	12:00 - 14:00	1/TLC	3-11

MCC-H

2330 EDT

FLIGHT PLAN

NOTES

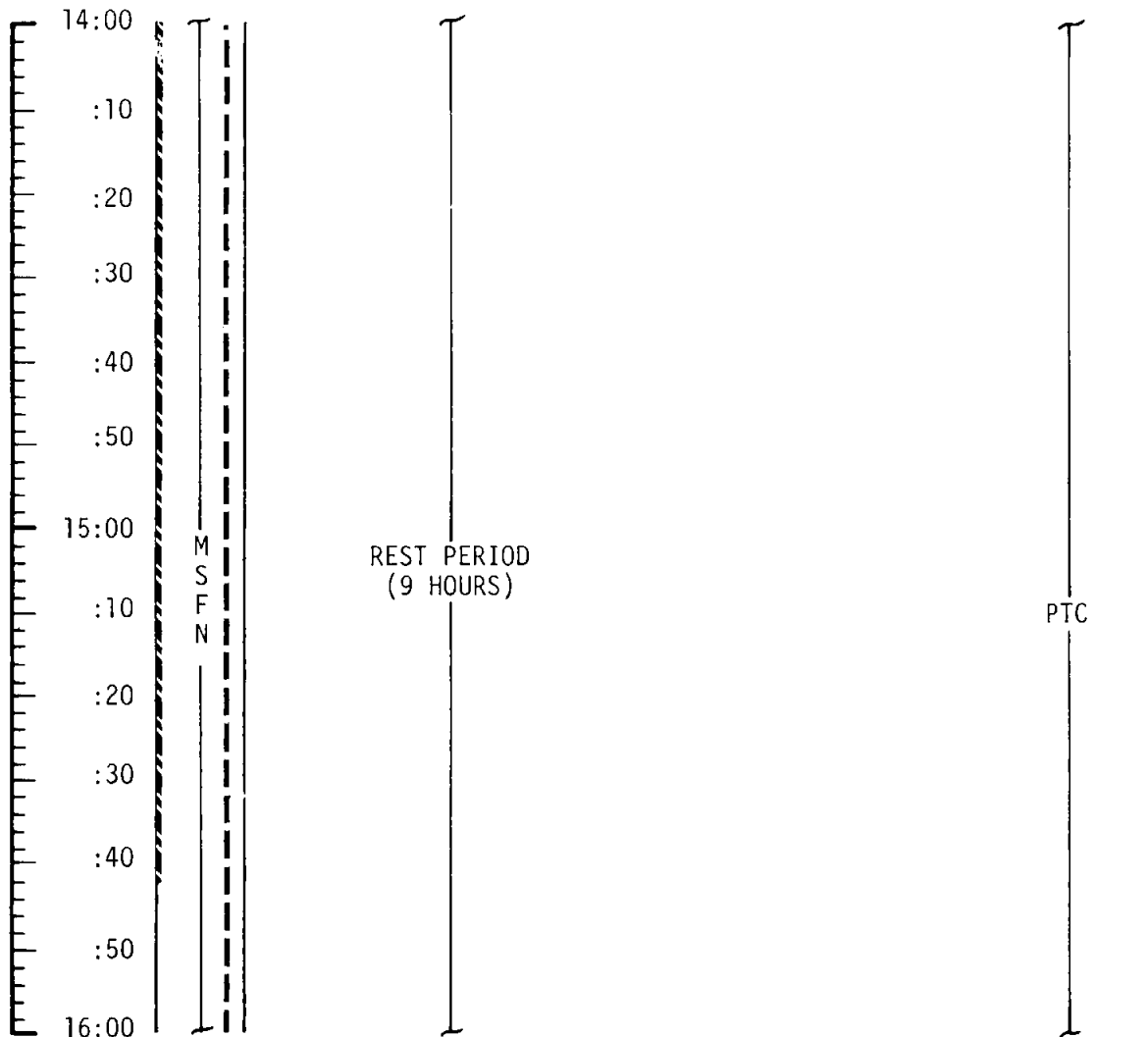

MISSION	EDITION	DATE	TIME	DAY/REV	PAGE
APOLLO 11	FINAL	JULY 1, 1969	14:00 - 16:00	1/TLC	3-12

MCC-H

FLIGHT PLAN

NOTES

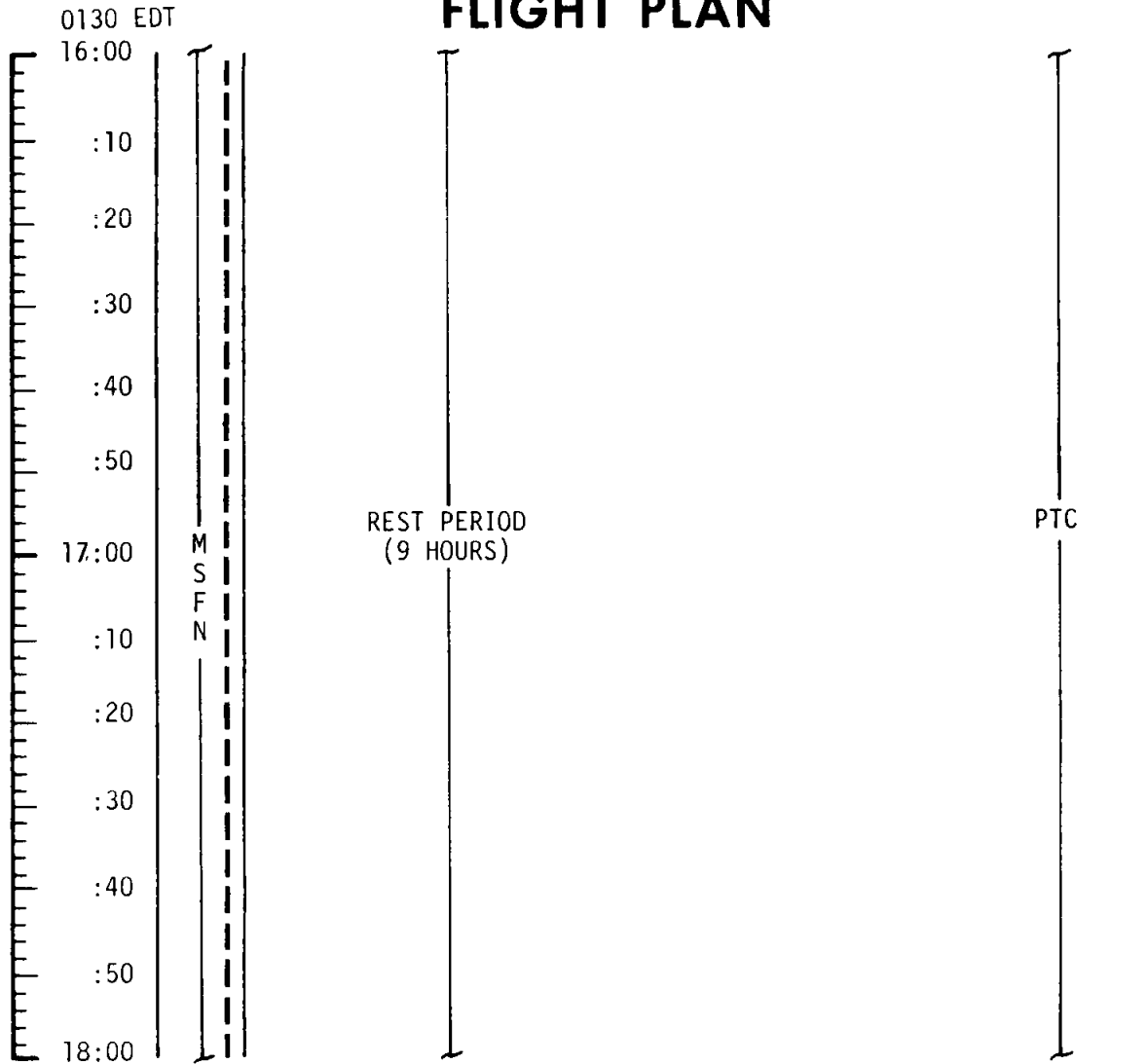

MISSION	EDITION	DATE	TIME	DAY/REV	PAGE
APOLLO 11	FINAL	JULY 1, 1969	16:00 - 18:00	1/TLC	3-13

MCC-H

0330 EDT

FLIGHT PLAN

NOTES

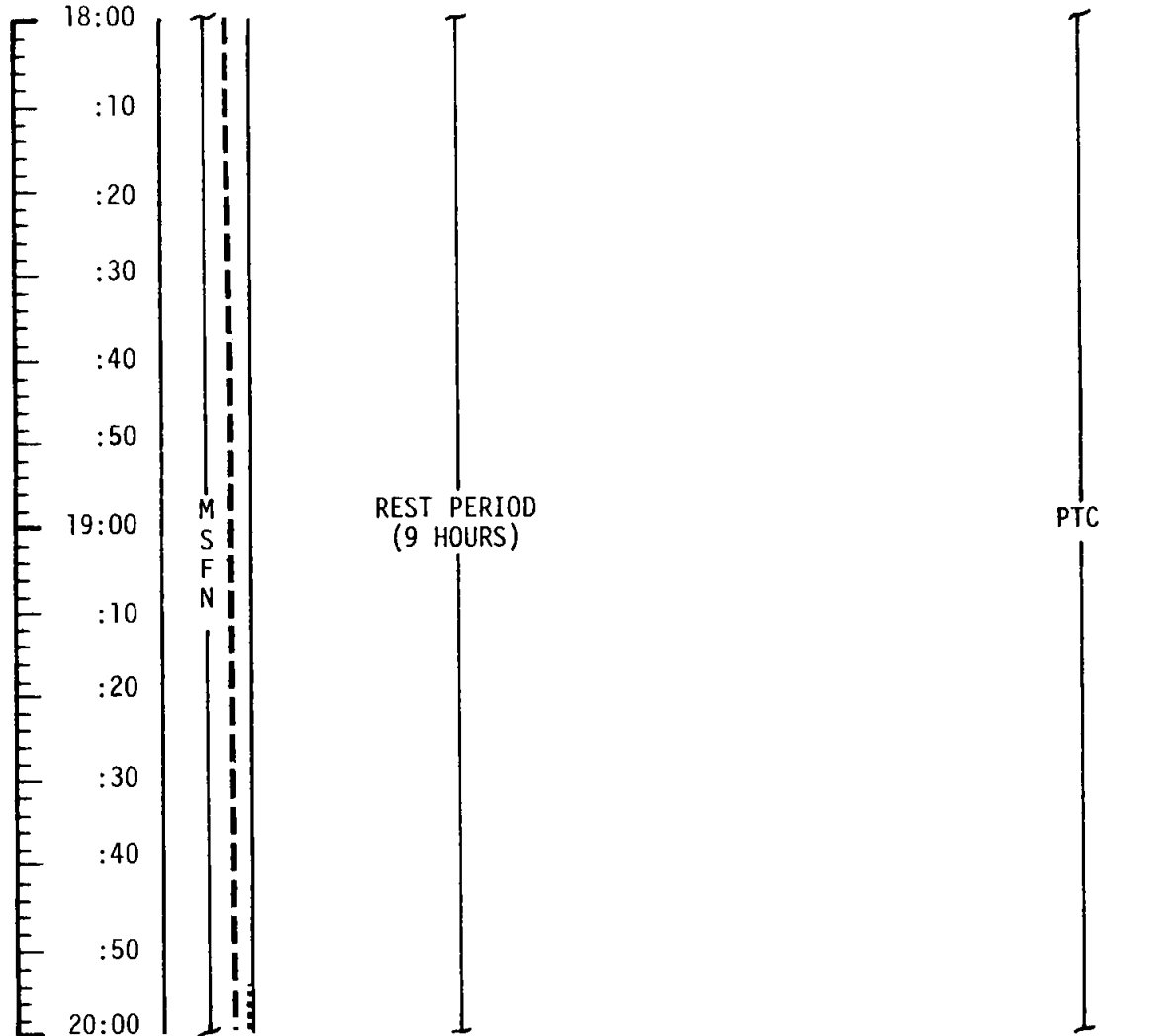

MISSION	EDITION	DATE	TIME	DAY/REV	PAGE
APOLLO 11	FINAL	JULY 1, 1969	18:00 - 20:00	1/TLC	3-14

MCC-H

0530 EDT

FLIGHT PLAN

NOTES

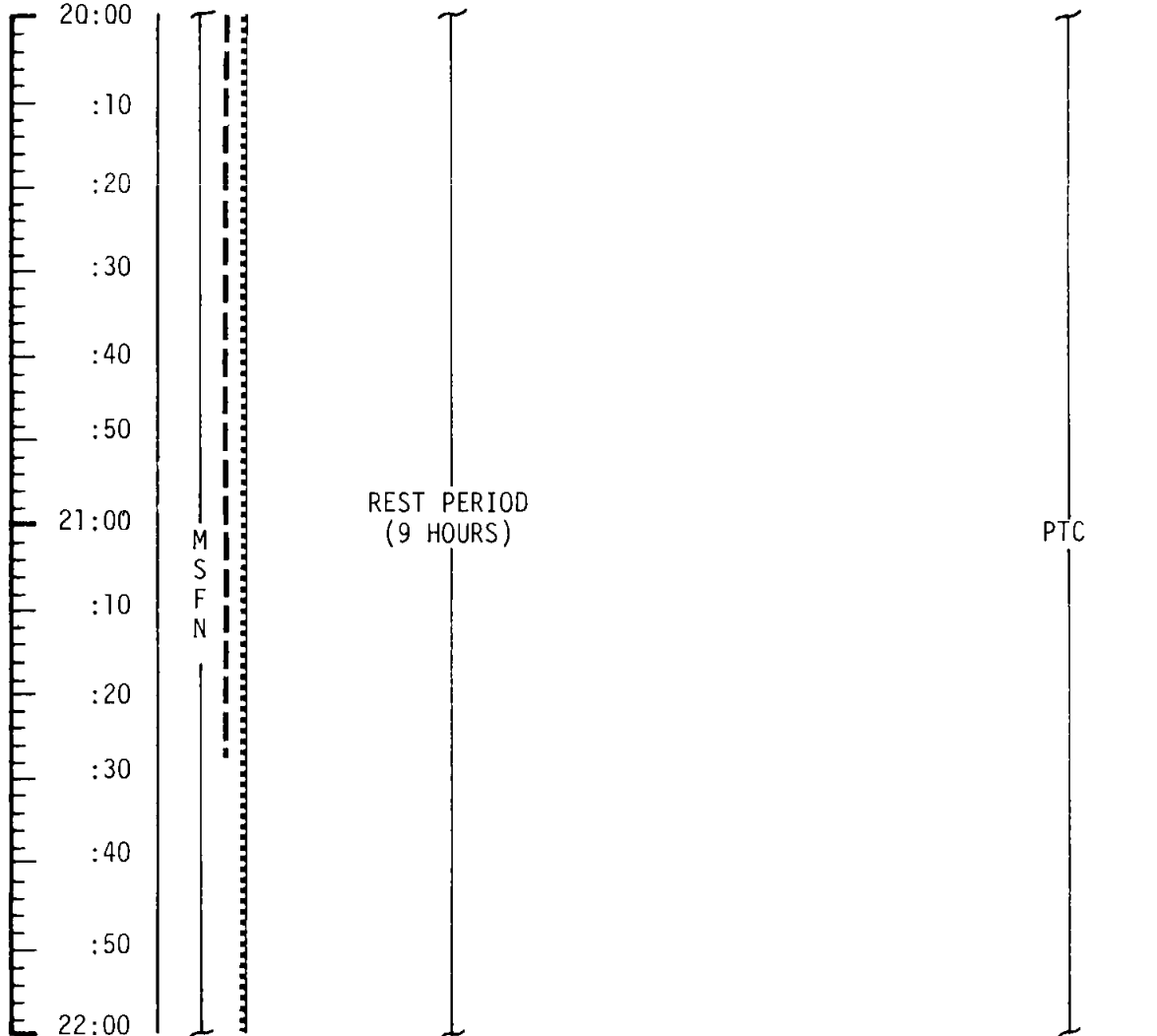

MISSION	EDITION	DATE	TIME	DAY/REV	PAGE
APOLLO 11	FINAL	JULY 1, 1969	20:00-22:00	1/TLC	3-15

MCC-H

0730 EDT

FLIGHT PLAN

NOTES

UPDATE
CONSUMABLES

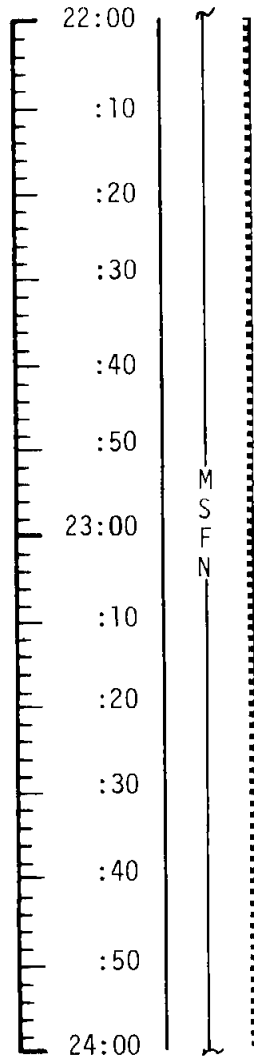

REST PERIOD
(9 HOURS)

CO₂ FILTER CHANGE NO.2
(4 INTO B, STORE 2 IN B5)

EAT PERIOD

POST SLEEP CHECKLIST

CREW STATUS REPORT (SLEEP)
 CYCLE O₂ & H₂ FANS
 GDC ALIGN TO IMU
 REPORT LM/CM ΔP
 CONSUMABLES UPDATE
 SELECT NORMAL LUNAR
 CONFIGURATION EXCEPT:
 S-BD AUX TAPE - OFF
 TAPE RCDR FWD - OFF
 POT H₂O HTR - ON
 AUTO RCS JET SELECT (16) - ON

CONSUMABLE UPDATE
(Δ FROM NOMINAL)

GET: _____

RCS TOT _____

A _____

B _____

C _____

D _____

H₂ TOT _____

O₂ TOT _____

PTC

MISSION	EDITION	DATE	TIME	DAY/REV	PAGE
APOLLO 11	FINAL	JULY 1, 1969	22:00 - 24:00	2/TLC	3-16

MCC-H

FLIGHT PLAN

NOTES

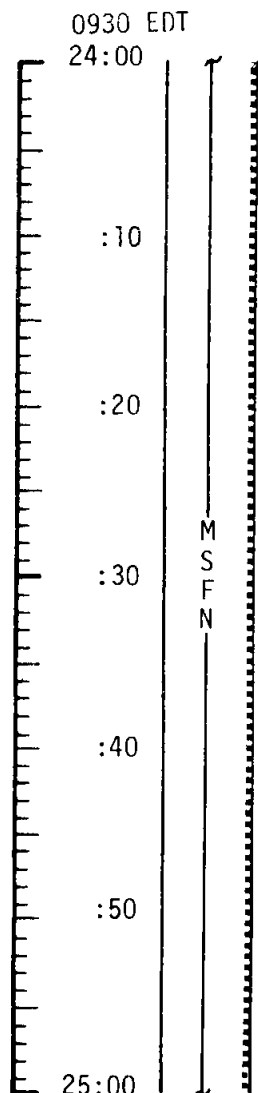

O₂ FUEL CELL PURGE

IMU REALIGN - P52
OPTION 3 - REFSMMAT

GDC ALIGN TO IMU

MNVR TO SIGHTING ATT

CISLUNAR NAVIGATION P23

OPTICS CALIBRATION

1. STAR 01 ENH (R3=00110)

2. STAR 02 ENH (R3 00110)

PTC

REPORT:

P52 - PTC REFSMMAT

N71: _____, _____

N05: _____ . _____

N93:

X _____ . _____

Y _____ . _____

Z _____ . _____

GET _____ : _____ : _____

3 MARKS ON EACH STAR
INCORPORATE P23 MARK
DATA AND UPDATE
ONBOARD STATE VECTOR
TRN BIAS CALIBRATION
REPEATED UNTIL 2 CKS
AGREE TO WITHIN 0.003°
REPEAT CKS EVERY 30
MIN DURING P23'S

MISSION	EDITION	DATE	TIME	DAY/REV	PAGE
APOLLO 11	FINAL	JULY 1, 1969	24:00 - 25:00	2/TLC	3-17

MSC Form 29 (May 69)

FLIGHT PLANNING BRANCH

MCC-H

1030 EDT
25:00

FLIGHT PLAN

NOTES

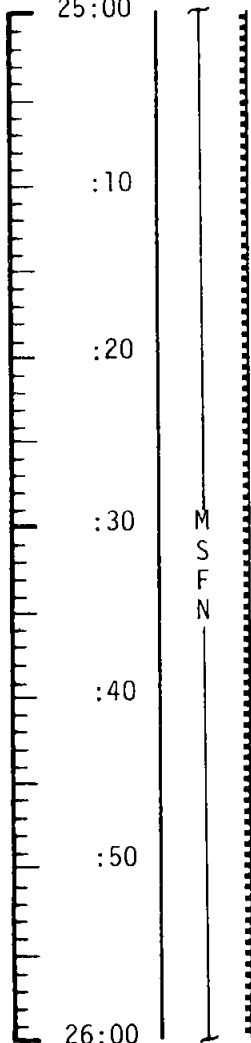

3. STAR 44 EFH (R3=00120)

4. STAR 44 EFH (R3=00120)

5. STAR 45 EFH (R3=00120)

UPLINK CMC

CSM STATE VECTOR
MCC2 TGT LOAD

UPDATE

MCC2 PAD DATA

:30

:40

:50

26:00

M
S
F
N

V66 - TRANS CSM STATE VECTOR
TO LM SLOT

RECORD MCC2 MNVR PAD

FOV=4°
GET=26:00

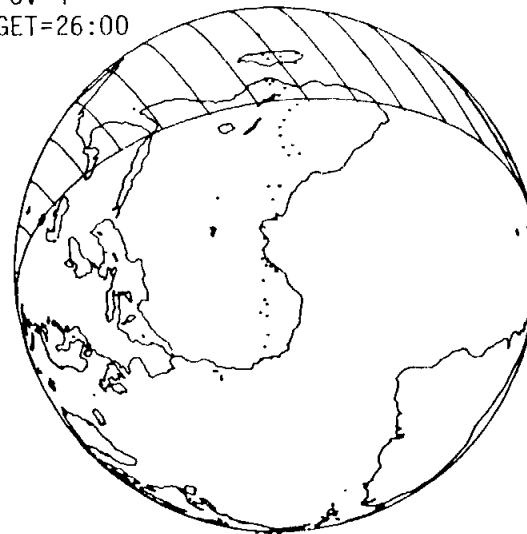

MISSION	EDITION	DATE	TIME	DAY/REV	PAGE
APOLLO 11	FINAL	JULY 1, 1969	25:00 - 26:00	2/TLC	3-18

MCC
BURN CHART

	P OR Y RATES	ATT DEVIATION	SHUTDOWN TIME	RESIDUALS
MCC2	10°/SEC TAKEOVER	+10° TAKEOVER	BT + 1 SEC	TRIM X AXIS ONLY (UNLESS X > 2 FPS)

MCC-H

1130 EDT

26:00

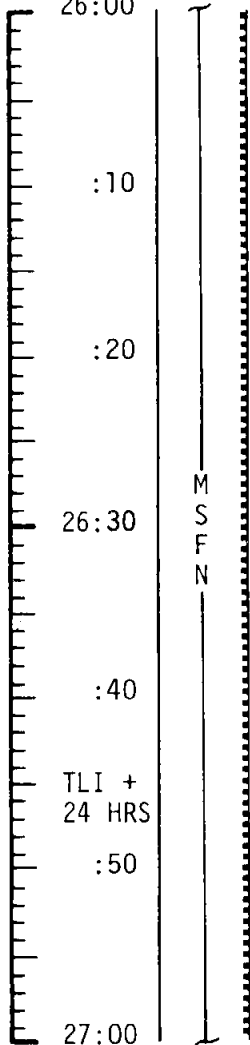

FLIGHT PLAN

NOTES

EXT ΔV - P30

SPS/RCS THRUST - P40/41

MNVR TO BURN ATT

SXT STAR CK

26:30

EMS ΔV TEST

SM RCS MON CK

:40

GDC ALIGN TO IMU

TLI +
24 HRS

MCC2 ΔV =NOMINALLY ZERO

SM RCS MON

SPS MON CK

MCC2 BURN STATUS REPORT

:50

V66 - TRANS CSM STATE VECTOR TO LM SLOT

27:00

BURN STATUS REPORT

X	X	<input type="checkbox"/>	•	ΔTIG
X	X	<input type="checkbox"/>	•	BT
<input type="checkbox"/>			•	V_{gx}
TRIM				
X	X	X		R
X	X	X		P
X	X	X		Y
<input type="checkbox"/>			•	V_{gx}
<input type="checkbox"/>			•	V_{gy}
<input type="checkbox"/>			•	V_{gz}
<input type="checkbox"/>			•	ΔV_c
X	X	X		FUEL
X	X	X		OX
X	X	X		UNBAL

MCC2 WILL BE PERFORMED IF ΔV WOULD EXCEED 25 FPS IF DELAYED TO MCC3 (LOI-22 HRS)

MISSION	EDITION	DATE	TIME	DAY/REV	PAGE
APOLLO 11	FINAL	JULY 1, 1969	26:00 - 27:00	2/TLC	3-19

MCC-H

1230 EDT

FLIGHT PLAN

NOTES

UPLINK

EARTH HORIZON
BIAS (ΔH)
(IF REQUIRED)

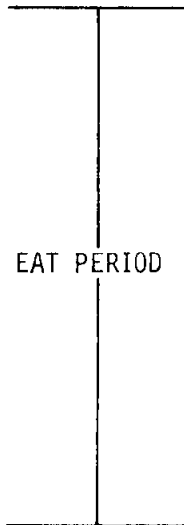
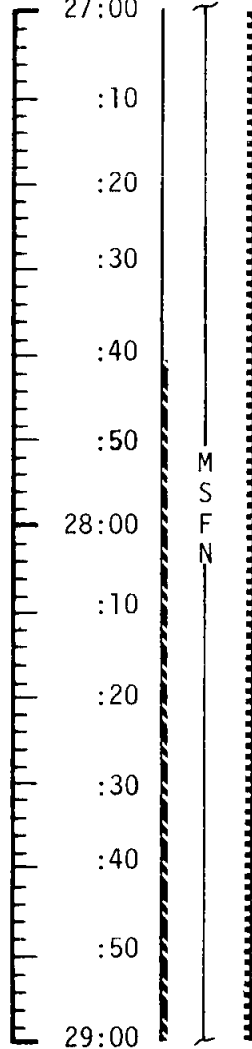

START PTC
P 90 Y 0

PTC

THE EARTH HORIZON
BIAS WILL BE UP-
DATED TO THE CMC
IF THE DIFFERENCE
BETWEEN THE SIGHT-
ING ΔH IS $\geq 8.3\text{KM}$

PTC ESTABLISHED
IN G&N P, Y
+30° DB, R RATE
OF 0.3°/SEC

MISSION	EDITION	DATE	TIME	DAY/REV	PAGE
APOLLO 11	FINAL	JULY 1, 1969	27:00 - 29:00	2/TLC	3-20

MSC Form 29 (May 69)

FLIGHT PLANNING BRANCH

MCC-H

FLIGHT PLAN

NOTES

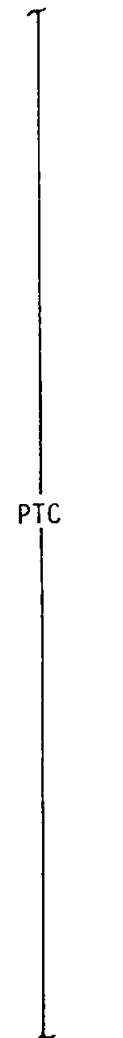
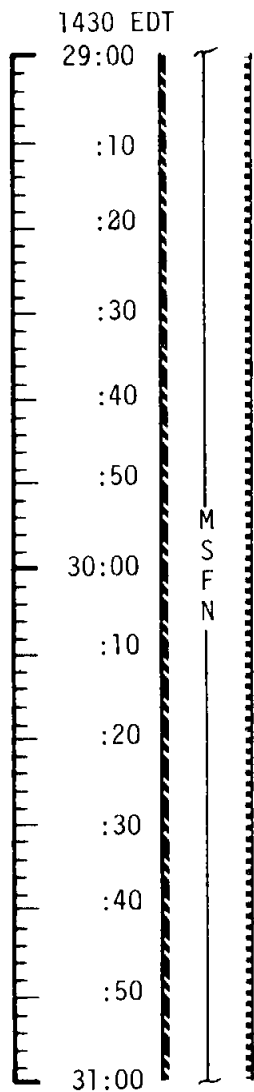

MISSION	EDITION	DATE	TIME	DAY/REV	PAGE
APOLLO 11	FINAL	JULY 1, 1969	29:00 - 31:00	2/TLC	3-21

MCC-H

FLIGHT PLAN

NOTES

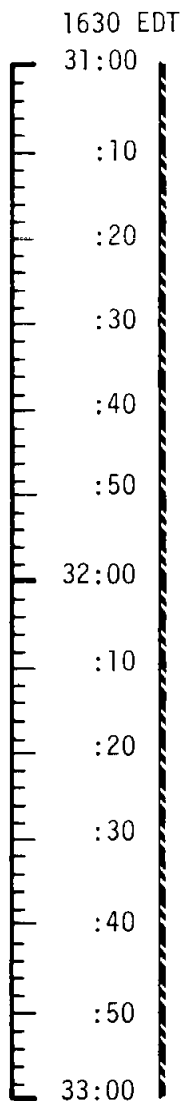

M
S
F
N

PTC

MISSION	EDITION	DATE	TIME	DAY/REV	PAGE
APOLLO 11	FINAL	JULY 1, 1969	31:00 - 33:00	2/TLC	3-22

MCC-H

FLIGHT PLAN

NOTES

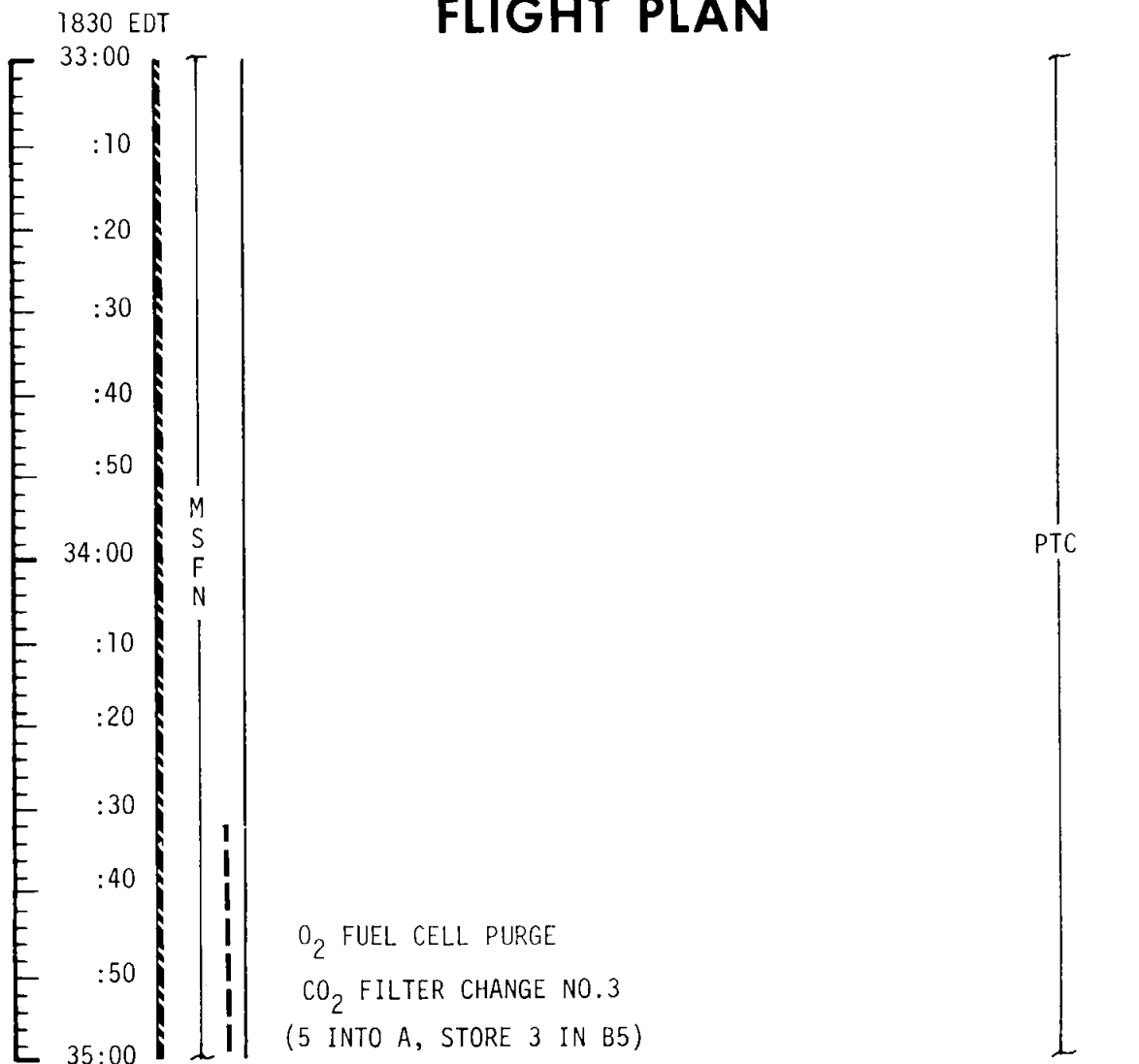

MISSION	EDITION	DATE	TIME	DAY/REV	PAGE
APOLLO 11	FINAL	JULY 1, 1969	33:00 - 35:00	2/TLC	3-23

MCC-H

UPDATE
BLOCK DATA

(2030 EDT)

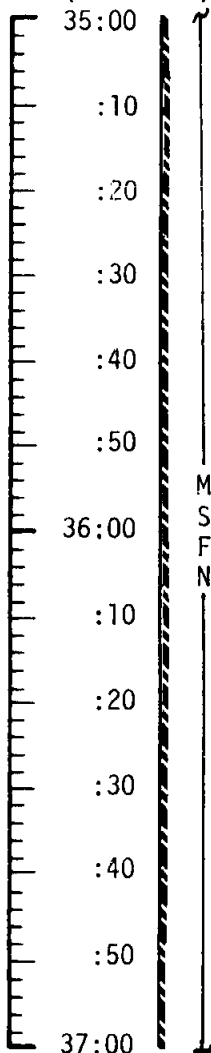

FLIGHT PLAN

NOTES

RECORD BLOCK DATA-
LOI-5 FLYBY TO
PRIME CLA

PRESLEEP CHECKLIST

CREW STATUS REPORT (RADIATION,
MEDICATION)
CYCLES O₂ & H₂ FANS
CHLORINATE POTABLE WATER
SELECT NORMAL LUNAR CONFIG
EXCEPT: (FOR COAST ASLEEP)
S-BD NORMAL MODE VOICE - OFF
S-BD AUX TAPE - OFF
TAPE RCDR FWD - OFF
GO TO HGA OR CONTINUE OMNI
OPS PER MSFN

OMNI OPS

S-BD ANT OMNI - OMNI
S-BD ANT OMNI - B

HI GAIN OPS

HI GAIN ANT BEAM - NARROW
HI GAIN ANT TRACK - REACQ
S-BD ANT-HI GAIN

VERIFY:

WASTE MNGT OVBD DRAIN-OFF
WASTE STOW VENT VLV-CLOSED
EMERG CABIN PRESS VLV-BOTH
SURGE TK O₂ VLV-ON
REPRESS PACK O₂ VLV-OFF
LM TUNNEL VENT VLV-LM/CM ΔP
POT H₂O HTR - OFF
AUTO RCS JET SELECT (16) - OFF

EAT PERIOD - ALL

REPORT LM/CM ΔP
REINITIATE CSM PURGE
(IF REQUIRED)

NOTE: THE LENGTH OF THE SECOND CSM CABIN PURGE
WILL BE DETERMINED REAL TIME BASED ON THE
LM LEAK RATE ENSURING LM O₂ PURITY REQUIRE-
MENTS ON THE LUNAR SURFACE

ONBOARD READOUT

BAT C _____
PYRO BAT A _____
PYRO BAT B _____

RCS A _____
B _____
C _____
D _____

DC IND SEL TO MNA
OR MNB

MISSION	EDITION	DATE	TIME	DAY/REV	PAGE
APOLLO 11	FINAL	JULY 1, 1969	35:00 - 37:00	2/TLC	3-24

MCC-H

2230 EDT

FLIGHT PLAN

NOTES

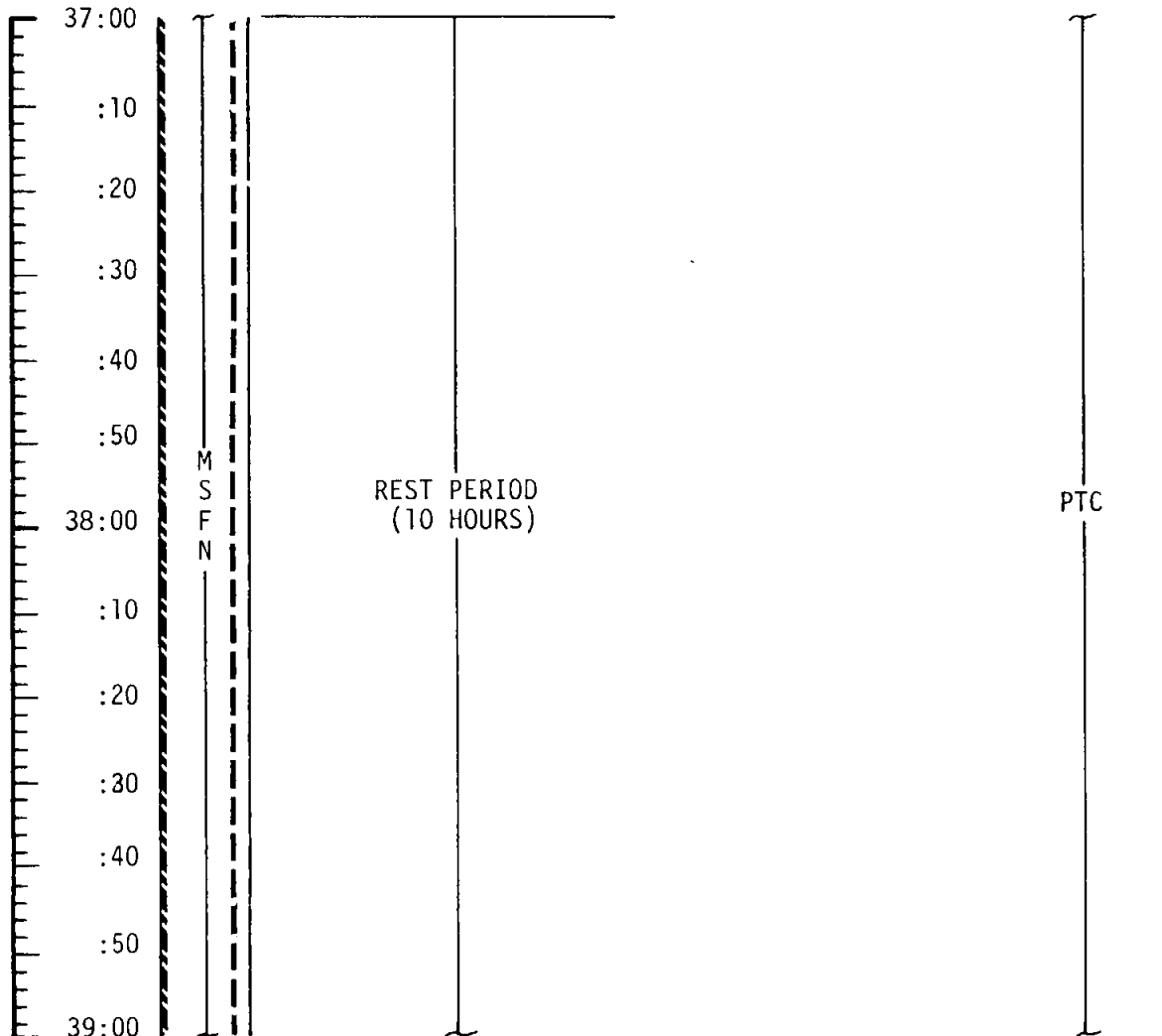

DURING REST PERIOD
2 CREWMEN IN REST
STATION, 1 IN LEFT
COUCH

MISSION	EDITION	DATE	TIME	DAY/REV	PAGE
APOLLO 11	FINAL	JULY 1, 1969	37:00 - 39:00	2/TLC	3-25

MCC-H

0030 EDT

FLIGHT PLAN

NOTES

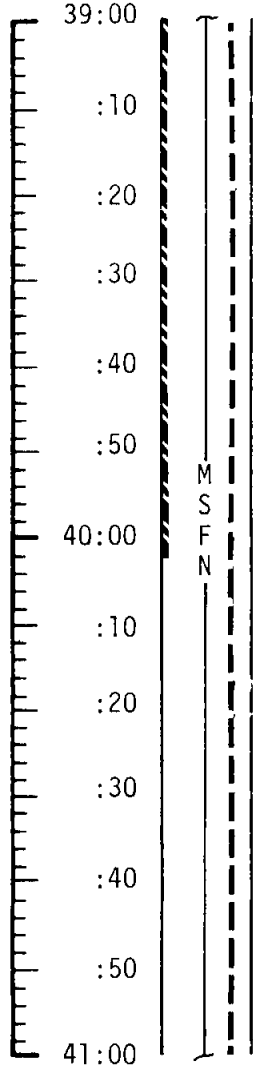

REST PERIOD
(10 HOURS)

PTC

MISSION	EDITION	DATE	TIME	DAY/REV	PAGE
APOLLO 11	FINAL	JULY 1, 1969	39:00 - 41:00	2/TLC	3-26

MCC-M

0230 EDT

FLIGHT PLAN

NOTES

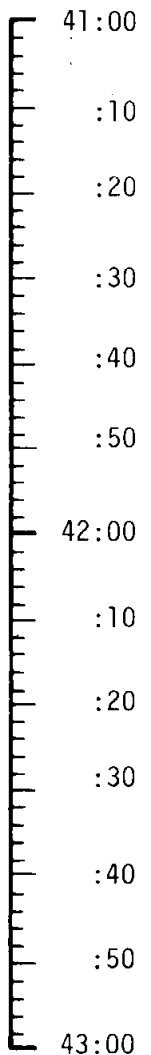

M
S
F
N

REST PERIOD
(10 HOURS)

PTC

MISSION	EDITION	DATE	TIME	DAY/REV	PAGE
APOLLO 11	FINAL	JULY 1, 1969	41:00 - 43:00	2/ILC	3-27

MCC-H

0430 EDT

FLIGHT PLAN

NOTES

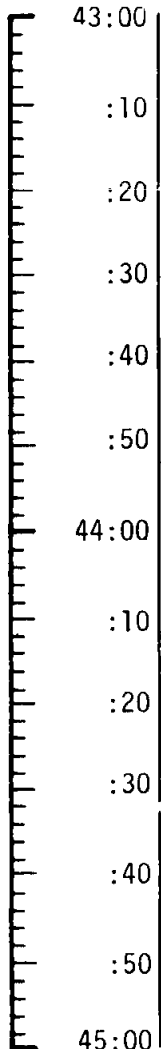

REST PERIOD
(10 HRS)

PTC

MISSION	EDITION	DATE	TIME	DAY/REV	PAGE
APOLLO 11	FINAL	JULY 1, 1969	43:00 - 45:00	2/TLC	3-28

MCC-H

0630 EDT

FLIGHT PLAN

NOTES

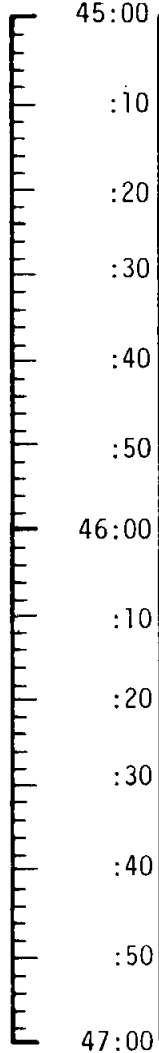

REST PERIOD
(10 HRS)

PTC

MISSION	EDITION	DATE	TIME	DAY/REV	PAGE
APOLLO 11	FINAL	JULY 1, 1969	45:00 - 47:00	2/TLC	3-29

MCC-H

0830 EDT

FLIGHT PLAN

NOTES

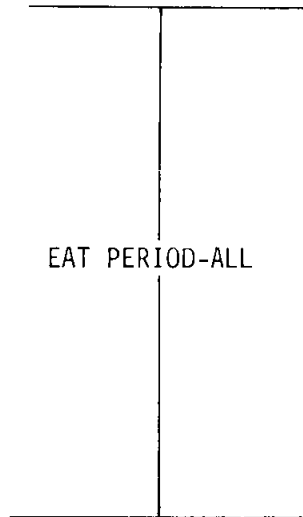
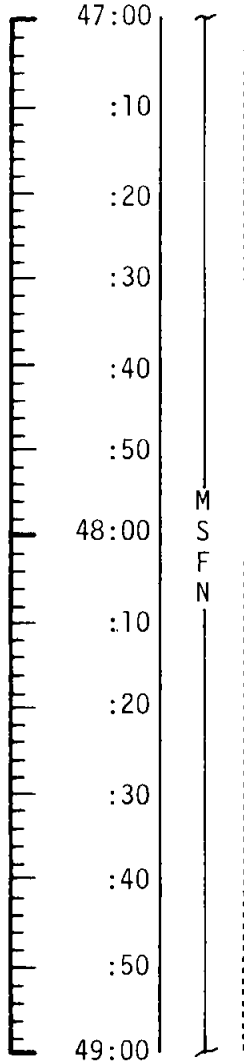

BATTERY CHARGE, BATTERY B

CO2 FILTER CHANGE NO.4
 (6 INTO B, STORE 4 IN B5)
 POST SLEEP CHECKLIST

CREW STATUS REPORT(SLEEP)
 CYCLE O₂ & H₂ FANS
 GDC ALIGN TO IMU
 CONSUMABLES UPDATE
 SELECT NORMAL LUNAR
 CONFIGURATION EXCEPT:
 S-BD AUX TAPE - OFF
 TAPE RCDR FWD - OFF
 POT H₂O HTR - ON
 AUTO RCS JET SELECT (16) - ON

PTC

UPDATE
 CONSUMABLES

CONSUMABLES UPDATE
 (Δ FROM NOMINAL)

GET: _____
 RCS TOT _____
 A _____
 B _____
 C _____
 D _____
 H₂ TOT _____
 O₂ TOT _____

MISSION	EDITION	DATE	TIME	DAY/REV	PAGE
APOLLO 11	FINAL	JULY 1, 1969	47:00 - 49:00	3/TLC	3-30

MCC-H

FLIGHT PLAN

NOTES

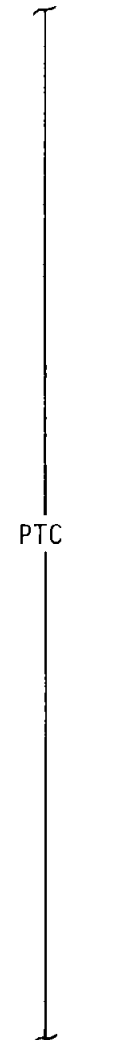
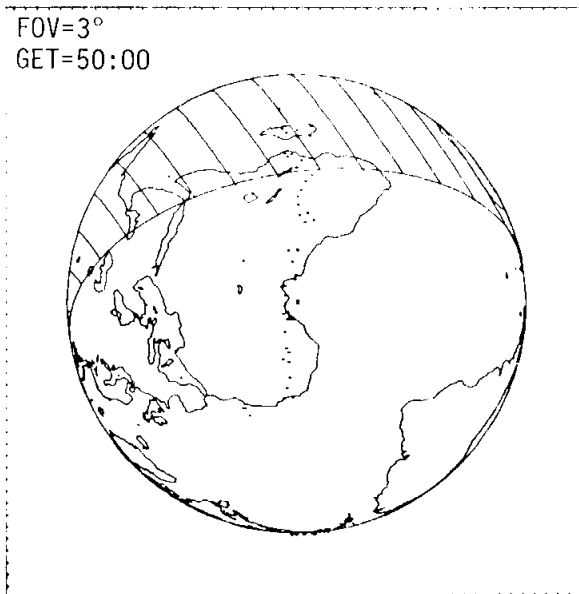
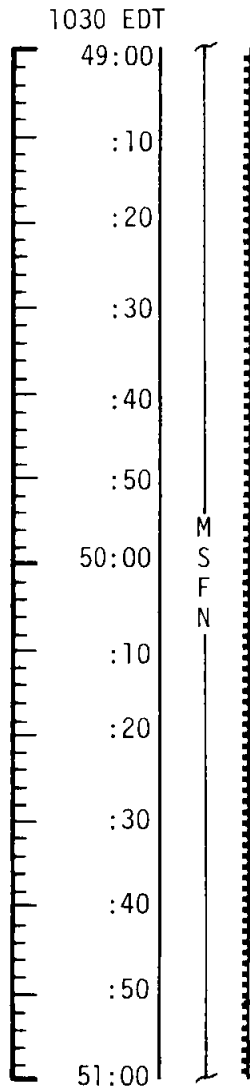

MISSION	EDITION	DATE	TIME	DAY/REV	PAGE
APOLLO 11	FINAL	JULY 1, 1969	49:00 - 51:00	3/TLC	3-31

MCC-H

1230 EDT

FLIGHT PLAN

NOTES

UPLINK

CSM STATE VECTOR

MCC 3 TGT LOAD

UPDATE

MCC 3 MNVR PAD

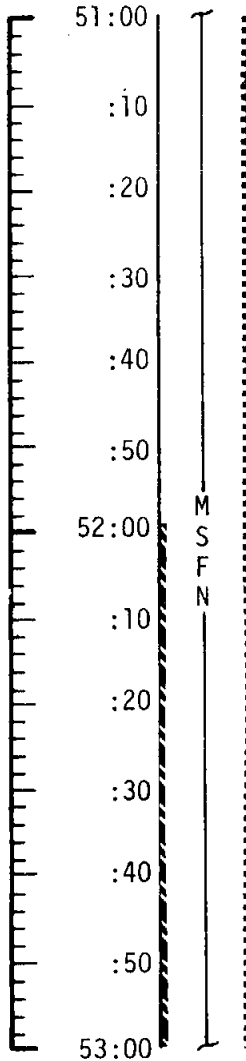

V66 TRANSFER CSM STATE VECTOR TO LM SLOT

RECORD MCC3 MNVR PAD
H₂ PURGE LINE HTRS-ON

O₂ & H₂ FUEL CELL PURGE

EAT PERIOD-ALL

PTC

MISSION	EDITION	DATE	TIME	DAY/REV	PAGE
APOLLO 11	FINAL	JULY 1, 1969	51:00 - 53:00	3/TLC	3-32

THIS PAGE INTENTIONALLY LEFT BLANK.

MCC
BURN CHART

	P OR Y RATES	ATT DEVIATION	SHUTDOWN TIME	RESIDUALS
MCC3	10°/SEC TAKEOVER	+10° TAKEOVER	BT + 1 SEC	TRIM X AXIS ONLY (UNLESS X > 2 FPS)

MCC-H

1430 EDT

FLIGHT PLAN

NOTES

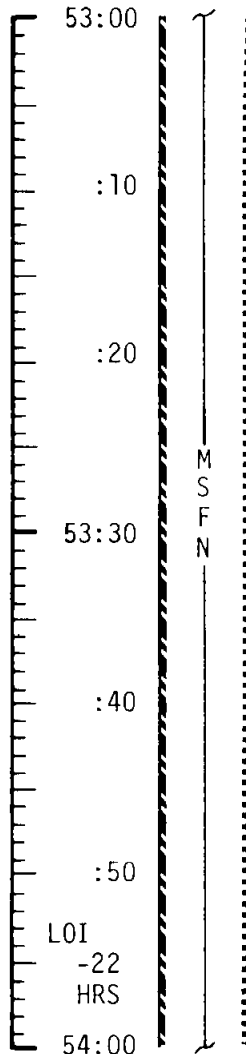

IMU REALIGN - P52
OPTION 3 - REFSMMAT

BURN STATUS REPORT

X	X	<input type="checkbox"/>	•	ΔTIG
X	X	<input type="checkbox"/>	•	BT
<input type="checkbox"/>	<input type="checkbox"/>	<input type="checkbox"/>	•	V _{gx}
TRIM				
X	X	X		R
X	X	X		P
X	X	X		Y
<input type="checkbox"/>	<input type="checkbox"/>	<input type="checkbox"/>	•	V _{gx}
<input type="checkbox"/>	<input type="checkbox"/>	<input type="checkbox"/>	•	V _{gy}
<input type="checkbox"/>	<input type="checkbox"/>	<input type="checkbox"/>	•	V _{gz}
<input type="checkbox"/>	<input type="checkbox"/>	<input type="checkbox"/>	•	ΔV _c
X	X	X		FUEL
X	X	X		OX
X	X	X		UNBAL

EXT ΔV - P30

SPS/RCS THRUST - P40/41

MNVR TO BURN ATT

SXT STAR CK (STOW OPTICS)

EMS ΔV TEST

SM RCS MON CK

GDC ALIGN TO IMU

MCC3 ΔV=NOMINALLY ZERO

SM RCS MON CK

SPS MON CK

P52 (PTC REFSMMAT)

N71: _____

N05: _____

N93: _____

X _____

Y _____

Z _____

GET _____ : _____ :

MCC3 WILL BE EXECUTED
IF ΔV > 3 FPS
AND IF LOI1 CANNOT BE
TARGETED TO CORRECT
THE TLC DISPERSIONS.

MISSION	EDITION	DATE	TIME	DAY/REV	PAGE
APOLLO 11	FINAL	JULY 1, 1969	53:00 - 54:00	3/TLC	3-33

MCC-H

FLIGHT PLAN

NOTES

1530 EDT
 54:00
 :10
 :20
 :30
 :40
 :50
 55:00
 :10
 :20
 :30
 :40
 :50
 56:00

M
S
F
N

MCC 3 BURN STATUS REPORT
 V66 - TRANS CSM STATE VECTOR
 TO LM SLOT

START PTC
 P 90 Y 0°
 PTC

PRESS CM TO 5.7 PSIA
 CM/LM PRESSURE EQUALIZATION
 VLV - OPEN
 PRESSURIZE LM

MISSION	EDITION	DATE	TIME	DAY/REV	PAGE
APOLLO 11	FINAL	JULY 1, 1969	54:00 - 56:00	3/TLC	3-34

FLIGHT PLAN

CSM

LM

MCC-H

CMP

1730 EDT

CDR

LMP

CLEAR TUNNEL OF CM HATCH
 INSPECT TUNNEL & DOCKING LATCHES
 REMOVE PROBE & DROGUE
 TEMPORARILY STOW PROBE AND DROGUE
 CONFIGURE DSE TO RECORD LM DATA
 DUMP DSE (LM DATA)

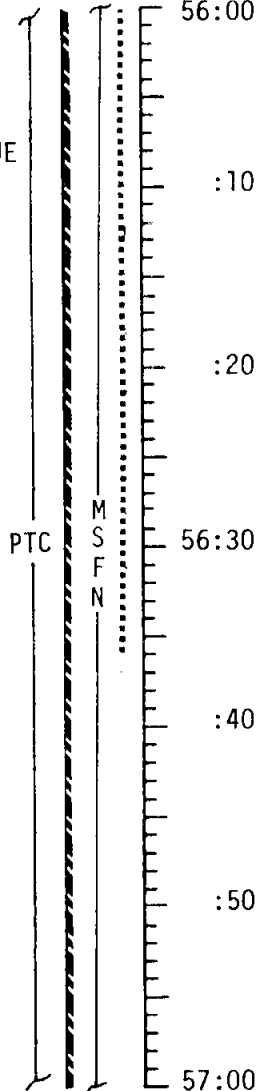

	OPEN LM HATCH RECORD ROLL CAL ANGLE IVT TO LM
	ACT VHF B FOR DATA XMIT FOR 5 MINUTES
IVT TO LM	ASSIST CDR
LM FAMILIARIZATION	LM FAMILIARIZATION

VERIFY OPERATION OF LM 16mm CAMERA

MISSION	EDITION	DATE	TIME	DAY/REV	PAGE
APOLLO 11	FINAL	JULY 1, 1969	56:00 - 57:00	3/TLC	3-35

FLIGHT PLANNING BRANCH

FLIGHT PLAN

CSM
CMP

LM

MCC-H

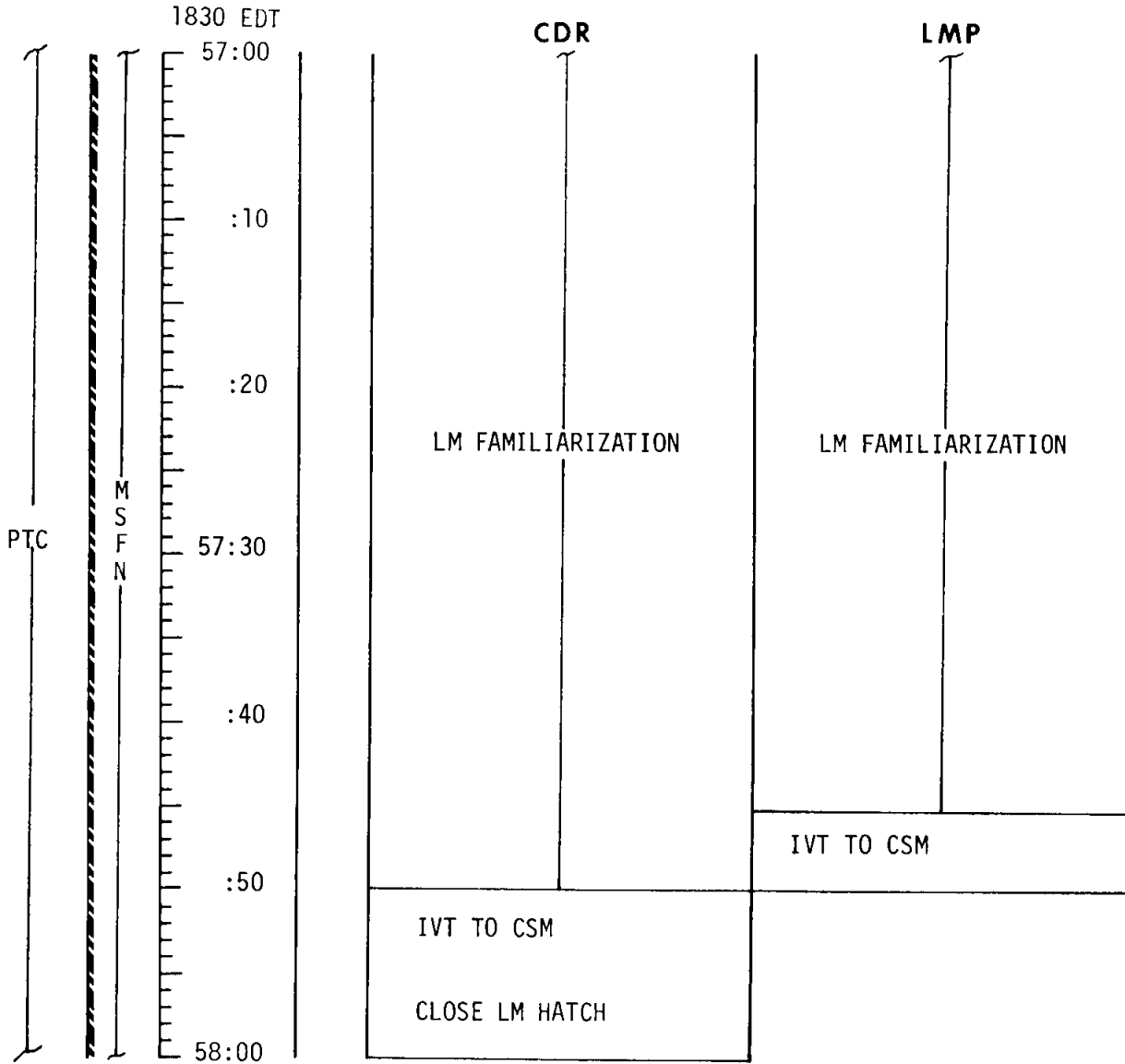

MISSION	EDITION	DATE	TIME	DAY/REV	PAGE
APOLLO 11	FINAL	JULY 1, 1969	57:00 - 58:00	3/TLC	3-36

MCC-H

FLIGHT PLAN

NOTES

1930 EDT

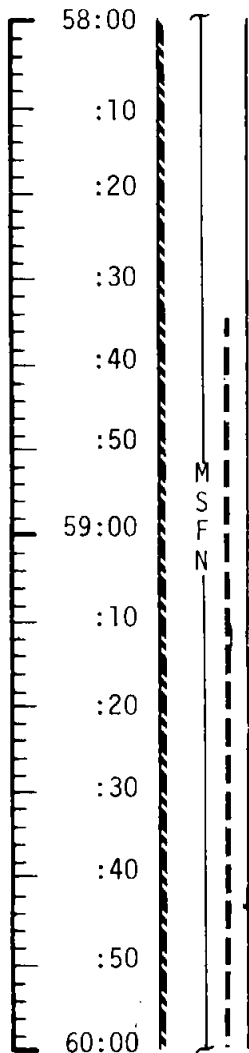

INSTALL PROBE AND DROGUE
 INSTALL CM HATCH
 LM TUNNEL VENT VALVE - LM/CM AP

CO₂ FILTER CHANGE NO.5
 (7 INTO A, STORE 5 IN B6)

EAT PERIOD-ALL

PTC

180,000 NM from EARTH

ONBOARD READOUT	
BAT C	_____
PYRO BAT A	_____
PYRO BAT B	_____
RCS A	_____
B	_____
C	_____
D	_____
DC IND SEL TO MNA	
OR MNB	

MISSION	EDITION	DATE	TIME	DAY/REV	PAGE
APOLLO 11	FINAL	JULY 1, 1969	58:00 - 60:00	3/TLC	3-37

MCC-H

2130 EDT

FLIGHT PLAN

NOTES

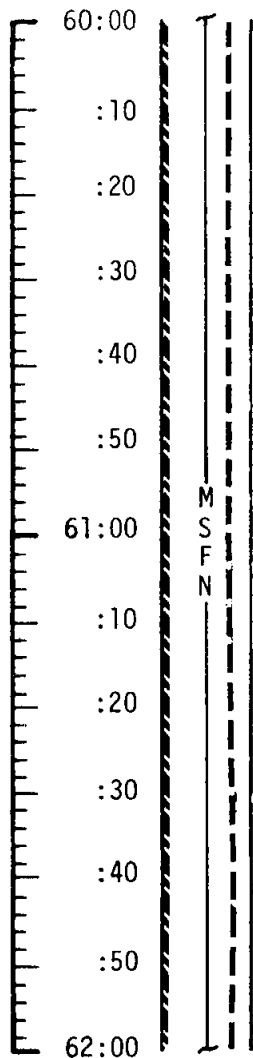

REST PERIOD
(9 HOURS)

PRESLEEP CHECKLIST

CREW STATUS REPORT (RADIATION & MEDICATION)
CYCLE O₂ & H₂ FANS

CHLORINATE POTABLE WATER
SELECT NORMAL LUNAR CONFIGURATION EXCEPT:
S-BD NORMAL MODE
VOICE - OFF
S-BD SQUELCH - ENABLE
S-BD AUX TAPE OFF
TAPE RCDR FWD - OFF
GO TO HGA OR CONTINUE OMNI OPS PER MSFN

OMNI OPS

S-BD ANT OMNI - OMNI
S-BD ANT OMNI - B

HI GAIN OPS

HI GAIN ANT BEAM - NARROW
HI GAIN ANT TRACK - REAQ
S-BD ANT - HI GAIN

VERIFY:

WASTE MNGT OVBD DRAIN - OFF
WASTE STOW VENT VLV - CLOSED
EMERG CABIN PRESS VLV - ON
REPRESS PACK O₂
VLV - OFF
LM TUNNEL VENT VLV - LM/CM ΔP
POT H₂O HTR - OFF

AUTO RCS JET SELECT (16) - OFF

PTC

DURING REST PERIOD
2 CREWMAN IN REST STATIONS, 1 IN LEFT COUCH.

MISSION	EDITION	DATE	TIME	DAY/REV	PAGE
APOLLO 11	FINAL	JULY 1, 1969	60:00 - 62:00	3/TLC	3-38

MCC-H

FLIGHT PLAN

NOTES

2330 EDT
 62:00
 :10
 :20
 :30
 :40
 :50
 63:00
 :10
 :20
 :30
 :40
 :50
 64:00

M
S
F
N

REST PERIOD
(9 HOURS)

PTC

MISSION	EDITION	DATE	TIME	DAY/REV	PAGE
APOLLO 11	FINAL	JULY 1, 1969	62:00 - 64:00	3/TLC	3-39

MCC-H

0130 EDT

FLIGHT PLAN

NOTES

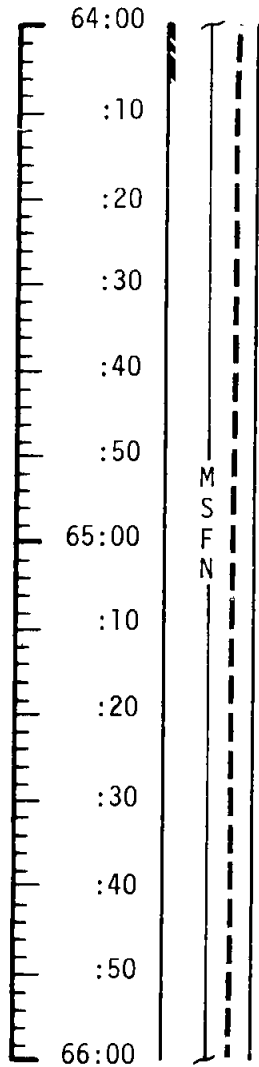

REST PERIOD
(9 HOURS)

PTC

MISSION	EDITION	DATE	TIME	DAY/REV	PAGE
APOLLO 11	FINAL	JULY 1, 1969	64:00 - 66:00	3/TLC	3-40

MCC-H

0330 EDT

FLIGHT PLAN

NOTES

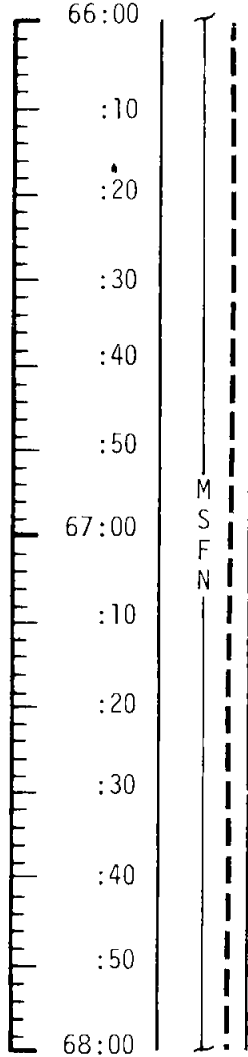

REST PERIOD
(9 HOURS)

PTC

MISSION	EDITION	DATE	TIME	DAY/REV	PAGE
APOLLO 11	FINAL	JULY 1, 1969	66:00 - 68:00	3/TLC	3-41

MCC-H

0530 EDT

FLIGHT PLAN

NOTES

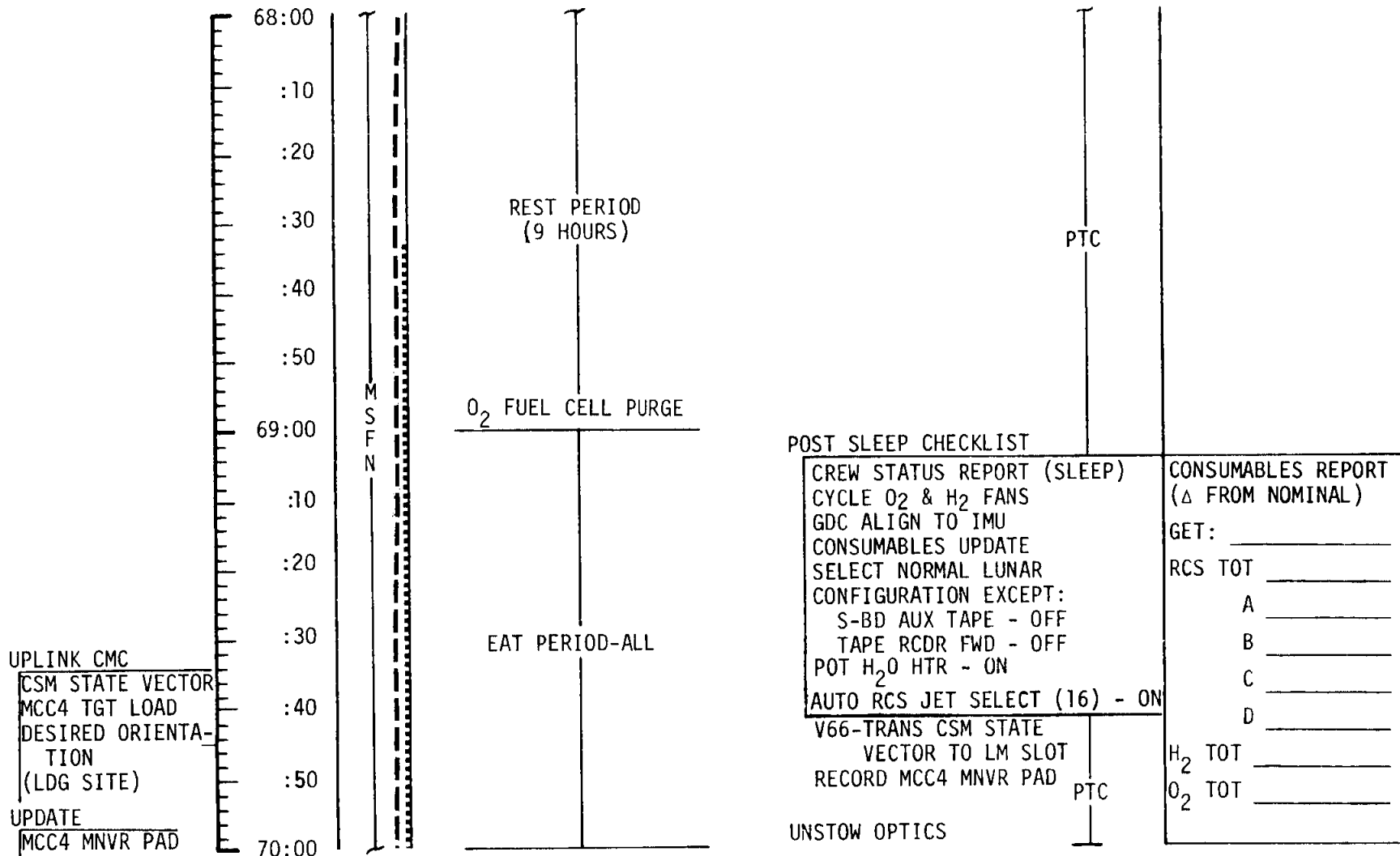

MISSION	EDITION	DATE	TIME	DAY/REV	PAGE
APOLLO 11	FINAL	JULY 1, 1969	68:00 - 70:00	3/TLC	3-42

THIS PAGE INTENTIONALLY LEFT BLANK.

MCC
BURN CHART

	P OR Y RATES	ATT DEVIATION	SHUTDOWN TIME	RESIDUALS
MCC4	10°/SEC TAKEOVER	+10° TAKEOVER	BT + 1 SEC	TRIM X AXIS ONLY

MCC-H

0730 EDT

FLIGHT PLAN

NOTES

UPDATE
BLOCK DATA

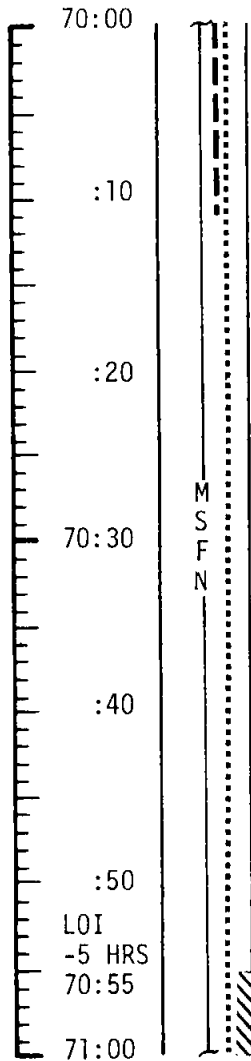

IMU REALIGN - P52
(OPTION 1 - PREFERRED)

RECORD BLOCK DATA-
PC + 2 HRS FAST
RETURN TO ANY CLA

REPORT:

P52 (LDG SITE REFSMMAT)

N71: _____

N05: _____

N93: _____

X _____

Y _____

Z _____

GET _____ : _____ : _____

EXT ΔV - P30

BURN STATUS REPORT

X	X	<input type="checkbox"/>	•	Δ TIG
X	X	<input type="checkbox"/>	•	BT
<input type="checkbox"/>	<input type="checkbox"/>	<input type="checkbox"/>	•	V_{gx}
TRIM				
X	X	X		R
X	X	X		P
X	X	X		Y
<input type="checkbox"/>	<input type="checkbox"/>	<input type="checkbox"/>	•	V_{gx}
<input type="checkbox"/>	<input type="checkbox"/>	<input type="checkbox"/>	•	V_{gy}
<input type="checkbox"/>	<input type="checkbox"/>	<input type="checkbox"/>	•	V_{gz}
<input type="checkbox"/>	<input type="checkbox"/>	<input type="checkbox"/>	•	ΔV_c
X	X	X		FUEL
X	X	X		OX
X	X	X		UNBAL

SPS/RCS THRUST P40/41

MNVR TO BURN ATT

SXT STAR CK

EMS ΔV TEST

SM RCS MON CK

GDC ALIGN TO IMU

MCC 4 ΔV =NOMINALLY ZERO

SM RCS MON CK

MCC 4 WILL BE
EXECUTED ONLY IF
LOI₁ CANNOT BE
TARGETED TO CONNECT
MCC 3 DISPERSIONS

MISSION	EDITION	DATE	TIME	DAY/REV	PAGE
APOLLO 11	FINAL	JULY 1, 1969	70:00 - 71:00	3/TLC	3-43

MCC-H

0830 EDT

FLIGHT PLAN

NOTES

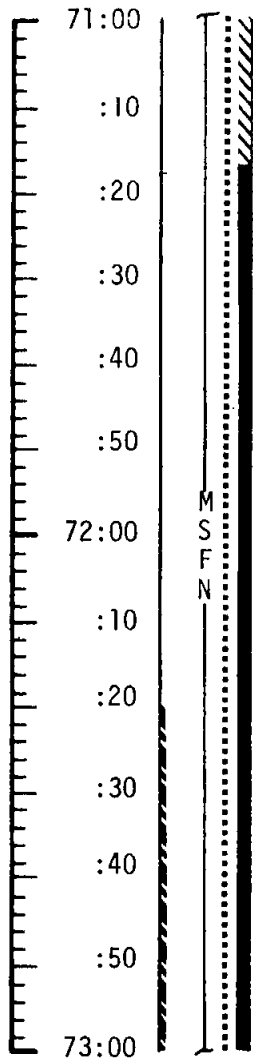

SPS MON CK
 MCC 4 BURN STATUS REPORT
 V66 - TRANS CSM STATE VECTOR TO LM SLOT

CO₂ FILTER CHANGE NO.6
 (8 INTO B, STORE 6 IN B6)
 PRE-LOI ECS REDUNDANT COMPONENT CK
 ACTIVATE PRIMARY EVAPORATOR

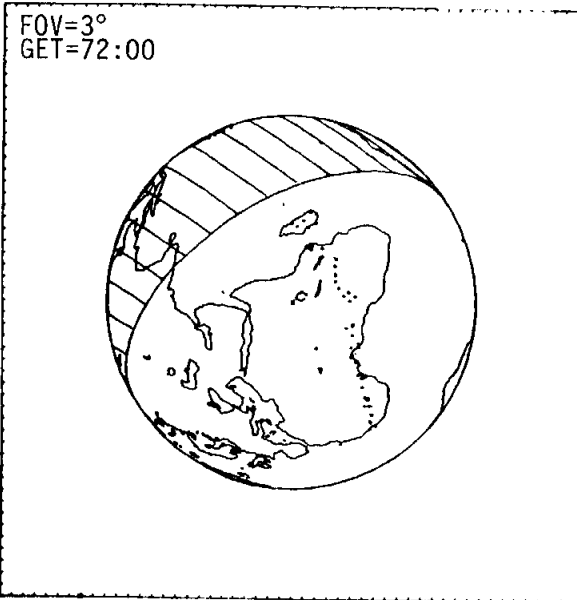

MISSION	EDITION	DATE	TIME	DAY/REV	PAGE
APOLLO 11	FINAL	JULY 1, 1969	71:00 - 73:00	4/TLC	3-44

FLIGHT PLAN

NOTES

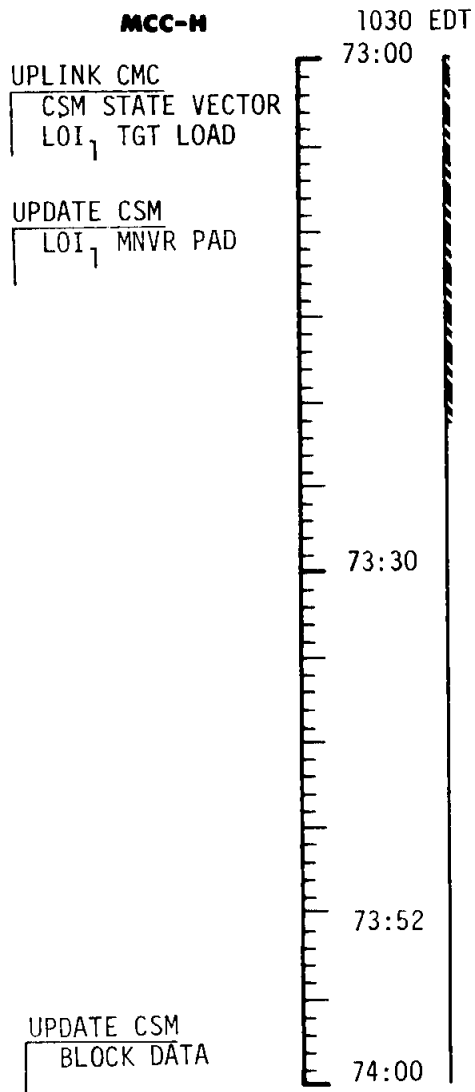

V66 TRANSFER CSM STATE VECTOR TO LM SLOT

COPY LOI₁ P30 MANEUVER PAD

IMU REALIGN - P52
AND DRIFT CK
OPTION 3 - REFSMMAT

COPY BLOCK DATA (TEI₁ & TEI₄)

TEI₁ BLOCK DATA ASSUM
LOI₁ ACCOMPLISHED
TEI₄ ASSUMES LOI₁
ACCOMPLISHED BUT
NO LOI₂

REPORT:

P52 (LDG SITE REFSMMAT)
N71: _____
N05: _____
N93: _____
X _____
Y _____
Z _____
GET _____ : _____ :

MISSION	EDITION	DATE	TIME	DAY/REV	PAGE
APOLLO 11	FINAL	JULY 1, 1969	73:00 - 74:00	4/TLC	3-45

MCC-H

1130 EDT

FLIGHT PLAN

NOTES

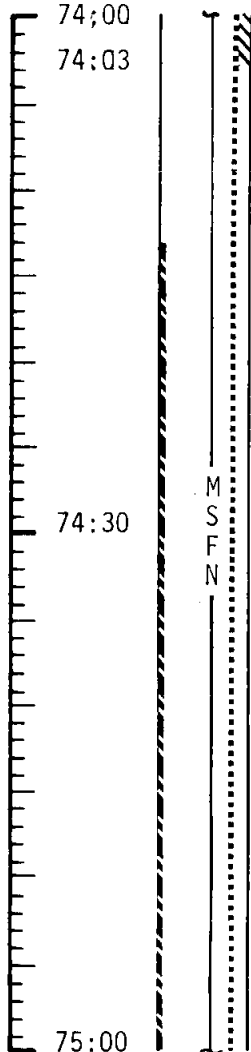

P30 EXTERNAL ΔV
 EXT ΔV - P30
 P00. V49
 MANEUVER TO BURN ATTITUDE R 357.9, P 225.4, Y 346.2

SEXTANT STAR CHECK

ROLL TO ACQUIRE MSFN
 SPS PRETHRUST - P40 (TVC TEST)
 ROLL TO BURN ATTITUDE

S-BAND SQUELCH - OFF

PITCH UP 360° AT 0.2°/SEC
 TO OBSERVE LUNAR SURFACE

GO INERTIAL
 V64 REACQUIRE MSFN

EMS ΔV TEST

MISSION	EDITION	DATE	TIME	DAY/REV	PAGE
APOLLO 11	FINAL	JULY 1, 1969	74:00 - 75:00	4/TLC	3-46

THIS PAGE INTENTIONALLY LEFT BLANK.

LOI₁
BURN CHART

	P OR Y RATES	ATT DEVIATION	SHUTDOWN TIME	RESIDUALS
LOI ₁	10°/SEC TAKEOVER	+10° TAKEOVER	BT + 10 SEC	DO NOT TRIM
LOI ₁ ABORT MODES				
LOI ₁ V _{GO}	BT	TRAJECTORY	ABORT MODE	
2924.0 - 2129.0	0 - 110	HYPERBOLIC	MODE I - COAST 2 HR - DPS - P37 (P37 BEYOND SPHERE FOR VGO >2279 AND BT <90)	
2129.0 - 1589.0	110 - 180	UNSTABLE	MODE II - COAST 2 HR - 2 DPS BURNS FOR STABILIZATION AND WATER or CLA LANDING	
1589.0 - 0	180 - 365	LUNAR ORBIT	MODE III - DPS BURN AFTER ONE REV	

MCC-H

1230 EDT

FLIGHT PLAN

NOTES

UPDATE CSM
 LOS AND AOS
 (WITH & WITHOUT
 LOI₁)

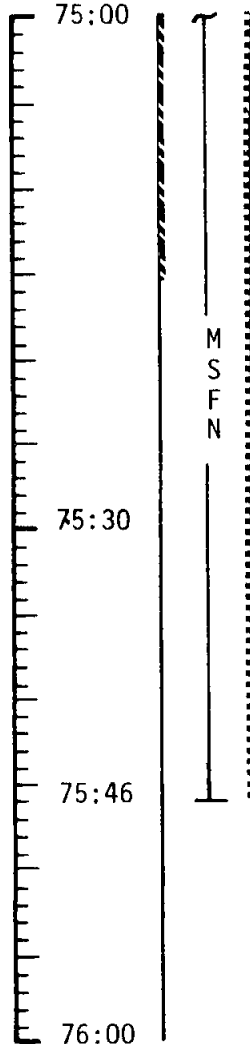

CMP - PRE LOI₁ SYSTEMS CKS

C&W CK
 CM RCS CK
 SM RCS CK
 SPS PERIODIC MON
 EPS PERIODIC MON
 ECS PERIODIC MON

COPY UPDATE: LOS : :
 AOS WITH LOI₁ : :
 AOS W/O LOI₁ : :

EXT ΔV - P30 (RELOAD N81 WITH PAD VALUES)
 SPS THRUST - P40
 MNVR TO BURN ATTITUDE

R357.9, P225.4, Y346.2

SEXTANT STAR CHECK

GO/NO GO FOR LOI₁
 PCM-LO
 S-BAND AUX-DOWN VOICE BACKUP

GO/NO GO

75:46

GDC ALIGN TO IMU

LOI₁

GETI: 75:54:28
 NO ULLAGE
 BT: 5 MIN 59.9 SEC
 ΔV_T: 2924.1 FPS
 ORBIT: 59.2 X 169.8
 RETROGRADE
 DO NOT TRIM

NOTE: INITIATE LOI₁
 WITH BANK B BALL VALVES

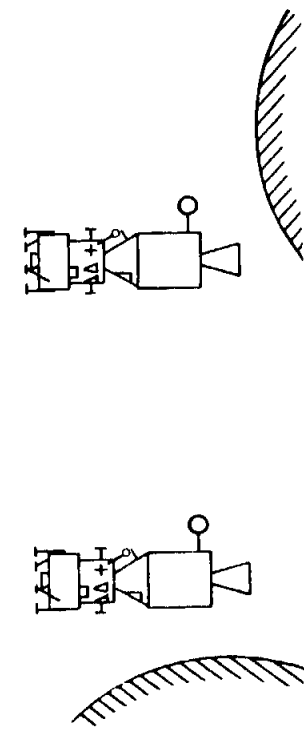

MISSION	EDITION	DATE	TIME	DAY/REV	PAGE
APOLLO 11	FINAL	JULY 1, 1969	75:00 - 76:00	4/1	3-47

MCC-H

1330 EDT

FLIGHT PLAN

NOTES

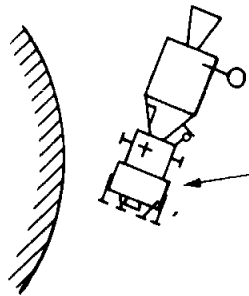

R180, P315/295 YO
HGA P-20, Y355
DUMP DSE

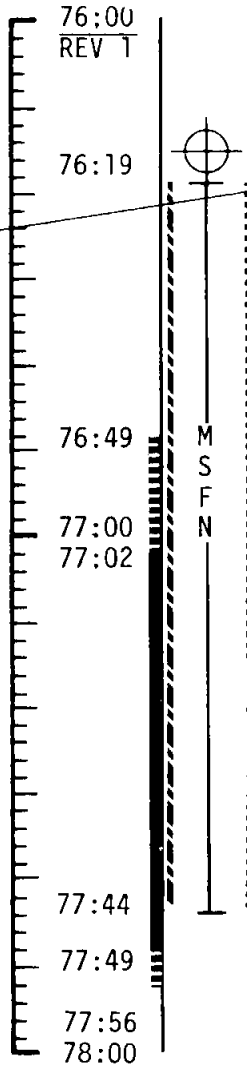

V66 - TRANSFER CSM STATE
VECTOR TO LM SLOT
SM RCS AND SPS MON CK
ROLL 180°, PITCH DOWN 70°,
YAW LEFT 14°
V64 REACQUIRE MSFN
ORB RATE

LOI₁ BURN STATUS REPORT

BURN STATUS REPORT

X	X	<input type="checkbox"/>	•	ΔTIG
X	X		•	BT
<input type="checkbox"/>			•	V _{gx}
TRIM				
X	X	X		R
X	X	X		P
X	X	X		Y
<input type="checkbox"/>			•	V _{gx}
<input type="checkbox"/>			•	V _{gy}
<input type="checkbox"/>			•	V _{gz}
<input type="checkbox"/>			•	ΔV _c
X	X	X		FUEL
X	X	X		OX
X	X	X		UNBAL

MISSION	EDITION	DATE	TIME	DAY/REV	PAGE
APOLLO 11	FINAL	JULY 1, 1969	76:00 - 78:00	4/1	3-48

MCC-H

1530 EDT

78:00

REV 2

FLIGHT PLAN

NOTES

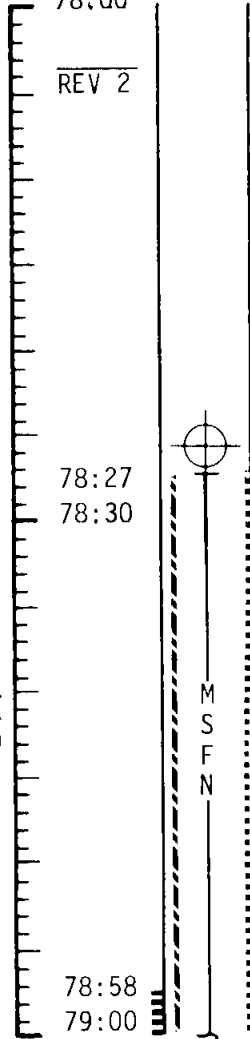

DUMP DSE

UPLINK CMC

CSM STATE VECTOR
LOI ₂ TARGET LOAD

UPDATE CSM

LOI ₂ MNVR PAD
BLOCK DATA

EAT PERIOD

V64 REACQUIRE MSFN
HGA P-20, Y359

V66 TRANSFER CSM STATE VECTOR TO LM SLOT

RECORD LOI₂ MNVR PAD AND BLOCK DATA (TEI₅)

TEI₅ BLOCK DATA
ASSUMES LOI₁ & LOI₂
ACCOMPLISHED

MISSION	EDITION	DATE	TIME	DAY/REV	PAGE
APOLLO 11	FINAL	JULY 1, 1969	78:00 - 79:00	4/2	3-49

MCC-H

1630 EDT

FLIGHT PLAN

NOTES

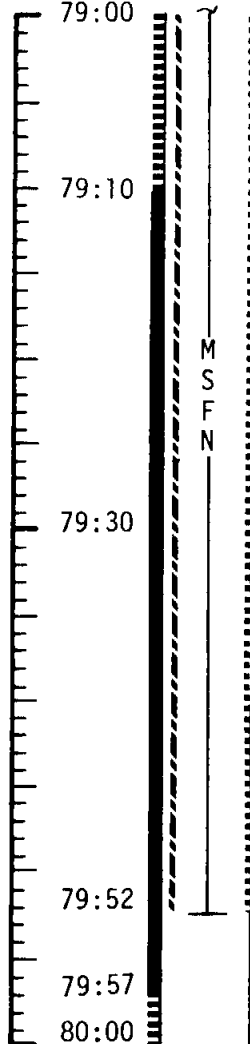

PIPA BIAS CHECK

CMP - PRE LOI₂ SYSTEMS MONITOR

GO INERTIAL

IMU REALIGN - P52
 OPTION 3 - REFSMMAT
 DRIFT CHECK

R 180, P 315/182, Y 0
 HGA P -45, Y 180

P30 EXTERNAL ΔV
 MANEUVER TO LOI₂ BURN ATTITUDE

P40 SPS THRUST
 GO INERTIAL

R 0, P 50.1/212.3, Y 359.6

SEXTANT STAR CHECK
 EMS ΔV TEST
 SM RCS CHECK
 LOAD DAP FOR 2 JET ULLAGE
 R1 = 20111
 R2 = 11111

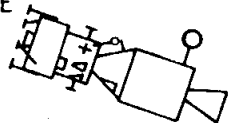
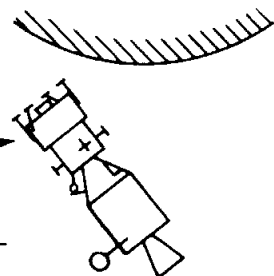

REPORT:

P52 (LDG SITE REFSMMAT)

N71: _____

N05: _____

N93: _____

X _____

Y _____

Z _____

GET _____:_____:_____

79:15

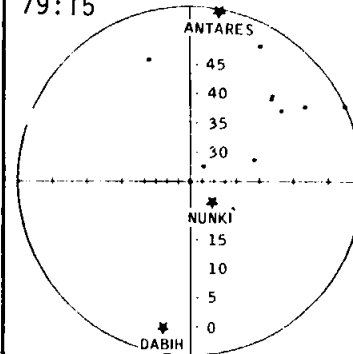

MISSION	EDITION	DATE	TIME	DAY/REV	PAGE
APOLLO 11	FINAL	JULY 1, 1969	79:00 - 80:00	4/2	3-50

MSC Form 29 (May 69)

FLIGHT PLANNING BRANCH

THIS PAGE INTENTIONALLY LEFT BLANK.

LOI₂
BURN CHART

	P OR Y RATES	ATT DEVIATION	SHUTDOWN TIME	RESIDUALS
LOI ₂	10°/SEC TAKEOVER	+10° TAKEOVER	BT + 1 SEC	TRIM X AXIS TO 1 FPS

FLIGHT PLAN

NOTES

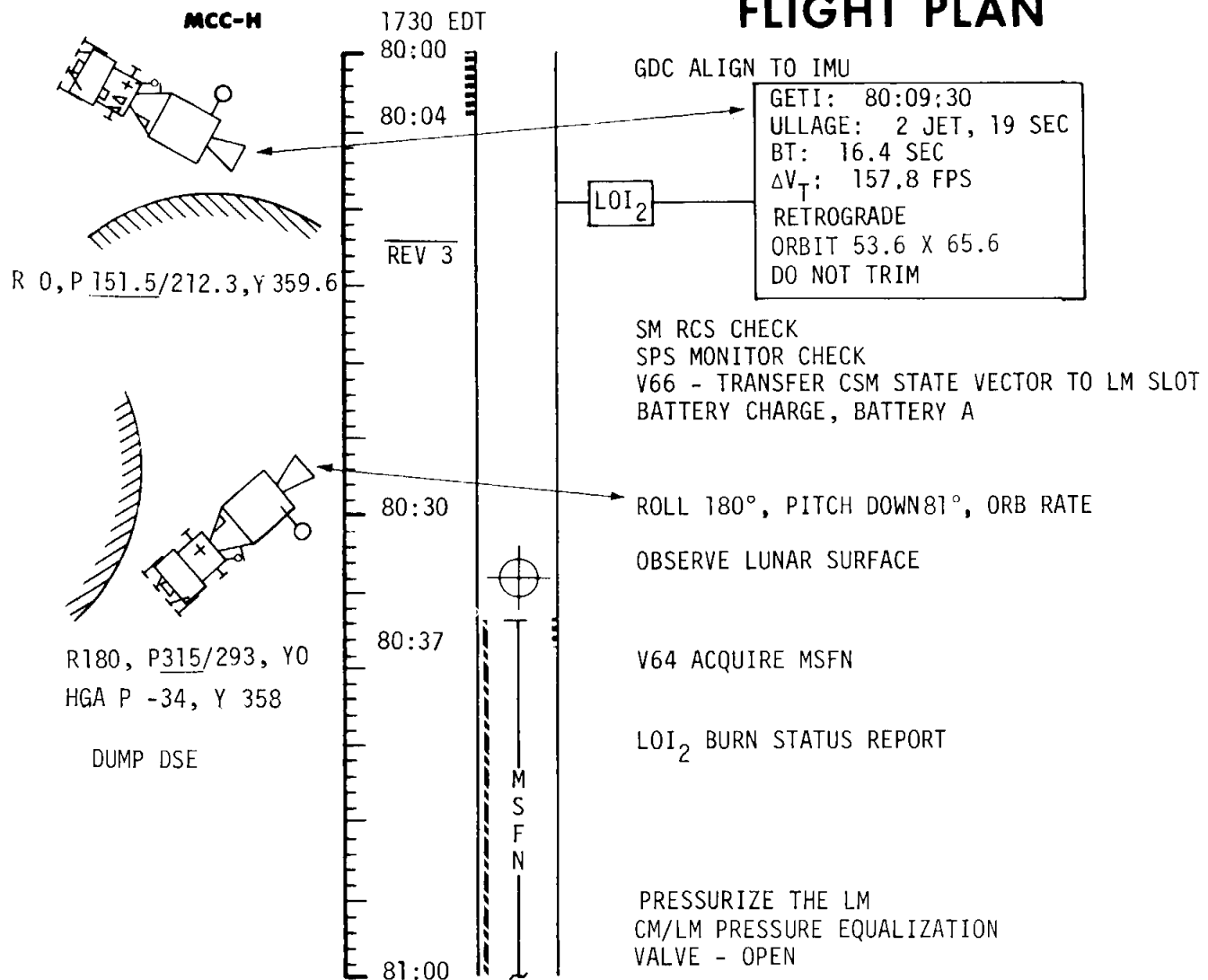

BURN STATUS REPORT				
X	X	<input type="checkbox"/>	•	ΔTIG
X	X		•	BT
<input type="checkbox"/>			•	V _{gx}
TRIM				
X	X	X		R
X	X	X		P
X	X	X		Y
<input type="checkbox"/>			•	V _{gx}
<input type="checkbox"/>			•	V _{gy}
<input type="checkbox"/>			•	V _{gz}
<input type="checkbox"/>			•	ΔV _c
X	X	X		FUEL
X	X	X		OX
X	X	X		UNBAL

MISSION	EDITION	DATE	TIME	DAY/REV	PAGE
APOLLO 11	FINAL	JULY 1, 1969	80:00 - 81:00	4/3	3-51

MCC-H

1830 EDT

FLIGHT PLAN

NOTES

UPDATE CSM

P22 AUTO OPTICS
ALT LMK (A-1)
TRACKING
(SEE GET 82:35)

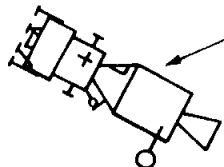

R 180, P 318/196, Y 0

HGA P -60, Y 182

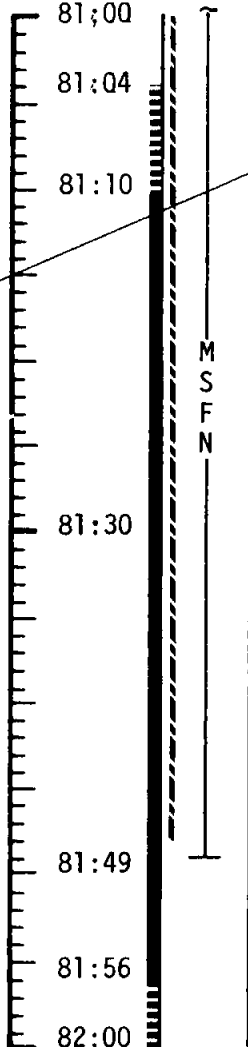

RECORD UPDATE (SEE GET 82:40)

GO INERTIAL

IMU REALIGN - P52
OPTION 3 REFSMMAT

TUNNEL VENT VALVE - LM/CM ΔP

VERIFY LM/CM ΔP < 0.2

STOW OPTICS

PREPARE FOR LM INGRESS

CMP - CLEAR TUNNEL OF CM HATCH
INSPECT TUNNEL & DOCKING LATCHES
REMOVE PROBE & DROGUE
STOW CM HATCH, PROBE & DROGUE

LMP - OPEN LM HATCH
VERIFY DOCKING TUNNEL INDEX ANGLE
IVT TO LM

LMP - LM ENTRY STATUS CHECKS

REPORT:

P52 (LDG SITE REFSMMAT)

N71: _____

N05: _____

N93:

X _____

Y _____

Z _____

GET _____:_____:_____

MISSION	EDITION	DATE	TIME	DAY/REV	PAGE
APOLLO 11	FINAL	JULY 1, 1969	81:00 - 82:00	4/3	3-52

THIS PAGE INTENTIONALLY LEFT BLANK.

CSM/LM TYPICAL LANDMARK TRACKING PROFILE

2 DEG PITCH DOWN FROM
LOCAL HORIZONTAL BEGIN
0.3 DEG/SEC PITCH DOWN
AT AOS.

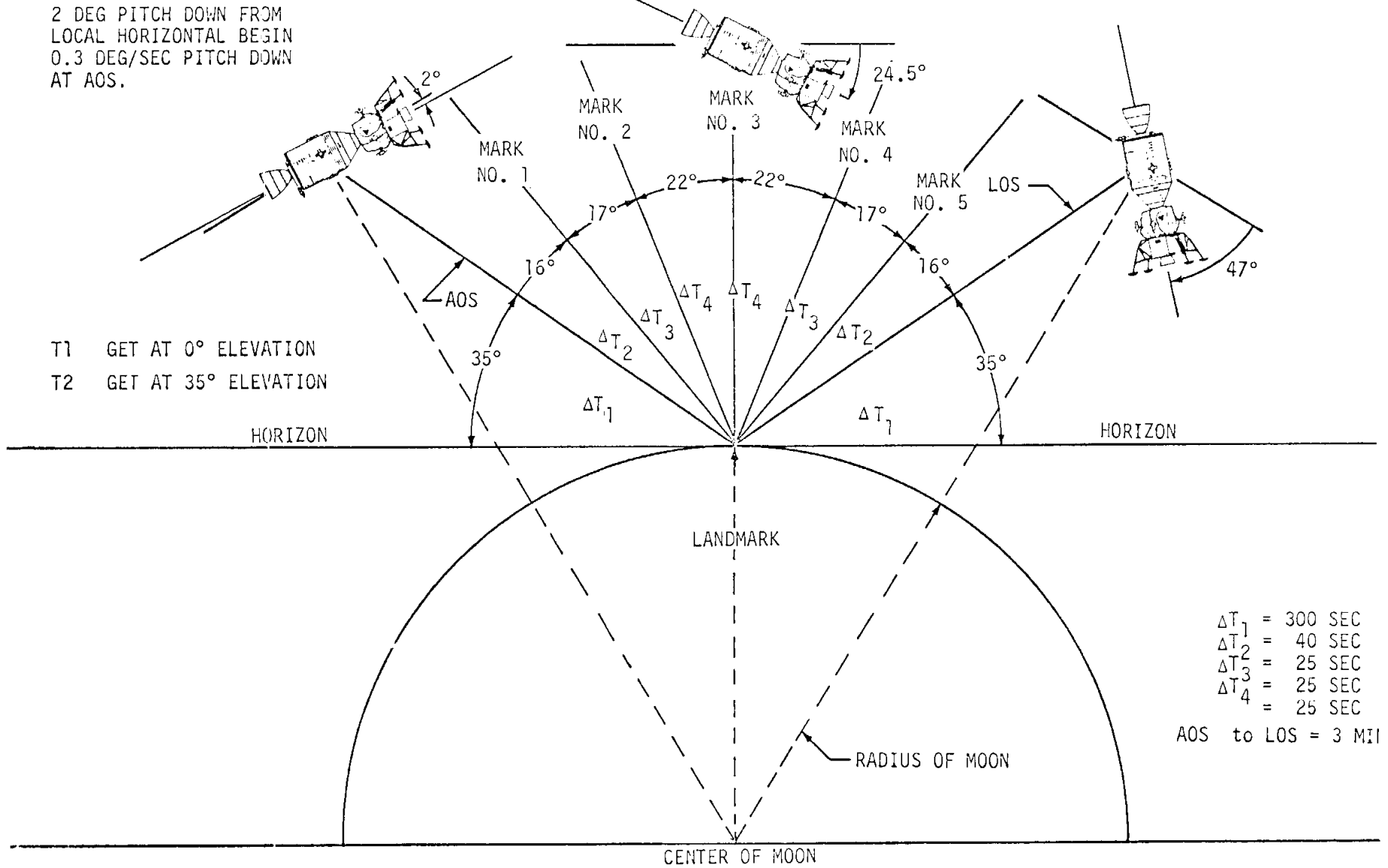

T1 GET AT 0° ELEVATION
T2 GET AT 35° ELEVATION

ΔT_1 = 300 SEC
 ΔT_2 = 40 SEC
 ΔT_3 = 25 SEC
 ΔT_4 = 25 SEC
 AOS to LOS = 3 MI

FLIGHT PLAN

CSM

1930 EDT

82:00
82:02

REV 4

82:30

82:35

83:00

CMP

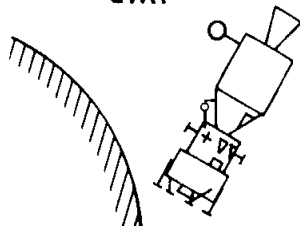

R 0, P 257/297, Y 0

MANEUVER TO LANDMARK
TRACK ATTITUDE
GO INERTIAL
SELECT OMNI B

P22 ORBITAL NAVIGATION
UNSTOW OPTICS

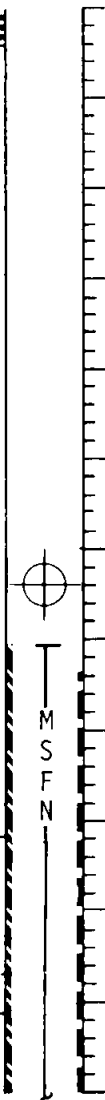

TRACK LANDMARK ALT LMK
(A-1)
(5 MARKS ON LMK)
PITCH DOWN 0.3°/SEC
DO NOT INCORPORATE MARKS

STOW OPTICS

CDR

AID LMP AS REQUIRED

LM

LMP

PERFORM HOUSEKEEPING CHORES

- 1 STOW HELMET STOWAGE BAGS
- 2 UNSTOW MIRROR, CHECKLIST AND DISPOSAL ASSEMBLY
- 3 STOW INTERIM STOWAGE ASSEMBLY
- 4 UNSTOW AND CONFIGURE FOR USE: 16mm/HCEX (f4,500,INF) 6 fps

P22 AUTO OPTICS

LMK ID A-1

T1 8 2 : 4 1 : 0 6 (HOR)

T2 8 2 : 4 6 : 1 7 (35°)

1 4 NM (N)

N 89

LAT 0 2 . 0 0 0

LONG/2 3 2 . 7 5 0

ALTITUDE- 0 0 0 . 0 0 NM

MISSION	EDITION	DATE	TIME	DAY/REV	PAGE
APOLLO 11	FINAL	JULY 1, 1969	82:00 - 83:00	4/4	3-53

FLIGHT PLANNING BRANCH

FLIGHT PLAN

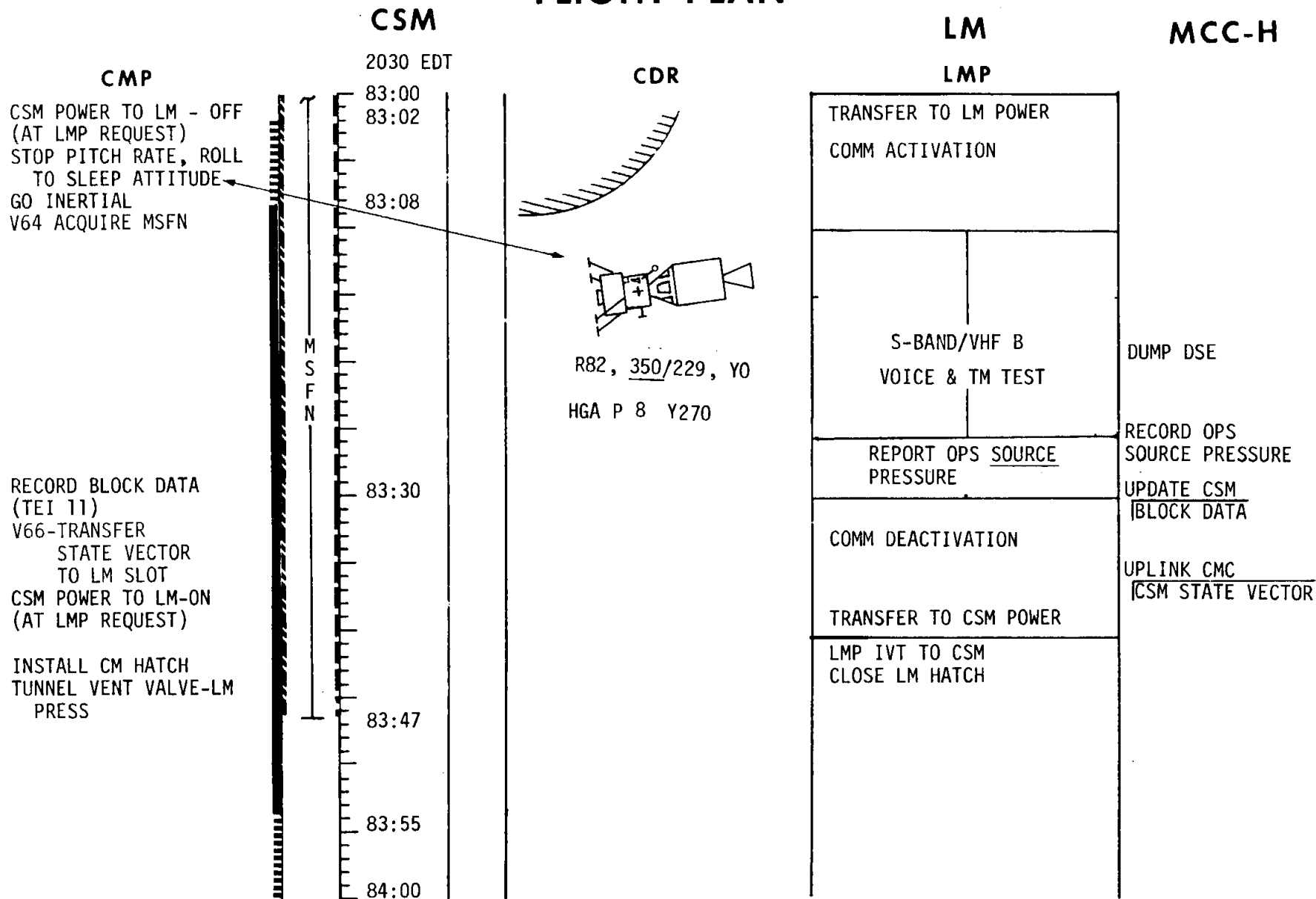

MISSION	EDITION	DATE	TIME	DAY/REV	PAGE
APOLLO 11	FINAL	JULY 1, 1969	83:00 - 84:00	4/4	3-54

MCC-H

2130 EDT

FLIGHT PLAN

NOTES

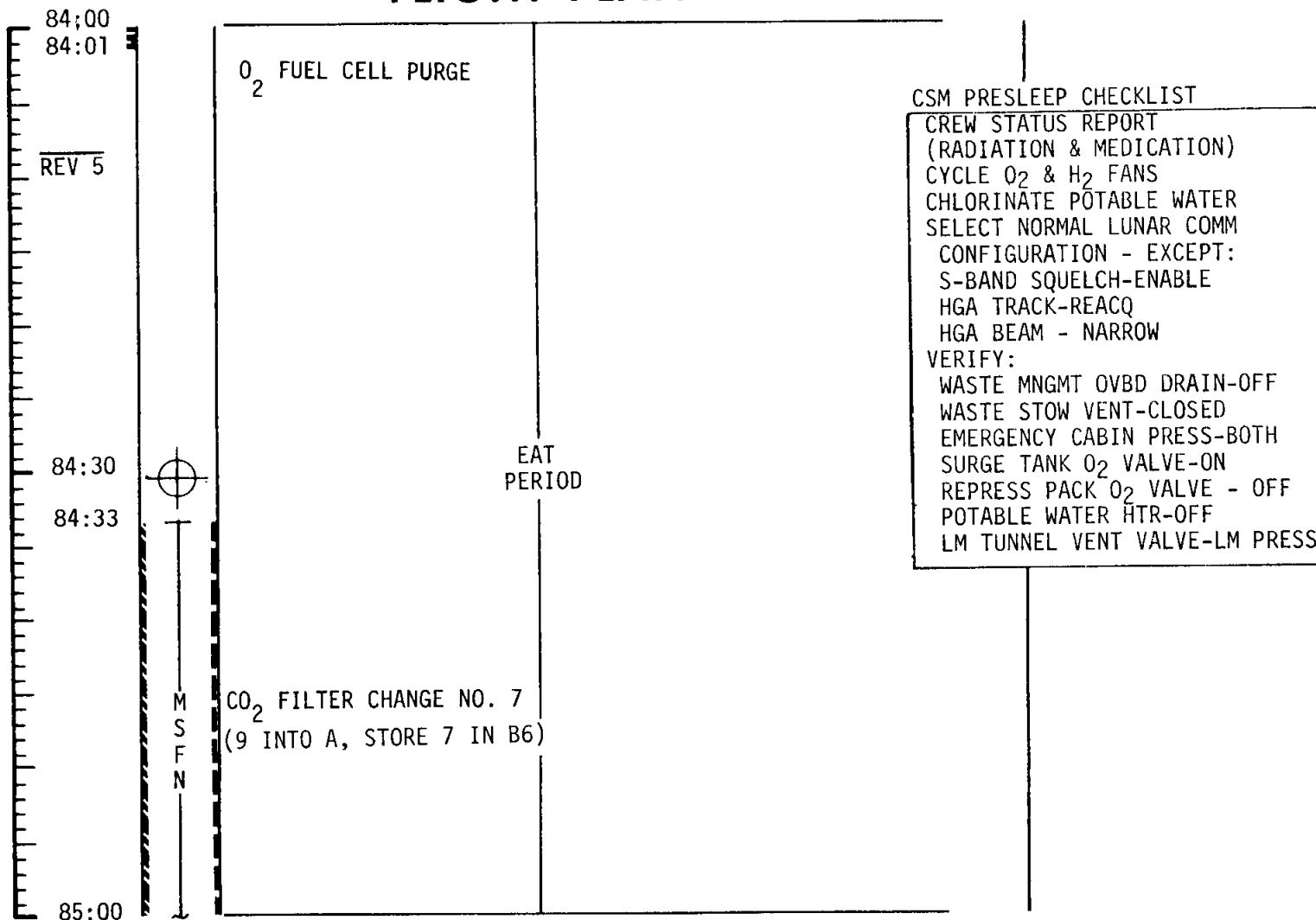

MISSION	EDITION	DATE	TIME	DAY/REV	PAGE
APOLLO 11	FINAL	JULY 1, 1969	84:00 - 85:00	4/5	3-55

LUNAR ORBIT REST PERIOD ATTITUDE

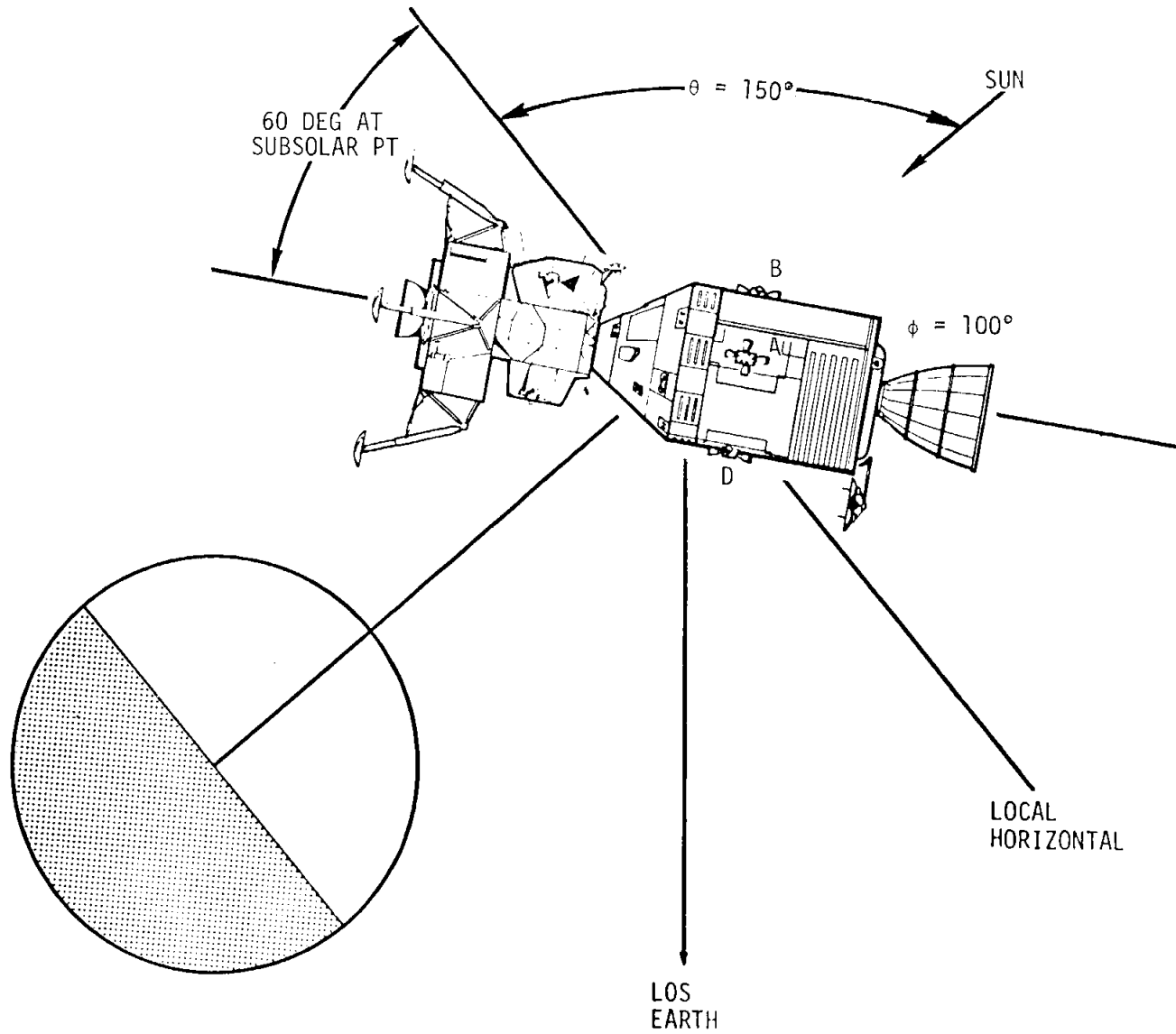

3-55a

MCC-H

DUMP DSE

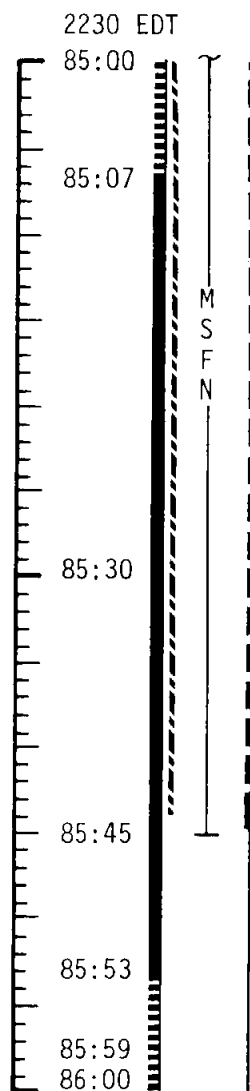

FLIGHT PLAN

NOTES

REST PERIOD
(9 HOURS)

MISSION	EDITION	DATE	TIME	DAY/REV	PAGE
APOLLO 11	FINAL	JULY 1, 1969	85:00 - 86:00	4/5	3-56

MSC Form 29 (May 69)

FLIGHT PLANNING BRANCH

MCC-M

FLIGHT PLAN

NOTES

2330 EDT

86:00

REV 6

86:30

86:32

86:59

87:00

87:05

87:30

87:43

87:52

87:58

88:00

M
S
F
N

REST PERIOD
(9 HOURS)

DUMP DSE

MISSION	EDITION	DATE	TIME	DAY/REV	PAGE
APOLLO 11	FINAL	JULY 1, 1969	86:00 - 88:00	4/6	3-57

MCC-H

FLIGHT PLAN

NOTES

DUMP DSE

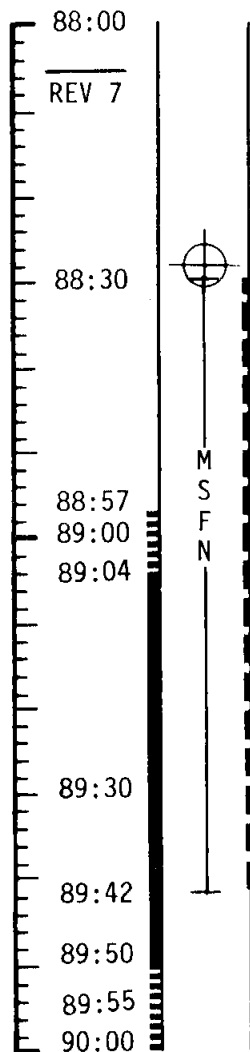

REST PERIOD
(9 HOURS)

MISSION	EDITION	DATE	TIME	DAY/REV	PAGE
APOLLO 11	FINAL	JULY 1, 1969	88:00 - 90:00	4/7	3-58

MCC-H

FLIGHT PLAN

NOTES

DUMP DSE

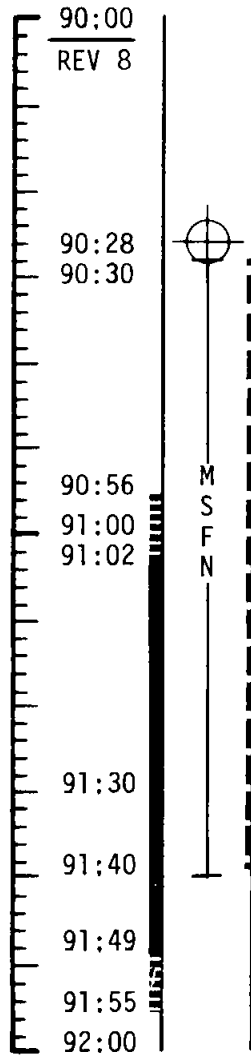

REST PERIOD
(9 HOURS)

MISSION	EDITION	DATE	TIME	DAY/REV	PAGE
APOLLO 11	FINAL	JULY 1, 1969	90:00 - 92:00	4/8	3-59

MCC-H

FLIGHT PLAN

NOTES

0530 EDT

92:00

REV 9

DUMP DSE

92:26

92:30

92:55

93:00

93:01

93:30

93:37

93:47

93:54

94:00

REV 10

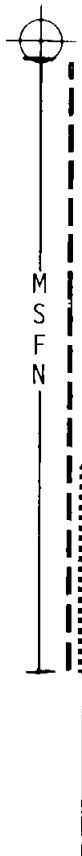

REST PERIOD
(9 HOURS)

MISSION	EDITION	DATE	TIME	DAY/REV	PAGE
APOLLO 11	FINAL	JULY 1, 1969	92:00 - 94:00	4/9 - 10	3-60

MSC Form 29 (May 69)

FLIGHT PLANNING BRANCH

MCC-H

FLIGHT PLAN

NOTES

0730 EDT

94:00

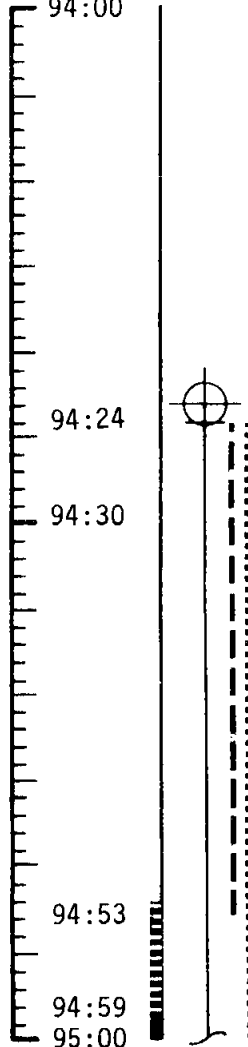

DUMP DSE

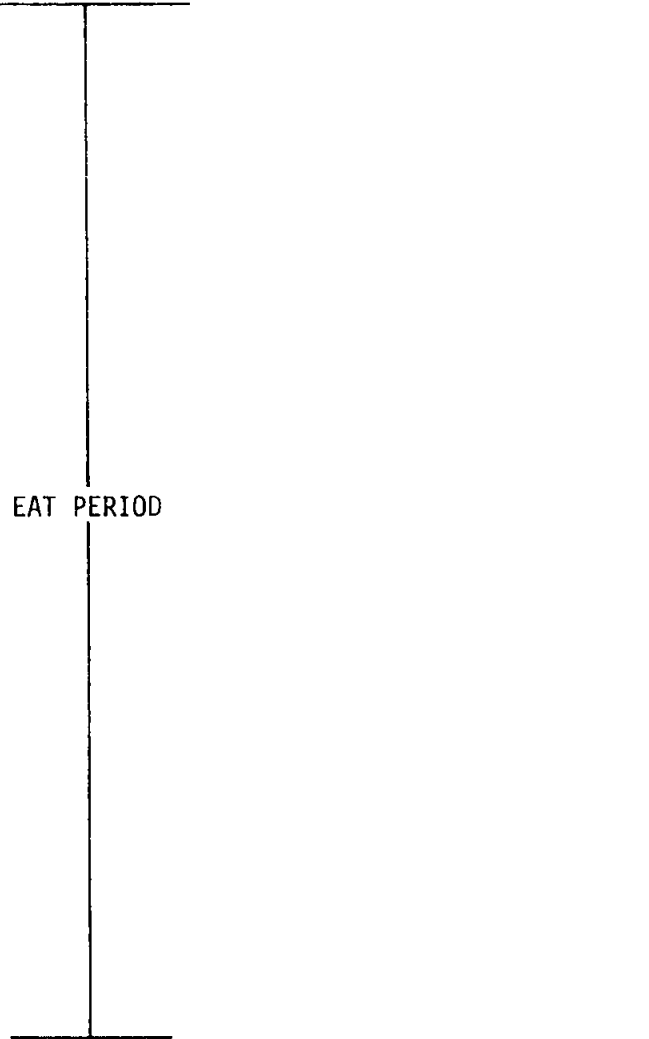

MISSION	EDITION	DATE	TIME	DAY/REV	PAGE
APOLLO 11	FINAL	JULY 1, 1969	94:00 - 95:00	5/10	3-61

MCC-H

0830 EDT

FLIGHT PLAN

NOTES

UPDATE

BLOCK DATA

UPDATE

BASELINE
ALTITUDE FOR
DESCENT ALTITUDE
SIGHTINGS

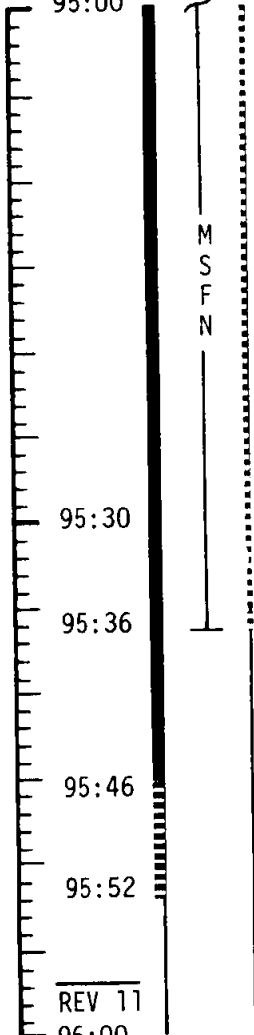

CDR & LMP DON LCG'S
CMP-RECORD BLOCK DATA - TEI₃₀

LMP-COPY BASELINE ALTITUDE

POST SLEEP CHECKLIST

CREW STATUS REPORT (SLEEP)
CYCLE H ₂ , O ₂ FANS
GDC ALIGN TO IMU
CONSUMABLES UPDATE
SELECT COMM NORMAL
LUNAR CONFIGURATION

CO₂ FILTER CHANGE NO. 8
(10 INTO B, STORE 8 IN B6)

CONSUMABLES UPDATE

(Δ FROM NOMINAL)

GET: _____

RCS TOT _____

A _____

B _____

C _____

D _____

H₂TOT _____

O₂TOT _____

CMP: DON PGA W/O HELMET
AND GLOVES
H₂ - PURGE LINE HTRS - ON

LM TUNNEL VENT VALVE - LM/CM ΔP
VERIFY LM/CM ΔP < 0.2
OPEN AND STOW CM HATCH

LMP: VERIFY DOCKING TUNNEL INDEX ANGLE
IVT TO LM

REV 11

96:00

MISSION	EDITION	DATE	TIME	DAY/REV	PAGE
APOLLO 11	FINAL	JULY 1, 1969	95:00 - 96:00	5/10-11	3-62

FLIGHT PLAN

CSM

LM

MCC-H

CMP

CDR

LMP

UNDOCKING PHOTO
16mm/18/CEX-BRKT-MIR
(f8,250,7) 6 fps
O₂ & H₂ FUEL CELL PURGE

V64 ACQUIRE MSFN
CREW STATUS REPORT
REPORT DOCKING TUNNEL
INDEX ANGLE TO MSFN
DEACTIVATE B3 & C4 JETS
CONFIGURE DAP 21112
WIDE DB 11001
(FOR LM STEERABLE
ANTENNA ACTIVATION)

RECORD LMK 130 PAD
DATA (SEE GET 98:35)
AND CSM DAP DATA
AND LOAD

UNSTOW OPTICS
P52-IMU REALIGN
OPTION 1 PREFERRED

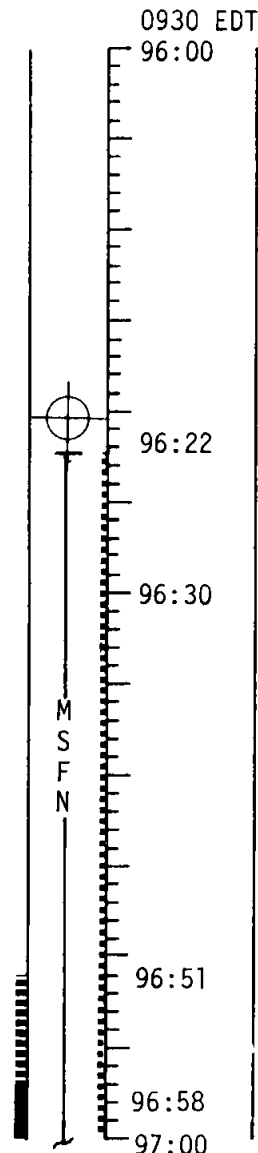

DON PGA W/O HELMET AND GLOVES	LM FAMILIARIZATION
CSM POWER TO LM-OFF (P.T LMP REQUEST)	LM POWER-ON
DISCONNECT AND STOW LM POWER UMBILICAL	EPS ACTIVATION MISSION TIMER ACTIVATION PRIMARY GLYCOL LOOP ACT
IVT TO LM TRANSFER HELMET & GLOVES	CAUTION/WARNING CHECKOUT CB ACTIVATION TB VERIFICATION
ECS ACTIVATION AND C/O CONNECT TO LM ECS	PGNCS TURN - ON AND SELF TEST
	BIO MED SWITCH - LEFT

DUMP DSE

UPLINK CMC

CSM STATE VECTOR
DESIRED ORIENT
(LS REFSMMAT)

UPDATE CSM

LMK 130 PAD
BLOCK DATA
CSM DAP DATA

MISSION	EDITION	DATE	TIME	DAY/REV	PAGE
APOLLO 11	FINAL	JULY 1, 1969	96:00 - 97:00	5/11	3-63

FLIGHT PLAN

CSM

LM

MCC-H

REPORT: **CMP**

1030 EDT
97:00

P52 (LDG SITE REFSMMAT)
N71: _____
N05: _____
N93: _____
X _____
Y _____
Z _____
GET _____:_____:_____

M
S
F
N

VHF CHECKOUT
CSM TIME MARK TO LM
STOW OPTICS

VO6N20E
(ON MARK FROM CDR)

RECORD LM PCM DATA

DON HELMET AND GLOVES
PGA PRESSURE INTEGRITY
CHECK
INSTALL DROGUE & PROBE,
PRELOAD PROBE
INHIBIT ROLL COMMANDS
UNTIL LM/CM ΔP>3.5psia

COCK LATCHES (12)
INSTALL HATCH
VENT TUNNEL
HATCH INTEGRITY CHECK
INSTALL AND ALIGN DOCK-
ING TARGET

97:30

97:34

97:44

97:49

REV 12

98:00

CDR

LMP

SUIT FAN/H2O SEP CHECK	SEC S-BAND T/R AND POWER AMPLIFIER CHECK
GLYCOL PUMP CHECK	S-BAND STEERABLE ANTENNA ACTIVATION P 152, Y -9
VHF-B ACTIVATION	
E MEMORY DUMP	IVT TO CSM
VHF CHECKOUT (COMM CHECK WITH CSM)	
LGC/CMC CLOCK SYNC T EPHEM UPDATE	DON PGA
DOCKED IMU COARSE ALIGN REPORT GIMBAL ANGLES AND TIME TO MSFN	
AFT OMNI - LBR SLEW STEERABLE ANTENNA P 187, Y 70	IVT TO LM TRANSFER HELMET & GLOVES
VERIFY DROGUE AND PROBE INSTALLATION CLOSE AND SECURE HATCH	CONNECT TO LM ECS AND COMM
	ASCENT BATTERY ACTIVATION AND CHECKOUT RECORD ED BAT VOLTS

UPDATE LM
STEERABLE ANTENNA
ANGLES
(GET :97:10)

UPDATE LM
STEERABLE ANTENNA
ANGLES P 187, Y 70
(GET: 98:55)

COPY GIMBAL
ANGLES AND TIME

MISSION	EDITION	DATE	TIME	DAY/REV	PAGE
APOLLO 11	FINAL	JULY 1, 1969	97:00 - 98:00	5/11-12	3-64

FLIGHT PLANNING BRANCH

CSM/LM TYPICAL LANDMARK TRACKING PROFILE

2 DEG PITCH DOWN FROM
LOCAL HORIZONTAL BEGIN
0.3 DEG/SEC PITCH DOWN
AT AOS.

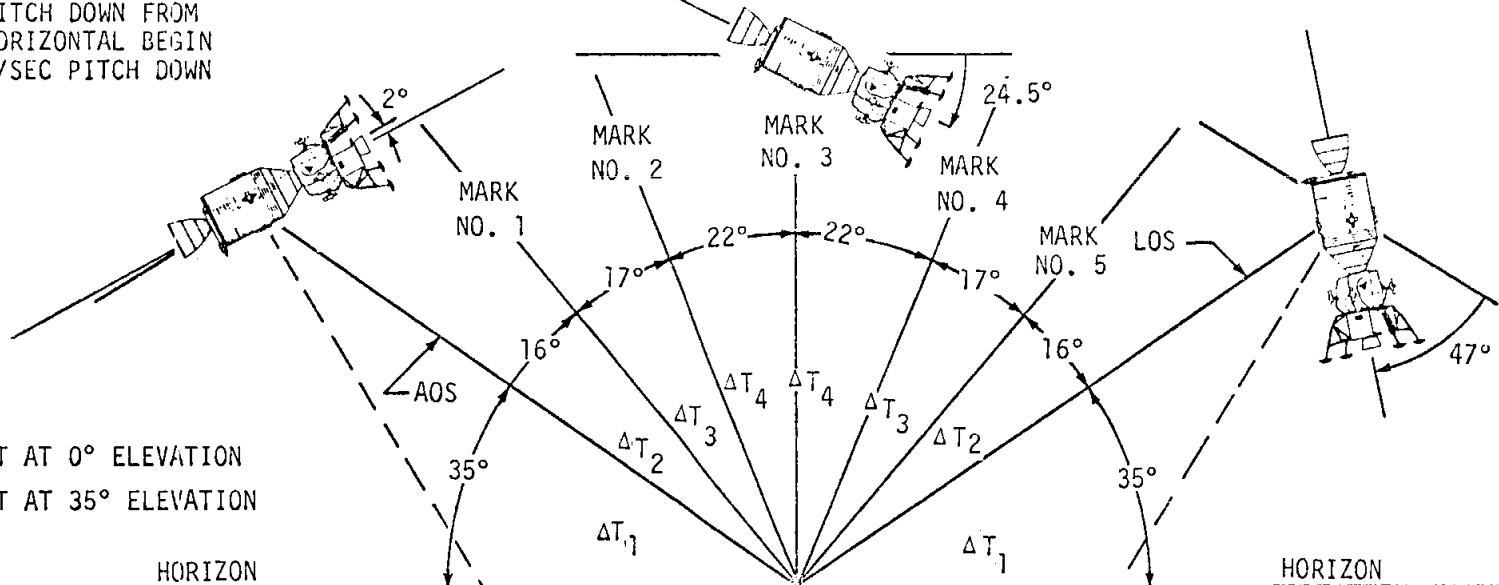

T1 GET AT 0° ELEVATION
T2 GET AT 35° ELEVATION

HORIZON

HORIZON

LANDMARK

RADIUS OF MOON

CENTER OF MOON

$\Delta T_1 = 300 \text{ SEC}$
 $\Delta T_2 = 40 \text{ SEC}$
 $\Delta T_3 = 25 \text{ SEC}$
 $\Delta T_4 = 25 \text{ SEC}$
 AOS to LOS = 3 MI

FLIGHT PLAN

CSM

LM

MCC-H

CMP

1130 EDT
98:00

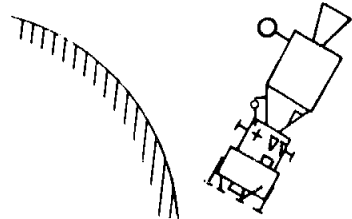

MANEUVER TO TRACKING ATTITUDE

R 0, P278/290, Y0
DOFF HELMET & GLOVES

SELECT OMNI C

GO INERTIAL
UNSTOW OPTICS
P22 ORBITAL NAVIGATION

TRACK LDG SITE LANDMARK
(5 MARKS ON LDMK 130)
PITCH DOWN 0.3°/SEC AT T2
DO NOT INCORPORATE MARKS

PITCH DOWN, 0.5°/SEC

STOP PITCH AND GO INERTIAL

V64 ACQUIRE MSFN



MSFN

98:21

98:30

98:50

98:56

99:00

CDR

LMP

DON HELMET & GLOVES	DON HELMET & GLOVES
ARS/PGA PRESSURE INTEGRITY CHECK	ARS/PGA PRESSURE INTEGRITY CHECK
CABIN REGULATOR CHECK	CABIN REGULATOR CHECK
DOFF HELMET & GLOVES COPY DAP DATA COPY GYRO TORQUE ANGLES AND FINE ALIGN IMU X __, Y __, Z __	DOFF HELMET & GLOVES SELECT OMNI FWD BIO MED SWITCH - RIGHT
RATE GYRO CHECK	AGS ACT & SELF TEST
<p>R 0, P 135/14, Y 0 HGA P-45, Y3</p>	V64 ACQUIRE MSFN ANT P 187, Y 70

UPDATE LM
DAP DATA
GYRO TORQUE ANGLES

P22 AUTO OPTICS	
LMK ID	130
T1	9 8:4 0:0 2 (HOR)
T2	9 8:4 5:0 8 (35°)
	9 6 NM (N OR S)
N	89
LAT	+ 0 1.2 4 3
LONG/2	+ 1 1.8 4 4
ALTITUDE-	0 0 1.4 6 NM

DUMP DSE

MISSION	EDITION	DATE	TIME	DAY/REV	PAGE
APOLLO 11	FINAL	JULY 1, 1969	98:00 - 99:00	5/12	3-65

FLIGHT PLAN

CSM

LM

MCC-H

CMP

STOW FLIGHT PLAN
UNSTOW SOLO BOOK
COPY PADS

DON HELMET & GLOVES
SC CONT - SCS
MIN/MAX DB, LOW/HIGH
RATE
(AT REQUEST OF CDR)
GO/NO-GO FOR UNDOCKING
DISABLE ROLL JETS FOR
RCS HOT FIRE

VERIFY TUNNEL VENT
VALVE - OFF

RECORD LM PCM DATA

MANEUVER TO
AGS CALIBRATION ATTITUDE

RATES <0.1°/SEC
DISABLE THRUSTERS FOR
32 SEC

(AT REQUEST OF LMP)
MANEUVER TO UNDOCKING
ATTITUDE

RO, P320/14, YO

1230 EDT
99:00

M
S
F
N

99:30
99:32

99:43

99:49
REV 13

100:00

CDR

LMP

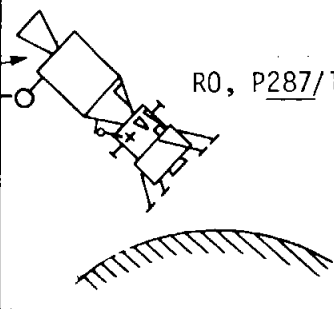
DRIFT CHECK-REPORT GIMBAL -ANGLES & TIME TO MSFN DEPLOY LANDING GEAR ORDEAL INITIALIZATION	
LOAD DAP DATA - 32012 CSM WT _____ P TRIM _____ Y TRIM _____ DPS GIMBAL DRIVE AND THROTTLE TEST	V47 INITIALIZE AGS
RCS PRESSURIZATION	RCS PRESSURIZATION
RCS CHECKOUT	GO/NO-GO FOR UNDOCKING RCS CHECKOUT
RR ACT & SELF TEST	AFT OMNI - LBR
	SLEW STEERABLE ANTENNA ANT P 123, Y -37
	AGS ACCEL & GYRO CALIBRATION
DPS PRESS & CHECKOUT	

UPLINK LGC

LS REFSMMAT
LM & CSM STATE
VECTORS
LGC/CMC CLOCK SYNC
PIPA BIAS
LGC ABORT CONSTANT

UPDATE LM

AGS ABORT CONSTANT
AGS K FACTOR
UPLINK CMC

LM & CSM STATE
VECTORS

UPDATE CSM

P30 MNVR PAD
(SEPARATION)
GO/NO-GO
UPDATE LM

STEERABLE ANTENNA
ANGLES(GET:100:25)

MISSION	EDITION	DATE	TIME	DAY/REV	PAGE
APOLLO 11	FINAL	JULY 1, 1969	99:00 - 100:00	5/12-13	3-66

FLIGHT PLAN

CSM

LM

MCC-H

CMP

CDR

LMP

REPORT:
 P52 (LDG SITE REFSMMAT)
 N71: _____, _____
 N05: _____
 N93:
 X _____
 Y _____
 Z _____
 GET: _____ : _____ :

1630 EDT
 103:00

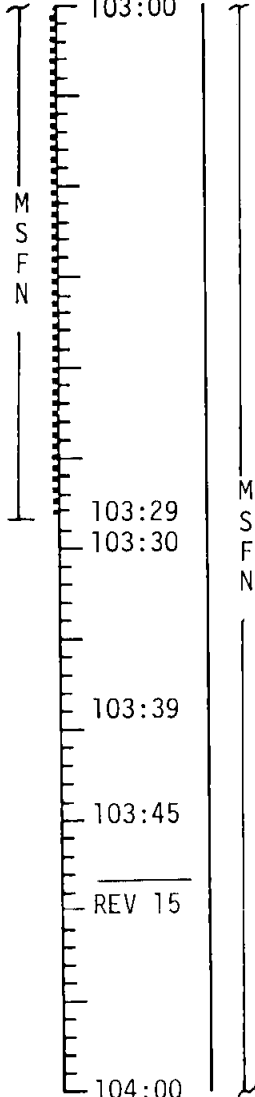

RR TO STANDBY
 REPORT ESTIMATE OF LANDED
 LOCATION
 CLOSE SHADES, DOFF HELMET
 AND GLOVES

AGS LUNAR SURFACE GYRO
 CALIBRATION
 LOAD AGS ASCENT TARGET
 H=60,000 FT, H DOT=32 FPS
 CLOSE SHADES, DOFF
 HELMET AND GLOVES

COPY AGS
 AZIMUTH

BEGIN SIMULATED COUNTDOWN

P57-IMU ALIGN (REFSMMAT)
 GRAVITY MEASUREMENT
 N04: _____

COPY LANDED
 LOCATION, GRAVITY
 MEASURE

AGS LUNAR ALIGNMENT

80mm/BW/CHECKLIST
 60mm/HCEX/CHECKLIST

P57-IMU ALIGN (REFSMMAT)
 2 CELESTIAL BODIES

UPDATE CSM

6 FRAMES FAR FIELD
 (FOCUS 50') 6 FRAMES
 NEAR FIELD (FOCUS 20')
 WITH EACH CAMERA
 REMOVE MAGS AND STOW
 INSTALL PROTECTIVE
 COVER AND STOW CAMERAS

N04: _____
 N05: _____

LM TRACKING
 PAD

N71: _____, _____
 N93:
 X _____
 Y _____
 Z _____

COPY P57 DATA

N89:
 LAT _____
 LONG/2 _____
 ALT _____

COPY AGS
 AZIMUTH

GET _____ : _____ :

UPLINK LGC

PHOTOGRAPH LUNAR
 SURFACE
 DON HELMET AND GLOVES

INITIALIZE AGS
 COPY AND LOAD
 ASCENT PAD DATA
 DON HELMET AND GLOVES
 VERIFY AGS ASCENT PROGRAM

RLS
 CSM STATE
 VECTOR
 (TD + 1:40)
 UPDATE LM
 ASCENT PAD

ALIGN GDC, VERIFY ORDEAL

COPY LM TRACKING PAD
 (SEE GET - 104:35)

P22 AUTO MNVR TO
 TRACKING ATTITUDE
 ORB RATE

RO P338/76, Y0

MISSION	EDITION	DATE	TIME	DAY/REV	PAGE
APOLLO 11	FINAL	JULY 1, 1969	103:00 - 104:00	5/14-15	3-70

FLIGHT PLAN

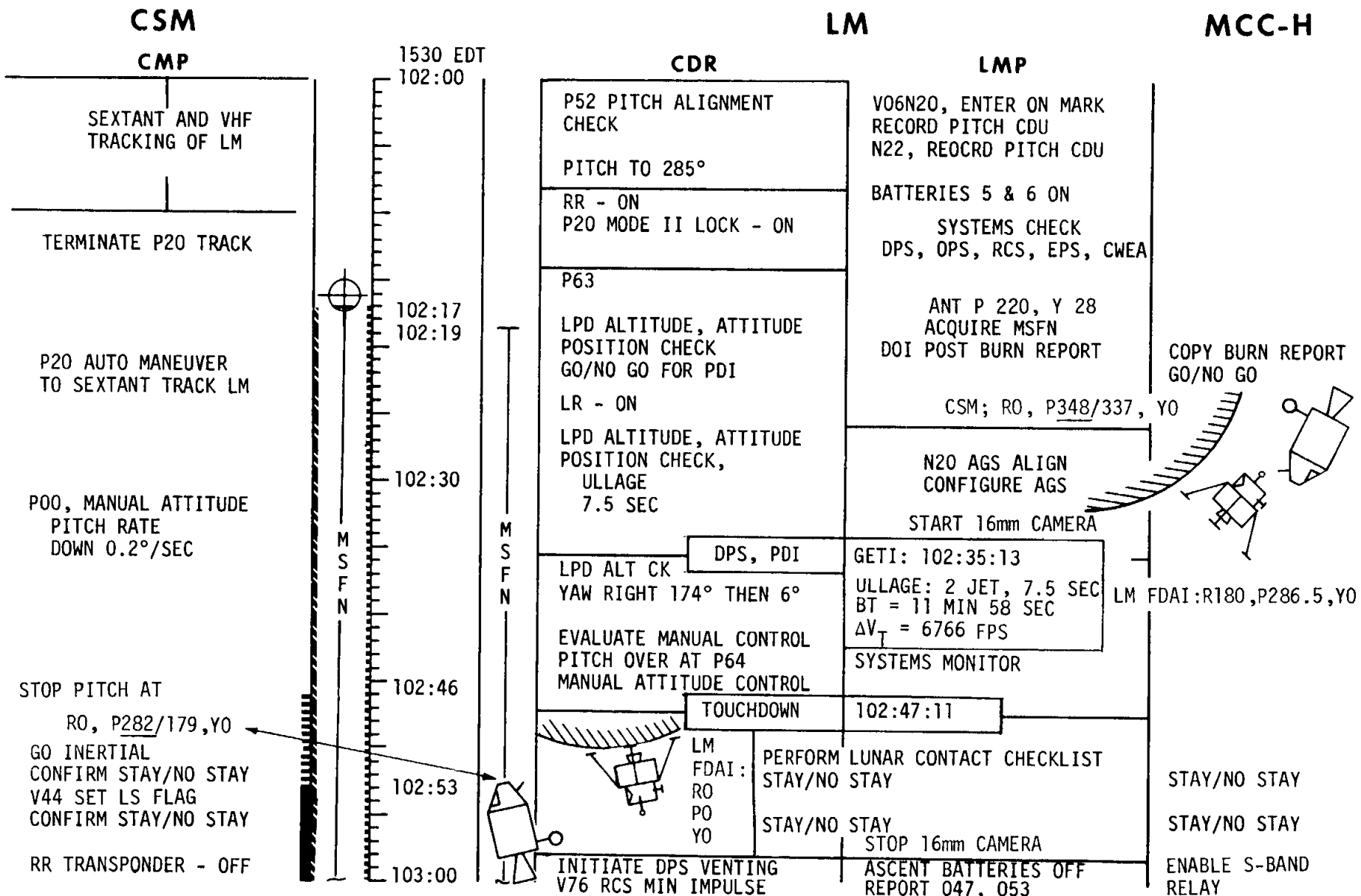

MISSION	EDITION	DATE	TIME	DAY/REV	PAGE
APOLLO 11	FINAL	JULY 1, 1969	102:00 - 103:00	5/14	3-69

FLIGHT PLAN

CSM

LM

MCC-H

CMP

CDR

LMP

UPLINK CMC

P27 UPDATE
P52 IMU REALIGN
OPTION 3 REFSMMAT
REPORT:

P52 (LDG SITE REFSMMAT)

N71: _____,
N05: _____.
N93: _____
X _____.
Y _____.
Z _____.
GET _____:_____:

GDC ALIGN TO IMU
VHF B - DATA
P20 AUTO MANEUVER
TO SEXTANT TRACK LM

CONFIRM DOI-VHF RANGING
INCORPORATE P76
P20 AUTO MANEUVER
TO SEXTANT TRACK LM
SEXTANT TRACK ONLY
DOFF HELMET & GLOVES

1430 EDT
101:00

M
S
F
N

M
S
F
N

101:30

101:41

101:47

REV 14

102:00

REPORT:

P52 (LDG SITE REFSMMAT)

N71: _____,

N05: _____.

N93: _____

X _____.

Y _____.

Z _____.

GET _____:_____:

P40 DPS THRUST
MNVR TO DOI ATTITUDE

SYSTEMS CHECKS

V47 AGS ALIGN

OMNI AFT, PCM LBR
VHF A-VOICE, B-DATA

SLEW STEERABLE ANTENNA
ANT P 220, Y 28

N20 AGS ALIGN
LOADS AGS EXT ΔV

GETI: 101:38:48
ULLAGE: 2 JET, 7.5 SEC
BT: 28.5 SEC
ΔV: 70 FPS
RETROGRADE
ORBIT 8.97 X 57.87

TRIM V_x RESIDUALS
PITCH DOWN, P=195, RR-ON
P20 MAN LOCK - ON

RR-OFF

P30 EXT ΔV
LOAD PDI + 12 ABORT
PITCH DOWN TO 125°
YAW LEFT 180°

VHF A-VOICE/RNG LM FDAI: R0, P294.9, Y0

VHF B - XMTR - OFF
SET CAMERA
16mm/HCEX(4,500,INF) 6 fps
COAS OVERHEAD

CSM STATE VECTOR
(PDI + 25)
LM STATE VECTOR
(DOI - 10)
PIPA BIAS

DUMP DSE

GO/NO GO FOR DOI

UPDATE LM

STEERABLE ANTENNA
ANGLES
(GET: 102:19)

CSM: R0, P215/319, Y0

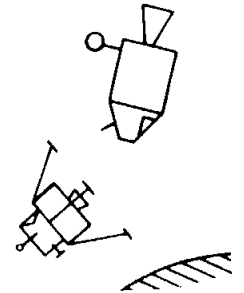

MISSION	EDITION	DATE	TIME	DAY/REV	PAGE
APOLLO 11	FINAL	JULY 1, 1969	101:00 - 102:00	5/13-14	3-68

FLIGHT PLANNING BRANCH

FLIGHT PLAN

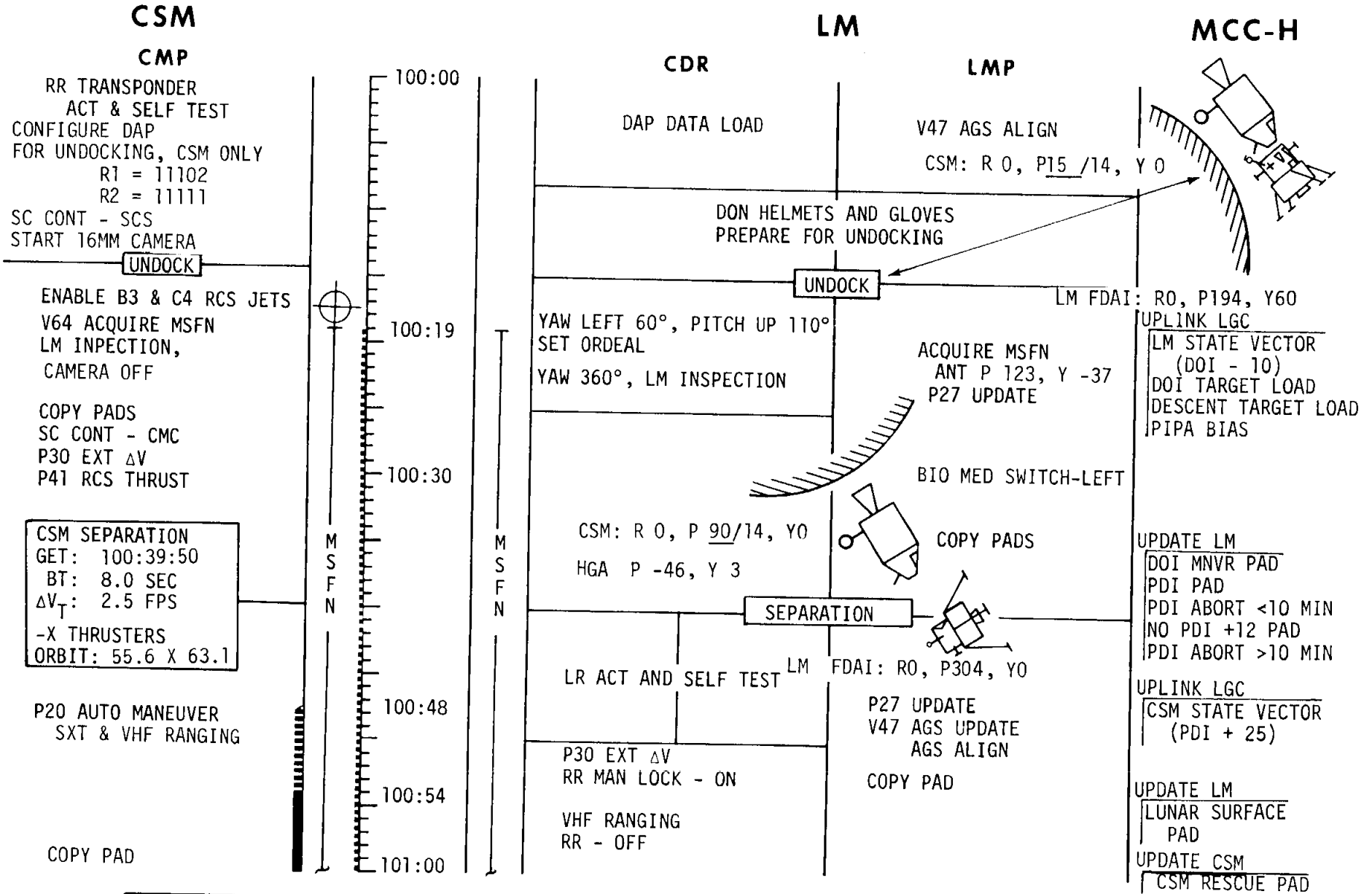

MISSION	EDITION	DATE	TIME	DAY/REV	PAGE
APOLLO 11	FINAL	JULY 1, 1969	100:00 - 101:00	5/13	3-67

THIS PAGE INTENTIONALLY LEFT BLANK.

CSM TYPICAL LANDMARK TRACKING PROFILE

22 DEG PITCH DOWN FROM
LOCAL HORIZONTAL ORBITAL
RATE THROUGHOUT TRACKING

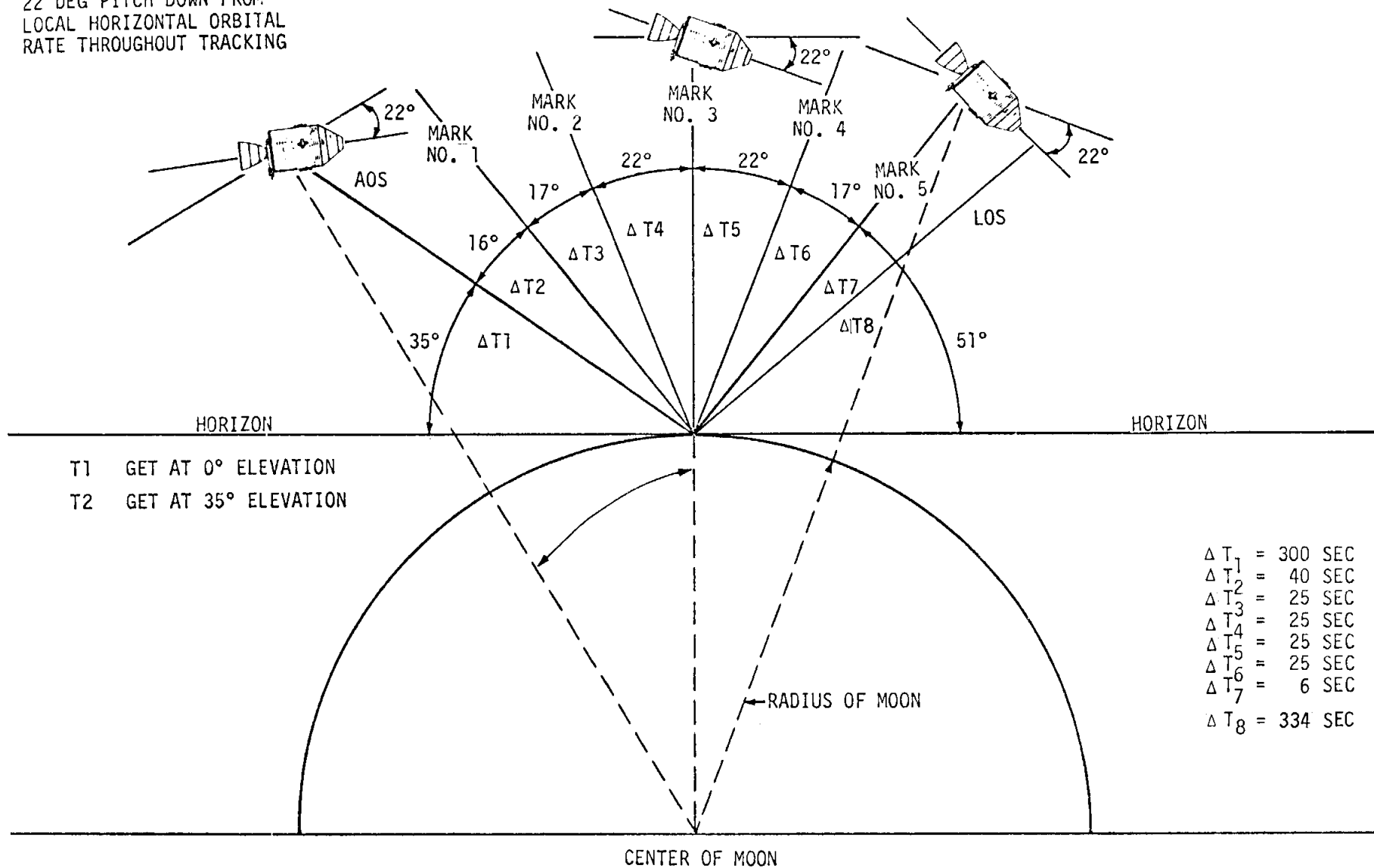

T1 GET AT 0° ELEVATION
T2 GET AT 35° ELEVATION

$\Delta T_1 = 300$ SEC
 $\Delta T_2 = 40$ SEC
 $\Delta T_3 = 25$ SEC
 $\Delta T_4 = 25$ SEC
 $\Delta T_5 = 25$ SEC
 $\Delta T_6 = 25$ SEC
 $\Delta T_7 = 6$ SEC
 $\Delta T_8 = 334$ SEC

FLIGHT PLAN

CSM

LM

MCC-H

CMP

CDR

REPORT: LMP

P57 - GRAVITY AND ONE
CELESTIAL BODY (T-ALIGN)

N04: _____

N71: _____

N93: _____

X _____

Y _____

Z _____

GET _____ : _____ :

P22 AUTO MANEUVER TO
TRACKING ATTITUDE,
ORB RATE

RO, P338/342, Y0

CONFIRM STAY/NO STAY

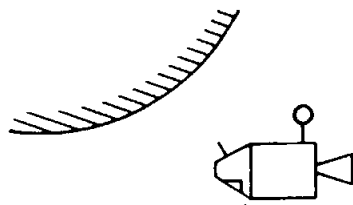

LM TRACKING
5 MARKS ON LM
ORB RATE

PITCH DOWN 0.05°/SEC
STOP ORB RATE
GO INERTIAL
ROLL 170° TO ACQ MSFN
V64 ACQUIRE MSFN

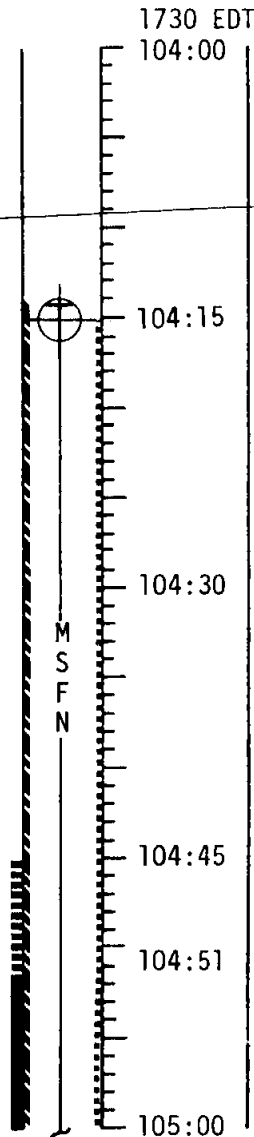

STAY/NO STAY FOR LUNAR SURFACE OPERATIONS

P12 - ASCENT PROGRAM
DAP LOAD 12012

END SIMULATED COUNTDOWN AT TIG -1 MINUTE

DOFF HELMET & GLOVES

EAT PERIOD
(40 MIN)

CONFIGURE COMM
FOR LUNAR STAY
AGS LUNAR ALIGN

BIOMED SWITCH-RIGHT
COPY UPDATE

V47 - INITIALIZE AGS
AGS GUIDANCE STEERING
AGS POWER DOWN
(AGS STATUS SW - OFF)

DOFF HELMET & GLOVES

EAT PERIOD
(40 MIN)

STAY/NO STAY

UPDATE LM

T₄ THRU T₇

LIFT OFF TIMES

P22 AUTO OPTICS
LUNAR MODULE
T1 104:34:31

(HOR)

T2 104:39:32

(35°)

0.2 NM (N OR S)

N89

LAT + 00.691°

LONG/2 + 11.858°

ALT - 001.44 NM

(IF REQUIRED)

UPLINK CMC

DESIRED ORIENT
(PLANE CHANGE)

MISSION	EDITION	DATE	TIME	DAY/REV	PAGE
APOLLO 11	FINAL	JULY 1, 1969	104:00 - 105:00	5/15	3-71

FLIGHT PLAN

CSM

LM

MCC-H

CMP

P52 (OPT 1 - PREFERRED)
GYRO TORQUE TO
DESIRED ORIENTATION
FOR PLANE CHANGE
(IF PLANE CHANGE
IS REQUIRED)

GDC ALIGN TO IMU

1830 EDT

105:00

M
S
F
N

105:26

105:30

105:38

105:44

REV 16

106:00

M
S
F
N

CDR

EAT PERIOD
(40 MIN)

CREW STATUS REPORT (RADIATION, MEDICATION)

CONFIGURE SLEEP STATION
STOW PLSS IN DONNING STATION

REST PERIOD
(4 HOURS)

LMP

EAT PERIOD
(40 MIN)

REST PERIOD
(4 HOURS)

DUMP DSE

EAT PERIOD
(1 HOUR)

MISSION	EDITION	DATE	TIME	DAY/REV	PAGE
APOLLO 11	FINAL	JULY 1, 1969	105:00 - 106:00	5/15-16	3-72

FLIGHT PLANNING BRANCH

FLIGHT PLAN

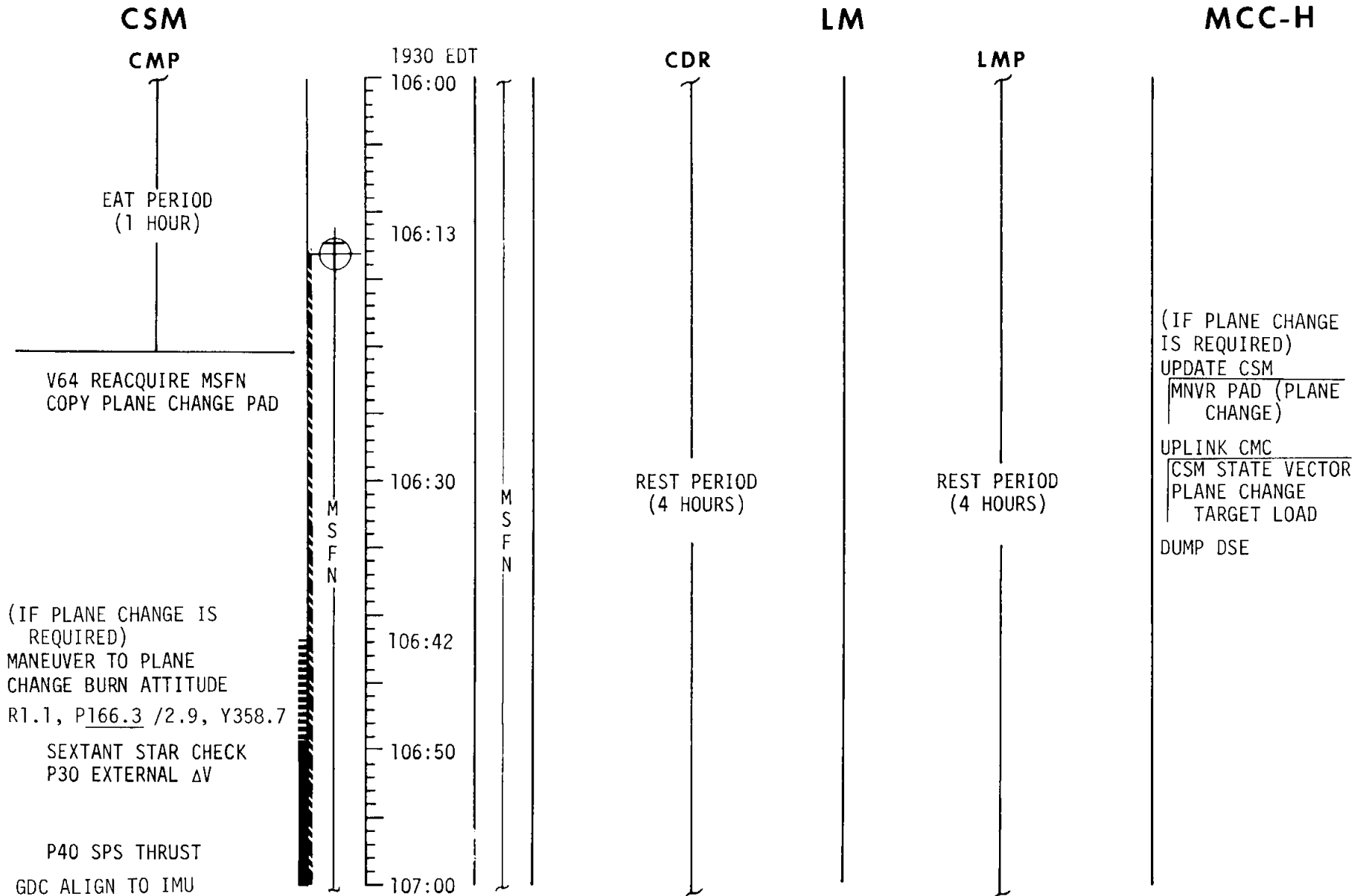

MISSION	EDITION	DATE	TIME	DAY/REV	PAGE
APOLLO 11	FINAL	JULY 1, 1969	106:00 - 107:00	5/16	3-73

FLIGHT PLAN

CSM

LM

MCC-H

CMP

CDR

LMP

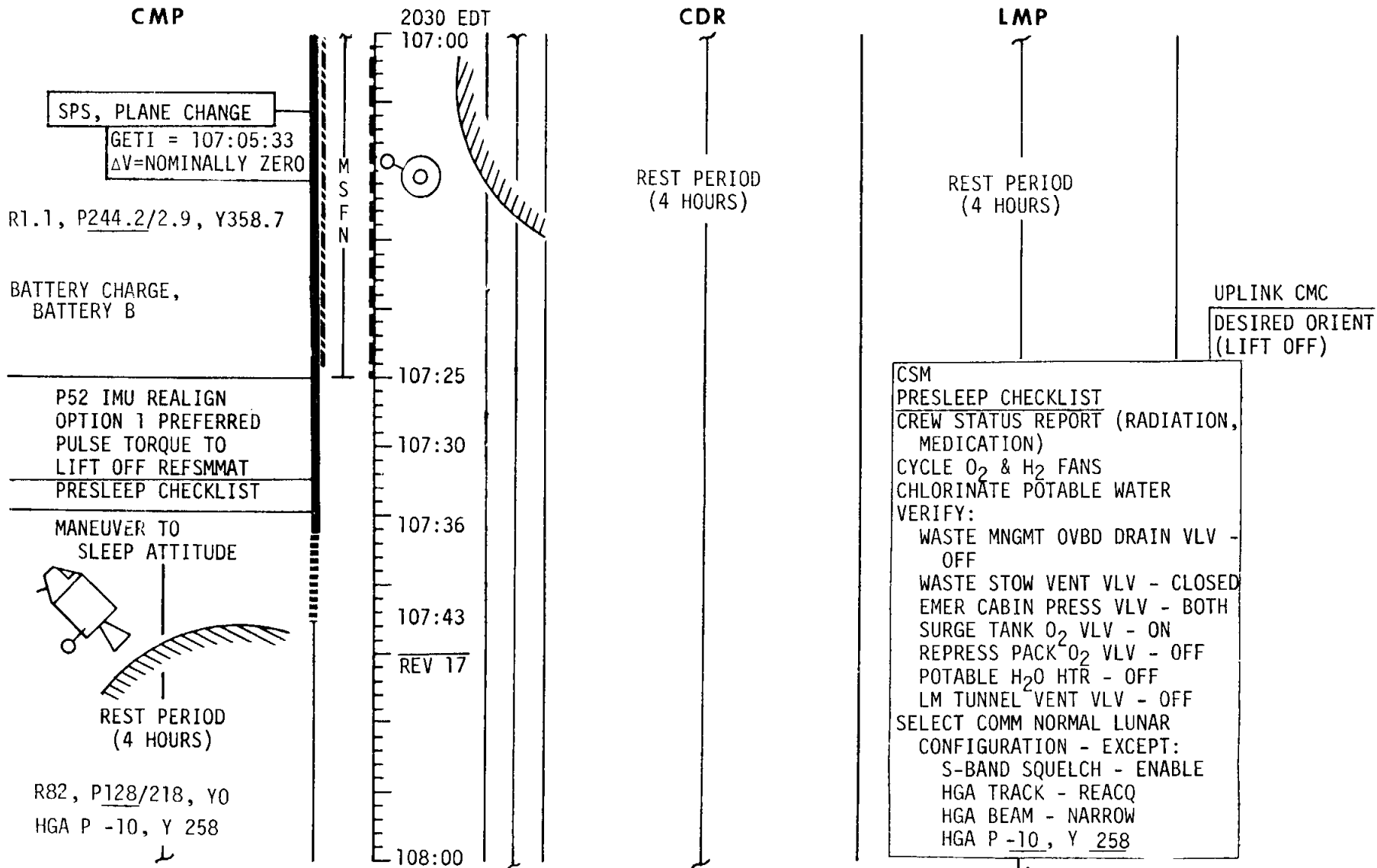

MISSION	EDITION	DATE	TIME	DAY/REV	PAGE
APOLLO 11	FINAL	JULY 1, 1969	107:00 - 108:00	5/16-17	3-74

FLIGHT PLAN

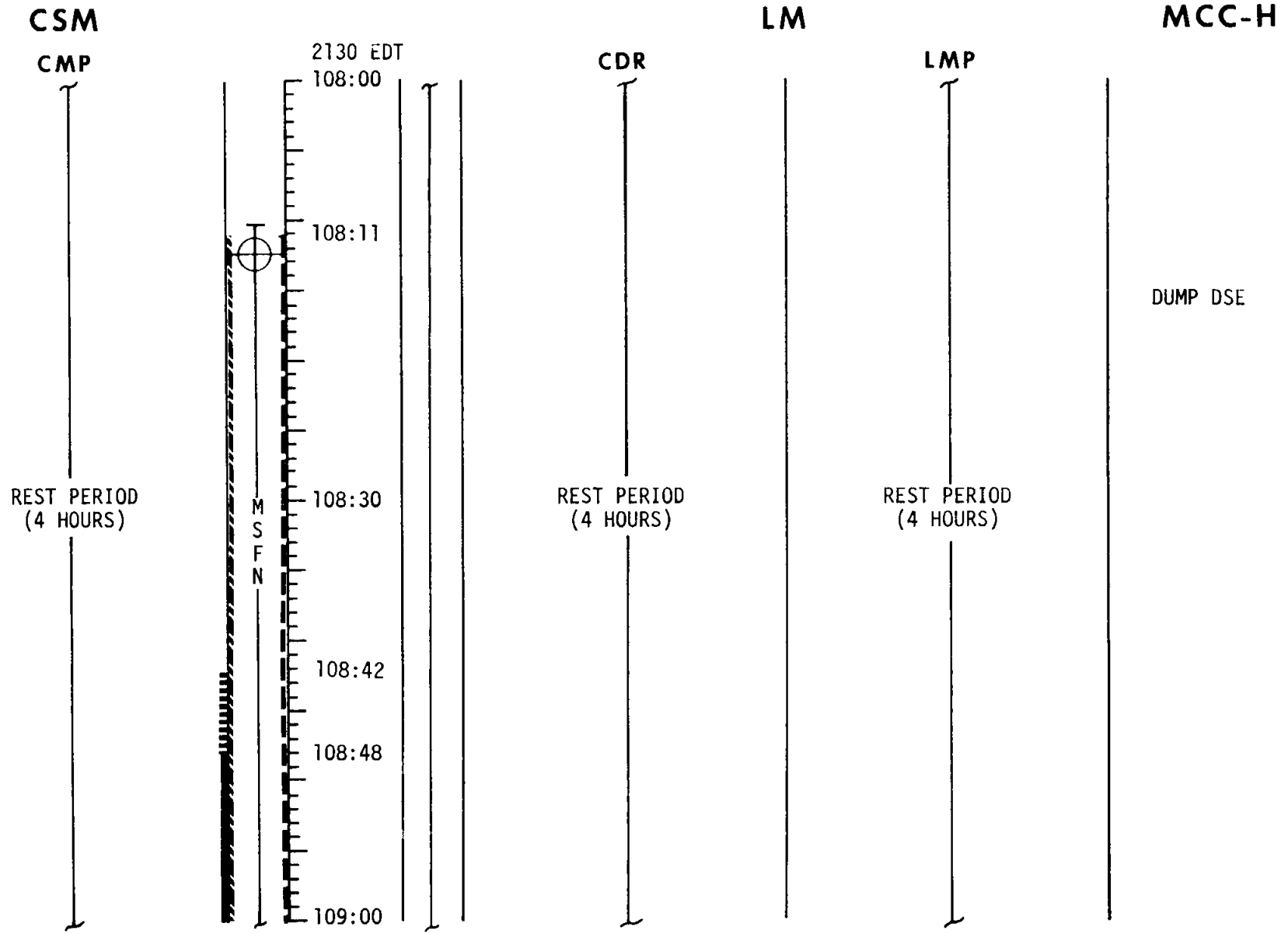

MISSION	EDITION	DATE	TIME	DAY/REV	PAGE
APOLLO 11	FINAL	JULY 1, 1969	108:00 - 109:00	5/17	3-75

FLIGHT PLAN

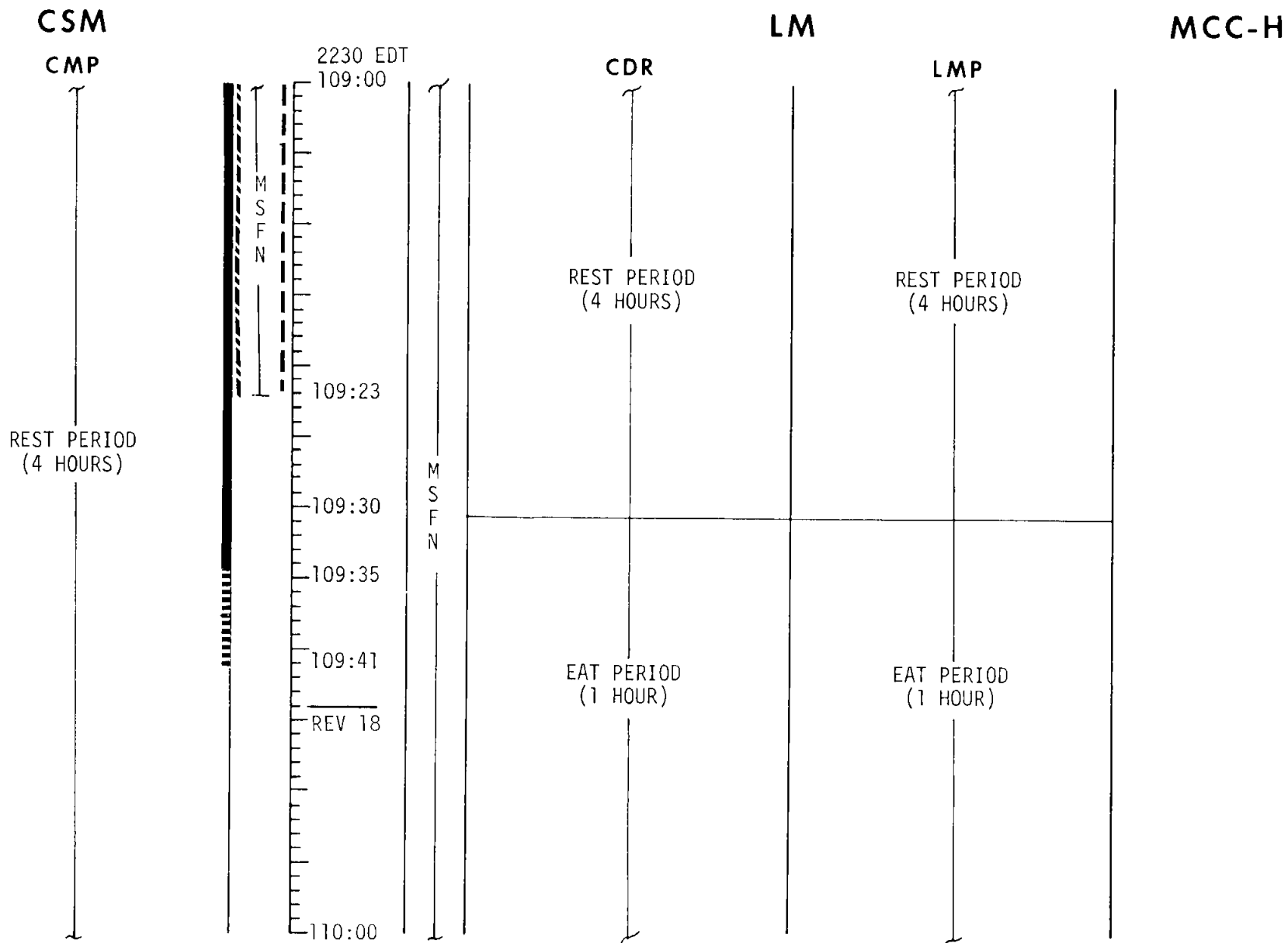

MISSION	EDITION	DATE	TIME	DAY/REV	PAGE
APOLLO 11	FINAL	JULY 1, 1969	109:00 - 110:00	5/17-18	3-76

FLIGHT PLANNING BRANCH

FLIGHT PLAN

CSM

LM

MCC-H

CMP

2330 EDT

CDR

LMP

110:00

110:09

110:30

110:40

110:47

111:00

REST PERIOD
(4 HOUR)

EAT PERIOD
(1 HOUR)

EAT PERIOD
(1 HOUR)

COPY UPDATE

CHANGE CO₂ FILTER

STAY NO STAY FOR EVA PREP
CREW STATUS REPORT (SLEEP, RADIATION)

DUMP DSE

UPDATE LM

CAMERA EXPOSURE
UPDATED FOR
LM AZIMUTH AND
T₇ THRU T₁₀

STAY/NO STAY

16mm/HCEX/AS PER DECAL
60mm/FRESH HCEX/
AS PER DECAL
80mm/HCEX/AS PER DECAL

M
S
F
N

M
S
F
N

CREW STATUS
SYSTEMS PREPARATION FOR EGRESS
C&W LIGHT CK, ADJUST INTERIOR LIGHTING

LM CONSUMABLES UPDATE

GET _____ : _____

RCS A _____ B _____

DESC O₂ _____

DESC A-H _____

ASC A-H _____

PREPARATION FOR EGRESS
STOW LOOSE ITEMS AND ARMREST
PREPARE CAMERAS

PLSS/OPS DOWNING
UNSTOW PLSS AND OPS
CONFIGURE PLSS AND OPS
FOR DOWNING

MISSION	EDITION	DATE	TIME	DAY/REV	PAGE
APOLLO 11	FINAL	JULY 1, 1969	110:00 - 111:00	5/18	3-77

FLIGHT PLAN

CSM

LM

MCC-H

CMP

CDR

LMP

0030 EDT

111:00

REST PERIOD
(4 HOURS)

LMP UNSTOW AND DON OVERSHOES
ATTACH OPS TO PLSS

CDR UNSTOW AND DON OVERSHOES
ATTACH OPS TO PLSS

LMP DON PLSS

UNSTOW AND CONNECT RCU

VERIFY PLSS SWITCH AND VALVE POSITIONS

PREPARE CDR PLSS FOR DONNING

CDR DON PLSS

UNSTOW AND CONNECT RCU

VERIFY PLSS SWITCH AND VALVE POSITIONS

CO₂ FILTER CHANGE NO. 9
(11 INTO A, STORE 9 IN A3)

111:21

111:30

111:33

111:39

REV 19

O₂ FUEL CELL PURGE

EAT PERIOD
(1 HOUR)

PLSS/EXTRA VEHICULAR COMM SYSTEM ELECTRICAL CHECKOUT
AUDIO SWITCHES CHECK
ACTIVATE PLSS COMM SYSTEMS

FINAL EVA EQUIPMENT PREP FOR EGRESS
UNSTOW AND CONNECT OPS O₂ HOSE AND ACTUATOR

FINAL SYSTEMS PREP FOR EGRESS
CONFIRM "GO" FOR CABIN DEPRESS
VERIFY C/B, VALVES AND O₂/H₂O QUANTITY

GO/NO GO

112:00

MISSION	EDITION	DATE	TIME	DAY/REV	PAGE
APOLLO 11	FINAL	JULY 1, 1969	111:00 - 112:00	5/18-19	3-78

FLIGHT PLAN

CSM

LM

MCC-H

CMP

CDR

LMP

PRESLEEP CHECKLIST
 CREW STATUS REPORT (RADIATION, MEDICATION)
 CYCLE O₂ & H₂ FANS
 CHLORINATE WATER
 VERIFY:
 WASTE MNGMT OVBD DRAIN VLV - OFF
 WASTE STOW VENT VLV - CLOSED
 EMER CABIN PRESS VLV - BOTH
 SURGE TANK O₂ VLV - ON
 REPRESS PACK O₂ VLV - OFF
 POTABLE H₂O HTR - OFF
 SELECT COMM NORMAL LUNAR CONFIGURATION - EXCEPT:
 S-BAND SQUELCH - ENABLE
 HGA TRACK - REACQ
 HGA BEAM - NARROW
 HGA P -59, Y 355

EAT PERIOD
(1 HOUR)

0430 EDT

115:00

115:18

115:30

115:37

REV 21

116:00

M
S
F
N

TERMINATE EVA WIPE FEET ON LANDING PAD AND LADDER ASCEND LADDER CABIN REPRESS	CLOSE FWD HATCH
POST EVA SYSTEMS CONFIGURATION VERIFY CAUTION LIGHTS OFF DISCONNECT RCU DISCONNECT OPS O ₂ HOSES CONNECT LM O ₂ HOSES (TV-OFF) CONFIGURE VALVES AND CIRCUIT BREAKERS DISCONNECT PLSS H ₂ O HOSES SWITCH TO LM COMM SYSTEM	
PLSS/OPS DOFFING REMOVE LMP RCU OPS CHECK STOW PLSS/OPS ON CABIN FLOOR REMOVE CDR RCU STOW PLSS/OPS ON CABIN FLOOR	
FINAL SYSTEMS CONFIGURATION PREP FOR EQUIPMENT JETTISON REPORT PLSS FEEDWATER REMOVE OPS FROM PLSS	

2+30

2+40
END EVA

80mm/HCEX/EVA CARD #1
 3 FRAMES EACH, FAR & NEAR FIELD (FOCUS 50') AND
 80mm/BW/EVA CARD #1
 3 FRAMES EACH, FAR & NEAR FIELD (FOCUS 20')

COPY REPORT

MISSION	EDITION	DATE	TIME	DAY/REV	PAGE
APOLLO 11	FINAL	JULY 1, 1969	115:00-116:00	5/20-21	3-82

FLIGHT PLAN

CSM

LM

MCC-H

CMP

CDR

LMP

0330 EDT
114:00

EL/250/BW-BRKT, INT
(f5.6, 250, INF)

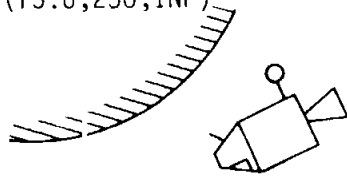

IF CONVENIENT CHANGE
SHUTTER TO 1/125
PITCH UP 38°
ROLL 180° TO HEADS UP
RO, P320/260, YO
PITCH DOWN, PHOTOGRAPH
LM WHILE TRACKING
THROUGH COAS

STOP PITCH AND
ROLL 180° TO HEADS DOWN
ATTITUDE FOR SURFACE
OBSERVATIONS
STOP CAMERA

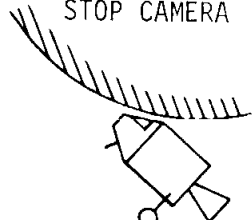

R180, P282/185, YO
HGA P -7, Y 183

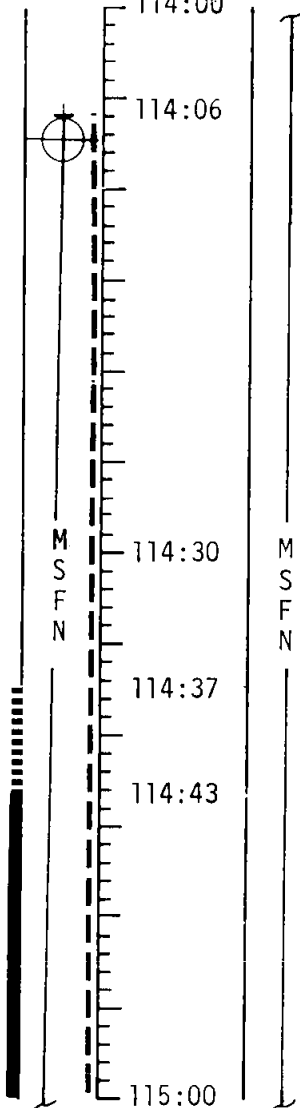

SELECT DEPLOY SITE CARRY CAMERAS DEPLOY LR ³ EXPERIMENT PHOTO EXPERIMENTS	SELECT DEPLOY SITE CARRY EXPERIMENTS DEPLOY PSE TAKE CLOSEUP PHOTOS	1+30
<u>DOCUMENTED SAMPLE COLLECTION</u> REST/PHOTO LMP CLOSE-UP PHOTOS TETHER SAMPLE BAG TO LMP PHOTO SAMPLING UNSTOW GNOMON PHOTO DS AREA PHOTO SAMPLE COLLECTION STOW ALSCC FILM COLLECT ENVIRONMENTAL SAMPLES RETRIEVE AND STOW SWC PACK SRC CLOSE AND SEAL SRC REST/PHOTO LMP	<u>DOCUMENTED SAMPLE COLLECTION</u> MOVE BULK SRC TO STRUTS OR FOOT PAD PREPARE DS SRC COLLECT CORE TUBE SAMPLE UNSTOW TOOLS COLLECT SAMPLES STOW ALSCC FILM COLLECT ENVIRONMENTAL SAMPLES COLLECT LOOSE MATERIAL CORE TUBE SAMPLE	1+40 DUMP DSE 1+50 LM ACQUISITION GET: : : 2+00
<u>SRC TRANSFER</u> TRANSFER BULK SRC AND PHOTO LMP STILL CAMERA MAGAZINE REST TRANSFER DS SRC	<u>EVA TERMINATION</u> WIPE SUIT AND EMU WIPE FEET ON LANDING PAD AND LADDER ASCEND LADDER INGRESS CABIN CHECK LM OPERATE SEQ CAMERA RECEIVE AND STOW SRC AND MAGAZINE RECEIVE AND STOW SRC	2+10 2+20
		2+30

MISSION	EDITION	DATE	TIME	DAY/REV	PAGE
APOLLO 11	FINAL	JULY 1, 1969	114:00-115:00	5/21	3-81

FLIGHT PLAN

CSM

LM

MCC-H

CMP

EAT PERIOD
(1 HOUR)

MANEUVER TO
SLEEP ATTITUDE
R82, P256/218, YO
HGA P -59, Y 355

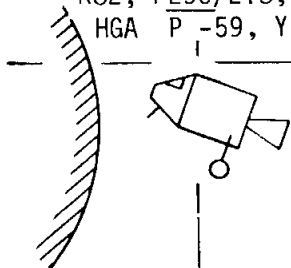

REST PERIOD
(4 HR 50 MIN)

0530 EDT

116:00

116:04

116:30

116:36

116:42

117:00

M
S
F
N

M
S
F
N

CDR

LMP

STOW EQUIPMENT IN LHSCC

PRESSURE INTEGRITY CHECK
CHECK VALVE POSITIONS
VERIFY GAGE READINGS

CABIN DEPRESS
OPEN RELIEF AND DUMP VALVES

HATCH OPENING
EQUIPMENT JETTISON

JETTISON 2 PLSS, LHSCC AND 1 ARMREST

CABIN REPRESS
RELIEF AND DUMP VALVES - AUTO
VERIFY MASTER ALARM AND WARN LIGHTS ON
POST EVA SYSTEMS CONFIGURATION

FINAL SYSTEMS CONFIGURATION

POST EVA CABIN CONFIGURATION
STOW EQUIPMENT
RECONFIGURE CAMERAS

EAT PERIOD
(40 MIN)

COPY UPDATE

EAT PERIOD
(40 MIN)

DUMP DSE

UPDATE LM
T₁₀ THRU T₁₃

MISSION	EDITION	DATE	TIME	DAY/REV	PAGE
APOLLO 11	FINAL	JULY 1, 1969	116:00 - 117:00	5/21	3-83

FLIGHT PLAN

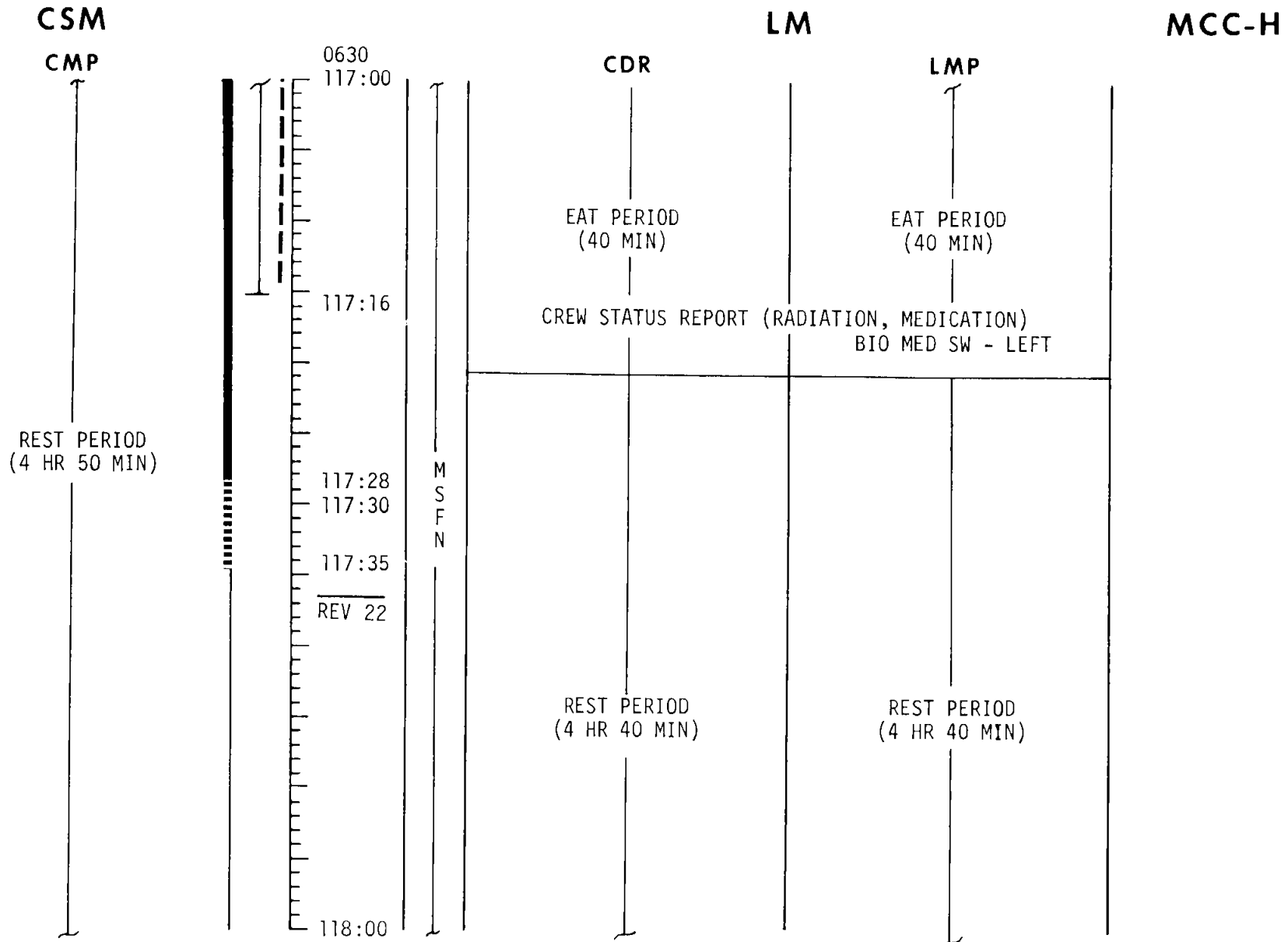

MISSION	EDITION	DATE	TIME	DAY/REV	PAGE
APOLLO 11	FINAL	JULY 1, 1969	117:00 - 118:00	5/20-21	3-84

FLIGHT PLAN

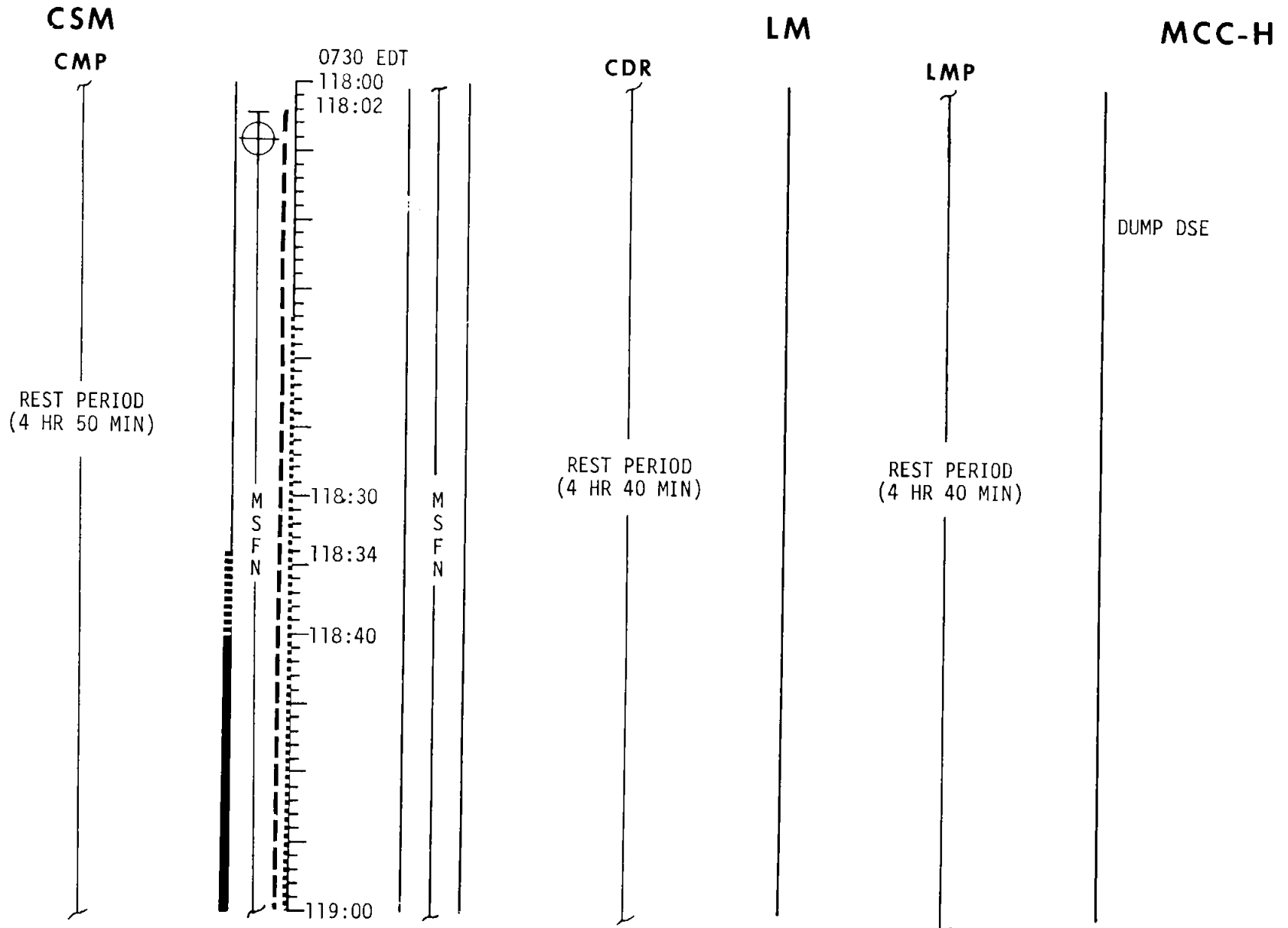

MISSION	EDITION	DATE	TIME	DAY/REV	PAGE
APOLLO 11	FINAL	JULY 1, 1969	118:00 - 119:00	5/22-23	3-85

FLIGHT PLAN

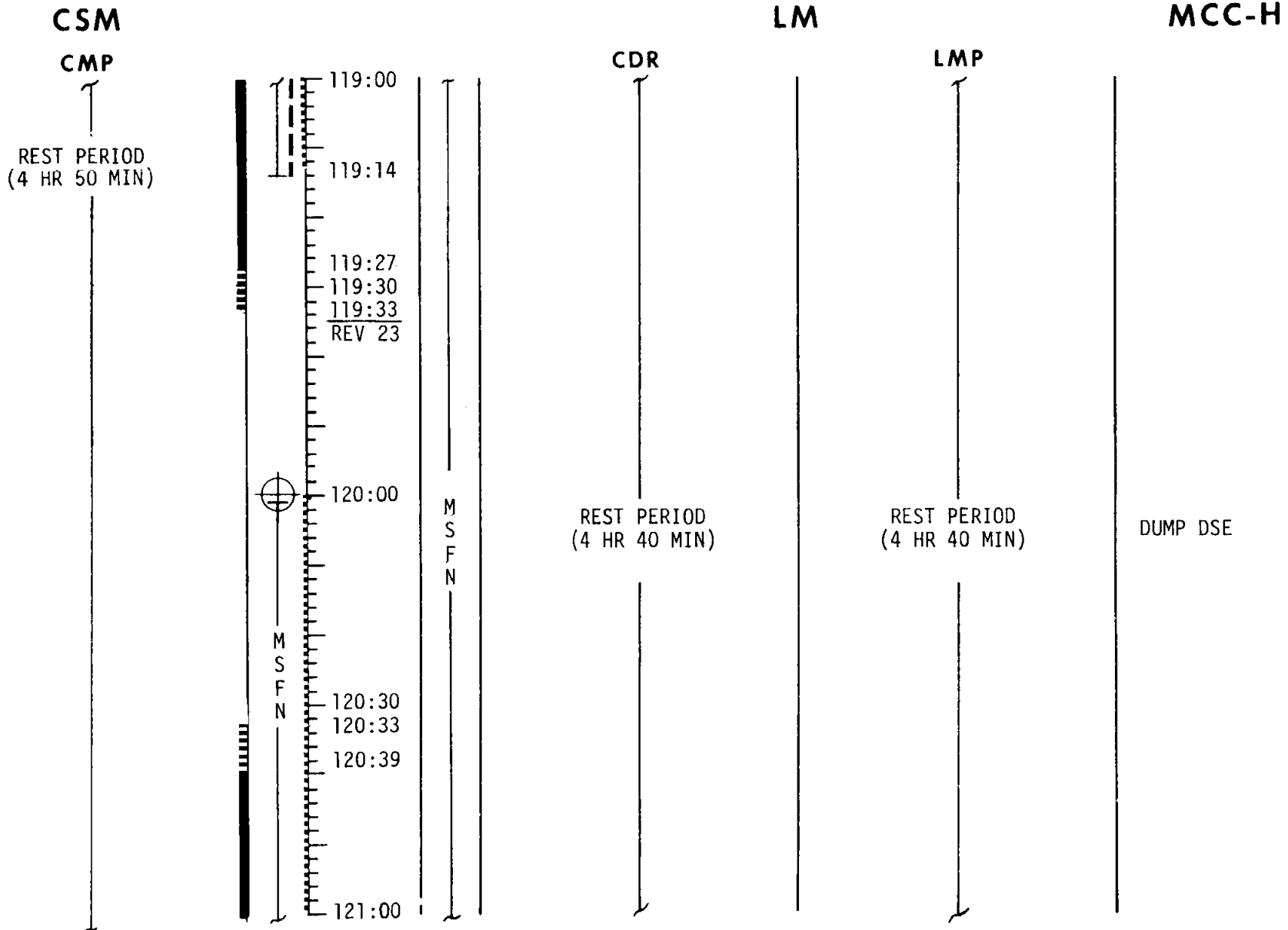

MISSION	EDITION	DATE	TIME	DAY/REV	PAGE
APOLLO 11	FINAL	JULY 1, 1969	119:00 - 121:00	5/22-23	3-86

FLIGHT PLAN

CSM

LM

MCC-H

CMP

CDR

LMP

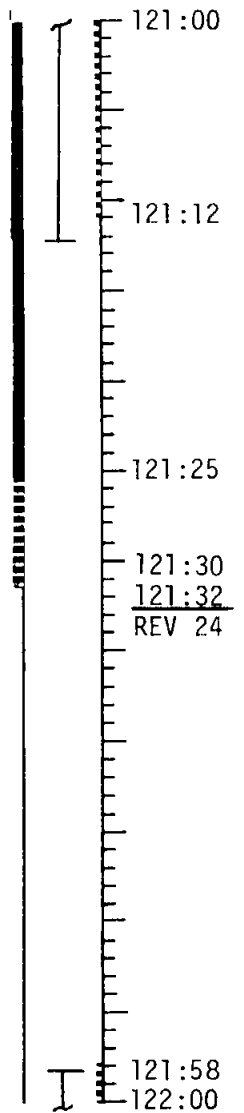
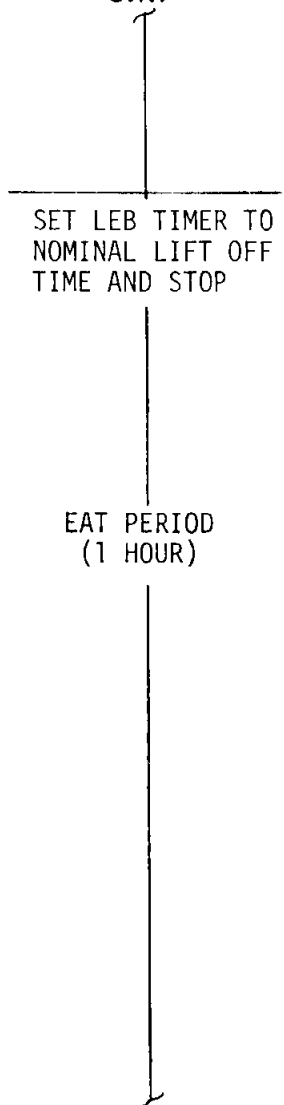

M
S
F
N

REST PERIOD
(4 HR 40 MIN)

REST PERIOD
(4 HR 40 MIN)

DUMP DSE

MISSION	EDITION	DATE	TIME	DAY/REV	PAGE
APOLLO 11	FINAL	JULY 1, 1969	121:00 - 122:00	5/23-24	3-87

FLIGHT PLAN

CSM

LM

MCC-H

CMP

CDR

LMP

SELECT COMM: NORMAL
LUNAR CONFIGURATION
CREW STATUS REPORT(SLEEP)

1130 EDT
122:00

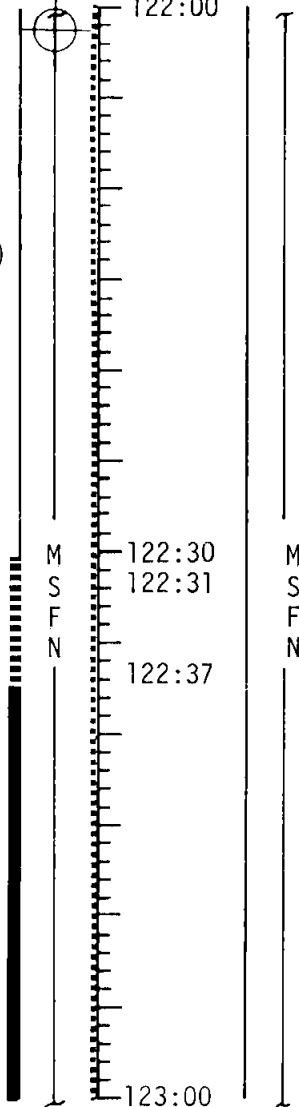

V45 RESET LUNAR SURFACE
FLAG

CREW STATUS REPORT (SLEEP)
RR - ON, SELF TEST

AGS TURN ON, SELF TEST
AND SYSTEM TESTS
INITIALIZE AGS TIME
REPORT BIAS TO MCC-H
REPORT:

COPY TIME BIAS

P57 - GRAVITY AND ONE
CELESTIAL BODY (REFSMAT)
N04: _ _ _ . _ _ _
N71: _ _ _ . _ _ _
N93: X _ _ . _ _ _
Y _ _ . _ _ _
Z _ _ . _ _ _
GET _ _ _ : _ _ _ : _ _ _

EAT PERIOD
(35 MIN)

EAT PERIOD
(35 MIN)

UPLINK LGC
CSM STATE VECTOR
(INSERTION +18 MIN)
PGNCS GYRO COMP
(IF REQUIRED)

UPLINK CMC
CSM STATE VECTOR
(INSERTION +18 MIN)
NOMINAL LM S. V.
(INSERTION +18 MIN)

MISSION	EDITION	DATE	TIME	DAY/REV	PAGE
APOLLO 11	FINAL	JULY 1, 1969	122:00 - 123:00	6/24	3-88

FLIGHT PLANNING BRANCH

FLIGHT PLAN

CSM

LM

MCC-H

CMP

CDR

LMP

COPY CONSUMABLES UPDATE

COPY ASCENT PAD
LOAD PAD DATA

UPDATE LM
ASCENT PAD

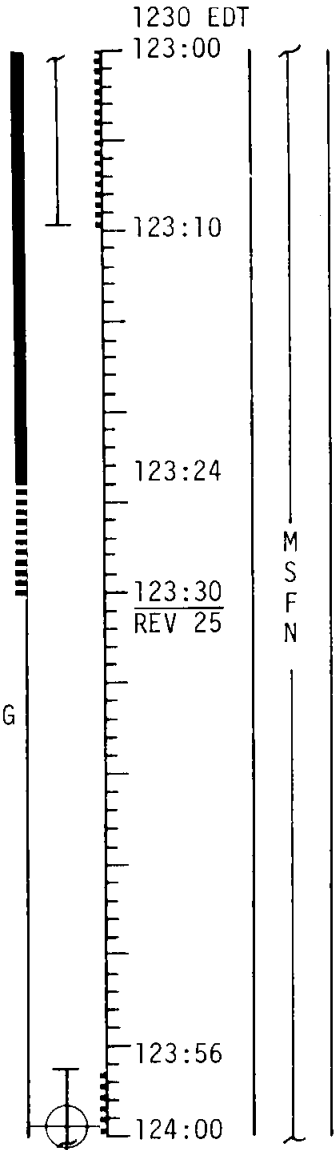

1230 EDT

123:00

123:10

123:24

123:30

REV 25

M
S
F
N

O₂ FUEL CELL PURGE

COPY CONSUMABLES UPDATE

REPORT:

CONSUMABLES REPORT
(Δ FROM NOMINAL)

GET: _____

RCS TOT _____

A _____

B _____

C _____

D _____

H₂ TOT _____

O₂ TOT _____

SET UP CAMERA FOR DOCKING
16mm/18/CEX-BRKT
MIR(f8,250,INF) 6 fps

P57-GRAVITY AND ONE
CELESTIAL BODY (T-ALIGN)

N04: _____

N71: _____

N93: _____

X _____

Y _____

Z _____

GET: _____ : _____ : _____

LM CONSUMABLES UPDATE

GET: _____ : _____

RCS A _____ B _____

DESC O₂ _____

DESC A-H _____

ASC A-H _____

RR TRANSPONDER - PWR

123:56

124:00

RCS HOT FIRE

ENTER AGS LUNAR ALIGN

MISSION	EDITION	DATE	TIME	DAY/REV	PAGE
APOLLO 11	FINAL	JULY 1, 1969	123:00-124:00	6/24-25	3-89

FLIGHT PLAN

CSM

LM

MCC-H

CMP

CDR

LMP

V64 ACQUIRE MSFN

VHF RANGING
MNVR TO SUPPORT
LIFT OFF
RO, P250/207, YO

PITCH DOWN, 0.2°/SEC

CONFIRM INSERTION

VHF RANGING
REPORT:

P52 (LIFT OFF REFSMMAT)
OPTION 3
N71: _____
N05: _____
N93: _____
X _____
Y _____
Z _____
GET _____:_____:_____

1330 EDT
124:00

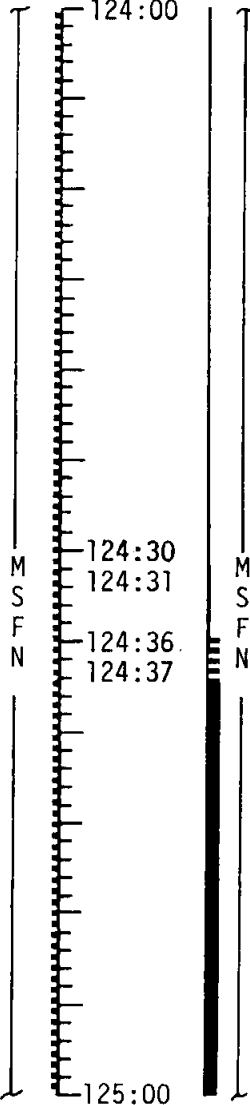

LOAD DAP - 12012
DON HELMET AND GLOVES
P12 ASCENT PROGRAM
RR-ON

PRELAUNCH SWITCH CK
VERIFY RESTRAINTS

TIG-5 SEC, ABORT STAGE

APS, LIFT OFF

RR LOCK ON, MODE II

ORBIT INSERTION

RR-OFF
VERIFY INSERTION VEL

P52 (LIFT OFF REFSMMAT)
N71: _____
N05: _____
N93: _____
X _____
Y _____
Z _____
GET _____:_____:_____

RR - ON

DON HELMET AND GLOVES

GO/NO GO FOR PGNC
ASCENT GUIDANCE AND
LIFT OFF THIS REV
PRELAUNCH SWITCH CK
VERIFY RESTRAINTS

LIFT OFF COMM
START 16mm CAMERA
V47 INITIALIZE AGS
AGS GUIDANCE STEERING

TIG: 124:23:26
BT: 7 MIN 18 SEC
ΔV: 6060 FPS
ORBIT: 60 KFT x 45NM

124:30:44

P00 - DOWNLINK LM S. V.
STOP 16mm CAMERA
ECS CHECK
V48 LOAD DAP N46, 12002
V56, V41 - RR-OFF
TURN ON TRACK LIGHT

LM FDAI: RO, P257.3, YO

V93 (BEFORE FIRST MARK)
V80, V47 INITIALIZE AGS
P32 CSI PRETHRUST

UPDATE LM
GO/NO GO

LIFT OFF -6 MIN
DISABLE S-BAND
RELAY

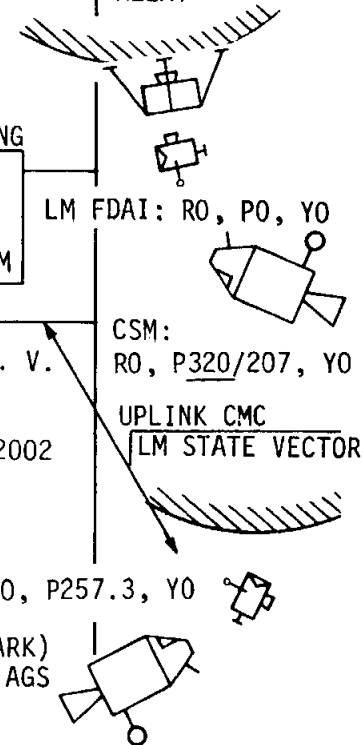

CSM: RO, P235/119, YO

MISSION	EDITION	DATE	TIME	DAY/REV	PAGE
APOLLO 11	FINAL	JULY 1, 1969	124:00 - 125:00	6/25	3-90

FLIGHT PLAN

CSM

LM

MCC-H

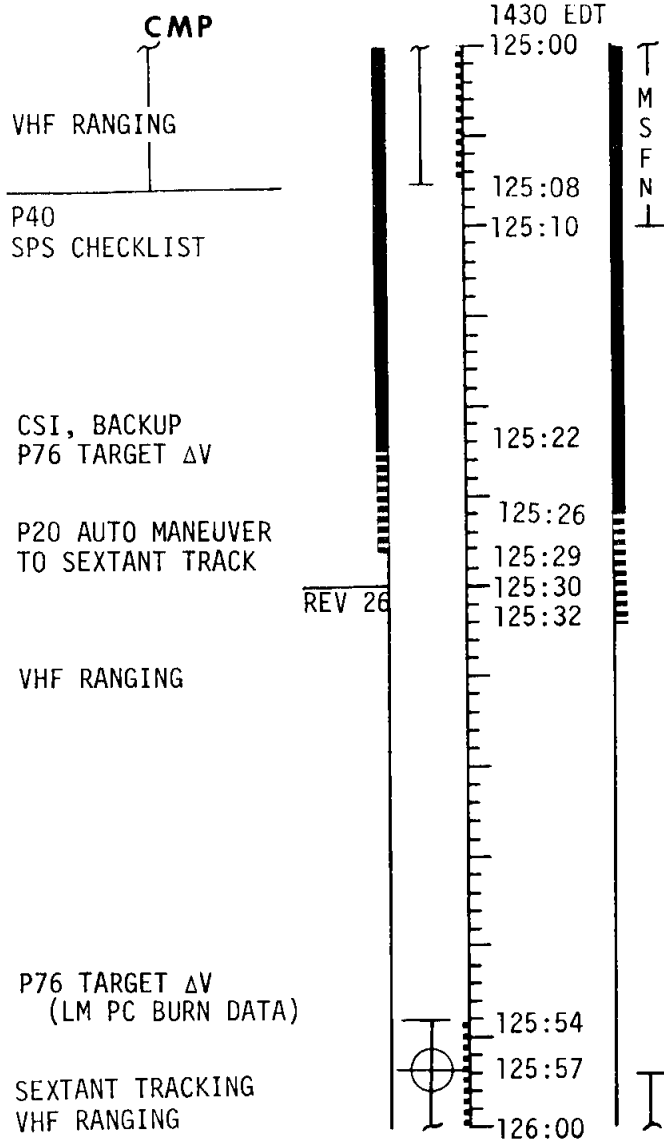

CDR	LMP
P20 RENDEZVOUS NAVIGATION ACQUIRE AND TRACK CSM MAINTAIN RR TRACKING ATTITUDE SLEW STEERABLE ANT ANT P 58, Y -38	V32-MARKS = 5 V32-MARKS = 10 RCS TEMP/PRESS/QTY CK AFT OMNI, PCM LBR
V83 SET ORDEAL	FINAL CSI COMPUTATION V90 OUT OF PLANE V47 INITIALIZE AGS(PCM-HI)
P41 RCS THRUSTING	CSI DATA TO CSM (PCM-LO) LOAD AGS ΔV
VERIFICATION	TIG: 125:21:19 BT: 45 sec ΔV: 49.5 FPS
Z AXIS BORESIGHT	V76, V67, VHF RANGING P33 CDH PRETHRUST V93 MARKS=4 V32 MARKS=3 V90 OUT OF PLANE
MAINTAIN RR AND VHF TRACKING ATTITUDE	V32 MARKS=10 P30 EXTERNAL ΔV V90 OUT OF PLANE
P41 RCS THRUSTING	LOAD AGS ΔV
PLANE CHANGE	TIG: 125:50:28 ΔV=NOMINALLY ZERO V76, P33 CDH PRETHRUST

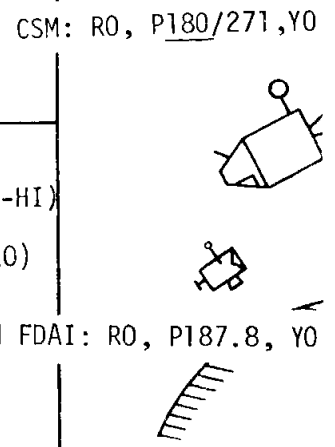

MISSION	EDITION	DATE	TIME	DAY/REV	PAGE
APOLLO 11	FINAL	JULY 1, 1969	125:00 - 126:00	2/25-26	3-91

FLIGHT PLAN

CSM

LM

MCC-H

CMP

CDR

LMP

1530 EDT
126:00

V90 YDOT
TRANSMIT YDOT TO LM
P33 FINAL COMPUTATION

P41
CDH BACKUP

P76 TARGET ΔV

P20 AUTO MANEUVER
TO SEXTANT TRACK
VHF RANGING

SEXTANT TRACKING
VHF RANGING

P34 TPI

SET EVENT TIMER
P40 ΔV THRUST
SPS CHECKLIST

P76 TARGET ΔV

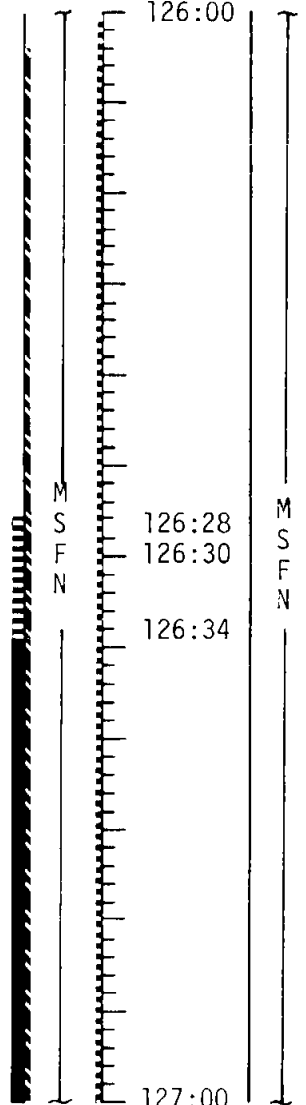

MAINTAIN RR
AND VHF TRACKING
ATTITUDE

V83 SET ORDEAL
P41 RCS THRUSTING

RCS, CDH

MAINTAIN RR
AND VHF TRACKING
ATTITUDE

P41 RCS THRUSTING
COUNTDOWN TO CSM

RCS, TPI

VERIFY RESIDUALS

V93, MARKS=4
ACQUIRE MSFN-S BAND
STEERABLE ANTENNA

P -58 Y -38
V32, MARKS=5
RCS TEMP/PRESS/QTY CK
ECS CHECK

FINAL COMPUTATION LM FDAI: RO, P352.8, Y0
V90 OUT OF PLANE
COPY CSM YDOT, LOAD NEG
V47 INITIALIZE AGS
LOAD ΔV

TIG: 126:19:37
BT: 1.9 SEC
 ΔV : 4.3 FPS

V76, P34 TPI PRETHRUST
V93, MARKS=4
V32, MARKS=3

CSM: R180, P264/177, Y0

V32, MARKS=10

RCS-TEMP/PRESS/QTY CK
ECS CHECK

CSM: RO, P208/9, Y0

FINAL COMPUTATION
COPY CSM YDOT, LOAD NEG
V47 INITIALIZE AGS
COPY CSM TPI SOLUTION
LOAD AGS ΔV

TIG: 126:58:08
BT: 22.4 SEC
 ΔV : 24.8 FPS

LM FDAI: RO, P274.6, Y0

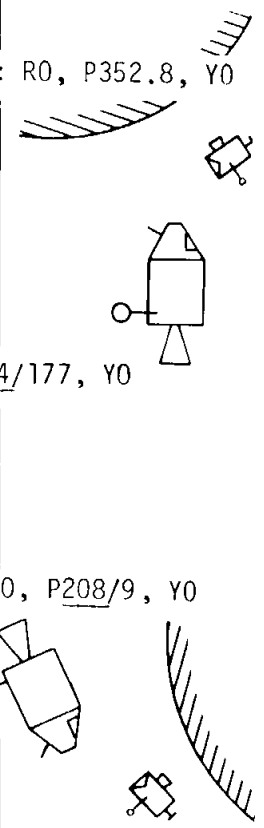

MISSION	EDITION	DATE	TIME	DAY/REV	PAGE
APOLLO 11	FINAL	JULY 1, 1969	126:00 - 127:00	6/26	3-92

FLIGHT PLAN

CSM

LM

MCC-H

CMP

CDR

LMP

P20 AUTO MNVR TO
P35 TPM PRETHRUST
SXT AND VHF TRACKING

P41
MCC1 BACKUP
P76 TARGET ΔV

SXT AND VHF TRACKING

P35 TPM PRETHRUST
P41
MCC2 BACKUP
P76 TARGET ΔV
V89 MANEUVER TO COAS
TRACKING ATTITUDE
DON HELMET & GLOVES

START 16mm CAMERA
DOCK CHECKLIST
LOAD DAP R1 = 61112
R2 = 11111
FOR LM ASCENT STAGE
DOCKING
CMC - AUTO

1630 EDT
127:00

127:06

127:21

127:27
REV 27
127:30

127:53

128:00

ANT P Y

P41 RCS THRUSTING

RCS, MCC1

MAINTAIN LOS CSM

P41 RCS THRUSTING

RCS, MCC2

V63 RR SELF TEST
P47 THRUST MONITOR

V76, V93(BEFORE FIRST MARK)
P35 TPM PRETHRUST
AFT OMNI, PCM LBR

COMPUTE MCC1 (TPI + 15)

TIG: 127:13:08

V76, V93(BEFORE FIRST MARK)
P35 TPM PRETHRUST

COMPUTE MCC2 (TPI + 30)

TIG: 127:28:08

P00

RCS BRAKING

GET	ΔT FROM TPI	BT SEC	ΔV FT/SEC	RANGE NM	RANGE RATE FT/SEC
127:36:57	28:49		NOMINALLY NOT PERFORMED		
127:39:24	41:16	10.8	12.0	2724	-19.7
127:40:37	42:29	8.8	9.8	1370	-9.8
127:42:16	44:08	4.3	4.8	469	-4.8
127:43:35	45:27	4.2	4.7	89	-0.2

MISSION	EDITION	DATE	TIME	DAY/REV	PAGE
APOLLO 11	FINAL	JULY 1, 1969	127:00 - 128:00	6/26-27	3-93

FLIGHT PLAN

CSM

CMP

CONTACT: CMC - FREE
NULL RATES

ROLL RIGHT 60°,
PITCH UP 53°

GO INERTIAL
PRESS CSM TO 5.5 PSIA
DISABLE JETS B3 & C4
ADJUST O₂ FLOW TO
.6 LBS/HR
PRESS TUNNEL TO 3 PSID
FOR LEAK CK, THEN
EQUALIZE CM/LM ΔP
INFORM LM WHEN PRESS
EQUAL.
REMOVE HATCH AND STOW
VERIFY LATCHES
PASS BAGS & BRUSH
TO LM

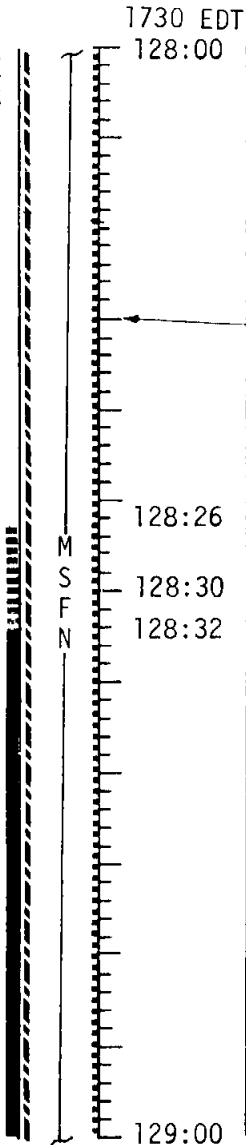

CDR

DOCKING 128:00

DOFF HELMET & GLOVES
AND TEMPORARILY STOW
OPEN LM HATCH
REMOVE AND STOW PROBE
& DROGUE

RETRIEVE THE FOLLOWING
ITEMS FROM CSM:
HELMET STOWAGE BAGS (2)
SRC (ROCK BOX) BAGS (2)
CSC (GRAB SAMPLE) BAG (1)
70MM MAGAZINE BAG (1)
CLOSEUP MAGAZINE BAG (1)
VACUUM BRUSH & HOSE
GLOVE BAGS (2)

CONFIGURE CDR SUIT
LOOP FOR VACUUM
CLEANING

LM

LMP

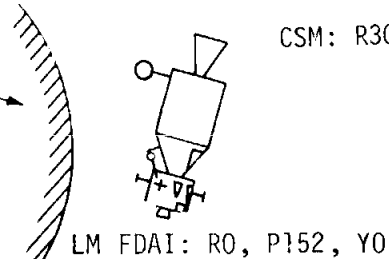

DOFF HELMET & GLOVES
AND TEMPORARILY STOW

ASSIST CDR

TEMPORARILY STOW
BAGS AND BRUSH

ASSIST CDR

MCC-H

CSM: R300, P4/332, Y0

CSM: R 0, P 102/25, Y 0

HGA: P -53, Y 3

LM FDAI: R 0, P 205, Y 60

ANT: P 173, Y 72

MISSION	EDITION	DATE	TIME	DAY/REV	PAGE
APOLLO 11	FINAL	JULY 1, 1969	128:00 - 129:00	6/27	3-94

FLIGHT PLAN

CSM

LM

MCC-H

CMP

CDR

LMP

V66 - TRANS CSM STATE
VECTOR TO LM SLOT

RETRIEVE SRC'S FROM
LM AND STOW IN
B5 AND B6

RETRIEVE BAGGED
ITEMS FROM LM
AND STOW:
CSC - A5
CLOSEUP MAGAZINE - A5
70MM MAGAZINES - R13
HELMETS-FOOD
CONTAINERS

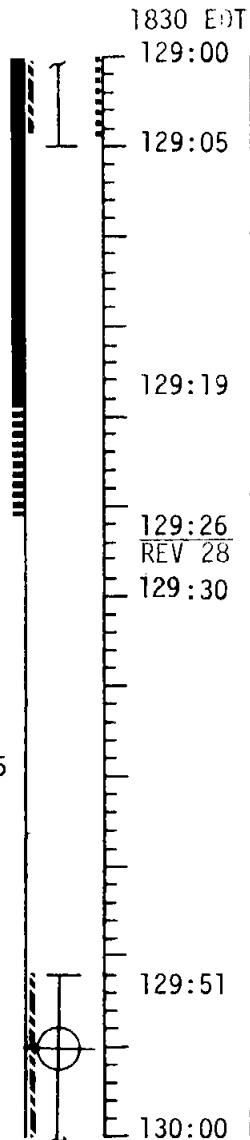

VACUUM BRUSH FWD
DUMP VALVE FILTER

VACUUM SRC'S

VACUUM:

CSC

70MM MAGAZINE

CLOSEUP MAGAZINE

HELMETS

GLOVES

VACUUM BRUSH LMP'S PGA

VACUUM THE BRUSH
AND STOW IN ISA

UNSTOW AND HOLD
SRC'S FOR CLEANING

BAG SRC'S AND
TRANSFER TO CM

HOLD EQUIPMENT FOR
CLEANING

BAG ITEMS AND
TRANSFER TO CSM
(GLOVES IN HELMETS)

VACUUM BRUSH CDR'S PGA

UPLINK
CSM STATE VECTOR

MISSION	EDITION	DATE	TIME	DAY/REV	PAGE
APOLLO 11	FINAL	JULY 1, 1969	129:00 - 130:00	6/28	3-95

FLIGHT PLAN

CSM
CMP

LM

MCC-H

CDR

LMP

REMOVE ISA CONTENTS
AND STOW. PLACE
CM JETTISONABLE
ITEMS INTO ISA AND
TRANSFER ISA TO LM

DISCONNECT FROM
LM AND TRANSFER
TO CM WITH ISA

RETRIEVE ISA AND
INSTALL ON PANELS
1 & 2

CONFIGURE LM
SYSTEMS FOR JETTISON

DISCONNECT FROM
LM HOSES
CLOSE LM HATCH

IVT TO CSM

UNSTOW AND INSTALL
CSM HATCH

HATCH INTEGRITY CHECK
DEPRESSURIZE TUNNEL

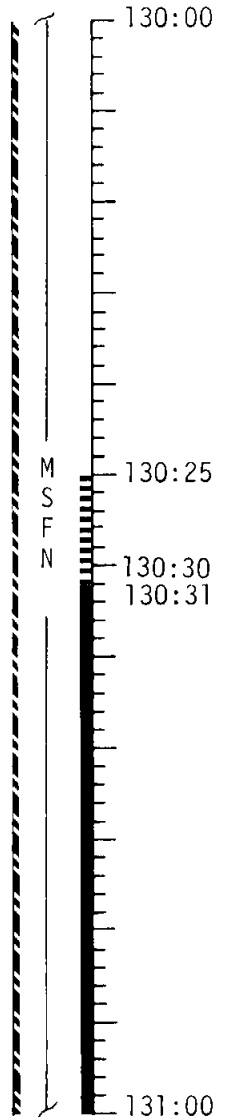

MISSION	EDITION	DATE	TIME	DAY/REV	PAGE
APOLLO 11	FINAL	JULY 1, 1969	130:00 - 131:00	6/29	3-96

FLIGHT PLANNING BRANCH

MCC-H

FLIGHT PLAN

NOTES

2030 EDT

131:00
131:03

131:18

131:25
REV 29

131:30

131:50

132:00

EQUIPMENT STOWAGE

VACUUM PGAS

SET UP CAMERA FOR LM JETTISON
16mm/18/CEX-BRKT,MIR
(f8,250,7) 12 fps

SM RCS CHECK
ENABLE JETS B-3 AND C-4
CONFIGURE DAP - R1=11102, R2=11111

GO/NO-GO FOR PYRO ARM
PYRO LOGIC ARM
THRUST MONITOR - P47
START CAMERA

LM JETTISON
SM RCS CHECK

GETI = 131:53:05
BT = 3.1 SEC
 $\Delta V = 1$ FPS
RETROGRADE
ORBIT: 58.5 X 59.4

DAP CONFIGURATION
FOR LM JETTISON
CSM, 0.5° DB, 0.5°/SEC
A/C ROLL, 4 JET

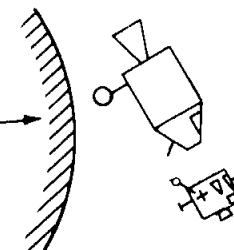

RO, P45/25, Y0
HGA P-53, Y3

GO/NO GO

MISSION	EDITION	DATE	TIME	DAY/REV	PAGE
APOLLO 11	FINAL	JULY 1, 1969	131:00 - 132:00	6/29	3-97

MSC Form 29 (May 69)

FLIGHT PLANNING BRANCH

MCC-H

2130 EDT
132:00

FLIGHT PLAN

NOTES

MNVR TO TEI BURN ATTITUDE

V66 - TRANS CSM STATE VECTOR TO LM SLOT
BURN STATUS REPORT
RECORD PRELIMINARY TEI₃₀ MNVR PAD

GO INERTIAL

DOFF AND BAG PGA'S HELMETS
AND GLOVES

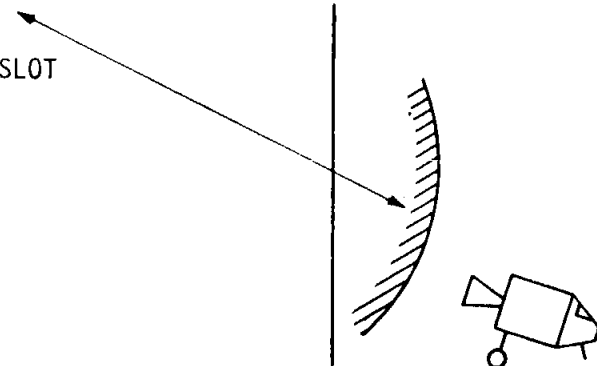

R1.1 P93.2/52.6 Y13.8
HGA P -79, Y 10

UPDATE
TEI₃₀ MNVR PAD

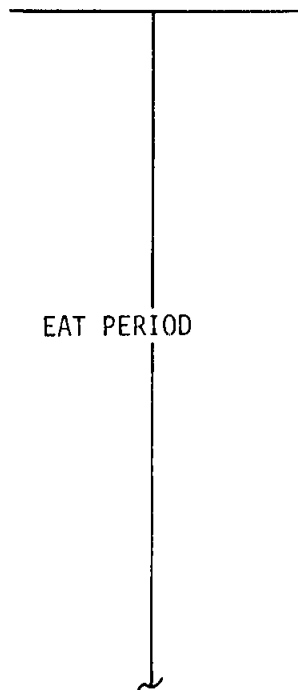
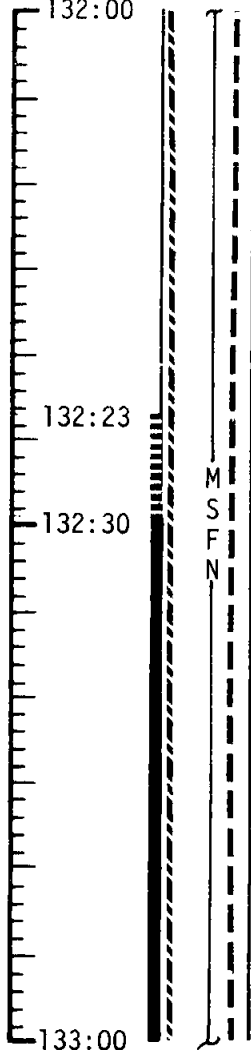

MISSION	EDITION	DATE	TIME	DAY/REV	PAGE
APOLLO 11	FINAL	JULY 1, 1969	132:00 - 133:00	6/29	3-98

MCC-M

2330 EDT

134:00

FLIGHT PLAN

NOTES

UPDATE

TEI₃₀ MNVR PAD
 BLOCK DATA
 (TEI₃₁)
 GO/NO GO

UPLINK CMC

CSM STATE VECTOR
 TEI TGT LOAD

134:29

134:30

135:00

M
S
F
N

PRE TEI SYSTEMS CKS:
 C&W CK
 CM RCS MON CK
 SM RCS MON CK
 EPS MONITOR CK
 ECS REDUNDANT COMPONENTS CK

RECORD FINAL TEI₃₀ MNVR PAD AND
 BLOCK DATA
 GO/NO GO FOR TEI₃₁
 THIS REV

V66 - TRANS CSM STATE VECTOR TO LM SLOT

IMU REALIGN - P52
 OPTION 3 - REFSMMAT
 AND DRIFT CHECK

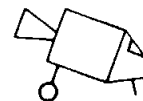
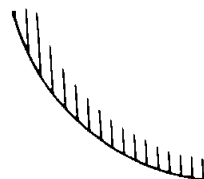

R1.1 P201.4/52.6 Y13.8
 HGA P -78, Y 5

P30 EXTERNAL ΔV

REPORT:

P52 (LIFT OFF REFSMMAT)
 N71: _____
 N05: _____
 N93: _____
 X _____
 Y _____
 Z _____
 GET _____ : _____ :

MISSION	EDITION	DATE	TIME	DAY/REV	PAGE
APOLLO 11	FINAL	JULY 1, 1969	134:00 - 135:00	6/30	3-100

MSC Form 29 (May 69)

FLIGHT PLANNING BRANCH

THIS PAGE INTENTIONALLY LEFT BLANK.

TEI
BURN CHART

	P OR Y RATES	ATT DEVIATION	SHUTDOWN TIME	RESIDUALS
TEI	10°/SEC TAKEOVER	+10° TAKEOVER	BT + 2 SEC & $\Delta V_c = -40$ FPS	TRIM X AND Z AXIS TO 0.2 FPS
TEI ABORT MODES				
TEI V_{GO}	BT	TRAJECTORY	ABORT MODE	
3292.7 - 1436.0	0 - 90	LUNAR ORBIT	MODE III - AFTER 1 REV	
1436.0 - 1207.0	90 - 100	UNSTABLE	MODE II - 2 SPS BURNS FOR ORBIT STABILIZATION AND WATER OR CLA LANDING.	
1207.0 - 0	100 - 149	UNSTABLE/ HYPERBOLIC	MODE I - 1 BURN AT TEI + 2 HRS P37 AT SPHERE OF INFLUENCE HYPERBOLIC (ΔV 580 to 0, BT 125-149)	

MCC-H

0030 EDT

FLIGHT PLAN

NOTES

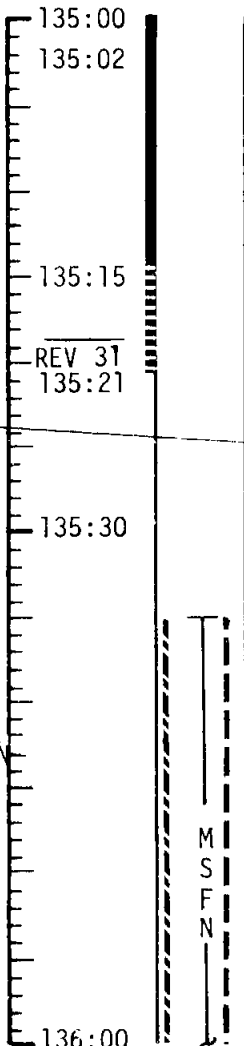

SPS THRUST - P40
 ROLL TO BURN ATT
 R181.1, P280.4/52.6, Y13.8

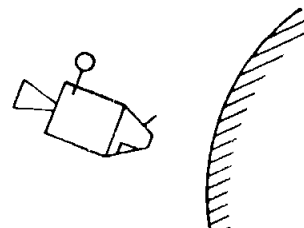

SXT STAR CK

DAP CONFIGURATION FOR TEI
 CSM, 5°DB, 0.2°/SEC
 A/C ROLL, 4 JET

EMS ΔV TEST

DAP-R1=10111 R2=11111

SM RCS CK

GET: 135:24:34
 ULLAGE = 2 JET 16 SEC
 ΔV = 3292.7 FPS
 BT = 2 MIN 29 SEC

GDC ALIGN TO IMU

TEI

V48-DAP UPDATE (S/C WT)
 SM RCS MON CK
 SPS MON CK
 V66 - TRANS CSM STATE VECTOR TO LM SLOT
 PITCH DOWN TO ACQ MSFN AND
 VISUALLY ACQ MOON

IMU REALIGN - P52
 OPTION 1 - PREFERRED
 AND STAR CK

BURN STATUS REPORT

X	X		•	ΔTIG
X	X		•	BT
			•	V _{gx}
TRIM				
X	X	X		R
X	X	X		P
X	X	X		Y
			•	V _{gy}
			•	V _{gz}
			•	ΔV _c
X	X	X		FUEL
X	X	X		OX
X	X	X		UNBAL

P52 - PULSE TORQUE
 TO PTC REFSMMAT
 PLATFORM ALIGN
 CHECKED WITH
 OPTICS

REV 31
 135:21

R181.1, P355/52.6, Y13.8

UPLINK
 DESIRED ORIENTATION
 (PTC)

SET CAMERA FOR POST-TEI
 EL/80/CEX(f5.6,250,INF)
 OR
 EL/80/BW(f4,250,INF)

MISSION	EDITION	DATE	TIME	DAY/REV	PAGE
APOLLO 11	FINAL	JULY 1, 1969	135:00 - 136:00	6/TEC	3-101

MCC-H

0130 EDT

FLIGHT PLAN

NOTES

136:00
:10
:20
:30
:40
:50
137:00
:10
:20
:30
:40
:50
138:00

M
S
F
N

WIPE EXCESSIVE
MOISTURE FROM
TUNNEL HATCH AREA

START PTC
P 270° Y 0

EAT PERIOD-ALL

PRESLEEP CHECKLIST ↓

CREW STATUS REPORT (RADIATION
AND MEDICATION)
CYCLE O₂ & H₂ FANS
CHLORINATE POTABLE WATER
SELECT NORMAL LUNAR CONFIG
EXCEPT: (FOR COAST ASLEEP)
S-BD NORMAL MODE VOICE - OFF
S-BD AUX TAPE - OFF
TAPE RCDR FWD - OFF
GO TO HGA OR CONTINUE OMNI
OPS PER MSFN
OMNI OPS
S-BD ANT OMNI - OMNI
S-BD ANT OMNI - B
HI GAIN OPS
HI GAIN ANT BEAM - NARROW
HI GAIN ANT TRACK - REACQ
S-BD ANT-HI GAIN
VERIFY:
WASTE MNGT OVBD DRAIN-OFF
WASTE STOW VENT VLV-CLOSED
EMERG CABIN PRESS VLV-BOTH
SURGE TK O₂ VLV - OFF
LM TUNNEL VENT VLV - OFF
POT H₂O HTR - OFF
AUTO RCS JET SELECT (16) - OFF

REST PERIOD
(10 HOURS)

PTC ESTABLISHED IN
G&N P, Y +30° DB,
R RATE OF 0.3°/SEC

P23-NO COMM, (5 SETS)
TEI + 30 MIN (136:00)
MENKENT (30), LNH
MENKENT (30), LNH
ATRIA (34), LNH
NUNKI (37), LFH
NUNKI (37), LFH

ONBOARD READOUT

BAT C _____
PYRO BAT A _____
PYRO BAT B _____
RCS A _____
B _____
C _____
D _____
DC IND SEL TO MNA
OR MNB

MISSION	EDITION	DATE	TIME	DAY/REV	PAGE
APOLLO 11	FINAL	JULY 1, 1969	136:00 - 138:00	6/TEC	3-102

MCC-H

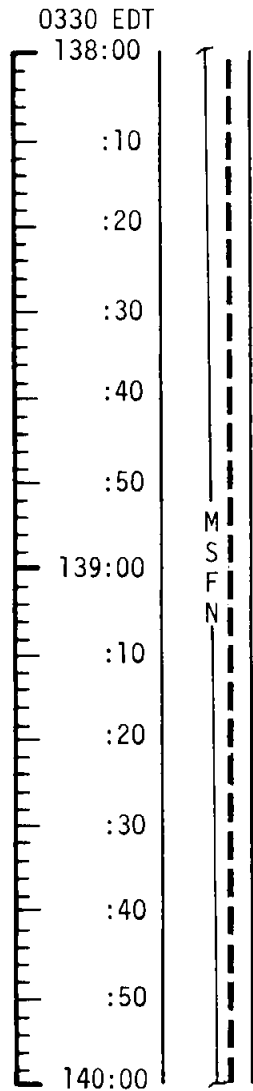

FLIGHT PLAN

NOTES

REST PERIOD
(10 HOURS)

PTC

MISSION	EDITION	DATE	TIME	DAY/REV	PAGE
APOLLO 11	FINAL	JULY 1, 1969	138:00 - 140:00	6/TEC	3-103

MCC-H

FLIGHT PLAN

NOTES

0530 EDT
 140:00
 :10
 :20
 :30
 :40
 :50
 141:00
 :10
 :20
 :30
 :40
 :50
 142:00

M
S
F
N

REST PERIOD
(10 HOURS)

PTC

MISSION	EDITION	DATE	TIME	DAY/REV	PAGE
APOLLO 11	FINAL	JULY 1, 1969	140:00 - 142:00	6/TEC	3-104

MSC Form 29 (May 69)

FLIGHT PLANNING BRANCH

MCC-H

0730 EDT

FLIGHT PLAN

NOTES

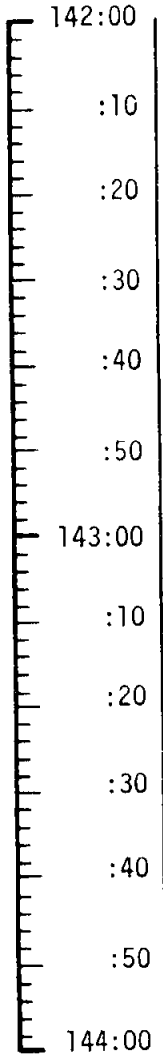

REST PERIOD
(10 HOURS)

PTC

MISSION	EDITION	DATE	TIME	DAY/REV	PAGE
APOLLO 11	FINAL	JULY 1, 1969	142:00 - 144:00	6/TEC	3-105

MCC-H

FLIGHT PLAN

NOTES

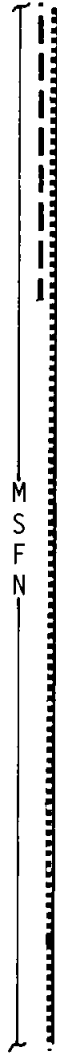
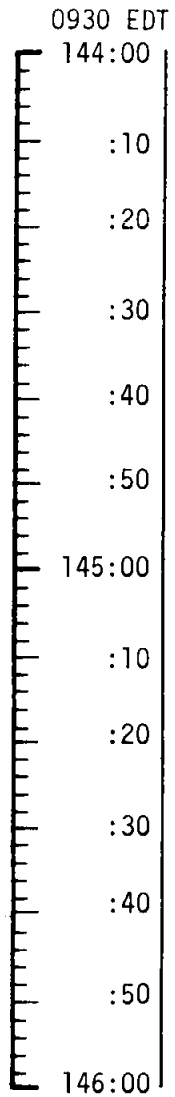

REST PERIOD
(10 HOURS)

PTC

MISSION	EDITION	DATE	TIME	DAY/REV	PAGE
APOLLO 11	FINAL	JULY 1, 1969	144:00 - 146:00	6/TEC	3-106

MCC-H

FLIGHT PLAN

NOTES

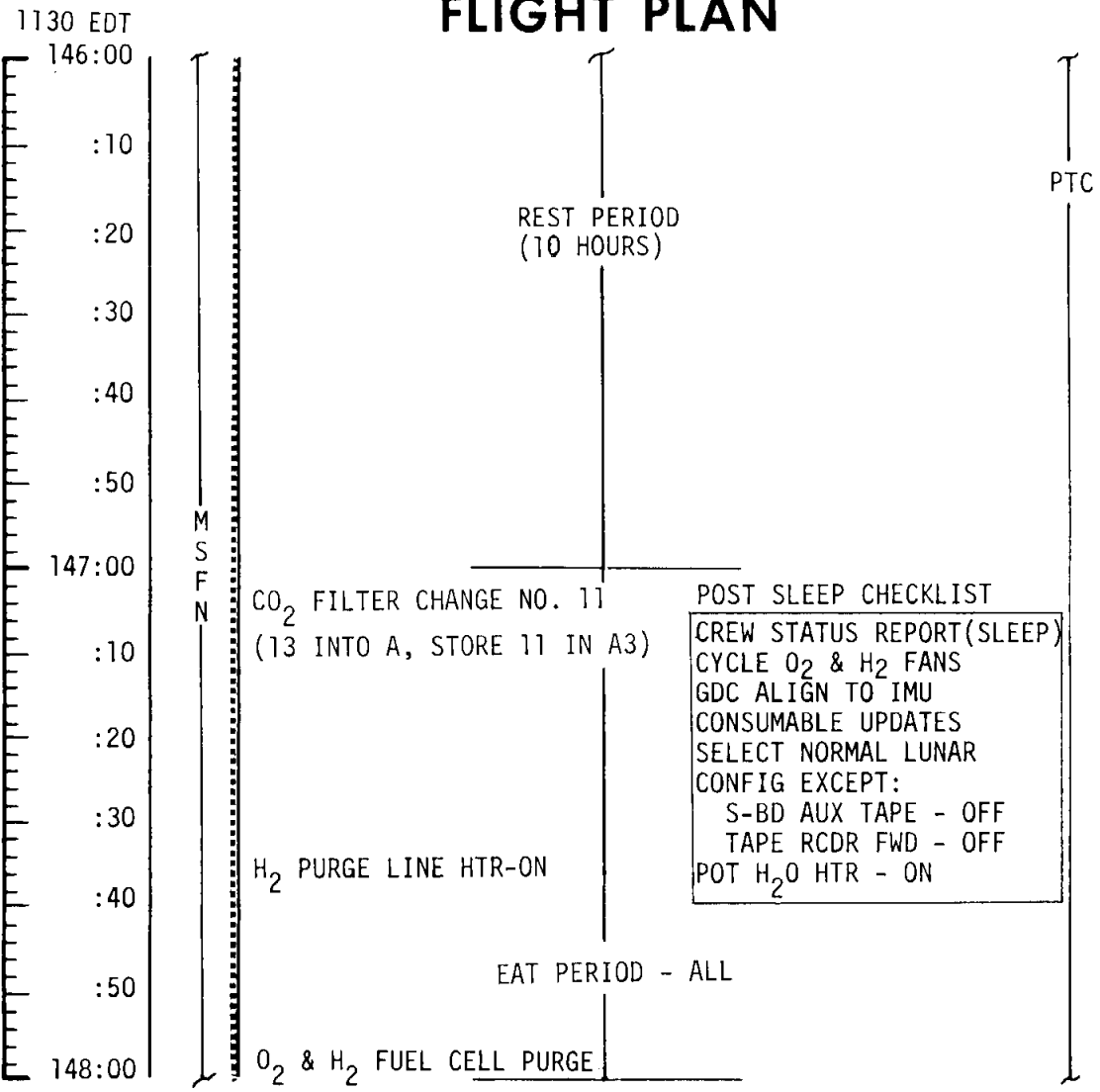

P23-NO COMM, (5 SETS)
TEI + 11:30 (147:00)
SPICA (26), LNH
SPICA (26), LNH
MENKENT (30), LNH
NUNKI (37), LFH
NUNKI (37), LFH

CONSUMABLE UPDATE
(Δ FROM NOMINAL)

GET: _____

RCS TOT _____

A _____

B _____

C _____

D _____

H₂ TOT _____

O₂ TOT _____

MISSION	EDITION	DATE	TIME	DAY/REV	PAGE
APOLLO 11	FINAL	JULY 1, 1969	146:00 - 148:00	7/TEC	3-107

MCC-H

1330 EDT

FLIGHT PLAN

NOTES

148:00
:10
:20
:30
:40
:50
149:00
:10
:20
:30
:40
:50
150:00

M
S
F
N

WIPE EXCESSIVE MOISTURE
FROM TUNNEL HATCH AREA

V66 - TRANS CSM STATE VECTOR TO
LM SLOT

RECORD MCC5 MNVR PAD

IMU REALIGN - P52
OPTION 3 - REFSMMAT

EXT ΔV - P30

SPS/RCS THRUST - P40/41

P23-NO COMM, (5 SETS)
TEI + 13:00 (148:00)
ALPHERATZ (01), EFH
DIPHDA (02), EFH
MIRFAK (10), ENH
MIRFAK (10), ENH
ALDEBARAN (11), ENH

P52 (PTC REFSMMAT)
N71: _____
N05: _____
N93:
X _____
Y _____
Z _____
GET _____:_____:_____

UPLINK
CSM STATE VECTOR
MCC5 TGT LOAD

UPDATE
MCC5 MNVR PAD

PTC

MISSION	EDITION	DATE	TIME	DAY/REV	PAGE
APOLLO 11	FINAL	JULY 1, 1969	148:00 - 150:00	7/TEC	3-108

THIS PAGE INTENTIONALLY LEFT BLANK.

MCC
BURN CHART

	P OR Y RATES	ATT DEVIATION	SHUTDOWN TIME	RESIDUALS
MCC5	10°/SEC TAKEOVER	10° TAKEOVER	BT + 1 SEC	TRIM X AXIS ONLY

MCC-H

1530 EDT
150:00

FLIGHT PLAN

NOTES

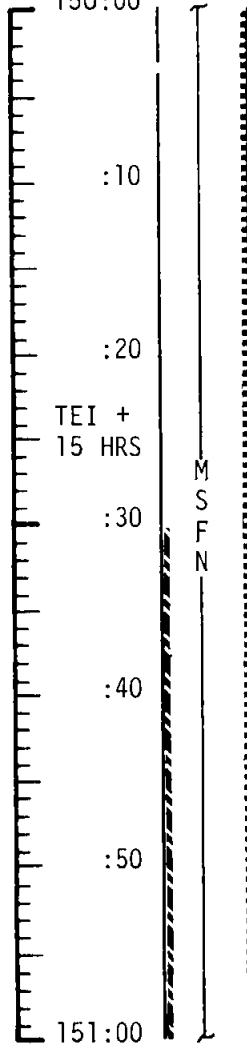

MNVR TO BURN ATT

SXT STAR CK

EMS ΔV TEST

SM RCS MON CK

GDC ALIGN TO IMU

MCC5 ΔV=NOMINALLY ZERO

SM RCS MON CK

SPS MON CK

V66-TRANS CSM STATE VECTOR
TO LM SLOT

BURN STATUS REPORT

BATTERY CHARGE, BATTERY A

PTC ESTABLISHED IN
G & N P, Y +30° DB
R RATE OF 0.3/SEC

BURN STATUS REPORT

X	X	<input type="checkbox"/>	•	ΔTIG
X	X	<input type="checkbox"/>	•	BT
<input type="checkbox"/>	<input type="checkbox"/>	<input type="checkbox"/>	•	V _{gx}
TRIM				
X	X	X		R
X	X	X		P
X	X	X		Y
<input type="checkbox"/>	<input type="checkbox"/>	<input type="checkbox"/>	•	V _{gx}
<input type="checkbox"/>	<input type="checkbox"/>	<input type="checkbox"/>	•	V _{gy}
<input type="checkbox"/>	<input type="checkbox"/>	<input type="checkbox"/>	•	V _{gz}
<input type="checkbox"/>	<input type="checkbox"/>	<input type="checkbox"/>	•	ΔV _c
X	X	X		FUEL
X	X	X		OX
X	X	X		UNBAL

START PTC
P 270° Y 0

PTC

MISSION	EDITION	DATE	TIME	DAY/REV	PAGE
APOLLO 11	FINAL	JULY 1, 1969	150:00 - 151:00	7/TEC	3-109

MCC-H

FLIGHT PLAN

NOTES

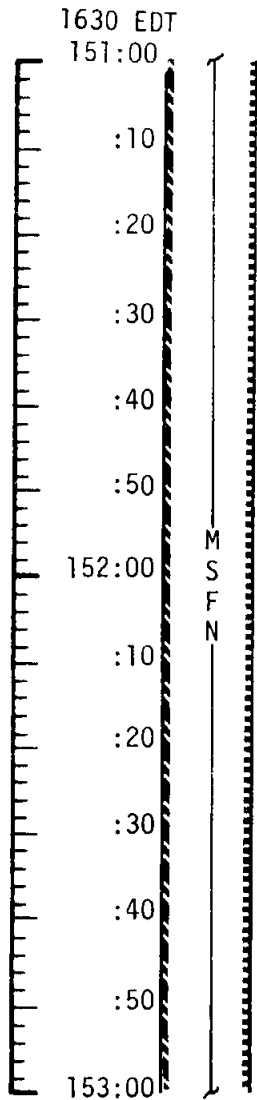

M
S
F
N

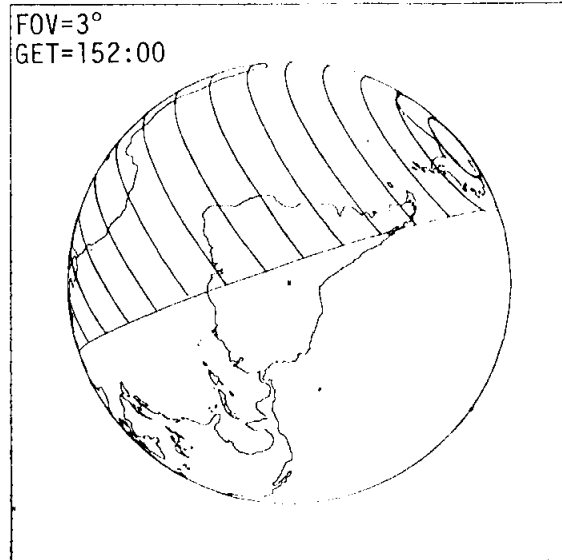

PTC

P23-NO COMM, (5 SETS)
TEI + 15:30 (152:00)
DIPHDA (02), EFH
DIPHDA (02), EFH
NAVI (03), ENH
MIRFAK (10), ENH
ALDEBARAN (11), ENH

MISSION	EDITION	DATE	TIME	DAY/REV	PAGE
APOLLO 11	FINAL	JULY 1, 1969	151:00 - 153:00	7/TEC	3-110

MCC-H

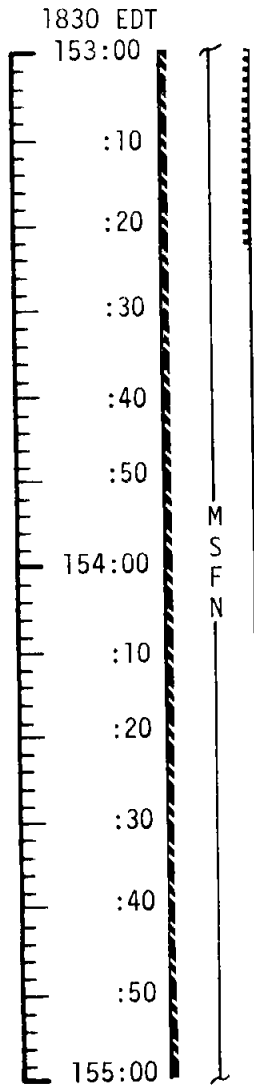

FLIGHT PLAN

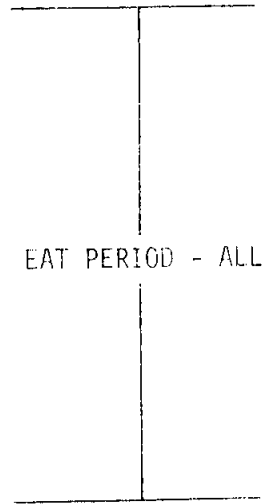

NOTES

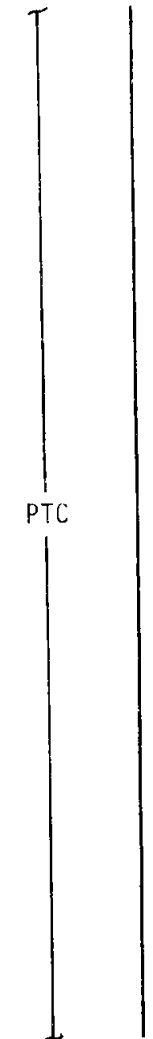

P23-NO COMM (3 SETS)
TEI + 19:00 (154:30)
SPICA (26), ENH
ANTARES (33), EFH
NUNKI (37), EFH

MISSION	EDITION	DATE	TIME	DAY/REV	PAGE
APOLLO 11	FINAL	JULY 1, 1969	153:00 - 155:00	7/TEC	3-111

MCC-H

2030 EDT

FLIGHT PLAN

NOTES

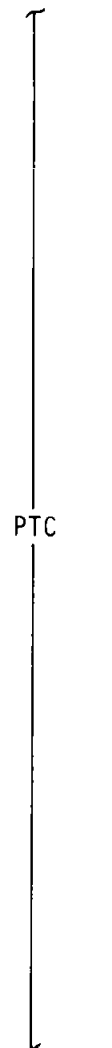
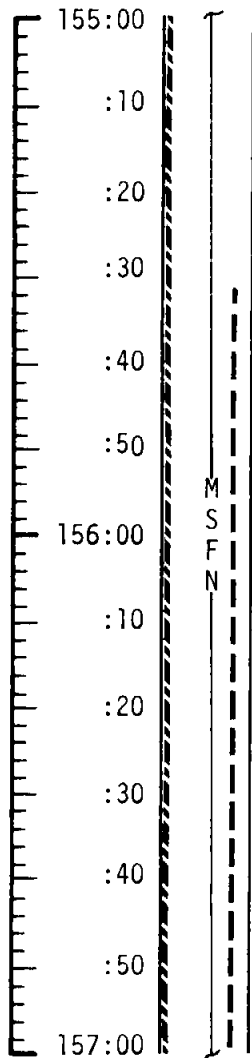

MISSION	EDITION	DATE	TIME	DAY/REV	PAGE
APOLLO 11	FINAL	JULY 1, 1969	155:00 - 157:00	7/TEC	3-112

MCC-H

FLIGHT PLAN

NOTES

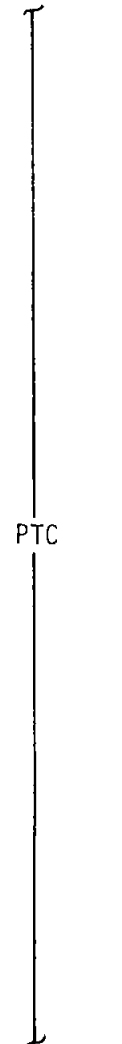
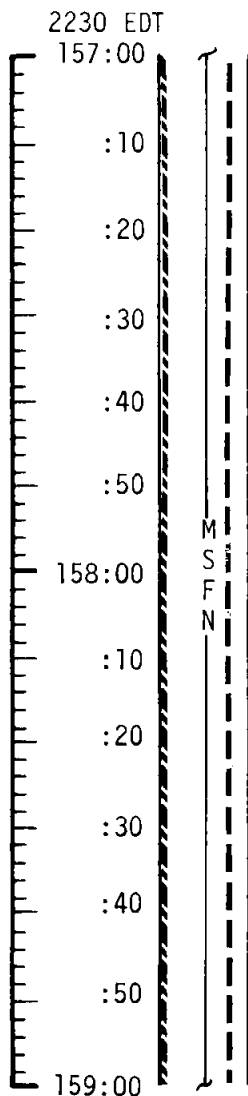

P23-NO COMM, (5 SETS)
TEI + 22:30 (158:00)
DIPHDA (02), EFH
DIPHDA (02), EFH
MENKAR (07), ENH
MIRFAK (10), ENH
ALDEBARAN (11), ENH

WIPE EXCESSIVE MOISTURE
FROM TUNNEL HATCH AREA
O₂ FUEL CELL PURGE

CO₂ FILTER CHANGE NO. 12
(14 INTO B, STORE 12 IN A3)

MISSION	EDITION	DATE	TIME	DAY/REV	PAGE
APOLLO 11	FINAL	JULY 1, 1969	157:00 - 159:00	7/TEC	3-113

MCC-H

FLIGHT PLAN

NOTES

0030 EDT

159:00

:10

:20

:30

:40

:50

160:00

:10

:20

:30

:40

:50

161:00

M
S
F
N

EAT PERIOD - ALL

EMS CK
RECORD MCC6 &
PRELIMINARY ENTRY PADS

REST PERIOD
(10 HOURS)

PRESLEEP CHECKLIST

CREW STATUS REPORT (RADIATION,
MEDICATION)

CYCLE O₂ & H₂ FANS

CHLORINATE POTABLE WATER

SELECT NORMAL LUNAR CONFIG

EXCEPT: (FOR COAST ASLEEP)

S-BD NORMAL MODE VOICE - OFF

S-BD AUX TAPE - OFF

TAPE RCDR FWD - OFF

GO TO HGA OR CONTINUE OMNI

OPS PER MSFN

OMNI OPS

S-BD ANT OMNI - OMNI

S-BD ANT OMNI - B

HI GAIN OPS

HI GAIN ANT BEAM - NARROW

HI GAIN ANT TRACK - REACQ

S-BD ANT-HI GAIN

VERIFY:

WASTE MNGT OVBD DRAIN-OFF

WASTE STOW VENT VLV-CLOSED

EMERG CABIN PRESS VLV-BOTH

SURGE TK O₂ VLV-ON

REPRESS PACK O₂ VLV-OFF

LM TUNNEL VENT VLV - OFF

POT H₂O HTR - OFF

AUTO RCS JET SELECT (16) - OFF

ON BOARD READOUT

BAT C _____

PYRO BAT A _____

PYRO BAT B _____

RCS A _____

B _____

C _____

D _____

DC IND SEL TO MNA OR
MNB

UPDATE

PRELIMINARY MCC6
MNVR PAD &
ENTRY PAD
(ASSUMES MCC6)

MISSION	EDITION	DATE	TIME	DAY/REV	PAGE
APOLLO 11	FINAL	JULY 1, 1969	159:00 - 161:00	7/TEC	3-114

MCC-M

0230 EDT

161:00

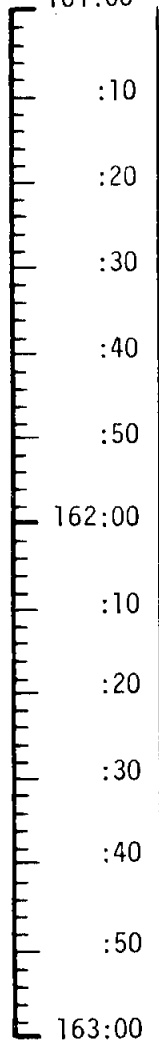

M
S
F
N

FLIGHT PLAN

REST PERIOD
(10 HOURS)

PTC

NOTES

MISSION	EDITION	DATE	TIME	DAY/REV	PAGE
APOLLO 11	FINAL	JULY 1, 1969	161:00 - 163:00	7/TEC	3-115

MCC-H

FLIGHT PLAN

NOTES

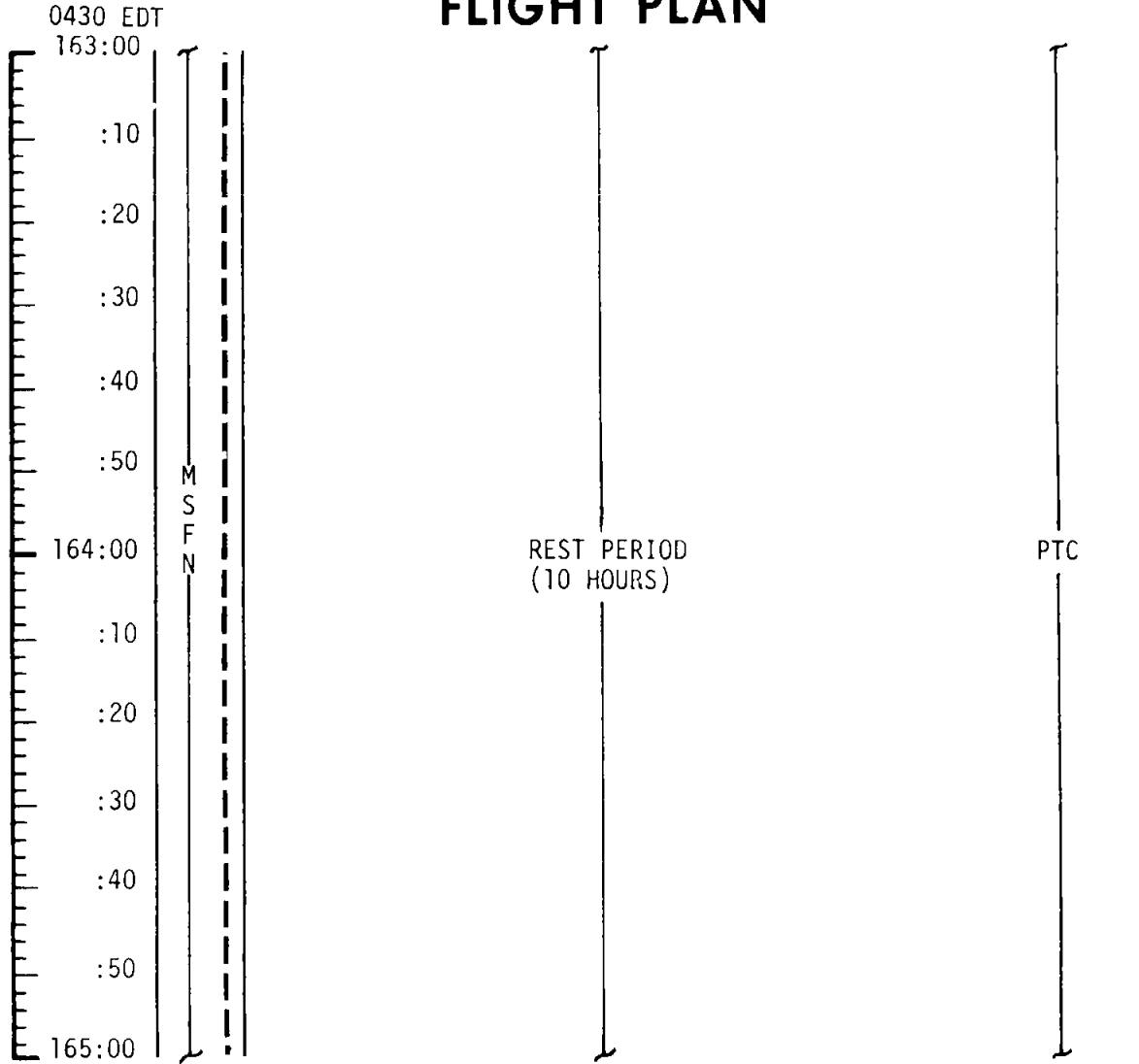

MISSION	EDITION	DATE	TIME	DAY/REV	PAGE
APOLLO 11	FINAL	JULY 1, 1969	163:00 - 165:00	7/TEC	3-116

MCC-H

FLIGHT PLAN

NOTES

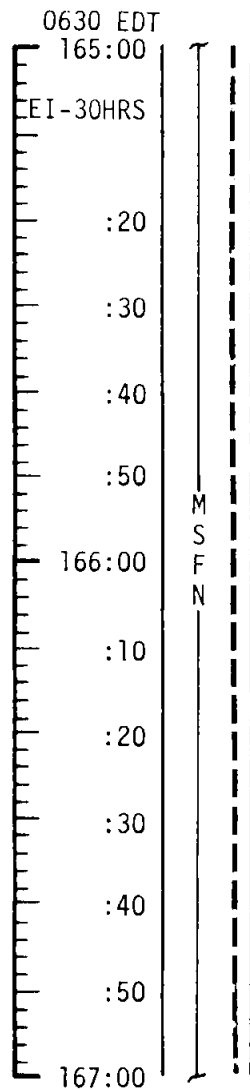

REST PERIOD
(10 HOURS)

PTC

MISSION	EDITION	DATE	TIME	DAY/REV	PAGE
APOLLO 11	FINAL	JULY 1, 1969	165:00 - 167:00	7/TEC	3-117

MCC-H

FLIGHT PLAN

NOTES

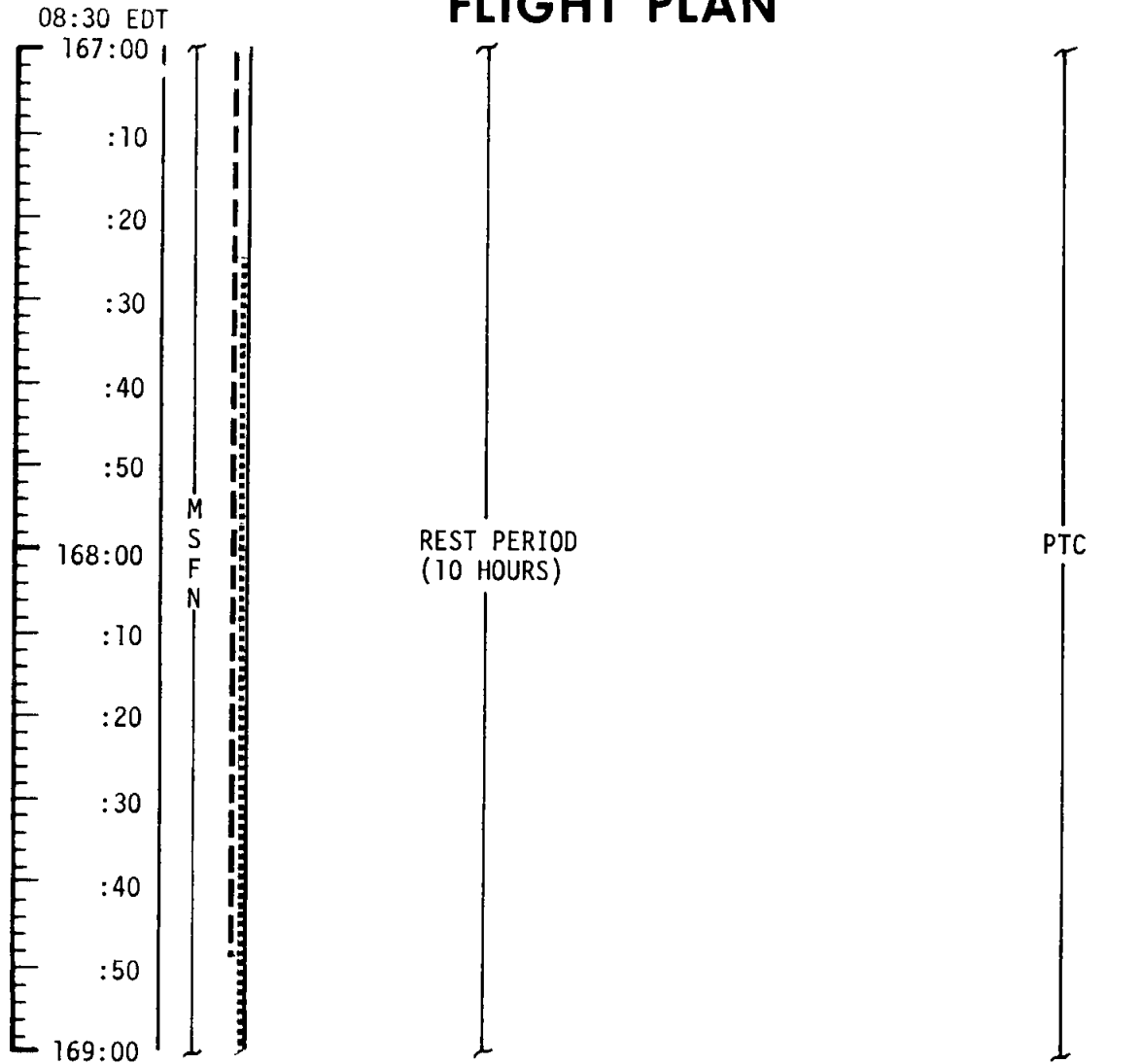

MISSION	EDITION	DATE	TIME	DAY/REV	PAGE
APOLLO 11	FINAL	JULY 1, 1969	167:00 - 169:00	7/TEC	3-118

MCC-H

FLIGHT PLAN

NOTES

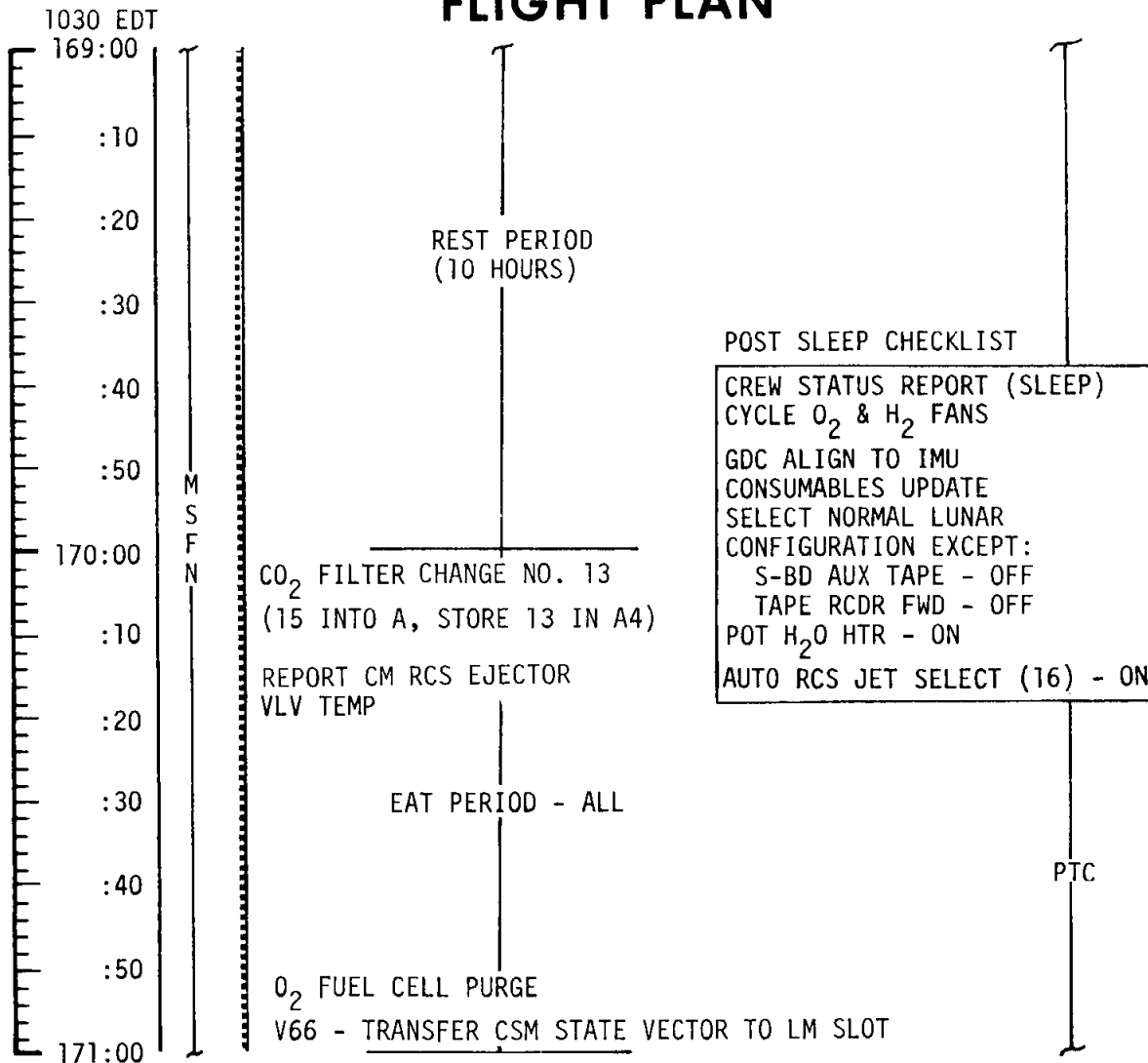

P23-NO COMM (5 SETS)
TEI + 35:00 (170:30)
DIPHDA (02), EFH
DIPHDA (02), EFH
NAVI (03), ENH
MIRFAK (10), ENH
ALDEBARAN (11), ENH

UPLINK CMC
CSM STATE VECTOR
MCC6 TGT LOAD

CONSUMABLE UPDATE
(Δ FROM NOMINAL)

GET: _____

RCS TOT _____

A _____

B _____

C _____

D _____

H₂ TOT _____

O₂ TOT _____

MISSION	EDITION	DATE	TIME	DAY/REV	PAGE
APOLLO 11	FINAL	JULY 1, 1969	169:00 - 171:00	8/TEC	3-119

MCC
BURN CHART

	P OR Y RATES	ATT DEVIATION	SHUTDOWN TIME	RESIDUALS
MCC6	10°/SEC TAKEOVER	10° TAKEOVER	BT + 1 SEC	TRIM X AXIS ONLY

MCC-H

1230 EDT

171:00

UPDATE

MCC6 PAD DATA
ENTRY PAD
(ASSUMES
MCC6)

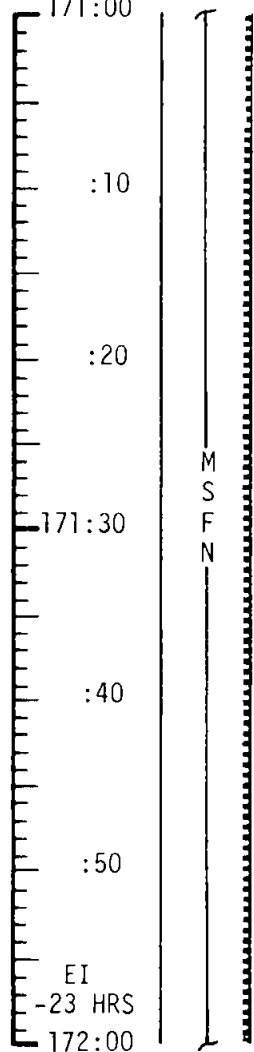

FLIGHT PLAN

NOTES

WIPE EXCESSIVE MOISTURE
FROM TUNNEL HATCH AREA
RECORD MCC6 AND PRELIMINARY ENTRY PAD DATA

IMU REALIGN - P52
(OPTION 3 - REFSMMAT)

P52 - PTC REFSMMAT	
N71:	____, ____
N05:	____. ____
N93:	____. ____
X	____. ____
Y	____. ____
Z	____. ____
GET	____: ____: ____

EXT ΔV - P30
SPS/RCS THRUST - P40/41

MNVR TO BURN ATT

SXT STAR CK
EMS ΔV TEST

SM RCS MON, CK
GDC ALIGN TO IMU

MCC6 ΔV=NOMINALLY ZERO

BURN STATUS REPORT

X	X	<input type="checkbox"/>	•	ΔTIG
X	X		•	BT
<input type="checkbox"/>			•	V _{gx}
TRIM				
X	X	X		R
X	X	X		P
X	X	X		Y
<input type="checkbox"/>			•	V _{gx}
<input type="checkbox"/>			•	V _{gy}
<input type="checkbox"/>			•	V _{gz}
<input type="checkbox"/>			•	ΔV _c
X	X	X		FUEL
X	X	X		OX
X	X	X		UNBAL

MISSION	EDITION	DATE	TIME	DAY/REV	PAGE
APOLLO 11	FINAL	JULY 1, 1969	171:00 - 172:00	8/TEC	3-120

MCC-H

1330 EDT

FLIGHT PLAN

NOTES

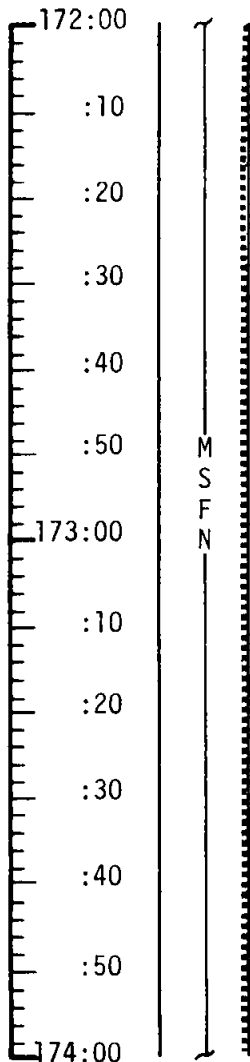

SM RCS MON CK
 SPS MON CK
 V66-TRANS CSM STATE VECTOR
 TO LM SLOT
 BURN STATUS REPORT
 BATTERY CHARGE, BATTERY B

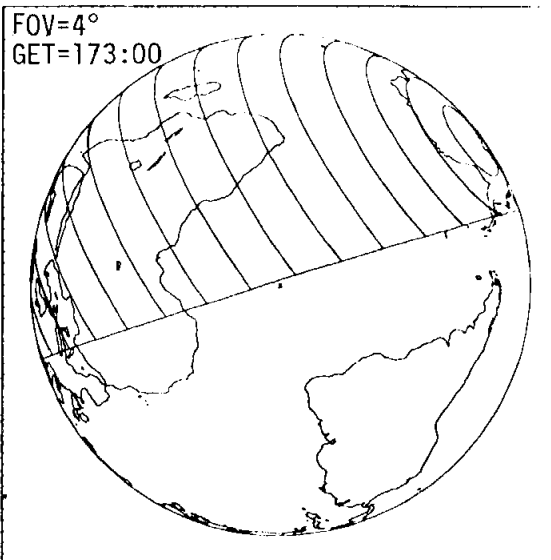

START PTC
 P 270° Y 0

PTC ESTABLISHED
 IN G&N P, Y + 30°DB
 R RATE OF 0.3°/SEC

P23-NO COMM (3 SETS)
 TEI + 37:00 (172:30)
 SPICA (26) LNH
 ANTARES (33) LFH
 NUNKI (37) LFH

PTC

MISSION	EDITION	DATE	TIME	DAY/REV	PAGE
APOLLO 11	FINAL	JULY 1, 1969	172:00 - 174:00	8/TEC	3-121

MCC-H

1530 EDT
174:00

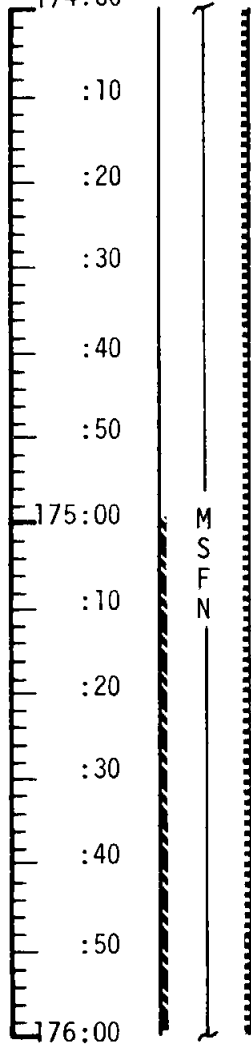

FLIGHT PLAN

NOTES

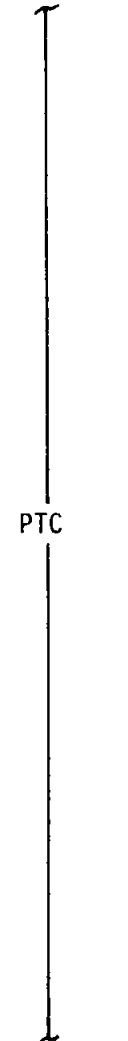
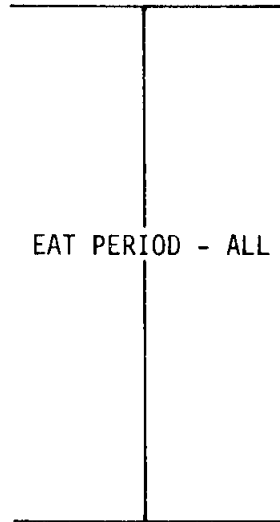

MISSION	EDITION	DATE	TIME	DAY/REV	PAGE
APOLLO 11	FINAL	JULY 1, 1969	174:00 - 176:00	8/TEC	3-122

MCC-M

FLIGHT PLAN

NOTES

1730 EDT
 176:00
 :10
 :20
 :30
 :40
 :50
 177:00
 :10
 :20
 :30
 :40
 :50
 178:00

M
S
F
N

PTC

P23-NO COMM (5 SETS)
 TEI + 41:00 (176:30)
 DIPHDA (02), EFH
 MIRFAK (10), ENH
 ALDEBARAN (11), ENH
 CAPELLA (13), ENH
 CAPELLA (13), ENH

MISSION	EDITION	DATE	TIME	DAY/REV	PAGE
APOLLO 11	FINAL	JULY 1, 1969	176:00 - 178:00	8/TEC	3-123

MCC-M

FLIGHT PLAN

NOTES

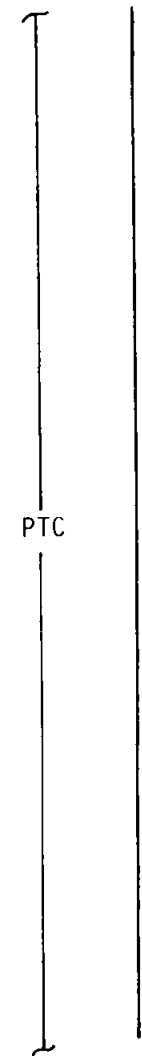
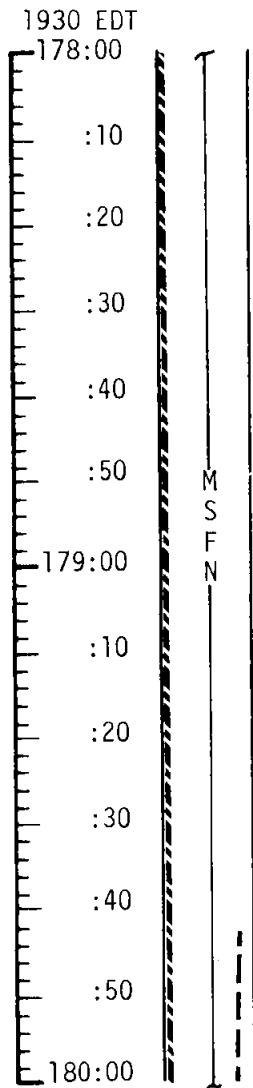

MISSION	EDITION	DATE	TIME	DAY/REV	PAGE
APOLLO 11	FINAL	JULY 1, 1969	178:00 - 180:00	8/TEC	3-124

MCC-H

2130 EDT

FLIGHT PLAN

NOTES

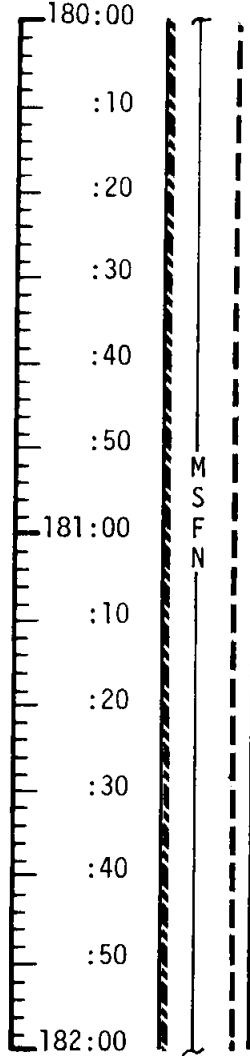

WIPE EXCESSIVE MOISTURE
FROM TUNNEL HATCH AREA

O₂ FUEL CELL PURGE
CO₂ FILTER CHANGE NO. 14
(16 INTO B, STORE 14 IN A4)

EAT PERIOD-ALL

PTC

P23-NO COMM (5 SETS)
TEI + 44:30 (180:00)
DIPHDA (02), EFH
DIPHDA (02), EFH
MIRFAK (10), ENH
CAPELLA (13), ENH
CAPELLA (13), ENH

ONBOARD READOUT	
BAT C	_____
PYRO BAT A	_____
PYRO BAT B	_____
RCS A	_____
B	_____
C	_____
D	_____
DC IND SEL TO MNA OR MNB	

MISSION	EDITION	DATE	TIME	DAY/REV	PAGE
APOLLO 11	FINAL	JULY 1, 1969	180:00 - 182:00	8/TEC	3-125

MCC-H

2330 EDT

182:00

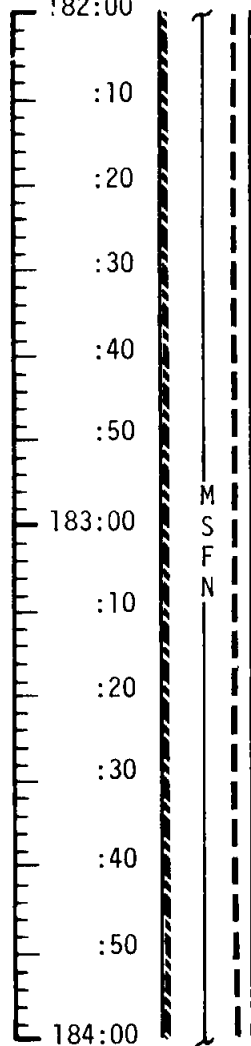

FLIGHT PLAN

NOTES

PRE SLEEP CHECKLIST

CREW STATUS REPORT
 (RADIATION, MEDICATION)
 CYCLE O₂ & H₂ FANS
 CHLORINATE POTABLE WATER
 SELECT COMM NORMAL CONFIGURATION
 EXCEPT:
 S-BD NORMAL MODE VOICE SW - OFF
 S-BD SQUELCH - ENABLE
 S-BD AUX TAPE - OFF
 S-BD ANT - OMNI
 S-BD ANT OMNI - B
 TAPE RCDR FWD - OFF
 VERIFY:
 WASTE MNGT OVBD DRAIN - OFF
 WASTE STOWAGE VENT VLV - CLOSED
 EMERG CABIN PRESS VLV - BOTH
 SURGE TK O₂ VLV - ON
 REPRESS PACK O₂ VLV - OFF
 POT H₂O HTR - OFF
 AUTO RCS JET SELECT (16) - OFF

REST PERIOD
(7 HOURS)

PTC

MISSION	EDITION	DATE	TIME	DAY/REV	PAGE
APOLLO 11	FINAL	JULY 1, 1969	182:00 - 184:00	8/TEC	3-126

MSC Form 29 (May 69)

FLIGHT PLANNING BRANCH

MCC-M

0130 EDT

FLIGHT PLAN

NOTES

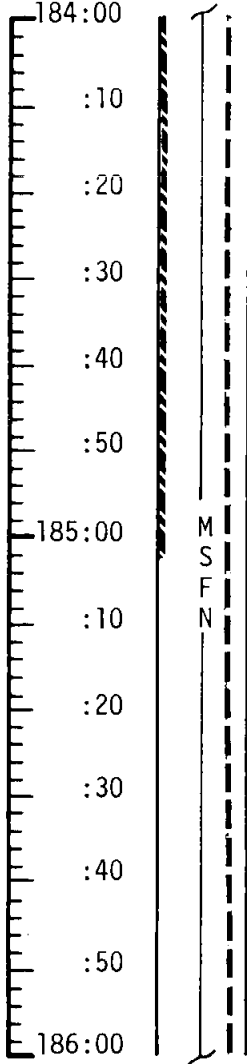

REST PERIOD
(7 HOURS)

PTC

P23-NO COMM (5 SETS)
TEI + 50 (185:30)
ALPHERATZ (01), EFH
MIRFAK (10), ENH
ALDEBARAN (11), ENH
CAPELLA (13), ENH
CAPELLA (13), ENH

MISSION	EDITION	DATE	TIME	DAY/REV	PAGE
APOLLO 11	FINAL	JULY 1, 1969	184:00 - 186:00	8/TEC	3-127

MCC-H

0330 EDT
186:00

FLIGHT PLAN

NOTES

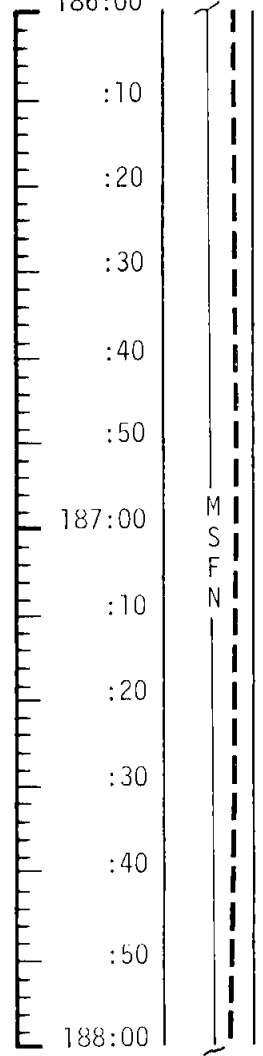

REST PERIOD
(7 HOURS)

PTC

MISSION	EDITION	DATE	TIME	DAY/REV	PAGE
APOLLO 11	FINAL	JULY 1, 1969	186:00 - 188:00	8/TEC	3-128

MCC-H

FLIGHT PLAN

NOTES

0530 EDT

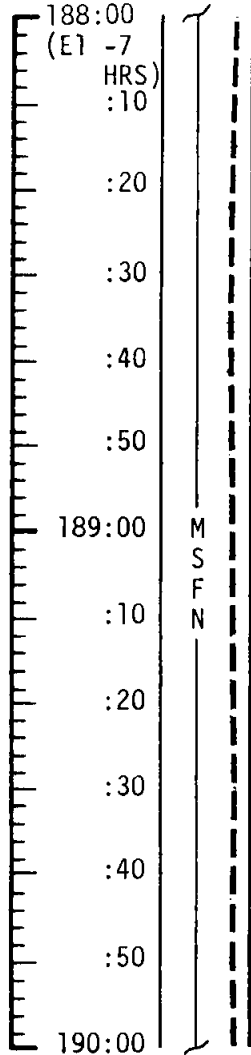

REST PERIOD
(7 HOURS)

POST SLEEP CHECKLIST
 CREW STATUS REPORT (SLEEP)
 CYCLE O₂ & H₂ FANS
 GDC ALIGN TO IMU
 CONSUMABLES UPDATE
 SELECT COM NORMAL LUNAR
 CONFIGURATION EXCEPT:
 S-BD AUX TAPE - OFF
 TAPE RCDR FWD - OFF
 POT H₂O HTR - ON
 AUTO RCS JET SELECT (16) - ON

GO/NO GO FOR MCC7
 REPORT CM RCS INJECTOR
 VALVE TEMPERATURE

EAT PERIOD-ALL

PTC

CONSUMABLE UPDATE
(Δ FROM NOMINAL)

GET: _____

RCS TOT _____

A _____

B _____

C _____

D _____

H₂ TOT _____

O₂ TOT _____

MISSION	EDITION	DATE	TIME	DAY/REV	PAGE
APOLLO 11	FINAL	JULY 1, 1969	188:00 - 190:00	8/TEC	3-129

MCC-H

0730 EDT

FLIGHT PLAN

NOTES

190:00

(EI -5

HRS)

:10

UPLINK CMC

CSM STATE VECTOR
MCC7 TGT LOAD
DESIRED ORIENT
(ENTRY)
ENTRY LAT & LONG

:20

UPLINK CMC

MCC7 MNVR PAD
ENTRY PAD

190:30

:40

:50

191:00

M
S
F
N

DON MAE WEST & FOOT RESTRAINTS

V66 - TRANS CSM STATE VECTOR TO LM SLOT

RECORD MCC7 MNVR PAD & ENTRY PAD

EPS CHECK

SPS CHECK
CM RCS MON CK

SM RCS MON CK

C & W SYS CK

CMC SELF TEST

DSKY COND LT TEST

PTC

P23-NO COMM, (5 SETS)
TEI + 54:30 (190:00)
ALPHERATZ (01), EFH
MIRFAK (10), ENH
ALDEBARAN (11), ENH
CAPELLA (13), ENH
CAPELLA (13), ENH

MISSION	EDITION	DATE	TIME	DAY/REV	PAGE
APOLLO 11	FINAL	JULY 1, 1969	190:00 - 191:00	9 /TEC	3-130

MCC-H

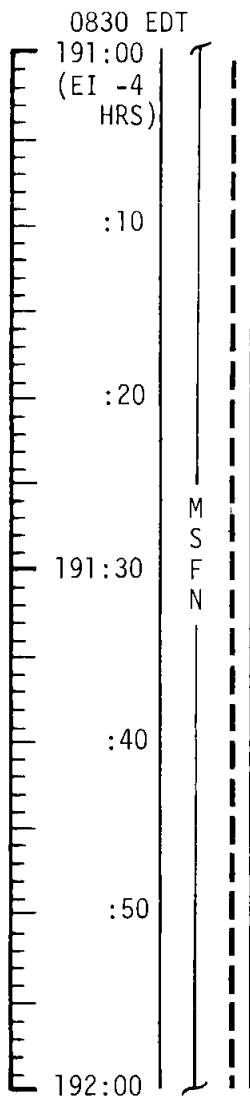

FLIGHT PLAN

IMU REALIGN - P52
OPTION 1 - PREFERRED

EXT ΔV - P30

SPS/RCS THRUST - P40/41

MNVR TO BURN ATT

SXT STAR CK

EMS ΔV TEST

SM RCS MON CK

GDC ALIGN TO IMU

NOTES

P52 (ENTRY REFSMMAT)

N71: _____, _____

N05: _____ . _____

N93: _____

X _____ . _____

Y _____ . _____

Z _____ . _____

GET _____ : _____ : _____

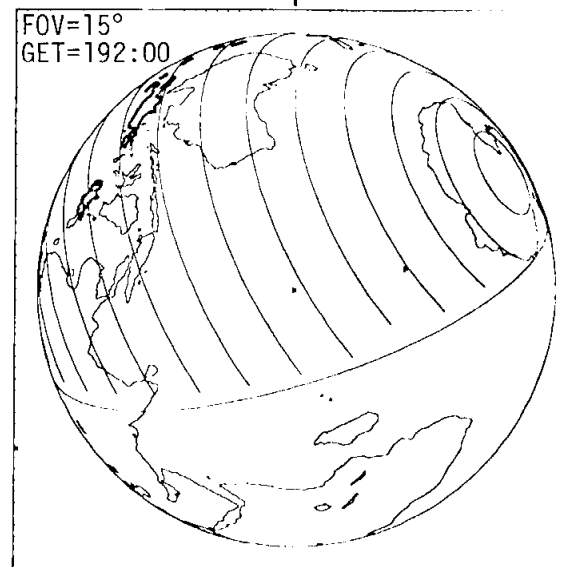

MISSION	EDITION	DATE	TIME	DAY/REV	PAGE
APOLLO 11	FINAL	JULY 1, 1969	191:00 - 192:00	9/TEC	3-131

THIS PAGE INTENTIONALLY LEFT BLANK.

MCC
BURN CHART

	P OR Y RATES	ATT DEVIATION	SHUTDOWN TIME	RESIDUALS
MCC7	10°/SEC TAKEOVER	10° TAKEOVER	BT + 1 SEC	TRIM X AXIS ONLY

MCC-H

0930 EDT

FLIGHT PLAN

NOTES

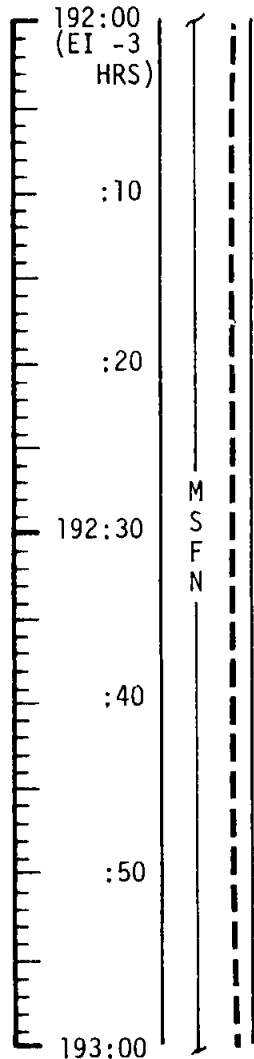

MCC7 ΔV =NOMINALLY ZERO

SM RCS MON CK
 SPS MON CK
 BURN STATUS REPORT
 V66 - TRANS CSM STATE VECTOR
 TO LM SLOT

P23-NO COMM (3 SETS)
 TEI + 57:00 (192:30)
 MENKAR (07) ENH
 CAPELLA (13) ENH
 CAPELLA (13) ENH

BURN STATUS REPORT

X	X	<input type="checkbox"/>	•	ΔTIG
X	X	<input type="checkbox"/>	•	BT
<input type="checkbox"/>	<input type="checkbox"/>	<input type="checkbox"/>	•	V _{gx}
TRIM				
X	X	X		R
X	X	X		P
X	X	X		Y
<input type="checkbox"/>	<input type="checkbox"/>	<input type="checkbox"/>	•	V _{gx}
<input type="checkbox"/>	<input type="checkbox"/>	<input type="checkbox"/>	•	V _{gy}
<input type="checkbox"/>	<input type="checkbox"/>	<input type="checkbox"/>	•	V _{gz}
<input type="checkbox"/>	<input type="checkbox"/>	<input type="checkbox"/>	•	ΔV _c
X	X	<input type="checkbox"/>		FUEL
X	X	X		OX
X	X	X		UNBAL

GO/NO GO

GO/NO GO FOR PYRO ARM SEQUENCE
 VHF ACTIVATION

MISSION	EDITION	DATE	TIME	DAY/REV	PAGE
APOLLO 11	FINAL	JULY 1, 1969	192:00 - 193:00	9/TEC	3-132

MCC-H

FLIGHT PLAN

NOTES

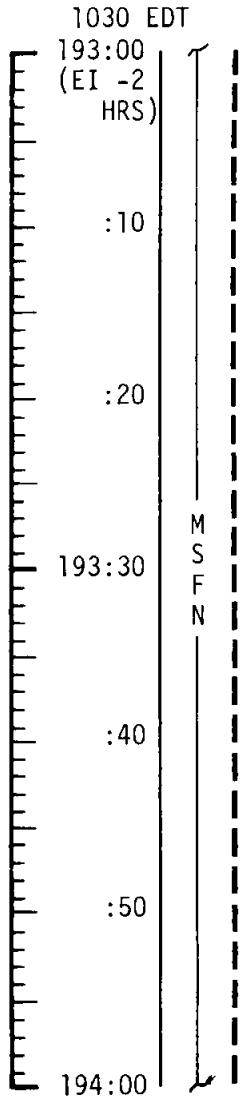

LOGIC SEQUENCE CHECK

MNVR TO ENTRY ATTITUDE

COAS STAR CHECK

SXT STAR CHECK

IMU REALIGN - P52
(OPTION 3 - REFSMMAT)

GDC ALIGN TO IMU
CM RCS PREHEAT

P52 (ENTRY REFSMMAT)

N71: _ _ , _ _

N05: _ _ . _ _

N93:

X _ _ . _ _

Y _ _ . _ _

Z _ _ . _ _

GET _ _ : _ _ : _ _

MISSION	EDITION	DATE	TIME	DAY/REV	PAGE
APOLLO 11	FINAL	JULY 1, 1969	193:00 - 194:00	9/TEC	3-133

MCC-H

1130 EDT

FLIGHT PLAN

NOTES

194:00

(EI -1
HR)

:10

:20

194:30
(EI -30)

:40

:50

195:00

UPDATE

ENTRY PAD
RCVY PAD

UPLINK

CSM STATE VECTOR

GO FOR PYRO ARM

M
S
F
N

PRIMARY EVAPORATOR ACTIVATION

FINAL GDC DRIFT CHECK
TERM CM RCS PRFHEAT

SECONDARY EVAPORATOR ACTIVATION
PYRO BATTERY CHECK
RECORD ENTRY PAD AND RECOVERY DATA

P27 UPDATE - V66 - TRANS CSM STATE VECTOR TO
LM SLOT

SET DET TO RRT
EMS INITIALIZATION
RSI ALIGN TO GDC

CM RCS CK
ENTRY BATTS - ON

SEPARATION CHECKLIST
GO FOR PYRO ARM

P61 ENTRY PREP
MNVR TO CM/SM SEP ATT

CM/SM SEP

P62 - ENTRY ATTITUDE
MNVR TO ENTRY ATT

MISSION	EDITION	DATE	TIME	DAY/REV	PAGE
APOLLO 11	FINAL	JULY 1, 1969	194:00 - 195:00	9/TEC	3-134

MCC-H

1230 EDT

FLIGHT PLAN

NOTES

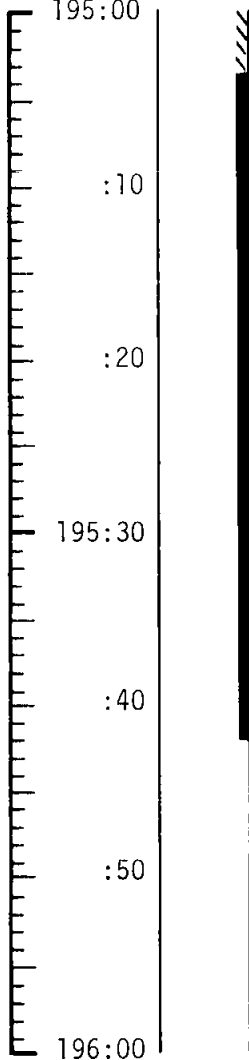

P63 - ENTRY INITIATE

EI - GET = 195:03:27

P64 - ENTRY POST .05G

TRAJECTORY EVENT

TIME FROM
ENTRY INTERFACE
MIN:SEC

400,000 FEET (GET 195:03:27)	00:00
ENTER S-BAND BLACKOUT	00:18
0.05G	00:28
KA - INITIATE CONSTANT DRAG	00:52
RDOT = -700 FPS	01:18
PEAK G (6.6)	01:22
SUBCIRCULAR VELOCITY	02:08
P64 to P67	02:08
EXIT S-BAND BLACKOUT	03:24
GUIDANCE TERMINATION	07:14
DROGUE DEPLOYMENT	08:12
MAIN DEPLOYMENT	09:00
SPLASHDOWN	13:55

$\gamma = -6.52^\circ$, $L/D = 0.295$, $V = 36,309$, & $R = 1285$

MISSION	EDITION	DATE	TIME	DAY/REV	PAGE
APOLLO 11	FINAL	JULY 1, 1969	195:00 - 196:00	9/TEC	3-135

SECTION IV - DETAILED TEST OBJECTIVES

SECTION 4

DETAILED OBJECTIVE ACTIVITIES

This section contains the activity summaries which reflect the test objectives for Mission G as described in "Mission Requirements G Type Mission", SPD9-R-038, Change A dated May 1, 1969. These activity summaries are presented in the approximate sequence in which they are planned to occur during the mission.

Each activity summary provides the following information:

- A. TEST OBJECTIVES. This is the listing of the Functional Test Objectives (complete or partial) which relate to the particular activity;
- B. TEST REQUIREMENTS. Here the special test prerequisites (and mission phase if necessary) are presented in addition to brief statements of the requirements for performing the activity;
- C. TEST PROCEDURES/CHECKLISTS. These are the procedural references for the performance of the activity as far as the test objectives are concerned; and
- D. DATA REQUIREMENTS. This part of the summary identifies the gross data which are needed for evaluation of test results in terms of flight crew and ground support requirements.

Cross references for relating Detailed and Functional Test Objectives with the activity summaries and relating activities to Functional Test Objectives, are provided as the initial part of this section.

The following ground rules are to be used in implementing data requirements:

- A. The collection of highly desirable (HD) data should not constrain the timeline of the crew procedures.
- B. Post-flight debriefing requirements which are fulfilled by real time transmission of data per the DATA REQUIREMENTS sections may be deleted from the post-flight debriefing.

All of the Test Requirements have not been totally implemented into the mission timeline. These items are identified in this section as "Not Implemented" or with the conditions by which they will be implemented.

TABLE 4-1
MISSION ACTIVITY AND
TEST OBJECTIVE CROSS REFERENCE

<u>ACTIVITY</u>	<u>FTO</u>
LM Descent	D-1, G-1, G-3, H-1, M-1
Lunar Surface Navigation	G-1, G-2, G-3, L-4, M-2
EVA Preparation and Egress	B-1, B-2, C-1, C-2, C-3, L-1
Surface Sample Collection	A-1, E-1, F-1, F-2, I-3, J-2, J-3, J-4, M-3
External LM Observations and Photography	D-1, D-2, D-3, D-4, L-2, M-3
Lunar Surface Observations and Photography	E-1, E-2, E-3, H-2, J-5, L-3, L-4, M-3
Experiment Deployment/Conduct	S-031, S-078, S-080
Post EVA Operations	B-1, C-1, C-2
Contamination Prevention	I-1, I-2

TABLE 4-2
 TEST OBJECTIVE/MISSION ACTIVITY
 CROSS REFERENCE

DTO/FTO NUMBER	TEST OBJECTIVE	MISSION ACTIVITY	SECTION PAGE NO.
A A-1	Contingency Sample Collection Provide a Contingency Lunar Surface Sample	Surface Sample Collection	4-13
B B-1	Lunar Surface EVA Operations Demonstrate Egress-To/Ingress-From the Lunar Surface	EVA Preparation and Egress Post EVA Operations	4-10 4-21
B-2	Evaluate Crew Lunar Surface EVA Capability	EVA Preparation and Egress	4-10
C	EMU Lunar Surface Operations		
C-1	EMU Capability to Provide a Habitable Environment	EVA Preparation and Egress	4-10
C-2	EMU Effects on Crew Mobility, Dexterity & Comfort	EVA Preparation and Egress	4-10
C-3	Demonstrate EVA Data/Voice Communications	EVA Preparation and Egress	4-10
D	Landing Effects on LM		
D-1	LM Landing Gear Performance Under Landing Conditions	LM Descent	4-6
D-2	Effects of Landing on LM Structure and Components	External LM Observ/Photo	4-15
D-3	Descent Engine Skirt Damage/Clearance After Landing	External LM Observ/Photo	4-15
D-4	Effects of RCS Plume Impingement on LM Structure & Components	External LM Observ/Photo	4-15
E	Lunar Surface Characteristics		
E-1	Data on Behavior/Characteristics of the Lunar Surface	Surface Sample Collection	4-13
E-2	Lunar Soil Erosion from DPS Plume Impingement	Lunar Surface Observ/Photo	4-17
E-3	Effect of DPS Venting on the Lunar Surface	Lunar Surface Observ/Photo	4-17
F	Bulk Sample Collection		
F-1	Collect Rock Samples and Fine Grained Material	Surface Sample Collection	4-13
F-2	Photograph Collection Area of Samples	Surface Sample Collection	4-13

TABLE 4-2
TEST OBJECTIVE/MISSION ACTIVITY
CROSS REFERENCE

DTO/FTO NUMBER	TEST OBJECTIVE	MISSION ACTIVITY	SECTION PAGE NO.
G G-1	Landed LM Location Determine Location of Landed LM from LM Data	LM Descent	4-6
G-2 G-3	Determine Location of Landed LM from CSM Data Capability of Locating Landed LM in Real Time	Lunar Surface Navigation Lunar Surface Navigation LM Descent	4-8 4-8 4-6
H H-1 H-2	Lunar Environment Visibility Data on Landing Aids & Final Approach Visibility Crew Performance of Visual Tasks on Lunar Surface	Lunar Surface Navigation LM Descent Lunar Surface Observ/Photo	4-6 4-8 4-8
I I-1 I-2	Assessment of Contamination by Lunar Material Prevent Earth Contamination by Lunar Exposed Materials Minimize Crew/CM Contamination by Lunar Exposed Materials	LM Descent Lunar Surface Observ/Photo	4-6 4-17
I-3	Lunar Sample for Quarantine Testing	Contamination Prevention Contamination Prevention	4-22 4-22
J J-1 J-2 J-3 J-4 J-5	Documented Sample Collection Obtain an Aseptic Sample of the Lunar Surface Obtain a Core Sample of the Lunar Surface Collect Lunar Geologic Samples Collect a Lunar Environment Sample Study and Describe Lunar Topography Features	Lunar Sample for Quarantine Testing	4-13
K	Lunar Surface Structure Photograph (Objective Deleted)	Deleted	Deleted

4-4

TABLE 4-2
 TEST OBJECTIVE/MISSION ACTIVITY
 CROSS REFERENCE

DTO/FTO NUMBER	TEST OBJECTIVE	MISSION ACTIVITY	SECTION PAGE NO.
L	Television Coverage		
L-1	TV Coverage of Astronaut Descending to the Lunar Surface	EVA Preparation and Egress	4-10
L-2	TV Coverage of External Landed LM	External LM Observ/Photo	4-15
L-3	TV Coverage of Lunar Surface Near LM	Lunar Surface Observ/Photo	4-17
L-4	TV Panoramic Coverage of Distant Terrain Features	Lunar Surface Navigation	4-8
		Lunar Surface Observ/Photo	4-17
L-5	TV Coverage of Astronaut Activities on the Lunar Surface	Lunar Surface Observ/Photo	4-17
M	Photographic Coverage		
M-1	Photograph Lunar Surface During LM Descent	LM Descent	4-6
M-2	Photograph Lunar Surface Post Touchdown/Pre EVA	Lunar Surface Navigation	4-8
M-3	Obtain Phtotgraphs During EVA	Surface Sample Collections	4-13
		External LM Observ/Photo	4-15
		Lunar Surface Observ/Photo	4-17
S-031	Lunar Passive Seismology	Experiment Deployment/Conduct	4-20
S-078	Laser Ranging Retro-Reflector	Experiment Deployment/Conduct	4-20
S-080	Solar Wind Composition	Experiment Deployment/Conduct	4-20

LM DESCENT

A. Test Objective

- D-1 LM Landing Gear Performance Under Landing Conditions
- G-1 Location of the Landed LM from LM Data
- G-3 Capability of Locating the Landed LM in Real Time from LM/CSM/MSFN Data
- H-1 Data on Landing Aids and Final Approach Visibility
- M-1 Photograph Lunar Surface During LM Descent

B. Test Requirements

1. Determine landing site visibility, extent of washout and visibility of landing site landmarks. [H]
2. Photograph the landing site during the approach through the LM pilot's window with the data acquisition camera. [G, H, M]
3. Evaluate landing aids, i.e., Landing Point Designator, maps, photographs. [G, H]
4. Assess visual phenomena during LM landing which are significantly different from expected. [H]
5. Voice anotate location and identity of features during final descent. [G]
6. Determine landing location in real time by description of terrain features during descent. [G]
7. Assess LM landing conditions on the lunar surface. [D]

C. Procedures/Checklist

1. Photographic and Television Operations Plan.
2. Descent Procedures Document.

D. Data Requirements

1. Flight Crew Reports/Logs/Photographs
 - a. LM crew comments on landing site visibility during final approach and landing phases and on effectiveness of the Landing Point Designator and landing site recognition aids. [H] (M)
 - b. GET at start of data acquisition camera photographs during LM final approach. [H] (M)
 - c. Voice track regarding observations of surface features during the descent phase. [G] (M)
 - d. Photographs of the landing site and surrounding lunar surface features taken through a LM window during descent. [G, M] (M)

- e. Data Acquisition Camera photographs of the landing site from high gate to touchdown. [H, M] (M)
- f. Photographs of the landing site and surrounding lunar surface features taken through a LM window during descent. [G, M] (M)
- g. Comments on any lunar dust observed during the final approach, the severity of the landing and vehicle stability after touchdown. [D] (M)

2. Ground Support

- a. LM TM HBR. [D, G, H] (M)
- b. LM TM LBR. [D, G] (M)
- c. LM BET from DOI through touchdown. [G, H] (M)
- d. MSFN tracking data of LM from acquisition of signal through touchdown. [G] (M)

LUNAR SURFACE NAVIGATION

A. Test Objectives

- G-1 Determine the Location of the Landed LM from LM Data
- G-2 Determine the Location of the Landed LM from CSM Data
- G-3 Determine Capability of Locating the Landed LM in Real Time from LM/CSM/MSFN Data
- L-4 Panoramic Coverage of Distant Terrain Features
- M-2 Photograph Lunar Surface Post Touchdown/Pre EVA

B. Test Requirements

1. Correlate lunar surface features surrounding the landing site with photomaps and mark the LM location. [G, L, M]
2. Photograph terrain features thru the LM window to correlate LM location. [G, M]
3. Obtain two sets of LM IMU alignments after landing [G]
4. Provide TV coverage of prominent terrain features. [G, L]
5. Track the landed LM from the CSM during two orbital passes. Mark on a landmark near the landed LM. [G] - (Only one pass is implemented.)
6. Track the CSM with LM RR during one pass. [G] - (Not Implemented.)
7. Obtain 70 MM photographs of the landed LM or its shadow and the surrounding lunar features. [G]
8. Assist MCCH in determining the landing LM location in real time. [G, L]

C. Procedures/Checklist

1. Photographic and Television Operations Plan.
2. LM AOH, "PGNCS Lunar Surface Align Program (P57)".
3. LM AOH, "Lunar Surface Navigation Program (P22)".
4. CSM AOH, "Orbital Navigation (P22)".

D. Data Requirements

1. Flight Crew Reports/Logs/Photographs
 - a. Estimate of the landed LM location on lunar photomaps. [G] (M)

- b. Comments by LM crew regarding any difficulties encountered in estimating the location of the LM with respect to lunar surface features. [G] (HD)
- c. Comments by LM crewman on location of landed LM with respect to prominent terrain features. [G] (M)
- d. Obtain high resolution photographs of the landing area from the CSM. [G] (M)
- e. Photographs of the landing site and surrounding lunar surface features taken through a LM window after landing. [G, M] (M)
- f. Provide TV coverage of the lunar surface as viewed from the LM. [G, L] (M)

2. Ground Support

- a. LM TLM HBR. [G] (M)
- b. LM TLM LBR. [G] (M)
- c. BET of CSM during the lunar surface phase. [G] (M)
- d. BET of LM from DOI through touchdown. [G] (M)
- e. Photographs of the landing area obtained during previous lunar missions. [G] (M)
- f. Post-scan conversion video tape of all TV coverage. [L] (M)
- g. Estimate solar illumination established by mission geometry. [L] (M)
- h. Reflectivity and geometry of surfaces contributing to indirect illumination. [L] (HD)

EVA PREPARATION AND EGRESS

A. Test Objectives

- B-1 Demonstrate Egress-to/Ingress-from the Lunar Surface
- B-2 Evaluate Crew Lunar Surface EVA Capability
- C-1 EMU Capability to Provide a Habitable Environment
- C-2 EMU Effects on Crew Mobility/Dexterity/Comfort
- C-3 Data/Voice Communications Capability During EVA
- L-1 TV Coverage of an Astronaut Descending to the Lunar Surface

B. Test Requirements

1. Perform EVA preparations. [C]
2. Release the MESA pallet with pre-mounted TV camera and turn camera power on prior to descent to the lunar surface. [L]
3. Egress to the lunar surface. [B, C]
4. Deploy and set the TV camera to provide TV coverage of the lunar surface EVA. [L]
5. During EVA, communicate with MSFN via the EVA-LM-MSFN two way voice relay. [C]
6. Two-way voice communications to be performed between two EVA crewmen. [C]
7. EMU and biomedical data from two EVA crewmen will be simultaneously transmitted to MSFN via EVA-LM-MSFN one-way relay. [C]

C. Procedures/Checklist

1. EVA Procedures Document.
2. Lunar Surface Operations Plan.

D. Data Requirements

1. Flight Crew Reports/Logs/Photographs
 - a. Notify MSFN of the initial and final positions of the PLSS water diverter valve, primary oxygen shutoff valve and water shutoff/relief valve each time they are changed. [C] (M)
 - b. Notify MSFN when PLSS; High O₂ flowrate, low vent flow, low feed water pressure or PGA pressure low remote control unit status indicators and audible warning tone come on. [C] (M)

- c. Record EMU radiation dosimeter readings just prior to the EVA. [C] (M)
- d. Notify MSFN if noxious odors occur or any condensation on the visor assembly. [C] (HD)
- e. Comment on the adequacy of procedures and difficulties encountered during donning of EMU equipment. [C] (HD)
- f. Comment on time required and adequacy of the EMU checkout procedures. [C] (HD)
- g. Comment on the adequacy of EMU thermal environment when walking from a sunlit area to shadow and vice versa. [C] (M)
- h. Comment on estimated energy expenditure and comfort as compared to simulation experience. [C] (HD)
- i. Provide data on the adequacy of hardware and procedures, and the time required to perform the egress from the LM. [B] (M)
- j. Comment on voice quality for EVA-EVA and EVA-LM-MSFN communications. [C] (M)
- k. Provide sequence camera coverage and TV camera coverage of: [B, M] (M)
 - 1) A crew member descending to the lunar surface.
 - 2) A crew member walking on the lunar surface.
 - 3) A crew member performing lunar surface EVA operations.

2. Ground Support

- a. LM TM FM. [B, C] (M)
- b. Ground recorded TV signals. [B] (HD)
- c. LM TM LBR. [L] (HD)
- d. Post-scan conversion video tape of all TV coverage. [L] (M)
- e. Record of S-band signal strength during video transmission. [L] (HD)
- f. GET at beginning and end of TV transmission. [L]
- g. Time period, if any, when LBR TM (in lieu of HBR TM) transmitted simultaneously with TV data. [L] (M)

- h. Identity of ground station(s) used to record video transmission from LM. [L] (M)
- i. Time period, if any, when erectable antenna used to transmit TV data. [L] (M)
- j. Estimate of incident illumination. [L] (M)
- k. LM position on lunar surface. [H] (HD)
- l. MSFN recording of EVA-LM-MSFN voice. [C] (M)

SURFACE SAMPLE COLLECTION

A. Test Objectives

- A-1 Provide a Contingency Lunar Surface Sample
- E-1 Behavior and Characteristics of the Lunar Surface
- F-1 Collect Rock Samples and Fine Grained Material
- F-2 Photograph Collection Area of Samples
- I-3 Obtain a Lunar Sample for Quarantine Testing
- J-2 Obtain a Core Sample of the Lunar Surface
- J-3 Collect Lunar Geologic Samples
- J-4 Collect a Lunar Environment Sample
- M-3 Obtain Photographs of Geologic Inspection & Sampling

B. Test Requirements

1. Contingency Sample - Obtain upon first descending to the lunar surface. [A]
2. Bulk Material - Obtain 30 pounds consisting of 1/3 fragmentary and 2/3 loose samples. [F]
3. Core Sample - Obtain with the drive tube. [I, J]
4. Geologic Samples - Obtain using tools stowed in the MESA. Photograph sample areas. [J, M]
5. Lunar Environment Sample - Seal in gas analysis container. [J]

C. Procedures/Checklist

1. Lunar Landing Mission Flight Plan.
2. Lunar Surface Operations Plan.
3. Photographic and Television Operations Plan.

D. Data Requirements

1. Flight Crew Reports/Logs/Photographs
 - a. Record areas in relation to LM where samples were collected. [A, F, J] (M)
 - b. Record unusual lunar surface observations. [A, F, J] (M)
 - c. Comment on soil behavior during collection of Bulk Sample. [E] (M)
 - d. Comment on soil behavior during collection of Documented Sample. [E] (HD)
 - e. Estimates of volume of fine grained material collected in one bag of the Documented Sample. [E] (HD)

- f. Take photographs during sample collection. [A, F] (HD)
- g. Photograph the lunar surface sample areas and of the samples as defined in the Photographic Operations Plan. [J] (M)

2. Ground Support

- a. LM position on lunar surface. [J] (M)
- b. MSFN recordings of all MSFN/EVA voice conferences. [J] (M)

EXTERNAL LM OBSERVATIONS AND PHOTOGRAPHY

A. Test Objectives

- D-1 Effects of Landing on LM Landing Gear
- D-2 Effects of Landing on LM Structure and Components
- D-3 Descent Engine Skirt Damage and Clearance After Landing
- D-4 Effects of RCS Plume Impingement on LM Structure and Components
- L-2 TV Coverage of External Landed LM
- M-3 Obtain Photographs of Landed LM

B. Test Requirements

1. Operate the TV camera to provide an external view of the LM. [L]
2. Photograph any observed LM external structural damage. [D, M]
3. Determine descent engine skirt ground clearance. [D, M]
4. Photograph any effects of RCS plume impingement observed. [D, M]
5. Obtain photographs of any lunar material collected on the LM. [D, M]

C. Procedures/Checklist

1. Mission G Photographic and Television Operations Plan.

D. Data Requirements

1. Flight Crew Reports/Logs/Photographs
 - a. Comment on any LM component damage to include any visible discoloration or lunar soil accumulation. [D] (M)
 - b. Comments describing any descent engine skirt damage and estimate of any skirt ground clearance. [D] (M)
 - c. If the landing gear strut assembly photographs cannot be obtained, estimate the amount of stroking of each primary and secondary strut assembly. [D] (M)
 - d. Photograph the landing gear to show the stroking of the primary and secondary strut assemblies. [D, M] (M)
 - e. Photograph the LM exterior showing any structural damage. [D, M] (M)
 - f. Photograph each landing gear assembly along the Z axis and the Y axis. [D, M] (HD)

- g. Photograph the descent engine skirt. [D, M] (HD)
- h. Photograph the LM base heat shield. [D, M] (HD)
- i. Photograph the LM exterior, i.e., structure antenna, RCS jets, windows and foot pads. [D, M] (HD)
- j. Photograph soil accumulation on the LM. [D, M] (HD)
- k. Photographs by the close up stereo camera of lunar material adhering to LM surfaces. [M] (HD)

2. Ground Support

- a. LM TM HBR. [D] (M), [L] (HD)
- b. LM Mass, center of gravity and mass moment of inertia calculations. [E] (M)
- c. Video tape of all TV coverage. [L] (M)
- d. Record of S-band signal strength during TV coverage. [L] (HD)
- e. GET at beginning and end of TV operations.
- f. Time period of simultaneous LBR TM and TV transmission. [L] (M)
- g. Identification of ground station(s) used to record video transmission. [L] (M)
- h. Time period when erectable antenna was used to transmit from lunar surface. [L] (M)

LUNAR SURFACE OBSERVATIONS AND PHOTOGRAPHY

A. Test Objectives

- E-1 Behavior and Characteristics of the Lunar Surface
- E-2 Erosion of Lunar Surface by DPS Plume Impingement
- E-3 Effect of Any DPS Venting on the Lunar Surface
- H-2 Crew Performance of Visual Tasks on the Lunar Surface
- J-5 Study and Description of Lunar Topography Features
- L-3 TV Coverage of Lunar Surface Near LM
- L-4 TV Panoramic Coverage of Distant Terrain Features
- L-5 Coverage of Astronaut Activities on the Lunar Surface
- M-3 Obtain Photographs During EVA

B. Test Requirements

1. Provide TV coverage of the lunar surface in the vicinity of the LM and panoramic scenes of distant terrain features. [L]
2. Photograph the lunar terrain at various azimuths with respect to the sun including 9, 90 and 180 degrees. Comment on ability to see terrain features in these areas. [H, M]
3. Estimate the distance to prominent terrain features within the field of view of photographs taken. [H]
4. Observe lunar surface characteristics including texture, consistency, compressibility, cohesiveness, adhesiveness, density and color. [E]
5. Study and photograph the mechanical behavior of the lunar surface from interactions of astronauts boots and equipment with the lunar soil, erosion by DPS plume impingement and DPS venting. [E, M]
6. Describe and photograph field relationships such as shape, size, range, pattern of alignment or distribution of all accessible types of lunar topographic features. [J,M]
7. Photograph the structure of lunar surface material in its natural state. [M]

C. Procedures/Checklist

1. Mission G Photographic and Television Operations Plan.

D. Data Requirements

1. Flight Crew Report/Logs/Photographs
 - a. Report condition of the temperature indicator viewing ports on the TV camera at the beginning and the end of the TV operations. [L] (M)

- b. Position of the TV camera scan rate switch at start of TV operation. [L] (M)
- c. Comments describing the interaction between astronaut boots and lunar surface while walking. [E] (M)
- d. Comments on slope and roughness characteristics of the landing terrain to include descriptions of craters, depressions, embankments or other obstacles. [E] (M)
- e. Comments on the color and texture of both undisturbed and mechanically disturbed areas of the lunar surface. [E] (M)
- f. Comments on lunar soil conditions adjacent to DPS vents to include any discoloration. [E] (M)
- g. Comments describing the lunar surface penetration by the Solar Wind Composition Staff and core sample tool under their own weight and the estimated force. [E] (Mandatory for either the staff or the core sample tool: highly desirable for the other.)
- h. Comments on lunar soil erosion as caused by the DPS plume impingement during landing. [E] (M)
- i. Record vent valves opened. [E] (M)
- j. Photograph the lunar surface showing DPS plume impingement erosive effects. [E, M] (M)
- k. Photograph the lunar surface adjacent to DPS vents if soil discoloration is observed. [E, M] (M)
- l. Photograph an astronaut footprint showing interaction between astronaut boots and lunar surface. [E, M] (M)
- m. Photograph the Solar Wind Composition Experiment Staff and core sampling tool after being inserted to their maximum depth as penetrometers. [E, M] (HD)
- n. Photograph the natural slopes, crater walls and embankments in the vicinity of the landing site. [E,M] (M)
- o. Photograph from the CSM of the lunar surface surrounding the LM. [E, M] (HD)
- p. Comments on the visibility of the lunar terrain as a function of the sun/viewing angle and on their ability to perform visual tasks while on the lunar surface. [H] (M)

- q. Comments on color/contrast perception. [H] (M)
 - r. Comments on and significant unexpected visual phenomena. [H] (M)
 - s. Estimate of distance to at least one prominent terrain feature within the field of view of the photographs in item t below. [H] (M)
 - t. Photograph the lunar terrain at various sun azimuths to include 0 degrees, 90 degrees and 180 degrees. [H, M] (M)
 - u. Photograph any unexpected visual phenomena. [H, M] (HD)
 - v. Photograph a representative depression caused by use of the scoop in collecting fine grained fragmental material. [E, M] (M)
 - w. Photograph one scoop of fine grained fragmental material placed in one of the pre-numbered bags. [E, M] (HD)
 - x. Photograph of each LM foot pad and surrounding lunar soil exhibiting evidence of LM foot pad-lunar soil interaction. [M] (HD)
2. Ground Support
- a. LM TM HBR. [E, L] (HD)
 - b. Estimate of incident illumination. [D] (M)
 - c. Video tape of all TV coverage. [L] (M)
 - d. Record of S-band signal strength during TV transmission. [L] (M)
 - e. GET at beginning and end of TV transmission. [L] (M)
 - f. Time period when LBR TM was transmitted simultaneously with TV. [L] (M)
 - g. Identity of ground station(s) used to record LM video transmission. [L] (M)
 - h. Time period when erectable antenna was used to transmit from the lunar surface. [L] (M)

EXPERIMENT DEPLOYMENT/CONDUCT

A. Test Objectives

- S-031 Deploy the Passive Seismic Experiment Package
- S-078 Deploy the Laser Ranging Retro-Reflector Experiment
- S-080 Conduct the Solar Wind Composition Experiment

B. Test Requirements

1. Emplace, level and orient the Passive Seismic Experiment Package (PSEP). Deploy the solar panels and aim the antenna at the earth. [S-031]
2. Photograph the deployed PSEP and deployment area. [S-031]
3. Remove the Laser Ranging Retro-Reflector (LRRR) from the descent stage and carry it to the deployment site. [S-078]
4. Emplace, level and orient the LRRR to the alignment marks corresponding to the landing site. [S-078]
5. Remove the Solar Wind Composition Experiment from the LM MESA and deploy it on the lunar surface. [S-080]
6. After one hour operation, disassemble the Solar Wind Composition Experiment, place the reel and foil in a teflon bag and store in a sample return container. [S-080]

C. Procedures/Checklist

None

D. Data Requirements

1. Flight Crew Reports/Logs/Photographs
 - a. Comment on deployment of experiment. [S-031] (M)
 - b. Photograph deployment area. [S-031, S-078, S-080] (HD)
 - c. Comment on location of deployed experiment with respect to the LM, attitude of deployed foil with respect to the sun and total time foil was deployed. [S-080] (M)
 - d. Retrieve reel and foil from the Solar Wind Composition Experiment. [S-080] (M)
 - e. Comments on orientation and elevation setting used for deployment. [S-078] (HD)
2. Ground Support
 - a. Experiment TLM Data [S-031] (M)

POST EVA OPERATIONS

A. Test Objectives

- B-1 Demonstrate Egress-to/Ingress-from the Lunar Surface
- C-1 EMU Capability to Provide a Habitable Environment
- C-2 EMU Effects on Crew Mobility, Dexterity/Comfort

B. Test Requirements

1. Perform post EVA preparations and ingress. [B]
2. Perform PLSS shutdown. [C]

C. Procedures/Checklist

1. EVA Procedures Document.

D. Data Requirements

1. Flight Crew Reports/Logs/Photographs

- a. Notify MSFN of the initial and final positions of the PLSS water diverter valve, primary oxygen shutoff valve and water shutoff/relief valve each time they are changed. [C] (M)
- b. Notify MSFN when PLSS; High O₂ flowrate, low vent flow, low feed water pressure or PGA pressure low remote control unit status indicators and audible warning tone come on. [C] (M)
- c. Provide data on the adequacy of hardware and procedures, and the time required to perform the ingress to the LM. [B] (M)
- d. Comment on the adequacy of procedures and difficulties encountered during doffing of EMU equipment. [C] (HD)
- e. Record quantity of water drained from PLSS at end of EVA period. [C] (M)
- f. Record EMU radiation dosimeter readings after completion of the EVA. [C] (M)
- g. Provide sequence camera coverage and TV camera coverage of a crew member ascending the LM ladder. [B] (M)

Contamination Prevention

A. Test Objectives

- I-1 Prevent Earth Contamination by Lunar Exposed Materials
- I-2 Minimize Crew/CM Contamination by Lunar Exposed Materials

B. Test Requirements

- 1. All contamination related operations from the initial astronaut egress to the lunar surface until postflight crew/cm quarantine will be completed per procedures contained in the documents listed below. [I]

C. Procedures/Checklist

- 1. Lunar Surface Operations Plan
- 2. EVA Procedures Document
- 3. Quarantine Procedures

D. Data Requirements

- 1. Flight Crew Reports/Logs/Photographs
 - a. Crew comments on the adequacy of Biological Isolation Garment, sample return containers, Mobile Quarantine Facility and related equipment and procedures used to prevent back contamination. [I] (M)
 - b. Photograph boots, clothing and equipment showing adhesion of particles. [I, M] (HD)
- 2. Ground Support
 - a. Deliver samples, CM and Mobile Quarantine Facility to the Lunar Receiving Laboratory. [I] (M)
 - b. Comment on ground procedures and hardware used for retrieval, biological isolation and CM transfer to the Lunar Receiving Laboratory. [I] (M)
 - c. Report on the existence of contamination of the crew on CM. [I] (M)

SECTION V - CONSUMABLES ANALYSIS

NOTE

Acknowledgement is made to the Consumables Analysis Section (CAS) of the Mission Planning and Analysis Division (MPAD) for their work in the preparation of the consumable analysis presented herein and to the Crew Systems Division for the PLSS Consumables.

CSM-107/LM5 PROPELLANT BUDGET

The results of the Propellant Budget Analysis are summarized in the following Tables and Figures:

TABLE 5-1	SM RCS Propellant Loading And Usage Summary
TABLE 5-2	SM RCS Budget
TABLE 5-3	CM RCS Propellant Summary
TABLE 5-4	SPS Propellant Summary
TABLE 5-5	SPS Assumptions
TABLE 5-6	LM RCS Propellant Loading And Usage Summary
TABLE 5-7	LM RCS Budget
TABLE 5-8	DPS Propellant Summary
TABLE 5-9	DPS Assumptions
TABLE 5-10	APS Propellant Summary
TABLE 5-11	APS Assumptions
FIGURE 5-1	Total SM RCS Propellant Profile
FIGURE 5-2	Quad A SM RCS Propellant Profile
FIGURE 5-3	Quad B SM RCS Propellant Profile
FIGURE 5-4	Quad C SM RCS Propellant Profile
FIGURE 5-5	Quad D SM RCS Propellant Profile
FIGURE 5-6	Total LM RCS Propellant Profile

SM-RCS BUDGET

GROUND RULES and ASSUMPTIONS

1. The transposition and docking phase of the mission includes an SPS evasive maneuver.
2. The first and third midcourse corrections (translunar) are executed as SPS burns with the third MCC followed by an RCS trim.
3. No SM RCS propellant is required during PTC or lunar orbit coast.
4. The sixth midcourse correction (transearth) is executed as an RCS burn of 5 fps.
5. The individual quad plots are included for reference only as quad management is determined by the flight controllers during the mission.

TABLE 5-1

SM RCS PROPELLANT LOADING AND USAGE SUMMARY

Nominal loaded	1342.4 lb
Initial outage due to loaded mixture ratio	15.6
Total trapped	26.4
Gauging inaccuracy	<u>80.4</u>
Deliverable SM-RCS propellant	1220.0
Nominal usage	590
Translunar phase (through LOI-2)	204
Lunar orbit phase	311
Transearth Phase (includes TEI)	75
Nominal remaining	630 lb

TABLE 5-2

SM-RCS PROPELLANT BUDGET					
TIME (HR)	EVENT	S/C WT (LBS)	(a)	(b)	(b)
			SM-RCS USED (LBS)	SM-RCS LEFT (LBS)	SM- RCS LEFT (%)
.0	MISSION G	63457.	.0	1220.0	100.
.0	INITIALIZE PROP LOADING	63457.	.0	1220.0	100.
1.7	SM RCS CHECKOUT	63451.	5.8	1214.2	100.
3.2	TRANSPOSITION AND DOCKING +X 0.8 FPS	63445.	6.1	1208.1	99.
3.2	-X 0.3 FPS	63443.	2.4	1205.7	99.
3.2	PITCH TO ACQUIRE SIVB PITCH 180 DEG AT 1.5 DEG/SEC	63440.	2.3	1203.4	99.
3.2	ROLL CSM 60 DEG 2 DEG/SEC	63439.	1.3	1202.1	99.
3.2	NULL RELATIVE DEL V 0.5 FPS	63435.	4.0	1198.1	98.
3.5	INDEX AND DOCK	63409.	26.0	1172.1	96.
4.2	LM EJECTION -X 5 SEC 4 JET	96717.	7.4	1164.6	95.
4.5	SPS BURN TO EVADE SIVB ORIENT AT 0.2 DEG/SEC	96712.	4.4	1160.2	95.
4.5	ATTITUDE HOLD 0.5 DEG DB PGNC	96712.	.8	1159.4	95.
4.5	START TRANSIENT CONTROL	96710.	1.3	1158.1	95.
4.5	SPS BURN BUILD UP	96707.	.0	1158.1	95.
4.5	STEADY STATE BURN	96508.	.3	1157.8	95.

(a) Spacecraft weights are approximate and are included for reference only.
 (b) Note: These refer to usable SM RCS propellant.

TABLE 5-2 (CONT'D)

SM-RCS PROPELLANT BUDGET					
TIME (HR)	EVENT	S/C WT (LBS)	SM-RCS USED (LBS)	SM-RCS LEFT (LBS)	SM- RCS LEFT (%)
4.5	TAILOFF	96467.	.7	1157.2	95.
4.5	DAMP SHUTDOWN TRANSIENT	96466.	1.1	1156.1	95.
5.5	P52 IMU ALIGN	96466.	.2	1155.9	95.
5.9	NAVIGATION SIGHTINGS ORIENT AT 0.2 DEG/SEC	96461.	4.4	1151.5	94.
6.1	NAVIGATION SIGHTINGS ORIENT AT 0.2 DEG/SEC	96457.	4.4	1147.1	94.
7.0	ORIENT FOR PTC 3 AXIS 0.2 DEG/SEC	96453.	4.1	1143.0	94.
7.0	ATTITUDE HOLD 0.5 DEG DB PGNC5	96452.	.8	1142.2	94.
7.0	ROLL 0.3 DEG/SEC	96451.	.4	1141.8	94.
10.6	TERMINATE PIC DAMP RATES	96447.	4.4	1137.4	93.
10.7	P52 IMU ALIGN	96447.	.2	1137.1	93.
11.5	MIDCOURSE CORRECTION NO 1 3 AXIS ORIENT PGNC5	96442.	4.4	1132.7	93.
11.5	ATTITUDE HOLD 0.5 DEG DB PGNC5	96442.	.8	1131.9	93.
11.5	START TRANSIENT CONTROL	96440.	1.3	1130.6	93.
11.5	SPS BURN BUILD UP	96437.	.0	1130.6	93.
11.5	STEADY STATE BURN 3 FPS PGNC5	96402.	.1	1130.5	93.

TABLE 5-2 (CONT'D)

SM-RCS PROPELLANT BUDGET					
TIME (HR)	EVENT	S/C WT (LBS)	SM-RCS USED (LBS)	SM-RCS LEFT (LBS)	SM- RCS LEFT (%)
11.5	TAILOFF	96361.	.8	1129.7	93.
11.5	DAMP SHUT-DOWN TRANSIENT	96359.	1.1	1128.6	93.
12.0	P52 IMU ALIGN	96359.	.2	1128.4	92.
12.5	ORIENT FOR PTC 3 AXIS 0.2 DEG/SEC	96355.	4.1	1124.3	92.
12.5	ATTITUDE HOLD 0.5 DEG DB PGNC5	96354.	.8	1123.5	92.
12.5	ROLL 0.3 DEG/SEC	96354.	.4	1123.1	92.
24.2	TERMINATE PTC DAMP RATES	96349.	4.4	1118.7	92.
24.3	P52 IMU ALIGN	96349.	.2	1118.5	92.
24.5	CISLUNAR NAVIGATION STAR/EARTH HORIZON ORIENT	96345.	4.4	1114.2	91.
24.7	NAVIGATION SIGHTINGS ORIENT AT 0.2 DEG/SEC	96341.	4.4	1109.8	91.
26.6	MIDCOURSE CORRECTION NO 2 MNVK TO BURN ATT	96336.	4.4	1105.4	91.
26.6	ATTITUDE HOLD 0.5 DEG DB PGNC5	96335.	.8	1104.7	91.
26.7	DELTA VEL = NUMINALLY ZERO	96335.	.0	1104.7	91.
27.0	ORIENT FOR PTC 3 AXIS 0.2 DEG/SEC	96331.	4.2	1100.5	90.
27.0	ATTITUDE HOLD 0.5 DEG DB PGNC5	96330.	.8	1099.7	90.

TABLE 5-2 (CONT'D)

SM-RCS PROPELLANT BUDGET					
TIME (HR)	EVENT	S/C WT (LBS)	SM-RCS USED (LBS)	SM-RCS LEFT (LBS)	SM- RCS LEFT (%)
27.0	ROLL 0.3 DEG/SEC	96330.	.4	1099.3	90.
52.8	TERMINATE PTC DAMP RATES	96326.	4.4	1094.9	90.
53.0	PSZ IMU ALIGN	96325.	.2	1094.7	90.
53.6	MIDCOURSE CORRECTION NO 3 MNVF TO BURN ATT	96321.	4.4	1090.3	89.
53.6	ATTITUDE HOLD 0.5 DEG DB PGCS	96320.	.8	1089.5	89.
53.6	START TRANSIENT CONTROL	96319.	1.3	1088.2	89.
53.6	SPS BURN BUILD UP	96316.	.0	1088.2	89.
53.6	STEADY STATE BURN 3 FPS	96281.	.1	1088.1	89.
53.6	TAILOFF	96239.	.8	1087.3	89.
53.6	DAMP SHUT-DOWN TRANSIENT	96238.	1.1	1086.2	89.
53.6	RCS TRIM 1 FPS	96227.	11.2	1075.0	88.
54.0	ORIENT FOR PTC 3 AXIS 0.2 DEG/SEC	96223.	4.1	1070.9	88.
54.0	ATTITUDE HOLD 0.5 DEG DB PGCS	96222.	.8	1070.1	88.
54.0	ROLL 0.3 DEG/SEC	96222.	.4	1069.8	88.
69.5	TERMINATE PTC DAMP RATES	96217.	4.4	1065.3	87.

TABLE 5-2 (CONT'D)

SM-RCS PROPELLANT BUDGET					
TIME (HR)	EVENT	S/C WT (LBS)	SM-RCS USED (LBS)	SM-RCS LEFT (LBS)	SM- RCS LEFT (%)
70.0	PS2 IMU ALIGN	96217.	.2	1065.1	87.
70.5	MIDCOURSE CORRECTION NO 4 MNVF TO BURN ATT	96213.	4.4	1060.7	87.
70.5	ATTITUDE HOLD 0.5 DEG DB PGNC5	96212.	.8	1059.9	87.
70.5	DEL VEL = NOM ZERO	96212.	.0	1059.9	87.
72.7	PS2 IMU ALIGN	96212.	.2	1059.7	87.
74.0	ORIENT AND SXT STAR CHECK	96207.	4.4	1055.2	86.
74.5	ORIENT AND OBSERVE LUNAR SURFACE	96203.	4.4	1050.8	86.
75.5	LUNAR ORBIT INSERTION BURN 1 3-AXIS ORIENT PGNC5	96198.	4.4	1046.5	86.
75.5	ATTITUDE HOLD 0.5 DEG DB PGNC5	96198.	.8	1045.7	86.
75.5	START TRANSIENT CONTROL	96196.	1.3	1044.4	86.
75.9	LOI BURN BUILD UP	96193.	.0	1044.4	86.
75.9	STEADY STATE BURN	72357.	.5	1043.9	86.
75.9	TAILOFF	72316.	.0	1043.9	86.
75.9	DAMP SHUT DOWN TRANSIENT	72315.	1.1	1042.8	85.
76.2	REV 1 ATTITUDE HOLD WIDE DEADBAND	72312.	3.0	1039.8	85.

TABLE 5-2 (CONT'D)

SM-RCS PROPELLANT BUDGET					
TIME (HR)	EVENT	S/C WT (LBS)	SM-RCS USED (LBS)	SM-RCS LEFT (LBS)	SM- RCS LEFT (%)
77.5	P52 IMU ALIGN	72312.	.1	1039.6	85.
78.2	REV 2 ATTITUDE HOLD	72309.	3.0	1036.6	85.
79.2	P52 IMU ALIGN	72309.	.1	1036.5	85.
80.0	LD1 2 LPO CIRC MNR TO BURN ATT	72306.	3.5	1033.0	85.
80.0	ATTITUDE HOLD 0.5 DEG DB PGNC	72305.	.8	1032.2	85.
80.0	B-D ULLAGE	72290.	15.1	1017.1	83.
80.1	SPS BURN BUILD UP	72287.	.0	1017.1	83.
80.1	STEADY STATE BURN	71316.	.2	1017.0	83.
80.1	TAILOFF	71276.	.0	1017.0	83.
80.1	DAMP SHUTDOWN TRANSIENT	71275.	1.1	1015.9	83.
80.2	REV 3 ATTITUDE HOLD	71272.	3.0	1012.9	83.
80.4	REACQUIRE MSFN ROLL 0.2 DEG/SEC.	71272.	.1	1012.8	83.
82.2	REV 4 ATTITUDE HOLD	71269.	3.0	1009.8	83.
82.3	MNR TO LDG SITE OBS ATT	71265.	3.5	1006.3	82.
82.3	LDG SITE OBSERVATION	71265.	.4	1005.8	82.

TABLE 5-2 (CONT'D)

SM-RCS PROPELLANT BUDGET					
TIME (HR)	EVENT	S/C WT (LBS)	SM-RCS USED (LBS)	SM-RCS LEFT (LBS)	SM-RCS LEFT (%)
82.3	REORIENT	71261.	3.5	1002.3	82.
82.3	REACQUIRE MSFN	71261.	.2	1002.1	82.
84.2	MANEUVER TO SLEEP ATTITUDE 3 AXIS 0.2 DEG/SEC	71258.	3.5	998.6	82.
94.4	DAMP RATES	71254.	3.5	995.0	82.
94.5	REACQUIRE MSFN	71254.	.1	994.9	82.
95.1	MNVR TO ALIGN ATT	71250.	3.5	991.4	81.
96.2	REV 11 ATTITUDE HOLD	71247.	3.0	988.4	81.
98.2	REV 12 ATTITUDE HOLD	71244.	3.0	985.4	81.
98.5	MNVR TO LDG SITE OBS ATT	71241.	3.5	981.8	80.
98.5	LDG SITE OBSERVATION	71240.	.4	981.4	80.
98.9	REACQUIRE MSFN NULL 0.2 DEG/SEC	71240.	.2	981.3	80.
99.8	MANEUVER TO AGS CAL ATTITUDE	71237.	3.5	977.7	80.
100.0	PRE UNDOCKING ALLOCATION	71213.	24.0	953.7	78.
100.0	ORIENT TO UNDOCKING ATTITUDE ROLL 0.2 DEG/SEC	71212.	.2	953.6	78.
100.2	CSM ACTIVE UNDOCK SEP AND NULL VEL 0.5 FPS	37893.	4.5	949.0	78.

TABLE 5-2 (CONT'D)

SM-RCS PROPELLANT BUDGET					
TIME (HR)	EVENT	S/C WT (LBS)	SM-RCS USED (LBS)	SM-RCS LEFT (LBS)	SM- RCS LEFT (#)
100.2	FORMATION FLYING	37883.	10.0	939.0	77.
100.2	REACQUIRE MSFN	37883.	.1	938.9	77.
100.6	ORIENT FOR SEP BURN	37880.	3.1	935.8	77.
100.7	RCS SEPARATION BURN 2.5 FPS	37868.	11.2	924.6	76.
100.7	REV 13 ATTITUDE HOLD	37865.	3.0	921.6	76.
101.5	MANEUVER TO SXT TRACKING	37862.	3.1	918.6	75.
102.6	MANEUVER TO SXT TRACKING	37859.	3.1	915.5	75.
104.4	REACQUIRE MSFN ROLL 0.5 DEG/SEC	37859.	.3	915.3	75.
104.5	MANEUVER TO SXT TRACKING	37856.	3.1	912.2	75.
104.6	REV 14 ATTITUDE HOLD	37853.	3.0	909.2	75.
104.6	MNVR TO LDG SITE OBS ATT	37850.	3.1	906.1	74.
104.6	LDG SITE OBS	37850.	.4	905.7	74.
104.7	TRACK LM	37846.	3.1	902.6	74.
104.9	REACQUIRE MSFN ROLL 0.5 DEG/SEC	37846.	.3	902.3	74.
105.0	REV 15 ATTITUDE HOLD	37843.	3.0	899.3	74.

TABLE 5-2 (CONT'D)

SM-RCS PROPELLANT BUDGET					
TIME (HR)	EVENT	S/C WT (LBS)	SM-RCS USED (LBS)	SM-RCS LEFT (LBS)	SM- RCS LEFT (#)
105.0	REACQUIRE MSFN ROLL 0.5 DEG/SEC	37843.	.3	899.1	74.
107.0	PLANE CHANGE MNR TO BURN ATT	37840.	3.1	896.0	73.
107.0	ATTITUDE HOLD 0.5 DEG DB PGNC	37839.	.8	895.2	73.
107.0	ULLAGE	37825.	14.3	880.9	72.
107.0	SPS BURN BUILD UP	37822.	.0	880.9	72.
107.0	STEADY STATE	37754.	.1	880.8	72.
107.0	TAILOFF	37713.	1.0	879.8	72.
107.0	DAMP SHUTDOWN TRANSIENT	37712.	1.1	878.7	72.
107.2	PS2 IMU ALIGN	37712.	.1	878.6	72.
107.2	MANEUVER TO SLEEP ATTITUDE	37710.	1.7	876.9	72.
111.5	DAMP RATES	37707.	3.1	873.9	72.
112.2	REV 19 ATTITUDE HOLD	37704.	3.0	870.9	71.
114.2	REV 20 ATTITUDE HOLD	37701.	3.0	867.9	71.
114.3	ORIENT FOR SEXTANT TRACKING	37698.	3.1	864.8	71.
115.0	MANEUVER TO SLEEP ATT	37697.	.7	864.1	71.

TABLE 5-2 (CONT'D)

SM-RCS PROPELLANT BUDGET					
TIME (HR)	EVENT	S/C WT (LBS)	SM-RCS USED (LBS)	SM-RCS LEFT (LBS)	SM- RCS LEFT (%)
120.0	DAMP RATES	37697.	.7	863.5	71.
120.0	SEATANT TRACKING	37695.	1.3	862.2	71.
120.0	REACQUIRE MSFN	37695.	.1	862.1	71.
120.2	REV 23 ATTITUDE HOLD	37692.	3.0	859.1	70.
122.2	REV 24 ATTITUDE HOLD NARROW DEADBAND	37687.	5.2	853.9	70.
124.5	SUPPORT LM LIFT OFF	37669.	18.0	835.9	69.
124.6	MANEUVER TO TRACK LM POST LIFTOFF	37666.	3.1	832.8	68.
125.5	MANEUVER TO SUPPORT LM CSI BURN	37663.	3.1	829.7	68.
125.6	MANEUVER TO TRACK LM POST CSI	37660.	3.1	826.6	68.
125.6	REV 25 ATTITUDE HOLD NARROW DEADBAND	37654.	5.2	821.4	67.
126.5	MANEUVER TO SUPPORT LM CDH BURN	37651.	3.0	818.4	67.
126.6	MANEUVER TO TRACK LM POST CDH	37648.	3.1	815.3	67.
126.6	RNDZ NAV	37645.	3.1	812.2	67.
126.6	REINITIATE RNDZ NAV	37642.	3.1	809.1	66.
127.0	MANEUVER TO SUPPORT LM TPI BURN	37639.	3.1	806.1	66.

TABLE 5-2 (CONT'D)

SM-RCS PROPELLANT BUDGET					
TIME (HR)	EVENT	S/C WT (LBS)	SM-RCS USED (LBS)	SM-RCS LEFT (LBS)	SM-RCS LEFT (%)
127.1	MANEUVER TO TRACK LM POST TPI	37636.	3.1	803.0	66.
127.1	MANEUVER TO COAS TRACK	37633.	3.1	799.9	66.
127.1	MANEUVER TO SXT TRACKING	37630.	3.1	796.9	65.
127.2	MANEUVER TO SUPPORT LM MCC1 BURN	37627.	3.1	793.8	65.
127.2	MANEUVER TO SXT TRACKING	37624.	3.1	790.8	65.
127.5	MANEUVER TO SUPPORT LM MCC2 BURN	37621.	3.1	787.7	65.
127.5	MANEUVER TO SUPPORT LM TPF BURN	37618.	3.0	784.7	64.
127.5	MANEUVER TO SXT TRACKING	37615.	3.1	781.6	64.
127.8	ORIENT TO DOCKING ATTITUDE	37612.	3.1	778.5	64.
127.8	ALLOCATION FOR TERMINAL RDZ USAGE FROM POSTFLIGHT	37577.	35.0	743.5	61.
127.9	MAINTAIN BURESIGHT	37574.	3.1	740.5	61.
128.0	DOCKING	43212.	26.0	714.5	57.
131.5	MNVR TO JETTISON ATT	43210.	1.1	713.5	58.
132.0	JETTISON LM 1 FPS	37542.	4.7	708.6	58.
132.0	ORIENT TO TRACKING ATT	37540.	1.6	707.0	58.

TABLE 5-2 (CONT'D)

SM-RCS PROPELLANT BUDGET					
TIME (HR)	EVENT	S/C WT (LBS)	SM-RCS USED (LBS)	SM-RCS LEFT (LBS)	SM-RCS LEFT (#)
132.0	TRACK LM	37540.	.4	706.6	58.
132.6	HOLD INERTIAL ATT	37539.	.4	706.1	58.
132.6	PS2 IMU ALIGN	37539.	.7	705.5	58.
134.5	PS2 IMU ALIGN	37538.	.7	704.8	58.
134.5	SXT STAR CHECK	37537.	.4	704.4	58.
135.0	TRANS-EARTH INJECTION MNR TO BURN ATT	37536.	1.6	702.7	58.
135.0	ATTITUDE HOLD 0.5 DEG DB PGCS	37535.	.8	702.0	58.
135.0	ULLAGE	37521.	14.3	687.6	56.
135.5	SPS BURN BUILD UP	37518.	.0	687.6	56.
135.5	STEADY STATE SPS BURN	27478.	.2	687.4	56.
135.5	TAILOFF	27437.	.0	687.4	56.
135.5	DAMP SHUTDOWN TRANSIENT	27436.	1.1	686.3	56.
136.0	PS2 IMU ALIGN	27436.	.6	685.7	56.
136.0	ORIENT FOR PTC	27435.	1.1	684.6	56.
136.0	ATTITUDE HOLD 0.5 DEG DB PGCS	27434.	.8	683.8	56.

TABLE 5-2 (CONT'D)

SM-RCS PROPELLANT BUDGET					
TIME (HR)	EVENT	S/C WT (LBS)	SM-RCS USED (LBS)	SM-RCS LEFT (LBS)	SM- RCS LEFT (#)
136.0	ROLL 0.3 DEG/SEC	27434.	.1	683.7	56.
147.5	TERMINATE PTC DAMP RATES	27432.	1.3	682.3	56.
147.6	PS2 IMU ALIGN	27432.	.6	681.8	56.
150.0	MIDCOURSE CORRECTION NO 5 MNVF TO BURN ATT	27430.	1.3	680.5	56.
150.0	ATTITUDE HOLD 0.5 DEG DB PGCS	27430.	.8	679.7	56.
150.0	DEL VEL = NOM ZERO	27430.	.0	679.7	56.
150.5	ORIENT FOR PTC	27428.	1.1	678.5	56.
150.5	ATTITUDE HOLD 0.5 DEG DB PGCS	27428.	.8	677.8	56.
150.5	ROLL 0.3 DEG/SEC	27428.	.1	677.6	56.
171.0	TERMINATE PTC	27426.	1.3	676.3	55.
172.0	PS2 IMU ALIGN	27426.	.6	675.8	55.
172.5	MIDCOURSE CORRECTION NO 6 MNVF TO BURN ATT	27424.	1.3	674.5	55.
172.5	ATTITUDE HOLD 0.5 DEG DB PGCS	27424.	.8	673.7	55.
172.5	RCS -X TRANS 5 FPS	27408.	15.9	657.8	54.
173.0	ORIENT FOR PTC	27407.	1.1	656.6	54.

TABLE 5-2 (CONT'D)

SM-RCS PROPELLANT BUDGET					
TIME (HR)	EVENT	S/C WT (LBS)	SM-RCS USED (LBS)	SM-RCS LEFT (LBS)	SM- RCS LEFT (%)
173.0	ATTITUDE HOLD 0.5 DEG DB PGCS	27406.	.8	655.8	54.
173.0	ROLL 0.3 DEG/SEC	27406.	.1	655.7	54.
190.0	TERMINATE PTC	27404.	1.3	654.4	54.
191.2	P52 IMU ALIGN	27404.	.6	653.8	54.
192.0	MIDCOURSE CORRECTION NO 7 MNVF TO BURN ATT	27402.	1.3	652.5	53.
192.0	ATTITUDE HOLD 0.5 DEG DB PGCS	27402.	.8	651.7	53.
192.0	DEL VEL = NOM ZERO	27402.	.0	651.7	53.
192.0	STAR CHECK MIN IMPULSE	27401.	.4	651.3	53.
193.0	MANEUVER TO REENTRY ATTITUDE	27399.	2.6	648.7	53.
193.0	ATTITUDE HOLD 0.5 DEG DB PGCS	27390.	8.6	640.1	52.
194.8	MANEUVER TO SEP ATTITUDE	27387.	2.6	637.4	52.
194.8	CM/SM SEPARATION DELTA VEL=3 FPS	15001.	7.9	629.6	52.

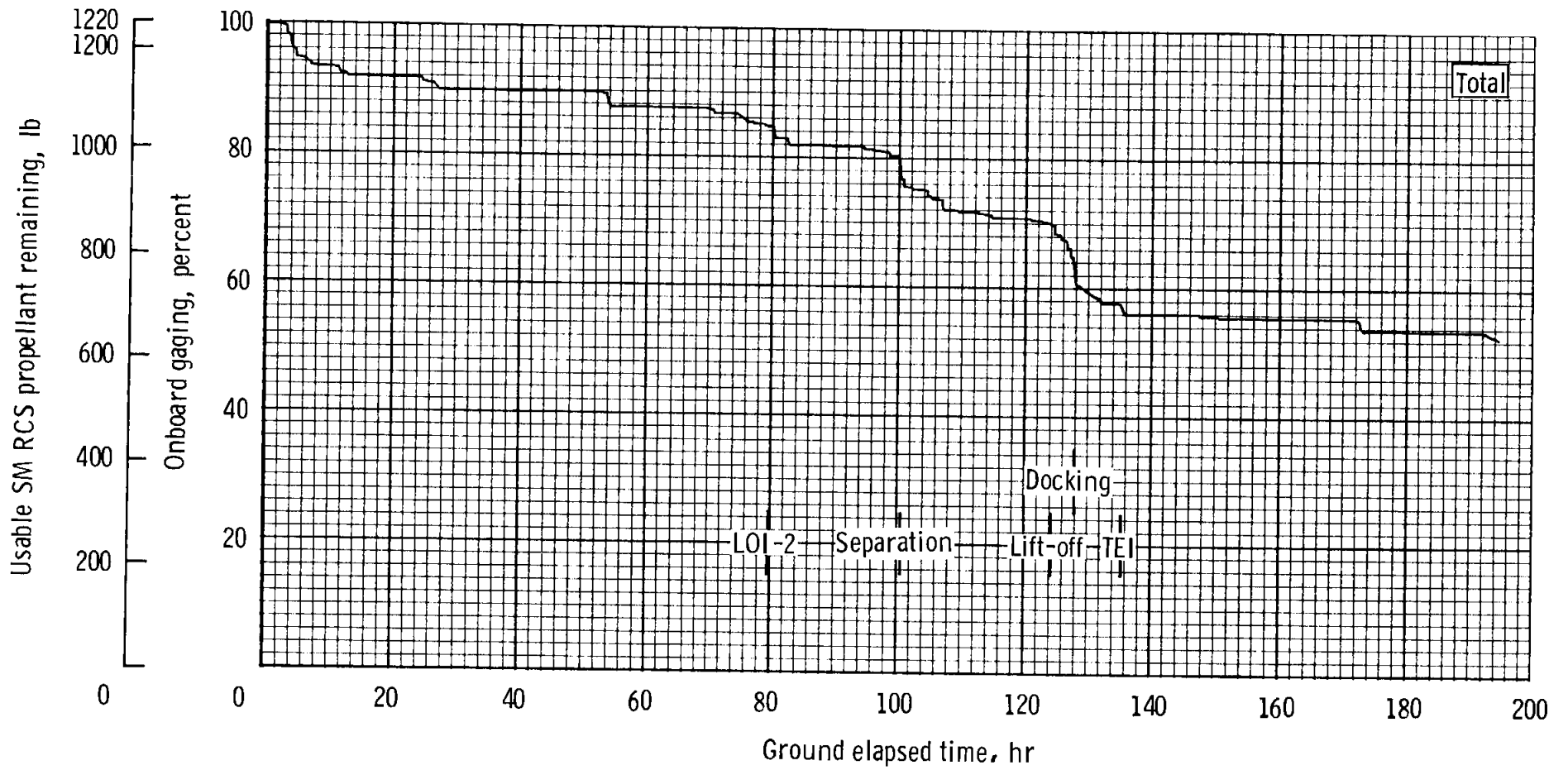

FIGURE 5-1
SM RCS propellant profile - total.

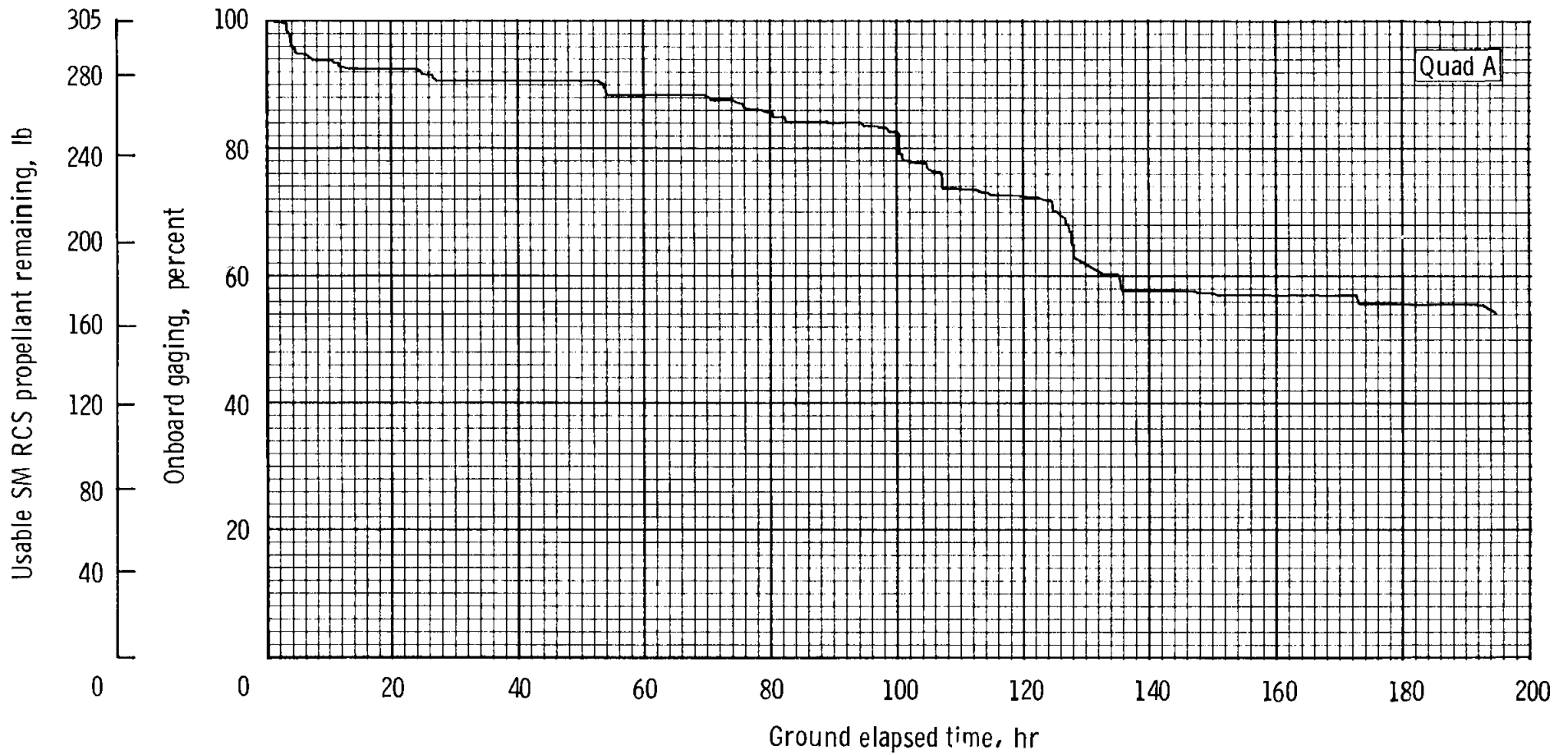

FIGURE 5-2
SM RCS propellant profile - quad A.

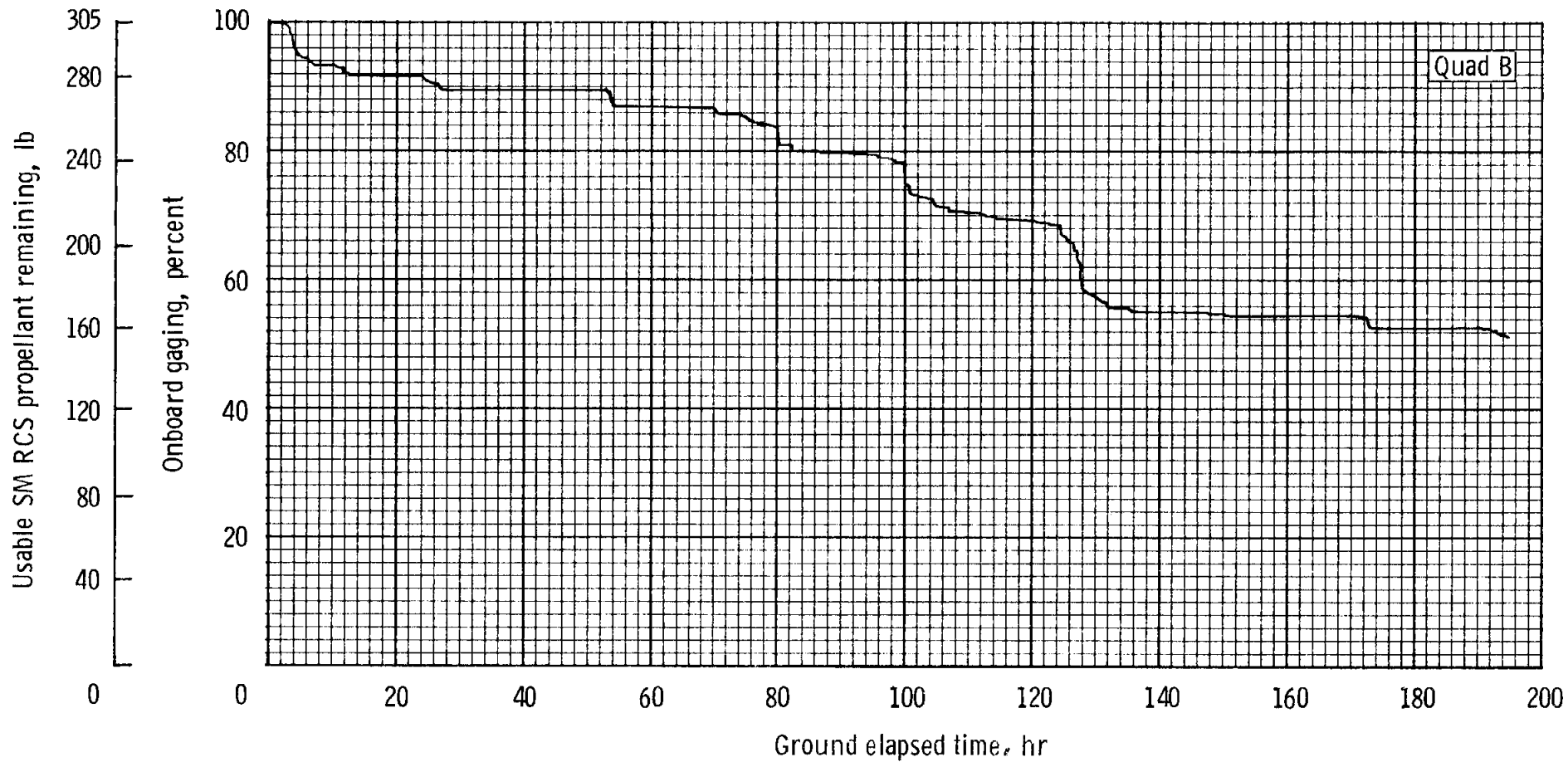

FIGURE 5-3
SM RCS propellant profile - quad B.

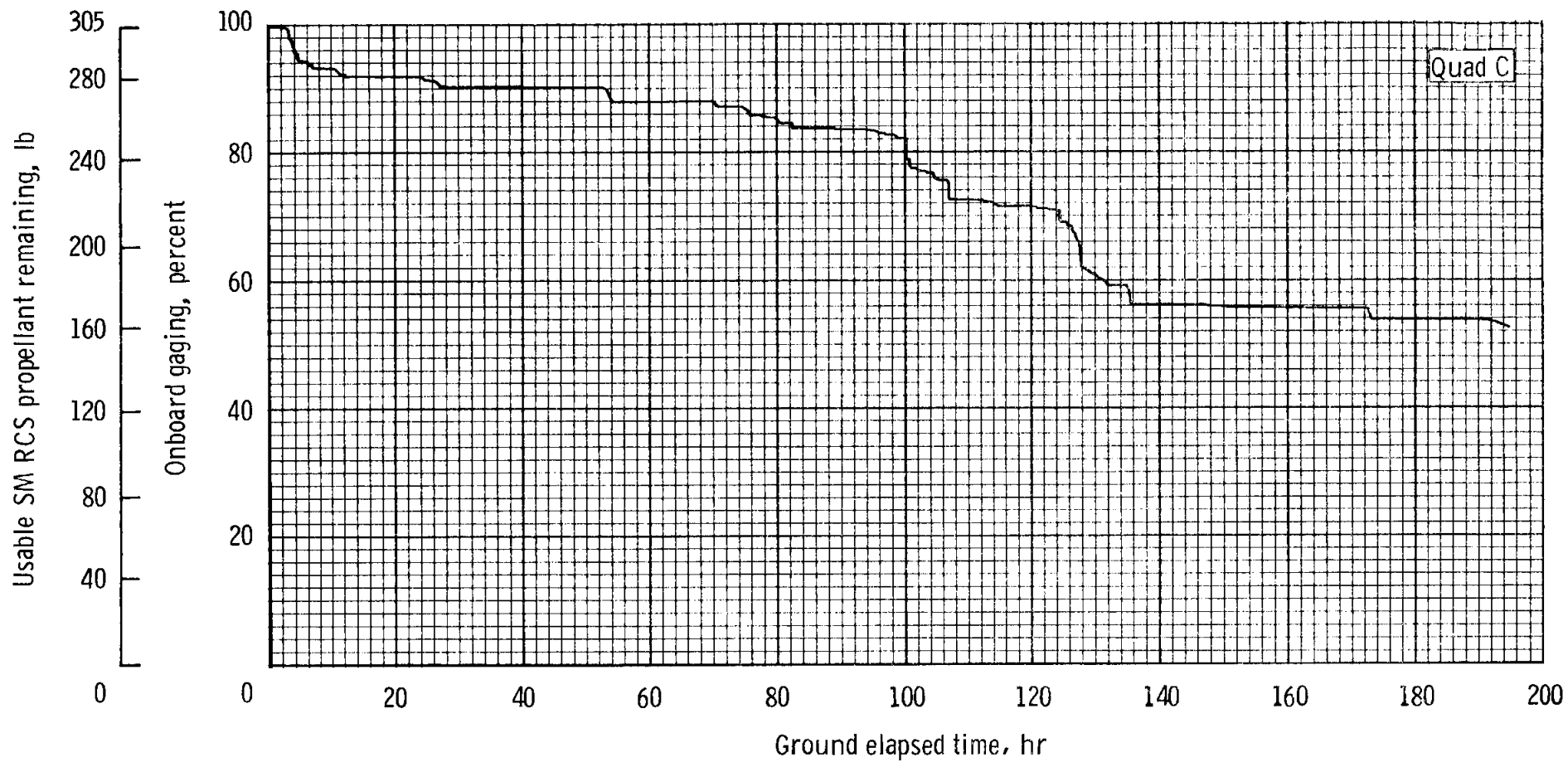

FIGURE 5-4
SM RCS propellant profile - quad C.

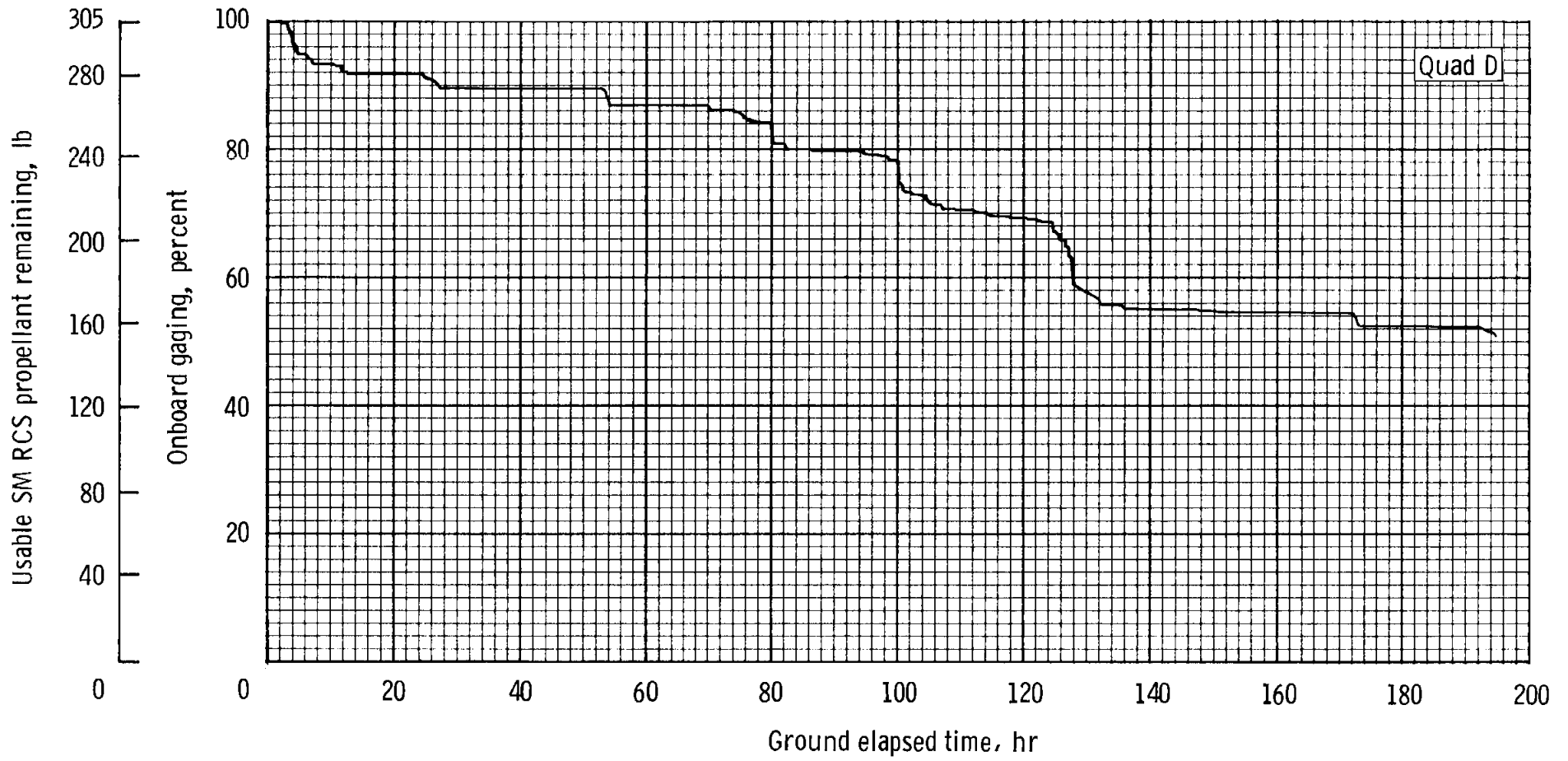

FIGURE 5-5
SM RCS propellant profile - quad D.

TABLE 5-3
 CM RCS Propellant Summary

Item	Propellant required, lb.	Propellant remaining, lb.
Loaded	--	245.0
Trapped	36.4	208.6
Available for mission planning	--	208.6
Nominal usage	39.3	169.3
Nominal remaining	--	169.3

SERVICE PROPULSION SYSTEM

SERVICE PROPULSION SYSTEM (SPS). - The budget presented in table 5-4 is for a July 16 launch, 72 degree launch azimuth, first opportunity injection, 59.5 hour lunar parking orbit, and fast earth return. The assumptions used in preparing this budget are presented in table 5-5. ΔV requirements were coordinated with INAB in MPAD.

It should be noted that the mission flexibility allowance of 900 fps has been used in addition to the fast return. In real time however, it is highly likely that a slower earth return would be performed in the mission flexibility ΔV had already been used (e.g., for LM rescue). Table 5-4 shows 3906 lbs of propellant remaining nominally and a total propellant margin (accounting both for the flexibility ΔV and the fast return) of 1268 lb.

TABLE 5-4 - APOLLO 11 SPS PROPELLANT SUMMARY

ITEM	PROPELLANT REQUIRED, LB	PROPELLANT REMAINING, LB
Loaded ^a	--	40803.0
Trapped and unavailable	441.4	40361.6
Outage	59.5	40302.1
Unbalance meter	100.0	40202.1
Available for ΔV	--	40202.1
Required for ΔV		
TLMC (120 fps) ^b	1166.4	39035.7
LOI-1 (2924 fps, 5 min. 59 sec.)	23862.4	15173.3
LOI-2 (157.8 fps, 16.4 sec.)	1115.4	14057.9
IOPC (16.6 fps, .9 sec.)	73.8	13984.1
TEI (3292.7 fps, 149 sec.)	10077.8	3906.3
Nominal remaining	--	3906.3
Mission flexibility (900 fps)	2212.4	1693.9
Dispersions (-3 σ)	426.0	1267.9
Propellant margin	--	1267.9

^a 15712.0 lb of fuel and 25091.0 lb of oxidizer; this is loaded on CS4-107.

^b Includes 19.7 fps for evasive maneuver

TABLE 5-5 - ASSUMPTIONS FOR THE APOLLO 11 SPS PROPELLANT BUDGET

1.	There is a non-propulsive propellant loss of 14.4 lb for each engine start. LM rescue assumed three engine starts.	
2.	A mission flexibility ΔV of 900 fps has been included in the SPS budget to provide the capability to perform a worst case LM rescue, or to handle several other contingencies (such as loss of PCNCS), or to perform a quicker earth return.	
3.	Spacecraft weight:	
	CM	12 280.0 lb
	SM	10 551.3 lb
	SLA Ring	98.0 lb
	Tanked SPS	40 600.7 lb
	LM (unmanned)	33 278.3 lb
	Total	96 808.3 lb
4.	Lunar Orbit Activity	
	Total weight transfer (CSM to LM) = 436.7 lb	
	Total weight transfer (LM to CSM) = 284.0 lb	
5.	SM RCS, EPS, and ECS weight losses:	
	<u>Mission Period</u>	<u>Incremental Weight Loss, lb</u>
	EL to TLMC	151.8
	TLMC to LOI-1	327.1
	LOI-1 to LOI-2	32.0
	LOI-2 to LOPC	146.5
	LOPC to TEI	216.1
6.	SM RCS usage (above nominal rendezvous requirement) for LM rescue was 216 lb.	

LM RCS BUDGET

Ground Rules and Assumptions

1. Data for the LM RCS engine performance and propellant requirements were obtained from the Spacecraft Operational Data Book and postflight analysis from Apollo 9 and Apollo 10.
2. All orientation maneuvers were assumed to be made at $2.0^\circ/\text{sec}$.
3. All orientation maneuvers were assumed to be three-axis maneuvers.

TABLE 5-6
LM RCS Propellant Loading and Usage Summary

Loaded	633.0
Trapped	40.6
Nominal deliverable	592.4
Gaging Inaccuracy and loading tolerance	39.5
Mixture ratio uncertainty	17.0
Usable	555.9
Nominal mission requirement	252.7
Nominal remaining	283.2

TABLE 5-7

		LM - RCS PROPELLANT BUDGET	PAGE 1		
TIME	EVENT TITLE	^a S/C WT (LBS)	LM RCS USED (LBS)	LM ^b RCS LEFT (LBS)	LM ^b RCS LEFT (%)
0 0	OUTPUT PROPELLANT LOADINGS	33714.	.0	633.0	100.0
99 25	RCS HOT FIRE	33709.	5.0	628.0	99.2
100 15	UNDOCKING	33709.	.0	628.0	99.2
100 15	NULL UNDOCKING VELOCITY	33707.	1.9	626.1	98.9
100 20	LM MNVR FOR INSPECTION YAW	33705.	1.7	624.4	98.6
100 20	LM MNVR FOR INSPECTION PITCH	33703.	2.0	622.4	98.3
100 25	LM MNVR FOR INSPECTION YAW	33702.	.8	621.6	98.2
100 25	FORMATION FLYING	33690.	2.0	619.6	97.9
100 50	RR LOCK ON MNVR	33687.	3.6	616.0	97.3
101 0	IMU REALIGN STAR 1	33683.	3.6	612.4	96.7
101 0	IMU REALIGN STAR 2	33680.	3.6	608.8	96.2
101 0	IMU REALIGN STAR 3	33676.	3.6	605.2	95.6
101 32	MNVR TO DOI BURN ATTITUDE	33672.	3.6	601.6	95.0
101 32	ATTITUDE HOLD	33672.	.1	601.5	95.0
101 38	2 JET ULLAGE	33667.	5.9	595.6	94.1
101 38	DOI BURN	33419.	.0	595.6	94.1
101 38	MOMENT CONTROL DOI BURN	33414.	5.0	590.6	93.3
101 38	TRIM HORIZONTAL RESIDUAL	33407.	7.6	583.0	92.1
101 38	ATTITUDE HOLD	33407.	.3	582.8	92.1
101 38	PITCH DOWN	33406.	1.0	581.8	91.9
101 42	RR LOCK ON MNVR	33402.	3.6	578.2	91.3
101 55	PITCH DOWN	33401.	.6	577.6	91.3
101 55	YAW LEFT	33401.	.6	577.0	91.2
102 0	ALIGNMENT CHECK	33400.	1.2	575.8	91.0
102 10	RR LOCK ON MNVR	33396.	3.6	572.2	90.4

^a These weights were used for analysis only and do not reflect the actual weight after consumables loading.

^b RCS propellant remaining of total loaded

TABLE 5-7 (CONT'D)

LM - RCS PROPELLANT BUDGET						PAGE 2
TIME HRS M	EVENT TITLE	S/C WT ^a (LBS)	LM RCS USED (LBS)	LM ^b RCS LEFT (LBS)	LM ^b RCS LEFT (%)	
102 14	MNVR TO PDI ATTITUDE	33392.	3.6	568.6	89.8	
102 14	MAINTAIN LOS	33391.	1.0	567.6	89.7	
102 29	ATTITUDE HOLD	33391.	.1	567.5	89.7	
102 35	2 JET ULLAGE	33385.	5.9	561.7	88.7	
102 35	PDI BURN	16753.	.0	561.7	88.7	
102 35	POWERED DESCENT	16710.	34.1	527.5	83.3	
102 47	TOUCHDOWN	16710.	.0	527.5	83.3	
112 40	ADD LUNAR SAMPLES	16580.	.0	527.5	83.3	
124 23	LUNAR LIFT OFF	10840.	.0	527.5	83.3	
124 23	POWERED ASCENT PHASE WITH RCS/ APS INTERCONNECT	6087.	.0	527.5	83.3	
124 23	POWERED ASCENT PHASE WITHOUT R CS/APS INTERCONNECT	5969.	.9	526.7	83.2	
124 25	RR LOCK ON MNVR	5969.	.4	526.2	83.1	
124 30	INSERTION BURN CONTROL	5967.	1.8	524.4	82.8	
124 30	TRIM OUT OF PLANE ERROR	5964.	3.3	521.2	82.3	
124 36	ATTITUDE HOLD	5962.	1.3	519.9	82.1	
124 37	IMU REALIGN STAR 1	5962.	.4	519.5	82.1	
124 37	IMU REALIGN STAR2	5961.	.4	519.0	82.0	
124 37	IMU REALIGN STAR3	5961.	.4	518.6	81.9	
124 55	RR LOCK ON MNVR	5961.	.4	518.1	81.9	
124 55	MAINTAIN LOS	5958.	2.7	515.5	81.4	
125 15	ATTITUDE HOLD	5957.	1.3	514.2	81.2	
125 21	CSI BURN RCS +Z	5923.	33.6	480.6	75.9	
125 26	MAINTAIN LOS	5920.	3.3	477.2	75.4	
125 44	MNVR TO PLANE CHANGE ATTITUDE	5919.	.4	476.8	75.3	

^a These weights were used for analysis only and do not reflect the actual weight after consumables loading.

^b RCS propellant remaining of total loaded

TABLE 5-7 (CONT'D)

LM - RCS PROPELLANT BUDGET						PAGE 3
TIME HRS	EVENT TITLE	S/C WT ^a (LBS)	LM ^b RCS USED (LBS)	LM ^b RCS LEFT (LBS)	LM ^b RCS LEFT (%)	
125 45	ATTITUDE HOLD	5918.	1.3	475.5	75.1	
125 50	RCS PLANE CHANGE BURN	5914.	4.1	471.4	74.5	
126 0	PR LOCK ON MNVR	5913.	.4	471.0	74.4	
126 0	MAINTAIN LOS	5911.	2.0	469.0	74.1	
126 15	ATTITUDE HOLD	5910.	1.3	467.7	73.9	
126 15	CEP RCS BURN	5906.	4.0	463.7	73.3	
126 15	MAINTAIN LOS	5902.	4.0	459.7	72.6	
126 33	ATTITUDE HOLD	5901.	1.3	458.4	72.4	
126 36	RCS TPI BURN	5884.	17.0	441.4	69.7	
126 55	MAINTAIN LOS	5883.	1.3	440.1	69.5	
127 36	FCC AND BRAKING	5849.	33.9	406.3	64.2	
127 36	ATTITUDE AND LOS CONTROL	5833.	16.0	390.3	61.7	
128 00	LM CONTROL OSM ACTIVE DOCKING	5823.	10.0	380.3	60.1	

^a These weights were used for analysis only and do not reflect the actual weight after consumables loading.

^b RCS propellant remaining of total loaded

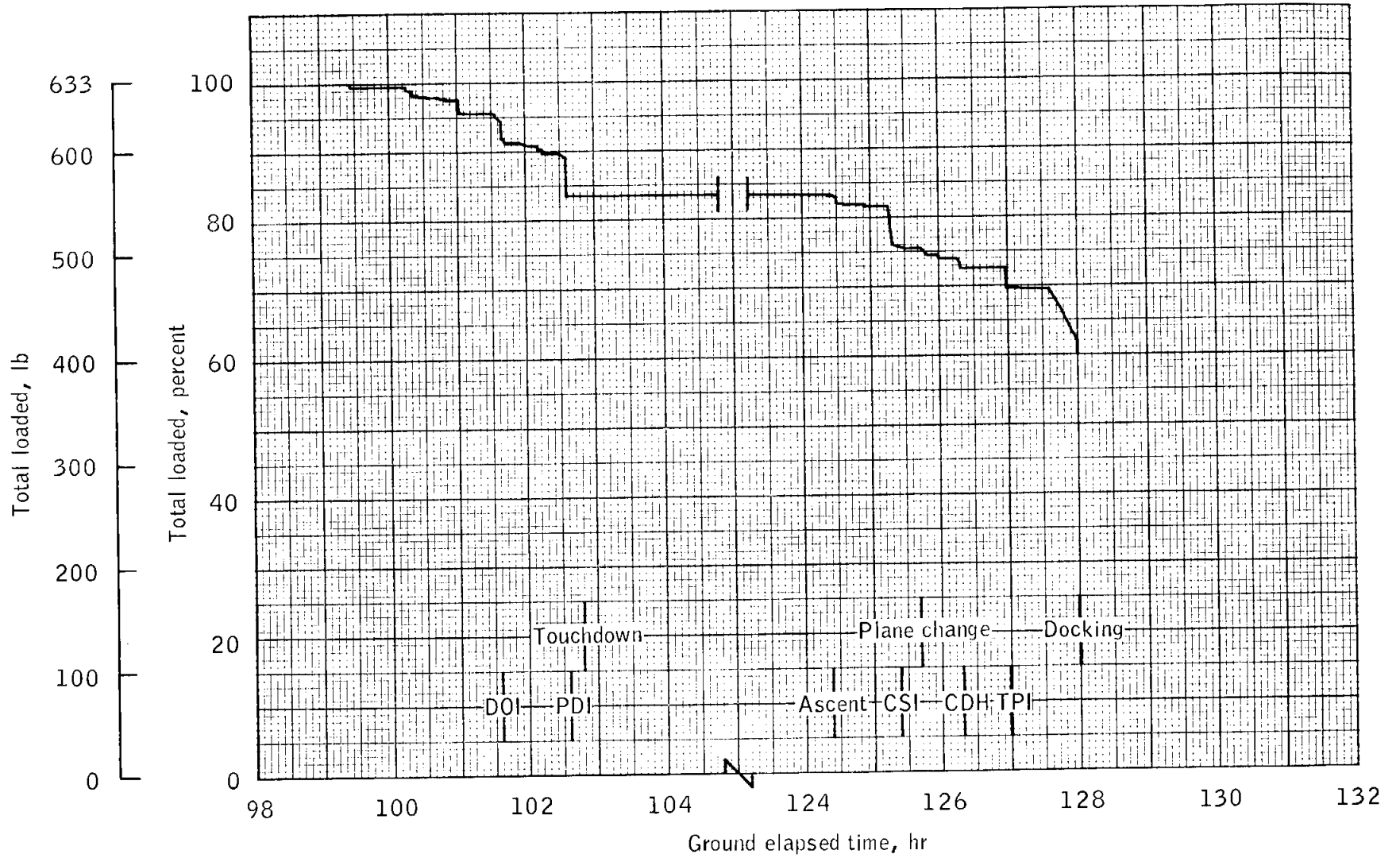

Figure 5-6.- LM RCS propellant profile.

DESCENT PROPULSION SYSTEM PROPELLANT BUDGET

Descent Propulsion Subsystem (DPS) - The DPS budget is shown in table 5-8 and the ground rules and assumptions in table 5-9.

Previously, the uncertainty in the low-level sensor (68.7 lb) has been shown as a contingency allowance. This is now included as part of the unusables. Also, there has previously been a contingency allowance for manual hover to allow for 2 minutes of burn time from 500 feet to touchdown. The present budget shows a nominal ΔV which includes a manual allowance of 477 fps (90 sec) from 500 feet to touchdown. Any additional hover time will be used from the propellant margin (unassigned capability). The rate of use for hover is approximately 9.1 lb/sec.

Propellant loads are those actually loaded on LM-5, and trapped and residual propellants are from Volume III, SODB. Engine performance data and ΔV requirements have been coordinated with LAB in MPAD.

Three sigma dispersions represent total propellant cost due to 3σ uncertainties in propellant loading, trapped, I_{sp} , ΔV , separation weight, non- ΔV consumables weight, and mixture ratio. There is a total propellant margin of 669 lb or approximately 73 seconds of hover time.

TABLE 5-8 - APOLLO 11 DPS PROPELLANT SUMMARY

ITEM	PROPELLANT REQUIRED, LB	PROPELLANT REMAINING, LB
Loaded ^a	--	18184.2
Trapped and unavailable	223.5	17960.7
Outage	14.0	17946.7
Low-Level Sensor Uncertainty	68.7	17878.0
Available for ΔV	--	17878.0
Nominal Required for ΔV of 6728.6 fps	16799.7	1078.3
Dispersions (-3 σ)	224.7	853.6
Contingencies		
Engine Valve-Pair Malfunction ($\Delta MR = \pm .016$)	81.1	772.5
Redesignation (60 fps)	104.0	668.5
Margin (73 sec. hover)	--	668.5

^a 6974.8 lb fuel and 11209.4 lb oxidizer; this is loaded on the LM-5 spacecraft.

TABLE 5-9 - ASSUMPTIONS FOR THE APOLLO 11 DPS PROPELLANT BUDGET

1. Integrated average $I_{sp} = 301.9 \pm 3.54$ seconds
2. IM separation weight = 33746. lb
3. Mixture ratio = 1.596 ± 0.0108
4. Nominal $\Delta V = 6728.6 \pm 96$ fps
5. Non- ΔV consumables of 47.4 lb from separation to DOI and 106.1 lb from DOI to touchdown

ASCENT PROPULSION SYSTEM PROPELLANT BUDGET

Ascent Propulsion Subsystem (APS) - Tables 5-10 and 5-11 present the ascent propellant budget for the current mission. Propellant loads are those actually on IM-5. Mission ΔV was coordinated with LAB in MPAD. The budget shown in table 5-10 accounts for an engine valve-pair malfunction, a PGNCs to AGS switchover, and a touchdown abort. There is a total propellant margin of 68 lb or about 6 seconds of burn time.

TABLE 5-10 - APOLLO 11 APS PROPELLANT SUMMARY

ITEM	PROPELLANT REQUIRED, LB	PROPELLANT REMAINING, LB
Loaded ^a	--	5238.4
Trapped and Unavailable	48.9	5189.5
Outage	17.5	5172.0
Available for ΔV	--	5172.0
Nominal Required for ΔV of 6072.5 fps	4965.8	206.2
Dispersions (-3σ)	57.8	148.4
Contingencies		
Engine Valve-pair Malfunction ($\Delta MR = \pm .016$)	19.6	128.8
PGNCs to AGS Switchover (40 fps)	23.8	105.0
Touchdown Abort ($\Delta V = +99.9$ lb, $\Delta V = -15$ fps)	36.8	68.2
Margin (6 seconds)	--	68.2

^a Includes 2019.9 lb fuel and 3218.5 lb oxidizer; this is loaded on the IM-5 spacecraft.

TABLE 5-11 - ASSUMPTIONS FOR THE APOLLO 11 APS PROPELLANT BUDGET

1. $I_{sp} = 308.97 \pm 3.553$ seconds
2. Mixture ratio = 1.602 ± 0.0225
3. Nominal $\Delta V = 6072.5 \pm 33.5$ fps
4. Ascent stage lift-off weight = 10873.6 lb

CSM-107/LM5 CRYOGENIC/EPS AND ECS BUDGET

The results of the Cryogenic, EPS, and ECS analysis are summarized in the following tables and figures:

TABLE 5-11	CSM Cryogenic Loading And Usage Summary
TABLE 5-13	LM EPS Summary
TABLE 5-14	LM ECS Summary
FIGURE 5-7	CSM O ₂ PROFILE
FIGURE 5-8	CSM H ₂ PROFILE
FIGURE 5-9	CSM POWER PROFILE
FIGURE 5-10	CSM BUS VOLTAGE VS TIME
FIGURE 5-11	LM DESCENT POWER PROFILE
FIGURE 5-12	LM ASCENT POWER PROFILE
FIGURE 5-13	LM TOTAL CURRENT PROFILE
FIGURE 5-14	LM DESCENT O ₂ PROFILE
FIGURE 5-15	LM ASCENT O ₂ PROFILE
FIGURE 5-16	LM DESCENT H ₂ O PROFILE
FIGURE 5-17	LM ASCENT H ₂ O PROFILE

CSM EPS BUDGET

ASSUMPTIONS AND GROUND RULES

1. The system was assumed to operate with three fuel cells and two inverters.
2. Fuel cell purging is included in the EPS requirements.
3. 100% fill for both H₂ and O₂.
4. Three entry and postlanding batteries were considered available to supply the total spacecraft power required for entry, parachute descent, and postlanding time. Each battery was assumed to have a 40 A-h capacity until splashdown, at which time the capacity was updated to 45 A-h.
5. Two batteries were considered to be in parallel with the fuel cells during ascent and for each SPS maneuver.
6. No cryogenic venting was assumed in flight.
7. The EPS hydrogen consumption rate (lb/hr) = $0.00257 \times I_{fc}$
8. The EPS oxygen consumption rate (lb/hr) = $7.936 \times \dot{H}_2$
9. Six battery charges were assumed: three on battery A and three on battery B.

TABLE 5-12
APOLLO 11 CRYOGENIC SUMMARY

I. Planning Allowance	H ₂ , lb	O ₂ , lb
A. Total Loaded	58.60	660.20
B. Less Residual	2.32	13.00
C. Less Instrumentation Error	<u>1.50</u>	<u>17.50</u>
Available for Mission Planning	54.78	629.70
II. Predicted Usages		
A. Prelaunch ¹		
1. Inline HTR + Pressure Relief (T-28 to T-3 (Incl 12.5 hr hold))	1.61	18.60
2. Power Production (plus ECS O ₂) (T-3 to liftoff)	<u>.57</u>	<u>6.96</u>
Total Prelaunch requirements	2.18	25.50
B. Flight		
1. EPS Requirements (Incl FC Purge)	36.60	288.33
2. CM ECS (Incl Cabin Purge)	-	72.40
3. LM Pressurizations	<u>-</u>	<u>10.35</u>
Total Flight Requirements	36.60	371.08
III. Nominal Reserves (RSS)		
EPS Uncertainty (5 percent)	1.83	14.42
ECS Uncertainty (.08 lb/hr)	-	15.60
Tank Unbalance (AOH)	.80	12.90
Launch Window	<u>.86</u>	<u>10.20</u>
RSS Subtotal	2.17	26.87
IV. Operational Reserves		
A. Available for Mission Planning	54.78	629.70
B. Less Nominal Predicted Usage	38.78	396.58
C. Less Nominal Reserves	<u>2.17</u>	<u>26.87</u>
Operational Reserve	13.83	206.25

¹ KSC Supplied Data

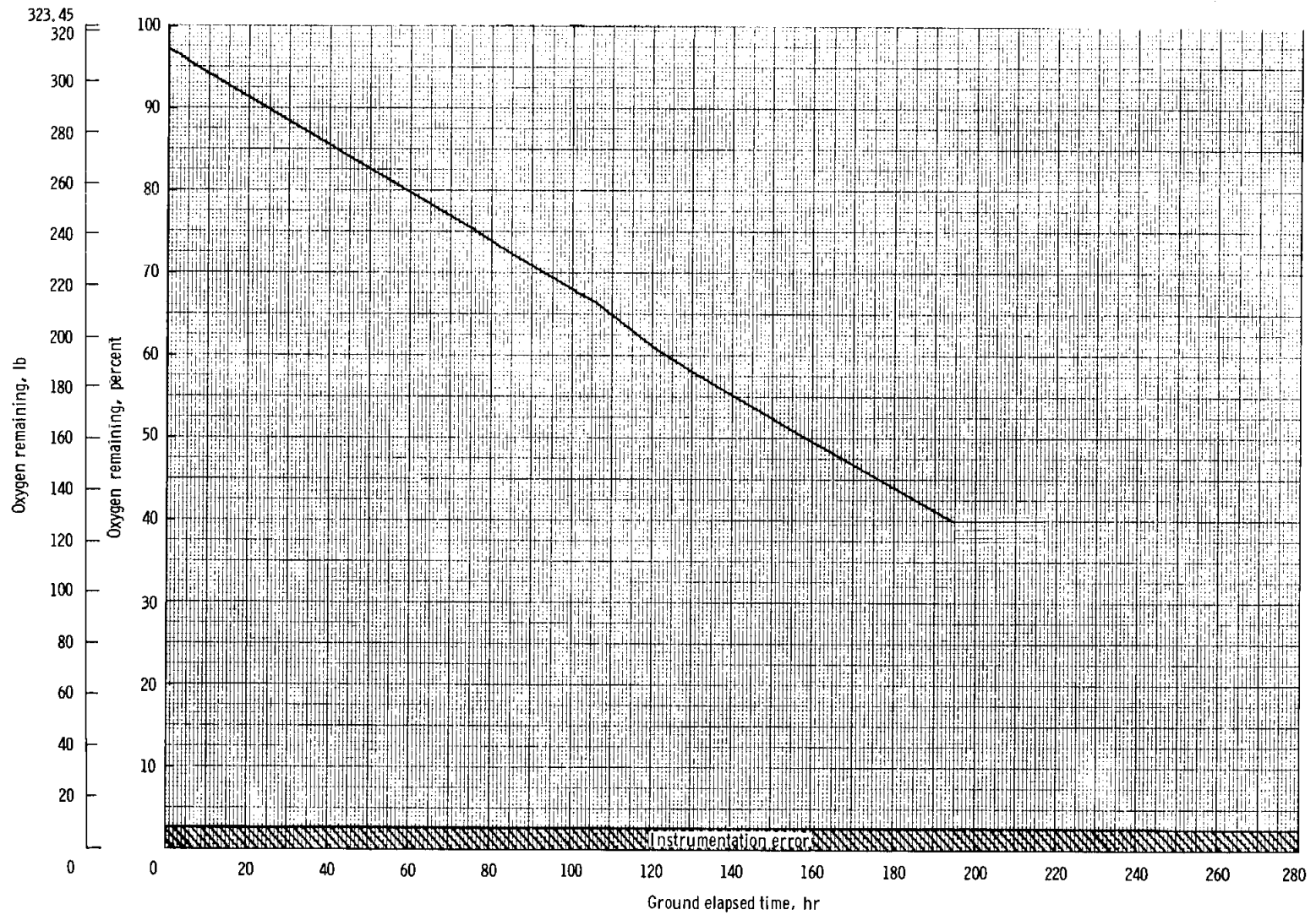

Figure 5-7. - Oxygen remaining for mission for one tank versus time.

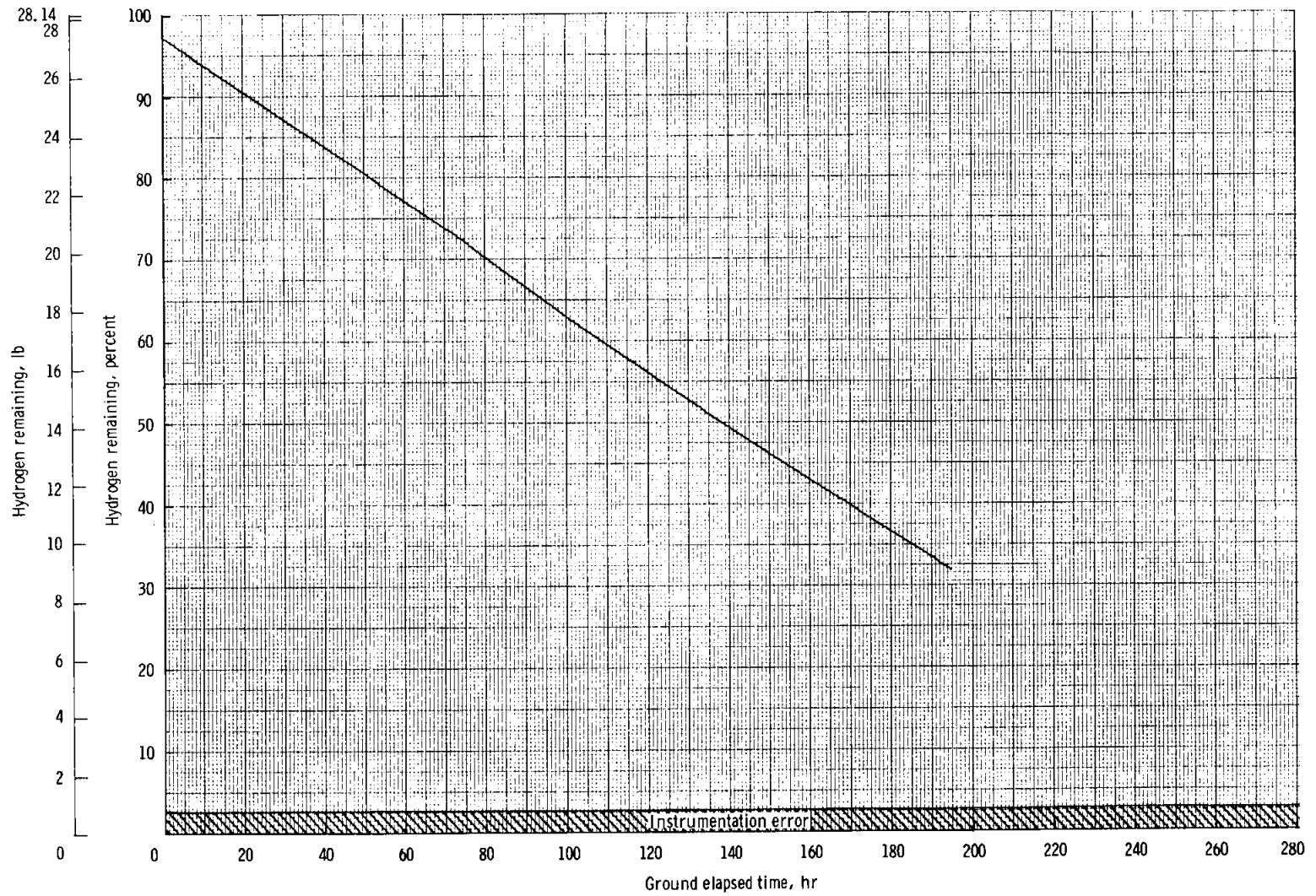

Figure 5-8. - Hydrogen remaining for mission for one tank versus time.

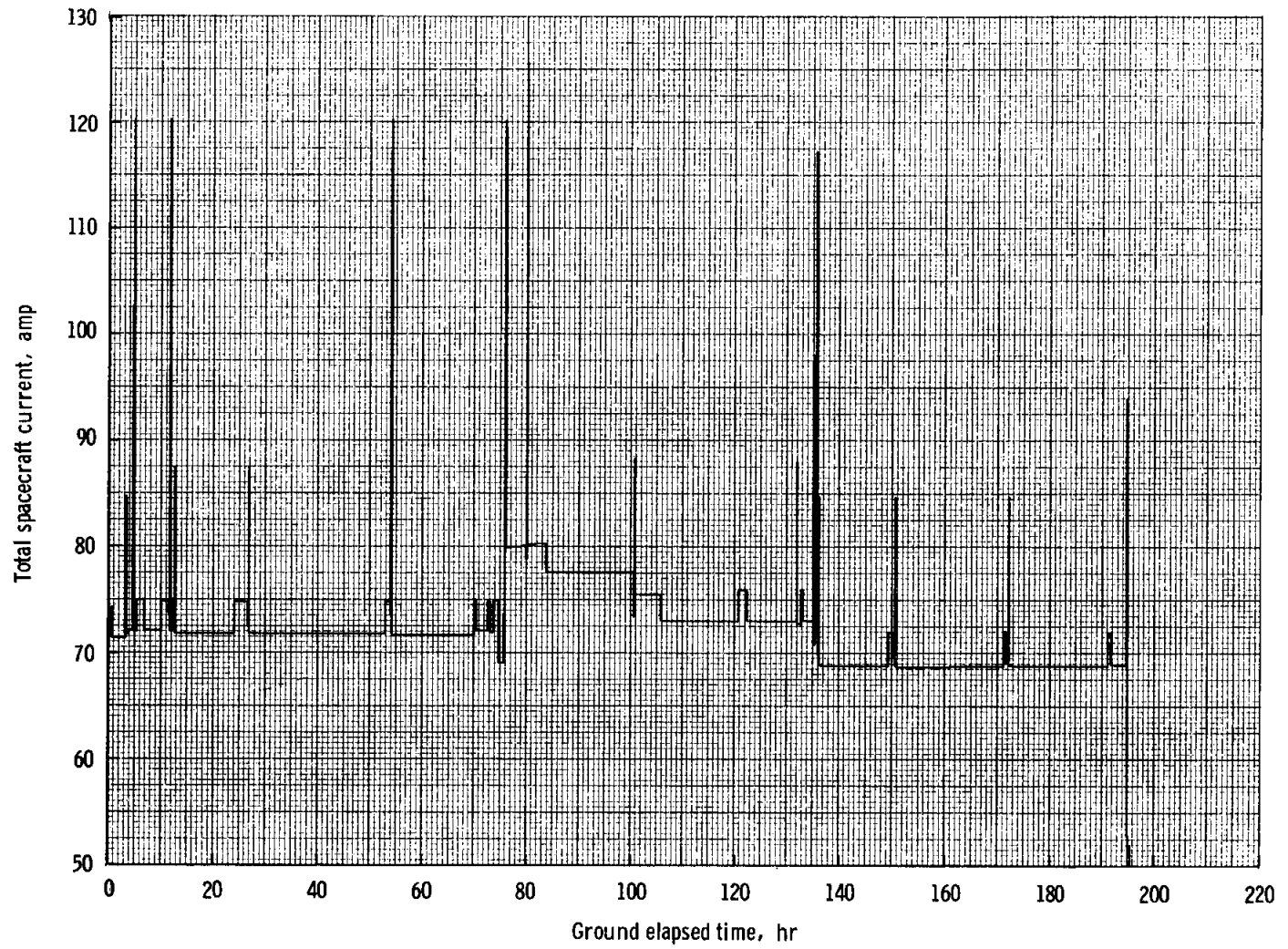

Figure 5-9.- CSM total spacecraft current profile.

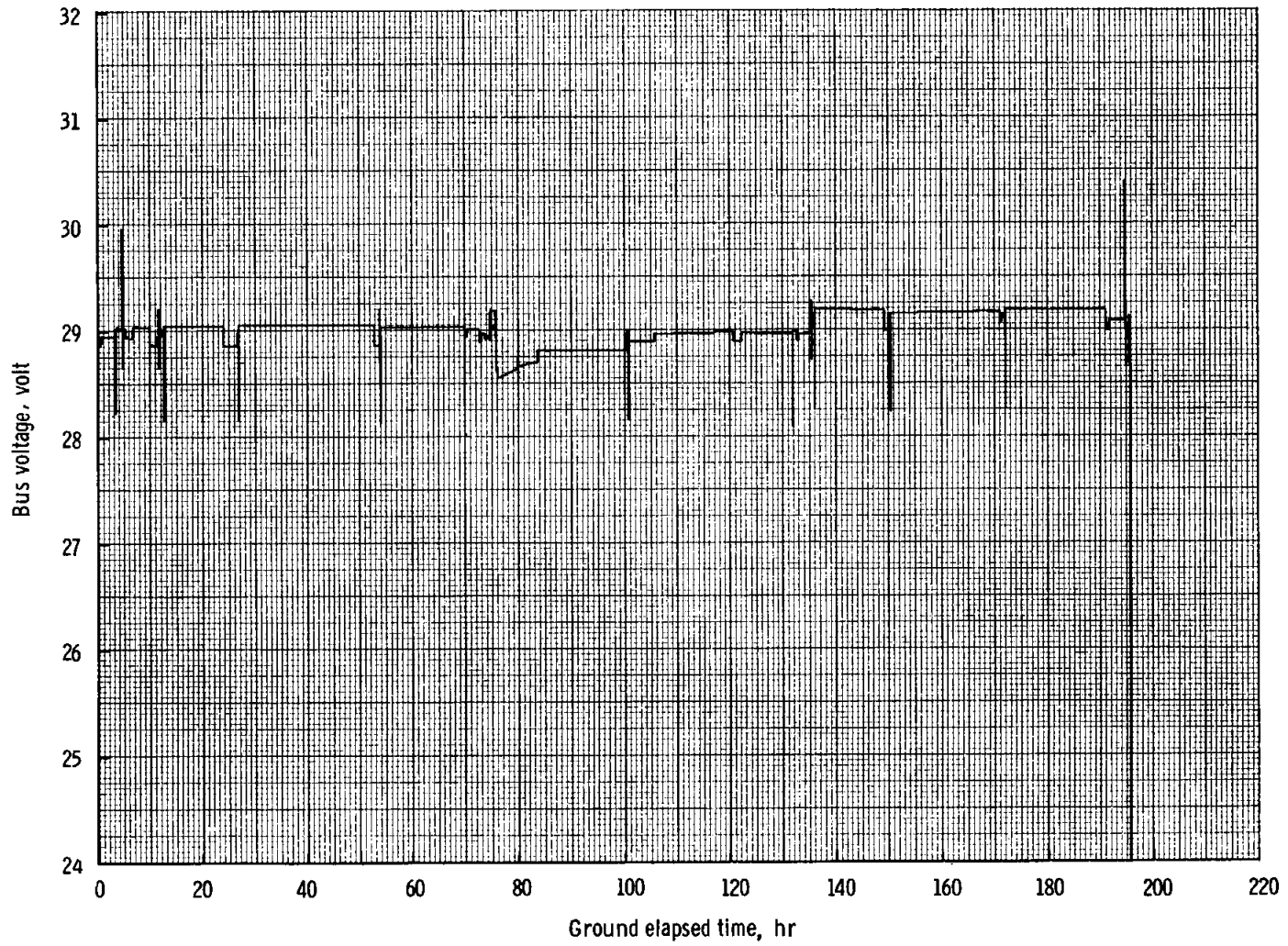

Figure5-10. - CSM bus voltage versus time.

LM EPS ANALYSIS

GROUND RULES AND ASSUMPTIONS

1. The descent stage batteries go on the line 30 minutes prior to earth liftoff.
2. A 3.8 hour checkout was assumed for lunar orbit.
3. Ascent and descent batteries were paralleled for the powered descent burn and prior to liftoff from the lunar surface.
4. The S-band equipment was assumed on 100 percent from initial activation in lunar orbit until completion of the mission.
5. The rendezvous radar electronics was assumed to be operational for the period of time dictated by the current G Mission flight plan.
6. The primary navigation and guidance subsystem (PGNCS) was left in the operate mode for the entire lunar stay.
7. The forward window heaters were left off for the entire mission.

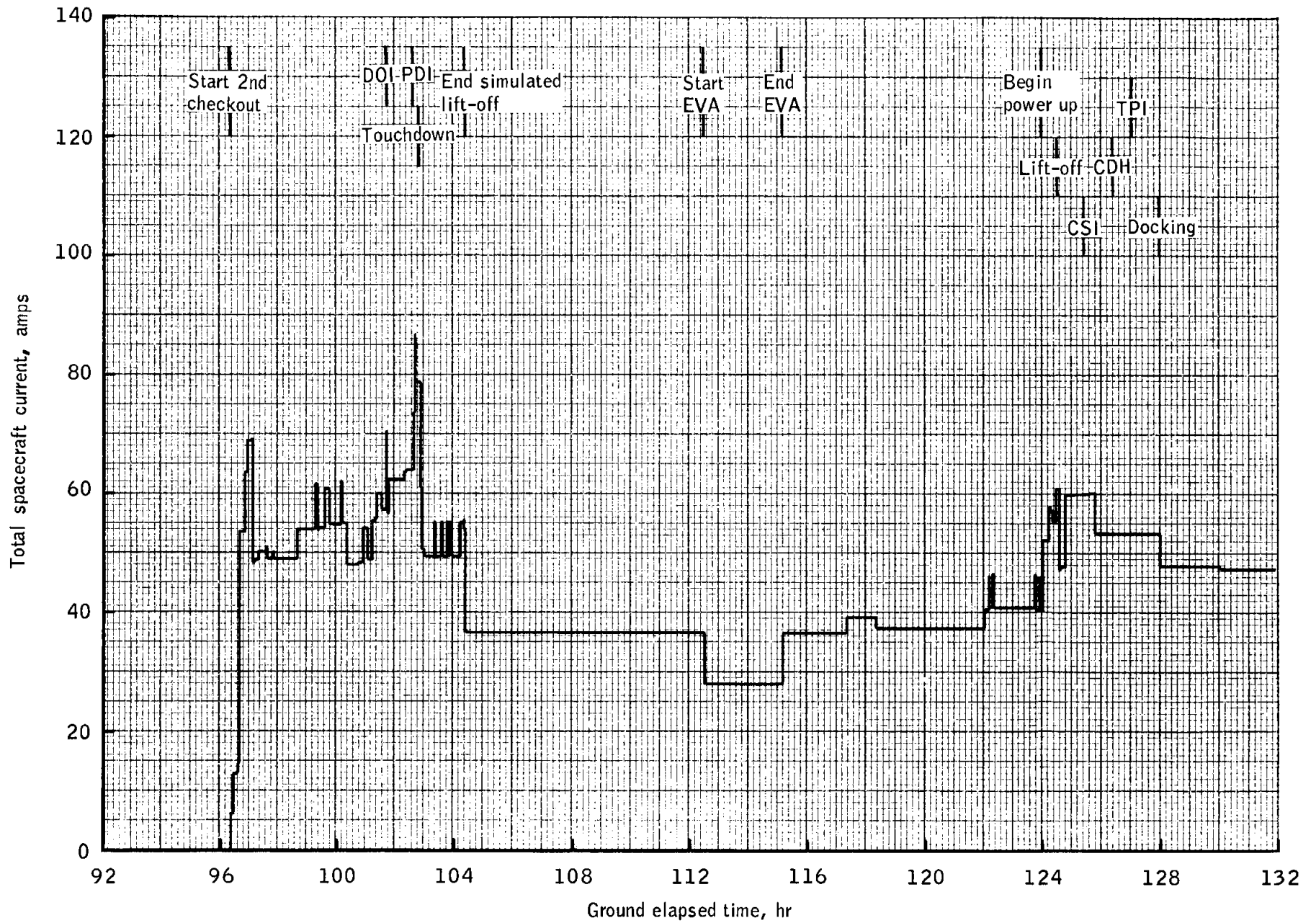

Figure 5-11.- LM-5 total spacecraft current.

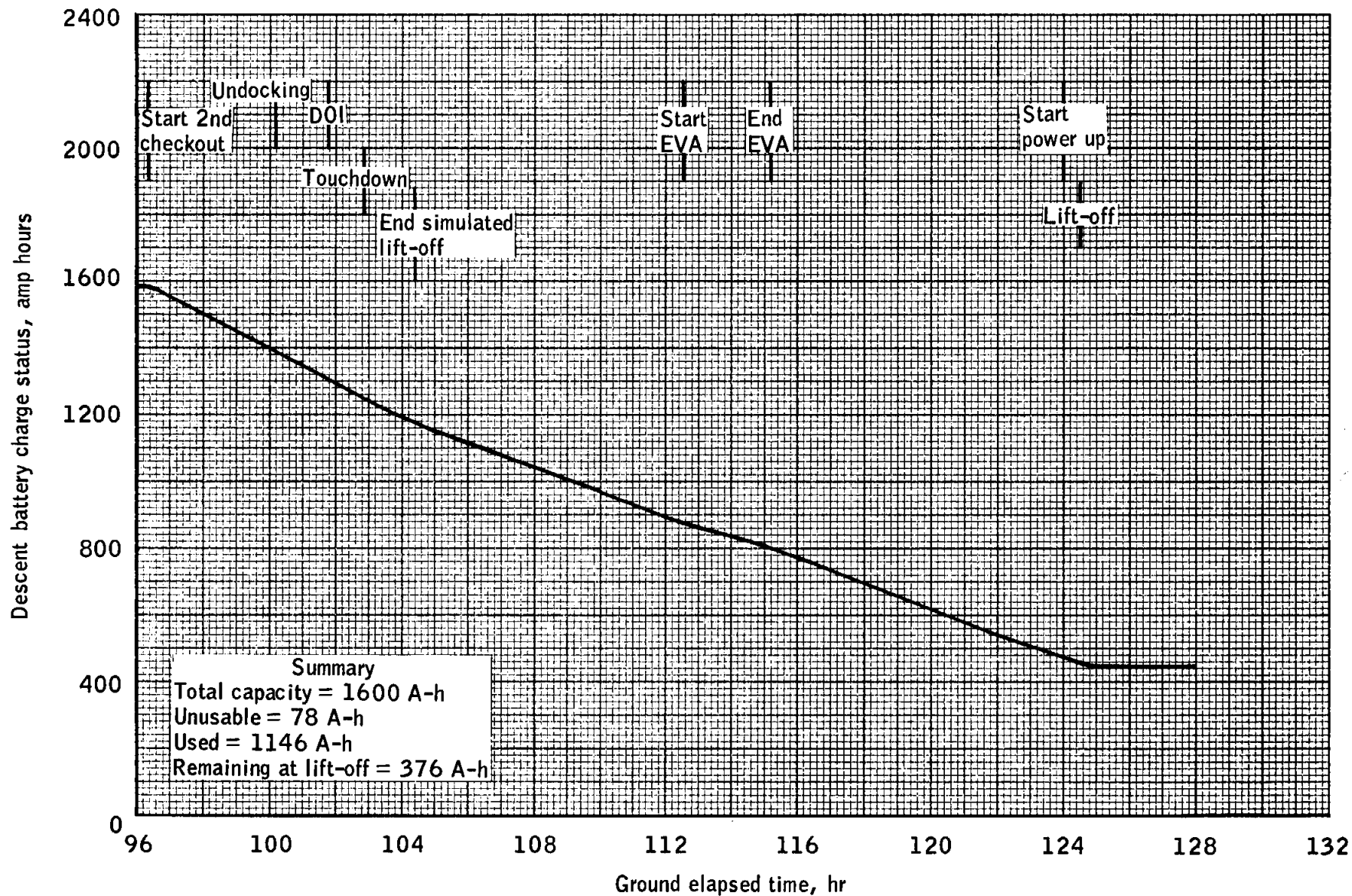

Figure 5-12.- Descent stage amp hours remaining.

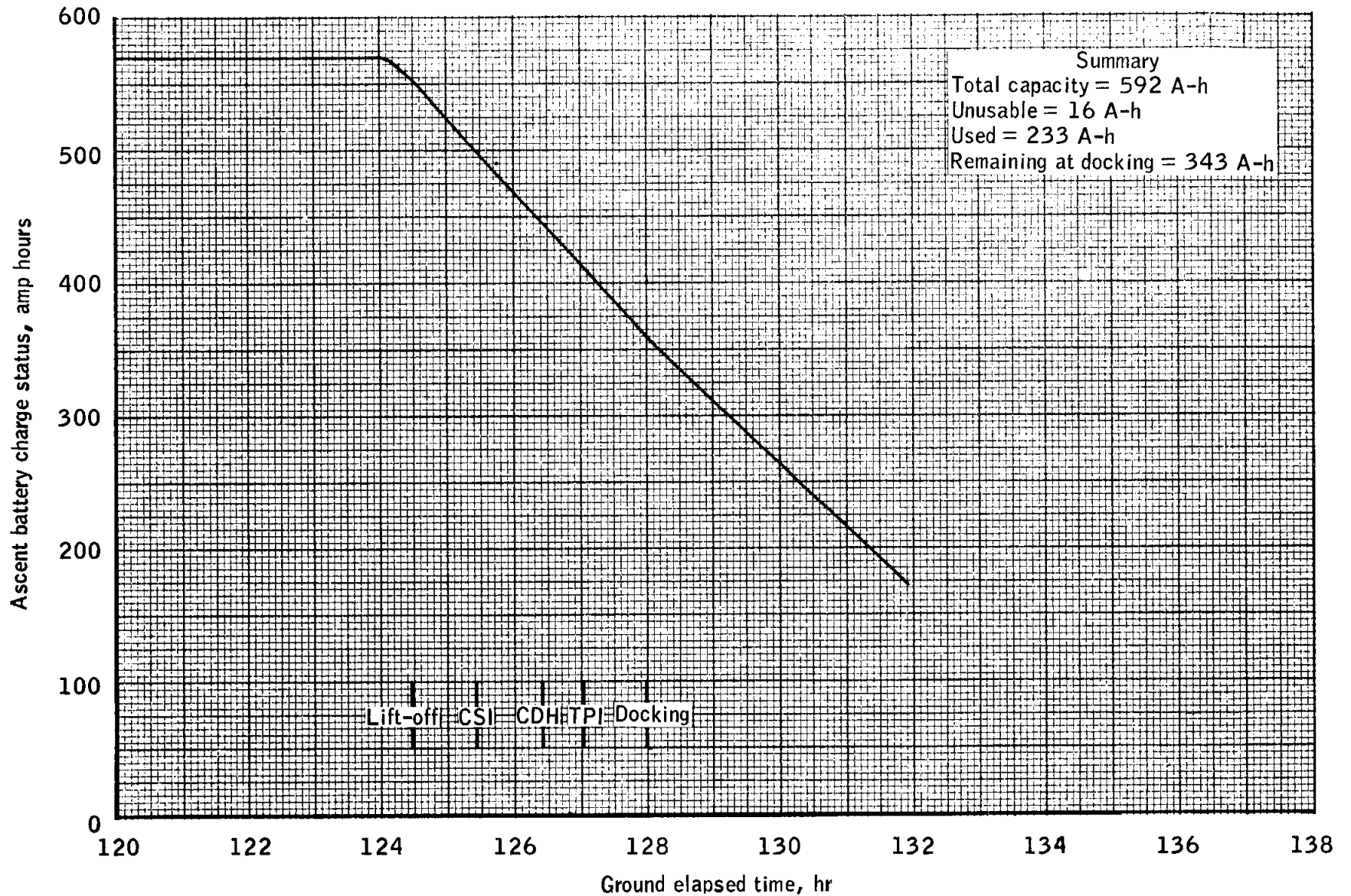

Figure 5-13.- Ascent stage amp hours remaining.

LM ECS BUDGET

GROUND RULES AND ASSUMPTIONS

1. Cabin O₂ leakage rate was 0.2 lb/hr while pressurized
2. Metabolic rates were varied according to Volume 2 of the Spacecraft Operational Data Book
3. Metabolic O₂ consumed was $(1.643 \times 10^{-4}) \times (\text{metabolic rate})$
4. LM pressurization requires 6.62 lb of O₂
5. Cabin pressure regulator check requires 2.65 lb of O₂
6. H₂O consumed because of sublimator cooling was total heat removed divided by 10⁴0 (btu per lb) of H₂O
7. H₂O lost due to urination was 0.11 lb/hr per man
8. Cabin temperature control was set to 72° F
9. Average glycol flow rate was 250 lb/hr
10. Budget was performed on the operational trajectory and may change when the revision 1 is analyzed.

TABLE 5-13
LM ECS Summary

(a) Descent Stage

<u>Description</u>	<u>O₂, lb</u>	<u>H₂O, lb</u>
Loaded	48.00	210.6
Unusable	3.40	16.4
Available for mission.	44.60	194.2
Required for mission	26.17	142.4
Usable remaining in tanks	18.43	51.8

(b) Ascent Stage

Loaded	4.86	85.00
Unusable74	4.20
Available for mission	4.12	80.80
Required for mission	1.95	45.48
Usable remaining in tanks	2.17	35.32

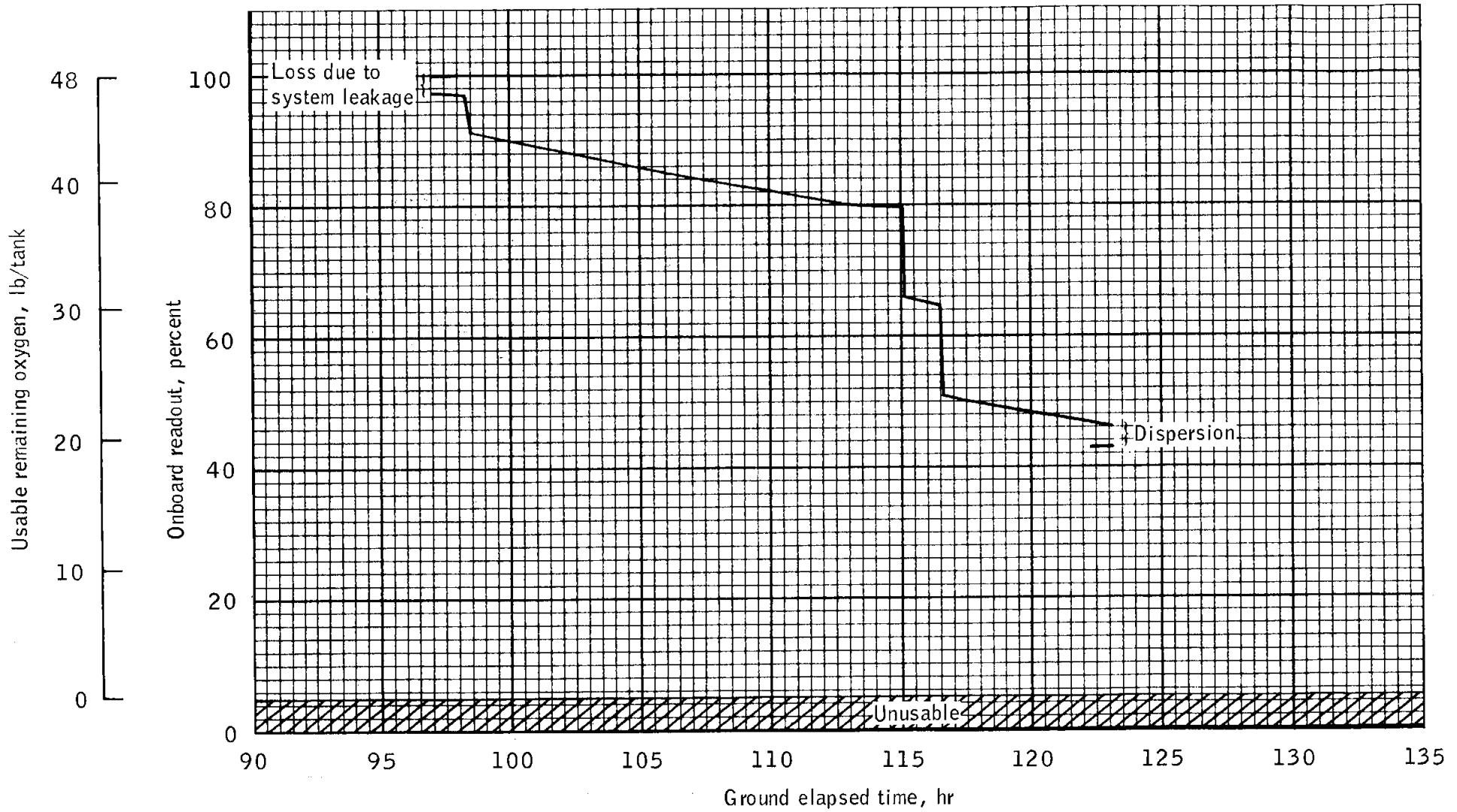

Figure 5-14.- Descent oxygen tank quantities as a function of mission time.

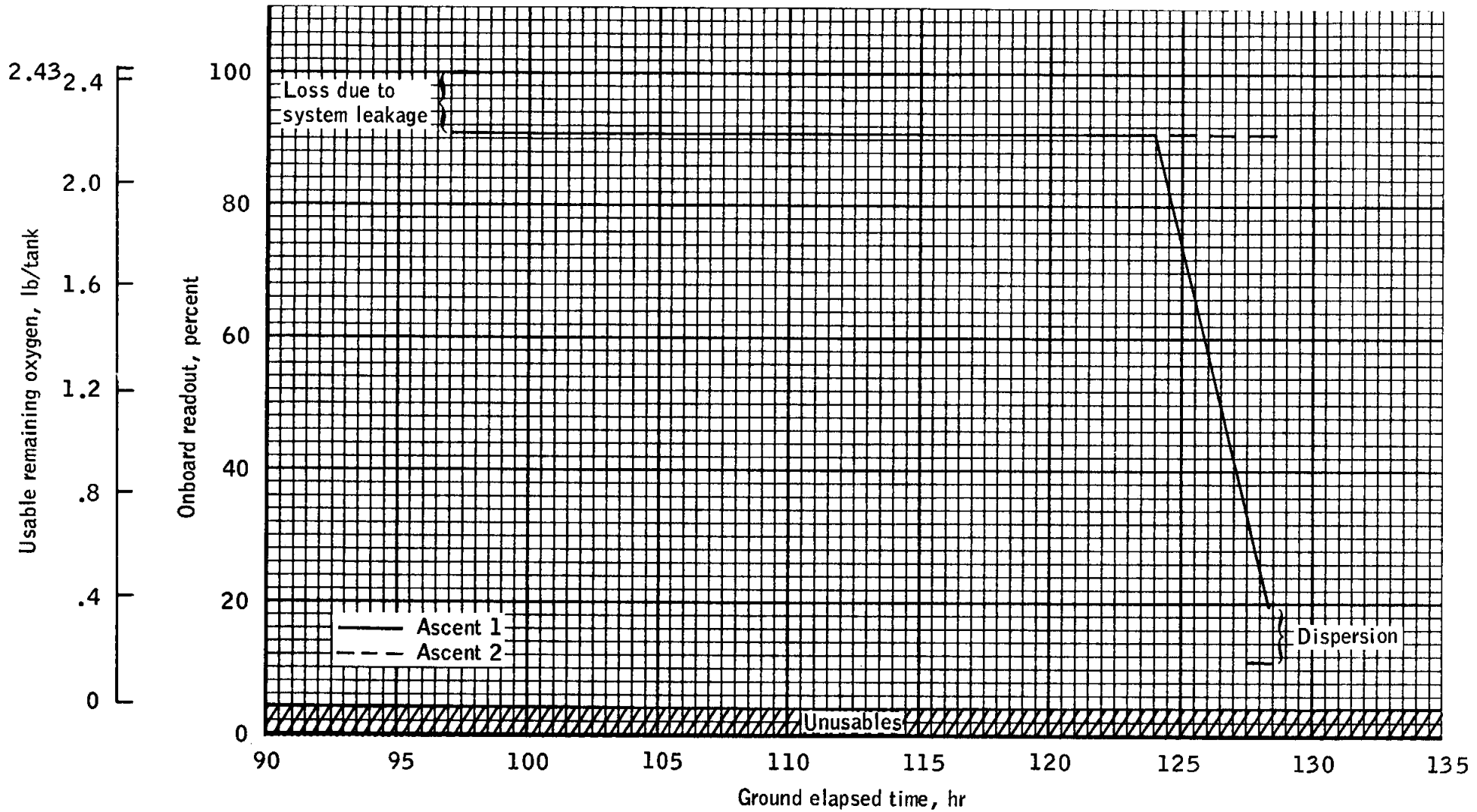

Figure 5-15 .- Ascent oxygen tank quantities as a function of mission time .

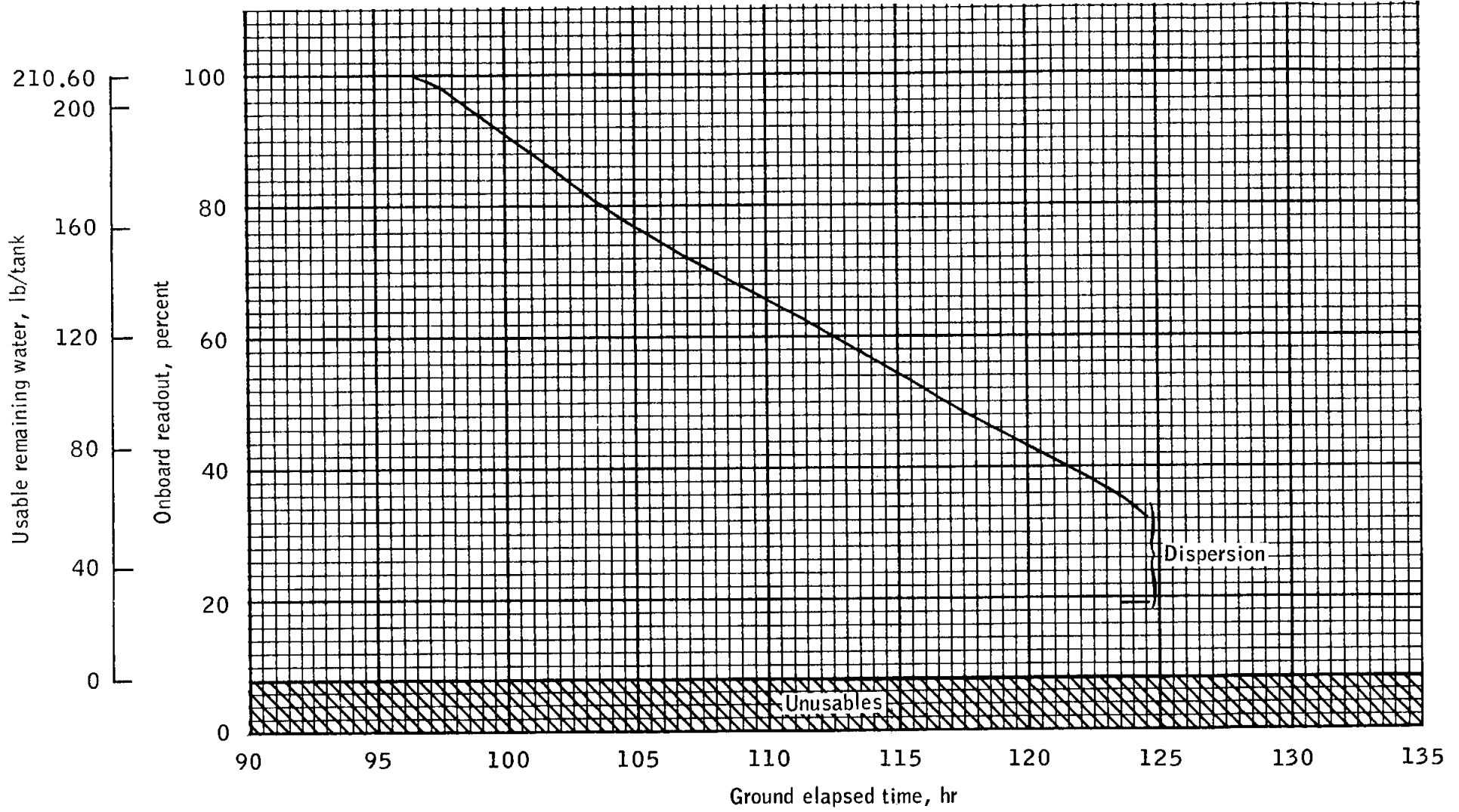

Figure 5-16 .- Descent water tank quantities as a function of mission time .

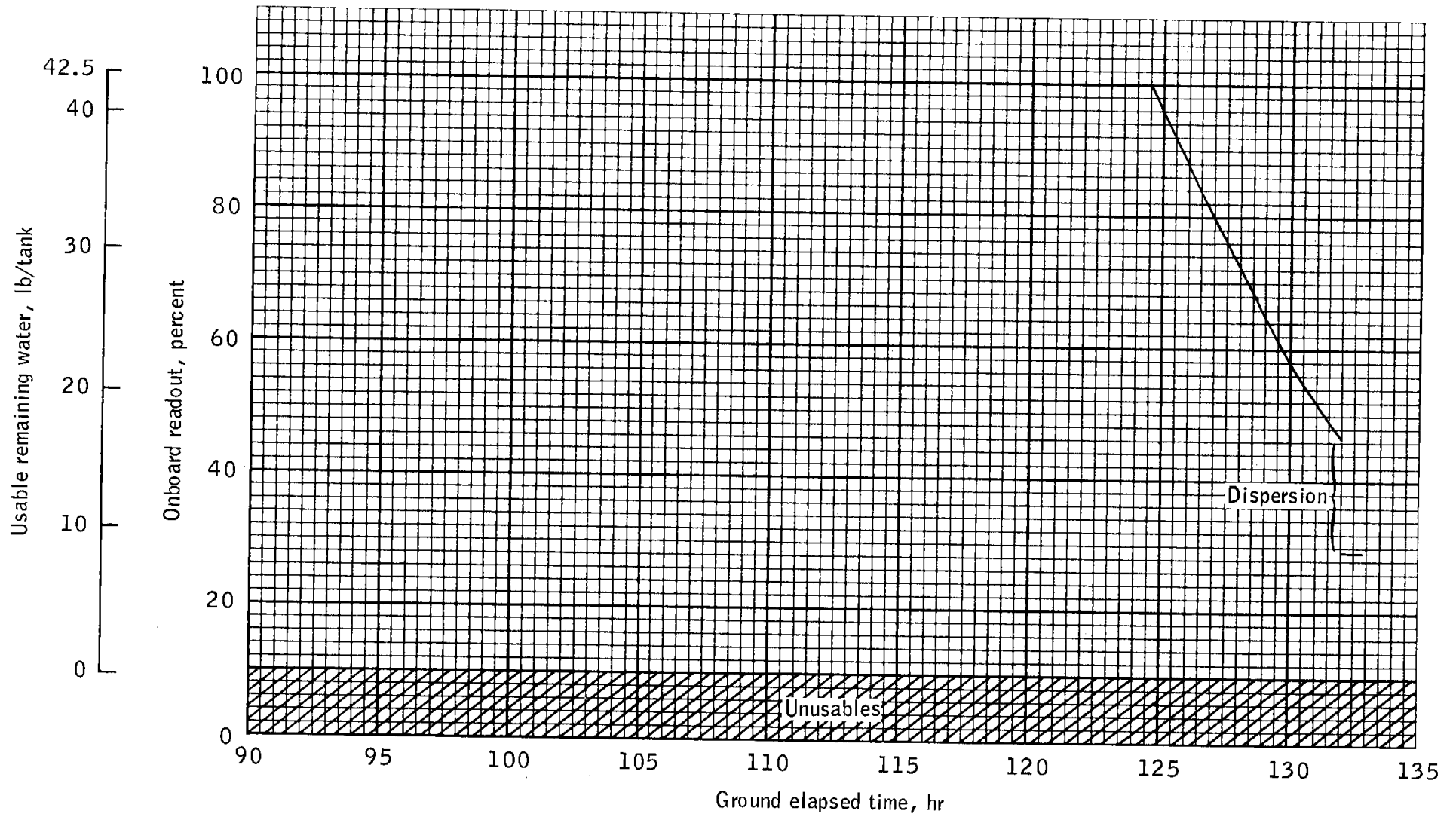

Figure 5-17.- Ascent water tank quantities as a function of mission time.

MISSION G PLSS CONSUMABLE ANALYSIS

THE RESULTS OF THE PLSS BATTERY, OXYGEN, WATER AND LiOH CONSUMABLE ANALYSIS ARE SUMMARIZED IN THE FOLLOWING FIGURES:

FIGURE 5-18	LMP AND CDR PLSS BATTERY PROFILE
FIGURE 5-19	CDR OXYGEN PROFILE
FIGURE 5-20	LMP OXYGEN PROFILE
FIGURE 5-21	CDR H ₂ O PROFILE
FIGURE 5-22	LMP H ₂ O PROFILE
FIGURE 5-23	LMP AND CDR LiOH CO ₂ PROFILE

NOMINAL LUNAR SURFACE EVA

FIGURE 5-18 LMP AND CDR - PLSS BATTERY

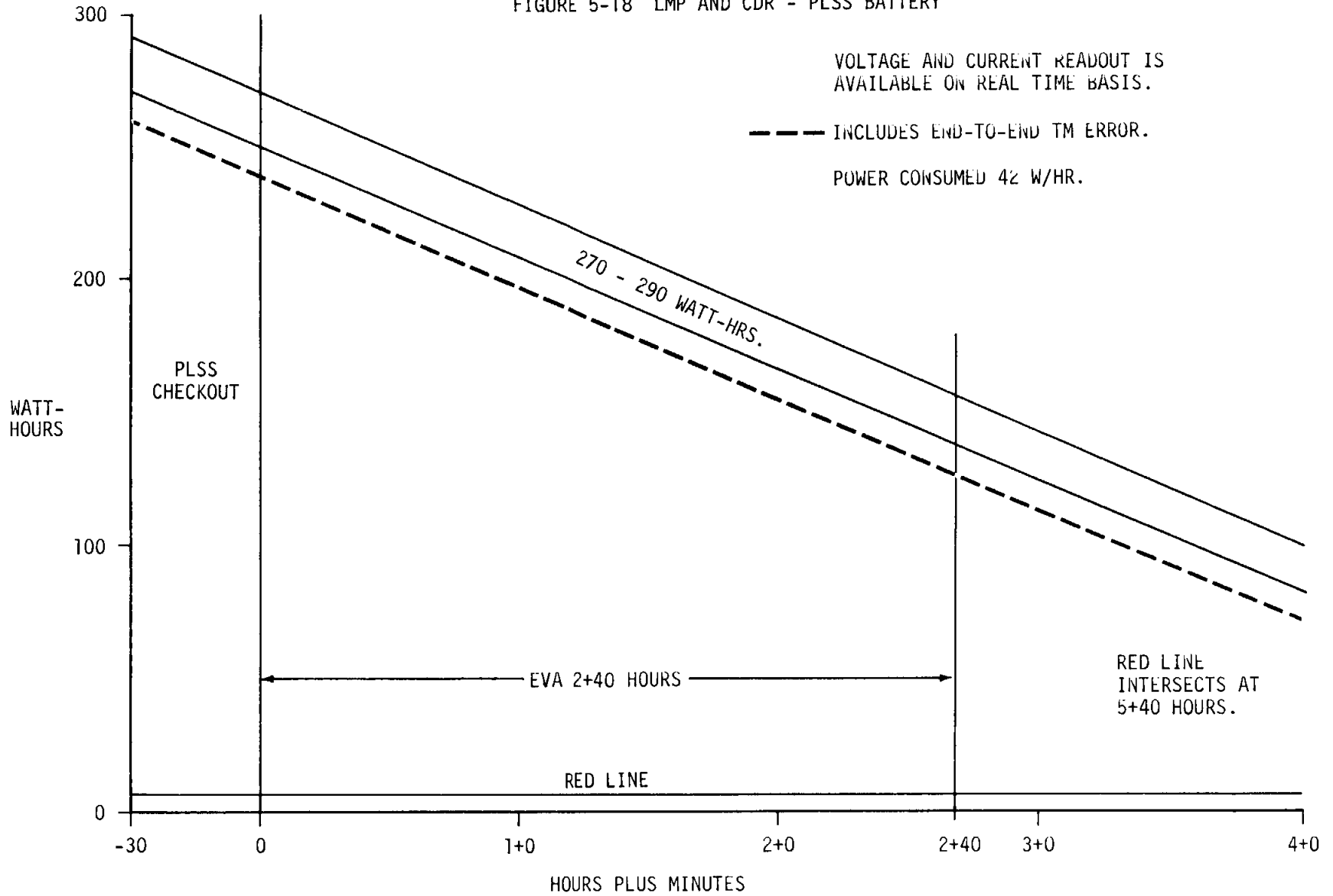

NOMINAL LUNAR SURFACE EVA

FIGURE 5-19 CDR - OXYGEN

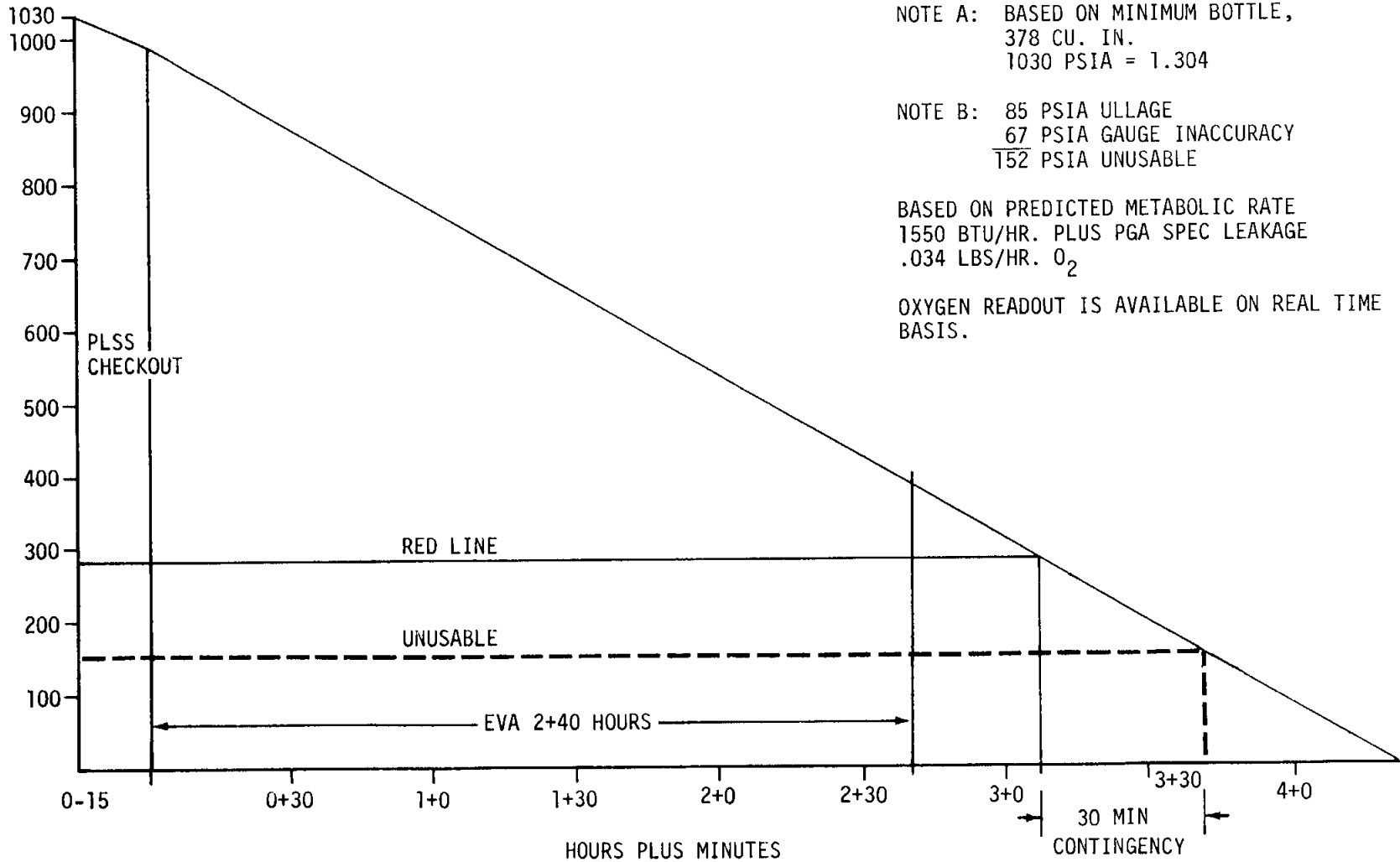

NOTE A: BASED ON MINIMUM BOTTLE,
378 CU. IN.
1030 PSIA = 1.304

NOTE B: 85 PSIA ULLAGE
67 PSIA GAUGE INACCURACY
152 PSIA UNUSABLE

BASED ON PREDICTED METABOLIC RATE
1550 BTU/HR. PLUS PGA SPEC LEAKAGE
.034 LBS/HR. O₂

OXYGEN READOUT IS AVAILABLE ON REAL TIME
BASIS.

NOMINAL LUNAR SURFACE EVA

FIGURE 5-20 LMP - OXYGEN

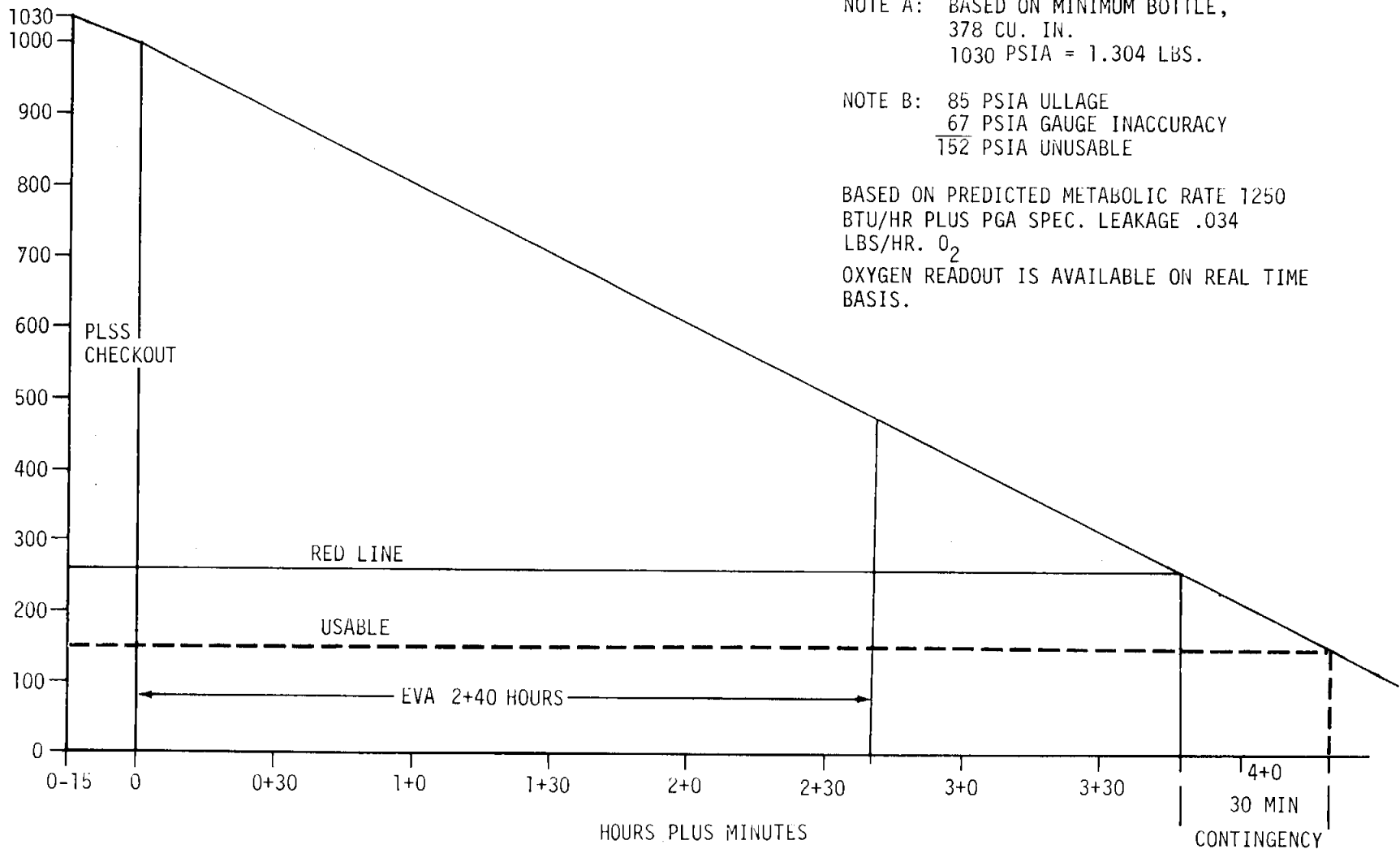

NOTE A: BASED ON MINIMUM BOTTLE,
378 CU. IN.
1030 PSIA = 1.304 LBS.

NOTE B: 85 PSIA ULLAGE
67 PSIA GAUGE INACCURACY
152 PSIA UNUSABLE

BASED ON PREDICTED METABOLIC RATE 1250
BTU/HR PLUS PGA SPEC. LEAKAGE .034
LBS/HR. O₂
OXYGEN READOUT IS AVAILABLE ON REAL TIME
BASIS.

NOMINAL LUNAR SURFACE EVA

FIGURE 5-21 CDR - WATER

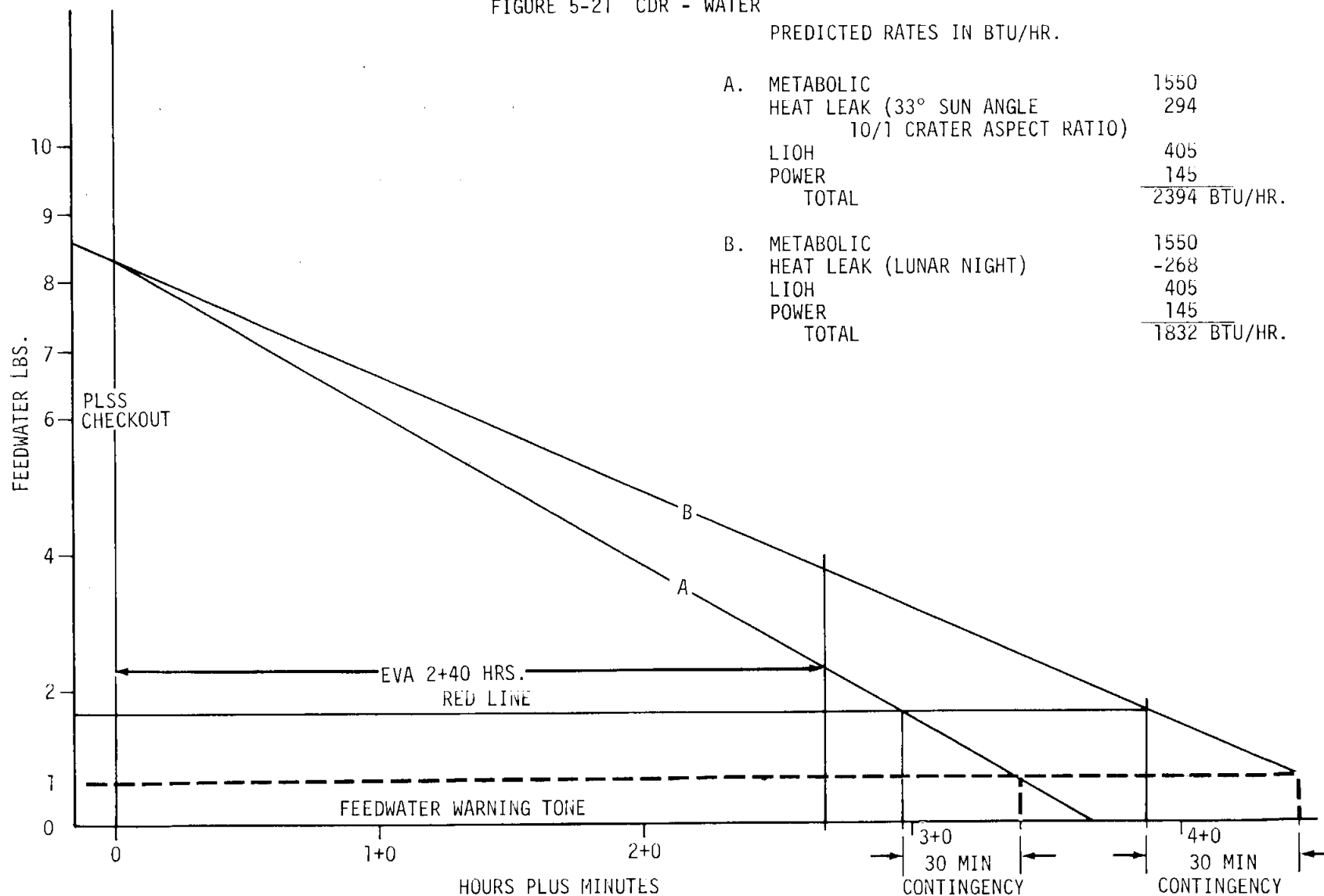

NOMINAL LUNAR SURFACE EVA

FIGURE 5-22 LMP - WATER

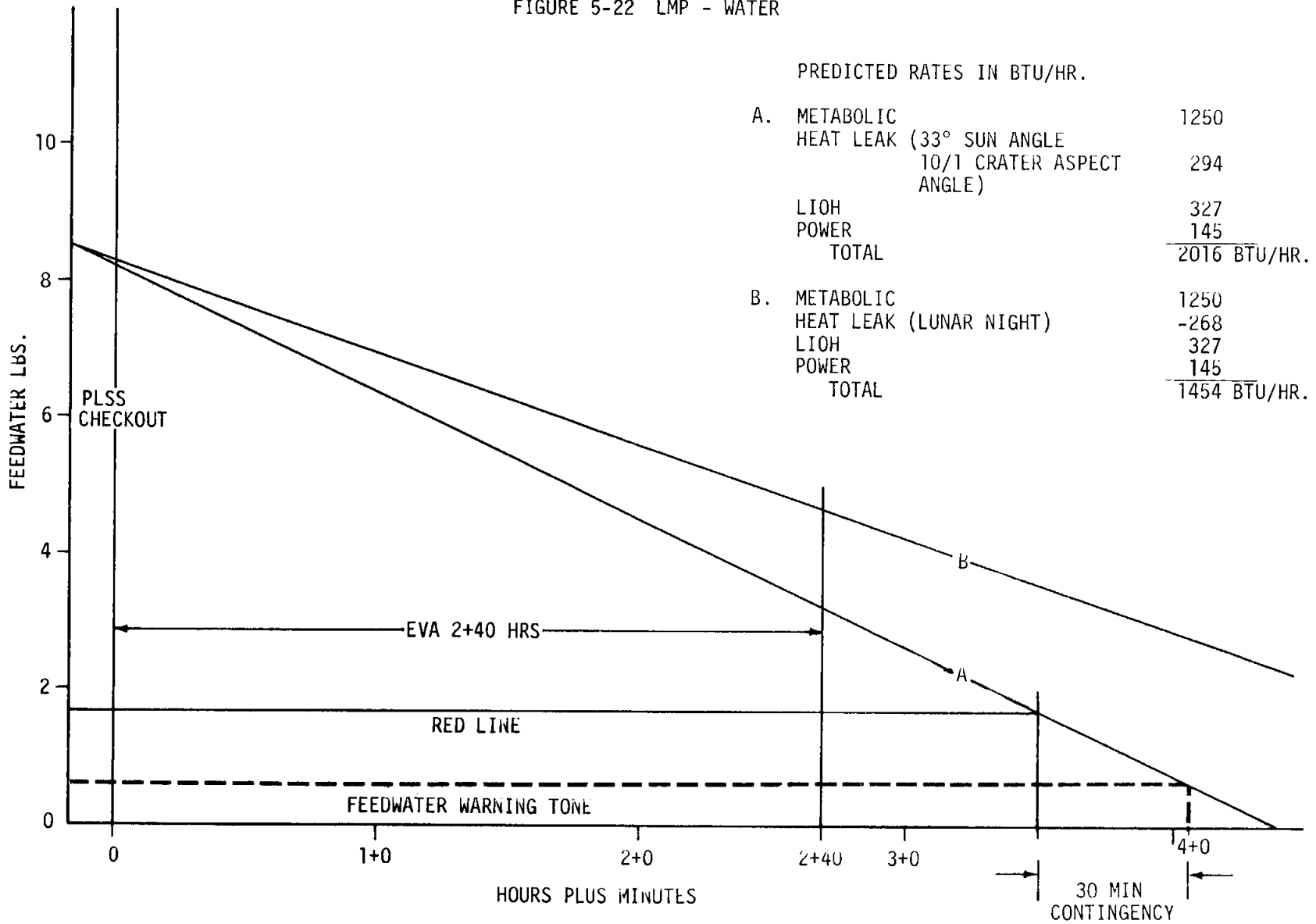

THIS PAGE INTENTIONALLY LEFT BLANK.

NOMINAL LUNAR SURFACE EVA
 FIGURE 5-23 LMP & CDR LiOH

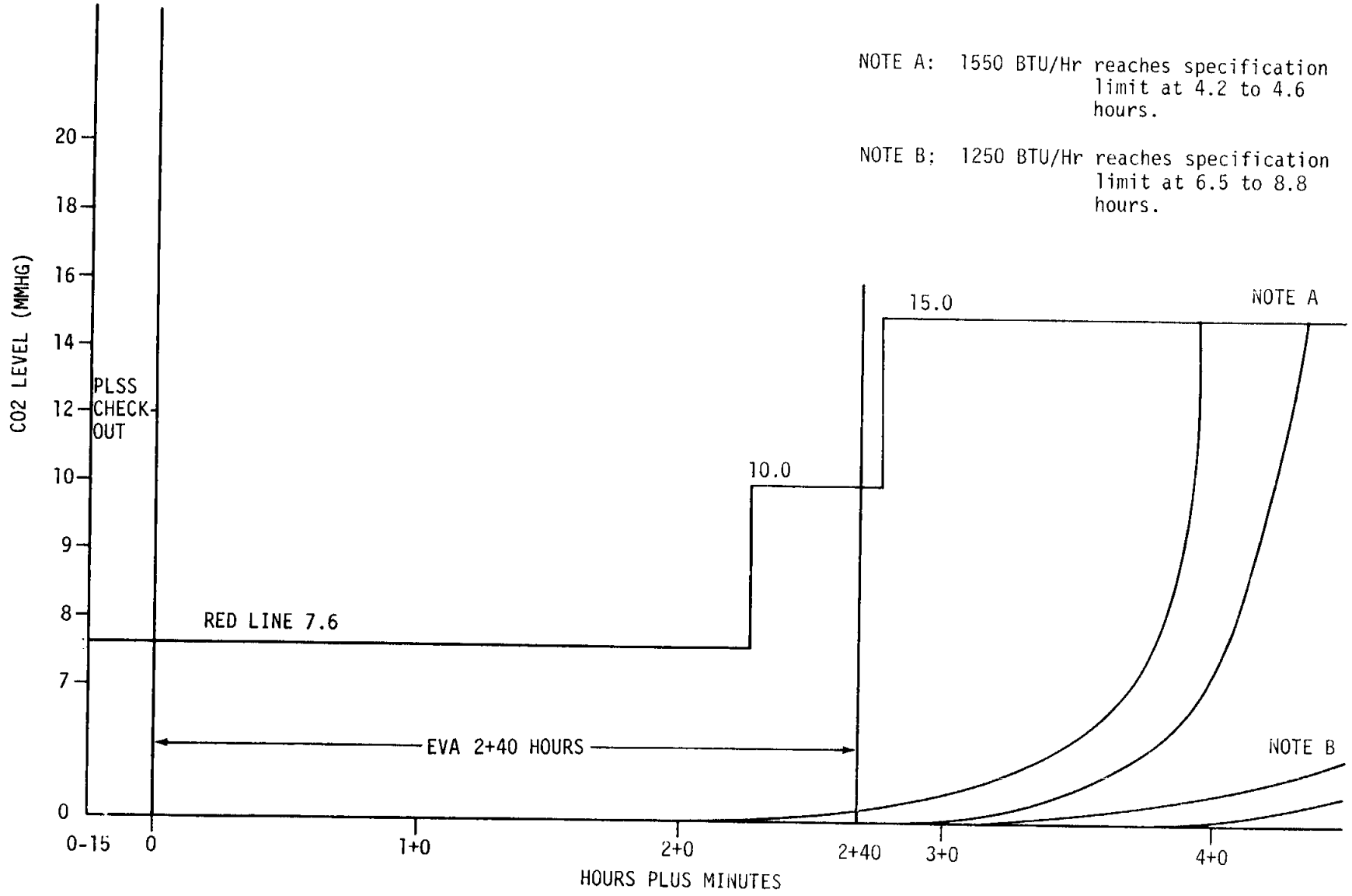

NOTE A: 1550 BTU/Hr reaches specification limit at 4.2 to 4.6 hours.

NOTE B: 1250 BTU/Hr reaches specification limit at 6.5 to 8.8 hours.

SECTION VI - SUMMARY FLIGHT PLAN

FLIGHT PLAN

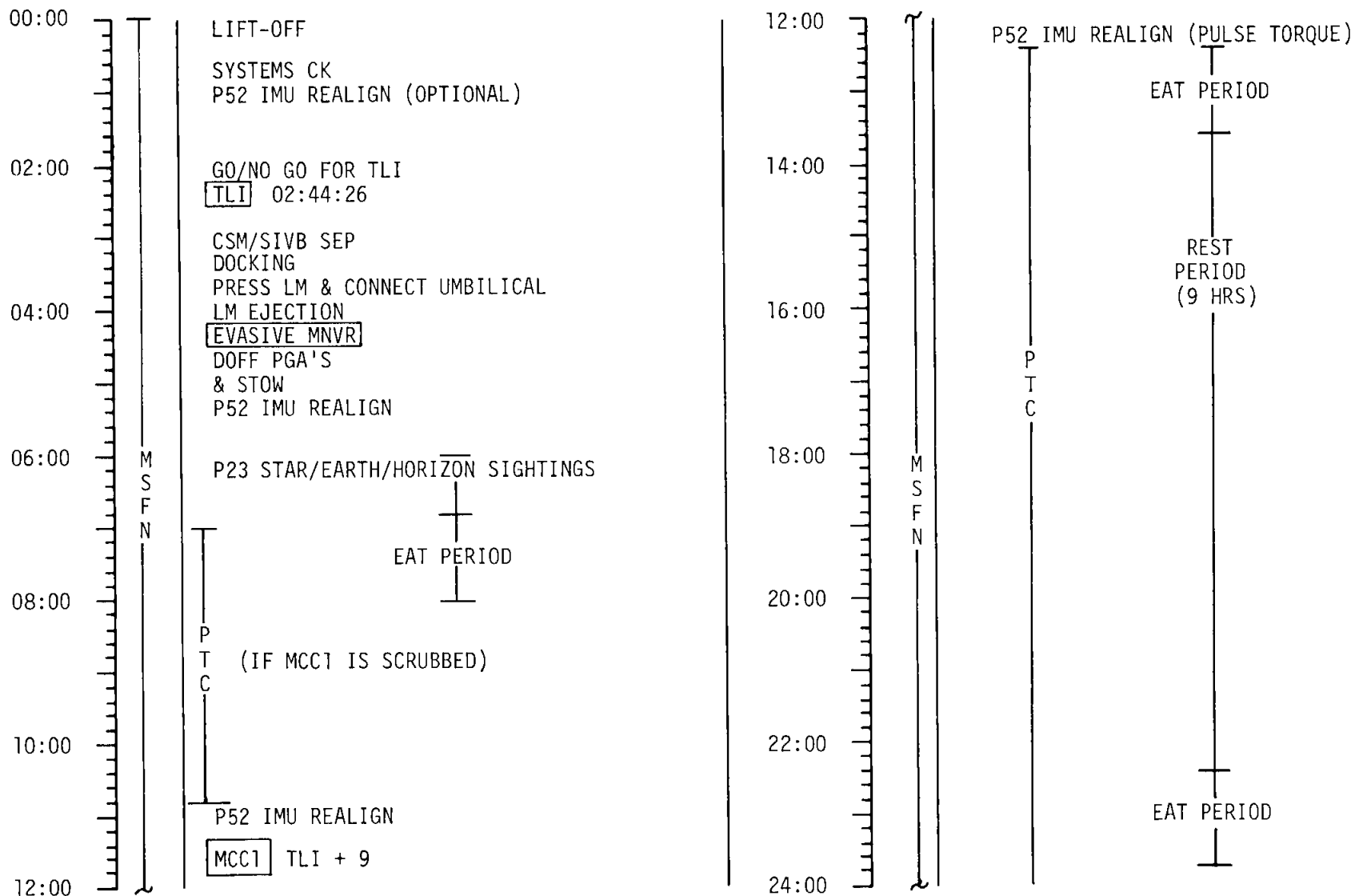

MISSION	EDITION	DATE	TIME	DAY/REV	PAGE
APOLLO 11	FINAL	JULY 1, 1969	00:00 - 24:00	1/TLC	6-1

FLIGHT PLAN

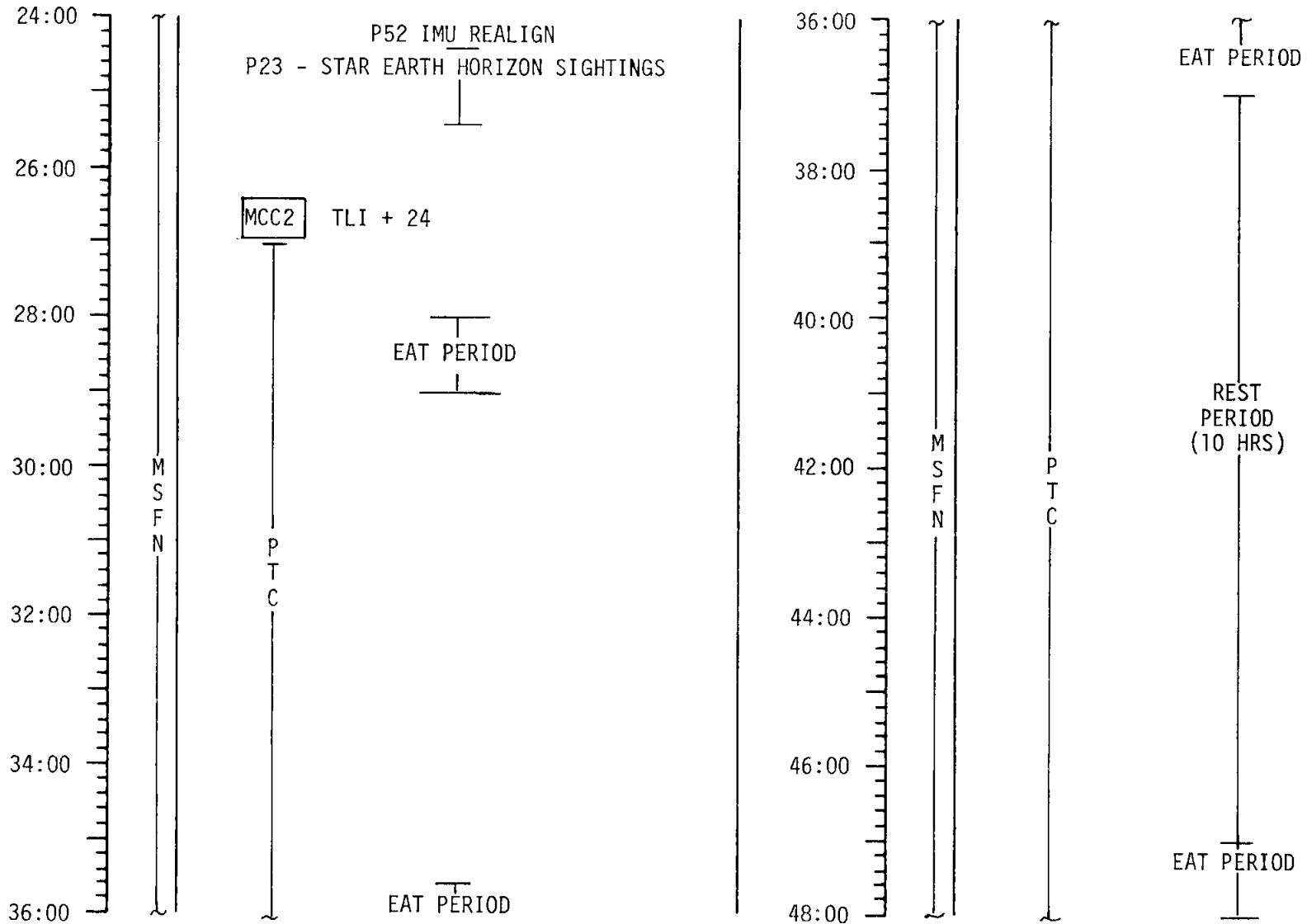

MISSION	EDITION	DATE	TIME	DAY/REV	PAGE
APOLLO 11	FINAL	JULY 1, 1969	24:00 - 48:00	2/TLC	6-2

FLIGHT PLAN

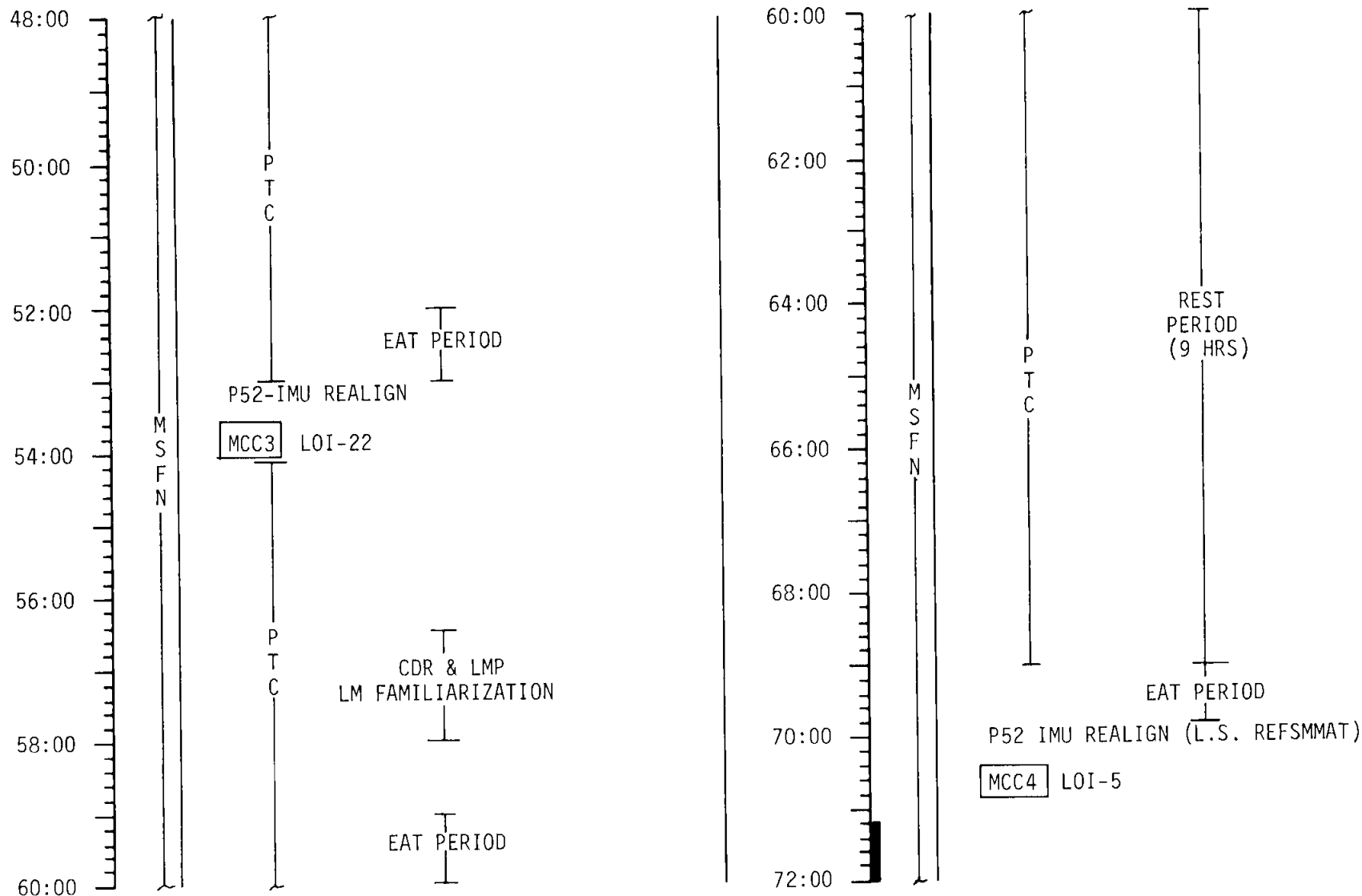

MISSION	EDITION	DATE	TIME	DAY/REV	PAGE
APOLLO 11	FINAL	JULY 1, 1969	48:00 - 72:00	3/TLC	6-3

FLIGHT PLAN

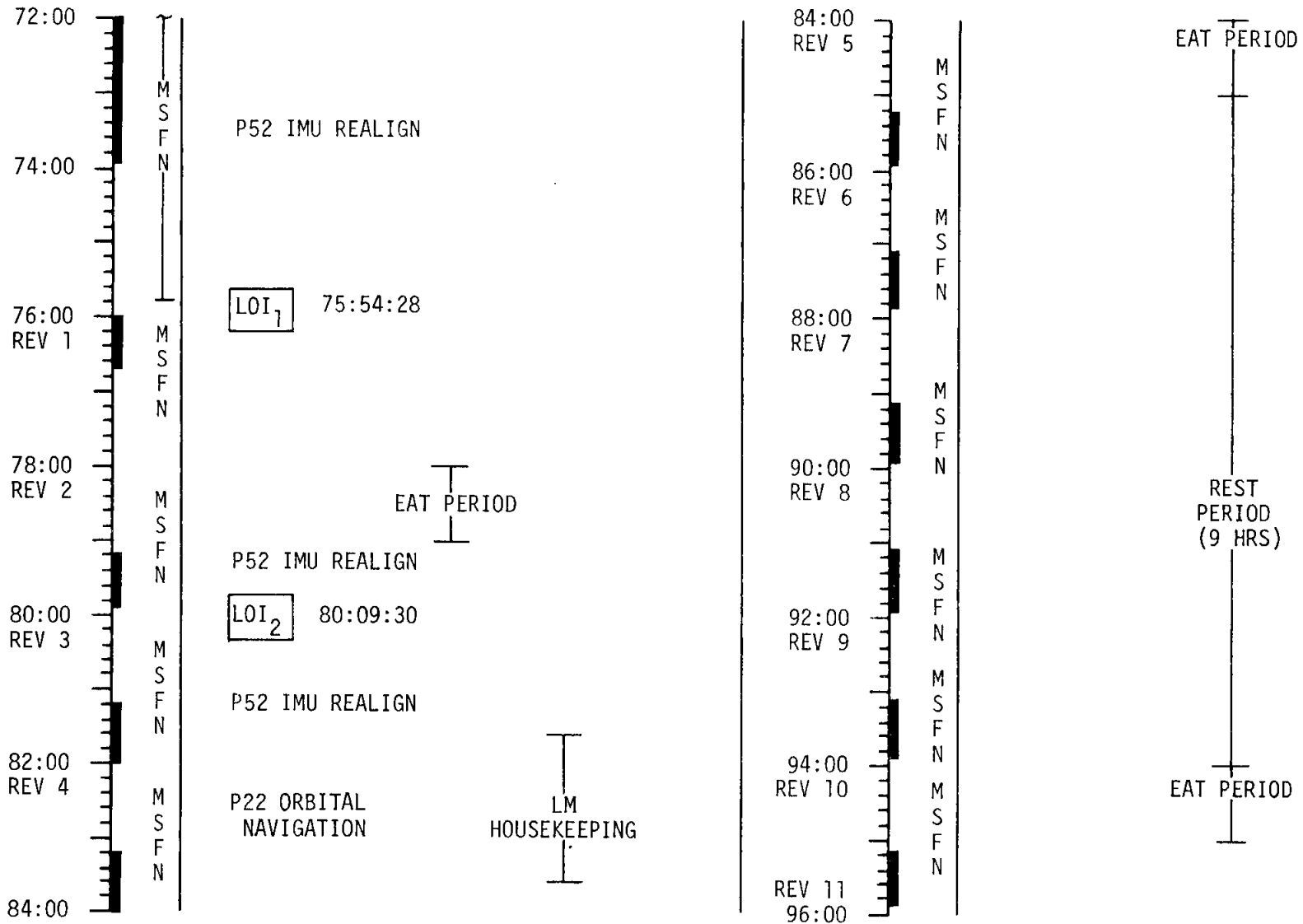

MISSION	EDITION	DATE	TIME	DAY/REV	PAGE
APOLLO 11	FINAL	JULY 1, 1969	72:00 - 96:00	4/1 THRU 10	6-4

FLIGHT PLAN

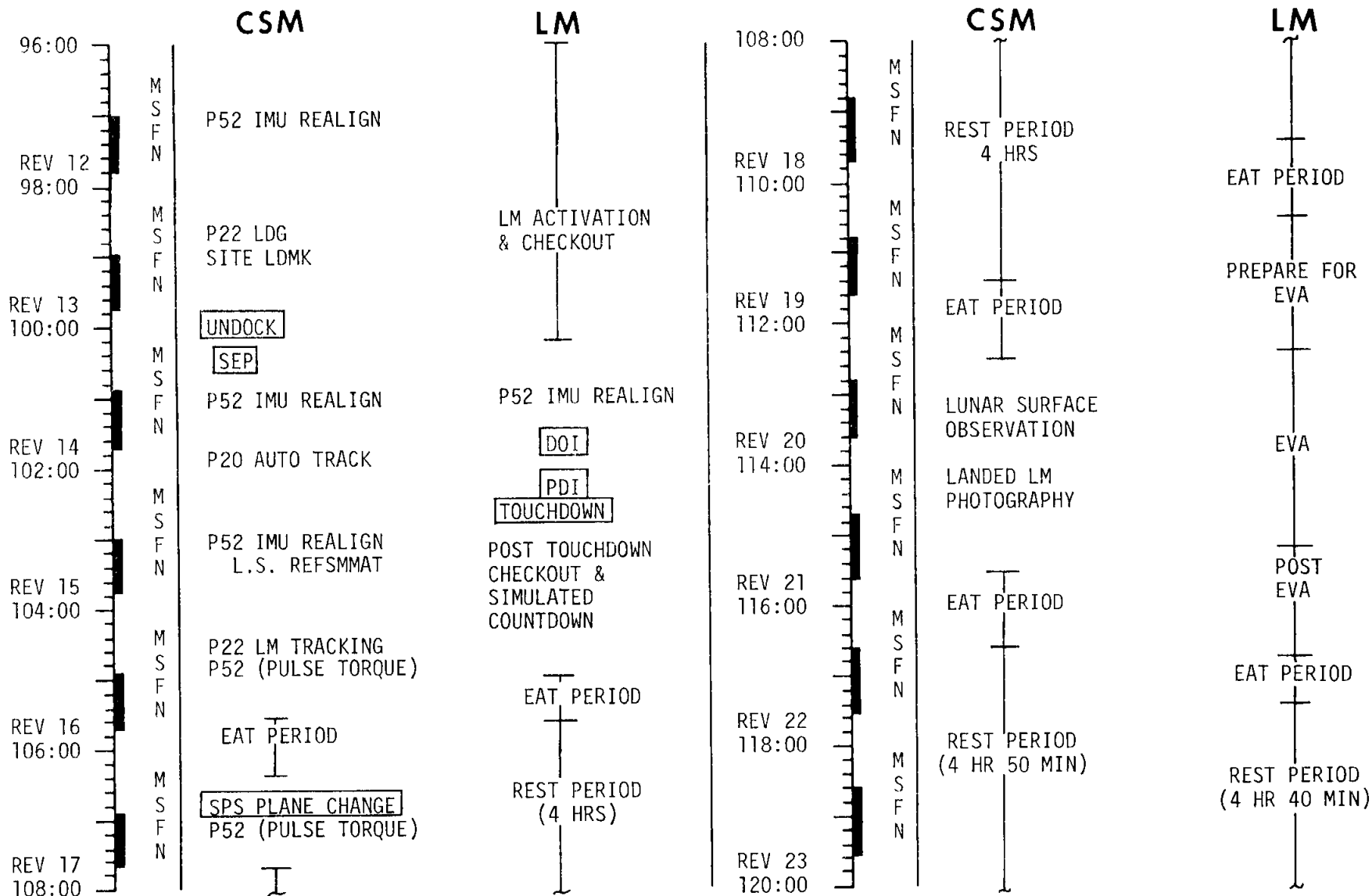

MISSION	EDITION	DATE	TIME	DAY/REV	PAGE
APOLLO 11	FINAL	JULY 1, 1969	96:00 - 120:00	5/LPO	6-5

FLIGHT PLAN

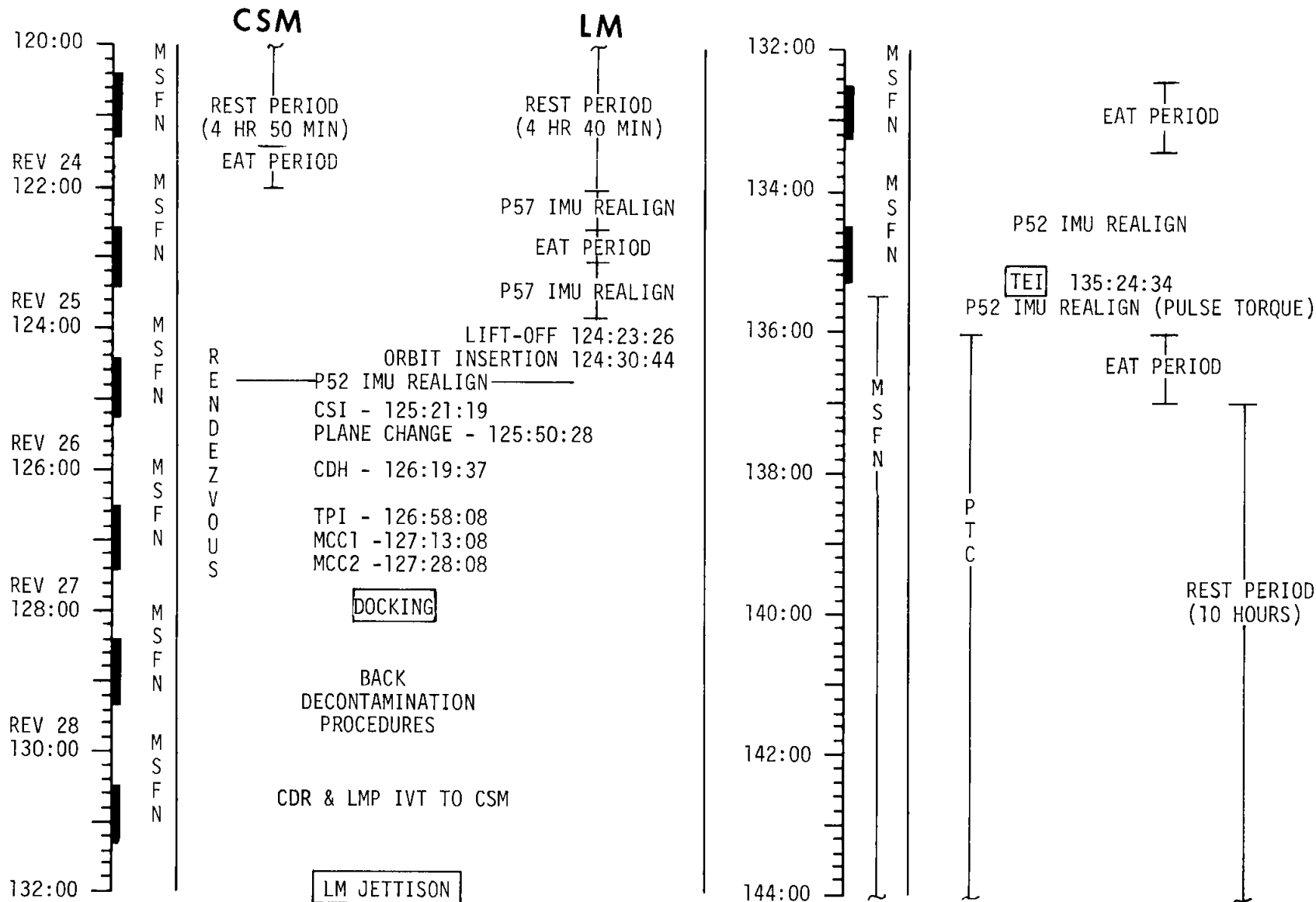

MISSION	EDITION	DATE	TIME	DAY/REV	PAGE
APOLLO 11	FINAL	JULY 1, 1969	120:00 - 144:00	6/LPO	6-6

FLIGHT PLAN

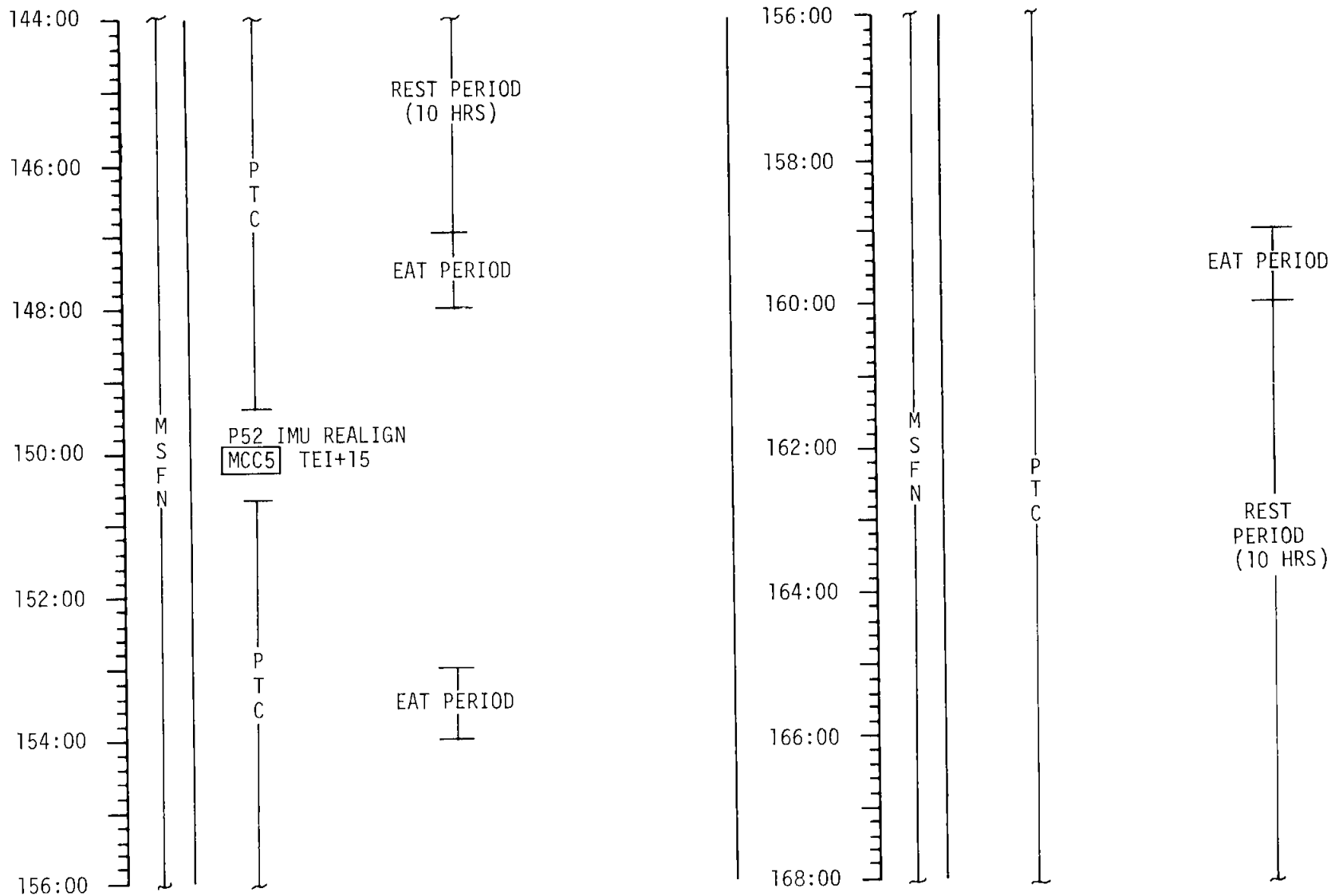

MISSION	EDITION	DATE	TIME	DAY/REV	PAGE
APOLLO 11	FINAL	JULY 1, 1969	144:00 - 168:00	7/TEC	6-7

FLIGHT PLAN

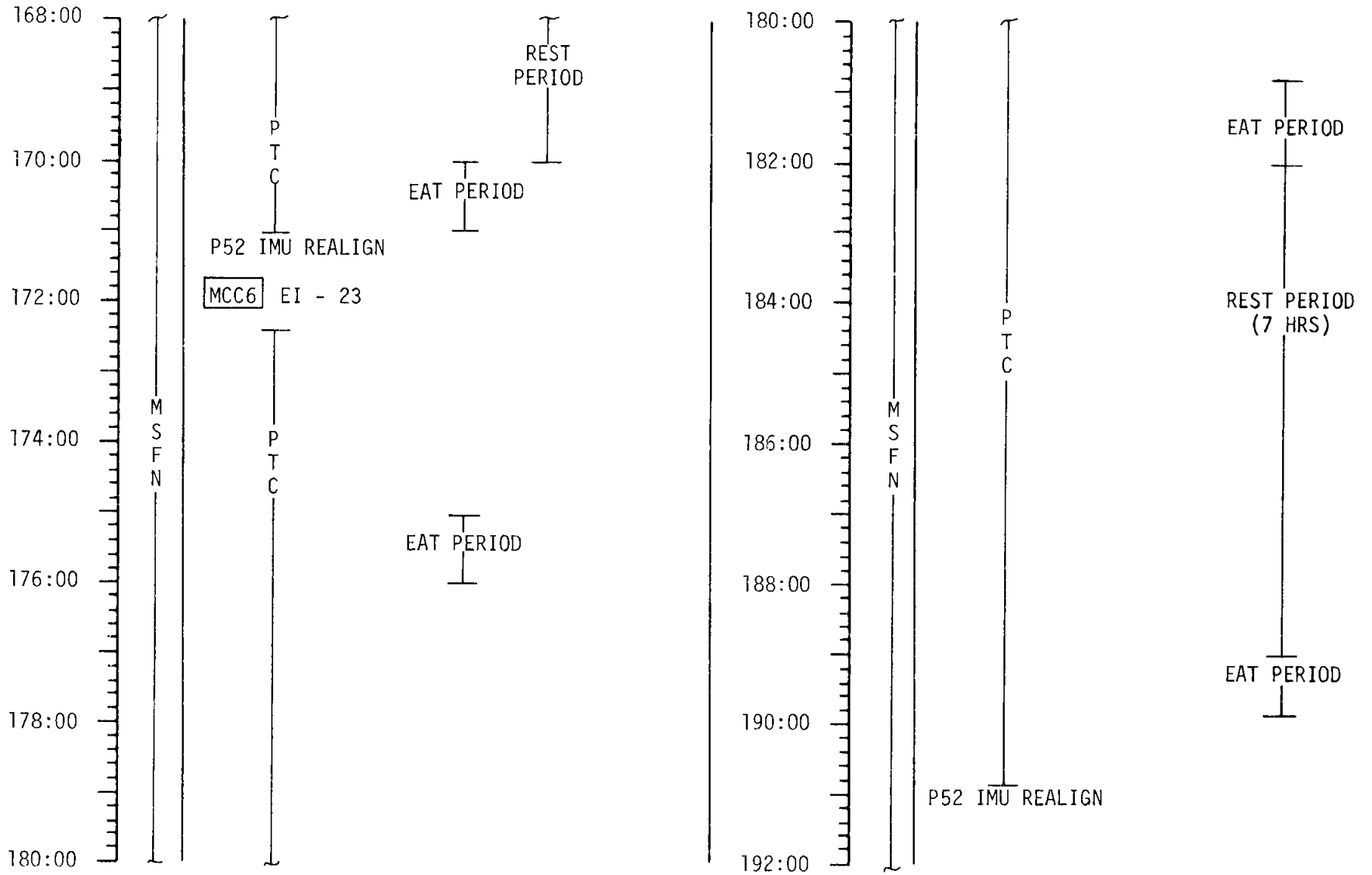

MISSION	EDITION	DATE	TIME	DAY/REV	PAGE
APOLLO 11	FINAL	JULY 1, 1969	168:00 - 192:00	8/TEC	6-8

FLIGHT PLAN

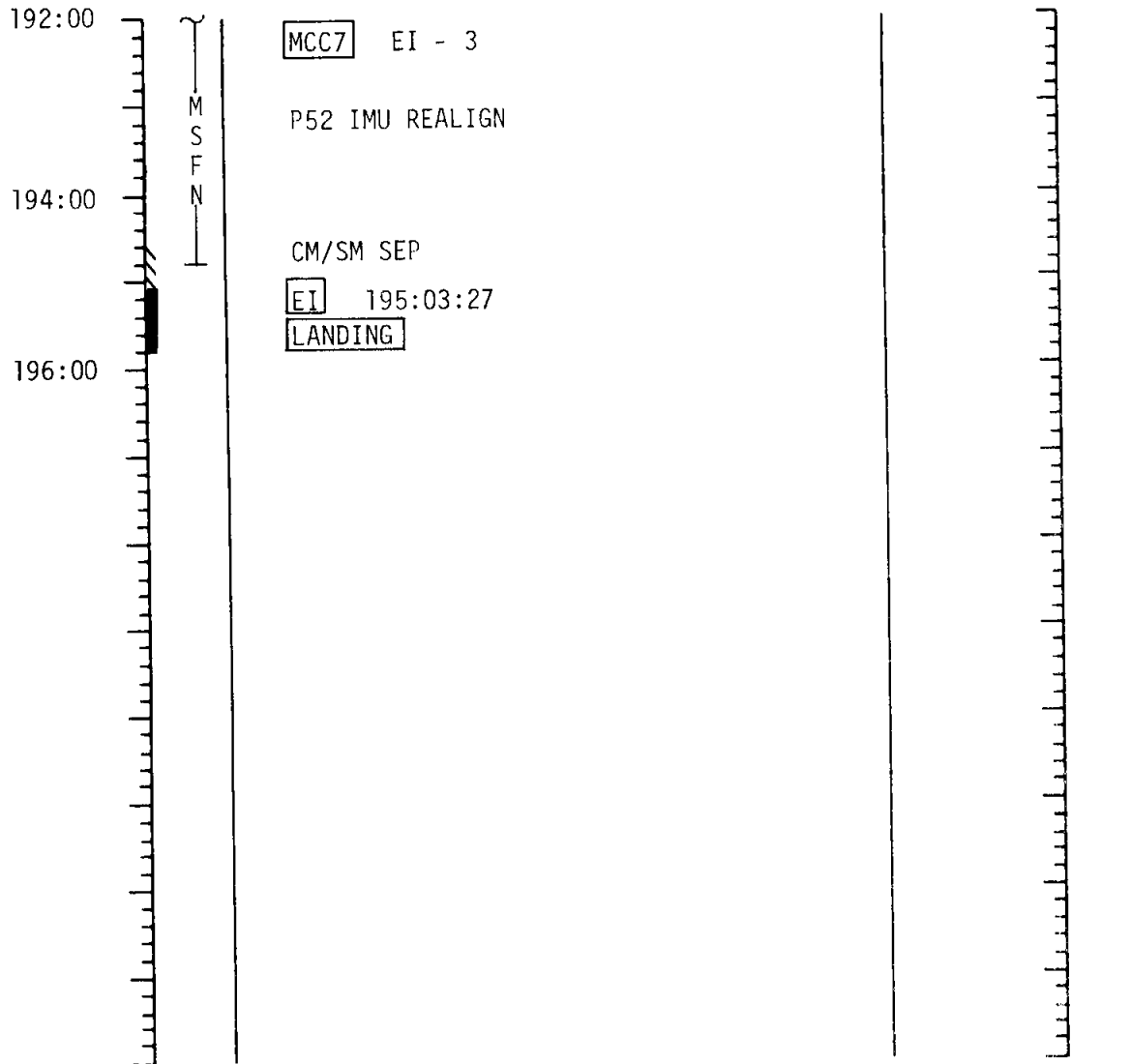

MISSION	EDITION	DATE	TIME	DAY/REV	PAGE
APOLLO 11	FINAL	JULY 1, 1969	192:00 - 195:00	9	6-9