



To  
space  
&  
back!



How we  
can all use  
NASA's  
tools

COLORING  
BOOK





## Technology Transfer:

### How we can all use the tools NASA creates for their space program

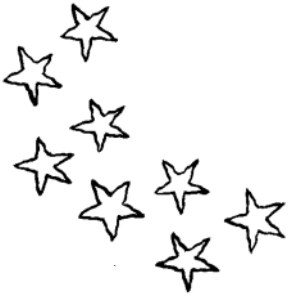

Did you ever think about all of the work NASA puts into creating the tools they use to study outer space? Every year, NASA scientists come up with new and better ways to explore and learn about our world and the universe. We call the new tools they create "technologies." Technologies help scientists, astronauts, and other people in the space program do their jobs better, safer, and easier.

#### ***What is Technology Transfer?***

Many times the tools NASA creates can also help us do things better here on Earth. When NASA sees a way to put a tool that they use in space to use for something in our world, they "transfer" that technology to a company that can use it. This is called "Technology Transfer."

Each of NASA's ten Field Centers has people whose job it is to find new uses for the tools their scientists have developed. This coloring book was put together by the people at the Technology Transfer Program office at NASA's Goddard Space Flight Center.



With the help of Space Pup, Goddard's technology transfer mascot, we'll show you how we use some of those space technologies here on Earth!

# See how Technology Transfer happens:

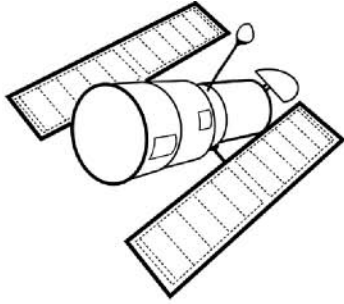

NASA needs to find a new way to study space or solve a problem.



Their scientists study the problem and come up with a new technology that solves it.

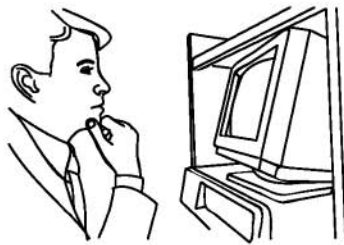

People at NASA's Technology Transfer Program get a patent for the new technology and study it to find ways it could be used in everyday life.



Then they find companies or other organizations that are interested in licensing the technology.



Those companies use the new technology to make a new product or to make existing products better.



**patent:** A patent is an official document that describes an invention to protect it and keep others from making, using, or selling something just like it without the inventor's permission. (**Inventors** are people who use their imaginations to create something useful that is different from anything else.)

**license:** A license is an agreement between the inventor and another person that allows the other person to use the inventor's invention in their own work—usually for a fee.



# Space words jumble:



tuanotrosa

a (s) \_ \_ \_ n \_ \_ \_

noolalb



\_ \_ l \_ o \_ \_



fsapeccrat

\_ (a) \_ \_ \_ r \_ \_ \_



htear cissenec

e \_ \_ \_ h \_ (c) \_ \_ \_ \_ \_ s

scinortelec

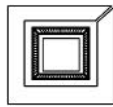

\_ l \_ c \_ r \_ \_ \_ \_

reenig

e \_ g \_ \_ \_ \_ \_

xylaga



\_ (a) \_ \_ x \_

lebbhu pecoseelt

\_ \_ b \_ \_ \_ \_ e \_ \_ \_ \_ \_ (p) \_

toobr

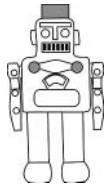

\_ o \_ \_ \_

ralso metssy

s \_ \_ \_ \_ \_ \_ \_ s \_ \_ m

cpase ttlushe

\_ (a) \_ \_ \_ (e) \_ \_ \_ (t) \_ l \_

yx-ar

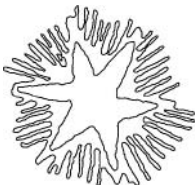

\_ \_ a \_

Now arrange the circled letters to form the name of Goddard's technology transfer mascot:



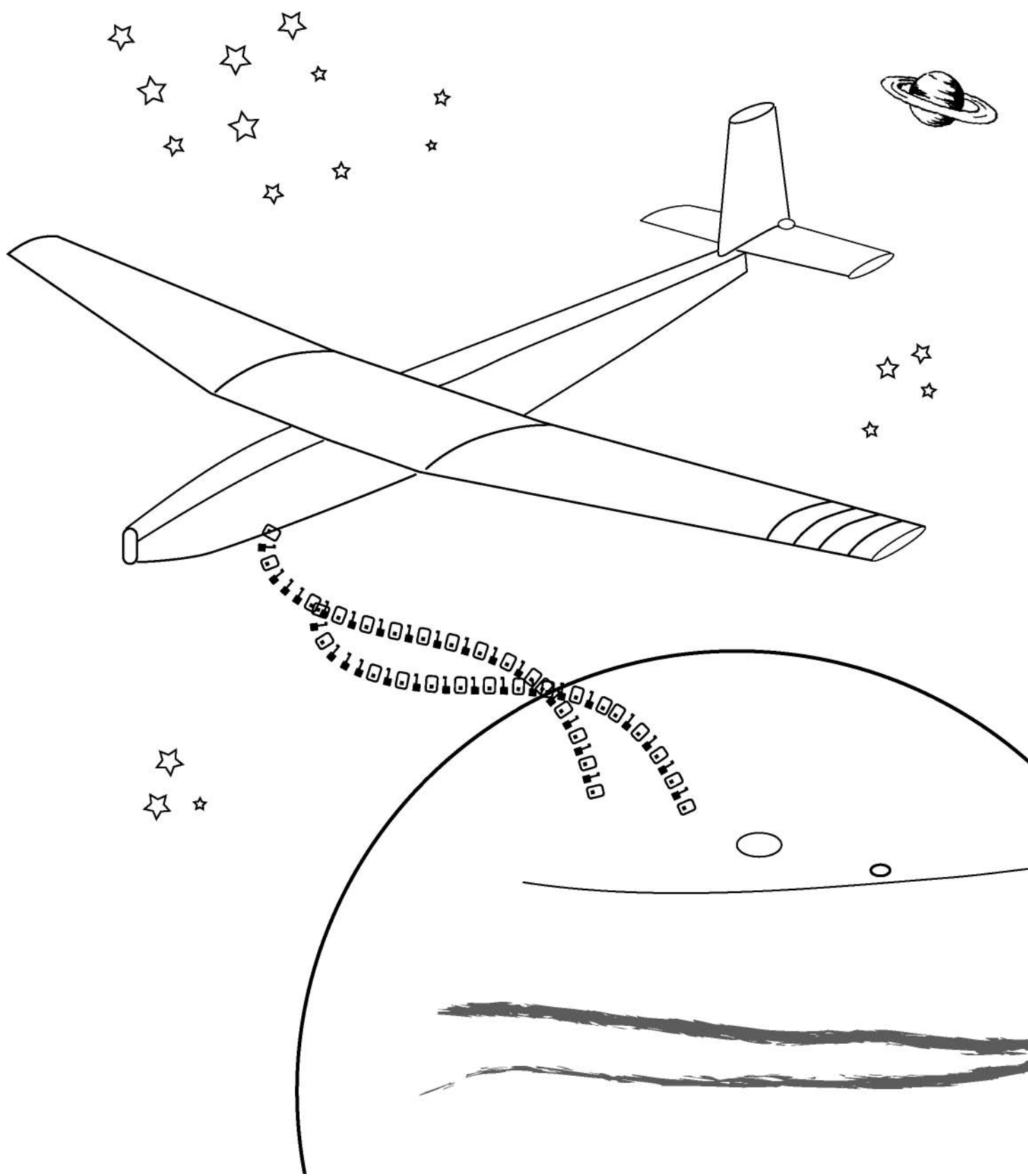

NASA uses this unmanned vehicle to gather information about the atmosphere around planets and other things in space.

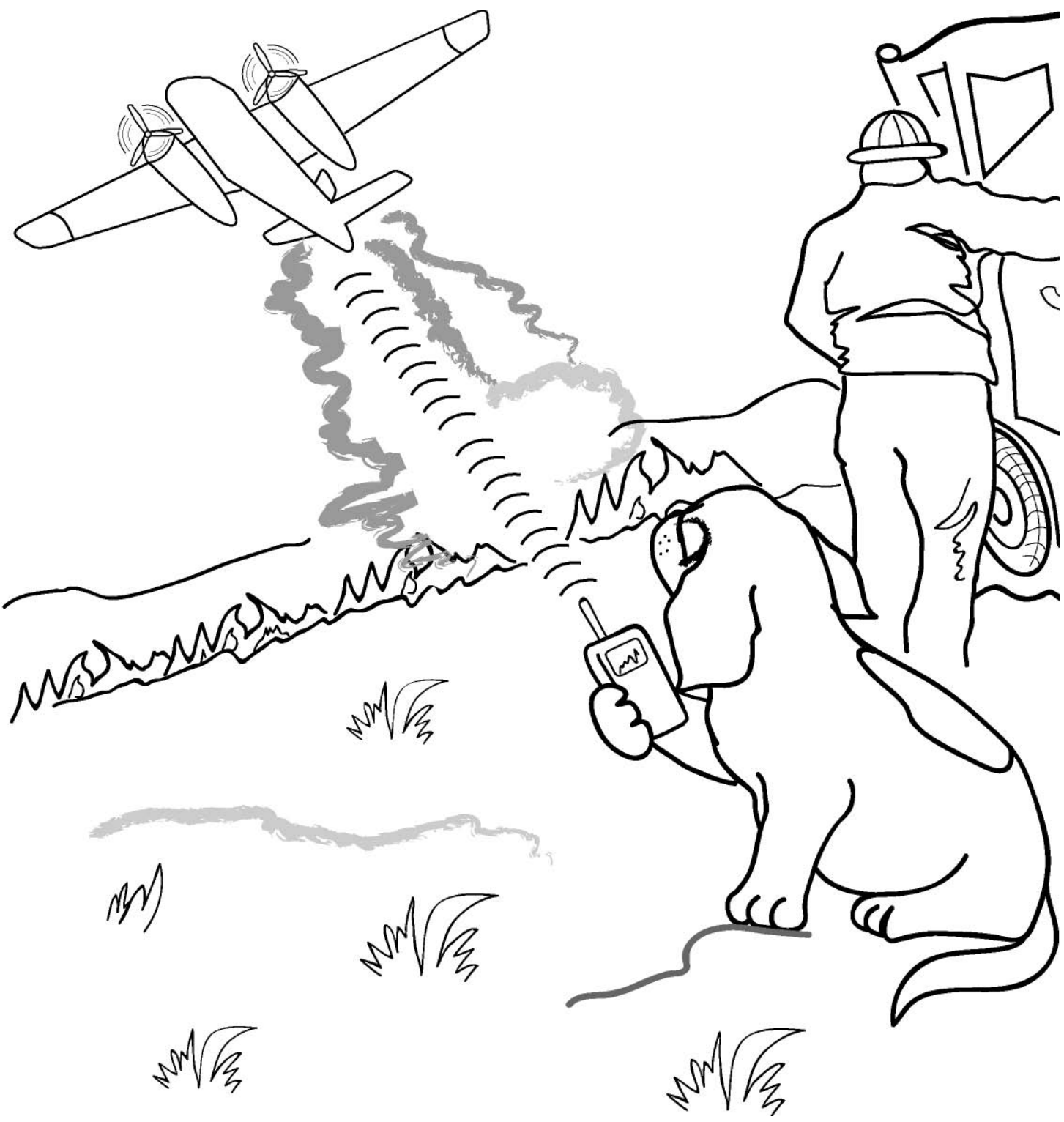

Space Pup can fly the unmanned vehicle over forest fires using a remote control. This lets us gather information about the fire without putting someone in danger.

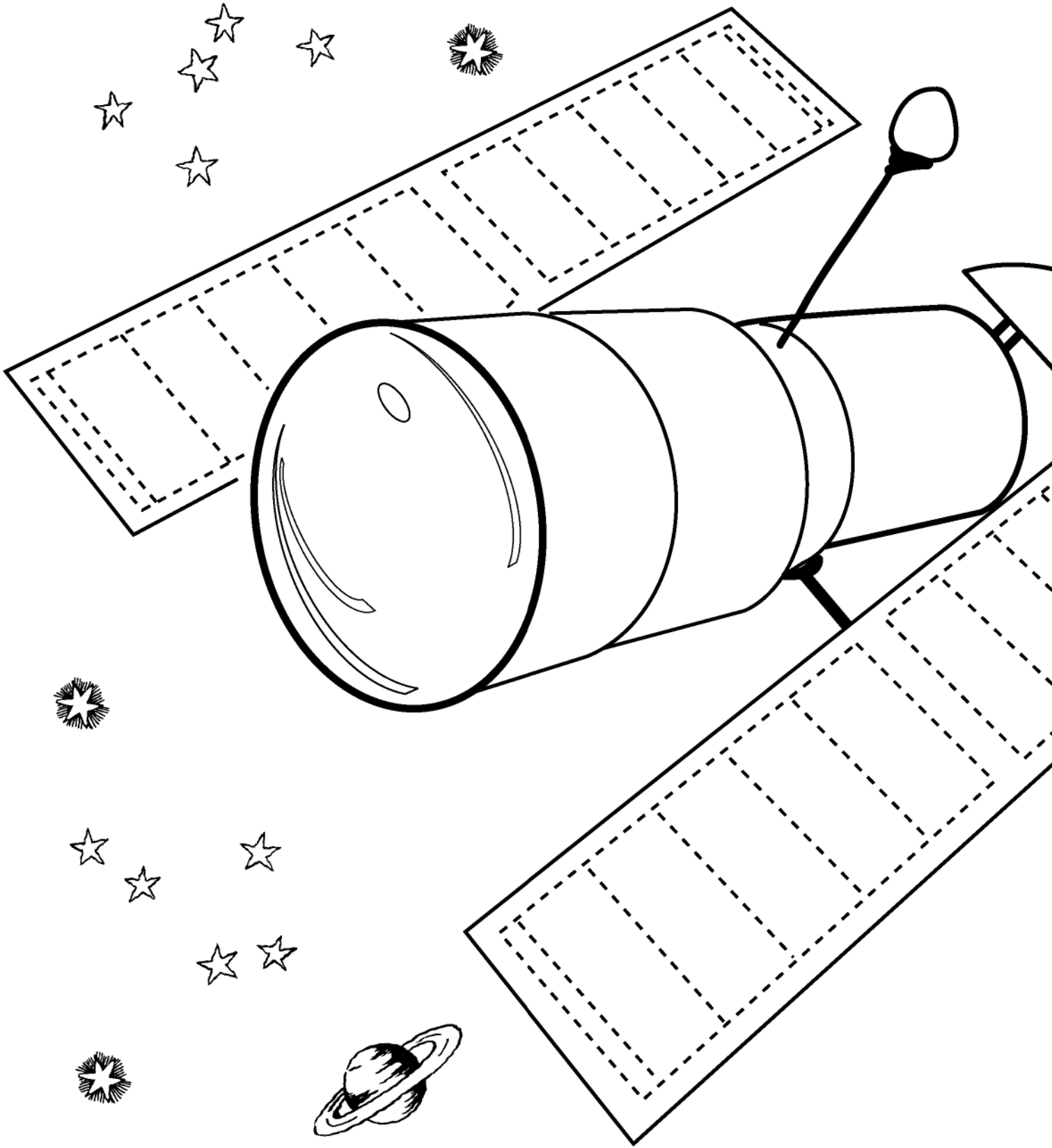

NASA uses a special polishing technology to polish mirrors used in space telescopes like the Hubble!

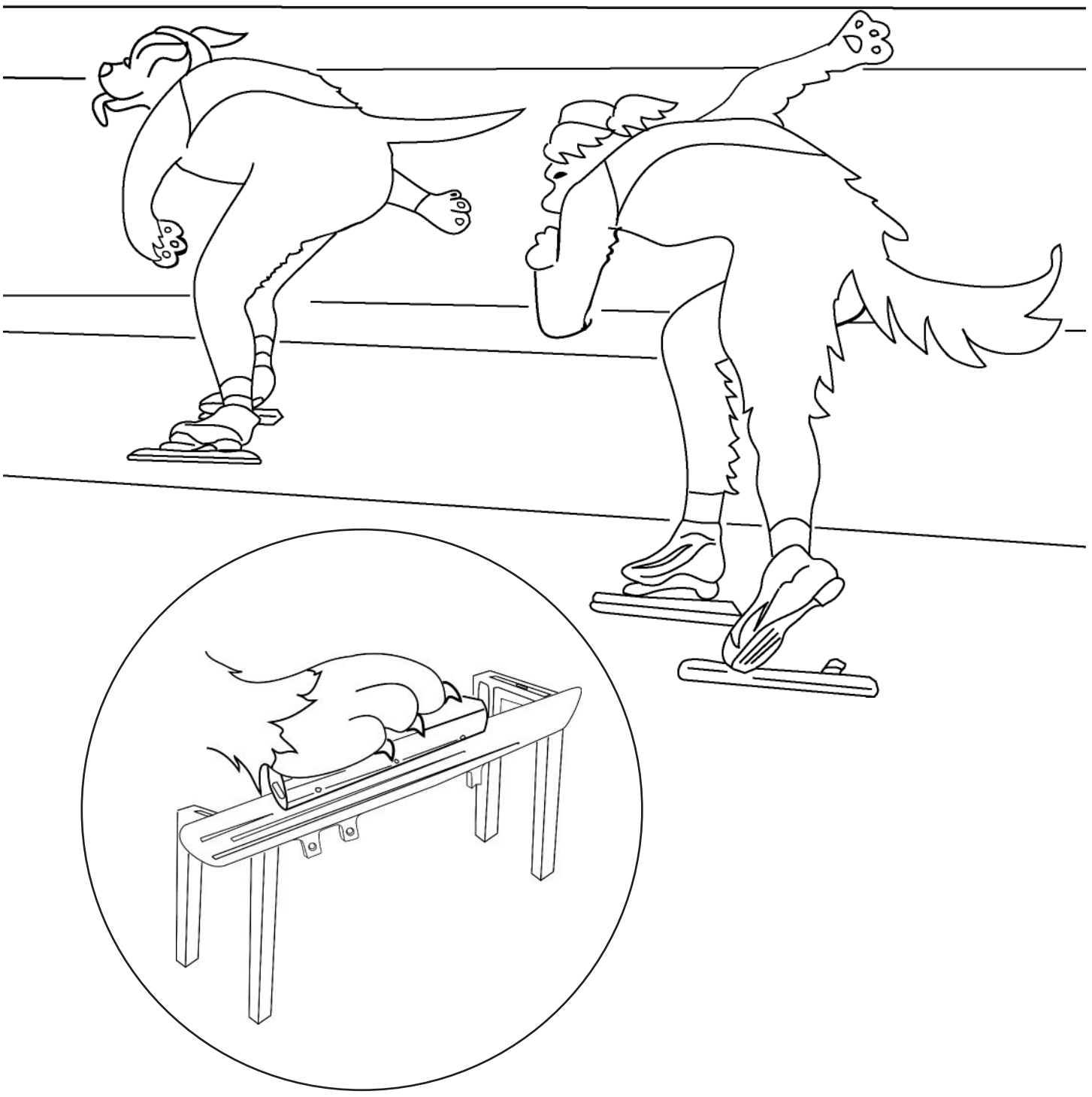

We can use this polishing tool to smooth the surface of ice skate blades to make them go super fast!



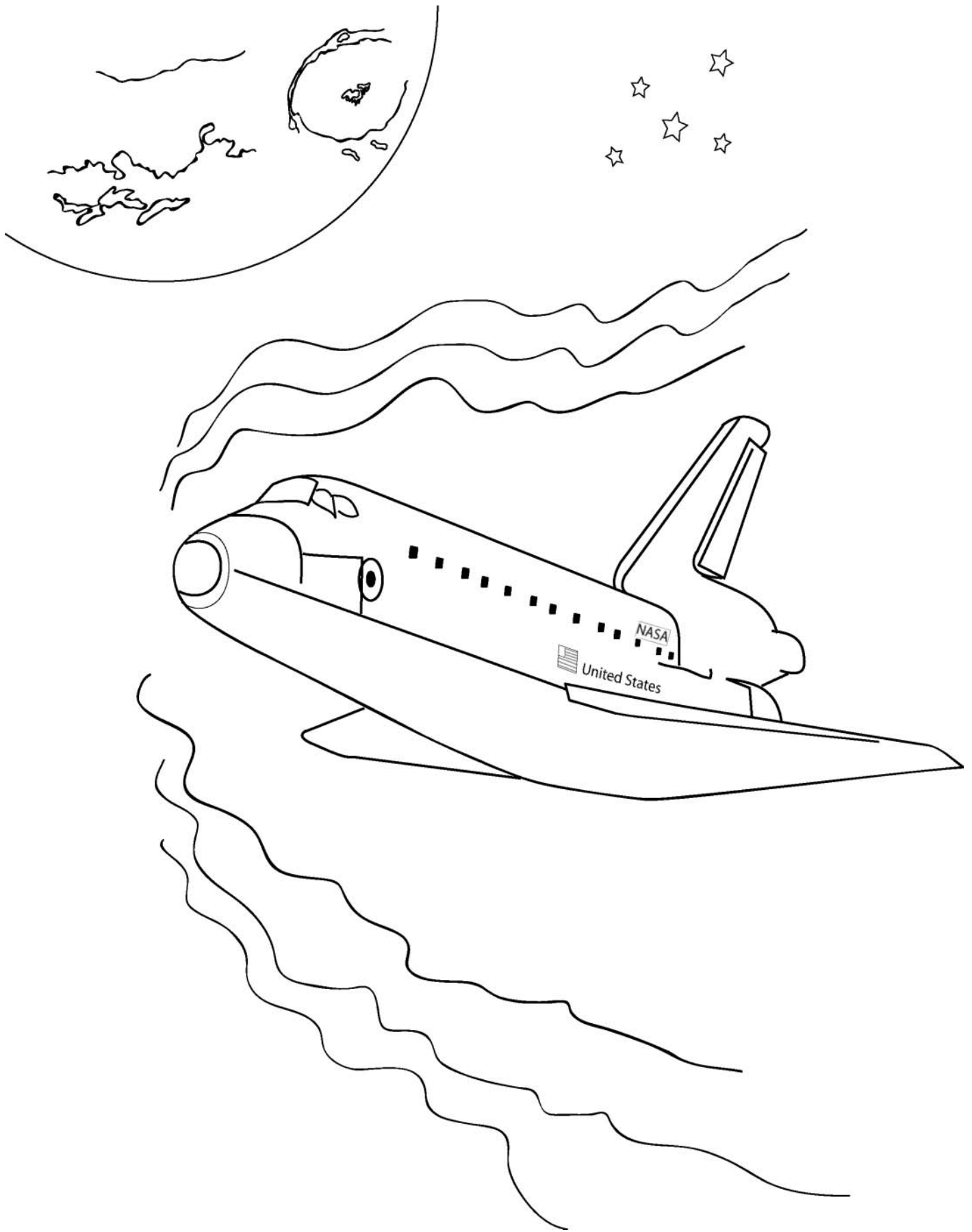

NASA uses this capillary [kap-ə-'lar-ē] pumped loop warmer technology to control the temperature of their spacecraft.

A **capillary** is a tiny tube.



Space Pup can keep his hands or feet warm and toasty even in the coldest places wearing gloves with capillaries (tubes) that carry heat from warm places on his body to the cold places on his body. His friend, Rex, wishes he had some of those gloves!

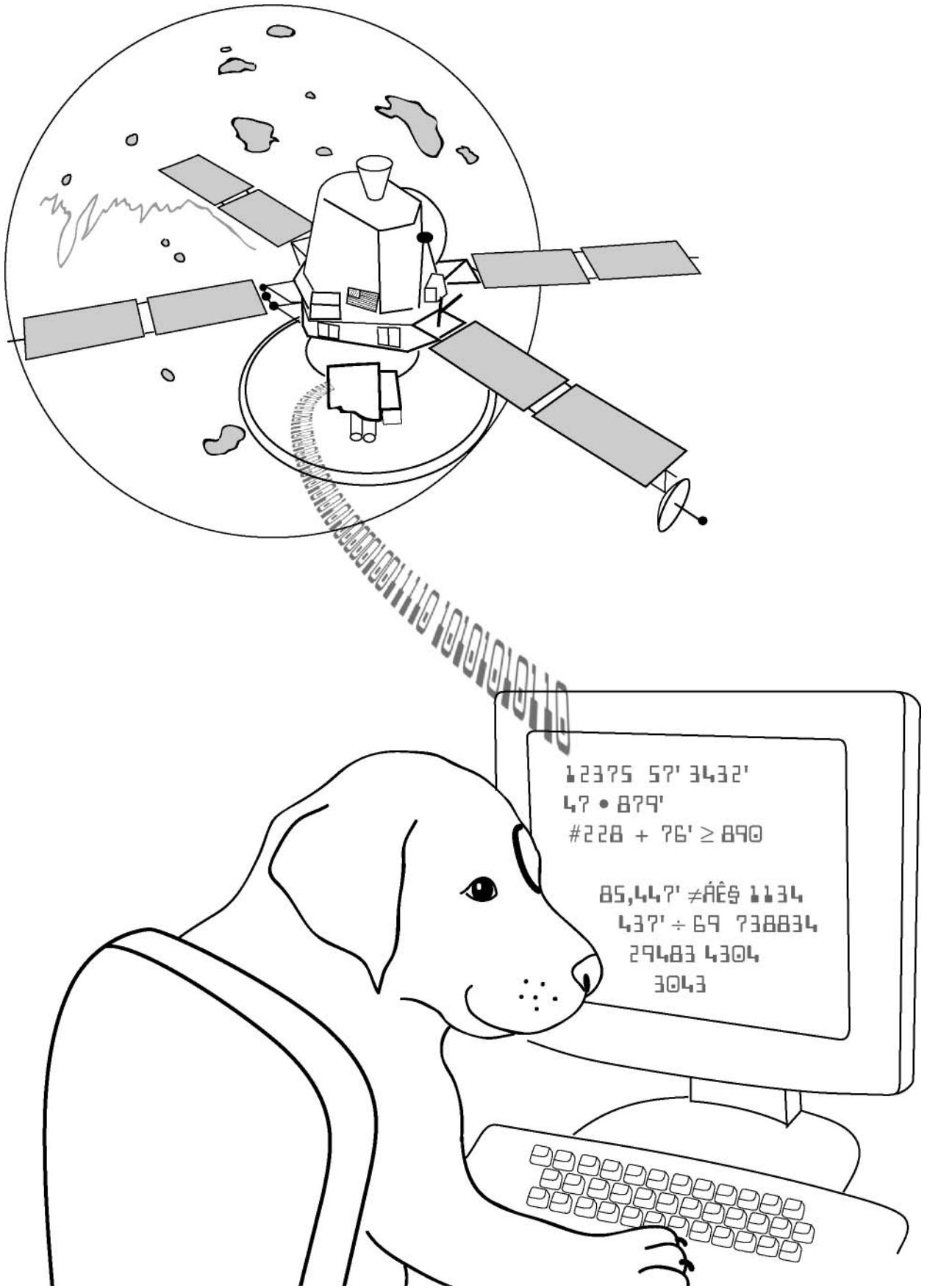

Telemetry [tə-'lem-ə-trē] is when a device, known as a telemeter [tə-'lem-e-tər], measures something and sends the information by radio to another location. NASA used this technology in life science experiments on the Mars Viking space probe.

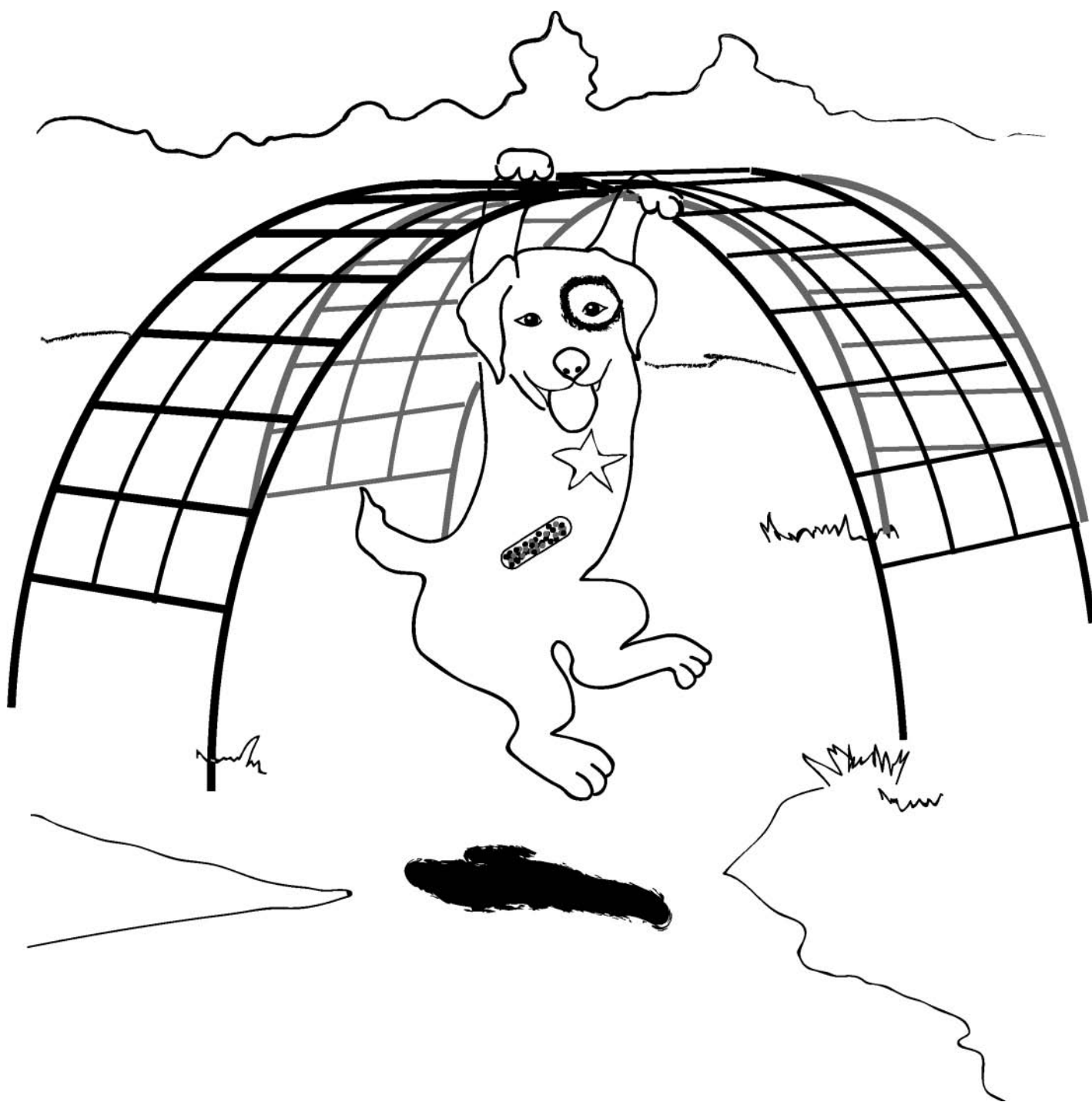

A PIMS is a small medication system that can be put inside someone's body to give them medicine from the inside. Space Pup's doctor put a PIMS in his body so he gets the right amount of medicine right when he needs it. Using the **telemetry** technology from Viking, the doctor can also change the amount of medicine that Space Pup gets.



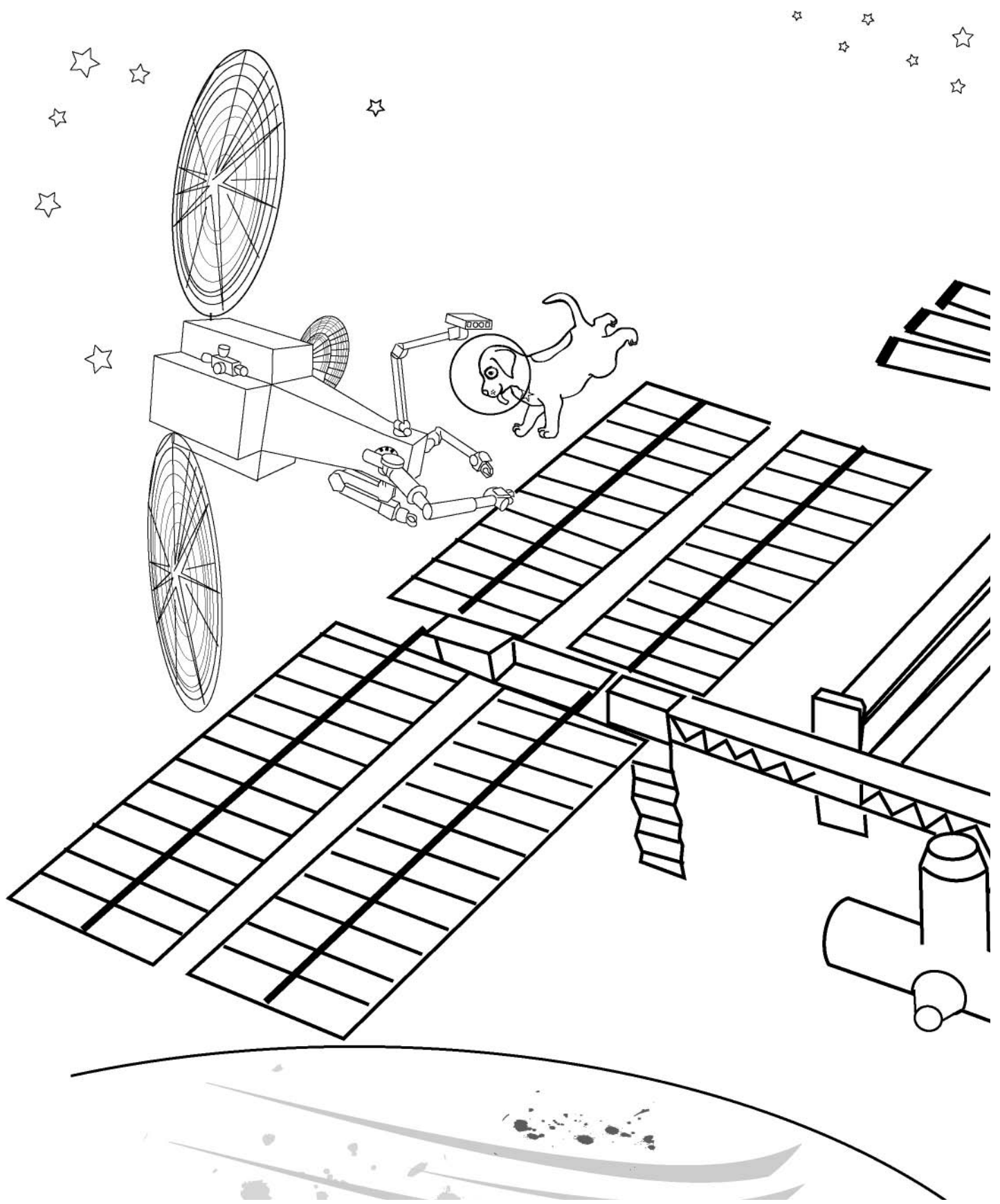

NASA uses this capacitive [kə-'pas-ə-flək-tiv] sensor on robots that do work on spacecraft. The sensor allows the robots to "see" a person or object so they can avoid running into them while working on the ship.



This cool interactive monitor uses the same type of sensor that allows the robots to "see". Space Pup can use his hands to control his computer game WITHOUT touching the screen or a mouse!

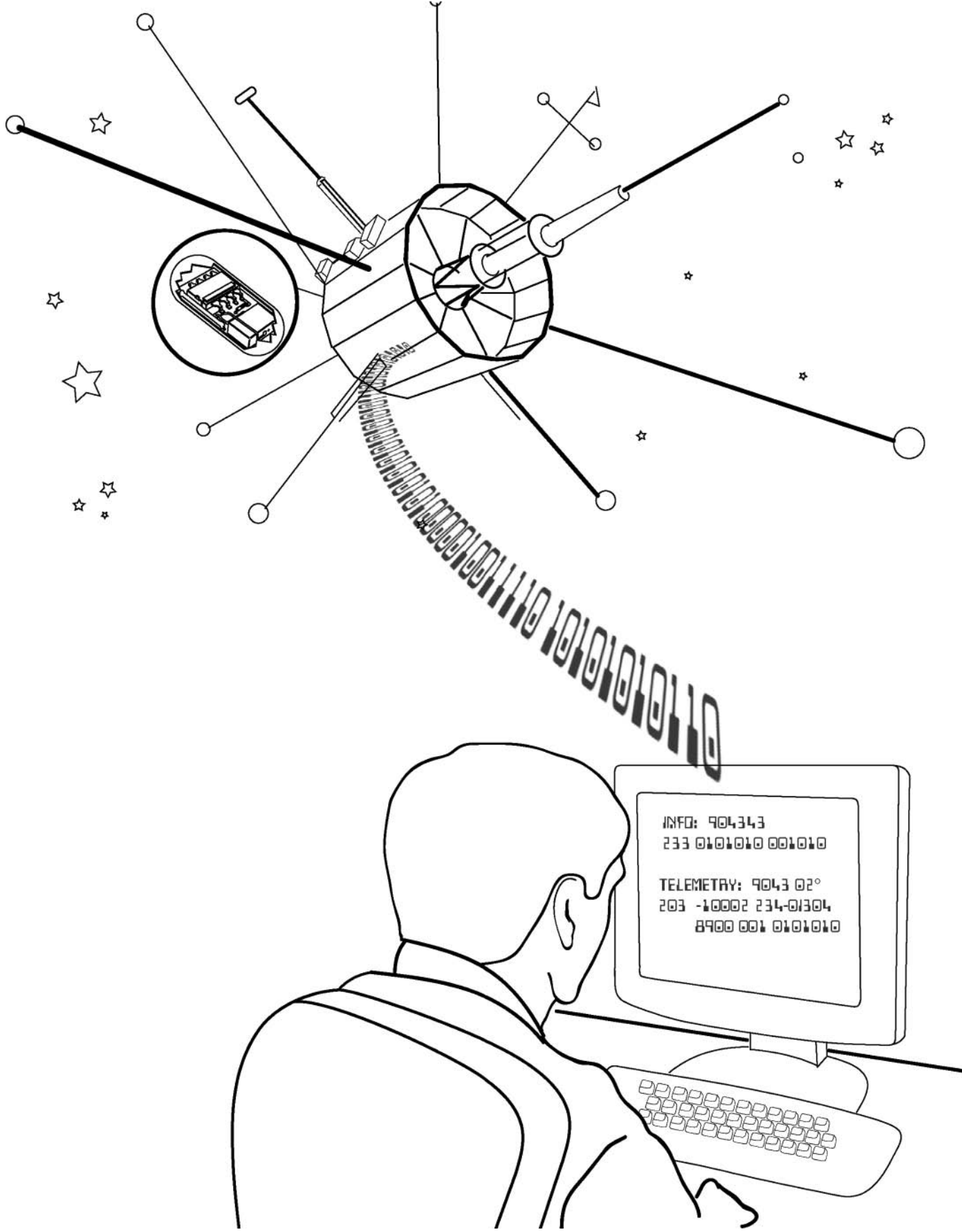

NASA has developed tiny electronic chips — not to be confused with potato chips! — to improve communication between satellites, spacecraft, and scientists on earth.

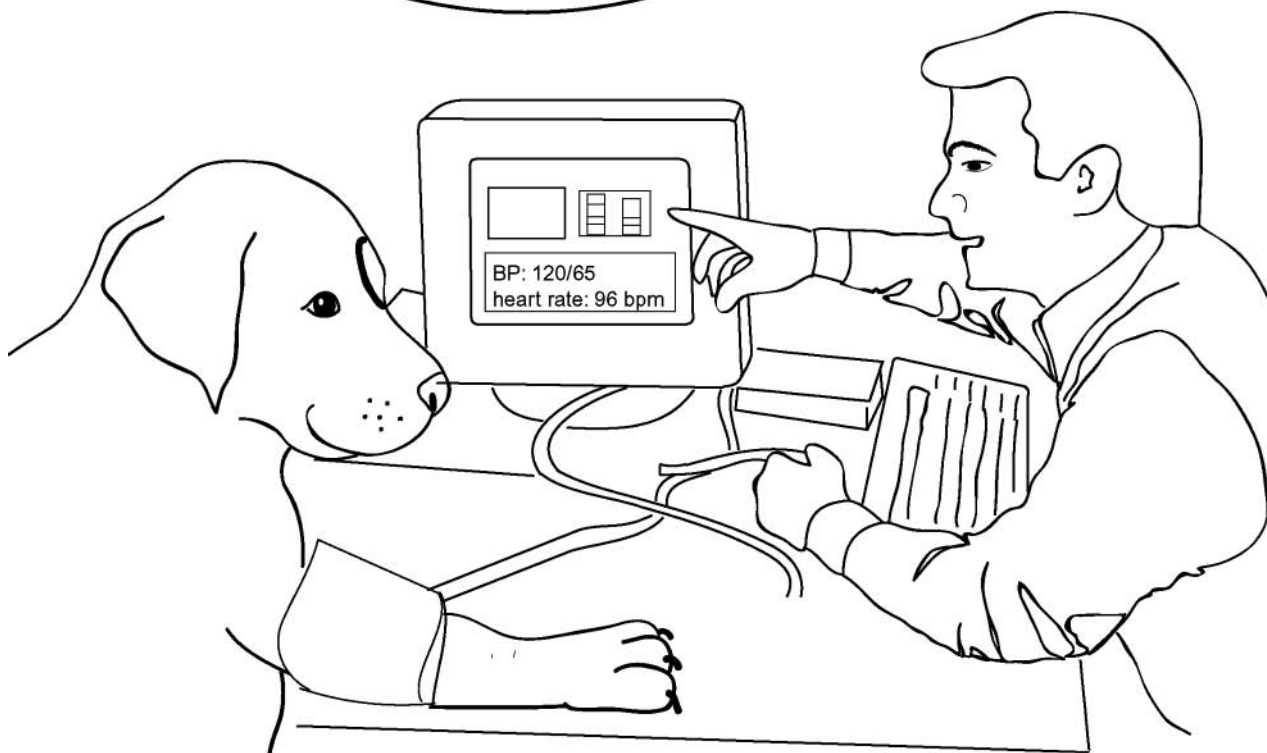

The same types of tiny chips helped engineers create this temperature monitoring pill. By swallowing this temperature monitoring pill, Space Pup gives his doctor a constant reading of his temperature and heart rate while he goes about his usual business.

**Heart rate** is how fast your heart is beating.



# Find-a-word

C I N O R T C E L E T N U Z C  
Y U R E K W F X N U K T A T I  
G G G D X O L A A G I G L O R  
O P Q X G H S N R L I U I B C  
L P K V B C O C I C E N V O U  
O F J P I R L Z F C E E E R I  
N N T E T O A C F R A C I E T  
H B N S A T E L L I T E A Q R  
C C A S I R E H T A E W P P G  
E O R O E K K R Z V K Z D C S  
T J N V O L E I S B T Z A Q P  
T A X E B B B F M V X J B F Q  
P I S L P G H A X Z C A J X M  
T V X T F P D Q C H U R V J Q  
G K I C Z V J C S T L L G U R

astronaut  
electronic  
satellite  
technology

cables  
engineer  
science  
weather

circuit  
robot  
spacecraft

# Match the technologies

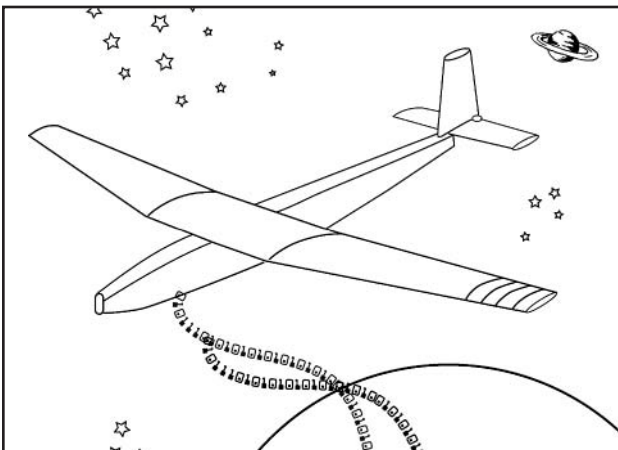
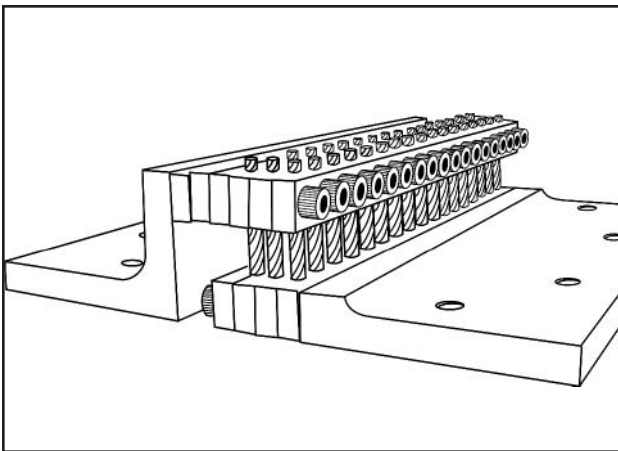
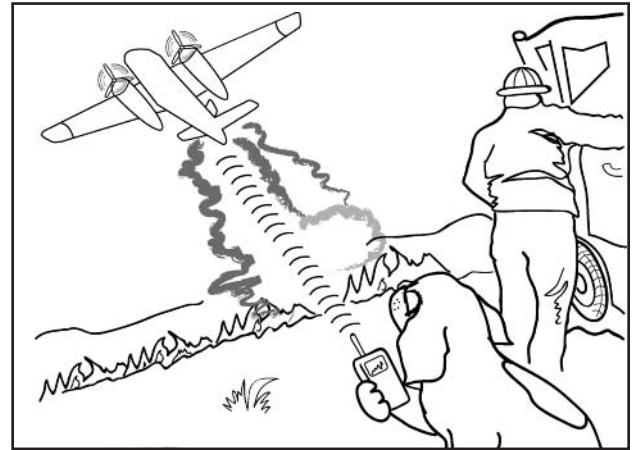
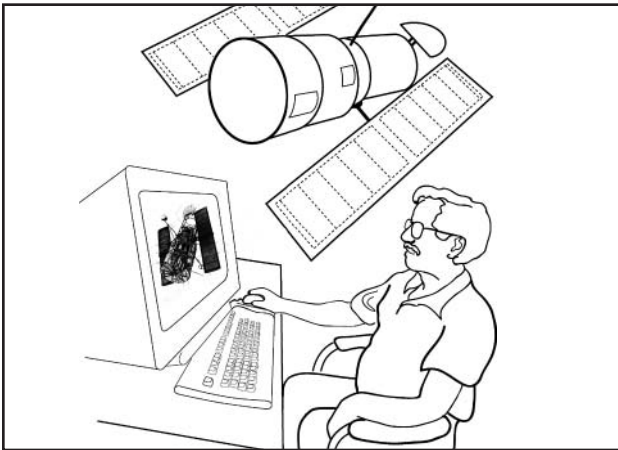

Match NASA's use for the technologies on the left to the technology developed for our use on the right.



NASA uses this software on satellites to make three-dimensional maps of planets and other things in space

**Three-dimensional** means it looks more realistic, like some parts are further away than others.

**Photons** ['fō-tän] are tiny particles of energy or radiation.

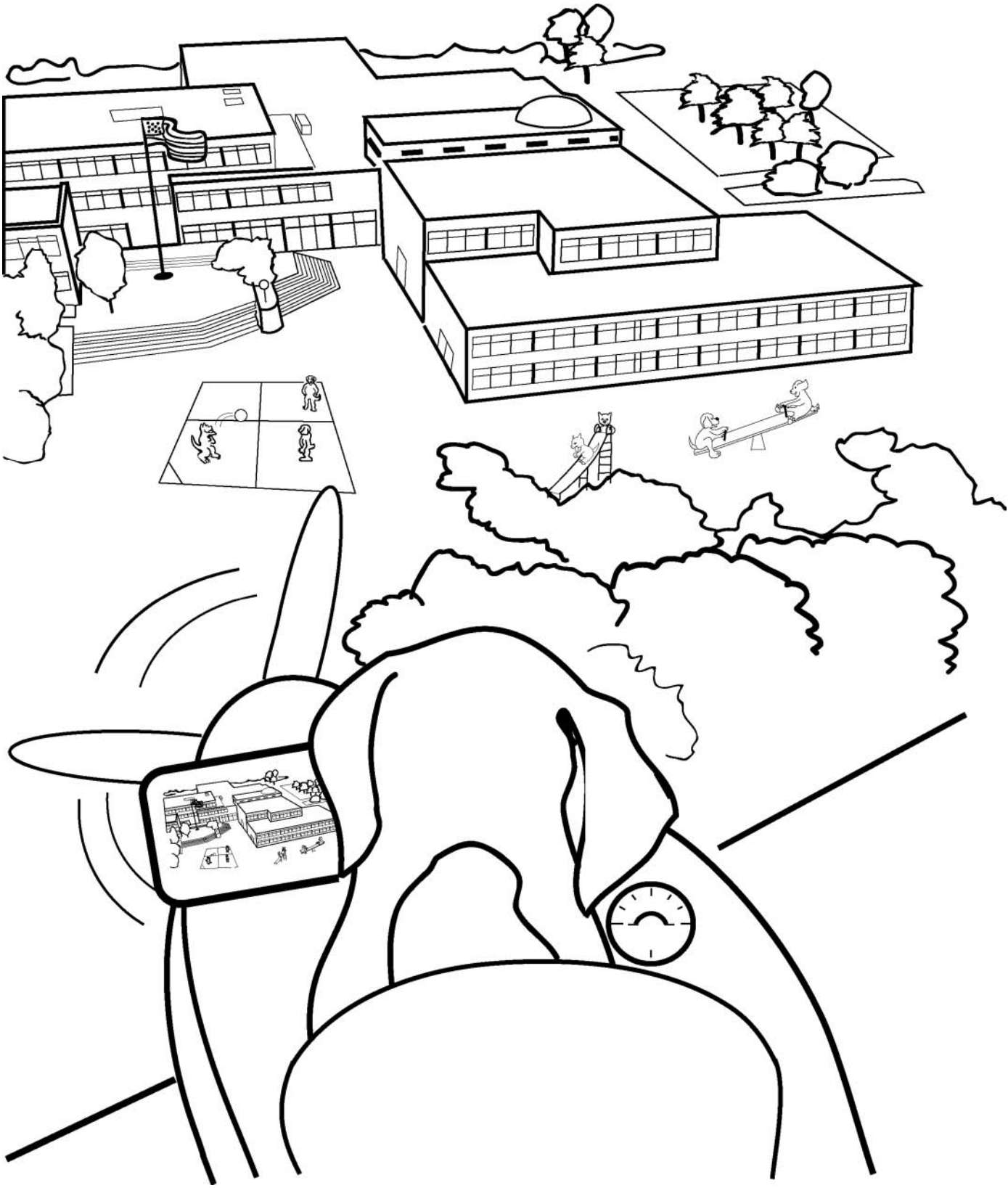

Using NASA's photon-counting altimeter software, Space Pup is making a three-dimensional map of his school.

An **altimeter** is an instrument that measures altitude (how high something is).

**Micro** means "very small," so a **microaltimeter** is a very small instrument that measures how high something is.



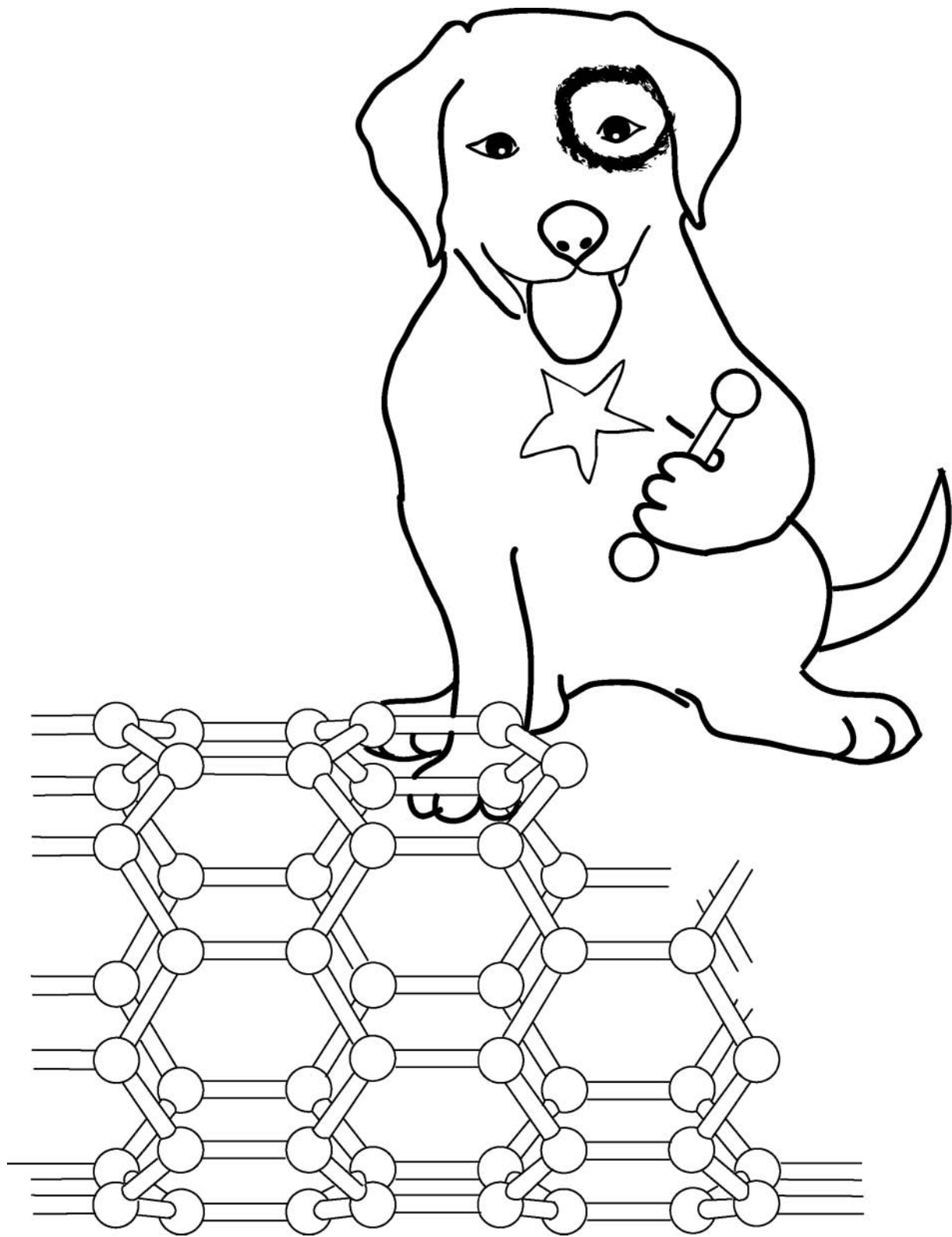

Carbon nanotubes ['nan-ō-tübz] are tiny tubes that are very strong and very good conductors of electricity and heat. They can be used as a type of fuel cell (like a battery) as well as for lots of other things. NASA came up with a new way to make carbon nanotubes that is a lot safer and also saves companies a lot of money.

**Nano** means one billionth! That's small—about 150,000 times smaller than a human hair!

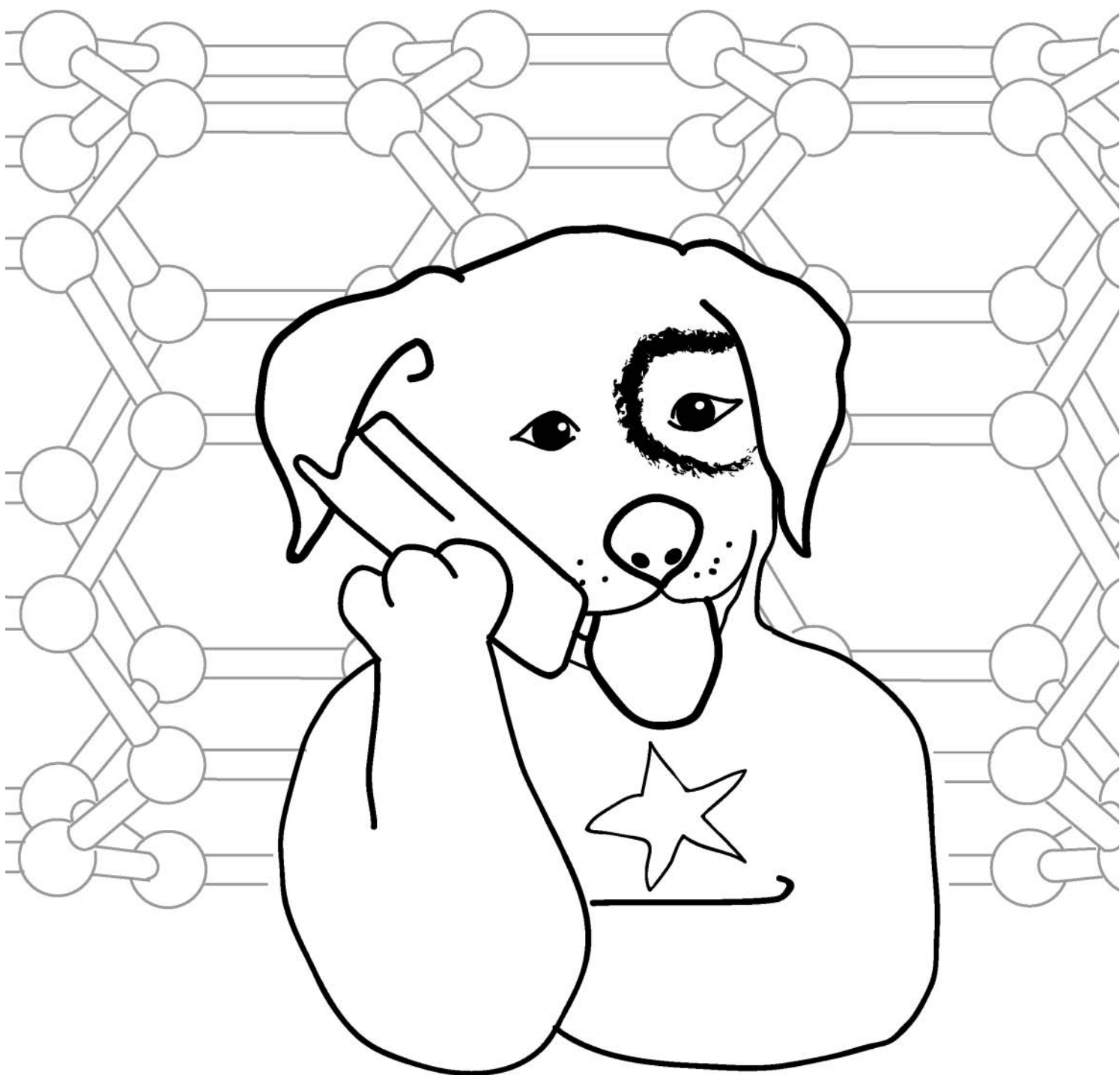

Because NASA came up with a better way to make carbon nanotubes, companies will be able to find new ways to use them. In the future they could be used to make better computers, cell phones, electronic toys, and lots of other things.

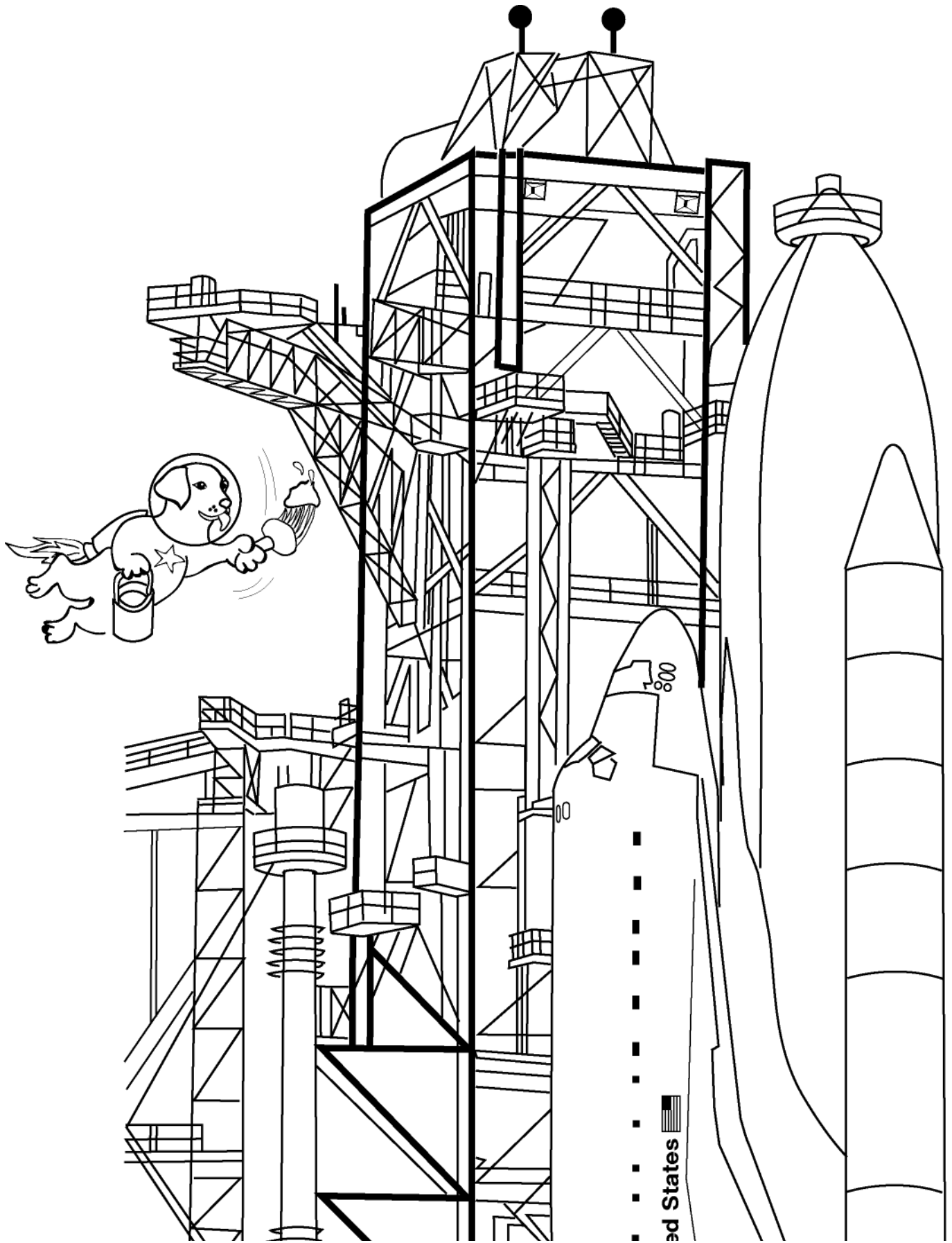

NASA developed this coating on gantries at rocket launch sites. Gantries are big vertical structures that support rockets. The coating helps protect the gantry from salt water corrosion and the effects of the heat from the rocket. This makes it last longer.



Space Pup can use NASA's coating to protect the Statue of Liberty from rust and pollution.



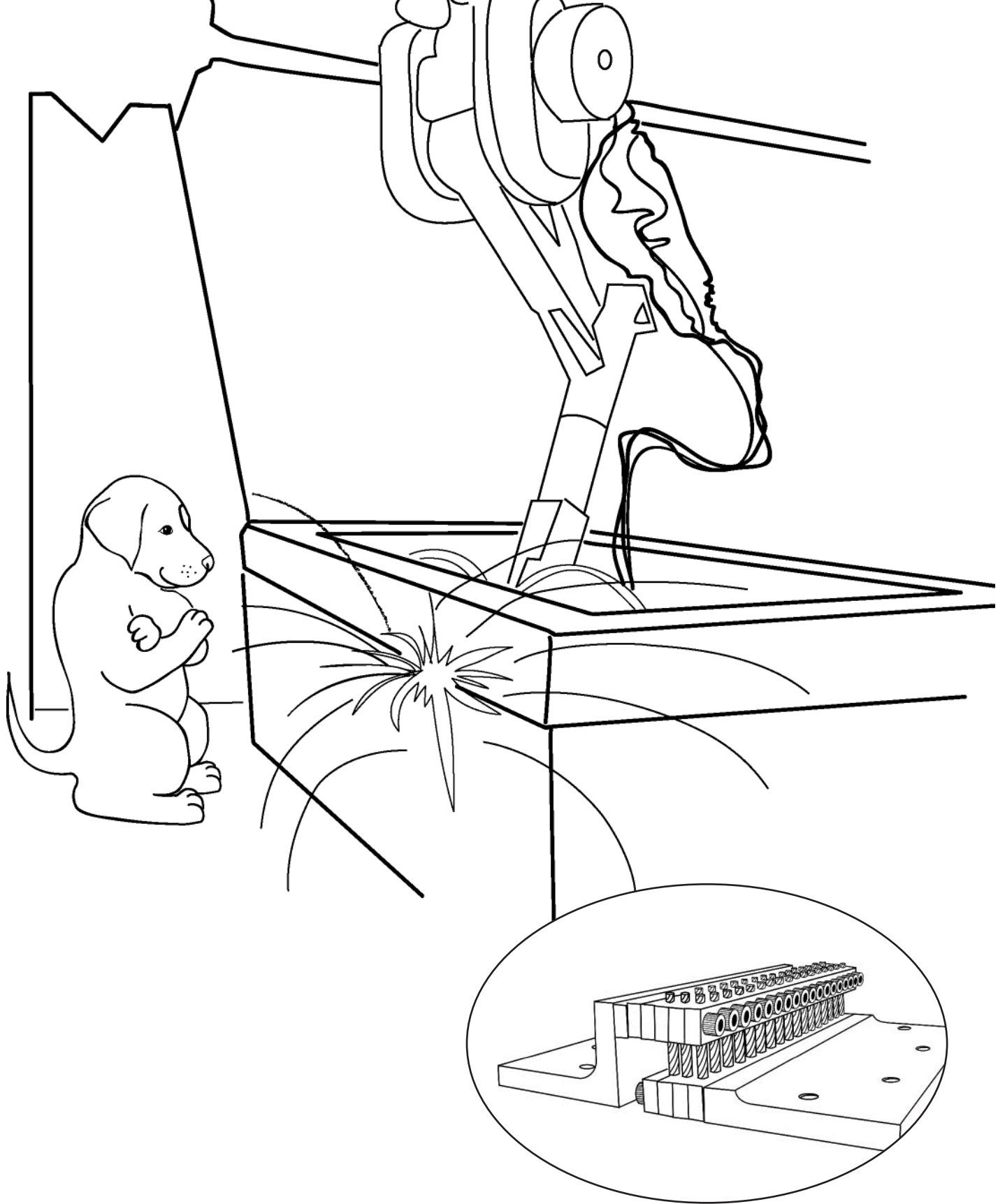

NASA developed this very strong and flexible cable mechanism to help scientists control the flight and movement of spacecraft and other machines.

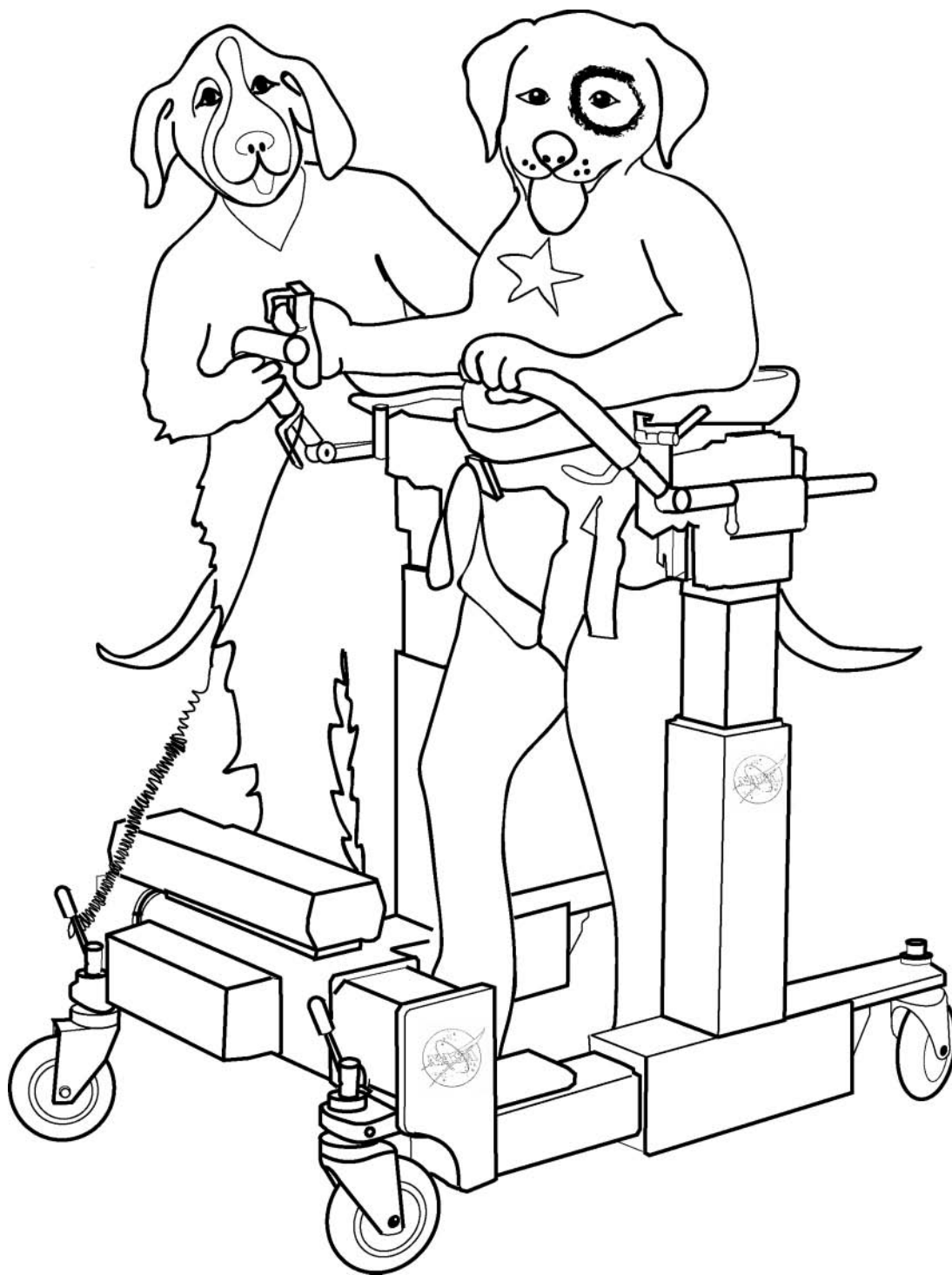

Space Pup is showing us a type of walker called "SAM" that uses NASA's cable mechanism. SAM helps people who have trouble walking move around without any help and without having to use their arms to support themselves. SAM makes it easier for people who have been in accidents to learn how to walk again.



You can't really fly kites in space!

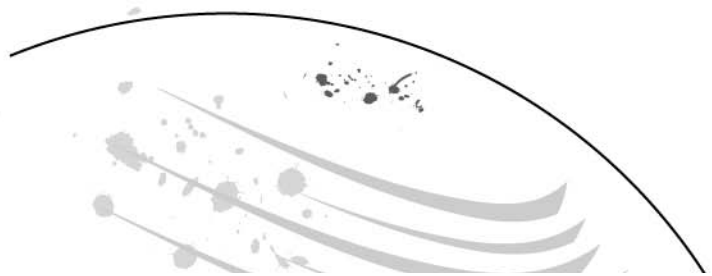

NASA came up with this technology when they were working on a Doppler ['däp-lər] lidar ['lī-där] to measure wind from space.

**Doppler lidars** are devices that measure how fast air is moving.

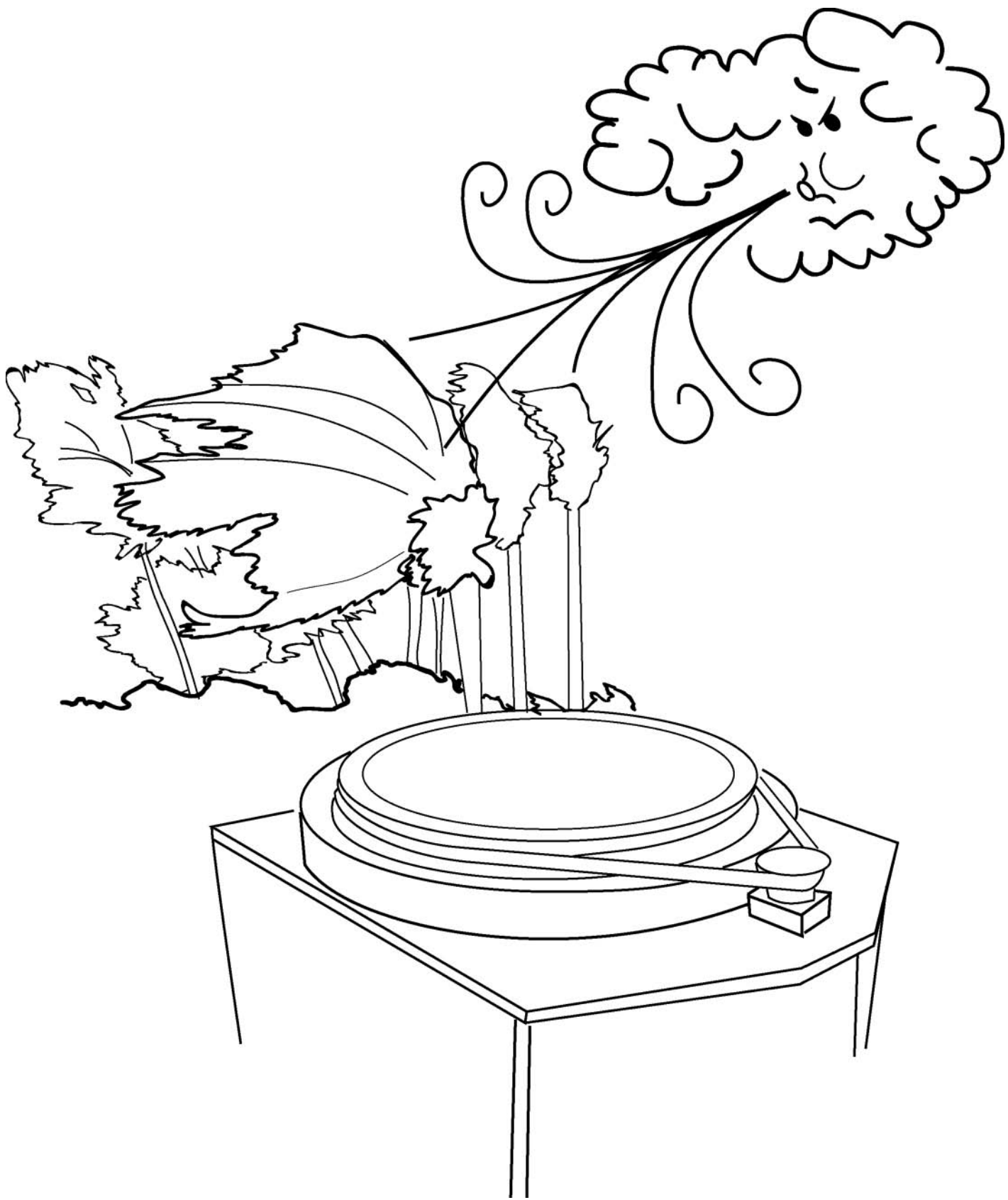

With this tool, Space Pup can "see" how the wind is moving. This could help airplanes avoid turbulence (or bumpy air) when flying.



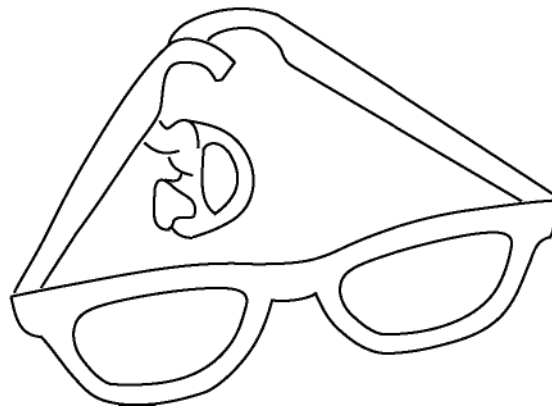
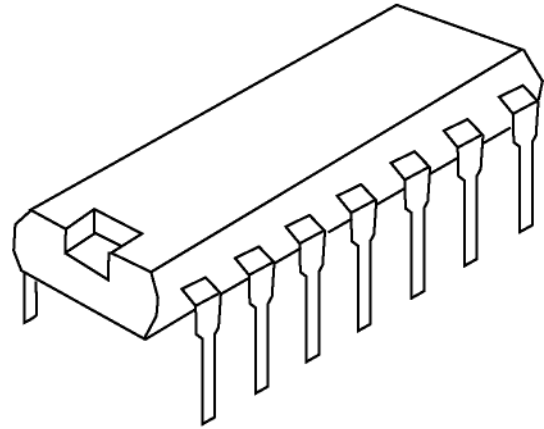
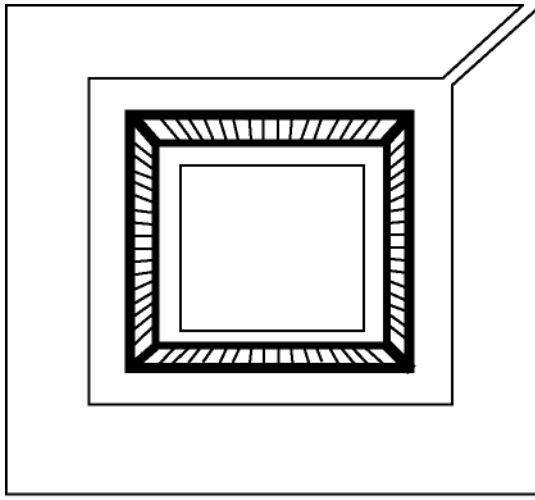

NASA engineers created the tiny electronic chip that is used in the directional hearing aid glasses. Tiny electronic chips can make many new things possible.

An **engineer** is a person who uses science and math to create things that are useful to us.

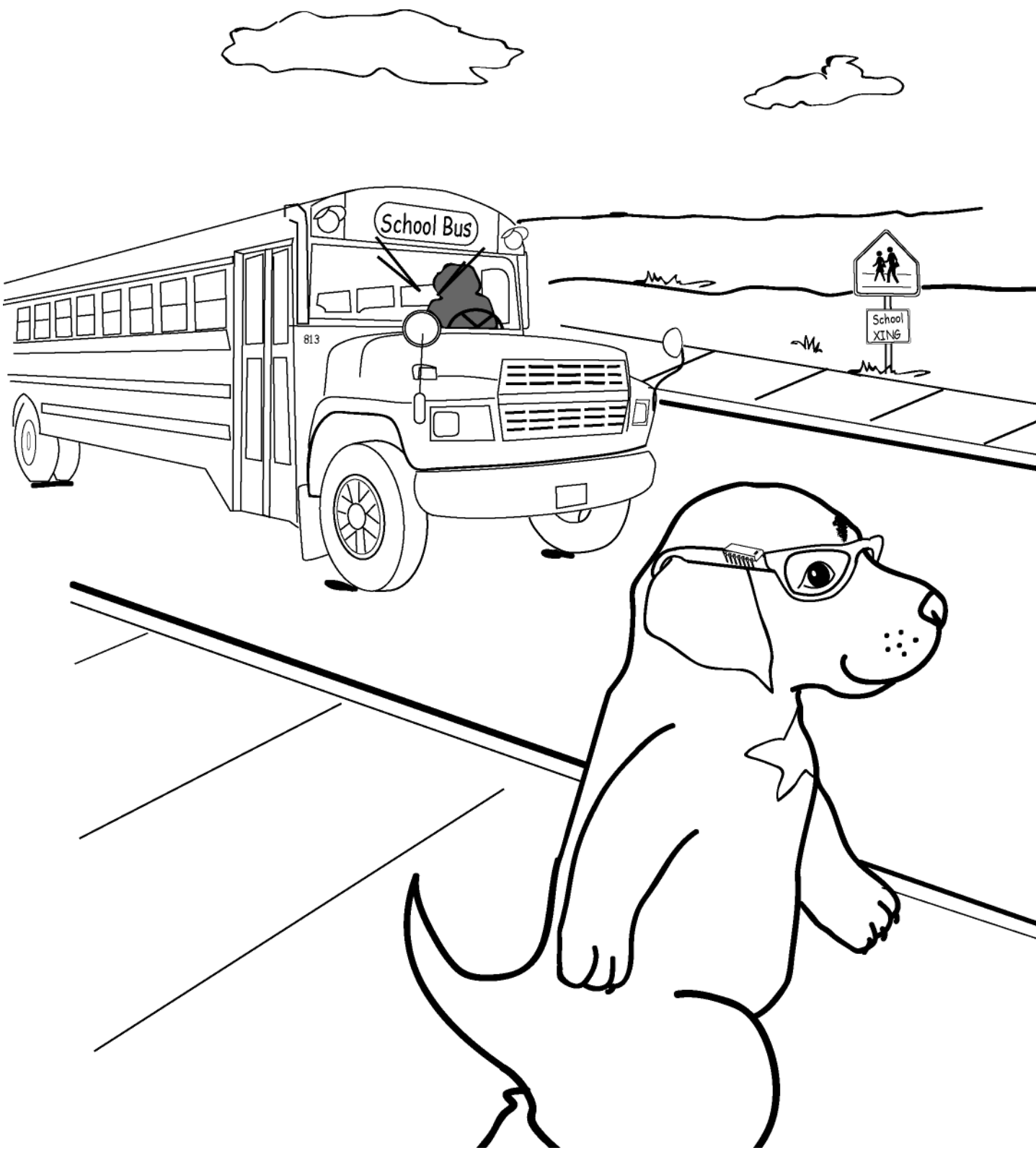

The glasses Space Pup is wearing use NASA's tiny electronics. They have flashing lights in in the frame that tell him whether a sound is coming from the left, right, front, or back. For people who can't hear, these glasses can help warn them that something is coming and they need to move out of the way.

# Stars

X-rays are a type of energy. Stars and many other bodies in space (like black holes, supernovas, and pulsars) send out x-rays. Studying these x-rays helps scientists learn more about the star.

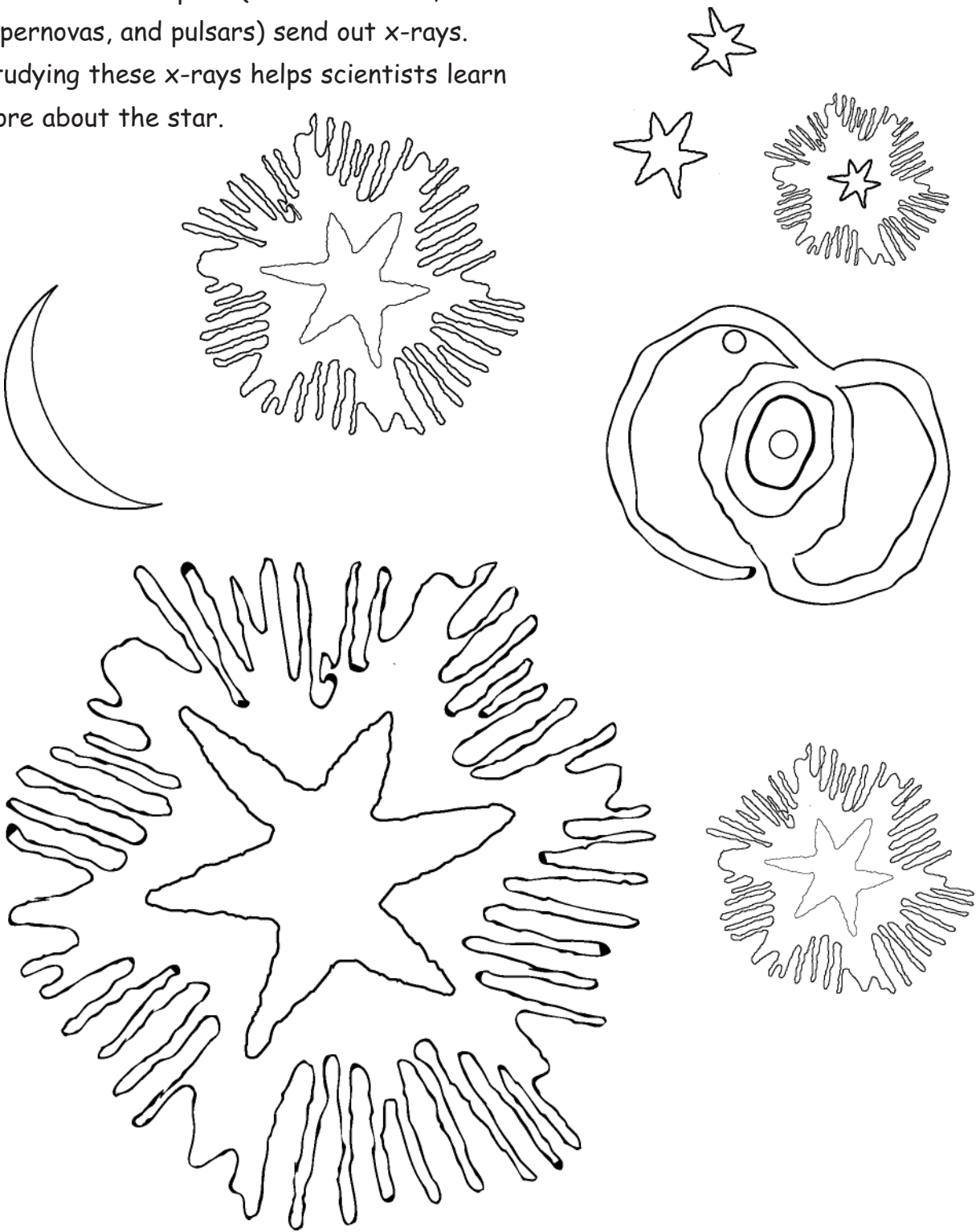

NASA engineers created this new x-ray technology and its tiny electronics when they were looking for better ways to detect x-rays from distant stars.



By using NASA's x-ray technology and tiny electronics used to study space, engineers were able to create the Lixiscope[lik-'sə-skōp]. The Lixiscope is a portable x-ray device. A team doctor could use it at a ball game. If a player got hurt, the doctor could use the lixoscope to see if any bones are broken.



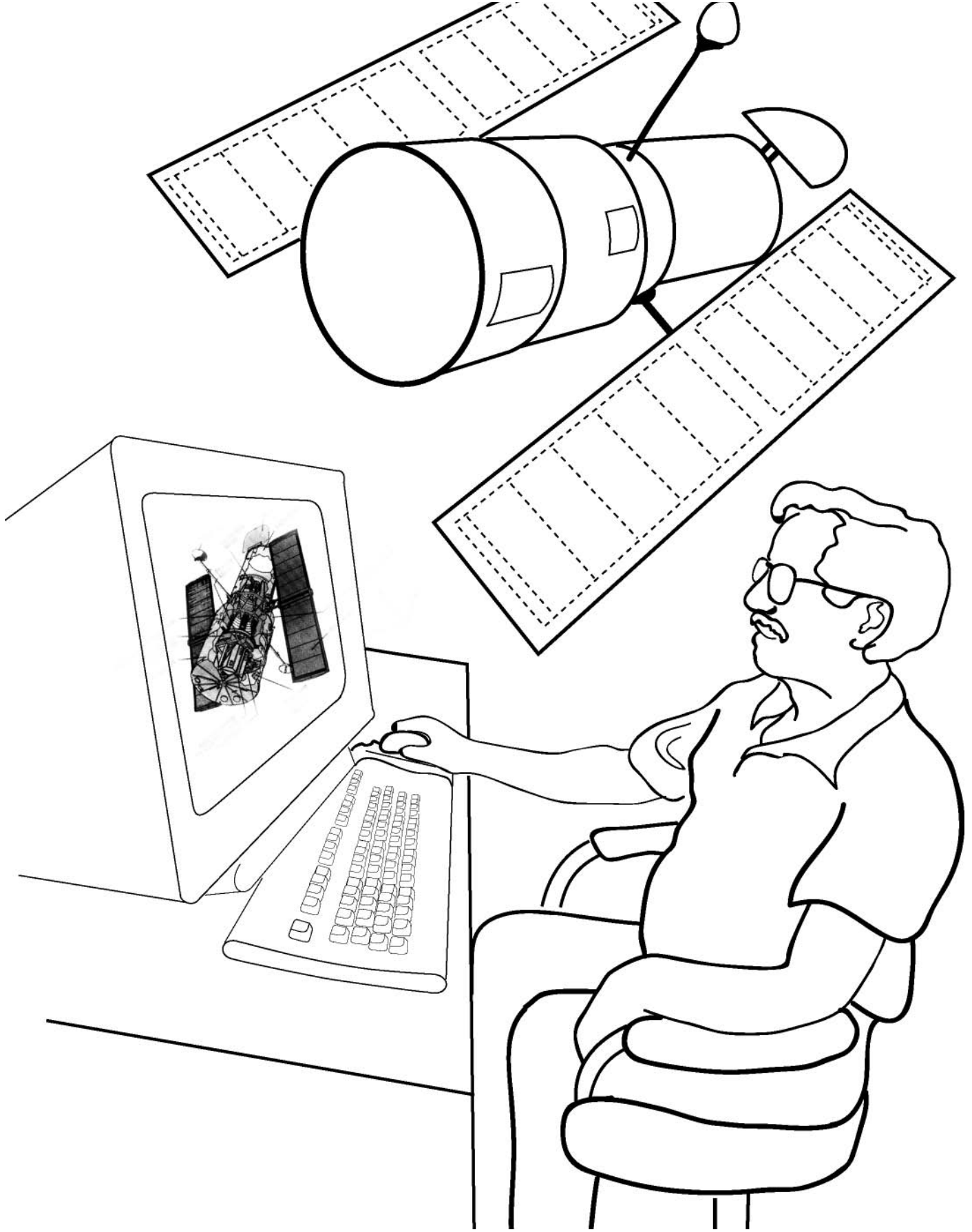

NASA engineers wrote the NASA Structural Analysis (NASTRAN) program to help them build instruments and spacecraft. The program also shows the engineers how well the instruments and spacecraft will do when they fly.



NASTRAN helps engineers design better cars, planes, ships, bridges, and buildings. Space Pup is trying NASTRAN out to design a faster set of roller blades.

# Crossword puzzle

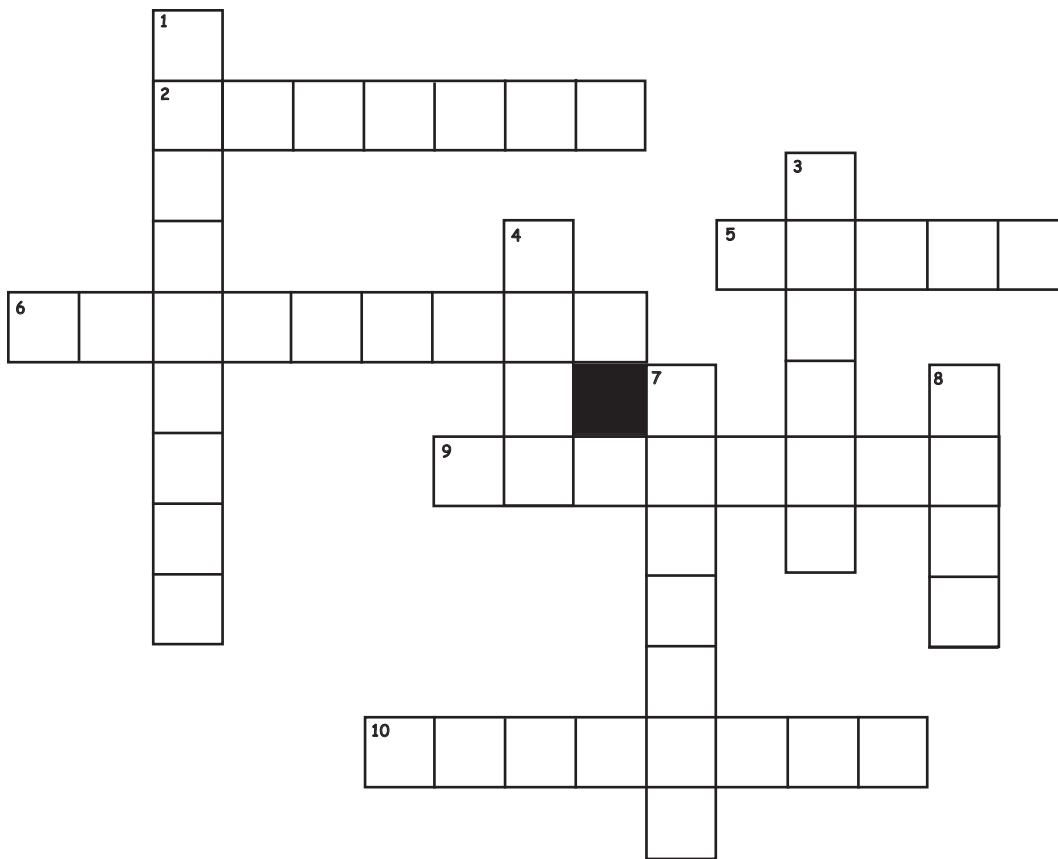

## Across:

2. Object to send or receive radio or TV signals
5. The planet on which we live
6. Stuff that makes air and water dirty
9. Person who uses science to plan and design useful things
10. Bend without breaking

## Down:

1. Spacecraft that moves in orbit around Earth
3. Strong, thick wire ropes
4. Object that orbits the earth
7. Path for electricity
8. Force that sees skeletons

# Our Solar System

Can you find Earth?

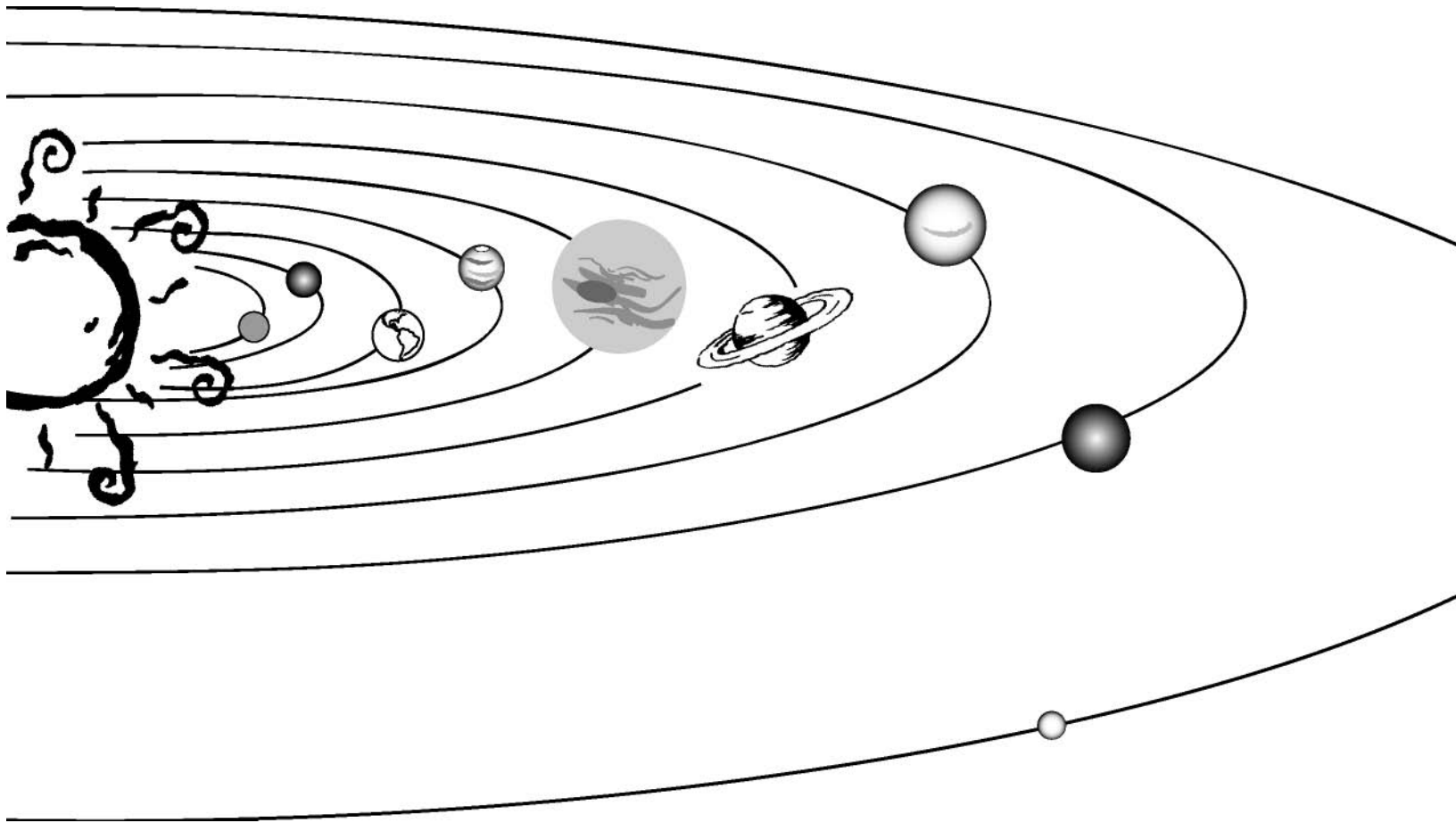

Can you name all of the planets  
in order from the sun?

1. \_\_\_\_\_
2. \_\_\_\_\_
3. \_\_\_\_\_
4. \_\_\_\_\_
5. \_\_\_\_\_
6. \_\_\_\_\_
7. \_\_\_\_\_
8. \_\_\_\_\_
9. \_\_\_\_\_

Our solar system has nine planets that revolve around the sun.



# Celestial decoder

Decode the answers to these questions ....

A	B	C	D	E	F	G	H	I	J	K	L	M	N	O	P	Q	R	S	T	U	V	W	X	Y	Z
26	25	24	23	22	21	20	19	18	17	16	15	14	13	12	11	10	9	8	7	6	5	4	3	2	1

1. This computer program has helped engineers design spacecraft as well as cars, planes, bridges, and buildings.

Code: 13–26– 8– 7– 9–26–13

2. These tiny tubes can help engineers create better computers, cell phones, electronic toys, and lots of other things.

Code: 24–26–9–25–12–13    13–26–13–12–7– 6–25–22– 8

3. How can you measure how fast the wind is moving?

Code: 23–12–11–15–22– 9    15–18–23–26– 9

4. With this instrument, Space Pup's doctor can check to see if any bones are broken even when they're not at the hospital or doctor's office.

Code: 15–18– 3 –18– 8 –24–12–11–22

5. What technology helps NASA control the temperature of their spacecraft?

Code:

24–26–11–18–15–15–26– 9 – 2    11– 6–14–11–22–23    15–12–12–11    4–26–9–14–22–9

# Connect the dots

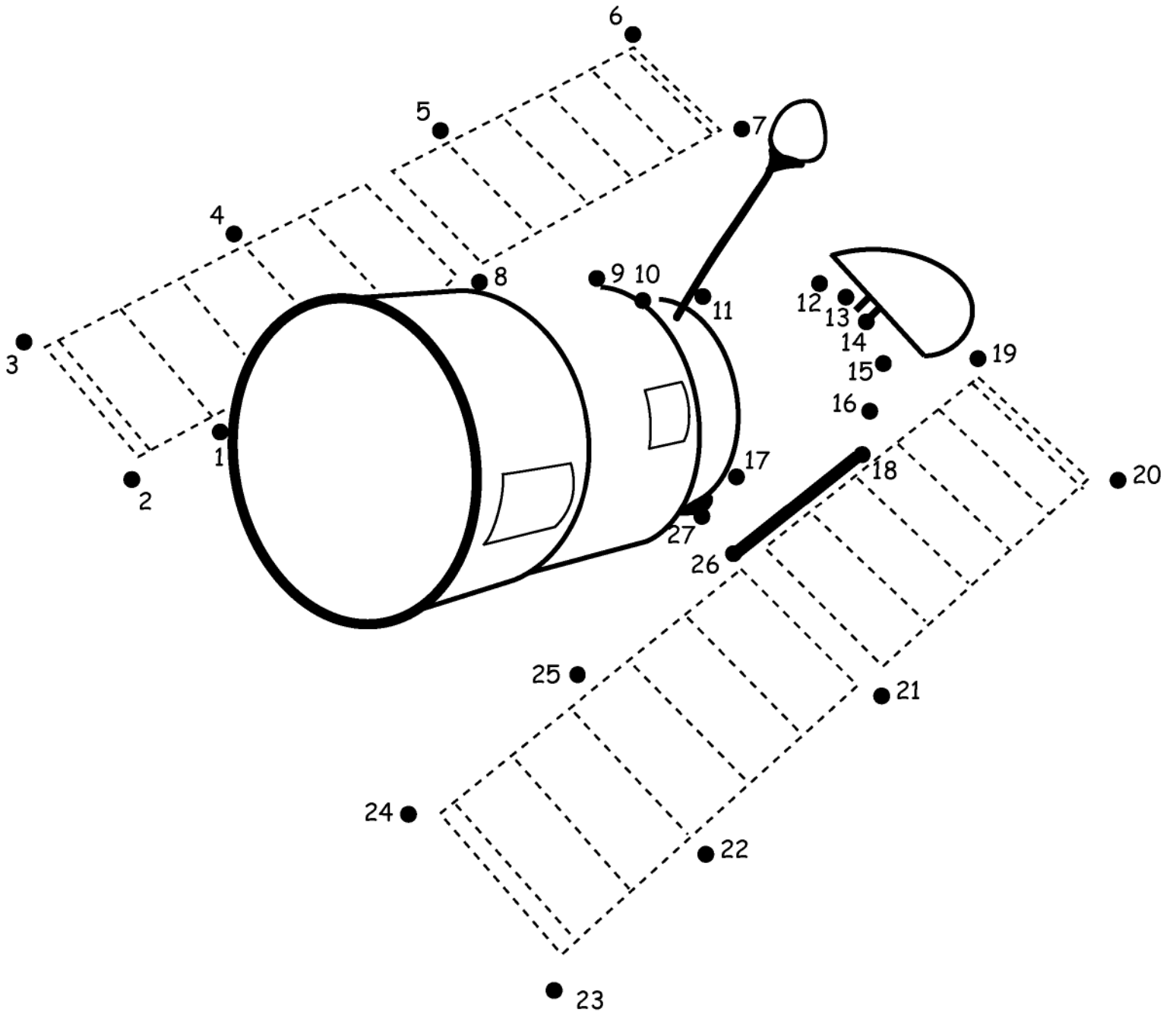

# The A-mazing Hubble!

Help Hubble find its way to Jupiter!

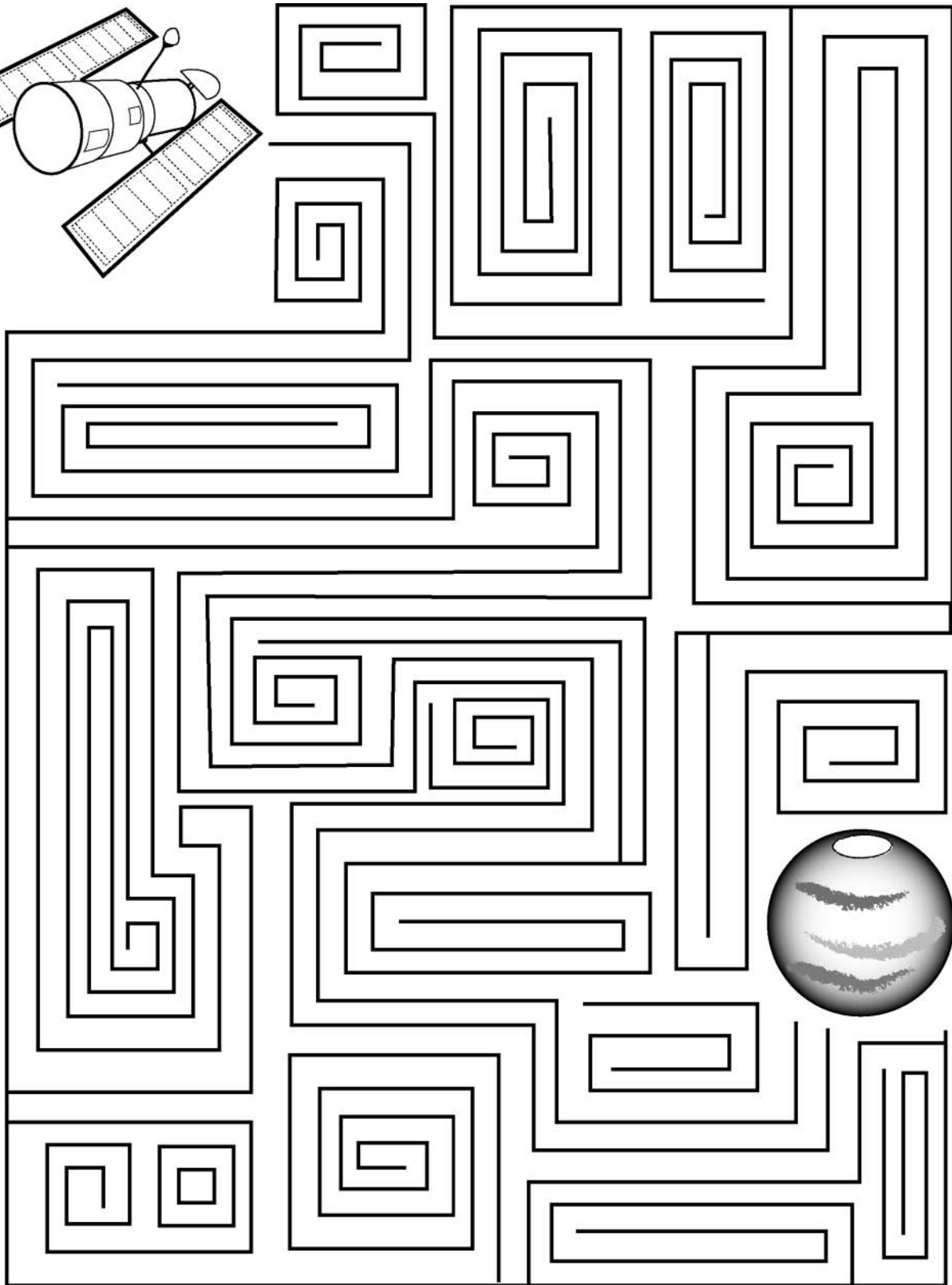
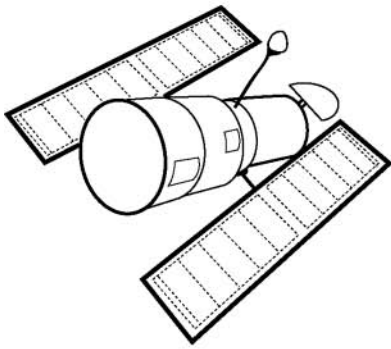

# Word search puzzle

A H D F F E F O N J E E B E O Z L R O O  
 X I T H N S W O T R Z A G D R P V A T Z  
 H W M R Q D I D M E D I C I N E L L M P  
 C B S E A T X C F K G H G E F Y G O U D  
 S U P X U E E F E A D V K H W O O S J Q  
 K P U L Q P T N E M U R T S N I D L J Z  
 A K L E Q T G W Y E G S R I M Y D H Q H  
 M O X N C T X F P C N A S A C S A T J A  
 P M Z G Q T R Y B A K M T O D R R X H H  
 S B R P I X A A J P A S A I G D D U R T  
 A Q X F M F Y P N X K T L E P C B O G N  
 I N W Q V K Y S W S T X C G C B N N B C  
 P I O L S W F Z U T F A X S L Y I C O K  
 F V I I W N Z P K P P E A E B M H P O I  
 Q X Q H T I H L U S T U R T O R N E X A  
 K B W Q I N R E E A L H O Y Z E V N B P  
 T N C U Q U E E A D L A F X H Y G Q W J  
 G I E T G A X V B Z A M E T S Y S P N S  
 U R X W R Y E Y N D B V H K I Y U K U H  
 Y Z Q F F P X N H I I T Y H X P R L F X

earth  
 instrument  
 NASA  
 pup  
 system  
 Xray

Goddard  
 invention  
 pacemaker  
 solar  
 transfer

Hubble  
 medicine  
 pollution  
 space  
 wire

# Puzzle answers

Word jumble page 3

- astronaut
- balloon
- spacecraft
- earth sciences
- electronics
- engineer
- galaxy
- hubble telescope
- robot
- solar system
- space shuttle
- x-ray

"Space Pup"

Word search answers—page 16

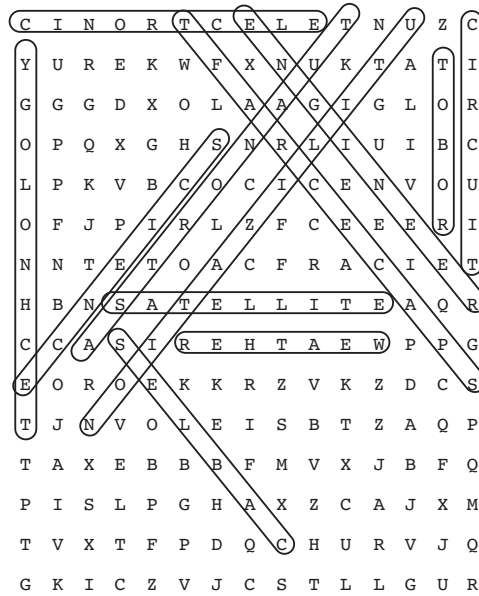

Crossword answers—page 34

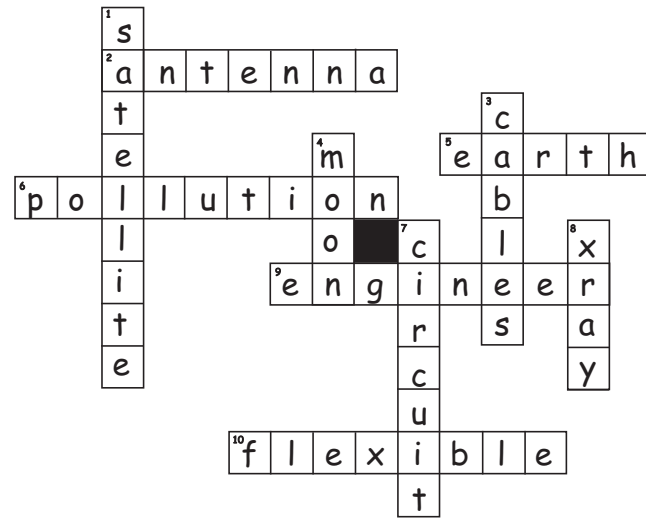

Celestial decoder answers from page 36

1. NASTRAN
2. Carbon nanotubes
3. Doppler lidar
4. Lixiscope
5. Capillary pumped loop warmer

Hubble maze answer—page 38

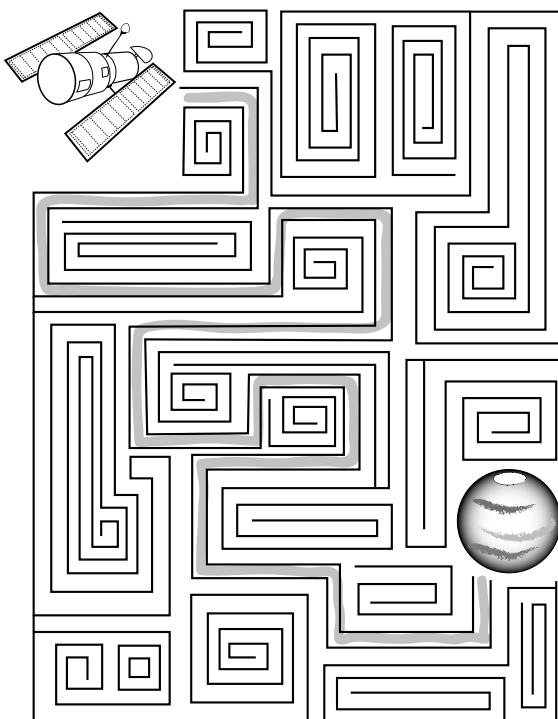

Word search answers—page 39

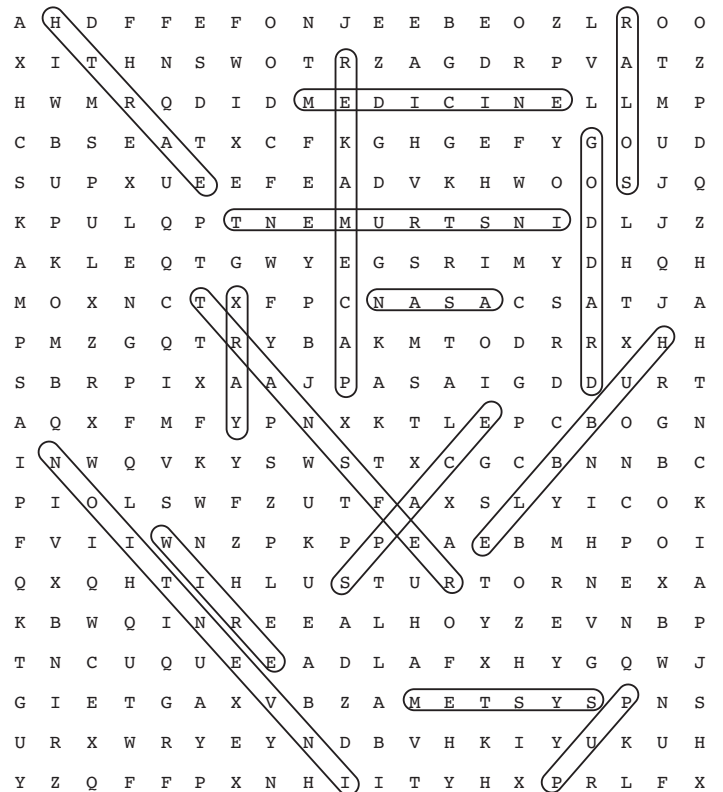



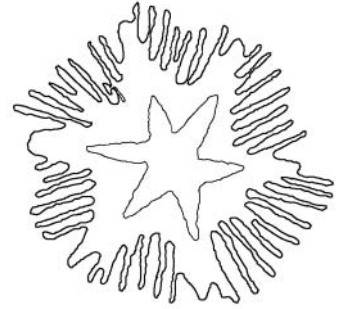

## Our favorite Web sites for kids:

NASA Star Child:

<http://www.starchild.gsfc.nasa.gov>

Goddard Space Flight Center Education Programs:

<http://education.gsfc.nasa.gov/>

Educator Astronaut Program:

<http://eduspace.nasa.gov/>

NASA Explores:

<http://www.nasaexplores.com/fun.php>

NASA Kids:

<http://kids.msfc.nasa.gov/>

NASA Quest:

<http://quest.arc.nasa.gov/>

NASA's Earth Science Enterprise for Kids:

<http://kids.earth.nasa.gov/>

Ultra Efficient Engine Technology:

<http://www.ueet.nasa.gov/StudentSite/>

Space Science Data Operations Education Page:

[http://ssdoo.gsfc.nasa.gov/education/  
education\\_home.html](http://ssdoo.gsfc.nasa.gov/education/education_home.html)

Space Research Fun and Learning:

[http://spaceresearch.nasa.gov/fun\\_learning/edu.html](http://spaceresearch.nasa.gov/fun_learning/edu.html)

National Air and Space Museum's Online Activity Page:

<http://www.nasm.si.edu/nasm/edu/activity.html>

ISS SpaceKam:

<http://www.earthkam.ucsd.edu>

Johnson Space Center — Just for Kids:

<http://www.jsc.nasa.gov/people/justforkids.html>

Windows to the Universe:

<http://www.windows.ucar.edu/>

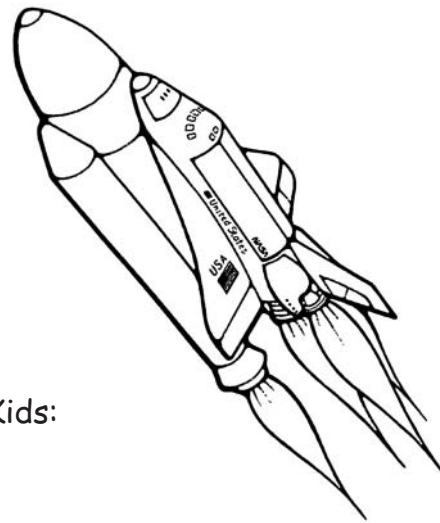



National Aeronautics and Space Administration

**Goddard Space Flight Center**  
Innovative Partnerships Program Office  
Building 22, Room 290, Mailstop 504  
Greenbelt, Maryland 20771

p: 301.286.5810  
f: 301.286.0301  
e: [techtransfer@gssc.nasa.gov](mailto:techtransfer@gssc.nasa.gov)  
w: <http://ipp.gsfc.nasa.gov>

[www.nasa.gov](http://www.nasa.gov)

NP-2008-02-006-GSFC

