

**Outer Continental Shelf  
Natural Gas and Oil  
Resource Management**

---

Summary and Decision

---

**Comprehensive Program  
1992 - 1997**

**Proposed Final**

**We are pleased to issue the Proposed Final Comprehensive Outer Continental Shelf Natural Gas and Oil Resource Management Program, 1992-1997. This is the final draft of the program. When approved, the Comprehensive Program will guide the efforts of the Department of the Interior's Minerals Management Service in making offshore natural gas and oil resources available for the Nation's benefit while affording a high degree of protection to the marine and coastal environments.**

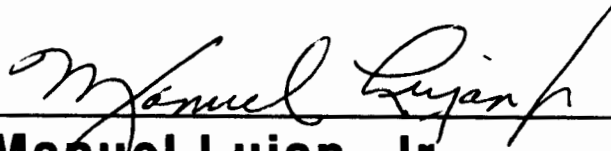

  
\_\_\_\_\_  
**Manuel Lujan, Jr.**  
**Secretary of the Interior**

**Outer Continental Shelf  
Natural Gas and Oil  
Resource Management**

---

Summary and Decision

---

**Comprehensive Program  
1992 - 1997**

**Proposed Final**

Copies of this document and companion documents may be obtained from any of the following Minerals Management Service offices:

Alaska OCS Region:	907-271-6435
Atlantic OCS Region:	703-787-1118
Gulf of Mexico:	504-736-2519
Pacific OCS Region:	805-389-7520
Headquarters:	202-208-3072

# CONTENTS

<b>EXECUTIVE SUMMARY</b>	v
<b>INTRODUCTION</b>	1
THE 5-YEAR PROGRAM PROCESS	2
<b>FRAMEWORK AND CRITERIA FOR PROGRAM DECISIONS</b>	4
SECTION 18 CRITERIA	4
COMMENTS ON THE PROPOSED PROGRAM	7
CONGRESSIONAL MORATORIA	11
PRINCIPLES FOR DEVELOPING PROGRAM OPTIONS	12
<b>ACHIEVING A BALANCED PROGRAM</b>	14
PRESERVING THE ENVIRONMENT	14
OCS Pollution Control Record	15
Protecting Sensitive Coastal and Marine Resources	16
MEETING U.S. PETROLEUM AND NATURAL GAS REQUIREMENTS	17
National Energy Strategy Proposals	19
The Role of the OCS in Meeting U.S. Energy Needs	20
<b>DETAILS OF THE DECISION</b>	22
TIMING AND LOCATION OF LEASING CONSIDERATION	22
General Program Decisions	22
Atlantic Region	23
Gulf of Mexico Region	23

Pacific Region	26
Alaska Region	26
AREA EVALUATION AND DECISION PROCESS	31
FAIR MARKET VALUE	34
<b>GLOSSARY</b>	35
<b>TABLES</b>	
1. Proposed Activity by OCS Region and Planning Area, 1992-1997	vii
2. Tentative Plan for the Area Evaluation and Decision Process	24
<b>FIGURE</b>	
1. Area Evaluation and Decision Process	32
<b>MAPS</b>	
1. Atlantic Region	x
2. Gulf of Mexico Region	xi
3. Alaska Region	xii
4. Gulf of Alaska– Coastal Buffer Offshore the Yakutat Area	27
5. St. George Basin– Coastal Buffer	28
6. Hope Basin– Coastal Buffer	29
7. Beaufort Sea and Chukchi Sea– Coastal Buffers	30

## **EXECUTIVE SUMMARY**

The Outer Continental Shelf (OCS) Lands Act requires the U.S. Department of the Interior to prepare a 5-year program that specifies the size, timing and location of areas to be assessed for Federal offshore natural gas and oil leasing. This Summary and Decision document presents Secretary of the Interior Manuel Lujan, Jr.'s decisions for the Proposed Final Program for mid-1992 to mid-1997. The Proposed Final Program is being submitted, along with related program documents, to the President and the Congress. After a 60-day waiting period, the Secretary may give final approval to the new program.

The material comprising the Proposed Final Program submitted to the President and the Congress include: this document; a volume entitled, "Decision Documents," dated April 1992, which provides the details of the assessments and options that form the basis for the Secretary's decision; a final Environmental Impact Statement which analyzes the impacts of program alternatives on the physical, biological, and socioeconomic environments; and copies of relevant correspondence between the Department and the Governors of affected States and other interested parties.

The Secretary has carefully considered a broad range of factors in reaching his decisions, including the more than 400 comments received on the July 1991 Proposed Program from Governors of affected coastal States, local governments, other Federal agencies, industry, environmental groups, and the general public. In so doing, the Secretary has sought to design a program that best meets the energy needs of the American people and strikes the appropriate balance between environmental concerns and the opportunity to find and develop new energy resources.

## **PROPOSED FINAL PROGRAM DECISIONS**

Throughout the program development process, the Secretary has been committed to tailoring proposed OCS activities to the differences among OCS regions. This commitment has led to refinements in the 5-year program at each stage of formulation from the February 1991 Draft Proposed Program to the July 1991 Proposed Program, and now to the Proposed Final Program. The public will have further opportunities for participation in decisions about prospective OCS activities during the Area Evaluation and Decision Process which precedes a decision on each proposed OCS lease sale.

This 5-year program will consider making available for leasing areas containing economically recoverable resources consisting of an estimated 10 trillion cubic feet of natural gas and one billion barrels of oil, representing net economic benefits in present value to the nation of more than \$5 billion. Based on experience with OCS activities to date, it is anticipated that these resources can be developed and produced in a safe and environmentally clean manner. While some areas may experience socioeconomic and other environmental impacts from these activities, these potential impacts must be balanced against the associated economic benefits, as well as the environmental advantages of reduced oil imports and greater availability of natural gas.

By producing natural gas and oil in the areas included in the 5-year program, thousands of jobs will be retained in the United States. If this production does not occur, these OCS-related jobs will be lost. Production of these domestic resources, with a present value estimated at \$26 billion, will reduce the trade deficit by \$19 billion compared to importing the energy supplies that would be needed to replace them.

The Secretary's decisions on leasing consideration for each of the OCS regions and planning areas (see Maps 1-3 at the end of this Executive Summary) are described below and summarized in Table 1.



**Table 1. PROPOSED ACTIVITY BY OCS REGION AND PLANNING AREA  
1992-1997**

<b>REGION: Planning Area</b>	<b>Consider Leasing*</b>	<b>REGION: Planning Area</b>	<b>Consider Leasing*</b>
<b>ATLANTIC REGION:</b>		<b>ALASKA REGION:</b>	
North Atlantic	—	Gulf of Alaska	
Mid-/South Atlantic	1996	• Yakutat	1995
Straits of Florida	—	• Middleton Island	—
		Kodiak	—
<b>GULF OF MEXICO REGION:</b>		Cook Inlet/Shelikof Strait	1994
Eastern Gulf		Shumagin	—
• North of 26°	1995	North Aleutian Basin	—
• South of 26°	—	Aleutian Arc	—
Central Gulf	Annually	St. George Basin	1994
Western Gulf	Annually	Bowers Basin	—
		Aleutian Basin	—
<b>PACIFIC REGION:</b>		Navarin Basin	—
Southern California	—	St. Matthew-Hall	—
Central California	—	Norton Basin	—
Northern California	—	Hope Basin	1997
Washington-Oregon	—	Chukchi Sea	1996
		Beaufort Sea	1995
<p>Consider for geologic and environmental studies all OCS Planning Areas, with the exception of Straits of Florida, Aleutian Arc, Bowers Basin and Aleutian Basin. Such studies would support decisions for sales proposed in 1992-1997 as well as decisions on subsequent 5-year programs, based on leasing decision needs and budgetary constraints.</p>			

\* Actual dates depend upon the outcome of the Area Evaluation and Decision Process described in text.

## **Atlantic Region**

In the Proposed Final Program, one sale in 1996 combining portions of the Mid- and South Atlantic Planning Areas will be considered. A total of 916 blocks (approximately 5000 acres each) extending southward to the Florida-Georgia border will be considered for the sale (see Map 1); however, these will be narrowed to 250 or fewer blocks at an early stage in the Area Evaluation and Decision Process.

## **Gulf of Mexico Region**

In the Eastern Gulf of Mexico, one sale in 1995 will be considered. The area to be considered generally lies west of 84° W. longitude and north of 26° N. latitude (see Map 2). At an early step in the consideration process, the area for further consideration will be narrowed to 200 blocks.

In the Central and Western Gulf of Mexico, the most prospective areas of the OCS, the current annual pace of leasing will be maintained, and all but the Flower Garden Banks blocks will be available for leasing consideration. Further consultation with affected States on the pace of offering deepwater tracts will be sought during sale specific planning.

## **Alaska Region**

Gulf of Alaska - A 1995 sale limited to the Yakutat area will be considered (Alaska Region Planning Areas are depicted in Map 3).

Cook Inlet/Shelikof Strait - A total of 761 blocks will be considered for a 1994 sale but with a limit of 250 leases issued.

Hope Basin and St. George Basin - The Proposed Final Program considers a sale in 1994 in the St. George Basin and a sale in 1997 in the Hope Basin.

Chukchi Sea - The Proposed Final Program considers one sale in 1996.

Beaufort Sea - One sale in 1995 will be considered.

Consideration will be given to establishing certain buffer areas in the Gulf of Alaska, Hope Basin, St. George Basin, Chukchi Sea, and Beaufort Sea Planning Areas prior to holding any lease sales in those areas.

### **Other Program Decisions**

The Proposed Final Program adopts the Area Evaluation and Decision Process described in the Proposed Program except that the two earliest steps, the Request for Interest and Comments and the Information Base Review, will be combined in all planning areas proposed for leasing consideration.

The Proposed Final Program requires a minimum bid of \$25 per acre on all tracts offered, subject to a sale-by-sale reconsideration. Established bid adequacy criteria will be applied for each sale to ensure that fair market value is received for all leases awarded.

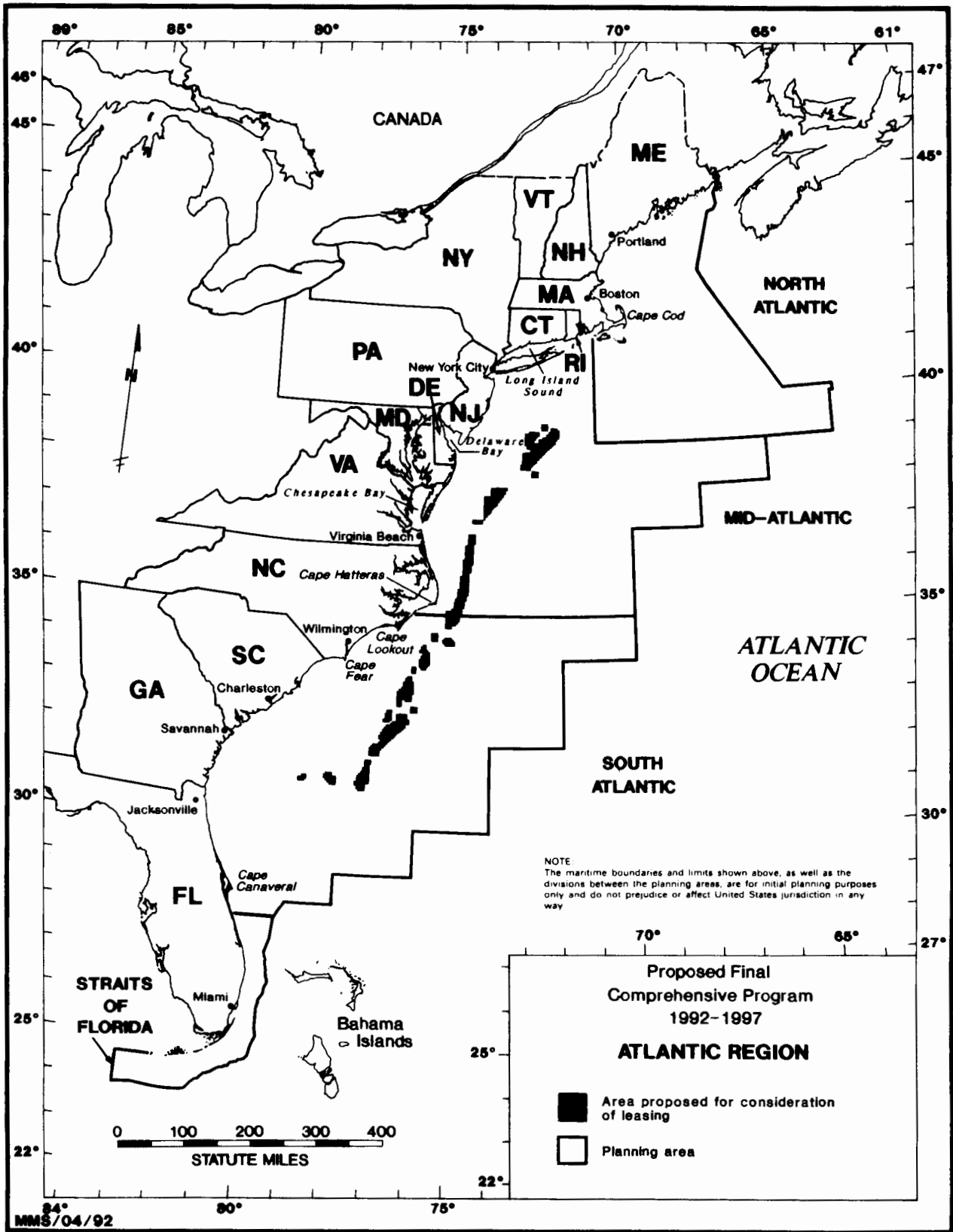

Map 1. Atlantic Region

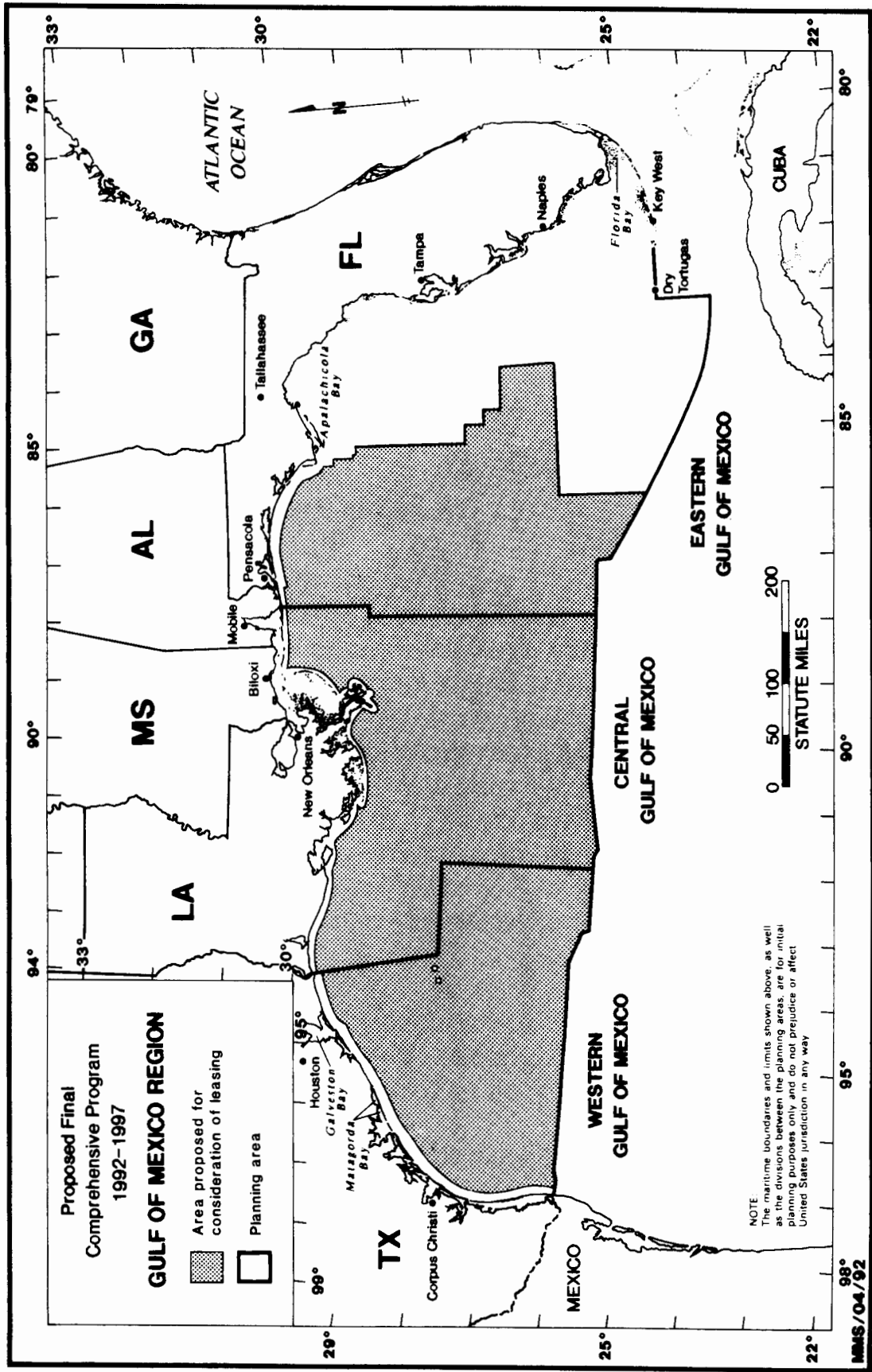

Map 2. Gulf of Mexico Region

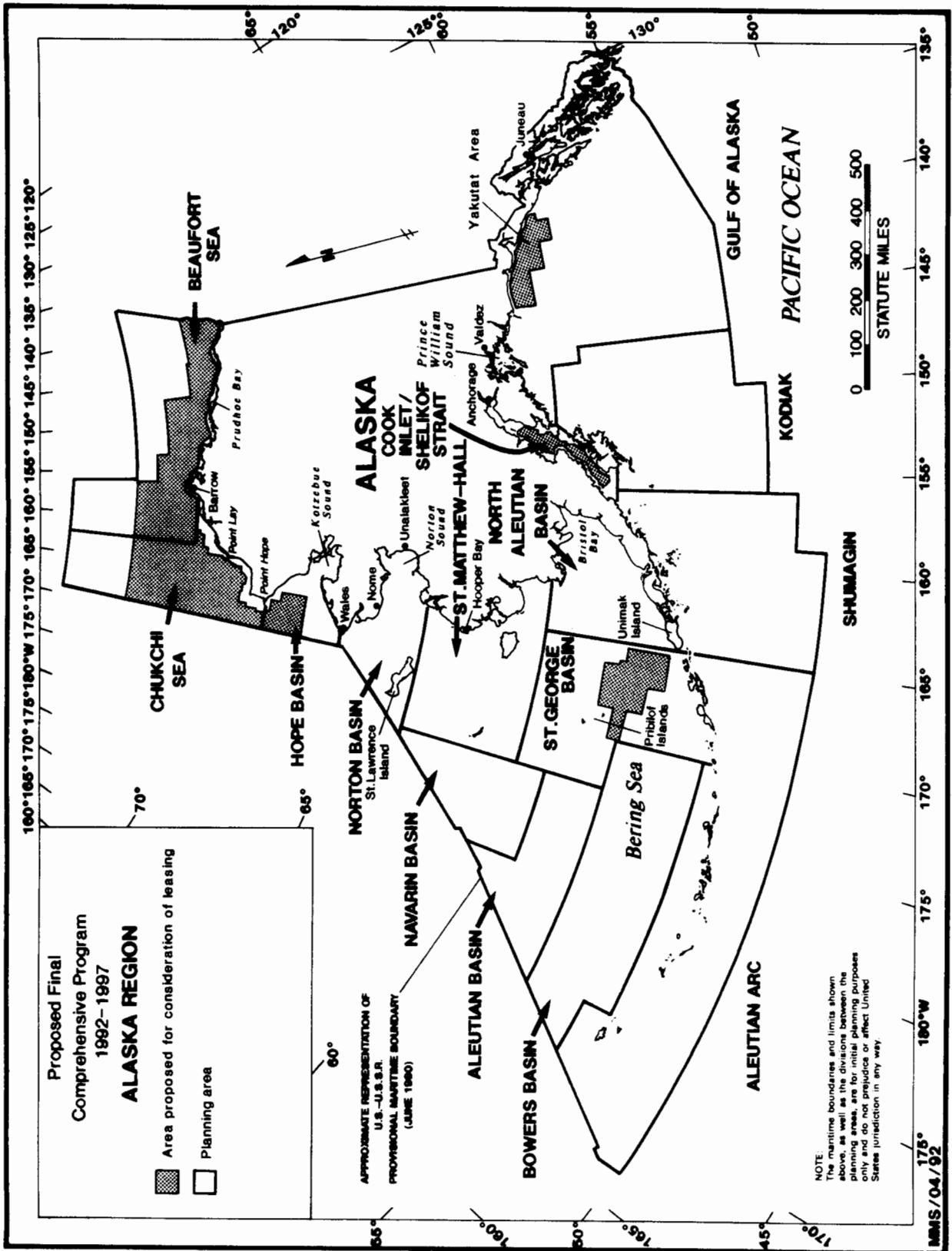

# INTRODUCTION

The Outer Continental Shelf (OCS) Lands Act provides overall guidance for OCS natural gas and oil leasing, exploration, development and production activities. The OCS Lands Act states, as national policy, that “the outer Continental Shelf is a vital national resource held by the Federal Government for the public, which should be made available for expeditious and orderly development, subject to environmental safeguards, in a manner which is consistent with the maintenance of competition and other national needs.”

To this end, the Act directs the Secretary of the Interior to prepare a program which “shall consist of a schedule of proposed lease sales indicating, as precisely as possible, the size, timing, and location of leasing activity which he determines will best meet national energy needs for the five-year period following its approval or reapproval.” In designing the program, the Secretary must balance the potential for discovering natural gas and oil with the potential for environmental effects and coastal zone impacts. The program must also ensure that the Government receives fair market value for the lands leased. The OCS Lands Act affords affected State and local governments and other parties opportunities to review and participate in the program’s development.

This Summary and Decision document describes the Secretary of the Interior’s Proposed Final Program for mid-1992 to mid-1997. The new program will succeed the July 1987 to July 1992 program.

Concurrently, the Department is publishing a volume entitled, “Decision Documents,” dated April 1992, which provides the details of the assessments and options that form the basis for the Secretary’s decision. In addition, a final Environmental Impact Statement which analyzes the impacts of program alternatives on the physical, biological, and socioeconomic environments is being issued.

## **THE 5-YEAR PROGRAM PROCESS**

The preparation of the new program and accompanying Environmental Impact Statement (EIS) began in July 1989, when the Department of the Interior's (DOI) Minerals Management Service (MMS) solicited information from States, local governments, industry and the public. The information received, along with information obtained from environmental studies, geological analyses and other sources, was used to develop a Draft Proposed Program, which was released for a 60-day public comment period in February 1991.

In late July 1991, the second draft of the program—the Proposed Program—and a draft EIS were submitted to the Congress, the Attorney General and the heads of other Federal Agencies, and the Governors of affected States. Along with the proposal, the Governors and heads of Federal Agencies also received a written explanation from DOI concerning the reasons for the program decision. Notices concerning the Proposed Program and draft EIS were published in the *Federal Register* on August 1, 1991. Public hearings on the draft EIS were held during the 90-day comment period following publication of the Proposed Program and draft EIS.

This third draft—the Proposed Final Program—is based on the consideration of comments received and the results of updated analyses. It is being submitted to the President and the Congress along with related program documents, copies of comments received, and DOI's responses to the comments. After a 60-day waiting period, the Secretary may give final approval to the new program.

The program not only addresses the years 1992-1997, but also lays the groundwork for decisions that will be faced after that 5-year period. It includes efforts to gather environmental and other information and to enhance the opportunities for States, localities, and other interested parties to participate in the decisionmaking process. The initiation of studies and long-term planning now can facilitate future decisions by ensuring the availability of information to clarify and resolve environmental and other issues before the development of future OCS programs.



The program has been tailored to fit the different characteristics of the Nation's coastal regions and to respond to the views expressed by States, local governments, and the public. For many planning areas, fewer sales are scheduled and less acreage will be offered. The Secretary has made judicious decisions on where to consider leasing, focusing on the geologic basins with resource potential that can be developed in an environmentally sound manner.

Tailoring OCS activities to regional and planning area concerns will continue during the Program's implementation. MMS is establishing a process for the consideration of leasing—the Area Evaluation and Decision Process (AEDP)—that includes decision points where determinations will be made to continue, delay, or stop the process leading to a lease sale. The AEDP will order and focus activities necessary to effectively manage OCS natural gas and oil resources.

# **FRAMEWORK AND CRITERIA FOR PROGRAM DECISIONS**

Section 18 of the OCS Lands Act specifies the criteria and analysis which must be considered in developing a 5-year OCS program. It also specifies how public comments are to be considered, and requires that a balance be struck by the Secretary in selecting the program. Given the uncertainties inherent in predictive analysis, and the importance of circumstances beyond his control, the decisions required of the Secretary do not readily lend themselves to the use of a strict formula.

Wisely, the OCS Lands Act vests the Secretary with discretion to weigh the criteria, analysis, and comments and to use his judgement in selecting the size, timing, and location of leasing for the 5-year period. Certain guiding principles were used by the Secretary in his judgements and decisions on the Proposed Final Program.

## **SECTION 18 CRITERIA**

The section 18 criteria establish an analytical basis for program decisions. Section 18(a)(2) of the OCS Lands Act states:

Timing and location of exploration, development, and production of oil and gas among the oil-and gas-bearing physiographic regions of the outer Continental Shelf shall be based on a consideration of —

- (A) existing information concerning the geographical, geological, and ecological characteristics of such regions;
- (B) an equitable sharing of developmental benefits and environmental risks among the various regions;

(C) the location of such regions with respect to, and the relative needs of, regional and national energy markets;

(D) the location of such regions with respect to other uses of the sea and seabed, including fisheries, navigation, existing or proposed sealanes, potential sites of deepwater ports, and other anticipated uses of the resources and space of the outer Continental Shelf;

(E) the interest of potential oil and gas producers in the development of oil and gas resources as indicated by exploration or nomination;

(F) laws, goals, and policies of affected States which have been specifically identified by the Governors of such States as relevant matters for the Secretary's consideration;

(G) the relative environmental sensitivity and marine productivity of different areas of the outer Continental Shelf; and

(H) relevant environmental and predictive information for different areas of the outer Continental Shelf.

For purposes of conducting the section 18 analyses, MMS has divided the OCS into 26 planning areas. Eleven OCS planning areas were not analyzed at this stage of program development. The North Atlantic, Central California, Northern California, and Washington-Oregon Planning Areas were withdrawn by the President on June 26, 1990, along with the portion of the Eastern Gulf of Mexico Planning Area north of 26° N. latitude and all but 87 blocks in the Southern California Planning Area. The Kodiak, Shumagin, Aleutian Arc, Aleutian Basin, North Aleutian Basin, Bowers Basin, and the Straits of Florida were excluded from further consideration by the Secretary's decision on the Draft Proposed Program in February 1991. The results of the section 18 analyses for the remaining 15 planning areas are presented in detail in the Proposed Final Program Secretarial Issue Document.

While these analyses establish an analytical baseline and offer some indication of the merits of considering leasing in the planning areas (e.g., for each area with resource estimates, the developmental benefits far outweigh social costs), they are by no means conclusive. The section 18 analyses contain certain inherent limitations that necessitate considerable judgement by the Secretary. The limitations arise, in part, from the fact that OCS development involves substantial uncertainties. Benefits and costs vary in differing ways depending upon:

- the precise locations of areas leased and whether industry explores for, discovers, and produces hydrocarbons in economically recoverable quantities;
- whether it is natural gas or oil that is discovered;
- future world events affecting the availability of oil imports;
- future prices of natural gas and oil;
- technological developments affecting natural gas and oil development costs and risks;
- future actions by Federal, State, and local governments affecting the levels, timing or costs of exploration for and development of natural gas and oil resources; and
- the circumstances relating to the actual effects of OCS natural gas and oil activities on the environment.

Thus, in reviewing previous 5-year programs, the courts have recognized the need for judgement in applying the results of the section 18 analyses. In *Natural Resources Defense Council, Inc, et al. v. Hodel*, 865 F.2d 288, 300 and 302 (D.C. Cir. 1988), the court states:

The standards for our review of the Secretary's program are set out in *Watt I*, 688 F.2d at 1300-03, and restated in *Watt II*, 712 F.2d. at 590-91. Briefly summarized, those deferential standards require that the record show that the

Secretary's factual determinations are based upon substantial evidence, that the Secretary's policy judgements are based upon rational consideration of identified, relevant factors, and that the Secretary's construction of the statute is permissible ... The statute sets only broad standards, and leaves much to the Secretary's discretion in achieving its goals.

Accordingly, a comprehensive approach to OCS natural gas and oil resource management has been adopted. This approach takes into account numerous factors, including comments received, guiding principles, criteria, and analyses.

## **COMMENTS ON THE PROPOSED PROGRAM**

The OCS Lands Act requires the Secretary to invite and consider suggestions on the preparation of the 5-year program from interested Federal Agencies, including the Attorney General, in consultation with the Federal Trade Commission, and from the Governors of potentially affected coastal States. The Secretary may also invite or consider suggestions from the executive of any affected local government, that have been previously submitted to the Governor of the State, and from any other person.

As of January 27, 1992, a total of 403 written comments were received on the July 1991 Proposed Program. Several petitions were also received. Comments were grouped into eight categories based on their source as indicated below.

The comments generally paralleled those received on the Draft Proposed Program. The Governors of Maine, Rhode Island, and Washington expressed satisfaction that leasing off their coasts would not be considered in the program being developed and would not be considered until additional studies have been completed. They strongly encouraged MMS to undertake a thorough environmental and geologic studies program as a necessary basis for future program decisions.

<b>Respondents</b>	<b>Number of Responses</b>
Governors	5
State Agencies	17
Local Governments	40
Congress and State Legislatures	3
Federal Agencies	11
Industry	13
Environmental/Other Organizations	39
General Public	<u>275</u>
<b>Total</b>	<b>403</b>

The Governors of Florida and California stated their opposition to OCS activities off their States' coasts. The Governor of California said that the Proposed Program was not responsive to his comments since the 87 remaining tracts to be considered offshore California had not been deleted. The Florida Governor supported the creation of a 100-mile, no-oil-and-gas-activity buffer zone for the entire State.

Comments from State agencies dealt with specific issues related to the size, timing, and location of areas to be considered for leasing. Some agencies recommended the adoption of one or more of the alternatives to the Proposed Program. Several agencies indicated their willingness to work with MMS to resolve their concerns. The North Carolina Outer Continental Shelf Office expressed its continued opposition to the program as long as leasing was scheduled off the North Carolina coast.

Twenty of the 40 local governments commenting were in California and they, as well as those in Florida, were consistently opposed to OCS development. Elsewhere, reactions of local governments were somewhat mixed. Most were concerned that OCS development could adversely affect their communities and said that the United States should rely more heavily on conservation and the development of alternative fuels. Comments from members of the California Congressional delegation and from State legislators were similar in nature.

The State of Alaska was generally supportive and some local governments in Alaska requested early consideration of leasing in their areas. Others wanted leasing delayed or prohibited because of the possible impacts on native subsistence activities and questions about the capability of industry to clean up oil spills in the Arctic environment. They argued for more studies before further consideration of leasing.

Federal agencies commenting on the environmental aspects of the Proposed Program (National Oceanic and Atmospheric Administration, Fish and Wildlife Service, and the Environmental Protection Agency) expressed no serious objections to the program, but suggested some specific areas that warrant additional study and identified areas where the creation of buffers should be considered.

The Air Force and the National Aeronautics and Space Administration expressed satisfaction at the steps being taken to ensure that no conflicts arise between OCS activities and their operations.

The Department of Justice (DOJ) stated its opinion that the program would not significantly affect competition in any relevant market. The DOJ stated that it had consulted with the Federal Trade Commission which had no comments.

With few exceptions, comments from environmental organizations and the general public were opposed to the Proposed Program. The comments are summarized below:

- Many suggested that no leasing should be permitted for specified geographic areas or for the OCS as a whole.
- The continued development, production, and consumption of fossil fuels poses a significant environmental threat, according to some respondents. The United States should undertake new and more aggressive efforts to require energy conservation and speed the development of alternative fuels.
- Many suggested that more environmental study is needed. In many instances, specific topics were cited as not having been

adequately studied or addressed in the Proposed Program Secretarial Issue Document.

- Some commenters said that compared to petroleum demand, the volume of resources on the OCS is not worth developing and that the United States has little choice but to continue to rely on oil imports.

However, some individuals and organizations were concerned that growing reliance on oil imports posed an unacceptable risk to the economy and to national security. They stated that environmentally sound development and production of natural gas and oil resources from the OCS could make an important contribution to United States energy supplies.

The general consensus of the comments from industry was that, at best, the Proposed Program provided minimal opportunities to find and develop OCS resources. However, some companies said that the program was so limited that it fell short of the mandate in the OCS Lands Act which calls for a program that "...best meets national energy needs..." Companies said that the reduced scope of the program in comparison to previous programs would mean lost revenues to the Treasury, higher oil imports, and the loss of reserves in high potential basins. Areas offshore California and Florida in the Eastern Gulf of Mexico were cited as areas that should be made available for leasing.

Companies said that claims about the potential environmental risks of OCS development were greatly exaggerated and did not reflect industry's record for safe and pollution-free operations. These claims have caused States and local governments in some areas to adopt laws and policies which have made it virtually impossible to conduct OCS operations in an orderly, businesslike manner. Consequently, many companies are increasingly moving overseas where countries are eager to take advantage of their expertise and the energy and economic benefits they generate. The companies said that this trend is detrimental to the best interests of the United States because it will cause a loss of jobs and economic opportunities domestically and will ultimately lead to higher oil imports. Some companies pointed out that



tankers entering U.S. waters with imported oil pose a far greater risk to the coastal and marine environments than do OCS operations.

Of the comments received on the AEDP, most respondents supported the process and said that it should lead to better decisions about future activities on the OCS. Some respondents suggested specific changes to the process to make it more effective.

A *Federal Register* Notice was published on December 17, 1991, asking for comments on the alternative of expanding the area proposed for leasing consideration and renaming the planning area for the Proposed OCS Oil and Gas Lease Sale 149, from Cook Inlet to Cook Inlet/Shelikof Strait. Additionally, comments were requested on the alternative of selecting St. George Basin and Hope Basin as the two areas for leasing consideration among the five lower potential Alaska planning areas in the Proposed Program. Thirty-two comments were received in response to the Notice.

Four local governmental bodies commented on the proposed expansion of the Cook Inlet Planning Area; three governments supported the expansion and one opposed it. One other local government urged that the Norton Basin not be deleted from the program, but did not comment on the expansion of the Cook Inlet Planning Area. The proposed expansion was supported by industry, but opposed by environmental groups. The proposed name change was generally supported by all respondents.

The State of Alaska and industry supported the option of considering Hope Basin and St. George Basin as the two planning areas among the five low interest Alaskan planning areas in the Proposed Final Program. This option was supported by some local governments but was opposed by other local governments and by environmental groups.

## **CONGRESSIONAL MORATORIA**

Through the annual appropriations process, Congress has enacted a series of "one-year" leasing moratoria on large portions of the OCS.

Beginning in 1982 with a 736,000-acre leasing moratorium, Congress has extended and enlarged the areas under moratoria. The fiscal year 1992 DOI appropriations bill contains prohibitions against preleasing, leasing, and/or the permitting of exploratory activities for, in effect, the entire Atlantic and Pacific Coasts, the entire Eastern Gulf of Mexico, and the North Aleutian Basin in Alaska. In total, the fiscal year 1992 moratoria place more than 462 million acres off-limits, more than a 600-fold increase since 1982.

The Administration and the Department have consistently opposed these moratoria because they are not a sound approach to designing offshore leasing policy. Imposing moratoria in this manner negates the orderly procedures for making leasing decisions established in the OCS Lands Act and ignores the consultation process and analyses involved in the development of the 5-year program and in the planning for specific sales. Nevertheless, the moratoria have been continued and, as such, were considered in developing the Proposed Final Program.

## **PRINCIPLES FOR DEVELOPING PROGRAM OPTIONS**

Many of the factors, criteria and constraints discussed above are inherently incompatible. For example, comments from State and local governments in some geographic areas strongly oppose all OCS leasing and development activities even though the section 18 analyses and previous experience indicate that such activities can take place in a manner that poses no undue environmental risks. To attempt to reconcile these conflicts, the following guiding principles were applied, consistent with the OCS Lands Act requirements, in developing and selecting options for the size, timing and location of areas proposed for consideration of leasing.

- Balance consideration of leasing areas which have proven to be reliable sources of OCS natural gas and oil with leasing in areas elsewhere on the OCS in which exploration is needed to expeditiously determine the extent of natural gas and oil resources.

- **Emphasize gas-prone areas to promote the expeditious development of natural gas as an environmentally preferable energy source.**
- **Give priority leasing consideration to areas where the combination of previous experience; expressions of local, State, and national laws and policies; and industry interest indicate that potential leasing and development activities could be expected to proceed in an orderly manner.**
- **For areas with estimated hydrocarbon resources, only consider leasing if, from a national perspective, estimated developmental benefits substantially outweigh estimated environmental risks.**
- **Consider environmentally sound leasing in areas where MMS estimates there is little or no hydrocarbon potential if some industry interest exists.**
- **Seek to accommodate the recommendations of coastal Governors, and State and local agencies.**
- **Consider measures such as buffer zones to mitigate potential damages in clearly defined environmentally sensitive areas.**
- **Develop a process designed to improve communication with affected parties, further promote informed decisionmaking, and resolve conflicts prior to a decision to hold a lease sale.**
- **In light of the above principles, schedule proposed lease sales based on the net social value groupings of planning areas, the analyses prepared for the other section 18 factors, public comments, and the expected length of the evaluation and decision process for each OCS region.**

**The program options described in detail in the Secretarial Issue Document have been formulated in light of the factors and principles described above and the balancing considerations described in the following section.**

## **ACHIEVING A BALANCED PROGRAM**

Although the section 18 analyses and a rigorous environmental impact analysis are necessary for the formulation and evaluation of program options, they do not yield a precise formula which the Secretary can use to select a leasing program. The OCS Lands Act recognizes this in requiring the exercise of judgement in balancing a broad range of relevant factors rather than imposing such a formula. Specifically, the Act requires that:

The Secretary shall select the timing and location of leasing, to the maximum extent possible, so as to obtain a proper balance between the potential for environmental damage, the potential for the discovery of oil and gas, and the potential for adverse impact on the coastal zone.

Thus, in making decisions on the program, the Secretary must weigh the possible environmental and coastal impacts that might result from proposed OCS activities against the likelihood of discovering natural gas and oil and, under the stated purposes of the Act, the significance of any production that might result to U.S. economic and security interests.

### **PRESERVING THE ENVIRONMENT**

In their comments on the Draft Proposed Program and the Proposed Program and the accompanying EIS, State and local governments, environmental organizations, and the public expressed a wide range of concerns about the potential environmental and socioeconomic impacts of OCS leasing and development. Overshadowing all other concerns was the fear that a large oil spill would cause permanent, widespread damage to coastal areas and marine life. Many commenters said that such a spill would be an environmental and economic disaster since coastal communities rely heavily on tourism and fishing as their main sources of revenue.

Even though the risk of an oil spill is small, because of the potential threat to coastal and marine environments, MMS has devoted substantial resources over the years to deal with this issue. Therefore, in assessing the risks associated with OCS operations, it is necessary to examine the record of the offshore natural gas and oil industry and the measures taken to protect sensitive coastal and marine resources.

### **OCS Pollution Control Record**

Through advancements in drilling and production technology and continuing improvements in MMS regulation of operations, the OCS program has achieved an admirable record for conducting clean, safe operations. For the 20-year period 1971-1990, total spillage associated with OCS operations was 107,648 barrels, an average of 5,382 barrels per year. In comparison, crude oil production during this same period has averaged 340 million barrels per year, resulting in a spill rate of one barrel spilled for every 63,174 barrels produced, or less than 2 one-thousandths of one percent. During the same 20-year period, there have been only 11 spills greater than 1,000 barrels from OCS activities and none is known to have caused any significant environmental damage.

The record of OCS operations is outstanding compared to other potential sources of oil released into the world's oceans. The 1985 National Academy of Sciences (NAS) report, *Oil in the Sea - Inputs, Fates, and Effects*, found that offshore oil production accounted for less than two percent of all the oil in the world's seas and oceans. By contrast, marine transportation accounted for almost 46 percent. Natural sources—primarily seepage of oil from the ocean floor—accounted for four times the amount of oil that came from offshore oil production.

The environmental advantage of offshore production, about 95 percent of which is brought to shore via pipelines, compared to oil tankering was recognized by the Congressional Research Service (CRS) in a 1990 report. The CRS stated:

It is widely recognized that the spill risk for domestically produced OCS oil is far less than that for tankered oil both from abroad and from domestic onshore production ... . The volume of oil spilled into U.S. waters will likely increase as tankered imported oil is substituted for OCS production. <sup>1</sup>

Furthermore, more than two-thirds of the hydrocarbons produced offshore is natural gas, a clean burning fuel that would produce little or no ocean pollution in the event of an accident. Increased use of natural gas is a vital component of the Nation's energy and environmental policies. Many OCS areas which have experienced little or no development, including the North and Mid-Atlantic, the Eastern Gulf of Mexico, off the Alabama-Florida Panhandle coasts, and the Pacific Northwest, are thought to contain significant gas resources.

### **Protecting Sensitive Coastal and Marine Resources**

MMS, in its leasing and permitting decisions, places great emphasis on identifying and analyzing the potential damage that could result from OCS operations. Environmental analyses are conducted at various stages, beginning with the broad-based programmatic EIS for the 5-year program to analyses prior to a lease sale through postlease operations.

At the programmatic stage, hypothetical scenarios are developed to estimate the level of exploration and development activities and accidental events (such as oil spills) that might result if the areas were actually leased and developed. The impacts on the environmental resources, representing the aggregation of all the changes that result from activities and accidental events, are described in a draft and final programmatic EIS. This information is then used, along with other factors, in making decisions to include or exclude areas from further consideration of leasing.

---

<sup>1</sup> "Impact of Persian Gulf Crisis on Federal Offshore Leasing," CRS Review, Congressional Research Service, November-December 1990.

Once an area is designated for consideration of leasing in an approved 5-year program, more detailed, site-specific studies are performed. Enhanced opportunities for State and local participation in the assessment and evaluation of the environmental data for leasing decisions are provided and particular attention is focused on the adequacy of data for decisionmaking purposes. An integral part of this process is the preparation of sale-specific draft and final EIS documents.

If a decision is made to conduct a sale, lease stipulations, designed to offer an extra measure of protection to particular biological, geological, or cultural features, are included in the sale and lease terms. Before a lease sale can be held, potentially affected States having an approved coastal zone management program are given an opportunity to indicate their views on whether the proposed sale and subsequent development activities are consistent with their management programs.

Environmental reviews continue even after the leases are issued to ensure that operations will not cause serious, long-term damage to the environment. Through this ongoing, iterative analysis and review process, MMS ensures that potential impacts from OCS operations, including oil spills, do not pose unacceptable environmental risks. To date, MMS has spent more than \$530 million on scientific research to enhance the understanding of the potential impacts of natural gas and oil exploration on the OCS.

## **MEETING U.S. PETROLEUM AND NATURAL GAS REQUIREMENTS**

The importance of energy to the quality of life in the United States cannot be overstated. Energy use, in its various forms, touches the lives of every American in thousands of ways every day. Energy is a major factor underlying the Nation's economic strength and prosperity. The United States represents less than five percent of the world's population, but produces one-fourth of global economic output. Energy, especially oil and natural gas, is at the heart of this productivity. However, the fact that nearly one-half of the oil consumed must be imported, much of it from the politically volatile Persian Gulf region, poses a serious threat to the Nation's economic well-being.

Following the major oil supply disruptions and resulting price shocks of the 1970's, the United States has made substantial strides in using energy more efficiently and in converting many fuel uses from oil to other energy sources. As a result, the severe energy shortfalls predicted in many of the energy forecasts of the 1970's have been avoided.

In spite of these accomplishments, the United States is still dependent on petroleum for about 40 percent of the energy it consumes. Most significant is the U.S. transportation sector's 98 percent dependence on oil. While there has been only a moderate increase in demand over the last few years, domestic crude oil exploration and production have fallen sharply, leading to higher levels of oil imports.

The gap between domestic demand and production must be met with oil purchased abroad. Net imports of crude oil and refined products in 1991 were about 40 percent of domestic petroleum consumption as compared to 35 percent in 1973, the year of the Arab oil embargo. Since 1985, imports from the politically volatile Persian Gulf region have risen from 300,000 barrels per day to about 1.8 million barrels per day, representing 28 percent of U.S. net oil imports, thus making the United States significantly more vulnerable to a serious disruption in oil imports.

The purchase of large quantities of imported oil is a continuing strain on the U.S. economy. In 1991, the United States spent nearly \$51 billion on imported oil—money spent abroad instead of in the domestic economy. In contrast, money invested in the production of OCS petroleum resources would help reduce the trade deficit and would create economic growth and development all across the country. According to the Bureau of Labor Statistics, each \$1 million invested in the oil and gas extraction industry creates about 20 new jobs in all sectors of the economy.

In addition to jobs, economic benefits from the OCS program include OCS bonus payments, rents, and royalties. To date, the OCS program has collected about \$100 billion in revenues which are dispersed to U.S. Treasury accounts, to coastal States under section 8(g) of the OCS Lands Act, and to the Land and Water Conservation Fund for Federal acquisition of park, conservation, and recreation areas nationwide, and



for grants-in-aid to States and local governments to help them acquire, develop, and improve outdoor recreation areas. Funds are also provided to the States for the preservation of historic sites.

## **National Energy Strategy Proposals**

The National Energy Strategy (NES) issued by the Department of Energy (DOE) in February 1991, points out that the United States is part of a complex and interdependent world market for oil. Products flow to where the demand is greatest, as reflected by the highest price. Any increase in world oil prices will raise oil prices in the United States. The oil price shocks of the past have demonstrated the harmful consequences—inflation, unemployment, and recession—that abrupt price increases have on the American economy.

To reduce our economic vulnerability, the NES proposes a wide range of actions for petroleum conservation and the development of alternative fuels. Nevertheless, the NES recognizes that these measures, alone, cannot protect the U.S. economy. Steps to increase domestic energy production are essential and include: the use of advanced oil recovery technology; the environmentally responsible development of the coastal plain of the Arctic National Wildlife Refuge; and the implementation of an environmentally sound OCS leasing program.

With regard to the OCS, the NES states:

... production of the economically recoverable oil and gas reserves of the OCS is important for meeting national energy needs. The National Energy Strategy recommends that the OCS areas currently under congressional moratoria, along with those now available for leasing, be considered by the Secretary of the Interior in formulating the new 5-Year OCS Program for 1992-1997. All areas that can be developed in an environmentally sound manner should be included in the new program.

## **The Role of the OCS in Meeting U.S. Energy Needs**

The OCS plays a major role in U.S. energy production today, and could play an even larger role in the future. In 1991, OCS lessees produced about 4.5 trillion cubic feet of natural gas and about 323 million barrels of crude oil and condensate—about 25 percent of the natural gas and 12 percent of the crude oil produced in the entire United States. The latest estimate of undiscovered economically recoverable resources on the OCS is about 75 trillion cubic feet of natural gas and about 11 billion barrels of crude oil—about one-third of all the recoverable natural gas and oil resources remaining to be discovered in the United States. However, these resources can be found and produced for the benefit of the American economy only if leasing, exploration, and development are permitted.

Some respondents to the Proposed Program said that offshore areas should not be developed because they can only provide the whole nation a few days or weeks of oil and gas supplies at current rates of consumption. Measuring a field's potential production in this manner is misleading. Few fields ever discovered in the United States provide anything more than this amount. Furthermore, most fields contribute to domestic energy supplies over decades—a typical field produces for 20 to 30 years. Comparing any field's reserves to the nation's total consumption can make it appear insignificant, just as any individual farm produces only a small portion of the total food supply. Indeed, even the combined output of many fields is insufficient to support U.S. energy demand.

Specifically, of the more than 27,000 producing oilfields in the United States, almost 80 percent have reserves of less than 1 million barrels—far less than the U.S. daily consumption of 17 million barrels. About three-fourths of the more than 620,000 producing wells in the United States at the beginning of 1988 produced 10 barrels of oil or less per day. Thus, individually, the vast majority of the thousands of fields and hundreds of thousands of wells can produce only a few minutes' consumption, but taken together they make up our total domestic production.

While most discussion of the OCS tends to focus on the exploration and production of oil, offshore production of natural gas accounts for two-thirds of all hydrocarbons produced on the OCS, on an energy equivalent basis. Natural gas can replace oil and coal in important applications such as home heating, industrial processing, and electricity generation. Compressed natural gas and methanol derived from natural gas can substitute for gasoline and diesel fuel in automobiles.

## **DETAILS OF THE DECISION**

Comments received in response to the Proposed Program included a variety of recommendations and suggestions for change. The comments were thoroughly reviewed and with revisions to the analyses, were instrumental in the development of new options in the Decision Documents and in the EIS. These documents were presented to Secretary of the Interior Manuel Lujan, Jr. for his consideration in selecting the program that, within the constraints discussed above, best meets the energy needs of the Nation and achieves the appropriate balance between avoiding adverse impacts on the environment and providing opportunities for the discovery of natural gas and oil.

The following provides the details of the Secretary's decision.

### **TIMING AND LOCATION OF LEASING CONSIDERATION**

Evaluation and management of OCS natural gas and oil activities will be regionally tailored so they better reflect each OCS region's environmental features and respond to views expressed by State and local governments and the public.

#### **General Program Decisions**

The Proposed Final Program considers for geologic and environmental studies all OCS Planning Areas, with the exception of the Straits of Florida, Aleutian Arc, Bowers Basin, and Aleutian Basin. Such studies would support decisions for sales proposed in 1992-1997 as well as decisions on subsequent 5-year programs. The extent and timing of the studies would be based on information needs for the AEDP for each sale in the 1992-1997 program, other study plans and commitments and budgetary constraints. The planning area boundaries remain the same as those in the Proposed Program, with minor technical adjustments.

The following sections present the decisions made for each of the OCS regions and the differences, if any, between the decisions in the Proposed Program and the Proposed Final Program. The timing of the steps leading up to the proposed lease sales is shown in Table 2.

### **Atlantic Region**

The Proposed Final Program considers one sale in 1996 combining portions of the Mid- and South Atlantic. A total of 916 blocks extending from 40° N. latitude to the Florida-Georgia boundary (see Map 1) will be considered. The Proposed Final Program deletes from consideration 22 blocks adjacent to the North Atlantic Planning Area which had been included in the Proposed Program. At the Area Identification stage of the AEDP process, the leasing proposal for further consideration will be capped at 250 blocks.

The Proposed Program considered two sales in the combined planning areas, one each in 1994 and 1997.

### **Gulf of Mexico Region**

In the Eastern Gulf of Mexico, the scheduling of one sale in 1995 will be considered. The area to be considered generally lies west of 84° W. longitude and north of 26° N. latitude (see Map 2). The Proposed Final Program deletes the low interest area which had been included in the Proposed Program. The Area Identification step will cap the area to be considered further at 200 blocks.

The Proposed Program decision was to consider two sales, one each in 1994 and 1997.

In the Central and Western Gulf of Mexico, an annual pace of leasing will be maintained; the area under consideration for leasing generally encompasses the entire planning area with the exception of the Flower Garden Banks National Marine Sanctuary (see Map 2). In addition, MMS will pursue further consultation on the pace of offering deepwater tracts.

Table 2. TENTATIVE PLAN FOR THE AREA EVALUATION AND DECISION PROCESS

Planning Area/Sale	I*	CALL	AREA ID	DEIS PNS	HEARINGS	FEIS CD	NOS	SALE
Mid & South Sale 164	Early 93	Mid 93	Mid 94	Early 95	Mid 95	Mid 96	Mid 96	Late 96
Eastern GOM Sale 151	Late 92	Early 93	Mid 93	Mid 94	Late 94	Mid 95	Late 95	Late 95
Central GOM Sale 142	**	**	**	**	Mid 92	Late 92	Early 93	Early 93
Central GOM Sale 147 <sup>1</sup>	**	**	Mid 92	Early 93	Mid 93	Late 93	Early 94	Early 94
Western GOM Sale 141	**	**	**	**	**	**	**	Mid 92
Western GOM Sale 143	**	**	**	**	Mid 92	***	Mid 93	Mid 93
Western GOM Sale 150 <sup>2</sup>	**	**	Mid 92	Early 93	Mid 93	***	Mid 94	Mid 94

See footnotes below

Table 2. Continued

Gulf of Alaska/Yakutat Sale 158	**	Late 92	Early 93	Mid 94	Mid 94	Early 95	Mid 95	Mid 95
Cook Inlet/Shelikof Strait Sale 149	**	**	Mid 92	Mid 93	Mid 93	Mid 94	Mid 94	Late 94
St. George Basin Sale 153	**	**	Mid 92	Late 93	Late 93	Mid 94	Late 94	Late 94
Hope Basin Sale 159	Mid 94	Late 94	Early 95	Mid 96	Mid 96	Early 97	Mid 97	Mid 97
Chukchi Sea Sale 148	Mid 93	Mid 93	Early 94	Early 95	Mid 95	Late 95	Mid 96	Mid 96
Beaufort Sea Sale 144	Early 93	Early 93	Mid 93	Late 94	Late 94	Mid 95	Late 95	Late 95

<sup>1</sup>The timing for the process as applied to sale 147 will also apply to the balance of the Central GOM sales (sale 152 - Early 1995; sale 157 - Early 1996; and sale 166 - Early 1997)

<sup>2</sup>The timing for the process as applied to sale 150 will also apply to the balance of the Western GOM sales (sale 155 - Mid 1995; and sale 161 - Mid 1996)

\* Steps in the Area Evaluation and Decision Process (AEDP)

I	
CALL	
PAAM	
AREA ID	
DEIS	

Information Base Review

Call for Information and Nominations (45-day comment period)

Proposed Action and Alternatives Memorandum

Area Identification

Draft Environmental Impact Statement

PNS
FEIS
CD
NOS

Proposed Notice of Sale (90-day comment period)

Final Environmental Impact Statement (30-day comment period)

Consistency Determination (90-days before decision on NOS)

Notice of Sale

\*\* Completed

\*\*\* FEIS only - the CDs for sales 143 and 150 will be prepared in early 1993 and 1994, respectively

## **Pacific Region**

The Proposed Final Program will not consider a sale in the Southern California Planning Area.

The Proposed Program considered a sale in this area, but only after certain conditions set forth by the President were met.

## **Alaska Region**

(All Alaska Planning Areas are depicted in Map 3.)

Gulf of Alaska - As in the Proposed Program, a 1995 sale limited to the Yakutat area will be considered . During the sale AEDP, an alternative to establish a coastal buffer off the Yakutat area will be considered (see Map 4).

Cook Inlet/Shelikof Strait - As in the Proposed Program, a 1994 sale will be considered. However, in the Proposed Final Program an enlarged area of 761 blocks will be considered with a limit of 250 leases issued.

Hope Basin and St. George Basin - The Proposed Final Program considers a 1994 sale in the St. George Basin and a 1997 sale in the Hope Basin. During the AEDP for the St. George Basin, consideration will be given to establishing a 30-mile buffer off the Pribilof Islands (see Map 5). Similarly, consideration will be given to establishing a coastal buffer for migratory whales in Hope Basin (see Map 6).

The Proposed Program decision was to consider a 1995 sale in either Hope Basin or St. George Basin.

Norton Basin, Navarin Basin, and St. Matthew-Hall - The Proposed Final Program will not consider a sale in any of these areas in 1992-1997.

The Proposed Program considered the scheduling of a 1996 lease sale in one of the three areas.



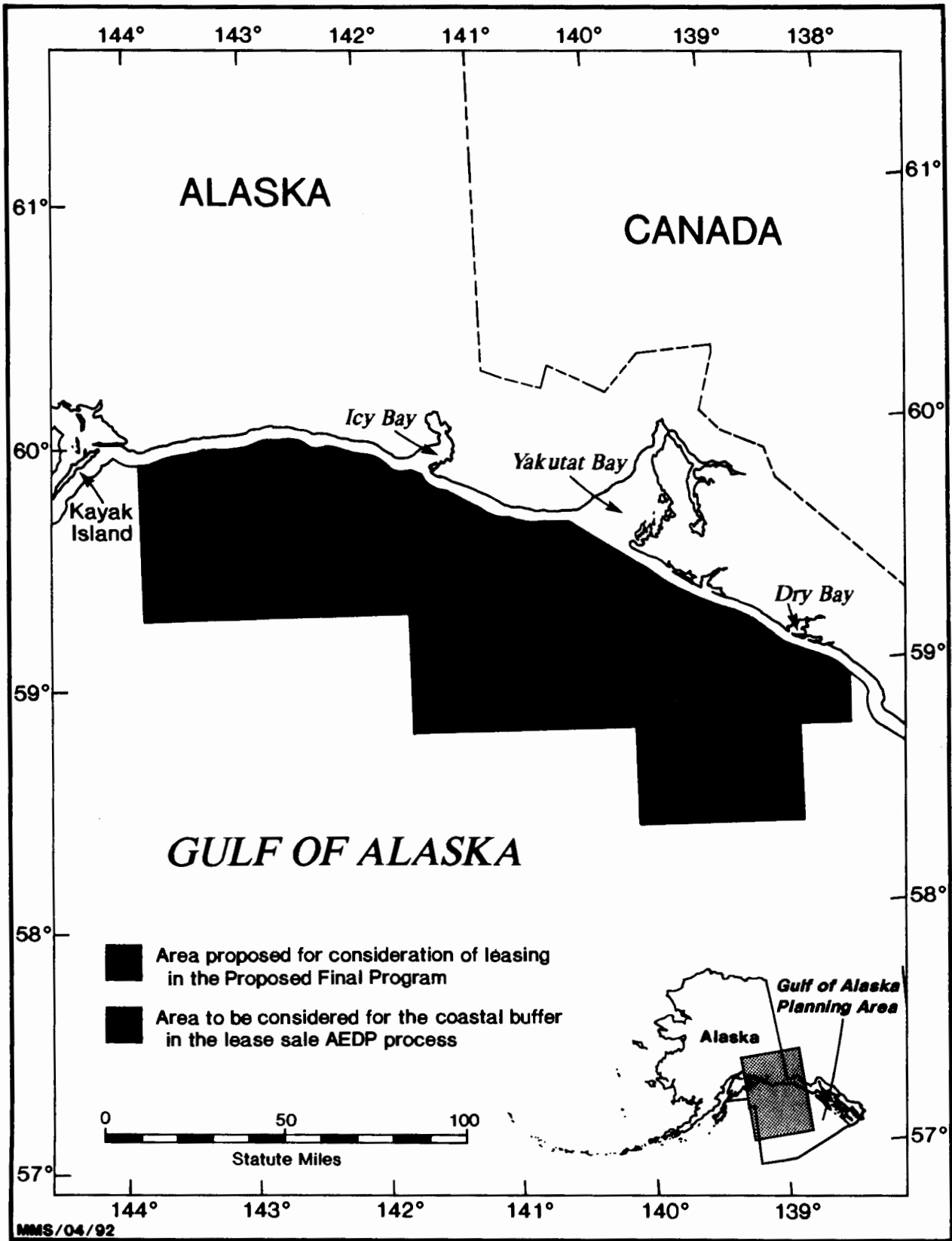

Map 4. Gulf of Alaska - Coastal Buffer Offshore the Yakutat Area

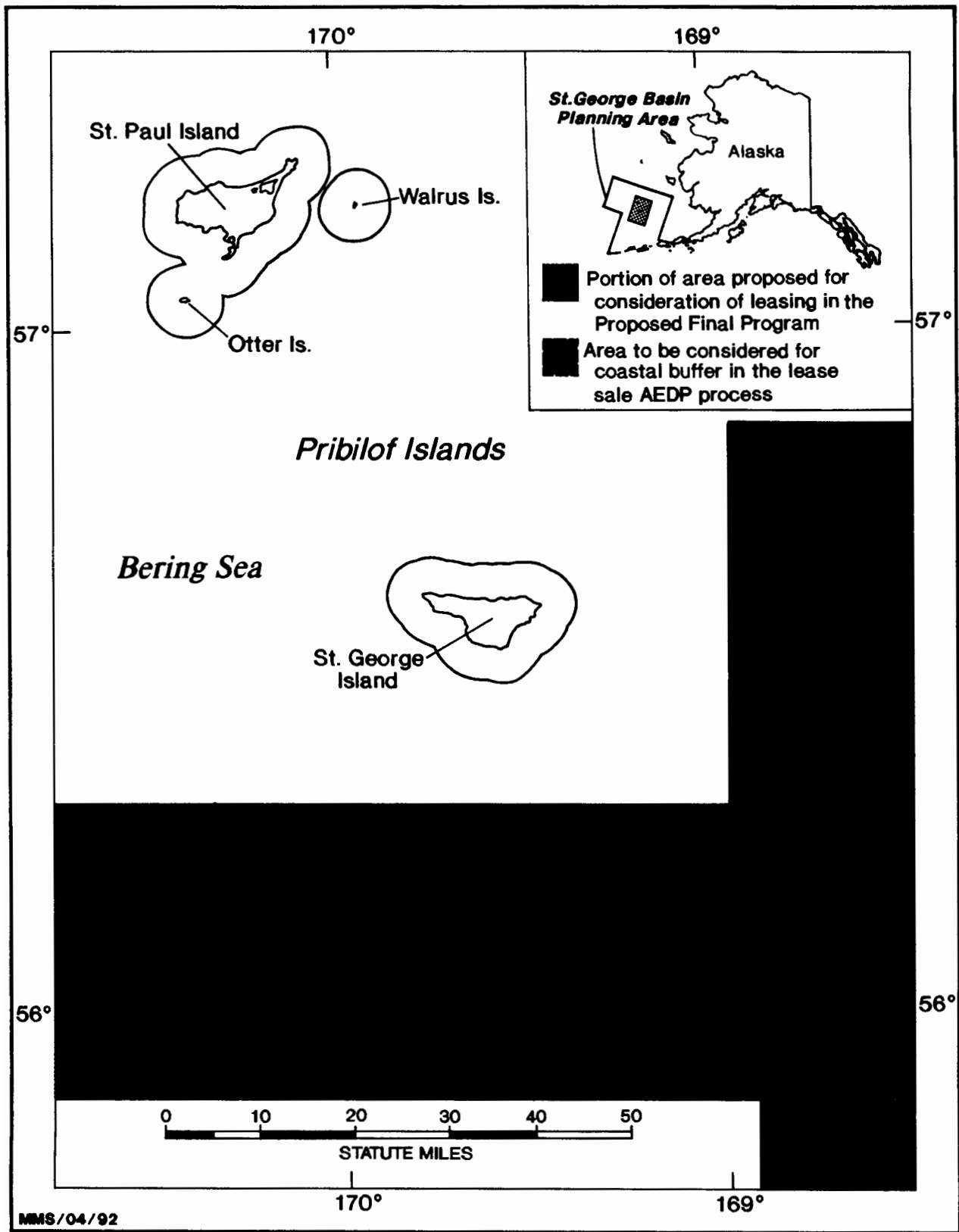

**Map 5. St. George Basin– Coastal Buffer**

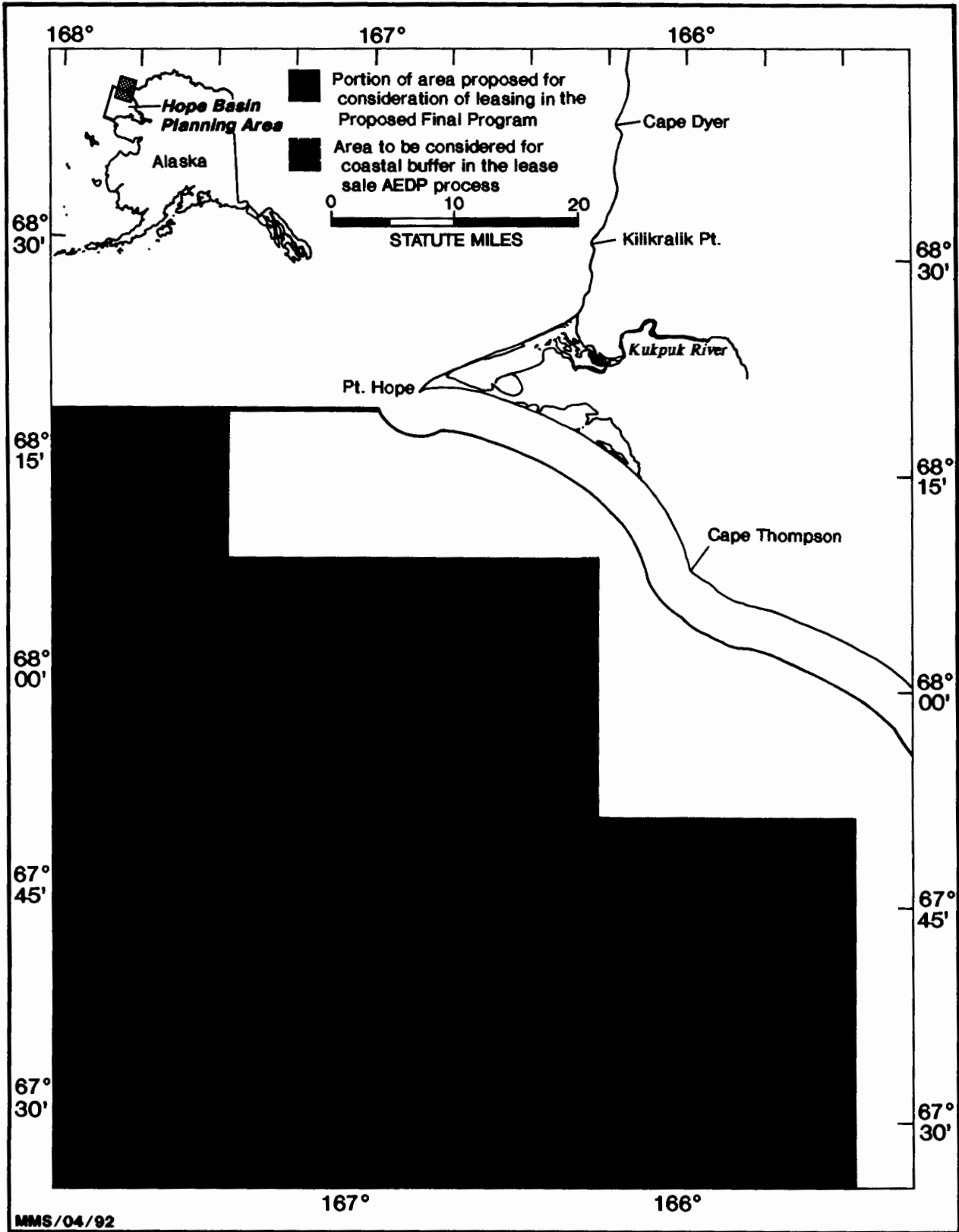

Map 6. Hope Basin– Coastal Buffer

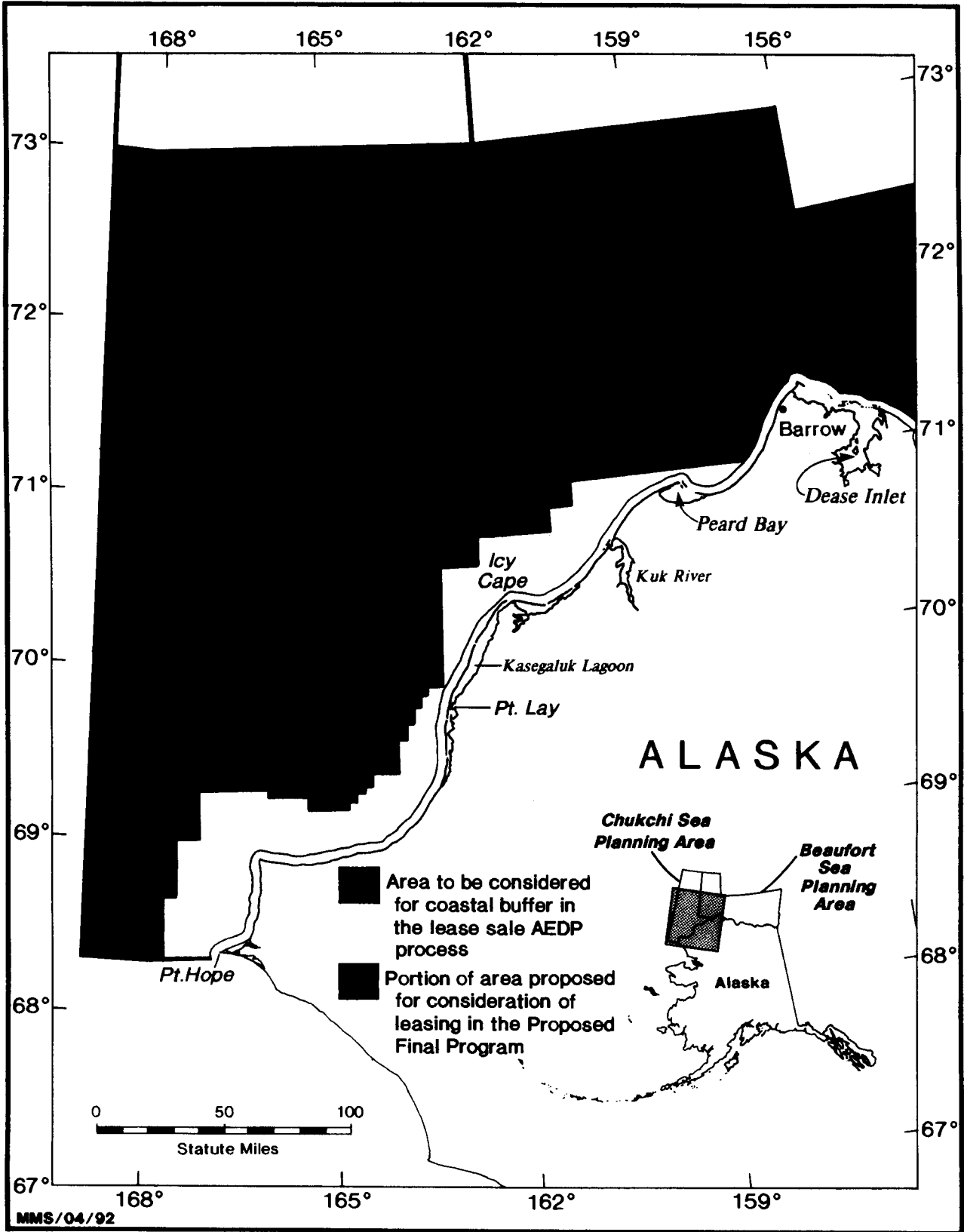

**Map 7. Beaufort Sea and Chukchi Sea—Coastal Buffers**

**Chukchi Sea** - The Proposed Final Program will consider only one sale in 1996 in this planning area. During the AEDP for the 1996 sale, consideration will be given to establishing a coastal buffer (see Map 7).

The Proposed Program extended the planning area boundary and considered lease sales in 1994 and 1997.

**Beaufort Sea** - The Proposed Final Program will consider one sale in 1995. During the AEDP for the 1995 sale, consideration will be given to establishing a coastal buffer adjacent to Barrow (see Map 7).

The Proposed Program extended the planning area boundary and considered lease sales in 1993 and 1996.

## **AREA EVALUATION AND DECISION PROCESS**

The AEDP provides a framework for the activities which precede the decision on whether and under what conditions to hold an individual lease sale. The AEDP has three objectives:

- Improving the acquisition and integration of environmental, mineral resource, and socioeconomic information to improve the quality of decisions;
- Defining leasing proposals more selectively; and
- Enhancing the opportunities for States, coastal communities, and other concerned parties to provide input into the development of plans for the management of offshore natural gas and oil resources.

The Proposed Final Program adopts the AEDP as described in the Proposed Program except that the two earliest steps, the Request for Interest and Comments and the Information Base Review, will be combined in all planning areas proposed for leasing consideration.

The AEDP process is depicted in Figure 1.

# Area Evaluation and Decision Process

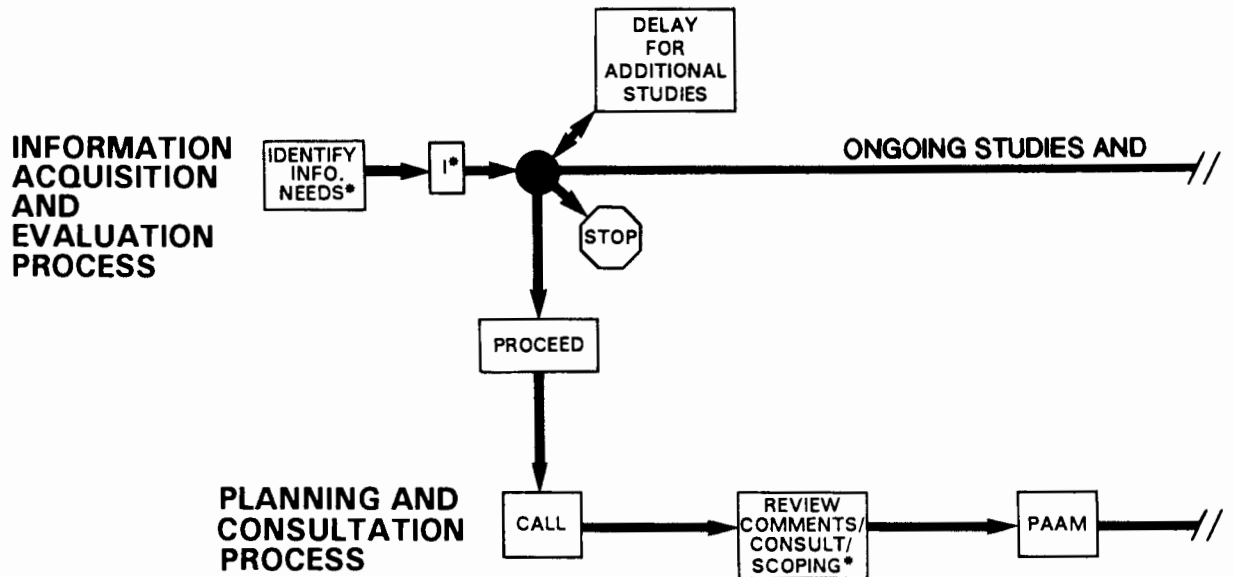

Decision Point

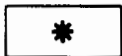

Consultation, using appropriate coordination mechanisms (Options: Workshops; ITM's; RTWG's; Biological Task Forces; State/Federal Task Forces; Regional Studies; etc.)

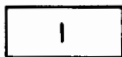

Information Base Review

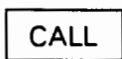

Call for Information and Nominations (45-day comment period)

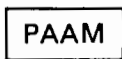

Proposed Action and Alternatives Memorandum

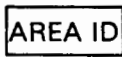

Area Identification



Draft Environmental Impact Statement Proposed Notice of Sale (90-day comment period)

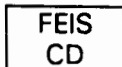

Final Environmental Impact Statement (30-day comment period) Consistency Determination (90-days before decision on Notice of Sale)

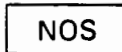

Notice of Sale



Action line



Future planning

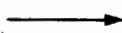

Information transfer

**ANALYSIS OF  
DECISION  
OPTIONS  
PROCESS**

# Proposed Final Program

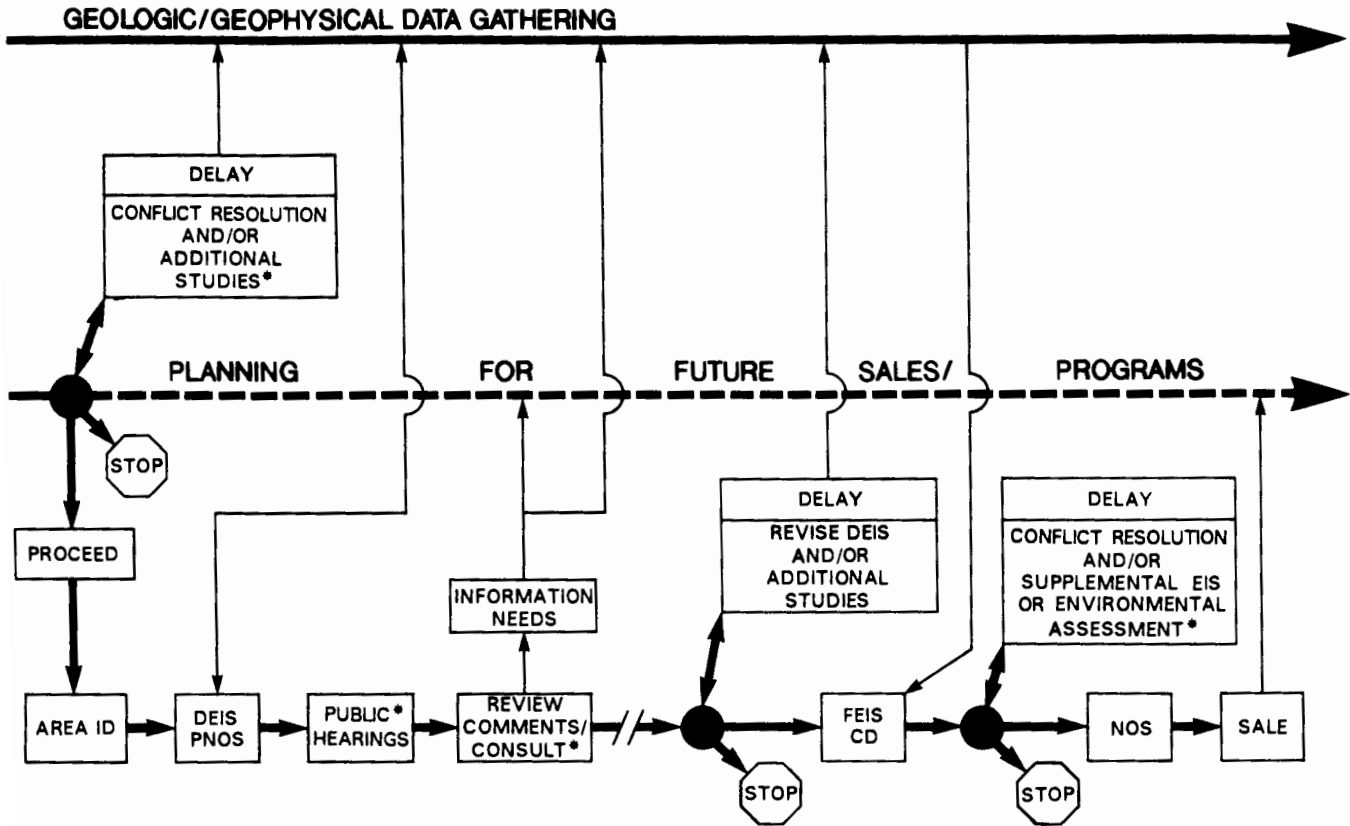

## **FAIR MARKET VALUE**

The Proposed Final Program requires a minimum bid of \$25 per acre on all tracts offered, subject to a sale-by-sale reconsideration. Beyond the minimum bid level, MMS applies established bid adequacy criteria for each sale to ensure that fair market value is received for all leases awarded. There is no change from the Proposed Program.



## GLOSSARY

**Area of Hydrocarbon Potential** - An area which has the primary geologic characteristics favorable for the generation and the accumulation of hydrocarbons.

**BBL** - Billions of barrels.

**BBOE** - Billions of barrels of oil equivalent.

**Bid** - An offer for an OCS lease submitted by a potential lessee in the form of a cash bonus dollar amount or other commitments as specified in the final notice of sale.

**Block** - A numbered area on an OCS leasing map or official protraction diagram. (See "OCS Leasing Maps and Official Protraction Diagrams.") Blocks are segments of OCS leasing maps and official protraction diagrams that are portions of planning areas. Blocks vary in size, but are typically ones are 5,000 to 5,760 acres (approximately 9 square miles). Each block has a specific identifying number, area, and latitude and longitude coordinates that can be pinpointed on a leasing map or official protraction diagram. See "Tract."

**Bonus** - Advance money offered by a bidder for the right to be awarded an oil and gas lease.

**Coastal Zone** - Coastal waters and the adjacent shorelands strongly influenced by each other. Note: the term "Coastal Zone" has a special meaning when the word is used in the context of Coastal Zone Management

(CZM) programs. When used in that context, "Coastal Zone" means State coastal waters and adjacent lands identified by a State in its approved CZM program.

**Crude Oil** - A mixture of liquid hydrocarbons that exists in natural underground reservoirs. It remains liquid at atmospheric pressure after passing through surface separating facilities. The term does not include liquid hydrocarbons produced from tar sand, gilsonite, oil shale, or coal. Crude oil ranges from very light (high in gasoline) to very heavy (high in residual oil). Sour crude is high in sulphur content.

**Development** - Activities following exploration including the installation of facilities and the drilling and completion of wells for production.

**Development and Production Plan** - A plan submitted by industry to MMS for approval which describes activities beyond exploration until the lease expires, such as facility installation, drilling and production, etc.

**Economically Recoverable Resource Estimate** - An assessment of hydrocarbon potential that takes into account (1) physical and technological constraints on production and, (2) the influence of development, operation, and transportation costs as well as market price on industry investment in OCS production activities. These estimates may be conditional (i.e., exclude the outcome where all of the designated prospects are either dry or

uneconomical to develop) or risked (i.e., include the possibility of no production in the area).

**EIS** - See "Environmental Impact Statement."

**Environmental Assessment** - A public document required by the National Environmental Policy Act (NEPA). In the document, a Federal Agency proposing an action provides evidence and analysis for determining whether it must prepare an EIS or whether it finds there is no significant impact.

**Environment Impact Statement** - A statement prepared by a Federal Agency in compliance with NEPA for any major action that could have a significant effect on the human environment.

**Exploration** - The process of searching for minerals preliminary to development. Exploration activities include (1) geophysical surveys, (2) any drilling to locate an oil or gas reservoir, and (3) the drilling of additional wells after a discovery to delineate a reservoir. It enables the lessee to determine whether to proceed with development and production.

**Exploration Plan** - A plan submitted by a lessee that identifies and evaluate all the potential hydrocarbon accumulations and wells that the lessee proposes to drill. All lease operators are required to obtain approval of such a plan by an MMS Regional Director before exploration activities may commence.

**Field** - A geographical area in which one or more oil or gas wells produce. A field may refer to surface area only or

to underground productive formations. A single field may include several reservoirs separated either horizontally or vertically.

**Hydrocarbon** - Any of a large class of organic compounds containing primarily carbon and hydrogen. Hydrocarbons include crude oil and natural gas.

**Lease** - A contract authorizing exploration for and development and production of minerals for a specified period of time over a given area. The meaning of "lease" depends upon its use in context.

**Lease Sale** - An MMS proceeding by which leases for certain OCS tracts are offered for sale by competitive sealed bidding and during which bids are received, announced, and recorded.

**Lease Term** - Duration of a lease. Oil and gas leases are issued for an initial period of 5 years or not to exceed 10 years where such a longer period is necessary to encourage exploration and development in areas because of unusually deep water or other adverse conditions. Once production is achieved, the term continues as long as production continues.

**Lessee** - A person or person to whom a lease is awarded; the recipient of a lease. See Operator."

**Marginal Probability** - Probability that economically recoverable oil and gas resources exist in the area under study.

**Mean** - The average or expected value; calculated by summing all values and dividing by the number of values.

**Natural Gas** - A mixture of hydrocarbon compounds and small quantities of various nonhydrocarbons existing in gaseous phase at the surface or in solution with crude oil in natural underground reservoirs at reservoir conditions.

**NEPA** - National Environmental Policy Act

**Net Economic Value** - The difference between the estimated gross market value of production and the associated costs of production, expressed in terms of risked, discounted dollars.

**Net Social Costs** - Social costs minus oil spill costs associated with tankering avoided because OCS production reduces the nation's need to import oil.

**Net Social Value** - The difference between the net economic value and the net social costs.

**OCS Leasing Maps and Official Protraction Diagrams** - Basic geographical records; maps used in lease sales. Leasing maps are used in the Gulf of Mexico (nearshore Texas and Louisiana) and in small areas offshore California. Leasing maps are developed on the basis of extensions of the leasing grids used onshore. Most of the offshore area is mapped on official protraction diagrams (OPD's) using the Universal Transverse Mercator grid system. Each OPD covers 1° latitude by 2° longitude (except for offshore Alaska which is 1° latitude by 3° longitude) and is divided into blocks. See "Block."

Each leasing map or OPD bears a distinct alphanumeric number and in most cases a name based on onshore

land features, a nearby city or town, or the hydrographic features contained within the limits of the diagrams. Shoreline detail is also depicted on the OPD when it falls within the limits of the particular diagram.

**Official Protraction Diagram** - See "OCS Leasing Maps and Official Protraction Diagrams."

**Operator** - The individual, partnership, firm, or corporation having control or management of operations on a leased area or a portion thereof. The operator may be a lessee, designated agent of the lessee, or holder of rights under an approved operating agreement.

**Outer Continental Shelf (OCS)** - The part of the continental shelf beyond the line that marks State ownership; that part of the offshore lands under Federal jurisdiction.

**Planning Area** - Most of the OCS is analyzed by MMS. For this purpose, the OCS is divided into planning areas. The configuration of planning areas is based on various factors, including: geologic and environmental data; coordination with onshore governmental entities; mapping consideration; jurisdictional claims; and administrative requirements. Over the past decades, planning area boundaries have been changed many times based on one or another of these considerations. There are currently 26 planning areas (see maps).

**Platform** - An offshore structure built on pilings from which offshore wells are drilled, produced, or both.

**Production** - The phase of oil and gas

operations involved with well fluids extraction, separation, treatment, storage, measurement, and (sometimes) transportation.

**Prospect** - An untested geologic feature having the potential for trapping and accumulating hydrocarbons.

**Reserves** - A discovered resource. That portion (in barrels or cubic feet) of an identified oil or gas resource which can be economically extracted using current technology.

**Reservoir** - A subsurface, porous, permeable rock body in which oil or gas or both are found.

**Resources** - Concentrations of naturally occurring solid, liquid, or gaseous materials in or on the Earth's crust. In this document, this term refers only to undiscovered resources.

**Risked Economically Recoverable Resource Estimates** - An assessment of undiscovered oil and gas resources that has been modified to take into account physical and technological constraints on production; the influence of the costs of development, production, transportation and market price on industry investment in OCS post-exploration activities; and, the likelihood economically recoverable resources may not exist within the area of interest.

**Risked Mean Resources** - The product obtained by multiplying the conditional mean value by the marginal probability that economically recoverable hydrocarbon resources exist in the area under study.

**Royalty** - A share of the minerals

produced from a lease; a percentage of production either in money or in kind which the lessee of a Federal or Indian lease is required to pay.

**Scoping** - An outreach process intended to involve all interested persons and groups (Federal and non-Federal) in determining issues, areas, and alternatives to be studied in an EIS.

**Social Costs** - Damages associated with unavoided (residual) adverse effects of OCS natural gas and oil development and foregone uses.

**Stipulations** - Specific measures or limitations imposed upon a lease. Stipulations are attached as a provision of a lease; they may apply to some or all tracts in a sale. For example, a stipulation might limit drilling to a certain time period of the year.

**TCF** - Trillion cubic feet

**Tract** - A designation assigned for administrative and statutory purposes to a block or combination of blocks that are identified on a leasing map or an official protraction diagram prepared by MMS. A tract may not exceed 5,760 acres unless it is determined that a larger area is necessary to comprise a reasonable economic production unit. See "Leasing Pay" and "Block."

**Undiscovered Economically Recoverable Resources** - Potential commercial accumulations of resources outside of known fields, estimated from geologic, engineering, and economic inferences.