

**Int. Cl.: 9**

**Prior U.S. Cls.: 21, 23, 26, 36 and 38**

**Reg. No. 3,568,795**

**United States Patent and Trademark Office**

**Registered Feb. 3, 2009**

**TRADEMARK  
PRINCIPAL REGISTER**

**THE EDGE**

EDGE TECH CORPORATION (OKLAHOMA CORPORATION)  
327 EAST 14TH STREET  
ADA, OK 74820

THE MARK CONSISTS OF STANDARD CHARACTERS WITHOUT CLAIM TO ANY PARTICULAR FONT, STYLE, SIZE, OR COLOR.

FOR: COMPUTER PERIPHERALS, NAMELY, CIRCUIT BOARDS, SOLD TO COMPUTER USERS, IN CLASS 9 (U.S. CLS. 21, 23, 26, 36 AND 38).

SER. NO. 75-321,910, FILED 7-9-1997.

FIRST USE 6-0-1997; IN COMMERCE 6-0-1997.

JANICE L. MCMORROW, EXAMINING ATTORNEY

**Int. Cl.: 28**

**Prior U.S. Cls.: 22, 23, 38 and 50**

**Reg. No. 3,568,796**

**United States Patent and Trademark Office**

**Registered Feb. 3, 2009**

**TRADEMARK  
PRINCIPAL REGISTER**



DRASTRUP, CLAUS (DENMARK INDIVIDUAL)  
KRATMOSEVEJ 32  
VEDBACK, DENMARK

VIDEO GAMES, IN CLASS 28 (U.S. CLS. 22, 23, 38  
AND 50).

FOR: GAMES OTHER THAN THOSE ADAPTED  
FOR USE WITH TELEVISION RECEIVERS; NAME-  
LY, BOARD GAMES, PARLOR GAMES, ARCADE  
GAME, COIN OPERATED VIDEO GAMES, HAND-  
HELD UNITS FOR PLAYING ELECTRONIC AND

OWNER OF ERPN CMNTY TM OFC REG. NO.  
001352866, DATED 12-15-2000, EXPIRES 1-7-2010.

SER. NO. 76-015,990, FILED 4-3-2000.

JERI J. FICKES, EXAMINING ATTORNEY

**Int. Cl.: 10**

**Prior U.S. Cls.: 26, 39 and 44**

**United States Patent and Trademark Office**

**Reg. No. 3,568,797**

**Registered Feb. 3, 2009**

**TRADEMARK  
PRINCIPAL REGISTER**

**VARIOSKOP**

CARL ZEISS AG (FED REP GERMANY COR-  
PORATION)

73447

OBERKOCHEN, FED REP GERMANY

FOR: OBJECTIVE AND ILLUMINATION COM-  
PONENT, WITH AUTOMATIC FOCUSING, ADAP-  
TED FOR USE WITH SURGICAL MICROSCOPES,  
IN CLASS 10 (U.S. CLS. 26, 39 AND 44).

FIRST USE 0-0-1990; IN COMMERCE 0-0-1990.

SER. NO. 76-032,501, FILED 4-24-2000.

TRACY FLETCHER, EXAMINING ATTORNEY

**Int. Cls.: 18 and 25**

**Prior U.S. Cls.: 1, 2, 3, 22, 39 and 41**

**Reg. No. 3,568,798**

**United States Patent and Trademark Office**

**Registered Feb. 3, 2009**

**TRADEMARK  
PRINCIPAL REGISTER**



ROSA S.R.L. (ITALY CORPORATION)  
VIA SAN PIETRO ALL'ORTO 22  
MILAN, ITALY

FOR: BAGS, NAMELY SPORT BAGS, HAND BAGS, TOTE BAGS, IN CLASS 18 (U.S. CLS. 1, 2, 3, 22 AND 41).

FIRST USE 6-0-1998; IN COMMERCE 6-0-1998.

FOR: ARTICLES OF CLOTHING FOR MEN AND WOMEN, NAMELY CARDIGANS, SWEATERS, PULLOVERS, JERSEYS, T-SHIRTS, POLO SHIRTS, TROUSERS, COATS, OVERCOATS, MANTLES, JACKETS, VESTS, WAISTCOATS, SHIRTS, TIES, UNDERWEAR, BATHROBES, SCARVES, FOU-LARDS, SOCKS, STOCKINGS, GLOVES, SKIRTS,

HATS, BERETS, DRESSES, SUITS, BLOUSES, BODY STOCKINGS, SHORTS, IN CLASS 25 (U.S. CLS. 22 AND 39).

FIRST USE 6-0-1998; IN COMMERCE 6-0-1998.

NO CLAIM IS MADE TO THE EXCLUSIVE RIGHT TO USE 1922, APART FROM THE MARK AS SHOWN.

THE NAME AVON CELLI DOES NOT IDENTIFY A LIVING INDIVIDUAL.

SER. NO. 76-381,421, FILED 3-8-2002.

GEORGE LORENZO, EXAMINING ATTORNEY

**Int. Cls.: 5 and 44**

**Prior U.S. Cls.: 6, 18, 44, 46, 51, 52, 100 and 101**

**United States Patent and Trademark Office**

**Reg. No. 3,568,799**

**Registered Feb. 3, 2009**

---

**TRADEMARK  
SERVICE MARK  
PRINCIPAL REGISTER**

**TARGIT**

ARCHIMEDES DEVELOPMENT LIMITED (UNITED KINGDOM LIMITED COMPANY)  
NOTTINGHAM SCIENCE AND TECHNOLOGY PARK  
ALBERT EINSTEIN CENTRE  
NOTTINGHAM, UNITED KINGDOM NG7 2TN

FOR: DRUG DELIVERY SYSTEMS, NAMELY COATED STARCH CAPSULES FOR LOCALIZED DELIVERY AND RELEASE OF PHARMACEUTICALS IN THE INTESTINES, IN CLASS 5 (U.S. CLS. 6, 18, 44, 46, 51 AND 52).

FOR: MEDICAL AND PHARMACEUTICAL CONSULTATION IN CONNECTION WITH THE LOCALIZED DELIVERY AND RELEASE OF PHARMACEUTICALS IN THE INTESTINES, IN CLASS 44 (U.S. CLS. 100 AND 101).

OWNER OF UNITED KINGDOM REG. NO. 2408389, DATED 12-15-2006, EXPIRES 12-6-2015.

SER. NO. 76-497,158, FILED 3-13-2003.

GEORGE LORENZO, EXAMINING ATTORNEY

**Int. Cl.: 35**

**Prior U.S. Cls.: 100, 101 and 102**

**United States Patent and Trademark Office**

**Reg. No. 3,568,800**

**Registered Feb. 3, 2009**

**SERVICE MARK  
PRINCIPAL REGISTER**

**HEARTSTRINGS**

HEARTSTRINGS ENTERPRISES, INC. (ALABAMA CORPORATION)  
1415 PUMPHREY AVENUE  
AUBURN, AL 36832

FOR: WHOLESALE DISTRIBUTORSHIP SERVICES FEATURING EMBROIDERED FABRICS, NOT INCLUDING CHILDREN'S CLOTHING OR LINENS OTHER THAN MONOGRAMMED BABY BLANKETS, JEWELRY AND ENGRAVED NICKEL PLA-

TED GIFTS, IN CLASS 35 (U.S. CLS. 100, 101 AND 102).

FIRST USE 9-0-1986; IN COMMERCE 6-0-1997.

SER. NO. 76-512,915, FILED 5-9-2003.

GEORGE LORENZO, EXAMINING ATTORNEY

**Int. Cl.: 35**

**Prior U.S. Cls.: 100, 101 and 102**

**United States Patent and Trademark Office**

**Reg. No. 3,568,801**

**Registered Feb. 3, 2009**

**SERVICE MARK  
PRINCIPAL REGISTER**

**INTELLIFIND**

INTELLIDYN CORP. (DELAWARE CORPORATION)  
1055 STEWART AVENUE, SUITE 15  
BETHPAGE, NY 11714

FOR: MANAGEMENT SERVICES, NAMELY,  
PROVIDING MANAGEMENT ANALYSIS AND AD-  
VICE RELATED TO RESIDENTIAL AND BUSINESS  
MAILING LOCATOR LISTS FOR USE IN DEVEL-

OPING AND CONDUCTING MARKETING CAM-  
PAIGNS, IN CLASS 35 (U.S. CLS. 100, 101 AND 102).

FIRST USE 11-30-2002; IN COMMERCE 11-30-2002.

SER. NO. 76-562,104, FILED 11-26-2003.

KRISTIN DAHLING, EXAMINING ATTORNEY

**Int. Cl.: 20**

**Prior U.S. Cls.: 2, 13, 22, 25, 32 and 50**

**Reg. No. 3,568,802**

**United States Patent and Trademark Office**

**Registered Feb. 3, 2009**

---

**TRADEMARK  
PRINCIPAL REGISTER**

**M-D-S**

MODULAR DISPLAY SYSTEMS, INC. (NEW  
YORK CORPORATION)  
582 MONTAUK AVENUE  
BROOKLYN, NY 11208

FIRST USE 8-14-2003; IN COMMERCE 8-14-2003.

SER. NO. 76-584,927, FILED 4-1-2004.

FOR: CLOTHING DISPLAY RACKS, IN CLASS 20  
(U.S. CLS. 2, 13, 22, 25, 32 AND 50).

KATHY DE JONGE, EXAMINING ATTORNEY



**Int. Cl.: 25**

**Prior U.S. Cls.: 22 and 39**

**United States Patent and Trademark Office**

**Reg. No. 3,568,803**

**Registered Feb. 3, 2009**

**TRADEMARK  
PRINCIPAL REGISTER**

**FIGLEAVES**

FIGLEAVES GLOBAL TRADING LTD. (UNITED  
KINGDOM PRIVATE LIMITED COMPANY)  
2ND FLOOR, SOLAR HOUSE  
915 HIGH ROAD, LONDON, ENGLAND N12 8QJ

FOR: CLOTHING, NAMELY, MEN'S AND WO-  
MEN'S UNDERWEAR, UNDERSHIRTS, BRAS,  
HOSIERY, SOCKS, SLEEPWEAR, LOUNGEWEAR  
AND DAYWEAR, NAMELY, SHIRTS, SHORTS,  
TROUSERS, JACKETS AND HATS, IN CLASS 25  
(U.S. CLS. 22 AND 39).

THE MARK CONSISTS OF STANDARD CHAR-  
ACTERS WITHOUT CLAIM TO ANY PARTICULAR  
FONT, STYLE, SIZE, OR COLOR.

OWNER OF ERPN CMNTY TM OFC REG. NO.  
1772300, DATED 7-22-2002, EXPIRES 7-22-2012.

OWNER OF U.S. REG. NO. 2,652,313.

SER. NO. 76-593,465, FILED 5-21-2004.

KELLY CHOE, EXAMINING ATTORNEY

**Int. Cls.: 9 and 42**

**Prior U.S. Cls.: 21, 23, 26, 36, 38, 100 and 101**

**Reg. No. 3,568,804**

**United States Patent and Trademark Office**

**Registered Feb. 3, 2009**

**TRADEMARK  
SERVICE MARK  
PRINCIPAL REGISTER**

# RfStream

RFSTREAM CORPORATION (JAPAN CORPORATION)  
2-10-70, NANBA-NAKA  
NANIWA-KU, OSAKA-SHI  
OSAKA, JAPAN

FOR: SEMICONDUCTOR CHIPS; SEMICONDUCTOR CHIPS THAT LOCK ON TO A SELECTED CARRIER STATION AND FILTER OUT THE AUDIO AND VIDEO SIGNALS FOR AMPLIFICATION AND DISPLAY; SEMICONDUCTOR INTEGRATED CIRCUITS FOR TUNERS AND TELEVISION TUNERS; AND RADIO FREQUENCY COMPONENTS FOR BROADCASTING, NAMELY, TUNER AND TELEVISION TUNER COMPONENTS AND CIRCUIT BOARDS, IN CLASS 9 (U.S. CLS. 21, 23, 26, 36 AND 38).

FOR: COMPUTER SOFTWARE DEVELOPMENT; COMPUTER SOFTWARE PROGRAMMING; COMPUTER SOFTWARE MAINTENANCE; DESIGN OF SEMICONDUCTOR CHIPS FOR OTHERS; DESIGN OF ELECTRONIC TUNER DEVICES FOR OTHERS; RESEARCH AND DEVELOPMENT ON SEMICONDUCTOR CHIPS; RESEARCH AND DEVELOPMENT ON ELECTRONIC TUNER DEVICES; DESIGNING OF RADIO FREQUENCY COMPONENTS FOR BROADCASTING FOR OTHERS, NAMELY, TUNERS, BS TUNERS AND TV TUNERS; DESIGNING OF COMPUTER HARDWARE FOR OTHERS, NAMELY, IMAGE CAPTURE BOARDS; DESIGNING OF LOCAL AREA NETWORK EQUIPMENT FOR OTHERS, NAMELY, NETWORK INTERFACE CARDS, REPEATERS, SWITCHES,

ROUTERS, AND WIRELESS LAN ACCESS POINT; PROVIDING COMPUTER PROGRAMS TO COMPUTER TERMINALS BY ACCESSING A CENTRAL COMPUTER; PROVIDING COMPUTER PROGRAMS FOR OTHERS FOR DATA PROCESSING; LICENSING OF INTELLECTUAL PROPERTY; CONSULTING SERVICES RELATING TO INTELLECTUAL PROPERTY; CONSULTING IN THE FIELD OF PERFORMANCE AND OPERATION OF COMPUTERS; TESTING, INSPECTION OR RESEARCH ON PHARMACEUTICALS, COSMETICS OR FOODSTUFF; TESTING OR RESEARCH ON ELECTRICITY; TESTING OR RESEARCH ON MACHINES, APPARATUS AND INSTRUMENTS; COPYRIGHT LICENSING SERVICES; AGENCY OF PROCEDURE RELATING TO SOCIAL INSURANCE; RENTAL OF MEASURING APPARATUS; RENTAL AND LEASING OF COMPUTERS; RENTAL OF LABORATORY APPARATUS AND INSTRUMENTS, IN CLASS 42 (U.S. CLS. 100 AND 101).

THE MARK CONSISTS OF STANDARD CHARACTERS WITHOUT CLAIM TO ANY PARTICULAR FONT, STYLE, SIZE, OR COLOR.

PRIORITY CLAIMED UNDER SEC. 44(D) ON JAPAN APPLICATION NO. 2004-031256, FILED 4-2-2004, REG. NO. 4812091, DATED 10-22-2004, EXPIRES 10-22-2014.

SER. NO. 76-605,724, FILED 8-5-2004.

DAWN FELDMAN, EXAMINING ATTORNEY

**Int. Cls.: 29 and 35**

**Prior U.S. Cls.: 46, 100, 101 and 102**

**United States Patent and Trademark Office**

**Reg. No. 3,568,805**

**Registered Feb. 3, 2009**

**TRADEMARK  
SERVICE MARK  
PRINCIPAL REGISTER**

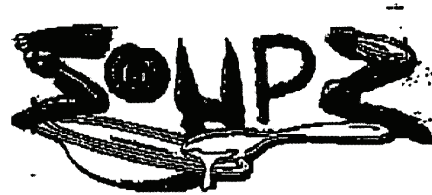

4187229 CANADA INC. (CANADA CORPORATION)  
116 LAURENT STREET  
DOLLARD-DES-ORMEAUX  
QUÉBEC, CANADA H9A 1X4

FOR: FRESH AND FROZEN SOUPS SOLD IN CONTAINERS, IN CLASS 29 (U.S. CL. 46).

FOR: WHOLESALE DISTRIBUTORSHIP SERVICES FEATURING SOUPS, IN CLASS 35 (U.S. CLS. 100, 101 AND 102).

PRIORITY CLAIMED UNDER SEC. 44(D) ON CANADA APPLICATION NO. 1234645, FILED 10-14-2004, REG. NO. TMA710442, DATED 3-31-2008, EXPIRES 3-31-2023.

NO CLAIM IS MADE TO THE EXCLUSIVE RIGHT TO USE "SOUPS", APART FROM THE MARK AS SHOWN.

SER. NO. 76-618,464, FILED 10-29-2004.

SHARON MEIER, EXAMINING ATTORNEY

**Int. Cl.: 41**

**Prior U.S. Cls.: 100, 101 and 107**

**United States Patent and Trademark Office**

**Reg. No. 3,568,806**

**Registered Feb. 3, 2009**

**SERVICE MARK  
PRINCIPAL REGISTER**

**PETS AND THE CITY**

ATTAS, AMY (UNITED STATES INDIVIDUAL)  
101 WEST 57TH STREET  
NEW YORK, NY 10019

FOR: RADIO ENTERTAINMENT SERVICES,  
NAMELY RADIO PROGRAMS FEATURING PER-  
FORMANCES BY A DOCTOR OF VETERINARY  
MEDICINE, IN CLASS 41 (U.S. CLS. 100, 101 AND  
107).

FIRST USE 8-1-2003; IN COMMERCE 8-1-2003.

THE MARK CONSISTS OF STANDARD CHAR-  
ACTERS WITHOUT CLAIM TO ANY PARTICULAR  
FONT, STYLE, SIZE, OR COLOR.

NO CLAIM IS MADE TO THE EXCLUSIVE  
RIGHT TO USE "PETS", APART FROM THE MARK  
AS SHOWN.

SER. NO. 76-639,995, FILED 6-2-2005.

GINA FINK, EXAMINING ATTORNEY

**Int. Cl.: 9**

**Prior U.S. Cls.: 21, 23, 26, 36 and 38**

**Reg. No. 3,568,807**

**United States Patent and Trademark Office**

**Registered Feb. 3, 2009**

**TRADEMARK  
PRINCIPAL REGISTER**

**RSX**

KABUSHIKI KAISHA SONY COMPUTER ENTERTAINMENT (JAPAN CORPORATION), TA SONY COMPUTER ENTERTAINMENT INC.

2-6-21, MINAMI-AOYAMA, MINATO-KU  
TOKYO 107-0062, JAPAN

FOR: AUDIO-VISUAL CABLES; AMPLIFIERS; APPARATUS FOR GAMES ADAPTED FOR USE WITH TELEVISION RECEIVERS ONLY, NAMELY, VIDEO GAME MACHINES FOR USE WITH TELEVISIONS; BATTERY CHARGERS; BLANK OPTICAL DISCS; ELECTRIC CABLES; CAR ADAPTERS; CONTROLLERS ESPECIALLY DESIGNED FOR CD RECORDERS; CONTROLLERS ESPECIALLY DESIGNED FOR DVD PLAYERS; VOLUME CONTROLLERS ESPECIALLY DESIGNED FOR DVD RECORDERS; VOLUME CONTROLLERS ESPECIALLY DESIGNED FOR DVD VIDEO RECORDERS; VOLUME CONTROLLERS ESPECIALLY DESIGNED FOR DVD-ROM PLAYERS; DIGITAL STILL CAMERAS; DOWNLOADABLE ELECTRONIC PUBLICATIONS IN THE NATURE OF MAGAZINES, MAGAZINE ARTICLES, JOURNALS, NEWSLETTERS, BROCHURES, LEAFLETS, PAMPHLETS, HANDBOOKS, BOOKLETS, AND INSTRUCTION MANUALS, IN THE FIELD OF MUSIC, MOVIE PICTURES AND VIDEO GAMES; CRT DISPLAY UNITS; PLASMA DISPLAY UNITS; ELECTROLUMINESCENCE DISPLAY UNIT; ENCODED MICRO TAGS OF PLASTIC, METAL OR SILICATE FOR USE IN THE FIELD OF PASSIVE LABELING, TRACING OR TRACKING OF PERSONS, ANIMALS, VEHICLES OR GOODS OF ANY KIND; GAME PROGRAMS FOR VIDEO GAME MACHINE ADAPTED FOR USE WITH TELEVISION RECEIVERS ONLY; OPTICAL SCANNERS; FM RADIO TRANSMITTERS; SATELLITE NAVIGATIONAL SYSTEM, NAMELY, A GLOBAL POSITIONING SYSTEM (GPS); HARD DISC RECORDERS; HARD DISK DRIVES; KEYBOARDS; KEYBOARDS FOR USE WITH VIDEO GAME MACHINES FOR USE WITH TELEVISION FOR PERSONAL USE ONLY;

LARGE SCALE INTEGRATED CIRCUITS FOR IMAGE PROCESSING; SEMICONDUCTOR MICROCHIPS; LIQUID CRYSTAL DISPLAYS; LIQUID CRYSTAL MONITORS; LOUD SPEAKERS; MEMORY CARDS; MICROPHONES; MODEMS; MICE FOR COMPUTERS; ONE-SHOT CAMERAS WITH UNEXPOSED FILMS; OPTICAL DISC PLAYERS INCLUDING REMOTE CONTROLLERS; OPTICAL DISC RECORDERS INCLUDING VOLUME CONTROLLERS; OPTICAL FIBER CABLES; PORTABLE DIGITAL AUDIO PLAYERS; GAME PROGRAMS FOR HAND-HELD GAMES WITH LIQUID CRYSTAL DISPLAYS; RECEIVING TUNERS FOR SATELLITE TELEVISION BROADCASTING. RECEIVING TUNERS FOR TERRESTRIAL DIGITAL BROADCASTING; RECHARGEABLE BATTERIES; RECORDED OPTICAL DISCS FEATURING COMPUTER GAME PROGRAMS; REMOTE CONTROLLERS FOR USE WITH HAND-HELD GAMES WITH LIQUID CRYSTAL DISPLAYS ONLY; REMOTE CONTROLLERS ESPECIALLY DESIGNED FOR CD PLAYERS; REMOTE CONTROLLERS ESPECIALLY DESIGNED FOR DVD PLAYERS; REMOTE CONTROLLERS FOR USE WITH COMPUTERS; REMOTE CONTROLLERS FOR USE WITH PORTABLE AUDIO-VISUAL PLAYERS ONLY; REMOTE CONTROLLERS FOR USE WITH PORTABLE DIGITAL AUDIO PLAYERS ONLY; REMOTE CONTROLLERS FOR USE WITH VIDEO GAME MACHINES WITH TELEVISION FOR PERSONAL USE ONLY; ROUTERS FOR NETWORK COMMUNICATION; SOUND RECORDED COMPACT DISCS FEATURING MUSIC, MOVIE PICTURES; SOUND RECORDED MAGNETIC CARDS, SHEETS AND TAPES; TUNERS FOR TELEVISION RECEIVERS; VIDEO RECORDED OPTICAL DISCS FEATURING MUSIC VIDEOS AND MOVIE PICTURES; VIDEO RECORDED OPTICAL MAGNETIC DISCS FEATURING MUSIC VIDEOS AND MOVIE PICTURES, IN CLASS 9 (U.S. CLS. 21, 23, 26, 36 AND 38).

OWNER OF ERPN CMNTY TM OFC REG. NO.  
004729307, DATED 11-9-2006, EXPIRES 11-8-2015.

SER. NO. 76-650,039, FILED 11-9-2005.

OWNER OF JAPAN REG. NO. 4897794, DATED 9-  
30-2005, EXPIRES 9-30-2015.

FLORENTINA BLANDU, EXAMINING ATTORNEY

**Int. Cl.: 8**

**Prior U.S. Cls.: 23, 28 and 44**

**Reg. No. 3,568,808**

**United States Patent and Trademark Office**

**Registered Feb. 3, 2009**

**TRADEMARK  
PRINCIPAL REGISTER**



PROFESSIONAL ENGINEERING COMPANY,  
INC. (MASSACHUSETTS CORPORATION)  
110 FERRY STREET  
LAWRENCE, MA 01841

NO CLAIM IS MADE TO THE EXCLUSIVE  
RIGHT TO USE "SUSPENDED CEILING WIRECUT-  
TERS", APART FROM THE MARK AS SHOWN.

FOR: HANDHELD TOOLS, NAMELY, WIRE CUT-  
TERS, IN CLASS 8 (U.S. CLS. 23, 28 AND 44).

SER. NO. 76-672,683, FILED 2-14-2007.

FIRST USE 1-21-2002; IN COMMERCE 1-21-2002.

LESLEY LAMOTHE, EXAMINING ATTORNEY

**Int. Cl.: 25**

**Prior U.S. Cls.: 22 and 39**

**United States Patent and Trademark Office**

**Reg. No. 3,568,809**

**Registered Feb. 3, 2009**

**TRADEMARK  
PRINCIPAL REGISTER**

**GRISHKO**

I. M. WILSON, INC. (PENNSYLVANIA CORPORATION)  
241 KING MANOR DRIVE, SUITE D  
KING OF PRUSSIA, PA 19406

FOR: BALLET SLIPPERS; DANCE SHOES; DANCE TIGHTS; DANCE LEOTARDS; AND DANCE DRESSES, IN CLASS 25 (U.S. CLS. 22 AND 39).

FIRST USE 5-19-1990; IN COMMERCE 7-17-1990.

THE MARK CONSISTS OF STANDARD CHARACTERS WITHOUT CLAIM TO ANY PARTICULAR FONT, STYLE, SIZE, OR COLOR.

OWNER OF U.S. REG. NO. 1,807,637.

THE NAME(S), PORTRAIT(S), AND/OR SIGNATURE(S) SHOWN IN THE MARK IDENTIFIES NICOLAI GRISHKO, WHOSE CONSENT(S) TO REGISTER IS SUBMITTED.

THE WORDING "GRISHKO" HAS NO MEANING IN A FOREIGN LANGUAGE.

SER. NO. 76-674,869, FILED 3-30-2007.

SUZANNE BLANE, EXAMINING ATTORNEY



Int. Cls.: 7, 8, 9 and 12

Prior U.S. Cls.: 13, 19, 21, 23, 26, 28, 31, 34, 35, 36, 38  
and 44

Reg. No. 3,568,810

United States Patent and Trademark Office

Registered Feb. 3, 2009

TRADEMARK  
PRINCIPAL REGISTER



GRAY TOOLS CANADA INC. (CANADA CORPORATION)

299 ORENDA ROAD

BRAMPTON, ONTARIO, CANADA L6T 1E8

FOR: SCREWDRIVER BITS FOR POWER DRILLS, IN CLASS 7 (U.S. CLS. 13, 19, 21, 23, 31, 34 AND 35).

FIRST USE 12-31-2003; IN COMMERCE 12-31-2003.

FOR: HAND OPERATED MATERIAL CLAMPING DEVICES; SCREWDRIVER BITS FOR HAND OPERATED DRILLS; HAND STAMPING DIES; HAND OPERATED TOOLS, NAMELY, HONING STONES; MANUAL TOOLS FOR LOAD PROCUREMENT, NAMELY, LOAD BINDERS; VISES AND ACCESSORIES, NAMELY, SWIVEL BASES, FIBER GRIP AND COOPER GRIP JAWS; HAND OPERATED CROW-FOOT WRENCHES; HAND TOOLS, NAMELY, DEBURRING TOOLS, IN CLASS 8 (U.S. CLS. 23, 28 AND 44).

FIRST USE 12-31-2002; IN COMMERCE 12-31-2002.

FOR: MANUALLY OPERATED MEASUREMENT TOOLS, NAMELY, CALIPERS AND TAPE MEASURES, IN CLASS 9 (U.S. CLS. 21, 23, 26, 36 AND 38).

FIRST USE 12-31-2006; IN COMMERCE 12-31-2006.

FOR: MOVABLE STEEL UTILITY CARTS, IN CLASS 12 (U.S. CLS. 19, 21, 23, 31, 35 AND 44).

FIRST USE 12-31-2004; IN COMMERCE 12-31-2004.

PRIORITY CLAIMED UNDER SEC. 44(D) ON CANADA APPLICATION NO. 1140946, FILED 1-29-2007, REG. NO. TMA610,206, DATED 5-13-2004, EXPIRES 5-13-2019.

OWNER OF U.S. REG. NO. 2,932,680.

NO CLAIM IS MADE TO THE EXCLUSIVE RIGHT TO USE "TOOLS", APART FROM THE MARK AS SHOWN.

SER. NO. 76-675,374, FILED 4-12-2007.

DANIEL CAPSHAW, EXAMINING ATTORNEY

Int. Cl.: 7

Prior U.S. Cls.: 13, 19, 21, 23, 31, 34 and 35

United States Patent and Trademark Office

Reg. No. 3,568,811

Registered Feb. 3, 2009

TRADEMARK  
PRINCIPAL REGISTER

ALKITORC

KIPFELSBERGER, ALBERT (FED REP GERMA-  
NY INDIVIDUAL)  
WELFENSTRASSE 7  
85051 INGOLSTADT, FED REP GERMANY

PRIORITY CLAIMED UNDER SEC. 44(D) ON FED  
REP GERMANY APPLICATION NO. 30702552.7,  
FILED 1-11-2007, REG. NO. 30702552.7, DATED 1-11-  
2007, EXPIRES 1-11-2017.

FOR: POWER OPERATED TORQUE WRENCHES,  
POWER OPERATED THREAD CLEANERS, HY-  
DRAULIC PUMPS, PNEUMATIC PUMPS, IN CLASS  
7 (U.S. CLS. 13, 19, 21, 23, 31, 34 AND 35).

SER. NO. 76-675,804, FILED 4-20-2007.

THE MARK CONSISTS OF STANDARD CHAR-  
ACTERS WITHOUT CLAIM TO ANY PARTICULAR  
FONT, STYLE, SIZE, OR COLOR.

KRISTINA MORRIS, EXAMINING ATTORNEY

**Int. Cl.: 41**

**Prior U.S. Cls.: 100, 101 and 107**

**United States Patent and Trademark Office**

**Reg. No. 3,568,812**

**Registered Feb. 3, 2009**

**SERVICE MARK  
PRINCIPAL REGISTER**

**BAD GIRLS CLUB**

O2 HOLDINGS, LLC (DELAWARE LIMITED  
LIABILITY COMPANY)  
75 NINTH AVENUE  
NEW YORK, NY 10011

FOR: ENTERTAINMENT SERVICES, NAMELY,  
AN ON-GOING TELEVISION PROGRAM FEATUR-  
ING A REALITY PROGRAM CHRONICLING THE  
LIVES AND EXPLOITS OF SEVEN YOUNG WOMEN

LIVING WITHIN THE SAME HOUSEHOLD, IN  
CLASS 41 (U.S. CLS. 100, 101 AND 107).

FIRST USE 12-5-2006; IN COMMERCE 12-5-2006.

SER. NO. 76-676,973, FILED 5-16-2007.

ERIN FALK, EXAMINING ATTORNEY

**Int. Cl.: 10**

**Prior U.S. Cls.: 26, 39 and 44**

**Reg. No. 3,568,813**

**United States Patent and Trademark Office**

**Registered Feb. 3, 2009**

**TRADEMARK  
PRINCIPAL REGISTER**

**TRIO**

DATASCOPE TRADEMARK CORP. (DELAWARE  
CORPORATION)  
1011 CENTRE ROAD, SUITE 300  
WILMINGTON, DE 19805

THE MARK CONSISTS OF STANDARD CHAR-  
ACTERS WITHOUT CLAIM TO ANY PARTICULAR  
FONT, STYLE, SIZE, OR COLOR.

FOR: MEDICAL DEVICE FOR PATIENT MONI-  
TORING, NAMELY, HEART AND VITAL SIGNS  
MONITORS, IN CLASS 10 (U.S. CLS. 26, 39 AND 44).

SER. NO. 76-677,853, FILED 6-6-2007.

FIRST USE 3-11-2004; IN COMMERCE 3-11-2004.

JULIE WATSON, EXAMINING ATTORNEY

**Int. Cl.: 10**

**Prior U.S. Cls.: 26, 39 and 44**

**Reg. No. 3,568,814**

**United States Patent and Trademark Office**

**Registered Feb. 3, 2009**

**TRADEMARK  
PRINCIPAL REGISTER**

**VIEW 12**

DATASCOPE TRADEMARK CORP. (DELAWARE CORPORATION)  
1011 CENTRE ROAD, SUITE 300  
WILMINGTON, DE 19805

FOR: MEDICAL APPARATUS, NAMELY, ECG ANALYSIS MODULE, IN CLASS 10 (U.S. CLS. 26, 39 AND 44).

FIRST USE 1-3-2006; IN COMMERCE 1-3-2006.

THE MARK CONSISTS OF STANDARD CHARACTERS WITHOUT CLAIM TO ANY PARTICULAR FONT, STYLE, SIZE, OR COLOR.

NO CLAIM IS MADE TO THE EXCLUSIVE RIGHT TO USE "12", APART FROM THE MARK AS SHOWN.

SER. NO. 76-677,878, FILED 6-6-2007.

JULIE WATSON, EXAMINING ATTORNEY

**Int. Cl.: 36**

**Prior U.S. Cls.: 100, 101 and 102**

**United States Patent and Trademark Office**

**Reg. No. 3,568,815**

**Registered Feb. 3, 2009**

**SERVICE MARK  
PRINCIPAL REGISTER**



BAJA INSURANCE SERVICES, INC. (CALIFORNIA CORPORATION)  
1483 SHORE STREET  
WEST SACRAMENTO, CA 95691

FIRST USE 10-10-1998; IN COMMERCE 10-10-1998.

SEC. 2(F).

FOR: INSURANCE AGENCY AND BROKERAGE, NAMELY, AUTO, HOME, MOTORCYCLE, BUSINESS, COMMERCIAL INSURANCE, HEALTH AND DISABILITY, IN CLASS 36 (U.S. CLS. 100, 101 AND 102).

SER. NO. 76-678,062, FILED 6-11-2007.

LEIGH CAROLINE CASE, EXAMINING ATTORNEY

Int. Cls.: 29, 30, 35 and 43

Prior U.S. Cls.: 46, 100, 101 and 102

United States Patent and Trademark Office

Reg. No. 3,568,816

Registered Feb. 3, 2009

TRADEMARK  
SERVICE MARK  
PRINCIPAL REGISTER



SAFEWAY INC. (DELAWARE CORPORATION)  
5918 STONERIDGE MALL ROAD  
PLEASANTON, CA 945882322

FOR: PREPARED FOODS, NAMELY, SOUP, DIPS EXCLUDING SALSA AND OTHER SAUCES USED AS DIPS, RIBS, MEAT LOAF, PORK LOIN, CHICKEN WINGS, AND TURKEY; PRE-CUT VEGETABLE SALAD; SALADS EXCEPT FOR MACARONI, RICE, AND PASTA SALAD; MASHED POTATOES AND VEGETABLES SERVED AS A SIDE DISH, IN CLASS 29 (U.S. CL. 46).

FIRST USE 8-1-2007; IN COMMERCE 8-1-2007.

FOR: PREPARED FOODS, NAMELY, SANDWICHES, PIZZA, GRAVY, SAUCES, ENTREES CONSISTING PRIMARILY OF PASTA; MACARONI AND CHEESE, PASTA SAUCES, IN CLASS 30 (U.S. CL. 46).

FIRST USE 8-1-2007; IN COMMERCE 8-1-2007.

FOR: RETAIL DELICATESSEN SERVICES, IN CLASS 35 (U.S. CLS. 100, 101 AND 102).

FIRST USE 8-1-2007; IN COMMERCE 8-1-2007.

FOR: DELICATESSENS; PREPARATION OF FOODS, IN CLASS 43 (U.S. CLS. 100 AND 101).

FIRST USE 8-1-2007; IN COMMERCE 8-1-2007.

NO CLAIM IS MADE TO THE EXCLUSIVE RIGHT TO USE "CAFE", APART FROM THE MARK AS SHOWN.

SER. NO. 76-678,710, FILED 6-25-2007.

ALYSSA STEEL, EXAMINING ATTORNEY

**Int. Cl.: 43**

**Prior U.S. Cls.: 100 and 101**

**United States Patent and Trademark Office**

**Reg. No. 3,568,817**

**Registered Feb. 3, 2009**

---

**SERVICE MARK  
PRINCIPAL REGISTER**

**NAZQA**

NAZQA FOOD GROUP LLC (MICHIGAN LIMITED LIABILITY COMPANY)  
24552 ROSS DRIVE  
REDFORD, MI 48239

FOR: RESTAURANT SERVICES, IN CLASS 43 (U.S. CLS. 100 AND 101).

FIRST USE 5-1-2007; IN COMMERCE 5-1-2007.

THE MARK CONSISTS OF STANDARD CHARACTERS WITHOUT CLAIM TO ANY PARTICULAR FONT, STYLE, SIZE, OR COLOR.

THE WORDING "NAZQA" HAS NO MEANING IN A FOREIGN LANGUAGE.

SER. NO. 76-679,016, FILED 7-2-2007.

APRIL HESIK, EXAMINING ATTORNEY



Int. Cl.: 16

Prior U.S. Cls.: 2, 5, 22, 23, 29, 37, 38 and 50

Reg. No. 3,568,818

United States Patent and Trademark Office

Registered Feb. 3, 2009

TRADEMARK  
PRINCIPAL REGISTER

# LOGOGEL

M.D.O. TRADING (SWITZERLAND COMPANY)  
CHEMIN DE PLANTAZ  
1095 LUTRY, SWITZERLAND

FOR: STATIONERY, NAMELY, STICKERS; PAPER AND CARDBOARD FOR STATIONERY, PRINTING OR PHOTOGRAPHY; STATIONERY, NAMELY, DUST COVER FOR BOOKS AND JACKET FOR DOCUMENTS OF PAPER OR PLASTICS; BOOKBINDING MATERIAL; PHOTOGRAPHS; STATIONERY; GLUES, NAMELY, ADHESIVES FOR STATIONERY OR HOUSEHOLD PURPOSES; PAINTBRUSHES; TYPEWRITERS; PRINTERS' TYPE; PRINTING BLOCKS; NAPKINS, TOWELS AND HANDKERCHIEFS OF PAPER; POSTERS; ALMANACS; CALENDARS; GRAPHIC PRINTS; GRAPHIC ART REPRODUCTIONS; GRAPHIC REPRESENTATIONS; NEWSPAPERS; COMMEMORATIVE POSTAGE STAMPS SHEETS; ADVERTISEMENT BOARDS OF PAPER OR CARDBOARD; WRAPPING PAPER; BAGS, NAMELY, ENVELOPES AND POUCHES OF PAPER OR PLASTICS, FOR PACKAGING; STATIONERY, NAMELY, PA-

PER OR PLASTIC SHEETS FOR WRAPPING OR PACKAGING; PLASTIC BUBBLE PACKS FOR WRAPPING OR PACKAGING; FLAGS OF PAPER; TABLE LINEN OF PAPER; PHOTOGRAPH STANDS; PICTURES; SIGNBOARDS OF PAPER OR CARDBOARD; ADHESIVE LABELS; ADHESIVE MATERIALS FOR OFFICE USE; PROTECTIVE COVERS FOR BOOKS; PROTECTIVE COVERS FOR SHEETS OR PAPER AND PAGES OF BOOKS AND THE LIKE; BUSINESS CARDS, IN CLASS 16 (U.S. CLS. 2, 5, 22, 23, 29, 37, 38 AND 50).

THE MARK CONSISTS OF STANDARD CHARACTERS WITHOUT CLAIM TO ANY PARTICULAR FONT, STYLE, SIZE, OR COLOR.

OWNER OF FRANCE REG. NO. 053352578, DATED 4-13-2005, EXPIRES 4-13-2015.

SER. NO. 76-680,142, FILED 8-1-2007.

KATINA MISTER, EXAMINING ATTORNEY

**Int. Cls.: 9, 16 and 28**

**Prior U.S. Cls.: 2, 5, 21, 22, 23, 26, 29, 36, 37, 38 and 50**

**United States Patent and Trademark Office**

**Reg. No. 3,568,819**

**Registered Feb. 3, 2009**

**TRADEMARK  
PRINCIPAL REGISTER**

# **TOXIC AVENGER**

TROMA, INC. (NEW YORK CORPORATION)  
733 NINTH AVENUE  
NEW YORK, NY 10019

FOR: MOVING PICTURE FILM AND PRE-RECORDED VIDEO TAPES FEATURING FICTIONAL CHARACTERS INVOLVED IN FARCICAL SITUATIONS FOR ENTERTAINMENT , IN CLASS 9 (U.S. CLS. 21, 23, 26, 36 AND 38).

FIRST USE 1-1-1986; IN COMMERCE 1-1-1986.

FOR: PAPER GOODS AND PRINTED MATTER, NAMELY, POSTERS AND COMIC BOOKS, IN CLASS 16 (U.S. CLS. 2, 5, 22, 23, 29, 37, 38 AND 50).

FIRST USE 1-1-1986; IN COMMERCE 1-1-1986.

FOR: TOYS, NAMELY, ACTION FIGURES AND MASKS, IN CLASS 28 (U.S. CLS. 22, 23, 38 AND 50).

FIRST USE 8-1-1983; IN COMMERCE 11-1-1985.

THE MARK CONSISTS OF STANDARD CHARACTERS WITHOUT CLAIM TO ANY PARTICULAR FONT, STYLE, SIZE, OR COLOR.

SER. NO. 76-682,591, FILED 10-4-2007.

GRETTA YAO, EXAMINING ATTORNEY

**Int. Cl.: 35**

**Prior U.S. Cls.: 100, 101 and 102**

**United States Patent and Trademark Office**

**Reg. No. 3,568,820**

**Registered Feb. 3, 2009**

**SERVICE MARK  
PRINCIPAL REGISTER**

**VISIT MYRTLE BEACH**

MYRTLE BEACH AREA CHAMBER OF COM-  
MERCE (SOUTH CAROLINA CORPORATION)  
1200 NORTH OAK STREET  
MYRTLE BEACH, SC 29577

FOR: CHAMBER OF COMMERCE SERVICES,  
NAMELY, PROMOTING BUSINESS AND TOURISM  
IN SOUTH CAROLINA, IN CLASS 35 (U.S. CLS. 100,  
101 AND 102).

FIRST USE 6-0-2006; IN COMMERCE 6-0-2006.

THE MARK CONSISTS OF STANDARD CHAR-  
ACTERS WITHOUT CLAIM TO ANY PARTICULAR  
FONT, STYLE, SIZE, OR COLOR.

OWNER OF U.S. REG. NOS. 1,463,057, 3,200,185  
AND OTHERS.

SEC. 2(F) AS TO "MYRTLE BEACH".

SER. NO. 76-682,947, FILED 10-15-2007.

TEJBIR SINGH, EXAMINING ATTORNEY

Int. Cl.: 35

Prior U.S. Cls.: 100, 101 and 102

United States Patent and Trademark Office

Reg. No. 3,568,821

Registered Feb. 3, 2009

SERVICE MARK  
PRINCIPAL REGISTER



REALTOR ASSOCIATION OF GREATER FORT  
MYERS AND THE BEACH, INC. (FLORIDA  
CORPORATION)  
2840 WINKLER AVENUE  
FORT MYERS, FL 33916

FOR: REAL ESTATE ASSOCIATION SERVICES,  
NAMELY, DEVELOPING GOODWILL AND PRO-  
MOTING THE INTERESTS OF THE ASSOCIATION  
AND ITS MEMBERS BY ADVERTISING AND DIS-  
SEMINATING INFORMATION REGARDING COM-  
MUNITY, PUBLIC, AND, CHARITABLE  
ACTIVITIES AND ACCOMPLISHMENTS OF MEM-

BER REAL ESTATE BROKERS AND AGENTS, IN  
CLASS 35 (U.S. CLS. 100, 101 AND 102).

FIRST USE 5-3-2006; IN COMMERCE 5-3-2006.

NO CLAIM IS MADE TO THE EXCLUSIVE  
RIGHT TO USE "REALTORS", APART FROM THE  
MARK AS SHOWN.

SER. NO. 76-683,017, FILED 10-17-2007.

MARY BOAGNI, EXAMINING ATTORNEY

**Int. Cl.: 41**

**Prior U.S. Cls.: 100, 101 and 107**

**United States Patent and Trademark Office**

**Reg. No. 3,568,822**

**Registered Feb. 3, 2009**

**SERVICE MARK  
PRINCIPAL REGISTER**

**APA'S PAYTRAIN COLLEGE & UNIVERSITY**

AMERICAN PAYROLL INSTITUTE, INC. (NEW  
YORK CORPORATION)  
30 EAST 33RD STREET, 5TH FLOOR  
NEW YORK, NY 100165386

FOR: PUBLICATION OF EDUCATIONAL LIT-  
ERATURE FOR OTHERS, NAMELY, BOOKS, MA-  
GAZINES, NEWSLETTERS AND PAMPHLETS IN  
THE FIELD OF PAYROLL MANAGEMENT; AND  
EDUCATIONAL SERVICES, NAMELY, CONDUCT-  
ING ON-LINE AND IN-PERSON CLASSES, SEMI-  
NARS AND WORKSHOPS IN THE FIELD OF  
PAYROLL MANAGEMENT AND ADMINISTRA-  
TION, IN CLASS 41 (U.S. CLS. 100, 101 AND 107).

FIRST USE 3-1-2007; IN COMMERCE 3-1-2007.

THE MARK CONSISTS OF STANDARD CHAR-  
ACTERS WITHOUT CLAIM TO ANY PARTICULAR  
FONT, STYLE, SIZE, OR COLOR.

OWNER OF U.S. REG. NOS. 1,709,205, 2,342,841  
AND OTHERS.

NO CLAIM IS MADE TO THE EXCLUSIVE  
RIGHT TO USE "COLLEGE & UNIVERSITY",  
APART FROM THE MARK AS SHOWN.

SER. NO. 76-683,041, FILED 10-17-2007.

TEJBIR SINGH, EXAMINING ATTORNEY

**Int. Cl.: 30**

**Prior U.S. Cl.: 46**

**United States Patent and Trademark Office**

**Reg. No. 3,568,823**

**Registered Feb. 3, 2009**

**TRADEMARK  
PRINCIPAL REGISTER**

**NeutraGerm**

QUALITY TECHNOLOGY INTERNATIONAL,  
INC. (DELAWARE CORPORATION)  
2250 POINT BOULEVARD, SUITE 322  
ELGIN, IL 60123

THE MARK CONSISTS OF STANDARD CHAR-  
ACTERS WITHOUT CLAIM TO ANY PARTICULAR  
FONT, STYLE, SIZE, OR COLOR.

FOR: FOOD INGREDIENTS PRODUCED FROM  
CORN, NAMELY, CORN STARCH, CORN MEAL  
AND CORN GERM, IN CLASS 30 (U.S. CL. 46).

SER. NO. 76-683,354, FILED 10-26-2007.

FIRST USE 7-1-2006; IN COMMERCE 7-1-2006.

JILL C. ALT, EXAMINING ATTORNEY

**Int. Cl.: 41**

**Prior U.S. Cls.: 100, 101 and 107**

**United States Patent and Trademark Office**

**Reg. No. 3,568,824**

**Registered Feb. 3, 2009**

**SERVICE MARK  
PRINCIPAL REGISTER**

**THE LIVING ROOM**

NEW LIVING ROOM CAFÉ, INC. (NEW YORK  
CORPORATION)  
54 LUDLOW STREET  
NEW YORK, NY 10002

THE MARK CONSISTS OF STANDARD CHAR-  
ACTERS WITHOUT CLAIM TO ANY PARTICULAR  
FONT, STYLE, SIZE, OR COLOR.

FOR: RADIO, TELEVISION AND INTERNET  
PROGRAMMING, IN CLASS 41 (U.S. CLS. 100, 101  
AND 107).

SER. NO. 76-684,141, FILED 11-19-2007.

FIRST USE 12-29-1997; IN COMMERCE 12-29-1997.

ANTHONY RINKER, EXAMINING ATTORNEY

**Int. Cl.: 42**

**Prior U.S. Cls.: 100 and 101**

**United States Patent and Trademark Office**

**Reg. No. 3,568,825**

**Registered Feb. 3, 2009**

**SERVICE MARK  
PRINCIPAL REGISTER**

**SCRIMSHAW FORENSICS**

FRANK, STUART M. (UNITED STATES INDIVIDUAL), DBA SCRIMSHAW FORENSICS LABORATORY

791 PURCHASE STREET

NEW BEDFORD, MA 02740

FOR: LABORATORY SERVICES, NAMELY, ANALYSIS OF IVORY AND BONE OBJECTS, IN CLASS 42 (U.S. CLS. 100 AND 101).

FIRST USE 12-0-1989; IN COMMERCE 12-0-1989.

THE MARK CONSISTS OF STANDARD CHARACTERS WITHOUT CLAIM TO ANY PARTICULAR FONT, STYLE, SIZE, OR COLOR.

NO CLAIM IS MADE TO THE EXCLUSIVE RIGHT TO USE "FORENSICS", APART FROM THE MARK AS SHOWN.

SEC. 2(F).

SER. NO. 76-684,344, FILED 11-26-2007.

TAMARA FRAZIER, EXAMINING ATTORNEY



Int. Cl.: 30

Prior U.S. Cl.: 46

Reg. No. 3,568,826

United States Patent and Trademark Office

Registered Feb. 3, 2009

TRADEMARK  
PRINCIPAL REGISTER



LANDER, FLORA (VENEZUELA INDIVIDUAL)  
821 BROWN SQUIRREL LANE  
GOLDEN, CO 80401 AND  
LANDER, MIGUEL (VENEZUELA INDIVIDUAL)  
821 BROWN SQUIRREL LANE  
GOLDEN, CO 80401

FIRST USE 5-2-2007; IN COMMERCE 5-4-2007.

NO CLAIM IS MADE TO THE EXCLUSIVE  
RIGHT TO USE "EMPANADA" AND "GOURMET",  
APART FROM THE MARK AS SHOWN.

SER. NO. 76-687,032, FILED 2-22-2008.

FOR: TURNOVERS FILLED PRIMARILY WITH  
MEATS, POULTRY AND VEGETABLES OR FRUIT,  
IN CLASS 30 (U.S. CL. 46).

TRACY WHITTAKER-BROWN, EXAMINING AT-  
TORNEY

**Int. Cls.: 6 and 20**

**Prior U.S. Cls.: 2, 12, 13, 14, 22, 23, 25, 32 and 50**

**United States Patent and Trademark Office**

**Reg. No. 3,568,827**

**Registered Feb. 3, 2009**

**TRADEMARK  
PRINCIPAL REGISTER**

**GREEN BULL**

WERNER CO. (PENNSYLVANIA CORPORATION)  
93 WERNER ROAD  
GREENVILLE, PA 16125

FOR: METAL LADDERS AND SCAFFOLDING,  
IN CLASS 6 (U.S. CLS. 2, 12, 13, 14, 23, 25 AND 50).

FIRST USE 10-1-1979; IN COMMERCE 10-1-1979.

FOR: NON-METAL LADDERS, NAMELY, FIBER-  
GLASS LADDERS, IN CLASS 20 (U.S. CLS. 2, 13, 22,  
25, 32 AND 50).

FIRST USE 10-1-1979; IN COMMERCE 10-1-1979.

THE MARK CONSISTS OF STANDARD CHAR-  
ACTERS WITHOUT CLAIM TO ANY PARTICULAR  
FONT, STYLE, SIZE, OR COLOR.

SER. NO. 76-687,248, FILED 2-29-2008.

RON FAIRBANKS, EXAMINING ATTORNEY

**Int. Cl.: 41**

**Prior U.S. Cls.: 100, 101 and 107**

**Reg. No. 3,568,828**

**United States Patent and Trademark Office**

**Registered Feb. 3, 2009**

**SERVICE MARK  
PRINCIPAL REGISTER**

The logo for Centura College features the word "Centura" in a large, blue, serif font. Below it, the word "COLLEGE" is written in a smaller, blue, sans-serif font. The entire logo is framed by two horizontal blue lines, one above "Centura" and one below "COLLEGE".

YAGEN, GERALD W. (UNITED STATES INDIVIDUAL)  
4455 SOUTH BOULEVARD, SUITE 500  
VIRGINIA BEACH, VA 23452

THE COLOR(S) BLUE IS/ARE CLAIMED AS A FEATURE OF THE MARK.

FOR: VOCATIONAL EDUCATION AND TRAINING IN THE FIELDS OF NURSING, DENTAL, MEDICAL, ELECTRONICS, BUSINESS, COMPUTERS, NETWORKING, PARALEGAL, MASSAGE, AND AVIATION MAINTENANCE, IN CLASS 41 (U.S. CLS. 100, 101 AND 107).

THE MARK CONSISTS OF THE WORDING "CENTURA COLLEGE" ON TWO HORIZONTAL LINES IN BLUE WITH A BLUE HORIZONTAL LINE ABOVE THE WORD "CENTURA" AND A BLUE HORIZONTAL LINE UNDERNEATH THE "CEN" OF "CENTURA".

FIRST USE 1-10-2008; IN COMMERCE 1-10-2008.

SER. NO. 76-687,303, FILED 3-3-2008.

NO CLAIM IS MADE TO THE EXCLUSIVE RIGHT TO USE "COLLEGE", APART FROM THE MARK AS SHOWN.

ERIN FALK, EXAMINING ATTORNEY

**Int. Cl.: 7**

**Prior U.S. Cls.: 13, 19, 21, 23, 31, 34 and 35**

**Reg. No. 3,568,829**

**United States Patent and Trademark Office**

**Registered Feb. 3, 2009**

**TRADEMARK  
PRINCIPAL REGISTER**

**PATRIOT**

PERTRONIX, INC. (CALIFORNIA CORPORATION)  
440 EAST ARROW HIGHWAY  
SAN DIMAS, CA 91773

FIRST USE 0-0-2001; IN COMMERCE 0-0-2001.

FOR: VEHICLE HEADERS, NAMELY, HEADERS AS PART OF VEHICLE EXHAUST SYSTEM; SIDE EXHAUST PIPES FOR LAND VEHICLES; ENGINE MUFFLERS; ENGINE EXHAUST TIPS FOR LAND VEHICLES AND STRUCTURAL PARTS THEREFOR, IN CLASS 7 (U.S. CLS. 13, 19, 21, 23, 31, 34 AND 35).

THE MARK CONSISTS OF STANDARD CHARACTERS WITHOUT CLAIM TO ANY PARTICULAR FONT, STYLE, SIZE, OR COLOR.

SER. NO. 76-688,279, FILED 3-28-2008.

ANDREA SAUNDERS, EXAMINING ATTORNEY

Int. Cl.: 28

Prior U.S. Cls.: 22, 23, 38 and 50

United States Patent and Trademark Office

Reg. No. 3,568,830

Registered Feb. 3, 2009

TRADEMARK  
PRINCIPAL REGISTER



GROWING UP GREEN, LLC (NORTH CAROLINA LIMITED LIABILITY COMPANY)  
331 SOUTH MAIN STREET  
WINSTON-SALEM, NC 27101

FOR: TOYS, GAMES AND PLAYTHINGS, NAME-  
LY, PUZZLES, AND JIGSAW PUZZLES, IN CLASS 28  
(U.S. CLS. 22, 23, 38 AND 50).

FIRST USE 10-31-2007; IN COMMERCE 10-31-2007.

THE COLOR(S) GREEN, LIGHT GREEN, BLACK,  
RED, WHITE, YELLOW AND ORANGE IS/ARE  
CLAIMED AS A FEATURE OF THE MARK.

THE COLOR LIGHT GREEN APPEARS IN THE  
WORDING "GROWING UP" AND THE WORD  
"GREEN" APPEARS BELOW THE WORDING

"GROWING UP" IN THE COLOR GREEN WITH  
THE LETTERS "G", "R", "E", AND "N" HAVING  
BLACK STRIPES. THE DESIGN OF A FACE AND  
FRONT LEGS OF A STYLIZED FROG IS SITTING  
ABOVE AND BETWEEN THE WORDS "GROWING"  
AND "UP". THE FACE OF THE FROG IS THE  
COLOR GREEN WITH YELLOW EYES WITH  
BLACK AND WHITE PUPILS, AND THE OPEN  
MOUTH IS THE COLOR BLACK WITH A COLOR  
RED TONGUE. THE FRONT OF THE FROG IS  
WHITE AND THE FROG'S LEGS ARE GREEN  
WITH YELLOW AND ORANGE TIPS.

SER. NO. 76-688,298, FILED 4-2-2008.

KATHLEEN M. VANSTON, EXAMINING ATTOR-  
NEY

**Int. Cl.: 35**

**Prior U.S. Cls.: 100, 101 and 102**

**United States Patent and Trademark Office**

**Reg. No. 3,568,831**

**Registered Feb. 3, 2009**

**SERVICE MARK  
PRINCIPAL REGISTER**

**EGAMEPLACE**

EGAMEPLACE, LLC (MASSACHUSETTS LIMITED LIABILITY COMPANY)  
190 LOWELL ST.  
LYNNFIELD, MA 01940

FOR: COMPUTERIZED, ON-LINE SERVICES IN THE FIELD OF ELECTRONIC GAMES, NAMELY, PROVIDING A WEB SITE AT WHICH USERS CAN OFFER ELECTRONIC GAMES FOR SALE OR TRADE AND BUY OR TRADE ELECTRONIC GAMES OFFERED BY OTHERS, IN CLASS 35 (U.S. CLS. 100, 101 AND 102).

FIRST USE 10-0-2004; IN COMMERCE 10-0-2004.

THE MARK CONSISTS OF STANDARD CHARACTERS WITHOUT CLAIM TO ANY PARTICULAR FONT, STYLE, SIZE, OR COLOR.

SER. NO. 76-688,488, FILED 4-9-2008.

NANCY CLARKE, EXAMINING ATTORNEY

Prior U.S. Cl.: A

United States Patent and Trademark Office

Reg. No. 3,568,832

Registered Feb. 3, 2009

CERTIFICATION MARK  
PRINCIPAL REGISTER



INTERNATIONAL BROTHERHOOD OF ELECTRICAL WORKERS (D.C. UNINCORPORATED ASSOCIATION)  
900 SEVENTH ST, N.W.  
WASHINGTON, DC 200013886

FOR: ELECTRICAL EQUIPMENT AND SUPPLIES, IN CLASS A (U.S. CL. A).

FIRST USE 12-0-2002; IN COMMERCE 12-0-2002.

OWNER OF U.S. REG. NOS. 442,826, 3,358,402 AND OTHERS.

NO CLAIM IS MADE TO THE EXCLUSIVE RIGHT TO USE "UNION ASSEMBLED, AFFILIATED WITH AMERICAN FEDERATION OF LABOR & CONGRESS OF INDUSTRIAL ORGANIZATIONS

& CANADIAN LABOUR CONGRESS", AND "ORGANIZED NOV. 28, 1891", APART FROM THE MARK AS SHOWN.

THE CERTIFICATION MARK, AS USED BY AUTHORIZED PERSONS, CERTIFIES THAT THE WORK OR LABOR ON THE SAID GOODS WAS PERFORMED BY MEMBERS OF THE CERTIFIER UNION.

SEC. 2(F) AS TO "INTERNATIONAL BROTHERHOOD OF ELECTRICAL WORKERS" .

SER. NO. 76-688,524, FILED 4-10-2008.

PATRICIA EVANKO, EXAMINING ATTORNEY

Int. Cl.: 41

Prior U.S. Cls.: 100, 101 and 107

**United States Patent and Trademark Office**

**Reg. No. 3,568,833**

Registered Feb. 3, 2009

**SERVICE MARK  
PRINCIPAL REGISTER**



FUJAREK, GARY (UNITED STATES INDIVIDUAL)  
P.O. BOX 430287  
MIAMI, FL 332430287

FOR: ENTERTAINMENT SERVICES IN THE NATURE OF AN ONGOING MUSICAL, NEWS, RELIGIOUS AND POLITICAL SHOW FOR GLOBAL

AND UNIVERSAL ENLIGHTENMENT AND EDUCATION, IN CLASS 41 (U.S. CLS. 100, 101 AND 107).

FIRST USE 2-29-2008; IN COMMERCE 2-29-2008.

SER. NO. 76-688,603, FILED 4-14-2008.

FLORENTINA BLANDU, EXAMINING ATTORNEY



**Int. Cl.: 41**

**Prior U.S. Cls.: 100, 101 and 107**

**Reg. No. 3,568,834**

**United States Patent and Trademark Office**

**Registered Feb. 3, 2009**

**SERVICE MARK  
PRINCIPAL REGISTER**

**FROM A WOMAN'S SOUL. THROUGH A WOMAN'S EYES.  
BY A WOMAN'S HANDS.**

TOLIVER, SARA (UNITED STATES INDIVIDUAL)  
215 HISTORIC 25TH STREET  
OGDEN, UT 84401 AND  
BUEHLER, JUSTIN (UNITED STATES INDIVIDUAL)  
215 HISTORIC 25TH STREET  
OGDEN, UT 84401

FOR: EDUCATIONAL AND ENTERTAINMENT SERVICES, NAMELY, ORGANIZING AND CONDUCTING WORKSHOPS, SEMINARS, SYMPOSIUMS, RETREATS, AND CLASSES IN CRAFTS, SCRAPBOOKING, KNITTING, STAINED GLASS MAKING, SMALL BUSINESS DEVELOPMENT, AND WOMEN'S ISSUES; DEVELOPMENT AND DISSEMINATION OF EDUCATIONAL MATERIALS OF OTHERS IN THE FIELDS OF CRAFTS, SCRAP-

BOOKING, KNITTING, STAINED GLASS MAKING, SMALL BUSINESS DEVELOPMENT, AND WOMEN'S ISSUES; PUBLICATION OF MAGAZINES, IN CLASS 41 (U.S. CLS. 100, 101 AND 107).

FIRST USE 7-0-2004; IN COMMERCE 7-0-2004.

THE MARK CONSISTS OF STANDARD CHARACTERS WITHOUT CLAIM TO ANY PARTICULAR FONT, STYLE, SIZE, OR COLOR.

OWNER OF U.S. REG. NO. 3,161,417.

SER. NO. 76-688,964, FILED 4-24-2008.

MARIAM MAHMOUDI, EXAMINING ATTORNEY

**Int. Cl.: 41**

**Prior U.S. Cls.: 100, 101 and 107**

**United States Patent and Trademark Office**

**Reg. No. 3,568,835**

**Registered Feb. 3, 2009**

**SERVICE MARK  
PRINCIPAL REGISTER**



STEVENSON-PEREZ, HENRY (UNITED STATES  
INDIVIDUAL)  
11223 VALLEY VIEW AVENUE  
KENSINGTON, MD 20895

FOR: EDUCATION AND TRAINING SERVICES,  
NAMELY, PROVIDING CLASSES, SEMINARS,  
WORKSHOPS, TUTORIALS, CONFERENCES, IN-  
TERACTIVE ONLINE SCIENTIFIC PROGRAMS IN  
THE FIELD OF SCIENCE, AND DISTRIBUTING

SCIENTIFIC INFORMATIONAL MATERIALS IN  
CONNECTION THEREWITH VIA WORLD WIDE  
WEB, IN CLASS 41 (U.S. CLS. 100, 101 AND 107).

FIRST USE 1-2-2008; IN COMMERCE 3-15-2008.

SER. NO. 76-689,240, FILED 5-2-2008.

KELLY MCCOY, EXAMINING ATTORNEY

Int. Cl.: 37

Prior U.S. Cls.: 100, 103 and 106

United States Patent and Trademark Office

Reg. No. 3,568,836

Registered Feb. 3, 2009

SERVICE MARK  
PRINCIPAL REGISTER



PYRO-FIX (OHIO SOLE PROPRIETORSHIP)  
731 EVERGREEN PLACE  
LOVELAND, OH 45140

FOR: REPAIR AND MAINTENANCE OF COMPUTERIZED OR DIGITAL EQUIPMENT WHICH IS USED TO ELECTRICALLY DISCHARGE FIREWORKS FOR PUBLIC DISPLAY, IN CLASS 37 (U.S. CLS. 100, 103 AND 106).

FIRST USE 1-1-2007; IN COMMERCE 1-1-2007.

THE COLOR(S) BLACK, RED AND WHITE IS/ARE CLAIMED AS A FEATURE OF THE MARK.

THE LITERAL ELEMENT OF THE MARK CONSISTS OF "PYRO FIX" WITH THE FIRECRACKER REPRESENTING A HYPHEN. THE COLOR BLACK APPEARS IN THE WORDS "PYRO", "FIX" AND THE FIRECRACKER FUSE; THE COLOR RED APPEARS IN THE FIRECRACKER AND SPARK; THE COLOR WHITE APPEARS IN THE CIRCUIT BOARD MARKINGS ON THE FIRECRACKER.

SER. NO. 76-689,893, FILED 5-22-2008.

MICHELE SWAIN, EXAMINING ATTORNEY

Int. Cl.: 29

Prior U.S. Cl.: 46

United States Patent and Trademark Office

Reg. No. 3,568,837

Registered Feb. 3, 2009

TRADEMARK  
PRINCIPAL REGISTER



PERFORMANCE FOOD GROUP COMPANY, LLC  
(DELAWARE LIMITED LIABILITY COMPAN-  
NY)  
12500 WEST CREEK PARKWAY  
RICHMOND, VA 23238

FOR: HAM, BEEF, BACON AND POULTRY, IN  
CLASS 29 (U.S. CL. 46).

FIRST USE 10-0-2006; IN COMMERCE 10-0-2006.

NO CLAIM IS MADE TO THE EXCLUSIVE  
RIGHT TO USE "CULINARY", APART FROM THE  
MARK AS SHOWN.

THE MARK CONSISTS OF THE WORDING "RID-  
GECREST CULINARY" AND DESIGN COMPRISED  
IN REPRESENTATIVE PART OF A PLATE CROS-  
SED BY CUTLERY PLACED OVER A HALF COM-  
PASS WHICH CONTAINS MOUNTAIN AND LAKE  
SCENERY.

SER. NO. 76-690,167, FILED 5-29-2008.

EUGENIA MARTIN, EXAMINING ATTORNEY

Int. Cl.: 18

Prior U.S. Cls.: 1, 2, 3, 22 and 41

United States Patent and Trademark Office

Reg. No. 3,568,838

Registered Feb. 3, 2009

TRADEMARK  
PRINCIPAL REGISTER



MOLLYWOOD PAW COATURE (NEW YORK  
SOLE PROPRIETORSHIP)  
76 LYNHURST AVENUE  
STATEN ISLAND, NY 10305

FOR: DOG COATS IN PAW PRINT FLEECE,  
SLICKER AND BLUE JEAN MATERIALS, IN CLASS  
18 (U.S. CLS. 1, 2, 3, 22 AND 41).

FIRST USE 4-22-2008; IN COMMERCE 4-24-2008.

THE MARK CONSISTS OF A RECTANGLE WITH  
FOUR ROUNDED CORERS. INSIDE THE RECTAN-  
GLE APPEARS THE WORDING "MOLLYWOOD  
PAW COATURE COZY COATS FOR YOUR BEST  
FRIEND MOLLYWOODPAWCOATURE.COM 866-

996-MOLLY (6559)" ON FOUR LINES. THE FIRST  
LINE CONTAINS THE WORDING "MOLLYWOOD  
PAW COATURE" IN STYLIZED LETTERING. THE  
SECOND LINE CONTAINS TWO SMALL PAW DE-  
SIGNS. IN BETWEEN THE TWO SMALL PAWS  
APPEARS THE WORDING "COZY COATS FOR  
YOUR BEST FRIEND". THE THIRD LINE CON-  
TAINS THE WORDING "MOLLYWOODPAWCOA-  
TURE.COM". THE FOURTH LINE CONTAINS "866-  
996-MOLLY (6559)".

SER. NO. 76-690,245, FILED 6-4-2008.

STEPHEN AQUILA, EXAMINING ATTORNEY

**Int. Cl.: 25**

**Prior U.S. Cls.: 22 and 39**

**United States Patent and Trademark Office**

**Reg. No. 3,568,839**

**Registered Feb. 3, 2009**

**TRADEMARK  
PRINCIPAL REGISTER**

**ONE WITH NATURE**

MUASHER, GHADA (JORDAN INDIVIDUAL)  
31 DIMASHQ STREET P.O.BOX 830271  
AMMAN 11183, JORDAN

FOR: MEN'S, WOMEN'S AND CHILDREN'S  
CLOTHING, NAMELY, SHIRTS, T-SHIRTS, BLOU-  
SES, JACKETS, SWEATSHIRTS, SWEATPANTS,  
SHORTS, NIGHTGOWNS, NIGHTSHIRTS, LEO-  
TARDS, LEGGINGS AND SOCKS , IN CLASS 25  
(U.S. CLS. 22 AND 39).

FIRST USE 10-13-1996; IN COMMERCE 10-13-1996.

THE MARK CONSISTS OF STANDARD CHAR-  
ACTERS WITHOUT CLAIM TO ANY PARTICULAR  
FONT, STYLE, SIZE, OR COLOR.

OWNER OF U.S. REG. NOS. 2,132,949 AND  
2,544,479.

SER. NO. 76-690,341, FILED 6-6-2008.

KRISTINA MORRIS, EXAMINING ATTORNEY

**Int. Cls.: 32 and 40**

**Prior U.S. Cls.: 45, 46, 48, 100, 103 and 106**

**United States Patent and Trademark Office**

**Reg. No. 3,568,840**

**Registered Feb. 3, 2009**

**TRADEMARK  
SERVICE MARK  
PRINCIPAL REGISTER**

**CASA ARRIBA BREWING COMPANY**

JEST ENTERPRISES, INC. (ARIZONA CORPORATION)  
15025 N. 74TH STREET  
SCOTTSDALE, AZ 85260

OWNER OF U.S. REG. NOS. 2,225,637 AND 3,155,914.

FOR: BEERS AND ALES, IN CLASS 32 (U.S. CLS. 45, 46 AND 48).

NO CLAIM IS MADE TO THE EXCLUSIVE RIGHT TO USE "BREWING COMPANY", APART FROM THE MARK AS SHOWN.

FIRST USE 10-1-1999; IN COMMERCE 10-1-1999.

FOR: BREWERY SERVICES FOR OTHERS, NAMELY, BREWING BEERS AND ALES, IN CLASS 40 (U.S. CLS. 100, 103 AND 106).

THE ENGLISH TRANSLATION FOR "CASA ARRIBA" IS HOUSE ABOVE.

FIRST USE 10-1-1999; IN COMMERCE 10-1-1999.

SER. NO. 76-690,541, FILED 6-13-2008.

THE MARK CONSISTS OF STANDARD CHARACTERS WITHOUT CLAIM TO ANY PARTICULAR FONT, STYLE, SIZE, OR COLOR.

CIMMERIAN COLEMAN, EXAMINING ATTORNEY

**Int. Cl.: 25**

**Prior U.S. Cls.: 22 and 39**

**United States Patent and Trademark Office**

**Reg. No. 3,568,841**

**Registered Feb. 3, 2009**

**TRADEMARK  
PRINCIPAL REGISTER**

**PRPS WRKSHOP**

KEMISTRE 8, LLC. (NEW YORK LIMITED LIABILITY COMPANY)  
31 WEST 34TH STREET, SUITE 401  
NEW YORK, NY 10001

FOR: CLOTHING AND APPAREL FOR MEN, WOMEN, YOUNG ADULTS, CHILDREN, NAMELY, SHIRTS, EMBROIDERED SHIRTS, TEE SHIRTS, SHORTS, SPORT SHIRTS, SWEATSHIRTS, SWEATPANTS, VESTS, BELTS, LOUNGEWEAR, SLEEPWEAR, FOOTWEAR, SWIMSUITS, WARM-UP SUITS, JACKETS, JERSEYS, TANK TOPS, SWEATERS, PANTS, JEANS, SUITS, SPORT COATS, PARKAS, PAJAMAS, HEADWEAR, HATS, BASEBALL CAPS, EMBROIDERED CAPS, KNITTED HATS, SHOES, SLIPPERS, BOOTS, SANDALS, SNEAKERS, JUMPSUITS; CLOTHING FOR WOMEN AND

YOUNG ADULTS, NAMELY, BLOUSES, DRESSES, SKIRTS, TOPS, SCARVES, HALTER TOPS, JUMPERS, AND WRAPS, IN CLASS 25 (U.S. CLS. 22 AND 39).

FIRST USE 10-1-2007; IN COMMERCE 1-1-2008.

THE MARK CONSISTS OF STANDARD CHARACTERS WITHOUT CLAIM TO ANY PARTICULAR FONT, STYLE, SIZE, OR COLOR.

OWNER OF U.S. REG. NO. 2,849,405.

SER. NO. 76-690,590, FILED 6-16-2008.

LINDA M. KING, EXAMINING ATTORNEY



**Int. Cl.: 42**

**Prior U.S. Cls.: 100 and 101**

**United States Patent and Trademark Office**

**Reg. No. 3,568,842**

**Registered Feb. 3, 2009**

**SERVICE MARK  
PRINCIPAL REGISTER**

**PLATFORM SOLUTIONS**

PLATFORM SOLUTIONS INC. (MASSACHU-  
SETTS CORPORATION)  
150 WOOD ROAD, SUITE 102  
BRAINTREE, MA 02184

FOR: INFORMATION TECHNOLOGY CON-  
SULTING SERVICES, IN CLASS 42 (U.S. CLS. 100  
AND 101).

FIRST USE 4-0-2001; IN COMMERCE 4-0-2001.

THE MARK CONSISTS OF STANDARD CHAR-  
ACTERS WITHOUT CLAIM TO ANY PARTICULAR  
FONT, STYLE, SIZE, OR COLOR.

OWNER OF U.S. REG. NO. 2,726,092.

SEC. 2(F).

SER. NO. 76-690,683, FILED 6-19-2008.

WILLIAM ROSSMAN, EXAMINING ATTORNEY

Int. Cl.: 6

Prior U.S. Cls.: 2, 12, 13, 14, 23, 25 and 50

Reg. No. 3,568,843

United States Patent and Trademark Office

Registered Feb. 3, 2009

TRADEMARK  
PRINCIPAL REGISTER

SCROOSCOOP FASTENER CO.

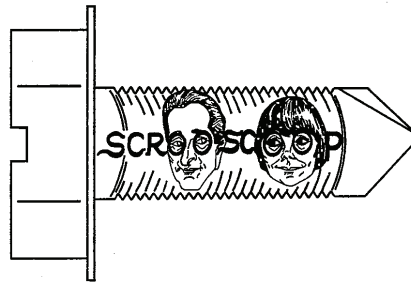

APPAREL RELATED ITEMS, INC. (CALIFORNIA CORPORATION), DBA SCROOSCOOP FASTENER CO.  
2180 LAS PALMAS DRIVE  
CARLSBAD, CA 920111520

FOR: METAL NUTS, BOLTS AND SCREWS, IN CLASS 6 (U.S. CLS. 2, 12, 13, 14, 23, 25 AND 50).

FIRST USE 4-1-1996; IN COMMERCE 4-1-1996.

NO CLAIM IS MADE TO THE EXCLUSIVE RIGHT TO USE "FASTENER CO.", APART FROM THE MARK AS SHOWN.

THE LINING SHOWN ON THE MARK ON THE DRAWING IS A FEATURE OF THE MARK AND IS NOT INTENDED TO INDICATED COLOR.

THE PORTRAITS OF THE MAN AND THE WOMAN SHOWN IN THE MARK ON THE DRAWING

ARE FANCIFUL AND DO NOT REPRESENT ANY LIVING INDIVIDUAL.

THE MARK CONSISTS OF THE WORDS "SCROOSCOOP FASTENER CO. SCROOSCOOP" AND THE DESIGN OF A SCREW. THE MARK CONSISTS OF THE WORDS "SCROOSCOOP FASTENER CO. SCROOSCOOP" AND THE DESIGN AS SHOWN IN THE DRAWING WHICH CONSISTS OF A FANCIFUL SCREW WITH A MAN AND A WOMAN WITH THE EYES OF THE MAN BEING THE FIRST TWO "O'S" OF "SCROO" AND THE EYES OF THE WOMAN BEING THE TWO "O'S" OF "SCOOP".

SER. NO. 76-690,832, FILED 6-25-2008.

GINA FINK, EXAMINING ATTORNEY

Int. Cl.: 45

Prior U.S. Cls.: 100 and 101

United States Patent and Trademark Office

Reg. No. 3,568,844

Registered Feb. 3, 2009

SERVICE MARK  
PRINCIPAL REGISTER



POWER & DIXON, P.C. (ILLINOIS CORPORATION)  
123 W. MADISON (SUITE 1900)  
CHICAGO, IL 60602

FOR: LEGAL RESEARCH; LEGAL SERVICES, IN CLASS 45 (U.S. CLS. 100 AND 101).

FIRST USE 4-1-2008; IN COMMERCE 5-1-2008.

THE COLOR(S) RED AND BLACK IS/ARE CLAIMED AS A FEATURE OF THE MARK.

THE MARK CONSISTS OF "POWER & DIXON" IN BLACK WITH A BLACK LINE OVER "POWER" AND A BLACK LINE UNDER "DIXON". AROUND THE "&" IS A STYLIZED "PD" DESIGN WITH THE "P" IN BLACK AND THE "D" IN RED. THE WHITE IN AND BEHIND THE MARK IS BACKGROUND AREA WHICH IS NOT A PART OF THE MARK.

SER. NO. 76-690,858, FILED 6-26-2008.

REBECCA GILBERT, EXAMINING ATTORNEY

**Int. Cl.: 29**

**Prior U.S. Cl.: 46**

**United States Patent and Trademark Office**

**Reg. No. 3,568,845**

**Registered Feb. 3, 2009**

**TRADEMARK  
PRINCIPAL REGISTER**

**GEM**

SOVENA U.S.A., INC. (NEW YORK CORPORATION)  
1 OLIVE GROVE ST.  
ROME, NY 13441

FOR: EDIBLE OILS, NAMELY, EXTRA VIRGIN OLIVE OIL, ORGANIC EXTRA VIRGIN OLIVE OIL, POMACE OLIVE OIL, CANOLA OIL, SALAD OIL, IN CLASS 29 (U.S. CL. 46).

FIRST USE 0-0-1954; IN COMMERCE 8-0-1995.

THE MARK CONSISTS OF STANDARD CHARACTERS WITHOUT CLAIM TO ANY PARTICULAR FONT, STYLE, SIZE, OR COLOR.

OWNER OF U.S. REG. NO. 3,152,596.

SER. NO. 76-690,864, FILED 6-26-2008.

CHARLES L. JENKINS, EXAMINING ATTORNEY

**Int. Cl.: 41**

**Prior U.S. Cls.: 100, 101 and 107**

**United States Patent and Trademark Office**

**Reg. No. 3,568,846**

**Registered Feb. 3, 2009**

**SERVICE MARK  
PRINCIPAL REGISTER**



HOLLAND DANCE INSTITUTE, LLC (TEXAS  
LIMITED LIABILITY COMPANY)  
6612 SITIO DEL RIO BOULEVARD  
AUSTIN, TX 78730

FOR: EDUCATIONAL SERVICES, NAMELY,  
CONDUCTING CLASSES, WORKSHOPS AND IN-  
STRUCTION IN THE FIELD OF DANCE AND  
PHYSICAL FITNESS; ENTERTAINMENT SERVICES  
IN THE NATURE OF DANCE PERFORMANCES;  
DANCE AND PHYSICAL FITNESS SCHOOL;  
DANCE STUDIO, IN CLASS 41 (U.S. CLS. 100, 101  
AND 107).

FIRST USE 5-17-2008; IN COMMERCE 6-6-2008.

THE MARK CONSISTS OF A CAPITAL LETTER  
"D" WHEREBY THE VERTICAL PART OF THE "D"  
LOOKS LIKE A CAPITAL LETTER "I" AND THE  
CURVING PART OF THE "D" CONSISTS OF THE  
SILHOUETTE OF TWO PEOPLE DANCING, WITH  
THE MAN LEANING FORWARD AND THE WO-  
MAN BENDING BACKWARDS. THE MARK IS  
TYPICALLY PICTURED IN WHITE.

SER. NO. 76-691,015, FILED 7-3-2008.

HENRY S. ZAK, EXAMINING ATTORNEY

**Int. Cl.: 45**

**Prior U.S. Cls.: 100 and 101**

**United States Patent and Trademark Office**

**Reg. No. 3,568,847**

**Registered Feb. 3, 2009**

**SERVICE MARK  
PRINCIPAL REGISTER**



POWER & DIXON, P.C. (ILLINOIS CORPORATION)  
123 W. MADISON, 19TH FLOOR  
CHICAGO, IL 60602

FOR: LEGAL SERVICES; LEGAL RESEARCH, IN  
CLASS 45 (U.S. CLS. 100 AND 101).

FIRST USE 4-2-2008; IN COMMERCE 5-1-2008.

THE COLOR(S) RED AND BLACK IS/ARE  
CLAIMED AS A FEATURE OF THE MARK.

THE MARK CONSISTS OF STYLIZED "P & D"  
WITH "P &" IN BLACK AND "D" IN RED. THE  
WHITE IN AND BEHIND THE MARK IS BACK-  
GROUND AREA WHICH IS NOT A PART OF THE  
MARK.

SER. NO. 76-691,083, FILED 7-7-2008.

REBECCA GILBERT, EXAMINING ATTORNEY

**Int. Cls.: 35, 38 and 41**

**Prior U.S. Cls.: 100, 101, 102, 104 and 107**

**Reg. No. 3,568,848**

**United States Patent and Trademark Office**

**Registered Feb. 3, 2009**

**SERVICE MARK  
PRINCIPAL REGISTER**



UNIVISION COMMUNICATIONS INC. (DELAWARE CORPORATION)  
5999 CENTER DRIVE  
LOS ANGELES, CA 90045

FOR: PROVIDING ADVERTISING SERVICES FOR OTHERS; PROMOTING THE GOODS AND SERVICES OF OTHERS BY DISTRIBUTING ADVERTISING MATERIALS THROUGH RADIO STATIONS, RADIO NETWORKS, THE INTERNET, GLOBAL COMPUTER NETWORKS, AND WIRELESS COMMUNICATION DEVICES, IN CLASS 35 (U.S. CLS. 100, 101 AND 102).

FIRST USE 9-23-2003; IN COMMERCE 9-23-2003.

FOR: RADIO, INTERNET AND WIRELESS BROADCASTING SERVICES, NAMELY, THE AUDIO AND VIDEO TRANSMISSION OF LIVE AND PRE-RECORDED EVENTS OVER RADIO FREQUENCIES, OVER GLOBAL COMPUTER NETWORKS AND VIA WIRELESS COMMUNICATION DEVICES, IN CLASS 38 (U.S. CLS. 100, 101 AND 104).

FIRST USE 9-23-2003; IN COMMERCE 9-23-2003.

FOR: ENTERTAINMENT SERVICES, NAMELY, RADIO PROGRAMMING SERVICES AND PRODUCTION OF RADIO PROGRAMS IN THE FIELD OF MUSIC, NEWS, SPORTS, HEALTH AND WELLNESS, FINANCE, IMMIGRATION, CURRENT

EVENTS AND ENTERTAINMENT; ENTERTAINMENT SERVICES, NAMELY, TELEVISION AND RADIO PROGRAMMING AND PRODUCTION OF TELEVISION AND RADIO PROGRAMS IN THE FIELD OF MUSIC, NEWS, SPORTS, HEALTH AND WELLNESS, FINANCE, IMMIGRATION, CURRENT EVENTS AND ENTERTAINMENT DESIGNED TO BE TRANSMITTED OVER GLOBAL COMPUTER NETWORKS AND VIA WIRELESS COMMUNICATION DEVICES, IN CLASS 41 (U.S. CLS. 100, 101 AND 107).

FIRST USE 9-23-2003; IN COMMERCE 9-23-2003.

OWNER OF U.S. REG. NOS. 1,672,807, 3,483,636 AND OTHERS.

NO CLAIM IS MADE TO THE EXCLUSIVE RIGHT TO USE "RADIO", APART FROM THE MARK AS SHOWN.

THE MARK CONSISTS OF THE STYLIZED WORDING "UNIVISION RADIO"; TO THE LEFT OF THE WORDING IS A FANCIFUL DESIGN OF THE LETTER "U" COMPRISE OF THREE TRIANGLES WITH CURVED SIDES AND A SQUARE.

SER. NO. 76-691,635, FILED 7-28-2008.

MICHAEL TANNER, EXAMINING ATTORNEY

**Int. Cl.: 45**

**Prior U.S. Cls.: 100 and 101**

**United States Patent and Trademark Office**

**Reg. No. 3,568,849**

**Registered Feb. 3, 2009**

**SERVICE MARK  
PRINCIPAL REGISTER**

**My Law Firm's Got My Back**

POWER & DIXON, P.C. (ILLINOIS CORPORATION)  
123 W. MADISON, 19TH FLOOR  
CHICAGO, IL 60602

THE MARK CONSISTS OF STANDARD CHARACTERS WITHOUT CLAIM TO ANY PARTICULAR FONT, STYLE, SIZE, OR COLOR.

FOR: LEGAL SERVICES; LEGAL RESEARCH, IN CLASS 45 (U.S. CLS. 100 AND 101).

SER. NO. 76-691,755, FILED 8-1-2008.

FIRST USE 7-5-2008; IN COMMERCE 7-10-2008.

REBECCA GILBERT, EXAMINING ATTORNEY



**Int. Cls.: 35 and 42**

**Prior U.S. Cls.: 100, 101 and 102**

**United States Patent and Trademark Office**

**Reg. No. 3,568,850**

**Registered Feb. 3, 2009**

**SERVICE MARK  
PRINCIPAL REGISTER**

**POWER2MOTIVATE**

CARLTON GROUP LTD. (CANADA CORPORATION)  
SUITE 702  
100 ALLSTATE PARKWAY  
MARKHAM, ONTARIO L3R6H3

FOR: ON-LINE WEB SERVICES, NAMELY, PROVIDING A WEBSITE THAT PROVIDES BUSINESS RELATED TOOLS FOR OTHERS TO MANAGE THE OPERATION OF A FULLY HOSTED INTERNET ACCESSIBLE SITE FOR THE SELF-MANAGEMENT OF EMPLOYEE INCENTIVE AWARD AND RECOGNITION PROGRAMS AND SALES AND CHANNEL INCENTIVE PROGRAMS, NAMELY, PROGRAM BUSINESS RULES, TRACKING AND REPORTING, AND FOR PROVIDING TRAINING, CONTESTS, SURVEYS AND ELECTRONIC GAMES, IN CLASS 35 (U.S. CLS. 100, 101 AND 102).

FIRST USE 11-14-2006; IN COMMERCE 5-27-2007.

FOR: PROVIDING ON-LINE NON-DOWNLOADABLE SOFTWARE, NAMELY, PROGRAMS TO AUTOMATE FOR AUTOMATION OF ALL OF THE FOLLOWING- THE SETUP AND MANAGEMENT OF EMPLOYEE INCENTIVE AWARD AND RECOGNITION PROGRAMS, SALES AND CHANNEL INCENTIVES PROGRAMS, THE TRACKING AND REPORTING OF CLIENT PROGRAMS, AND RE-

WARD FULFILLMENT AND ACCOUNTING; PROVIDING ON-LINE NON-DOWNLOADABLE SOFTWARE, NAMELY, PROGRAMS THAT INTEGRATE FOR INTEGRATION OF WEB BASED TOOLS INCLUDING EMPLOYEE, SALES AND BUSINESS TRAINING, CONTESTS, SURVEYS, GAMES AND SALES FORCE AUTOMATION; ON-LINE WEB SERVICES, NAMELY, WEB SITE CREATION, DESIGN AND MAINTENANCE SERVICES IN THE FIELD OF EMPLOYEE, SALES AND CHANNEL INCENTIVE AWARD AND RECOGNITION PROGRAMS, IN CLASS 42 (U.S. CLS. 100 AND 101).

FIRST USE 11-14-2006; IN COMMERCE 5-27-2007.

THE MARK CONSISTS OF STANDARD CHARACTERS WITHOUT CLAIM TO ANY PARTICULAR FONT, STYLE, SIZE, OR COLOR.

PRIORITY CLAIMED UNDER SEC. 44(D) ON CANADA APPLICATION NO. 1316551, FILED 9-14-2006, REG. NO. TMA697800, DATED 10-3-2007, EXPIRES 10-3-2022.

SER. NO. 77-002,463, FILED 9-19-2006.

JULIE VEPPUMTHARA, EXAMINING ATTORNEY

**Int. Cl.: 16**

**Prior U.S. Cls.: 2, 5, 22, 23, 29, 37, 38 and 50**

**United States Patent and Trademark Office**

**Reg. No. 3,568,851**

**Registered Feb. 3, 2009**

**TRADEMARK  
PRINCIPAL REGISTER**

**EDUINNOVA**

PONTIFICIA UNIVERSIDAD CATOLICA DE  
CHILE (CHILE CORPORATION OF SUPERIOR  
STUDIES)

BERNARDO O'HIGGINS NO. 340

AV. LIBERTADOR  
SANTIAGO, CHILE

FOR: MAGAZINES ON THE SUBJECT OF EDU-  
CATION, IN CLASS 16 (U.S. CLS. 2, 5, 22, 23, 29, 37, 38  
AND 50).

THE MARK CONSISTS OF STANDARD CHAR-  
ACTERS WITHOUT CLAIM TO ANY PARTICULAR  
FONT, STYLE, SIZE, OR COLOR.

OWNER OF CHILE REG. NO. 792.674, DATED 8-6-  
2007, EXPIRES 7-20-2017.

SER. NO. 77-003,816, FILED 9-20-2006.

ODESSA BIBBINS, EXAMINING ATTORNEY

**Int. Cl.: 25**

**Prior U.S. Cls.: 22 and 39**

**United States Patent and Trademark Office**

**Reg. No. 3,568,852**

**Registered Feb. 3, 2009**

**TRADEMARK  
PRINCIPAL REGISTER**

**URBAN MONK**

MEDD, MICHAEL C (UNITED STATES INDIVIDUAL)  
#808 YU YUET LAI BLDG, 43-55 WYNDHAM ST  
CENTRAL, HONG KONG 00000

FOR: CAPS; CARGO PANTS; DRESSES; MEN AND WOMEN JACKETS, COATS, TROUSERS, VESTS; OPEN-NECKED SHIRTS; PANTS; PULL-OVERS; SHORT-SLEEVED OR LONG-SLEEVED T-SHIRTS; SWEAT PANTS, IN CLASS 25 (U.S. CLS. 22 AND 39).

THE MARK CONSISTS OF STANDARD CHARACTERS WITHOUT CLAIM TO ANY PARTICULAR FONT, STYLE, SIZE, OR COLOR.

OWNER OF HONG KONG REG. NO. 30920745,  
DATED 1-11-2008, EXPIRES 10-26-2016.

SER. NO. 77-006,084, FILED 9-24-2006.

KIM SAITO, EXAMINING ATTORNEY

**Int. Cls.: 29 and 30**

**Prior U.S. Cl.: 46**

**United States Patent and Trademark Office**

**Reg. No. 3,568,853**

**Registered Feb. 3, 2009**

**TRADEMARK  
PRINCIPAL REGISTER**

**BARI**

PEDOTA, INC. (ILLINOIS CORPORATION), DBA  
BARI  
1120 WEST GRAND AVENUE  
CHICAGO, IL 606225801

FOR: CANNED VEGETABLE PRODUCTS,  
NAMELY, TOMATOES, TOMATO PASTE, TOMATO  
PUREE, PEELED TOMATOES AND HOT MARINA-  
TED VEGETABLES, NAMELY, HOT, MILD AND  
MEDIUM GIARDINIERA; AND GRATED CHEESE,  
IN CLASS 29 (U.S. CL. 46).

FIRST USE 12-20-1949; IN COMMERCE 12-20-1949.

FOR: WINE VINEGAR, IN CLASS 30 (U.S. CL. 46).

FIRST USE 12-20-1949; IN COMMERCE 12-20-1949.

THE MARK CONSISTS OF STANDARD CHAR-  
ACTERS WITHOUT CLAIM TO ANY PARTICULAR  
FONT, STYLE, SIZE, OR COLOR.

SER. NO. 77-008,354, FILED 9-27-2006.

KELLY MCCOY, EXAMINING ATTORNEY

**Int. Cl.: 36**

**Prior U.S. Cls.: 100, 101 and 102**

**United States Patent and Trademark Office**

**Reg. No. 3,568,854**

**Registered Feb. 3, 2009**

**SERVICE MARK  
PRINCIPAL REGISTER**

**CANYON CAPITAL ADVISORS**

CANYON CAPITAL ADVISORS LLC (DELA-  
WARE LIMITED LIABILITY COMPANY)  
2000 AVENUE OF THE STARS  
11TH FLOOR  
LOS ANGELES, CA 90067

FOR: FINANCIAL MANAGEMENT, FINANCIAL INVESTMENT ADVICE, AND FINANCIAL ANALYSIS SERVICES OFFERED IN CONNECTION WITH PRIVATE EQUITY INVESTMENTS IN STRESSED AND DISTRESSED SECURITIES, SPECIAL SITUATION DEBT SECURITIES AND UNDERVALUED SECURITIES IN BANK DEBT, HIGH YIELD BONDS, TRADE CLAIMS AND EQUITY SECURITIES; VENTURE CAPITAL FUNDS MANAGEMENT SERVICES; EQUITY AND FIXED INCOME INVESTMENT MANAGEMENT SERVICES; INVESTMENT MANAGEMENT SERVICES, NAMELY, MANAGEMENT OF VALUE FUNDS; INVESTMENT MANAGEMENT SERVICES, NAMELY, MANAGEMENT OF REAL ESTATE INVESTMENT TRUSTS; COMMERCIAL REAL ESTATE LENDING SERVICES; MANAGE-

MENT OF HEDGE FUND INVESTMENTS; SECURITIES ARBITRAGE SERVICES, NAMELY, CONVERTIBLE ARBITRAGE AND MERGER ARBITRAGE SERVICES; ECONOMIC FINANCIAL RESEARCH; INFORMATION AND CONSULTING SERVICES RELATING TO ALL THE AFORESAID SERVICES, IN CLASS 36 (U.S. CLS. 100, 101 AND 102).

FIRST USE 5-21-1999; IN COMMERCE 5-21-1999.

THE MARK CONSISTS OF STANDARD CHARACTERS WITHOUT CLAIM TO ANY PARTICULAR FONT, STYLE, SIZE, OR COLOR.

NO CLAIM IS MADE TO THE EXCLUSIVE RIGHT TO USE "CAPITAL ADVISORS", APART FROM THE MARK AS SHOWN.

SER. NO. 77-016,414, FILED 10-7-2006.

DEBRA LEE, EXAMINING ATTORNEY

**Int. Cl.: 36**

**Prior U.S. Cls.: 100, 101 and 102**

**United States Patent and Trademark Office**

**Reg. No. 3,568,855**

**Registered Feb. 3, 2009**

**SERVICE MARK  
PRINCIPAL REGISTER**

**CANYON CAPITAL REALTY  
ADVISORS**

CANYON CAPITAL ADVISORS LLC (DELA-  
WARE LIMITED LIABILITY COMPANY)  
2000 AVENUE OF THE STARS  
11TH FLOOR  
LOS ANGELES, CA 90067

FOR: FINANCIAL SERVICES, NAMELY, REAL ESTATE INVESTMENT SERVICES PROVIDING DEBT AND EQUITY CAPITAL TO REAL ESTATE OWNERS AND OPERATORS; REAL ESTATE LENDING SERVICES; MANAGEMENT OF PORTFOLIOS COMPRISING SECURITIES COLLATERALIZED BY REAL ESTATE AND BROKERAGE OF SECURITIES COLLATERALIZED BY REAL ESTATE; MANAGEMENT OF INVESTMENT PORTFOLIOS THAT PROVIDE DEBT AND EQUITY CAPITAL TO REAL ESTATE OWNERS, OPERATORS, DEVELOPERS, CORPORATIONS AND ENTREPRENEURS; FINANCIAL INVESTMENT ADVICE AND ANALYSIS SERVICES FOR UNDERWRITING AND STRUCTURING DEBT AND EQUITY CAPITAL TO REAL ESTATE OWNERS, OPERATORS, DEVELOPERS,

PERS, CORPORATIONS AND ENTREPRENEURS; INVESTMENT MANAGEMENT SERVICES, NAMELY, MANAGEMENT OF REAL ESTATE INVESTMENT TRUSTS; ECONOMIC FINANCIAL RESEARCH; INFORMATION AND CONSULTING SERVICES RELATING TO ALL THE AFORESAID SERVICES, IN CLASS 36 (U.S. CLS. 100, 101 AND 102).

FIRST USE 5-24-1999; IN COMMERCE 5-24-1999.

THE MARK CONSISTS OF STANDARD CHARACTERS WITHOUT CLAIM TO ANY PARTICULAR FONT, STYLE, SIZE, OR COLOR.

NO CLAIM IS MADE TO THE EXCLUSIVE RIGHT TO USE "CAPITAL REALTY ADVISORS", APART FROM THE MARK AS SHOWN.

SER. NO. 77-016,416, FILED 10-7-2006.

DEBRA LEE, EXAMINING ATTORNEY

**Int. Cl.: 32**

**Prior U.S. Cls.: 45, 46 and 48**

**Reg. No. 3,568,856**

**United States Patent and Trademark Office**

**Registered Feb. 3, 2009**

**TRADEMARK  
PRINCIPAL REGISTER**

# IAF Beverage

IAF BEVERAGE INC. (TEXAS CORPORATION)  
9761 CLIFFORD DRIVE  
DALLAS, TX 75220

FIRST USE 3-9-2004; IN COMMERCE 3-9-2004.

FOR: FROZEN FRUIT BEVERAGES; FROZEN FRUIT-BASED BEVERAGES; FRUIT BEVERAGES; FRUIT-FLAVORED BEVERAGES; ICED FRUIT BEVERAGES; NON-ALCOHOLIC BEVERAGES CONTAINING FRUIT JUICES; NON-ALCOHOLIC FRUIT JUICE BEVERAGES; NON-CARBONATED, NON-ALCOHOLIC FROZEN FLAVORED BEVERAGES; ORANGE JUICE BEVERAGES; SMOOTHIES; SYRUPS FOR BEVERAGES, IN CLASS 32 (U.S. CLS. 45, 46 AND 48).

THE MARK CONSISTS OF STANDARD CHARACTERS WITHOUT CLAIM TO ANY PARTICULAR FONT, STYLE, SIZE, OR COLOR.

NO CLAIM IS MADE TO THE EXCLUSIVE RIGHT TO USE "BEVERAGE", APART FROM THE MARK AS SHOWN.

SER. NO. 77-018,355, FILED 10-11-2006.

ESTHER BELENKER, EXAMINING ATTORNEY

**Int. Cls.: 35, 36 and 45**

**Prior U.S. Cls.: 100, 101 and 102**

**United States Patent and Trademark Office**

**Reg. No. 3,568,857**

**Registered Feb. 3, 2009**

**SERVICE MARK  
PRINCIPAL REGISTER**

**Huron**  
**CONSULTING GROUP**

HURON CONSULTING GROUP INC. (DELA-  
WARE CORPORATION)  
550 WEST VAN BUREN STREET  
CHICAGO, IL 60607

FOR: CONSULTING SERVICES AND INFORMATION SERVICES PROVIDED TO ORGANIZATIONS IN THE BUSINESS FIELD IN THE AREAS OF BUSINESS MANAGEMENT, ECONOMICS, AND BUSINESS STRATEGY AND OPERATIONS; CONSULTING AND INFORMATION SERVICES IN THE AREA OF PROCUREMENT, NAMELY CONTRACTING FOR THE PURCHASE OF GOODS AND SERVICES AND IN THE AREA OF BUSINESS INVESTIGATIONS AND BUSINESS DISPUTES; CONSULTING SERVICES AND INFORMATION SERVICES PROVIDED TO ORGANIZATIONS IN THE HIGHER EDUCATION FIELD IN THE AREAS OF BUSINESS MANAGEMENT, ECONOMICS, AND BUSINESS STRATEGY AND OPERATIONS; CONSULTING SERVICES AND INFORMATION SERVICES PROVIDED TO ORGANIZATIONS IN THE HEALTHCARE FIELD IN THE AREAS OF BUSINESS MANAGEMENT, ECONOMICS, AND BUSINESS STRATEGY AND OPERATIONS; RESEARCH SERVICES PROVIDED TO ORGANIZATIONS IN THE BUSINESS, HEALTHCARE AND HIGHER EDUCATION FIELDS IN THE AREAS OF BUSINESS

MANAGEMENT, ECONOMICS, AND BUSINESS STRATEGY AND OPERATIONS, IN CLASS 35 (U.S. CLS. 100, 101 AND 102).

FIRST USE 4-0-2002; IN COMMERCE 4-0-2002.

FOR: CONSULTING SERVICES, INFORMATION SERVICES AND RESEARCH SERVICES IN THE AREA OF FINANCE, IN CLASS 36 (U.S. CLS. 100, 101 AND 102).

FIRST USE 4-0-2002; IN COMMERCE 4-0-2002.

FOR: CONSULTING SERVICES AND INFORMATION SERVICES IN THE AREA OF LEGAL DISPUTES AND INVESTIGATIONS, IN CLASS 45 (U.S. CLS. 100 AND 101).

FIRST USE 4-0-2002; IN COMMERCE 4-0-2002.

NO CLAIM IS MADE TO THE EXCLUSIVE RIGHT TO USE "CONSULTING GROUP", APART FROM THE MARK AS SHOWN.

SER. NO. 77-019,846, FILED 10-12-2006.

DOMINICK J. SALEMI, EXAMINING ATTORNEY



**Int. Cl.: 37**

**Prior U.S. Cls.: 100, 103 and 106**

**United States Patent and Trademark Office**

**Reg. No. 3,568,858**

**Registered Feb. 3, 2009**

**SERVICE MARK  
PRINCIPAL REGISTER**

**ECO HANDYMAN**

ECO HANDYMAN, LLC (COLORADO LIMITED  
LIABILITY COMPANY)  
1600 REDWOOD AVE  
BOULDER, CO 80304

FOR: BUILDING MAINTENANCE, CONSTRUCTION,  
REMODELING AND REPAIR, IN CLASS 37  
(U.S. CLS. 100, 103 AND 106).

FIRST USE 7-1-2005; IN COMMERCE 7-1-2005.

THE MARK CONSISTS OF STANDARD CHARACTERS  
WITHOUT CLAIM TO ANY PARTICULAR  
FONT, STYLE, SIZE, OR COLOR.

NO CLAIM IS MADE TO THE EXCLUSIVE  
RIGHT TO USE "HANDYMAN", APART FROM  
THE MARK AS SHOWN.

SER. NO. 77-022,126, FILED 10-16-2006.

ODESSA BIBBINS, EXAMINING ATTORNEY

**Int. Cl.: 14**

**Prior U.S. Cls.: 2, 27, 28 and 50**

**United States Patent and Trademark Office**

**Reg. No. 3,568,859**

**Registered Feb. 3, 2009**

**TRADEMARK  
PRINCIPAL REGISTER**

**KAVITA KOLLECTION**

DIACENTRE INC. (NEW YORK CORPORATION)  
22 WEST 48TH STREET – SUITE NO. 704  
NEW YORK, NY 100361803

FOR: 10K, 14K, AND 18K GOLD AND PLATINUM JEWELRY, NAMELY, BANGLES, BRACELETS, EARRINGS, NECKLACES, PENDANTS, AND RINGS; DIAMONDS, NAMELY, IN ROUND AND FANCY SHAPES AND BOTH CERTIFIED AND NON-CERTIFIED DIAMONDS; AND COLORED PRECIOUS AND SEMI-PRECIOUS GEMSTONES, IN CLASS 14 (U.S. CLS. 2, 27, 28 AND 50).

FIRST USE 7-1-2005; IN COMMERCE 7-1-2005.

THE MARK CONSISTS OF STANDARD CHARACTERS WITHOUT CLAIM TO ANY PARTICULAR FONT, STYLE, SIZE, OR COLOR.

NO CLAIM IS MADE TO THE EXCLUSIVE RIGHT TO USE "COLLECTION", APART FROM THE MARK AS SHOWN.

THE FOREIGN WORDING IN THE MARK TRANSLATES INTO ENGLISH AS POEMS OR POETRY.

SER. NO. 77-022,665, FILED 10-17-2006.

WILLIAM VERHOSEK, EXAMINING ATTORNEY

**Int. Cl.: 9**

**Prior U.S. Cls.: 21, 23, 26, 36 and 38**

**United States Patent and Trademark Office**

**Reg. No. 3,568,860**

**Registered Feb. 3, 2009**

**TRADEMARK  
PRINCIPAL REGISTER**

**SCANIMETRICS**

SCANIMETRICS INC. (CANADA CORPORATION)  
3021 RESEARCH TRANSITION FACILITY (RTF)  
8308 114TH STREET  
EDMONTON, CANADA T6G2E1

FOR: SCANNERS FOR WIRELESS NON-CONTACT TESTING OF SEMI-CONDUCTOR WAFERS, IN CLASS 9 (U.S. CLS. 21, 23, 26, 36 AND 38).

THE MARK CONSISTS OF STANDARD CHARACTERS WITHOUT CLAIM TO ANY PARTICULAR FONT, STYLE, SIZE, OR COLOR.

PRIORITY CLAIMED UNDER SEC. 44(D) ON CANADA APPLICATION NO. 1299610, FILED 4-28-2006, REG. NO. TMA717515, DATED 6-26-2008, EXPIRES 6-26-2023.

SER. NO. 77-027,963, FILED 10-24-2006.

JACLYN KIDWELL, EXAMINING ATTORNEY

**Int. Cl.: 3**

**Prior U.S. Cls.: 1, 4, 6, 50, 51 and 52**

**Reg. No. 3,568,861**

**United States Patent and Trademark Office**

**Registered Feb. 3, 2009**

**TRADEMARK  
PRINCIPAL REGISTER**

# Care & Sens

BLUE SKIN S.A. (FRANCE CORPORATION)  
34, CAMILLE-PELLETAN 92300  
LEVALLOIS-PERRET, FRANCE

FOR: COSMETICS, NAMELY, HYDRATING MASKS FOR THE SKIN, THE BODY AND THE FACE; COSMETIC POWDERS FOR THE FACE AND THE BODY, POMADES FOR HAIR AND LIPS AND BODY, BEAUTY MILKS, BODY MILKS, LIP BALMS, BODY LOTIONS, BATH AND BODY OILS, BEAUTY CREAMS, MOUSSE FOR SKIN CARE; MAKE-UP REMOVING MILKS AND GELS AND LOTIONS AND CREAMS, EAU DE TOILETTE, ESSENTIAL OILS FOR USE IN AROMATHERAPY AND MASSAGE AND BODY CARE, BATH PREPARATIONS, NAMELY, MOUSSES, BATH OILS AND SHOWER GELS; MAKE-UP PRODUCTS FOR THE FACE; PERFUMES; SHAMPOOS, SKIN SOAPS, SOAPS

FOR BODY CARE, IN CLASS 3 (U.S. CLS. 1, 4, 6, 50, 51 AND 52).

THE MARK CONSISTS OF STANDARD CHARACTERS WITHOUT CLAIM TO ANY PARTICULAR FONT, STYLE, SIZE, OR COLOR.

PRIORITY CLAIMED UNDER SEC. 44(D) ON CANADA APPLICATION NO. 1321290, FILED 10-23-2006.

OWNER OF CANADA REG. NO. TMA698087, DATED 10-9-2007, EXPIRES 10-9-2022.

SER. NO. 77-032,074, FILED 10-30-2006.

LINDA POWELL, EXAMINING ATTORNEY

**Int. Cl.: 25**

**Prior U.S. Cls.: 22 and 39**

**United States Patent and Trademark Office**

**Reg. No. 3,568,862**

**Registered Feb. 3, 2009**

**TRADEMARK  
PRINCIPAL REGISTER**

# Yakoo Baby

KE, ZHIJIAN (CHINA SOLE PROPRIETORSHIP),  
DBA YAKOO BABY  
45055 WALNUT RIDGE CT.  
NORTHVILLE, MI 48168

FOR: CLOTHING FOR BABIES, NAMELY, TOPS  
AND SWEATERS, HOODS, BOTTOMS, DRESSES,  
COSTUMES, ONE PIECE CLOTHING, T-SHIRTS,  
SHORTS, PANTS, JACKETS, SKIRTS, HATS, SOCKS,  
TIGHTS, COATS, NIGHTGOWNS, PAJAMAS, AND  
SHIRTS, IN CLASS 25 (U.S. CLS. 22 AND 39).

FIRST USE 1-1-2007; IN COMMERCE 1-1-2007.

THE MARK CONSISTS OF STANDARD CHAR-  
ACTERS WITHOUT CLAIM TO ANY PARTICULAR  
FONT, STYLE, SIZE, OR COLOR.

NO CLAIM IS MADE TO THE EXCLUSIVE  
RIGHT TO USE "BABY", APART FROM THE MARK  
AS SHOWN.

THE WORD "YAKOO" MEANS GRACEFUL AND  
COOL.

SER. NO. 77-040,995, FILED S.R. 11-9-2006 AM. P.R.  
8-31-2007.

ANDREA SAUNDERS, EXAMINING ATTORNEY

Int. Cl.: 16

Prior U.S. Cls.: 2, 5, 22, 23, 29, 37, 38 and 50

United States Patent and Trademark Office

Reg. No. 3,568,863

Registered Feb. 3, 2009

TRADEMARK  
PRINCIPAL REGISTER



LMN PUBLICATIONS, LLC (FLORIDA LIMITED  
LIABILITY COMPANY)  
3838 TAMiami TRAIL NORTH, THIRD FLOOR  
NAPLES, FL 34103

FOR: ADHESIVE NOTE PADS, IN CLASS 16 (U.S.  
CLS. 2, 5, 22, 23, 29, 37, 38 AND 50).

FIRST USE 6-15-2006; IN COMMERCE 11-11-2006.

OWNER OF U.S. REG. NO. 3,380,192.

THE MARK CONSISTS OF POLICEMAN LIKE  
PERSON HOLDING A STOP SIGN.

SER. NO. 77-042,153, FILED 11-12-2006.

JERI J. FICKES, EXAMINING ATTORNEY

Int. Cl.: 12

Prior U.S. Cls.: 19, 21, 23, 31, 35 and 44

Reg. No. 3,568,864

United States Patent and Trademark Office

Registered Feb. 3, 2009

TRADEMARK  
PRINCIPAL REGISTER



SIXTH AVENUE OUTFITTERS (ALASKA PART-  
NERSHIP)  
520 WEST SIXTH AVENUE  
ANCHORAGE, AK 99501

FOR: RAFTS; RAFT FRAMES, IN CLASS 12 (U.S.  
CLS. 19, 21, 23, 31, 35 AND 44).

FIRST USE 3-1-2002; IN COMMERCE 3-1-2002.

NO CLAIM IS MADE TO THE EXCLUSIVE  
RIGHT TO USE "61° 13' NORTH 149° 52' WEST",  
APART FROM THE MARK AS SHOWN.

SEC. 2(F).

SER. NO. 77-046,670, FILED 11-17-2006.

JORDAN BAKER, EXAMINING ATTORNEY

**Int. Cl.: 8**

**Prior U.S. Cls.: 23, 28 and 44**

**Reg. No. 3,568,865**

**United States Patent and Trademark Office**

**Registered Feb. 3, 2009**

**TRADEMARK  
PRINCIPAL REGISTER**

**SUPER** 

WATCH CLUB, INC. (CALIFORNIA CORPORATION)  
4632 PACIFIC BLVD.  
VERNON, CA 90058

FOR: NAIL CLIPPERS; NAIL FILES; NAIL NIPPERS;  
NAIL SCISSORS, IN CLASS 8 (U.S. CLS. 23, 28  
AND 44).

FIRST USE 7-18-2004; IN COMMERCE 7-18-2004.

NO CLAIM IS MADE TO THE EXCLUSIVE  
RIGHT TO USE "SUPER", APART FROM THE  
MARK AS SHOWN.

THE MARK CONSISTS OF THE WORD "SUPER"  
AND "TRY" WITH AN ELONGATED HORIZONTAL  
LINE ON THE LETTER "T".

SER. NO. 77-049,111, FILED 11-21-2006.

TINA BROWN, EXAMINING ATTORNEY



**Int. Cls.: 14 and 35**

**Prior U.S. Cls.: 2, 27, 28, 50, 100, 101 and 102**

**United States Patent and Trademark Office**

**Reg. No. 3,568,866**

**Registered Feb. 3, 2009**

**TRADEMARK  
SERVICE MARK  
PRINCIPAL REGISTER**

**IGC**

IGC GROUP (BELGIUM JOINT STOCK COMPANY)

HOVENIERSSTRAAT 2 BUS 248

ANTWERPEN, BELGIUM 2018

FOR: DIAMONDS, POLISHED OR ROUGH;  
EARRINGS, NECKLACES, BRACELETS AND  
RINGS, IN CLASS 14 (U.S. CLS. 2, 27, 28 AND 50).

FOR: IMPORT AND EXPORT OF POLISHED OR  
ROUGH DIAMONDS, EARRINGS, NECKLACES,  
BRACELETS AND RINGS, IN CLASS 35 (U.S. CLS.  
100, 101 AND 102).

THE MARK CONSISTS OF STANDARD CHARACTERS WITHOUT CLAIM TO ANY PARTICULAR FONT, STYLE, SIZE, OR COLOR.

OWNER OF ERPN CMNTY TM OFC REG. NO. 5524343, DATED 5-14-2007, EXPIRES 12-5-2016.

OWNER OF U.S. REG. NO. 3,189,610.

THE WORDING "IGC" HAS NO MEANING IN A FOREIGN LANGUAGE.

SER. NO. 77-056,937, FILED 12-5-2006.

COLLEEN KEARNEY, EXAMINING ATTORNEY

**Int. Cl.: 41**

**Prior U.S. Cls.: 100, 101 and 107**

**United States Patent and Trademark Office**

**Reg. No. 3,568,867**

**Registered Feb. 3, 2009**

**SERVICE MARK  
PRINCIPAL REGISTER**

**IAMHAWAII**

IAM HAWAII, LLC (HAWAII LIMITED LIABILITY COMPANY)  
1000 BISHOP STREET  
HONOLULU, HI 96813

FOR: ENTERTAINMENT AND EDUCATIONAL SERVICES, NAMELY, PROVIDING A WEBSITE FEATURING INFORMATION ON NEWS, ACTIVITIES, FORUMS, OPPORTUNITIES, GROUPS, ORGANIZATIONS AND COMMUNITIES, IDEAS, COMMENTS AND REVIEWS ABOUT HAWAII, PROVIDING AN INTERACTIVE WEBSITE FEATURING EDUCATIONAL AND ENTERTAINMENT

INFORMATION ON HAWAII, IN CLASS 41 (U.S. CLS. 100, 101 AND 107).

FIRST USE 9-0-2004; IN COMMERCE 9-0-2004.

THE MARK CONSISTS OF STANDARD CHARACTERS WITHOUT CLAIM TO ANY PARTICULAR FONT, STYLE, SIZE, OR COLOR.

SER. NO. 77-057,294, FILED 12-5-2006.

ANNE E. GUSTASON, EXAMINING ATTORNEY

**Int. Cls.: 14, 16, 25, 35 and 41**

**Prior U.S. Cls.: 2, 5, 22, 23, 27, 28, 29, 37, 38, 39, 50,  
100, 101, 102 and 107**

**Reg. No. 3,568,868**

**Registered Feb. 3, 2009**

**United States Patent and Trademark Office**

**TRADEMARK  
SERVICE MARK  
PRINCIPAL REGISTER**



ABOLISH THE "N" WORD PROJECT CORP (NEW  
YORK CORPORATION)  
328 FLATBUSH AVE #373  
BROOKLYN, NY 11238

FOR: IDENTIFICATION BRACELETS, IN CLASS  
14 (U.S. CLS. 2, 27, 28 AND 50).

FIRST USE 4-5-2006; IN COMMERCE 4-5-2006.

FOR: PRINTED INFORMATIONAL CARDS IN  
THE FIELD OF AFRICAN AMERICAN HISTORY;  
PRINTED INSTRUCTIONAL, EDUCATIONAL,  
AND TEACHING MATERIALS IN THE FIELD OF  
AFRICAN AMERICAN HISTORY, IN CLASS 16 (U.S.  
CLS. 2, 5, 22, 23, 29, 37, 38 AND 50).

FIRST USE 4-5-2006; IN COMMERCE 4-5-2006.

FOR: CLOTHING, NAMELY, T-SHIRTS, BASE-  
BALL CAPS, IN CLASS 25 (U.S. CLS. 22 AND 39).

FIRST USE 4-5-2006; IN COMMERCE 4-5-2006.

FOR: PROMOTING PUBLIC AWARENESS OF  
THE NEED FOR AFRICAN AMERICAN HISTORY,  
IN CLASS 35 (U.S. CLS. 100, 101 AND 102).

FIRST USE 4-5-2006; IN COMMERCE 4-5-2006.

FOR: CONDUCTING WORKSHOPS AND SEMI-  
NARS IN AFRICAN AMERICAN HISTORY, IN  
CLASS 41 (U.S. CLS. 100, 101 AND 107).

FIRST USE 4-5-2006; IN COMMERCE 4-5-2006.

THE MARK CONSISTS OF STYLIZED TEXT OF  
THE WORDING "ABOLISH THE "N" WORD".

SER. NO. 77-058,121, FILED 12-6-2006.

SUE LAWRENCE, EXAMINING ATTORNEY

**Int. Cl.: 9**

**Prior U.S. Cls.: 21, 23, 26, 36 and 38**

**Reg. No. 3,568,869**

**United States Patent and Trademark Office**

**Registered Feb. 3, 2009**

**TRADEMARK  
PRINCIPAL REGISTER**

**BEST AUTHORITY**

LEVIT & JAMES, INC. (VIRGINIA CORPORATION)  
P.O. BOX 2503  
LEESBURG, VA 20177

FOR: SINGLE MEDIA SOFTWARE DESIGNED FOR INSTALLATION IN THE PERMANENT STORAGE OF A COMPUTER, FOR CREATING AND ORGANIZING TABLES OF AUTHORITIES FOR LEGAL BRIEFS AND OTHER DOCUMENTS , IN CLASS 9 (U.S. CLS. 21, 23, 26, 36 AND 38).

FIRST USE 8-18-2004; IN COMMERCE 7-1-2005.

THE MARK CONSISTS OF STANDARD CHARACTERS WITHOUT CLAIM TO ANY PARTICULAR FONT, STYLE, SIZE, OR COLOR.

SER. NO. 77-064,703, FILED 12-14-2006.

DAVID MILLER, EXAMINING ATTORNEY

**Int. Cls.: 35 and 42**

**Prior U.S. Cls.: 100, 101 and 102**

**United States Patent and Trademark Office**

**Reg. No. 3,568,870**

**Registered Feb. 3, 2009**

**SERVICE MARK  
PRINCIPAL REGISTER**

**CUSTOMER INSIGHT REALIZED**

ALLIANCE DATA SYSTEMS CORPORATION  
(DELAWARE CORPORATION)  
17655 WATERVIEW PARKWAY  
DALLAS, TX 75252

FOR: BUSINESS MARKETING CONSULTING SERVICES; BUSINESS MARKETING DATA ANALYSIS AND MODELING SERVICES; PREPARING AND ANALYZING MAILING LISTS FOR OTHERS; DIRECT MARKETING ADVERTISING SERVICES FOR OTHERS; RESPONSE MANAGEMENT SERVICES; MARKETING RESPONSE ANALYSIS SERVICES, NAMELY, MEASUREMENT, ANALYSIS AND ASSESSMENT OF THE RESPONSES AND EFFECTIVENESS OF MARKETING, SALES AND ADVERTISING CAMPAIGNS, AND PROVIDING REPORTS AND RECOMMENDATIONS REGARDING SUCH CAMPAIGNS; MARKETING CAMPAIGN MANAGEMENT SERVICES; WEB SITE ANALYTIC SERVICES, NAMELY, ASSESSING AND ANALYZING WEB SITES AND WEB SITE USAGE FOR EFFECTIVENESS IN ATTRACTING AND RETAINING CUSTOMERS; ORDER FULFILLMENT SERVICES, NAMELY, RECEIVING, ASSEMBLING, SELECTING, PACKAGING, CONSOLIDATING AND PREPARING MERCHANDISE AND MARKETING COLLATERAL ORDERS FOR SHIPMENT; DESIGN, CREATING, AND DISTRIBUTION OF PAPER AND ELECTRONIC BUSINESS FORMS; CREATIVE DESIGN AND COPY SERVICES FOR OTHERS, NAMELY, CREATING AND DESIGNING FORMS, LOGOS, PUBLICATIONS AND MARKETING COLLATERAL FOR USE IN BUSINESS OPERATIONS, MARKETING AND ADVERTISING; ADVERTISING AGENCIES; MARKETING AGENCY SERVICES, NAMELY, MARKETING PLAN AUDIT AND ANA-

LYSIS, MARKETING PLAN DEVELOPMENT, AND MARKETING PLAN EXECUTION AND REPORTING SERVICES; MARKETING CONSULTATION AND DEVELOPMENT SERVICES FOR THE MANAGEMENT OF MARKETING SYSTEMS; PROVIDING MARKETING DATABASES FOR THE FINANCIAL INDUSTRY; TRACKING AND MONITORING OF GOODS FOR OTHERS; BUSINESS CONSULTING SERVICES, NAMELY, PROVIDING CUSTOMER LOYALTY AND PROMOTION PROGRAMS; BUSINESS CONSULTANT SERVICES FOR DIRECT MARKETING PROGRAMS OF OTHERS, IN CLASS 35 (U.S. CLS. 100, 101 AND 102).

FIRST USE 6-20-2006; IN COMMERCE 6-20-2006.

FOR: DATABASE DEVELOPMENT AND MANAGEMENT SERVICES; COMPUTER SERVICES, NAMELY, DESIGNING AND IMPLEMENTING WEB SITES FOR OTHERS; CUSTOM DESIGN SERVICES FOR THE DIRECT MARKETING PROGRAMS OF OTHERS UTILIZING COMPUTER-GENERATED INFORMATION, IN CLASS 42 (U.S. CLS. 100 AND 101).

FIRST USE 6-20-2006; IN COMMERCE 6-20-2006.

THE MARK CONSISTS OF STANDARD CHARACTERS WITHOUT CLAIM TO ANY PARTICULAR FONT, STYLE, SIZE, OR COLOR.

SER. NO. 77-066,410, FILED 12-18-2006.

DAVID TAYLOR, EXAMINING ATTORNEY

**Int. Cls.: 1 and 42**

**Prior U.S. Cls.: 1, 5, 6, 10, 26, 46, 100 and 101**

**United States Patent and Trademark Office**

**Reg. No. 3,568,871**

**Registered Feb. 3, 2009**

**TRADEMARK  
SERVICE MARK  
PRINCIPAL REGISTER**

# RAPMAT

MORPHOSYS AG (FED REP GERMANY CORPORATION)  
LENA-CHRIST-STRASSE 48  
82152 MARTINSRIED/PLAN, FED REP GERMANY

FOR: CHEMICAL, BIOCHEMICAL, BIOLOGICAL, AND BIOTECHNOLOGICAL PREPARATIONS FOR USE IN THE DEVELOPMENT OF IMMUNOLOGICAL REAGENTS FOR INDUSTRIAL AND SCIENTIFIC USE; BIOLOGICAL PREPARATIONS FOR LABORATORIES, DIAGNOSTICS AND ANALYTICS FOR SCIENTIFIC OR RESEARCH USE, IN CLASS 1 (U.S. CLS. 1, 5, 6, 10, 26 AND 46).

FOR: SCIENTIFIC, BIOLOGICAL AND MEDICAL RESEARCH, IN PARTICULAR IN THE FIELDS OF DISCOVERY, DEVELOPMENT AND MANUFACTURE OF IMMUNOLOGICAL REAGENTS, ANTIBODIES AND RESEARCH UNDER CONTRACT; LABORATORY RESEARCH IN THE FIELD OF

ANALYTICAL CHEMISTRY, BIOCHEMISTRY, MEDICINAL CHEMISTRY, DRUG DEVELOPMENT, BIOTECHNOLOGY, MICROBIOLOGY AND MOLECULAR BIOLOGY; CHEMICAL, BIOCHEMICAL AND BIOTECHNOLOGICAL ANALYSIS, IN CLASS 42 (U.S. CLS. 100 AND 101).

THE MARK CONSISTS OF STANDARD CHARACTERS WITHOUT CLAIM TO ANY PARTICULAR FONT, STYLE, SIZE, OR COLOR.

PRIORITY CLAIMED UNDER SEC. 44(D) ON ERPN CMNTY TM OFC APPLICATION NO. 5561527, FILED 12-18-2006, REG. NO. 005561527, DATED 10-22-2007, EXPIRES 12-18-2016.

SER. NO. 77-067,061, FILED 12-19-2006.

REGINA DRUMMOND, EXAMINING ATTORNEY

**Int. Cls.: 16 and 35**

**Prior U.S. Cls.: 2, 5, 22, 23, 29, 37, 38, 50, 100, 101 and 102**

**Reg. No. 3,568,872**

**United States Patent and Trademark Office**

**Registered Feb. 3, 2009**

**TRADEMARK  
SERVICE MARK  
PRINCIPAL REGISTER**



AMERICAN LIBRARY ASSOCIATION (MASSACHUSETTS CORPORATION)  
50 EAST HURON  
CHICAGO, IL 606112795

FOR: POSTERS TO PROMOTE USE OF PRINTED MATERIAL IN AN AUDIO FORMAT, IN CLASS 16 (U.S. CLS. 2, 5, 22, 23, 29, 37, 38 AND 50).

FIRST USE 10-1-2006; IN COMMERCE 10-1-2006.

FOR: PROMOTIONAL SERVICES, NAMELY, DISTRIBUTION OF ADVERTISING AND PRINTED AND OTHER PROMOTIONAL MATERIALS TO

PROMOTE USE OF PRINTED MATERIAL IN AN AUDIO FORMAT, IN CLASS 35 (U.S. CLS. 100, 101 AND 102).

FIRST USE 10-1-2006; IN COMMERCE 10-1-2006.

THE MARK CONSISTS OF THE WORD "LISTEN" CONTAINED IN ROWS OF SMALL RECTANGLES, ARRANGED TO REPLICATE SOUND BARS.

SER. NO. 77-067,616, FILED 12-19-2006.

KIMBERLY FRYE, EXAMINING ATTORNEY

**Int. Cl.: 35**

**Prior U.S. Cls.: 100, 101 and 102**

**United States Patent and Trademark Office**

**Reg. No. 3,568,873**

**Registered Feb. 3, 2009**

**SERVICE MARK  
PRINCIPAL REGISTER**

**GCS BUSINESS CAPITAL**

GCS BUSINESS CAPITAL HOLDING COMPANY,  
LLC (ILLINOIS LLC)  
736 N. WESTERN AVE., #397  
LAKE FOREST, IL 60045

FOR: ASSISTANCE, ADVISORY SERVICES AND  
CONSULTANCY WITH BUSINESS PLANNING,  
SALES AND ACQUISITIONS, IN CLASS 35 (U.S.  
CLS. 100, 101 AND 102).

FIRST USE 5-31-2005; IN COMMERCE 5-31-2005.

THE MARK CONSISTS OF STANDARD CHAR-  
ACTERS WITHOUT CLAIM TO ANY PARTICULAR  
FONT, STYLE, SIZE, OR COLOR.

NO CLAIM IS MADE TO THE EXCLUSIVE  
RIGHT TO USE "BUSINESS CAPITAL", APART  
FROM THE MARK AS SHOWN.

SER. NO. 77-070,782, FILED 12-22-2006.

AMY HELLA, EXAMINING ATTORNEY



**Int. Cl.: 41**

**Prior U.S. Cls.: 100, 101 and 107**

**United States Patent and Trademark Office**

**Reg. No. 3,568,874**

**Registered Feb. 3, 2009**

**SERVICE MARK  
PRINCIPAL REGISTER**

**Joey's Blood Buddies**

MESSINA, HOLLY (UNITED STATES INDIVIDUAL)  
102 CHAMBERLAIN ROAD  
WESTFORD, MA 01886

FOR: CHARITABLE SERVICES, NAMELY, PROVIDING CANCER PATIENTS AND THEIR FAMILIES AND FRIENDS WITH EDUCATIONAL MATERIALS AND MOTIVATIONAL MATERIALS RELATED TO CANCER AND CANCER TREATMENT, IN CLASS 41 (U.S. CLS. 100, 101 AND 107).

FIRST USE 2-5-2003; IN COMMERCE 8-17-2006.

THE MARK CONSISTS OF STANDARD CHARACTERS WITHOUT CLAIM TO ANY PARTICULAR FONT, STYLE, SIZE, OR COLOR.

SER. NO. 77-070,977, FILED 12-23-2006.

LESLEY LAMOTHE, EXAMINING ATTORNEY

**Int. Cl.: 42**

**Prior U.S. Cls.: 100 and 101**

**United States Patent and Trademark Office**

**Reg. No. 3,568,875**

**Registered Feb. 3, 2009**

**SERVICE MARK  
PRINCIPAL REGISTER**

**IPIQI**

IPIQI (DELAWARE CORPORATION)  
330 NORTH CHARLES ST. APT 5D  
BALTIMORE, MD 21201

FOR: COMPUTER SERVICES, NAMELY, HOST-  
ING ON-LINE WEB FACILITIES FOR OTHERS FOR  
ORGANIZING AND CONDUCTING ONLINE  
MEETINGS, GATHERINGS, AND INTERACTIVE  
DISCUSSIONS, IN CLASS 42 (U.S. CLS. 100 AND 101).

FIRST USE 6-6-2006; IN COMMERCE 6-6-2006.

THE MARK CONSISTS OF STANDARD CHAR-  
ACTERS WITHOUT CLAIM TO ANY PARTICULAR  
FONT, STYLE, SIZE, OR COLOR.

SER. NO. 77-072,288, FILED 12-27-2006.

HEATHER BIDDULPH, EXAMINING ATTORNEY

**Int. Cl.: 32**

**Prior U.S. Cls.: 45, 46 and 48**

**United States Patent and Trademark Office**

**Reg. No. 3,568,876**

**Registered Feb. 3, 2009**

**TRADEMARK  
PRINCIPAL REGISTER**

# Hop Rocket

MOODY, REBECCA (ALGERIA INDIVIDUAL)  
624 LUDINGTON STREET  
ESCANABA, MI 49829

NO CLAIM IS MADE TO THE EXCLUSIVE  
RIGHT TO USE "HOP", APART FROM THE MARK  
AS SHOWN.

FOR: BEER, IN CLASS 32 (U.S. CLS. 45, 46 AND 48).

FIRST USE 8-28-2006; IN COMMERCE 8-28-2006.

SER. NO. 77-074,105, FILED 1-2-2007.

THE MARK CONSISTS OF STANDARD CHAR-  
ACTERS WITHOUT CLAIM TO ANY PARTICULAR  
FONT, STYLE, SIZE, OR COLOR.

ELISSA GARBER KON, EXAMINING ATTORNEY

**Int. Cl.: 10**

**Prior U.S. Cls.: 26, 39 and 44**

**United States Patent and Trademark Office**

**Reg. No. 3,568,877**

**Registered Feb. 3, 2009**

**TRADEMARK  
PRINCIPAL REGISTER**

**NC MERLIN**

ABBOTT LABORATORIES (ILLINOIS CORPORATION)  
100 ABBOTT PARK ROAD  
ABBOTT PARK, IL 60064

FOR: BALLOON CATHETERS FOR USE ONLY IN THE CARDIOVASCULAR SYSTEM, IN CLASS 10 (U.S. CLS. 26, 39 AND 44).

FIRST USE 10-16-2006; IN COMMERCE 10-16-2006.

THE MARK CONSISTS OF STANDARD CHARACTERS WITHOUT CLAIM TO ANY PARTICULAR FONT, STYLE, SIZE, OR COLOR.

NO CLAIM IS MADE TO THE EXCLUSIVE RIGHT TO USE "NC", APART FROM THE MARK AS SHOWN.

SER. NO. 77-083,766, FILED 1-16-2007.

TINA KUAN, EXAMINING ATTORNEY

**Int. Cls.: 35, 36 and 41**

**Prior U.S. Cls.: 100, 101, 102 and 107**

**United States Patent and Trademark Office**

**Reg. No. 3,568,878**

**Registered Feb. 3, 2009**

**SERVICE MARK  
PRINCIPAL REGISTER**

**KIDS CAN FREE THE CHILDREN**

KIDS CAN FREE THE CHILDREN (CANADA  
NON-PROFIT ORGANIZATION)  
233 CARLTON STREET  
TORONTO, CANADA

FOR: CHARITABLE SERVICES, NAMELY, ORGANIZING AND CONDUCTING VOLUNTEER PROGRAMS AND COMMUNITY SERVICE PROJECTS FOR CHILDREN; CHARITABLE SERVICES, NAMELY, ORGANIZING VOLUNTEER GROUPS TO UNDERTAKE PROJECTS TO BENEFIT NEEDY CHILDREN, IN CLASS 35 (U.S. CLS. 100, 101 AND 102).

FOR: CHARITABLE FUNDRAISING, IN CLASS 36 (U.S. CLS. 100, 101 AND 102).

FOR: CHARITABLE SERVICES, NAMELY, EDUCATIONAL PROGRAMS FOR CHILDREN, IN CLASS 41 (U.S. CLS. 100, 101 AND 107).

THE MARK CONSISTS OF STANDARD CHARACTERS WITHOUT CLAIM TO ANY PARTICULAR FONT, STYLE, SIZE, OR COLOR.

PRIORITY CLAIMED UNDER SEC. 44(D) ON CANADA APPLICATION NO. 1,323,997, FILED 11-14-2006, REG. NO. TMA712335, DATED 4-18-2008, EXPIRES 4-18-2023.

SER. NO. 77-084,532, FILED 1-17-2007.

LOURDES AYALA, EXAMINING ATTORNEY

**Int. Cl.: 5**

**Prior U.S. Cls.: 6, 18, 44, 46, 51 and 52**

**Reg. No. 3,568,879**

**United States Patent and Trademark Office**

**Registered Feb. 3, 2009**

**TRADEMARK  
PRINCIPAL REGISTER**

**TOKUYAMA TissueCare**

TOKUYAMA CORPORATION (JAPAN CORPORATION)  
1-1, MIKAGE-CHO  
SHUNAN-SHI  
YAMAGUCHI, JAPAN

FOR: DENTAL MATERIALS, NAMELY, BONDING AND PRIMING MATERIALS FOR DENTAL PURPOSE, DENTAL CEMENTS, ADHESIVES FOR DENTURES, DENTAL ADHESIVES, OXY BARRIER AGENTS FOR DENTAL USE, DENTAL ETCHING AGENTS, DENTAL RELINING MATERIALS, DENTAL LINING MATERIALS, TOOTH FILLING MATERIALS, DENTAL IMPRESSION MATERIALS MEDICINES FOR DENTAL PURPOSES, NAMELY, MEDICINES FOR THE TREATMENT OF PERIODONTITIS AND TOOTHACHES, DESENSITIZING AGENTS FOR TOOTH HYPERSENSITIVITY, AND DIAGNOSTIC AGENTS FOR DENTAL USE, MOULDING WAXES FOR DENTISTS, DENTAL ABRASIVES, DENTAL WAXES, ARTIFICIAL TOOTH MATERIALS, DENTAL COMPOSITE RE-

SINS, SELF-CURING RESINS FOR DENTAL USE, DENTAL GYPSUMS, DENTAL INVESTMENT, SEPARATING AGENT USED IN DENTISTRY IN THE MOLDING OF CROWN AND BRIDGE CASTINGS AND OF DENTURE BASES TO FACILITATE REMOVAL THEREOF FROM THE MOLD, DENTAL TISSUE CONDITIONER, IN CLASS 5 (U.S. CLS. 6, 18, 44, 46, 51 AND 52).

PRIORITY CLAIMED UNDER SEC. 44(D) ON JAPAN APPLICATION NO. 2007000774, FILED 1-10-2007, REG. NO. 5091613, DATED 11-16-2007, EXPIRES 11-16-2017.

NO CLAIM IS MADE TO THE EXCLUSIVE RIGHT TO USE "TISSUECARE", APART FROM THE MARK AS SHOWN.

SER. NO. 77-091,039, FILED 1-25-2007.

KIMBERLY FRYE, EXAMINING ATTORNEY

**Int. Cl.: 14**

**Prior U.S. Cls.: 2, 27, 28 and 50**

**Reg. No. 3,568,880**

**United States Patent and Trademark Office**

**Registered Feb. 3, 2009**

**TRADEMARK  
PRINCIPAL REGISTER**

**BLINGASAUR**

A.K. JAIN (INDIA INDIVIDUAL)  
BARAKHAMBA LANE  
523, WORLD TRADE CENTRE,  
NEW DELHI, INDIA 110001

FOR: PRECIOUS METALS AND THEIR ALLOYS;  
GOODS MADE OF PRECIOUS METALS, THEIR  
ALLOYS OR GOODS COATED THEREWITH,  
NAMELY JEWELRY, JEWELRY BOXES, AND  
WATCHES; JEWELRY, PRECIOUS STONES; HORO-  
LOGICAL AND CHRONOMETRIC INSTRUMENTS  
AND PARTS THEREOF, IN CLASS 14 (U.S. CLS. 2, 27,  
28 AND 50).

THE MARK CONSISTS OF STANDARD CHAR-  
ACTERS WITHOUT CLAIM TO ANY PARTICULAR  
FONT, STYLE, SIZE, OR COLOR.

PRIORITY CLAIMED UNDER SEC. 44(D) ON  
ERPNTM CMNTY TM OFC APPLICATION NO.  
005651914, FILED 1-30-2007.

OWNER OF ERPNTM CMNTY TM OFC REG. NO.  
005651914, DATED 3-26-2008, EXPIRES 1-30-2017.

SER. NO. 77-098,036, FILED 2-2-2007.

KATHERINE CONNOLLY, EXAMINING ATTOR-  
NEY

**Int. Cl.: 25**

**Prior U.S. Cls.: 22 and 39**

**United States Patent and Trademark Office**

**Reg. No. 3,568,881**

**Registered Feb. 3, 2009**

**TRADEMARK  
PRINCIPAL REGISTER**

**FRIENDLY FUR**

ASHLEY NETTYE, INC. (DELAWARE CORPORATION)  
463 SEVENTH AVENUE  
NEW YORK, NY 10018

FOR: OUTERWEAR GARMENTS WITH SYNTHETIC FUR TRIM, NAMELY, JACKETS, COATS AND VESTS, IN CLASS 25 (U.S. CLS. 22 AND 39).

FIRST USE 7-19-2007; IN COMMERCE 7-19-2007.

THE MARK CONSISTS OF STANDARD CHARACTERS WITHOUT CLAIM TO ANY PARTICULAR FONT, STYLE, SIZE, OR COLOR.

NO CLAIM IS MADE TO THE EXCLUSIVE RIGHT TO USE "FUR", APART FROM THE MARK AS SHOWN.

SER. NO. 77-104,149, FILED 2-9-2007.

TINA BROWN, EXAMINING ATTORNEY



**Int. Cls.: 9 and 10**

**Prior U.S. Cls.: 21, 23, 26, 36, 38, 39 and 44**

**Reg. No. 3,568,882**

**United States Patent and Trademark Office**

**Registered Feb. 3, 2009**

**TRADEMARK  
PRINCIPAL REGISTER**

**ISUITE**

STRYKER CORPORATION (MICHIGAN CORPORATION)  
2825 AIRVIEW BLVD.  
KALAMAZOO, MI 49002

FOR: COMPUTERIZED CONTROLLERS FOR CONTROLLING SURGICAL AND MEDICAL EQUIPMENT, FOR ROUTING VIDEO, AUDIO AND MEDICAL INFORMATION, AND SERVING AS VIDEO AND TELEPHONE CONFERENCING INTERFACES; COMPUTERIZED VIDEO NETWORK HUBS; SURGICAL CAMERAS; OPERATING ROOM SURVEILLANCE CAMERAS, IN CLASS 9 (U.S. CLS. 21, 23, 26, 36 AND 38).

FIRST USE 2-0-2004; IN COMMERCE 2-0-2004.

FOR: EQUIPMENT CARRIERS FOR SUPPORTING AND SUSPENDING OTHER MEDICAL OR SURGICAL EQUIPMENT FOR USE IN A HOSPITAL OR MEDICAL ENVIRONMENT, NAMELY, BOOMS AND COLUMNS; SERVICE HEADS FOR PROVIDING ELECTRICAL POWER, GAS AND COMMUNICATIONS CONNECTIONS TO OPERATE OTHER MEDICAL OR SURGICAL EQUIPMENT, WHICH

SERVICE HEADS ARE SOLD AS A COMPONENT OF THE EQUIPMENT CARRIERS; VENTILATION EQUIPMENT, NAMELY, SMOKE EVACUATION AND AIR PURIFIERS, WHICH VENTILATION EQUIPMENT IS SOLD AS A COMPONENT OF THE EQUIPMENT CARRIERS; FURNITURE FOR SUPPORTING, STORING AND ORGANIZING MEDICAL AND SURGICAL EQUIPMENT, WHICH IS SPECIALLY ADAPTED FOR THE MEDICAL AND SURGICAL EQUIPMENT; SURGICAL LIGHTING, NAMELY, OPERATING THEATER LIGHTS, IN CLASS 10 (U.S. CLS. 26, 39 AND 44).

FIRST USE 6-0-2004; IN COMMERCE 6-0-2004.

THE MARK CONSISTS OF STANDARD CHARACTERS WITHOUT CLAIM TO ANY PARTICULAR FONT, STYLE, SIZE, OR COLOR.

OWNER OF U.S. REG. NO. 2,887,740.

SER. NO. 77-109,579, FILED 2-16-2007.

SHANNON TWOHIG, EXAMINING ATTORNEY

**Int. Cl.: 19**

**Prior U.S. Cls.: 1, 12, 33 and 50**

**United States Patent and Trademark Office**

**Reg. No. 3,568,883**

**Registered Feb. 3, 2009**

**TRADEMARK  
PRINCIPAL REGISTER**



RICHMOND PLYWOOD CORPORATION LIM-  
ITED (CANADA CORPORATION)  
13911 VULCAN WAY  
RICHMOND, CANADA V6V1K7

PRIORITY CLAIMED UNDER SEC. 44(D) ON  
CANADA APPLICATION NO. 1333302, FILED 1-30-  
2007, REG. NO. TMA719320, DATED 7-25-2008, EX-  
PIRES 7-25-2023.

FOR: PLYWOOD AND WOOD VENEERS, IN  
CLASS 19 (U.S. CLS. 1, 12, 33 AND 50).

SER. NO. 77-111,249, FILED 2-20-2007.

FIRST USE 0-0-1997; IN COMMERCE 0-0-1997.

MICHAEL WEBSTER, EXAMINING ATTORNEY

**Int. Cls.: 35 and 39**

**Prior U.S. Cls.: 100, 101, 102 and 105**

**United States Patent and Trademark Office**

**Reg. No. 3,568,884**

**Registered Feb. 3, 2009**

**SERVICE MARK  
PRINCIPAL REGISTER**



DCCO, LLC (VIRGINIA LIMITED LIABILITY  
COMPANY)  
SUITE 3C  
6861 ELM STREET  
MCLEAN, VA 22101

FOR: PROVIDING ONLINE/INTERACTIVE AD-  
VERTISING SCREENSHOTS AND ADVERTISING  
CAMPAIGN ANALYSIS FOR OTHERS; PROVIDING  
WEB ANALYTICS AND AD PLACEMENT VERIFI-  
CATION SERVICES; PROVIDING ADVERTISING  
SCREENSHOT AND ADVERTISING TEARSHEET  
VERIFICATION SERVICES; INTERNET ADVERTIS-  
ING RESEARCH AND COMPETITIVE ANALYSIS;  
MOBILE AND CELLULAR PHONE ADVERTISING  
RESEARCH AND COMPETITIVE ANALYSIS; DIS-

SEMINATION OF ADVERTISING MATERIAL,  
NAMELY, TEARSHEETS; AUDITING OF MOBILE  
INTERNET ADVERTISING; BUSINESS AUDITING  
SERVICES, IN CLASS 35 (U.S. CLS. 100, 101 AND 102).

FIRST USE 4-0-2004; IN COMMERCE 4-0-2004.

FOR: ARCHIVING OF ADVERTISING TEAR  
SHEETS, IN CLASS 39 (U.S. CLS. 100 AND 105).

FIRST USE 4-0-2004; IN COMMERCE 4-0-2004.

SER. NO. 77-113,352, FILED 2-22-2007.

LESLEY LAMOTHE, EXAMINING ATTORNEY

**Int. Cl.: 5**

**Prior U.S. Cls.: 6, 18, 44, 46, 51 and 52**

**Reg. No. 3,568,885**

**United States Patent and Trademark Office**

**Registered Feb. 3, 2009**

**TRADEMARK  
PRINCIPAL REGISTER**

**EZEQUA**

SOLVAY PHARMACEUTICALS B.V. (NETHERLANDS LIMITED LIABILITY COMPANY)  
C.J. VAN HOUTENLAAN 36  
WEESP, NETHERLANDS 1381CP

FOR: PHARMACEUTICAL PREPARATIONS AND SUBSTANCES FOR THE TREATMENT OF DISEASES OF THE CENTRAL NERVOUS SYSTEM, GASTRO-INTESTINAL DISEASES, GYNECOLOGICAL DISEASES AND CARDIOVASCULAR DISEASES, IN CLASS 5 (U.S. CLS. 6, 18, 44, 46, 51 AND 52).

THE MARK CONSISTS OF STANDARD CHARACTERS WITHOUT CLAIM TO ANY PARTICULAR FONT, STYLE, SIZE, OR COLOR.

OWNER OF ERPN CMNTY TM OFC REG. NO. 006176937, DATED 5-28-2008, EXPIRES 8-7-2017.

SER. NO. 77-114,796, FILED 2-23-2007.

DAVID TAYLOR, EXAMINING ATTORNEY

**Int. Cl.: 9**

**Prior U.S. Cls.: 21, 23, 26, 36 and 38**

**United States Patent and Trademark Office**

**Reg. No. 3,568,886**

**Registered Feb. 3, 2009**

**TRADEMARK  
PRINCIPAL REGISTER**



OTT, REINHOLD (FED REP GERMANY INDIVIDUAL)  
6 WILLOW STREET, UNIT 2303  
WATERLOO, ONTARIO, CANADA N2J 4S3

FOR: ELECTRONIC ALARM DEVICES, NAME-  
LY, ELECTRONIC THEFT ALARMS, ANTI-INTRU-  
SION ALARMS, AND PERSONAL SECURITY  
ALARMS, AND STRUCTURAL PARTS THEREOF  
FOR THE PROTECTION OF GOODS AGAINST  
THEFT; ELECTRONIC COMPONENTS, NAME-  
LY, PROXIMITY SENSORS, LIQUID LEVEL SENSORS,  
PHOTOELECTRIC SENSORS, TEMPERATURE SEN-  
SORS, AND ULTRASONIC SENSORS; ELECTRO-  
NIC, ELECTROMECHANICAL AND MECHANICAL  
SENSORS FOR SENSING OF AN ELECTRIC SUR-  
VEILLANCE CURRENT AND LIGHT FOR THE  
AFOREMENTIONED DEVICES; NONE OF THE  
FOREGOING FOR MEDICAL USE, IN CLASS 9  
(U.S. CLS. 21, 23, 26, 36 AND 38).

PRIORITY CLAIMED UNDER SEC. 44(D) ON  
ERPNTY TM OFC APPLICATION NO.  
005717756, FILED 2-27-2007.

OWNER OF ERPNTY TM OFC REG. NO.  
5717756, DATED 1-23-2008, EXPIRES 2-27-2017.

OWNER OF U.S. REG. NO. 2,712,580.

THE MARK CONSISTS OF "OTTSECURITY"  
WITH 4 ARCS VARYING IN SIZE SURROUNDING  
THE "O".

SER. NO. 77-118,707, FILED 2-28-2007.

KATHERINE E. HALMEN, EXAMINING ATTOR-  
NEY

**Int. Cl.: 27**

**Prior U.S. Cls.: 19, 20, 37, 42 and 50**

**United States Patent and Trademark Office**

**Reg. No. 3,568,887**

**Registered Feb. 3, 2009**

**TRADEMARK  
PRINCIPAL REGISTER**

**DOUG&GENE MEYER**

DOUG & GENE MEYER, LLC (FLORIDA LIMITED LIABILITY COMPANY)

39 NE 39TH STREET

MIAMI, FL 33137

FOR: RUGS, IN CLASS 27 (U.S. CLS. 19, 20, 37, 42 AND 50).

FIRST USE 2-16-2007; IN COMMERCE 2-16-2007.

THE MARK CONSISTS OF STANDARD CHARACTERS WITHOUT CLAIM TO ANY PARTICULAR FONT, STYLE, SIZE, OR COLOR.

THE NAMES SHOWN IN THE MARK IDENTIFIES LIVING INDIVIDUALS WHOSE CONSENTS IS OF RECORD.

SER. NO. 77-119,364, FILED 3-1-2007.

MARY BOAGNI, EXAMINING ATTORNEY

**Int. Cl.: 42**

**Prior U.S. Cls.: 100 and 101**

**United States Patent and Trademark Office**

**Reg. No. 3,568,888**

**Registered Feb. 3, 2009**

**SERVICE MARK  
PRINCIPAL REGISTER**

**myPlasticsindustry.com**

THE SOCIETY OF THE PLASTICS INDUSTRY,  
INC. (NEW YORK CORPORATION)  
SUITE 1000  
1667 K STREET, NW  
WASHINGTON, DC 20006

FOR: COMPUTER SERVICES, NAMELY, CREAT-  
ING AN ONLINE COMMUNITY FOR REGISTERED  
USERS TO OBTAIN PLASTICS INDUSTRY INFOR-  
MATION, NETWORK, AND PARTICIPATE IN  
WEB-BASED INDUSTRY ACTIVITIES, IN CLASS 42  
(U.S. CLS. 100 AND 101).

FIRST USE 12-15-2006; IN COMMERCE 12-15-2006.

THE MARK CONSISTS OF STANDARD CHAR-  
ACTERS WITHOUT CLAIM TO ANY PARTICULAR  
FONT, STYLE, SIZE, OR COLOR.

SER. NO. 77-123,728, FILED 3-6-2007.

BERNICE MIDDLETON, EXAMINING ATTORNEY

**Int. Cl.: 42**

**Prior U.S. Cls.: 100 and 101**

**United States Patent and Trademark Office**

**Reg. No. 3,568,889**

**Registered Feb. 3, 2009**

**SERVICE MARK  
PRINCIPAL REGISTER**



THE SOCIETY OF THE PLASTICS INDUSTRY,  
INC. (NEW YORK CORPORATION)  
SUITE 1000  
1667 K STREET, NW  
WASHINGTON, DC 20006

FOR: COMPUTER SERVICES, NAMELY, CREAT-  
ING AN ONLINE COMMUNITY FOR REGISTERED  
USERS TO OBTAIN PLASTICS INDUSTRY INFOR-  
MATION, NETWORK, AND PARTICIPATE IN WEB-  
BASED INDUSTRY ACTIVITIES, IN CLASS 42 (U.S.  
CLS. 100 AND 101).

FIRST USE 12-15-2006; IN COMMERCE 12-15-2006.

THE MARK CONSISTS OF THE WORD "MY-  
PLASTICSINDUSTRY.COM" WITH AN ENLARGED  
LETTER P INSIDE OF A CIRCLE.

SER. NO. 77-124,180, FILED 3-7-2007.

BERNICE MIDDLETON, EXAMINING ATTORNEY



**Int. Cls.: 2 and 7**

**Prior U.S. Cls.: 6, 11, 13, 16, 19, 21, 23, 31, 34 and 35**

**United States Patent and Trademark Office**

**Reg. No. 3,568,890**

**Registered Feb. 3, 2009**

**TRADEMARK  
PRINCIPAL REGISTER**

**KEMPERLE PERFORMANCE  
DRIVEN PRODUCTS**

ALBERT KEMPERLE, INC. (NEW YORK CORPORATION)  
176 NEW HIGHWAY  
NORTH AMITYVILLE, NY 11701

FOR: PAINT, NAMELY, AUTO BODY, MARINE, AVIATION, JANITORIAL AND COMMERCIAL PAINT, PAINTS FOR AUTOMOTIVE USE, PAINT PRIMERS, REDUCERS, THINNERS, PAINTS FOR AUTO BODY REPAIR; AEROSOL PAINT AND COATINGS IN THE NATURE OF AUTOMOTIVE FINISHING, UNDERCOATING FOR VEHICLES CHASSIS, IN CLASS 2 (U.S. CLS. 6, 11 AND 16).

FIRST USE 11-30-2006; IN COMMERCE 11-30-2006.

FOR: AUTOMOTIVE AND VEHICLE PRODUCTS, PARTS, SUPPLIES, TOOLS AND ACCESSORIES, NAMELY, ABRASIVE DISCS FOR POWER-OPERATED GRINDERS OR SANDERS FOR STRIPPING RUST AND PAINT FROM AUTOMOTIVE BODY AND PARTS, AIR AND ELECTRIC TOOLS, NAMELY, IMPACT GUNS, AIR CHISELS, AIR RATCHETS, HYDRAULIC PUMPS, GRINDERS, SANDERS, LONG BOARD DUAL ACTION SANDER, AIR BRUSHES FOR ETCHING, AIR COMPRESSORS FOR AIRBRUSHING, ELECTRIC WELDING MACHINES, AIR LINE, FILTRATION AND BOOTH FILTERS, POWER OPERATED BLOWERS, AUTOMOTIVE

FRAME STRETCHING MACHINES, CAR LIFTS, POWER JACKS, STANDS FOR HYDRAULIC JACKS, POWER OPERATED POLISHERS AND GRINDERS, RESPIRATORS, SAND BLASTING APPARATUS, NAMELY, CABINET, PRESSURE, SIPHON AND SPOT BLASTERS, COMMERCIAL OR SHOP VACUUMS AND PARTS FOR SHOP VACUUM CLEANERS, NAMELY, NOZZLES AND HOSES; WELDING INSTRUMENTS; SPRAY GUNS FOR PAINT AND PARTS THEREFOR, NAMELY, PAINT CUPS, NOZZLE SETS AND VALVES; PAINT MIXERS AND SHAKERS; PRESSURE WASHING MACHINES, IN CLASS 7 (U.S. CLS. 13, 19, 21, 23, 31, 34 AND 35).

FIRST USE 8-9-2006; IN COMMERCE 8-9-2006.

THE MARK CONSISTS OF STANDARD CHARACTERS WITHOUT CLAIM TO ANY PARTICULAR FONT, STYLE, SIZE, OR COLOR.

NO CLAIM IS MADE TO THE EXCLUSIVE RIGHT TO USE "PRODUCTS", APART FROM THE MARK AS SHOWN.

SER. NO. 77-124,267, FILED 3-7-2007.

DORITT L. CARROLL, EXAMINING ATTORNEY

**Int. Cls.: 7 and 11**

**Prior U.S. Cls.: 13, 19, 21, 23, 31, 34 and 35**

**United States Patent and Trademark Office**

**Reg. No. 3,568,891**

**Registered Feb. 3, 2009**

**TRADEMARK  
PRINCIPAL REGISTER**



LAKE SHORE RADIATOR, INC. (FLORIDA CORPORATION)  
5355 RAMONA BLVD  
JACKSONVILLE, FL 32205

FOR: RADIATORS FOR VEHICLES, IN CLASS 7  
(U.S. CLS. 13, 19, 21, 23, 31, 34 AND 35).

FIRST USE 1-5-2000; IN COMMERCE 1-5-2000.

FOR: AIR CONDITIONERS FOR VEHICLES, IN  
CLASS 11 (U.S. CLS. 13, 21, 23, 31 AND 34).

FIRST USE 1-5-2000; IN COMMERCE 1-5-2000.

NO CLAIM IS MADE TO THE EXCLUSIVE  
RIGHT TO USE "RADIATOR", APART FROM THE  
MARK AS SHOWN.

SEC. 2(F).

SER. NO. 77-125,303, FILED 3-8-2007.

PATRICIA EVANKO, EXAMINING ATTORNEY

Prior U.S. Cl.: 200

United States Patent and Trademark Office

Reg. No. 3,568,892

Registered Feb. 3, 2009

COLLECTIVE MEMBERSHIP  
PRINCIPAL REGISTER



SOUTHERN THUNDER MOTORCYCLE CLUB,  
INC (TENNESSEE CORPORATION)  
3816 E. ABERCROMBIE CIRCLE  
CHATTANOOGA, TN 37415

FOR: INDICATING MEMBERSHIP IN A MOTOR-  
CYCLE CLUB, IN CLASS 200 (U.S. CL. 200).

FIRST USE 6-7-1990; IN COMMERCE 6-7-1990.

NO CLAIM IS MADE TO THE EXCLUSIVE  
RIGHT TO USE "TN" AND "MC", APART FROM  
THE MARK AS SHOWN.

THE MARK CONSISTS OF A CREST WITH AN  
"X" DESIGN FEATURING STARS IN IT AND TWO  
LIGHTNING BOLTS ON EITHER SIDE OF THE  
CREST. THE CREST IS SURROUNDED BY THE  
WORDS "SOUTHERN" ON THE TOP, "THUNDER"  
ON THE BOTTOM, "TN" TO ITS LEFT AND "MC"  
ON ITS RIGHT EACH IN THEIR OWN BANNER.

SER. NO. 77-126,687, FILED 3-9-2007.

FRANK LATTUCA, EXAMINING ATTORNEY

**Int. Cl.: 16**

**Prior U.S. Cls.: 2, 5, 22, 23, 29, 37, 38 and 50**

**Reg. No. 3,568,893**

**United States Patent and Trademark Office**

**Registered Feb. 3, 2009**

**TRADEMARK  
PRINCIPAL REGISTER**

**ASHER**

ASHER STUDENT FOUNDATION (MICHIGAN  
NON-PROFIT CORPORATION)  
4209 MICHIGAN ST. NE  
GRAND RAPIDS, MI 49525

FOR: NEWSLETTER PUBLISHED PERIODICAL-  
LY PERTAINING TO THE BUSINESS OF APPLI-  
CANT, NAMELY, PROVISION OF RELIGIOUS  
HOUSING UNITS FOR UNIVERSITY STUDENTS ,  
IN CLASS 16 (U.S. CLS. 2, 5, 22, 23, 29, 37, 38 AND 50).

FIRST USE 11-16-1953; IN COMMERCE 12-0-1953.

THE MARK CONSISTS OF STANDARD CHAR-  
ACTERS WITHOUT CLAIM TO ANY PARTICULAR  
FONT, STYLE, SIZE, OR COLOR.

OWNER OF U.S. REG. NO. 1,062,208.

SEC. 2(F).

SER. NO. 77-129,836, FILED 3-13-2007.

CARYN GLASSER, EXAMINING ATTORNEY

**Int. Cl.: 36**

**Prior U.S. Cls.: 100, 101 and 102**

**United States Patent and Trademark Office**

**Reg. No. 3,568,894**

**Registered Feb. 3, 2009**

**SERVICE MARK  
PRINCIPAL REGISTER**

**BLENHEIM**

BLENHEIM CAPITAL MANAGEMENT, L.L.C.  
(DELAWARE LIMITED LIABILITY COMPA-  
NY)  
2 WORLDS FAIR DRIVE, 3RD FLOOR  
SOMERSET, NJ 08873

THE MARK CONSISTS OF STANDARD CHAR-  
ACTERS WITHOUT CLAIM TO ANY PARTICULAR  
FONT, STYLE, SIZE, OR COLOR.

FOR: FINANCIAL SERVICES, NAMELY, CAPI-  
TAL MANAGEMENT SERVICES, IN CLASS 36 (U.S.  
CLS. 100, 101 AND 102).

SER. NO. 77-132,188, FILED 3-15-2007.

FIRST USE 1-31-1989; IN COMMERCE 1-31-1989.

MARGERY A. TIERNEY, EXAMINING ATTORNEY

**Int. Cl.: 36**

**Prior U.S. Cls.: 100, 101 and 102**

**United States Patent and Trademark Office**

**Reg. No. 3,568,895**

**Registered Feb. 3, 2009**

**SERVICE MARK  
PRINCIPAL REGISTER**



NEW YORK DISASTER INTERFAITH SERVICES,  
INC. (NEW YORK NON-PROFIT CORPORATION)  
20TH FLOOR  
22 CORTLANDT ST.  
NEW YORK, NY 10007

FOR: CHARITABLE FUND RAISING FOR DIS-  
ASTER RELIEF, IN CLASS 36 (U.S. CLS. 100, 101 AND  
102).

FIRST USE 5-0-2006; IN COMMERCE 5-0-2006.

THE MARK CONSISTS OF TWO SEMI-CIRCLES  
SIDE BY SIDE, BOTH WITHIN A LARGER CIRCLE.  
THE SEMI-CIRCLE ON THE LEFT CONTAINS THE  
OUTLINE OF A CITY SKYLINE. THE SEMI-CIRCLE  
ON THE RIGHT CONTAINS THE OUTLINE OF A  
HOUSE AND TREES.

SER. NO. 77-134,446, FILED 3-19-2007.

PAM WILLIS, EXAMINING ATTORNEY

**Int. Cl.: 19**

**Prior U.S. Cls.: 1, 12, 33 and 50**

**United States Patent and Trademark Office**

**Reg. No. 3,568,896**

**Registered Feb. 3, 2009**

**TRADEMARK  
PRINCIPAL REGISTER**

**BESTLOCK TECHNOLOGY**

UNIBOARD CANADA INC. (CANADA CORPORATION)  
2540, DANIEL JOHNSON BOULEVARD  
SUITE 500  
LAVAL, CANADA H7T2S3

FOR: LAMINATE FLOORING; ENGINEERED WOODEN FLOORING, IN CLASS 19 (U.S. CLS. 1, 12, 33 AND 50).

THE MARK CONSISTS OF STANDARD CHARACTERS WITHOUT CLAIM TO ANY PARTICULAR FONT, STYLE, SIZE, OR COLOR.

PRIORITY CLAIMED UNDER SEC. 44(D) ON CANADA APPLICATION NO. TMA1338919, FILED 3-12-2007, REG. NO. TMA721559, DATED 8-21-2008, EXPIRES 8-21-2023.

NO CLAIM IS MADE TO THE EXCLUSIVE RIGHT TO USE "TECHNOLOGY", APART FROM THE MARK AS SHOWN.

SER. NO. 77-134,993, FILED 3-20-2007.

LINDA M. KING, EXAMINING ATTORNEY

**Int. Cl.: 35**

**Prior U.S. Cls.: 100, 101 and 102**

**Reg. No. 3,568,897**

**United States Patent and Trademark Office**

**Registered Feb. 3, 2009**

**SERVICE MARK  
PRINCIPAL REGISTER**

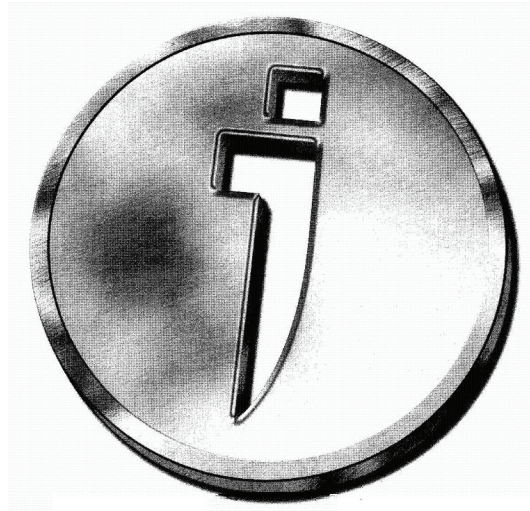

JACT MEDIA LLC (TEXAS LIMITED LIABILITY COMPANY)  
ROOM 10070, BOX 420102  
2050 N. STEMMONS FREEWAY  
DALLAS, TX 75342

PUTERS AND ACCESSORIES, AND HOME AND GARDEN PRODUCTS; PROMOTING THE GOODS AND SERVICES OF OTHERS BY MEANS OF OPERATING AN ON-LINE SHOPPING MALL, IN CLASS 35 (U.S. CLS. 100, 101 AND 102).

FOR: INCENTIVE AWARD PROGRAM TO PROMOTE THE PARTICIPATION OF ONLINE VIDEO GAME PLAY; ONLINE RETAIL STORE SERVICES FEATURING, GAMER GEAR, VIDEO GAMES, MOVIES, GAMES AND TOYS, ELECTRONICS, COM-

FIRST USE 3-30-2005; IN COMMERCE 3-30-2005.

SER. NO. 77-141,181, FILED 3-27-2007.

MARK SPARACINO, EXAMINING ATTORNEY



**Int. Cl.: 9**

**Prior U.S. Cls.: 21, 23, 26, 36 and 38**

**United States Patent and Trademark Office**

**Reg. No. 3,568,898**

**Registered Feb. 3, 2009**

**TRADEMARK  
PRINCIPAL REGISTER**

**AMARAY**

NEXPAK CORPORATION (DELAWARE CORPORATION)  
2444 MEADOWBROOK PARKWAY  
DULUTH, GA 30096

THE MARK CONSISTS OF STANDARD CHARACTERS WITHOUT CLAIM TO ANY PARTICULAR FONT, STYLE, SIZE, OR COLOR.

FOR: PLASTIC STORAGE CASES FOR HOLDING ITEMS OF RECORDED MEDIA, IN CLASS 9 (U.S. CLS. 21, 23, 26, 36 AND 38).

SER. NO. 77-141,434, FILED 3-27-2007.

FIRST USE 6-30-2000; IN COMMERCE 6-30-2000.

BERYL GARDNER, EXAMINING ATTORNEY

**Int. Cl.: 21**

**Prior U.S. Cls.: 2, 13, 23, 29, 30, 33, 40 and 50**

**Reg. No. 3,568,899**

**United States Patent and Trademark Office**

**Registered Feb. 3, 2009**

**TRADEMARK  
PRINCIPAL REGISTER**

**CENTURION**

LINCOLN FOODSERVICE PRODUCTS LLC (IN-  
DIANA LIMITED LIABILITY COMPANY)  
1111 N. HADLEY ROAD  
FORT WAYNE, IN 46804

FOR: COMMERCIAL COOKWARE, NAMELY,  
POTS, PANS, LIDS FOR POTS AND PANS, COLAN-  
DERS, STRAINERS, KITCHEN LADLES, SERVING  
LADLES, SKIMMERS, SPATULAS, SERVING  
FORKS, BASTING SPOONS, MIXING SPOONS, IN  
CLASS 21 (U.S. CLS. 2, 13, 23, 29, 30, 33, 40 AND 50).

FIRST USE 3-13-1985; IN COMMERCE 3-13-1985.

THE MARK CONSISTS OF STANDARD CHAR-  
ACTERS WITHOUT CLAIM TO ANY PARTICULAR  
FONT, STYLE, SIZE, OR COLOR.

OWNER OF U.S. REG. NO. 1,433,940.

SER. NO. 77-141,754, FILED 3-27-2007.

MARY MUNSON, EXAMINING ATTORNEY

Int. Cls.: 20, 21, 25, 27 and 28

Prior U.S. Cls.: 2, 13, 19, 20, 22, 23, 25, 29, 30, 32, 33,  
37, 38, 39, 40, 42 and 50

Reg. No. 3,568,900

United States Patent and Trademark Office

Registered Feb. 3, 2009

TRADEMARK  
PRINCIPAL REGISTER



ALMOST THERE, INC. (ARIZONA CORPORATION)  
1126 NORRIS DRIVE  
PRESCOTT, AZ 86305

FOR: FURNITURE; GARAGE AND HOME DECOR PRODUCTS, NAMELY, DECORATIVE CAN DISPLAY RACKS, IN CLASS 20 (U.S. CLS. 2, 13, 22, 25, 32 AND 50).

FIRST USE 6-0-2002; IN COMMERCE 6-0-2002.

FOR: GARAGE AND HOME DECOR PRODUCTS, NAMELY, DECORATIVE COOKIE JARS AND DECORATIVE PLATES, IN CLASS 21 (U.S. CLS. 2, 13, 23, 29, 30, 33, 40 AND 50).

FIRST USE 9-0-1998; IN COMMERCE 9-0-1998.

FOR: CLOTHING, NAMELY, T-SHIRTS, SWEATSHIRTS, SHIRTS, JACKETS, CAPS AND HATS, IN CLASS 25 (U.S. CLS. 22 AND 39).

FIRST USE 9-0-1998; IN COMMERCE 9-0-1998.

FOR: NON-TEXTILE WALL HANGINGS, NAMELY, TIN, WOOD, PORCELAIN, AND ALUMINUM WALL HANGINGS, IN CLASS 27 (U.S. CLS. 19, 20, 37, 42 AND 50).

FIRST USE 9-0-1998; IN COMMERCE 9-0-1998.

FOR: GIFTS AND COLLECTIBLES, NAMELY, SCALE MODEL VEHICLES, IN CLASS 28 (U.S. CLS. 22, 23, 38 AND 50).

FIRST USE 9-0-1998; IN COMMERCE 9-0-1998.

OWNER OF U.S. REG. NO. 3,203,539.

NO CLAIM IS MADE TO THE EXCLUSIVE RIGHT TO USE "GARAGE" IN CLASSES 20, 21, 27 AND 28, APART FROM THE MARK AS SHOWN.

THE MARK CONSISTS OF A HAND WITH SLEEVE HOLDING A WRENCH, PALM FACING OUTWARD, WITH INDEX FINGER AND THUMB EXTENDED, WITH A BLACK RIBBON TIED AROUND THE INDEX FINGER, ALL ENCIRCLED BY A BLACK BORDER INLAID WITH WHITE RIVETS. THE WORDS "THE BUSTED KNUCKLE" APPEAR INSIDE THE BORDER ABOVE THE HAND IN ARCING BLACK FONT AND THE WORDS "REPAIR & DESPAIR UNDER ONE ROOF" APPEAR INSIDE THE BORDER IN SMALLER ARCING BLACK FONT BENEATH THE HAND. THE WORD "GARAGE" APPEARS IN WHITE FONT OVER A BLACK BACKGROUND, OVER THE WRIST.

SER. NO. 77-142,747, FILED 3-28-2007.

WILLIAM VERHOSEK, EXAMINING ATTORNEY

Int. Cl.: 25

Prior U.S. Cls.: 22 and 39

United States Patent and Trademark Office

Reg. No. 3,568,901

Registered Feb. 3, 2009

TRADEMARK  
PRINCIPAL REGISTER

# Paste

LAURITS, JASON (UNITED STATES INDIVIDUAL)  
116 S. ELLIOTT PLACE #3  
BROOKLYN, NY 11217

FOR: BASEBALL CAPS; BATHING SUITS; BATHING SUITS FOR MEN; BATHING TRUNKS; BEACHWEAR; BELTS; BERMUDA SHORTS; BIKINIS; BLAZERS; BLOUSES; BOARD SHORTS; BOARD SHORTS; BOLEROS; BOTTOMS; BOW TIES; BOXER BRIEFS; BOXER SHORTS; BRAS; BRIEFS; BRIEFS; CAMP SHIRTS; CARDIGANS; CHILDREN'S AND INFANTS' CLOTH BIBS; CHILDREN'S CLOTH EATING BIBS; CHILDREN'S HEADWEAR; COATS; CUMMERBUNDS; DENIM JACKETS; DENIMS; DRESS SHIRTS; DRESSES; FLIP FLOPS; FOOTWEAR; GYM SHORTS; HATS; HOODS; HOODS; JACKETS; JEANS; JERSEYS; JOGGING OUTFITS; JOGGING PANTS; JOGGING SUITS; LEATHER COATS; LEATHER JACKETS; LOUNGEWEAR; MEN AND WOMEN JACKETS, COATS, TROUSERS, VESTS; MEN'S SOCKS; MEN'S SUITS; MUSCLE TOPS; NECKTIES; NECKWEAR; ONE PIECE GAR-

MENT FOR INFANTS AND TODDLERS; PANTIES; PANTIES, SHORTS AND BRIEFS; POLO SHIRTS; PONCHOS; PYJAMAS; RAIN COATS; ROBES; SCARVES; SHIRTS; SHOES; SHORT-SLEEVED OR LONG-SLEEVED T-SHIRTS; SHORT-SLEEVED SHIRTS; SKIRTS; SLEEPWEAR; SOCKS; SPORT COATS; SPORT SHIRTS; SPORTS SHIRTS; SPORTS SHIRTS WITH SHORT SLEEVES; SUIT COATS; SUSPENDERS; SWEATERS; T-SHIRTS; TANK TOPS; TANK-TOPS; TIES; TRACKSUITS; TURTLENECKS; VESTS, IN CLASS 25 (U.S. CLS. 22 AND 39).

FIRST USE 6-15-2007; IN COMMERCE 8-1-2007.

THE MARK CONSISTS OF STANDARD CHARACTERS WITHOUT CLAIM TO ANY PARTICULAR FONT, STYLE, SIZE, OR COLOR.

SER. NO. 77-143,755, FILED 3-29-2007.

BILL DAWE, EXAMINING ATTORNEY

**Int. Cls.: 9, 35 and 42**

**Prior U.S. Cls.: 21, 23, 26, 36, 38, 100, 101 and 102**

**Reg. No. 3,568,902**

**United States Patent and Trademark Office**

**Registered Feb. 3, 2009**

**TRADEMARK  
SERVICE MARK  
PRINCIPAL REGISTER**

**SPIDERMONKEY**

COREFILING LIMITED (UNITED KINGDOM CORPORATION)  
OSNEY MEAD HOUSE  
OSNEY MEAD, UNITED KINGDOM OX20FA

FOR: SOFTWARE, NAMELY, SOFTWARE FOR CREATING, PRODUCING, MAINTAINING AND REPORTING ABOUT EXTENSIBLE BUSINESS REPORTING LANGUAGE TAXONOMIES AND INSTANCES FOR BUSINESSES; SOFTWARE FOR CREATING, PRODUCING, MAINTAINING AND REPORTING ABOUT EXTENSIBLE BUSINESS REPORTING LANGUAGE TAXONOMIES AND INSTANCES FOR BUSINESSES DOWNLOADABLE FROM THE INTERNET; PRE RECORDED COMPACT DISCS AND PRE RECORDED FLASH MEMORY DEVICES FEATURING SOFTWARE FOR CREATING, PRODUCING, MAINTAINING AND REPORTING ABOUT EXTENSIBLE BUSINESS LANGUAGE TAXONOMIES FOR BUSINESS, IN CLASS 9 (U.S. CLS. 21, 23, 26, 36 AND 38).

FOR: CONSULTANCY SERVICES IN THE FIELD OF ACCOUNTING FUNCTIONS; ONLINE RETAIL

AND WHOLESALE STORE SERVICES FEATURING COMPUTER SOFTWARE, IN CLASS 35 (U.S. CLS. 100, 101 AND 102).

FOR: INSTALLATION, MAINTENANCE AND REPAIR OF COMPUTER SOFTWARE; CONSULTING IN THE FIELDS OF COMPUTERS AND COMPUTER SOFTWARE, IN CLASS 42 (U.S. CLS. 100 AND 101).

THE MARK CONSISTS OF STANDARD CHARACTERS WITHOUT CLAIM TO ANY PARTICULAR FONT, STYLE, SIZE, OR COLOR.

PRIORITY CLAIMED UNDER SEC. 44(D) ON ERPN CMNTY TM OFC APPLICATION NO. 005592795, FILED 1-1-2007, REG. NO. 005592795, DATED 1-24-2008, EXPIRES 1-1-2017.

SER. NO. 77-144,528, FILED 3-30-2007.

KRISTIN DAHLING, EXAMINING ATTORNEY

**Int. Cls.: 9 and 42**

**Prior U.S. Cls.: 21, 23, 26, 36, 38, 100 and 101**

**Reg. No. 3,568,903**

**United States Patent and Trademark Office**

**Registered Feb. 3, 2009**

**TRADEMARK  
SERVICE MARK  
PRINCIPAL REGISTER**



MONTAGE TECHNOLOGY, INC. (CALIFORNIA CORPORATION)  
SUITE 320  
4677 OLD IRONSIDES DRIVE  
SANTA CLARA, CA 95054

FOR: DIGITAL TELEVISION RECEIVERS AND COMPONENTS THEREOF, NAMELY, RADIO FREQUENCY, DIGITAL SIGNAL PROCESSING AND MIXED-SIGNAL INTEGRATED CIRCUITS, IN CLASS 9 (U.S. CLS. 21, 23, 26, 36 AND 38).

FIRST USE 3-15-2004; IN COMMERCE 4-1-2004.

FOR: RESEARCH IN THE FIELD OF INTEGRATED CIRCUITS; INDUSTRIAL ANALYSIS AND RESEARCH SERVICES IN THE FIELD OF INTEGRATED CIRCUIT DESIGN; DESIGN AND DEVELOPMENT OF COMPUTER HARDWARE, NAMELY, DESIGN AND DEVELOPMENT OF INTEGRATED CIRCUITS, MEMORY MODULES, RADIO FREQUENCY INTEGRATED CIRCUITS, DIGITAL SIGNAL PROCESSING INTEGRATED CIRCUITS, AND MIXED-SIGNAL INTEGRATED CIRCUITS FOR DI-

GITAL TELEVISION BROADCASTING; DESIGN AND DEVELOPMENT OF SOFTWARE RELATING TO INTEGRATED CIRCUITS AND MEMORY MODULES FOR DIGITAL TELEVISION BROADCASTING; ENGINEERING EVALUATION SERVICES IN THE FIELD OF INTEGRATED CIRCUIT DESIGN; SCIENTIFIC RESEARCH IN THE FIELD OF INTEGRATED CIRCUIT DESIGN; ENGINEERING; MATERIALS QUALITY CONTROL SERVICES FOR OTHERS IN THE FIELD OF INTEGRATED CIRCUITS; TESTING OF INTEGRATED CIRCUIT PRODUCTS; INDUSTRIAL DESIGN SERVICES, IN CLASS 42 (U.S. CLS. 100 AND 101).

FIRST USE 3-15-2004; IN COMMERCE 4-1-2004.

NO CLAIM IS MADE TO THE EXCLUSIVE RIGHT TO USE "TECHNOLOGY", APART FROM THE MARK AS SHOWN.

SER. NO. 77-149,311, FILED 4-5-2007.

LINDA LAVACHE, EXAMINING ATTORNEY

**Int. Cl.: 25**

**Prior U.S. Cls.: 22 and 39**

**United States Patent and Trademark Office**

**Reg. No. 3,568,904**

**Registered Feb. 3, 2009**

**TRADEMARK  
PRINCIPAL REGISTER**



OMC, INC. (CONNECTICUT CORPORATION)  
4 OVERVIEW DRIVE  
EASTON, CT 06612

HATS, SCARVES, BELTS, GLOVES, HOSIERY AND  
SOCKS, IN CLASS 25 (U.S. CLS. 22 AND 39).

FIRST USE 6-9-2004; IN COMMERCE 7-30-2005.

FOR: CLOTHING, NAMELY, HATS, UNDER-  
GARMENTS, SHIRTS, PANTS, SKIRTS AND JACK-  
ETS AND CLOTHING ACCESSORIES, NAMELY,

SER. NO. 77-150,497, FILED 4-6-2007.

EMILY CARLSEN, EXAMINING ATTORNEY

**Int. Cl.: 41**

**Prior U.S. Cls.: 100, 101 and 107**

**United States Patent and Trademark Office**

**Reg. No. 3,568,905**

**Registered Feb. 3, 2009**

**SERVICE MARK  
PRINCIPAL REGISTER**

**POLYMER**

ELSEVIER LIMITED (UNITED KINGDOM COR-  
PORATION)  
THE BOULEVARD, LANGFORD LANE,  
KIDLINGTON, OXFORD., UNITED KINGDOM  
OX51GB

FOR: PROVIDING ON-LINE PUBLICATIONS,  
NAMELY, JOURNALS IN THE FIELDS OF SCIENCE  
AND TECHNOLOGY, IN CLASS 41 (U.S. CLS. 100,  
101 AND 107).

FIRST USE 5-31-1998; IN COMMERCE 5-31-1998.

THE MARK CONSISTS OF STANDARD CHAR-  
ACTERS WITHOUT CLAIM TO ANY PARTICULAR  
FONT, STYLE, SIZE, OR COLOR.

SEC. 2(F).

SER. NO. 77-151,542, FILED 4-9-2007.

MICHELE SWAIN, EXAMINING ATTORNEY



**Int. Cl.: 31**

**Prior U.S. Cls.: 1 and 46**

**United States Patent and Trademark Office**

**Reg. No. 3,568,906**

**Registered Feb. 3, 2009**

**TRADEMARK  
PRINCIPAL REGISTER**

**KITTY SUSHI**

FULL PETENTIAL, INC. (CALIFORNIA CORPORATION)  
12881 KNOTT STREET  
SUITE 209  
GARDEN GROVE, CA 92841

FOR: EDIBLE PET TREATS, IN CLASS 31 (U.S. CLS. 1 AND 46).

FIRST USE 5-30-2006; IN COMMERCE 5-30-2006.

THE MARK CONSISTS OF STANDARD CHARACTERS WITHOUT CLAIM TO ANY PARTICULAR FONT, STYLE, SIZE, OR COLOR.

NO CLAIM IS MADE TO THE EXCLUSIVE RIGHT TO USE "KITTY", APART FROM THE MARK AS SHOWN.

SER. NO. 77-152,147, FILED 4-9-2007.

KATHERINE CHANG, EXAMINING ATTORNEY

**Int. Cl.: 36**

**Prior U.S. Cls.: 100, 101 and 102**

**United States Patent and Trademark Office**

**Reg. No. 3,568,907**

**Registered Feb. 3, 2009**

**SERVICE MARK  
PRINCIPAL REGISTER**

# REGWORKS

HEDGEWORKS, LLC (DELAWARE LIMITED  
LIABILITY COMPANY)  
SUITE 100  
1900 WRIGHT PLACE  
CARLSBAD, CA 92008

FOR: FINANCIAL CONSULTATION; FINANCIAL PORTFOLIO MANAGEMENT; FINANCIAL RESEARCH; FINANCIAL RISK MANAGEMENT; HEDGE FUND INVESTMENT CONSULTATION; HEDGE FUND INVESTMENT SERVICES; INVESTMENT ADVISORY SERVICES; INVESTMENT CONSULTATION; PROVIDING A WEBSITE WHERE USERS CAN ACCESS RATINGS, REVIEWS AND RECOMMENDATIONS ON HEDGE FUNDS AND

OTHER FINANCIAL INSTRUMENTS; AND FINANCIAL RISK MANAGEMENT CONSULTATION SERVICES, IN CLASS 36 (U.S. CLS. 100, 101 AND 102).

FIRST USE 1-0-2006; IN COMMERCE 1-0-2006.

THE MARK CONSISTS OF STANDARD CHARACTERS WITHOUT CLAIM TO ANY PARTICULAR FONT, STYLE, SIZE, OR COLOR.

SER. NO. 77-152,330, FILED 4-9-2007.

PRISCILLA MILTON, EXAMINING ATTORNEY

**Int. Cl.: 35**

**Prior U.S. Cls.: 100, 101 and 102**

**United States Patent and Trademark Office**

**Reg. No. 3,568,908**

**Registered Feb. 3, 2009**

**SERVICE MARK  
PRINCIPAL REGISTER**

**SPABUCKS REWARDS**

R&M MARKETING SERVICES, INC. (NEW JERSEY CORPORATION)  
789 ROUTE 202  
BRIDGEWATER, NJ 08807

FOR: ADMINISTERING AND CONDUCTING INCENTIVE AWARD PROGRAMS TO PROMOTE THE SALE OF PRODUCTS AND SERVICES OF OTHERS, IN CLASS 35 (U.S. CLS. 100, 101 AND 102).

FIRST USE 4-26-2005; IN COMMERCE 1-0-2006.

THE MARK CONSISTS OF STANDARD CHARACTERS WITHOUT CLAIM TO ANY PARTICULAR FONT, STYLE, SIZE, OR COLOR.

NO CLAIM IS MADE TO THE EXCLUSIVE RIGHT TO USE "REWARDS", APART FROM THE MARK AS SHOWN.

SER. NO. 77-152,475, FILED 4-10-2007.

MICHELE SWAIN, EXAMINING ATTORNEY

**Int. Cls.: 9, 38 and 42**

**Prior U.S. Cls.: 21, 23, 26, 36, 38, 100, 101 and 104**

**Reg. No. 3,568,909**

**United States Patent and Trademark Office**

**Registered Feb. 3, 2009**

**TRADEMARK  
SERVICE MARK  
PRINCIPAL REGISTER**

# COMPUTRITION

COMPUTRITION, INC. (CALIFORNIA CORPORATION)  
19808 NORDHOFF PLACE  
CHATSWORTH, CA 91311

FOR: COMPUTER SOFTWARE SUITE FOR DATA MANAGEMENT AND ANALYSIS IN THE FIELD OF FOOD OPERATIONS AND NUTRITIONAL CARE MANAGEMENT AND NUTRITIONAL ANALYSIS SOFTWARE; SOFTWARE FOR DATA MANAGEMENT AND ANALYSIS DESIGNED TO REDUCE COSTS AND INCREASE REVENUES IN A FOODSERVICE OPERATION, NAMELY, MENU COST ANALYSIS, INVENTORY AND PURCHASING CONTROL, PRODUCTION PLANNING, DATABASE MANAGEMENT AND PATIENT CARE MANAGEMENT, IN CLASS 9 (U.S. CLS. 21, 23, 26, 36 AND 38).

FIRST USE 4-1-1981; IN COMMERCE 10-31-1982.

FOR: PROVIDING ACCESS TO DATABASES FEATURING INFORMATION IN THE FIELD OF FOOD

MANAGEMENT, NAMELY, MENU COST ANALYSIS, INVENTORY AND PURCHASING CONTROL, AND FOOD PRODUCTION PLANNING, IN CLASS 38 (U.S. CLS. 100, 101 AND 104).

FIRST USE 5-1-1981; IN COMMERCE 5-1-1981.

FOR: RENTAL OF COMPUTER SOFTWARE IN THE FIELD OF FOOD MANAGEMENT, NAMELY, MENU COST ANALYSIS, INVENTORY AND PURCHASING CONTROLS, AND FOOD PRODUCTION PLANNING, IN CLASS 42 (U.S. CLS. 100 AND 101).

FIRST USE 5-1-1981; IN COMMERCE 5-1-1981.

THE MARK CONSISTS OF STANDARD CHARACTERS WITHOUT CLAIM TO ANY PARTICULAR FONT, STYLE, SIZE, OR COLOR.

SER. NO. 77-154,278, FILED 4-11-2007.

MATTHEW EINSTEIN, EXAMINING ATTORNEY

**Int. Cl.: 41**

**Prior U.S. Cls.: 100, 101 and 107**

**United States Patent and Trademark Office**

**Reg. No. 3,568,910**

**Registered Feb. 3, 2009**

**SERVICE MARK  
PRINCIPAL REGISTER**

# REDEMPTION

NICOLAS A. VAN DYK (UNITED STATES INDIVIDUAL)  
2154 LINDA FLORA DRIVE  
LOS ANGELES, CA 90077

FOR: ENTERTAINMENT IN THE NATURE OF VISUAL AND AUDIO PERFORMANCES, AND MUSICAL, VARIETY, NEWS AND COMEDY SHOWS; ENTERTAINMENT IN THE NATURE OF VISUAL AND AUDIO PERFORMANCES, NAMELY, MUSICAL BAND, ROCK GROUP, GYMNASTIC, DANCE, AND BALLET PERFORMANCES; ENTERTAINMENT, NAMELY, LIVE PERFORMANCES BY A MUSICAL BAND; ENTERTAINMENT SERVICES, NAMELY, NON-DOWNLOADABLE RINGTONES, PRE-RECORDED MUSIC, VIDEO AND GRAPHICS PRESENTED TO MOBILE COMMUNICATIONS DEVICES VIA A GLOBAL COMPUTER NETWORK AND WIRELESS NETWORKS; ENTERTAINMENT

SERVICES, NAMELY, PROVIDING A WEB SITE FEATURING MUSICAL PERFORMANCES, MUSICAL VIDEOS, RELATED FILM CLIPS, PHOTOGRAPHS, AND OTHER MULTIMEDIA MATERIALS; ENTERTAINMENT, NAMELY, LIVE PERFORMANCES BY MUSICAL BANDS; PRESENTATION OF MUSICAL PERFORMANCE, IN CLASS 41 (U.S. CLS. 100, 101 AND 107).

FIRST USE 7-1-2001; IN COMMERCE 7-1-2001.

THE MARK CONSISTS OF STANDARD CHARACTERS WITHOUT CLAIM TO ANY PARTICULAR FONT, STYLE, SIZE, OR COLOR.

SER. NO. 77-156,874, FILED 4-14-2007.

ESTHER A. BORSUK, EXAMINING ATTORNEY

**Int. Cl.: 7**

**Prior U.S. Cls.: 13, 19, 21, 23, 31, 34 and 35**

**United States Patent and Trademark Office**

**Reg. No. 3,568,911**

**Registered Feb. 3, 2009**

**TRADEMARK  
PRINCIPAL REGISTER**



NIPPON PILLAR KOGYO KABUSHIKI KAISHA  
(JAPAN LIMITED COMPANY), DBA NIPPON  
PILLAR PACKING CO., LTD.  
11-48, NONAKAMINAMI 2-CHOME  
YODOGAWA-KU, OSAKA-SHI  
OSAKA, JAPAN

FOR: BELLOWS PUMPS AND DIAPHRAGM  
PUMPS, IN CLASS 7 (U.S. CLS. 13, 19, 21, 23, 31, 34  
AND 35).

OWNER OF JAPAN REG. NO. 5059704, DATED 7-  
6-2007, EXPIRES 7-6-2017.

THE MARK CONSISTS OF "SPELA".

SER. NO. 77-157,486, FILED 4-16-2007.

DAVID C. REIHNER, EXAMINING ATTORNEY

**Int. Cls.: 9 and 12**

**Prior U.S. Cls.: 19, 21, 23, 26, 31, 35, 36, 38 and 44**

**United States Patent and Trademark Office**

**Reg. No. 3,568,912**

**Registered Feb. 3, 2009**

**TRADEMARK  
PRINCIPAL REGISTER**

**WIREYE**

KERETH, YEFIM (ISRAEL INDIVIDUAL)  
11 HAHARTZIT STREET  
RECHOVOT, ISRAEL 76568

FOR: MONITORING SYSTEMS COMPRISED OF ELECTRO-OPTICAL, ELECTRO-MAGNETIC, ACOUSTIC, SEISMIC, AND CHEMICAL MONITORS, DETECTORS, SIGNAL AND COMMUNICATION EQUIPMENT, SENSORS, COMPUTERS, CAMERAS, COMMUNICATION AND RECORDING EQUIPMENT, AND PHOTOGRAPHIC AND IMAGING APPARATUS AND INSTRUMENTS, NAMELY, CAMERAS AND IMAGE PROCESSING SOFTWARE FOR USE WITH LIGHT-WEIGHT UNMANNED VEHICLES FOR CARRYING MONITORS AND PAYLOADS, OVER LIGHT-WEIGHT LINES MADE OF FLEXIBLE AND RIGID TRACKS, AND FOR USE WITH LIGHT-WEIGHT SURVEILLANCE VEHICLES TRAVELING OVER LIGHT-WEIGHT LINES MADE OF FLEXIBLE AND RIGID TRACKS, IN CLASS 9 (U.S. CLS. 21, 23, 26, 36 AND 38).

FOR: LIGHT-WEIGHT UNMANNED VEHICLES FOR CARRYING MONITORS AND PAYLOADS IN

THE NATURE OF ELECTRO-OPTICAL, ELECTRO-MAGNETIC, ACOUSTIC, SEISMIC, CHEMICAL AND OTHER SENSORS, DETECTORS, AND SIGNAL AND COMMUNICATION EQUIPMENT OVER LIGHT-WEIGHT LINES MADE OF FLEXIBLE AND RIGID TRACKS; LIGHT-WEIGHT SURVEILLANCE VEHICLES TRAVELING OVER LIGHT-WEIGHT LINES MADE OF FLEXIBLE AND RIGID TRACKS, AND STRUCTURAL PARTS THEREFOR, IN CLASS 12 (U.S. CLS. 19, 21, 23, 31, 35 AND 44).

THE MARK CONSISTS OF STANDARD CHARACTERS WITHOUT CLAIM TO ANY PARTICULAR FONT, STYLE, SIZE, OR COLOR.

PRIORITY CLAIMED UNDER SEC. 44(D) ON ISRAEL APPLICATION NO. 194,851, FILED 10-24-2006, REG. NO. 194851, DATED 9-3-2008, EXPIRES 10-24-2016.

SER. NO. 77-158,299, FILED 4-17-2007.

LINDA POWELL, EXAMINING ATTORNEY

**Int. Cl.: 9**

**Prior U.S. Cls.: 21, 23, 26, 36 and 38**

**Reg. No. 3,568,913**

**United States Patent and Trademark Office**

**Registered Feb. 3, 2009**

**TRADEMARK  
PRINCIPAL REGISTER**



ATTORNEYS' TITLE GUARANTY FUND, INC.  
(ILLINOIS CORPORATION)

2408 WIDSOR PLACE  
CHAMPAIGN, IL 61826

FOR: COMPUTER SOFTWARE FOR USE IN THE PREPARATION OF REAL ESTATE DOCUMENTS, NAMELY, PREPARING TITLE SEARCH REPORTS, AND IN THE PREPARATION OF TITLE INSURANCE COMMITMENTS, POLICIES, AND OTHER DOCUMENTS USED IN CONNECTION WITH REAL ESTATE MATTERS, IN CLASS 9 (U.S. CLS. 21, 23, 26, 36 AND 38).

FIRST USE 5-1-2002; IN COMMERCE 5-1-2002.

OWNER OF U.S. REG. NOS. 2,125,322 AND 2,921,218.

NO CLAIM IS MADE TO THE EXCLUSIVE RIGHT TO USE "RESOURCE", APART FROM THE MARK AS SHOWN.

THE MARK CONSISTS OF THE WORDS "ATG RESOURCE" AND THE IMAGE OF A FLYING DOCUMENT WITH THE TOP EDGE OF THE DOCUMENT RESEMBLING THE ROOFLINE OF A HOUSE.

SER. NO. 77-158,941, FILED 4-17-2007.

MICHAEL WEBSTER, EXAMINING ATTORNEY



**Int. Cls.: 18 and 28**

**Prior U.S. Cls.: 1, 2, 3, 22, 23, 38, 41 and 50**

**United States Patent and Trademark Office**

**Reg. No. 3,568,914**

**Registered Feb. 3, 2009**

**TRADEMARK  
PRINCIPAL REGISTER**

**TRAVEL FRIENDS**

DAN-DEE INTERNATIONAL, LTD. (DELAWARE  
CORPORATION)  
106 HARBOR DRIVE  
JERSEY CITY, NJ 07305

FOR: TOTE BAGS, BACK PACKS, ROLLING  
BACK PACKS AND TRAVEL BAGS, LUGGAGE  
TAGS, COMBINATIONS OF BAGS OR BACK PACKS  
AND STUFFED TOYS SOLD AS A UNIT, IN CLASS  
18 (U.S. CLS. 1, 2, 3, 22 AND 41).

FIRST USE 9-20-2006; IN COMMERCE 9-20-2006.

FOR: PLUSH AND STUFFED TOYS, IN CLASS 28  
(U.S. CLS. 22, 23, 38 AND 50).

FIRST USE 9-21-1993; IN COMMERCE 9-21-1993.

THE MARK CONSISTS OF STANDARD CHAR-  
ACTERS WITHOUT CLAIM TO ANY PARTICULAR  
FONT, STYLE, SIZE, OR COLOR.

NO CLAIM IS MADE TO THE EXCLUSIVE  
RIGHT TO USE "TRAVEL", APART FROM THE  
MARK AS SHOWN.

SER. NO. 77-159,355, FILED 4-18-2007.

JOHN E. MICHOS, EXAMINING ATTORNEY

**Int. Cl.: 42**

**Prior U.S. Cls.: 100 and 101**

**United States Patent and Trademark Office**

**Reg. No. 3,568,915**

**Registered Feb. 3, 2009**

**SERVICE MARK  
PRINCIPAL REGISTER**



MAKE TECHNOLOGIES INC. (CANADA CORPORATION)  
1132 HAMILTON STREET, THIRD FLOOR  
VANCOUVER, B.C., CANADA V6B2S2

FOR: DESIGN AND DEVELOPMENT OF ENTERPRISE COMPUTER SOFTWARE SYSTEMS TO REPLACE OUTDATED COMPUTER SOFTWARE SYSTEMS, IN CLASS 42 (U.S. CLS. 100 AND 101).

FIRST USE 9-0-2000; IN COMMERCE 9-0-2000.

THE MARK CONSISTS OF FIVE HEXAGONS CENTERED ABOVE THE WORD "MAKE".

SER. NO. 77-160,523, FILED 4-19-2007.

COLLEEN DOMBROW, EXAMINING ATTORNEY

**Int. Cl.: 36**

**Prior U.S. Cls.: 100, 101 and 102**

**United States Patent and Trademark Office**

**Reg. No. 3,568,916**

**Registered Feb. 3, 2009**

**SERVICE MARK  
PRINCIPAL REGISTER**

FIRST NATIONAL INSURANCE  
AGENCY

F.N.B. CORPORATION (FLORIDA CORPORATION)  
ONE F.N.B. BOULEVARD  
HERMITAGE, PA 16148

FOR: INSURANCE BROKERAGE SERVICES IN THE FIELDS OF LIFE, HEALTH, ACCIDENT, FIRE, MARINE, MEDICAL, PRE-PAID HEALTH CARE, PROPERTY AND COMMERCIAL PROPERTY AND CASUALTY INSURANCE; INSURANCE INVESTMENT IN THE FIELD OF ANNUITIES; INSURANCE ADMINISTRATION, CONSULTATION AND AGENCIES IN THE FIELDS OF LIFE, HEALTH, ACCIDENT FIRE, MARINE, MEDICAL AND PRE-PAID HEALTH CARE, IN CLASS 36 (U.S. CLS. 100, 101 AND 102).

FIRST USE 1-1-2004; IN COMMERCE 1-1-2004.

THE MARK CONSISTS OF STANDARD CHARACTERS WITHOUT CLAIM TO ANY PARTICULAR FONT, STYLE, SIZE, OR COLOR.

OWNER OF U.S. REG. NOS. 2,407,469, 3,267,722 AND OTHERS.

NO CLAIM IS MADE TO THE EXCLUSIVE RIGHT TO USE "INSURANCE AGENCY", APART FROM THE MARK AS SHOWN.

SEC. 2(F).

SER. NO. 77-161,677, FILED 4-20-2007.

MARILYN IZZI, EXAMINING ATTORNEY

**Prior U.S. Cl.: B**

**United States Patent and Trademark Office**

**Reg. No. 3,568,917**

**Registered Feb. 3, 2009**

**CERTIFICATION MARK  
PRINCIPAL REGISTER**

# Crystal Energist

LUKOMSKI, JUDITH, E (UNITED STATES INDIVIDUAL)  
PO BOX 4017  
DANA POINT, CA 92629

FOR: PERSONAL DEVELOPMENT AND EMPOWERMENT CONSULTING SERVICES, IN CLASS B (U.S. CL. B).

FIRST USE 1-2-2007; IN COMMERCE 1-2-2007.

THE MARK CONSISTS OF STANDARD CHARACTERS WITHOUT CLAIM TO ANY PARTICULAR FONT, STYLE, SIZE, OR COLOR.

NO CLAIM IS MADE TO THE EXCLUSIVE RIGHT TO USE "CRYSTAL", APART FROM THE MARK AS SHOWN.

THIS CERTIFICATION MARK, AS USED BY AUTHORIZED PERSONS, CERTIFIES COMPLETION OF TRAINING COURSES IN THE PRACTICE OF CERTIFIER'S PROCESS OF PERSONAL DEVELOPMENT THROUGH THE USE OF INTUITIVE AND ENERGETIC READINGS, CRYSTAL LAYOUTS AND DIVINATION TOOLS.

SER. NO. 77-163,752, FILED 4-24-2007.

JOHN GARTNER, EXAMINING ATTORNEY

**Int. Cl.: 11**

**Prior U.S. Cls.: 13, 21, 23, 31 and 34**

**Reg. No. 3,568,918**

**United States Patent and Trademark Office**

**Registered Feb. 3, 2009**

**TRADEMARK  
PRINCIPAL REGISTER**

**STEAM100**

PIEN, SHIRLEY (UNITED STATES INDIVIDUAL)  
40613 PALATINO STREET  
FREMONT, CA 94539 AND  
PIEN, HSIAO-HUNG (TAIWAN INDIVIDUAL)  
40613 PALATINO STREET  
FREMONT, CA 94539

FIRST USE 8-0-2006; IN COMMERCE 8-0-2006.

THE MARK CONSISTS OF STANDARD CHARACTERS WITHOUT CLAIM TO ANY PARTICULAR FONT, STYLE, SIZE, OR COLOR.

FOR: CONDENSATE REMOVAL APPARATUS  
FOR USE IN STEAM SYSTEMS FOR HEATING  
PURPOSES TO HELP REDUCE STEAM CONSUMPTION,  
IN CLASS 11 (U.S. CLS. 13, 21, 23, 31 AND 34).

SER. NO. 77-164,729, FILED 4-24-2007.

DAVID H. STINE, EXAMINING ATTORNEY

**Int. Cl.: 5**

**Prior U.S. Cls.: 6, 18, 44, 46, 51 and 52**

**Reg. No. 3,568,919**

**United States Patent and Trademark Office**

**Registered Feb. 3, 2009**

**TRADEMARK  
PRINCIPAL REGISTER**



UNIVERSAL PROTEIN SUPPLEMENTS COR-  
PORATION (NEW JERSEY CORPORATION),  
DBA UNIVERSAL NUTRITION  
3 TERMINAL ROAD  
NEW BRUNSWICK, NJ 08901

FIRST USE 0-0-1980; IN COMMERCE 0-0-1980.

OWNER OF U.S. REG. NOS. 3,020,559 AND  
3,020,563.

THE COLOR(S) RED AND BLACK IS/ARE  
CLAIMED AS A FEATURE OF THE MARK.

FOR: SUPPLEMENTS, NAMELY, DIETARY  
FOOD SUPPLEMENTS, DIETARY SUPPLEMENTS,  
FOOD SUPPLEMENTS, HERBAL SUPPLEMENTS,  
MEAL REPLACEMENT AND DIETARY SUPPLE-  
MENT DRINK MIXES, MINERAL NUTRITIONAL  
SUPPLEMENTS, MINERAL SUPPLEMENTS, NU-  
TRITIONAL SUPPLEMENTS, POWDERED NUTRI-  
TIONAL SUPPLEMENT DRINK MIX, VITAMIN  
AND MINERAL SUPPLEMENTS, VITAMIN SUP-  
PLEMENTS, MEAL REPLACEMENT BARS, IN  
CLASS 5 (U.S. CLS. 6, 18, 44, 46, 51 AND 52).

THE MARK CONSISTS OF THE WORD "UNI-  
VERSAL" IN BLACK LETTERS, WHEREIN THE "I"  
IS COMPRISED OF A RED HUMAN FIGURE.

SER. NO. 77-165,041, FILED 4-25-2007.

SHAILA SETTLES, EXAMINING ATTORNEY

**Int. Cls.: 35, 36 and 43**

**Prior U.S. Cls.: 100, 101 and 102**

**United States Patent and Trademark Office**

**Reg. No. 3,568,920**

**Registered Feb. 3, 2009**

**SERVICE MARK  
PRINCIPAL REGISTER**

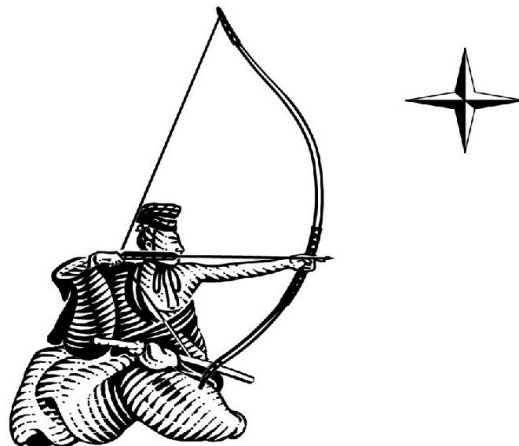

KUBLAI HOLDINGS LIMITED (BERMUDA CORPORATION)  
CORNER HOUSE, 20 PARLIAMENT STREET  
HAMILTON, BERMUDA HM12

THE FIELD OF INVESTMENT; TAX ADVISORY SERVICES; PREPARATION OF FINANCIAL REPORTS FOR OTHERS , IN CLASS 35 (U.S. CLS. 100, 101 AND 102).

FOR: BUSINESS MANAGEMENT CONSULTANCY; BUSINESS MANAGEMENT ASSISTANCE; BUSINESS ORGANISATION CONSULTANCY; PROFESSIONAL BUSINESS CONSULTANCY; BUSINESS ADMINISTRATION SERVICES AND BUSINESS ADVICE; BUSINESS RESEARCH; BUSINESS NETWORKING, NAMELY, BUSINESS INTRODUCTORY AND MEETINGS SERVICES; PROVIDING BUSINESS NETWORKING INFORMATION; INCENTIVE AWARD PROGRAMS TO PROMOTE THE SALE OF PRODUCTS AND SERVICES OF OTHERS; PROVIDING INFORMATION REGARDING INCENTIVE AWARD PROGRAMS TO PROMOTE THE SALE OF PRODUCTS AND SERVICES OF OTHERS; BUSINESS APPRAISALS; ACCOUNTANCY SERVICES; BUSINESS AUDITING; BOOK KEEPING; DATA COMPILING AND ELECTRONIC DATA COMPILING RELATING TO BUSINESS MANAGEMENT; COST PRICE ANALYSIS; ECONOMIC FORECASTING; PUBLIC OPINION POLLING; STATISTICAL INFORMATION; TAX PREPARATION; COMPUTERISED FILE MANAGEMENT; COMPANY RECORD KEEPING; PAYROLL PREPARATION; PROMOTIONAL, ADVERTISING AND MARKETING SERVICES; EMPLOYMENT HIRING RECRUITMENT; RECRUITMENT OF PILOTS; ARRANGING AND CONDUCTING TRADE SHOW EXHIBITIONS FOR BUSINESS PURPOSES IN

FOR: FINANCIAL SERVICES, NAMELY, INVESTMENT AND CAPITAL INVESTMENT SERVICES IN THE NATURE OF INVESTMENT FUND MANAGEMENT AND PROPRIETARY CAPITAL MANAGEMENT, INVESTMENT AND CAPITAL INVESTMENT SERVICES IN THE FIELDS OF REAL ESTATE, LAND, PROPERTY, PROPERTY DEVELOPMENT AND SECURITIES; FINANCIAL PLANNING AND MANAGEMENT; FINANCIAL CONSULTANCY SERVICES; FINANCIAL ANALYSIS; FISCAL ASSESSMENTS; FINANCIAL INVESTIGATION SERVICES, NAMELY, CREDIT INQUIRY SERVICES; INSURANCE AGENCY SERVICES AND REINSURANCE UNDERWRITING; INSURANCE UNDERWRITING IN THE FIELD OF HEALTH, LIFE AND ACCIDENT INSURANCE; AVIATION INSURANCE UNDERWRITING IN THE FIELD OF HEALTH, LIFE AND ACCIDENT INSURANCE; ADMINISTRATION OF EMPLOYEE PENSION PLANS; CAPITAL INVESTMENT CONSULTATION; FINANCIAL TRUST OPERATIONS; MANAGEMENT OF INVESTMENT PORTFOLIOS; TRUSTEESHIP REPRESENTATIVES; FINANCING OF LOANS; CAPITAL INVESTMENT, FUND INVESTMENT AND INVESTMENT ADVICE; SECURITIES BORROWING AND LENDING; STOCKS AND BONDS BROKERAGE; STOCK EXCHANGE PRICE QUOTA-

TIONS; LENDING ON MORTGAGES; CHARITABLE FUND RAISING SERVICES; FINANCIAL GUARANTEE SERVICES; BANKING SERVICES; FOREIGN CURRENCY EXCHANGE SERVICES; REAL ESTATE SERVICES, NAMELY, LEASING OF REAL ESTATE; REAL ESTATE AGENCY SERVICES; PROPERTY VALUATION SERVICES; INVESTMENT AND DISINVESTMENT IN PROPERTY AND PROPERTY DEVELOPMENTS; CREDIT AGENCY SERVICES; CONSUMER CREDIT CONSULTING SERVICES; CREDIT CARD SERVICES; DEBT COLLECTION SERVICES; FINANCIAL VALUATION OF PERSONAL PROPERTY AND REAL ESTATE; PROVIDING INFORMATION AND ADVISORY SERVICES IN THE FIELDS OF INVESTMENT AND INVESTMENT STRATEGY; PROVISION AND DISSEMINATION OF INFORMATION, ASSISTANCE AND ADVICE RELATING TO INVESTMENT, FOR

EXHIBITIONS, ATTENDANTS, VISITORS AND EXHIBITORS, IN CLASS 36 (U.S. CLS. 100, 101 AND 102).

FOR: SERVICES FOR PROVIDING FOOD AND DRINK; COFFEE SHOPS, CAFES, CAFETERIAS, SELF-SERVICE RESTAURANTS, SNACK-BARS, IN CLASS 43 (U.S. CLS. 100 AND 101).

PRIORITY CLAIMED UNDER SEC. 44(D) ON ERPN CMNTY TM OFC APPLICATION NO. 005450242, FILED 10-26-2006, REG. NO. 005450242, DATED 11-26-2007, EXPIRES 11-26-2016.

THE MARK CONSISTS OF AN ARCHER WITH BOW AND ARROW ACCOMPANIED BY A STAR.

SER. NO. 77-166,526, FILED 4-26-2007.

GENE MACIOL, EXAMINING ATTORNEY



**Int. Cls.: 35 and 36**

**Prior U.S. Cls.: 100, 101 and 102**

**United States Patent and Trademark Office**

**Reg. No. 3,568,921**

**Registered Feb. 3, 2009**

**SERVICE MARK  
PRINCIPAL REGISTER**

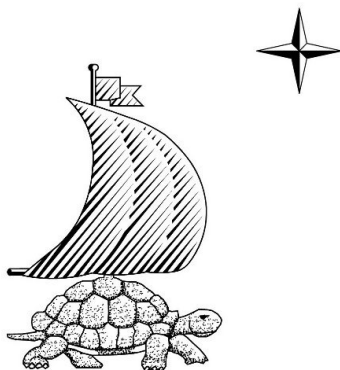

KUBLAI HOLDINGS LIMITED (BERMUDA CORPORATION)

CORNER HOUSE, 20 PARLIAMENT STREET

HAMILTON, BERMUDA HM12

FOR: BUSINESS MANAGEMENT CONSULTANCY; BUSINESS MANAGEMENT ASSISTANCE; BUSINESS ORGANISATION CONSULTANCY; PROFESSIONAL BUSINESS CONSULTANCY; BUSINESS ADMINISTRATION SERVICES AND BUSINESS ADVICE; BUSINESS RESEARCH; BUSINESS NETWORKING, NAMELY, BUSINESS INTRODUCTORY AND MEETINGS SERVICES; PROVIDING BUSINESS NETWORKING INFORMATION; INCENTIVE AWARD PROGRAMS TO PROMOTE THE SALE OF PRODUCTS AND SERVICES OF OTHERS; PROVIDING INFORMATION REGARDING INCENTIVE AWARD PROGRAMS TO PROMOTE THE SALE OF PRODUCTS AND SERVICES OF OTHERS; BUSINESS APPRAISALS; ACCOUNTANCY SERVICES; BUSINESS AUDITING; BOOK KEEPING; DATA COMPILING AND ELECTRONIC DATA COMPILING RELATING TO BUSINESS MANAGEMENT; COST PRICE ANALYSIS; ECONOMIC FORECASTING; PUBLIC OPINION POLLING; STATISTICAL INFORMATION; TAX PREPARATION; COMPUTERISED FILE MANAGEMENT; COMPANY RECORD KEEPING; PAYROLL PREPARATION; PROMOTIONAL, ADVERTISING AND MARKETING SERVICES; EMPLOYMENT HIRING RECRUITMENT; RECRUITMENT OF PILOTS; ARRANGING AND CONDUCTING TRADE SHOW EXHIBITIONS FOR BUSINESS PURPOSES IN THE FIELD OF INVESTMENT; TAX ADVISORY SERVICES; PREPARATION OF FINANCIAL RE-

PORTS FOR OTHERS, IN CLASS 35 (U.S. CLS. 100, 101 AND 102).

FOR: FINANCIAL SERVICES, NAMELY, INVESTMENT AND CAPITAL INVESTMENT SERVICES IN THE NATURE OF INVESTMENT FUND MANAGEMENT AND PROPRIETARY CAPITAL MANAGEMENT, INVESTMENT AND CAPITAL INVESTMENT SERVICES IN THE FIELDS OF REAL ESTATE, LAND, PROPERTY, PROPERTY DEVELOPMENT AND SECURITIES; FINANCIAL PLANNING AND MANAGEMENT; FINANCIAL CONSULTANCY SERVICES; FINANCIAL ANALYSIS; FISCAL ASSESSMENTS; FINANCIAL INVESTIGATION SERVICES, NAMELY, CREDIT INQUIRY SERVICES; INSURANCE AGENCY SERVICES AND REINSURANCE UNDERWRITING; INSURANCE UNDERWRITING IN THE FIELD OF HEALTH, LIFE AND ACCIDENT INSURANCE; AVIATION INSURANCE UNDERWRITING IN THE FIELD OF HEALTH, LIFE AND ACCIDENT INSURANCE; ADMINISTRATION OF EMPLOYEE PENSION PLANS; CAPITAL INVESTMENT CONSULTATION; FINANCIAL TRUST OPERATIONS; MANAGEMENT OF INVESTMENT PORTFOLIOS; TRUSTEESHIP REPRESENTATIVES; FINANCING OF LOANS; CAPITAL INVESTMENT, FUND INVESTMENT AND INVESTMENT ADVICE; SECURITIES BORROWING AND LENDING; STOCKS AND BONDS BROKERAGE; STOCK EXCHANGE PRICE QUOTATIONS; LENDING ON MORTGAGES; CHARITABLE FUND RAISING SERVICES; FINANCIAL GUARANTEE SERVICES; BANKING SERVICES; FOREIGN CURRENCY EXCHANGE SERVICES; REAL ESTATE SERVICES, NAMELY, LEASING OF REAL ESTATE; REAL ESTATE AGENCY SERVICES;

PROPERTY VALUATION SERVICES; INVESTMENT AND DISINVESTMENT IN PROPERTY AND PROPERTY DEVELOPMENTS; CREDIT AGENCY SERVICES; CONSUMER CREDIT CONSULTING SERVICES; CREDIT CARD SERVICES; DEBT COLLECTION SERVICES; FINANCIAL VALUATION OF PERSONAL PROPERTY AND REAL ESTATE; PROVIDING INFORMATION AND ADVISORY SERVICES IN THE FIELDS OF INVESTMENT AND INVESTMENT STRATEGY; PROVISION AND DISSEMINATION OF INFORMATION, ASSISTANCE AND ADVICE RELATING TO INVESTMENT, FOR EXHIBITIONS, ATTENDANTS, VISITORS AND EXHIBITORS, IN CLASS 36 (U.S. CLS. 100, 101 AND 102).

PRIORITY CLAIMED UNDER SEC. 44(D) ON ERPN CMNTY TM OFC APPLICATION NO. 005450259, FILED 10-26-2006, REG. NO. 005450529, DATED 10-10-2007, EXPIRES 10-26-2016.

THE MARK CONSISTS OF A TURTLE WITH MAST AND FLAG AND SAIL ON ITS BACK ACCOMPANIED BY A STAR.

SER. NO. 77-166,554, FILED 4-26-2007.

GENE MACIOL, EXAMINING ATTORNEY

Int. Cl.: 30

Prior U.S. Cl.: 46

United States Patent and Trademark Office

Reg. No. 3,568,922

Registered Feb. 3, 2009

TRADEMARK  
PRINCIPAL REGISTER



AB ANNAS PEPPARKAKOR (SWEDEN JOINT STOCK COMPANY)  
RAIOVAGEN 23  
135 48 TYRESO, SWEDEN

FOR: COOKIES, GINGERBREAD BISCUITS, AND BISCUITS, IN CLASS 30 (U.S. CL. 46).

FIRST USE 9-0-1997; IN COMMERCE 9-0-1997.

NO CLAIM IS MADE TO THE EXCLUSIVE RIGHT TO USE "GINGER THINS DELGADITAS DE JENGIBRE" AND "0 TRANS FAT", APART FROM THE MARK AS SHOWN.

THE COLOR(S) RED, WHITE, BLACK AND YELLOW IS/ARE CLAIMED AS A FEATURE OF THE MARK.

THE MARK CONSISTS OF "ANNA'S" IN RED, OUTLINED IN WHITE AT THE TOP. UNDER THE WORD "ANNA'S" IS A SPACE OR CUT-OUT IN THE SHAPE OF A GINGERBREAD BISCUIT OUTLINED

IN RED. THE WHITE COLOR AND LINES SHOWN IN THE BISCUIT-SHAPED CUT-OUT IS MEANT TO SYMBOLIZE TRANSPARENT PACKAGING AND DOES NOT INDICATE THAT THE CUT-OUT SPACE IS WHITE IN COLOR. UNDER THE BISCUITS ARE THE WORDS "GINGER THINS" AND "DELGADITAS DE JENGIBRE" IN WHITE. IN THE WORDING "0 TRANS FAT", THE "0" IS WHITE AND "TRANS FAT" IS BLACK. THE WORDING "0 TRANS FAT" IS INSIDE A YELLOW BANNER TO THE LEFT OF THE SPACE OR CUT OUT. THE DOTTED LINES IN THE DRAWING ARE NOT PART OF THE MARK AND ONLY SERVE TO SHOW THE POSITION OF THE MARK ON THE PACKAGING.

THE FOREIGN WORDING IN THE MARK TRANSLATES INTO ENGLISH AS "GINGERBREAD THINS".

SER. NO. 77-166,579, FILED 4-26-2007.

MARK SPARACINO, EXAMINING ATTORNEY

**Int. Cls.: 35 and 36**

**Prior U.S. Cls.: 100, 101 and 102**

**United States Patent and Trademark Office**

**Reg. No. 3,568,923**

**Registered Feb. 3, 2009**

**SERVICE MARK  
PRINCIPAL REGISTER**

**YOUTH VENTURE**

YOUTH VENTURE, INC. (VIRGINIA NON-PROFIT CORPORATION)  
SUITE 2000  
1700 NORTH MOORE ST.  
ARLINGTON, VA 22209

FOR: BUSINESS MANAGEMENT AND BUSINESS MANAGEMENT MARKETING CONSULTATION SERVICES, NAMELY, ASSISTING YOUTH IN THE CREATION AND OPERATION OF COMMUNITY SERVICE ORGANIZATIONS AND BUSINESS VENTURES, IN CLASS 35 (U.S. CLS. 100, 101 AND 102).

FIRST USE 3-27-1995; IN COMMERCE 3-27-1995.

FOR: CHARITABLE FUNDRAISING, NAMELY, RAISING FUNDS AND PROVIDING MONETARY GRANTS TO SUPPORT COMMUNITY SERVICE

AND BUSINESS VENTURES OF YOUNG PEOPLE, IN CLASS 36 (U.S. CLS. 100, 101 AND 102).

FIRST USE 3-27-1995; IN COMMERCE 3-27-1995.

THE MARK CONSISTS OF STANDARD CHARACTERS WITHOUT CLAIM TO ANY PARTICULAR FONT, STYLE, SIZE, OR COLOR.

OWNER OF U.S. REG. NO. 2,472,491.

SEC. 2(F).

SER. NO. 77-169,183, FILED 4-30-2007.

STEVEN R. FOSTER, EXAMINING ATTORNEY

**Int. Cl.: 9**

**Prior U.S. Cls.: 21, 23, 26, 36 and 38**

**Reg. No. 3,568,924**

**United States Patent and Trademark Office**

**Registered Feb. 3, 2009**

**TRADEMARK  
PRINCIPAL REGISTER**

**OPERA**

PERKINELMER CELLULAR TECHNOLOGIES  
GERMANY GMBH (FED REP GERMANY  
CORPORATION)  
SCHNACKENBURGALLEE 114  
22525 HAMBURG, FED REP GERMANY

FOR: LABORATORY EQUIPMENT, NAMELY,  
CONFOCAL MICROPLATE IMAGING READERS;  
COMPUTER SOFTWARE FOR OPERATING CON-  
FOCAL MICROPLATE IMAGING READERS, IN  
CLASS 9 (U.S. CLS. 21, 23, 26, 36 AND 38).

FIRST USE 10-20-2006; IN COMMERCE 10-20-2006.

THE MARK CONSISTS OF STANDARD CHAR-  
ACTERS WITHOUT CLAIM TO ANY PARTICULAR  
FONT, STYLE, SIZE, OR COLOR.

SER. NO. 77-169,791, FILED 5-1-2007.

SEAN CROWLEY, EXAMINING ATTORNEY

**Int. Cls.: 35 and 42**

**Prior U.S. Cls.: 100, 101 and 102**

**United States Patent and Trademark Office**

**Reg. No. 3,568,925**

**Registered Feb. 3, 2009**

**SERVICE MARK  
PRINCIPAL REGISTER**

# eZ Transition

ZURICH SERVICES CORPORATION (ILLINOIS CORPORATION)  
1400 AMERICAN LANE  
SCHAUMBURG, IL 60196

FOR: PROVIDING A WEB SITE FEATURING RETURN-TO-WORK PROGRAM INFORMATION, NAMELY, EMPLOYMENT COUNSELING INFORMATION AND JOB DESCRIPTION INFORMATION THAT IS SPECIFIC TO THE USER, IN CLASS 35 (U.S. CLS. 100, 101 AND 102).

FIRST USE 4-0-2007; IN COMMERCE 4-0-2007.

FOR: PROVIDING TEMPORARY USE OF ON-LINE NON-DOWNLOADABLE COMPUTER SOFT-

WARE FOR USE IN ADMINISTERING EMPLOYER RETURN-TO-WORK PROGRAMS, IN CLASS 42 (U.S. CLS. 100 AND 101).

FIRST USE 4-0-2007; IN COMMERCE 4-0-2007.

THE MARK CONSISTS OF STANDARD CHARACTERS WITHOUT CLAIM TO ANY PARTICULAR FONT, STYLE, SIZE, OR COLOR.

SER. NO. 77-177,236, FILED 5-10-2007.

BRENDAN MCCAULEY, EXAMINING ATTORNEY

**Int. Cl.: 14**

**Prior U.S. Cls.: 2, 27, 28 and 50**

**United States Patent and Trademark Office**

**Reg. No. 3,568,926**

**Registered Feb. 3, 2009**

**TRADEMARK  
PRINCIPAL REGISTER**

**DRAKE ANTHONY**

DRAKE ANTHONY, LLC (MISSOURI LIMITED  
LIABILITY COMPANY)

6206 E. 133RD ST.

GRANDVIEW, MO 64030

FOR: JEWELRY, IN CLASS 14 (U.S. CLS. 2, 27, 28  
AND 50).

FIRST USE 8-24-2004; IN COMMERCE 8-24-2004.

THE MARK CONSISTS OF STANDARD CHAR-  
ACTERS WITHOUT CLAIM TO ANY PARTICULAR  
FONT, STYLE, SIZE, OR COLOR.

THE NAME "DRAKE ANTHONY" IDENTIFIES A  
LIVING INDIVIDUAL WHOSE CONSENT IS OF  
RECORD.

SER. NO. 77-178,614, FILED 5-11-2007.

JACLYN KIDWELL, EXAMINING ATTORNEY

**Int. Cls.: 9, 25 and 41**

**Prior U.S. Cls.: 21, 22, 23, 26, 36, 38, 39, 100, 101 and 107**

**Reg. No. 3,568,927**

**United States Patent and Trademark Office**

**Registered Feb. 3, 2009**

**TRADEMARK  
SERVICE MARK  
PRINCIPAL REGISTER**

**U2 3D**

NOT US LIMITED (IRELAND CORPORATION)  
C/O PRINCIPLE MANAGEMENT  
30/32 SIR JOHN ROGERSON'S QUAY  
DUBLIN 2, IRELAND

FOR: AUDIO AND VIDEO RECORDINGS FEATURING PERFORMANCES BY A MUSICAL ARTIST, A MUSICAL BAND OR A MUSICAL GROUP; PHONOGRAPH RECORDS FEATURING PERFORMANCES BY A MUSICAL ARTIST, A MUSICAL BAND OR A MUSICAL GROUP; COMPACT DISCS FEATURING PERFORMANCES BY A MUSICAL ARTIST, A MUSICAL BAND OR A MUSICAL GROUP; AUDIO TAPES FEATURING PERFORMANCES BY A MUSICAL ARTIST, A MUSICAL BAND OR A MUSICAL GROUP; VIDEOTAPES FEATURING PERFORMANCES BY A MUSICAL ARTIST, A MUSICAL BAND OR A MUSICAL GROUP; OPTICAL DISCS FEATURING PERFORMANCES BY A MUSICAL ARTIST, A MUSICAL BAND OR A MUSICAL GROUP; DVD'S FEATURING PERFORMANCES BY A MUSICAL ARTIST, A MUSICAL BAND OR A MUSICAL GROUP; MULTIMEDIA SOFTWARE RECORDED ON CD-ROM FEATURING PERFORMANCES BY A MUSICAL ARTIST, A MUSICAL BAND OR A MUSICAL GROUP; DOWNLOADABLE ELECTRONIC PUBLICATIONS IN THE NATURE OF BOOKS, BOOKLETS, BROCHURES, MAGAZINES, NEWSLETTERS IN THE FIELD OF MUSIC; DOWNLOADABLE MULTIMEDIA FILES CONTAINING MUSIC, FILM, MOTION PICTURE FILM, VIDEO, AUDIO AND GRAPHIC IMAGES RELATING TO MUSIC; MP3 PLAYERS; MOBILE TELEPHONES; MAGNETICALLY ENCODED KEY CARDS; DOWNLOADABLE RINGTONES AND GRAPHICS FOR MOBILE PHONES; VIDEO GAME SOFTWARE, VIDEO GAME MACHINES FOR USE WITH EXTERNAL DISPLAY SCREEN OR MONITOR OR TELEVISION; COMPU-

TER MOUSES, MOUSE MATS AND MOUSE PADS; EYEGASSES, SUNGLASSES AND SPECTACLES, IN CLASS 9 (U.S. CLS. 21, 23, 26, 36 AND 38).

FOR: CLOTHING, NAMELY, JACKETS, SHIRTS, T-SHIRTS, PANTS, SWEATSHIRTS AND BELTS; FOOTWEAR; HEADWEAR, IN CLASS 25 (U.S. CLS. 22 AND 39).

FOR: ENTERTAINMENT SERVICES, NAMELY, LIVE PERFORMANCES BY A MUSICAL ARTIST, MUSICAL BAND OR MUSICAL GROUP AND PRESENTATION OF MUSICAL PERFORMANCES; ENTERTAINMENT, NAMELY, LIVE MUSIC CONCERTS BY A MUSICAL ARTIST, MUSICAL BAND OR MUSICAL GROUP; ENTERTAINMENT, NAMELY, PERSONAL APPEARANCES BY A MUSICAL ARTIST, MUSICAL BAND OR A MUSICAL GROUP; PRODUCTION OF AUDIO AND VIDEO RECORDINGS; PRODUCTION OF TELEVISION SHOWS, RADIO PROGRAMS, FILMS, MOTION PICTURE FILMS, MUSICAL PERFORMANCES AND MUSIC VIDEOS; DISTRIBUTION OF RADIO PROGRAMS AND TELEVISION SHOWS FEATURING MUSICAL PERFORMANCES; DISTRIBUTION OF FILMS, MOTION PICTURE FILMS, AND MOVIES; PUBLISHING OF BOOKS AND MAGAZINES; MUSIC PUBLISHING SERVICES; NON-DOWNLOADABLE MULTIMEDIA FILES CONTAINING MUSIC, FILM, MOTION PICTURE FILM, VIDEO, AUDIO AND GRAPHIC IMAGES RELATING TO MUSIC PROVIDED OVER A GLOBAL COMPUTER NETWORK; PROVIDING ON-LINE PUBLICATIONS IN THE NATURE OF BOOKS, BOOKLETS, BROCHURES, MAGAZINES, NEWSLETTERS IN THE FIELD OF MUSIC; ON-LINE LIBRARY SERVICES, NAMELY, PROVIDING ELECTRONIC LIBRARY SERVICES WHICH FEATURE BOOKS, MAGAZINES, PHOTOGRAPHS AND PICTURES VIA AN



ON-LINE COMPUTER NETWORK; ENTERTAINMENT SERVICES, NAMELY, PROVIDING A WEBSITE FEATURING MUSICAL PERFORMANCES, MUSICAL VIDEOS, FILM AND MOTION PICTURE FILM CLIPS, PHOTOGRAPHS, PRE-RECORDED MUSIC, INFORMATION IN THE FIELD OF MUSIC, COMMENTARY AND ARTICLES ABOUT MUSIC; ENTERTAINMENT TICKET AGENCY SERVICES; PROVIDING INFORMATION RELATED TO THE AFORESAID, IN CLASS 41 (U.S. CLS. 100, 101 AND 107).

THE MARK CONSISTS OF STANDARD CHARACTERS WITHOUT CLAIM TO ANY PARTICULAR FONT, STYLE, SIZE, OR COLOR.

PRIORITY CLAIMED UNDER SEC. 44(D) ON ERPN CMNTY TM OFC APPLICATION NO. 5857503, FILED 4-25-2007, REG. NO. 005857503, DATED 5-29-2008, EXPIRES 4-25-2017.

NO CLAIM IS MADE TO THE EXCLUSIVE RIGHT TO USE "3D", APART FROM THE MARK AS SHOWN.

SER. NO. 77-178,621, FILED 5-11-2007.

DAVID TOOLEY, EXAMINING ATTORNEY

**Int. Cls.: 35, 38 and 41**

**Prior U.S. Cls.: 100, 101, 102, 104 and 107**

**Reg. No. 3,568,928**

**United States Patent and Trademark Office**

**Registered Feb. 3, 2009**

**SERVICE MARK  
PRINCIPAL REGISTER**



LEE, SEUNGHWAN (REPUBLIC OF KOREA INDIVIDUAL)  
WONMI-GU, BUCHEON  
1127-8 DAEWON PLAZA 2ND FL. JUNG-DONG,  
KEYOUNGKI-DO, REPUBLIC OF KOREA 420-020

FOR: RETAIL AND WHOLESALE STORE SERVICES FEATURING BAGS, WALLETS, HEADGEAR, BOOKS, PERIODICALS, SPORTS MATS, SPORTS GEAR, SPORTSWEAR, SHOES, SHOE PARTS AND ACCESSORIES; ADVERTISING SERVICES, IN CLASS 35 (U.S. CLS. 100, 101 AND 102).

FIRST USE 6-1-2008; IN COMMERCE 6-1-2008.

FOR: NEWS TRANSMISSION SERVICES, ELECTRONIC DATA TRANSMISSION SERVICES VIA THE INTERNET, TRANSMISSION OF SOUND, VIDEO AND INFORMATION VIA THE INTERNET, PROVIDING ON-LINE ELECTRONIC BULLETIN BOARDS FOR TRANSMISSION OF MESSAGES AMONG COMPUTER USERS CONCERNING EDUCATIONAL PROGRAMS, BROADCASTING EDUCATIONAL PROGRAMS VIA A GLOBAL COMPUTER NETWORK, INTERNET BROADCASTING SERVICES OF EDUCATIONAL PROGRAMS, RADIO BROADCASTING VIA THE INTERNET, INTERNET BROADCASTING SERVICES, WIRELESS INTERNET BROADCASTING SERVICES, IN CLASS 38 (U.S. CLS. 100, 101 AND 104).

FIRST USE 6-1-2008; IN COMMERCE 6-1-2008.

FOR: NEWSPAPER PUBLICATION SERVICES, ON-LINE ELECTRONIC PUBLICATION OF JOURNALS AND ARTICLES IN THE FIELD OF SPORTS AND ATHLETICS, ON-LINE ELECTRONIC PUBLICATION OF BOOKS AND MAGAZINES, EDUCATIONAL SERVICES, NAMELY, ORGANIZING SYMPOSIA IN THE FIELD OF SPORTS AND ATHLETICS, EDUCATION SERVICES, NAMELY, PROVIDING ON-LINE LECTURES IN THE FIELD OF SPORTS AND ATHLETICS, EDUCATIONAL SERVICES, NAMELY, CONDUCTING INFORMAL ON-LINE PROGRAMS IN THE FIELDS OF SPORTS AND ATHLETICS AND PROVIDING VOCATIONAL GUIDANCE SERVICES, MARTIAL ARTS TRAINING SERVICES, PROVIDING A WEBSITE THAT PROVIDES SPORTS LEAGUE PLAYER STATISTICS, NEWS REPORTING SERVICES, PHOTOGRAPHIC REPORTING SERVICES, IN CLASS 41 (U.S. CLS. 100, 101 AND 107).

FIRST USE 6-1-2008; IN COMMERCE 6-1-2008.

THE MARK "MOOKAS" HAS NO MEANING IN A FOREIGN LANGUAGE.

SER. NO. 77-185,286, FILED 5-18-2007.

JAMES LOVELACE, EXAMINING ATTORNEY

**Int. Cl.: 9**

**Prior U.S. Cls.: 21, 23, 26, 36 and 38**

**Reg. No. 3,568,929**

**United States Patent and Trademark Office**

**Registered Feb. 3, 2009**

**TRADEMARK  
PRINCIPAL REGISTER**

**BẾN THÀNH AUDIO - VIDEO**

BEN THANH GENERAL CULTURAL JOINT  
STOCK COMPANY (VIETNAM JOINT STOCK  
COMPANY)

BEN NGHE WARD, DISTRICT 1  
142 PASTEUR STREET  
HO CHI MINH CITY, VIETNAM

FOR: SOUND RECORDINGS FEATURING MU-  
SIC; DVDS AND AUDIOVISUAL RECORDINGS  
FEATURING MUSIC AND MUSICAL PERFOR-  
MANCES, IN CLASS 9 (U.S. CLS. 21, 23, 26 AND  
38).

FIRST USE 5-15-1992; IN COMMERCE 5-15-1992.

THE MARK CONSISTS OF STANDARD CHAR-  
ACTERS WITHOUT CLAIM TO ANY PARTICULAR  
FONT, STYLE, SIZE, OR COLOR.

NO CLAIM IS MADE TO THE EXCLUSIVE  
RIGHT TO USE "AUDIO - VIDEO", APART FROM  
THE MARK AS SHOWN.

THE FOREIGN WORDING IN THE MARK  
TRANSLATES INTO ENGLISH AS WHARF TO [OR  
FOR] THE CITY.

SER. NO. 77-185,442, FILED 5-19-2007.

KATHY DE JONGE, EXAMINING ATTORNEY

**Int. Cl.: 41**

**Prior U.S. Cls.: 100, 101 and 107**

**United States Patent and Trademark Office**

**Reg. No. 3,568,930**

**Registered Feb. 3, 2009**

**SERVICE MARK  
PRINCIPAL REGISTER**

**YOUTUBE SKETCHIES**

GOOGLE INC. (DELAWARE CORPORATION)  
1600 AMPHITHEATRE PARKWAY  
MOUNTAIN VIEW, CA 94043

FOR: ENTERTAINMENT SERVICES, NAMELY, PROVIDING A WEBSITE FEATURING INFORMATION ABOUT OF AUDIO CLIPS, VIDEO CLIPS, MUSICAL PERFORMANCES, MUSICAL VIDEOS, FILM CLIPS, PHOTOGRAPHS, AND OTHER MULTIMEDIA MATERIALS; DIGITAL VIDEO, AUDIO, AND MULTIMEDIA PUBLISHING SERVICES; ENTERTAINMENT SERVICES, NAMELY, CONDUCT-

ING CONTESTS, IN CLASS 41 (U.S. CLS. 100, 101 AND 107).

FIRST USE 5-19-2007; IN COMMERCE 5-19-2007.

THE MARK CONSISTS OF STANDARD CHARACTERS WITHOUT CLAIM TO ANY PARTICULAR FONT, STYLE, SIZE, OR COLOR.

SER. NO. 77-187,550, FILED 5-22-2007.

NAAKWAMA ANKRAH, EXAMINING ATTORNEY

**Int. Cl.: 41**

**Prior U.S. Cls.: 100, 101 and 107**

**United States Patent and Trademark Office**

**Reg. No. 3,568,931**

**Registered Feb. 3, 2009**

**SERVICE MARK  
PRINCIPAL REGISTER**

**NEWCOMM FORUM**

SOCIETY FOR NEW COMMUNICATIONS RE-  
SEARCH (CALIFORNIA NON-PROFIT COR-  
PORATION)  
2625 MIDDLEFIELD ROAD, #662  
PALO ALTO, CA 94306

FOR: EDUCATIONAL SERVICES, NAMELY, DE-  
VELOPING, ARRANGING, AND CONDUCTING  
EDUCATIONAL CONFERENCES AND PROGRAMS  
AND PROVIDING COURSES OF INSTRUCTION IN  
THE FIELD OF MEDIA AND COMMUNICATIONS,  
INCLUDING ADVERTISING, MARKETING AND  
CORPORATE COMMUNICATIONS, IN CLASS 41  
(U.S. CLS. 100, 101 AND 107).

FIRST USE 9-1-2004; IN COMMERCE 10-1-2004.

THE MARK CONSISTS OF STANDARD CHAR-  
ACTERS WITHOUT CLAIM TO ANY PARTICULAR  
FONT, STYLE, SIZE, OR COLOR.

NO CLAIM IS MADE TO THE EXCLUSIVE  
RIGHT TO USE "FORUM", APART FROM THE  
MARK AS SHOWN.

SEC. 2(F).

SER. NO. 77-189,238, FILED 5-24-2007.

BARNEY CHARLON, EXAMINING ATTORNEY

**Int. Cl.: 14**

**Prior U.S. Cls.: 2, 27, 28 and 50**

**United States Patent and Trademark Office**

**Reg. No. 3,568,932**

**Registered Feb. 3, 2009**

**TRADEMARK  
PRINCIPAL REGISTER**

**SILVERAMERICA**

RICHLINE GROUP, INC (DELAWARE COR-  
PORATION)  
516 FIFTH AVENUE  
NEW YORK, NY 10036

FOR: JEWELRY COMPRISED PRIMARILY OF  
SILVER, IN CLASS 14 (U.S. CLS. 2, 27, 28 AND 50).

FIRST USE 5-1-1993; IN COMMERCE 5-1-1993.

THE MARK CONSISTS OF STANDARD CHAR-  
ACTERS WITHOUT CLAIM TO ANY PARTICULAR  
FONT, STYLE, SIZE, OR COLOR.

SEC. 2(F).

SER. NO. 77-192,083, FILED 5-29-2007.

JENNIFER DIXON, EXAMINING ATTORNEY

**Int. Cl.: 35**

**Prior U.S. Cls.: 100, 101 and 102**

**United States Patent and Trademark Office**

**Reg. No. 3,568,933**

**Registered Feb. 3, 2009**

**SERVICE MARK  
PRINCIPAL REGISTER**



ALI WING, INC. (DELAWARE CORPORATION)  
120 WOOSTER STREET  
NEW YORK, NY 10012

FOR: RETAIL STORE SERVICES FEATURING INFANTS AND CHILDREN'S FURNITURE, CLOTHING, BEDDING, BLANKETS AND THROWS, BOOKS, TOYS, CAR SEATS, STROLLERS, DIAPER BAGS, INFANT CARE PRODUCTS, HOUSEHOLD CLEANING PRODUCTS, INTERIOR PAINTS, LAUNDRY DETERGENT, FABRIC SOFTENERS, ELECTRONICS, STATIONERY AND NOTE CARDS, IN CLASS 35 (U.S. CLS. 100, 101 AND 102).

FIRST USE 10-0-2003; IN COMMERCE 10-0-2003.

OWNER OF U.S. REG. NO. 3,453,784.

THE COLOR(S) ORANGE, WHITE, BLACK, PURPLE, BLUE, RED, AND GREEN IS/ARE CLAIMED AS A FEATURE OF THE MARK.

THE MARK CONSISTS OF ALTERNATING STRIPES OF THE COLORS ORANGE, WHITE, BLACK, PURPLE, BLUE, RED, AND GREEN.

SEC. 2(F).

SER. NO. 77-192,278, FILED 5-29-2007.

BRIAN CALLAGHAN, EXAMINING ATTORNEY

**Int. Cl.: 24**

**Prior U.S. Cls.: 42 and 50**

**United States Patent and Trademark Office**

**Reg. No. 3,568,934**

**Registered Feb. 3, 2009**

**TRADEMARK  
PRINCIPAL REGISTER**

**CARBOFLEX**

KADENA INDUSTRIES COMPANY, LTD (HONG  
KONG CORPORATION)  
JIANGGAN TECH AND ECONOMIC PARK  
A06 9-11 JIUSHENG ROAD  
HANGZHOU, CHINA

FOR: ELASTIC FABRICS WITH A HIGH RESIS-  
TANCE TO ABRASION AND TEARING, WITH  
HIGH BREATH-ABILITY, FOR USE IN THE MAN-  
UFACTURE OF MOTORCYCLE JACKETS , IN  
CLASS 24 (U.S. CLS. 42 AND 50).

FIRST USE 2-1-2005; IN COMMERCE 2-1-2005.

THE MARK CONSISTS OF STANDARD CHAR-  
ACTERS WITHOUT CLAIM TO ANY PARTICULAR  
FONT, STYLE, SIZE, OR COLOR.

SER. NO. 77-192,320, FILED 5-29-2007.

BENJAMIN OKEKE, EXAMINING ATTORNEY



**Int. Cls.: 35, 36, 42 and 45**

**Prior U.S. Cls.: 100, 101 and 102**

**United States Patent and Trademark Office**

**Reg. No. 3,568,935**

**Registered Feb. 3, 2009**

**SERVICE MARK  
PRINCIPAL REGISTER**

**EXTERA**

EXTERA PARTNERS LLC (DELAWARE LIMITED LIABILITY COMPANY)  
ONE MEMORIAL DRIVE  
CAMBRIDGE, MA 02142

FOR: BUSINESS PLANNING; BUSINESS MANAGEMENT CONSULTATION SERVICES, NAMELY, PERSONNEL MANAGEMENT FOR OTHERS; MARKET RESEARCH; COMPETITIVE PRODUCT ANALYSIS; BUSINESS NETWORKING, NAMELY, INTRODUCING CLIENTS TO POTENTIAL BUSINESS PARTNERS AND INVESTORS AND IDENTIFICATION OF STRATEGIC PARTNERSHIP AND SCIENTIFIC PARTNERSHIP OPPORTUNITIES AND PRODUCT LICENSEES; SCIENTIFIC PERSONNEL RECRUITMENT; ACCOUNTING MANAGEMENT; BUSINESS NETWORKING IN THE SCIENTIFIC AND RESEARCH COMMUNITY; EXECUTIVE EMPLOYEE RECRUITMENT, IN CLASS 35 (U.S. CLS. 100, 101 AND 102).

FIRST USE 12-1-2006; IN COMMERCE 12-1-2006.

FOR: FINANCIAL MANAGEMENT; FINANCIAL CONSULTATION; INVESTMENT CONSULTATION; PROCUREMENT OF VENTURE CAPITAL INVESTMENT; EQUITY CAPITAL INVESTMENT, VENTURE CAPITAL INVESTMENT AND OTHER INVESTMENT SERVICES, NAMELY, PROVIDING INVESTMENT ADVICE; FINANCIAL INVESTMENT IN THE FIELD OF SCIENTIFIC DEVELOPMENT BUSINESSES; FORMATION, OFFERING, AND

MANAGEMENT OF LIMITED PARTNERSHIPS, IN CLASS 36 (U.S. CLS. 100, 101 AND 102).

FIRST USE 12-1-2006; IN COMMERCE 12-1-2006.

FOR: SCIENTIFIC CONSULTATION, NAMELY, BIOLOGY, CHEMISTRY, PHARMACEUTICAL, COMPUTER, ELECTRONICS, SEMICONDUCTOR AND LIFE SCIENCES; SCIENTIFIC RESEARCH CONSULTATION; RESEARCH AND DEVELOPMENT FOR NEW PRODUCTS FOR OTHERS; NEW PRODUCT DEVELOPMENT, IN CLASS 42 (U.S. CLS. 100 AND 101).

FIRST USE 12-1-2006; IN COMMERCE 12-1-2006.

FOR: CONSULTATION SERVICES IN THE FIELD OF LICENSING LIFE SCIENCES RELATED PRODUCTS, NAMELY, DIAGNOSTIC, THERAPEUTIC AND PROPHYLACTIC PRODUCTS, SOFTWARE, AND EQUIPMENT RELATED THERETO, IN CLASS 45 (U.S. CLS. 100 AND 101).

FIRST USE 12-1-2006; IN COMMERCE 12-1-2006.

THE MARK CONSISTS OF STANDARD CHARACTERS WITHOUT CLAIM TO ANY PARTICULAR FONT, STYLE, SIZE, OR COLOR.

SER. NO. 77-192,831, FILED 5-30-2007.

SHAUNIA CARLYLE, EXAMINING ATTORNEY

**Int. Cl.: 35**

**Prior U.S. Cls.: 100, 101 and 102**

**United States Patent and Trademark Office**

**Reg. No. 3,568,936**

**Registered Feb. 3, 2009**

**SERVICE MARK  
PRINCIPAL REGISTER**

**AVALION**

AVALION CONSULTING, LLC (TEXAS LIMITED LIABILITY COMPANY)  
2777 STEMMONS FREEWAY, SUITE 1200  
DALLAS, TX 75207

FOR: BUSINESS MANAGEMENT SERVICES; BUSINESS SERVICES, NAMELY, BUSINESS CONSULTING AND BUSINESS INFORMATION FOR ENTERPRISES, BUSINESS ORGANIZATION AND OPERATION CONSULTANCY, BUSINESS RISK MANAGEMENT, AUDIT SUPPORT SERVICES, NAMELY, ADVICE ON GOVERNMENT AUDIT PROCESSES, POLICIES AND STRATEGY, BUSINESS ACQUISITION AND MERGER CONSULTATION, AND BUSINESS MANAGEMENT AND

CONSULTATION IN THE FIELD OF INTERNAL AUDIT, ACCOUNTING, AND SARBANES-OXLEY COMPLIANCE, IN CLASS 35 (U.S. CLS. 100, 101 AND 102).

FIRST USE 4-2-2007; IN COMMERCE 4-2-2007.

THE MARK CONSISTS OF STANDARD CHARACTERS WITHOUT CLAIM TO ANY PARTICULAR FONT, STYLE, SIZE, OR COLOR.

SER. NO. 77-193,659, FILED 5-30-2007.

PAUL F. GAST, EXAMINING ATTORNEY

**Int. Cl.: 33**

**Prior U.S. Cls.: 47 and 49**

**United States Patent and Trademark Office**

**Reg. No. 3,568,937**

**Registered Feb. 3, 2009**

**TRADEMARK  
PRINCIPAL REGISTER**

**Robert R. Stuart**

SPARKLING OREGON, LLC (OREGON LIMITED  
LIABILITY COMPANY)  
SUITE # 100  
845 NE FIFTH STREET  
MCMINNVILLE, OR 97128

FOR: GRAPE WINE; SPARKLING GRAPE WINE;  
WINE, IN CLASS 33 (U.S. CLS. 47 AND 49).

FIRST USE 12-10-2000; IN COMMERCE 12-10-2000.

THE MARK CONSISTS OF STANDARD CHAR-  
ACTERS WITHOUT CLAIM TO ANY PARTICULAR  
FONT, STYLE, SIZE, OR COLOR.

THE NAME "ROBERT R. STUART" IDENTIFIES  
A LIVING INDIVIDUAL WHOSE CONSENT IS OF  
RECORD.

SER. NO. 77-194,295, FILED 5-31-2007.

ANNE MADDEN, EXAMINING ATTORNEY

**Int. Cl.: 28**

**Prior U.S. Cls.: 22, 23, 38 and 50**

**Reg. No. 3,568,938**

**United States Patent and Trademark Office**

**Registered Feb. 3, 2009**

**TRADEMARK  
PRINCIPAL REGISTER**



MICHAEL JAMES ADAMS (UNITED STATES  
INDIVIDUAL)  
307 1/2 HOWARD ST., #2  
PETOSKEY, MI 49770

FIRST USE 1-1-2000; IN COMMERCE 6-17-2000.

SER. NO. 77-196,172, FILED 6-2-2007.

FOR: JUGGLING EQUIPMENT, IN CLASS 28 (U.S.  
CLS. 22, 23, 38 AND 50).

VERNA BETH RIRIE, EXAMINING ATTORNEY

**Int. Cl.: 44**

**Prior U.S. Cls.: 100 and 101**

**United States Patent and Trademark Office**

**Reg. No. 3,568,939**

**Registered Feb. 3, 2009**

**SERVICE MARK  
PRINCIPAL REGISTER**

**ABSOLUTELY UNBELIEVABLE  
RESULTS!**

AVA, LLC (FLORIDA LIMITED LIABILITY  
COMPANY)  
15143 BROLIO LANE  
NAPLES, FL 34110

FOR: COSMETIC WEIGHT LOSS TREATMENTS, NAMELY, NON-INVASIVE COSMETIC PROCEDURES; FAT ELIMINATION TREATMENTS, NAMELY, INJECTION OF NATURALLY OCCURRING SUBSTANCES INTO HUMAN TISSUE OR TARGETED FAT CELLS, FAT REDUCTION TREATMENTS, NAMELY, INJECTION OF FORMULATIONS UNDER THE SKIN FOR FAT REDUCTION, SERVICES FOR COSMETIC WEIGHT LOSS PROCEDURES, NAMELY, NON-SURGICAL TREATMENT OF FAT CELLS; COSMETIC AND AESTHETIC CONSULTATION SERVICES IN THE FIELD OF COSMETIC SOLUTIONS FOR WEIGHT LOSS, FAT REDUCTION, AND FAT ELIMINATION; CONSULTATION SERVICES IN THE FIELD OF COSMETIC SOLUTIONS FOR WEIGHT LOSS, FAT REDUCTION, AND FAT ELIMINATION; MEDICAL SERVICES FOR THE ADMINISTRATION TO OTH-

ERS OF INJECTABLE SUBSTANCES USED IN THE CONTROL, REDUCTION, OR ELIMINATION OF FAT CELLS; AND MISCELLANEOUS SERVICES, NAMELY, PROVIDING COSMETIC AND AESTHETIC INFORMATION, CONSULTANCY, AND ADVISORY SERVICES, PROVIDING HEALTH INFORMATION, PROVIDING COSMETIC FAT LOSS INFORMATION, PROVIDING FAT REDUCTION AND FAT ELIMINATION INFORMATION, PROVIDING INFORMATION IN THE FIELD OF PERSONAL BEAUTY, IN CLASS 44 (U.S. CLS. 100 AND 101).

FIRST USE 1-31-2007; IN COMMERCE 1-31-2007.

THE MARK CONSISTS OF STANDARD CHARACTERS WITHOUT CLAIM TO ANY PARTICULAR FONT, STYLE, SIZE, OR COLOR.

SER. NO. 77-196,598, FILED 6-4-2007.

JENNIFER VASQUEZ, EXAMINING ATTORNEY

Int. Cl.: 44

Prior U.S. Cls.: 100 and 101

United States Patent and Trademark Office

Reg. No. 3,568,940

Registered Feb. 3, 2009

SERVICE MARK  
PRINCIPAL REGISTER

***ABSolutely  
Unbelievable  
Results!***

AVA, LLC (FLORIDA LIMITED LIABILITY  
COMPANY)  
15143 BROLIO LANE  
NAPLES, FL 34110

FOR: COSMETIC WEIGHT LOSS TREATMENTS, NAMELY, NON-INVASIVE COSMETIC PROCEDURES; FAT ELIMINATION TREATMENTS, NAMELY, INJECTION OF NATURALLY OCCURRING SUBSTANCES INTO HUMAN TISSUE OR TARGETED FAT CELLS, FAT REDUCTION TREATMENTS, NAMELY INJECTION OF FORMULATIONS UNDER THE SKIN FOR FAT REDUCTION, SERVICES FOR COSMETIC WEIGHT LOSS PROCEDURES, NAMELY, NON-SURGICAL TREATMENT OF FAT CELLS; COSMETIC AND AESTHETIC CONSULTATION SERVICES IN THE FIELD OF COSMETIC SOLUTIONS FOR WEIGHT LOSS, FAT REDUCTION, AND FAT ELIMINATION; CONSULTATION SERVICES IN THE FIELD OF COSMETIC SOLUTIONS FOR WEIGHT LOSS, FAT

REDUCTION, AND FAT ELIMINATION; MEDICAL SERVICES FOR THE ADMINISTRATION TO OTHERS OF INJECTABLE SUBSTANCES USED IN THE CONTROL, REDUCTION, OR ELIMINATION OF FAT CELLS; AND MISCELLANEOUS SERVICES, NAMELY PROVIDING COSMETIC AND AESTHETIC INFORMATION, CONSULTANCY, AND ADVISORY SERVICES, PROVIDING HEALTH INFORMATION, PROVIDING COSMETIC FAT LOSS INFORMATION, PROVIDING FAT REDUCTION AND FAT ELIMINATION INFORMATION, PROVIDING INFORMATION IN THE FIELD OF PERSONAL BEAUTY, IN CLASS 44 (U.S. CLS. 100 AND 101).

FIRST USE 1-31-2007; IN COMMERCE 1-31-2007.

SER. NO. 77-196,605, FILED 6-4-2007.

MELVIN AXILBUND, EXAMINING ATTORNEY

**Int. Cls.: 35, 36, 42 and 45**

**Prior U.S. Cls.: 100, 101 and 102**

**United States Patent and Trademark Office**

**Reg. No. 3,568,941**

**Registered Feb. 3, 2009**

**SERVICE MARK  
PRINCIPAL REGISTER**

**EGRAD**

JPMORGAN CHASE & CO. (DELAWARE CORPORATION)  
270 PARK AVENUE  
NEW YORK, NY 10017

FOR: GIFT REGISTRY SERVICES PROVIDED VIA A GLOBAL COMPUTER NETWORK; ADVERTISING, PROMOTING AND MARKETING THE GOODS AND SERVICES OF OTHERS VIA STUDENT'S NEWSPAPER ADVERTISEMENTS, MAGAZINE ADVERTISEMENTS, ELECTRONIC MAIL, DIRECT MARKETING MAIL AND VIA THE GLOBAL COMPUTER NETWORK, TO HIGH SCHOOL, COLLEGE, UNIVERSITY AND GRADUATE SCHOOL STUDENTS AND RECENT GRADUATES; ON-LINE INFORMATION, ORDERING AND RETAIL STORE SERVICES FEATURING GOODS AND SERVICES OF OTHERS OF INTEREST TO HIGH SCHOOL, COLLEGE, UNIVERSITY AND GRADUATE SCHOOL STUDENTS AND RECENT GRADUATES, NAMELY, CLASS RINGS, FRAMES FOR DIPLOMAS, CAPS AND GOWNS AND OTHER GOODS AND SERVICES OF INTEREST TO HIGH SCHOOL, COLLEGE, UNIVERSITY AND GRADUATE SCHOOL STUDENTS AND RECENT GRADUATES; ONLINE INFORMATION RELATED TO POST GRADUATE LIFESTYLE OF INTEREST TO COLLEGE, UNIVERSITY AND GRADUATE SCHOOL STUDENTS AND RECENT GRADUATES, NAMELY, ADVERTISING, PROMOTING AND MARKETING FINANCIAL LOAN PRODUCTS DESIGNED FOR STUDENTS, NAMELY, STUDENT LOANS, BANKING PRODUCTS AND AUTO LOANS; PROVIDING ONLINE COMPUTER DATABASES AND ONLINE SEARCHABLE DATABASES FEATURING CLASSIFIED LISTINGS AND WANTEDS; PROMOTING PUBLIC AWARENESS OF ISSUES OF INTEREST TO COLLEGE, UNIVERSITY AND GRADUATE SCHOOL STUDENTS AND RECENT GRADUATES, IN CLASS 35 (U.S. CLS. 100, 101 AND 102).

FIRST USE 3-15-2000; IN COMMERCE 3-15-2000.

FOR: PROVIDING INFORMATION OF INTEREST TO COLLEGE, UNIVERSITY, AND GRADUATE SCHOOL STUDENTS AND RECENT GRADUATES, NAMELY, FINANCIAL SERVICES PRODUCTS, NAMELY, STUDENT EDUCATION AND AUTO LOANS, IN CLASS 36 (U.S. CLS. 100, 101 AND 102).

FIRST USE 3-15-2000; IN COMMERCE 3-15-2000.

FOR: DESIGN OF ONLINE DATABASES FEATURING INFORMATION FOR COLLEGE AND UNIVERSITY STUDENTS AND RECENT GRADUATES VIA GLOBAL COMPUTER NETWORKS, IN CLASS 42 (U.S. CLS. 100 AND 101).

FIRST USE 3-15-2000; IN COMMERCE 3-15-2000.

FOR: ONLINE INFORMATION RELATED TO POST GRADUATE LIFESTYLE OF INTEREST TO COLLEGE, UNIVERSITY AND GRADUATE SCHOOL STUDENTS AND RECENT GRADUATES, IN CLASS 45 (U.S. CLS. 100 AND 101).

FIRST USE 3-15-2000; IN COMMERCE 3-15-2000.

THE MARK CONSISTS OF STANDARD CHARACTERS WITHOUT CLAIM TO ANY PARTICULAR FONT, STYLE, SIZE, OR COLOR.

OWNER OF U.S. REG. NO. 2,454,275.

SEC. 2(F).

SER. NO. 77-197,046, FILED 6-4-2007.

ZACHARY BELLO, EXAMINING ATTORNEY

**Int. Cl.: 30**

**Prior U.S. Cl.: 46**

**United States Patent and Trademark Office**

**Reg. No. 3,568,942**

**Registered Feb. 3, 2009**

**TRADEMARK  
PRINCIPAL REGISTER**

**meteabo**

POSITIVE HEALTH CREATIONS (COLORADO  
LIMITED LIABILITY COMPANY)  
P.O. BOX 4653  
BOULDER, CO 80306

THE MARK CONSISTS OF STANDARD CHAR-  
ACTERS WITHOUT CLAIM TO ANY PARTICULAR  
FONT, STYLE, SIZE, OR COLOR.

FOR: TEA, IN CLASS 30 (U.S. CL. 46).

SER. NO. 77-197,418, FILED 6-5-2007.

FIRST USE 5-1-2007; IN COMMERCE 5-1-2007.

GINA HAYES, EXAMINING ATTORNEY



**Int. Cl.: 39**

**Prior U.S. Cls.: 100 and 105**

**United States Patent and Trademark Office**

**Reg. No. 3,568,943**

**Registered Feb. 3, 2009**

**SERVICE MARK  
PRINCIPAL REGISTER**



AMERICAN TRANSMISSION COMPANY LLC  
(WISCONSIN LIMITED LIABILITY COMPAN-  
NY)  
N19 W23993 RIDGE VIEW PARKWAY WEST  
WAUKESHA, WI 531870047

FOR: PUBLIC UTILITY SERVICES IN THE NAT-  
URE OF ELECTRICITY TRANSMISSION, IN CLASS  
39 (U.S. CLS. 100 AND 105).

FIRST USE 3-1-2006; IN COMMERCE 3-1-2006.

OWNER OF U.S. REG. NO. 2,710,500.

NO CLAIM IS MADE TO THE EXCLUSIVE  
RIGHT TO USE "AMERICAN TRANSMISSION  
COMPANY", APART FROM THE MARK AS  
SHOWN.

THE MARK CONSISTS OF A CURVED BAR  
BEHIND THE LETTERS "ATC", BELOW THE LET-  
TERS "ATC" ARE THE WORDS "AMERICAN  
TRANSMISSION COMPANY".

SER. NO. 77-198,848, FILED 6-6-2007.

PATRICIA EVANKO, EXAMINING ATTORNEY

Int. Cls.: 29 and 30

Prior U.S. Cl.: 46

Reg. No. 3,568,944

United States Patent and Trademark Office

Registered Feb. 3, 2009

TRADEMARK  
PRINCIPAL REGISTER



LEAHY ORCHARDS INC./LES VERGERS LEAHY  
INC. (CANADA CORPORATION)  
1772, ROUTE 209, FRANKLIN CENTRE  
QUÉBEC, CANADA J0S1E0

FOR: FRUIT DESSERTS IN THE NATURE OF  
FRUIT SALADS, CANDIED FRUIT SNACKS,  
DRIED FRUIT SNACKS, FRUIT-BASED SNACKS;  
FRUIT DESSERTS, NAMELY, FROZEN FRUITS;  
CONGEALED FRUIT DESSERTS, NAMELY, PRO-  
CESSED FRUITS; FRUIT BASED ORGANIC FOOD  
BARS, IN CLASS 29 (U.S. CL. 46).

FOR: FRUIT DESSERTS, NAMELY, FRUIT PIES,  
FRUIT COBBLERS; FROZEN CONFECTIONS  
MADE PRIMARILY FROM APPLE SAUCE, APPLES,  
BLUEBERRIES, STRAWBERRIES, RASPBERRIES,  
PEACHES, ORANGES, TANGERINES, GRAPES  
AND MIXTURES OF SUCH FRUITS AND CON-  
CENTRATES THEREOF; CONGEALED CONFECC-  
TIONS, NAMELY, CONFECTIONERY FRUIT  
JELLIES MADE PRIMARILY FROM APPLE SAUCE,  
APPLES, BLUEBERRIES, STRAWBERRIES, RASP-  
BERRIES, PEACHES, ORANGES, TANGERINES,  
GRAPES AND MIXTURES OF SUCH FRUITS AND

CONCENTRATES THEREOF; FRUIT ICE BARS, IN  
CLASS 30 (U.S. CL. 46).

PRIORITY CLAIMED UNDER SEC. 44(D) ON  
CANADA APPLICATION NO. 1329768, FILED 12-20-  
2006, REG. NO. TMA701600, DATED 11-23-2007, EX-  
PIRES 11-23-2022.

OWNER OF U.S. REG. NOS. 2,073,395 AND  
2,842,099.

NO CLAIM IS MADE TO THE EXCLUSIVE  
RIGHT TO USE "FREEZE", APART FROM THE  
MARK AS SHOWN.

THE MARK CONSISTS OF THE STYLIZED  
WORDING "APPLESNAX" INSIDE OF AN ARC  
SHAPED BANNER, ABOVE THE STYLIZED WORD-  
ING "EXTREEM FREEZZ".

SEC. 2(F) AS TO "APPLESNAX".

SER. NO. 77-200,429, FILED 6-7-2007.

JAY BESCH, EXAMINING ATTORNEY

**Int. Cls.: 35, 36 and 41**

**Prior U.S. Cls.: 100, 101, 102 and 107**

**United States Patent and Trademark Office**

**Reg. No. 3,568,945**

**Registered Feb. 3, 2009**

**SERVICE MARK  
PRINCIPAL REGISTER**

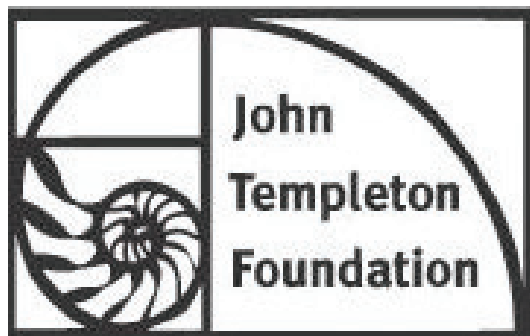

JOHN TEMPLETON FOUNDATION (TENNESSEE CORPORATION)

300 CONSHOHOCKEN STATE ROAD, SUITE 500  
WEST CONSHOHOCKEN, PA 19428

FOR: PROMOTING PUBLIC AWARENESS OF THE NEED FOR INTERNATIONAL TEACHING AND SCHOLARLY RESEARCH CONCERNING THE UNDERSTANDING AND BENEFITS OF FREEDOM, FREE MARKETS AND FREE SOCIETIES, IN CLASS 35 (U.S. CLS. 100, 101 AND 102).

FIRST USE 10-31-2003; IN COMMERCE 6-30-2004.

FOR: ELEEMOSYNARY SERVICES IN THE FIELD OF MONETARY GRANTS TO PROMOTE SCHOLARLY RESEARCH CONCERNING THE RELATIONSHIP BETWEEN SCIENCE AND RELIGION, IN CLASS 36 (U.S. CLS. 100, 101 AND 102).

FIRST USE 10-31-2003; IN COMMERCE 6-30-2004.

FOR: EDUCATIONAL SERVICES, NAMELY, CONDUCTING SEMINARS IN THE FIELD OF

BUILDING CHARACTER, IN CLASS 41 (U.S. CLS. 100, 101 AND 107).

FIRST USE 10-31-2003; IN COMMERCE 6-30-2004.

OWNER OF U.S. REG. NOS. 2,448,701 AND 2,477,142.

NO CLAIM IS MADE TO THE EXCLUSIVE RIGHT TO USE "FOUNDATION", APART FROM THE MARK AS SHOWN.

THE NAME "JOHN TEMPLETON" IDENTIFIES A LIVING INDIVIDUAL WHOSE CONSENT IS OF RECORD.

THE MARK CONSISTS OF A FOUR-SIDED FIGURE DIVIDED IN THREE INSIDE THE SECOND QUADRANGLE THERE IS A SEA SHELL.

SER. NO. 77-202,866, FILED 6-11-2007.

DOMINIC FATHY, EXAMINING ATTORNEY

**Int. Cl.: 9**

**Prior U.S. Cls.: 21, 23, 26, 36 and 38**

**United States Patent and Trademark Office**

**Reg. No. 3,568,946**

**Registered Feb. 3, 2009**

**TRADEMARK  
PRINCIPAL REGISTER**

**MAGICSPECTRUM**

SAMSUNG ELECTRONICS CO., LTD. (REPUBLIC OF KOREA CORPORATION)  
416, MAETAN-DONG, YEONGTONG-GU  
SUWON-SI, GYEONGGI-DO, REPUBLIC OF KOREA

FOR: COMPUTER MONITORS, IN CLASS 9 (U.S. CLS. 21, 23, 26, 36 AND 38).

FIRST USE 9-1-2007; IN COMMERCE 9-1-2007.

THE MARK CONSISTS OF STANDARD CHARACTERS WITHOUT CLAIM TO ANY PARTICULAR FONT, STYLE, SIZE, OR COLOR.

SER. NO. 77-202,933, FILED 6-11-2007.

DORITT L. CARROLL, EXAMINING ATTORNEY

**Int. Cl.: 42**

**Prior U.S. Cls.: 100 and 101**

**United States Patent and Trademark Office**

**Reg. No. 3,568,947**

**Registered Feb. 3, 2009**

**SERVICE MARK  
PRINCIPAL REGISTER**

**AP ONCALL**

TECH PHARMACY SERVICES, INC. (TEXAS  
CORPORATION)  
SUITE 100  
900 SOUTH LOOP WEST  
HOUSTON, TX 77054

FOR: PROVIDING QUALITY CONTROL SERVICES FOR OTHERS, NAMELY, REMOTE ELECTRONIC MONITORING VIA THE INTERNET AND REMOTE VISUAL MONITORING VIA THE INTERNET OF DRUG DISPENSING EQUIPMENT FOR THE PURPOSES OF ASSISTING MEDICAL PERSONNEL IN ENSURING ACCURACY IN DRUG DISPENSING, IN CLASS 42 (U.S. CLS. 100 AND 101).

FIRST USE 8-1-2007; IN COMMERCE 8-1-2007.

THE MARK CONSISTS OF STANDARD CHARACTERS WITHOUT CLAIM TO ANY PARTICULAR FONT, STYLE, SIZE, OR COLOR.

NO CLAIM IS MADE TO THE EXCLUSIVE RIGHT TO USE "ON CALL", APART FROM THE MARK AS SHOWN.

SER. NO. 77-204,090, FILED 6-12-2007.

MARK SPARACINO, EXAMINING ATTORNEY

**Int. Cls.: 1, 3, 4 and 29**

**Prior U.S. Cls.: 1, 4, 5, 6, 10, 15, 26, 46, 50, 51 and 52**

**Reg. No. 3,568,948**

**United States Patent and Trademark Office**

**Registered Feb. 3, 2009**

**TRADEMARK  
PRINCIPAL REGISTER**



AVATAR CORPORATION (ILLINOIS CORPORATION)  
500 CENTRAL AVENUE  
UNIVERSITY PARK, IL 60466

FOR: CHEMICAL ADDITIVE FOR USE IN THE MANUFACTURE OF FOOD PRODUCTS, PHARMACEUTICALS, AND COSMETICS; WETTING AGENTS FOR USE IN COSMETICS; CHEMICAL PRODUCTS FOR FRESH KEEPING AND PRESERVING FOOD; EMULSIFIERS FOR USE AS A FOOD ADDITIVE; FOOD PRESERVATION COMPOSITIONS; LECITHIN FOR INDUSTRIAL USE IN THE MANUFACTURE OF FOOD PRODUCTS; ANTIOXIDANTS FOR USE IN THE MANUFACTURE OF PHARMACEUTICALS; WHITE MINERAL OIL USED IN THE MANUFACTURE OF PHARMACEUTICALS, IN CLASS 1 (U.S. CLS. 1, 5, 6, 10, 26 AND 46).

FIRST USE 1-3-1983; IN COMMERCE 1-3-1983.

FOR: ESSENTIAL OILS FOR USE IN THE MANUFACTURE OF FOOD PRODUCTS, IN CLASS 3 (U.S. CLS. 1, 4, 6, 50, 51 AND 52).

FIRST USE 1-3-1983; IN COMMERCE 1-3-1983.

FOR: LUBRICANTS FOR USE IN INDUSTRIAL MACHINERY, VEGETABLE-BASED WAXES FOR USE IN COATING FOOD PRODUCTS, PHARMACEUTICAL-GRADE WHITE MINERAL OIL USED IN THE MANUFACTURE OF PHARMACEUTICALS; NUTRITIONAL OILS, PARAFFIN WAX, PETROLEUM JELLY, CREAMS AND OILS ALL FOR USE IN THE MANUFACTURE OF COSMETIC PRODUCTS, IN CLASS 4 (U.S. CLS. 1, 6 AND 15).

FIRST USE 11-12-1987; IN COMMERCE 11-12-1987.

FOR: VEGETABLE OIL AND EDIBLE MINERAL OIL COMPOSITION FOR RELEASING FOOD ARTICLES FROM ONE ANOTHER AND FROM OTHER SURFACES, COOKING OIL, CORN OIL, COCONUT OIL, EDIBLE OILS, AND EDIBLE FATS, IN CLASS 29 (U.S. CL. 46).

FIRST USE 1-3-1983; IN COMMERCE 1-3-1983.

THE MARK CONSISTS OF THE WORD "AVATAR" AND TRIANGULAR DESIGN.

SER. NO. 77-204,278, FILED 6-12-2007.

KAREN K. BUSH, EXAMINING ATTORNEY

**Int. Cl.: 28**

**Prior U.S. Cls.: 22, 23, 38 and 50**

**United States Patent and Trademark Office**

**Reg. No. 3,568,949**

**Registered Feb. 3, 2009**

**TRADEMARK  
PRINCIPAL REGISTER**

**SWORD STORM**

MATTEL, INC. (DELAWARE CORPORATION)

M1-1518

333 CONTINENTAL BLVD.

EL SEGUNDO, CA 90245

FOR: TOYS, GAMES AND PLAYTHINGS, NAME-  
LY, TOY ACTION FIGURES, TOY FIGURES, AND  
ACCESSORIES FOR ALL OF THE FOREGOING, IN  
CLASS 28 (U.S. CLS. 22, 23, 38 AND 50).

FIRST USE 2-6-2008; IN COMMERCE 2-6-2008.

THE MARK CONSISTS OF STANDARD CHAR-  
ACTERS WITHOUT CLAIM TO ANY PARTICULAR  
FONT, STYLE, SIZE, OR COLOR.

OWNER OF U.S. REG. NOS. 2,738,958 AND  
3,127,730.

NO CLAIM IS MADE TO THE EXCLUSIVE  
RIGHT TO USE "SWORD", APART FROM THE  
MARK AS SHOWN.

SER. NO. 77-205,275, FILED 6-13-2007.

YAT SYE, LEE, EXAMINING ATTORNEY

**Int. Cl.: 16**

**Prior U.S. Cls.: 2, 5, 22, 23, 29, 37, 38 and 50**

**United States Patent and Trademark Office**

**Reg. No. 3,568,950**

**Registered Feb. 3, 2009**

**TRADEMARK  
PRINCIPAL REGISTER**

**PRO-MARK**

RPM WOOD FINISHES GROUP, INC. (NEVADA  
CORPORATION)  
22 SOUTH CENTER STREET  
HICKORY, NC 286020220

THE MARK CONSISTS OF STANDARD CHAR-  
ACTERS WITHOUT CLAIM TO ANY PARTICULAR  
FONT, STYLE, SIZE, OR COLOR.

FOR: TOUCH-UP MARKERS FOR USE ON IN-  
TERIOR WOOD SURFACES, IN CLASS 16 (U.S. CLS.  
2, 5, 22, 23, 29, 37, 38 AND 50).

SER. NO. 77-206,049, FILED 6-14-2007.

FIRST USE 6-1-1997; IN COMMERCE 6-1-1997.

PAM WILLIS, EXAMINING ATTORNEY



**Int. Cl.: 16**

**Prior U.S. Cls.: 2, 5, 22, 23, 29, 37, 38 and 50**

**Reg. No. 3,568,951**

**United States Patent and Trademark Office**

**Registered Feb. 3, 2009**

**TRADEMARK  
PRINCIPAL REGISTER**

**EMERGENCY ESSENTIALS**

EMERGENCY ESSENTIALS, INC. (UTAH CORPORATION)  
653 NORTH 1500 WEST  
OREM, UT 84057

FOR: EDUCATIONAL BOOKS AND PUBLICATIONS, NAMELY, BOOKLETS AND PAMPHLETS FEATURING THE SUBJECT MATTER OF SURVIVAL SKILLS AND NECESSARY EQUIPMENT, FIRST AID, 72 HOUR PREPAREDNESS GUIDELINES FOR EMERGENCIES; GENERAL PURPOSE PLASTIC BAGS, IN CLASS 16 (U.S. CLS. 2, 5, 22, 23, 29, 37, 38 AND 50).

FIRST USE 6-0-1990; IN COMMERCE 6-0-1990.

THE MARK CONSISTS OF STANDARD CHARACTERS WITHOUT CLAIM TO ANY PARTICULAR FONT, STYLE, SIZE, OR COLOR.

SEC. 2(F).

SER. NO. 77-207,699, FILED 6-15-2007.

LESLEY LAMOTHE, EXAMINING ATTORNEY

**Int. Cl.: 21**

**Prior U.S. Cls.: 2, 13, 23, 29, 30, 33, 40 and 50**

**United States Patent and Trademark Office**

**Reg. No. 3,568,952**

**Registered Feb. 3, 2009**

**TRADEMARK  
PRINCIPAL REGISTER**

**EMERGENCY ESSENTIALS**

EMERGENCY ESSENTIALS, INC. (UTAH CORPORATION)  
653 NORTH 1500 WEST  
OREM, UT 84057

FOR: HOUSEHOLD CONTAINERS FOR FOOD; PLASTIC CONTAINERS AND LIDS TO STORE FOOD ITEMS; PLASTIC BOTTLES SOLD EMPTY; CONTAINERS FOR WATER STORAGE CONSISTING OF POLYCARBONATE BOTTLES SOLD EMPTY; PLASTIC JUGS FOR BEVERAGES SOLD EMPTY; PEPPER MILLS; COOKWARE, NAMELY, STEAMERS; NON-ELECTRIC JUICERS, IN CLASS 21 (U.S. CLS. 2, 13, 23, 29, 30, 33, 40 AND 50).

FIRST USE 12-0-1990; IN COMMERCE 12-0-1990.

THE MARK CONSISTS OF STANDARD CHARACTERS WITHOUT CLAIM TO ANY PARTICULAR FONT, STYLE, SIZE, OR COLOR.

SEC. 2(F).

SER. NO. 77-207,708, FILED 6-15-2007.

LESLEY LAMOTHE, EXAMINING ATTORNEY

**Int. Cl.: 16**

**Prior U.S. Cls.: 2, 5, 22, 23, 29, 37, 38 and 50**

**Reg. No. 3,568,953**

**United States Patent and Trademark Office**

**Registered Feb. 3, 2009**

**TRADEMARK  
PRINCIPAL REGISTER**

**BUSCH STADIUM**

ANHEUSER-BUSCH, INCORPORATED (MIS-  
SOURI CORPORATION)  
202-6  
ONE BUSCH PLACE  
ST. LOUIS, MO 63118

FOR: STICKERS, DECALS, PHOTOS, BASEBALL  
CARDS, YEARBOOKS, SCORECARDS, PRINTED  
MATERIALS, NAMELY, PRINTED TICKETS, POS-  
TERS AND POSTCARDS , IN CLASS 16 (U.S. CLS. 2,  
5, 22, 23, 29, 37, 38 AND 50).

FIRST USE 8-30-2005; IN COMMERCE 8-30-2005.

THE MARK CONSISTS OF STANDARD CHAR-  
ACTERS WITHOUT CLAIM TO ANY PARTICULAR  
FONT, STYLE, SIZE, OR COLOR.

OWNER OF U.S. REG. NOS. 2,050,640 AND  
3,391,391.

SER. NO. 77-211,784, FILED 6-21-2007.

LOURDES AYALA, EXAMINING ATTORNEY

**Int. Cls.: 37 and 42**

**Prior U.S. Cls.: 100, 101, 103 and 106**

**United States Patent and Trademark Office**

**Reg. No. 3,568,954**

**Registered Feb. 3, 2009**

**SERVICE MARK  
PRINCIPAL REGISTER**

**CFI**

BLAU, RAYMOND (UNITED STATES INDIVIDUAL)  
1135 SPRUCE DRIVE  
MOUNTAINSIDE, NJ 07092

FOR: INSTALLATION OF COMMERCIAL FURNITURE, IN CLASS 37 (U.S. CLS. 100, 103 AND 106).

FIRST USE 12-0-1994; IN COMMERCE 4-0-1995.

FOR: COMMERCIAL OFFICE INTERIOR DESIGN, INCLUDING OFFICE LAYOUT AND OFFICE

SPACE PLANNING SERVICES, IN CLASS 42 (U.S. CLS. 100 AND 101).

FIRST USE 12-0-1994; IN COMMERCE 4-0-1995.

THE MARK CONSISTS OF STANDARD CHARACTERS WITHOUT CLAIM TO ANY PARTICULAR FONT, STYLE, SIZE, OR COLOR.

SER. NO. 77-212,755, FILED 6-22-2007.

KATHERINE CHANG, EXAMINING ATTORNEY

**Int. Cl.: 41**

**Prior U.S. Cls.: 100, 101 and 107**

**United States Patent and Trademark Office**

**Reg. No. 3,568,955**

**Registered Feb. 3, 2009**

**SERVICE MARK  
PRINCIPAL REGISTER**



FITWELL COACHING, LLC (ARIZONA LIMITED LIABILITY COMPANY)  
2680 S. VAL VISTA DR., STE. #172  
GILBERT, AZ 85295

FOR: PERSONAL TRAINING SERVICES, NAME-  
LY, STRENGTH AND CONDITIONING TRAINING,  
IN CLASS 41 (U.S. CLS. 100, 101 AND 107).

FIRST USE 1-1-2005; IN COMMERCE 1-1-2005.

NO CLAIM IS MADE TO THE EXCLUSIVE  
RIGHT TO USE "COACHING", APART FROM THE  
MARK AS SHOWN.

THE COLOR(S) BLACK AND MAROON-BUR-  
GUNDY IS/ARE CLAIMED AS A FEATURE OF  
THE MARK.

THE COLOR BLACK APPEARS IN THE WORD-  
ING "FITWELL COACHING". THE STYLIZED LET-  
TER "F," WHICH IS SUPERIMPOSED UPON THE  
AFOREMENTIONED WORDING, IS IN THE COL-  
OR MAROON-BURGUNDY. THE BACKGROUND  
IS INTENDED TO BE TRANSPARENT.

SER. NO. 77-214,288, FILED 6-25-2007.

JENNIFER VASQUEZ, EXAMINING ATTORNEY

**Int. Cl.: 3**

**Prior U.S. Cls.: 1, 4, 6, 50, 51 and 52**

**Reg. No. 3,568,956**

**United States Patent and Trademark Office**

**Registered Feb. 3, 2009**

**TRADEMARK  
PRINCIPAL REGISTER**

**CANIGLIA MD**

CANIGLIA, DR. RONALD (UNITED STATES  
INDIVIDUAL)  
7102 E. ACOMA DRIVE  
SCOTTSDALE, AZ 85254

FIRST USE 6-16-2006; IN COMMERCE 6-16-2006.

FOR: SKIN CARE PRODUCTS, NAMELY, NON-MEDICATED SKIN SERUM; SKIN CREAMS; SKIN LOTIONS; SKIN SOAP; SKIN TONERS; EXFOLIANTS FOR SKIN; LOTIONS FOR SKIN; FACIAL CREAMS; FACIAL LOTION; FACIAL SCRUBS; FACE AND BODY LOTIONS; BEAUTY CREAMS; BEAUTY MASKS; SKIN MOISTURIZER MASKS, IN CLASS 3 (U.S. CLS. 1, 4, 6, 50, 51 AND 52).

THE MARK CONSISTS OF STANDARD CHARACTERS WITHOUT CLAIM TO ANY PARTICULAR FONT, STYLE, SIZE, OR COLOR.

SER. NO. 77-215,037, FILED 6-25-2007.

ROBIN CHOSID, EXAMINING ATTORNEY

**Int. Cls.: 41 and 43**

**Prior U.S. Cls.: 100, 101 and 107**

**United States Patent and Trademark Office**

**Reg. No. 3,568,957**

**Registered Feb. 3, 2009**

**SERVICE MARK  
PRINCIPAL REGISTER**

**CRAVE**

KHALIL RAMADAN (UNITED STATES INDIVIDUAL)  
466 BILTMORE  
DEARBORN HEIGHTS, MI 48127

FOR: NIGHTCLUB SERVICES, IN CLASS 41 (U.S. CLS. 100, 101 AND 107).

FIRST USE 10-22-2004; IN COMMERCE 10-22-2004.

FOR: BAR AND RESTAURANT SERVICES, EXCLUDING RESTAURANTS SPECIALIZING IN CHEESEBURGERS, HAMBURGERS, AND FRENCH

FRIES; COCKTAIL LOUNGES AND CAFES, IN CLASS 43 (U.S. CLS. 100 AND 101).

FIRST USE 10-22-2004; IN COMMERCE 10-22-2004.

THE MARK CONSISTS OF STANDARD CHARACTERS WITHOUT CLAIM TO ANY PARTICULAR FONT, STYLE, SIZE, OR COLOR.

SER. NO. 77-215,565, FILED 6-26-2007.

BARBARA GAYNOR, EXAMINING ATTORNEY

**Int. Cls.: 35, 38, 41, 42 and 45**

**Prior U.S. Cls.: 100, 101, 102, 104 and 107**

**Reg. No. 3,568,958**

**United States Patent and Trademark Office**

**Registered Feb. 3, 2009**

**SERVICE MARK  
PRINCIPAL REGISTER**



SULEKHA.COM NEW MEDIA PRIVATE LIMITED (INDIA PRIVATE LIMITED COMPANY)  
4TH FLOOR, #484 & 485  
PANTHEON RD, EGMORE PANTHEON PLAZA  
CHENNAI, INDIA 600008

FOR: PROVIDING COMPUTERIZED ON-LINE ORDERING SERVICES FEATURING GENERAL MERCHANDISE AND GENERAL CONSUMER GOODS OF OTHERS; ONLINE RETAIL STORE SERVICES FEATURING GOODS IN THE FIELDS OF TRAVEL, SPORTS, DINING, ENTERTAINMENT, MUSIC, AND EDUCATION; ONLINE RETAIL STORE SERVICES FEATURING BOOKS AND JEWELRY; PROMOTING THE GOODS AND SERVICES OF OTHERS BY PREPARING AND PLACING ADVERTISEMENTS IN ELECTRONIC COMMUNICATIONS NETWORKS; PROVIDING BUSINESS INFORMATION IN THE NATURE OF MARKETING, DEMOGRAPHIC, AND STATISTICAL INFORMATION; PROVIDING ONLINE DIRECTORY INFORMATION SERVICES FEATURING HYPERLINKS TO OTHER WEBSITES; PROVIDING A WEBSITE FEATURING BUSINESS TO BUSINESS INFORMATION; COMPILATION AND SYSTEMATIZATION OF INFORMATION INTO COMPUTER DATABASES; PROVIDING AN ONLINE COMPUTER DATABASE IN THE FIELD OF GOODS AND SERVICES PRICE QUOTATIONS; PROVIDING AN ONLINE DIRECTORY INFORMATION SERVICE FEATURING INFORMATION REGARDING NEWS, WEATHER, SPORTS, CURRENT EVENTS, AND REFERENCE MATERIALS, IN CLASS 35 (U.S. CLS. 100, 101 AND 102).

FIRST USE 3-9-2006; IN COMMERCE 3-9-2006.

FOR: PROVIDING MULTIPLE-USER ACCESS TO A GLOBAL COMPUTER INFORMATION NETWORK; PROVIDING ONLINE CHAT ROOMS AND ELECTRONIC BULLETIN BOARDS FOR TRANSMISSION OF MESSAGES AMONG COMPUTER USERS CONCERNING NEWS, WEATHER, FI-

NANCE, NETWORKING, SPORTS, DATING, AND ENTERTAINMENT; PROVIDING ONLINE CHAT ROOMS AND ELECTRONIC BULLETIN BOARDS FOR TRANSMISSION OF MESSAGES AMONG USERS IN THE FIELD OF GENERAL INTEREST; BROADCASTING PROGRAMS VIA A GLOBAL COMPUTER NETWORK, IN CLASS 38 (U.S. CLS. 100, 101 AND 104).

FIRST USE 3-9-2006; IN COMMERCE 3-9-2006.

FOR: ONLINE JOURNALS, NAMELY, BLOGS FEATURING BUSINESS INFORMATION; PROVIDING A WEBSITE FEATURING INFORMATION ON SPORTS, ENTERTAINMENT, AND EDUCATION; ELECTRONIC PUBLISHING SERVICES, NAMELY, ONLINE PUBLICATION OF TEXT, AUDIO, VIDEO, AND GRAPHIC WORKS OF OTHERS FEATURING NEWS, REVIEWS, DIARIES, COMMENTARY, PHOTOS, POETRY, MINI-ESSAYS, PROJECT UPDATES, NON-FICTION AND FICTION; ONLINE JOURNALS, NAMELY, BLOGS IN THE FIELD OF WEB DEVELOPMENT; ONLINE JOURNALS, NAMELY, BLOGS FEATURING AUTOBIOGRAPHICAL INFORMATION AND PERSONAL INFORMATION TO CONNECT INDIVIDUALS SHARING PERSONAL STORIES, IN CLASS 41 (U.S. CLS. 100, 101 AND 107).

FIRST USE 3-9-2006; IN COMMERCE 3-9-2006.

FOR: DESIGN, CREATION, HOSTING, MAINTENANCE OF WEBSITES FOR OTHERS; COMPUTER SERVICES, NAMELY, PROVIDING SEARCH ENGINES FOR OBTAINING DATA ON A GLOBAL COMPUTER NETWORK, IN CLASS 42 (U.S. CLS. 100 AND 101).

FIRST USE 3-9-2006; IN COMMERCE 3-9-2006.

FOR: WEBSITE SERVICES FEATURING ONLINE DATING CLUB; ONLINE SOCIAL NETWORKING SERVICES, IN CLASS 45 (U.S. CLS. 100 AND 101).



FIRST USE 3-9-2006; IN COMMERCE 3-9-2006.

THE MARK CONSISTS OF A STYLIZED LETTER "S" IN A CIRCLE, FOLLOWED BY THE STYLIZED "SULEKHA.COM", ALL ABOVE THE STYLIZED WORDS "CONNECTING INDIANS WORLDWIDE".

THE FOREIGN WORDING IN THE MARK TRANSLATES INTO ENGLISH AS "GOOD WRITING".

SER. NO. 77-217,206, FILED 6-27-2007.

ANDREA HACK, EXAMINING ATTORNEY

**Int. Cls.: 36, 39 and 45**

**Prior U.S. Cls.: 100, 101, 102 and 105**

**United States Patent and Trademark Office**

**Reg. No. 3,568,959**

**Registered Feb. 3, 2009**

**SERVICE MARK  
PRINCIPAL REGISTER**

**YACHTZOO**

S.A.R.L. YACHTZOO (MONACO LIMITED LIABILITY COMPANY)  
21, BOULEVARD ALBERT 1ER  
MONTE CARLO, MONACO 98000

FOR: YACHT BROKERAGE, IN CLASS 36 (U.S. CLS. 100, 101 AND 102).

FIRST USE 8-28-2007; IN COMMERCE 8-28-2007.

FOR: CHARTERING OF YACHTS FOR OTHERS; ARRANGING FOR DOCKING OF YACHTS FOR OTHERS, IN CLASS 39 (U.S. CLS. 100 AND 105).

FIRST USE 8-10-2007; IN COMMERCE 8-10-2007.

FOR: CONCIERGE SERVICES FOR OTHERS COMPRISING MAKING REQUESTED PERSONAL

ARRANGEMENTS AND RESERVATIONS AND PROVIDING CUSTOMER-SPECIFIC INFORMATION TO MEET INDIVIDUAL NEEDS RENDERED TOGETHER IN THE YACHT CHARTERING INDUSTRY, IN CLASS 45 (U.S. CLS. 100 AND 101).

FIRST USE 10-4-2007; IN COMMERCE 12-13-2007.

THE MARK CONSISTS OF STANDARD CHARACTERS WITHOUT CLAIM TO ANY PARTICULAR FONT, STYLE, SIZE, OR COLOR.

SER. NO. 77-221,118, FILED 7-3-2007.

WON TEAK OH, EXAMINING ATTORNEY

Int. Cl.: 43

Prior U.S. Cls.: 100 and 101

United States Patent and Trademark Office

Reg. No. 3,568,960

Registered Feb. 3, 2009

**SERVICE MARK  
PRINCIPAL REGISTER**



A SENSE OF WINE (CALIFORNIA LIMITED LIABILITY COMPANY)  
460 SUNNYSLOPE AVENUE  
PETALUMA, CA 94952

FOR: SOMMELIER SERVICES, NAMELY, PROVIDING ADVICE ON WINE AND WINE AND FOOD PAIRING, IN CLASS 43 (U.S. CLS. 100 AND 101).

FIRST USE 7-5-2007; IN COMMERCE 7-5-2007.

THE COLOR(S) PURPLE, YELLOW, GREEN, BLUE AND GRAY IS/ARE CLAIMED AS A FEATURE OF THE MARK.

THE MARK CONSISTS OF THE COLOR PURPLE APPEARS IN THE WINE GLASS ON THE LEFT. THE COLOR YELLOW APPEARS IN THE WINE GLASS ON THE RIGHT. THE COLOR GREEN APPEARS IN THE WORDING "A SENSE OF WINE". THE COLOR BLUE APPEARS IN THE OUTLINING OF THE WINE GLASSES AND IN THE WORDING "BLENDING EDUCATION WITH FUN". THE BACKGROUND OF THE DRAWING IS GRAY.

SER. NO. 77-222,941, FILED 7-5-2007.

JENNIFER VASQUEZ, EXAMINING ATTORNEY

**Int. Cl.: 9**

**Prior U.S. Cls.: 21, 23, 26, 36 and 38**

**Reg. No. 3,568,961**

**United States Patent and Trademark Office**

**Registered Feb. 3, 2009**

---

**TRADEMARK  
PRINCIPAL REGISTER**

**Acuvim**

PACIFIC ACCUENERGY AUTOMATION CO.,  
LTD. (CALIFORNIA CORPORATION)  
SUITE 600  
400 CONTINENTAL BLVD.  
EL SEGUNDO, CA 90245

THE MARK CONSISTS OF STANDARD CHAR-  
ACTERS WITHOUT CLAIM TO ANY PARTICULAR  
FONT, STYLE, SIZE, OR COLOR.

FOR: ELECTRIC METERS, IN CLASS 9 (U.S. CLS.  
21, 23, 26, 36 AND 38).

SER. NO. 77-223,277, FILED 7-6-2007.

FIRST USE 2-26-2007; IN COMMERCE 2-26-2007.

PAUL F. GAST, EXAMINING ATTORNEY

**Int. Cl.: 32**

**Prior U.S. Cls.: 45, 46 and 48**

**United States Patent and Trademark Office**

**Reg. No. 3,568,962**

**Registered Feb. 3, 2009**

**TRADEMARK  
PRINCIPAL REGISTER**

**ORGASMICA BEER**

GINA GOCHEZ (UNITED STATES INDIVIDUAL)  
20 LUCKY DR  
GREENBRAE, CA 94904 AND  
TAYLOR MAIA (BRAZIL INDIVIDUAL)  
20 LUCKY DR  
GREENBRAE, CA 94904

FOR: BEER, IN CLASS 32 (U.S. CLS. 45, 46 AND 48).

FIRST USE 9-1-2004; IN COMMERCE 10-1-2004.

THE MARK CONSISTS OF STANDARD CHARACTERS WITHOUT CLAIM TO ANY PARTICULAR FONT, STYLE, SIZE, OR COLOR.

OWNER OF U.S. REG. NO. 3,034,736.

NO CLAIM IS MADE TO THE EXCLUSIVE RIGHT TO USE "BEER", APART FROM THE MARK AS SHOWN.

SER. NO. 77-225,864, FILED 7-10-2007.

CARRIE GENOVESE, EXAMINING ATTORNEY

**Int. Cls.: 3 and 5**

**Prior U.S. Cls.: 1, 4, 6, 18, 44, 46, 50, 51 and 52**

**United States Patent and Trademark Office**

**Reg. No. 3,568,963**

**Registered Feb. 3, 2009**

**TRADEMARK  
PRINCIPAL REGISTER**

**YDEALYS**

PIERRE FABRE S.A. (FRANCE SOCIETE ANON-  
YME)  
12 AVENUE HOCHÉ  
PARIS, FRANCE 75008

FOR: COSMETICS AND CLEANING PREPARA-  
TIONS, NAMELY, TOILET SOAPS, PERFUMES,  
ESSENTIAL OILS FOR PERSONAL USE, SKIN  
CREAMS, SKIN OILS, SKIN GELS, SKIN LOTIONS,  
SKIN MILKS AND SKIN EMULSIONS, NON-MEDI-  
CATED SKIN BALMS, MAKE-UP, FOUNDATION,  
MASCARA, EYE LINER, NON-MEDICATED HAIR  
CARE PREPARATIONS, IN CLASS 3 (U.S. CLS. 1, 4, 6,  
50, 51 AND 52).

FOR: PHARMACEUTICALS, NAMELY, PRE-  
PARATIONS FOR THE TREATMENT OF ALLER-  
GY, CANCER, ASTHMA AND CARDIOVASCULAR  
DISEASES, PSYCHIATRIC, RESPIRATORY, URO-  
LOGIC AND DERMATOLOGIC DISORDERS AND

DISEASES, MEDICATED SKIN CARE PREPARA-  
TIONS, MEDICATED HAIR CARE PREPARATIONS;  
DIETARY FOOD SUPPLEMENTS, IN CLASS 5 (U.S.  
CLS. 6, 18, 44, 46, 51 AND 52).

THE MARK CONSISTS OF STANDARD CHAR-  
ACTERS WITHOUT CLAIM TO ANY PARTICULAR  
FONT, STYLE, SIZE, OR COLOR.

OWNER OF FRANCE REG. NO. 97710687, DATED  
12-17-1997, RENEWED AS REG. NO. 97710687, DA-  
TED 12-17-2007, EXPIRES 12-17-2017.

OWNER OF U.S. REG. NO. 2,477,327.

SER. NO. 77-229,101, FILED 7-13-2007.

JENNIFER VASQUEZ, EXAMINING ATTORNEY

**Int. Cl.: 44**

**Prior U.S. Cls.: 100 and 101**

**United States Patent and Trademark Office**

**Reg. No. 3,568,964**

**Registered Feb. 3, 2009**

**SERVICE MARK  
PRINCIPAL REGISTER**

**PUSH TO WALK**

PUSH TO WALK, A NEW JERSEY NON-PROFIT CORPORATION (NEW JERSEY CORPORATION)  
8 HONEYSUCKLE LANE  
KINNELON, NJ 07405

FOR: OCCUPATIONAL THERAPY SERVICES; HEALTH CARE SERVICES, NAMELY, TREATMENT OF PATIENTS WITH AMBULATORY DISORDERS, IN CLASS 44 (U.S. CLS. 100 AND 101).

FIRST USE 12-14-2006; IN COMMERCE 12-15-2006.

THE MARK CONSISTS OF STANDARD CHARACTERS WITHOUT CLAIM TO ANY PARTICULAR FONT, STYLE, SIZE, OR COLOR.

SER. NO. 77-230,563, FILED 7-16-2007.

DORITT L. CARROLL, EXAMINING ATTORNEY

**Int. Cl.: 3**

**Prior U.S. Cls.: 1, 4, 6, 50, 51 and 52**

**United States Patent and Trademark Office**

**Reg. No. 3,568,965**

**Registered Feb. 3, 2009**

**TRADEMARK  
PRINCIPAL REGISTER**



PERSONAL CARE PRODUCTS, INC. (MICHIGAN CORPORATION)  
32500 TELEGRAPH ROAD, SUITE 202  
BINGHAM FARMS, MI 48025

FOR: CLEANERS, NAMELY, ALL PURPOSE CLEANERS, BATHROOM CLEANERS, GLASS AND SURFACE CLEANERS, CARPET CLEANERS, FABRIC AND UPHOLSTERY CLEANERS, DRAIN CLEANERS, SHOWER CLEANERS, LAUNDRY SOAP, FABRIC SOFTENER, OVEN AND GRILL CLEANER, PATIO CLEANER, TOILET CLEANER, DISHWASHER SOAP, DISHWASHER GEL, FURNITURE POLISH, AUTOMOBILE CLEANERS, TIRE CLEANERS, LEATHER AND VINYL CLEANERS, FLOOR CLEANERS, IN CLASS 3 (U.S. CLS. 1, 4, 6, 50, 51 AND 52).

FIRST USE 6-0-1972; IN COMMERCE 6-0-1972.

NO CLAIM IS MADE TO THE EXCLUSIVE RIGHT TO USE "HOUSEHOLD PRODUCTS", APART FROM THE MARK AS SHOWN.

THE MARK CONSISTS OF A LABEL AFFIXED TO PACKAGING WITH THE WORDS "AHP AMERICAN HOUSEHOLD PRODUCTS".

SEC. 2(F) AS TO "AMERICAN HOUSEHOLD PRODUCTS".

SER. NO. 77-231,225, FILED 7-17-2007.

MIDGE BUTLER, EXAMINING ATTORNEY



**Int. Cl.: 16**

**Prior U.S. Cls.: 2, 5, 22, 23, 29, 37, 38 and 50**

**Reg. No. 3,568,966**

**United States Patent and Trademark Office**

**Registered Feb. 3, 2009**

**TRADEMARK  
PRINCIPAL REGISTER**



BAUER CONSUMER MEDIA LIMITED (UNITED  
KINGDOM CORPORATION)  
40 BERNARD STREET  
LONDON, UNITED KINGDOM WC1N 1LW

FOR: PRINTED MATERIALS, NAMELY, MAGAZINES, NEWSPAPERS, NEWSLETTERS AND PAMPHLETS IN THE FIELD OF HEALTH AND BEAUTY; PRINTED INSTRUCTIONAL, EDUCATIONAL AND TEACHING MATERIALS IN THE FIELD OF HEALTH AND BEAUTY; AND UNMOUNTED PHOTOGRAPHS, IN CLASS 16 (U.S. CLS. 2, 5, 22, 23, 29, 37, 38 AND 50).

OWNER OF UNITED KINGDOM REG. NO. 1513260, DATED 8-18-1995, EXPIRES 9-22-2009.

OWNER OF U.S. REG. NO. 2,486,693.

NO CLAIM IS MADE TO THE EXCLUSIVE RIGHT TO USE "SANTE" AND "HEALTH & BEAUTY", APART FROM THE MARK AS SHOWN.

THE MARK CONSISTS OF THE WORDS "TOP SANTÉ HEALTH & BEAUTY" IN WHITE LETTERS IN A BLACK BOX.

THE FOREIGN WORDING IN THE MARK TRANSLATES INTO ENGLISH AS "HEALTH".

SER. NO. 77-231,515, FILED 7-17-2007.

KELLY MCCOY, EXAMINING ATTORNEY

**Int. Cls.: 1, 5, 9, 10 and 16**

**Prior U.S. Cls.: 1, 2, 5, 6, 10, 18, 21, 22, 23, 26, 29, 36, 37, 38, 39, 44, 46, 50, 51 and 52**

**Reg. No. 3,568,967**

**United States Patent and Trademark Office**

**Registered Feb. 3, 2009**

**TRADEMARK  
PRINCIPAL REGISTER**



COVIDIEN AG (SWITZERLAND CORPORATION)  
VICTOR VON BRUNS-STRASSE 19  
NEUHAUSEN AM RHEINFALL, SWITZERLAND  
8212

FOR: CHEMICALS FOR LABORATORY USE; CHEMICALS AND CHEMICAL ADDITIVES FOR THE MANUFACTURE OF PHARMACEUTICALS, MEDICAL PRODUCTS, FOOD AND MICROELECTRONIC DEVICES; CHEMICALS USED IN THE FIELD OF PROCESS CHROMATOGRAPHY; REAGENTS FOR CHEMICAL OR BIOLOGICAL ANALYSIS; CHEMICAL COMPOSITIONS FOR SOLIDIFICATION AND ABSORPTION OF FLUIDS AND LIQUIDS; CHEMICAL SPILL CLEAN UP KITS COMPRISED PRIMARILY OF CHEMICAL COMPOSITIONS FOR SOLIDIFICATION AND ABSORPTION OF FLUIDS AND LIQUIDS; CHEMICAL ANTI FOG PREPARATIONS, IN CLASS 1 (U.S. CLS. 1, 5, 6, 10, 26 AND 46).

FOR: PHARMACEUTICALS AND PHARMACEUTICAL INGREDIENTS SOLD AS INTEGRAL COMPONENTS OF FINISHED PHARMACEUTICALS, NAMELY, PREPARATIONS FOR THE TREATMENT OF NEUROLOGICAL, LEARNING, BEHAVIORAL, SLEEPING, ATTENTION DEFICIT AND ATTENTION DEFICIT HYPERACTIVITY DISORDERS, SUBSTANCE ABUSE, COLD AND FLU SYMPTOMS, ALLERGIES, DEPRESSION AND PAIN; MEDICATED SKIN CARE PREPARATIONS; CLEANSING SOLUTIONS FOR MEDICAL AND SURGICAL USE; DISINFECTING HAND AND BODY WASH FOR USE BEFORE SURGERY; SURGICAL PAINTS TO MARK THE HUMAN BODY BEFORE SURGERY; MEDICAL GELS FOR CONDUCTIVITY AND IMAGING PURPOSES; BIOMATERIAL SURGICAL SEALANTS AND ADHESION BARRIERS; TOPICAL HUMAN TISSUE ADHESIVES; MEDICAL AND SURGICAL ANTI-ADHESIVES AND RESORBABLE HYDROPHILIC ADHESION-PREVENTION FILMS; PADS FOR ABSORPTION OF MEDICAL WASTE; CONTRAST MEDIA, DYES AND RADIOISOTOPES FOR MEDICAL IMAGING AND DIAGNOSTIC PURPOSES; CHEMICAL SOLUTIONS TO FILL AND FLUSH CATHETERS; PREFILLED SYRINGES CONTAINING CONTRAST MEDIA FOR IMAGING PURPOSES; SURGICAL AND WOUND DRESSINGS, SPONGES, PADS, AND TAPES; INCONTINENCE PADS, DIAPERS AND GARMENTS; DIETETIC FOOD AND PREPARATIONS FOR MEDICAL USE; ENTERAL FEEDING PREPARATIONS; NUTRITIONAL AND FOOD SUPPLEMENTS FOR MEDICAL PURPOSES; MEDICAL WAX; MEDICAL BANDAGES, NAMELY, ADHESIVE BANDAGES, BANDAGES FOR SKIN WOUNDS, BANDAGES FOR DRESSINGS AND/OR SURGICAL BANDAGES, IN CLASS 5 (U.S. CLS. 6, 18, 44, 46, 51 AND 52).

FOR: COMPUTER SOFTWARE AND FIRMWARE FOR USE IN OPERATING ELECTROSURGICAL GENERATORS, MRI DIAGNOSTIC APPARATUS, SLEEP DIAGNOSTIC APPARATUS AND SLEEP THERAPY APPARATUS; COMPUTER SOFTWARE USED FOR PATIENT RECORD MANAGEMENT; ELECTRONIC THERMOMETERS FOR LABORATORY USE; TEMPERATURE SENSORS AND MONITORS; PROTECTIVE CLOTHING, PROTECTIVE MASKS; NEEDLE AND BLADE COUNTING APPARATUS; ALKALINE BATTERIES, IN CLASS 9 (U.S. CLS. 21, 23, 26, 36 AND 38).

FOR: MEDICAL AND SURGICAL APPARATUS AND INSTRUMENTS, NAMELY, MEDICAL, SURGICAL AND PATIENT HEALTH SENSORS, SCANNERS, DETECTORS, METERS AND MONITORS ALL FOR USE IN MEASURING AND MONITORING THE VITAL FUNCTIONS IN HUMANS AND

ANIMALS AND ELECTRODES, CABLES AND LEAD WIRES AS ACCESSORIES THEREFOR; MEDICAL AND THERAPEUTIC PUMPS FOR ENTERAL FEEDING; AIR PUMPS TO BE USED AS PART OF MEDICAL VENTILATION SYSTEMS; DRUG DELIVERY SYSTEMS, AND INFUSION SETS; PAIN MANAGEMENT SYSTEMS PRIMARILY COMPOSED OF ELECTRICAL GENERATORS AND ELECTRODES; MEDICAL IMAGING APPARATUS FOR UROLOGICAL EXAMINATIONS; MEDICAL APPARATUS FOR THE TREATMENT OF PULMONARY DISORDERS AND CONDITIONS, NAMELY, PORTABLE AND STATIONARY OXYGEN THERAPY UNITS PRIMARILY COMPOSED OF AN OXYGEN RESERVOIR, A CONTROL UNIT AND TUBING; MEDICAL VENTILATION AND RESPIRATION SYSTEMS PRIMARILY COMPOSED OF MEDICAL VENTILATORS, MEDICAL RESPIRATORS, INHALERS AND NEBULIZERS; SURGICAL SCRUB SUITS, SURGICAL MASKS; MEDICAL AND SURGICAL GLOVES; APPARATUS FOR DRAWING BLOOD; CONTAINERS AND BAGS FOR MEDICAL WASTE AND BRACKETS THEREFOR; MEDICAL, SURGICAL AND DENTAL NEEDLES AND SYRINGES; MEDICAL NEEDLE HOLDERS AND NEEDLE TRAYS; CANNULAS, SCALPELS AND LANCETS FOR MEDICAL AND SURGICAL USE; BLOOD AND SPECIMEN COLLECTION TUBES, BAGS, CONTAINERS AND TRAYS; GUIDE WIRES FOR MEDICAL AND SURGICAL USE; MEDICAL AND SURGICAL TUBES AND CATHETERS; MEDICAL AND SURGICAL CHEST DRAINAGE APPARATUS; VASCULAR ACCESS SYSTEMS COMPOSED OF DILATORS, RADIALLY EXPANDABLE SLEEVES, REDUCERS AND SEALS; VASCULAR COMPRESSION SYSTEMS PRIMARILY COMPOSED OF ELECTRONIC CONTROLLER, TUBING AND MEDICAL LEG GARMENTS; ELASTIC STOCKINGS FOR MEDICAL USE; SEALS FOR MEDICAL BOTTLES, VIALS AND BAGS; SEALS FOR SYRINGES AND MEDICATION CONTAINERS; PATIENT SAFETY RESTRAINTS, NAMELY, HEAD AND BODY RESTRAINTS, HARNESES AND SURGICAL POSITIONERS; ELECTRIC BLANKETS FOR MEDICAL AND SURGICAL PURPOSES; HOT AND COLD PACKS FOR MEDICAL USE; ENTERAL FEEDING PUMPS, TUBES AND BAGS; INCONTINENCE BED PADS AND BED PROTECTORS; BRONCHIAL, TRACHEAL AND TRACHEOSTOMY TUBES; MEDICAL EQUIPMENT USED IN THE DIAGNOSIS AND TREATMENT OF SLEEP DISORDERS, NAMELY, RECORDING SYSTEMS, MASKS, HEADGEAR AND OXYGEN UNITS; RESUSCITATION APPARATUS AND BAGS; SURGICAL ASPIRATORS AND TUBING THEREFOR; MEDICAL SMOKE EVACUATOR SYSTEMS FOR CAPTURING AND FILTERING SMOKE DURING ELECTROSURGICAL PROCEDURES AND EVACUATOR TOOLS, TUBES AND TIPS TO BE USED THEREWITH; ARGON GAS DELIVERY UNITS FOR MEDICAL USE; BREATHING MASKS FOR SURGICAL PROCEDURES; WOUND DRAINAGE APPARATUS; SURGICAL IMPLANTS, NAMELY, ABSORBABLE AND NON-ABSORBABLE MESH; SURGICAL IMPLANTS

COMPRISING ARTIFICIAL MATERIAL; SURGICAL INSTRUMENTS FOR USE WITH IMPLANTS; MEDICAL THERMOMETERS AND TEMPERATURE PROBE; POWER INJECTORS FOR CONTRAST MEDIA IMAGING INJECTION PROCEDURES; PULSE OXIMETRY SENSORS AND CABLES USED AND SOLD THEREWITH; SUTURES, SUTURE ANCHORS, SUTURE LIGATURES, SUTURING NEEDLES AND DEVICES; ELECTROSURGICAL GENERATORS AND DEVICES AND ELECTRODES TO BE USED THEREWITH; MEDICAL AND SURGICAL VESSEL AND TISSUE SEALING DEVICES; ENDOSCOPIC AND LAPAROSCOPIC INSTRUMENTS AND DEVICES; SURGICAL TROCARS, BALLOON TROCARS, SURGICAL BALLOONS AND BALLOON DISSECTORS; STENTS; BIPOLAR SCISSORS FOR SURGICAL USE; SURGICAL DEVICES IN THE NATURE OF AORTIC PUNCHES; MEDICAL AND SURGICAL INSUFFLATION NEEDLES, LIGATING LOOPS, KNOT PUSHERS, DISSECTORS, CLAMPS, GRASPERS AND RETRACTORS; SURGICAL ANCHORING DEVICES, NAMELY, DRILL GUIDES AND BITS; SURGICAL DRILL GUIDE OBTURATORS; SURGICAL CLIP APPLIERS; SURGICAL TISSUE FIXATION DEVICES; MEDICAL AND SURGICAL STAPLERS AND FASTENERS; IRRIGATION SYSTEMS FOR CLEANSING BODY CAVITIES PRIMARILY COMPRISED OF SYRINGE, DISINFECTANT PREPARATION PAD AND PROTECTOR CAP; MEDICAL AND SURGICAL STERILIZATION TRAYS; VEIN HARVEST SYSTEMS AND DEVICES COMPRISED OF BALLOON DISSECTOR AND RETRACTOR; MEDICAL BANDAGES, NAMELY, BANDAGES FOR ANATOMICAL JOINTS, COMPRESSION BANDAGES, ELASTIC BANDAGES, SUPPORT BANDAGES AND/OR SUPPORTIVE BANDAGES, IN CLASS 10 (U.S. CLS. 26, 39 AND 44).

FOR: PRINTED EDUCATIONAL AND INSTRUCTIONAL MATERIALS, NAMELY, PAMPHLETS, BOOKS AND BOOKLETS CONCERNING HUMAN HEALTH AND DISPENSING OF PHARMACEUTICALS; MEDICAL CHARTING PAPER AND PRINTED MEDICAL LABELS, NAMELY, PRINTED MEDICAL LABELS MADE OF PAPER OR CARDBOARD AND ADHESIVE LABELS; DISPOSABLE DIAPERS AND TRAINING PANTS, IN CLASS 16 (U.S. CLS. 2, 5, 22, 23, 29, 37, 38 AND 50).

PRIORITY CLAIMED UNDER SEC. 44(D) ON SWITZERLAND APPLICATION NO. 50832/2007, FILED 1-23-2007, REG. NO. 555921, DATED 1-23-2007, EXPIRES 1-23-2017.

THE MARK CONSISTS OF TWO LETTER "C"'S, WITH ONE REVERSED SO THAT THEY ARE FACING EACH OTHER, COMBINED WITH THE DESIGNATION "COVIDIEN".

SER. NO. 77-233,865, FILED 7-19-2007.

DANIEL CAPSHAW, EXAMINING ATTORNEY

**Int. Cl.: 2**

**Prior U.S. Cls.: 6, 11 and 16**

**United States Patent and Trademark Office**

**Reg. No. 3,568,968**

**Registered Feb. 3, 2009**

**TRADEMARK  
PRINCIPAL REGISTER**

**Sterilcoat AM**

PROTECH CHEMICALS LTD./PROTECH CHIMIE  
LTEE (CANADA LIMITED LIABILITY COM-  
PANY)

7600 OUEST HENRI-BOURASSA

SAINT-LAURENT, QUEBEC, CANADA H4S1W3

FOR: POWDER COATINGS AND POWDER  
PAINTS CONSISTING OF RESINS AND PIGMENTS  
FOR APPLICATION TO METAL SUBSTRATES, IN  
CLASS 2 (U.S. CLS. 6, 11 AND 16).

THE MARK CONSISTS OF STANDARD CHAR-  
ACTERS WITHOUT CLAIM TO ANY PARTICULAR  
FONT, STYLE, SIZE, OR COLOR.

PRIORITY CLAIMED UNDER SEC. 44(D) ON  
CANADA APPLICATION NO. 1355946, FILED 7-17-  
2007, REG. NO. TMA723853, DATED 9-17-2008, EX-  
PIRES 9-17-2023.

SER. NO. 77-236,818, FILED 7-24-2007.

DAVID H. STINE, EXAMINING ATTORNEY

**Int. Cls.: 18 and 25**

**Prior U.S. Cls.: 1, 2, 3, 22, 39 and 41**

**United States Patent and Trademark Office**

**Reg. No. 3,568,969**

**Registered Feb. 3, 2009**

**TRADEMARK  
PRINCIPAL REGISTER**

# Concubine

CONCUBINE INC. (CANADA CORPORATION)  
2488 DUNKIRK  
MONT-ROYAL, CANADA H3R3K9

FOR: FASHION ACCESSORIES FOR WOMEN,  
NAMELY, HANDBAGS, IN CLASS 18 (U.S. CLS. 1,  
2, 3, 22 AND 41).

FOR: CLOTHING FOR WOMEN, NAMELY,  
PANTS, BLOUSES, SKIRTS, AND DRESSES , IN  
CLASS 25 (U.S. CLS. 22 AND 39).

THE MARK CONSISTS OF STANDARD CHAR-  
ACTERS WITHOUT CLAIM TO ANY PARTICULAR  
FONT, STYLE, SIZE, OR COLOR.

PRIORITY CLAIMED UNDER SEC. 44(D) ON  
CANADA APPLICATION NO. 1341537, FILED 3-29-  
2007, REG. NO. TMA718502, DATED 7-14-2008, EX-  
PIRES 7-14-2023.

SER. NO. 77-237,093, FILED 7-24-2007.

CHRISTINA SOBRAL, EXAMINING ATTORNEY

**Int. Cl.: 3**

**Prior U.S. Cls.: 1, 4, 6, 50, 51 and 52**

**Reg. No. 3,568,970**

**United States Patent and Trademark Office**

**Registered Feb. 3, 2009**

---

**TRADEMARK  
PRINCIPAL REGISTER**

# Island Gardenia

BELL, DENNIS EDWARD (UNITED STATES IN-  
DIVIDUAL)

APARTMENT 314 1002 SOUTH KIHEI ROAD

KIHEI, HI 96753

FOR: PERFUME; BODY LOTION, IN CLASS 3  
(U.S. CLS. 1, 4, 6, 50, 51 AND 52).

FIRST USE 11-23-1980; IN COMMERCE 11-23-1980.

THE MARK CONSISTS OF STANDARD CHAR-  
ACTERS WITHOUT CLAIM TO ANY PARTICULAR  
FONT, STYLE, SIZE, OR COLOR.

NO CLAIM IS MADE TO THE EXCLUSIVE  
RIGHT TO USE "GARDENIA", APART FROM THE  
MARK AS SHOWN.

SER. NO. 77-237,861, FILED 7-25-2007.

JULIE WATSON, EXAMINING ATTORNEY

Int. Cl.: 28

Prior U.S. Cls.: 22, 23, 38 and 50

Reg. No. 3,568,971

United States Patent and Trademark Office

Registered Feb. 3, 2009

TRADEMARK  
PRINCIPAL REGISTER

# Dekko Toys

DEKKO TOYS COMPANY (HONG KONG CORPORATION)  
14 SCIENCE MUSEUM ROAD, TSIM SHA TSUI EA  
1204-05, TOWER A., NEW MANDARIN PLAZA  
KOWLOON, HONG KONG

FOR: BABY MULTIPLE ACTIVITY TOYS; BATH TOYS; BATHTUB TOYS; BATTERY OPERATED ACTION TOYS; BENDABLE TOYS; CHILDREN'S ACTIVITY TABLES CONTAINING MANIPULATIVE TOYS WHICH CONVERT TO EASELS; CHILDREN'S MULTIPLE ACTIVITY TOYS; CHILDREN'S MULTIPLE ACTIVITY TOYS SOLD AS A UNIT WITH PRINTED BOOKS; CHILDREN'S WIRE CONSTRUCTION AND ART ACTIVITY TOYS; CLOCKWORK TOYS; CLOCKWORK TOYS; COLLECTABLE TOY FIGURES; CONSTRUCTION TOYS; CRIB TOYS; DISC TOSS TOYS; DRAWING TOYS; EDUCATIONAL TOY FOR THE PURPOSE OF THE DEMONSTRATION OF ALTERNATIVE ENERGY SOURCES; ELECTRIC ACTION TOYS; ELECTRIC EDUCATIONAL TOY USED TO DEMONSTRATE ALTERNATIVE ENERGY SOURCES; ELECTRIC TOY TRAIN TRANSFORMERS; ELECTRONIC ACTION TOYS; ELECTRONIC LEARNING TOYS; ELECTRONIC TOY BUILDING BLOCKS THAT LIGHT UP AS A NIGHT LIGHT; ELECTRONIC TOY VEHICLES; ELECTRONICALLY OPERATED TOY MOTOR VEHICLES; FANTASY CHARACTER TOYS; FLYING SAUCERS; INFANT ACTION CRIB TOYS; INFANT DEVELOPMENT TOYS; INFANT TOYS; INFLATABLE BATH TOYS; INFLATABLE RIDE-ON TOYS; INFLATABLE THIN RUBBER TOYS; INFLATABLE TOYS; INFLATABLE TOYS SHOWING DECORATIVE PICTURES; LEVER ACTION TOYS; MECHANICAL ACTION TOYS; MECHANICAL TOYS; MODEL TOY STEAM ENGINES; MODELED PLASTIC TOY FIGURINES; MOLDED TOY FIGURES; MUSIC BOX TOYS; MUSICAL TOYS; NON-ELECTRONIC TOY VEHICLES; NON-RIDING TRANSPORTATION TOYS; PARTY FAVORS IN THE NATURE OF SMALL TOYS;

PLASTIC CHARACTER TOYS; PLAY MATS CONTAINING INFANT TOYS; PLAY MATS FOR USE WITH TOY VEHICLES; PLUSH TOYS; POP UP TOYS; POSITIONABLE PRINTED TOY FIGURES FOR USE IN GAMES; POSITIONABLE PRINTED TOY FIGURES FOR USE IN PUZZLES; POSITIONABLE THREE DIMENSIONAL TOYS FOR USE IN GAMES; POSITIONABLE TOY FIGURES; PRINTING TOYS; PULL TOYS; PUNCHING TOYS; PUSH TOYS; RADIO CONTROLLED TOY VEHICLES; RADIO TRANSMITTERS FOR USE WITH RADIO-CONTROLLED TOYS; REMOTE CONTROL TOYS, NAMELY VEHICLES; RIDE-ON TOYS; RUBBER CHARACTER TOYS; SAND TOYS; SANDBOX TOYS; SKETCHING TOYS; SOFT SCULPTURE PLUSH TOYS; SOFT SCULPTURE TOYS; SQUEEZABLE SQUEAKING TOYS; SQUEEZE TOYS; STACKING TOYS; STUFFED TOY ANIMALS; STUFFED TOY BEARS; STUFFED TOYS; TALKING TOYS; TESSELLATION TOYS; TOSSING DISC TOYS; TOY CHRISTMAS TREES; TOY ACTION FIGURES; TOY ACTION FIGURES AND ACCESSORIES THEREFOR; TOY AIRPLANES; TOY ANIMALS AND ACCESSORIES THEREFOR; TOY ARMOR; TOY ARTIFICIAL FINGERNAILS; TOY BAKEWARE AND COOKWARE; TOY BANKS; TOY BOWS AND ARROWS; TOY BOXES; TOY BUILDING BLOCKS; TOY BUILDING BLOCKS CAPABLE OF INTERCONNECTION; TOY BUILDINGS AND ACCESSORIES THEREFOR; TOY BUTTERFLY NETS; TOY CAP PISTOLS; TOY CLOCKS AND WATCHES; TOY CONSTRUCTION BLOCKS; TOY CONSTRUCTION SETS; TOY FIGURES; TOY FILM CARTRIDGES AND VIEWERS; TOY FURNITURE; TOY GLIDERS; TOY GLOCKENSPIELS; TOY GUNS; TOY HARMONICAS; TOY HOLSTERS; TOY HOOP SETS; TOY HOUSES; TOY MAIL BOXES; TOY MASKS; TOY MOBILES; TOY MODEL CARS; TOY MODEL HOBBYCRAFT KITS; TOY MODEL KIT CARS; TOY MODEL TRAIN SETS; TOY MODEL VEHICLES AND RELATED ACCESSORIES SOLD AS UNITS; TOY MODELING DOUGH; TOY MUSIC

BOXES; TOY NOISEMAKERS; TOY PIANOS; TOY PIANOS, SOLD AS A UNIT WITH PRINTED BOOKS IN THE FIELD OF MUSIC EDUCATION; TOY PISTOLS; TOY PRISM GLASSES; TOY PUTTY; TOY RECORD PLAYERS; TOY ROBOTS; TOY ROCKETS; TOY SCOOTERS; TOY SETS OF CARPENTERS' TOOLS; TOY SNOW GLOBES; TOY STAMPS; TOY SWORDS; TOY TRAINS AND PARTS AND ACCESSORIES THEREFOR; TOY VEHICLE TRACK SETS AND ROADWAYS AND ACCESSORIES THEREFOR; TOY VEHICLES; TOY VEHICLES AND ACCESSORIES THEREFOR; TOY VEHICLES WITH TRANSFORMING PARTS; TOY WATCHES; TOY WATER GLOBES; TOY WEAPONS; TOY WIND SOCKS; TOY XYLOPHONES; TOY ZIP GUNS; TOY, NAMELY, BATTERY-POWERED COMPUTER GAME WITH LCD SCREEN WHICH FEATURES ANIMATION AND SOUND EFFECTS; TOYS DESIGNED TO BE ATTACHED TO CARS, STROLLERS, CRIBS; TOYS, NAMELY, A DISK TO TOSS IN PLAYING A GAME WHEREIN OTHER DISKS ARE FLIPPED AND COLLECTED; TRANSFORMING ROBOTIC TOY VEHICLES; TRANSFORMING ROBOTIC TOYS; WATER SQUIRTING TOYS; WIND-UP TOYS; WIND-UP WALKING TOYS; ACTION FIGURES; ACTION SKILL GAMES; ACTION TARGET GAMES; ACTION-TYPE TARGET GAMES;

ARCADE GAMES; ARCADE-TYPE ELECTRONIC EDUCATION VIDEO GAMES; ARCADE-TYPE ELECTRONIC VIDEO GAMES; CHECKER SETS; CHESS SETS; ELECTRONIC DART GAMES; ELECTRONIC EDUCATIONAL GAME MACHINES FOR CHILDREN; ELECTRONIC TARGETS FOR GAMES AND SPORTS, IN CLASS 28 (U.S. CLS. 22, 23, 38 AND 50).

FIRST USE 5-10-2007; IN COMMERCE 5-10-2007.

THE MARK CONSISTS OF STANDARD CHARACTERS WITHOUT CLAIM TO ANY PARTICULAR FONT, STYLE, SIZE, OR COLOR.

PRIORITY CLAIMED UNDER SEC. 44(D) ON HONG KONG APPLICATION NO. 300867385, FILED 5-9-2007, REG. NO. 300867385, DATED 5-9-2007, EXPIRES 5-9-2017.

NO CLAIM IS MADE TO THE EXCLUSIVE RIGHT TO USE "TOYS", APART FROM THE MARK AS SHOWN.

SER. NO. 77-243,455, FILED 7-31-2007.

MARY BOAGNI, EXAMINING ATTORNEY



Int. Cl.: 43

Prior U.S. Cls.: 100 and 101

United States Patent and Trademark Office

Reg. No. 3,568,972

Registered Feb. 3, 2009

SERVICE MARK  
PRINCIPAL REGISTER

Seito Sushi 

CHIN, SEIL (UNITED STATES INDIVIDUAL),  
DBA SEITO SUSHI  
4898 NEW BROAD ST  
ORLANDO, FL 32814

FOR: RESTAURANT AND BAR SERVICES; RESTAURANTS; TAKE-OUT RESTAURANT SERVICES, IN CLASS 43 (U.S. CLS. 100 AND 101).

FIRST USE 1-1-2002; IN COMMERCE 3-1-2003.

NO CLAIM IS MADE TO THE EXCLUSIVE RIGHT TO USE "SUSHI", APART FROM THE MARK AS SHOWN.

THE MARK CONSISTS OF THE WORDING "SEITO SUSHI" AND THE NON-LATIN CHARACTER

SIGNIFYING "SEITO" OVER A HORIZONTAL LINE THAT ENDS WITH A DIAMOND DESIGN AT THE RIGHT HAND SIDE.

THE FOREIGN WORDING "SEITO" IN THE MARK TRANSLATES INTO ENGLISH AS GREATNESS.

THE NON-LATIN CHARACTER(S) IN THE MARK TRANSLITERATES INTO SEITO, AND THIS MEANS GREATNESS IN ENGLISH.

SER. NO. 77-251,244, FILED 8-9-2007.

BRIAN PINO, EXAMINING ATTORNEY

**Int. Cl.: 27**

**Prior U.S. Cls.: 19, 20, 37, 42 and 50**

**Reg. No. 3,568,973**

**United States Patent and Trademark Office**

**Registered Feb. 3, 2009**

**TRADEMARK  
PRINCIPAL REGISTER**

**PRODECK**

SPORT RESOURCE GROUP, INC. (MINNESOTA  
CORPORATION)  
2751 HENNEPIN AVENUE SOUTH  
SUITE 279  
MINNEAPOLIS, MN 55408

FOR: PROTECTIVE FLOOR COVERINGS, NAME-  
LY, INSULATED ICE ARENA FLOOR COVER SYS-  
TEM, NAMELY, NON-POROUS WAFFLE AND  
SOLID SHEETS MADE FROM PLASTIC AND FI-  
BERGLASS COMPOSITE, IN CLASS 27 (U.S. CLS. 19,  
20, 37, 42 AND 50).

FIRST USE 4-27-2007; IN COMMERCE 4-27-2007.

THE MARK CONSISTS OF STANDARD CHAR-  
ACTERS WITHOUT CLAIM TO ANY PARTICULAR  
FONT, STYLE, SIZE, OR COLOR.

SER. NO. 77-251,536, FILED 8-9-2007.

PAUL MORENO, EXAMINING ATTORNEY

Int. Cl.: 41

Prior U.S. Cls.: 100, 101 and 107

United States Patent and Trademark Office

Reg. No. 3,568,974

Registered Feb. 3, 2009

SERVICE MARK  
PRINCIPAL REGISTER



UNITED STATES FOOTBALL CLUB, LLC (CALIFORNIA LIMITED LIABILITY COMPANY)  
SUITE 806  
16000 VENTURA BOULEVARD  
ENCINO, CA 91436

FOR: EDUCATION SERVICES, NAMELY, MENTORING IN THE FIELD OF YOUTH SOCCER DEVELOPMENT; EDUCATION SERVICES, NAMELY, ONE-ON-ONE MENTORING IN THE FIELD OF YOUTH SOCCER DEVELOPMENT; EDUCATION SERVICES, NAMELY, PROVIDING TECHNICAL SKILLS CLASSES, TESTING, AND ASSESSMENTS IN THE FIELD OF YOUTH SOCCER DEVELOPMENT; ENCOURAGING AMATEUR SPORTS AND PHYSICAL EDUCATION BY ORGANIZING, PRO-

MOTING, SPONSORING, SANCTIONING, CONDUCTING, ADMINISTERING, REGULATING AND GOVERNING AMATEUR ATHLETIC PROGRAMS AND ACTIVITIES, IN CLASS 41 (U.S. CLS. 100, 101 AND 107).

FIRST USE 4-23-2007; IN COMMERCE 4-23-2007.

NO CLAIM IS MADE TO THE EXCLUSIVE RIGHT TO USE "U.S. FOOTBALL CLUB" AND THE PICTORIAL REPRESENTATION OF A SOCCER BALL, APART FROM THE MARK AS SHOWN.

SER. NO. 77-251,675, FILED 8-9-2007.

PAUL MORENO, EXAMINING ATTORNEY

Int. Cl.: 38

Prior U.S. Cls.: 100, 101 and 104

United States Patent and Trademark Office

Reg. No. 3,568,975

Registered Feb. 3, 2009

SERVICE MARK  
PRINCIPAL REGISTER

# NEOPOET

ALKON, ANDREW LOUIS (UNITED STATES  
INDIVIDUAL)  
3904 CENTRAL AVENUE PMB A106  
CHEYENNE, WY 82001 AND  
ANAGNOSTOPOULOS, PAUL (UNITED STATES  
INDIVIDUAL)  
3904 CENTRAL AVENUE PMB A106  
CHEYENNE, WY 82001

FOR: INTERNET BROADCASTING SERVICES;  
PROVIDING MULTIPLE-USER ACCESS TO A GLO-  
BAL COMPUTER INFORMATION NETWORK;  
PROVIDING PRIVATE AND SECURE REAL TIME  
ELECTRONIC COMMUNICATION OVER A COM-  
PUTER NETWORK; PROVIDING TELECOMMUNI-  
CATIONS CONNECTIONS TO A GLOBAL  
COMPUTER NETWORK; VOICE CHAT SERVICES;  
VOICE MAIL SERVICES; VOICE OVER INTERNET  
PROTOCOL (VOIP) SERVICES; STREAMING OF  
VIDEO MATERIAL ON THE INTERNET; PROVID-  
ING ON-LINE CHAT ROOMS AND ELECTRONIC  
BULLETIN BOARDS FOR TRANSMISSION OF  
MESSAGES AMONG USERS IN THE FIELD OF

GENERAL INTEREST; PROVIDING ON-LINE  
CHAT ROOMS FOR TRANSMISSION OF MESSA-  
GES AMONG COMPUTER USERS CONCERNING  
POETRY; ELECTRONIC EXCHANGE OF DATA  
STORED IN DATABASES ACCESSIBLE VIA TELE-  
COMMUNICATION NETWORKS; TRANSMISSION  
AND RECEPTION OF DATABASE INFORMATION  
VIA THE TELECOMMUNICATION NETWORK;  
TRANSMISSION OF DATABASE INFORMATION  
VIA TELECOMMUNICATIONS NETWORKS, IN  
CLASS 38 (U.S. CLS. 100, 101 AND 104).

FIRST USE 2-28-2003; IN COMMERCE 3-3-2003.

THE MARK CONSISTS OF STANDARD CHAR-  
ACTERS WITHOUT CLAIM TO ANY PARTICULAR  
FONT, STYLE, SIZE, OR COLOR.

SER. NO. 77-253,398, FILED 8-13-2007.

BERYL GARDNER, EXAMINING ATTORNEY

**Int. Cl.: 39**

**Prior U.S. Cls.: 100 and 105**

**United States Patent and Trademark Office**

**Reg. No. 3,568,976**

**Registered Feb. 3, 2009**

**SERVICE MARK  
PRINCIPAL REGISTER**

**"Working today for a  
better tomorrow... The  
world may be a different  
place because I was  
important in a child's  
life."**

HUNTER INVESTIGATIONS LLC (GEORGIA  
LIMITED LIABILITY COMPANY)  
13309 FREEMANVILLE ROAD  
ALPHARETTA, GA 30004

THE MARK CONSISTS OF STANDARD CHAR-  
ACTERS WITHOUT CLAIM TO ANY PARTICULAR  
FONT, STYLE, SIZE, OR COLOR.

FOR: ADOLESCENT TRANSPORT SERVICE BY  
AIR, RAIL, OR CAR, IN CLASS 39 (U.S. CLS. 100  
AND 105).

SER. NO. 77-257,537, FILED 8-16-2007.

FIRST USE 12-1-2004; IN COMMERCE 12-1-2004.

TRACY CROSS, EXAMINING ATTORNEY

**Int. Cl.: 1**

**Prior U.S. Cls.: 1, 5, 6, 10, 26 and 46**

**Reg. No. 3,568,977**

**United States Patent and Trademark Office**

**Registered Feb. 3, 2009**

**TRADEMARK  
PRINCIPAL REGISTER**

**MICOCIN**

CANBIOCIN INC. (CANADA CORPORATION)  
1015, 8308-114 STREET  
EDMONTON, CANADA T5J4K1

FOR: PRESERVATIVES FOR CONTROLLING PATHOGENIC AND SPOILAGE BACTERIA IN FOOD, NOT FOR PHARMACEUTICAL, MEDICAL AND/OR THERAPEUTIC USE, AND NOT SOLD TO PHARMACEUTICAL WHOLESALERS, RETAILERS, HOSPITALS AND/OR ANY OTHER ENTITY OR PERSON DEALING IN THE MANUFACTURE, DISTRIBUTION AND/OR SALE OF PHARMACEUTI-

CAL AND/OR MEDICAL PRODUCTS, IN CLASS 1 (U.S. CLS. 1, 5, 6, 10, 26 AND 46).

THE MARK CONSISTS OF STANDARD CHARACTERS WITHOUT CLAIM TO ANY PARTICULAR FONT, STYLE, SIZE, OR COLOR.

OWNER OF CANADA REG. NO. TMA684582, DATED 3-23-2007, EXPIRES 3-23-2022.

SER. NO. 77-258,536, FILED 8-17-2007.

ALEX KEAM, EXAMINING ATTORNEY

**Int. Cls.: 12 and 25**

**Prior U.S. Cls.: 19, 21, 22, 23, 31, 35, 39 and 44**

**United States Patent and Trademark Office**

**Reg. No. 3,568,978**

**Registered Feb. 3, 2009**

**TRADEMARK  
PRINCIPAL REGISTER**

# Bagger Nation

PAUL YAFFE DESIGN, INC. (ARIZONA CORPORATION)  
2211 EAST INDIAN SCHOOL ROAD  
PHOENIX, AZ 85016

FOR: MOTORCYCLES AND STRUCTURAL PARTS THEREOF, AND MOTORCYCLE PARTS AND ACCESSORIES, NAMELY, GAS TANKS, FRONT AND REAR FENDERS, HANDLE BARS, HANDLE BAR GRIPS, LICENSE PLATE HOLDERS, WHEELS, AND DASH PANELS, IN CLASS 12 (U.S. CLS. 19, 21, 23, 31, 35 AND 44).

FIRST USE 8-20-2007; IN COMMERCE 8-20-2007.

FOR: APPAREL, NAMELY, MOTORCYCLE-THEMED SHIRTS, JACKETS, AND CLOTHING

ACCESSORIES BEING HEADWEAR, IN CLASS 25 (U.S. CLS. 22 AND 39).

FIRST USE 8-20-2007; IN COMMERCE 8-20-2007.

THE MARK CONSISTS OF STANDARD CHARACTERS WITHOUT CLAIM TO ANY PARTICULAR FONT, STYLE, SIZE, OR COLOR.

NO CLAIM IS MADE TO THE EXCLUSIVE RIGHT TO USE "BAGGER", APART FROM THE MARK AS SHOWN.

SER. NO. 77-260,110, FILED 8-20-2007.

BRENDAN REGAN, EXAMINING ATTORNEY

**Int. Cls.: 9, 18 and 25**

**Prior U.S. Cls.: 1, 2, 3, 21, 22, 23, 26, 36, 38, 39 and 41**

**United States Patent and Trademark Office**

**Reg. No. 3,568,979**

**Registered Feb. 3, 2009**

**TRADEMARK  
PRINCIPAL REGISTER**



BALENCIAGA (FRANCE CORPORATION)  
15 RUE CASSETTE  
PARIS, FRANCE 75006

FOR: SPECTACLE FRAMES; SPECTACLES; SUNGLASSES; TINTED OR FILTER OPTICAL GLASSES; OPTICAL GLASSES; PROTECTIVE GLASSES; EYEGASSES; OPERA GLASSES; MAGNIFYING GLASSES; OPTICAL LENSES; OPTICAL FRAMES AND THEIR CASES, IN CLASS 9 (U.S. CLS. 21, 23, 26, 36 AND 38).

FOR: LEATHER AND IMITATION OF LEATHER; ANIMAL SKINS AND IMITATION OF ANIMAL SKINS; LEATHER GOODS AND IMITATION OF LEATHER GOODS, NAMELY, HANDBAGS, LUGGAGE, WALLETS, PURSES, BRIEFCASES, SCHOOL BAGS, BEACH BAGS, TRAVEL BAGS, SUITCASES, HIDES, TRUNKS AND TRAVELING BAGS, RUCKSACKS, SHOPPING BAGS, VANITY CASES SOLD EMPTY, UMBRELLAS, PARASOLS, WALKING STICKS, CANES, TOILETRY BAGS SOLD EMPTY, TRAVELING CASES, TRAVELING LUGGAGE SETS, ATTACHÉ CASES, KEY CASES IN LEATHER, HARNESSES FOR ANIMALS; WHIPS; SADDLERY, IN CLASS 18 (U.S. CLS. 1, 2, 3, 22 AND 41).

FOR: MEN'S, WOMEN'S AND CHILDREN'S CLOTHING, NAMELY, SUITS, COATS, JACKETS,

PANTS, SHIRTS, RAINCOATS, SWEATSUITS, UNDERWEAR, PULLOVERS, KNIT SHIRTS, AND UNDER GARMENTS; EVENING WEAR, NAMELY, EVENING DRESSES, EVENING GOWNS, EVENING WRAPS, TUXEDOS, BLAZERS, AND THREE-QUARTER COATS; HOSIERY, NAMELY, SOCKS AND STOCKINGS; KNITWEAR CLOTHING, NAMELY, SWEATERS, KNITTED UNDERWEAR, AND KNIT CAPS; SPORTSWEAR, NAMELY, SPORTS SHIRTS, SPORT JERSEYS, SPORT PANTS; CLOTHING ACCESSORIES, NAMELY, SUSPENDERS, TIES, BOW TIES, AND SCARVES; BELTS FOR CLOTHING; GLOVES; FOOTWEAR AND HEADWEAR, IN CLASS 25 (U.S. CLS. 22 AND 39).

PRIORITY CLAIMED UNDER SEC. 44(D) ON FRANCE APPLICATION NO. 07/3520948, FILED 8-24-2007, REG. NO. 073520948, DATED 8-24-2007, EXPIRES 8-24-2017.

OWNER OF U.S. REG. NOS. 1,663,898 AND 2,373,372.

THE MARK CONSISTS OF THE LETTER "B" AND A REVERSE LETTER "B" SHOWN BACK TO BACK.

SER. NO. 77-263,915, FILED 8-24-2007.

DANIEL BRODY, EXAMINING ATTORNEY



**Int. Cl.: 35**

**Prior U.S. Cls.: 100, 101 and 102**

**United States Patent and Trademark Office**

**Reg. No. 3,568,980**

**Registered Feb. 3, 2009**

**SERVICE MARK  
PRINCIPAL REGISTER**

# Strategic BCP

STRATEGIC BCP, INC. (PENNSYLVANIA CORPORATION)  
102 AVA COURT  
PLYMOUTH MEETING, PA 19462

FOR: BUSINESS ORGANISATION AND MANAGEMENT CONSULTING SERVICES, IN CLASS 35 (U.S. CLS. 100, 101 AND 102).

FIRST USE 8-4-2003; IN COMMERCE 4-1-2004.

THE MARK CONSISTS OF STANDARD CHARACTERS WITHOUT CLAIM TO ANY PARTICULAR FONT, STYLE, SIZE, OR COLOR.

NO CLAIM IS MADE TO THE EXCLUSIVE RIGHT TO USE "STRATEGIC", APART FROM THE MARK AS SHOWN.

SEC. 2(F).

SER. NO. 77-264,786, FILED 8-27-2007.

HEATHER SAPP, EXAMINING ATTORNEY

**Int. Cl.: 9**

**Prior U.S. Cls.: 21, 23, 26, 36 and 38**

**United States Patent and Trademark Office**

**Reg. No. 3,568,981**

**Registered Feb. 3, 2009**

**TRADEMARK  
PRINCIPAL REGISTER**

**IRROLIS**

HORTAU INC. (CANADA CORPORATION)  
735 RUE DE L'EGLISE  
SAINT-ROMUALD (QUEBEC), CANADA G6W5M6

FOR: INTELLIGENT IRRIGATION MANAGEMENT SYSTEM, COMPRISED OF SOIL OR ENVIRONMENTAL PARAMETER PROBES, RADIO FREQUENCY WIRELESS COMMUNICATION DEVICES OR MICROWAVE TECHNOLOGY WIRELESS COMMUNICATION DEVICES AND COMPUTER SOFTWARE FOR LOGGING AND TRANSMISSION OF DATA TO THE IRRIGATION MANAGER, IN CLASS 9 (U.S. CLS. 21, 23, 26, 36 AND 38).

FIRST USE 2-7-2007; IN COMMERCE 2-7-2007.

THE MARK CONSISTS OF STANDARD CHARACTERS WITHOUT CLAIM TO ANY PARTICULAR FONT, STYLE, SIZE, OR COLOR.

PRIORITY CLAIMED UNDER SEC. 44(D) ON CANADA APPLICATION NO. 1338554, FILED 3-8-2007, REG. NO. TMA717667, DATED 6-30-2008, EXPIRES 6-30-2023.

SER. NO. 77-266,118, FILED 8-28-2007.

MARK PILARO, EXAMINING ATTORNEY

**Int. Cls.: 38 and 41**

**Prior U.S. Cls.: 100, 101, 104 and 107**

**United States Patent and Trademark Office**

**Reg. No. 3,568,982**

**Registered Feb. 3, 2009**

**SERVICE MARK  
PRINCIPAL REGISTER**



THE MUSICIAN NETWORK, LLC. (KANSAS  
LIMITED LIABILITY COMPANY)

#357

7111 W.151ST STREET  
OVERLAND PARK, KS 66223

FOR: INTERNET BROADCASTING SERVICES  
FOR PROFESSIONAL AND AMATEUR MUSI-  
CIANS, IN CLASS 38 (U.S. CLS. 100, 101 AND 104).

FIRST USE 4-22-2006; IN COMMERCE 8-21-2007.

FOR: FILM AND VIDEO PRODUCTION SERVI-  
CES IN THE NATURE OF PRODUCTION OF EDU-  
CATIONAL AUDIO-VISUAL PROGRAMMING  
AND SHOWS SPECIFIC TO PROFESSIONAL AND  
AMATEUR MUSICIANS FOR DISTRIBUTION ON

GLOBAL COMPUTER NETWORKS, IN CLASS 41  
(U.S. CLS. 100, 101 AND 107).

FIRST USE 4-22-2006; IN COMMERCE 8-21-2007.

NO CLAIM IS MADE TO THE EXCLUSIVE  
RIGHT TO USE "THE MUSICIAN NETWORK",  
APART FROM THE MARK AS SHOWN.

THE MARK CONSISTS OF A SILHOUETTE OF A  
MAN PLAYING A GUITAR ONTOP OF A STAGE  
WITH THE WORDS "THE MUSICIAN NETWORK"  
CONTAINED THEREIN.

SER. NO. 77-269,672, FILED 8-31-2007.

ERIN FALK, EXAMINING ATTORNEY

**Int. Cls.: 36 and 45**

**Prior U.S. Cls.: 100, 101 and 102**

**United States Patent and Trademark Office**

**Reg. No. 3,568,983**

**Registered Feb. 3, 2009**

**SERVICE MARK  
PRINCIPAL REGISTER**

**BEANSTREAM INTERNET  
COMMERCE INC.**

BEANSTREAM INTERNET COMMERCE INC.  
(CANADA CORPORATION)  
302-2659 DOUGLAS STREET  
VICTORIA, CANADA V8T4M3

FOR: PROVIDING ELECTRONIC PROCESSING OF ELECTRONIC FUNDS TRANSFER, ACH, CREDIT CARD, DEBIT CARD, ELECTRONIC CHECK AND ELECTRONIC PAYMENTS; PROVIDING FINANCIAL RISK MANAGEMENT SERVICES FOR ELECTRONIC FUNDS TRANSFER, CREDIT AND DEBIT CARD AND ELECTRONIC CHECK TRANSACTIONS VIA A GLOBAL COMPUTER NETWORK, IN CLASS 36 (U.S. CLS. 100, 101 AND 102).

FOR: PROVIDING FRAUD DETECTION SERVICES FOR ELECTRONIC FUNDS TRANSFER, CREDIT AND DEBIT CARD AND ELECTRONIC CHECK TRANSACTIONS VIA A GLOBAL COMPUTER NETWORK; PROVIDING USER AUTHENTICATION OF ELECTRONIC FUNDS TRANSFER, CREDIT AND DEBIT CARD AND ELECTRONIC

CHECK TRANSACTIONS VIA A GLOBAL COMPUTER NETWORK, IN CLASS 45 (U.S. CLS. 100 AND 101).

THE MARK CONSISTS OF STANDARD CHARACTERS WITHOUT CLAIM TO ANY PARTICULAR FONT, STYLE, SIZE, OR COLOR.

PRIORITY CLAIMED UNDER SEC. 44(D) ON CANADA APPLICATION NO. 1361851, FILED 8-31-2007, REG. NO. TMA722834, DATED 9-3-2008, EXPIRES 9-3-2023.

NO CLAIM IS MADE TO THE EXCLUSIVE RIGHT TO USE "INTERNET COMMERCE INC.", APART FROM THE MARK AS SHOWN.

SER. NO. 77-271,244, FILED 9-4-2007.

CHRIS WELLS, EXAMINING ATTORNEY

**Int. Cls.: 1, 2 and 9**

**Prior U.S. Cls.: 1, 5, 6, 10, 11, 16, 21, 23, 26, 36, 38 and 46**

**United States Patent and Trademark Office**

**Reg. No. 3,568,984**

**Registered Feb. 3, 2009**

**TRADEMARK  
PRINCIPAL REGISTER**

**OCE TONERSAFE**

OCE-TECHNOLOGIES B.V. (NETHERLANDS  
COMPANY)  
ST. URBANUSWEG 43  
NL-5900 MA VENLO, NETHERLANDS

FOR: PRINTING MATERIALS, NAMELY, DEVELOPER FOR ELECTROGRAPHIC PROCESSES, IN CLASS 1 (U.S. CLS. 1, 5, 6, 10, 26 AND 46).

FOR: PRINTING MATERIALS, NAMELY, TONER AND PRINTING INK FOR DIGITAL PRINTERS; TONER AND PRINTING INK CARTRIDGES FOR DIGITAL PRINTERS, IN CLASS 2 (U.S. CLS. 6, 11 AND 16).

FOR: DIGITAL PRINTERS, IN CLASS 9 (U.S. CLS. 21, 23, 26, 36 AND 38).

THE MARK CONSISTS OF STANDARD CHARACTERS WITHOUT CLAIM TO ANY PARTICULAR FONT, STYLE, SIZE, OR COLOR.

PRIORITY CLAIMED UNDER SEC. 44(D) ON ERPN CMNTY TM OFC APPLICATION NO. 005760624, FILED 3-15-2007, REG. NO. 005760624, DATED 12-18-2007, EXPIRES 3-15-2017.

OWNER OF U.S. REG. NOS. 283,635 AND 2,685,400.

SER. NO. 77-271,267, FILED 9-4-2007.

SHARON MEIER, EXAMINING ATTORNEY

**Int. Cls.: 36 and 45**

**Prior U.S. Cls.: 100, 101 and 102**

**United States Patent and Trademark Office**

**Reg. No. 3,568,985**

**Registered Feb. 3, 2009**

**SERVICE MARK  
PRINCIPAL REGISTER**

**BEANSTREAM**

BEANSTREAM INTERNET COMMERCE INC.  
(CANADA CORPORATION)  
302-2659 DOUGLAS STREET  
VICTORIA, CANADA V8T4M3

FOR: PROVIDING ELECTRONIC PROCESSING OF ELECTRONIC FUNDS TRANSFER, ACH, CREDIT CARD, DEBIT CARD, ELECTRONIC CHECK AND ELECTRONIC PAYMENTS; PROVIDING FINANCIAL RISK MANAGEMENT SERVICES FOR ELECTRONIC FUNDS TRANSFER, CREDIT AND DEBIT CARD AND ELECTRONIC CHECK TRANSACTIONS VIA A GLOBAL COMPUTER NETWORK, IN CLASS 36 (U.S. CLS. 100, 101 AND 102).

FOR: PROVIDING FRAUD DETECTION SERVICES FOR ELECTRONIC FUNDS TRANSFER, CREDIT AND DEBIT CARD AND ELECTRONIC CHECK TRANSACTIONS VIA A GLOBAL COMPUTER NETWORK; PROVIDING USER AUTHENTI-

CATION OF ELECTRONIC FUNDS TRANSFER, CREDIT AND DEBIT CARD AND ELECTRONIC CHECK TRANSACTIONS VIA A GLOBAL COMPUTER NETWORK, IN CLASS 45 (U.S. CLS. 100 AND 101).

THE MARK CONSISTS OF STANDARD CHARACTERS WITHOUT CLAIM TO ANY PARTICULAR FONT, STYLE, SIZE, OR COLOR.

PRIORITY CLAIMED UNDER SEC. 44(D) ON CANADA APPLICATION NO. 1361853, FILED 8-31-2007, REG. NO. TMA722828, DATED 9-3-2008, EXPIRES 9-3-2023.

SER. NO. 77-271,587, FILED 9-5-2007.

CHRIS WELLS, EXAMINING ATTORNEY

**Int. Cls.: 36 and 45**

**Prior U.S. Cls.: 100, 101 and 102**

**United States Patent and Trademark Office**

**Reg. No. 3,568,986**

**Registered Feb. 3, 2009**

**SERVICE MARK  
PRINCIPAL REGISTER**

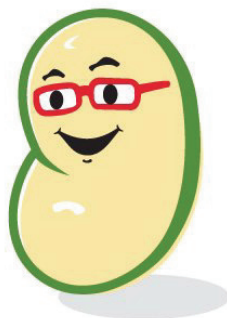

BEANSTREAM INTERNET COMMERCE INC.  
(CANADA CORPORATION)  
302-2659 DOUGLAS STREET  
VICTORIA, CANADA V8T4M3

FOR: PROVIDING ELECTRONIC PROCESSING OF ELECTRONIC FUNDS TRANSFER, ACH, CREDIT CARD, DEBIT CARD, ELECTRONIC CHECK AND ELECTRONIC PAYMENTS; PROVIDING FINANCIAL RISK MANAGEMENT SERVICES FOR ELECTRONIC FUNDS TRANSFER, CREDIT AND DEBIT CARD AND ELECTRONIC CHECK TRANSACTIONS VIA A GLOBAL COMPUTER NETWORK, IN CLASS 36 (U.S. CLS. 100, 101 AND 102).

FOR: (BASED ON 44(D) PRIORITY APPLICATION) PROVIDING FRAUD DETECTION SERVICES FOR ELECTRONIC FUNDS TRANSFER, CREDIT AND DEBIT CARD AND ELECTRONIC CHECK TRANSACTIONS VIA A GLOBAL COMPUTER NETWORK; PROVIDING USER AUTHENTICATION OF ELECTRONIC FUNDS TRANSFER, CREDIT AND DEBIT CARD AND ELECTRONIC CHECK TRANSACTIONS VIA A GLOBAL COMPUTER NETWORK, IN CLASS 45 (U.S. CLS. 100 AND 101).

PRIORITY CLAIMED UNDER SEC. 44(D) ON CANADA APPLICATION NO. 1362086, FILED 9-4-2007, REG. NO. TMA723239, DATED 9-9-2008, EXPIRES 9-9-2023.

THE COLOR(S) GREEN, RED, BLACK, YELLOW-TAN, WHITE, AND GRAY IS/ARE CLAIMED AS A FEATURE OF THE MARK.

THE MARK CONSISTS OF A BEAN DESIGN OUTLINED IN GREEN; THE BEAN HAS THE FACIAL FEATURES IN BLACK OF EYEBROWS, EYES, AND A MOUTH THAT APPEARS WITH A SMILING EXPRESSION; WITH RED EYEGLASSES SURROUNDING THE EYES; THE INTERIOR SURFACE OF THE EYEGLASSES IS WHITE; THE INTERIOR OF THE BEAN IS A TAN-YELLOW COLOR; A GRAY SHADOW APPEARS BENEATH THE BEAN DESIGN.

SER. NO. 77-272,090, FILED 9-5-2007.

CHRIS WELLS, EXAMINING ATTORNEY

Int. Cls.: 36 and 45

Prior U.S. Cls.: 100, 101 and 102

United States Patent and Trademark Office

Reg. No. 3,568,987

Registered Feb. 3, 2009

SERVICE MARK  
PRINCIPAL REGISTER



BEANSTREAM INTERNET COMMERCE INC.  
(CANADA CORPORATION)  
302-2659 DOUGLAS STREET  
VICTORIA, CANADA V8T4M3

FOR: PROVIDING ELECTRONIC PROCESSING OF ELECTRONIC FUNDS TRANSFER, ACH, CREDIT CARD, DEBIT CARD, ELECTRONIC CHECK AND ELECTRONIC PAYMENTS; PROVIDING FINANCIAL RISK MANAGEMENT SERVICES FOR ELECTRONIC FUNDS TRANSFER, CREDIT AND DEBIT CARD AND ELECTRONIC CHECK TRANSACTIONS VIA A GLOBAL COMPUTER NETWORK, IN CLASS 36 (U.S. CLS. 100, 101 AND 102).

FOR: (BASED ON 44(D) PRIORITY APPLICATION) PROVIDING FRAUD DETECTION SERVICES FOR ELECTRONIC FUNDS TRANSFER, CREDIT AND DEBIT CARD AND ELECTRONIC CHECK TRANSACTIONS VIA A GLOBAL COMPUTER NETWORK; PROVIDING USER AUTHENTICATION OF ELECTRONIC FUNDS TRANSFER, CREDIT AND DEBIT CARD AND ELECTRONIC CHECK TRANSACTIONS VIA A GLOBAL COMPUTER NETWORK, IN CLASS 45 (U.S. CLS. 100 AND 101).

PRIORITY CLAIMED UNDER SEC. 44(D) ON CANADA APPLICATION NO. 1361852, FILED 8-31-

2007, REG. NO. TMA722,829, DATED 9-3-2008, EXPIRES 9-3-2023.

THE COLOR(S) GREEN, RED, BLACK, YELLOW-TAN, WHITE, AND GRAY IS/ARE CLAIMED AS A FEATURE OF THE MARK.

THE MARK CONSISTS OF THE TEXT "BEANSTREAM" IN LOWER CASE NEXT TO A BEAN DESIGN, THE "BEAN" PORTION OF THE TEXT HAVING THE COLOR GREEN AND A BLACK SHADOW, AND THE "STREAM" PORTION OF THE TEXT HAVING THE COLOR RED AND A BLACK SHADOW; THE BEAN DESIGN IS OUTLINED IN GREEN; THE BEAN HAS THE FACIAL FEATURES IN BLACK OF EYEBROWS, EYES, AND A MOUTH THAT APPEARS WITH A SMILING EXPRESSION; WITH RED EYEGLASSES SURROUNDING THE EYES; THE INTERIOR SURFACE OF THE EYEGLASSES IS WHITE; THE INTERIOR OF THE BEAN IS A TAN-YELLOW COLOR; A GRAY SHADOW APPEARS BENEATH THE BEAN DESIGN.

SER. NO. 77-272,139, FILED 9-5-2007.

CHRIS WELLS, EXAMINING ATTORNEY



**Int. Cls.: 6 and 19**

**Prior U.S. Cls.: 1, 2, 12, 13, 14, 23, 25, 33 and 50**

**Reg. No. 3,568,988**

**United States Patent and Trademark Office**

**Registered Feb. 3, 2009**

**TRADEMARK  
PRINCIPAL REGISTER**

**!!!RAILSIMPLE**

BW CREATIVE WOOD INDUSTRIES LTD. (CANADA CORPORATION)  
23282 RIVER ROAD  
MAPLE RIDGE, B.C., CANADA V2W1B6

FOR: INTERIOR AND EXTERIOR RAILING SYSTEMS PRIMARILY COMPOSED OF METAL RAILS, METAL STRUCTURAL SUPPORTS IN THE NATURE OF METAL BALUSTERS, METAL NEWEL POSTS, METAL PORCH POSTS, METAL BALL TOPS, METAL POST CAPS AND METAL PANELS, IN CLASS 6 (U.S. CLS. 2, 12, 13, 14, 23, 25 AND 50).

FOR: INTERIOR AND EXTERIOR RAILING SYSTEMS PRIMARILY COMPOSED OF NON-METAL RAILS, NON-METAL STRUCTURAL SUPPORTS IN THE NATURE OF NON-METAL BALUSTERS, NON-METAL NEWEL POSTS, NON-METAL PORCH

POSTS, NON-METAL BALL TOPS, NON-METAL POST CAPS AND NON-METAL PANELS, IN CLASS 19 (U.S. CLS. 1, 12, 33 AND 50).

PRIORITY CLAIMED UNDER SEC. 44(D) ON CANADA APPLICATION NO. 1361075, FILED 8-24-2007, REG. NO. TMA721676, DATED 8-21-2008, EXPIRES 8-21-2023.

NO CLAIM IS MADE TO THE EXCLUSIVE RIGHT TO USE "RAIL", APART FROM THE MARK AS SHOWN.

SER. NO. 77-273,860, FILED 9-7-2007.

BERYL GARDNER, EXAMINING ATTORNEY

**Int. Cl.: 35**

**Prior U.S. Cls.: 100, 101 and 102**

**United States Patent and Trademark Office**

**Reg. No. 3,568,989**

**Registered Feb. 3, 2009**

**SERVICE MARK  
PRINCIPAL REGISTER**

**ZipWeb**

EBRIDGE, INC. (CALIFORNIA CORPORATION)  
16133 VENTURA BLVD, 8TH FLOOR  
ENCINO, CA 91436

FOR: ADVERTISING AND COMMERCIAL INFORMATION SERVICES, VIA THE INTERNET, IN CLASS 35 (U.S. CLS. 100, 101 AND 102).

FIRST USE 12-15-2005; IN COMMERCE 12-15-2005.

THE MARK CONSISTS OF STANDARD CHARACTERS WITHOUT CLAIM TO ANY PARTICULAR FONT, STYLE, SIZE, OR COLOR.

OWNER OF U.S. REG. NO. 3,143,030.

SER. NO. 77-276,029, FILED 9-10-2007.

LAURA HAMMEL, EXAMINING ATTORNEY

**Int. Cls.: 35, 38 and 41**

**Prior U.S. Cls.: 100, 101, 102, 104 and 107**

**Reg. No. 3,568,990**

**United States Patent and Trademark Office**

**Registered Feb. 3, 2009**

**SERVICE MARK  
PRINCIPAL REGISTER**

**BRAINFALL**

BRAINFALL.COM, INC. (CALIFORNIA CORPORATION)  
101 JEFFERSON DRIVE  
MENLO PARK, CA 94025

FOR: INTERNET ADVERTISING SERVICES, IN CLASS 35 (U.S. CLS. 100, 101 AND 102).

FIRST USE 4-15-2007; IN COMMERCE 4-15-2007.

FOR: PROVIDING ON-LINE CHAT ROOMS AND ELECTRONIC BULLETIN BOARDS FOR TRANSMISSION OF MESSAGES AMONG USERS IN THE FIELD OF GENERAL INTEREST, IN CLASS 38 (U.S. CLS. 100, 101 AND 104).

FIRST USE 4-15-2007; IN COMMERCE 4-15-2007.

FOR: PROVIDING A WEBSITE FEATURING ON-LINE INTERACTIVE QUIZZES; ONLINE JOURNALS, NAMELY, BLOGS IN THE FIELD OF GENERAL INTEREST, IN CLASS 41 (U.S. CLS. 100, 101 AND 107).

FIRST USE 4-15-2007; IN COMMERCE 4-15-2007.

THE MARK CONSISTS OF STANDARD CHARACTERS WITHOUT CLAIM TO ANY PARTICULAR FONT, STYLE, SIZE, OR COLOR.

SER. NO. 77-278,637, FILED 9-13-2007.

WENDY GOODMAN, EXAMINING ATTORNEY

Int. Cl.: 45

Prior U.S. Cls.: 100 and 101

United States Patent and Trademark Office

Reg. No. 3,568,991

Registered Feb. 3, 2009

**SERVICE MARK  
PRINCIPAL REGISTER**



KAY MORRISON (UNITED STATES INDIVIDUAL)  
615 BROCKENBROUGH COURT  
METAIRIE, LA 70005

FOR: PROVIDING NON-MEDICAL PERSONAL ASSISTANT SERVICES IN THE NATURE OF PLANNING, ORGANIZING, COORDINATING, ARRANGING AND ASSISTING INDIVIDUALS WITH HOMES AND BUSINESSES , IN CLASS 45 (U.S. CLS. 100 AND 101).

FIRST USE 4-1-2007; IN COMMERCE 4-1-2007.

NO CLAIM IS MADE TO THE EXCLUSIVE RIGHT TO USE "CONSULTANT", APART FROM THE MARK AS SHOWN.

THE COLOR(S) BLACK, WHITE, BLUE AND RED IS/ARE CLAIMED AS A FEATURE OF THE MARK.

THE MARK CONSISTS OF A STANDING WOMAN WITH BLACK HAIR AND EYES WEARING A BLACK DRESS, BLACK SHOES AND WHITE APRON. HER ARMS, FACE AND LEGS ARE WHITE AND HER LIPS ARE RED. SHE IS HOLDING A GLASS WITH A WHITE SEVEN-POINTED STAR BEHIND THE GLASS. ALL OF THE LETTERING IN THE MARK IS BLACK. THERE IS A LARGE WHITE SEVEN-POINTED STAR AND A BLUE BACKGROUND.

SER. NO. 77-281,598, FILED 9-17-2007.

MICHAEL WEBSTER, EXAMINING ATTORNEY

**Int. Cl.: 42**

**Prior U.S. Cls.: 100 and 101**

**United States Patent and Trademark Office**

**Reg. No. 3,568,992**

**Registered Feb. 3, 2009**

**SERVICE MARK  
PRINCIPAL REGISTER**

**DYNAMIC QUALITY ASSURANCE**

PRINCE AGRIPRODUCTS, INC. (DELAWARE CORPORATION)  
ONE PRINCE PLAZA, P.O. BOX 1009  
QUINCY, IL 62306

FOR: TESTING, INSPECTION OR RESEARCH OF FOODSTUFF, PHARMACEUTICALS OR COSMETICS, NAMELY, ANIMAL FEED, NUTRITIONAL SUPPLEMENTS, PHARMACEUTICAL INGREDIENTS AND MINERAL SUPPLEMENTS; TECHNOLOGY SUPERVISION, INSPECTION AND PRODUCT TESTING IN THE FIELDS OF ANIMAL FEED SAFETY, NUTRITIONAL SUPPLEMENTS, PHARMACEUTICAL INGREDIENTS, MINERAL SUPPLEMENTS, AND ENVIRONMENTAL HAZARD AND CONTAMINANT IDENTIFICATION AND MITIGATION WITH RESPECT TO ANIMAL FEEDS, NUTRITIONAL SUPPLEMENTS, PHARMACEUTICAL INGREDIENTS AND MINERAL SUPPLEMENTS; TECHNICAL ANALYSIS OF PRODUCTS, NAMELY,

ANIMAL FEED, NUTRITIONAL SUPPLEMENTS, PHARMACEUTICAL INGREDIENTS AND MINERAL SUPPLEMENTS IN ORDER TO DETERMINE HOW TO MAKE THEM MORE ENVIRONMENTALLY SOUND, IN CLASS 42 (U.S. CLS. 100 AND 101).

FIRST USE 6-25-2007; IN COMMERCE 6-25-2007.

THE MARK CONSISTS OF STANDARD CHARACTERS WITHOUT CLAIM TO ANY PARTICULAR FONT, STYLE, SIZE, OR COLOR.

NO CLAIM IS MADE TO THE EXCLUSIVE RIGHT TO USE "QUALITY ASSURANCE", APART FROM THE MARK AS SHOWN.

SER. NO. 77-282,120, FILED 9-18-2007.

JIM RINGLE, EXAMINING ATTORNEY

**Int. Cls.: 9 and 42**

**Prior U.S. Cls.: 21, 23, 26, 36, 38, 100 and 101**

**Reg. No. 3,568,993**

**United States Patent and Trademark Office**

**Registered Feb. 3, 2009**

**TRADEMARK  
SERVICE MARK  
PRINCIPAL REGISTER**

**Ancestry.com**

THE GENERATIONS NETWORK, INC. (DELAWARE CORPORATION)  
360 WEST 4800 NORTH  
PROVO, UT 84604

FOR: ELECTRONIC DATABASES IN THE FIELD OF GENEALOGY CONSISTING OF HISTORICAL RECORDS, HISTORICAL PUBLICATIONS, PHOTOGRAPHS, AND FAMILY TREES AND FAMILY HISTORIES SUBMITTED BY USERS, PROVIDED ON DIGITAL MEDIA, NAMELY, CDS AND RECORDED ON COMPUTER MEDIA, IN CLASS 9 (U.S. CLS. 21, 23, 26, 36 AND 38).

FIRST USE 1-7-2007; IN COMMERCE 1-7-2007.

FOR: PROVIDING ON-LINE ELECTRONIC DATABASES IN THE FIELD OF GENEALOGY RESEARCH FEATURING HISTORICAL RECORDS, HISTORICAL PUBLICATIONS, PHOTOGRAPHS, AND FAMILY TREES AND FAMILY HISTORIES SUBMITTED BY USERS, PROVIDED ON THE GLOBAL COMPUTER NETWORK; PROVIDING TEMPORARY USE OF NON-DOWNLOADABLE COMPUTER SOFTWARE FOR USE IN CREATING, DISPLAYING, SHARING AND STORING MULTIMEDIA PRESENTATIONS THAT INCLUDE PHOTOGRAPHS AND SOUND; PROVIDING TEMPORARY USE OF NON-DOWNLOADABLE COMPUTER SOFTWARE FOR APPLICATION AND DATABASE INTEGRATION FOR USE IN SEARCHABLE DATABASES AND INFORMATION STORAGE, MANIPULATION AND RETRIEVAL OF AUDIO FAMILY HISTORIES, AUDIO NOTES AT-

TACHED TO FAMILY TREES AND OTHER DATABASE ELEMENTS AND AUDIO NARRATIONS OF PHOTO STORIES, TIMELINES AND PERSONAL MEMORIALS; APPLICATION SERVICE PROVIDER (ASP) FEATURING SOFTWARE FOR USE IN CREATING, DISPLAYING, SHARING AND STORING MULTIMEDIA PRESENTATIONS THAT INCLUDE PHOTOGRAPHS AND SOUND; PROVIDING TEMPORARY USE OF NON-DOWNLOADABLE COMPUTER SOFTWARE FOR USE IN CREATING, DISPLAYING, SHARING AND STORING MULTIMEDIA PRESENTATIONS THAT INCLUDE PHOTOGRAPHS AND SOUND; GENEALOGICAL RESEARCH SERVICES, PROVIDING GENEALOGICAL AND FAMILY HISTORY INFORMATION SERVICES, NAMELY, RETRIEVING, RECORDING AND REVIEWING ANCESTRAL DATA VIA THE GLOBAL COMPUTER NETWORK, IN CLASS 42 (U.S. CLS. 100 AND 101).

FIRST USE 1-7-2007; IN COMMERCE 1-7-2007.

THE MARK CONSISTS OF STANDARD CHARACTERS WITHOUT CLAIM TO ANY PARTICULAR FONT, STYLE, SIZE, OR COLOR.

OWNER OF U.S. REG. NO. 1,577,711.

SEC. 2(F).

SER. NO. 77-283,850, FILED 9-19-2007.

RAMONA ORTIGA, EXAMINING ATTORNEY

**Int. Cls.: 35, 38 and 41**

**Prior U.S. Cls.: 100, 101, 102, 104 and 107**

**Reg. No. 3,568,994**

**United States Patent and Trademark Office**

**Registered Feb. 3, 2009**

**SERVICE MARK  
PRINCIPAL REGISTER**

**FIND YOUR CHARACTER**

BRAINFALL.COM, INC. (CALIFORNIA CORPORATION)  
101 JEFFERSON DRIVE  
MENLO PARK, CA 94025

FOR: INTERNET ADVERTISING SERVICES, IN CLASS 35 (U.S. CLS. 100, 101 AND 102).

FIRST USE 4-15-2007; IN COMMERCE 4-15-2007.

FOR: PROVIDING ON-LINE CHAT ROOMS AND ELECTRONIC BULLETIN BOARDS FOR TRANSMISSION OF MESSAGES AMONG USERS IN THE FIELD OF GENERAL INTEREST, IN CLASS 38 (U.S. CLS. 100, 101 AND 104).

FIRST USE 4-15-2007; IN COMMERCE 4-15-2007.

FOR: PROVIDING A WEBSITE FEATURING ON-LINE INTERACTIVE QUIZZES; ONLINE JOURNALS, NAMELY, BLOGS IN THE FIELD OF GENERAL INTEREST, IN CLASS 41 (U.S. CLS. 100, 101 AND 107).

FIRST USE 4-15-2007; IN COMMERCE 4-15-2007.

THE MARK CONSISTS OF STANDARD CHARACTERS WITHOUT CLAIM TO ANY PARTICULAR FONT, STYLE, SIZE, OR COLOR.

SER. NO. 77-284,230, FILED 9-20-2007.

WENDY GOODMAN, EXAMINING ATTORNEY

**Int. Cl.: 45**

**Prior U.S. Cls.: 100 and 101**

**United States Patent and Trademark Office**

**Reg. No. 3,568,995**

**Registered Feb. 3, 2009**

**SERVICE MARK  
PRINCIPAL REGISTER**



PULSE NETWORK LLC (DELAWARE LIMITED  
LIABILITY COMPANY)

1301 MCKINNEY, SUITE 2500

HOUSTON, TX 77010

FOR: FRAUD DETECTION SERVICES IN THE  
FIELD OF CREDIT CARDS AND DEBIT CARDS, IN  
CLASS 45 (U.S. CLS. 100 AND 101).

FIRST USE 10-4-2007; IN COMMERCE 10-4-2007.

NO CLAIM IS MADE TO THE EXCLUSIVE  
RIGHT TO USE "DEBIT PROTECT", APART FROM  
THE MARK AS SHOWN.

THE MARK CONSISTS OF THE WORDS "DEBIT-  
PROTECT" IN STYLIZED LETTERS WITH STY-  
LIZED LETTERS "D" AND "P" APPEARING TO  
THE LEFT.

SER. NO. 77-287,406, FILED 9-24-2007.

KAREN SEVERSON, EXAMINING ATTORNEY



**Int. Cl.: 20**

**Prior U.S. Cls.: 2, 13, 22, 25, 32 and 50**

**Reg. No. 3,568,996**

**United States Patent and Trademark Office**

**Registered Feb. 3, 2009**

---

**TRADEMARK  
PRINCIPAL REGISTER**

**Pegmore**

JOHNOLA ENTERPRISES, LLC (WISCONSIN  
LIMITED LIABILITY COMPANY), DBA PEG-  
MORE STORAGE SYSTEMS  
506 HERMAN STREET  
PORTAGE, WI 53901

FOR: STORAGE AND ORGANIZATION SYS-  
TEMS COMPRISING SHELVES, DRAWERS, CUP-  
BOARDS, BASKETS AND CLOTHES RODS, SOLD  
AS A UNIT, IN CLASS 20 (U.S. CLS. 2, 13, 22, 25, 32  
AND 50).

FIRST USE 12-24-2005; IN COMMERCE 11-8-2006.

THE MARK CONSISTS OF STANDARD CHAR-  
ACTERS WITHOUT CLAIM TO ANY PARTICULAR  
FONT, STYLE, SIZE, OR COLOR.

SER. NO. 77-287,533, FILED 9-24-2007.

KATINA MISTER, EXAMINING ATTORNEY

Int. Cl.: 25

Prior U.S. Cls.: 22 and 39

United States Patent and Trademark Office

Reg. No. 3,568,997

Registered Feb. 3, 2009

TRADEMARK  
PRINCIPAL REGISTER



MOTIVMEDIA (FLORIDA CORPORATION)

2637 EAST ATLANTIC BLVD #243

POMPANO BEACH, FL 33062

FOR: INFANT AND TODDLER ONE PIECE CLOTHING; PANTS; SHIRTS; T-SHIRTS, IN CLASS 25 (U.S. CLS. 22 AND 39).

FIRST USE 6-10-2004; IN COMMERCE 6-10-2004.

NO CLAIM IS MADE TO THE EXCLUSIVE RIGHT TO USE "COUTURE", APART FROM THE MARK AS SHOWN.

THE MARK CONSISTS OF HEARTS AND ROUND SHAPED LOLLIPOPS OVER THE WORDS "FLIRT COUTURE SAY IT ALL... WITHOUT SAYING A WORD" IN STYLIZED TEXT.

SER. NO. 77-287,586, FILED 9-24-2007.

DANNEAN HETZEL, EXAMINING ATTORNEY

**Int. Cl.: 44**

**Prior U.S. Cls.: 100 and 101**

**United States Patent and Trademark Office**

**Reg. No. 3,568,998**

**Registered Feb. 3, 2009**

**SERVICE MARK  
PRINCIPAL REGISTER**

**POLISHED**

POLISHED LLC (DELAWARE LIMITED LIABILITY COMPANY)  
SUITE 1620  
100 CRESCENT COURT  
DALLAS, TX 75201

THE MARK CONSISTS OF STANDARD CHARACTERS WITHOUT CLAIM TO ANY PARTICULAR FONT, STYLE, SIZE, OR COLOR.

FOR: NAIL SALON SERVICES, IN CLASS 44 (U.S. CLS. 100 AND 101).

SER. NO. 77-288,649, FILED 9-25-2007.

FIRST USE 5-29-2008; IN COMMERCE 5-29-2008.

MARK PILARO, EXAMINING ATTORNEY

**Int. Cls.: 35, 37, 39, 40 and 42**

**Prior U.S. Cls.: 100, 101, 102, 103, 105 and 106**

**Reg. No. 3,568,999**

**United States Patent and Trademark Office**

**Registered Feb. 3, 2009**

**SERVICE MARK  
PRINCIPAL REGISTER**



THE KANE COMPANY (MARYLAND CORPORATION)

6500 KANE WAY  
ELKRIDGE, MD 21075

FOR: MOVING AND RELOCATION SERVICES, NAMELY PLANNING AND IMPLEMENTING MOVES OF BUSINESSES AND OFFICES; LIBRARY AND FILE ROOM RELOCATIONS; BUSINESS RECORDS MANAGEMENT SERVICES; TRANSPORTATION LOGISTICS SERVICES, NAMELY, ARRANGING THE TRANSPORTATION OF GOODS FOR OTHERS; BUSINESS RELOCATION; BUSINESS RELOCATION CONSULTING; BUSINESS MANAGEMENT SERVICES, NAMELY, MANAGING LOGISTICS, REVERSE LOGISTICS, SUPPLY CHAIN SERVICES, SUPPLY CHAIN VISIBILITY AND SYNCHRONIZATION, SUPPLY AND DEMAND FORECASTING AND PRODUCT DISTRIBUTION PROCESSES FOR OTHERS; LOGISTICS MANAGEMENT IN THE FIELD OF MOVING AND RELOCATION SERVICES; BUSINESS PROFESSIONAL RECORDS MANAGEMENT; COMPUTERIZED AND CENTRAL FILE MANAGEMENT AND BUSINESS FILE MANAGEMENT; MANAGEMENT OF COMPUTERIZED FILES; DOCUMENT INDEXING FOR OTHERS, IN CLASS 35 (U.S. CLS. 100, 101 AND 102).

FIRST USE 2-0-1999; IN COMMERCE 2-0-1999.

FOR: COMPUTER EQUIPMENT INSTALLATION; INSTALLATION OF FURNITURE, IN CLASS 37 (U.S. CLS. 100, 103 AND 106).

FIRST USE 2-0-1999; IN COMMERCE 2-0-1999.

FOR: PHYSICAL STORAGE OF DATA AND DOCUMENTS; PHYSICAL STORAGE OF ELECTRONICALLY STORED DOCUMENTS; TRANSPORTATION AND STORAGE OF GOODS; FURNITURE MOVING AND FURNITURE STORAGE; SUPPLY CHAIN, LOGISTICS AND REVERSE LOGISTICS SERVICES, NAMELY, STORAGE, TRANSPORTATION AND DELIVERY OF DOCUMENTS FOR OTHERS BY AIR, RAIL, SHIP OR TRUCK; PROTECTED OFF-SITE STORAGE OF BUSINESS RECORDS; WAREHOUSING SERVICES, NAMELY, STORAGE, DISTRIBUTION, PICK-UP, AND PACKING FOR SHIPMENT OF DOCUMENTS, PACKAGES, RAW MATERIALS, AND OTHER FREIGHT FOR OTHERS; STORAGE SERVICES FOR ARCHIVING FILES; COMPUTER EQUIPMENT DELIVERY, IN CLASS 39 (U.S. CLS. 100 AND 105).

FIRST USE 2-0-1999; IN COMMERCE 2-0-1999.

FOR: BUSINESS TO BUSINESS SHREDDING OF DOCUMENTS; ASSEMBLY OF FURNITURE FOR OTHERS, IN CLASS 40 (U.S. CLS. 100, 103 AND 106).

FIRST USE 2-0-1999; IN COMMERCE 2-0-1999.

FOR: PLANNING AND LAYOUT DESIGN FOR THE INTERIOR SPACE OF RETAIL BUSINESS ESTABLISHMENTS AND HOME OFFICES; COMPUTER PROJECT MANAGEMENT SERVICES; OFFICE IMAGING AND DOCUMENT SOLUTIONS, NAMELY, ELECTRONIC CONVERSION OF DOCUMENTS FROM PHYSICAL TO ELECTRONIC MEDIA, IN CLASS 42 (U.S. CLS. 100 AND 101).

FIRST USE 2-0-1999; IN COMMERCE 2-0-1999.

OWNER OF U.S. REG. NO. 3,336,830.

NO CLAIM IS MADE TO THE EXCLUSIVE RIGHT TO USE "COMPANY", APART FROM THE MARK AS SHOWN.

THE COLOR(S) RED AND BLUE IS/ARE CLAIMED AS A FEATURE OF THE MARK.

THE MARK CONSISTS OF THE WORDS "THE KANE COMPANY" IN BLUE AND A STYLIZED ARCH ABOVE AND BELOW THE "THE KANE COMPANY" IN RED.

SER. NO. 77-290,636, FILED 9-27-2007.

RONALD DELGIZZI, EXAMINING ATTORNEY

**Int. Cl.: 1**

**Prior U.S. Cls.: 1, 5, 6, 10, 26 and 46**

**Reg. No. 3,569,000**

**United States Patent and Trademark Office**

**Registered Feb. 3, 2009**

---

**TRADEMARK  
PRINCIPAL REGISTER**

**GASTROBID**

AGUIAR, JOSE VICENTE (UNITED STATES IN-  
DIVIDUAL)  
7105 S.W. 8TH ST #203  
MIAMI, FL 33144

THE MARK CONSISTS OF STANDARD CHAR-  
ACTERS WITHOUT CLAIM TO ANY PARTICULAR  
FONT, STYLE, SIZE, OR COLOR.

FOR: ENZYME SUBSTRATES, IN CLASS 1 (U.S.  
CLS. 1, 5, 6, 10, 26 AND 46).

SER. NO. 77-292,282, FILED 9-29-2007.

FIRST USE 3-1-1980; IN COMMERCE 3-1-1980.

DEIRDRE ROBERTSON, EXAMINING ATTORNEY

**Int. Cls.: 38 and 41**

**Prior U.S. Cls.: 100, 101, 104 and 107**

**Reg. No. 3,569,001**

**United States Patent and Trademark Office**

**Registered Feb. 3, 2009**

**SERVICE MARK  
PRINCIPAL REGISTER**



GRUNDY MEDIA LIMITED (ANTIGUA & BARBUDA LIMITED COMPANY (LTD.))  
WOODS CENTRE, FRIARS HILL ROAD, BOX 1047  
C/O ANTIGUA MANAGEMENT & TRUST  
ST. JOHNS, ANTIGUA & BARBUDA

FOR: TELEVISION BROADCASTING, IN CLASS 38 (U.S. CLS. 100, 101 AND 104).

FOR: ENTERTAINMENT IN THE NATURE OF ON-GOING TELEVISION GAME SHOWS; EDUCATION SERVICES RELATING TO TELEVISION, SPECIFICALLY, CLASSES, SEMINARS, AND WORKSHOPS IN THE FIELDS OF PRIMARY, SECONDARY, TRADE, COLLEGE, UNIVERSITY, POST GRADUATE AND PROFESSIONAL DEGREE EDUCATIONAL ACTIVITY; ENTERTAINMENT SERVICES RELATING TO TELEVISION, SPECIFICALLY, PRODUCTION OF AUDIO-VISUAL RECORDINGS; PRODUCTION AND SCHEDULING OF TELEVISION PROGRAMS; ORGANIZATION OF ACADEMIC AND ATHLETIC COMPETITIONS; INTERACTIVE TELEPHONE COMPETITIONS, ALSO KNOWN AS CONDUCTING CONTESTS VIA TELEPHONE; PROVISION OF EDUCATION, SPECIFICALLY, CLASSES, SEMINARS, AND WORKSHOPS IN THE FIELDS OF PRIMARY, SECONDARY, TRADE, COLLEGE, UNIVERSITY, POST GRADUATE AND PROFESSIONAL DEGREE EDUCATIONAL ACTIVITY, BY MEANS OF TELEVISION, SATELLITE, CABLE, TELEPHONE AND THE INTERNET; PROVISION OF ENTERTAINMENT, SPECIFICALLY, AUDIO-VISUAL RECORDINGS FOR ADULTS, ADOLESCENTS AND CHILDREN BY MEANS OF TELEVISION, SATELLITE, CABLE, TELEPHONE AND THE INTERNET; INTERACTIVE ENTERTAINMENT SERVICES, SPECIFICALLY, TESTING, SURVEYING AND VOTING

ON A WIDE VARIETY OF TOPICS OF INTEREST TO ADULTS, ADOLESCENTS AND CHILDREN; ENTERTAINMENT SERVICES IN THE NATURE OF TELEVISION PROGRAMS FEATURING SPORTS, LEISURE, SCIENCE AND TECHNOLOGY, MOTORING, RELIGION, MUSIC, NEWS, EXERCISE AND FITNESS, FICTION, CURRENT AFFAIRS, COMEDY, DOCUMENTARIES, LAW, CRIME, CARTOONS, ANIMATION, GAMES, QUIZZES, GAME SHOWS, COOKERY, DRAMA, NATURE, GARDENING, POLITICS, ARTS, LITERATURE, CULTURE, TRAVEL, EDUCATION, NAMELY, PRESCHOOL, KINDERGARTEN, PRIMARY, SECONDARY, TRADE, COLLEGE, UNIVERSITY AND POST GRADUATE, FOR CHILDREN, STUDENTS AND ADULTS, LANGUAGE TEACHING, HISTORY, NATURAL HISTORY, GEOGRAPHY AND MATHEMATICS PRODUCTION OF TELEVISION PROGRAMS FEATURING SPORTS, LEISURE, SCIENCE AND TECHNOLOGY, MOTORING, RELIGION, MUSIC, NEWS, EXERCISE AND FITNESS, FICTION, CURRENT AFFAIRS, COMEDY, DOCUMENTARIES, LAW, CRIME, CARTOONS, ANIMATION, GAMES, QUIZZES, GAME SHOWS, COOKERY, DRAMA, NATURE, GARDENING, POLITICS, ARTS, LITERATURE, CULTURE, TRAVEL, EDUCATION, NAMELY, PRESCHOOL, KINDERGARTEN, PRIMARY, SECONDARY, TRADE, COLLEGE, UNIVERSITY AND POST GRADUATE, FOR CHILDREN, STUDENTS AND ADULTS, LANGUAGE TEACHING, HISTORY, NATURAL HISTORY, GEOGRAPHY AND MATHEMATICS; ENTERTAINMENT IN THE NATURE OF AN ONGOING TELEVISION GAME SHOW; EDUCATIONAL AND ENTERTAINMENT SERVICES, NAMELY, A CONTINUING TELEVISION PROGRAM FEATURING INFORMATIVE CONTENT; PRODUCTION AND DISTRIBUTION OF TELEVISION

PROGRAMS; ORGANIZATION OF INTERACTIVE TELEVISION COMPETITIONS; INTERACTIVE TELEPHONE COMPETITIONS, ALSO KNOWN AS CONDUCTING CONTESTS VIA TELEPHONE; PROVISION OF EDUCATION AND ENTERTAINMENT, SPECIFICALLY, PROVIDING AN ONGOING TELEVISION GAME SHOW FEATURING INFORMATIVE CONTENT, BY MEANS OF TELEVISION, SATELLITE, CABLE, TELEPHONE AND THE INTERNET; INTERACTIVE ENTERTAINMENT SERVICES, SPECIFICALLY, ENABLING VIEWER PARTICIPATION IN A TELEVISION GAME SHOW, IN CLASS 41 (U.S. CLS. 100, 101 AND 107).

PRIORITY CLAIMED UNDER SEC. 44(D) ON UNITED KINGDOM APPLICATION NO. 2468179, FILED 9-28-2007, REG. NO. 2468179, DATED 5-2-2008, EXPIRES 9-28-2017.

THE MARK CONSISTS OF THE LETTERS "RG" IN STYLIZED FORM.

SER. NO. 77-292,297, FILED 9-29-2007.

RONALD AIKENS, EXAMINING ATTORNEY



**Int. Cl.: 9**

**Prior U.S. Cls.: 21, 23, 26, 36 and 38**

**Reg. No. 3,569,002**

**United States Patent and Trademark Office**

**Registered Feb. 3, 2009**

**TRADEMARK  
PRINCIPAL REGISTER**

# 28 North

MIL MUSIC, LLC (PENNSYLVANIA LIMITED  
LIABILITY COMPANY)  
SUITE 504  
1500 ARDMORE BOULEVARD  
PITTSBURGH, PA 15221

FOR: MUSICAL SOUND RECORDINGS AND  
AUDIO VISUAL RECORDINGS, NAMELY, COM-  
PACT DISCS, TAPE CASSETTES, AUDIO CAS-  
SETTES, AUDIOTAPES, AUDIO DISCS, RECORDS,  
CD-ROMS, VIDEO TAPES, VIDEO CASSETTES, VI-  
DEO DISCS, DVDS, AND LASER DISCS ALL FEAT-  
URING MUSIC AND SUBJECT MATTERS  
GENERALLY RELATED TO THE ENTERTAIN-  
MENT INDUSTRY, NAMELY, MUSIC, MOVIES,  
TELEVISION, GAMING, MUSIC VIDEOS, AND BIO-  
GRAPHIES; DOWNLOADABLE VIDEO RECORD-  
INGS FEATURING MUSIC AND MUSICAL

PERFORMANCES; DOWNLOADABLE ELECTRO-  
NIC PUBLICATIONS IN THE NATURE OF BOOKS,  
MAGAZINES, JOURNALS, BROCHURES, PAMPH-  
LETS AND NEWSLETTERS ON THE SUBJECTS OF  
MUSIC, MOVIES, TELEVISION, GAMING, MUSIC  
VIDEOS, AND BIOGRAPHIES, IN CLASS 9 (U.S. CLS.  
21, 23, 26, 36 AND 38).

FIRST USE 8-5-2006; IN COMMERCE 4-17-2007.

THE MARK CONSISTS OF STANDARD CHAR-  
ACTERS WITHOUT CLAIM TO ANY PARTICULAR  
FONT, STYLE, SIZE, OR COLOR.

SER. NO. 77-292,964, FILED 10-1-2007.

RONALD MCMORROW, EXAMINING ATTORNEY

**Int. Cl.: 9**

**Prior U.S. Cls.: 21, 23, 26, 36 and 38**

**Reg. No. 3,569,003**

**United States Patent and Trademark Office**

**Registered Feb. 3, 2009**

---

**TRADEMARK  
PRINCIPAL REGISTER**

**PZFlex**

WEIDLINGER ASSOCIATES, INC. (MASSACHU-  
SETTS CORPORATION)  
399 WEST EL CAMINO REAL, SUITE 200  
MOUNTAIN VIEW, CA 94040

THE MARK CONSISTS OF STANDARD CHAR-  
ACTERS WITHOUT CLAIM TO ANY PARTICULAR  
FONT, STYLE, SIZE, OR COLOR.

FOR: COMPUTER SOFTWARE FOR FINITE ELE-  
MENT MODELING, IN CLASS 9 (U.S. CLS. 21, 23, 26,  
36 AND 38).

SER. NO. 77-296,115, FILED 10-4-2007.

FIRST USE 1-1-1993; IN COMMERCE 1-1-1993.

STEVEN JACKSON, EXAMINING ATTORNEY

Int. Cl.: 35

Prior U.S. Cls.: 100, 101 and 102

United States Patent and Trademark Office

Reg. No. 3,569,004

Registered Feb. 3, 2009

**SERVICE MARK  
PRINCIPAL REGISTER**



THE LAUGHABLE NEWS INC. (CANADA CORPORATION)

PO BOX 1238

JULIAN, CA 92036

FOR: ADVERTISING FLYER DISTRIBUTION, IN CLASS 35 (U.S. CLS. 100, 101 AND 102).

FIRST USE 3-9-2006; IN COMMERCE 3-9-2006.

NO CLAIM IS MADE TO THE EXCLUSIVE RIGHT TO USE "NEWS" , APART FROM THE MARK AS SHOWN.

THE MARK CONSISTS OF A CIRCLE CONTAINING A STYLIZED, CARTOON GIRAFFE, WEARING GLASSES AND HOLDING A NEWSPAPER AND A CUP WITH SAUCER, STANDING BEFORE A SERIES OF CARTOON, STYLIZED BUILDINGS, OUTSIDE OF THE CIRCLE, AROUND THE TOP PORTION OF THE CIRCLE, THE WORDS "THE LAUGHING NEWS" APPEAR WITH A BLACK DOT EXISTING BETWEEN THE WORDS "THE" AND "LAUGHING" AND THE WORDS "LAUGHING" AND "NEWS".

SER. NO. 77-296,352, FILED 10-4-2007.

ELLEN PERKINS, EXAMINING ATTORNEY

**Int. Cl.: 35**

**Prior U.S. Cls.: 100, 101 and 102**

**United States Patent and Trademark Office**

**Reg. No. 3,569,005**

**Registered Feb. 3, 2009**

**SERVICE MARK  
PRINCIPAL REGISTER**

# The Laughable News

THE LAUGHABLE NEWS INC. (CANADA CORPORATION)

PO BOX 1238

JULIAN, CA 92036

FOR: ADVERTISING FLYER DISTRIBUTION, IN CLASS 35 (U.S. CLS. 100, 101 AND 102).

FIRST USE 3-9-2006; IN COMMERCE 3-9-2006.

THE MARK CONSISTS OF STANDARD CHARACTERS WITHOUT CLAIM TO ANY PARTICULAR FONT, STYLE, SIZE, OR COLOR.

NO CLAIM IS MADE TO THE EXCLUSIVE RIGHT TO USE "NEWS", APART FROM THE MARK AS SHOWN.

SER. NO. 77-296,366, FILED 10-4-2007.

ELLEN PERKINS, EXAMINING ATTORNEY

**Int. Cl.: 43**

**Prior U.S. Cls.: 100 and 101**

**United States Patent and Trademark Office**

**Reg. No. 3,569,006**

**Registered Feb. 3, 2009**

**SERVICE MARK  
PRINCIPAL REGISTER**

**SriPraPhai**

TIPMANEE, LERSAK (UNITED STATES INDIVIDUAL)  
64-13 39TH AVE  
WOODSIDE, NY 11377

FOR: RESTAURANT AND BAR SERVICES; RESTAURANT SERVICES; TAKE-OUT RESTAURANT SERVICES, IN CLASS 43 (U.S. CLS. 100 AND 101).

FIRST USE 7-1-1991; IN COMMERCE 7-1-1991.

THE MARK CONSISTS OF STANDARD CHARACTERS WITHOUT CLAIM TO ANY PARTICULAR FONT, STYLE, SIZE, OR COLOR.

THE MARK DOES NOT HAVE ANY MEANING IN A FOREIGN LANGUAGE.

SER. NO. 77-300,093, FILED 10-9-2007.

MARLENE BELL, EXAMINING ATTORNEY

**Int. Cl.: 38**

**Prior U.S. Cls.: 100, 101 and 104**

**United States Patent and Trademark Office**

**Reg. No. 3,569,007**

**Registered Feb. 3, 2009**

**SERVICE MARK  
PRINCIPAL REGISTER**

**RACKTOBER**

QUEENB RADIO, INC. (WASHINGTON COR-  
PORATION)  
500 WEST BOONE AVENUE  
SPOKANE, WA 99201

THE MARK CONSISTS OF STANDARD CHAR-  
ACTERS WITHOUT CLAIM TO ANY PARTICULAR  
FONT, STYLE, SIZE, OR COLOR.

FOR: RADIO BROADCASTING, IN CLASS 38 (U.S.  
CLS. 100, 101 AND 104).

SER. NO. 77-308,183, FILED 10-19-2007.

FIRST USE 10-1-2000; IN COMMERCE 10-1-2000.

EDWARD FENNESSY, EXAMINING ATTORNEY

**Int. Cl.: 42**

**Prior U.S. Cls.: 100 and 101**

**United States Patent and Trademark Office**

**Reg. No. 3,569,008**

**Registered Feb. 3, 2009**

**SERVICE MARK  
PRINCIPAL REGISTER**



TERRA LOGOS (MARYLAND CORPORATION)  
3225 ELLERSLIE AVENUE  
SUITE B301  
BALTIMORE, MD 21218

FIRST USE 1-1-2002; IN COMMERCE 1-1-2002.

THE MARK CONSISTS OF THE DESIGN OF A  
HOUSE OVERLAYED WITH A LEAF.

FOR: STRUCTURAL AND ENERGY EFFICIEN-  
CY RESIDENTIAL AND COMMERCIAL BUILDING  
INSPECTIONS, IN CLASS 42 (U.S. CLS. 100 AND 101).

SER. NO. 77-310,569, FILED 10-23-2007.

DAWN HAN, EXAMINING ATTORNEY

**Int. Cl.: 35**

**Prior U.S. Cls.: 100, 101 and 102**

**United States Patent and Trademark Office**

**Reg. No. 3,569,009**

**Registered Feb. 3, 2009**

**SERVICE MARK  
PRINCIPAL REGISTER**

**Z-File**

INTEGRATED TEMPLATE RESOURCES, LLC  
(CALIFORNIA LIMITED LIABILITY COMPA-  
NY)  
SUITE 600  
3424 CARSON STREET  
TORRANCE, CA 90503

FOR: MANAGEMENT OF TAX FILES; TAX FIL-  
ING SERVICES; TAX PREPARATION, IN CLASS 35  
(U.S. CLS. 100, 101 AND 102).

FIRST USE 8-1-2007; IN COMMERCE 8-1-2007.

THE MARK CONSISTS OF STANDARD CHAR-  
ACTERS WITHOUT CLAIM TO ANY PARTICULAR  
FONT, STYLE, SIZE, OR COLOR.

SER. NO. 77-314,289, FILED 10-26-2007.

MICHAEL KEATING, EXAMINING ATTORNEY



**Int. Cl.: 9**

**Prior U.S. Cls.: 21, 23, 26, 36 and 38**

**Reg. No. 3,569,010**

**United States Patent and Trademark Office**

**Registered Feb. 3, 2009**

---

**TRADEMARK  
PRINCIPAL REGISTER**

**VitalPAC**

THE LEARNING CLINIC LIMITED (UNITED  
KINGDOM LIMITED LIABILITY COMPANY)  
ASHFORD HOUSE, GRENADIER ROAD  
EXETER, UNITED KINGDOM EX1-3LH

FOR: SOFTWARE FOR RECORDING, STORING,  
MONITORING, ANALYZING, SHARING, AND AC-  
CESSING INFORMATION AND DATA CONCERN-  
ING PATIENTS' VITAL SIGNS IN THE FIELD OF  
HEALTHCARE, IN CLASS 9 (U.S. CLS. 21, 23, 26, 36  
AND 38).

THE MARK CONSISTS OF STANDARD CHAR-  
ACTERS WITHOUT CLAIM TO ANY PARTICULAR  
FONT, STYLE, SIZE, OR COLOR.

OWNER OF UNITED KINGDOM REG. NO.  
2381895, DATED 5-19-2006, EXPIRES 1-6-2015.

SER. NO. 77-315,919, FILED 10-29-2007.

MICHAEL GAAFAR, EXAMINING ATTORNEY

**Int. Cl.: 36**

**Prior U.S. Cls.: 100, 101 and 102**

**United States Patent and Trademark Office**

**Reg. No. 3,569,011**

**Registered Feb. 3, 2009**

**SERVICE MARK  
PRINCIPAL REGISTER**



ENVISAGE INTERNATIONAL CORPORATION  
(DELAWARE CORPORATION)  
241 ATLANTIC BOULEVARD  
SUITE 3  
NEPTUNE BEACH, FL 32266

FOR: INSURANCE AGENCIES FOR INTERNATIONAL STUDENTS, IN CLASS 36 (U.S. CLS. 100, 101 AND 102).

FIRST USE 2-4-2000; IN COMMERCE 2-4-2000.

NO CLAIM IS MADE TO THE EXCLUSIVE RIGHT TO USE "INTERNATIONAL" AND "STUDENTINSURANCE.COM", APART FROM THE MARK AS SHOWN.

THE COLOR(S) PURPLE, WHITE AND BLACK IS/ ARE CLAIMED AS A FEATURE OF THE MARK.

THE MARK CONSISTS OF THE WORDINGS "INTERNATI", "NAL", "STUDENT", AND ".COM" IN BLACK. THE WORDING "INSURANCE" IS IN PURPLE AND THE DESIGN OF THE STUDENT READING ON THE GLOBE IS IN PURPLE AND WHITE.

SER. NO. 77-316,954, FILED 10-30-2007.

DAWN HAN, EXAMINING ATTORNEY

**Int. Cl.: 41**

**Prior U.S. Cls.: 100, 101 and 107**

**United States Patent and Trademark Office**

**Reg. No. 3,569,012**

**Registered Feb. 3, 2009**

---

**SERVICE MARK  
PRINCIPAL REGISTER**

**MY SCOOP**

BAILEY, AMY LEMLEY (UNITED STATES IN-  
DIVIDUAL), DBA MY SCOOP MEDIA  
5205 COTTAGE CIRCLE  
HOOVER, AL 35226

FOR: PROVIDING AN ONLINE MAGAZINE AND  
BLOG FEATURING FASHION, APPAREL, BEAU-  
TY, AND LIFESTYLE, IN CLASS 41 (U.S. CLS. 100,  
101 AND 107).

FIRST USE 1-1-2007; IN COMMERCE 1-1-2007.

THE MARK CONSISTS OF STANDARD CHAR-  
ACTERS WITHOUT CLAIM TO ANY PARTICULAR  
FONT, STYLE, SIZE, OR COLOR.

SER. NO. 77-320,427, FILED 11-2-2007.

SUZANNE BLANE, EXAMINING ATTORNEY

Int. Cl.: 41

Prior U.S. Cls.: 100, 101 and 107

United States Patent and Trademark Office

Reg. No. 3,569,013

Registered Feb. 3, 2009

SERVICE MARK  
PRINCIPAL REGISTER



BAILEY, AMY LEMLEY (UNITED STATES INDIVIDUAL), DBA MY SCOOP MEDIA  
5205 COTTAGE CIRCLE  
HOOVER, AL 35226

THE MARK CONSISTS OF THE LETTERS "MY SCOOP" WHEREIN THE TWO "O'S" ARE ONE ON TOP OF THE OTHER WITH A SMALL CONE SHAPE UNDERNEATH THEM.

FOR: PROVIDING AN ONLINE MAGAZINE AND BLOG FEATURING FASHION, APPAREL, BEAUTY, AND LIFESTYLE, IN CLASS 41 (U.S. CLS. 100, 101 AND 107).

SER. NO. 77-320,431, FILED 11-2-2007.

FIRST USE 5-1-2007; IN COMMERCE 5-1-2007.

SUZANNE BLANE, EXAMINING ATTORNEY

**Int. Cl.: 35**

**Prior U.S. Cls.: 100, 101 and 102**

**United States Patent and Trademark Office**

**Reg. No. 3,569,014**

**Registered Feb. 3, 2009**

**SERVICE MARK  
PRINCIPAL REGISTER**

# Intellect Resources

CRENSHAW, TIFFANY D (UNITED STATES IN-  
DIVIDUAL)  
1106 SUNSET DRIVE  
GREENSBORO, NC 27408

FOR: MANAGEMENT AND BUSINESS CON-  
SULTING SERVICES IN THE FIELD OF TRAINING  
AND RECRUITMENT, IN CLASS 35 (U.S. CLS. 100,  
101 AND 102).

FIRST USE 1-1-2000; IN COMMERCE 7-16-2001.

THE MARK CONSISTS OF STANDARD CHAR-  
ACTERS WITHOUT CLAIM TO ANY PARTICULAR  
FONT, STYLE, SIZE, OR COLOR.

NO CLAIM IS MADE TO THE EXCLUSIVE  
RIGHT TO USE "RESOURCES", APART FROM  
THE MARK AS SHOWN.

SER. NO. 77-321,091, FILED 11-5-2007.

MIDGE BUTLER, EXAMINING ATTORNEY

**Int. Cl.: 38**

**Prior U.S. Cls.: 100, 101 and 104**

**United States Patent and Trademark Office**

**Reg. No. 3,569,015**

**Registered Feb. 3, 2009**

**SERVICE MARK  
PRINCIPAL REGISTER**

**ALLTEL**

ALLTEL COMMUNICATIONS, LLC (DELAWARE  
LIMITED LIABILITY COMPANY)  
B01F06  
ONE ALLIED DRIVE  
LITTLE ROCK, AR 72202

FOR: WIRELESS TELEPHONE TELECOMMUNI-  
CATIONS SERVICES, NAMELY, WIRELESS MO-  
BILE TELEPHONE CALLING PLANS, IN CLASS 38  
(U.S. CLS. 100, 101 AND 104).

FIRST USE 8-31-1983; IN COMMERCE 10-12-1983.

THE MARK CONSISTS OF STANDARD CHAR-  
ACTERS WITHOUT CLAIM TO ANY PARTICULAR  
FONT, STYLE, SIZE, OR COLOR.

OWNER OF U.S. REG. NOS. 1,322,561 AND  
3,326,791.

SER. NO. 77-323,938, FILED 11-7-2007.

ESTHER A. BORSUK, EXAMINING ATTORNEY

**Int. Cl.: 38**

**Prior U.S. Cls.: 100, 101 and 104**

**United States Patent and Trademark Office**

**Reg. No. 3,569,016**

**Registered Feb. 3, 2009**

**SERVICE MARK  
PRINCIPAL REGISTER**



ALLTEL COMMUNICATIONS, LLC (DELAWARE  
LIMITED LIABILITY COMPANY)

ONE ALLIED DRIVE

B01F06

LITTLE ROCK, AR 72202

FOR: WIRELESS TELEPHONE TELECOMMUNI-  
CATIONS SERVICES, NAMELY, WIRELESS MO-  
BILE TELEPHONE CALLING PLANS, IN CLASS 38  
(U.S. CLS. 100, 101 AND 104).

FIRST USE 3-15-2005; IN COMMERCE 5-1-2005.

OWNER OF U.S. REG. NOS. 1,322,561 AND  
3,326,791.

THE MARK CONSISTS OF A STYLIZED LETTER  
"A". CIRCLES THAT ARE TOTALLY OR PARTIAL-  
LY SHADED.

SER. NO. 77-323,940, FILED 11-7-2007.

ESTHER A. BORSUK, EXAMINING ATTORNEY

**Int. Cl.: 36**

**Prior U.S. Cls.: 100, 101 and 102**

**United States Patent and Trademark Office**

**Reg. No. 3,569,017**

**Registered Feb. 3, 2009**

**SERVICE MARK  
PRINCIPAL REGISTER**

**BREVARD MLS**

SPACE COAST ASSOCIATION OF REALTORS,  
INC. (FLORIDA CORPORATION)

105 MCLEOD STREET

MERRITT ISLAND, FL 32953

FOR: REAL ESTATE LISTINGS FOR THE PUBLIC;  
REAL ESTATE MULTIPLE LISTING AND  
BROKERAGE SERVICES VIA THE WORLD WIDE  
WEB, IN CLASS 36 (U.S. CLS. 100, 101 AND 102).

FIRST USE 2-28-2002; IN COMMERCE 2-28-2002.

THE MARK CONSISTS OF STANDARD CHARACTERS  
WITHOUT CLAIM TO ANY PARTICULAR  
FONT, STYLE, SIZE, OR COLOR.

NO CLAIM IS MADE TO THE EXCLUSIVE  
RIGHT TO USE "MLS", APART FROM THE MARK  
AS SHOWN.

SEC. 2(F).

SER. NO. 77-326,224, FILED 11-9-2007.

GIANCARLO CASTRO, EXAMINING ATTORNEY



**Int. Cl.: 42**

**Prior U.S. Cls.: 100 and 101**

**United States Patent and Trademark Office**

**Reg. No. 3,569,018**

**Registered Feb. 3, 2009**

**SERVICE MARK  
PRINCIPAL REGISTER**

**eduphoria!**

EDUPHORIA!, INCORPORATED (TEXAS CORPORATION)  
1700 ALMA DRIVE, SUITE 410  
PLANO, TX 75075

THE MARK CONSISTS OF STANDARD CHARACTERS WITHOUT CLAIM TO ANY PARTICULAR FONT, STYLE, SIZE, OR COLOR.

FOR: COMPUTER SOFTWARE DESIGN, COMPUTER PROGRAMMING AND MAINTENANCE OF COMPUTER SOFTWARE, IN CLASS 42 (U.S. CLS. 100 AND 101).

SER. NO. 77-327,086, FILED 11-12-2007.

FIRST USE 10-10-2004; IN COMMERCE 10-10-2004.

ALICIA COLLINS, EXAMINING ATTORNEY

Int. Cl.: 16

Prior U.S. Cls.: 2, 5, 22, 23, 29, 37, 38 and 50

United States Patent and Trademark Office

Reg. No. 3,569,019

Registered Feb. 3, 2009

TRADEMARK  
PRINCIPAL REGISTER



EVERS,DAN E (UNITED STATES INDIVIDUAL)  
2169 NATIONAL AVE  
SAN DIEGO, CA 92113

FOR: GRAPHIC ART REPRODUCTIONS, IN  
CLASS 16 (U.S. CLS. 2, 5, 22, 23, 29, 37, 38 AND 50).

FIRST USE 11-12-2007; IN COMMERCE 11-12-2007.

THE COLOR(S) BLACK,YELLOW,RED,WHITE,-  
LIGHT ORANGE,GREEN,CHARTREUSE,ORAN-  
GE,LIGHT GREEN IS/ARE CLAIMED AS A  
FEATURE OF THE MARK.

BLACK ON LOWER BODY OF TOUCAN, TIP OF  
BEAK, EYE, AND BASE OF BEAK AS WELL AS  
OUTLINES AND TEXT. YELLOW ON TWO HALF  
OF LEAVES (BOTTOM HALF OF TOP LEAF ON  
LEFT, AND TOP HALF OF SECOND LEAF FROM  
RIGHT) SECTIONS OF BEAK, AND LEFT HALF  
WAY AROUND EYE. RED ON TWO SECTIONS OF

LOWER PART OF BEAK WHITE ON NECK OF  
TOUCAN AND CENTER OF EYE LIGHT ORANGE  
ON INNER CORNER OF LOWER SECTION OF  
BEAK ON RIGHT HALF WAY AROUND EYE,  
SECTION WITHIN YELLOW PART OF UPPER  
BEAK. GREEN ON BOTTOM HALF OF LEAVES  
ON RIGHT AND TIP OF POINTY PLANT ON  
RIGHT, AND TOP POINTY PLANT ON LEFT.  
CHARTREUSE ON TOP HALF OF FIRST LEAF  
FROM THE RIGHT AND BOTTOM OF LOWER  
LEAF ON THE LEFT, AND BASE OF POINTY  
PLANTS ON BOTH SIDES. ORANGE ON TIP OF  
LOWER POINTY PLANT ON LEFT, TOP RIGHT  
"HIGHLIGHT" ON TOP PART OF BEAK AND  
WITHIN RED AND YELLOW ON BOTTOM PART  
OF BEAK. LIGHT GREEN ON TOP HALF OF TOP  
LEAF ON LEFT SIDE AND BASE OF POINTY  
PLANT ON LEFT SIDE.

SER. NO. 77-327,508, FILED 11-12-2007.

KAREN M. STRYZ, EXAMINING ATTORNEY

**Int. Cl.: 41**

**Prior U.S. Cls.: 100, 101 and 107**

**United States Patent and Trademark Office**

**Reg. No. 3,569,020**

**Registered Feb. 3, 2009**

**SERVICE MARK  
PRINCIPAL REGISTER**

**WISDOM WORKER SOLUTIONS**

EMPLOYEE & FAMILY RESOURCE, INC. (IOWA CORPORATION)  
505 5TH AVENUE, SUITE 930  
DES MOINES, IA 50309

FOR: WORKFORCE DEVELOPMENT SERVICES, NAMELY, CONDUCTING EDUCATIONAL WORKSHOPS, EDUCATIONAL TRAINING PROGRAMS, AND LIFE COACHING SERVICES FOR EMPLOYERS AND EMPLOYEES IN THE FIELDS OF SUBSTANCE ABUSE PREVENTION, MENTAL HEALTH, RETIREMENT PLANNING, EMOTIONAL WELL-BEING, BUSINESS MANAGEMENT, AND

PSYCHOLOGICAL AND SOCIAL DEVELOPMENT, IN CLASS 41 (U.S. CLS. 100, 101 AND 107).

FIRST USE 2-1-2008; IN COMMERCE 2-1-2008.

THE MARK CONSISTS OF STANDARD CHARACTERS WITHOUT CLAIM TO ANY PARTICULAR FONT, STYLE, SIZE, OR COLOR.

SER. NO. 77-327,777, FILED 11-13-2007.

JAMES MACFARLANE, EXAMINING ATTORNEY

**Int. Cl.: 41**

**Prior U.S. Cls.: 100, 101 and 107**

**United States Patent and Trademark Office**

**Reg. No. 3,569,021**

**Registered Feb. 3, 2009**

**SERVICE MARK  
PRINCIPAL REGISTER**

**WISDOM WORKER**

EMPLOYEE & FAMILY RESOURCES, INC.  
(IOWA CORPORATION)  
505 5TH AVENUE, SUITE 930  
DES MOINES, IA 50309

FOR: WORKFORCE DEVELOPMENT SERVICES,  
NAMELY, CONDUCTING EDUCATIONAL WORK-  
SHOPS, EDUCATIONAL TRAINING PROGRAMS,  
AND LIFE COACHING SERVICES FOR EMPLOY-  
ERS AND EMPLOYEES IN THE FIELDS OF SUB-  
STANCE ABUSE PREVENTION, MENTAL  
HEALTH, RETIREMENT PLANNING, EMOTIONAL  
WELL-BEING, BUSINESS MANAGEMENT, AND  
PSYCHOLOGICAL AND SOCIAL DEVELOPMENT,  
IN CLASS 41 (U.S. CLS. 100, 101 AND 107).

FIRST USE 2-1-2008; IN COMMERCE 2-1-2008.

THE MARK CONSISTS OF STANDARD CHAR-  
ACTERS WITHOUT CLAIM TO ANY PARTICULAR  
FONT, STYLE, SIZE, OR COLOR.

THE MARK "WISDOM WORKER" HAS NO  
MEANING IN A FOREIGN LANGUAGE.

SER. NO. 77-329,654, FILED 11-14-2007.

JAMES MACFARLANE, EXAMINING ATTORNEY

**Int. Cl.: 35**

**Prior U.S. Cls.: 100, 101 and 102**

**United States Patent and Trademark Office**

**Reg. No. 3,569,022**

**Registered Feb. 3, 2009**

**SERVICE MARK  
PRINCIPAL REGISTER**

**ERAYO**

ERAYO INC. (DELAWARE CORPORATION)  
1313 N. MARKET STREET, SUITE 5100  
WILMINGTON, DE 19801

FOR: PROVIDING A WEBSITE THAT FEATURES AN ONLINE MARKET THAT ENABLES USERS TO POST GOODS AND SERVICES FOR RETAIL AND WHOLESALE SALE VIA A GLOBAL COMPUTER NETWORK; PROVIDING EVALUATIVE FEEDBACK AND RATINGS OF COMMERCIAL CONDUCT, TRANSACTIONS, PRICING, PERFORMANCE, DELIVERY AND GENERAL TRADING SERVICES CONNECTED THEREWITH; ON-LINE EXCHANGE SERVICES, NAMELY, PROVIDING A PLATFORM FOR THE BARTERING OF GOODS AND SERVICES BY OTHERS; PROVIDING ONLINE COMMERCIAL INFORMATION, BUSINESS MANAGEMENT ADVICE, BUSINESS INFOR-

MATION MANAGEMENT SERVICES AND ADVERTISING SERVICES FOR OTHERS VIA A GLOBAL COMPUTER NETWORK; PROVIDING ONLINE AUCTION SERVICES VIA A GLOBAL COMPUTER NETWORK , IN CLASS 35 (U.S. CLS. 100, 101 AND 102).

FIRST USE 11-12-2007; IN COMMERCE 11-12-2007.

THE MARK CONSISTS OF STANDARD CHARACTERS WITHOUT CLAIM TO ANY PARTICULAR FONT, STYLE, SIZE, OR COLOR.

SER. NO. 77-330,761, FILED 11-15-2007.

VIVIAN MICZNIK FIRST, EXAMINING ATTORNEY

**Int. Cls.: 2 and 17**

**Prior U.S. Cls.: 1, 5, 6, 11, 12, 13, 16, 35 and 50**

**United States Patent and Trademark Office**

**Reg. No. 3,569,023**

**Registered Feb. 3, 2009**

**TRADEMARK  
PRINCIPAL REGISTER**

**POLYVERS INTERNATIONAL**

VERSAFLEX INCORPORATED (KANSAS CORPORATION)  
87 SHAWNEE AVENUE  
KANSAS CITY, KS 66105

FOR: COATINGS IN THE NATURE OF INDUSTRIAL SEALANTS FOR WATERPROOFING AND SURFACE HARDENING; CONCRETE MOISTURE BARRIER COATING; CORROSION INHIBITANTS IN THE NATURE OF A COATING; RESIN-BASED COATINGS FOR USE ON ROOFS, WALLS AND PAVEMENTS; RUST PREVENTATIVES IN THE NATURE OF A COATING; SEALER COATINGS FOR USE IN INDUSTRIAL AND COMMERCIAL WOOD AND CONCRETE FLOORING, IN CLASS 2 (U.S. CLS. 6, 11 AND 16).

FIRST USE 8-10-2004; IN COMMERCE 8-10-2004.

FOR: ADHESIVE SEALANT AND CAULKING COMPOUND; ANTI-RUST SEALANTS; DUST

PROOFING SEALANTS; RESIN-BASED SEALANTS FOR USE ON ROOFS, WALLS AND PAVEMENTS; SEALANTS FOR BUILDINGS; SEALANTS FOR PAVEMENT JOINTS; WATERPROOF SEALANTS, IN CLASS 17 (U.S. CLS. 1, 5, 12, 13, 35 AND 50).

FIRST USE 8-10-2004; IN COMMERCE 8-10-2004.

THE MARK CONSISTS OF STANDARD CHARACTERS WITHOUT CLAIM TO ANY PARTICULAR FONT, STYLE, SIZE, OR COLOR.

NO CLAIM IS MADE TO THE EXCLUSIVE RIGHT TO USE "INTERNATIONAL", APART FROM THE MARK AS SHOWN.

SER. NO. 77-331,074, FILED 11-15-2007.

AMOS T. MATTHEWS, JR., EXAMINING ATTORNEY

**Int. Cl.: 17**

**Prior U.S. Cls.: 1, 5, 12, 13, 35 and 50**

**Reg. No. 3,569,024**

**United States Patent and Trademark Office**

**Registered Feb. 3, 2009**

**TRADEMARK  
PRINCIPAL REGISTER**



**INTERNATIONAL**

VERSAFLEX INCORPORATED (KANSAS CORPORATION)  
87 SHAWNEE AVENUE  
KANSAS CITY, KS 66105

FOR: ADHESIVE SEALANT AND CAULKING COMPOUND; ANTI-RUST SEALANTS; DUST PROOFING SEALANTS; RESIN-BASED SEALANTS FOR USE ON ROOFS, WALLS AND PAVEMENTS; SEALANTS FOR BUILDINGS; SEALANTS FOR PAVEMENT JOINTS; WATERPROOF SEALANTS, IN CLASS 17 (U.S. CLS. 1, 5, 12, 13, 35 AND 50).

FIRST USE 8-10-2004; IN COMMERCE 8-10-2004.

NO CLAIM IS MADE TO THE EXCLUSIVE RIGHT TO USE "INTERNATIONAL", APART FROM THE MARK AS SHOWN.

THE MARK CONSISTS OF THE WORD "POLYVERS", IN LETTERS THAT INCREASE IN SIZE FROM EITHER END OF THE WORD, EMBLAZONED ACROSS INTERLOCKING OVALS AND SURROUNDED BY A GENERALLY CIRCULAR ELEMENT; AND THE WORD "INTERNATIONAL" CENTERED BELOW THE ABOVE DESCRIBED ELEMENTS.

SER. NO. 77-331,086, FILED 11-15-2007.

AMOS T. MATTHEWS, JR., EXAMINING ATTORNEY

Int. Cl.: 9

Prior U.S. Cls.: 21, 23, 26, 36 and 38

Reg. No. 3,569,025

United States Patent and Trademark Office

Registered Feb. 3, 2009

TRADEMARK  
PRINCIPAL REGISTER

# TECORE Networks

TECORE, INC. (TEXAS CORPORATION), DBA  
TECORE NETWORKS  
7061 COLUMBIA GATEWAY DRIVE  
COLUMBIA, MD 21046

FOR: COMMUNICATION EQUIPMENT, NAME-  
LY, SWITCHES, RADIO TRANSMITTERS AND RE-  
CEIVERS, LOCAL LOOP ACCESS APPARATUS FOR  
WIRELESS RADIO SIGNAL TRANSMISSION OF  
ACOUSTIC INFORMATION COMPRISED OF BASE  
STATION CONTROLLERS, ANTENNAS, SUBSCRI-  
BER UNITS IN THE NATURE OF MOBILE RADIOS  
THAT TRANSMIT AND RECEIVE SIGNALS, AND  
NETWORK MANAGEMENT SWITCHES FOR USE  
IN MANAGING RADIO SIGNALS AND VOICE  
TRANSFER BETWEEN SUBSCRIBER TERMINALS  
AND LOCAL EXCHANGES; COMPUTER HARD-  
WARE, COMPUTER FIRMWARE FOR WIRELESS  
RADIO CALL PROCESSING AND NETWORK  
MANAGEMENT; COMPUTER SOFTWARE FOR  
WIRELESS RADIO CALL PROCESSING AND NET-  
WORK MANAGEMENT; COMPUTER NETWORKS

COMPRISING HARDWARE AND SOFTWARE FOR  
MANAGING AND INTERCONNECTING TELE-  
COMMUNICATIONS NETWORKS, IN CLASS 9  
(U.S. CLS. 21, 23, 26, 36 AND 38).

FIRST USE 11-1-2007; IN COMMERCE 11-16-2007.

THE MARK CONSISTS OF STANDARD CHAR-  
ACTERS WITHOUT CLAIM TO ANY PARTICULAR  
FONT, STYLE, SIZE, OR COLOR.

OWNER OF U.S. REG. NOS. 2,807,590, 2,807,591,  
AND 2,807,592.

NO CLAIM IS MADE TO THE EXCLUSIVE  
RIGHT TO USE "NETWORKS", APART FROM  
THE MARK AS SHOWN.

SER. NO. 77-331,302, FILED 11-16-2007.

GIANCARLO CASTRO, EXAMINING ATTORNEY



**Int. Cls.: 35, 36 and 44**

**Prior U.S. Cls.: 100, 101 and 102**

**United States Patent and Trademark Office**

**Reg. No. 3,569,026**

**Registered Feb. 3, 2009**

**SERVICE MARK  
PRINCIPAL REGISTER**

**HEALTH PROPONENT**

HEALTH ADVOCATE, INC. (DELAWARE CORPORATION)  
SUITE 150  
3043 WALTON ROAD  
PLYMOUTH MEETING, PA 19462

FOR: MEDICAL AND HEALTH-CARE COST REVIEW AND MANAGEMENT; MEDICAL AND HEALTH-CARE COST/PRICE ANALYSIS AND ACCOUNT AUDITING; REVIEW AND EVALUATING HEALTH AND MEDICAL RECORDS FOR CONSUMERS FOR PURPOSES OF ACCURACY AND COST MANAGEMENT; HEALTH CARE COST CONTAINMENT AND REVIEW AND PROVIDING MEDICAL REFERRALS; CONSUMER PRODUCT INFORMATION, IN CLASS 35 (U.S. CLS. 100, 101 AND 102).

FIRST USE 3-1-2008; IN COMMERCE 3-1-2008.

FOR: INSURANCE AND BENEFITS CONSULTATION IN THE FIELD OF HEALTHCARE; PROVIDING INFORMATION IN THE FIELD OF INSURANCE, NAMELY, PROVIDING INFORMATION ABOUT HEALTH INSURANCE CLAIMS, INSURANCE BILLING AND FEE NEGOTIATION

AND REMEDIATION, IN CLASS 36 (U.S. CLS. 100, 101 AND 102).

FIRST USE 3-1-2008; IN COMMERCE 3-1-2008.

FOR: GUIDANCE REGARDING HEALTH RELATED ISSUES; COORDINATION OF OVERALL HEALTH CARE NEEDS; PROVIDING MEDICAL INFORMATION VIA THE INTERNET; PROVIDING INFORMATION IN THE FIELD OF HEALTHCARE, IN CLASS 44 (U.S. CLS. 100 AND 101).

FIRST USE 3-1-2008; IN COMMERCE 3-1-2008.

THE MARK CONSISTS OF STANDARD CHARACTERS WITHOUT CLAIM TO ANY PARTICULAR FONT, STYLE, SIZE, OR COLOR.

NO CLAIM IS MADE TO THE EXCLUSIVE RIGHT TO USE "HEALTH", APART FROM THE MARK AS SHOWN.

SER. NO. 77-331,863, FILED 11-16-2007.

GIANCARLO CASTRO, EXAMINING ATTORNEY

**Int. Cls.: 39 and 43**

**Prior U.S. Cls.: 100, 101 and 105**

**United States Patent and Trademark Office**

**Reg. No. 3,569,027**

**Registered Feb. 3, 2009**

**SERVICE MARK  
PRINCIPAL REGISTER**



COMPANIA MEXICANA DE AVIACION, S.A. DE  
C.V. (MEXICO CORPORATION)  
XOLA 535, PISO 29 COL. DEL VALLE  
MEXICO, D.F. C.P., MEXICO 03100

FOR: AIR TRANSPORTATION SERVICES; TRAVEL AGENCY SERVICES, NAMELY, MAKING RESERVATIONS AND BOOKINGS FOR AIR TRANSPORTATION AND CAR RENTAL; ARRANGING TRAVEL TOURS; TOURIST AGENCY SERVICES, IN CLASS 39 (U.S. CLS. 100 AND 105).

FIRST USE 6-15-2007; IN COMMERCE 6-15-2007.

FOR: TRAVEL AGENCY SERVICES, NAMELY, MAKING RESERVATIONS AND BOOKING FOR TEMPORARY LODGING, IN CLASS 43 (U.S. CLS. 100 AND 101).

FIRST USE 6-15-2007; IN COMMERCE 6-15-2007.

OWNER OF U.S. REG. NOS. 2,415,038, 2,970,101, AND 3,243,314.

NO CLAIM IS MADE TO THE EXCLUSIVE RIGHT TO USE "VACATIONS", APART FROM THE MARK AS SHOWN.

THE MARK CONSISTS IN PART OF THE DESIGN OF A SUITCASE WITH AN AIRPLANE FLYING OUT OF THE UPPER RIGHT HAND CORNER, AND THE STYLIZED DESIGN OF THE LETTER "M" WITH A BIRD'S HEAD ABOVE IT.

THE FOREIGN WORDING IN THE MARK TRANSLATES INTO ENGLISH AS MEXICAN.

SEC. 2(F) AS TO "MEXICANA VACATIONS".

SER. NO. 77-333,274, FILED 11-19-2007.

STEVEN R. FOSTER, EXAMINING ATTORNEY

**Int. Cls.: 41 and 44**

**Prior U.S. Cls.: 100, 101 and 107**

**United States Patent and Trademark Office**

**Reg. No. 3,569,028**

**Registered Feb. 3, 2009**

**SERVICE MARK  
PRINCIPAL REGISTER**

# Soil Surgeon

SAFELAWNS AND LANDSCAPES, LLC (DELA-  
WARE LIMITED LIABILITY COMPANY)  
70 HIGHLAND PARK DRIVE  
BLOOMFIELD, CT 06002

FOR: EDUCATIONAL SERVICES IN THE FIELD  
OF ORGANIC LAWN, TREE, AND SHRUBBERY  
CARE, NAMELY, ON-LINE TUTORIALS AND NON-  
DOWNLOADABLE INSTRUCTIONAL AUDIO AND  
VIDEO RECORDINGS TO LAWN CARE PROFES-  
SIONALS AND THE PUBLIC AT LARGE, IN CLASS  
41 (U.S. CLS. 100, 101 AND 107).

FIRST USE 8-28-2007; IN COMMERCE 8-28-2007.

FOR: CONSULTING SERVICES IN THE FIELD  
OF ORGANIC LAWN, TREE, AND SHRUBBERY  
CARE, IN CLASS 44 (U.S. CLS. 100 AND 101).

FIRST USE 8-28-2007; IN COMMERCE 8-28-2007.

THE MARK CONSISTS OF STANDARD CHAR-  
ACTERS WITHOUT CLAIM TO ANY PARTICULAR  
FONT, STYLE, SIZE, OR COLOR.

NO CLAIM IS MADE TO THE EXCLUSIVE  
RIGHT TO USE "SOIL", APART FROM THE MARK  
AS SHOWN.

SER. NO. 77-333,460, FILED 11-19-2007.

ESTHER A. BORSUK, EXAMINING ATTORNEY

**Int. Cl.: 43**

**Prior U.S. Cls.: 100 and 101**

**United States Patent and Trademark Office**

**Reg. No. 3,569,029**

**Registered Feb. 3, 2009**

**SERVICE MARK  
PRINCIPAL REGISTER**

**SKY ASIAN FUSION**

DINE DESIGN GROUP, INC. (FLORIDA CORPORATION)

315 NE 14TH STREET

OCALA, FL 34470

FOR: RESTAURANT SERVICES, IN CLASS 43  
(U.S. CLS. 100 AND 101).

FIRST USE 8-31-2007; IN COMMERCE 8-31-2007.

THE MARK CONSISTS OF STANDARD CHARACTERS WITHOUT CLAIM TO ANY PARTICULAR FONT, STYLE, SIZE, OR COLOR.

NO CLAIM IS MADE TO THE EXCLUSIVE RIGHT TO USE "ASIAN FUSION", APART FROM THE MARK AS SHOWN.

SER. NO. 77-333,918, FILED 11-20-2007.

INGA ERVIN, EXAMINING ATTORNEY

**Int. Cl.: 35**

**Prior U.S. Cls.: 100, 101 and 102**

**United States Patent and Trademark Office**

**Reg. No. 3,569,030**

**Registered Feb. 3, 2009**

**SERVICE MARK  
PRINCIPAL REGISTER**

**NAP**

MELAMED, HOOTAN (UNITED STATES INDIVIDUAL)  
SUITE 835  
9663 SANTA MONICA BLVD.  
BEVERLY HILLS, CA 90210

THE MARK CONSISTS OF STANDARD CHARACTERS WITHOUT CLAIM TO ANY PARTICULAR FONT, STYLE, SIZE, OR COLOR.

FOR: RETAIL PHARMACY SERVICES; RETAIL DRUG STORE SERVICES, IN CLASS 35 (U.S. CLS. 100, 101 AND 102).

SER. NO. 77-334,727, FILED 11-20-2007.

FIRST USE 7-0-2007; IN COMMERCE 7-0-2007.

RICHARD WHITE, EXAMINING ATTORNEY

**Int. Cl.: 16**

**Prior U.S. Cls.: 2, 5, 22, 23, 29, 37, 38 and 50**

**United States Patent and Trademark Office**

**Reg. No. 3,569,031**

**Registered Feb. 3, 2009**

**TRADEMARK  
PRINCIPAL REGISTER**



SMART CIRCLE INTERNATIONAL CORP. (CANADA CORPORATION)  
SUITE 3  
2720 STEELES AVENUE WEST  
CONCORD, CANADA LK44S3

OWNER OF U.S. REG. NO. 3,341,372.

THE MARK CONSISTS OF A STYLIZED HUMAN FIGURE PARTIALLY CENTERED ON A CIRCLE.

FOR: PRINTED COUPONS FOR PROMOTING THE GOODS AND SERVICES OF OTHERS, IN CLASS 16 (U.S. CLS. 2, 5, 22, 23, 29, 37, 38 AND 50).

SER. NO. 77-335,406, FILED 11-21-2007.

FIRST USE 12-0-2005; IN COMMERCE 12-0-2005.

BERYL GARDNER, EXAMINING ATTORNEY

**Int. Cl.: 41**

**Prior U.S. Cls.: 100, 101 and 107**

**United States Patent and Trademark Office**

**Reg. No. 3,569,032**

**Registered Feb. 3, 2009**

**SERVICE MARK  
PRINCIPAL REGISTER**



FREAKSHOW DELUXE, LLC (CALIFORNIA  
LIMITED LIABILITY COMPANY)  
4228 LOCKWOOD AVENUE  
LOS ANGELES, CA 90029

FOR: ENTERTAINMENT IN THE NATURE OF  
LIVE PERFORMANCES BY A GROUP OF PROFES-  
SIONAL ENTERTAINERS PERFORMING IN A RE-  
CREATION OF FREAK SHOWS , IN CLASS 41 (U.S.  
CLS. 100, 101 AND 107).

FIRST USE 9-1-2002; IN COMMERCE 9-1-2002.

NO CLAIM IS MADE TO THE EXCLUSIVE  
RIGHT TO USE "FREAK SHOW", APART FROM  
THE MARK AS SHOWN.

THE MARK CONSISTS OF STYLIZED TEXT OF  
THE WORDS "THE FREAKSHOW DELUXE".

SEC. 2(F).

SER. NO. 77-336,118, FILED 11-24-2007.

KELLY BOULTON, EXAMINING ATTORNEY

**Int. Cl.: 9**

**Prior U.S. Cls.: 21, 23, 26, 36 and 38**

**United States Patent and Trademark Office**

**Reg. No. 3,569,033**

**Registered Feb. 3, 2009**

**TRADEMARK  
PRINCIPAL REGISTER**

**PRIMAVERA CONTRACT MANAGER**

PRIMAVERA TECHNOLOGIES, INC. (DELA-  
WARE CORPORATION)  
103 FOULK ROAD, SUITE 202  
WILMINGTON, DE 19083

FOR: COMPUTER PROGRAMS FOR USE IN  
PROJECT PLAN MANAGEMENT APPLICATIONS  
AND INSTRUCTION MANUALS SOLD AS A UNIT,  
IN CLASS 9 (U.S. CLS. 21, 23, 26, 36 AND 38).

FIRST USE 3-28-2007; IN COMMERCE 3-28-2007.

THE MARK CONSISTS OF STANDARD CHAR-  
ACTERS WITHOUT CLAIM TO ANY PARTICULAR  
FONT, STYLE, SIZE, OR COLOR.

OWNER OF U.S. REG. NOS. 1,835,276, 2,680,157  
AND OTHERS.

NO CLAIM IS MADE TO THE EXCLUSIVE  
RIGHT TO USE "CONTRACT MANAGER", APART  
FROM THE MARK AS SHOWN.

THE FOREIGN WORDING IN THE MARK  
TRANSLATES INTO ENGLISH AS "SPRINGTIME".

SER. NO. 77-336,266, FILED 11-25-2007.

ANDREA K. NADELMAN, EXAMINING ATTOR-  
NEY



**Int. Cls.: 25 and 41**

**Prior U.S. Cls.: 22, 39, 100, 101 and 107**

**Reg. No. 3,569,034**

**United States Patent and Trademark Office**

**Registered Feb. 3, 2009**

**TRADEMARK  
SERVICE MARK  
PRINCIPAL REGISTER**

**DIRT LATE MODEL DREAM**

ELDORA SPEEDWAY, INC. (INDIANA CORPORATION)  
13929 STATE ROUTE 118  
NEW WESTON, OH 45348

THE MARK CONSISTS OF STANDARD CHARACTERS WITHOUT CLAIM TO ANY PARTICULAR FONT, STYLE, SIZE, OR COLOR.

FOR: T-SHIRTS, IN CLASS 25 (U.S. CLS. 22 AND 39).

NO CLAIM IS MADE TO THE EXCLUSIVE RIGHT TO USE "DIRT LATE MODEL", APART FROM THE MARK AS SHOWN.

FIRST USE 6-0-2005; IN COMMERCE 6-0-2005.

FOR: ENTERTAINMENT IN THE NATURE OF AUTOMOBILERACES, IN CLASS 41 (U.S. CLS. 100, 101 AND 107).

SER. NO. 77-336,470, FILED 11-26-2007.

FIRST USE 6-0-1994; IN COMMERCE 6-0-1994.

CURTIS FRENCH, EXAMINING ATTORNEY

**Int. Cls.: 9 and 16**

**Prior U.S. Cls.: 2, 5, 21, 22, 23, 26, 29, 36, 37, 38 and 50**

**United States Patent and Trademark Office**

**Reg. No. 3,569,035**

**Registered Feb. 3, 2009**

**TRADEMARK  
PRINCIPAL REGISTER**

**in 24  
Hours**

PEARSON EDUCATION, INC. (DELAWARE CORPORATION)  
ONE LAKE STREET  
UPPER SADDLE RIVER, NJ 07458

FOR: DOWNLOADABLE PUBLICATIONS, NAMELY, BOOKS AND MANUALS IN THE FIELDS OF COMPUTERS, COMPUTER SOFTWARE, COMPUTER GRAPHICS, ELECTRONIC PUBLISHING, INFORMATION TECHNOLOGY, ON-LINE COMMUNICATIONS AND OPERATING SYSTEMS, IN CLASS 9 (U.S. CLS. 21, 23, 26, 36 AND 38).

FIRST USE 4-13-2007; IN COMMERCE 4-13-2007.

FOR: BOOKS IN THE FIELDS OF COMPUTERS, COMPUTER SOFTWARE, COMPUTER GRAPHICS, ELECTRONIC PUBLISHING, INFORMATION TECHNOLOGY, ON-LINE COMMUNICATIONS AND OPERATING SYSTEMS, IN CLASS 16 (U.S. CLS. 2, 5, 22, 23, 29, 37, 38 AND 50).

FIRST USE 4-26-2007; IN COMMERCE 4-26-2007.

OWNER OF U.S. REG. NO. 2,411,768.

SER. NO. 77-336,509, FILED 11-26-2007.

JASON LOTT, EXAMINING ATTORNEY

**Int. Cl.: 25**

**Prior U.S. Cls.: 22 and 39**

**United States Patent and Trademark Office**

**Reg. No. 3,569,036**

**Registered Feb. 3, 2009**

**TRADEMARK  
PRINCIPAL REGISTER**

**SEA QUEEN**

PHANTOM INDUSTRIES INC. (CANADA CORPORATION)  
207 WESTON ROAD  
TORONTO, CANADA M6N4Z3

FOR: BEACH ACCESSORIES, NAMELY, BATHING SUITS, BATHING CAPS, TERRY TOWEL BEACH ROBES, TERRY TOWEL BEACH JACKETS, AND BEACH COORDINATES COMPOSED OF T-SHIRTS AND SHORTS , IN CLASS 25 (U.S. CLS. 22 AND 39).

FIRST USE 2-0-2007; IN COMMERCE 11-1-2007.

THE MARK CONSISTS OF STANDARD CHARACTERS WITHOUT CLAIM TO ANY PARTICULAR FONT, STYLE, SIZE, OR COLOR.

OWNER OF U.S. REG. NO. 1,096,119.

SER. NO. 77-337,452, FILED 11-27-2007.

BARNEY CHARLON, EXAMINING ATTORNEY

**Int. Cl.: 10**

**Prior U.S. Cls.: 26, 39 and 44**

**United States Patent and Trademark Office**

**Reg. No. 3,569,037**

**Registered Feb. 3, 2009**

**TRADEMARK  
PRINCIPAL REGISTER**

**PERCUFIX**

SMALL BONE INNOVATIONS INTERNATIONAL  
(FRANCE SOCIÉTÉ PAR ACTIONS SIMPLIFIÉE (SAS))  
ZA LES BRUYERES BP 28  
PERONNAS, FRANCE 01960

FOR: ORTHOPEDIC ARTICLES, NAMELY,  
THREADED PINS, IN CLASS 10 (U.S. CLS. 26, 39  
AND 44).

THE MARK CONSISTS OF STANDARD CHAR-  
ACTERS WITHOUT CLAIM TO ANY PARTICULAR  
FONT, STYLE, SIZE, OR COLOR.

PRIORITY CLAIMED UNDER SEC. 44(D) ON  
FRANCE APPLICATION NO. 073504629, FILED 6-5-  
2007, REG. NO. 073504629, DATED 11-9-2007, EX-  
PIRES 6-5-2017.

SER. NO. 77-337,469, FILED 11-27-2007.

ROBIN CHOSID, EXAMINING ATTORNEY

**Int. Cl.: 9**

**Prior U.S. Cls.: 21, 23, 26, 36 and 38**

**Reg. No. 3,569,038**

**United States Patent and Trademark Office**

**Registered Feb. 3, 2009**

**TRADEMARK  
PRINCIPAL REGISTER**

**Adreka!**

ADREKA, INC (GEORGIA CORPORATION)  
4485 TENCH RD, SUITE 330  
SUWANEE, GA 30024

FOR: INTEGRATED, PROPRIETARY COMPUTER SERVER HARDWARE AND SOFTWARE USED IN COMMERCIAL INFORMATION SERVICES, NAMELY, ADVERTISEMENT SEARCH, PLACEMENT, COMMERCIAL CREATION AND MANAGEMENT BY PROVIDING ANALYTICAL REPORTS, ADVERTISEMENT TARGETING, AND MANAGEMENT OF ELECTRONICALLY STORED ADVERTISING, FOR USE ON THE GLOBAL TRADITIONAL, COMPUTER, AND MOBILE MEDIA NETWORKS PROMOTING THE GOODS AND

SERVICES OF OTHERS BY PREPARING AND PLACING ADVERTISEMENTS ON VARIOUS DELIVERY SYSTEMS AND NETWORKS, IN CLASS 9 (U.S. CLS. 21, 23, 26, 36 AND 38).

FIRST USE 11-12-2006; IN COMMERCE 11-12-2006.

THE MARK CONSISTS OF STANDARD CHARACTERS WITHOUT CLAIM TO ANY PARTICULAR FONT, STYLE, SIZE, OR COLOR.

SER. NO. 77-337,917, FILED 11-27-2007.

SALLY SHIH, EXAMINING ATTORNEY

**Int. Cl.: 9**

**Prior U.S. Cls.: 21, 23, 26, 36 and 38**

**United States Patent and Trademark Office**

**Reg. No. 3,569,039**

**Registered Feb. 3, 2009**

**TRADEMARK  
PRINCIPAL REGISTER**

**PRIMAVERA CONTRACTOR**

PRIMAVERA TECHNOLOGIES, INC. (DELA-  
WARE CORPORATION)  
103 FOULK ROAD, SUITE 202  
WILMINGTON, DE 19803

FOR: COMPUTER PROGRAMS FOR USE IN  
PROJECT PLAN MANAGEMENT APPLICATIONS  
AND INSTRUCTION MANUALS THEREFOR,  
SOLD AS A UNIT, IN CLASS 9 (U.S. CLS. 21, 23, 26,  
36 AND 38).

FIRST USE 8-31-2004; IN COMMERCE 8-31-2004.

THE MARK CONSISTS OF STANDARD CHAR-  
ACTERS WITHOUT CLAIM TO ANY PARTICULAR  
FONT, STYLE, SIZE, OR COLOR.

OWNER OF U.S. REG. NOS. 1,835,276, 2,680,157  
AND OTHERS.

NO CLAIM IS MADE TO THE EXCLUSIVE  
RIGHT TO USE "CONTRACTOR", APART FROM  
THE MARK AS SHOWN.

THE FOREIGN WORDING IN THE MARK  
TRANSLATES INTO ENGLISH AS SPRINGTIME.

SER. NO. 77-338,779, FILED 11-28-2007.

PAUL CROWLEY, EXAMINING ATTORNEY

**Int. Cls.: 9, 35, 38 and 42**

**Prior U.S. Cls.: 21, 23, 26, 36, 38, 100, 101, 102 and 104**

**Reg. No. 3,569,040**

**United States Patent and Trademark Office**

**Registered Feb. 3, 2009**

**TRADEMARK  
SERVICE MARK  
PRINCIPAL REGISTER**

# IMTRADER

PIVOT INCORPORATED (DELAWARE CORPORATION)  
SUITE 610  
10 MILK STREET  
BOSTON, MA 02108

FOR: COMPUTER PROGRAMS FOR INVESTMENT PURPOSES, NAMELY, THE TRANSLATION OF ELECTRONIC CONVERSATIONS INTO FINANCIAL TRANSACTIONS AND TRADING WORKFLOWS; A PLATFORM FOR THE SHARING OF INFORMATION AS A SINGLE UNIT RATHER THAN AS INDIVIDUALS; A PLATFORM OVER WHICH FINANCIAL SERVICE PROFESSIONALS CAN COMMUNICATE, INTEGRATE AND COLLABORATE WITH EXTERNAL AND INTERNAL AUDIENCES IN A FINANCIALLY COMPLIANT ENVIRONMENT; A SYSTEM THAT AGGREGATES AND INTEGRATES INFORMATION AND DATA INTO TRADING WORKFLOWS; CONVERSION OF INSTANT MESSAGES INTO A PLATFORM TO EXECUTE FINANCIAL TRANSACTIONS, IN CLASS 9 (U.S. CLS. 21, 23, 26, 36 AND 38).

FIRST USE 7-1-2002; IN COMMERCE 7-1-2002.

FOR: DATA PROCESSING, NAMELY, AGGREGATING AND INTEGRATING INFORMATION AND DATA INTO TRADING WORKFLOWS, IN CLASS 35 (U.S. CLS. 100, 101 AND 102).

FIRST USE 7-1-2002; IN COMMERCE 7-1-2002.

FOR: COMPUTER SERVICES, NAMELY, PROVIDING ON-LINE FACILITIES OVER WHICH FINANCIAL PROFESSIONALS CAN COMMUNICATE, INTEGRATE AND COLLABORATE WITH EXTERNAL AND INTERNAL AUDIENCES IN A FINANCIALLY COMPLIANT ENVIRONMENT, IN CLASS 38 (U.S. CLS. 100, 101 AND 104).

FIRST USE 7-1-2002; IN COMMERCE 7-1-2002.

FOR: DATA CONVERSION, NAMELY, TRANSLATION OF ELECTRONIC CONVERSATIONS INTO FINANCIAL TRANSACTIONS AND TRADING WORKFLOWS VIA A COMPUTER NETWORK; CONVERSION OF INSTANT MESSAGES INTO A PLATFORM TO EXECUTE FINANCIAL TRANSACTIONS, IN CLASS 42 (U.S. CLS. 100 AND 101).

FIRST USE 7-1-2002; IN COMMERCE 7-1-2002.

THE MARK CONSISTS OF STANDARD CHARACTERS WITHOUT CLAIM TO ANY PARTICULAR FONT, STYLE, SIZE, OR COLOR.

SER. NO. 77-339,316, FILED 11-28-2007.

JAMES A. RAUEN, EXAMINING ATTORNEY

**Int. Cls.: 9, 35, 38 and 42**

**Prior U.S. Cls.: 21, 23, 26, 36, 38, 100, 101, 102 and 104**

**Reg. No. 3,569,041**

**United States Patent and Trademark Office**

**Registered Feb. 3, 2009**

**TRADEMARK  
SERVICE MARK  
PRINCIPAL REGISTER**

# PIVOT

PIVOT INCORPORATED (DELAWARE CORPORATION)  
SUITE 610  
10 MILK STREET  
BOSTON, MA 02108

FOR: COMPUTER PROGRAMS FOR INVESTMENT PURPOSES, NAMELY, THE TRANSLATION OF ELECTRONIC CONVERSATIONS INTO FINANCIAL TRANSACTIONS AND TRADING WORKFLOWS; A PLATFORM FOR THE SHARING OF INFORMATION AS A SINGLE UNIT RATHER THAN AS INDIVIDUALS; A PLATFORM OVER WHICH FINANCIAL SERVICE PROFESSIONALS CAN COMMUNICATE, INTEGRATE AND COLLABORATE WITH EXTERNAL AND INTERNAL AUDIENCES IN A FINANCIALLY COMPLIANT ENVIRONMENT; A SYSTEM THAT AGGREGATES AND INTEGRATES INFORMATION AND DATA INTO TRADING WORKFLOWS; CONVERSION OF INSTANT MESSAGES INTO A PLATFORM TO EXECUTE FINANCIAL TRANSACTIONS, IN CLASS 9 (U.S. CLS. 21, 23, 26, 36 AND 38).

FIRST USE 5-2-2007; IN COMMERCE 5-2-2007.

FOR: DATA PROCESSING, NAMELY, AGGREGATING AND INTEGRATING INFORMATION AND DATA INTO TRADING WORKFLOWS, IN CLASS 35 (U.S. CLS. 100, 101 AND 102).

FIRST USE 5-2-2007; IN COMMERCE 5-2-2007.

FOR: COMPUTER SERVICES, NAMELY, PROVIDING ON-LINE FACILITIES OVER WHICH FINANCIAL PROFESSIONALS CAN COMMUNICATE, INTEGRATE AND COLLABORATE WITH EXTERNAL AND INTERNAL AUDIENCES IN A FINANCIALLY COMPLIANT ENVIRONMENT, IN CLASS 38 (U.S. CLS. 100, 101 AND 104).

FIRST USE 5-2-2007; IN COMMERCE 5-2-2007.

FOR: DATA CONVERSION, NAMELY, TRANSLATION OF ELECTRONIC CONVERSATIONS INTO FINANCIAL TRANSACTIONS AND TRADING WORKFLOWS VIA A COMPUTER NETWORK; CONVERSION OF INSTANT MESSAGES INTO A PLATFORM TO EXECUTE FINANCIAL TRANSACTIONS, IN CLASS 42 (U.S. CLS. 100 AND 101).

FIRST USE 5-2-2007; IN COMMERCE 5-2-2007.

THE MARK CONSISTS OF STANDARD CHARACTERS WITHOUT CLAIM TO ANY PARTICULAR FONT, STYLE, SIZE, OR COLOR.

SER. NO. 77-339,334, FILED 11-28-2007.

JAMES A. RAUEN, EXAMINING ATTORNEY



**Int. Cls.: 20 and 45**

**Prior U.S. Cls.: 2, 13, 22, 25, 32, 50, 100 and 101**

**United States Patent and Trademark Office**

**Reg. No. 3,569,042**

**Registered Feb. 3, 2009**

**TRADEMARK  
SERVICE MARK  
PRINCIPAL REGISTER**



TECHNET TRADING LIMITED (BR.VIRGIN IS-  
LANDS LIMITED COMPANY (LTD.))  
SING MEI IND. BUILDING, 10/F  
29-37 KWAI WING ROAD  
KWAI CHUNG, N.T., HONG KONG

FOR: DRESS FORMS FOR DRESS MAKERS AND  
TAILORS AND FOR DISPLAY PURPOSES , IN  
CLASS 20 (U.S. CLS. 2, 13, 22, 25, 32 AND 50).

FIRST USE 3-1-2007; IN COMMERCE 3-1-2007.

FOR: CONSULTING SERVICES IN THE FIELD  
OF FASHION, IN CLASS 45 (U.S. CLS. 100 AND 101).

FIRST USE 3-1-2007; IN COMMERCE 3-1-2007.

SER. NO. 77-339,587, FILED 11-29-2007.

VIVIAN MICZNIK FIRST, EXAMINING ATTOR-  
NEY

**Int. Cl.: 33**

**Prior U.S. Cls.: 47 and 49**

**United States Patent and Trademark Office**

**Reg. No. 3,569,043**

**Registered Feb. 3, 2009**

**TRADEMARK  
PRINCIPAL REGISTER**

**PLAYS WELL WITH OTHERS**

VALLEY VODKA, INC. (MASSACHUSETTS COR-  
PORATION)  
P.O. BOX 32  
HADLEY, MA 01035

THE MARK CONSISTS OF STANDARD CHAR-  
ACTERS WITHOUT CLAIM TO ANY PARTICULAR  
FONT, STYLE, SIZE, OR COLOR.

FOR: VODKA, IN CLASS 33 (U.S. CLS. 47 AND 49).

SER. NO. 77-339,677, FILED 11-29-2007.

FIRST USE 9-1-2005; IN COMMERCE 9-1-2005.

BRIAN PINO, EXAMINING ATTORNEY

**Int. Cl.: 28**

**Prior U.S. Cls.: 22, 23, 38 and 50**

**United States Patent and Trademark Office**

**Reg. No. 3,569,044**

**Registered Feb. 3, 2009**

**TRADEMARK  
PRINCIPAL REGISTER**

**OH! BABY**

FUENTE ALARCON S.L. (SPAIN LIMITED LIABILITY COMPANY)  
AVDA. DOCTOR GADEA 15-1  
ALICANTE, SPAIN 03003

FOR: DOLLS AND DOLL ACCESSORIES, IN CLASS 28 (U.S. CLS. 22, 23, 38 AND 50).

THE MARK CONSISTS OF STANDARD CHARACTERS WITHOUT CLAIM TO ANY PARTICULAR FONT, STYLE, SIZE, OR COLOR.

OWNER OF ERPN CMNTY TM OFC REG. NO. 005089198, DATED 5-18-2007, EXPIRES 5-22-2016.

NO CLAIM IS MADE TO THE EXCLUSIVE RIGHT TO USE "BABY", APART FROM THE MARK AS SHOWN.

SER. NO. 77-339,703, FILED 11-29-2007.

SAIMA MAKHDOOM, EXAMINING ATTORNEY

**Int. Cl.: 9**

**Prior U.S. Cls.: 21, 23, 26, 36 and 38**

**Reg. No. 3,569,045**

**United States Patent and Trademark Office**

**Registered Feb. 3, 2009**

**TRADEMARK  
PRINCIPAL REGISTER**

**WITHIN OUR REACH**

PREP EDUCATIONAL VIDEOS, INC. (COLOR-  
ADO CORPORATION), DBA PREP EDUCA-  
TIONAL PRODUCTS, INC.  
7400 EAST ORCHARD ROAD, SUITE 2800 N.  
GREENWOOD VILLAGE, CO 80111

FOR: SERIES OF DVDS AND CDS DEALING  
WITH RELATIONSHIP AND/OR MARRIAGE EDU-  
CATION, OR MARRIAGE COUNSELING TO HELP  
INDIVIDUALS OR COUPLES IN AREAS SUCH AS  
UNDERSTANDING HEALTHY AND UNHEALTHY  
RELATIONSHIPS, MATE/PARTNER SELECTION,  
MARRIAGE AND FAMILY RELATIONSHIPS, FA-  
THERHOOD, PARENTING, EXPECTATION CLAR-  
IFICATION, PERSONALITY COMPATIBILITY,

COMMUNICATION, CONFLICT MANAGEMENT,  
AND DEVELOPMENT OF COMMUNITY SUPPORT  
FOR FAMILIES, IN CLASS 9 (U.S. CLS. 21, 23, 26, 36  
AND 38).

FIRST USE 12-4-2006; IN COMMERCE 12-4-2006.

THE MARK CONSISTS OF STANDARD CHAR-  
ACTERS WITHOUT CLAIM TO ANY PARTICULAR  
FONT, STYLE, SIZE, OR COLOR.

SER. NO. 77-340,048, FILED 11-29-2007.

BRENDAN MCCAULEY, EXAMINING ATTORNEY

**Int. Cls.: 35, 36 and 37**

**Prior U.S. Cls.: 100, 101, 102, 103 and 106**

**United States Patent and Trademark Office**

**Reg. No. 3,569,046**

**Registered Feb. 3, 2009**

**SERVICE MARK  
PRINCIPAL REGISTER**

**SACYR VALLEHERMOSO**

SACYR VALLEHERMOSO, S.A. (SPAIN CORPORATION)  
PASEO DE LA CASTELLANA, 83-85  
MADRID, SPAIN 28046

FOR: ADVERTISING, INCLUDING ADVERTISING OF PRODUCTS, APPARATUS, GOODS AND SERVICES; BUSINESS MANAGEMENT; BUSINESS ADMINISTRATION; OFFICE FUNCTIONS; COMMERCIAL AND INDUSTRIAL BUSINESS MANAGEMENT AND BUSINESS MANAGEMENT ASSISTANCE AND CONSULTANCY; ONLINE RETAIL AND WHOLESALE STORE SERVICES AND MAIL ORDER CATALOGUE SERVICES FEATURING PREFABRICATED GOODS FOR BUILDINGS AND UNPROCESSED, SEMI-PROCESSED AND FINISHED BUILDING MATERIALS; BUSINESS, EMPLOYMENT AND ACCOUNTING CONSULTANCY; ADMINISTRATIVE MANAGEMENT OF BUSINESS SPACES, HOTELS, RESIDENCES AND OLD PEOPLE'S HOMES, TOURIST AND STUDENT RESIDENCES; IMPORT AND EXPORT AGENCIES FEATURING MACHINERY, EQUIPMENT AND ROAD-MAKING MATERIALS; INFORMATION AND ADVICE RELATED TO THESE SERVICES, IN CLASS 35 (U.S. CLS. 100, 101 AND 102).

FOR: INSURANCE BROKERAGE; INSURANCE CONSULTANCY; INSURANCE ADMINISTRATION; FINANCIAL MANAGEMENT AND CONSULTING; FINANCIAL CONSULTING IN THE FIELDS OF FINANCIAL AFFAIRS, MONETARY AFFAIRS AND REAL ESTATE AFFAIRS; REAL ESTATE INVESTMENT; REAL ESTATE APPRAISAL; REAL ESTATE MANAGEMENT; FISCAL VALUATIONS AND ASSESSMENTS; APARTMENT HOUSE MANAGEMENT; RENTAL OF REAL ESTATE; INFORMATION AND ADVICE RELATED TO THESE SERVICES, IN CLASS 36 (U.S. CLS. 100, 101 AND 102).

FOR: BUILDING CONSTRUCTION; CARRYING OUT OF CONSTRUCTION WORK OF ALL KINDS, BOTH PUBLIC AND PRIVATE, NAMELY, CONSTRUCTION OF HIGHWAYS, RAILWAYS, HYDRAULICS, AIRPORTS, BUILDINGS, WATER AND WASTE TREATMENT PLANTS, AND OTHER INFRASTRUCTURE FACILITIES; RESTORATION OF URBAN PROPERTIES; PRESERVATION AND MAINTENANCE OF INSTALLATIONS, NAMELY, PUBLIC UTILITY INSTALLATIONS AND URBAN PROPERTIES; REPAIR OF HIGHWAYS, RAILWAYS, HYDRAULICS, AIRPORTS, BUILDINGS, WATER AND WASTE TREATMENT PLANTS, AND OTHER INFRASTRUCTURE FACILITIES; BUILDING CONSTRUCTION SUPERVISION; MINING EXTRACTION AND QUARRYING; INSPECTING CONSTRUCTION PROJECTS, NAMELY, INSPECTION OF HIGHWAYS, RAILWAYS, HYDRAULICS, AIRPORTS, BUILDINGS, WATER AND WASTE TREATMENT PLANTS, AND OTHER INFRASTRUCTURE FACILITIES; RENTAL OF TOOLS AND CONSTRUCTION EQUIPMENT; INFORMATION AND ADVICE RELATED TO THESE SERVICES, IN CLASS 37 (U.S. CLS. 100, 103 AND 106).

THE MARK CONSISTS OF STANDARD CHARACTERS WITHOUT CLAIM TO ANY PARTICULAR FONT, STYLE, SIZE, OR COLOR.

OWNER OF ERPN CMNTY TM OFC REG. NO. 004414281, DATED 5-3-2006, EXPIRES 4-25-2015.

THE ENGLISH TRANSLATION OF "VALLEHERMOSO" IN THE MARK IS BEAUTIFUL VALLEY.

SER. NO. 77-340,402, FILED 11-29-2007.

DAVID MILLER, EXAMINING ATTORNEY

**Int. Cls.: 37 and 42**

**Prior U.S. Cls.: 100, 101, 103 and 106**

**United States Patent and Trademark Office**

**Reg. No. 3,569,047**

**Registered Feb. 3, 2009**

**SERVICE MARK  
PRINCIPAL REGISTER**

**FRANK'S INTERNATIONAL**

FRANK'S INTERNATIONAL, INC. (TEXAS CORPORATION)  
SUITE 700  
10260 WESTHEIMER  
HOUSTON, TX 77042

FOR: RENTAL, INSTALLATION, MAINTENANCE, AND REPAIR OF OIL AND GAS WELL DRILLING EQUIPMENT; AND OIL AND GAS DRILLING SERVICES, IN CLASS 37 (U.S. CLS. 100, 103 AND 106).

FIRST USE 5-11-1987; IN COMMERCE 5-11-1987.

FOR: INSPECTIONS OF OIL AND GAS WELL DRILLING EQUIPMENT, IN CLASS 42 (U.S. CLS. 100 AND 101).

FIRST USE 5-11-1987; IN COMMERCE 5-11-1987.

THE MARK CONSISTS OF STANDARD CHARACTERS WITHOUT CLAIM TO ANY PARTICULAR FONT, STYLE, SIZE, OR COLOR.

OWNER OF U.S. REG. NOS. 2,145,604 AND 2,491,723.

NO CLAIM IS MADE TO THE EXCLUSIVE RIGHT TO USE "INTERNATIONAL", APART FROM THE MARK AS SHOWN.

SER. NO. 77-340,423, FILED 11-29-2007.

CIMMERIAN COLEMAN, EXAMINING ATTORNEY

**Int. Cls.: 9, 35, 38 and 42**

**Prior U.S. Cls.: 21, 23, 26, 36, 38, 100, 101, 102 and 104**

**United States Patent and Trademark Office**

**Reg. No. 3,569,048**

**Registered Feb. 3, 2009**

**TRADEMARK  
SERVICE MARK  
PRINCIPAL REGISTER**

**IM**TRADER

PIVOT INCORPORATED (DELAWARE CORPORATION)  
SUITE 610  
10 MILK STREET  
BOSTON, MA 02108

FOR: COMPUTER PROGRAMS FOR INVESTMENT PURPOSES, NAMELY, THE TRANSLATION OF ELECTRONIC CONVERSATIONS INTO FINANCIAL TRANSACTIONS AND TRADING WORKFLOWS; A PLATFORM FOR THE SHARING OF INFORMATION AS A SINGLE UNIT RATHER THAN AS INDIVIDUALS; A PLATFORM OVER WHICH FINANCIAL SERVICE PROFESSIONALS CAN COMMUNICATE, INTEGRATE AND COLLABORATE WITH EXTERNAL AND INTERNAL AUDIENCES IN A FINANCIALLY COMPLIANT ENVIRONMENT; A SYSTEM THAT AGGREGATES AND INTEGRATES INFORMATION AND DATA INTO TRADING WORKFLOWS; CONVERSION OF INSTANT MESSAGES INTO A PLATFORM TO EXECUTE FINANCIAL TRANSACTIONS, IN CLASS 9 (U.S. CLS. 21, 23, 26, 36 AND 38).

FIRST USE 7-1-2002; IN COMMERCE 7-1-2002.

FOR: DATA PROCESSING, NAMELY, AGGREGATING AND INTEGRATING INFORMATION AND DATA INTO TRADING WORKFLOWS, IN CLASS 35 (U.S. CLS. 100, 101 AND 102).

FIRST USE 7-1-2002; IN COMMERCE 7-1-2002.

FOR: COMPUTER SERVICES, NAMELY, PROVIDING ON-LINE FACILITIES OVER WHICH FINANCIAL PROFESSIONALS CAN COMMUNICATE, INTEGRATE AND COLLABORATE WITH EXTERNAL AND INTERNAL AUDIENCES IN A FINANCIALLY COMPLIANT ENVIRONMENT, IN CLASS 38 (U.S. CLS. 100, 101 AND 104).

FIRST USE 7-1-2002; IN COMMERCE 7-1-2002.

FOR: DATA CONVERSION, NAMELY, TRANSLATION OF ELECTRONIC CONVERSATIONS INTO FINANCIAL TRANSACTIONS AND TRADING WORKFLOWS VIA A COMPUTER NETWORK; CONVERSION OF INSTANT MESSAGES INTO A PLATFORM TO EXECUTE FINANCIAL TRANSACTIONS, IN CLASS 42 (U.S. CLS. 100 AND 101).

FIRST USE 7-1-2002; IN COMMERCE 7-1-2002.

THE MARK CONSISTS OF THE STYLIZED WORDING "IMTRADER", WITH THE LETTERS "IM" APPEARING IN A BOLDER TYPEFACE THAN THE LETTERS "TRADER". THE COLORS BLACK, WHITE AND GRAY REPRESENT BACKGROUND, OUTLINING, SHADING AND/OR TRANSPARENT AREAS AND ARE NOT PART OF THE MARK.

SER. NO. 77-340,467, FILED 11-29-2007.

JAMES A. RAUEN, EXAMINING ATTORNEY

**Int. Cls.: 3 and 35**

**Prior U.S. Cls.: 1, 4, 6, 50, 51, 52, 100, 101 and 102**

**United States Patent and Trademark Office**

**Reg. No. 3,569,049**

**Registered Feb. 3, 2009**

**TRADEMARK  
SERVICE MARK  
PRINCIPAL REGISTER**



LES ATELIERS DU VERSO INC. (CANADA CORPORATION)  
831 ROUTE 505, STE-ANNE-DE-KENT  
NEW BRUNSWICK, CANADA E4S1J9

FOR: SKIN CARE PRODUCTS, NAMELY, SOAPS, BATH GELS, CREAMS, POWDERS, BATH SALTS, BALMS, PERFUMES AND SKIN CLEANSERS; BODY DEODORANT; ESSENTIAL OILS; MAKE-UP REMOVER PREPARATIONS; COSMETIC OLIVE OIL AND COCONUT OIL FOR THE FACE AND BODY; HAIR CARE PRODUCTS, NAMELY, SHAMPOOS AND CONDITIONERS, IN CLASS 3 (U.S. CLS. 1, 4, 6, 50, 51 AND 52).

FIRST USE 11-15-2003; IN COMMERCE 6-1-2007.

FOR: ONLINE RETAIL STORE SERVICES FOR SKIN CARE AND HAIR CARE PRODUCTS, IN CLASS 35 (U.S. CLS. 100, 101 AND 102).

FIRST USE 11-15-2003; IN COMMERCE 6-1-2007.

SER. NO. 77-340,655, FILED 11-29-2007.

DAVID MILLER, EXAMINING ATTORNEY



**Int. Cl.: 5**

**Prior U.S. Cls.: 6, 18, 44, 46, 51 and 52**

**United States Patent and Trademark Office**

**Reg. No. 3,569,050**

**Registered Feb. 3, 2009**

**TRADEMARK  
PRINCIPAL REGISTER**

**EXTREME HEALTH USA**

EXTREME HEALTH INC. (NEVADA CORPORATION)  
601 UNIVERSITY AVE. STE 278  
SACRAMENTO, CA 95825

FOR: DIETARY SUPPLEMENTS, IN CLASS 5 (U.S. CLS. 6, 18, 44, 46, 51 AND 52).

FIRST USE 10-30-1999; IN COMMERCE 10-30-1999.

THE MARK CONSISTS OF STANDARD CHARACTERS WITHOUT CLAIM TO ANY PARTICULAR FONT, STYLE, SIZE, OR COLOR.

OWNER OF U.S. REG. NO. 2,282,762.

NO CLAIM IS MADE TO THE EXCLUSIVE RIGHT TO USE "HEALTH USA", APART FROM THE MARK AS SHOWN.

SER. NO. 77-340,665, FILED 11-29-2007.

STEVEN JACKSON, EXAMINING ATTORNEY

**Int. Cl.: 1**

**Prior U.S. Cls.: 1, 5, 6, 10, 26 and 46**

**United States Patent and Trademark Office**

**Reg. No. 3,569,051**

**Registered Feb. 3, 2009**

**TRADEMARK  
PRINCIPAL REGISTER**



HARBIN SONGJIANG COPPER TRADE (GROUP)  
CO., LTD. (CHINA CORPORATION)  
BINXIAN  
BINXI ECONOMIC DEVELOPMENT DISTRICT  
HARBIN HEILONGJIANG, CHINA

FOR: SILICON; TUNGSTIC ACID; AMMONIUM  
TUNGSTATE; CALCIUM TUNGSTATE; ZINC  
TUNGSTATE; MOLYBDIC ACID; AMMONIUM  
MOLYBDATE; SODIUM MOLYBDATE; AMMO-  
NIUM DIMOLYBDATE; AMMONIUM TETRAMO-  
LYBDATE; AMMOINUM HEPTAMOLYBDATE;  
COPPER CARBONATE; COPPER SULPHATE; CHEM-  
ICALS FOR INDUSTRIAL PURPOSES; CHEMI-  
CALS FOR USE IN INDUSTRY; CHEMICALS FOR  
USE IN INDUSTRY AND SCIENCE; BISMUTH, IN  
CLASS 1 (U.S. CLS. 1, 5, 6, 10, 26 AND 46).

FIRST USE 2-1-2005; IN COMMERCE 2-1-2005.

THE MARK CONSISTS OF CHINESE CHARAC-  
TERS IN A BLACK SEMI-CIRCLE AND THE LET-  
TERS "SJ" IN A STRIPED SEMI-CIRCLE.

THE NON-LATIN CHARACTER(S) IN THE  
MARK TRANSLITERATES INTO MANDARIN IS  
"SONG" AND "JIANG", AND THIS MEANS "PINE"  
AND "RIVER" IN ENGLISH.

SER. NO. 77-340,738, FILED 11-30-2007.

ANTHONY RINKER, EXAMINING ATTORNEY

**Int. Cls.: 37 and 42**

**Prior U.S. Cls.: 100, 101, 103 and 106**

**United States Patent and Trademark Office**

**Reg. No. 3,569,052**

**Registered Feb. 3, 2009**

**SERVICE MARK  
PRINCIPAL REGISTER**

**FRANK'S WORLDWIDE**

FRANK'S INTERNATIONAL, INC. (TEXAS CORPORATION)  
SUITE 700  
10260 WESTHEIMER  
HOUSTON, TX 77042

FOR: RENTAL, INSTALLATION, MAINTENANCE, AND REPAIR OF OIL AND GAS WELL DRILLING EQUIPMENT; AND OIL AND GAS DRILLING SERVICES, IN CLASS 37 (U.S. CLS. 100, 103 AND 106).

FIRST USE 4-30-2007; IN COMMERCE 4-30-2007.

FOR: INSPECTIONS OF OIL AND GAS WELL DRILLING EQUIPMENT, IN CLASS 42 (U.S. CLS. 100 AND 101).

FIRST USE 4-30-2007; IN COMMERCE 4-30-2007.

THE MARK CONSISTS OF STANDARD CHARACTERS WITHOUT CLAIM TO ANY PARTICULAR FONT, STYLE, SIZE, OR COLOR.

OWNER OF U.S. REG. NOS. 2,145,604 AND 2,491,723.

NO CLAIM IS MADE TO THE EXCLUSIVE RIGHT TO USE "WORLDWIDE", APART FROM THE MARK AS SHOWN.

SER. NO. 77-340,813, FILED 11-30-2007.

CIMMERIAN COLEMAN, EXAMINING ATTORNEY

**Int. Cl.: 41**

**Prior U.S. Cls.: 100, 101 and 107**

**United States Patent and Trademark Office**

**Reg. No. 3,569,053**

**Registered Feb. 3, 2009**

**SERVICE MARK  
PRINCIPAL REGISTER**

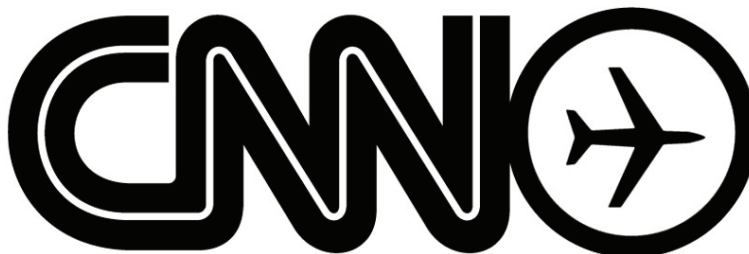

CABLE NEWS NETWORK, INC. (DELAWARE CORPORATION)  
ONE CNN CENTER, 13 NORTH  
ATLANTA, GA 30303

FOR: ENTERTAINMENT SERVICES IN THE NATURE OF ON-GOING TELEVISION NEWS PROGRAMS FEATURING INFORMATION ABOUT CURRENT EVENTS, SPORTS, WEATHER, GOVERNMENT, EDUCATION, ENTERTAINMENT, DINING, TRAVEL AND LEISURE, PROVIDED THROUGH SATELLITE TO VIDEO MONITORS LOCATED IN AIRPORTS; ENTERTAINMENT SERVICES, NAMELY, PROVIDING ON-GOING TELEVISION PROGRAMS FEATURING LIVE SPORTING EVENTS VIA SATELLITE TO VIDEO MONITORS LOCATED IN AIRPORTS AND VIA ON-LINE GLO-

BAL COMPUTER NETWORKS; NEWS REPORTING SERVICES PROVIDED VIA AN ON-LINE GLOBAL COMPUTER NETWORK, IN CLASS 41 (U.S. CLS. 100, 101 AND 107).

FIRST USE 6-0-2005; IN COMMERCE 6-0-2005.

OWNER OF U.S. REG. NOS. 1,597,839, 2,903,197 AND OTHERS.

THE MARK CONSISTS OF THE LETTERS "CNN" WITH AN AIRPLANE ENCLOSED IN A CIRCLE.

SER. NO. 77-340,923, FILED 11-30-2007.

MYRIAH HABEEB, EXAMINING ATTORNEY

**Int. Cl.: 38**

**Prior U.S. Cls.: 100, 101 and 104**

**United States Patent and Trademark Office**

**Reg. No. 3,569,054**

**Registered Feb. 3, 2009**

**SERVICE MARK  
PRINCIPAL REGISTER**

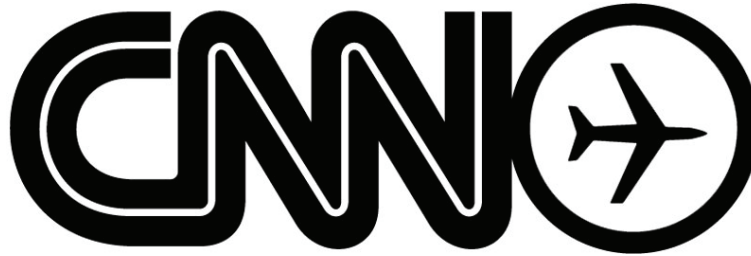

CABLE NEWS NETWORK, INC. (DELAWARE CORPORATION)  
ONE CNN CENTER, 13 NORTH  
ATLANTA, GA 30303

FOR: TELEVISION BROADCASTING SERVICES PROVIDED THROUGH SATELLITE TO VIDEO MONITORS LOCATED IN AIRPORTS; INTERNET BROADCASTING SERVICES; PROVIDING STREAMING OF AUDIO AND VIDEO IN THE NATURE OF NEWS, EDITORIAL CONTENT AND INFORMATION VIA GLOBAL COMPUTER NETWORKS; TRANSMISSION OF NEWS, IN CLASS 38 (U.S. CLS. 100, 101 AND 104).

FIRST USE 6-0-2005; IN COMMERCE 6-0-2005.

OWNER OF U.S. REG. NOS. 1,597,839, 2,903,197 AND OTHERS.

THE MARK CONSISTS OF THE LETTERS "CNN" WITH A PICTURE OF AN AIRPLANE ENCLOSED IN A CIRCLE.

SER. NO. 77-341,162, FILED 11-30-2007.

MYRIAH HABEEB, EXAMINING ATTORNEY

**Int. Cl.: 42**

**Prior U.S. Cls.: 100 and 101**

**United States Patent and Trademark Office**

**Reg. No. 3,569,055**

**Registered Feb. 3, 2009**

**SERVICE MARK  
PRINCIPAL REGISTER**

**BILADY**

SANOFI-AVENTIS (FRANCE CORPORATION)  
174, AVENUE DE FRANCE  
PARIS, FRANCE 75013

FOR: SCIENTIFIC RESEARCH IN THE MEDICAL FIELD, RESEARCH AND DEVELOPMENT OF NEW CLINICAL PRODUCTS; MEDICAL AND SCIENTIFIC RESEARCH, NAMELY, CONDUCTING CLINICAL TRIALS; MEDICAL AND SCIENTIFIC RESEARCH IN THE FIELD OF PHARMACEUTICALS, IN CLASS 42 (U.S. CLS. 100 AND 101).

THE MARK CONSISTS OF STANDARD CHARACTERS WITHOUT CLAIM TO ANY PARTICULAR FONT, STYLE, SIZE, OR COLOR.

PRIORITY CLAIMED UNDER SEC. 44(D) ON FRANCE APPLICATION NO. 073533667, FILED 10-23-2007, REG. NO. 073533667, DATED 10-23-2007, EXPIRES 10-23-2017.

THE WORDING "BILADY" HAS NO MEANING IN A FOREIGN LANGUAGE.

SER. NO. 77-341,202, FILED 11-30-2007.

SUSAN STIGLITZ, EXAMINING ATTORNEY

**Int. Cl.: 15**

**Prior U.S. Cls.: 2, 21 and 36**

**United States Patent and Trademark Office**

**Reg. No. 3,569,056**

**Registered Feb. 3, 2009**

**TRADEMARK  
PRINCIPAL REGISTER**

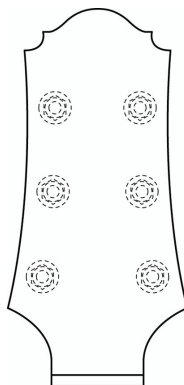

PARK, IN JAE (REPUBLIC OF KOREA INDIVIDUAL)  
JUNGGYEBON-DONG, NOWON-GU  
104-801 CHUNGGU JUNGGYEDONG APT.  
SEOUL, REPUBLIC OF KOREA

FOR: ACOUSTIC GUITARS, ELECTRIC GUITARS, BASS GUITARS, IN CLASS 15 (U.S. CLS. 2, 21 AND 36).

FIRST USE 5-9-1990; IN COMMERCE 3-24-1999.

OWNER OF U.S. REG. NO. 2,497,496.

THE MARK CONSISTS OF A CONFIGURATION OF A PEG HEAD OF A GUITAR WITH CONCAVE-

LY CURVED SIDE WALLS AND HAVING A TOP WITH A CONVEXLY ROUNDED PEAK FLANKED BY SHORTER HEIGHT POINTS. THE MATTER SHOWN BY DOTTED LINES IS NOT A PART OF THE MARK AND NO CLAIM IS MADE TO THIS MATTER. IT SERVES ONLY TO SHOW THE POSITION OF THE MARK ON THE GOODS.

SEC. 2(F).

SER. NO. 77-342,422, FILED 12-3-2007.

JENNIFER MARTIN, EXAMINING ATTORNEY

**Int. Cl.: 36**

**Prior U.S. Cls.: 100, 101 and 102**

**United States Patent and Trademark Office**

**Reg. No. 3,569,057**

**Registered Feb. 3, 2009**

**SERVICE MARK  
PRINCIPAL REGISTER**



MIDFIRST BANK (UNITED STATES FEDERAL-  
LY CHARTERED SAVINGS ASSOCIATION)  
3RD FLOOR  
501 N.W. GRAND  
OKLAHOMA CITY, OK 73118

FOR: BANKING AND FINANCING SERVICES,  
IN CLASS 36 (U.S. CLS. 100, 101 AND 102).

FIRST USE 4-1-2007; IN COMMERCE 5-1-2007.

OWNER OF U.S. REG. NO. 2,705,588.

NO CLAIM IS MADE TO THE EXCLUSIVE  
RIGHT TO USE "BEST RATE GUARANTEE",  
APART FROM THE MARK AS SHOWN.

THE MARK CONSISTS OF THE WORDING  
"BEST RATE GUARANTEE!" ENCLOSED IN A  
CIRCLE AND SURROUNDING A PARALLELO-  
GRAM DESIGN.

SER. NO. 77-343,230, FILED 12-4-2007.

LESLIE RICHARDS, EXAMINING ATTORNEY



**Int. Cl.: 35**

**Prior U.S. Cls.: 100, 101 and 102**

**United States Patent and Trademark Office**

**Reg. No. 3,569,058**

**Registered Feb. 3, 2009**

**SERVICE MARK  
PRINCIPAL REGISTER**

**CELLHUT**

KEEP ON TALKING, INC. (NEW YORK CORPORATION)  
269 WALNUT ROAD  
GLEN COVE, NY 11542

FOR: ONLINE STORE SERVICES FEATURING TELECOMMUNICATION APPARATUS, TELECOMMUNICATIONS PLANS AND SUBSCRIPTIONS, AND PRE-PAID CARDS, PERSONAL DIGITAL ASSISTANTS, MOBILE AND CELLULAR TELEPHONES AND ACCESSORIES, NAMELY, CHARGERS, HEADSETS, BATTERIES, DATA CABLES, PERSONAL DIGITAL ASSISTANTS, HANDHELD WIRELESS DEVICES, MICROPHONES, EARPIECES, CAMERAS, CARRYING

AND STORAGE CASES, AND SOFTWARE ALL FOR USE WITH ALL OF THE SAME, IN CLASS 35 (U.S. CLS. 100, 101 AND 102).

FIRST USE 1-31-2004; IN COMMERCE 1-31-2004.

THE MARK CONSISTS OF STANDARD CHARACTERS WITHOUT CLAIM TO ANY PARTICULAR FONT, STYLE, SIZE, OR COLOR.

SER. NO. 77-343,353, FILED 12-4-2007.

SUNG IN, EXAMINING ATTORNEY

**Int. Cls.: 9, 16 and 41**

**Prior U.S. Cls.: 2, 5, 21, 22, 23, 26, 29, 36, 37, 38, 50,  
100, 101 and 107**

**Reg. No. 3,569,059**

**United States Patent and Trademark Office**

**Registered Feb. 3, 2009**

**TRADEMARK  
SERVICE MARK  
PRINCIPAL REGISTER**

**DIPI**

SENTIS PTY LTD (AUSTRALIA CORPORATION)  
63 DOGGETT STREET  
NEWSTEAD, AUSTRALIA 4006

FOR: INSTRUCTION, ASSESSMENT AND EDUCATIONAL SOFTWARE IN THE FIELDS OF OCCUPATIONAL HEALTH AND SAFETY, PSYCHOLOGICAL TESTING AND EMPLOYEE RELATIONS; COMPACT-DISCS, PRERECORDED AUDIO AND VIDEO CASSETTES FEATURING MATERIAL IN THE FIELD OF PSYCHOLOGICAL TESTING, EMPLOYEE RELATIONS AND OCCUPATIONAL HEALTH AND SAFETY, BLANK CD-ROMS FOR SOUND AND/OR VIDEO RECORDING; APPARATUS FOR RECORDING, TRANSMISSION OR REPRODUCTION OF SOUND OR IMAGES, NAMELY, VIDEO CASSETTE RECORDERS; COMPUTER PROGRAMS TO ADMINISTER AND PERFORM EDUCATIONAL TESTS FOR PARTICIPANTS, IN CLASS 9 (U.S. CLS. 21, 23, 26, 36 AND 38).

FOR: PRINTED MATERIALS, NAMELY, MAGAZINES, POSTERS, PRINTED VISUALS IN THE NATURE OF PROMOTIONAL MATERIALS AND PRINTED TESTS IN THE FIELD OF EDUCATION,

PSYCHOLOGICAL TESTING, EMPLOYEE RELATIONS AND OCCUPATIONAL HEALTH AND SAFETY, IN CLASS 16 (U.S. CLS. 2, 5, 22, 23, 29, 37, 38 AND 50).

FOR: EDUCATIONAL SERVICES, NAMELY, PROVIDING CLASSES AND TRAINING SERVICES IN THE FIELDS OF PSYCHOLOGICAL TESTING, EMPLOYEE RELATIONS AND OCCUPATIONAL HEALTH AND SAFETY; PERFORMING EDUCATIONAL AND STANDARDIZED TESTS IN RELATION TO HEALTH, SAFETY AND ACCIDENT PREVENTION, IN CLASS 41 (U.S. CLS. 100, 101 AND 107).

THE MARK CONSISTS OF STANDARD CHARACTERS WITHOUT CLAIM TO ANY PARTICULAR FONT, STYLE, SIZE, OR COLOR.

OWNER OF AUSTRALIA REG. NO. 1164154, DATED 3-2-2007, EXPIRES 3-2-2017.

SER. NO. 77-343,413, FILED 12-4-2007.

JOHN SCHUYLER YARD, EXAMINING ATTORNEY

**Int. Cls.: 9, 16 and 41**

**Prior U.S. Cls.: 2, 5, 21, 22, 23, 26, 29, 36, 37, 38, 50,  
100, 101 and 107**

**Reg. No. 3,569,060**

**United States Patent and Trademark Office**

**Registered Feb. 3, 2009**

**TRADEMARK  
SERVICE MARK  
PRINCIPAL REGISTER**

**ELoC**

SENTIS PTY LTD (AUSTRALIA CORPORATION)  
63 DOGGETT STREET  
NEWSTEAD, AUSTRALIA 4006

FOR: INSTRUCTION, ASSESSMENT AND EDUCATIONAL SOFTWARE IN THE FIELDS OF OCCUPATIONAL HEALTH AND SAFETY, PSYCHOLOGICAL TESTING AND EMPLOYEE RELATIONS; COMPACT-DISCS, PRERECORDED AUDIO AND VIDEO CASSETTES FEATURING MATERIAL IN THE FIELD OF PSYCHOLOGICAL TESTING, EMPLOYEE RELATIONS AND OCCUPATIONAL HEALTH AND SAFETY, BLANK CD-ROMS FOR SOUND AND/OR VIDEO RECORDING; APPARATUS FOR RECORDING, TRANSMISSION OR REPRODUCTION OF SOUND OR IMAGES, NAMELY, VIDEO CASSETTE RECORDERS; COMPUTER PROGRAMS TO ADMINISTER AND PERFORM EDUCATIONAL TESTS FOR PARTICIPANTS, IN CLASS 9 (U.S. CLS. 21, 23, 26, 36 AND 38).

FOR: PRINTED MATERIALS, NAMELY, MAGAZINES, POSTERS, PRINTED VISUALS IN THE NATURE OF PROMOTIONAL MATERIALS AND PRINTED TESTS IN THE FIELD OF EDUCATION,

PSYCHOLOGICAL TESTING, EMPLOYEE RELATIONS AND OCCUPATIONAL HEALTH AND SAFETY, IN CLASS 16 (U.S. CLS. 2, 5, 22, 23, 29, 37, 38 AND 50).

FOR: EDUCATIONAL SERVICES, NAMELY, PROVIDING CLASSES AND TRAINING SERVICES IN THE FIELDS OF PSYCHOLOGICAL TESTING, EMPLOYEE RELATIONS AND OCCUPATIONAL HEALTH AND SAFETY; PERFORMING EDUCATIONAL AND STANDARDIZED TESTS IN RELATION TO HEALTH, SAFETY AND ACCIDENT PREVENTION, IN CLASS 41 (U.S. CLS. 100, 101 AND 107).

THE MARK CONSISTS OF STANDARD CHARACTERS WITHOUT CLAIM TO ANY PARTICULAR FONT, STYLE, SIZE, OR COLOR.

OWNER OF AUSTRALIA REG. NO. 1164156, DATED 3-2-2007, EXPIRES 3-2-2017.

SER. NO. 77-343,451, FILED 12-4-2007.

JOHN SCHUYLER YARD, EXAMINING ATTORNEY

**Int. Cl.: 3**

**Prior U.S. Cls.: 1, 4, 6, 50, 51 and 52**

**United States Patent and Trademark Office**

**Reg. No. 3,569,061**

**Registered Feb. 3, 2009**

**TRADEMARK  
PRINCIPAL REGISTER**

**SOFN'FREE N'PRETTY**

RIVERSTONE MARKETING LIMITED (BR.VIR-  
GIN ISLANDS CORPORATION)  
WICKHAMS CAY 1  
AKARA BUILDING, 24 DE CASTRO STREET  
ROAD TOWN, TORTOLA, BR.VIRGIN ISLANDS

FOR: HAIR CARE PREPARATIONS, IN CLASS 3  
(U.S. CLS. 1, 4, 6, 50, 51 AND 52).

FIRST USE 8-31-2000; IN COMMERCE 8-31-2000.

THE MARK CONSISTS OF STANDARD CHAR-  
ACTERS WITHOUT CLAIM TO ANY PARTICULAR  
FONT, STYLE, SIZE, OR COLOR.

OWNER OF U.S. REG. NOS. 1,273,265, 2,315,404  
AND OTHERS.

SER. NO. 77-343,480, FILED 12-4-2007.

ELIZABETH KAJUBI, EXAMINING ATTORNEY

**Int. Cls.: 6 and 20**

**Prior U.S. Cls.: 2, 12, 13, 14, 22, 23, 25, 32 and 50**

**Reg. No. 3,569,062**

**United States Patent and Trademark Office**

**Registered Feb. 3, 2009**

**TRADEMARK  
PRINCIPAL REGISTER**

**GO BEYOND THE BASICS...GET  
UNCOMMONLY ORGANIZED!**

SPACE-METRICS USA, LLC (WISCONSIN LIMITED LIABILITY COMPANY)  
167 E. 5TH STREET  
MONTELO, WI 53949

FOR: METAL SHELF BRACKETS, MIRROR HANGERS AND HOOKS, METAL STORAGE BASKETS, METAL STORAGE BINS, IN CLASS 6 (U.S. CLS. 2, 12, 13, 14, 23, 25 AND 50).

FIRST USE 3-2-2006; IN COMMERCE 3-2-2006.

FOR: STORAGE AND ORGANIZATIONAL PRODUCTS, NAMELY, SHELVES, CABINETS, DOORS FOR FURNITURE, DRAWERS, BOOKCASES, STORAGE ISLANDS IN THE NATURE OF STAND-ALONE CABINETS, HUTCHES, FITTED INSERTS FOR USE AS CUBBY HOLES, TIE RACKS, BELT RACKS, SHOE RACKS, PANT RACKS, HANGING RODS FOR CLOTHES, STORAGE BASKETS, NON-METAL STORAGE BINS, LAUNDRY HAMPERS, FITTED INSERTS FOR USE AS DRAWER ORGANIZERS, CLOTHING VALETS IN THE NATURE OF SLIDING CLOTHES RODS, NON-METAL HANG-

ERS AND HOOKS; WALL-MOUNTED HANGING SYSTEMS COMPRISED PRIMARILY OF NON-METAL VERTICAL PANELS AND NON-METAL MOUNTING RAIL FOR HANGING SHELVES, CABINETS, DRAWERS AND HANGING BARS; AND FLOOR-SUPPORTED HANGING SYSTEMS COMPRISED PRIMARILY OF NON-METAL VERTICAL PANELS, FIXED SHELVES AND KICK BOARDS FOR HANGING SHELVES, CABINETS, DRAWERS AND HANGING BARS; METAL CLOTHES HANGERS, IN CLASS 20 (U.S. CLS. 2, 13, 22, 25, 32 AND 50).

FIRST USE 3-2-2006; IN COMMERCE 3-2-2006.

THE MARK CONSISTS OF STANDARD CHARACTERS WITHOUT CLAIM TO ANY PARTICULAR FONT, STYLE, SIZE, OR COLOR.

SER. NO. 77-343,776, FILED 12-4-2007.

LEIGH CAROLINE CASE, EXAMINING ATTORNEY

**Int. Cl.: 36**

**Prior U.S. Cls.: 100, 101 and 102**

**United States Patent and Trademark Office**

**Reg. No. 3,569,063**

**Registered Feb. 3, 2009**

**SERVICE MARK  
PRINCIPAL REGISTER**



STROUSE FINANCIAL GROUP, LLC (INDIANA  
LIMITED LIABILITY COMPANY)  
421 METRO AVENUE  
EVANSVILLE, IN 47715

FOR: FINANCIAL PLANNING AND INVEST-  
MENT ADVISORY SERVICES; LIFE INSURANCE  
BROKERAGE; ADVICE RELATING TO INVEST-  
MENTS; INVESTMENT ADVICE; INVESTMENT  
SERVICES, NAMELY, ASSET ACQUISITION, CON-  
SULTATION, DEVELOPMENT AND MANAGE-  
MENT SERVICES; ESTATE PLANNING;  
FINANCIAL PLANNING FOR RETIREMENT; IN-  
SURANCE BROKERAGE IN THE FIELD OF DIS-  
ABILITY, IN CLASS 36 (U.S. CLS. 100, 101 AND 102).

FIRST USE 11-30-2005; IN COMMERCE 12-31-2005.

THE COLOR(S) WHITE AND BLUE IS/ARE  
CLAIMED AS A FEATURE OF THE MARK.

THE MARK CONSISTS OF A WHITE STYLIZED  
LETTER "S" WITHIN A BLUE CIRCLE CONTAIN-  
ING SHADING.

SER. NO. 77-343,900, FILED 12-4-2007.

GIANCARLO CASTRO, EXAMINING ATTORNEY

**Int. Cls.: 35 and 36**

**Prior U.S. Cls.: 100, 101 and 102**

**United States Patent and Trademark Office**

**Reg. No. 3,569,064**

**Registered Feb. 3, 2009**

**SERVICE MARK  
PRINCIPAL REGISTER**

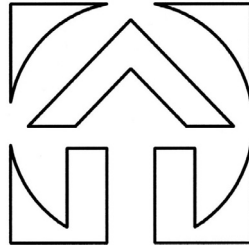

RISK TO REWARD, INC. (CALIFORNIA CORPORATION)  
4508A ATLANTIC AVENUE, SUITE 1219  
LONG BEACH, CA 90807

FOR: BUSINESS RISK MANAGEMENT CONSULTATION IN THE CONSTRUCTION FIELD, IN CLASS 35 (U.S. CLS. 100, 101 AND 102).

FIRST USE 5-1-2007; IN COMMERCE 5-1-2007.

FOR: INSURANCE RISK CONSULTATION AND MANAGEMENT IN THE CONSTRUCTION FIELD, IN CLASS 36 (U.S. CLS. 100, 101 AND 102).

FIRST USE 5-1-2007; IN COMMERCE 5-1-2007.

THE MARK CONSISTS OF THE OUTLINE OF A HOUSE WITHIN A CIRCLE. THE CORNERS OF THE MARK ARE TRIANGLES WHICH BORDER THE DESIGN TO FORM A SQUARE.

SER. NO. 77-344,085, FILED 12-4-2007.

PAULA MAHONEY, EXAMINING ATTORNEY

**Int. Cl.: 41**

**Prior U.S. Cls.: 100, 101 and 107**

**United States Patent and Trademark Office**

**Reg. No. 3,569,065**

**Registered Feb. 3, 2009**

**SERVICE MARK  
PRINCIPAL REGISTER**

**SALTWATER EXPERIENCE**

REDFISHTEAM.COM, INC. (FLORIDA CORPORATION)  
133 SEASHORE DRIVE  
ISLAMORADA, FL 33036

FOR: ENTERTAINMENT IN THE NATURE OF ON-GOING TELEVISION PROGRAMS IN THE FIELD OF FISHING; ENTERTAINMENT SERVICES, NAMELY, PROVIDING A TELEVISION PROGRAM IN THE FIELD OF FISHING VIA A GLOBAL COMPUTER NETWORK; FISHING GUIDE SERVICES, IN CLASS 41 (U.S. CLS. 100, 101 AND 107).

FIRST USE 10-8-2005; IN COMMERCE 10-8-2005.

THE MARK CONSISTS OF STANDARD CHARACTERS WITHOUT CLAIM TO ANY PARTICULAR FONT, STYLE, SIZE, OR COLOR.

NO CLAIM IS MADE TO THE EXCLUSIVE RIGHT TO USE "SALTWATER", APART FROM THE MARK AS SHOWN.

SER. NO. 77-344,304, FILED 12-5-2007.

EUGENIA MARTIN, EXAMINING ATTORNEY



**Int. Cl.: 3**

**Prior U.S. Cls.: 1, 4, 6, 50, 51 and 52**

**United States Patent and Trademark Office**

**Reg. No. 3,569,066**

**Registered Feb. 3, 2009**

**TRADEMARK  
PRINCIPAL REGISTER**

**VITA-XYLANE**

L'OREAL (FRANCE SOCIÉTÉ ANONYME (SA))  
14 RUE ROYALE  
PARIS, FRANCE 75008

FOR: PERFUME, TOILET WATER; BATH AND SHOWER GELS AND SALTS NOT FOR MEDICAL PURPOSE; TOILET SOAPS, BODY DEODORANTS; COSMETICS, NAMELY, CREAMS, MILKS, LOTIONS, GELS AND POWDERS FOR THE FACE, THE BODY AND THE HANDS; NON-MEDICATED SUN CARE PREPARATIONS; MAKEUP PREPARATIONS; SHAMPOOS; GELS, SPRAYS, MOUSSES, BALMS, CREAM, SERUMS AND WAX FOR THE HAIR STYLING AND HAIR CARE; HAIR LACQUERS; HAIR COLOURING AND HAIR DECOLORANT PREPARATIONS; PERMANENT WAVING

AND CURLING PREPARATIONS; ESSENTIAL OILS FOR PERSONAL USE, IN CLASS 3 (U.S. CLS. 1, 4, 6, 50, 51 AND 52).

THE MARK CONSISTS OF STANDARD CHARACTERS WITHOUT CLAIM TO ANY PARTICULAR FONT, STYLE, SIZE, OR COLOR.

PRIORITY CLAIMED UNDER SEC. 44(D) ON FRANCE APPLICATION NO. 073507517, FILED 6-19-2007, REG. NO. 073507517, DATED 6-19-2007, EXPIRES 6-19-2017.

SER. NO. 77-344,329, FILED 12-5-2007.

DAVID ELTON, EXAMINING ATTORNEY

**Int. Cls.: 35 and 36**

**Prior U.S. Cls.: 100, 101 and 102**

**United States Patent and Trademark Office**

**Reg. No. 3,569,067**

**Registered Feb. 3, 2009**

**SERVICE MARK  
PRINCIPAL REGISTER**



**F.A.M.E.**  
FALK ASSOCIATES MANAGEMENT ENTERPRISES

FALK F.A.M.E LLC (DELAWARE LIMITED LIABILITY COMPANY)  
SUITE 850  
5335 WISCONSIN AVENUE, N.W.  
WASHINGTON, DC 20004

FOR: AGENCY REPRESENTATION FOR SPORTS, ENTERTAINMENT AND CELEBRITY CLIENTS, IN CLASS 35 (U.S. CLS. 100, 101 AND 102).

FIRST USE 1-31-2007; IN COMMERCE 1-31-2007.

FOR: FINANCIAL CONSULTATION SERVICES FOR SPORTS, ENTERTAINMENT AND CELEBRITY CLIENTS, IN CLASS 36 (U.S. CLS. 100, 101 AND 102).

FIRST USE 1-31-2007; IN COMMERCE 1-31-2007.

OWNER OF U.S. REG. NOS. 3,136,125, 3,160,991, AND 3,389,314.

NO CLAIM IS MADE TO THE EXCLUSIVE RIGHT TO USE "ASSOCIATES MANAGEMENT ENTERPRISES", APART FROM THE MARK AS SHOWN.

THE MARK CONSISTS OF THE WORDS "F.A.M.E FALK ASSOCIATES MANAGEMENT ENTERPRISES". BASKETBALLS ARE SUBSTITUTED AS PERIODS SEPARATING THE LETTERS "F" "A" "M" AND "E" IN THE WORD "F.A.M.E".

SER. NO. 77-344,923, FILED 12-5-2007.

RONALD DELGIZZI, EXAMINING ATTORNEY

**Int. Cl.: 41**

**Prior U.S. Cls.: 100, 101 and 107**

**United States Patent and Trademark Office**

**Reg. No. 3,569,068**

**Registered Feb. 3, 2009**

**SERVICE MARK  
PRINCIPAL REGISTER**



**V A N I T Y H E A L T H C L U B S**

VANITY HEALTH CLUBS, LLC (NEW JERSEY  
LIMITED LIABILITY COMPANY)  
52 SOUTH BROADWAY  
PITMAN, NJ 08071

NO CLAIM IS MADE TO THE EXCLUSIVE  
RIGHT TO USE "HEALTH CLUBS", APART FROM  
THE MARK AS SHOWN.

FOR: HEALTH CLUB SERVICES, NAMELY, PRO-  
VIDING INSTRUCTION AND EQUIPMENT IN THE  
FIELD OF PHYSICAL EXERCISE, IN CLASS 41 (U.S.  
CLS. 100, 101 AND 107).

SER. NO. 77-345,319, FILED 12-6-2007.

FIRST USE 7-17-2007; IN COMMERCE 7-17-2007.

MARY CRAWFORD, EXAMINING ATTORNEY

Int. Cls.: 9, 16, 25 and 41

Prior U.S. Cls.: 2, 5, 21, 22, 23, 26, 29, 36, 37, 38, 39,  
50, 100, 101 and 107

Reg. No. 3,569,069

United States Patent and Trademark Office

Registered Feb. 3, 2009

TRADEMARK  
SERVICE MARK  
PRINCIPAL REGISTER



JACKSON, RONALD DAVID (UNITED STATES  
INDIVIDUAL)

G-304

7157 ALVERN STREET  
LOS ANGELES, CA 90045

FOR: BLANK MAGNETIC DATA CARRIERS; PRERECORDED MAGNETIC DATA CARRIERS FEATURING MUSICAL SOUND RECORDINGS AND VIDEO RECORDINGS FEATURING MUSICAL PERFORMANCES; BLANK RECORDABLE OPTICAL DISKS; PRERECORDED OPTICAL DISCS FEATURING MUSICAL SOUND RECORDINGS AND VIDEO RECORDINGS FEATURING MUSICAL PERFORMANCES; RECORDED SOUND AND VIDEO TAPES, CASSETTES, CD-ROM AND DVDS, FEATURING MUSICAL SOUND RECORDINGS AND VIDEO RECORDINGS FEATURING MUSICAL PERFORMANCES; COMPUTER BASED AND ELECTRONIC ENTERTAINMENT APPARATUS, NAMELY NON-PORTABLE, PORTABLE AND POCKET COMPUTERS, PORTABLE TELEPHONES, FIXED AND PORTABLE ELECTRONIC PERSONAL ORGANIZERS; DOWNLOADABLE MUSICAL SOUND RECORDINGS AND VIDEO RECORDINGS FEATURING MUSICAL PERFORMANCES VIA THE INTERNET AND WIRELESS DEVICES; DOWNLOADABLE SOFTWARE ON THE INTERNET FOR COMPUTERS FEATURING MUSICAL ENTERTAINMENT; DOWNLOADABLE COMPUTER SOFTWARE FOR USE IN INFORMATION RETRIE-

VAL ON THE INTERNET, IN CLASS 9 (U.S. CLS. 21, 23, 26, 36 AND 38).

FIRST USE 6-1-2007; IN COMMERCE 6-1-2007.

FOR: MAGAZINES, NEWSLETTERS, BOOKS AND BROCHURES FEATURING INFORMATION ON MUSICAL ENTERTAINMENT AND MUSICAL ENTERTAINERS, PLASTIC WRAP, PLASTIC BAGS FOR PACKING AND PACKAGING, IN CLASS 16 (U.S. CLS. 2, 5, 22, 23, 29, 37, 38 AND 50).

FIRST USE 6-1-2007; IN COMMERCE 6-1-2007.

FOR: MEN'S, WOMEN'S AND CHILDREN'S CLOTHING, NAMELY T-SHIRTS, TANK TOPS, SWEATSHIRTS, SWEATPANTS, HATS, BASEBALL CAPS, JACKETS, SHORTS, PANTS, BLOUSES, DRESSES, SKIRTS, NECKTIES, HOSIERY, FOOTWEAR, POLO SHIRTS, DRESS SHIRTS, KNIT SHIRTS, NIGHT SHIRTS, PIQUET SHIRTS, POLO SHIRTS, SHIRT FRONTS, DRESS SHIRTS FOR SUITS, SHORT-SLEEVES SHIRTS, WIND SHIRTS, LEATHER PANTS, NURSE PANTS, DENIM JACKETS, DOWN JACKETS, FISHERMAN'S JACKETS, JACKETS, LEATHER JACKETS, LONG JACKETS, MEN AND WOMEN JACKETS, COATS TROUSERS, VESTS, RAIN JACKETS, SLEEVED OR SLEEVELESS JACKETS, SMOKING JACKETS, SORTS JACKETS, SUEDE JACKETS, WIND-JACKETS, SHOES, HATS AND SOCKS, IN CLASS 25 (U.S. CLS. 22 AND 39).

FIRST USE 6-1-2007; IN COMMERCE 6-1-2007.

FOR: ENTERTAINMENT, NAMELY, LIVE MUSIC CONCERTS; CONCERT BOOKING, ARRANGING AND CONDUCTING OF CONCERTS; ORGANIZING COMMUNITY CULTURAL EVENTS AND CULTURAL ENTERTAINMENT EVENTS; PHOTOGRAPHY SERVICES; AUDIO AND VIDEO RECORDING SERVICES, IN CLASS 41 (U.S. CLS. 100, 101 AND 107).

FIRST USE 6-1-2007; IN COMMERCE 6-1-2007.

THE NAME(S), PORTRAIT(S), AND/OR SIGNATURE(S) SHOWN IN THE MARK DOES NOT IDENTIFY A PARTICULAR LIVING INDIVIDUAL.

THE MARK CONSISTS OF A TREE POINT CROWN, TILTED AT A 45 DEGREE ANGLE, CUTTING THROUGH THE TOP LEFT HAND CORNER OF A CAPITAL "R", WITH THE CAPITAL "R" THEN BEING COMBINED WITH OTHER STYLIZED LETTERING, SPELLING OUT THE NAME "RUTH"; AND, WITH THE CAPITAL "R" THEN BEING PHYSICALLY CONNECTED TO THE TOP OF A CAPITAL "B", WITH THE FRONT LEG OR BASE OF THE CAPITAL "R" RESTING TO THE TOP REAR OF THE CAPITAL "B", WITH THE CAPITAL "B" THEN BEING COMBINED WITH OTHER STYLIZED LETTERING, SPELLING OUT THE NAME "BROWN".

SER. NO. 77-346,061, FILED 12-6-2007.

DOMINIC J. FERRAIUOLO, EXAMINING ATTORNEY

**Int. Cls.: 9 and 14**

**Prior U.S. Cls.: 2, 21, 23, 26, 27, 28, 36, 38 and 50**

**United States Patent and Trademark Office**

**Reg. No. 3,569,070**

**Registered Feb. 3, 2009**

**TRADEMARK  
PRINCIPAL REGISTER**

**HEUER**

TAG HEUER SA (SWITZERLAND CORPORATION)  
RUE LOUIS-JOSEPH CHEVROLET 6A  
2300 LA CHAUX-DE-FONDS, SWITZERLAND

FOR: OPTICAL GOODS, NAMELY, SPECTACLES, SUNGLASSES, SPECTACLE FRAMES, SPECTACLES CASES; TIME MEASURING APPARATUS AND INSTRUMENTS, NAMELY, ELECTRONIC STOP WATCHES, REMOTE CONTROL MINIPRINTER TIMERS, ELECTRONIC AND MANUAL TIMERS, PHOTOCCELL TIMERS, STARTING GATE TIMERS, TELEPHONE LIAISON TIMERS, IMPULSE DISTRIBUTOR TIMERS, ELECTRONIC PISTOL STARTING TIMERS, MANUAL CONTACTOR TIMERS, CALCULATORS INCORPORATING WATCH FUNCTIONS, ELECTRIC TIME CONTROL SWITCHES AND THEIR PARTS; TELEPHONES, MOBILE PHONES, CAMERAS, DIGITAL AUDIO PLAYERS AND HANDHELD MOBILE DIGITAL ELECTRONIC DEVICES FOR THE SENDING AND RECEIVING OF TELEPHONE CALLS, FOR USE AS A DIGITAL AUDIO PLAYER, AND FOR USE AS A CAMERA; ACCESSORIES FOR TELEPHONES, MOBILE PHONES AND HANDHELD MOBILE DIGITAL ELECTRONIC DEVICES, NAMELY, CASES, BATTERIES, CHARGERS, LOUDSPEAKERS, MI-

CROPHONES, STANDS, RESTS AND FRAMES, IN CLASS 9 (U.S. CLS. 21, 23, 26, 36 AND 38).

FOR: JEWELRY; HOROLOGICAL AND CHRONOMETRIC INSTRUMENTS, NAMELY, WATCHES, WATCHBANDS, CHRONOMETERS, CHRONOGRAPHS FOR USE AS WATCHES, AND CLOCKS, IN CLASS 14 (U.S. CLS. 2, 27, 28 AND 50).

THE MARK CONSISTS OF STANDARD CHARACTERS WITHOUT CLAIM TO ANY PARTICULAR FONT, STYLE, SIZE, OR COLOR.

PRIORITY CLAIMED UNDER SEC. 44(D) ON SWITZERLAND APPLICATION NO. 63554/2007, FILED 11-29-2007, REG. NO. 569977, DATED 11-29-2007, EXPIRES 11-29-2017.

OWNER OF U.S. REG. NOS. 1,471,988, 2,407,950 AND OTHERS.

SEC. 2(F).

SER. NO. 77-346,150, FILED 12-6-2007.

HEATHER THOMPSON, EXAMINING ATTORNEY

**Int. Cls.: 37, 41, 42 and 45**

**Prior U.S. Cls.: 100, 101, 103, 106 and 107**

**United States Patent and Trademark Office**

**Reg. No. 3,569,071**

**Registered Feb. 3, 2009**

**SERVICE MARK  
PRINCIPAL REGISTER**

# THE HALO TRUST

THE HALO TRUST (UNITED KINGDOM CORPORATION)  
CARRONFOOT, THORNHILL  
DUMFRIES, UNITED KINGDOM DG35AY

FOR: CLEARANCE OF MINES AND OTHER UN-EXPLODED ORDNANCES, IN CLASS 37 (U.S. CLS. 100, 103 AND 106).

FIRST USE 8-1-2004; IN COMMERCE 8-1-2004.

FOR: EDUCATIONAL SERVICES, NAMELY, PROVIDING CLASSES IN THE FIELD OF SAFETY REGARDING CLEARANCE OF MINES AND OTHER UN-EXPLODED ORDNANCES, IN CLASS 41 (U.S. CLS. 100, 101 AND 107).

FIRST USE 8-1-2004; IN COMMERCE 8-1-2004.

FOR: SCIENTIFIC AND TECHNOLOGICAL SERVICES, NAMELY, PROVIDING SCIENTIFIC AND TECHNOLOGICAL FIELD TRIALS ON NEW TECH-

NOLOGY FOR THE CLEARANCE OF MINES AND OTHER UN-EXPLODED ORDNANCES, IN CLASS 42 (U.S. CLS. 100 AND 101).

FIRST USE 8-1-2004; IN COMMERCE 8-1-2004.

FOR: SECURITY AND SAFETY SERVICES, NAMELY, DETECTION AND DISPOSAL OF MINES AND OTHER UN-EXPLODED ORDNANCES, IN CLASS 45 (U.S. CLS. 100 AND 101).

FIRST USE 8-1-2004; IN COMMERCE 8-1-2004.

THE MARK CONSISTS OF STANDARD CHARACTERS WITHOUT CLAIM TO ANY PARTICULAR FONT, STYLE, SIZE, OR COLOR.

SER. NO. 77-346,712, FILED 12-7-2007.

TOBY BULLOFF, EXAMINING ATTORNEY

**Int. Cls.: 35 and 36**

**Prior U.S. Cls.: 100, 101 and 102**

**United States Patent and Trademark Office**

**Reg. No. 3,569,072**

**Registered Feb. 3, 2009**

**SERVICE MARK  
PRINCIPAL REGISTER**



GROUND BREAK LLC (NEVADA LIMITED LIABILITY COMPANY)

#650

3960 HOWARD HUGHES PARKWAY  
LAS VEGAS, NV 89169

FOR: PROVIDING MARKETING AND ADVERTISING SERVICES FOR RESIDENTIAL DEVELOPMENT AND REAL ESTATE PROJECTS; PROVIDING INTERACTIVE ADVERTISING AND MARKETING SERVICES FOR RESIDENTIAL REAL ESTATE PROJECTS; PUBLIC RELATIONS SERVICES FOR REAL ESTATE AND RESIDENTIAL DEVELOPMENT PROJECTS; REAL ESTATE SALES MANAGEMENT SERVICES, NAMELY, PROVIDING RESIDENTIAL REAL ESTATE SALES MANAGEMENT ASSISTANCE IN THE NATURE OF CREATING, DEVELOPING, AND COORDINATING

SALES TEAMS, SALES AND RESERVATION PROGRAMS, PRICING AND INVENTORY PROGRAMS, AND BUDGETARY PROGRAMS, IN CLASS 35 (U.S. CLS. 100, 101 AND 102).

FIRST USE 1-30-2007; IN COMMERCE 1-30-2007.

FOR: REAL ESTATE BROKERAGE SERVICES; REAL ESTATE AGENCY SERVICES, IN CLASS 36 (U.S. CLS. 100, 101 AND 102).

FIRST USE 1-30-2007; IN COMMERCE 1-30-2007.

SER. NO. 77-347,253, FILED 12-7-2007.

JUSTINE D. PARKER, EXAMINING ATTORNEY



Int. Cl.: 35

Prior U.S. Cls.: 100, 101 and 102

United States Patent and Trademark Office

Reg. No. 3,569,073

Registered Feb. 3, 2009

SERVICE MARK  
PRINCIPAL REGISTER



PORT OF SEATTLE (WASHINGTON MUNICIPAL CORPORATION)  
P.O. BOX 1209  
SEATTLE, WA 98104

FOR: ADVERTISING AND PROMOTION SERVICES AND RELATED CONSULTING; ASSOCIATION SERVICES, NAMELY, PROMOTING THE INTERESTS OF INTERNATIONAL TRADE GROUPS AND THE TRANSPORTATION INDUSTRY; BUSINESS ADMINISTRATION AND MANAGEMENT; DEVELOPMENT OF CONCEPTS FOR BUSINESS ECONOMY; ECONOMIC CONSULTING AND INFORMATION FOR THE INDUSTRIAL AND COMMERCIAL SECTORS FOR PLANNING, ORGANIZING, MONITORING AND CARRYING OUT UNIQUE AND COMPLEX PROJECTS IN DIFFERENT SECTORS OF ONE OR SEVERAL COMPANIES; ECONOMIC FORECASTING AND ANALYSIS; INFORMATION SERVICES RELATING TO BUSINESS MATTERS; LOGISTICS MANAGEMENT IN THE FIELD OF INTERNATIONAL TRADE, SHIPPING, TRANSPORTATION, AIRPORT SERVICES AND SEAPORT SERVICES; NEGOTIATION AND RENEGOTIATION OF LEASES AND SUBLEASES AND THE PURCHASE AND SALE OF BUILDINGS; OPERATION OF PORT FACILITIES FOR OTHERS; ORGANIZING EXHIBITIONS FOR INTERNATIONAL TRADE, SHIPPING, TRANSPORTATION, AIRPORT SERVICES AND SEAPORT SERVICES; PROMOTING PUBLIC AWARENESS OF INTERNATIONAL TRADE, SHIPPING, TRANSPORTATION, AIRPORT SERVICES AND SEAPORT SERVICES;

PROMOTING THE ECONOMIC DEVELOPMENT IN THE STATE OF WASHINGTON; PROVIDING FACILITIES FOR BUSINESS MEETINGS; PROVIDING MARKETING AND PROMOTION OF SPECIAL EVENTS; PROVIDING TRADE INFORMATION; PROVIDING TRANSPORTATION DOCUMENTATION FOR OTHERS; SERVICES FOR PROVISION OF FOREIGN TRADE INFORMATION; TRANSPORTATION MANAGEMENT SERVICES, NAMELY, PLANNING AND COORDINATING TRANSPORTATION OF PEOPLE FOR OTHERS; TRANSPORTATION LOGISTICS SERVICES, NAMELY, ARRANGING THE TRANSPORTATION OF GOODS FOR OTHERS; TRANSPORTATION LOGISTICS SERVICES, NAMELY, PLANNING AND SCHEDULING SHIPMENTS FOR USERS OF TRANSPORTATION SERVICES, IN CLASS 35 (U.S. CLS. 100, 101 AND 102).

FIRST USE 10-17-2007; IN COMMERCE 10-17-2007.

OWNER OF U.S. REG. NO. 2,600,142.

THE MARK CONSISTS OF THE WORDS PORT OF SEATTLE WITH THREE BANDS.

SEC. 2(F) AS TO "PORT OF SEATTLE".

SER. NO. 77-347,312, FILED 12-7-2007.

HENRY S. ZAK, EXAMINING ATTORNEY

Int. Cl.: 25

Prior U.S. Cls.: 22 and 39

United States Patent and Trademark Office

Reg. No. 3,569,074

Registered Feb. 3, 2009

TRADEMARK  
PRINCIPAL REGISTER



BEAUDOIN, JAMES C. (UNITED STATES INDIVIDUAL)  
6005 STATION VIEW COURT  
FAIRFAX STATION, VA 22039

FOR: CLOTHING AND ATHLETIC WEAR FOR MEN AND WOMEN, NAMELY, T-SHIRTS, DRESS SHIRTS, LONG SLEEVE SHIRTS, SWEATSHIRTS, SHORTS, WARM UP PANTS AND TOPS, HATS, BASEBALL CAPS, JACKETS, GLOVES, PANTS, UNDERWEAR, TANK TOPS, JEANS, SHOES, BOOTS, JACKETS, WIND RESISTANT JACKETS, BOARD

SHORTS, AND FIGHTING SHORTS, IN CLASS 25 (U.S. CLS. 22 AND 39).

FIRST USE 9-1-2007; IN COMMERCE 10-1-2007.

NO CLAIM IS MADE TO THE EXCLUSIVE RIGHT TO USE "FIGHT GEAR", APART FROM THE MARK AS SHOWN.

SER. NO. 77-347,607, FILED 12-9-2007.

JASON LOTT, EXAMINING ATTORNEY

**Int. Cl.: 1**

**Prior U.S. Cls.: 1, 5, 6, 10, 26 and 46**

**United States Patent and Trademark Office**

**Reg. No. 3,569,075**

**Registered Feb. 3, 2009**

**TRADEMARK  
PRINCIPAL REGISTER**

**PRI-RS**

POWER RESEARCH, INC. (NEVADA CORPORATION)  
1350 EAST FLAMINGO, SUITE 44  
LAS VEGAS, NV 89119

THE MARK CONSISTS OF STANDARD CHARACTERS WITHOUT CLAIM TO ANY PARTICULAR FONT, STYLE, SIZE, OR COLOR.

FOR: CHEMICAL ADDITIVES FOR FUEL TREATMENT, IN CLASS 1 (U.S. CLS. 1, 5, 6, 10, 26 AND 46).

SER. NO. 77-347,867, FILED 12-10-2007.

FIRST USE 1-1-1999; IN COMMERCE 1-1-1999.

MARY ROSSMAN, EXAMINING ATTORNEY

**Int. Cl.: 9**

**Prior U.S. Cls.: 21, 23, 26, 36 and 38**

**Reg. No. 3,569,076**

**United States Patent and Trademark Office**

**Registered Feb. 3, 2009**

**TRADEMARK  
PRINCIPAL REGISTER**

**FRAMESTAR**

4TITUDE LTD. (UNITED KINGDOM LIMITED  
COMPANY (LTD.))  
UNIT 4BC  
JAYES PARK COURTYARD, OCKLEY  
SURREY, UNITED KINGDOM RH55PR

FOR: LABORATORY EQUIPMENT AND SCIENTIFIC, BIOLOGICAL AND CHEMICAL APPARATUS AND INSTRUMENTS, NAMELY, MULTI-WELL PLATES FOR CHEMICAL AND BIOLOGICAL SPECIMENS, SAMPLES AND REAGENTS ALL FOR LABORATORY USE IN SCIENTIFIC AND LABORATORY ANALYSIS; HOLDERS FOR MULTI-WELL PLATES FOR CHEMICAL AND BIOLOGICAL SPECIMENS, SAMPLES AND REAGENTS ALL FOR LABORATORY USE IN SCIENTIFIC AND LABORATORY USE; AND MICROTITRATION

PLATES FOR LABORATORY USE IN SCIENTIFIC AND LABORATORY ANALYSIS, IN CLASS 9 (U.S. CLS. 21, 23, 26, 36 AND 38).

THE MARK CONSISTS OF STANDARD CHARACTERS WITHOUT CLAIM TO ANY PARTICULAR FONT, STYLE, SIZE, OR COLOR.

PRIORITY CLAIMED UNDER SEC. 44(D) ON ERPN CMNTY TM OFC APPLICATION NO. 006006068, FILED 6-15-2007, REG. NO. 006006068, DATED 8-28-2008, EXPIRES 6-15-2017.

SER. NO. 77-348,650, FILED 12-11-2007.

FRED MANDIR, EXAMINING ATTORNEY

**Int. Cl.: 35**

**Prior U.S. Cls.: 100, 101 and 102**

**United States Patent and Trademark Office**

**Reg. No. 3,569,077**

**Registered Feb. 3, 2009**

**SERVICE MARK  
PRINCIPAL REGISTER**

**T.J. MAXX SHOPPING  
INSTITUTE**

NBC FOURTH REALTY CORP. (NEVADA CORPORATION)  
4100 EAST LONE MOUNTAIN ROAD  
NORTH LAS VEGAS, NV 89031

FOR: RETAIL DEPARTMENT STORE SERVICES,  
IN CLASS 35 (U.S. CLS. 100, 101 AND 102).

FIRST USE 9-24-2007; IN COMMERCE 9-24-2007.

THE MARK CONSISTS OF STANDARD CHARACTERS WITHOUT CLAIM TO ANY PARTICULAR FONT, STYLE, SIZE, OR COLOR.

OWNER OF U.S. REG. NOS. 1,199,126, 1,637,243 AND OTHERS.

NO CLAIM IS MADE TO THE EXCLUSIVE RIGHT TO USE "SHOPPING INSTITUTE", APART FROM THE MARK AS SHOWN.

THE NAME(S), PORTRAIT(S), AND/OR SIGNATURE(S) SHOWN IN THE MARK DOES NOT IDENTIFY A PARTICULAR LIVING INDIVIDUAL.

SER. NO. 77-348,751, FILED 12-11-2007.

DANIEL BRODY, EXAMINING ATTORNEY

**Int. Cl.: 30**

**Prior U.S. Cl.: 46**

**United States Patent and Trademark Office**

**Reg. No. 3,569,078**

**Registered Feb. 3, 2009**

**TRADEMARK  
PRINCIPAL REGISTER**



MICHAEL ANGELO'S GOURMET FOODS, INC.  
(DELAWARE CORPORATION)  
200 MICHAEL ANGELO WAY  
AUSTIN, TX 78728

FOR: PREPARED FROZEN FOODS, NAMELY,  
PASTAS, CHEESE-STUFFED PASTAS, LASAGNAS,  
SPAGHETTIS, NOODLES, RICES, FRESH FROZEN  
PASTAS, TOMATO SAUCE, PIZZA SAUCE, SPA-  
GHETTI SAUCE , IN CLASS 30 (U.S. CL. 46).

FIRST USE 12-0-2001; IN COMMERCE 12-0-2001.

NO CLAIM IS MADE TO THE EXCLUSIVE  
RIGHT TO USE "PREMIUM QUALITY", APART  
FROM THE MARK AS SHOWN.

SER. NO. 77-349,100, FILED 12-11-2007.

ERNEST SHOSHO, EXAMINING ATTORNEY

**Int. Cl.: 29**

**Prior U.S. Cl.: 46**

**United States Patent and Trademark Office**

**Reg. No. 3,569,079**

**Registered Feb. 3, 2009**

**TRADEMARK  
PRINCIPAL REGISTER**

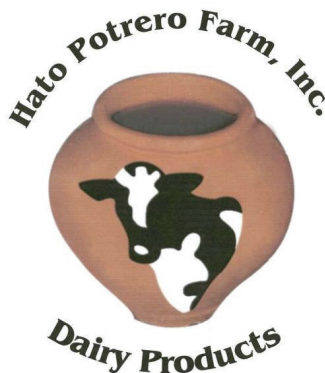

HATO POTRERO FARM, INC. (FLORIDA CORPORATION)  
611 EAST OBISPO AVENUE  
CLEWISTON, FL 33440

FOR: CHEESE; YOGURT, IN CLASS 29 (U.S. CL. 46).

FIRST USE 6-1-2007; IN COMMERCE 6-1-2007.

NO CLAIM IS MADE TO THE EXCLUSIVE RIGHT TO USE "FARM, INC." AND "DAIRY PRODUCTS", APART FROM THE MARK AS SHOWN.

THE COLOR(S) BLACK, BROWN, DARK BROWN, AND WHITE IS/ARE CLAIMED AS A FEATURE OF THE MARK.

THE MARK CONSISTS OF THE WORDS "HATO POTRERO FARM, INC." IN BLACK LETTERING OVER THE PICTURE OF A BROWN VASE, THE VASE SHOWING A DARK BROWN OPENING NEAR THE TOP OF THE VASE, THE VASE FURTHER SHOWING THE PICTURE OF A BLACK AND WHITE COW, AND THE WORDS "DAIRY PRODUCTS" IN BLACK LETTERING BELOW THE PICTURE OF THE VASE.

THE ENGLISH TRANSLATION OF THE WORD "HATO POTRERO" IN THE MARK IS CATTLE RANCH PASTURE.

SER. NO. 77-349,460, FILED 12-11-2007.

BRENDAN MCCAULEY, EXAMINING ATTORNEY

Int. Cl.: 43

Prior U.S. Cls.: 100 and 101

United States Patent and Trademark Office

Reg. No. 3,569,080

Registered Feb. 3, 2009

SERVICE MARK  
PRINCIPAL REGISTER



THECORNERBAR, LLC (ILLINOIS LIMITED  
LIABILITY COMPANY)  
201 DES PLAINES  
FOREST PARK, IL 60130

FOR: BAR SERVICES, IN CLASS 43 (U.S. CLS. 100  
AND 101).

FIRST USE 1-1-2007; IN COMMERCE 1-1-2007.

NO CLAIM IS MADE TO THE EXCLUSIVE  
RIGHT TO USE "BAR" , APART FROM THE MARK  
AS SHOWN.

THE MARK CONSISTS OF A RECTANGLE THAT  
CONTAINS THE WORD "CORNER" IN THE MID-  
DLE THE WORD "THE" INTERSECTING THE  
UPPER LEFT HAND CORNER OF THE RECTAN-  
GLE AND THE WORD "BAR" INTERSECTING THE  
LOWER RIGHT HAND CORNER OF THE RECTAN-  
GLE.

SER. NO. 77-349,800, FILED 12-12-2007.

MARK SPARACINO, EXAMINING ATTORNEY



**Int. Cls.: 9 and 42**

**Prior U.S. Cls.: 21, 23, 26, 36, 38, 100 and 101**

**United States Patent and Trademark Office**

**Reg. No. 3,569,081**

**Registered Feb. 3, 2009**

**TRADEMARK  
SERVICE MARK  
PRINCIPAL REGISTER**

**humbledaisy**



HUMBLE DAISY, INC. (MICHIGAN CORPORATION)  
1342 ARELLA BOULEVARD  
ANN ARBOR, MI 48103

FOR: COMPUTER SOFTWARE FOR THE INTEGRATION OF TEXT, AUDIO, GRAPHICS, STILL IMAGE AND MOVING PICTURES INTO AN INTERACTIVE DELIVERY FOR MULTIMEDIA APPLICATIONS; COMPUTER SOFTWARE FOR MANIPULATING DIGITAL AUDIO INFORMATION FOR USE IN AUDIO MEDIA APPLICATIONS; COMPUTER SOFTWARE FOR PROCESSING DIGITAL MUSIC FILES; COMPUTER SOFTWARE FOR CONTROLLING AND IMPROVING COMPUTER AND AUDIO EQUIPMENT SOUND QUALITY; COMPUTER SOFTWARE FOR ENHANCING THE AUDIO-VISUAL CAPABILITIES OF MULTIMEDIA APPLICATIONS, NAMELY, FOR THE INTEGRATION OF TEXT, AUDIO, GRAPHICS, STILL IMAGES AND MOVING PICTURES, IN CLASS 9 (U.S. CLS. 21, 23, 26, 36 AND 38).

FIRST USE 1-31-2006; IN COMMERCE 1-31-2006.

FOR: COMPUTER SERVICES, NAMELY, CREATING AND MAINTAINING WEB SITES FOR OTHERS; COMPUTER SERVICES, NAMELY, DESIGNING AND IMPLEMENTING WEB SITES FOR OTHERS; DESIGN OF HOME PAGES, COMPUTER SOFTWARE AND WEB SITES, IN CLASS 42 (U.S. CLS. 100 AND 101).

FIRST USE 9-30-2002; IN COMMERCE 9-30-2002.

THE MARK CONSISTS OF THE WORDING "HUMBLEDAISY" WITH THREE FLOWER PETALS APPEARING ABOVE THE DOT ON THE LETTER "I".

SER. NO. 77-350,142, FILED 12-12-2007.

KAREN SEVERSON, EXAMINING ATTORNEY

**Int. Cl.: 41**

**Prior U.S. Cls.: 100, 101 and 107**

**United States Patent and Trademark Office**

**Reg. No. 3,569,082**

**Registered Feb. 3, 2009**

**SERVICE MARK  
PRINCIPAL REGISTER**

**CHARLES HAMILTON HOUSTON  
INSTITUTE**

CHARLES HAMILTON HOUSTON INSTITUTE,  
INC. (WISCONSIN CORPORATION)  
PO BOX 56165  
MADISON, WI 53705

FOR: COMMUNITY SERVICES, NAMELY, PROVIDING EDUCATION IN THE FORM OF MENTORING, TUTORING, SEMINARS, WORKSHOPS AND CLASSES IN THE FIELDS OF PRE-KINDERGARTEN THROUGH HIGH SCHOOL LEVEL ACADEMICS, COLLEGE LEVEL ACADEMICS, COLLEGE PREPARATION, CAREER COUNSELING, LIFE SKILLS, FINANCE AND INVESTING, ETHNIC PRIDE, HEALTH AND WELLNESS, BUSINESS DEVELOPMENT, COACHING AND TEAMWORK, PARENTING SKILLS, TIME MANAGEMENT, TECHNOLOGY, EVENT PLANNING, RELATIONSHIP DEVELOPMENT OR THE ARTS, INCLUDING THE PERFORMING ARTS, DESIGNED TO ACHIEVE ECONOMIC INDEPEN-

DENCE FOR MINORITIES, IN CLASS 41 (U.S. CLS. 100, 101 AND 107).

FIRST USE 7-31-2004; IN COMMERCE 7-31-2004.

THE MARK CONSISTS OF STANDARD CHARACTERS WITHOUT CLAIM TO ANY PARTICULAR FONT, STYLE, SIZE, OR COLOR.

NO CLAIM IS MADE TO THE EXCLUSIVE RIGHT TO USE "INSTITUTE", APART FROM THE MARK AS SHOWN.

THE NAME "CHARLES HAMILTON HOUSTON" DOES NOT IDENTIFY A LIVING INDIVIDUAL.

SER. NO. 77-350,225, FILED 12-12-2007.

MARK PILARO, EXAMINING ATTORNEY

**Int. Cl.: 33**

**Prior U.S. Cls.: 47 and 49**

**United States Patent and Trademark Office**

**Reg. No. 3,569,083**

**Registered Feb. 3, 2009**

**TRADEMARK  
PRINCIPAL REGISTER**

**ALGAREIRO**

MAR DE FRADES, S.L. (SPAIN S.L.)  
AVDA. COLON 136-146  
CARTAGENA, SPAIN

THE ENGLISH TRANSLATION OF THE WORD  
"ALGAREIRO" IN THE MARK IS "JOKER" FROM  
GALACIAN.

FOR: WINES, IN CLASS 33 (U.S. CLS. 47 AND 49).

FIRST USE 5-22-2003; IN COMMERCE 10-23-2006.

SER. NO. 77-350,557, FILED 12-12-2007.

THE MARK CONSISTS OF STANDARD CHAR-  
ACTERS WITHOUT CLAIM TO ANY PARTICULAR  
FONT, STYLE, SIZE, OR COLOR.

BONNIE LUKEN, EXAMINING ATTORNEY

**Int. Cl.: 31**

**Prior U.S. Cls.: 1 and 46**

**United States Patent and Trademark Office**

**Reg. No. 3,569,084**

**Registered Feb. 3, 2009**

**TRADEMARK  
PRINCIPAL REGISTER**

**FLIRTATION**

PROVEN WINNERS NORTH AMERICA LLC  
(CALIFORNIA LIMITED LIABILITY COMPAN-  
NY)  
45 NORTH FIRST STREET, SUITE B  
CAMPBELL, CA 95008

THE MARK CONSISTS OF STANDARD CHAR-  
ACTERS WITHOUT CLAIM TO ANY PARTICULAR  
FONT, STYLE, SIZE, OR COLOR.

FOR: LIVING PLANTS, NAMELY, DIASCIA, IN  
CLASS 31 (U.S. CLS. 1 AND 46).

SER. NO. 77-350,955, FILED 12-13-2007.

FIRST USE 9-24-2008; IN COMMERCE 9-24-2008.

AMEETA JORDAN, EXAMINING ATTORNEY

**Int. Cls.: 37 and 42**

**Prior U.S. Cls.: 100, 101, 103 and 106**

**United States Patent and Trademark Office**

**Reg. No. 3,569,085**

**Registered Feb. 3, 2009**

**SERVICE MARK  
PRINCIPAL REGISTER**

**GFA INTERNATIONAL**

GFA INTERNATIONAL, INC. (FLORIDA CORPORATION)  
1215 WALLACE DRIVE  
DELRAY BEACH, FL 33444

FOR: WELL DRILLING; PILE DRIVING SERVICES; CONSTRUCTION QUALITY CONTROL SERVICES, NAMELY, BUILDING INSPECTIONS, IN CLASS 37 (U.S. CLS. 100, 103 AND 106).

FIRST USE 10-27-1995; IN COMMERCE 10-27-1995.

FOR: ENGINEERING SERVICES, NAMELY, GEOTECHNICAL ENGINEERING, CIVIL ENGINEERING, STRUCTURAL ENGINEERING, MECHANICAL ENGINEERING, ELECTRICAL ENGINEERING; ENVIRONMENTAL ENGINEERING; QUALITY CONTROL FOR OTHERS; CONSTRUCTION QUALITY CONTROL SERVICES, NAMELY, MATERIALS TESTING OF CONCRETE, MASONRY, SOILS, ASPHALT PAVING, METALS,

ROOFS, THRESHOLDS, PAVEMENT, COATINGS AND STUCCO; VIBRATION MONITORING; STRUCTURAL, MECHANICAL, ELECTRICAL, AND PLUMBING BUILDING INSPECTIONS AND BUILDING CONSTRUCTION PLAN REVIEWS, IN CLASS 42 (U.S. CLS. 100 AND 101).

FIRST USE 10-27-1995; IN COMMERCE 10-27-1995.

THE MARK CONSISTS OF STANDARD CHARACTERS WITHOUT CLAIM TO ANY PARTICULAR FONT, STYLE, SIZE, OR COLOR.

NO CLAIM IS MADE TO THE EXCLUSIVE RIGHT TO USE "INTERNATIONAL", APART FROM THE MARK AS SHOWN.

SER. NO. 77-351,451, FILED 12-13-2007.

JESSICA A. POWERS, EXAMINING ATTORNEY

**Int. Cl.: 35**

**Prior U.S. Cls.: 100, 101 and 102**

**United States Patent and Trademark Office**

**Reg. No. 3,569,086**

**Registered Feb. 3, 2009**

**SERVICE MARK  
PRINCIPAL REGISTER**

**MARRIOTT**

MARRIOTT INTERNATIONAL, INC. (DELA-  
WARE CORPORATION)  
10400 FERNWOOD ROAD  
BETHESDA, MD 20817

FOR: ONLINE RETAIL STORE AND MAIL OR-  
DER CATALOG SERVICES FEATURING APPAREL,  
HOUSEHOLD GOODS, LINENS, BEDDING PRO-  
DUCTS, TOWELS, INTERIOR FURNISHINGS, PER-  
SONAL CARE PRODUCTS, PLUSH TOYS, MUSIC  
RECORDINGS; RETAIL STORE SERVICES, NAME-  
LY, GIFT SHOP, SOUVENIR AND CONVENIENCE  
STORE SERVICES, IN CLASS 35 (U.S. CLS. 100, 101  
AND 102).

FIRST USE 0-0-1959; IN COMMERCE 0-0-1959.

THE MARK CONSISTS OF STANDARD CHAR-  
ACTERS WITHOUT CLAIM TO ANY PARTICULAR  
FONT, STYLE, SIZE, OR COLOR.

OWNER OF U.S. REG. NOS. 1,277,443, 2,750,340  
AND OTHERS.

SEC. 2(F).

SER. NO. 77-351,683, FILED 12-13-2007.

NATALIE POLZER, EXAMINING ATTORNEY

**Int. Cls.: 16 and 41**

**Prior U.S. Cls.: 2, 5, 22, 23, 29, 37, 38, 50, 100, 101 and 107**

**Reg. No. 3,569,087**

**United States Patent and Trademark Office**

**Registered Feb. 3, 2009**

**TRADEMARK  
SERVICE MARK  
PRINCIPAL REGISTER**

# StageBook

PLAYBOOKS, INC. (DELAWARE CORPORATION)  
111 CORPORATE DR. STE 240  
LADERA RANCH, CA 92694

FOR: PRINTED MATTER, NAMELY, A SERIES OF CHILDREN'S BOOKS AND PERIODICALS IN THE FIELD OF CHILDREN'S LITERATURE , IN CLASS 16 (U.S. CLS. 2, 5, 22, 23, 29, 37, 38 AND 50).

FIRST USE 12-9-2007; IN COMMERCE 12-9-2007.

FOR: PUBLICATION OF BOOKS AND MAGAZINES RELATED TO ROLE-PLAY READING MA-

TERIALS FOR CHILDREN IN THE FIELDS OF EDUCATION, RECREATION AND ENTERTAINMENT, IN CLASS 41 (U.S. CLS. 100, 101 AND 107).

FIRST USE 12-9-2007; IN COMMERCE 12-9-2007.

THE MARK CONSISTS OF STANDARD CHARACTERS WITHOUT CLAIM TO ANY PARTICULAR FONT, STYLE, SIZE, OR COLOR.

SER. NO. 77-351,768, FILED 12-13-2007.

JIM RINGLE, EXAMINING ATTORNEY

**Int. Cl.: 9**

**Prior U.S. Cls.: 21, 23, 26, 36 and 38**

**Reg. No. 3,569,088**

**United States Patent and Trademark Office**

**Registered Feb. 3, 2009**

**TRADEMARK  
PRINCIPAL REGISTER**



TRIANGLE GLOBAL INDUSTRIES, INC. (FLOR-  
IDA CORPORATION)  
SUITE 105  
5401 NORTH HAVERHILL ROAD  
WEST PALM BEACH, FL 33407

FOR: CELL PHONES, TV'S, PROJECTORS AND  
COMPUTERS, IN CLASS 9 (U.S. CLS. 21, 23, 26, 36  
AND 38).

FIRST USE 11-28-2006; IN COMMERCE 11-28-2006.

THE COLOR(S) GOLD IS/ARE CLAIMED AS A  
FEATURE OF THE MARK.

THE MARK CONSISTS OF THE LETTERS "T G I"  
STYLIZED AND IN GOLD.

SER. NO. 77-352,069, FILED 12-14-2007.

KELLEY WELLS, EXAMINING ATTORNEY



**Int. Cl.: 14**

**Prior U.S. Cls.: 2, 27, 28 and 50**

**United States Patent and Trademark Office**

**Reg. No. 3,569,089**

**Registered Feb. 3, 2009**

**TRADEMARK  
PRINCIPAL REGISTER**

**PINK LACEY**

LACEY SISCO (UNITED STATES INDIVIDUAL)  
C/O LOEB & LOEB LLP  
1906 ACKLEN AVENUE  
NASHVILLE, TN 37212

FOR: JEWELRY AND IMITATION JEWELRY, IN  
CLASS 14 (U.S. CLS. 2, 27, 28 AND 50).

FIRST USE 8-21-2006; IN COMMERCE 11-18-2006.

THE MARK CONSISTS OF STANDARD CHAR-  
ACTERS WITHOUT CLAIM TO ANY PARTICULAR  
FONT, STYLE, SIZE, OR COLOR.

THE NAME "PINK LACEY" IDENTIFIES A LIV-  
ING INDIVIDUAL WHOSE CONSENT IS OF RE-  
CORD.

SER. NO. 77-352,126, FILED 12-14-2007.

MARK RADEMACHER, EXAMINING ATTORNEY

**Int. Cl.: 9**

**Prior U.S. Cls.: 21, 23, 26, 36 and 38**

**Reg. No. 3,569,090**

**United States Patent and Trademark Office**

**Registered Feb. 3, 2009**

---

**TRADEMARK  
PRINCIPAL REGISTER**

**APECS**

COLLABRIENT NETWORKS (CALIFORNIA CORPORATION)  
109 S. LAKE MERCED HILL, STE 2F  
SAN FRANCISCO, CA 94132

FOR: COMPUTER SOFTWARE PLATFORM FOR USE IN ENABLING THIRD PARTY BUSINESS COMMUNICATION USING AN IP MULTIMEDIA SUBSYSTEM, IN CLASS 9 (U.S. CLS. 21, 23, 26, 36 AND 38).

FIRST USE 7-20-2007; IN COMMERCE 7-20-2007.

THE MARK CONSISTS OF STANDARD CHARACTERS WITHOUT CLAIM TO ANY PARTICULAR FONT, STYLE, SIZE, OR COLOR.

SER. NO. 77-352,440, FILED 12-14-2007.

PAM WILLIS, EXAMINING ATTORNEY

**Int. Cl.: 14**

**Prior U.S. Cls.: 2, 27, 28 and 50**

**United States Patent and Trademark Office**

**Reg. No. 3,569,091**

**Registered Feb. 3, 2009**

**TRADEMARK  
PRINCIPAL REGISTER**

# LOGOART

THE HERFF JONES COMPANY OF INDIANA,  
INC. (INDIANA CORPORATION)  
4625 WEST 62ND STREET  
INDIANAPOLIS, IN 46268

FOR: WATCHES, IN CLASS 14 (U.S. CLS. 2, 27, 28  
AND 50).

FIRST USE 6-17-1905; IN COMMERCE 6-17-1905.

THE MARK CONSISTS OF STANDARD CHAR-  
ACTERS WITHOUT CLAIM TO ANY PARTICULAR  
FONT, STYLE, SIZE, OR COLOR.

OWNER OF U.S. REG. NO. 1,991,419.

SER. NO. 77-352,738, FILED 12-14-2007.

SUZANNE BLANE, EXAMINING ATTORNEY

**Int. Cl.: 30**

**Prior U.S. Cl.: 46**

**United States Patent and Trademark Office**

**Reg. No. 3,569,092**

**Registered Feb. 3, 2009**

**TRADEMARK  
PRINCIPAL REGISTER**

# Delicious Tamales

DELICIOUS, INC. (TEXAS CORPORATION)  
1330 CULEBRA ROAD  
SAN ANTONIO, TX 78201

NO CLAIM IS MADE TO THE EXCLUSIVE  
RIGHT TO USE "DELICIOUS", APART FROM THE  
MARK AS SHOWN.

FOR: CANDY MINTS, IN CLASS 30 (U.S. CL. 46).

FIRST USE 5-31-2004; IN COMMERCE 5-31-2004.

SER. NO. 77-353,345, FILED 12-17-2007.

THE MARK CONSISTS OF STANDARD CHAR-  
ACTERS WITHOUT CLAIM TO ANY PARTICULAR  
FONT, STYLE, SIZE, OR COLOR.

TRACY CROSS, EXAMINING ATTORNEY

**Int. Cl.: 6**

**Prior U.S. Cls.: 2, 12, 13, 14, 23, 25 and 50**

**Reg. No. 3,569,093**

**United States Patent and Trademark Office**

**Registered Feb. 3, 2009**

**TRADEMARK  
PRINCIPAL REGISTER**

**STACK-ON STRONG BOX**

STACK-ON PRODUCTS CO. (ILLINOIS CORPORATION)

PO BOX 489

1360 OLD RAND ROAD

WAUCONDA, IL 60084

FOR: METAL SAFES, METAL GUN SAFES, AND FIRE RESISTANT SAFES AND WATERPROOF SAFES MADE PRIMARILY OF METAL, IN CLASS 6 (U.S. CLS. 2, 12, 13, 14, 23, 25 AND 50).

FIRST USE 3-0-2002; IN COMMERCE 3-0-2002.

THE MARK CONSISTS OF STANDARD CHARACTERS WITHOUT CLAIM TO ANY PARTICULAR FONT, STYLE, SIZE, OR COLOR.

OWNER OF U.S. REG. NOS. 1,007,898 AND 2,051,799.

NO CLAIM IS MADE TO THE EXCLUSIVE RIGHT TO USE "STRONG BOX", APART FROM THE MARK AS SHOWN.

SER. NO. 77-353,391, FILED 12-17-2007.

KIMBERLY FRYE, EXAMINING ATTORNEY

**Int. Cl.: 12**

**Prior U.S. Cls.: 19, 21, 23, 31, 35 and 44**

**Reg. No. 3,569,094**

**United States Patent and Trademark Office**

**Registered Feb. 3, 2009**

---

**TRADEMARK  
PRINCIPAL REGISTER**

**RAWHIDE**

MACK TRUCKS, INC. (PENNSYLVANIA CORPORATION)  
2100 MACK BOULEVARD  
ALLENTOWN, PA 181055000

THE MARK CONSISTS OF STANDARD CHARACTERS WITHOUT CLAIM TO ANY PARTICULAR FONT, STYLE, SIZE, OR COLOR.

FOR: HEAVY DUTY TRUCKS, IN CLASS 12 (U.S. CLS. 19, 21, 23, 31, 35 AND 44).

SER. NO. 77-353,427, FILED 12-17-2007.

FIRST USE 12-17-2007; IN COMMERCE 12-17-2007.

JOHN DALIER, EXAMINING ATTORNEY

**Int. Cl.: 17**

**Prior U.S. Cls.: 1, 5, 12, 13, 35 and 50**

**Reg. No. 3,569,095**

**United States Patent and Trademark Office**

**Registered Feb. 3, 2009**

---

**TRADEMARK  
PRINCIPAL REGISTER**

**DARFLEX**

DARTEX COATINGS, INC. (RHODE ISLAND  
CORPORATION)  
22 STEEL STREET  
SLATERSVILLE, RI 02876

THE MARK CONSISTS OF STANDARD CHAR-  
ACTERS WITHOUT CLAIM TO ANY PARTICULAR  
FONT, STYLE, SIZE, OR COLOR.

FOR: NON-METAL LINER MATERIAL FOR  
CURED-IN-PLACE REPAIR OF CONDUITS, PIPES  
AND TUNNELS, IN CLASS 17 (U.S. CLS. 1, 5, 12, 13, 35  
AND 50).

SER. NO. 77-353,459, FILED 12-17-2007.

FIRST USE 11-30-2007; IN COMMERCE 11-30-2007.

KEVON CHISOLM, EXAMINING ATTORNEY

**Int. Cl.: 17**

**Prior U.S. Cls.: 1, 5, 12, 13, 35 and 50**

**Reg. No. 3,569,096**

**United States Patent and Trademark Office**

**Registered Feb. 3, 2009**

---

**TRADEMARK  
PRINCIPAL REGISTER**

**DARFLEX PLUS**

DARTEX COATINGS, INC. (RHODE ISLAND  
CORPORATION)  
22 STEEL STREET  
SLATERSVILLE, RI 02876

THE MARK CONSISTS OF STANDARD CHAR-  
ACTERS WITHOUT CLAIM TO ANY PARTICULAR  
FONT, STYLE, SIZE, OR COLOR.

FOR: NON-METAL LINER MATERIAL FOR  
CURED-IN-PLACE REPAIR OF CONDUITS, PIPES  
AND TUNNELS, IN CLASS 17 (U.S. CLS. 1, 5, 12, 13, 35  
AND 50).

SER. NO. 77-353,460, FILED 12-17-2007.

FIRST USE 11-30-2007; IN COMMERCE 11-30-2007.

KEVON CHISOLM, EXAMINING ATTORNEY



**Int. Cls.: 7 and 37**

**Prior U.S. Cls.: 13, 19, 21, 23, 31, 34, 35, 100, 103 and 106**

**Reg. No. 3,569,097**

**United States Patent and Trademark Office**

**Registered Feb. 3, 2009**

**TRADEMARK  
SERVICE MARK  
PRINCIPAL REGISTER**



COMANDULLI COSTRUZIONI MECCANICHE  
S.R.L. (ITALY LIMITED LIABILITY COMPAN-  
NY)

VIA MEDAGLIE D'ARGENTO, 20 Z.I  
26012 CASTELLEONE (CR), ITALY

FOR: MACHINE TOOLS FOR WORKING AND  
POLISHING MARBLE AND GRANITE; MACHINES  
FOR WORKING MARBLE AND GRANITE, MA-  
CHINES FOR MARBLE AND GRANITE POLISH-  
ING, IN CLASS 7 (U.S. CLS. 13, 19, 21, 23, 31, 34 AND  
35).

FOR: SERVICES FOR INSTALLATION AND  
MAINTENANCE OF MACHINE TOOLS, MA-  
CHINES FOR WORKING MARBLE AND GRANITE,

MACHINES FOR MARBLE AND GRANITE POL-  
ISHING, IN CLASS 37 (U.S. CLS. 100, 103 AND 106).

PRIORITY CLAIMED UNDER SEC. 44(D) ON  
ITALY APPLICATION NO. MI2007C00805, FILED 7-  
25-2007, REG. NO. 0001127401, DATED 7-15-2008,  
EXPIRES 7-25-2017.

THE MARK CONSISTS OF THE WORD "COMAN-  
DULLI" WITH A DOT IN THE MIDDLE OF THE "C",  
AND A HALF OF A GEAR TO THE LEFT OF THE  
WORD.

SER. NO. 77-353,694, FILED 12-17-2007.

TOBY BULLOFF, EXAMINING ATTORNEY

Int. Cl.: 36

Prior U.S. Cls.: 100, 101 and 102

United States Patent and Trademark Office

Reg. No. 3,569,098

Registered Feb. 3, 2009

SERVICE MARK  
PRINCIPAL REGISTER

# ICE eConfirm

INTERCONTINENTALEXCHANGE, INC. (DELAWARE CORPORATION)  
2100 RIVEREDGE PARKWAY, 5TH FLOOR  
ATLANTA, GA 30328

FOR: PROVIDING ON-LINE FINANCIAL SERVICES VIA THE INTERNET AND/OR OTHER INTERACTIVE ELECTRONIC MEDIA, NAMELY, MATCHING AND ASSESSING A LEVEL CONSISTENCY BETWEEN TRADE TERMS OF TRADE TRANSACTIONS; GENERATING WEB-BASED MATCHES AND CONSISTENCY ASSESSMENTS OF TRADE TRANSACTIONS CONSUMMATED VIA AN EXCHANGE, AN ELECTRONIC TRADING PLATFORM, AN OVER-THE-COUNTER VENUE, THROUGH VOICE BROKERS, AND/OR DIRECTLY BETWEEN COUNTER PARTIES; MATCHING AND ASSESSING A LEVEL CONSISTENCY BETWEEN TRADE TERMS OF TRADE TRANSACTIONS IN GLOBAL MARKETS INVOLVING COMMODITIES, DERIVATIVES, FUTURES AND/OR OPTIONS; ANALYZING, CLASSIFYING, AND DETERMINING THE STATUS OF TRADE TRANSACTIONS INVOLVING TRADERS, COUNTER PARTIES, BROKERS, AND/OR BROKERAGE FIRMS; PROVIDING AUTOMATED MATCHING AND ASSESSMENT SERVICES FOR PHYSICALLY OR FINANCIALLY SETTLED TRADE TRANSACTIONS INVOLVING GLOBAL ENERGY PRODUCTS, PRECIOUS METALS, AND/OR BASE METALS; PROVIDING FINANCIAL INFORMATION RELATING TO COMMODITIES, DERIVATIVES, FUTURES, AND/OR OPTIONS; ELECTRONIC COMMODITIES EX-

CHANGE SERVICES; PROVIDING FINANCIAL SERVICES IN THE NATURE OF PROVIDING AN EXCHANGE FOR COMMODITIES, DERIVATIVES, FUTURES, AND/OR OPTIONS; PROVIDING ON-LINE EXCHANGE SERVICES IN THE NATURE OF ONLINE PURCHASING AND/OR SELLING COMMODITIES, DERIVATIVES, FUTURES, AND/OR OPTIONS; FINANCIAL SERVICES IN THE NATURE OF ASSISTING OTHERS WITH THE COMPLETION OF FINANCIAL TRANSACTIONS FOR COMMODITIES, DERIVATIVES, FUTURES, AND/OR OPTIONS; SERVICES RELATING TO FINANCIAL TRANSACTIONS, NAMELY, TRADING COMMODITIES, DERIVATIVES, FUTURES, AND/OR OPTIONS; OFFERING, SPONSORING, MANAGING, AND/OR ADMINISTERING COMMODITIES, DERIVATIVES, FUTURES, AND/OR OPTIONS, IN CLASS 36 (U.S. CLS. 100, 101 AND 102).

FIRST USE 11-1-2005; IN COMMERCE 11-1-2005.

THE MARK CONSISTS OF STANDARD CHARACTERS WITHOUT CLAIM TO ANY PARTICULAR FONT, STYLE, SIZE, OR COLOR.

NO CLAIM IS MADE TO THE EXCLUSIVE RIGHT TO USE "ECONFIRM", APART FROM THE MARK AS SHOWN.

SER. NO. 77-353,702, FILED 12-17-2007.

MARK T. MULLEN, EXAMINING ATTORNEY

**Int. Cls.: 35 and 39**

**Prior U.S. Cls.: 100, 101, 102 and 105**

**United States Patent and Trademark Office**

**Reg. No. 3,569,099**

**Registered Feb. 3, 2009**

**SERVICE MARK  
PRINCIPAL REGISTER**

**BRIDGE WORLDWIDE  
RELOCATIONS**

BRIDGE WORLDWIDE RELOCATIONS, LLC  
(CALIFORNIA LIMITED LIABILITY COMPAN-  
NY)  
18809 COX AVENUE, SUITE 250  
SARATOGA, CA 95070

FOR: PERSONNEL RELOCATION SERVICES  
FOR BUSINESS, NAMELY, PLANNING AND IM-  
PLEMENTING MOVES OF PERSONNEL AND  
THEIR FAMILIES, IN CLASS 35 (U.S. CLS. 100, 101  
AND 102).

FIRST USE 1-1-2002; IN COMMERCE 1-1-2002.

FOR: TRAVEL ARRANGEMENT SERVICES,  
NAMELY, ARRANGING FOR TRAVEL VISAS  
AND TRAVEL DOCUMENTS FOR PERSONS TRA-

VELING OR RELOCATING ABROAD, IN CLASS 39  
(U.S. CLS. 100 AND 105).

FIRST USE 1-1-2002; IN COMMERCE 1-1-2002.

THE MARK CONSISTS OF STANDARD CHAR-  
ACTERS WITHOUT CLAIM TO ANY PARTICULAR  
FONT, STYLE, SIZE, OR COLOR.

NO CLAIM IS MADE TO THE EXCLUSIVE  
RIGHT TO USE "WORLDWIDE RELOCATIONS",  
APART FROM THE MARK AS SHOWN.

SER. NO. 77-354,194, FILED 12-17-2007.

SUSAN LESLIE DUBOIS, EXAMINING ATTORNEY

**Int. Cl.: 14**

**Prior U.S. Cls.: 2, 27, 28 and 50**

**United States Patent and Trademark Office**

**Reg. No. 3,569,100**

**Registered Feb. 3, 2009**

**TRADEMARK  
PRINCIPAL REGISTER**

**KIRSTEN GOSS**

KIRSTEN BRIDGET BANYARD (SOUTH AFRICA INDIVIDUAL)  
9 HAYLE AVENUE  
BEREA, DURBAN, SOUTH AFRICA 4001

FOR: PRECIOUS METALS AND THEIR ALLOYS; JEWELRY; PRECIOUS STONES; HOROLOGICAL AND CHRONOMETRIC INSTRUMENTS; TIE PINS; TIE CLIPS; CUFFLINKS; ORNAMENTAL PINS; NECKLACES; RINGS; BRACELETS; EARRINGS; PENDANTS; ANKLE BRACELETS; TIARAS; BROOCHES; KEY RINGS OF PRECIOUS METAL; GOODS IN PRECIOUS METAL OR COATED THEREWITH, NAMELY, HOROLOGICAL AND CHRONOMETRIC INSTRUMENTS, TIE PINS, TIE CLIPS, CUFFLINKS, ORNAMENTAL PINS, NECKLACES, RINGS, BRACELETS, EARRINGS, PENDANTS, ANKLE BRACELETS, TIARAS AND BROOCHES, IN CLASS 14 (U.S. CLS. 2, 27, 28 AND 50).

THE MARK CONSISTS OF STANDARD CHARACTERS WITHOUT CLAIM TO ANY PARTICULAR FONT, STYLE, SIZE, OR COLOR.

PRIORITY CLAIMED UNDER SEC. 44(D) ON ERPN CMNTY TM OFC APPLICATION NO. 6159529, FILED 8-1-2007, REG. NO. 006159529, DATED 7-3-2008, EXPIRES 8-1-2017.

THE NAME(S), PORTRAIT(S), AND/OR SIGNATURE(S) SHOWN IN THE MARK IDENTIFIES "KIRSTEN BRIDGET BANYARD", WHOSE CONSENT(S) TO REGISTER IS SUBMITTED.

SER. NO. 77-354,366, FILED 12-18-2007.

MICHAEL GAAFAR, EXAMINING ATTORNEY

**Int. Cl.: 5**

**Prior U.S. Cls.: 6, 18, 44, 46, 51 and 52**

**Reg. No. 3,569,101**

**United States Patent and Trademark Office**

**Registered Feb. 3, 2009**

**TRADEMARK  
PRINCIPAL REGISTER**

# Diabatrol

DIABCO LIFE SCIENCES LLC (INDIANA LIMITED LIABILITY COMPANY)  
484 EAST CARMEL DRIVE, #204  
CARMEL, IN 46033

THE MARK CONSISTS OF STANDARD CHARACTERS WITHOUT CLAIM TO ANY PARTICULAR FONT, STYLE, SIZE, OR COLOR.

FOR: NUTRACEUTICALS FOR USE AS A DIETARY SUPPLEMENT, IN CLASS 5 (U.S. CLS. 6, 18, 44, 46, 51 AND 52).

SER. NO. 77-354,568, FILED 12-18-2007.

FIRST USE 9-25-2007; IN COMMERCE 9-25-2007.

CURTIS FRENCH, EXAMINING ATTORNEY

**Int. Cl.: 39**

**Prior U.S. Cls.: 100 and 105**

**United States Patent and Trademark Office**

**Reg. No. 3,569,102**

**Registered Feb. 3, 2009**

**SERVICE MARK  
PRINCIPAL REGISTER**



FUSIONONE ELECTRONIC HEALTHCARE, INC.  
(DELAWARE CORPORATION)  
210 E THORNDALE AVENUE  
ROSELLE, IL 60172

FOR: ELECTRONIC STORAGE OF MEDICAL  
IMAGES AND DATA, IN CLASS 39 (U.S. CLS. 100  
AND 105).

FIRST USE 4-30-2004; IN COMMERCE 4-30-2004.

THE COLOR(S) BLUE AND WHITE IS/ARE  
CLAIMED AS A FEATURE OF THE MARK.

THE MARK CONSISTS OF AN ABSTRACT DE-  
SIGN OF A WAVY BLUE LINE WITH TWO BLUE  
SPHERES INTERSECTING THE LINE. THE INTER-  
SECTION POINT OF THE SPHERES AND LINE IS IN  
WHITE. THERE IS AN ADDITIONAL SOLID BLUE  
SPHERE ABOVE THE WAVY LINE.

SER. NO. 77-354,580, FILED 12-18-2007.

TOBY BULLOFF, EXAMINING ATTORNEY

**Int. Cls.: 37 and 42**

**Prior U.S. Cls.: 100, 101, 103 and 106**

**United States Patent and Trademark Office**

**Reg. No. 3,569,103**

**Registered Feb. 3, 2009**

**SERVICE MARK  
PRINCIPAL REGISTER**

**SPEEDFIX**

SPEEDFIX SOLUTIONS LLC (TEXAS LIMITED  
LIABILITY COMPANY)  
9400 NORTH CENTRAL EXPRESSWAY, SUITE 910  
DALLAS, TX 75231

FOR: MAINTENANCE AND/OR REPAIR OF  
COMPUTER NUMERICALLY CONTROLLED  
TRUCK ENGINES AND TRANSMISSIONS, IN  
CLASS 37 (U.S. CLS. 100, 103 AND 106).

FIRST USE 12-12-2007; IN COMMERCE 12-12-2007.

FOR: DIAGNOSTIC SERVICES IN THE FIELD OF  
COMPUTER CONTROLLED TRUCK ENGINES

AND TRANSMISSIONS, IN CLASS 42 (U.S. CLS. 100  
AND 101).

FIRST USE 12-12-2007; IN COMMERCE 12-12-2007.

THE MARK CONSISTS OF STANDARD CHAR-  
ACTERS WITHOUT CLAIM TO ANY PARTICULAR  
FONT, STYLE, SIZE, OR COLOR.

SER. NO. 77-354,718, FILED 12-18-2007.

RONALD MCMORROW, EXAMINING ATTORNEY

**Int. Cl.: 31**

**Prior U.S. Cls.: 1 and 46**

**United States Patent and Trademark Office**

**Reg. No. 3,569,104**

**Registered Feb. 3, 2009**

**TRADEMARK  
PRINCIPAL REGISTER**



MARS, INCORPORATED (DELAWARE CORPORATION)  
6885 ELM STREET  
MCLEAN, VA 22101

FOR: DOG FOOD, IN CLASS 31 (U.S. CLS. 1 AND 46).

FIRST USE 1-0-1999; IN COMMERCE 1-0-1999.

OWNER OF U.S. REG. NO. 3,179,272.

THE COLOR(S) BLACK, WHITE, AND PINK IS/  
ARE CLAIMED AS A FEATURE OF THE MARK.

THE MARK CONSISTS OF A REPRESENTATION OF A WESTIE DOG. THE WESTIE DOG HAS WHITE FUR, BLACK EYES, AND A BLACK NOSE. ITS PINK MOUTH IS SURROUNDED BY BLACK, WITH ITS WHITE LOWER TEETH VISIBLE. THE INSIDES OF ITS EARS ARE PINK.

SEC. 2(F).

SER. NO. 77-354,828, FILED 12-18-2007.

WENDY GOODMAN, EXAMINING ATTORNEY



**Int. Cl.: 36**

**Prior U.S. Cls.: 100, 101 and 102**

**United States Patent and Trademark Office**

**Reg. No. 3,569,105**

**Registered Feb. 3, 2009**

**SERVICE MARK  
PRINCIPAL REGISTER**

**Guzman & Company**

GUZMAN & COMPANY (FLORIDA CORPORATION)  
101 ARAGON AVENUE  
CORAL GABLES, FL 33134

FOR: FINANCIAL AND INVESTMENT SERVICES, NAMELY, MANAGEMENT AND BROKERAGE IN THE FIELDS OF STOCKS, BONDS, OPTIONS, COMMODITIES, FUTURES AND OTHER SECURITIES, AND THE INVESTMENT OF FUNDS OF OTHERS, IN CLASS 36 (U.S. CLS. 100, 101 AND 102).

FIRST USE 9-0-1987; IN COMMERCE 12-0-1987.

THE MARK CONSISTS OF STANDARD CHARACTERS WITHOUT CLAIM TO ANY PARTICULAR FONT, STYLE, SIZE, OR COLOR.

NO CLAIM IS MADE TO THE EXCLUSIVE RIGHT TO USE "& COMPANY", APART FROM THE MARK AS SHOWN.

SEC. 2(F).

SER. NO. 77-354,927, FILED 12-18-2007.

YONG KIM, EXAMINING ATTORNEY

**Int. Cl.: 36**

**Prior U.S. Cls.: 100, 101 and 102**

**United States Patent and Trademark Office**

**Reg. No. 3,569,106**

**Registered Feb. 3, 2009**

**SERVICE MARK  
PRINCIPAL REGISTER**

**Liquidity Management  
Series (LMS)**

THE FRANCIS FINANCIAL GROUP (LOUISIANA LIMITED LIABILITY COMPANY)  
SUITE 2400  
400 POYDRAST STREET  
NEW ORLEANS, LA 70130

FOR: PROVIDING INFORMATION AND ADVICE IN THE FIELD OF FINANCE, FINANCIAL INVESTMENTS, FINANCIAL VALUATIONS, AND THE FINANCIAL ASPECTS OF RETIREMENT; PROVISION OF FINANCIAL INFORMATION; PROVIDING FINANCIAL INFORMATION; INVESTMENT ADVISORY SERVICES; INVESTMENT SERVICES, NAMELY, ASSET ACQUISITION, CONSULTATION, DEVELOPMENT AND MANAGEMENT SERVICES; FINANCIAL SERVICES, NAMELY, INVESTMENT FUND TRANSFER AND TRANSACTION SERVICES; FINANCIAL PLANNING AND INVESTMENT

ADVISORY SERVICES; FINANCIAL PORTFOLIO MANAGEMENT, IN CLASS 36 (U.S. CLS. 100, 101 AND 102).

FIRST USE 11-1-2007; IN COMMERCE 11-1-2007.

THE MARK CONSISTS OF STANDARD CHARACTERS WITHOUT CLAIM TO ANY PARTICULAR FONT, STYLE, SIZE, OR COLOR.

NO CLAIM IS MADE TO THE EXCLUSIVE RIGHT TO USE "LIQUIDITY MANAGEMENT SERIES", APART FROM THE MARK AS SHOWN.

SER. NO. 77-355,053, FILED 12-18-2007.

ANDREA HACK, EXAMINING ATTORNEY

**Int. Cl.: 35**

**Prior U.S. Cls.: 100, 101 and 102**

**United States Patent and Trademark Office**

**Reg. No. 3,569,107**

**Registered Feb. 3, 2009**

**SERVICE MARK  
PRINCIPAL REGISTER**

**MILLION MILE MOTOR**

CAPITAL ADMINISTRATIVE RESOURCES, INC.  
(NEBRASKA CORPORATION)  
8055 "O" STREET  
LINCOLN, NE 68510

FOR: BUSINESS MARKETING SERVICES AND  
DIRECT MAIL ADVERTISING, NAMELY, MAIL-  
ING OF ADVERTISING PROMOTING A LIMITED  
EXTENDED WARRANTY ON ENGINES AND EN-  
GINE PARTS OFFERED TO CUSTOMERS BY AU-  
TOMOBILE DEALERSHIPS, IN CLASS 35 (U.S. CLS.  
100, 101 AND 102).

FIRST USE 2-1-2007; IN COMMERCE 2-1-2007.

THE MARK CONSISTS OF STANDARD CHAR-  
ACTERS WITHOUT CLAIM TO ANY PARTICULAR  
FONT, STYLE, SIZE, OR COLOR.

SER. NO. 77-355,462, FILED 12-19-2007.

DAVID ELTON, EXAMINING ATTORNEY

**Int. Cl.: 35**

**Prior U.S. Cls.: 100, 101 and 102**

**United States Patent and Trademark Office**

**Reg. No. 3,569,108**

**Registered Feb. 3, 2009**

**SERVICE MARK  
PRINCIPAL REGISTER**

**CSIMAX**

CAPITAL ADMINISTRATIVE RESOURCES, INC.  
(NEBRASKA CORPORATION)  
8055 "O" STREET  
LINCOLN, NE 68510

FOR: DIRECT MAIL ADVERTISING, NAMELY,  
DIRECT MAILING OF ADVERTISING TARGETED  
TO PREVIOUS AUTOMOBILE DEALERSHIP CUSTOMERS WHO DO NOT YET HAVE PROTECTION AFFORDED BY THE DEALERSHIP'S VEHICLE SERVICE CONTRACT PROGRAM FOR THE PURPOSE OF PROMOTING THE DEALERSHIP'S VEHICLE SERVICE CONTRACT PROGRAM AND SOLICITING THE PREVIOUS CUSTOMER'S PUR-

CHASE OF THE DEALERSHIP'S VEHICLE SERVICE CONTRACT PROGRAM, IN CLASS 35 (U.S. CLS. 100, 101 AND 102).

FIRST USE 2-1-2007; IN COMMERCE 2-1-2007.

THE MARK CONSISTS OF STANDARD CHARACTERS WITHOUT CLAIM TO ANY PARTICULAR FONT, STYLE, SIZE, OR COLOR.

SER. NO. 77-355,528, FILED 12-19-2007.

DAVID ELTON, EXAMINING ATTORNEY

**Int. Cl.: 36**

**Prior U.S. Cls.: 100, 101 and 102**

**United States Patent and Trademark Office**

**Reg. No. 3,569,109**

**Registered Feb. 3, 2009**

**SERVICE MARK  
PRINCIPAL REGISTER**

**Total Portfolio Series  
(TPS)**

THE FRANCIS FINANCIAL GROUP (LOUISIANA LIMITED LIABILITY COMPANY)  
SUITE 2400  
400 POYDRAS STREET  
NEW ORLEANS, LA 70130

FOR: PROVIDING INFORMATION AND ADVICE IN THE FIELD OF FINANCE, FINANCIAL INVESTMENTS, FINANCIAL VALUATIONS, AND THE FINANCIAL ASPECTS OF RETIREMENT; PROVISION OF FINANCIAL INFORMATION; PROVIDING FINANCIAL INFORMATION; INVESTMENT ADVISORY SERVICES; INVESTMENT SERVICES, NAMELY, ASSET ACQUISITION, CONSULTATION, DEVELOPMENT AND MANAGEMENT SERVICES; FINANCIAL SERVICES, NAMELY, INVESTMENT FUND TRANSFER AND TRANSACTION SERVICES; FINANCIAL PLANNING AND INVESTMENT

ADVISORY SERVICES; FINANCIAL PORTFOLIO MANAGEMENT, IN CLASS 36 (U.S. CLS. 100, 101 AND 102).

FIRST USE 11-1-2007; IN COMMERCE 11-1-2007.

THE MARK CONSISTS OF STANDARD CHARACTERS WITHOUT CLAIM TO ANY PARTICULAR FONT, STYLE, SIZE, OR COLOR.

NO CLAIM IS MADE TO THE EXCLUSIVE RIGHT TO USE "TOTAL PORTFOLIO SERIES", APART FROM THE MARK AS SHOWN.

SER. NO. 77-355,577, FILED 12-19-2007.

ANDREA HACK, EXAMINING ATTORNEY

**Int. Cl.: 36**

**Prior U.S. Cls.: 100, 101 and 102**

**United States Patent and Trademark Office**

**Reg. No. 3,569,110**

**Registered Feb. 3, 2009**

**SERVICE MARK  
PRINCIPAL REGISTER**

**All Cap Equity Series  
(ACES)**

THE FRANCIS FINANCIAL GROUP (LOUISIANA LIMITED LIABILITY COMPANY)  
SUITE 2400  
400 POYDRAS STREET  
NEW ORLEANS, LA 70130

FOR: PROVIDING INFORMATION AND ADVICE IN THE FIELD OF FINANCE, FINANCIAL INVESTMENTS, FINANCIAL VALUATIONS, AND THE FINANCIAL ASPECTS OF RETIREMENT; PROVISION OF FINANCIAL INFORMATION; PROVIDING FINANCIAL INFORMATION; INVESTMENT ADVISORY SERVICES; INVESTMENT SERVICES, NAMELY, ASSET ACQUISITION, CONSULTATION, DEVELOPMENT AND MANAGEMENT SERVICES; FINANCIAL SERVICES, NAMELY, INVESTMENT FUND TRANSFER AND TRANSACTION SERVICES; FINANCIAL PLANNING AND INVESTMENT

ADVISORY SERVICES; FINANCIAL PORTFOLIO MANAGEMENT, IN CLASS 36 (U.S. CLS. 100, 101 AND 102).

FIRST USE 11-1-2007; IN COMMERCE 11-1-2007.

THE MARK CONSISTS OF STANDARD CHARACTERS WITHOUT CLAIM TO ANY PARTICULAR FONT, STYLE, SIZE, OR COLOR.

NO CLAIM IS MADE TO THE EXCLUSIVE RIGHT TO USE "ALL CAP EQUITY SERIES", APART FROM THE MARK AS SHOWN.

SER. NO. 77-355,585, FILED 12-19-2007.

ANDREA HACK, EXAMINING ATTORNEY

**Int. Cl.: 5**

**Prior U.S. Cls.: 6, 18, 44, 46, 51 and 52**

**Reg. No. 3,569,111**

**United States Patent and Trademark Office**

**Registered Feb. 3, 2009**

---

**TRADEMARK  
PRINCIPAL REGISTER**

**CHOMEGA**

1-800-HEALTHY.COM, INC. (DELAWARE CORPORATION)  
834 WILSON DRIVE, SUITE B  
RIDGELAND, MS 39157

THE MARK CONSISTS OF STANDARD CHARACTERS WITHOUT CLAIM TO ANY PARTICULAR FONT, STYLE, SIZE, OR COLOR.

FOR: DIETARY AND NUTRITIONAL SUPPLEMENTS, IN CLASS 5 (U.S. CLS. 6, 18, 44, 46, 51 AND 52).

SER. NO. 77-355,618, FILED 12-19-2007.

FIRST USE 5-29-2004; IN COMMERCE 5-29-2004.

CYNTHIA SLOAN, EXAMINING ATTORNEY

**Int. Cls.: 37, 41 and 43**

**Prior U.S. Cls.: 100, 101, 103, 106 and 107**

**United States Patent and Trademark Office**

**Reg. No. 3,569,112**

**Registered Feb. 3, 2009**

**SERVICE MARK  
PRINCIPAL REGISTER**

**GREEN LEVEL CROSSING**

TB PROPRIETARY CORP. (DELAWARE CORPORATION)  
SUITE 612  
1105 N. MARKET STREET  
WILMINGTON, DE 19801

FOR: LAND DEVELOPMENT SERVICES, NAME-  
LY, PLANNING AND LAYING OUT OF RESIDEN-  
TIAL COMMUNITIES, IN CLASS 37 (U.S. CLS. 100,  
103 AND 106).

FIRST USE 11-30-2006; IN COMMERCE 11-30-2006.

FOR: PROVIDING RECREATIONAL SERVICES  
IN RESIDENTIAL COMMUNITIES IN THE NAT-  
URE OF SWIMMING POOLS, IN CLASS 41 (U.S. CLS.  
100, 101 AND 107).

FIRST USE 11-30-2006; IN COMMERCE 11-30-2006.

FOR: PROVIDING COMMUNITY CENTERS FOR  
SOCIAL GATHERINGS AND MEETINGS, IN CLASS  
43 (U.S. CLS. 100 AND 101).

FIRST USE 11-30-2006; IN COMMERCE 11-30-2006.

THE MARK CONSISTS OF STANDARD CHAR-  
ACTERS WITHOUT CLAIM TO ANY PARTICULAR  
FONT, STYLE, SIZE, OR COLOR.

NO CLAIM IS MADE TO THE EXCLUSIVE  
RIGHT TO USE "GREEN" AND "CROSSING",  
APART FROM THE MARK AS SHOWN.

SER. NO. 77-355,708, FILED 12-19-2007.

ANDREA HACK, EXAMINING ATTORNEY



**Int. Cl.: 1**

**Prior U.S. Cls.: 1, 5, 6, 10, 26 and 46**

**Reg. No. 3,569,113**

**United States Patent and Trademark Office**

**Registered Feb. 3, 2009**

**TRADEMARK  
PRINCIPAL REGISTER**

**EKHO**

WESTECH AEROSOL CORPORATION (WASHINGTON CORPORATION)  
5405 CONSTANCE DRIVE SOUTHWEST  
PORT ORCHARD, WA 98367

FOR: ADHESIVES, NAMELY, HIGH STRENGTH THERMOSET ADHESIVES FOR USE ON CONCRETE, TEAK, CORK, NOMINAL FINISH METAL, PARTICLE BOARD, PLYWOOD, AND FOR GENERAL INDUSTRIAL APPLICATIONS; AEROSOL ADHESIVES FOR USE ON CONCRETE, TEAK, CORK, NOMINAL FINISH METAL, PARTICLE BOARD, PLYWOOD, AND FOR GENERAL INDUSTRIAL APPLICATIONS; MULTI-PURPOSE, WATERPROOF, HIGH TACK, MOISTURE CURE, SPECIALTY ADHESIVES FOR HIGH EFFICIENCY AND EXTERIOR AND INTERIOR APPLICATIONS, NAMELY, FOR USE ON CONCRETE, TEAK, CORK,

NOMINAL FINISH METAL, PARTICLE BOARD, PLYWOOD, AND FOR GENERAL INDUSTRIAL APPLICATIONS; MULTI-PURPOSE, WATERPROOF, HIGH TACK, MOISTURE CURE, SPECIALTY ADHESIVES FOR INDUSTRIAL USE, IN CLASS 1 (U.S. CLS. 1, 5, 6, 10, 26 AND 46).

FIRST USE 3-15-2004; IN COMMERCE 3-15-2004.

THE MARK CONSISTS OF STANDARD CHARACTERS WITHOUT CLAIM TO ANY PARTICULAR FONT, STYLE, SIZE, OR COLOR.

SER. NO. 77-355,917, FILED 12-19-2007.

TOBY BULLOFF, EXAMINING ATTORNEY

Int. Cl.: 1

Prior U.S. Cls.: 1, 5, 6, 10, 26 and 46

Reg. No. 3,569,114

United States Patent and Trademark Office

Registered Feb. 3, 2009

TRADEMARK  
PRINCIPAL REGISTER

# DMEASY

WESTECH AEROSOL CORPORATION (WASHINGTON CORPORATION)  
5405 CONSTANCE DRIVE SOUTHWEST  
PORT ORCHARD, WA 98367

FOR: ADHESIVES, NAMELY, MULTI-PURPOSE, HIGH TACK SPRAY ADHESIVES FOR USE ON FIBERGLASS INSULATION, BLUE FOAM INSULATION, BLACK FOAM INSULATION, FABRIC UPHOLSTERY, URETHANE FOAM, CUSHION FOAM, PAPER, FOIL, PARTICLE BOARD, PLYWOOD, STYROFOAM, TAR PAPER, UPHOLSTERY, AND FOR GENERAL INDUSTRIAL USE; AEROSOL ADHESIVES FOR USE ON FIBERGLASS INSULATION, BLUE FOAM INSULATION, BLACK FOAM INSULATION, FABRIC UPHOLSTERY, URETHANE FOAM, CUSHION FOAM, PAPER, FOIL, PARTICLE BOARD, PLYWOOD, STYROFOAM, TAR PAPER, UPHOLSTERY, AND FOR GENERAL INDUSTRIAL USE; MULTI-PURPOSE, WATERPROOF, QUICK DRYING SPECIALTY ADHESIVES FOR INDUS-

TRIAL USE; MULTI-PURPOSE, WATERPROOF, QUICK DRYING SPECIALTY ADHESIVES FOR EXTERIOR AND INTERIOR APPLICATIONS, NAMELY, FIBERGLASS INSULATION, BLUE FOAM INSULATION, BLACK FOAM INSULATION, FABRIC UPHOLSTERY, URETHANE FOAM, CUSHION FOAM, PAPER, FOIL, PARTICLE BOARD, PLYWOOD, STYROFOAM, TAR PAPER, UPHOLSTERY, AND FOR GENERAL INDUSTRIAL USE, IN CLASS 1 (U.S. CLS. 1, 5, 6, 10, 26 AND 46).

FIRST USE 7-22-2004; IN COMMERCE 7-22-2004.

THE MARK CONSISTS OF STANDARD CHARACTERS WITHOUT CLAIM TO ANY PARTICULAR FONT, STYLE, SIZE, OR COLOR.

SER. NO. 77-355,995, FILED 12-19-2007.

TOBY BULLOFF, EXAMINING ATTORNEY

Int. Cl.: 19

Prior U.S. Cls.: 1, 12, 33 and 50

United States Patent and Trademark Office

Reg. No. 3,569,115

Registered Feb. 3, 2009

TRADEMARK  
PRINCIPAL REGISTER

**ROATAN**  
MAHOGANY MILLWORK, INC.  
*Solid Elegance.*

DE LEON, ROBERT (UNITED STATES INDIVIDUAL)  
4004C AURORA STREET  
CORAL GABLES, FL 33146

FOR: WOOD DOOR FRAMES; WOOD MOLDINGS; WOOD WINDOW FRAMES; NON-METAL DOORS; NON-METAL GARAGE DOORS; NON-METAL PATIO DOORS; NON-METAL DOOR FRAMES; NON-METAL DOOR PANELS; NON-METAL DOOR UNITS; NON-METAL EXTERIOR WINDOW SHADES; NON-METAL FLOORS; NON-METAL JALOUSIES; NON-METAL SLIDING DOORS; NON-METAL WINDOW CASEMENTS; NON-METAL WINDOW FRAMES; NON-METAL WINDOW SHUTTERS; NON-METAL WINDOWS, IN CLASS 19 (U.S. CLS. 1, 12, 33 AND 50).

FIRST USE 1-1-1999; IN COMMERCE 6-1-2000.

NO CLAIM IS MADE TO THE EXCLUSIVE RIGHT TO USE "INC.", APART FROM THE MARK AS SHOWN.

THE MARK CONSISTS OF LOGO FOR THE "ROATAN MAHOGANY MILLWORKS, INC. SOLID ELEGANCE".

SEC. 2(F) AS TO "MAHOGANY MILLWORK, INC.".

SER. NO. 77-356,218, FILED 12-19-2007.

JOHN WILKE, EXAMINING ATTORNEY

**Int. Cl.: 11**

**Prior U.S. Cls.: 13, 21, 23, 31 and 34**

**United States Patent and Trademark Office**

**Reg. No. 3,569,116**

**Registered Feb. 3, 2009**

**TRADEMARK  
PRINCIPAL REGISTER**

**Horizon Smoker Company**

HORIZON MANUFACTURING, INC. (OKLAHOMA CORPORATION), AKA HORIZON SMOKER COMPANY  
P. O. BOX 737  
802 NORTH 15TH STREET  
PERRY, OK 73061

FOR: BARBECUE GRILLS; BARBECUES; BARBECUES AND GRILLS; CHARCOAL GRILLS; GRILL ACCESSORIES, NAMELY, WARMING TRAYS; BARBECUE SMOKER ACCESSORIES, NAMELY, CONVECTION PLATES; BARBECUE SMOKERS, IN CLASS 11 (U.S. CLS. 13, 21, 23, 31 AND 34).

FIRST USE 8-1-2002; IN COMMERCE 8-1-2002.

THE MARK CONSISTS OF STANDARD CHARACTERS WITHOUT CLAIM TO ANY PARTICULAR FONT, STYLE, SIZE, OR COLOR.

NO CLAIM IS MADE TO THE EXCLUSIVE RIGHT TO USE "SMOKER COMPANY", APART FROM THE MARK AS SHOWN.

SER. NO. 77-356,287, FILED 12-19-2007.

ELIZABETH HUGHITT, EXAMINING ATTORNEY

**Int. Cl.: 41**

**Prior U.S. Cls.: 100, 101 and 107**

**United States Patent and Trademark Office**

**Reg. No. 3,569,117**

**Registered Feb. 3, 2009**

**SERVICE MARK  
PRINCIPAL REGISTER**

**FCRC**

ASSOCIATION FOR COMPUTING MACHINERY,  
INC. (DELAWARE NON-PROFIT CORPORATION)  
SUITE 701  
2 PENN PLAZA  
NEW YORK, NY 101210701

FOR: EDUCATIONAL SERVICES IN THE NATURE OF A SERIES OF CONFERENCES IN THE FIELD OF COMPUTER SCIENCE AND ENGINEERING THAT ASSEMBLES A SPECTRUM OF AFFILIATED RESEARCH CONFERENCES AND WORKSHOPS IN ORDER TO FACILITATE COM-

MUNICATION AMONG RESEARCHERS, IN CLASS 41 (U.S. CLS. 100, 101 AND 107).

FIRST USE 6-1-1993; IN COMMERCE 6-1-1993.

THE MARK CONSISTS OF STANDARD CHARACTERS WITHOUT CLAIM TO ANY PARTICULAR FONT, STYLE, SIZE, OR COLOR.

SER. NO. 77-356,433, FILED 12-20-2007.

ELLEN PERKINS, EXAMINING ATTORNEY

**Int. Cl.: 9**

**Prior U.S. Cls.: 21, 23, 26, 36 and 38**

**Reg. No. 3,569,118**

**United States Patent and Trademark Office**

**Registered Feb. 3, 2009**

**TRADEMARK  
PRINCIPAL REGISTER**

**SURF CITY USA**

HUNTINGTON BEACH CONFERENCE AND  
VISITORS BUREAU (CALIFORNIA COR-  
PORATION)  
301 MAIN STREET, SUITE 208  
HUNTINGTON BEACH, CA 926485171

FOR: PRERECORDED CDS, AUDIO AND VIDEO  
TAPES FEATURING IMAGES AND SONGS RE-  
LATED TO SURFING AND SURF CULTURE; MOUSE  
PADS, AND MAGNETS, IN CLASS 9 (U.S. CLS. 21, 23,  
26, 36 AND 38).

FIRST USE 3-7-2005; IN COMMERCE 3-7-2005.

THE MARK CONSISTS OF STANDARD CHAR-  
ACTERS WITHOUT CLAIM TO ANY PARTICULAR  
FONT, STYLE, SIZE, OR COLOR.

OWNER OF U.S. REG. NOS. 3,140,635, 3,161,068  
AND OTHERS.

SEC. 2(F).

SER. NO. 77-356,486, FILED 12-20-2007.

FRED MANDIR, EXAMINING ATTORNEY

**Int. Cl.: 12**

**Prior U.S. Cls.: 19, 21, 23, 31, 35 and 44**

**Reg. No. 3,569,119**

**United States Patent and Trademark Office**

**Registered Feb. 3, 2009**

**TRADEMARK  
PRINCIPAL REGISTER**

**SURF CITY USA**

HUNTINGTON BEACH CONFERENCE AND  
VISITORS BUREAU (CALIFORNIA COR-  
PORATION)

301 MAIN STREET, SUITE 208  
HUNTINGTON BEACH, CA 926485171

FOR: BICYCLES, IN CLASS 12 (U.S. CLS. 19, 21, 23,  
31, 35 AND 44).

FIRST USE 5-12-2006; IN COMMERCE 5-12-2006.

THE MARK CONSISTS OF STANDARD CHAR-  
ACTERS WITHOUT CLAIM TO ANY PARTICULAR  
FONT, STYLE, SIZE, OR COLOR.

OWNER OF U.S. REG. NOS. 3,140,635, 3,161,067,  
AND 3,161,068.

SEC. 2(F).

SER. NO. 77-356,487, FILED 12-20-2007.

FRED MANDIR, EXAMINING ATTORNEY

**Int. Cl.: 16**

**Prior U.S. Cls.: 2, 5, 22, 23, 29, 37, 38 and 50**

**Reg. No. 3,569,120**

**United States Patent and Trademark Office**

**Registered Feb. 3, 2009**

**TRADEMARK  
PRINCIPAL REGISTER**

**SURF CITY USA**

HUNTINGTON BEACH CONFERENCE AND  
VISITORS BUREAU (CALIFORNIA COR-  
PORATION)  
301 MAIN STREET, SUITE 208  
HUNTINGTON BEACH, CA 926485171

FOR: PRINTED MATERIALS NAMELY BRO-  
CHURES IN THE FIELD OF DESTINATION TRA-  
VEL MARKETING, NEWSLETTERS IN THE FIELD  
OF DESTINATION TRAVEL MARKETING,  
PAMPHLETS IN THE FIELD OF DESTINATION  
TRAVEL MARKETING, PICTURES, POSTERS, DEC-  
ALS AND GREETING CARDS, IN CLASS 16 (U.S.  
CLS. 2, 5, 22, 23, 29, 37, 38 AND 50).

FIRST USE 12-3-2004; IN COMMERCE 12-3-2004.

THE MARK CONSISTS OF STANDARD CHAR-  
ACTERS WITHOUT CLAIM TO ANY PARTICULAR  
FONT, STYLE, SIZE, OR COLOR.

OWNER OF U.S. REG. NOS. 3,140,635, 3,161,068  
AND OTHERS.

SEC. 2(F).

SER. NO. 77-356,490, FILED 12-20-2007.

FRED MANDIR, EXAMINING ATTORNEY



**Int. Cl.: 24**

**Prior U.S. Cls.: 42 and 50**

**United States Patent and Trademark Office**

**Reg. No. 3,569,121**

**Registered Feb. 3, 2009**

**TRADEMARK  
PRINCIPAL REGISTER**

**SURF CITY USA**

HUNTINGTON BEACH CONFERENCE AND  
VISITORS BUREAU (CALIFORNIA COR-  
PORATION)

301 MAIN STREET, SUITE 208  
HUNTINGTON BEACH, CA 926485171

FOR: BLANKETS, NAMELY, STADIUM BLAN-  
KETS, AND TOWELS, IN CLASS 24 (U.S. CLS. 42  
AND 50).

FIRST USE 5-12-2006; IN COMMERCE 5-12-2006.

THE MARK CONSISTS OF STANDARD CHAR-  
ACTERS WITHOUT CLAIM TO ANY PARTICULAR  
FONT, STYLE, SIZE, OR COLOR.

OWNER OF U.S. REG. NOS. 3,140,635, 3,161,067,  
AND 3,161,068.

SEC. 2(F).

SER. NO. 77-356,492, FILED 12-20-2007.

FRED MANDIR, EXAMINING ATTORNEY

**Int. Cl.: 25**

**Prior U.S. Cls.: 22 and 39**

**United States Patent and Trademark Office**

**Reg. No. 3,569,122**

**Registered Feb. 3, 2009**

**TRADEMARK  
PRINCIPAL REGISTER**

**SURF CITY USA**

HUNTINGTON BEACH CONFERENCE AND  
VISITORS BUREAU (CALIFORNIA COR-  
PORATION)  
301 MAIN STREET, SUITE 208  
HUNTINGTON BEACH, CA 926485171

FOR: CLOTHING, NAMELY, APRONS, DRESSES,  
FOOTWEAR, JEANS, SCARVES, SHIRTS, SHORTS,  
SKIRTS, SWEATSHIRTS, SWEATPANTS, TOPS, T-  
SHIRTS, AND OUTERWEAR CLOTHING, NAME-  
LY, HOODED SWEATSHIRTS, JACKETS, HATS,  
AND CAPS, IN CLASS 25 (U.S. CLS. 22 AND 39).

FIRST USE 8-31-2005; IN COMMERCE 8-31-2005.

THE MARK CONSISTS OF STANDARD CHAR-  
ACTERS WITHOUT CLAIM TO ANY PARTICULAR  
FONT, STYLE, SIZE, OR COLOR.

OWNER OF U.S. REG. NOS. 3,140,635, 3,161,068  
AND OTHERS.

SEC. 2(F).

SER. NO. 77-356,493, FILED 12-20-2007.

FRED MANDIR, EXAMINING ATTORNEY

**Int. Cl.: 35**

**Prior U.S. Cls.: 100, 101 and 102**

**United States Patent and Trademark Office**

**Reg. No. 3,569,123**

**Registered Feb. 3, 2009**

**SERVICE MARK  
PRINCIPAL REGISTER**

**SURF CITY USA**

HUNTINGTON BEACH CONFERENCE AND  
VISITORS BUREAU (CALIFORNIA COR-  
PORATION)  
301 MAIN STREET, SUITE 208  
HUNTINGTON BEACH, CA 926485171

FOR: ADVERTISING AND MARKETING; PRO-  
MOTING THE ECONOMIC DEVELOPMENT IN  
THE CITY OF HUNTINGTON BEACH, CALIFOR-  
NIA ; RETAIL STORE SERVICES FEATURING  
CLOTHING, IN CLASS 35 (U.S. CLS. 100, 101 AND  
102).

FIRST USE 11-19-2004; IN COMMERCE 11-19-2004.

THE MARK CONSISTS OF STANDARD CHAR-  
ACTERS WITHOUT CLAIM TO ANY PARTICULAR  
FONT, STYLE, SIZE, OR COLOR.

OWNER OF U.S. REG. NOS. 3,140,635, 3,161,067,  
AND 3,161,068.

SEC. 2(F).

SER. NO. 77-356,494, FILED 12-20-2007.

FRED MANDIR, EXAMINING ATTORNEY

**Int. Cl.: 43**

**Prior U.S. Cls.: 100 and 101**

**United States Patent and Trademark Office**

**Reg. No. 3,569,124**

**Registered Feb. 3, 2009**

**SERVICE MARK  
PRINCIPAL REGISTER**

**SURF CITY USA**

HUNTINGTON BEACH CONFERENCE AND  
VISITORS BUREAU (CALIFORNIA COR-  
PORATION)

301 MAIN STREET, SUITE 208  
HUNTINGTON BEACH, CA 926485171

FOR: RESERVATIONS OF HOTEL ROOMS FOR  
TRAVELERS, IN CLASS 43 (U.S. CLS. 100 AND 101).

FIRST USE 4-7-2007; IN COMMERCE 4-7-2007.

THE MARK CONSISTS OF STANDARD CHAR-  
ACTERS WITHOUT CLAIM TO ANY PARTICULAR  
FONT, STYLE, SIZE, OR COLOR.

OWNER OF U.S. REG. NOS. 3,140,635, 3,161,068  
AND OTHERS.

SEC. 2(F).

SER. NO. 77-356,495, FILED 12-20-2007.

FRED MANDIR, EXAMINING ATTORNEY

**Int. Cl.: 28**

**Prior U.S. Cls.: 22, 23, 38 and 50**

**Reg. No. 3,569,125**

**United States Patent and Trademark Office**

**Registered Feb. 3, 2009**

**TRADEMARK  
PRINCIPAL REGISTER**

**SURF CITY USA**

HUNTINGTON BEACH CONFERENCE AND  
VISITORS BUREAU (CALIFORNIA COR-  
PORATION)

301 MAIN STREET, SUITE 208  
HUNTINGTON BEACH, CA 926485171

FOR: TOYS, NAMELY, TOY CARS, IN CLASS 28  
(U.S. CLS. 22, 23, 38 AND 50).

FIRST USE 6-14-2006; IN COMMERCE 6-14-2006.

THE MARK CONSISTS OF STANDARD CHAR-  
ACTERS WITHOUT CLAIM TO ANY PARTICULAR  
FONT, STYLE, SIZE, OR COLOR.

OWNER OF U.S. REG. NOS. 3,140,635, 3,161,068  
AND OTHERS.

SEC. 2(F).

SER. NO. 77-356,500, FILED 12-20-2007.

FRED MANDIR, EXAMINING ATTORNEY

Int. Cl.: 41

Prior U.S. Cls.: 100, 101 and 107

United States Patent and Trademark Office

Reg. No. 3,569,126

Registered Feb. 3, 2009

SERVICE MARK  
PRINCIPAL REGISTER



WYOMING CATHOLIC COLLEGE (WYOMING  
NON-PROFIT CORPORATION)  
163 LEEDY DRIVE  
LANDER, WY 82520

FOR: EDUCATION SERVICES IN THE NATURE  
OF COURSES AT THE UNIVERSITY LEVEL AND  
DISTRIBUTION OF COURSE MATERIAL IN CON-  
NECTION THEREWITH, IN CLASS 41 (U.S. CLS. 100,  
101 AND 107).

FIRST USE 8-9-2007; IN COMMERCE 8-9-2007.

THE MARK CONSISTS OF A SOARING EAGLE  
WITH SHIELD WITHIN ITS BREST DIVIDED

INTO FOUR SEPARATE SYMBOLS - THE MOUN-  
TAIN, SUN AND WHEAT; LION STANDING ON ITS  
HIND LEGS; CRESCENT MOON ON A WALL  
OVERLOOKING AN ANCHOR CROSS; AND OPEN  
BOOK WITH A SWORD WITHIN.

THE FOREIGN WORDING IN THE MARK  
TRANSLATES INTO ENGLISH AS THE TRUE,  
THE GOOD, THE BEAUTIFUL.

SER. NO. 77-356,511, FILED 12-20-2007.

WILLIAM BRECKENFELD, EXAMINING ATTOR-  
NEY

**Int. Cl.: 41**

**Prior U.S. Cls.: 100, 101 and 107**

**United States Patent and Trademark Office**

**Reg. No. 3,569,127**

**Registered Feb. 3, 2009**

**SERVICE MARK  
PRINCIPAL REGISTER**

**THE LONELY DOG**

LONELY DOG LIMITED (NEW ZEALAND LIMITED LIABILITY COMPANY)  
11 POLYGON ROAD, ST. HELIERS  
AUCKLAND, NEW ZEALAND

FOR: PRODUCTION, DISTRIBUTION AND RENTAL OF MOTION PICTURE FILMS; PRESENTATION OF MOTION PICTURE FILMS IN THEATERS, IN CLASS 41 (U.S. CLS. 100, 101 AND 107).

THE MARK CONSISTS OF STANDARD CHARACTERS WITHOUT CLAIM TO ANY PARTICULAR FONT, STYLE, SIZE, OR COLOR.

PRIORITY CLAIMED UNDER SEC. 44(D) ON NEW ZEALAND APPLICATION NO. 781274, FILED 12-13-2007, REG. NO. 781274, DATED 12-13-2007, EXPIRES 12-13-2017.

OWNER OF U.S. REG. NO. 3,035,620.

SER. NO. 77-356,573, FILED 12-20-2007.

DAVID HOFFMAN, EXAMINING ATTORNEY

**Int. Cl.: 41**

**Prior U.S. Cls.: 100, 101 and 107**

**United States Patent and Trademark Office**

**Reg. No. 3,569,128**

**Registered Feb. 3, 2009**

**SERVICE MARK  
PRINCIPAL REGISTER**



CORPORATE BROADCAST COMPANY, INC.  
(FLORIDA CORPORATION)  
1539 MOFFETT STREET  
HOLLYWOOD, FL 33020

FOR: TELEVISION SHOW PRODUCTION; INTERNET TELEVISION PROGRAMMING; AND DISTRIBUTION OF TELEVISION PROGRAMS FOR OTHERS, IN CLASS 41 (U.S. CLS. 100, 101 AND 107).

FIRST USE 12-11-2007; IN COMMERCE 12-11-2007.

NO CLAIM IS MADE TO THE EXCLUSIVE RIGHT TO USE "TV", APART FROM THE MARK AS SHOWN.

THE FOREIGN WORDING IN THE MARK TRANSLATES INTO ENGLISH AS MESSAGE.

SER. NO. 77-356,969, FILED 12-20-2007.

VERNA BETH RIRIE, EXAMINING ATTORNEY



Int. Cl.: 35

Prior U.S. Cls.: 100, 101 and 102

United States Patent and Trademark Office

Reg. No. 3,569,129

Registered Feb. 3, 2009

SERVICE MARK  
PRINCIPAL REGISTER



ADVOCATES AGAINST IMPAIRED DRIVING,  
INC. (INDIANA CORPORATION)  
5360 ROCKVILLE ROAD  
INDIANAPOLIS, IN 46224

FOR: PROMOTING PUBLIC AWARENESS OF THE DANGERS OF IMPAIRED DRIVING AND THE PREVENTION OF IMPAIRED DRIVING; ASSOCIATION SERVICES, NAMELY, PROMOTING THE INTERESTS OF ENTITIES OPPOSED TO IMPAIRED DRIVING, IN CLASS 35 (U.S. CLS. 100, 101 AND 102).

FIRST USE 12-2-2005; IN COMMERCE 4-0-2006.

NO CLAIM IS MADE TO THE EXCLUSIVE RIGHT TO USE "ADVOCATES AGAINST IMPAIRED DRIVING", APART FROM THE MARK AS SHOWN.

THE COLOR(S) BLACK, BLUE, GREEN, RED AND WHITE IS/ARE CLAIMED AS A FEATURE OF THE MARK.

THE MARK CONSISTS OF AN OUTER BLUE CIRCLE ENCLOSED THE TERMS "ADVOCATES AGAINST IMPAIRED DRIVING" AROUND AN INNER RED CIRCLE WITH A RED DIAGONAL TRANSVERSE BAR THAT ENCIRCLES DRAWINGS OF AN AUTOMOBILE, A BOTTLE, PILLS AND A GREEN MARIJUANA LEAF. THE WORDING, OUTLINE AND TIRES OF THE CAR, MOST OF THE BOTTLE AND SOME PILLS ARE BLACK. THE OUTER CIRCLE IS BLUE. THE MARIJUANA LEAF IS GREEN. THE PROHIBITION SYMBOL, BOTTLE LABEL AND ONE PILL ARE RED. SOME PILLS AND THE BACKGROUND OF THE MARK ARE WHITE.

SER. NO. 77-357,042, FILED 12-20-2007.

IRA J. GOODSaid, EXAMINING ATTORNEY

Int. Cl.: 35

Prior U.S. Cls.: 100, 101 and 102

United States Patent and Trademark Office

Reg. No. 3,569,130

Registered Feb. 3, 2009

**SERVICE MARK  
PRINCIPAL REGISTER**



information to  
implementation

CONSTELLATION ENERGY GROUP, INC.  
(MARYLAND CORPORATION)  
750 EAST PRATT STREET  
BALTIMORE, MD 21202

FOR: PROCUREMENT, NAMELY, PURCHASING OF ENERGY FOR OTHERS; COMMERCIAL ENERGY USE MANAGEMENT SERVICES; CONSULTATION SERVICES IN THE FIELDS OF ENERGY CONSUMPTION, ENERGY CONSERVATION AND ENERGY USE MANAGEMENT; FORMULATING ENERGY CONSUMPTION PLANS TO REDUCE ENERGY COSTS AND REDUCE RISKS ASSOCIATED WITH CHANGING ENERGY COSTS; ENERGY AUDITING, NAMELY, REVIEW AND ANALYSIS OF ENERGY CONSUMPTION; PREPARING CUSTOMIZED BUSINESS REPORTS FEATURING ENERGY SAVINGS DATA, ENERGY PROFILE DEVELOPMENT, ENERGY PROFILE BENCHMARKING, RATE ANALYSIS AND VERIFICA-

TION, RISK TOLERANCE, PROCUREMENT STRATEGY AND ENERGY PRODUCT SELECTION; AND PROVIDING A WEBSITE FEATURING INFORMATION ABOUT ENERGY MANAGEMENT, USE, COSTS AND CONSERVATION; MONITORING ENERGY MARKETS FOR OTHERS, IN CLASS 35 (U.S. CLS. 100, 101 AND 102).

FIRST USE 11-24-2005; IN COMMERCE 11-24-2005.

THE MARK CONSISTS OF A SQUARE BACKGROUND BEHIND THE "i2i" PORTION OF THE MARK, ALONG WITH THE WORDS "INFORMATION TO IMPLEMENTATION" BELOW THE SQUARE.

SER. NO. 77-357,092, FILED 12-20-2007.

MARK SPARACINO, EXAMINING ATTORNEY

**Int. Cls.: 6, 12, 18, 21, 25 and 41**

**Prior U.S. Cls.: 1, 2, 3, 12, 13, 14, 19, 21, 22, 23, 25, 29, 30, 31, 33, 35, 39, 40, 41, 44, 50, 100, 101 and 107**

**Reg. No. 3,569,131**

**United States Patent and Trademark Office**

**Registered Feb. 3, 2009**

**TRADEMARK  
SERVICE MARK  
PRINCIPAL REGISTER**

**GOLDEN BULLS**

JOHNSON C. SMITH UNIVERSITY (NORTH  
CAROLINA CORPORATION)  
100-300 BEATTIES FORD ROAD  
CHARLOTTE, NC 28216

FOR: METAL KEY RINGS, IN CLASS 6 (U.S. CLS.  
2, 12, 13, 14, 23, 25 AND 50).

FIRST USE 1-1-2004; IN COMMERCE 1-1-2004.

FOR: LICENSE PLATE FRAMES, IN CLASS 12  
(U.S. CLS. 19, 21, 23, 31, 35 AND 44).

FIRST USE 1-1-2004; IN COMMERCE 1-1-2004.

FOR: BACKPACKS, LUGGAGE, AND UMBRELLAS,  
IN CLASS 18 (U.S. CLS. 1, 2, 3, 22 AND 41).

FIRST USE 1-1-2004; IN COMMERCE 1-1-2004.

FOR: DRINKING GLASSES, MUGS, PITCHERS  
AND VASES, IN CLASS 21 (U.S. CLS. 2, 13, 23, 29, 30,  
33, 40 AND 50).

FIRST USE 1-1-2004; IN COMMERCE 1-1-2004.

FOR: APPAREL, NAMELY, SHIRTS, JACKETS,  
SWEATERS, CAPS, PARKAS, SHORTS, JOGGING  
SUITS, SWEAT SUITS, NECKTIES, LEISURE SUITS,  
RAIN JACKETS, SCARVES, SLEEPWEAR, SOCKS,  
ATHLETIC JERSEYS AND SHORTS, IN CLASS 25  
(U.S. CLS. 22 AND 39).

FIRST USE 1-1-2004; IN COMMERCE 1-1-2004.

FOR: ENCOURAGING AMATEUR SPORTS AND  
PHYSICAL EDUCATION BY ORGANIZING, PRO-  
MOTING, SPONSORING, SANCTIONING, CON-  
DUCTING, ADMINISTERING, REGULATING  
AND GOVERNING AMATEUR ATHLETIC PRO-  
GRAMS AND ACTIVITIES, IN CLASS 41 (U.S. CLS.  
100, 101 AND 107).

FIRST USE 1-1-2004; IN COMMERCE 1-1-2004.

THE MARK CONSISTS OF STANDARD CHAR-  
ACTERS WITHOUT CLAIM TO ANY PARTICULAR  
FONT, STYLE, SIZE, OR COLOR.

SER. NO. 77-357,176, FILED 12-20-2007.

GILBERT SWIFT, EXAMINING ATTORNEY

**Int. Cl.: 41**

**Prior U.S. Cls.: 100, 101 and 107**

**United States Patent and Trademark Office**

**Reg. No. 3,569,132**

**Registered Feb. 3, 2009**

**SERVICE MARK  
PRINCIPAL REGISTER**

**Leaders Without Borders**

CARLOS A. SANCHEZ (TEXAS SOLE PROPRIETORSHIP)  
6016 CAVE RIVER DR.  
PLANO, TX 75093

FOR: BUSINESS TRAINING; TEACHING AND TRAINING IN BUSINESS, INDUSTRY AND INFORMATION TECHNOLOGY, IN CLASS 41 (U.S. CLS. 100, 101 AND 107).

FIRST USE 6-10-2005; IN COMMERCE 6-10-2005.

THE MARK CONSISTS OF STANDARD CHARACTERS WITHOUT CLAIM TO ANY PARTICULAR FONT, STYLE, SIZE, OR COLOR.

SER. NO. 77-357,516, FILED 12-20-2007.

JANICE L. MCMORROW, EXAMINING ATTORNEY

Int. Cl.: 9

Prior U.S. Cls.: 21, 23, 26, 36 and 38

United States Patent and Trademark Office

Reg. No. 3,569,133

Registered Feb. 3, 2009

TRADEMARK  
PRINCIPAL REGISTER



BURRITO BABY SLEEP SOLUTIONS (UTAH CORPORATION), DBA B.B. SLEEP SOLUTIONS  
592 WEST 300 NORTH  
SPRINGVILLE, UT 84663

FOR: PRERECORDED INSTRUCTIONAL DVDS FEATURING INFORMATION CONCERNING SWADDLING TECHNIQUES AND BABY SLEEP HEALTH, IN CLASS 9 (U.S. CLS. 21, 23, 26, 36 AND 38).

FIRST USE 5-0-2007; IN COMMERCE 5-0-2007.

NO CLAIM IS MADE TO THE EXCLUSIVE RIGHT TO USE "SLEEP SOLUTIONS", APART FROM THE MARK AS SHOWN.

THE COLOR(S) CHOCOLATE BROWN, LIGHT BLUE, PINK IS/ARE CLAIMED AS A FEATURE OF THE MARK.

THE MARK CONSISTS OF A BABY WRAPPED IN A BLANKET WITH THE WORDS "B B SLEEP SOLUTIONS" ABOVE THE BABY. THE OUTLINE OF THE BABY AND BLANKET ARE IN CHOCOLATE BROWN COLOR AS ARE THE WORDS "B B SLEEP SOLUTIONS". THE BLANKET HAS LIGHT BLUE SHADING AND THE BABY'S CHEEK HAS A PINK CIRCLE.

SER. NO. 77-357,711, FILED 12-21-2007.

MICHELE SWAIN, EXAMINING ATTORNEY

**Int. Cl.: 35**

**Prior U.S. Cls.: 100, 101 and 102**

**United States Patent and Trademark Office**

**Reg. No. 3,569,134**

**Registered Feb. 3, 2009**

**SERVICE MARK  
PRINCIPAL REGISTER**



MAXIMUM VALUE PARTNERS, LLC (OHIO  
LIMITED LIABILITY COMPANY)  
SUITE C  
1790 STONEY HILL DRIVE  
HUDSON, OH 44236

FOR: BUSINESS MANAGEMENT SERVICES;  
BUSINESS MANAGEMENT AND ORGANIZATION  
CONSULTING; BUSINESS APPRAISALS; BUSINESS  
INVESTIGATION; BUSINESS MARKETING CON-  
SULTING SERVICES; BUSINESS EVALUATION  
AND RESEARCH OF OPERATIONAL METHODOL-  
OGIES; BUSINESS CONSULTING SERVICES RE-  
LATING TO LEADERSHIP, PERSONAL  
MANAGEMENT, BUSINESS MANAGEMENT,  
COMMUNICATION SKILLS, NEGOTIATION  
SKILLS, PROBLEM SOLVING SKILLS, HUMAN  
CAPITAL, MARKET ASSESSMENT AND ANALY-  
SIS, STRATEGIC PLANNING, AND SALES ANALY-

SIS TECHNOLOGY, IN CLASS 35 (U.S. CLS. 100, 101  
AND 102).

FIRST USE 10-0-2006; IN COMMERCE 10-0-2006.

THE COLOR(S) GREEN, LIGHT GREEN AND  
DARK GREEN IS/ARE CLAIMED AS A FEATURE  
OF THE MARK.

THE MARK CONSISTS OF A THREE POINTED  
DESIGN WITH THE POINTS IN GREEN, LIGHT  
GREEN AND DARK GREEN.

SER. NO. 77-357,966, FILED 12-21-2007.

BRIAN NEVILLE, EXAMINING ATTORNEY

**Int. Cl.: 11**

**Prior U.S. Cls.: 13, 21, 23, 31 and 34**

**Reg. No. 3,569,135**

**United States Patent and Trademark Office**

**Registered Feb. 3, 2009**

---

**TRADEMARK  
PRINCIPAL REGISTER**

**DUAL**

BUNN-O-MATIC CORPORATION (DELAWARE  
CORPORATION)  
1400 STEVENSON DRIVE  
SPRINGFIELD, IL 62703

FOR: ELECTRIC COFFEE MAKERS FOR COM-  
MERCIAL USE AND COMPONENT PARTS AND  
REPLACEMENT PARTS THEREFORE, IN CLASS 11  
(U.S. CLS. 13, 21, 23, 31 AND 34).

FIRST USE 3-1-1991; IN COMMERCE 3-1-1991.

THE MARK CONSISTS OF STANDARD CHAR-  
ACTERS WITHOUT CLAIM TO ANY PARTICULAR  
FONT, STYLE, SIZE, OR COLOR.

OWNER OF U.S. REG. NO. 2,633,590.

SEC. 2(F).

SER. NO. 77-358,268, FILED 12-21-2007.

LINDSEY RUBIN, EXAMINING ATTORNEY

**Int. Cl.: 11**

**Prior U.S. Cls.: 13, 21, 23, 31 and 34**

**United States Patent and Trademark Office**

**Reg. No. 3,569,136**

**Registered Feb. 3, 2009**

**TRADEMARK  
PRINCIPAL REGISTER**

**SINGLE**

BUNN-O-MATIC CORPORATION (DELAWARE  
CORPORATION)  
1400 STEVENSON DRIVE  
SPRINGFIELD, IL 62703

FOR: ELECTRIC COFFEE MAKERS FOR COM-  
MERCIAL USE AND COMPONENT PARTS AND  
REPLACEMENT PARTS THEREFORE, IN CLASS 11  
(U.S. CLS. 13, 21, 23, 31 AND 34).

FIRST USE 4-1-1993; IN COMMERCE 4-1-1993.

THE MARK CONSISTS OF STANDARD CHAR-  
ACTERS WITHOUT CLAIM TO ANY PARTICULAR  
FONT, STYLE, SIZE, OR COLOR.

OWNER OF U.S. REG. NO. 2,633,591.

SEC. 2(F).

SER. NO. 77-358,285, FILED 12-21-2007.

LINDSEY RUBIN, EXAMINING ATTORNEY



**Int. Cl.: 35**

**Prior U.S. Cls.: 100, 101 and 102**

**United States Patent and Trademark Office**

**Reg. No. 3,569,137**

**Registered Feb. 3, 2009**

**SERVICE MARK  
PRINCIPAL REGISTER**

**SEMISURPLUS**

SEMISURPLUS.COM, INC. (OHIO CORPORATION)  
6029 SCHUMACHER PARK  
WEST CHESTER, OH 45069

FOR: ON-LINE RETAIL STORE SERVICES FEATURING NEW AND USED COMPONENTS FOR MANUFACTURING EQUIPMENT USED IN THE PRODUCTION OF SEMICONDUCTORS, MICRO-ELECTROMECHANICAL DEVICES, AND NANOTECHNOLOGY DEVICES, IN CLASS 35 (U.S. CLS. 100, 101 AND 102).

FIRST USE 2-8-2001; IN COMMERCE 2-8-2001.

THE MARK CONSISTS OF STANDARD CHARACTERS WITHOUT CLAIM TO ANY PARTICULAR FONT, STYLE, SIZE, OR COLOR.

SER. NO. 77-358,351, FILED 12-21-2007.

APRIL ROACH, EXAMINING ATTORNEY

**Int. Cl.: 36**

**Prior U.S. Cls.: 100, 101 and 102**

**United States Patent and Trademark Office**

**Reg. No. 3,569,138**

**Registered Feb. 3, 2009**

**SERVICE MARK  
PRINCIPAL REGISTER**

**AEC INTERNATIONAL**

AEC VALUATIONS, INC. (CANADA CORPORATION)  
SUITE 760  
100 SHEPPARD AVENUE EAST  
TORONTO, CANADA M2N6N5

FOR: BUSINESS SERVICES, NAMELY, REAL AND PERSONAL PROPERTY ASSESSMENT, IN CLASS 36 (U.S. CLS. 100, 101 AND 102).

FIRST USE 7-1-2004; IN COMMERCE 3-1-2007.

THE MARK CONSISTS OF STANDARD CHARACTERS WITHOUT CLAIM TO ANY PARTICULAR FONT, STYLE, SIZE, OR COLOR.

NO CLAIM IS MADE TO THE EXCLUSIVE RIGHT TO USE "INTERNATIONAL", APART FROM THE MARK AS SHOWN.

SER. NO. 77-358,366, FILED 12-21-2007.

MARK SPARACINO, EXAMINING ATTORNEY

**Int. Cl.: 42**

**Prior U.S. Cls.: 100 and 101**

**United States Patent and Trademark Office**

**Reg. No. 3,569,139**

**Registered Feb. 3, 2009**

**SERVICE MARK  
PRINCIPAL REGISTER**

**NETWORK ANYWARE**

OFFICE ANYWARE, INC. (UTAH CORPORATION)  
10421 SOUTH JORDAN GATEWAY  
SUITE 500  
SOUTH JORDAN, UT 84095

FOR: COMPUTER COLLOCATION SERVICES, NAMELY, PROVIDING FACILITIES FOR THE LOCATION OF COMPUTER SERVICES WITH THE EQUIPMENT OF OTHERS; COMPUTER SECURITY SERVICE, NAMELY, RESTRICTING ACCESS TO AND BY COMPUTER NETWORKS TO AND OF UNDESIRE WEB SITES, MEDIA AND INDIVIDUALS AND FACILITIES, IN CLASS 42 (U.S. CLS. 100 AND 101).

FIRST USE 11-0-2007; IN COMMERCE 11-0-2007.

THE MARK CONSISTS OF STANDARD CHARACTERS WITHOUT CLAIM TO ANY PARTICULAR FONT, STYLE, SIZE, OR COLOR.

NO CLAIM IS MADE TO THE EXCLUSIVE RIGHT TO USE "NETWORK", APART FROM THE MARK AS SHOWN.

SER. NO. 77-358,494, FILED 12-21-2007.

LINDA ORNDORFF, EXAMINING ATTORNEY

**Int. Cl.: 42**

**Prior U.S. Cls.: 100 and 101**

**United States Patent and Trademark Office**

**Reg. No. 3,569,140**

**Registered Feb. 3, 2009**

**SERVICE MARK  
PRINCIPAL REGISTER**

**SERVER ANYWARE**

OFFICE ANYWARE, INC. (UTAH CORPORATION)  
10421 SOUTH JORDAN GATEWAY  
SUITE 500  
SOUTH JORDAN, UT 84095

FOR: COMPUTER COLLOCATION SERVICES, NAMELY, PROVIDING FACILITIES FOR THE LOCATION OF COMPUTER SERVICES WITH THE EQUIPMENT OF OTHERS, IN CLASS 42 (U.S. CLS. 100 AND 101).

FIRST USE 11-0-2007; IN COMMERCE 11-0-2007.

THE MARK CONSISTS OF STANDARD CHARACTERS WITHOUT CLAIM TO ANY PARTICULAR FONT, STYLE, SIZE, OR COLOR.

NO CLAIM IS MADE TO THE EXCLUSIVE RIGHT TO USE "SERVER", APART FROM THE MARK AS SHOWN.

SER. NO. 77-358,552, FILED 12-21-2007.

LINDA ORNDORFF, EXAMINING ATTORNEY

**Int. Cl.: 38**

**Prior U.S. Cls.: 100, 101 and 104**

**United States Patent and Trademark Office**

**Reg. No. 3,569,141**

**Registered Feb. 3, 2009**

**SERVICE MARK  
PRINCIPAL REGISTER**

**STORAGE ANYWARE**

OFFICE ANYWARE, INC. (UTAH CORPORATION)  
SUITE 500  
10421 SOUTH JORDAN GATEWAY  
SOUTH JORDAN, UT 84095

FOR: PROVISION OF ACCESS TO DATA OR DOCUMENTS STORED ELECTRONICALLY IN CENTRAL FILES FOR REMOTE CONSULTATION, IN CLASS 38 (U.S. CLS. 100, 101 AND 104).

FIRST USE 11-0-2007; IN COMMERCE 11-0-2007.

THE MARK CONSISTS OF STANDARD CHARACTERS WITHOUT CLAIM TO ANY PARTICULAR FONT, STYLE, SIZE, OR COLOR.

NO CLAIM IS MADE TO THE EXCLUSIVE RIGHT TO USE "STORAGE", APART FROM THE MARK AS SHOWN.

SER. NO. 77-358,592, FILED 12-21-2007.

LINDA ORNDORFF, EXAMINING ATTORNEY

**Int. Cl.: 35**

**Prior U.S. Cls.: 100, 101 and 102**

**United States Patent and Trademark Office**

**Reg. No. 3,569,142**

**Registered Feb. 3, 2009**

**SERVICE MARK  
PRINCIPAL REGISTER**

**EMMIS INTERACTIVE**

EMMIS INTERACTIVE, INC. (INDIANA CORPORATION)  
SUITE 700  
40 MONUMENT CIRCLE  
INDIANAPOLIS, IN 46204

FOR: PROMOTING, ADVERTISING AND MARKETING OF THE GOODS, SERVICES, AND ONLINE WEBSITES OF OTHERS; BUSINESS CONSULTATION SERVICES TO OTHERS IN THE FIELD OF SELLING GOODS AND SERVICES VIA THE GLOBAL INFORMATION NETWORK; INTERACTIVE ADVERTISING AGENCY AND BUSINESS MARKETING CONSULTING SERVICES; DIRECT MARKETING ADVERTISING SERVICES; MARKET RESEARCH SERVICES; EVENT MARKETING SERVICES; CONDUCTING ONLINE BUSINESS AND MARKET RESEARCH SURVEYS THAT INCLUDE FEEDBACK FORMS FOR WEBSITE ADMINISTRATION

TORS FOR USE TO SOLICIT INPUT AND FEEDBACK FROM VISITORS OF A WEBSITE, IN CLASS 35 (U.S. CLS. 100, 101 AND 102).

FIRST USE 5-30-2004; IN COMMERCE 5-30-2004.

THE MARK CONSISTS OF STANDARD CHARACTERS WITHOUT CLAIM TO ANY PARTICULAR FONT, STYLE, SIZE, OR COLOR.

NO CLAIM IS MADE TO THE EXCLUSIVE RIGHT TO USE "INTERACTIVE", APART FROM THE MARK AS SHOWN.

SER. NO. 77-359,476, FILED 12-26-2007.

TOBY BULLOFF, EXAMINING ATTORNEY

**Int. Cl.: 1**

**Prior U.S. Cls.: 1, 5, 6, 10, 26 and 46**

**Reg. No. 3,569,143**

**United States Patent and Trademark Office**

**Registered Feb. 3, 2009**

---

**TRADEMARK  
PRINCIPAL REGISTER**

**NUTRIPURE-CALCIUM**

S.A. REVERTE PRODUCTOS MINERALES  
(SPAIN CORPORATION)  
AFORES, S/N  
CASTELLET I LA GORNAL  
BARCELONA, SPAIN 08729

FOR: CALCIUM CARBONATE; CHEMICALS  
USED IN INDUSTRY, IN CLASS 1 (U.S. CLS. 1, 5, 6,  
10, 26 AND 46).

PRIORITY CLAIMED UNDER SEC. 44(D) ON  
SPAIN APPLICATION NO. 2.802.054, FILED 11-28-  
2007, REG. NO. 2.802.054, DATED 11-28-2007, EX-  
PIRES 11-28-2017.

SER. NO. 77-359,919, FILED 12-27-2007.

MELVIN AXILBUND, EXAMINING ATTORNEY

**Int. Cl.: 42**

**Prior U.S. Cls.: 100 and 101**

**United States Patent and Trademark Office**

**Reg. No. 3,569,144**

**Registered Feb. 3, 2009**

**SERVICE MARK  
PRINCIPAL REGISTER**

**PRE-HIRE 360**

SKILLSURVEY, INC. (DELAWARE CORPORATION)  
SUITE 300  
1055 WESTLAKES DRIVE  
BERWYN, PA 19312

FOR: APPLICATION SERVICE PROVIDER (ASP)  
FEATURING SOFTWARE FOR USE IN CONDUCTING  
SEMI-AUTOMATED JOB REFERENCE  
CHECKS, IN CLASS 42 (U.S. CLS. 100 AND 101).

FIRST USE 10-31-2007; IN COMMERCE 10-31-2007.

THE MARK CONSISTS OF STANDARD CHARACTERS WITHOUT CLAIM TO ANY PARTICULAR FONT, STYLE, SIZE, OR COLOR.

NO CLAIM IS MADE TO THE EXCLUSIVE RIGHT TO USE "PRE-HIRE", APART FROM THE MARK AS SHOWN.

SER. NO. 77-360,490, FILED 12-27-2007.

ANDREA HACK, EXAMINING ATTORNEY



**Int. Cl.: 3**

**Prior U.S. Cls.: 1, 4, 6, 50, 51 and 52**

**United States Patent and Trademark Office**

**Reg. No. 3,569,145**

**Registered Feb. 3, 2009**

**TRADEMARK  
PRINCIPAL REGISTER**



L'OREAL (FRANCE SOCIÉTÉ ANONYME (SA))  
14 RUE ROYALE  
PARIS, FRANCE 75008

OWNER OF U.S. REG. NOS. 2,434,100, 2,710,627,  
AND 3,194,138.

FOR: SHAMPOOS; GELS, SPRAYS, MOUSSES  
AND BALMS FOR THE HAIR STYLING AND HAIR  
CARE; HAIR LACQUERS; HAIR COLOURING AND  
HAIR DECOLORANT PREPARATIONS; PERMA-  
NENT WAVING AND CURLING PREPARATIONS  
, IN CLASS 3 (U.S. CLS. 1, 4, 6, 50, 51 AND 52).

NO CLAIM IS MADE TO THE EXCLUSIVE  
RIGHT TO USE "BIOTIC", APART FROM THE  
MARK AS SHOWN.

THE MARK "KÉRASTASE" HAS NO MEANING  
IN A FOREIGN LANGUAGE.

PRIORITY CLAIMED UNDER SEC. 44(D) ON  
FRANCE APPLICATION NO. 073512969, FILED 7-  
11-2007, REG. NO. 073512969, DATED 7-11-2007, EX-  
PIRES 7-11-2017.

SER. NO. 77-360,795, FILED 12-28-2007.

BARNEY CHARLON, EXAMINING ATTORNEY

Int. Cl.: 33

Prior U.S. Cls.: 47 and 49

**United States Patent and Trademark Office**

**Reg. No. 3,569,146**

Registered Feb. 3, 2009

**TRADEMARK  
PRINCIPAL REGISTER**

**MARANI**

MARGRIT ENTERPRISES INTERNATIONAL,  
INC. (CALIFORNIA CORPORATION)  
13152 RAYMER STREET E/F  
NORTH HOLLYWOOD, CA 91605

FOR: FLAVORED DISTILLED SPIRITS; VODKA,  
IN CLASS 33 (U.S. CLS. 47 AND 49).

FIRST USE 8-1-2002; IN COMMERCE 8-1-2002.

OWNER OF U.S. REG. NO. 2,922,839.

THE MARK CONSISTS OF THE WORD "MARA-  
NI" IN A STYLIZED FORMAT.

SEC. 2(F).

SER. NO. 77-360,937, FILED 12-28-2007.

LANA PHAM, EXAMINING ATTORNEY

Int. Cl.: 32

Prior U.S. Cls.: 45, 46 and 48

United States Patent and Trademark Office

Reg. No. 3,569,147

Registered Feb. 3, 2009

TRADEMARK  
PRINCIPAL REGISTER



TRADE WINDS CITRUS (INTL.) LTD. (ST.LUCIA  
COMPANY)  
BOURBON HOUSE, BOURBON STREET  
P.O. BOX 1695  
CASTRIES, ST.LUCIA

FOR: CHILLED FRUIT JUICES, IN CLASS 32 (U.S.  
CLS. 45, 46 AND 48).

FIRST USE 6-13-2006; IN COMMERCE 6-13-2006.

NO CLAIM IS MADE TO THE EXCLUSIVE  
RIGHT TO USE "PREMIUM QUALITY", APART  
FROM THE MARK AS SHOWN.

THE COLOR(S) GREEN, WHITE, BLACK IS/ARE  
CLAIMED AS A FEATURE OF THE MARK.

THE MARK CONSISTS OF THE WORDS "TRU-  
JUICE" IN SPECIAL FORM IN GREEN, WHITE AND  
BLACK, THE WORDS "PREMIUM QUALITY" IN  
WHITE ON A GREEN BACKGROUND WITH  
WHITE AND BLACK BORDER.

SER. NO. 77-361,063, FILED 12-28-2007.

JULIE GUTTADAURO, EXAMINING ATTORNEY

**Int. Cl.: 9**

**Prior U.S. Cls.: 21, 23, 26, 36 and 38**

**Reg. No. 3,569,148**

**United States Patent and Trademark Office**

**Registered Feb. 3, 2009**

---

**TRADEMARK  
PRINCIPAL REGISTER**

**PORTHOS**

BLOCK ENGINEERING, INC. (DELAWARE  
CORPORATION)  
64 CEDAR HILL STREET  
MARLBOROUGH, MA 01752

THE MARK CONSISTS OF STANDARD CHAR-  
ACTERS WITHOUT CLAIM TO ANY PARTICULAR  
FONT, STYLE, SIZE, OR COLOR.

FOR: STAND-OFF CHEMICAL SENSING SYS-  
TEMS COMPRISED OF SPECTROMETERS, IN  
CLASS 9 (U.S. CLS. 21, 23, 26, 36 AND 38).

SER. NO. 77-361,153, FILED 12-28-2007.

FIRST USE 8-1-2007; IN COMMERCE 8-1-2007.

PAULA MAHONEY, EXAMINING ATTORNEY

**Int. Cl.: 39**

**Prior U.S. Cls.: 100 and 105**

**United States Patent and Trademark Office**

**Reg. No. 3,569,149**

**Registered Feb. 3, 2009**

**SERVICE MARK  
PRINCIPAL REGISTER**



LIGHTNING JOE'S, INC. (PENNSYLVANIA CORPORATION)  
802 FAR HILLS DRIVE  
NEW FREEDOM, PA 17349

FOR: FREIGHT FORWARDING; FREIGHT FORWARDING SERVICES; GLOBAL TRANSPORTATION OF FREIGHT FOR OTHERS BY ALL AVAILABLE MEANS, IN CLASS 39 (U.S. CLS. 100 AND 105).

FIRST USE 4-7-2006; IN COMMERCE 4-7-2006.

NO CLAIM IS MADE TO THE EXCLUSIVE RIGHT TO USE "CHEAP & QUICK", APART FROM THE MARK AS SHOWN.

THE COLOR(S) RED, ORANGE, GOLD, BLACK, AND WHITE IS/ARE CLAIMED AS A FEATURE OF THE MARK.

THE MARK CONSISTS OF AN OVAL DESIGN WITH THE INITIALS "CAQ" IN THE CENTER ON A BLACK BACKGROUND THAT IS ALSO IN AN OVAL SHAPE. THE OUTSIDE OF THE MARK CONSISTS OF A COLOR OVAL BAND UPON WHICH THE WORDS "CHEAP & QUICK" APPEAR IN WHITE IMMEDIATELY BELOW THE INITIALS "CAQ". THE COLORS OF BOTH THE INITIALS "CAQ" AND THE OUTER COLOR OVAL BAND TRANSITION FROM RED STARTING AT THE BOTTOM THROUGH ORANGE TO GOLD AT THE TOP. BETWEEN THE OUTER OVAL AND THE INNER BLACK OVAL IS ANOTHER SMALL OVAL BAND, IN GOLD AND BLACK.

SER. NO. 77-361,449, FILED 12-29-2007.

WANDA KAY PRICE, EXAMINING ATTORNEY

Int. Cls.: 33, 39 and 41

Prior U.S. Cls.: 47, 49, 100, 101, 105 and 107

Reg. No. 3,569,150

United States Patent and Trademark Office

Registered Feb. 3, 2009

TRADEMARK  
SERVICE MARK  
PRINCIPAL REGISTER



August Ridge

BACKER, JOHN AUGUST (CALIFORNIA SOLE PROPRIETORSHIP), DBA AUGUST RIDGE VINEYARDS  
8790 E. HIGHWAY 41  
CRESTON, CA 93432

FOR: WINE, IN CLASS 33 (U.S. CLS. 47 AND 49).

FIRST USE 8-14-2005; IN COMMERCE 7-28-2007.

FOR: WINE CLUB SERVICES FEATURING PERIODIC SHIPMENTS OF WINE TO MEMBERS, IN CLASS 39 (U.S. CLS. 100 AND 105).

FIRST USE 7-28-2007; IN COMMERCE 7-28-2007.

FOR: ENTERTAINMENT SERVICES, NAMELY, WINE AND FOOD TASTINGS; ENTERTAINMENT SERVICES, NAMELY, WINE TASTINGS, IN CLASS 41 (U.S. CLS. 100, 101 AND 107).

FIRST USE 7-28-2007; IN COMMERCE 7-28-2007.

THE NAME(S), PORTRAIT(S), AND/OR SIGNATURE(S) SHOWN IN THE MARK DOES NOT IDENTIFY A PARTICULAR LIVING INDIVIDUAL.

THE COLOR(S) BURGUNDY, YELLOW, GREEN, AND BLACK IS/ARE CLAIMED AS A FEATURE OF THE MARK.

THE MARK CONSISTS OF A HAND PAINTED STYLIZED SETTING YELLOW AND BURGUNDY SUN OVER GREEN HILLS AND A BURGUNDY BACKGROUND, AND THE WORDING "AUGUST RIDGE" IN BLACK.

SER. NO. 77-361,528, FILED 12-29-2007.

MARTHA SANTOMARTINO, EXAMINING ATTORNEY

**Int. Cl.: 42**

**Prior U.S. Cls.: 100 and 101**

**United States Patent and Trademark Office**

**Reg. No. 3,569,151**

**Registered Feb. 3, 2009**

**SERVICE MARK  
PRINCIPAL REGISTER**

**Stone Mountain Software**

LEVY, PETER FLEMING (UNITED STATES INDIVIDUAL)  
4831 NORTH FARMSTEAD COURT  
BEL AIRE, KS 672201638

FOR: COMPUTER PROGRAMMING AND SOFTWARE DESIGN; COMPUTER SOFTWARE CONSULTANCY; COMPUTER SOFTWARE CONSULTATION; COMPUTER SOFTWARE DESIGN; COMPUTER SOFTWARE DESIGN FOR OTHERS; COMPUTER SOFTWARE DESIGN, COMPUTER PROGRAMMING, OR MAINTENANCE OF COMPUTER SOFTWARE; COMPUTER SOFTWARE DEVELOPMENT; CONSULTANCY IN THE FIELD OF SOFTWARE DESIGN; CUSTOMIZATION OF COMPUTER HARDWARE AND SOFTWARE; DESIGN AND DEVELOPMENT OF COMPUTER HARDWARE AND SOFTWARE; DESIGN AND DEVELOPMENT OF ON-LINE COMPUTER SOFTWARE SYSTEMS; DESIGN, DEVELOPMENT AND IMPLEMENTATION OF SOFTWARE; DESIGN, MAINTENANCE, DEVELOPMENT AND UPDATING OF COMPUTER SOFTWARE; DEVELOPING AND UPDATING COMPUTER SOFTWARE; DEVELOPING COMPUTER SOFTWARE; DEVELOPMENT AND CREATION OF COMPUTER PROGRAMMES FOR DATA PROCESSING; DEVELOPMENT OF DATA PROCES-

SING PROGRAMS BY ORDER OF THIRD PARTIES; DEVELOPMENT, UPDATING AND MAINTENANCE OF SOFTWARE AND DATA BASES; RESEARCH AND DEVELOPMENT FOR NEW PRODUCTS FOR OTHERS; RESEARCH AND DEVELOPMENT OF COMPUTER SOFTWARE; RESEARCH, DEVELOPMENT, DESIGN AND UPGRADING OF COMPUTER SOFTWARE; SOFTWARE AUTHORING; SOFTWARE DESIGN AND DEVELOPMENT; TECHNICAL SUPPORT SERVICES, NAMELY, TROUBLESHOOTING OF COMPUTER SOFTWARE PROBLEMS, IN CLASS 42 (U.S. CLS. 100 AND 101).

FIRST USE 1-1-2000; IN COMMERCE 1-1-2000.

THE MARK CONSISTS OF STANDARD CHARACTERS WITHOUT CLAIM TO ANY PARTICULAR FONT, STYLE, SIZE, OR COLOR.

NO CLAIM IS MADE TO THE EXCLUSIVE RIGHT TO USE "SOFTWARE", APART FROM THE MARK AS SHOWN.

SER. NO. 77-361,582, FILED 12-30-2007.

JENNIFER MARTIN, EXAMINING ATTORNEY

Int. Cl.: 20

Prior U.S. Cls.: 2, 13, 22, 25, 32 and 50

Reg. No. 3,569,152

United States Patent and Trademark Office

Registered Feb. 3, 2009

**TRADEMARK  
PRINCIPAL REGISTER**



THE LEATHER CONSULTANT, LLC (TEXAS  
LIMITED LIABILITY COMPANY), DBA CON-  
TINENTAL SEATING  
6800 CR 995  
MCKINNEY, TX 75071

FOR: HOME THEATER SEATING AND FURNI-  
TURE, IN CLASS 20 (U.S. CLS. 2, 13, 22, 25, 32 AND  
50).

FIRST USE 6-1-2004; IN COMMERCE 6-1-2004.

THE COLOR(S) GRAY, BLACK, AND RED IS/  
ARE CLAIMED AS A FEATURE OF THE MARK.

THE MARK CONSISTS OF THE STYLIZED  
WORD BRAVO! IN GRAY COLOR, WITH A BLACK  
DROP SHADOW WITHIN A RED TICKET DESIGN.

SER. NO. 77-361,874, FILED 12-31-2007.

MICHAEL ENGEL, EXAMINING ATTORNEY



**Int. Cl.: 36**

**Prior U.S. Cls.: 100, 101 and 102**

**United States Patent and Trademark Office**

**Reg. No. 3,569,153**

**Registered Feb. 3, 2009**

**SERVICE MARK  
PRINCIPAL REGISTER**

**A Fresh Start for Your  
Community**

MAJERLE MANAGEMENT, INC. (MARYLAND  
CORPORATION)  
SUITE D  
7347 HANOVER PKWY, GREENBELT, MD 20770  
GREENBELT, MD 20770

FOR: REAL ESTATE MANAGEMENT, IN CLASS  
36 (U.S. CLS. 100, 101 AND 102).

FIRST USE 1-1-2008; IN COMMERCE 1-1-2008.

THE MARK CONSISTS OF STANDARD CHAR-  
ACTERS WITHOUT CLAIM TO ANY PARTICULAR  
FONT, STYLE, SIZE, OR COLOR.

SER. NO. 77-362,223, FILED 1-1-2008.

DAVID TAYLOR, EXAMINING ATTORNEY

**Int. Cls.: 37 and 42**

**Prior U.S. Cls.: 100, 101, 103 and 106**

**United States Patent and Trademark Office**

**Reg. No. 3,569,154**

**Registered Feb. 3, 2009**

**SERVICE MARK  
PRINCIPAL REGISTER**

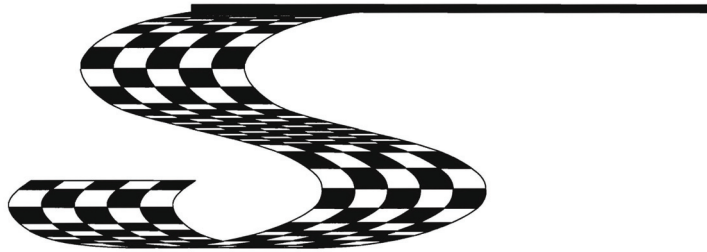

SPEEDFIX SOLUTIONS LLC (TEXAS LIMITED LIABILITY COMPANY)  
9400 NORTH CENTRAL EXPRESSWAY, SUITE 910  
DALLAS, TX 75231

FOR: MAINTENANCE AND/OR REPAIR OF COMPUTER NUMERICALLY CONTROLLED TRUCK ENGINES AND TRANSMISSIONS, IN CLASS 37 (U.S. CLS. 100, 103 AND 106).

FIRST USE 12-12-2007; IN COMMERCE 12-12-2007.

FOR: DIAGNOSTIC SERVICES IN THE FIELD OF COMPUTER NUMERICALLY CONTROLLED

TRUCK ENGINES AND TRANSMISSIONS, IN CLASS 42 (U.S. CLS. 100 AND 101).

FIRST USE 12-12-2007; IN COMMERCE 12-12-2007.

THE MARK CONSISTS OF A STYLIZED LETTER "S."

SER. NO. 77-362,381, FILED 1-2-2008.

RONALD MCMORROW, EXAMINING ATTORNEY

Int. Cl.: 45

Prior U.S. Cls.: 100 and 101

**United States Patent and Trademark Office**

**Reg. No. 3,569,155**

Registered Feb. 3, 2009

**SERVICE MARK  
PRINCIPAL REGISTER**



WILLIAMS, MONTY (UNITED STATES INDIVIDUAL)  
2320 ROGUE WAY  
WEST LINN, OR 97068

FOR: EVANGELISTIC AND MINISTERIAL SERVICES, IN CLASS 45 (U.S. CLS. 100 AND 101).

FIRST USE 10-3-2007; IN COMMERCE 11-30-2007.

THE MARK CONSISTS OF A FOOTPRINT BEING EXAMINED BY A MAGNIFYING GLASS. BELOW THE FOOTPRINT ARE THE STYLIZED WORDS "LOOK AGAIN."

SER. NO. 77-362,452, FILED 1-2-2008.

DAVID COLLIER, EXAMINING ATTORNEY

**Int. Cl.: 20**

**Prior U.S. Cls.: 2, 13, 22, 25, 32 and 50**

**United States Patent and Trademark Office**

**Reg. No. 3,569,156**

**Registered Feb. 3, 2009**

**TRADEMARK  
PRINCIPAL REGISTER**

**OUTRÉ**

OUTRÉ LLC (INDIANA LIMITED LIABILITY  
COMPANY)  
P.O. BOX 97  
711 S. POPLAR STREET  
LA GRANGE, IN 47671

FOR: FURNITURE, IN CLASS 20 (U.S. CLS. 2, 13,  
22, 25, 32 AND 50).

FIRST USE 6-1-2007; IN COMMERCE 6-1-2007.

THE MARK CONSISTS OF THE WORD "OUTRE"  
WITH AN ACCENT OVER THE "E".

THE FOREIGN WORDING IN THE MARK  
TRANSLATES INTO ENGLISH AS OUTRAGED.

SER. NO. 77-363,198, FILED 1-3-2008.

ANDREA K. NADELMAN, EXAMINING ATTOR-  
NEY

**Int. Cl.: 42**

**Prior U.S. Cls.: 100 and 101**

**United States Patent and Trademark Office**

**Reg. No. 3,569,157**

**Registered Feb. 3, 2009**

**SERVICE MARK  
PRINCIPAL REGISTER**



**Aldor Solutions**

ALDOR SOLUTIONS CORPORATION (TEXAS CORPORATION)  
SUITE 104  
860 F AVENUE  
PLANO, TX 75074

FOR: DESIGN OF HOMEPAGES AND WEBSITES; DESIGN, CREATION, HOSTING, MAINTENANCE OF WEBSITES FOR OTHERS; HOSTING OF WEBSITES; WEBSITE DEVELOPMENT FOR OTHERS, IN CLASS 42 (U.S. CLS. 100 AND 101).

FIRST USE 10-1-2007; IN COMMERCE 10-1-2007.

NO CLAIM IS MADE TO THE EXCLUSIVE RIGHT TO USE "SOLUTIONS", APART FROM THE MARK AS SHOWN.

THE MARK CONSISTS OF TWO INTERLOCKING MARQUIS SHAPES WITH THE WORDS "ALDOR SOLUTIONS" DIRECTLY UNDERNEATH.

SER. NO. 77-363,616, FILED 1-3-2008.

MICHAEL LITZAU, EXAMINING ATTORNEY

Int. Cl.: 36

Prior U.S. Cls.: 100, 101 and 102

United States Patent and Trademark Office

Reg. No. 3,569,158

Registered Feb. 3, 2009

**SERVICE MARK  
PRINCIPAL REGISTER**



EGAN, GEORGE A. (UNITED STATES INDIVIDUAL)  
3150 HILLTOP MALL RD.  
RICHMOND, CA 94806

FOR: FINANCIAL CONSULTATION; FINANCIAL ANALYSIS AND CONSULTATION; FINANCIAL MANAGEMENT; FINANCIAL PLANNING; FINANCIAL PORTFOLIO MANAGEMENT; FINANCIAL RESEARCH AND INFORMATION SERVICES; FINANCIAL RISK MANAGEMENT CONSULTATION; FINANCIAL SERVICES, NAMELY, MORTGAGE PLANNING; ESTATE PLANNING; FINANCIAL ADMINISTRATION OF RETIREMENT PLANS; FINANCIAL PLANNING CONSULTATION; FINANCIAL PLANNING FOR RETIREMENT; FINANCIAL PLANNING, NAMELY, THE CREATION OF PERSONALIZED STRATEGIES TO ACHIEVE FINANCIAL INDEPENDENCE, IN CLASS 36 (U.S. CLS. 100, 101 AND 102).

FIRST USE 10-1-2004; IN COMMERCE 10-1-2004.

OWNER OF U.S. REG. NO. 3,142,550.

NO CLAIM IS MADE TO THE EXCLUSIVE RIGHT TO USE "CAPITAL SYSTEMS", APART FROM THE MARK AS SHOWN.

THE COLOR(S) RED, BLUE, AND WHITE IS/ARE CLAIMED AS A FEATURE OF THE MARK.

THE MARK CONSISTS OF A CAPITAL "C" IN WHITE ENCLOSED IN A RED SHIELD SHAPED BOX. ON EITHER SIDE OF THE SHIELD IS A BLUE MARK SHAPED LIKE HALF AN OVAL. THE WORD "CORNERSTONE" IN CAPITAL LETTERS IS RIGHT BELOW THE SHIELD IN RED AND RIGHT BELOW THAT ARE THE WORDS "CAPITAL SYSTEMS" IN BLUE CAPITAL LETTERS. THE FIRST "S" IN "SYSTEMS" IS A DOLLAR SIGN.

SER. NO. 77-363,774, FILED 1-3-2008.

JAMES LOVELACE, EXAMINING ATTORNEY

**Int. Cl.: 41**

**Prior U.S. Cls.: 100, 101 and 107**

**United States Patent and Trademark Office**

**Reg. No. 3,569,159**

**Registered Feb. 3, 2009**

**SERVICE MARK  
PRINCIPAL REGISTER**

**SAFER EVERYDAY**

ARBILL INDUSTRIES, INC. (PENNSYLVANIA CORPORATION), DBA ARBILL  
10450 DRUMMOND ROAD  
PHILADELPHIA, PA 19154

FOR: SAFETY COMPLIANCE TRAINING SERVICES FOR THE PROTECTION OF PROPERTY AND INDIVIDUALS IN THE FIELD OF INDUSTRIAL SAFETY PRODUCTS , IN CLASS 41 (U.S. CLS. 100, 101 AND 107).

FIRST USE 6-25-2007; IN COMMERCE 6-25-2007.

THE MARK CONSISTS OF STANDARD CHARACTERS WITHOUT CLAIM TO ANY PARTICULAR FONT, STYLE, SIZE, OR COLOR.

SER. NO. 77-364,053, FILED 1-4-2008.

ODESSA BIBBINS, EXAMINING ATTORNEY

**Int. Cl.: 36**

**Prior U.S. Cls.: 100, 101 and 102**

**United States Patent and Trademark Office**

**Reg. No. 3,569,160**

**Registered Feb. 3, 2009**

**SERVICE MARK  
PRINCIPAL REGISTER**

**NYISO**

NEW YORK INDEPENDENT SYSTEM OPERA-  
TOR (NEW YORK NON-PROFIT CORPORA-  
TION)  
10 KREY BOULEVARD  
RENSSELAER, NY 12144

FOR: ELECTRICITY BROKERAGE SERVICES IN  
THE NATURE OF CONDUCTING AN ELECTRICI-  
TY COMMODITY MARKET IN WHICH POWER IS  
PURCHASED AND SOLD ON THE BASIS OF COM-  
PETITIVE BIDDING, IN CLASS 36 (U.S. CLS. 100, 101  
AND 102).

FIRST USE 4-1-1999; IN COMMERCE 4-1-1999.

THE MARK CONSISTS OF STANDARD CHAR-  
ACTERS WITHOUT CLAIM TO ANY PARTICULAR  
FONT, STYLE, SIZE, OR COLOR.

OWNER OF U.S. REG. NO. 2,528,686.

SEC. 2(F).

SER. NO. 77-364,285, FILED 1-4-2008.

DANIEL BRODY, EXAMINING ATTORNEY



**Int. Cls.: 16, 25, 41 and 45**

**Prior U.S. Cls.: 2, 5, 22, 23, 29, 37, 38, 39, 50, 100, 101  
and 107**

**Reg. No. 3,569,161**

**United States Patent and Trademark Office**

**Registered Feb. 3, 2009**

**TRADEMARK  
SERVICE MARK  
PRINCIPAL REGISTER**

**You were made for this**

YOUNG LIFE (TEXAS CORPORATION)  
420 N. CASCADE AVE  
COLORADO SPRINGS, CO 80903

FOR: PRINTED MATERIALS FEATURING INFORMATION ABOUT ACTIVITIES, PROGRAMS, ENTERTAINMENT, AND MINISTRY FOR MIDDLE SCHOOL, HIGH SCHOOL, AND COLLEGE STUDENTS, NAMELY, NEWSLETTERS, PAMPHLETS, JOURNALS, RESOURCE BOOKS, BROCHURES, TRAINING MANUALS, PRINTED TEACHING MATERIALS, NOTEPADS, HOLDERS FOR NOTEPADS, DECALS, MERCHANDISE BAGS, PAPER BANNERS, DOCUMENT PORTFOLIOS, BALLPOINT PENS, AND PENCILS, IN CLASS 16 (U.S. CLS. 2, 5, 22, 23, 29, 37, 38 AND 50).

FIRST USE 1-15-2008; IN COMMERCE 1-15-2008.

FOR: CLOTHING, NAMELY, MEN'S AND WOMEN'S SHIRTS, TEE SHIRTS, GOLF SHIRTS, POLO-STYLE SHIRTS, SWEATERS, JOGGING SUITS, COATS, JACKETS, VESTS, PANTS, SWEAT PANTS, SWEAT SHIRTS, SWEATSUITS, HOODED SWEAT SHIRTS, SHORTS, SOCKS, BOXER-TYPE SHORTS, BASEBALL-STYLE CAPS, SKI CAPS, BEANIES, VI-

SORS, AND INFANT AND TODDLER ONE-PIECE CLOTHING, IN CLASS 25 (U.S. CLS. 22 AND 39).

FIRST USE 1-15-2008; IN COMMERCE 1-15-2008.

FOR: RECREATIONAL SERVICES, NAMELY, PROVIDING CAMPS OF A CHRISTIAN AND EVANGELISTIC NATURE FOR MIDDLE SCHOOL, HIGH SCHOOL, AND COLLEGE STUDENTS, IN CLASS 41 (U.S. CLS. 100, 101 AND 107).

FIRST USE 6-8-2008; IN COMMERCE 6-8-2008.

FOR: EVANGELISTIC AND CHRISTIAN MINISTERIAL SERVICES DIRECTED TOWARDS MIDDLE SCHOOL, HIGH SCHOOL, AND COLLEGE STUDENTS, IN CLASS 45 (U.S. CLS. 100 AND 101).

FIRST USE 6-8-2008; IN COMMERCE 6-8-2008.

THE MARK CONSISTS OF STANDARD CHARACTERS WITHOUT CLAIM TO ANY PARTICULAR FONT, STYLE, SIZE, OR COLOR.

SER. NO. 77-364,434, FILED 1-4-2008.

G. MAYERSCHOFF, EXAMINING ATTORNEY

**Int. Cls.: 16, 25 and 45**

**Prior U.S. Cls.: 2, 5, 22, 23, 29, 37, 38, 39, 50, 100 and 101**

**Reg. No. 3,569,162**

**United States Patent and Trademark Office**

**Registered Feb. 3, 2009**

**TRADEMARK  
SERVICE MARK  
PRINCIPAL REGISTER**



YOUNG LIFE (TEXAS CORPORATION)  
420 N. CASCADE AVE  
COLORADO SPRINGS, CO 80903

FOR: PRINTED MATERIALS FEATURING INFORMATION ABOUT ACTIVITIES, PROGRAMS, ENTERTAINMENT, AND MINISTRY FOR MIDDLE SCHOOL, HIGH SCHOOL, AND COLLEGE STUDENTS, NAMELY, NEWSLETTERS, PAMPHLETS, JOURNALS, RESOURCE BOOKS, BROCHURES, TRAINING MANUALS, PRINTED TEACHING MATERIALS, NOTEPADS, HOLDERS FOR NOTEPADS, DECALS, MERCHANDISE BAGS, PAPER BANNERS, DOCUMENT PORTFOLIOS, BALLPOINT PENS, AND PENCILS, IN CLASS 16 (U.S. CLS. 2, 5, 22, 23, 29, 37, 38 AND 50).

FIRST USE 9-8-2008; IN COMMERCE 9-8-2008.

FOR: CLOTHING, NAMELY, MEN'S AND WOMEN'S SHIRTS, TEE SHIRTS, GOLF SHIRTS, POLO-STYLE SHIRTS, SWEATERS, JOGGING SUITS, COATS, JACKETS, VESTS, PANTS, SWEAT PANTS, SWEAT SHIRTS, SWEATSUITS, HOODED SWEAT

SHIRTS, SHORTS, SOCKS, BOXER-TYPE SHORTS, BASEBALL-STYLE CAPS, SKI CAPS, BEANIES, VISORS, AND INFANT AND TODDLER ONE-PIECE CLOTHING, IN CLASS 25 (U.S. CLS. 22 AND 39).

FIRST USE 8-8-2008; IN COMMERCE 8-8-2008.

FOR: EVANGELISTIC AND CHRISTIAN MINISTERIAL SERVICES DIRECTED TOWARDS MIDDLE SCHOOL, HIGH SCHOOL, AND COLLEGE STUDENTS, IN CLASS 45 (U.S. CLS. 100 AND 101).

FIRST USE 9-8-2008; IN COMMERCE 9-8-2008.

OWNER OF U.S. REG. NOS. 1,626,452, 2,709,770 AND OTHERS.

THE MARK CONSISTS OF STYLIZED LETTERS "YL" COMBINED WITH WORD MARKS "YOUNGLIFE" AND "WYLDLIFE".

SER. NO. 77-364,446, FILED 1-4-2008.

G. MAYERSCHOFF, EXAMINING ATTORNEY

**Int. Cl.: 30**

**Prior U.S. Cl.: 46**

**United States Patent and Trademark Office**

**Reg. No. 3,569,163**

**Registered Feb. 3, 2009**

**TRADEMARK  
PRINCIPAL REGISTER**

**Mama's Special Sweet Hot  
Mamas**

MAMA'S SPECIAL FAMILY, INC. (VERMONT CORPORATION)

P.O. BOX 555

HYDE PARK, VT 05655

FOR: POPPED POPCORN, IN CLASS 30 (U.S. CL. 46).

FIRST USE 8-31-2004; IN COMMERCE 8-31-2004.

THE MARK CONSISTS OF STANDARD CHARACTERS WITHOUT CLAIM TO ANY PARTICULAR FONT, STYLE, SIZE, OR COLOR.

NO CLAIM IS MADE TO THE EXCLUSIVE RIGHT TO USE "SPECIAL" OR "SWEET HOT", APART FROM THE MARK AS SHOWN.

SER. NO. 77-365,128, FILED 1-6-2008.

BRIAN PINO, EXAMINING ATTORNEY

**Int. Cls.: 9 and 42**

**Prior U.S. Cls.: 21, 23, 26, 36, 38, 100 and 101**

**United States Patent and Trademark Office**

**Reg. No. 3,569,164**

**Registered Feb. 3, 2009**

**TRADEMARK  
SERVICE MARK  
PRINCIPAL REGISTER**

# SPECTRAN

AARONIA AG (FED REP GERMANY CORPORATION)  
KAUTHENBERGSTRASSE 14  
STRICKSCHEID, FED REP GERMANY 54597

FOR: MEASURING DEVICES FOR SPECTRUM ANALYSIS, NAMELY, SPECTROMETERS, IN CLASS 9 (U.S. CLS. 21, 23, 26, 36 AND 38).

FIRST USE 6-25-2003; IN COMMERCE 6-25-2003.

FOR: DEVELOPMENT, NAMELY, DESIGN OF MEASURING DEVICES FOR SPECTRUM ANALYSIS; TECHNOLOGICAL CONSULTING CONCERNING THE FIELD OF DESIGN AND USE OF

MEASURING DEVICES FOR SPECTRUM ANALYSIS, IN CLASS 42 (U.S. CLS. 100 AND 101).

THE MARK CONSISTS OF STANDARD CHARACTERS WITHOUT CLAIM TO ANY PARTICULAR FONT, STYLE, SIZE, OR COLOR.

OWNER OF FED REP GERMANY REG. NO. 30331274, DATED 2-17-2004, EXPIRES 6-30-2013.

SER. NO. 77-365,322, FILED 1-7-2008.

KATHERINE CHANG, EXAMINING ATTORNEY

**Int. Cl.: 25**

**Prior U.S. Cls.: 22 and 39**

**United States Patent and Trademark Office**

**Reg. No. 3,569,165**

**Registered Feb. 3, 2009**

**TRADEMARK  
PRINCIPAL REGISTER**



TRIPLE THREAT FIGHT GEAR (CALIFORNIA  
PARTNERSHIP)  
6537 N. CONSTANCE  
FRESNO, CA 93722

THE MARK CONSISTS OF THREE SPARTAN  
HELMETS.

FOR: HATS; JACKETS; SHIRTS; SHORTS; SWEAT  
SHIRTS, IN CLASS 25 (U.S. CLS. 22 AND 39).

SER. NO. 77-365,386, FILED 1-7-2008.

FIRST USE 6-15-2007; IN COMMERCE 6-15-2007.

KHANH LE, EXAMINING ATTORNEY

**Int. Cl.: 35**

**Prior U.S. Cls.: 100, 101 and 102**

**United States Patent and Trademark Office**

**Reg. No. 3,569,166**

**Registered Feb. 3, 2009**

**SERVICE MARK  
PRINCIPAL REGISTER**

**THOMPSON XCHANGE**

THOMPSON HOTELS LLC (DELAWARE LIMITED LIABILITY COMPANY)  
100 VANDAM STREET, 4TH FLOOR  
NEW YORK, NY 10013

OWNER OF U.S. REG. NOS. 3,257,290 AND 3,455,502.

FOR: RETAIL AND GIFT STORE SERVICES FEATURING A WIDE VARIETY OF CONSUMER GOODS, IN CLASS 35 (U.S. CLS. 100, 101 AND 102).

NO CLAIM IS MADE TO THE EXCLUSIVE RIGHT TO USE "EXCHANGE", APART FROM THE MARK AS SHOWN.

FIRST USE 5-15-2007; IN COMMERCE 5-15-2007.

SER. NO. 77-365,516, FILED 1-7-2008.

THE MARK CONSISTS OF STANDARD CHARACTERS WITHOUT CLAIM TO ANY PARTICULAR FONT, STYLE, SIZE, OR COLOR.

ELLEN B. AWRICH, EXAMINING ATTORNEY

**Int. Cl.: 41**

**Prior U.S. Cls.: 100, 101 and 107**

**United States Patent and Trademark Office**

**Reg. No. 3,569,167**

**Registered Feb. 3, 2009**

**SERVICE MARK  
PRINCIPAL REGISTER**

**THE HOLLYTONES**

CURTIN, BRIAN, T (UNITED STATES INDIVIDUAL)  
PO BOX 25313  
ANAHEIM, CA 92825

THE MARK CONSISTS OF STANDARD CHARACTERS WITHOUT CLAIM TO ANY PARTICULAR FONT, STYLE, SIZE, OR COLOR.

FOR: ENTERTAINMENT, NAMELY, LIVE PERFORMANCES BY A MUSICAL BAND, IN CLASS 41 (U.S. CLS. 100, 101 AND 107).

SER. NO. 77-366,044, FILED 1-7-2008.

FIRST USE 12-15-1988; IN COMMERCE 12-15-1988.

ALYSSA STEEL, EXAMINING ATTORNEY

**Int. Cl.: 9**

**Prior U.S. Cls.: 21, 23, 26, 36 and 38**

**Reg. No. 3,569,168**

**United States Patent and Trademark Office**

**Registered Feb. 3, 2009**

---

**TRADEMARK  
PRINCIPAL REGISTER**

**THE HOLLYTONES**

CURTIN, BRIAN T (UNITED STATES INDIVIDUAL)  
PO BOX 25313  
ANAHEIM, CA 92825

FIRST USE 12-15-1988; IN COMMERCE 12-15-1992.

FOR: COMPACT DISCS FEATURING MUSICAL RECORDINGS; DOWNLOADABLE MUSIC VIA A GLOBAL COMPUTER NETWORK AND WIRELESS DEVICES, IN CLASS 9 (U.S. CLS. 21, 23, 26, 36 AND 38).

THE MARK CONSISTS OF STANDARD CHARACTERS WITHOUT CLAIM TO ANY PARTICULAR FONT, STYLE, SIZE, OR COLOR.

SER. NO. 77-366,074, FILED 1-7-2008.

ALYSSA STEEL, EXAMINING ATTORNEY



**Int. Cl.: 36**

**Prior U.S. Cls.: 100, 101 and 102**

**United States Patent and Trademark Office**

**Reg. No. 3,569,169**

**Registered Feb. 3, 2009**

**SERVICE MARK  
PRINCIPAL REGISTER**

**MY PERLS**

PRINCIPAL FINANCIAL SERVICES, INC. (IOWA CORPORATION)  
711 HIGH STREET  
DES MOINES, IA 50392

FOR: FINANCIAL SERVICES, NAMELY, PROVIDING FINANCIAL AND INVESTMENT ADVICE AND INFORMATION IN CONNECTION WITH EMPLOYEE STOCK OWNERSHIP PLANS, IN CLASS 36 (U.S. CLS. 100, 101 AND 102).

FIRST USE 11-8-2007; IN COMMERCE 11-8-2007.

THE MARK CONSISTS OF STANDARD CHARACTERS WITHOUT CLAIM TO ANY PARTICULAR FONT, STYLE, SIZE, OR COLOR.

OWNER OF U.S. REG. NO. 2,782,064.

SER. NO. 77-366,568, FILED 1-8-2008.

REBECCA GILBERT, EXAMINING ATTORNEY

**Int. Cl.: 24**

**Prior U.S. Cls.: 42 and 50**

**United States Patent and Trademark Office**

**Reg. No. 3,569,170**

**Registered Feb. 3, 2009**

**TRADEMARK  
PRINCIPAL REGISTER**



ZHEJIANG SOUTH TECHNOLOGY CO., LTD  
(CHINA CORPORATION)  
KEBEI INDUSTRY ZONE, KEQIAO, SHAO XING  
ZHEJIANG, CHINA

FOR: CLOTH TEXTILES FOR USE IN THE MANUFACTURE OF CURTAINS; FABRICS FOR TEXTILE USE; TOWELS OF TEXTILE, PILLOWCASES AND SHAMS, BED CLOTHES NAMELY SHEETS, COMFORTERS AND SKIRTS, UNFITTED FABRIC FURNITURE COVERS; CURTAINS OF TEXTILE OR PLASTIC, SILK ARTWORK; FELT; NONWOVEN FABRICS; FABRICS FOR USE IN THE MANUFACTURE OF UPHOLSTERY, IN CLASS 24 (U.S. CLS. 42 AND 50).

FIRST USE 8-18-2006; IN COMMERCE 8-18-2006.

THE MARK CONSISTS OF A CIRCULAR DESIGN OVER CHINESE CHARACTERS AND THE WORDS "JING CAI".

THE FOREIGN WORDING IN THE MARK TRANSLATES INTO ENGLISH AS GOLDEN AND COLORFUL (IN COMBINATION, IT HAS NO MEANING).

THE NON-LATIN CHARACTER(S) IN THE MARK TRANSLITERATES INTO "JING CAI", AND THIS MEANS GOLDEN AND COLORFUL IN ENGLISH.

SER. NO. 77-366,868, FILED 1-8-2008.

DAVID MURRAY, EXAMINING ATTORNEY

**Int. Cl.: 7**

**Prior U.S. Cls.: 13, 19, 21, 23, 31, 34 and 35**

**Reg. No. 3,569,171**

**United States Patent and Trademark Office**

**Registered Feb. 3, 2009**

**TRADEMARK  
PRINCIPAL REGISTER**

**MUDSLINGER**

CHINAMERICA SERVICES INC. (CANADA CORPORATION)  
#204 - 1807 FIR STREET  
VANCOUVER, CANADA V6J3A9

FOR: PETROLEUM EQUIPMENT, NAMELY, CENTRIFUGAL MUD PUMPS AND PARTS THEREFOR, SOLD SEPARATELY AND/OR AS A UNIT, NAMELY, PUMP LINERS, PUMP SLEEVES, VALVES AND VALVE PARTS, CONNECTING RODS, LIQUID CYLINDERS, POWER FRAMES, GEARS, CENTRIFUGAL PUMPS, CENTRIFUGAL

FRACTURING PUMPS, IN CLASS 7 (U.S. CLS. 13, 19, 21, 23, 31, 34 AND 35).

FIRST USE 2-1-1994; IN COMMERCE 2-1-1994.

THE MARK CONSISTS OF STANDARD CHARACTERS WITHOUT CLAIM TO ANY PARTICULAR FONT, STYLE, SIZE, OR COLOR.

SER. NO. 77-367,132, FILED 1-9-2008.

AMY HELLA, EXAMINING ATTORNEY

**Int. Cls.: 29 and 32**

**Prior U.S. Cls.: 45, 46 and 48**

**United States Patent and Trademark Office**

**Reg. No. 3,569,172**

**Registered Feb. 3, 2009**

**TRADEMARK  
PRINCIPAL REGISTER**



DORA'S NATURALS (NEW YORK CORPORATION)  
155-04 LIBERTY AVENUE  
JAMAICA, NY 11433

FOR: SOY-BASED BEVERAGES AS MILK SUBSTITUTES, INCLUDING VANILLA, CHOCOLATE AND CAPPUCCINO FLAVORS, IN CLASS 29 (U.S. CL. 46).

FIRST USE 10-24-2006; IN COMMERCE 10-24-2006.

FOR: SOY-BASED BEVERAGES NOT BEING MILK SUBSTITUTES, INCLUDING VANILLA, CHOCOLATE AND CAPPUCCINO FLAVORS, IN CLASS 32 (U.S. CLS. 45, 46 AND 48).

FIRST USE 10-24-2006; IN COMMERCE 10-24-2006.

THE COLOR(S) BLACK AND WHITE IS/ARE CLAIMED AS A FEATURE OF THE MARK.

THE MARK CONSISTS OF THE COLOR(S) BLACK AND WHITE, WITH THE COLOR BLACK APPEARING IN THE EARS, EYES, NOSE, MOUTH, NECK AND SHOULDERS OF A PANDA BEAR, AND THE COLOR WHITE APPEARING IN THE PANDA BEAR'S HEAD AND CHEST.

SER. NO. 77-367,223, FILED 1-9-2008.

EDWARD FENNESSY, EXAMINING ATTORNEY

**Int. Cl.: 41**

**Prior U.S. Cls.: 100, 101 and 107**

**United States Patent and Trademark Office**

**Reg. No. 3,569,173**

**Registered Feb. 3, 2009**

**SERVICE MARK  
PRINCIPAL REGISTER**

# True Companions

POOL, WENDY S. (OREGON SOLE PROPRIETORSHIP), AKA TRUE COMPANIONS  
4360 COAL MINE RD  
MEDFORD, OR 97504

FOR: EDUCATION SERVICES, NAMELY, PROVIDING CLASSES, ONLINE, AND ONE-ON-ONE INSTRUCTION IN THE FIELD OF PET TRAINING AND BEHAVIOR , IN CLASS 41 (U.S. CLS. 100, 101 AND 107).

FIRST USE 1-1-2000; IN COMMERCE 1-30-2000.

THE MARK CONSISTS OF STANDARD CHARACTERS WITHOUT CLAIM TO ANY PARTICULAR FONT, STYLE, SIZE, OR COLOR.

SER. NO. 77-367,772, FILED 1-9-2008.

WON TEAK OH, EXAMINING ATTORNEY

**Int. Cl.: 33**

**Prior U.S. Cls.: 47 and 49**

**United States Patent and Trademark Office**

**Reg. No. 3,569,174**

**Registered Feb. 3, 2009**

**TRADEMARK  
PRINCIPAL REGISTER**

**X-RATED**

SKYY SPIRITS, LLC (DELAWARE LIMITED LIABILITY COMPANY)  
ONE BEACH STREET, SUITE 300  
SAN FRANCISCO, CA 94133

FOR: DISTILLED SPIRITS; ALCOHOLIC BEVERAGES; LIQUEURS, IN CLASS 33 (U.S. CLS. 47 AND 49).

FIRST USE 0-0-2004; IN COMMERCE 0-0-2004.

THE MARK CONSISTS OF STANDARD CHARACTERS WITHOUT CLAIM TO ANY PARTICULAR FONT, STYLE, SIZE, OR COLOR.

OWNER OF U.S. REG. NOS. 3,149,625, 3,200,805, AND 3,220,537.

SER. NO. 77-368,449, FILED 1-10-2008.

ANDREA HACK, EXAMINING ATTORNEY

**Int. Cl.: 35**

**Prior U.S. Cls.: 100, 101 and 102**

**United States Patent and Trademark Office**

**Reg. No. 3,569,175**

**Registered Feb. 3, 2009**

**SERVICE MARK  
PRINCIPAL REGISTER**

**Your Destination for  
Inspiration**

REACH PUBLISHING, LLC (OHIO LIMITED  
LIABILITY COMPANY)  
9933 ALLIANCE ROAD  
CINCINNATI, OH 45242

FOR: PROVIDING A WEBSITE FEATURING AD-  
VERTISEMENTS AND PROMOTIONAL DIS-  
 COUNTS OF OTHERS ALL IN THE FIELD OF  
 HOME IMPROVEMENT, HOME CONSTRUCTION,  
 DECORATING AND LANDSCAPING, IN CLASS 35  
 (U.S. CLS. 100, 101 AND 102).

FIRST USE 1-1-2008; IN COMMERCE 1-1-2008.

THE MARK CONSISTS OF STANDARD CHAR-  
 ACTERS WITHOUT CLAIM TO ANY PARTICULAR  
 FONT, STYLE, SIZE, OR COLOR.

SER. NO. 77-369,540, FILED 1-11-2008.

LINDA ESTRADA, EXAMINING ATTORNEY

Int. Cl.: 33

Prior U.S. Cls.: 47 and 49

United States Patent and Trademark Office

Reg. No. 3,569,176

Registered Feb. 3, 2009

TRADEMARK  
PRINCIPAL REGISTER



**SUMMERS**

SUMMERS WINERY, LLC (CALIFORNIA LIMITED LIABILITY COMPANY)  
1171 TUBBS LANE  
CALISTOGA, CA 94515

SIGN OF A HORSE HEAD IN PROFILE. A CURVED VINE APPEARS BELOW THE HORSE HEAD WITH THE WORDING "SUMMERS" BELOW THE VINE.

FOR: WINES, IN CLASS 33 (U.S. CLS. 47 AND 49).

SER. NO. 77-369,718, FILED 1-11-2008.

FIRST USE 1-1-1994; IN COMMERCE 1-1-1994.

THE MARK CONSISTS OF THE WORDING "MCMLXXXVII" IN A BANNER ABOVE THE DE-

WILLIAM BRECKENFELD, EXAMINING ATTORNEY



**Int. Cls.: 41 and 42**

**Prior U.S. Cls.: 100, 101 and 107**

**United States Patent and Trademark Office**

**Reg. No. 3,569,177**

**Registered Feb. 3, 2009**

**SERVICE MARK  
PRINCIPAL REGISTER**



ILIKE, INC. (CALIFORNIA CORPORATION)  
1605 BOYLSTON AVENUE, SUITE 202  
SEATTLE, WA 98122

FOR: ENTERTAINMENT SERVICES, NAMELY, ARRANGING AND CONDUCTING INTERACTIVE MUSIC CONTESTS; PROVIDING REVIEWS AND RATINGS OF MUSICIANS, MUSIC AND VIDEOS; PROVIDING COMMENTARY AND INFORMATION ABOUT MUSIC, MUSICAL ARTISTS AND VIDEOS; PROVIDING INFORMATION ABOUT MUSICAL PERFORMANCES, CONCERTS AND ENTERTAINMENT, IN CLASS 41 (U.S. CLS. 100, 101 AND 107).

FIRST USE 5-24-2007; IN COMMERCE 5-24-2007.

FOR: PROVIDING TEMPORARY USE OF NON-DOWNLOADABLE SOFTWARE FOR ADDING MU-

SIC AND VIDEO TO PROFILES ON THE INTERNET, FOR LISTENING TO MP3'S AND FOR SHARING MP3'S AND MUSIC PLAYLISTS WITH OTHERS, IN CLASS 42 (U.S. CLS. 100 AND 101).

FIRST USE 5-24-2007; IN COMMERCE 5-24-2007.

THE COLOR(S) ORANGE AND WHITE IS/ARE CLAIMED AS A FEATURE OF THE MARK.

THE MARK CONSISTS OF ORANGE BOX WITH THE WORDS "ILIKE" AND IMAGE OF MUSIC NOTE IN WHITE.

SER. NO. 77-369,946, FILED 1-11-2008.

LOURDES AYALA, EXAMINING ATTORNEY

**Int. Cl.: 16**

**Prior U.S. Cls.: 2, 5, 22, 23, 29, 37, 38 and 50**

**Reg. No. 3,569,178**

**United States Patent and Trademark Office**

**Registered Feb. 3, 2009**

**TRADEMARK  
PRINCIPAL REGISTER**



EVOLUTION ART GROUP LLC (OHIO LIMITED  
LIABILITY COMPANY)  
49 B HOME PLACE  
BRANFORD, CT 06405

FOR: ART PRINTS; ART ETCHINGS; ART PIC-  
TURES; ART PRINTS ON CANVAS; GRAPHIC ART  
REPRODUCTIONS; LITHOGRAPHIC WORKS OF  
ART; PRINTED ART REPRODUCTIONS, IN CLASS  
16 (U.S. CLS. 2, 5, 22, 23, 29, 37, 38 AND 50).

FIRST USE 6-21-2007; IN COMMERCE 1-10-2008.

THE COLOR(S) GREEN AND WHITE IS/ARE  
CLAIMED AS A FEATURE OF THE MARK.

THE MARK CONSISTS OF ALL GREEN BACK-  
GROUND WITH WHITE LETTERING WITH A  
DARKER GREEN VERTICAL BACKGROUND  
STRIPE ON THE LEFT HAND SIDE OF THE MARK.

SER. NO. 77-371,263, FILED 1-14-2008.

KIMBERLY PERRY, EXAMINING ATTORNEY

Int. Cl.: 3

Prior U.S. Cls.: 1, 4, 6, 50, 51 and 52

United States Patent and Trademark Office

Reg. No. 3,569,179

Registered Feb. 3, 2009

TRADEMARK  
PRINCIPAL REGISTER

# Perfume For Less

MAC, MIKE H (UNITED STATES INDIVIDUAL),  
DBA PERFUME FOR LESS  
8901 GOLDSTONE AVE  
LAS VEGAS, NV 89143 AND  
MAC, NIRMA M (UNITED STATES INDIVIDUAL),  
DBA PERFUME FOR LESS  
8901 GOLDSTONE AVE  
LAS VEGAS, NV 89143

FOR: FRAGRANCES AND PERFUMERY , IN  
CLASS 3 (U.S. CLS. 1, 4, 6, 50, 51 AND 52).

FIRST USE 11-0-1995; IN COMMERCE 11-0-1995.

THE MARK CONSISTS OF STANDARD CHAR-  
ACTERS WITHOUT CLAIM TO ANY PARTICULAR  
FONT, STYLE, SIZE, OR COLOR.

NO CLAIM IS MADE TO THE EXCLUSIVE  
RIGHT TO USE "PERFUME", APART FROM THE  
MARK AS SHOWN.

SEC. 2(F).

SER. NO. 77-371,365, FILED 1-14-2008.

DANIEL CAPSHAW, EXAMINING ATTORNEY

**Int. Cl.: 33**

**Prior U.S. Cls.: 47 and 49**

**United States Patent and Trademark Office**

**Reg. No. 3,569,180**

**Registered Feb. 3, 2009**

**TRADEMARK  
PRINCIPAL REGISTER**

**SANTO MAGUEY**

SALAZAR, ARMANDO (MEXICO INDIVIDUAL)  
AV. HIDALGO 1866  
GUADALAJARA, MEXICO 44650

OWNER OF MEXICO REG. NO. 1006250, DATED  
9-11-2007, EXPIRES 9-11-2017.

FOR: ALCOHOLIC BEVERAGES, NAMELY, TE-  
QUILA, IN CLASS 33 (U.S. CLS. 47 AND 49).

SER. NO. 77-371,960, FILED 1-15-2008.

THE MARK CONSISTS OF STANDARD CHAR-  
ACTERS WITHOUT CLAIM TO ANY PARTICULAR  
FONT, STYLE, SIZE, OR COLOR.

RAUL CORDOVA, EXAMINING ATTORNEY

**Int. Cl.: 42**

**Prior U.S. Cls.: 100 and 101**

**United States Patent and Trademark Office**

**Reg. No. 3,569,181**

**Registered Feb. 3, 2009**

**SERVICE MARK  
PRINCIPAL REGISTER**

**TEKSCOUT**

UTEK CORPORATION (DELAWARE CORPORATION)  
2109 E. PALM AVENUE  
TAMPA, FL 33605

FOR: INTERNET BASED INTERACTIVE SERVICE PROVIDING SPECIFIC INFORMATION AS REQUESTED BY CUSTOMERS VIA THE INTERNET IN THE FIELDS OF SCIENCE AND ENGINEERING, IN CLASS 42 (U.S. CLS. 100 AND 101).

FIRST USE 1-7-2008; IN COMMERCE 1-7-2008.

THE MARK CONSISTS OF STANDARD CHARACTERS WITHOUT CLAIM TO ANY PARTICULAR FONT, STYLE, SIZE, OR COLOR.

SER. NO. 77-373,115, FILED 1-16-2008.

KAELIE KUNG, EXAMINING ATTORNEY

**Int. Cl.: 41**

**Prior U.S. Cls.: 100, 101 and 107**

**United States Patent and Trademark Office**

**Reg. No. 3,569,182**

**Registered Feb. 3, 2009**

**SERVICE MARK  
PRINCIPAL REGISTER**

**Paparazzi As An Art Form**

BUZZ FOTO LLC (CALIFORNIA LIMITED LIABILITY COMPANY)  
P.O. BOX 180 BEVERLY HILLS  
BEVERLY HILLS, CA 90213

FOR: ENTERTAINMENT SERVICES, NAMELY, PROVIDING A WEBSITE FEATURING NEWS, INFORMATION, AND PHOTOGRAPHS OF CELEBRITIES IN THE ENTERTAINMENT INDUSTRY, IN CLASS 41 (U.S. CLS. 100, 101 AND 107).

FIRST USE 12-1-2007; IN COMMERCE 12-1-2007.

THE MARK CONSISTS OF STANDARD CHARACTERS WITHOUT CLAIM TO ANY PARTICULAR FONT, STYLE, SIZE, OR COLOR.

SER. NO. 77-373,671, FILED 1-16-2008.

JACLYN KIDWELL, EXAMINING ATTORNEY

**Int. Cls.: 35 and 36**

**Prior U.S. Cls.: 100, 101 and 102**

**United States Patent and Trademark Office**

**Reg. No. 3,569,183**

**Registered Feb. 3, 2009**

**SERVICE MARK  
PRINCIPAL REGISTER**

**FESTIVA RESORTS**

FESTIVA HOSPITALITY GROUP, INC. (NEVADA CORPORATION)  
ONE VANCE GAP ROAD  
ASHEVILLE, NC 28805

FOR: OPERATING A MARKETPLACE FOR THE SALE AND EXCHANGE OF VACATION PROPERTIES AND VACATION PROPERTY USAGE RIGHTS AMONG OWNERS OF TIMESHARES AND FRACTIONAL INTERESTS IN REAL ESTATE AND YACHTS AND AMONG VACATION CLUB MEMBERS, IN CLASS 35 (U.S. CLS. 100, 101 AND 102).

FIRST USE 8-14-2000; IN COMMERCE 8-14-2000.

FOR: SHORT TERM RENTAL OF VACATION LODGING; VACATION CLUB SERVICES, NAMELY, PROVIDING NON-OWNERSHIP RIGHT-TO-USE INTERESTS TO OTHERS FOR VACATION LODGINGS AND RESORTS FACILITIES; VACATION REAL ESTATE TIMESHARE SERVICES AND

OFFERING FRACTIONAL OWNERSHIP PROGRAMS TO OTHERS IN REAL ESTATE AND YACHTS, IN CLASS 36 (U.S. CLS. 100, 101 AND 102).

FIRST USE 8-14-2000; IN COMMERCE 8-14-2000.

THE MARK CONSISTS OF STANDARD CHARACTERS WITHOUT CLAIM TO ANY PARTICULAR FONT, STYLE, SIZE, OR COLOR.

NO CLAIM IS MADE TO THE EXCLUSIVE RIGHT TO USE "RESORTS", APART FROM THE MARK AS SHOWN.

THE ENGLISH TRANSLATION OF "FESTIVA" IS "FESTIVE".

SER. NO. 77-373,673, FILED 1-16-2008.

BRIAN PINO, EXAMINING ATTORNEY

**Int. Cl.: 41**

**Prior U.S. Cls.: 100, 101 and 107**

**United States Patent and Trademark Office**

**Reg. No. 3,569,184**

**Registered Feb. 3, 2009**

**SERVICE MARK  
PRINCIPAL REGISTER**

**THE BRA WHISPERER**

INTIMACY MANAGEMENT COMPANY LLC  
(DELAWARE LIMITED LIABILITY COMPAN-  
NY)  
SUITE 760  
3980 DEKALB TECHNOLOGY PARKWAY  
ATLANTA, GA 30340

FOR: ENTERTAINMENT AND EDUCATIONAL  
SERVICES, NAMELY, PERSONAL AND TELEVI-  
SION APPEARANCES BY AN UNDERGARMENT  
FITTING EXPERT, IN CLASS 41 (U.S. CLS. 100, 101  
AND 107).

FIRST USE 12-18-2007; IN COMMERCE 12-18-2007.

THE MARK CONSISTS OF STANDARD CHAR-  
ACTERS WITHOUT CLAIM TO ANY PARTICULAR  
FONT, STYLE, SIZE, OR COLOR.

NO CLAIM IS MADE TO THE EXCLUSIVE  
RIGHT TO USE "BRA", APART FROM THE MARK  
AS SHOWN.

SER. NO. 77-374,013, FILED 1-17-2008.

SHAUNIA CARLYLE, EXAMINING ATTORNEY



**Int. Cl.: 9**

**Prior U.S. Cls.: 21, 23, 26, 36 and 38**

**Reg. No. 3,569,185**

**United States Patent and Trademark Office**

**Registered Feb. 3, 2009**

**TRADEMARK  
PRINCIPAL REGISTER**

**BLOCK HEAD**

12, LLC (MINNESOTA LIMITED LIABILITY  
COMPANY)  
520 SEQUOIA LANE  
ZUMBROTA, MN 55992

FOR: VIDEO GAME ACCESSORIES, NAMELY,  
VIDEO GAME CONSOLE CARRYING CASES, SUR-  
FACE PROTECTORS IN THE NATURE OF PRO-  
TECTORS FOR GAME CONSOLES, GAME  
CONTROLLERS AND GAMING DEVICE SCREENS,  
VIDEO GAME CONTROLLERS, VIDEO GAME  
CONTROLLERS IN THE NATURE OF GUITAR-  
SHAPED INTERACTIVE REMOTE CONTROL  
UNITS AND DRUMSTICKS FOR CONTROLLING  
VIDEO GAMES, VIDEO GAME CONTROLLERS IN  
THE NATURE OF STRAPS AND PICKS FOR USE  
WITH GUITAR-SHAPED INTERACTIVE REMOTE

CONTROL UNITS, BATTERY PACKS FOR VIDEO  
GAME CONTROLLERS, GAME CONSOLE CABLES  
AND VIDEO GAME WIRELESS DEVICES IN THE  
NATURE OF WIRELESS GAMING CONTROLLERS  
AND CONTROLLER SIGNAL CONVERTORS, IN  
CLASS 9 (U.S. CLS. 21, 23, 26, 36 AND 38).

FIRST USE 1-15-2008; IN COMMERCE 1-15-2008.

THE MARK CONSISTS OF STANDARD CHAR-  
ACTERS WITHOUT CLAIM TO ANY PARTICULAR  
FONT, STYLE, SIZE, OR COLOR.

SER. NO. 77-374,388, FILED 1-17-2008.

DANIEL CAPSHAW, EXAMINING ATTORNEY

**Int. Cl.: 9**

**Prior U.S. Cls.: 21, 23, 26, 36 and 38**

**Reg. No. 3,569,186**

**United States Patent and Trademark Office**

**Registered Feb. 3, 2009**

---

**TRADEMARK  
PRINCIPAL REGISTER**

**VEKTOR**

BOWE BELL + HOWELL COMPANY (DELA-  
WARE CORPORATION)  
3791 S. ALSTON AVENUE  
DURHAM, NC 27713

FOR: OPTICAL SCANNERS AND COMPUTER  
SOFTWARE USED TO OPERATE OPTICAL SCAN-  
NERS; AND USER MANUALS SOLD AS A UNIT  
THEREWITH, IN CLASS 9 (U.S. CLS. 21, 23, 26, 36  
AND 38).

FIRST USE 9-0-2005; IN COMMERCE 9-0-2005.

THE MARK CONSISTS OF STANDARD CHAR-  
ACTERS WITHOUT CLAIM TO ANY PARTICULAR  
FONT, STYLE, SIZE, OR COLOR.

SER. NO. 77-375,173, FILED 1-18-2008.

ELIZABETH KAJUBI, EXAMINING ATTORNEY

**Int. Cl.: 41**

**Prior U.S. Cls.: 100, 101 and 107**

**United States Patent and Trademark Office**

**Reg. No. 3,569,187**

**Registered Feb. 3, 2009**

**SERVICE MARK  
PRINCIPAL REGISTER**

# The Tree Press

PARKER, TRACEY (UNITED STATES INDIVIDUAL)  
SUITE 650, #125  
3300 BEE CAVE ROAD  
AUSTIN, TX 78746

FOR: PUBLICATION OF BOOKS, CARDS, FIELD GUIDES, AND TEXTBOOKS ON TREES, ECOLOGY, BOTANY AND NATURE, IN CLASS 41 (U.S. CLS. 100, 101 AND 107).

FIRST USE 3-12-2008; IN COMMERCE 3-12-2008.

THE MARK CONSISTS OF STANDARD CHARACTERS WITHOUT CLAIM TO ANY PARTICULAR FONT, STYLE, SIZE, OR COLOR.

NO CLAIM IS MADE TO THE EXCLUSIVE RIGHT TO USE "PRESS", APART FROM THE MARK AS SHOWN.

SER. NO. 77-375,259, FILED 1-18-2008.

BILL DAWE, EXAMINING ATTORNEY

Int. Cl.: 37

Prior U.S. Cls.: 100, 103 and 106

Reg. No. 3,569,188

United States Patent and Trademark Office

Registered Feb. 3, 2009

**SERVICE MARK  
PRINCIPAL REGISTER**



THE TERMINIX INTERNATIONAL COMPANY  
LIMITED PARTNERSHIP (DELAWARE LIMITED PARTNERSHIP)  
860 RIDGE LAKE BOULEVARD  
MEMPHIS, TN 38120

FOR: TERMITE AND PEST CONTROL, IN CLASS  
37 (U.S. CLS. 100, 103 AND 106).

FIRST USE 12-29-2007; IN COMMERCE 12-29-2007.

NO CLAIM IS MADE TO THE EXCLUSIVE  
RIGHT TO USE "TERMITE INSPECTION PROTECTION PLAN", APART FROM THE MARK AS SHOWN.

THE COLOR(S) GREEN AND GRAY IS/ARE  
CLAIMED AS A FEATURE OF THE MARK.

THE MARK CONSISTS OF A SHIELD IN THE  
COLOR GREEN OUTLINED IN THE COLOR GRAY  
AND LETTER "T" IN THE COLOR GRAY, IN  
WHICH THE BASE OF THE "T" EXTENDS AT AN  
ANGLE TOWARD THE UPPER RIGHT PORTION  
OF THE SHIELD, AND THE CROSS MEMBER OF  
THE "T" IS HORIZONTALLY LOCATED IN THE  
UPPER RIGHT PORTION OF THE SHIELD. THE  
WORDING "TERMITE" IN THE COLOR GREEN  
AND "INSPECTION" IN THE COLOR GRAY AP-  
PEAR ON THE LEFT SIDE OF THE SHIELD  
WHEREAS THE WORDING "PROTECTION" AP-  
PEARING IN THE COLOR GREEN AND "PLAN"  
IN THE COLOR GRAY ARE LOCATED TO THE  
RIGHT OF THE SHIELD.

SER. NO. 77-375,984, FILED 1-19-2008.

WILLIAM ROSSMAN, EXAMINING ATTORNEY

**Int. Cl.: 32**

**Prior U.S. Cls.: 45, 46 and 48**

**United States Patent and Trademark Office**

**Reg. No. 3,569,189**

**Registered Feb. 3, 2009**

**TRADEMARK  
PRINCIPAL REGISTER**

**FOCUS YOUR ENERGY**

MONTES VINICIO (UNITED STATES INDIVIDUAL)  
2117A ROSALIND AVE  
ROANOKE, VA 24014

THE MARK CONSISTS OF STANDARD CHARACTERS WITHOUT CLAIM TO ANY PARTICULAR FONT, STYLE, SIZE, OR COLOR.

FOR: ENERGY DRINKS, IN CLASS 32 (U.S. CLS. 45, 46 AND 48).

SER. NO. 77-376,352, FILED 1-21-2008.

FIRST USE 12-1-2007; IN COMMERCE 12-1-2007.

DAWN FELDMAN, EXAMINING ATTORNEY

**Int. Cl.: 14**

**Prior U.S. Cls.: 2, 27, 28 and 50**

**United States Patent and Trademark Office**

**Reg. No. 3,569,190**

**Registered Feb. 3, 2009**

**TRADEMARK  
PRINCIPAL REGISTER**

**Tanya Trahtemberg**

TRAHTEMBERG TANYA (PERU INDIVIDUAL)  
OFFICE 1002  
SAN MARTIN 351  
LIMA, PERU

FOR: JEWELRY, IN CLASS 14 (U.S. CLS. 2, 27, 28  
AND 50).

FIRST USE 12-1-2006; IN COMMERCE 7-1-2007.

THE MARK CONSISTS OF STANDARD CHAR-  
ACTERS WITHOUT CLAIM TO ANY PARTICULAR  
FONT, STYLE, SIZE, OR COLOR.

OWNER OF PERU REG. NO. 00129158, DATED 7-  
20-2007, EXPIRES 7-20-2017.

THE NAME(S), PORTRAIT(S), AND/OR SIGNA-  
TURE(S) SHOWN IN THE MARK IDENTIFIES  
TANYA TRAHTEMBERG, WHOSE CONSENT(S)  
TO REGISTER IS SUBMITTED.

SER. NO. 77-376,943, FILED 1-22-2008.

KATHY DE JONGE, EXAMINING ATTORNEY

**Int. Cl.: 41**

**Prior U.S. Cls.: 100, 101 and 107**

**United States Patent and Trademark Office**

**Reg. No. 3,569,191**

**Registered Feb. 3, 2009**

**SERVICE MARK  
PRINCIPAL REGISTER**

**PF BLACK CARD**

PFIP, LLC (NEW HAMPSHIRE LIMITED LIABILITY COMPANY)

113 CROSBY ROAD, UNIT 15

DOVER, NH 03820

FOR: PHYSICAL FITNESS INSTRUCTION AND TRAINING; HEALTH CLUB SERVICES, NAMELY, PROVIDING INSTRUCTION AND EQUIPMENT IN THE FIELD OF PHYSICAL EXERCISE, IN CLASS 41 (U.S. CLS. 100, 101 AND 107).

FIRST USE 8-0-2005; IN COMMERCE 8-0-2005.

THE MARK CONSISTS OF STANDARD CHARACTERS WITHOUT CLAIM TO ANY PARTICULAR FONT, STYLE, SIZE, OR COLOR.

OWNER OF U.S. REG. NOS. 2,370,028, 2,438,677 AND OTHERS.

NO CLAIM IS MADE TO THE EXCLUSIVE RIGHT TO USE "BLACK CARD", APART FROM THE MARK AS SHOWN.

SER. NO. 77-377,062, FILED 1-22-2008.

MARY ROSSMAN, EXAMINING ATTORNEY

**Int. Cl.: 31**

**Prior U.S. Cls.: 1 and 46**

**United States Patent and Trademark Office**

**Reg. No. 3,569,192**

**Registered Feb. 3, 2009**

**TRADEMARK  
PRINCIPAL REGISTER**

**TANTAU**

ROSEN TANTAU MATHIAS TANTAU NACH-  
FOLGER (FED REP GERMANY COMPANY)  
TORNESCHER WEG 13  
UETERSEN, FED REP GERMANY 25436

FOR: LIVE PLANTS, NATURAL FLOWERS AND  
PLANT MATERIALS FOR PROPOGATION, NAME-  
LY, SEEDLINGS, IN CLASS 31 (U.S. CLS. 1 AND 46).

FIRST USE 8-0-1999; IN COMMERCE 8-0-1999.

THE MARK CONSISTS OF STANDARD CHAR-  
ACTERS WITHOUT CLAIM TO ANY PARTICULAR  
FONT, STYLE, SIZE, OR COLOR.

OWNER OF U.S. REG. NO. 2,518,824.

SEC. 2(F).

SER. NO. 77-377,278, FILED 1-22-2008.

GEORGE LORENZO, EXAMINING ATTORNEY



**Int. Cls.: 9 and 16**

**Prior U.S. Cls.: 2, 5, 21, 22, 23, 26, 29, 36, 37, 38 and 50**

**United States Patent and Trademark Office**

**Reg. No. 3,569,193**

**Registered Feb. 3, 2009**

**TRADEMARK  
PRINCIPAL REGISTER**

**GODDESS IN THE CORNER  
OFFICE**

LIERZ, JANICE (UNITED STATES INDIVIDUAL)  
14 WALNUT LN  
FLECTCHER, NC 28732

FOR: DIGITAL MEDIA, NAMELY, CDS, DVDS AND AUDIO TAPES FEATURING INSPIRATIONAL, MOTIVATIONAL AND SELF-IMPROVEMENT CONTENT; DOWNLOADABLE WEBCASTS AND PODCASTS FEATURING INSPIRATIONAL, MOTIVATIONAL AND SELF-IMPROVEMENT CONTENT, IN CLASS 9 (U.S. CLS. 21, 23, 26, 36 AND 38).

FIRST USE 2-9-2007; IN COMMERCE 8-26-2007.

FOR: PRINTED MATTER, NAMELY, BOOKLETS, INFORMATIONAL CARDS, CALENDARS, NEWSLETTERS AND A SERIES OF BOOKS FEATURING

INSPIRATIONAL, MOTIVATIONAL AND SELF-IMPROVEMENT CONTENT; EDUCATIONAL PUBLICATIONS, NAMELY, WORKBOOKS, TRAINING MANUALS AND PRINTED INSTRUCTIONAL MATERIAL FEATURING INSPIRATIONAL, MOTIVATIONAL AND SELF-IMPROVEMENT CONTENT, IN CLASS 16 (U.S. CLS. 2, 5, 22, 23, 29, 37, 38 AND 50).

FIRST USE 2-9-2007; IN COMMERCE 8-26-2007.

THE MARK CONSISTS OF STANDARD CHARACTERS WITHOUT CLAIM TO ANY PARTICULAR FONT, STYLE, SIZE, OR COLOR.

SER. NO. 77-379,001, FILED 1-23-2008.

DAVID YONTEF, EXAMINING ATTORNEY

**Int. Cls.: 16, 21, 25, 28 and 35**

**Prior U.S. Cls.: 2, 5, 13, 22, 23, 29, 30, 33, 37, 38, 39, 40, 50, 100, 101 and 102**

**Reg. No. 3,569,194**

**Registered Feb. 3, 2009**

**United States Patent and Trademark Office**

**TRADEMARK  
SERVICE MARK  
PRINCIPAL REGISTER**



LF, LLC (DELAWARE LIMITED LIABILITY COMPANY)  
SUITE 17  
2601 ANNAND DRIVE  
WILMINGTON, DE 19808

FOR: PRINTED MATERIALS, NAMELY, BROCHURES, BOOKS, AND MAGAZINES IN THE FIELD OF AUTOMOBILE RACING; PRINTED SCHEDULES IN THE FIELD OF AUTOMOBILE RACING; POSTERS; MOUNTED PHOTOGRAPHS; STICKERS; PENS, IN CLASS 16 (U.S. CLS. 2, 5, 22, 23, 29, 37, 38 AND 50).

FIRST USE 10-0-2001; IN COMMERCE 10-0-2001.

FOR: MUGS; CUPS; SERVING TRAYS; PORTABLE COOLERS; INSULATING SLEEVE HOLDERS FOR BEVERAGE CANS, IN CLASS 21 (U.S. CLS. 2, 13, 23, 29, 30, 33, 40 AND 50).

FIRST USE 10-0-2001; IN COMMERCE 10-0-2001.

FOR: HATS; T-SHIRTS; JACKETS; SHIRTS; PAJAMAS, IN CLASS 25 (U.S. CLS. 22 AND 39).

FIRST USE 10-0-2001; IN COMMERCE 10-0-2001.

FOR: DIE-CAST TOY CARS, IN CLASS 28 (U.S. CLS. 22, 23, 38 AND 50).

FIRST USE 10-0-2001; IN COMMERCE 10-0-2001.

FOR: ADVERTISING AND MARKETING SERVICES THROUGH PRINT, AUDIO, VIDEO, DIGITAL AND ON-LINE MEDIUM, IN CLASS 35 (U.S. CLS. 100, 101 AND 102).

FIRST USE 10-0-2001; IN COMMERCE 10-0-2001.

OWNER OF U.S. REG. NOS. 1,168,799, 2,294,323 AND OTHERS.

NO CLAIM IS MADE TO THE EXCLUSIVE RIGHT TO USE "RACING" AS TO CL.16 AND CL.35, APART FROM THE MARK AS SHOWN.

SER. NO. 77-379,265, FILED 1-24-2008.

DEIRDRE ROBERTSON, EXAMINING ATTORNEY

**Int. Cl.: 25**

**Prior U.S. Cls.: 22 and 39**

**United States Patent and Trademark Office**

**Reg. No. 3,569,195**

**Registered Feb. 3, 2009**

**TRADEMARK  
PRINCIPAL REGISTER**

**SILENT HONOR**

SILENT HONOR, LLC (OHIO LIMITED LIABILITY COMPANY)  
5652 KLAUSRIDGE COURT  
CINCINNATI, OH 45247

FOR: CLOTHING, NAMELY, HATS, CAPS, SHIRTS, SWEATSHIRTS, WIND RESISTANT JACKETS, JACKETS, COATS, WRISTBANDS, IN CLASS 25 (U.S. CLS. 22 AND 39).

FIRST USE 1-1-2007; IN COMMERCE 1-1-2007.

THE MARK CONSISTS OF STANDARD CHARACTERS WITHOUT CLAIM TO ANY PARTICULAR FONT, STYLE, SIZE, OR COLOR.

SER. NO. 77-379,391, FILED 1-24-2008.

MICHAEL GAAFAR, EXAMINING ATTORNEY

Int. Cl.: 37

Prior U.S. Cls.: 100, 103 and 106

Reg. No. 3,569,196

United States Patent and Trademark Office

Registered Feb. 3, 2009

**SERVICE MARK  
PRINCIPAL REGISTER**



STEVE GRAY RENOVATIONS, INC. (INDIANA CORPORATION)  
7111 FREMONT COURT  
INDIANAPOLIS, IN 46256

THE COLOR(S) BLACK, DARK BROWN, AND LIGHT BROWN IS/ARE CLAIMED AS A FEATURE OF THE MARK.

FOR: RENOVATION IN THE FIELD OF HOUSES, IN CLASS 37 (U.S. CLS. 100, 103 AND 106).

THE MARK CONSISTS OF THE WORDING "STEVE GRAY RENOVATIONS" PLACED BELOW A DESIGN ELEMENT COMPRISED OF FOUR STYLIZED BUILDINGS AND TWO FOUR-POINT STARS. THE COLOR BLACK APPEARS IN THE WORDING "STEVE GRAY RENOVATIONS"; THE COLOR DARK BROWN APPEARS IN THE LEFT-MOST BUILDING AND THE TWO RIGHT-MOST BUILDINGS; THE COLOR LIGHT BROWN APPEARS IN THE SECOND LEFT-MOST BUILDING AND THE TWO STARS.

FIRST USE 8-17-2005; IN COMMERCE 8-22-2005.

NO CLAIM IS MADE TO THE EXCLUSIVE RIGHT TO USE "RENOVATIONS", APART FROM THE MARK AS SHOWN.

THE NAME(S), PORTRAIT(S), AND/OR SIGNATURE(S) SHOWN IN THE MARK IDENTIFIES "STEVE GRAY", WHOSE CONSENT(S) TO REGISTER IS SUBMITTED.

SER. NO. 77-379,649, FILED 1-24-2008.

MICHAEL GAAFAR, EXAMINING ATTORNEY

**Int. Cl.: 9**

**Prior U.S. Cls.: 21, 23, 26, 36 and 38**

**Reg. No. 3,569,197**

**United States Patent and Trademark Office**

**Registered Feb. 3, 2009**

**TRADEMARK  
PRINCIPAL REGISTER**

**The Core of Convergence**

TECORE, INC. (TEXAS CORPORATION), DBA  
TECORE NETWORKS  
7061 COLUMBIA GATEWAY DRIVE  
COLUMBIA, MD 21046

FOR: COMMUNICATION EQUIPMENT, NAME-  
LY, SWITCHES, RADIO TRANSMITTERS AND RE-  
CEIVERS, LOCAL LOOP ACCESS APPARATUS FOR  
WIRELESS RADIO SIGNAL TRANSMISSION OF  
ACOUSTIC INFORMATION COMPRISED OF BASE  
STATION CONTROLLERS, ANTENNAS, SUBSCRI-  
BER UNITS IN THE NATURE OF MOBILE RADIOS  
THAT TRANSMIT AND RECEIVE SIGNALS, AND  
NETWORK MANAGEMENT SWITCHES FOR USE  
IN MANAGING RADIO SIGNALS AND VOICE  
TRANSFER BETWEEN SUBSCRIBER TERMINALS  
AND LOCAL EXCHANGES; COMPUTER HARD-  
WARE, COMPUTER FIRMWARE FOR WIRELESS  
RADIO CALL PROCESSING AND NETWORK  
MANAGEMENT; COMPUTER SOFTWARE FOR  
WIRELESS RADIO CALL PROCESSING AND NET-

WORK MANAGEMENT; COMPUTER NETWORKS  
COMPRISING HARDWARE AND SOFTWARE FOR  
MANAGING AND INTERCONNECTING TELE-  
COMMUNICATIONS NETWORKS, IN CLASS 9  
(U.S. CLS. 21, 23, 26, 36 AND 38).

FIRST USE 12-15-2007; IN COMMERCE 1-21-2008.

THE MARK CONSISTS OF STANDARD CHAR-  
ACTERS WITHOUT CLAIM TO ANY PARTICULAR  
FONT, STYLE, SIZE, OR COLOR.

NO CLAIM IS MADE TO THE EXCLUSIVE  
RIGHT TO USE "CORE AND CONVERGENCE",  
APART FROM THE MARK AS SHOWN.

SER. NO. 77-379,886, FILED 1-24-2008.

GIANCARLO CASTRO, EXAMINING ATTORNEY

**Int. Cl.: 41**

**Prior U.S. Cls.: 100, 101 and 107**

**United States Patent and Trademark Office**

**Reg. No. 3,569,198**

**Registered Feb. 3, 2009**

**SERVICE MARK  
PRINCIPAL REGISTER**

# DayGlow

COMMITTEE ENTERTAINMENT (FLORIDA  
LIMITED LIABILITY COMPANY)  
9140 SW 23ST UNIT A  
DAVIE, FL 33324

FOR: PROVIDING ENTERTAINMENT, NAME-  
LY, DANCE EVENTS; SOCIAL CLUB SERVICES,  
NAMELY, ARRANGING, ORGANIZING, CON-  
DUCTING AND HOSTING SOCIAL EVENTS, GET-  
TOGETHERS, PAINT PARTIES, SPECIAL EVENT  
PARTIES, AND NIGHTCLUB PARTIES, IN CLASS 41  
(U.S. CLS. 100, 101 AND 107).

FIRST USE 11-1-2007; IN COMMERCE 11-1-2007.

THE MARK CONSISTS OF STANDARD CHAR-  
ACTERS WITHOUT CLAIM TO ANY PARTICULAR  
FONT, STYLE, SIZE, OR COLOR.

SER. NO. 77-379,966, FILED 1-24-2008.

LEIGH CAROLINE CASE, EXAMINING ATTOR-  
NEY

**Int. Cl.: 42**

**Prior U.S. Cls.: 100 and 101**

**United States Patent and Trademark Office**

**Reg. No. 3,569,199**

**Registered Feb. 3, 2009**

**SERVICE MARK  
PRINCIPAL REGISTER**



DEERWOOD TECHNOLOGIES, INC. (MINNESOTA CORPORATION)  
PO BOX 393  
21301 ARCHIBALD ROAD  
DEERWOOD, MN 564440393

FOR: TECHNICAL SUPPORT, NAMELY, MONITORING OF NETWORK SYSTEMS, IN CLASS 42 (U.S. CLS. 100 AND 101).

FIRST USE 1-15-2007; IN COMMERCE 1-15-2007.

NO CLAIM IS MADE TO THE EXCLUSIVE RIGHT TO USE "NETWORK SUPPORT", APART FROM THE MARK AS SHOWN.

THE COLOR(S) GREEN, GOLD, BROWN, SILVER, WHITE IS/ARE CLAIMED AS A FEATURE OF THE MARK.

THE MARK CONSISTS OF GREEN BACKGROUND AND TREES, GOLD LETTERING WITH BROWN BACKGROUND, SILVER LOCK, WHITE MOON AND BORDER.

SER. NO. 77-380,348, FILED 1-25-2008.

ANDREA K. NADELMAN, EXAMINING ATTORNEY

**Int. Cl.: 36**

**Prior U.S. Cls.: 100, 101 and 102**

**United States Patent and Trademark Office**

**Reg. No. 3,569,200**

**Registered Feb. 3, 2009**

**SERVICE MARK  
PRINCIPAL REGISTER**

**RETIREMENTREDZONE.COM**

THE PRUDENTIAL INSURANCE COMPANY OF  
AMERICA (NEW JERSEY CORPORATION)  
22ND FLOOR  
751 BROAD STREET  
NEWARK, NJ 07102

FOR: FINANCIAL SERVICES, NAMELY, INVESTMENT AND ADVISORY SERVICES, UNDERWRITING AND INVESTMENT MANAGEMENT OF ANNUITIES AND DEFINED CONTRIBUTION PLANS; INVESTMENT MANAGEMENT SERVICES; ADMINISTRATION OF EMPLOYEE RETIREMENT PLANS; RETIREMENT PLANNING SERVICES; ESTATE PLANNING SERVICES; INSURANCE UNDERWRITING, ADMINISTRATION AND AGENCY SERVICES IN THE FIELDS OF LIFE, LONG TERM CARE AND DISABILITY INSURANCE; PROVIDING FINANCIAL INFORMATION AND RESEARCH BY MEANS OF A GLOBAL COMPUTER NETWORK, PERSONAL DIGITAL ASSISTANTS, BEEPERS, AND

CELL PHONES, IN CLASS 36 (U.S. CLS. 100, 101 AND 102).

FIRST USE 12-2-2005; IN COMMERCE 12-2-2005.

THE MARK CONSISTS OF STANDARD CHARACTERS WITHOUT CLAIM TO ANY PARTICULAR FONT, STYLE, SIZE, OR COLOR.

OWNER OF U.S. REG. NO. 3,167,976.

NO CLAIM IS MADE TO THE EXCLUSIVE RIGHT TO USE "RETIREMENT", APART FROM THE MARK AS SHOWN.

SER. NO. 77-380,623, FILED 1-25-2008.

MELVIN AXILBUND, EXAMINING ATTORNEY



**Int. Cl.: 45**

**Prior U.S. Cls.: 100 and 101**

**United States Patent and Trademark Office**

**Reg. No. 3,569,201**

**Registered Feb. 3, 2009**

**SERVICE MARK  
PRINCIPAL REGISTER**

# All Things Organized

CLAUDIA BLUME (NEW YORK CORPORATION), DBA ALL THINGS ORGANIZED, A DIVISION OF CLAUDIA PRODUCTIONS INC. 16 KNOX RD. EASTCHESTER, NY 10709

FOR: ORGANIZATIONAL SERVICES FOR HOME OR PERSONAL PURPOSES, NAMELY, CLOSET, KITCHEN, AND HOME OFFICE SPACE, IN CLASS 45 (U.S. CLS. 100 AND 101).

FIRST USE 11-1-2005; IN COMMERCE 11-1-2005.

THE MARK CONSISTS OF STANDARD CHARACTERS WITHOUT CLAIM TO ANY PARTICULAR FONT, STYLE, SIZE, OR COLOR.

NO CLAIM IS MADE TO THE EXCLUSIVE RIGHT TO USE "ORGANIZED", APART FROM THE MARK AS SHOWN.

SER. NO. 77-381,270, FILED 1-25-2008.

ELI HELLMAN, EXAMINING ATTORNEY

**Int. Cls.: 20 and 24**

**Prior U.S. Cls.: 2, 13, 22, 25, 32, 42 and 50**

**United States Patent and Trademark Office**

**Reg. No. 3,569,202**

**Registered Feb. 3, 2009**

**TRADEMARK  
PRINCIPAL REGISTER**

**SKINGLOW**

LONDON LUXURY LLC (NEW YORK LIMITED  
LIABILITY COMPANY)  
SUITE 613  
271 NORTH AVENUE  
NEW ROCHELLE, NY 10801

FOR: PILLOWS, IN CLASS 20 (U.S. CLS. 2, 13, 22,  
25, 32 AND 50).

FIRST USE 7-0-2007; IN COMMERCE 7-0-2007.

FOR: BATH LINENS, NAMELY, BATH TOWELS,  
HAND TOWELS, WASH CLOTHS, BATH SHEETS,  
SHOWER CURTAINS; BED LINENS, NAMELY, BED  
BLANKETS, DUVET COVERS, COVERLETS, COM-

FORTERS, THROWS, QUILTS, PILLOW SHAMS,  
BED SKIRTS, BED SHEETS, PILLOW CASES, IN  
CLASS 24 (U.S. CLS. 42 AND 50).

FIRST USE 7-0-2007; IN COMMERCE 7-0-2007.

THE MARK CONSISTS OF STANDARD CHAR-  
ACTERS WITHOUT CLAIM TO ANY PARTICULAR  
FONT, STYLE, SIZE, OR COLOR.

SER. NO. 77-381,955, FILED 1-28-2008.

KELLY BOULTON, EXAMINING ATTORNEY

**Int. Cls.: 20 and 24**

**Prior U.S. Cls.: 2, 13, 22, 25, 32, 42 and 50**

**United States Patent and Trademark Office**

**Reg. No. 3,569,203**

**Registered Feb. 3, 2009**

**TRADEMARK  
PRINCIPAL REGISTER**

**SKINELEMENCE**

LONDON LUXURY LLC (NEW YORK LIMITED  
LIABILITY COMPANY)  
SUITE 613  
271 NORTH AVENUE  
NEW ROCHELLE, NY 10801

FOR: PILLOWS, IN CLASS 20 (U.S. CLS. 2, 13, 22,  
25, 32 AND 50).

FIRST USE 6-0-2007; IN COMMERCE 6-0-2007.

FOR: BATH LINENS, NAMELY, BATH TOWELS,  
HAND TOWELS, WASH CLOTHS, BATH SHEETS,  
SHOWER CURTAINS; BED LINENS, NAMELY, BED  
BLANKETS, DUVET COVERS, COVERLETS, COM-

FORTERS, THROWS, QUILTS, PILLOW SHAMS,  
BED SKIRTS, BED SHEETS, PILLOW CASES, IN  
CLASS 24 (U.S. CLS. 42 AND 50).

FIRST USE 6-0-2007; IN COMMERCE 6-0-2007.

THE MARK CONSISTS OF STANDARD CHAR-  
ACTERS WITHOUT CLAIM TO ANY PARTICULAR  
FONT, STYLE, SIZE, OR COLOR.

SER. NO. 77-382,259, FILED 1-28-2008.

KELLY BOULTON, EXAMINING ATTORNEY

**Int. Cl.: 45**

**Prior U.S. Cls.: 100 and 101**

**United States Patent and Trademark Office**

**Reg. No. 3,569,204**

**Registered Feb. 3, 2009**

**SERVICE MARK  
PRINCIPAL REGISTER**

**SCHOOL OF UNIVERSAL  
LEARNING**

RUBACK, KEITH (UNITED STATES INDIVIDUAL)  
6624 SWEET MAPLE LANE  
BOCA RATON, FL 33433

FOR: MINISTERIAL SERVICES, NAMELY, HOLDING SPIRITUAL RETREATS TO ASSIST RELIGIOUS LEADERS, BOTH CLERGY AND LAY, TO DEVELOP AND ENHANCE THEIR SPIRITUAL LIVES; PROVIDING BOTH IN-PERSON AND ON-LINE HOLISTIC SPIRITUAL COUNSELING SERVICES; PROVIDING ON-LINE INFORMATION IN THE FIELD OF SPIRITUALITY, SELF-HELP, AND PERSONAL EMPOWERMENT SUBJECT MATTERS; RELIGIOUS AND SPIRITUAL SERVICES, NAMELY, PROVIDING GATHERINGS AND RETREATS TO DEVELOP AND ENHANCE THE SPIRITUAL LIVES OF INDIVIDUALS; CONDUCTING RELI-

GIOUS PRAYER SERVICES; PERSONAL GROWTH AND MOTIVATION CONSULTING SERVICES, IN CLASS 45 (U.S. CLS. 100 AND 101).

FIRST USE 1-15-2007; IN COMMERCE 1-28-2008.

THE MARK CONSISTS OF STANDARD CHARACTERS WITHOUT CLAIM TO ANY PARTICULAR FONT, STYLE, SIZE, OR COLOR.

NO CLAIM IS MADE TO THE EXCLUSIVE RIGHT TO USE "LEARNING", APART FROM THE MARK AS SHOWN.

SER. NO. 77-382,315, FILED 1-28-2008.

JUSTINE D. PARKER, EXAMINING ATTORNEY

**Int. Cls.: 35, 36 and 42**

**Prior U.S. Cls.: 100, 101 and 102**

**United States Patent and Trademark Office**

**Reg. No. 3,569,205**

**Registered Feb. 3, 2009**

**SERVICE MARK  
PRINCIPAL REGISTER**

**conNext**

WILLIS RE INC. (NEW YORK CORPORATION)  
THIRD FLOOR  
ONE WORLD FINANCIAL CTR, 200 LIBERTY ST  
NEW YORK, NY 10281

FOR: PROVIDING BUSINESS INFORMATION  
AND BUSINESS CONSULTING SERVICES IN THE  
FIELD OF REINSURANCE, IN CLASS 35 (U.S. CLS.  
100, 101 AND 102).

FIRST USE 11-1-2007; IN COMMERCE 11-1-2007.

FOR: ACTUARIAL SERVICES IN SUPPORT OF  
UNDERWRITING; PROVIDING FINANCIAL IN-  
FORMATION AND FINANCIAL CONSULTING  
SERVICES IN THE FIELD OF REINSURANCE, IN  
CLASS 36 (U.S. CLS. 100, 101 AND 102).

FIRST USE 11-1-2007; IN COMMERCE 11-1-2007.

FOR: ONLINE, NON-DOWNLOADABLE COMPU-  
TER SOFTWARE FOR THE MANAGEMENT OF  
PROJECTS AND THE ANALYSIS OF INFORMA-  
TION FOR THE PURPOSES OF ASSESSING AND  
MANAGING RISKS, ALL IN THE FIELD OF RE-  
INSURANCE, IN CLASS 42 (U.S. CLS. 100 AND 101).

FIRST USE 11-1-2007; IN COMMERCE 11-1-2007.

THE MARK CONSISTS OF STANDARD CHAR-  
ACTERS WITHOUT CLAIM TO ANY PARTICULAR  
FONT, STYLE, SIZE, OR COLOR.

SER. NO. 77-382,890, FILED 1-29-2008.

JAMES MACFARLANE, EXAMINING ATTORNEY

**Int. Cls.: 9 and 16**

**Prior U.S. Cls.: 2, 5, 21, 22, 23, 26, 29, 36, 37, 38 and 50**

**Reg. No. 3,569,206**

**United States Patent and Trademark Office**

**Registered Feb. 3, 2009**

**TRADEMARK  
PRINCIPAL REGISTER**

**VISAGE**

SCHLUMBERGER TECHNOLOGY CORPORATION (TEXAS CORPORATION)  
5599 SAN FELIPE  
SUITE 100  
HOUSTON, TX 77056

FOR: COMPUTER SOFTWARE FOR OIL AND GAS EXPLORATION AND PRODUCTION, IN CLASS 9 (U.S. CLS. 21, 23, 26, 36 AND 38).

FIRST USE 7-1-1996; IN COMMERCE 7-1-1996.

FOR: COMPUTER SOFTWARE INSTRUCTION MANUALS FOR OIL AND GAS EXPLORATION

AND PRODUCTION, IN CLASS 16 (U.S. CLS. 2, 5, 22, 23, 29, 37, 38 AND 50).

FIRST USE 7-1-1996; IN COMMERCE 7-1-1996.

THE MARK CONSISTS OF STANDARD CHARACTERS WITHOUT CLAIM TO ANY PARTICULAR FONT, STYLE, SIZE, OR COLOR.

SER. NO. 77-383,260, FILED 1-29-2008.

KHANH LE, EXAMINING ATTORNEY

**Int. Cl.: 35**

**Prior U.S. Cls.: 100, 101 and 102**

**United States Patent and Trademark Office**

**Reg. No. 3,569,207**

**Registered Feb. 3, 2009**

**SERVICE MARK  
PRINCIPAL REGISTER**

**MAKE THE CONNECTION**

ILLINOIS HISPANIC CHAMBER OF COM-  
MERCE (ILLINOIS CORPORATION)  
SUITE 1660  
111 W. WASHINGTON  
CHICAGO, IL 60602

FOR: CHAMBER OF COMMERCE SERVICES,  
NAMELY, PROMOTING BUSINESS IN THE STATE  
OF ILLINOIS; PROVIDING RESOURCES TO BUSI-  
NESSES; ADVOCATING ON ISSUES THAT AFFECT  
THE HISPANIC BUSINESS COMMUNITY; PROVID-  
ING AND FOSTERING BUSINESS DEVELOPMENT  
OPPORTUNITIES AND EDUCATIONAL ASSIS-

TANCE FOR BUSINESSES, IN CLASS 35 (U.S. CLS.  
100, 101 AND 102).

FIRST USE 10-31-2003; IN COMMERCE 10-31-2003.

THE MARK CONSISTS OF STANDARD CHAR-  
ACTERS WITHOUT CLAIM TO ANY PARTICULAR  
FONT, STYLE, SIZE, OR COLOR.

SER. NO. 77-383,359, FILED 1-29-2008.

STEVEN JACKSON, EXAMINING ATTORNEY

**Int. Cl.: 36**

**Prior U.S. Cls.: 100, 101 and 102**

**United States Patent and Trademark Office**

**Reg. No. 3,569,208**

**Registered Feb. 3, 2009**

**SERVICE MARK  
PRINCIPAL REGISTER**



MINNESOTA DEPARTMENT OF HUMAN SERVICES (MINNESOTA STATE AGENCY)  
444 LAFAYETTE ROAD  
ST. PAUL, MN 55155

FOR: INSURANCE SERVICES, NAMELY, STATE-PROVIDED HEALTH INSURANCE UNDERWRITING FOR OTHERWISE UNINSURED OR UNDERINSURED INDIVIDUALS , IN CLASS 36 (U.S. CLS. 100, 101 AND 102).

FIRST USE 9-1-1998; IN COMMERCE 9-1-1998.

OWNER OF U.S. REG. NOS. 1,833,521 AND 2,606,760.

THE MARK CONSISTS OF TWO STYLIZED HUMAN FIGURES, ONE LARGER THAN THE OTHER AND LEANING TO THE LEFT, ONE SMALLER AND LEANING TO THE RIGHT, ARMS OUTSTRETCHED, BOTH FIGURES BENEATH A STYLIZED RISING SUN WITH FIVE POINTED RAY ELEMENTS, TOGETHER WITH THE WORD MINNESOTACARE.

SER. NO. 77-384,058, FILED 1-30-2008.

SUE LAWRENCE, EXAMINING ATTORNEY



**Int. Cl.: 44**

**Prior U.S. Cls.: 100 and 101**

**United States Patent and Trademark Office**

**Reg. No. 3,569,209**

**Registered Feb. 3, 2009**

**SERVICE MARK  
PRINCIPAL REGISTER**



**HAWAII VEIN INSTITUTE**

HAWAII VEIN INSTITUTE, LLC (HAWAII LIMITED LIABILITY COMPANY)  
1600 KAPIOLANI BLVD  
SUITE 808  
HONOLULU, HI 96814

FOR: HEALTHCARE, IN CLASS 44 (U.S. CLS. 100 AND 101).

FIRST USE 10-22-2007; IN COMMERCE 10-22-2007.

NO CLAIM IS MADE TO THE EXCLUSIVE RIGHT TO USE "HAWAII VEIN INSTITUTE", APART FROM THE MARK AS SHOWN.

THE COLOR(S) GREEN, TURQUOISE, AND WHITE IS/ARE CLAIMED AS A FEATURE OF THE MARK.

THE MARK CONSISTS OF THREE GREEN AND WHITE FLOWER PETALS WITH THE MIDDLE PETAL CONTAINING A WHITE STEM WHICH REPRESENTS A LASER TIP. THIS IS LOCATED ABOVE THE WORDING "HAWAII VEIN INSTITUTE" IN TURQUOISE.

SER. NO. 77-384,885, FILED 1-30-2008.

SCOTT BIBB, EXAMINING ATTORNEY

Int. Cls.: 29, 30 and 32

Prior U.S. Cls.: 45, 46 and 48

United States Patent and Trademark Office

Reg. No. 3,569,210

Registered Feb. 3, 2009

TRADEMARK  
PRINCIPAL REGISTER



THAI WORLD IMPORT & EXPORT CO., LTD.  
(THAILAND LIMITED LIABILITY COMPANY)  
2532 TROK NOKKET, RATCHADAPHISEK ROAD  
BANGKLO, BANGKHOLAEM  
BANGKOK 10120, THAILAND

FOR: MEAT; PRESERVED FISH EXTRACTS;  
CANNED FRUITS AND VEGETABLES; PRE-  
SERVED FRUITS AND VEGETABLES; PRESERVED  
BEANS AND NUTS; DRIED AND COOKED FRUITS  
AND VEGETABLES; MILK; MILK PRODUCTS EX-  
CLUDING ICE CREAM, ICE MILK AND FROZEN  
YOGURT; FROZEN FOODS, NAMELY, FROZEN  
FRUITS AND VEGETABLES; COCONUT PRO-  
DUCTS, NAMELY, COCONUT CREAM, COCONUT  
POWDER, DESICCATED COCONUT, FLAKED CO-  
CONUT, PREPARED COCONUT, PROCESSED CO-  
CONUT, IN CLASS 29 (U.S. CL. 46).

FIRST USE 12-31-2000; IN COMMERCE 6-24-2003.

FOR: RICE IN STICK FORM; RICE; JASMINE  
RICE; FLOUR; SNACKS, NAMELY, CRACKERS;  
READY TO EAT PRODUCTS, NAMELY, RICE  
CRACKERS; GINGER; SAUCES; SPICES; MUS-  
TARD; PASTE PRODUCTS, NAMELY, ALIMEN-  
TARY PASTE, BEAN PASTE, FARINACEOUS  
FOOD PASTES FOR HUMAN CONSUMPTION,  
GINGER PASTE FOR USE AS A SEASONING,  
SEASONING PASTES, MISO BEAN PASTE, SOY  
BEAN PASTE; RICE PRODUCTS, NAMELY, RICE  
NOODLES, RICE FLOUR; CURRY PRODUCTS,  
NAMELY, CURRY PASTES AND CURRY POWDER;

NOODLE PRODUCTS, NAMELY, NOODLES,  
CHOW MEIN NOODLES, INSTANT NOODLES, IN-  
STANT SOBA NOODLES, NOODLES AND SEASON-  
ING MIXES COMBINED IN UNITARY PACKAGES;  
SEASONINGS; TAPIOCA; TAPIOCA FLOUR, IN  
CLASS 30 (U.S. CL. 46).

FIRST USE 12-31-2000; IN COMMERCE 6-24-2003.

FOR: COCONUT MILK, IN CLASS 32 (U.S. CLS. 45,  
46 AND 48).

FIRST USE 1-27-2008; IN COMMERCE 1-27-2008.

NO CLAIM IS MADE TO THE EXCLUSIVE  
RIGHT TO USE "INDOCHINE", APART FROM  
THE MARK AS SHOWN.

THE NAME(S), PORTRAIT(S), AND/OR SIGNA-  
TURE(S) SHOWN IN THE MARK DOES NOT IDEN-  
TIFY A PARTICULAR LIVING INDIVIDUAL.

THE MARK CONSISTS OF THE WORD "INDO-  
CHINE" BELOW FOUR WOMEN DRESSED IN  
DIFFERENT TYPES OF CLOTHING.

THE FOREIGN WORDING IN THE MARK  
TRANSLATES INTO ENGLISH AS INDOCHINA.

SER. NO. 77-385,136, FILED 1-31-2008.

FRED MANDIR, EXAMINING ATTORNEY

**Int. Cl.: 35**

**Prior U.S. Cls.: 100, 101 and 102**

**United States Patent and Trademark Office**

**Reg. No. 3,569,211**

**Registered Feb. 3, 2009**

**SERVICE MARK  
PRINCIPAL REGISTER**



KLEIN'S TOWER PLAZA, INC. (MARYLAND CORPORATION)

2101 ROCKSPRING ROAD  
FOREST HILL, MD 21050

FOR: RETAIL GROCERY, SUPERMARKET AND  
DRUG STORE SERVICES, IN CLASS 35 (U.S. CLS.  
100, 101 AND 102).

FIRST USE 12-0-2004; IN COMMERCE 12-0-2004.

OWNER OF U.S. REG. NO. 2,161,681.

NO CLAIM IS MADE TO THE EXCLUSIVE  
RIGHT TO USE "MARKETS", APART FROM THE  
MARK AS SHOWN.

THE MARK CONSISTS OF TWO DIAMOND  
SHAPED BOXES, WITH ONE HAVING THE SHAPE  
OF A LEAF IN THE MIDDLE, AND THE WORDS  
"KLEIN'S FAMILY MARKETS", WITH THE APOS-  
TROPHE IN "KLEIN'S" BEING IN THE SHAPE OF A  
LEAF.

SER. NO. 77-385,329, FILED 1-31-2008.

JANET LEE, EXAMINING ATTORNEY

**Int. Cls.: 40 and 42**

**Prior U.S. Cls.: 100, 101, 103 and 106**

**United States Patent and Trademark Office**

**Reg. No. 3,569,212**

**Registered Feb. 3, 2009**

**SERVICE MARK  
PRINCIPAL REGISTER**

**FLEXIBILITY IN MOTION**

STELKAST, INC. (PENNSYLVANIA CORPORATION)  
200 HIDDEN VALLEY ROAD  
MCMURRAY, PA 15317

FOR: MANUFACTURING SERVICES, NAMELY,  
MANUFACTURING ORTHOPEDIC IMPLANTS, IN  
CLASS 40 (U.S. CLS. 100, 103 AND 106).

FIRST USE 10-31-2006; IN COMMERCE 12-13-2006.

FOR: DESIGN SERVICES, NAMELY, DESIGNING  
ORTHOPEDIC IMPLANTS, IN CLASS 42 (U.S. CLS.  
100 AND 101).

FIRST USE 10-31-2006; IN COMMERCE 12-13-2006.

THE MARK CONSISTS OF STANDARD CHAR-  
ACTERS WITHOUT CLAIM TO ANY PARTICULAR  
FONT, STYLE, SIZE, OR COLOR.

SER. NO. 77-386,574, FILED 2-1-2008.

MICHAEL ENGEL, EXAMINING ATTORNEY

**Int. Cl.: 9**

**Prior U.S. Cls.: 21, 23, 26, 36 and 38**

**United States Patent and Trademark Office**

**Reg. No. 3,569,213**

**Registered Feb. 3, 2009**

**TRADEMARK  
PRINCIPAL REGISTER**

**POWERBALL**

NAMCO BANDAI GAMES INC. (JAPAN CORPORATION)  
4-5-15 HIGASHI SHINAGAWA, SHINAGAWA-KU  
TOKYO, JAPAN 140-8590

FOR: VIDEO GAME CARTRIDGES AND COMPUTER GAME PROGRAMS FEATURING PLAYERS COMPETING AGAINST EACH OTHER IN A HYBRID SPORT THAT IS A COMBINATION OF FOOTBALL, SOCCER, RUGBY AND WRESTLING, IN CLASS 9 (U.S. CLS. 21, 23, 26, 36 AND 38).

FIRST USE 0-0-1991; IN COMMERCE 0-0-1991.

THE MARK CONSISTS OF STANDARD CHARACTERS WITHOUT CLAIM TO ANY PARTICULAR FONT, STYLE, SIZE, OR COLOR.

SER. NO. 77-386,943, FILED 2-1-2008.

JEAN IM, EXAMINING ATTORNEY

**Int. Cl.: 9**

**Prior U.S. Cls.: 21, 23, 26, 36 and 38**

**United States Patent and Trademark Office**

**Reg. No. 3,569,214**

**Registered Feb. 3, 2009**

**TRADEMARK  
PRINCIPAL REGISTER**

**Crystal Touch**

LUMIO (DELAWARE CORPORATION)  
325 SHARON PARK DRIVE, SUITE 710  
MENLO PARK, CA 94025

FOR: COMPUTER TOUCHSCREENS, IN CLASS 9  
(U.S. CLS. 21, 23, 26, 36 AND 38).

FIRST USE 3-15-2007; IN COMMERCE 3-15-2007.

THE MARK CONSISTS OF STANDARD CHAR-  
ACTERS WITHOUT CLAIM TO ANY PARTICULAR  
FONT, STYLE, SIZE, OR COLOR.

NO CLAIM IS MADE TO THE EXCLUSIVE  
RIGHT TO USE "TOUCH", APART FROM THE  
MARK AS SHOWN.

SER. NO. 77-387,265, FILED 2-3-2008.

JANICE L. MCMORROW, EXAMINING ATTOR-  
NEY

**Int. Cl.: 14**

**Prior U.S. Cls.: 2, 27, 28 and 50**

**United States Patent and Trademark Office**

**Reg. No. 3,569,215**

**Registered Feb. 3, 2009**

**TRADEMARK  
PRINCIPAL REGISTER**

**NOBLIA**

CITIZEN HOLDINGS KABUSHIKI KAISHA (JAPAN CORPORATION), DBA CITIZEN HOLDINGS CO., LTD.  
1-12, 6-CHOME, TANASHI-CHO  
NISHI-TOKYO-SHI, TOKYO, JAPAN

OWNER OF JAPAN REG. NO. 1809487, DATED 9-27-1985, EXPIRES 9-27-2015.

SER. NO. 77-387,291, FILED 2-3-2008.

FOR: WATCHES, IN CLASS 14 (U.S. CLS. 2, 27, 28 AND 50).

ALEX KEAM, EXAMINING ATTORNEY

Int. Cl.: 30

Prior U.S. Cl.: 46

United States Patent and Trademark Office

Reg. No. 3,569,216

Registered Feb. 3, 2009

TRADEMARK  
PRINCIPAL REGISTER

MRS. PRIMROSE ENGLISH  
TOFFEE & UNIQUE TREATS

IZBICKI, JENIFER (UNITED STATES INDIVIDUAL)  
P.O. BOX 234  
MONROVIA, CA 91017

FOR: ENGLISH TOFFEE, CAKES, GRANOLA, PRETZELS, AND TOFFEES, IN CLASS 30 (U.S. CL. 46).

FIRST USE 10-0-2005; IN COMMERCE 10-0-2005.

THE MARK CONSISTS OF STANDARD CHARACTERS WITHOUT CLAIM TO ANY PARTICULAR FONT, STYLE, SIZE, OR COLOR.

NO CLAIM IS MADE TO THE EXCLUSIVE RIGHT TO USE "ENGLISH TOFFEE" AND "TREATS", APART FROM THE MARK AS SHOWN.

THE NAME "MRS. PRIMROSE" DOES NOT IDENTIFY A LIVING INDIVIDUAL.

SER. NO. 77-388,662, FILED 2-5-2008.

DANNEAN HETZEL, EXAMINING ATTORNEY



**Int. Cl.: 37**

**Prior U.S. Cls.: 100, 103 and 106**

**United States Patent and Trademark Office**

**Reg. No. 3,569,217**

**Registered Feb. 3, 2009**

**SERVICE MARK  
PRINCIPAL REGISTER**

**GRUNLEY**

GRUNLEY CONSTRUCTION CO., INC. (MARY-  
LAND CORPORATION)  
SUITE 500  
15020 SHADY GROVE ROAD  
ROCKVILLE, MD 20850

FOR: CONSTRUCTION SERVICES, NAMELY,  
BUILDING CONSTRUCTION AND REPAIR SERVI-  
CES; CONSTRUCTION CONSULTATION, CON-  
STRUCTION MANAGEMENT; CONSTRUCTION  
OF COMMERCIAL AND RESIDENTIAL BUILD-  
INGS; BUILDING RENOVATION AND RESTORA-  
TION, IN CLASS 37 (U.S. CLS. 100, 103 AND 106).

FIRST USE 8-0-1988; IN COMMERCE 8-0-1988.

THE MARK CONSISTS OF STANDARD CHAR-  
ACTERS WITHOUT CLAIM TO ANY PARTICULAR  
FONT, STYLE, SIZE, OR COLOR.

SEC. 2(F).

SER. NO. 77-389,374, FILED 2-5-2008.

ALLISON HOLTZ, EXAMINING ATTORNEY

**Int. Cls.: 25 and 43**

**Prior U.S. Cls.: 22, 39, 100 and 101**

**United States Patent and Trademark Office**

**Reg. No. 3,569,218**

**Registered Feb. 3, 2009**

**TRADEMARK  
SERVICE MARK  
PRINCIPAL REGISTER**

**FIVE GUYS BURGERS AND FRIES**

FIVE GUYS HOLDINGS, INC. (DELAWARE CORPORATION)  
SUITE 205  
10440 FURNACE ROAD  
LORTON, VA 22079

FOR: CLOTHING, NAMELY, SHIRTS, HATS, IN CLASS 25 (U.S. CLS. 22 AND 39).

FIRST USE 0-0-2004; IN COMMERCE 0-0-2004.

FOR: RESTAURANT SERVICES, IN CLASS 43 (U.S. CLS. 100 AND 101).

FIRST USE 0-0-2004; IN COMMERCE 0-0-2004.

THE MARK CONSISTS OF STANDARD CHARACTERS WITHOUT CLAIM TO ANY PARTICULAR FONT, STYLE, SIZE, OR COLOR.

OWNER OF U.S. REG. NOS. 2,576,160 AND 3,079,591.

NO CLAIM IS MADE TO THE EXCLUSIVE RIGHT TO USE "BURGERS AND FRIES", APART FROM THE MARK AS SHOWN.

SER. NO. 77-389,864, FILED 2-6-2008.

SHAUNIA CARLYLE, EXAMINING ATTORNEY

Int. Cl.: 45

Prior U.S. Cls.: 100 and 101

United States Patent and Trademark Office

Reg. No. 3,569,219

Registered Feb. 3, 2009

SERVICE MARK  
PRINCIPAL REGISTER



WLF | THE WILLIAMS LINDBERG LAW FIRM,  
PC (CALIFORNIA CORPORATION)  
100 BAYVIEW CIR., SOUTH TOWER, STE. 330  
NEWPORT BEACH, CA 926602984

FOR: LEGAL SERVICES, IN CLASS 45 (U.S. CLS.  
100 AND 101).

FIRST USE 11-8-2007; IN COMMERCE 11-8-2007.

OWNER OF U.S. REG. NO. 3,195,648.

NO CLAIM IS MADE TO THE EXCLUSIVE  
RIGHT TO USE "LAW FIRM, PC", APART FROM  
THE MARK AS SHOWN.

THE MARK CONSISTS OF THE ACRONYM  
"WLF", WHICH APPEARS ON THE LEFT SIDE OF  
A PIPE CHARACTER, OR VERTICAL LINE; TO THE  
RIGHT OF THE LINE THE WORD "THE" APPEARS  
STACKED ON TOP OF THE WORD "WILLIAMS",  
WHICH APPEARS STACKED ON TOP OF "LIND-  
BERG". "LINDBERG" APPEARS STACKED ON TOP  
OF "LAW FIRM, PC".

SER. NO. 77-389,987, FILED 2-6-2008.

MARILYN IZZI, EXAMINING ATTORNEY

**Int. Cl.: 31**

**Prior U.S. Cls.: 1 and 46**

**United States Patent and Trademark Office**

**Reg. No. 3,569,220**

**Registered Feb. 3, 2009**

**TRADEMARK  
PRINCIPAL REGISTER**

**LEGEND DAIRY FARMS**

RONALD C. PIETERSMA (UNITED STATES IN-  
DIVIDUAL)

P.O. BOX 2500

CHINO, CA 91708

FOR: LIVESTOCK, NAMELY, DAIRY ANIMALS,  
IN CLASS 31 (U.S. CLS. 1 AND 46).

FIRST USE 12-15-1978; IN COMMERCE 12-22-1978.

THE MARK CONSISTS OF STANDARD CHAR-  
ACTERS WITHOUT CLAIM TO ANY PARTICULAR  
FONT, STYLE, SIZE, OR COLOR.

NO CLAIM IS MADE TO THE EXCLUSIVE  
RIGHT TO USE "DAIRY FARMS", APART FROM  
THE MARK AS SHOWN.

SER. NO. 77-391,213, FILED 2-7-2008.

TEJBIR SINGH, EXAMINING ATTORNEY

**Int. Cl.: 41**

**Prior U.S. Cls.: 100, 101 and 107**

**United States Patent and Trademark Office**

**Reg. No. 3,569,221**

**Registered Feb. 3, 2009**

**SERVICE MARK  
PRINCIPAL REGISTER**

**YOUR INVITATION TO DESIGN**

RSVP STYLE, LLC (HAWAII LIMITED LIABILITY COMPANY)  
P.O.BOX 25760  
HONOLULU, HI 96825

FOR: EDUCATIONAL SERVICES, NAMELY, CONDUCTING WORKSHOPS IN THE FIELD OF HOME DECOR, DESIGNING, AND DECORATING AND DISTRIBUTION OF COURSE MATERIAL IN CONNECTION THEREWITH; PROVIDING A WEB SITE THAT FEATURES INFORMAL INSTRUCTION ON INTERIOR DESIGN AND DECORATING, IN CLASS 41 (U.S. CLS. 100, 101 AND 107).

FIRST USE 3-1-2007; IN COMMERCE 3-1-2007.

THE MARK CONSISTS OF STANDARD CHARACTERS WITHOUT CLAIM TO ANY PARTICULAR FONT, STYLE, SIZE, OR COLOR.

NO CLAIM IS MADE TO THE EXCLUSIVE RIGHT TO USE "DESIGN", APART FROM THE MARK AS SHOWN.

SER. NO. 77-391,355, FILED 2-7-2008.

TEJBIR SINGH, EXAMINING ATTORNEY

**Int. Cl.: 35**

**Prior U.S. Cls.: 100, 101 and 102**

**United States Patent and Trademark Office**

**Reg. No. 3,569,222**

**Registered Feb. 3, 2009**

**SERVICE MARK  
PRINCIPAL REGISTER**



99 WEST, LLC (CALIFORNIA LIMITED LIABILITY COMPANY)  
9860 HIGHWAY 99 WEST  
PROBERTA, CA 96078

FOR: "ON-LINE CUSTOM MOTORCYCLE RETAIL STORE SERVICES; CUSTOM MOTORCYCLE RETAIL STORE SERVICES", IN CLASS 35 (U.S. CLS. 100, 101 AND 102).

FIRST USE 5-1-2007; IN COMMERCE 5-1-2007.

THE STIPLING IS FOR SHADING PURPOSES ONLY.

THE MARK CONSISTS OF THE TEXT "HISTORICAL 99 WEST" PRINTED ON A DIPCTION OF A STATE HIGHWAY SHIELD, WITH CYLINDER HEADS IN THE BACKGROUND.

SER. NO. 77-392,967, FILED 2-8-2008.

ZACHARY BELLO, EXAMINING ATTORNEY

Int. Cl.: 30

Prior U.S. Cl.: 46

United States Patent and Trademark Office

Reg. No. 3,569,223

Registered Feb. 3, 2009

TRADEMARK  
PRINCIPAL REGISTER



WIEDOW, MICHELLE D. (UNITED STATES INDIVIDUAL)  
211 SADDLE LAKE DRIVE  
ALABASTER, AL 35007

DARK GREEN IS/ARE CLAIMED AS A FEATURE OF THE MARK.

FOR: CANDIES, CHOCOLATE COVERED NUTS, SNACK FOOD, NAMELY, TRAIL MIXES CONSISTING OF MIXED NUTS, KEY LIME PECANS, HONEY ROASTED PECANS, SALTED PECANS, MIXED NUTS, POPCORN, AND HOT CHOCOLATE MIXES, IN CLASS 30 (U.S. CL. 46).

THE MARK CONSISTS OF ACORN TOP DARK BROWN, ACORN BODY YELLOW AND LIGHT BROWN, SQUIRREL EYE BLACK AND WHITE, SQUIRREL TEETH WHITE, SQUIRREL TAIL BROWN, SQUIRREL BODY BROWN, LIGHT BROWN AND DARK BROWN BUSHES DARK GREEN AND GREEN, OUTLINE OF BUSHES YELLOW, WORDS NUT AND CANDY COMPANY BLACK, WORDS SQUIRRELY ACRES BROWN OUTLINED IN BLACK AND WHITE.

FIRST USE 11-20-2007; IN COMMERCE 11-20-2007.

NO CLAIM IS MADE TO THE EXCLUSIVE RIGHT TO USE "NUT AND CANDY COMPANY", APART FROM THE MARK AS SHOWN.

SER. NO. 77-393,274, FILED 2-10-2008.

THE COLOR(S) GREEN, BROWN, YELLOW, BLACK, WHITE, LIGHT BROWN, DARK BROWN,

MIDGE BUTLER, EXAMINING ATTORNEY

**Int. Cl.: 45**

**Prior U.S. Cls.: 100 and 101**

**United States Patent and Trademark Office**

**Reg. No. 3,569,224**

**Registered Feb. 3, 2009**

**SERVICE MARK  
PRINCIPAL REGISTER**

**AS YOU WISH**

CIRCLE COMPANY ASSOCIATES, INC. (DELA-  
WARE CORPORATION)  
300 A STREET, 5TH FLOOR  
BOSTON, MA 02210

FOR: GIFT CONSULTING SERVICES, NAMELY,  
ADVISING OTHERS ABOUT GIFTS AND GIFT  
PACKAGES IN THE FIELDS OF MEALS, FOOD  
AND BEVERAGES, PERSONAL CARE SERVICES,  
PERSONAL CARE PRODUCTS, SPORTS INSTRUC-  
TION, LEISURE ACTIVITIES, JEWELRY, HOUSE-  
HOLD APPLIANCES AND ACCESSORIES, TRAVEL  
ACCESSORIES, AND ART, IN CLASS 45 (U.S. CLS.  
100 AND 101).

FIRST USE 11-30-2004; IN COMMERCE 11-30-2004.

THE MARK CONSISTS OF STANDARD CHAR-  
ACTERS WITHOUT CLAIM TO ANY PARTICULAR  
FONT, STYLE, SIZE, OR COLOR.

OWNER OF U.S. REG. NO. 3,424,800.

SER. NO. 77-394,065, FILED 2-11-2008.

MARIAM MAHMOUDI, EXAMINING ATTORNEY



**Int. Cls.: 1 and 4**

**Prior U.S. Cls.: 1, 5, 6, 10, 15, 26 and 46**

**Reg. No. 3,569,225**

**United States Patent and Trademark Office**

**Registered Feb. 3, 2009**

**TRADEMARK  
PRINCIPAL REGISTER**

# Quality Supreme

WARREN OIL COMPANY, INC. (NORTH CAROLINA CORPORATION)  
POST OFFICE BOX 1507  
DUNN, NC 28334

FOR: BRAKE FLUID, POWER STEERING FLUID AND HYDRAULIC FLUID, IN CLASS 1 (U.S. CLS. 1, 5, 6, 10, 26 AND 46).

FIRST USE 8-0-2000; IN COMMERCE 8-0-2000.

FOR: MOTOR OIL, ENGINE OIL, TRANSMISSION FLUID, GEAR OILS, TRACTOR GEAR OILS, AUTOMOTIVE LUBRICATING AND GENERAL PURPOSE GREASES AND ALL PURPOSE LUBRICANTS, IN CLASS 4 (U.S. CLS. 1, 6 AND 15).

FIRST USE 8-0-2000; IN COMMERCE 8-0-2000.

THE MARK CONSISTS OF STANDARD CHARACTERS WITHOUT CLAIM TO ANY PARTICULAR FONT, STYLE, SIZE, OR COLOR.

OWNER OF U.S. REG. NO. 2,633,671.

NO CLAIM IS MADE TO THE EXCLUSIVE RIGHT TO USE "SUPREME", APART FROM THE MARK AS SHOWN.

SEC. 2(F).

SER. NO. 77-394,089, FILED 2-11-2008.

HANNO RITTNER, EXAMINING ATTORNEY

**Int. Cl.: 41**

**Prior U.S. Cls.: 100, 101 and 107**

**United States Patent and Trademark Office**

**Reg. No. 3,569,226**

**Registered Feb. 3, 2009**

**SERVICE MARK  
PRINCIPAL REGISTER**



AMERICAN ASSOCIATION OF ADAPTED  
SPORTS PROGRAMS, INC. (GEORGIA COR-  
PORATION)  
PO BOX 451047  
ATLANTA, GA 31145

FOR: CHARITABLE SERVICES, NAMELY, PRO-  
VIDING TRAINING IN THE FIELD OF INTRA-  
MURAL SPORTS FOR DISABLED STUDENTS;  
DEVELOPMENT AND DISSEMINATION OF EDU-  
CATIONAL MATERIALS OF OTHERS IN THE  
FIELD OF INTRAMURAL SPORTS FOR DISABLED  
STUDENTS; EDUCATIONAL SERVICES, NAMELY,  
CONDUCTING WORKSHOPS, SEMINARS AND  
CONFERENCES IN THE FIELD OF INTRAMURAL  
SPORTS FOR DISABLED STUDENTS AND DISTRI-  
BUTION OF COURSE MATERIAL IN CONNEC-  
TION THEREWITH; ENCOURAGING AMATEUR  
SPORTS AND PHYSICAL EDUCATION BY ORGA-  
NIZING, PROMOTING, SPONSORING, SANCTION-  
ING, CONDUCTING, ADMINISTERING,  
REGULATING AND GOVERNING AMATEUR  
ATHLETIC PROGRAMS AND ACTIVITIES; ORGA-

NIZING SPORTING EVENTS, NAMELY, INTRA-  
MURAL ACTIVITIES FOR DISABLED STUDENTS,  
IN CLASS 41 (U.S. CLS. 100, 101 AND 107).

FIRST USE 1-11-2006; IN COMMERCE 1-11-2006.

NO CLAIM IS MADE TO THE EXCLUSIVE  
RIGHT TO USE "AMERICAN ASSOCIATION OF  
ADAPTED SPORTS PROGRAMS", APART FROM  
THE MARK AS SHOWN.

THE COLOR(S) BLUE, BLACK AND WHITE IS/  
ARE CLAIMED AS A FEATURE OF THE MARK.

THE MARK CONSISTS OF THE LOGO INSIDE  
THE "O" OF THE WORD "SPORTS".

SER. NO. 77-394,586, FILED 2-12-2008.

FLORENTINA BLANDU, EXAMINING ATTORNEY

**Int. Cl.: 42**

**Prior U.S. Cls.: 100 and 101**

**United States Patent and Trademark Office**

**Reg. No. 3,569,227**

**Registered Feb. 3, 2009**

**SERVICE MARK  
PRINCIPAL REGISTER**

**RELATENOW.COM**

RELATENOW, LLC (WISCONSIN LIMITED LIABILITY COMPANY)  
N8855 BLUE VISTA LANE  
NEW GLARUS, WI 53574

FOR: APPLICATION SERVICE PROVIDER (ASP) FEATURING SOFTWARE FOR USE BY BEHAVIORAL HEALTH PROFESSIONALS AND THEIR CLIENTS, NAMELY, SOFTWARE FOR CASE MANAGEMENT, TRAINING, COMMUNICATION, TREATMENT PLANNING AND PROGRESS TRACKING, IN CLASS 42 (U.S. CLS. 100 AND 101).

FIRST USE 7-1-2005; IN COMMERCE 10-31-2005.

THE MARK CONSISTS OF STANDARD CHARACTERS WITHOUT CLAIM TO ANY PARTICULAR FONT, STYLE, SIZE, OR COLOR.

SER. NO. 77-394,796, FILED 2-12-2008.

BARBARA A. GOLD, EXAMINING ATTORNEY

**Int. Cl.: 35**

**Prior U.S. Cls.: 100, 101 and 102**

**United States Patent and Trademark Office**

**Reg. No. 3,569,228**

**Registered Feb. 3, 2009**

**SERVICE MARK  
PRINCIPAL REGISTER**



CONSTELLATION ENERGY GROUP, INC.  
(MARYLAND CORPORATION)  
750 EAST PRATT STREET  
BALTIMORE, MD 21202

FOR: PROCUREMENT, NAMELY, PURCHASING  
NATURAL GAS FOR OTHERS; CONSULTATION  
SERVICES IN THE FIELDS OF ENERGY CON-  
SUMPTION, ENERGY CONSERVATION AND EN-  
ERGY USE MANAGEMENT; AND ENERGY  
MANAGEMENT SERVICES, NAMELY, FORMU-  
LATING ENERGY CONSUMPTION PLANS TO RE-  
DUCE ENERGY COSTS AND TO REDUCE RISKS

ASSOCIATED WITH CHANGING ENERGY COSTS,  
IN CLASS 35 (U.S. CLS. 100, 101 AND 102).

FIRST USE 9-22-1986; IN COMMERCE 9-22-1986.

NO CLAIM IS MADE TO THE EXCLUSIVE  
RIGHT TO USE "ENERGY MANAGEMENT, INC.",  
APART FROM THE MARK AS SHOWN.

SER. NO. 77-394,809, FILED 2-12-2008.

APRIL ROACH, EXAMINING ATTORNEY

**Int. Cls.: 9, 35, 38 and 42**

**Prior U.S. Cls.: 21, 23, 26, 36, 38, 100, 101, 102 and 104**

**United States Patent and Trademark Office**

**Reg. No. 3,569,229**

**Registered Feb. 3, 2009**

**TRADEMARK  
SERVICE MARK  
PRINCIPAL REGISTER**



PIVOT INCORPORATED (DELAWARE CORPORATION)  
SUITE 610  
10 MILK STREET  
BOSTON, MA 02108

FOR: COMPUTER PROGRAMS FOR INVESTMENT PURPOSES, NAMELY, THE TRANSLATION OF ELECTRONIC CONVERSATIONS INTO FINANCIAL TRANSACTIONS AND TRADING WORKFLOWS; A PLATFORM FOR THE SHARING OF INFORMATION AS A SINGLE UNIT RATHER THAN AS INDIVIDUALS; A PLATFORM OVER WHICH FINANCIAL SERVICE PROFESSIONALS CAN COMMUNICATE, INTEGRATE AND COLLABORATE WITH EXTERNAL AND INTERNAL AUDIENCES IN A FINANCIALLY COMPLIANT ENVIRONMENT; A SYSTEM THAT AGGREGATES AND INTEGRATES INFORMATION AND DATA INTO TRADING WORKFLOWS; CONVERSION OF INSTANT MESSAGES INTO A PLATFORM TO EXECUTE FINANCIAL TRANSACTIONS, IN CLASS 9 (U.S. CLS. 21, 23, 26, 36 AND 38).

FIRST USE 5-15-2007; IN COMMERCE 6-19-2007.

FOR: DATA PROCESSING, NAMELY, AGGREGATING AND INTEGRATING INFORMATION AND DATA INTO TRADING WORKFLOWS, IN CLASS 35 (U.S. CLS. 100, 101 AND 102).

FIRST USE 5-21-2007; IN COMMERCE 6-19-2007.

FOR: COMPUTER SERVICES, NAMELY, PROVIDING ON-LINE FACILITIES OVER WHICH FINANCIAL PROFESSIONALS CAN COMMUNICATE, INTEGRATE AND COLLABORATE WITH EXTERNAL AND INTERNAL AUDIENCES IN A FINANCIALLY COMPLIANT ENVIRONMENT, IN CLASS 38 (U.S. CLS. 100, 101 AND 104).

FIRST USE 5-21-2007; IN COMMERCE 6-19-2007.

FOR: DATA CONVERSION, NAMELY, TRANSLATION OF ELECTRONIC CONVERSATIONS INTO FINANCIAL TRANSACTIONS AND TRADING WORKFLOWS VIA A COMPUTER NETWORK; CONVERSION OF INSTANT MESSAGES INTO A PLATFORM TO EXECUTE FINANCIAL TRANSACTIONS, IN CLASS 42 (U.S. CLS. 100 AND 101).

FIRST USE 5-21-2007; IN COMMERCE 6-19-2007.

THE MARK CONSISTS OF THE WORD "PIVOT" WITH A STYLIZED LETTER "O". THE LETTER "O" DESIGN CONSISTS OF AN INTERNAL POINT SURROUNDED BY STAGGERED CRESCENTS OF INCREASING SIZE PIVOTING AROUND THE CENTER POINT.

SER. NO. 77-394,850, FILED 2-12-2008.

JAMES A. RAUEN, EXAMINING ATTORNEY

**Int. Cl.: 42**

**Prior U.S. Cls.: 100 and 101**

**United States Patent and Trademark Office**

**Reg. No. 3,569,230**

**Registered Feb. 3, 2009**

**SERVICE MARK  
PRINCIPAL REGISTER**

**UNDER THE HOOD**

UNITED BUSINESS MEDIA LLC (DELAWARE  
LIMITED LIABILITY COMPANY)  
600 COMMUNITY DRIVE  
4TH FLOOR  
MANHASSET, NY 11030

FOR: PROVIDING INFORMATION IN THE  
FIELDS OF INFORMATION TECHNOLOGY, HIGH  
TECHNOLOGY, ELECTRONICS AND ENGINEER-  
ING DESIGN, IN CLASS 42 (U.S. CLS. 100 AND 101).

FIRST USE 4-12-2006; IN COMMERCE 4-12-2006.

THE MARK CONSISTS OF STANDARD CHAR-  
ACTERS WITHOUT CLAIM TO ANY PARTICULAR  
FONT, STYLE, SIZE, OR COLOR.

SER. NO. 77-395,343, FILED 2-12-2008.

WILLIAM P. SHANAHAN, EXAMINING ATTOR-  
NEY

**Int. Cl.: 5**

**Prior U.S. Cls.: 6, 18, 44, 46, 51 and 52**

**Reg. No. 3,569,231**

**United States Patent and Trademark Office**

**Registered Feb. 3, 2009**

**TRADEMARK  
PRINCIPAL REGISTER**



SHIJIAZHUANG PHARMACEUTICAL GROUP  
CO., LTD. (CHINA CORPORATION)  
276, ZHONGSHAN WEST ROAD  
SHIJIAZHUANG, CHINA

FOR: PHARMACEUTICAL PREPARATIONS, NAMELY A DRUG DELIVERY SYSTEM COMPRISING POLYMER-BASED ORAL TABLETS FOR THE CONTINUOUS RELEASE OF A WIDE VARIETY OF THERAPEUTIC AGENTS; PHARMACEUTICAL PREPARATIONS ACTING ON THE CENTRAL NERVOUS SYSTEM; PHARMACEUTICAL PREPARATIONS AND SUBSTANCES FOR THE TREATMENT OF GASTRO-INTESTINAL DISEASES; PHARMACEUTICAL PREPARATIONS FOR OCULAR OR INTRAOCULAR SURGERY; PHARMACEUTICAL PREPARATIONS FOR THE TREATMENT OF HORMONAL DISORDERS AND THE PREVENTION OF OSTEOPOROSIS; PHARMACEUTICAL PREPARATIONS FOR TREATING ALLERGIC RHINITIS AND ASTHMA; PHARMACEUTICAL PREPARATIONS FOR TREATING DIABETES; PHARMACEUTICAL PREPARATIONS FOR USE IN UROLOGY; PHARMACEUTICAL PREPARATIONS FOR THE TREATMENT OF EYE DISEASES AND CONDITIONS; PHARMACEUTICAL PREPARATIONS FOR THE PREVENTION AND TREATMENT OF DISORDERS OF THE NERVOUS SYSTEM, THE IMMUNE SYSTEM, THE CARDIO-VASCULAR SYSTEM, THE METABOLIC SYSTEM, THE RESPIRATORY SYSTEM, THE MUSCULO-SKELETAL SYSTEM, THE GENITOURINARY SYSTEM; FOR

THE TREATMENT OF INFLAMMATORY DISORDERS; FOR USE IN DERMATOLOGY, ONCOLOGY, HEMATOLOGY AND IN TISSUE AND ORGAN TRANSPLANTATION, IN OPHTHALMOLOGY AND FOR GASTROENTEROLOGICAL DISORDERS; PHARMACEUTICAL PREPARATIONS FOR THE PREVENTION AND TREATMENT OF OCULAR DISORDERS OR DISEASES, FOR THE TREATMENT OF BACTERIA-BASED DISEASES, AND FOR THE TREATMENT OF DIABETES, AND ANTI-INFECTIVE PREPARATIONS, ANTIVIRAL PREPARATIONS, ANTIBIOTICS, ANTIFUNGAL PREPARATIONS AND VACCINES; MIXED VITAMIN PREPARATIONS; MULTI-VITAMIN PREPARATIONS; VITAMIN AND MINERAL PREPARATIONS FOR MEDICAL USE; VITAMIN B PREPARATIONS, VITAMIN C PREPARATIONS; VITAMIN D PREPARATIONS; VITAMINS AND VITAMIN PREPARATIONS; ANALGESICS; DIETETIC FOODS ADAPTED FOR MEDICAL USE; NUTRITIONAL ADDITIVES FOR MEDICAL PURPOSES FOR USE IN FOODS AND DIETARY SUPPLEMENTS FOR HUMAN CONSUMPTION; TRANQUILIZERS; BIOCHEMICAL PREPARATIONS FOR MEDICAL OR VETERINARY PURPOSES; DIAGNOSTIC PREPARATIONS FOR MEDICAL AND VETERINARY USE; MEDICINAL DRINKS; DIET PILLS, SLEEPING PILLS, ANTIBIOTICS; BIOLOGICAL PREPARATIONS FOR MEDICAL PURPOSES, IN CLASS 5 (U.S. CLS. 6, 18, 44, 46, 51 AND 52).

FIRST USE 7-0-2000; IN COMMERCE 7-0-2000.

THE COLOR(S) BLACK, RED, WHITE AND GRAY IS/ARE CLAIMED AS A FEATURE OF THE MARK.

THE MARK CONSISTS OF THE WORD "CSPC" IS BLACK, THE BACKDROP OF THE SQUARE DE-

VICE IS RED, AND THERE ARE TWO PARALLEL BIASES IN THE SQUARE, LEFT ONE IS WHITE, RIGHT ONE IS GRAY .

SER. NO. 77-395,511, FILED 2-13-2008.

PRISCILLA MILTON, EXAMINING ATTORNEY



**Int. Cl.: 25**

**Prior U.S. Cls.: 22 and 39**

**United States Patent and Trademark Office**

**Reg. No. 3,569,232**

**Registered Feb. 3, 2009**

**TRADEMARK  
PRINCIPAL REGISTER**

**XTREME-TEK**

UNITED RETAIL INCORPORATED (DELAWARE  
CORPORATION)  
365 WEST PASSAIC STREET  
ROCHELLE PARK, NJ 07662

THE MARK CONSISTS OF STANDARD CHAR-  
ACTERS WITHOUT CLAIM TO ANY PARTICULAR  
FONT, STYLE, SIZE, OR COLOR.

FOR: OUTERWEAR, NAMELY, COATS AND  
JACKETS, IN CLASS 25 (U.S. CLS. 22 AND 39).

SER. NO. 77-396,030, FILED 2-13-2008.

FIRST USE 9-0-2005; IN COMMERCE 9-0-2005.

LINDA ESTRADA, EXAMINING ATTORNEY

**Int. Cl.: 36**

**Prior U.S. Cls.: 100, 101 and 102**

**United States Patent and Trademark Office**

**Reg. No. 3,569,233**

**Registered Feb. 3, 2009**

**SERVICE MARK  
PRINCIPAL REGISTER**



AMERICAN EXPRESS INCENTIVE SERVICES  
LLC (MISSOURI LIMITED LIABILITY COM-  
PANY)  
1309 NORTH HIGHWAY DRIVE  
FENTON, MO 63099

FOR: ISSUING STORED VALUE CARDS, IN  
CLASS 36 (U.S. CLS. 100, 101 AND 102).

FIRST USE 10-1-2006; IN COMMERCE 10-1-2006.

OWNER OF U.S. REG. NO. 3,370,872.

THE LINING IS A FEATURE OF THE MARK  
AND DOES NOT INDICATE COLOR.

THE MARK CONSISTS OF 3 TRIANGLES FORM-  
ING ONE LARGER SLANTED TRIANGLE AND  
WORDS "PORTICO" WITH A TRIANGLE OVER  
THE LETTER "I".

SER. NO. 77-397,322, FILED 2-14-2008.

TEJBIR SINGH, EXAMINING ATTORNEY

**Int. Cl.: 33**

**Prior U.S. Cls.: 47 and 49**

**United States Patent and Trademark Office**

**Reg. No. 3,569,234**

**Registered Feb. 3, 2009**

**TRADEMARK  
PRINCIPAL REGISTER**

**AGAVE CENTURIA**

SALAZAR, ARMANDO (MEXICO INDIVIDUAL)  
AV HIDALGO 1870-A  
GUADALAJARA, MEXICO 44650

FOR: ALCOHOLIC BEVERAGES, NAMELY, TE-  
QUILA, IN CLASS 33 (U.S. CLS. 47 AND 49).

THE MARK CONSISTS OF STANDARD CHAR-  
ACTERS WITHOUT CLAIM TO ANY PARTICULAR  
FONT, STYLE, SIZE, OR COLOR.

OWNER OF MEXICO REG. NO. 1017429, DATED  
11-13-2007, EXPIRES 11-13-2017.

NO CLAIM IS MADE TO THE EXCLUSIVE  
RIGHT TO USE "AGAVE", APART FROM THE  
MARK AS SHOWN.

THE ENGLISH TRANSLATION OF THE SPANISH  
TERM "CENTURIA" IN THE MARK IS "CENTU-  
RY". "AGAVE" IS A PLANT.

SER. NO. 77-397,541, FILED 2-14-2008.

RAUL CORDOVA, EXAMINING ATTORNEY

**Int. Cl.: 25**

**Prior U.S. Cls.: 22 and 39**

**United States Patent and Trademark Office**

**Reg. No. 3,569,235**

**Registered Feb. 3, 2009**

**TRADEMARK  
PRINCIPAL REGISTER**

**UNCOMMON THREADS**

V-TEX, INC. (ILLINOIS CORPORATION)  
1027 BUSCH PARKWAY  
BUFFALO GROVE, IL 60089

FOR: CLOTHING, NAMELY, UNIFORMS, WORK AND UTILITY SHIRTS, WORK AND UTILITY TROUSERS, WORK AND UTILITY COATS; APRONS; SMOCKS AND SCRUBS NOT FOR MEDICAL PURPOSES; HATS, CAPS AND BEANIES; NECKERCHIEFS, IN CLASS 25 (U.S. CLS. 22 AND 39).

FIRST USE 8-15-2003; IN COMMERCE 8-15-2003.

THE MARK CONSISTS OF STANDARD CHARACTERS WITHOUT CLAIM TO ANY PARTICULAR FONT, STYLE, SIZE, OR COLOR.

OWNER OF U.S. REG. NO. 2,868,001.

NO CLAIM IS MADE TO THE EXCLUSIVE RIGHT TO USE "THREADS", APART FROM THE MARK AS SHOWN.

SER. NO. 77-397,583, FILED 2-14-2008.

HOWARD B. LEVINE, EXAMINING ATTORNEY

**Int. Cls.: 35 and 39**

**Prior U.S. Cls.: 100, 101, 102 and 105**

**United States Patent and Trademark Office**

**Reg. No. 3,569,236**

**Registered Feb. 3, 2009**

**SERVICE MARK  
PRINCIPAL REGISTER**

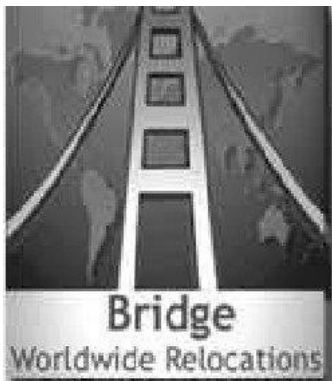

BRIDGE WORLDWIDE RELOCATIONS, LLC  
(CALIFORNIA LIMITED LIABILITY COMPAN-  
NY)  
18809 COX AVENUE, SUITE 250  
SARATOGA, CA 95070

FOR: PERSONNEL RELOCATION SERVICES  
FOR BUSINESS, NAMELY, PLANNING AND IM-  
PLEMENTING MOVES OF PERSONNEL AND  
THEIR FAMILIES, IN CLASS 35 (U.S. CLS. 100, 101  
AND 102).

FIRST USE 1-1-2002; IN COMMERCE 1-1-2002.

FOR: TRAVEL ARRANGEMENT SERVICES,  
NAMELY, ARRANGING FOR TRAVEL VISAS  
AND TRAVEL DOCUMENTS FOR PERSONS TRA-  
VELING OR RELOCATING ABROAD, IN CLASS 39  
(U.S. CLS. 100 AND 105).

FIRST USE 1-1-2002; IN COMMERCE 1-1-2002.

NO CLAIM IS MADE TO THE EXCLUSIVE  
RIGHT TO USE "WORLDWIDE RELOCATIONS",  
APART FROM THE MARK AS SHOWN.

THE MARK CONSISTS OF THE WORDS  
"BRIDGE WORLDWIDE RELOCATIONS", ABOVE  
WHICH IS A REPRESENTATION OF A BRIDGE  
TOWER BEHIND WHICH IS A MAP OF THE  
WORLD.

SER. NO. 77-397,707, FILED 2-14-2008.

SUSAN LESLIE DUBOIS, EXAMINING ATTORNEY

Int. Cl.: 32

Prior U.S. Cls.: 45, 46 and 48

Reg. No. 3,569,237

United States Patent and Trademark Office

Registered Feb. 3, 2009

TRADEMARK  
PRINCIPAL REGISTER

The logo consists of the lowercase letters 'gn&r' in a stylized, cursive script font. The 'g' is a simple lowercase 'g'. The 'n' is a simple lowercase 'n'. The ampersand is a simple, stylized ampersand. The 'r' is a simple lowercase 'r'.

GNAR JUICE COMPANY, INC. (DELAWARE  
CORPORATION)  
SUITE C114  
1500 FIRST AVENUE NORTH  
BIRMINGHAM, AL 35203

FOR: FRUIT JUICES AND FRUIT DRINKS, IN  
CLASS 32 (U.S. CLS. 45, 46 AND 48).

FIRST USE 12-10-2007; IN COMMERCE 12-10-2007.

THE MARK CONSISTS OF THE WORD GNAR  
WITH THE SCRIPT STYLED ON LETTERS OF THE  
ARMENIAN ALPHABET.

THE TERM "GNAR" HAS NO MEANING IN A  
FOREIGN LANGUAGE.

SER. NO. 77-399,313, FILED 2-18-2008.

PATRICIA EVANKO, EXAMINING ATTORNEY

Int. Cl.: 42

Prior U.S. Cls.: 100 and 101

United States Patent and Trademark Office

Reg. No. 3,569,238

Registered Feb. 3, 2009

**SERVICE MARK  
PRINCIPAL REGISTER**



NUMAL TECHNOLOGIES, INC. (VIRGINIA CORPORATION)  
SUITE 105  
1984 ISAAC NEWTON SQUARE WEST  
RESTON, VA 20190

FOR: CUSTOM DESIGN AND DEVELOPMENT OF COMPUTER SOFTWARE FOR USE IN WEB BASED HOTEL BOOKING, WEB HOSTING, AND CONSULTING SERVICES IN CONNECTION THEREWITH, IN CLASS 42 (U.S. CLS. 100 AND 101).

FIRST USE 10-1-2006; IN COMMERCE 10-1-2006.

THE COLOR(S) BLUE, BLACK AND WHITE IS/ ARE CLAIMED AS A FEATURE OF THE MARK.

THE MARK CONSISTS OF A STYLIZED "N" DESIGN WITH CONCENTRIC CIRCLES BRANCHING OUT FROM THE CENTER, EACH CIRCLE BEING A LIGHTER SHADE OF BLUE THAN THE ONE IMMEDIATELY INSIDE IT. AT THE CENTER OF "N" DESIGN IS A WHITE ARROW. BENEATH THE DESIGN IS THE WORD "NUMAL" IN A STYLIZED BLACK FONT.

SER. NO. 77-402,749, FILED 2-21-2008.

RUSS HERMAN, EXAMINING ATTORNEY

**Int. Cl.: 9**

**Prior U.S. Cls.: 21, 23, 26, 36 and 38**

**Reg. No. 3,569,239**

**United States Patent and Trademark Office**

**Registered Feb. 3, 2009**

**TRADEMARK  
PRINCIPAL REGISTER**

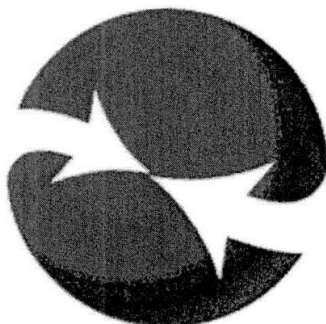

BIA INFORMATION NETWORK, LLC (VIRGINIA LIMITED LIABILITY COMPANY)  
SUITE 100  
15120 ENTERPRISE COURT  
CHANTILLY, VA 20151

FOR: CUSTOMIZABLE COMPUTER SOFTWARE DOWNLOADABLE FROM A COMPUTER DATABASE, THE INTERNET, OR AN ELECTRONIC NETWORK THAT RUNS AS A COMPONENT OF A COMPUTER DESKTOP FOR USE IN TRANSMITTING, DISSEMINATING, AND DISPLAYING INFORMATION IN THE NATURE OF LIVE WEATHER CONDITIONS, WEATHER FORECASTS, WEATHER ALERTS, NETWORK-SPECIFIC MESSAGES AND NOTIFICATIONS, TARGETED ADVERTISING AND MARKETING COMMUNICATIONS, SECURITY AND EMERGENCY MANAGEMENT ALERTS AND INFORMATION, AND ENTERTAINMENT INFORMATION; COMPUTER SOFTWARE FOR AGGREGATING, DISSEMINATING, TRANSMITTING AND DISPLAYING SITE-SPECIFIC LIVE WEATHER CONDITIONS, WEATHER FORECASTS, WEATHER ALERTS, AND OTHER WEATHER RELATED INFORMATION BY MEANS OF A GLOBAL COMPUTER NETWORK TO A DESKTOP SOFTWARE APPLICATION; COMPUTER SOFTWARE FOR CREATION AND MANAGEMENT OF MESSAGES AND NOTIFICATIONS; COMPUTER NOTIFICATION SOFTWARE FOR PROVIDING EVENT, EMERGENCY MANAGEMENT, BREAKING NEWS, AND MARKETING-RELATED NOTIFICATIONS TO APPLICATION USERS; COMPUTER ADVERTISING AND MARKETING SOFTWARE FOR MANAGEMENT OF TARGETED ADVISORY AND MARKETING COMMUNICATIONS; COMPUTER

SOFTWARE PROVIDING A USER WITH COMPUTER-BASED INFORMATION, NEWS, WEATHER, AND LICENSEE-RELATED CONTENT DISSEMINATION SERVICES AT A SPECIFIC TIME; COMPUTER SOFTWARE PROVIDING A USER WITH ENTERTAINMENT SERVICES, NAMELY, RSS FEEDS, VIDEO, HTML LINKS, WEATHER, GAMES, AND OTHER LICENSEE-RELATED CONTENT; COMPUTER SOFTWARE FOR UPLOADING GRAPHICAL, TEXT, AUDIO AND/OR VIDEO CONTENT FOR END-USER VIEW AND CONSUMPTION VIA A DESKTOP WEB-ENABLED APPLICATION; COMPUTER SOFTWARE FOR STREAMING GRAPHICAL, TEXT, AUDIO AND/OR VIDEO CONTENT FOR END-USER VIEW AND CONSUMPTION VIA A DESKTOP WEB-ENABLED APPLICATION; COMPUTER SOFTWARE PROVIDING AUDIO AND/OR VIDEO PLAYBACK CAPABILITY; COMPUTER GRAPHICS AND ANIMATION SOFTWARE; COMPUTER SOFTWARE FOR USING THE INTERNET AND WORLD WIDE WEB; COMPUTER SOFTWARE FOR PROVIDING ELECTRONIC ADVERTISEMENTS SPACE FOR OTHERS AND PLACING ADVERTISEMENTS FOR OTHERS IN A DESKTOP SOFTWARE APPLICATION; COMPUTER SOFTWARE FOR THE COLLECTION, EDITING, ORGANIZING, MODIFYING, BOOK MARKING, TRANSMISSION, STORAGE AND SHARING OF DATA AND INFORMATION, IN CLASS 9 (U.S. CLS. 21, 23, 26, 36 AND 38).

FIRST USE 8-29-2007; IN COMMERCE 9-21-2007.

THE MARK CONSISTS OF AN ORB SURROUNDED BY TWO ARROWS.



SER. NO. 77-402,765, FILED 2-21-2008.

CAROLYN GRAY, EXAMINING ATTORNEY

Int. Cl.: 9

Prior U.S. Cls.: 21, 23, 26, 36 and 38

Reg. No. 3,569,240

United States Patent and Trademark Office

Registered Feb. 3, 2009

TRADEMARK  
PRINCIPAL REGISTER

The logo for VITESTA features a stylized satellite dish icon above the word "vitesta" in a lowercase, bold, sans-serif font.

A-DATA TECHNOLOGY CO., LTD. (TAIWAN CORPORATION)  
18F, NO.258, LIAN CHENG RD.  
CHUNG HO CI, TAIPEI, TAIWAN

FOR: COMPUTER HARDWARE; MEMORIES AND MEMORY MODULES FOR COMPUTERS AND OTHER ELECTRONIC DEVICES, NAMELY, MEMORY CARDS, FLASH MEMORY CARDS, FLASH MEMORY DISKS, DRAM (DYNAMIC RANDOM ACCESS MEMORY) CARDS, RAM (RANDOM ACCESS MEMORY) CARDS, COMPUTER MEMORIES, DATA MEMORIES, ELECTRONIC MEMORIES, SEMI-CONDUCTOR MEMORY UNITS, BLANK DIGITAL CARDS FOR COMPUTERS, DIGITAL MEMORY CARDS; DISC MEMORIES; COMPACT DISC READ-ONLY MEMORY DRIVES; DISC DRIVES FOR COMPUTERS; MAGNETIC DISK DRIVES; OPTICAL DISC READING AND RECORDING APPARATUS; READING APPARATUS FOR MAGNETIC CARDS, DISKS AND TAPES; ELECTRICAL, ELECTRO-TECHNICAL AND ELECTRONIC DEVICES, NAMELY, DATA INPUT, DATA PROCESSING, DATA TRANSMISSION, DATA STORAGE AND DATA OUTPUT DEVICES; DISC DRIVE CONTROL-

TERS; INTERFACE CARDS FOR COMPUTERS AND ELECTRICAL APPARATUS; INTEGRATED CIRCUITS; INTEGRATED CIRCUIT BOARDS; SEMICONDUCTORS; CAMERAS; DIGITAL CAMERAS; VIDEO CAMERAS; DIGITAL AUDIO PLAYERS; MP3 PLAYERS; CHIP CARD READERS; ELECTRONIC CARD READERS; FLASH CARD READERS; SMART CARD READERS; DIGITAL PHOTO FRAMES FOR DISPLAYING DIGITAL PICTURES, VIDEO CLIPS AND MUSIC, IN CLASS 9 (U.S. CLS. 21, 23, 26, 36 AND 38).

FIRST USE 6-30-2007; IN COMMERCE 8-31-2007.

THE MARK CONSISTS OF THE STYLIZED WORDING "VITESTA" WITH A DESIGN AS THE DOT OVER THE LETTER "I".

THE MARK "VITESTA" HAS NO MEANING IN A FOREIGN LANGUAGE.

SER. NO. 77-403,461, FILED 2-22-2008.

ANDREA HACK, EXAMINING ATTORNEY

**Int. Cls.: 25 and 28**

**Prior U.S. Cls.: 22, 23, 38, 39 and 50**

**United States Patent and Trademark Office**

**Reg. No. 3,569,241**

**Registered Feb. 3, 2009**

**TRADEMARK  
PRINCIPAL REGISTER**

**23<sup>e</sup> SPORT**

KABUSHIKI KAISHA ONWARD HOLDINGS (JAPAN JOINT STOCK COMPANY), DBA ONWARD HOLDINGS CO., LTD.  
10-5 NIHONBASHI 3-CHOME, CHUO-KU  
TOKYO, JAPAN

FOR: CLOTHING, NAMELY, SUITS, COATS, JACKETS, SHIRTS, T-SHIRTS, DRESSES, SKIRTS, BLOUSES, TROUSERS, PANTS, SHORTS, JUMPERS, SWEATERS, CARDIGANS, VESTS, UNDERCLOTHES, PAJAMAS, BATH ROBES, SWIMSUITS, GOLF WEAR, NAMELY, GOLF CLEATS, GOLF TROUSERS, GOLF SHIRTS, GOLF SPIKES, GOLF RAINWEAR, BELTS FOR GOLF CLOTHING, GOLF CAPS, SUN VISORS FOR GOLF AND GOLF SKIRTS, ANORAKS, UNIFORMS, WRISTBANDS; FOOTWEAR, NAMELY, SHOES, SLIPPERS, SPORT SHOES, GOLF SHOES, SNEAKERS; SOCKS, STOCKINGS; HEADGEAR, NAMELY, CAPS, HATS, VEILS, SUN VISORS; GLOVES FOR CLOTHING, BELTS FOR CLOTHING, APRONS, IN CLASS 25 (U.S. CLS. 22 AND 39).

FOR: GOLF CLUBS, GOLF BALLS, GOLF BAGS, GOLF BALL MARKERS, GOLF TEES, GOLF GLOVES, PARAGLIDERS, HANG GLIDERS, DOLLS, IN CLASS 28 (U.S. CLS. 22, 23, 38 AND 50).

PRIORITY CLAIMED UNDER SEC. 44(D) ON JAPAN APPLICATION NO. 2008-008147, FILED 2-6-2008, REG. NO. 5159819, DATED 8-15-2008, EXPIRES 8-15-2018.

OWNER OF JAPAN REG. NO. 4967553, DATED 7-7-2006, EXPIRES 7-7-2016.

OWNER OF U.S. REG. NO. 3,358,427.

NO CLAIM IS MADE TO THE EXCLUSIVE RIGHT TO USE "SPORT" , APART FROM THE MARK AS SHOWN.

SER. NO. 77-403,976, FILED 2-22-2008.

CARRIE GENOVESE, EXAMINING ATTORNEY

**Int. Cl.: 20**

**Prior U.S. Cls.: 2, 13, 22, 25, 32 and 50**

**United States Patent and Trademark Office**

**Reg. No. 3,569,242**

**Registered Feb. 3, 2009**

**TRADEMARK  
PRINCIPAL REGISTER**

**DREAM MATE**

NATURA WORLD INC. (CANADA CORPORATION)  
ONE NATURA WAY  
CAMBRIDGE, ONTARIO N3C 0A4

FOR: BEDDING PRODUCTS, NAMELY, PILLOWS, IN CLASS 20 (U.S. CLS. 2, 13, 22, 25, 32 AND 50).

THE MARK CONSISTS OF STANDARD CHARACTERS WITHOUT CLAIM TO ANY PARTICULAR FONT, STYLE, SIZE, OR COLOR.

OWNER OF CANADA REG. NO. TMA613567, DATED 6-23-2004, EXPIRES 6-23-2019.

OWNER OF U.S. REG. NOS. 3,031,349 AND 3,046,745.

SER. NO. 77-404,193, FILED 2-22-2008.

BRIDGETT SMITH, EXAMINING ATTORNEY

**Int. Cl.: 28**

**Prior U.S. Cls.: 22, 23, 38 and 50**

**Reg. No. 3,569,243**

**United States Patent and Trademark Office**

**Registered Feb. 3, 2009**

---

**TRADEMARK  
PRINCIPAL REGISTER**

**CONCEPT ARCHERY**

WILLE, KURT (UNITED STATES INDIVIDUAL)  
148 OLD CROTON RD  
FLEMINGTON, NJ 08822 AND  
KNITTEL, JONATHAN (UNITED STATES INDIVIDUAL)  
134 JACKSON VALLEY RD  
OXFORD, NJ 07863

FOR: ARCHERY BOWS; BOWS FOR ARCHERY,  
IN CLASS 28 (U.S. CLS. 22, 23, 38 AND 50).

FIRST USE 1-29-2008; IN COMMERCE 1-29-2008.

THE MARK CONSISTS OF STANDARD CHARACTERS WITHOUT CLAIM TO ANY PARTICULAR FONT, STYLE, SIZE, OR COLOR.

NO CLAIM IS MADE TO THE EXCLUSIVE RIGHT TO USE "ARCHERY", APART FROM THE MARK AS SHOWN.

SER. NO. 77-404,612, FILED 2-23-2008.

LIEF MARTIN, EXAMINING ATTORNEY

**Int. Cl.: 20**

**Prior U.S. Cls.: 2, 13, 22, 25, 32 and 50**

**Reg. No. 3,569,244**

**United States Patent and Trademark Office**

**Registered Feb. 3, 2009**

---

**TRADEMARK  
PRINCIPAL REGISTER**

**ALL STAR FRAME SERIES**

NORTH AMERICAN ENCLOSURES, INC. (NEW  
YORK CORPORATION)

65 JETSON LANE

CENTRAL ISLIP, NY 11722

FOR: PICTURE FRAMES, IN CLASS 20 (U.S. CLS.  
2, 13, 22, 25, 32 AND 50).

FIRST USE 2-13-2008; IN COMMERCE 2-13-2008.

THE MARK CONSISTS OF STANDARD CHAR-  
ACTERS WITHOUT CLAIM TO ANY PARTICULAR  
FONT, STYLE, SIZE, OR COLOR.

NO CLAIM IS MADE TO THE EXCLUSIVE  
RIGHT TO USE "FRAME SERIES", APART FROM  
THE MARK AS SHOWN.

SER. NO. 77-404,931, FILED 2-25-2008.

MARK SPARACINO, EXAMINING ATTORNEY

**Int. Cl.: 42**

**Prior U.S. Cls.: 100 and 101**

**United States Patent and Trademark Office**

**Reg. No. 3,569,245**

**Registered Feb. 3, 2009**

**SERVICE MARK  
PRINCIPAL REGISTER**



REAGAN SMITH ENERGY SOLUTIONS, INC.  
(OKLAHOMA CORPORATION)  
1219 CLASSEN DRIVE  
OKLAHOMA CITY, OK 73103

FOR: OIL AND GAS CONSULTING, IN CLASS 42  
(U.S. CLS. 100 AND 101).

FIRST USE 1-1-2007; IN COMMERCE 1-1-2007.

NO CLAIM IS MADE TO THE EXCLUSIVE  
RIGHT TO USE "ENERGY SOLUTIONS, INC.",  
APART FROM THE MARK AS SHOWN.

THE NAME "REAGAN SMITH" DOES NOT IDENTIFY  
A LIVING INDIVIDUAL.

THE COLOR(S) BLUE, WHITE, AND GREEN IS/  
ARE CLAIMED AS A FEATURE OF THE MARK.

THE MARK CONSISTS OF ON THE LEFT, A  
HORIZONTALLY SPLIT CIRCLE WITH A BLUE  
TOP AND GREEN BOTTOM WITH THREE WHITE  
CUT OUTS GOING AROUND THE EDGE OF THE  
CIRCLE, ONE ON THE LEFT SIDE OF THE BOT-  
TOM HALF, ONE ON THE RIGHT SIDE GOING  
THROUGH THE GREEN AND BLUE AND ONE ON  
THE LEFT SIDE OF THE TOP HALF AND TO THE  
RIGHT OF THE TOP HALF OF THE CIRCLE ARE  
THE WORDS IN GREEN "REAGAN SMITH" WITH  
A GREEN LINE UNDERNEATH AND UNDER THE  
LINE ARE THE WORDS, IN BLUE "ENERGY  
SOLUTIONS, INC."

SER. NO. 77-405,434, FILED 2-25-2008.

PAUL E. FAHRENKOPF, EXAMINING ATTORNEY

**Int. Cl.: 5**

**Prior U.S. Cls.: 6, 18, 44, 46, 51 and 52**

**Reg. No. 3,569,246**

**United States Patent and Trademark Office**

**Registered Feb. 3, 2009**

**TRADEMARK  
PRINCIPAL REGISTER**

**CENOVIS**

CENOVIS HEALTH CO PTY LTD (AUSTRALIA  
COMPANY)  
LEVEL 7, 5 QUEENS ROAD  
MELBOURNE, 3004 VIC, AUSTRALIA

FOR: PHARMACEUTICAL PRODUCTS AND  
PREPARATIONS FOR THE TREATMENT OF AR-  
THRITIS, IRON DEFICIENCY, SKIN WOUNDS,  
FREE RADICAL DAMAGE, COLD SYMPTOMS,  
UPPER RESPIRATORY TRACT INFECTIONS,  
COUGHS, CATARRH, SINUSITIS, MENTAL OR  
PHYSICAL FATIGUE, PREMENSTRUAL SYN-  
DROME, IRRITABLE BOWEL SYNDROME, IN-  
SOMNIA, NERVOUS TENSION, STRESS,  
IRRITABILITY, MILD ANXIETY, AND DIGESTIVE  
DISORDERS; NUTRITIONAL SUPPLEMENTS;

DIETARY SUPPLEMENTS, IN CLASS 5 (U.S. CLS.  
6, 18, 44, 46, 51 AND 52).

THE MARK CONSISTS OF STANDARD CHAR-  
ACTERS WITHOUT CLAIM TO ANY PARTICULAR  
FONT, STYLE, SIZE, OR COLOR.

OWNER OF AUSTRALIA REG. NO. 563003, DA-  
TED 9-3-1991, EXPIRES 9-3-2018.

OWNER OF U.S. REG. NOS. 2,542,313 AND  
2,616,256.

SER. NO. 77-405,935, FILED 2-26-2008.

GILBERT SWIFT, EXAMINING ATTORNEY



**Int. Cl.: 41**

**Prior U.S. Cls.: 100, 101 and 107**

**United States Patent and Trademark Office**

**Reg. No. 3,569,247**

**Registered Feb. 3, 2009**

**SERVICE MARK  
PRINCIPAL REGISTER**

**AL ROKER ENTERTAINMENT**

AL ROKER ENTERTAINMENT, INC. (NEW  
YORK CORPORATION)  
SUITE 1525  
250 WEST 57TH STREET  
NEW YORK, NY 10019

FOR: TELEVISION PRODUCTION; DISTRIBUTION OF TELEVISION PROGRAMS FOR OTHERS, IN CLASS 41 (U.S. CLS. 100, 101 AND 107).

FIRST USE 9-9-1999; IN COMMERCE 9-9-1999.

THE MARK CONSISTS OF STANDARD CHARACTERS WITHOUT CLAIM TO ANY PARTICULAR FONT, STYLE, SIZE, OR COLOR.

NO CLAIM IS MADE TO THE EXCLUSIVE RIGHT TO USE "ENTERTAINMENT", APART FROM THE MARK AS SHOWN.

THE NAME(S), PORTRAIT(S), AND/OR SIGNATURE(S) SHOWN IN THE MARK IDENTIFIES A LIVING INDIVIDUAL, WHOSE CONSENT(S) TO REGISTER IS SUBMITTED.

SER. NO. 77-406,863, FILED 2-26-2008.

BENJAMIN OKEKE, EXAMINING ATTORNEY

**Int. Cl.: 33**

**Prior U.S. Cls.: 47 and 49**

**United States Patent and Trademark Office**

**Reg. No. 3,569,248**

**Registered Feb. 3, 2009**

**TRADEMARK  
PRINCIPAL REGISTER**

SAN ANTONIO WINERY HERITAGE

SAN ANTONIO WINERY, INC. (CALIFORNIA  
CORPORATION)  
737 LAMAR STREET  
LOS ANGELES, CA 90031

NO CLAIM IS MADE TO THE EXCLUSIVE  
RIGHT TO USE "WINERY", APART FROM THE  
MARK AS SHOWN.

FOR: WINE, IN CLASS 33 (U.S. CLS. 47 AND 49).

SEC. 2(F) AS TO "SAN ANTONIO".

FIRST USE 10-6-2006; IN COMMERCE 1-9-2007.

SER. NO. 77-407,649, FILED 2-27-2008.

THE MARK CONSISTS OF STANDARD CHAR-  
ACTERS WITHOUT CLAIM TO ANY PARTICULAR  
FONT, STYLE, SIZE, OR COLOR.

RUSS HERMAN, EXAMINING ATTORNEY

**Int. Cl.: 5**

**Prior U.S. Cls.: 6, 18, 44, 46, 51 and 52**

**Reg. No. 3,569,249**

**United States Patent and Trademark Office**

**Registered Feb. 3, 2009**

**TRADEMARK  
PRINCIPAL REGISTER**

**COFLEX·AFD**

ANDOVER HEALTHCARE, INC. (MASSACHU-  
SETTS CORPORATION)  
9 FANARAS DRIVE  
SALISBURY, MA 01952

THE MARK CONSISTS OF STANDARD CHAR-  
ACTERS WITHOUT CLAIM TO ANY PARTICULAR  
FONT, STYLE, SIZE, OR COLOR.

FOR: A HYDROPHILIC FOAM PAD USED AS A  
DRESSING IN WOUND CARE FOR BOTH ANI-  
MALS AND HUMANS, IN CLASS 5 (U.S. CLS. 6, 18,  
44, 46, 51 AND 52).

OWNER OF U.S. REG. NO. 1,758,160.

SER. NO. 77-408,532, FILED 2-28-2008.

FIRST USE 10-24-2007; IN COMMERCE 10-24-2007.

JAMES STEIN, EXAMINING ATTORNEY

Int. Cls.: 41 and 45

Prior U.S. Cls.: 100, 101 and 107

United States Patent and Trademark Office

Reg. No. 3,569,250

Registered Feb. 3, 2009

**SERVICE MARK  
PRINCIPAL REGISTER**



VOLUNTEER SERVICES FOR ANIMALS  
(RHODE ISLAND NON-PROFIT CORPORATION)

27 DRYDEN LANE  
PROVIDENCE, RI 02904

FOR: DEVELOPMENT AND DISSEMINATION OF EDUCATIONAL MATERIALS OF OTHERS IN THE COMMUNITY IN THE FIELD OF ANIMAL WELL-BEING; EDUCATIONAL AND ENTERTAINMENT SERVICES, NAMELY, PROVIDING MOTIVATIONAL AND EDUCATIONAL SPEAKERS TO THE COMMUNITY ON ANIMAL WELL-BEING, IN CLASS 41 (U.S. CLS. 100, 101 AND 107).

FIRST USE 3-6-1980; IN COMMERCE 3-6-1980.

FOR: REUNITING LOST ANIMALS AND THEIR OWNERS; FACILITATING PET ADOPTIONS, IN CLASS 45 (U.S. CLS. 100 AND 101).

FIRST USE 3-6-1980; IN COMMERCE 3-6-1980.

NO CLAIM IS MADE TO THE EXCLUSIVE RIGHT TO USE "VOLUNTEER SERVICES FOR ANIMALS", APART FROM THE MARK AS SHOWN.

THE MARK CONSISTS OF A RACCOON AND DOG FACING EACH OTHER WITH THE WORDS "VOLUNTEER SERVICES FOR ANIMALS" POSITIONED THEREUNDER.

SER. NO. 77-408,913, FILED 2-28-2008.

LINDA MICKLEBURGH, EXAMINING ATTORNEY

**Int. Cl.: 28**

**Prior U.S. Cls.: 22, 23, 38 and 50**

**United States Patent and Trademark Office**

**Reg. No. 3,569,251**

**Registered Feb. 3, 2009**

**TRADEMARK  
PRINCIPAL REGISTER**

**POD ROCKET**

TIPPMANN SPORTS, LLC (DELAWARE LIMITED LIABILITY COMPANY)  
2955 ADAMS CENTER ROAD  
FORT WAYNE, IN 46803

FOR: PAINTBALLS IN THE SHAPE OF HAND GRENADES FOR PLAYING PAINTBALL GAMES, IN CLASS 28 (U.S. CLS. 22, 23, 38 AND 50).

FIRST USE 1-1-2004; IN COMMERCE 2-1-2004.

THE MARK CONSISTS OF STANDARD CHARACTERS WITHOUT CLAIM TO ANY PARTICULAR FONT, STYLE, SIZE, OR COLOR.

NO CLAIM IS MADE TO THE EXCLUSIVE RIGHT TO USE "POD", APART FROM THE MARK AS SHOWN.

SER. NO. 77-409,492, FILED 2-29-2008.

LOURDES AYALA, EXAMINING ATTORNEY

**Int. Cl.: 28**

**Prior U.S. Cls.: 22, 23, 38 and 50**

**United States Patent and Trademark Office**

**Reg. No. 3,569,252**

**Registered Feb. 3, 2009**

**TRADEMARK  
PRINCIPAL REGISTER**

**BOOBY BOMB**

TIPPMANN SPORTS, LLC (DELAWARE LIMITED LIABILITY COMPANY)  
2955 ADAMS CENTER ROAD  
FORT WAYNE, IN 46803

FOR: PAINTBALLS IN THE SHAPE OF HAND GRENADES FOR PLAYING PAINTBALL GAMES, IN CLASS 28 (U.S. CLS. 22, 23, 38 AND 50).

FIRST USE 1-1-2004; IN COMMERCE 2-1-2004.

THE MARK CONSISTS OF STANDARD CHARACTERS WITHOUT CLAIM TO ANY PARTICULAR FONT, STYLE, SIZE, OR COLOR.

NO CLAIM IS MADE TO THE EXCLUSIVE RIGHT TO USE "BOMB", APART FROM THE MARK AS SHOWN.

SER. NO. 77-409,499, FILED 2-29-2008.

LOURDES AYALA, EXAMINING ATTORNEY

**Int. Cl.: 36**

**Prior U.S. Cls.: 100, 101 and 102**

**United States Patent and Trademark Office**

**Reg. No. 3,569,253**

**Registered Feb. 3, 2009**

**SERVICE MARK  
PRINCIPAL REGISTER**

**OPTHOME**

OPTNOW REAL ESTATE CORPORATION (DE-  
LAWARE CORPORATION)  
144 TURNPIKE STREET, SUITE 370  
SOUTHBOROUGH, MA 01772

FOR: RESOURCE AND SUPPORT SERVICES TO  
HOMEOWNERS, NAMELY, REAL ESTATE CON-  
SULTATION REGARDING SALE AND PURCHASE  
ADVICE, REAL ESTATE FINANCING ADVICE;  
AND REAL ESTATE BROKERAGE SERVICES,  
NAMELY, BROKERING REAL ESTATE OPTIONS,  
IN CLASS 36 (U.S. CLS. 100, 101 AND 102).

FIRST USE 6-1-2007; IN COMMERCE 6-1-2007.

THE MARK CONSISTS OF STANDARD CHAR-  
ACTERS WITHOUT CLAIM TO ANY PARTICULAR  
FONT, STYLE, SIZE, OR COLOR.

SER. NO. 77-409,810, FILED 2-29-2008.

WILLIAM P. SHANAHAN, EXAMINING ATTOR-  
NEY

**Int. Cl.: 36**

**Prior U.S. Cls.: 100, 101 and 102**

**United States Patent and Trademark Office**

**Reg. No. 3,569,254**

**Registered Feb. 3, 2009**

**SERVICE MARK  
PRINCIPAL REGISTER**



OPTNOW REAL ESTATE CORPORATION (DE-  
LAWARE CORPORATION)  
144 TURNPIKE STREET, SUITE 370  
SOUTHBOROUGH, MA 01772

FOR: RESOURCE AND SUPPORT SERVICES TO  
HOMEOWNERS, NAMELY, REAL ESTATE CON-  
SULTATION REGARDING SALE AND PURCHASE  
ADVICE, REAL ESTATE FINANCING ADVICE;  
AND REAL ESTATE BROKERAGE SERVICES,  
NAMELY, BROKERING REAL ESTATE OPTIONS,  
IN CLASS 36 (U.S. CLS. 100, 101 AND 102).

FIRST USE 6-1-2007; IN COMMERCE 6-1-2007.

THE MARK CONSISTS OF STYLIZED WORDS  
"OPT HOME" AND IN THE MIDDLE A HOUSE  
INSIDE A CIRCLE.

SER. NO. 77-409,817, FILED 2-29-2008.

WILLIAM P. SHANAHAN, EXAMINING ATTOR-  
NEY



**Int. Cl.: 9**

**Prior U.S. Cls.: 21, 23, 26, 36 and 38**

**Reg. No. 3,569,255**

**United States Patent and Trademark Office**

**Registered Feb. 3, 2009**

**TRADEMARK  
PRINCIPAL REGISTER**

**IFIT**

CONFORMIS, INC. (DELAWARE CORPORATION)  
2 FOURTH AVE.  
BURLINGTON, MA 01803

FOR: COMPUTER SOFTWARE WHICH CONVERTS RADIOGRAPHIC IMAGING DATA INTO PATIENT-SPECIFIC MEDICAL IMPLANTS AND INSTRUMENTATION FOR USE IN ORTHOPEDIC SURGERY, IN CLASS 9 (U.S. CLS. 21, 23, 26, 36 AND 38).

FIRST USE 6-0-2007; IN COMMERCE 7-0-2007.

THE MARK CONSISTS OF STANDARD CHARACTERS WITHOUT CLAIM TO ANY PARTICULAR FONT, STYLE, SIZE, OR COLOR.

SER. NO. 77-409,883, FILED 2-29-2008.

LESLEY LAMOTHE, EXAMINING ATTORNEY

**Int. Cl.: 44**

**Prior U.S. Cls.: 100 and 101**

**United States Patent and Trademark Office**

**Reg. No. 3,569,256**

**Registered Feb. 3, 2009**

**SERVICE MARK  
PRINCIPAL REGISTER**

**TMSARANG ACUPUNCTURE &  
MOXIBUSTION RESEARCH  
INSTITUTE**

YONG SEOK KIM (REPUBLIC OF KOREA IN-  
DIVIDUAL)  
937 S. CRENSHAW BOULEVARD  
LOS ANGELES, CA 90019

FOR: ACUPUNCTURE SERVICES, IN CLASS 44  
(U.S. CLS. 100 AND 101).

FIRST USE 2-10-2006; IN COMMERCE 2-10-2006.

THE MARK CONSISTS OF STANDARD CHAR-  
ACTERS WITHOUT CLAIM TO ANY PARTICULAR  
FONT, STYLE, SIZE, OR COLOR.

OWNER OF U.S. REG. NO. 3,315,769.

NO CLAIM IS MADE TO THE EXCLUSIVE  
RIGHT TO USE "ACUPUNCTURE & MOXIBUS-  
TION RESEARCH INSTITUTE", APART FROM THE  
MARK AS SHOWN.

THE ENGLISH TRANSLATION OF THE KOR-  
EAN WORDS "TM" AND "SARANG" IN THE MARK  
ARE MOXIBUSTION AND LOVE, RESPECTIVELY,  
THOUGH "TMSARANG" HAS NO MEANING IN A  
FOREIGN LANGUAGE.

SER. NO. 77-411,415, FILED 3-3-2008.

MARY MUNSON, EXAMINING ATTORNEY

**Int. Cl.: 9**

**Prior U.S. Cls.: 21, 23, 26, 36 and 38**

**Reg. No. 3,569,257**

**United States Patent and Trademark Office**

**Registered Feb. 3, 2009**

**TRADEMARK  
PRINCIPAL REGISTER**

**STERILCHEMGARD**

THE BAKER COMPANY (MAINE CORPORATION)  
PO DRAWER E  
161 GATEHOUSE ROAD  
SANFORD, ME 04073

FOR: EXHAUST WORK CABINET AND HOOD WITH HEPA FILTERS FOR LABORATORY USE FOR USE IN CREATING PARTICULATE FREE STERILE AIR FLOW THROUGHOUT WORK AREA, IN CLASS 9 (U.S. CLS. 21, 23, 26, 36 AND 38).

FIRST USE 6-1-1988; IN COMMERCE 6-1-1988.

THE MARK CONSISTS OF STANDARD CHARACTERS WITHOUT CLAIM TO ANY PARTICULAR FONT, STYLE, SIZE, OR COLOR.

SER. NO. 77-411,418, FILED 3-3-2008.

KIMBERLY PERRY, EXAMINING ATTORNEY

**Int. Cl.: 24**

**Prior U.S. Cls.: 42 and 50**

**United States Patent and Trademark Office**

**Reg. No. 3,569,258**

**Registered Feb. 3, 2009**

**TRADEMARK  
PRINCIPAL REGISTER**

**COMPRINO**

BOULDER APPAREL LIMITED (NEW ZEALAND  
COMPANY)  
146 BRIDGE STREET  
NELSON, NEW ZEALAND

FOR: TEXTILES AND FABRICS, NAMELY, FAB-  
RICS FOR TEXTILE USE; KNITTED WOOL AND  
KNITTED WOOL COMPOSITES FOR CLOTHING,  
NAMELY, WOOL BASED MIXED FABRICS, IN  
CLASS 24 (U.S. CLS. 42 AND 50).

THE MARK CONSISTS OF STANDARD CHAR-  
ACTERS WITHOUT CLAIM TO ANY PARTICULAR  
FONT, STYLE, SIZE, OR COLOR.

PRIORITY CLAIMED UNDER SEC. 44(D) ON  
NEW ZEALAND APPLICATION NO. 781684, FILED  
12-19-2007, REG. NO. 781684, DATED 12-19-2007,  
EXPIRES 12-19-2017.

THE ENGLISH TRANSLATION OF "COMPRINO"  
IN THE MARK IS "THEY BUY".

SER. NO. 77-412,595, FILED 3-4-2008.

ANDREW RHIM, EXAMINING ATTORNEY

**Int. Cl.: 41**

**Prior U.S. Cls.: 100, 101 and 107**

**United States Patent and Trademark Office**

**Reg. No. 3,569,259**

**Registered Feb. 3, 2009**

**SERVICE MARK  
PRINCIPAL REGISTER**

*Where Italy Comes Alive!*

GENEROSO POPE FOUNDATION, INC. (NEW  
YORK CORPORATION)  
ONE GENEROSO POPE PLACE  
TUCKAHOE, NY 10707

FOR: ORGANIZATION OF NON-PROFIT ETH-  
NIC HERITAGE EVENTS AND CULTURAL EDU-  
CATION AND FESTIVITIES, IN CLASS 41 (U.S. CLS.  
100, 101 AND 107).

FIRST USE 9-18-2007; IN COMMERCE 2-1-2008.

THE MARK CONSISTS OF ITALICIZED PHRASE  
WITH EXCLAMATION POINT.

SER. NO. 77-413,233, FILED 3-5-2008.

LINDA ESTRADA, EXAMINING ATTORNEY

Int. Cl.: 37

Prior U.S. Cls.: 100, 103 and 106

United States Patent and Trademark Office

Reg. No. 3,569,260

Registered Feb. 3, 2009

SERVICE MARK  
PRINCIPAL REGISTER



DEUTSCHE TELEKOM (FED REP GERMANY  
AG CORPORATION)  
FRIEDRICH-EBERT-ALLEE 140  
BONN, FED REP GERMANY 53113

FOR: BUILDING CONSTRUCTION; INSTALLA-  
TION OF COMPUTER AND TELECOMMUNICA-  
TIONS SYSTEMS, NETWORKS AND HARDWARE;  
REPAIR AND MAINTENANCE OF COMPUTER  
AND TELECOMMUNICATIONS SYSTEMS, NET-  
WORKS AND HARDWARE, IN CLASS 37 (U.S.  
CLS. 100, 103 AND 106).

PRIORITY CLAIMED UNDER SEC. 44(D) ON FED  
REP GERMANY APPLICATION NO. 30758552,  
FILED 9-6-2007, REG. NO. 30758552, DATED 1-17-  
2008, EXPIRES 9-30-2017.

OWNER OF U.S. REG. NOS. 3,190,981 AND  
3,219,373.

THE COLOR(S) MAGENTA, WHITE IS/ARE  
CLAIMED AS A FEATURE OF THE MARK.

THE MARK CONSISTS OF A MAGENTA REC-  
TANGLE CONTAINING THE WORDING "QUALI-  
FIED PARTNER" IN WHITE. IN THE BOTTOM  
SECTION, THE COLOR WHITE APPEARS AS THE  
BACKGROUND AND THE COLOR MAGENTA  
APPEARS IN THE 10 SMALL SQUARES AND  
LETTER "T".

SER. NO. 77-414,736, FILED 3-6-2008.

CYNTHIA SLOAN, EXAMINING ATTORNEY

**Int. Cl.: 35**

**Prior U.S. Cls.: 100, 101 and 102**

**United States Patent and Trademark Office**

**Reg. No. 3,569,261**

**Registered Feb. 3, 2009**

**SERVICE MARK  
PRINCIPAL REGISTER**

where the future takes  
shape

NATIONAL ASSOCIATION OF REALTORS (IL-  
LINOIS CORPORATION)  
LEGAL AFFAIRS DEPARTMENT  
430 N. MICHIGAN AVE.  
CHICAGO, IL 60611

FOR: ASSOCIATION SERVICES, NAMELY, PRO-  
MOTING THE INTERESTS OF REAL ESTATE  
AGENTS WHO SPECIALIZE IN THE NEEDS OF  
MATURE AMERICANS, IN CLASS 35 (U.S. CLS. 100,  
101 AND 102).

FIRST USE 6-1-2007; IN COMMERCE 6-1-2007.

THE MARK CONSISTS OF STANDARD CHAR-  
ACTERS WITHOUT CLAIM TO ANY PARTICULAR  
FONT, STYLE, SIZE, OR COLOR.

SER. NO. 77-415,274, FILED 3-6-2008.

MARY BOAGNI, EXAMINING ATTORNEY

**Int. Cl.: 35**

**Prior U.S. Cls.: 100, 101 and 102**

**United States Patent and Trademark Office**

**Reg. No. 3,569,262**

**Registered Feb. 3, 2009**

**SERVICE MARK  
PRINCIPAL REGISTER**



CITY OF BROKEN ARROW, OKLAHOMA (OKLAHOMA MUNICIPAL CORPORATION)  
220 SOUTH FIRST STREET  
BROKEN ARROW, OK 74013

FOR: PROMOTING TOURISM AND BUSINESS INVESTMENT REGARDING BROKEN ARROW, OKLAHOMA, IN CLASS 35 (U.S. CLS. 100, 101 AND 102).

FIRST USE 1-15-2008; IN COMMERCE 1-15-2008.

THE COLOR(S) ORANGE AND BLUE IS/ARE CLAIMED AS A FEATURE OF THE MARK.

THE MARK CONSISTS OF AN ORANGE STYLIZED CIRCLE, WITH A BLUE BOW AND BLUE ARROW.

SER. NO. 77-417,705, FILED 3-10-2008.

KHANH LE, EXAMINING ATTORNEY



**Int. Cls.: 3 and 5**

**Prior U.S. Cls.: 1, 4, 6, 18, 44, 46, 50, 51 and 52**

**United States Patent and Trademark Office**

**Reg. No. 3,569,263**

**Registered Feb. 3, 2009**

**TRADEMARK  
PRINCIPAL REGISTER**

**MISSILOR**

PIERRE FABRE MEDICAMENT (FRANCE SOCI-  
ETE ANONYME (SA))  
45, PLACE ABEL GANCE  
BOULOGNE, FRANCE 92100

FOR: SKIN SOAPS; PERFUMES; ESSENTIAL OILS  
FOR PERSONAL USE; COSMETICS, NAMELY,  
SKIN CREAMS, OILS, SKIN GELS, MILKS, LO-  
TIONS AND SKIN EMULSIONS; MAKEUP, NAME-  
LY, MASCARA, EYESHADOW, AND ROUGE; NON-  
MEDICATED HAIR CARE PREPARATIONS; AND  
DENTIFRICES, IN CLASS 3 (U.S. CLS. 1, 4, 6, 50, 51  
AND 52).

FOR: PHARMACEUTICAL PREPARATIONS FOR  
THE PREVENTION AND TREATMENT OF DISOR-  
DERS AND DISEASES OF THE CENTRAL NER-  
VOUS SYSTEM AND IMMUNOLOGICAL SYSTEM;  
ANTIBIOTICS; MEDICATED SKIN LOTIONS AND

SKIN CREAMS; AND DIETARY FOOD SUPPLE-  
MENTS, IN CLASS 5 (U.S. CLS. 6, 18, 44, 46, 51 AND  
52).

THE MARK CONSISTS OF STANDARD CHAR-  
ACTERS WITHOUT CLAIM TO ANY PARTICULAR  
FONT, STYLE, SIZE, OR COLOR.

OWNER OF FRANCE REG. NO. 92/445,282, DA-  
TED 12-1-1992, RENEWED AS REG. NO. 92445282,  
DATED 10-10-2002, EXPIRES 10-10-2012.

OWNER OF U.S. REG. NO. 2,557,877.

SER. NO. 77-417,925, FILED 3-10-2008.

TOBY BULLOFF, EXAMINING ATTORNEY

**Int. Cl.: 30**

**Prior U.S. Cl.: 46**

**United States Patent and Trademark Office**

**Reg. No. 3,569,264**

**Registered Feb. 3, 2009**

**TRADEMARK  
PRINCIPAL REGISTER**

**PAISANO**

STANISLAUS PARTNERS (CALIFORNIA LIMITED PARTNERSHIP)  
P.O. BOX 3951  
MODESTO, CA 95352

FOR: TOMATO-BASED SAUCES, IN CLASS 30 (U.S. CL. 46).

FIRST USE 8-27-1997; IN COMMERCE 8-27-1997.

THE MARK CONSISTS OF STANDARD CHARACTERS WITHOUT CLAIM TO ANY PARTICULAR FONT, STYLE, SIZE, OR COLOR.

OWNER OF U.S. REG. NO. 1,497,888.

THE FOREIGN WORDING IN THE MARK TRANSLATES INTO ENGLISH AS COUNTRYMAN.

SER. NO. 77-418,176, FILED 3-10-2008.

CHRISTINE BLOMQUIST, EXAMINING ATTORNEY

**Int. Cl.: 41**

**Prior U.S. Cls.: 100, 101 and 107**

**United States Patent and Trademark Office**

**Reg. No. 3,569,265**

**Registered Feb. 3, 2009**

**SERVICE MARK  
PRINCIPAL REGISTER**

**YOUTH HAVEN**

YOUTH HAVEN, INC. (MICHIGAN NON-PROFIT CORPORATION)  
3796 PERRINE RD., P.O. BOX 97  
RIVES JUNCTION, MI 49277

FOR: RECREATION, SPORT AND SWIMMING CAMPS, EDUCATIONAL SERVICES, NAMELY, CONDUCTING INDOOR AND OUTDOOR CLASSES, SEMINARS, CONFERENCES, WORKSHOPS IN THE FIELDS OF ARTS AND CRAFTS, ATHLETICS, INDOOR AND OUTDOOR RECREATION, RELIGION AND DRUG AWARENESS FOR YOUNG PEOPLE, AND DISTRIBUTING COURSE MATERIALS IN CONNECTION THEREWITH, IN CLASS 41 (U.S. CLS. 100, 101 AND 107).

FIRST USE 6-14-1968; IN COMMERCE 5-0-1969.

THE MARK CONSISTS OF STANDARD CHARACTERS WITHOUT CLAIM TO ANY PARTICULAR FONT, STYLE, SIZE, OR COLOR.

NO CLAIM IS MADE TO THE EXCLUSIVE RIGHT TO USE "YOUTH", APART FROM THE MARK AS SHOWN.

SER. NO. 77-418,441, FILED 3-11-2008.

DORITT L. CARROLL, EXAMINING ATTORNEY

**Int. Cl.: 35**

**Prior U.S. Cls.: 100, 101 and 102**

**United States Patent and Trademark Office**

**Reg. No. 3,569,266**

**Registered Feb. 3, 2009**

**SERVICE MARK  
PRINCIPAL REGISTER**

**TRANSWORLD MEDIA**

TRANSWORLD MAGAZINE CORPORATION  
(NEW YORK CORPORATION)  
353 AIRPORT ROAD  
OCEANSIDE, CA 92054

FOR: MARKETING AND ADVERTISING SERVICES; DISSEMINATION OF ADVERTISING MATERIAL IN PRINT AND ONLINE; PROVIDING ADVERTISING SPACE IN MAGAZINES AND ONLINE; ADVERTISING SERVICES, NAMELY, PROMOTING THE GOODS AND SERVICES OF THIRD PARTIES THROUGH ALL PUBLIC COMMUNICATION MEANS, IN CLASS 35 (U.S. CLS. 100, 101 AND 102).

FIRST USE 5-31-2000; IN COMMERCE 5-31-2000.

THE MARK CONSISTS OF STANDARD CHARACTERS WITHOUT CLAIM TO ANY PARTICULAR FONT, STYLE, SIZE, OR COLOR.

OWNER OF U.S. REG. NOS. 2,307,131, 2,382,801 AND OTHERS.

NO CLAIM IS MADE TO THE EXCLUSIVE RIGHT TO USE "MEDIA", APART FROM THE MARK AS SHOWN.

SER. NO. 77-418,650, FILED 3-11-2008.

CHRISTINE BLOMQUIST, EXAMINING ATTORNEY

**Int. Cl.: 35**

**Prior U.S. Cls.: 100, 101 and 102**

**United States Patent and Trademark Office**

**Reg. No. 3,569,267**

**Registered Feb. 3, 2009**

**SERVICE MARK  
PRINCIPAL REGISTER**

# Three Buckets

PILKO & ASSOCIATES, LP (TEXAS LIMITED  
PARTNERSHIP)  
700 LOUISIANA STREET, #4500  
HOUSTON, TX 77002

FOR: MANAGEMENT AND BUSINESS CON-  
SULTING SERVICES IN THE FIELD OF ENVIRON-  
MENTAL, HEALTH & SAFETY, IN CLASS 35 (U.S.  
CLS. 100, 101 AND 102).

FIRST USE 1-0-2005; IN COMMERCE 1-0-2005.

THE MARK CONSISTS OF STANDARD CHAR-  
ACTERS WITHOUT CLAIM TO ANY PARTICULAR  
FONT, STYLE, SIZE, OR COLOR.

SER. NO. 77-420,329, FILED 3-12-2008.

LOURDES AYALA, EXAMINING ATTORNEY

**Int. Cls.: 9 and 42**

**Prior U.S. Cls.: 21, 23, 26, 36, 38, 100 and 101**

**United States Patent and Trademark Office**

**Reg. No. 3,569,268**

**Registered Feb. 3, 2009**

**TRADEMARK  
SERVICE MARK  
PRINCIPAL REGISTER**

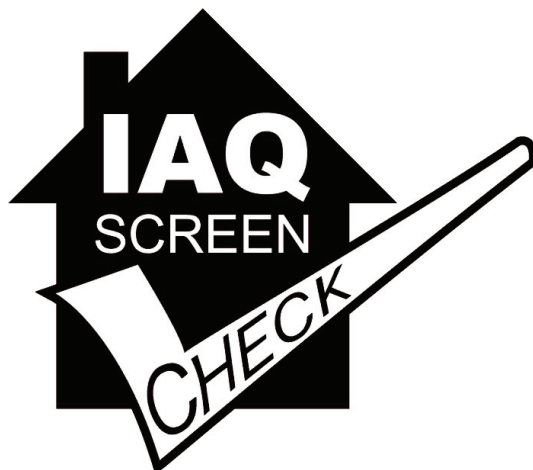

PURE AIR CONTROL SERVICES, INC. (FLORIDA CORPORATION)  
4911 CREEKSIDE DRIVE  
CLEARWATER, FL 33760

FOR: INDOOR AIR ANALYSIS APPARATUS; ELECTRONIC-BASED INSTRUMENTS FOR MEASURING ENVIRONMENTAL PARAMETERS INCLUDING AIR QUALITY; AIR QUALITY TEST SAMPLING KITS COMPRISED OF PARTICLE COUNTERS, HIGH VOLUME PUMP, BIO-AEROSOL SAMPLER, WALL MOISTURE METER, AEROBIOLOGY CASSETTES, SURFACE MICROSCOPY PREPARATIONS, DUST ALLERGEN SCREEN, MILLIPORE CASSETTES, TELESCOPIC STAND, DIGITAL TIMER, VINYL TUBING, AND A CARRYING CASE SOLD AS A UNIT, IN CLASS 9 (U.S. CLS. 21, 23, 26, 36 AND 38).

FIRST USE 2-1-2007; IN COMMERCE 2-1-2007.

FOR: INDOOR ENVIRONMENTAL SERVICES, NAMELY, AIR QUALITY TESTING AND EVALUATION, IN CLASS 42 (U.S. CLS. 100 AND 101).

FIRST USE 2-1-2007; IN COMMERCE 2-1-2007.

NO CLAIM IS MADE TO THE EXCLUSIVE RIGHT TO USE "IAQ SCREEN" AND "CHECK", APART FROM THE MARK AS SHOWN.

THE MARK CONSISTS OF THE WORDING "IAQ SCREEN" WHICH APPEARS ON AN OUTLINE OF A HOUSE, AND THE WORD "CHECK" APPEARS ON A CHECK MARK THAT EXTENDS OVER A PORTION OF THE HOUSE DESIGN.

SER. NO. 77-420,760, FILED 3-13-2008.

CHRISTINE BLOMQUIST, EXAMINING ATTORNEY

**Int. Cl.: 33**

**Prior U.S. Cls.: 47 and 49**

**United States Patent and Trademark Office**

**Reg. No. 3,569,269**

**Registered Feb. 3, 2009**

**TRADEMARK  
PRINCIPAL REGISTER**

**KURA SELECTIONS**

VINO DEL SOL, INC. (MISSISSIPPI CORPORATION)  
P.O. BOX 1575  
CORINTH, MS 38835

FOR: SAKE, IN CLASS 33 (U.S. CLS. 47 AND 49).

FIRST USE 9-5-2008; IN COMMERCE 9-5-2008.

THE MARK CONSISTS OF STANDARD CHARACTERS WITHOUT CLAIM TO ANY PARTICULAR FONT, STYLE, SIZE, OR COLOR.

NO CLAIM IS MADE TO THE EXCLUSIVE RIGHT TO USE "SELECTIONS", APART FROM THE MARK AS SHOWN.

THE FOREIGN WORDING IN THE MARK TRANSLATES INTO ENGLISH AS WAREHOUSE.

SER. NO. 77-422,343, FILED 3-14-2008.

NANCY CLARKE, EXAMINING ATTORNEY

**Int. Cl.: 10**

**Prior U.S. Cls.: 26, 39 and 44**

**Reg. No. 3,569,270**

**United States Patent and Trademark Office**

**Registered Feb. 3, 2009**

**TRADEMARK  
PRINCIPAL REGISTER**

**ONE WELLNESS**

ONE WELLNESS, LLC (MONTANA LIMITED  
LIABILITY COMPANY)  
7 WEST 6TH AVENUE  
SUITE 3D  
HELENA, MT 59601

FIRST USE 3-12-2008; IN COMMERCE 3-12-2008.

FOR: ORTHOPEDIC ARTICLES, NAMELY, LUM-  
BAR SUPPORT APPARATUS, NAMELY, PILLOWS  
AND CUSHIONS; THERAPEUTIC EXERCISE  
EQUIPMENT, NAMELY, STRENGTH-BUILDING,  
STRETCHING AND CARDIO-AEROBIC EQUIP-  
MENT; AND ORTHOPEDIC FOOTWEAR, INSOLES  
AND SOCKS, IN CLASS 10 (U.S. CLS. 26, 39 AND 44).

THE MARK CONSISTS OF STANDARD CHAR-  
ACTERS WITHOUT CLAIM TO ANY PARTICULAR  
FONT, STYLE, SIZE, OR COLOR.

SER. NO. 77-422,759, FILED 3-14-2008.

MICHELE SWAIN, EXAMINING ATTORNEY



Int. Cls.: 36, 43 and 45

Prior U.S. Cls.: 100, 101 and 102

United States Patent and Trademark Office

Reg. No. 3,569,271

Registered Feb. 3, 2009

SERVICE MARK  
PRINCIPAL REGISTER

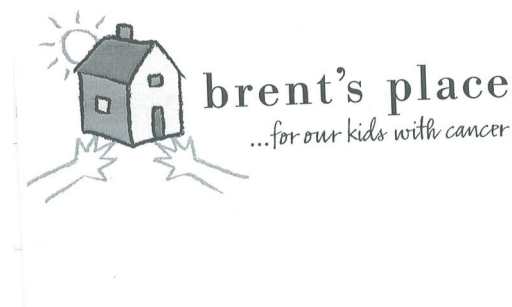

BRENT ELEY FOUNDATION (COLORADO NON-PROFIT CORPORATION)  
1728 DOWNING STREET  
DENVER, CO 80218

FOR: MEMORIAL AND CHARITABLE FUND-RAISING; MEMORIAL AND CHARITABLE FUND-RAISING THROUGH SPORTS TOURNAMENTS, IN CLASS 36 (U.S. CLS. 100, 101 AND 102).

FIRST USE 9-0-2002; IN COMMERCE 9-0-2002.

FOR: PROVIDING TEMPORARY HOUSING FOR CHILDREN AND THEIR FAMILIES SUFFERING CHILDHOOD ILLNESS, IN CLASS 43 (U.S. CLS. 100 AND 101).

FIRST USE 9-0-2002; IN COMMERCE 9-0-2002.

FOR: PROVIDING PERSONAL SUPPORT SERVICES FOR FAMILIES OF PATIENTS WITH LIFE

THREATENING DISORDERS, NAMELY, COMPANIONSHIP, HELP WITH MEDICAL FORMS, COUNSELING AND EMOTIONAL SUPPORT, IN CLASS 45 (U.S. CLS. 100 AND 101).

FIRST USE 9-0-2002; IN COMMERCE 9-0-2002.

OWNER OF U.S. REG. NOS. 2,426,476 AND 2,426,484.

THE MARK CONSISTS OF A HOUSE WITH A SUN PEEKING OVER THE ROOF AND TWO STYLIZED HANDS REACHING TOWARD THE HOUSE TO THE LEFT OF THE STACKED WORDING "BRENT'S PLACE" AND "...FOR OUR KIDS WITH CANCER".

SER. NO. 77-423,146, FILED 3-16-2008.

JAMES LOVELACE, EXAMINING ATTORNEY

**Int. Cl.: 35**

**Prior U.S. Cls.: 100, 101 and 102**

**United States Patent and Trademark Office**

**Reg. No. 3,569,272**

**Registered Feb. 3, 2009**

**SERVICE MARK  
PRINCIPAL REGISTER**

**Man on the Street Marketing**

MITCHELL, LINDBERG AND TAYLOR (GEORGIA CORPORATION)  
4020 EAST PONCE DE LEON AVENUE  
CLARKSTON, GA 30021

FOR: ADVERTISING AGENCIES, NAMELY, PROMOTING THE GOODS AND SERVICES OF OTHERS; CONSUMER RESEARCH; MARKET RESEARCH; ADVERTISING AND PUBLICITY SERVICES, NAMELY, PROMOTING THE GOODS, SERVICES, BRAND IDENTITY AND COMMERCIAL INFORMATION AND NEWS OF THIRD PARTIES THROUGH PRINT, AUDIO, VIDEO, DIGITAL AND ON-LINE MEDIUM; ADVERTISING, MARKETING AND PROMOTION SERVICES; ADVERTISING AND MARKETING; ADVERTISING SERVICES, NAMELY, PROMOTING AND MARKETING THE GOODS AND SERVICES OF OTHERS THROUGH ALL PUBLIC COMMUNICATION MEANS; CONDUCTING BUSINESS AND MARKET RESEARCH SURVEYS; CREATION OF MARKETING TOOLS DESIGNED TO INCREASE A CLIENT COMPANY'S KNOWLEDGE OF CUSTOMER NEEDS, AND ITS COMPETITORS' PRODUCTS AND SERVICES, PRICING, ADVERTISING STRATEGY AND SALES STRATEGY; MARKET RESEARCH SERVICES; MARKET RESEARCH STUDIES; MARKET STUDY AND ANALYSIS OF

MARKET STUDIES; ADVERTISING AND PROMOTION SERVICES AND RELATED CONSULTING; ADVERTISING AND PROMOTIONAL SERVICES; DEVELOPING PROMOTIONAL CAMPAIGNS FOR BUSINESS; ORGANISATION OF PROMOTIONS USING AUDIOVISUAL MEDIA; PRODUCING PROMOTIONAL VIDEOTAPES, VIDEO DISCS, AND AUDIO VISUAL RECORDINGS; PROMOTION USING AUDIOVISUAL MEDIA; PROMOTING THE SALE OF GOODS AND SERVICES OF OTHERS THROUGH THE DISTRIBUTION OF PRINTED MATERIAL AND PROMOTIONAL CONTESTS, IN CLASS 35 (U.S. CLS. 100, 101 AND 102).

FIRST USE 3-12-2008; IN COMMERCE 3-12-2008.

THE MARK CONSISTS OF STANDARD CHARACTERS WITHOUT CLAIM TO ANY PARTICULAR FONT, STYLE, SIZE, OR COLOR.

NO CLAIM IS MADE TO THE EXCLUSIVE RIGHT TO USE "MARKETING", APART FROM THE MARK AS SHOWN.

SER. NO. 77-423,352, FILED 3-17-2008.

ANN E. SAPPENFIELD, EXAMINING ATTORNEY

**Int. Cl.: 41**

**Prior U.S. Cls.: 100, 101 and 107**

**United States Patent and Trademark Office**

**Reg. No. 3,569,273**

**Registered Feb. 3, 2009**

**SERVICE MARK  
PRINCIPAL REGISTER**

# Man on the Street Productions

MITCHELL, LINDBERG & TAYLOR, INC.  
(GEORGIA CORPORATION)  
4020 EAST PONCE DE LEON AVENUE  
CLARKSTON, GA 30021

FOR: FILM AND VIDEO PRODUCTION; MEDIA  
PRODUCTION SERVICES, NAMELY, VIDEO AND  
FILM PRODUCTION; VIDEO TAPE FILM PRODUC-  
TION, IN CLASS 41 (U.S. CLS. 100, 101 AND 107).

FIRST USE 3-12-2008; IN COMMERCE 3-12-2008.

THE MARK CONSISTS OF STANDARD CHAR-  
ACTERS WITHOUT CLAIM TO ANY PARTICULAR  
FONT, STYLE, SIZE, OR COLOR.

NO CLAIM IS MADE TO THE EXCLUSIVE  
RIGHT TO USE "PRODUCTIONS", APART FROM  
THE MARK AS SHOWN.

SER. NO. 77-423,357, FILED 3-17-2008.

ANN E. SAPPENFIELD, EXAMINING ATTORNEY

**Int. Cls.: 1 and 32**

**Prior U.S. Cls.: 1, 5, 6, 10, 26, 45, 46 and 48**

**United States Patent and Trademark Office**

**Reg. No. 3,569,274**

**Registered Feb. 3, 2009**

**TRADEMARK  
PRINCIPAL REGISTER**

**CRYSTALBROOK**

BROOKSHIRE GROCERY COMPANY (TEXAS  
CORPORATION)  
1600 W.S.W. LOOP 323  
TYLER, TX 75701

FOR: DISTILLED WATER, IN CLASS 1 (U.S. CLS.  
1, 5, 6, 10, 26 AND 46).

FIRST USE 5-0-2005; IN COMMERCE 5-0-2005.

FOR: DRINKING WATER; SPRING WATER , IN  
CLASS 32 (U.S. CLS. 45, 46 AND 48).

FIRST USE 5-0-2005; IN COMMERCE 5-0-2005.

THE MARK CONSISTS OF STANDARD CHAR-  
ACTERS WITHOUT CLAIM TO ANY PARTICULAR  
FONT, STYLE, SIZE, OR COLOR.

OWNER OF U.S. REG. NO. 3,171,076.

SER. NO. 77-424,652, FILED 3-18-2008.

ALICIA COLLINS, EXAMINING ATTORNEY

**Int. Cls.: 12 and 25**

**Prior U.S. Cls.: 19, 21, 22, 23, 31, 35, 39 and 44**

**United States Patent and Trademark Office**

**Reg. No. 3,569,275**

**Registered Feb. 3, 2009**

**TRADEMARK  
PRINCIPAL REGISTER**

**MIKELSON YACHTS**

MIKELSON YACHTS, INC. (CALIFORNIA CORPORATION)  
SUITE 202  
2330 SHELTER ISLAND DRIVE  
SAN DIEGO, CA 92106

FOR: YACHTS, IN CLASS 12 (U.S. CLS. 19, 21, 23, 31, 35 AND 44).

FIRST USE 6-1-1985; IN COMMERCE 6-1-1985.

FOR: SHIRTS; JACKETS; HATS; BELTS, IN CLASS 25 (U.S. CLS. 22 AND 39).

FIRST USE 6-1-1985; IN COMMERCE 6-1-1985.

THE MARK CONSISTS OF STANDARD CHARACTERS WITHOUT CLAIM TO ANY PARTICULAR FONT, STYLE, SIZE, OR COLOR.

NO CLAIM IS MADE TO THE EXCLUSIVE RIGHT TO USE "YACHTS", APART FROM THE MARK AS SHOWN.

SEC. 2(F).

SER. NO. 77-425,474, FILED 3-18-2008.

GIANCARLO CASTRO, EXAMINING ATTORNEY

**Int. Cls.: 35 and 42**

**Prior U.S. Cls.: 100, 101 and 102**

**United States Patent and Trademark Office**

**Reg. No. 3,569,276**

**Registered Feb. 3, 2009**

**SERVICE MARK  
PRINCIPAL REGISTER**

**ASCENDIUM**

ASCENDIUM, INC. (INDIANA CORPORATION)  
SUITE 270  
7820 INNOVATION BOULEVARD  
INDIANAPOLIS, IN 46278

FOR: BUSINESS PLANNING FOR HEALTHCARE  
FACILITIES, IN CLASS 35 (U.S. CLS. 100, 101 AND  
102).

FIRST USE 1-8-2008; IN COMMERCE 1-8-2008.

FOR: CONSULTATION IN THE FIELDS OF ER-  
GONOMICS, PROCESS OPTIMIZATION, INFOR-  
MATION TECHNOLOGY, STRATEGIC  
PLANNING, AND MANAGEMENT, NAMELY, DE-  
SIGNING WORKPLACE HEALTH FACILITIES TO

OPTIMIZE EFFICIENCY AND SAFETY; DESIGN  
OF HEALTHCARE FACILITIES; INFORMATION  
TECHNOLOGY CONSULTATION FOR HEALTH-  
CARE FACILITIES, IN CLASS 42 (U.S. CLS. 100  
AND 101).

FIRST USE 1-8-2008; IN COMMERCE 1-8-2008.

THE MARK CONSISTS OF STANDARD CHAR-  
ACTERS WITHOUT CLAIM TO ANY PARTICULAR  
FONT, STYLE, SIZE, OR COLOR.

SER. NO. 77-425,767, FILED 3-19-2008.

TEJBIR SINGH, EXAMINING ATTORNEY

**Int. Cl.: 9**

**Prior U.S. Cls.: 21, 23, 26, 36 and 38**

**Reg. No. 3,569,277**

**United States Patent and Trademark Office**

**Registered Feb. 3, 2009**

---

**TRADEMARK  
PRINCIPAL REGISTER**

**CODELINK**

MENTOR GRAPHICS CORPORATION (OREGON  
CORPORATION)  
8005 S.W. BOECKMAN ROAD  
WILSONVILLE, OR 97070

THE MARK CONSISTS OF STANDARD CHAR-  
ACTERS WITHOUT CLAIM TO ANY PARTICULAR  
FONT, STYLE, SIZE, OR COLOR.

FOR: COMPUTER SOFTWARE FOR ELECTRO-  
NIC DESIGN AUTOMATION, IN CLASS 9 (U.S. CLS.  
21, 23, 26, 36 AND 38).

SER. NO. 77-425,863, FILED 3-19-2008.

FIRST USE 12-29-2006; IN COMMERCE 12-29-2006.

TIMOTHY FINNEGAN, EXAMINING ATTORNEY

**Int. Cl.: 35**

**Prior U.S. Cls.: 100, 101 and 102**

**United States Patent and Trademark Office**

**Reg. No. 3,569,278**

**Registered Feb. 3, 2009**

**SERVICE MARK  
PRINCIPAL REGISTER**

**RAIN OR SHINE**

PEGGY LEEVE UMBRELLAS, INC. (NEW YORK CORPORATION)  
RAIN OR SHINE 18 WEST 55TH STREET  
NEW YORK, NY 10019

FOR: ON-LINE RETAIL STORE SERVICES FEATURING UMBRELLAS AND PARASOLS; RETAIL SHOPS FEATURING UMBRELLAS AND PARASOLS, IN CLASS 35 (U.S. CLS. 100, 101 AND 102).

FIRST USE 1-1-2001; IN COMMERCE 5-3-2004.

THE MARK CONSISTS OF STANDARD CHARACTERS WITHOUT CLAIM TO ANY PARTICULAR FONT, STYLE, SIZE, OR COLOR.

OWNER OF U.S. REG. NO. 3,067,488.

SER. NO. 77-427,182, FILED 3-20-2008.

TEJBIR SINGH, EXAMINING ATTORNEY



**Int. Cls.: 36 and 41**

**Prior U.S. Cls.: 100, 101, 102 and 107**

**United States Patent and Trademark Office**

**Reg. No. 3,569,279**

**Registered Feb. 3, 2009**

**SERVICE MARK  
PRINCIPAL REGISTER**



RIBBON OF HOPE FOUNDATION, INC. (WIS-  
CONSIN NON-PROFIT CORPORATION)  
#199  
421 GEORGE STREET  
DE PERE, WI 54115

FOR: CHARITABLE SERVICES, NAMELY, PRO-  
VIDING FINANCIAL ASSISTANCE TO INDIVI-  
DUALS DIAGNOSED WITH BREAST CANCER,  
ORGANIZING FUND RAISING ACTIVITIES BY  
MEANS OF ENTERTAINMENT AND SOCIAL  
EVENTS, IN CLASS 36 (U.S. CLS. 100, 101 AND 102).

FIRST USE 6-14-2004; IN COMMERCE 8-21-2004.

FOR: CHARITABLE SERVICES, NAMELY, PRO-  
VIDING EDUCATION ASSISTANCE VIA LENDING  
LIBRARIES TO LEND RESOURCE MATERIALS  
AND RESEARCH MATERIALS TO INDIVIDUALS  
THAT HAVE BEEN DIAGNOSED WITH BREAST  
CANCER, IN CLASS 41 (U.S. CLS. 100, 101 AND 107).

FIRST USE 6-14-2004; IN COMMERCE 8-21-2004.

NO CLAIM IS MADE TO THE EXCLUSIVE  
RIGHT TO USE "FOUNDATION" , APART FROM  
THE MARK AS SHOWN.

THE COLOR(S) BLACK, BLUE, PINK AND LIGHT  
PINK IS/ARE CLAIMED AS A FEATURE OF THE  
MARK.

THE COLOR LIGHT PINK APPEARS IN THE PIG  
AND LEFT WING. THE COLOR PINK APPEARS IN  
THE RIBBON AND THE RIGHT WING. THE PIG  
AND RIBBON ARE OUTLINED IN BLACK. THE  
WORDING "RIBBON OF HOPE FOUNDATION"  
APPEARS IN BLUE.

SER. NO. 77-427,463, FILED 3-20-2008.

AMEETA JORDAN, EXAMINING ATTORNEY

**Int. Cls.: 36 and 41**

**Prior U.S. Cls.: 100, 101, 102 and 107**

**United States Patent and Trademark Office**

**Reg. No. 3,569,280**

**Registered Feb. 3, 2009**

**SERVICE MARK  
PRINCIPAL REGISTER**

**Ribbon of Hope Foundation**

RIBBON OF HOPE FOUNDATION, INC. (WIS-  
CONSIN NON-PROFIT CORPORATION)  
#199  
421 GEORGE STREET  
DE PERE, WI 54115

FOR: CHARITABLE SERVICES, NAMELY, PRO-  
VIDING FINANCIAL ASSISTANCE TO INDIVI-  
DUALS DIAGNOSED WITH BREAST CANCER,  
ORGANIZING FUND RAISING ACTIVITIES BY  
MEANS OF ENTERTAINMENT AND SOCIAL  
EVENTS, IN CLASS 36 (U.S. CLS. 100, 101 AND 102).

FIRST USE 1-23-2003; IN COMMERCE 1-23-2003.

FOR: CHARITABLE SERVICES, NAMELY, PRO-  
VIDING EDUCATION ASSISTANCE VIA LENDING  
LIBRARIES TO LEND RESOURCE MATERIALS

AND RESEARCH MATERIALS TO INDIVIDUALS  
THAT HAVE BEEN DIAGNOSED WITH BREAST  
CANCER, IN CLASS 41 (U.S. CLS. 100, 101 AND 107).

FIRST USE 1-23-2003; IN COMMERCE 1-23-2003.

THE MARK CONSISTS OF STANDARD CHAR-  
ACTERS WITHOUT CLAIM TO ANY PARTICULAR  
FONT, STYLE, SIZE, OR COLOR.

NO CLAIM IS MADE TO THE EXCLUSIVE  
RIGHT TO USE "FOUNDATION", APART FROM  
THE MARK AS SHOWN.

SER. NO. 77-427,502, FILED 3-20-2008.

AMEETA JORDAN, EXAMINING ATTORNEY

**Int. Cl.: 35**

**Prior U.S. Cls.: 100, 101 and 102**

**United States Patent and Trademark Office**

**Reg. No. 3,569,281**

**Registered Feb. 3, 2009**

**SERVICE MARK  
PRINCIPAL REGISTER**

**Step<sup>1</sup>  
BRANDING**

STEP ONE BRANDING, LLC (CALIFORNIA LIMITED LIABILITY COMPANY)  
1 BLACKFIELD DRIVE, STE. 114  
TIBURON, CA 94920

FOR: ADVERTISING SERVICES, NAMELY, CREATING CORPORATE AND BRAND IDENTITY FOR OTHERS; ADVERTISING AND PUBLICITY SERVICES, NAMELY, PROMOTING THE GOODS, SERVICES, AND COMMERCIAL INFORMATION AND NEWS OF THIRD PARTIES THROUGH PRINT, AUDIO, VIDEO, DIGITAL AND ON-LINE MEDIUM; SERVICES RELATING TO THE ANALYSIS, EVALUATION, CREATION AND BRAND ESTABLISHMENT OF TRADEMARKS, TRADE NAMES AND DOMAIN NAMES, IN CLASS 35 (U.S. CLS. 100, 101 AND 102).

FIRST USE 6-25-2007; IN COMMERCE 6-25-2007.

NO CLAIM IS MADE TO THE EXCLUSIVE RIGHT TO USE "BRANDING", APART FROM THE MARK AS SHOWN.

THE COLOR(S) BLACK AND GREEN IS/ARE CLAIMED AS A FEATURE OF THE MARK.

THE MARK CONSISTS OF BLACK LETTERS FOR THE WORDS "STEP" AND "BRANDING"; AND GREEN FOR THE NUMERAL "1".

SER. NO. 77-427,781, FILED 3-20-2008.

PAUL E. FAHRENKOPF, EXAMINING ATTORNEY

**Int. Cl.: 29**

**Prior U.S. Cl.: 46**

**United States Patent and Trademark Office**

**Reg. No. 3,569,282**

**Registered Feb. 3, 2009**

**TRADEMARK  
PRINCIPAL REGISTER**



CHRIS' SPECIALTY MEATS, INC. (LOUISIANA CORPORATION)  
3075 MILLERVILLE ROAD  
BATON ROUGE, LA 70816

THE STIPLING IS FOR SHADING PURPOSES ONLY.

FOR: CHICKEN; MEAT; SAUSAGES; FRESH, PREPARED AND PACKAGED MEALS CONSISTING PRIMARILY OF MEAT, FISH, POULTRY OR VEGETABLES, IN CLASS 29 (U.S. CL. 46).

THE MARK CONSISTS OF AN IMAGE OF A LOBSTER AND THE TEXT "CHRIS' SPECIALTY MEATS" FORMED BY A PATTERN OF SMALL DARK AND LIGHT DOTS.

FIRST USE 2-1-1994; IN COMMERCE 2-1-1994.

SER. NO. 77-428,236, FILED 3-21-2008.

NO CLAIM IS MADE TO THE EXCLUSIVE RIGHT TO USE "SPECIALTY MEATS", APART FROM THE MARK AS SHOWN.

ALLISON SCHRODY, EXAMINING ATTORNEY

**Int. Cls.: 35 and 45**

**Prior U.S. Cls.: 100, 101 and 102**

**United States Patent and Trademark Office**

**Reg. No. 3,569,283**

**Registered Feb. 3, 2009**

**SERVICE MARK  
PRINCIPAL REGISTER**

# CRA INSIGHTS

CRA INTERNATIONAL, INC. (MASSACHU-  
SETTS CORPORATION)  
200 CLARENDON ST., T-33  
BOSTON, MA 02116

FOR: PROFESSIONAL BUSINESS CONSULTING,  
IN CLASS 35 (U.S. CLS. 100, 101 AND 102).

FIRST USE 9-1-2007; IN COMMERCE 9-1-2007.

FOR: LITIGATION CONSULTANCY , IN CLASS  
45 (U.S. CLS. 100 AND 101).

FIRST USE 9-1-2007; IN COMMERCE 9-1-2007.

THE MARK CONSISTS OF STANDARD CHAR-  
ACTERS WITHOUT CLAIM TO ANY PARTICULAR  
FONT, STYLE, SIZE, OR COLOR.

OWNER OF U.S. REG. NOS. 1,692,065, 1,735,152  
AND OTHERS.

SER. NO. 77-428,473, FILED 3-21-2008.

KAREN BRACEY, EXAMINING ATTORNEY

**Int. Cl.: 36**

**Prior U.S. Cls.: 100, 101 and 102**

**United States Patent and Trademark Office**

**Reg. No. 3,569,284**

**Registered Feb. 3, 2009**

**SERVICE MARK  
PRINCIPAL REGISTER**

**FIRST REPUBLIC BANK**

MERRILL LYNCH BANK & TRUST CO., FSB  
(UNITED STATES FEDERAL SAVINGS  
BANK), DBA FIRST REPUBLIC BANK  
4 WORLD FINANCIAL CENTER  
NEW YORK, NY 10038

FOR: CREDIT CARD SERVICES; DEBIT CARD SERVICES; COMMERCIAL AND CONSUMER LENDING, LEASING OF REAL ESTATE, AND FINANCING; TRUST, ESTATE, AND FIDUCIARY MANAGEMENT, PLANNING, AND CONSULTING; INVESTMENT SERVICES, NAMELY, PROVIDING INVESTMENT ANALYSIS, CONSULTATION, PLANNING, MANAGEMENT, ADVISORY, BROKERAGE, BANKING, AND RESEARCH SERVICES WITH RESPECT TO STOCKS, MUTUAL FUNDS, SECURITIES, BONDS, COMMODITIES, REAL ESTATE AND OTHER INSTRUMENTS OF INVESTMENT; PROVIDING SECURE FINANCIAL TRANSACTIONS IN THE NATURE OF ELECTRONIC CASH TRANSACTIONS, ELECTRONIC CREDIT CARD TRANSACTIONS, ELECTRONIC DEBIT TRANSACTIONS, ELECTRONIC CHECK PROCESSING TRANSACTIONS AND ELECTRONIC TRANS-

MISSION OF BILL PAYMENT DATA VIA A GLOBAL COMPUTER NETWORK; FINANCIAL PLANNING AND INVESTMENT ADVISORY SERVICES; FINANCIAL PLANNING CONSULTATION; AUTOMATED TELLER MACHINE SERVICES, IN CLASS 36 (U.S. CLS. 100, 101 AND 102).

FIRST USE 9-1-1997; IN COMMERCE 9-1-1997.

THE MARK CONSISTS OF STANDARD CHARACTERS WITHOUT CLAIM TO ANY PARTICULAR FONT, STYLE, SIZE, OR COLOR.

OWNER OF U.S. REG. NOS. 2,699,808, 2,898,413, AND 3,185,144.

NO CLAIM IS MADE TO THE EXCLUSIVE RIGHT TO USE "BANK", APART FROM THE MARK AS SHOWN.

SER. NO. 77-428,766, FILED 3-21-2008.

NATALIE POLZER, EXAMINING ATTORNEY

**Int. Cl.: 36**

**Prior U.S. Cls.: 100, 101 and 102**

**United States Patent and Trademark Office**

**Reg. No. 3,569,285**

**Registered Feb. 3, 2009**

**SERVICE MARK  
PRINCIPAL REGISTER**

**THE MALL AT GREECE RIDGE**

WILMORITE MANAGEMENT GROUP, LLC  
(NEW YORK LIMITED LIABILITY COMPANY)  
1265 SCOTTSVILLE ROAD  
ROCHESTER, NY 14624

FOR: REAL ESTATE LEASING AND MANAGEMENT SERVICES, IN CLASS 36 (U.S. CLS. 100, 101 AND 102).

FIRST USE 5-1-1967; IN COMMERCE 5-1-1967.

THE MARK CONSISTS OF STANDARD CHARACTERS WITHOUT CLAIM TO ANY PARTICULAR FONT, STYLE, SIZE, OR COLOR.

NO CLAIM IS MADE TO THE EXCLUSIVE RIGHT TO USE "MALL" AND "GREECE", APART FROM THE MARK AS SHOWN.

SER. NO. 77-432,077, FILED 3-26-2008.

SCOTT BIBB, EXAMINING ATTORNEY

**Int. Cl.: 6**

**Prior U.S. Cls.: 2, 12, 13, 14, 23, 25 and 50**

**Reg. No. 3,569,286**

**United States Patent and Trademark Office**

**Registered Feb. 3, 2009**

**TRADEMARK  
PRINCIPAL REGISTER**

**PRESON**

CROWN PACKAGING TECHNOLOGY, INC. (DE-  
LAWARE CORPORATION)  
11535 SOUTH CENTRAL AVENUE  
ALSIP, IL 60803

FOR: CLOSURES FOR BOTTLES AND CONTAIN-  
ERS MADE OF A COMBINATION OF METAL AND  
PLASTIC, THE METAL PREDOMINATING, IN  
CLASS 6 (U.S. CLS. 2, 12, 13, 14, 23, 25 AND 50).

FIRST USE 0-0-1983; IN COMMERCE 0-0-1983.

THE MARK CONSISTS OF STANDARD CHAR-  
ACTERS WITHOUT CLAIM TO ANY PARTICULAR  
FONT, STYLE, SIZE, OR COLOR.

SEC. 2(F).

SER. NO. 77-432,188, FILED 3-26-2008.

SUNG IN, EXAMINING ATTORNEY



**Int. Cl.: 19**

**Prior U.S. Cls.: 1, 12, 33 and 50**

**United States Patent and Trademark Office**

**Reg. No. 3,569,287**

**Registered Feb. 3, 2009**

**TRADEMARK  
PRINCIPAL REGISTER**

**ELDORADO STONE**

ELDORADO STONE OPERATIONS, LLC (UTAH  
LIMITED LIABILITY COMPANY)  
10653 S. RIVER FRONT PARKWAY, SUITE 300  
SOUTH JORDAN, UT 84095

FOR: BUILDING MATERIALS, NAMELY, SYN-  
THETIC, ARTIFICIAL, MANUFACTURED, AND  
REFORMED STONES, BRICKS, VENEER, BLOCKS  
AND SHEETS; PRE-CAST CONCRETE FOR EXTER-  
IOR USE, IN CLASS 19 (U.S. CLS. 1, 12, 33 AND 50).

FIRST USE 0-0-1968; IN COMMERCE 0-0-1968.

THE MARK CONSISTS OF STANDARD CHAR-  
ACTERS WITHOUT CLAIM TO ANY PARTICULAR  
FONT, STYLE, SIZE, OR COLOR.

OWNER OF U.S. REG. NOS. 1,182,120, 2,901,565  
AND OTHERS.

NO CLAIM IS MADE TO THE EXCLUSIVE  
RIGHT TO USE "STONE", APART FROM THE  
MARK AS SHOWN.

THE FOREIGN WORDING IN THE MARK  
TRANSLATES INTO ENGLISH AS THE GOLDEN.

SER. NO. 77-432,956, FILED 3-27-2008.

KIMBERLY PERRY, EXAMINING ATTORNEY

**Int. Cl.: 22**

**Prior U.S. Cls.: 1, 2, 7, 19, 22, 42 and 50**

**United States Patent and Trademark Office**

**Reg. No. 3,569,288**

**Registered Feb. 3, 2009**

**TRADEMARK  
PRINCIPAL REGISTER**

# Strapworks

FOSTER, DONNA SUE (OREGON SOLE PROPRIETORSHIP), DBA STRAPWORKS  
3170 ELMIRA RD  
EUGENE, OR 97402

FOR: SYNTHETIC ROPE AND WEBBING; ALL-PURPOSE STRAPS; NON-METAL STRAPPING OR TIE DOWNS; NON-METAL SUPPORT STRAPS FOR HOLDING PLANTED TREES IN AN UPWARD POSITION; STRAPS FOR HANDLING LOADS; STRAPS FOR SECURING BUNDLES; TIE DOWN STRAPS; TOWING STRAPS; VINYL AND FABRIC STRAPPING USED IN THE MANUFACTURE/RE-

PAIR OF LAWN CHAIRS, IN CLASS 22 (U.S. CLS. 1, 2, 7, 19, 22, 42 AND 50).

FIRST USE 6-1-1977; IN COMMERCE 11-1-1999.

THE MARK CONSISTS OF STANDARD CHARACTERS WITHOUT CLAIM TO ANY PARTICULAR FONT, STYLE, SIZE, OR COLOR.

SER. NO. 77-433,147, FILED 3-27-2008.

SUNG IN, EXAMINING ATTORNEY

**Int. Cl.: 5**

**Prior U.S. Cls.: 6, 18, 44, 46, 51 and 52**

**Reg. No. 3,569,289**

**United States Patent and Trademark Office**

**Registered Feb. 3, 2009**

**TRADEMARK  
PRINCIPAL REGISTER**



PRO-BIOTIKS LABS, INC. (UTAH CORPORATION)  
PO BOX 12608  
OGDEN, UT 84111

FOR: VITAMIN AND NUTRITIONAL SUPPLEMENTS, IN CLASS 5 (U.S. CLS. 6, 18, 44, 46, 51 AND 52).

FIRST USE 4-30-2007; IN COMMERCE 4-30-2007.

OWNER OF U.S. REG. NO. 1,445,957.

NO CLAIM IS MADE TO THE EXCLUSIVE RIGHT TO USE "PROBIOTICS", APART FROM THE MARK AS SHOWN.

THE MARK CONSISTS OF THE TERM "PRO-BIOTIKS", A CIRCLE AND A GRAPHICAL REPRESENTATION OF A TARE OF WHEAT.

SER. NO. 77-433,754, FILED 3-27-2008.

ANDREA HACK, EXAMINING ATTORNEY

**Int. Cl.: 36**

**Prior U.S. Cls.: 100, 101 and 102**

**United States Patent and Trademark Office**

**Reg. No. 3,569,290**

**Registered Feb. 3, 2009**

**SERVICE MARK  
PRINCIPAL REGISTER**

# Schofield Properties

SCHOFIELD, EDWARD (UNITED STATES INDIVIDUAL)  
38 ASHWOOD  
IRVINE, CA 92604

FOR: REAL ESTATE INVESTMENT SERVICES IN THE NATURE OF PURCHASING AND SELLING OF BUILDINGS, LAND, OFFICE SPACE, REAL ESTATE, AND REAL PROPERTY, LEASING OF BUILDINGS, LAND, OFFICE SPACE, REAL ESTATE, AND REAL PROPERTY, MANAGEMENT OF BUILDINGS, LAND, OFFICE SPACE, REAL ESTATE, AND REAL PROPERTY, AND RENTAL OF BUILDINGS, LAND, OFFICE SPACE, REAL ESTATE, AND REAL PROPERTY, IN CLASS 36 (U.S. CLS. 100, 101 AND 102).

FIRST USE 6-0-1996; IN COMMERCE 6-0-1996.

THE MARK CONSISTS OF STANDARD CHARACTERS WITHOUT CLAIM TO ANY PARTICULAR FONT, STYLE, SIZE, OR COLOR.

NO CLAIM IS MADE TO THE EXCLUSIVE RIGHT TO USE "PROPERTIES", APART FROM THE MARK AS SHOWN.

SEC. 2(F).

SER. NO. 77-433,821, FILED 3-27-2008.

COURTNEY MCCORMICK, EXAMINING ATTORNEY

Int. Cl.: 30

Prior U.S. Cl.: 46

United States Patent and Trademark Office

Reg. No. 3,569,291

Registered Feb. 3, 2009

TRADEMARK  
PRINCIPAL REGISTER



SIMPLY FABULOUS DESSERTS AND TREATS,  
LLC (GEORGIA LIMITED LIABILITY COM-  
PANY), DBA UNCLE ED'S, INC.

1961 MORRIS DRIVE  
RIVERDALE, GA 30296

FOR: CHOCOLATE TRUFFLES; FOOD PACK-  
AGE COMBINATIONS CONSISTING PRIMARILY  
OF BREAD, CRACKERS AND/OR COOKIES; FRO-  
ZEN CONFECTIONERY; FROZEN CONFECTIONS;  
DESSERT MOUSSE; PARFAITS; BAKERY DES-  
SERTS; MUFFINS; COFFEE AND TEA; ICED COF-  
FEE; BEVERAGES MADE OF COFFEE; COFFEE;  
PASTRIES; BAGELS; CANDIES; SWEETS, IN CLASS  
30 (U.S. CL. 46).

FIRST USE 9-1-2007; IN COMMERCE 10-29-2007.

NO CLAIM IS MADE TO THE EXCLUSIVE  
RIGHT TO USE "SIMPLY FABULOUS DESSERTS

& TREATS TO GO", APART FROM THE MARK AS  
SHOWN.

THE COLOR(S) ORANGE, LIME, BLUE AND  
BROWN IS/ARE CLAIMED AS A FEATURE OF  
THE MARK.

THE MARK CONSISTS OF "SIMPLY FABULOUS!  
DESSERTS & TREATS TO GO. . ." ARE IN BROWN.  
THE TOP OVERLAPPING OVAL IN THE CENTER  
OF THE MARK IS BLUE AND THE BOTTOM OVAL  
IS ORANGE. THE THREE ASTERISKS ARE OR-  
ANGE. THE THREE OVALS TO THE OUTSIDE OF  
THE MARK ARE FROM TOP TO BOTTOM: BLUE,  
LIME AND BROWN.

SER. NO. 77-433,913, FILED 3-27-2008.

MARY CRAWFORD, EXAMINING ATTORNEY

**Int. Cl.: 9**

**Prior U.S. Cls.: 21, 23, 26, 36 and 38**

**Reg. No. 3,569,292**

**United States Patent and Trademark Office**

**Registered Feb. 3, 2009**

**TRADEMARK  
PRINCIPAL REGISTER**

**RIVERAIN MEDICAL**

RIVERAIN MEDICAL GROUP, LLC (OHIO LIMITED LIABILITY COMPANY)  
3020 SOUTH TECH BLVD.  
MIAMISBURG, OH 453424860

THE MARK CONSISTS OF STANDARD CHARACTERS WITHOUT CLAIM TO ANY PARTICULAR FONT, STYLE, SIZE, OR COLOR.

FOR: COMPUTER SERVER CAPABLE OF MOUNTING ON A RACK ON A RADIOLOGIST WORKSTATION THAT IS SOLD AS A UNIT WITH COMPUTER SOFTWARE APPLICATIONS FOR MEDICAL IMAGING AND GENERATING X-RAYS, IN CLASS 9 (U.S. CLS. 21, 23, 26, 36 AND 38).

NO CLAIM IS MADE TO THE EXCLUSIVE RIGHT TO USE "MEDICAL", APART FROM THE MARK AS SHOWN.

SER. NO. 77-434,464, FILED 3-28-2008.

FIRST USE 11-28-2004; IN COMMERCE 11-28-2004.

FRANK LATTUCA, EXAMINING ATTORNEY

**Int. Cl.: 41**

**Prior U.S. Cls.: 100, 101 and 107**

**United States Patent and Trademark Office**

**Reg. No. 3,569,293**

**Registered Feb. 3, 2009**

**SERVICE MARK  
PRINCIPAL REGISTER**



CONN, TERESA L (UNITED STATES INDIVIDUAL), DBA / PITTSBURGH PASSION  
1411 BEAR RUN DR.  
PITTSBURGH, PA 15237

FOR: ENTERTAINMENT IN THE NATURE OF FOOTBALL GAMES, IN CLASS 41 (U.S. CLS. 100, 101 AND 107).

FIRST USE 4-1-2003; IN COMMERCE 8-28-2004.

NO CLAIM IS MADE TO THE EXCLUSIVE RIGHT TO USE "PITTSBURGH", APART FROM THE MARK AS SHOWN.

THE COLOR(S) BLACK, GOLD, AND WHITE IS/ARE CLAIMED AS A FEATURE OF THE MARK.

THE MARK CONSISTS OF THE WORD "PITTSBURGH" IN WHITE AND THE WORD "PASSION" IN GOLD. A WHITE LINE APPEARS TO THE LEFT AND THE RIGHT OF THE TERM "PITTSBURGH"

AND UNDER THE TERM "PASSION". THE WORDING AND LINES APPEAR ON A BLACK BACKGROUND OUTLINED IN GOLD. THE SKYLINE DESIGN APPEARS IN GOLD WITH WHITE SHADING UPON A BLACK HEART DESIGN WITH WHITE SHADING AND GOLD OUTLINING. A GOLD FOOTBALL APPEARS UNDER THE WORDING, EXTENDING FROM THE OVERALL DESIGN BY CURVED BANDS, THE TOP-MOST OF WHICH IS GOLD, FOLLOWED BY BLACK, FOLLOWED BY GOLD, FOLLOWED BY WHITE, FOLLOWED BY GOLD. THE GOLD FOOTBALL HAS WHITE STITCHING AND WHITE SHADING AND IS LINED IN BLACK WITH THE LOWER HALF OF THE BALL APPEARING IN BLACK OUTLINED IN GOLD. THE TOP AND LEFT TO MIDDLE BOTTOM PORTION OF THE BALL IS OUTLINED IN BLACK, FOLLOWED BY GOLD OUTLINING.

SER. NO. 77-435,306, FILED S.R. 3-31-2008 AM. P.R. 10-7-2008.

KAREN SEVERSON, EXAMINING ATTORNEY

**Int. Cls.: 13 and 22**

**Prior U.S. Cls.: 1, 2, 7, 9, 19, 22, 42 and 50**

**Reg. No. 3,569,294**

**United States Patent and Trademark Office**

**Registered Feb. 3, 2009**

**TRADEMARK  
PRINCIPAL REGISTER**

**ENVELOP**

CREATE INC. (NEW HAMPSHIRE CORPORATION)  
ETNA ROAD  
HANOVER, NH 03755

FOR: COVERS FOR FIREARMS, IN CLASS 13 (U.S. CLS. 2 AND 9).

FIRST USE 12-6-2007; IN COMMERCE 12-6-2007.

FOR: PROTECTIVE SYSTEMS, WHICH ARE DESIGNED TO REDUCE CORROSION IN METALLIC OBJECTS COVERED BY THE PROTECTIVE SYSTEM THROUGH USE OF SUPERABSORBENT MATERIALS AND/OR VAPOR CORROSION INHIBITORS, CONSISTING OF FITTED AND UN-

FITTED TARPAULINS, IN CLASS 22 (U.S. CLS. 1, 2, 7, 19, 22, 42 AND 50).

FIRST USE 11-15-2002; IN COMMERCE 11-15-2002.

THE MARK CONSISTS OF STANDARD CHARACTERS WITHOUT CLAIM TO ANY PARTICULAR FONT, STYLE, SIZE, OR COLOR.

OWNER OF U.S. REG. NO. 2,814,311.

SEC. 2(F).

SER. NO. 77-435,360, FILED 3-31-2008.

ANDREA HACK, EXAMINING ATTORNEY



Int. Cl.: 35

Prior U.S. Cls.: 100, 101 and 102

United States Patent and Trademark Office

Reg. No. 3,569,295

Registered Feb. 3, 2009

SERVICE MARK  
PRINCIPAL REGISTER

relooks

RELOOKS, LLC (DELAWARE LIMITED LIABILITY COMPANY)  
126 HIGH ST.  
NEWBURYPORT, MA 01950

FOR: THE BRINGING TOGETHER, FOR THE BENEFIT OF OTHERS, OF A VARIETY OF GOODS AND SERVICES, ENABLING CUSTOMERS TO CONVENIENTLY VIEW AND PURCHASE THOSE GOODS AND SERVICES FROM AN INTERNET WEBSITE PARTICULARLY SPECIALIZING IN THE MARKETING OF THE SALE OF GOODS

AND SERVICES OF OTHERS, IN CLASS 35 (U.S. CLS. 100, 101 AND 102).

FIRST USE 3-28-2007; IN COMMERCE 3-24-2008.

THE MARK CONSISTS OF STANDARD CHARACTERS WITHOUT CLAIM TO ANY PARTICULAR FONT, STYLE, SIZE, OR COLOR.

SER. NO. 77-435,767, FILED 3-31-2008.

DAVID I, EXAMINING ATTORNEY

**Int. Cl.: 7**

**Prior U.S. Cls.: 13, 19, 21, 23, 31, 34 and 35**

**Reg. No. 3,569,296**

**United States Patent and Trademark Office**

**Registered Feb. 3, 2009**

---

**TRADEMARK  
PRINCIPAL REGISTER**

**SOLIMAR USA**

WEBB TECH GROUP, LLC (DELAWARE LIMITED LIABILITY COMPANY), DBA SOLIMAR PNEUMATICS

8001 RANCHERS ROAD NE  
FRIDLEY, MN 55432

FOR: DRY BULK HANDLING EQUIPMENT, NAMELY, FLUIDIZERS AND PARTS THEREFOR, IN CLASS 7 (U.S. CLS. 13, 19, 21, 23, 31, 34 AND 35).

FIRST USE 1-31-2002; IN COMMERCE 1-31-2002.

THE MARK CONSISTS OF STANDARD CHARACTERS WITHOUT CLAIM TO ANY PARTICULAR FONT, STYLE, SIZE, OR COLOR.

NO CLAIM IS MADE TO THE EXCLUSIVE RIGHT TO USE "USA", APART FROM THE MARK AS SHOWN.

SER. NO. 77-436,153, FILED 3-31-2008.

ANDREA SAUNDERS, EXAMINING ATTORNEY

**Int. Cl.: 31**

**Prior U.S. Cls.: 1 and 46**

**United States Patent and Trademark Office**

**Reg. No. 3,569,297**

**Registered Feb. 3, 2009**

**TRADEMARK  
PRINCIPAL REGISTER**

**ADF**

AMERICAN DEHYDRATED FOODS, INC. (MISSOURI CORPORATION)  
P.O. BOX 4087  
SPRINGFIELD, MO 65808

FOR: NON-MEDICATED PET AND ANIMAL FEED INGREDIENTS, NAMELY, PROTEIN FOR ANIMAL CONSUMPTION; NON-MEDICATED PET AND ANIMAL FEED INGREDIENTS, NAMELY, ANIMAL FEED ADDITIVES FOR NONNUTRITIONAL PURPOSES FOR USE AS AN INGREDIENT OR FLAVORING, IN CLASS 31 (U.S. CLS. 1 AND 46).

FIRST USE 1-1-1984; IN COMMERCE 1-1-1984.

THE MARK CONSISTS OF STANDARD CHARACTERS WITHOUT CLAIM TO ANY PARTICULAR FONT, STYLE, SIZE, OR COLOR.

OWNER OF U.S. REG. NO. 2,126,822.

SER. NO. 77-437,161, FILED 4-1-2008.

MEGHAN REINHART, EXAMINING ATTORNEY

**Int. Cl.: 16**

**Prior U.S. Cls.: 2, 5, 22, 23, 29, 37, 38 and 50**

**Reg. No. 3,569,298**

**United States Patent and Trademark Office**

**Registered Feb. 3, 2009**

**TRADEMARK  
PRINCIPAL REGISTER**

# Heritage

METCALF, LOUIS (UNITED STATES INDIVIDUAL)  
2616 CREEK MOOR COURT  
WOODBIDGE, VA 221914763

FOR: BALLPOINT PENS; ROLLER BALL PENS; DIP PENS; CALLIGRAPHY PENS; STYLI IN THE NATURE OF STEEL OR OTHER METAL PENS; FOUNTAIN PENS; PEN NIBS; PEN COMPONENT PARTS, NAMELY, CLIPS, CENTER BANDS, FINIALS, SECTIONS, CONVERTERS, PUMPS AND REFILLS; PEN ACCESSORIES, NAMELY, STANDS, CASES, DISPLAY CASES, BOXES, INK REFILLS, INK WELLS, AND KITS COMPRISED OF PENS, INK

REFILLS AND PEN NIBS; MECHANICAL PENCILS, IN CLASS 16 (U.S. CLS. 2, 5, 22, 23, 29, 37, 38 AND 50).

FIRST USE 10-24-2004; IN COMMERCE 10-24-2004.

THE MARK CONSISTS OF STANDARD CHARACTERS WITHOUT CLAIM TO ANY PARTICULAR FONT, STYLE, SIZE, OR COLOR.

SER. NO. 77-437,642, FILED 4-2-2008.

APRIL ROACH, EXAMINING ATTORNEY

**Int. Cl.: 20**

**Prior U.S. Cls.: 2, 13, 22, 25, 32 and 50**

**United States Patent and Trademark Office**

**Reg. No. 3,569,299**

**Registered Feb. 3, 2009**

**TRADEMARK  
PRINCIPAL REGISTER**

**I CRATE**

MID-WEST METAL PRODUCTS CO., INC. (IN-  
DIANA CORPORATION)

P.O. BOX 1031

MUNCIE, IN 47308

FOR: PET CRATES, IN CLASS 20 (U.S. CLS. 2, 13,  
22, 25, 32 AND 50).

FIRST USE 4-3-2007; IN COMMERCE 4-3-2007.

THE MARK CONSISTS OF STANDARD CHAR-  
ACTERS WITHOUT CLAIM TO ANY PARTICULAR  
FONT, STYLE, SIZE, OR COLOR.

NO CLAIM IS MADE TO THE EXCLUSIVE  
RIGHT TO USE "CRATE", APART FROM THE  
MARK AS SHOWN.

SER. NO. 77-437,654, FILED 4-2-2008.

ELIZABETH KAJUBI, EXAMINING ATTORNEY

**Int. Cl.: 45**

**Prior U.S. Cls.: 100 and 101**

**United States Patent and Trademark Office**

**Reg. No. 3,569,300**

**Registered Feb. 3, 2009**

**SERVICE MARK  
PRINCIPAL REGISTER**

**IRELL & MANELLA LLP**

IRELL & MANELLA LLP (CALIFORNIA LIMITED LIABILITY PARTNERSHIP)  
SUITE 900  
1800 AVENUE OF THE STARS  
LOS ANGELES, CA 90067

FOR: LEGAL SERVICES, IN CLASS 45 (U.S. CLS. 100 AND 101).

FIRST USE 0-0-2003; IN COMMERCE 0-0-2003.

THE MARK CONSISTS OF STANDARD CHARACTERS WITHOUT CLAIM TO ANY PARTICULAR FONT, STYLE, SIZE, OR COLOR.

OWNER OF U.S. REG. NO. 2,475,770.

NO CLAIM IS MADE TO THE EXCLUSIVE RIGHT TO USE "LLP", APART FROM THE MARK AS SHOWN.

SER. NO. 77-438,103, FILED 4-2-2008.

JORDAN BAKER, EXAMINING ATTORNEY

**Int. Cls.: 3 and 21**

**Prior U.S. Cls.: 1, 2, 4, 6, 13, 23, 29, 30, 33, 40, 50, 51  
and 52**

**Reg. No. 3,569,301**

**United States Patent and Trademark Office**

**Registered Feb. 3, 2009**

**TRADEMARK  
PRINCIPAL REGISTER**

**FAST-FIX JEWELRY AND WATCH  
REPAIRS**

JEWELRY REPAIR ENTERPRISES, INC. (PENN-  
SYLVANIA CORPORATION)  
SUITE 170  
1300 NW 17TH AVENUE  
DELRAY BEACH, FL 334452579

FOR: CLEANING PREPARATIONS FOR USE ON  
JEWELRY, IN CLASS 3 (U.S. CLS. 1, 4, 6, 50, 51 AND  
52).

FIRST USE 9-1-2004; IN COMMERCE 9-1-2004.

FOR: CLEANING AND POLISHING CLOTHS  
FOR USE ON JEWELRY, IN CLASS 21 (U.S. CLS. 2,  
13, 23, 29, 30, 33, 40 AND 50).

FIRST USE 9-1-2004; IN COMMERCE 9-1-2004.

THE MARK CONSISTS OF STANDARD CHAR-  
ACTERS WITHOUT CLAIM TO ANY PARTICULAR  
FONT, STYLE, SIZE, OR COLOR.

OWNER OF U.S. REG. NOS. 3,048,421 AND  
3,067,269.

NO CLAIM IS MADE TO THE EXCLUSIVE  
RIGHT TO USE "JEWELRY AND WATCH RE-  
PAIRS", APART FROM THE MARK AS SHOWN.

SER. NO. 77-438,717, FILED 4-3-2008.

MICHELLE DUBOIS, EXAMINING ATTORNEY

**Int. Cls.: 35, 38 and 41**

**Prior U.S. Cls.: 100, 101, 102, 104 and 107**

**United States Patent and Trademark Office**

**Reg. No. 3,569,302**

**Registered Feb. 3, 2009**

**SERVICE MARK  
PRINCIPAL REGISTER**



VENEVISION INTERNATIONAL LLC (FLORIDA LIMITED LIABILITY COMPANY)  
121 ALHAMBRA PLAZA, SUITE 1400  
CORAL GABLES, FL 33134

FOR: ONLINE RETAIL STORE SERVICES FEATURING AUDIOVISUAL RECORDINGS, MUSIC AND MOBILE CONTENT, NAMELY, RINGTONES, WALLPAPERS, GAMES AND IMAGES, IN CLASS 35 (U.S. CLS. 100, 101 AND 102).

FIRST USE 1-0-2006; IN COMMERCE 1-0-2006.

FOR: PAY TELEVISION BROADCASTING SERVICES; MOBILE MEDIA AND ENTERTAINMENT SERVICES IN THE NATURE OF ELECTRONIC TRANSMISSION OF ENTERTAINMENT MEDIA CONTENT, IN CLASS 38 (U.S. CLS. 100, 101 AND 104).

FIRST USE 9-0-2006; IN COMMERCE 9-0-2006.

FOR: HOUSE MARK FOR ENTERTAINMENT CONTENT PROVIDER IN THE FIELDS OF TELEVI-

SION PROGRAMMING; PRODUCTION AND DISTRIBUTION OF TELEVISION PROGRAMS; DISTRIBUTION OF MOTION PICTURES; MUSIC PUBLISHING, IN CLASS 41 (U.S. CLS. 100, 101 AND 107).

FIRST USE 5-0-1991; IN COMMERCE 5-0-1991.

OWNER OF U.S. REG. NOS. 1,775,524 AND 3,424,617.

NO CLAIM IS MADE TO THE EXCLUSIVE RIGHT TO USE "INTERNATIONAL", APART FROM THE MARK AS SHOWN.

THE MARK CONSISTS OF THE WORDING "VENEVISION INTERNATIONAL" BELOW THE LETTER "V" AND TWO LAUREL BRANCHES.

SER. NO. 77-438,963, FILED 4-3-2008.

TOBY BULLOFF, EXAMINING ATTORNEY



**Int. Cls.: 35, 38 and 41**

**Prior U.S. Cls.: 100, 101, 102, 104 and 107**

**United States Patent and Trademark Office**

**Reg. No. 3,569,303**

**Registered Feb. 3, 2009**

**SERVICE MARK  
PRINCIPAL REGISTER**

VENEVISION INTERNATIONAL

VENEVISION INTERNATIONAL LLC (FLORIDA  
LIMITED LIABILITY COMPANY)  
121 ALHAMBRA PLAZA, SUITE 1400  
CORAL GABLES, FL 33134

FOR: ONLINE RETAIL STORE SERVICES FEATURING AUDIOVISUAL RECORDINGS, MUSIC AND MOBILE CONTENT, NAMELY, RINGTONES, WALLPAPERS, GAMES AND IMAGES, IN CLASS 35 (U.S. CLS. 100, 101 AND 102).

FIRST USE 1-0-2006; IN COMMERCE 1-0-2006.

FOR: PAY TELEVISION BROADCASTING SERVICES; MOBILE MEDIA AND ENTERTAINMENT SERVICES IN THE NATURE OF ELECTRONIC TRANSMISSION OF ENTERTAINMENT MEDIA CONTENT, IN CLASS 38 (U.S. CLS. 100, 101 AND 104).

FIRST USE 9-0-2006; IN COMMERCE 9-0-2006.

FOR: HOUSE MARK FOR ENTERTAINMENT CONTENT PROVIDER IN THE FIELDS OF TELEVI-

SION PROGRAMMING; PRODUCTION AND DISTRIBUTION OF TELEVISION PROGRAMS; DISTRIBUTION OF MOTION PICTURES; MUSIC PUBLISHING, IN CLASS 41 (U.S. CLS. 100, 101 AND 107).

FIRST USE 5-0-1991; IN COMMERCE 5-0-1991.

THE MARK CONSISTS OF STANDARD CHARACTERS WITHOUT CLAIM TO ANY PARTICULAR FONT, STYLE, SIZE, OR COLOR.

OWNER OF U.S. REG. NOS. 1,775,524 AND 3,424,617.

NO CLAIM IS MADE TO THE EXCLUSIVE RIGHT TO USE "INTERNATIONAL", APART FROM THE MARK AS SHOWN.

SER. NO. 77-439,054, FILED 4-3-2008.

TOBY BULLOFF, EXAMINING ATTORNEY

**Int. Cl.: 9**

**Prior U.S. Cls.: 21, 23, 26, 36 and 38**

**Reg. No. 3,569,304**

**United States Patent and Trademark Office**

**Registered Feb. 3, 2009**

**TRADEMARK  
PRINCIPAL REGISTER**

**SCIENCE SCREEN REPORT**

ALLEGRO PRODUCTIONS, INC. (FLORIDA CORPORATION)  
1000 CLINT MOORE ROAD  
BOCA RATON, FL 33487

FOR: EDUCATIONAL KIT COMPRISING DVDS FEATURING SECONDARY LEVEL CURRICULUM ON ALL SCIENTIFIC DISCIPLINES, ALONG WITH TEACHER GUIDES, SOLD AS A UNIT, IN CLASS 9 (U.S. CLS. 21, 23, 26, 36 AND 38).

FIRST USE 10-1-1970; IN COMMERCE 10-1-1970.

THE MARK CONSISTS OF STANDARD CHARACTERS WITHOUT CLAIM TO ANY PARTICULAR FONT, STYLE, SIZE, OR COLOR.

NO CLAIM IS MADE TO THE EXCLUSIVE RIGHT TO USE "SCIENCE" AND "REPORT", APART FROM THE MARK AS SHOWN.

SER. NO. 77-439,304, FILED 4-3-2008.

ELLEN BURNS, EXAMINING ATTORNEY

**Int. Cl.: 9**

**Prior U.S. Cls.: 21, 23, 26, 36 and 38**

**Reg. No. 3,569,305**

**United States Patent and Trademark Office**

**Registered Feb. 3, 2009**

**TRADEMARK  
PRINCIPAL REGISTER**

**SCIENCE SCREEN REPORT FOR  
KIDS**

ALLEGRO PRODUCTIONS, INC. (FLORIDA  
CORPORATION)  
1000 CLINT MOORE ROAD  
BOCA RATON, FL 33487

THE MARK CONSISTS OF STANDARD CHAR-  
ACTERS WITHOUT CLAIM TO ANY PARTICULAR  
FONT, STYLE, SIZE, OR COLOR.

FOR: EDUCATIONAL KIT COMPRISING DVDS  
FEATURING PRIMARY OR LOWER LEVEL CUR-  
RICULUM-BASED PROGRAMS FOCUSING ON  
NEW DEVELOPMENTS IN ALL SCIENTIFIC DIS-  
CIPLINES, INCLUDING TEACHER GUIDES - SOLD  
AS A UNIT, IN CLASS 9 (U.S. CLS. 21, 23, 26, 36 AND  
38).

NO CLAIM IS MADE TO THE EXCLUSIVE  
RIGHT TO USE "SCIENCE" AND "REPORT FOR  
KIDS", APART FROM THE MARK AS SHOWN.

SER. NO. 77-439,365, FILED 4-3-2008.

FIRST USE 11-1-1991; IN COMMERCE 11-1-1991.

ELLEN BURNS, EXAMINING ATTORNEY

**Int. Cls.: 9 and 28**

**Prior U.S. Cls.: 21, 22, 23, 26, 36, 38 and 50**

**Reg. No. 3,569,306**

**United States Patent and Trademark Office**

**Registered Feb. 3, 2009**

**TRADEMARK  
PRINCIPAL REGISTER**

# TIER TOYS

3D FUNTIMES LIMITED (AUSTRALIA CORPORATION)  
UNIT 1, 112 HAYES AVENUE  
YOKINE, AUSTRALIA 6060

FOR: COMPUTER GAMES PROGRAMS; COMPUTER GAMES SOFTWARE; PROGRAM CARTRIDGES FOR COMPUTER GAMES; PROGRAM DISCS FOR VIDEO GAMES; PROGRAMMED VIDEO GAMES; VIDEO GAMES ON DISC; VIDEO GAMES ON TAPE; VIDEO GAMES PROGRAMS, IN CLASS 9 (U.S. CLS. 21, 23, 26, 36 AND 38).

FOR: TOY BUILDING BLOCKS; TOY BUILDING BRICKS; CHILDREN'S TOYS, NAMELY, CONSTRUCTION TOYS; CRAFT TOYS SOLD COMPLETE, NAMELY, HOBBY CRAFT SETS FOR ART; EDUCATIONAL TOYS, NAMELY, EDUCATIONAL CARD GAMES; ELECTRONIC TOYS, NAMELY, REMOTE CONTROL CARS; MODEL TOY ANIMALS; TOY MODEL FIGURINES; MODEL TOYS HOBBYCRAFT KITS; TOY MODEL VEHICLES; PLASTIC TOY HOOPS; RUBBER CHARACTER TOYS; WOODEN TOYS, NAMELY, TOY FIGUR-

INES; CONSTRUCTION BUILDING GAMES; BOARD GAMES; BOARD GAMES FOR CHILDREN; CHILDREN'S PLAYTHINGS, NAMELY, PUPPETS; EDUCATIONAL PLAYTHINGS, NAMELY, EDUCATIONAL CARD GAMES; TOY MODEL TRAIN SETS, IN CLASS 28 (U.S. CLS. 22, 23, 38 AND 50).

THE MARK CONSISTS OF STANDARD CHARACTERS WITHOUT CLAIM TO ANY PARTICULAR FONT, STYLE, SIZE, OR COLOR.

PRIORITY CLAIMED UNDER SEC. 44(D) ON AUSTRALIA APPLICATION NO. 1202782, FILED 10-5-2007, REG. NO. 1202782, DATED 10-5-2007, EXPIRES 10-5-2017.

NO CLAIM IS MADE TO THE EXCLUSIVE RIGHT TO USE "TOYS", APART FROM THE MARK AS SHOWN.

SER. NO. 77-439,609, FILED 4-3-2008.

KAPIL BHANOT, EXAMINING ATTORNEY

**Int. Cl.: 9**

**Prior U.S. Cls.: 21, 23, 26, 36 and 38**

**Reg. No. 3,569,307**

**United States Patent and Trademark Office**

**Registered Feb. 3, 2009**

**TRADEMARK  
PRINCIPAL REGISTER**

**CRA INSIGHTS**

CRA INTERNATIONAL, INC. (MASSACHU-  
SETTS CORPORATION)  
T-33  
200 CLARENDON ST.  
BOSTON, MA 02116

FOR: DOWNLOADABLE ELECTRONIC NEWS-  
LETTERS IN THE FIELD OF BUSINESS AND  
LITIGATION CONSULTING, IN CLASS 9 (U.S. CLS.  
21, 23, 26, 36 AND 38).

FIRST USE 9-1-2007; IN COMMERCE 9-1-2007.

THE MARK CONSISTS OF STANDARD CHAR-  
ACTERS WITHOUT CLAIM TO ANY PARTICULAR  
FONT, STYLE, SIZE, OR COLOR.

OWNER OF U.S. REG. NOS. 1,692,065, 1,735,152  
AND OTHERS.

SER. NO. 77-441,714, FILED 4-7-2008.

KAREN BRACEY, EXAMINING ATTORNEY

**Int. Cls.: 35, 36 and 37**

**Prior U.S. Cls.: 100, 101, 102, 103 and 106**

**United States Patent and Trademark Office**

**Reg. No. 3,569,308**

**Registered Feb. 3, 2009**

**SERVICE MARK  
PRINCIPAL REGISTER**

**MEMBERSHIP. FOR LIFE.**

AMERICAN AUTOMOBILE ASSOCIATION, INC.  
(CONNECTICUT CORPORATION)  
1000 AAA DRIVE  
HEATHROW, FL 327465063

FOR: ARRANGING DISCOUNTS FOR MEMBERS OF AN AUTOMOBILE CLUB FOR VENDORS OF AUTOMOTIVE SERVICES, HOTEL CHAINS, TOURIST ATTRACTIONS, RESTAURANTS, AND RETAIL OUTLETS; SCHEDULING REPAIRS IN THE NATURE OF VEHICLE GLASS REPLACEMENT FOR OTHERS, IN CLASS 35 (U.S. CLS. 100, 101 AND 102).

FIRST USE 1-1-2008; IN COMMERCE 1-1-2008.

FOR: ADJUSTING AND COLLECTING INSURANCE DAMAGE CLAIMS; INSURANCE BROKERAGE SERVICES, NAMELY, OBTAINING INSURANCE, PLACING INSURANCE WITH UN-

DERWRITERS; AND AUTO LOAN SERVICES, IN CLASS 36 (U.S. CLS. 100, 101 AND 102).

FIRST USE 1-1-2008; IN COMMERCE 1-1-2008.

FOR: EMERGENCY ROAD SERVICES, IN CLASS 37 (U.S. CLS. 100, 103 AND 106).

FIRST USE 1-1-2008; IN COMMERCE 1-1-2008.

THE MARK CONSISTS OF STANDARD CHARACTERS WITHOUT CLAIM TO ANY PARTICULAR FONT, STYLE, SIZE, OR COLOR.

SER. NO. 77-442,361, FILED 4-8-2008.

NORA BUCHANAN WILL, EXAMINING ATTORNEY

**Int. Cl.: 30**

**Prior U.S. Cl.: 46**

**United States Patent and Trademark Office**

**Reg. No. 3,569,309**

**Registered Feb. 3, 2009**

**TRADEMARK  
PRINCIPAL REGISTER**

**CUSANO'S**

CUSANO'S ITALIAN BAKERY, INC. (FLORIDA  
CORPORATION)  
213 NW 4TH AVENUE  
HALLANDALE, FL 33009

FOR: BISCUITS AND BREAD; BREAD; BREAD  
AND BUNS; BREAD AND PASTRY; BREAD  
DOUGHS; BREAD MIXES; BREAD ROLLS, IN  
CLASS 30 (U.S. CL. 46).

FIRST USE 11-24-1970; IN COMMERCE 1-1-2000.

THE MARK CONSISTS OF STANDARD CHAR-  
ACTERS WITHOUT CLAIM TO ANY PARTICULAR  
FONT, STYLE, SIZE, OR COLOR.

SEC. 2(F).

SER. NO. 77-442,368, FILED 4-8-2008.

MARIAM MAHMOUDI, EXAMINING ATTORNEY

**Int. Cl.: 44**

**Prior U.S. Cls.: 100 and 101**

**United States Patent and Trademark Office**

**Reg. No. 3,569,310**

**Registered Feb. 3, 2009**

**SERVICE MARK  
PRINCIPAL REGISTER**

# Ink-B-Gone

INK B GONE, INC. (COLORADO CORPORATION)  
124 WEST 5TH AVENUE  
DENVER, CO 80204

THE MARK CONSISTS OF STANDARD CHARACTERS WITHOUT CLAIM TO ANY PARTICULAR FONT, STYLE, SIZE, OR COLOR.

FOR: TATTOO REMOVAL, IN CLASS 44 (U.S. CLS. 100 AND 101).

SER. NO. 77-443,102, FILED 4-8-2008.

FIRST USE 8-10-2006; IN COMMERCE 8-10-2006.

REBECCA SMITH, EXAMINING ATTORNEY



**Int. Cl.: 44**

**Prior U.S. Cls.: 100 and 101**

**United States Patent and Trademark Office**

**Reg. No. 3,569,311**

**Registered Feb. 3, 2009**

**SERVICE MARK  
PRINCIPAL REGISTER**



INK-B-GONE, INC. (COLORADO CORPORATION)  
124 WEST 5TH AVENUE  
DENVER, CO 80204

FOR: TATTOO REMOVAL, IN CLASS 44 (U.S. CLS. 100 AND 101).

FIRST USE 8-10-2006; IN COMMERCE 8-10-2006.

NO CLAIM IS MADE TO THE EXCLUSIVE RIGHT TO USE "PRECISION LASER TATTOO REMOVAL", APART FROM THE MARK AS SHOWN.

THE MARK CONSISTS OF THE WORDS "INK-B-GONE" ARE ON THE TOP LINE WITH THE WORDS "PRECISION LASER TATTOO REMOVAL" BELOW THEM. THERE ARE TRIBAL DESIGNS ABOVE AND BELOW THE WORDS.

SER. NO. 77-443,158, FILED 4-8-2008.

DORITT L. CARROLL, EXAMINING ATTORNEY

**Int. Cl.: 37**

**Prior U.S. Cls.: 100, 103 and 106**

**United States Patent and Trademark Office**

**Reg. No. 3,569,312**

**Registered Feb. 3, 2009**

**SERVICE MARK  
PRINCIPAL REGISTER**

**SAGEHAVEN**

CLARK, PAUL A. (UNITED STATES INDIVIDUAL)  
576 S CENTER STREET  
MIDWAY, UT 84049

THE MARK CONSISTS OF STANDARD CHARACTERS WITHOUT CLAIM TO ANY PARTICULAR FONT, STYLE, SIZE, OR COLOR.

FOR: BUILDING CONSTRUCTION SUPERVISION; CONSTRUCTION OF BUILDINGS; CONSTRUCTION SUPERVISION, IN CLASS 37 (U.S. CLS. 100, 103 AND 106).

SER. NO. 77-443,275, FILED 4-8-2008.

FIRST USE 2-29-2008; IN COMMERCE 3-1-2008.

ROBIN CHOSID, EXAMINING ATTORNEY

**Int. Cl.: 44**

**Prior U.S. Cls.: 100 and 101**

**United States Patent and Trademark Office**

**Reg. No. 3,569,313**

**Registered Feb. 3, 2009**

**SERVICE MARK  
PRINCIPAL REGISTER**

**THE FACTORY HAIR & MAKEUP  
STUDIO**

THE FACTORY HAIR & MAKEUP STUDIO  
(CALIFORNIA CORPORATION)  
ALAFANADOR9@YAHOO.COM  
PASADENA, CA 91101

FOR: HAIR SALON SERVICES, NAMELY, HAIR CUTTING, STYLING, COLORING, AND HAIR EXTENSION SERVICES; CONSULTATION SERVICES IN THE FIELD OF MAKEUP, NAMELY, ON-LINE MAKEUP CONSULTATION SERVICES AND IN-PERSON MAKEUP CONSULTATION AND APPLICATION SERVICES, IN CLASS 44 (U.S. CLS. 100 AND 101).

FIRST USE 7-1-2004; IN COMMERCE 7-1-2004.

THE MARK CONSISTS OF STANDARD CHARACTERS WITHOUT CLAIM TO ANY PARTICULAR FONT, STYLE, SIZE, OR COLOR.

NO CLAIM IS MADE TO THE EXCLUSIVE RIGHT TO USE "HAIR & MAKEUP STUDIO", APART FROM THE MARK AS SHOWN.

SER. NO. 77-444,380, FILED 4-9-2008.

ERNEST SHOSHO, EXAMINING ATTORNEY

Int. Cl.: 35

Prior U.S. Cls.: 100, 101 and 102

United States Patent and Trademark Office

Reg. No. 3,569,314

Registered Feb. 3, 2009

SERVICE MARK  
PRINCIPAL REGISTER



DIAL TONE SERVICES, LLC (CALIFORNIA LIMITED LIABILITY COMPANY)

#360

111 N. SEPULVEDA BLVD.  
MANHATTAN BEACH, CA 90266

FOR: BUSINESS RELOCATION CONSULTING,  
IN CLASS 35 (U.S. CLS. 100, 101 AND 102).

FIRST USE 1-1-2008; IN COMMERCE 1-1-2008.

NO CLAIM IS MADE TO THE EXCLUSIVE  
RIGHT TO USE "OFFICERELO.NET" AND "A DIAL

TONE SERVICES COMPANY", APART FROM THE  
MARK AS SHOWN.

THE MARK CONSISTS OF THE STYLIZED  
WORDS "OFFICERELO.NET A DIAL TONE SERVICES  
COMPANY". ABOVE THE STYLIZED WORDS  
IS AN ARROW FORMING FROM THE "I" IN "OFFICE"  
TO THE "T" IN "NET".

SER. NO. 77-444,809, FILED 4-10-2008.

RAMONA ORTIGA, EXAMINING ATTORNEY

**Int. Cls.: 38, 42 and 45**

**Prior U.S. Cls.: 100, 101 and 104**

**United States Patent and Trademark Office**

**Reg. No. 3,569,315**

**Registered Feb. 3, 2009**

**SERVICE MARK  
PRINCIPAL REGISTER**

## Creating Trust Online

COMODO CA LIMITED (UNITED KINGDOM CORPORATION)  
EXCHANGE QUAY  
26 OFFICE VILLAGE, 3D FLR, TRAFFORD ROAD  
SALFORD, UNITED KINGDOM M53EQ

FOR: SECURE E-MAIL SERVICES, IN CLASS 38 (U.S. CLS. 100, 101 AND 104).

FIRST USE 6-29-2005; IN COMMERCE 6-29-2005.

FOR: DEVELOPMENT OF SOFTWARE FOR SECURE NETWORK OPERATIONS; ON-LINE SECURITY SERVICES, NAMELY, PROVIDING SECURITY AND ANONYMITY FOR ELECTRONICALLY TRANSMITTED CREDIT CARD TRANSACTIONS; COMPUTER SERVICES, NAMELY, ONLINE SCANNING, DETECTING, QUARANTINING AND ELIMINATING VIRUSES, WORMS, TROJANS, SPYWARE, ADWARE, MALWARE AND UNAUTHORIZED DATA AND PROGRAMS ON COMPUTERS AND ELECTRONIC DEVICES, IN CLASS 42 (U.S. CLS. 100 AND 101).

FIRST USE 6-29-2005; IN COMMERCE 6-29-2005.

FOR: AUTHENTICATION, ISSUANCE AND VALIDATION OF DIGITAL CERTIFICATES; COMPUTER SECURITY SERVICES IN THE NATURE OF PROVIDING AN INTERNET TRUST CENTER, NAMELY, COMPUTER SECURITY ASSURANCE AND ADMINISTRATION OF DIGITAL KEYS AND DIGITAL CERTIFICATES; PROVIDING A WEB SITE FEATURING INFORMATION IN THE FIELD OF SECURITY; PROVIDING A WEBSITE FEATURING INFORMATION ON THE DEVELOPMENT OF PRIVACY, SECURITY AND DATA GOVERNANCE LAW; MONITORING OF COMPUTER SYSTEMS FOR SECURITY PURPOSES, IN CLASS 45 (U.S. CLS. 100 AND 101).

FIRST USE 6-29-2005; IN COMMERCE 6-29-2005.

THE MARK CONSISTS OF STANDARD CHARACTERS WITHOUT CLAIM TO ANY PARTICULAR FONT, STYLE, SIZE, OR COLOR.

SER. NO. 77-444,818, FILED 4-10-2008.

DAWN FELDMAN, EXAMINING ATTORNEY

**Int. Cl.: 35**

**Prior U.S. Cls.: 100, 101 and 102**

**United States Patent and Trademark Office**

**Reg. No. 3,569,316**

**Registered Feb. 3, 2009**

**SERVICE MARK  
PRINCIPAL REGISTER**

**NINJA MARKETING**

KHAN, SAMEER A (INDIA INDIVIDUAL), DBA  
SAMEER KHAN

9623 TREE SPARROW LANE

HOUSTON, TX 77083

FOR: BUSINESS MARKETING CONSULTING  
SERVICES, IN CLASS 35 (U.S. CLS. 100, 101 AND 102).

FIRST USE 3-17-2006; IN COMMERCE 1-1-2008.

THE MARK CONSISTS OF STANDARD CHAR-  
ACTERS WITHOUT CLAIM TO ANY PARTICULAR  
FONT, STYLE, SIZE, OR COLOR.

NO CLAIM IS MADE TO THE EXCLUSIVE  
RIGHT TO USE "MARKETING", APART FROM  
THE MARK AS SHOWN.

SER. NO. 77-445,557, FILED 4-10-2008.

DAWN HAN, EXAMINING ATTORNEY

**Int. Cls.: 41 and 45**

**Prior U.S. Cls.: 100, 101 and 107**

**United States Patent and Trademark Office**

**Reg. No. 3,569,317**

**Registered Feb. 3, 2009**

**SERVICE MARK  
PRINCIPAL REGISTER**



THE CENTER FOR CAMPUS FIRE SAFETY, INC.  
(MASSACHUSETTS CORPORATION)  
10 STATE STREET  
NEWBURYPORT, MA 01950

FOR: EDUCATIONAL SERVICES, NAMELY, CONDUCTING WORKSHOPS AND CONFERENCES IN THE FIELDS OF FIRE PREVENTION AND FIRE SAFETY, IN CLASS 41 (U.S. CLS. 100, 101 AND 107).

FIRST USE 10-1-2003; IN COMMERCE 10-1-2003.

FOR: EDUCATIONAL RESOURCE SERVICES, NAMELY, PROVIDING ON-LINE AND HARD COPY RESOURCE GUIDES IN THE FIELDS OF FIRE PREVENTION AND FIRE SAFETY, IN CLASS 45 (U.S. CLS. 100 AND 101).

FIRST USE 10-1-2003; IN COMMERCE 10-1-2003.

NO CLAIM IS MADE TO THE EXCLUSIVE RIGHT TO USE "THE CENTER FOR CAMPUS FIRE SAFETY", APART FROM THE MARK AS SHOWN.

THE COLOR(S) BLACK, RED AND WHITE IS/ ARE CLAIMED AS A FEATURE OF THE MARK.

THE WORDS "THE CENTER FOR" IN BLACK APPEAR ABOVE A RED CRESCENT SHAPE, AND THE BLACK WORDS "CAMPUS FIRE SAFETY" ARE LOCATED WITHIN THE RED CRESCENT SHAPE. THE BACKGROUND BEHIND THE IMAGE IS WHITE.

SER. NO. 77-445,825, FILED 4-11-2008.

BRIAN PINO, EXAMINING ATTORNEY

**Int. Cls.: 41 and 45**

**Prior U.S. Cls.: 100, 101 and 107**

**United States Patent and Trademark Office**

**Reg. No. 3,569,318**

**Registered Feb. 3, 2009**

**SERVICE MARK  
PRINCIPAL REGISTER**



THE CENTER FOR CAMPUS FIRE SAFETY, INC.  
(MASSACHUSETTS CORPORATION)  
10 STATE STREET  
NEWBURYPORT, MA 01950

FOR: EDUCATIONAL SERVICES, NAMELY, CONDUCTING WORKSHOPS AND CONFERENCES IN THE FIELDS OF FIRE PREVENTION AND FIRE SAFETY, IN CLASS 41 (U.S. CLS. 100, 101 AND 107).

FIRST USE 3-1-2008; IN COMMERCE 3-1-2008.

FOR: EDUCATIONAL RESOURCE SERVICES, NAMELY, PROVIDING ON-LINE AND HARD COPY RESOURCE GUIDES IN THE FIELDS OF FIRE PREVENTION AND FIRE SAFETY, IN CLASS 45 (U.S. CLS. 100 AND 101).

FIRST USE 3-1-2008; IN COMMERCE 3-1-2008.

NO CLAIM IS MADE TO THE EXCLUSIVE RIGHT TO USE "CAMPUS FIRE SAFETY MONTH NETWORK", APART FROM THE MARK AS SHOWN.

THE COLOR(S) BLACK, GRAY, GREEN, ORANGE, RED, WHITE AND YELLOW IS/ARE CLAIMED AS A FEATURE OF THE MARK.

THE MARK CONSISTS OF A RED CRESCENT AND THE WORDING "THE CFM CAMPUS FIRE SAFETY MONTH NETWORK". WITHIN THE RED CRESCENT IS THE WORD "THE" IN BLACK TEXT. IMMEDIATELY BENEATH THE WORD "THE" IS THE LETTER "C" IN BLACK TEXT. NEXT TO THE "C" IS THE LETTER "F" WITH ORANGE, RED AND YELLOW FLAMES CONTAINED WITHIN IT. NEXT TO THE "F" IS THE LETTER "S" IN BLACK TEXT. NEXT TO THE "S" IS THE LETTER "M" IN WITH A GRAY, GREEN, AND WHITE CALENDAR CONTAINED WITHIN IT WITH BLACK IN THE UPPER RIGHT PORTION ABOVE THE CALENDAR. IMMEDIATELY BENEATH THE LETTER "F" IS THE WORD "CAMPUS" IN BLACK TEXT, "FIRE SAFETY" IN RED TEXT AND "MONTH NETWORK" IN BLACK TEXT.

SER. NO. 77-445,860, FILED 4-11-2008.

BRIAN PINO, EXAMINING ATTORNEY



Int. Cl.: 41

Prior U.S. Cls.: 100, 101 and 107

United States Patent and Trademark Office

Reg. No. 3,569,319

Registered Feb. 3, 2009

SERVICE MARK  
PRINCIPAL REGISTER



PILICZAR CHRIS (CANADA INDIVIDUAL)  
P.O. BOX 323  
CANOGA PARK, CA 91305

FOR: EDUCATIONAL SERVICES, NAMELY, PROVIDING INTERNSHIPS AND APPRENTICESHIPS IN THE FIELD OF INDEPENDENT FILM INDUSTRY, IN CLASS 41 (U.S. CLS. 100, 101 AND 107).

FIRST USE 11-5-1988; IN COMMERCE 2-5-1997.

NO CLAIM IS MADE TO THE EXCLUSIVE RIGHT TO USE "FILM ARTISTS NETWORK" AND "INDEPENDENT CINEMA", APART FROM THE MARK AS SHOWN.

THE COLOR(S) RED, BLACK, VERY LIGHT CREAM (VERY CLOSE TO WHITE), GRAY, IS/ARE CLAIMED AS A FEATURE OF THE MARK.

THE MARK CONSISTS OF A LEFT HAND WITH REDDISH FINGERNAILS WEARING A PEARL

RING ON THE RING FINGER AND A PEARL BRACELET ON THE WRIST. THE LEFT HAND IS HOLDING AN UNFOLDED FAN, WITH A DECORATIVE DESIGN IN DIFFERENT SHADES OF GRAY COLOR. IT INCLUDES THE STATEMENT "TRULY INDEPENDENT CINEMA" IN VERY LIGHT CREAM (ALMOST WHITE) AT THE BOTTOM OF THE FAN. ABOVE THE FAN THERE IS THE NAME " FILM ARTISTS NETWORK". THE BEGINNING LETTERS OF THE NAME " FILM ARTISTS NETWORK" ARE IN A REDDISH COLOR. EACH OF THE THREE WORDS ARE PRINTED HORIZONTALLY IN DESCENDING ORDER WITH THE FIRST LETTER OF EACH WORD SPELLING OUT VERTICALLY THE WORD " FAN". THE BACKGROUND IS VERY LIGHT GRAY (ALMOST WHITE) .

SER. NO. 77-447,048, FILED 4-14-2008.

JANICE L. MCMORROW, EXAMINING ATTORNEY

**Int. Cl.: 16**

**Prior U.S. Cls.: 2, 5, 22, 23, 29, 37, 38 and 50**

**United States Patent and Trademark Office**

**Reg. No. 3,569,320**

**Registered Feb. 3, 2009**

**TRADEMARK  
PRINCIPAL REGISTER**

THE ROAD GOES ON FOREVER

KEEN, ROBERT EARL (UNITED STATES INDIVIDUAL)  
C/O KEEN PRODUCTIONS, INC.  
448 SIDNEY BAKER STREET S., SUITE 106  
KERRVILLE, TX 78028

THE MARK CONSISTS OF STANDARD CHARACTERS WITHOUT CLAIM TO ANY PARTICULAR FONT, STYLE, SIZE, OR COLOR.

FOR: BUMPER STICKERS, IN CLASS 16 (U.S. CLS. 2, 5, 22, 23, 29, 37, 38 AND 50).

SER. NO. 77-447,231, FILED 4-14-2008.

FIRST USE 2-0-1989; IN COMMERCE 2-0-1989.

ELLEN B. AWRICH, EXAMINING ATTORNEY

**Int. Cl.: 25**

**Prior U.S. Cls.: 22 and 39**

**United States Patent and Trademark Office**

**Reg. No. 3,569,321**

**Registered Feb. 3, 2009**

**TRADEMARK  
PRINCIPAL REGISTER**

THE ROAD GOES ON FOREVER

KEEN, ROBERT EARL (UNITED STATES INDIVIDUAL)  
C/O KEEN PRODUCTIONS, INC.  
448 SIDNEY BAKER STREET S., SUITE 106  
KERRVILLE, TX 78028

THE MARK CONSISTS OF STANDARD CHARACTERS WITHOUT CLAIM TO ANY PARTICULAR FONT, STYLE, SIZE, OR COLOR.

FOR: SHIRTS AND HATS, IN CLASS 25 (U.S. CLS. 22 AND 39).

SER. NO. 77-447,253, FILED 4-14-2008.

FIRST USE 5-0-2007; IN COMMERCE 5-0-2007.

ELLEN B. AWRICH, EXAMINING ATTORNEY

**Int. Cl.: 36**

**Prior U.S. Cls.: 100, 101 and 102**

**United States Patent and Trademark Office**

**Reg. No. 3,569,322**

**Registered Feb. 3, 2009**

**SERVICE MARK  
PRINCIPAL REGISTER**



ALAMO CAPITAL (CALIFORNIA CORPORATION)  
1777 BOTELHO DRIVE, SUITE 375  
WALNUT CREEK, CA 94596

FOR: FINANCIAL SERVICES, NAMELY, ASSISTING OTHERS WITH THE COMPLETION OF FINANCIAL TRANSACTIONS FOR STOCKS, BONDS, SECURITIES AND EQUITIES, IN CLASS 36 (U.S. CLS. 100, 101 AND 102).

FIRST USE 1-1-2007; IN COMMERCE 1-1-2008.

NO CLAIM IS MADE TO THE EXCLUSIVE RIGHT TO USE "BOND ON-LINE TRADING SYSTEM", APART FROM THE MARK AS SHOWN.

THE COLOR(S) BLUE, ORANGE, YELLOW AND WHITE IS/ARE CLAIMED AS A FEATURE OF THE MARK.

THE MARK CONSISTS OF THE COLORS BLUE, ORANGE, YELLOW AND WHITE, WITH THE COLOR BLUE APPEARING IN WORDING "BOLTS" AND "TRADING SYSTEM", THE COLOR ORANGE APPEARING IN THE RIGHT TRIANGULAR HALF OF THE SQUARE DESIGN, THE COLOR YELLOW APPEARING IN THE LEFT TRIANGULAR HALF OF THE SQUARE DESIGN, AND THE COLOR WHITE APPEARING IN THE LIGHTENING BOLT DESIGN AND THE WORDING "BOND ON-LINE".

SER. NO. 77-447,264, FILED 4-14-2008.

WILLIAM P. SHANAHAN, EXAMINING ATTORNEY

**Int. Cl.: 35**

**Prior U.S. Cls.: 100, 101 and 102**

**United States Patent and Trademark Office**

**Reg. No. 3,569,323**

**Registered Feb. 3, 2009**

**SERVICE MARK  
PRINCIPAL REGISTER**

**WantAds4U**

CHRISTENSEN, CHRIS (UNITED STATES INDIVIDUAL)  
1718 AVENUE F  
LUBBOCK, TX 79401

FOR: PROVIDING A WEB SITE THAT ENABLES USERS TO POST ITEMS FOR SALE THROUGH ON-LINE CLASSIFIED ADVERTISEMENTS; PROVIDING AN ON-LINE SEARCHABLE DATABASE FEATURING CLASSIFIED AD LISTINGS AND EMPLOYMENT OPPORTUNITIES; DISSEMINATION OF ADVERTISING FOR OTHERS VIA THE INTERNET; ON-LINE ADVERTISING AND MARKETING SERVICES; ADVERTISING SERVICES,

NAMELY, PROVIDING ADVERTISING SPACE IN A PERIODICAL; PUBLISHING OF ADVERTISING TEXTS, IN CLASS 35 (U.S. CLS. 100, 101 AND 102).

FIRST USE 6-1-2000; IN COMMERCE 6-1-2000.

THE MARK CONSISTS OF A STYLIZED BANNER OF STARS AND STRIPES SUPERIMPOSED ON THE WORDING "WANTADS4U".

SER. NO. 77-447,544, FILED 4-14-2008.

HANNO RITTNER, EXAMINING ATTORNEY

**Int. Cls.: 37 and 44**

**Prior U.S. Cls.: 100, 101, 103 and 106**

**United States Patent and Trademark Office**

**Reg. No. 3,569,324**

**Registered Feb. 3, 2009**

**SERVICE MARK  
PRINCIPAL REGISTER**

**LADYBUGLAWN**

DAY, ALAN (UNITED STATES INDIVIDUAL)  
#510-244  
2222 FRANCISCO DR.  
EL DORADO HILLS, CA 95762

FOR: INSTALLATION AND MAINTENANCE OF  
IRRIGATION SYSTEMS AND LANDSCAPE LIGHT-  
ING, IN CLASS 37 (U.S. CLS. 100, 103 AND 106).

FIRST USE 12-1-2005; IN COMMERCE 12-1-2005.

FOR: LANDSCAPE GARDENING AND LAND-  
SCAPE DESIGN, NAMELY, THE IMPROVEMENT

OF OUTDOOR LANDSCAPES, GARDENS, PLANTS,  
TREES, FLOWERS, LAWNS, SOIL, MULCH, BARK,  
IN CLASS 44 (U.S. CLS. 100 AND 101).

FIRST USE 12-1-2005; IN COMMERCE 12-1-2005.

THE MARK CONSISTS OF STANDARD CHAR-  
ACTERS WITHOUT CLAIM TO ANY PARTICULAR  
FONT, STYLE, SIZE, OR COLOR.

SER. NO. 77-447,770, FILED 4-14-2008.

SALLY SHIH, EXAMINING ATTORNEY

**Int. Cl.: 35**

**Prior U.S. Cls.: 100, 101 and 102**

**United States Patent and Trademark Office**

**Reg. No. 3,569,325**

**Registered Feb. 3, 2009**

**SERVICE MARK  
PRINCIPAL REGISTER**



TAIGA COMPANY (TEXAS LIMITED LIABILITY  
COMPANY)

P.O. BOX 271255

HOUSTON, TX 77277

FOR: BUSINESS CONSULTATION IN THE FIELD  
OF SUSTAINABLE DEVELOPMENT AND BUSI-  
NESS STRATEGY, IN CLASS 35 (U.S. CLS. 100, 101  
AND 102).

FIRST USE 1-1-2008; IN COMMERCE 1-1-2008.

NO CLAIM IS MADE TO THE EXCLUSIVE  
RIGHT TO USE "COMPANY" AND "BUSINESS",  
APART FROM THE MARK AS SHOWN.

THE MARK CONSISTS OF THE STYLIZED  
WORDS "TAIGA COMPANY OXYGEN FOR YOUR  
BUSINESS". TO THE RIGHT OF THE WORD IS AN  
IMAGE OF A GLOBE CONTAINING A LEAF IN-  
SIDE .

SER. NO. 77-447,796, FILED 4-14-2008.

DAWN HAN, EXAMINING ATTORNEY

**Int. Cl.: 12**

**Prior U.S. Cls.: 19, 21, 23, 31, 35 and 44**

**United States Patent and Trademark Office**

**Reg. No. 3,569,326**

**Registered Feb. 3, 2009**

**TRADEMARK  
PRINCIPAL REGISTER**

**BAR CRUSHER**

CLELAND, PETER (AUSTRALIA INDIVIDUAL)  
29 WEBSTER STREET  
CAMBERWELL, VICTORIA, AUSTRALIA 3124

FOR: VEHICLES FOR LOCOMOTION BY WATER, NAMELY, BOATS, SHIPS, FERRY BOATS AND BARGES; STRUCTURAL PARTS FOR BOATS, SHIPS, FERRY BOATS AND BARGES, NAMELY, MASTS, DAVITS, FENDERS, SCREW PROPELLERS, DISENGAGING GEARS, AND STEERING GEARS; ACCESSORIES FOR BOATS, SHIPS, FERRY BOATS AND BARGES, NAMELY, BOAT TRAILERS AND BOAT HOOKS, IN CLASS 12 (U.S. CLS. 19, 21, 23, 31, 35 AND 44).

THE MARK CONSISTS OF STANDARD CHARACTERS WITHOUT CLAIM TO ANY PARTICULAR FONT, STYLE, SIZE, OR COLOR.

OWNER OF AUSTRALIA REG. NO. 1066977,  
DATED 10-11-2006, EXPIRES 7-27-2015.

SER. NO. 77-448,023, FILED 4-14-2008.

ALICE SUE CARRUTHERS, EXAMINING ATTORNEY



**Int. Cl.: 8**

**Prior U.S. Cls.: 23, 28 and 44**

**Reg. No. 3,569,327**

**United States Patent and Trademark Office**

**Registered Feb. 3, 2009**

**TRADEMARK  
PRINCIPAL REGISTER**

**CLIPPER KEEPER**

BARNETT, WALTER T. JR. (UNITED STATES  
INDIVIDUAL)  
4304 BRINKLEY ROAD  
TEMPLE HILLS, MD 20748

FOR: CONTAINERS ESPECIALLY DESIGNED  
FOR STORING, ORGANIZING, PROTECTING,  
AND TRANSPORTING ELECTRIC HAIR CLIPPERS,  
FOR USE BY BARBERS AND HAIRSTYLISTS, IN  
CLASS 8 (U.S. CLS. 23, 28 AND 44).

FIRST USE 1-5-2005; IN COMMERCE 1-5-2005.

THE MARK CONSISTS OF STANDARD CHAR-  
ACTERS WITHOUT CLAIM TO ANY PARTICULAR  
FONT, STYLE, SIZE, OR COLOR.

NO CLAIM IS MADE TO THE EXCLUSIVE  
RIGHT TO USE "CLIPPER", APART FROM THE  
MARK AS SHOWN.

SER. NO. 77-448,246, FILED 4-15-2008.

BARBARA BROWN, EXAMINING ATTORNEY

**Int. Cl.: 9**

**Prior U.S. Cls.: 21, 23, 26, 36 and 38**

**Reg. No. 3,569,328**

**United States Patent and Trademark Office**

**Registered Feb. 3, 2009**

**TRADEMARK  
PRINCIPAL REGISTER**

**Planot**

PLANOT, LLC (NEBRASKA LIMITED LIABILITY  
COMPANY)  
16314 MADISON STREET  
OMAHA, NE 68135

THE MARK CONSISTS OF STANDARD CHAR-  
ACTERS WITHOUT CLAIM TO ANY PARTICULAR  
FONT, STYLE, SIZE, OR COLOR.

FOR: AUDIO SPEAKERS AND LOUD SPEAKERS,  
IN CLASS 9 (U.S. CLS. 21, 23, 26, 36 AND 38).

SER. NO. 77-448,316, FILED 4-15-2008.

FIRST USE 9-2-2007; IN COMMERCE 9-2-2007.

JIM RINGLE, EXAMINING ATTORNEY

**Int. Cls.: 37, 39 and 42**

**Prior U.S. Cls.: 100, 101, 103, 105 and 106**

**United States Patent and Trademark Office**

**Reg. No. 3,569,329**

**Registered Feb. 3, 2009**

**SERVICE MARK  
PRINCIPAL REGISTER**



DISTRIBUTED DATA SERVICES, INC. (FLORIDA CORPORATION)  
1717 W. FAIRBANKS AVENUE  
WINTER PARK, FL 32789

FOR: COMPUTER SERVICES, NAMELY, INSTALLATION, MAINTENANCE AND REPAIR OF COMPUTER NETWORKS AND HARDWARE FOR OTHERS, IN CLASS 37 (U.S. CLS. 100, 103 AND 106).

FIRST USE 4-7-2008; IN COMMERCE 4-7-2008.

FOR: ELECTRONIC STORAGE OF DATA FOR OTHERS, IN CLASS 39 (U.S. CLS. 100 AND 105).

FIRST USE 4-7-2008; IN COMMERCE 4-7-2008.

FOR: COMPUTER SERVICES, NAMELY, MANAGEMENT AND MONITORING OF COMPUTER NETWORKS, COMPUTER HARDWARE, AND COMPUTER SOFTWARE FOR OTHERS; PROVIDING REMOTE BACK-UP SERVICES OF COMPUTER DATA FOR OTHERS, IN CLASS 42 (U.S. CLS. 100 AND 101).

FIRST USE 4-7-2008; IN COMMERCE 4-7-2008.

THE MARK CONSISTS OF THE WORDS "EVEN KEEL" WITH AN IMAGE OF A LIGHTHOUSE, BEAM OF LIGHT, AND ROCKS.

SER. NO. 77-448,463, FILED 4-15-2008.

JORDAN BAKER, EXAMINING ATTORNEY

**Int. Cl.: 35**

**Prior U.S. Cls.: 100, 101 and 102**

**United States Patent and Trademark Office**

**Reg. No. 3,569,330**

**Registered Feb. 3, 2009**

**SERVICE MARK  
PRINCIPAL REGISTER**

**GO FOR THE BOLD**

TACO JOHN'S SEASONINGS LIMITED PART-  
NERSHIP (WYOMING LIMITED PARTNER-  
SHIP)  
808 W. 20TH STREET  
CHEYENNE, WY 82001

THE MARK CONSISTS OF STANDARD CHAR-  
ACTERS WITHOUT CLAIM TO ANY PARTICULAR  
FONT, STYLE, SIZE, OR COLOR.

FOR: EMPLOYMENT RECRUITING SERVICES  
IN THE RESTAURANT INDUSTRY, IN CLASS 35  
(U.S. CLS. 100, 101 AND 102).

SER. NO. 77-448,778, FILED 4-15-2008.

FIRST USE 7-30-2007; IN COMMERCE 7-30-2007.

RONALD MCMORROW, EXAMINING ATTORNEY

**Int. Cl.: 28**

**Prior U.S. Cls.: 22, 23, 38 and 50**

**United States Patent and Trademark Office**

**Reg. No. 3,569,331**

**Registered Feb. 3, 2009**

**TRADEMARK  
PRINCIPAL REGISTER**

**LA BABY**

J.C. TOYS GROUP, INC. (FLORIDA CORPORATION)  
9590 N.W. 40TH STREET ROAD  
MIAMI, FL 33178

FOR: DOLLS, IN CLASS 28 (U.S. CLS. 22, 23, 38 AND 50).

FIRST USE 3-0-1984; IN COMMERCE 4-0-1984.

THE MARK CONSISTS OF STANDARD CHARACTERS WITHOUT CLAIM TO ANY PARTICULAR FONT, STYLE, SIZE, OR COLOR.

NO CLAIM IS MADE TO THE EXCLUSIVE RIGHT TO USE "BABY", APART FROM THE MARK AS SHOWN.

SEC. 2(F).

SER. NO. 77-449,256, FILED 4-16-2008.

ANNE FARRELL, EXAMINING ATTORNEY

**Int. Cl.: 28**

**Prior U.S. Cls.: 22, 23, 38 and 50**

**United States Patent and Trademark Office**

**Reg. No. 3,569,332**

**Registered Feb. 3, 2009**

**TRADEMARK  
PRINCIPAL REGISTER**

**LA NEWBORN**

J.C. TOYS GROUP, INC. (FLORIDA CORPORATION)  
9590 N.W. 40TH STREET ROAD  
MIAMI, FL 33178

FOR: DOLLS, IN CLASS 28 (U.S. CLS. 22, 23, 38 AND 50).

FIRST USE 7-19-1985; IN COMMERCE 7-19-1985.

THE MARK CONSISTS OF STANDARD CHARACTERS WITHOUT CLAIM TO ANY PARTICULAR FONT, STYLE, SIZE, OR COLOR.

SEC. 2(F).

SER. NO. 77-449,276, FILED 4-16-2008.

ANNE FARRELL, EXAMINING ATTORNEY

**Int. Cl.: 33**

**Prior U.S. Cls.: 47 and 49**

**United States Patent and Trademark Office**

**Reg. No. 3,569,333**

**Registered Feb. 3, 2009**

**TRADEMARK  
PRINCIPAL REGISTER**

**SIBYLLINE**

CARINA CELLARS (CALIFORNIA LIMITED  
LIABILITY COMPANY)  
P.O. BOX 644  
LOS OLIVOS, CA 93441

THE MARK CONSISTS OF STANDARD CHAR-  
ACTERS WITHOUT CLAIM TO ANY PARTICULAR  
FONT, STYLE, SIZE, OR COLOR.

FOR: WINE, IN CLASS 33 (U.S. CLS. 47 AND 49).

SER. NO. 77-449,373, FILED 4-16-2008.

FIRST USE 5-1-2007; IN COMMERCE 5-10-2007.

JOHN DWYER, EXAMINING ATTORNEY

**Int. Cl.: 16**

**Prior U.S. Cls.: 2, 5, 22, 23, 29, 37, 38 and 50**

**Reg. No. 3,569,334**

**United States Patent and Trademark Office**

**Registered Feb. 3, 2009**

---

**TRADEMARK  
PRINCIPAL REGISTER**

**STEP IT UP QUEEN**

EMBRACING EXCELLENCE, LLC (UTAH LIMITED LIABILITY COMPANY)  
10196 NORTH HIDDEN POND DRIVE  
HIGHLAND, UT 84003

FOR: BOOKS AND ARTICLES IN THE FIELD OF SELF-HELP, SELF-IMPROVEMENT, SELF-MOTIVATION, PERSONAL EMPOWERMENT, LIFE COACHING, AND HUMAN POTENTIAL, IN CLASS 16 (U.S. CLS. 2, 5, 22, 23, 29, 37, 38 AND 50).

FIRST USE 11-13-2007; IN COMMERCE 11-13-2007.

THE MARK CONSISTS OF STANDARD CHARACTERS WITHOUT CLAIM TO ANY PARTICULAR FONT, STYLE, SIZE, OR COLOR.

SER. NO. 77-449,378, FILED 4-16-2008.

GENE MACIOL, EXAMINING ATTORNEY



**Int. Cls.: 37 and 39**

**Prior U.S. Cls.: 100, 103, 105 and 106**

**United States Patent and Trademark Office**

**Reg. No. 3,569,335**

**Registered Feb. 3, 2009**

**SERVICE MARK  
PRINCIPAL REGISTER**

**RANDIVE**

RANDIVE, INC. (NEW JERSEY CORPORATION)  
1160 STATE ST.  
PERTH AMBOY, NJ 08861

FOR: COMMERCIAL DIVING SERVICES, NAME-  
LY, UNDERWATER BUILDING CONSTRUCTION  
SERVICES, IN CLASS 37 (U.S. CLS. 100, 103 AND 106).

FIRST USE 1-1-1992; IN COMMERCE 1-1-1992.

FOR: COMMERCIAL DIVING SERVICES, NAME-  
LY, UNDERWATER SALVAGE, IN CLASS 39 (U.S.  
CLS. 100 AND 105).

FIRST USE 1-1-1992; IN COMMERCE 1-1-1992.

THE MARK CONSISTS OF STANDARD CHAR-  
ACTERS WITHOUT CLAIM TO ANY PARTICULAR  
FONT, STYLE, SIZE, OR COLOR.

SER. NO. 77-450,231, FILED 4-16-2008.

MICHAEL LITZAU, EXAMINING ATTORNEY

Int. Cl.: 7

Prior U.S. Cls.: 13, 19, 21, 23, 31, 34 and 35

United States Patent and Trademark Office

Reg. No. 3,569,336

Registered Feb. 3, 2009

TRADEMARK  
PRINCIPAL REGISTER

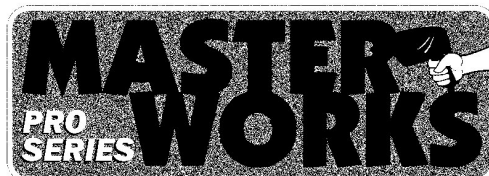

YANG, XIAOFEI (CHINA INDIVIDUAL)  
RM 603  
739 DONGFENG DONG ROAD  
GUANGZHOU, CHINA

FOR: GASOLINE GENERATORS; ELECTRIC GENERATORS; DIESEL GENERATORS; AIR COMPRESSORS; GRINDERS; ANGLE GRINDER; POWER-OPERATED POLISHERS; POWER-OPERATED SCREWDRIVERS; ELECTRIC POWER TOOLS COMPRISED OF CIRCULAR SAW, IMPACT DRILL; ELECTRIC ANGLE DRILL; ELECTRIC ROTARY HAMMER; ELECTRIC RECIPROCATING SAW; HAND-HELD POWER OPERATED MARBLE CUTTING DEVICE; ELECTRIC SANDERS; COMPOUND ELECTRIC MITER SAW; ELECTRIC PLANER; ELECTRIC ROUTER MACHINE; HAND-HELD POWER OPERATED IMPACT WRENCHES; ELECTRIC DIE GRINDER; ELECTRIC HAND DRILL MIXER; ELECTRIC BELT SANDER; ELECTRIC CHOP SAW; ELECTRIC WELDING MACHINES; ELECTRIC POWER TOOL KITS COMPRISED OF DRILL, JIG SAW, ANGLE GRINDER, LIGHT, SAN-

DER, CIRCULAR SAW, RECIPROCATING SAW, IN CLASS 7 (U.S. CLS. 13, 19, 21, 23, 31, 34 AND 35).

FIRST USE 8-0-2006; IN COMMERCE 8-0-2006.

NO CLAIM IS MADE TO THE EXCLUSIVE RIGHT TO USE "PRO SERIES", APART FROM THE MARK AS SHOWN.

THE STIPPLING IS FOR SHADING PURPOSES ONLY.

THE MARK CONSISTS OF A RECTANGLE WITH THE STYLIZED TEXT "MASTER WORKS PRO SERIES". TO THE RIGHT OF THE TEXT "MASTER" IS AN IMAGE OF A HAND HOLDING A DRILL. THE TEXT "PRO SERIES" IS LOCATED BELOW THE "M" IN "MASTER" AND TO THE LEFT OF THE TEXT "WORKS".

SER. NO. 77-450,276, FILED 4-16-2008.

KELLEY WELLS, EXAMINING ATTORNEY

Int. Cl.: 21

Prior U.S. Cls.: 2, 13, 23, 29, 30, 33, 40 and 50

United States Patent and Trademark Office

Reg. No. 3,569,337

Registered Feb. 3, 2009

TRADEMARK  
PRINCIPAL REGISTER



THE BEAUTY COMPANY, INC. (CANADA CORPORATION)  
79 ST. REGIS CRESCENT NORTH  
NORTH YORK, CANADA M3J1Y9

FOR: COSMETIC AND BATH SPONGES, NAME-  
LY, COSMETIC CLEANSING SPONGES, BODY  
SPONGES, EXFOLIATING SPONGES, EXFOLIAT-  
ING BODY SPONGES, AND MAKE-UP SPONGE  
APPLICATORS, IN CLASS 21 (U.S. CLS. 2, 13, 23, 29,  
30, 33, 40 AND 50).

FIRST USE 1-24-2008; IN COMMERCE 1-24-2008.

NO CLAIM IS MADE TO THE EXCLUSIVE  
RIGHT TO USE "THE BEAUTY COMPANY INC",  
APART FROM THE MARK AS SHOWN.

THE MARK CONSISTS OF THE WORD "THE" IN  
ALL LOWER CASE LETTERS, FOLLOWED BY  
"BEAUTY" IN ITALICIZED FORMAT AND WITH  
THE FIRST LETTER BEING CAPITALIZED, FOL-  
LOWED BY "COMPANY INC" WITH THE FIRST  
LETTERS OF EACH WORD BEING CAPITALIZED,  
AND A LEAF APPEARING DIRECTLY ABOVE THE  
WORDS.

SER. NO. 77-450,579, FILED 4-17-2008.

KRISTIN DAHLING, EXAMINING ATTORNEY

**Int. Cls.: 16, 25 and 41**

**Prior U.S. Cls.: 2, 5, 22, 23, 29, 37, 38, 39, 50, 100, 101  
and 107**

**Reg. No. 3,569,338**

**United States Patent and Trademark Office**

**Registered Feb. 3, 2009**

**TRADEMARK  
SERVICE MARK  
PRINCIPAL REGISTER**

# Mighty Milers

NEW YORK ROAD RUNNERS FOUNDATION,  
INC. (NEW YORK NON-PROFIT CORPORATION)

9 EAST 89TH STREET  
NEW YORK, NY 10128

FOR: PRINTED MATERIALS, NAMELY, POSTERS, NEWSLETTERS, LEAFLETS, PAMPHLETS AND TEACHING MATERIALS ALL FEATURING INFORMATION ON PROGRAMS FOR STUDENTS INTENDED TO ENCOURAGE PHYSICAL FITNESS AND OVERALL HEALTH, IN CLASS 16 (U.S. CLS. 2, 5, 22, 23, 29, 37, 38 AND 50).

FIRST USE 9-0-2006; IN COMMERCE 9-0-2006.

FOR: CLOTHING, NAMELY, HATS, CAPS, T-SHIRTS AND SWEATSHIRTS, IN CLASS 25 (U.S. CLS. 22 AND 39).

FIRST USE 9-0-2006; IN COMMERCE 9-0-2006.

FOR: EDUCATIONAL SERVICES, NAMELY, RUNNING AND WALKING PROGRAMS FOR STUDENTS INTENDED TO ENCOURAGE PHYSICAL FITNESS AND OVERALL HEALTH, IN CLASS 41 (U.S. CLS. 100, 101 AND 107).

FIRST USE 9-0-2006; IN COMMERCE 9-0-2006.

THE MARK CONSISTS OF STANDARD CHARACTERS WITHOUT CLAIM TO ANY PARTICULAR FONT, STYLE, SIZE, OR COLOR.

NO CLAIM IS MADE TO THE EXCLUSIVE RIGHT TO USE "MILERS", APART FROM THE MARK AS SHOWN.

SER. NO. 77-450,963, FILED 4-17-2008.

EMILY CARLSEN, EXAMINING ATTORNEY

**Int. Cl.: 19**

**Prior U.S. Cls.: 1, 12, 33 and 50**

**United States Patent and Trademark Office**

**Reg. No. 3,569,339**

**Registered Feb. 3, 2009**

**TRADEMARK  
PRINCIPAL REGISTER**

**Door-A-Last**

HOUSTON ART GLASS ENTERPRISES (TEXAS  
CORPORATION)  
2002 BRITTMOORE ROAD  
SPRING, TX 77043

THE MARK CONSISTS OF STANDARD CHAR-  
ACTERS WITHOUT CLAIM TO ANY PARTICULAR  
FONT, STYLE, SIZE, OR COLOR.

FOR: COATINGS IN THE NATURE OF STAINS  
FOR HARDWOOD DOORS SOLD AS A COMPO-  
NENT OF THE DOORS, IN CLASS 19 (U.S. CLS. 1, 12,  
33 AND 50).

SER. NO. 77-450,976, FILED 4-17-2008.

FIRST USE 4-17-2008; IN COMMERCE 4-17-2008.

IRA J. GOODSaid, EXAMINING ATTORNEY

Int. Cl.: 42

Prior U.S. Cls.: 100 and 101

United States Patent and Trademark Office

Reg. No. 3,569,340

Registered Feb. 3, 2009

**SERVICE MARK  
PRINCIPAL REGISTER**



SIGMA SCIENCE, INC. (NEW MEXICO CORPORATION)  
P.O. BOX 487  
LOS ALAMOS, NM 87544

FOR: CONSULTING IN THE FIELDS OF ENGINEERING AND ARCHITECTURE, IN CLASS 42 (U.S. CLS. 100 AND 101).

FIRST USE 9-12-2007; IN COMMERCE 9-12-2007.

NO CLAIM IS MADE TO THE EXCLUSIVE RIGHT TO USE "SCIENCE, INC.", APART FROM THE MARK AS SHOWN.

THE MARK CONSISTS OF A STYLIZED LIKENESS TO THE GREEK LOWERCASE LETTER "SIGMA" CREATED FROM SEVEN (7) HORIZONTAL BARS AND THE WORDS "SIGMA SCIENCE, INC." BELOW THE TOPMOST HORIZONTAL BAR. THE GRAPHIC PORTION OF THE LOGO CONSISTS OF SEVEN (7) HORIZONTAL BAR THAT, TAKEN TOGETHER, COMPRISE A LIKENESS TO THE

GREEK LOWERCASE LETTER "SIGMA". THE THREE CENTER HORIZONTAL BARS (COUNTING UPWARDS FROM THE BOTTOM HORIZONTAL BAR, THESE ARE BARS NUMBER THREE (3), FOUR (4) AND FIVE (5)) TAPER TO A POINT FROM THE LEFT AND RIGHT PORTIONS OF EACH INDIVIDUAL HORIZONTAL BAR. THE LEFT AND RIGHT EDGE OF EACH OF THE SEVEN (7) HORIZONTAL BAR ELEMENTS ARE SHEARED THIRTY (30) DEGREE CLOCKWISE FROM VERTICAL (RELATIVE TO A ZERO DEGREE (0) VERTICAL LINE DEFINED AS POINTING STRAIGHT UP ON THE SCREEN). THE TEXT BENEATH THE TOPMOST HORIZONTAL BAR, "SIGMA SCIENCE, INC.", IS SHEARED TWENTY (20) DEGREE FROM VERTICAL (RELATIVE TO A ZERO DEGREE (0) VERTICAL LINE DEFINED AS POINTING STRAIGHT UP ON THE SCREEN).

SER. NO. 77-451,088, FILED 4-17-2008.

SCOTT BIBB, EXAMINING ATTORNEY

**Int. Cl.: 5**

**Prior U.S. Cls.: 6, 18, 44, 46, 51 and 52**

**Reg. No. 3,569,341**

**United States Patent and Trademark Office**

**Registered Feb. 3, 2009**

**TRADEMARK  
PRINCIPAL REGISTER**

**ACNE AWAY**

USA ACNE AWAY LLC (FLORIDA LIMITED  
LIABILITY COMPANY)  
9580 S. FEDERAL HWY  
PORT ST. LUCIE, FL 34952

THE MARK CONSISTS OF STANDARD CHAR-  
ACTERS WITHOUT CLAIM TO ANY PARTICULAR  
FONT, STYLE, SIZE, OR COLOR.

FOR: ANTIBACTERIALS IN THE NATURE OF  
ANTIBACTERIAL SUBSTANCES FOR MEDICAL  
PURPOSES, ANTI-INFLAMMATORIES, ANTI-IN-  
FECTION PREPARATIONS, NAMELY, ANTI-IN-  
FECTIVES, AND ACNE TREATMENT  
PREPARATIONS, IN CLASS 5 (U.S. CLS. 6, 18, 44,  
46, 51 AND 52).

NO CLAIM IS MADE TO THE EXCLUSIVE  
RIGHT TO USE "ACNE", APART FROM THE MARK  
AS SHOWN.

SER. NO. 77-451,976, FILED 4-18-2008.

FIRST USE 1-31-1991; IN COMMERCE 1-31-1991.

MARIAM MAHMOUDI, EXAMINING ATTORNEY

Int. Cl.: 41

Prior U.S. Cls.: 100, 101 and 107

United States Patent and Trademark Office

Reg. No. 3,569,342

Registered Feb. 3, 2009

**SERVICE MARK  
PRINCIPAL REGISTER**

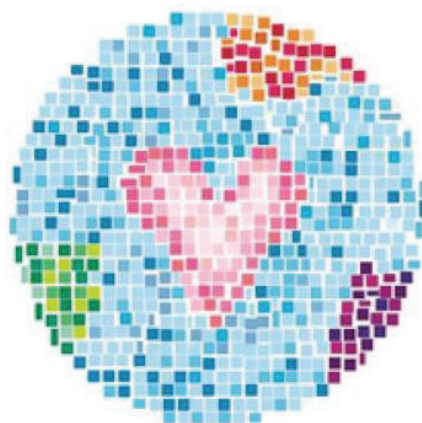

DELMAN, LISA (UNITED STATES INDIVIDUAL)  
65 N.E. 90TH STREET  
EL PORTAL, FL 33138

FOR: EDUCATION SERVICES, NAMELY, PROVIDING LECTURES, SEMINARS AND WORKSHOPS IN THE FIELD OF PERSONAL GROWTH AND MANAGING INTERPERSONAL RELATIONSHIPS; PROVIDING NEWSLETTERS IN THE FIELD OF PERSONAL GROWTH AND MANAGING INTERPERSONAL RELATIONSHIPS VIA E-MAIL, IN CLASS 41 (U.S. CLS. 100, 101 AND 107).

FIRST USE 0-0-2004; IN COMMERCE 0-0-2004.

THE COLOR(S) BLUE, PINK, RED, PURPLE, WHITE, ORANGE AND GREEN IS/ARE CLAIMED AS A FEATURE OF THE MARK.

THE MARK CONSISTS OF A GRAPHICAL DEPICTION OF THE EARTH WITH A HEART IN THE

CENTER, ALL OF WHICH ARE FORMED BY NUMEROUS RECTANGULAR AND SQUARE TILES. THE TILES FORMING THE HEART ARE VARIOUS SHADES OF PINK AND WHITE. THE WATER PORTIONS OF THE EARTH DESIGN ARE FORMED BY TILES OF VARIOUS SHADES OF BLUE AND WHITE. THE CONTINENT IN THE UPPER RIGHT PORTION OF THE EARTH DESIGN IS FORMED BY TILES OF PINK, RED, AND VARIOUS SHADES OF ORANGE. THE CONTINENT APPEARING IN THE LOWER RIGHT PORTION OF THE EARTH DESIGN IS FORMED BY TILES OF VARIOUS SHADES OF PURPLE. THE CONTINENT IN THE LOWER LEFT PORTION OF THE EARTH DESIGN IS FORMED BY TILES OF VARIOUS SHADES OF GREEN.

SER. NO. 77-452,181, FILED 4-18-2008.

NELSON SNYDER, EXAMINING ATTORNEY



Int. Cl.: 11

Prior U.S. Cls.: 13, 21, 23, 31 and 34

United States Patent and Trademark Office

Reg. No. 3,569,343

Registered Feb. 3, 2009

**TRADEMARK  
PRINCIPAL REGISTER**

EARTH'S PURE ESSENTIALS  
EARTH, WIND & WATER



BASICS FOR LIFE

CABADOS, RICK H. (UNITED STATES INDIVIDUAL)  
C/O E.HANSCOM 7395 PORTAGE WAY  
CARLSBAD, CA 92011

FOR: TAP-WATER PURIFYING APPARATUS; WATER PURIFYING APPARATUS; WATER PURIFYING UNITS, FOR POTABLE WATER FOR DRINKING; FILTERS FOR DRINKING WATER; FILTERS MADE OF FIBER FOR WATER FILTRATION; WATER FILTERING APPARATUS; WATER FILTERING DEVICES, NAMELY, WATER PURIFICATION INSTALLATIONS FOR WASTE WATER AND SEWAGE CONSISTING OF CURTAINS AND TEXTILE FABRICS; WATER FILTERS; INDUSTRIAL-WATER PURIFYING APPARATUS; OZONE SANITIZERS FOR AIR AND WATER; WATER CONDITIONING UNITS; WATER DISTILLATION UNITS; WATER DISTILLING UNITS; WATER IONIZERS; WATER PURIFICATION AND FILTRATION APPARATUS; WATER PURIFICATION INSTALLATIONS; WATER PURIFICATION TANKS; WATER PURIFICATION UNITS; WATER PURIFIERS; WATER SOFTENING UNITS; WATER STERILISERS; WATER STERILIZERS; WATER TREATMENT EQUIPMENT, NAMELY, CARTRIDGE FILTRATION UNITS; WATER TREATMENT EQUIPMENT, NAMELY, CHEMICAL STERILIZATION UNITS; WATER TREATMENT EQUIPMENT, NAMELY, REVERSE OSMOSIS FILTRATION UNITS; WATER TREATMENT EQUIPMENT, NAMELY, ULTRAVIOLET STERILIZATION UNITS, IN CLASS 11 (U.S. CLS. 13, 21, 23, 31 AND 34).

FIRST USE 2-15-2008; IN COMMERCE 2-15-2008.

NO CLAIM IS MADE TO THE EXCLUSIVE RIGHT TO USE "EARTH'S PURE ESSENTIALS" AND "EARTH, WIND & WATER" AND THE STYLIZED REPRESENTATION OF THE EARTH, APART FROM THE MARK AS SHOWN.

THE COLOR(S) BLUE, GREEN, YELLOW, ORANGE, WHITE, AND BLACK IS/ARE CLAIMED AS A FEATURE OF THE MARK.

THE MARK CONSISTS OF A STYLIZED WATER DROPLET WITH A STYLIZED EARTH EMBEDDED WITHIN THE STYLIZED WATER DROPLET, WHERE THE INSIDE OF THE STYLIZED WATER DROPLET IS WHITE AND THE STYLIZED EARTH HAS A BLUE OCEAN, CONTINENTS WITH VARIOUS TOPOGRAPHIC FEATURES IN GREEN, ORANGE AND YELLOW, AND WHITE CLOUD FORMATIONS, WITH THE PHRASES "EARTH'S PURE ESSENTIALS" AND "EARTH, WIND & WATER" ABOVE THE STYLIZED WATER DROPLET, AND THE PHRASE "BASICS FOR LIFE" BELOW, WHEREIN ALL THE PHRASES APPEAR IN THE COLOR BLACK.

SER. NO. 77-452,264, FILED 4-18-2008.

RONALD DELGIZZI, EXAMINING ATTORNEY

Int. Cl.: 11

Prior U.S. Cls.: 13, 21, 23, 31 and 34

United States Patent and Trademark Office

Reg. No. 3,569,344

Registered Feb. 3, 2009

**TRADEMARK  
PRINCIPAL REGISTER**

LIFE'S PURE ESSENTIALS  
EARTH, WIND & WATER



BASICS FOR LIFE

CABADOS, RICK H. (UNITED STATES INDIVIDUAL)  
C/O E.HANSCOM 7395 PORTAGE WAY  
CARLSBAD, CA 92011

FOR: FILTERS FOR DRINKING WATER; FILTERS MADE OF FIBER FOR WATER FILTRATION; FLOW RESTRICTORS FOR REVERSE OSMOSIS WATER PURIFICATION UNITS; INDUSTRIAL-WATER PURIFYING APPARATUS; STRAINERS FOR WATER LINES; TAP-WATER PURIFYING APPARATUS; WATER DESALINATION PLANTS; WATER DISTILLATION UNITS; WATER DISTILLING UNITS; WATER FILTERING APPARATUS; WATER FILTERS; WATER IONIZERS; WATER PURIFICATION AND FILTRATION APPARATUS; WATER PURIFICATION INSTALLATIONS; WATER PURIFICATION TANKS; WATER PURIFICATION UNITS; WATER PURIFIERS; WATER PURIFYING APPARATUS; WATER SOFTENING APPARATUS AND INSTALLATIONS; WATER SOFTENING UNITS; WATER STERILISERS; WATER STERILIZERS; WATER TREATMENT EQUIPMENT, NAMELY, CARTRIDGE FILTRATION UNITS; WATER TREATMENT EQUIPMENT, NAMELY, CHEMICAL STERILIZATION UNITS; WATER TREATMENT EQUIPMENT, NAMELY, REVERSE OSMOSIS FILTRATION UNITS; WATER TREATMENT EQUIPMENT, NAMELY, ULTRAVIOLET STERILIZATION UNITS, IN CLASS 11 (U.S. CLS. 13, 21, 23, 31 AND 34).

FIRST USE 2-15-2008; IN COMMERCE 2-15-2008.

NO CLAIM IS MADE TO THE EXCLUSIVE RIGHT TO USE "LIFE'S PURE ESSENTIALS" AND "EARTH, WIND & WATER" AND THE STYLIZED REPRESENTATION OF THE EARTH, APART FROM THE MARK AS SHOWN.

THE COLOR(S) BLUE, GREEN, YELLOW, ORANGE, WHITE, AND BLACK IS/ARE CLAIMED AS A FEATURE OF THE MARK.

THE MARK CONSISTS OF A STYLIZED WATER DROPLET WITH A STYLIZED EARTH EMBEDDED WITHIN THE STYLIZED WATER DROPLET, WHERE THE INSIDE OF THE STYLIZED WATER DROPLET IS WHITE AND THE STYLIZED EARTH HAS A BLUE OCEAN, CONTINENTS WITH VARIOUS TOPOGRAPHIC FEATURES IN GREEN, ORANGE AND YELLOW, AND WHITE CLOUD FORMATIONS, WITH THE PHRASES "EARTH'S PURE ESSENTIALS" AND "EARTH, WIND & WATER" ABOVE THE STYLIZED WATER DROPLET, AND THE PHRASE "BASICS FOR LIFE" BELOW, WHEREIN ALL THE PHRASES APPEAR IN THE COLOR BLACK.

SER. NO. 77-452,303, FILED 4-18-2008.

RONALD DELGIZZI, EXAMINING ATTORNEY

**Int. Cl.: 41**

**Prior U.S. Cls.: 100, 101 and 107**

**United States Patent and Trademark Office**

**Reg. No. 3,569,345**

**Registered Feb. 3, 2009**

**SERVICE MARK  
PRINCIPAL REGISTER**

MULTINATIONAL ASSOCIATION  
OF SUPPORTIVE CARE IN  
CANCER

MULTINATIONAL ASSOCIATION OF SUPPORTIVE CARE IN CANCER (LOUISIANA NON-PROFIT CORPORATION)

SUITE 223  
500 RUE ST. ANN  
METAIRIE, LA 70005

FOR: EDUCATIONAL SERVICES, NAMELY, DEVELOPING, ARRANGING, AND CONDUCTING SYMPOSIA, CONFERENCES, AND PROGRAMS IN THE FIELD OF PREVENTION AND MANAGEMENT OF THE ADVERSE EFFECTS OF CANCER AND ITS TREATMENT, IN CLASS 41 (U.S. CLS. 100, 101 AND 107).

FIRST USE 12-12-1990; IN COMMERCE 12-12-1990.

THE MARK CONSISTS OF STANDARD CHARACTERS WITHOUT CLAIM TO ANY PARTICULAR FONT, STYLE, SIZE, OR COLOR.

NO CLAIM IS MADE TO THE EXCLUSIVE RIGHT TO USE "ASSOCIATION", APART FROM THE MARK AS SHOWN.

SEC. 2(F).

SER. NO. 77-452,413, FILED 4-18-2008.

EMILY CARLSEN, EXAMINING ATTORNEY

**Int. Cl.: 35**

**Prior U.S. Cls.: 100, 101 and 102**

**United States Patent and Trademark Office**

**Reg. No. 3,569,346**

**Registered Feb. 3, 2009**

**SERVICE MARK  
PRINCIPAL REGISTER**

# MyCockpit

MYCOCKPIT, INC. (ILLINOIS CORPORATION)  
285 HEATHER  
DECATUR, IL 62522

FOR: PROVIDING ONLINE CONSUMER PRODUCT INFORMATION IN THE FIELD OF FLIGHT SIMULATORS, IN CLASS 35 (U.S. CLS. 100, 101 AND 102).

FIRST USE 2-1-2006; IN COMMERCE 2-1-2006.

THE MARK CONSISTS OF STANDARD CHARACTERS WITHOUT CLAIM TO ANY PARTICULAR FONT, STYLE, SIZE, OR COLOR.

SER. NO. 77-452,841, FILED 4-20-2008.

JANICE L. MCMORROW, EXAMINING ATTORNEY

**Int. Cl.: 41**

**Prior U.S. Cls.: 100, 101 and 107**

**United States Patent and Trademark Office**

**Reg. No. 3,569,347**

**Registered Feb. 3, 2009**

**SERVICE MARK  
PRINCIPAL REGISTER**

# Hooked On Safety

JUBILEE ENTERPRISES INTERNATIONAL, INC.  
(OKLAHOMA CORPORATION)  
P.O. BOX 506  
BROKEN ARROW, OK 74013

FOR: EDUCATIONAL AND ENTERTAINMENT  
SERVICES, NAMELY, PROVIDING MOTIVATION-  
AL SPEAKING SERVICES IN THE FIELD OF  
WORKPLACE SAFETY , IN CLASS 41 (U.S. CLS.  
100, 101 AND 107).

FIRST USE 5-12-1990; IN COMMERCE 1-5-1991.

THE MARK CONSISTS OF STANDARD CHAR-  
ACTERS WITHOUT CLAIM TO ANY PARTICULAR  
FONT, STYLE, SIZE, OR COLOR.

NO CLAIM IS MADE TO THE EXCLUSIVE  
RIGHT TO USE "SAFETY", APART FROM THE  
MARK AS SHOWN.

SER. NO. 77-452,948, FILED 4-20-2008.

G. MAYERSCHOFF, EXAMINING ATTORNEY

**Int. Cl.: 35**

**Prior U.S. Cls.: 100, 101 and 102**

**United States Patent and Trademark Office**

**Reg. No. 3,569,348**

**Registered Feb. 3, 2009**

**SERVICE MARK  
PRINCIPAL REGISTER**

# YOUNG JOBS

YOUNG JOBS INC. (CALIFORNIA CORPORATION)  
812 ROSECRANS AVENUE  
MANHATTAN BEACH, CA 90266

FOR: PROVIDING ON-LINE INFORMATION IN THE FIELDS OF EMPLOYMENT, RECRUITMENT, CAREERS, PERSONAL ISSUES RELATED TO CAREERS AND WORK LIFE, JOB RESOURCES, JOB LISTINGS AND RESUMES; PROVIDING ON-LINE INTERACTIVE EMPLOYMENT COUNSELING AND RECRUITMENT SERVICES; PROVIDING ON-LINE EMPLOYMENT PLACEMENT SERVICES, NAMELY, RESUME MATCHING SERVICES VIA A GLOBAL COMPUTER NETWORK, IN CLASS 35 (U.S. CLS. 100, 101 AND 102).

FIRST USE 7-5-2000; IN COMMERCE 7-5-2000.

THE MARK CONSISTS OF STANDARD CHARACTERS WITHOUT CLAIM TO ANY PARTICULAR FONT, STYLE, SIZE, OR COLOR.

NO CLAIM IS MADE TO THE EXCLUSIVE RIGHT TO USE "JOBS", APART FROM THE MARK AS SHOWN.

SER. NO. 77-452,980, FILED 4-20-2008.

ODESSA BIBBINS, EXAMINING ATTORNEY

**Int. Cl.: 41**

**Prior U.S. Cls.: 100, 101 and 107**

**United States Patent and Trademark Office**

**Reg. No. 3,569,349**

**Registered Feb. 3, 2009**

**SERVICE MARK  
PRINCIPAL REGISTER**

**RAPTOR ENTERTAINMENT**

METCALFE, TIMOTHY D. (UNITED STATES  
INDIVIDUAL)  
34120 TYLER DR.  
STERLING HEIGHTS, MI 48310

FOR: ENTERTAINMENT SERVICES, NAMELY,  
CONDUCTING KARAOKE PARTIES, AND DISC  
JOCKEY SERVICES FOR PARTIES AND SPECIAL  
EVENTS, IN CLASS 41 (U.S. CLS. 100, 101 AND 107).

FIRST USE 12-24-2007; IN COMMERCE 12-24-2007.

THE MARK CONSISTS OF STANDARD CHAR-  
ACTERS WITHOUT CLAIM TO ANY PARTICULAR  
FONT, STYLE, SIZE, OR COLOR.

NO CLAIM IS MADE TO THE EXCLUSIVE  
RIGHT TO USE "ENTERTAINMENT", APART  
FROM THE MARK AS SHOWN.

SER. NO. 77-453,041, FILED 4-21-2008.

DAWN HAN, EXAMINING ATTORNEY

**Int. Cl.: 16**

**Prior U.S. Cls.: 2, 5, 22, 23, 29, 37, 38 and 50**

**Reg. No. 3,569,350**

**United States Patent and Trademark Office**

**Registered Feb. 3, 2009**

**TRADEMARK  
PRINCIPAL REGISTER**

**WIREMASTER**

SPIRAL BINDING COMPANY, INC. (NEW YORK CORPORATION)  
1 MALTESE DRIVE  
TOTOWA, NJ 07511

FOR: DOCUMENT BINDING MACHINES FOR GENERAL OFFICE USE, NAMELY, MACHINES FOR PUNCHING HOLES IN PAPER AND CLOSING THE BINDING, IN CLASS 16 (U.S. CLS. 2, 5, 22, 23, 29, 37, 38 AND 50).

FIRST USE 4-18-2008; IN COMMERCE 4-18-2008.

THE MARK CONSISTS OF STANDARD CHARACTERS WITHOUT CLAIM TO ANY PARTICULAR FONT, STYLE, SIZE, OR COLOR.

SER. NO. 77-453,379, FILED 4-21-2008.

DAVID C. REIHNER, EXAMINING ATTORNEY



**Int. Cl.: 18**

**Prior U.S. Cls.: 1, 2, 3, 22 and 41**

**United States Patent and Trademark Office**

**Reg. No. 3,569,351**

**Registered Feb. 3, 2009**

**TRADEMARK  
PRINCIPAL REGISTER**



**Bags Go Green**

FINISHING TOUCHES & DECOR, LTD. (WASHINGTON LIMITED LIABILITY COMPANY),  
DBA BAGS GO GREEN

13 RUTH'S PLACE  
SEQUIM, WA 98382

FOR: TOTE BAGS, NAMELY, ECO-FRIENDLY REUSABLE NATURAL FIBER BAGS OF JUTE AND COTTON FIBER; TEXTILE SHOPPING BAGS, NAMELY, ECO-FRIENDLY REUSABLE NATURAL FIBER BAGS COMPRISED PRIMARILY OF JUTE AND COTTON FIBERS, IN CLASS 18 (U.S. CLS. 1, 2, 3, 22 AND 41).

FIRST USE 7-8-2007; IN COMMERCE 2-2-2008.

NO CLAIM IS MADE TO THE EXCLUSIVE RIGHT TO USE "BAGS" AND "GREEN", APART FROM THE MARK AS SHOWN.

THE COLOR(S) GREEN AND WHITE IS/ARE CLAIMED AS A FEATURE OF THE MARK.

THE MARK CONSISTS OF A GREEN RECTANGLE HAVING ROUNDED CORNERS WITH THE WORDS "BAGS GO GREEN" IN WHITE CENTERED IN THE RECTANGLE. THE GREEN IN THE UPPER HALF OF THE RECTANGLE IS A GRADUATED SHADING, LIGHTER TO DARKER FROM TOP TO CENTER. THE UPPER HALF OF THE RECTANGLE AND THE WORDS ARE BORDERED BY A THIN, SOLID GREEN LINE. THE LOWER HALF OF THE WORDS ARE LIGHTLY SHADED WITH PARTIAL TONE GREEN.

SER. NO. 77-453,411, FILED 4-21-2008.

COURTNEY MCCORMICK, EXAMINING ATTORNEY

**Int. Cl.: 16**

**Prior U.S. Cls.: 2, 5, 22, 23, 29, 37, 38 and 50**

**Reg. No. 3,569,352**

**United States Patent and Trademark Office**

**Registered Feb. 3, 2009**

**TRADEMARK  
PRINCIPAL REGISTER**

**COMBMASTER**

SPIRAL BINDING COMPANY, INC. (NEW YORK CORPORATION)  
1 MALTESE DRIVE  
TOTOWA, NJ 07511

FOR: DOCUMENT BINDING MACHINES FOR GENERAL OFFICE USE, NAMELY, MACHINES FOR PUNCHING HOLES IN PAPER AND CLOSING THE BINDING, IN CLASS 16 (U.S. CLS. 2, 5, 22, 23, 29, 37, 38 AND 50).

FIRST USE 4-18-2008; IN COMMERCE 4-18-2008.

THE MARK CONSISTS OF STANDARD CHARACTERS WITHOUT CLAIM TO ANY PARTICULAR FONT, STYLE, SIZE, OR COLOR.

SER. NO. 77-453,479, FILED 4-21-2008.

DAVID C. REIHNER, EXAMINING ATTORNEY

Int. Cl.: 16

Prior U.S. Cls.: 2, 5, 22, 23, 29, 37, 38 and 50

Reg. No. 3,569,353

United States Patent and Trademark Office

Registered Feb. 3, 2009

TRADEMARK  
PRINCIPAL REGISTER



CHRISTENSEN, BRENDA JEAN (UNITED STATES INDIVIDUAL)  
APT 26  
6476 RIVERSIDE AVENUE  
RIVERSIDE, CA 92506

FOR: GIFT BOOKS FEATURING RECIPES AND MEASURING TOOLS FOR NOVICE COOKS; COOK BOOKS, IN CLASS 16 (U.S. CLS. 2, 5, 22, 23, 29, 37, 38 AND 50).

FIRST USE 8-6-2008; IN COMMERCE 8-6-2008.

NO CLAIM IS MADE TO THE EXCLUSIVE RIGHT TO USE "BOOK", APART FROM THE MARK AS SHOWN.

THE COLOR(S) BLACK AND/OR WHITE IS/ARE CLAIMED AS A FEATURE OF THE MARK.

THE MARK CONSISTS OF THE WORDING "THE LITTLE BLACK COOK BOOK" AND A CARET BETWEEN THE WORDS "BLACK" AND "BOOK" EACH IN THE COLOR WHITE ON A BLACK BACKGROUND.

SER. NO. 77-453,665, FILED 4-21-2008.

HANNO RITTNER, EXAMINING ATTORNEY

**Int. Cl.: 43**

**Prior U.S. Cls.: 100 and 101**

**United States Patent and Trademark Office**

**Reg. No. 3,569,354**

**Registered Feb. 3, 2009**

**SERVICE MARK  
PRINCIPAL REGISTER**

**101 COOKBOOKS**

HEIDI SWANSON, LLC (CALIFORNIA LIMITED  
LIABILITY COMPANY)  
58 PIERCE STREET  
SAN FRANCISCO, CA 94117

FOR: PROVIDING A WEBSITE FEATURING A  
SEARCHABLE COLLECTION OF RECIPES AND  
COOKING INFORMATION, IN CLASS 43 (U.S.  
CLS. 100 AND 101).

FIRST USE 2-1-2003; IN COMMERCE 7-1-2003.

THE MARK CONSISTS OF STANDARD CHAR-  
ACTERS WITHOUT CLAIM TO ANY PARTICULAR  
FONT, STYLE, SIZE, OR COLOR.

NO CLAIM IS MADE TO THE EXCLUSIVE  
RIGHT TO USE "COOKBOOKS", APART FROM  
THE MARK AS SHOWN.

SER. NO. 77-454,128, FILED 4-21-2008.

SUSAN LESLIE DUBOIS, EXAMINING ATTORNEY

Int. Cls.: 29 and 30

Prior U.S. Cl.: 46

United States Patent and Trademark Office

Reg. No. 3,569,355

Registered Feb. 3, 2009

TRADEMARK  
PRINCIPAL REGISTER

EMPEROR'S KITCHEN

GREAT EASTERN SUN TRADING CO., INC.  
(NORTH CAROLINA CORPORATION)  
92 MCINTOSH ROAD  
ASHEVILLE, NC 28802

FOR: PRESERVED FRUITS AND VEGETABLES;  
FLAKES OF DRIED FISH MEAT (KEZURI-BUSHI);  
INSTANT OR PRE-COOKED MISO SOUP; DRIED  
EDIBLE SEAWEED (HOSHI-WAKAME); SHEETS OF  
DRIED LAVER (HOSHI-NORI); PROCESSED MUSH-  
ROOMS; DRIED BEANS; PROCESSED BEANS, IN  
CLASS 29 (U.S. CL. 46).

FIRST USE 0-0-1990; IN COMMERCE 0-0-1990.

FOR: FOOD STARCH; SALT; SOY SAUCE; JAPA-  
NESE HORSERADISH POWDER SPICE (WASABI  
POWDER); PREPARED WASABI; PICKLED GIN-  
GER; ROASTED AND GROUND SESAME SEEDS;

TABLE SALT MIXED WITH SESAME SEEDS; MISO  
BEAN PASTE; RICE; RICE NOODLES; BRAN; PRO-  
CESSED GARLIC FOR USE AS SEASONING; CHUT-  
NEY; NOODLES; PROCESSED GRAINS, IN CLASS  
30 (U.S. CL. 46).

FIRST USE 0-0-1990; IN COMMERCE 0-0-1990.

THE MARK CONSISTS OF STANDARD CHAR-  
ACTERS WITHOUT CLAIM TO ANY PARTICULAR  
FONT, STYLE, SIZE, OR COLOR.

OWNER OF U.S. REG. NO. 1,534,497.

SER. NO. 77-455,195, FILED 4-22-2008.

MIDGE BUTLER, EXAMINING ATTORNEY

**Int. Cl.: 35**

**Prior U.S. Cls.: 100, 101 and 102**

**United States Patent and Trademark Office**

**Reg. No. 3,569,356**

**Registered Feb. 3, 2009**

**SERVICE MARK  
PRINCIPAL REGISTER**

**TAB EMERGING ENTREPRENEUR  
BOARD**

TAB BOARDS INTERNATIONAL, INC. (COLOR-  
ADO CORPORATION)  
11031 SHERIDAN BOULEVARD  
WESTMINSTER, CO 80020

FOR: BUSINESS MANAGEMENT AND CON-  
SULTING SERVICES, IN CLASS 35 (U.S. CLS. 100,  
101 AND 102).

FIRST USE 3-31-2008; IN COMMERCE 3-31-2008.

THE MARK CONSISTS OF STANDARD CHAR-  
ACTERS WITHOUT CLAIM TO ANY PARTICULAR  
FONT, STYLE, SIZE, OR COLOR.

NO CLAIM IS MADE TO THE EXCLUSIVE  
RIGHT TO USE "ENTREPRENEUR", APART FROM  
THE MARK AS SHOWN.

SER. NO. 77-455,440, FILED 4-23-2008.

RICHARD WHITE, EXAMINING ATTORNEY

**Int. Cl.: 9**

**Prior U.S. Cls.: 21, 23, 26, 36 and 38**

**Reg. No. 3,569,357**

**United States Patent and Trademark Office**

**Registered Feb. 3, 2009**

**TRADEMARK  
PRINCIPAL REGISTER**

**GBD**

B.E. MEYERS & COMPANY, INC. (WASHINGTON CORPORATION), DBA MEYERS  
ACCOUNTS PAYABLE FOR INVOICES  
14540 NE 91ST STREET  
REDMOND, WA 980526553

FOR: LASER OBJECT DETECTORS FOR USE ON VEHICLES; LASER POINTERS; LASER POINTING DEVICE FOR USE WITH FIREARMS; LASERS NOT FOR MEDICAL USE, IN CLASS 9 (U.S. CLS. 21, 23, 26, 36 AND 38).

FIRST USE 4-1-1990; IN COMMERCE 4-1-1990.

THE MARK CONSISTS OF STANDARD CHARACTERS WITHOUT CLAIM TO ANY PARTICULAR FONT, STYLE, SIZE, OR COLOR.

SER. NO. 77-455,591, FILED S.R. 4-23-2008 AM. P.R. 10-7-2008.

DAYNA BROWNE, EXAMINING ATTORNEY

**Int. Cl.: 9**

**Prior U.S. Cls.: 21, 23, 26, 36 and 38**

**Reg. No. 3,569,358**

**United States Patent and Trademark Office**

**Registered Feb. 3, 2009**

**TRADEMARK  
PRINCIPAL REGISTER**

**NEXTBILL**

BRINKMAN FINANCIAL COMPANY, L.P.  
(TEXAS LIMITED PARTNERSHIP)  
2245 KELLER WAY, SUITE 360  
CARROLLTON, TX 75006

FOR: COMPUTER SOFTWARE FOR USE IN THE  
FINANCIAL INDUSTRY FOR THE PRESENTA-  
TION OF FINANCIAL INFORMATION, NAMELY,  
BILLS AND CHECKING ACCOUNT STATEMENTS,  
IN CLASS 9 (U.S. CLS. 21, 23, 26, 36 AND 38).

FIRST USE 10-0-2003; IN COMMERCE 10-0-2003.

THE MARK CONSISTS OF STANDARD CHAR-  
ACTERS WITHOUT CLAIM TO ANY PARTICULAR  
FONT, STYLE, SIZE, OR COLOR.

SER. NO. 77-455,597, FILED 4-23-2008.

KELLY MCCOY, EXAMINING ATTORNEY



**Int. Cl.: 43**

**Prior U.S. Cls.: 100 and 101**

**United States Patent and Trademark Office**

**Reg. No. 3,569,359**

**Registered Feb. 3, 2009**

**SERVICE MARK  
PRINCIPAL REGISTER**

**Express Your Inner Pizza**

THE LINEAGE GROUP, LLC. (GEORGIA LIMITED LIABILITY COMPANY)

110 FORTSON DRIVE

ATHENS, GA 30606

FOR: RESTAURANT SERVICES FEATURING PIZZA, IN CLASS 43 (U.S. CLS. 100 AND 101).

FIRST USE 3-12-2008; IN COMMERCE 4-12-2008.

THE MARK CONSISTS OF STANDARD CHARACTERS WITHOUT CLAIM TO ANY PARTICULAR FONT, STYLE, SIZE, OR COLOR.

NO CLAIM IS MADE TO THE EXCLUSIVE RIGHT TO USE "PIZZA", APART FROM THE MARK AS SHOWN.

SER. NO. 77-455,797, FILED 4-23-2008.

GINA HAYES, EXAMINING ATTORNEY

**Int. Cl.: 40**

**Prior U.S. Cls.: 100, 103 and 106**

**United States Patent and Trademark Office**

**Reg. No. 3,569,360**

**Registered Feb. 3, 2009**

**SERVICE MARK  
PRINCIPAL REGISTER**

**DRAVO**

CARMEUSE NORTH AMERICA SERVICES, INC  
(DELAWARE CORPORATION)  
11 STANWIX STREET  
PITTSBURGH, PA 15222

THE MARK CONSISTS OF STANDARD CHAR-  
ACTERS WITHOUT CLAIM TO ANY PARTICULAR  
FONT, STYLE, SIZE, OR COLOR.

FOR: CONSULTING SERVICES IN THE FIELD  
OF TREATMENT OF FLUE GAS EMISSIONS FROM  
PLANTS INCLUDING TREATMENT OPTIONS AND  
TREATMENT REAGENT SELECTION , IN CLASS 40  
(U.S. CLS. 100, 103 AND 106).

OWNER OF U.S. REG. NO. 1,101,739.

SER. NO. 77-455,911, FILED 4-23-2008.

FIRST USE 8-29-2008; IN COMMERCE 8-29-2008.

DANIEL CAPSHAW, EXAMINING ATTORNEY

**Int. Cl.: 36**

**Prior U.S. Cls.: 100, 101 and 102**

**United States Patent and Trademark Office**

**Reg. No. 3,569,361**

**Registered Feb. 3, 2009**

**SERVICE MARK  
PRINCIPAL REGISTER**

**YOUR FINANCIAL FUTURE.  
OUR DISCIPLINE.**

BINGHAM, OSBORN & SCARBOROUGH LLC  
(CALIFORNIA LIMITED LIABILITY COMPANY)  
SUITE 1100  
345 CALIFORNIA STREET  
SAN FRANCISCO, CA 94104

FOR: INVESTMENT MANAGEMENT SERVICES, NAMELY, WEALTH MANAGEMENT; FINANCIAL PLANNING; FINANCIAL PLANNING FOR RETIREMENT; ESTATE PLANNING; FINANCIAL CHARITABLE PLANNING, NAMELY, DEVELOPING AND MANAGING CHARITABLE GIVING PROGRAMS FOR OTHERS; FINANCIAL PORTFOLIO MANAGEMENT FEATURING PORTFOLIO DIVERSIFICATION; INSURANCE PROGRAMS, NAMELY, LIFE INSURANCE, DISABILITY INSUR-

ANCE, LONG-TERM CARE INSURANCE, AND HEALTH INSURANCE UNDERWRITING AND SUBROGATION; AND TAX MANAGEMENT FEATURING TAX-ADVANTAGED INVESTMENTS AND ACCOUNTS, AND TAX-DEFERRED STRATEGIES, IN CLASS 36 (U.S. CLS. 100, 101 AND 102).

FIRST USE 9-25-2007; IN COMMERCE 9-25-2007.

THE MARK CONSISTS OF STANDARD CHARACTERS WITHOUT CLAIM TO ANY PARTICULAR FONT, STYLE, SIZE, OR COLOR.

SER. NO. 77-456,967, FILED 4-24-2008.

ODESSA BIBBINS, EXAMINING ATTORNEY

Int. Cl.: 36

Prior U.S. Cls.: 100, 101 and 102

United States Patent and Trademark Office

Reg. No. 3,569,362

Registered Feb. 3, 2009

SERVICE MARK  
PRINCIPAL REGISTER



YOUR FINANCIAL FUTURE. OUR DISCIPLINE.

BINGHAM, OSBORN & SCARBOROUGH LLC  
(CALIFORNIA LIMITED LIABILITY COMPAN-  
NY)  
SUITE 1100  
345 CALIFORNIA STREET  
SAN FRANCISCO, CA 94104

FOR: INVESTMENT MANAGEMENT SERVICES, NAMELY, WEALTH MANAGEMENT; FINANCIAL PLANNING; FINANCIAL PLANNING FOR RETIREMENT; ESTATE PLANNING; FINANCIAL CHARITABLE PLANNING, NAMELY, DEVELOPING AND MANAGING CHARITABLE GIVING PROGRAMS FOR OTHERS; FINANCIAL PORTFOLIO MANAGEMENT FEATURING PORTFOLIO DIVERSIFICATION; INSURANCE PROGRAMS, NAMELY, LIFE INSURANCE, DISABILITY INSURANCE, LONG-TERM CARE INSURANCE, AND HEALTH INSURANCE UNDERWRITING AND SUBROGATION; AND TAX MANAGEMENT FEATURING TAX-ADVANTAGED INVESTMENTS AND ACCOUNTS, AND TAX-DEFERRED STRATEGIES, IN CLASS 36 (U.S. CLS. 100, 101 AND 102).

FIRST USE 9-25-2007; IN COMMERCE 9-25-2007.

OWNER OF U.S. REG. NO. 2,925,264.

NO CLAIM IS MADE TO THE EXCLUSIVE RIGHT TO USE "LLC", APART FROM THE MARK AS SHOWN.

THE MARK CONSISTS OF TWO SHADED IRREGULAR TRIANGLES ON TOP OF A CURVED HORIZONTAL LINE FORMING THE SHAPE OF A SAILBOAT, WITH THE WORDING, "BINGHAM", FOLLOWED BY A CENTERED SHADED DOT, "OSBORN. & SCARBOROUGH" FOLLOWED BY A CENTERED SHADED DOT, "LLC", WITH THE WORDING "YOUR FINANCIAL FUTURE. OUR DISCIPLINE", BELOW, AND TO THE RIGHT OF THE SAILBOAT.

SER. NO. 77-457,091, FILED 4-24-2008.

ODESSA BIBBINS, EXAMINING ATTORNEY

**Int. Cl.: 36**

**Prior U.S. Cls.: 100, 101 and 102**

**United States Patent and Trademark Office**

**Reg. No. 3,569,363**

**Registered Feb. 3, 2009**

**SERVICE MARK  
PRINCIPAL REGISTER**



BINGHAM, OSBORN & SCARBOROUGH LLC  
(CALIFORNIA LIMITED LIABILITY COMPAN-  
NY)  
SUITE 1100  
345 CALIFORNIA STREET  
SAN FRANCISCO, CA 94104

FOR: INVESTMENT MANAGEMENT SERVICES, NAMELY, WEALTH MANAGEMENT; FINANCIAL PLANNING; FINANCIAL PLANNING FOR RETIREMENT; ESTATE PLANNING; FINANCIAL CHARITABLE PLANNING, NAMELY, DEVELOPING AND MANAGING CHARITABLE GIVING PROGRAMS FOR OTHERS; FINANCIAL PORTFOLIO MANAGEMENT FEATURING PORTFOLIO DIVERSIFICATION; INSURANCE PROGRAMS, NAMELY, LIFE INSURANCE, DISABILITY INSURANCE, LONG-TERM CARE INSURANCE, AND HEALTH INSURANCE UNDERWRITING AND SUBROGATION; AND TAX MANAGEMENT FEATURING TAX-ADVANTAGED INVESTMENTS AND ACCOUNTS, AND TAX-DEFERRED STRATEGIES, IN CLASS 36 (U.S. CLS. 100, 101 AND 102).

FIRST USE 9-25-2007; IN COMMERCE 9-25-2007.

OWNER OF U.S. REG. NO. 2,925,264.

NO CLAIM IS MADE TO THE EXCLUSIVE RIGHT TO USE "LLC", APART FROM THE MARK AS SHOWN.

THE MARK CONSISTS OF TWO SHADED IRREGULAR TRIANGLES ON TOP OF A CURVED HORIZONTAL LINE FORMING THE SHAPE OF A SAILBOAT, WITH THE WORDING "BINGHAM" FOLLOWED BY A CENTERED SHADED DOT, "OSBORN & SCARBOROUGH" FOLLOWED BY A CENTERED SHADED DOT, "LLC", TO THE RIGHT OF THE SAILBOAT.

SER. NO. 77-457,152, FILED 4-24-2008.

ODESSA BIBBINS, EXAMINING ATTORNEY

**Int. Cl.: 10**

**Prior U.S. Cls.: 26, 39 and 44**

**United States Patent and Trademark Office**

**Reg. No. 3,569,364**

**Registered Feb. 3, 2009**

**TRADEMARK  
PRINCIPAL REGISTER**

**REIDSLEEVE**

REID, TONY (UNITED STATES INDIVIDUAL)  
P.O. BOX 66149  
SCOTTS VALLEY, CA 950676149

THE MARK CONSISTS OF STANDARD CHAR-  
ACTERS WITHOUT CLAIM TO ANY PARTICULAR  
FONT, STYLE, SIZE, OR COLOR.

FOR: COMPRESSION GARMENT FOR THE ARM  
AND LEG FOR TREATMENT OF EDEMA, IN  
CLASS 10 (U.S. CLS. 26, 39 AND 44).

SER. NO. 77-457,429, FILED 4-24-2008.

FIRST USE 6-1-1994; IN COMMERCE 6-1-1994.

CURTIS FRENCH, EXAMINING ATTORNEY

**Int. Cl.: 19**

**Prior U.S. Cls.: 1, 12, 33 and 50**

**United States Patent and Trademark Office**

**Reg. No. 3,569,365**

**Registered Feb. 3, 2009**

**TRADEMARK  
PRINCIPAL REGISTER**

**STORMCHASER**

REHAU INCORPORATED (DELAWARE CORPORATION)  
1501 EDWARDS FERRY ROAD, NE  
LEESBURG, VA 20176

FOR: FULLY-WELDED PVC WINDOW COMPONENTS, NAMELY, FRAMES, SASHES AND GLAZING BEADS FOR SIDE-LOAD, SINGLE-HUNG, NON-METAL WINDOWS, IN CLASS 19 (U.S. CLS. 1, 12, 33 AND 50).

FIRST USE 2-0-2007; IN COMMERCE 2-0-2007.

THE MARK CONSISTS OF STANDARD CHARACTERS WITHOUT CLAIM TO ANY PARTICULAR FONT, STYLE, SIZE, OR COLOR.

SER. NO. 77-457,823, FILED 4-25-2008.

IRA J. GOODSaid, EXAMINING ATTORNEY

**Int. Cl.: 3**

**Prior U.S. Cls.: 1, 4, 6, 50, 51 and 52**

**United States Patent and Trademark Office**

**Reg. No. 3,569,366**

**Registered Feb. 3, 2009**

**TRADEMARK  
PRINCIPAL REGISTER**

**BRONZING MIST**

ST. TROPEZ ACQUISITION CO. LIMITED (UNI-  
TED KINGDOM PRIVATE LIMITED COMPA-  
NY)

4 TISSINGTON CLOSE

BEESTON, NOTTINGHAM, UNITED KINGDOM  
NG96QG

FOR: SELF-TANNING PREPARATIONS, IN  
CLASS 3 (U.S. CLS. 1, 4, 6, 50, 51 AND 52).

FIRST USE 7-15-2001; IN COMMERCE 7-15-2001.

THE MARK CONSISTS OF STANDARD CHAR-  
ACTERS WITHOUT CLAIM TO ANY PARTICULAR  
FONT, STYLE, SIZE, OR COLOR.

OWNER OF U.S. REG. NO. 2,584,112.

SEC. 2(F).

SER. NO. 77-458,666, FILED 4-25-2008.

GIANCARLO CASTRO, EXAMINING ATTORNEY



**Int. Cl.: 37**

**Prior U.S. Cls.: 100, 103 and 106**

**United States Patent and Trademark Office**

**Reg. No. 3,569,367**

**Registered Feb. 3, 2009**

**SERVICE MARK  
PRINCIPAL REGISTER**



RMA LAND CONSTRUCTION, INC. (CALIFORNIA CORPORATION)  
2707 SATURN STREET  
BREA, CA 92821

FOR: BUILDING CONSTRUCTION AND REPAIR; BUILDING CONSTRUCTION SERVICES; BUILDING CONSTRUCTION SUPERVISION; CONSTRUCTION AND RENOVATION OF BUILDINGS; CONSTRUCTION AND REPAIR OF BUILDINGS; CONSTRUCTION GRADING SERVICES; CONSTRUCTION MANAGEMENT; CONSTRUCTION OF BUILDINGS; CONSTRUCTION OF MEDICAL ESTABLISHMENTS; CONSTRUCTION PLANNING; CONSTRUCTION SUPERVISION; CONSTRUCTION, MAINTENANCE AND RENOVATION OF PROPERTY; CUSTOM CONSTRUCTION AND BUILDING RENOVATION; ELECTRICAL CONTRACTOR SERVICES; FRAMING CONTRACTOR SERVICES; GENERAL CONSTRUCTION CONTRACTING; WAREHOUSE CONSTRUCTION AND REPAIR, IN CLASS 37 (U.S. CLS. 100, 103 AND 106).

FIRST USE 1-1-1999; IN COMMERCE 1-1-1999.

NO CLAIM IS MADE TO THE EXCLUSIVE RIGHT TO USE "LAND CONSTRUCTION", APART FROM THE MARK AS SHOWN.

THE COLOR(S) BURGUNDY AND OLIVE IS/ARE CLAIMED AS A FEATURE OF THE MARK.

THE MARK CONSISTS OF A TRIANGLE DESIGN AND THE WORDING "RMA LAND CONSTRUCTION." THE COLOR BURGUNDY APPEARS IN THE TRIANGLE DESIGN. THE COLOR OLIVE APPEARS IN THE WORDING "RMA LAND CONSTRUCTION." THE COLOR WHITE CONSTITUTES BACKGROUND, OUTLINING, SHADING OR TRANSPARENT AREAS, AND IS NOT PART OF THE MARK.

SER. NO. 77-458,729, FILED 4-25-2008.

PAUL MORENO, EXAMINING ATTORNEY

Int. Cl.: 44

Prior U.S. Cls.: 100 and 101

United States Patent and Trademark Office

Reg. No. 3,569,368

Registered Feb. 3, 2009

SERVICE MARK  
PRINCIPAL REGISTER



CREW CUTTERS, LLC (GEORGIA LIMITED LIABILITY COMPANY)  
1720 MARS HILL RD., SUITE 8-172  
ACWORTH, GA 30101

FOR: GARDEN CARE SERVICES; GARDEN OR FLOWER BED CARE; GARDEN TREE PLANTING; GARDENER AND GARDENING SERVICES; LANDSCAPE GARDENING; LANDSCAPE GARDENING DESIGN FOR OTHERS; LAWN CARE; LAWN MOWING SERVICES; LANDSCAPE DESIGN, IN CLASS 44 (U.S. CLS. 100 AND 101).

FIRST USE 7-29-2005; IN COMMERCE 7-29-2005.

NO CLAIM IS MADE TO THE EXCLUSIVE RIGHT TO USE "LLC", APART FROM THE MARK AS SHOWN.

THE COLOR(S) LIGHT GREEN, DARK GREEN, BLACK, AND WHITE IS/ARE CLAIMED AS A FEATURE OF THE MARK.

THE MARK CONSISTS OF A BLACK AND WHITE HEAD AND FACE WITH A BLACK AND WHITE PERSON ON TOP PUSHING A BLACK AND WHITE LAWN MOWER, GIVING THE HEAD A CREW CUT AS IF CUTTING LAWN; THE PHRASE "GET LAWN CARE OFF YOUR MIND" APPEARS BELOW IN LIGHT GREEN ON A BLACK RECTANGLE; THE NAME "CREW CUTTERS LLC" APPEARS TO THE RIGHT OF THE HEAD WITH THE WORDS "CREW" AND "LLC" APPEARING IN LIGHT GREEN AND THE WORD "CUTTERS" APPEARING IN DARK GREEN.

SER. NO. 77-458,784, FILED 4-25-2008.

SHAILA SETTLES, EXAMINING ATTORNEY

**Int. Cl.: 31**

**Prior U.S. Cls.: 1 and 46**

**United States Patent and Trademark Office**

**Reg. No. 3,569,369**

**Registered Feb. 3, 2009**

**TRADEMARK  
PRINCIPAL REGISTER**

**Pine Straw By The Box**

THE PINE STRAW STORE LLC (GEORGIA LIMITED LIABILITY COMPANY), DBA THE PINE STRAW STORE

1609 HARTRICH ROAD  
AUGUSTA, GA 30906

FOR: PINE CONES, IN CLASS 31 (U.S. CLS. 1 AND 46).

FIRST USE 1-1-2005; IN COMMERCE 1-1-2005.

THE MARK CONSISTS OF STANDARD CHARACTERS WITHOUT CLAIM TO ANY PARTICULAR FONT, STYLE, SIZE, OR COLOR.

NO CLAIM IS MADE TO THE EXCLUSIVE RIGHT TO USE "PINE STRAW", APART FROM THE MARK AS SHOWN.

SER. NO. 77-458,934, FILED 4-26-2008.

SUSAN STIGLITZ, EXAMINING ATTORNEY

**Int. Cl.: 29**

**Prior U.S. Cl.: 46**

**United States Patent and Trademark Office**

**Reg. No. 3,569,370**

**Registered Feb. 3, 2009**

**TRADEMARK  
PRINCIPAL REGISTER**



CRISPY GREEN, INC. (NEW JERSEY CORPORATION)  
20 HOWELL DRIVE  
WEST ORANGE, NJ 07052

FOR: FRUIT BASED SNACK FOODS, IN CLASS 29  
(U.S. CL. 46).

FIRST USE 5-17-2005; IN COMMERCE 5-17-2005.

OWNER OF U.S. REG. NO. 3,048,059.

NO CLAIM IS MADE TO THE EXCLUSIVE  
RIGHT TO USE "CRISPY", APART FROM THE  
MARK AS SHOWN.

THE COLOR(S) LIGHT GREEN AND DARK  
GREEN IS/ARE CLAIMED AS A FEATURE OF  
THE MARK.

THE MARK CONSISTS OF A DESIGN ELEMENT  
IN LIGHT GREEN CONSISTING OF TWO  
SPROUTS, A CURVED LINE AND TWO CIRCLES.  
NEXT TO THE DESIGN ELEMENT ARE THE  
WORDS "CRISPY GREEN" IN DARK GREEN.

SER. NO. 77-458,951, FILED 4-26-2008.

ERNEST SHOSHO, EXAMINING ATTORNEY

**Int. Cl.: 42**

**Prior U.S. Cls.: 100 and 101**

**United States Patent and Trademark Office**

**Reg. No. 3,569,371**

**Registered Feb. 3, 2009**

**SERVICE MARK  
PRINCIPAL REGISTER**

**ADVANCED OBJECTS**

ADVANCED OBJECTS, INC. (ILLINOIS CORPORATION)  
SUITE 409  
155 NORTH MICHIGAN AVENUE  
CHICAGO, IL 60601

FOR: CONSULTING SERVICES IN THE FIELD OF IDENTIFICATION, SUPPORT AND IMPLEMENTATION OF COMPUTER-BASED INFORMATION SYSTEMS FOR BUSINESSES IN THE FINANCIAL SERVICES INDUSTRY; COMPUTER SERVICES, NAMELY, HOSTING AND MAINTAINING ON-LINE WEB SITES FOR OTHERS FOR CONDUCTING FINANCIAL SERVICES; CUSTOM DEVELOPMENT AND DESIGN OF SOFTWARE AND NEW PRODUCTS FOR OTHERS FOR USE IN THE FINANCIAL INDUSTRY; PROVIDING ON-LINE, NON-DOWNLOADABLE SOFTWARE FOR FINANCIAL PORTFOLIO ANALYSIS; COMPUTER PROJECT MANAGEMENT SERVICES; TECHNOLOGY CONSULTING SERVICES, NAMELY, STRATEGIC TECHNOLOGY PLANNING IN THE FIELD OF

FINANCIAL PLANNING AND FINANCIAL PORTFOLIO MANAGEMENT; AND PROVIDING ON-LINE NON-DOWNLOADABLE SOFTWARE FOR GENERATING PROPOSALS IN THE FIELD OF FINANCIAL PLANNING AND FINANCIAL PORTFOLIO MANAGEMENT, IN CLASS 42 (U.S. CLS. 100 AND 101).

FIRST USE 6-1-2000; IN COMMERCE 6-1-2000.

THE MARK CONSISTS OF STANDARD CHARACTERS WITHOUT CLAIM TO ANY PARTICULAR FONT, STYLE, SIZE, OR COLOR.

NO CLAIM IS MADE TO THE EXCLUSIVE RIGHT TO USE "ADVANCED", APART FROM THE MARK AS SHOWN.

SER. NO. 77-459,694, FILED 4-28-2008.

SETH A. RAPPAPORT, EXAMINING ATTORNEY

**Int. Cl.: 33**

**Prior U.S. Cls.: 47 and 49**

**United States Patent and Trademark Office**

**Reg. No. 3,569,372**

**Registered Feb. 3, 2009**

**TRADEMARK  
PRINCIPAL REGISTER**

**ZIPPY'S BLOCK**

TWO HANDS WINES PTY. LTD. (AUSTRALIA  
LIMITED LIABILITY COMPANY)  
205 GREENHILL ROAD  
C/O TILBROOK RASHEED  
EASTWOOD, AUSTRALIA 5063

PRIORITY CLAIMED UNDER SEC. 44(D) ON  
AUSTRALIA APPLICATION NO. 1208379, FILED  
11-2-2007, REG. NO. 1208379, DATED 11-2-2007, EX-  
PIRES 11-2-2017.

FOR: ALCOHOLIC BEVERAGES, OTHER THAN  
BEER, NAMELY, WINES, IN CLASS 33 (U.S. CLS. 47  
AND 49).

SER. NO. 77-460,230, FILED 4-29-2008.

THE MARK CONSISTS OF STANDARD CHAR-  
ACTERS WITHOUT CLAIM TO ANY PARTICULAR  
FONT, STYLE, SIZE, OR COLOR.

JOHN DWYER, EXAMINING ATTORNEY

**Int. Cl.: 41**

**Prior U.S. Cls.: 100, 101 and 107**

**United States Patent and Trademark Office**

**Reg. No. 3,569,373**

**Registered Feb. 3, 2009**

**SERVICE MARK  
PRINCIPAL REGISTER**



BRETT ALLAN JOHNSON (UNITED STATES  
INDIVIDUAL), DBA BRETT ALLEN  
4735 VIA VIENTO  
SIERRA VISTA, AZ 85635

FOR: PROVIDING IN-DEPTH TELEVISION PRO-  
GRAMS AND ONLINE MEDIA, NAMELY, NON-  
DOWNLOADABLE VIDEOS, ALL FEATURING  
TRAVEL DESTINATIONS, TOURIST ATTRAC-  
TIONS, AND OTHER LOCAL POINTS OF INTEREST  
THROUGHOUT THE UNITED STATES, IN CLASS  
41 (U.S. CLS. 100, 101 AND 107).

FIRST USE 10-29-2005; IN COMMERCE 3-4-2006.

NO CLAIM IS MADE TO THE EXCLUSIVE  
RIGHT TO USE "THE OFFICIAL BEST OF", APART  
FROM THE MARK AS SHOWN.

THE COLOR(S) BLACK, WHITE, RED, AND  
GRAY IS/ARE CLAIMED AS A FEATURE OF THE  
MARK.

THE MARK CONSISTS OF THE WORDS "THE  
OFFICIAL BEST OF" ON AN OVAL BLACK-AND-  
GRAY SWIRLED BACKGROUND WITH A BLACK  
BORDER; THE WORD "THE" IS WHITE, SMALLER,  
AND LOCATED INSIDE THE LETTER "O" IN THE  
WORD "OFFICIAL"; THE WORD "OFFICIAL" IS  
WHITE; THE WORD "BEST" IS RED; AND THE  
WORD "OF" IS GRAY.

SER. NO. 77-461,094, FILED 4-29-2008.

MARK PILARO, EXAMINING ATTORNEY

**Int. Cl.: 19**

**Prior U.S. Cls.: 1, 12, 33 and 50**

**United States Patent and Trademark Office**

**Reg. No. 3,569,374**

**Registered Feb. 3, 2009**

**TRADEMARK  
PRINCIPAL REGISTER**

**FLO - CELL**

ASTRAL PROPERTY PTY LIMITED (AUSTRALIA LIMITED LIABILITY COMPANY)  
UNIT 3  
19 - 21 GIBBES STREET  
CHATSWOOD, AUSTRALIA 2067

FOR: UNDERGROUND PLASTICS DRAINAGE AND INFILTRATION CELLS, UNDERGROUND PLASTICS PERFORATED INFILTRATION AND DRAINAGE PIPES, UNDERGROUND PLASTICS MODULAR PERFORATED OR POROUS TANK UNITS AND PLASTICS PERFORATED OR POROUS WALL PANELS FOR USE IN WATER TREATMENT, INFILTRATION, RECTICULATION OR LEACH AND DRAINAGE SYSTEMS, IN CLASS 19 (U.S. CLS. 1, 12, 33 AND 50).

THE MARK CONSISTS OF STANDARD CHARACTERS WITHOUT CLAIM TO ANY PARTICULAR FONT, STYLE, SIZE, OR COLOR.

PRIORITY CLAIMED UNDER SEC. 44(D) ON AUSTRALIA APPLICATION NO. 1223845, FILED 2-12-2008, REG. NO. 1223845, DATED 2-12-2008, EXPIRES 2-12-2018.

SER. NO. 77-461,258, FILED 4-29-2008.

ALICIA COLLINS, EXAMINING ATTORNEY



**Int. Cl.: 40**

**Prior U.S. Cls.: 100, 103 and 106**

**United States Patent and Trademark Office**

**Reg. No. 3,569,375**

**Registered Feb. 3, 2009**

**SERVICE MARK  
PRINCIPAL REGISTER**

# Tigerpress

SHAFIIS', INC. (MASSACHUSETTS CORPORATION), DBA TIGERPRESS  
155 INDUSTRIAL DRIVE  
NORTHAMPTON, MA 01060

FOR: PRINTING, NAMELY, COMMERCIAL PRINTING, DIGITAL PRINTING, PACKAGING PRINTING, SIGNS AND BANNER PRINTING, BLUE PRINTING, OVERSIZE COLOR PRINTING; PRINTING OF ADVERTISING MATTER; STATIONERY PRINTING SERVICES; BINDERY SERVICES FOR OTHERS, NAMELY, COLLATING, FOLDING, STAPLING, PERFORATING, CUTTING AND BINDING OF PRINTED, PHOTOCOPIED AND TYPE-

WRITTEN MATERIALS; BOOKBINDING, IN CLASS 40 (U.S. CLS. 100, 103 AND 106).

FIRST USE 12-31-1995; IN COMMERCE 12-31-1995.

THE MARK CONSISTS OF STANDARD CHARACTERS WITHOUT CLAIM TO ANY PARTICULAR FONT, STYLE, SIZE, OR COLOR.

SER. NO. 77-462,129, FILED 4-30-2008.

INGRID C. EULIN, EXAMINING ATTORNEY

Int. Cl.: 41

Prior U.S. Cls.: 100, 101 and 107

United States Patent and Trademark Office

Reg. No. 3,569,376

Registered Feb. 3, 2009

SERVICE MARK  
PRINCIPAL REGISTER



RIGGAN, KAINE (UNITED STATES INDIVIDUAL)  
579 LOCKWOOD DR  
NASHVILLE, TN 37214

FOR: DINNER THEATERS; ENTERTAINMENT IN THE NATURE OF THEATER PRODUCTIONS, IN CLASS 41 (U.S. CLS. 100, 101 AND 107).

FIRST USE 3-0-2008; IN COMMERCE 3-0-2008.

NO CLAIM IS MADE TO THE EXCLUSIVE RIGHT TO USE "DINNER THEATRE", APART FROM THE MARK AS SHOWN.

THE COLOR(S) BLACK, WHITE, PURPLE AND GRAY IS/ARE CLAIMED AS A FEATURE OF THE MARK.

THE MARK CONSISTS OF THE COLOR(S) BLACK, WHITE, PURPLE AND GRAY, WITH THE TERM "NASHVILLE" IN BLACK WITH THE IMAGE OF A FORK AND KNIFE IN GRAY FORMING THE IMAGE OF THE TWO LETTER L'S IN "NASHVILLE", WITH THE TERMS "DINNER THEATRE" IN BLACK LOCATED BELOW THAT WITH A PURPLE LINE IN BETWEEN "DINNER" AND "THEATRE", WITH THE IMAGE OF A BOTTLE AND AN ICE-PICK IN PURPLE AND GRAY AND THE IMAGE OF A STOVE IN PURPLE, WHITE AND GREY LOCATED TO THE RIGHT.

SER. NO. 77-462,608, FILED 4-30-2008.

KIM SAITO, EXAMINING ATTORNEY

**Int. Cl.: 38**

**Prior U.S. Cls.: 100, 101 and 104**

**United States Patent and Trademark Office**

**Reg. No. 3,569,377**

**Registered Feb. 3, 2009**

**SERVICE MARK  
PRINCIPAL REGISTER**

**AT&T BUSINESSTALK**

AT&T INTELLECTUAL PROPERTY II, L.P. (NE-  
VADA LIMITED PARTNERSHIP)  
645 EAST PLUMB LANE  
RENO, NV 89502

FOR: TELECOMMUNICATIONS SERVICES,  
NAMELY, WIRELESS TELEPHONE TRANSMIS-  
SION OF VOICE, TEXT, FACSIMILE, IMAGES,  
VIDEO AND DATA; WIRELESS TELEPHONE COM-  
MUNICATIONS SERVICES, NAMELY, WIRELESS  
TELEPHONE CALLING PLANS, IN CLASS 38 (U.S.  
CLS. 100, 101 AND 104).

FIRST USE 3-30-2008; IN COMMERCE 3-30-2008.

THE MARK CONSISTS OF STANDARD CHAR-  
ACTERS WITHOUT CLAIM TO ANY PARTICULAR  
FONT, STYLE, SIZE, OR COLOR.

OWNER OF U.S. REG. NOS. 1,699,744, 3,248,449  
AND OTHERS.

SER. NO. 77-463,079, FILED 5-1-2008.

TEJBIR SINGH, EXAMINING ATTORNEY

**Int. Cl.: 31**

**Prior U.S. Cls.: 1 and 46**

**United States Patent and Trademark Office**

**Reg. No. 3,569,378**

**Registered Feb. 3, 2009**

**TRADEMARK  
PRINCIPAL REGISTER**

**Pine Needles By The Box**

THE PINE STRAW STORE LLC (GEORGIA LIMITED LIABILITY COMPANY), DBA THE PINE STRAW STORE

1609 HARTRICH ROAD  
AUGUSTA, GA 30906

FOR: PINE CONES, IN CLASS 31 (U.S. CLS. 1 AND 46).

FIRST USE 1-1-2005; IN COMMERCE 1-1-2005.

THE MARK CONSISTS OF STANDARD CHARACTERS WITHOUT CLAIM TO ANY PARTICULAR FONT, STYLE, SIZE, OR COLOR.

NO CLAIM IS MADE TO THE EXCLUSIVE RIGHT TO USE "PINE NEEDLES", APART FROM THE MARK AS SHOWN.

SER. NO. 77-463,817, FILED 5-1-2008.

SUSAN STIGLITZ, EXAMINING ATTORNEY

**Int. Cl.: 31**

**Prior U.S. Cls.: 1 and 46**

**United States Patent and Trademark Office**

**Reg. No. 3,569,379**

**Registered Feb. 3, 2009**

**TRADEMARK  
PRINCIPAL REGISTER**

**Pine Straw To Your Door**

THE PINE STRAW STORE LLC (GEORGIA LIMITED LIABILITY COMPANY), DBA THE PINE STRAW STORE  
1609 HARTRICH ROAD  
AUGUSTA, GA 30906

FOR: PINE CONES, IN CLASS 31 (U.S. CLS. 1 AND 46).

FIRST USE 1-1-2005; IN COMMERCE 1-1-2005.

THE MARK CONSISTS OF STANDARD CHARACTERS WITHOUT CLAIM TO ANY PARTICULAR FONT, STYLE, SIZE, OR COLOR.

OWNER OF U.S. REG. NO. 3,404,565.

NO CLAIM IS MADE TO THE EXCLUSIVE RIGHT TO USE "PINE STRAW", APART FROM THE MARK AS SHOWN.

SER. NO. 77-463,824, FILED 5-1-2008.

SUSAN STIGLITZ, EXAMINING ATTORNEY

**Int. Cls.: 37 and 42**

**Prior U.S. Cls.: 100, 101, 103 and 106**

**United States Patent and Trademark Office**

**Reg. No. 3,569,380**

**Registered Feb. 3, 2009**

**SERVICE MARK  
PRINCIPAL REGISTER**



HANEUL A/V INC. (NEW YORK CORPORATION), DBA SKY A/V PRO  
38 W. 32ND ST. SUITE 803  
NEW YORK, NY 10001

FOR: INSTALLATION OF PROFESSIONAL ACOUSTIC, AUDIO, VISUAL, LIGHTING, HOME AUTOMATION, HOME THEATER AND SECURITY SYSTEMS, IN CLASS 37 (U.S. CLS. 100, 103 AND 106).

FIRST USE 6-1-2003; IN COMMERCE 7-1-2003.

FOR: DESIGN FOR OTHERS IN THE FIELD OF PROFESSIONAL ACOUSTIC, AUDIO, VIDEO, LIGHTING, HOME AUTOMATION, HOME THEATER, AND SECURITY SYSTEMS, IN CLASS 42 (U.S. CLS. 100 AND 101).

FIRST USE 6-1-2003; IN COMMERCE 7-1-2003.

THE COLOR(S) SKYBLUE AND DARK GRAY IS/ARE CLAIMED AS A FEATURE OF THE MARK.

THE MARK CONSISTS OF SKYBLUE ARCH OVER THE DARK GRAY WORD "SKY AV PRO" AND THE WHITE COLOR IS NOT A FEATURE OF THE MARK, ITS A TRANSPARENT PART.

SER. NO. 77-463,852, FILED 5-2-2008.

BARBARA RUTLAND, EXAMINING ATTORNEY

**Int. Cl.: 41**

**Prior U.S. Cls.: 100, 101 and 107**

**United States Patent and Trademark Office**

**Reg. No. 3,569,381**

**Registered Feb. 3, 2009**

**SERVICE MARK  
PRINCIPAL REGISTER**

**PULASKI CADETS**

PULASKI CADETS-USA, NEW JERSEY NONPROFIT CORPORATION (NEW JERSEY CORPORATION)  
429 DEVON STREET  
KEARNY, NJ 07032

FOR: CONDUCTING EDUCATIONAL EXHIBITIONS IN THE NATURE OF HONORING POLISH MILITARY HERITAGE, EXHIBITING POLISH MILITARY UNIFORMS, MILITARY REENACTMENTS AND PERSONS MARCHING IN PARADES WHILE ATTIRED IN MILITARY UNIFORMS; EDUCATIONAL DEMONSTRATIONS; EDUCATIONAL SERVICES, NAMELY, PROVIDING CONVENTIONS IN THE FIELDS OF POLISH MILITARY HISTORY AND PATRIOTISM; ENTERTAINMENT IN THE NATURE OF LIVE PERFORMANCES BY PERSONS DRESSED IN MILITARY UNIFORMS; SOCIAL CLUB SERVICES, NAMELY, ARRANGING, ORGANIZING, AND HOSTING SOCIAL EVENTS, GET-

TOGETHERS, AND PARTIES FOR CLUB MEMBERS; CHARITABLE SERVICES, NAMELY, PROVIDING TRAINING IN THE FIELD OF MARKSMANSHIP AND MILITARY TRAINING, IN CLASS 41 (U.S. CLS. 100, 101 AND 107).

FIRST USE 2-1-1995; IN COMMERCE 2-1-1995.

THE MARK CONSISTS OF STANDARD CHARACTERS WITHOUT CLAIM TO ANY PARTICULAR FONT, STYLE, SIZE, OR COLOR.

NO CLAIM IS MADE TO THE EXCLUSIVE RIGHT TO USE "CADETS", APART FROM THE MARK AS SHOWN.

SER. NO. 77-464,360, FILED 5-2-2008.

FRANK LATTUCA, EXAMINING ATTORNEY

**Int. Cls.: 35 and 41**

**Prior U.S. Cls.: 100, 101, 102 and 107**

**United States Patent and Trademark Office**

**Reg. No. 3,569,382**

**Registered Feb. 3, 2009**

**SERVICE MARK  
PRINCIPAL REGISTER**



ORGANICWORKS MARKETING, LLC (NEW  
YORK LIMITED LIABILITY COMPANY)  
SUITE 1508  
200 PARK AVENUE SOUTH,  
NEW YORK, NY 10003

FOR: BUSINESS MANAGEMENT CONSULTING  
WITH RELATION TO COMMUNICATION STRAT-  
EGY AND MARKETING, BRAND POSITIONING  
AND BRAND DEVELOPMENT; DEVELOPMENT  
OF MARKETING STRATEGIES AND CONCEPTS;  
PUBLIC AND MEDIA RELATIONS; MARKETING  
SERVICES, NAMELY, PROMOTING AND MAR-  
KETING THE GOODS AND SERVICES OF OTHERS  
THROUGH ALL PUBLIC COMMUNICATION  
MEANS, IN CLASS 35 (U.S. CLS. 100, 101 AND 102).

FIRST USE 4-11-2002; IN COMMERCE 4-11-2002.

FOR: SPECIAL EVENT PLANNING AND CON-  
SULTATION, IN CLASS 41 (U.S. CLS. 100, 101 AND  
107).

FIRST USE 4-11-2002; IN COMMERCE 4-11-2002.

NO CLAIM IS MADE TO THE EXCLUSIVE  
RIGHT TO USE "ORGANIC" , APART FROM THE  
MARK AS SHOWN.

THE MARK CONSISTS OF THE COMBINED  
WORDS "ORGANIC" AND WORKS" WITH TITLE  
CAPITAL CASES AND THE TITLE LETTER "O" IS  
DIVIDED IN THE MIDDLE AND THE RIGHT HALF  
IS SHADED.

SER. NO. 77-464,529, FILED 5-2-2008.

AMY HELLA, EXAMINING ATTORNEY



**Int. Cl.: 42**

**Prior U.S. Cls.: 100 and 101**

**United States Patent and Trademark Office**

**Reg. No. 3,569,383**

**Registered Feb. 3, 2009**

**SERVICE MARK  
PRINCIPAL REGISTER**

# Ibelis

IBELIS CORPORATION (CANADA CORPORATION)  
SUITE #147  
925 DE MAISONNEUVE OUEST  
MONTREAL, CANADA H3A0A5

FOR: SOFTWARE DESIGN AND DEVELOPMENT, IN CLASS 42 (U.S. CLS. 100 AND 101).

FIRST USE 11-27-2006; IN COMMERCE 0-0-2007.

THE MARK CONSISTS OF STANDARD CHARACTERS WITHOUT CLAIM TO ANY PARTICULAR FONT, STYLE, SIZE, OR COLOR.

SEC. 2(F).

SER. NO. 77-465,565, FILED 5-5-2008.

PAULA MAHONEY, EXAMINING ATTORNEY

**Int. Cls.: 23 and 40**

**Prior U.S. Cls.: 43, 100, 103 and 106**

**Reg. No. 3,569,384**

**United States Patent and Trademark Office**

**Registered Feb. 3, 2009**

**TRADEMARK  
SERVICE MARK  
PRINCIPAL REGISTER**

**AMTEX**

AMTEX (YARN) MANUFACTURING INC. (CANADA CORPORATION)  
5960 SHAWSON DRIVE  
MISSISSAUGA, ONTARIO, CANADA L4W3W5

FOR: YARNS, IN CLASS 23 (U.S. CL. 43).

FIRST USE 0-0-2001; IN COMMERCE 0-0-2001.

FOR: MANUFACTURE OF YARNS TO THE SPECIFICATION OF OTHERS, IN CLASS 40 (U.S. CLS. 100, 103 AND 106).

FIRST USE 0-0-2001; IN COMMERCE 0-0-2001.

THE MARK CONSISTS OF STANDARD CHARACTERS WITHOUT CLAIM TO ANY PARTICULAR FONT, STYLE, SIZE, OR COLOR.

SER. NO. 77-465,785, FILED 5-5-2008.

AMY ALFIERI, EXAMINING ATTORNEY

**Int. Cls.: 16 and 41**

**Prior U.S. Cls.: 2, 5, 22, 23, 29, 37, 38, 50, 100, 101 and 107**

**Reg. No. 3,569,385**

**United States Patent and Trademark Office**

**Registered Feb. 3, 2009**

**TRADEMARK  
SERVICE MARK  
PRINCIPAL REGISTER**

**LEARNING LEADERS**

BERSIN & ASSOCIATES, LLC (CALIFORNIA LIMITED LIABILITY COMPANY)  
SUITE 746  
6114 LA SALLE AVENUE  
OAKLAND, CA 94611

FOR: RESEARCH REPORTS FEATURING THE BEST PRACTICES, FINDINGS AND OBSERVATIONS COLLECTED DURING THE JUDGING PROCESS OF AN AWARDS PROGRAM IN THE FIELD OF CORPORATE TRAINING, IN CLASS 16 (U.S. CLS. 2, 5, 22, 23, 29, 37, 38 AND 50).

FIRST USE 4-7-2006; IN COMMERCE 6-1-2007.

FOR: EDUCATIONAL SERVICES, NAMELY, PROVIDING INCENTIVES TO ORGANIZATIONS TO DEMONSTRATE EXCELLENCE IN THE FIELD OF CORPORATE TRAINING THROUGH THE ISSU-

ANCE OF AWARDS; EDUCATIONAL RESEARCH IN THE FIELD OF CORPORATE TRAINING; PROVIDING RECOGNITION AND INCENTIVES BY THE WAY OF AWARDS TO DEMONSTRATE EXCELLENCE IN THE FIELD OF CORPORATE TRAINING, IN CLASS 41 (U.S. CLS. 100, 101 AND 107).

FIRST USE 4-7-2006; IN COMMERCE 4-7-2006.

THE MARK CONSISTS OF STANDARD CHARACTERS WITHOUT CLAIM TO ANY PARTICULAR FONT, STYLE, SIZE, OR COLOR.

SER. NO. 77-466,191, FILED 5-5-2008.

BARBARA RUTLAND, EXAMINING ATTORNEY

**Int. Cls.: 16, 20 and 21**

**Prior U.S. Cls.: 2, 5, 13, 22, 23, 25, 29, 30, 32, 33, 37, 38, 40 and 50**

**Reg. No. 3,569,386**

**United States Patent and Trademark Office**

**Registered Feb. 3, 2009**

**TRADEMARK  
PRINCIPAL REGISTER**



CITY OF SANTA CLARITA (CALIFORNIA MUNICIPAL CORPORATION)  
23920 VALENCIA BLVD.  
SANTA CLARITA, CA 91355

FOR: BROCHURES ABOUT MUNICIPAL SERVICES; NEWSLETTERS IN THE FIELD OF MUNICIPAL SERVICES; PAPER STATIONERY; DECALS, IN CLASS 16 (U.S. CLS. 2, 5, 22, 23, 29, 37, 38 AND 50).

FIRST USE 1-2-2007; IN COMMERCE 3-6-2007.

FOR: PLASTIC BANNERS; PLASTIC KEY CHAINS, IN CLASS 20 (U.S. CLS. 2, 13, 22, 25, 32 AND 50).

FIRST USE 1-2-2007; IN COMMERCE 3-6-2007.

FOR: NON-METAL PIGGY BANKS; CUPS AND MUGS, IN CLASS 21 (U.S. CLS. 2, 13, 23, 29, 30, 33, 40 AND 50).

FIRST USE 1-2-2007; IN COMMERCE 3-6-2007.

OWNER OF U.S. REG. NO. 1,625,888.

NO CLAIM IS MADE TO THE EXCLUSIVE RIGHT TO USE "CITY OF SANTA CLARITA FOUNDED 15 DECEMBER 1987", APART FROM THE MARK AS SHOWN.

THE MARK CONSISTS OF A CIRCLE WITH "CITY OF SANTA CLARITA" PRINTED ALONG THE INTERIOR TOP EDGE OF THE CIRCLE AND "FOUNDED 15 DECEMBER 1987" PRINTED ALONG THE INTERIOR BOTTOM EDGE OF THE CIRCLE. THE REMAINING INTERIOR OF THE CIRCLE DEPICTS ROLLING HILLS AND A SKY WITH CLOUDS. A PATH TRAVERSES THE ROLLING HILLS AND LEADS TO A TREE. A HOUSE WITH A PICKET FENCE IS DEPICTED ON THE RIGHT. A BUILDING IS OFF IN THE DISTANCE ON THE LEFT.

SER. NO. 77-466,823, FILED 5-6-2008.

SHAUNIA CARLYLE, EXAMINING ATTORNEY

Int. Cl.: 10

Prior U.S. Cls.: 26, 39 and 44

United States Patent and Trademark Office

Reg. No. 3,569,387

Registered Feb. 3, 2009

TRADEMARK  
PRINCIPAL REGISTER



BETH BROMBERG (UNITED STATES INDIVIDUAL)  
2225 E. FLAMINGO RD. #204  
LAS VEGAS, CA 89119

FOR: A GLOVE-LIKE DEVICE FOR USE IN BREAST EXAMINATION, IN CLASS 10 (U.S. CLS. 26, 39 AND 44).

FIRST USE 11-1-2007; IN COMMERCE 11-1-2007.

NO CLAIM IS MADE TO THE EXCLUSIVE RIGHT TO USE "MITT" OR "SELF BREAST EXAM", APART FROM THE MARK AS SHOWN.

THE COLOR(S) PINK, PURPLE, LIGHT PINK, DARK PURPLE IS/ARE CLAIMED AS A FEATURE OF THE MARK.

THE MARK CONSISTS OF THE TEXT "B.E." IN STYLIZED SCRIPT WITH THE "B." AND SECOND "." IN PURPLE AND THE "E" WITH FIRST HALF OF THE LETTER IN PINK AND THE SECOND HALF IN PURPLE. THE TEXT "MITT", IN PINK, BELOW AND TO THE RIGHT OF THE "B.E." WITH THE TEXT "SELF BREAST EXAM," IN BOLD TEXT AND PURPLE, FOLLOWED BY "SIMPLIFIED!" IN LIGHT PURPLE DIRECTLY BELOW THE "B.E." AND "MITT". WITH A SOLID CIRCLE OF LIGHT PINK BEHIND THE TEXT.

SER. NO. 77-467,934, FILED 5-7-2008.

CARRIE GENOVESE, EXAMINING ATTORNEY

**Int. Cl.: 12**

**Prior U.S. Cls.: 19, 21, 23, 31, 35 and 44**

**Reg. No. 3,569,388**

**United States Patent and Trademark Office**

**Registered Feb. 3, 2009**

**TRADEMARK  
PRINCIPAL REGISTER**



CHUMBA (CALIFORNIA CORPORATION)  
3325 E. MIRALOMA AVENUE, UNIT 123  
ANAHEIM, CA 92806

FOR: BICYCLE HANDLEBAR GRIPS; BICYCLE  
PEDALS; BICYCLE SADDLES; BICYCLE WHEELS;  
BICYCLES; FRAMES FOR BICYCLES, IN CLASS 12  
(U.S. CLS. 19, 21, 23, 31, 35 AND 44).

FIRST USE 2-1-2008; IN COMMERCE 2-1-2008.

THE MARK CONSISTS OF THE CAPITALIZED  
LETTERS "VF" FOLLOWED BY THE NUMBER "2",  
ALL SLANTED TO THE LEFT. THE LETTER "F"  
AND NUMBER "2" ARE ATTACHED TO EACH  
OTHER.

SER. NO. 77-468,360, FILED 5-7-2008.

ALYSSA STEEL, EXAMINING ATTORNEY

**Int. Cl.: 42**

**Prior U.S. Cls.: 100 and 101**

**United States Patent and Trademark Office**

**Reg. No. 3,569,389**

**Registered Feb. 3, 2009**

**SERVICE MARK  
PRINCIPAL REGISTER**

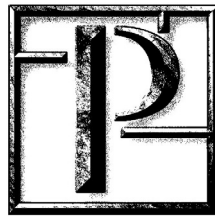

PLANWORX ARCHITECTURE, PA (NORTH  
CAROLINA PROFESSIONAL ASSOCIATION)  
SUITE #100  
5711 SIX FORKS RD.  
RALEIGH, NC 27609

FOR: ARCHITECTURE AND ENGINEERING DE-  
SIGN SERVICES FOR RESIDENTIAL AND COM-  
MERCIAL STRUCTURES, IN CLASS 42 (U.S. CLS.  
100 AND 101).

FIRST USE 8-16-2006; IN COMMERCE 8-16-2006.

THE STIPPLING IS FOR SHADING PURPOSES  
ONLY.

THE MARK CONSISTS OF THE STYLIZED "P"  
INSIDE A SQUARE WITH TWO HORIZONTAL  
LINES, ONE TO THE LEFT OF THE STEM OF THE  
"P" AND THE OTHER FEATURED UNDERNEATH  
THE LOOP OF THE LETTER "P" AND ONE VER-  
TICAL LINE FEATURED AT THE TOP OF THE  
LOOP OF THE LETTER "P".

SER. NO. 77-468,436, FILED 5-7-2008.

CHARISMA HAMPTON, EXAMINING ATTORNEY

**Int. Cls.: 25 and 28**

**Prior U.S. Cls.: 22, 23, 38, 39 and 50**

**United States Patent and Trademark Office**

**Reg. No. 3,569,390**

**Registered Feb. 3, 2009**

**TRADEMARK  
PRINCIPAL REGISTER**

**OCEAN RODEO**

RICHARD MYERSCOUGH (CANADA INDIVIDUAL)  
437 MONTEREY AVENUE  
VICTORIA, B.C., CANADA V8T4S8

FOR: WET SUIT GLOVES; WET SUITS; WET SUITS FOR WATER-SKIING AND SUB-AQUA; DRY SUITS; BOOTS; HATS; T-SHIRTS; HOODED SWEAT SHIRTS; SWEAT SHIRTS; WIND RESISTANT JACKETS; WIND-JACKETS; FLEECE PULL-OVERS; SKI JACKETS; SKI PANTS; HOODS, IN CLASS 25 (U.S. CLS. 22 AND 39).

FIRST USE 1-12-2000; IN COMMERCE 1-11-2001.

FOR: KITE BOARDS; KITE HANDLES; KITE LINES; KITE PARTS; KITES; SAIL BOARD FOOT

RESTRAINTS; SAIL BOARD FOOT STRAPS; SURFBOARD FINS; BAGS ESPECIALLY DESIGNED FOR SURFBOARDS; BAGS SPECIALLY ADAPTED FOR SPORTS EQUIPMENT, IN CLASS 28 (U.S. CLS. 22, 23, 38 AND 50).

FIRST USE 1-12-2000; IN COMMERCE 1-12-2001.

THE MARK CONSISTS OF STANDARD CHARACTERS WITHOUT CLAIM TO ANY PARTICULAR FONT, STYLE, SIZE, OR COLOR.

SER. NO. 77-468,747, FILED 5-7-2008.

ANDREW RHIM, EXAMINING ATTORNEY



Int. Cl.: 5

Prior U.S. Cls.: 6, 18, 44, 46, 51 and 52

United States Patent and Trademark Office

Reg. No. 3,569,391

Registered Feb. 3, 2009

TRADEMARK  
PRINCIPAL REGISTER



CHEMOTECHNIQUE  
DIAGNOSTICS

CHEMOTECHNIQUE MB DIAGNOSTICS AB  
(SWEDEN CORPORATION)  
MODEMGATAN 9  
SE-235 39 VELLINGE, SWEDEN

FOR: DIAGNOSTIC PREPARATIONS FOR MEDICAL PURPOSES, FOR EXAMPLE DIAGNOSTIC PREPARATIONS FOR CONTACT ALLERGY, IN CLASS 5 (U.S. CLS. 6, 18, 44, 46, 51 AND 52).

FIRST USE 0-0-1986; IN COMMERCE 0-0-1986.

NO CLAIM IS MADE TO THE EXCLUSIVE RIGHT TO USE "DIAGNOSTICS", APART FROM THE MARK AS SHOWN.

THE COLOR(S) DARK BLUE, LIGHT BLUE AND WHITE IS/ARE CLAIMED AS A FEATURE OF THE MARK.

THE MARK CONSISTS OF THE COLOR DARK BLUE WHICH APPEARS IN THE OUTLINE OF THE HEXAGON, THE GLOBE, THE GLOBE'S MERIDIAN LINES, THE LETTERS "CT" AND THE WORDING "CHEMOTECHNIQUE DIAGNOSTICS". THE COLOR LIGHT BLUE APPEARS IN THE BACKGROUND OF THE HEXAGON AND THE COLOR WHITE APPEARS IN THE BACKGROUND OF THE GLOBE.

SER. NO. 77-469,237, FILED 5-8-2008.

ESTHER A. BORSUK, EXAMINING ATTORNEY

**Int. Cl.: 41**

**Prior U.S. Cls.: 100, 101 and 107**

**United States Patent and Trademark Office**

**Reg. No. 3,569,392**

**Registered Feb. 3, 2009**

**SERVICE MARK  
PRINCIPAL REGISTER**

**NEXT TESTING**

NEXT TESTING, LLC (WISCONSIN LIMITED  
LIABILITY COMPANY)  
SUITE 120  
7617 MINERAL POINT RD  
MADISON, WI 53717

FOR: STANDARDIZED TESTING, ANALYSIS  
AND EVALUATION OF ATHLETIC SKILLS,  
TRAITS AND PERFORMANCE, IN CLASS 41 (U.S.  
CLS. 100, 101 AND 107).

FIRST USE 4-30-2007; IN COMMERCE 4-30-2007.

THE MARK CONSISTS OF STANDARD CHAR-  
ACTERS WITHOUT CLAIM TO ANY PARTICULAR  
FONT, STYLE, SIZE, OR COLOR.

NO CLAIM IS MADE TO THE EXCLUSIVE  
RIGHT TO USE "TESTING", APART FROM THE  
MARK AS SHOWN.

SER. NO. 77-469,245, FILED 5-8-2008.

JOHN GARTNER, EXAMINING ATTORNEY

**Int. Cl.: 41**

**Prior U.S. Cls.: 100, 101 and 107**

**United States Patent and Trademark Office**

**Reg. No. 3,569,393**

**Registered Feb. 3, 2009**

**SERVICE MARK  
PRINCIPAL REGISTER**

**Fibroga**

THE GROVE APPROACH, LLC. (PENNSYLVANIA LIMITED LIABILITY COMPANY)  
116 LYNWOOD DRIVE, SUITE 4  
EDINBORO, PA 16412

FOR: PROVIDING ASSISTANCE, PERSONAL TRAINING AND PHYSICAL FITNESS CONSULTATION TO INDIVIDUALS TO HELP THEM MAKE PHYSICAL FITNESS, STRENGTH, CONDITIONING, AND EXERCISE IMPROVEMENT IN THEIR DAILY LIVING, IN CLASS 41 (U.S. CLS. 100, 101 AND 107).

FIRST USE 4-25-2007; IN COMMERCE 4-25-2007.

THE MARK CONSISTS OF STANDARD CHARACTERS WITHOUT CLAIM TO ANY PARTICULAR FONT, STYLE, SIZE, OR COLOR.

SER. NO. 77-469,521, FILED 5-8-2008.

LINDA POWELL, EXAMINING ATTORNEY

**Int. Cls.: 16 and 41**

**Prior U.S. Cls.: 2, 5, 22, 23, 29, 37, 38, 50, 100, 101 and 107**

**United States Patent and Trademark Office**

**Reg. No. 3,569,394**

**Registered Feb. 3, 2009**

**TRADEMARK  
SERVICE MARK  
PRINCIPAL REGISTER**

**FROG DESIGN MIND**

FROG DESIGN, INC. (CALIFORNIA CORPORATION)  
660 THIRD STREET, 4TH FLOOR  
SAN FRANCISCO, CA 94107

FOR: PRINTED PUBLICATIONS, NAMELY, MAGAZINES IN THE FIELDS OF MARKETING, BUSINESS GROWTH, AND GRAPHIC AND INDUSTRIAL DESIGN, IN CLASS 16 (U.S. CLS. 2, 5, 22, 23, 29, 37, 38 AND 50).

FIRST USE 1-1-2005; IN COMMERCE 1-1-2005.

FOR: ONLINE NEWSLETTERS, MAGAZINES, AND BLOGS IN THE FIELDS OF MARKETING, BUSINESS GROWTH, AND GRAPHIC AND INDUSTRIAL DESIGN, IN CLASS 41 (U.S. CLS. 100, 101 AND 107).

FIRST USE 1-1-2005; IN COMMERCE 1-1-2005.

THE MARK CONSISTS OF STANDARD CHARACTERS WITHOUT CLAIM TO ANY PARTICULAR FONT, STYLE, SIZE, OR COLOR.

OWNER OF U.S. REG. NOS. 1,312,760, 2,781,008, AND 3,120,953.

NO CLAIM IS MADE TO THE EXCLUSIVE RIGHT TO USE "DESIGN", APART FROM THE MARK AS SHOWN.

SER. NO. 77-469,658, FILED 5-8-2008.

PAULA MAHONEY, EXAMINING ATTORNEY

**Int. Cl.: 41**

**Prior U.S. Cls.: 100, 101 and 107**

**United States Patent and Trademark Office**

**Reg. No. 3,569,395**

**Registered Feb. 3, 2009**

**SERVICE MARK  
PRINCIPAL REGISTER**

wovel

UNDERLAND PRESS (OREGON LIMITED LIABILITY COMPANY)  
1835 SE OAK  
PORTLAND, OR 97214

FOR: PUBLISHING OF ELECTRONIC PUBLICATIONS; PUBLISHING OF WEB MAGAZINES; ONLINE ELECTRONIC PUBLISHING OF BOOKS AND PERIODICALS, IN CLASS 41 (U.S. CLS. 100, 101 AND 107).

FIRST USE 10-1-2007; IN COMMERCE 10-1-2007.

THE MARK CONSISTS OF STANDARD CHARACTERS WITHOUT CLAIM TO ANY PARTICULAR FONT, STYLE, SIZE, OR COLOR.

SER. NO. 77-469,892, FILED 5-9-2008.

DANIEL CAPSHAW, EXAMINING ATTORNEY

**Int. Cls.: 1, 2, 17 and 19**

**Prior U.S. Cls.: 1, 5, 6, 10, 11, 12, 13, 16, 26, 33, 35, 46  
and 50**

**Reg. No. 3,569,396**

**United States Patent and Trademark Office**

**Registered Feb. 3, 2009**

**TRADEMARK  
PRINCIPAL REGISTER**

**KONCOTE**

NATIONAL WALL SYSTEMS, INC. (MINNESOTA CORPORATION)  
1111 HIGHWAY 25 NORTH  
BUFFALO, MN 55313

FOR: CONCRETE ADDITIVES; CONCRETE ADMIXTURES; CEMENT PRESERVATIVES AND CEMENT-WATERPROOFING CHEMICAL COMPOSITIONS, IN CLASS 1 (U.S. CLS. 1, 5, 6, 10, 26 AND 46).

FIRST USE 1-5-2008; IN COMMERCE 1-5-2008.

FOR: CONCRETE MOISTURE BARRIER COATING, IN CLASS 2 (U.S. CLS. 6, 11 AND 16).

FIRST USE 1-5-2008; IN COMMERCE 1-5-2008.

FOR: RAPID CURE, HIGH STRENGTH, POLYMER-BASED CONCRETE PATCHING COMPOUND, IN CLASS 17 (U.S. CLS. 1, 5, 12, 13, 35 AND 50).

FIRST USE 1-5-2008; IN COMMERCE 1-5-2008.

FOR: CONCRETE; FLOOR PATCHING MATERIALS, NAMELY, CONCRETE SEALERS, IN CLASS 19 (U.S. CLS. 1, 12, 33 AND 50).

FIRST USE 1-5-2008; IN COMMERCE 1-5-2008.

THE MARK CONSISTS OF STANDARD CHARACTERS WITHOUT CLAIM TO ANY PARTICULAR FONT, STYLE, SIZE, OR COLOR.

SER. NO. 77-469,941, FILED 5-9-2008.

LINDA POWELL, EXAMINING ATTORNEY

**Int. Cl.: 18**

**Prior U.S. Cls.: 1, 2, 3, 22 and 41**

**United States Patent and Trademark Office**

**Reg. No. 3,569,397**

**Registered Feb. 3, 2009**

**TRADEMARK  
PRINCIPAL REGISTER**

# The Handbag House

THE HANDBAG HOUSE INC. (FLORIDA CORPORATION)  
10608 OPUS DRIVE  
RIVERVIEW, FL 33579

FOR: CHANGE PURSES; CLUTCH PURSES; HANDBAGS, PURSES AND WALLETS; TOTE BAGS; LUGGAGE; LUGGAGE TAGS; STRAPS FOR LUGGAGE; BABY BACKPACKS; BACKPACKS; POUCHES AND BAGS SOLD EMPTY FOR ATTACHMENT TO BACKPACKS; PROTECTIVE FITTED LINERS FOR BACKPACKS AND LUGGAGE; SCHOOLCHILDREN'S BACKPACKS; GARMENT BAGS FOR TRAVEL; GARMENTS FOR PETS; BILLFOLDS; ALL PURPOSE SPORT BAGS; ALL-PURPOSE ATHLETIC BAGS; ALL-PURPOSE CARRYING BAGS; BABY CARRIERS WORN ON THE BODY; BABY CARRYING BAGS; BAGS AND HOLDALLS FOR SPORTS CLOTHING; BAGS FOR CARRYING BABIES' ACCESSORIES; BAGS FOR

UMBRELLAS; CANVAS SHOPPING BAGS; CARRY-ALL BAGS; DIAPER BAGS; LEATHER AND IMITATION LEATHER BAGS; MAKE-UP BAGS SOLD EMPTY; BEACH BAGS, IN CLASS 18 (U.S. CLS. 1, 2, 3, 22 AND 41).

FIRST USE 10-3-2007; IN COMMERCE 10-3-2007.

THE MARK CONSISTS OF STANDARD CHARACTERS WITHOUT CLAIM TO ANY PARTICULAR FONT, STYLE, SIZE, OR COLOR.

NO CLAIM IS MADE TO THE EXCLUSIVE RIGHT TO USE "HANDBAG", APART FROM THE MARK AS SHOWN.

SER. NO. 77-470,334, FILED 5-9-2008.

TOBY BULLOFF, EXAMINING ATTORNEY

**Int. Cls.: 9 and 36**

**Prior U.S. Cls.: 21, 23, 26, 36, 38, 100, 101 and 102**

**Reg. No. 3,569,398**

**United States Patent and Trademark Office**

**Registered Feb. 3, 2009**

**TRADEMARK  
SERVICE MARK  
PRINCIPAL REGISTER**

**RETIREMENT PROGRAM DESIGNER**

BUCK CONSULTANTS, LLC (DELAWARE LIMITED LIABILITY COMPANY)  
ONE PENNSYLVANIA PLAZA  
NEW YORK, NY 10119

FOR: COMPUTER PROGRAMS FOR USE IN MODELING AND VALUING RETIREMENT BENEFIT PLANS, IN CLASS 9 (U.S. CLS. 21, 23, 26, 36 AND 38).

FIRST USE 3-1-1999; IN COMMERCE 3-1-1999.

FOR: RETIREMENT BENEFIT PLAN CONSULTING SERVICES, NAMELY, DESIGNING, EVALUATING AND MODIFYING BUSINESS AND GOVERNMENTAL EMPLOYEE RETIREMENT BENEFIT PLANS, IN CLASS 36 (U.S. CLS. 100, 101 AND 102).

FIRST USE 3-1-1999; IN COMMERCE 3-1-1999.

THE MARK CONSISTS OF STANDARD CHARACTERS WITHOUT CLAIM TO ANY PARTICULAR FONT, STYLE, SIZE, OR COLOR.

OWNER OF U.S. REG. NO. 2,596,199.

NO CLAIM IS MADE TO THE EXCLUSIVE RIGHT TO USE "PROGRAM", APART FROM THE MARK AS SHOWN.

SEC. 2(F).

SER. NO. 77-470,555, FILED 5-9-2008.

LOURDES AYALA, EXAMINING ATTORNEY



**Int. Cl.: 41**

**Prior U.S. Cls.: 100, 101 and 107**

**United States Patent and Trademark Office**

**Reg. No. 3,569,399**

**Registered Feb. 3, 2009**

**SERVICE MARK  
PRINCIPAL REGISTER**

**UNDESIRABLE ELEMENTS**

FIJI THEATRE COMPANY, INC. A/K/A PING  
CHONG & COMPANY (NEW YORK COR-  
PORATION)  
47 GREAT JONES STREET  
NEW YORK, NY 10012

FOR: ENTERTAINMENT SERVICES, NAMELY,  
PRODUCTION OF A SERIES OF LIVE THEATRI-  
CAL PERFORMANCES IN THE NATURE OF  
PLAYS, IN CLASS 41 (U.S. CLS. 100, 101 AND 107).

FIRST USE 10-1-1992; IN COMMERCE 10-1-1992.

THE MARK CONSISTS OF STANDARD CHAR-  
ACTERS WITHOUT CLAIM TO ANY PARTICULAR  
FONT, STYLE, SIZE, OR COLOR.

SER. NO. 77-470,730, FILED 5-9-2008.

MATTHEW MCDOWELL, EXAMINING ATTOR-  
NEY

**Int. Cls.: 35 and 45**

**Prior U.S. Cls.: 100, 101 and 102**

**United States Patent and Trademark Office**

**Reg. No. 3,569,400**

**Registered Feb. 3, 2009**

**SERVICE MARK  
PRINCIPAL REGISTER**

**LegalZoom.com**

LEGALZOOM.COM, INC. (CALIFORNIA CORPORATION)  
SUITE 180  
7083 HOLLYWOOD BLVD.  
LOS ANGELES, CA 90028

FOR: PROVIDING ONLINE DIRECTORY INFORMATION ON ATTORNEY LISTINGS AND ATTORNEY REFERRAL AND MATCHING SERVICES, IN CLASS 35 (U.S. CLS. 100, 101 AND 102).

FIRST USE 6-20-2000; IN COMMERCE 7-15-2000.

FOR: LEGAL SERVICES; LEGAL DOCUMENT PREPARATION SERVICES AND PROVIDING GENERAL LEGAL INFORMATION VIA A WEBSITE ON

GLOBAL COMPUTER NETWORKS, IN CLASS 45 (U.S. CLS. 100 AND 101).

FIRST USE 6-20-2000; IN COMMERCE 7-15-2000.

THE MARK CONSISTS OF STANDARD CHARACTERS WITHOUT CLAIM TO ANY PARTICULAR FONT, STYLE, SIZE, OR COLOR.

OWNER OF U.S. REG. NOS. 2,540,549, 3,210,861 AND OTHERS.

SER. NO. 77-471,025, FILED 5-9-2008.

JUSTINE D. PARKER, EXAMINING ATTORNEY

**Int. Cl.: 43**

**Prior U.S. Cls.: 100 and 101**

**United States Patent and Trademark Office**

**Reg. No. 3,569,401**

**Registered Feb. 3, 2009**

**SERVICE MARK  
PRINCIPAL REGISTER**

**DUGAN'S PUB**

DOOGIE CORPORATION (NORTH CAROLINA  
CORPORATION)  
100 EAST MAIN STREET  
BREVARD, NC 28712

FOR: BAR AND RESTAURANT SERVICES, IN  
CLASS 43 (U.S. CLS. 100 AND 101).

FIRST USE 3-15-2003; IN COMMERCE 3-15-2003.

THE MARK CONSISTS OF STANDARD CHAR-  
ACTERS WITHOUT CLAIM TO ANY PARTICULAR  
FONT, STYLE, SIZE, OR COLOR.

NO CLAIM IS MADE TO THE EXCLUSIVE  
RIGHT TO USE "PUB", APART FROM THE MARK  
AS SHOWN.

SEC. 2(F).

SER. NO. 77-471,597, FILED 5-12-2008.

STEVEN R. FOSTER, EXAMINING ATTORNEY

**Int. Cl.: 41**

**Prior U.S. Cls.: 100, 101 and 107**

**United States Patent and Trademark Office**

**Reg. No. 3,569,402**

**Registered Feb. 3, 2009**

**SERVICE MARK  
PRINCIPAL REGISTER**

# Redemption Reign

HOUSE OF DAVID MINISTRIES, INC. (OKLA-  
HOMA CORPORATION)  
P O BOX 452407  
GROVE, OK 74345

THE MARK CONSISTS OF STANDARD CHAR-  
ACTERS WITHOUT CLAIM TO ANY PARTICULAR  
FONT, STYLE, SIZE, OR COLOR.

FOR: ENTERTAINMENT SERVICES IN THE  
NATURE OF AN ONGOING RELIGIOUS TELEVI-  
SION PROGRAM, IN CLASS 41 (U.S. CLS. 100, 101  
AND 107).

SER. NO. 77-472,277, FILED 5-12-2008.

FIRST USE 4-15-2008; IN COMMERCE 4-15-2008.

CURTIS FRENCH, EXAMINING ATTORNEY

**Int. Cl.: 10**

**Prior U.S. Cls.: 26, 39 and 44**

**United States Patent and Trademark Office**

**Reg. No. 3,569,403**

**Registered Feb. 3, 2009**

**TRADEMARK  
PRINCIPAL REGISTER**

**MICROLIGHT ML 830**

MICROLIGHT CORPORATION OF AMERICA  
(TEXAS CORPORATION)  
1312 CASTLE COURT  
HOUSTON, TX 77006

FOR: SURGICAL INSTRUMENTS, NAMELY.  
LOW LEVEL LASERS, IN CLASS 10 (U.S. CLS. 26,  
39 AND 44).

FIRST USE 1-15-2003; IN COMMERCE 1-15-2003.

THE MARK CONSISTS OF STANDARD CHAR-  
ACTERS WITHOUT CLAIM TO ANY PARTICULAR  
FONT, STYLE, SIZE, OR COLOR.

OWNER OF U.S. REG. NO. 2,734,505.

SEC. 2(F) AS TO "MICROLIGHT" AND "830".

SER. NO. 77-472,434, FILED 5-12-2008.

VERNA BETH RIRIE, EXAMINING ATTORNEY

**Int. Cl.: 5**

**Prior U.S. Cls.: 6, 18, 44, 46, 51 and 52**

**Reg. No. 3,569,404**

**United States Patent and Trademark Office**

**Registered Feb. 3, 2009**

**TRADEMARK  
PRINCIPAL REGISTER**

**REPLASYN**

FIDIA FARMACEUTICI S.P.A. (ITALY LIMITED  
LIABILITY COMPANY)

VIA PONTE DELLA FABRICCA 3/A

ABANO TERME, ITALY I-35031

FOR: PHARMACEUTICAL PREPARATION FOR  
THE TREATMENT OF AILMENTS OF THE JOINTS  
AND FOR USE DURING ORTHOPEDIC SURGERY,  
IN CLASS 5 (U.S. CLS. 6, 18, 44, 46, 51 AND 52).

THE MARK CONSISTS OF STANDARD CHAR-  
ACTERS WITHOUT CLAIM TO ANY PARTICULAR  
FONT, STYLE, SIZE, OR COLOR.

OWNER OF ITALY REG. NO. 1024867, DATED 2-  
10-1993, RENEWED AS REG. NO. 0001024867, DATED  
10-17-2006, EXPIRES 6-24-2012.

SER. NO. 77-472,609, FILED 5-12-2008.

INGA ERVIN, EXAMINING ATTORNEY

**Int. Cl.: 5**

**Prior U.S. Cls.: 6, 18, 44, 46, 51 and 52**

**Reg. No. 3,569,405**

**United States Patent and Trademark Office**

**Registered Feb. 3, 2009**

**TRADEMARK  
PRINCIPAL REGISTER**

**XTREME WHITETAIL  
TECHNOLOGIES**

XTREME WHITETAIL TECHNOLOGIES, LLC  
(IOWA LIMITED LIABILITY COMPANY)

4054 20TH STREET

GRINNELL, IA 50112

FOR: FEED SUPPLEMENTS FOR DEER, IN  
CLASS 5 (U.S. CLS. 6, 18, 44, 46, 51 AND 52).

FIRST USE 2-28-2008; IN COMMERCE 5-1-2008.

THE MARK CONSISTS OF STANDARD CHAR-  
ACTERS WITHOUT CLAIM TO ANY PARTICULAR  
FONT, STYLE, SIZE, OR COLOR.

NO CLAIM IS MADE TO THE EXCLUSIVE  
RIGHT TO USE "WHITETAIL TECHNOLOGIES",  
APART FROM THE MARK AS SHOWN.

SER. NO. 77-472,697, FILED 5-13-2008.

CAROLYN CATALDO, EXAMINING ATTORNEY

Int. Cl.: 35

Prior U.S. Cls.: 100, 101 and 102

United States Patent and Trademark Office

Reg. No. 3,569,406

Registered Feb. 3, 2009

SERVICE MARK  
PRINCIPAL REGISTER



AMERICAN SESAME GROWERS ASSOCIATION (TEXAS CORPORATION)  
15820 CARROLL ROAD  
MONKTON, DC 21111

FOR: ASSOCIATION SERVICES, NAMELY, PROMOTING THE INTERESTS OF THE SESAME GROWERS, IN CLASS 35 (U.S. CLS. 100, 101 AND 102).

FIRST USE 6-5-2006; IN COMMERCE 6-5-2006.

NO CLAIM IS MADE TO THE EXCLUSIVE RIGHT TO USE "US GROWN SESAME", APART FROM THE MARK AS SHOWN.

THE COLOR(S) GREEN, DARK GREEN, WHITE AND GOLD IS/ARE CLAIMED AS A FEATURE OF THE MARK.

THE MARK CONSISTS OF LETTERS "ASGA" IN WHITE AND A DROP OF GOLD ENCIRCLED IN AN OVAL DESIGN, WHICH IS COLORED IN GREEN; UNDER THE OVAL DESIGN IS A GREEN COLOR BRUSH STROKE, WHICH IS OVER THE WORDS "US GROWN SESAME". THE OVAL AND THE LETTERS "ASGA" ARE OUTLINED IN DARK GREEN, AND THE WORDS "US GROWN SESAME" ARE WRITTEN IN DARK GREEN".

SER. NO. 77-472,739, FILED 5-13-2008.

INGA ERVIN, EXAMINING ATTORNEY



**Int. Cl.: 43**

**Prior U.S. Cls.: 100 and 101**

**United States Patent and Trademark Office**

**Reg. No. 3,569,407**

**Registered Feb. 3, 2009**

**SERVICE MARK  
PRINCIPAL REGISTER**

**Surin**

SURIN OF THAILAND, INC. (GEORGIA CORPORATION)  
3595 RIDGEVIEW DR. W.  
BIRMINGHAM, AL 35213

THE MARK CONSISTS OF STANDARD CHARACTERS WITHOUT CLAIM TO ANY PARTICULAR FONT, STYLE, SIZE, OR COLOR.

FOR: RESTAURANT; RESTAURANT, BAR AND CATERING SERVICES, IN CLASS 43 (U.S. CLS. 100 AND 101).

SER. NO. 77-472,902, FILED 5-13-2008.

FIRST USE 7-1-1990; IN COMMERCE 7-1-1990.

IRA J. GOODSaid, EXAMINING ATTORNEY

**Int. Cl.: 43**

**Prior U.S. Cls.: 100 and 101**

**United States Patent and Trademark Office**

**Reg. No. 3,569,408**

**Registered Feb. 3, 2009**

**SERVICE MARK  
PRINCIPAL REGISTER**

**REX PIZZA**

GREVENITIS, DIMITRIOS (UNITED STATES IN-  
DIVIDUAL)

APT. 2F

131 NORTH MOLE STREET

PHILADELPHIA, PA 19102

FOR: RESTAURANT SERVICES, IN CLASS 43  
(U.S. CLS. 100 AND 101).

FIRST USE 3-1-2005; IN COMMERCE 3-1-2005.

THE MARK CONSISTS OF STANDARD CHAR-  
ACTERS WITHOUT CLAIM TO ANY PARTICULAR  
FONT, STYLE, SIZE, OR COLOR.

NO CLAIM IS MADE TO THE EXCLUSIVE  
RIGHT TO USE "PIZZA", APART FROM THE  
MARK AS SHOWN.

SER. NO. 77-472,983, FILED 5-13-2008.

SOPHIA S. KIM, EXAMINING ATTORNEY

Int. Cls.: 29 and 30

Prior U.S. Cl.: 46

United States Patent and Trademark Office

Reg. No. 3,569,409

Registered Feb. 3, 2009

TRADEMARK  
PRINCIPAL REGISTER



THE BACHMAN COMPANY (PENNSYLVANIA  
CORPORATION)  
ONE PARK PLAZA  
WYOMISSING, PA 19610

FOR: SNACKS, NAMELY, ONION RINGS, IN  
CLASS 29 (U.S. CL. 46).

FIRST USE 9-1-2007; IN COMMERCE 11-5-2007.

FOR: SNACK FOODS, NAMELY, TORTILLA  
CHIPS; CORN CHIPS; CHEESE TWISTS; AND PRE-  
TZELS, IN CLASS 30 (U.S. CL. 46).

FIRST USE 9-1-2007; IN COMMERCE 11-5-2007.

OWNER OF U.S. REG. NO. 854,251.

THE MARK CONSISTS OF THE WORD "TREAT"  
IN A STYLIZED FORMAT SET FORTH IN AN  
ENCLOSED RECTANGULAR SHAPE, WITH THE  
WORDS "TREAT 'EM TO THE BEST!" IN A STY-  
LIZED FORMAT SET FORTH IN A RECTANGULAR  
SHAPE BELOW THE WORD "TREAT" .

SER. NO. 77-473,307, FILED 5-13-2008.

WILLIAM BRECKENFELD, EXAMINING ATTOR-  
NEY

Int. Cl.: 35

Prior U.S. Cls.: 100, 101 and 102

United States Patent and Trademark Office

Reg. No. 3,569,410

Registered Feb. 3, 2009

**SERVICE MARK  
PRINCIPAL REGISTER**



THE NATURAL STONE & TILE COMPANY INC.  
(MINNESOTA CORPORATION)  
3451 W BURNSVILLE PKWY  
BURNSVILLE, MN 55437

FOR: RETAIL STORE SERVICES FEATURING CERAMIC TILE, PORCELAIN TILE, SLATE TILE, MARBLE TILE, TRAVERTINE TILE, LIMESTONE TILE, GRANITE TILE, GRANITE COUNTERTOPS, CULTURED STONE PRODUCTS, GLASS MOSAIC AND TILE, METAL MOSAICS, DECOS, AND TILES; DEALERSHIPS IN THE FIELD OF CERAMIC TILE, PORCELAIN TILE, SLATE TILE, MARBLE TILE, TRAVERTINE TILE, LIMESTONE TILE, GRANITE TILE, GRANITE COUNTERTOPS, CULTURED STONE PRODUCTS, GLASS MOSAIC AND TILE,

METAL MOSAICS, DECOS, AND TILES, IN CLASS 35 (U.S. CLS. 100, 101 AND 102).

FIRST USE 0-0-2004; IN COMMERCE 0-0-2004.

NO CLAIM IS MADE TO THE EXCLUSIVE RIGHT TO USE "NATURAL STONE & TILE", APART FROM THE MARK AS SHOWN.

THE MARK CONSISTS OF THE STYLIZED TERMS "NST NATURAL STONE & TILE".

SER. NO. 77-473,790, FILED 5-14-2008.

APRIL ROACH, EXAMINING ATTORNEY

**Int. Cl.: 9**

**Prior U.S. Cls.: 21, 23, 26, 36 and 38**

**Reg. No. 3,569,411**

**United States Patent and Trademark Office**

**Registered Feb. 3, 2009**

---

**TRADEMARK  
PRINCIPAL REGISTER**

**3K FLAGSHIP**

3K COMPUTERS, LLC (DELAWARE LIMITED  
LIABILITY COMPANY)  
SUITE 105  
21301 POWERLINE ROAD  
BOCA RATON, FL 33433

FOR: COMPUTER SERVERS, IN CLASS 9 (U.S.  
CLS. 21, 23, 26, 36 AND 38).

FIRST USE 5-9-2008; IN COMMERCE 5-9-2008.

THE MARK CONSISTS OF STANDARD CHAR-  
ACTERS WITHOUT CLAIM TO ANY PARTICULAR  
FONT, STYLE, SIZE, OR COLOR.

NO CLAIM IS MADE TO THE EXCLUSIVE  
RIGHT TO USE "FLAGSHIP", APART FROM THE  
MARK AS SHOWN.

SER. NO. 77-473,886, FILED 5-14-2008.

BARNEY CHARLON, EXAMINING ATTORNEY

**Int. Cl.: 28**

**Prior U.S. Cls.: 22, 23, 38 and 50**

**United States Patent and Trademark Office**

**Reg. No. 3,569,412**

**Registered Feb. 3, 2009**

**TRADEMARK  
PRINCIPAL REGISTER**

**BIG KEY**

ROCKET USA, INC. (ILLINOIS CORPORATION)  
7775 VAN BUREN STREET  
FOREST PARK, IL 60301

FOR: WIND-UP TOYS, NAMELY, WHEELED  
VEHICLES, TOY ROBOTS, FLYING SAUCERS,  
AND SIMULATED BUGS, INSECTS, AND ANI-  
MALS, IN CLASS 28 (U.S. CLS. 22, 23, 38 AND 50).

FIRST USE 8-23-2001; IN COMMERCE 8-23-2001.

THE MARK CONSISTS OF STANDARD CHAR-  
ACTERS WITHOUT CLAIM TO ANY PARTICULAR  
FONT, STYLE, SIZE, OR COLOR.

OWNER OF U.S. REG. NO. 2,586,903.

SEC. 2(F).

SER. NO. 77-474,296, FILED 5-14-2008.

MEGHAN REINHART, EXAMINING ATTORNEY

**Int. Cl.: 21**

**Prior U.S. Cls.: 2, 13, 23, 29, 30, 33, 40 and 50**

**Reg. No. 3,569,413**

**United States Patent and Trademark Office**

**Registered Feb. 3, 2009**

**TRADEMARK  
PRINCIPAL REGISTER**



OKLAHOMA CITY NATIONAL MEMORIAL  
FOUNDATION (OKLAHOMA CORPORATION)  
620 NORTH HARVEY AVENUE  
OKLAHOMA CITY, OK 73102

FOR: CUPS, MUGS, IN CLASS 21 (U.S. CLS. 2, 13,  
23, 29, 30, 33, 40 AND 50).

FIRST USE 7-0-2005; IN COMMERCE 7-0-2005.

OWNER OF U.S. REG. NOS. 2,603,681, 2,620,000  
AND OTHERS.

NO CLAIM IS MADE TO THE EXCLUSIVE  
RIGHT TO USE "OKLAHOMA CITY", APART  
FROM THE MARK AS SHOWN.

THE MARK CONSISTS OF A TREE WITH THE  
WORDS "ON AMERICAN SOIL" IN A BLOCK  
ABOVE THE TREE AND THE WORDS "OKLAHO-  
MA CITY NATIONAL MEMORIAL & MUSEUM" IN  
A BLOCK BELOW THE TREE.

SER. NO. 77-475,560, FILED 5-15-2008.

ELI HELLMAN, EXAMINING ATTORNEY

**Int. Cl.: 14**

**Prior U.S. Cls.: 2, 27, 28 and 50**

**United States Patent and Trademark Office**

**Reg. No. 3,569,414**

**Registered Feb. 3, 2009**

**TRADEMARK  
PRINCIPAL REGISTER**

**OKLAHOMA CITY NATIONAL  
MEMORIAL & MUSEUM**

OKLAHOMA CITY NATIONAL MEMORIAL  
FOUNDATION (OKLAHOMA CORPORA-  
TION)  
620 NORTH HARVEY AVENUE  
OKLAHOMA CITY, OK 73102

FOR: JEWELRY, CHARMS, PINS, COMMEM-  
ORATIVE COINS, IN CLASS 14 (U.S. CLS. 2, 27, 28  
AND 50).

FIRST USE 7-0-2005; IN COMMERCE 7-0-2005.

THE MARK CONSISTS OF STANDARD CHAR-  
ACTERS WITHOUT CLAIM TO ANY PARTICULAR  
FONT, STYLE, SIZE, OR COLOR.

OWNER OF U.S. REG. NOS. 2,603,681, 2,608,962,  
AND 2,620,000.

NO CLAIM IS MADE TO THE EXCLUSIVE  
RIGHT TO USE "OKLAHOMA CITY", APART  
FROM THE MARK AS SHOWN.

SER. NO. 77-475,622, FILED 5-15-2008.

ELI HELLMAN, EXAMINING ATTORNEY



**Int. Cl.: 42**

**Prior U.S. Cls.: 100 and 101**

**United States Patent and Trademark Office**

**Reg. No. 3,569,415**

**Registered Feb. 3, 2009**

**SERVICE MARK  
PRINCIPAL REGISTER**

**DIGG IT**

DIGG INC. (DELAWARE CORPORATION)  
135 MISSISSIPPI STREET, 3RD FLOOR  
SAN FRANCISCO, CA 94107

FOR: PROVIDING ON-LINE NONDOWNLOAD-  
ABLE SOFTWARE FOR ENABLING INTERNET  
USERS TO SHARE DATA AND ENABLING INTER-  
NET USERS TO VOTE AND RATE THE IMPOR-  
TANCE OF DATA MADE AVAILABLE ONLINE BY  
OTHERS, IN CLASS 42 (U.S. CLS. 100 AND 101).

FIRST USE 12-5-2004; IN COMMERCE 12-5-2004.

THE MARK CONSISTS OF STANDARD CHAR-  
ACTERS WITHOUT CLAIM TO ANY PARTICULAR  
FONT, STYLE, SIZE, OR COLOR.

OWNER OF U.S. REG. NOS. 3,317,123 AND  
3,422,895.

SER. NO. 77-475,653, FILED 5-15-2008.

ROBIN MITTLER, EXAMINING ATTORNEY

**Int. Cl.: 14**

**Prior U.S. Cls.: 2, 27, 28 and 50**

**Reg. No. 3,569,416**

**United States Patent and Trademark Office**

**Registered Feb. 3, 2009**

**TRADEMARK  
PRINCIPAL REGISTER**



OKLAHOMA CITY NATIONAL MEMORIAL  
FOUNDATION (OKLAHOMA CORPORATION)  
620 NORTH HARVEY AVENUE  
OKLAHOMA CITY, OK 73102

FOR: JEWELRY, CHARMS, PINS, COMMEMORATIVE COINS, IN CLASS 14 (U.S. CLS. 2, 27, 28 AND 50).

FIRST USE 7-0-2005; IN COMMERCE 7-0-2005.

OWNER OF U.S. REG. NOS. 2,603,681, 2,620,000 AND OTHERS.

NO CLAIM IS MADE TO THE EXCLUSIVE RIGHT TO USE "OKLAHOMA CITY", APART FROM THE MARK AS SHOWN.

THE MARK CONSISTS OF A TREE WITH THE WORDS "ON AMERICAN SOIL" IN A BLOCK ABOVE THE TREE AND THE WORDS "OKLAHOMA CITY NATIONAL MEMORIAL & MUSEUM" IN A BLOCK BELOW THE TREE.

SER. NO. 77-475,671, FILED 5-15-2008.

ELI HELLMAN, EXAMINING ATTORNEY

**Int. Cl.: 41**

**Prior U.S. Cls.: 100, 101 and 107**

**United States Patent and Trademark Office**

**Reg. No. 3,569,417**

**Registered Feb. 3, 2009**

**SERVICE MARK  
PRINCIPAL REGISTER**



UTAH MONTESSORI COUNCIL (UTAH NON-  
PROFIT CORPORATION)  
2083 EQUESTRIAN COURT  
2083 EQUESTRIAN COURT  
PARK CITY, UT 84060

FOR: EDUCATIONAL SERVICES, NAMELY, DEVELOPING, ARRANGING, AND CONDUCTING EDUCATIONAL CONFERENCES AND PROGRAMS AND PROVIDING COURSES OF INSTRUCTION IN THE FIELD OF THE MONTESSORI METHOD OF INSTRUCTION, IN CLASS 41 (U.S. CLS. 100, 101 AND 107).

FIRST USE 1-1-2008; IN COMMERCE 1-1-2008.

NO CLAIM IS MADE TO THE EXCLUSIVE RIGHT TO USE "CERTIFIED GREEN SCHOOL", APART FROM THE MARK AS SHOWN.

THE COLOR(S) WHITE, BLACK, GREEN, BLUE, AND GRAY IS/ARE CLAIMED AS A FEATURE OF THE MARK.

THE MARK CONSISTS OF THE TERMS, "CERTIFIED GREEN SCHOOL" IN WHITE INSIDE THE TOP PART OF THE DESIGN OF A GLOBE OUTLINED IN BLACK AND GRAY, CONTAINING THE DESIGN OF A GREEN FOOT OUTLINED IN BLACK AND WHITE OVER THE DESIGN OF GRAY AND WHITE CLOUDS OVER GREEN CONTINENTS AND THE BLUE OCEAN.

SER. NO. 77-475,683, FILED 5-15-2008.

BARBARA A. GOLD, EXAMINING ATTORNEY

**Int. Cl.: 21**

**Prior U.S. Cls.: 2, 13, 23, 29, 30, 33, 40 and 50**

**United States Patent and Trademark Office**

**Reg. No. 3,569,418**

**Registered Feb. 3, 2009**

**TRADEMARK  
PRINCIPAL REGISTER**

**OKLAHOMA CITY NATIONAL  
MEMORIAL & MUSEUM**

OKLAHOMA CITY NATIONAL MEMORIAL  
FOUNDATION (OKLAHOMA CORPORATION)  
620 NORTH HARVEY AVENUE  
OKLAHOMA CITY, OK 73102

FOR: CUPS, MUGS, IN CLASS 21 (U.S. CLS. 2, 13,  
23, 29, 30, 33, 40 AND 50).

FIRST USE 7-0-2005; IN COMMERCE 7-0-2005.

THE MARK CONSISTS OF STANDARD CHAR-  
ACTERS WITHOUT CLAIM TO ANY PARTICULAR  
FONT, STYLE, SIZE, OR COLOR.

OWNER OF U.S. REG. NOS. 2,603,681, 2,608,962,  
AND 2,620,000.

NO CLAIM IS MADE TO THE EXCLUSIVE  
RIGHT TO USE "OKLAHOMA CITY", APART  
FROM THE MARK AS SHOWN.

SER. NO. 77-475,725, FILED 5-15-2008.

ELI HELLMAN, EXAMINING ATTORNEY

**Int. Cl.: 41**

**Prior U.S. Cls.: 100, 101 and 107**

**United States Patent and Trademark Office**

**Reg. No. 3,569,419**

**Registered Feb. 3, 2009**

**SERVICE MARK  
PRINCIPAL REGISTER**



UTAH MONTESSORI COUNCIL (UTAH NON-PROFIT CORPORATION)  
2083 EQUESTRIAN COURT  
2083 EQUESTRIAN COURT  
PARK CITY, UT 84060

FOR: EDUCATIONAL SERVICES, NAMELY, DEVELOPING, ARRANGING, AND CONDUCTING EDUCATIONAL CONFERENCES AND PROGRAMS AND PROVIDING COURSES OF INSTRUCTION IN THE FIELD OF THE MONTESSORI METHOD OF INSTRUCTION, IN CLASS 41 (U.S. CLS. 100, 101 AND 107).

FIRST USE 1-1-2008; IN COMMERCE 1-1-2008.

NO CLAIM IS MADE TO THE EXCLUSIVE RIGHT TO USE "CERTIFIED HEALTHY SCHOOL", APART FROM THE MARK AS SHOWN.

THE COLOR(S) RED, GREEN, BLACK AND WHITE IS/ARE CLAIMED AS A FEATURE OF THE MARK.

THE MARK CONSISTS OF THE TERMS, "CERTIFIED HEALTHY SCHOOL" IN BLACK, TO THE LEFT OF THE DESIGN OF A RED APPLE OUTLINED IN BLACK WITH A GREEN STEM AND LEAF, ALL SUPERIMPOSED OVER THE DESIGN OF THE CONTINENTS OF THE WORLD IN DARKER GREEN, WITHIN THE DESIGN OF A SHADED GREEN SQUARE WITH A DOUBLE EDGED WHITE SQUARE BORDER INSIDE THE GREEN SQUARE, WHICH IS OUTLINED ON THE BOTTOM AND RIGHT SIDES WITH BLACK.

SER. NO. 77-475,734, FILED 5-15-2008.

BARBARA A. GOLD, EXAMINING ATTORNEY

**Int. Cl.: 41**

**Prior U.S. Cls.: 100, 101 and 107**

**United States Patent and Trademark Office**

**Reg. No. 3,569,420**

**Registered Feb. 3, 2009**

**SERVICE MARK  
PRINCIPAL REGISTER**



UTAH MONTESSORI COUNCIL (UTAH NON-PROFIT CORPORATION)  
2083 EQUESTRIAN COURT  
2083 EQUESTRIAN COURT  
PARK CITY, UT 84060

FOR: EDUCATIONAL SERVICES, NAMELY, DEVELOPING, ARRANGING, AND CONDUCTING EDUCATIONAL CONFERENCES AND PROGRAMS AND PROVIDING COURSES OF INSTRUCTION IN THE FIELD OF THE MONTESSORI METHOD OF INSTRUCTION, IN CLASS 41 (U.S. CLS. 100, 101 AND 107).

FIRST USE 1-1-2008; IN COMMERCE 1-1-2008.

NO CLAIM IS MADE TO THE EXCLUSIVE RIGHT TO USE "CERTIFIED SAFE SCHOOL", APART FROM THE MARK AS SHOWN.

THE COLOR(S) YELLOW, BLACK, WHITE, GRAY, BEIGE, TAN AND PINK IS/ARE CLAIMED AS A FEATURE OF THE MARK.

THE MARK CONSISTS OF THE TERMS, "CERTIFIED SAFE SCHOOL" IN BLACK, WITHIN THE DESIGN OF A SHADED YELLOW TRIANGLE OUTLINED ON THE BOTTOM AND RIGHT SIDES IN BLACK AND GRAY, WITH A SLIGHTLY SMALL SINGLE LINE TRIANGLE IN BLACK INSIDE THE BORDER OF THE YELLOW TRIANGLE, AND THE DESIGN OF A CHILD'S ARM AND HAND IN LIGHT BEIGE, WHITE AND PINK, HOLDING THE FINGERS OF AN ADULT'S HAND IN TAN AND WHITE, SUPERIMPOSED OVER THE DESIGN OF THE CONTINENTS OF THE WORLD IN GRAY.

SER. NO. 77-475,766, FILED 5-15-2008.

BARBARA A. GOLD, EXAMINING ATTORNEY

**Int. Cls.: 25 and 41**

**Prior U.S. Cls.: 22, 39, 100, 101 and 107**

**Reg. No. 3,569,421**

**United States Patent and Trademark Office**

**Registered Feb. 3, 2009**

**TRADEMARK  
SERVICE MARK  
PRINCIPAL REGISTER**

**Austin Junior Volleyball**

JUNIOR VOLLEYBALL ASSOCIATION OF AUSTIN (TEXAS NON-PROFIT CORPORATION)  
AUSTIN SPORTS CENTER  
425 WOODWARD ST  
AUSTIN, TX 78794

FOR: CLOTHING, NAMELY, T-SHIRTS, CAPS SHORTS AND POLO SHIRTS, IN CLASS 25 (U.S. CLS. 22 AND 39).

FIRST USE 4-1-1992; IN COMMERCE 4-1-1992.

FOR: EDUCATIONAL SERVICES, NAMELY, PROVIDING CLASSES AND SEMINARS IN THE FIELD OF VOLLEYBALL AND SPORT COMPETITIONS; ENTERTAINMENT SERVICES, NAMELY, ORGANIZING AND CONDUCTING VOLLEYBALL GAMES, VOLLEYBALL COMPETITIONS, VOLLEYBALL SPORTING EVENTS AND VOLLEYBALL TOURNAMENTS, IN CLASS 41 (U.S. CLS. 100, 101 AND 107).

FIRST USE 4-1-1992; IN COMMERCE 4-1-1992.

THE MARK CONSISTS OF STANDARD CHARACTERS WITHOUT CLAIM TO ANY PARTICULAR FONT, STYLE, SIZE, OR COLOR.

OWNER OF U.S. REG. NOS. 2,523,997 AND 2,577,076.

NO CLAIM IS MADE TO THE EXCLUSIVE RIGHT TO USE "JUNIOR VOLLEYBALL", APART FROM THE MARK AS SHOWN.

SEC. 2(F).

SER. NO. 77-475,777, FILED 5-15-2008.

WON TEAK OH, EXAMINING ATTORNEY

**Int. Cl.: 6**

**Prior U.S. Cls.: 2, 12, 13, 14, 23, 25 and 50**

**Reg. No. 3,569,422**

**United States Patent and Trademark Office**

**Registered Feb. 3, 2009**

**TRADEMARK  
PRINCIPAL REGISTER**

**RIMMAX**

RIMWALKER PACIFIC (WASHINGTON LIMITED LIABILITY COMPANY)  
11272 ARROWPOINT DRIVE  
BAINBRIDGE ISLAND, WA 98110

FIRST USE 4-28-2006; IN COMMERCE 5-8-2007.

FOR: METAL PADLOCKS; METAL KEYS FOR LOCKS; WINDING KEYS OF METAL; METAL LOCKS; METAL SPRING LOCK; METAL LOCK BOLTS; LOCKS OF METAL FOR VEHICLES; LOCKS OF METAL FOR BAGS; BRAZING ALLOYS; METAL WELDING RODS, IN CLASS 6 (U.S. CLS. 2, 12, 13, 14, 23, 25 AND 50).

THE MARK CONSISTS OF STANDARD CHARACTERS WITHOUT CLAIM TO ANY PARTICULAR FONT, STYLE, SIZE, OR COLOR.

SER. NO. 77-476,166, FILED 5-16-2008.

JULIE WATSON, EXAMINING ATTORNEY



**Int. Cls.: 16 and 41**

**Prior U.S. Cls.: 2, 5, 22, 23, 29, 37, 38, 50, 100, 101 and 107**

**Reg. No. 3,569,423**

**United States Patent and Trademark Office**

**Registered Feb. 3, 2009**

**TRADEMARK  
SERVICE MARK  
PRINCIPAL REGISTER**

**SOC**

BP P.L.C. (UNITED KINGDOM PUBLIC LIMITED COMPANY (PLC))  
1 ST. JAMES'S SQUARE  
LONDON SW1Y 4PD, UNITED KINGDOM

FOR: PRINTED PUBLICATIONS, NAMELY, MANUALS AND PRINTED CHECKLISTS IN THE FIELDS OF WORKPLACE SAFETY, PHYSICAL PLANT SAFETY, PROCESS SAFETY, PHYSICAL SECURITY, WORK PLACE SECURITY AND PLANT SECURITY AND ENVIRONMENTAL PROTECTION IN INDUSTRY, IN CLASS 16 (U.S. CLS. 2, 5, 22, 23, 29, 37, 38 AND 50).

FOR: TRAINING SERVICES IN THE FIELDS OF WORKPLACE SAFETY, PHYSICAL PLANT SAFETY, PROCESS SAFETY, PHYSICAL SECURITY,

WORK PLACE SECURITY AND PLANT SECURITY AND ENVIRONMENTAL PROTECTION IN INDUSTRY, IN CLASS 41 (U.S. CLS. 100, 101 AND 107).

THE MARK CONSISTS OF STANDARD CHARACTERS WITHOUT CLAIM TO ANY PARTICULAR FONT, STYLE, SIZE, OR COLOR.

OWNER OF UNITED KINGDOM REG. NO. 2472680, DATED 11-19-2007, EXPIRES 11-19-2017.

SER. NO. 77-476,247, FILED 5-16-2008.

MATTHEW MCDOWELL, EXAMINING ATTORNEY

Int. Cl.: 42

Prior U.S. Cls.: 100 and 101

United States Patent and Trademark Office

Reg. No. 3,569,424

Registered Feb. 3, 2009

SERVICE MARK  
PRINCIPAL REGISTER

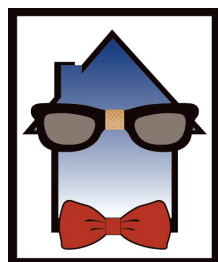

Home Comfort Diagnostics  
By  
Comfort  
Geek

KING, WILLIAM R. (UNITED STATES INDIVIDUAL)  
STE C  
133 L STREET  
SACRAMENTO, CA 95814

FOR: DIAGNOSTIC SERVICES IN THE FIELD OF HOME COMFORT AS IT RELATES TO HEATING AND AIR CONDITIONING SYSTEMS THIS SERVICE WILL INCLUDE TESTING AND MEASURING THE PERFORMANCE OF RESIDENTIAL HEATING AND COOLING SYSTEMS AND MAKING RECOMMENDATIONS ON HOW TO IMPROVE IT PARTICULAR ATTENTION WILL BE PAID TO THE HOME'S DUCTING SYSTEM AND AIRFLOW DISTRIBUTION IT WILL INCLUDE AN ON SITE ROOM-BY-ROOM MEASUREMENT OF THE PHYSICAL DIMENSIONS OF THE HOUSE WHICH WILL BE ENTERED INTO A COMPUTER PROGRAM TO EVALUATE THE DATA COLLECTED AND ESTIMATE WHAT THE ROOM-BY-ROOM HEATING AND COOLING REQUIREMENTS ARE, IN CLASS 42 (U.S. CLS. 100 AND 101).

FIRST USE 1-1-2008; IN COMMERCE 1-1-2008.

NO CLAIM IS MADE TO THE EXCLUSIVE RIGHT TO USE "HOME COMFORT DIAGNOSTICS"

AND "COMFORT", APART FROM THE MARK AS SHOWN.

THE COLOR(S) BLACK, RED, BLUE, WHITE, GRAY AND TAN IS/ARE CLAIMED AS A FEATURE OF THE MARK.

THE COLOR BLACK APPEARS IN THE WORDING "HOME COMFORT DIAGNOSTICS BY COMFORT" "GEEK", THE RECTANGULAR BORDER AROUND THE DESIGN, AND THE LINES FORMING THE DESIGN OF A STYLIZED HOUSE WEARING GLASSES AND A BOW TIE; THE COLOR RED APPEARS IN THE BOW TIE; THE COLOR BLUE FADING TO WHITE APPEARS IN THE HOUSE DESIGN; THE COLOR WHITE APPEARS IN THE BACKGROUND, THE COLOR GRAY APPEARS IN THE LENSES OF THE GLASSES; AND THE COLOR TAN APPEARS IN THE BANDAGE ON THE GLASSES.

SER. NO. 77-476,604, FILED 5-16-2008.

JOHN GARTNER, EXAMINING ATTORNEY

**Int. Cl.: 6**

**Prior U.S. Cls.: 2, 12, 13, 14, 23, 25 and 50**

**United States Patent and Trademark Office**

**Reg. No. 3,569,425**

**Registered Feb. 3, 2009**

**TRADEMARK  
PRINCIPAL REGISTER**

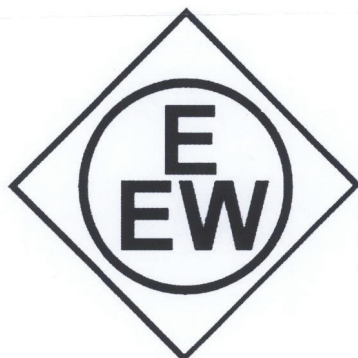

ERNDTEBRUCKER EISENWERK GMBH & CO.  
KG (FED REP GERMANY CORPORATION)  
IM GRUNEWALD 2  
ERNDTEBRUCK, FED REP GERMANY 57339

OWNER OF FED REP GERMANY REG. NO.  
302008005637, DATED 1-30-2008, EXPIRES 1-31-2018.

FOR: GOODS MADE WHOLLY OR PREDOMINANTLY OF METAL, NAMELY, LARGE PIPES FOR THE TRANSPORT OF LIQUID AND GASEOUS MEDIA AND OF MEDIA CONTAINING SOLID MATTER, CONSTRUCTION PIPES FOR USE IN STEEL CONSTRUCTIONS, IN BUILDING OR IN WATER CONSTRUCTION PROJECTS, RAM PIPES, STORAGE PIPES FOR USE IN STORAGE RESERVOIRS, IN CLASS 6 (U.S. CLS. 2, 12, 13, 14, 23, 25 AND 50).

THE MARK CONSISTS OF THE CAPITAL LETTERS "EEW" INSIDE OF A CIRCLE THAT IS INSIDE OF A SQUARE ROTATED AT A 90 DEGREE ANGLE.

SER. NO. 77-476,695, FILED 5-16-2008.

MARLENE BELL, EXAMINING ATTORNEY

**Int. Cls.: 9 and 10**

**Prior U.S. Cls.: 21, 23, 26, 36, 38, 39 and 44**

**Reg. No. 3,569,426**

**United States Patent and Trademark Office**

**Registered Feb. 3, 2009**

**TRADEMARK  
PRINCIPAL REGISTER**

**ICEPlex**

PRIMERA BIOSYSTEMS, INC. (DELAWARE CORPORATION), DBA PRIMERADX  
171 FORBES BOULEVARD  
MANSFIELD, MA 02048

FOR: MULTI-PURPOSE RESEARCH APPARATUS FOR DETECTION OF BIOMARKERS IN BIOLOGICAL SAMPLES, IN CLASS 9 (U.S. CLS. 21, 23, 26, 36 AND 38).

FIRST USE 4-27-2008; IN COMMERCE 4-27-2008.

FOR: MULTI-PURPOSE MEDICAL DIAGNOSTIC APPARATUS FOR DETECTION OF BIOMARKERS

IN PATIENT SAMPLES, IN CLASS 10 (U.S. CLS. 26, 39 AND 44).

FIRST USE 4-27-2008; IN COMMERCE 4-27-2008.

THE MARK CONSISTS OF STANDARD CHARACTERS WITHOUT CLAIM TO ANY PARTICULAR FONT, STYLE, SIZE, OR COLOR.

SER. NO. 77-477,086, FILED 5-16-2008.

PAUL F. GAST, EXAMINING ATTORNEY

Int. Cl.: 28

Prior U.S. Cls.: 22, 23, 38 and 50

Reg. No. 3,569,427

United States Patent and Trademark Office

Registered Feb. 3, 2009

TRADEMARK  
PRINCIPAL REGISTER



GOANYWHERE PUZZLES (INDIANA LIMITED  
LIABILITY COMPANY)  
5004 OAK CREEK COURT  
FORT WAYNE, IN 46835

FOR: JIGSAW PUZZLES, IN CLASS 28 (U.S. CLS.  
22, 23, 38 AND 50).

FIRST USE 12-20-2007; IN COMMERCE 4-12-2008.

NO CLAIM IS MADE TO THE EXCLUSIVE  
RIGHT TO USE "PUZZLES", APART FROM THE  
MARK AS SHOWN.

THE MARK CONSISTS OF A SCOTTISH TERRI-  
ER ("SCOTTIE") DOG HOLDING A JIGSAW PUZ-  
ZLE PIECE. THE DOG AND PUZZLE PIECE ARE  
SURROUNDED BY A BORDER. THE WORD "GOA-  
NYWHERE" IS ON THE LEFT HAND SIDE GOING  
VERTICALLY AND THE WORD "PUZZLES" IS ON  
THE TOP GOING HORIZONTALLY.

SER. NO. 77-477,471, FILED 5-18-2008.

BRIAN PINO, EXAMINING ATTORNEY

**Int. Cl.: 41**

**Prior U.S. Cls.: 100, 101 and 107**

**United States Patent and Trademark Office**

**Reg. No. 3,569,428**

**Registered Feb. 3, 2009**

**SERVICE MARK  
PRINCIPAL REGISTER**

# Passion for Birth

SHILLING, TERESA (UNITED STATES INDIVIDUAL), DBA PASSION FOR BIRTH  
2507 NORTH WOODS LOOP  
MOUNT VERNON, WA 98273

FOR: EDUCATIONAL SERVICES, NAMELY, CONDUCTING SEMINARS IN THE FIELD OF BREASTFEEDING, LABOR SUPPORT, PRENATAL CARE, PRENATAL HEALTH AND OUTREACH, IN CLASS 41 (U.S. CLS. 100, 101 AND 107).

FIRST USE 4-1-2002; IN COMMERCE 4-1-2002.

THE MARK CONSISTS OF STANDARD CHARACTERS WITHOUT CLAIM TO ANY PARTICULAR FONT, STYLE, SIZE, OR COLOR.

NO CLAIM IS MADE TO THE EXCLUSIVE RIGHT TO USE "BIRTH", APART FROM THE MARK AS SHOWN.

SER. NO. 77-477,572, FILED 5-19-2008.

AMOS T. MATTHEWS, JR., EXAMINING ATTORNEY

**Int. Cl.: 35**

**Prior U.S. Cls.: 100, 101 and 102**

**United States Patent and Trademark Office**

**Reg. No. 3,569,429**

**Registered Feb. 3, 2009**

**SERVICE MARK  
PRINCIPAL REGISTER**

**TOWN & COUNTRY FENCE**

THE FENCE STORE, INC. (MINNESOTA CORPORATION)  
8511 XYLON AVENUE NORTH  
BROOKLYN PARK, MN 55445

FOR: WHOLESALE DISTRIBUTORSHIPS, RETAIL STORE SERVICES AND ON-LINE RETAIL STORE SERVICES FEATURING FENCES AND FENCE MATERIALS AND ACCESSORIES, IN CLASS 35 (U.S. CLS. 100, 101 AND 102).

FIRST USE 4-1-1983; IN COMMERCE 4-1-1983.

THE MARK CONSISTS OF STANDARD CHARACTERS WITHOUT CLAIM TO ANY PARTICULAR FONT, STYLE, SIZE, OR COLOR.

NO CLAIM IS MADE TO THE EXCLUSIVE RIGHT TO USE "FENCE", APART FROM THE MARK AS SHOWN.

SER. NO. 77-477,640, FILED 5-19-2008.

LOURDES AYALA, EXAMINING ATTORNEY

Int. Cl.: 44

Prior U.S. Cls.: 100 and 101

United States Patent and Trademark Office

Reg. No. 3,569,430

Registered Feb. 3, 2009

**SERVICE MARK  
PRINCIPAL REGISTER**



PIEDMONT PAIN CONSULTANTS, PC (GEORGIA CORPORATION)  
1662 MONTCLIFF COURT  
DECATUR, GA 30033

FOR: MEDICAL SERVICES, NAMELY, PAIN MANAGEMENT, IN CLASS 44 (U.S. CLS. 100 AND 101).

FIRST USE 4-16-2008; IN COMMERCE 5-1-2008.

NO CLAIM IS MADE TO THE EXCLUSIVE RIGHT TO USE "PIEDMONT PAIN CONSULTANTS", APART FROM THE MARK AS SHOWN.

THE MARK CONSISTS OF A STYLIZED OUTLINE OF A HUMAN BACK FROM NECK TO WAIST

WITH ALTERNATING BLOCKS VERTICALLY ARRANGED IN THE CENTER REPRESENTING THE SPINE. THE BACK IMAGE SITS OVER THE BASE OF TWO LINES CURVING UPWARD TOWARD THE LEFT, REPRESENTING HILLS OR MOUNTAINS, WHICH SUGGEST THE PIEDMONT REGION; A HORIZONTAL LINE SEPARATES THE TEXT "PIEDMONT PAIN CONSULTANTS" AND "CARE SERVICE EXPERIENCE", AND "CARE SERVICE EXPERIENCE" ARE SEPARATED BY TWO DOTS.

SER. NO. 77-477,846, FILED 5-19-2008.

DEIRDRE ROBERTSON, EXAMINING ATTORNEY



**Int. Cls.: 35 and 39**

**Prior U.S. Cls.: 100, 101, 102 and 105**

**United States Patent and Trademark Office**

**Reg. No. 3,569,431**

**Registered Feb. 3, 2009**

**SERVICE MARK  
PRINCIPAL REGISTER**

**LET ME GO**

TORRENEGRA IP, LLC (NEW JERSEY LIMITED LIABILITY COMPANY)  
459 DUNLIN PLAZA  
PO BOX 1167  
SECAUCUS, NJ 07096

FOR: AUCTION MANAGEMENT SERVICES PROVIDED TO OTHERS OVER AN ON-LINE WEB SITE ACCESSED THROUGH A GLOBAL COMPUTER NETWORK; BUSINESS SERVICES, NAMELY, PROVIDING COMPUTER DATABASES REGARDING THE PURCHASE AND SALE OF A WIDE VARIETY OF PRODUCTS AND SERVICES OF OTHERS; ON-LINE BUSINESS DIRECTORIES FEATURING TRAVEL-RELATED SERVICES; ON-LINE TRADING SERVICES IN WHICH SELLER POSTS PRODUCTS TO BE AUCTIONED AND BIDDING IS DONE VIA THE INTERNET; OPERATING ON-LINE MARKETPLACES FOR SELLERS OF GOODS AND/OR SERVICES; PROVIDING A SEARCHABLE ON-LINE ADVERTISING GUIDE FEATURING THE GOODS AND SERVICES OF OTHER ON-LINE VENDORS ON THE INTERNET; PROVIDING A WEB SITE WHEREBY BUYERS OF GOODS OR SERVICES LOCATE AND RECEIVE QUOTATIONS FROM MULTIPLE COMPETITIVE SOURCES AND SELLERS OF GOODS OR SERVICES IDENTIFY AND BID ON MULTIPLE NEW SALES OPPORTUNITIES; PROVIDING AN ON-LINE COMPUTER DATABASE FEATURING TRADE INFORMATION IN THE FIELD OF TRAVEL-RELATED SERVICES; PROVIDING ON-LINE DIRECTORY INFORMATION SERVICES ALSO FEATURING HYPERLINKS TO OTHER WEB SITES, IN CLASS 35 (U.S. CLS. 100, 101 AND 102).

FIRST USE 3-11-2008; IN COMMERCE 3-11-2008.

FOR: ARRANGING AND COORDINATING TRAVEL ARRANGEMENTS FOR INDIVIDUALS AND GROUPS NAMELY DESTINATIONS STAYS, HONEYMOONS, FAMILY VACATIONS, AND DESTINATION WEDDINGS; ARRANGING TRAVEL TOURS; BOOKING OF SEATS FOR TRAVEL; COORDINATING TRAVEL ARRANGEMENTS FOR INDIVIDUALS AND FOR GROUPS; ORGANISATION OF TRAVEL; ORGANIZATION OF EXCURSIONS, SIGHTSEEING TOURS, HOLIDAYS, TOURS AND TRAVEL; ORGANIZATION OF TRAVEL AND BOAT TRIPS; PROVIDING AN ON-LINE COMPUTER DATABASE IN THE FIELD OF TRAVEL INFORMATION SERVICES; PROVIDING INFORMATION, NEWS AND COMMENTARY IN THE FIELD OF TRAVEL; PROVIDING LINKS TO WEB SITES OF OTHERS FEATURING TRAVEL; PROVIDING REVIEWS OF TRAVEL SERVICE PROVIDERS; PROVISION OF TRAVEL INFORMATION; RESERVATION AND BOOKING OF SEATS FOR TRAVEL; TRANSPORT OF TRAVELLERS; TRAVEL AGENCY SERVICES, NAMELY, MAKING RESERVATIONS AND BOOKINGS FOR TRANSPORTATION; TRAVEL AND TOUR INFORMATION SERVICE; TRAVEL BOOKING AGENCIES; TRAVEL GUIDE AND TRAVEL INFORMATION SERVICES; TRAVEL GUIDE SERVICES, IN CLASS 39 (U.S. CLS. 100 AND 105).

FIRST USE 3-11-2008; IN COMMERCE 3-11-2008.

THE MARK CONSISTS OF STANDARD CHARACTERS WITHOUT CLAIM TO ANY PARTICULAR FONT, STYLE, SIZE, OR COLOR.

SER. NO. 77-478,152, FILED 5-19-2008.

ESTHER BELENKER, EXAMINING ATTORNEY

**Int. Cl.: 41**

**Prior U.S. Cls.: 100, 101 and 107**

**United States Patent and Trademark Office**

**Reg. No. 3,569,432**

**Registered Feb. 3, 2009**

**SERVICE MARK  
PRINCIPAL REGISTER**

# Quantum Rhythm

SURYA, KOLPAKOV SLAVA (UNITED STATES  
INDIVIDUAL)  
SUITE #21  
72 LANGLEY ROAD  
NEWTON, MA 02459

FOR: EDUCATIONAL SERVICES, NAMELY,  
PROVIDING SEMINARS, LECTURES, WORK-  
SHOPS, CLASSES, AND INDIVIDUAL SESSIONS IN  
THE FIELDS OF HOLISTIC HEALING, WELL-  
BEING, THE MIND-BODY CONNECTION, YOGA,  
YOGA THERAPY AND MEDITATION, IN CLASS 41  
(U.S. CLS. 100, 101 AND 107).

FIRST USE 5-1-2008; IN COMMERCE 5-1-2008.

THE MARK CONSISTS OF STANDARD CHAR-  
ACTERS WITHOUT CLAIM TO ANY PARTICULAR  
FONT, STYLE, SIZE, OR COLOR.

NO CLAIM IS MADE TO THE EXCLUSIVE  
RIGHT TO USE "QUANTUM", APART FROM THE  
MARK AS SHOWN.

SER. NO. 77-478,414, FILED 5-19-2008.

MARK SPARACINO, EXAMINING ATTORNEY

**Int. Cl.: 35**

**Prior U.S. Cls.: 100, 101 and 102**

**United States Patent and Trademark Office**

**Reg. No. 3,569,433**

**Registered Feb. 3, 2009**

**SERVICE MARK  
PRINCIPAL REGISTER**

**ROCK THE VOTE**

ROCK THE VOTE (D.C. NON-PROFIT CORPORATION)  
1505 22ND STREET NW  
WASHINGTON, DC 20037

OWNER OF U.S. REG. NOS. 2,140,119, 2,193,104  
AND OTHERS.

FOR: PROMOTING PUBLIC AWARENESS OF THE NEED FOR EDUCATING YOUNG PEOPLE ABOUT ISSUES THAT AFFECT THEM AND ENCOURAGING YOUNG PEOPLE TO PARTICIPATE IN THE POLITICAL PROCESS BY REGISTERING, VOTING AND SPEAKING OUT, IN CLASS 35 (U.S. CLS. 100, 101 AND 102).

THE MARK CONSISTS OF THE WORDS "ROCK THE VOTE" WITH THE WORD "THE" IN A VERTICAL FORMAT, AND LETTER "V" AS A STYLIZED CHECK MARK.

SER. NO. 77-478,832, FILED 5-20-2008.

FIRST USE 5-1-2008; IN COMMERCE 5-1-2008.

REBECCA SMITH, EXAMINING ATTORNEY

**Int. Cl.: 20**

**Prior U.S. Cls.: 2, 13, 22, 25, 32 and 50**

**Reg. No. 3,569,434**

**United States Patent and Trademark Office**

**Registered Feb. 3, 2009**

**TRADEMARK  
PRINCIPAL REGISTER**

**HARDEN**

HARDEN FURNITURE, INC. (DELAWARE CORPORATION)  
8550 MILL POND WAY  
MCCONNELLSVILLE, NY 13401

FOR: FURNITURE; FURNITURE MADE FROM WOOD OR SUBSTITUTES OF WOOD; FURNITURE, MIRRORS, PICTURE FRAMES; FURNITURE, NAMELY, DRESSERS; FURNITURE, NAMELY, WALL UNITS; LIVING ROOM FURNITURE; RESIDENTIAL AND COMMERCIAL FURNITURE; SEATING FURNITURE; TABLES; TELEVISION STANDS; UPHOLSTERED FURNITURE; WOOD BEDSTEADS; BEDROOM FURNITURE; DINING CHAIRS; DINING ROOM TABLES; DINING TABLES; ARMOIRES; SLEEPER SOFAS; SOFAS;

CHAISE LONGUES; DESKS; WRITING DESKS, IN CLASS 20 (U.S. CLS. 2, 13, 22, 25, 32 AND 50).

FIRST USE 1-1-1952; IN COMMERCE 1-1-1952.

THE MARK CONSISTS OF STANDARD CHARACTERS WITHOUT CLAIM TO ANY PARTICULAR FONT, STYLE, SIZE, OR COLOR.

SEC. 2(F).

SER. NO. 77-478,871, FILED 5-20-2008.

ESTHER A. BORSUK, EXAMINING ATTORNEY

**Int. Cl.: 9**

**Prior U.S. Cls.: 21, 23, 26, 36 and 38**

**Reg. No. 3,569,435**

**United States Patent and Trademark Office**

**Registered Feb. 3, 2009**

**TRADEMARK  
PRINCIPAL REGISTER**



TRACK WHAT MATTERS (TEXAS LIMITED LIABILITY COMPANY)

1277 PORTER RD

FLOWER MOUND, TX 75022

FOR: VEHICLE LOCATOR AND RECOVERY DEVICE PROGRAMMED TO USE GLOBAL POSITIONING SYSTEMS (GPS) AND CELLULAR TELECOMMUNICATIONS; VEHICLE MOUNTED GPS SENSOR FOR DETERMINING THE RATE OF MOTION FOR A VEHICLE, IN CLASS 9 (U.S. CLS. 21, 23, 26, 36 AND 38).

FIRST USE 11-1-2007; IN COMMERCE 11-1-2007.

THE COLOR(S) DARK BLUE, LIGHT BLUE, ORANGE, GRAY, WHITE IS/ARE CLAIMED AS A FEATURE OF THE MARK.

THE MARK CONSISTS OF DARK BLUE GLOBE WITH LIGHT BLUE REFLECTION, WHITE CONTINENTS, WHITE LATITUDE AND LONGITUDE LINES, WHITE BLURRED DOTS, ORANGE ARROW ROTATING AROUND GLOBE, GRAY HANDS BENEATH GLOBE, GRAY LITERAL ELEMENT TRACK WHAT MATTERS.

SER. NO. 77-478,985, FILED 5-20-2008.

SKYE YOUNG, EXAMINING ATTORNEY

**Int. Cl.: 41**

**Prior U.S. Cls.: 100, 101 and 107**

**United States Patent and Trademark Office**

**Reg. No. 3,569,436**

**Registered Feb. 3, 2009**

**SERVICE MARK  
PRINCIPAL REGISTER**

# The SKY Quest

SKYSHAPERS FITNESS FOUNDATION, INC  
(UNITED STATES FOUNDATION)  
105 CHAMBERS STREET 3 FLR  
NEW YORK, NY 10007

FOR: ENTERTAINMENT SERVICES, NAMELY,  
PROVIDING AN ON-LINE COMPUTER GAME DE-  
SIGN TO MOTIVATE AND INSPIRE CHILDREN  
IN ORGANIZATION, PERSONAL DEVELOPMENT  
AND THE REALIZATION OF THEIR GOALS, IN  
CLASS 41 (U.S. CLS. 100, 101 AND 107).

FIRST USE 1-23-2005; IN COMMERCE 1-23-2005.

THE MARK CONSISTS OF STANDARD CHAR-  
ACTERS WITHOUT CLAIM TO ANY PARTICULAR  
FONT, STYLE, SIZE, OR COLOR.

OWNER OF U.S. REG. NO. 2,204,573.

SER. NO. 77-479,403, FILED 5-20-2008.

ROBERT C. CLARK JR., EXAMINING ATTORNEY

**Int. Cl.: 44**

**Prior U.S. Cls.: 100 and 101**

**United States Patent and Trademark Office**

**Reg. No. 3,569,437**

**Registered Feb. 3, 2009**

**SERVICE MARK  
PRINCIPAL REGISTER**

**S.A.F.E. EXPRESSIONS**

S.A.F.E. ALTERNATIVES, LLC (DELAWARE CORPORATION)  
SUITE 103B  
800 WEST 5TH STREET  
NAPERVILLE, IL 60563

FOR: HEALTHCARE; PSYCHOLOGICAL COUNSELING, IN CLASS 44 (U.S. CLS. 100 AND 101).

FIRST USE 10-0-2003; IN COMMERCE 10-0-2003.

THE MARK CONSISTS OF STANDARD CHARACTERS WITHOUT CLAIM TO ANY PARTICULAR FONT, STYLE, SIZE, OR COLOR.

NO CLAIM IS MADE TO THE EXCLUSIVE RIGHT TO USE "S.A.F.E.", APART FROM THE MARK AS SHOWN.

SER. NO. 77-479,405, FILED 5-20-2008.

ROBERT C. CLARK JR., EXAMINING ATTORNEY

**Int. Cl.: 39**

**Prior U.S. Cls.: 100 and 105**

**United States Patent and Trademark Office**

**Reg. No. 3,569,438**

**Registered Feb. 3, 2009**

**SERVICE MARK  
PRINCIPAL REGISTER**

# StoreSmart

STORESMART DEVELOPMENT, LLC (FLORIDA  
LIMITED LIABILITY COMPANY)  
25 OVERLOOK CIRCLE  
LITTLE ROCK, AR 72207

FOR: WAREHOUSING SERVICES, NAMELY,  
STORAGE, DISTRIBUTION, PICK-UP, AND PACK-  
ING FOR SHIPMENT OF DOCUMENTS, PACKA-  
GES, RAW MATERIALS, AND OTHER FREIGHT  
FOR OTHERS, IN CLASS 39 (U.S. CLS. 100 AND 105).

FIRST USE 3-1-2004; IN COMMERCE 3-1-2004.

THE MARK CONSISTS OF STANDARD CHAR-  
ACTERS WITHOUT CLAIM TO ANY PARTICULAR  
FONT, STYLE, SIZE, OR COLOR.

SER. NO. 77-479,885, FILED 5-21-2008.

JANICE KIM, EXAMINING ATTORNEY



**Int. Cls.: 6, 14, 16, 18, 21, 24, 25, 28 and 41**

**Prior U.S. Cls.: 1, 2, 3, 5, 12, 13, 14, 22, 23, 25, 27, 28, 29, 30, 33, 37, 38, 39, 40, 41, 42, 50, 100, 101 and 107**

**Reg. No. 3,569,439**

**United States Patent and Trademark Office**

**Registered Feb. 3, 2009**

**TRADEMARK  
SERVICE MARK  
PRINCIPAL REGISTER**



KENTUCKY SPEEDWAY, LLC (KENTUCKY LIMITED LIABILITY COMPANY)  
SUITE 100  
400 BUTTERMILK PIKE  
FORT MITCHELL, KY 41017

FOR: METAL NOVELTY ITEMS, NAMELY, KEY CHAINS AND TROPHIES OF COMMON METAL, IN CLASS 6 (U.S. CLS. 2, 12, 13, 14, 23, 25 AND 50).

FIRST USE 9-22-2003; IN COMMERCE 9-22-2003.

FOR: PRECIOUS METAL JEWELRY, NAMELY, WATCHES, COINS, MEDALLIONS, LAPEL PINS, PENDANTS, AND CHARMS; TROPHIES OF PRECIOUS METAL, IN CLASS 14 (U.S. CLS. 2, 27, 28 AND 50).

FIRST USE 9-22-2003; IN COMMERCE 9-22-2003.

FOR: PAPER GOODS AND PRINTED MATTER, NAMELY, POSTERS, BUMPER STICKERS, TRADING CARDS, EVENT PROGRAMS, SCORECARDS, BOOKS AND MAGAZINES CONCERNING AUTOMOBILE RACES AND EXHIBITIONS, CALENDARS, PENS, PENCILS, AND MONEY CLIPS, IN CLASS 16 (U.S. CLS. 2, 5, 22, 23, 29, 37, 38 AND 50).

FIRST USE 9-22-2003; IN COMMERCE 9-22-2003.

FOR: LUGGAGE, NAMELY, ATHLETIC BAGS, BACKPACKS, TOTE BAGS, BILLFOLDS, UMBRELLAS, FANNY PACKS AND KEY CASES, IN CLASS 18 (U.S. CLS. 1, 2, 3, 22 AND 41).

FIRST USE 9-22-2003; IN COMMERCE 9-22-2003.

FOR: CONTAINERS, NAMELY, THERMAL-INSULATED BEVERAGE CONTAINERS, WASTEPA-

PER BASKETS, PLASTIC WATER BOTTLES SOLD EMPTY, LUNCH BOXES, DRINKING GLASSES, SHOT GLASSES, COFFEE CUPS, IN CLASS 21 (U.S. CLS. 2, 13, 23, 29, 30, 33, 40 AND 50).

FIRST USE 9-22-2003; IN COMMERCE 9-22-2003.

FOR: FABRICS, NAMELY, PENNANTS AND BEDDING BEING BED SHEETS, FITTED BED SHEET COVERS, BED FLAT SHEETS, AND PILLOW CASES, IN CLASS 24 (U.S. CLS. 42 AND 50).

FIRST USE 9-22-2003; IN COMMERCE 9-22-2003.

FOR: CLOTHING, NAMELY, COATS, JACKETS, SHIRTS, PANTS, CAPS, SCARVES AND BANDANAS, IN CLASS 25 (U.S. CLS. 22 AND 39).

FIRST USE 9-22-2003; IN COMMERCE 9-22-2003.

FOR: GAMES AND PLAYTHINGS, NAMELY, SPORTING GOODS AND TOYS, NAMELY, DIE CAST METAL CARS, ACTION FIGURES, BOARD GAMES AND TOY FLAGS AND TOY PENNANTS, IN CLASS 28 (U.S. CLS. 22, 23, 38 AND 50).

FIRST USE 9-22-2003; IN COMMERCE 9-22-2003.

FOR: ENTERTAINMENT SERVICES IN THE NATURE OF AUTOMOBILE RACES AND EXHIBITIONS, IN CLASS 41 (U.S. CLS. 100, 101 AND 107).

FIRST USE 9-22-2003; IN COMMERCE 9-22-2003.

OWNER OF U.S. REG. NO. 2,491,098.

NO CLAIM IS MADE TO THE EXCLUSIVE RIGHT TO USE "KENTUCKY" AS TO ALL CLASSES

OR "KENTUCKY SPEEDWAY" AS TO CLASS 41,  
APART FROM THE MARK AS SHOWN.

THE MARK CONSISTS OF THE WORD "KEN-  
TUCKY" HAVING THE LETTER "K" IN LARGER  
FORM, WITH THE WORD "SPEEDWAY" NEXT TO  
THE "K" AND BELOW THE LAST SEVEN LETTERS  
OF "KENTUCKY"; WITH A CHECKERED FLAG

DEPICTED ON THE MIDDLE OF THE "K"; AND A  
STYLIZED ELIPSE IN TWO PARTS SURROUND-  
ING THE WORDS.

SER. NO. 77-480,006, FILED 5-21-2008.

BRENDAN REGAN, EXAMINING ATTORNEY

**Int. Cl.: 41**

**Prior U.S. Cls.: 100, 101 and 107**

**United States Patent and Trademark Office**

**Reg. No. 3,569,440**

**Registered Feb. 3, 2009**

**SERVICE MARK  
PRINCIPAL REGISTER**

**Blessings Photography**

CHRISTIANSON, TERA (NORTH DAKOTA SOLE  
PROPRIETORSHIP), DBA BLESSINGS PHOTO-  
GRAPHY

113 15TH AVE W  
WEST FARGO, ND 58078

FOR: PHOTOGRAPHY; PHOTOGRAPHY SERVI-  
CES; PORTRAIT PHOTOGRAPHY, IN CLASS 41  
(U.S. CLS. 100, 101 AND 107).

FIRST USE 10-18-2003; IN COMMERCE 10-18-2003.

THE MARK CONSISTS OF STANDARD CHAR-  
ACTERS WITHOUT CLAIM TO ANY PARTICULAR  
FONT, STYLE, SIZE, OR COLOR.

NO CLAIM IS MADE TO THE EXCLUSIVE  
RIGHT TO USE "PHOTOGRAPHY", APART FROM  
THE MARK AS SHOWN.

SER. NO. 77-480,050, FILED 5-21-2008.

CURTIS FRENCH, EXAMINING ATTORNEY

**Int. Cl.: 20**

**Prior U.S. Cls.: 2, 13, 22, 25, 32 and 50**

**United States Patent and Trademark Office**

**Reg. No. 3,569,441**

**Registered Feb. 3, 2009**

**TRADEMARK  
PRINCIPAL REGISTER**

**HARDEN CONTRACT**

HARDEN FURNITURE, INC. (DELAWARE CORPORATION)  
8550 MILL POND WAY  
MCCONNELLSVILLE, NY 13401

FOR: OFFICE ARMCHAIRS; OFFICE CHAIRS;  
OFFICE DESKS; OFFICE FURNITURE; OFFICE  
SEATS; OFFICE TABLES, IN CLASS 20 (U.S. CLS. 2,  
13, 22, 25, 32 AND 50).

FIRST USE 12-31-1985; IN COMMERCE 12-31-1985.

THE MARK CONSISTS OF STANDARD CHARACTERS WITHOUT CLAIM TO ANY PARTICULAR FONT, STYLE, SIZE, OR COLOR.

NO CLAIM IS MADE TO THE EXCLUSIVE RIGHT TO USE "CONTRACT", APART FROM THE MARK AS SHOWN.

SER. NO. 77-480,224, FILED 5-21-2008.

ESTHER A. BORSUK, EXAMINING ATTORNEY

Int. Cl.: 29

Prior U.S. Cl.: 46

United States Patent and Trademark Office

Reg. No. 3,569,442

Registered Feb. 3, 2009

TRADEMARK  
PRINCIPAL REGISTER

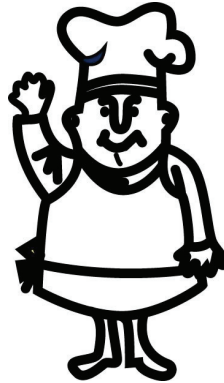

YORKSHIRE FOOD SALES CORP (NEW YORK  
CORPORATION)  
2000 PLAZA AVENUE  
NEW HYDE PARK, NY 11040

THE MARK CONSISTS OF A CHEF CHARAC-  
TER.

FOR: BEEF SAUSAGE, BEEF SAUSAGE SNACK  
FOODS, IN CLASS 29 (U.S. CL. 46).

SER. NO. 77-480,511, FILED 5-21-2008.

FIRST USE 0-0-1978; IN COMMERCE 0-0-1978.

DAVID I, EXAMINING ATTORNEY

**Int. Cl.: 4**

**Prior U.S. Cls.: 1, 6 and 15**

**United States Patent and Trademark Office**

**Reg. No. 3,569,443**

**Registered Feb. 3, 2009**

**TRADEMARK  
PRINCIPAL REGISTER**

**SHUR-PLUG**

ARNOLD BROS. FOREST PRODUCTS, INC.  
(TEXAS CORPORATION)  
201 N. BELTLINE RD.  
IRVING, TX 75061

THE MARK CONSISTS OF STANDARD CHAR-  
ACTERS WITHOUT CLAIM TO ANY PARTICULAR  
FONT, STYLE, SIZE, OR COLOR.

FOR: NON-CHEMICAL ADDITIVES FOR OIL  
AND GAS DRILLING FLUIDS, NAMELY, LOST  
CIRCULATION MATERIAL MADE OF WOOD FI-  
BER, IN CLASS 4 (U.S. CLS. 1, 6 AND 15).

SER. NO. 77-480,576, FILED 5-21-2008.

FIRST USE 7-30-2003; IN COMMERCE 8-15-2003.

MEGHAN REINHART, EXAMINING ATTORNEY

Int. Cl.: 43

Prior U.S. Cls.: 100 and 101

United States Patent and Trademark Office

Reg. No. 3,569,444

Registered Feb. 3, 2009

SERVICE MARK  
PRINCIPAL REGISTER



MANSOUR BROS. INC. (CALIFORNIA CORPORATION)

2334 PERSEUS COURT

BAKERSFIELD, CA 93308

FOR: RESTAURANT SERVICES, IN CLASS 43 (U.S. CLS. 100 AND 101).

FIRST USE 1-26-2006; IN COMMERCE 1-26-2006.

NO CLAIM IS MADE TO THE EXCLUSIVE RIGHT TO USE "MEDITERRANEAN RESTAURANT", APART FROM THE MARK AS SHOWN.

THE COLOR(S) BLACK, WHITE, GRAY, ORANGE AND RED IS/ARE CLAIMED AS A FEATURE OF THE MARK.

THE MARK CONSISTS OF TWO INTERSECTING BLACK SKEWERS WITH GRAY ENDS BEHIND AN ABSTRACT RED AND ORANGE FLAME ON A WHITE CIRCLE ENCLOSED BY A LARGER BLACK CIRCLE WITH WHITE WORDING AND TWO WHITE CIRCLES WITHIN THE BLACK BAND.

SER. NO. 77-480,652, FILED 5-21-2008.

MARY BOAGNI, EXAMINING ATTORNEY

**Int. Cl.: 35**

**Prior U.S. Cls.: 100, 101 and 102**

**United States Patent and Trademark Office**

**Reg. No. 3,569,445**

**Registered Feb. 3, 2009**

**SERVICE MARK  
PRINCIPAL REGISTER**



ONLINE FLOWER SEARCH, LLC (GEORGIA  
LIMITED LIABILITY COMPANY)  
2122 FAULKNER RD.  
ATLANTA, GA 30324

FOR: ONLINE RETAIL STORE SERVICES FEATURING FLOWERS AND FLORAL ARRANGEMENTS; CATALOG ORDERING SERVICES FEATURING FLOWERS AND FLORAL ARRANGEMENTS, IN CLASS 35 (U.S. CLS. 100, 101 AND 102).

FIRST USE 7-5-2006; IN COMMERCE 7-5-2006.

NO CLAIM IS MADE TO THE EXCLUSIVE RIGHT TO USE "ONLINE FLOWER SEARCH.COM", APART FROM THE MARK AS SHOWN.

THE MARK CONSISTS OF A FLOWER WITHIN A MAGNIFYING GLASS WITH THE WORDS "ONLINEFLOWERSEARCH.COM" BELOW THE FLOWER AND MAGNIFYING GLASS.

SER. NO. 77-480,766, FILED 5-21-2008.

RICHARD A. STRASER, EXAMINING ATTORNEY



**Int. Cls.: 16 and 41**

**Prior U.S. Cls.: 2, 5, 22, 23, 29, 37, 38, 50, 100, 101 and 107**

**Reg. No. 3,569,446**

**United States Patent and Trademark Office**

**Registered Feb. 3, 2009**

**TRADEMARK  
SERVICE MARK  
PRINCIPAL REGISTER**

**TELL ME WHY LEARNING**

MANAGEMENT INTERGRATION PROCESS  
CORP. (ILLINOIS CORPORATION)  
848 WEST BELDEN AVENUE  
CHICAGO, IL 60614

FOR: PUBLICATIONS, NAMELY, BOOKS, WORKBOOKS, BROCHURES AND TEACHING MATERIALS IN THE FIELDS OF KNOWLEDGE/EXPERTISE ACQUISITION, TRANSFER, RETENTION, INTEGRATION AND CONTINUOUS IMPROVEMENT, IN CLASS 16 (U.S. CLS. 2, 5, 22, 23, 29, 37, 38 AND 50).

FIRST USE 11-12-2007; IN COMMERCE 11-12-2007.

FOR: EDUCATIONAL SERVICES, NAMELY, CONDUCTING WORKSHOPS, CLASSES AND SEMINARS AND PROVIDING MENTORING AND TUTORING, IN PERSON, ON-LINE AND VIA VIDEO CONFERENCING, IN THE FIELDS OF KNOWLEDGE AND EXPERTISE ACQUISITION, TRANSFER, RETENTION, INTEGRATION AND CONTINUOUS IMPROVEMENT, AND DISTRIBUT-

ING WORKBOOK COURSE MATERIAL IN CONNECTION THEREWITH; PROVIDING ON-LINE PUBLICATIONS IN THE NATURE OF INTERACTIVE WORKBOOKS IN THE FIELD OF KNOWLEDGE AND EXPERTISE ACQUISITION, TRANSFER, RETENTION, INTEGRATION AND CONTINUOUS IMPROVEMENT, IN CLASS 41 (U.S. CLS. 100, 101 AND 107).

FIRST USE 11-12-2007; IN COMMERCE 11-12-2007.

THE MARK CONSISTS OF STANDARD CHARACTERS WITHOUT CLAIM TO ANY PARTICULAR FONT, STYLE, SIZE, OR COLOR.

NO CLAIM IS MADE TO THE EXCLUSIVE RIGHT TO USE "LEARNING" , APART FROM THE MARK AS SHOWN.

SER. NO. 77-480,992, FILED 5-22-2008.

MICHELE SWAIN, EXAMINING ATTORNEY

**Int. Cl.: 39**

**Prior U.S. Cls.: 100 and 105**

**United States Patent and Trademark Office**

**Reg. No. 3,569,447**

**Registered Feb. 3, 2009**

**SERVICE MARK  
PRINCIPAL REGISTER**

**LOAD 'EM UP**

LOAD 'EM UP FREIGHT BROKERS LLC (OKLAHOMA LIMITED LIABILITY COMPANY)  
P. O. BOX 457  
MEDFORD, MA 02155

FOR: FREIGHT AND TRANSPORT BROKERAGE; FREIGHT BROKERAGE; FREIGHT FORWARDING; FREIGHT FORWARDING SERVICES; FREIGHT SHIP TRANSPORT; FREIGHT TRAIN TRANSPORT; GLOBAL TRANSPORTATION OF FREIGHT FOR OTHERS BY ALL AVAILABLE MEANS, IN CLASS 39 (U.S. CLS. 100 AND 105).

FIRST USE 9-1-2005; IN COMMERCE 9-1-2005.

THE MARK CONSISTS OF STANDARD CHARACTERS WITHOUT CLAIM TO ANY PARTICULAR FONT, STYLE, SIZE, OR COLOR.

SER. NO. 77-481,290, FILED 5-22-2008.

ELI HELLMAN, EXAMINING ATTORNEY

Int. Cl.: 39

Prior U.S. Cls.: 100 and 105

United States Patent and Trademark Office

Reg. No. 3,569,448

Registered Feb. 3, 2009

SERVICE MARK  
PRINCIPAL REGISTER

**LOAD  
'EM  
UP**  
FREIGHT BROKERS

LOAD 'EM UP FREIGHT BROKERS LLC (OKLAHOMA LIMITED LIABILITY COMPANY)  
P. O. BOX 457  
MEDFORD, MA 02155

FOR: FREIGHT AND TRANSPORT BROKERAGE; FREIGHT BROKERAGE; FREIGHT FORWARDING; FREIGHT FORWARDING SERVICES; FREIGHT SHIP TRANSPORT; FREIGHT TRAIN TRANSPORT; GLOBAL TRANSPORTATION OF FREIGHT FOR OTHERS BY ALL AVAILABLE MEANS, IN CLASS 39 (U.S. CLS. 100 AND 105).

FIRST USE 9-1-2005; IN COMMERCE 9-1-2005.

NO CLAIM IS MADE TO THE EXCLUSIVE RIGHT TO USE "FREIGHT BROKERS", APART FROM THE MARK AS SHOWN.

THE MARK CONSISTS OF THE WORDS "LOAD 'EM UP" WRITTEN STYLISTICALLY TO FORM A SQUARE WITH THE WORD "LOAD" WRITTEN FROM BOTTOM TO TOP AND THE WORD "EM" OVER THE WORD "UP" TO THE RIGHT OF THE WORD "LOAD". AN ARROW BETWEEN "LOAD" AND "EM UP" ENDS WITH AN ARROWHEAD FORMING THE APOSTROPHE IN THE WORD "'EM".

SER. NO. 77-481,309, FILED 5-22-2008.

ELI HELLMAN, EXAMINING ATTORNEY

**Int. Cl.: 16**

**Prior U.S. Cls.: 2, 5, 22, 23, 29, 37, 38 and 50**

**United States Patent and Trademark Office**

**Reg. No. 3,569,449**

**Registered Feb. 3, 2009**

**TRADEMARK  
PRINCIPAL REGISTER**

# Lone Star Classic

JUNIOR VOLLEYBALL ASSOCIATION OF AUSTIN (TEXAS NON-PROFIT CORPORATION)  
AUSTIN SPORTS CENTER  
425 WOODWARD ST.  
AUSTIN, TX 78704

FOR: PRINTED MATTER, NAMELY, SOUVENIR VOLLEYBALL PROGRAMS, BROCHURES ABOUT VOLLEYBALL AND VOLLEYBALL GAME AND TOURNAMENT SCHEDULES, IN CLASS 16 (U.S. CLS. 2, 5, 22, 23, 29, 37, 38 AND 50).

FIRST USE 4-1-1992; IN COMMERCE 4-1-1992.

THE MARK CONSISTS OF STANDARD CHARACTERS WITHOUT CLAIM TO ANY PARTICULAR FONT, STYLE, SIZE, OR COLOR.

OWNER OF U.S. REG. NOS. 2,516,274 AND 2,589,026.

NO CLAIM IS MADE TO THE EXCLUSIVE RIGHT TO USE "CLASSIC", APART FROM THE MARK AS SHOWN.

SEC. 2(F).

SER. NO. 77-481,446, FILED 5-22-2008.

WON TEAK OH, EXAMINING ATTORNEY

**Int. Cl.: 2**

**Prior U.S. Cls.: 6, 11 and 16**

**United States Patent and Trademark Office**

**Reg. No. 3,569,450**

**Registered Feb. 3, 2009**

**TRADEMARK  
PRINCIPAL REGISTER**

**BEYCOAT**

BEYNON ENTERPRISES, INC. (MARYLAND  
CORPORATION)  
16 ALT ROAD  
HUNT VALLEY, MD 21030

THE MARK CONSISTS OF STANDARD CHAR-  
ACTERS WITHOUT CLAIM TO ANY PARTICULAR  
FONT, STYLE, SIZE, OR COLOR.

FOR: SINGLE-COMPONENT, ALIPHATIC BASED  
POLYURETHANE COATING FOR USE ON IN-  
DOOR AND OUTDOOR SURFACING SYSTEMS,  
IN CLASS 2 (U.S. CLS. 6, 11 AND 16).

SER. NO. 77-482,702, FILED 5-23-2008.

FIRST USE 1-31-2005; IN COMMERCE 1-31-2005.

KYLE PEETE, EXAMINING ATTORNEY

**Int. Cls.: 36 and 45**

**Prior U.S. Cls.: 100, 101 and 102**

**United States Patent and Trademark Office**

**Reg. No. 3,569,451**

**Registered Feb. 3, 2009**

**SERVICE MARK  
PRINCIPAL REGISTER**



**FUNDING RESOURCES**

FUNDING RESOURCES, LLC (TEXAS LIMITED  
LIABILITY COMPANY)  
17000 DALLAS PARKWAY, SUITE 219  
DALLAS, TX 75248

FOR: ADVISORY SERVICES RELATING TO AND  
ARRANGING OF LOANS, IN CLASS 36 (U.S. CLS.  
100, 101 AND 102).

FIRST USE 6-15-2006; IN COMMERCE 6-15-2006.

FOR: CLOSING SERVICES FOR LOANS, NAME-  
LY, PREPARING AND ORGANIZING LOAN CLOS-  
ING DOCUMENTS, IN CLASS 45 (U.S. CLS. 100 AND  
101).

FIRST USE 6-15-2006; IN COMMERCE 6-15-2006.

NO CLAIM IS MADE TO THE EXCLUSIVE  
RIGHT TO USE "FUNDING RESOURCES", APART  
FROM THE MARK AS SHOWN.

THE MARK CONSISTS OF AN ARC POSITIONED  
OVER THE WORDS "FUNDING RESOURCES."

SER. NO. 77-482,808, FILED 5-23-2008.

EVELYN BRADLEY, EXAMINING ATTORNEY

**Int. Cl.: 9**

**Prior U.S. Cls.: 21, 23, 26, 36 and 38**

**Reg. No. 3,569,452**

**United States Patent and Trademark Office**

**Registered Feb. 3, 2009**

---

**TRADEMARK  
PRINCIPAL REGISTER**

# Volcano Valve

LEAPING WIZARDS INC. (TEXAS CORPORATION)  
123 WALEETKA ST.  
SAN ANTONIO, TX 78210

FOR: PRESSURE RELIEF VALVES FOR DEMONSTRATING A VOLCANO ERUPTION, IN CLASS 9 (U.S. CLS. 21, 23, 26, 36 AND 38).

FIRST USE 2-0-2008; IN COMMERCE 2-0-2008.

THE MARK CONSISTS OF STANDARD CHARACTERS WITHOUT CLAIM TO ANY PARTICULAR FONT, STYLE, SIZE, OR COLOR.

NO CLAIM IS MADE TO THE EXCLUSIVE RIGHT TO USE "VALVE", APART FROM THE MARK AS SHOWN.

SER. NO. 77-483,080, FILED 5-24-2008.

MARY CRAWFORD, EXAMINING ATTORNEY

**Int. Cl.: 42**

**Prior U.S. Cls.: 100 and 101**

**United States Patent and Trademark Office**

**Reg. No. 3,569,453**

**Registered Feb. 3, 2009**

**SERVICE MARK  
PRINCIPAL REGISTER**

# SongLogix

SHO-BUD MUSIC, INC. (TENNESSEE CORPORATION)  
2926 SHIELD CT  
MURFREESBORO, TN 37129

FOR: PROVIDING ON-LINE NON-DOWNLOADABLE SOFTWARE FOR USE IN DATABASE MANAGEMENT IN THE FIELD OF MUSIC CATALOGS; COMPUTER SERVICE, NAMELY, ACTING AS AN APPLICATION SERVICES PROVIDER IN THE FIELD OF KNOWLEDGE MANAGEMENT TO HOST COMPUTER APPLICATION SOFTWARE FOR SEARCHING AND RETRIEVING INFORMATION CONCERNING MUSIC CATALOGS FROM

DATABASES AND NETWORKS, IN CLASS 42 (U.S. CLS. 100 AND 101).

FIRST USE 3-1-2008; IN COMMERCE 3-1-2008.

THE MARK CONSISTS OF STANDARD CHARACTERS WITHOUT CLAIM TO ANY PARTICULAR FONT, STYLE, SIZE, OR COLOR.

SER. NO. 77-483,319, FILED 5-26-2008.

ZACHARY BELLO, EXAMINING ATTORNEY



**Int. Cls.: 35, 36 and 38**

**Prior U.S. Cls.: 100, 101, 102 and 104**

**United States Patent and Trademark Office**

**Reg. No. 3,569,454**

**Registered Feb. 3, 2009**

**SERVICE MARK  
PRINCIPAL REGISTER**

**REPLY7**

REPLY7, INC. (TEXAS CORPORATION)  
SUITE 388  
12777 JONES ROAD  
HOUSTON, TX 77070

FOR: REAL ESTATE MARKETING SERVICES, NAMELY, PROVIDING INFORMATION AS TO THE AVAILABILITY OF REAL ESTATE FOR PURCHASE OR RENT VIA TEXT MESSAGE SERVICES AND VIA A GLOBAL COMPUTER NETWORK, IN CLASS 35 (U.S. CLS. 100, 101 AND 102).

FIRST USE 5-12-2008; IN COMMERCE 5-12-2008.

FOR: PROVIDING REAL ESTATE LISTINGS AND REAL ESTATE INFORMATION VIA THE INTERNET AND BY TEXT MESSAGING SERVICES, IN CLASS 36 (U.S. CLS. 100, 101 AND 102).

FIRST USE 5-12-2008; IN COMMERCE 5-12-2008.

FOR: ELECTRONIC TRANSMISSION OF MESSAGES AND DATA, NAMELY, ON-LINE AND TEXT MESSAGING SERVICES FOR THE DELIVERY OF REAL ESTATE LISTINGS AND REAL ESTATE INFORMATION, IN CLASS 38 (U.S. CLS. 100, 101 AND 104).

FIRST USE 5-12-2008; IN COMMERCE 5-12-2008.

THE MARK CONSISTS OF STANDARD CHARACTERS WITHOUT CLAIM TO ANY PARTICULAR FONT, STYLE, SIZE, OR COLOR.

SER. NO. 77-483,560, FILED 5-27-2008.

JAMES LOVELACE, EXAMINING ATTORNEY

**Int. Cl.: 43**

**Prior U.S. Cls.: 100 and 101**

**United States Patent and Trademark Office**

**Reg. No. 3,569,455**

**Registered Feb. 3, 2009**

**SERVICE MARK  
PRINCIPAL REGISTER**

**THE CORNER**  
PUB & GRILL

FGB GROUP, LLC (MISSOURI LIMITED LIABILITY COMPANY)  
SUITE 101  
13645 BIG BEND RD.  
ST. LOUIS, MO 63122

FOR: RESTAURANT AND BAR SERVICES, IN CLASS 43 (U.S. CLS. 100 AND 101).

FIRST USE 10-20-2007; IN COMMERCE 10-20-2007.

NO CLAIM IS MADE TO THE EXCLUSIVE RIGHT TO USE "PUB & GRILL", APART FROM THE MARK AS SHOWN.

THE MARK CONSISTS OF THE WORDS "THE CORNER PUB & GRILL" WITH THE WORDS "THE CORNER" ON TOP AND "PUB & GRILL" UNDERNEATH, AND WITH THE LETTER "O" IN "CORNER" UNDERLINED AND THE WORD "THE" ON ITS SIDE.

SER. NO. 77-483,648, FILED 5-27-2008.

DAYNA BROWNE, EXAMINING ATTORNEY

**Int. Cl.: 35**

**Prior U.S. Cls.: 100, 101 and 102**

**United States Patent and Trademark Office**

**Reg. No. 3,569,456**

**Registered Feb. 3, 2009**

**SERVICE MARK  
PRINCIPAL REGISTER**



The logo consists of the word "emerse" in a lowercase, sans-serif font. The second letter 'e' is replaced by a shaded sphere with a stippled texture, giving it a three-dimensional appearance. The rest of the letters are in a standard black font.

EMERSE, INC. (MICHIGAN CORPORATION)  
#340  
2153 WEALTHY ST. SE  
GRAND RAPIDS, MI 49506

THE MARK CONSISTS OF THE STYLIZED TEXT "EMERSE". THERE IS A SPHERE IN THE BACKGROUND OF THE SECOND "E".

FOR: MARKETING SERVICES, NAMELY, PRODUCT MARKETING RESEARCH, IN CLASS 35 (U.S. CLS. 100, 101 AND 102).

THE ENGLISH TRANSLATION OF THE ITALIAN WORD "EMERSE" IN THE MARK IS "EMERGED".

FIRST USE 3-12-2008; IN COMMERCE 3-12-2008.

SER. NO. 77-483,666, FILED 5-27-2008.

THE STIPLING IS FOR SHADING PURPOSES ONLY.

STEPHEN AQUILA, EXAMINING ATTORNEY

Int. Cl.: 9

Prior U.S. Cls.: 21, 23, 26, 36 and 38

United States Patent and Trademark Office

Reg. No. 3,569,457

Registered Feb. 3, 2009

TRADEMARK  
PRINCIPAL REGISTER

AttentiveCare 

CAREGIVER TECHNOLOGIES, INC. (OKLAHOMA CORPORATION)  
13101 S. PENNSYLVANIA, SUITE 12  
OKLAHOMA CITY, OK 73170

FOR: COMPUTER SOFTWARE FOR REMOTELY PROVIDING CARE TO INDIVIDUALS, IN CLASS 9 (U.S. CLS. 21, 23, 26, 36 AND 38).

FIRST USE 10-1-2006; IN COMMERCE 10-1-2006.

THE COLOR(S) BLUE, LIGHT BLUE, RED, YELLOW, GREEN, AND PURPLE IS/ARE CLAIMED AS A FEATURE OF THE MARK.

THE MARK CONSISTS OF THE COLORS BLUE, LIGHT BLUE, RED, YELLOW, GREEN, AND PURPLE, WITH THE COLORS BLUE AND LIGHT BLUE APPEARING IN THE WORDING AND THE COLORS BLUE, RED, YELLOW, GREEN, AND PURPLE LOCATED IN THE DESIGN ELEMENT LOCATED TO THE RIGHT OF THE WORDING .

SER. NO. 77-484,108, FILED 5-27-2008.

KEVON CHISOLM, EXAMINING ATTORNEY

**Int. Cl.: 41**

**Prior U.S. Cls.: 100, 101 and 107**

**United States Patent and Trademark Office**

**Reg. No. 3,569,458**

**Registered Feb. 3, 2009**

**SERVICE MARK  
PRINCIPAL REGISTER**

**DAVE DRESDEN**

DRESDEN, DAVID MITCHELL (UNITED STATES INDIVIDUAL)  
THIRD FLOOR  
C/O 3207A M STREET, NW  
WASHINGTON, DC 20007

FOR: ENTERTAINMENT SERVICES, NAMELY, MUSIC PRODUCTION, LIVE PERFORMANCES BY A MUSICAL PERFORMER AND THE PLAYING OF LIVE AND RECORDED MUSIC BY A DISC JOCKEY, NAMELY, A DISC JOCKEY FOR PARTIES AND SPECIAL EVENTS, IN CLASS 41 (U.S. CLS. 100, 101 AND 107).

FIRST USE 4-1-2008; IN COMMERCE 4-1-2008.

THE MARK CONSISTS OF STANDARD CHARACTERS WITHOUT CLAIM TO ANY PARTICULAR FONT, STYLE, SIZE, OR COLOR.

THE NAME SHOWN IN THE MARK IDENTIFIES A LIVING INDIVIDUAL, WHOSE CONSENT IS OF RECORD.

SER. NO. 77-484,285, FILED 5-27-2008.

ERIN FALK, EXAMINING ATTORNEY

**Int. Cl.: 36**

**Prior U.S. Cls.: 100, 101 and 102**

**United States Patent and Trademark Office**

**Reg. No. 3,569,459**

**Registered Feb. 3, 2009**

**SERVICE MARK  
PRINCIPAL REGISTER**

**POSE FOR THE CURE**

THE SUSAN G. KOMEN BREAST CANCER  
FOUNDATION, INC. (TEXAS NON-PROFIT  
CORPORATION)

5005 LBJ FREEWAY, SUITE 250  
DALLAS, TX 75244

FOR: CHARITABLE FUNDRAISING SERVICES,  
NAMELY, RAISING MONEY FOR BREAST CAN-  
CER RESEARCH AND RAISING MONEY FOR  
LOCAL COMMUNITY BREAST HEALTH AWARE-  
NESS PROGRAMS, IN CLASS 36 (U.S. CLS. 100, 101  
AND 102).

FIRST USE 9-1-2006; IN COMMERCE 9-1-2006.

THE MARK CONSISTS OF STANDARD CHAR-  
ACTERS WITHOUT CLAIM TO ANY PARTICULAR  
FONT, STYLE, SIZE, OR COLOR.

OWNER OF U.S. REG. NOS. 1,593,469, 2,075,352,  
AND 2,406,792.

NO CLAIM IS MADE TO THE EXCLUSIVE  
RIGHT TO USE "POSE", APART FROM THE MARK  
AS SHOWN.

SER. NO. 77-484,403, FILED 5-27-2008.

PAUL MORENO, EXAMINING ATTORNEY

**Int. Cl.: 44**

**Prior U.S. Cls.: 100 and 101**

**United States Patent and Trademark Office**

**Reg. No. 3,569,460**

**Registered Feb. 3, 2009**

**SERVICE MARK  
PRINCIPAL REGISTER**



THE HOTEL EMPLOYEES AND RESTAURANT  
EMPLOYEES INTERNATIONAL UNION WEL-  
FARE FUND (NEVADA TRUST)  
SUITE 101  
1901 LAS VEGAS BOULEVARD SOUTH  
LAS VEGAS, NV 89104

FOR: PROVIDING HEALTH CARE INFORMA-  
TION BY TELEPHONE AND THE INTERNET, IN  
CLASS 44 (U.S. CLS. 100 AND 101).

FIRST USE 7-31-2004; IN COMMERCE 7-31-2004.

NO CLAIM IS MADE TO THE EXCLUSIVE  
RIGHT TO USE "CULINARY HEALTH FUND",  
APART FROM THE MARK AS SHOWN.

THE MARK CONSISTS OF THE WORD "CULIN-  
ARY" OVER THE WORDS "HEALTH FUND" ALL  
RIGHT-JUSTIFIED AGAINST A CARTOON FIG-  
URE REPRESENTING AN ADULT FEATURING A  
HEART SHAPE IN THE CENTER OF ITS CHEST  
WHICH IS TO THE LEFT OF A CARTOON FIGURE  
REPRESENTING A CHILD FEATURING A HEART  
SHAPE IN THE CENTER OF ITS CHEST.

SER. NO. 77-484,555, FILED 5-27-2008.

ANGELA M. MICHELI, EXAMINING ATTORNEY

**Int. Cl.: 36**

**Prior U.S. Cls.: 100, 101 and 102**

**United States Patent and Trademark Office**

**Reg. No. 3,569,461**

**Registered Feb. 3, 2009**

**SERVICE MARK  
PRINCIPAL REGISTER**



THE HOTEL EMPLOYEES AND RESTAURANT  
EMPLOYEES INTERNATIONAL UNION WEL-  
FARE FUND, COMPRISED OF THOMAS S.  
ZUMTOBEL AND ELIZABETH GILBERTSON,  
BOTH U.S. CITIZENS (NEVADA TRUST)

SUITE 101  
1901 LAS VEGAS BOULEVARD SOUTH  
LAS VEGAS, NV 89104

FOR: ADMINISTRATION AND UNDERWRIT-  
ING SERVICES IN THE FIELD OF HEALTH CARE  
INSURANCE, IN CLASS 36 (U.S. CLS. 100, 101 AND  
102).

FIRST USE 7-31-2004; IN COMMERCE 7-31-2004.

NO CLAIM IS MADE TO THE EXCLUSIVE  
RIGHT TO USE "CULINARY HEALTH FUND",  
APART FROM THE MARK AS SHOWN.

THE MARK CONSISTS OF THE WORD "CULIN-  
ARY" OVER THE WORDS "HEALTH FUND" ALL  
RIGHT-JUSTIFIED AGAINST A CARTOON FIG-  
URE REPRESENTING AN ADULT FEATURING A  
HEART SHAPE IN THE CENTER OF ITS CHEST  
WHICH IS TO THE LEFT OF A CARTOON FIGURE  
REPRESENTING A CHILD FEATURING A HEART  
SHAPE IN THE CENTER OF ITS CHEST.

SER. NO. 77-484,556, FILED 5-27-2008.

ANGELA M. MICHELI, EXAMINING ATTORNEY



**Int. Cls.: 9 and 42**

**Prior U.S. Cls.: 21, 23, 26, 36, 38, 100 and 101**

**United States Patent and Trademark Office**

**Reg. No. 3,569,462**

**Registered Feb. 3, 2009**

**TRADEMARK  
SERVICE MARK  
PRINCIPAL REGISTER**

# 4S VisiLog

FOUR SOFT LIMITED (INDIA LIMITED COMPANY (LTD.))  
5Q1 A3, CYBER TOWERS  
HITEC CITY, MADHAPUR, INDIA

FOR: COMPUTER PROGRAMS FOR USE IN SUPPLY CHAIN MANAGEMENT, IN CLASS 9 (U.S. CLS. 21, 23, 26, 36 AND 38).

FIRST USE 10-7-2006; IN COMMERCE 10-7-2006.

FOR: COMPUTER SERVICE, NAMELY, ACTING AS AN APPLICATION SERVICE PROVIDER IN THE FIELD OF KNOWLEDGE MANAGEMENT TO HOST COMPUTER APPLICATION SOFTWARE

FOR THE COLLECTION, EDITING, ORGANIZING, MODIFYING, BOOK MARKING, TRANSMISSION, STORAGE AND SHARING OF DATA AND INFORMATION, IN CLASS 42 (U.S. CLS. 100 AND 101).

FIRST USE 10-7-2006; IN COMMERCE 10-7-2006.

THE MARK CONSISTS OF THE NUMBER "4" AND THE LETTER "S" FOLLOWED BY THE STYLED LETTERS "VISILOG".

SER. NO. 77-484,576, FILED 5-28-2008.

KAREN K. BUSH, EXAMINING ATTORNEY

**Int. Cl.: 44**

**Prior U.S. Cls.: 100 and 101**

**United States Patent and Trademark Office**

**Reg. No. 3,569,463**

**Registered Feb. 3, 2009**

**SERVICE MARK  
PRINCIPAL REGISTER**

**S.A.F.E. FOCUS**

S.A.F.E. ALTERNATIVES, LLC (DELAWARE  
CORPORATION)  
SUITE 103B  
800 WEST 5TH STREET  
NAPERVILLE, IL 60563

FOR: PSYCHOLOGICAL COUNSELING, IN  
CLASS 44 (U.S. CLS. 100 AND 101).

FIRST USE 3-0-2008; IN COMMERCE 3-0-2008.

THE MARK CONSISTS OF STANDARD CHAR-  
ACTERS WITHOUT CLAIM TO ANY PARTICULAR  
FONT, STYLE, SIZE, OR COLOR.

NO CLAIM IS MADE TO THE EXCLUSIVE  
RIGHT TO USE "S.A.F.E.", APART FROM THE  
MARK AS SHOWN.

SER. NO. 77-484,869, FILED 5-28-2008.

ROBERT C. CLARK JR., EXAMINING ATTORNEY

**Int. Cl.: 44**

**Prior U.S. Cls.: 100 and 101**

**United States Patent and Trademark Office**

**Reg. No. 3,569,464**

**Registered Feb. 3, 2009**

**SERVICE MARK  
PRINCIPAL REGISTER**

**S.A.F.E. INTENSIVE**

S.A.F.E. ALTERNATIVES, LLC (DELAWARE  
CORPORATION)  
SUITE 103B  
800 WEST 5TH STREET  
NAPERVILLE, IL 60563

FOR: HEALTHCARE; PSYCHOLOGICAL COUN-  
SELING, IN CLASS 44 (U.S. CLS. 100 AND 101).

FIRST USE 7-0-2007; IN COMMERCE 7-0-2007.

THE MARK CONSISTS OF STANDARD CHAR-  
ACTERS WITHOUT CLAIM TO ANY PARTICULAR  
FONT, STYLE, SIZE, OR COLOR.

NO CLAIM IS MADE TO THE EXCLUSIVE  
RIGHT TO USE "S.A.F.E.", APART FROM THE  
MARK AS SHOWN.

SER. NO. 77-484,878, FILED 5-28-2008.

ROBERT C. CLARK JR., EXAMINING ATTORNEY

Int. Cl.: 35

Prior U.S. Cls.: 100, 101 and 102

Reg. No. 3,569,465

United States Patent and Trademark Office

Registered Feb. 3, 2009

**SERVICE MARK  
PRINCIPAL REGISTER**



MESSINA, LILY (UNITED STATES INDIVIDUAL)  
2784 E VERMONT AVE  
ANAHEIM, CA 92806

FOR: RETAIL SHOP-AT-HOME PARTY SERVICES IN THE FIELD OF CHILDREN'S THEME PARTIES, IN CLASS 35 (U.S. CLS. 100, 101 AND 102).

FIRST USE 5-26-2008; IN COMMERCE 5-26-2008.

NO CLAIM IS MADE TO THE EXCLUSIVE RIGHT TO USE "PARTY PACK THEME PARTIES COSTUMES ACCESSORIES", APART FROM THE MARK AS SHOWN.

THE MARK CONSISTS OF TWO CHILDREN IN THE CENTER ONE BOY CHILD FACING LEFT

WEARING A COWBOY HAT AND HOLDING THREE BALLOONS ONE GIRL CHILD FACING RIGHT WEARING A CROWN AND HOLDING THREE BALLOONS IN FRONT OF THEM CENTERED IS A LARGE PLATE WITH A BIRTHDAY CAKE ON IT AND WRITTEN ACROSS THE BOTTOM OF THE CAKE IN A CURVE ARE THE WORDS "NIC NAC" BELOW THAT CENTERED AND WRITTEN STRAIGHT ACROSS ARE THE WORDS "PARTY PACK" AND WRITTEN BELOW THAT CENTERED AND IN A STRAIGHT LINE ARE "THEME PARTIES COSTUMES ACCESSORIES".

SER. NO. 77-485,009, FILED 5-28-2008.

JANICE L. MCMORROW, EXAMINING ATTORNEY

Int. Cl.: 41

Prior U.S. Cls.: 100, 101 and 107

United States Patent and Trademark Office

Reg. No. 3,569,466

Registered Feb. 3, 2009

SERVICE MARK  
PRINCIPAL REGISTER



DELUTES, JAMES J. (UNITED STATES INDIVIDUAL)  
PO BOX 1634  
BOULDER, CO 80306

FOR: ART EXHIBITIONS, IN CLASS 41 (U.S. CLS. 100, 101 AND 107).

FIRST USE 3-1-2007; IN COMMERCE 3-1-2007.

NO CLAIM IS MADE TO THE EXCLUSIVE RIGHT TO USE "DOWNTOWN DENVER" AND "ARTS FESTIVAL", APART FROM THE MARK AS SHOWN.

THE COLOR(S) BLACK AND RED IS/ARE CLAIMED AS A FEATURE OF THE MARK.

THE MARK CONSISTS OF THE BLACK WORDING "DOWNTOWN DENVER" WHICH APPEARS IN AN ARC ABOVE THE RED STYLIZED LETTER "A", TO THE BOTTOM RIGHT OF THE LETTER "A" IS THE BLACK WORDING "ARTS FESTIVAL".

SER. NO. 77-485,724, FILED 5-29-2008.

CHRISTINA SOBRAL, EXAMINING ATTORNEY

**Int. Cl.: 14**

**Prior U.S. Cls.: 2, 27, 28 and 50**

**United States Patent and Trademark Office**

**Reg. No. 3,569,467**

**Registered Feb. 3, 2009**

**TRADEMARK  
PRINCIPAL REGISTER**

# Diwa Designs

DIWA DESIGNS STUDIO, LLC (MARYLAND  
LIMITED LIABILITY COMPANY)  
10482 BALTIMORE AVENUE, PMB 154  
BELTSVILLE, MD 20705

FOR: JEWELRY, PRECIOUS METAL, NAMELY,  
GOLD AND SILVER; PRECIOUS METALS AND  
THEIR ALLOYS, GOODS IN PRECIOUS METALS  
OR COATED THEREWITH, NOT INCLUDED IN  
OTHER CLASSES, NAMELY, STATUES AND  
SCULPTURES; PRECIOUS STONES, HANDMADE  
JEWELRY, JEWELRY AND IMITATION JEWELRY,  
GEMSTONE JEWELRY, PRECIOUS GEMSTONES,  
SEMI-PRECIOUS GEMSTONES, PRECIOUS GEMS,  
NAMELY, DIAMONDS, EMERALDS, RUBIES AND  
WATCHES, IN CLASS 14 (U.S. CLS. 2, 27, 28 AND 50).

FIRST USE 6-0-2007; IN COMMERCE 1-0-2008.

THE MARK CONSISTS OF STANDARD CHAR-  
ACTERS WITHOUT CLAIM TO ANY PARTICULAR  
FONT, STYLE, SIZE, OR COLOR.

NO CLAIM IS MADE TO THE EXCLUSIVE  
RIGHT TO USE "DESIGNS" , APART FROM THE  
MARK AS SHOWN.

THE FOREIGN WORDING IN THE MARK  
TRANSLATES INTO ENGLISH AS "ESSENCE".

SER. NO. 77-485,819, FILED S.R. 5-29-2008 AM. P.R.  
10-10-2008.

MELISSA VALLILLO, EXAMINING ATTORNEY

**Int. Cl.: 45**

**Prior U.S. Cls.: 100 and 101**

**United States Patent and Trademark Office**

**Reg. No. 3,569,468**

**Registered Feb. 3, 2009**

**SERVICE MARK  
PRINCIPAL REGISTER**

**IP LITIGATION BY DESIGN**

GRUBER HURST JOHANSEN & HAIL LLP  
(TEXAS LIMITED LIABILITY PARTNERSHIP)

1445 ROSS AVENUE, SUITE 2500

DALLAS, TX 75202

FOR: LEGAL SERVICES, IN CLASS 45 (U.S. CLS.  
100 AND 101).

FIRST USE 5-26-2008; IN COMMERCE 5-26-2008.

THE MARK CONSISTS OF STANDARD CHAR-  
ACTERS WITHOUT CLAIM TO ANY PARTICULAR  
FONT, STYLE, SIZE, OR COLOR.

NO CLAIM IS MADE TO THE EXCLUSIVE  
RIGHT TO USE "IP LITIGATION", APART FROM  
THE MARK AS SHOWN.

SER. NO. 77-486,198, FILED 5-29-2008.

LINDA ORNDORFF, EXAMINING ATTORNEY

**Int. Cl.: 3**

**Prior U.S. Cls.: 1, 4, 6, 50, 51 and 52**

**Reg. No. 3,569,469**

**United States Patent and Trademark Office**

**Registered Feb. 3, 2009**

**TRADEMARK  
PRINCIPAL REGISTER**

**BIOTONE**

NATURAL THOUGHTS, INC. (CALIFORNIA CORPORATION)  
4757 OLD CLIFFS ROAD  
SAN DIEGO, CA 92120

FOR: MASSAGE PREPARATIONS, NAMELY, CREMES, OILS, LOTIONS, GELS, SALT GLOWS IN THE NATURE OF BODY OIL COMBINED WITH SALT, BUTTERS, BALMS; ESSENTIAL OILS FOR PERSONAL USE; AROMATHERAPY PRODUCTS, NAMELY, ROOM MIST IN THE NATURE OF SCENTED ROOM SPRAY; SKIN CARE PREPARATIONS, NAMELY, SALT GLOWS IN THE NATURE OF BODY OIL COMBINED WITH SALT, BODY POLISHES, CREMES, BODY MUD, OILS, BUTTERS,

LOTIONS, BALMS, IN CLASS 3 (U.S. CLS. 1, 4, 6, 50, 51 AND 52).

FIRST USE 4-1-1997; IN COMMERCE 4-1-1997.

THE MARK CONSISTS OF STANDARD CHARACTERS WITHOUT CLAIM TO ANY PARTICULAR FONT, STYLE, SIZE, OR COLOR.

OWNER OF U.S. REG. NO. 2,159,105.

SER. NO. 77-486,484, FILED 5-29-2008.

MARC LEIPZIG, EXAMINING ATTORNEY



**Int. Cl.: 20**

**Prior U.S. Cls.: 2, 13, 22, 25, 32 and 50**

**United States Patent and Trademark Office**

**Reg. No. 3,569,470**

**Registered Feb. 3, 2009**

**TRADEMARK  
PRINCIPAL REGISTER**

# Island Living

HUNEYCUTT, TRISH (UNITED STATES INDIVIDUAL)  
3535 E. COAST HWY., SUITE 100  
CORONA DEL MAR, CA 92625

THE MARK CONSISTS OF STANDARD CHARACTERS WITHOUT CLAIM TO ANY PARTICULAR FONT, STYLE, SIZE, OR COLOR.

FOR: FURNITURE, IN CLASS 20 (U.S. CLS. 2, 13, 22, 25, 32 AND 50).

SER. NO. 77-486,548, FILED 5-29-2008.

FIRST USE 1-1-2007; IN COMMERCE 2-1-2007.

EUGENIA MARTIN, EXAMINING ATTORNEY

**Int. Cl.: 39**

**Prior U.S. Cls.: 100 and 105**

**United States Patent and Trademark Office**

**Reg. No. 3,569,471**

**Registered Feb. 3, 2009**

**SERVICE MARK  
PRINCIPAL REGISTER**



CRYOPORT SYSTEMS, INC. (NEVADA CORPORATION)  
20382 BARENTS SEA CIRCLE  
LAKE FOREST, CA 92630

FOR: TRANSPORTATION BY TRUCK, TRAIN OR AIR OF TEMPERATURE SENSITIVE MATERIALS IN THE NATURE OF LIVE CELL BIOLOGICALS AND OTHER FROZEN BIOLOGICAL MATERIAL, IN CLASS 39 (U.S. CLS. 100 AND 105).

FIRST USE 11-0-2006; IN COMMERCE 7-0-2007.

NO CLAIM IS MADE TO THE EXCLUSIVE RIGHT TO USE "EXPRESS", APART FROM THE MARK AS SHOWN.

THE MARK CONSISTS OF A RENDERING OF THE WORDS "CRYOPORT EXPRESS" WITH A RECIRCULATING DOUBLE ARROW PASSING THE THE LETTER "X" IN THE WORD "EXPRESS".

SER. NO. 77-486,673, FILED 5-29-2008.

TIMOTHY FINNEGAN, EXAMINING ATTORNEY

**Int. Cl.: 35**

**Prior U.S. Cls.: 100, 101 and 102**

**United States Patent and Trademark Office**

**Reg. No. 3,569,472**

**Registered Feb. 3, 2009**

**SERVICE MARK  
PRINCIPAL REGISTER**

**POSHTOTS**

POSHTOTS, INC. (COLORADO CORPORATION)  
717 17TH STREET, SUITE 1300  
DENVER, CO 80202

FOR: ONLINE AND CATALOG RETAIL STORE  
SERVICES FEATURING A FULL LINE OF CHILDREN'S  
FURNITURE, CLOTHING, BEDDING, DECOR,  
AND TOYS, IN CLASS 35 (U.S. CLS. 100,  
101 AND 102).

FIRST USE 10-18-2000; IN COMMERCE 10-18-2000.

THE MARK CONSISTS OF STANDARD CHARACTERS  
WITHOUT CLAIM TO ANY PARTICULAR FONT,  
STYLE, SIZE, OR COLOR.

OWNER OF U.S. REG. NO. 3,092,160.

SER. NO. 77-486,738, FILED 5-29-2008.

DOMINICK J. SALEMI, EXAMINING ATTORNEY

**Int. Cl.: 41**

**Prior U.S. Cls.: 100, 101 and 107**

**United States Patent and Trademark Office**

**Reg. No. 3,569,473**

**Registered Feb. 3, 2009**

**SERVICE MARK  
PRINCIPAL REGISTER**



BAYERISCHE MOTOREN WERKE AG (FED REP  
GERMANY CORPORATION)

DEPT. AJ-35

PETUELRING 130

MUNICH, FED REP GERMANY 80788

FOR: DRIVER TRAINING SERVICES, NAMELY,  
HIGH PERFORMANCE DRIVER TRAINING, AD-  
VANCED AUTOMOBILE DRIVER TRAINING, VE-  
HICLE HANDLING INSTRUCTION, EDUCATION  
AND INSTRUCTION REGARDING VEHICLES

AND DRIVING OF VEHICLES, IN CLASS 41 (U.S.  
CLS. 100, 101 AND 107).

FIRST USE 1-1-2000; IN COMMERCE 1-1-2000.

THE MARK CONSISTS OF 3 STRIPES AND THE  
LETTER M.

SER. NO. 77-486,870, FILED S.R. 5-30-2008 AM. P.R.  
8-29-2008.

JANICE KIM, EXAMINING ATTORNEY

**Int. Cl.: 3**

**Prior U.S. Cls.: 1, 4, 6, 50, 51 and 52**

**Reg. No. 3,569,474**

**United States Patent and Trademark Office**

**Registered Feb. 3, 2009**

**TRADEMARK  
PRINCIPAL REGISTER**

**Armour**

ARMOUR BEAUTY (CALIFORNIA PARTNER-SHIP)

#C-1

663 PRESIDENT STREET  
BROOKLYN, NY 11215

FOR: COSMETICS, NAMELY, LIP GLOSS, LIP-STICK, LIP BALM, EYELINER, MASCARA, IN CLASS 3 (U.S. CLS. 1, 4, 6, 50, 51 AND 52).

FIRST USE 1-12-2007; IN COMMERCE 3-3-2008.

THE MARK CONSISTS OF STANDARD CHARACTERS WITHOUT CLAIM TO ANY PARTICULAR FONT, STYLE, SIZE, OR COLOR.

THE FOREIGN WORDING IN THE MARK TRANSLATES INTO ENGLISH AS ARMOR.

SER. NO. 77-487,023, FILED 5-30-2008.

JOHN SCHUYLER YARD, EXAMINING ATTORNEY

**Int. Cl.: 31**

**Prior U.S. Cls.: 1 and 46**

**United States Patent and Trademark Office**

**Reg. No. 3,569,475**

**Registered Feb. 3, 2009**

**TRADEMARK  
PRINCIPAL REGISTER**

**SIERRA APRICOT**

CAMELOT NURSERIES, INC. (ARIZONA CORPORATION), DBA MOUNTAIN STATES WHOLESALE NURSERY

PO BOX 2500

LITCHFIELD PARK, AZ 85340

FOR: LIVE SHRUBS, IN CLASS 31 (U.S. CLS. 1 AND 46).

FIRST USE 1-2-2008; IN COMMERCE 1-2-2008.

THE MARK CONSISTS OF STANDARD CHARACTERS WITHOUT CLAIM TO ANY PARTICULAR FONT, STYLE, SIZE, OR COLOR.

NO CLAIM IS MADE TO THE EXCLUSIVE RIGHT TO USE "APRICOT", APART FROM THE MARK AS SHOWN.

SER. NO. 77-487,328, FILED 5-30-2008.

HEATHER SAPP, EXAMINING ATTORNEY

Prior U.S. Cl.: 200

United States Patent and Trademark Office

Reg. No. 3,569,476

Registered Feb. 3, 2009

COLLECTIVE MEMBERSHIP  
PRINCIPAL REGISTER

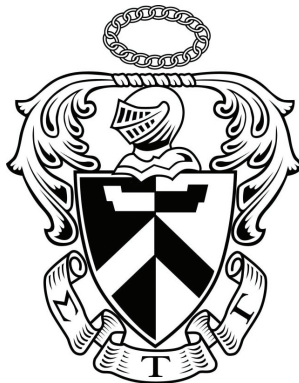

SIGMA TAU GAMMA FRATERNITY, INC. (MISSOURI NON-PROFIT CORPORATION)  
101 MING STREET, P.O. BOX 54  
WARRENSBURG, MO 640930054

FOR: INDICATING MEMBERSHIP IN A NATIONAL COLLEGIATE FRATERNAL SOCIETY ORGANIZED TO FURTHER THE CULTURAL, SOCIAL AND EDUCATIONAL IDEALS OF MEMBERS, IN CLASS 200 (U.S. CL. 200).

FIRST USE 4-0-1927; IN COMMERCE 4-0-1927.

THE MARK CONSISTS OF A SHIELD HAVING AN INVERTED CHEVRON, THE LEFT SIDE OF THE SHIELD BEING DARK, THE RIGHT SIDE OF THE SHIELD BEING LIGHT IN COLOR, THE LEFT SIDE OF THE CHEVRON BEING LIGHT IN COLOR

AND THE RIGHT SIDE OF THE CHEVRON BEING DARK, A SCROLL LOCATED ABOVE THE INVERTED CHEVRON, A HELMET LOCATED ATOP THE SHIELD, A FIGURATIVE DESIGN OF LEAVES EXTENDING FROM THE TOP OF THE HELMET DOWNWARDLY TO EACH THE UPPER LEFT AND RIGHT CORNERS OF THE SHIELD, A CHAIN ARRANGED IN AN OVAL SHAPE POSITIONED ABOVE THE HELMET, AND A BANNER EXTENDING BELOW THE BOTTOM TIP OF THE SHIELD BEARING THE GREEK LETTERS SIGMA TAU GAMMA THEREON.

SER. NO. 77-487,548, FILED 5-30-2008.

SUE LAWRENCE, EXAMINING ATTORNEY

**Int. Cl.: 44**

**Prior U.S. Cls.: 100 and 101**

**United States Patent and Trademark Office**

**Reg. No. 3,569,477**

**Registered Feb. 3, 2009**

**SERVICE MARK  
PRINCIPAL REGISTER**

**MASSAGEMAXX**

MASSAGE MAX LLC (TEXAS LIMITED LIABILITY COMPANY), DBA MASSAGE MAXX  
6410 HARBOURSIDE LN  
MISSOURI CITY, TX 77459

FOR: DAY SPA SERVICES, NAMELY, NAIL CARE, MANICURES, PEDICURES AND NAIL ENHANCEMENTS; HEALTH SPA SERVICES FOR HEALTH AND WELLNESS OF THE BODY AND SPIRIT OFFERED AT A HEALTH RESORT; MAKING RESERVATIONS AND BOOKINGS FOR OTHERS AT BEAUTY SALONS; MAKING RESERVATIONS AND BOOKINGS FOR OTHERS FOR PHYSICAL AND BEAUTY TREATMENTS AT

HEALTH SPAS; MASSAGE, IN CLASS 44 (U.S. CLS. 100 AND 101).

FIRST USE 5-15-2008; IN COMMERCE 5-20-2008.

THE MARK CONSISTS OF STANDARD CHARACTERS WITHOUT CLAIM TO ANY PARTICULAR FONT, STYLE, SIZE, OR COLOR.

SER. NO. 77-488,016, FILED 5-31-2008.

DOMINIC J. FERRAIUOLO, EXAMINING ATTORNEY



**Int. Cl.: 37**

**Prior U.S. Cls.: 100, 103 and 106**

**United States Patent and Trademark Office**

**Reg. No. 3,569,478**

**Registered Feb. 3, 2009**

**SERVICE MARK  
PRINCIPAL REGISTER**

**BASEMENT LIVING SYSTEMS BY  
CHAMPION**

CHAMPION WINDOW MANUFACTURING AND  
SUPPLY CO. LLC (DELAWARE LIMITED LIA-  
BILITY COMPANY), DBA CHAMPION WIN-  
DOW MANUFACTURING AND SUPPLY CO.,  
INC.

12121 CHAMPION WAY  
CINCINNATI, OH 45241

FOR: REMODELING OF INTERIOR BASEMENTS  
AND ROOMS , IN CLASS 37 (U.S. CLS. 100, 103 AND  
106).

FIRST USE 6-1-2003; IN COMMERCE 6-1-2003.

THE MARK CONSISTS OF STANDARD CHAR-  
ACTERS WITHOUT CLAIM TO ANY PARTICULAR  
FONT, STYLE, SIZE, OR COLOR.

OWNER OF U.S. REG. NOS. 2,195,330 AND  
2,195,331.

NO CLAIM IS MADE TO THE EXCLUSIVE  
RIGHT TO USE "BASEMENT" AND "SYSTEMS",  
APART FROM THE MARK AS SHOWN.

SER. NO. 77-488,307, FILED 6-2-2008.

MEGHAN REINHART, EXAMINING ATTORNEY

**Int. Cl.: 31**

**Prior U.S. Cls.: 1 and 46**

**United States Patent and Trademark Office**

**Reg. No. 3,569,479**

**Registered Feb. 3, 2009**

**TRADEMARK  
PRINCIPAL REGISTER**

**Gold Seed Co.**

ZUCKERBRAUN, ELIEZER (UNITED STATES  
INDIVIDUAL), DBA GOLD SEED CO.

PO BOX 8209

ASHDOD, ISRAEL 77181

FOR: AGRICULTURAL SEEDS, IN CLASS 31 (U.S.  
CLS. 1 AND 46).

FIRST USE 8-21-2006; IN COMMERCE 11-7-2007.

THE MARK CONSISTS OF STANDARD CHAR-  
ACTERS WITHOUT CLAIM TO ANY PARTICULAR  
FONT, STYLE, SIZE, OR COLOR.

NO CLAIM IS MADE TO THE EXCLUSIVE  
RIGHT TO USE "SEED CO.", APART FROM THE  
MARK AS SHOWN.

SER. NO. 77-488,323, FILED 6-2-2008.

SETH A. RAPPAPORT, EXAMINING ATTORNEY

Int. Cls.: 30 and 35

Prior U.S. Cls.: 46, 100, 101 and 102

United States Patent and Trademark Office

Reg. No. 3,569,480

Registered Feb. 3, 2009

TRADEMARK  
SERVICE MARK  
PRINCIPAL REGISTER



ANNY'S BREAD SHOPPE, INC. (FLORIDA CORPORATION)  
18282 WEST DIXIE HIGHWAY  
NORTH MIAMI, FL 33160

FOR: CHALLAH, BREADS, BROWNIES, COOKIES, CAKES, PASTRIES, EMPANADAS, IN CLASS 30 (U.S. CL. 46).

FIRST USE 9-30-1996; IN COMMERCE 9-30-1996.

FOR: RETAIL BAKERY STORE SERVICES FEATURING CHALLAH, BREADS, BROWNIES, COOKIES, CAKES, PASTRIES, EMPANADAS; WHOLESALE BAKERY SERVICES IN THE FIELD OF CHALLAH, BREADS, BROWNIES, COOKIES, CAKES, PASTRIES, EMPANADAS, IN CLASS 35 (U.S. CLS. 100, 101 AND 102).

FIRST USE 9-30-1996; IN COMMERCE 9-30-1996.

NO CLAIM IS MADE TO THE EXCLUSIVE RIGHT TO USE "BREAD SHOPPE QUALITY SINCE 1996", APART FROM THE MARK AS SHOWN.

THE MARK CONSISTS OF THE WORDS "HAND MADE WITH LOVE" ABOVE A HORIZONTAL CHECKERBOARD PATTERN WITH A DRAWING OF A WOMAN WEARING CHEF'S ATTIRE APPEARING TO THE LEFT, WITH THE NAME "ANNY'S" APPEARING TO THE WOMAN'S RIGHT, AND A HORIZONTAL CHECKERBOARD PATTERN APPEARING BELOW WITH THE WORDS "BREAD SHOPPE" UNDERNEATH AND THE WORDS "QUALITY SINCE 1996" APPEARING BELOW.

SER. NO. 77-488,376, FILED 6-2-2008.

RONALD AIKENS, EXAMINING ATTORNEY

**Int. Cl.: 41**

**Prior U.S. Cls.: 100, 101 and 107**

**United States Patent and Trademark Office**

**Reg. No. 3,569,481**

**Registered Feb. 3, 2009**

**SERVICE MARK  
PRINCIPAL REGISTER**



LEE, YEE-CHING (TAIWAN INDIVIDUAL)  
35-15 167TH STREET  
FLUSHING, NY 11375

THE COLOR(S) WHITE, GREEN AND PINK IS/  
ARE CLAIMED AS A FEATURE OF THE MARK.

FOR: EDUCATIONAL SERVICES, NAMELY,  
CONDUCTING COURSES, SEMINARS, CONFER-  
ENCES, AND WORKSHOPS IN THE FIELD OF  
PERSONAL DEVELOPMENT AND CORPORATE  
TRAINING, AND DISTRIBUTING COURSE MATE-  
RIALS THEREWITH, IN CLASS 41 (U.S. CLS. 100, 101  
AND 107).

THE MARK CONSISTS OF LITERAL ELEMENT  
"BREATH OF CHANGE" IN WHITE TO THE RIGHT  
OF A GREEN LEAF AND ABOVE A PINK FLOWER,  
ALL ON A GREEN BACKGROUND.

SER. NO. 77-488,483, FILED 6-2-2008.

FIRST USE 6-15-2006; IN COMMERCE 6-15-2006.

ANGELA GAW, EXAMINING ATTORNEY

**Int. Cl.: 9**

**Prior U.S. Cls.: 21, 23, 26, 36 and 38**

**Reg. No. 3,569,482**

**United States Patent and Trademark Office**

**Registered Feb. 3, 2009**

**TRADEMARK  
PRINCIPAL REGISTER**

**Action Language Learning**

ACTION LANGUAGE LEARNING (WISCONSIN  
SOLE PROPRIETORSHIP)  
APARTMENT 3  
3211 STEVENS STREET  
MADISON, WI 53705

FOR: CHILDREN'S EDUCATIONAL MUSIC CDS  
AND DVDS DESIGNED FOR LEARNING LANGUA-  
GES THROUGH SONGS, IN CLASS 9 (U.S. CLS. 21,  
23, 26, 36 AND 38).

FIRST USE 8-1-2002; IN COMMERCE 8-1-2002.

THE MARK CONSISTS OF STANDARD CHAR-  
ACTERS WITHOUT CLAIM TO ANY PARTICULAR  
FONT, STYLE, SIZE, OR COLOR.

NO CLAIM IS MADE TO THE EXCLUSIVE  
RIGHT TO USE "LANGUAGE LEARNING", APART  
FROM THE MARK AS SHOWN.

SER. NO. 77-488,507, FILED 6-2-2008.

RUSS HERMAN, EXAMINING ATTORNEY

Int. Cl.: 41

Prior U.S. Cls.: 100, 101 and 107

United States Patent and Trademark Office

Reg. No. 3,569,483

Registered Feb. 3, 2009

SERVICE MARK  
PRINCIPAL REGISTER



LEARNING INSIGHTS, INC. (MISSOURI CORPORATION)  
11560 FLETCHER LANE  
HOLTS SUMMIT, MO 65043

FOR: CONSULTATION IN THE FIELD OF K-12 EDUCATIONAL SYSTEMS; DEVELOPING EDUCATIONAL MANUALS FOR OTHERS IN THE FIELD OF VISION IMPROVEMENT; EDUCATION SERVICES IN THE NATURE OF EARLY CHILDHOOD INSTRUCTION; EDUCATION SERVICES, NAMELY, PROVIDING MENTORING, TUTORING, CLASSES, SEMINARS AND WORKSHOPS IN THE FIELD OF VISION IMPROVEMENT; EDUCATION SERVICES, NAMELY, PROVIDING TUTORING IN THE FIELD OF VISION IMPROVEMENT; EDUCATION SERVICES, NAMELY, PROVIDING TUTORING IN THE FIELDS OF COOPERATIVE LEARNING; EDUCATION SERVICES, NAMELY, PROVIDING TRAINING AND CERTIFICATION IN THE FIELD OF VISION AND VISION IMPROVEMENT K - 3; EDUCATION SERVICES, NAMELY, PROVIDING TRAINING AND CERTIFICATION IN THE FIELDS OF VISION AND VISION IMPROVEMENT PRE-SCHOOL; EDUCATIONAL SERVICES, NAMELY, CONDUCTING CERTIFICATION TRAINING AND RECERTIFICATION IN THE FIELD OF VISION SCREENING AND VISION TUTORING AND DISTRIBUTION OF COURSE MATERIAL IN CONNEC-

TION THEREWITH; EDUCATIONAL SERVICES, NAMELY, DEVELOPING, ARRANGING, AND CONDUCTING EDUCATIONAL CONFERENCES AND PROGRAMS AND PROVIDING COURSES OF INSTRUCTION IN THE FIELD OF VISION, IN CLASS 41 (U.S. CLS. 100, 101 AND 107).

FIRST USE 2-28-2008; IN COMMERCE 2-28-2008.

NO CLAIM IS MADE TO THE EXCLUSIVE RIGHT TO USE "LEARNING", APART FROM THE MARK AS SHOWN.

THE COLOR(S) GREEN, YELLOW, AND WHITE IS/ARE CLAIMED AS A FEATURE OF THE MARK.

THE MARK CONSISTS OF STYLIZED WORDING "LEARNING INSIGHTS" IN GREEN, PRECEDED BY A STYLIZED FIGURE OF A PERSON IN GREEN HOLDING A LIGHT BULB; THE LIGHT BULB IS OUTLINED IN GREEN WITH YELLOW IN THE INTERIOR AND WHITE IN THE INTERIOR.

SER. NO. 77-488,905, FILED 6-2-2008.

MARY ROSSMAN, EXAMINING ATTORNEY

**Int. Cl.: 9**

**Prior U.S. Cls.: 21, 23, 26, 36 and 38**

**United States Patent and Trademark Office**

**Reg. No. 3,569,484**

**Registered Feb. 3, 2009**

**TRADEMARK  
PRINCIPAL REGISTER**



METRA ELECTRONICS CORPORATION (FLORIDA CORPORATION)  
460 WALKER STREET  
HOLLY HILL, FL 321172699

FOR: BATTERIES FOR AUTOMOTIVE APPLICATIONS, IN CLASS 9 (U.S. CLS. 21, 23, 26, 36 AND 38).

FIRST USE 7-15-2008; IN COMMERCE 7-15-2008.

NO CLAIM IS MADE TO THE EXCLUSIVE RIGHT TO USE "HIGH PERFORMANCE BATTERIES", APART FROM THE MARK AS SHOWN.

THE COLOR(S) ORANGE IS/ARE CLAIMED AS A FEATURE OF THE MARK.

THE MARK CONSISTS OF THE WORDS "SHURIKEN HIGH PERFORMANCE BATTERIES" IN ORANGE WITH A THROWING STAR GRAPHIC ABOVE THE "U".

THE FOREIGN WORDING IN THE MARK TRANSLATES INTO ENGLISH AS THROWING STARS.

SER. NO. 77-489,079, FILED 6-2-2008.

C. DIONNE CLYBURN, EXAMINING ATTORNEY

**Int. Cl.: 9**

**Prior U.S. Cls.: 21, 23, 26, 36 and 38**

**Reg. No. 3,569,485**

**United States Patent and Trademark Office**

**Registered Feb. 3, 2009**

**TRADEMARK  
PRINCIPAL REGISTER**



METRA ELECTRONICS CORPORATION (FLORIDA CORPORATION)  
460 WALKER STREET  
HOLLY HILL, FL 321172699

FOR: BATTERIES FOR AUTOMOTIVE APPLICATIONS, IN CLASS 9 (U.S. CLS. 21, 23, 26, 36 AND 38).

FIRST USE 7-15-2008; IN COMMERCE 7-15-2008.

THE COLOR(S) RED, GOLD, LIGHT GREY AND DARK GREY IS/ARE CLAIMED AS A FEATURE OF THE MARK.

THE MARK CONSISTS OF A CROUCHING, LIGHT GREY HUMAN FIGURE, DRESSED IN DARK GREY BODY SUIT, GLOVES AND LEFT ARM BAND, HOLDING A LIGHT AND DARK

GREY SWORD WITH GOLD HANDLE AND GUARD, WITH RED THROWING STAR GRAPHICS ON HIS MASK AND CHEST AND A LIGHT GREY RIBBON OVER HIS RIGHT SHOULDER MARKED WITH DARK GREY JAPANESE CHARACTERS.

THE ENGLISH TRANSLATION OF THE WORD SHURIKEN IN THE MARK IS THROWING STAR.

THE NON-LATIN CHARACTER(S) IN THE MARK TRANSLITERATE INTO SHURIKEN, AND THIS MEANS THROWING STARS IN ENGLISH.

SER. NO. 77-489,103, FILED 6-2-2008.

C. DIONNE CLYBURN, EXAMINING ATTORNEY



**Int. Cl.: 7**

**Prior U.S. Cls.: 13, 19, 21, 23, 31, 34 and 35**

**United States Patent and Trademark Office**

**Reg. No. 3,569,486**

**Registered Feb. 3, 2009**

**TRADEMARK  
PRINCIPAL REGISTER**

**DIXIE CHOPPER The  
World's Fastest Lawn Mower**

MAGIC CIRCLE CORPORATION (INDIANA  
CORPORATION)  
6302 E COUNTY RD 100 N  
COATESVILLE, IN 46121

FOR: LAWN MOWERS, IN CLASS 7 (U.S. CLS. 13,  
19, 21, 23, 31, 34 AND 35).

FIRST USE 4-1-2008; IN COMMERCE 4-1-2008.

THE MARK CONSISTS OF STANDARD CHAR-  
ACTERS WITHOUT CLAIM TO ANY PARTICULAR  
FONT, STYLE, SIZE, OR COLOR.

OWNER OF U.S. REG. NOS. 1,616,421, 1,619,440,  
AND 3,316,039.

NO CLAIM IS MADE TO THE EXCLUSIVE  
RIGHT TO USE "THE WORLD'S FASTEST LAWN  
MOWER", APART FROM THE MARK AS SHOWN.

SER. NO. 77-489,444, FILED 6-3-2008.

APRIL ROACH, EXAMINING ATTORNEY

**Int. Cl.: 7**

**Prior U.S. Cls.: 13, 19, 21, 23, 31, 34 and 35**

**Reg. No. 3,569,487**

**United States Patent and Trademark Office**

**Registered Feb. 3, 2009**

**TRADEMARK  
PRINCIPAL REGISTER**

**KENTWOOD**

STILES MACHINERY, INC. (MICHIGAN CORPORATION)  
3965 - 44TH STREET SE  
GRAND RAPIDS, MI 49512

FOR: MACHINE TOOLS, NAMELY, MOULDERS, GRINDERS, AND RIP SAWS, IN CLASS 7 (U.S. CLS. 13, 19, 21, 23, 31, 34 AND 35).

FIRST USE 8-23-2006; IN COMMERCE 8-23-2006.

THE MARK CONSISTS OF THE STYLIZED WORD "KENTWOOD" WITH STYLIZED LETTER "E" AND INTERCONNECTED LETTERS "T" AND "W".

SER. NO. 77-489,450, FILED 6-3-2008.

STEPHEN AQUILA, EXAMINING ATTORNEY

**Int. Cl.: 9**

**Prior U.S. Cls.: 21, 23, 26, 36 and 38**

**Reg. No. 3,569,488**

**United States Patent and Trademark Office**

**Registered Feb. 3, 2009**

**TRADEMARK  
PRINCIPAL REGISTER**

# THE 7 HABITS

FRANKLIN COVEY CO. (UTAH CORPORATION)  
2200 WEST PARKWAY BLVD. MS 0213  
SALT LAKE CITY, UT 84119

FOR: PRE-RECORDED ELECTRONIC MEDIA  
FEATURING INFORMATION AND SELF-PACED  
TRAINING PROGRAMS IN THE FIELDS OF AGEN-  
DA AND TIME MANAGEMENT, LEADERSHIP,  
MANAGEMENT, EDUCATION, SALES, COMMU-  
NICATION, CORPORATE AND PERSONAL AS-  
SESSMENT AND MEASUREMENT, AND  
PROFESSIONAL AND PERSONAL DEVELOP-  
MENT, IN CLASS 9 (U.S. CLS. 21, 23, 26, 36 AND 38).

FIRST USE 9-18-1997; IN COMMERCE 9-18-1997.

THE MARK CONSISTS OF STANDARD CHAR-  
ACTERS WITHOUT CLAIM TO ANY PARTICULAR  
FONT, STYLE, SIZE, OR COLOR.

OWNER OF U.S. REG. NOS. 2,208,058, 3,084,533  
AND OTHERS.

SER. NO. 77-489,648, FILED 6-3-2008.

DAVID ELTON, EXAMINING ATTORNEY

**Int. Cl.: 35**

**Prior U.S. Cls.: 100, 101 and 102**

**United States Patent and Trademark Office**

**Reg. No. 3,569,489**

**Registered Feb. 3, 2009**

**SERVICE MARK  
PRINCIPAL REGISTER**

**BounceMyListing.com**

BOUNCE MY LISTING, LLC (NEBRASKA LIMITED LIABILITY COMPANY)  
3704 SOUTH 202ND STREET  
OMAHA, NE 68130

THE MARK CONSISTS OF STANDARD CHARACTERS WITHOUT CLAIM TO ANY PARTICULAR FONT, STYLE, SIZE, OR COLOR.

FOR: MATCHING CONSUMERS WITH REAL ESTATE PROFESSIONALS IN THE FIELD OF REAL ESTATE SERVICES VIA COMPUTER NETWORK, IN CLASS 35 (U.S. CLS. 100, 101 AND 102).

SER. NO. 77-489,706, FILED 6-3-2008.

FIRST USE 3-18-2008; IN COMMERCE 5-16-2008.

ZHALEH DELANEY, EXAMINING ATTORNEY

**Int. Cl.: 16**

**Prior U.S. Cls.: 2, 5, 22, 23, 29, 37, 38 and 50**

**Reg. No. 3,569,490**

**United States Patent and Trademark Office**

**Registered Feb. 3, 2009**

**TRADEMARK  
PRINCIPAL REGISTER**

# THE 7 HABITS

FRANKLIN COVEY CO. (UTAH CORPORATION)  
2200 WEST PARKWAY BLVD. MS 0213  
SALT LAKE CITY, UT 84119

FOR: PRINTED MATERIALS, NAMELY, MANUALS, REFERENCE GUIDES AND PAMPHLETS IN THE FIELDS OF AGENDA AND TIME MANAGEMENT, LEADERSHIP, MANAGEMENT, EDUCATION, SALES, COMMUNICATION, CORPORATE AND PERSONAL ASSESSMENT AND MEASUREMENT, AND PROFESSIONAL AND PERSONAL DEVELOPMENT, IN CLASS 16 (U.S. CLS. 2, 5, 22, 23, 29, 37, 38 AND 50).

FIRST USE 9-18-1997; IN COMMERCE 9-18-1997.

THE MARK CONSISTS OF STANDARD CHARACTERS WITHOUT CLAIM TO ANY PARTICULAR FONT, STYLE, SIZE, OR COLOR.

OWNER OF U.S. REG. NOS. 2,208,058, 3,084,533 AND OTHERS.

SER. NO. 77-489,709, FILED 6-3-2008.

DAVID ELTON, EXAMINING ATTORNEY

**Int. Cl.: 41**

**Prior U.S. Cls.: 100, 101 and 107**

**United States Patent and Trademark Office**

**Reg. No. 3,569,491**

**Registered Feb. 3, 2009**

**SERVICE MARK  
PRINCIPAL REGISTER**

# THE 7 HABITS

FRANKLIN COVEY CO. (UTAH CORPORATION)  
2200 WEST PARKWAY BLVD. MS 0213  
SALT LAKE CITY, UT 84119

FOR: EDUCATIONAL SERVICES, NAMELY, CONDUCTING SEMINARS, WORKSHOPS, LECTURES AND CLASSES IN THE FIELDS OF AGENDA AND TIME MANAGEMENT, LEADERSHIP, MANAGEMENT, EDUCATION, SALES, COMMUNICATION, CORPORATE AND PERSONAL ASSESSMENT AND MEASUREMENT, AND PROFESSIONAL AND PERSONAL DEVELOPMENT, AND DISTRIBUTION OF COURSE MATERIALS IN CONNECTION THEREWITH, IN CLASS 41 (U.S. CLS. 100, 101 AND 107).

FIRST USE 1-1-1992; IN COMMERCE 1-1-1992.

THE MARK CONSISTS OF STANDARD CHARACTERS WITHOUT CLAIM TO ANY PARTICULAR FONT, STYLE, SIZE, OR COLOR.

OWNER OF U.S. REG. NOS. 2,208,058, 3,084,533 AND OTHERS.

SER. NO. 77-489,737, FILED 6-3-2008.

DAVID ELTON, EXAMINING ATTORNEY

**Int. Cl.: 3**

**Prior U.S. Cls.: 1, 4, 6, 50, 51 and 52**

**United States Patent and Trademark Office**

**Reg. No. 3,569,492**

**Registered Feb. 3, 2009**

**TRADEMARK  
PRINCIPAL REGISTER**

**CHAPARRAL**

VILLA, ROXANA (CALIFORNIA SOLE PROPRIETORSHIP), DBA ROXANA ILLUMINATED PERFUME  
P.O. BOX 884  
WOODLAND HILLS, CA 91365

THE MARK CONSISTS OF STANDARD CHARACTERS WITHOUT CLAIM TO ANY PARTICULAR FONT, STYLE, SIZE, OR COLOR.

FOR: PERFUME, IN CLASS 3 (U.S. CLS. 1, 4, 6, 50, 51 AND 52).

SER. NO. 77-489,933, FILED 6-3-2008.

FIRST USE 9-27-2006; IN COMMERCE 10-25-2006.

MAUREEN DALL, EXAMINING ATTORNEY

**Int. Cl.: 35**

**Prior U.S. Cls.: 100, 101 and 102**

**United States Patent and Trademark Office**

**Reg. No. 3,569,493**

**Registered Feb. 3, 2009**

**SERVICE MARK  
PRINCIPAL REGISTER**

**KARDWELL**

KARDWELL INTERNATIONAL, INC. (NEW  
YORK CORPORATION)  
P.O. BOX 33  
MATTITUCK, NY 11952

FOR: RETAIL MAIL ORDER SERVICES, ONLINE  
ORDERING AND ONLINE RETAIL STORE SERVI-  
CES, MAIL ORDER, PHONE ORDER AND ONLINE  
CATALOG SERVICES ALL FEATURING CASINO  
AND GAMING SUPPLIES AND EQUIPMENT,  
MONEY HANDLING SUPPLIES AND EQUIPMENT,  
BAR, NIGHTCLUB AND RESTAURANT SUPPLIES  
AND PROMOTIONAL ITEMS, DECORATIONS  
AND PARTY SUPPLIES AND CUSTOM PRINTED  
GAMING SUPPLIES AND PROMOTIONAL ITEMS;  
ELECTRONIC COMMERCE SERVICES, NAMELY,

PROVIDING INFORMATION ABOUT PRODUCTS  
VIA AN ONLINE COMPUTER NETWORK FOR  
ADVERTISING AND SALES PURPOSES, IN CLASS  
35 (U.S. CLS. 100, 101 AND 102).

FIRST USE 10-0-1985; IN COMMERCE 10-0-1985.

THE MARK CONSISTS OF STANDARD CHAR-  
ACTERS WITHOUT CLAIM TO ANY PARTICULAR  
FONT, STYLE, SIZE, OR COLOR.

SER. NO. 77-489,971, FILED 6-3-2008.

NORA BUCHANAN WILL, EXAMINING ATTOR-  
NEY



**Int. Cl.: 30**

**Prior U.S. Cl.: 46**

**United States Patent and Trademark Office**

**Reg. No. 3,569,494**

**Registered Feb. 3, 2009**

**TRADEMARK  
PRINCIPAL REGISTER**

**YOU CEREAL**

FED-UP BARS, INC. (CALIFORNIA CORPORATION), DBA YOU BAR

3515 GRIFFITH PARK BLVD.

LOS ANGELES, CA 90027

FOR: BREAKFAST CEREALS, IN CLASS 30 (U.S. CL. 46).

FIRST USE 10-0-2007; IN COMMERCE 4-15-2008.

THE MARK CONSISTS OF STANDARD CHARACTERS WITHOUT CLAIM TO ANY PARTICULAR FONT, STYLE, SIZE, OR COLOR.

NO CLAIM IS MADE TO THE EXCLUSIVE RIGHT TO USE "CEREAL", APART FROM THE MARK AS SHOWN.

SER. NO. 77-490,110, FILED 6-3-2008.

PRISCILLA MILTON, EXAMINING ATTORNEY

**Int. Cls.: 39 and 41**

**Prior U.S. Cls.: 100, 101, 105 and 107**

**United States Patent and Trademark Office**

**Reg. No. 3,569,495**

**Registered Feb. 3, 2009**

**SERVICE MARK  
PRINCIPAL REGISTER**

**MOON MOUNTAIN VINEYARD**

DIAGEO CHATEAU & ESTATE WINES COMPAN-  
NY (CALIFORNIA CORPORATION)  
240 GATEWAY ROAD WEST  
NAPA, CA 94558

FOR: WINE CLUB SERVICES FEATURING PER-  
IODIC SHIPMENTS OF WINE TO MEMBERS; AND  
ARRANGING OF TOURS, IN CLASS 39 (U.S. CLS.  
100 AND 105).

FIRST USE 1-0-2003; IN COMMERCE 1-0-2003.

FOR: EDUCATIONAL AND ENTERTAINMENT  
SERVICES, NAMELY, WINE TASTING AND GUI-  
DED TOURS OF A WINERY; PROVIDING NEWS-  
LETTERS IN THE FIELD OF INFORMATION  
RELATING TO WINES, NAMELY, WINE SELEC-  
TION, WINE LISTS, RELATED RECIPES, PROMO-  
TIONS AND DISCOUNTS, WINE TASTING AND  
TOUR EVENTS, AND WINE CLUB MEMBERSHIP  
EVENTS, VIA EMAIL; AND SOCIAL CLUB SERVI-

CES, NAMELY, ARRANGING, ORGANIZING, AND  
HOSTING SOCIAL EVENTS, GET-TOGETHERS,  
WINERY TOURS AND PARTIES FOR CLUB MEM-  
BERS, IN CLASS 41 (U.S. CLS. 100, 101 AND 107).

FIRST USE 1-0-2003; IN COMMERCE 1-0-2003.

THE MARK CONSISTS OF STANDARD CHAR-  
ACTERS WITHOUT CLAIM TO ANY PARTICULAR  
FONT, STYLE, SIZE, OR COLOR.

OWNER OF U.S. REG. NO. 2,536,209.

NO CLAIM IS MADE TO THE EXCLUSIVE  
RIGHT TO USE "VINEYARD", APART FROM THE  
MARK AS SHOWN.

SER. NO. 77-490,445, FILED 6-4-2008.

VERNA BETH RIRIE, EXAMINING ATTORNEY

Int. Cl.: 16

Prior U.S. Cls.: 2, 5, 22, 23, 29, 37, 38 and 50

United States Patent and Trademark Office

Reg. No. 3,569,496

Registered Feb. 3, 2009

TRADEMARK  
PRINCIPAL REGISTER



LICHTCSIEN, SHARON J. (UNITED STATES INDIVIDUAL)  
1914 ATLANTIC AVENUE  
SANDUSKY, OH 44870

FOR: BOOKLETS IN THE FIELD OF INSPIRATIONAL SAYINGS/QUOTATIONS, IN CLASS 16 (U.S. CLS. 2, 5, 22, 23, 29, 37, 38 AND 50).

FIRST USE 5-16-2008; IN COMMERCE 5-16-2008.

THE COLOR(S) ORANGE, BRIGHT PINK, BRIGHT LIME GREEN, WHITE IS/ARE CLAIMED AS A FEATURE OF THE MARK.

THE MARK CONSISTS OF WHITE HALF CIRCLE WITH FIRST LINE (CHAIN REACTION) AND SECOND LINE (DAILY DOSE OF WISDOM) USING POPYRUS FONT IN BRIGHT PINK COLOR, THE THIRD LINE (A TRAVEL SIZE "TAG" OF INSPIRATION) USES COMIC SANS MS FONT IN ORANGE COLOR, A BORDER OF BRIGHT LIME GREEN IS AROUND THE WHITE HALF CIRCLE FOLLOWED BY A ARCH OF ORANGE WITH AN ARCH OF BRIGHT PINK DOT OVERLAPPING WHERE THE ORANGE AND LIME GREEN MEET.

SER. NO. 77-490,499, FILED 6-4-2008.

EVELYN BRADLEY, EXAMINING ATTORNEY

**Int. Cl.: 32**

**Prior U.S. Cls.: 45, 46 and 48**

**United States Patent and Trademark Office**

**Reg. No. 3,569,497**

**Registered Feb. 3, 2009**

**TRADEMARK  
PRINCIPAL REGISTER**

**HOP CZAR**

COMEBACK BREWING, INC. (TEXAS CORPORATION)

14800 SAN PEDRO, SUITE 310

SAN ANTONIO, TX 78232

FOR: ALE; BEER, IN CLASS 32 (U.S. CLS. 45, 46 AND 48).

FIRST USE 7-23-2008; IN COMMERCE 7-23-2008.

THE MARK CONSISTS OF STANDARD CHARACTERS WITHOUT CLAIM TO ANY PARTICULAR FONT, STYLE, SIZE, OR COLOR.

NO CLAIM IS MADE TO THE EXCLUSIVE RIGHT TO USE "HOP", APART FROM THE MARK AS SHOWN.

SER. NO. 77-490,653, FILED 6-4-2008.

FRANK LATTUCA, EXAMINING ATTORNEY

**Int. Cl.: 1**

**Prior U.S. Cls.: 1, 5, 6, 10, 26 and 46**

**Reg. No. 3,569,498**

**United States Patent and Trademark Office**

**Registered Feb. 3, 2009**

**TRADEMARK  
PRINCIPAL REGISTER**

**Aquabloc**

AQUASOL (NORTH CAROLINA CORPORATION)  
316 COLLEGE ST  
PINEVILLE, NC 28134

THE MARK CONSISTS OF STANDARD CHARACTERS WITHOUT CLAIM TO ANY PARTICULAR FONT, STYLE, SIZE, OR COLOR.

FOR: CHEMICAL ADDITIVES FOR OIL AND GAS WELL DRILLING FLUIDS, IN CLASS 1 (U.S. CLS. 1, 5, 6, 10, 26 AND 46).

SER. NO. 77-490,703, FILED S.R. 6-4-2008 AM. P.R. 9-29-2008.

FIRST USE 1-1-1999; IN COMMERCE 1-1-1999.

JENNIFER DIXON, EXAMINING ATTORNEY

**Int. Cls.: 7 and 11**

**Prior U.S. Cls.: 13, 19, 21, 23, 31, 34 and 35**

**United States Patent and Trademark Office**

**Reg. No. 3,569,499**

**Registered Feb. 3, 2009**

**TRADEMARK  
PRINCIPAL REGISTER**

**DRAIN HERO**

NICELIFE, LLC (NEW JERSEY LIMITED LIABILITY COMPANY)  
P.O. BOX 1661  
BURLINGTON, NJ 08016

FOR: PLUMBING PARTS AND ACCESSORIES, NAMELY, WET/DRY VACUUM ATTACHMENTS, NAMELY, HOSES AND SUCTION AND VACUUM NOZZELS, IN CLASS 7 (U.S. CLS. 13, 19, 21, 23, 31, 34 AND 35).

FIRST USE 3-1-2005; IN COMMERCE 6-1-2006.

FOR: PLUMBING PARTS AND ACCESSORIES, NAMELY, DRAIN FITTINGS, IN CLASS 11 (U.S. CLS. 13, 21, 23, 31 AND 34).

FIRST USE 3-1-2005; IN COMMERCE 6-1-2006.

THE MARK CONSISTS OF STANDARD CHARACTERS WITHOUT CLAIM TO ANY PARTICULAR FONT, STYLE, SIZE, OR COLOR.

NO CLAIM IS MADE TO THE EXCLUSIVE RIGHT TO USE "DRAIN", APART FROM THE MARK AS SHOWN.

SER. NO. 77-490,809, FILED 6-4-2008.

LINDSEY RUBIN, EXAMINING ATTORNEY

**Int. Cl.: 38**

**Prior U.S. Cls.: 100, 101 and 104**

**United States Patent and Trademark Office**

**Reg. No. 3,569,500**

**Registered Feb. 3, 2009**

**SERVICE MARK  
PRINCIPAL REGISTER**

TRUE UNLIMITED NATIONWIDE

CELLULAR SOUTH, INC. (MISSISSIPPI CORPORATION)  
SUITE 300  
1018 HIGHLAND COLONY PARKWAY  
RIDGELAND, MS 39157

FOR: TELEPHONE TELECOMMUNICATIONS SERVICES, NAMELY, WIRELESS MOBILE TELEPHONE SERVICES AND RELATED TEXT MESSAGING, EMAIL AND INTERNET CONNECTION SERVICES, IN CLASS 38 (U.S. CLS. 100, 101 AND 104).

FIRST USE 10-3-2007; IN COMMERCE 10-20-2007.

THE MARK CONSISTS OF STANDARD CHARACTERS WITHOUT CLAIM TO ANY PARTICULAR FONT, STYLE, SIZE, OR COLOR.

NO CLAIM IS MADE TO THE EXCLUSIVE RIGHT TO USE "UNLIMITED NATIONWIDE", APART FROM THE MARK AS SHOWN.

SER. NO. 77-491,044, FILED 6-4-2008.

CHRISTINA SOBRAL, EXAMINING ATTORNEY

Int. Cl.: 28

Prior U.S. Cls.: 22, 23, 38 and 50

Reg. No. 3,569,501

United States Patent and Trademark Office

Registered Feb. 3, 2009

TRADEMARK  
PRINCIPAL REGISTER

The logo for "Strongboard Balance" features the word "STRONGBOARD" in a large, bold, black, sans-serif font. The word "BOARD" is enclosed within a thick black rectangular border. Below this, the word "BALANCE" is written in a smaller, bold, black, sans-serif font, with each letter spaced out evenly.

STRONGHOLD FITNESS, LLC (CALIFORNIA  
LIMITED LIABILITY COMPANY)  
13910 OLD HARBOR LANE #207  
MARINA DEL REY, CA 90292

FOR: EXERCISE EQUIPMENT, NAMELY,  
STANDING DEVICE FOR IMPROVING CORE  
STRENGTH AND BALANCE, IN CLASS 28 (U.S.  
CLS. 22, 23, 38 AND 50).

FIRST USE 6-1-2008; IN COMMERCE 6-1-2008.

NO CLAIM IS MADE TO THE EXCLUSIVE  
RIGHT TO USE "BALANCE", APART FROM THE  
MARK AS SHOWN.

THE MARK CONSISTS OF THE WORD  
"STRONGBOARD" IN BOLD CAPITALIZED LET-  
TERS, WITH THE TERM "BOARD" SURROUNDED  
BY AN INCOMPLETE RECTANGLE; THE WORD  
"BALANCE" IS PLACED DIRECTLY UNDER-  
NEATH THE WORD "STRONGBOARD" AND IS  
WRITTEN IN MUCH SMALLER BOLD, CAPITA-  
LIZED AND EVENLY-SPACED LETTERS THAT  
ARE EQUAL IN LENGTH TO THE WORD  
"STRONGBOARD" ABOVE IT.

SER. NO. 77-491,047, FILED 6-4-2008.

TINA L. SNAPP, EXAMINING ATTORNEY



**Int. Cl.: 19**

**Prior U.S. Cls.: 1, 12, 33 and 50**

**United States Patent and Trademark Office**

**Reg. No. 3,569,502**

**Registered Feb. 3, 2009**

**TRADEMARK  
PRINCIPAL REGISTER**

**BUILDERS ACCESSORIES, INC.**

BUILDERS ACCESSORIES, INC. (ARIZONA CORPORATION)  
3621 E. WIER AVENUE  
PHOENIX, AZ 85040

NO CLAIM IS MADE TO THE EXCLUSIVE RIGHT TO USE "INC.", APART FROM THE MARK AS SHOWN.

FOR: BUILDING MATERIALS, NAMELY, ACRYLIC BLOCK AND GLASS BLOCK WINDOWS, IN CLASS 19 (U.S. CLS. 1, 12, 33 AND 50).

SEC. 2(F).

FIRST USE 2-28-1995; IN COMMERCE 3-15-1995.

SER. NO. 77-491,086, FILED 6-4-2008.

THE MARK CONSISTS OF STANDARD CHARACTERS WITHOUT CLAIM TO ANY PARTICULAR FONT, STYLE, SIZE, OR COLOR.

JEAN IM, EXAMINING ATTORNEY

**Int. Cls.: 16 and 41**

**Prior U.S. Cls.: 2, 5, 22, 23, 29, 37, 38, 50, 100, 101 and 107**

**Reg. No. 3,569,503**

**United States Patent and Trademark Office**

**Registered Feb. 3, 2009**

**TRADEMARK  
SERVICE MARK  
PRINCIPAL REGISTER**



RICCI, CHRISTINA (UNITED STATES INDIVIDUAL)  
128 NE 99TH STREET  
MIAMI SHORES, FL 33138

FOR: SERIES OF BOOKS, PRINTED EDUCATIONAL MATERIALS AND PRINTED PUBLICATIONS IN THE NATURE OF TRAINING MANUALS AND MAGAZINES REGARDING GOLF, GOLF INSTRUCTION, FITNESS AND TRAINING, AND WOMEN'S INTEREST IN GOLF, IN CLASS 16 (U.S. CLS. 2, 5, 22, 23, 29, 37, 38 AND 50).

FIRST USE 3-4-2008; IN COMMERCE 3-4-2008.

FOR: EDUCATIONAL AND ENTERTAINMENT SERVICES, NAMELY, PROVIDING AN INTERACTIVE WEBSITE FEATURING GOLF INSTRUCTION,

FITNESS AND TRAINING METHODS; PROVIDING A WEBSITE FEATURING AUDIO CLIPS, VIDEO CLIPS, PHOTOGRAPHS AND OTHER MULTIMEDIA MATERIALS AND INFORMATION RELATED TO GOLF AND GOLF FITNESS, IN CLASS 41 (U.S. CLS. 100, 101 AND 107).

FIRST USE 3-4-2008; IN COMMERCE 3-4-2008.

THE MARK CONSISTS OF A DESIGN OF A WOMAN SWINGING A GOLF CLUB, ALONG WITH A DESIGN OF TWO PALM TREES AND BUSHES APPEARING BEHIND THE WOMAN.

SER. NO. 77-491,203, FILED 6-4-2008.

BRIAN CALLAGHAN, EXAMINING ATTORNEY

**Int. Cl.: 12**

**Prior U.S. Cls.: 19, 21, 23, 31, 35 and 44**

**Reg. No. 3,569,504**

**United States Patent and Trademark Office**

**Registered Feb. 3, 2009**

**TRADEMARK  
PRINCIPAL REGISTER**

LONGZHONG HOLDING GROUP CO., LTD.  
(CHINA LIMITED LIABILITY COMPANY)  
LINGJIAO, CHENGGUAN  
YUHUAN COUNTY  
ZHEJIANG PROVINCE, CHINA

BICYCLE WHEELS; VEHICLE WHEEL RIMS, IN  
CLASS 12 (U.S. CLS. 19, 21, 23, 31, 35 AND 44).

FIRST USE 1-8-2005; IN COMMERCE 1-8-2005.

FOR: ANTI-SKID CHAINS FOR VEHICLES; AU-  
TOMOBILE CHASSIS; BICYCLE BRAKES; BRAKE  
SEGMENTS FOR MOTOR CARS; BRAKES FOR  
LAND VEHICLES; ENGINES FOR LAND VEHI-  
CLES; INTERNAL COMBUSTION ENGINES FOR  
LAND VEHICLES; MOTORCYCLES; SPOKES FOR

THE MARK CONSISTS OF THE WORD "CNLZ".

SER. NO. 77-491,277, FILED 6-4-2008.

JASON BLAIR, EXAMINING ATTORNEY

**Int. Cl.: 35**

**Prior U.S. Cls.: 100, 101 and 102**

**United States Patent and Trademark Office**

**Reg. No. 3,569,505**

**Registered Feb. 3, 2009**

**SERVICE MARK  
PRINCIPAL REGISTER**

**IBPM**

SCHLUMBERGER TECHNOLOGY CORPORATION (TEXAS CORPORATION)  
5599 SAN FELIPE  
SUITE 100  
HOUSTON, TX 77056

THE MARK CONSISTS OF STANDARD CHARACTERS WITHOUT CLAIM TO ANY PARTICULAR FONT, STYLE, SIZE, OR COLOR.

FOR: BUSINESS CONSULTING IN THE FIELD OF OIL AND GAS EXPLORATION AND PRODUCTION, IN CLASS 35 (U.S. CLS. 100, 101 AND 102).

SER. NO. 77-491,371, FILED 6-5-2008.

FIRST USE 6-19-2007; IN COMMERCE 6-19-2007.

MEGHAN REINHART, EXAMINING ATTORNEY

**Int. Cl.: 16**

**Prior U.S. Cls.: 2, 5, 22, 23, 29, 37, 38 and 50**

**Reg. No. 3,569,506**

**United States Patent and Trademark Office**

**Registered Feb. 3, 2009**

**TRADEMARK  
PRINCIPAL REGISTER**

**ALL INSPIRED ABOUT DES  
MOINES**

INSPIRED MEDIA GROUP, LLC (IOWA LIMITED LIABILITY COMPANY)  
SUITE 1200  
206 SIXTH AVENUE  
DES MOINES, IA 50309

FOR: MAGAZINES FEATURING INFORMATION ABOUT DES MOINES, IOWA, NAMELY, COMMUNITY ACTIVITIES, PEOPLE, HISTORY, CULTURE AND QUALITY OF LIFE , IN CLASS 16 (U.S. CLS. 2, 5, 22, 23, 29, 37, 38 AND 50).

FIRST USE 6-4-2008; IN COMMERCE 6-4-2008.

THE MARK CONSISTS OF STANDARD CHARACTERS WITHOUT CLAIM TO ANY PARTICULAR FONT, STYLE, SIZE, OR COLOR.

NO CLAIM IS MADE TO THE EXCLUSIVE RIGHT TO USE "DES MOINES", APART FROM THE MARK AS SHOWN.

SER. NO. 77-491,428, FILED 6-5-2008.

KRISTIN CARLSON, EXAMINING ATTORNEY

**Int. Cl.: 35**

**Prior U.S. Cls.: 100, 101 and 102**

**United States Patent and Trademark Office**

**Reg. No. 3,569,507**

**Registered Feb. 3, 2009**

**SERVICE MARK  
PRINCIPAL REGISTER**

**WELLNET**

ZANZETA, LLC (TEXAS LIMITED LIABILITY  
COMPANY)  
PO BOX 836761  
RICHARDSON, TX 75080

THE MARK CONSISTS OF STANDARD CHAR-  
ACTERS WITHOUT CLAIM TO ANY PARTICULAR  
FONT, STYLE, SIZE, OR COLOR.

FOR: WEB-BASED BUSINESS INFORMATION  
MANAGEMENT FOR OIL AND GAS COMPANIES,  
IN CLASS 35 (U.S. CLS. 100, 101 AND 102).

SER. NO. 77-491,441, FILED 6-5-2008.

FIRST USE 1-1-2008; IN COMMERCE 1-1-2008.

WILLIAM BRECKENFELD, EXAMINING ATTOR-  
NEY

**Int. Cls.: 39 and 41**

**Prior U.S. Cls.: 100, 101, 105 and 107**

**United States Patent and Trademark Office**

**Reg. No. 3,569,508**

**Registered Feb. 3, 2009**

**SERVICE MARK  
PRINCIPAL REGISTER**

**STARTSMART...THE KEYS TO  
SAFE TEEN DRIVING**

AMERICAN AUTOMOBILE ASSOCIATION, INC.  
(CONNECTICUT CORPORATION)  
1000 AAA DRIVE  
HEATHROW, FL 327465063

FOR: PROVIDING TRAFFIC SAFETY INFORMATION VIA ELECTRONIC NEWSLETTERS, IN CLASS 39 (U.S. CLS. 100 AND 105).

FIRST USE 4-7-2008; IN COMMERCE 4-7-2008.

FOR: PROVIDING DRIVER TRAINING INFORMATION VIA ELECTRONIC NEWSLETTERS, IN CLASS 41 (U.S. CLS. 100, 101 AND 107).

FIRST USE 4-7-2008; IN COMMERCE 4-7-2008.

THE MARK CONSISTS OF STANDARD CHARACTERS WITHOUT CLAIM TO ANY PARTICULAR FONT, STYLE, SIZE, OR COLOR.

OWNER OF U.S. REG. NO. 2,626,663.

SER. NO. 77-491,468, FILED 6-5-2008.

GILBERT SWIFT, EXAMINING ATTORNEY

Int. Cl.: 36

Prior U.S. Cls.: 100, 101 and 102

United States Patent and Trademark Office

Reg. No. 3,569,509

Registered Feb. 3, 2009

SERVICE MARK  
PRINCIPAL REGISTER



IIC,LLC (GEORGIA LIMITED LIABILITY COMPANY)

#2-450

2727 PACES FERRY RD. SE  
ATLANTA, GA 30339

FOR: CONSULTING SERVICES IN THE FIELD OF INSURANCE, IN CLASS 36 (U.S. CLS. 100, 101 AND 102).

FIRST USE 2-1-1986; IN COMMERCE 2-1-1986.

NO CLAIM IS MADE TO THE EXCLUSIVE RIGHT TO USE "INSURANCE INDUSTRY CON-

SULTANTS" AND "LLC", APART FROM THE MARK AS SHOWN.

THE MARK CONSISTS OF A RECTANGULAR BOX WITH THE STYLIZED TEXT "INSURANCE INDUSTRY CONSULTANTS IIC, LLC" LOCATED AT THE BOTTOM. OVERLAYED ACROSS THE TOP PART OF THE RECTANGULAR BOX IS THE STYLIZED TEXT "IIC".

SER. NO. 77-491,542, FILED 6-5-2008.

JOHN WILKE, EXAMINING ATTORNEY



**Int. Cl.: 29**

**Prior U.S. Cl.: 46**

**United States Patent and Trademark Office**

**Reg. No. 3,569,510**

**Registered Feb. 3, 2009**

**TRADEMARK  
PRINCIPAL REGISTER**

**YOU TRAIL MIX**

FED-UP BARS, INC. (CALIFORNIA CORPORATION), DBA YOU BAR  
3515 GRIFFITH PARK BLVD.  
LOS ANGELES, CA 90027

FOR: SNACK MIX CONSISTING PRIMARILY OF PROCESSED FRUITS, PROCESSED NUTS AND/OR RAISINS, IN CLASS 29 (U.S. CL. 46).

FIRST USE 10-0-2007; IN COMMERCE 4-15-2008.

THE MARK CONSISTS OF STANDARD CHARACTERS WITHOUT CLAIM TO ANY PARTICULAR FONT, STYLE, SIZE, OR COLOR.

NO CLAIM IS MADE TO THE EXCLUSIVE RIGHT TO USE "TRAIL MIX", APART FROM THE MARK AS SHOWN.

SER. NO. 77-491,599, FILED 6-5-2008.

PRISCILLA MILTON, EXAMINING ATTORNEY

**Int. Cl.: 30**

**Prior U.S. Cl.: 46**

**United States Patent and Trademark Office**

**Reg. No. 3,569,511**

**Registered Feb. 3, 2009**

**TRADEMARK  
PRINCIPAL REGISTER**

**GioV**

VALLONE, JOHN F. SR. (UNITED STATES INDIVIDUAL)  
63 CRESTMONT RD.  
BINGHAMTON, NY 13905 AND  
VALLONE, LOUISE P (UNITED STATES INDIVIDUAL)  
63 CRESTMONT RD.  
BINGHAMTON, NY 13905

FIRST USE 1-1-2003; IN COMMERCE 1-1-2003.

THE MARK CONSISTS OF STANDARD CHARACTERS WITHOUT CLAIM TO ANY PARTICULAR FONT, STYLE, SIZE, OR COLOR.

SER. NO. 77-491,754, FILED 6-5-2008.

FOR: PASTRIES, IN CLASS 30 (U.S. CL. 46).

TARA PATE, EXAMINING ATTORNEY

**Int. Cl.: 5**

**Prior U.S. Cls.: 6, 18, 44, 46, 51 and 52**

**Reg. No. 3,569,512**

**United States Patent and Trademark Office**

**Registered Feb. 3, 2009**

**TRADEMARK  
PRINCIPAL REGISTER**

# Beyond Chelation

GORDON RESEARCH INSTITUTE, LLC (ARIZONA LIMITED LIABILITY COMPANY)  
600 N. BEELINE HIGHWAY  
PAYSON, AZ 85541

FOR: DIETARY AND NUTRITIONAL SUPPLEMENTS; DIETARY FOOD SUPPLEMENTS; DIETARY SUPPLEMENTS; DIETARY SUPPLEMENTS FOR HUMAN CONSUMPTION; FOOD SUPPLEMENTS; MINERAL FOOD SUPPLEMENTS; MINERAL NUTRITIONAL SUPPLEMENTS; MINERAL SUPPLEMENTS; MIXED VITAMIN PREPARATIONS; MULTI-VITAMIN PREPARATIONS; NUTRACEUTICALS FOR USE AS A DIETARY SUPPLEMENT; NUTRITIONAL SUPPLEMENTS; VITAMIN SUPPLEMENTS, IN CLASS 5 (U.S. CLS. 6, 18, 44, 46, 51 AND 52).

FIRST USE 3-18-1998; IN COMMERCE 3-18-1998.

THE MARK CONSISTS OF STANDARD CHARACTERS WITHOUT CLAIM TO ANY PARTICULAR FONT, STYLE, SIZE, OR COLOR.

NO CLAIM IS MADE TO THE EXCLUSIVE RIGHT TO USE "CHELATION" , APART FROM THE MARK AS SHOWN.

SER. NO. 77-491,866, FILED 6-5-2008.

PAULA MAHONEY, EXAMINING ATTORNEY

**Int. Cl.: 7**

**Prior U.S. Cls.: 13, 19, 21, 23, 31, 34 and 35**

**United States Patent and Trademark Office**

**Reg. No. 3,569,513**

**Registered Feb. 3, 2009**

**TRADEMARK  
PRINCIPAL REGISTER**

**TEMPEST**

AERO ACCESSORIES, INC. (NORTH CAROLINA CORPORATION)  
1240 SPRINGWOOD AVENUE  
GIBSONVILLE, NC 27249

FOR: AIRCRAFT ENGINE PARTS, NAMELY, AIR PUMPS, FUEL PUMPS, CARBURETORS, CHECK VALVE MANIFOLDS, VACUUM SWITCH MANIFOLDS, IGNITION SOURCES, IGNITION WIRES, AIR FILTERS, AND OIL FILTERS, IN CLASS 7 (U.S. CLS. 13, 19, 21, 23, 31, 34 AND 35).

FIRST USE 1-1-2001; IN COMMERCE 1-1-2001.

THE MARK CONSISTS OF STANDARD CHARACTERS WITHOUT CLAIM TO ANY PARTICULAR FONT, STYLE, SIZE, OR COLOR.

SER. NO. 77-491,874, FILED 6-5-2008.

MARIA-VICTORIA SUAREZ, EXAMINING ATTORNEY

Int. Cl.: 21

Prior U.S. Cls.: 2, 13, 23, 29, 30, 33, 40 and 50

United States Patent and Trademark Office

Reg. No. 3,569,514

Registered Feb. 3, 2009

TRADEMARK  
PRINCIPAL REGISTER



ASPECTS, INC. (RHODE ISLAND CORPORATION)  
P.O. BOX 408  
WARREN, RI 02885

FOR: BIRD FEEDERS, IN CLASS 21 (U.S. CLS. 2, 13, 23, 29, 30, 33, 40 AND 50).

FIRST USE 5-15-2008; IN COMMERCE 5-15-2008.

OWNER OF U.S. REG. NOS. 1,159,183 AND 1,598,315.

NO CLAIM IS MADE TO THE EXCLUSIVE RIGHT TO USE "MADE IN THE USA", APART FROM THE MARK AS SHOWN.

THE MARK CONSISTS OF A BIRD IN A NEST HOLDING A FLAG ABOVE THE WORD "ASPECTS" IN AN OVAL AND THE WORDS "MADE IN THE USA" THEREBELOW, ALL WITH IN AN OVAL.

SER. NO. 77-492,078, FILED 6-5-2008.

KARANENDRA S. CHHINA, EXAMINING ATTORNEY

**Int. Cl.: 9**

**Prior U.S. Cls.: 21, 23, 26, 36 and 38**

**United States Patent and Trademark Office**

**Reg. No. 3,569,515**

**Registered Feb. 3, 2009**

**TRADEMARK  
PRINCIPAL REGISTER**

**MICHELE**

FOSSIL, INC. (DELAWARE CORPORATION)  
2280 N. GREENVILLE AVENUE  
RICHARDSON, TX 75082

FOR: SUNGLASSES, IN CLASS 9 (U.S. CLS. 21, 23,  
26, 36 AND 38).

FIRST USE 4-9-2008; IN COMMERCE 4-9-2008.

THE MARK CONSISTS OF STANDARD CHAR-  
ACTERS WITHOUT CLAIM TO ANY PARTICULAR  
FONT, STYLE, SIZE, OR COLOR.

OWNER OF U.S. REG. NOS. 1,812,074, 3,237,434  
AND OTHERS.

SER. NO. 77-492,120, FILED 6-5-2008.

FRANK LATTUCA, EXAMINING ATTORNEY

**Int. Cl.: 9**

**Prior U.S. Cls.: 21, 23, 26, 36 and 38**

**United States Patent and Trademark Office**

**Reg. No. 3,569,516**

**Registered Feb. 3, 2009**

**TRADEMARK  
PRINCIPAL REGISTER**

# Atomic Mail Sender

MEDVEDNIKOV, EVGENY (RUSSIAN FED. INDIVIDUAL)

KV. 69

UL. DREZDENSKAJA 11, KORPUS 2

SAINT - PETERSBURG, RUSSIAN FED. 194017

FOR: COMPUTER PROGRAMMES FOR DOCUMENT MANAGEMENT; COMPUTER PROGRAMS FOR CREATING NEWSLETTERS, MANAGING MAILING LISTS, CREATING AND DISTRIBUTING PERSONALIZED E-MAIL MESSAGES IN BULK; DOWNLOADABLE SOFTWARE FOR CREATING NEWSLETTERS, MANAGING MAILING LISTS, CREATING AND DISTRIBUTING PERSONALIZED E-MAIL MESSAGES IN BULK; SOFTWARE FOR PROCESSING IMAGES, GRAPHICS AND TEXT, IN CLASS 9 (U.S. CLS. 21, 23, 26, 36 AND 38).

FIRST USE 9-3-2001; IN COMMERCE 9-3-2001.

THE MARK CONSISTS OF STANDARD CHARACTERS WITHOUT CLAIM TO ANY PARTICULAR FONT, STYLE, SIZE, OR COLOR.

NO CLAIM IS MADE TO THE EXCLUSIVE RIGHT TO USE "MAIL SENDER" , APART FROM THE MARK AS SHOWN.

SER. NO. 77-492,163, FILED 6-5-2008.

MICHELE SWAIN, EXAMINING ATTORNEY

**Int. Cl.: 3**

**Prior U.S. Cls.: 1, 4, 6, 50, 51 and 52**

**United States Patent and Trademark Office**

**Reg. No. 3,569,517**

**Registered Feb. 3, 2009**

**TRADEMARK  
PRINCIPAL REGISTER**

**SolvAge**

MARKMAN, LEONID (UNITED STATES INDIVIDUAL)  
151 AVE O  
BROOKLYN, NY 11204

FOR: NON MEDICATED SKIN CARE PREPARATIONS FOR THE FACE AND BODY, NAMELY, FACIAL MOISTURIZING CREAMS AND LOTIONS, SERUMS FOR THE FACE AND BODY, FACIAL TONERS, FACIAL SCRUBS, FACIAL CLEANSING GEL, MILK AND LOTION, FACIAL BEAUTY MASKS, ANTI WRINKLE CREAMS, ANTI WRINKLE SKIN PATCHES, SUNSCREENS, FOOT CREAM AND LOTION, BATH AND SHOWER PREPARATIONS, NAMELY, BATH OILS, SHOWER CLEANS-

ING GELS, MOISTURIZING GELS AND OILS, SKIN CREAMS, IN CLASS 3 (U.S. CLS. 1, 4, 6, 50, 51 AND 52).

FIRST USE 9-10-2007; IN COMMERCE 1-15-2008.

THE MARK CONSISTS OF STANDARD CHARACTERS WITHOUT CLAIM TO ANY PARTICULAR FONT, STYLE, SIZE, OR COLOR.

SER. NO. 77-492,348, FILED 6-5-2008.

MARTHA FROMM, EXAMINING ATTORNEY



**Int. Cl.: 5**

**Prior U.S. Cls.: 6, 18, 44, 46, 51 and 52**

**Reg. No. 3,569,518**

**United States Patent and Trademark Office**

**Registered Feb. 3, 2009**

**TRADEMARK  
PRINCIPAL REGISTER**

**YOU SHAKE**

FED-UP BARS, INC. (CALIFORNIA CORPORATION), DBA YOU BAR  
3515 GRIFFITH PARK BLVD.  
LOS ANGELES, CA 90027

FOR: MEAL REPLACEMENT SHAKES; NUTRITIONAL DRINK MIX FOR USE AS A MEAL REPLACEMENT; NUTRITIONAL SUPPLEMENT IN THE NATURE OF A NUTRIENT-DENSE, PROTEIN-BASED DRINK MIX, IN CLASS 5 (U.S. CLS. 6, 18, 44, 46, 51 AND 52).

FIRST USE 10-0-2007; IN COMMERCE 2-15-2008.

THE MARK CONSISTS OF STANDARD CHARACTERS WITHOUT CLAIM TO ANY PARTICULAR FONT, STYLE, SIZE, OR COLOR.

NO CLAIM IS MADE TO THE EXCLUSIVE RIGHT TO USE "SHAKE", APART FROM THE MARK AS SHOWN.

SER. NO. 77-492,446, FILED 6-6-2008.

PRISCILLA MILTON, EXAMINING ATTORNEY

**Int. Cls.: 9 and 41**

**Prior U.S. Cls.: 21, 23, 26, 36, 38, 100, 101 and 107**

**United States Patent and Trademark Office**

**Reg. No. 3,569,519**

**Registered Feb. 3, 2009**

**TRADEMARK  
SERVICE MARK  
PRINCIPAL REGISTER**



COLUMBIA PICTURES INDUSTRIES, INC. (DE-  
LAWARE CORPORATION)  
10202 W. WASHINGTON BLVD.  
CULVER CITY, CA 90232

FOR: MOTION PICTURE FILMS FOR GENERAL  
RELEASE, FEATURING DRAMA, COMEDY, SCI-  
ENCE FICTION AND MUSICAL ENTERTAIN-  
MENT; PRERECORDED VIDEO DISCS AND NON-  
DISC DATA CARRIERS FEATURING MOTION  
PICTURE FILMS IN THE FIELD OF DRAMA,  
COMEDY, SCIENCE FICTION AND MUSICAL EN-  
TERTAINMENT, IN CLASS 9 (U.S. CLS. 21, 23, 26, 36  
AND 38).

FIRST USE 2-26-1999; IN COMMERCE 2-26-1999.

FOR: PRODUCTION OF MOTION PICTURE  
FILMS AND TELEVISION PROGRAMMING, IN  
CLASS 41 (U.S. CLS. 100, 101 AND 107).

FIRST USE 2-26-1999; IN COMMERCE 2-26-1999.

OWNER OF U.S. REG. NOS. 680,821, 826,260, AND  
840,659.

THE MARK CONSISTS OF A STYLIZED "S" WITH  
A DOT IN THE MIDDLE.

SER. NO. 77-492,611, FILED 6-6-2008.

MARTHA SANTOMARTINO, EXAMINING ATTOR-  
NEY

**Int. Cl.: 35**

**Prior U.S. Cls.: 100, 101 and 102**

**United States Patent and Trademark Office**

**Reg. No. 3,569,520**

**Registered Feb. 3, 2009**

**SERVICE MARK  
PRINCIPAL REGISTER**

**qhycc.com**

QUEEN'S HARBOUR YACHT & COUNTRY  
CLUB OWNERS ASSOCIATION, INC. (FLOR-  
IDA CORPORATION)  
238 QUEEN'S HARBOR BLVD.  
JACKSONVILLE, FL 32225

FOR: ASSOCIATION SERVICES, NAMELY, PRO-  
MOTING THE INTERESTS OF HOMEOWNERS  
AND RESIDENTS IN QUEEN'S HARBOUR, IN  
CLASS 35 (U.S. CLS. 100, 101 AND 102).

FIRST USE 10-19-1998; IN COMMERCE 10-19-1998.

THE MARK CONSISTS OF STANDARD CHAR-  
ACTERS WITHOUT CLAIM TO ANY PARTICULAR  
FONT, STYLE, SIZE, OR COLOR.

NO CLAIM IS MADE TO THE EXCLUSIVE  
RIGHT TO USE ".COM", APART FROM THE MARK  
AS SHOWN.

SER. NO. 77-492,923, FILED 6-6-2008.

AMEETA JORDAN, EXAMINING ATTORNEY

**Int. Cl.: 30**

**Prior U.S. Cl.: 46**

**United States Patent and Trademark Office**

**Reg. No. 3,569,521**

**Registered Feb. 3, 2009**

**TRADEMARK  
PRINCIPAL REGISTER**

THE BAGEL THAT WON THE WEST

WESTERN BAGEL BAKING CORPORATION  
(CALIFORNIA CORPORATION)  
7814 SEPULVEDA BLVD.  
VAN NUYS, CA 91405

FOR: MUFFINS; PITA BREAD, IN CLASS 30 (U.S.  
CL. 46).

FIRST USE 7-29-2002; IN COMMERCE 7-29-2002.

THE MARK CONSISTS OF STANDARD CHAR-  
ACTERS WITHOUT CLAIM TO ANY PARTICULAR  
FONT, STYLE, SIZE, OR COLOR.

OWNER OF U.S. REG. NO. 1,686,607.

SER. NO. 77-492,926, FILED 6-6-2008.

NANCY CLARKE, EXAMINING ATTORNEY

**Int. Cl.: 41**

**Prior U.S. Cls.: 100, 101 and 107**

**Reg. No. 3,569,522**

**United States Patent and Trademark Office**

**Registered Feb. 3, 2009**

**SERVICE MARK  
PRINCIPAL REGISTER**



QUEEN'S HARBOUR YACHT & COUNTRY  
CLUB OWNERS ASSOCIATION, INC. (FLOR-  
IDA CORPORATION)  
238 QUEEN'S HARBOR BLVD.  
JACKSONVILLE, FL 32225

FOR: GOLF CLUBS AND COUNTRY CLUBS  
SERVICES, IN CLASS 41 (U.S. CLS. 100, 101 AND 107).

FIRST USE 12-1-1993; IN COMMERCE 12-1-1993.

OWNER OF U.S. REG. NOS. 2,866,528, 3,183,760  
AND OTHERS.

NO CLAIM IS MADE TO THE EXCLUSIVE  
RIGHT TO USE "YACHT AND COUNTRY CLUB",  
APART FROM THE MARK AS SHOWN.

THE MARK CONSISTS OF LAUREL WREATH  
WITH A CROWN ON TOP AND ENCLOSING A LIFE  
BUOY WITH CROSSED ANCHORS ABOVE THE  
WORDS "QUEEN'S HARBOUR YACHT AND  
COUNTRY CLUB".

SER. NO. 77-492,984, FILED 6-6-2008.

AMEETA JORDAN, EXAMINING ATTORNEY

**Int. Cl.: 43**

**Prior U.S. Cls.: 100 and 101**

**United States Patent and Trademark Office**

**Reg. No. 3,569,523**

**Registered Feb. 3, 2009**

**SERVICE MARK  
PRINCIPAL REGISTER**

**MERCURYS COFFEE**

MERCURY MADNESS, INC. (WASHINGTON CORPORATION)

13110 NE 177TH PL. #323

WOODINVILLE, WA 98072

FOR: COFFEE SHOPS, IN CLASS 43 (U.S. CLS. 100 AND 101).

FIRST USE 12-1-1998; IN COMMERCE 12-1-1998.

THE MARK CONSISTS OF STANDARD CHARACTERS WITHOUT CLAIM TO ANY PARTICULAR FONT, STYLE, SIZE, OR COLOR.

NO CLAIM IS MADE TO THE EXCLUSIVE RIGHT TO USE "COFFEE", APART FROM THE MARK AS SHOWN.

SER. NO. 77-493,289, FILED 6-6-2008.

BRIAN CALLAGHAN, EXAMINING ATTORNEY

**Int. Cl.: 41**

**Prior U.S. Cls.: 100, 101 and 107**

**United States Patent and Trademark Office**

**Reg. No. 3,569,524**

**Registered Feb. 3, 2009**

**SERVICE MARK  
PRINCIPAL REGISTER**

# Damn Thirsty

DAMN THIRSTY (WASHINGTON SOLE PROPRIETORSHIP)  
7051 LINCOLN PARK WAY SW, UNIT F  
SEATTLE, WA 98136

FOR: LIFE COACHING SERVICES IN THE FIELD OF PERSONAL DEVELOPMENT; PERSONAL COACHING SERVICES IN THE FIELD OF PERSONAL DEVELOPMENT; PROFESSIONAL COACHING SERVICES IN THE FIELD OF PERSONAL DEVELOPMENT, IN CLASS 41 (U.S. CLS. 100, 101 AND 107).

FIRST USE 9-12-2003; IN COMMERCE 9-12-2003.

THE MARK CONSISTS OF STANDARD CHARACTERS WITHOUT CLAIM TO ANY PARTICULAR FONT, STYLE, SIZE, OR COLOR.

SER. NO. 77-493,594, FILED 6-7-2008.

RUSS HERMAN, EXAMINING ATTORNEY

**Int. Cl.: 25**

**Prior U.S. Cls.: 22 and 39**

**United States Patent and Trademark Office**

**Reg. No. 3,569,525**

**Registered Feb. 3, 2009**

**TRADEMARK  
PRINCIPAL REGISTER**

**PENELOPE WILDBERRY**

O'LEARY, STACY (UNITED STATES INDIVIDUAL)  
2352 MARTINIQUE AVE  
HENDERSON, NV 89044

FOR: CLOTHING AND ACCESSORIES, NAMELY, MEN'S, WOMEN'S, AND CHILDREN'S T-SHIRTS, SWEATPANTS, SWEATSHIRTS, SHORTS, JEANS, PANTS, OVERALLS, SHIRTS, BLOUSES, VESTS, SKIRTS, UNDERWEAR, SLEEPWEAR, COATS, JACKETS, TRACKSUITS, FOOTWEAR, HEADWEAR, NECKWEAR, SWIMWEAR, SKI WEAR, SWEATERS, LEGGINGS, AND BELTS, IN CLASS 25 (U.S. CLS. 22 AND 39).

FIRST USE 1-28-2008; IN COMMERCE 5-13-2008.

THE MARK CONSISTS OF STANDARD CHARACTERS WITHOUT CLAIM TO ANY PARTICULAR FONT, STYLE, SIZE, OR COLOR.

THE NAME "PENELOPE WILDBERRY" DOES NOT IDENTIFY A LIVING INDIVIDUAL.

SER. NO. 77-493,607, FILED 6-7-2008.

RUSS HERMAN, EXAMINING ATTORNEY



**Int. Cl.: 21**

**Prior U.S. Cls.: 2, 13, 23, 29, 30, 33, 40 and 50**

**United States Patent and Trademark Office**

**Reg. No. 3,569,526**

**Registered Feb. 3, 2009**

**TRADEMARK  
PRINCIPAL REGISTER**

**AQUA MOLE**

AQUA MOLE TECHNOLOGIES, INC. (OHIO  
CORPORATION)  
P O BOX 30609  
MIDDLEBURG HEIGHTS, OH 44130

FOR: HOSE NOZZLES FOR PIPE CLEANING  
AND TUBE CLEANING; ACCESSORIES IN THE  
NATURE OF ORIFICE CLEANING PICKS ESPE-  
CIALY ADAPTED FOR USE WITH HOSE NOZ-  
ZLES TO UNCLOG THE NOZZLE OPENINGS, PIPE  
FITTINGS, VALVES, AND HOSES USED TO CON-  
VEY AND CONTROL THE PRESSURIZED FLUIDS  
THAT FLOW TO AND THROUGH THE HOSE  
NOZZLES, IN CLASS 21 (U.S. CLS. 2, 13, 23, 29, 30,  
33, 40 AND 50).

FIRST USE 3-24-1999; IN COMMERCE 8-31-1999.

THE MARK CONSISTS OF STANDARD CHAR-  
ACTERS WITHOUT CLAIM TO ANY PARTICULAR  
FONT, STYLE, SIZE, OR COLOR.

NO CLAIM IS MADE TO THE EXCLUSIVE  
RIGHT TO USE "AQUA", APART FROM THE  
MARK AS SHOWN.

SER. NO. 77-493,671, FILED 6-8-2008.

TOBY BULLOFF, EXAMINING ATTORNEY

**Int. Cl.: 19**

**Prior U.S. Cls.: 1, 12, 33 and 50**

**United States Patent and Trademark Office**

**Reg. No. 3,569,527**

**Registered Feb. 3, 2009**

**TRADEMARK  
PRINCIPAL REGISTER**



AZEK BUILDING PRODUCTS, INC. (DELAWARE CORPORATION)  
801 COREY STREET  
SCRANTON, PA 18505

FOR: BUILDING MATERIALS, NAMELY, POLY-VINYL CHLORIDE BOARDS HAVING A TONGUE AND GROOVE, IN CLASS 19 (U.S. CLS. 1, 12, 33 AND 50).

FIRST USE 4-28-2008; IN COMMERCE 4-28-2008.

OWNER OF U.S. REG. NOS. 2,696,724 AND 3,068,158.

NO CLAIM IS MADE TO THE EXCLUSIVE RIGHT TO USE "PORCH", APART FROM THE MARK AS SHOWN.

THE COLOR(S) DARK BLUE (PANTONE PMS 2945) AND DARK BROWN (PANTONE PMS 4625) IS/ARE CLAIMED AS A FEATURE OF THE MARK.

THE MARK CONSISTS OF THE WORD "AZEK" IN DARK BLUE ABOVE THE WORD "PORCH" IN DARK BROWN AND AN ARROW IN DARK BROWN TO THE RIGHT OF THE WORDS "AZEK" AND "PORCH".

SER. NO. 77-493,961, FILED 6-9-2008.

VIVIAN MICZNIK FIRST, EXAMINING ATTORNEY

**Int. Cl.: 3**

**Prior U.S. Cls.: 1, 4, 6, 50, 51 and 52**

**Reg. No. 3,569,528**

**United States Patent and Trademark Office**

**Registered Feb. 3, 2009**

**TRADEMARK  
PRINCIPAL REGISTER**



CRANO CORP. (NEW JERSEY CORPORATION)  
730 GRAND AVENUE  
RIDGEFIELD, NJ 07657

THE MARK CONSISTS OF THE STYLIZED  
WORDS "ORIGINAL" AND "BADI NATURE" IN A  
STYLIZED DRAWING OF A POSTMARK.

FOR: BODY AND BEAUTY CARE COSMETICS,  
IN CLASS 3 (U.S. CLS. 1, 4, 6, 50, 51 AND 52).

SER. NO. 77-493,972, FILED 6-9-2008.

FIRST USE 4-25-2008; IN COMMERCE 4-25-2008.

NO CLAIM IS MADE TO THE EXCLUSIVE  
RIGHT TO USE "ORIGINAL BODY", APART FROM  
THE MARK AS SHOWN.

VIVIAN MICZNIK FIRST, EXAMINING ATTOR-  
NEY

**Int. Cls.: 3 and 21**

**Prior U.S. Cls.: 1, 2, 4, 6, 13, 23, 29, 30, 33, 40, 50, 51  
and 52**

**Reg. No. 3,569,529**

**United States Patent and Trademark Office**

**Registered Feb. 3, 2009**

**TRADEMARK  
PRINCIPAL REGISTER**



S. C. JOHNSON & SON, INC. (WISCONSIN CORPORATION)  
1525 HOWE STREET  
RACINE, WI 53403

FOR: ALL PURPOSE HOUSEHOLD CLEANER, DISPOSABLE WIPES IMPREGNATED WITH CHEMICALS OR COMPOUNDS FOR HOUSEHOLD USE, IN CLASS 3 (U.S. CLS. 1, 4, 6, 50, 51 AND 52).

FIRST USE 4-5-2007; IN COMMERCE 4-5-2007.

FOR: BRUSH FOR HOUSEHOLD CLEANING; BATTERY OPERATED UNIT SOLD EMPTY FOR

DISPENSING ALL PURPOSE CLEANER, IN CLASS 21 (U.S. CLS. 2, 13, 23, 29, 30, 33, 40 AND 50).

FIRST USE 9-14-2007; IN COMMERCE 9-14-2007.

OWNER OF U.S. REG. NOS. 1,302,352, 2,680,700 AND OTHERS.

THE MARK CONSISTS OF A BUBBLE CHARACTER WITH BUBBLES INSIDE A CIRCLE.

SER. NO. 77-494,140, FILED 6-9-2008.

LESLIE RICHARDS, EXAMINING ATTORNEY

**Int. Cl.: 35**

**Prior U.S. Cls.: 100, 101 and 102**

**United States Patent and Trademark Office**

**Reg. No. 3,569,530**

**Registered Feb. 3, 2009**

**SERVICE MARK  
PRINCIPAL REGISTER**

# VETcentral

DIRECTEMPLOYERS ASSOCIATION, INC. (INDIANA CORPORATION)  
9002 N. PURDUE ROAD - SUITE 100  
INDIANAPOLIS, IN 46268

FOR: PROVIDING AN ON-LINE SEARCHABLE DATABASE FEATURING CLASSIFIED AD LISTINGS AND EMPLOYMENT OPPORTUNITIES; PROVIDING AN ON-LINE SEARCHABLE DATABASE FEATURING EMPLOYMENT OPPORTUNITIES AND CONTENT RELEVANT TO PEOPLE 50 YEARS OF AGE AND OLDER, IN CLASS 35 (U.S. CLS. 100, 101 AND 102).

FIRST USE 12-21-2006; IN COMMERCE 3-1-2007.

THE MARK CONSISTS OF STANDARD CHARACTERS WITHOUT CLAIM TO ANY PARTICULAR FONT, STYLE, SIZE, OR COLOR.

SER. NO. 77-494,191, FILED 6-9-2008.

STEPHEN AQUILA, EXAMINING ATTORNEY

**Int. Cl.: 42**

**Prior U.S. Cls.: 100 and 101**

**United States Patent and Trademark Office**

**Reg. No. 3,569,531**

**Registered Feb. 3, 2009**

**SERVICE MARK  
PRINCIPAL REGISTER**

**RPI BEST PRACTICE STANDARDS**

NATIONAL ASSOCIATION FOR EMPLOYEE RE-  
COGNITION (ILLINOIS NON-PROFIT COR-  
PORATION)  
1601 N. BOND ST., STE. 303  
NAPERVILLE, IL 60563

FOR: SERVICES IN THE NATURE OF ESTAB-  
LISHING AND IMPLEMENTING OBJECTIVE  
STANDARDS BY WHICH TO EVALUATE EMPLOY-  
EE RECOGNITION PROGRAMS OF THIRD PAR-  
TIES, IN CLASS 42 (U.S. CLS. 100 AND 101).

FIRST USE 6-6-2008; IN COMMERCE 6-6-2008.

THE MARK CONSISTS OF STANDARD CHAR-  
ACTERS WITHOUT CLAIM TO ANY PARTICULAR  
FONT, STYLE, SIZE, OR COLOR.

NO CLAIM IS MADE TO THE EXCLUSIVE  
RIGHT TO USE "BEST PRACTICE STANDARDS",  
APART FROM THE MARK AS SHOWN.

SER. NO. 77-494,308, FILED 6-9-2008.

MARK RADEMACHER, EXAMINING ATTORNEY

**Int. Cl.: 28**

**Prior U.S. Cls.: 22, 23, 38 and 50**

**United States Patent and Trademark Office**

**Reg. No. 3,569,532**

**Registered Feb. 3, 2009**

**TRADEMARK  
PRINCIPAL REGISTER**

**EXOTEK RACING**

RYDWELL, MICHAEL (UNITED STATES INDIVIDUAL), DBA EXOTEK RACING  
STE 9-511  
125 OLD GROVE RD  
OCEANSIDE, CA 92057

FOR: RADIO CONTROLLED MODEL VEHICLES,  
IN CLASS 28 (U.S. CLS. 22, 23, 38 AND 50).

FIRST USE 2-1-2007; IN COMMERCE 4-1-2007.

THE MARK CONSISTS OF STANDARD CHARACTERS WITHOUT CLAIM TO ANY PARTICULAR FONT, STYLE, SIZE, OR COLOR.

NO CLAIM IS MADE TO THE EXCLUSIVE RIGHT TO USE "RACING", APART FROM THE MARK AS SHOWN.

SER. NO. 77-494,573, FILED 6-9-2008.

KELLY MCCOY, EXAMINING ATTORNEY

**Int. Cl.: 35**

**Prior U.S. Cls.: 100, 101 and 102**

**United States Patent and Trademark Office**

**Reg. No. 3,569,533**

**Registered Feb. 3, 2009**

**SERVICE MARK  
PRINCIPAL REGISTER**



CONDO GUIDE LLC (TENNESSEE LIMITED LIABILITY COMPANY)  
810 WALNUT  
MEMPHIS, TN 38126

THE COLOR(S) BURGUNDY AND YELLOW IS/ ARE CLAIMED AS A FEATURE OF THE MARK.

FOR: PROMOTING THE GOODS AND SERVICES OF OTHERS BY DISTRIBUTING ADVERTISING MATERIALS THROUGH A VARIETY OF METHODS; REAL ESTATE MARKETING SERVICES IN THE FIELD OF CONDOMINIUMS , IN CLASS 35 (U.S. CLS. 100, 101 AND 102).

THE MARK CONSISTS OF THE WORDS "CONDO GUIDE" IN BURGUNDY WHICH APPEARS TO THE RIGHT OF A YELLOW AND BURGUNDY BUILDING.

FIRST USE 5-1-2008; IN COMMERCE 5-1-2008.

SER. NO. 77-494,966, FILED 6-10-2008.

NO CLAIM IS MADE TO THE EXCLUSIVE RIGHT TO USE "CONDO GUIDE", APART FROM THE MARK AS SHOWN.

ROSELLE HERRERA, EXAMINING ATTORNEY



**Int. Cl.: 9**

**Prior U.S. Cls.: 21, 23, 26, 36 and 38**

**Reg. No. 3,569,534**

**United States Patent and Trademark Office**

**Registered Feb. 3, 2009**

**TRADEMARK  
PRINCIPAL REGISTER**

# Phoenix Suite

LDP SOLUTIONS, INC. (COLORADO CORPORATION)  
6369 SOUTH OLD HAMMER WAY  
AURORA, CO 80016

FOR: COMPUTER SOFTWARE, NAMELY, AN ENTERPRISE SUITE OF TOOLS THAT PROVIDE END-TO-END AUTOMATION FOR BUSINESS, IT, AND SOFTWARE DEVELOPMENT PROCESSES, FEATURING TOOLS FOR COMPLIANCE WITH CERTAIN GOVERNMENTAL REGULATIONS, IN CLASS 9 (U.S. CLS. 21, 23, 26, 36 AND 38).

FIRST USE 5-1-2006; IN COMMERCE 5-21-2008.

THE MARK CONSISTS OF STANDARD CHARACTERS WITHOUT CLAIM TO ANY PARTICULAR FONT, STYLE, SIZE, OR COLOR.

NO CLAIM IS MADE TO THE EXCLUSIVE RIGHT TO USE "SUITE", APART FROM THE MARK AS SHOWN.

SER. NO. 77-495,150, FILED 6-10-2008.

KATINA MISTER, EXAMINING ATTORNEY

**Int. Cl.: 25**

**Prior U.S. Cls.: 22 and 39**

**United States Patent and Trademark Office**

**Reg. No. 3,569,535**

**Registered Feb. 3, 2009**

**TRADEMARK  
PRINCIPAL REGISTER**

**PELLE MODA**

CHAINSON FOOTWEAR, INC. (CALIFORNIA  
CORPORATION)  
301 NORTH RICE AVENUE  
OXNARD, CA 93030

FOR: FOOTWEAR IN WHOLE OR SUBSTANTIAL  
PART OF LEATHER, IN CLASS 25 (U.S. CLS. 22 AND  
39).

FIRST USE 9-12-2002; IN COMMERCE 9-12-2002.

THE MARK CONSISTS OF STANDARD CHAR-  
ACTERS WITHOUT CLAIM TO ANY PARTICULAR  
FONT, STYLE, SIZE, OR COLOR.

OWNER OF U.S. REG. NO. 2,691,748.

THE FOREIGN WORDING IN THE MARK  
TRANSLATES INTO ENGLISH AS LEATHER FASH-  
IONS.

SEC. 2(F).

SER. NO. 77-495,168, FILED 6-10-2008.

DEIRDRE ROBERTSON, EXAMINING ATTORNEY

**Int. Cl.: 42**

**Prior U.S. Cls.: 100 and 101**

**United States Patent and Trademark Office**

**Reg. No. 3,569,536**

**Registered Feb. 3, 2009**

**SERVICE MARK  
PRINCIPAL REGISTER**

**IMAGERENOVATIONS**

IMAGEPOINT INC. (TENNESSEE CORPORATION)  
SUITE 100  
445 S. GAY ST.  
KNOXVILLE, TN 37902

FOR: DESIGN OF EXTERIOR STRUCTURAL ELEMENTS, NAMELY, SIGNS, FASCIA CLADDING, AWNINGS, AND CANOPY SYSTEMS, IN CLASS 42 (U.S. CLS. 100 AND 101).

FIRST USE 10-23-2007; IN COMMERCE 10-23-2007.

THE MARK CONSISTS OF STANDARD CHARACTERS WITHOUT CLAIM TO ANY PARTICULAR FONT, STYLE, SIZE, OR COLOR.

OWNER OF U.S. REG. NO. 3,471,024.

SER. NO. 77-495,330, FILED 6-10-2008.

JORDAN BAKER, EXAMINING ATTORNEY

**Int. Cls.: 35, 36 and 41**

**Prior U.S. Cls.: 100, 101, 102 and 107**

**United States Patent and Trademark Office**

**Reg. No. 3,569,537**

**Registered Feb. 3, 2009**

**SERVICE MARK  
PRINCIPAL REGISTER**

**GLOBAL LAW ENFORCEMENT  
TORCH RUN**

SPECIAL OLYMPICS, INC. (D.C. CORPORATION)  
1133 19TH STREET, NW  
WASHINGTON, DC 20036

FOR: CHARITABLE SERVICES, NAMELY, PROMOTING PUBLIC AWARENESS OF ATHLETIC COMPETITIONS FOR ATHLETES WITH INTELLECTUAL AND OTHER DISABILITIES; PROMOTING PUBLIC AWARENESS ABOUT PEOPLE WITH INTELLECTUAL AND OTHER DISABILITIES; RECRUITING VOLUNTEERS TO PARTICIPATE IN CEREMONIAL EVENTS AND FESTIVITIES THAT CELEBRATE PEOPLE WITH INTELLECTUAL AND OTHER DISABILITIES, IN CLASS 35 (U.S. CLS. 100, 101 AND 102).

FIRST USE 6-0-2007; IN COMMERCE 6-0-2007.

FOR: CHARITABLE FUND RAISING SERVICES, IN CLASS 36 (U.S. CLS. 100, 101 AND 102).

FIRST USE 3-0-2007; IN COMMERCE 3-0-2007.

FOR: ENTERTAINMENT SERVICES IN THE NATURE OF CEREMONIAL EVENTS AND FESTIVITIES TO PROMOTE PUBLIC AWARENESS OF

ATHLETIC COMPETITIONS FOR ATHLETES WITH INTELLECTUAL AND OTHER DISABILITIES AND TO PROMOTE PUBLIC AWARENESS ABOUT PEOPLE WITH INTELLECTUAL AND OTHER DISABILITIES, IN CLASS 41 (U.S. CLS. 100, 101 AND 107).

FIRST USE 6-0-2007; IN COMMERCE 6-0-2007.

THE MARK CONSISTS OF STANDARD CHARACTERS WITHOUT CLAIM TO ANY PARTICULAR FONT, STYLE, SIZE, OR COLOR.

OWNER OF U.S. REG. NOS. 1,959,703, 2,188,346, AND 2,964,514.

NO CLAIM IS MADE TO THE EXCLUSIVE RIGHT TO USE "GLOBAL" AND "RUN", APART FROM THE MARK AS SHOWN.

SEC. 2(F) AS TO "LAW ENFORCEMENT TORCH RUN".

SER. NO. 77-495,352, FILED 6-10-2008.

PATRICIA EVANKO, EXAMINING ATTORNEY

**Int. Cls.: 16 and 35**

**Prior U.S. Cls.: 2, 5, 22, 23, 29, 37, 38, 50, 100, 101 and 102**

**Reg. No. 3,569,538**

**United States Patent and Trademark Office**

**Registered Feb. 3, 2009**

**TRADEMARK  
SERVICE MARK  
PRINCIPAL REGISTER**



RETAILWIRE LLC (NEW YORK LIMITED LIABILITY COMPANY)  
322 HIGHLAND AVENUE  
UPPER MONTCLAIR, NJ 07043

FOR: PUBLICATIONS, NAMELY, NEWSLETTERS, DIGESTS, AND MAGAZINES IN THE RETAILING FIELDS FOR INDUSTRY PROFESSIONALS, IN CLASS 16 (U.S. CLS. 2, 5, 22, 23, 29, 37, 38 AND 50).

FIRST USE 9-1-2002; IN COMMERCE 9-1-2002.

FOR: PROVIDING ON-LINE BUSINESS INFORMATION AND BUSINESS NEWS REGARDING THE RETAIL INDUSTRY FOR RETAIL PROFESSIONALS, IN CLASS 35 (U.S. CLS. 100, 101 AND 102).

FIRST USE 4-2-2002; IN COMMERCE 4-2-2002.

NO CLAIM IS MADE TO THE EXCLUSIVE RIGHT TO USE "RETAILWIRE", APART FROM THE MARK AS SHOWN.

THE COLOR(S) BLACK, YELLOW AND WHITE IS/ARE CLAIMED AS A FEATURE OF THE MARK.

THE MARK CONSISTS OF THE WORD "RETAIL" IN YELLOW FOLLOWED BY THE WORD "WIRE" IN WHITE, BOTH INSIDE A BLACK OVAL, WITH A YELLOW THUNDERBOLT INSTEAD OF A DOT OVER THE LETTER "I" IN "WIRE".

SER. NO. 77-495,382, FILED 6-10-2008.

KATHLEEN M. VANSTON, EXAMINING ATTORNEY

**Int. Cl.: 29**

**Prior U.S. Cl.: 46**

**United States Patent and Trademark Office**

**Reg. No. 3,569,539**

**Registered Feb. 3, 2009**

**TRADEMARK  
PRINCIPAL REGISTER**

**MOZZA BLEND**

SCHREIBER FOODS, INC. (WISCONSIN CORPORATION)  
425 PINE STREET  
GREEN BAY, WI 54301

NO CLAIM IS MADE TO THE EXCLUSIVE RIGHT TO USE "BLEND", APART FROM THE MARK AS SHOWN.

FOR: CHEESE, IN CLASS 29 (U.S. CL. 46).

FIRST USE 10-31-2007; IN COMMERCE 10-31-2007.

SER. NO. 77-495,385, FILED 6-10-2008.

THE MARK CONSISTS OF STANDARD CHARACTERS WITHOUT CLAIM TO ANY PARTICULAR FONT, STYLE, SIZE, OR COLOR.

SOPHIA S. KIM, EXAMINING ATTORNEY

**Int. Cl.: 29**

**Prior U.S. Cl.: 46**

**United States Patent and Trademark Office**

**Reg. No. 3,569,540**

**Registered Feb. 3, 2009**

**TRADEMARK  
PRINCIPAL REGISTER**

THE ORIGINAL COOPER BRAND  
QUALITY SINCE 1893

SCHREIBER FOODS, INC. (WISCONSIN CORPORATION)  
425 PINE STREET  
GREEN BAY, WI 54301

FOR: CHEESE, IN CLASS 29 (U.S. CL. 46).

FIRST USE 11-30-2007; IN COMMERCE 11-30-2007.

THE MARK CONSISTS OF STANDARD CHARACTERS WITHOUT CLAIM TO ANY PARTICULAR FONT, STYLE, SIZE, OR COLOR.

OWNER OF U.S. REG. NOS. 1,060,434, 1,066,850, AND 3,372,557.

NO CLAIM IS MADE TO THE EXCLUSIVE RIGHT TO USE "THE ORIGINAL" AND "BRAND QUALITY SINCE 1893", APART FROM THE MARK AS SHOWN.

SER. NO. 77-495,390, FILED 6-10-2008.

SOPHIA S. KIM, EXAMINING ATTORNEY

**Int. Cl.: 29**

**Prior U.S. Cl.: 46**

**United States Patent and Trademark Office**

**Reg. No. 3,569,541**

**Registered Feb. 3, 2009**

**TRADEMARK  
PRINCIPAL REGISTER**

**AMERA BLEND**

SCHREIBER FOODS, INC. (WISCONSIN CORPORATION)  
425 PINE STREET  
GREEN BAY, WI 54301

NO CLAIM IS MADE TO THE EXCLUSIVE RIGHT TO USE "BLEND", APART FROM THE MARK AS SHOWN.

FOR: CHEESE, IN CLASS 29 (U.S. CL. 46).

FIRST USE 9-30-2007; IN COMMERCE 9-30-2007.

SER. NO. 77-495,393, FILED 6-10-2008.

THE MARK CONSISTS OF STANDARD CHARACTERS WITHOUT CLAIM TO ANY PARTICULAR FONT, STYLE, SIZE, OR COLOR.

SOPHIA S. KIM, EXAMINING ATTORNEY



**Int. Cl.: 35**

**Prior U.S. Cls.: 100, 101 and 102**

**United States Patent and Trademark Office**

**Reg. No. 3,569,542**

**Registered Feb. 3, 2009**

**SERVICE MARK  
PRINCIPAL REGISTER**



AUTOMOTIVE BODY PARTS ASSOCIATION  
(TEXAS TAX EXEMPT CORPORATION)  
P.O. BOX 820689  
HOUSTON, TX 772820689

NO CLAIM IS MADE TO THE EXCLUSIVE  
RIGHT TO USE "NUMBERING SYSTEM", APART  
FROM THE MARK AS SHOWN.

FOR: PROVIDING A SECURED ACCESS DATA-  
BASE VIA THE INTERNET THROUGH WHICH  
DATABASE FILES AND SPREADSHEETS CAN BE  
DOWNLOADED FOR THE PURPOSES OF OBTAIN-  
ING NUMBERING AND PRICING INFORMATION  
RELATED TO NEW AND RECYCLED AUTOMO-  
TIVE PARTS, IN CLASS 35 (U.S. CLS. 100, 101 AND  
102).

THE MARK CONSISTS OF THE WORDS "AB-  
PARTSLINK" CONNECTED BY A CHAIN WITH  
THE WORDS "NUMBERING SYSTEM" APPEAR-  
ING UNDERNEATH.

SER. NO. 77-495,508, FILED 6-10-2008.

FIRST USE 5-12-2008; IN COMMERCE 5-12-2008.

CHARLES L. JENKINS, EXAMINING ATTORNEY

Int. Cl.: 9

Prior U.S. Cls.: 21, 23, 26, 36 and 38

United States Patent and Trademark Office

Reg. No. 3,569,543

Registered Feb. 3, 2009

TRADEMARK  
PRINCIPAL REGISTER

**Emergency Information**   
S Y S T E M S .

CHILD AFFILIATED RESOURCE ENDEAVOR,  
INC. (NORTH CAROLINA CORPORATION)  
976 FREEMANTOWN ROAD  
RUTHERFORDTON, NC 28139

FOR: KITS FOR PARENTS OF MISSING OR ABDUCTED CHILDREN, COMPRISED OF A SOFTWARE PROGRAM FOR CREATING POSTERS CONTAINING E-MAIL LINKS TO LAW ENFORCEMENT OFFICIALS, IDENTIFICATION CARDS, AND ACTIVITY WRISTBANDS, AND FOR DOWNLOADING SAID POSTERS, IDENTIFICATION CARDS AND ACTIVITY WRISTBANDS ONTO A SECURE USB FLASH DRIVE FOR USE WHEN A CHILD SUDDENLY BECOMES ABDUCTED OR MISSING, AS WELL AS TWO SELF-LAMINATING ID CARDS, A COMPLETE DNA KIT, USB FLASH DRIVE, POSTER, AND A SELF- LAMINATING ACTIVITY WRISTBAND, SOLD AS A UNIT, IN CLASS 9 (U.S. CLS. 21, 23, 26, 36 AND 38).

FIRST USE 3-1-2008; IN COMMERCE 3-1-2008.

NO CLAIM IS MADE TO THE EXCLUSIVE RIGHT TO USE "EMERGENCY INFORMATION SYSTEMS", APART FROM THE MARK AS SHOWN.

THE MARK CONSISTS OF THE STYLIZED WORDS "EMERGENCY INFORMATION SYSTEMS". TO THE RIGHT OF THE STYLIZED WORDS IS AN IMAGE OF A PERSON STANDING WITH RADIO FREQUENCY WAVES IN THE BACKGROUND.

SER. NO. 77-495,614, FILED 6-10-2008.

ANDREA K. NADELMAN, EXAMINING ATTORNEY

**Int. Cl.: 36**

**Prior U.S. Cls.: 100, 101 and 102**

**United States Patent and Trademark Office**

**Reg. No. 3,569,544**

**Registered Feb. 3, 2009**

**SERVICE MARK  
PRINCIPAL REGISTER**



RENEWABLE ENERGY FINANCIAL, LLC (COLORADO LIMITED LIABILITY COMPANY)  
SUITE 100  
1836 GRANT STREET  
DENVER, CO 80203

FOR: FINANCIAL SERVICES, NAMELY, MONEY LENDING, IN CLASS 36 (U.S. CLS. 100, 101 AND 102).

FIRST USE 12-1-2007; IN COMMERCE 12-1-2007.

NO CLAIM IS MADE TO THE EXCLUSIVE RIGHT TO USE "RENEWABLE ENERGY FINANCIAL", APART FROM THE MARK AS SHOWN.

THE MARK CONSISTS OF A SUN WITH AN ARROW AND THE WORDS "RENEWABLE ENERGY FINANCIAL".

SER. NO. 77-495,669, FILED 6-10-2008.

BRIAN NEVILLE, EXAMINING ATTORNEY

**Int. Cl.: 38**

**Prior U.S. Cls.: 100, 101 and 104**

**United States Patent and Trademark Office**

**Reg. No. 3,569,545**

**Registered Feb. 3, 2009**

**SERVICE MARK  
PRINCIPAL REGISTER**

**MARTINI LOUNGE RADIO**

MAX GLUTEUS PROPERTIES, LLC (PENNSYLVANIA LIMITED LIABILITY COMPANY)  
139 EAST HATHAWAY LANE  
HAVERTOWN, PA 19083

FOR: RADIO BROADCASTING SERVICES AND INTERNET BROADCASTING SERVICES, IN CLASS 38 (U.S. CLS. 100, 101 AND 104).

FIRST USE 8-31-2007; IN COMMERCE 8-31-2007.

THE MARK CONSISTS OF STANDARD CHARACTERS WITHOUT CLAIM TO ANY PARTICULAR FONT, STYLE, SIZE, OR COLOR.

NO CLAIM IS MADE TO THE EXCLUSIVE RIGHT TO USE "RADIO", APART FROM THE MARK AS SHOWN.

SER. NO. 77-495,694, FILED 6-10-2008.

ELISSA GARBER KON, EXAMINING ATTORNEY

Int. Cl.: 35

Prior U.S. Cls.: 100, 101 and 102

United States Patent and Trademark Office

Reg. No. 3,569,546

Registered Feb. 3, 2009

SERVICE MARK  
PRINCIPAL REGISTER



JPAK & ASSOCIATES ACCOUNTANCY CORP.  
(CALIFORNIA CORPORATION)  
WWW.JPAKPC.COM  
9465 GARDEN GROVE BLVD #200  
GARDEN GROVE, CA 92844

FOR: ADVERTISING, MARKETING AND PRO-  
MOTION SERVICES, IN CLASS 35 (U.S. CLS. 100, 101  
AND 102).

FIRST USE 1-1-2007; IN COMMERCE 1-1-2007.

NO CLAIM IS MADE TO THE EXCLUSIVE  
RIGHT TO USE "& ASSOCIATES", APART FROM  
THE MARK AS SHOWN.

THE COLOR(S) WHITE, BLACK, BURGUNDY IS/  
ARE CLAIMED AS A FEATURE OF THE MARK.

THE MARK CONSISTS OF STYLIZED LETTER  
"JP" IN WHITE LETTERS INSIDE BURGUNDY  
CIRCLE, STYLIZED LETTER "JPAK" IN BLACK  
LETTERS, STYLIZED SYMBOL AND LETTER "&  
ASSOCIATES" IN BURGUNDY LETTERS.

SER. NO. 77-495,711, FILED 6-10-2008.

SUSAN STIGLITZ, EXAMINING ATTORNEY

**Int. Cl.: 21**

**Prior U.S. Cls.: 2, 13, 23, 29, 30, 33, 40 and 50**

**Reg. No. 3,569,547**

**United States Patent and Trademark Office**

**Registered Feb. 3, 2009**

---

**TRADEMARK  
PRINCIPAL REGISTER**

**HOT LAVA GLASS Co.**

TPG HAWAII LTD (HAWAII CORPORATION),  
DBA HOT LAVA GLASS COMPANY

1136 B KUMUKUMU ST

HONOLULU, HI 96825

FOR: DECORATIVE GLASS, IN CLASS 21 (U.S.  
CLS. 2, 13, 23, 29, 30, 33, 40 AND 50).

FIRST USE 9-5-2005; IN COMMERCE 9-8-2005.

THE MARK CONSISTS OF STANDARD CHAR-  
ACTERS WITHOUT CLAIM TO ANY PARTICULAR  
FONT, STYLE, SIZE, OR COLOR.

NO CLAIM IS MADE TO THE EXCLUSIVE  
RIGHT TO USE "GLASS CO.", APART FROM THE  
MARK AS SHOWN.

SER. NO. 77-495,791, FILED 6-10-2008.

APRIL HESIK, EXAMINING ATTORNEY

**Int. Cl.: 39**

**Prior U.S. Cls.: 100 and 105**

**United States Patent and Trademark Office**

**Reg. No. 3,569,548**

**Registered Feb. 3, 2009**

**SERVICE MARK  
PRINCIPAL REGISTER**

**Nuthin' But Doo Wop Cruise**

SCHURDELL STEPHEN J. (UNITED STATES IN-  
DIVIDUAL)  
6533 ALCESTER DRIVE  
NEW PORT RICHEY, FL 34655

FOR: ARRANGING OF CRUISES; ARRANGING  
OF TOURS AND CRUISES; CRUISE SHIP SERVI-  
CES; TRAVEL, EXCURSION AND CRUISE AR-  
RANGEMENT, IN CLASS 39 (U.S. CLS. 100 AND 105).

FIRST USE 5-1-2007; IN COMMERCE 5-1-2007.

THE MARK CONSISTS OF STANDARD CHAR-  
ACTERS WITHOUT CLAIM TO ANY PARTICULAR  
FONT, STYLE, SIZE, OR COLOR.

NO CLAIM IS MADE TO THE EXCLUSIVE  
RIGHT TO USE "CRUISE", APART FROM THE  
MARK AS SHOWN.

SER. NO. 77-495,937, FILED 6-11-2008.

MARK T. MULLEN, EXAMINING ATTORNEY

**Int. Cl.: 25**

**Prior U.S. Cls.: 22 and 39**

**United States Patent and Trademark Office**

**Reg. No. 3,569,549**

**Registered Feb. 3, 2009**

**TRADEMARK  
PRINCIPAL REGISTER**

**SANSHA**

RAOUL-DUVAL, FRANCK (FRANCE INDIVIDUAL)

5TH FL. SILOM 17, SILOM SHIANHAI BLDG

BANGKOK, THAILAND 10500

FOR: BALLET SHOES; DANCE SHOES; SHOE INSERTS FOR PRIMARILY NON-ORTHOPEDIC PURPOSES; UNITARDS, IN CLASS 25 (U.S. CLS. 22 AND 39).

FIRST USE 1-1-1984; IN COMMERCE 1-1-1984.

THE MARK CONSISTS OF STANDARD CHARACTERS WITHOUT CLAIM TO ANY PARTICULAR FONT, STYLE, SIZE, OR COLOR.

OWNER OF U.S. REG. NO. 1,998,082.

"SANSHA" IS A TRANSLITERATION OF A CHINESE WORD THAT MEANS "THREE SANDS" OR "THREE GRAINS OF SAND."

SER. NO. 77-496,260, FILED 6-11-2008.

KIM SAITO, EXAMINING ATTORNEY



**Int. Cl.: 42**

**Prior U.S. Cls.: 100 and 101**

**United States Patent and Trademark Office**

**Reg. No. 3,569,550**

**Registered Feb. 3, 2009**

**SERVICE MARK  
PRINCIPAL REGISTER**

**GENESYST**

GENESYST INTERNATIONAL, INC. (DELA-  
WARE CORPORATION)  
SUITE J  
1737 GEORGETOWN ROAD  
HUDSON, OH 44236

FOR: CONSULTING SERVICES, NAMELY, PRO-  
VIDING TECHNICAL ASSISTANCE IN CONNEC-  
TION WITH THE GRAVITY PRESSURE VESSEL  
INSTALLATIONS OF OTHERS, IN CLASS 42 (U.S.  
CLS. 100 AND 101).

FIRST USE 6-15-1990; IN COMMERCE 6-15-1990.

THE MARK CONSISTS OF STANDARD CHAR-  
ACTERS WITHOUT CLAIM TO ANY PARTICULAR  
FONT, STYLE, SIZE, OR COLOR.

SER. NO. 77-496,332, FILED 6-11-2008.

JAMES A. RAUEN, EXAMINING ATTORNEY

Prior U.S. Cl.: A

United States Patent and Trademark Office

Reg. No. 3,569,551

Registered Feb. 3, 2009

**CERTIFICATION MARK  
PRINCIPAL REGISTER**



US ENVIRONMENTAL PROTECTION AGENCY  
(UNITED STATES FEDERAL AGENCY)

MC 2377A

1200 PENNSYLVANIA AVENUE., NW  
WASHINGTON, DC 20460

FOR: CONSUMER ELECTRONICS, KITCHEN AND HOUSEHOLD APPLIANCES, HOUSEHOLD FANS, ROOF PRODUCTS, COMMERCIAL AND RESIDENTIAL SPACE CONDITIONING EQUIPMENT, FENESTRATION PRODUCTS, COMMERCIAL AND RESIDENTIAL LIGHTING PRODUCTS, OFFICE EQUIPMENT, COMMERCIAL FOOD SERVICE EQUIPMENT, NEW AND EXISTING HOMES AND COMMERCIAL AND INDUSTRIAL BUILDINGS, IN CLASS A (U.S. CL. A).

FIRST USE 1-31-2002; IN COMMERCE 1-31-2002.

OWNER OF U.S. REG. NOS. 1,999,485, 2,817,628 AND OTHERS.

NO CLAIM IS MADE TO THE EXCLUSIVE RIGHT TO USE ENERGY, APART FROM THE MARK AS SHOWN.

THE COLOR(S) WHITE AND CYAN BLUE IS/ARE CLAIMED AS A FEATURE OF THE MARK.

THE MARK CONSISTS OF A CYAN BLUE BOX WITH WHITE WRITING AND TRIM CONTAINING THE WORD "ENERGY" AND A STAR BELOW A CURVED LINE, WITH THE WORDS "ENERGY STAR" IN WHITE IN A SMALL CYAN BOX BELOW THE DESIGN.

THE CERTIFICATION MARK, AS USED BY AUTHORIZED PERSONS, CERTIFIES THAT THE ITEMS ARE MORE ENERGY EFFICIENT THAN MOST ITEMS SOLD IN THE SAME CATEGORY.

SER. NO. 77-496,402, FILED 6-11-2008.

KAPIL BHANOT, EXAMINING ATTORNEY

**Int. Cl.: 35**

**Prior U.S. Cls.: 100, 101 and 102**

**United States Patent and Trademark Office**

**Reg. No. 3,569,552**

**Registered Feb. 3, 2009**

**SERVICE MARK  
PRINCIPAL REGISTER**

**THE HOMECARE PEOPLE**

NDSI HEALTHCARE, INC. (DELAWARE CORPORATION)  
11846 ROCK LANDING DRIVE - SUITE C  
NEWPORT NEWS, VA 23606

FOR: DATA MANAGEMENT SERVICES FOR THE HEALTH CARE INDUSTRY, IN CLASS 35 (U.S. CLS. 100, 101 AND 102).

FIRST USE 10-13-2006; IN COMMERCE 10-13-2006.

THE MARK CONSISTS OF STANDARD CHARACTERS WITHOUT CLAIM TO ANY PARTICULAR FONT, STYLE, SIZE, OR COLOR.

NO CLAIM IS MADE TO THE EXCLUSIVE RIGHT TO USE "HOME CARE", APART FROM THE MARK AS SHOWN.

SER. NO. 77-496,478, FILED 6-11-2008.

COLLEEN KEARNEY, EXAMINING ATTORNEY

**Int. Cl.: 41**

**Prior U.S. Cls.: 100, 101 and 107**

**United States Patent and Trademark Office**

**Reg. No. 3,569,553**

**Registered Feb. 3, 2009**

**SERVICE MARK  
PRINCIPAL REGISTER**

**SAFESCAN**

NALCO COMPANY (DELAWARE CORPORATION)  
1601 W. DIEHL RD.  
NAPERVILLE, IL 605631198

FOR: EDUCATIONAL SERVICES, NAMELY,  
PROVIDING SAFETY TRAINING PROGRAMS  
FOR CONDUCTING FELT SCANNING IN THE  
PAPER INDUSTRY, IN CLASS 41 (U.S. CLS. 100, 101  
AND 107).

FIRST USE 5-30-2008; IN COMMERCE 5-30-2008.

THE MARK CONSISTS OF STANDARD CHARACTERS WITHOUT CLAIM TO ANY PARTICULAR FONT, STYLE, SIZE, OR COLOR.

SER. NO. 77-497,082, FILED 6-12-2008.

TEJBIR SINGH, EXAMINING ATTORNEY

**Int. Cls.: 35 and 42**

**Prior U.S. Cls.: 100, 101 and 102**

**United States Patent and Trademark Office**

**Reg. No. 3,569,554**

**Registered Feb. 3, 2009**

**SERVICE MARK  
PRINCIPAL REGISTER**

# Adhere

MILLET, THOMAS A. (FRANCE INDIVIDUAL)  
54, RUE HERMESINDE L-1469  
LUXEMBOURG, LUXEMBOURG

FOR: MOBILE INTERACTIVE MARKETING SERVICES, NAMELY, PROVIDING DIRECT MARKETING FOR OTHERS VIA TEXT MESSAGING, SHORT-MESSAGING SERVICES (SMS), SURVEYS, POLLS, CONTESTS, AND MULTIMEDIA MESSAGING SERVICES (MMS); ADVERTISING AND INTERACTIVE MARKETING SERVICES; ELECTRONIC COMMERCE SERVICES, NAMELY, PROVIDING INFORMATION ABOUT PRODUCTS VIA TELECOMMUNICATIONS NETWORKS FOR ADVERTISING AND SALES PURPOSES; BUSINESS MARKETING AND MANAGEMENT CONSULTATION SERVICES, NAMELY, PROVIDING DATA COLLECTION, DATA VERIFICATION, DATA DELIVERY, REPORTING AND ANALYTICS FOR OPTIMIZING MARKETING STRATEGIES OF OTHERS, IN CLASS 35 (U.S. CLS. 100, 101 AND 102).

FIRST USE 2-0-2007; IN COMMERCE 2-0-2007.

FOR: TECHNOLOGY SERVICES, NAMELY, DEVELOPMENT OF CONSUMER AND ENTERPRISE SOFTWARE APPLICATIONS FOR WIRELESS AND MOBILE DEVICES AND HANDSETS DISTRIBUTED

VIA A GLOBAL COMPUTER NETWORK, WIRELESS CARRIERS AND RETAIL ESTABLISHMENTS; HOSTING THE COMPUTER SOFTWARE APPLICATIONS OF OTHERS ON PROPRIETARY SERVERS FOR MULTIPLE WIRELESS DEVICES AND MOBILE HANDSETS; APPLICATION SERVICE PROVIDER PROVIDING SOFTWARE AND TECHNOLOGY FOR DESIGNING, DEVELOPING, TESTING, DISTRIBUTING, ACCESSING, VIEWING AND NAVIGATING WIRELESS APPLICATIONS FOR MULTIPLE WIRELESS DEVICES AND MOBILE HANDSETS, MINING DATA, DELIVERING ADVERTISEMENTS AND OTHER MOBILE MESSAGING CONTENT TO WIRELESS AND MOBILE DEVICES AND HANDSETS, AND BUILDING MOBILE COMMUNITIES, IN CLASS 42 (U.S. CLS. 100 AND 101).

FIRST USE 2-0-2007; IN COMMERCE 2-0-2007.

THE MARK CONSISTS OF STANDARD CHARACTERS WITHOUT CLAIM TO ANY PARTICULAR FONT, STYLE, SIZE, OR COLOR.

SER. NO. 77-497,320, FILED 6-12-2008.

ROBERT C. CLARK JR., EXAMINING ATTORNEY

**Int. Cl.: 16**

**Prior U.S. Cls.: 2, 5, 22, 23, 29, 37, 38 and 50**

**Reg. No. 3,569,555**

**United States Patent and Trademark Office**

**Registered Feb. 3, 2009**

**TRADEMARK  
PRINCIPAL REGISTER**

**GOBO**

SANDVIK INNOVATIONS LLC (PENNSYLVANIA LIMITED LIABILITY COMPANY)  
SUITE 2030  
460 EAST SWEDES FORD ROAD  
WAYNE, PA 19087

FOR: CHILDREN'S BOOKS, IN CLASS 16 (U.S. CLS. 2, 5, 22, 23, 29, 37, 38 AND 50).

FIRST USE 7-0-2004; IN COMMERCE 7-0-2004.

THE MARK CONSISTS OF STANDARD CHARACTERS WITHOUT CLAIM TO ANY PARTICULAR FONT, STYLE, SIZE, OR COLOR.

OWNER OF U.S. REG. NO. 2,613,154.

SER. NO. 77-497,486, FILED 6-12-2008.

JOSETTE BEVERLY, EXAMINING ATTORNEY

**Int. Cls.: 35 and 36**

**Prior U.S. Cls.: 100, 101 and 102**

**United States Patent and Trademark Office**

**Reg. No. 3,569,556**

**Registered Feb. 3, 2009**

**SERVICE MARK  
PRINCIPAL REGISTER**

**WEALTHPRINT**

CLIFTON GUNDERSON LLP (DELAWARE LIMITED LIABILITY PARTNERSHIP)  
301 SOUTHWEST ADAMS STREET  
PEORIA, IL 61602

FOR: TAX AND TAXATION PLANNING, ADVICE, INFORMATION AND CONSULTANCY SERVICES, IN CLASS 35 (U.S. CLS. 100, 101 AND 102).

FIRST USE 2-29-2008; IN COMMERCE 2-29-2008.

FOR: FINANCIAL PLANNING AND INVESTMENT ADVISORY SERVICES, IN CLASS 36 (U.S. CLS. 100, 101 AND 102).

FIRST USE 2-29-2008; IN COMMERCE 2-29-2008.

THE MARK CONSISTS OF STANDARD CHARACTERS WITHOUT CLAIM TO ANY PARTICULAR FONT, STYLE, SIZE, OR COLOR.

SER. NO. 77-497,775, FILED 6-12-2008.

SUNG IN, EXAMINING ATTORNEY

Int. Cl.: 3

Prior U.S. Cls.: 1, 4, 6, 50, 51 and 52

United States Patent and Trademark Office

Reg. No. 3,569,557

Registered Feb. 3, 2009

**TRADEMARK  
PRINCIPAL REGISTER**

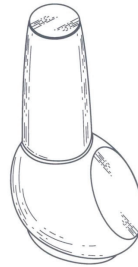

OPI PRODUCTS, INC. (CALIFORNIA CORPORATION)  
13034 SATICOY STREET  
NORTH HOLLYWOOD, CA 91605

IS A GENERALLY SPHERICAL BOTTLE WITH A  
FLAT SIDE AND A GENERALLY CYLINDRICAL  
CAP.

FOR: NAIL LACQUERS, IN CLASS 3 (U.S. CLS. 1,  
4, 6, 50, 51 AND 52).

SEC. 2(F).

FIRST USE 1-1-2000; IN COMMERCE 1-1-2000.

SER. NO. 77-497,964, FILED 6-12-2008.

THE MARK CONSISTS OF THE CONFIGURATION  
OF THE PACKAGING OF THE GOODS AND

JULIE WATSON, EXAMINING ATTORNEY



Int. Cl.: 3

Prior U.S. Cls.: 1, 4, 6, 50, 51 and 52

**United States Patent and Trademark Office**

**Reg. No. 3,569,558**

Registered Feb. 3, 2009

**TRADEMARK  
PRINCIPAL REGISTER**

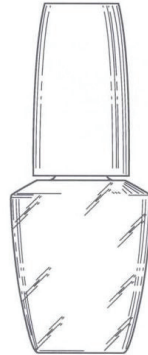

OPI PRODUCTS, INC. (CALIFORNIA CORPORATION)  
13034 SATICOY STREET  
NORTH HOLLYWOOD, CA 91605

FOR: NAIL LACQUERS, IN CLASS 3 (U.S. CLS. 1, 4, 6, 50, 51 AND 52).

FIRST USE 1-1-1992; IN COMMERCE 1-1-1992.

THE MARK CONSISTS OF THE CONFIGURATION OF THE PACKAGING OF THE GOODS AND IS A GENERALLY SPHERICAL BOTTLE AND A GENERALLY CYLINDRICAL CAP.

SEC. 2(F).

SER. NO. 77-497,968, FILED 6-12-2008.

JULIE WATSON, EXAMINING ATTORNEY

**Int. Cls.: 36 and 45**

**Prior U.S. Cls.: 100, 101 and 102**

**United States Patent and Trademark Office**

**Reg. No. 3,569,559**

**Registered Feb. 3, 2009**

**SERVICE MARK  
PRINCIPAL REGISTER**



FAMILY ADVOCATES (FLORIDA LIMITED LIABILITY COMPANY)  
2600 TAMPA RD.  
PALM HARBOR, FL 34684

FOR: ESTATE PLANNING; ESTATE TRUST MANAGEMENT; FINANCIAL SERVICES, NAME- LY, ESTATE SETTLEMENT SERVICES; REAL ES- TATE TRUSTEE SERVICES , IN CLASS 36 (U.S. CLS. 100, 101 AND 102).

FIRST USE 5-1-2008; IN COMMERCE 5-1-2008.

FOR: GUARDIANSHIP, IN CLASS 45 (U.S. CLS. 100 AND 101).

FIRST USE 5-1-2008; IN COMMERCE 5-1-2008.

NO CLAIM IS MADE TO THE EXCLUSIVE RIGHT TO USE "FAMILY ADVOCATES PROFES- SIONAL ASSISTANCE FOR EXECUTORS", APART FROM THE MARK AS SHOWN.

THE MARK CONSISTS OF THE STYLIZED TEXT "FAMILY ADVOCATES PROFESSIONAL ASSIS- TANCE FOR EXECUTORS". ABOVE THE TEXT IS A VAGUE IMAGE OF THREE FAMILY MEMBERS WITH A HEART IN THE CENTER OF THE CENTER FAMILY MEMBER.

SER. NO. 77-498,237, FILED 6-13-2008.

MICHELE SWAIN, EXAMINING ATTORNEY

Int. Cl.: 30

Prior U.S. Cl.: 46

United States Patent and Trademark Office

Reg. No. 3,569,560

Registered Feb. 3, 2009

TRADEMARK  
PRINCIPAL REGISTER



BROOKLYN FUDGE, LLC (NEW YORK LIMITED LIABILITY COMPANY)  
172 FIFTH AVENUE, #101  
BROOKLYN, NY 11217

THE MARK CONSISTS OF THE WORD "BROOKLYN" IN SCRIPT LETTERING APPEARING ABOVE THE WORD "FUDGE" IN UPPER CASE LETTERS, EACH OF WHICH APPEARS IN A CIRCLE.

FOR: FUDGE, IN CLASS 30 (U.S. CL. 46).

FIRST USE 11-18-2006; IN COMMERCE 11-0-2007.

SER. NO. 77-498,276, FILED 6-13-2008.

NO CLAIM IS MADE TO THE EXCLUSIVE RIGHT TO USE "BROOKLYN FUDGE", APART FROM THE MARK AS SHOWN.

KEVON CHISOLM, EXAMINING ATTORNEY

**Int. Cl.: 28**

**Prior U.S. Cls.: 22, 23, 38 and 50**

**United States Patent and Trademark Office**

**Reg. No. 3,569,561**

**Registered Feb. 3, 2009**

**TRADEMARK  
PRINCIPAL REGISTER**

**WE'LL TAKE YOUR BREATH AWAY**

KIRSCHNER SAFETY PRODUCTS INC. (CANADA CORPORATION)  
8260 LONDWOODS ROAD  
LONDON, ONTARIO, CANADA N6P1L4

FOR: HUNTING AND OUTDOOR SPORTS FACE MASKS WHICH PROTECT THE FACE, REDUCE SCENT, FILTRATE AIR, ABSORB ODORS, AND ABSORB LIQUIDS, IN CLASS 28 (U.S. CLS. 22, 23, 38 AND 50).

FIRST USE 4-0-2008; IN COMMERCE 4-0-2008.

THE MARK CONSISTS OF STANDARD CHARACTERS WITHOUT CLAIM TO ANY PARTICULAR FONT, STYLE, SIZE, OR COLOR.

SER. NO. 77-498,555, FILED 6-13-2008.

C. DIONNE CLYBURN, EXAMINING ATTORNEY

**Int. Cls.: 25 and 41**

**Prior U.S. Cls.: 22, 39, 100, 101 and 107**

**Reg. No. 3,569,562**

**United States Patent and Trademark Office**

**Registered Feb. 3, 2009**

**TRADEMARK  
SERVICE MARK  
PRINCIPAL REGISTER**

# BAYOU BOWL

LOUISIANA ATHLETICS DOWN ON THE  
BAYOU, LLC (LOUISIANA LIMITED LIABILITY  
COMPANY)  
7245 BAYOU PAUL ROAD STREET  
GABRIEL, LA 70776

FOR: SPORT SHIRTS; SPORTS JERSEYS, IN  
CLASS 25 (U.S. CLS. 22 AND 39).

FIRST USE 9-15-2002; IN COMMERCE 9-15-2002.

FOR: AMATEUR YOUTH SPORTS SERVICES,  
NAMELY, ORGANIZING, PROVIDING AND  
MANAGING YOUTH SPORTS ACTIVITIES; ORGA-  
NISATION OF SPORTS EVENTS IN THE FIELD OF  
FOOTBALL, IN CLASS 41 (U.S. CLS. 100, 101 AND  
107).

FIRST USE 9-15-2002; IN COMMERCE 9-15-2002.

THE MARK CONSISTS OF STANDARD CHAR-  
ACTERS WITHOUT CLAIM TO ANY PARTICULAR  
FONT, STYLE, SIZE, OR COLOR.

NO CLAIM IS MADE TO THE EXCLUSIVE  
RIGHT TO USE "BOWL", APART FROM THE  
MARK AS SHOWN.

SER. NO. 77-498,657, FILED 6-13-2008.

ANDREA BUTLER, EXAMINING ATTORNEY

**Int. Cls.: 35, 39 and 42**

**Prior U.S. Cls.: 100, 101, 102 and 105**

**United States Patent and Trademark Office**

**Reg. No. 3,569,563**

**Registered Feb. 3, 2009**

**SERVICE MARK  
PRINCIPAL REGISTER**

**YRC WORLDWIDE BIZCONNECT**

YRC WORLDWIDE INC. (DELAWARE CORPORATION)  
10990 ROE AVENUE  
OVERLAND PARK, KS 66211

FOR: BUSINESS CONSULTING SERVICES RELATING TO PRODUCT DISTRIBUTION, OPERATIONS MANAGEMENT SERVICES, LOGISTICS, REVERSE LOGISTICS, SUPPLY CHAIN, AND PRODUCTION SYSTEMS AND DISTRIBUTION SOLUTIONS; BUSINESS MANAGEMENT SERVICES, NAMELY, MANAGING LOGISTICS, REVERSE LOGISTICS, SUPPLY CHAIN SERVICES, SUPPLY CHAIN VISIBILITY AND SYNCHRONIZATION, SUPPLY AND DEMAND FORECASTING AND PRODUCT DISTRIBUTION PROCESSES FOR OTHERS; TRANSPORTATION LOGISTICS SERVICES, NAMELY, ARRANGING THE TRANSPORTATION OF GOODS FOR OTHERS; TRANSPORTATION LOGISTICS SERVICES, NAMELY, PLANNING AND SCHEDULING SHIPMENTS FOR USERS OF TRANSPORTATION SERVICES; COMPUTERIZED TRACKING AND TRACING OF PACKAGES IN TRANSIT; INFORMATION MANAGEMENT SERVICES, NAMELY, SHIPMENT PROCESSING, PREPARING SHIPPING DOCUMENTS AND INVOICES, TRACKING DOCUMENTS, PACKAGES AND FREIGHT OVER COMPUTER NETWORKS, INTRANETS AND INTERNET; MONITORING AND TRACKING OF PACKAGE SHIPMENTS; PROVIDING ELECTRONIC TRACKING OF FREIGHT INFORMATION TO OTHERS; TRACKING, LOCATING AND MONITORING OF VEHICLES, MARITIME VESSELS AND AIRCRAFT SERVICES, CUSTOMS CLEARANCE SERVICES; ARRANGING FOR PICKUP, DELIVERY, STORAGE AND TRANSPORTATION OF DOCUMENTS, PACKAGES, FREIGHT AND PARCELS VIA GROUND AND AIR CARRIERS; ORDER FULFILLMENT SERVICES, IN CLASS 35 (U.S. CLS. 100, 101 AND 102).

FIRST USE 6-9-2008; IN COMMERCE 6-9-2008.

FOR: DOMESTIC AND INTERNATIONAL COMMON CARRIER FREIGHT TRANSPORTATION BY MEANS OF TRUCK, AIR, OR SEA, AND DOMESTIC AND INTERNATIONAL FREIGHT FORWARDING SERVICES; SUPPLY CHAIN, LOGISTICS AND REVERSE LOGISTICS SERVICES, NAMELY, STORAGE, TRANSPORTATION AND DELIVERY OF DOCUMENTS, PACKAGES, RAW MATERIALS, AND OTHER FREIGHT FOR OTHERS BY AIR, RAIL, SHIP OR TRUCK; WAREHOUSING SERVICES, NAMELY, STORAGE, DISTRIBUTION, PICKUP, AND PACKING FOR SHIPMENT OF DOCUMENTS, PACKAGES, RAW MATERIALS, AND OTHER FREIGHT FOR OTHERS; PROVIDING ONLINE INFORMATION IN THE FIELD OF FREIGHT TRANSFER SERVICES VIA A GLOBAL COMPUTER NETWORK, IN CLASS 39 (U.S. CLS. 100 AND 105).

FIRST USE 6-9-2008; IN COMMERCE 6-9-2008.

FOR: PROVIDING TEMPORARY USE OF ONLINE NON-DOWNLOADABLE COMPUTER SOFTWARE ALLOWING USERS TO OBTAIN QUOTES FOR SHIPMENTS OF GOODS AND TO BOOK AND TRACK SHIPMENTS OF GOODS; PROVIDING TEMPORARY USE OF ONLINE NON-DOWNLOADABLE COMPUTER SOFTWARE FOR TRACKING FREIGHT OVER COMPUTER NETWORKS, INTRANETS AND THE INTERNET, IN CLASS 42 (U.S. CLS. 100 AND 101).

FIRST USE 6-9-2008; IN COMMERCE 6-9-2008.

THE MARK CONSISTS OF STANDARD CHARACTERS WITHOUT CLAIM TO ANY PARTICULAR FONT, STYLE, SIZE, OR COLOR.

OWNER OF U.S. REG. NOS. 3,174,011, 3,272,882 AND OTHERS.

NO CLAIM IS MADE TO THE EXCLUSIVE  
RIGHT TO USE "WORLDWIDE", APART FROM  
THE MARK AS SHOWN.

SER. NO. 77-498,793, FILED 6-13-2008.

CAROL SPILS, EXAMINING ATTORNEY

**Int. Cl.: 35**

**Prior U.S. Cls.: 100, 101 and 102**

**United States Patent and Trademark Office**

**Reg. No. 3,569,564**

**Registered Feb. 3, 2009**

**SERVICE MARK  
PRINCIPAL REGISTER**

**BevMo!**

BEVERAGES & MORE!, INC. (DELAWARE CORPORATION)  
1470 ENEA CIRCLE, SUITE 1600  
CONCORD, CA 94520

FOR: RETAIL STORE SERVICES FOR BEVERAGES, ONLINE RETAIL STORE SERVICES FOR BEVERAGES, IN CLASS 35 (U.S. CLS. 100, 101 AND 102).

FIRST USE 9-0-2006; IN COMMERCE 9-0-2006.

OWNER OF U.S. REG. NOS. 1,967,347, 3,219,702 AND OTHERS.

THE MARK CONSISTS OF STYLIZED LETTERS "BEVMO" FOLLOWED BY AN EXCLAMATION POINT.

SER. NO. 77-498,909, FILED 6-13-2008.

JULIE GUTTADAURO, EXAMINING ATTORNEY



**Int. Cl.: 35**

**Prior U.S. Cls.: 100, 101 and 102**

**United States Patent and Trademark Office**

**Reg. No. 3,569,565**

**Registered Feb. 3, 2009**

**SERVICE MARK  
PRINCIPAL REGISTER**

**WAVSYS**

WAVSYS (DELAWARE LIMITED LIABILITY  
COMPANY)  
SUITE #201  
1027 PENNSYLVANIA AVENUE  
MIAMI, FL 33139

FOR: JOB AND PERSONNEL PLACEMENT, IN  
CLASS 35 (U.S. CLS. 100, 101 AND 102).

FIRST USE 5-1-2007; IN COMMERCE 5-1-2007.

THE STIPPLING IS FOR SHADING PURPOSES  
ONLY.

THE MARK CONSISTS OF THE STYLIZED  
WORD "WAVSYS".

SER. NO. 77-498,968, FILED 6-13-2008.

JOSETTE BEVERLY, EXAMINING ATTORNEY

**Int. Cl.: 35**

**Prior U.S. Cls.: 100, 101 and 102**

**United States Patent and Trademark Office**

**Reg. No. 3,569,566**

**Registered Feb. 3, 2009**

**SERVICE MARK  
PRINCIPAL REGISTER**



THE TOP LEFT CORNER LLC (NEW JERSEY  
LIMITED LIABILITY COMPANY)  
38 COUNTY ROAD 645  
SANDYSTON, NJ 078265045

FOR: BUSINESS CONSULTATION, IN CLASS 35  
(U.S. CLS. 100, 101 AND 102).

FIRST USE 6-2-2006; IN COMMERCE 6-2-2006.

THE STIPPLING IS FOR SHADING PURPOSES  
ONLY.

THE MARK CONSISTS OF THE WORDS "RE-  
GHELL.COM HELPING YOU PUT OUT THE FIRES"  
ADJACENT TO THE IMAGE OF A FIREMAN  
HOLDING A HOSE AND NOZZLE

SER. NO. 77-499,072, FILED 6-13-2008.

RUDY R. SINGLETON, EXAMINING ATTORNEY

Int. Cl.: 35

Prior U.S. Cls.: 100, 101 and 102

United States Patent and Trademark Office

Reg. No. 3,569,567

Registered Feb. 3, 2009

SERVICE MARK  
PRINCIPAL REGISTER



INDA ASSOCIATION OF THE NONWOVEN FABRICS INDUSTRY (DELAWARE CORPORATION)  
SUITE 115  
1100 CRESCENT GREEN  
CARY, NC 27518

FOR: ARRANGING AND CONDUCTING BUSINESS CONFERENCES, IN CLASS 35 (U.S. CLS. 100, 101 AND 102).

FIRST USE 1-1-2007; IN COMMERCE 1-1-2007.

NO CLAIM IS MADE TO THE EXCLUSIVE RIGHT TO USE "INDIA", APART FROM THE MARK AS SHOWN.

THE MARK CONSISTS OF STYLIZED WORDS "THE LINK WITH INDIA" WITH THE WORD "INDIA" UNDERLINED BY A LONG RECTANGLE.

SER. NO. 77-499,118, FILED 6-14-2008.

LOURDES AYALA, EXAMINING ATTORNEY

**Int. Cl.: 35**

**Prior U.S. Cls.: 100, 101 and 102**

**United States Patent and Trademark Office**

**Reg. No. 3,569,568**

**Registered Feb. 3, 2009**

**SERVICE MARK  
PRINCIPAL REGISTER**

**THE LINK WITH INDIA**

INDA ASSOCIATION OF THE NONWOVEN FAB-  
RICS INDUSTRY (DELAWARE CORPORA-  
TION)  
SUITE 115  
1100 CRESCENT GREEN  
CARY, NC 27518

FOR: ARRANGING AND CONDUCTING BUSI-  
NESS CONFERENCES, IN CLASS 35 (U.S. CLS. 100,  
101 AND 102).

FIRST USE 1-1-2007; IN COMMERCE 1-1-2007.

THE MARK CONSISTS OF STANDARD CHAR-  
ACTERS WITHOUT CLAIM TO ANY PARTICULAR  
FONT, STYLE, SIZE, OR COLOR.

NO CLAIM IS MADE TO THE EXCLUSIVE  
RIGHT TO USE "INDIA", APART FROM THE  
MARK AS SHOWN.

SER. NO. 77-499,119, FILED 6-14-2008.

LOURDES AYALA, EXAMINING ATTORNEY

**Int. Cl.: 35**

**Prior U.S. Cls.: 100, 101 and 102**

**United States Patent and Trademark Office**

**Reg. No. 3,569,569**

**Registered Feb. 3, 2009**

**SERVICE MARK  
PRINCIPAL REGISTER**

**THE LINK WITH ASIA**

INDA ASSOCIATION OF THE NONWOVEN FAB-  
RICS INDUSTRY (DELAWARE CORPORA-  
TION)  
SUITE 115  
1100 CRESCENT GREEN  
CARY, NC 27518

FOR: ARRANGING AND CONDUCTING BUSI-  
NESS CONFERENCES, IN CLASS 35 (U.S. CLS. 100,  
101 AND 102).

FIRST USE 5-29-2008; IN COMMERCE 5-29-2008.

THE MARK CONSISTS OF STANDARD CHAR-  
ACTERS WITHOUT CLAIM TO ANY PARTICULAR  
FONT, STYLE, SIZE, OR COLOR.

NO CLAIM IS MADE TO THE EXCLUSIVE  
RIGHT TO USE "ASIA", APART FROM THE MARK  
AS SHOWN.

SER. NO. 77-499,121, FILED 6-14-2008.

LOURDES AYALA, EXAMINING ATTORNEY

Int. Cl.: 35

Prior U.S. Cls.: 100, 101 and 102

United States Patent and Trademark Office

Reg. No. 3,569,570

Registered Feb. 3, 2009

SERVICE MARK  
PRINCIPAL REGISTER



INDA ASSOCIATION OF THE NONWOVEN FABRICS INDUSTRY (DELAWARE CORPORATION)  
SUITE 115  
1100 CRESCENT GREEN  
CARY, NC 27518

FOR: ARRANGING AND CONDUCTING BUSINESS CONFERENCES, IN CLASS 35 (U.S. CLS. 100, 101 AND 102).

FIRST USE 5-29-2008; IN COMMERCE 5-29-2008.

NO CLAIM IS MADE TO THE EXCLUSIVE RIGHT TO USE "ASIA", APART FROM THE MARK AS SHOWN.

THE MARK CONSISTS OF STYLIZED WORDS "THE LINK WITH ASIA" WITH THE WORD "ASIA" UNDERLINED BY A LONG RECTANGLE.

SER. NO. 77-499,123, FILED 6-14-2008.

LOURDES AYALA, EXAMINING ATTORNEY

**Int. Cl.: 42**

**Prior U.S. Cls.: 100 and 101**

**United States Patent and Trademark Office**

**Reg. No. 3,569,571**

**Registered Feb. 3, 2009**

**SERVICE MARK  
PRINCIPAL REGISTER**

**IsaSoft**

ISASOFT INC. (NEVADA CORPORATION)  
1785 EAST SAHARA AVENUE, SUITE 490-205  
LAS VEGAS, NV 89104

CES; CONSULTANCY IN THE FIELD OF  
SOFTWARE DESIGN, IN CLASS 42 (U.S. CLS. 100  
AND 101).

FOR: COMPUTER SOFTWARE CONSULTANCY;  
COMPUTER SOFTWARE CONSULTATION; COM-  
PUTER SOFTWARE DESIGN; COMPUTER SOFT-  
WARE DESIGN FOR OTHERS; COMPUTER  
SOFTWARE DESIGN, COMPUTER PROGRAM-  
MING, OR MAINTENANCE OF COMPUTER SOFT-  
WARE; COMPUTER SOFTWARE DEVELOPMENT;  
COMPUTER SOFTWARE DEVELOPMENT AND  
COMPUTER PROGRAMMING DEVELOPMENT  
FOR OTHERS; COMPUTER TECHNOLOGY SUP-  
PORT SERVICES, NAMELY, HELP DESK SERVI-

FIRST USE 7-15-2008; IN COMMERCE 7-15-2008.

THE MARK CONSISTS OF STANDARD CHAR-  
ACTERS WITHOUT CLAIM TO ANY PARTICULAR  
FONT, STYLE, SIZE, OR COLOR.

SER. NO. 77-499,150, FILED 6-14-2008.

LEIGH CAROLINE CASE, EXAMINING ATTOR-  
NEY

**Int. Cl.: 12**

**Prior U.S. Cls.: 19, 21, 23, 31, 35 and 44**

**Reg. No. 3,569,572**

**United States Patent and Trademark Office**

**Registered Feb. 3, 2009**

**TRADEMARK  
PRINCIPAL REGISTER**



MOBILE BARRIERS LLC (COLORADO LIMITED LIABILITY COMPANY)  
24918 GENESEE TRAIL ROAD  
GOLDEN, CO 80401

FOR: SEMI-TRAILER EQUIPPED WITH A PROTECTIVE WALL AND A WORK AREA, IN CLASS 12 (U.S. CLS. 19, 21, 23, 31, 35 AND 44).

FIRST USE 6-5-2008; IN COMMERCE 6-5-2008.

NO CLAIM IS MADE TO THE EXCLUSIVE RIGHT TO USE "MOBILE BARRIERS", APART FROM THE MARK AS SHOWN.

THE MARK CONSISTS OF THE WORD "MOBILE" WITH AN UNDERLINE WITH THE ENDS EXTENDING UP IN DIAGONAL LINES AWAY FROM THE WORDING, AND APPEARING OVER THE WORD "BARRIERS" AND WITH A THREE TRIANGLE DESIGN ON BOTH SIDES OF THE WORDING, AND WITH AN ADDITIONAL UNDERLINE UNDER ALL OF THE FOREGOING.

SER. NO. 77-499,183, FILED 6-14-2008.

BARBARA BROWN, EXAMINING ATTORNEY



**Int. Cl.: 11**

**Prior U.S. Cls.: 13, 21, 23, 31 and 34**

**Reg. No. 3,569,573**

**United States Patent and Trademark Office**

**Registered Feb. 3, 2009**

---

**TRADEMARK  
PRINCIPAL REGISTER**

**PHUSOR**

MITCHELL SWARTZ (UNITED STATES INDIVIDUAL)  
16 PEMBROKE ROAD  
WESTON, MA 02493

THE MARK CONSISTS OF STANDARD CHARACTERS WITHOUT CLAIM TO ANY PARTICULAR FONT, STYLE, SIZE, OR COLOR.

FOR: HEATING ELEMENTS, IN CLASS 11 (U.S. CLS. 13, 21, 23, 31 AND 34).

SER. NO. 77-499,310, FILED 6-15-2008.

FIRST USE 7-1-1997; IN COMMERCE 8-15-2003.

ELLEN PERKINS, EXAMINING ATTORNEY

Int. Cl.: 9

Prior U.S. Cls.: 21, 23, 26, 36 and 38

Reg. No. 3,569,574

United States Patent and Trademark Office

Registered Feb. 3, 2009

TRADEMARK  
PRINCIPAL REGISTER

*xl* **TRANSFER**

LOG-IN, INC. (ILLINOIS CORPORATION)  
932 COUNTRY LANE  
BUFFALO GROVE, IL 60089

THE MARK CONSISTS OF SCRIPTED ITALIC  
LOWER CASE: "XL" FOLLOWED BY CAPITALIZED  
ITALIC UNDERLINED: "TRANSFER".

FOR: ELECTRONIC INTERFACE EQUIPMENT  
FOR MACHINE TOOLS TO INPUT OR OUTPUT  
CNC (COMPUTER NUMERICAL CONTROL) DATA,  
IN CLASS 9 (U.S. CLS. 21, 23, 26, 36 AND 38).

THE WORDING "XL" HAS NO MEANING IN A  
FOREIGN LANGUAGE.

FIRST USE 6-6-2008; IN COMMERCE 6-6-2008.

SER. NO. 77-499,312, FILED 6-15-2008.

NO CLAIM IS MADE TO THE EXCLUSIVE  
RIGHT TO USE "TRANSFER", APART FROM THE  
MARK AS SHOWN.

JIM RINGLE, EXAMINING ATTORNEY

**Int. Cl.: 35**

**Prior U.S. Cls.: 100, 101 and 102**

**United States Patent and Trademark Office**

**Reg. No. 3,569,575**

**Registered Feb. 3, 2009**

**SERVICE MARK  
PRINCIPAL REGISTER**



TECHFORCE, INC. (DELAWARE CORPORATION)  
SUITE 20098  
6470 FREETOWN ROAD  
COLUMBIA, MD 21044

FOR: BUSINESS CONSULTATION; BUSINESS MANAGEMENT CONSULTANCY SERVICES; BUSINESS MANAGEMENT CONSULTATION; BUSINESS MANAGEMENT CONSULTATION IN THE FIELD OF EXECUTIVE AND LEADERSHIP DEVELOPMENT, IN CLASS 35 (U.S. CLS. 100, 101 AND 102).

FIRST USE 10-15-2004; IN COMMERCE 10-15-2004.

THE COLOR(S) BLUE AND WHITE IS/ARE CLAIMED AS A FEATURE OF THE MARK.

THE MARK CONSISTS OF THREE DOLPHINS JUMPING THROUGH A HOOP WITH THE WORDS "TECHFORCE" UNDERNEATH. THE DESIGN ELEMENT AND THE WORDS ARE ALL BLUE IN COLOR ON A WHITE BACKGROUND.

SER. NO. 77-499,317, FILED 6-15-2008.

JIM RINGLE, EXAMINING ATTORNEY

**Int. Cl.: 41**

**Prior U.S. Cls.: 100, 101 and 107**

**United States Patent and Trademark Office**

**Reg. No. 3,569,576**

**Registered Feb. 3, 2009**

**SERVICE MARK  
PRINCIPAL REGISTER**

**Turbocharge Your Career**

MANHATTAN REVIEW LLC (DELAWARE LIMITED LIABILITY COMPANY)  
420 LEXINGTON AVENUE  
NEW YORK, NY 10170

FOR: DEVELOPING EDUCATIONAL MANUALS FOR OTHERS IN THE FIELD OF GRADUATE STUDY PREPARATION COURSES; EDUCATION SERVICES, NAMELY, PROVIDING LIVE AND ON-LINE CLASSES, SEMINARS AND WORKSHOPS IN THE FIELD OF GRADUATE STUDY PREPARATION COURSES; EDUCATION SERVICES, NAMELY, PROVIDING MENTORING, TUTORING, CLASSES, SEMINARS AND WORKSHOPS IN THE FIELD OF GRADUATE STUDY PREPARATION COURSES; EDUCATION SERVICES, NAMELY, PROVIDING TUTORIAL SESSIONS IN THE FIELD(S) OF GRADUATE STUDY PREPARATION COURSES; EDUCATION SERVICES, NAMELY, PROVIDING TUTORIAL SESSIONS IN THE FIELDS OF GRADUATE STUDY PREPARATION COURSES; EDUCATION SERVICES, NAMELY, PROVIDING TUTORING IN THE FIELD OF GRADUATE STUDY PREPARATION COURSES; EDUCATION SERVICES, NAMELY, PROVIDING TUTORING IN THE

FIELDS OF GRADUATE STUDY PREPARATION COURSES; EDUCATION SERVICES, NAMELY, PROVIDING CLASSES, SEMINARS AND WORKSHOPS IN THE FIELD OF GRADUATE STUDY PREPARATION COURSES; EDUCATION SERVICES, NAMELY, PROVIDING CLASSES, SEMINARS AND WORKSHOPS IN THE FIELDS OF GRADUATE STUDY PREPARATION COURSES, IN CLASS 41 (U.S. CLS. 100, 101 AND 107).

FIRST USE 10-1-2006; IN COMMERCE 1-1-2007.

THE MARK CONSISTS OF STANDARD CHARACTERS WITHOUT CLAIM TO ANY PARTICULAR FONT, STYLE, SIZE, OR COLOR.

NO CLAIM IS MADE TO THE EXCLUSIVE RIGHT TO USE "CAREER", APART FROM THE MARK AS SHOWN.

SER. NO. 77-499,327, FILED 6-15-2008.

LOURDES AYALA, EXAMINING ATTORNEY

**Int. Cl.: 35**

**Prior U.S. Cls.: 100, 101 and 102**

**United States Patent and Trademark Office**

**Reg. No. 3,569,577**

**Registered Feb. 3, 2009**

**SERVICE MARK  
PRINCIPAL REGISTER**

**WWISH**

WWISH, INC. (WASHINGTON CORPORATION)  
218 MAIN STREET, #422  
KIRKLAND, WA 98033

THE MARK CONSISTS OF STANDARD CHAR-  
ACTERS WITHOUT CLAIM TO ANY PARTICULAR  
FONT, STYLE, SIZE, OR COLOR.

FOR: ADVERTISING AND MARKETING, IN  
CLASS 35 (U.S. CLS. 100, 101 AND 102).

SER. NO. 77-499,652, FILED 6-16-2008.

FIRST USE 3-1-2008; IN COMMERCE 5-15-2008.

MICHELE SWAIN, EXAMINING ATTORNEY

**Int. Cl.: 41**

**Prior U.S. Cls.: 100, 101 and 107**

**Reg. No. 3,569,578**

**United States Patent and Trademark Office**

**Registered Feb. 3, 2009**

---

**SERVICE MARK  
PRINCIPAL REGISTER**

**WORRY-FREE DINNERS**

ALLERGIC GIRL RESOURCES, INC. (NEW  
YORK CORPORATION)  
10K  
301 EAST 47TH STREET  
NEW YORK, NY 10017

FOR: EDUCATION SERVICES, NAMELY, PRO-  
VIDING CLASSES, SEMINARS, WORKSHOPS IN  
THE FIELD OF HEALTH; PROFESSIONAL COACH-  
ING SERVICES IN THE FIELD OF RESTAURANT  
AND FOOD SERVICES, IN CLASS 41 (U.S. CLS. 100,  
101 AND 107).

FIRST USE 4-1-2008; IN COMMERCE 4-1-2008.

THE MARK CONSISTS OF STANDARD CHAR-  
ACTERS WITHOUT CLAIM TO ANY PARTICULAR  
FONT, STYLE, SIZE, OR COLOR.

NO CLAIM IS MADE TO THE EXCLUSIVE  
RIGHT TO USE "DINNERS", APART FROM THE  
MARK AS SHOWN.

SER. NO. 77-499,656, FILED 6-16-2008.

MICHELE SWAIN, EXAMINING ATTORNEY

**Int. Cl.: 35**

**Prior U.S. Cls.: 100, 101 and 102**

**United States Patent and Trademark Office**

**Reg. No. 3,569,579**

**Registered Feb. 3, 2009**

**SERVICE MARK  
PRINCIPAL REGISTER**



WWISH, INC. (WASHINGTON CORPORATION)  
218 MAIN STREET, #422  
KIRKLAND, WA 98033

THE MARK CONSISTS OF AN ARTISTIC RENDERING OF THE THREE GRACES.

FOR: ADVERTISING AND MARKETING, IN  
CLASS 35 (U.S. CLS. 100, 101 AND 102).

SER. NO. 77-499,668, FILED 6-16-2008.

FIRST USE 3-1-2008; IN COMMERCE 5-15-2008.

MICHELE SWAIN, EXAMINING ATTORNEY

Int. Cl.: 17

Prior U.S. Cls.: 1, 5, 12, 13, 35 and 50

Reg. No. 3,569,580

United States Patent and Trademark Office

Registered Feb. 3, 2009

TRADEMARK  
PRINCIPAL REGISTER

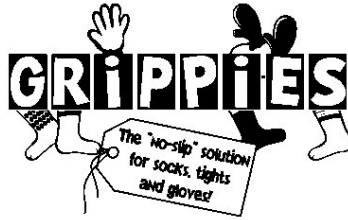

GRIPPIES, LLC (NEW YORK LIMITED LIABILITY COMPANY)  
2773 BELLMORE AVENUE  
BELLMORE, NY 11710

FOR: NON-SLIP, ADHESIVE-BACKED APPLIQUES FOR USE ON TEXTILES, IN CLASS 17 (U.S. CLS. 1, 5, 12, 13, 35 AND 50).

FIRST USE 5-21-2007; IN COMMERCE 11-1-2007.

THE MARK CONSISTS OF THE STYLIZED WORD "GRIPPIES" WITH LOWER CASE "I"'S, EACH

LETTER WITHIN OUTLINED BOXES "GRIPPIES" IS SURROUNDED BY OUTLINES OF SOCKS, GLOVES AND A PAIR OF MITTENS. THERE IS A HANG TAG OUTLINE UNDERNEATH CONTAINING THE STYLIZED WORD "THE "NO-SLIP" SOLUTION FOR SOCKS, TIGHTS AND GLOVES".

SER. NO. 77-499,741, FILED 6-16-2008.

JILL C. ALT, EXAMINING ATTORNEY



**Int. Cls.: 42 and 45**

**Prior U.S. Cls.: 100 and 101**

**United States Patent and Trademark Office**

**Reg. No. 3,569,581**

**Registered Feb. 3, 2009**

**SERVICE MARK  
PRINCIPAL REGISTER**

**SIGNAL PATTERNS**

SIGNAL MATCH, INC. (NEW YORK CORPORATION)  
1858 PLEASANTVILLE ROAD, #137  
BRIARCLIFF MANOR, NY 10510

FOR: COMPUTER SERVICES, NAMELY, AN APPLICATION SERVICE PROVIDER (ASP) FEATURING SOFTWARE AND WEB APPLICATION FOR USE IN DISCOVERING NEW FRIENDS, PRODUCTS, SERVICES AND COMMUNITIES BASED ON USERS' INDIVIDUAL AND GROUP PERSONALITY, INTEREST AND PREFERENCE PROFILES, IN CLASS 42 (U.S. CLS. 100 AND 101).

FIRST USE 12-3-2007; IN COMMERCE 12-3-2007.

FOR: COMPUTER-BASED SOCIAL NETWORKING SERVICES, NAMELY, PROVIDING A WEBSITE

FOR USE IN DISCOVERING NEW FRIENDS AND COMMUNITIES BASED ON THE USERS' INDIVIDUAL AND GROUP PERSONALITY, INTEREST AND PREFERENCE PROFILES, IN CLASS 45 (U.S. CLS. 100 AND 101).

FIRST USE 12-3-2007; IN COMMERCE 12-3-2007.

THE MARK CONSISTS OF STANDARD CHARACTERS WITHOUT CLAIM TO ANY PARTICULAR FONT, STYLE, SIZE, OR COLOR.

SER. NO. 77-499,868, FILED 6-16-2008.

NORA BUCHANAN WILL, EXAMINING ATTORNEY

**Int. Cl.: 35**

**Prior U.S. Cls.: 100, 101 and 102**

**United States Patent and Trademark Office**

**Reg. No. 3,569,582**

**Registered Feb. 3, 2009**

**SERVICE MARK  
PRINCIPAL REGISTER**

# CaterStock

STRATEGIC ALTERNATIVES, LLC (TENNESSEE  
LIMITED LIABILITY COMPANY)  
SUITE 101  
91 PEYTON PARKWAY  
MEMPHIS, TN 38017

FOR: WHOLESALE AND RETAIL STORE SERVI-  
CES FEATURING DISPOSABLE FOODSERVICE  
PACKAGING, IN CLASS 35 (U.S. CLS. 100, 101 AND  
102).

FIRST USE 5-28-2008; IN COMMERCE 5-28-2008.

THE MARK CONSISTS OF STANDARD CHAR-  
ACTERS WITHOUT CLAIM TO ANY PARTICULAR  
FONT, STYLE, SIZE, OR COLOR.

SER. NO. 77-499,885, FILED 6-16-2008.

LEIGH CAROLINE CASE, EXAMINING ATTOR-  
NEY

**Int. Cls.: 42 and 45**

**Prior U.S. Cls.: 100 and 101**

**United States Patent and Trademark Office**

**Reg. No. 3,569,583**

**Registered Feb. 3, 2009**

**SERVICE MARK  
PRINCIPAL REGISTER**

**DISCOVER THE REAL ME**

SIGNAL MATCH, INC. (NEW YORK CORPORATION)  
1858 PLEASANTVILLE ROAD, #137  
BRIARCLIFF MANOR, NY 10510

FOR: COMPUTER SERVICES, NAMELY, AN APPLICATION SERVICE PROVIDER (ASP) FEATURING SOFTWARE AND WEB APPLICATION FOR USE IN DISCOVERING NEW FRIENDS, PRODUCTS, SERVICES AND COMMUNITIES BASED ON USERS' INDIVIDUAL AND GROUP PERSONALITY, INTEREST AND PREFERENCE PROFILES, IN CLASS 42 (U.S. CLS. 100 AND 101).

FIRST USE 1-11-2008; IN COMMERCE 1-11-2008.

FOR: COMPUTER-BASED SOCIAL NETWORKING SERVICES, NAMELY, PROVIDING A WEBSITE

FOR USE IN DISCOVERING NEW FRIENDS AND COMMUNITIES BASED ON THE USERS' INDIVIDUAL AND GROUP PERSONALITY, INTEREST AND PREFERENCE PROFILES, IN CLASS 45 (U.S. CLS. 100 AND 101).

FIRST USE 1-11-2008; IN COMMERCE 1-11-2008.

THE MARK CONSISTS OF STANDARD CHARACTERS WITHOUT CLAIM TO ANY PARTICULAR FONT, STYLE, SIZE, OR COLOR.

SER. NO. 77-499,894, FILED 6-16-2008.

NORA BUCHANAN WILL, EXAMINING ATTORNEY

**Int. Cl.: 36**

**Prior U.S. Cls.: 100, 101 and 102**

**United States Patent and Trademark Office**

**Reg. No. 3,569,584**

**Registered Feb. 3, 2009**

**SERVICE MARK  
PRINCIPAL REGISTER**

**CELTICARE PREFERRED**

CELTIC INSURANCE COMPANY (ILLINOIS CORPORATION)  
233 W WACKER DR #700 SEARS TOWER  
CHICAGO, IL 606066393

OWNER OF U.S. REG. NOS. 2,295,730, 3,137,275 AND OTHERS.

FOR: INSURANCE UNDERWRITING IN THE FIELD OF HEALTH, IN CLASS 36 (U.S. CLS. 100, 101 AND 102).

NO CLAIM IS MADE TO THE EXCLUSIVE RIGHT TO USE "PREFERRED", APART FROM THE MARK AS SHOWN.

FIRST USE 5-1-2008; IN COMMERCE 5-1-2008.

SER. NO. 77-499,899, FILED 6-16-2008.

THE MARK CONSISTS OF STANDARD CHARACTERS WITHOUT CLAIM TO ANY PARTICULAR FONT, STYLE, SIZE, OR COLOR.

NORA BUCHANAN WILL, EXAMINING ATTORNEY

Int. Cl.: 16

Prior U.S. Cls.: 2, 5, 22, 23, 29, 37, 38 and 50

United States Patent and Trademark Office

Reg. No. 3,569,585

Registered Feb. 3, 2009

TRADEMARK  
PRINCIPAL REGISTER



NIERMAN, DEBORAH ANNE (UNITED STATES  
INDIVIDUAL)  
441 SALEM END RD.  
FRAMINGHAM, MA 01702

FOR: PRINTED VISUALS IN THE NATURE OF  
POINT-OF-SALE PROMOTIONAL ITEMS FOR USE  
IN GROCERY STORES, NAMELY, PRINTED SHELF  
TALKERS, DANGLERS, POSTERS AND RECIPE  
CARDS , IN CLASS 16 (U.S. CLS. 2, 5, 22, 23, 29, 37,  
38 AND 50).

FIRST USE 12-15-2006; IN COMMERCE 2-1-2007.

THE MARK CONSISTS OF THE WORDS  
"KITCH'N KIDS" TO THE LEFT OF AN ILLUSTRATED  
VERSION OF A CHILD'S FACE WEARING A  
CHEFS HAT WITH A STAR IN THE HAT. THE  
WORDING AND ILLUSTRATION ARE ON TOP OF  
AN OVAL DESIGN.

SER. NO. 77-499,911, FILED 6-16-2008.

DAVID MURRAY, EXAMINING ATTORNEY

**Int. Cl.: 35**

**Prior U.S. Cls.: 100, 101 and 102**

**United States Patent and Trademark Office**

**Reg. No. 3,569,586**

**Registered Feb. 3, 2009**

**SERVICE MARK  
PRINCIPAL REGISTER**

**ReferralBlast** 

REFERRALBLAST.COM WEB SITE PROMOTION, LLC (NEW JERSEY LIMITED LIABILITY COMPANY), DBA REFERRAL BLAST  
PO BOX 2254  
1175 LINCOLN SQUARE  
LONG BRANCH, NJ 077402254

FOR: ADVERTISING, MARKETING AND PROMOTION SERVICES, IN CLASS 35 (U.S. CLS. 100, 101 AND 102).

FIRST USE 11-23-2000; IN COMMERCE 11-23-2000.

THE MARK CONSISTS OF THE WORD "REFERRAL" (NO-ITALICS) FIRST, IMMEDIATELY FOLLOWED BY THE WORD "BLAST" (ITALICS) ON THE SAME LINE WITH VERY LITTLE SPACING. THERE IS A BOOMERANG-TYPE GRAPHIC THAT PARTIALLY SURROUNDS THE LATTER PART OF WORD "BLAST" WITH ITS ROUNDED PORTION POINTING TO THE RIGHT.

SER. NO. 77-499,966, FILED 6-16-2008.

TAMARA FRAZIER, EXAMINING ATTORNEY

**Int. Cls.: 35 and 39**

**Prior U.S. Cls.: 100, 101, 102 and 105**

**United States Patent and Trademark Office**

**Reg. No. 3,569,587**

**Registered Feb. 3, 2009**

**SERVICE MARK  
PRINCIPAL REGISTER**

**YRC TRANSPORTATION**

YRC WORLDWIDE INC. (DELAWARE CORPORATION)  
10990 ROE AVENUE  
OVERLAND PARK, KS 66211

FOR: BUSINESS CONSULTING SERVICES RELATING TO PRODUCT DISTRIBUTION, OPERATIONS MANAGEMENT SERVICES, LOGISTICS, REVERSE LOGISTICS, SUPPLY CHAIN, AND PRODUCTION SYSTEMS AND DISTRIBUTION SOLUTIONS; BUSINESS MANAGEMENT SERVICES, NAMELY, MANAGING LOGISTICS, REVERSE LOGISTICS, SUPPLY CHAIN SERVICES, SUPPLY CHAIN VISIBILITY AND SYNCHRONIZATION, SUPPLY AND DEMAND FORECASTING AND PRODUCT DISTRIBUTION PROCESSES FOR OTHERS; TRANSPORTATION LOGISTICS SERVICES, NAMELY, ARRANGING THE TRANSPORTATION OF GOODS FOR OTHERS; TRANSPORTATION LOGISTICS SERVICES, NAMELY, PLANNING AND SCHEDULING SHIPMENTS FOR USERS OF TRANSPORTATION SERVICES; COMPUTERIZED TRACKING AND TRACING OF PACKAGES IN TRANSIT; INFORMATION MANAGEMENT SERVICES, NAMELY, SHIPMENT PROCESSING, PREPARING SHIPPING DOCUMENTS AND INVOICES, TRACKING DOCUMENTS, PACKAGES AND FREIGHT OVER COMPUTER NETWORKS, INTRANETS AND INTERNETS; MONITORING AND TRACKING OF PACKAGE SHIPMENTS; PROVIDING ELECTRONIC TRACKING OF FREIGHT INFORMATION TO OTHERS; TRACKING, LOCATING AND MONITORING OF VEHICLES, MARITIME VESSELS AND AIRCRAFT SERVICES; CUSTOMS CLEARANCE SERVICES; ARRANGING FOR PICKUP, DELIVERY, STORAGE AND TRANSPORTATION OF DOCUMENTS, PACKAGES, FREIGHT AND PARCELS VIA GROUND AND

AIR CARRIERS; ORDER FULFILLMENT SERVICES, IN CLASS 35 (U.S. CLS. 100, 101 AND 102).

FIRST USE 6-2-2008; IN COMMERCE 6-2-2008.

FOR: DOMESTIC AND INTERNATIONAL COMMON CARRIER FREIGHT TRANSPORTATION BY MEANS OF TRUCK, AIR, OR SEA, AND DOMESTIC AND INTERNATIONAL FREIGHT FORWARDING SERVICES; SUPPLY CHAIN, LOGISTICS AND REVERSE LOGISTICS SERVICES, NAMELY, STORAGE, TRANSPORTATION AND DELIVERY OF DOCUMENTS, PACKAGES, RAW MATERIALS, AND OTHER FREIGHT FOR OTHERS BY AIR, RAIL, SHIP OR TRUCK; WAREHOUSING SERVICES, NAMELY, STORAGE, DISTRIBUTION, PICKUP, AND PACKING FOR SHIPMENT OF DOCUMENTS, PACKAGES, RAW MATERIALS, AND OTHER FREIGHT FOR OTHERS, IN CLASS 39 (U.S. CLS. 100 AND 105).

FIRST USE 6-2-2008; IN COMMERCE 6-2-2008.

THE MARK CONSISTS OF STANDARD CHARACTERS WITHOUT CLAIM TO ANY PARTICULAR FONT, STYLE, SIZE, OR COLOR.

OWNER OF U.S. REG. NOS. 3,174,011, 3,395,557 AND OTHERS.

NO CLAIM IS MADE TO THE EXCLUSIVE RIGHT TO USE "TRANSPORTATION", APART FROM THE MARK AS SHOWN.

SER. NO. 77-500,305, FILED 6-16-2008.

CAROL SPILS, EXAMINING ATTORNEY

**Int. Cl.: 41**

**Prior U.S. Cls.: 100, 101 and 107**

**United States Patent and Trademark Office**

**Reg. No. 3,569,588**

**Registered Feb. 3, 2009**

**SERVICE MARK  
PRINCIPAL REGISTER**



THE IAMS COMPANY (OHIO CORPORATION)  
ONE PROCTER & GAMBLE PLAZA  
CINCINNATI, OH 45202

FOR: DOG SHOWS, IN CLASS 41 (U.S. CLS. 100,  
101 AND 107).

FIRST USE 5-31-2007; IN COMMERCE 5-31-2007.

OWNER OF U.S. REG. NOS. 970,296 AND 1,163,990.

NO CLAIM IS MADE TO THE EXCLUSIVE  
RIGHT TO USE "WORLD CHALLENGE", APART  
FROM THE MARK AS SHOWN.

THE MARK CONSISTS OF AN IMAGE OF A  
GLOBE WITH THE WORDS "EUKANUBA WORLD  
CHALLENGE" IN THE CIRCULAR ORB. THERE IS  
ALSO A FOUR TOED PAW PRINT AFTER THE  
WORD "EUKANUBA" AND TWO DOGS FACING  
EACH OTHER BELOW THE WORD "CHALLENGE".

SER. NO. 77-500,434, FILED 6-17-2008.

Laurie Mayes, Examining Attorney



**Int. Cl.: 16**

**Prior U.S. Cls.: 2, 5, 22, 23, 29, 37, 38 and 50**

**Reg. No. 3,569,589**

**United States Patent and Trademark Office**

**Registered Feb. 3, 2009**

**TRADEMARK  
PRINCIPAL REGISTER**

**Complete School Guide by  
ParentWise**

MCCO COMMUNICATIONS, INC. (FLORIDA CORPORATION)  
1037 PATHFINDER WAY SUITE 140  
ROCKLEDGE, FL 32955

FOR: A MAGAZINE THAT PRESENTS TO THE READER INFORMATION PERTAINING TO PUBLIC AND PRIVATE ELEMENTARY MIDDLE AND HIGH SCHOOLS WITHIN A DEFINED GEOGRAPHIC AREA, IN CLASS 16 (U.S. CLS. 2, 5, 22, 23, 29, 37, 38 AND 50).

FIRST USE 6-13-1998; IN COMMERCE 6-13-1998.

THE MARK CONSISTS OF STANDARD CHARACTERS WITHOUT CLAIM TO ANY PARTICULAR FONT, STYLE, SIZE, OR COLOR.

NO CLAIM IS MADE TO THE EXCLUSIVE RIGHT TO USE "SCHOOL GUIDE", APART FROM THE MARK AS SHOWN.

SER. NO. 77-500,466, FILED 6-17-2008.

APRIL HESIK, EXAMINING ATTORNEY

Int. Cl.: 41

Prior U.S. Cls.: 100, 101 and 107

United States Patent and Trademark Office

Reg. No. 3,569,590

Registered Feb. 3, 2009

**SERVICE MARK  
PRINCIPAL REGISTER**

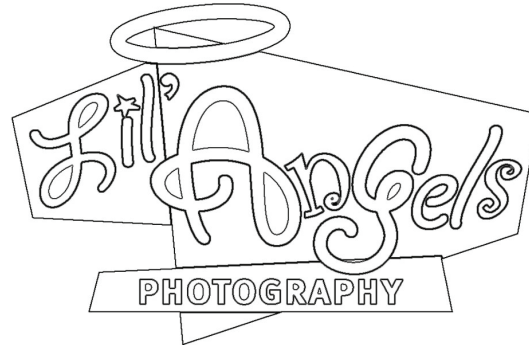

LIL' ANGELS, LLC (TENNESSEE LIMITED LIABILITY COMPANY), DBA LIL' ANGELS PHOTOGRAPHY  
4041 HATCHER CIRCLE  
MEMPHIS, TN 381186815

FOR: PORTRAIT PHOTOGRAPHY, IN CLASS 41 (U.S. CLS. 100, 101 AND 107).

FIRST USE 1-24-2005; IN COMMERCE 1-24-2005.

OWNER OF U.S. REG. NO. 2,137,312.

NO CLAIM IS MADE TO THE EXCLUSIVE RIGHT TO USE "PHOTOGRAPHY", APART FROM THE MARK AS SHOWN.

THE MARK CONSISTS OF THREE DIFFERENT-SIZED QUADRILATERAL FIGURES WITH ONE WORD OF THE LITERAL ELEMENT OF THE MARK IN EACH OF THE QUADRILATERAL FIGURES; THE LITERAL ELEMENT WORDS "LIL" AND "ANGELS" ARE IN CURSIVE, AND A CIRCULAR HALO IS IN PERSPECTIVE ABOVE THE LETTER "A" OF THE LITERAL ELEMENT WORD "ANGELS".

SER. NO. 77-500,511, FILED 6-17-2008.

MARIA-VICTORIA SUAREZ, EXAMINING ATTORNEY

Int. Cl.: 34

Prior U.S. Cls.: 2, 8, 9 and 17

United States Patent and Trademark Office

Reg. No. 3,569,591

Registered Feb. 3, 2009

TRADEMARK  
PRINCIPAL REGISTER

NATIVE

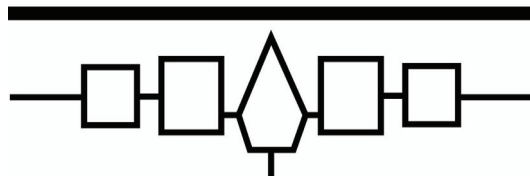

SUSAN M. JESMER (UNITED STATES INDIVIDUAL), DBA NATIVE TRADING ASSOCIATES  
442 FROGTOWN ROAD  
HOGANSBURG, NY 13655

FOR: CIGARETTES, IN CLASS 34 (U.S. CLS. 2, 8, 9 AND 17).

FIRST USE 11-1-2003; IN COMMERCE 11-1-2003.

OWNER OF U.S. REG. NOS. 2,986,748 AND 2,991,054.

THE MARK CONSISTS OF THE TERM "NATIVE" WITH A HORIZONTAL LINE UNDER IT AND WITH A DESIGN UNDER THE HORIZONTAL LINE CONSISTING OF FIVE GEOMETRIC SHAPES, NAMELY, A PENTAGON IN THE CENTER SURROUNDED BY TWO SQUARES ON EACH SIDE, WITH VERTICAL LINE DESCENDING FROM THE BOTTOM ON THE PENTAGON.

SER. NO. 77-500,556, FILED 6-17-2008.

LEIGH CAROLINE CASE, EXAMINING ATTORNEY

**Int. Cl.: 5**

**Prior U.S. Cls.: 6, 18, 44, 46, 51 and 52**

**Reg. No. 3,569,592**

**United States Patent and Trademark Office**

**Registered Feb. 3, 2009**

**TRADEMARK  
PRINCIPAL REGISTER**



**JING LUO TONG**

LEUNG, ALVAN (UNITED STATES INDIVIDUAL)  
3216 S. RACINE AVE.  
CHICAGO, IL 60608

FOR: HERBAL SUPPLEMENTS, IN CLASS 5 (U.S. CLS. 6, 18, 44, 46, 51 AND 52).

FIRST USE 3-26-1988; IN COMMERCE 3-26-1988.

OWNER OF U.S. REG. NO. 3,065,620.

THE MARK CONSISTS OF AN ABSTRACT DESIGN TO LEFT OF CHINESE CHARACTERS. BELOW THE ABSTRACT DESIGN AND THE CHINESE

CHARACTERS IS A BANNER WITH THE STYLIZED TEXT "JING LUO TONG".

THE ENGLISH TRANSLATION OF JING LUO TONG IS FREE FLOW.

THE NON-LATIN CHARACTER(S) IN THE MARK TRANSLITERATES INTO "JING LUO TONG" , AND THIS MEANS FREE FLOW IN ENGLISH.

SER. NO. 77-500,559, FILED 6-17-2008.

ERNEST SHOSHO, EXAMINING ATTORNEY

Int. Cl.: 36

Prior U.S. Cls.: 100, 101 and 102

United States Patent and Trademark Office

Reg. No. 3,569,593

Registered Feb. 3, 2009

SERVICE MARK  
PRINCIPAL REGISTER



SISTERS IN CHRIST MINISTRIES, INC. (GEOR-  
GIA NON-PROFIT CORPORATION)  
111 MATTHEWS LANE  
TEMPLE, GA 30179

FOR: CHARITABLE FUNDRAISING SERVICES,  
IN CLASS 36 (U.S. CLS. 100, 101 AND 102).

FIRST USE 7-20-2007; IN COMMERCE 7-20-2007.

THE MARK CONSISTS OF THE WORDS "UNI-  
TED IN CHRIST" WITH A DESIGN INCLUDING A  
GLOBE AND A CROSS, PART OF WHICH HAS THE  
APPEARANCE OF A RIBBON.

SER. NO. 77-500,630, FILED 6-17-2008.

MARTHA FROMM, EXAMINING ATTORNEY

**Int. Cl.: 42**

**Prior U.S. Cls.: 100 and 101**

**United States Patent and Trademark Office**

**Reg. No. 3,569,594**

**Registered Feb. 3, 2009**

**SERVICE MARK  
PRINCIPAL REGISTER**

**ENDURANCEPLANET**

ENDURANCE PLANET, INC. (KANSAS CORPORATION)  
15685 SOUTH BLACKFEATHER STREET  
OLATHE, KS 66062

FOR: PROVIDING A WEBSITE THAT ALLOWS USERS TO DOWNLOAD AUDIO, VIDEO, TEXT AND MULTIMEDIA FILES IN THE FIELD OF ENDURANCE ATHLETICS, IN CLASS 42 (U.S. CLS. 100 AND 101).

FIRST USE 1-1-2005; IN COMMERCE 1-1-2005.

THE MARK CONSISTS OF STANDARD CHARACTERS WITHOUT CLAIM TO ANY PARTICULAR FONT, STYLE, SIZE, OR COLOR.

SER. NO. 77-500,660, FILED 6-17-2008.

BENJAMIN OKEKE, EXAMINING ATTORNEY

**Int. Cl.: 9**

**Prior U.S. Cls.: 21, 23, 26, 36 and 38**

**United States Patent and Trademark Office**

**Reg. No. 3,569,595**

**Registered Feb. 3, 2009**

**TRADEMARK  
PRINCIPAL REGISTER**

**WEATHERPRODUCER**

WSI CORPORATION (MASSACHUSETTS CORPORATION)  
400 MINUTEMAN ROAD  
ANDOVER, MA 01810

FOR: COMPUTER HARDWARE AND SOFTWARE FOR RECEIVING AND GENERATING WEATHER DATA AND IMAGERY, IN CLASS 9 (U.S. CLS. 21, 23, 26, 36 AND 38).

FIRST USE 4-30-1995; IN COMMERCE 4-30-1995.

THE MARK CONSISTS OF STANDARD CHARACTERS WITHOUT CLAIM TO ANY PARTICULAR FONT, STYLE, SIZE, OR COLOR.

SER. NO. 77-500,747, FILED 6-17-2008.

KIM MONINGHOFF, EXAMINING ATTORNEY

**Int. Cl.: 9**

**Prior U.S. Cls.: 21, 23, 26, 36 and 38**

**United States Patent and Trademark Office**

**Reg. No. 3,569,596**

**Registered Feb. 3, 2009**

**TRADEMARK  
PRINCIPAL REGISTER**

**SHOWFX**

WSI CORPORATION (MASSACHUSETTS CORPORATION)  
400 MINUTEMAN ROAD  
ANDOVER, MA 01810

THE MARK CONSISTS OF STANDARD CHARACTERS WITHOUT CLAIM TO ANY PARTICULAR FONT, STYLE, SIZE, OR COLOR.

FOR: COMPUTER SOFTWARE FOR THE CREATION OF ANIMATED SPECIAL EFFECTS, IN CLASS 9 (U.S. CLS. 21, 23, 26, 36 AND 38).

SER. NO. 77-500,749, FILED 6-17-2008.

FIRST USE 5-28-1998; IN COMMERCE 5-28-1998.

KIM MONINGHOFF, EXAMINING ATTORNEY



**Int. Cl.: 9**

**Prior U.S. Cls.: 21, 23, 26, 36 and 38**

**Reg. No. 3,569,597**

**United States Patent and Trademark Office**

**Registered Feb. 3, 2009**

**TRADEMARK  
PRINCIPAL REGISTER**

**VIOT**

MIDAMERICA INTERNATIONAL (ILLINOIS CORPORATION)  
1608 OAK PARK DRIVE  
CHAMPAIGN, IL 61822

FOR: ENVIRONMENTAL MONITORING SYSTEM COMPRISED OF METERS AND SENSORS THAT MEASURE PRESSURE, HUMIDITY, TEMPERATURE AND INCLUDES ALARM AND REPORTING FUNCTIONS; GAS SENSORS FOR MEASURING GAS CONCENTRATION; MEASURING APPARATUS FOR TEMPERATURE AND HUMIDITY LEVELS IN GASES AND SOLID SUBSTANCES; PORTABLE ELECTRONIC RECORDER FOR MEASURING AND RECORDING MULTIPLE VOLTAGE, CURRENT AND THERMOCOUPLE READINGS FROM VARIOUS

TRANSDUCERS, IN CLASS 9 (U.S. CLS. 21, 23, 26, 36 AND 38).

FIRST USE 7-15-2005; IN COMMERCE 7-15-2005.

THE MARK CONSISTS OF STANDARD CHARACTERS WITHOUT CLAIM TO ANY PARTICULAR FONT, STYLE, SIZE, OR COLOR.

THE WORDING "VIOT" HAS NO MEANING IN A FOREIGN LANGUAGE.

SER. NO. 77-500,796, FILED 6-17-2008.

MICHAEL LITZAU, EXAMINING ATTORNEY

Int. Cl.: 36

Prior U.S. Cls.: 100, 101 and 102

United States Patent and Trademark Office

Reg. No. 3,569,598

Registered Feb. 3, 2009

**SERVICE MARK  
PRINCIPAL REGISTER**



MONTPELIER GROUP HOLDINGS LTD. (BER-  
MUDA LIMITED LIABILITY COMPANY)  
PO BOX HM 2079  
94 PITTS BAY ROAD  
PEMBROKE, BERMUDA HMHX

FOR: PROVIDING CUSTOMIZED AND INNOVA-  
TIVE REINSURANCE AND INSURANCE SOLU-  
TIONS TO THE GLOBAL MARKET, NAMELY,  
PROPERTY AND CASUALTY, SURPLUS LINES  
AND SPECIALTY CASUALTY INSURANCE, IN  
CLASS 36 (U.S. CLS. 100, 101 AND 102).

FIRST USE 11-14-2001; IN COMMERCE 11-14-2001.

NO CLAIM IS MADE TO THE EXCLUSIVE  
RIGHT TO USE "GROUP", APART FROM THE  
MARK AS SHOWN.

THE MARK CONSISTS OF A STYLIZED "M"  
FOLLOWED BY THE WORDS "MONTPELIER  
GROUP."

SER. NO. 77-500,855, FILED 6-17-2008.

JOHN WILKE, EXAMINING ATTORNEY

**Int. Cl.: 36**

**Prior U.S. Cls.: 100, 101 and 102**

**United States Patent and Trademark Office**

**Reg. No. 3,569,599**

**Registered Feb. 3, 2009**

**SERVICE MARK  
PRINCIPAL REGISTER**

**MONTPELIER GROUP**

MONTPELIER RE HOLDINGS LTD. (BERMUDA  
LIMITED LIABILITY COMPANY)  
PO BOX HM 2079  
94 PITTS BAY ROAD  
PEMBROKE, BERMUDA HMHX

FOR: PROVIDING CUSTOMIZED AND INNOVA-  
TIVE REINSURANCE AND INSURANCE SOLU-  
TIONS TO THE GLOBAL MARKET, NAMELY,  
PROPERTY AND CASUALTY, SURPLUS LINES  
AND SPECIALTY CASUALTY INSURANCE, IN  
CLASS 36 (U.S. CLS. 100, 101 AND 102).

FIRST USE 11-14-2001; IN COMMERCE 11-14-2001.

THE MARK CONSISTS OF STANDARD CHAR-  
ACTERS WITHOUT CLAIM TO ANY PARTICULAR  
FONT, STYLE, SIZE, OR COLOR.

NO CLAIM IS MADE TO THE EXCLUSIVE  
RIGHT TO USE "GROUP", APART FROM THE  
MARK AS SHOWN.

SER. NO. 77-500,857, FILED 6-17-2008.

JOHN WILKE, EXAMINING ATTORNEY

**Int. Cl.: 5**

**Prior U.S. Cls.: 6, 18, 44, 46, 51 and 52**

**United States Patent and Trademark Office**

**Reg. No. 3,569,600**

**Registered Feb. 3, 2009**

**TRADEMARK  
PRINCIPAL REGISTER**



PRO-SERVE, INC. (TENNESSEE CORPORATION)  
3390 WINBROOK DRIVE  
MEMPHIS, TN 38116

FOR: HERBICIDES FOR AGRICULTURAL USE,  
IN CLASS 5 (U.S. CLS. 6, 18, 44, 46, 51 AND 52).

FIRST USE 9-15-1998; IN COMMERCE 10-24-1998.

THE MARK CONSISTS OF THE WORDING  
'BARE SPOT' IN STYLIZED FONT. A DESIGN OF

AN ANIMAL FOOTPRINT APPEARS BELOW THE  
STYLIZED WORDING "BARE". A SECOND DESIGN  
OF AN ANIMAL FOOTPRINT APPEARS BEHIND  
THE WORDING "SPOT".

SER. NO. 77-500,928, FILED 6-17-2008.

CIMMERIAN COLEMAN, EXAMINING ATTOR-  
NEY

**Int. Cls.: 6, 22, 41 and 42**

**Prior U.S. Cls.: 1, 2, 7, 12, 13, 14, 19, 22, 23, 25, 42, 50,  
100, 101 and 107**

**Reg. No. 3,569,601**

**United States Patent and Trademark Office**

**Registered Feb. 3, 2009**

**TRADEMARK  
SERVICE MARK  
PRINCIPAL REGISTER**

# LIFE FIRST

HALO, L.L.C. (LOUISIANA LIMITED LIABILITY  
COMPANY)  
1133 BEVERLY GARDEN DRIVE  
METAIRIE, LA 70002

FOR: WIRE ROPES; WIRE ROPE SLINGS; METAL  
SLINGS FOR LOADING; ALL FOR USE IN THE  
MARINE INDUSTRY OR FOR INDUSTRIAL USE,  
IN CLASS 6 (U.S. CLS. 2, 12, 13, 14, 23, 25 AND 50).

FIRST USE 10-0-2007; IN COMMERCE 10-0-2007.

FOR: NON-METAL SLINGS FOR LOADING FOR  
USE IN THE MARINE INDUSTRY OR FOR INDUS-  
TRIAL USE, IN CLASS 22 (U.S. CLS. 1, 2, 7, 19, 22, 42  
AND 50).

FIRST USE 10-0-2007; IN COMMERCE 10-0-2007.

FOR: EDUCATIONAL SERVICES, NAMELY,  
COURSES ON SAFETY, USE AND INSPECTION

OF RIGGING AND GEAR FOR USE IN THE  
MARINE INDUSTRY OR FOR INDUSTRIAL USE,  
IN CLASS 41 (U.S. CLS. 100, 101 AND 107).

FIRST USE 10-0-2007; IN COMMERCE 10-0-2007.

FOR: INSPECTION OF RIGGING AND GEAR  
FOR USE IN MARINE INDUSTRY OR FOR INDUS-  
TRIAL USE, IN CLASS 42 (U.S. CLS. 100 AND 101).

FIRST USE 10-0-2007; IN COMMERCE 10-0-2007.

THE MARK CONSISTS OF STANDARD CHAR-  
ACTERS WITHOUT CLAIM TO ANY PARTICULAR  
FONT, STYLE, SIZE, OR COLOR.

SER. NO. 77-500,930, FILED 6-17-2008.

DEZMONA MIZELLE, EXAMINING ATTORNEY

**Int. Cl.: 37**

**Prior U.S. Cls.: 100, 103 and 106**

**United States Patent and Trademark Office**

**Reg. No. 3,569,602**

**Registered Feb. 3, 2009**

**SERVICE MARK  
PRINCIPAL REGISTER**



FREeworld ENTERPRISES CORPORATION  
(MISSOURI CORPORATION)  
14949 MANCHESTER ROAD  
BALLWIN, MO 63011

OWNER OF U.S. REG. NO. 2,621,571.

FOR: AUTOMOTIVE REPAIR SERVICES, AUTO-  
MOTIVE PINSTRIPING, AUTOMOTIVE DETAIL-  
ING AND SEALING SERVICES TO PROTECT  
AUTOMOTIVE EXTERIOR AND INTERIOR SUR-  
FACES, IN CLASS 37 (U.S. CLS. 100, 103 AND 106).

THE MARK CONSISTS OF CARTOON DEVIL  
HOLDING PITCHFORK.

SER. NO. 77-500,978, FILED 6-17-2008.

FIRST USE 12-18-2000; IN COMMERCE 12-18-2000.

B. PARADEWELAI, EXAMINING ATTORNEY

**Int. Cl.: 29**

**Prior U.S. Cl.: 46**

**United States Patent and Trademark Office**

**Reg. No. 3,569,603**

**Registered Feb. 3, 2009**

**TRADEMARK  
PRINCIPAL REGISTER**

**PHILLY MAID**

SHEINMAN PROVISION COMPANY, INC.  
(PENNSYLVANIA CORPORATION)  
4192 VIOLA STREET  
PHILADELPHIA, PA 19104

FOR: FRANKFURTERS; HOT DOGS; LUNCHEON MEATS; MEAT; PREPARED MEAT; PRESERVED MEATS AND SAUSAGES; PROCESSED MEAT, NAMELY, CORNED BEEF, SPICED BEEF, PASTRAMI, ROAST BEEF, BEEF TONGUE, BOLOGNA, SALAMI, BACON SMOKED SAUSAGE, FRANKFURTERS, KNOCKWURST AND LIVERWURST; SEASONED MEAT, IN CLASS 29 (U.S. CL. 46).

FIRST USE 0-0-1947; IN COMMERCE 0-0-1947.

THE MARK CONSISTS OF STANDARD CHARACTERS WITHOUT CLAIM TO ANY PARTICULAR FONT, STYLE, SIZE, OR COLOR.

NO CLAIM IS MADE TO THE EXCLUSIVE RIGHT TO USE "PHILLY", APART FROM THE MARK AS SHOWN.

SER. NO. 77-501,260, FILED 6-17-2008.

TASNEEM HUSSAIN, EXAMINING ATTORNEY

**Int. Cl.: 35**

**Prior U.S. Cls.: 100, 101 and 102**

**United States Patent and Trademark Office**

**Reg. No. 3,569,604**

**Registered Feb. 3, 2009**

**SERVICE MARK  
PRINCIPAL REGISTER**

# WineDoc

COTTRELL, THOMAS H. (KENTUCKY SOLE  
PROPRIETORSHIP), DBA WINEDOC  
600 ATHENS-BOONESBORO ROAD  
WINCHESTER, KY 403917906

FOR: BUSINESS CONSULTATION SERVICES;  
BUSINESS DEVELOPMENT SERVICES, NAMELY,  
PROVIDING START-UP SUPPORT FOR BUSINES-  
SES OF OTHERS; BUSINESS MANAGEMENT CON-  
SULTING AND ADVISORY SERVICES;  
CONDUCTING FEASIBILITY STUDIES FOR BUSI-  
NESS PURPOSES; CONSULTING SERVICES IN  
BUSINESS ORGANIZATION AND MANAGEMENT;  
ECONOMIC FEASIBILITY STUDIES; PROFESSION-

AL BUSINESS CONSULTING, IN CLASS 35 (U.S.  
CLS. 100, 101 AND 102).

FIRST USE 3-6-1999; IN COMMERCE 7-18-2000.

THE MARK CONSISTS OF STANDARD CHAR-  
ACTERS WITHOUT CLAIM TO ANY PARTICULAR  
FONT, STYLE, SIZE, OR COLOR.

SER. NO. 77-501,324, FILED 6-17-2008.

SANI KHOURI, EXAMINING ATTORNEY



**Int. Cl.: 42**

**Prior U.S. Cls.: 100 and 101**

**United States Patent and Trademark Office**

**Reg. No. 3,569,605**

**Registered Feb. 3, 2009**

**SERVICE MARK  
PRINCIPAL REGISTER**



GROUND HOUND DETECTION SERVICES, INC.  
(FLORIDA CORPORATION)  
SUITE 1  
2930 NW COMMERCE PARK DRIVE  
BOYNTON BEACH, FL 33426

FOR: UTILITY LOCATING SERVICES, NAMELY,  
LOCATING SUBTERRANEAN ELECTRICAL AND  
FIBER OPTIC CABLES, AND, NAMELY, LOCATING  
SUBTERRANEAN WATER, SEWER, STEAM, GAS  
PIPES AND TANKS, IN CLASS 42 (U.S. CLS. 100 AND  
101).

FIRST USE 10-31-1994; IN COMMERCE 12-31-2007.

NO CLAIM IS MADE TO THE EXCLUSIVE  
RIGHT TO USE "DETECTION SERVICES, INC.",  
APART FROM THE MARK AS SHOWN.

THE MARK CONSISTS OF THE LETTERS "GHD"  
WITH A TRIANGLE ON THE H AND A SERIES OF  
CONCENTRIC RINGS POSITIONED ABOVE A  
HORIZONTAL LINE, WITH THE WORDS  
"GROUND HOUND DETECTION SERVICES, INC"  
LOCATED BELOW THE LINE.

SER. NO. 77-501,514, FILED 6-18-2008.

BENJAMIN ALLEN, EXAMINING ATTORNEY

**Int. Cl.: 41**

**Prior U.S. Cls.: 100, 101 and 107**

**United States Patent and Trademark Office**

**Reg. No. 3,569,606**

**Registered Feb. 3, 2009**

**SERVICE MARK  
PRINCIPAL REGISTER**



CHRISTIAN TELEVISION NETWORK (FLORIDA CORPORATION)  
6922 142ND AVENUE  
LARGO, FL 33771

FOR: EDUCATIONAL AND ENTERTAINMENT SERVICES, NAMELY, AN ON-GOING SERIES FEATURING FITNESS BROADCAST OVER TELEVISION, SATELLITE, CABLE, WEBCASTS, AUDIO, AND VIDEO MEDIA , IN CLASS 41 (U.S. CLS. 100, 101 AND 107).

FIRST USE 11-21-2007; IN COMMERCE 2-26-2008.

NO CLAIM IS MADE TO THE EXCLUSIVE RIGHT TO USE "CHRISTIAN FITNESS", APART FROM THE MARK AS SHOWN.

THE MARK CONSISTS OF THE STYLIZED LETTERS AND WORDS "C F CHRISTIAN FITNESS". THE LETTER "C" AND "F" ARE IN THE SHAPE OF A FISH WITH THE TEXT TRAILING BEHIND THE TAIL.

SER. NO. 77-501,521, FILED 6-18-2008.

TRACY FLETCHER, EXAMINING ATTORNEY

**Int. Cl.: 36**

**Prior U.S. Cls.: 100, 101 and 102**

**United States Patent and Trademark Office**

**Reg. No. 3,569,607**

**Registered Feb. 3, 2009**

---

**SERVICE MARK  
PRINCIPAL REGISTER**

**EXCELVISION**

EXCELVISION, LLC (NEW YORK LIMITED LIABILITY COMPANY)  
520 8TH AVE, 9TH FLOOR  
NEW YORK, NY 10018

THE MARK CONSISTS OF STANDARD CHARACTERS WITHOUT CLAIM TO ANY PARTICULAR FONT, STYLE, SIZE, OR COLOR.

FOR: HEALTH INSURANCE ADMINISTRATION  
IN THE FIELD OF VISION, IN CLASS 36 (U.S. CLS. 100, 101 AND 102).

SER. NO. 77-501,535, FILED 6-18-2008.

FIRST USE 2-11-2008; IN COMMERCE 2-11-2008.

GILBERT SWIFT, EXAMINING ATTORNEY

**Int. Cl.: 17**

**Prior U.S. Cls.: 1, 5, 12, 13, 35 and 50**

**Reg. No. 3,569,608**

**United States Patent and Trademark Office**

**Registered Feb. 3, 2009**

---

**TRADEMARK  
PRINCIPAL REGISTER**

**GREEN BEAR**

PORTERCORP (MICHIGAN CORPORATION),  
DBA W. H. PORTER, INC.  
4240 NORTH 136TH AVENUE  
HOLLAND, MI 49424

THE MARK CONSISTS OF STANDARD CHAR-  
ACTERS WITHOUT CLAIM TO ANY PARTICULAR  
FONT, STYLE, SIZE, OR COLOR.

FOR: STRUCTURAL INSULATED PANELS IN  
THE CONSTRUCTION AND BUILDING INDUS-  
TRY, IN CLASS 17 (U.S. CLS. 1, 5, 12, 13, 35 AND 50).

SER. NO. 77-501,546, FILED 6-18-2008.

FIRST USE 6-18-2008; IN COMMERCE 6-18-2008.

LOURDES AYALA, EXAMINING ATTORNEY

**Int. Cl.: 41**

**Prior U.S. Cls.: 100, 101 and 107**

**United States Patent and Trademark Office**

**Reg. No. 3,569,609**

**Registered Feb. 3, 2009**

**SERVICE MARK  
PRINCIPAL REGISTER**

**WORLDS OF FLAVOR**

THE CULINARY INSTITUTE OF AMERICA  
(NEW YORK CORPORATION)  
1946 CAMPUS DRIVE  
HYDE PARK, NY 125381499

FOR: EDUCATIONAL SERVICES, NAMELY, ARRANGING AND CONDUCTING CLASSES, SEMINARS, CONFERENCES, FORUMS, RETREATS AND WORKSHOPS IN THE FIELDS OF CULINARY ARTS, AGRICULTURE, FOOD, WINE, NUTRITION SCIENCE, AND HEALTH CARE, AND DISTRIBUTION OF COURSE MATERIALS IN CONNECTION THEREWITH IN THE NATURE OF PRINTED MATERIALS, VIDEOS, AND HAND-OUTS WITH INSTRUCTIONS FOR ACCESSING ONLINE COURSE

MATERIALS, IN CLASS 41 (U.S. CLS. 100, 101 AND 107).

FIRST USE 11-0-1998; IN COMMERCE 11-0-1998.

THE MARK CONSISTS OF STANDARD CHARACTERS WITHOUT CLAIM TO ANY PARTICULAR FONT, STYLE, SIZE, OR COLOR.

OWNER OF U.S. REG. NO. 2,573,281.

SER. NO. 77-501,586, FILED 6-18-2008.

JAMES MACFARLANE, EXAMINING ATTORNEY

**Int. Cl.: 28**

**Prior U.S. Cls.: 22, 23, 38 and 50**

**Reg. No. 3,569,610**

**United States Patent and Trademark Office**

**Registered Feb. 3, 2009**

**TRADEMARK  
PRINCIPAL REGISTER**



LASER ENGINEERING DESIGN INC. (FLORIDA CORPORATION)  
5050 BEACH RIVER ROAD  
WINDERMERE, FL 34786

THE MARK CONSISTS OF AN IMAGE OF THE SHADOW OF A GOLF BALL SITTING ON THE EDGE OF A GOLF HOLE.

FOR: BATTERY POWERED MICRO-COMPUTER CONTROLLED GOLF SWING AID USED FOR TRAINING PURPOSES, IN CLASS 28 (U.S. CLS. 22, 23, 38 AND 50).

SER. NO. 77-501,603, FILED 6-18-2008.

FIRST USE 6-1-2008; IN COMMERCE 8-1-2008.

JUDITH HELFMAN, EXAMINING ATTORNEY

Int. Cl.: 11

Prior U.S. Cls.: 13, 21, 23, 31 and 34

United States Patent and Trademark Office

Reg. No. 3,569,611

Registered Feb. 3, 2009

TRADEMARK  
PRINCIPAL REGISTER

ALTER

ALTER SAS (FRANCE SOCIÉTÉ PAR ACTIONS  
SIMPLIFIÉE (SAS))  
5 BIS RUE GABRIEL PERI  
MONTROUGE, FRANCE 92120

FOR: ELECTRIC LIGHTING FIXTURES, IN  
CLASS 11 (U.S. CLS. 13, 21, 23, 31 AND 34).

FIRST USE 0-0-1982; IN COMMERCE 0-0-1996.

THE MARK CONSISTS OF STANDARD CHAR-  
ACTERS WITHOUT CLAIM TO ANY PARTICULAR  
FONT, STYLE, SIZE, OR COLOR.

OWNER OF U.S. REG. NO. 2,161,700.

SER. NO. 77-501,707, FILED 6-18-2008.

TEJBIR SINGH, EXAMINING ATTORNEY

**Int. Cls.: 35 and 40**

**Prior U.S. Cls.: 100, 101, 102, 103 and 106**

**United States Patent and Trademark Office**

**Reg. No. 3,569,612**

**Registered Feb. 3, 2009**

**SERVICE MARK  
PRINCIPAL REGISTER**

**WEAR A PAIR, SHARE A PAIR**

CROCS, INC. (DELAWARE CORPORATION)  
6328 MONARCH PARK PLACE  
NIWOT, CO 80503

FOR: CHARITABLE SERVICES, NAMELY, CO-ORDINATION OF THE PROCUREMENT AND DISTRIBUTION OF FOOTWEAR TO INDIVIDUALS AND ORGANIZATIONS PROVIDING FREE FOOTWEAR TO NEEDY PEOPLE, IN CLASS 35 (U.S. CLS. 100, 101 AND 102).

FIRST USE 1-31-2008; IN COMMERCE 1-31-2008.

FOR: RECYCLING OF FOOTWEAR, IN CLASS 40 (U.S. CLS. 100, 103 AND 106).

FIRST USE 1-31-2008; IN COMMERCE 1-31-2008.

THE MARK CONSISTS OF STANDARD CHARACTERS WITHOUT CLAIM TO ANY PARTICULAR FONT, STYLE, SIZE, OR COLOR.

SER. NO. 77-501,809, FILED 6-18-2008.

CURTIS FRENCH, EXAMINING ATTORNEY



**Int. Cl.: 35**

**Prior U.S. Cls.: 100, 101 and 102**

**United States Patent and Trademark Office**

**Reg. No. 3,569,613**

**Registered Feb. 3, 2009**

**SERVICE MARK  
PRINCIPAL REGISTER**

**THE COACHING MASTERIES**

INTERNATIONAL ASSOCIATION OF COACHING (TENNESSEE NON-PROFIT ORGANIZATION)  
P.O. BOX 158555  
NASHVILLE, TN 37215

FOR: ASSOCIATION SERVICES, NAMELY, PROMOTING THE PROFESSIONAL GROWTH, DEVELOPMENT AND CERTIFICATION OF COACHES IN THE FIELD OF PERSONAL, LIFE, PROFESSIONAL AND BUSINESS ISSUES, IN CLASS 35 (U.S. CLS. 100, 101 AND 102).

FIRST USE 5-5-2005; IN COMMERCE 5-5-2005.

THE MARK CONSISTS OF STANDARD CHARACTERS WITHOUT CLAIM TO ANY PARTICULAR FONT, STYLE, SIZE, OR COLOR.

NO CLAIM IS MADE TO THE EXCLUSIVE RIGHT TO USE "COACHING", APART FROM THE MARK AS SHOWN.

SER. NO. 77-501,856, FILED 6-18-2008.

JOHN WILKE, EXAMINING ATTORNEY

**Int. Cl.: 35**

**Prior U.S. Cls.: 100, 101 and 102**

**United States Patent and Trademark Office**

**Reg. No. 3,569,614**

**Registered Feb. 3, 2009**

**SERVICE MARK  
PRINCIPAL REGISTER**

**INTERNATIONAL ASSOCIATION  
OF COACHING**

INTERNATIONAL ASSOCIATION OF COACH-  
ING (TENNESSEE NON-PROFIT ORGANIZA-  
TION)  
P.O. BOX 158555  
NASHVILLE, TN 37215

FOR: ASSOCIATION SERVICES, NAMELY, PRO-  
MOTING THE PROFESSIONAL GROWTH, DEVEL-  
OPMENT AND CERTIFICATION OF COACHES IN  
THE FIELD OF PERSONAL, LIFE, PROFESSIONAL  
AND BUSINESS ISSUES, IN CLASS 35 (U.S. CLS. 100,  
101 AND 102).

FIRST USE 3-11-2003; IN COMMERCE 3-11-2003.

THE MARK CONSISTS OF STANDARD CHAR-  
ACTERS WITHOUT CLAIM TO ANY PARTICULAR  
FONT, STYLE, SIZE, OR COLOR.

NO CLAIM IS MADE TO THE EXCLUSIVE  
RIGHT TO USE "ASSOCIATION", APART FROM  
THE MARK AS SHOWN.

SEC. 2(F).

SER. NO. 77-501,883, FILED 6-18-2008.

JOHN WILKE, EXAMINING ATTORNEY

**Int. Cl.: 41**

**Prior U.S. Cls.: 100, 101 and 107**

**United States Patent and Trademark Office**

**Reg. No. 3,569,615**

**Registered Feb. 3, 2009**

**SERVICE MARK  
PRINCIPAL REGISTER**

**ENGAGED LEARNING**

CLEVELAND STATE UNIVERSITY (OHIO STATE UNIVERSITY)  
2300 EUCLID AVENUE, AC 321  
CLEVELAND, OH 44115

FOR: LENDING LIBRARIES; PUBLICATION OF BOOKS; PUBLICATION OF ELECTRONIC BOOKS AND JOURNALS ON-LINE; EDUCATIONAL SERVICES, NAMELY, PROVIDING COURSES AT THE UNDERGRADUATE AND GRADUATE UNIVERSITY LEVEL AND DISTRIBUTING COURSE MATERIAL THEREWITH; EXTENSION, CONTINUING AND COMMUNITY EDUCATIONAL SERVICES, NAMELY, CONDUCTING CLASSES, PUBLIC LECTURES, WORKSHOPS, SEMINARS, CONFERENCES AND EXHIBITIONS IN THE FIELDS OF ENGINEERING, LAW, BUSINESS, ARTS AND HUMANITIES, NATURAL AND PHYSICAL SCIENCES, ARCHITECTURE, JOURNALISM, EDUCATION, INTERNATIONAL AND PUBLIC AFFAIRS, PUBLIC HEALTH, SOCIAL WORK, BEHAVIORAL SCIENCES, AND MATHEMATICS AND DISTRIBUTING COURSE MATERIAL THEREWITH; EDUCATION-

AL RESEARCH; ENTERTAINMENT SERVICES, NAMELY, ARRANGING AND CONDUCTING ATHLETIC EVENTS AND TOURNAMENTS, EXHIBITIONS, CONFERENCES, LIVE PERFORMANCES AND FESTIVALS, IN CLASS 41 (U.S. CLS. 100, 101 AND 107).

FIRST USE 2-0-2008; IN COMMERCE 2-0-2008.

THE MARK CONSISTS OF STANDARD CHARACTERS WITHOUT CLAIM TO ANY PARTICULAR FONT, STYLE, SIZE, OR COLOR.

NO CLAIM IS MADE TO THE EXCLUSIVE RIGHT TO USE "LEARNING", APART FROM THE MARK AS SHOWN.

SER. NO. 77-501,885, FILED 6-18-2008.

MATTHEW MCDOWELL, EXAMINING ATTORNEY

**Int. Cl.: 30**

**Prior U.S. Cl.: 46**

**United States Patent and Trademark Office**

**Reg. No. 3,569,616**

**Registered Feb. 3, 2009**

**TRADEMARK  
PRINCIPAL REGISTER**

***Dorot***

GARLIC & HERBS DOROT AGRICULTURAL  
COOPERATION LTD. (ISRAEL COOPERA-  
TIVE SOCIETY)  
KIBBUTZ DOROT  
D.N. HOF ASHKELON, ISRAEL 79175

FOR: PROCESSED HERBS, IN CLASS 30 (U.S. CL.  
46).

FIRST USE 3-9-1988; IN COMMERCE 3-19-1998.

THE MARK CONSISTS OF THE WORD "DOROT".

SER. NO. 77-501,913, FILED 6-18-2008.

KAREN K. BUSH, EXAMINING ATTORNEY

**Int. Cl.: 10**

**Prior U.S. Cls.: 26, 39 and 44**

**United States Patent and Trademark Office**

**Reg. No. 3,569,617**

**Registered Feb. 3, 2009**

**TRADEMARK  
PRINCIPAL REGISTER**

**Trigger It!**

AGUILAR, LISA (UNITED STATES INDIVIDUAL)  
602 PLEASURE DRIVE  
MUNDELEIN, IL 60060

THE MARK CONSISTS OF STANDARD CHARACTERS WITHOUT CLAIM TO ANY PARTICULAR FONT, STYLE, SIZE, OR COLOR.

FOR: MASSAGE APPARATUS, IN CLASS 10 (U.S. CLS. 26, 39 AND 44).

SER. NO. 77-501,926, FILED 6-18-2008.

FIRST USE 3-1-2008; IN COMMERCE 3-1-2008.

REBECCA GILBERT, EXAMINING ATTORNEY

**Int. Cl.: 9**

**Prior U.S. Cls.: 21, 23, 26, 36 and 38**

**Reg. No. 3,569,618**

**United States Patent and Trademark Office**

**Registered Feb. 3, 2009**

**TRADEMARK  
PRINCIPAL REGISTER**

**EASYPORT**

TOMTOM INTERNATIONAL B.V. (NETHERLANDS LIMITED LIABILITY COMPANY)  
REMBRANDTPLEIN 35  
AMSTERDAM, NETHERLANDS 1017CT

FIRST USE 6-16-2008; IN COMMERCE 6-16-2008.

FOR: MOUNTING KIT FOR PORTABLE GLOBAL POSITIONING SYSTEM (GPS) UNITS, CONSISTING OF A DEVICE FOR ATTACHING THE GLOBAL POSITIONING SYSTEM UNIT TO A VEHICLE WINDSHIELD AND POWER ADAPTER FOR THE GLOBAL POSITIONING SYSTEM (GPS) UNIT, IN CLASS 9 (U.S. CLS. 21, 23, 26, 36 AND 38).

THE MARK CONSISTS OF STANDARD CHARACTERS WITHOUT CLAIM TO ANY PARTICULAR FONT, STYLE, SIZE, OR COLOR.

SER. NO. 77-501,930, FILED 6-18-2008.

JUSTINE D. PARKER, EXAMINING ATTORNEY

**Int. Cls.: 35 and 36**

**Prior U.S. Cls.: 100, 101 and 102**

**United States Patent and Trademark Office**

**Reg. No. 3,569,619**

**Registered Feb. 3, 2009**

**SERVICE MARK  
PRINCIPAL REGISTER**



GENCORP INSURANCE GROUP, INC. (RHODE ISLAND CORPORATION)  
16 MAIN ST.  
EAST GREENWICH, RI 02818

FOR: MANAGING THE OPERATIONS OF INSURANCE AGENCIES AND BROKERS ON AN OUTSOURCING BASIS, IN CLASS 35 (U.S. CLS. 100, 101 AND 102).

FIRST USE 11-11-1996; IN COMMERCE 11-11-1996.

FOR: ESTATE PLANNING; FINANCIAL MANAGEMENT; INSURANCE AGENCY AND BROKERAGE; INSURANCE BROKERAGE IN THE FIELD OF PROPERTY, CASUALTY, LIFE AND HEALTH INSURANCE AND CLAIMS ADMINISTRATION; INSURANCE CONSULTATION, IN CLASS 36 (U.S. CLS. 100, 101 AND 102).

FIRST USE 11-11-1996; IN COMMERCE 11-11-1996.

OWNER OF U.S. REG. NO. 2,167,313.

NO CLAIM IS MADE TO THE EXCLUSIVE RIGHT TO USE "INSURANCE GROUP", APART FROM THE MARK AS SHOWN.

THE COLOR(S) BLUE, RED, GREEN AND YELLOW IS/ARE CLAIMED AS A FEATURE OF THE MARK.

THE MARK CONSISTS OF THE WORDS "GENCORP INSURANCE GROUP" IN THE COLOR BLUE WHEREIN THE LETTER "O" IN THE WORD "CORP" IS STYLIZED IN THE COLORS BLUE, RED, YELLOW AND GREEN.

SER. NO. 77-501,936, FILED 6-18-2008.

JOHN KELLY, EXAMINING ATTORNEY

**Int. Cl.: 41**

**Prior U.S. Cls.: 100, 101 and 107**

**Reg. No. 3,569,620**

**United States Patent and Trademark Office**

**Registered Feb. 3, 2009**

**SERVICE MARK  
PRINCIPAL REGISTER**



VICTORY STUDIOS, LLC (WASHINGTON LIMITED LIABILITY COMPANY), DBA VICTORY STUDIOS  
2247 15TH AVENUE WEST  
SEATTLE, WA 98119

NO CLAIM IS MADE TO THE EXCLUSIVE RIGHT TO USE "STUDIOS", APART FROM THE MARK AS SHOWN.

FOR: MEDIA PRODUCTION SERVICES, NAME-  
LY, VIDEO AND FILM PRODUCTION, IN CLASS 41  
(U.S. CLS. 100, 101 AND 107).

SER. NO. 77-501,940, FILED 6-18-2008.

FIRST USE 1-2-2003; IN COMMERCE 1-2-2003.

JOHN KELLY, EXAMINING ATTORNEY



**Int. Cl.: 33**

**Prior U.S. Cls.: 47 and 49**

**United States Patent and Trademark Office**

**Reg. No. 3,569,621**

**Registered Feb. 3, 2009**

**TRADEMARK  
PRINCIPAL REGISTER**

**CHATEAU BUBBA**

RLWM, LLC (TEXAS LIMITED LIABILITY COMPANY)  
P.O. BOX 226  
MATAGORDA, TX 77457

NO CLAIM IS MADE TO THE EXCLUSIVE  
RIGHT TO USE "CHATEAU", APART FROM THE  
MARK AS SHOWN.

FOR: WINE, IN CLASS 33 (U.S. CLS. 47 AND 49).

FIRST USE 11-23-2007; IN COMMERCE 11-23-2007.

SER. NO. 77-501,958, FILED 6-18-2008.

THE MARK CONSISTS OF STANDARD CHARACTERS WITHOUT CLAIM TO ANY PARTICULAR FONT, STYLE, SIZE, OR COLOR.

ESTHER A. BORSUK, EXAMINING ATTORNEY

**Int. Cls.: 41 and 44**

**Prior U.S. Cls.: 100, 101 and 107**

**United States Patent and Trademark Office**

**Reg. No. 3,569,622**

**Registered Feb. 3, 2009**

**SERVICE MARK  
PRINCIPAL REGISTER**

**PREVENTION TV**

RODALE INC. (PENNSYLVANIA CORPORATION)  
33 EAST MINOR STREET  
EMMAUS, PA 180980099

FOR: PROVIDING FITNESS AND EXERCISE VIDEOS VIA AN INTERNET WEBSITE, IN CLASS 41 (U.S. CLS. 100, 101 AND 107).

FIRST USE 6-1-2008; IN COMMERCE 6-1-2008.

FOR: PROVIDING VIDEOS VIA AN INTERNET WEBSITE FEATURING INFORMATION IN THE FIELD OF HEALTH, DIET, HEALTHY LIFESTYLE, NUTRITION AND WEIGHT LOSS, IN CLASS 44 (U.S. CLS. 100 AND 101).

FIRST USE 6-1-2008; IN COMMERCE 6-1-2008.

THE MARK CONSISTS OF STANDARD CHARACTERS WITHOUT CLAIM TO ANY PARTICULAR FONT, STYLE, SIZE, OR COLOR.

OWNER OF U.S. REG. NOS. 2,550,507, 3,006,983 AND OTHERS.

NO CLAIM IS MADE TO THE EXCLUSIVE RIGHT TO USE "TV", APART FROM THE MARK AS SHOWN.

SER. NO. 77-502,161, FILED 6-18-2008.

SHAUNIA CARLYLE, EXAMINING ATTORNEY

**Int. Cl.: 39**

**Prior U.S. Cls.: 100 and 105**

**United States Patent and Trademark Office**

**Reg. No. 3,569,623**

**Registered Feb. 3, 2009**

**SERVICE MARK  
PRINCIPAL REGISTER**

**family express**

CENTER FOR RESTORATIVE JUSTICE WORKS  
(CALIFORNIA CORPORATION)  
5411 CAMELLIA AVENUE  
NORTH HOLLYWOOD, CA 91601

FOR: ARRANGING AND COORDINATING TRAVEL ARRANGEMENTS FOR INDIVIDUALS AND GROUPS, NAMELY, DESTINATIONS STAYS, HONEYMOONS, FAMILY VACATIONS, AND DESTINATION WEDDINGS, IN CLASS 39 (U.S. CLS. 100 AND 105).

FIRST USE 2-1-2007; IN COMMERCE 2-1-2007.

THE MARK CONSISTS OF STANDARD CHARACTERS WITHOUT CLAIM TO ANY PARTICULAR FONT, STYLE, SIZE, OR COLOR.

NO CLAIM IS MADE TO THE EXCLUSIVE RIGHT TO USE "FAMILY", APART FROM THE MARK AS SHOWN.

SER. NO. 77-502,298, FILED 6-18-2008.

KAPIL BHANOT, EXAMINING ATTORNEY

**Int. Cl.: 31**

**Prior U.S. Cls.: 1 and 46**

**United States Patent and Trademark Office**

**Reg. No. 3,569,624**

**Registered Feb. 3, 2009**

**TRADEMARK  
PRINCIPAL REGISTER**

**K · 9 ELITE**

K-9 FOODS, LLC (KANSAS LIMITED LIABILITY  
COMPANY)  
P.O. BOX 170  
SENECA, KS 66538

FOR: ANIMAL FOODSTUFFS, IN CLASS 31 (U.S.  
CLS. 1 AND 46).

FIRST USE 7-0-2003; IN COMMERCE 7-0-2003.

THE MARK CONSISTS OF STANDARD CHAR-  
ACTERS WITHOUT CLAIM TO ANY PARTICULAR  
FONT, STYLE, SIZE, OR COLOR.

OWNER OF U.S. REG. NO. 1,528,515.

NO CLAIM IS MADE TO THE EXCLUSIVE  
RIGHT TO USE "K-9", APART FROM THE MARK  
AS SHOWN.

SER. NO. 77-502,299, FILED 6-18-2008.

KRISTIN CARLSON, EXAMINING ATTORNEY

**Int. Cl.: 41**

**Prior U.S. Cls.: 100, 101 and 107**

**United States Patent and Trademark Office**

**Reg. No. 3,569,625**

**Registered Feb. 3, 2009**

**SERVICE MARK  
PRINCIPAL REGISTER**

**TOMMY GUNN**

STRADA, THOMAS (UNITED STATES INDIVIDUAL)  
5825 WINNETKA AVENUE  
WOODLAND HILLS, CA 91367

FOR: ENTERTAINMENT SERVICES IN THE NATURE OF LIVE ACTING AND MODELING PERFORMANCES WITH AN ADULT-THEME, ACTING AND MODELING IN MOTION PICTURE FILMS WITH AN ADULT-THEME, PERSONAL APPEARANCES BY A STAR OF ADULT MOVIES, AND PROVIDING A WEB SITE FEATURING ADULT-THEMED PHOTOGRAPHS AND VIDEOS, IN CLASS 41 (U.S. CLS. 100, 101 AND 107).

FIRST USE 5-1-1992; IN COMMERCE 5-1-1992.

THE MARK CONSISTS OF STANDARD CHARACTERS WITHOUT CLAIM TO ANY PARTICULAR FONT, STYLE, SIZE, OR COLOR.

THE NAME "TOMMY GUNN" IDENTIFIES A LIVING INDIVIDUAL WHOSE CONSENT IS OF RECORD.

SER. NO. 77-502,301, FILED 6-18-2008.

ALICIA COLLINS, EXAMINING ATTORNEY

**Int. Cl.: 38**

**Prior U.S. Cls.: 100, 101 and 104**

**United States Patent and Trademark Office**

**Reg. No. 3,569,626**

**Registered Feb. 3, 2009**

**SERVICE MARK  
PRINCIPAL REGISTER**

**ZILVIA.NET**

SYNDICATE STUDIO, LLC (COLORADO LIMITED LIABILITY COMPANY)  
8781 KACHINA WAY  
LONE TREE, CO 80124

FOR: PROVIDING AN ON-LINE COMMUNITY FEATURING CHAT ROOMS AND ELECTRONIC BULLETIN BOARDS FOR TRANSMISSION OF MESSAGES AMONG COMPUTER USERS IN THE FIELD OF AUTOMOTIVE PERFORMANCE MODIFICATIONS, TECHNOLOGY AND RACING, IN CLASS 38 (U.S. CLS. 100, 101 AND 104).

FIRST USE 2-23-2001; IN COMMERCE 2-23-2001.

THE MARK CONSISTS OF STANDARD CHARACTERS WITHOUT CLAIM TO ANY PARTICULAR FONT, STYLE, SIZE, OR COLOR.

SER. NO. 77-502,350, FILED 6-18-2008.

JOSETTE BEVERLY, EXAMINING ATTORNEY

**Int. Cl.: 3**

**Prior U.S. Cls.: 1, 4, 6, 50, 51 and 52**

**United States Patent and Trademark Office**

**Reg. No. 3,569,627**

**Registered Feb. 3, 2009**

**TRADEMARK  
PRINCIPAL REGISTER**

# Rich Girl

CDS EAST, LLC (FLORIDA LIMITED LIABILITY  
COMPANY)  
2301 COLLINS AVENUE, PH #5  
MIAMI BEACH, FL 33139

FOR: BLUSH; BODY CRAYONS; BODY POWDER;  
CONCEALERS; COSMETIC CREAMS; COSMETICS;  
EYE SHADOW; EYEBROW PENCILS; EYELINER;  
FACE AND BODY LOTIONS; FACE POWDER;  
FACIAL WASHES; FOUNDATION; HAIR CONDI-  
TIONER; HAIR LOTION; HAIR SHAMPOO; HAIR  
SPRAY; LIP GLOSS; LIP LINER; LIPSTICK; MAKE-  
UP; MASCARA; NAIL GLITTER; NAIL POLISH;  
PERFUME; POTPOURRI; SCENTED ROOM  
SPRAYS; SHOWER GEL; SKIN CLEANSERS; SKIN  
MOISTURIZER; TONERS, IN CLASS 3 (U.S. CLS. 1, 4,  
6, 50, 51 AND 52).

FIRST USE 6-0-2006; IN COMMERCE 6-0-2006.

THE MARK CONSISTS OF STANDARD CHAR-  
ACTERS WITHOUT CLAIM TO ANY PARTICULAR  
FONT, STYLE, SIZE, OR COLOR.

NO CLAIM IS MADE TO THE EXCLUSIVE  
RIGHT TO USE GIRL, APART FROM THE MARK  
AS SHOWN.

SER. NO. 77-502,481, FILED 6-19-2008.

JASON TURNER, EXAMINING ATTORNEY

**Int. Cl.: 36**

**Prior U.S. Cls.: 100, 101 and 102**

**United States Patent and Trademark Office**

**Reg. No. 3,569,628**

**Registered Feb. 3, 2009**

**SERVICE MARK  
PRINCIPAL REGISTER**

# 401(K) INSIGHT

J.J.B. HILLIARD, W.L. LYONS, LLC (KENTUCKY  
LIMITED LIABILITY COMPANY), DBA D/B/A  
HILLIARD LYONS  
P.O. BOX 32760  
LOUISVILLE, KY 402022517

FOR: FINANCIAL ADMINISTRATION OF RE-  
TIREMENT PLANS; FINANCIAL AND INVEST-  
MENT SERVICES, NAMELY, MANAGEMENT  
AND BROKERAGE IN THE FIELDS OF STOCKS,  
BONDS, OPTIONS, COMMODITIES, FUTURES  
AND OTHER SECURITIES, AND THE INVEST-  
MENT OF FUNDS OF OTHERS; FINANCIAL PLAN-  
NING AND INVESTMENT ADVISORY SERVICES;  
FINANCIAL PLANNING FOR RETIREMENT, IN  
CLASS 36 (U.S. CLS. 100, 101 AND 102).

FIRST USE 6-19-2008; IN COMMERCE 6-19-2008.

THE MARK CONSISTS OF STANDARD CHAR-  
ACTERS WITHOUT CLAIM TO ANY PARTICULAR  
FONT, STYLE, SIZE, OR COLOR.

NO CLAIM IS MADE TO THE EXCLUSIVE  
RIGHT TO USE "401(K)", APART FROM THE MARK  
AS SHOWN.

SER. NO. 77-502,524, FILED 6-19-2008.

MELISSA VALLILLO, EXAMINING ATTORNEY



**Int. Cl.: 9**

**Prior U.S. Cls.: 21, 23, 26, 36 and 38**

**Reg. No. 3,569,629**

**United States Patent and Trademark Office**

**Registered Feb. 3, 2009**

**TRADEMARK  
PRINCIPAL REGISTER**



MAXIM AUTOMOTIVE PRODUCTS, LLC (PENN-  
SYLVANIA LIMITED LIABILITY COMPANY)  
SUITE 2802  
950 WEST VALLEY ROAD  
WAYNE, PA 19087

FIRST USE 9-1-2006; IN COMMERCE 9-1-2006.

THE MARK CONSISTS OF THE LITERAL ELE-  
MENT AND A DESIGN OF A WINDING ROAD.

FOR: COMPUTER SOFTWARE, NAMELY, A  
SALES TRACKING AND ANALYSIS MANAGE-  
MENT DATABASE SOFTWARE DIRECTED TO  
FINANCE AND INSURANCE PERSONNEL IN THE  
FIELD OF AUTOMOBILE DEALERSHIPS, IN CLASS  
9 (U.S. CLS. 21, 23, 26, 36 AND 38).

SER. NO. 77-502,547, FILED 6-19-2008.

MARK T. MULLEN, EXAMINING ATTORNEY

**Int. Cl.: 41**

**Prior U.S. Cls.: 100, 101 and 107**

**United States Patent and Trademark Office**

**Reg. No. 3,569,630**

**Registered Feb. 3, 2009**

**SERVICE MARK  
PRINCIPAL REGISTER**

**BUBBLELOOSA**

EDVENTURE, INC. (SOUTH CAROLINA NON-  
PROFIT CORPORATION)  
211 GERVAIS STREET  
COLUMBIA, SC 29202

FOR: EDUCATION AND ENTERTAINMENT  
SERVICES, NAMELY, PROVIDING AN INTERAC-  
TIVE MUSEUM EXHIBIT RELATED TO THE PROP-  
ERTIES OF BUBBLES, IN CLASS 41 (U.S. CLS. 100,  
101 AND 107).

FIRST USE 5-31-2006; IN COMMERCE 5-31-2006.

THE MARK CONSISTS OF STANDARD CHAR-  
ACTERS WITHOUT CLAIM TO ANY PARTICULAR  
FONT, STYLE, SIZE, OR COLOR.

SER. NO. 77-502,592, FILED 6-19-2008.

KATHLEEN M. VANSTON, EXAMINING ATTOR-  
NEY

**Int. Cl.: 1**

**Prior U.S. Cls.: 1, 5, 6, 10, 26 and 46**

**Reg. No. 3,569,631**

**United States Patent and Trademark Office**

**Registered Feb. 3, 2009**

---

**TRADEMARK  
PRINCIPAL REGISTER**

# Dragon's Breath

JOHNSON, RICHARD (UNITED STATES INDIVIDUAL)  
P.O. BOX 283  
COLUMBIA FALLS, MT 59912

THE MARK CONSISTS OF STANDARD CHARACTERS WITHOUT CLAIM TO ANY PARTICULAR FONT, STYLE, SIZE, OR COLOR.

FOR: CHEMICAL ADDITIVE FOR MOTOR VEHICLE FUEL TREATMENT EXTRACTED FROM WATER IN THE FORM OF HYDROGEN GAS, IN CLASS 1 (U.S. CLS. 1, 5, 6, 10, 26 AND 46).

SER. NO. 77-502,653, FILED 6-19-2008.

FIRST USE 5-1-2008; IN COMMERCE 5-1-2008.

CHRISTINA SOBRAL, EXAMINING ATTORNEY

**Int. Cl.: 3**

**Prior U.S. Cls.: 1, 4, 6, 50, 51 and 52**

**Reg. No. 3,569,632**

**United States Patent and Trademark Office**

**Registered Feb. 3, 2009**

**TRADEMARK  
PRINCIPAL REGISTER**

**swift kick**

PRIMA VISTA, LLC (FLORIDA LIMITED LIABILITY COMPANY)  
601 NE.36TH STREET, SUITE 2012  
MIAMI, FL 33137

THE MARK CONSISTS OF STANDARD CHARACTERS WITHOUT CLAIM TO ANY PARTICULAR FONT, STYLE, SIZE, OR COLOR.

FOR: CLEANER FOR USE ON FOOTWEAR, SNEAKERS, SHOES, IN CLASS 3 (U.S. CLS. 1, 4, 6, 50, 51 AND 52).

SER. NO. 77-502,660, FILED 6-19-2008.

FIRST USE 1-22-2007; IN COMMERCE 1-22-2007.

STEVEN R. FINE, EXAMINING ATTORNEY

**Int. Cl.: 9**

**Prior U.S. Cls.: 21, 23, 26, 36 and 38**

**Reg. No. 3,569,633**

**United States Patent and Trademark Office**

**Registered Feb. 3, 2009**

---

**TRADEMARK  
PRINCIPAL REGISTER**

**ALLTANK**

MID-TOWN PETROLEUM, INC. (ILLINOIS CORPORATION)  
9707 S. 76TH AVENUE  
BRIDGEVIEW, IL 60455

THE MARK CONSISTS OF STANDARD CHARACTERS WITHOUT CLAIM TO ANY PARTICULAR FONT, STYLE, SIZE, OR COLOR.

FOR: LIQUID LEVEL SENSING DEVICES, IN CLASS 9 (U.S. CLS. 21, 23, 26, 36 AND 38).

SER. NO. 77-502,665, FILED 6-19-2008.

FIRST USE 9-0-1993; IN COMMERCE 9-0-1993.

G. MAYERSCHOFF, EXAMINING ATTORNEY

**Int. Cl.: 16**

**Prior U.S. Cls.: 2, 5, 22, 23, 29, 37, 38 and 50**

**Reg. No. 3,569,634**

**United States Patent and Trademark Office**

**Registered Feb. 3, 2009**

**TRADEMARK  
PRINCIPAL REGISTER**

**FRECKLEBOX**

SARPA-FELDMAN ENTERPRISES, INC. (CALIFORNIA CORPORATION), DBA PROGRESSIVE SOLUTIONS  
374 REED ST.  
SANTA CLARA, CA 95050

FIRST USE 9-19-2007; IN COMMERCE 9-19-2007.

FOR: CHILDREN'S ACTIVITY BOOKS; CHILDREN'S BOOKS; CHILDREN'S STORYBOOKS; COLORING BOOKS; PERSONALIZED COLORING BOOKS FOR CHILDREN; PERSONALIZED PAPER PLACE MATS; PERSONALIZED WRITING JOURNALS; POSTERS MADE OF PAPER, IN CLASS 16 (U.S. CLS. 2, 5, 22, 23, 29, 37, 38 AND 50).

THE MARK CONSISTS OF STANDARD CHARACTERS WITHOUT CLAIM TO ANY PARTICULAR FONT, STYLE, SIZE, OR COLOR.

SER. NO. 77-502,760, FILED 6-19-2008.

G. MAYERSCHOFF, EXAMINING ATTORNEY

**Int. Cl.: 33**

**Prior U.S. Cls.: 47 and 49**

**United States Patent and Trademark Office**

**Reg. No. 3,569,635**

**Registered Feb. 3, 2009**

**TRADEMARK  
PRINCIPAL REGISTER**

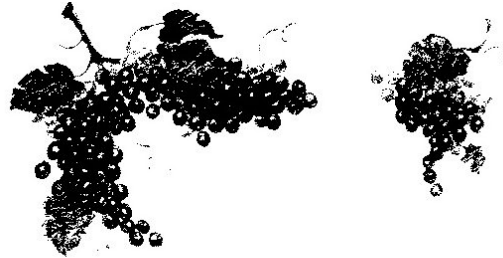

**ANTONIO**

SARAIVA ENTERPRISES, INC. (MASSACHU-  
SETTS CORPORATION)  
74 CONWAY STREET  
NEW BEDFORD, MA 02740

THE MARK CONSISTS OF THE NAME "ANTO-  
NIO" APPEARING WITH THE IMAGE OF GRAPES.

FOR: TABLE WINES, IN CLASS 33 (U.S. CLS. 47  
AND 49).

SER. NO. 77-502,816, FILED 6-19-2008.

FIRST USE 1-1-1989; IN COMMERCE 1-1-1989.

JERI J. FICKES, EXAMINING ATTORNEY

**Int. Cl.: 35**

**Prior U.S. Cls.: 100, 101 and 102**

**United States Patent and Trademark Office**

**Reg. No. 3,569,636**

**Registered Feb. 3, 2009**

**SERVICE MARK  
PRINCIPAL REGISTER**

**COYLE HOSPITALITY GROUP**

HOSPITALITY SERVICES, INC. (NEW YORK CORPORATION), DBA COYLE HOSPITALITY GROUP  
4 EAST LOVELL STEEET  
MAHOPAC, NY 10541

FOR: ASSISTANCE, ADVISORY SERVICES AND CONSULTANCY WITH REGARD TO BUSINESS PLANNING, BUSINESS ANALYSIS, BUSINESS MANAGEMENT, AND BUSINESS ORGANIZATION; BUSINESS ADVISORY SERVICES, CONSULTANCY AND INFORMATION; BUSINESS CONSULTATION IN THE FIELD OF QUALITY ASSURANCE; BUSINESS MANAGEMENT AND CONSULTATION; BUSINESS MANAGEMENT AND CONSULTATION IN THE FIELD OF QUALITY ASSURANCE; BUSINESS MANAGEMENT CONSULTING WITH RELATION TO STRATEGY, MARKETING, PRODUCTION, PERSONNEL AND

RETAIL SALE MATTERS, IN CLASS 35 (U.S. CLS. 100, 101 AND 102).

FIRST USE 4-30-1996; IN COMMERCE 4-30-1996.

THE MARK CONSISTS OF STANDARD CHARACTERS WITHOUT CLAIM TO ANY PARTICULAR FONT, STYLE, SIZE, OR COLOR.

NO CLAIM IS MADE TO THE EXCLUSIVE RIGHT TO USE "HOSPITALITY GROUP", APART FROM THE MARK AS SHOWN.

SEC. 2(F).

SER. NO. 77-502,868, FILED 6-19-2008.

RUDY R. SINGLETON, EXAMINING ATTORNEY



Int. Cl.: 8

Prior U.S. Cls.: 23, 28 and 44

United States Patent and Trademark Office

Reg. No. 3,569,637

Registered Feb. 3, 2009

TRADEMARK  
PRINCIPAL REGISTER



138060 CANADA INC. (CANADA CORPORATION)  
797 BERTRAND STREET  
CITY OF ST-LAURENT, CANADA H4M1W1

FOR: CHEF KNIVES, DIVING KNIVES, FISHING KNIVES, FOLDING KNIVES, HAND TOOLS, NAMELY, KNIFE SHARPENERS, HOUSEHOLD KNIVES, HUNTING KNIVES, JACK KNIVES, KNIFE SHEATHS, KNIVES FOR HOBBY USE, PARING KNIVES, PEN KNIVES, POCKET KNIVES, RAZOR KNIVES, SPORT KNIVES, THROWING KNIVES, UTILITY KNIVES, WORKING KNIVES, IN CLASS 8 (U.S. CLS. 23, 28 AND 44).

FIRST USE 3-15-2006; IN COMMERCE 3-15-2006.

OWNER OF U.S. REG. NO. 2,860,193.

NO CLAIM IS MADE TO THE EXCLUSIVE RIGHT TO USE "KNIVES", APART FROM THE MARK AS SHOWN.

THE MARK CONSISTS OF THE WORDS "TRUE NORTH KNIVES" ABOVE A DESIGN OF AN OVAL BADGE WITHIN WHICH IS A VERTICAL COLUMN OF THREE DOTS BEFORE THE LETTERS "TNK".

SER. NO. 77-502,998, FILED 6-19-2008.

CHRISTINE COOPER, EXAMINING ATTORNEY

**Int. Cl.: 41**

**Prior U.S. Cls.: 100, 101 and 107**

**United States Patent and Trademark Office**

**Reg. No. 3,569,638**

**Registered Feb. 3, 2009**

**SERVICE MARK  
PRINCIPAL REGISTER**

**ALL AUBURN ALL ORANGE**

AUBURN UNIVERSITY (ALABAMA STATE UNIVERSITY)  
107 SAMFORD HALL  
AUBURN, AL 36849

FOR: ENTERTAINMENT SERVICES, NAMELY, ORGANIZING AND CONDUCTING SPORTS COMPETITIONS, IN CLASS 41 (U.S. CLS. 100, 101 AND 107).

FIRST USE 9-0-2004; IN COMMERCE 9-0-2004.

THE MARK CONSISTS OF STANDARD CHARACTERS WITHOUT CLAIM TO ANY PARTICULAR FONT, STYLE, SIZE, OR COLOR.

OWNER OF U.S. REG. NOS. 2,054,439, 3,052,639 AND OTHERS.

SER. NO. 77-503,015, FILED 6-19-2008.

MARC LEIPZIG, EXAMINING ATTORNEY

**Int. Cl.: 35**

**Prior U.S. Cls.: 100, 101 and 102**

**United States Patent and Trademark Office**

**Reg. No. 3,569,639**

**Registered Feb. 3, 2009**

**SERVICE MARK  
PRINCIPAL REGISTER**

**US CURRENCY ENTERTAINMENT**

LABERTHA SANDERS (UNITED STATES INDIVIDUAL)  
106 ASTALOT  
PIEDMONT, SC 29643

FOR: ARRANGING AND CONDUCTING MARKETING PROMOTIONAL EVENTS FOR OTHERS; BUSINESS MANAGEMENT AND CONSULTATION; ENTERTAINMENT MARKETING SERVICES, NAMELY, MARKETING, PROMOTION AND ADVERTISING FOR INDEPENDENT RECORDING ARTISTS; MANAGEMENT OF PERFORMING ARTISTS; PERSONAL MANAGEMENT SERVICES FOR ENTERTAINERS; PERSONNEL MANAGEMENT CONSULTATION; PROMOTING THE PARTIES AND SPECIAL EVENTS OF OTHERS; PROVIDING CONSUMER INFORMATION SERVICES AND MAKING REFERRALS IN THE FIELD OF ENTERTAINMENT SERVICES FOR PRODUCTS, SERVICES, EVENTS, ACTIVITIES, FACILITIES AND

LOCATIONS; PROVIDING MARKETING AND PROMOTION OF SPECIAL EVENTS, IN CLASS 35 (U.S. CLS. 100, 101 AND 102).

FIRST USE 2-8-2008; IN COMMERCE 2-8-2008.

THE MARK CONSISTS OF STANDARD CHARACTERS WITHOUT CLAIM TO ANY PARTICULAR FONT, STYLE, SIZE, OR COLOR.

NO CLAIM IS MADE TO THE EXCLUSIVE RIGHT TO USE "ENTERTAINMENT", APART FROM THE MARK AS SHOWN.

SER. NO. 77-503,048, FILED 6-19-2008.

JOHN SCHUYLER YARD, EXAMINING ATTORNEY

**Int. Cl.: 35**

**Prior U.S. Cls.: 100, 101 and 102**

**United States Patent and Trademark Office**

**Reg. No. 3,569,640**

**Registered Feb. 3, 2009**

**SERVICE MARK  
PRINCIPAL REGISTER**

# Label Rack

ADAZON INC. (ILLINOIS CORPORATION)  
1485 N. WESTERN AVE  
LAKE FOREST, IL 60045

FOR: COMPUTERIZED ON-LINE ORDERING SERVICES IN THE FIELD OF BLANK AND PRE-PRINTED LABELS, SHIPPING LABELS, LASER LABELS, INKJET LABELS, BARCODE LABELS, PRIME PRODUCT LABELS, CUSTOM LABELS, AND LABELING EQUIPMENT AND SUPPLIES, IN CLASS 35 (U.S. CLS. 100, 101 AND 102).

FIRST USE 10-1-2003; IN COMMERCE 6-1-2007.

THE MARK CONSISTS OF STANDARD CHARACTERS WITHOUT CLAIM TO ANY PARTICULAR FONT, STYLE, SIZE, OR COLOR.

NO CLAIM IS MADE TO THE EXCLUSIVE RIGHT TO USE "LABEL", APART FROM THE MARK AS SHOWN.

SER. NO. 77-503,194, FILED 6-19-2008.

ELLEN PERKINS, EXAMINING ATTORNEY

**Int. Cl.: 41**

**Prior U.S. Cls.: 100, 101 and 107**

**United States Patent and Trademark Office**

**Reg. No. 3,569,641**

**Registered Feb. 3, 2009**

**SERVICE MARK  
PRINCIPAL REGISTER**

# Change at the Edge

SYNCRETICS GROUP, INC., THE (CONNECTICUT CORPORATION)  
250 WEST MAIN STREET  
BRANFORD, CT 06405

FOR: EDUCATIONAL SERVICES, NAMELY, CONDUCTING PRESENTATIONS, SEMINARS, CONFERENCES, AND WORKSHOPS FOR CONVEYING PRINCIPLES, SKILLS AND STRATEGIES IN THE FIELD OF LEADERSHIP, TEAMWORK, AND CHANGE MANAGEMENT USING STORIES OF ADVENTURE AND SURVIVAL AND DISTRIBUTION OF COURSE MATERIAL IN CONNEC-

TION THEREWITH, IN CLASS 41 (U.S. CLS. 100, 101 AND 107).

FIRST USE 9-21-2006; IN COMMERCE 9-21-2006.

THE MARK CONSISTS OF STANDARD CHARACTERS WITHOUT CLAIM TO ANY PARTICULAR FONT, STYLE, SIZE, OR COLOR.

SER. NO. 77-503,273, FILED 6-19-2008.

THEODORE MCBRIDE, EXAMINING ATTORNEY

**Int. Cl.: 7**

**Prior U.S. Cls.: 13, 19, 21, 23, 31, 34 and 35**

**United States Patent and Trademark Office**

**Reg. No. 3,569,642**

**Registered Feb. 3, 2009**

**TRADEMARK  
PRINCIPAL REGISTER**

**DOSMATIC**

DOSMATIC U.S.A., INC. (TEXAS CORPORATION)  
1230 CROWLEY CIRCLE  
CARROLLTON, TX 75006

FOR: NON-ELECTRIC, WATER-DRIVEN CHEMICAL FEED PUMPS FOR USE IN AGRICULTURAL, INDUSTRIAL AND HORTICULTURAL APPLICATIONS, IN CLASS 7 (U.S. CLS. 13, 19, 21, 23, 31, 34 AND 35).

FIRST USE 12-31-1983; IN COMMERCE 12-31-1983.

THE MARK CONSISTS OF STANDARD CHARACTERS WITHOUT CLAIM TO ANY PARTICULAR FONT, STYLE, SIZE, OR COLOR.

OWNER OF U.S. REG. NOS. 1,342,257 AND 3,237,979.

THE WORDING "DOSMATIC" HAS NO MEANING IN A FOREIGN LANGUAGE.

SER. NO. 77-503,348, FILED 6-19-2008.

JAMES MACFARLANE, EXAMINING ATTORNEY

**Int. Cl.: 42**

**Prior U.S. Cls.: 100 and 101**

**United States Patent and Trademark Office**

**Reg. No. 3,569,643**

**Registered Feb. 3, 2009**

**SERVICE MARK  
PRINCIPAL REGISTER**

**LIVE MARKET VIEW**

VAUTO, INC. (ILLINOIS CORPORATION)  
2221 CAMDEN COURT, SUITE 210  
OAKBROOK, IL 60523

FOR: PROVIDING TEMPORARY USE OF ON-  
LINE, NON-DOWNLOADABLE OPTIMIZATION  
SOFTWARE FOR ENHANCING PROFITABILITY  
IN THE FIELDS OF VEHICLE ACQUISITION, AP-  
PRaisal AND PRICING, IN CLASS 42 (U.S. CLS. 100  
AND 101).

FIRST USE 1-30-2008; IN COMMERCE 1-30-2008.

THE MARK CONSISTS OF STANDARD CHAR-  
ACTERS WITHOUT CLAIM TO ANY PARTICULAR  
FONT, STYLE, SIZE, OR COLOR.

SER. NO. 77-503,394, FILED 6-19-2008.

JENNIFER VASQUEZ, EXAMINING ATTORNEY

**Int. Cl.: 7**

**Prior U.S. Cls.: 13, 19, 21, 23, 31, 34 and 35**

**United States Patent and Trademark Office**

**Reg. No. 3,569,644**

**Registered Feb. 3, 2009**

**TRADEMARK  
PRINCIPAL REGISTER**

**SUPERDOS**

DOSMATIC U.S.A., INC. (TEXAS CORPORATION)  
1230 CROWLEY CIRCLE  
CARROLLTON, TX 75006

FOR: NON-ELECTRIC, WATER-DRIVEN CHEMICAL FEED PUMPS FOR USE IN AGRICULTURAL, INDUSTRIAL AND HORTICULTURAL APPLICATIONS, IN CLASS 7 (U.S. CLS. 13, 19, 21, 23, 31, 34 AND 35).

FIRST USE 10-31-2007; IN COMMERCE 10-31-2007.

THE MARK CONSISTS OF STANDARD CHARACTERS WITHOUT CLAIM TO ANY PARTICULAR FONT, STYLE, SIZE, OR COLOR.

THE WORDING "SUPERDOS" HAS NO MEANING IN A FOREIGN LANGUAGE.

SER. NO. 77-503,408, FILED 6-19-2008.

JAMES MACFARLANE, EXAMINING ATTORNEY



**Int. Cl.: 7**

**Prior U.S. Cls.: 13, 19, 21, 23, 31, 34 and 35**

**Reg. No. 3,569,645**

**United States Patent and Trademark Office**

**Registered Feb. 3, 2009**

**TRADEMARK  
PRINCIPAL REGISTER**

**MINIDOS**

DOSMATIC U.S.A., INC. (TEXAS CORPORATION)  
1230 CROWLEY CIRCLE  
CARROLLTON, TX 75006

THE MARK CONSISTS OF STANDARD CHARACTERS WITHOUT CLAIM TO ANY PARTICULAR FONT, STYLE, SIZE, OR COLOR.

FOR: NON-ELECTRIC, WATER-DRIVEN CHEMICAL FEED PUMPS FOR USE IN AGRICULTURAL, INDUSTRIAL AND HORTICULTURAL APPLICATIONS, IN CLASS 7 (U.S. CLS. 13, 19, 21, 23, 31, 34 AND 35).

THE WORDING "MINIDOS" HAS NO MEANING IN A FOREIGN LANGUAGE.

SER. NO. 77-503,427, FILED 6-19-2008.

FIRST USE 7-31-2005; IN COMMERCE 7-31-2005.

JAMES MACFARLANE, EXAMINING ATTORNEY

**Int. Cls.: 3 and 5**

**Prior U.S. Cls.: 1, 4, 6, 18, 44, 46, 50, 51 and 52**

**Reg. No. 3,569,646**

**United States Patent and Trademark Office**

**Registered Feb. 3, 2009**

**TRADEMARK  
PRINCIPAL REGISTER**

# CLEAROGEN

ADVANCED SKIN AND HAIR, INC. (CALIFORNIA CORPORATION)  
12121 WILSHIRE BLVD. SUITE 1012  
LOS ANGELES, CA 90035

FOR: NON-MEDICATED SKIN LOTION; NON-MEDICATED ACNE TREATMENT PREPARATIONS; FACIAL MASK LOTION; SKIN CLEANSER; SKIN TONER; LIP BALM; EYE LOTION; HAIR SHAMPOO; HAIR CONDITIONER; HAIR LOTION; BATHING LOTION; BEAUTY LOTION; MAKE-UP REMOVING LOTION; TONING LOTION FOR THE FACE, BODY, AND HANDS; SUN-TAN LOTION; SUN-BLOCK LOTION; SHAVING LOTION; AFTER-SHAVE LOTION; ANTI-AGING LOTION; ANTI-WRINKLE LOTION; SKIN EXFOLIANT LOTION, IN CLASS 3 (U.S. CLS. 1, 4, 6, 50, 51 AND 52).

FIRST USE 10-20-2005; IN COMMERCE 10-20-2005.

FOR: MEDICATED SKIN LOTION; MEDICATED ACNE TREATMENT PREPARATIONS; MEDICA-

TED SKIN TONER; MEDICATED FACIAL MASK LOTION; MEDICATED SKIN CLEANSER; MEDICATED LIP BALM; MEDICATED EYE LOTION; MEDICATED HAIR SHAMPOO; MEDICATED HAIR CONDITIONER; MEDICATED HAIR LOTION; MEDICATED BATHING LOTION; MEDICATED SUN-TAN LOTION; MEDICATED SUN-BLOCK LOTION, IN CLASS 5 (U.S. CLS. 6, 18, 44, 46, 51 AND 52).

FIRST USE 10-20-2005; IN COMMERCE 10-20-2005.

THE MARK CONSISTS OF STANDARD CHARACTERS WITHOUT CLAIM TO ANY PARTICULAR FONT, STYLE, SIZE, OR COLOR.

SER. NO. 77-503,567, FILED 6-19-2008.

STEPHEN AQUILA, EXAMINING ATTORNEY

**Int. Cl.: 42**

**Prior U.S. Cls.: 100 and 101**

**United States Patent and Trademark Office**

**Reg. No. 3,569,647**

**Registered Feb. 3, 2009**

**SERVICE MARK  
PRINCIPAL REGISTER**

**EXCELSIOR MEDIA**

EXCELSIOR MEDIA CORP. (NEVADA CORPORATION)  
302 WASHINGTON STREET #321  
SAN DIEGO, CA 92103

FOR: WEB SITE DEVELOPMENT FOR OTHERS,  
IN CLASS 42 (U.S. CLS. 100 AND 101).

FIRST USE 11-19-2003; IN COMMERCE 5-15-2008.

THE MARK CONSISTS OF STANDARD CHARACTERS WITHOUT CLAIM TO ANY PARTICULAR FONT, STYLE, SIZE, OR COLOR.

NO CLAIM IS MADE TO THE EXCLUSIVE RIGHT TO USE "MEDIA", APART FROM THE MARK AS SHOWN.

SER. NO. 77-503,724, FILED 6-20-2008.

JOHN SCHUYLER YARD, EXAMINING ATTORNEY

**Int. Cl.: 21**

**Prior U.S. Cls.: 2, 13, 23, 29, 30, 33, 40 and 50**

**Reg. No. 3,569,648**

**United States Patent and Trademark Office**

**Registered Feb. 3, 2009**

---

**TRADEMARK  
PRINCIPAL REGISTER**

**NORTHERN LODGE**

CARSON PIRIE SCOTT II, INC. (MISSISSIPPI  
CORPORATION)  
2801 EAST MARKET STREET  
YORK, PA 17402

THE MARK CONSISTS OF STANDARD CHAR-  
ACTERS WITHOUT CLAIM TO ANY PARTICULAR  
FONT, STYLE, SIZE, OR COLOR.

FOR: DINNERWARE, IN CLASS 21 (U.S. CLS. 2, 13,  
23, 29, 30, 33, 40 AND 50).

SER. NO. 77-503,747, FILED 6-20-2008.

FIRST USE 7-31-2007; IN COMMERCE 7-31-2007.

SANDRA MANIOS, EXAMINING ATTORNEY

**Int. Cl.: 31**

**Prior U.S. Cls.: 1 and 46**

**United States Patent and Trademark Office**

**Reg. No. 3,569,649**

**Registered Feb. 3, 2009**

**TRADEMARK  
PRINCIPAL REGISTER**

**DELIGHTFUL DOG BITES**

MOST DELIGHTFUL FOODS, L.L.C. (LOUISIANA LIMITED LIABILITY COMPANY)

3642 PERKINS ROAD

BATON ROUGE, LA 70808

FOR: DOG TREATS, IN CLASS 31 (U.S. CLS. 1 AND 46).

FIRST USE 10-1-2007; IN COMMERCE 1-25-2008.

THE MARK CONSISTS OF STANDARD CHARACTERS WITHOUT CLAIM TO ANY PARTICULAR FONT, STYLE, SIZE, OR COLOR.

NO CLAIM IS MADE TO THE EXCLUSIVE RIGHT TO USE "DOG", APART FROM THE MARK AS SHOWN.

SER. NO. 77-503,780, FILED 6-20-2008.

RENEE SERVANCE, EXAMINING ATTORNEY

**Int. Cl.: 31**

**Prior U.S. Cls.: 1 and 46**

**United States Patent and Trademark Office**

**Reg. No. 3,569,650**

**Registered Feb. 3, 2009**

**TRADEMARK  
PRINCIPAL REGISTER**

**DELIGHTFUL DOG FROST BITES**

MOST DELIGHTFUL FOODS, L.L.C. (LOUISIANA LIMITED LIABILITY COMPANY)

3642 PERKINS ROAD

BATON ROUGE, LA 70808

FOR: DOG TREATS, IN CLASS 31 (U.S. CLS. 1 AND 46).

FIRST USE 5-1-2008; IN COMMERCE 6-9-2008.

THE MARK CONSISTS OF STANDARD CHARACTERS WITHOUT CLAIM TO ANY PARTICULAR FONT, STYLE, SIZE, OR COLOR.

NO CLAIM IS MADE TO THE EXCLUSIVE RIGHT TO USE "DOG", APART FROM THE MARK AS SHOWN.

SER. NO. 77-503,814, FILED 6-20-2008.

RENEE SERVANCE, EXAMINING ATTORNEY

**Int. Cls.: 9 and 16**

**Prior U.S. Cls.: 2, 5, 21, 22, 23, 26, 29, 36, 37, 38 and 50**

**Reg. No. 3,569,651**

**United States Patent and Trademark Office**

**Registered Feb. 3, 2009**

**TRADEMARK  
PRINCIPAL REGISTER**

**INSIDE DENTAL ASSISTING**

AEGIS PUBLICATIONS, LLC (PENNSYLVANIA  
LIMITED LIABILITY COMPANY)  
104 PHEASANT RUN, SUITE 105  
NEWTOWN, PA 18940

FOR: DOWNLOADABLE ELECTRONIC PUBLI-  
CATIONS IN THE NATURE OF JOURNALS, NEWS-  
LETTERS, SUPPLEMENTS, MONOGRAPHS AND  
FEATURE REPORTS IN THE FIELD OF DENTIS-  
TRY, IN CLASS 9 (U.S. CLS. 21, 23, 26, 36 AND 38).

FIRST USE 10-1-2007; IN COMMERCE 6-16-2008.

FOR: TRADE JOURNALS IN THE FIELD OF  
DENTISTRY, IN CLASS 16 (U.S. CLS. 2, 5, 22, 23, 29,  
37, 38 AND 50).

FIRST USE 10-1-2007; IN COMMERCE 4-0-2008.

THE MARK CONSISTS OF STANDARD CHAR-  
ACTERS WITHOUT CLAIM TO ANY PARTICULAR  
FONT, STYLE, SIZE, OR COLOR.

NO CLAIM IS MADE TO THE EXCLUSIVE  
RIGHT TO USE "DENTAL ASSISTING", APART  
FROM THE MARK AS SHOWN.

SER. NO. 77-503,829, FILED 6-20-2008.

KELLY MCCOY, EXAMINING ATTORNEY

**Int. Cl.: 35**

**Prior U.S. Cls.: 100, 101 and 102**

**United States Patent and Trademark Office**

**Reg. No. 3,569,652**

**Registered Feb. 3, 2009**

**SERVICE MARK  
PRINCIPAL REGISTER**

**INSIDE DENTAL ASSISTING**

AEGIS PUBLICATIONS, LLC (PENNSYLVANIA  
LIMITED LIABILITY COMPANY)  
104 PHEASANT RUN, SUITE 105  
NEWTOWN, PA 18940

FOR: ADVERTISING SERVICES, NAMELY, PRO-  
VIDING ADVERTISING SPACE IN A PERIODICAL;  
ADVERTISING VIA ELECTRONIC MEDIA AND  
SPECIFICALLY THE INTERNET , IN CLASS 35  
(U.S. CLS. 100, 101 AND 102).

FIRST USE 10-1-2007; IN COMMERCE 6-16-2008.

THE MARK CONSISTS OF STANDARD CHAR-  
ACTERS WITHOUT CLAIM TO ANY PARTICULAR  
FONT, STYLE, SIZE, OR COLOR.

NO CLAIM IS MADE TO THE EXCLUSIVE  
RIGHT TO USE "DENTAL ASSISTING", APART  
FROM THE MARK AS SHOWN.

SER. NO. 77-503,832, FILED 6-20-2008.

KELLY MCCOY, EXAMINING ATTORNEY



**Int. Cl.: 9**

**Prior U.S. Cls.: 21, 23, 26, 36 and 38**

**Reg. No. 3,569,653**

**United States Patent and Trademark Office**

**Registered Feb. 3, 2009**

**TRADEMARK  
PRINCIPAL REGISTER**

**falcon talon ballistic  
system**

FALCON INTERNATIONAL, INC. (ALABAMA  
CORPORATION)  
8401 N. CENTRAL EXPRESSWAY, SUITE 840  
DALLAS, TX 75225

FOR: PROTECTIVE ARMOR PANELS FOR PRO-  
TECTING AGAINST BALLISTIC PROJECTILES  
AND EXPLOSIVE FRAGMENTS INSTALLED IN  
OR ATTACHED TO VEHICLES, BUILDINGS OR  
OTHER STRUCTURES, IN CLASS 9 (U.S. CLS. 21, 23,  
26, 36 AND 38).

FIRST USE 7-31-2006; IN COMMERCE 7-31-2006.

THE MARK CONSISTS OF STANDARD CHAR-  
ACTERS WITHOUT CLAIM TO ANY PARTICULAR  
FONT, STYLE, SIZE, OR COLOR.

NO CLAIM IS MADE TO THE EXCLUSIVE  
RIGHT TO USE "BALLISTIC SYSTEM", APART  
FROM THE MARK AS SHOWN.

SER. NO. 77-503,834, FILED 6-20-2008.

CARRIE GENOVESE, EXAMINING ATTORNEY

**Int. Cl.: 41**

**Prior U.S. Cls.: 100, 101 and 107**

**United States Patent and Trademark Office**

**Reg. No. 3,569,654**

**Registered Feb. 3, 2009**

**SERVICE MARK  
PRINCIPAL REGISTER**

**INSIDE DENTAL ASSISTING**

AEGIS PUBLICATIONS, LLC (PENNSYLVANIA  
LIMITED LIABILITY COMPANY)  
104 PHEASANT RUN, SUITE 105  
NEWTOWN, PA 18940

FOR: PROVIDING CONTINUING DENTAL EDU-  
CATION COURSES, IN CLASS 41 (U.S. CLS. 100, 101  
AND 107).

FIRST USE 10-1-2007; IN COMMERCE 4-0-2008.

THE MARK CONSISTS OF STANDARD CHAR-  
ACTERS WITHOUT CLAIM TO ANY PARTICULAR  
FONT, STYLE, SIZE, OR COLOR.

NO CLAIM IS MADE TO THE EXCLUSIVE  
RIGHT TO USE "DENTAL ASSISTING", APART  
FROM THE MARK AS SHOWN.

SER. NO. 77-503,835, FILED 6-20-2008.

KELLY MCCOY, EXAMINING ATTORNEY

**Int. Cl.: 36**

**Prior U.S. Cls.: 100, 101 and 102**

**United States Patent and Trademark Office**

**Reg. No. 3,569,655**

**Registered Feb. 3, 2009**

**SERVICE MARK  
PRINCIPAL REGISTER**

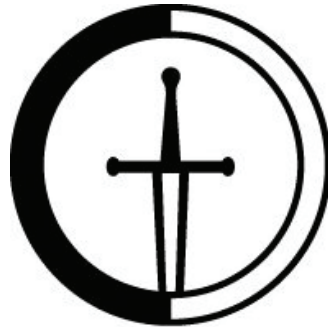

**CLAYMORE**

CLAYMORE SECURITIES, INC. (KANSAS CORPORATION)  
2455 CORPORATE WEST DRIVE  
LISLE, IL 60532

FOR: INVESTMENT ADVISORY SERVICES; SECURITIES BROKERAGE SERVICES; MUTUAL FUND BROKERAGE, DISTRIBUTION AND INVESTMENT SERVICES, IN CLASS 36 (U.S. CLS. 100, 101 AND 102).

FIRST USE 6-2-2008; IN COMMERCE 6-2-2008.

OWNER OF U.S. REG. NOS. 2,800,058, 2,802,044, AND 2,802,050.

THE MARK CONSISTS OF THE WORD "CLAYMORE", A SWORD AND A CIRCLE CONSISTING OF TWO STYLIZED LETTER "C'S".

SER. NO. 77-503,841, FILED 6-20-2008.

BILL DAWE, EXAMINING ATTORNEY

**Int. Cl.: 35**

**Prior U.S. Cls.: 100, 101 and 102**

**United States Patent and Trademark Office**

**Reg. No. 3,569,656**

**Registered Feb. 3, 2009**

**SERVICE MARK  
PRINCIPAL REGISTER**

**SOUTHERN RECYCLING**

SOUTHERN RECYCLING, LLC (LOUISIANA  
LIMITED LIABILITY COMPANY)  
SUITE 320  
109 NORTH PARK BLVD.  
COVINGTON, LA 70433

FOR: SCRAP DEALERSHIPS, IN CLASS 35 (U.S.  
CLS. 100, 101 AND 102).

FIRST USE 9-24-1975; IN COMMERCE 9-24-1975.

THE MARK CONSISTS OF STANDARD CHAR-  
ACTERS WITHOUT CLAIM TO ANY PARTICULAR  
FONT, STYLE, SIZE, OR COLOR.

OWNER OF U.S. REG. NOS. 1,831,691 AND  
3,029,903.

NO CLAIM IS MADE TO THE EXCLUSIVE  
RIGHT TO USE "RECYCLING", APART FROM  
THE MARK AS SHOWN.

SER. NO. 77-503,849, FILED 6-20-2008.

ANN E. SAPPENFIELD, EXAMINING ATTORNEY

**Int. Cl.: 45**

**Prior U.S. Cls.: 100 and 101**

**United States Patent and Trademark Office**

**Reg. No. 3,569,657**

**Registered Feb. 3, 2009**

**SERVICE MARK  
PRINCIPAL REGISTER**

**MR. PREPARED**

MY EMERGENCY CARD, INC. (MICHIGAN CORPORATION)  
SUITE 403  
1809 E. BROADWAY  
OVIEDO, FL 32765

FOR: PROVIDING INFORMATION IN THE FIELD OF EMERGENCY AND DISASTER PREPAREDNESS VIA THE INTERNET USING AN INTERACTIVE WEBSITE, IN CLASS 45 (U.S. CLS. 100 AND 101).

FIRST USE 4-1-2008; IN COMMERCE 5-23-2008.

THE MARK CONSISTS OF STANDARD CHARACTERS WITHOUT CLAIM TO ANY PARTICULAR FONT, STYLE, SIZE, OR COLOR.

NO CLAIM IS MADE TO THE EXCLUSIVE RIGHT TO USE "PREPARED", APART FROM THE MARK AS SHOWN.

SER. NO. 77-503,860, FILED 6-20-2008.

EDWARD FENNESSY, EXAMINING ATTORNEY

**Int. Cl.: 3**

**Prior U.S. Cls.: 1, 4, 6, 50, 51 and 52**

**United States Patent and Trademark Office**

**Reg. No. 3,569,658**

**Registered Feb. 3, 2009**

**TRADEMARK  
PRINCIPAL REGISTER**

**Ticklebones Soap Company**

RIZZA, SUSAN (UNITED STATES INDIVIDUAL)  
44 CUSHING STREET  
WINTERPORT, ME 04496

FOR: BAR SOAP, IN CLASS 3 (U.S. CLS. 1, 4, 6, 50,  
51 AND 52).

FIRST USE 4-1-2006; IN COMMERCE 4-8-2006.

THE MARK CONSISTS OF STANDARD CHAR-  
ACTERS WITHOUT CLAIM TO ANY PARTICULAR  
FONT, STYLE, SIZE, OR COLOR.

NO CLAIM IS MADE TO THE EXCLUSIVE  
RIGHT TO USE "SOAP COMPANY", APART FROM  
THE MARK AS SHOWN.

SER. NO. 77-503,878, FILED 6-20-2008.

LIEF MARTIN, EXAMINING ATTORNEY

**Int. Cl.: 45**

**Prior U.S. Cls.: 100 and 101**

**United States Patent and Trademark Office**

**Reg. No. 3,569,659**

**Registered Feb. 3, 2009**

**SERVICE MARK  
PRINCIPAL REGISTER**

**BRINGING AWARENESS TO  
PREPAREDNESS**

MY EMERGENCY CARD, INC. (MICHIGAN CORPORATION)  
SUITE 403  
1809 E. BROADWAY  
OVIEDO, FL 32765

FOR: PROVIDING INFORMATION IN THE FIELD OF EMERGENCY AND DISASTER PREPAREDNESS VIA THE INTERNET USING AN INTERACTIVE WEBSITE, IN CLASS 45 (U.S. CLS. 100 AND 101).

FIRST USE 4-1-2008; IN COMMERCE 5-23-2008.

THE MARK CONSISTS OF STANDARD CHARACTERS WITHOUT CLAIM TO ANY PARTICULAR FONT, STYLE, SIZE, OR COLOR.

NO CLAIM IS MADE TO THE EXCLUSIVE RIGHT TO USE "PREPAREDNESS", APART FROM THE MARK AS SHOWN.

SER. NO. 77-503,880, FILED 6-20-2008.

EDWARD FENNESSY, EXAMINING ATTORNEY

**Int. Cl.: 36**

**Prior U.S. Cls.: 100, 101 and 102**

**United States Patent and Trademark Office**

**Reg. No. 3,569,660**

**Registered Feb. 3, 2009**

**SERVICE MARK  
PRINCIPAL REGISTER**

**America's Houseboat Queen**

HOUSEBOATS BUY TERRY, INC. (KENTUCKY CORPORATION)  
220 ALLEN DR.  
SOMERSET, KY 42503

FOR: BROKERAGE IN THE FIELD OF HOUSEBOATS, RUNABOUTS, CRUISERS, PONTOON BOATS, AND RV'S, IN CLASS 36 (U.S. CLS. 100, 101 AND 102).

FIRST USE 7-7-1999; IN COMMERCE 6-1-2004.

THE MARK CONSISTS OF STANDARD CHARACTERS WITHOUT CLAIM TO ANY PARTICULAR FONT, STYLE, SIZE, OR COLOR.

NO CLAIM IS MADE TO THE EXCLUSIVE RIGHT TO USE "AMERICA'S HOUSEBOAT", APART FROM THE MARK AS SHOWN.

SER. NO. 77-503,915, FILED 6-20-2008.

WANDA KAY PRICE, EXAMINING ATTORNEY



**Int. Cl.: 41**

**Prior U.S. Cls.: 100, 101 and 107**

**United States Patent and Trademark Office**

**Reg. No. 3,569,661**

**Registered Feb. 3, 2009**

**SERVICE MARK  
PRINCIPAL REGISTER**



INTELEGRAM, LLC (FLORIDA LIMITED LIABILITY COMPANY)  
PO BOX 1584  
BROOKSVILLE, FL 34605

FOR: ON-LINE JOURNALS, NAMELY, BLOGS FEATURING INFORMATION AND OPINIONS ABOUT HOBBIES AND GOODS RELATED TO HOBBIES, IN CLASS 41 (U.S. CLS. 100, 101 AND 107).

FIRST USE 1-1-2001; IN COMMERCE 1-1-2001.

NO CLAIM IS MADE TO THE EXCLUSIVE RIGHT TO USE "HOBBY", APART FROM THE MARK AS SHOWN.

THE COLOR(S) YELLOW WHITE, BLACK AND BROWN IS/ARE CLAIMED AS A FEATURE OF THE MARK.

THE MARK CONSISTS OF THE WORDS "HOBBY NOTES" WRITTEN IN A YELLOW FONT WITH A BROWN OUTLINE. TO THE LEFT OF THE WORDS IS A CIRCULAR CARTOON IMAGE OUTLINED IN BLACK OF A BROWN DOG WITH BLACK NOSE, WHITE EYES, AND IN FRONT OF A YELLOW BACKGROUND.

SER. NO. 77-503,945, FILED 6-20-2008.

ANTHONY RINKER, EXAMINING ATTORNEY

**Int. Cl.: 12**

**Prior U.S. Cls.: 19, 21, 23, 31, 35 and 44**

**United States Patent and Trademark Office**

**Reg. No. 3,569,662**

**Registered Feb. 3, 2009**

**TRADEMARK  
PRINCIPAL REGISTER**

**piggyBACK**

MONAHAN PRODUCTS, LLC (MASSACHU-  
SETTS LIMITED LIABILITY COMPANY)  
SUITE 502  
371 LIBERTY STREET  
ROCKLAND, MA 02370

THE MARK CONSISTS OF THE WORD "PIGGY-  
BACK" WITH AN ABSTRACT IMAGE OF A FOOT-  
BOARD FOR A STROLLER BACK POSITIONED  
BENEATH THE "-BACK" PORTION OF THE WORD.

FOR: FOOTBOARD FOR ATTACHMENT TO  
STROLLER BACK, IN CLASS 12 (U.S. CLS. 19, 21,  
23, 31, 35 AND 44).

SER. NO. 77-503,952, FILED 6-20-2008.

FIRST USE 1-31-2008; IN COMMERCE 1-31-2008.

INGRID C. EULIN, EXAMINING ATTORNEY

Int. Cl.: 35

Prior U.S. Cls.: 100, 101 and 102

United States Patent and Trademark Office

Reg. No. 3,569,663

Registered Feb. 3, 2009

**SERVICE MARK  
PRINCIPAL REGISTER**

**THE NINE BAR**  
COFFEE ROASTING COMPANY

NINE BAR COFFEE ROASTING COMPANY LLC  
(ARIZONA LIMITED LIABILITY COMPANY)  
3981 EAST HUMMINGBIRD LANE  
PHOENIX, AZ 85050

FOR: RETAIL STORE SERVICES FEATURING  
FRESH ROASTED COFFEE AND TEA; WHOLE-  
SALE DISTRIBUTORSHIPS FEATURING FRESH  
ROASTED COFFEE AND TEA , IN CLASS 35 (U.S.  
CLS. 100, 101 AND 102).

FIRST USE 12-31-2007; IN COMMERCE 12-31-2007.

NO CLAIM IS MADE TO THE EXCLUSIVE  
RIGHT TO USE "COFFEE ROASTING COMPANY",  
APART FROM THE MARK AS SHOWN.

THE MARK CONSISTS OF THE WORDS "THE  
NINE BAR" UNDERLINED WITH THE WORDS  
"COFFEE ROASTING COMPANY" BENEATH IT.

SER. NO. 77-503,965, FILED 6-20-2008.

STEPHEN AQUILA, EXAMINING ATTORNEY

**Int. Cl.: 16**

**Prior U.S. Cls.: 2, 5, 22, 23, 29, 37, 38 and 50**

**United States Patent and Trademark Office**

**Reg. No. 3,569,664**

**Registered Feb. 3, 2009**

**TRADEMARK  
PRINCIPAL REGISTER**

**Package From Santa**

INNOVATIVE MARKETING, INC (MICHIGAN CORPORATION), DBA SANTA'S WORKSHOP  
44302 WHITHORN  
STERLING HEIGHTS, MI 48313

THE MARK CONSISTS OF STANDARD CHARACTERS WITHOUT CLAIM TO ANY PARTICULAR FONT, STYLE, SIZE, OR COLOR.

FOR: PRINTED VISUALS IN THE NATURE OF CHRISTMAS ITEMS, IN CLASS 16 (U.S. CLS. 2, 5, 22, 23, 29, 37, 38 AND 50).

SER. NO. 77-504,007, FILED 6-20-2008.

FIRST USE 8-28-2007; IN COMMERCE 8-28-2007.

ESTHER BELENKER, EXAMINING ATTORNEY

Int. Cl.: 43

Prior U.S. Cls.: 100 and 101

United States Patent and Trademark Office

Reg. No. 3,569,665

Registered Feb. 3, 2009

**SERVICE MARK  
PRINCIPAL REGISTER**



GUANA SUNSET BEACH, LTD. (BAHAMAS CORPORATION)  
518 RIVERSIDE DRIVE  
ORMOND BEACH, FL 32176

FOR: HOTEL, RESTAURANT AND BAR SERVICES, IN CLASS 43 (U.S. CLS. 100 AND 101).

FIRST USE 10-0-2007; IN COMMERCE 10-0-2007.

NO CLAIM IS MADE TO THE EXCLUSIVE RIGHT TO USE "BED BAR & GRILL", APART FROM THE MARK AS SHOWN.

THE COLOR(S) YELLOW, GREEN, RED, GOLD, BLUE AND BLACK IS/ARE CLAIMED AS A FEATURE OF THE MARK.

THE MARK CONSISTS OF A GREEN LIZARD WEARING BLACK SUNGLASSES AND A GOLD-

ISH-YELLOW HAT SITTING ON THE WORD "GRABBERS". THE WORD "GRABBERS" APPEARS IN RED AND SHADES TO YELLOW AS IT PROGRESSES FROM THE TOP OF THE LETTERS TO THE BOTTOM THEREOF. TWO BLACK PALM TREES APPEAR ON EITHER SIDE OF THE "GRABBERS" TERM WITH A YELLOW SUN SETTING BEHIND THE WORD. BELOW THE "GRABBERS" TERM APPEARS A GOLDISH-YELLOW BANNER WITH THE TERMS "BED BAR & GRILL" THEREON. THE LETTERS COMPRISING THE TERMS "BED BAR & GRILL" APPEAR IN YELLOW FADING TO RED FROM TOP TO BOTTOM. THE SKY BEHIND THE PALM TREES, THE LIZARD, THE SUN AND THE WORDS IS BLUE.

SER. NO. 77-504,010, FILED 6-20-2008.

ESTHER BELENKER, EXAMINING ATTORNEY

**Int. Cls.: 16 and 25**

**Prior U.S. Cls.: 2, 5, 22, 23, 29, 37, 38, 39 and 50**

**Reg. No. 3,569,666**

**United States Patent and Trademark Office**

**Registered Feb. 3, 2009**

**TRADEMARK  
PRINCIPAL REGISTER**



JOE W. NEFF (UNITED STATES INDIVIDUAL)  
1861 MOTT COURT  
CAMARILLO, CA 93012 AND  
SHAUN M. NEFF (UNITED STATES INDIVIDUAL)  
1861 MOTT COURT  
CAMARILLO, CA 93012

FOR: PAPER, CARDBOARD AND PRINTED MATERIAL, NAMELY, PHOTOGRAPHS, STATIONERY, POSTERS, PAPER BANNERS, ADHESIVES FOR STATIONERY OR HOUSEHOLD PURPOSES, STICKERS, CARDBOARD FLOOR DISPLAY UNITS FOR MERCHANDISING PRODUCTS; CATALOGS FEATURING APPAREL PRODUCTS, PERFUME, BAGS, ACCESSORIES, VIDEOS, COMPACT DISCS, JEWELRY, WATCHES, AND OPTICS, IN CLASS 16 (U.S. CLS. 2, 5, 22, 23, 29, 37, 38 AND 50).

FIRST USE 1-11-2003; IN COMMERCE 1-11-2003.

FOR: MEN'S, WOMEN'S AND CHILDREN'S CLOTHING, NAMELY, FOOTWEAR, HEADWEAR, WETSUITS, SWIMWEAR, SINGLET, T-SHIRTS, SHIRTS AND CASUAL TOPS WITH LONG AND SHORT SLEEVES, SLEEVELESS SHIRTS AND TOPS, SLEEVELESS TOPS, JERSEYS, TANK TOPS, SWEAT PANTS, SWEAT SHIRTS, DRESSES, SKIRTS, PAJAMAS, ROBES, JERSEYS, SWEAT SUITS, HOODED PARKAS, JACKETS, COATS, SHORTS, BEACHWEAR, BOARD SHORTS, WALKING SHORTS,

LONG PANTS, TROUSERS, JEANS, LOUNGEWEAR, FOUNDATION GARMENTS, BRIEFS, RASH GUARDS, SOCKS, BELTS, GLOVES, THERMAL UNDERWEAR, BEANIES, HATS, VISORS, CAPS, BERETS, TIES, VESTS, SUITS, SURF HOODS, BOOTS, SHOES, SLIPPERS, THONGED AND STRAPPED SANDALS, SPORTING FOOTWEAR, ATHLETIC SHOES, BOOTS FOR SPORTS, SNOW BOOTS, SNOWBOARD BOOTS, KITEBOARD BOOTS, SURFBOARD BOOTS, WAKEBOARD BOOTS; SKI WEAR AND SNOWBOARD WEAR, NAMELY, SKI PANTS, SKI TROUSERS, SKI JACKETS, SNOWBOARD PANTS, SNOWBOARD TROUSERS AND SNOWBOARD JACKETS; SKATEBOARD WEAR, NAMELY, SHIRTS, SHORTS, PANTS, AND HEADWEAR, IN CLASS 25 (U.S. CLS. 22 AND 39).

FIRST USE 1-11-2003; IN COMMERCE 1-11-2003.

OWNER OF U.S. REG. NO. 2,690,151.

THE MARK CONSISTS OF A ROUND SMILING FACE SHOWING AN EXPOSED TONGUE, ROUND EYES, AN UP SLANTED SLIT NOSE AND SWEEPING HAIR WITH THE STYLIZED NAME "NEFF" WRITTEN BELOW THE FACE.

SER. NO. 77-504,013, FILED 6-20-2008.

KIM MONINGHOFF, EXAMINING ATTORNEY

**Int. Cl.: 42**

**Prior U.S. Cls.: 100 and 101**

**United States Patent and Trademark Office**

**Reg. No. 3,569,667**

**Registered Feb. 3, 2009**

**SERVICE MARK  
PRINCIPAL REGISTER**

**SPARKLECREATIVE**

FRIEDMAN, CINDY (UNITED STATES INDIVIDUAL)  
7109 MESA DRIVE  
AUSTIN, TX 78731

THE MARK CONSISTS OF STANDARD CHARACTERS WITHOUT CLAIM TO ANY PARTICULAR FONT, STYLE, SIZE, OR COLOR.

FOR: GRAPHIC DESIGN SERVICES, IN CLASS 42 (U.S. CLS. 100 AND 101).

SER. NO. 77-504,014, FILED 6-20-2008.

FIRST USE 12-31-2000; IN COMMERCE 12-31-2000.

KAPIL BHANOT, EXAMINING ATTORNEY

Int. Cl.: 35

Prior U.S. Cls.: 100, 101 and 102

**United States Patent and Trademark Office**

**Reg. No. 3,569,668**

Registered Feb. 3, 2009

**SERVICE MARK  
PRINCIPAL REGISTER**



THE ADOPT LEAN GROUP, INC. (SOUTH CAROLINA CORPORATION)  
P.O. BOX 80883  
SIMPSONVILLE, SC 29680

FOR: BUSINESS CONSULTING SERVICES IN THE FIELD OF ORGANIZATIONAL CHANGE MANAGEMENT, IN CLASS 35 (U.S. CLS. 100, 101 AND 102).

FIRST USE 10-17-2005; IN COMMERCE 10-17-2005.

THE MARK CONSISTS OF A LEFT-FACING CRESCENT WITH THREE INTERSECTING RINGS, SHADED TO APPEAR THREE-DIMENSIONAL, WITH THE WORDS "ADOPT LEAN" TO THE RIGHT OF THE GRAPHIC.

SER. NO. 77-504,028, FILED 6-20-2008.

H. M. FISHER, EXAMINING ATTORNEY



**Int. Cl.: 43**

**Prior U.S. Cls.: 100 and 101**

**United States Patent and Trademark Office**

**Reg. No. 3,569,669**

**Registered Feb. 3, 2009**

**SERVICE MARK  
PRINCIPAL REGISTER**



PEPPERS BURRITO GRILL LLC (FLORIDA LIMITED LIABILITY COMPANY)  
1238 WASHINGTON AVE  
MIAMI BEACH, FL 33139

FOR: RESTAURANT SERVICES; RESTAURANTS,  
IN CLASS 43 (U.S. CLS. 100 AND 101).

FIRST USE 10-0-2007; IN COMMERCE 10-0-2007.

NO CLAIM IS MADE TO THE EXCLUSIVE RIGHT TO USE "BURRITO GRILL", APART FROM THE MARK AS SHOWN.

THE MARK CONSISTS OF THE IMAGE OF A PEPPER, WITH THE TERMS "PEPPER'S BURRITO GRILL", WHEREIN THE "P" FORMS PART OF THE OUTLINE OF A SHADED CIRCLE.

SER. NO. 77-504,056, FILED 6-20-2008.

HELENE LIWINSKI, EXAMINING ATTORNEY

**Int. Cl.: 41**

**Prior U.S. Cls.: 100, 101 and 107**

**United States Patent and Trademark Office**

**Reg. No. 3,569,670**

**Registered Feb. 3, 2009**

**SERVICE MARK  
PRINCIPAL REGISTER**

**Learning That Changes Lives**

MASTERMIND PREP LEARNING SOLUTIONS,  
INC. (NORTH CAROLINA CORPORATION)  
1534 LAFAYETTE AVE  
ROCKY MOUNT, NC 27803

FOR: EDUCATIONAL SERVICES, NAMELY,  
PROVIDING TUTORING AND EDUCATIONAL IN-  
STRUCTION VIA ONE-ON-ONE SETTINGS, SMALL  
GROUPS, CLASSES, SEMINARS AND SUMMER  
CAMPS, TO STUDENTS IN KINDERGARTEN  
THROUGH ADULT, IN ALL ACADEMIC SUB-  
JECTS, NAMELY, READING, WRITING, MATHE-  
MATICS, SCIENCE, ENGLISH/LANGUAGE ARTS,  
FOREIGN LANGUAGES, STUDY SKILLS, AND

PREPARATION FOR STANDARDIZED TESTS, IN  
CLASS 41 (U.S. CLS. 100, 101 AND 107).

FIRST USE 4-23-2008; IN COMMERCE 4-23-2008.

THE MARK CONSISTS OF STANDARD CHAR-  
ACTERS WITHOUT CLAIM TO ANY PARTICULAR  
FONT, STYLE, SIZE, OR COLOR.

OWNER OF U.S. REG. NO. 2,932,259.

SER. NO. 77-504,081, FILED 6-20-2008.

REGINA DRUMMOND, EXAMINING ATTORNEY

**Int. Cl.: 30**

**Prior U.S. Cl.: 46**

**United States Patent and Trademark Office**

**Reg. No. 3,569,671**

**Registered Feb. 3, 2009**

**TRADEMARK  
PRINCIPAL REGISTER**

# Badger Breakfast

GRAEF, RENEE (UNITED STATES INDIVIDUAL)  
W66 N545 MADISON AVE.  
CEDARBURG, WI 53012

FOR: MAPLE SYRUP; BISCUITS; MUFFIN MIXES, WAFFLE AND PANCAKE MIX, CAKE MIX AND BREAD MIX, BISCUIT MIX; BISCUITS AND BREAD, BAKERY GOODS, COOKIE MIXES, DONUT MIXES, CEREAL MIXES, CEREAL BASED SNACKS, HONEY, GRANOLA, GRANOLA BASED SNACKS, IN CLASS 30 (U.S. CL. 46).

FIRST USE 5-1-2008; IN COMMERCE 6-18-2008.

THE MARK CONSISTS OF STANDARD CHARACTERS WITHOUT CLAIM TO ANY PARTICULAR FONT, STYLE, SIZE, OR COLOR.

NO CLAIM IS MADE TO THE EXCLUSIVE RIGHT TO USE "BREAKFAST", APART FROM THE MARK AS SHOWN.

SER. NO. 77-504,095, FILED 6-20-2008.

TEJBIR SINGH, EXAMINING ATTORNEY

Int. Cls.: 5 and 29

Prior U.S. Cls.: 6, 18, 44, 46, 51 and 52

United States Patent and Trademark Office

Reg. No. 3,569,672

Registered Feb. 3, 2009

TRADEMARK  
PRINCIPAL REGISTER

**BrEggFast**

NEWSTEDER, ROBERT (UNITED STATES INDIVIDUAL)  
31 MAIN STREET  
SANDOWN, NH 03873

FOR: NUTRITIONAL SUPPLEMENTS, IN CLASS 5 (U.S. CLS. 6, 18, 44, 46, 51 AND 52).

FIRST USE 1-1-2007; IN COMMERCE 1-1-2007.

FOR: EGG PRODUCT , IN CLASS 29 (U.S. CL. 46).

FIRST USE 1-1-2007; IN COMMERCE 1-1-2007.

THE COLOR(S) YELLOW AND BLACK IS/ARE CLAIMED AS A FEATURE OF THE MARK.

THE MARK CONSISTS OF THE WORD "BREGGFAST" WITH YELLOW LETTERS OUTLINED IN BLACK WITH A DROPPED SHADOW IN BLACK AND TWO BLACK EYES IN THE LETTERS "GG".

SER. NO. 77-504,098, FILED 6-20-2008.

MICHAEL ENGEL, EXAMINING ATTORNEY

**Int. Cls.: 16 and 25**

**Prior U.S. Cls.: 2, 5, 22, 23, 29, 37, 38, 39 and 50**

**Reg. No. 3,569,673**

**United States Patent and Trademark Office**

**Registered Feb. 3, 2009**

**TRADEMARK  
PRINCIPAL REGISTER**



JOE W. NEFF (UNITED STATES INDIVIDUAL)  
1861 MOTT COURT  
CAMARILLO, CA 93012 AND  
SHAUN M. NEFF (UNITED STATES INDIVIDUAL)  
1861 MOTT COURT  
CAMARILLO, CA 93012

FOR: PAPER, CARDBOARD AND PRINTED MATERIAL, NAMELY, PHOTOGRAPHS, STATIONERY, POSTERS, PAPER BANNERS, ADHESIVES FOR STATIONERY OR HOUSEHOLD PURPOSES, STICKERS, CARDBOARD FLOOR DISPLAY UNITS FOR MERCHANDISING PRODUCTS; CATALOGS FEATURING APPAREL PRODUCTS, PERFUME, BAGS, ACCESSORIES, VIDEOS, COMPACT DISCS, JEWELRY, WATCHES, AND OPTICS, IN CLASS 16 (U.S. CLS. 2, 5, 22, 23, 29, 37, 38 AND 50).

FIRST USE 1-11-2003; IN COMMERCE 1-11-2003.

FOR: MEN'S, WOMEN'S AND CHILDREN'S CLOTHING, NAMELY, FOOTWEAR, HEADWEAR, WETSUITS, SWIMWEAR, SINGLET, T-SHIRTS, SHIRTS AND CASUAL TOPS WITH LONG AND SHORT SLEEVES, SLEEVELESS SHIRTS AND TOPS, SLEEVELESS TOPS, JERSEYS, TANK TOPS, SWEAT PANTS, SWEAT SHIRTS, DRESSES, SKIRTS, PAJAMAS, ROBES, JERSEYS, SWEAT SUITS, HOODED PARKAS, JACKETS, COATS, SHORTS, BEACH-

WEAR, BOARD SHORTS, WALKING SHORTS, LONG PANTS, TROUSERS, JEANS, LOUNGEWEAR, FOUNDATION GARMENTS, BRIEFS, RASH GUARDS, SOCKS, BELTS, GLOVES, THERMAL UNDERWEAR, BEANIES, HATS, VISORS, CAPS, BERETS, TIES, VESTS, SUITS, SURF HOODS, BOOTS, SHOES, SLIPPERS, THONGED AND STRAPPED SANDALS, SPORTING FOOTWEAR, ATHLETIC SHOES, BOOTS FOR SPORTS, SNOW BOOTS, SNOWBOARD BOOTS, KITEBOARD BOOTS, SURFBOARD BOOTS, WAKEBOARD BOOTS; SKI WEAR AND SNOWBOARD WEAR, NAMELY, SKI PANTS, SKI TROUSERS, SKI JACKETS, SNOWBOARD PANTS, SNOWBOARD TROUSERS AND SNOWBOARD JACKETS; SKATEBOARD WEAR, NAMELY, SHIRTS, SHORTS, PANTS, AND HEADWEAR, IN CLASS 25 (U.S. CLS. 22 AND 39).

FIRST USE 1-11-2003; IN COMMERCE 1-11-2003.

THE MARK CONSISTS OF A ROUND SMILING FACE SHOWING AN EXPOSED TONGUE, ROUND EYES, AN UP SLANTED SLIT NOSE AND SWEEPING HAIR.

SER. NO. 77-504,183, FILED 6-20-2008.

KIM MONINGHOFF, EXAMINING ATTORNEY

**Int. Cl.: 5**

**Prior U.S. Cls.: 6, 18, 44, 46, 51 and 52**

**Reg. No. 3,569,674**

**United States Patent and Trademark Office**

**Registered Feb. 3, 2009**

**TRADEMARK  
PRINCIPAL REGISTER**

**Acuity**

GUYER AESTHETICS (INDIANA LIMITED LIABILITY COMPANY)  
836 EAST 86TH STREET  
INDIANAPOLIS, IN 46240

THE MARK CONSISTS OF STANDARD CHARACTERS WITHOUT CLAIM TO ANY PARTICULAR FONT, STYLE, SIZE, OR COLOR.

FOR: NUTRACEUTICALS FOR USE AS A DIETARY SUPPLEMENT, IN CLASS 5 (U.S. CLS. 6, 18, 44, 46, 51 AND 52).

SER. NO. 77-504,189, FILED 6-20-2008.

FIRST USE 11-3-2006; IN COMMERCE 11-3-2006.

EMILY CHUO, EXAMINING ATTORNEY

**Int. Cl.: 42**

**Prior U.S. Cls.: 100 and 101**

**United States Patent and Trademark Office**

**Reg. No. 3,569,675**

**Registered Feb. 3, 2009**

**SERVICE MARK  
PRINCIPAL REGISTER**

**MANAGEMYNET**

SYNCHRONET INDUSTRIES, INC. (NEW YORK CORPORATION)  
3654 CLINTON STREET  
WEST SENECA, NY 14224

FOR: COMPUTER SERVICES, NAMELY, REMOTE AND ONSITE TECHNICAL SUPPORT, MONITORING AND MAINTENANCE OF COMPUTER PROGRAMS AND SYSTEMS, AND THIRD PARTY SOFTWARE CONSULTATION AND INSTALLATION, IN CLASS 42 (U.S. CLS. 100 AND 101).

FIRST USE 11-30-2007; IN COMMERCE 5-28-2008.

THE MARK CONSISTS OF STANDARD CHARACTERS WITHOUT CLAIM TO ANY PARTICULAR FONT, STYLE, SIZE, OR COLOR.

SER. NO. 77-504,263, FILED 6-20-2008.

KARANENDRA S. CHHINA, EXAMINING ATTORNEY

**Int. Cl.: 41**

**Prior U.S. Cls.: 100, 101 and 107**

**United States Patent and Trademark Office**

**Reg. No. 3,569,676**

**Registered Feb. 3, 2009**

**SERVICE MARK  
PRINCIPAL REGISTER**

**SHOWBIZ CINEMAS**

SHOWBIZ CINEMAS, LLC (TEXAS LIMITED  
LIABILITY COMPANY)  
SUITE 800  
12400 COIT ROAD  
DALLAS, TX 752512009

FOR: MOVIE THEATERS, IN CLASS 41 (U.S. CLS.  
100, 101 AND 107).

FIRST USE 5-2-2008; IN COMMERCE 5-2-2008.

THE MARK CONSISTS OF STANDARD CHAR-  
ACTERS WITHOUT CLAIM TO ANY PARTICULAR  
FONT, STYLE, SIZE, OR COLOR.

OWNER OF U.S. REG. NO. 3,463,548.

NO CLAIM IS MADE TO THE EXCLUSIVE  
RIGHT TO USE "CINEMAS", APART FROM THE  
MARK AS SHOWN.

SER. NO. 77-504,270, FILED 6-20-2008.

DOMINICK J. SALEMI, EXAMINING ATTORNEY



**Int. Cl.: 41**

**Prior U.S. Cls.: 100, 101 and 107**

**United States Patent and Trademark Office**

**Reg. No. 3,569,677**

**Registered Feb. 3, 2009**

**SERVICE MARK  
PRINCIPAL REGISTER**

**MODA AL RESCATE**

UNIVISION COMMUNICATIONS INC. (DELA-  
WARE CORPORATION)  
5999 CENTER DRIVE  
LOS ANGELES, CA 90045

FOR: ENTERTAINMENT SERVICES, NAMELY,  
AN ON-GOING TELEVISION PROGRAM ABOUT  
FASHION AND STYLE ADVICE AND FASHION  
AND STYLE ADVICE COMMENTARY, IN CLASS 41  
(U.S. CLS. 100, 101 AND 107).

FIRST USE 2-7-2008; IN COMMERCE 2-7-2008.

THE MARK CONSISTS OF STANDARD CHAR-  
ACTERS WITHOUT CLAIM TO ANY PARTICULAR  
FONT, STYLE, SIZE, OR COLOR.

THE FOREIGN WORDING IN THE MARK  
TRANSLATES INTO ENGLISH AS FASHION TO  
THE RESCUE.

SER. NO. 77-504,323, FILED 6-20-2008.

MICHAEL TANNER, EXAMINING ATTORNEY

**Int. Cl.: 41**

**Prior U.S. Cls.: 100, 101 and 107**

**United States Patent and Trademark Office**

**Reg. No. 3,569,678**

**Registered Feb. 3, 2009**

**SERVICE MARK  
PRINCIPAL REGISTER**

**BORDERLESS THINKING**

BORDERLESS THINKING LLC (PENNSYLVANIA LIMITED LIABILITY COMPANY)  
PO BOX 694  
BETHLEHEM, PA 180160694

FOR: PERSONAL COACHING SERVICES IN THE FIELD OF PROBLEM SOLVING AND CRITICAL THINKING PRACTICES; WORKSHOPS AND SEMINARS IN THE FIELD OF PROBLEM SOLVING AND CRITICAL THINKING PRACTICES, IN CLASS 41 (U.S. CLS. 100, 101 AND 107).

FIRST USE 9-30-2007; IN COMMERCE 9-30-2007.

THE MARK CONSISTS OF STANDARD CHARACTERS WITHOUT CLAIM TO ANY PARTICULAR FONT, STYLE, SIZE, OR COLOR.

SER. NO. 77-504,331, FILED 6-20-2008.

TAMARA FRAZIER, EXAMINING ATTORNEY

**Int. Cl.: 7**

**Prior U.S. Cls.: 13, 19, 21, 23, 31, 34 and 35**

**United States Patent and Trademark Office**

**Reg. No. 3,569,679**

**Registered Feb. 3, 2009**

**TRADEMARK  
PRINCIPAL REGISTER**

**FAST FUSION**

FAST FUSION, LLC (COLORADO LIMITED LIABILITY COMPANY)  
101 WEST 8TH STREET  
PALISADE, CO 81526

FOR: PIPE FUSION MACHINES, IN CLASS 7 (U.S. CLS. 13, 19, 21, 23, 31, 34 AND 35).

FIRST USE 6-3-2003; IN COMMERCE 6-3-2003.

THE MARK CONSISTS OF STANDARD CHARACTERS WITHOUT CLAIM TO ANY PARTICULAR FONT, STYLE, SIZE, OR COLOR.

NO CLAIM IS MADE TO THE EXCLUSIVE RIGHT TO USE "FUSION", APART FROM THE MARK AS SHOWN.

SEC. 2(F).

SER. NO. 77-504,357, FILED 6-20-2008.

KELLY MCCOY, EXAMINING ATTORNEY

**Int. Cls.: 29, 30, 32 and 43**

**Prior U.S. Cls.: 45, 46, 48, 100 and 101**

**Reg. No. 3,569,680**

**United States Patent and Trademark Office**

**Registered Feb. 3, 2009**

**TRADEMARK  
SERVICE MARK  
PRINCIPAL REGISTER**

**CALIFORNIA PIZZA KITCHEN  
ASAP**

CPK MANAGEMENT COMPANY (CALIFORNIA CORPORATION)  
6053 WEST CENTURY BLVD., 11TH FLOOR  
LOS ANGELES, CA 90045

FOR: MEAT; POULTRY; PROCESSED VEGETABLES; VEGETABLE SALADS; GARDEN SALADS; SALADS CONSISTING OF MEAT AND POULTRY; SOUPS; MILK; CHOCOLATE MILK; SNACK DIPS; PROCESSED TOMATO CHECCA; POTATO CHIPS; AND HUMMUS, FOR CONSUMPTION ON OR OFF THE PREMISES, IN CLASS 29 (U.S. CL. 46).

FIRST USE 7-0-2006; IN COMMERCE 7-0-2006.

FOR: PIZZA; BREAKFAST PIZZA; BAKERY GOODS; PIZZA BREAD; BREAD; FOCCACIA BREAD; PANINI BREAD; CIABATTA BREAD; SANDWICHES; BREAKFAST SANDWICHES; DESSERTS, NAMELY, BROWNIES, COOKIES, AND CHEESECAKE; SALAD DRESSINGS; COFFEE; TEA; ICED TEAS; TORTILLA CHIPS; PASTAS; AND MACARONI AND CHEESE, FOR CONSUMPTION ON OR OFF THE PREMISES, IN CLASS 30 (U.S. CL. 46).

FIRST USE 7-0-2006; IN COMMERCE 7-0-2006.

FOR: BEVERAGES, NAMELY, SPARKLING WATER, STILL WATER, FRUIT JUICE, LEMONADE, CARBONATED SOFT DRINKS, SODA POP, FRUIT

PUNCH, AND BEER, FOR CONSUMPTION ON OR OFF THE PREMISES, IN CLASS 32 (U.S. CLS. 45, 46 AND 48).

FIRST USE 7-0-2006; IN COMMERCE 7-0-2006.

FOR: RESTAURANT SERVICES; CARRY-OUT AND TAKE-OUT RESTAURANT SERVICES; BEVERAGE SERVICES, NAMELY, PREPARATION AND SERVING OF BEVERAGES; CATERING SERVICES; RESTAURANTS FEATURING HOME AND OFFICE DELIVERY SERVICES; AND RESTAURANTS FEATURING CURB-SIDE DELIVERY SERVICE, IN CLASS 43 (U.S. CLS. 100 AND 101).

FIRST USE 7-0-2006; IN COMMERCE 7-0-2006.

THE MARK CONSISTS OF STANDARD CHARACTERS WITHOUT CLAIM TO ANY PARTICULAR FONT, STYLE, SIZE, OR COLOR.

OWNER OF U.S. REG. NOS. 1,637,904, 3,108,542 AND OTHERS.

SEC. 2(F) AS TO CALIFORNIA PIZZA KITCHEN.

SER. NO. 77-504,362, FILED 6-20-2008.

DANIEL BRODY, EXAMINING ATTORNEY

**Int. Cl.: 5**

**Prior U.S. Cls.: 6, 18, 44, 46, 51 and 52**

**Reg. No. 3,569,681**

**United States Patent and Trademark Office**

**Registered Feb. 3, 2009**

**TRADEMARK  
PRINCIPAL REGISTER**

**SUMMER GAMES**

KENTUCKY PERFORMANCE PRODUCTS, LLC  
(KENTUCKY LIMITED LIABILITY COMPAN-  
NY)  
SUITES C AND D  
460 WILSON AVE  
VERSAILLES, KY 40383

THE MARK CONSISTS OF STANDARD CHAR-  
ACTERS WITHOUT CLAIM TO ANY PARTICULAR  
FONT, STYLE, SIZE, OR COLOR.

FOR: ANIMAL FEED SUPPLEMENTS, IN CLASS  
5 (U.S. CLS. 6, 18, 44, 46, 51 AND 52).

SER. NO. 77-504,365, FILED 6-20-2008.

FIRST USE 11-0-1995; IN COMMERCE 11-0-1995.

JACLYN KIDWELL, EXAMINING ATTORNEY

**Int. Cl.: 44**

**Prior U.S. Cls.: 100 and 101**

**United States Patent and Trademark Office**

**Reg. No. 3,569,682**

**Registered Feb. 3, 2009**

**SERVICE MARK  
PRINCIPAL REGISTER**

# Supertouch

CHI, TOM (UNITED STATES INDIVIDUAL)  
63 GREY ROAD  
SOUTH FALLSBURG, NY 12779

THE MARK CONSISTS OF STANDARD CHAR-  
ACTERS WITHOUT CLAIM TO ANY PARTICULAR  
FONT, STYLE, SIZE, OR COLOR.

FOR: ACUPUNCTURE; ACUPUNCTURE SERVI-  
CES, IN CLASS 44 (U.S. CLS. 100 AND 101).

SER. NO. 77-504,367, FILED 6-20-2008.

FIRST USE 5-10-2006; IN COMMERCE 5-10-2006.

JACLYN KIDWELL, EXAMINING ATTORNEY

**Int. Cl.: 41**

**Prior U.S. Cls.: 100, 101 and 107**

**United States Patent and Trademark Office**

**Reg. No. 3,569,683**

**Registered Feb. 3, 2009**

**SERVICE MARK  
PRINCIPAL REGISTER**

# Waking Up Fabulous

THE TRUSTEES OF THE MARY TINA LIFFORD  
INTER VIVOS TRUST DATED MARCH 9, 2005  
(CALIFORNIA TRUST)  
10835 ALTA VIEW DRIVE  
STUDIO CITY, CA 91604

THE MARK CONSISTS OF STANDARD CHAR-  
ACTERS WITHOUT CLAIM TO ANY PARTICULAR  
FONT, STYLE, SIZE, OR COLOR.

FOR: CONDUCTING WORKSHOPS AND SEMI-  
NARS IN SELF AWARENESS, IN CLASS 41 (U.S.  
CLS. 100, 101 AND 107).

SER. NO. 77-504,371, FILED 6-20-2008.

FIRST USE 1-25-2006; IN COMMERCE 1-10-2008.

YAT SYE, LEE, EXAMINING ATTORNEY

**Int. Cl.: 35**

**Prior U.S. Cls.: 100, 101 and 102**

**United States Patent and Trademark Office**

**Reg. No. 3,569,684**

**Registered Feb. 3, 2009**

**SERVICE MARK  
PRINCIPAL REGISTER**

**RockyMountainTrail**

ROCKYMOUNTAINTRAIL.COM, INC. (COLOR-  
ADO CORPORATION), DBA ROCKYMOUN-  
TAINTRAIL  
105 ISABEL COURT  
BUENA VISTA, CO 81211

THE MARK CONSISTS OF STANDARD CHAR-  
ACTERS WITHOUT CLAIM TO ANY PARTICULAR  
FONT, STYLE, SIZE, OR COLOR.

FOR: ON-LINE RETAIL STORE SERVICES FEA-  
TURING OUTDOOR GEAR, IN CLASS 35 (U.S. CLS.  
100, 101 AND 102).

SER. NO. 77-504,382, FILED 6-20-2008.

FIRST USE 5-23-2003; IN COMMERCE 5-23-2003.

ANDREA BUTLER, EXAMINING ATTORNEY



Int. Cl.: 35

Prior U.S. Cls.: 100, 101 and 102

United States Patent and Trademark Office

Reg. No. 3,569,685

Registered Feb. 3, 2009

SERVICE MARK  
PRINCIPAL REGISTER



KIPPER TOOL COMPANY (GEORGIA CORPORATION)  
2375 MURPHY BLVD.  
GAINESVILLE, GA 30504

FOR: BUSINESS MANAGEMENT SERVICES, NAMELY, MANAGING LOGISTICS, REVERSE LOGISTICS, SUPPLY CHAIN SERVICES, SUPPLY CHAIN VISIBILITY AND SYNCHRONIZATION, SUPPLY AND DEMAND FORECASTING AND PRODUCT DISTRIBUTION PROCESSES FOR OTHERS, IN CLASS 35 (U.S. CLS. 100, 101 AND 102).

FIRST USE 1-0-2004; IN COMMERCE 1-0-2004.

NO CLAIM IS MADE TO THE EXCLUSIVE RIGHT TO USE "LOGISTICS SYSTEMS INTERNATIONAL", APART FROM THE MARK AS SHOWN.

THE MARK CONSISTS OF THE LETTER "K" INSIDE A CIRCLE WITH A GRID PATTERN. THE CIRCLE IS OUTLINED BY A THICK LINE AND THE THICK LINE IS OUTLINED BY A NARROWER LINE. TO THE RIGHT OF THE CIRCLE ARE THE STYLIZED LETTERS "KLSI" WITH THE STYLIZED WORDS "KIPPER", "LOGISTICS", "SYSTEMS" AND "INTERNATIONAL" RUNNING THROUGH THE CENTER OF THE "KLSI" LETTERS.

SER. NO. 77-504,397, FILED 6-20-2008.

KOURTNEE HODGES, EXAMINING ATTORNEY

**Int. Cl.: 45**

**Prior U.S. Cls.: 100 and 101**

**United States Patent and Trademark Office**

**Reg. No. 3,569,686**

**Registered Feb. 3, 2009**

**SERVICE MARK  
PRINCIPAL REGISTER**

**CROCKETT LAW FIRM**

CROCKETT LAW FIRM, L.C. (UTAH LIMITED  
LIABILITY COMPANY)  
311 SOUTH STATE STREET, SUITE 440  
SALT LAKE CITY, UT 84111

FOR: LEGAL SERVICES, IN CLASS 45 (U.S. CLS.  
100 AND 101).

FIRST USE 9-26-2000; IN COMMERCE 10-3-2000.

THE MARK CONSISTS OF STANDARD CHAR-  
ACTERS WITHOUT CLAIM TO ANY PARTICULAR  
FONT, STYLE, SIZE, OR COLOR.

OWNER OF U.S. REG. NO. 2,610,887.

NO CLAIM IS MADE TO THE EXCLUSIVE  
RIGHT TO USE "LAW FIRM", APART FROM THE  
MARK AS SHOWN.

SEC. 2(F).

SER. NO. 77-504,413, FILED 6-20-2008.

DANIEL BRODY, EXAMINING ATTORNEY

**Int. Cl.: 43**

**Prior U.S. Cls.: 100 and 101**

**United States Patent and Trademark Office**

**Reg. No. 3,569,687**

**Registered Feb. 3, 2009**

**SERVICE MARK  
PRINCIPAL REGISTER**

**CONQUER YOUR HUNGER**

HUHOT MONGOLIAN GRILLS, LLC (MONTANA LIMITED LIABILITY COMPANY)  
223 EAST MAIN STREET  
MISSOULA, MT 59802

THE MARK CONSISTS OF STANDARD CHARACTERS WITHOUT CLAIM TO ANY PARTICULAR FONT, STYLE, SIZE, OR COLOR.

FOR: RESTAURANT SERVICES, IN CLASS 43 (U.S. CLS. 100 AND 101).

SER. NO. 77-504,428, FILED 6-20-2008.

FIRST USE 6-30-2005; IN COMMERCE 6-30-2005.

JORDAN BAKER, EXAMINING ATTORNEY

**Int. Cl.: 7**

**Prior U.S. Cls.: 13, 19, 21, 23, 31, 34 and 35**

**United States Patent and Trademark Office**

**Reg. No. 3,569,688**

**Registered Feb. 3, 2009**

**TRADEMARK  
PRINCIPAL REGISTER**

**MOBILEFUSION TRAC**

FAST FUSION, LLC (COLORADO LIMITED LIABILITY COMPANY)  
101 WEST 8TH STREET  
PALISADE, CO 81526

THE MARK CONSISTS OF STANDARD CHARACTERS WITHOUT CLAIM TO ANY PARTICULAR FONT, STYLE, SIZE, OR COLOR.

FOR: PIPE FUSION MACHINES, IN CLASS 7 (U.S. CLS. 13, 19, 21, 23, 31, 34 AND 35).

SER. NO. 77-504,462, FILED 6-20-2008.

FIRST USE 6-3-2003; IN COMMERCE 6-3-2003.

KELLY MCCOY, EXAMINING ATTORNEY

**Int. Cl.: 9**

**Prior U.S. Cls.: 21, 23, 26, 36 and 38**

**Reg. No. 3,569,689**

**United States Patent and Trademark Office**

**Registered Feb. 3, 2009**

---

**TRADEMARK  
PRINCIPAL REGISTER**

**Loop-A-Lator**

BRANDON T. MONTGOMERY (UNITED STATES  
INDIVIDUAL), DBA BLUDOTONE AMP  
WORKS  
12847 E. PEAKVIEW AVE  
CENTENNIAL, CO 80111

FOR: GUITAR EFFECTS PROCESSORS; GUITAR  
PEDALS, IN CLASS 9 (U.S. CLS. 21, 23, 26, 36 AND 38).

FIRST USE 1-1-2006; IN COMMERCE 1-2-2006.

THE MARK CONSISTS OF STANDARD CHAR-  
ACTERS WITHOUT CLAIM TO ANY PARTICULAR  
FONT, STYLE, SIZE, OR COLOR.

SER. NO. 77-504,600, FILED 6-20-2008.

COURTNEY MCCORMICK, EXAMINING ATTOR-  
NEY

**Int. Cl.: 45**

**Prior U.S. Cls.: 100 and 101**

**United States Patent and Trademark Office**

**Reg. No. 3,569,690**

**Registered Feb. 3, 2009**

**SERVICE MARK  
PRINCIPAL REGISTER**

**PermitPlace**

PERMIT PLACE, INC. (CALIFORNIA CORPORATION), DBA PERMIT PLACE  
13648 BURBANK BLVD  
VAN NUYS, CA 91401

FOR: PERMITTING, NAMELY, OBTAINING ENVIRONMENTAL, DESIGN, ZONING AND OTHER GOVERNMENTAL PERMITS FOR DEVELOPMENT PROJECTS, IN CLASS 45 (U.S. CLS. 100 AND 101).

FIRST USE 11-8-1999; IN COMMERCE 11-8-1999.

THE COLOR(S) GREEN AND BLACK IS/ARE CLAIMED AS A FEATURE OF THE MARK.

THE MARK CONSISTS OF THE WORDS "PERMIT" AND "PLACE" IN STYLIZED FORM. THE WORD "PERMIT" IS IN GREEN AND THE WORD "PLACE" IS IN BLACK.

SER. NO. 77-504,650, FILED 6-20-2008.

NANCY CLARKE, EXAMINING ATTORNEY

Int. Cls.: 25, 35 and 41

Prior U.S. Cls.: 22, 39, 100, 101, 102 and 107

United States Patent and Trademark Office

Reg. No. 3,569,691

Registered Feb. 3, 2009

TRADEMARK  
SERVICE MARK  
PRINCIPAL REGISTER



MT. BACHELOR, INC. (OREGON CORPORATION)  
335 SW CENTURY DRIVE  
BEND, OR 97702

FOR: T-SHIRTS, SWEATSHIRTS, POLO SHIRTS, SPORT SHIRTS, PULLOVERS, JACKETS, NECK GAITERS, HEAD BANDS, HEAD WEAR, CAPS, BANDANNAS, SKI WEAR, PORTABLE SKI BOOT BAGS, PORTABLE SKI BOOT CARRIER STRAPS, HARD PLASTIC PORTABLE SKI BOOT CARRIERS, IN CLASS 25 (U.S. CLS. 22 AND 39).

FIRST USE 11-0-1963; IN COMMERCE 11-0-1963.

FOR: RETAIL STORE SERVICES IN THE FIELD OF SKI EQUIPMENT, CLOTHING AND ACCESSORIES, IN CLASS 35 (U.S. CLS. 100, 101 AND 102).

FIRST USE 11-0-1963; IN COMMERCE 11-0-1963.

FOR: SKI RESORTS; SKI RESORT SERVICES IN THE NATURE OF SLED DOG RIDES; RENTAL OF SKIING AND SNOWBOARD EQUIPMENT, NAME- LY, SKIS, SNOWBOARDS, POLES AND BOOTS; EDUCATIONAL SERVICES, NAMELY, COURSES OF INSTRUCTION IN THE FIELD OF SKIING AND SNOWBOARDING, IN CLASS 41 (U.S. CLS. 100, 101 AND 107).

FIRST USE 11-0-1963; IN COMMERCE 11-0-1963.

THE MARK CONSISTS OF A FACE WITH AN OUTER CIRCULAR DESIGN.

SER. NO. 77-504,673, FILED 6-20-2008.

KAPIL BHANOT, EXAMINING ATTORNEY

**Int. Cl.: 41**

**Prior U.S. Cls.: 100, 101 and 107**

**United States Patent and Trademark Office**

**Reg. No. 3,569,692**

**Registered Feb. 3, 2009**

**SERVICE MARK  
PRINCIPAL REGISTER**

**ACUMEN POKER**

ACUMEN POKER, INC. (VIRGINIA CORPORATION)  
3836 WATKINS MILL DRIVE  
ALEXANDRIA, VA 22304

FOR: PROVIDING INSTRUCTIONAL INFORMATION ON POKER, IN CLASS 41 (U.S. CLS. 100, 101 AND 107).

FIRST USE 3-18-2008; IN COMMERCE 3-29-2008.

THE MARK CONSISTS OF STANDARD CHARACTERS WITHOUT CLAIM TO ANY PARTICULAR FONT, STYLE, SIZE, OR COLOR.

NO CLAIM IS MADE TO THE EXCLUSIVE RIGHT TO USE "POKER", APART FROM THE MARK AS SHOWN.

SER. NO. 77-504,726, FILED 6-20-2008.

JAY FLOWERS, EXAMINING ATTORNEY



**Int. Cl.: 41**

**Prior U.S. Cls.: 100, 101 and 107**

**Reg. No. 3,569,693**

**United States Patent and Trademark Office**

**Registered Feb. 3, 2009**

**SERVICE MARK  
PRINCIPAL REGISTER**



ACUMEN POKER, INC. (VIRGINIA CORPORATION)  
3836 WATKINS MILL DRIVE  
ALEXANDRIA, VA 22304

FOR: PROVIDING INSTRUCTIONAL INFORMATION ON POKER, IN CLASS 41 (U.S. CLS. 100, 101 AND 107).

FIRST USE 3-18-2008; IN COMMERCE 3-29-2008.

THE MARK CONSISTS OF A SPADE ENCLOSING THE LETTER "A" TWO LINES WITH ONE END STRAIGHT AND THE OTHER SWIRLED CROSS UNDER THE SPADE WITH A DIAMOND BELOW A CROWN SHAPE ABOVE THE SPADE WITH A DIAMOND ON EACH SIDE.

SER. NO. 77-504,727, FILED 6-20-2008.

JAY FLOWERS, EXAMINING ATTORNEY

**Int. Cl.: 16**

**Prior U.S. Cls.: 2, 5, 22, 23, 29, 37, 38 and 50**

**Reg. No. 3,569,694**

**United States Patent and Trademark Office**

**Registered Feb. 3, 2009**

**TRADEMARK  
PRINCIPAL REGISTER**

**EARTH BETTER**

BETTER OFFICE PRODUCTS (CALIFORNIA CORPORATION)  
8102 DEERING AVENUE  
CANOGA PARK, CA 91304

FOR: EXPANDABLE FILES, REUSABLE ENVELOPES, TELEPHONE NUMBER/ADDRESS BOOKS, BLANK WRITING JOURNALS, NOTE PAD HOLDERS, NOTE PADS, NOTEBOOKS, DOCUMENT PORTFOLIOS, STATIONERY-TYPE PORTFOLIOS, REPORT COVERS, BINDERS, INDEX DIVIDERS, INDEX CARD CASES, CARRYING CASES FOR WRITING INSTRUMENTS, CARRYING BOXES FOR WRITING INSTRUMENTS, CARRYING POUCHES FOR WRITING INSTRUMENTS, DOCUMENT CARRY-ALLS, NAMELY, DOCUMENT PORTFOLIOS, FILE FOLDERS, SINGLE-POCKET DOCUMENT FOLDERS, MULTIPLE-POCKET DOCUMENT FOLDERS, BINDER POCKETS,

STICKERS, LABELS, NAMELY, ADDRESS, ADHESIVE, BAR CODE, NAME TAG, BLANK OR PARTIALLY PRINTED, PAPER, PRINTED NOVELTY WINE, PRINTED PAPER, AND SHIPPING LABELS, CALENDARS, PLASTIC GIFT BAGS, PLASTIC PROMOTIONAL BAGS, AND PLASTIC MERCHANDISE BAGS, IN CLASS 16 (U.S. CLS. 2, 5, 22, 23, 29, 37, 38 AND 50).

FIRST USE 4-7-2008; IN COMMERCE 4-7-2008.

THE MARK CONSISTS OF STANDARD CHARACTERS WITHOUT CLAIM TO ANY PARTICULAR FONT, STYLE, SIZE, OR COLOR.

SER. NO. 77-504,740, FILED 6-20-2008.

ALICE BENMAMAN, EXAMINING ATTORNEY

**Int. Cl.: 16**

**Prior U.S. Cls.: 2, 5, 22, 23, 29, 37, 38 and 50**

**Reg. No. 3,569,695**

**United States Patent and Trademark Office**

**Registered Feb. 3, 2009**

**TRADEMARK  
PRINCIPAL REGISTER**

**ECO BETTER**

BETTER OFFICE PRODUCTS (CALIFORNIA CORPORATION)  
8102 DEERING AVENUE  
CANOGA PARK, CA 91304

FOR: EXPANDABLE FILES, REUSABLE ENVELOPES, TELEPHONE NUMBER/ADDRESS BOOKS, BLANK WRITING JOURNALS, NOTE PAD HOLDERS, NOTE PADS, NOTEBOOKS, DOCUMENT PORTFOLIOS, STATIONERY-TYPE PORTFOLIOS, REPORT COVERS, BINDERS, INDEX DIVIDERS, INDEX CARD CASES, CARRYING CASES FOR WRITING INSTRUMENTS, CARRYING BOXES FOR WRITING INSTRUMENTS, CARRYING POUCHES FOR WRITING INSTRUMENTS, DOCUMENT CARRY-ALLS, NAMELY, DOCUMENT PORTFOLIOS, FILE FOLDERS, SINGLE-POCKET DOCUMENT FOLDERS, MULTIPLE-POCKET DOCUMENT FOLDERS, BINDER POCKETS,

STICKERS, LABELS, NAMELY, ADDRESS, ADHESIVE, BAR CODE, NAME TAG, BLANK OR PARTIALLY PRINTED, PAPER, PRINTED NOVELTY WINE, PRINTED PAPER, AND SHIPPING LABELS, CALENDARS, PLASTIC GIFT BAGS, PLASTIC PROMOTIONAL BAGS, AND PLASTIC MERCHANDISE BAGS, IN CLASS 16 (U.S. CLS. 2, 5, 22, 23, 29, 37, 38 AND 50).

FIRST USE 4-7-2008; IN COMMERCE 4-7-2008.

THE MARK CONSISTS OF STANDARD CHARACTERS WITHOUT CLAIM TO ANY PARTICULAR FONT, STYLE, SIZE, OR COLOR.

SER. NO. 77-504,742, FILED 6-20-2008.

ALICE BENMAMAN, EXAMINING ATTORNEY

**Int. Cl.: 30**

**Prior U.S. Cl.: 46**

**United States Patent and Trademark Office**

**Reg. No. 3,569,696**

**Registered Feb. 3, 2009**

**TRADEMARK  
PRINCIPAL REGISTER**

**TWIN FLO**

HARRIS FREEMAN & CO., LP (CALIFORNIA  
LIMITED PARTNERSHIP)  
344 NEW ALBANY ROAD  
MOORESTOWN, NJ 08057

THE MARK CONSISTS OF STANDARD CHAR-  
ACTERS WITHOUT CLAIM TO ANY PARTICULAR  
FONT, STYLE, SIZE, OR COLOR.

FOR: TEA BAGS, IN CLASS 30 (U.S. CL. 46).

SER. NO. 77-504,867, FILED 6-21-2008.

FIRST USE 3-1-1972; IN COMMERCE 3-1-1972.

LOURDES AYALA, EXAMINING ATTORNEY

**Int. Cls.: 35 and 37**

**Prior U.S. Cls.: 100, 101, 102, 103 and 106**

**United States Patent and Trademark Office**

**Reg. No. 3,569,697**

**Registered Feb. 3, 2009**

**SERVICE MARK  
PRINCIPAL REGISTER**



MOTORCARS WEST, LLC (DELAWARE LIMITED LIABILITY COMPANY), DBA THE AUTO GALLERY, THE FERRARI GALLERY, THE AUDI GALLERY  
21301 VENTURA BOULEVARD  
WOODLAND HILLS, CA 91364

FOR: DEALERSHIPS IN THE FIELD OF AUTOMOBILES, IN CLASS 35 (U.S. CLS. 100, 101 AND 102).

FIRST USE 12-1-2001; IN COMMERCE 12-1-2001.

FOR: AUTOMOBILE REPAIR AND MAINTENANCE, IN CLASS 37 (U.S. CLS. 100, 103 AND 106).

FIRST USE 12-1-2001; IN COMMERCE 12-1-2001.

THE MARK CONSISTS OF ARROW SHAPED LINES POINTED UP INSIDE THE LETTER "G" WITH THE MIDDLE LINE IN THE "G" FORMING AN "A" IN CONJUNCTION WITH THE ARROW SHAPED LINES POINTED UP.

SER. NO. 77-504,875, FILED 6-21-2008.

ESTHER A. BORSUK, EXAMINING ATTORNEY

**Int. Cl.: 35**

**Prior U.S. Cls.: 100, 101 and 102**

**United States Patent and Trademark Office**

**Reg. No. 3,569,698**

**Registered Feb. 3, 2009**

---

**SERVICE MARK  
PRINCIPAL REGISTER**

**tagsellit**

TAG SELL IT INC. (NEW YORK CORPORATION)  
55 WEST DEVONIA AVE  
FLEETWOOD, NY 10552

THE MARK CONSISTS OF STANDARD CHAR-  
ACTERS WITHOUT CLAIM TO ANY PARTICULAR  
FONT, STYLE, SIZE, OR COLOR.

FOR: PROVIDING A WEB SITE THAT ENABLES  
USERS TO POST ITEMS FOR SALE THROUGH ON-  
LINE CLASSIFIED ADVERTISEMENTS, IN CLASS  
35 (U.S. CLS. 100, 101 AND 102).

SER. NO. 77-504,920, FILED 6-22-2008.

FIRST USE 3-25-2008; IN COMMERCE 4-28-2008.

JORDAN BAKER, EXAMINING ATTORNEY

**Int. Cl.: 35**

**Prior U.S. Cls.: 100, 101 and 102**

**United States Patent and Trademark Office**

**Reg. No. 3,569,699**

**Registered Feb. 3, 2009**

**SERVICE MARK  
PRINCIPAL REGISTER**



TAG SELL IT INC. (NEW YORK CORPORATION)  
55 WEST DEVONIA AVENUE  
FLEETWOOD, NY 10552

FOR: PROVIDING A WEB SITE THAT ENABLES  
USERS TO POST ITEMS FOR SALE THROUGH ON-  
LINE CLASSIFIED ADVERTISEMENTS, IN CLASS  
35 (U.S. CLS. 100, 101 AND 102).

FIRST USE 3-25-2008; IN COMMERCE 4-28-2008.

THE COLOR(S) BLACK GREEN BLUE RED  
WHITE IS/ARE CLAIMED AS A FEATURE OF  
THE MARK.

THE MARK CONSISTS OF BLACK RECTANGLE  
AT AN ANGLE WITH A BLACK CURVED LINE  
EMANATING FROM A SMALL CIRCLE ON THE  
RIGHT SIDE OF THE RECTANGLE WITH THE  
WORDS "TAGSELLIT" ENCLOSED AND CEN-  
TERED IN THE RECTANGLE ON A WHITE BACK-  
GROUND, AND "TAG" IS GREEN, "SELL" IS BLUE  
AND "IT" IS RED.

SER. NO. 77-504,932, FILED 6-22-2008.

JORDAN BAKER, EXAMINING ATTORNEY

**Int. Cl.: 41**

**Prior U.S. Cls.: 100, 101 and 107**

**United States Patent and Trademark Office**

**Reg. No. 3,569,700**

**Registered Feb. 3, 2009**

**SERVICE MARK  
PRINCIPAL REGISTER**

# West Coast Leaf

CONRAD, CHRISTOPHER P. (UNITED STATES INDIVIDUAL), DBA CREATIVE XPRESSIONS  
PO BOX 1716  
EL CERRITO, CA 94530 AND  
NORRIS, MONICA "NIKKI" (UNITED STATES INDIVIDUAL), DBA CREATIVE XPRESSIONS  
PO BOX 1716  
EL CERRITO, CA 94530

FOR: PUBLICATION OF BOOKS, MAGAZINES, JOURNALS, NEWSPAPERS, PERIODICALS, CATALOGS AND BROCHURES, IN CLASS 41 (U.S. CLS. 100, 101 AND 107).

FIRST USE 1-1-2008; IN COMMERCE 2-12-2008.

THE MARK CONSISTS OF STANDARD CHARACTERS WITHOUT CLAIM TO ANY PARTICULAR FONT, STYLE, SIZE, OR COLOR.

NO CLAIM IS MADE TO THE EXCLUSIVE RIGHT TO USE "WEST COAST", APART FROM THE MARK AS SHOWN.

SER. NO. 77-505,027, FILED 6-23-2008.

MICHELE SWAIN, EXAMINING ATTORNEY



**Int. Cls.: 35 and 36**

**Prior U.S. Cls.: 100, 101 and 102**

**United States Patent and Trademark Office**

**Reg. No. 3,569,701**

**Registered Feb. 3, 2009**

**SERVICE MARK  
PRINCIPAL REGISTER**

**MYSMARTCLAIMS.COM**

SMARTCLAIMS.COM, LLC (DELAWARE LIMITED LIABILITY COMPANY)  
2601 SOUTH BAYSHORE DRIVE, SUITE 725  
COCONUT GROVE, FL 33143

FOR: ASSISTING OTHERS IN DOCUMENTING AN INSURED LOSS AND PREPARING A CLAIM, IN CLASS 35 (U.S. CLS. 100, 101 AND 102).

FIRST USE 6-18-2008; IN COMMERCE 6-18-2008.

FOR: CLAIMS ADJUSTMENT IN THE FIELD OF INSURANCE, APPRAISALS FOR INSURANCE CLAIMS FOR DAMAGE OR LOSS TO PERSONAL

PROPERTY AND REAL ESTATE, IN CLASS 36 (U.S. CLS. 100, 101 AND 102).

FIRST USE 6-18-2008; IN COMMERCE 6-18-2008.

THE MARK CONSISTS OF STANDARD CHARACTERS WITHOUT CLAIM TO ANY PARTICULAR FONT, STYLE, SIZE, OR COLOR.

SER. NO. 77-505,058, FILED 6-23-2008.

SANDRA MANIOS, EXAMINING ATTORNEY

Int. Cl.: 43

Prior U.S. Cls.: 100 and 101

United States Patent and Trademark Office

Reg. No. 3,569,702

Registered Feb. 3, 2009

SERVICE MARK  
PRINCIPAL REGISTER



INNOVATIVE RESTAURANT SERVICES EXTON,  
LLC (PENNSYLVANIA LIMITED LIABILITY  
COMPANY)  
143 W. LINCOLN HIGHWAY  
EXTON, PA 19341

FOR: RESTAURANT, BAR AND CATERING SER-  
VICES, IN CLASS 43 (U.S. CLS. 100 AND 101).

FIRST USE 3-1-2001; IN COMMERCE 9-1-2006.

NO CLAIM IS MADE TO THE EXCLUSIVE  
RIGHT TO USE "SPORTS GRILLE", APART FROM  
THE MARK AS SHOWN.

THE MARK CONSISTS OF AN OUTSIDE CIRCLE  
WITH THE WORDS "WINNER'S" AND "SPORTS  
GRILLE" AND AN INNER CIRCLE WITH VERTI-  
CAL STRIPES THROUGH THE CENTER AND THE  
WORD "CIRCLE" STYLIZED AND LARGER FONT  
IN THE CENTER ACROSS BOTH.

SER. NO. 77-505,061, FILED 6-23-2008.

MARCIE MILONE, EXAMINING ATTORNEY

**Int. Cl.: 35**

**Prior U.S. Cls.: 100, 101 and 102**

**United States Patent and Trademark Office**

**Reg. No. 3,569,703**

**Registered Feb. 3, 2009**

**SERVICE MARK  
PRINCIPAL REGISTER**

**S&P**

THE MCGRAW-HILL COMPANIES, INC. (NEW  
YORK CORPORATION)  
1221 AVENUE OF THE AMERICAS  
NEW YORK, NY 10020

FOR: PROVIDING FINANCIAL INDICES IN THE  
NATURE OF QUANTITATIVE MEASUREMENTS  
TO EVALUATE INVESTMENTS, MARKET TRENDS  
AND FINANCIAL INSTRUMENTS , IN CLASS 35  
(U.S. CLS. 100, 101 AND 102).

FIRST USE 12-31-1940; IN COMMERCE 12-31-1940.

THE MARK CONSISTS OF STANDARD CHAR-  
ACTERS WITHOUT CLAIM TO ANY PARTICULAR  
FONT, STYLE, SIZE, OR COLOR.

OWNER OF U.S. REG. NOS. 1,481,545, 1,521,758  
AND OTHERS.

SER. NO. 77-505,101, FILED 6-23-2008.

DAWN HAN, EXAMINING ATTORNEY

**Int. Cl.: 9**

**Prior U.S. Cls.: 21, 23, 26, 36 and 38**

**Reg. No. 3,569,704**

**United States Patent and Trademark Office**

**Registered Feb. 3, 2009**

**TRADEMARK  
PRINCIPAL REGISTER**

***RAISECOM***

RAISECOM TECHNOLOGY CO., LTD. (CHINA CORPORATION)  
2 FL. S. BLDG. OF RAINBOW PLAZA  
NO. 11 SHANGDI INFORMATION RD.  
HAIDIAN DIST., BEIJING, CHINA

FOR: TRANSMITTERS OF ELECTRONIC SIGNALS; MODEMS; TELEGRAPHS; TELEGRAPHIC TRANSMITTING APPARATUS; TELECOMMUNICATIONS TRANSMITTERS; INTERCOMS; AUTOMATIC TELEPHONE EXCHANGES; ELECTRONIC AND OPTICAL COMMUNICATIONS INSTRUMENTS AND COMPONENTS, NAMELY, OPTICAL TRANSMITTERS, OPTICAL RECEIVERS, OPTICAL DATA LINKS, OPTICAL TRANSCEIVERS, CABLE TELEVISION TRANSMITTERS, DIGITAL TRANSMITTERS AND COMMUNICATION LINK TESTERS

FOR TESTING COMMUNICATION LINKS, IN CLASS 9 (U.S. CLS. 21, 23, 26, 36 AND 38).

FIRST USE 1-0-2000; IN COMMERCE 3-25-2005.

THE MARK CONSISTS OF AN INVENTED STYLIZED WORD "RAISECOM", WHICH HAS NO SIGNIFICANCE IN THE RELEVANT TRADE OR INDUSTRY OR AS APPLIED TO THE GOODS LISTED IN THE APPLICATION, NO GEOGRAPHICAL SIGNIFICANCE.

SER. NO. 77-505,103, FILED 6-23-2008.

INGRID C. EULIN, EXAMINING ATTORNEY

**Int. Cl.: 43**

**Prior U.S. Cls.: 100 and 101**

**United States Patent and Trademark Office**

**Reg. No. 3,569,705**

**Registered Feb. 3, 2009**

**SERVICE MARK  
PRINCIPAL REGISTER**

**MELLOW MUSHROOM**

HOME-GROWN INDUSTRIES OF GEORGIA,  
INC. (GEORGIA CORPORATION)  
150 GREAT SOUTHWEST PARKWAY  
ATLANTA, GA 30336

FOR: RESTAURANT SERVICES, IN CLASS 43  
(U.S. CLS. 100 AND 101).

FIRST USE 7-30-1974; IN COMMERCE 7-30-1974.

THE MARK CONSISTS OF STANDARD CHAR-  
ACTERS WITHOUT CLAIM TO ANY PARTICULAR  
FONT, STYLE, SIZE, OR COLOR.

OWNER OF U.S. REG. NO. 1,469,516.

SER. NO. 77-505,142, FILED 6-23-2008.

SUNG IN, EXAMINING ATTORNEY

**Int. Cl.: 28**

**Prior U.S. Cls.: 22, 23, 38 and 50**

**United States Patent and Trademark Office**

**Reg. No. 3,569,706**

**Registered Feb. 3, 2009**

**TRADEMARK  
PRINCIPAL REGISTER**

**HEALTHBOUNDER**

NATURMED, INC. (NEVADA CORPORATION)  
SUITE C  
661 E. HOWARDS ROAD  
CAMP VERDE, AZ 86322

THE MARK CONSISTS OF STANDARD CHAR-  
ACTERS WITHOUT CLAIM TO ANY PARTICULAR  
FONT, STYLE, SIZE, OR COLOR.

FOR: EXERCISE TRAMPOLINES, IN CLASS 28  
(U.S. CLS. 22, 23, 38 AND 50).

SER. NO. 77-505,229, FILED 6-23-2008.

FIRST USE 1-1-2008; IN COMMERCE 1-1-2008.

THOMAS MANOR, EXAMINING ATTORNEY

**Int. Cl.: 42**

**Prior U.S. Cls.: 100 and 101**

**United States Patent and Trademark Office**

**Reg. No. 3,569,707**

**Registered Feb. 3, 2009**

**SERVICE MARK  
PRINCIPAL REGISTER**



GEOKINETICS, INC. (TEXAS CORPORATION)  
SUITE 800  
1500 CITY WEST BLVD.  
HOUSTON, TX 77042

FOR: GEOPHYSICAL SERVICES FOR THE OIL  
AND GAS INDUSTRIES, NAMELY, SEISMIC DATA  
ACQUISITION AND PROCESSING, IN CLASS 42  
(U.S. CLS. 100 AND 101).

FIRST USE 9-0-2006; IN COMMERCE 9-0-2006.

THE MARK CONSISTS OF A STYLIZED "G"  
WITH THE WORD "GEOKINETICS" IN THE MID-  
DLE.

SER. NO. 77-505,230, FILED 6-23-2008.

MATTHEW MCDOWELL, EXAMINING ATTOR-  
NEY

**Int. Cl.: 35**

**Prior U.S. Cls.: 100, 101 and 102**

**United States Patent and Trademark Office**

**Reg. No. 3,569,708**

**Registered Feb. 3, 2009**

**SERVICE MARK  
PRINCIPAL REGISTER**

**POLKALOCA**

POLKALOCA, INC. (NEW YORK CORPORATION)  
119-20 UNION TPKE  
KEW GARDENS, NY 11415

FOR: ON-LINE RETAIL STORE SERVICES FEATURING CLOTHING AND TOYS FOR INFANTS AND CHILDREN; RETAIL CLOTHING BOUTIQUES; RETAIL STORE AND ON-LINE RETAIL STORE SERVICES FEATURING CLOTHING AND TOYS FOR INFANTS AND CHILDREN, IN CLASS 35 (U.S. CLS. 100, 101 AND 102).

FIRST USE 1-1-2008; IN COMMERCE 2-1-2008.

THE MARK CONSISTS OF STANDARD CHARACTERS WITHOUT CLAIM TO ANY PARTICULAR FONT, STYLE, SIZE, OR COLOR.

THE FOREIGN WORDING IN THE MARK TRANSLATES INTO ENGLISH AS CRAZY POLKA.

SER. NO. 77-505,257, FILED 6-23-2008.

RAMONA ORTIGA, EXAMINING ATTORNEY



**Int. Cl.: 25**

**Prior U.S. Cls.: 22 and 39**

**United States Patent and Trademark Office**

**Reg. No. 3,569,709**

**Registered Feb. 3, 2009**

**TRADEMARK  
PRINCIPAL REGISTER**

**SIMPLY PURE**

PURE & SIMPLE CONCEPTS INC. (CANADA CORPORATION)  
6150 TRANSCANADA HIGHWAY  
MONTREAL (ST-LAURENT), CANADA H4T1X5

FOR: MEN'S, WOMEN'S, BOYS' AND GIRLS' CLOTHING NAMELY, SHIRTS, PANTS, BLAZERS, JACKETS, VESTS, SKIRTS, SHORTS, JEANS, SWEATERS, T-SHIRTS, UNDERCLOTHING, UNDERGARMENTS, UNDERWEAR, LINGERIE, PANTIES, HOSIERY, CAMISOLES AND SLEEPWEAR, TOGETHER WITH ALL ACCESSORIES, NAMELY, BELTS,

SOCKS, TIES, CAPS AND HATS, IN CLASS 25 (U.S. CLS. 22 AND 39).

FIRST USE 6-2-2008; IN COMMERCE 6-2-2008.

THE MARK CONSISTS OF STANDARD CHARACTERS WITHOUT CLAIM TO ANY PARTICULAR FONT, STYLE, SIZE, OR COLOR.

SER. NO. 77-505,288, FILED 6-23-2008.

BENJAMIN OKEKE, EXAMINING ATTORNEY

Int. Cl.: 35

Prior U.S. Cls.: 100, 101 and 102

United States Patent and Trademark Office

Reg. No. 3,569,710

Registered Feb. 3, 2009

SERVICE MARK  
PRINCIPAL REGISTER



MANGAR, LENNY (UNITED STATES INDIVIDUAL)  
218 21ST STREET #1R  
BROOKLYN, NY 11232

THE MARK CONSISTS OF A MAN HOLDING A CHAIN WITH A HOOD OVER HIS HEAD, AND THE TEXT "STILL STRONG AC" WRITTEN IN DREAMSCAR FONT.

FOR: CLUB SERVICES, NAMELY, PROMOTING THE INTERESTS OF CARS, IN CLASS 35 (U.S. CLS. 100, 101 AND 102).

SER. NO. 77-505,323, FILED 6-23-2008.

FIRST USE 8-17-2005; IN COMMERCE 8-17-2005.

SHAUNIA CARLYLE, EXAMINING ATTORNEY

**Int. Cl.: 41**

**Prior U.S. Cls.: 100, 101 and 107**

**United States Patent and Trademark Office**

**Reg. No. 3,569,711**

**Registered Feb. 3, 2009**

**SERVICE MARK  
PRINCIPAL REGISTER**

**CAREER BY CHOICE**

FITZGERALD, MEGAN (UNITED STATES INDIVIDUAL)  
INT. 24  
VIA EMANUELE GIANTURCO, 1  
ROME, ITALY 00196

FOR: PROFESSIONAL COACHING SERVICES IN THE FIELD OF EXPAT CAREERS AND BUSINESSES, IN CLASS 41 (U.S. CLS. 100, 101 AND 107).

FIRST USE 1-0-2006; IN COMMERCE 5-0-2006.

THE MARK CONSISTS OF STANDARD CHARACTERS WITHOUT CLAIM TO ANY PARTICULAR FONT, STYLE, SIZE, OR COLOR.

SER. NO. 77-505,326, FILED 6-23-2008.

SUNG IN, EXAMINING ATTORNEY

**Int. Cls.: 9 and 16**

**Prior U.S. Cls.: 2, 5, 21, 22, 23, 26, 29, 36, 37, 38 and 50**

**Reg. No. 3,569,712**

**United States Patent and Trademark Office**

**Registered Feb. 3, 2009**

**TRADEMARK  
PRINCIPAL REGISTER**



MONMOUTH COUNTY ARTS COUNCIL, INC.  
(NEW JERSEY NON-PROFIT CORPORATION)  
SUITE 3  
107 MONMOUTH STREET  
RED BANK, NJ 07701

FOR: DOWNLOADABLE ELECTRONIC PUBLICATIONS IN THE NATURE OF MAGAZINES IN THE FIELD OF ART, THEATER, VISUAL ARTS, MUSIC, FILM, DANCE, AND ENTERTAINMENT, IN CLASS 9 (U.S. CLS. 21, 23, 26, 36 AND 38).

FIRST USE 4-18-2008; IN COMMERCE 4-18-2008.

FOR: PUBLICATIONS, NAMELY, MAGAZINES IN THE FIELDS OF ART, THEATER, VISUAL ARTS,

MUSIC, FILM, DANCE, AND ENTERTAINMENT, IN CLASS 16 (U.S. CLS. 2, 5, 22, 23, 29, 37, 38 AND 50).

FIRST USE 4-18-2008; IN COMMERCE 4-18-2008.

THE MARK CONSISTS OF THE LETTER "X" IN THE BACKGROUND WITH THE LETTERS "IT" SUPERIMPOSED IN THE CENTER OF THE LETTER "X".

SER. NO. 77-505,337, FILED 6-23-2008.

SUNG IN, EXAMINING ATTORNEY

**Int. Cl.: 28**

**Prior U.S. Cls.: 22, 23, 38 and 50**

**United States Patent and Trademark Office**

**Reg. No. 3,569,713**

**Registered Feb. 3, 2009**

**TRADEMARK  
PRINCIPAL REGISTER**

**LUCKY BINGO BALLS**

ARROW INTERNATIONAL, INC. (OHIO CORPORATION)  
9900 CLINTON ROAD  
CLEVELAND, OH 44144

FOR: GAME PLAYING EQUIPMENT, NAMELY, PULL TAB TICKETS FOR BINGO RELATED GAMES, IN CLASS 28 (U.S. CLS. 22, 23, 38 AND 50).

FIRST USE 12-31-2003; IN COMMERCE 12-31-2003.

THE MARK CONSISTS OF STANDARD CHARACTERS WITHOUT CLAIM TO ANY PARTICULAR FONT, STYLE, SIZE, OR COLOR.

NO CLAIM IS MADE TO THE EXCLUSIVE RIGHT TO USE "BINGO BALLS", APART FROM THE MARK AS SHOWN.

SER. NO. 77-505,349, FILED 6-23-2008.

CHRISIE B. KING, EXAMINING ATTORNEY

**Int. Cl.: 41**

**Prior U.S. Cls.: 100, 101 and 107**

**United States Patent and Trademark Office**

**Reg. No. 3,569,714**

**Registered Feb. 3, 2009**

**SERVICE MARK  
PRINCIPAL REGISTER**

**DIARIOS DE UN CRIMEN**

UNIVISION COMMUNICATIONS INC. (DELA-  
WARE CORPORATION)

5999 CENTER DRIVE

LOS ANGELES, CA 90045

FOR: ENTERTAINMENT SERVICES, NAMELY,  
AN ON-GOING TELEVISION SERIES ABOUT TRUE  
CRIME STORIES, IN CLASS 41 (U.S. CLS. 100, 101  
AND 107).

FIRST USE 2-6-2008; IN COMMERCE 2-6-2008.

THE MARK CONSISTS OF STANDARD CHAR-  
ACTERS WITHOUT CLAIM TO ANY PARTICULAR  
FONT, STYLE, SIZE, OR COLOR.

OWNER OF U.S. REG. NO. 3,190,714.

THE FOREIGN WORDING IN THE MARK  
TRANSLATES INTO ENGLISH AS DIARIES OF A  
CRIME.

SER. NO. 77-505,394, FILED 6-23-2008.

MICHAEL TANNER, EXAMINING ATTORNEY

**Int. Cl.: 21**

**Prior U.S. Cls.: 2, 13, 23, 29, 30, 33, 40 and 50**

**Reg. No. 3,569,715**

**United States Patent and Trademark Office**

**Registered Feb. 3, 2009**

**TRADEMARK  
PRINCIPAL REGISTER**

**THE GOPHER SNAKE**

GOUFF, ROD (UNITED STATES INDIVIDUAL)  
4400-C PORTOLA ROAD  
4400-C PORTOLA ROAD, CA 93422 AND  
GOUFF, KEN (UNITED STATES INDIVIDUAL)  
4400-C PORTOLA ROAD  
ATASCADERO, CA 93422 AND  
LARSEN, JANA (UNITED STATES INDIVIDUAL)  
4400-C PORTOLA ROAD  
ATASCADERO, CA 93422

FOR: MANUALLY ACTUATED POISON BAIT  
DISPENSER FOR RODENTS, IN CLASS 21 (U.S.  
CLS. 2, 13, 23, 29, 30, 33, 40 AND 50).

FIRST USE 1-1-1969; IN COMMERCE 5-1-2005.

THE MARK CONSISTS OF STANDARD CHAR-  
ACTERS WITHOUT CLAIM TO ANY PARTICULAR  
FONT, STYLE, SIZE, OR COLOR.

NO CLAIM IS MADE TO THE EXCLUSIVE  
RIGHT TO USE "GOPHER", APART FROM THE  
MARK AS SHOWN.

SER. NO. 77-505,411, FILED 6-23-2008.

SHAILA SETTLES, EXAMINING ATTORNEY

**Int. Cl.: 35**

**Prior U.S. Cls.: 100, 101 and 102**

**United States Patent and Trademark Office**

**Reg. No. 3,569,716**

**Registered Feb. 3, 2009**

**SERVICE MARK  
PRINCIPAL REGISTER**

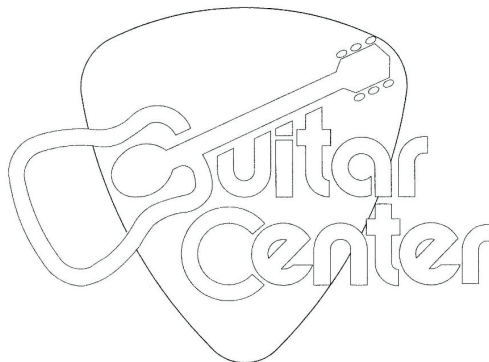

GUITAR CENTER, INC. (DELAWARE CORPORATION)  
5795 LINDERO CANYON ROAD  
WESTLAKE VILLAGE, CA 91362

FOR: RETAIL STORE SERVICES AND ON-LINE RETAIL STORE SERVICES FEATURING GUITARS, AMPLIFIERS, KEYBOARDS, PERCUSSION PRO-AUDIO, DRUMS, SHEET MUSIC, MUSIC BOOKS AND ACCESSORIES AND PRODUCTS RELATED THERETO, IN CLASS 35 (U.S. CLS. 100, 101 AND 102).

FIRST USE 11-30-2007; IN COMMERCE 11-30-2007.

OWNER OF U.S. REG. NOS. 1,290,481, 3,053,666 AND OTHERS.

NO CLAIM IS MADE TO THE EXCLUSIVE RIGHT TO USE "CENTER", APART FROM THE MARK AS SHOWN.

THE MARK CONSISTS OF THE WORDS "GUITAR CENTER" APPEARING OVER A DRAWING OF A GUITAR PICK. THE "G" OF "GUITAR" IS FANCIFUL IN THE FORM OF A GUITAR DRAWING. THE WORD "GUITAR" APPEARS ON TOP OF THE WORD "CENTER" AND SLIGHTLY TO THE LEFT.

SER. NO. 77-505,461, FILED 6-23-2008.

ERNEST SHOSHO, EXAMINING ATTORNEY



**Int. Cl.: 35**

**Prior U.S. Cls.: 100, 101 and 102**

**United States Patent and Trademark Office**

**Reg. No. 3,569,717**

**Registered Feb. 3, 2009**

**SERVICE MARK  
PRINCIPAL REGISTER**

**TONE BENDER MUSIC**

TONE BENDER MUSIC (NEW YORK PARTNER-  
SHIP)  
SUITE 330  
6 NORTH MAIN STREET  
FAIRPORT, NY 14450

FOR: CONSULTATION AND ADVICE FOR THE  
PURCHASE OF MUSICAL INSTRUMENTS AND  
SOUND RECORDING DEVICES; RETAIL STORE  
SERVICES FEATURING MUSICAL INSTRUMENTS  
AND SOUND RECORDING DEVICES, IN CLASS 35  
(U.S. CLS. 100, 101 AND 102).

FIRST USE 6-12-2006; IN COMMERCE 6-12-2006.

THE MARK CONSISTS OF STANDARD CHAR-  
ACTERS WITHOUT CLAIM TO ANY PARTICULAR  
FONT, STYLE, SIZE, OR COLOR.

NO CLAIM IS MADE TO THE EXCLUSIVE  
RIGHT TO USE "MUSIC", APART FROM THE  
MARK AS SHOWN.

SER. NO. 77-505,484, FILED 6-23-2008.

SKYE YOUNG, EXAMINING ATTORNEY

Int. Cl.: 35

Prior U.S. Cls.: 100, 101 and 102

United States Patent and Trademark Office

Reg. No. 3,569,718

Registered Feb. 3, 2009

SERVICE MARK  
PRINCIPAL REGISTER

*dots*

DOTS, LLC (DELAWARE LIMITED LIABILITY  
COMPANY)  
30801 CARTER STREET  
SOLON, OH 44139

FOR: RETAIL STORE SERVICES FEATURING  
CLOTHING AND ACCESSORIES, IN CLASS 35 (U.S.  
CLS. 100, 101 AND 102).

FIRST USE 6-14-2007; IN COMMERCE 6-14-2007.

OWNER OF U.S. REG. NOS. 2,568,849, 2,948,673  
AND OTHERS.

THE MARK CONSISTS OF THE WORD "DOTS"  
IN A STYLIZED FONT.

SER. NO. 77-505,526, FILED 6-23-2008.

SHAUNIA CARLYLE, EXAMINING ATTORNEY

**Int. Cl.: 35**

**Prior U.S. Cls.: 100, 101 and 102**

**United States Patent and Trademark Office**

**Reg. No. 3,569,719**

**Registered Feb. 3, 2009**

**SERVICE MARK  
PRINCIPAL REGISTER**

**FISHERMAN'S FACTORY OUTLET**

PURE FISHING, INC. (IOWA CORPORATION)  
1900 18TH STREET  
SPIRIT LAKE, IA 51360

FOR: RETAIL STORE SERVICES IN THE FIELD  
OF FISHING PRODUCTS, APPAREL AND ACCES-  
SORIES, IN CLASS 35 (U.S. CLS. 100, 101 AND 102).

FIRST USE 7-4-1996; IN COMMERCE 7-4-1996.

THE MARK CONSISTS OF STANDARD CHAR-  
ACTERS WITHOUT CLAIM TO ANY PARTICULAR  
FONT, STYLE, SIZE, OR COLOR.

OWNER OF U.S. REG. NO. 2,110,123.

NO CLAIM IS MADE TO THE EXCLUSIVE  
RIGHT TO USE "FACTORY OUTLET", APART  
FROM THE MARK AS SHOWN.

SEC. 2(F) AS TO "FISHERMAN'S".

SER. NO. 77-505,569, FILED 6-23-2008.

NICHOLAS ALTREE, EXAMINING ATTORNEY

**Int. Cl.: 38**

**Prior U.S. Cls.: 100, 101 and 104**

**United States Patent and Trademark Office**

**Reg. No. 3,569,720**

**Registered Feb. 3, 2009**

**SERVICE MARK  
PRINCIPAL REGISTER**

**ROSETTA STONE**

ROSETTA STONE LTD. (VIRGINIA CORPORATION)  
1101 WILSON BOULEVARD, SUITE 1130  
ARLINGTON, VA 22209

FOR: COMPUTER SERVICES, NAMELY, PROVIDING ON-LINE FACILITIES FOR REAL-TIME INTERACTION WITH OTHER COMPUTER USERS IN THE FIELD OF FOREIGN LANGUAGES, IN CLASS 38 (U.S. CLS. 100, 101 AND 104).

FIRST USE 11-3-2006; IN COMMERCE 11-3-2006.

THE MARK CONSISTS OF STANDARD CHARACTERS WITHOUT CLAIM TO ANY PARTICULAR FONT, STYLE, SIZE, OR COLOR.

OWNER OF U.S. REG. NOS. 2,761,492 AND 2,781,324.

SER. NO. 77-505,721, FILED 6-23-2008.

COURTNEY MCCORMICK, EXAMINING ATTORNEY

**Int. Cl.: 45**

**Prior U.S. Cls.: 100 and 101**

**United States Patent and Trademark Office**

**Reg. No. 3,569,721**

**Registered Feb. 3, 2009**

**SERVICE MARK  
PRINCIPAL REGISTER**



GROUPNEX CORP. (NEW YORK CORPORATION)  
SUITE 2F  
425 SHORE ROAD  
LONG BEACH, NY 11561

THE MARK CONSISTS OF A RECTANGULAR BOX CONTAINING A GROUP OF PEOPLE AS A SILHOUETTE OVER THE STYLIZED TEXT "GROUPNEX", WHICH IS FOLLOWED BY A STAR.

FOR: ON-LINE SOCIAL NETWORKING SERVICES, IN CLASS 45 (U.S. CLS. 100 AND 101).

SER. NO. 77-505,949, FILED 6-23-2008.

FIRST USE 3-25-2008; IN COMMERCE 3-25-2008.

RONALD DELGIZZI, EXAMINING ATTORNEY

**Int. Cl.: 35**

**Prior U.S. Cls.: 100, 101 and 102**

**United States Patent and Trademark Office**

**Reg. No. 3,569,722**

**Registered Feb. 3, 2009**

**SERVICE MARK  
PRINCIPAL REGISTER**

**TAP IS BACK**

ZERO TECHNOLOGIES, LLC. (DELAWARE LIMITED LIABILITY COMPANY)  
4510 E. ADAMS CIRCLE  
BENSALEM, PA 19020

THE MARK CONSISTS OF STANDARD CHARACTERS WITHOUT CLAIM TO ANY PARTICULAR FONT, STYLE, SIZE, OR COLOR.

FOR: RETAIL STORE SERVICES FEATURING WATER FILTRATION PRODUCTS AND ACCESSORIES, IN CLASS 35 (U.S. CLS. 100, 101 AND 102).

SER. NO. 77-505,970, FILED 6-23-2008.

FIRST USE 9-0-2007; IN COMMERCE 9-0-2007.

MICHAEL KEATING, EXAMINING ATTORNEY

**Int. Cl.: 44**

**Prior U.S. Cls.: 100 and 101**

**United States Patent and Trademark Office**

**Reg. No. 3,569,723**

**Registered Feb. 3, 2009**

**SERVICE MARK  
PRINCIPAL REGISTER**

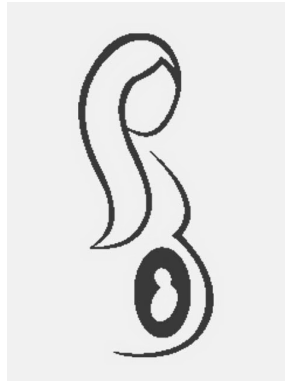

CORYELL, NANCY C (UNITED STATES INDIVIDUAL)  
5055 S 78 E AVE  
TULSA, OK 74145

FOR: MEDICAL IMAGING SERVICES, NAMELY, CONSULTING SERVICES IN THE FIELD OF USING AND OPERATING MEDICAL IMAGING APPARATUS INCLUDING X-RAY, COMPUTED TOMOGRAPHY, MAGNETIC RESONANCE IMAGING, ULTRASOUND, AND POSITRON EMISSION TO-

MOGRAPHY APPARATUS, IN CLASS 44 (U.S. CLS. 100 AND 101).

FIRST USE 1-1-2003; IN COMMERCE 1-1-2003.

THE MARK CONSISTS OF THE OUTLINE OF A PREGNANCY LADY WITH THE FETUS INSIDE.

SER. NO. 77-506,000, FILED 6-23-2008.

DAWN FELDMAN, EXAMINING ATTORNEY

**Int. Cl.: 44**

**Prior U.S. Cls.: 100 and 101**

**United States Patent and Trademark Office**

**Reg. No. 3,569,724**

**Registered Feb. 3, 2009**

**SERVICE MARK  
PRINCIPAL REGISTER**



FINN, WENDY SUZANNE (UNITED STATES  
INDIVIDUAL)

2311 WEST LAWSON ST.

FAYETTEVILLE, AR 72703

FOR: MASSAGE THERAPY SERVICES, IN CLASS  
44 (U.S. CLS. 100 AND 101).

FIRST USE 1-1-1994; IN COMMERCE 1-1-1994.

NO CLAIM IS MADE TO THE EXCLUSIVE  
RIGHT TO USE "SPA" , APART FROM THE MARK  
AS SHOWN.

THE MARK CONSISTS OF PAIR OF HANDS  
WITH DOVES AS THE PALMS, POSITIONED OVER  
I.M. SPA.

SER. NO. 77-506,003, FILED 6-23-2008.

DAWN FELDMAN, EXAMINING ATTORNEY



**Int. Cls.: 35 and 42**

**Prior U.S. Cls.: 100, 101 and 102**

**United States Patent and Trademark Office**

**Reg. No. 3,569,725**

**Registered Feb. 3, 2009**

**SERVICE MARK  
PRINCIPAL REGISTER**

# Fresh Element

FRESH ELEMENT, INC. (CALIFORNIA CORPORATION)  
24730 AVENUE TIBBITTS, SUITE 160  
VALENCIA, CA 91355

FOR: FULL SERVICE ADVERTISING AGENCY SERVICES PROVIDING ON-LINE AND OFF-LINE MARKETING AND ADVERTISING; MARKETING AND ADVERTISING CONSULTATION; DEVELOPMENT OF ADVERTISING CAMPAIGNS FOR PRINT, TELEVISION, RADIO, AND INTERNET; PRODUCTION OF COMMERCIALS FOR USE WITH BROADCAST MEDIA, RADIO, TELEVISION, AND INTERNET; MARKET RESEARCH; STRATEGIC PLANNING FOR MARKETING AND ADVERTISING CAMPAIGNS; DIRECT MAIL ADVERTISING; PROMOTING THE GOODS AND SERVICES OF OTHERS THROUGH SEARCH ENGINES AND ON-LINE MEDIA VENUES, IN CLASS 35 (U.S. CLS. 100, 101 AND 102).

FIRST USE 3-1-2006; IN COMMERCE 3-1-2006.

FOR: COMPUTER SERVICES, NAMELY, DESIGNING AND IMPLEMENTING WEB SITES FOR OTHERS; HOSTING THE WEB SITES OF OTHERS ON A COMPUTER SERVER FOR A GLOBAL COMPUTER NETWORK; MANAGING WEB SITES FOR OTHERS; COMPUTER CONSULTATION, NAMELY, PROVIDING TECHNICAL CONSULTATION IN THE FIELD OF WEB SITE DEVELOPMENT, IN CLASS 42 (U.S. CLS. 100 AND 101).

FIRST USE 3-1-2006; IN COMMERCE 3-1-2006.

THE MARK CONSISTS OF STANDARD CHARACTERS WITHOUT CLAIM TO ANY PARTICULAR FONT, STYLE, SIZE, OR COLOR.

SER. NO. 77-506,034, FILED 6-24-2008.

AISHA CLARKE, EXAMINING ATTORNEY

Int. Cl.: 33

Prior U.S. Cls.: 47 and 49

United States Patent and Trademark Office

Reg. No. 3,569,726

Registered Feb. 3, 2009

TRADEMARK  
PRINCIPAL REGISTER

# Mango Mia

VIAVANTI, LLC (NEW YORK LIMITED LIABILITY COMPANY)

226 SOUTH GREELEY AVE.

CHAPPAQUA, NY 10514

FOR: ALCOHOLIC FRUIT COCKTAIL DRINKS,  
IN CLASS 33 (U.S. CLS. 47 AND 49).

FIRST USE 12-1-2005; IN COMMERCE 2-1-2006.

THE MARK CONSISTS OF STANDARD CHARACTERS WITHOUT CLAIM TO ANY PARTICULAR FONT, STYLE, SIZE, OR COLOR.

NO CLAIM IS MADE TO THE EXCLUSIVE RIGHT TO USE "MANGO", APART FROM THE MARK AS SHOWN.

SER. NO. 77-506,046, FILED 6-24-2008.

JASON TURNER, EXAMINING ATTORNEY

**Int. Cl.: 30**

**Prior U.S. Cl.: 46**

**United States Patent and Trademark Office**

**Reg. No. 3,569,727**

**Registered Feb. 3, 2009**

**TRADEMARK  
PRINCIPAL REGISTER**

**Duomo d'Oro**

VIAVANTI, LLC (NEW YORK LIMITED LIABILITY COMPANY)  
226 SOUTH GREELEY AVE.  
CHAPPAQUA, NY 10514

THE FOREIGN WORDING IN THE MARK  
TRANSLATES INTO ENGLISH AS DOME OF  
GOLD.

FOR: MUFFINS, IN CLASS 30 (U.S. CL. 46).

FIRST USE 8-1-2007; IN COMMERCE 9-1-2007.

SER. NO. 77-506,050, FILED 6-24-2008.

THE MARK CONSISTS OF STANDARD CHARACTERS WITHOUT CLAIM TO ANY PARTICULAR FONT, STYLE, SIZE, OR COLOR.

JASON TURNER, EXAMINING ATTORNEY

Int. Cl.: 25

Prior U.S. Cls.: 22 and 39

United States Patent and Trademark Office

Reg. No. 3,569,728

Registered Feb. 3, 2009

TRADEMARK  
PRINCIPAL REGISTER

SWEET & POISON

SAVE TEKSTIL SANAYI IHRACAÇ VE TİCARET  
LIMITED SİRKETİ (TURKEY TÜRK LIMITED  
SİRKET (TİS))

SK. NO. 14, KALKALI KUCUKCEKMECE  
HALKALI MERKEZ MAH. AYTAC MEVKİİ 2  
İSTANBUL, TURKEY

FOR: A-SHIRTS; ANKLE BOOTS; ANKLE SOCKS;  
ANKLETS; ATHLETIC APPAREL, NAMELY,  
SHIRTS, PANTS, JACKETS, FOOTWEAR, HATS  
AND CAPS, ATHLETIC UNIFORMS; ATHLETIC  
FOOTWEAR; ATHLETIC SHOES; BANDANAS;  
BATH SLIPPERS; BATHING COSTUMES; BATHING  
SUITS; BATHROBES; BEACH COVER-UPS; BEACH  
COVERUPS; BEACH FOOTWEAR; BEACH SHOES;  
BEACHWEAR; BELTS; BELTS MADE OF LEATHER;  
BERMUDA SHORTS; BIKINIS; BLAZERS; BLOU-  
SES; BLOUSONS; BOARDSHORTS; BODY SHA-  
PERS; BODY STOCKINGS; BODY SUITS;  
BONNETS; BOOTIES; BOOTS; BOTTOMS; BOXER  
BRIEFS; BOXER SHORTS; BRALETTES; BRAS;  
BRASSIERES; CAMISETTES; CAMISOLES; CAMP  
SHIRTS; CANVAS SHOES; CAP VISORS; CAPELETS;  
CAPES; CAPRI PANTS; CAPRIS; CAPS; CAPS WITH  
VISORS; CARDIGANS; CARGO PANTS; CHIL-  
DREN'S HEADWEAR; CLAM DIGGERS; CLOGS;  
CLOTHING, NAMELY, NECK TUBES; CLOTHING,  
NAMELY, WRAP-AROUNDS; COATS; COATS FOR  
MEN AND WOMEN; COATS MADE OF COTTON;  
COATS OF DENIM; COVERALLS; COVERUPS;  
CREWNECKS; CROP TOPS; CULOTTES; DECK-  
SHOES; DENIM JACKETS; DENIMS; DRESS  
SHIRTS; DRESS SUITS; DRESSES; DRESSING  
GOWNS; DUNGAREES; EAR MUFFS; EAR WAR-  
MERS; EARBANDS; ESPADRILLES; EVENING  
DRESSES; EVENING GOWNS; FABRIC BELTS;  
FLEECE PULLOVERS; FLEECE SHORTS; FLEECE  
VESTS; FLIP FLOPS; FOOTIES; FOOTWEAR; FOOT-  
WEAR; FOOTWEAR FOR MEN; FOOTWEAR FOR  
MEN AND WOMEN; FOOTWEAR FOR WOMEN;  
FOOTWEAR MADE OF WOOD; FOOTWEAR NOT  
FOR SPORTS; FOOTWEAR, NAMELY, PUMPS;

FOOTWEAR, NAMELY, RUBBERS; FOUL WEATH-  
ER GEAR; FOUNDATION GARMENTS; GARTERS;  
GAUCHOS; GIRDLES; GLOVES; GOLF CAPS; GOLF  
SHIRTS; GOWNS; GYM SHORTS; GYM SUITS;  
GYMNASTIC SHOES; HALTER TOPS; HATS; HEAD  
SCARVES; HEAD SWEATBANDS; HEAD WEAR;  
HEADBANDS; HEADBANDS AGAINST SWEAT-  
ING; HEADWEAR; HEAVY COATS; HEAVY JACK-  
ETS; HOODED PULLOVERS; HOODED SWEAT  
SHIRTS; HOODS; HOODS; HOSIERY; INSOLES;  
JACKETS; JEANS; JERSEYS; JOGGING OUTFITS;  
JOGGING PANTS; JOGGING SUITS; JUDO SUITS;  
JUMPERS; JUMPSUITS; KNEE HIGHS; KNEE-HIGH  
STOCKINGS; KNIT SHIRTS; KNITTED CAPS; KNIT-  
TED UNDERWEAR; LADIES' BOOTS; LADIES'  
SUITS; LADIES' UNDERWEAR; LEATHER COATS;  
LEATHER HEADWEAR; LEATHER JACKETS; LEA-  
THER PANTS; LEATHER SHOES; LEG SHAPERS;  
LEG WARMERS; LEGGINGS; LEOTARDS; LIN-  
GERIE; LONG JACKETS; LONG SLEEVED VESTS;  
LONG UNDERWEAR; LONG-SLEEVED SHIRTS;  
LOUNGE PANTS; LOUNGEWEAR; MATERNITY  
LINGERIE; MATERNITY SLEEPWEAR; MEN'S  
AND WOMEN'S JACKETS, COATS, TROUSERS,  
VESTS; MEN'S SUITS, WOMEN'S SUITS; MINIS-  
KIRTS; MITTENS; MUSCLE TOPS; NECKWEAR;  
NEGLIGEEES; NIGHT GOWNS; NIGHTDRESSES;  
NIGHTGOWNS; NIGHTTIES; NIGHTWEAR; ONE  
PIECE GARMENT FOR INFANTS AND TOD-  
DLERS; ONE-PIECE PLAY SUITS; OPEN-NECKED  
SHIRTS; OVERALLS; OVERCOATS; PAJAMA BOT-  
TOMS; PAJAMAS; PANTIES; PANTIES, SHORTS  
AND BRIEFS; PANTS; PANTSUITS; POLO SHIRTS;  
PONCHOS; PULLOVERS; RAIN BOOTS; RAIN  
COATS; RAIN JACKETS; RAIN SLICKERS; RAIN  
SUITS; RAIN TROUSERS; RAINCOATS; RAIN-  
PROOF JACKETS; RAINWEAR; REVERSIBLE  
JACKETS; ROBES; ROMPERS; RUGBY SHIRTS;  
RUGBY SHORTS; RUGBY TOPS; RUNNING SHOES;  
SANDAL-CLOGS; SANDALS; SARIS; SARONGS;  
SASHES; SCARVES; SHAWLS; SHAWLS AND  
HEADSCARVES; SHAWLS AND STOLEES; SHELL

JACKETS; SHIRTS; SHIRTS FOR SUITS; SHOES; SHORT SETS; SHORT TROUSERS; SHORT-SLEEVED OR LONG-SLEEVED T-SHIRTS; SHORT-SLEEVED SHIRTS; SHORTALLS; SHORTS; SHOULDER SCARVES; SHOULDER WRAPS; SHRUGS; SILK SCARVES; SINGLET; SKIRT SUITS; SKIRTS; SKIRTS AND DRESSES; SKORTS; SLACKS; SLEEP SHIRTS; SLEEPING GARMENTS; SLEEPWEAR; SLEEVED OR SLEEVELESS JACKETS; SLEEVELESS JERSEYS; SLIPPERS; SLIPS; SMALL HATS; SNEAKERS; SOCKS; SOCKS AND STOCKINGS; SPORT COATS; SPORT SHIRTS; SPORTS JACKETS; SPORTS JERSEYS; SPORTS PANTS; SPORTS SHIRTS; SPORTS SHIRTS WITH SHORT SLEEVES; STOCKINGS; STRETCH PANTS; SUEDE JACKETS; SUIT COATS; SUITS; SUN SLEEVES; SUN VISORS; SUNSUITS; SURF WEAR; SUSPENDER BELTS FOR MEN; SUSPENDER BELTS FOR WOMEN; SUSPENDERS; SWEAT BANDS; SWEAT JACKETS; SWEAT PANTS; SWEAT SHIRTS; SWEAT SHORTS; SWEAT SUITS; SWEATBANDS; SWEATERS; SWEATSOCKS; SWIM WEAR; SWIMSUITS; SWIMWEAR; T-SHIRTS; TANK TOPS; TANK-TOPS; TANKINIS; TEDDIES; TEE SHIRTS; TENNIS SHOES; TENNIS WEAR; THONGS; THONGS; TIGHTS; TOP COATS; TOPCOATS; TOPS; TRACK JACKETS; TRACK PANTS; TRACK SUITS; TRACKSUITS; TRAINING SUITS; TROUSERS; TROUSERS FOR

SWEATING; TROUSERS OF LEATHER; TRUNKS; TUBE TOPS; TURBANS; TURTLENECK SWEATERS; TURTLENECKS; UNDER GARMENTS; UNDERCLOTHES; UNDERGARMENTS; UNDERPANTS; UNDERSHIRTS; UNDERSKIRTS; UNDERWEAR; UNITARDS; V-NECK SWEATERS; VEILS; VESTS; VISORS; WAIST BELTS; WAISTBANDS; WAISTCOATS; WALKING SHORTS; WARM UP OUTFITS; WARM UP SUITS; WEARABLE GARMENTS AND CLOTHING, NAMELY, SHIRTS; WIND COATS; WIND PANTS; WIND RESISTANT JACKETS; WIND SHIRTS; WIND VESTS; WIND-JACKETS; WINDCHEATERS; WINDJAMMERS; WINDSHIRTS; WOMEN'S CEREMONIAL DRESSES; WOMEN'S SHOES; WOMEN'S UNDERWEAR; WRAPS; WRIST BANDS; WRISTBANDS; YOGA PANTS; YOGA SHIRTS; ZORI, IN CLASS 25 (U.S. CLS. 22 AND 39).

FIRST USE 1-1-2005; IN COMMERCE 1-1-2005.

THE MARK CONSISTS OF STANDARD CHARACTERS WITHOUT CLAIM TO ANY PARTICULAR FONT, STYLE, SIZE, OR COLOR.

SER. NO. 77-506,077, FILED 6-24-2008.

ELLEN PERKINS, EXAMINING ATTORNEY

**Int. Cl.: 35**

**Prior U.S. Cls.: 100, 101 and 102**

**United States Patent and Trademark Office**

**Reg. No. 3,569,729**

**Registered Feb. 3, 2009**

**SERVICE MARK  
PRINCIPAL REGISTER**

**HORRORBLES**

ARANZA, JOHN D. (UNITED STATES INDIVIDUAL)  
1131 S. EAST AVE.  
OAK PARK, IL 60304

THE MARK CONSISTS OF STANDARD CHARACTERS WITHOUT CLAIM TO ANY PARTICULAR FONT, STYLE, SIZE, OR COLOR.

FOR: RETAIL STORE AND ON-LINE RETAIL STORE SERVICES FEATURING MOVIE MEMORABILIA, IN CLASS 35 (U.S. CLS. 100, 101 AND 102).

SER. NO. 77-506,093, FILED 6-24-2008.

FIRST USE 0-0-2004; IN COMMERCE 0-0-2004.

SKYE YOUNG, EXAMINING ATTORNEY

**Int. Cl.: 40**

**Prior U.S. Cls.: 100, 103 and 106**

**United States Patent and Trademark Office**

**Reg. No. 3,569,730**

**Registered Feb. 3, 2009**

**SERVICE MARK  
PRINCIPAL REGISTER**

**CASTING INTEGRITY**

GREDE FOUNDRIES, INC. (WISCONSIN CORPORATION)  
9898 W. BLUEMOUND ROAD  
MILWAUKEE, WI 53226

FOR: METAL CASTING; PROTOTYPE FABRICATION OF NEW PRODUCTS FOR OTHERS; MACHINE SHOP SERVICES, NAMELY, MACHINING PARTS FOR OTHERS; ASSEMBLY OF PRODUCTS FOR OTHERS, IN CLASS 40 (U.S. CLS. 100, 103 AND 106).

FIRST USE 0-0-2002; IN COMMERCE 0-0-2002.

THE MARK CONSISTS OF STANDARD CHARACTERS WITHOUT CLAIM TO ANY PARTICULAR FONT, STYLE, SIZE, OR COLOR.

NO CLAIM IS MADE TO THE EXCLUSIVE RIGHT TO USE "CASTING", APART FROM THE MARK AS SHOWN.

SER. NO. 77-506,160, FILED 6-24-2008.

SETH A. RAPPAPORT, EXAMINING ATTORNEY

**Int. Cl.: 12**

**Prior U.S. Cls.: 19, 21, 23, 31, 35 and 44**

**Reg. No. 3,569,731**

**United States Patent and Trademark Office**

**Registered Feb. 3, 2009**

**TRADEMARK  
PRINCIPAL REGISTER**

# Trends for Kids

TRENDS FOR KIDS GMBH (FED REP GERMA-  
NY GESELLSCHAFT MIT BESCHRÄNKTER  
HAFTUNG (GMBH))  
AM INDUSTRIEGLEIS 9  
ERGOLDING, FED REP GERMANY 84030

FOR: BABY CARRIAGES AND STRUCTURAL  
PARTS THEREFOR; BABY STROLLERS AND  
STRUCTURAL PARTS THEREFOR; PRAMS AND  
STRUCTURAL PARTS THEREFOR; STROLLERS  
AND STRUCTURAL PARTS THEREFOR; COVERS  
FOR BABY STROLLERS; CANOPIES FOR BABY  
STROLLERS; WHEELS AND TIRES FOR STROL-  
LERS; TRANSPORT BAGS SPECIALLY ADAPTED  
FOR STROLLERS; INSULATING COVERS AND  
LININGS FOR BABIES AND CHILDREN SPECIAL-  
LY ADAPTED FOR BUGGIES AND STROLLERS;  
COVERS FOR STROLLERS, NAMELY, BUG COV-

ERS, SUN COVERS, AND RAIN COVERS, IN CLASS  
12 (U.S. CLS. 19, 21, 23, 31, 35 AND 44).

FIRST USE 4-0-2008; IN COMMERCE 4-0-2008.

THE MARK CONSISTS OF STANDARD CHAR-  
ACTERS WITHOUT CLAIM TO ANY PARTICULAR  
FONT, STYLE, SIZE, OR COLOR.

NO CLAIM IS MADE TO THE EXCLUSIVE  
RIGHT TO USE "KIDS", APART FROM THE MARK  
AS SHOWN.

SER. NO. 77-506,216, FILED 6-24-2008.

ANTHONY RINKER, EXAMINING ATTORNEY



**Int. Cls.: 29 and 30**

**Prior U.S. Cl.: 46**

**United States Patent and Trademark Office**

**Reg. No. 3,569,732**

**Registered Feb. 3, 2009**

**TRADEMARK  
PRINCIPAL REGISTER**

**KARMIC KITCHEN**

THE BEST OF ORGANIC LLC (MICHIGAN LIMITED LIABILITY COMPANY)  
2289 OAKWAY  
WEST BLOOMFIELD, MI 48324

FOR: NUTRITIONAL HEALTH FOODS, NAME-  
LY, HEALTH BARS IN THE FORM OF PROTEIN  
BASED NUTRITIONAL-DENSE SNACK BARS, IN  
CLASS 29 (U.S. CL. 46).

FIRST USE 3-1-2001; IN COMMERCE 3-1-2001.

FOR: HEALTH FOOD BARS MADE FROM CER-  
EAL PRODUCTS AND COCOA AND COCOA SUB-  
STITUTES, IN CLASS 30 (U.S. CL. 46).

FIRST USE 3-1-2001; IN COMMERCE 3-1-2001.

THE MARK CONSISTS OF STANDARD CHAR-  
ACTERS WITHOUT CLAIM TO ANY PARTICULAR  
FONT, STYLE, SIZE, OR COLOR.

OWNER OF U.S. REG. NOS. 2,547,277, 2,614,701  
AND OTHERS.

SER. NO. 77-506,221, FILED 6-24-2008.

BARBARA RUTLAND, EXAMINING ATTORNEY

**Int. Cl.: 43**

**Prior U.S. Cls.: 100 and 101**

**United States Patent and Trademark Office**

**Reg. No. 3,569,733**

**Registered Feb. 3, 2009**

**SERVICE MARK  
PRINCIPAL REGISTER**



USA COOKS, INC. (ILLINOIS CORPORATION)  
#2308  
500 W. SUPERIOR  
CHICAGO, IL 60610

FOR: PROVIDING ON-LINE INFORMATION IN  
THE FIELD OF HOME DINING, IN CLASS 43 (U.S.  
CLS. 100 AND 101).

FIRST USE 2-1-2008; IN COMMERCE 2-1-2008.

OWNER OF U.S. REG. NO. 2,535,101.

NO CLAIM IS MADE TO THE EXCLUSIVE  
RIGHT TO USE "CHICAGO COOKS", APART FROM  
THE MARK AS SHOWN.

THE MARK CONSISTS OF A PLATE, A FORK, A  
SPOON AND A KNIFE WITH CHICAGO COOKS  
AND A CITY SKYSCRAPER SCENE LOCATED ON  
PLATE.

SER. NO. 77-506,255, FILED 6-24-2008.

RUDY R. SINGLETON, EXAMINING ATTORNEY

**Int. Cl.: 9**

**Prior U.S. Cls.: 21, 23, 26, 36 and 38**

**Reg. No. 3,569,734**

**United States Patent and Trademark Office**

**Registered Feb. 3, 2009**

**TRADEMARK  
PRINCIPAL REGISTER**

# NEWS2PAGE

INTERLASA.COM S.A. DE C.V. (MEXICO CORPORATION)  
GUYANA HOLANDESA 309  
MONTERREY, MEXICO 64620

FOR: COMPUTER SOFTWARE FOR USE IN THE PRODUCTION OF PRINTED PUBLICATIONS, ELECTRONIC PUBLICATIONS, NEWSPAPERS, AND ELECTRONIC NEWSPAPERS AS WELL AS IN AUDITING AND CONSULTING SERVICES RELATED TO PRINTED PUBLICATIONS, ELECTRONIC PUBLICATIONS, NEWSPAPERS, AND

ELECTRONIC NEWSPAPERS, IN CLASS 9 (U.S. CLS. 21, 23, 26, 36 AND 38).

FIRST USE 10-29-2003; IN COMMERCE 10-29-2003.

THE MARK CONSISTS OF STANDARD CHARACTERS WITHOUT CLAIM TO ANY PARTICULAR FONT, STYLE, SIZE, OR COLOR.

SER. NO. 77-506,294, FILED 6-24-2008.

SHANNON TWOHIG, EXAMINING ATTORNEY

**Int. Cl.: 9**

**Prior U.S. Cls.: 21, 23, 26, 36 and 38**

**Reg. No. 3,569,735**

**United States Patent and Trademark Office**

**Registered Feb. 3, 2009**

**TRADEMARK  
PRINCIPAL REGISTER**

**FASTRESS**

PARAGON APPLICATION SYSTEMS, INC.  
(NORTH CAROLINA CORPORATION)  
326 RALEIGH STREET  
HOLLY SPRINGS, NC 27540

FIRST USE 3-16-2001; IN COMMERCE 3-16-2001.

FOR: DOWNLOADABLE COMPUTER SOFTWARE FOR CONFIGURING, SIMULATING AND TESTING AUTOMATED TELLER MACHINES, ELECTRONIC FUNDS TRANSFER SYSTEMS AND OTHER FINANCIAL TRANSACTION PROCESSING SYSTEMS, IN CLASS 9 (U.S. CLS. 21, 23, 26, 36 AND 38).

THE MARK CONSISTS OF STANDARD CHARACTERS WITHOUT CLAIM TO ANY PARTICULAR FONT, STYLE, SIZE, OR COLOR.

SER. NO. 77-506,303, FILED 6-24-2008.

MATTHEW MCDOWELL, EXAMINING ATTORNEY

**Int. Cls.: 16 and 41**

**Prior U.S. Cls.: 2, 5, 22, 23, 29, 37, 38, 50, 100, 101 and 107**

**Reg. No. 3,569,736**

**United States Patent and Trademark Office**

**Registered Feb. 3, 2009**

**TRADEMARK  
SERVICE MARK  
PRINCIPAL REGISTER**



TARLETON STATE UNIVERSITY (TEXAS STATE  
INSTITUTE OF HIGHER EDUCATION)  
BOX T-0001  
1333 W. WASHINGTON  
STEPHENVILLE, TX 76042

FOR: BUMPER STICKERS; DECALS; GREET-  
INGS CARDS AND POSTCARDS; STATIONERY;  
STATIONERY WRITING PAPER AND ENVELOPES,  
IN CLASS 16 (U.S. CLS. 2, 5, 22, 23, 29, 37, 38 AND 50).

FIRST USE 5-0-2005; IN COMMERCE 5-0-2005.

FOR: EDUCATIONAL SERVICES, NAMELY,  
PROVIDING COURSES OF INSTRUCTION AT  
THE COLLEGE LEVEL AND DISTRIBUTION OF  
COURSE MATERIAL IN CONNECTION THERE-  
WITH; ENTERTAINMENT SERVICES, NAMELY,  
ARRANGING AND CONDUCTING OF COMPETI-

TIONS FOR INTERCOLLEGIATE SPORTING  
EVENTS, IN CLASS 41 (U.S. CLS. 100, 101 AND 107).

FIRST USE 5-0-2005; IN COMMERCE 5-0-2005.

THE COLOR(S) WHITE AND SHADES OF PUR-  
PLE IS/ARE CLAIMED AS A FEATURE OF THE  
MARK.

THE MARK CONSISTS OF THE BEVELED LET-  
TER T WHEREIN THE SUBSTANTIAL PORTION OF  
THE LETTER IS WHITE WITH SLIGHT SHADES OF  
PURPLE THROUGHOUT PROMOTING THE BEV-  
ELED EDGES OF THE MARK.

SER. NO. 77-506,323, FILED 6-24-2008.

CYNTHIA TRIPI, EXAMINING ATTORNEY

**Int. Cl.: 17**

**Prior U.S. Cls.: 1, 5, 12, 13, 35 and 50**

**United States Patent and Trademark Office**

**Reg. No. 3,569,737**

**Registered Feb. 3, 2009**

**TRADEMARK  
PRINCIPAL REGISTER**



**SUPERSEALCW**

WALNUT INDUSTRIES, INC. (PENNSYLVANIA CORPORATION)  
1344 ADAMS ROAD  
BENSALEM, PA 19020

FOR: SPUN BONDED NON WOVEN IMPERMEABLE TAPE FOR USE IN CONSTRUCTION AS A REPLACEMENT FOR PRIMER, NAMELY, FOR USE IN FLOORING AND DECKING, IN CLASS 17 (U.S. CLS. 1, 5, 12, 13, 35 AND 50).

FIRST USE 1-3-2008; IN COMMERCE 1-3-2008.

THE COLOR(S) GREEN AND BROWN IS/ARE CLAIMED AS A FEATURE OF THE MARK.

THE MARK CONSISTS OF THE WORD "SUPERSEALCW" IN STYLIZED UPPER-CASE LETTERS, WITH THE WORD "SUPER" IN GREEN AND THE WORD "SEAL" AND THE SQUARE DOT IN BROWN. THE TERM "CW" IS IN BROWN COLOR IN A SMALLER FONT SIZE.

SER. NO. 77-506,326, FILED 6-24-2008.

MICHAEL KEATING, EXAMINING ATTORNEY

**Int. Cl.: 16**

**Prior U.S. Cls.: 2, 5, 22, 23, 29, 37, 38 and 50**

**Reg. No. 3,569,738**

**United States Patent and Trademark Office**

**Registered Feb. 3, 2009**

**TRADEMARK  
PRINCIPAL REGISTER**

# FRESH TOPICS

PERO VEGETABLE COMPANY, LLC (FLORIDA  
LIMITED LIABILITY COMPANY)  
14095 STATE ROAD 7  
DELRAY BEACH, FL 33446

FOR: PRINTED PERIODICALS IN THE FIELD OF  
THE PRODUCE INDUSTRY; PUBLICATIONS,  
NAMELY, FLYERS, MAGAZINES AND NEWSLET-  
TERS IN THE FIELDS OF THE PRODUCE INDUS-  
TRY, IN CLASS 16 (U.S. CLS. 2, 5, 22, 23, 29, 37, 38  
AND 50).

FIRST USE 6-20-2008; IN COMMERCE 6-20-2008.

THE MARK CONSISTS OF STANDARD CHAR-  
ACTERS WITHOUT CLAIM TO ANY PARTICULAR  
FONT, STYLE, SIZE, OR COLOR.

NO CLAIM IS MADE TO THE EXCLUSIVE  
RIGHT TO USE "TOPICS", APART FROM THE  
MARK AS SHOWN.

SER. NO. 77-506,390, FILED 6-24-2008.

ANDREA HACK, EXAMINING ATTORNEY

**Int. Cl.: 9**

**Prior U.S. Cls.: 21, 23, 26, 36 and 38**

**United States Patent and Trademark Office**

**Reg. No. 3,569,739**

**Registered Feb. 3, 2009**

**TRADEMARK  
PRINCIPAL REGISTER**

**DUMMY NATOR**

INTERLASA.COM S.A. DE C.V. (MEXICO CORPORATION)  
GUYANA HOLANDESA 309  
MONTERREY, MEXICO 64620

FOR: COMPUTER SOFTWARE FOR USE IN THE PRODUCTION OF PRINTED PUBLICATIONS, ELECTRONIC PUBLICATIONS, NEWSPAPERS, AND ELECTRONIC NEWSPAPERS AS WELL AS IN AUDITING AND CONSULTING SERVICES RELATED TO PRINTED PUBLICATIONS, ELECTRONIC PUBLICATIONS, NEWSPAPERS, AND

ELECTRONIC NEWSPAPERS, IN CLASS 9 (U.S. CLS. 21, 23, 26, 36 AND 38).

FIRST USE 11-1-2005; IN COMMERCE 11-1-2005.

THE MARK CONSISTS OF STANDARD CHARACTERS WITHOUT CLAIM TO ANY PARTICULAR FONT, STYLE, SIZE, OR COLOR.

SER. NO. 77-506,392, FILED 6-24-2008.

SHANNON TWOHIG, EXAMINING ATTORNEY



**Int. Cl.: 36**

**Prior U.S. Cls.: 100, 101 and 102**

**United States Patent and Trademark Office**

**Reg. No. 3,569,740**

**Registered Feb. 3, 2009**

**SERVICE MARK  
PRINCIPAL REGISTER**

# The Rico Strategy

WILSON, SEAN E. (UNITED STATES INDIVIDUAL), DBA RICO CONSULTING  
9807 N. FM 620 #25106  
AUSTIN, TX 78726

FOR: HOUSING SERVICES, NAMELY, REAL PROPERTY ACQUISITION AND CONSUMER FINANCING TO FACILITATE HOME OWNERSHIP; REAL ESTATE CONSULTANCY; REAL ESTATE CONSULTATION; REAL ESTATE FINANCING SERVICES; REAL ESTATE INVESTMENT, IN CLASS 36 (U.S. CLS. 100, 101 AND 102).

FIRST USE 2-2-2008; IN COMMERCE 2-2-2008.

THE MARK CONSISTS OF STANDARD CHARACTERS WITHOUT CLAIM TO ANY PARTICULAR FONT, STYLE, SIZE, OR COLOR.

NO CLAIM IS MADE TO THE EXCLUSIVE RIGHT TO USE "STRATEGY", APART FROM THE MARK AS SHOWN.

SER. NO. 77-506,439, FILED 6-24-2008.

KATHERINE E. HALMEN, EXAMINING ATTORNEY

**Int. Cl.: 9**

**Prior U.S. Cls.: 21, 23, 26, 36 and 38**

**United States Patent and Trademark Office**

**Reg. No. 3,569,741**

**Registered Feb. 3, 2009**

**TRADEMARK  
PRINCIPAL REGISTER**

**CORRIDOR4DM**

INVIA LLC (MICHIGAN LIMITED LIABILITY  
COMPANY)  
3025 BOARDWALK STREET, SUITE 200  
ANN ARBOR, MI 48108

FOR: COMPUTER SOFTWARE FOR MEDICAL  
IMAGING, IN CLASS 9 (U.S. CLS. 21, 23, 26, 36 AND  
38).

FIRST USE 9-7-2006; IN COMMERCE 8-13-2007.

THE MARK CONSISTS OF STANDARD CHAR-  
ACTERS WITHOUT CLAIM TO ANY PARTICULAR  
FONT, STYLE, SIZE, OR COLOR.

OWNER OF U.S. REG. NO. 3,280,759.

SER. NO. 77-506,442, FILED 6-24-2008.

MARY ROSSMAN, EXAMINING ATTORNEY

**Int. Cl.: 36**

**Prior U.S. Cls.: 100, 101 and 102**

**United States Patent and Trademark Office**

**Reg. No. 3,569,742**

**Registered Feb. 3, 2009**

**SERVICE MARK  
PRINCIPAL REGISTER**

**Critical Mass No Boundaries**

THE VERMONT AGENCY, YOUR FINANCIAL  
SOLUTIONS PARTNER, LLC (VERMONT  
LIMITED LIABILITY COMPANY)  
P.O. BOX 909  
BURLINGTON, VT 054020909

FOR: FINANCIAL PLANNING, NAMELY, THE  
CREATION OF PERSONALIZED STRATEGIES TO  
ACHIEVE FINANCIAL INDEPENDENCE, IN CLASS  
36 (U.S. CLS. 100, 101 AND 102).

FIRST USE 2-12-2008; IN COMMERCE 3-18-2008.

THE MARK CONSISTS OF STANDARD CHAR-  
ACTERS WITHOUT CLAIM TO ANY PARTICULAR  
FONT, STYLE, SIZE, OR COLOR.

SER. NO. 77-506,517, FILED 6-24-2008.

NORA BUCHANAN WILL, EXAMINING ATTOR-  
NEY

**Int. Cls.: 3 and 44**

**Prior U.S. Cls.: 1, 4, 6, 50, 51, 52, 100 and 101**

**United States Patent and Trademark Office**

**Reg. No. 3,569,743**

**Registered Feb. 3, 2009**

**TRADEMARK  
SERVICE MARK  
PRINCIPAL REGISTER**

# SlenderTone

MORTON, VICTORIA M. (UNITED STATES INDIVIDUAL)  
172 BELCHER ROAD  
CLEARWATER, CA 34625

FOR: MINERAL POWDER FOR USE IN COSMETIC BODY WRAP APPLICATIONS, IN CLASS 3 (U.S. CLS. 1, 4, 6, 50, 51 AND 52).

FIRST USE 12-31-1973; IN COMMERCE 12-31-1973.

FOR: COSMETIC BODY CARE SERVICES IN THE NATURE OF BODY WRAPS, IN CLASS 44 (U.S. CLS. 100 AND 101).

FIRST USE 12-31-1973; IN COMMERCE 12-31-1973.

THE MARK CONSISTS OF STANDARD CHARACTERS WITHOUT CLAIM TO ANY PARTICULAR FONT, STYLE, SIZE, OR COLOR.

SER. NO. 77-506,546, FILED 6-24-2008.

MATTHEW MCDOWELL, EXAMINING ATTORNEY

**Int. Cl.: 43**

**Prior U.S. Cls.: 100 and 101**

**United States Patent and Trademark Office**

**Reg. No. 3,569,744**

**Registered Feb. 3, 2009**

**SERVICE MARK  
PRINCIPAL REGISTER**

**MONMOUTH CROSSING**

CENTRASTATE ASSISTED LIVING, INC. (NEW  
JERSEY CORPORATION)  
ADMINISTRATION C/O ALICE J GUTTNER  
901 WEST MAIN STREET  
FREEHOLD, NJ 07728

FOR: PROVIDING ASSISTED LIVING FACIL-  
ITIES, IN CLASS 43 (U.S. CLS. 100 AND 101).

FIRST USE 9-1-1998; IN COMMERCE 9-1-1998.

THE MARK CONSISTS OF STANDARD CHAR-  
ACTERS WITHOUT CLAIM TO ANY PARTICULAR  
FONT, STYLE, SIZE, OR COLOR.

NO CLAIM IS MADE TO THE EXCLUSIVE  
RIGHT TO USE "MONMOUTH", APART FROM  
THE MARK AS SHOWN.

SER. NO. 77-506,584, FILED 6-24-2008.

MATTHEW MCDOWELL, EXAMINING ATTOR-  
NEY

**Int. Cl.: 30**

**Prior U.S. Cl.: 46**

**United States Patent and Trademark Office**

**Reg. No. 3,569,745**

**Registered Feb. 3, 2009**

**TRADEMARK  
PRINCIPAL REGISTER**

OPEN ROAD COFFEE COMPANY

MHC TT LEASING COMPANY, INC. (DELA-  
WARE CORPORATION)  
TWO NORTH RIVERSIDE PLAZA, SUITE 800  
CHICAGO, IL 60606

NO CLAIM IS MADE TO THE EXCLUSIVE  
RIGHT TO USE "COFFEE COMPANY", APART  
FROM THE MARK AS SHOWN.

FOR: COFFEE, IN CLASS 30 (U.S. CL. 46).

FIRST USE 1-1-2008; IN COMMERCE 1-1-2008.

SER. NO. 77-506,650, FILED 6-24-2008.

THE MARK CONSISTS OF STANDARD CHAR-  
ACTERS WITHOUT CLAIM TO ANY PARTICULAR  
FONT, STYLE, SIZE, OR COLOR.

MARY ROSSMAN, EXAMINING ATTORNEY

Int. Cl.: 36

Prior U.S. Cls.: 100, 101 and 102

United States Patent and Trademark Office

Reg. No. 3,569,746

Registered Feb. 3, 2009

SERVICE MARK  
PRINCIPAL REGISTER



THE VERMONT AGENCY, YOUR FINANCIAL  
SOLUTIONS PARTNER, LLC (VERMONT  
LIMITED LIABILITY COMPANY)

P.O. BOX 090

BURLINGTON, VT 054020909

FOR: FINANCIAL PLANNING, NAMELY, THE  
CREATION OF PERSONALIZED STRATEGIES TO  
ACHIEVE FINANCIAL INDEPENDENCE, IN CLASS  
36 (U.S. CLS. 100, 101 AND 102).

FIRST USE 2-12-2008; IN COMMERCE 3-18-2008.

THE COLOR(S) MAROON, RED, ORANGE, OR-  
ANGE-YELLOW, YELLOW, BLACK, WHITE IS/ARE  
CLAIMED AS A FEATURE OF THE MARK.

THE MARK CONSISTS OF A PYRAMID, SLICED  
INTO FIVE HORIZONTAL SECTIONS, EACH A  
DIFFERENT COLOR, STARTING FROM THE BOT-  
TOM UP AS FOLLOWS: MAROON, RED, ORANGE,  
ORANGE-YELLOW, AND YELLOW, SURROUND-  
ED BY THE FOUR LETTERS C, M, N AND B IN  
BLACK, ALL OF WHICH APPEAR ATOP A WHITE  
BACKGROUND SQUARE WITH A BLACK OUT-  
LINE.

SER. NO. 77-506,652, FILED 6-24-2008.

NORA BUCHANAN WILL, EXAMINING ATTOR-  
NEY

**Int. Cl.: 5**

**Prior U.S. Cls.: 6, 18, 44, 46, 51 and 52**

**Reg. No. 3,569,747**

**United States Patent and Trademark Office**

**Registered Feb. 3, 2009**

**TRADEMARK  
PRINCIPAL REGISTER**

**ODOR MAGIC**

GIFTECH FILTER PRODUCTS, INC. (TEXAS  
CORPORATION)  
P.O. BOX 92730  
SOUTHLAKE, TX 76092

FOR: AIR FRESHENER IN THE NATURE OF AN  
ACTIVATED CARBON FILTER FOR ABSORBING  
FOOD ODOR, IN CLASS 5 (U.S. CLS. 6, 18, 44, 46, 51  
AND 52).

FIRST USE 6-0-1994; IN COMMERCE 9-0-1994.

THE MARK CONSISTS OF STANDARD CHAR-  
ACTERS WITHOUT CLAIM TO ANY PARTICULAR  
FONT, STYLE, SIZE, OR COLOR.

NO CLAIM IS MADE TO THE EXCLUSIVE  
RIGHT TO USE "ODOR", APART FROM THE  
MARK AS SHOWN.

SER. NO. 77-506,679, FILED 6-24-2008.

SANDRA MANIOS, EXAMINING ATTORNEY



**Int. Cl.: 35**

**Prior U.S. Cls.: 100, 101 and 102**

**United States Patent and Trademark Office**

**Reg. No. 3,569,748**

**Registered Feb. 3, 2009**

**SERVICE MARK  
PRINCIPAL REGISTER**

# Wedding Mafia

REACH EVENT MARKETING, LLC (OHIO LIMITED LIABILITY COMPANY)  
9933 ALLIANCE ROAD  
CINCINNATI, OH 45242

FOR: COOPERATIVE ADVERTISING AND MARKETING FOR WEDDING PROFESSIONALS AND THOSE IN THE BRIDAL INDUSTRY, IN CLASS 35 (U.S. CLS. 100, 101 AND 102).

FIRST USE 6-1-2008; IN COMMERCE 6-1-2008.

THE MARK CONSISTS OF STANDARD CHARACTERS WITHOUT CLAIM TO ANY PARTICULAR FONT, STYLE, SIZE, OR COLOR.

NO CLAIM IS MADE TO THE EXCLUSIVE RIGHT TO USE "WEDDING", APART FROM THE MARK AS SHOWN.

SER. NO. 77-506,706, FILED 6-24-2008.

JOHN SCHUYLER YARD, EXAMINING ATTORNEY

Int. Cls.: 18 and 25

Prior U.S. Cls.: 1, 2, 3, 22, 39 and 41

United States Patent and Trademark Office

Reg. No. 3,569,749

Registered Feb. 3, 2009

TRADEMARK  
PRINCIPAL REGISTER



BOSTWICK, LEIGH ALISON (UNITED STATES  
INDIVIDUAL), DBA J'ALLEN  
77 PARK LANE  
HUTCHINS, TX 75141

FOR: LEATHER PURSES; PURSES, IN CLASS 18  
(U.S. CLS. 1, 2, 3, 22 AND 41).

FIRST USE 1-1-2008; IN COMMERCE 1-10-2008.

FOR: CAPRI PANTS; CARGO PANTS; DENIMS;  
DRESS SHIRTS; DRESS SUITS; EVENING DRESSES;  
MEN'S SUITS, WOMEN'S SUITS; OPEN-NECKED  
SHIRTS; PANTS; POLO SHIRTS; SPORTS PANTS;  
SPORTS SHIRTS; T-SHIRTS, IN CLASS 25 (U.S. CLS.  
22 AND 39).

FIRST USE 1-1-2008; IN COMMERCE 1-10-2008.

THE MARK CONSISTS OF A "C", "J", "L", TREBLE  
CLEF, AND A FISH. THE "C" SURROUNDS THE  
ENTIRE DESIGN AND FORMS INTO THE SHAPE  
OF THE FISH. THE "J" FORMS INTO THE BEGIN-  
NING OF A TREBLE CLEF AND THE TOP AND  
BOTTOM OF THE "J" FORM INTO THE LETTER  
"L", WHICH FORMS THE FISH TAIL.

SER. NO. 77-506,730, FILED 6-24-2008.

TRACY CROSS, EXAMINING ATTORNEY

**Int. Cl.: 25**

**Prior U.S. Cls.: 22 and 39**

**United States Patent and Trademark Office**

**Reg. No. 3,569,750**

**Registered Feb. 3, 2009**

**TRADEMARK  
PRINCIPAL REGISTER**



ONE PEOPLE PROJECT, LLC (CALIFORNIA  
LIMITED LIABILITY COMPANY)  
1769 CREST DRIVE  
ENCINITAS, CA 92024

FOR: HATS; JACKETS; PANTS; SHIRTS; SHORTS;  
SWEATERS; T-SHIRTS; TANK TOPS, IN CLASS 25  
(U.S. CLS. 22 AND 39).

FIRST USE 3-8-2007; IN COMMERCE 3-8-2007.

OWNER OF U.S. REG. NO. 3,440,669.

THE MARK CONSISTS OF THE SILHOUETTE OF  
A PERSON WITH ONE ARM UPRAISED.

SER. NO. 77-506,759, FILED 6-24-2008.

DEZMONA MIZELLE, EXAMINING ATTORNEY

**Int. Cl.: 2**

**Prior U.S. Cls.: 6, 11 and 16**

**United States Patent and Trademark Office**

**Reg. No. 3,569,751**

**Registered Feb. 3, 2009**

**TRADEMARK  
PRINCIPAL REGISTER**

**E2000 BLUE**

DOUGLAS D ELLARD (UNITED STATES INDIVIDUAL)

1159 SOUTH BROAD ST

MOBILE, AL 36603

FOR: CORROSION INHIBITANTS IN THE NATURE OF A COATING, IN CLASS 2 (U.S. CLS. 6, 11 AND 16).

FIRST USE 6-16-2008; IN COMMERCE 6-16-2008.

THE MARK CONSISTS OF STANDARD CHARACTERS WITHOUT CLAIM TO ANY PARTICULAR FONT, STYLE, SIZE, OR COLOR.

NO CLAIM IS MADE TO THE EXCLUSIVE RIGHT TO USE "BLUE", APART FROM THE MARK AS SHOWN.

SER. NO. 77-506,780, FILED S.R. 6-24-2008 AM. P.R. 10-9-2008.

COLLEEN KEARNEY, EXAMINING ATTORNEY

**Int. Cl.: 12**

**Prior U.S. Cls.: 19, 21, 23, 31, 35 and 44**

**United States Patent and Trademark Office**

**Reg. No. 3,569,752**

**Registered Feb. 3, 2009**

**TRADEMARK  
PRINCIPAL REGISTER**



BIG M (MINNESOTA CORPORATION)  
PO BOX 23  
ALBERTVILLE, MN 553019775

FOR: RECREATIONAL WATERCRAFT ACCESSORY, NAMELY, A METAL-FABRICATED WATER INTAKE GRILL SELECTIVELY CONFIGURED TO MOUNT ONTO AND ATTACH TO A WATER INTAKE PORT OF RECREATIONAL WATERCRAFT, IN CLASS 12 (U.S. CLS. 19, 21, 23, 31, 35 AND 44).

FIRST USE 6-18-2008; IN COMMERCE 6-18-2008.

NO CLAIM IS MADE TO THE EXCLUSIVE RIGHT TO USE "WATER INTAKE GRILL", APART FROM THE MARK AS SHOWN.

THE COLOR(S) BLUE AND BLACK IS/ARE CLAIMED AS A FEATURE OF THE MARK.

THE MARK CONSISTS OF A HORIZONTAL LINE EXTENDING BELOW THE PHRASE "WATER INTAKE GRILL BY BIG M" AND ABOVE THE PHRASE "THE ONE THAT MAKES A DIFFERENCE" AND RIGHTWARDLY TERMINATING AT A WAVY, ANGULAR LINE ALONGSIDE TWO ADDITIONAL, SEPARATE WAVY, ANGULAR LINES, WITH EACH OF THE LINES APPEARING BLUE IN COLOR WITH BLACK OUTLINE. THE PHRASES "WATER INTAKE GRILL" AND "THE ONE THAT MAKES A DIFFERENCE" APPEAR IN UPPER CASE AND BLACK IN COLOR. THE TERM "BY" APPEARS IN LOWER CASE AND BLACK IN COLOR AND THE PHRASE "BIG M" APPEARS IN TITLE CASE AND BLACK IN COLOR.

SER. NO. 77-506,789, FILED 6-24-2008.

SANDRA MANIOS, EXAMINING ATTORNEY

**Int. Cl.: 6**

**Prior U.S. Cls.: 2, 12, 13, 14, 23, 25 and 50**

**Reg. No. 3,569,753**

**United States Patent and Trademark Office**

**Registered Feb. 3, 2009**

**TRADEMARK  
PRINCIPAL REGISTER**

**LIL BUDDY**

LILBUDDY, LLC (WISCONSIN LIMITED LIABILITY COMPANY)  
SUITE A  
N69W25055 INDIAN GRASS LANE  
SUSSEX, WI 53089

THE MARK CONSISTS OF STANDARD CHARACTERS WITHOUT CLAIM TO ANY PARTICULAR FONT, STYLE, SIZE, OR COLOR.

FOR: WINDSHIELD REPAIR DEVICE, NAMELY, A FRAME, MADE PRIMARILY OF METAL, REMOVABLY MOUNTABLE TO A VEHICLE FOR ASSISTING A PERSON IN MOUNTING A WINDSHIELD, IN CLASS 6 (U.S. CLS. 2, 12, 13, 14, 23, 25 AND 50).

OWNER OF U.S. REG. NO. 2,786,407.

SER. NO. 77-506,858, FILED 6-24-2008.

FIRST USE 10-30-2004; IN COMMERCE 10-30-2004.

JUDITH HELFMAN, EXAMINING ATTORNEY

**Int. Cl.: 16**

**Prior U.S. Cls.: 2, 5, 22, 23, 29, 37, 38 and 50**

**United States Patent and Trademark Office**

**Reg. No. 3,569,754**

**Registered Feb. 3, 2009**

**TRADEMARK  
PRINCIPAL REGISTER**

**FAST TRACK**

PENTON OVERSEAS, INC. (CALIFORNIA CORPORATION)  
1958 KELLOGG AVENUE  
CARLSBAD, CA 92008

FOR: PRE-PRINTED CARDS, BOOKS, AND PRE-RECORDED COMPACT DISKS SOLD AS A UNIT AND ALL RELATING TO A FOREIGN LANGUAGE STUDY PROGRAM, IN CLASS 16 (U.S. CLS. 2, 5, 22, 23, 29, 37, 38 AND 50).

FIRST USE 2-0-1999; IN COMMERCE 2-0-1999.

THE MARK CONSISTS OF STANDARD CHARACTERS WITHOUT CLAIM TO ANY PARTICULAR FONT, STYLE, SIZE, OR COLOR.

SER. NO. 77-506,859, FILED 6-24-2008.

JERI J. FICKES, EXAMINING ATTORNEY

**Int. Cl.: 41**

**Prior U.S. Cls.: 100, 101 and 107**

**United States Patent and Trademark Office**

**Reg. No. 3,569,755**

**Registered Feb. 3, 2009**

**SERVICE MARK  
PRINCIPAL REGISTER**

SEE WHAT YOUR BODY CAN DO

ALIGN PILATES, LLC (MINNESOTA CORPORATION)  
SUITE 150  
708 NORTH FIRST STREET  
MINNEAPOLIS, MN 55401

THE MARK CONSISTS OF STANDARD CHARACTERS WITHOUT CLAIM TO ANY PARTICULAR FONT, STYLE, SIZE, OR COLOR.

FOR: PROVIDING FITNESS AND EXERCISE FACILITIES, IN CLASS 41 (U.S. CLS. 100, 101 AND 107).

SER. NO. 77-506,863, FILED 6-24-2008.

FIRST USE 10-31-2003; IN COMMERCE 10-31-2003.

KELLY BOULTON, EXAMINING ATTORNEY



**Int. Cl.: 37**

**Prior U.S. Cls.: 100, 103 and 106**

**United States Patent and Trademark Office**

**Reg. No. 3,569,756**

**Registered Feb. 3, 2009**

**SERVICE MARK  
PRINCIPAL REGISTER**



ASSIST U2 BUILD DEVELOPMENT COMPANY,  
INC. (CALIFORNIA CORPORATION)  
SUITE D  
4820 MERCURY STREET  
SAN DIEGO, CA 92111

FOR: RESIDENTIAL AND BUILDING CON-  
STRUCTION CONSULTING, IN CLASS 37 (U.S.  
CLS. 100, 103 AND 106).

FIRST USE 5-15-2008; IN COMMERCE 5-15-2008.

OWNER OF U.S. REG. NO. 3,365,254.

NO CLAIM IS MADE TO THE EXCLUSIVE  
RIGHT TO USE "BUILDING CONSULTING AND  
MANAGEMENT", APART FROM THE MARK AS  
SHOWN.

THE COLOR(S) REFLEX BLUE AND WHITE IS/  
ARE CLAIMED AS A FEATURE OF THE MARK.

THE MARK CONSISTS OF A HOUSE LIKE  
SHAPE, CONSISTING OF A REFLEX BLUE OUT-  
LINED RECTANGULAR BOX WITH THE TOP TWO  
CORNERS CUT AT AN ANGLE DIRECTED TO-  
WARDS A SOLID REFLEX BLUE TRIANGLE ON  
TOP OF THE RECTANGLE. INSIDE THE RECTAN-  
GLE, THE CHARACTERS "AU2B" ARE LOCATED  
IN THE TOP ONE-HALF OF THE BOX IN REFLEX  
BLUE ON A WHITE BACKGROUND. UNDER  
"AU2B" BUT NOT FILLING THE BOTTOM HALF  
OF THE RECTANGLE IS A REFLEX BLUE BAR  
WITH THE WORDS "BUILDING CONSULTING  
AND MANAGEMENT" IN WHITE, LEAVING A  
BOTTOM BAR OF WHITE BACKGROUND WITHIN  
THE MAIN RECTANGLE.

SER. NO. 77-506,887, FILED 6-24-2008.

SANDRA MANIOS, EXAMINING ATTORNEY

**Int. Cl.: 41**

**Prior U.S. Cls.: 100, 101 and 107**

**Reg. No. 3,569,757**

**United States Patent and Trademark Office**

**Registered Feb. 3, 2009**

**SERVICE MARK  
PRINCIPAL REGISTER**



UNIVISION COMMUNICATIONS INC. (DELA-  
WARE CORPORATION)  
5999 CENTER DRIVE  
LOS ANGELES, CA 90045

FOR: ENTERTAINMENT SERVICES, NAMELY,  
AN ON-GOING TELEVISION SERIES ABOUT NAT-  
URE AND THE ENVIRONMENT, IN CLASS 41 (U.S.  
CLS. 100, 101 AND 107).

FIRST USE 11-30-2007; IN COMMERCE 11-30-2007.

NO CLAIM IS MADE TO THE EXCLUSIVE  
RIGHT TO USE "VIDA SALVAJE", APART FROM  
THE MARK AS SHOWN.

THE MARK CONSISTS OF THE STYLIZED  
WORDING "VIDA SALVAJE" BELOW THE IMAGE  
OF A TREE, GRASSES, AN ELEPHANT, A BEAR, A  
TIGER, A MONKEY, A BIRD, AND A DEER; THE  
IMAGE OF SEVERAL CURVED LINES, TWO SEPA-  
RATE GROUPS OF LEAVES, WHALES, DOLPHINS  
AND SHARKS APPEAR BELOW THE WORDING  
"VIDA SALVAJE".

THE FOREIGN WORDING IN THE MARK  
TRANSLATES INTO ENGLISH AS WILD LIFE.

SER. NO. 77-506,907, FILED 6-24-2008.

MICHAEL TANNER, EXAMINING ATTORNEY

**Int. Cl.: 25**

**Prior U.S. Cls.: 22 and 39**

**United States Patent and Trademark Office**

**Reg. No. 3,569,758**

**Registered Feb. 3, 2009**

**TRADEMARK  
PRINCIPAL REGISTER**



AMERICAN BOOKSELLERS ASSOCIATION, INC.  
(NEW YORK NON-PROFIT CORPORATION)  
SUITE 600  
200 WHITE PLAINS ROAD  
TARRYTOWN, NY 10591

FOR: T-SHIRTS, IN CLASS 25 (U.S. CLS. 22 AND 39).

FIRST USE 5-29-2008; IN COMMERCE 5-29-2008.

THE MARK CONSISTS OF A STYLIZED SCRIBBLE WITH A PORTION OF A LOWER CASE LETTER "I" DELINEATED IN THE MIDDLE PORTION OF THE SCRIBBLE.

SER. NO. 77-506,910, FILED 6-24-2008.

KARANENDRA S. CHHINA, EXAMINING ATTORNEY

**Int. Cl.: 43**

**Prior U.S. Cls.: 100 and 101**

**United States Patent and Trademark Office**

**Reg. No. 3,569,759**

**Registered Feb. 3, 2009**

**SERVICE MARK  
PRINCIPAL REGISTER**

**RIBFEST**

THE RIB CRIB BBQ, INC. (OKLAHOMA CORPORATION)

4535 S HARVARD AVE.

TULSA, OK 74135

FOR: RESTAURANT SERVICES, IN CLASS 43  
(U.S. CLS. 100 AND 101).

FIRST USE 10-0-2006; IN COMMERCE 10-0-2006.

THE MARK CONSISTS OF STANDARD CHARACTERS WITHOUT CLAIM TO ANY PARTICULAR FONT, STYLE, SIZE, OR COLOR.

OWNER OF U.S. REG. NOS. 2,117,216, 2,788,640,  
AND 2,794,310.

SER. NO. 77-506,931, FILED 6-24-2008.

KARANENDRA S. CHHINA, EXAMINING ATTORNEY

**Int. Cl.: 9**

**Prior U.S. Cls.: 21, 23, 26, 36 and 38**

**Reg. No. 3,569,760**

**United States Patent and Trademark Office**

**Registered Feb. 3, 2009**

**TRADEMARK  
PRINCIPAL REGISTER**

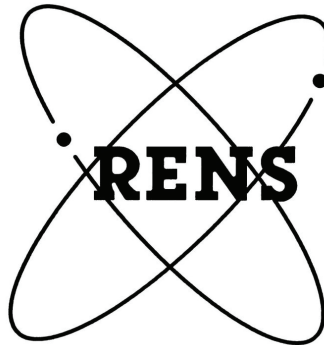

LAHARCO, INC. (OREGON CORPORATION),  
DBA LACEY-HARMER CO.  
4270 NW YEON AVE.  
PORTLAND, OR 97210

FIRST USE 6-0-1948; IN COMMERCE 6-0-1948.

OWNER OF U.S. REG. NO. 702,184.

FOR: ELECTRONIC METAL DETECTORS FOR  
USE IN INDUSTRIAL PROCESSES SUCH AS SCAN-  
NING CONVEYORS FOR FOREIGN MATTER, IN  
CLASS 9 (U.S. CLS. 21, 23, 26, 36 AND 38).

SER. NO. 77-506,933, FILED 6-24-2008.

BENJAMIN ALLEN, EXAMINING ATTORNEY

**Int. Cl.: 9**

**Prior U.S. Cls.: 21, 23, 26, 36 and 38**

**Reg. No. 3,569,761**

**United States Patent and Trademark Office**

**Registered Feb. 3, 2009**

**TRADEMARK  
PRINCIPAL REGISTER**

**BodyComm**

CME AMERICA, LLC (DELAWARE LIMITED  
LIABILITY COMPANY)  
14998 WEST 6TH AVENUE, SUITE 830  
GOLDEN, CO 80401

THE MARK CONSISTS OF STANDARD CHAR-  
ACTERS WITHOUT CLAIM TO ANY PARTICULAR  
FONT, STYLE, SIZE, OR COLOR.

FOR: REMOTE PROGRAMMERS FOR USE WITH  
ELECTRONIC AMBULATORY INFUSION PUMPS,  
IN CLASS 9 (U.S. CLS. 21, 23, 26, 36 AND 38).

SER. NO. 77-506,949, FILED 6-24-2008.

FIRST USE 8-0-2006; IN COMMERCE 8-0-2006.

HEATHER THOMPSON, EXAMINING ATTORNEY

**Int. Cl.: 35**

**Prior U.S. Cls.: 100, 101 and 102**

**United States Patent and Trademark Office**

**Reg. No. 3,569,762**

**Registered Feb. 3, 2009**

**SERVICE MARK  
PRINCIPAL REGISTER**

# FlexPlan Combo

AMERICAN HOME SHIELD CORPORATION  
(DELAWARE CORPORATION)  
889 RIDGE LAKE BOULEVARD  
MEMPHIS, TN 38120

FOR: WARRANTY SERVICES, NAMELY, ARRANGING FOR REPAIRS AND REPLACEMENT OF MAJOR HOME SYSTEMS, APPLIANCES AND PARTS THEREOF PROVIDED BY OTHERS PURSUANT TO SERVICE AGREEMENTS; PROVIDING BUSINESS INFORMATION IN THE FIELD OF HOME WARRANTIES TO REAL ESTATE PROFESSIONALS, HOME BUYERS, HOME SELLERS, HOME INSPECTORS AND HOME REPAIR CONTRACTORS; PROVIDING CLIENT REFERRAL PROGRAMS IN THE FIELD OF HOME WARRANTIES FOR REAL ESTATE PROFESSIONALS, HOME IN-

SPECTORS AND HOME REPAIR CONTRACTORS, IN CLASS 35 (U.S. CLS. 100, 101 AND 102).

FIRST USE 3-1-2008; IN COMMERCE 3-1-2008.

THE MARK CONSISTS OF STANDARD CHARACTERS WITHOUT CLAIM TO ANY PARTICULAR FONT, STYLE, SIZE, OR COLOR.

OWNER OF U.S. REG. NOS. 3,377,597, 3,414,157 AND OTHERS.

SER. NO. 77-506,956, FILED 6-24-2008.

RONALD AIKENS, EXAMINING ATTORNEY

**Int. Cl.: 9**

**Prior U.S. Cls.: 21, 23, 26, 36 and 38**

**United States Patent and Trademark Office**

**Reg. No. 3,569,763**

**Registered Feb. 3, 2009**

**TRADEMARK  
PRINCIPAL REGISTER**

**GAMEMAKER**

BALLY GAMING, INC. (NEVADA CORPORATION)  
ATTN: PAMELA BOWSHER, LAW DEPT.  
6601 SOUTH BERMUDA ROAD  
LAS VEGAS, NV 89119

FOR: GAMING DEVICES, NAMELY, SLOT MACHINES WITH OR WITHOUT VIDEO OUTPUT, IN CLASS 9 (U.S. CLS. 21, 23, 26, 36 AND 38).

FIRST USE 2-9-1993; IN COMMERCE 2-9-1993.

THE MARK CONSISTS OF STANDARD CHARACTERS WITHOUT CLAIM TO ANY PARTICULAR FONT, STYLE, SIZE, OR COLOR.

SER. NO. 77-506,965, FILED 6-24-2008.

KARANENDRA S. CHHINA, EXAMINING ATTORNEY



Int. Cl.: 41

Prior U.S. Cls.: 100, 101 and 107

United States Patent and Trademark Office

Reg. No. 3,569,764

Registered Feb. 3, 2009

SERVICE MARK  
PRINCIPAL REGISTER



UNIVISION COMMUNICATIONS INC. (DELA-  
WARE CORPORATION)  
5999 CENTER DRIVE  
LOS ANGELES, CA 90045

FOR: ENTERTAINMENT SERVICES, NAMELY,  
AN ON-GOING TELEVISION PROGRAM ABOUT  
FASHION AND STYLE ADVICE AND FASHION  
AND STYLE ADVICE COMMENTARY, IN CLASS 41  
(U.S. CLS. 100, 101 AND 107).

FIRST USE 2-7-2008; IN COMMERCE 2-7-2008.

THE MARK CONSISTS OF THE SILHOUETTES  
OF A MALE AND A FEMALE, STANDING ON

OPPOSITE ENDS OF AN OUTSIZED POLICE  
ALARM OR SIREN, WITH THE PHRASE "MODA  
AL RESCATE" SUPERIMPOSED OVER THE SIREN,  
AND RANDOM BLOTCHES OF INK AS THE BACK-  
GROUND.

THE FOREIGN WORDING IN THE MARK  
TRANSLATES INTO ENGLISH AS FASHION TO  
THE RESCUE.

SER. NO. 77-506,976, FILED 6-24-2008.

MICHAEL TANNER, EXAMINING ATTORNEY

**Int. Cl.: 10**

**Prior U.S. Cls.: 26, 39 and 44**

**United States Patent and Trademark Office**

**Reg. No. 3,569,765**

**Registered Feb. 3, 2009**

**TRADEMARK  
PRINCIPAL REGISTER**

**TSyringePump**

CME AMERICA, LLC (DELAWARE LIMITED  
LIABILITY COMPANY)  
14998 WEST 6TH AVENUE, SUITE 830  
GOLDEN, CO 80401

THE MARK CONSISTS OF STANDARD CHAR-  
ACTERS WITHOUT CLAIM TO ANY PARTICULAR  
FONT, STYLE, SIZE, OR COLOR.

FOR: MEDICAL APPARATUS, NAMELY, INFU-  
SION AND INJECTION DEVICES FOR ADMINIS-  
TERING DRUGS, IN CLASS 10 (U.S. CLS. 26, 39 AND  
44).

SER. NO. 77-506,979, FILED 6-24-2008.

FIRST USE 11-30-2007; IN COMMERCE 11-30-2007.

HEATHER THOMPSON, EXAMINING ATTORNEY

**Int. Cl.: 16**

**Prior U.S. Cls.: 2, 5, 22, 23, 29, 37, 38 and 50**

**United States Patent and Trademark Office**

**Reg. No. 3,569,766**

**Registered Feb. 3, 2009**

**TRADEMARK  
PRINCIPAL REGISTER**

**It Comes Down To Trust**

HENNION & WALSH, INC. (NEW JERSEY CORPORATION)  
WATERVIEW PLAZA  
2001 ROUTE 46  
PARSIPPANY, NJ 07054

FOR: PRINTED MATERIALS AND MARKETING MATERIALS, NAMELY, NEWSLETTERS, BULLETINS, MAGAZINES, BOOKS, REPORTS, BROCHURES AND DATA SHEETS IN THE FIELDS OF FINANCE AND INVESTMENT, IN CLASS 16 (U.S. CLS. 2, 5, 22, 23, 29, 37, 38 AND 50).

FIRST USE 10-0-2007; IN COMMERCE 10-0-2007.

THE MARK CONSISTS OF STANDARD CHARACTERS WITHOUT CLAIM TO ANY PARTICULAR FONT, STYLE, SIZE, OR COLOR.

SER. NO. 77-506,992, FILED 6-24-2008.

NATALIE POLZER, EXAMINING ATTORNEY

**Int. Cl.: 36**

**Prior U.S. Cls.: 100, 101 and 102**

**United States Patent and Trademark Office**

**Reg. No. 3,569,767**

**Registered Feb. 3, 2009**

**SERVICE MARK  
PRINCIPAL REGISTER**

**It Comes Down To Trust**

HENNION & WALSH, INC. (NEW JERSEY CORPORATION)  
WATERVIEW PLAZA  
2001 ROUTE 46  
PARSIPPANY, NJ 07054

FOR: FINANCIAL SERVICES, NAMELY, COMMODITY BROKERAGE, ESTATE TRUST MANAGEMENT AND INVESTMENT BROKERAGE SERVICES, NAMELY, CREATION AND DISTRIBUTION OF MUNICIPAL BONDS, CORPORATE BONDS, MORTGAGE-BACKED SECURITIES, UNIT INVESTMENT TRUSTS, BOND SWAPS, MUTUAL FUNDS, RESEARCH, STOCKS, OPTIONS, IRAS, PENSION AND PROFIT SHARING PLANS; PROVIDING INFORMATION IN THE FIELDS OF INVESTMENT AND FINANCE BY ELECTRONIC

MEANS, PHONE AND ONLINE MEANS; PROVIDING AN ONLINE COMPUTER DATABASE IN THE FIELDS OF INVESTING, FINANCE, FINANCIAL PLANNING, FINANCIAL NEWS, FINANCIAL INFORMATION, IN CLASS 36 (U.S. CLS. 100, 101 AND 102).

FIRST USE 10-0-2007; IN COMMERCE 10-0-2007.

THE MARK CONSISTS OF STANDARD CHARACTERS WITHOUT CLAIM TO ANY PARTICULAR FONT, STYLE, SIZE, OR COLOR.

SER. NO. 77-507,014, FILED 6-24-2008.

NATALIE POLZER, EXAMINING ATTORNEY

**Int. Cl.: 35**

**Prior U.S. Cls.: 100, 101 and 102**

**United States Patent and Trademark Office**

**Reg. No. 3,569,768**

**Registered Feb. 3, 2009**

**SERVICE MARK  
PRINCIPAL REGISTER**

**RIB CRIB**

THE RIB CRIB BBQ, INC. (OKLAHOMA CORPORATION)  
4535 S HARVARD AVE.  
TULSA, OK 74135

FOR: ONLINE RETAIL STORE SERVICES FEATURING FOOD, SAUCES AND GIFT CARDS; ISSUING GIFT CERTIFICATES WHICH MAY THEN BE REDEEMED FOR GOODS OR SERVICES; FRANCHISING, NAMELY, OFFERING TECHNICAL ASSISTANCE IN THE ESTABLISHMENT AND/OR OPERATION OF RESTAURANTS; AND RESTAURANT FRANCHISING, IN CLASS 35 (U.S. CLS. 100, 101 AND 102).

FIRST USE 1-0-2005; IN COMMERCE 1-0-2005.

THE MARK CONSISTS OF STANDARD CHARACTERS WITHOUT CLAIM TO ANY PARTICULAR FONT, STYLE, SIZE, OR COLOR.

OWNER OF U.S. REG. NOS. 2,117,216, 2,788,640, AND 2,794,310.

SER. NO. 77-507,025, FILED 6-24-2008.

KARANENDRA S. CHHINA, EXAMINING ATTORNEY

**Int. Cl.: 41**

**Prior U.S. Cls.: 100, 101 and 107**

**United States Patent and Trademark Office**

**Reg. No. 3,569,769**

**Registered Feb. 3, 2009**

**SERVICE MARK  
PRINCIPAL REGISTER**

**It Comes Down To Trust**

HENNION & WALSH, INC. (NEW JERSEY CORPORATION)  
WATERVIEW PLAZA  
2001 ROUTE 46  
PARSIPPANY, NJ 07054

FOR: EDUCATIONAL SERVICES, NAMELY, CONDUCTING SEMINARS, CLASSES, CONFERENCES, AND WORKSHOPS IN THE FIELDS OF FINANCIAL INVESTMENTS, FINANCE, FINANCIAL PLANNING, PORTFOLIO MANAGEMENT, RETIREMENT PLANNING, MONEY MANAGEMENT,

INVESTMENT STRATEGY, ESTATE PLANNING, IN CLASS 41 (U.S. CLS. 100, 101 AND 107).

FIRST USE 10-0-2007; IN COMMERCE 10-0-2007.

THE MARK CONSISTS OF STANDARD CHARACTERS WITHOUT CLAIM TO ANY PARTICULAR FONT, STYLE, SIZE, OR COLOR.

SER. NO. 77-507,032, FILED 6-24-2008.

NATALIE POLZER, EXAMINING ATTORNEY

**Int. Cl.: 25**

**Prior U.S. Cls.: 22 and 39**

**United States Patent and Trademark Office**

**Reg. No. 3,569,770**

**Registered Feb. 3, 2009**

**TRADEMARK  
PRINCIPAL REGISTER**

**DICK SOLID**

DANIEL, WILLIAM (UNITED STATES INDIVIDUAL)  
17832 MEADOWVIEW DRIVE  
YORBA LINDA, CA 92886

FOR: BELTS; COATS; DRESSES; FOOTWEAR;  
HATS; HEADWEAR; JACKETS; PANTS; SHIRTS;  
SHOES; SHORTS; SWEAT PANTS; SWEAT SHIRTS;  
SWIM WEAR; T-SHIRTS; TANK TOPS; TIES; TOPS,  
IN CLASS 25 (U.S. CLS. 22 AND 39).

FIRST USE 4-1-2008; IN COMMERCE 4-1-2008.

THE MARK CONSISTS OF STANDARD CHARACTERS WITHOUT CLAIM TO ANY PARTICULAR FONT, STYLE, SIZE, OR COLOR.

SER. NO. 77-507,111, FILED 6-24-2008.

NELSON SNYDER, EXAMINING ATTORNEY

**Int. Cl.: 37**

**Prior U.S. Cls.: 100, 103 and 106**

**United States Patent and Trademark Office**

**Reg. No. 3,569,771**

**Registered Feb. 3, 2009**

**SERVICE MARK  
PRINCIPAL REGISTER**



R AND I WELTER INC. (CALIFORNIA CORPORATION), DBA CABINETMAN REMODELING SERVICES  
3288 E WILLOW STREET  
SIGNAL HILL, CA 90755

FOR: CABINET REFACING; CABINET REPAIR; INSTALLATION OF KITCHEN CABINETS, IN CLASS 37 (U.S. CLS. 100, 103 AND 106).

FIRST USE 6-18-2007; IN COMMERCE 6-18-2007.

NO CLAIM IS MADE TO THE EXCLUSIVE RIGHT TO USE "REMODELING SERVICES", APART FROM THE MARK AS SHOWN.

THE COLOR(S) BLUE AND BLACK IS/ARE CLAIMED AS A FEATURE OF THE MARK.

THE MARK CONSISTS OF BLUE "CABINET-MAN" ABOVE A BLACK LINE SUPPORTED BY A BLACK OUTLINE OF A HUMAN FIGURE. BELOW IN BLACK IS "REMODELING SERVICES".

SER. NO. 77-507,130, FILED 6-24-2008.

GISELLE AGOSTO, EXAMINING ATTORNEY



**Int. Cl.: 35**

**Prior U.S. Cls.: 100, 101 and 102**

**United States Patent and Trademark Office**

**Reg. No. 3,569,772**

**Registered Feb. 3, 2009**

**SERVICE MARK  
PRINCIPAL REGISTER**

**Showcase Your Place!**

SYNADIGM (WASHINGTON LIMITED LIABILITY COMPANY)  
19215 SE 34TH STREET #106-244  
CAMAS, WA 98607

FOR: ADVERTISING AND COMMERCIAL INFORMATION SERVICES, VIA THE INTERNET; ADVERTISING AND MARKETING; ADVERTISING SERVICES, NAMELY, PROMOTING PROPERTIES FOR SALE BY OWNER VIA THE INTERNET; DISSEMINATION OF ADVERTISING FOR OTHERS VIA AN ON-LINE COMMUNICATIONS NETWORK ON THE INTERNET; DISSEMINATION OF ADVERTISING FOR OTHERS VIA THE INTERNET; INTER-

NET ADVERTISING SERVICES, IN CLASS 35 (U.S. CLS. 100, 101 AND 102).

FIRST USE 6-20-2008; IN COMMERCE 6-20-2008.

THE MARK CONSISTS OF STANDARD CHARACTERS WITHOUT CLAIM TO ANY PARTICULAR FONT, STYLE, SIZE, OR COLOR.

SER. NO. 77-507,160, FILED 6-24-2008.

SKYE YOUNG, EXAMINING ATTORNEY

**Int. Cl.: 35**

**Prior U.S. Cls.: 100, 101 and 102**

**United States Patent and Trademark Office**

**Reg. No. 3,569,773**

**Registered Feb. 3, 2009**

**SERVICE MARK  
PRINCIPAL REGISTER**

**TUSANTE**

TUSANTE, INC. (DELAWARE CORPORATION)  
6920 MIRAMAR ROAD, SUITE 300  
SAN DIEGO, CA 92121

THE MARK CONSISTS OF STANDARD CHAR-  
ACTERS WITHOUT CLAIM TO ANY PARTICULAR  
FONT, STYLE, SIZE, OR COLOR.

FOR: PROVIDING ADVERTISING, MARKETING  
AND PROMOTIONAL SERVICES FOR THE  
HEALTH CARE INDUSTRY, IN CLASS 35 (U.S.  
CLS. 100, 101 AND 102).

SER. NO. 77-507,169, FILED 6-24-2008.

FIRST USE 5-15-2008; IN COMMERCE 5-15-2008.

LIEF MARTIN, EXAMINING ATTORNEY

**Int. Cls.: 9 and 42**

**Prior U.S. Cls.: 21, 23, 26, 36, 38, 100 and 101**

**United States Patent and Trademark Office**

**Reg. No. 3,569,774**

**Registered Feb. 3, 2009**

**TRADEMARK  
SERVICE MARK  
PRINCIPAL REGISTER**



AWS CONVERGENCE TECHNOLOGIES, INC.  
(DELAWARE CORPORATION)  
12410 MILESTONE CENTER DRIVE  
GERMANTOWN, MD 20876

FOR: DOWNLOADABLE SOFTWARE FOR DISPLAYING WEATHER RELATED INFORMATION BY MEANS OF MOBILE TELEPHONES OR OTHER WIRELESS NETWORK BASED DEVICES, IN CLASS 9 (U.S. CLS. 21, 23, 26, 36 AND 38).

FIRST USE 4-0-2005; IN COMMERCE 4-0-2005.

FOR: PROVIDING WEATHER RELATED INFORMATION ACCESSIBLE BY BROADCAST TELEVISION, CABLE TELEVISION; PROVIDING WEATHER RELATED INFORMATION ACCESSI-

BLE BY MOBILE TELEPHONES OR OTHER WIRELESS NETWORK BASED DEVICES, IN CLASS 42 (U.S. CLS. 100 AND 101).

FIRST USE 4-0-2004; IN COMMERCE 4-0-2004.

OWNER OF U.S. REG. NO. 2,825,198.

THE MARK CONSISTS OF A FANCIFUL DRAWING OF A LADYBUG WITH IMAGES OF RAIN-DROPS AND SNOWFLAKES CONTAINED THEREIN.

SER. NO. 77-507,189, FILED 6-24-2008.

ARETHA SOMERVILLE, EXAMINING ATTORNEY

**Int. Cl.: 41**

**Prior U.S. Cls.: 100, 101 and 107**

**United States Patent and Trademark Office**

**Reg. No. 3,569,775**

**Registered Feb. 3, 2009**

**SERVICE MARK  
PRINCIPAL REGISTER**

# Hands to Hearts International

HANDS TO HEARTS INTERNATIONAL (OREGON NON-PROFIT CORPORATION)  
1125 NW 9TH AVE., ST. 307  
PORTLAND, OR 97209

FOR: CHARITABLE SERVICES, NAMELY, PROVIDING TRAINING IN THE FIELD OF THE BASICS OF CHILD DEVELOPMENT AND GOOD CHILD-CARE PRACTICES, WHICH CAN THEN BE PRESENTED TO TEACHERS, CAREGIVERS, AND PARENTS ACROSS A WIDE RANGE OF CULTURES AND COMMUNITIES AND IN A VARIETY OF SETTINGS, IN CLASS 41 (U.S. CLS. 100, 101 AND 107).

FIRST USE 8-20-2004; IN COMMERCE 9-22-2004.

THE MARK CONSISTS OF STANDARD CHARACTERS WITHOUT CLAIM TO ANY PARTICULAR FONT, STYLE, SIZE, OR COLOR.

NO CLAIM IS MADE TO THE EXCLUSIVE RIGHT TO USE "INTERNATIONAL", APART FROM THE MARK AS SHOWN.

SER. NO. 77-507,251, FILED 6-24-2008.

JAY FLOWERS, EXAMINING ATTORNEY

Int. Cl.: 9

Prior U.S. Cls.: 21, 23, 26, 36 and 38

United States Patent and Trademark Office

Reg. No. 3,569,776

Registered Feb. 3, 2009

TRADEMARK  
PRINCIPAL REGISTER

# Dyno-Master



PETER M VACCARELLA (UNITED STATES INDIVIDUAL)  
101 WEST SAUL DRIVE  
SCOTT, LA 70583

FOR: DYNAMOMETERS, IN CLASS 9 (U.S. CLS. 21, 23, 26, 36 AND 38).

FIRST USE 12-20-1999; IN COMMERCE 12-20-1999.

NO CLAIM IS MADE TO THE EXCLUSIVE RIGHT TO USE "PROGRESSIVE CAVITY MOTOR VERIFICATION SYSTEM", APART FROM THE MARK AS SHOWN.

THE COLOR(S) BLACK, RED, YELLOW, GREEN, BLUE IS/ARE CLAIMED AS A FEATURE OF THE MARK.

THE MARK CONSISTS OF BLACK LETTERING "DYNO-MASTER", LEFT SIDE OF GRAPHIC IS CURVED ARROW POINTING UP RED IN COLOR, CURVED ARROW POINTING DOWN GREEN IN COLOR, HORIZONTAL BAR YELLOW IN COLOR WITH BLACK OUTLINE, BLACK LETTERING WITHIN YELLOW BAR "PROGRESSIVE CAVITY MOTOR VERIFICATION SYSTEM", CURVED ARROW POINTING UP BLUE IN COLOR.

SEC. 2(F).

SER. NO. 77-507,272, FILED 6-25-2008.

SHAILA SETTLES, EXAMINING ATTORNEY

**Int. Cl.: 31**

**Prior U.S. Cls.: 1 and 46**

**United States Patent and Trademark Office**

**Reg. No. 3,569,777**

**Registered Feb. 3, 2009**

**TRADEMARK  
PRINCIPAL REGISTER**



DAIRYLAND SEED CO., INC. (WISCONSIN CORPORATION)  
P.O. BOX 958  
WEST BEND, WI 53095

FOR: AGRICULTURAL SEEDS, NAMELY, CORN, SOYBEANS, ALFALFA, AND SILAGE, IN CLASS 31 (U.S. CLS. 1 AND 46).

FIRST USE 10-11-1965; IN COMMERCE 10-11-1965.

THE MARK CONSISTS OF AN IMAGE RESEMBLING A SHIELD WITH THE LETTER "D" IN UPPER LEFT TRIANGLE AND THE LETTER "S" IN THE LOWER RIGHT TRIANGLE.

SER. NO. 77-507,312, FILED 6-25-2008.

JENNIFER MARTIN, EXAMINING ATTORNEY

**Int. Cl.: 28**

**Prior U.S. Cls.: 22, 23, 38 and 50**

**Reg. No. 3,569,778**

**United States Patent and Trademark Office**

**Registered Feb. 3, 2009**

**TRADEMARK  
PRINCIPAL REGISTER**

**MAGNUM**

DANIEL E ROBBINS (UNITED STATES INDIVIDUAL), DBA ROBBINS TABLE TENNIS  
38462 JAMES DRIVE  
CLINTON TWP., MI 48036

THE MARK CONSISTS OF STANDARD CHARACTERS WITHOUT CLAIM TO ANY PARTICULAR FONT, STYLE, SIZE, OR COLOR.

FOR: TABLE TENNIS PADDLES, IN CLASS 28 (U.S. CLS. 22, 23, 38 AND 50).

SER. NO. 77-507,328, FILED 6-25-2008.

FIRST USE 12-31-1997; IN COMMERCE 12-31-1997.

SHAILA SETTLES, EXAMINING ATTORNEY

**Int. Cl.: 35**

**Prior U.S. Cls.: 100, 101 and 102**

**United States Patent and Trademark Office**

**Reg. No. 3,569,779**

**Registered Feb. 3, 2009**

**SERVICE MARK  
PRINCIPAL REGISTER**



VIRGINIA WINE BOARD (VIRGINIA STATE AGENCY)  
102 GOVERNOR STREET  
RICHMOND, VA 23219

FOR: ADVERTISING AND PROMOTIONAL SERVICES, IN CLASS 35 (U.S. CLS. 100, 101 AND 102).

FIRST USE 2-1-2008; IN COMMERCE 2-1-2008.

NO CLAIM IS MADE TO THE EXCLUSIVE RIGHT TO USE "VIRGINIA WINE", APART FROM THE MARK AS SHOWN.

THE COLOR(S) BLUE, GREEN AND WHITE IS/ARE CLAIMED AS A FEATURE OF THE MARK.

THE MARK CONSISTS OF STYLIZED MOUNTAINS IN BLUE ABOVE STYLIZED CULTIVATED FIELDS DEPICTED IN GREEN AND WHITE STRIPES, WITH A WHITE LETTER V IMPOSED OVER THE FOREGROUND OF THE LANDSCAPE, THE CENTRAL SHAPE OF THE V FORMING A BLUE WINE GLASS, AND THE WORDS "VIRGINIA WINE" IN BLUE TO THE RIGHT OF THE LANDSCAPE DESIGN.

SER. NO. 77-507,367, FILED 6-25-2008.

JEFFERY COWARD, EXAMINING ATTORNEY



**Int. Cl.: 35**

**Prior U.S. Cls.: 100, 101 and 102**

**United States Patent and Trademark Office**

**Reg. No. 3,569,780**

**Registered Feb. 3, 2009**

**SERVICE MARK  
PRINCIPAL REGISTER**

# AtlasOnline

MUSIC RESOURCE GROUP, LLC (NEW JERSEY  
LIMITED LIABILITY COMPANY)  
38 PORTER PLACE  
MONTCLAIR, NJ 07042

THE MARK CONSISTS OF STANDARD CHAR-  
ACTERS WITHOUT CLAIM TO ANY PARTICULAR  
FONT, STYLE, SIZE, OR COLOR.

FOR: PROVIDING AN ON-LINE COMPUTER  
DATABASE FEATURING TRADE INFORMATION  
IN THE FIELD OF INDEPENDENT MUSIC, IN  
CLASS 35 (U.S. CLS. 100, 101 AND 102).

SER. NO. 77-507,380, FILED 6-25-2008.

FIRST USE 12-0-2002; IN COMMERCE 12-0-2002.

JENNIFER MARTIN, EXAMINING ATTORNEY

**Int. Cl.: 35**

**Prior U.S. Cls.: 100, 101 and 102**

**United States Patent and Trademark Office**

**Reg. No. 3,569,781**

**Registered Feb. 3, 2009**

**SERVICE MARK  
PRINCIPAL REGISTER**

**ACCESSTOLIFE**

THE GLOBAL FUND TO FIGHT AIDS, TUBER-  
CULOSIS AND MALARIA (SWITZERLAND  
FOUNDATION)  
1214 VERNIER  
CHEMIN BLANDONEET 6-8  
GENEVA, SWITZERLAND

FOR: PUBLIC ADVOCACY TO PROMOTE  
AWARENESS OF HIV/AIDS, IN CLASS 35 (U.S.  
CLS. 100, 101 AND 102).

FIRST USE 2-0-2008; IN COMMERCE 2-0-2008.

THE MARK CONSISTS OF STANDARD CHAR-  
ACTERS WITHOUT CLAIM TO ANY PARTICULAR  
FONT, STYLE, SIZE, OR COLOR.

SER. NO. 77-507,398, FILED 6-25-2008.

ESTHER A. BORSUK, EXAMINING ATTORNEY

**Int. Cl.: 36**

**Prior U.S. Cls.: 100, 101 and 102**

**United States Patent and Trademark Office**

**Reg. No. 3,569,782**

**Registered Feb. 3, 2009**

**SERVICE MARK  
PRINCIPAL REGISTER**

**reserveplus**

RESERVE MANAGEMENT CORPORATION  
(NEW JERSEY CORPORATION)  
1250 BROADWAY  
NEW YORK, NY 10001

FOR: FINANCIAL SERVICES, NAMELY, PROVIDING DEBIT CARDS AND CASH DISBURSEMENTS RELATED TO PENSION PLANS, IN CLASS 36 (U.S. CLS. 100, 101 AND 102).

FIRST USE 8-20-2007; IN COMMERCE 8-20-2007.

OWNER OF U.S. REG. NOS. 2,989,669, 2,994,919 AND OTHERS.

THE MARK CONSISTS OF THE WORD RESERVEPLUS WITH THE "RESERVE" ELEMENT IN A LIGHTER FONT THAN THE "PLUS" ELEMENT.

SER. NO. 77-507,403, FILED 6-25-2008.

JAY FLOWERS, EXAMINING ATTORNEY

**Int. Cl.: 17**

**Prior U.S. Cls.: 1, 5, 12, 13, 35 and 50**

**United States Patent and Trademark Office**

**Reg. No. 3,569,783**

**Registered Feb. 3, 2009**

**TRADEMARK  
PRINCIPAL REGISTER**

**E-Z TAPING SYSTEM**

E-Z TAPING SYSTEM, INC. (WISCONSIN CORPORATION)  
P.O. BOX 11263  
GREEN BAY, WI 543071263

FOR: DRYWALL JOINT TAPE, IN CLASS 17 (U.S. CLS. 1, 5, 12, 13, 35 AND 50).

FIRST USE 8-11-1995; IN COMMERCE 8-11-1995.

THE MARK CONSISTS OF STANDARD CHARACTERS WITHOUT CLAIM TO ANY PARTICULAR FONT, STYLE, SIZE, OR COLOR.

OWNER OF U.S. REG. NO. 2,003,787.

NO CLAIM IS MADE TO THE EXCLUSIVE RIGHT TO USE "TAPING SYSTEM", APART FROM THE MARK AS SHOWN.

SEC. 2(F).

SER. NO. 77-507,418, FILED 6-25-2008.

SUSAN RICHARDS, EXAMINING ATTORNEY

**Int. Cl.: 37**

**Prior U.S. Cls.: 100, 103 and 106**

**United States Patent and Trademark Office**

**Reg. No. 3,569,784**

**Registered Feb. 3, 2009**

**SERVICE MARK  
PRINCIPAL REGISTER**

**TWO GUYS AND SOME WIRE**

TOUCHSTONE, R. WAYNE (UNITED STATES  
INDIVIDUAL)

1411 MELROSE PLACE

BIRMINGHAM, AL 35209

FOR: HOME THEATER INSTALLATION SERVICES,  
IN CLASS 37 (U.S. CLS. 100, 103 AND 106).

FIRST USE 9-30-1998; IN COMMERCE 1-31-1999.

THE MARK CONSISTS OF STANDARD CHARACTERS  
WITHOUT CLAIM TO ANY PARTICULAR  
FONT, STYLE, SIZE, OR COLOR.

NO CLAIM IS MADE TO THE EXCLUSIVE  
RIGHT TO USE "WIRE", APART FROM THE MARK  
AS SHOWN.

SER. NO. 77-507,424, FILED 6-25-2008.

LAURA HAMMEL, EXAMINING ATTORNEY

**Int. Cl.: 35**

**Prior U.S. Cls.: 100, 101 and 102**

**United States Patent and Trademark Office**

**Reg. No. 3,569,785**

**Registered Feb. 3, 2009**

**SERVICE MARK  
PRINCIPAL REGISTER**

**EYEWONDER**

EYEWONDER, INC. (DELAWARE CORPORATION)  
SUITE 500  
233 PEACHTREE STREET, NE  
ATLANTA, GA 30303

FOR: ADVERTISING VIA ELECTRONIC MEDIA AND SPECIFICALLY THE INTERNET; ADVERTISING SERVICES, NAMELY, CREATING, COMPOSING, UPDATING, COMPILING, DISSEMINATING, SUPPORTING AND REPORTING ON ADVERTISEMENTS FOR USE ON INTERNET WEB PAGES AND

WIRELESS NETWORKS, IN CLASS 35 (U.S. CLS. 100, 101 AND 102).

FIRST USE 9-0-2000; IN COMMERCE 9-0-2000.

THE MARK CONSISTS OF STANDARD CHARACTERS WITHOUT CLAIM TO ANY PARTICULAR FONT, STYLE, SIZE, OR COLOR.

SER. NO. 77-507,440, FILED 6-25-2008.

REBECCA GILBERT, EXAMINING ATTORNEY

**Int. Cl.: 44**

**Prior U.S. Cls.: 100 and 101**

**United States Patent and Trademark Office**

**Reg. No. 3,569,786**

**Registered Feb. 3, 2009**

**SERVICE MARK  
PRINCIPAL REGISTER**



GREENSBORO CENTER FOR FACIAL REJUVENATION, INC. (NORTH CAROLINA CORPORATION)  
321 WEST WENDOVER AVE.  
GREENSBORO, NC 27408

FOR: CONSULTATION SERVICES IN THE FIELD OF MAKEUP, NAMELY, ON-LINE MAKEUP CONSULTATION SERVICES AND IN-PERSON MAKEUP CONSULTATION AND APPLICATION SERVICES; FACIAL TREATMENT SERVICES, NAMELY, COSMETIC PEELS; LASER AND IPL (INTENSE PULSE LIGHT) SKIN ENHANCEMENT PROCEDURES; MICRODERMABRASION, NAMELY, A TOPICAL SKIN TREATMENT INVOLVING ABRASION OF THE SKIN WITH A HIGH-PRESSURE FLOW OF CRYSTALS; SKIN TREATMENT, NAMELY, THE

INJECTION OF DERMAL FILLERS TO REDUCE THE APPEARANCE OF FACIAL FINE LINES; SKIN TREATMENTS, NAMELY, THE INJECTION OF DERMAL FILLING AGENTS AND NEUROMUSCULAR BLOCKING AGENTS TO REDUCE THE APPEARANCE OF FACIAL LINES AND WRINKLES, IN CLASS 44 (U.S. CLS. 100 AND 101).

FIRST USE 6-19-2008; IN COMMERCE 6-19-2008.

THE MARK CONSISTS OF A STYLIZED IMAGE OF A FACE.

SER. NO. 77-507,442, FILED 6-25-2008.

KIM SAITO, EXAMINING ATTORNEY

**Int. Cl.: 44**

**Prior U.S. Cls.: 100 and 101**

**United States Patent and Trademark Office**

**Reg. No. 3,569,787**

**Registered Feb. 3, 2009**

**SERVICE MARK  
PRINCIPAL REGISTER**

**Movement is Medicine**

ANDERSON & CATTONE PHYSICAL THERAPY  
(WASHINGTON CORPORATION)

#312

1408 12TH AVENUE  
SEATTLE, WA 98122

FOR: PHYSICAL THERAPY EVALUATION,  
IDENTIFICATION, AND MANAGEMENT OF  
MOVEMENT TO RESTORE, MAINTAIN, AND PRO-  
MOTE OPTIMAL PHYSICAL FUNCTION PRE-  
VENTING THE ONSET, SYMPTOMS AND  
PROGRESSION OF IMPAIRMENTS, FUNCTIONAL  
LIMITATIONS, AND DISABILITIES RESULTING

FROM DISEASE, DISORDERS, CONDITIONS, OR  
INJURIES, IN CLASS 44 (U.S. CLS. 100 AND 101).

FIRST USE 1-1-2006; IN COMMERCE 1-1-2006.

THE MARK CONSISTS OF STANDARD CHAR-  
ACTERS WITHOUT CLAIM TO ANY PARTICULAR  
FONT, STYLE, SIZE, OR COLOR.

SER. NO. 77-507,448, FILED 6-25-2008.

REGINA DRUMMOND, EXAMINING ATTORNEY



Int. Cl.: 43

Prior U.S. Cls.: 100 and 101

United States Patent and Trademark Office

Reg. No. 3,569,788

Registered Feb. 3, 2009

SERVICE MARK  
PRINCIPAL REGISTER



LA COSECHA, INC. (GEORGIA CORPORATION)  
SUITE 150  
1145 ROTTENWOOD DRIVE  
MARIETTA, GA 30067

FOR: CATERING OF FOOD AND DRINKS; RESTAURANT AND BAR SERVICES, IN CLASS 43 (U.S. CLS. 100 AND 101).

FIRST USE 4-2-2008; IN COMMERCE 4-2-2008.

OWNER OF U.S. REG. NO. 3,337,909.

NO CLAIM IS MADE TO THE EXCLUSIVE RIGHT TO USE "LA PARRILLA MEXICAN RESTAURANT", APART FROM THE MARK AS SHOWN.

THE COLOR(S) YELLOW, ORANGE, BLACK, GOLD, RED AND GREEN IS/ARE CLAIMED AS A FEATURE OF THE MARK.

THE MARK CONSISTS OF A YELLOW CIRCLE AS THE SUN; AROUND THE SUN ARE FLARES OF YELLOW AND ORANGE; ACROSS THE SUN AND LOWER FLARES IN STYLIZED BLACK SCRIPT PARTIALLY BANDED IN GOLD ARE THE WORDS LA PARRILLA, THE LETTER I BEING DOTTED WITH A RED AND GREEN PEPPER; BENEATH LA PARRILLA IS A RED CURVED IRREGULAR LINE AND BENEATH IT AND FOLLOWING THE CURVE SHAPE ARE THE WORDS MEXICAN RESTAURANT IN STYLIZED GREEN CAPITAL LETTERS.

THE FOREIGN WORDING IN THE MARK TRANSLATES INTO ENGLISH AS GRILL.

SER. NO. 77-507,453, FILED 6-25-2008.

KELLY MCCOY, EXAMINING ATTORNEY

**Int. Cl.: 43**

**Prior U.S. Cls.: 100 and 101**

**United States Patent and Trademark Office**

**Reg. No. 3,569,789**

**Registered Feb. 3, 2009**

**SERVICE MARK  
PRINCIPAL REGISTER**



CHOICE HOTELS INTERNATIONAL, INC. (DE-  
LAWARE CORPORATION)  
10750 COLUMBIA PIKE  
SILVER SPRING, MD 20901

FOR: HOTEL AND MOTEL SERVICES, HOTEL  
AND MOTEL RESERVATION SERVICES FOR OTH-  
ERS, AND ONLINE HOTEL AND MOTEL RESER-  
VATION SERVICES FOR OTHERS, IN CLASS 43  
(U.S. CLS. 100 AND 101).

FIRST USE 5-31-2001; IN COMMERCE 5-31-2001.

OWNER OF U.S. REG. NOS. 2,729,999, 2,946,054  
AND OTHERS.

NO CLAIM IS MADE TO THE EXCLUSIVE  
RIGHT TO USE "HOTEL", APART FROM THE  
MARK AS SHOWN.

THE MARK CONSISTS OF A STYLIZED LETTER  
"Q" AND THE WORDS "QUALITY HOTEL".

SER. NO. 77-507,502, FILED 6-25-2008.

HENRY S. ZAK, EXAMINING ATTORNEY

**Int. Cl.: 35**

**Prior U.S. Cls.: 100, 101 and 102**

**United States Patent and Trademark Office**

**Reg. No. 3,569,790**

**Registered Feb. 3, 2009**

**SERVICE MARK  
PRINCIPAL REGISTER**

**GAMERZ PLANET**

CHERRY & CHERRY GAMES, INC. (ARKANSAS CORPORATION)  
7124 SOUTH MEMORIAL DRIVE  
TULSA, OK 74133

FOR: RETAIL STORE SERVICES FEATURING VIDEO GAMES, VIDEO GAME CONSOLES, VIDEO GAME CONSOLE ACCESSORIES, MOVIES, SKATEBOARDS AND SKATEBOARD ACCESSORIES, IN CLASS 35 (U.S. CLS. 100, 101 AND 102).

FIRST USE 5-23-2008; IN COMMERCE 5-23-2008.

THE MARK CONSISTS OF STANDARD CHARACTERS WITHOUT CLAIM TO ANY PARTICULAR FONT, STYLE, SIZE, OR COLOR.

NO CLAIM IS MADE TO THE EXCLUSIVE RIGHT TO USE "GAMERS", APART FROM THE MARK AS SHOWN.

SER. NO. 77-507,514, FILED 6-25-2008.

HENRY S. ZAK, EXAMINING ATTORNEY

**Int. Cl.: 18**

**Prior U.S. Cls.: 1, 2, 3, 22 and 41**

**United States Patent and Trademark Office**

**Reg. No. 3,569,791**

**Registered Feb. 3, 2009**

**TRADEMARK  
PRINCIPAL REGISTER**

**GoGoBag**

YOSHIDA, SHIZUE (JAPAN INDIVIDUAL)  
839 SOUTHWESTERN RUN  
YOUNGSTOWN, OH 44514

THE MARK CONSISTS OF STANDARD CHAR-  
ACTERS WITHOUT CLAIM TO ANY PARTICULAR  
FONT, STYLE, SIZE, OR COLOR.

FOR: MAKE-UP BAGS SOLD EMPTY, IN CLASS  
18 (U.S. CLS. 1, 2, 3, 22 AND 41).

SER. NO. 77-507,521, FILED 6-25-2008.

FIRST USE 8-25-2008; IN COMMERCE 8-25-2008.

FRED MANDIR, EXAMINING ATTORNEY

**Int. Cls.: 38 and 41**

**Prior U.S. Cls.: 100, 101, 104 and 107**

**United States Patent and Trademark Office**

**Reg. No. 3,569,792**

**Registered Feb. 3, 2009**

**SERVICE MARK  
PRINCIPAL REGISTER**

**FREE RANGE STUDIOS**

FREE RANGE STUDIOS (D.C. LIMITED LIABILITY COMPANY)  
4TH FLOOR  
1605 CONNECTICUT AVENUE, NW  
WASHINGTON, DC 20009

FOR: VIDEO STREAMING SERVICES VIA THE INTERNET, FEATURING INDEPENDENT FILMS AND MOVIES, IN CLASS 38 (U.S. CLS. 100, 101 AND 104).

FIRST USE 1-1-1999; IN COMMERCE 1-1-1999.

FOR: ENTERTAINMENT SERVICES, NAMELY, PRODUCTION OF SPECIAL EFFECTS INCLUDING MODEL-MAKING SERVICES, COMPUTER-GENERATED IMAGERY AND COMPUTER-GENERATED GRAPHICS FOR THE PRODUCTION OF MOTION PICTURES, VIDEOS, AND MOVIE TRAI-

TERS; PRODUCTION AND DISTRIBUTION OF TELEVISION SHOWS AND MOVIES, IN CLASS 41 (U.S. CLS. 100, 101 AND 107).

FIRST USE 1-1-1999; IN COMMERCE 1-1-1999.

THE MARK CONSISTS OF STANDARD CHARACTERS WITHOUT CLAIM TO ANY PARTICULAR FONT, STYLE, SIZE, OR COLOR.

NO CLAIM IS MADE TO THE EXCLUSIVE RIGHT TO USE "STUDIOS", APART FROM THE MARK AS SHOWN.

SER. NO. 77-507,543, FILED 6-25-2008.

KOURTNEE HODGES, EXAMINING ATTORNEY

**Int. Cl.: 35**

**Prior U.S. Cls.: 100, 101 and 102**

**United States Patent and Trademark Office**

**Reg. No. 3,569,793**

**Registered Feb. 3, 2009**

**SERVICE MARK  
PRINCIPAL REGISTER**

**ZATISTA**

ZATISTA LLC (PENNSYLVANIA LIMITED LIABILITY COMPANY)  
SUITE 205B  
301 OXFORD VALLEY ROAD  
YARDLEY, PA 19067

FOR: OPERATING ON-LINE MARKETPLACES FEATURING ART, SCULPTURE, JEWELRY, FURNITURE, AND HAND MADE GOODS, IN CLASS 35 (U.S. CLS. 100, 101 AND 102).

FIRST USE 4-1-2008; IN COMMERCE 5-15-2008.

THE MARK CONSISTS OF STANDARD CHARACTERS WITHOUT CLAIM TO ANY PARTICULAR FONT, STYLE, SIZE, OR COLOR.

SER. NO. 77-507,546, FILED 6-25-2008.

NANCY CLARKE, EXAMINING ATTORNEY

**Int. Cl.: 35**

**Prior U.S. Cls.: 100, 101 and 102**

**United States Patent and Trademark Office**

**Reg. No. 3,569,794**

**Registered Feb. 3, 2009**

**SERVICE MARK  
PRINCIPAL REGISTER**

**URBAN BOUNDARIES**

THE SOURCE GROUP (MISSOURI LIMITED  
LIABILITY COMPANY)  
SUITE 100  
1676 BRYAN ROAD  
O'FALLON, MO 63368

FOR: ON-LINE RETAIL STORE SERVICES FEATURING SUNGLASSES, GLOVES, APPAREL, AND GIFTS, IN CLASS 35 (U.S. CLS. 100, 101 AND 102).

FIRST USE 12-1-2005; IN COMMERCE 1-1-2006.

THE MARK CONSISTS OF STANDARD CHARACTERS WITHOUT CLAIM TO ANY PARTICULAR FONT, STYLE, SIZE, OR COLOR.

SER. NO. 77-507,563, FILED 6-25-2008.

JENNIFER MARTIN, EXAMINING ATTORNEY

**Int. Cl.: 25**

**Prior U.S. Cls.: 22 and 39**

**United States Patent and Trademark Office**

**Reg. No. 3,569,795**

**Registered Feb. 3, 2009**

**TRADEMARK  
PRINCIPAL REGISTER**

# Ultra Teeze

JADE APPAREL, INC. (CALIFORNIA CORPORATION)  
4551 LOMA VISTA AVENUE  
VERNON, CA 90058

THE MARK CONSISTS OF STANDARD CHARACTERS WITHOUT CLAIM TO ANY PARTICULAR FONT, STYLE, SIZE, OR COLOR.

FOR: PANTS; SHIRTS; SKIRTS; SLEEPWEAR; SWEATERS; TANK TOPS; UNDERWEAR, IN CLASS 25 (U.S. CLS. 22 AND 39).

SER. NO. 77-507,578, FILED 6-25-2008.

FIRST USE 5-22-2008; IN COMMERCE 5-22-2008.

KIM MONINGHOFF, EXAMINING ATTORNEY



**Int. Cl.: 41**

**Prior U.S. Cls.: 100, 101 and 107**

**United States Patent and Trademark Office**

**Reg. No. 3,569,796**

**Registered Feb. 3, 2009**

**SERVICE MARK  
PRINCIPAL REGISTER**

# The Dads of Comedy

STRAIT, CHRISTOPHER (UNITED STATES IN-  
DIVIDUAL)  
4878 134TH PL.  
HAWTHORNE, CA 90250

FOR: ENTERTAINMENT IN THE NATURE OF A  
STAND-UP COMEDY SHOW, IN CLASS 41 (U.S. CLS.  
100, 101 AND 107).

FIRST USE 7-1-2007; IN COMMERCE 12-31-2007.

THE MARK CONSISTS OF STANDARD CHAR-  
ACTERS WITHOUT CLAIM TO ANY PARTICULAR  
FONT, STYLE, SIZE, OR COLOR.

NO CLAIM IS MADE TO THE EXCLUSIVE  
RIGHT TO USE "COMEDY", APART FROM THE  
MARK AS SHOWN.

SER. NO. 77-507,580, FILED 6-25-2008.

HELENE LIWINSKI, EXAMINING ATTORNEY

**Int. Cl.: 10**

**Prior U.S. Cls.: 26, 39 and 44**

**Reg. No. 3,569,797**

**United States Patent and Trademark Office**

**Registered Feb. 3, 2009**

---

**TRADEMARK  
PRINCIPAL REGISTER**

**EXCELSIOR**

BOSTON SCIENTIFIC SCIMED, INC. (MINNESOTA CORPORATION)  
ONE SCIMED PLACE  
MAPLE GROVE, MN 55311

THE MARK CONSISTS OF STANDARD CHARACTERS WITHOUT CLAIM TO ANY PARTICULAR FONT, STYLE, SIZE, OR COLOR.

FOR: MEDICAL MICROCATHETERS, IN CLASS 10 (U.S. CLS. 26, 39 AND 44).

SER. NO. 77-507,583, FILED 6-25-2008.

FIRST USE 7-0-2000; IN COMMERCE 7-0-2000.

JEAN IM, EXAMINING ATTORNEY

**Int. Cl.: 16**

**Prior U.S. Cls.: 2, 5, 22, 23, 29, 37, 38 and 50**

**Reg. No. 3,569,798**

**United States Patent and Trademark Office**

**Registered Feb. 3, 2009**

**TRADEMARK  
PRINCIPAL REGISTER**

**RECALL**

MASSANUTTEN MILITARY ACADEMY ALUMNI ASSOCIATION (VIRGINIA CORPORATION)  
623 S. MAIN STREET P.O. BOX 298  
WOODSTOCK, VA 22664

THE MARK CONSISTS OF STANDARD CHARACTERS WITHOUT CLAIM TO ANY PARTICULAR FONT, STYLE, SIZE, OR COLOR.

FOR: NEWSLETTERS IN THE FIELD OF A MILITARY ACADEMY AND ITS ALUMNI, IN CLASS 16 (U.S. CLS. 2, 5, 22, 23, 29, 37, 38 AND 50).

SER. NO. 77-507,601, FILED 6-25-2008.

FIRST USE 1-1-1969; IN COMMERCE 1-1-1969.

DAVID HOFFMAN, EXAMINING ATTORNEY

**Int. Cl.: 12**

**Prior U.S. Cls.: 19, 21, 23, 31, 35 and 44**

**Reg. No. 3,569,799**

**United States Patent and Trademark Office**

**Registered Feb. 3, 2009**

**TRADEMARK  
PRINCIPAL REGISTER**

**TROLL**

TELPRO INC. (NORTH DAKOTA CORPORATION)  
7251 42ND STREET SOUTH  
GRAND FORKS, ND 58201

FOR: DRYWALL OR PANEL TRANSPORTING DEVICES IN THE NATURE OF DOLLIES SPECIALLY DESIGNED TO MOVE DRYWALL AND PANELS, IN CLASS 12 (U.S. CLS. 19, 21, 23, 31, 35 AND 44).

FIRST USE 8-16-1998; IN COMMERCE 8-16-1998.

THE MARK CONSISTS OF STANDARD CHARACTERS WITHOUT CLAIM TO ANY PARTICULAR FONT, STYLE, SIZE, OR COLOR.

SER. NO. 77-507,626, FILED 6-25-2008.

JEFFERY COWARD, EXAMINING ATTORNEY

**Int. Cl.: 6**

**Prior U.S. Cls.: 2, 12, 13, 14, 23, 25 and 50**

**Reg. No. 3,569,800**

**United States Patent and Trademark Office**

**Registered Feb. 3, 2009**

**TRADEMARK  
PRINCIPAL REGISTER**

**TELE-TOWER**

TELPRO INC. (NORTH DAKOTA CORPORATION)  
7251 42ND STREET SOUTH  
GRAND FORKS, ND 58201

THE MARK CONSISTS OF STANDARD CHARACTERS WITHOUT CLAIM TO ANY PARTICULAR FONT, STYLE, SIZE, OR COLOR.

FOR: METAL ADJUSTABLE SCAFFOLD, IN CLASS 6 (U.S. CLS. 2, 12, 13, 14, 23, 25 AND 50).

SER. NO. 77-507,630, FILED 6-25-2008.

FIRST USE 2-24-1975; IN COMMERCE 2-24-1975.

JEFFERY COWARD, EXAMINING ATTORNEY

**Int. Cl.: 35**

**Prior U.S. Cls.: 100, 101 and 102**

**United States Patent and Trademark Office**

**Reg. No. 3,569,801**

**Registered Feb. 3, 2009**

**SERVICE MARK  
PRINCIPAL REGISTER**

**COLOR, ENERGY & LIGHT**

CLEAR CHANNEL OUTDOOR, INC. (DELA-  
WARE CORPORATION)  
200 EAST BASSE ROAD  
SAN ANTONIO, TX 78209

FOR: OUT-OF-HOME ADVERTISING SERVICES,  
NAMELY, RENTAL OF ADVERTISING SPACE IN  
SINGLE-DEVELOPER MIXED USE REAL ESTATE  
PROPERTIES, IN CLASS 35 (U.S. CLS. 100, 101 AND  
102).

FIRST USE 5-0-2008; IN COMMERCE 5-0-2008.

THE MARK CONSISTS OF STANDARD CHAR-  
ACTERS WITHOUT CLAIM TO ANY PARTICULAR  
FONT, STYLE, SIZE, OR COLOR.

SER. NO. 77-507,631, FILED 6-25-2008.

BARBARA BROWN, EXAMINING ATTORNEY

**Int. Cl.: 44**

**Prior U.S. Cls.: 100 and 101**

**United States Patent and Trademark Office**

**Reg. No. 3,569,802**

**Registered Feb. 3, 2009**

**SERVICE MARK  
PRINCIPAL REGISTER**

# INSIDE ADHD

INFLEXION, INC. (MASSACHUSETTS CORPORATION)  
SUITE 100  
320 NEEDHAM STREET  
NEWTON, MA 02464

FOR: WEBSITE FEATURING INFORMATION ABOUT ATTENTION DEFICIT HYPERACTIVITY DISORDER, IN CLASS 44 (U.S. CLS. 100 AND 101).

FIRST USE 5-28-2008; IN COMMERCE 5-28-2008.

THE MARK CONSISTS OF STANDARD CHARACTERS WITHOUT CLAIM TO ANY PARTICULAR FONT, STYLE, SIZE, OR COLOR.

NO CLAIM IS MADE TO THE EXCLUSIVE RIGHT TO USE ADHD, APART FROM THE MARK AS SHOWN.

SER. NO. 77-507,645, FILED 6-25-2008.

DAVID TAYLOR, EXAMINING ATTORNEY

**Int. Cl.: 19**

**Prior U.S. Cls.: 1, 12, 33 and 50**

**Reg. No. 3,569,803**

**United States Patent and Trademark Office**

**Registered Feb. 3, 2009**

**TRADEMARK  
PRINCIPAL REGISTER**



OMEGA PRODUCTS INTERNATIONAL (CALIFORNIA CORPORATION)  
1681 CALIFORNIA AVENUE  
CORONA, CA 92881

FOR: GROUT; MORTARS, IN CLASS 19 (U.S. CLS. 1, 12, 33 AND 50).

FIRST USE 6-11-2008; IN COMMERCE 6-11-2008.

THE MARK CONSISTS OF AN OUTLINED SHIELD WHICH IS SPLIT INTO FOUR SECTIONS,

FILLED WITH A CHECKERED PATTERN, SOLID, FILLED WITH A CHECKERED PATTERN, AND SOLID, CLOCKWISE STARTING FROM THE TOP LEFT, WHICH ARE ALL OVERLAID BY THE SILHOUETTE OF A DRAGON CENTERED IN THE CREST, ALL SET BEHIND A STYLIZED LETTER "S".

SER. NO. 77-507,647, FILED 6-25-2008.

SHAILA SETTLES, EXAMINING ATTORNEY



**Int. Cl.: 41**

**Prior U.S. Cls.: 100, 101 and 107**

**Reg. No. 3,569,804**

**United States Patent and Trademark Office**

**Registered Feb. 3, 2009**

**SERVICE MARK  
PRINCIPAL REGISTER**

**Inspire. Empower. Connect.**

COMPASS LIFE AND BUSINESS DESIGNS, INC.  
(CALIFORNIA CORPORATION)  
SUITE 403  
5655 SILVER CREEK VALLEY RD.  
SAN JOSE, CA 95138

FOR: PROFESSIONAL ONE-ON-ONE AND GROUP COACHING SERVICES, NAMELY, PROVIDING A PROFESSIONAL COACHING PROGRAM IN THE FIELD OF BEAUTY AND STYLE, CAREER TRANSITIONS, PERSONAL AND PROFESSIONAL FINANCIAL GOALS, HOUSEHOLD MANAGEMENT, PERSONAL PLANNING, PERSONAL MOTIVATION, PERSONAL ORGANIZATION, ORGANIZATION OF PHYSICAL HOME AND OFFICE SPACE, TIME MANAGEMENT, WEALTH BUILDING AND INVESTING, HEALTH AND FITNESS, MOTHERHOOD AND PARENTING, ENTREPRENEURIAL SKILLS, AND SPIRITUAL GROWTH; EDUCATIONAL SERVICES, NAMELY, CONDUCTING LIVE AND ONLINE CLASSES, SEMINARS, CONFERENCES, SYMPOSIA, AND WORKSHOPS IN THE FIELD OF BEAUTY AND STYLE, CAREER TRANSITIONS, PERSONAL AND PROFESSIONAL FINANCIAL GOALS, HOUSEHOLD MANAGEMENT, PERSONAL PLANNING, PERSONAL MOTIVATION, PERSONAL ORGANIZATION, ORGANIZATION OF PHYSICAL HOME AND OFFICE SPACE, TIME MANAGEMENT, WEALTH

BUILDING AND INVESTING, HEALTH AND FITNESS, MOTHERHOOD AND PARENTING, ENTREPRENEURIAL SKILLS, AND SPIRITUAL GROWTH AND DISTRIBUTION OF COURSE MATERIAL IN CONNECTION THEREWITH; ONLINE BLOGS FEATURING COMMENTARY AND INFORMATION IN THE FIELD OF BEAUTY AND STYLE, CAREER TRANSITIONS, PERSONAL AND PROFESSIONAL FINANCIAL GOALS, HOUSEHOLD MANAGEMENT, PERSONAL PLANNING, PERSONAL MOTIVATION, PERSONAL ORGANIZATION, ORGANIZATION OF PHYSICAL HOME AND OFFICE SPACE, TIME MANAGEMENT, WEALTH BUILDING AND INVESTING, HEALTH AND FITNESS, MOTHERHOOD AND PARENTING, ENTREPRENEURIAL SKILLS, AND SPIRITUAL GROWTH, IN CLASS 41 (U.S. CLS. 100, 101 AND 107).

FIRST USE 5-1-2008; IN COMMERCE 5-1-2008.

THE MARK CONSISTS OF STANDARD CHARACTERS WITHOUT CLAIM TO ANY PARTICULAR FONT, STYLE, SIZE, OR COLOR.

SER. NO. 77-507,668, FILED 6-25-2008.

NICHOLAS COLEMAN, EXAMINING ATTORNEY

**Int. Cl.: 9**

**Prior U.S. Cls.: 21, 23, 26, 36 and 38**

**Reg. No. 3,569,805**

**United States Patent and Trademark Office**

**Registered Feb. 3, 2009**

---

**TRADEMARK  
PRINCIPAL REGISTER**

**DESIGNER**

BUCK CONSULTANTS, LLC (DELAWARE LIMITED LIABILITY COMPANY)  
ONE PENNSYLVANIA PLAZA  
NEW YORK, NY 10119

FOR: COMPUTER PROGRAMS FOR USE IN MODELING AND VALUING RETIREMENT BENEFIT PLANS, IN CLASS 9 (U.S. CLS. 21, 23, 26, 36 AND 38).

FIRST USE 3-1-1999; IN COMMERCE 3-1-1999.

THE MARK CONSISTS OF STANDARD CHARACTERS WITHOUT CLAIM TO ANY PARTICULAR FONT, STYLE, SIZE, OR COLOR.

OWNER OF U.S. REG. NO. 2,596,199.

SEC. 2(F).

SER. NO. 77-507,675, FILED 6-25-2008.

LOURDES AYALA, EXAMINING ATTORNEY

**Int. Cl.: 40**

**Prior U.S. Cls.: 100, 103 and 106**

**United States Patent and Trademark Office**

**Reg. No. 3,569,806**

**Registered Feb. 3, 2009**

**SERVICE MARK  
PRINCIPAL REGISTER**

**SOLAR ART**

SUGAI, CHRIS K. (UNITED STATES INDIVIDUAL)  
13122 SATICOY  
NORTH HOLLYWOOD, CA 91605

FOR: GLASS TINTING SERVICES, IN CLASS 40  
(U.S. CLS. 100, 103 AND 106).

FIRST USE 0-0-1985; IN COMMERCE 0-0-1987.

THE MARK CONSISTS OF STANDARD CHARACTERS WITHOUT CLAIM TO ANY PARTICULAR FONT, STYLE, SIZE, OR COLOR.

OWNER OF U.S. REG. NO. 2,573,898.

SER. NO. 77-507,689, FILED 6-25-2008.

CHRISTINE COOPER, EXAMINING ATTORNEY

**Int. Cl.: 1**

**Prior U.S. Cls.: 1, 5, 6, 10, 26 and 46**

**Reg. No. 3,569,807**

**United States Patent and Trademark Office**

**Registered Feb. 3, 2009**

**TRADEMARK  
PRINCIPAL REGISTER**



AGRIUM ADVANCED TECHNOLOGIES (U.S.)  
INC. (DELAWARE CORPORATION)  
100 TECHNOLOGY LOOP  
SYLACAUGA, AL 35151

FOR: FERTILIZERS; CHEMICAL PREPARA-  
TIONS FOR USE IN THE MANUFACTURE OF  
FERTILIZERS, IN CLASS 1 (U.S. CLS. 1, 5, 6, 10, 26  
AND 46).

FIRST USE 6-0-2005; IN COMMERCE 6-0-2005.

OWNER OF U.S. REG. NOS. 1,737,442, 2,702,360  
AND OTHERS.

THE MARK CONSISTS OF THE WORDING  
"POLYON INSIDE" WITH THE TERM "INSIDE"  
DISPLAYED WITHIN AN OVAL AND A CURVED  
BAND SURROUNDING A PORTION OF THE TERM  
"POLYON".

SER. NO. 77-507,714, FILED 6-25-2008.

YAT SYE, LEE, EXAMINING ATTORNEY

**Int. Cl.: 10**

**Prior U.S. Cls.: 26, 39 and 44**

**United States Patent and Trademark Office**

**Reg. No. 3,569,808**

**Registered Feb. 3, 2009**

**TRADEMARK  
PRINCIPAL REGISTER**

**CT MASK**

POLARWRAP, LLC (TENNESSEE LIMITED LIABILITY COMPANY)

6047 EXECUTIVE CENTER DRIVE #8

MEMPHIS, TN 38134

FOR: RESPIRATORY MASKS FOR MEDICAL PURPOSES, IN CLASS 10 (U.S. CLS. 26, 39 AND 44).

FIRST USE 2-0-2008; IN COMMERCE 2-0-2008.

THE MARK CONSISTS OF STANDARD CHARACTERS WITHOUT CLAIM TO ANY PARTICULAR FONT, STYLE, SIZE, OR COLOR.

NO CLAIM IS MADE TO THE EXCLUSIVE RIGHT TO USE "MASK", APART FROM THE MARK AS SHOWN.

SER. NO. 77-507,753, FILED 6-25-2008.

JENNIFER MARTIN, EXAMINING ATTORNEY

**Int. Cl.: 41**

**Prior U.S. Cls.: 100, 101 and 107**

**United States Patent and Trademark Office**

**Reg. No. 3,569,809**

**Registered Feb. 3, 2009**

**SERVICE MARK  
PRINCIPAL REGISTER**

**SAMSERA**

SHARMA, SANGEETA (UNITED KINGDOM IN-  
DIVIDUAL)  
222 EAST 34TH ST,APT.# 1211, NY,NY,10016  
NEW YORK, NY 10016

FOR: ENTERTAINMENT IN THE NATURE OF  
LIVE PERFORMANCES BY MUSICAL ARTIST; EN-  
TERTAINMENT SERVICES, NAMELY, PROVIDING  
A WEB SITE FEATURING MUSICAL PERFORMAN-  
CES, MUSICAL VIDEOS, RELATED FILM CLIPS,  
PHOTOGRAPHS, AND OTHER MULTIMEDIA MA-  
TERIALS; ENTERTAINMENT, NAMELY, LIVE MU-

SIC CONCERTS; SONG WRITING SERVICES, IN  
CLASS 41 (U.S. CLS. 100, 101 AND 107).

FIRST USE 1-1-1998; IN COMMERCE 1-1-1999.

THE MARK CONSISTS OF STANDARD CHAR-  
ACTERS WITHOUT CLAIM TO ANY PARTICULAR  
FONT, STYLE, SIZE, OR COLOR.

SER. NO. 77-507,769, FILED 6-25-2008.

REGINA DRUMMOND, EXAMINING ATTORNEY

Int. Cl.: 41

Prior U.S. Cls.: 100, 101 and 107

United States Patent and Trademark Office

Reg. No. 3,569,810

Registered Feb. 3, 2009

**SERVICE MARK  
PRINCIPAL REGISTER**



ARMSTRONG'S MIDSOUTH MAFIA ORGANIZATION, LLC (MISSISSIPPI LIMITED LIABILITY COMPANY)  
3449 COBBLESTONE SOUTH  
SOUTHAVEN, MS 38672

FOR: HEALTH CLUB SERVICES, NAMELY, PROVIDING INSTRUCTION AND EQUIPMENT IN THE FIELD OF PHYSICAL EXERCISE, IN CLASS 41 (U.S. CLS. 100, 101 AND 107).

FIRST USE 6-1-2008; IN COMMERCE 6-1-2008.

NO CLAIM IS MADE TO THE EXCLUSIVE RIGHT TO USE "MIDSOUTH FITNESS", APART FROM THE MARK AS SHOWN.

THE COLOR(S) RED, WHITE, BLACK AND SKIN TONE IS/ARE CLAIMED AS A FEATURE OF THE MARK.

THE COLOR RED APPEARS IN THE WORDING "MIDSOUTH FITNESS." THE COLORS RED, WHITE AND BLACK APPEAR IN THE CIRCLE DESIGN. THE COLORS WHITE, BLACK AND SKIN TONE APPEAR IN THE ARM AND BARBELL DESIGN.

SER. NO. 77-507,774, FILED 6-25-2008.

JAY FLOWERS, EXAMINING ATTORNEY

**Int. Cl.: 29**

**Prior U.S. Cl.: 46**

**United States Patent and Trademark Office**

**Reg. No. 3,569,811**

**Registered Feb. 3, 2009**

**TRADEMARK  
PRINCIPAL REGISTER**

**skout**

SKOUT, INC. (OREGON CORPORATION)  
P.O. BOX 2421  
PORTLAND, OR 97208

FOR: FRUIT-BASED ORGANIC FOOD BARS,  
ALSO CONTAINING FRUITS, DRIED FRUITS,  
FRUIT JUICE, GRAIN, VEGETABLES, NUTS,  
SEEDS, AND/OR CHOCOLATE, IN CLASS 29 (U.S.  
CL. 46).

FIRST USE 5-19-2008; IN COMMERCE 5-19-2008.

THE MARK CONSISTS OF STANDARD CHAR-  
ACTERS WITHOUT CLAIM TO ANY PARTICULAR  
FONT, STYLE, SIZE, OR COLOR.

SER. NO. 77-507,780, FILED 6-25-2008.

ELISSA GARBER KON, EXAMINING ATTORNEY



**Int. Cl.: 7**

**Prior U.S. Cls.: 13, 19, 21, 23, 31, 34 and 35**

**Reg. No. 3,569,812**

**United States Patent and Trademark Office**

**Registered Feb. 3, 2009**

---

**TRADEMARK  
PRINCIPAL REGISTER**

**GRAPHINATOR**

FSC CUTTING TOLLS TECHNOLOGY, LLC  
(SOUTH CAROLINA LIMITED LIABILITY  
COMPANY)  
5909 OLD BUNCOMBE ROAD  
GREENVILLE, SC 29609

FOR: BITS FOR POWER DRILLS; POWER DRILL  
BITS; POWER TOOLS, NAMELY, END MILLS;  
POWER TOOLS, NAMELY, REAMERS, IN CLASS 7  
(U.S. CLS. 13, 19, 21, 23, 31, 34 AND 35).

FIRST USE 5-31-2007; IN COMMERCE 5-31-2007.

THE MARK CONSISTS OF STANDARD CHAR-  
ACTERS WITHOUT CLAIM TO ANY PARTICULAR  
FONT, STYLE, SIZE, OR COLOR.

SER. NO. 77-507,795, FILED 6-25-2008.

TARA PATE, EXAMINING ATTORNEY

**Int. Cl.: 42**

**Prior U.S. Cls.: 100 and 101**

**United States Patent and Trademark Office**

**Reg. No. 3,569,813**

**Registered Feb. 3, 2009**

**SERVICE MARK  
PRINCIPAL REGISTER**

**STB**

STB LIFESAVING TECHNOLOGIES INC. (WA-  
SHINGTON CORPORATION)  
13212 NE 16TH ST. SUITE #312  
BELLEVUE, WA 98005

FOR: DESIGN, ENGINEERING, RESEARCH, DE-  
VELOPMENT AND TESTING SERVICES IN THE  
FIELD OF POLYMERIC MATERIALS, POLYMER  
SYNTHESIS, AND MATERIALS CUSTOMIZATION  
FOR MEDICAL, SCIENTIFIC, AND TECHNOLOGI-  
CAL APPLICATIONS, IN CLASS 42 (U.S. CLS. 100  
AND 101).

FIRST USE 6-30-2007; IN COMMERCE 6-19-2008.

THE MARK CONSISTS OF STANDARD CHAR-  
ACTERS WITHOUT CLAIM TO ANY PARTICULAR  
FONT, STYLE, SIZE, OR COLOR.

SER. NO. 77-507,804, FILED 6-25-2008.

NATALIE POLZER, EXAMINING ATTORNEY

**Int. Cl.: 42**

**Prior U.S. Cls.: 100 and 101**

**United States Patent and Trademark Office**

**Reg. No. 3,569,814**

**Registered Feb. 3, 2009**

**SERVICE MARK  
PRINCIPAL REGISTER**

STB LIFESAVING TECHNOLOGIES

STB LIFESAVING TECHNOLOGIES INC. (WASHINGTON CORPORATION)  
13212 NE 16TH ST. SUITE #312  
BELLEVUE, WA 98005

FOR: DESIGN, ENGINEERING, RESEARCH, DEVELOPMENT AND TESTING SERVICES IN THE FIELD OF POLYMERIC MATERIALS, POLYMER SYNTHESIS, AND MATERIALS CUSTOMIZATION FOR MEDICAL, SCIENTIFIC, AND TECHNOLOGICAL APPLICATIONS, IN CLASS 42 (U.S. CLS. 100 AND 101).

FIRST USE 6-30-2007; IN COMMERCE 6-19-2008.

THE MARK CONSISTS OF STANDARD CHARACTERS WITHOUT CLAIM TO ANY PARTICULAR FONT, STYLE, SIZE, OR COLOR.

NO CLAIM IS MADE TO THE EXCLUSIVE RIGHT TO USE "LIFESAVING TECHNOLOGIES", APART FROM THE MARK AS SHOWN.

SER. NO. 77-507,819, FILED 6-25-2008.

NATALIE POLZER, EXAMINING ATTORNEY

**Int. Cl.: 30**

**Prior U.S. Cl.: 46**

**United States Patent and Trademark Office**

**Reg. No. 3,569,815**

**Registered Feb. 3, 2009**

**TRADEMARK  
PRINCIPAL REGISTER**

**SAZON + CUBITOS**

GOYA FOODS, INC. (DELAWARE CORPORATION)  
100 SEAVIEW DRIVE  
SECAUCUS, NY 07096

FOR: SEASONING MIXES; SEASONINGS; SPICES, IN CLASS 30 (U.S. CL. 46).

FIRST USE 10-0-2000; IN COMMERCE 10-0-2000.

THE MARK CONSISTS OF STANDARD CHARACTERS WITHOUT CLAIM TO ANY PARTICULAR FONT, STYLE, SIZE, OR COLOR.

OWNER OF U.S. REG. NO. 2,681,981.

NO CLAIM IS MADE TO THE EXCLUSIVE RIGHT TO USE "SAZON", APART FROM THE MARK AS SHOWN.

THE FOREIGN WORDING IN THE MARK TRANSLATES INTO ENGLISH AS SEASONINGS AND SMALL CUBES.

SEC. 2(F).

SER. NO. 77-507,834, FILED 6-25-2008.

MAYUR VAGHANI, EXAMINING ATTORNEY

**Int. Cls.: 39 and 40**

**Prior U.S. Cls.: 100, 103, 105 and 106**

**United States Patent and Trademark Office**

**Reg. No. 3,569,816**

**Registered Feb. 3, 2009**

**SERVICE MARK  
PRINCIPAL REGISTER**

**Conquer Your Paper Jungle**

PAPER TIGER, LLC (ILLINOIS LIMITED LIABILITY COMPANY)  
1478 W. WEBSTER  
CHICAGO, IL 60614

FOR: ELECTRONIC STORAGE OF FILES AND DOCUMENTS; PHYSICAL STORAGE OF ELECTRONICALLY-STORED DATA OR DOCUMENTS; WAREHOUSING SERVICES, NAMELY, STORAGE, DISTRIBUTION, PICK-UP, AND PACKING FOR SHIPMENT OF DOCUMENTS, PACKAGES, RAW MATERIALS, AND OTHER FREIGHT FOR OTHERS, IN CLASS 39 (U.S. CLS. 100 AND 105).

FIRST USE 6-20-2008; IN COMMERCE 6-20-2008.

FOR: DOCUMENT DESTRUCTION; DOCUMENT SHREDDING SERVICES, IN CLASS 40 (U.S. CLS. 100, 103 AND 106).

FIRST USE 6-20-2008; IN COMMERCE 6-20-2008.

THE MARK CONSISTS OF STANDARD CHARACTERS WITHOUT CLAIM TO ANY PARTICULAR FONT, STYLE, SIZE, OR COLOR.

SER. NO. 77-507,843, FILED 6-25-2008.

DAVID MILLER, EXAMINING ATTORNEY

**Int. Cl.: 35**

**Prior U.S. Cls.: 100, 101 and 102**

**United States Patent and Trademark Office**

**Reg. No. 3,569,817**

**Registered Feb. 3, 2009**

**SERVICE MARK  
PRINCIPAL REGISTER**

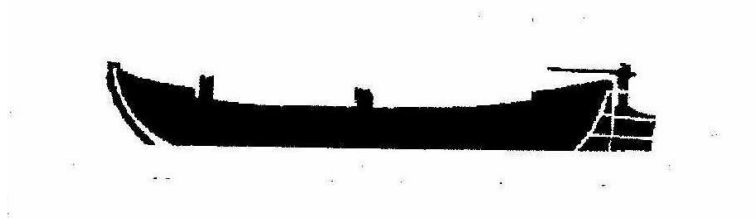

HARBOR HISTORICAL ASSOCIATION, INC.  
(SOUTH CAROLINA CORPORATION)  
P. O. BOX 2228  
GEORGETOWN, SC 29442

FOR: MARKETING AND PROMOTIONAL SERVICES IN THE FIELD OF PLANNED GIVING FOR NON-PROFIT AND CHARITABLE ORGANIZATIONS, IN CLASS 35 (U.S. CLS. 100, 101 AND 102).

FIRST USE 10-1-1991; IN COMMERCE 10-1-1991.

THE MARK CONSISTS OF WOODEN BOAT.

SER. NO. 77-507,898, FILED 6-25-2008.

ANNE E. GUSTASON, EXAMINING ATTORNEY

**Int. Cl.: 5**

**Prior U.S. Cls.: 6, 18, 44, 46, 51 and 52**

**Reg. No. 3,569,818**

**United States Patent and Trademark Office**

**Registered Feb. 3, 2009**

**TRADEMARK  
PRINCIPAL REGISTER**

**GABAdone**

TARGETED MEDICAL PHARMA INC. (CALI-  
FORNIA CORPORATION)  
SUITE 301  
2980 BEVERLY GLEN CIRCLE  
LOS ANGELES, CA 90077

FOR: AMINO ACIDS FOR MEDICAL OR VETER-  
INARY PURPOSES; AMINO ACIDS FOR NUTRI-  
TIONAL PURPOSES, IN CLASS 5 (U.S. CLS. 6, 18, 44,  
46, 51 AND 52).

FIRST USE 11-1-2003; IN COMMERCE 11-1-2003.

THE MARK CONSISTS OF STANDARD CHAR-  
ACTERS WITHOUT CLAIM TO ANY PARTICULAR  
FONT, STYLE, SIZE, OR COLOR.

SER. NO. 77-507,919, FILED 6-25-2008.

BARBARA BROWN, EXAMINING ATTORNEY

**Int. Cl.: 41**

**Prior U.S. Cls.: 100, 101 and 107**

**United States Patent and Trademark Office**

**Reg. No. 3,569,819**

**Registered Feb. 3, 2009**

---

**SERVICE MARK  
PRINCIPAL REGISTER**

**7th Wish**

STONE, CLIFFORD DOYLE (UNITED STATES  
INDIVIDUAL)  
6631 GODWIN DRIVE  
SPOTSYLVANIA, VA 22553

THE MARK CONSISTS OF STANDARD CHAR-  
ACTERS WITHOUT CLAIM TO ANY PARTICULAR  
FONT, STYLE, SIZE, OR COLOR.

FOR: COMPOSITION OF MUSIC FOR OTHERS;  
MUSIC PRODUCTION SERVICES; LIVE MUSICAL  
PERFORMANCES, IN CLASS 41 (U.S. CLS. 100, 101  
AND 107).

SER. NO. 77-507,933, FILED 6-25-2008.

FIRST USE 3-25-2003; IN COMMERCE 6-10-2003.

HEATHER THOMPSON, EXAMINING ATTORNEY



**Int. Cl.: 5**

**Prior U.S. Cls.: 6, 18, 44, 46, 51 and 52**

**Reg. No. 3,569,820**

**United States Patent and Trademark Office**

**Registered Feb. 3, 2009**

**TRADEMARK  
PRINCIPAL REGISTER**

# Trepadone

TARGETED MEDICAL PHARMA INC. (CALI-  
FORNIA CORPORATION)  
SUITE 301  
2980 BEVERLY GLEN CIRCLE  
LOS ANGELES, CA 90077

FOR: AMINO ACIDS FOR MEDICAL OR VETER-  
INARY PURPOSES; AMINO ACIDS FOR NUTRI-  
TIONAL PURPOSES, IN CLASS 5 (U.S. CLS. 6, 18, 44,  
46, 51 AND 52).

FIRST USE 11-1-2003; IN COMMERCE 11-1-2003.

THE MARK CONSISTS OF STANDARD CHAR-  
ACTERS WITHOUT CLAIM TO ANY PARTICULAR  
FONT, STYLE, SIZE, OR COLOR.

SER. NO. 77-507,939, FILED 6-25-2008.

BARBARA BROWN, EXAMINING ATTORNEY

**Int. Cl.: 30**

**Prior U.S. Cl.: 46**

**United States Patent and Trademark Office**

**Reg. No. 3,569,821**

**Registered Feb. 3, 2009**

**TRADEMARK  
PRINCIPAL REGISTER**

**AVILES**

VIRGINIA WHETSTONE (UNITED STATES IN-  
DIVIDUAL)  
297 ST. GEORGE ST.  
ST. AUGUSTINE, FL 32084

THE MARK CONSISTS OF STANDARD CHAR-  
ACTERS WITHOUT CLAIM TO ANY PARTICULAR  
FONT, STYLE, SIZE, OR COLOR.

FOR: CHOCOLATE AND CHOCOLATES, IN  
CLASS 30 (U.S. CL. 46).

SER. NO. 77-507,950, FILED 6-25-2008.

FIRST USE 3-10-2008; IN COMMERCE 3-10-2008.

TEJBIR SINGH, EXAMINING ATTORNEY

**Int. Cl.: 41**

**Prior U.S. Cls.: 100, 101 and 107**

**Reg. No. 3,569,822**

**United States Patent and Trademark Office**

**Registered Feb. 3, 2009**

**SERVICE MARK  
PRINCIPAL REGISTER**

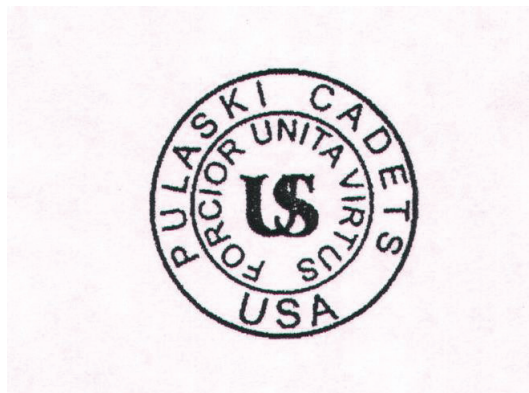

PULASKI CADETS-USA, NEW JERSEY NONPROFIT CORPORATION (NEW JERSEY CORPORATION)

429 DEVON STREET  
KEARNY, NJ 07032

FOR: CHARITABLE SERVICES, NAMELY, PROVIDING TRAINING IN THE FIELD OF MARKSMANSHIP AND MILITARY TRAINING; CONDUCTING EDUCATIONAL EXHIBITIONS IN THE NATURE OF HONORING POLISH MILITARY HERITAGE, EXHIBITING POLISH MILITARY UNIFORMS, MILITARY REENACTMENTS AND PERSONS MARCHING IN PARADES WHILE ATTIRED IN MILITARY UNIFORMS; EDUCATIONAL DEMONSTRATIONS; EDUCATIONAL SERVICES, NAMELY, PROVIDING CONVENTIONS IN THE FIELDS OF POLISH MILITARY HISTORY AND PATRIOTISM; ENTERTAINMENT IN THE NATURE OF LIVE PERFORMANCES BY PERSONS DRESSED IN MILITARY UNIFORMS; SOCIAL CLUB SERVICES, NAMELY, ARRANGING, ORGANIZING, AND HOSTING SOCIAL EVENTS, GET-

TOGETHERS, AND PARTIES FOR CLUB MEMBERS, IN CLASS 41 (U.S. CLS. 100, 101 AND 107).

FIRST USE 9-1-1995; IN COMMERCE 9-1-1995.

NO CLAIM IS MADE TO THE EXCLUSIVE RIGHT TO USE "CADETS, USA AND US", APART FROM THE MARK AS SHOWN.

THE MARK CONSISTS OF AN ANNULAR RING CONTAINING THE WORDS "PULASKI CADETS USA"; A CIRCLE DEFINED BY THE ANNULAR RING CONTAINING THE WORDS "FORCIOR UNITA VIRTUS" WITH AN OVERLAPPING US IN THE CENTER OF THE CIRCLE.

THE FOREIGN WORDING IN THE MARK TRANSLATES INTO ENGLISH AS UNITED IN VIRTUE AND FORCE.

SER. NO. 77-507,951, FILED 6-25-2008.

FRANK LATTUCA, EXAMINING ATTORNEY

**Int. Cl.: 5**

**Prior U.S. Cls.: 6, 18, 44, 46, 51 and 52**

**Reg. No. 3,569,823**

**United States Patent and Trademark Office**

**Registered Feb. 3, 2009**

**TRADEMARK  
PRINCIPAL REGISTER**

**SENTRA AM**

TARGETED MEDICAL PHARMA INC. (CALI-  
FORNIA CORPORATION)  
SUITE 301  
2980 BEVERLY GLEN CIRCLE  
LOS ANGELES, CA 90077

FOR: AMINO ACIDS FOR MEDICAL OR VETER-  
INARY PURPOSES; AMINO ACIDS FOR NUTRI-  
TIONAL PURPOSES, IN CLASS 5 (U.S. CLS. 6, 18, 44,  
46, 51 AND 52).

FIRST USE 11-1-2003; IN COMMERCE 11-1-2003.

THE MARK CONSISTS OF STANDARD CHAR-  
ACTERS WITHOUT CLAIM TO ANY PARTICULAR  
FONT, STYLE, SIZE, OR COLOR.

NO CLAIM IS MADE TO THE EXCLUSIVE  
RIGHT TO USE "AM", APART FROM THE MARK  
AS SHOWN.

SER. NO. 77-507,969, FILED 6-25-2008.

BARBARA BROWN, EXAMINING ATTORNEY

**Int. Cl.: 30**

**Prior U.S. Cl.: 46**

**United States Patent and Trademark Office**

**Reg. No. 3,569,824**

**Registered Feb. 3, 2009**

**TRADEMARK  
PRINCIPAL REGISTER**

**San Marco**

VIRGINIA WHETSTONE (AFGHANISTAN INDIVIDUAL)  
297 ST. GEORGE ST.  
ST. AUGUSTINE, FL 32084

THE MARK CONSISTS OF STANDARD CHARACTERS WITHOUT CLAIM TO ANY PARTICULAR FONT, STYLE, SIZE, OR COLOR.

FOR: CHOCOLATE AND CHOCOLATES, IN CLASS 30 (U.S. CL. 46).

SER. NO. 77-507,973, FILED 6-25-2008.

FIRST USE 3-10-2008; IN COMMERCE 3-10-2008.

TEJBIR SINGH, EXAMINING ATTORNEY

**Int. Cl.: 6**

**Prior U.S. Cls.: 2, 12, 13, 14, 23, 25 and 50**

**Reg. No. 3,569,825**

**United States Patent and Trademark Office**

**Registered Feb. 3, 2009**

**TRADEMARK  
PRINCIPAL REGISTER**

**AD-CADE**

C.J. THEOBALD III (UNITED STATES INDIVIDUAL)  
1709 CLAYTON RD.  
LOUISVILLE, KY 40205

THE MARK CONSISTS OF STANDARD CHARACTERS WITHOUT CLAIM TO ANY PARTICULAR FONT, STYLE, SIZE, OR COLOR.

FOR: METAL HOLDERS FOR SIGNS, IN CLASS 6 (U.S. CLS. 2, 12, 13, 14, 23, 25 AND 50).

SER. NO. 77-507,979, FILED 6-25-2008.

FIRST USE 3-27-2008; IN COMMERCE 3-27-2008.

REGINA DRUMMOND, EXAMINING ATTORNEY

**Int. Cl.: 5**

**Prior U.S. Cls.: 6, 18, 44, 46, 51 and 52**

**Reg. No. 3,569,826**

**United States Patent and Trademark Office**

**Registered Feb. 3, 2009**

**TRADEMARK  
PRINCIPAL REGISTER**

**SENTRA PM**

TARGETED MEDICAL PHARMA INC. (CALI-  
FORNIA CORPORATION)  
SUITE 301  
2980 BEVERLY GLEN CIRCLE  
LOS ANGELES, CA 90077

FOR: AMINO ACIDS FOR MEDICAL OR VETER-  
INARY PURPOSES; AMINO ACIDS FOR NUTRI-  
TIONAL PURPOSES, IN CLASS 5 (U.S. CLS. 6, 18, 44,  
46, 51 AND 52).

FIRST USE 11-1-2003; IN COMMERCE 11-1-2003.

THE MARK CONSISTS OF STANDARD CHAR-  
ACTERS WITHOUT CLAIM TO ANY PARTICULAR  
FONT, STYLE, SIZE, OR COLOR.

NO CLAIM IS MADE TO THE EXCLUSIVE  
RIGHT TO USE "PM", APART FROM THE MARK  
AS SHOWN.

SER. NO. 77-507,984, FILED 6-25-2008.

BARBARA BROWN, EXAMINING ATTORNEY

**Int. Cl.: 35**

**Prior U.S. Cls.: 100, 101 and 102**

**United States Patent and Trademark Office**

**Reg. No. 3,569,827**

**Registered Feb. 3, 2009**

**SERVICE MARK  
PRINCIPAL REGISTER**

**ONLY HANGERS**

MAIER, RON L. (UNITED STATES INDIVIDUAL)  
3755 NW 115TH AVE  
MIAMI, FL 33178

FOR: RETAIL STORE AND ON-LINE RETAIL  
STORE SERVICES FEATURING CLOTHING  
HANGERS, IN CLASS 35 (U.S. CLS. 100, 101 AND  
102).

FIRST USE 7-2-2006; IN COMMERCE 7-2-2006.

THE MARK CONSISTS OF STANDARD CHAR-  
ACTERS WITHOUT CLAIM TO ANY PARTICULAR  
FONT, STYLE, SIZE, OR COLOR.

NO CLAIM IS MADE TO THE EXCLUSIVE  
RIGHT TO USE "HANGERS", APART FROM THE  
MARK AS SHOWN.

SER. NO. 77-507,985, FILED 6-25-2008.

REGINA DRUMMOND, EXAMINING ATTORNEY



**Int. Cls.: 11 and 37**

**Prior U.S. Cls.: 13, 21, 23, 31, 34, 100, 103 and 106**

**United States Patent and Trademark Office**

**Reg. No. 3,569,828**

**Registered Feb. 3, 2009**

**TRADEMARK  
SERVICE MARK  
PRINCIPAL REGISTER**

**BLUE CANYON HEALTHY HOME  
SYSTEM**

DBA B-DRY, LLC (VIRGINIA LIMITED LIABILITY COMPANY)  
455 SOUTH 4TH STREET, SUITE 350  
LOUISVILLE, KY 40202

FOR: AIR VENTILATION AND QUALITY CONTROL SYSTEMS COMPRISED OF WATER REMOVAL PUMPS AND PIPING, WATERPROOFING PIPING AND SEALANT, RANDON EXHAUST EQUIPMENT, DUAL FLOW VENTILATION INFRASTRUCTURE, ENCAPSULATION SHEETING, MICROBIAL SPRAY TREATMENT, AND ONGOING AIR MONITORING AND SUPPORT EQUIPMENT, IN CLASS 11 (U.S. CLS. 13, 21, 23, 31 AND 34).

FIRST USE 2-15-2008; IN COMMERCE 2-15-2008.

FOR: REPAIR, MAINTENANCE AND CONSULTATION IN THE FIELDS OF WATERPROOFING OF

BASEMENTS AND CRAWL SPACES, FOUNDATION REPAIR SERVICES AND CONSULTATION WITH RESPECT THERETO, AND INSTALLATION AND MAINTENANCE OF AIR VENTILATION AND QUALITY CONTROL SYSTEMS AND CONSULTATION WITH RESPECT THERETO, IN CLASS 37 (U.S. CLS. 100, 103 AND 106).

FIRST USE 2-15-2008; IN COMMERCE 2-15-2008.

THE MARK CONSISTS OF STANDARD CHARACTERS WITHOUT CLAIM TO ANY PARTICULAR FONT, STYLE, SIZE, OR COLOR.

SER. NO. 77-507,988, FILED 6-25-2008.

REGINA DRUMMOND, EXAMINING ATTORNEY

**Int. Cl.: 5**

**Prior U.S. Cls.: 6, 18, 44, 46, 51 and 52**

**Reg. No. 3,569,829**

**United States Patent and Trademark Office**

**Registered Feb. 3, 2009**

**TRADEMARK  
PRINCIPAL REGISTER**

# Hypertensa

TARGETED MEDICAL PHARMA INC. (CALI-  
FORNIA CORPORATION)  
SUITE 301  
2980 BEVERLY GLEN CIRCLE  
LOS ANGELES, CA 90077

FOR: AMINO ACIDS FOR MEDICAL OR VETER-  
INARY PURPOSES; AMINO ACIDS FOR NUTRI-  
TIONAL PURPOSES, IN CLASS 5 (U.S. CLS. 6, 18, 44,  
46, 51 AND 52).

FIRST USE 11-1-2003; IN COMMERCE 11-1-2003.

THE MARK CONSISTS OF STANDARD CHAR-  
ACTERS WITHOUT CLAIM TO ANY PARTICULAR  
FONT, STYLE, SIZE, OR COLOR.

SER. NO. 77-507,996, FILED 6-25-2008.

BARBARA BROWN, EXAMINING ATTORNEY

Int. Cl.: 8

Prior U.S. Cls.: 23, 28 and 44

Reg. No. 3,569,830

United States Patent and Trademark Office

Registered Feb. 3, 2009

TRADEMARK  
PRINCIPAL REGISTER



RICK HINDERER (UNITED STATES INDIVIDUAL), DBA HINDERER KNIVES

5373 COLUMBUS ROAD

SHREVE, OH 44676

FOR: KNIVES, IN CLASS 8 (U.S. CLS. 23, 28 AND 44).

FIRST USE 7-1-2003; IN COMMERCE 7-1-2003.

NO CLAIM IS MADE TO THE EXCLUSIVE RIGHT TO USE "KNIVES" , APART FROM THE MARK AS SHOWN.

THE MARK CONSISTS OF THE WORDS "HINDERER" AND "KNIVES" AND A STYLIZED HORSE HEAD.

SER. NO. 77-508,038, FILED 6-25-2008.

MARK PILARO, EXAMINING ATTORNEY

**Int. Cl.: 7**

**Prior U.S. Cls.: 13, 19, 21, 23, 31, 34 and 35**

**Reg. No. 3,569,831**

**United States Patent and Trademark Office**

**Registered Feb. 3, 2009**

**TRADEMARK  
PRINCIPAL REGISTER**

**TSUDO**

ULTIMATE PRODUCT CORPORATION (CALIFORNIA CORPORATION)  
3231 EVERGREEN AVENUE  
W SACRAMENTO, CA 956912905

FOR: AUTOMOTIVE PRODUCTS, NAMELY, EXHAUST SYSTEMS COMPRISED OF MUFFLERS, MUFFLER TIPS, HANGERS FOR MUFFLERS, PIPING FOR MUFFLERS , IN CLASS 7 (U.S. CLS. 13, 19, 21, 23, 31, 34 AND 35).

FIRST USE 12-0-1998; IN COMMERCE 12-0-1998.

THE MARK CONSISTS OF STANDARD CHARACTERS WITHOUT CLAIM TO ANY PARTICULAR FONT, STYLE, SIZE, OR COLOR.

OWNER OF U.S. REG. NO. 2,584,480.

THE FOREIGN WORDING IN THE MARK TRANSLATES INTO ENGLISH AS SPEED.

SER. NO. 77-508,047, FILED 6-25-2008.

JAMES GRIFFIN, EXAMINING ATTORNEY

**Int. Cl.: 30**

**Prior U.S. Cl.: 46**

**United States Patent and Trademark Office**

**Reg. No. 3,569,832**

**Registered Feb. 3, 2009**

**TRADEMARK  
PRINCIPAL REGISTER**

**Lazwaab**

SAI CREATIONS LLC (ILLINOIS LIMITED LIABILITY COMPANY)  
1190 MCCORMICK STREET  
CAROL STREAM, IL 60188

FOR: WAFERS ; COOKIES ; TEA BISCUITS, IN CLASS 30 (U.S. CL. 46).

FIRST USE 8-6-2006; IN COMMERCE 8-6-2006.

THE MARK CONSISTS OF STANDARD CHARACTERS WITHOUT CLAIM TO ANY PARTICULAR FONT, STYLE, SIZE, OR COLOR.

THE ENGLISH TRANSLATION OF "LAZWAAB" IS WONDERFUL.

SER. NO. 77-508,049, FILED 6-25-2008.

JAMES GRIFFIN, EXAMINING ATTORNEY

Int. Cl.: 42

Prior U.S. Cls.: 100 and 101

United States Patent and Trademark Office

Reg. No. 3,569,833

Registered Feb. 3, 2009

SERVICE MARK  
PRINCIPAL REGISTER



CHANTEST CORPORATION (OHIO CORPORATION)  
14656 NEO PARKWAY  
CLEVELAND, OH 44128

FOR: BIOLOGICAL RESEARCH; DEVELOPMENT OF NEW TECHNOLOGY FOR OTHERS IN THE FIELD OF BIOTECHNOLOGY, PHARMACEUTICALS AND DRUG SCREENING; MEDICAL AND SCIENTIFIC RESEARCH IN THE FIELD OF BIOTECHNOLOGY, PHARMACEUTICALS AND DRUG SCREENING; MEDICAL RESEARCH; PRODUCT SAFETY TESTING; PRODUCT TESTING; PROVIDING MEDICAL AND SCIENTIFIC RESEARCH INFORMATION IN THE FIELD OF PHARMACEUTICALS AND CLINICAL TRIALS; PROVIDING REAGENT SAMPLE TESTING AND DIAGNOSTIC SERVICES FOR OTHERS IN THE FIELDS OF SCIENCE AND RESEARCH RELATED THERETO; REPAIR OF DAMAGED COMPUTER PROGRAMS; RESEARCH AND DEVELOPMENT OF VACCINES AND MEDICINES; RESEARCH IN THE FIELD OF CHEMISTRY; RESEARCH ON THE SUBJECT OF PHARMACEUTICALS; SCIENTIFIC INVESTIGATIONS FOR MEDICAL PURPOSES;

SCIENTIFIC RESEARCH AND DEVELOPMENT; TECHNOLOGY CONSULTATION AND RESEARCH IN THE FIELD OF BIOTECHNOLOGY, PHARMACEUTICALS AND DRUG SCREENING; TESTING, INSPECTION OR RESEARCH OF PHARMACEUTICALS, COSMETICS OR FOODSTUFF, IN CLASS 42 (U.S. CLS. 100 AND 101).

FIRST USE 2-12-2008; IN COMMERCE 2-12-2008.

THE COLOR(S) BLUE, WHITE AND GRAY IS/ARE CLAIMED AS A FEATURE OF THE MARK.

THE MARK CONSISTS OF A DESIGN OF A BLUE OVAL CONTAINING THE WORDING "CHANTEST" IN A STYLIZED FONT IN WHITE AND A DESIGN OF STRAIGHT POLYGONS AND A CURVED POLYGON IN GRAY.

SER. NO. 77-508,053, FILED 6-25-2008.

RENEE MCCRAY, EXAMINING ATTORNEY

**Int. Cls.: 25 and 43**

**Prior U.S. Cls.: 22, 39, 100 and 101**

**United States Patent and Trademark Office**

**Reg. No. 3,569,834**

**Registered Feb. 3, 2009**

**TRADEMARK  
SERVICE MARK  
PRINCIPAL REGISTER**

**Twin  Turtles**

BOOKER, KELVIN E. (UNITED STATES INDIVIDUAL)  
5570 NEW KENT ROAD  
RICHMOND, VA 23225

FOR: HATS; SHOES; SHORTS; SWEAT SHIRTS; T-SHIRTS, IN CLASS 25 (U.S. CLS. 22 AND 39).

FIRST USE 9-1-2007; IN COMMERCE 9-1-2007.

FOR: HOTEL SERVICES; RESORT LODGING SERVICES, IN CLASS 43 (U.S. CLS. 100 AND 101).

FIRST USE 9-1-2007; IN COMMERCE 9-1-2007.

THE STIPPLING IS FOR SHADING PURPOSES ONLY.

THE MARK CONSISTS OF THE STYLIZED WORDS "TWIN TURTLES". IN BETWEEN THE WORDS "TWIN" AND "TURTLES" IS AN IMAGE OF A SUN WITH FLARES. IN THE CENTER OF THE SUN IS AN IMAGE OF A PAIR OF TURTLES WITH CONNECTING FINS. SMALL DOTS AROUND THE LETTER "E" IN "TURTLES."

SER. NO. 77-508,060, FILED 6-25-2008.

LINDA ORNDORFF, EXAMINING ATTORNEY

**Int. Cl.: 35**

**Prior U.S. Cls.: 100, 101 and 102**

**United States Patent and Trademark Office**

**Reg. No. 3,569,835**

**Registered Feb. 3, 2009**

**SERVICE MARK  
PRINCIPAL REGISTER**

**CRAZY K FARM**

CRAZY K POULTRY AND LIVESTOCK, LLC  
(TEXAS LIMITED LIABILITY COMPANY)  
28384 MELLMAN ROAD  
HEMPSTEAD, TX 77445

FOR: RETAIL STORE AND ON-LINE RETAIL  
STORE SERVICES FEATURING CHICKEN AND  
DUCK EGGS, POULTRY, AND AVIAN, PARROT  
AND AVIAN PET-RELATED ITEMS; WHOLESALE  
DISTRIBUTORSHIPS FEATURING CHICKEN AND  
DUCK EGGS, POULTRY, AND AVIAN, PARROT  
AND AVIAN PET-RELATED ITEMS, IN CLASS 35  
(U.S. CLS. 100, 101 AND 102).

FIRST USE 10-9-2006; IN COMMERCE 1-15-2008.

THE MARK CONSISTS OF STANDARD CHAR-  
ACTERS WITHOUT CLAIM TO ANY PARTICULAR  
FONT, STYLE, SIZE, OR COLOR.

NO CLAIM IS MADE TO THE EXCLUSIVE  
RIGHT TO USE "FARM", APART FROM THE  
MARK AS SHOWN.

SER. NO. 77-508,061, FILED 6-25-2008.

ELISSA GARBER KON, EXAMINING ATTORNEY



Int. Cl.: 42

Prior U.S. Cls.: 100 and 101

United States Patent and Trademark Office

Reg. No. 3,569,836

Registered Feb. 3, 2009

SERVICE MARK  
PRINCIPAL REGISTER



*The Ion Channel Company*

CHANTEST CORPORATION (OHIO CORPORATION)  
14656 NEO PARKWAY  
CLEVELAND, OH 44128

FOR: BIOLOGICAL RESEARCH; DEVELOPMENT OF NEW TECHNOLOGY FOR OTHERS IN THE FIELD OF BIOTECHNOLOGY, PHARMACEUTICALS AND DRUG SCREENING; MEDICAL AND SCIENTIFIC RESEARCH IN THE FIELD OF BIOTECHNOLOGY, PHARMACEUTICALS AND DRUG SCREENING; MEDICAL RESEARCH; PRODUCT SAFETY TESTING; PRODUCT TESTING; PROVIDING MEDICAL AND SCIENTIFIC RESEARCH INFORMATION IN THE FIELD OF PHARMACEUTICALS AND CLINICAL TRIALS; PROVIDING REAGENT SAMPLE TESTING AND DIAGNOSTIC SERVICES FOR OTHERS IN THE FIELDS OF SCIENCE AND RESEARCH RELATED THERETO; REPAIR OF DAMAGED COMPUTER PROGRAMS; RESEARCH AND DEVELOPMENT OF VACCINES AND MEDICINES; RESEARCH IN THE FIELD OF CHEMISTRY; RESEARCH ON THE SUBJECT OF PHARMACEUTICALS; SCIENTIFIC INVESTIGATIONS FOR MEDICAL PURPOSES; SCIENTIFIC RESEARCH AND DEVELOPMENT; TECHNOLOGY CONSULTATION AND RESEARCH IN THE FIELD OF BIOTECHNOLOGY, PHARMA-

CEUTICALS AND DRUG SCREENING; TESTING, INSPECTION OR RESEARCH OF PHARMACEUTICALS, COSMETICS OR FOODSTUFF, IN CLASS 42 (U.S. CLS. 100 AND 101).

FIRST USE 2-12-2008; IN COMMERCE 2-12-2008.

NO CLAIM IS MADE TO THE EXCLUSIVE RIGHT TO USE "ION CHANNEL COMPANY", APART FROM THE MARK AS SHOWN.

THE COLOR(S) BLUE, WHITE, GRAY AND BLACK IS/ARE CLAIMED AS A FEATURE OF THE MARK.

THE MARK CONSISTS OF A DESIGN OF A BLUE OVAL CONTAINING THE WORDING "CHANTEST" IN A STYLIZED FONT IN WHITE AND A DESIGN OF STRAIGHT POLYGONS AND A CURVED POLYGON IN GRAY, WITH THE WORDING "THE ION CHANNEL COMPANY" IN A STYLIZED FONT IN BLACK BENEATH THE OVAL.

SER. NO. 77-508,063, FILED 6-25-2008.

RENEE MCCRAY, EXAMINING ATTORNEY

**Int. Cl.: 5**

**Prior U.S. Cls.: 6, 18, 44, 46, 51 and 52**

**Reg. No. 3,569,837**

**United States Patent and Trademark Office**

**Registered Feb. 3, 2009**

**TRADEMARK  
PRINCIPAL REGISTER**

**O2X**

GREENHOUSE INTERNATIONAL, LLC (DELA-  
WARE LIMITED LIABILITY COMPANY)  
100 DEAN DRIVE  
NEWARK, DE 19711

THE MARK CONSISTS OF STANDARD CHAR-  
ACTERS WITHOUT CLAIM TO ANY PARTICULAR  
FONT, STYLE, SIZE, OR COLOR.

FOR: DIETARY AND NUTRITIONAL SUPPLE-  
MENTS; GROUND FLAXSEED FIBER FOR USE AS  
A DIETARY SUPPLEMENT, IN CLASS 5 (U.S. CLS. 6,  
18, 44, 46, 51 AND 52).

SER. NO. 77-508,064, FILED 6-25-2008.

FIRST USE 6-23-2008; IN COMMERCE 6-23-2008.

LINDA ORNDORFF, EXAMINING ATTORNEY

**Int. Cl.: 37**

**Prior U.S. Cls.: 100, 103 and 106**

**United States Patent and Trademark Office**

**Reg. No. 3,569,838**

**Registered Feb. 3, 2009**

**SERVICE MARK  
PRINCIPAL REGISTER**



NETMERGENCE, INC. (NEVADA CORPORATION)  
529 W. 2ND ST.  
RENO, NV 89503

FOR: COMPUTER INSTALLATION AND REPAIR; INSTALLATION, MAINTENANCE AND REPAIR OF COMPUTER HARDWARE; MAINTENANCE AND REPAIR OF COMPUTER NETWORKS; UPGRADING OF COMPUTER HARDWARE, IN CLASS 37 (U.S. CLS. 100, 103 AND 106).

FIRST USE 10-2-2007; IN COMMERCE 10-25-2007.

THE MARK CONSISTS OF THE STYLIZED LETTER "N" INSIDE A ABSTRACT DESIGN. THE ABSTRACT DESIGN CONSISTS OF TWO ARROWS WITH 90 DEGREE BENDS POINTED TOWARDS THE TAILS OF ONE ANOTHER. IN THE NEGATIVE SPACE BETWEEN THE TWO ARROWS IS THE LETTER "N."

SER. NO. 77-508,065, FILED 6-25-2008.

KOURTNEE HODGES, EXAMINING ATTORNEY

**Int. Cl.: 42**

**Prior U.S. Cls.: 100 and 101**

**United States Patent and Trademark Office**

**Reg. No. 3,569,839**

**Registered Feb. 3, 2009**

**SERVICE MARK  
PRINCIPAL REGISTER**

**EduStor**

REMOTE INTERNET STORAGE, LLC (NEW  
YORK LIMITED LIABILITY COMPANY),  
DBA VOCES GROUP, LLC  
28 W 75TH ST 1A  
NEW YORK CITY, NY 10023

THE MARK CONSISTS OF STANDARD CHAR-  
ACTERS WITHOUT CLAIM TO ANY PARTICULAR  
FONT, STYLE, SIZE, OR COLOR.

FOR: BACK-UP SERVICES FOR COMPUTER  
HARD DRIVE DATA, IN CLASS 42 (U.S. CLS. 100  
AND 101).

SER. NO. 77-508,076, FILED 6-25-2008.

FIRST USE 1-18-2007; IN COMMERCE 1-18-2007.

LYDIA BELZER, EXAMINING ATTORNEY

**Int. Cl.: 35**

**Prior U.S. Cls.: 100, 101 and 102**

**Reg. No. 3,569,840**

**United States Patent and Trademark Office**

**Registered Feb. 3, 2009**

**SERVICE MARK  
PRINCIPAL REGISTER**



GORILLA DESIGN STUDIO LLC (LOUISIANA  
LIMITED LIABILITY COMPANY)  
1211 HAWN AVENUE  
SHREVEPORT, LA 71107

FIRST USE 11-30-2005; IN COMMERCE 11-30-2005.

FOR: ADVERTISING AND PUBLICITY SERVICES, NAMELY, PROMOTING THE GOODS, SERVICES, BRAND IDENTITY AND COMMERCIAL INFORMATION AND NEWS OF THIRD PARTIES THROUGH PRINT, AUDIO, VIDEO, DIGITAL AND ON-LINE MEDIUM; ADVERTISING SERVICES, NAMELY, CREATING CORPORATE AND BRAND IDENTITY FOR OTHERS; ADVERTISING SERVICES, NAMELY, CREATING CORPORATE LOGOS FOR OTHERS; DESIGN OF ADVERTISING MATERIALS FOR OTHERS; DESIGN OF INTERNET ADVERTISING; PROVIDING ADVERTISING SERVICES USING 3D AND ANIMATION DESIGNS, IN CLASS 35 (U.S. CLS. 100, 101 AND 102).

NO CLAIM IS MADE TO THE EXCLUSIVE RIGHT TO USE "DESIGN STUDIO", APART FROM THE MARK AS SHOWN.

THE MARK CONSISTS OF AN IMAGE OF A GORILLA WITH TWO PALM TREES ON EACH SIDE. THE STYLIZED WORDS "GORILLA DESIGN STUDIO" IS BELOW THE IMAGE OF THE GORILLA. AN IMAGE OF A STAR IS IN BETWEEN THE WORDS "DESIGN" AND "STUDIO".

SER. NO. 77-508,087, FILED 6-25-2008.

KIM SAITO, EXAMINING ATTORNEY

**Int. Cl.: 9**

**Prior U.S. Cls.: 21, 23, 26, 36 and 38**

**Reg. No. 3,569,841**

**United States Patent and Trademark Office**

**Registered Feb. 3, 2009**

**TRADEMARK  
PRINCIPAL REGISTER**

**ATTUNE**

ROBERTS, CRAIG S. (UNITED STATES INDIVIDUAL)  
145 WEST 96TH STREET, APT. 3B  
NEW YORK, NY 10025

THE MARK CONSISTS OF STANDARD CHARACTERS WITHOUT CLAIM TO ANY PARTICULAR FONT, STYLE, SIZE, OR COLOR.

FOR: DVDS FEATURING INFORMATION AND INSTRUCTION IN THE FIELDS OF FITNESS, EXERCISE, STRENGTH AND CONDITIONING, GENERAL HEALTH AND WELL-BEING, IN CLASS 9 (U.S. CLS. 21, 23, 26, 36 AND 38).

OWNER OF U.S. REG. NO. 3,201,916.

SER. NO. 77-508,159, FILED 6-25-2008.

FIRST USE 2-4-2008; IN COMMERCE 2-4-2008.

JULIE GUTTADAURO, EXAMINING ATTORNEY

**Int. Cl.: 14**

**Prior U.S. Cls.: 2, 27, 28 and 50**

**United States Patent and Trademark Office**

**Reg. No. 3,569,842**

**Registered Feb. 3, 2009**

**TRADEMARK  
PRINCIPAL REGISTER**

**TIFFANY LEGACY**

TIFFANY (NJ) LLC (DELAWARE LIMITED LIABILITY COMPANY)  
15 SYLVAN WAY  
PARSIPPANY, NJ 07054

FOR: JEWELRY AND RINGS, IN CLASS 14 (U.S. CLS. 2, 27, 28 AND 50).

FIRST USE 2-0-2007; IN COMMERCE 4-0-2007.

THE MARK CONSISTS OF STANDARD CHARACTERS WITHOUT CLAIM TO ANY PARTICULAR FONT, STYLE, SIZE, OR COLOR.

OWNER OF U.S. REG. NOS. 133,063, 3,310,859 AND OTHERS.

SER. NO. 77-508,161, FILED 6-25-2008.

GINA HAYES, EXAMINING ATTORNEY

**Int. Cl.: 9**

**Prior U.S. Cls.: 21, 23, 26, 36 and 38**

**Reg. No. 3,569,843**

**United States Patent and Trademark Office**

**Registered Feb. 3, 2009**

**TRADEMARK  
PRINCIPAL REGISTER**

**KITCHEN ELEMENTS**

DOLLAR GENERAL MERCHANDISING, INC.  
(TENNESSEE CORPORATION)  
100 MISSION RIDGE  
GOODLETTSVILLE, TN 37072

OWNER OF U.S. REG. NO. 2,589,304.

FOR: MEASURING SPOONS, IN CLASS 9 (U.S.  
CLS. 21, 23, 26, 36 AND 38).

NO CLAIM IS MADE TO THE EXCLUSIVE  
RIGHT TO USE "KITCHEN", APART FROM THE  
MARK AS SHOWN.

FIRST USE 9-0-2006; IN COMMERCE 9-0-2006.

SER. NO. 77-508,179, FILED 6-25-2008.

THE MARK CONSISTS OF STANDARD CHAR-  
ACTERS WITHOUT CLAIM TO ANY PARTICULAR  
FONT, STYLE, SIZE, OR COLOR.

GIANCARLO CASTRO, EXAMINING ATTORNEY



**Int. Cl.: 21**

**Prior U.S. Cls.: 2, 13, 23, 29, 30, 33, 40 and 50**

**Reg. No. 3,569,844**

**United States Patent and Trademark Office**

**Registered Feb. 3, 2009**

**TRADEMARK  
PRINCIPAL REGISTER**

**KITCHEN ELEMENTS**

DOLLAR GENERAL MERCHANDISING, INC.  
(TENNESSEE CORPORATION)  
100 MISSION RIDGE  
GOODLETTSVILLE, TN 37072

FOR: COOKWARE, NAMELY, COOKING POTS AND PANS, SKILLETS, FRYING PANS, TEA KETTLES; BAKEWARE, NAMELY, CAKE PANS, CUP-CAKE PANS, LOAF PANS; KITCHEN UTENSILS, NAMELY, SLOTTED SPOONS, SPATULAS, TURNERS; SPICE RACKS; KNIFE BLOCKS, IN CLASS 21 (U.S. CLS. 2, 13, 23, 29, 30, 33, 40 AND 50).

FIRST USE 9-0-2005; IN COMMERCE 9-0-2005.

THE MARK CONSISTS OF STANDARD CHARACTERS WITHOUT CLAIM TO ANY PARTICULAR FONT, STYLE, SIZE, OR COLOR.

OWNER OF U.S. REG. NO. 2,589,304.

NO CLAIM IS MADE TO THE EXCLUSIVE RIGHT TO USE "KITCHEN", APART FROM THE MARK AS SHOWN.

SER. NO. 77-508,209, FILED 6-25-2008.

GIANCARLO CASTRO, EXAMINING ATTORNEY

**Int. Cl.: 35**

**Prior U.S. Cls.: 100, 101 and 102**

**United States Patent and Trademark Office**

**Reg. No. 3,569,845**

**Registered Feb. 3, 2009**

**SERVICE MARK  
PRINCIPAL REGISTER**

**ASHBALAND**

DJ ASHBA (UNITED STATES INDIVIDUAL)  
700 SAN VICENTE, SUITE G410  
WEST HOLLYWOOD, CA 90069

FIRST USE 3-3-2003; IN COMMERCE 3-3-2003.

FOR: ONLINE RETAIL STORE SERVICES FEATURING DOWNLOADABLE RING TONES, CLOTHING, HEADWEAR, PRINTED MATTER, DECORATIVE MAGNETS, MOUSE PADS, WALL CLOCKS, DOG CLOTHING, MUGS, DRINKING STEINS, BUTTONS, AND GUITARS, IN CLASS 35 (U.S. CLS. 100, 101 AND 102).

THE MARK CONSISTS OF STANDARD CHARACTERS WITHOUT CLAIM TO ANY PARTICULAR FONT, STYLE, SIZE, OR COLOR.

SER. NO. 77-508,224, FILED 6-25-2008.

SKYE YOUNG, EXAMINING ATTORNEY

**Int. Cl.: 8**

**Prior U.S. Cls.: 23, 28 and 44**

**United States Patent and Trademark Office**

**Reg. No. 3,569,846**

**Registered Feb. 3, 2009**

**TRADEMARK  
PRINCIPAL REGISTER**

**KITCHEN ELEMENTS**

DOLLAR GENERAL MERCHANDISING, INC.  
(TENNESSEE CORPORATION)  
100 MISSION RIDGE  
GOODLETTSVILLE, TN 37072

OWNER OF U.S. REG. NO. 2,589,304.

FOR: PIZZA CUTTERS; PARING KNIVES; VEGETABLE PEELERS, IN CLASS 8 (U.S. CLS. 23, 28 AND 44).

NO CLAIM IS MADE TO THE EXCLUSIVE RIGHT TO USE "KITCHEN", APART FROM THE MARK AS SHOWN.

FIRST USE 9-0-2006; IN COMMERCE 9-0-2006.

SER. NO. 77-508,236, FILED 6-25-2008.

THE MARK CONSISTS OF STANDARD CHARACTERS WITHOUT CLAIM TO ANY PARTICULAR FONT, STYLE, SIZE, OR COLOR.

GIANCARLO CASTRO, EXAMINING ATTORNEY

**Int. Cl.: 41**

**Prior U.S. Cls.: 100, 101 and 107**

**United States Patent and Trademark Office**

**Reg. No. 3,569,847**

**Registered Feb. 3, 2009**

**SERVICE MARK  
PRINCIPAL REGISTER**

**ASHBALAND**

DJ ASHBA (UNITED STATES INDIVIDUAL)  
700 SAN VICENTE, SUITE G410  
WEST HOLLYWOOD, CA 90069

THE MARK CONSISTS OF STANDARD CHAR-  
ACTERS WITHOUT CLAIM TO ANY PARTICULAR  
FONT, STYLE, SIZE, OR COLOR.

FOR: PRODUCTION SERVICES IN THE FIELDS  
OF FILM, TELEVISION, TELEVISION COMMER-  
CIALS, VIDEO, GAMES AND MUSIC, IN CLASS 41  
(U.S. CLS. 100, 101 AND 107).

SER. NO. 77-508,243, FILED 6-25-2008.

FIRST USE 9-0-2006; IN COMMERCE 9-0-2006.

SKYE YOUNG, EXAMINING ATTORNEY

**Int. Cl.: 25**

**Prior U.S. Cls.: 22 and 39**

**United States Patent and Trademark Office**

**Reg. No. 3,569,848**

**Registered Feb. 3, 2009**

**TRADEMARK  
PRINCIPAL REGISTER**

**JACK DANIEL'S WORLD  
CHAMPIONSHIP INVITATIONAL  
BARBECUE**

JACK DANIEL'S PROPERTIES, INC. (DELA-  
WARE CORPORATION)  
SUITE 528  
4040 CIVIC CENTER DRIVE  
SAN RAFAEL, CA 94903

FOR: HEADGEAR, NAMELY, CAPS, HATS, VI-  
SORS, BANDANNAS; CLOTHING, NAMELY,  
APRONS, T-SHIRTS, GOLF SHIRTS, BASEBALL  
SHIRTS, POLO SHIRTS, WOMEN'S SHIRTS, TOPS,  
TANK TOPS, SWEATSHIRTS, IN CLASS 25 (U.S. CLS.  
22 AND 39).

FIRST USE 10-31-1989; IN COMMERCE 10-31-1989.

THE MARK CONSISTS OF STANDARD CHAR-  
ACTERS WITHOUT CLAIM TO ANY PARTICULAR  
FONT, STYLE, SIZE, OR COLOR.

OWNER OF U.S. REG. NOS. 582,789, 1,329,704 AND  
OTHERS.

NO CLAIM IS MADE TO THE EXCLUSIVE  
RIGHT TO USE "BARBECUE", APART FROM THE  
MARK AS SHOWN.

THE NAME(S), PORTRAIT(S), AND/OR SIGNA-  
TURE(S) SHOWN IN THE MARK DOES NOT IDENT-  
TIFY A PARTICULAR LIVING INDIVIDUAL.

SER. NO. 77-508,253, FILED 6-25-2008.

STEPHEN AQUILA, EXAMINING ATTORNEY

**Int. Cl.: 25**

**Prior U.S. Cls.: 22 and 39**

**United States Patent and Trademark Office**

**Reg. No. 3,569,849**

**Registered Feb. 3, 2009**

**TRADEMARK  
PRINCIPAL REGISTER**



NELSON CHAN (PHILIPPINES INDIVIDUAL)  
1318 FRANCO COR. MORIONES STS.  
TONDO, MANILA, PHILIPPINES

FIRST USE 9-18-2006; IN COMMERCE 9-18-2006.

FOR: MEN'S AND WOMEN'S APPAREL, NAME-  
LY, POLO SHIRTS, SWEATERS, SWEATER SETS;  
OUTERWEAR IN THE NATURE OF JACKETS,  
FLEECE PULLOVERS AND WINDSHIRTS; PANTS,  
SHORTS, SKORTS, SKIRTS, CAPS, VISORS, T-  
SHIRTS, SWEATSHIRTS, BRIEFS, SOCKS, SHOES  
AND SANDALS, IN CLASS 25 (U.S. CLS. 22 AND 39).

THE MARK CONSISTS OF A STYLIZED LOWER-  
CASE LETTER "F", FOLLOWED BY AN APOSTRO-  
PHE, FOLLOWED BY A STYLIZED LOWERCASE  
LETTER "G".

SER. NO. 77-508,278, FILED 6-25-2008.

LANA PHAM, EXAMINING ATTORNEY

**Int. Cl.: 35**

**Prior U.S. Cls.: 100, 101 and 102**

**United States Patent and Trademark Office**

**Reg. No. 3,569,850**

**Registered Feb. 3, 2009**

**SERVICE MARK  
PRINCIPAL REGISTER**

# Progressive Concepts

HOPPE, ERIC D. (UNITED STATES INDIVIDUAL)  
305 SOUTH BARTLETT ROAD  
STREAMWOOD, IL 60107

FOR: CATALOG ORDERING SERVICE FEATURING RADIO BROADCASTING EQUIPMENT; OPERATING AN ON-LINE SHOPPING SITE IN THE FIELD OF RADIO BROADCASTING EQUIPMENT, IN CLASS 35 (U.S. CLS. 100, 101 AND 102).

FIRST USE 6-16-1989; IN COMMERCE 6-16-1989.

THE MARK CONSISTS OF STANDARD CHARACTERS WITHOUT CLAIM TO ANY PARTICULAR FONT, STYLE, SIZE, OR COLOR.

SER. NO. 77-508,343, FILED 6-25-2008.

ARETHA SOMERVILLE, EXAMINING ATTORNEY

**Int. Cl.: 40**

**Prior U.S. Cls.: 100, 103 and 106**

**United States Patent and Trademark Office**

**Reg. No. 3,569,851**

**Registered Feb. 3, 2009**

**SERVICE MARK  
PRINCIPAL REGISTER**



H-SQUARED, LLC (WASHINGTON LIMITED  
LIABILITY COMPANY)  
16350 SE 66TH STREET  
BELLEVUE, WA 98006

FOR: MANUFACTURING SERVICES FOR OTHERS IN THE FIELD OF COMPUTER FURNISHING AND ACCESSORIES FOR COMPUTING AND ELECTRONIC PERIPHERALS, IN CLASS 40 (U.S. CLS. 100, 103 AND 106).

FIRST USE 5-1-2008; IN COMMERCE 5-1-2008.

THE STIPPLING IS FOR SHADING PURPOSES ONLY.

THE MARK CONSISTS OF A STYLIZED "H" THAT IS IN THE SHAPE OF A SYMBOL REMINISCENT OF THE INTERNATIONAL SYMBOL FOR POWER SWITCH. THERE IS A MOSTLY CLOSED CIRCLE WITH A LINE GOING FROM SLIGHTLY ABOVE THE CIRCLE THROUGH TO THE CENTER.

SER. NO. 77-508,349, FILED 6-25-2008.

TRACY CROSS, EXAMINING ATTORNEY



**Int. Cl.: 42**

**Prior U.S. Cls.: 100 and 101**

**United States Patent and Trademark Office**

**Reg. No. 3,569,852**

**Registered Feb. 3, 2009**

**SERVICE MARK  
PRINCIPAL REGISTER**

**WE CAN SAVE IT!**

DRIVESAVERS, INC. (CALIFORNIA CORPORATION)  
400 BEL MARIN KEYS BOULEVARD  
NOVATO, CA 94949

FOR: COMPUTER SERVICES, NAMELY, DATA RECOVERY SERVICES; RECOVERY OF COMPUTER DATA, IN CLASS 42 (U.S. CLS. 100 AND 101).

FIRST USE 12-31-1996; IN COMMERCE 12-31-1996.

THE MARK CONSISTS OF STANDARD CHARACTERS WITHOUT CLAIM TO ANY PARTICULAR FONT, STYLE, SIZE, OR COLOR.

SEC. 2(F).

SER. NO. 77-508,365, FILED 6-25-2008.

REGINA DRUMMOND, EXAMINING ATTORNEY

**Int. Cl.: 9**

**Prior U.S. Cls.: 21, 23, 26, 36 and 38**

**Reg. No. 3,569,853**

**United States Patent and Trademark Office**

**Registered Feb. 3, 2009**

---

**TRADEMARK  
PRINCIPAL REGISTER**

**SKILLBUILDING BUDDIES**

MAZZARELLA MEDIA, LLC (CONNECTICUT  
LIMITED LIABILITY COMPANY)  
P.O. BOX 86  
51 CAMERON DRIVE  
BRISTOL, CT 06011

FIRST USE 4-0-2007; IN COMMERCE 9-0-2007.

THE MARK CONSISTS OF STANDARD CHAR-  
ACTERS WITHOUT CLAIM TO ANY PARTICULAR  
FONT, STYLE, SIZE, OR COLOR.

FOR: DIGITAL MATERIALS, NAMELY, DVDS,  
DOWNLOADABLE VIDEO FILES FEATURING  
CHILDREN'S EDUCATION AND ENTERTAIN-  
MENT, IN CLASS 9 (U.S. CLS. 21, 23, 26, 36 AND 38).

SER. NO. 77-508,369, FILED 6-25-2008.

REGINA DRUMMOND, EXAMINING ATTORNEY

Int. Cl.: 35

Prior U.S. Cls.: 100, 101 and 102

United States Patent and Trademark Office

Reg. No. 3,569,854

Registered Feb. 3, 2009

SERVICE MARK  
PRINCIPAL REGISTER



GOLD-N-DETECTORS

CHAPMAN, WILLIAM (UNITED STATES INDIVIDUAL)  
802 WASHINGTON AVENUE  
GOLDEN, CO 80401

FOR: RETAIL STORE SERVICES FEATURING ELECTRONIC METAL DETECTION EQUIPMENT AND GOLD PROSPECTING SUPPLIES, IN CLASS 35 (U.S. CLS. 100, 101 AND 102).

FIRST USE 8-15-1996; IN COMMERCE 8-15-1996.

NO CLAIM IS MADE TO THE EXCLUSIVE RIGHT TO USE "GOLDEN DETECTORS", APART FROM THE MARK AS SHOWN.

THE MARK CONSISTS OF A BEARDED, HAT WEARING PROSPECTOR WITH A PICK OVER HIS RIGHT SHOULDER AND A METAL DETECTOR IN HIS LEFT HAND, AND A HORIZONTAL LINE PLACED ABOVE AND BELOW THE TEXT "GOLD-N- DETECTORS".

SER. NO. 77-508,370, FILED 6-25-2008.

MATTHEW MCDOWELL, EXAMINING ATTORNEY

**Int. Cl.: 37**

**Prior U.S. Cls.: 100, 103 and 106**

**United States Patent and Trademark Office**

**Reg. No. 3,569,855**

**Registered Feb. 3, 2009**

**SERVICE MARK  
PRINCIPAL REGISTER**

**CITADEL PERIMETER**

TYSON, CHRIS (UNITED STATES INDIVIDUAL)  
#103  
111 EAST 14TH STREET  
NEW YORK, NY 10003

THE MARK CONSISTS OF STANDARD CHAR-  
ACTERS WITHOUT CLAIM TO ANY PARTICULAR  
FONT, STYLE, SIZE, OR COLOR.

FOR: INSTALLATION, MAINTENANCE AND  
REPAIR OF COMPUTER NETWORKS, IN CLASS  
37 (U.S. CLS. 100, 103 AND 106).

SER. NO. 77-508,375, FILED 6-25-2008.

FIRST USE 6-15-2005; IN COMMERCE 6-15-2005.

LESLEY LAMOTHE, EXAMINING ATTORNEY

Int. Cl.: 42

Prior U.S. Cls.: 100 and 101

United States Patent and Trademark Office

Reg. No. 3,569,856

Registered Feb. 3, 2009

SERVICE MARK  
PRINCIPAL REGISTER



GLEXIA, INC. (MASSACHUSETTS CORPORATION)  
1 HANSOM DR.  
MERRIMAC, MA 01860

FOR: APPLICATION SERVICE PROVIDER (ASP), NAMELY, HOSTING COMPUTER SOFTWARE APPLICATIONS OF OTHERS; COMPUTER PROGRAMMING; COMPUTER PROGRAMMING AND COMPUTER SYSTEM ANALYSIS; COMPUTER PROGRAMMING AND SOFTWARE DESIGN; COMPUTER PROGRAMMING FOR OTHERS; COMPUTER PROGRAMMING SERVICES; COMPUTER SERVICES, NAMELY, DESIGNING AND IMPLEMENTING WEB SITES FOR OTHERS; COMPUTER SITE DESIGN; COMPUTER SOFTWARE DESIGN; COMPUTER SOFTWARE DESIGN FOR OTHERS; COMPUTER SOFTWARE DESIGN, COMPUTER PROGRAMMING, OR MAINTENANCE OF COMPUTER SOFTWARE; DESIGN OF COMPUTERS FOR OTHERS; DESIGN OF HOME PAGES; DESIGN OF HOME PAGES AND WEB SITES; DESIGN OF HOME PAGES, COMPUTER SOFTWARE AND WEB SITES; DESIGN OF HOMEPAGES AND WEB-SITES; DESIGN, CREATION, HOSTING AND MAINTENANCE OF INTERNET SITES FOR THIRD PARTIES; DESIGN, CREATION, HOSTING, MAINTENANCE OF WEB SITES FOR OTHERS; HOSTING OF DIGITAL CONTENT ON THE INTER-

NET; HOSTING OF WEB SITES; PROVIDING COMPUTER PROGRAMMING SERVICES TO CUSTOMERS THAT ENABLES THE CUSTOMER'S WEB-SITE TO PROCESS NATURAL LANGUAGE QUERIES; UPDATING AND DESIGN OF COMPUTER SOFTWARE; UPDATING OF COMPUTER PROGRAMS FOR THIRD PARTIES; WEB SITE DESIGN; WEB SITE HOSTING SERVICES, IN CLASS 42 (U.S. CLS. 100 AND 101).

FIRST USE 5-15-2005; IN COMMERCE 6-15-2005.

THE COLOR(S) GRAY, ORANGE, WHITE IS/ARE CLAIMED AS A FEATURE OF THE MARK.

THE MARK CONSISTS OF THE CAPITAL SEMI-STYLIZED GRAY LETTERS "GLE" WITH A DARKER GRAY OUTLINE. A STYLIZED CAPITAL LETTER "X" WITH A SWOOSH THROUGH IT, FROM THE TOP RIGHT BENDING THROUGH THE "X" DOWN TO THE BOTTOM RIGHT. A CAPITAL GRAY I WITH AN ORANGE DOT ON TOP. A STYLIZED LETTER "A".

SER. NO. 77-508,402, FILED 6-25-2008.

REGINA DRUMMOND, EXAMINING ATTORNEY

**Int. Cl.: 36**

**Prior U.S. Cls.: 100, 101 and 102**

**United States Patent and Trademark Office**

**Reg. No. 3,569,857**

**Registered Feb. 3, 2009**

**SERVICE MARK  
PRINCIPAL REGISTER**

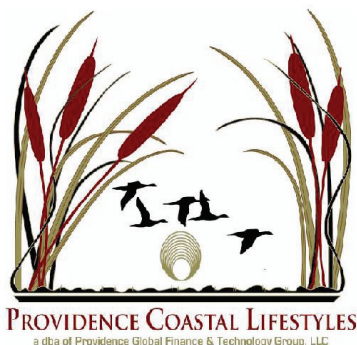

PROVIDENCE GLOBAL FINANCE & TECHNOLOGY GROUP, LLC (VIRGINIA LIMITED LIABILITY COMPANY), DBA PROVIDENCE COASTAL LIFESTYLES, LLC  
SUITE 355  
8521 LEESBURG PIKE  
VIENNA, VA 22182

FOR: FINANCING OF REAL ESTATE DEVELOPMENT PROJECTS; HOUSING SERVICES, NAMELY, REAL PROPERTY ACQUISITION AND CONSUMER FINANCING TO FACILITATE HOME OWNERSHIP; INVESTMENT SERVICES, NAMELY, ASSET ACQUISITION, CONSULTATION, DEVELOPMENT AND MANAGEMENT SERVICES, IN CLASS 36 (U.S. CLS. 100, 101 AND 102).

FIRST USE 4-1-2008; IN COMMERCE 4-1-2008.

NO CLAIM IS MADE TO THE EXCLUSIVE RIGHT TO USE "DBA" OR "GLOBAL FINANCE & TECHNOLOGY GROUP, LLC", APART FROM THE MARK AS SHOWN.

THE COLOR(S) BURGUNDY, GOLD AND BLACK IS/ARE CLAIMED AS A FEATURE OF THE MARK.

THE MARK CONSISTS OF A DESIGN OF FIVE FLYING BIRDS IN BLACK, FRAMED BY A DESIGN OF CATTAILS, STEMS AND GRASS WITH BURGUNDY CATTAILS, GOLD PLANT STEMS WITH BURGUNDY STRIPE, BLACK PLANT STEMS, BLACK GRASS STEMMING INTO BLACK PLANT STEMS AND GOLD BLADES OF GRASS OUTLINED IN BLACK. THERE IS SUN DESIGN IN GOLD BELOW THE BIRDS AND BLACK BOTTOM BORDER BELOW THE SUN DESIGN. UNDERNEATH THE DESIGN ELEMENT, THE WORDING "PROVIDENCE COASTAL LIFESTYLES" APPEARS IN LARGE PRINT IN BURGUNDY AND BELOW THAT IN SMALLER PRINT AND GOLD LETTERING IS THE WORDING "A DBA OF PROVIDENCE GLOBAL FINANCE & TECHNOLOGY GROUP, LLC"

SER. NO. 77-508,409, FILED 6-25-2008.

MATTHEW MCDOWELL, EXAMINING ATTORNEY

**Int. Cl.: 11**

**Prior U.S. Cls.: 13, 21, 23, 31 and 34**

**United States Patent and Trademark Office**

**Reg. No. 3,569,858**

**Registered Feb. 3, 2009**

**TRADEMARK  
PRINCIPAL REGISTER**

**POLAR-RAY**

POLAR RAY, LLC (COLORADO LIMITED LIABILITY COMPANY)  
5171 ELDORADO SPRINGS DRIVE  
BOULDER, CO 80303

FOR: ELECTRIC BULBS; ELECTRIC LIGHT BULBS; ELECTRIC LIGHTING FIXTURES; ELECTRIC TRACK LIGHTING UNITS; LED (LIGHT EMITTING DIODE) LIGHTING FIXTURES; LED (LIGHT EMITTING DIODES) LIGHTING FIXTURES FOR USE IN DISPLAY, COMMERCIAL, INDUSTRIAL, RESIDENTIAL, AND ARCHITECTURAL ACCENT LIGHTING APPLICATIONS; LED LIGHT BULBS; LIGHT BULBS; LIGHTING FIX-

TURES; LIGHTING TRACKS; LIGHTING TUBES; SOCKETS FOR ELECTRIC LIGHTS, IN CLASS 11 (U.S. CLS. 13, 21, 23, 31 AND 34).

FIRST USE 1-11-2008; IN COMMERCE 1-11-2008.

THE MARK CONSISTS OF STANDARD CHARACTERS WITHOUT CLAIM TO ANY PARTICULAR FONT, STYLE, SIZE, OR COLOR.

SER. NO. 77-508,418, FILED 6-26-2008.

REBECCA GILBERT, EXAMINING ATTORNEY

**Int. Cl.: 9**

**Prior U.S. Cls.: 21, 23, 26, 36 and 38**

**Reg. No. 3,569,859**

**United States Patent and Trademark Office**

**Registered Feb. 3, 2009**

---

**TRADEMARK  
PRINCIPAL REGISTER**

**LightGirl**

GREYFRAME LLC (DELAWARE LIMITED LIABILITY COMPANY)  
505 14TH AVE. #12  
SAN FRANCISCO, CA 94118

THE MARK CONSISTS OF STANDARD CHARACTERS WITHOUT CLAIM TO ANY PARTICULAR FONT, STYLE, SIZE, OR COLOR.

FOR: COMPUTER GRAPHICS SOFTWARE, IN CLASS 9 (U.S. CLS. 21, 23, 26, 36 AND 38).

SER. NO. 77-508,507, FILED 6-26-2008.

FIRST USE 7-1-2001; IN COMMERCE 5-16-2008.

IRA J. GOODSaid, EXAMINING ATTORNEY



**Int. Cl.: 35**

**Prior U.S. Cls.: 100, 101 and 102**

**United States Patent and Trademark Office**

**Reg. No. 3,569,860**

**Registered Feb. 3, 2009**

**SERVICE MARK  
PRINCIPAL REGISTER**

FEEL GOOD ABOUT WHERE YOU  
SHOP

WHOLE FOODS MARKET IP, L.P. (DELAWARE  
LIMITED PARTNERSHIP)  
550 BOWIE STREET, 6TH FLOOR  
AUSTIN, TX 78703

THE MARK CONSISTS OF STANDARD CHAR-  
ACTERS WITHOUT CLAIM TO ANY PARTICULAR  
FONT, STYLE, SIZE, OR COLOR.

FOR: RETAIL GROCERY STORE SERVICES;  
AND RETAIL BAKERY SERVICES, IN CLASS 35  
(U.S. CLS. 100, 101 AND 102).

SER. NO. 77-508,508, FILED 6-26-2008.

FIRST USE 5-0-2006; IN COMMERCE 5-0-2006.

REGINA DRUMMOND, EXAMINING ATTORNEY

**Int. Cl.: 41**

**Prior U.S. Cls.: 100, 101 and 107**

**United States Patent and Trademark Office**

**Reg. No. 3,569,861**

**Registered Feb. 3, 2009**

**SERVICE MARK  
PRINCIPAL REGISTER**

**Huntin' the Backwoods**

TEAM BACKWOODS, LLC (OHIO LIMITED LIABILITY COMPANY)  
6931 WOODWARD CLAYPOOL RD.  
MORROW, OH 45152

FOR: ENTERTAINMENT SERVICES, NAMELY, AN ON-GOING SERIES FEATURING BIG GAME HUNTING PROVIDED THROUGH CABLE TELEVISION, SATTELITE, AND INTERNET STREAMING VIDEO, IN CLASS 41 (U.S. CLS. 100, 101 AND 107).

FIRST USE 12-10-2007; IN COMMERCE 3-3-2008.

THE MARK CONSISTS OF STANDARD CHARACTERS WITHOUT CLAIM TO ANY PARTICULAR FONT, STYLE, SIZE, OR COLOR.

NO CLAIM IS MADE TO THE EXCLUSIVE RIGHT TO USE "HUNTING", APART FROM THE MARK AS SHOWN.

SER. NO. 77-508,513, FILED 6-26-2008.

APRIL HESIK, EXAMINING ATTORNEY

**Int. Cl.: 35**

**Prior U.S. Cls.: 100, 101 and 102**

**United States Patent and Trademark Office**

**Reg. No. 3,569,862**

**Registered Feb. 3, 2009**

**SERVICE MARK  
PRINCIPAL REGISTER**

**STAPLESLINK PLUS**

STAPLES THE OFFICE SUPERSTORE, LLC. (DE-  
LAWARE LIMITED LIABILITY COMPANY)  
500 STAPLES DRIVE  
FRAMINGHAM, MA 01702

FOR: ONLINE RETAIL STORE SERVICES, FEATURING OFFICE SUPPLIES, OFFICE EQUIPMENT AND OFFICE FURNITURE, IN CLASS 35 (U.S. CLS. 100, 101 AND 102).

FIRST USE 6-26-2000; IN COMMERCE 6-26-2000.

THE MARK CONSISTS OF STANDARD CHARACTERS WITHOUT CLAIM TO ANY PARTICULAR FONT, STYLE, SIZE, OR COLOR.

SER. NO. 77-508,514, FILED 6-26-2008.

KARANENDRA S. CHHINA, EXAMINING ATTORNEY

**Int. Cl.: 41**

**Prior U.S. Cls.: 100, 101 and 107**

**United States Patent and Trademark Office**

**Reg. No. 3,569,863**

**Registered Feb. 3, 2009**

**SERVICE MARK  
PRINCIPAL REGISTER**

**Globalmalepass**

SMALL BALL INTERNET CREATIONS, INC.  
(CALIFORNIA CORPORATION)  
1642 WESTWOOD BL. PENTHOUSE SUITE  
LOS ANGELES, CA 90024

FOR: ENTERTAINMENT SERVICES, NAMELY,  
PROVIDING A WEB SITE FEATURING ADULT-  
THEMED PHOTOGRAPHS AND VIDEOS, IN CLASS  
41 (U.S. CLS. 100, 101 AND 107).

FIRST USE 11-1-1998; IN COMMERCE 11-1-1998.

THE MARK CONSISTS OF STANDARD CHAR-  
ACTERS WITHOUT CLAIM TO ANY PARTICULAR  
FONT, STYLE, SIZE, OR COLOR.

OWNER OF U.S. REG. NO. 2,587,829.

SER. NO. 77-508,596, FILED 6-26-2008.

APRIL HESIK, EXAMINING ATTORNEY

**Int. Cl.: 43**

**Prior U.S. Cls.: 100 and 101**

**United States Patent and Trademark Office**

**Reg. No. 3,569,864**

**Registered Feb. 3, 2009**

**SERVICE MARK  
PRINCIPAL REGISTER**

**ROWDY BEAVER RESTAURANT &  
TAVERN**

MINNER, RODNEY LOUIS (UNITED STATES  
INDIVIDUAL)  
417 WEST VAN BUREN  
EUREKA SPRINGS, AR 72632 AND  
MINNER, SHARON VERONICA (UNITED STATES  
INDIVIDUAL)  
417 VAN BUREN  
EUREKA SPRINGS, AR 72632

FOR: RESTAURANT AND BAR SERVICES, IN  
CLASS 43 (U.S. CLS. 100 AND 101).

FIRST USE 1-1-2007; IN COMMERCE 1-1-2007.

THE MARK CONSISTS OF STANDARD CHAR-  
ACTERS WITHOUT CLAIM TO ANY PARTICULAR  
FONT, STYLE, SIZE, OR COLOR.

OWNER OF U.S. REG. NO. 3,439,444.

NO CLAIM IS MADE TO THE EXCLUSIVE  
RIGHT TO USE "RESTAURANT & TAVERN",  
APART FROM THE MARK AS SHOWN.

SER. NO. 77-508,599, FILED 6-26-2008.

JEFFERY COWARD, EXAMINING ATTORNEY

**Int. Cl.: 25**

**Prior U.S. Cls.: 22 and 39**

**United States Patent and Trademark Office**

**Reg. No. 3,569,865**

**Registered Feb. 3, 2009**

**TRADEMARK  
PRINCIPAL REGISTER**

**B-O-D-Y XPRESSION**

ISSAR & ISSAR,LLC (NEW YORK LIMITED  
LIABILITY COMPANY)  
252 WEST 38 TH STREET SUITE# 804  
NEW YORK, NY 10018

FOR: LADIES, TOPS, SHIRTS, SKIRTS, JEANS,  
SHORTS, JACKETS, DRESSES, SWEATERS, LIN-  
GERIE, SLEEPWEAR, IN CLASS 25 (U.S. CLS. 22  
AND 39).

FIRST USE 6-25-2008; IN COMMERCE 6-25-2008.

THE MARK CONSISTS OF STANDARD CHAR-  
ACTERS WITHOUT CLAIM TO ANY PARTICULAR  
FONT, STYLE, SIZE, OR COLOR.

SER. NO. 77-508,635, FILED 6-26-2008.

LINDA M. KING, EXAMINING ATTORNEY

**Int. Cl.: 5**

**Prior U.S. Cls.: 6, 18, 44, 46, 51 and 52**

**United States Patent and Trademark Office**

**Reg. No. 3,569,866**

**Registered Feb. 3, 2009**

**TRADEMARK  
PRINCIPAL REGISTER**

**WAYNE**

HUBBARD FEEDS INC. (MINNESOTA CORPORATION)  
424 NORTH RIVERFRONT DRIVE  
MANKATO, MN 56002

FOR: ANIMAL FEED SUPPLEMENTS, IN CLASS  
5 (U.S. CLS. 6, 18, 44, 46, 51 AND 52).

FIRST USE 6-22-1998; IN COMMERCE 6-22-1998.

THE MARK CONSISTS OF STANDARD CHARACTERS WITHOUT CLAIM TO ANY PARTICULAR FONT, STYLE, SIZE, OR COLOR.

OWNER OF U.S. REG. NO. 2,194,143.

SER. NO. 77-508,641, FILED 6-26-2008.

CHARLES L. JENKINS, EXAMINING ATTORNEY

**Int. Cl.: 31**

**Prior U.S. Cls.: 1 and 46**

**United States Patent and Trademark Office**

**Reg. No. 3,569,867**

**Registered Feb. 3, 2009**

**TRADEMARK  
PRINCIPAL REGISTER**

**WAYNE**

HUBBARD FEEDS INC. (MINNESOTA CORPORATION)  
424 NORTH RIVERFRONT DRIVE  
MANKATO, MN 56002

FOR: ANIMAL FEED, IN CLASS 31 (U.S. CLS. 1 AND 46).

FIRST USE 6-22-1998; IN COMMERCE 6-22-1998.

THE MARK CONSISTS OF STANDARD CHARACTERS WITHOUT CLAIM TO ANY PARTICULAR FONT, STYLE, SIZE, OR COLOR.

OWNER OF U.S. REG. NO. 2,194,143.

SER. NO. 77-508,642, FILED 6-26-2008.

CHARLES L. JENKINS, EXAMINING ATTORNEY



**Int. Cl.: 35**

**Prior U.S. Cls.: 100, 101 and 102**

**United States Patent and Trademark Office**

**Reg. No. 3,569,868**

**Registered Feb. 3, 2009**

**SERVICE MARK  
PRINCIPAL REGISTER**



AIR FORCE SERGEANTS ASSOCIATION (D.C.  
CORPORATION)  
5211 AUTH ROAD  
SUITLAND, MD 20746

FOR: LOBBYING SERVICES, NAMELY, PROMOTING THE INTERESTS OF UNITED STATES AIR FORCE ENLISTED MEN AND WOMEN IN THE FIELDS OF LEGISLATION AND REGULATION, IN CLASS 35 (U.S. CLS. 100, 101 AND 102).

FIRST USE 5-0-1961; IN COMMERCE 5-0-1961.

THE MARK CONSISTS OF THE LETTERS "AFSA" INSCRIBED INSIDE OF A CIRCLE WITH WINGS ON EITHER SIDE.

SER. NO. 77-508,655, FILED 6-26-2008.

HAI-LY LAM, EXAMINING ATTORNEY

**Int. Cl.: 42**

**Prior U.S. Cls.: 100 and 101**

**United States Patent and Trademark Office**

**Reg. No. 3,569,869**

**Registered Feb. 3, 2009**

**SERVICE MARK  
PRINCIPAL REGISTER**

**ALTUS**

ALTUS TECHNOLOGIES CORPORATION (OHIO  
CORPORATION)  
6100 OAK TREE BLVD.  
INDEPENDENCE, OH 44131

FOR: COMPUTER CONSULTING SERVICES RE-  
GARDING HIGH TECHNOLOGIES SUCH AS AD-  
VANCED COMPUTER SYSTEMS AND  
NETWORKS, IN CLASS 42 (U.S. CLS. 100 AND 101).

FIRST USE 1-29-1996; IN COMMERCE 12-19-1996.

THE MARK CONSISTS OF STANDARD CHAR-  
ACTERS WITHOUT CLAIM TO ANY PARTICULAR  
FONT, STYLE, SIZE, OR COLOR.

OWNER OF U.S. REG. NO. 2,641,396.

THE ENGLISH TRANSLATION OF THE MARK IS  
HIGH.

SER. NO. 77-508,656, FILED 6-26-2008.

REBECCA SMITH, EXAMINING ATTORNEY

**Int. Cl.: 36**

**Prior U.S. Cls.: 100, 101 and 102**

**United States Patent and Trademark Office**

**Reg. No. 3,569,870**

**Registered Feb. 3, 2009**

**SERVICE MARK  
PRINCIPAL REGISTER**



TREEHOUSE GROUP, LLC (ARIZONA LIMITED  
LIABILITY COMPANY)  
2023 E. UNIVERSITY, SUITE 3  
TEMPE, AZ 85281

THE MARK CONSISTS OF STYLIZED TREE  
IMAGE WITH DISCRETE BRANCHES AND  
LEAVES.

FOR: INVESTMENT OF FUNDS FOR OTHERS, IN  
CLASS 36 (U.S. CLS. 100, 101 AND 102).

SER. NO. 77-508,663, FILED 6-26-2008.

FIRST USE 6-20-2008; IN COMMERCE 6-20-2008.

JASON TURNER, EXAMINING ATTORNEY

Int. Cl.: 36

Prior U.S. Cls.: 100, 101 and 102

United States Patent and Trademark Office

Reg. No. 3,569,871

Registered Feb. 3, 2009

SERVICE MARK  
PRINCIPAL REGISTER



PAWNMART, INC. (NEVADA CORPORATION)  
6400 ATLANTIC BLVD., SUITE 190  
NORCROSS, GA 30071

FOR: PAWN BROKERAGE SERVICES, IN CLASS  
36 (U.S. CLS. 100, 101 AND 102).

FIRST USE 8-1-2007; IN COMMERCE 8-1-2007.

OWNER OF U.S. REG. NO. 2,221,218.

NO CLAIM IS MADE TO THE EXCLUSIVE  
RIGHT TO USE "PAWN", APART FROM THE  
MARK AS SHOWN.

THE COLOR(S) RED, LIGHT BLUE, TURQUOISE  
AND WHITE IS/ARE CLAIMED AS A FEATURE OF  
THE MARK.

THE MARK CONSISTS OF A WHITE DIAMOND  
OUTLINED IN LIGHT BLUE BETWEEN THE  
WORD "PAWN" WHICH IS RED AND OUTLINED  
IN TURQUOISE AND THE WORD "MART" WHICH  
IS TURQUOISE AND OUTLINED IN RED. BELOW  
THE WORDS "PAWN MART" ARE THE WORDS  
"MORE CASH MORE CHOICES" IN BLACK WITH A  
FILLED IN CIRCLE BETWEEN "CASH" AND  
"MORE".

SER. NO. 77-508,667, FILED 6-26-2008.

JOHN WILKE, EXAMINING ATTORNEY

**Int. Cl.: 40**

**Prior U.S. Cls.: 100, 103 and 106**

**United States Patent and Trademark Office**

**Reg. No. 3,569,872**

**Registered Feb. 3, 2009**

**SERVICE MARK  
PRINCIPAL REGISTER**

# Recyclogic

DANCY, MARK A (UNITED STATES INDIVIDUAL)  
5180 HORRY DRIVE #B  
MURRELLS INLET, SC 29576

THE MARK CONSISTS OF STANDARD CHARACTERS WITHOUT CLAIM TO ANY PARTICULAR FONT, STYLE, SIZE, OR COLOR.

FOR: RECYCLING, IN CLASS 40 (U.S. CLS. 100, 103 AND 106).

SER. NO. 77-508,672, FILED 6-26-2008.

FIRST USE 10-10-2007; IN COMMERCE 11-8-2007.

LANA PHAM, EXAMINING ATTORNEY

**Int. Cl.: 36**

**Prior U.S. Cls.: 100, 101 and 102**

**United States Patent and Trademark Office**

**Reg. No. 3,569,873**

**Registered Feb. 3, 2009**

**SERVICE MARK  
PRINCIPAL REGISTER**



TREEHOUSE GROUP, LLC (ARIZONA LIMITED  
LIABILITY COMPANY)  
2023 E. UNIVERSITY, SUITE 3  
TEMPE, AZ 85281

FOR: REAL ESTATE INVESTMENT SERVICES IN  
THE NATURE OF PURCHASING AND SELLING  
OF REAL ESTATE FOR OTHERS, IN CLASS 36 (U.S.  
CLS. 100, 101 AND 102).

FIRST USE 6-20-2008; IN COMMERCE 6-20-2008.

THE MARK CONSISTS OF STYLIZED TREE  
WITH DISCRETE BRANCHES AND LEAVES.

SER. NO. 77-508,678, FILED 6-26-2008.

JASON TURNER, EXAMINING ATTORNEY

**Int. Cls.: 16 and 37**

**Prior U.S. Cls.: 2, 5, 22, 23, 29, 37, 38, 50, 100, 103 and 106**

**Reg. No. 3,569,874**

**United States Patent and Trademark Office**

**Registered Feb. 3, 2009**

**TRADEMARK  
SERVICE MARK  
PRINCIPAL REGISTER**

# Work Green

MACK-CALI REALTY, L.P. (DELAWARE LIMITED PARTNERSHIP)  
343 THORNALL STREET  
EDISON, NJ 088362206

FOR: PUBLICATIONS, NAMELY, PERIODIC NEWSLETTERS FEATURING INFORMATION ON REAL ESTATE, IN CLASS 16 (U.S. CLS. 2, 5, 22, 23, 29, 37, 38 AND 50).

FIRST USE 11-28-2007; IN COMMERCE 11-28-2007.

FOR: REAL ESTATE DEVELOPMENT SERVICES, IN CLASS 37 (U.S. CLS. 100, 103 AND 106).

FIRST USE 11-28-2007; IN COMMERCE 11-28-2007.

THE MARK CONSISTS OF STANDARD CHARACTERS WITHOUT CLAIM TO ANY PARTICULAR FONT, STYLE, SIZE, OR COLOR.

NO CLAIM IS MADE TO THE EXCLUSIVE RIGHT TO USE "GREEN", APART FROM THE MARK AS SHOWN.

SER. NO. 77-508,695, FILED 6-26-2008.

MATTHEW MCDOWELL, EXAMINING ATTORNEY

**Int. Cl.: 9**

**Prior U.S. Cls.: 21, 23, 26, 36 and 38**

**United States Patent and Trademark Office**

**Reg. No. 3,569,875**

**Registered Feb. 3, 2009**

**TRADEMARK  
PRINCIPAL REGISTER**



KOLO LLC (DELAWARE LIMITED LIABILITY COMPANY)  
241 ASYLUM STREET  
HARTFORD, CT 06103

FOR: CD CASES; CD SLEEVES; CD ALBUMS SPECIFICALLY DESIGNED TO HOLD CDS; CD HOLDERS, IN CLASS 9 (U.S. CLS. 21, 23, 26, 36 AND 38).

FIRST USE 8-0-2006; IN COMMERCE 8-0-2006.

OWNER OF U.S. REG. NOS. 2,356,171, 2,480,117, AND 3,307,673.

THE COLOR(S) BLUE, ORANGE AND WHITE IS/ ARE CLAIMED AS A FEATURE OF THE MARK.

THE MARK CONSISTS OF ADJACENT BLOCKS, WITH THE LEFT BLOCK IN THE COLOR BLUE AND THE RIGHT BLOCK IN THE COLOR ORANGE, AND THE WORD "KOLO" IN THE COLOR WHITE WRITTEN ACROSS THE BLOCKS.

SER. NO. 77-508,699, FILED 6-26-2008.

JEFFERY COWARD, EXAMINING ATTORNEY



**Int. Cls.: 16 and 37**

**Prior U.S. Cls.: 2, 5, 22, 23, 29, 37, 38, 50, 100, 103 and 106**

**Reg. No. 3,569,876**

**United States Patent and Trademark Office**

**Registered Feb. 3, 2009**

**TRADEMARK  
SERVICE MARK  
PRINCIPAL REGISTER**



MACK-CALI REALTY, L.P. (DELAWARE LIMITED PARTNERSHIP)  
343 THORNALL STREET  
EDISON, NJ 088362206

FOR: PUBLICATIONS, NAMELY, PERIODIC NEWSLETTERS FEATURING INFORMATION ON REAL ESTATE, IN CLASS 16 (U.S. CLS. 2, 5, 22, 23, 29, 37, 38 AND 50).

FIRST USE 11-28-2007; IN COMMERCE 11-28-2007.

FOR: REAL ESTATE DEVELOPMENT SERVICES, IN CLASS 37 (U.S. CLS. 100, 103 AND 106).

FIRST USE 11-28-2007; IN COMMERCE 11-28-2007.

NO CLAIM IS MADE TO THE EXCLUSIVE RIGHT TO USE "GREEN", APART FROM THE MARK AS SHOWN.

THE MARK CONSISTS OF A CUBE DESIGN WITH THREE SIDES OF THE CUBE SHOWN, AND WITH A LEAF AND STEM DESIGN COVERING TWO OF THE THREE SIDES, ALL ADJACENT TO THE WORDING "WORK GREEN" WITH THE WORD "WORK" APPEARING ABOVE THE WORD "GREEN".

SER. NO. 77-508,708, FILED 6-26-2008.

MATTHEW MCDOWELL, EXAMINING ATTORNEY

**Int. Cl.: 35**

**Prior U.S. Cls.: 100, 101 and 102**

**United States Patent and Trademark Office**

**Reg. No. 3,569,877**

**Registered Feb. 3, 2009**

**SERVICE MARK  
PRINCIPAL REGISTER**

**CULTURE PUNDITS**

TRISTAN MEDIA, LLC (NEW YORK LIMITED  
LIABILITY COMPANY)  
225 W. 23RD ST. #2HE  
NEW YORK, NY 10011

FOR: DISSEMINATION OF ADVERTISING FOR  
OTHERS VIA THE INTERNET, IN CLASS 35 (U.S.  
CLS. 100, 101 AND 102).

FIRST USE 8-13-2007; IN COMMERCE 8-13-2007.

THE MARK CONSISTS OF STANDARD CHAR-  
ACTERS WITHOUT CLAIM TO ANY PARTICULAR  
FONT, STYLE, SIZE, OR COLOR.

NO CLAIM IS MADE TO THE EXCLUSIVE  
RIGHT TO USE "CULTURE", APART FROM THE  
MARK AS SHOWN.

SER. NO. 77-508,723, FILED 6-26-2008.

WANDA KAY PRICE, EXAMINING ATTORNEY

**Int. Cl.: 36**

**Prior U.S. Cls.: 100, 101 and 102**

**United States Patent and Trademark Office**

**Reg. No. 3,569,878**

**Registered Feb. 3, 2009**

**SERVICE MARK  
PRINCIPAL REGISTER**

**VRS UNI-VERSE**

VRS UNI-VERSE ADJUSTERS NETWORK LLC  
(DELAWARE LIMITED LIABILITY COMPAN-  
NY)  
1833 CENTRE POINT CIRCLE, SUITE 139  
NAPERVILLE, IL 605631484

FOR: INSURANCE SERVICES, NAMELY,  
CLAIMS ADMINISTRATION, CLAIMS ADJUST-  
MENT AND LOSS ADJUSTING SERVICES, IN  
CLASS 36 (U.S. CLS. 100, 101 AND 102).

FIRST USE 1-0-2003; IN COMMERCE 1-0-2003.

THE MARK CONSISTS OF STANDARD CHAR-  
ACTERS WITHOUT CLAIM TO ANY PARTICULAR  
FONT, STYLE, SIZE, OR COLOR.

SER. NO. 77-508,727, FILED 6-26-2008.

KELLEY WELLS, EXAMINING ATTORNEY

**Int. Cl.: 36**

**Prior U.S. Cls.: 100, 101 and 102**

**United States Patent and Trademark Office**

**Reg. No. 3,569,879**

**Registered Feb. 3, 2009**

**SERVICE MARK  
PRINCIPAL REGISTER**

**Move In. Get More.**

MACK-CALI REALTY, L.P. (DELAWARE LIMITED PARTNERSHIP)  
343 THORNALL STREET  
EDISON, NJ 088362206

FOR: REAL ESTATE SERVICES, NAMELY, INVESTMENT, LEASING, MANAGEMENT AND FINANCING SERVICES, PROPERTY MANAGEMENT SERVICES, REAL ESTATE ACQUISITION AND REAL ESTATE AGENCY SERVICES, AND REAL ESTATE BROKERAGE SERVICES; FINANCIAL MANAGEMENT SERVICES IN THE FIELD OF REAL ESTATE, NAMELY, MANAGING REAL PROPERTY FINANCES ON BEHALF OF PASSIVE

INVESTORS, IN CLASS 36 (U.S. CLS. 100, 101 AND 102).

FIRST USE 9-30-2006; IN COMMERCE 9-30-2006.

THE MARK CONSISTS OF STANDARD CHARACTERS WITHOUT CLAIM TO ANY PARTICULAR FONT, STYLE, SIZE, OR COLOR.

SER. NO. 77-508,728, FILED 6-26-2008.

MATTHEW MCDOWELL, EXAMINING ATTORNEY

**Int. Cl.: 35**

**Prior U.S. Cls.: 100, 101 and 102**

**United States Patent and Trademark Office**

**Reg. No. 3,569,880**

**Registered Feb. 3, 2009**

**SERVICE MARK  
PRINCIPAL REGISTER**

**1stSeniorCare**

1STSENIORCARE LLC (OREGON LIMITED LIABILITY COMPANY)  
16387 SW O'NEILL CT.  
TIGARD, OR 97223

THE MARK CONSISTS OF STANDARD CHARACTERS WITHOUT CLAIM TO ANY PARTICULAR FONT, STYLE, SIZE, OR COLOR.

FOR: ON-LINE RETAIL STORE SERVICES FEATURING ADJUSTABLE BEDS, FOLDING BEDS, HOSPITAL BEDS, HIGH LOW BEDS, IN CLASS 35 (U.S. CLS. 100, 101 AND 102).

SER. NO. 77-508,729, FILED 6-26-2008.

FIRST USE 9-17-2002; IN COMMERCE 12-1-2002.

NANCY CLARKE, EXAMINING ATTORNEY

**Int. Cl.: 36**

**Prior U.S. Cls.: 100, 101 and 102**

**Reg. No. 3,569,881**

**United States Patent and Trademark Office**

**Registered Feb. 3, 2009**

**SERVICE MARK  
PRINCIPAL REGISTER**

**vrs uni»verse**

VRS UNI-VERSE ADJUSTERS NETWORK LLC  
(DELAWARE LIMITED LIABILITY COMPAN-  
NY)  
1833 CENTRE POINT CIRCLE, SUITE 139  
NAPERVILLE, IL 605631484

FOR: INSURANCE SERVICES, NAMELY,  
CLAIMS ADMINISTRATION, CLAIMS ADJUST-  
MENT AND LOSS ADJUSTING SERVICES, IN  
CLASS 36 (U.S. CLS. 100, 101 AND 102).

FIRST USE 1-0-2003; IN COMMERCE 1-0-2003.

THE MARK CONSISTS OF THE LETTERS "VRS"  
FOLLOWED BY THE LETTERS "UNI", FOLLOWED  
WITH A STYLIZED DASH IN THE FORM OF TWO  
RIGHT FACING ARROW TIPS, FOLLOWED BY  
THE LETTERS "VERSE".

SER. NO. 77-508,736, FILED 6-26-2008.

KELLEY WELLS, EXAMINING ATTORNEY

**Int. Cl.: 1**

**Prior U.S. Cls.: 1, 5, 6, 10, 26 and 46**

**Reg. No. 3,569,882**

**United States Patent and Trademark Office**

**Registered Feb. 3, 2009**

**TRADEMARK  
PRINCIPAL REGISTER**



ENVIROSERVE CHEMICALS, INC. (NORTH  
CAROLINA CORPORATION)  
603 S WILSON AVENUE  
DUNN, NC 28334

THE MARK CONSISTS OF THE LETTERS "ES" IN  
BOLD DENMARK FONT WITH THE WORD "EN-  
VIROSERVE" SPACED UNDER THE LETTERS.

FOR: INDUSTRIAL CHEMICALS, IN CLASS 1  
(U.S. CLS. 1, 5, 6, 10, 26 AND 46).

SER. NO. 77-508,754, FILED 6-26-2008.

FIRST USE 9-1-1996; IN COMMERCE 9-1-1996.

CHRIS DONINGER, EXAMINING ATTORNEY

**Int. Cl.: 35**

**Prior U.S. Cls.: 100, 101 and 102**

**United States Patent and Trademark Office**

**Reg. No. 3,569,883**

**Registered Feb. 3, 2009**

**SERVICE MARK  
PRINCIPAL REGISTER**

**SANE**

CONVERGENT HRS, LLC (FLORIDA LIMITED  
LIABILITY COMPANY)  
3100 PADDOCK ROAD  
WESTON, FL 33331

THE MARK CONSISTS OF STANDARD CHAR-  
ACTERS WITHOUT CLAIM TO ANY PARTICULAR  
FONT, STYLE, SIZE, OR COLOR.

FOR: MANAGEMENT AND BUSINESS CON-  
SULTING SERVICES IN THE FIELD OF HEALTH-  
CARE PRODUCTIVITY AND SAFETY, IN CLASS 35  
(U.S. CLS. 100, 101 AND 102).

SER. NO. 77-508,810, FILED 6-26-2008.

FIRST USE 6-26-2008; IN COMMERCE 6-26-2008.

JESSICA A. POWERS, EXAMINING ATTORNEY



**Int. Cl.: 36**

**Prior U.S. Cls.: 100, 101 and 102**

**United States Patent and Trademark Office**

**Reg. No. 3,569,884**

**Registered Feb. 3, 2009**

**SERVICE MARK  
PRINCIPAL REGISTER**

**KNOWING YOU MAKES THE  
DIFFERENCE.**

AGCHOICE FARM CREDIT, ACA (PENNSYLVANIA CORPORATION)  
900 BENT CREEK BOULEVARD  
MECHANICSBURG, PA 17050

FOR: BANKING, MORTGAGE LENDING, AND FINANCIAL ANALYSIS AND CONSULTATION, AS AUTHORIZED BY THE FARM CREDIT ACT AND REGULATIONS OF THE FARM CREDIT ADMINISTRATION , IN CLASS 36 (U.S. CLS. 100, 101 AND 102).

FIRST USE 10-1-2007; IN COMMERCE 11-1-2007.

THE MARK CONSISTS OF STANDARD CHARACTERS WITHOUT CLAIM TO ANY PARTICULAR FONT, STYLE, SIZE, OR COLOR.

SER. NO. 77-508,833, FILED 6-26-2008.

REGINA DRUMMOND, EXAMINING ATTORNEY

**Int. Cl.: 35**

**Prior U.S. Cls.: 100, 101 and 102**

**United States Patent and Trademark Office**

**Reg. No. 3,569,885**

**Registered Feb. 3, 2009**

**SERVICE MARK  
PRINCIPAL REGISTER**

**USI ELECTRIC**

UNIVERSAL SECURITY INSTRUMENTS, INC.  
(MARYLAND CORPORATION)  
7-A GWYNNNS MILL COURT  
OWINGS MILLS, MD 21117

FOR: RETAIL STORE SERVICES FEATURING SMOKE, FIRE, HEAT, AND CARBON MONOXIDE ALARM DETECTORS, DOOR CHIMES AND DOOR CHIME KITS AND VENTILATION PRODUCTS SUCH AS FANS WITH DUCT ADAPTERS; WHOLE-SALE DISTRIBUTORSHIPS FEATURING SMOKE, FIRE, HEAT, AND CARBON MONOXIDE ALARM DETECTORS, DOOR CHIMES AND DOOR CHIME KITS AND VENTILATION PRODUCTS SUCH AS FANS WITH DUCT ADAPTERS, IN CLASS 35 (U.S. CLS. 100, 101 AND 102).

FIRST USE 6-12-1998; IN COMMERCE 1-1-2001.

THE MARK CONSISTS OF STANDARD CHARACTERS WITHOUT CLAIM TO ANY PARTICULAR FONT, STYLE, SIZE, OR COLOR.

OWNER OF U.S. REG. NO. 2,797,140.

NO CLAIM IS MADE TO THE EXCLUSIVE RIGHT TO USE "ELECTRIC" , APART FROM THE MARK AS SHOWN.

SER. NO. 77-508,860, FILED 6-26-2008.

REGINA DRUMMOND, EXAMINING ATTORNEY

**Int. Cl.: 38**

**Prior U.S. Cls.: 100, 101 and 104**

**United States Patent and Trademark Office**

**Reg. No. 3,569,886**

**Registered Feb. 3, 2009**

**SERVICE MARK  
PRINCIPAL REGISTER**

**MIND CANDI**

MIND CANDI LLC (NORTH CAROLINA LIMITED LIABILITY COMPANY)  
106 MISTY WATERS LANE  
JAMESTOWN, NC 272828860

FOR: PROVIDING ON-LINE CHAT ROOMS FOR TRANSMISSION OF MESSAGES AMONG COMPUTER USERS CONCERNING DATING, RELATIONSHIPS AND TOPICS OF GENERAL INTEREST, AND ELECTRONIC VOICE MESSAGING, NAMELY, THE RECORDING AND SUBSEQUENT TRANSMISSION OF VOICE MESSAGES FOR SOCIAL PURPOSES BY

TELEPHONE; TELEPHONE COMMUNICATION SERVICES, IN CLASS 38 (U.S. CLS. 100, 101 AND 104).

FIRST USE 4-1-2008; IN COMMERCE 4-1-2008.

THE MARK CONSISTS OF STANDARD CHARACTERS WITHOUT CLAIM TO ANY PARTICULAR FONT, STYLE, SIZE, OR COLOR.

SER. NO. 77-508,904, FILED 6-26-2008.

MARLENE BELL, EXAMINING ATTORNEY

**Int. Cl.: 3**

**Prior U.S. Cls.: 1, 4, 6, 50, 51 and 52**

**United States Patent and Trademark Office**

**Reg. No. 3,569,887**

**Registered Feb. 3, 2009**

**TRADEMARK  
PRINCIPAL REGISTER**

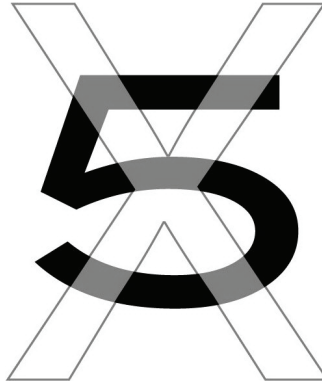

KLABIN DESIGN, INC. (NEW JERSEY CORPORATION)  
71 VILLAGE PARK ROAD  
CEDAR GROVE, NJ 07009

FOR: HAND CLEANERS, IN CLASS 3 (U.S. CLS. 1, 4, 6, 50, 51 AND 52).

FIRST USE 3-17-2008; IN COMMERCE 4-18-2008.

THE MARK CONSISTS OF THE CAPITAL LETTER "X" HAS NO COLOR FILL AND HAS A SEMI-TRANSPARENT OUTLINE AND IS PLACED DIRECTLY OVER A BOLD NUMBER "5".

SER. NO. 77-508,923, FILED 6-26-2008.

DARRYL SPRUILL, EXAMINING ATTORNEY

**Int. Cl.: 35**

**Prior U.S. Cls.: 100, 101 and 102**

**United States Patent and Trademark Office**

**Reg. No. 3,569,888**

**Registered Feb. 3, 2009**

**SERVICE MARK  
PRINCIPAL REGISTER**

**WE'RE IN YOUR CORNER**

MEYER MANAGEMENT AGENCY, INC. (CALI-  
FORNIA CORPORATION)  
P.O. BOX 886  
SLOUGHHOUSE, CA 95683

THE MARK CONSISTS OF STANDARD CHAR-  
ACTERS WITHOUT CLAIM TO ANY PARTICULAR  
FONT, STYLE, SIZE, OR COLOR.

FOR: MANAGEMENT OF PROFESSIONAL ATH-  
LETES, IN CLASS 35 (U.S. CLS. 100, 101 AND 102).

SER. NO. 77-508,926, FILED 6-26-2008.

FIRST USE 1-1-2007; IN COMMERCE 1-1-2007.

DARRYL SPRUILL, EXAMINING ATTORNEY

**Int. Cl.: 41**

**Prior U.S. Cls.: 100, 101 and 107**

**United States Patent and Trademark Office**

**Reg. No. 3,569,889**

**Registered Feb. 3, 2009**

**SERVICE MARK  
PRINCIPAL REGISTER**

**THE WISER CHOICE**

SPECIAL EDUCATION SERVICES (ILLINOIS  
CORPORATION)  
1720 N. RANDALL ROAD  
AURORA, IL 60506

FOR: EDUCATION SERVICES, NAMELY, THER-  
APEUTIC DAY SCHOOLS PROVIDING MENTAL  
HEALTH AND ACADEMIC SUPPORT FOR AT-  
RISK STUDENTS, IN CLASS 41 (U.S. CLS. 100, 101  
AND 107).

FIRST USE 3-29-2008; IN COMMERCE 3-29-2008.

THE MARK CONSISTS OF STANDARD CHAR-  
ACTERS WITHOUT CLAIM TO ANY PARTICULAR  
FONT, STYLE, SIZE, OR COLOR.

SER. NO. 77-508,938, FILED 6-26-2008.

TRACY CROSS, EXAMINING ATTORNEY

**Int. Cl.: 41**

**Prior U.S. Cls.: 100, 101 and 107**

**United States Patent and Trademark Office**

**Reg. No. 3,569,890**

**Registered Feb. 3, 2009**

**SERVICE MARK  
PRINCIPAL REGISTER**

**WISER**

SPECIAL EDUCATION SERVICES (ILLINOIS  
CORPORATION)  
1720 N. RANDALL ROAD  
AURORA, IL 60506

FOR: EDUCATION SERVICES, NAMELY, THER-  
APEUTIC DAY SCHOOLS PROVIDING MENTAL  
HEALTH AND ACADEMIC SUPPORT FOR AT-  
RISK STUDENTS, IN CLASS 41 (U.S. CLS. 100, 101  
AND 107).

FIRST USE 3-29-2008; IN COMMERCE 3-29-2008.

THE MARK CONSISTS OF STANDARD CHAR-  
ACTERS WITHOUT CLAIM TO ANY PARTICULAR  
FONT, STYLE, SIZE, OR COLOR.

SER. NO. 77-508,970, FILED 6-26-2008.

TRACY CROSS, EXAMINING ATTORNEY

**Int. Cl.: 28**

**Prior U.S. Cls.: 22, 23, 38 and 50**

**United States Patent and Trademark Office**

**Reg. No. 3,569,891**

**Registered Feb. 3, 2009**

**TRADEMARK  
PRINCIPAL REGISTER**

**PUFF DOGS**

ROCKET USA INC. (ILLINOIS CORPORATION)  
7775 VAN BUREN STREET  
FOREST PARK, IL 60301

FOR: PLUSH TOYS, IN CLASS 28 (U.S. CLS. 22, 23,  
38 AND 50).

FIRST USE 6-19-2008; IN COMMERCE 6-19-2008.

THE MARK CONSISTS OF STANDARD CHAR-  
ACTERS WITHOUT CLAIM TO ANY PARTICULAR  
FONT, STYLE, SIZE, OR COLOR.

NO CLAIM IS MADE TO THE EXCLUSIVE  
RIGHT TO USE "DOGS", APART FROM THE MARK  
AS SHOWN.

SER. NO. 77-508,972, FILED 6-26-2008.

NICHOLAS ALTREE, EXAMINING ATTORNEY



**Int. Cl.: 35**

**Prior U.S. Cls.: 100, 101 and 102**

**United States Patent and Trademark Office**

**Reg. No. 3,569,892**

**Registered Feb. 3, 2009**

**SERVICE MARK  
PRINCIPAL REGISTER**

# Remarkd

REMARKD, INC. (CALIFORNIA CORPORATION)  
1575 SILVERADO TRAIL  
NAPA, CA 94559

FOR: OPERATING ON-LINE MARKETPLACES  
FOR SELLERS OF GOODS AND/OR SERVICES, IN  
CLASS 35 (U.S. CLS. 100, 101 AND 102).

FIRST USE 12-15-2007; IN COMMERCE 3-31-2008.

THE MARK CONSISTS OF STANDARD CHARACTERS WITHOUT CLAIM TO ANY PARTICULAR FONT, STYLE, SIZE, OR COLOR.

SER. NO. 77-508,986, FILED 6-26-2008.

CHRISTOPHER BUONGIORNO, EXAMINING ATTORNEY

**Int. Cl.: 29**

**Prior U.S. Cl.: 46**

**United States Patent and Trademark Office**

**Reg. No. 3,569,893**

**Registered Feb. 3, 2009**

**TRADEMARK  
PRINCIPAL REGISTER**



BORGES USA, INC. (DELAWARE CORPORATION)

4652 EAST DATE AVENUE

FRESNO, CA 937252123

FOR: MARINATED ARTICHOKE; ARTICHOKE IN WATER; HORS D'OEUVRES, NAMELY PROCESSED OLIVES, PROCESSED ONIONS, PROCESSED PEPPERS AND GHERKINS; MARINATED MUSHROOMS; PIQUILLO PEPPERS IN BRINE; WHITE ASPARAGUS IN BRINE; GREEN ASPARAGUS IN BRINE; ARTICHOKE SALAD COMPOSED OF ARTICHOKE, OLIVES, PEPPERS IN A MARINADE; SUN DRIED TOMATOES, IN CLASS 29 (U.S. CL. 46).

FIRST USE 6-30-1994; IN COMMERCE 6-30-1994.

OWNER OF U.S. REG. NOS. 827,948, 3,180,879 AND OTHERS.

THE COLOR(S) RED, WHITE AND GOLD IS/ARE CLAIMED AS A FEATURE OF THE MARK.

THE MARK CONSISTS OF THE WORDS "CARA MIA" IN WHITE, OUTLINED IN GOLD, PRINTED INSIDE A RED OVAL WHICH HAS A WHITE THIN BORDER JUST INSIDE THE OVAL.

THE FOREIGN WORDING IN THE MARK TRANSLATES INTO ENGLISH AS MY DEAR.

SER. NO. 77-508,998, FILED 6-26-2008.

MARY ROSSMAN, EXAMINING ATTORNEY

**Int. Cl.: 36**

**Prior U.S. Cls.: 100, 101 and 102**

**United States Patent and Trademark Office**

**Reg. No. 3,569,894**

**Registered Feb. 3, 2009**

**SERVICE MARK  
PRINCIPAL REGISTER**

**ART FOR THE CURE**

THE SUSAN G. KOMEN BREAST CANCER  
FOUNDATION, INC. (TEXAS NON-PROFIT  
CORPORATION)

5005 LBJ FREEWAY, SUITE 250  
DALLAS, TX 75244

FOR: CHARITABLE FUNDRAISING SERVICES,  
NAMELY, RAISING MONEY FOR BREAST CAN-  
CER RESEARCH AND RAISING MONEY FOR  
LOCAL COMMUNITY BREAST HEALTH AWARE-  
NESS, IN CLASS 36 (U.S. CLS. 100, 101 AND 102).

FIRST USE 9-0-2001; IN COMMERCE 9-0-2001.

THE MARK CONSISTS OF STANDARD CHAR-  
ACTERS WITHOUT CLAIM TO ANY PARTICULAR  
FONT, STYLE, SIZE, OR COLOR.

OWNER OF U.S. REG. NOS. 1,593,469, 2,075,352,  
AND 2,406,792.

NO CLAIM IS MADE TO THE EXCLUSIVE  
RIGHT TO USE "ART", APART FROM THE MARK  
AS SHOWN.

SER. NO. 77-509,043, FILED 6-26-2008.

PAUL MORENO, EXAMINING ATTORNEY

**Int. Cl.: 37**

**Prior U.S. Cls.: 100, 103 and 106**

**United States Patent and Trademark Office**

**Reg. No. 3,569,895**

**Registered Feb. 3, 2009**

**SERVICE MARK  
PRINCIPAL REGISTER**



SANYANG INDUSTRY CO., LTD. (TAIWAN CORPORATION)  
NO. 3, CHUNG HUA ROAD  
HUKOU HSINCHU, TAIWAN

FOR: AUTOMOBILE MAINTENANCE AND REPAIR; MOTORCYCLE MAINTENANCE AND REPAIR; AUTOMOBILE WASHING; MOTORCYCLE WASHING; AUTOMOBILE RUSTPROOFING; MOTORCYCLE RUSTPROOFING; AUTOMOBILE GREASING; MOTORCYCLE GREASING; AUTOMOBILE CLEANING; MOTORCYCLE CLEANING; AUTOMOBILE SERVICE STATION SERVICES; MOTORCYCLE SERVICE STATION SERVICES; TIRE RETREADING; INSTALLATION, MAINTENANCE AND REPAIR OF MACHINES IN THE FIELD OF AUTOMOBILES; INSTALLATION, MAINTENANCE AND REPAIR OF MACHINES IN THE FIELD OF MOTORCYCLES, IN CLASS 37 (U.S. CLS. 100, 103 AND 106).

FIRST USE 6-1-1995; IN COMMERCE 11-1-2007.

OWNER OF U.S. REG. NOS. 2,089,581 AND 2,271,340.

THE COLOR(S) BLUE AND RED IS/ARE CLAIMED AS A FEATURE OF THE MARK.

THE MARK CONSISTS OF A STYLIZED FORM OF THE WORD "SYM" WITH THE LETTERS "S" AND "M" APPEARING IN BLUE AND THE LETTER "Y" APPEARING IN HALF RED AND HALF BLUE.

SER. NO. 77-509,059, FILED 6-26-2008.

ANDREA SAUNDERS, EXAMINING ATTORNEY

**Int. Cl.: 40**

**Prior U.S. Cls.: 100, 103 and 106**

**United States Patent and Trademark Office**

**Reg. No. 3,569,896**

**Registered Feb. 3, 2009**

**SERVICE MARK  
PRINCIPAL REGISTER**

**NLS**

VITACOST.COM, INC. (DELAWARE CORPORATION)  
SUITE 500  
5400 BROKEN SOUND BLVD., NW  
BOCA RATON, FL 33487

THE MARK CONSISTS OF STANDARD CHARACTERS WITHOUT CLAIM TO ANY PARTICULAR FONT, STYLE, SIZE, OR COLOR.

FOR: CUSTOM MANUFACTURE OF NUTRITIONAL SUPPLEMENTS AND VITAMINS FOR OTHERS, IN CLASS 40 (U.S. CLS. 100, 103 AND 106).

SER. NO. 77-509,095, FILED 6-26-2008.

FIRST USE 11-12-2007; IN COMMERCE 11-12-2007.

KELLY MCCOY, EXAMINING ATTORNEY

**Int. Cl.: 30**

**Prior U.S. Cl.: 46**

**United States Patent and Trademark Office**

**Reg. No. 3,569,897**

**Registered Feb. 3, 2009**

**TRADEMARK  
PRINCIPAL REGISTER**

**Q50**

CESAR O. TORRES (UNITED STATES INDIVIDUAL)  
1309 MAIN STREET, SUITE 1806  
DALLAS, TX 75202

THE MARK CONSISTS OF STANDARD CHARACTERS WITHOUT CLAIM TO ANY PARTICULAR FONT, STYLE, SIZE, OR COLOR.

FOR: COFFEE, IN CLASS 30 (U.S. CL. 46).

SER. NO. 77-509,104, FILED 6-26-2008.

FIRST USE 6-3-2008; IN COMMERCE 6-3-2008.

SHAUNIA CARLYLE, EXAMINING ATTORNEY

**Int. Cl.: 41**

**Prior U.S. Cls.: 100, 101 and 107**

**United States Patent and Trademark Office**

**Reg. No. 3,569,898**

**Registered Feb. 3, 2009**

**SERVICE MARK  
PRINCIPAL REGISTER**

**O15**

O15 WORKOUT, LLC (PENNSYLVANIA LIMITED LIABILITY COMPANY)  
1ST FLOOR  
1233 LOCUST STREET  
PHILADELPHIA, PA 19107

FOR: PHYSICAL FITNESS CONSULTATION; PHYSICAL FITNESS INSTRUCTION; PROVIDING FITNESS AND EXERCISE FACILITIES, IN CLASS 41 (U.S. CLS. 100, 101 AND 107).

FIRST USE 8-0-2006; IN COMMERCE 8-0-2006.

THE MARK CONSISTS OF STANDARD CHARACTERS WITHOUT CLAIM TO ANY PARTICULAR FONT, STYLE, SIZE, OR COLOR.

SER. NO. 77-509,141, FILED 6-26-2008.

LESLEY LAMOTHE, EXAMINING ATTORNEY

**Int. Cl.: 30**

**Prior U.S. Cl.: 46**

**United States Patent and Trademark Office**

**Reg. No. 3,569,899**

**Registered Feb. 3, 2009**

**TRADEMARK  
PRINCIPAL REGISTER**



CESAR O. TORRES (UNITED STATES INDIVIDUAL)  
1309 MAIN STREET  
DALLAS, TX 75202

FOR: COFFEE, IN CLASS 30 (U.S. CL. 46).

FIRST USE 6-3-2008; IN COMMERCE 6-3-2008.

THE COLOR(S) GREEN, RED, AND WHITE IS/  
ARE CLAIMED AS A FEATURE OF THE MARK.

THE MARK CONSISTS OF THE LETTER "Q" IN GREEN, ADJACENT TO A RED FLAG WITH ROUNDED CORNERS ON THE RIGHT, WITH THE FLAG DISPLAYING THE NUMBER "50" IN WHITE.

SER. NO. 77-509,153, FILED 6-26-2008.

SHAUNIA CARLYLE, EXAMINING ATTORNEY



**Int. Cl.: 14**

**Prior U.S. Cls.: 2, 27, 28 and 50**

**Reg. No. 3,569,900**

**United States Patent and Trademark Office**

**Registered Feb. 3, 2009**

**TRADEMARK  
PRINCIPAL REGISTER**

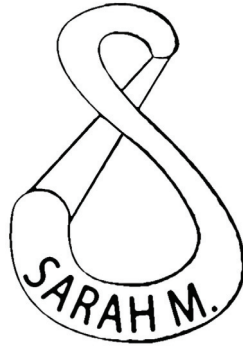

SARAH MORRIS (UNITED STATES INDIVIDUAL), DBA SARAH M. JEWELRY DESIGNS  
2186 FIFTH AVENUE, # 7A  
NEW YORK, NY 10037

THE MARK CONSISTS OF AN "S" SHAPED  
FIGURE CONTAINING THE TERM "SARAH M."

FOR: JEWELRY, IN CLASS 14 (U.S. CLS. 2, 27, 28  
AND 50).

SER. NO. 77-509,172, FILED 6-26-2008.

FIRST USE 7-16-2007; IN COMMERCE 7-16-2007.

JENNIFER VASQUEZ, EXAMINING ATTORNEY

**Int. Cl.: 35**

**Prior U.S. Cls.: 100, 101 and 102**

**United States Patent and Trademark Office**

**Reg. No. 3,569,901**

**Registered Feb. 3, 2009**

**SERVICE MARK  
PRINCIPAL REGISTER**

MAKING DREAMS COME TRUE

WOOD-MIZER PRODUCTS, INC. (INDIANA  
CORPORATION)  
8180 WEST 10TH STREET  
INDIANAPOLIS, IN 46214

FOR: RETAIL STORE, ONLINE RETAIL STORE,  
AND MAIL ORDER CATALOG SERVICES IN THE  
FIELD OF SAWMILLS, WOOD PROCESSING  
EQUIPMENT, INDUSTRIAL BLADE, KILNS, AND  
WOOD-CARVING MACHINES, IN CLASS 35 (U.S.  
CLS. 100, 101 AND 102).

FIRST USE 0-0-1998; IN COMMERCE 0-0-1998.

THE MARK CONSISTS OF STANDARD CHAR-  
ACTERS WITHOUT CLAIM TO ANY PARTICULAR  
FONT, STYLE, SIZE, OR COLOR.

SER. NO. 77-509,182, FILED 6-26-2008.

EVELYN BRADLEY, EXAMINING ATTORNEY

**Int. Cl.: 36**

**Prior U.S. Cls.: 100, 101 and 102**

**United States Patent and Trademark Office**

**Reg. No. 3,569,902**

**Registered Feb. 3, 2009**

**SERVICE MARK  
PRINCIPAL REGISTER**



CORNERSTONE ALLIANCE, LTD. (KANSAS CORPORATION)  
P.O. BOX 545  
WINFIELD, KS 67156

FOR: BANKING; ESTATE TRUST MANAGEMENT; SECURITY BROKERAGE; CREDIT CARD SERVICES; COMMERCIAL, CONSUMER AND MORTGAGE LENDING SERVICES; INSURANCE AGENCY SERVICES AND INSURANCE BROKERAGE SERVICES, IN CLASS 36 (U.S. CLS. 100, 101 AND 102).

FIRST USE 5-12-2008; IN COMMERCE 5-12-2008.

THE MARK CONSISTS OF A LINE DRAWING OF A DIAMOND SHAPE WITH A SOLID DIAMOND SHAPE AT ONE CORNER FOLLOWED BY THE WORDS "CORNERBANK".

SER. NO. 77-509,216, FILED 6-26-2008.

KELLY MCCOY, EXAMINING ATTORNEY

**Int. Cl.: 35**

**Prior U.S. Cls.: 100, 101 and 102**

**United States Patent and Trademark Office**

**Reg. No. 3,569,903**

**Registered Feb. 3, 2009**

**SERVICE MARK  
PRINCIPAL REGISTER**

DISCOVER WHAT YOU CAN DO

SOS STAFFING SERVICES, INC. (UTAH CORPORATION)  
SUITE 500  
2650 DECKER LAKE BLVD.  
SALT LAKE CITY, UT 84119

FOR: EMPLOYMENT AGENCY SERVICES; RECRUITMENT AND PLACEMENT OF TEMPORARY AND PERMANENT PERSONNEL; TEMPORARY STAFFING OF EMPLOYEES FOR OTHERS , IN CLASS 35 (U.S. CLS. 100, 101 AND 102).

FIRST USE 10-1-2007; IN COMMERCE 10-1-2007.

THE MARK CONSISTS OF STANDARD CHARACTERS WITHOUT CLAIM TO ANY PARTICULAR FONT, STYLE, SIZE, OR COLOR.

SER. NO. 77-509,241, FILED 6-26-2008.

CHARLES L. JENKINS, EXAMINING ATTORNEY

**Int. Cl.: 41**

**Prior U.S. Cls.: 100, 101 and 107**

**United States Patent and Trademark Office**

**Reg. No. 3,569,904**

**Registered Feb. 3, 2009**

**SERVICE MARK  
PRINCIPAL REGISTER**

REDUXION THEATRE COMPANY

REDUXION THEATRE COMPANY, INC. (OKLAHOMA NON-PROFIT CORPORATION)  
P.O. BOX 61128  
OKLAHOMA CITY, OK 73146

FOR: ENTERTAINMENT IN THE NATURE OF THEATER PRODUCTIONS, IN CLASS 41 (U.S. CLS. 100, 101 AND 107).

FIRST USE 5-19-2006; IN COMMERCE 5-19-2006.

THE MARK CONSISTS OF STANDARD CHARACTERS WITHOUT CLAIM TO ANY PARTICULAR FONT, STYLE, SIZE, OR COLOR.

NO CLAIM IS MADE TO THE EXCLUSIVE RIGHT TO USE "THEATRE COMPANY", APART FROM THE MARK AS SHOWN.

SER. NO. 77-509,279, FILED 6-26-2008.

HELENE LIWINSKI, EXAMINING ATTORNEY

**Int. Cls.: 9 and 41**

**Prior U.S. Cls.: 21, 23, 26, 36, 38, 100, 101 and 107**

**Reg. No. 3,569,905**

**United States Patent and Trademark Office**

**Registered Feb. 3, 2009**

**TRADEMARK  
SERVICE MARK  
PRINCIPAL REGISTER**

# Rich Mind Records

RICH MIND RECORDS, INC. (TEXAS CORPORATION)  
1400 GOLDMARK DRIVE SUITE 275  
DALLAS, TX 75240

FOR: AUDIO AND VIDEO RECORDINGS FEATURING MUSICAL PERFORMANCES; AUDIO RECORDINGS FEATURING MUSICAL PERFORMANCES; CD CASES; CD SLEEVES; DIGITAL MATERIALS, NAMELY, CDS AND DVDS FEATURING MUSICAL PERFORMANCES; DIGITAL MEDIA, NAMELY, PRE-RECORDED VIDEO CASSETTES, DIGITAL VIDEO DISCS, DIGITAL VERSATILE DISCS, DOWNLOADABLE AUDIO AND VIDEO RECORDINGS, DVDS, AND HIGH DEFINITION DIGITAL DISKS FEATURING MUSICAL PERFORMANCES; DIGITAL MUSIC DOWNLOADABLE FROM THE INTERNET; DOWNLOADABLE MUSICAL SOUND RECORDINGS; MUSICAL SOUND RECORDINGS; MUSICAL VIDEO RECORDINGS; PRE-RECORDED CDS, VIDEO TAPES, LASER DISKS AND DVDS FEATURING MUSICAL PERFORMANCES; PRE-RECORDED DIGITAL MEDIA FEATURING MUSICAL PERFORMANCES; SOUND RECORDINGS FEATURING MUSICAL PERFORMANCES; VIDEO RECORDINGS FEATURING MUSICAL PERFORMANCES, IN CLASS 9 (U.S. CLS. 21, 23, 26, 36 AND 38).

FIRST USE 7-15-2004; IN COMMERCE 9-1-2004.

FOR: ARRANGING AND CONDUCTING NIGHT-CLUB ENTERTAINMENT EVENTS; CONSULTATION AND ADVICE REGARDING MUSICAL

SELECTIONS AND ARRANGEMENTS FOR SOUND RECORDINGS AND LIVE PERFORMANCES; ENTERTAINMENT IN THE NATURE OF VISUAL AND AUDIO PERFORMANCES, NAMELY, MUSICAL BAND, ROCK GROUP, GYMNASIAC, DANCE, AND BALLET PERFORMANCES; ENTERTAINMENT SERVICES IN THE NATURE OF LIVE MUSICAL PERFORMANCES; ENTERTAINMENT, NAMELY, LIVE MUSIC CONCERTS; ENTERTAINMENT, NAMELY, PRODUCTION OF SOUND RECORDINGS; MUSIC PRODUCTION SERVICES; POST-PRODUCTION EDITING SERVICES IN THE FIELD OF MUSIC, VIDEOS AND FILMS; PRODUCTION OF SOUND AND MUSIC VIDEO RECORDINGS; PROVIDING FACILITIES FOR MOVIES, SHOWS, PLAYS, MUSIC OR EDUCATIONAL TRAINING; RECORD PRODUCTION; RECORDING STUDIO SERVICES; SOUND RECORDING STUDIOS, IN CLASS 41 (U.S. CLS. 100, 101 AND 107).

FIRST USE 12-10-2003; IN COMMERCE 7-15-2004.

THE MARK CONSISTS OF STANDARD CHARACTERS WITHOUT CLAIM TO ANY PARTICULAR FONT, STYLE, SIZE, OR COLOR.

NO CLAIM IS MADE TO THE EXCLUSIVE RIGHT TO USE "RECORDS", APART FROM THE MARK AS SHOWN.

SER. NO. 77-509,280, FILED 6-26-2008.

SHAILA SETTLES, EXAMINING ATTORNEY

Int. Cl.: 41

Prior U.S. Cls.: 100, 101 and 107

United States Patent and Trademark Office

Reg. No. 3,569,906

Registered Feb. 3, 2009

SERVICE MARK  
PRINCIPAL REGISTER



REDUXION THEATRE COMPANY, INC. (OKLAHOMA NON-PROFIT CORPORATION)  
P.O. BOX 61128  
OKLAHOMA CITY, OK 73146

FOR: ENTERTAINMENT IN THE NATURE OF THEATER PRODUCTIONS, IN CLASS 41 (U.S. CLS. 100, 101 AND 107).

FIRST USE 3-26-2007; IN COMMERCE 3-26-2007.

NO CLAIM IS MADE TO THE EXCLUSIVE RIGHT TO USE "THEATRE", APART FROM THE MARK AS SHOWN.

THE MARK CONSISTS OF A SET OF COMEDY/TRAGEDY MASKS CONJOINED IN A STYLIZED "R" AND THE WORDS "REDUXION THEATRE" SPACED DIRECTLY BELOW, THE AFOREMENTIONED BEING ENCOMPASSED INSIDE AN OUTLINE OF A FREE STYLE SQUARE.

SER. NO. 77-509,316, FILED 6-26-2008.

HELENE LIWINSKI, EXAMINING ATTORNEY

**Int. Cl.: 25**

**Prior U.S. Cls.: 22 and 39**

**United States Patent and Trademark Office**

**Reg. No. 3,569,907**

**Registered Feb. 3, 2009**

**TRADEMARK  
PRINCIPAL REGISTER**

**ENVY YOUR STYLE**

J & F APPAREL INC (CALIFORNIA CORPORATION)  
3540 RIVERSIDE PLAZA DR STE 334  
RIVERSIDE, CA 92506

FOR: BLOUSES; COATS FOR MEN AND WOMEN; FOOTWEAR FOR MEN AND WOMEN; HATS; JACKETS AND SOCKS; MEN'S AND WOMEN'S JACKETS, COATS, TROUSERS, VESTS; MEN'S SUITS, WOMEN'S SUITS; PANTS; SKIRTS AND DRESSES, IN CLASS 25 (U.S. CLS. 22 AND 39).

FIRST USE 5-7-2008; IN COMMERCE 5-10-2008.

THE MARK CONSISTS OF STANDARD CHARACTERS WITHOUT CLAIM TO ANY PARTICULAR FONT, STYLE, SIZE, OR COLOR.

SER. NO. 77-509,370, FILED 6-26-2008.

TRACY CROSS, EXAMINING ATTORNEY



**Int. Cls.: 3 and 4**

**Prior U.S. Cls.: 1, 4, 6, 15, 50, 51 and 52**

**United States Patent and Trademark Office**

**Reg. No. 3,569,908**

**Registered Feb. 3, 2009**

**TRADEMARK  
PRINCIPAL REGISTER**

**JULIE HEWETT LOS ANGELES**

HUE COSMETICS, INC. (CALIFORNIA CORPORATION)  
2408 W. OLIVE AVE.  
BURBANK, CA 91506

FOR: COSMETICS, IN CLASS 3 (U.S. CLS. 1, 4, 6, 50, 51 AND 52).

FIRST USE 8-1-2001; IN COMMERCE 8-1-2001.

FOR: CANDLES, IN CLASS 4 (U.S. CLS. 1, 6 AND 15).

FIRST USE 6-1-2007; IN COMMERCE 6-1-2007.

THE MARK CONSISTS OF STANDARD CHARACTERS WITHOUT CLAIM TO ANY PARTICULAR FONT, STYLE, SIZE, OR COLOR.

NO CLAIM IS MADE TO THE EXCLUSIVE RIGHT TO USE "LOS ANGELES", APART FROM THE MARK AS SHOWN.

THE NAME "JULIE HEWETT" IDENTIFIES A LIVING INDIVIDUAL WHOSE CONSENT IS OF RECORD.

SER. NO. 77-509,375, FILED 6-26-2008.

TRACY CROSS, EXAMINING ATTORNEY

**Int. Cl.: 25**

**Prior U.S. Cls.: 22 and 39**

**United States Patent and Trademark Office**

**Reg. No. 3,569,909**

**Registered Feb. 3, 2009**

**TRADEMARK  
PRINCIPAL REGISTER**

**Text me... 4 a PLAYDATE**

TUNI & G (CALIFORNIA PARTNERSHIP)  
10755 F SCRIPPS POWAY PKWY., SUITE #515  
SAN DIEGO, CA 92131

FIRST USE 4-11-2008; IN COMMERCE 4-11-2008.

FOR: ADULT, CHILD AND INFANT CLOTHING, NAMELY, HATS, SOCKS, TANK TOPS, T-SHIRTS, LONG SLEEVE SHIRTS, SHORT SLEEVE SHIRTS, HOODED SHIRTS, SWEAT SHIRTS, SWEAT PANTS, RELAXED PANTS; WOMEN'S CLOTHING, NAMELY MATERNITY SHIRTS; INFANT AND TODDLER CLOTHING, NAMELY ONE-PIECE CLOTHING, IN CLASS 25 (U.S. CLS. 22 AND 39).

THE MARK CONSISTS OF STANDARD CHARACTERS WITHOUT CLAIM TO ANY PARTICULAR FONT, STYLE, SIZE, OR COLOR.

SER. NO. 77-509,383, FILED 6-26-2008.

TRACY CROSS, EXAMINING ATTORNEY

Int. Cl.: 18

Prior U.S. Cls.: 1, 2, 3, 22 and 41

Reg. No. 3,569,910

United States Patent and Trademark Office

Registered Feb. 3, 2009

TRADEMARK  
PRINCIPAL REGISTER



A GIRL & HER DOG, LLC (WASHINGTON  
LIMITED LIABILITY COMPANY)  
SUITE #275  
1516 COMMERCE STREET  
TACOMA, WA 98402

THE MARK CONSISTS OF AN ORIGINAL IM-  
AGE OF A GIRL WALKING HER DOG WITH  
STYLIZED WORDS UNDERNEATH THAT READ  
"GIRL & HER DOG". THE MARK IS IN A STYLIZED  
OUTLINE.

FOR: PET CLOTHING, IN CLASS 18 (U.S. CLS. 1, 2,  
3, 22 AND 41).

SER. NO. 77-509,428, FILED 6-26-2008.

FIRST USE 5-20-2008; IN COMMERCE 5-20-2008.

NO CLAIM IS MADE TO THE EXCLUSIVE  
RIGHT TO USE "DOG", APART FROM THE MARK  
AS SHOWN.

KATHERINE E. HALMEN, EXAMINING ATTOR-  
NEY

**Int. Cl.: 41**

**Prior U.S. Cls.: 100, 101 and 107**

**United States Patent and Trademark Office**

**Reg. No. 3,569,911**

**Registered Feb. 3, 2009**

**SERVICE MARK  
PRINCIPAL REGISTER**

**just be you**

WHITNEY, TARA (UNITED STATES INDIVIDUAL)  
131 MELROSE DRIVE  
MISSION VIEJO, CA 92692

FOR: PHOTOGRAPHY SERVICES, IN CLASS 41  
(U.S. CLS. 100, 101 AND 107).

FIRST USE 1-0-2005; IN COMMERCE 1-0-2005.

THE MARK CONSISTS OF STANDARD CHARACTERS WITHOUT CLAIM TO ANY PARTICULAR FONT, STYLE, SIZE, OR COLOR.

SER. NO. 77-509,431, FILED 6-26-2008.

WILLIAM P. SHANAHAN, EXAMINING ATTORNEY

**Int. Cl.: 41**

**Prior U.S. Cls.: 100, 101 and 107**

**United States Patent and Trademark Office**

**Reg. No. 3,569,912**

**Registered Feb. 3, 2009**

**SERVICE MARK  
PRINCIPAL REGISTER**

**EL OCTAGONO DEL UFC**

ZUFFA, LLC (NEVADA LIMITED LIABILITY  
COMPANY)  
2960 W. SAHARA AVE., STE. 100  
LAS VEGAS, NV 89102

FOR: ENTERTAINMENT, NAMELY, LIVE  
STAGE SHOWS AND PERFORMANCES FEATUR-  
ING SPORTS AND MIXED MARTIAL ARTS; AND  
ENTERTAINMENT IN THE NATURE OF AN ON-  
GOING TELEVISION PROGRAM IN THE FIELD OF  
SPORTS AND MIXED MARTIAL ARTS, IN CLASS  
41 (U.S. CLS. 100, 101 AND 107).

FIRST USE 5-10-2008; IN COMMERCE 5-10-2008.

THE MARK CONSISTS OF STANDARD CHAR-  
ACTERS WITHOUT CLAIM TO ANY PARTICULAR  
FONT, STYLE, SIZE, OR COLOR.

OWNER OF U.S. REG. NOS. 2,645,312, 3,052,007  
AND OTHERS.

THE FOREIGN WORDING IN THE MARK  
TRANSLATES INTO ENGLISH AS THE OCTAGON  
OF THE UFC.

SER. NO. 77-509,443, FILED 6-26-2008.

CHERYL CLAYTON, EXAMINING ATTORNEY

Int. Cl.: 35

Prior U.S. Cls.: 100, 101 and 102

United States Patent and Trademark Office

Reg. No. 3,569,913

Registered Feb. 3, 2009

SERVICE MARK  
PRINCIPAL REGISTER



SOUTHERN DISTRIBUTING COMPANY, INC.  
(FLORIDA CORPORATION)  
750 N DIXIE HWY  
HOLLYWOOD, FL 33020

FOR: ON-LINE RETAIL STORE SERVICES FEATURING PAINT BRUSHES, PAINT ROLLERS, PAINT BUCKETS, PAINT ROLLER TRAYS, FAUX FINISHING SUPPLIES, AND PAINTING SUPPLIES, NAMELY, PAINTERS PANTS AND SHORTS, CAULKING GUNS, CAULK, DRYWALL TOOLS, PUTTY KNIVES, AIRLESS PAINT SPRAYERS AND PARTS, RAZOR KNIVES, PAINT SCRAPERS, MASKING TAPE, MASKING PAPER, SAND PAPER, SANDING SPONGES, DROP CLOTHS, AND PAINTING RAGS, IN CLASS 35 (U.S. CLS. 100, 101 AND 102).

FIRST USE 5-1-2006; IN COMMERCE 11-15-2006.

NO CLAIM IS MADE TO THE EXCLUSIVE RIGHT TO USE "THEPAINTSTORE.COM", APART FROM THE MARK AS SHOWN.

THE MARK CONSISTS OF A RENDERING OF A PAINT CAN FILLED WITH PAINTING ACCESSORIES ABOVE THE WORDS "THEPAINTSTORE.COM".

SER. NO. 77-509,447, FILED 6-26-2008.

WILLIAM P. SHANAHAN, EXAMINING ATTORNEY

**Int. Cl.: 41**

**Prior U.S. Cls.: 100, 101 and 107**

**United States Patent and Trademark Office**

**Reg. No. 3,569,914**

**Registered Feb. 3, 2009**

**SERVICE MARK  
PRINCIPAL REGISTER**

**GLADIADORES DEL UFC**

ZUFFA, LLC (NEVADA LIMITED LIABILITY  
COMPANY)  
2960 W. SAHARA AVE., STE. 100  
LAS VEGAS, NV 89102

FOR: ENTERTAINMENT, NAMELY, LIVE  
STAGE SHOWS AND PERFORMANCES FEATUR-  
ING SPORTS AND MIXED MARTIAL ARTS; AND  
ENTERTAINMENT IN THE NATURE OF AN ON-  
GOING TELEVISION PROGRAM IN THE FIELD OF  
SPORTS AND MIXED MARTIAL ARTS, IN CLASS  
41 (U.S. CLS. 100, 101 AND 107).

FIRST USE 11-3-2006; IN COMMERCE 11-3-2006.

THE MARK CONSISTS OF STANDARD CHAR-  
ACTERS WITHOUT CLAIM TO ANY PARTICULAR  
FONT, STYLE, SIZE, OR COLOR.

OWNER OF U.S. REG. NOS. 2,645,312, 3,052,007  
AND OTHERS.

THE FOREIGN WORDING IN THE MARK  
TRANSLATES INTO ENGLISH AS GLADIATORS  
OF THE UFC.

SER. NO. 77-509,449, FILED 6-26-2008.

CHERYL CLAYTON, EXAMINING ATTORNEY

**Int. Cl.: 41**

**Prior U.S. Cls.: 100, 101 and 107**

**United States Patent and Trademark Office**

**Reg. No. 3,569,915**

**Registered Feb. 3, 2009**

**SERVICE MARK  
PRINCIPAL REGISTER**

**GUERREROS DEL UFC**

ZUFFA, LLC (NEVADA LIMITED LIABILITY  
COMPANY)  
2960 W. SAHARA AVE., STE. 100  
LAS VEGAS, NV 89102

FOR: ENTERTAINMENT, NAMELY, LIVE  
STAGE SHOWS AND PERFORMANCES FEATUR-  
ING SPORTS AND MIXED MARTIAL ARTS; AND  
ENTERTAINMENT IN THE NATURE OF AN ON-  
GOING TELEVISION PROGRAM IN THE FIELD OF  
SPORTS AND MIXED MARTIAL ARTS, IN CLASS  
41 (U.S. CLS. 100, 101 AND 107).

FIRST USE 12-18-2007; IN COMMERCE 12-18-2007.

THE MARK CONSISTS OF STANDARD CHAR-  
ACTERS WITHOUT CLAIM TO ANY PARTICULAR  
FONT, STYLE, SIZE, OR COLOR.

OWNER OF U.S. REG. NOS. 2,645,312, 3,052,007  
AND OTHERS.

THE FOREIGN WORDING IN THE MARK  
TRANSLATES INTO ENGLISH AS SOLDIERS OF  
UFC.

SER. NO. 77-509,452, FILED 6-26-2008.

CHERYL CLAYTON, EXAMINING ATTORNEY



Int. Cl.: 25

Prior U.S. Cls.: 22 and 39

United States Patent and Trademark Office

Reg. No. 3,569,916

Registered Feb. 3, 2009

TRADEMARK  
PRINCIPAL REGISTER



MIBLOX, INC. (GEORGIA CORPORATION)  
2100 COVENTRY  
DALTON, GA 30720

FOR: FOOTWEAR, IN CLASS 25 (U.S. CLS. 22 AND 39).

FIRST USE 1-26-2007; IN COMMERCE 2-8-2008.

THE MARK CONSISTS OF THE "I" IN "MIBLOX" IS THE ONLY LETTER THAT IS LEFT LOWERCASE

THE "MB" "L" "O" "X" IS ALL CAPITALIZED. THE "MI" IN "MIBLOX" IS OUTLINED. THE "BLOX" IS FILLED IN. A THICK HORIZONTAL LINE SITS ON TOP OF THE "I". THE THICK HORIZONTAL LINE IS OUTLINED..

SER. NO. 77-509,496, FILED 6-26-2008.

JEFFERY COWARD, EXAMINING ATTORNEY

**Int. Cl.: 41**

**Prior U.S. Cls.: 100, 101 and 107**

**United States Patent and Trademark Office**

**Reg. No. 3,569,917**

**Registered Feb. 3, 2009**

**SERVICE MARK  
PRINCIPAL REGISTER**

**SILVER CURVE MUSIC**

MY TRUE LOVE, INC. (NEW YORK CORPORATION)  
SUITE 154  
603 WEST 115TH STREET  
NEW YORK, NY 10025

FOR: MUSIC PUBLISHING SERVICES, IN CLASS  
41 (U.S. CLS. 100, 101 AND 107).

FIRST USE 6-7-2008; IN COMMERCE 6-7-2008.

THE MARK CONSISTS OF STANDARD CHARACTERS WITHOUT CLAIM TO ANY PARTICULAR FONT, STYLE, SIZE, OR COLOR.

NO CLAIM IS MADE TO THE EXCLUSIVE RIGHT TO USE "MUSIC", APART FROM THE MARK AS SHOWN.

SER. NO. 77-509,559, FILED 6-27-2008.

PAUL F. GAST, EXAMINING ATTORNEY

**Int. Cls.: 39 and 44**

**Prior U.S. Cls.: 100, 101 and 105**

**United States Patent and Trademark Office**

**Reg. No. 3,569,918**

**Registered Feb. 3, 2009**

**SERVICE MARK  
PRINCIPAL REGISTER**

**FLORATECH**

FLORA TECH, INC. (NEW YORK CORPORATION)  
51 BEACH STREET  
NEW YORK, NY 10013

FOR: FLOWER DELIVERY, IN CLASS 39 (U.S. CLS. 100 AND 105).

FIRST USE 6-1-1987; IN COMMERCE 6-1-1987.

FOR: FLOWER ARRANGING, IN CLASS 44 (U.S. CLS. 100 AND 101).

FIRST USE 6-1-1987; IN COMMERCE 6-1-1987.

THE MARK CONSISTS OF STANDARD CHARACTERS WITHOUT CLAIM TO ANY PARTICULAR FONT, STYLE, SIZE, OR COLOR.

SER. NO. 77-509,574, FILED 6-27-2008.

MICHAEL ENGEL, EXAMINING ATTORNEY

**Int. Cl.: 36**

**Prior U.S. Cls.: 100, 101 and 102**

**United States Patent and Trademark Office**

**Reg. No. 3,569,919**

**Registered Feb. 3, 2009**

**SERVICE MARK  
PRINCIPAL REGISTER**

**KURIO**

MOST HOME REAL ESTATE SERVICES INC.  
(CANADA CORPORATION)  
#1 - 11491 KINGSTON STREET  
MAPLE RIDGE, BC, CANADA V2X0Y6

THE MARK CONSISTS OF STANDARD CHAR-  
ACTERS WITHOUT CLAIM TO ANY PARTICULAR  
FONT, STYLE, SIZE, OR COLOR.

FOR: PROVIDING REAL ESTATE LISTING IN-  
FORMATION VIA WIRELESS COMMUNICATIONS  
NETWORKS, IN CLASS 36 (U.S. CLS. 100, 101 AND  
102).

SER. NO. 77-509,603, FILED 6-27-2008.

FIRST USE 6-17-2008; IN COMMERCE 6-17-2008.

MARK RADEMACHER, EXAMINING ATTORNEY

**Int. Cl.: 35**

**Prior U.S. Cls.: 100, 101 and 102**

**United States Patent and Trademark Office**

**Reg. No. 3,569,920**

**Registered Feb. 3, 2009**

**SERVICE MARK  
PRINCIPAL REGISTER**

**SMART2 RADIUS**

DATABASE MARKETING GROUP, INC. (CALIFORNIA CORPORATION)  
SUITE 380  
5 PETERS CANYON  
IRVINE, CA 92606

FOR: ADVERTISING CONSULTING SERVICES, NAMELY, IDENTIFYING GEOGRAPHIC AREAS IN WHICH ADVERTISING WILL BE DISTRIBUTED TO POTENTIAL CONSUMERS BY GROCERY STORES, RESTAURANTS, AND OTHER DISTRIBUTION-BASED RETAILERS, IN CLASS 35 (U.S. CLS. 100, 101 AND 102).

FIRST USE 5-0-2008; IN COMMERCE 5-0-2008.

THE MARK CONSISTS OF STANDARD CHARACTERS WITHOUT CLAIM TO ANY PARTICULAR FONT, STYLE, SIZE, OR COLOR.

SER. NO. 77-509,733, FILED 6-27-2008.

REBECCA GILBERT, EXAMINING ATTORNEY

**Int. Cl.: 35**

**Prior U.S. Cls.: 100, 101 and 102**

**United States Patent and Trademark Office**

**Reg. No. 3,569,921**

**Registered Feb. 3, 2009**

**SERVICE MARK  
PRINCIPAL REGISTER**

**READY AIM MAIL**

DATABASE MARKETING GROUP, INC. (CALI-  
FORNIA CORPORATION)  
SUITE 380  
5 PETERS CANYON  
IRVINE, CA 92606

FOR: CUSTOMIZING AND MAILING ADVER-  
TISING MATERIALS TO PROSPECTIVE PURCHA-  
SERS PURSUANT TO THE ADVERTISING  
REQUIREMENTS OF RETAILERS , IN CLASS 35  
(U.S. CLS. 100, 101 AND 102).

FIRST USE 5-9-2003; IN COMMERCE 5-9-2003.

THE MARK CONSISTS OF STANDARD CHAR-  
ACTERS WITHOUT CLAIM TO ANY PARTICULAR  
FONT, STYLE, SIZE, OR COLOR.

SER. NO. 77-509,745, FILED 6-27-2008.

REBECCA GILBERT, EXAMINING ATTORNEY

**Int. Cl.: 1**

**Prior U.S. Cls.: 1, 5, 6, 10, 26 and 46**

**Reg. No. 3,569,922**

**United States Patent and Trademark Office**

**Registered Feb. 3, 2009**

---

**TRADEMARK  
PRINCIPAL REGISTER**

**UNLOK**

AGRAKEY SOLUTIONS, LLC (IDAHO LIMITED  
LIABILITY COMPANY)  
3586 HIGHWAY 93  
TWIN FALLS, ID 83301

THE MARK CONSISTS OF STANDARD CHAR-  
ACTERS WITHOUT CLAIM TO ANY PARTICULAR  
FONT, STYLE, SIZE, OR COLOR.

FOR: SOIL AMENDMENT AND ODOR CON-  
TROLLING AGENT TO CONTROL ODORS AND  
HYDROGEN SULFIDE PRODUCTION IN WASTE  
WATER, IN CLASS 1 (U.S. CLS. 1, 5, 6, 10, 26 AND 46).

SER. NO. 77-509,762, FILED 6-27-2008.

FIRST USE 5-4-2006; IN COMMERCE 5-4-2006.

WILLIAM VERHOSEK, EXAMINING ATTORNEY

**Int. Cl.: 41**

**Prior U.S. Cls.: 100, 101 and 107**

**United States Patent and Trademark Office**

**Reg. No. 3,569,923**

**Registered Feb. 3, 2009**

**SERVICE MARK  
PRINCIPAL REGISTER**

**SEAWORLD**

SEA WORLD, INC. (DELAWARE CORPORATION)  
202-6  
ONE BUSCH PLACE  
ST. LOUIS, MO 63118

FOR: AMUSEMENT PARKS, IN CLASS 41 (U.S. CLS. 100, 101 AND 107).

FIRST USE 3-11-1998; IN COMMERCE 3-11-1998.

THE MARK CONSISTS OF STANDARD CHARACTERS WITHOUT CLAIM TO ANY PARTICULAR FONT, STYLE, SIZE, OR COLOR.

OWNER OF U.S. REG. NOS. 1,195,498, 2,199,930 AND OTHERS.

SER. NO. 77-509,778, FILED 6-27-2008.

RENEE MCCRAY, EXAMINING ATTORNEY



**Int. Cl.: 35**

**Prior U.S. Cls.: 100, 101 and 102**

**United States Patent and Trademark Office**

**Reg. No. 3,569,924**

**Registered Feb. 3, 2009**

**SERVICE MARK  
PRINCIPAL REGISTER**



ESPINOZA, ELIAS (UNITED STATES INDIVIDUAL)  
SUITE A  
580 E. THIRD STREET  
OXNARD, CA 93030

FIRST USE 4-0-2006; IN COMMERCE 5-0-2006.

THE MARK CONSISTS OF A DOVE NEXT TO THE STYLIZED TEXT "DAYSE.WARE".

FOR: RETAIL STORE SERVICES FEATURING STAINLESS STEEL COOKWARE; WHOLESALE DISTRIBUTORSHIPS FEATURING STAINLESS STEEL COOKWARE, IN CLASS 35 (U.S. CLS. 100, 101 AND 102).

SER. NO. 77-509,813, FILED 6-27-2008.

RONALD AIKENS, EXAMINING ATTORNEY

Int. Cl.: 16

Prior U.S. Cls.: 2, 5, 22, 23, 29, 37, 38 and 50

Reg. No. 3,569,925

United States Patent and Trademark Office

Registered Feb. 3, 2009

TRADEMARK  
PRINCIPAL REGISTER

WILDLIFE EDUCATION, LTD. (CALIFORNIA CORPORATION)  
SUITE 211  
1123 EMERSON STREET  
EVANSTON, IL 60201

FOR: BOOKS AND MAGAZINES FOR CHILDREN ABOUT ANIMALS, IN CLASS 16 (U.S. CLS. 2, 5, 22, 23, 29, 37, 38 AND 50).

FIRST USE 6-27-2008; IN COMMERCE 6-27-2008.

THE COLOR(S) WHITE, RED, ORANGE, YELLOW, GREEN AND BLUE IS/ARE CLAIMED AS A FEATURE OF THE MARK.

THE MARK CONSISTS OF THE LETTERS "Z" "O" "O" "B" "I" "E" "S" IN THE COLOR WHITE APPEARING ON A WHITE BACKGROUND WITH EACH LETTER BEING OUTLINED IN COLOR AS FOLLOWS: THE LETTER "Z" IS OUTLINED IN THE COLOR RED; THE LETTER "O" IS OUTLINED IN THE COLOR ORANGE WITH A SMALLER LETTER "O" OUTLINED IN THE COLOR ORANGE APPEARING INSIDE IT; THE NEXT LETTER "O" IS OUT-

LINED IN THE COLOR ORANGE ON THE LEFT SIDE AND YELLOW-ORANGE ON RIGHT SIDE WITH A SMALL LETTER "O" IN THE COLOR YELLOW-ORANGE APPEARING INSIDE IT; THE LETTER "B" IS OUTLINED IN THE COLOR YELLOW ON THE LEFT SIDE AND GREEN-YELLOW ON RIGHT SIDE WITH THE IMAGE OF A LETTER "D" IN THE COLOR GREEN-YELLOW APPEARING INSIDE THE UPPER PORTION OF THE LETTER "B" AND ANOTHER IMAGE OF A LETTER "D" IN THE COLOR GREEN-YELLOW APPEARING INSIDE THE LOWER PORTION OF THE LETTER "B"; THE LETTER I IS OUTLINED IN THE COLOR LIGHT GREEN ON LEFT SIDE AND THE COLOR MEDIUM GREEN ON RIGHT SIDE; THE LETTER E IS OUTLINED IN THE COLOR GREEN ON LEFT SIDE AND THE COLOR GREEN-BLUE ON RIGHT SIDE; THE LETTER "S" IS OUTLINED IN THE COLOR BLUE-GREEN ON LEFT SIDE AND THE COLOR BLUE ON RIGHT SIDE.

SER. NO. 77-509,816, FILED 6-27-2008.

RONALD AIKENS, EXAMINING ATTORNEY

**Int. Cl.: 24**

**Prior U.S. Cls.: 42 and 50**

**United States Patent and Trademark Office**

**Reg. No. 3,569,926**

**Registered Feb. 3, 2009**

**TRADEMARK  
PRINCIPAL REGISTER**

**Burpie Buddies**

CHAPMAN, KATHLEEN (UNITED STATES IN-  
DIVIDUAL)  
1100 CONCORD DRIVE  
MEDINA, OH 44256 AND  
MIKESELL, JENNIFER (UNITED STATES INDIVI-  
DUAL)  
4870 WEST 12TH STREET  
CLEVELAND, OH 44109

FOR: BURP CLOTHS, IN CLASS 24 (U.S. CLS. 42  
AND 50).

FIRST USE 6-27-2008; IN COMMERCE 6-27-2008.

THE MARK CONSISTS OF STANDARD CHAR-  
ACTERS WITHOUT CLAIM TO ANY PARTICULAR  
FONT, STYLE, SIZE, OR COLOR.

SER. NO. 77-509,818, FILED 6-27-2008.

RONALD AIKENS, EXAMINING ATTORNEY

**Int. Cl.: 7**

**Prior U.S. Cls.: 13, 19, 21, 23, 31, 34 and 35**

**Reg. No. 3,569,927**

**United States Patent and Trademark Office**

**Registered Feb. 3, 2009**

**TRADEMARK  
PRINCIPAL REGISTER**



OPTIGENERATORS INTERNATIONAL, INC  
(GEORGIA CORPORATION)  
1256 OAKBROOK DR., SUITE E  
NORCROSS, GA 30093

FOR: AC GENERATORS; AIR COMPRESSORS;  
CENTRIFUGAL PUMPS; DIESEL ENGINES FOR  
MACHINES; GASOLINE ENGINES NOT FOR LAND  
VEHICLES; MULTI-PURPOSE HIGH PRESSURE  
WASHERS, IN CLASS 7 (U.S. CLS. 13, 19, 21, 23, 31,  
34 AND 35).

FIRST USE 5-18-2006; IN COMMERCE 5-18-2006.

THE COLOR(S) BLUE, RED IS/ARE CLAIMED AS  
A FEATURE OF THE MARK.

THE MARK CONSISTS OF LETTERS "O", "P", "T"  
AND "I" IN THE ORDER FROM LEFT TO RIGHT,  
ALL LETTERS ARE IN BLUE COLOR EXCEPT  
THAT LETTER "I" HAS AN RED DOT ON THE  
TOP. THE TOP HORIZONTAL STROKE OF LETTER  
"T" TOUCHES THE TOP PORTION OF LETTERS "O"  
AND "P" AND ALSO PROTRUDES OUT BETWEEN  
TOP DOT AND BOTTOM VERTICAL STROKE. THE  
OVERALL SHAPE OF MARK IS LIKE A HOUSE  
WITH A LIT TORCH IN THE FRONT.

SER. NO. 77-509,828, FILED 6-27-2008.

RONALD AIKENS, EXAMINING ATTORNEY

**Int. Cl.: 36**

**Prior U.S. Cls.: 100, 101 and 102**

**United States Patent and Trademark Office**

**Reg. No. 3,569,928**

**Registered Feb. 3, 2009**

**SERVICE MARK  
PRINCIPAL REGISTER**

**REALRATE**

QUADRANT INFORMATION SERVICES, LLC  
(NEVADA LIMITED LIABILITY COMPANY)  
770 TRADEMARK DRIVE, SUITE 100  
RENO, NV 89521

THE MARK CONSISTS OF STANDARD CHAR-  
ACTERS WITHOUT CLAIM TO ANY PARTICULAR  
FONT, STYLE, SIZE, OR COLOR.

FOR: INSURANCE INFORMATION, IN CLASS 36  
(U.S. CLS. 100, 101 AND 102).

SER. NO. 77-509,866, FILED 6-27-2008.

FIRST USE 12-0-2001; IN COMMERCE 12-0-2001.

ELISSA GARBER KON, EXAMINING ATTORNEY

**Int. Cl.: 41**

**Prior U.S. Cls.: 100, 101 and 107**

**United States Patent and Trademark Office**

**Reg. No. 3,569,929**

**Registered Feb. 3, 2009**

**SERVICE MARK  
PRINCIPAL REGISTER**

**I Do, I Do!**

ALENE K. GAMEL (ALABAMA LIMITED LIABILITY COMPANY)  
1315 SHADES RUN CIRCLE  
BIRMINGHAM, AL 35244

THE MARK CONSISTS OF STANDARD CHARACTERS WITHOUT CLAIM TO ANY PARTICULAR FONT, STYLE, SIZE, OR COLOR.

FOR: WEDDING PLANNING AND COORDINATION SERVICES, IN CLASS 41 (U.S. CLS. 100, 101 AND 107).

SER. NO. 77-509,925, FILED 6-27-2008.

FIRST USE 2-1-2002; IN COMMERCE 2-1-2002.

KYLE PEETE, EXAMINING ATTORNEY

**Int. Cls.: 35, 36, 37 and 39**

**Prior U.S. Cls.: 100, 101, 102, 103, 105 and 106**

**United States Patent and Trademark Office**

**Reg. No. 3,569,930**

**Registered Feb. 3, 2009**

**SERVICE MARK  
PRINCIPAL REGISTER**



MURPHY-HOFFMAN COMPANY (MISSOURI CORPORATION)  
1524 NORTH CORRINGTON  
KANSAS CITY, MO 64120

FOR: DEALERSHIP SERVICES IN THE FIELD OF NEW AND USED COMMERCIAL TRUCKS AND TRUCK PARTS AND DEALERSHIP SERVICES IN THE FIELD OF TRUCK AND TRAILER REFRIGERATION SYSTEMS AND PARTS THEREFOR, IN CLASS 35 (U.S. CLS. 100, 101 AND 102).

FIRST USE 12-0-2005; IN COMMERCE 12-0-2005.

FOR: TRUCK FINANCING, IN CLASS 36 (U.S. CLS. 100, 101 AND 102).

FIRST USE 12-0-2005; IN COMMERCE 12-0-2005.

FOR: COMMERCIAL TRUCK REPAIR AND MAINTENANCE, IN CLASS 37 (U.S. CLS. 100, 103 AND 106).

FIRST USE 12-0-2005; IN COMMERCE 12-0-2005.

FOR: LEASING OF COMMERCIAL TRUCKS, IN CLASS 39 (U.S. CLS. 100 AND 105).

FIRST USE 12-0-2005; IN COMMERCE 12-0-2005.

THE MARK CONSISTS OF THE LETTERS "MHC" WITH AN ARC PARTIALLY AROUND THE BOTTOM, LEFT SIDE AND TOP OF THE LETTERS.

SER. NO. 77-509,948, FILED 6-27-2008.

RONALD AIKENS, EXAMINING ATTORNEY

**Int. Cl.: 35**

**Prior U.S. Cls.: 100, 101 and 102**

**United States Patent and Trademark Office**

**Reg. No. 3,569,931**

**Registered Feb. 3, 2009**

**SERVICE MARK  
PRINCIPAL REGISTER**

**Wag This Way**

CORSON, NICOLE (UNITED STATES INDIVIDUAL)  
6116 S. CARRIAGE PARK CIR.  
SALT LAKE CITY, UT 84121

THE MARK CONSISTS OF STANDARD CHARACTERS WITHOUT CLAIM TO ANY PARTICULAR FONT, STYLE, SIZE, OR COLOR.

FOR: RETAIL PET STORES, IN CLASS 35 (U.S. CLS. 100, 101 AND 102).

SER. NO. 77-509,964, FILED 6-27-2008.

FIRST USE 4-1-2005; IN COMMERCE 4-1-2005.

JENNIFER VASQUEZ, EXAMINING ATTORNEY



**Int. Cl.: 40**

**Prior U.S. Cls.: 100, 103 and 106**

**United States Patent and Trademark Office**

**Reg. No. 3,569,932**

**Registered Feb. 3, 2009**

**SERVICE MARK  
PRINCIPAL REGISTER**

# INTERFORM

INTERMOUNTAIN BUSINESS FORMS, INC.  
(UTAH CORPORATION)  
22 SOUTH 1400 WEST  
CENTERVILLE, UT 84014

FOR: PRINTING SERVICES, DESIGN PRINTING  
FOR OTHERS, CUSTOM PRINTING OF BUSINESS  
FORMS IN THE NATURE OF INVOICES, ORDER  
FORMS, LETTERHEAD, BUSINESS CARDS, AD-  
VERTISING BROCHURES, CHECKS, POSTERS,  
AND BANNERS, IN CLASS 40 (U.S. CLS. 100, 103  
AND 106).

FIRST USE 1-31-2001; IN COMMERCE 1-31-2001.

THE MARK CONSISTS OF STANDARD CHAR-  
ACTERS WITHOUT CLAIM TO ANY PARTICULAR  
FONT, STYLE, SIZE, OR COLOR.

OWNER OF U.S. REG. NO. 2,133,331.

SER. NO. 77-509,979, FILED 6-27-2008.

KAREN BRACEY, EXAMINING ATTORNEY

**Int. Cl.: 42**

**Prior U.S. Cls.: 100 and 101**

**United States Patent and Trademark Office**

**Reg. No. 3,569,933**

**Registered Feb. 3, 2009**

**SERVICE MARK  
PRINCIPAL REGISTER**

**FLEXDRAW**

GTECH CORPORATION (DELAWARE CORPORATION)  
10 MEMORIAL BOULEVARD  
PROVIDENCE, RI 02903

THE MARK CONSISTS OF STANDARD CHARACTERS WITHOUT CLAIM TO ANY PARTICULAR FONT, STYLE, SIZE, OR COLOR.

FOR: APPLICATION SERVICE PROVIDER FEATURING SOFTWARE FOR USE IN GENERATING RANDOM NUMBERS IN THE GAMING AND LOTTERY FIELD, IN CLASS 42 (U.S. CLS. 100 AND 101).

SER. NO. 77-510,000, FILED 6-27-2008.

FIRST USE 10-20-2006; IN COMMERCE 10-20-2006.

MICHAEL WIENER, EXAMINING ATTORNEY

**Int. Cls.: 9 and 35**

**Prior U.S. Cls.: 21, 23, 26, 36, 38, 100, 101 and 102**

**Reg. No. 3,569,934**

**United States Patent and Trademark Office**

**Registered Feb. 3, 2009**

**TRADEMARK  
SERVICE MARK  
PRINCIPAL REGISTER**

# WaveMark

WAVEMARK, INC. (DELAWARE CORPORATION), DBA MANIFESTECH, INC.  
ONE MONARCH DR. SUITE 140  
LITTLETON, MA 01460

FOR: COMPUTER SOFTWARE AND HARDWARE FOR RFID; COMPUTER SOFTWARE FOR PROVIDING AN ON-LINE DATABASE IN THE FIELD OF TRANSACTION PROCESSING TO UPLOAD TRANSACTIONAL DATA, PROVIDE STATISTICAL ANALYSIS, AND PRODUCE NOTIFICATIONS AND REPORTS; COMPUTER SOFTWARE FOR THE COLLECTION, EDITING, ORGANIZING, MODIFYING, BOOK MARKING, TRANSMISSION, STORAGE AND SHARING OF DATA AND INFORMATION; COMPUTER SOFTWARE FOR THE FIELD OF WAREHOUSING AND DISTRIBUTION, TO MANAGE TRANSACTIONAL DATA, PROVIDE STATISTICAL ANALYSIS, AND PRODUCE NOTIFICATIONS AND REPORTS; COMPUTER SOFTWARE THAT PROVIDES REAL-TIME, INTEGRATED BUSINESS MANAGEMENT INTELLIGENCE BY COMBINING INFORMATION FROM VARIOUS DATABASES AND PRESENTING IT IN AN EASY-TO-UNDERSTAND USER INTERFACE; COMPUTER SOFTWARE THAT PROVIDES WEB-BASED ACCESS TO APPLICATIONS AND SERVICES THROUGH A WEB OPERATING SYSTEM OR PORTAL INTERFACE; COMPUTER SOFTWARE, NAMELY, AN APPLICATION ALLOWING SALES AND FIELD SERVICE EMPLOYEES TO UPDATE AND RECEIVE DATA STORED IN AN ENTERPRISE'S COMPUTER DATABASES IN REAL TIME, USING A MOBILE DEVICE, WITH FULL TELEPHONY INTEGRATION WITH THE TELEPHONE

AND/OR SOFTWARE FEATURES OF THE MOBILE DEVICE; GLOBAL POSITIONING SYSTEM (GPS) CONSISTING OF COMPUTERS, COMPUTER SOFTWARE, TRANSMITTERS, RECEIVERS, AND NETWORK INTERFACE DEVICES, IN CLASS 9 (U.S. CLS. 21, 23, 26, 36 AND 38).

FIRST USE 12-1-2004; IN COMMERCE 12-1-2004.

FOR: BUSINESS MANAGEMENT SERVICES, NAMELY, MANAGING LOGISTICS, REVERSE LOGISTICS, SUPPLY CHAIN SERVICES, SUPPLY CHAIN VISIBILITY AND SYNCHRONIZATION, SUPPLY AND DEMAND FORECASTING AND PRODUCT DISTRIBUTION PROCESSES FOR OTHERS; ELECTRONIC DATA COLLECTION AND DATA SUBMISSION SERVICES FOR BUSINESS PURPOSES IN THE FIELDS OF MEDICINE AND HEALTHCARE; INVENTORY MANAGEMENT; INVENTORY MANAGEMENT IN THE FIELD OF HEALTHCARE; PROVIDING BUSINESS INTELLIGENCE SERVICES; SUPPLY CHAIN MANAGEMENT SERVICES, IN CLASS 35 (U.S. CLS. 100, 101 AND 102).

FIRST USE 12-1-2004; IN COMMERCE 12-1-2004.

THE MARK CONSISTS OF STANDARD CHARACTERS WITHOUT CLAIM TO ANY PARTICULAR FONT, STYLE, SIZE, OR COLOR.

SER. NO. 77-510,036, FILED 6-27-2008.

REGINA DRUMMOND, EXAMINING ATTORNEY

**Int. Cl.: 9**

**Prior U.S. Cls.: 21, 23, 26, 36 and 38**

**United States Patent and Trademark Office**

**Reg. No. 3,569,935**

**Registered Feb. 3, 2009**

**TRADEMARK  
PRINCIPAL REGISTER**

# TotalFreedom

METROLOGIC INSTRUMENTS, INC. (NEW JERSEY CORPORATION)  
90 COLES ROAD  
BLACKWOOD, NJ 08012

FOR: SOFTWARE PROGRAM THAT ALLOWS END USERS AND THIRD PARTY INTEGRATORS TO DEVELOP CUSTOM PLUG-INS FOR DATA CAPTURE AND COLLECTION DEVICES, IN CLASS 9 (U.S. CLS. 21, 23, 26, 36 AND 38).

FIRST USE 2-15-2008; IN COMMERCE 5-15-2008.

THE MARK CONSISTS OF STANDARD CHARACTERS WITHOUT CLAIM TO ANY PARTICULAR FONT, STYLE, SIZE, OR COLOR.

SER. NO. 77-510,042, FILED 6-27-2008.

ANTHONY RINKER, EXAMINING ATTORNEY

**Int. Cl.: 29**

**Prior U.S. Cl.: 46**

**United States Patent and Trademark Office**

**Reg. No. 3,569,936**

**Registered Feb. 3, 2009**

**TRADEMARK  
PRINCIPAL REGISTER**

**HIGÜERAL**

CENTRAL ROMANA CORPORATION, LTD. (DOMINICAN REP CORPORATION)

CENTRAL ROMANA

DEPTO. DE ADMINISTRACION

LA ROMANA, DOMINICAN REP

FOR: PROCESSED MEATS, IN CLASS 29 (U.S. CL. 46).

FIRST USE 2-0-1989; IN COMMERCE 7-29-1993.

THE MARK CONSISTS OF STANDARD CHARACTERS WITHOUT CLAIM TO ANY PARTICULAR FONT, STYLE, SIZE, OR COLOR.

THE FOREIGN WORDING IN THE MARK TRANSLATES INTO ENGLISH AS PLANTATION OF FIG TREES.

SER. NO. 77-510,044, FILED 6-27-2008.

JENNIFER VASQUEZ, EXAMINING ATTORNEY

**Int. Cl.: 16**

**Prior U.S. Cls.: 2, 5, 22, 23, 29, 37, 38 and 50**

**Reg. No. 3,569,937**

**United States Patent and Trademark Office**

**Registered Feb. 3, 2009**

**TRADEMARK  
PRINCIPAL REGISTER**

**FLORIDA REVIEW**

INTERNATIONAL BRAZILIAN ADVERTISING  
CORPORATION (FLORIDA CORPORATION)  
BOX 19  
801 BRICKELL BAY DR  
MIAMI, FL 33131

FOR: GENERAL FEATURE MAGAZINES; MAGAZINES FEATURING ENTERTAINMENT, POLITICS, IMMIGRATION ADVICE, FAMILY ADVICE, CURRENT EVENTS, SOCIAL EVENTS; PRINTED PERIODICALS IN THE FIELD OF ENTERTAINMENT, POLITICS, IMMIGRATION ADVICE, FAMILY ADVICE, CURRENT EVENTS, SOCIAL EVENTS; PUBLICATIONS, NAMELY, MAGAZINES IN THE FIELDS OF ENTERTAINMENT, POLITICS, IMMIGRATION ADVICE, FAMILY ADVICE, CURRENT EVENTS, SOCIAL EVENTS, IN CLASS 16 (U.S. CLS. 2, 5, 22, 23, 29, 37, 38 AND 50).

FIRST USE 1-1-1983; IN COMMERCE 1-1-1983.

THE MARK CONSISTS OF STANDARD CHARACTERS WITHOUT CLAIM TO ANY PARTICULAR FONT, STYLE, SIZE, OR COLOR.

NO CLAIM IS MADE TO THE EXCLUSIVE RIGHT TO USE "REVIEW", APART FROM THE MARK AS SHOWN.

SEC. 2(F).

SER. NO. 77-510,091, FILED 6-27-2008.

DAVID HOFFMAN, EXAMINING ATTORNEY

**Int. Cl.: 7**

**Prior U.S. Cls.: 13, 19, 21, 23, 31, 34 and 35**

**United States Patent and Trademark Office**

**Reg. No. 3,569,938**

**Registered Feb. 3, 2009**

**TRADEMARK  
PRINCIPAL REGISTER**

**ECONOLINE**

FORD MOTOR COMPANY (DELAWARE CORPORATION)  
ONE AMERICAN ROAD  
DEARBORN, MI 48126

FOR: ENGINE AIR INLET DUCTS FOR MOTOR VEHICLE ENGINES, IN CLASS 7 (U.S. CLS. 13, 19, 21, 23, 31, 34 AND 35).

FIRST USE 1-1-1999; IN COMMERCE 1-1-1999.

THE MARK CONSISTS OF STANDARD CHARACTERS WITHOUT CLAIM TO ANY PARTICULAR FONT, STYLE, SIZE, OR COLOR.

OWNER OF U.S. REG. NO. 1,494,156.

SER. NO. 77-510,105, FILED 6-27-2008.

BENJAMIN ALLEN, EXAMINING ATTORNEY

**Int. Cl.: 32**

**Prior U.S. Cls.: 45, 46 and 48**

**Reg. No. 3,569,939**

**United States Patent and Trademark Office**

**Registered Feb. 3, 2009**

---

**TRADEMARK  
PRINCIPAL REGISTER**

**DIGGLE**

DIGGLE WATER COMPANY LLC (NEW YORK  
LIMITED LIABILITY COMPANY)  
10 HAVEN CT.  
CENTERPORT, NY 11721

THE MARK CONSISTS OF STANDARD CHAR-  
ACTERS WITHOUT CLAIM TO ANY PARTICULAR  
FONT, STYLE, SIZE, OR COLOR.

FOR: BOTTLED DRINKING WATER; BOTTLED  
WATER; DRINKING WATER; SPRING WATER, IN  
CLASS 32 (U.S. CLS. 45, 46 AND 48).

SER. NO. 77-510,138, FILED 6-27-2008.

FIRST USE 12-1-2007; IN COMMERCE 12-1-2007.

KELLEY WELLS, EXAMINING ATTORNEY



Int. Cl.: 41

Prior U.S. Cls.: 100, 101 and 107

United States Patent and Trademark Office

Reg. No. 3,569,940

Registered Feb. 3, 2009

SERVICE MARK  
PRINCIPAL REGISTER

LEARNING ROOM



DIVERSIFIED ACADEMIC SOLUTIONS LLC  
(NEW YORK LIMITED LIABILITY COMPAN-  
NY), DBA LEARNING ROOM  
STORE RIGHT  
311 EAST 76TH STREET  
NEW YORK, NY 10021

FOR: EDUCATION SERVICES, NAMELY, PRO-  
VIDING MENTORING, TUTORING, CLASSES,  
SEMINARS AND WORKSHOPS IN THE FIELD OF  
GENERAL EDUCATION AT THE SECONDARY,  
COLLEGE, GRADUATE AND ADULT LEARNING  
LEVELS; TEACHING, TRAINING, TUTORING AND  
COURSES OF INSTRUCTION AT THE UNDER-  
GRADUATE, GRADUATE AND POST-GRADUATE  
LEVEL, IN CLASS 41 (U.S. CLS. 100, 101 AND 107).

FIRST USE 5-1-2008; IN COMMERCE 5-1-2008.

NO CLAIM IS MADE TO THE EXCLUSIVE  
RIGHT TO USE "LEARNING", APART FROM THE  
MARK AS SHOWN.

THE MARK CONSISTS OF THE WORDING  
"LEARNING ROOM" ABOVE A DESIGN OF AN  
OPEN BOOK WITH A DIAMOND SHAPED BOX IN  
THE MIDDLE WITH THE CAPITAL LETTER "L"  
STACKED ON TOP OF A CAPITAL LETTER "R"  
APPEARING WITHIN THE DIAMOND.

SER. NO. 77-510,195, FILED 6-27-2008.

MATTHEW MCDOWELL, EXAMINING ATTOR-  
NEY

**Int. Cl.: 9**

**Prior U.S. Cls.: 21, 23, 26, 36 and 38**

**Reg. No. 3,569,941**

**United States Patent and Trademark Office**

**Registered Feb. 3, 2009**

**TRADEMARK  
PRINCIPAL REGISTER**

**HQRP**

RESURS2 CORPORATION (NEW JERSEY CORPORATION)  
160 ESSEX AVENUE E  
AVENEL, NJ 07001

FOR: BATTERIES AND BATTERY CHARGERS; BATTERIES, ELECTRIC; BATTERY CABLES; CABLE CONNECTORS; CABLES FOR ELECTRICAL AND OPTICAL SIGNAL TRANSMISSION SYSTEMS; CAMERA TRIPODS; CHARGING APPLIANCES FOR RECHARGEABLE EQUIPMENT; COMPUTER CABLES; COMPUTER HARDWARE; CONNECTION CABLES; ELECTRIC CABLES, WIRES, CONDUCTORS AND CONNECTION FITTINGS THEREFOR; ELECTRICAL AND ELECTRONIC CONNECTORS; ELECTRONIC CABLES; ELECTRONIC COMPONENTS FOR COMPUTERS; ELECTRONIC INTERCONNECTERS FOR AUDIO AND VIDEO SIGNALS; ELECTRONIC METERING FAUCETS; KEY-

BOARDS; MICROPHONES; PLUG ADAPTORS; POWER CABLES; POWER SUPPLIES; POWER SUPPLY CONNECTORS AND ADAPTORS FOR USE WITH PORTABLE ELECTRONIC DEVICES; SIGNAL SPLITTERS FOR ELECTRONIC APPARATUS; WIRELESS COMPUTER PERIPHERALS, IN CLASS 9 (U.S. CLS. 21, 23, 26, 36 AND 38).

FIRST USE 5-1-2008; IN COMMERCE 5-1-2008.

THE MARK CONSISTS OF STANDARD CHARACTERS WITHOUT CLAIM TO ANY PARTICULAR FONT, STYLE, SIZE, OR COLOR.

SER. NO. 77-510,205, FILED 6-27-2008.

CHRISTOPHER BUONGIORNO, EXAMINING ATTORNEY

**Int. Cl.: 40**

**Prior U.S. Cls.: 100, 103 and 106**

**United States Patent and Trademark Office**

**Reg. No. 3,569,942**

**Registered Feb. 3, 2009**

**SERVICE MARK  
PRINCIPAL REGISTER**

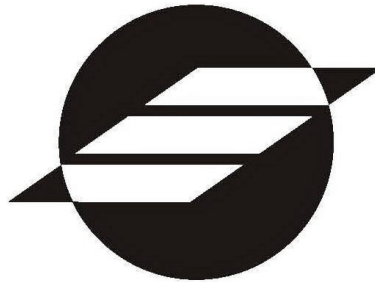

INTERMOUNTAIN BUSINESS FORMS, INC.  
(UTAH CORPORATION)  
22 SOUTH 1400 WEST  
CENTERVILLE, UT 84014

FIRST USE 1-31-2001; IN COMMERCE 1-31-2001.

FOR: PRINTING SERVICES, DESIGN PRINTING  
FOR OTHERS, CUSTOM PRINTING OF BUSINESS  
FORMS IN THE NATURE OF INVOICES, ORDER  
FORMS, LETTERHEAD, BUSINESS CARDS, AD-  
VERTISING BROCHURES, CHECKS, POSTERS,  
AND BANNERS, IN CLASS 40 (U.S. CLS. 100, 103  
AND 106).

THE MARK CONSISTS OF A CIRCLE WITH  
THREE SLANTED LINES OVERLAID THEREON.

SER. NO. 77-510,207, FILED 6-27-2008.

KAREN BRACEY, EXAMINING ATTORNEY

**Int. Cl.: 9**

**Prior U.S. Cls.: 21, 23, 26, 36 and 38**

**United States Patent and Trademark Office**

**Reg. No. 3,569,943**

**Registered Feb. 3, 2009**

**TRADEMARK  
PRINCIPAL REGISTER**

**RemoteMasterMind**

METROLOGIC INSTRUMENTS, INC. (NEW JERSEY CORPORATION)  
90 COLES ROAD  
BLACKWOOD, NJ 08012

FOR: COMPUTER SOFTWARE THAT ALLOWS REMOTE MANAGMENT AND ADMINISTRATION OF AN END USERS DATA CAPTURE AND COLLECTION DEVICE, IN CLASS 9 (U.S. CLS. 21, 23, 26, 36 AND 38).

FIRST USE 2-1-2008; IN COMMERCE 6-27-2008.

THE MARK CONSISTS OF STANDARD CHARACTERS WITHOUT CLAIM TO ANY PARTICULAR FONT, STYLE, SIZE, OR COLOR.

SER. NO. 77-510,217, FILED 6-27-2008.

ANTHONY RINKER, EXAMINING ATTORNEY

**Int. Cl.: 42**

**Prior U.S. Cls.: 100 and 101**

**United States Patent and Trademark Office**

**Reg. No. 3,569,944**

**Registered Feb. 3, 2009**

**SERVICE MARK  
PRINCIPAL REGISTER**

**APRICOT**

COMMUNITY TECHKNOWLEDGE, INC. (DELA-  
WARE CORPORATION)  
701 BRAZOS STREET, STE 1425  
AUSTIN, TX 78701

FOR: APPLICATION SERVICE PROVIDER (ASP)  
FEATURING SOFTWARE FOR USE IN DATABASE  
MANAGEMENT, IN CLASS 42 (U.S. CLS. 100 AND  
101).

FIRST USE 12-4-2007; IN COMMERCE 12-4-2007.

THE MARK CONSISTS OF STANDARD CHAR-  
ACTERS WITHOUT CLAIM TO ANY PARTICULAR  
FONT, STYLE, SIZE, OR COLOR.

SER. NO. 77-510,234, FILED 6-27-2008.

ANTHONY RINKER, EXAMINING ATTORNEY

**Int. Cl.: 12**

**Prior U.S. Cls.: 19, 21, 23, 31, 35 and 44**

**United States Patent and Trademark Office**

**Reg. No. 3,569,945**

**Registered Feb. 3, 2009**

**TRADEMARK  
PRINCIPAL REGISTER**

**THE TOTAL SOLUTION!**

TENNECO AUTOMOTIVE OPERATING COMP-  
NY INC. (DELAWARE CORPORATION)  
500 NORTH FIELD DRIVE  
LAKE FOREST, IL 60045

FOR: BRAKE PADS FOR LAND VEHICLES, IN  
CLASS 12 (U.S. CLS. 19, 21, 23, 31, 35 AND 44).

FIRST USE 2-0-2005; IN COMMERCE 2-0-2005.

THE MARK CONSISTS OF STANDARD CHAR-  
ACTERS WITHOUT CLAIM TO ANY PARTICULAR  
FONT, STYLE, SIZE, OR COLOR.

SER. NO. 77-510,243, FILED 6-27-2008.

WILLIAM BRECKENFELD, EXAMINING ATTOR-  
NEY

**Int. Cl.: 36**

**Prior U.S. Cls.: 100, 101 and 102**

**United States Patent and Trademark Office**

**Reg. No. 3,569,946**

**Registered Feb. 3, 2009**

**SERVICE MARK  
PRINCIPAL REGISTER**



**MOST HOME REAL ESTATE SERVICES INC.  
(CANADA CORPORATION)  
#1 - 11491 KINGSTON STREET  
MAPLE RIDGE, BC, CANADA V2X0Y6**

**FOR: PROVIDING REAL ESTATE LISTING IN-  
FORMATION VIA WIRELESS COMMUNICATIONS  
NETWORKS, IN CLASS 36 (U.S. CLS. 100, 101 AND  
102).**

**FIRST USE 6-17-2008; IN COMMERCE 6-17-2008.**

**THE MARK CONSISTS OF "KURIO" IMPOSED  
ON HOUSE-LIKE STYLISTIC FIGURES.**

**SER. NO. 77-510,249, FILED 6-27-2008.**

**MARK RADEMACHER, EXAMINING ATTORNEY**

**Int. Cl.: 35**

**Prior U.S. Cls.: 100, 101 and 102**

**United States Patent and Trademark Office**

**Reg. No. 3,569,947**

**Registered Feb. 3, 2009**

**SERVICE MARK  
PRINCIPAL REGISTER**

**OSPREY-TALON**

RESURS2 CORPORATION (NEW JERSEY CORPORATION)  
160 ESSEX AVENUE E  
AVENEL, NJ 07001

FOR: ON-LINE RETAIL STORE SERVICES FEATURING ELECTRIC STORAGE BATTERIES AND BATTERY CHARGES, ELECTRICAL CONNECTION CABLES, POWER SUPPLY CONNECTORS AND ADAPTORS FOR USE WITH PORTABLE ELECTRONIC DEVICES, REPLACEMENT PARTS AND ACCESSORIES FOR COMPUTERS, HOUSEHOLD ELECTRONIC APPLIANCES, AND PORTABLE

ELECTRONIC DEVICES, IN CLASS 35 (U.S. CLS. 100, 101 AND 102).

FIRST USE 6-1-2007; IN COMMERCE 6-1-2007.

THE MARK CONSISTS OF STANDARD CHARACTERS WITHOUT CLAIM TO ANY PARTICULAR FONT, STYLE, SIZE, OR COLOR.

SER. NO. 77-510,273, FILED 6-27-2008.

CHRISTOPHER BUONGIORNO, EXAMINING ATTORNEY



**Int. Cl.: 5**

**Prior U.S. Cls.: 6, 18, 44, 46, 51 and 52**

**Reg. No. 3,569,948**

**United States Patent and Trademark Office**

**Registered Feb. 3, 2009**

**TRADEMARK  
PRINCIPAL REGISTER**

**SUPER DAILY**

J. R. CARLSON LABORATORIES, INC. (ILLINOIS  
CORPORATION)  
15 W. COLLEGE DRIVE  
ARLINGTON HEIGHTS, IL 60004

OWNER OF U.S. REG. NOS. 2,148,354 AND  
2,760,536.

FOR: DIETARY SUPPLEMENTS; NUTRITIONAL  
SUPPLEMENTS, IN CLASS 5 (U.S. CLS. 6, 18, 44, 46, 51  
AND 52).

NO CLAIM IS MADE TO THE EXCLUSIVE  
RIGHT TO USE "DAILY", APART FROM THE  
MARK AS SHOWN.

FIRST USE 11-1-2006; IN COMMERCE 11-1-2006.

SER. NO. 77-510,289, FILED 6-27-2008.

THE MARK CONSISTS OF STANDARD CHAR-  
ACTERS WITHOUT CLAIM TO ANY PARTICULAR  
FONT, STYLE, SIZE, OR COLOR.

DAVID TAYLOR, EXAMINING ATTORNEY

**Int. Cl.: 5**

**Prior U.S. Cls.: 6, 18, 44, 46, 51 and 52**

**Reg. No. 3,569,949**

**United States Patent and Trademark Office**

**Registered Feb. 3, 2009**

**TRADEMARK  
PRINCIPAL REGISTER**

# Lifecard

HALL, MICHAEL J (FLORIDA LIMITED LIABILITY COMPANY), DBA HALL MEDICAL FOUNDATION

SUITE 430  
1674 MERIDIAN AVE  
MIAMI BEACH, FL 33139

FOR: DIAGNOSTIC KITS CONSISTING PRIMARILY OF MONOCLONAL ANTIBODIES, BUFFERS, AND REAGENTS FOR USE IN DISEASE TESTING; DRUG TESTING KITS COMPRISED OF MEDICAL DIAGNOSTIC REAGENTS AND ASSAYS FOR

TESTING BODY FLUIDS, IN CLASS 5 (U.S. CLS. 6, 18, 44, 46, 51 AND 52).

FIRST USE 6-20-2008; IN COMMERCE 6-20-2008.

THE MARK CONSISTS OF STANDARD CHARACTERS WITHOUT CLAIM TO ANY PARTICULAR FONT, STYLE, SIZE, OR COLOR.

SER. NO. 77-510,307, FILED 6-27-2008.

KELLY MCCOY, EXAMINING ATTORNEY

**Int. Cls.: 39 and 42**

**Prior U.S. Cls.: 100, 101 and 105**

**United States Patent and Trademark Office**

**Reg. No. 3,569,950**

**Registered Feb. 3, 2009**

**SERVICE MARK  
PRINCIPAL REGISTER**



CYPACE, INC. (CALIFORNIA CORPORATION)  
1810 SHADOW CANYON ROAD  
ACTON, CA 93510

FOR: PARKING DOMAIN NAMES FOR OTHERS, NAMELY, PROVIDING COMPUTER SERVERS FOR FACILITATION OF THE STORAGE OF DOMAIN NAME ADDRESSES FOR USE ON A GLOBAL COMPUTER NETWORK, IN CLASS 39 (U.S. CLS. 100 AND 105).

FIRST USE 4-1-2008; IN COMMERCE 6-1-2008.

FOR: DESIGNING, DEVELOPING AND HOSTING WEB SITES FOR OTHERS ON A GLOBAL COMPUTER NETWORK; PROVIDING E-MAIL AND SPAM FILTERING SERVICES; BLOCKING POP-UP MESSAGES AND PROTECTING THE PRIVACY OF USERS DURING THE COURSE OF INTER-

ACTING WITH A GLOBAL COMPUTER NETWORK, IN CLASS 42 (U.S. CLS. 100 AND 101).

FIRST USE 4-1-2008; IN COMMERCE 6-1-2008.

NO CLAIM IS MADE TO THE EXCLUSIVE RIGHT TO USE "INC.", APART FROM THE MARK AS SHOWN.

THE MARK CONSISTS OF THE STYLIZED WORDS "CYPACE, INC. MY PLACE IN CYBERSPACE". TO THE LEFT OF THE STYLIZED WORDS IS AN IMAGE OF A STICK FIGURE MAN WITH HIS LEFT ARM POINTING UPWARD. SIX ORBS INCREASING IN SIZE OVERHEAD FROM RIGHT ARM TO LEFT ARM.

SER. NO. 77-510,310, FILED 6-27-2008.

ANTHONY RINKER, EXAMINING ATTORNEY

**Int. Cl.: 3**

**Prior U.S. Cls.: 1, 4, 6, 50, 51 and 52**

**Reg. No. 3,569,951**

**United States Patent and Trademark Office**

**Registered Feb. 3, 2009**

**TRADEMARK  
PRINCIPAL REGISTER**



**BEACH  
HOUSE  
LANE**

BEACH HOUSE LANE (CALIFORNIA LIMITED  
LIABILITY COMPANY)

#352

245-M MT. HERMON ROAD  
SCOTTS VALLEY, CA 95066

FOR: BODY CREAMS; BODY LOTIONS; BODY  
SCRUB; BODY WASHES; COSMETICS; NON-MEDI-  
CATED SKIN CARE PREPARATIONS, IN CLASS 3  
(U.S. CLS. 1, 4, 6, 50, 51 AND 52).

FIRST USE 1-1-2006; IN COMMERCE 6-30-2007.

THE MARK CONSISTS OF THE STYLIZED  
WORDS "BEACH HOUSE LANE". ABOVE THE  
STYLIZED WORDS IS AN IMAGE OF A RIGHT  
FACING SEAHORSE WITH A BACK FIN AND  
LINES THROUGHOUT. THE WORD "HOUSE" IS  
BELOW THE WORD "BEACH". THE WORD "LANE"  
IS BELOW THE WORD "HOUSE".

SER. NO. 77-510,326, FILED 6-27-2008.

DOMINICK J. SALEMI, EXAMINING ATTORNEY

**Int. Cls.: 25 and 41**

**Prior U.S. Cls.: 22, 39, 100, 101 and 107**

**United States Patent and Trademark Office**

**Reg. No. 3,569,952**

**Registered Feb. 3, 2009**

**TRADEMARK  
SERVICE MARK  
PRINCIPAL REGISTER**

**!K7**

!K7 RECORDS GMBH (FED REP GERMANY CORPORATION)  
HEIDESTR. 52  
BERLIN, FED REP GERMANY 10557

FOR: A-SHIRTS; ATHLETIC APPAREL, NAME-  
LY, SHIRTS, PANTS, JACKETS, FOOTWEAR, HATS  
AND CAPS, ATHLETIC UNIFORMS; BUTTON-  
FRONT ALOHA SHIRTS; CAMP SHIRTS; DRESS  
SHIRTS; GOLF SHIRTS; HOODED SWEAT SHIRTS;  
KNIT SHIRTS; LONG-SLEEVED SHIRTS; MOIST-  
URE-WICKING SPORTS SHIRTS; NIGHT SHIRTS;  
OPEN-NECKED SHIRTS; PIQUE SHIRTS; POLO  
SHIRTS; RUGBY SHIRTS; SHIRT FRONTS; SHIRT  
YOKES; SHIRTS; SHIRTS FOR SUITS; SHORT-  
SLEEVED OR LONG-SLEEVED T-SHIRTS; SHORT-  
SLEEVED SHIRTS; SLEEP SHIRTS; SPORT SHIRTS;  
SPORTS SHIRTS; SPORTS SHIRTS WITH SHORT  
SLEEVES; SWEAT SHIRTS; T-SHIRTS; TEE SHIRTS;  
TRIATHLON CLOTHING, NAMELY, TRIATHLON  
TIGHTS, TRIATHLON SHORTS, TRIATHLON  
SINGLETS, TRIATHLON SHIRTS, TRIATHLON  
SUITS; WEARABLE GARMENTS AND CLOTHING,

NAMELY, SHIRTS; WIND SHIRTS; YOGA SHIRTS,  
IN CLASS 25 (U.S. CLS. 22 AND 39).

FIRST USE 11-1-2005; IN COMMERCE 11-1-2005.

FOR: ARRANGING AND CONDUCTING OF  
CONCERTS; CONCERT BOOKING; ENTERTAIN-  
MENT, NAMELY, LIVE MUSIC CONCERTS, IN  
CLASS 41 (U.S. CLS. 100, 101 AND 107).

FIRST USE 11-1-2005; IN COMMERCE 11-1-2005.

THE MARK CONSISTS OF STANDARD CHAR-  
ACTERS WITHOUT CLAIM TO ANY PARTICULAR  
FONT, STYLE, SIZE, OR COLOR.

OWNER OF U.S. REG. NO. 2,604,261.

SER. NO. 77-510,348, FILED 6-27-2008.

KAREN BRACEY, EXAMINING ATTORNEY

**Int. Cl.: 41**

**Prior U.S. Cls.: 100, 101 and 107**

**United States Patent and Trademark Office**

**Reg. No. 3,569,953**

**Registered Feb. 3, 2009**

**SERVICE MARK  
PRINCIPAL REGISTER**

**DARKBLOOM**

SCOTT FELDMAN (UNITED STATES INDIVIDUAL)

#4122

550 SOUTH BARRINGTON AVENUE  
LOS ANGELES, CA 90049

THE MARK CONSISTS OF STANDARD CHARACTERS WITHOUT CLAIM TO ANY PARTICULAR FONT, STYLE, SIZE, OR COLOR.

FOR: PRODUCTION OF SOUND AND MUSIC VIDEO RECORDINGS, IN CLASS 41 (U.S. CLS. 100, 101 AND 107).

SER. NO. 77-510,358, FILED 6-27-2008.

FIRST USE 3-5-2008; IN COMMERCE 3-5-2008.

KAREN BRACEY, EXAMINING ATTORNEY

**Int. Cl.: 41**

**Prior U.S. Cls.: 100, 101 and 107**

**United States Patent and Trademark Office**

**Reg. No. 3,569,954**

**Registered Feb. 3, 2009**

**SERVICE MARK  
PRINCIPAL REGISTER**

# The Third Third

SENTILLES, ANN S. (UNITED STATES INDIVIDUAL)  
4439 SHADY HILL DRIVE  
DALLAS, TX 75229

FOR: ON-LINE JOURNALS, NAMELY, BLOGS FEATURING LIFE ISSUES FOR PEOPLE OVER 50 YEARS OF AGE, PARTICULARLY WOMEN, IN CLASS 41 (U.S. CLS. 100, 101 AND 107).

FIRST USE 5-2-2005; IN COMMERCE 9-13-2006.

THE MARK CONSISTS OF STANDARD CHARACTERS WITHOUT CLAIM TO ANY PARTICULAR FONT, STYLE, SIZE, OR COLOR.

SER. NO. 77-510,395, FILED 6-27-2008.

TRACY CROSS, EXAMINING ATTORNEY

**Int. Cl.: 20**

**Prior U.S. Cls.: 2, 13, 22, 25, 32 and 50**

**United States Patent and Trademark Office**

**Reg. No. 3,569,955**

**Registered Feb. 3, 2009**

**TRADEMARK  
PRINCIPAL REGISTER**

**building possibilities**

REVUR INTERNATIONAL (CALIFORNIA CORPORATION)  
18195 MCDURMOTT STREET EAST, SUITE G  
IRVINE, CA 92614

THE MARK CONSISTS OF STANDARD CHARACTERS WITHOUT CLAIM TO ANY PARTICULAR FONT, STYLE, SIZE, OR COLOR.

FOR: FURNITURE, IN CLASS 20 (U.S. CLS. 2, 13, 22, 25, 32 AND 50).

SER. NO. 77-510,402, FILED 6-27-2008.

FIRST USE 6-2-2008; IN COMMERCE 6-2-2008.

KAREN BRACEY, EXAMINING ATTORNEY



**Int. Cl.: 41**

**Prior U.S. Cls.: 100, 101 and 107**

**United States Patent and Trademark Office**

**Reg. No. 3,569,956**

**Registered Feb. 3, 2009**

**SERVICE MARK  
PRINCIPAL REGISTER**



SENTILLES, ANN S. (UNITED STATES INDIVIDUAL)  
4439 SHADY HILL DRIVE  
DALLAS, TX 75229

FOR: ON-LINE JOURNALS, NAMELY, BLOGS FEATURING LIFE ISSUES FOR PEOPLE OVER 50 YEARS OF AGE, PARTICULARLY WOMEN, IN CLASS 41 (U.S. CLS. 100, 101 AND 107).

THE MARK CONSISTS OF MIRROR-IMAGE 3S FORMING AN UPWARD POINTING ARROW BETWEEN THEM AND THE WORDS "THE THIRD THIRD".

SER. NO. 77-510,433, FILED 6-27-2008.

FIRST USE 9-13-2006; IN COMMERCE 9-13-2006.

TRACY CROSS, EXAMINING ATTORNEY

**Int. Cl.: 14**

**Prior U.S. Cls.: 2, 27, 28 and 50**

**United States Patent and Trademark Office**

**Reg. No. 3,569,957**

**Registered Feb. 3, 2009**

**TRADEMARK  
PRINCIPAL REGISTER**

**PRETTI VACANT**

PONCE, MICHELLE (UNITED STATES INDIVIDUAL)

#369

34145 PACIFIC COAST HIGHWAY

DANA POINT, CA 92629

THE MARK CONSISTS OF STANDARD CHARACTERS WITHOUT CLAIM TO ANY PARTICULAR FONT, STYLE, SIZE, OR COLOR.

FOR: JEWELRY, NAMELY, NECKLACES, PINS, AND BRACELETS, IN CLASS 14 (U.S. CLS. 2, 27, 28 AND 50).

SER. NO. 77-510,446, FILED 6-27-2008.

FIRST USE 2-12-2004; IN COMMERCE 9-15-2004.

NICHOLAS ALTREE, EXAMINING ATTORNEY

**Int. Cl.: 35**

**Prior U.S. Cls.: 100, 101 and 102**

**United States Patent and Trademark Office**

**Reg. No. 3,569,958**

**Registered Feb. 3, 2009**

**SERVICE MARK  
PRINCIPAL REGISTER**

**PRETZEL WORLD**

MOLKIM LLC (MARYLAND LIMITED LIABILITY COMPANY)  
3015 WINDY KNOLL COURT  
ROCKVILLE, MD 20850

FOR: RETAIL STORE SERVICES FEATURING PRETZELS, SANDWICHES, PIZZA, HOT DOGS AND OTHER FOOD ITEMS; WHOLESALE FOOD DISTRIBUTORSHIP SERVICES, IN CLASS 35 (U.S. CLS. 100, 101 AND 102).

FIRST USE 3-15-2008; IN COMMERCE 4-24-2008.

THE MARK CONSISTS OF STANDARD CHARACTERS WITHOUT CLAIM TO ANY PARTICULAR FONT, STYLE, SIZE, OR COLOR.

NO CLAIM IS MADE TO THE EXCLUSIVE RIGHT TO USE "PRETZEL", APART FROM THE MARK AS SHOWN.

SER. NO. 77-510,448, FILED 6-27-2008.

NICHOLAS ALTREE, EXAMINING ATTORNEY

**Int. Cls.: 9 and 16**

**Prior U.S. Cls.: 2, 5, 21, 22, 23, 26, 29, 36, 37, 38 and 50**

**United States Patent and Trademark Office**

**Reg. No. 3,569,959**

**Registered Feb. 3, 2009**

**TRADEMARK  
PRINCIPAL REGISTER**

***Act*  *Fast***

ACTFASTMED LLC (CALIFORNIA LIMITED  
LIABILITY COMPANY)

4520 ECHO SPRINGS CIRCLE

EL DORADO HILLS, CA 95762

FOR: TRAINING DEVICE, NAMELY, A VEST  
WORN ON THE BODY USED TO TEACH CHOKING  
RESCUE PROCEDURES, IN CLASS 9 (U.S. CLS. 21,  
23, 26, 36 AND 38).

FIRST USE 6-1-2008; IN COMMERCE 6-12-2008.

FOR: PRINTED INSTRUCTION CARD FEATUR-  
ING CHOKING RESCUE PROCEDURES, IN CLASS  
16 (U.S. CLS. 2, 5, 22, 23, 29, 37, 38 AND 50).

FIRST USE 6-1-2008; IN COMMERCE 6-12-2008.

THE MARK CONSISTS OF A SQUARE WITH A  
CROSS INSIDE IN THE MIDDLE OF THE STY-  
LIZED TEXT "ACT" AND "FAST".

SER. NO. 77-510,462, FILED 6-27-2008.

LINDA MICKLEBURGH, EXAMINING ATTORNEY

**Int. Cl.: 25**

**Prior U.S. Cls.: 22 and 39**

**United States Patent and Trademark Office**

**Reg. No. 3,569,960**

**Registered Feb. 3, 2009**

**TRADEMARK  
PRINCIPAL REGISTER**

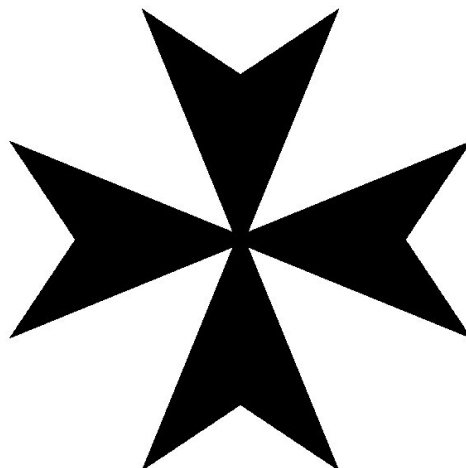

**WARRIOR WORN (TEXAS LIMITED LIABILITY  
COMPANY)**

1405 CANYON WREN DRIVE  
MCKINNEY, TX 75071

FOR: CLOTHING, NAMELY, SHIRTS, BOTTOMS,  
TOPS, JACKETS, BLAZERS, COATS, VESTS, TROU-  
SERS, PANTS, UNDERWEAR, SWEATERS, POLO  
SHIRTS, TURTLE NECKS, KNIT SHIRTS, JEANS,  
JERSEYS, FOOTWEAR, SNEAKERS, BOOTS, HEAD-  
WEAR, CAPS, HATS, NECKWEAR, NECK TIES,  
SCARVES, BEACHWEAR, T-SHIRTS, JOGGING  
SUITS, LEATHER BELTS, LEATHER JACKETS,  
LEATHER PANTS, LEATHER SKIRTS, LEATHER

BOOTS, SWIMWEAR, IN CLASS 25 (U.S. CLS. 22  
AND 39).

FIRST USE 4-0-2008; IN COMMERCE 6-0-2008.

THE MARK CONSISTS OF A CROSS MADE  
FROM FOUR STRAIGHT LINED POINTED AR-  
ROWHEADS, MEETING AT THEIR POINTS, WITH  
THE ENDS OF THE ARMS CONSISTING OF IN-  
DENTED VS.

SER. NO. 77-510,481, FILED 6-27-2008.

CIMMERIAN COLEMAN, EXAMINING ATTOR-  
NEY

Int. Cl.: 35

Prior U.S. Cls.: 100, 101 and 102

United States Patent and Trademark Office

Reg. No. 3,569,961

Registered Feb. 3, 2009

SERVICE MARK  
PRINCIPAL REGISTER



MAIN STREET CUPCAKES (OHIO LIMITED  
LIABILITY COMPANY)  
238 N. MAIN ST.  
HUDSON, OH 44236

FOR: RETAIL BAKERY SHOPS, IN CLASS 35 (U.S.  
CLS. 100, 101 AND 102).

FIRST USE 11-1-2006; IN COMMERCE 2-2-2007.

NO CLAIM IS MADE TO THE EXCLUSIVE  
RIGHT TO USE "CUPCAKES" OR THE DESIGN  
OF A CUPCAKE, APART FROM THE MARK AS  
SHOWN.

THE STIPPLING IS FOR SHADING PURPOSES  
ONLY.

THE MARK CONSISTS OF THE STYLIZED TEXT  
"MAIN STREET CUPCAKES OOOH SO SWEET!"  
WITH A CUPCAKE ON THE TOP RIGHT HAND  
CORNER.

SER. NO. 77-510,486, FILED 6-27-2008.

KELLEY WELLS, EXAMINING ATTORNEY

**Int. Cl.: 28**

**Prior U.S. Cls.: 22, 23, 38 and 50**

**United States Patent and Trademark Office**

**Reg. No. 3,569,962**

**Registered Feb. 3, 2009**

**TRADEMARK  
PRINCIPAL REGISTER**

**A MUTT'S LIFE**

A MUTT'S LIFE (CALIFORNIA PARTNERSHIP)  
15181 DONNINGTON LN.  
TRUCKEE, CA 96161

THE MARK CONSISTS OF STANDARD CHAR-  
ACTERS WITHOUT CLAIM TO ANY PARTICULAR  
FONT, STYLE, SIZE, OR COLOR.

FOR: DOG TOYS, IN CLASS 28 (U.S. CLS. 22, 23, 38  
AND 50).

SER. NO. 77-510,497, FILED 6-27-2008.

FIRST USE 2-1-2008; IN COMMERCE 2-1-2008.

HELENE LIWINSKI, EXAMINING ATTORNEY

**Int. Cl.: 44**

**Prior U.S. Cls.: 100 and 101**

**United States Patent and Trademark Office**

**Reg. No. 3,569,963**

**Registered Feb. 3, 2009**

**SERVICE MARK  
PRINCIPAL REGISTER**

# Vivowhite

POSTAL, ROBERT (UNITED STATES INDIVIDUAL)  
1 POND VIEW DRIVE  
GLEN COVE, NY 11542

THE MARK CONSISTS OF STANDARD CHARACTERS WITHOUT CLAIM TO ANY PARTICULAR FONT, STYLE, SIZE, OR COLOR.

FOR: TEETH WHITENING SERVICES, IN CLASS 44 (U.S. CLS. 100 AND 101).

SER. NO. 77-510,508, FILED 6-27-2008.

FIRST USE 6-1-2008; IN COMMERCE 6-1-2008.

YONG KIM, EXAMINING ATTORNEY



**Int. Cl.: 37**

**Prior U.S. Cls.: 100, 103 and 106**

**United States Patent and Trademark Office**

**Reg. No. 3,569,964**

**Registered Feb. 3, 2009**

**SERVICE MARK  
PRINCIPAL REGISTER**

**CERTSYS**

CERTSYS, LLC (PENNSYLVANIA LIMITED LIABILITY COMPANY), DBA CERTSYS  
507 SPRINGFIELD RD.  
SHIPPENSBURG, PA 17257

FOR: COMPUTER INSTALLATION AND REPAIR; INSTALLATION AND REPAIR OF COMPUTER HARDWARE; INSTALLATION OF COMPUTER NETWORKS; INSTALLATION OF COMPUTER SYSTEMS; INSTALLATION, MAINTENANCE AND REPAIR OF COMPUTER HARDWARE; MAINTENANCE AND REPAIR OF COMPUTER HARDWARE; MAINTENANCE AND REPAIR OF COMPUTER NETWORKS; MAINTENANCE OF COMPUTER HARDWARE; MAINTENANCE OF COMPUTER HARDWARE SYSTEMS; REPAIR OF COMPUTER HARDWARE; REPAIR OF

DAMAGED COMPUTERS; REPAIR OR MAINTENANCE OF COMPUTERS; UPDATING OF COMPUTER HARDWARE; UPGRADING OF COMPUTER HARDWARE, IN CLASS 37 (U.S. CLS. 100, 103 AND 106).

FIRST USE 11-21-2007; IN COMMERCE 11-21-2007.

THE MARK CONSISTS OF STANDARD CHARACTERS WITHOUT CLAIM TO ANY PARTICULAR FONT, STYLE, SIZE, OR COLOR.

SER. NO. 77-510,509, FILED 6-27-2008.

MARILYN IZZI, EXAMINING ATTORNEY

**Int. Cl.: 19**

**Prior U.S. Cls.: 1, 12, 33 and 50**

**United States Patent and Trademark Office**

**Reg. No. 3,569,965**

**Registered Feb. 3, 2009**

**TRADEMARK  
PRINCIPAL REGISTER**

**Ascension Stair Parts**

SOURCE BUILDING PRODUCTS USA INC (WASHINGTON CORPORATION)  
25617 GATEWAY BOULEVARD  
TRACY, CA 95377

NO CLAIM IS MADE TO THE EXCLUSIVE RIGHT TO USE "STAIR PARTS", APART FROM THE MARK AS SHOWN.

FOR: MILLWORK, EXCLUSIVE OF CABINETS, IN CLASS 19 (U.S. CLS. 1, 12, 33 AND 50).

SER. NO. 77-510,512, FILED 6-27-2008.

FIRST USE 12-15-2007; IN COMMERCE 4-1-2008.

THE MARK CONSISTS OF STANDARD CHARACTERS WITHOUT CLAIM TO ANY PARTICULAR FONT, STYLE, SIZE, OR COLOR.

JOHN SCHUYLER YARD, EXAMINING ATTORNEY

**Int. Cl.: 44**

**Prior U.S. Cls.: 100 and 101**

**United States Patent and Trademark Office**

**Reg. No. 3,569,966**

**Registered Feb. 3, 2009**

**SERVICE MARK  
PRINCIPAL REGISTER**



BROOKHAVEN RETREAT, LLC (TENNESSEE  
LIMITED LIABILITY COMPANY)  
1016 I.C. KING ROAD  
SEYMOUR, TN 37865

FOR: CONSULTING SERVICES IN THE FIELD  
OF MENTAL HEALTH AND WELLNESS; COUN-  
SELING SERVICES IN THE FIELDS OF HEALTH,  
NUTRITION AND LIFESTYLE WELLNESS;  
HEALTH CARE SERVICES, NAMELY, WELLNESS  
PROGRAMS; PROVIDING A WEB SITE FEATUR-  
ING INFORMATION IN THE FIELD OF MENTAL

HEALTH AND WELLNESS, IN CLASS 44 (U.S. CLS.  
100 AND 101).

FIRST USE 3-1-2006; IN COMMERCE 3-1-2006.

THE MARK CONSISTS OF A WATER LILY.

SER. NO. 77-510,544, FILED 6-27-2008.

MARGARET POWER, EXAMINING ATTORNEY

**Int. Cl.: 16**

**Prior U.S. Cls.: 2, 5, 22, 23, 29, 37, 38 and 50**

**United States Patent and Trademark Office**

**Reg. No. 3,569,967**

**Registered Feb. 3, 2009**

**TRADEMARK  
PRINCIPAL REGISTER**



**BROOKHAVEN RETREAT, LLC (TENNESSEE  
LIMITED LIABILITY COMPANY)  
1016 I.C. KING ROAD  
SEYMOUR, TN 37865**

**FOR: PUBLICATIONS, NAMELY, BOOKS,  
HAND-OUTS, AND WORKBOOKS IN THE FIELDS  
OF MENTAL HEALTH AND WELLNESS, IN CLASS  
16 (U.S. CLS. 2, 5, 22, 23, 29, 37, 38 AND 50).**

**FIRST USE 3-1-2006; IN COMMERCE 3-1-2006.**

**THE MARK CONSISTS OF A WATER LILY.**

**SER. NO. 77-510,546, FILED 6-27-2008.**

**MARGARET POWER, EXAMINING ATTORNEY**

**Int. Cls.: 14 and 16**

**Prior U.S. Cls.: 2, 5, 22, 23, 27, 28, 29, 37, 38 and 50**

**United States Patent and Trademark Office**

**Reg. No. 3,569,968**

**Registered Feb. 3, 2009**

**TRADEMARK  
PRINCIPAL REGISTER**



A.F. GILMORE COMPANY (CALIFORNIA CORPORATION)  
6301 WEST THIRD STREET  
LOS ANGELES, CA 90036

FOR: ORNAMENTAL LAPEL PINS, IN CLASS 14 (U.S. CLS. 2, 27, 28 AND 50).

FIRST USE 0-0-1998; IN COMMERCE 0-0-1998.

FOR: PAPER PRODUCTS, NAMELY, DECALS AND STICKERS, IN CLASS 16 (U.S. CLS. 2, 5, 22, 23, 29, 37, 38 AND 50).

FIRST USE 0-0-2008; IN COMMERCE 0-0-2008.

THE MARK CONSISTS OF A LION LEAPING WITHIN THE UPPER PART OF A CIRCLE AND A CHECKERED FLAG.

SER. NO. 77-510,547, FILED 6-27-2008.

MICHAEL ENGEL, EXAMINING ATTORNEY

Int. Cl.: 44

Prior U.S. Cls.: 100 and 101

United States Patent and Trademark Office

Reg. No. 3,569,969

Registered Feb. 3, 2009

SERVICE MARK  
PRINCIPAL REGISTER



COPLEY DENTAL ASSOCIATES (MASSACHU-  
SETTS CORPORATION)  
SUITE 501  
551 BOYLSTON STREET  
BOSTON, MA 02116

FOR: DENTISTRY, IN CLASS 44 (U.S. CLS. 100  
AND 101).

FIRST USE 7-1-1990; IN COMMERCE 7-1-1990.

NO CLAIM IS MADE TO THE EXCLUSIVE  
RIGHT TO USE "DENTAL ASSOCIATES", APART  
FROM THE MARK AS SHOWN.

THE MARK CONSISTS OF THE STYLIZED TEXT  
"CDA COPLEY DENTAL ASSOCIATES".

SER. NO. 77-510,631, FILED 6-28-2008.

PAUL F. GAST, EXAMINING ATTORNEY

**Int. Cl.: 36**

**Prior U.S. Cls.: 100, 101 and 102**

**United States Patent and Trademark Office**

**Reg. No. 3,569,970**

**Registered Feb. 3, 2009**

**SERVICE MARK  
PRINCIPAL REGISTER**



LAKHANI INSURANCE AGENCY, INC. (CALIFORNIA CORPORATION)

7537 SAN RAFAEL DRIVE

BUENA PARK, CA 90620

FOR: INSURANCE AGENCIES, IN CLASS 36 (U.S. CLS. 100, 101 AND 102).

FIRST USE 2-25-2001; IN COMMERCE 2-25-2001.

NO CLAIM IS MADE TO THE EXCLUSIVE RIGHT TO USE "INSURANCE AGENCY, INC.", APART FROM THE MARK AS SHOWN.

THE MARK CONSISTS OF AN ABSTRACT OVAL AND THE STYLIZED TEXT "LAKHANI INSURANCE AGENCY, INC. L I A".

SER. NO. 77-510,632, FILED 6-28-2008.

PAUL F. GAST, EXAMINING ATTORNEY

**Int. Cl.: 9**

**Prior U.S. Cls.: 21, 23, 26, 36 and 38**

**Reg. No. 3,569,971**

**United States Patent and Trademark Office**

**Registered Feb. 3, 2009**

**TRADEMARK  
PRINCIPAL REGISTER**

**LITHIUMPOWER**

ULTRALIFE CORPORATION (DELAWARE CORPORATION), DBA ULTRALIFE BATTERIES, INC.

2000 TECHNOLOGY PARKWAY  
NEWARK, NY 14513

FOR: BATTERIES; ELECTRICAL CELLS AND BATTERIES, IN CLASS 9 (U.S. CLS. 21, 23, 26, 36 AND 38).

FIRST USE 3-11-2002; IN COMMERCE 3-11-2002.

THE MARK CONSISTS OF STANDARD CHARACTERS WITHOUT CLAIM TO ANY PARTICULAR FONT, STYLE, SIZE, OR COLOR.

OWNER OF U.S. REG. NOS. 2,593,294, 3,048,998 AND OTHERS.

SEC. 2(F).

SER. NO. 77-510,641, FILED 6-28-2008.

SANDRA MANIOS, EXAMINING ATTORNEY



**Int. Cl.: 41**

**Prior U.S. Cls.: 100, 101 and 107**

**United States Patent and Trademark Office**

**Reg. No. 3,569,972**

**Registered Feb. 3, 2009**

**SERVICE MARK  
PRINCIPAL REGISTER**

a comedy about  
relationships, sex,  
dating, sex, love, and sex  
(but not necessarily in  
that order)

WARDELL, TIM (UNITED STATES INDIVIDUAL)  
9710 PRESTMONT PLACE  
FRISCO, TX 75035

THE MARK CONSISTS OF STANDARD CHARACTERS WITHOUT CLAIM TO ANY PARTICULAR FONT, STYLE, SIZE, OR COLOR.

FOR: ENTERTAINMENT SERVICES IN THE NATURE OF COMEDY SHOWS, IN CLASS 41 (U.S. CLS. 100, 101 AND 107).

SER. NO. 77-510,655, FILED 6-28-2008.

FIRST USE 3-4-2004; IN COMMERCE 7-7-2004.

HANNO RITTNER, EXAMINING ATTORNEY

Int. Cl.: 14

Prior U.S. Cls.: 2, 27, 28 and 50

United States Patent and Trademark Office

Reg. No. 3,569,973

Registered Feb. 3, 2009

**TRADEMARK  
PRINCIPAL REGISTER**



ROXANNE TROTTA WARD, INC. (ILLINOIS CORPORATION), DBA ROX-ANNE  
1218 CALCIONE DRIVE  
HENDERSON, NV 89011

FOR: BEADS FOR USE IN THE MANUFACTURE OF JEWELRY; BRACELETS; BROOCHES; COSTUME JEWELRY; DIAMOND JEWELRY; GEMSTONE JEWELRY; JEWELRY; JEWELRY CHAINS; JEWELRY FINDINGS; JEWELRY FOR ATTACHMENT TO CLOTHING; JEWELRY, NAMELY, ANKLETS; JEWELRY, NAMELY, STONE PENDANTS; LAPEL PINS; LEATHER JEWELRY AND ACCESSORY BOXES; METAL WIRE FOR USE IN THE MAKING OF JEWELRY, NAMELY, JEWELRY CABLE; PET JEWELRY; PINS BEING JEWELRY; RINGS; RINGS BEING JEWELRY, IN CLASS 14 (U.S. CLS. 2, 27, 28 AND 50).

FIRST USE 5-0-2006; IN COMMERCE 5-0-2006.

THE COLOR(S) BLACK, WHITE, TAN, PURPLE, BLUE AND HOT PINK IS/ARE CLAIMED AS A FEATURE OF THE MARK.

THE MARK CONSISTS OF A CARTOON DESIGN OF A LITTLE GIRL WITH CURLY HAIR, DRAWN IN BLACK LINES, DRESSED IN TAN HIGH HEEL SHOES WITH A PURPLE AND PINK FLOWER ON EACH SHOE, WEARING A WHITE DRESS WITH PURPLE TRIM AND A PURPLE, TAN AND HOT PINK FLOWER NECKLACE, AND HOLDING A BLUE AND WHITE PURSE IN ONE HAND AND A HOT PINK AND WHITE PURSE IN THE OTHER.

SER. NO. 77-510,665, FILED 6-28-2008.

HANNO RITTNER, EXAMINING ATTORNEY

**Int. Cl.: 35**

**Prior U.S. Cls.: 100, 101 and 102**

**United States Patent and Trademark Office**

**Reg. No. 3,569,974**

**Registered Feb. 3, 2009**

**SERVICE MARK  
PRINCIPAL REGISTER**



HAPIOCA, LLC (DELAWARE LIMITED LIABILITY COMPANY)  
#10905  
548 MARKET ST.  
SAN FRANCISCO, CA 94104

FOR: PROVIDING A WEB SITE WHERE USERS CAN POST RATINGS, REVIEWS AND RECOMMENDATIONS ON PRODUCTS AND SERVICES; PROVIDING A WEB SITE WHICH FEATURES ADVERTISEMENTS FOR THE GOODS AND SERVICES OF OTHERS ON A GLOBAL COMPUTER

NETWORK, IN CLASS 35 (U.S. CLS. 100, 101 AND 102).

FIRST USE 6-19-2008; IN COMMERCE 6-19-2008.

THE MARK CONSISTS OF STYLIZED WRITING OF "HAPIOCA" WITH FLOWER DESIGN.

SER. NO. 77-510,675, FILED 6-28-2008.

GEORGE LORENZO, EXAMINING ATTORNEY

**Int. Cl.: 44**

**Prior U.S. Cls.: 100 and 101**

**United States Patent and Trademark Office**

**Reg. No. 3,569,975**

**Registered Feb. 3, 2009**

**SERVICE MARK  
PRINCIPAL REGISTER**

ISABELLE GERARD SKIN CARE

GERARD, ISABELLE (FRANCE INDIVIDUAL),  
DBA GERARD, ISABELLE MARGUERITE

4370 NORTON AVE  
OAKLAND, CA 94602

FOR: BEAUTY SPA SERVICES, NAMELY, COS-  
METIC BODY CARE; SKIN CARE SALONS, IN  
CLASS 44 (U.S. CLS. 100 AND 101).

FIRST USE 1-1-1990; IN COMMERCE 1-1-1991.

THE MARK CONSISTS OF STANDARD CHAR-  
ACTERS WITHOUT CLAIM TO ANY PARTICULAR  
FONT, STYLE, SIZE, OR COLOR.

NO CLAIM IS MADE TO THE EXCLUSIVE  
RIGHT TO USE "SKIN CARE", APART FROM THE  
MARK AS SHOWN.

SER. NO. 77-510,695, FILED 6-28-2008.

ANDREA K. NADELMAN, EXAMINING ATTOR-  
NEY

**Int. Cls.: 25 and 41**

**Prior U.S. Cls.: 22, 39, 100, 101 and 107**

**Reg. No. 3,569,976**

**United States Patent and Trademark Office**

**Registered Feb. 3, 2009**

**TRADEMARK  
SERVICE MARK  
PRINCIPAL REGISTER**

# Zen Rizing

SCOTT F. HARRIS (UNITED STATES INDIVIDUAL)  
PO BOX 1633  
FRANKLIN, TN 37065

FOR: SHIRTS, IN CLASS 25 (U.S. CLS. 22 AND 39).

FIRST USE 5-9-2007; IN COMMERCE 5-9-2007.

FOR: ENTERTAINMENT IN THE NATURE OF VISUAL AND AUDIO PERFORMANCES, NAMELY, MUSICAL BAND, ROCK GROUP, GYMNASTIC, DANCE, AND BALLET PERFORMANCES; ENTERTAINMENT SERVICES, NAMELY, PROVIDING A WEB SITE FEATURING PHOTOGRAPHIC, AUDIO, VIDEO AND PROSE PRESENTATIONS FEATURING MUSICAL GROUPS AND ROCK BANDS; ENTERTAINMENT SERVICES, NAMELY, PROVIDING A WEB SITE FEATURING MUSICAL PERFORMANCES, MUSICAL VIDEOS, RELATED FILM CLIPS, PHOTOGRAPHS, AND OTHER MULTIMEDIA MA-

TERIALS; ENTERTAINMENT SERVICES, NAMELY, PROVIDING PRERECORDED MUSIC, INFORMATION IN THE FIELD OF MUSIC, AND COMMENTARY AND ARTICLES ABOUT MUSIC, ALL ON-LINE VIA A GLOBAL COMPUTER NETWORK; ENTERTAINMENT, NAMELY, LIVE PERFORMANCES BY ROCK GROUPS; PRODUCTION OF SOUND AND MUSIC VIDEO RECORDINGS; PRODUCTION OF SOUND RECORDINGS, IN CLASS 41 (U.S. CLS. 100, 101 AND 107).

FIRST USE 5-9-2007; IN COMMERCE 2-13-2008.

THE MARK CONSISTS OF STANDARD CHARACTERS WITHOUT CLAIM TO ANY PARTICULAR FONT, STYLE, SIZE, OR COLOR.

SER. NO. 77-510,728, FILED 6-29-2008.

LINDA E. BLOHM, EXAMINING ATTORNEY

**Int. Cl.: 45**

**Prior U.S. Cls.: 100 and 101**

**United States Patent and Trademark Office**

**Reg. No. 3,569,977**

**Registered Feb. 3, 2009**

**SERVICE MARK  
PRINCIPAL REGISTER**

**CALLDUI**

SCHULENBERG, MICHAEL T. (UNITED STATES  
INDIVIDUAL)  
1770 S. RANDALL ROAD, SUITE A229  
GENEVA, IL 60134

THE MARK CONSISTS OF STANDARD CHAR-  
ACTERS WITHOUT CLAIM TO ANY PARTICULAR  
FONT, STYLE, SIZE, OR COLOR.

FOR: LEGAL SERVICES, IN CLASS 45 (U.S. CLS.  
100 AND 101).

SER. NO. 77-510,789, FILED 6-29-2008.

FIRST USE 1-31-2008; IN COMMERCE 4-1-2008.

DANIEL CAPSHAW, EXAMINING ATTORNEY

**Int. Cl.: 45**

**Prior U.S. Cls.: 100 and 101**

**United States Patent and Trademark Office**

**Reg. No. 3,569,978**

**Registered Feb. 3, 2009**

**SERVICE MARK  
PRINCIPAL REGISTER**

# Ghost Quest

GHOST QUEST (NEW HAMPSHIRE PARTNER-  
SHIP)  
146 FLAHERTY LANE #2  
MANCHESTER, NH 03102

FOR: PARANORMAL INVESTIGATION SERVI-  
CES, IN CLASS 45 (U.S. CLS. 100 AND 101).

FIRST USE 2-5-2002; IN COMMERCE 6-15-2002.

THE MARK CONSISTS OF STANDARD CHAR-  
ACTERS WITHOUT CLAIM TO ANY PARTICULAR  
FONT, STYLE, SIZE, OR COLOR.

SEC. 2(F).

SER. NO. 77-510,952, FILED 6-30-2008.

BARBARA A. GOLD, EXAMINING ATTORNEY

**Int. Cls.: 35 and 36**

**Prior U.S. Cls.: 100, 101 and 102**

**United States Patent and Trademark Office**

**Reg. No. 3,569,979**

**Registered Feb. 3, 2009**

**SERVICE MARK  
PRINCIPAL REGISTER**

**THE FAMILY OFFICE FOR THE  
MMILLIONAIRE**

D.B. ROOT & COMPANY (PENNSYLVANIA  
CORPORATION)  
3100 KOPPERS BUILDING  
436 SEVENTH AVENUE  
PITTSBURGH, PA 15219

FOR: TAX ADVISORY SERVICES, TAX PRE-  
PARATION, ACCOUNTING SERVICES, BUSINESS  
SUCCESSION PLANNING, IN CLASS 35 (U.S. CLS.  
100, 101 AND 102).

FIRST USE 10-31-2007; IN COMMERCE 10-31-2007.

FOR: FINANCIAL ADVISORY AND CONSUL-  
TANCY SERVICES, FINANCIAL PLANNING AND  
INVESTMENT ADVISORY SERVICES, DEVELOP-

ING AND MANAGING CHARITABLE GIVING  
PROGRAMS ON BEHALF OF WEALTHY INDIVI-  
DUALS OR FAMILIES, INSURANCE INFORMA-  
TION AND CONSULTANCY, ESTATE PLANNING,  
IN CLASS 36 (U.S. CLS. 100, 101 AND 102).

FIRST USE 10-31-2007; IN COMMERCE 10-31-2007.

THE MARK CONSISTS OF STANDARD CHAR-  
ACTERS WITHOUT CLAIM TO ANY PARTICULAR  
FONT, STYLE, SIZE, OR COLOR.

SER. NO. 77-511,002, FILED 6-30-2008.

KELLEY WELLS, EXAMINING ATTORNEY



**Int. Cl.: 36**

**Prior U.S. Cls.: 100, 101 and 102**

**United States Patent and Trademark Office**

**Reg. No. 3,569,980**

**Registered Feb. 3, 2009**

**SERVICE MARK  
PRINCIPAL REGISTER**



MONTPELIER RE HOLDINGS LTD. (BERMUDA  
LIMITED LIABILITY COMPANY)  
94 PITTS BAY ROAD  
PO BOX HM 2079  
PEMBROKE, BERMUDA HMHX

FOR: PROVIDING CUSTOMIZED AND INNOVA-  
TIVE REINSURANCE AND INSURANCE SOLU-  
TIONS TO THE NORTH AMERICAN MARKET,  
NAMELY, PROPERTY AND CASUALTY, SURPLUS  
LINES AND SPECIALTY CASUALTY INSURANCE,  
IN CLASS 36 (U.S. CLS. 100, 101 AND 102).

FIRST USE 4-30-2007; IN COMMERCE 4-30-2007.

NO CLAIM IS MADE TO THE EXCLUSIVE  
RIGHT TO USE "US", APART FROM THE MARK  
AS SHOWN.

THE MARK CONSISTS OF A STYLIZED "M"  
FOLLOWED BY THE WORDS "MONTPELIER US".

SER. NO. 77-511,024, FILED 6-30-2008.

JOHN WILKE, EXAMINING ATTORNEY

**Int. Cl.: 36**

**Prior U.S. Cls.: 100, 101 and 102**

**United States Patent and Trademark Office**

**Reg. No. 3,569,981**

**Registered Feb. 3, 2009**

**SERVICE MARK  
PRINCIPAL REGISTER**

**MONTPELIER US**

MONTPELIER RE HOLDINGS LTD. (BERMUDA  
LIMITED LIABILITY COMPANY)  
94 PITTS BAY ROAD  
PO BOX HM 2079  
PEMBROKE, BERMUDA HMHX

FOR: PROVIDING CUSTOMIZED AND INNOVA-  
TIVE REINSURANCE AND INSURANCE SOLU-  
TIONS TO THE NORTH AMERICAN MARKET,  
NAMELY, PROPERTY AND CASUALTY, SURPLUS  
LINES AND SPECIALTY CASUALTY INSURANCE,  
IN CLASS 36 (U.S. CLS. 100, 101 AND 102).

FIRST USE 4-30-2007; IN COMMERCE 4-30-2007.

THE MARK CONSISTS OF STANDARD CHAR-  
ACTERS WITHOUT CLAIM TO ANY PARTICULAR  
FONT, STYLE, SIZE, OR COLOR.

NO CLAIM IS MADE TO THE EXCLUSIVE  
RIGHT TO USE "US", APART FROM THE MARK  
AS SHOWN.

SER. NO. 77-511,027, FILED 6-30-2008.

JOHN WILKE, EXAMINING ATTORNEY

Int. Cl.: 30

Prior U.S. Cl.: 46

United States Patent and Trademark Office

Reg. No. 3,569,982

Registered Feb. 3, 2009

**TRADEMARK  
PRINCIPAL REGISTER**

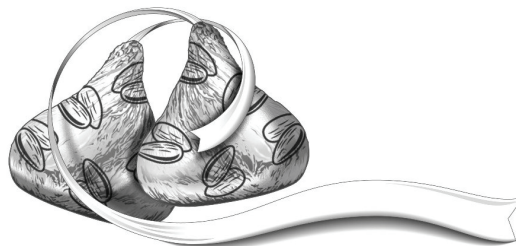

HERSHEY CHOCOLATE & CONFECTIONERY  
CORPORATION (DELAWARE CORPORATION)

4860 ROBB STREET SUITE 204  
WHEAT RIDGE, CO 80033

FOR: CANDY, IN CLASS 30 (U.S. CL. 46).

FIRST USE 4-15-2008; IN COMMERCE 4-15-2008.

OWNER OF U.S. REG. NOS. 186,828, 1,731,428 AND  
OTHERS.

THE MARK CONSISTS OF TWO CONICAL CON-  
FIGURATIONS REPRESENTING INDIVIDUALLY  
WRAPPED CANDIES, TILTING INWARD TOWARD  
EACH OTHER, WITH MULTIPLE SHELLLED AL-  
MOND DESIGNS ON THE FANCIFUL DESIGN OF

METALLIC WRAP. THE LEFT CONFIGURATION  
DESIGN HAS A PLUME DEVICE EXTENDING TO  
THE RIGHT AND WRAPPING AROUND THE  
RIGHT CONICAL CONFIGURATION TO THE CEN-  
TER OF THAT DESIGN. THE RIGHT CONICAL  
CONFIGURATION DESIGN HAS A PLUME DE-  
VICE WRAPPING AROUND THE LEFT CONICAL  
CONFIGURATION DESIGN AND EXTENDING BE-  
LOW AND TO THE FAR RIGHT OF THE ENTIRE  
DESIGN.

SEC. 2(F).

SER. NO. 77-511,030, FILED 6-30-2008.

JUDITH HELFMAN, EXAMINING ATTORNEY

**Int. Cl.: 38**

**Prior U.S. Cls.: 100, 101 and 104**

**United States Patent and Trademark Office**

**Reg. No. 3,569,983**

**Registered Feb. 3, 2009**

---

**SERVICE MARK  
PRINCIPAL REGISTER**

**WTUZ**

WTUZ RADIO, INC. (OHIO CORPORATION)  
2424 EAST HIGH AVENUE  
NEW PHILADELPHIA, OH 44663

THE MARK CONSISTS OF STANDARD CHAR-  
ACTERS WITHOUT CLAIM TO ANY PARTICULAR  
FONT, STYLE, SIZE, OR COLOR.

FOR: RADIO BROADCASTING, IN CLASS 38 (U.S.  
CLS. 100, 101 AND 104).

SER. NO. 77-511,421, FILED 6-30-2008.

FIRST USE 5-1-1990; IN COMMERCE 5-1-1990.

SALLY SHIH, EXAMINING ATTORNEY

**Int. Cl.: 14**

**Prior U.S. Cls.: 2, 27, 28 and 50**

**United States Patent and Trademark Office**

**Reg. No. 3,569,984**

**Registered Feb. 3, 2009**

**TRADEMARK  
PRINCIPAL REGISTER**

**MIANSAI**

MIANSAI LLC (DELAWARE LIMITED LIABILITY COMPANY)  
C/O MICHAEL I. SAIGER  
1228 WEST AVE., APT 1110  
MIAMI BEACH, FL 33139

THE MARK CONSISTS OF STANDARD CHARACTERS WITHOUT CLAIM TO ANY PARTICULAR FONT, STYLE, SIZE, OR COLOR.

FOR: JEWELRY, IN CLASS 14 (U.S. CLS. 2, 27, 28 AND 50).

SER. NO. 77-511,537, FILED 6-30-2008.

FIRST USE 6-4-2008; IN COMMERCE 6-4-2008.

MARK RADEMACHER, EXAMINING ATTORNEY

**Int. Cl.: 42**

**Prior U.S. Cls.: 100 and 101**

**United States Patent and Trademark Office**

**Reg. No. 3,569,985**

**Registered Feb. 3, 2009**

**SERVICE MARK  
PRINCIPAL REGISTER**

# HYDRAULLIFT

S&L LIFTING & LEVELING, INC. (SOUTH DA-  
KOTA CORPORATION)  
3209 DANIEL DRIVE  
SIOUX FALLS, SD 57110

FOR: TESTING, ANALYZING AND EVALUAT-  
ING THE STRUCTURAL PROPERTIES OF MASON-  
RY AND CONCRETE STRUCTURES, IN CLASS 42  
(U.S. CLS. 100 AND 101).

FIRST USE 4-1-2008; IN COMMERCE 4-1-2008.

THE MARK CONSISTS OF STANDARD CHAR-  
ACTERS WITHOUT CLAIM TO ANY PARTICULAR  
FONT, STYLE, SIZE, OR COLOR.

SER. NO. 77-511,543, FILED 6-30-2008.

CYNTHIA SLOAN, EXAMINING ATTORNEY

**Int. Cl.: 35**

**Prior U.S. Cls.: 100, 101 and 102**

**United States Patent and Trademark Office**

**Reg. No. 3,569,986**

**Registered Feb. 3, 2009**

**SERVICE MARK  
PRINCIPAL REGISTER**



**Protocol Link**

PROTOCOL LINK, INC. (ILLINOIS CORPORATION)  
175 E. HAWTHORN PARKWAY, SUITE 210  
VERNON HILLS, IL 60061

FOR: BUSINESS ADVISORY SERVICES, CONSULTANCY AND INFORMATION, IN CLASS 35 (U.S. CLS. 100, 101 AND 102).

FIRST USE 6-8-2007; IN COMMERCE 6-8-2007.

THE COLOR(S) BLUE (PMS 306), GRAY (COOL GRAY 8), AND BLACK ARE CLAIMED AS A FEATURE OF THE MARK. IS/ARE CLAIMED AS A FEATURE OF THE MARK.

THE MARK CONSISTS OF A STYLIZED LETTER "P" WITH AN OVERLAPPING LETTER "L". WHERE THE LETTER "L" OVERLAPS THE LETTER "P", THE GRAY COLOR OF THE LETTER "L" IS TRANSLUCENT. TO COMPLETE THE MARK, THE WORDS "PROTOOCOL LINK" ARE PLACED BELOW THE INSIGNIA. THE COLOR BLUE (PMS 306) APPEAR IN THE LETTER "P" AND THE WORD "LINK" OF THE MARK, THE COLOR GRAY (COOL GRAY 8) APPEAR IN THE LETTER "L" OF THE MARK, AND THE COLOR BLACK APPEAR IN THE WORD "PROTOCOL" OF THE MARK.

SER. NO. 77-511,550, FILED 6-30-2008.

ODESSA BIBBINS, EXAMINING ATTORNEY

**Int. Cl.: 36**

**Prior U.S. Cls.: 100, 101 and 102**

**United States Patent and Trademark Office**

**Reg. No. 3,569,987**

**Registered Feb. 3, 2009**

**SERVICE MARK  
PRINCIPAL REGISTER**

**GLAZER CAPITAL**

GLAZER CAPITAL, LLC (DELAWARE LIMITED  
LIABILITY COMPANY)  
237 PARK AVENUE SOUTH  
NEW YORK, NY 10017

FOR: FINANCIAL ADVISORY AND CONSUL-  
TANCY SERVICES, IN CLASS 36 (U.S. CLS. 100, 101  
AND 102).

FIRST USE 11-30-1998; IN COMMERCE 11-30-1998.

THE MARK CONSISTS OF STANDARD CHAR-  
ACTERS WITHOUT CLAIM TO ANY PARTICULAR  
FONT, STYLE, SIZE, OR COLOR.

NO CLAIM IS MADE TO THE EXCLUSIVE  
RIGHT TO USE "CAPITAL", APART FROM THE  
MARK AS SHOWN.

SER. NO. 77-511,659, FILED 6-30-2008.

ELISSA GARBER KON, EXAMINING ATTORNEY



**Int. Cl.: 36**

**Prior U.S. Cls.: 100, 101 and 102**

**United States Patent and Trademark Office**

**Reg. No. 3,569,988**

**Registered Feb. 3, 2009**

**SERVICE MARK  
PRINCIPAL REGISTER**

GLAZER CAPITAL MANAGEMENT

GLAZER CAPITAL, LLC (DELAWARE LIMITED  
LIABILITY COMPANY)  
237 PARK AVENUE SOUTH  
NEW YORK, NY 10017

FOR: FINANCIAL ADVISORY AND CONSUL-  
TANCY SERVICES, IN CLASS 36 (U.S. CLS. 100, 101  
AND 102).

FIRST USE 11-30-1998; IN COMMERCE 11-30-1998.

THE MARK CONSISTS OF STANDARD CHAR-  
ACTERS WITHOUT CLAIM TO ANY PARTICULAR  
FONT, STYLE, SIZE, OR COLOR.

NO CLAIM IS MADE TO THE EXCLUSIVE  
RIGHT TO USE "CAPITAL MANAGEMENT",  
APART FROM THE MARK AS SHOWN.

SER. NO. 77-511,683, FILED 6-30-2008.

ELISSA GARBER KON, EXAMINING ATTORNEY

**Int. Cl.: 7**

**Prior U.S. Cls.: 13, 19, 21, 23, 31, 34 and 35**

**Reg. No. 3,569,989**

**United States Patent and Trademark Office**

**Registered Feb. 3, 2009**

---

**TRADEMARK  
PRINCIPAL REGISTER**

**SUNCRANE**

LEWIS, KRISTOPHER KYLE (UNITED STATES  
INDIVIDUAL)  
1400 SHADY GROVE RD.  
GRAND PRAIRIE, TX 75053

THE MARK CONSISTS OF STANDARD CHAR-  
ACTERS WITHOUT CLAIM TO ANY PARTICULAR  
FONT, STYLE, SIZE, OR COLOR.

FOR: TOWER CRANES, IN CLASS 7 (U.S. CLS. 13,  
19, 21, 23, 31, 34 AND 35).

SER. NO. 77-511,766, FILED 6-30-2008.

FIRST USE 6-6-2008; IN COMMERCE 6-6-2008.

SHANNON TWOHIG, EXAMINING ATTORNEY

**Int. Cl.: 7**

**Prior U.S. Cls.: 13, 19, 21, 23, 31, 34 and 35**

**United States Patent and Trademark Office**

**Reg. No. 3,569,990**

**Registered Feb. 3, 2009**

**TRADEMARK  
PRINCIPAL REGISTER**



LEWIS, KRISTOPHER KYLE (UNITED STATES  
INDIVIDUAL)  
1400 SHADY GROVE RD.  
GRAND PRAIRIE, TX 75053

THE MARK CONSISTS OF THE WORD "SUN-  
CRANE" SUPERIMPOSED OVER A PARALLELO-  
GRAM.

FOR: TOWER CRANES, IN CLASS 7 (U.S. CLS. 13,  
19, 21, 23, 31, 34 AND 35).

SER. NO. 77-511,768, FILED 6-30-2008.

FIRST USE 6-6-2008; IN COMMERCE 6-6-2008.

SHANNON TWOHIG, EXAMINING ATTORNEY

**Int. Cls.: 35 and 41**

**Prior U.S. Cls.: 100, 101, 102 and 107**

**United States Patent and Trademark Office**

**Reg. No. 3,569,991**

**Registered Feb. 3, 2009**

**SERVICE MARK  
PRINCIPAL REGISTER**

**NAEMSP**

NATIONAL ASSOCIATION OF EMS PHYSICIANS, INC. (PENNSYLVANIA CORPORATION)  
P.O. BOX 15945-281  
LENEXA, KS 662855945

FOR: ASSOCIATION SERVICES, NAMELY, PROMOTING THE INTERESTS OF EMERGENCY MEDICAL PHYSICIANS WHO OVERSEE OUT-OF-HOSPITAL EMERGENCY MEDICAL CARE, IN CLASS 35 (U.S. CLS. 100, 101 AND 102).

FIRST USE 1-1-1987; IN COMMERCE 1-1-1987.

FOR: EDUCATIONAL SERVICES, NAMELY, PROVIDING A COURSE OF INSTRUCTION TO EMS MEDICAL DIRECTORS WHO OVERSEE

OUT-OF-HOSPITAL EMERGENCY MEDICAL SERVICES, IN CLASS 41 (U.S. CLS. 100, 101 AND 107).

FIRST USE 1-1-1987; IN COMMERCE 1-1-1987.

THE MARK CONSISTS OF STANDARD CHARACTERS WITHOUT CLAIM TO ANY PARTICULAR FONT, STYLE, SIZE, OR COLOR.

OWNER OF U.S. REG. NOS. 3,063,594 AND 3,153,031.

SER. NO. 77-511,852, FILED 6-30-2008.

DAVID MURRAY, EXAMINING ATTORNEY

**Int. Cl.: 28**

**Prior U.S. Cls.: 22, 23, 38 and 50**

**Reg. No. 3,569,992**

**United States Patent and Trademark Office**

**Registered Feb. 3, 2009**

---

**TRADEMARK  
PRINCIPAL REGISTER**

**SURF YOUR SKATE**

STRATTON, NEIL (UNITED STATES INDIVIDUAL)  
706 6TH AVE.  
VENICE, CA 90291

FOR: BALL BEARINGS FOR SKATEBOARDS; NUTS AND BOLTS FOR SKATEBOARDS; SKATEBOARD DECKS; SKATEBOARD GRIP TAPES; SKATEBOARD RISER PADS; SKATEBOARD TRUCKS; SKATEBOARD WHEELS; SKATEBOARDS , IN CLASS 28 (U.S. CLS. 22, 23, 38 AND 50).

FIRST USE 7-1-2004; IN COMMERCE 7-1-2004.

THE MARK CONSISTS OF STANDARD CHARACTERS WITHOUT CLAIM TO ANY PARTICULAR FONT, STYLE, SIZE, OR COLOR.

SER. NO. 77-511,902, FILED 6-30-2008.

JAY FLOWERS, EXAMINING ATTORNEY

**Int. Cl.: 28**

**Prior U.S. Cls.: 22, 23, 38 and 50**

**United States Patent and Trademark Office**

**Reg. No. 3,569,993**

**Registered Feb. 3, 2009**

**TRADEMARK  
PRINCIPAL REGISTER**



STRATTON, NEIL (UNITED STATES INDIVIDUAL)  
706 6TH AVE.  
VENICE, CA 90291

FOR: BALL BEARINGS FOR SKATEBOARDS;  
NUTS AND BOLTS FOR SKATEBOARDS; SKATEBOARD DECKS; SKATEBOARD GRIP TAPES; SKATEBOARD RISER PADS; SKATEBOARD TRUCKS; SKATEBOARD WHEELS; SKATEBOARDS , IN CLASS 28 (U.S. CLS. 22, 23, 38 AND 50).

FIRST USE 1-1-2004; IN COMMERCE 1-1-2004.

THE MARK CONSISTS OF A TRIDENT DESIGN.

SER. NO. 77-511,905, FILED 6-30-2008.

JAY FLOWERS, EXAMINING ATTORNEY

**Int. Cl.: 25**

**Prior U.S. Cls.: 22 and 39**

**United States Patent and Trademark Office**

**Reg. No. 3,569,994**

**Registered Feb. 3, 2009**

**TRADEMARK  
PRINCIPAL REGISTER**



STRATTON, NEIL (UNITED STATES INDIVIDUAL)  
706 6TH AVE.  
VENICE, CA 90291

FOR: ATHLETIC APPAREL, NAMELY, SHIRTS, PANTS, JACKETS, FOOTWEAR, HATS AND CAPS, ATHLETIC UNIFORMS; BELTS; BOARD SHORTS; SHOES; SHORTS; SOCKS, IN CLASS 25 (U.S. CLS. 22 AND 39).

FIRST USE 1-1-2004; IN COMMERCE 1-1-2004.

THE MARK CONSISTS OF A TRIDENT DESIGN.

SER. NO. 77-511,906, FILED 6-30-2008.

JAY FLOWERS, EXAMINING ATTORNEY

**Int. Cl.: 31**

**Prior U.S. Cls.: 1 and 46**

**United States Patent and Trademark Office**

**Reg. No. 3,569,995**

**Registered Feb. 3, 2009**

**TRADEMARK  
PRINCIPAL REGISTER**

**LOVERS**

971016 ONTARIO LIMITED (CANADA COR-  
PORATION)  
1621 ROAD 3, BOX 249  
RUTHVEN, CANADA N9P2G0

THE MARK CONSISTS OF STANDARD CHAR-  
ACTERS WITHOUT CLAIM TO ANY PARTICULAR  
FONT, STYLE, SIZE, OR COLOR.

FOR: FRESH VEGETABLES, IN CLASS 31 (U.S.  
CLS. 1 AND 46).

SER. NO. 77-511,989, FILED 7-1-2008.

FIRST USE 6-30-2008; IN COMMERCE 6-30-2008.

G. MAYERSCHOFF, EXAMINING ATTORNEY



Prior U.S. Cl.: B

United States Patent and Trademark Office

Reg. No. 3,569,996

Registered Feb. 3, 2009

CERTIFICATION MARK  
PRINCIPAL REGISTER

CWPC

AMERICAN CULINARY FEDERATION (NEW YORK CORPORATION)  
180 CENTER PLACE WAY  
ST. AUGUSTINE, FL 32095

FOR: COOKING SERVICES, IN CLASS B (U.S. CL. B).

FIRST USE 0-0-1999; IN COMMERCE 0-0-1999.

THE MARK CONSISTS OF STANDARD CHARACTERS WITHOUT CLAIM TO ANY PARTICULAR FONT, STYLE, SIZE, OR COLOR.

THE CERTIFICATION MARK, AS USED BY AUTHORIZED PERSONS, CERTIFIES THAT THE PERSON IS A PROFESSIONAL BAKER OR PASTRY WORKER WHO HAS DEMONSTRATED BASIC AND ADVANCED KNOWLEDGE AND SKILLS PERTAINING TO PROFESSIONAL BAKING AND PASTRIES AS DETERMINED BY A TEST OF BAK-

ING SKILL AND KNOWLEDGE AUTHORIZED BY THE CERTIFIER. THIS CAN BE DOCUMENTED BY BEING SUCCESSFULLY EMPLOYED FOR A MINIMUM OF THREE YEARS AFTER GRADUATING FROM AN ACCREDITED COLLEGE WITH A TWO YEAR DEGREE IN BAKING AND PASTRY ARTS OR HIGHER, GRADUATING FROM A FORMAL BAKING AND PASTRY APPRENTICESHIP TRAINING PROGRAM, BY DOCUMENTING A MINIMUM OF A HIGH SCHOOL EDUCATION PLUS FIVE YEARS EXPERIENCE AS A PROFESSIONAL BAKER OR PASTRY WORKER AND BY PASSING THE CERTIFICATION KNOWLEDGE AND SKILL PROFICIENCY TESTS ESTABLISHED BY THE CERTIFIER FOR THE CERTIFICATION LEVEL.

SER. NO. 77-512,145, FILED 7-1-2008.

MICHAEL KEATING, EXAMINING ATTORNEY

**Int. Cl.: 3**

**Prior U.S. Cls.: 1, 4, 6, 50, 51 and 52**

**United States Patent and Trademark Office**

**Reg. No. 3,569,997**

**Registered Feb. 3, 2009**

**TRADEMARK  
PRINCIPAL REGISTER**

**ARCTIC REFRESH**

THE DIAL CORPORATION (DELAWARE COR-  
PORATION)  
M.S. 2214  
15501 NORTH DIAL BOULEVARD  
SCOTTSDALE, AZ 852601619

THE MARK CONSISTS OF STANDARD CHAR-  
ACTERS WITHOUT CLAIM TO ANY PARTICULAR  
FONT, STYLE, SIZE, OR COLOR.

FOR: DEODORANTS AND ANTIPERSPIRANTS,  
IN CLASS 3 (U.S. CLS. 1, 4, 6, 50, 51 AND 52).

SER. NO. 77-512,302, FILED 7-1-2008.

FIRST USE 2-1-2005; IN COMMERCE 2-1-2005.

MARK PILARO, EXAMINING ATTORNEY

**Int. Cl.: 35**

**Prior U.S. Cls.: 100, 101 and 102**

**United States Patent and Trademark Office**

**Reg. No. 3,569,998**

**Registered Feb. 3, 2009**

**SERVICE MARK  
PRINCIPAL REGISTER**

# Pip Berry Place

GRIMES, TINA D (OHIO SOLE PROPRIETOR-  
SHIP), DBA PIP BERRY PLACE  
1128 SCHULTZ STREET  
DEFIANCE, OH 43512

FOR: OPERATING AN ON-LINE SHOPPING SITE  
IN THE FIELD OF COUNTRY PRIMITIVE HOME  
DECOR, IN CLASS 35 (U.S. CLS. 100, 101 AND 102).

FIRST USE 2-1-2007; IN COMMERCE 2-1-2007.

THE MARK CONSISTS OF STANDARD CHAR-  
ACTERS WITHOUT CLAIM TO ANY PARTICULAR  
FONT, STYLE, SIZE, OR COLOR.

NO CLAIM IS MADE TO THE EXCLUSIVE  
RIGHT TO USE "PIP BERRY", APART FROM THE  
MARK AS SHOWN.

SER. NO. 77-512,848, FILED 7-1-2008.

JASON LOTT, EXAMINING ATTORNEY

**Int. Cls.: 25 and 41**

**Prior U.S. Cls.: 22, 39, 100, 101 and 107**

**Reg. No. 3,569,999**

**United States Patent and Trademark Office**

**Registered Feb. 3, 2009**

**TRADEMARK  
SERVICE MARK  
PRINCIPAL REGISTER**

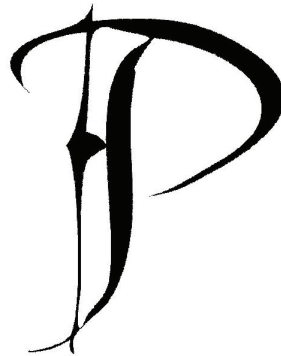

PHILADELPHIA UNIVERSITY (PENNSYLVANIA  
NON-PROFIT CORPORATION)  
HENRY AVENUE AND SCHOOL HOUSE LANE  
PHILADELPHIA, PA 19144

FOR: CLOTHING, NAMELY, DECORATIVE T-SHIRTS, SWEATERS, JACKETS, SWEATSHIRTS, SWEATPANTS, SHORTS, TIES, CAPS, HATS, SUN VISORS, HEADBANDS, WRISTBANDS, SOCKS, RAIN PONCHOS, BELTS AND SUSPENDERS, IN CLASS 25 (U.S. CLS. 22 AND 39).

FIRST USE 7-13-1999; IN COMMERCE 7-13-1999.

FOR: EDUCATIONAL SERVICES, NAMELY, PROVIDING INSTRUCTION AND TRAINING AT THE UNDERGRADUATE AND GRADUATE LEVELS, PROVIDING CONTINUING PROFESSIONAL EDUCATION CLASSES IN THE FIELDS OF ARCHITECTURE, BUSINESS, DESIGN, FASHION, HEALTH, SCIENCE AND TEXTILES; PROVIDING EDUCATIONAL RESEARCH PROGRAMS FOR THE STUDY OF ARCHITECTURE, BUSINESS, DESIGN, FASHION, HEALTH, SCIENCE AND TEXTILES; PROVIDING CONTINUING PROFESSIONAL EDUCATION CONFERENCES, SEMINARS AND WORKSHOPS IN THE FIELDS OF ARCHITECTURE, BUSINESS, DESIGN, FASHION, HEALTH, SCIENCE AND TEXTILES; CONDUCTING CONFERENCES, SEMINARS AND

WORKSHOPS RELATING TO THE STUDY OF ARCHITECTURE, BUSINESS, DESIGN, FASHION, HEALTH, SCIENCE AND TEXTILES; PUBLICATION OF NEWSLETTERS, MONOGRAPHS, NEWSPAPERS, BOOKS, COMMEMORATIVE PROGRAMS AND OTHER ELECTRONIC AND PRINTED PUBLICATIONS RELATING TO THE EDUCATIONAL SERVICES PROVIDED, NONE OF THE AFOREMENTIONED SERVICES BEING FOR ADVERTISING MATERIALS; AND ENTERTAINMENT SERVICES IN THE NATURE OF THE PRESENTATION OF A VARIETY OF INTERCOLLEGIATE SPORTING EVENTS; NAMELY, BASEBALL, BASKETBALL, FIELD HOCKEY, GOLF, LACROSSE, SOFTBALL, CROSS-COUNTRY RUNNING, ROWING, TENNIS AND VOLLEYBALL EVENTS, IN CLASS 41 (U.S. CLS. 100, 101 AND 107).

FIRST USE 7-13-1999; IN COMMERCE 7-13-1999.

OWNER OF U.S. REG. NOS. 2,601,672 AND 2,709,727.

THE MARK CONSISTS OF A STYLIZED LETTER "P".

SER. NO. 77-513,079, FILED 7-2-2008.

DAYNA BROWNE, EXAMINING ATTORNEY

**Int. Cl.: 38**

**Prior U.S. Cls.: 100, 101 and 104**

**United States Patent and Trademark Office**

**Reg. No. 3,570,000**

**Registered Feb. 3, 2009**

**SERVICE MARK  
PRINCIPAL REGISTER**



SPEETI CORPORATION, INC. (DELAWARE CORPORATION)  
3025 ASHLEY PHOSPHATE ROAD, SUITE C1  
NORTH CHARLESTON, SC 29418

FOR: EMERGENCY AND NON-EMERGENCY NOTIFICATION SERVICE PROVIDED TO SCHOOLS FOR PARENTS, STUDENTS AND FACULTY WHICH DELIVERS ALERTS VIA PHONE CALL OR VOICE MESSAGE, TEXT MESSAGE, AND/OR E-MAIL, IN CLASS 38 (U.S. CLS. 100, 101 AND 104).

FIRST USE 11-16-2007; IN COMMERCE 6-17-2008.

THE COLOR(S) RED AND BLUE IS/ARE CLAIMED AS A FEATURE OF THE MARK.

THE COLORS RED AND BLUE IS/ARE CLAIMED AS A FEATURE OF THE MARK. THE MARK IS COMPRISED OF A BLUE HOUSE FOLLOWED BY THREE RED SOUND WAVES FOLLOWED BY A STYLIZED FIGURE RESEMBLING THE LETTER "I" IN BLUE, ALL ABOVE THE TERM "SCHOOL2-PHONE" WITH THE WORDS "SCHOOL" AND "PHONE" IN BLUE AND THE "2" IN THE COLOR RED.

SER. NO. 77-513,303, FILED 7-2-2008.

LINDA POWELL, EXAMINING ATTORNEY

**Int. Cl.: 28**

**Prior U.S. Cls.: 22, 23, 38 and 50**

**United States Patent and Trademark Office**

**Reg. No. 3,570,001**

**Registered Feb. 3, 2009**

**TRADEMARK  
PRINCIPAL REGISTER**

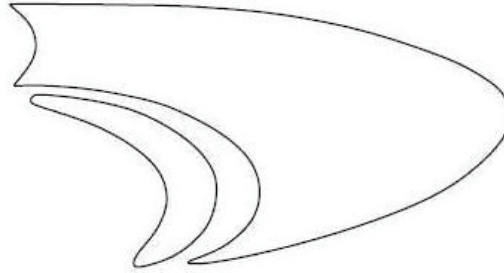

TECHNIQUE GOLF, L.L.C. (MICHIGAN LIMITED LIABILITY COMPANY)  
8130 SOUTHERN DRIVE  
BRIGHTON, MI 48114

THE MARK CONSISTS OF STYLIZED SHARK HEAD LOGO.

FOR: GOLF CLUB GRIPS; GOLF CLUBS, IN CLASS 28 (U.S. CLS. 22, 23, 38 AND 50).

SER. NO. 77-513,786, FILED 7-2-2008.

FIRST USE 11-30-2007; IN COMMERCE 11-30-2007.

OWNER OF U.S. REG. NO. 2,273,213.

LEIGH CAROLINE CASE, EXAMINING ATTORNEY

**Int. Cl.: 37**

**Prior U.S. Cls.: 100, 103 and 106**

**United States Patent and Trademark Office**

**Reg. No. 3,570,002**

**Registered Feb. 3, 2009**

**SERVICE MARK  
PRINCIPAL REGISTER**

# CertaPro

CERTA PROPAINTERS, LTD. (PENNSYLVANIA CORPORATION)  
150 GREEN TREE ROAD, SUITE 1003  
OAKS, PA 19456

FOR: PAINTING SERVICES, NAMELY, PAINTING RESIDENTIAL AND COMMERCIAL BUILDINGS, IN CLASS 37 (U.S. CLS. 100, 103 AND 106).

FIRST USE 12-1-1991; IN COMMERCE 12-1-1991.

THE MARK CONSISTS OF STANDARD CHARACTERS WITHOUT CLAIM TO ANY PARTICULAR FONT, STYLE, SIZE, OR COLOR.

OWNER OF U.S. REG. NOS. 1,809,577 AND 1,815,143.

SER. NO. 77-513,801, FILED 7-2-2008.

DAVID C. REIHNER, EXAMINING ATTORNEY

**Int. Cl.: 37**

**Prior U.S. Cls.: 100, 103 and 106**

**United States Patent and Trademark Office**

**Reg. No. 3,570,003**

**Registered Feb. 3, 2009**

**SERVICE MARK  
PRINCIPAL REGISTER**

# CertaPro Painters

CERTA PROPAINTERS, LTD. (PENNSYLVANIA CORPORATION)  
150 GREEN TREE ROAD, SUITE 1003  
OAKS, PA 19456

FOR: PAINTING SERVICES, NAMELY, PAINTING RESIDENTIAL AND COMMERCIAL BUILDINGS, IN CLASS 37 (U.S. CLS. 100, 103 AND 106).

FIRST USE 12-1-1991; IN COMMERCE 12-1-1991.

THE MARK CONSISTS OF STANDARD CHARACTERS WITHOUT CLAIM TO ANY PARTICULAR FONT, STYLE, SIZE, OR COLOR.

OWNER OF U.S. REG. NOS. 1,809,577 AND 1,815,143.

NO CLAIM IS MADE TO THE EXCLUSIVE RIGHT TO USE "PAINTERS", APART FROM THE MARK AS SHOWN.

SER. NO. 77-513,828, FILED 7-2-2008.

DAVID C. REIHNER, EXAMINING ATTORNEY



Int. Cl.: 32

Prior U.S. Cls.: 45, 46 and 48

Reg. No. 3,570,004

United States Patent and Trademark Office

Registered Feb. 3, 2009

TRADEMARK  
PRINCIPAL REGISTER



SWEETWATER BREWING COMPANY, LLC  
(GEORGIA LIMITED LIABILITY COMPANY)  
195 OTTLEY DRIVE NE  
ATLANTA, GA 30324

FOR: BEER, IN CLASS 32 (U.S. CLS. 45, 46 AND 48).

FIRST USE 0-0-1996; IN COMMERCE 0-0-1996.

OWNER OF U.S. REG. NOS. 3,282,291, 3,392,654  
AND OTHERS.

NO CLAIM IS MADE TO THE EXCLUSIVE  
RIGHT TO USE "BREWING COMPANY", APART  
FROM THE MARK AS SHOWN.

THE MARK CONSISTS OF THE WORDING  
"SWEETWATER BREWING COMPANY" IN A STY-  
LIZED FONT APPEARING ON A DESIGN OF A  
BANNER BEHIND WHICH APPEARS A DESIGN OF  
A FISH.

SER. NO. 77-513,851, FILED 7-2-2008.

RENEE MCCRAY, EXAMINING ATTORNEY

**Int. Cl.: 35**

**Prior U.S. Cls.: 100, 101 and 102**

**United States Patent and Trademark Office**

**Reg. No. 3,570,005**

**Registered Feb. 3, 2009**

**SERVICE MARK  
PRINCIPAL REGISTER**

# Got Cars?

ACQUIRECORP'S NORWALK AUTO AUCTION  
(CALIFORNIA CORPORATION), DBA NOR-  
WALK AUTO AUCTION

12405 E. ROSECRANS AVENUE  
NORWALK, CA 90650

FOR: AUTOMOBILE AUCTION SERVICES, IN  
CLASS 35 (U.S. CLS. 100, 101 AND 102).

FIRST USE 8-18-1997; IN COMMERCE 8-18-1997.

THE MARK CONSISTS OF STANDARD CHAR-  
ACTERS WITHOUT CLAIM TO ANY PARTICULAR  
FONT, STYLE, SIZE, OR COLOR.

NO CLAIM IS MADE TO THE EXCLUSIVE  
RIGHT TO USE "CARS", APART FROM THE MARK  
AS SHOWN.

SER. NO. 77-513,860, FILED S.R. 7-2-2008 AM. P.R.  
7-22-2008.

ESTHER A. BORSUK, EXAMINING ATTORNEY

**Int. Cl.: 41**

**Prior U.S. Cls.: 100, 101 and 107**

**United States Patent and Trademark Office**

**Reg. No. 3,570,006**

**Registered Feb. 3, 2009**

**SERVICE MARK  
PRINCIPAL REGISTER**

**SOUND ADVICE SESSIONS**

BROADCAST MUSIC, INC. (NEW YORK CORPORATION)  
320 WEST 57TH STREET  
NEW YORK, NY 10019

FOR: EDUCATIONAL SERVICES, NAMELY, CONDUCTING PROGRAMS IN THE FIELD OF MUSIC, SONGWRITING, VOCAL PERFORMANCE, MUSIC PUBLISHING, COPYRIGHT, AND PERFORMING RIGHTS, IN CLASS 41 (U.S. CLS. 100, 101 AND 107).

FIRST USE 4-30-2008; IN COMMERCE 4-30-2008.

THE MARK CONSISTS OF STANDARD CHARACTERS WITHOUT CLAIM TO ANY PARTICULAR FONT, STYLE, SIZE, OR COLOR.

NO CLAIM IS MADE TO THE EXCLUSIVE RIGHT TO USE "SESSIONS", APART FROM THE MARK AS SHOWN.

SER. NO. 77-514,478, FILED 7-3-2008.

DAVID TOOLEY, EXAMINING ATTORNEY

**Int. Cl.: 41**

**Prior U.S. Cls.: 100, 101 and 107**

**United States Patent and Trademark Office**

**Reg. No. 3,570,007**

**Registered Feb. 3, 2009**

**SERVICE MARK  
PRINCIPAL REGISTER**

**ACHIS CACHIS**

UNIVISION COMMUNICATIONS INC. (DELA-  
WARE CORPORATION)

5999 CENTER DRIVE

LOS ANGELES, CA 90045

FOR: ENTERTAINMENT SERVICES, NAMELY,  
AN ON-GOING LATE NIGHT TELEVISION TALK  
SHOW, IN CLASS 41 (U.S. CLS. 100, 101 AND 107).

FIRST USE 5-30-2008; IN COMMERCE 5-30-2008.

THE MARK CONSISTS OF STANDARD CHAR-  
ACTERS WITHOUT CLAIM TO ANY PARTICULAR  
FONT, STYLE, SIZE, OR COLOR.

THE PHRASE "ACHIS CACHIS" IS A SLANG  
TERM IN SPANISH USED TO DESIGNATE SUR-  
PRISE, WONDERMENT, OR LAMENT. THE TERM  
HAS NO MEANING IN ENGLISH.

SER. NO. 77-514,541, FILED 7-3-2008.

MICHAEL TANNER, EXAMINING ATTORNEY

**Int. Cls.: 18 and 25**

**Prior U.S. Cls.: 1, 2, 3, 22, 39 and 41**

**United States Patent and Trademark Office**

**Reg. No. 3,570,008**

**Registered Feb. 3, 2009**

**TRADEMARK  
PRINCIPAL REGISTER**

**BEACHSIDE**

BEACHSIDE, LLC (NEW JERSEY LIMITED LIABILITY COMPANY)  
P. O. BOX 204  
PITTSTOWN, NJ 08867

FOR: TOTE BAGS; BACK PACKS; BEACH BAGS; REUSABLE SHOPPING BAGS, NAMELY, CANVAS, MESH, OR TEXTILE SHOPPING BAGS, IN CLASS 18 (U.S. CLS. 1, 2, 3, 22 AND 41).

FIRST USE 5-14-2008; IN COMMERCE 5-22-2008.

FOR: CLOTHING FOR MEN, WOMEN, AND CHILDREN, NAMELY, THE FOLLOWING: LONG-SLEEVED AND SHORT-SLEEVED T-SHIRTS; HOODED, ZIPPERED OR CREW NECK SWEAT SHIRTS;

HATS, CAPS AND VISORS; OUTERWEAR AND JACKETS, NAMELY, FLEECE JACKETS, WIND JACKETS, WIND SHIRTS, AND VESTS; POLO SHIRTS; TWILL SHIRTS; FLIP-FLOPS, IN CLASS 25 (U.S. CLS. 22 AND 39).

FIRST USE 5-14-2008; IN COMMERCE 5-22-2008.

THE MARK CONSISTS OF STANDARD CHARACTERS WITHOUT CLAIM TO ANY PARTICULAR FONT, STYLE, SIZE, OR COLOR.

SER. NO. 77-514,565, FILED 7-3-2008.

JASON LOTT, EXAMINING ATTORNEY

**Int. Cl.: 35**

**Prior U.S. Cls.: 100, 101 and 102**

**United States Patent and Trademark Office**

**Reg. No. 3,570,009**

**Registered Feb. 3, 2009**

**SERVICE MARK  
PRINCIPAL REGISTER**

**MACHINERYZONE**

VIRTUAL KREATION, INC. (FLORIDA CORPORATION), DBA MACHINERYZONE  
1210 PINAR DRIVE  
ORLANDO, FL 32825

THE MARK CONSISTS OF STANDARD CHARACTERS WITHOUT CLAIM TO ANY PARTICULAR FONT, STYLE, SIZE, OR COLOR.

FOR: PROVIDING A WEB SITE THAT ENABLES USERS TO POST ITEMS FOR SALE THROUGH ON-LINE CLASSIFIED ADVERTISEMENTS, IN CLASS 35 (U.S. CLS. 100, 101 AND 102).

SER. NO. 77-515,291, FILED 7-6-2008.

FIRST USE 10-2-2001; IN COMMERCE 10-2-2001.

CHRISTINA SOBRAL, EXAMINING ATTORNEY

**Int. Cl.: 41**

**Prior U.S. Cls.: 100, 101 and 107**

**United States Patent and Trademark Office**

**Reg. No. 3,570,010**

**Registered Feb. 3, 2009**

**SERVICE MARK  
PRINCIPAL REGISTER**

**ICOMS**

INTERNATIONAL ASSOCIATION OF ORAL  
AND MAXILLOFACIAL SURGEONS (ILLI-  
NOIS CORPORATION)  
SUITE 420  
17 W. 220 22ND STREET  
OAK BROOK TERRACE, IL 60181

FOR: EDUCATIONAL SERVICES, NAMELY,  
PROVIDING CONFERENCES AND SEMINARS IN  
THE FIELD OF ORAL AND MAXILLOFACIAL  
SURGERY, IN CLASS 41 (U.S. CLS. 100, 101 AND 107).

FIRST USE 5-0-1986; IN COMMERCE 5-0-1986.

THE MARK CONSISTS OF STANDARD CHAR-  
ACTERS WITHOUT CLAIM TO ANY PARTICULAR  
FONT, STYLE, SIZE, OR COLOR.

SER. NO. 77-515,886, FILED 7-7-2008.

KIMBERLY PERRY, EXAMINING ATTORNEY

**Int. Cl.: 8**

**Prior U.S. Cls.: 23, 28 and 44**

**Reg. No. 3,570,011**

**United States Patent and Trademark Office**

**Registered Feb. 3, 2009**

**TRADEMARK  
PRINCIPAL REGISTER**

**HINDERER**

RICK HINDERER (UNITED STATES INDIVIDUAL), DBA HINDERER KNIVES  
5373 COLUMBUS ROAD  
SHREVE, OH 44676

THE MARK CONSISTS OF STANDARD CHARACTERS WITHOUT CLAIM TO ANY PARTICULAR FONT, STYLE, SIZE, OR COLOR.

FOR: KNIVES, IN CLASS 8 (U.S. CLS. 23, 28 AND 44).

SER. NO. 77-516,398, FILED 7-7-2008.

FIRST USE 7-1-1988; IN COMMERCE 7-1-1988.

MARK PILARO, EXAMINING ATTORNEY



**Int. Cl.: 18**

**Prior U.S. Cls.: 1, 2, 3, 22 and 41**

**United States Patent and Trademark Office**

**Reg. No. 3,570,012**

**Registered Feb. 3, 2009**

**TRADEMARK  
PRINCIPAL REGISTER**

**BOMBER JACKET**

LEVINGER COMPANY (FLORIDA CORPORATION)  
420 CONGRESS AVENUE  
DELRAY BEACH, FL 334454696

THE MARK CONSISTS OF STANDARD CHARACTERS WITHOUT CLAIM TO ANY PARTICULAR FONT, STYLE, SIZE, OR COLOR.

FOR: BRIEFCASES, IN CLASS 18 (U.S. CLS. 1, 2, 3, 22 AND 41).

SER. NO. 77-516,523, FILED 7-8-2008.

FIRST USE 12-0-2006; IN COMMERCE 12-0-2006.

HEATHER THOMPSON, EXAMINING ATTORNEY

**Int. Cl.: 18**

**Prior U.S. Cls.: 1, 2, 3, 22 and 41**

**Reg. No. 3,570,013**

**United States Patent and Trademark Office**

**Registered Feb. 3, 2009**

---

**TRADEMARK  
PRINCIPAL REGISTER**

# BRIEFOLIO

LEVENGER COMPANY (FLORIDA CORPORATION)  
420 CONGRESS AVENUE  
DELRAY BEACH, FL 334454696

THE MARK CONSISTS OF STANDARD CHARACTERS WITHOUT CLAIM TO ANY PARTICULAR FONT, STYLE, SIZE, OR COLOR.

FOR: BRIEFCASES, IN CLASS 18 (U.S. CLS. 1, 2, 3, 22 AND 41).

SER. NO. 77-516,533, FILED 7-8-2008.

FIRST USE 9-0-2005; IN COMMERCE 9-0-2005.

HEATHER THOMPSON, EXAMINING ATTORNEY

**Int. Cl.: 20**

**Prior U.S. Cls.: 2, 13, 22, 25, 32 and 50**

**Reg. No. 3,570,014**

**United States Patent and Trademark Office**

**Registered Feb. 3, 2009**

---

**TRADEMARK  
PRINCIPAL REGISTER**

# Décor Elements

STAMPIN' UP! INC. (UTAH CORPORATION)  
12907 SOUTH 3600 WEST  
RIVERTON, UT 84065

FOR: HOME DECOR ITEMS, NAMELY SELF-ADHESIVE VINYL ART FOR WALLS, MIRRORS, WINDOWS, OR OTHER HARD, SMOOTH SURFACES, IN CLASS 20 (U.S. CLS. 2, 13, 22, 25, 32 AND 50).

FIRST USE 7-8-2008; IN COMMERCE 7-8-2008.

THE MARK CONSISTS OF STANDARD CHARACTERS WITHOUT CLAIM TO ANY PARTICULAR FONT, STYLE, SIZE, OR COLOR.

NO CLAIM IS MADE TO THE EXCLUSIVE RIGHT TO USE "DÉCOR", APART FROM THE MARK AS SHOWN.

SER. NO. 77-516,691, FILED 7-8-2008.

KAREN K. BUSH, EXAMINING ATTORNEY

**Int. Cl.: 9**

**Prior U.S. Cls.: 21, 23, 26, 36 and 38**

**United States Patent and Trademark Office**

**Reg. No. 3,570,015**

**Registered Feb. 3, 2009**

**TRADEMARK  
PRINCIPAL REGISTER**

**ROSETTA STONE**

ROSETTA STONE LTD. (VIRGINIA CORPORATION)  
1101 WILSON BOULEVARD, SUITE 1130  
ARLINGTON, VA 22209

FOR: COMPACT DISCS FOR TEACHING AND  
LEARNING FOREIGN LANGUAGES, IN CLASS 9  
(U.S. CLS. 21, 23, 26, 36 AND 38).

FIRST USE 6-10-2008; IN COMMERCE 6-10-2008.

THE MARK CONSISTS OF STANDARD CHARACTERS WITHOUT CLAIM TO ANY PARTICULAR FONT, STYLE, SIZE, OR COLOR.

OWNER OF U.S. REG. NOS. 2,761,492, 2,781,324,  
AND 3,454,358.

SER. NO. 77-516,775, FILED 7-8-2008.

COURTNEY MCCORMICK, EXAMINING ATTORNEY

**Int. Cl.: 9**

**Prior U.S. Cls.: 21, 23, 26, 36 and 38**

**United States Patent and Trademark Office**

**Reg. No. 3,570,016**

**Registered Feb. 3, 2009**

**TRADEMARK  
PRINCIPAL REGISTER**

**STARDUST**

CHRISTIAN DALLOZ SUNOPTICS (FRANCE SOCIÉTÉ PAR ACTIONS SIMPLIFIÉE (SAS))  
ROUTE DE GENEVE  
SAINT CLAUDE, FRANCE 39200

PRIORITY CLAIMED UNDER SEC. 44(D) ON  
FRANCE APPLICATION NO. 083551249, FILED 1-  
24-2008, REG. NO. 083551249, DATED 6-27-2008, EX-  
PIRES 6-27-2018.

FOR: SPECTACLE LENSES, IN CLASS 9 (U.S. CLS.  
21, 23, 26, 36 AND 38).

SER. NO. 77-517,007, FILED 7-8-2008.

THE MARK CONSISTS OF STANDARD CHAR-  
ACTERS WITHOUT CLAIM TO ANY PARTICULAR  
FONT, STYLE, SIZE, OR COLOR.

DORITT L. CARROLL, EXAMINING ATTORNEY

**Int. Cl.: 16**

**Prior U.S. Cls.: 2, 5, 22, 23, 29, 37, 38 and 50**

**United States Patent and Trademark Office**

**Reg. No. 3,570,017**

**Registered Feb. 3, 2009**

**TRADEMARK  
PRINCIPAL REGISTER**

**SILVERDALE LIFE**

BRV, LLC (DELAWARE LIMITED LIABILITY  
COMPANY)

545 FIFTH STREET

BREMERTON, WA 98337

FOR: BI-MONTHLY COMMUNITY NEWSPAPER,  
IN CLASS 16 (U.S. CLS. 2, 5, 22, 23, 29, 37, 38 AND 50).

FIRST USE 11-14-2007; IN COMMERCE 11-14-2007.

THE MARK CONSISTS OF STANDARD CHAR-  
ACTERS WITHOUT CLAIM TO ANY PARTICULAR  
FONT, STYLE, SIZE, OR COLOR.

NO CLAIM IS MADE TO THE EXCLUSIVE  
RIGHT TO USE "SILVERDALE", APART FROM  
THE MARK AS SHOWN.

SER. NO. 77-517,713, FILED 7-9-2008.

STEVEN PEREZ, EXAMINING ATTORNEY

**Int. Cl.: 25**

**Prior U.S. Cls.: 22 and 39**

**United States Patent and Trademark Office**

**Reg. No. 3,570,018**

**Registered Feb. 3, 2009**

**TRADEMARK  
PRINCIPAL REGISTER**



NAPOLITANO, DENNIS (UNITED STATES INDIVIDUAL)  
39642 248TH ST.  
MT. VERNON, SD 57363 AND  
NAPOLITANO, LINDA (UNITED STATES INDIVIDUAL)  
39642 248TH ST.  
MT. VERNON, SD 57363 AND  
NAPOLITANO, DAVID (UNITED STATES INDIVIDUAL)  
39642 248TH ST.  
MT. VERNON, SD 57363

FOR: ATHLETIC SHOES; BANDANAS; BEANIES;  
BELTS; BLOUSES; BOXER SHORTS; CAPS; COATS;  
DRESSES; FOOTWEAR; HATS; HEADWEAR; JACK-

ETS; JEANS; JERSEYS; PAJAMAS; PANTS; SHIRTS;  
SHOES; SHORTS; SKIRTS; SOCKS; SWEAT JACKETS;  
SWEAT PANTS; SWEAT SHIRTS; SWEATERS;  
T-SHIRTS; TANK TOPS; TIES; TOPS; UNDERWEAR;  
VISORS, IN CLASS 25 (U.S. CLS. 22 AND 39).

FIRST USE 4-1-2006; IN COMMERCE 4-1-2006.

OWNER OF U.S. REG. NO. 3,196,595.

THE MARK CONSISTS OF DOG FACE.

SER. NO. 77-517,848, FILED 7-9-2008.

JORDAN BAKER, EXAMINING ATTORNEY

**Int. Cl.: 16**

**Prior U.S. Cls.: 2, 5, 22, 23, 29, 37, 38 and 50**

**Reg. No. 3,570,019**

**United States Patent and Trademark Office**

**Registered Feb. 3, 2009**

---

**TRADEMARK  
PRINCIPAL REGISTER**

**POULSBO LIFE**

BRV, LLC (DELAWARE LIMITED LIABILITY  
COMPANY)

545 FIFTH STREET

BREMERTON, WA 98337

FOR: BI-MONTHLY COMMUNITY NEWSPAPER,  
IN CLASS 16 (U.S. CLS. 2, 5, 22, 23, 29, 37, 38 AND 50).

FIRST USE 11-7-2007; IN COMMERCE 11-7-2007.

THE MARK CONSISTS OF STANDARD CHAR-  
ACTERS WITHOUT CLAIM TO ANY PARTICULAR  
FONT, STYLE, SIZE, OR COLOR.

NO CLAIM IS MADE TO THE EXCLUSIVE  
RIGHT TO USE "POULSBO", APART FROM THE  
MARK AS SHOWN.

SER. NO. 77-517,863, FILED 7-9-2008.

STEVEN PEREZ, EXAMINING ATTORNEY



**Int. Cl.: 41**

**Prior U.S. Cls.: 100, 101 and 107**

**United States Patent and Trademark Office**

**Reg. No. 3,570,020**

**Registered Feb. 3, 2009**

**SERVICE MARK  
PRINCIPAL REGISTER**

**SILVERDALE LIFE**

BRV, LLC (DELAWARE LIMITED LIABILITY  
COMPANY)  
545 FIFTH STREET  
BREMERTON, WA 98337

FOR: PROVIDING AN INTERACTIVE COMPU-  
TER DATABASE CONTAINING INFORMATION IN  
THE FIELDS OF SPORTS, ENTERTAINMENT, FINE  
ARTS, AND LOCAL AND NATIONAL NEWS, IN  
CLASS 41 (U.S. CLS. 100, 101 AND 107).

FIRST USE 11-14-2007; IN COMMERCE 11-14-2007.

THE MARK CONSISTS OF STANDARD CHAR-  
ACTERS WITHOUT CLAIM TO ANY PARTICULAR  
FONT, STYLE, SIZE, OR COLOR.

NO CLAIM IS MADE TO THE EXCLUSIVE  
RIGHT TO USE "SILVERDALE", APART FROM  
THE MARK AS SHOWN.

SER. NO. 77-518,159, FILED 7-9-2008.

STEVEN PEREZ, EXAMINING ATTORNEY

**Int. Cl.: 41**

**Prior U.S. Cls.: 100, 101 and 107**

**United States Patent and Trademark Office**

**Reg. No. 3,570,021**

**Registered Feb. 3, 2009**

**SERVICE MARK  
PRINCIPAL REGISTER**

**POULSBO LIFE**

BRV, LLC (DELAWARE LIMITED LIABILITY  
COMPANY)  
545 FIFTH STREET  
BREMERTON, WA 98337

FOR: PROVIDING AN INTERACTIVE COMPU-  
TER DATABASE CONTAINING INFORMATION IN  
THE FIELDS OF SPORTS, ENTERTAINMENT, FINE  
ARTS, AND LOCAL AND NATIONAL NEWS, IN  
CLASS 41 (U.S. CLS. 100, 101 AND 107).

FIRST USE 11-7-2007; IN COMMERCE 11-7-2007.

THE MARK CONSISTS OF STANDARD CHAR-  
ACTERS WITHOUT CLAIM TO ANY PARTICULAR  
FONT, STYLE, SIZE, OR COLOR.

NO CLAIM IS MADE TO THE EXCLUSIVE  
RIGHT TO USE "POULSBO", APART FROM THE  
MARK AS SHOWN.

SER. NO. 77-518,180, FILED 7-9-2008.

STEVEN PEREZ, EXAMINING ATTORNEY

**Int. Cl.: 41**

**Prior U.S. Cls.: 100, 101 and 107**

**United States Patent and Trademark Office**

**Reg. No. 3,570,022**

**Registered Feb. 3, 2009**

**SERVICE MARK  
PRINCIPAL REGISTER**

**OUTDOORSITE**

BASS PRO INTELLECTUAL PROPERTY, L.L.C.  
(MISSOURI LIMITED LIABILITY COMPANY)  
2500 EAST KEARNEY STREET  
SPRINGFIELD, MO 65898

FOR: ON-LINE LIBRARY SERVICES, NAMELY,  
PROVIDING ELECTRONIC LIBRARY SERVICES  
WHICH FEATURE NEWS ARTICLES, INSTRU-  
CTIONAL ARTICLES, PRODUCT REVIEWS, BUYING  
GUIDES, IMAGES AND AUDIO-VISUAL PRO-  
GRAMMING VIA AN ON-LINE COMPUTER NET-  
WORK, IN CLASS 41 (U.S. CLS. 100, 101 AND 107).

FIRST USE 10-7-2000; IN COMMERCE 10-7-2000.

THE MARK CONSISTS OF STANDARD CHAR-  
ACTERS WITHOUT CLAIM TO ANY PARTICULAR  
FONT, STYLE, SIZE, OR COLOR.

OWNER OF U.S. REG. NOS. 2,100,712, 3,028,334  
AND OTHERS.

SEC. 2(F).

SER. NO. 77-518,586, FILED 7-10-2008.

MARLENE BELL, EXAMINING ATTORNEY

**Int. Cl.: 30**

**Prior U.S. Cl.: 46**

**United States Patent and Trademark Office**

**Reg. No. 3,570,023**

**Registered Feb. 3, 2009**

**TRADEMARK  
PRINCIPAL REGISTER**

# Putti Cakes

VIAVANTI, LLC (NEW YORK LIMITED LIABILITY COMPANY)  
226 SOUTH GREELEY AVE.  
CHAPPAQUA, NY 10514

FOR: CAKES, IN CLASS 30 (U.S. CL. 46).

FIRST USE 8-1-2007; IN COMMERCE 10-1-2007.

THE MARK CONSISTS OF STANDARD CHARACTERS WITHOUT CLAIM TO ANY PARTICULAR FONT, STYLE, SIZE, OR COLOR.

NO CLAIM IS MADE TO THE EXCLUSIVE RIGHT TO USE "CAKES", APART FROM THE MARK AS SHOWN.

THE ENGLISH TRANSLATION OF THE WORD "PUTTI" IN THE MARK IS BABY ANGELS.

SER. NO. 77-521,005, FILED 7-14-2008.

ELLEN PERKINS, EXAMINING ATTORNEY

**Int. Cl.: 29**

**Prior U.S. Cl.: 46**

**United States Patent and Trademark Office**

**Reg. No. 3,570,024**

**Registered Feb. 3, 2009**

**TRADEMARK  
PRINCIPAL REGISTER**

**Tre Tuffi**

VIAVANTI, LLC (NEW YORK LIMITED LIABILITY COMPANY)

226 SOUTH GREELEY AVE.

CHAPPAQUA, NY 10514

FOR: VEGETABLE-BASED SPREADS, IN CLASS 29 (U.S. CL. 46).

FIRST USE 8-1-2007; IN COMMERCE 10-1-2007.

THE MARK CONSISTS OF STANDARD CHARACTERS WITHOUT CLAIM TO ANY PARTICULAR FONT, STYLE, SIZE, OR COLOR.

THE ENGLISH TRANSLATION OF THE WORD "TRE TUFFI" IN THE MARK IS TRE MEANS THREE, TUFFI MEANS DIVE.

SER. NO. 77-521,339, FILED 7-14-2008.

ELLEN PERKINS, EXAMINING ATTORNEY

**Int. Cl.: 44**

**Prior U.S. Cls.: 100 and 101**

**United States Patent and Trademark Office**

**Reg. No. 3,570,025**

**Registered Feb. 3, 2009**

**SERVICE MARK  
PRINCIPAL REGISTER**

**OX**

HICKORY & SELNICK, D.D.S., LLC (MARY-  
LAND LIMITED LIABILITY COMPANY)  
SUITE 202  
5082 DORSEY HALL DRIVE  
ELLCOTT CITY, MD 21042

THE MARK CONSISTS OF STANDARD CHAR-  
ACTERS WITHOUT CLAIM TO ANY PARTICULAR  
FONT, STYLE, SIZE, OR COLOR.

FOR: DENTISTRY, IN CLASS 44 (U.S. CLS. 100  
AND 101).

SER. NO. 77-521,341, FILED 7-14-2008.

FIRST USE 12-1-2005; IN COMMERCE 12-1-2005.

KEVIN DINALLO, EXAMINING ATTORNEY

**Int. Cl.: 9**

**Prior U.S. Cls.: 21, 23, 26, 36 and 38**

**Reg. No. 3,570,026**

**United States Patent and Trademark Office**

**Registered Feb. 3, 2009**

---

**TRADEMARK  
PRINCIPAL REGISTER**

**LEAKWARN**

ENERGY SOLUTIONS INTERNATIONAL, INC.  
(TEXAS CORPORATION)  
SUITE 235  
13831 NORTHWEST FREEWAY  
HOUSTON, TX 77040

THE MARK CONSISTS OF STANDARD CHAR-  
ACTERS WITHOUT CLAIM TO ANY PARTICULAR  
FONT, STYLE, SIZE, OR COLOR.

FOR: SOFTWARE FOR USE IN THE OPERATION  
OF LIQUID PIPELINES, IN CLASS 9 (U.S. CLS. 21, 23,  
26, 36 AND 38).

SER. NO. 77-523,370, FILED 7-16-2008.

FIRST USE 1-1-1984; IN COMMERCE 1-1-1984.

RONALD AIKENS, EXAMINING ATTORNEY

**Int. Cl.: 9**

**Prior U.S. Cls.: 21, 23, 26, 36 and 38**

**Reg. No. 3,570,027**

**United States Patent and Trademark Office**

**Registered Feb. 3, 2009**

---

**TRADEMARK  
PRINCIPAL REGISTER**

**PIPEWORKS**

ENERGY SOLUTIONS INTERNATIONAL, INC.  
(TEXAS CORPORATION)  
SUITE 235  
13831 NORTHWEST FREEWAY  
HOUSTON, TX 77040

THE MARK CONSISTS OF STANDARD CHAR-  
ACTERS WITHOUT CLAIM TO ANY PARTICULAR  
FONT, STYLE, SIZE, OR COLOR.

FOR: SOFTWARE FOR USE IN THE OPERATION  
OF LIQUID PIPELINES, IN CLASS 9 (U.S. CLS. 21, 23,  
26, 36 AND 38).

SER. NO. 77-523,387, FILED 7-16-2008.

FIRST USE 12-31-1997; IN COMMERCE 12-31-1997.

RONALD AIKENS, EXAMINING ATTORNEY



**Int. Cls.: 9, 16 and 41**

**Prior U.S. Cls.: 2, 5, 21, 22, 23, 26, 29, 36, 37, 38, 50,  
100, 101 and 107**

**Reg. No. 3,570,028**

**United States Patent and Trademark Office**

**Registered Feb. 3, 2009**

**TRADEMARK  
SERVICE MARK  
PRINCIPAL REGISTER**

**FORTRESS PRESS**

PUBLISHING HOUSE OF THE EVANGELICAL  
LUTHERAN CHURCH IN AMERICA (MINNE-  
SOTA NON-PROFIT CORPORATION)  
SUITE 700, 100 SOUTH FIFTH STREET  
MINNEAPOLIS, MN 55440

FOR: PRE-RECORDED CDS FEATURING MU-  
SIC, PRE-RECORDED DVDS IN THE FIELD OF  
RELIGIOUS TOPICS, SPIRITUAL TOPICS, ETHICAL  
TOPICS AND EDUCATIONAL TOPICS FEATUR-  
ING RELIGION, SPIRITUALITY AND ETHICS, IN  
CLASS 9 (U.S. CLS. 21, 23, 26, 36 AND 38).

FIRST USE 3-0-2001; IN COMMERCE 3-0-2001.

FOR: PRINTED RELIGIOUS PUBLICATIONS,  
NAMELY, BOOKS FEATURING PRAYERS,  
HYMNS, LITURGY AND MUSIC; BIBLE STUDY  
BOOKS, WORKBOOKS, AND PAMPHLETS CON-  
TAINING WORSHIP MATERIALS; AND BOOKS IN  
THE FIELD OF RELIGIOUS TOPICS, SPIRITUAL  
TOPICS, ETHICAL TOPICS, AND EDUCATIONAL  
TOPICS FEATURING RELIGION, SPIRITUALITY  
AND ETHICS, IN CLASS 16 (U.S. CLS. 2, 5, 22, 23, 29,  
37, 38 AND 50).

FIRST USE 0-0-1965; IN COMMERCE 0-0-1965.

FOR: PROVIDING ONLINE NEWSLETTERS,  
BOOKS, MANUALS, WORKBOOKS, DISTRIBUTED  
ONLINE VIA THE INTERNET, IN THE FIELD OF  
RELIGIOUS TOPICS, SPIRITUAL TOPICS, ETHICAL  
TOPICS, AND EDUCATIONAL TOPICS FEATUR-  
ING RELIGION, SPIRITUALITY AND ETHICS, IN  
CLASS 41 (U.S. CLS. 100, 101 AND 107).

FIRST USE 0-0-2001; IN COMMERCE 0-0-2001.

THE MARK CONSISTS OF STANDARD CHAR-  
ACTERS WITHOUT CLAIM TO ANY PARTICULAR  
FONT, STYLE, SIZE, OR COLOR.

NO CLAIM IS MADE TO THE EXCLUSIVE  
RIGHT TO USE "PRESS", APART FROM THE  
MARK AS SHOWN.

SER. NO. 77-523,397, FILED 7-16-2008.

PAM WILLIS, EXAMINING ATTORNEY

**Int. Cls.: 35, 36 and 41**

**Prior U.S. Cls.: 100, 101, 102 and 107**

**United States Patent and Trademark Office**

**Reg. No. 3,570,029**

**Registered Feb. 3, 2009**

**SERVICE MARK  
PRINCIPAL REGISTER**

**POWER OF COALITION**

GREATER PHILADELPHIA URBAN AFFAIRS  
COALITION (PENNSYLVANIA NON-PROFIT  
CORPORATION)

SUITE 700  
1207 CHESTNUT STREET  
PHILADELPHIA, PA 19107

FOR: PROMOTING THE INTERESTS OF CHARITABLE ORGANIZATIONS AND COMMUNITY ORGANIZATIONS BY OFFERING THE ORGANIZATIONS PROFESSIONAL SERVICES, NAMELY, ACCOUNTING SERVICES, MARKETING, PAYROLL AND ADMINISTRATION, PROVIDING OFFICE SPACE AND PROVIDING BUSINESS NETWORKING SERVICES, NAMELY, MATCHING THE CHARITABLE AND COMMUNITY ORGANIZATIONS WITH THIRD PARTIES IN THE FIELDS OF EDUCATION AND TECHNICAL COMPUTER ASSISTANCE, IN CLASS 35 (U.S. CLS. 100, 101 AND 102).

FIRST USE 6-0-2006; IN COMMERCE 6-0-2006.

FOR: CHARITABLE SERVICES, NAMELY, FINANCIAL SPONSORSHIP OF CHARITABLE AND COMMUNITY ORGANIZATIONS AND BENEFITS ADMINISTRATION FOR CHARITABLE AND COM-

MUNITY ORGANIZATIONS, IN CLASS 36 (U.S. CLS. 100, 101 AND 102).

FIRST USE 2-0-1991; IN COMMERCE 2-0-1991.

FOR: EDUCATIONAL SERVICES, NAMELY, ARRANGING PROFESSIONAL WORKSHOPS IN THE FIELDS OF WEALTH-BUILDING AND ENTREPRENEURSHIP FOR CHARITABLE AND COMMUNITY ORGANIZATIONS, IN CLASS 41 (U.S. CLS. 100, 101 AND 107).

FIRST USE 2-0-1991; IN COMMERCE 2-0-1991.

THE MARK CONSISTS OF STANDARD CHARACTERS WITHOUT CLAIM TO ANY PARTICULAR FONT, STYLE, SIZE, OR COLOR.

NO CLAIM IS MADE TO THE EXCLUSIVE RIGHT TO USE "COALITION", APART FROM THE MARK AS SHOWN.

SER. NO. 77-523,605, FILED 7-16-2008.

TRACY WHITTAKER-BROWN, EXAMINING ATTORNEY

**Int. Cl.: 14**

**Prior U.S. Cls.: 2, 27, 28 and 50**

**Reg. No. 3,570,030**

**United States Patent and Trademark Office**

**Registered Feb. 3, 2009**

**TRADEMARK  
PRINCIPAL REGISTER**



CITIZEN HOLDINGS KABUSHIKI KAISHA (JAPAN CORPORATION), DBA CITIZEN HOLDINGS CO., LTD.  
1-12, 6-CHOME, TANASHI-CHO  
NISHI-TOKYO-SHI, TOKYO, JAPAN

THE MARK CONSISTS OF AN INCOMPLETE OVAL THAT IS THICKER ON THE SIDES THAN ON THE TOP, AND HAS AN OPENING ON THE BOTTOM. IN THE MIDDLE OF THE OPENING OF THE OVAL IS A STYLIZED TRIANGULAR SHAPE.

FOR: WATCHES, IN CLASS 14 (U.S. CLS. 2, 27, 28 AND 50).

SER. NO. 77-527,278, FILED 7-21-2008.

OWNER OF JAPAN REG. NO. 4703235, DATED 8-22-2003, EXPIRES 8-22-2013.

COLLEEN KEARNEY, EXAMINING ATTORNEY

**Int. Cl.: 9**

**Prior U.S. Cls.: 21, 23, 26, 36 and 38**

**Reg. No. 3,570,031**

**United States Patent and Trademark Office**

**Registered Feb. 3, 2009**

**TRADEMARK  
PRINCIPAL REGISTER**

# SafetyBook

SJOMAN BJORN CORPORATION (FLORIDA  
CORPORATION)  
8332 NW 9TH AVE  
BOCA RATON, FL 33487

THE MARK CONSISTS OF STANDARD CHAR-  
ACTERS WITHOUT CLAIM TO ANY PARTICULAR  
FONT, STYLE, SIZE, OR COLOR.

FOR: BULLET-PROOF VESTS AND CLOTHING,  
IN CLASS 9 (U.S. CLS. 21, 23, 26, 36 AND 38).

SER. NO. 77-527,805, FILED 7-21-2008.

FIRST USE 5-21-2008; IN COMMERCE 5-21-2008.

CHRIS DONINGER, EXAMINING ATTORNEY

**Int. Cl.: 9**

**Prior U.S. Cls.: 21, 23, 26, 36 and 38**

**Reg. No. 3,570,032**

**United States Patent and Trademark Office**

**Registered Feb. 3, 2009**

**TRADEMARK  
PRINCIPAL REGISTER**

**UNLEASH YOUR INNER ROCK  
STAR**

ACTIVISION PUBLISHING, INC. (DELAWARE  
CORPORATION)  
3100 OCEAN PARK BOULEVARD  
SANTA MONICA, CA 90405

FOR: VIDEO GAME SOFTWARE AND RELATED  
INSTRUCTION MANUAL SOLD TOGETHER AS A  
UNIT; INTERACTIVE VIDEO GAME PROGRAMS;  
VIDEO GAME DISCS; DOWNLOADABLE COMPU-  
TER GAME SOFTWARE; VIDEO GAME CONTROL-  
LERS, IN CLASS 9 (U.S. CLS. 21, 23, 26, 36 AND 38).

FIRST USE 4-3-2007; IN COMMERCE 4-3-2007.

THE MARK CONSISTS OF STANDARD CHAR-  
ACTERS WITHOUT CLAIM TO ANY PARTICULAR  
FONT, STYLE, SIZE, OR COLOR.

SER. NO. 77-528,508, FILED 7-22-2008.

CORY BOONE, EXAMINING ATTORNEY

**Int. Cl.: 38**

**Prior U.S. Cls.: 100, 101 and 104**

**United States Patent and Trademark Office**

**Reg. No. 3,570,033**

**Registered Feb. 3, 2009**

**SERVICE MARK  
PRINCIPAL REGISTER**

**SHARED TALK**

ROSETTA STONE LTD. (VIRGINIA CORPORATION)  
1101 WILSON BOULEVARD, SUITE 1130  
ARLINGTON, VA 22209

FOR: COMPUTER SERVICES, NAMELY, PROVIDING ON-LINE FACILITIES FOR REAL-TIME INTERACTION WITH OTHER COMPUTER USERS IN THE FIELD OF FOREIGN LANGUAGES, IN CLASS 38 (U.S. CLS. 100, 101 AND 104).

FIRST USE 11-3-2006; IN COMMERCE 11-3-2006.

THE MARK CONSISTS OF STANDARD CHARACTERS WITHOUT CLAIM TO ANY PARTICULAR FONT, STYLE, SIZE, OR COLOR.

SER. NO. 77-528,628, FILED 7-22-2008.

COURTNEY MCCORMICK, EXAMINING ATTORNEY

**Int. Cl.: 9**

**Prior U.S. Cls.: 21, 23, 26, 36 and 38**

**United States Patent and Trademark Office**

**Reg. No. 3,570,034**

**Registered Feb. 3, 2009**

**TRADEMARK  
PRINCIPAL REGISTER**

**AUDIO COMPANION**

ROSETTA STONE LTD. (VIRGINIA CORPORATION)

1101 WILSON BOULEVARD, SUITE 1130

ARLINGTON, VA 22209

FOR: COMPACT DISCS FOR TEACHING AND LEARNING FOREIGN LANGUAGES, IN CLASS 9 (U.S. CLS. 21, 23, 26, 36 AND 38).

FIRST USE 6-10-2008; IN COMMERCE 6-10-2008.

THE MARK CONSISTS OF STANDARD CHARACTERS WITHOUT CLAIM TO ANY PARTICULAR FONT, STYLE, SIZE, OR COLOR.

NO CLAIM IS MADE TO THE EXCLUSIVE RIGHT TO USE "AUDIO", APART FROM THE MARK AS SHOWN.

SER. NO. 77-528,632, FILED 7-22-2008.

COURTNEY MCCORMICK, EXAMINING ATTORNEY

**Int. Cl.: 45**

**Prior U.S. Cls.: 100 and 101**

**United States Patent and Trademark Office**

**Reg. No. 3,570,035**

**Registered Feb. 3, 2009**

**SERVICE MARK  
PRINCIPAL REGISTER**

**CHP**

DEPARTMENT OF THE CALIFORNIA HIGH-  
WAY PATROL (CALIFORNIA STATE AGEN-  
CY)  
2555 FIRST AVENUE  
SACRAMENTO, CA 95818

THE MARK CONSISTS OF STANDARD CHAR-  
ACTERS WITHOUT CLAIM TO ANY PARTICULAR  
FONT, STYLE, SIZE, OR COLOR.

FOR: POLICE AND CIVIL PROTECTION SERVI-  
CES, IN CLASS 45 (U.S. CLS. 100 AND 101).

SER. NO. 77-528,805, FILED 7-22-2008.

FIRST USE 8-14-1929; IN COMMERCE 8-14-1929.

JEFFERY COWARD, EXAMINING ATTORNEY



**Int. Cl.: 9**

**Prior U.S. Cls.: 21, 23, 26, 36 and 38**

**Reg. No. 3,570,036**

**United States Patent and Trademark Office**

**Registered Feb. 3, 2009**

---

**TRADEMARK  
PRINCIPAL REGISTER**

**RED ASPHALT**

DEPARTMENT OF THE CALIFORNIA HIGH-  
WAY PATROL (CALIFORNIA STATE AGEN-  
CY)  
2555 FIRST AVENUE  
SACRAMENTO, CA 95818

FOR: PRERECORDED DIGITAL VIDEO DISKS  
FEATURING AUTOMOBILE CRASH SCENES TO  
PROMOTE TRAFFIC SAFETY, IN CLASS 9 (U.S.  
CLS. 21, 23, 26, 36 AND 38).

FIRST USE 6-15-1978; IN COMMERCE 6-15-1978.

THE MARK CONSISTS OF STANDARD CHAR-  
ACTERS WITHOUT CLAIM TO ANY PARTICULAR  
FONT, STYLE, SIZE, OR COLOR.

SER. NO. 77-529,167, FILED 7-23-2008.

JEFFERY COWARD, EXAMINING ATTORNEY

**Int. Cl.: 9**

**Prior U.S. Cls.: 21, 23, 26, 36 and 38**

**Reg. No. 3,570,037**

**United States Patent and Trademark Office**

**Registered Feb. 3, 2009**

---

**TRADEMARK  
PRINCIPAL REGISTER**

**TECH XL**

ELECTRIC VISUAL EVOLUTION, LLC (CALIFORNIA LIMITED LIABILITY COMPANY)  
1062 CALLE NEGOCIO, SUITE H  
SAN CLEMENTE, CA 92673

THE MARK CONSISTS OF STANDARD CHARACTERS WITHOUT CLAIM TO ANY PARTICULAR FONT, STYLE, SIZE, OR COLOR.

FOR: SUNGLASSES AND CASES FOR SUNGLASSES, IN CLASS 9 (U.S. CLS. 21, 23, 26, 36 AND 38).

SER. NO. 77-529,437, FILED 7-23-2008.

FIRST USE 5-16-2008; IN COMMERCE 5-16-2008.

APRIL HESIK, EXAMINING ATTORNEY

**Int. Cls.: 9 and 41**

**Prior U.S. Cls.: 21, 23, 26, 36, 38, 100, 101 and 107**

**Reg. No. 3,570,038**

**United States Patent and Trademark Office**

**Registered Feb. 3, 2009**

**TRADEMARK  
SERVICE MARK  
PRINCIPAL REGISTER**



MAZZARELLA MEDIA, LLC (CONNECTICUT  
LIMITED LIABILITY COMPANY)  
PO BOX 86  
BRISTOL, CT 06011

FOR: DIGITAL MEDIA, NAMELY, DVDS AND  
DOWNLOADABLE AUDIO AND VIDEO FILES  
FEATURING DVDS AND DOWNLOADABLE  
AUDIO AND VIDEO FILES, IN CLASS 9 (U.S. CLS.  
21, 23, 26, 36 AND 38).

FIRST USE 6-8-2003; IN COMMERCE 12-8-2004.

FOR: ENTERTAINMENT, NAMELY, PRODUC-  
TION OF A LIVE INTERACTIVE STAGE SHOW FOR

CHILDREN, IN CLASS 41 (U.S. CLS. 100, 101 AND  
107).

FIRST USE 6-8-2003; IN COMMERCE 12-8-2004.

THE MARK CONSISTS OF THE STYLIZED TEXT  
"THE MONKEYDOOS". A CLOUD APPEARS OVER  
HALF OF THE TEXT.

SER. NO. 77-530,483, FILED 7-24-2008.

REGINA DRUMMOND, EXAMINING ATTORNEY

Int. Cl.: 16

Prior U.S. Cls.: 2, 5, 22, 23, 29, 37, 38 and 50

Reg. No. 3,570,039

United States Patent and Trademark Office

Registered Feb. 3, 2009

TRADEMARK  
PRINCIPAL REGISTER



DEMAR, DIANA (CALIFORNIA SOLE PROPRIETORSHIP)  
PO BOX 55741  
SHERMAN OAKS, CA 914135741

FOR: A SERIES OF BOOKS AND WRITTEN ARTICLES IN THE FIELD OF SELF-HELP; A SERIES OF BOOKS, WRITTEN ARTICLES, HANDOUTS

AND WORKSHEETS IN THE FIELD OF SELF-HELP, IN CLASS 16 (U.S. CLS. 2, 5, 22, 23, 29, 37, 38 AND 50).

FIRST USE 5-18-2008; IN COMMERCE 5-18-2008.

SER. NO. 77-532,164, FILED 7-26-2008.

RICHARD A. STRASER, EXAMINING ATTORNEY

Int. Cl.: 43

Prior U.S. Cls.: 100 and 101

**United States Patent and Trademark Office**

**Reg. No. 3,570,040**

Registered Feb. 3, 2009

**SERVICE MARK  
PRINCIPAL REGISTER**

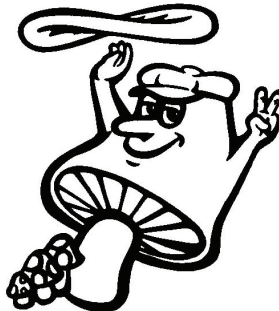

HOME-GROWN INDUSTRIES OF GEORGIA,  
INC. (GEORGIA CORPORATION)  
150 GREAT SOUTHWEST PARKWAY  
ATLANTA, GA 30336

FOR: RESTAURANT SERVICES, IN CLASS 43  
(U.S. CLS. 100 AND 101).

FIRST USE 1-31-2001; IN COMMERCE 1-31-2001.

OWNER OF U.S. REG. NO. 1,469,516.

THE MARK CONSISTS OF CARICATURE OF A  
MUSHROOM TWIRLING A PIZZA IN THE RIGHT  
HAND AND CREATING THE PEACE SIGN WITH  
THE LEFT HAND.

SER. NO. 77-532,660, FILED 7-28-2008.

SUNG IN, EXAMINING ATTORNEY

**Int. Cl.: 35**

**Prior U.S. Cls.: 100, 101 and 102**

**United States Patent and Trademark Office**

**Reg. No. 3,570,041**

**Registered Feb. 3, 2009**

**SERVICE MARK  
PRINCIPAL REGISTER**



NEIGHBOR TO NEIGHBOR, INC. (CALIFORNIA CORPORATION)  
332 BROOKS AVENUE  
VENICE, CA 90291

THE COLOR(S) OLIVE IS/ARE CLAIMED AS A FEATURE OF THE MARK.

FOR: PROVIDING INFORMATION ABOUT AND MAKING REFERRALS IN THE FIELD OF CONSUMER PRODUCTS AND SERVICES FOR RETAIL SERVICES CONCERNING PRODUCTS, SERVICES, EVENTS, ACTIVITIES, ATTRACTIONS AND FACILITIES IN PARTICULAR GEOGRAPHIC LOCATIONS, IN CLASS 35 (U.S. CLS. 100, 101 AND 102).

THE MARK CONSISTS OF TWO LOWER CASE, CURSIVE N'S IN A WESTERN BRAND STYLE IN WHICH THE FINAL "N" WRAPS AROUND INTO AN OVAL ALL IN OLIVE.

SER. NO. 77-533,125, FILED 7-28-2008.

FIRST USE 1-1-2005; IN COMMERCE 1-1-2005.

MARC LEIPZIG, EXAMINING ATTORNEY

**Int. Cl.: 12**

**Prior U.S. Cls.: 19, 21, 23, 31, 35 and 44**

**Reg. No. 3,570,042**

**United States Patent and Trademark Office**

**Registered Feb. 3, 2009**

---

**TRADEMARK  
PRINCIPAL REGISTER**

**RAKE**

CONFEDERATE MOTOR COMPANY (LOUISIANA CORPORATION)  
101 CERF PLACE  
MANDEVILLE, LA 70471

THE MARK CONSISTS OF STANDARD CHARACTERS WITHOUT CLAIM TO ANY PARTICULAR FONT, STYLE, SIZE, OR COLOR.

FOR: MOTORCYCLES AND STRUCTURAL PARTS THEREFOR, IN CLASS 12 (U.S. CLS. 19, 21, 23, 31, 35 AND 44).

SER. NO. 77-534,062, FILED 7-29-2008.

FIRST USE 1-8-2008; IN COMMERCE 1-8-2008.

SKYE YOUNG, EXAMINING ATTORNEY

**Int. Cl.: 35**

**Prior U.S. Cls.: 100, 101 and 102**

**United States Patent and Trademark Office**

**Reg. No. 3,570,043**

**Registered Feb. 3, 2009**

**SERVICE MARK  
PRINCIPAL REGISTER**

**MAIN STREET CUPCAKES**

MAIN STREET CUPCAKES (OHIO LIMITED  
LIABILITY COMPANY)

238 N. MAIN STREET

HUDSON, OH 44236

FOR: RETAIL BAKERY SHOPS, IN CLASS 35 (U.S.  
CLS. 100, 101 AND 102).

FIRST USE 11-1-2006; IN COMMERCE 11-1-2006.

THE MARK CONSISTS OF STANDARD CHAR-  
ACTERS WITHOUT CLAIM TO ANY PARTICULAR  
FONT, STYLE, SIZE, OR COLOR.

NO CLAIM IS MADE TO THE EXCLUSIVE  
RIGHT TO USE "CUPCAKES", APART FROM THE  
MARK AS SHOWN.

SER. NO. 77-534,199, FILED 7-29-2008.

KELLEY WELLS, EXAMINING ATTORNEY



**Int. Cl.: 29**

**Prior U.S. Cl.: 46**

**United States Patent and Trademark Office**

**Reg. No. 3,570,044**

**Registered Feb. 3, 2009**

**TRADEMARK  
PRINCIPAL REGISTER**



FRITO-LAY NORTH AMERICA, INC. (DELA-  
WARE CORPORATION)  
7701 LEGACY DRIVE  
PLANO, TX 75024

FOR: PROCESSED NUTS; SHELLED NUTS; PRO-  
CESSED EDIBLE SEEDS; PROCESSED NUTS IN  
CLUSTER FORM; PROCESSED NUTS IN CRISP  
FORM; PROCESSED NUT-BASED SNACKS; SEA-  
SONED NUTS; ROASTED NUTS; NUT-BASED  
SNACK FOODS, IN CLASS 29 (U.S. CL. 46).

FIRST USE 2-3-2008; IN COMMERCE 2-3-2008.

THE MARK CONSISTS OF THE WORD "TRUE-  
NORTH" WITH A DARK RECTANGULAR STRIP  
BEHIND THE LETTER "N".

SER. NO. 77-534,588, FILED 7-30-2008.

JOHN DWYER, EXAMINING ATTORNEY

**Int. Cls.: 39 and 41**

**Prior U.S. Cls.: 100, 101, 105 and 107**

**United States Patent and Trademark Office**

**Reg. No. 3,570,045**

**Registered Feb. 3, 2009**

**SERVICE MARK  
PRINCIPAL REGISTER**

**RED RANGERS CLUB**

DIAGEO CHATEAU & ESTATE WINES COMP-  
NY (CALIFORNIA CORPORATION)  
240 GATEWAY ROAD WEST  
NAPA, CA 94558

FOR: WINE CLUB SERVICES FEATURING PER-  
IODIC SHIPMENTS OF WINE TO MEMBERS, IN  
CLASS 39 (U.S. CLS. 100 AND 105).

FIRST USE 8-0-2006; IN COMMERCE 8-0-2006.

FOR: EDUCATIONAL AND ENTERTAINMENT  
SERVICES, NAMELY, WINE TASTINGS; PROVID-  
ING NEWSLETTERS IN THE FIELD OF INFORMA-  
TION RELATING TO WINES, NAMELY, WINE  
MAKING, VITICULTURE INFORMATION, WINE  
SELECTION, WINE LISTS, RELATED RECIPES,  
PROMOTIONS AND DISCOUNTS, WINE TAST-  
INGS, AND WINE CLUB MEMBERSHIP EVENTS,  
VIA E-MAIL; AND SOCIAL CLUB SERVICES,

NAMELY, ARRANGING, ORGANIZING AND  
HOSTING SOCIAL EVENTS, GET-TOGETHERS  
AND PARTIES FOR CLUB MEMBERS, IN CLASS  
41 (U.S. CLS. 100, 101 AND 107).

FIRST USE 8-0-2006; IN COMMERCE 8-0-2006.

THE MARK CONSISTS OF STANDARD CHAR-  
ACTERS WITHOUT CLAIM TO ANY PARTICULAR  
FONT, STYLE, SIZE, OR COLOR.

NO CLAIM IS MADE TO THE EXCLUSIVE  
RIGHT TO USE "CLUB", APART FROM THE MARK  
AS SHOWN.

SER. NO. 77-534,805, FILED 7-30-2008.

VERNA BETH RIRIE, EXAMINING ATTORNEY

**Int. Cl.: 29**

**Prior U.S. Cl.: 46**

**United States Patent and Trademark Office**

**Reg. No. 3,570,046**

**Registered Feb. 3, 2009**

**TRADEMARK  
PRINCIPAL REGISTER**

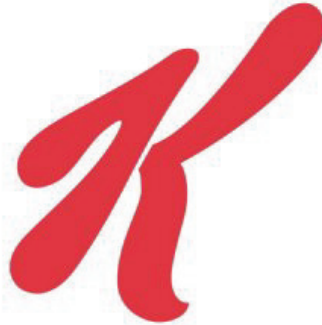

KELLOGG NORTH AMERICA COMPANY (DE-  
LAWARE CORPORATION)  
ONE KELLOGG SQUARE, PO BOX 3599  
BATTLE CREEK, MI 490163599

FOR: PROTEIN BASED, NUTRIENT-DENSE  
SNACK BARS, IN CLASS 29 (U.S. CL. 46).

FIRST USE 9-5-2006; IN COMMERCE 9-5-2006.

OWNER OF U.S. REG. NOS. 1,278,007, 2,344,341  
AND OTHERS.

THE COLOR(S) RED IS/ARE CLAIMED AS A  
FEATURE OF THE MARK.

THE MARK CONSISTS OF THE STYLIZED LET-  
TER "K" IN THE COLOR RED.

SER. NO. 77-535,145, FILED 7-30-2008.

REGINA DRUMMOND, EXAMINING ATTORNEY

**Int. Cl.: 35**

**Prior U.S. Cls.: 100, 101 and 102**

**United States Patent and Trademark Office**

**Reg. No. 3,570,047**

**Registered Feb. 3, 2009**

**SERVICE MARK  
PRINCIPAL REGISTER**

**TRUEADS**

TRUE ANTHEM (CALIFORNIA CORPORATION)  
369 HAWTHORN ROAD  
LAGUNA BEACH, CA 92651

FOR: PROMOTING THE GOODS AND SERVICES  
OF OTHERS VIA THE INTERNET, AND OTHER  
COMPUTER AND ELECTRONIC COMMUNICA-  
TION NETWORKS; ADVERTISING SERVICES, IN  
CLASS 35 (U.S. CLS. 100, 101 AND 102).

FIRST USE 4-0-2008; IN COMMERCE 4-0-2008.

THE MARK CONSISTS OF STANDARD CHAR-  
ACTERS WITHOUT CLAIM TO ANY PARTICULAR  
FONT, STYLE, SIZE, OR COLOR.

SER. NO. 77-535,408, FILED 7-30-2008.

EMILY CARLSEN, EXAMINING ATTORNEY

**Int. Cls.: 37 and 40**

**Prior U.S. Cls.: 100, 103 and 106**

**United States Patent and Trademark Office**

**Reg. No. 3,570,048**

**Registered Feb. 3, 2009**

**SERVICE MARK  
PRINCIPAL REGISTER**

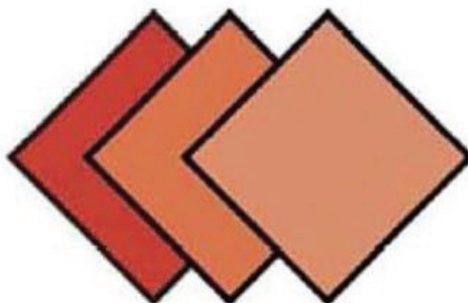

WILLIAM A. MOLOGOUSIS (UNITED STATES  
INDIVIDUAL)  
1615 S. 55TH AVENUE  
CICERO, IL 60804

FOR: PRESSURE WASHING, CLEANING, SEALING AND REPAIRING SERVICES, NAMELY, PRESSURE WASHING, CLEANING, SEALING, AND REPAIRING EXTERIOR SURFACES OF COMMERCIAL AND RESIDENTIAL FENCES, DECKS, AND STRUCTURES, IN CLASS 37 (U.S. CLS. 100, 103 AND 106).

FIRST USE 4-6-1994; IN COMMERCE 4-6-1994.

FOR: STAINING SERVICES, NAMELY, STAINING EXTERIOR SURFACES OF COMMERCIAL AND RESIDENTIAL FENCES, DECKS, AND

STRUCTURES, IN CLASS 40 (U.S. CLS. 100, 103 AND 106).

FIRST USE 4-6-1994; IN COMMERCE 4-6-1994.

THE COLOR(S) RED, ORANGE, AND PEACH IS/ARE CLAIMED AS A FEATURE OF THE MARK.

THE MARK CONSISTS OF THREE DIAMONDS, WITH THE COLOR RED APPEARING IN THE LEFT DIAMOND, THE COLOR ORANGE APPEARING IN THE CENTER DIAMOND, AND THE COLOR PEACH APPEARING IN THE RIGHT DIAMOND.

SER. NO. 77-536,078, FILED 7-31-2008.

AISHA SALEM, EXAMINING ATTORNEY

**Int. Cl.: 14**

**Prior U.S. Cls.: 2, 27, 28 and 50**

**Reg. No. 3,570,049**

**United States Patent and Trademark Office**

**Registered Feb. 3, 2009**

**TRADEMARK  
PRINCIPAL REGISTER**



TIFFANY (NJ) LLC (DELAWARE LIMITED LIABILITY COMPANY)  
15 SYLVAN WAY  
PARSIPPANY, NJ 07054

FIRST USE 2-13-2004; IN COMMERCE 4-28-2004.

SER. NO. 77-536,464, FILED 7-31-2008.

FOR: WATCHES, IN CLASS 14 (U.S. CLS. 2, 27, 28 AND 50).

GINA HAYES, EXAMINING ATTORNEY

**Int. Cl.: 45**

**Prior U.S. Cls.: 100 and 101**

**United States Patent and Trademark Office**

**Reg. No. 3,570,050**

**Registered Feb. 3, 2009**

**SERVICE MARK  
PRINCIPAL REGISTER**



DEPARTMENT OF THE CALIFORNIA HIGH-  
WAY PATROL (CALIFORNIA STATE AGEN-  
CY)  
2555 FIRST AVENUE  
SACRAMENTO, CA 95818

THE MARK CONSISTS OF THE STYLIZED LET-  
TERS "CHP" WITH A DESIGN OF A CIRCLE WITH-  
IN A STAR INSIDE THE LETTER "C".

FOR: POLICE AND CIVIL PROTECTION SERVI-  
CES, IN CLASS 45 (U.S. CLS. 100 AND 101).

SER. NO. 77-536,553, FILED 7-31-2008.

FIRST USE 7-1-2003; IN COMMERCE 7-1-2003.

JEFFERY COWARD, EXAMINING ATTORNEY

**Int. Cls.: 42 and 45**

**Prior U.S. Cls.: 100 and 101**

**United States Patent and Trademark Office**

**Reg. No. 3,570,051**

**Registered Feb. 3, 2009**

**SERVICE MARK  
PRINCIPAL REGISTER**

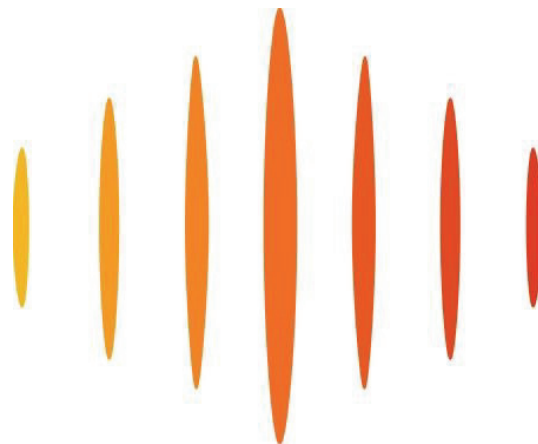

SIGNAL MATCH, INC. (NEW YORK CORPORATION)  
1858 PLEASANTVILLE ROAD, #137  
BRIARCLIFF MANOR, NY 10510

FOR: COMPUTER SERVICES, NAMELY, AN APPLICATION SERVICE PROVIDER (ASP) FEATURING SOFTWARE AND WEB APPLICATION FOR USE IN DISCOVERING NEW FRIENDS, PRODUCTS, SERVICES AND COMMUNITIES BASED ON USERS' INDIVIDUAL AND GROUP PERSONALITY, INTEREST AND PREFERENCE PROFILES, IN CLASS 42 (U.S. CLS. 100 AND 101).

FIRST USE 12-3-2007; IN COMMERCE 12-3-2007.

FOR: COMPUTER-BASED SOCIAL NETWORKING SERVICES, NAMELY, PROVIDING A WEBSITE FOR USE IN DISCOVERING NEW FRIENDS AND COMMUNITIES BASED ON THE USERS' INDIVIDUAL AND GROUP PERSONALITY, INTEREST

AND PREFERENCE PROFILES, IN CLASS 45 (U.S. CLS. 100 AND 101).

FIRST USE 12-3-2007; IN COMMERCE 12-3-2007.

THE COLOR(S) YELLOW, ORANGE, RED AND SHADES THEREBETWEEN IS/ARE CLAIMED AS A FEATURE OF THE MARK.

THE MARK CONSISTS OF A SERIES OF VERTICAL LINES IN A DIAMOND SHAPED CONFIGURATION. THE LINES ARE MARKED IN PROGRESSIVE SHADES OF YELLOW, ORANGE AND RED FROM LEFT TO RIGHT.

SER. NO. 77-538,078, FILED 8-4-2008.

NORA BUCHANAN WILL, EXAMINING ATTORNEY



**Int. Cl.: 9**

**Prior U.S. Cls.: 21, 23, 26, 36 and 38**

**Reg. No. 3,570,052**

**United States Patent and Trademark Office**

**Registered Feb. 3, 2009**

**TRADEMARK  
PRINCIPAL REGISTER**

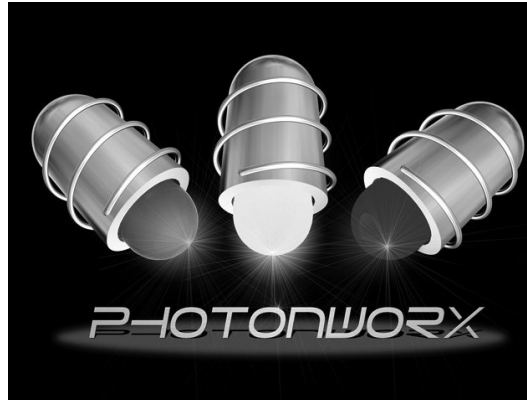

TYLER VAN PATTEN (UNITED STATES INDIVIDUAL), DBA DRIVEN MOTORING CONCEPTS  
696 SOUTH YONGE ST. SUITE D  
ORMOND BEACH, FL 32174

THE MARK CONSISTS OF THREE LED LIGHTS (LIGHT-EMITTING DIODE) ILLUMINATING THE WORD "PHOTONWORX".

FOR: LIGHT EMITTING DIODES (LEDS), IN CLASS 9 (U.S. CLS. 21, 23, 26, 36 AND 38).

SER. NO. 77-538,173, FILED 8-4-2008.

FIRST USE 5-6-2008; IN COMMERCE 5-6-2008.

PAM WILLIS, EXAMINING ATTORNEY

**Int. Cl.: 33**

**Prior U.S. Cls.: 47 and 49**

**United States Patent and Trademark Office**

**Reg. No. 3,570,053**

**Registered Feb. 3, 2009**

**TRADEMARK  
PRINCIPAL REGISTER**

# Gulleyan

JACOB GULARIAN (UNITED STATES INDIVIDUAL)  
8412 FALLBROOK AVENUE  
WEST HILLS, CA 91304

FOR: COOKING WINE; FRUIT WINE; GRAPE WINE; KITS FOR MAKING WINE; NATURAL SPARKLING WINES; PORT; PORT WINES; PREPARED WINE COCKTAILS; RED WINES; SPARKLING FRUIT WINE; SPARKLING GRAPE WINE; SPARKLING WINES; SWEET WINES; TABLE WINES; TONIC SWEET GRAPE WINE CONTAINING EXTRACTS FROM GINSENG AND CONCHONA BARK (NINJIN-KINATETSU WINE); WHITE

WINE; WINE; WINE COOLERS; WINE PUNCHES; WINES AND FORTIFIED WINES; WINES AND LIQUEURS, IN CLASS 33 (U.S. CLS. 47 AND 49).

FIRST USE 8-1-2008; IN COMMERCE 8-1-2008.

THE MARK CONSISTS OF STANDARD CHARACTERS WITHOUT CLAIM TO ANY PARTICULAR FONT, STYLE, SIZE, OR COLOR.

SER. NO. 77-539,496, FILED 8-5-2008.

ANDREA BUTLER, EXAMINING ATTORNEY

Int. Cls.: 29, 30 and 32

Prior U.S. Cls.: 45, 46 and 48

Reg. No. 3,570,054

United States Patent and Trademark Office

Registered Feb. 3, 2009

TRADEMARK  
PRINCIPAL REGISTER

GOYA

GOYA FOODS, INC. (DELAWARE CORPORATION)  
100 SEAVIEW DRIVE  
SECAUCUS, NY 07096

FOR: APPLESAUCE; ARTICHOKE PASTE; BOUILLON; CHEESE; CHEESE FOOD; CHILI; CRANBERRY SAUCE; DAIRY PRODUCTS EXCLUDING ICE CREAM, ICE MILK AND FROZEN YOGURT; DRIED FRUIT AND VEGETABLES; DRIED FRUIT MIXES; DRIED FRUITS; DRIED MEAT; EDIBLE FATS; EDIBLE OILS; FISH; FISH CROQUETTES; FROZEN FRUITS; FROZEN VEGETABLES; FRUIT PASTE; FRUIT PRESERVES; FRUIT-BASED SNACK FOOD; INSTANT OR PRE-COOKED SOUP; JAMS; LARD; MEAT; MEAT EXTRACTS; MILK; OLIVE OIL; PICKLED VEGETABLES; PORK; PORK RINDS; POULTRY; PRESERVED FRUITS; PROCESSED ARTICHOKE; PROCESSED COCONUT; PROCESSED MEAT; PROCESSED OLIVES; PROCESSED VEGETABLES; SEAFOOD; SNACK MIX CONSISTING PRIMARILY OF PROCESSED FRUITS, PROCESSED NUTS AND/OR RAISINS; SOUPS; VEGETABLE CHIPS; VEGETABLE OILS; VEGETABLE-BASED SNACK FOODS; VEGETABLE, FISH, AND MEAT CROQUETTES, IN CLASS 29 (U.S. CL. 46).

FIRST USE 8-0-1939; IN COMMERCE 8-0-1939.

FOR: ALIMENTARY PASTE; BAKERY DESERTS; BAKERY GOODS; BARBECUE SAUCE; BURRITOS; CANDY; CAPERS; CHOCOLATE; CHOCOLATES AND CHOCOLATE BASED READY TO EAT CANDIES AND SNACKS; COCOA; COFFEE; CORN FRITTERS; CUSTARDS; DUMPLINGS; EMPANADAS; ENCHILADAS; FAJITAS; FISH DUMPLINGS; FLOUR; FOOD SEASONINGS; FROZEN

CONFECTIONS; GRAIN-BASED FOOD BEVERAGES; GRAIN-BASED SNACK FOODS; HOMINY; HONEY; HOT SAUCE; MARINADES; MIXES FOR BAKERY GOODS; MIXES FOR MAKING BAKING BATTERS; MIXES FOR MAKING BATTER FOR HUSHPUPIES; MIXES FOR MAKING BATTERS FOR FRIED FOODS; NOODLES; PASTRIES; PEPPER; PICANTE SAUCE; RICE; RICE-BASED SNACK FOODS; SALSA; SAUCES; SEASONED COATING FOR MEAT, FISH, POULTRY; SEASONED COATING MIXTURES FOR FOODS; SEASONINGS; SNACK CAKES; SPICES; TACO CHIPS; TACOS; TAMALES; TAPIOCA; TOMATO SAUCE; TORTILLA CHIPS; TORTILLAS; VINEGAR; WINE VINEGAR, IN CLASS 30 (U.S. CL. 46).

FIRST USE 8-0-1939; IN COMMERCE 8-0-1939.

FOR: FRUIT NECTARS; FRUITS DRINKS AND FRUIT JUICES; NON-ALCOHOLIC MALT BEVERAGE; SOFT DRINKS; SYRUPS FOR MAKING SOFT DRINKS; VEGETABLE JUICE, IN CLASS 32 (U.S. CLS. 45, 46 AND 48).

FIRST USE 4-6-1959; IN COMMERCE 4-6-1959.

THE MARK CONSISTS OF STANDARD CHARACTERS WITHOUT CLAIM TO ANY PARTICULAR FONT, STYLE, SIZE, OR COLOR.

OWNER OF U.S. REG. NOS. 2,155,280, 2,502,127 AND OTHERS.

SER. NO. 77-539,854, FILED 8-5-2008.

MAYUR VAGHANI, EXAMINING ATTORNEY

**Int. Cl.: 41**

**Prior U.S. Cls.: 100, 101 and 107**

**United States Patent and Trademark Office**

**Reg. No. 3,570,055**

**Registered Feb. 3, 2009**

**SERVICE MARK  
PRINCIPAL REGISTER**

**BOP-O-RAMA**

ROCKET USA INC. (ILLINOIS CORPORATION)  
7775 VAN BUREN STREET  
FOREST PARK, IL 60301

FOR: ENTERTAINMENT SERVICES, NAMELY,  
PROVIDING AN ON-LINE COMPUTER GAME, IN  
CLASS 41 (U.S. CLS. 100, 101 AND 107).

FIRST USE 7-31-2008; IN COMMERCE 7-31-2008.

THE MARK CONSISTS OF STANDARD CHAR-  
ACTERS WITHOUT CLAIM TO ANY PARTICULAR  
FONT, STYLE, SIZE, OR COLOR.

SER. NO. 77-540,786, FILED 8-6-2008.

NICHOLAS ALTREE, EXAMINING ATTORNEY

**Int. Cl.: 41**

**Prior U.S. Cls.: 100, 101 and 107**

**United States Patent and Trademark Office**

**Reg. No. 3,570,056**

**Registered Feb. 3, 2009**

**SERVICE MARK  
PRINCIPAL REGISTER**

**BOP-O-METER**

ROCKET USA INC. (ILLINOIS CORPORATION)  
7775 VAN BUREN STREET  
FOREST PARK, IL 60301

FOR: ENTERTAINMENT SERVICES, NAMELY,  
PROVIDING AN ON-LINE COMPUTER GAME, IN  
CLASS 41 (U.S. CLS. 100, 101 AND 107).

FIRST USE 7-31-2008; IN COMMERCE 7-31-2008.

THE MARK CONSISTS OF STANDARD CHAR-  
ACTERS WITHOUT CLAIM TO ANY PARTICULAR  
FONT, STYLE, SIZE, OR COLOR.

SER. NO. 77-540,796, FILED 8-6-2008.

NICHOLAS ALTREE, EXAMINING ATTORNEY

**Int. Cl.: 43**

**Prior U.S. Cls.: 100 and 101**

**United States Patent and Trademark Office**

**Reg. No. 3,570,057**

**Registered Feb. 3, 2009**

**SERVICE MARK  
PRINCIPAL REGISTER**

**CLARION INN & SUITES**

CHOICE HOTELS INTERNATIONAL, INC. (DE-  
LAWARE CORPORATION)

10750 COLUMBIA PIKE

SILVER SPRING, MD 20901

FOR: HOTEL AND MOTEL SERVICES, HOTEL  
AND MOTEL RESERVATION SERVICES FOR OTH-  
ERS, AND ONLINE HOTEL AND MOTEL RESER-  
VATION SERVICES FOR OTHERS, IN CLASS 43  
(U.S. CLS. 100 AND 101).

FIRST USE 12-10-1996; IN COMMERCE 12-10-1996.

THE MARK CONSISTS OF STANDARD CHAR-  
ACTERS WITHOUT CLAIM TO ANY PARTICULAR  
FONT, STYLE, SIZE, OR COLOR.

OWNER OF U.S. REG. NOS. 1,710,603, 2,008,016  
AND OTHERS.

NO CLAIM IS MADE TO THE EXCLUSIVE  
RIGHT TO USE "INN & SUITES", APART FROM  
THE MARK AS SHOWN.

SER. NO. 77-545,022, FILED 8-12-2008.

HENRY S. ZAK, EXAMINING ATTORNEY

**Int. Cl.: 41**

**Prior U.S. Cls.: 100, 101 and 107**

**United States Patent and Trademark Office**

**Reg. No. 3,570,058**

**Registered Feb. 3, 2009**

**SERVICE MARK  
PRINCIPAL REGISTER**

# Predisposed

STRATEGIC ALTERNATIVES, LLC (TENNESSEE  
LIMITED LIABILITY COMPANY)  
SUITE 101  
91 PEYTON PARKWAY  
MEMPHIS, TN 38017

FOR: ON-LINE JOURNALS, NAMELY, BLOGS  
ON THE SUBJECT OF DISPOSABLE FOODSERVICE  
PACKAGING; PROVIDING NEWSLETTERS IN THE  
FIELD OF DISPOSABLE FOODSERVICE PACKA-  
GING VIA E-MAIL, IN CLASS 41 (U.S. CLS. 100, 101  
AND 107).

FIRST USE 7-15-2008; IN COMMERCE 7-15-2008.

THE MARK CONSISTS OF STANDARD CHAR-  
ACTERS WITHOUT CLAIM TO ANY PARTICULAR  
FONT, STYLE, SIZE, OR COLOR.

SER. NO. 77-546,186, FILED 8-13-2008.

LEIGH CAROLINE CASE, EXAMINING ATTOR-  
NEY

**Int. Cl.: 41**

**Prior U.S. Cls.: 100, 101 and 107**

**United States Patent and Trademark Office**

**Reg. No. 3,570,059**

**Registered Feb. 3, 2009**

**SERVICE MARK  
PRINCIPAL REGISTER**



STRATEGIC ALTERNATIVES, LLC (TENNESSEE  
LIMITED LIABILITY COMPANY)  
SUITE 101  
91 PEYTON PARKWAY  
MEMPHIS, TN 38017

FOR: ON-LINE JOURNALS, NAMELY, BLOGS  
ON THE SUBJECT OF DISPOSABLE FOODSERVICE  
PACKAGING; PROVIDING NEWSLETTERS IN THE  
FIELD OF DISPOSABLE FOODSERVICE PACKA-  
GING VIA E-MAIL, IN CLASS 41 (U.S. CLS. 100, 101  
AND 107).

FIRST USE 7-15-2008; IN COMMERCE 7-15-2008.

NO CLAIM IS MADE TO THE EXCLUSIVE  
RIGHT TO USE "DISPOSABLES", APART FROM  
THE MARK AS SHOWN.

THE COLOR(S) GRAY AND BLUE IS/ARE  
CLAIMED AS A FEATURE OF THE MARK.

THE MARK CONSISTS OF THE TEXT "PREDIS-  
POSED" OVER THE TEXT "NEWS AND VIEWS ON  
DISPOSABLES". THE SUFFIX "PRE" AND THE  
TEXT "ON DISPOSABLES" ARE A BLUE FONT  
AND THE REMAINING TEXT IS A GRAY FONT.

SER. NO. 77-546,236, FILED 8-13-2008.

LEIGH CAROLINE CASE, EXAMINING ATTOR-  
NEY



**Int. Cl.: 37**

**Prior U.S. Cls.: 100, 103 and 106**

**Reg. No. 3,570,060**

**United States Patent and Trademark Office**

**Registered Feb. 3, 2009**

**SERVICE MARK  
PRINCIPAL REGISTER**

**SPINTEK USA INC.**

SPINTEK USA, INC. (CONNECTICUT CORPORATION)  
154 RESEARCH PARKWAY  
MERIDEN, CT 06450

FOR: REPAIR, SERVICING AND/OR MAINTENANCE OF SPINDLES, SPINDLE SYSTEMS, GRINDING MACHINES, BORING MACHINES AND MILLING MACHINES, IN CLASS 37 (U.S. CLS. 100, 103 AND 106).

FIRST USE 11-1-2002; IN COMMERCE 11-1-2002.

THE MARK CONSISTS OF STANDARD CHARACTERS WITHOUT CLAIM TO ANY PARTICULAR FONT, STYLE, SIZE, OR COLOR.

NO CLAIM IS MADE TO THE EXCLUSIVE RIGHT TO USE "USA INC.", APART FROM THE MARK AS SHOWN.

SER. NO. 77-548,249, FILED 8-15-2008.

ANTHONY RINKER, EXAMINING ATTORNEY

**Int. Cl.: 8**

**Prior U.S. Cls.: 23, 28 and 44**

**Reg. No. 3,570,061**

**United States Patent and Trademark Office**

**Registered Feb. 3, 2009**

---

**TRADEMARK  
PRINCIPAL REGISTER**

**ELITE**

ACME UNITED CORPORATION (CONNECTI-  
CUT CORPORATION)  
60 ROUND HILL ROAD  
FAIRFIELD, CT 06824

THE MARK CONSISTS OF STANDARD CHAR-  
ACTERS WITHOUT CLAIM TO ANY PARTICULAR  
FONT, STYLE, SIZE, OR COLOR.

FOR: SCISSORS; SHEARS, IN CLASS 8 (U.S. CLS.  
23, 28 AND 44).

SER. NO. 77-550,788, FILED 8-19-2008.

FIRST USE 0-0-1998; IN COMMERCE 0-0-1998.

JENNIFER MARTIN, EXAMINING ATTORNEY

**Int. Cl.: 8**

**Prior U.S. Cls.: 23, 28 and 44**

**Reg. No. 3,570,062**

**United States Patent and Trademark Office**

**Registered Feb. 3, 2009**

---

**TRADEMARK  
PRINCIPAL REGISTER**

**VALUE**

ACME UNITED CORPORATION (CONNECTI-  
CUT CORPORATION)  
60 ROUND HILL ROAD  
FAIRFIELD, CT 06824

THE MARK CONSISTS OF STANDARD CHAR-  
ACTERS WITHOUT CLAIM TO ANY PARTICULAR  
FONT, STYLE, SIZE, OR COLOR.

FOR: SCISSORS; SHEARS, IN CLASS 8 (U.S. CLS.  
23, 28 AND 44).

SER. NO. 77-550,792, FILED 8-19-2008.

FIRST USE 0-0-1998; IN COMMERCE 0-0-1998.

JENNIFER MARTIN, EXAMINING ATTORNEY

**Int. Cl.: 8**

**Prior U.S. Cls.: 23, 28 and 44**

**Reg. No. 3,570,063**

**United States Patent and Trademark Office**

**Registered Feb. 3, 2009**

**TRADEMARK  
PRINCIPAL REGISTER**

**PREFERRED**

ACME UNITED CORPORATION (CONNECTI-  
CUT CORPORATION)  
60 ROUND HILL ROAD  
FAIRFIELD, CT 06824

THE MARK CONSISTS OF STANDARD CHAR-  
ACTERS WITHOUT CLAIM TO ANY PARTICULAR  
FONT, STYLE, SIZE, OR COLOR.

FOR: SCISSORS; SHEARS, IN CLASS 8 (U.S. CLS.  
23, 28 AND 44).

SER. NO. 77-550,794, FILED 8-19-2008.

FIRST USE 0-0-1998; IN COMMERCE 0-0-1998.

JENNIFER MARTIN, EXAMINING ATTORNEY

**Int. Cls.: 14, 18 and 25**

**Prior U.S. Cls.: 1, 2, 3, 22, 27, 28, 39, 41 and 50**

**United States Patent and Trademark Office**

**Reg. No. 3,570,064**

**Registered Feb. 3, 2009**

**TRADEMARK  
PRINCIPAL REGISTER**

**STUDIO WORKS**

CARSON PIRIE SCOTT II, INC. (MISSISSIPPI  
CORPORATION)  
331 WEST WISCONSIN AVE  
MILWAUKEE, WI 53203

FOR: COSTUME JEWELRY, IN CLASS 14 (U.S.  
CLS. 2, 27, 28 AND 50).

FIRST USE 8-0-1997; IN COMMERCE 8-0-1997.

FOR: WALLETTS AND HANDBAGS, IN CLASS 18  
(U.S. CLS. 1, 2, 3, 22 AND 41).

FIRST USE 8-0-1997; IN COMMERCE 8-0-1997.

FOR: SHOES, IN CLASS 25 (U.S. CLS. 22 AND 39).

FIRST USE 8-0-2002; IN COMMERCE 8-0-2002.

THE MARK CONSISTS OF STANDARD CHAR-  
ACTERS WITHOUT CLAIM TO ANY PARTICULAR  
FONT, STYLE, SIZE, OR COLOR.

OWNER OF U.S. REG. NO. 2,407,600.

NO CLAIM IS MADE TO THE EXCLUSIVE  
RIGHT TO USE "WORKS" IN INTERNATIONAL  
CLASS 014, APART FROM THE MARK AS SHOWN.

SER. NO. 77-553,578, FILED 8-22-2008.

SANDRA MANIOS, EXAMINING ATTORNEY

**Int. Cl.: 3**

**Prior U.S. Cls.: 1, 4, 6, 50, 51 and 52**

**United States Patent and Trademark Office**

**Reg. No. 3,570,065**

**Registered Feb. 3, 2009**

**TRADEMARK  
PRINCIPAL REGISTER**

**RGX**

THE DIAL CORPORATION (DELAWARE CORPORATION)  
M.S. 2214  
15501 NORTH DIAL BOULEVARD  
SCOTTSDALE, AZ 852601619

FOR: BODY SPRAYS, IN CLASS 3 (U.S. CLS. 1, 4, 6, 50, 51 AND 52).

FIRST USE 7-2-2007; IN COMMERCE 7-2-2007.

THE MARK CONSISTS OF STANDARD CHARACTERS WITHOUT CLAIM TO ANY PARTICULAR FONT, STYLE, SIZE, OR COLOR.

OWNER OF U.S. REG. NOS. 3,357,922 AND 3,358,070.

SER. NO. 77-553,781, FILED 8-22-2008.

MARK PILARO, EXAMINING ATTORNEY

**Int. Cl.: 35**

**Prior U.S. Cls.: 100, 101 and 102**

**United States Patent and Trademark Office**

**Reg. No. 3,570,066**

**Registered Feb. 3, 2009**

**SERVICE MARK  
PRINCIPAL REGISTER**



NATIONAL ASSOCIATION OF EMS PHYSICIANS, INC. (PENNSYLVANIA CORPORATION)

P.O. BOX 15945-281  
LENEXA, KS 662855945

FOR: ASSOCIATION SERVICES, NAMELY, PROMOTING THE INTERESTS OF EMERGENCY MEDICAL PHYSICIANS WHO OVERSEE OUT-OF-HOSPITAL EMERGENCY MEDICAL CARE , IN CLASS 35 (U.S. CLS. 100, 101 AND 102).

FIRST USE 1-1-1987; IN COMMERCE 1-1-1987.

OWNER OF U.S. REG. NOS. 3,063,594 AND 3,153,031.

THE MARK CONSISTS OF A BOX WITH A CHOPPED UPPER RIGHT CORNER AND A CURVED ELEMENT IN THE LOWER LEFT THAT CONTAINS THE LETTERING "NAEMSP". THE STAR OF LIFE IS IN THE UPPER RIGHT PORTION OF THE MARK AND CONTAINS THE ROD OF ASCLEPIUS.

SER. NO. 77-554,047, FILED 8-22-2008.

DAVID MURRAY, EXAMINING ATTORNEY

**Int. Cl.: 35**

**Prior U.S. Cls.: 100, 101 and 102**

**United States Patent and Trademark Office**

**Reg. No. 3,570,067**

**Registered Feb. 3, 2009**

**SERVICE MARK  
PRINCIPAL REGISTER**

**ECO EASY**

STAPLES THE OFFICE SUPERSTORE, LLC (DE-  
LAWARE LIMITED LIABILITY COMPANY)  
500 STAPLES DRIVE  
FRAMINGHAM, MA 01702

FOR: RETAIL STORE SERVICES, MAIL ORDER  
CATALOG SERVICES, AND COMPUTERIZED ON-  
LINE RETAIL STORE SERVICES FEATURING OF-  
FICE SUPPLIES, CLEANING SUPPLIES, IMAGING  
AND COMPUTER GRAPHIC SUPPLIES, DOCU-  
MENT AND PRINT MANAGEMENT SUPPLIES,  
OFFICE EQUIPMENT, INCLUDING COMPUTER  
HARDWARE, COPIERS AND TELEPHONES, AND

OFFICE FURNITURE, IN CLASS 35 (U.S. CLS. 100,  
101 AND 102).

FIRST USE 9-0-2007; IN COMMERCE 9-0-2007.

THE MARK CONSISTS OF STANDARD CHAR-  
ACTERS WITHOUT CLAIM TO ANY PARTICULAR  
FONT, STYLE, SIZE, OR COLOR.

SER. NO. 77-555,533, FILED 8-26-2008.

KARANENDRA S. CHHINA, EXAMINING ATTOR-  
NEY



**Int. Cl.: 38**

**Prior U.S. Cls.: 100, 101 and 104**

**United States Patent and Trademark Office**

**Reg. No. 3,570,068**

**Registered Feb. 3, 2009**

**SERVICE MARK  
PRINCIPAL REGISTER**

**TBN**

TRINITY CHRISTIAN CENTER OF SANTA ANA,  
INC. (CALIFORNIA CORPORATION)  
2442 MICHELLE DRIVE  
SANTA ANA, CA 92680

FOR: CABLE TELEVISION BROADCASTING  
SERVICES; TELEVISION BROADCASTING SERVI-  
CES, IN CLASS 38 (U.S. CLS. 100, 101 AND 104).

FIRST USE 9-30-1978; IN COMMERCE 9-30-1978.

THE MARK CONSISTS OF STANDARD CHAR-  
ACTERS WITHOUT CLAIM TO ANY PARTICULAR  
FONT, STYLE, SIZE, OR COLOR.

OWNER OF U.S. REG. NOS. 3,135,360, 3,150,713,  
AND 3,153,317.

SER. NO. 77-555,987, FILED 8-26-2008.

SUSAN RICHARDS, EXAMINING ATTORNEY

**Int. Cl.: 41**

**Prior U.S. Cls.: 100, 101 and 107**

**United States Patent and Trademark Office**

**Reg. No. 3,570,069**

**Registered Feb. 3, 2009**

**SERVICE MARK  
PRINCIPAL REGISTER**

**THE REAL MCCOY**

DEPARTMENT OF THE ARMY (UNITED STATES AGENCY OF THE UNITED STATES GOVERNMENT)

JALS-RL/IP

901 N. STUART ST., STE. 700  
ARLINGTON, VA 22203

FOR: AN ON-LINE NEWSPAPER DELIVERED VIA THE INTERNET OF LOCAL, NATIONAL, AND WORLD NEWS AND ISSUES OF INTEREST TO PERSONS INTERESTED IN THE MILITARY, IN CLASS 41 (U.S. CLS. 100, 101 AND 107).

FIRST USE 7-24-1942; IN COMMERCE 1-0-2008.

THE MARK CONSISTS OF STANDARD CHARACTERS WITHOUT CLAIM TO ANY PARTICULAR FONT, STYLE, SIZE, OR COLOR.

SER. NO. 77-556,984, FILED 8-27-2008.

LAURA KOVALSKY, EXAMINING ATTORNEY

**Int. Cl.: 36**

**Prior U.S. Cls.: 100, 101 and 102**

**United States Patent and Trademark Office**

**Reg. No. 3,570,070**

**Registered Feb. 3, 2009**

**SERVICE MARK  
PRINCIPAL REGISTER**

**CORNERBANK**

CORNERSTONE ALLIANCE, LTD. (KANSAS  
CORPORATION)  
P.O. BOX 545  
WINFIELD, KS 67156

FOR: BANKING; ESTATE TRUST MAN-  
AGEMENT; SECURITY BROKERAGE; CREDIT CARD  
SERVICES; COMMERCIAL, CONSUMER AND  
MORTGAGE LENDING SERVICES; INSURANCE  
AGENCY SERVICES AND INSURANCE BROKER-  
AGE SERVICES, IN CLASS 36 (U.S. CLS. 100, 101  
AND 102).

FIRST USE 5-12-2008; IN COMMERCE 5-12-2008.

THE MARK CONSISTS OF STANDARD CHAR-  
ACTERS WITHOUT CLAIM TO ANY PARTICULAR  
FONT, STYLE, SIZE, OR COLOR.

OWNER OF U.S. REG. NO. 2,333,151.

SER. NO. 77-557,578, FILED 8-28-2008.

KELLY MCCOY, EXAMINING ATTORNEY

**Int. Cl.: 36**

**Prior U.S. Cls.: 100, 101 and 102**

**United States Patent and Trademark Office**

**Reg. No. 3,570,071**

**Registered Feb. 3, 2009**

**SERVICE MARK  
PRINCIPAL REGISTER**



CORNERSTONE ALLIANCE, LTD. (KANSAS CORPORATION)  
P.O. BOX 545  
WINFIELD, KS 67156

FOR: BANKING; ESTATE TRUST MANAGEMENT; SECURITY BROKERAGE; CREDIT CARD SERVICES; COMMERCIAL, CONSUMER AND MORTGAGE LENDING SERVICES; INSURANCE AGENCY SERVICES AND INSURANCE BROKER-

AGE SERVICES, IN CLASS 36 (U.S. CLS. 100, 101 AND 102).

FIRST USE 5-12-2008; IN COMMERCE 5-12-2008.

THE MARK CONSISTS OF DIAMOND DESIGN.

SER. NO. 77-557,597, FILED 8-28-2008.

KELLY MCCOY, EXAMINING ATTORNEY

Int. Cl.: 9

Prior U.S. Cls.: 21, 23, 26, 36 and 38

Reg. No. 3,570,072

United States Patent and Trademark Office

Registered Feb. 3, 2009

TRADEMARK  
PRINCIPAL REGISTER



UNIVISION COMMUNICATIONS INC. (DELA-  
WARE CORPORATION)  
5999 CENTER DRIVE  
LOS ANGELES, CA 90045

FOR: DOWNLOADABLE RINGTONES, MUSIC,  
PHOTOGRAPHS, IMAGES, ELECTRONIC GAMES,  
AUDIO FILES, VIDEO FILES, FILM CLIPS, AND  
OTHER MULTIMEDIA MATERIALS VIA MOBILE  
PHONES AND OTHER HAND-HELD OR WIRELESS  
DEVICES; DOWNLOADABLE PODCASTS TO MO-  
BILE PHONES AND OTHER HAND-HELD OR  
WIRELESS DEVICES IN THE FIELD OF NEWS  
AND ENTERTAINMENT PROGRAMS, IN CLASS 9  
(U.S. CLS. 21, 23, 26, 36 AND 38).

FIRST USE 2-29-2004; IN COMMERCE 2-29-2004.

OWNER OF U.S. REG. NOS. 1,672,807, 3,483,636  
AND OTHERS.

NO CLAIM IS MADE TO THE EXCLUSIVE  
RIGHT TO USE "MOVIL", APART FROM THE  
MARK AS SHOWN.

THE MARK CONSISTS OF THE STYLIZED  
WORD "UNIVISION" WITH THE STYLIZED WORD  
"MOVIL" UNDERNEATH IT, AND WITH THE  
FANCIFUL DESIGN OF THE LETTER "U" TO THE  
LEFT OF BOTH WORD.

THE FOREIGN WORDING IN THE MARK  
TRANSLATES INTO ENGLISH AS UNIVISION MO-  
BILE.

SER. NO. 77-560,698, FILED 9-2-2008.

MICHAEL TANNER, EXAMINING ATTORNEY

**Int. Cls.: 14, 18, 21, 25 and 36**

**Prior U.S. Cls.: 1, 2, 3, 13, 22, 23, 27, 28, 29, 30, 33, 39,  
40, 41, 50, 100, 101 and 102**

**Reg. No. 3,570,073**

**United States Patent and Trademark Office**

**Registered Feb. 3, 2009**

**TRADEMARK  
SERVICE MARK  
PRINCIPAL REGISTER**



NYGARD INTERNATIONAL PARTNERSHIP  
(CANADA PARTNERSHIP)  
1771 INKSTER BOULEVARD  
WINNIPEG, CANADA R2X1R3

FOR: RUBBER OR SILICON WRISTBANDS IN  
THE NATURE OF A BRACELET , IN CLASS 14 (U.S.  
CLS. 2, 27, 28 AND 50).

FIRST USE 8-0-2004; IN COMMERCE 8-0-2004.

FOR: TOTE BAGS, IN CLASS 18 (U.S. CLS. 1, 2, 3, 22  
AND 41).

FIRST USE 8-0-2004; IN COMMERCE 8-0-2004.

FOR: PLASTIC WATER BOTTLES SOLD EMPTY,  
IN CLASS 21 (U.S. CLS. 2, 13, 23, 29, 30, 33, 40 AND 50).

FIRST USE 8-0-2004; IN COMMERCE 8-0-2004.

FOR: T-SHIRTS, SCARVES, IN CLASS 25 (U.S.  
CLS. 22 AND 39).

FIRST USE 8-0-2004; IN COMMERCE 8-0-2004.

FOR: CHARITABLE FUND RAISING SERVICES ,  
IN CLASS 36 (U.S. CLS. 100, 101 AND 102).

FIRST USE 8-0-2004; IN COMMERCE 8-0-2004.

PRIORITY CLAIMED UNDER SEC. 44(D) ON  
CANADA APPLICATION NO. 1337732, FILED 3-2-  
2007.

OWNER OF U.S. REG. NOS. 2,080,489, 2,716,981  
AND OTHERS.

THE MARK CONSISTS OF THE WORD "NY-  
GÅRD" IN STYLIZED AND CAPITALIZED BLOCK  
TYPE, FOLLOWED BY A RIBBON DESIGN, FOL-  
LOWED BY THE WORDS "FOR LIFE" IN THIN  
TYPE WITH THE WORDS "FOR" AND "LIFE"  
BEING IN LOWER-CASE LETTERS WITH THE  
EXCEPTION OF THE "L" IN "LIFE", WHICH IS  
CAPITALIZED.

SER. NO. 77-975,731, FILED 8-28-2007.

AISHA SALEM, EXAMINING ATTORNEY

**Int. Cl.: 10**

**Prior U.S. Cls.: 26, 39 and 44**

**United States Patent and Trademark Office**

**Reg. No. 3,570,074**

**Registered Feb. 3, 2009**

**TRADEMARK  
PRINCIPAL REGISTER**

**CONQUEST TTC**

WILSON-COOK MEDICAL INC. (NORTH CAROLINA CORPORATION)  
4900 BETHANIA STATION ROAD  
WINSTON-SALEM, NC 27105

FIRST USE 6-20-2001; IN COMMERCE 6-20-2001.

SER. NO. 78-141,911, FILED 7-8-2002.

FOR: LITHOTRIPTORS AND PARTS THEREFOR,  
LITHOTRIPSY CABLES, IN CLASS 10 (U.S. CLS. 26,  
39 AND 44).

TRACY FLETCHER, EXAMINING ATTORNEY

**Int. Cls.: 37 and 42**

**Prior U.S. Cls.: 100, 101, 103 and 106**

**United States Patent and Trademark Office**

**Reg. No. 3,570,075**

**Registered Feb. 3, 2009**

**SERVICE MARK  
PRINCIPAL REGISTER**

**COMBATSWORLD**

DIAMOND SCENT LIMITED (BR.VIRGIN ISLANDS CORPORATION)  
TRIDENT CHAMBERS, PO BOX 146  
ROAD TOWN, TORTOLA, BR.VIRGIN ISLANDS

FOR: COMPUTER SERVICES, NAMELY, COMPUTER HARDWARE INSTALLATION, REPAIR AND MAINTENANCE SERVICES FOR OTHERS , IN CLASS 37 (U.S. CLS. 100, 103 AND 106).

FOR: COMPUTER SERVICES, NAMELY, SOFTWARE INSTALLATION, DIAGNOSTIC, REPAIR AND MAINTENANCE SERVICES FOR OTHERS; COMPUTER DIAGNOSTIC SERVICES; DESIGN, UPDATING AND MAINTENANCE OF COMPUTER SOFTWARE AND PROGRAMS FOR OTHERS; COMPUTER PROGRAMMING SERVICES FOR OTHERS; DESIGN OF COMPUTER AND VIDEO GAMES PLAYED VIA THE INTERNET AND TELECOMMUNICATIONS NETWORKS, FOR OTHERS; PREPARATION AND PROVISION OF INFORMATION IN RELATION TO COMPUTERS AND COMPUTER NETWORK FACILITIES, NAMELY, CROSS-PLATFORM CONVERSION OF DIGITAL CONTENT INTO OTHER FORMS OF DIGITAL CONTENT, NETWORK INTERFACES, ORGANIZATION, MAINTENANCE AND UPGRADES; ON-LINE COM-

PUTER SERVICES, NAMELY, DIAGNOSTIC COMPUTER SERVICES, COMPUTER AND SOFTWARE PROGRAMMING SERVICES FOR OTHERS PROVIDED VIA THE INTERNET; COMPUTER RENTAL; COMPUTER SERVICES, NAMELY, DESIGNING AND CREATING CONTENT AND INTERFACES, SPECIFICALLY DRAWING AND COMMISSIONED WRITING FOR THE COMPILATION OF WEB PAGES ON THE INTERNET FOR OTHERS; CREATING, DEVELOPING AND MAINTAINING WEB SITES FOR OTHERS; HOSTING THE WEB SITES OF OTHERS; PROVIDING ON-LINE DATABASE IN THE FIELD OF COMPUTERS AND COMPUTER SOFTWARE, IN CLASS 42 (U.S. CLS. 100 AND 101).

PRIORITY CLAIMED UNDER SEC. 44(D) ON ERPN CMNTY TM OFC APPLICATION NO. 3085016, FILED 3-17-2003, REG. NO. 003085016, DATED 9-28-2006, EXPIRES 9-28-2016.

OWNER OF U.S. REG. NOS. 3,435,958, 3,484,874 AND OTHERS.

SER. NO. 78-240,222, FILED 4-21-2003.

RICHARD WHITE, EXAMINING ATTORNEY



**Int. Cl.: 9**

**Prior U.S. Cls.: 21, 23, 26, 36 and 38**

**United States Patent and Trademark Office**

**Reg. No. 3,570,076**

**Registered Feb. 3, 2009**

**TRADEMARK  
PRINCIPAL REGISTER**

**SINAPSE**

JONATHON LUNARDI (UNITED STATES INDIVIDUAL)  
175 KUHLMAN COURT  
NORMAN, OK 73019

FOR: OPEN SOURCE AND DOWNLOADABLE  
COMPUTER SOFTWARE FOR USE BY UNIVERSITIES  
FOR THE DEVELOPMENT AND DESIGN OF  
ACADEMIC COMMUNITY FOCUSED WEBSITES

AND STUDENT MESSAGE BOARDS , IN CLASS 9  
(U.S. CLS. 21, 23, 26, 36 AND 38).

FIRST USE 8-1-2001; IN COMMERCE 8-1-2001.

SER. NO. 78-244,051, FILED 4-30-2003.

TRACY FLETCHER, EXAMINING ATTORNEY

**Int. Cl.: 3**

**Prior U.S. Cls.: 1, 4, 6, 50, 51 and 52**

**Reg. No. 3,570,077**

**United States Patent and Trademark Office**

**Registered Feb. 3, 2009**

**TRADEMARK  
PRINCIPAL REGISTER**

**COW**

COWSHED PRODUCTS LIMITED (UNITED KINGDOM CORPORATION)  
3-5 BATEMAN STREET  
SOHO, LONDON, UNITED KINGDOM W1D 4AG

FOR: SOAPS; PERFUME; ESSENTIAL OILS FOR PERSONAL USE; COSMETICS; HAIR LOTIONS; TOILET WATERS; EAU DE COLOGNE; AFTER-SHAVE PREPARATIONS; PREPARATIONS FOR THE HAIR, NAMELY, HIGHLIGHTING PREPARATIONS, HAIR COLORANTS, INTENSIVE HAIR MOISTURIZERS; HAIR SPRAYS, SPRAY GELS, GELS, MOUSSES, CREAMS, LOTIONS, POMADES AND WAXES; PREPARATIONS FOR THE SCALP, NAMELY, NON-MEDICATED SCALP TREATMENT CREAM AND SCALP CONDITIONERS; PREPARATIONS FOR THE SKIN, NAMELY, NON-MEDICA-

TED SKIN CARE PREPARATIONS; NAIL CARE PREPARATIONS; SHAMPOOS AND CONDITIONERS; BEAUTY AND BODY CARE PREPARATIONS, NAMELY, MASSAGE OILS AND BODY SCRUBS; HAND AND BODY LOTIONS; DENTIFRICES; SHAVING PREPARATIONS, BATH FOAM AND BATH OIL; SHOWER GEL; BODY SPRAYS; BUT NOT INCLUDING SOAPS IN THE SHAPE OF COWS, IN CLASS 3 (U.S. CLS. 1, 4, 6, 50, 51 AND 52).

OWNER OF UNITED KINGDOM REG. NO. 2199598, DATED 5-11-2001, EXPIRES 6-9-2009.

SER. NO. 78-255,388, FILED 5-28-2003.

MATTHEW PAPPAS, EXAMINING ATTORNEY

**Int. Cls.: 42 and 45**

**Prior U.S. Cls.: 100 and 101**

**United States Patent and Trademark Office**

**Reg. No. 3,570,078**

**Registered Feb. 3, 2009**

**SERVICE MARK  
PRINCIPAL REGISTER**



KELLY REGISTRATION SYSTEMS, INC. (GEORGIA CORPORATION)  
10115 HIGHWAY 142 NORTH  
COVINGTON, GA 30014

FOR: APPLICATION SERVICE PROVIDER (ASP) FEATURING DATABASE SOFTWARE AND APPLICATIONS IN THE FIELD OF AGRICULTURAL RELATED PRODUCTS AND SERVICES FOR USE IN ASSISTING GOVERNMENTAL ENTITIES, REGULATED BUSINESSES AND CONSUMERS OF THE ABOVE STATED REGULATED GOODS IN COMPLYING WITH GOVERNMENTAL LAWS AND REGULATIONS, IN CLASS 42 (U.S. CLS. 100 AND 101).

FIRST USE 5-1-2002; IN COMMERCE 5-1-2002.

FOR: PROVIDING AN ON-LINE COMPUTER DATABASE IN THE FIELD OF AGRICULTURAL RELATED PRODUCTS AND SERVICES FOR ASSISTING GOVERNMENTAL ENTITIES, REGULATED BUSINESSES AND CONSUMERS OF THE ABOVE STATED REGULATED GOODS IN COM-

PLYING WITH GOVERNMENTAL LAWS AND REGULATIONS; CONSULTING SERVICES IN THE FIELD OF REGULATORY COMPLIANCE WITH AGRICULTURAL, ENVIRONMENTAL AND PUBLIC HEALTH LAWS AND REGULATIONS, IN CLASS 45 (U.S. CLS. 100 AND 101).

FIRST USE 5-1-2002; IN COMMERCE 5-1-2002.

OWNER OF U.S. REG. NO. 2,906,339.

NO CLAIM IS MADE TO THE EXCLUSIVE RIGHT TO USE "NETWORK", APART FROM THE MARK AS SHOWN.

THE MARK CONSISTS OF THE LETTERS "KRS" WITH THE "K" IN A LARGER STYLIZED FORMAT ABOVE THE TERM "NETWORK".

SER. NO. 78-256,016, FILED 5-29-2003.

NELSON SNYDER, EXAMINING ATTORNEY

**Int. Cls.: 3, 4, 5, 9, 16, 18, 21 and 35**

**Prior U.S. Cls.: 1, 2, 3, 4, 5, 6, 13, 15, 18, 21, 22, 23, 26, 29, 30, 33, 36, 37, 38, 40, 41, 44, 46, 50, 51, 52, 100, 101 and 102**

**Reg. No. 3,570,079**

**United States Patent and Trademark Office**

**Registered Feb. 3, 2009**

**TRADEMARK  
SERVICE MARK  
PRINCIPAL REGISTER**

**CULTI**

CULTI S.R.L. (ITALY LIMITED LIABILITY COMPANY)  
VIA BERNARDINO LUINI, 73 MEDA  
MILANO, ITALY

FOR: ROOM PERFUMES, IN CLASS 3 (U.S. CLS. 1, 4, 6, 50, 51 AND 52).

FIRST USE 9-17-1993; IN COMMERCE 9-17-1993.

FOR: SCENTED AND UNSCENTED CANDLES, IN CLASS 4 (U.S. CLS. 1, 6 AND 15).

FIRST USE 9-17-1993; IN COMMERCE 9-17-1993.

FOR: AIR DEODORIZERS, ROOM DEODORANTS, ROOM PERFUMES, AIR FRESHENERS, CAR DEODORANTS, CARPET DEODORIZERS, SHOE DEODORIZERS, IN CLASS 5 (U.S. CLS. 6, 18, 44, 46, 51 AND 52).

FIRST USE 9-17-1993; IN COMMERCE 9-17-1993.

FOR: (BASED ON 44(E)) SPECTACLES, SUNGLASSES, CASES FOR GLASSES, FRAMES FOR GLASSES, CHAINS FOR GLASSES; LENSES FOR GLASSES, PINCE-NEZ; LOUDSPEAKERS; EYEGLASS CORDS, IN CLASS 9 (U.S. CLS. 21, 23, 26, 36 AND 38).

FOR: LEISURE BOOKLETS, PAMPHLETS AND BOOKS, ADVERTISING BOOKLETS, PAMPHLETS AND BOOKS; ANNIVERSARY BOOKS, RECIPE BOOKS, PICTURE BOOKS, COPY BOOKS, GUEST BOOKS, NOTE BOOKS, STORY BOOKS, DRAWING BOOKS, TELEPHONE NUMBER BOOKS, EXERCISE BOOKS, GENERAL FEATURE MAGAZINES, DIARIES, PENS, PENCILS, BOND PAPER, ILLUSTRATION PAPER, GIFT WRAPPING PAPER, WRITING PAPER, ENVELOPES, GIFT CARDS, OCCASION

CARDS, POSTCARDS, BLANK CARDS, SCRATCH PADS, PAPER BOXES, PAPER BOARDS, POSTERS, GREETING CARDS, CARDBOARD BOXES, PICTURES, CALENDARS, NEWSPAPERS FOR GENERAL CIRCULATION, PHOTOGRAPH ALBUMS, ERASERS, MAGNETIC BOARDS, PENCIL SHARPENERS, PENCIL CASES, PEN CASES, OFFICE REQUISITES, NAMELY, PUNCHES, PAPER CUTTERS, PAPERWEIGHTS, PAPER FASTENERS, FILE FOLDERS, DOCUMENT HOLDERS, DESK SETS, DESK TOP ORGANIZERS, PAPER BAGS, GENERAL PURPOSE PLASTIC BAGS, PAPER BATHMATS, PAPER RIBBONS AND PAPER BOWS, PAPER CAKE DECORATION, DECORATIVE PAPER CENTERPIECES, PAPER DOILIES, PAPER HANDKERCHIEFS, PAPER TABLE CLOTH, PAPER NAPKINS, TABLE LINEN OF PAPER, PAPER MATS, PAPER TOWELS, PAPER TRAY COVERS, PAPER FILTERS FOR COFFEE MAKERS, IN CLASS 16 (U.S. CLS. 2, 5, 22, 23, 29, 37, 38 AND 50).

FIRST USE 9-17-1993; IN COMMERCE 9-17-1993.

FOR: (BASED ON 44(E)) BANDS OF LEATHER, BOXES OF LEATHER, ENVELOPES OF LEATHER FOR PACKAGING; SHOE BAGS FOR TRAVEL, GARMENT BAGS FOR TRAVEL, HANDBAGS, LUGGAGE, SHOULDER BAGS, BEACH BAGS, CLUTCH BAGS, ALL PURPOSE SPORTS BAGS, ATTACHÉ CASES, SCHOOL BAGS, TOTE BAGS, TRAVELING BAGS, CREDIT CARD CASES, DOCUMENT CASES, COSMETIC CASES SOLD EMPTY, KEYCASES, KNAPSACKS, RUCKSACKS, BRIEFCASES, PURSES, WALLETS, TRAVELING TRUNKS, SUITCASES, UMBRELLAS, PARASOLS, IN CLASS 18 (U.S. CLS. 1, 2, 3, 22 AND 41).

FOR: EMPTY PERFUME ATOMIZERS, PLASTIC BATH RACKS, SOAP BOXES, SOAP DISPENSERS, PAPER TOWEL DISPENSERS, SHAVING BRUSHES

AND BRUSH STANDS, COSMETIC BRUSHES, HAIR BRUSHES, FITTED VANITY CASES, COMB CASES, HAIR COMBS, SPONGE HOLDERS, TOILET TISSUE HOLDERS, HOUSEHOLD SPONGES, POWDER PUFFS, TOWEL BARS AND RINGS, WASH BASINS; BAKEWARE AND COOKWARE, NAMELY, GRILLS, CONFECTIONER'S DECORATING BAGS, SERVING SPOONS, SLOTTED SPOONS, MIXING SPOONS, CUTTING BOARDS, BREAD BOXES, CAKE SERVERS, CASSEROLES, STRAINERS, SIEVES AND COLLANDERS FOR HOUSEHOLD USE, COOKERY MOLDS, COOKIE CUTTERS, CORN COB HOLDERS, CRUETS NOT OF PRECIOUS METALS FOR OIL AND VINEGAR, GARLIC PRESSES, PEPPER GRINDERS, NON-ELECTRIC GRIDDLES, LEMON AND ORANGE SQUEEZERS, REAMERS FOR FRUIT JUICERS, NON-ELECTRIC JUICERS, GRATERS, SPATULAS, TURNERS, WHISKS, ICE CUBE MOLDS FOR REFRIGERATORS, KITCHEN LADLES, SCOOPS, SALT AND PEPPER SHAKERS, CONTAINERS FOR FOODS, INSULATING JARS, PITCHERS, NAPKIN HOLDERS, TOOTHPICK HOLDERS, NON-ELECTRIC KETTLES, NON-ELECTRIC PRESSURE COOKERS; FRYING PANS, COOKING POTS, SAUCEPANS; HAND-OPERATED COFFEE GRINDERS, DOMESTIC COFFEE MEASURES, NON-ELECTRIC COFFEE PERCOLATORS AND POTS, TEA INFUSERS AND TEA POTS NOT OF PRECIOUS METALS, CANNISTER SETS, CONTAINERS FOR FOOD, GRAVY-BOATS, COVERS FOR DISHES AND POTS, BUTTER DISHES, PANS, PLATES, SERVING PLATTERS, SAUCERS, SOUP TUREENS, SERVING TRAYS NOT OF PRECIOUS METALS; BEVERAGEWARE, NAMELY, DRINKING GLASSES, BOTTLE OPENERS, CORK SCREWS; SELTZER BOTTLES, CAVIAR COOLERS, COCKTAIL PICKS, COCKTAIL SHAKERS, DECANTERS, BEVERAGE STIRRERS, SWIZZLE STICKS, FUNNELS; CUPS, JUGS, MUGS, BASINS AND BOWLS, BOWLS FOR SCENTED DRIED FLOWERS, POTS, VASES, NON-METAL

BASKETS, DUST BINS, IRONING BOARDS AND SHAPED COVERS THEREFOR, CLOTH BRUSHES, ROLL-UP LEATHER CONTAINERS WITH SHOE CARE KIT; SHOE BRUSHES, SHOE POLISHING MITTS, SHOE POLISHING CLOTHS, SHOE POLISH APPLICATORS NOT CONTAINING SHOE POLISH, SHOE STRETCHERS OF WOOD, SHOE-TREES, SHOE HORNS, LAWN SPRINKLERS, GARDENING GLOVES, PAILS, WASTEPAPER BASKETS, NON-METAL DECORATIVE BOXES AND PLATES, NON-ELECTRIC CANDELABRAS NOT OF PRECIOUS METAL, CANDLESTICKS NOT OF PRECIOUS METALS, FLOWER POTS, FLOWER POT HOLDERS; GLASS, STAINED GLASS, UNWROUGHT GLASS, DECORATIVE CRYSTAL PRISMS; EARTHENWARE, CRYSTAL, IN CLASS 21 (U.S. CLS. 2, 13, 23, 29, 30, 33, 40 AND 50).

FIRST USE 10-26-1992; IN COMMERCE 9-17-1993.

FOR: (BASED ON 44(E)) SHOP WINDOW DISPLAY ARRANGEMENT SERVICES; FRANCHISING, NAMELY, OFFERING TECHNICAL ASSISTANCE IN THE ESTABLISHMENT AND OPERATION OF HOTELS, SPAS, INTERIORS OF SHOPS AND WAREHOUSES, IN CLASS 35 (U.S. CLS. 100, 101 AND 102).

PRIORITY CLAIMED UNDER SEC. 44(D) ON ITALY APPLICATION NO. 2003002497, FILED 3-10-2003, REG. NO. 00896995, DATED 6-11-2003, EXPIRES 3-10-2013.

OWNER OF U.S. REG. NO. 2,262,046.

THE ENGLISH TRANSLATION OF THE WORD CULTI IS "CULTS".

SER. NO. 78-288,103, FILED 8-15-2003.

MARY MUNSON, EXAMINING ATTORNEY

**Int. Cls.: 7, 8, 21, 29 and 30**

**Prior U.S. Cls.: 2, 13, 19, 21, 23, 28, 29, 30, 31, 33, 34, 35, 40, 44, 46 and 50**

**Reg. No. 3,570,080**

**United States Patent and Trademark Office**

**Registered Feb. 3, 2009**

**TRADEMARK  
PRINCIPAL REGISTER**

**LE CORDON BLEU**

LE CORDON BLEU INTERNATIONAL B.V.  
(NETHERLANDS CORPORATION)  
STRAWINSKYLAAN 3105, 7TH FLOOR  
AMSTERDAM, NETHERLANDS 1077 ZX

FOR: ELECTRIC AND NON-ELECTRIC APPARATUS AND APPLIANCES FOR THE PREPARATION OF FOOD, NAMELY, ELECTRIC TIN AND CAN OPENERS; ELECTRIC GRINDERS AND CRUSHERS; ELECTRIC COFFEE MILLS; ELECTRIC KNIVES AND SCISSORS; ELECTRIC WHISKS; ELECTRIC MACHINES FOR MINCING AND CHOPPING MEAT; ELECTRIC BLENDERS; ELECTRIC BEATERS; DISHWASHERS; WASHING MACHINES; KNEADING MACHINES; ELECTRIC APPARATUS FOR PEELING AND GRATING FRUIT; ELECTRIC BUTTER MAKERS; ELECTRIC FOOD PRESSERS; ELECTRIC FOOD PROCESSORS; AERATED BEVERAGE MAKING MACHINES, ELECTRO MECHANICAL BEVERAGE PREPARATION MACHINES, SAUSAGE MAKING MACHINES; EDIBLE PASTE MAKING MACHINES, IN CLASS 7 (U.S. CLS. 13, 19, 21, 23, 31, 34 AND 35).

FOR: HAND OPERATED HAND TOOLS AND IMPLEMENTS, NAMELY, HAND-OPERATED COFFEE GRINDERS AND PEPPER MILLS; CUTLERY, FORKS AND SPOONS; SIDE ARMS, NOT INCLUDING FIREARMS, NAMELY, HUNTING KNIVES; RAZORS; NON-ELECTRIC TIN AND CAN OPENERS; NON-ELECTRIC APPARATUS FOR PEELING AND GRATING FRUIT; FOOD PRESSERS; HAND-OPERATED FOOD PROCESSORS, IN CLASS 8 (U.S. CLS. 23, 28 AND 44).

FOR: ELECTRIC PEPPER MILLS AND ELECTRIC AND NON-ELECTRIC WHISKS; HOUSEHOLD, KITCHEN AND COOKING UTENSILS AND CONTAINERS NOT OF PRECIOUS METAL OR COATED THEREWITH, NAMELY, SAUCE PANS, SKILLETS, DUTCH OVENS, CASSEROLE COOKERS, COOKING RACKS AND CUPS TO FIT THE RACKS, STRAINERS, AND COVERS; GLASSWARE, PORCE-

LAIN AND EARTHENWARE, NAMELY, CUPS AND MUGS, COFFEE MUGS, DRINKING GLASSES, BOWLS, PANS, DISHES, SAUCERS, SOUP TUREENS, SERVING DISHES, FIGURES, FIGURINES, SCULPTURES TEA KETTLES, TEA POTS, TEA SETS, IN CLASS 21 (U.S. CLS. 2, 13, 23, 29, 30, 33, 40 AND 50).

FOR: PRESERVED, DRIED AND COOKED FRUITS AND VEGETABLES; JELLIES; JAMS; EGGS; MILK AND BUTTER; CHEESES; CREAM AND EDIBLE OILS AND FATS; FRUIT PRESERVES, IN CLASS 29 (U.S. CL. 46).

FOR: COFFEE, TEA; COCOA; SUGAR; RICE; TAPIOCA; SAGO, ARTIFICIAL COFFEE, NAMELY, GRAIN AND CHICORY BASED COFFEE SUBSTITUTES; FLOUR; PREPARATIONS MADE FROM CEREALS, NAMELY, CEREAL BASED SNACK FOODS AND READY TO EAT, CEREAL DERIVED FOOD BARS; BREAD; BISCUITS; PASTRY AND CONFECTIONERY, NAMELY, CONFECTIONERY CHIPS FOR BAKING AND CANDY; FLAVORED ICES; HONEY; TREACLE; YEAST; BAKING-POWDER; SALT; MUSTARD; VINEGAR; SAUCES; SPICES; ICE, NAMELY, COOLING ICE; SALAD DRESSINGS; DAIRY PRODUCTS, NAMELY, ICE CREAM, ICE MILK AND FROZEN YOGURT, IN CLASS 30 (U.S. CL. 46).

OWNER OF FRANCE REG. NO. 1655966, DATED 4-15-2001, EXPIRES 4-15-2011.

OWNER OF U.S. REG. NOS. 786,557, 1,243,897 AND OTHERS.

THE FOREIGN WORDING IN THE MARK TRANSLATES INTO ENGLISH AS "THE BLUE RIBBON".

SER. NO. 78-319,531, FILED 10-28-2003.

INGA ERVIN, EXAMINING ATTORNEY

**Int. Cl.: 36**

**Prior U.S. Cls.: 100, 101 and 102**

**United States Patent and Trademark Office**

**Reg. No. 3,570,081**

**Registered Feb. 3, 2009**

**SERVICE MARK  
PRINCIPAL REGISTER**

**CALL ALFA**

ALFA CORPORATION (DELAWARE CORPORATION)  
2108 EAST SOUTH BOULEVARD  
MONTGOMERY, AL 36116

FOR: PROPERTY AND CASUALTY INSURANCE UNDERWRITING SERVICES; REAL ESTATE SERVICES, NAMELY, PROVISION OF COMMERCIAL AND RESIDENTIAL REAL ESTATE BROKERAGE SERVICES; REINSURANCE UNDERWRITING SERVICES AND OTHER REINSURANCE SERVICES, NAMELY, REINSURANCE CLAIMS ADMINISTRATION, PROCESSING, EVALUATION AND SUBROGATION; CONSULTATION IN THE FIELD OF REINSURANCE CLAIMS ADMINISTRATION, PROCESSING, EVALUATION AND SUBROGATION; LIFE INSURANCE SERVICES, NAMELY, UNDERWRITING, ADMINISTRATION, AND CLAIMS AD-

MINISTRATION SERVICES; ANNUITIES SERVICES, NAMELY, ANNUITY UNDERWRITING, IN CLASS 36 (U.S. CLS. 100, 101 AND 102).

FIRST USE 6-0-1988; IN COMMERCE 6-0-1988.

THE MARK CONSISTS OF STANDARD CHARACTERS WITHOUT CLAIM TO ANY PARTICULAR FONT, STYLE, SIZE, OR COLOR.

OWNER OF U.S. REG. NOS. 1,473,508, 2,671,857 AND OTHERS.

SER. NO. 78-406,920, FILED 4-23-2004.

STEVEN JACKSON, EXAMINING ATTORNEY

**Int. Cl.: 42**

**Prior U.S. Cls.: 100 and 101**

**United States Patent and Trademark Office**

**Reg. No. 3,570,082**

**Registered Feb. 3, 2009**

**SERVICE MARK  
PRINCIPAL REGISTER**

**REALITY MOBILE**

REALITY MOBILE LLC (DELAWARE LIMITED LIABILITY COMPANY)  
13800 COPPERMINE ROAD  
HERNDON, VA 20171

FOR: CONSULTING AND MANAGEMENT SERVICES IN THE FIELD OF PLANNING, DESIGNING, ARCHITECTING, DEVELOPING, TESTING, MAINTAINING, ENHANCING AND SUPPORTING COMPUTER SYSTEMS FOR OTHERS THAT INTEGRATE WIRELESS COMMUNICATION HARDWARE AND NETWORK EQUIPMENT, SOFTWARE AND COMMUNICATIONS TECHNOLOGIES AND APPLICATIONS; PLANNING, DESIGNING, ARCHITECTING, DEVELOPING, TESTING, MAINTAINING, ENHANCING AND SUPPORTING COMPUTER SOFTWARE FOR USE IN COMMUNICATIONS NETWORKS AND SYSTEMS, INCLUDING WIRELESS AND MOBILE APPLICATIONS; TECHNICAL SUPPORT, NAMELY, MONITORING COMPUTER NETWORK SYSTEMS AND TROUBLESHOOTING COMPUTER HARDWARE

AND COMPUTER SOFTWARE PROBLEMS; AND CONSULTING SERVICES IN THE FIELD OF COMMUNICATIONS SYSTEMS AND INFORMATION TECHNOLOGY, NAMELY, EVALUATING AND MONITORING THE SECURITY OF MOBILE AND WIRELESS COMMUNICATIONS NETWORKS AND SYSTEMS, IN CLASS 42 (U.S. CLS. 100 AND 101).

FIRST USE 11-19-2003; IN COMMERCE 11-19-2003.

THE MARK CONSISTS OF STANDARD CHARACTERS WITHOUT CLAIM TO ANY PARTICULAR FONT, STYLE, SIZE, OR COLOR.

NO CLAIM IS MADE TO THE EXCLUSIVE RIGHT TO USE "MOBILE", APART FROM THE MARK AS SHOWN.

SER. NO. 78-437,530, FILED 6-18-2004.

PATRICIA EVANKO, EXAMINING ATTORNEY



**Int. Cls.: 9 and 42**

**Prior U.S. Cls.: 21, 23, 26, 36, 38, 100 and 101**

**Reg. No. 3,570,083**

**United States Patent and Trademark Office**

**Registered Feb. 3, 2009**

**TRADEMARK  
SERVICE MARK  
PRINCIPAL REGISTER**

**Karndean**  
**floorstyle!**  
interactive floor design program

PEACHTREE INTERNATIONAL LIMITED (BERMUDA CORPORATION)  
C/O CENTURY HOUSE, RICHMOND ROAD  
P.O. BOX HM 1806  
HAMILTON HM, MX, BERMUDA

FOR: COMPUTER SOFTWARE FOR TRANSMISSION OR REPRODUCTION OF IMAGES; COMPUTER PROGRAMS FOR TRANSMISSION OR REPRODUCTION OF IMAGES; DATA PROCESSING EQUIPMENT AND APPARATUS FOR TRANSMISSION OR REPRODUCTION OF IMAGES, NAMELY, DATA PROCESSORS, IN CLASS 9 (U.S. CLS. 21, 23, 26, 36 AND 38).

FOR: ADVICE REGARDING INTERIOR DÉCORS AND DECORATION; INTERIOR DESIGN SERVICES, INTERIOR DÉCOR CONSULTATIONS; INTERIOR DECORATING, NAMELY, THE PLANNING AND DESIGN OF INTERIOR FLOOR COVERINGS AND INTERIOR FLOORING PRODUCTS; SELEC-

TION AND IMPLEMENTATION OF COMPUTER PROGRAMS AND DEVELOPMENTS OF COMPUTER SOFTWARE; TECHNICAL SUPPORT SERVICES IN THE NATURE OF TROUBLESHOOTING OF COMPUTER SOFTWARE FOR OTHERS, IN CLASS 42 (U.S. CLS. 100 AND 101).

PRIORITY CLAIMED UNDER SEC. 44(D) ON BERMUDA APPLICATION NO. 3926458, FILED 7-9-2004, REG. NO. 3926458, DATED 11-17-2005, EXPIRES 7-9-2014.

NO CLAIM IS MADE TO THE EXCLUSIVE RIGHT TO USE "INTERACTIVE FLOOR DESIGN PROGRAM", APART FROM THE MARK AS SHOWN.

SER. NO. 78-448,297, FILED 7-9-2004.

ROBERT C. CLARK JR., EXAMINING ATTORNEY

**Int. Cls.: 10 and 42**

**Prior U.S. Cls.: 26, 39, 44, 100 and 101**

**Reg. No. 3,570,084**

**United States Patent and Trademark Office**

**Registered Feb. 3, 2009**

**TRADEMARK  
SERVICE MARK  
PRINCIPAL REGISTER**

# JAC SYSTEM

LABCOAT LIMITED (IRELAND CORPORATION)  
UNIT 4 BALLYBRIT BUSINESS PARK  
GALWAY, IRELAND

FOR: SURGICAL AND MEDICAL APPARATUS AND INSTRUMENTS, NAMELY, SURGICAL AND MEDICAL INSTRUMENTS USED IN THE TREATMENT OF RESTENOSIS OR VASCULOPATHY, NAMELY, SURGICAL INSTRUMENTS FOR USE IN SURGERIES TO CORRECT RESTENOSIS, MEDICAL INSTRUMENTS FOR USE IN SURGERIES TO CORRECT RESTENOSIS, MEDICAL INSTRUMENTS IN THE NATURE OF AN INFUSION PUMP FOR THE INFUSION OF INTRAVENOUS MEDICATIONS FOR THE TREATMENT OF VASCULOPATHY; DRUG DELIVERY DEVICES, NAMELY, DRUG DELIVERY SYSTEMS; MEDICAL IMPLANTS COMPRISED OF ARTIFICIAL MATERIALS FOR USE IN PERFORMING ANGIOPLASTY SURGERY; MEDICAL STENTS; MEDICAL CATHETERS, IN CLASS 10 (U.S. CLS. 26, 39 AND 44).

FOR: SCIENTIFIC RESEARCH AND DEVELOPMENT SERVICES; SCIENTIFIC AND INDUSTRIAL RESEARCH SERVICES; MEDICAL RESEARCH SERVICES, IN CLASS 42 (U.S. CLS. 100 AND 101).

THE MARK CONSISTS OF STANDARD CHARACTERS WITHOUT CLAIM TO ANY PARTICULAR FONT, STYLE, SIZE, OR COLOR.

PRIORITY CLAIMED UNDER SEC. 44(D) ON ERPN CMNTY TM OFC APPLICATION NO. 003778842, FILED 4-20-2004, REG. NO. 003778842, DATED 12-4-2007, EXPIRES 4-20-2014.

NO CLAIM IS MADE TO THE EXCLUSIVE RIGHT TO USE "SYSTEM" , APART FROM THE MARK AS SHOWN.

SER. NO. 78-501,162, FILED 10-18-2004.

MICHAEL TANNER, EXAMINING ATTORNEY

**Int. Cl.: 11**

**Prior U.S. Cls.: 13, 21, 23, 31 and 34**

**Reg. No. 3,570,085**

**United States Patent and Trademark Office**

**Registered Feb. 3, 2009**

**TRADEMARK  
PRINCIPAL REGISTER**



LAMP WAREHOUSE INC. (NEW JERSEY CORPORATION)  
1293 ROUTE 23 SOUTH  
WAYNE, NJ 07470

NO CLAIM IS MADE TO THE EXCLUSIVE RIGHT TO USE "LIGHTING" AND "LAMP", APART FROM THE MARK AS SHOWN.

FOR: LAMPS, LIGHTING FIXTURES, CHANDELIERS, FLUSH AND SEMI-FLUSH MOUNTED LIGHTING FIXTURES, OUTDOOR LIGHTING FIXTURES, WALL SCONCES, BATH LIGHTING FIXTURES, TABLE LAMPS, FLOOR LAMPS, CEILING FANS, IN CLASS 11 (U.S. CLS. 13, 21, 23, 31 AND 34).

SEC. 2(F) "EXPO AND "WAREHOUSE CO.".

SER. NO. 78-512,227, FILED 11-5-2004.

FIRST USE 6-1-1994; IN COMMERCE 9-1-1998.

KIMBERLY FRYE, EXAMINING ATTORNEY

**Int. Cl.: 10**

**Prior U.S. Cls.: 26, 39 and 44**

**United States Patent and Trademark Office**

**Reg. No. 3,570,086**

**Registered Feb. 3, 2009**

**TRADEMARK  
PRINCIPAL REGISTER**

**COOLHEAD**

COOLHEAD TECHNOLOGIES INC. (CANADA  
CORPORATION)  
7455 CONWAY AVENUE  
BURNABY, CANADA V5E 2P7

FOR: FLUID COOLED PAD FOR USE IN COOL-  
ING THE HUMAN BODY, IN CLASS 10 (U.S. CLS. 26,  
39 AND 44).

THE MARK CONSISTS OF STANDARD CHAR-  
ACTERS WITHOUT CLAIM TO ANY PARTICULAR  
FONT, STYLE, SIZE, OR COLOR.

PRIORITY CLAIMED UNDER SEC. 44(D) ON  
CANADA APPLICATION NO. 1225809, FILED 8-3-  
2004, REG. NO. TMA708,586, DATED 2-29-2008, EX-  
PIRES 2-28-2023.

SER. NO. 78-558,735, FILED 2-2-2005.

DOMINICK J. SALEMI, EXAMINING ATTORNEY

**Int. Cl.: 13**

**Prior U.S. Cls.: 2 and 9**

**United States Patent and Trademark Office**

**Reg. No. 3,570,087**

**Registered Feb. 3, 2009**

**TRADEMARK  
PRINCIPAL REGISTER**

**TRIPLEX**

SAN SWISS ARMS AG (SWITZERLAND CORPORATION)  
INDUSTRIEPLATZ 1  
NEUHAUSEN AM RHEINFALL, SWITZERLAND  
8212

FOR: HUNTING AND SPORTING ARMS, NAME-  
LY, FIREARMS AND RIFLES AND PARTS THERE-  
OF; ACCESSORIES FOR HUNTING AND  
SPORTING ARMS, NAMELY, RIFLE CASES, RIFLE  
BAGS, RIFLE COVERS, RIFLE SLING STRAPS;  
BULLETS AND AMMUNITION, IN CLASS 13 (U.S.  
CLS. 2 AND 9).

THE MARK CONSISTS OF STANDARD CHAR-  
ACTERS WITHOUT CLAIM TO ANY PARTICULAR  
FONT, STYLE, SIZE, OR COLOR.

OWNER OF SWITZERLAND REG. NO. 530829,  
DATED 2-22-2005, EXPIRES 9-14-2014.

SER. NO. 78-587,169, FILED 3-15-2005.

MATTHEW MCDOWELL, EXAMINING ATTOR-  
NEY

**Int. Cl.: 9**

**Prior U.S. Cls.: 21, 23, 26, 36 and 38**

**Reg. No. 3,570,088**

**United States Patent and Trademark Office**

**Registered Feb. 3, 2009**

---

**TRADEMARK  
PRINCIPAL REGISTER**

**LTC KENNERLEY**

P22 TYPE FOUNDRY, INC. (NEW YORK CORPORATION)  
325 ELMWOOD AVENUE, NO. 1  
BUFFALO, NY 14222

FOR: TYPE FACE FONTS RECORDED ON MAGNETIC AND OPTICAL MEDIA AND COMPUTER SOFTWARE DOWNLOADABLE VIA A GLOBAL COMPUTER INFORMATION NETWORK FEATURING TYPE FACE FONTS, IN CLASS 9 (U.S. CLS. 21, 23, 26, 36 AND 38).

FIRST USE 1-1-1992; IN COMMERCE 1-1-1992.

THE MARK CONSISTS OF STANDARD CHARACTERS WITHOUT CLAIM TO ANY PARTICULAR FONT, STYLE, SIZE, OR COLOR.

SER. NO. 78-599,742, FILED 3-31-2005.

JASON TURNER, EXAMINING ATTORNEY

**Int. Cls.: 35 and 39**

**Prior U.S. Cls.: 100, 101, 102 and 105**

**United States Patent and Trademark Office**

**Reg. No. 3,570,089**

**Registered Feb. 3, 2009**

**SERVICE MARK  
PRINCIPAL REGISTER**

**MOVING SOLUTIONS**

THE EXTRA STEP, INC. D/B/A MOVING SOLUTIONS, INC. (PENNSYLVANIA CORPORATION)  
115 W. EAGLE ROAD  
HAVERTOWN, PA 19083

FOR: RELOCATIONS SERVICES, NAMELY, PLANNING AND IMPLEMENTING MOVES OF HOMES AND OFFICES INCLUDING DEVELOPING FLOOR PLAN, ASSISTING WITH HOUSEHOLD DOWNSIZING, DECLUTTERING, SORTING AND ORGANIZING, SCHEDULING AND OVERSEEING MOVERS, ARRANGING FOR OTHERS FOR SHIPPING OF HOUSEHOLD ITEMS; RETAIL STORE FEATURING CARDBOARD BOXES, PACKING TAPE, PACKING PAPER, PLASTIC PACKAGING OR CUSHIONING MATERIAL THAT CONTAINS ENCAPSULATED AIR CELLS; PROVIDING WEBSITE CONTAINING INFORMATION IN THE FIELD OF RELOCATION SERVICES, NAMELY, PROVIDING INFORMATION ABOUT RELOCATION AND PROVIDING LINKS IN THE FIELD OF RELOCATION; FRANCHISE SERVICES, NAMELY, OFFERING TECHNICAL ASSISTANCE IN THE

ESTABLISHMENT AND/OR OPERATION OF RELOCATION SERVICES BUSINESSES, IN CLASS 35 (U.S. CLS. 100, 101 AND 102).

FIRST USE 6-20-1996; IN COMMERCE 9-15-1996.

FOR: PACKING AND UNPACKING ARTICLES FOR TRANSPORTATION, IN CLASS 39 (U.S. CLS. 100 AND 105).

FIRST USE 6-20-1996; IN COMMERCE 9-15-1996.

THE MARK CONSISTS OF STANDARD CHARACTERS WITHOUT CLAIM TO ANY PARTICULAR FONT, STYLE, SIZE, OR COLOR.

NO CLAIM IS MADE TO THE EXCLUSIVE RIGHT TO USE "MOVING", APART FROM THE MARK AS SHOWN.

SER. NO. 78-615,009, FILED 4-22-2005.

MARK SPARACINO, EXAMINING ATTORNEY

**Int. Cl.: 12**

**Prior U.S. Cls.: 19, 21, 23, 31, 35 and 44**

**Reg. No. 3,570,090**

**United States Patent and Trademark Office**

**Registered Feb. 3, 2009**

**TRADEMARK  
PRINCIPAL REGISTER**

**BLIZZARD**

BOMBARDIER RECREATIONAL PRODUCTS  
INC. (CANADA CORPORATION)  
726 ST-JOSEPH STREET  
VALCOURT, CANADA J0E2L0

FOR: RECREATIONAL VEHICLES, NAMELY,  
SNOWMOBILES AND STRUCTURAL PARTS  
THEREOF, IN CLASS 12 (U.S. CLS. 19, 21, 23, 31, 35  
AND 44).

THE MARK CONSISTS OF STANDARD CHAR-  
ACTERS WITHOUT CLAIM TO ANY PARTICULAR  
FONT, STYLE, SIZE, OR COLOR.

OWNER OF CANADA REG. NO. TMA182499,  
DATED 4-14-1972, EXPIRES 4-14-2017.

SER. NO. 78-638,730, FILED 5-27-2005.

INGA ERVIN, EXAMINING ATTORNEY



**Int. Cl.: 17**

**Prior U.S. Cls.: 1, 5, 12, 13, 35 and 50**

**Reg. No. 3,570,091**

**United States Patent and Trademark Office**

**Registered Feb. 3, 2009**

**TRADEMARK  
PRINCIPAL REGISTER**



AT FILMS INC. (CANADA CORPORATION)  
2507, 10088-102 AVENUE  
EDMONTON, ALBERTA, CANADA T5J 2K1

2005, REG. NO. TMA717596, DATED 6-27-2008, EXPIRES 6-27-2023.

FOR: POLYETHYLENE FILM FOR USE IN CONSTRUCTING GREENHOUSES, IN CLASS 17 (U.S. CLS. 1, 5, 12, 13, 35 AND 50).

NO CLAIM IS MADE TO THE EXCLUSIVE RIGHT TO USE "WITH CONDENSATION CONTROL", APART FROM THE MARK AS SHOWN.

SER. NO. 78-644,652, FILED 6-6-2005.

PRIORITY CLAIMED UNDER SEC. 44(D) ON CANADA APPLICATION NO. 1259562, FILED 6-1-

LESLIE RICHARDS, EXAMINING ATTORNEY

**Int. Cls.: 4, 9 and 17**

**Prior U.S. Cls.: 1, 5, 6, 12, 13, 15, 21, 23, 26, 35, 36, 38  
and 50**

**Reg. No. 3,570,092**

**United States Patent and Trademark Office**

**Registered Feb. 3, 2009**

**TRADEMARK  
PRINCIPAL REGISTER**

**eINano**

ELECTOVAC AG (AUSTRIA JOINT STOCK COMPANY)  
AUFELDGASSE 37-39  
KLOSTERNEUBURG, AUSTRIA 3400

FOR: THERMALLY CONDUCTING GREASE FOR INDUSTRIAL USE, IN CLASS 4 (U.S. CLS. 1, 6 AND 15).

FOR: THERMALLY CONDUCTING PADS FOR USE AS HEAT SINKS IN ELECTRONIC EQUIPMENT, IN CLASS 9 (U.S. CLS. 21, 23, 26, 36 AND 38).

FOR: THERMALLY CONDUCTING ADHESIVE TAPE FOR INDUSTRIAL AND COMMERCIAL USE;

THERMALLY CONDUCTING PLASTIC FOILS, IN CLASS 17 (U.S. CLS. 1, 5, 12, 13, 35 AND 50).

THE MARK CONSISTS OF STANDARD CHARACTERS WITHOUT CLAIM TO ANY PARTICULAR FONT, STYLE, SIZE, OR COLOR.

PRIORITY CLAIMED UNDER SEC. 44(D) ON ERPN CMNTY TM OFC APPLICATION NO. 004450318, FILED 6-17-2005, REG. NO. 004450318, DATED 6-17-2005, EXPIRES 6-17-2015.

SER. NO. 78-653,143, FILED 6-17-2005.

MARK SPARACINO, EXAMINING ATTORNEY

**Int. Cl.: 25**

**Prior U.S. Cls.: 22 and 39**

**United States Patent and Trademark Office**

**Reg. No. 3,570,093**

**Registered Feb. 3, 2009**

**TRADEMARK  
PRINCIPAL REGISTER**

**RS SURF**

CREATIVE WRAPS, INC. (NEW JERSEY CORPORATION)  
600 KENNEDY BOULEVARD  
SOMERDALE, NJ 08083

FOR: MEN'S, WOMEN'S AND CHILDREN'S CLOTHING, NAMELY, SHIRTS, SHORTS, TOPS, HATS, BATHING SUITS AND SWIMWEAR, IN CLASS 25 (U.S. CLS. 22 AND 39).

FIRST USE 3-1-2005; IN COMMERCE 3-1-2005.

THE MARK CONSISTS OF STANDARD CHARACTERS WITHOUT CLAIM TO ANY PARTICULAR FONT, STYLE, SIZE, OR COLOR.

NO CLAIM IS MADE TO THE EXCLUSIVE RIGHT TO USE "SURF", APART FROM THE MARK AS SHOWN.

SER. NO. 78-667,547, FILED 7-11-2005.

BILL DAWE, EXAMINING ATTORNEY

**Int. Cl.: 36**

**Prior U.S. Cls.: 100, 101 and 102**

**United States Patent and Trademark Office**

**Reg. No. 3,570,094**

**Registered Feb. 3, 2009**

**SERVICE MARK  
PRINCIPAL REGISTER**

**URBAN BLUEPRINT**

WELLINGTON MANAGEMENT, INC. (MINNESOTA CORPORATION)  
1625 ENERGY PARK DRIVE, SUITE 100  
SAINT PAUL, MN 55108

FOR: REAL ESTATE SERVICES, NAMELY, REAL ESTATE AGENCIES, REAL ESTATE BROKERAGE, REAL ESTATE CONSULTATION, REAL ESTATE LISTING, REAL ESTATE MANAGEMENT AND REAL ESTATE VALUATION SERVICES, IN CLASS 36 (U.S. CLS. 100, 101 AND 102).

FIRST USE 7-31-2005; IN COMMERCE 7-31-2005.

THE MARK CONSISTS OF STANDARD CHARACTERS WITHOUT CLAIM TO ANY PARTICULAR FONT, STYLE, SIZE, OR COLOR.

NO CLAIM IS MADE TO THE EXCLUSIVE RIGHT TO USE "URBAN", APART FROM THE MARK AS SHOWN.

SER. NO. 78-668,879, FILED 7-12-2005.

WILLIAM BRECKENFELD, EXAMINING ATTORNEY

**Int. Cl.: 9**

**Prior U.S. Cls.: 21, 23, 26, 36 and 38**

**Reg. No. 3,570,095**

**United States Patent and Trademark Office**

**Registered Feb. 3, 2009**

**TRADEMARK  
PRINCIPAL REGISTER**

**TOP MONKEY**

ARISTOCRAT TECHNOLOGIES AUSTRALIA  
PTY LTD (AUSTRALIA LIMITED LIABILITY  
COMPANY)  
71 LONGUEVILLE ROAD  
LANE COVE, NEW SOUTH WALES, AUSTRALIA  
2066

FOR: GAMING DEVICES, NAMELY, GAMING  
MACHINES AND COMPUTER SOFTWARE USED  
THEREWITH TO ENABLE THE GAMING MA-  
CHINE TO RUN , IN CLASS 9 (U.S. CLS. 21, 23, 26,  
36 AND 38).

THE MARK CONSISTS OF STANDARD CHAR-  
ACTERS WITHOUT CLAIM TO ANY PARTICULAR  
FONT, STYLE, SIZE, OR COLOR.

OWNER OF AUSTRALIA REG. NO. 1135576,  
DATED 9-14-2006, EXPIRES 9-14-2016.

SER. NO. 78-669,869, FILED 7-13-2005.

SUSAN RICHARDS, EXAMINING ATTORNEY

**Int. Cl.: 10**

**Prior U.S. Cls.: 26, 39 and 44**

**Reg. No. 3,570,096**

**United States Patent and Trademark Office**

**Registered Feb. 3, 2009**

**TRADEMARK  
PRINCIPAL REGISTER**

**VIPER**

DEPUY, INC. (DELAWARE CORPORATION)  
700 ORTHOPAEDIC DRIVE  
WARSAW, IN 46581

FOR: SPINAL IMPLANTS NOT COMPOSED OF  
LIVING TISSUE, SURGICAL INSTRUMENTS FOR  
USE IN SPINAL SURGERY, IN CLASS 10 (U.S. CLS.  
26, 39 AND 44).

FIRST USE 0-0-2005; IN COMMERCE 0-0-2005.

THE MARK CONSISTS OF STANDARD CHAR-  
ACTERS WITHOUT CLAIM TO ANY PARTICULAR  
FONT, STYLE, SIZE, OR COLOR.

PRIORITY CLAIMED UNDER SEC. 44(D) ON  
SOUTH AFRICA APPLICATION NO. 2005/08623,  
FILED 5-3-2005.

SER. NO. 78-693,219, FILED 8-16-2005.

KIMBERLY PERRY, EXAMINING ATTORNEY

**Int. Cls.: 6 and 9**

**Prior U.S. Cls.: 2, 12, 13, 14, 21, 23, 25, 26, 36, 38 and 50**

**Reg. No. 3,570,097**

**United States Patent and Trademark Office**

**Registered Feb. 3, 2009**

**TRADEMARK  
PRINCIPAL REGISTER**

**ROADID**

WIMMER, EDWARD III (UNITED STATES INDIVIDUAL)

221 GRANDVIEW DRIVE  
FORT MITCHELL, KY 41707 AND

WIMMER, EDWARD IV (UNITED STATES INDIVIDUAL)

221 GRANDVIEW DRIVE  
FORT MITCHELL, KY 41017

FOR: METAL IDENTIFICATION BRACELETS, ANKLETS, BANDS AND TAGS, IN CLASS 6 (U.S. CLS. 2, 12, 13, 14, 23, 25 AND 50).

FIRST USE 2-1-2001; IN COMMERCE 2-1-2001.

FOR: SAFETY PRODUCTS, NAMELY, WEARABLE REFLECTIVE SAFETY LIGHTS; REFLEC-

TIVE CLOTHING FOR SAFETY PURPOSES, NAMELY, BELTS, WRIST BANDS, ANKLE BANDS, IN CLASS 9 (U.S. CLS. 21, 23, 26, 36 AND 38).

FIRST USE 2-1-2001; IN COMMERCE 2-1-2001.

THE MARK CONSISTS OF STANDARD CHARACTERS WITHOUT CLAIM TO ANY PARTICULAR FONT, STYLE, SIZE, OR COLOR.

OWNER OF U.S. REG. NO. 2,674,160.

SER. NO. 78-709,618, FILED 9-9-2005.

REBECCA EISINGER, EXAMINING ATTORNEY

**Int. Cl.: 5**

**Prior U.S. Cls.: 6, 18, 44, 46, 51 and 52**

**Reg. No. 3,570,098**

**United States Patent and Trademark Office**

**Registered Feb. 3, 2009**

---

**TRADEMARK  
PRINCIPAL REGISTER**

**ORA MUNE**

SAID YODIM D/B/A IMMUNE THERAPY RE-  
SEARCH LABORATORY (UNITED STATES  
INDIVIDUAL)  
1640 S. BENTLEY AVENUE #3  
LOS ANGELES, CA 90025

FOR: DIETARY SUPPLEMENTS, IN CLASS 5 (U.S.  
CLS. 6, 18, 44, 46, 51 AND 52).

FIRST USE 6-0-2000; IN COMMERCE 6-0-2000.

THE MARK CONSISTS OF STANDARD CHAR-  
ACTERS WITHOUT CLAIM TO ANY PARTICULAR  
FONT, STYLE, SIZE, OR COLOR.

SER. NO. 78-717,043, FILED 9-20-2005.

MARTHA SANTOMARTINO, EXAMINING ATTOR-  
NEY



**Int. Cl.: 9**

**Prior U.S. Cls.: 21, 23, 26, 36 and 38**

**Reg. No. 3,570,099**

**United States Patent and Trademark Office**

**Registered Feb. 3, 2009**

---

**TRADEMARK  
PRINCIPAL REGISTER**

**SCIP**

MICRODASYS, INC. (NEVADA CORPORATION)  
SUITE A  
385 PILOT ROAD  
LAS VEGAS, NV 89119

FOR: COMPUTER SOFTWARE FOR ENCRYPTED CONTENT SECURITY, NAMELY, FOR USE TO SECURE COMPUTER NETWORKS FROM ATTACK BY ENCRYPTED WEB TRAFFIC, IN CLASS 9 (U.S. CLS. 21, 23, 26, 36 AND 38).

FIRST USE 3-21-2002; IN COMMERCE 3-21-2002.

THE MARK CONSISTS OF STANDARD CHARACTERS WITHOUT CLAIM TO ANY PARTICULAR FONT, STYLE, SIZE, OR COLOR.

SER. NO. 78-732,577, FILED 10-13-2005.

REBECCA SMITH, EXAMINING ATTORNEY

**Int. Cl.: 35**

**Prior U.S. Cls.: 100, 101 and 102**

**United States Patent and Trademark Office**

**Reg. No. 3,570,100**

**Registered Feb. 3, 2009**

**SERVICE MARK  
PRINCIPAL REGISTER**

**MARIA PIA**

SHENANDOAH TRADING CO., LTD. (TAIWAN CORPORATION)  
NO. 40, ZHOH SHI, DIN SHI LI  
HUWET TOWN, YUU LIN HSIEN, TAIWAN

FOR: IMPORT AND EXPORT AGENCIES; SALE PROMOTION FOR OTHERS; RETAIL STORE, COMPUTERIZED ONLINE RETAIL ORDERING AND RETAIL DISTRIBUTORSHIP SERVICES ALL FEATURING TRAVELING BAGS, TRUNKS, HANDBAGS, ATTACHE CASES, UMBRELLAS, PARASOLS, SUITS, JACKETS, DRESSES, SKIRTS, UNDERWEAR, SWIMSUITS, T-SHIRTS, PARKAS, SPORTS UNIFORMS, SHORTS, SHOES, BOOTS, SPORTS SHOES, SANDALS, HATS, SOCKS, GLOVES, BELTS, TIES AND NECKERCHIEFS, IN CLASS 35 (U.S. CLS. 100, 101 AND 102).

THE MARK CONSISTS OF STANDARD CHARACTERS WITHOUT CLAIM TO ANY PARTICULAR FONT, STYLE, SIZE, OR COLOR.

OWNER OF TAIWAN REG. NO. 01226980, DATED 9-1-2006, EXPIRES 8-31-2016.

"THE NAME(S), PORTRAIT(S), AND/OR SIGNATURE(S) SHOWN IN THE MARK DOES NOT IDENTIFY A PARTICULAR LIVING INDIVIDUAL."

SER. NO. 78-780,961, FILED 12-27-2005.

NORA BUCHANAN WILL, EXAMINING ATTORNEY

**Int. Cl.: 37**

**Prior U.S. Cls.: 100, 103 and 106**

**Reg. No. 3,570,101**

**United States Patent and Trademark Office**

**Registered Feb. 3, 2009**

---

**SERVICE MARK  
PRINCIPAL REGISTER**

**RELM**

THE MORIARTY CORPORATION (CONNECTI-  
CUT CORPORATION)  
SUITE 204  
90 MAIN STREET  
CENTERBROOK, CT 06409

THE MARK CONSISTS OF STANDARD CHAR-  
ACTERS WITHOUT CLAIM TO ANY PARTICULAR  
FONT, STYLE, SIZE, OR COLOR.

FOR: ROOF INSPECTION AND ROOF MAINTENANCE SERVICES, IN CLASS 37 (U.S. CLS. 100, 103 AND 106).

SER. NO. 78-788,233, FILED 1-10-2006.

FIRST USE 10-1-1990; IN COMMERCE 10-1-1990.

TINA BROWN, EXAMINING ATTORNEY

**Int. Cl.: 20**

**Prior U.S. Cls.: 2, 13, 22, 25, 32 and 50**

**United States Patent and Trademark Office**

**Reg. No. 3,570,102**

**Registered Feb. 3, 2009**

**TRADEMARK  
PRINCIPAL REGISTER**

**CUMBERLAND VALLEY**

DAVIS CABINET COMPANY (TENNESSEE CORPORATION)  
P.O BOX 60444  
NASHVILLE, TN 37206

FOR: FURNITURE, NAMELY, DRESSERS; CHESTS; MIRRORS; BEDS; NIGHT TABLES; LIN-  
GERIE CHESTS; DINING ROOM PIECES, NAMELY,  
SIDE AND ARM CHAIRS; HOME OFFICE PIECES,  
NAMELY, CHAIRS; OCCASIONAL PIECES, NAME-  
LY SIDE TABLES, END TABLES, COFFEE TABLES  
AND ETAGERES; ALL OF THE AREMENTIONED  
GOODS BEING EXCLUSIVE OF KITCHEN CABI-  
NETS AND BATHROOM CABINETS AND BEING

FURNITURE, IN CLASS 20 (U.S. CLS. 2, 13, 22, 25, 32  
AND 50).

FIRST USE 12-31-1936; IN COMMERCE 12-31-1936.

THE MARK CONSISTS OF STANDARD CHAR-  
ACTERS WITHOUT CLAIM TO ANY PARTICULAR  
FONT, STYLE, SIZE, OR COLOR.

SER. NO. 78-791,594, FILED 1-13-2006.

TRACY WHITTAKER-BROWN, EXAMINING AT-  
TORNEY

**Int. Cl.: 36**

**Prior U.S. Cls.: 100, 101 and 102**

**United States Patent and Trademark Office**

**Reg. No. 3,570,103**

**Registered Feb. 3, 2009**

**SERVICE MARK  
PRINCIPAL REGISTER**

**GOOGLE**

GOOGLE INC. (DELAWARE CORPORATION)  
1600 AMPHITHEATRE PARKWAY  
MOUNTAIN VIEW, CA 94043

FOR: CHARITABLE FUNDRAISING; PROVIDING GRANTS TO CHARITABLE ORGANIZATIONS; FINANCIAL SERVICES, NAMELY, PROVIDING STOCK, BOND, COMMODITY, INDEX, FUTURES, OPTIONS, SECURITIES, AND CURRENCY PRICES AND MARKET INFORMATION; FINANCIAL SERVICES, NAMELY, PROVIDING A WEB SITE WITH INFORMATION CONCERNING STOCKS, BONDS, COMMODITIES, INDEXES, FUTURES, OPTIONS, SECURITIES, AND CURRENCY PRICES, AND WHERE USERS CAN POST RATINGS, REVIEWS AND RECOMMENDATIONS ON THE SAME; FINANCIAL TRANSACTION PROCESSING SERVI-

CES, NAMELY, CLEARING AND RECONCILING FINANCIAL TRANSACTIONS VIA A GLOBAL COMPUTER NETWORK; BILL PAYMENT SERVICES, IN CLASS 36 (U.S. CLS. 100, 101 AND 102).

FIRST USE 4-1-2003; IN COMMERCE 4-1-2003.

THE MARK CONSISTS OF STANDARD CHARACTERS WITHOUT CLAIM TO ANY PARTICULAR FONT, STYLE, SIZE, OR COLOR.

OWNER OF U.S. REG. NOS. 2,806,075, 2,884,502, AND 2,954,071.

SER. NO. 78-828,053, FILED 3-2-2006.

COLLEEN KEARNEY, EXAMINING ATTORNEY

**Int. Cl.: 29**

**Prior U.S. Cl.: 46**

**United States Patent and Trademark Office**

**Reg. No. 3,570,104**

**Registered Feb. 3, 2009**

**TRADEMARK  
PRINCIPAL REGISTER**

**SANDWICH'IN**

NEPTUNE (FRANCE CORPORATION)  
42 RUE RIEUSSEC  
VIROFLAY, FRANCE 78220

FOR: MEAT, FISH (NOT LIVE), CULINARY PREPARATIONS BASED ON FISH, POULTRY AND GAME, NAMELY, PREPARED OR PACKAGED ENTREES AND MEALS CONSISTING PRIMARILY OF FISH, POULTRY AND GAME; MEAT EXTRACTS; EGGS; PROCESSED SOYA BEANS AND PROCESSED SOYA SPROUTS, IN CLASS 29 (U.S. CL. 46).

THE MARK CONSISTS OF STANDARD CHARACTERS WITHOUT CLAIM TO ANY PARTICULAR FONT, STYLE, SIZE, OR COLOR.

OWNER OF FRANCE REG. NO. 97703024, DATED 11-4-1997, EXPIRES 11-4-2017.

OWNER OF U.S. REG. NO. 2,315,575.

SER. NO. 78-828,693, FILED 3-3-2006.

KATHY DE JONGE, EXAMINING ATTORNEY

**Int. Cl.: 36**

**Prior U.S. Cls.: 100, 101 and 102**

**United States Patent and Trademark Office**

**Reg. No. 3,570,105**

**Registered Feb. 3, 2009**

**SERVICE MARK  
PRINCIPAL REGISTER**

**CORE<sub>plus</sub>**

COREPLUS MMGP, L.L.C. (DELAWARE LIMITED LIABILITY COMPANY)  
10 SOUTH WACKER DRIVE  
CHICAGO, IL 60606

FOR: INVESTMENT SERVICES, NAMELY, FORMATION AND MANAGEMENT OF PRIVATE EQUITY FUNDS; PROVIDING INVESTMENT ADVICE

TO PRIVATE EQUITY FUNDS AND OTHERS , IN CLASS 36 (U.S. CLS. 100, 101 AND 102).

FIRST USE 3-0-2001; IN COMMERCE 3-0-2001.

SER. NO. 78-832,480, FILED 3-8-2006.

SHAUNIA CARLYLE, EXAMINING ATTORNEY

**Int. Cl.: 33**

**Prior U.S. Cls.: 47 and 49**

**United States Patent and Trademark Office**

**Reg. No. 3,570,106**

**Registered Feb. 3, 2009**

**TRADEMARK  
PRINCIPAL REGISTER**

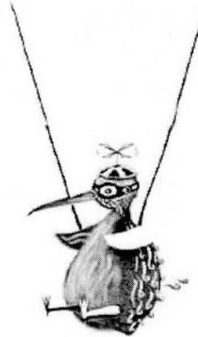

M J MUNDY LIMITED (NEW ZEALAND CORPORATION)  
COUTTS ISLAND ROAD  
CHRISTCHURCH, NEW ZEALAND

FOR: WINE, IN CLASS 33 (U.S. CLS. 47 AND 49).

OWNER OF NEW ZEALAND REG. NO. 780335,  
DATED 5-29-2008, EXPIRES 5-29-2018.

THE MARK CONSISTS OF THE PICTORIAL DESIGN OF A FLYING KIWI BIRD.

SER. NO. 78-833,842, FILED 3-9-2006.

SUSAN STIGLITZ, EXAMINING ATTORNEY



**Int. Cls.: 9 and 36**

**Prior U.S. Cls.: 21, 23, 26, 36, 38, 100, 101 and 102**

**United States Patent and Trademark Office**

**Reg. No. 3,570,107**

**Registered Feb. 3, 2009**

**TRADEMARK  
SERVICE MARK  
PRINCIPAL REGISTER**

**ALL-IN-1 ATM**

CASH SYSTEMS, INC. (DELAWARE CORPORATION)  
7350 DEAN MARTIN DRIVE, STE. 309  
LAS VEGAS, NV 89139

FOR: AUTOMATED TELLER MACHINES FOR DISPENSING CASH AND CONDUCTING FINANCIAL TRANSACTIONS OFFERED IN CASINOS AND OTHER PLACES FOR GAMING, IN CLASS 9 (U.S. CLS. 21, 23, 26, 36 AND 38).

FIRST USE 3-31-2002; IN COMMERCE 3-31-2002.

FOR: FINANCIAL SERVICES, NAMELY, CASH DISPENSING, CURRENCY EXCHANGE, CHECK CASHING, MONEY WIRE TRANSFERS, CASH ADVANCE, DEBIT AND DEPOSITS, ALL OFFERED IN

CASINOS AND OTHER PLACES FOR GAMING, IN CLASS 36 (U.S. CLS. 100, 101 AND 102).

FIRST USE 3-31-2002; IN COMMERCE 3-31-2002.

THE MARK CONSISTS OF STANDARD CHARACTERS WITHOUT CLAIM TO ANY PARTICULAR FONT, STYLE, SIZE, OR COLOR.

NO CLAIM IS MADE TO THE EXCLUSIVE RIGHT TO USE "ATM", APART FROM THE MARK AS SHOWN.

SER. NO. 78-839,852, FILED 3-17-2006.

ARETHA SOMERVILLE, EXAMINING ATTORNEY

**Int. Cls.: 4, 36, 37 and 42**

**Prior U.S. Cls.: 1, 6, 15, 100, 101, 102, 103 and 106**

**Reg. No. 3,570,108**

**United States Patent and Trademark Office**

**Registered Feb. 3, 2009**

**TRADEMARK  
SERVICE MARK  
PRINCIPAL REGISTER**

**ANADARKO ENERGY SERVICES**

ANADARKO PETROLEUM CORPORATION (DELAWARE CORPORATION)  
P.O. BOX 1330  
HOUSTON, TX 772511330

FOR: LUBRICANTS AND FUELS, NAMELY, OIL, NATURAL GAS AND LIQUID NATURAL GAS; INDUSTRIAL OILS AND GREASES; DUST-BINDING COMPOSITIONS; MOTOR OILS AND MOTOR FUELS, NAMELY, GASOLINE AND DIESEL MOTOR FUELS, IN CLASS 4 (U.S. CLS. 1, 6 AND 15).

FOR: INSURANCE AND FINANCIAL SERVICES, NAMELY, SERVICES RENDERED IN FINANCIAL AND MONETARY AFFAIRS, NAMELY, FINANCIAL MANAGEMENT AND SERVICES RENDERED IN RELATION TO INSURANCE AND ESCROW CONTRACTS, NAMELY, MAINTAINING ESCROW ACCOUNTS FOR INVESTMENTS; SERVICES OF AN INVESTMENT TRUST, AND OF A HOLDING COMPANY, NAMELY, HOLDING, ESCROW, AND TRUST SERVICES; BROKERAGE SERVICES DEALING IN SHARES OF REAL PROPERTY; SERVICES CONNECTED WITH MONETARY AFFAIRS VOUCHERED FOR BY TRUSTEES, NAMELY, TRUSTEESHIP REPRESENTATIVES; AND SERVICES RENDERED IN CONNECTION WITH THE ISSUANCE, RECEIPT AND TRANSFER OF LINES OF CREDIT, NAMELY, HOLDING, ESCROW, TRUST AND CREDIT PROCESSING SERVICES; RENTAL OF SHOP AND WORK SPACE, IN CLASS 36 (U.S. CLS. 100, 101 AND 102).

FOR: BUILDING CONSTRUCTION AND REPAIR, NAMELY, BUILDING, CONSTRUCTION, MAINTENANCE AND REPAIR OF BUILDINGS USED IN THE FIELDS OF ENERGY EXPLORATION AND PRODUCTION; SERVICES RENDERED BY INDIVIDUALS OR ORGANIZATIONS, NAMELY, RESTORATION OF THE ENVIRONMENT, NAMELY, THE PHYSICAL LOCATIONS OF EXPLORA-

TION AND DRILLING PROJECTS, TO THEIR ORIGINAL CONDITION, AND IN THEIR PRESERVATION WITHOUT ALTERING THEIR PHYSICAL PROPERTIES; SERVICES AUXILIARY TO CONSTRUCTION SERVICES, NAMELY, INSPECTION OF CONSTRUCTION SITES; MAINTENANCE AND REPAIR OF SHIPS AND OTHER SEA VESSELS, NAMELY, WATER-BORNE MODULAR EXPLORATION AND PRODUCTION SYSTEMS; RENTAL OF ENERGY EXPLORATION AND PRODUCTION POWER TOOLS AND BUILDING MATERIALS, NAMELY, CONSTRUCTION EQUIPMENT, IN CLASS 37 (U.S. CLS. 100, 103 AND 106).

FOR: COMPUTER, SCIENTIFIC AND LEGAL SERVICES, NAMELY, SERVICES RENDERED BY PERSONS, BOTH INDIVIDUALLY AND COLLECTIVELY, RELATING TO THE THEORETICAL AND PRACTICAL ASPECTS OF COMPLEX FIELDS OF ACTIVITIES, NAMELY, LEGAL SERVICES, ENGINEERING, COMPUTER CONSULTATION, CHEMIST SERVICES, PHYSICISTS SERVICES, NAMELY, RESEARCH IN THE FIELDS OF OCEANOGRAPHY, PHYSICS AND GEOPHYSICS, ALL IN THE FIELDS OF ENERGY EXPLORATION AND PRODUCTION; SERVICES AUXILIARY TO CONSTRUCTION SERVICES, NAMELY, INSPECTION OF CONSTRUCTION PLANS, IN CLASS 42 (U.S. CLS. 100 AND 101).

THE MARK CONSISTS OF STANDARD CHARACTERS WITHOUT CLAIM TO ANY PARTICULAR FONT, STYLE, SIZE, OR COLOR.

PRIORITY CLAIMED UNDER SEC. 44(D) ON ERPN CMNTY TM OFC APPLICATION NO. 004944211, FILED 3-3-2006, REG. NO. 004944211, DATED 8-31-2007, EXPIRES 3-3-2016.

OWNER OF U.S. REG. NO. 1,435,026.

NO CLAIM IS MADE TO THE EXCLUSIVE  
RIGHT TO USE "ENERGY SERVICES", APART  
FROM THE MARK AS SHOWN.

SER. NO. 78-841,173, FILED 3-20-2006.

SEC. 2(F) AS TO "ANADARKO".

ALEX KEAM, EXAMINING ATTORNEY

**Int. Cls.: 4, 36, 37 and 42**

**Prior U.S. Cls.: 1, 6, 15, 100, 101, 102, 103 and 106**

**United States Patent and Trademark Office**

**Reg. No. 3,570,109**

**Registered Feb. 3, 2009**

**TRADEMARK  
SERVICE MARK  
PRINCIPAL REGISTER**

ANADARKO GATHERING COMPANY

ANADARKO PETROLEUM CORPORATION (DE-  
LAWARE CORPORATION)  
P.O. BOX 1330  
HOUSTON, TX 772511330

FOR: LUBRICANTS AND FUELS, NAMELY, OIL,  
NATURAL GAS AND LIQUID NATURAL GAS;  
INDUSTRIAL OILS AND GREASES; DUST-BIND-  
ING COMPOSITIONS; MOTOR OILS AND MOTOR  
FUELS, NAMELY, GASOLINE AND DIESEL MO-  
TOR FUELS, IN CLASS 4 (U.S. CLS. 1, 6 AND 15).

FOR: INSURANCE AND FINANCIAL SERVICES,  
NAMELY, SERVICES RENDERED IN FINANCIAL  
AND MONETARY AFFAIRS, NAMELY, FINAN-  
CIAL MANAGEMENT AND SERVICES RENDERED  
IN RELATION TO INSURANCE AND ESCROW  
CONTRACTS, NAMELY, MAINTAINING ESCROW  
ACCOUNTS FOR INVESTMENTS; SERVICES OF  
AN INVESTMENT TRUST, AND OF A HOLDING  
COMPANY, NAMELY, HOLDING, ESCROW, AND  
TRUST SERVICES; BROKERAGE SERVICES DEAL-  
ING IN SHARES OF REAL PROPERTY; SERVICES  
CONNECTED WITH MONETARY AFFAIRS VOU-  
CHED FOR BY TRUSTEES, NAMELY, TRUSTEE-  
SHIP REPRESENTATIVES; AND SERVICES  
RENDERED IN CONNECTION WITH THE ISSU-  
ANCE, RECEIPT AND TRANSFER OF LINES OF  
CREDIT, NAMELY, HOLDING, ESCROW, TRUST  
AND CREDIT PROCESSING SERVICES; RENTAL  
OF SHOP AND WORK SPACE, IN CLASS 36 (U.S.  
CLS. 100, 101 AND 102).

FOR: BUILDING CONSTRUCTION AND RE-  
PAIR, NAMELY, BUILDING, CONSTRUCTION,  
MAINTENANCE AND REPAIR OF BUILDINGS  
USED IN THE FIELDS OF ENERGY EXPLORATION  
AND PRODUCTION; SERVICES RENDERED BY  
INDIVIDUALS OR ORGANIZATIONS, NAMELY,  
RESTORATION OF THE ENVIRONMENT, NAME-  
LY, THE PHYSICAL LOCATIONS OF EXPLORA-

TION AND DRILLING PROJECTS, TO THEIR  
ORIGINAL CONDITION, AND IN THEIR PRESER-  
VATION WITHOUT ALTERING THEIR PHYSICAL  
PROPERTIES; SERVICES AUXILIARY TO CON-  
STRUCTION SERVICES, NAMELY, INSPECTION  
OF CONSTRUCTION SITES; MAINTENANCE AND  
REPAIR OF SHIPS AND OTHER SEA VESSELS,  
NAMELY, WATER-BORNE MODULAR EXPLORA-  
TION AND PRODUCTION SYSTEMS; RENTAL OF  
ENERGY EXPLORATION AND PRODUCTION  
POWER TOOLS AND BUILDING MATERIALS,  
NAMELY, CONSTRUCTION EQUIPMENT, IN  
CLASS 37 (U.S. CLS. 100, 103 AND 106).

FOR: COMPUTER, SCIENTIFIC AND LEGAL  
SERVICES, NAMELY, SERVICES RENDERED BY  
PERSONS, BOTH INDIVIDUALLY AND COLLEC-  
TIVELY, RELATING TO THE THEORETICAL AND  
PRACTICAL ASPECTS OF COMPLEX FIELDS OF  
ACTIVITIES, NAMELY, LEGAL SERVICES, ENGI-  
NEERING, COMPUTER CONSULTATION, CHE-  
MIST SERVICES, PHYSICISTS SERVICES,  
NAMELY, RESEARCH IN THE FIELDS OF OCEA-  
NOGRAPHY, PHYSICS AND GEOPHYSICS, ALL IN  
THE FIELDS OF ENERGY EXPLORATION AND  
PRODUCTION; SERVICES AUXILIARY TO CON-  
STRUCTION SERVICES, NAMELY, INSPECTION  
OF CONSTRUCTION PLANS, IN CLASS 42 (U.S.  
CLS. 100 AND 101).

THE MARK CONSISTS OF STANDARD CHAR-  
ACTERS WITHOUT CLAIM TO ANY PARTICULAR  
FONT, STYLE, SIZE, OR COLOR.

PRIORITY CLAIMED UNDER SEC. 44(D) ON  
ERPN CMNTY TM OFC APPLICATION NO.  
004944542, FILED 3-3-2006, REG. NO. 004944542,  
DATED 8-30-2007, EXPIRES 3-3-2016.

OWNER OF U.S. REG. NO. 1,435,026.

NO CLAIM IS MADE TO THE EXCLUSIVE  
RIGHT TO USE "GATHERING COMPANY", APART  
FROM THE MARK AS SHOWN.

SER. NO. 78-841,209, FILED 3-20-2006.

SEC. 2(F) AS TO "ANADARKO".

ALEX KEAM, EXAMINING ATTORNEY

**Int. Cls.: 16, 35, 42, 43 and 44**

**Prior U.S. Cls.: 2, 5, 22, 23, 29, 37, 38, 50, 100, 101 and 102**

**Reg. No. 3,570,110**

**United States Patent and Trademark Office**

**Registered Feb. 3, 2009**

**TRADEMARK  
SERVICE MARK  
PRINCIPAL REGISTER**

# SPABOOM

SEVENCE, LLC (NEW MEXICO LIMITED LIABILITY COMPANY)  
ONE TECHNOLOGY CENTER  
1155 UNIVERSITY BLVD SE  
ALBUQUERQUE, NM 87106

FOR: PAPER PRODUCTS, NAMELY, PRINTED GIFT CERTIFICATES FOR USE AS PROMOTIONAL MATERIALS BY SPAS AND BEAUTY SALONS; GIFT CARDS, GIFT WRAPPING PAPER, WRITING PAPER, PRINTING PAPER, STATIONERY, NOTE-PADS, WRITING PADS; POST CARDS AND ENVELOPES, CORRESPONDENCE CARDS, MAILING ENVELOPES, BLANK NOTE CARDS SUITABLE FOR CUSTOMIZING PERSONAL MESSAGES; GREETING CARDS, PAPER BAGS, PAPER BOXES, PAPER LABELS, PAPER TAGS, INFORMATIONAL FLYERS FEATURING SPA OR SALON PRODUCTS OR SERVICES; POSTERS, AND PRINTED PAPER SIGNS, IN CLASS 16 (U.S. CLS. 2, 5, 22, 23, 29, 37, 38 AND 50).

FIRST USE 1-7-2005; IN COMMERCE 1-7-2005.

FOR: PROVIDING ADVERTISING AND MARKETING SERVICES TO THE SPA AND BEAUTY INDUSTRY; COLLECTING CONSUMER INFORMATION ABOUT SPA AND BEAUTY SERVICES OFFERED AT PARTICULAR LOCATIONS AND PROVIDING SUCH INFORMATION OVER A GLOBAL COMPUTER NETWORK; BUSINESS MARKET ANALYSIS SERVICES IN THE NATURE OF COLLECTING BUSINESS INFORMATION ABOUT SPA AND BEAUTY SERVICES OFFERED AT PARTICULAR LOCATIONS AND PROVIDING SUCH BUSINESS MARKETING ANALYSIS INFORMATION OVER A GLOBAL COMPUTER NETWORK; PROVIDING BUSINESS ANALYSIS OF CUSTOMER FEEDBACK MARKETING SURVEY INFORMATION REGARDING TREATMENTS PROVIDED BY

SPAS, BEAUTY SALONS AND OTHER PERSONAL CARE PROVIDERS OFFERING HEALTH OR COSMETIC TREATMENTS, IN CLASS 35 (U.S. CLS. 100, 101 AND 102).

FIRST USE 1-7-2005; IN COMMERCE 1-7-2005.

FOR: DEVELOPMENT OF WEB-BASED SOFTWARE FOR DELIVERY OF ELECTRONIC COMMERCE AND RELATED MARKETING SERVICES, IN CLASS 42 (U.S. CLS. 100 AND 101).

FIRST USE 1-7-2005; IN COMMERCE 1-7-2005.

FOR: MAKING OR REQUESTING RESERVATIONS FOR OTHERS FOR ACCOMMODATIONS AND MEALS AT HEALTH SPAS OR BEAUTY SALONS, OVER A GLOBAL COMPUTER NETWORK, IN CLASS 43 (U.S. CLS. 100 AND 101).

FIRST USE 1-7-2005; IN COMMERCE 1-7-2005.

FOR: PROVIDING SPA TREATMENT INFORMATION ABOUT THE AVAILABILITY OF SPA AND BEAUTY SERVICES AT PARTICULAR LOCATIONS AND MAKING RESERVATIONS FOR OTHERS FOR SUCH SPA TREATMENTS OR BEAUTY SERVICES OVER A GLOBAL COMPUTER NETWORK, IN CLASS 44 (U.S. CLS. 100 AND 101).

FIRST USE 1-7-2005; IN COMMERCE 1-7-2005.

THE MARK CONSISTS OF STANDARD CHARACTERS WITHOUT CLAIM TO ANY PARTICULAR FONT, STYLE, SIZE, OR COLOR.

SER. NO. 78-853,279, FILED 4-4-2006.

RUSS HERMAN, EXAMINING ATTORNEY

**Int. Cl.: 36**

**Prior U.S. Cls.: 100, 101 and 102**

**United States Patent and Trademark Office**

**Reg. No. 3,570,111**

**Registered Feb. 3, 2009**

**SERVICE MARK  
PRINCIPAL REGISTER**

ROCKHILL INSURANCE COMPANY

ROCKHILL INSURANCE COMPANY (ARIZONA  
CORPORATION)  
SUITE 411  
801 W. 47TH STREET  
KANSAS CITY, MO 64112

FOR: INSURANCE SERVICES, NAMELY, WRIT-  
ING PROPERTY AND CASUALTY INSURANCE, IN  
CLASS 36 (U.S. CLS. 100, 101 AND 102).

FIRST USE 8-12-2002; IN COMMERCE 8-12-2002.

THE MARK CONSISTS OF STANDARD CHAR-  
ACTERS WITHOUT CLAIM TO ANY PARTICULAR  
FONT, STYLE, SIZE, OR COLOR.

NO CLAIM IS MADE TO THE EXCLUSIVE  
RIGHT TO USE "INSURANCE COMPANY", APART  
FROM THE MARK AS SHOWN.

SER. NO. 78-856,020, FILED 4-6-2006.

ASMAT KHAN, EXAMINING ATTORNEY

**Int. Cl.: 41**

**Prior U.S. Cls.: 100, 101 and 107**

**United States Patent and Trademark Office**

**Reg. No. 3,570,112**

**Registered Feb. 3, 2009**

**SERVICE MARK  
PRINCIPAL REGISTER**

**TORREY PINES STATE BEACH**

THE STATE OF CALIFORNIA, DEPARTMENT  
OF PARKS AND RECREATION (CALIFORNIA  
STATE AGENCY)

P.O. BOX 942869

SACRAMENTO, CA 942960001

FOR: PROVIDING RECREATIONAL PARK SER-  
VICES AND DIRECTED TOURS OF A HISTORICAL  
SITE, IN CLASS 41 (U.S. CLS. 100, 101 AND 107).

FIRST USE 1-1-1958; IN COMMERCE 1-1-1958.

THE MARK CONSISTS OF STANDARD CHAR-  
ACTERS WITHOUT CLAIM TO ANY PARTICULAR  
FONT, STYLE, SIZE, OR COLOR.

NO CLAIM IS MADE TO THE EXCLUSIVE  
RIGHT TO USE "STATE BEACH", APART FROM  
THE MARK AS SHOWN.

SEC. 2(F).

SER. NO. 78-870,920, FILED 4-27-2006.

DARRYL SPRUILL, EXAMINING ATTORNEY



**Int. Cl.: 25**

**Prior U.S. Cls.: 22 and 39**

**United States Patent and Trademark Office**

**Reg. No. 3,570,113**

**Registered Feb. 3, 2009**

**TRADEMARK  
PRINCIPAL REGISTER**

**RED HEAD**

BASS PRO INTELLECTUAL PROPERTY, L.L.C.  
(UNITED STATES LIMITED LIABILITY COMPANY)  
2500 EAST KEARNEY STREET  
SPRINGFIELD, MO 65898

FOR: CLOTHING, NAMELY, JACKETS, PONCHOS, SWEATERS, SHIRTS, VESTS, HUNTING BIBS, THERMALS, PANTS, SHORTS, WADERS, SUSPENDERS, BELTS, GLOVES, AND COVERALLS, FOOTWEAR, AND HEADGEAR, NAMELY, HATS, CAPS, VISORS, EARBANDS, BALACLAVAS, BANDANAS, AND BEANIES, IN CLASS 25 (U.S. CLS. 22 AND 39).

FIRST USE 1-1-2000; IN COMMERCE 1-1-2000.

THE MARK CONSISTS OF STANDARD CHARACTERS WITHOUT CLAIM TO ANY PARTICULAR FONT, STYLE, SIZE, OR COLOR.

OWNER OF U.S. REG. NOS. 157,633, 1,264,756, AND 2,207,956.

SER. NO. 78-881,323, FILED 5-11-2006.

FLORENTINA BLANDU, EXAMINING ATTORNEY

**Int. Cl.: 36**

**Prior U.S. Cls.: 100, 101 and 102**

**United States Patent and Trademark Office**

**Reg. No. 3,570,114**

**Registered Feb. 3, 2009**

**SERVICE MARK  
PRINCIPAL REGISTER**



TRADITIONS CAPITAL, LLC (DELAWARE LIMITED LIABILITY COMPANY)  
ONE SAUCON VIEW DRIVE  
BETHLEHEM, PA 18015

FOR: COMMERCIAL FINANCIAL SERVICES, NAMELY, PROVIDING CUSTOMIZED LOANS AND INVESTMENT STRATEGIES FOR REAL ESTATE DEVELOPERS AND HOME BUILDERS, IN CLASS 36 (U.S. CLS. 100, 101 AND 102).

FIRST USE 1-9-2006; IN COMMERCE 1-9-2006.

NO CLAIM IS MADE TO THE EXCLUSIVE RIGHT TO USE "CAPITAL", APART FROM THE MARK AS SHOWN.

THE MARK CONSISTS OF "TRADITIONS CAPITAL" PRINTED TO THE RIGHT OF AN EAGLE IN A BOX.

SER. NO. 78-883,940, FILED 5-15-2006.

BENJAMIN OKEKE, EXAMINING ATTORNEY

**Int. Cl.: 36**

**Prior U.S. Cls.: 100, 101 and 102**

**United States Patent and Trademark Office**

**Reg. No. 3,570,115**

**Registered Feb. 3, 2009**

**SERVICE MARK  
PRINCIPAL REGISTER**

**TRADITIONS CAPITAL**

TRADITIONS CAPITAL, LLC (DELAWARE LIMITED LIABILITY COMPANY)  
ONE SAUCON VIEW DRIVE  
BETHLEHEM, PA 18015

FOR: COMMERCIAL FINANCIAL SERVICES, NAMELY, PROVIDING CUSTOMIZED LOANS AND INVESTMENT STRATEGIES FOR REAL ESTATE DEVELOPERS AND HOME BUILDERS, IN CLASS 36 (U.S. CLS. 100, 101 AND 102).

FIRST USE 1-9-2006; IN COMMERCE 1-9-2006.

THE MARK CONSISTS OF STANDARD CHARACTERS WITHOUT CLAIM TO ANY PARTICULAR FONT, STYLE, SIZE, OR COLOR.

NO CLAIM IS MADE TO THE EXCLUSIVE RIGHT TO USE "CAPITAL", APART FROM THE MARK AS SHOWN.

SER. NO. 78-883,946, FILED 5-15-2006.

BENJAMIN OKEKE, EXAMINING ATTORNEY

**Int. Cls.: 3 and 28**

**Prior U.S. Cls.: 1, 4, 6, 22, 23, 38, 50, 51 and 52**

**United States Patent and Trademark Office**

**Reg. No. 3,570,116**

**Registered Feb. 3, 2009**

**TRADEMARK  
PRINCIPAL REGISTER**

**ESP**

DEAD DOWN WIND, LLC (MISSOURI LIMITED  
LIABILITY COMPANY)  
7009 STEWART ROAD  
PLEASANT VALLEY, MO 64068

FOR: LAUNDRY DETERGENT; CLEANING PRE-  
PARATIONS FOR USE ON WOOL; SKIN SOAP FOR  
USE BY HUNTERS AND FISHERMEN TO REDUCE  
HUMAN SCENT; SHAMPOO AND BODY SPRAY  
FOR USE BY HUNTERS AND FISHERMEN TO  
REDUCE HUMAN SCENT, IN CLASS 3 (U.S. CLS. 1,  
4, 6, 50, 51 AND 52).

FIRST USE 12-27-2004; IN COMMERCE 12-27-2004.

FOR: HUNTER'S SCENT CAMOUFLAGE WHICH  
IMPEDES AND DISGUISES HUMAN ODOR, IN  
CLASS 28 (U.S. CLS. 22, 23, 38 AND 50).

FIRST USE 12-27-2004; IN COMMERCE 12-27-2004.

THE MARK CONSISTS OF STANDARD CHAR-  
ACTERS WITHOUT CLAIM TO ANY PARTICULAR  
FONT, STYLE, SIZE, OR COLOR.

SER. NO. 78-891,803, FILED 5-24-2006.

DAWN FELDMAN, EXAMINING ATTORNEY

**Int. Cl.: 35**

**Prior U.S. Cls.: 100, 101 and 102**

**United States Patent and Trademark Office**

**Reg. No. 3,570,117**

**Registered Feb. 3, 2009**

**SERVICE MARK  
PRINCIPAL REGISTER**

**HUSH BABY**

HUSH BABY, LLC (CALIFORNIA LIMITED LIABILITY COMPANY)  
26731 ALISO CREEK ROAD, SUITE B  
ALISO VIEJO, CA 92656

FOR: FRANCHISE SERVICES, NAMELY, OFFERING TECHNICAL ASSISTANCE IN THE ESTABLISHMENT AND OPERATION OF RETAIL STORES FEATURING CLOTHING AND ACCESSORIES; BUSINESS CONSULTING, NAMELY, PROVIDING ADVISORY SERVICES TO BUSINESSES WISHING TO ESTABLISH A FRANCHISE RETAIL STORE FEATURING CLOTHING AND ACCESSORIES; CO-OPERATIVE ADVERTISING AND MARKETING FOR CLOTHING AND ACCESSORIES STORES; RETAIL STORE SERVICES FEATURING CLOTHING, AND ACCESSORIES., IN CLASS 35 (U.S. CLS. 100, 101 AND 102).

FIRST USE 10-1-2004; IN COMMERCE 11-5-2004.

THE MARK CONSISTS OF STANDARD CHARACTERS WITHOUT CLAIM TO ANY PARTICULAR FONT, STYLE, SIZE, OR COLOR.

OWNER OF U.S. REG. NO. 3,138,252.

NO CLAIM IS MADE TO THE EXCLUSIVE RIGHT TO USE "BABY", APART FROM THE MARK AS SHOWN.

SER. NO. 78-902,625, FILED 6-7-2006.

ANDREA K. NADELMAN, EXAMINING ATTORNEY

**Int. Cl.: 37**

**Prior U.S. Cls.: 100, 103 and 106**

**United States Patent and Trademark Office**

**Reg. No. 3,570,118**

**Registered Feb. 3, 2009**

**SERVICE MARK  
PRINCIPAL REGISTER**

**CROWN ACQUISITIONS, INC.**

CROWN ACQUISITIONS, INC. (CALIFORNIA CORPORATION)  
PO BOX 7200  
LAGUNA NIGUEL, CA 92607

FOR: REAL ESTATE RENOVATION AND RESTORATION OF BUILDINGS, NAMELY, REHABILITATION, REFURBISHMENT AND RENOVATION OF HIGH-RISK URBAN COMMERCIAL AND RESIDENTIAL PROPERTIES , IN CLASS 37 (U.S. CLS. 100, 103 AND 106).

FIRST USE 4-1-2003; IN COMMERCE 4-1-2003.

THE MARK CONSISTS OF STANDARD CHARACTERS WITHOUT CLAIM TO ANY PARTICULAR FONT, STYLE, SIZE, OR COLOR.

NO CLAIM IS MADE TO THE EXCLUSIVE RIGHT TO USE "ACQUISITIONS, INC.", APART FROM THE MARK AS SHOWN.

SER. NO. 78-908,777, FILED 6-15-2006.

LOURDES AYALA, EXAMINING ATTORNEY

**Int. Cl.: 32**

**Prior U.S. Cls.: 45, 46 and 48**

**Reg. No. 3,570,119**

**United States Patent and Trademark Office**

**Registered Feb. 3, 2009**

**TRADEMARK  
PRINCIPAL REGISTER**



FLATHEAD LAKE MONSTER, INC. (MONTANA CORPORATION)  
333 MAIN STREET  
SUITE 2  
KALISPELL, MT 59901

FOR: CARBONATED BEVERAGES, NAMELY, FRUIT FLAVORED BEVERAGES AND NON-ALCOHOLIC BEVERAGES, NAMELY, CARBONATED BEVERAGES, NON-CARBONATED BEVERAGES, NAMELY, FRUIT JUICE BEVERAGES, FRUIT BEVERAGES, NAMELY, HUCKLEBERRY, GRAPE, CHERRY, APPLE AND RASPBERRY FLAVORED BEVERAGES, FRUIT- FLAVORED BEVERAGES, FRUIT JUICES, BOTTLED DRINKING WATER, FLAVORED BOTTLED WATER AND OTHER NON-CARBONATED BEVERAGES, NAMELY,

FRUIT FLAVORED BEVERAGES; NON-ALCOHOLIC CARBONATED BEVERAGES; NON-ALCOHOLIC NON-CARBONATED FRUIT FLAVORED BEVERAGES, IN CLASS 32 (U.S. CLS. 45, 46 AND 48).

FIRST USE 1-17-2006; IN COMMERCE 1-17-2006.

OWNER OF U.S. REG. NOS. 322,586 AND 3,092,601.

NO CLAIM IS MADE TO THE EXCLUSIVE RIGHT TO USE "GOURMET SODA", APART FROM THE MARK AS SHOWN.

SER. NO. 78-918,695, FILED 6-28-2006.

ELLEN PERKINS, EXAMINING ATTORNEY

**Int. Cl.: 41**

**Prior U.S. Cls.: 100, 101 and 107**

**United States Patent and Trademark Office**

**Reg. No. 3,570,120**

**Registered Feb. 3, 2009**

**SERVICE MARK  
PRINCIPAL REGISTER**

**JAMAICA**

NEW YORK STATE FRANCHISE OVERSIGHT  
BOARD (NEW YORK STATE AGENCY)  
C/O EXECUTIVE CHAMBER  
THE CAPITOL  
ALBANY, NY 12224

FOR: ENTERTAINMENT IN THE NATURE OF  
HORSERACES, IN CLASS 41 (U.S. CLS. 100, 101 AND  
107).

FIRST USE 0-0-1929; IN COMMERCE 0-0-1929.

THE MARK CONSISTS OF STANDARD CHAR-  
ACTERS WITHOUT CLAIM TO ANY PARTICULAR  
FONT, STYLE, SIZE, OR COLOR.

SEC. 2(F).

SER. NO. 78-918,884, FILED 6-28-2006.

CORY BOONE, EXAMINING ATTORNEY



**Int. Cl.: 7**

**Prior U.S. Cls.: 13, 19, 21, 23, 31, 34 and 35**

**United States Patent and Trademark Office**

**Reg. No. 3,570,121**

**Registered Feb. 3, 2009**

**TRADEMARK  
PRINCIPAL REGISTER**

**CAMERON BUCKET**

CAZES, LYLE (CANADA INDIVIDUAL)  
BOX 23283  
GRANDE PRAIRIE, CANADA T8V 7G7

OWNER OF CANADA REG. NO. TMA690,515,  
DATED 6-21-2007, EXPIRES 6-21-2022.

FOR: ATTACHMENTS FOR VEHICLES, NAME-  
LY, EXCAVATION BUCKETS FOR MOVING  
EARTH AND LOOSE OBJECTS, IN CLASS 7 (U.S.  
CLS. 13, 19, 21, 23, 31, 34 AND 35).

NO CLAIM IS MADE TO THE EXCLUSIVE  
RIGHT TO USE "BUCKET", APART FROM THE  
MARK AS SHOWN.

THE MARK CONSISTS OF STANDARD CHAR-  
ACTERS WITHOUT CLAIM TO ANY PARTICULAR  
FONT, STYLE, SIZE, OR COLOR.

SER. NO. 78-923,492, FILED 7-6-2006.

LINDA M. KING, EXAMINING ATTORNEY

**Int. Cls.: 1, 2, 16 and 17**

**Prior U.S. Cls.: 1, 2, 5, 6, 10, 11, 12, 13, 16, 22, 23, 26,  
29, 35, 37, 38, 46 and 50**

**Reg. No. 3,570,122**

**United States Patent and Trademark Office**

**Registered Feb. 3, 2009**

**TRADEMARK  
PRINCIPAL REGISTER**

**VpCI**

CORTEC CORPORATION (MINNESOTA CORPORATION)  
4119 WHITE BEAR PARKWAY  
ST. PAUL, MN 55110

FOR: CORROSION INHIBITORS IN POWDER FORM USED TO PROTECT FERROUS AND NON-FERROUS METALS; POUCHES AND TABLETS CONTAINING CORROSION INHIBITORS AND PRESERVATIVES AGAINST RUST, IN CLASS 1 (U.S. CLS. 1, 5, 6, 10, 26 AND 46).

FIRST USE 12-13-2000; IN COMMERCE 8-0-2001.

FOR: CORROSION INHIBITORS AND PRESERVATIVES AGAINST RUST IN LIQUID FORM; CORROSION INHIBITORS AND PRESERVATIVES AGAINST RUST IN THE NATURE OF COATINGS; CORROSION INHIBITORS AND PRESERVATIVES AGAINST RUST IN THE NATURE OF ADDITIVES FOR COATINGS, IN CLASS 2 (U.S. CLS. 6, 11 AND 16).

FIRST USE 12-13-2000; IN COMMERCE 8-1-2001.

FOR: PLASTIC BAGS CONTAINING CORROSION INHIBITORS AND PRESERVATIVES AGAINST RUST USED TO PROTECT ITEMS SUBJECT TO CORROSION, IN CLASS 16 (U.S. CLS. 2, 5, 22, 23, 29, 37, 38 AND 50).

FIRST USE 12-13-2000; IN COMMERCE 8-1-2001.

FOR: PACKAGING FOAMS INCORPORATING CORROSION INHIBITORS AND PRESERVATIVES AGAINST RUST; PLASTIC FILM INCORPORATING CORROSION INHIBITORS AND PRESERVATIVES AGAINST RUST; PLASTIC SHEETING INCORPORATING CORROSION INHIBITORS AND PRESERVATIVES AGAINST RUST; PACKING FILM INCORPORATING CORROSION INHIBITORS AND PRESERVATIVES AGAINST RUST FOR INDUSTRIAL AND COMMERCIAL USE; PLASTIC WRAPPING FILM INCORPORATING CORROSION INHIBITORS AND PRESERVATIVES AGAINST RUST FOR INDUSTRIAL AND COMMERCIAL WRAPPING; POLYETHYLENE PACKING INCORPORATING CORROSION INHIBITORS AND PRESERVATIVES AGAINST RUST FOR PACKING, IN CLASS 17 (U.S. CLS. 1, 5, 12, 13, 35 AND 50).

FIRST USE 12-13-2000; IN COMMERCE 8-0-2001.

THE MARK CONSISTS OF STANDARD CHARACTERS WITHOUT CLAIM TO ANY PARTICULAR FONT, STYLE, SIZE, OR COLOR.

SER. NO. 78-936,898, FILED 7-25-2006.

HEATHER SAPP, EXAMINING ATTORNEY

Int. Cl.: 1

Prior U.S. Cls.: 1, 5, 6, 10, 26 and 46

Reg. No. 3,570,123

United States Patent and Trademark Office

Registered Feb. 3, 2009

TRADEMARK  
PRINCIPAL REGISTER

# Peprich

SEMPIO FOODS COMPANY (REPUBLIC OF KOREA CORPORATION)  
51-9 PILDONG-1KA, JOONG-KU  
SEOUL, REPUBLIC OF KOREA 100-728

FOR: OLIGOPEPTIDE, NAMELY, AMINO ACIDS FOR USE IN THE MANUFACTURE OF FOOD PRODUCTS, FOOD SUPPLEMENTS AND COSMETICS, CHEMICAL ADDITIVES FOR USE IN THE MANUFACTURE OF FOODS, PROTEINS AS ARTIFICIAL SWEETENERS, CHEMICAL ADDITIVES CONTAINING OLIGOPEPTIDE, NAMELY, AMINO ACIDS FOR USE IN THE MANUFACTURE OF FOOD PRODUCTS, FOOD SUPPLEMENTS AND COSMETICS, SPECIALTY CHEMICALS, NAMELY, CHEMICAL ADDITIVES FOR GENERAL INDUSTRIAL USE IN THE MANUFACTURE OF A WIDE VARIETY OF GOODS, NAMELY, OLIGOPEPTIDE, CAUSTIC ALKALI, GALLOTANNIC ACID, SALTS FOR GALVANIC CELLS, CAUSTIC SODA FOR INDUSTRIAL PURPOSES, DIOXIDE OF HYDROGEN, CITRIC ACID FOR INDUSTRIAL PURPOSES, SALTS OF PRECIOUS METALS FOR INDUSTRIAL PURPOSES, NAMELY, METTALLATES, GLYCERINE FOR INDUSTRIAL PURPOSES, BORIC ACID FOR INDUSTRIAL PURPOSES, COBALT OXIDE FOR INDUSTRIAL PURPOSES, AMMONIA FOR INDUSTRIAL PURPOSES, SALTS FOR INDUSTRIAL PURPOSES, ALKALINE IODIDES FOR INDUSTRIAL PURPOSES, TITANIUM DIOXIDE FOR INDUSTRIAL PURPOSES, MAGNETIC FLUID FOR INDUSTRIAL PURPOSES, ACETATES FOR INDUSTRIAL PURPOSES, SEA WATER FOR INDUSTRIAL USE, SODIUM PERBORATE, PERCHLORATES, PERCARBONATES, PERSULPHUNC ACID, PERSULPHATES, ALUMINIUM SILICATE, SILICATES FOR INDUSTRIAL PURPOSES, SILICON, GOLD SALTS, SODIUM, SODIUM SALTS, NEON, MANGANATE, MINERAL ACIDS, ANHYDROUS AMMONIA, BARIUM COMPOUNDS, DOUBLE SALTS, FLUORINE, FLUORINE COMPOUNDS, HYDROFLUORIC ACID, BORAX, BORATES, LEAD AR-

SENATE, ARSENIC, SORREL SALT, OXYGEN, LITHIUM OXIDES, MERCURIC OXIDES, ANTIMONY OXIDES, LEAD OXIDES, URANIUM OXIDES, ZIRCONIA, CHROMIUM OXIDES, CAESIUM, SODA ASH, ALUMINIUM HYDRATE, CALCIUM HYDROXIDES, CARBONIC HYDRATES, HYDROGEN, MERCURY SALTS, SULFONIC ACIDS, CYANATES, CYANIDES, ARGON, ARSENIUS ACID, ASTATINE, SULFUROUS ACID, ALUMINA, ALUMINIUM ALUM, ALKALINE METALS, SALTS OF ALKALINE METALS, ALKALIES, ALKALINE-EARTH METALS, AMMONIUM SALTS, AMMONIUM ALUM, AMMONIACAL SALTS, HYDROCHLORIC ACID, HYDROCHLORATES. CHLORINE, CHLORATES, MAGNESIUM CHLONDE, LIME CHLORIDE, ALUMINIUM CHLORIDE, SAL AMMONIAC, SAL AMMONIAC SPIRITS, PALLADIUM CHLORIDES, IODIC ACID, ALUMINIUM IODIDE, IODISED SALTS, SULPHATES, SULPHIDES, SULPHUR, SILVER SALT SOLUTIONS FOR SILVERING, MANGANESE DIOXIDE, CARBON DIOXIDE, BICHLORIDE OF TIN, PHOSPHORUS, PHOSPHORIC ACID, NITRIC MONOXIDE, HEAVY WATER, BICHROMATE OF SODA, CHROMIC SALTS, BICHROMATE OF POTASSIUM, BICARBONATE OF POTASSIUM, BARYTA, DISTILLED WATER, SALPETRE, NITRIC ACID, NITRATES, SILVER NITRATE, NITROGEN, HYPOCHLORITE OF SODA, HYPOSULPHITES, IRON SALTS, LEAD ACETATE, LIME ACETATE, SODIUM NITRATE, AMYL ACETATE, ALUMINUM ACETATE, AMMONIUM NITRATE, KAINITE, POTASSIUM, CALCIUM SALTS, CHROME ALUM, CHROMIC ACID, CHROMATES, CHROME SALTS, KRYPTON, XENON, CARBONIC ACID, MAGNESIUM CARBONATE, LIME CARBONATE, CARBONATES, POTASH, CARBON, CARBIDES, CALCIUM CARBIDE, TUNGSTIC ACID, FENTCYANIDES, HALOIDS, HALIDES, HELIUM, BISMUTH NITRITE FOR CHEMICAL PURPOSES, FLOWERS OF SULPHUR FOR CHEMICAL PURPOSES, BICARBONATE OF SODA FOR CHEMICAL PURPOSES,

SULPHURIC ACID, COPPER SULPHATE, BARIUM SULPHATE, AMMONIUM SULPHATE, ANTIMONY SULPHIDE, CARBON SULPHIDE, DILUTED ACETIC ACID, SALTS FROM RARE EARTH METALS, DIASTASE FOR INDUSTRIAL PURPOSES, GALLIC ACID FOR INDUSTRIAL PURPOSES, CELLULOSE FOR INDUSTRIAL PURPOSES, CELLULOSE ESTERS FOR INDUSTRIAL PURPOSES, ESTER FOR INDUSTRIAL PURPOSES, CAMPHOR FOR INDUSTRIAL PURPOSES, CASEIN FOR INDUSTRIAL PURPOSES, QUEBRACHO FOR INDUSTRIAL PURPOSES, PHENOL FOR INDUSTRIAL PURPOSES, GLUCOSE FOR INDUSTRIAL PURPOSES, ENZYMES FOR INDUSTRIAL PURPOSES, GLUCOSIDES, GLYCERIDES, GLYCOL, GLYCOL ETHER, NAPHTHALENE, POTASSIUM DIOXALATE, MALT ALBUMEN, METHANE, METHYL BENZENE, METHYL ETHER, WOOD ALCOHOL, PYROLIGNEOUS ACID, LECITHIN FOR INDUSTRIAL USE, ALBUMEN FOR INDUSTRIAL USE, BENZENE-BASED ACIDS, BENZENE DERIVATIVES, BENZOIC ACID, BENZOIC SULPHINIDE, VISCOSE, TARTAR-OTHER THAN FOR PHARMACEUTICAL PURPOSES, CREAM OF TARTAR OTHER THAN FOR PHARMACEUTICAL PURPOSES, TETRACHLORIDES, ACETYLENE TETRACHLORIDES, CARBON TETRACHLORIDES, SALICYLIC ACID, SEBACIC ACID, STEARIC ACID, CYMENE, AMYL ALCOHOL, ACETONE, ACETYLENE, ANTRANILIC ACID, ALDEHYDES, ALCOHOL, AMMONIUM ALDEHYDE, ETHANE, ETHERS, ETHYL ALCOHOL, ETHYL ETHER, OXALIC ACID, OXALATES, OLEIC ACID, IODISED ALBUMEN, ORGANO-METALLIC COMPOUNDS, ORGANOARSENIC COMPOUNDS, ORGANIC ACID, ORGANIC ACID SALTS, ORGANOPHOSPHOROUS COMPOUNDS, ORGANIC HALOGENIDES, HETEROCYCLIC COMPOUNDS, PHOSPHATIDES, LACTIC ACID, VINIC ALCOHOL, FATTY ACIDS, NITROGEN COMPOUNDS, KETONES, CHOLIC ACID, CROTONIC ALDEHYDE, TARTARIC ACID, TANNIN, TANNIC ACID, CARBOHYDRATES, HYDROCARBON, TOLUENE, TOLUOL, THIOCARBANILIDE, PHENOL FOR INDUSTRIAL PURPOSES, CHEMICALS USED IN FERMENTING WINE, FORMIC ACID, PICRIC ACID, BROMINE FOR CHEMICAL PURPOSES, FORMIC ALDEHYDE FOR CHEMICAL PURPOSES, EMOLLIENTS FOR INDUSTRIAL PURPOSES, ANTISTATIC PREPARATIONS FOR USE IN THE MANUFACTURE OF CLOTHING, DEFOAMING AGENTS, WETTING AGENTS, CHEMICAL PREPARATIONS, EXCEPT PIGMENTS, FOR THE MANUFACTURE OF ENAMEL, DYEING ASSISTANTS, MOLD-RELEASE PREPARATIONS, PLASTISOLS, CHEMICAL ADSORBENTS FOR REMOVING IMPURITIES FROM FUEL, PLASTICIZERS, TANNING AGENTS FOR USE IN THE MANUFACTURE OF LEATHER, NAMELY, SUMAC FOR USE IN TANNING, TANNING MATERIAL, NAMELY, ALGAROVILLA, VULCANISATION ACCELERATORS, WATER-SOFTENING PREPARATIONS, CHEMICAL RUBBER PRESERVATIVES, DEFOLIANTS, CHEMICAL PREPARATIONS TO PREVENT MILDEW, MEAT TENDERIZERS FOR INDUSTRIAL PURPOSES, ABSORBING CARBONS FOR INDUSTRIAL PURPOSES, METAL TEMPERING PREPARATIONS, SEQUESTERING AGENTS, FLOWER

PRESERVATIVES, ANTI-KNOCK SUBSTANCES FOR INTERNAL COMBUSTION ENGINES, FIRE-PROOFING PREPARATIONS, ANTI-AGING AGENTS FOR USE IN THE MANUFACTURE OF FOOD PRODUCTS, FOOD SUPPLEMENTS AND COSMETICS, RADIATOR FLUSHING CHEMICALS, PREPARATIONS, NAMELY, ANTI-TARNISHING CHEMICALS FOR PREVENTING THE TARNISHING OF LENSES, CHEMICAL PRODUCTS FOR THE FRESH KEEPING AND PRESERVING OF FOOD, NAMELY, BEER PRESERVING AGENTS, BEER-CLARIFYING AND PRESERVING AGENTS, CHEMICAL PREPARATIONS FOR THE TREATMENT OF WATER, ANTIFREEZING AGENTS, NAMELY, ANTIFREEZE, CHEMICAL REAGENTS OTHER THAN FOR MEDICAL PURPOSES, CHEMICAL ADDITIVES FOR FUNGICIDES, CHEMICAL ADDITIVES FOR INSECTICIDES, DETERGENT ADDITIVES TO PETROL, FIRE EXTINGUISHING COMPOSITIONS, FOOD PRESERVATIVE COMPOSITIONS, NAMELY, OILS FOR THE PRESERVATION OF FOOD AND CHEMICAL SUBSTANCES FOR PRESERVING FOODSTUFFS, GALVANIZING BATHS, PRESERVATIVES FOR PHARMACEUTICAL PREPARATIONS, GAS PROPELLANTS FOR AEROSOLS, CHEMICAL ADDITIVE IN THE NATURE OF ANTI-BOIL PREPARATIONS FOR ENGINE COOLANTS, CHEMICAL PREPARATIONS, NAMELY, FILTERING MATERIALS AND ION EXCHANGE RESINS, COMBUSTING PREPARATIONS, NAMELY, CHEMICAL ADDITIVES TO MOTOR FUEL, SOLDERING FLUXES, CHEMICAL ADDITIVES FOR MOTOR FUEL, MODERATING MATERIALS, NAMELY, FUEL FOR NUCLEAR REACTORS, ANTI-TARNISHING CHEMICALS FOR WINDOWS, DRILLING MUD FOR USE IN OIL WELL DRILLING, CHEMICAL ADDITIVES FOR OIL WELL DRILLING FLUID, FLOCCULANTS, NAMELY, FLOCCULANTS IN THE MANUFACTURE OF FOOD PRODUCTS, FLOCCULANTS FOR USE IN WASTE WATER TREATMENT, WATER PURIFYING CHEMICALS, SEED PRESERVING SUBSTANCES, NAMELY, CHEMICAL PREPARATIONS FOR THE TREATMENT OF SEEDS, TEXTILE-WATERPROOFING CHEMICALS, STAIN-PREVENTING CHEMICALS, NAMELY, STAIN REPELLANTS FOR USE ON FABRICS, ACIDULATED WATER FOR RECHARGING BATTERIES, CHEMICAL ADDITIVE FOR USE AS CONCRETE PRESERVATIVE EXCEPT PAINTS AND OILS, CONCRETE-AERATION CHEMICALS AND AGGLUTINANTS FOR CONCRETE, SOIL STABILIZING AGENTS FOR USE IN AGRICULTURE, HORTICULTURE AND FORESTRY, CHEMICAL PREPARATIONS FOR THE MANUFACTURE OF PAINTS, TANNING AGENTS, NAMELY, OILS FOR TANNING LEATHER, LEATHER-WATERPROOFING CHEMICALS, IN CLASS 1 (U.S. CLS. 1, 5, 6, 10, 26 AND 46).

THE MARK CONSISTS OF STANDARD CHARACTERS WITHOUT CLAIM TO ANY PARTICULAR FONT, STYLE, SIZE, OR COLOR.

OWNER OF REPUBLIC OF KOREA REG. NO. 40-0653433-0, DATED 3-3-2006, EXPIRES 3-3-2016.

SER. NO. 78-941,118, FILED 7-31-2006.

BARBARA BROWN, EXAMINING ATTORNEY

**Int. Cl.: 35**

**Prior U.S. Cls.: 100, 101 and 102**

**United States Patent and Trademark Office**

**Reg. No. 3,570,124**

**Registered Feb. 3, 2009**

**SERVICE MARK  
PRINCIPAL REGISTER**

**SCRAP OPTIMISER**

TUBE CITY IMS, LLC (DELAWARE LIMITED  
LIABILITY COMPANY)  
12 MONONGAHELA AVENUE  
GLASSPORT, PA 15045

FOR: BUSINESS CONSULTATION SERVICES IN  
THE FIELD OF SCRAP SUPPLY OPTIMIZATION, IN  
CLASS 35 (U.S. CLS. 100, 101 AND 102).

FIRST USE 4-1-2005; IN COMMERCE 4-1-2005.

THE MARK CONSISTS OF STANDARD CHAR-  
ACTERS WITHOUT CLAIM TO ANY PARTICULAR  
FONT, STYLE, SIZE, OR COLOR.

OWNER OF U.S. REG. NO. 3,044,883.

NO CLAIM IS MADE TO THE EXCLUSIVE  
RIGHT TO USE "SCRAP", APART FROM THE  
MARK AS SHOWN.

SEC. 2(F).

SER. NO. 78-948,659, FILED 8-9-2006.

WON TEAK OH, EXAMINING ATTORNEY

**Int. Cl.: 9**

**Prior U.S. Cls.: 21, 23, 26, 36 and 38**

**Reg. No. 3,570,125**

**United States Patent and Trademark Office**

**Registered Feb. 3, 2009**

**TRADEMARK  
PRINCIPAL REGISTER**

**EDGEWOOD**

CUSTOM HOME ACCESSORIES, INC. (CALIFORNIA CORPORATION)  
11300 TRADE CENTER DRIVE #A  
RANCHO CORDOVA, CA 95742

THE MARK CONSISTS OF STANDARD CHARACTERS WITHOUT CLAIM TO ANY PARTICULAR FONT, STYLE, SIZE, OR COLOR.

FOR: BACKLIT SIGNS; ELECTRIC SIGNS; LUMINOUS HOUSE NUMBERS; LUMINOUS SIGNS, IN CLASS 9 (U.S. CLS. 21, 23, 26, 36 AND 38).

SER. NO. 78-950,448, FILED 8-11-2006.

FIRST USE 9-29-2000; IN COMMERCE 9-29-2000.

WILLIAM VERHOSEK, EXAMINING ATTORNEY

**Int. Cls.: 1, 4, 37, 39 and 40**

**Prior U.S. Cls.: 1, 5, 6, 10, 15, 26, 46, 100, 103, 105 and 106**

**Reg. No. 3,570,126**

**United States Patent and Trademark Office**

**Registered Feb. 3, 2009**

**TRADEMARK  
SERVICE MARK  
PRINCIPAL REGISTER**

# GLYCTEC

BIOPETROL INDUSTRIES AG (SWITZERLAND  
AKTIENGESELLSCHAFT (AG))

BAARERSTRASSE 53/55

ZUG, SWITZERLAND CH-6300

FOR: SATURATED AND UNSATURATED HYDROCARBONS FOR USE IN FURTHER MANUFACTURE, NAMELY, OLEFINS AND DIRENESS, AND THEIR POLYMERS; PROPANE FOR USE IN INDUSTRIAL SOLVENTS, ETHYLENE, PROPYLENE, POLYETHYLENE, POLYPROPYLENE, BUTADIENE, BENZENE FOR INDUSTRY USE AND NOT AS FUEL, TOLUENE, ETHYL BENZENE FRACTION; C4 FRACTIONS, C5 FRACTIONS, C9-C200 HYDROCARBONS, PHENOL, ACETONE, CUMENE, ETHYLENE GLYCOL, ETHYLENE OXIDE, SULFUR, HYDROGEN SULFIDE; SOLVENTS AND AROMATICS, NAMELY, AROMATIC SOLVENTS FOR INDUSTRIAL OR CHEMICAL USE; CHEMICAL SUBSTANCES FOR INDUSTRY AND SCIENCE; ETHERS, NAMELY, BENZYL ETHER, CHLOROMETHYL ETHER, DISOPROPYL ETHER; HYDROGEN; CHEMICAL ADDITIVES FOR GASOLINE FUELS AND LUBRICANT, GASES FOR INDUSTRIAL PURPOSES; ANTIFREEZE LIQUIDS, BRAKE-LIQUIDS; UNPROCESSED PLASTICS, DISTILLED WATER; ANTI-KNOCK SUBSTANCES FOR INTERNAL COMBUSTION ENGINES; FUEL SAVING PREPARATIONS, NAMELY, CHEMICAL ADDITIVES FOR FUEL TREATMENT; TIRE REPAIRING COMPOSITIONS, VULCANIZING PREPARATIONS, NAMELY, VULCANIZATION ACCELERATORS; ANTI-MIST CHEMICALS FOR WINDOWS; OIL SEPARATING PREPARATIONS, NAMELY, OIL RECLAMATION FLUID FOR THE SEPARATION OF CRUDE OIL FROM SOIL AND WATER; XYLENE FOR INDUSTRIAL USE, IN CLASS 1 (U.S. CLS. 1, 5, 6, 10, 26 AND 46).

FOR: PROPANE FOR USE AS FUELS; BENZENE FOR USE AS FUEL; FUELS, LIQUEFIED PETROLEUM GASES, GASOLINE, DIESEL OILS, FUEL OILS, INDUSTRIAL OILS, MOTOR OILS, PARAFFIN, AVIATION FUELS, COKE, ZYLENES FOR FUELS AND OILS; MOTOR FUELS, NAMELY, GASOLINE, DIESEL, IN CLASS 4 (U.S. CLS. 1, 6 AND 15).

FOR: REFUELING OF SEA AND AIR VEHICLES; SERVICES FOR THE TREATMENT OF OIL USED LUBRICANTS, NAMELY, WASTE OIL COLLECTION FOR RECYCLING, ALL OF THE AFORESAID SERVICES PERFORMED FOR OTHERS, IN CLASS 37 (U.S. CLS. 100, 103 AND 106).

FOR: TRANSPORTATION SERVICES, NAMELY, TRANSPORTATION OF GOODS BY AIR, SEA AND LAND, AND COURIER SERVICES; PACKING AND STORAGE OF GOODS, NAMELY, PACKAGING OF ARTICLES FOR TRANSPORTATION AND WAREHOUSE STORAGE; ROAD TRANSPORT SERVICES, NAMELY, TRANSPORT OF GOODS BY CARS, TRUCKS OR OTHER CARGO VEHICLES; RAILWAY TRANSPORT SERVICES; PIPELINE TRANSPORTATION SERVICES; STORING OF PETROLEUM AND LIQUID FUELS AND HOLDING FUEL RESERVES; SEA AND LAND TRANSHIPMENTS SERVICE, NAMELY, SHIP UNLOADING; ELECTRICAL AND THERMAL ENERGY DISTRIBUTION; VEHICLE RENTAL INCLUDING CAR, TRUCK AND TRAILER RENTAL; VEHICLE TOWING; VEHICLE PARKING; TRANSPORTATION, PACKAGING AND STORAGE OF GOODS; TRAVEL ARRANGEMENTS, NAMELY, ORGANIZATION OF TRAVEL, ARRANGING OF TRAVEL TOURS; STORING OF SOLID FUELS, LIQUID AND GAS FUELS AS WELL AS CHEMICAL PRODUCTS; DISTRIBUTION OF FUELS, BOTH LIQUID AND GAS



AS WELL AS CHEMICAL PRODUCTS, NAMELY, TRANSPORTING THESE GOODS AND GAS SUPPLYING, IN CLASS 39 (U.S. CLS. 100 AND 105).

FOR: TRANSFORMING AND BLENDING OF SOLID FUELS, LIQUID AND GAS FUELS AS WELL AS CHEMICAL PRODUCTS, NAMELY, CHEMICAL ENCAPSULATION AND DISPERSION OF HAZARDOUS CHEMICAL; FABRICATION OF CRUDE OIL AND PROCESSING OF REFINED PETROLEUM PRODUCTS AND INTERMEDIATE PETROLEUM PRODUCTS, NAMELY, LIQUID AND GAS FUEL REFINING, OIL REFINING; SERVICES FOR THE TREATMENT OF OIL AND USED LUBRICANTS, NAMELY, MIXING LUBRICANTS FOR THIRD PARTIES, RECYCLING USED OIL AND LUBRICANTS; RECYCLING OF PLASTICS; MATERIAL TREATMENT SERVICES RELATING TO APPARATUS, MACHINES, NAMELY, TREATMENT OF METAL; PRINTING SERVICES; TREATMENT OF MATERIAL AND PROCESSING OF USED OILS AND OTHER WASTE CHEMICAL MATERIAL,

NAMELY, RECYCLING AND CHEMICAL TREATMENT OF HAZARDOUS WASTE; PROCESSING OF PLASTICS, PETROLEUM AND RAFFINATES, NAMELY, RECYCLING; GENERATION OF THERMAL AND ELECTRICAL ENERGY, ALL OF AFORESAID SERVICES PERFORMED FOR OTHERS, IN CLASS 40 (U.S. CLS. 100, 103 AND 106).

THE MARK CONSISTS OF STANDARD CHARACTERS WITHOUT CLAIM TO ANY PARTICULAR FONT, STYLE, SIZE, OR COLOR.

PRIORITY CLAIMED UNDER SEC. 44(D) ON FED REP GERMANY APPLICATION NO. 30612009.7/0, FILED 2-21-2006, REG. NO. 30612009, DATED 12-20-2006, EXPIRES 2-21-2016.

SER. NO. 78-956,601, FILED 8-21-2006.

REBECCA POVARCHUK, EXAMINING ATTORNEY

**Int. Cls.: 41 and 42**

**Prior U.S. Cls.: 100, 101 and 107**

**United States Patent and Trademark Office**

**Reg. No. 3,570,127**

**Registered Feb. 3, 2009**

**SERVICE MARK  
PRINCIPAL REGISTER**

# EXODUS WEB

EXODUS WEB, INC. (ARIZONA CORPORATION)  
2943 E. LAUREL LANE  
PHOENIX, AZ 85028

FOR: COMPUTER EDUCATION TRAINING, IN  
CLASS 41 (U.S. CLS. 100, 101 AND 107).

FIRST USE 10-9-2003; IN COMMERCE 10-9-2003.

FOR: COMPUTER CONSULTATION SERVICES;  
COMPUTER PROGRAMMING FOR OTHERS; DE-  
VELOPMENT AND CUSTOMIZATION OF COMPU-  
TER SOFTWARE; COMPUTER DATABASE DESIGN  
FOR OTHERS; INTEGRATION OF COMPUTER  
SOFTWARE; DESIGN, CREATION, HOSTING,  
AND MAINTENANCE OF WEBSITES FOR OTHERS;  
GRAPHIC DESIGN SERVICES; TECHNICAL SUP-  
PORT SERVICES, NAMELY, TROUBLESHOOTING

OF COMPUTER HARDWARE AND SOFTWARE  
PROBLEMS, IN CLASS 42 (U.S. CLS. 100 AND 101).

FIRST USE 10-9-2003; IN COMMERCE 10-9-2003.

THE MARK CONSISTS OF STANDARD CHAR-  
ACTERS WITHOUT CLAIM TO ANY PARTICULAR  
FONT, STYLE, SIZE, OR COLOR.

NO CLAIM IS MADE TO THE EXCLUSIVE  
RIGHT TO USE "WEB", APART FROM THE MARK  
AS SHOWN.

SER. NO. 78-965,799, FILED 9-1-2006.

DOMINIC J. FERRAIUOLO, EXAMINING ATTOR-  
NEY

**Int. Cls.: 36 and 43**

**Prior U.S. Cls.: 100, 101 and 102**

**United States Patent and Trademark Office**

**Reg. No. 3,570,128**

**Registered Feb. 3, 2009**

**SERVICE MARK  
PRINCIPAL REGISTER**



**C A P C A N A**

CAP CANA S.A. (DOMINICAN REP CORPORATION)  
ESQ. ROBERTO PASTORIZA  
AVENIDA TIRADENTES NO. 158  
SANTO DOMINGO, DOMINICAN REP

FOR: REAL ESTATE BUSINESSES, NAMELY, REAL ESTATE AGENCIES, REAL ESTATE CONSULTATION, REAL ESTATE BROKERAGE, REAL ESTATE MANAGEMENT AND REAL ESTATE TIME SHARING SERVICES, IN CLASS 36 (U.S. CLS. 100, 101 AND 102).

FOR: RESTAURANTS; TEMPORARY LODGING SERVICES, NAMELY, PROVIDING TEMPORARY LODGING ACCOMMODATIONS FOR OTHERS; RESORT LODGING SERVICES AND HOTEL SERVICES, IN CLASS 43 (U.S. CLS. 100 AND 101).

PRIORITY CLAIMED UNDER SEC. 44(D) ON DOMINICAN REP APPLICATION NO. 2006-34907, FILED 5-24-2006, REG. NO. 155932, DATED 8-29-2006, EXPIRES 8-29-2016.

PRIORITY CLAIMED UNDER SEC. 44(D) ON DOMINICAN REP APPLICATION NO. 2006-34905, FILED 5-24-2006, REG. NO. 155931, DATED 8-29-2006, EXPIRES 8-29-2016.

OWNER OF U.S. REG. NO. 3,047,416.

THE COLOR(S) TURQUOISE, BLUE AND WHITE IS/ARE CLAIMED AS A FEATURE OF THE MARK.

THE MARK CONSISTS OF A TURQUOISE AND BLUE CREST CONTAINING A WHITE LETTER "C", A WHITE GOLF CLUB, A WHITE AND BLUE FISH AND A WHITE AND BLUE WAVE. THE FLAG ABOVE THE CREST IS TURQUOISE AND BLUE. THE WRITING BELOW THE CREST IS BLUE.

SER. NO. 78-966,430, FILED 9-1-2006.

KATHRYN COWARD, EXAMINING ATTORNEY

**Int. Cls.: 9, 16 and 41**

**Prior U.S. Cls.: 2, 5, 21, 22, 23, 26, 29, 36, 37, 38, 50,  
100, 101 and 107**

**Reg. No. 3,570,129**

**United States Patent and Trademark Office**

**Registered Feb. 3, 2009**

**TRADEMARK  
SERVICE MARK  
PRINCIPAL REGISTER**

# SAFEDAYS

SENTIS PTY LTD. (AUSTRALIA CORPORATION)  
63 DOGGETT STREET  
NEWSTEAD, QUEENSLAND, AUSTRALIA 4006

FOR: EDUCATIONAL COMPUTER SOFTWARE FEATURING INSTRUCTION IN THE FIELD OF EDUCATION, PSYCHOLOGICAL TESTING, EMPLOYEE RELATIONS AND OCCUPATIONAL HEALTH AND SAFETY; BLANK COMPUTER COMPACT-DISCS; PRERECORDED AUDIO AND VIDEO CASSETTES FEATURING MATERIAL IN THE FIELD OF PSYCHOLOGICAL TESTING, EMPLOYEE RELATIONS AND OCCUPATIONAL HEALTH AND SAFETY; BLANK CD-ROMS FOR SOUND OR VIDEO RECORDING; APPARATUS FOR RECORDING, TRANSMISSION OR REPRODUCTION OF SOUND OR IMAGES, NAMELY, VIDEO CASSETTE RECORDERS; COMPUTER PROGRAMS TO ADMINISTER AND PERFORM EDUCATION TESTS FOR STUDENTS, IN CLASS 9 (U.S. CLS. 21, 23, 26, 36 AND 38).

FOR: PRINTED MATERIALS, NAMELY, MAGAZINES, POSTERS, PROMOTIONAL MATERIALS AND PRINTED TESTS IN THE FIELD OF EDUCA-

TION, PSYCHOLOGICAL TESTING, EMPLOYEE RELATIONS AND OCCUPATIONAL HEALTH AND SAFETY, IN CLASS 16 (U.S. CLS. 2, 5, 22, 23, 29, 37, 38 AND 50).

FOR: EDUCATIONAL SERVICES, NAMELY, PROVIDING CLASSES AND TRAINING SERVICES IN THE FIELDS OF PSYCHOLOGICAL TESTING, EMPLOYEE RELATIONS AND OCCUPATIONAL HEALTH AND SAFETY; PERFORMING EDUCATIONAL AND STANDARDIZED TESTS IN RELATION TO HEALTH, SAFETY AND ACCIDENT PREVENTION, IN CLASS 41 (U.S. CLS. 100, 101 AND 107).

THE MARK CONSISTS OF STANDARD CHARACTERS WITHOUT CLAIM TO ANY PARTICULAR FONT, STYLE, SIZE, OR COLOR.

OWNER OF AUSTRALIA REG. NO. 1105826, DATED 3-27-2006, EXPIRES 3-27-2016.

SER. NO. 78-967,250, FILED 9-5-2006.

ERNEST SHOSHO, EXAMINING ATTORNEY

**Int. Cls.: 9, 16 and 41**

**Prior U.S. Cls.: 2, 5, 21, 22, 23, 26, 29, 36, 37, 38, 50,  
100, 101 and 107**

**Reg. No. 3,570,130**

**United States Patent and Trademark Office**

**Registered Feb. 3, 2009**

**TRADEMARK  
SERVICE MARK  
PRINCIPAL REGISTER**

# THE BIG5

SENTIS PTY LTD (AUSTRALIA CORPORATION)  
63 DOGGETT STREET  
NEWSTEAD, QUEENSLAND, AUSTRALIA 4006

FOR: EDUCATIONAL COMPUTER SOFTWARE FEATURING INSTRUCTION IN THE FIELD OF EDUCATION, PSYCHOLOGICAL TESTING, EMPLOYEE RELATIONS AND OCCUPATIONAL HEALTH AND SAFETY; BLANK COMPUTER COMPACT-DISCS; PRERECORDED AUDIO AND VIDEO CASSETTES FEATURING MATERIAL IN THE FIELD OF PSYCHOLOGICAL TESTING, EMPLOYEE RELATIONS AND OCCUPATIONAL HEALTH AND SAFETY; BLANK CD-ROMS FOR SOUND OR VIDEO RECORDING; APPARATUS FOR RECORDING, TRANSMISSION OR REPRODUCTION OF SOUND OR IMAGES, NAMELY, VIDEO CASSETTE RECORDERS; COMPUTER PROGRAMS TO ADMINISTER AND PERFORM EDUCATION TESTS FOR STUDENTS, IN CLASS 9 (U.S. CLS. 21, 23, 26, 36 AND 38).

FOR: PRINTED MATERIALS, NAMELY, MAGAZINES, POSTERS, PROMOTIONAL MATERIALS AND PRINTED TESTS IN THE FIELD OF EDUCA-

TION, PSYCHOLOGICAL TESTING, EMPLOYEE RELATIONS AND OCCUPATIONAL HEALTH AND SAFETY, IN CLASS 16 (U.S. CLS. 2, 5, 22, 23, 29, 37, 38 AND 50).

FOR: EDUCATIONAL SERVICES, NAMELY, PROVIDING CLASSES AND TRAINING SERVICES IN THE FIELDS OF PSYCHOLOGICAL TESTING, EMPLOYEE RELATIONS AND OCCUPATIONAL HEALTH AND SAFETY; PERFORMING EDUCATIONAL AND STANDARDIZED TESTS IN RELATION TO HEALTH, SAFETY AND ACCIDENT PREVENTION, IN CLASS 41 (U.S. CLS. 100, 101 AND 107).

THE MARK CONSISTS OF STANDARD CHARACTERS WITHOUT CLAIM TO ANY PARTICULAR FONT, STYLE, SIZE, OR COLOR.

OWNER OF AUSTRALIA REG. NO. 1105611, DATED 3-24-2006, EXPIRES 3-24-2016.

SER. NO. 78-967,255, FILED 9-5-2006.

ERNEST SHOSHO, EXAMINING ATTORNEY

**Int. Cls.: 9, 16 and 41**

**Prior U.S. Cls.: 2, 5, 21, 22, 23, 26, 29, 36, 37, 38, 50,  
100, 101 and 107**

**Reg. No. 3,570,131**

**United States Patent and Trademark Office**

**Registered Feb. 3, 2009**

**TRADEMARK  
SERVICE MARK  
PRINCIPAL REGISTER**

# WHAT'S MY 50%?

SENTIS PTY LTD (AUSTRALIA CORPORATION)  
63 DOGGETT STREET  
NEWSTEAD, QUEENSLAND, AUSTRALIA 4006

FOR: EDUCATIONAL COMPUTER SOFTWARE FEATURING INSTRUCTION IN THE FIELD OF EDUCATION, PSYCHOLOGICAL TESTING, EMPLOYEE RELATIONS AND OCCUPATIONAL HEALTH AND SAFETY; BLANK COMPUTER COMPACT-DISCS; PRERECORDED AUDIO AND VIDEO CASSETTES FEATURING MATERIAL IN THE FIELD OF PSYCHOLOGICAL TESTING, EMPLOYEE RELATIONS AND OCCUPATIONAL HEALTH AND SAFETY; BLANK CD-ROMS FOR SOUND OR VIDEO RECORDING; APPARATUS FOR RECORDING, TRANSMISSION OR REPRODUCTION OF SOUND OR IMAGES, NAMELY, VIDEO CASSETTE RECORDERS; COMPUTER PROGRAMS TO ADMINISTER AND PERFORM EDUCATION TESTS FOR STUDENTS, IN CLASS 9 (U.S. CLS. 21, 23, 26, 36 AND 38).

FOR: PRINTED MATERIALS, NAMELY, MAGAZINES, POSTERS, PROMOTIONAL MATERIALS AND PRINTED TESTS IN THE FIELD OF EDUCA-

TION, PSYCHOLOGICAL TESTING, EMPLOYEE RELATIONS AND OCCUPATIONAL HEALTH AND SAFETY, IN CLASS 16 (U.S. CLS. 2, 5, 22, 23, 29, 37, 38 AND 50).

FOR: EDUCATIONAL SERVICES, NAMELY, PROVIDING CLASSES AND TRAINING SERVICES IN THE FIELDS OF PSYCHOLOGICAL TESTING, EMPLOYEE RELATIONS AND OCCUPATIONAL HEALTH AND SAFETY; PERFORMING EDUCATIONAL AND STANDARDIZED TESTS IN RELATION TO HEALTH, SAFETY AND ACCIDENT PREVENTION, IN CLASS 41 (U.S. CLS. 100, 101 AND 107).

THE MARK CONSISTS OF STANDARD CHARACTERS WITHOUT CLAIM TO ANY PARTICULAR FONT, STYLE, SIZE, OR COLOR.

OWNER OF AUSTRALIA REG. NO. 1105612, DATED 3-24-2006, EXPIRES 3-24-2016.

SER. NO. 78-967,260, FILED 9-5-2006.

ERNEST SHOSHO, EXAMINING ATTORNEY

**Int. Cl.: 14**

**Prior U.S. Cls.: 2, 27, 28 and 50**

**United States Patent and Trademark Office**

**Reg. No. 3,570,132**

**Registered Feb. 3, 2009**

**TRADEMARK  
PRINCIPAL REGISTER**

**EDDY Z**

EMMI, INC. (CALIFORNIA CORPORATION)  
323 W. 8TH STREET  
LOS ANGELES, CA 90014

THE MARK CONSISTS OF STANDARD CHAR-  
ACTERS WITHOUT CLAIM TO ANY PARTICULAR  
FONT, STYLE, SIZE, OR COLOR.

FOR: GEMSTONES; JEWELRY; PRECIOUS GEM-  
STONES; SEMI-PRECIOUS GEMSTONES, IN CLASS  
14 (U.S. CLS. 2, 27, 28 AND 50).

SER. NO. 78-972,778, FILED 9-12-2006.

FIRST USE 4-1-2005; IN COMMERCE 4-1-2005.

SUNG IN, EXAMINING ATTORNEY

**Int. Cls.: 35, 36, 43 and 45**

**Prior U.S. Cls.: 100, 101 and 102**

**United States Patent and Trademark Office**

**Reg. No. 3,570,133**

**Registered Feb. 3, 2009**

**SERVICE MARK  
PRINCIPAL REGISTER**

# ASMALLWORLD

ASMALLWORLD LTD. (UNITED KINGDOM CORPORATION)  
EAGLE HOUSE, 110 JERMYN STREET  
LONDON, UNITED KINGDOM SW1Y 6RH

FOR: ON-LINE ADVERTISING AND MARKETING SERVICES; ADVERTISING VIA ELECTRONIC MEDIA AND SPECIFICALLY THE INTERNET; PROMOTING THE GOODS AND SERVICES OF OTHERS BY DISTRIBUTING ADVERTISING MATERIALS THROUGH A VARIETY OF METHODS; PROVISION OF ADVERTISING SPACE BY ELECTRONIC MEANS AND GLOBAL INFORMATION NETWORKS; PROVIDING AND RENTAL OF ADVERTISING SPACE ON THE INTERNET; DISSEMINATION OF ADVERTISING FOR OTHERS VIA THE INTERNET; COMMERCIAL INFORMATION SERVICES AND ADVICE FOR MEMBERS, PROVIDED ONLINE VIA A COMPUTER NETWORK; PROVIDING CONSUMER PRODUCT INFORMATION VIA THE INTERNET; MARKETING BY COMPILATION AND DISPLAY OF A VARIETY OF GOODS AND SERVICES, ON BEHALF OF OTHERS, TO PERMIT CUSTOMERS AND USERS TO ACQUIRE INFORMATION ON AND PURCHASE GOODS AND SERVICES; BUSINESS ADVICE AND INFORMATION PROVIDED ON-LINE VIA COMPUTER NETWORK; GENERAL BUSINESS NETWORKING REFERRAL SERVICES, NAMELY, PROMOTING THE GOODS AND SERVICES OF OTHERS BY PASSING BUSINESS LEADS, BUSINESS CONTACTS AND REFERRALS AMONG GROUP MEMBERS; EMPLOYMENT HIRING, RECRUITING, PLACEMENT, STAFFING AND CAREER NETWORKING SERVICES AND INFORMATION PROVIDED ON-LINE VIA COMPUTER NETWORK; ORGANIZING BUSINESS COMPETITIONS ON-LINE VIA COMPUTER NETWORKS FOR THE PURPOSE OF ADVERTISING AND SALES PROMOTION; COMPUTERIZED COLLECTION OF BUSINESS INFORMATION INDICES, NAMELY, CUSTOMER INDEXES; COLLECTION, PREPARA-

TION, COMPOSITION, PROCESSING, ACQUISITION AND PROVISION OF BUSINESS INFORMATION IN DATABASES; MANAGEMENT OF COMPUTERIZED FILES, IN CLASS 35 (U.S. CLS. 100, 101 AND 102).

FIRST USE 3-18-2004; IN COMMERCE 3-18-2004.

FOR: PROVIDING INFORMATION ON INSURANCE MATTERS, FINANCIAL SERVICES AND REAL ESTATE LISTINGS VIA THE INTERNET, IN CLASS 36 (U.S. CLS. 100, 101 AND 102).

FIRST USE 3-18-2004; IN COMMERCE 3-18-2004.

FOR: PROVIDING ONLINE REVIEWS OF RESTAURANTS AND HOTELS, IN CLASS 43 (U.S. CLS. 100 AND 101).

FIRST USE 3-18-2004; IN COMMERCE 3-18-2004.

FOR: INTERNET BASED DATING SERVICES; PROVIDING INFORMATION IN THE FIELD OF CLOTHING RENTAL ONLINE VIA COMPUTER NETWORK, IN CLASS 45 (U.S. CLS. 100 AND 101).

FIRST USE 3-18-2004; IN COMMERCE 3-18-2004.

THE MARK CONSISTS OF STANDARD CHARACTERS WITHOUT CLAIM TO ANY PARTICULAR FONT, STYLE, SIZE, OR COLOR.

PRIORITY CLAIMED UNDER SEC. 44(D) ON ERPN CMNTY TM OFC APPLICATION NO. 004462561, FILED 5-31-2005.

SER. NO. 78-979,411, FILED 9-21-2005.

JANICE KIM, EXAMINING ATTORNEY



**Int. Cl.: 9**

**Prior U.S. Cls.: 21, 23, 26, 36 and 38**

**Reg. No. 3,570,134**

**United States Patent and Trademark Office**

**Registered Feb. 3, 2009**

**TRADEMARK  
PRINCIPAL REGISTER**

**CamSemi**

CAMBRIDGE SEMICONDUCTOR LIMITED  
(UNITED KINGDOM LIMITED LIABILITY  
COMPANY)  
ST ANDREWS HOUSE  
ST ANDREWS ROAD  
CAMBRIDGE CB4 1DL, UNITED KINGDOM

FOR: ELECTRONIC POWER SUPPLIES; BATTERY CHARGERS; ELECTRONIC CONTROLS FOR MOTORS; ELECTRONIC POWER CONVERTERS; SEMICONDUCTORS; INTEGRATED CIRCUITS, IN CLASS 9 (U.S. CLS. 21, 23, 26, 36 AND 38).

THE MARK CONSISTS OF STANDARD CHARACTERS WITHOUT CLAIM TO ANY PARTICULAR FONT, STYLE, SIZE, OR COLOR.

OWNER OF INTERNATIONAL REGISTRATION  
0861417 DATED 6-1-2005, EXPIRES 6-1-2015.

SER. NO. 79-015,080, FILED 6-1-2005.

TOBY BULLOFF, EXAMINING ATTORNEY

**Int. Cls.: 11 and 42**

**Prior U.S. Cls.: 13, 21, 23, 31, 34, 100 and 101**

**United States Patent and Trademark Office**

**Reg. No. 3,570,135**

**Registered Feb. 3, 2009**

**TRADEMARK  
SERVICE MARK  
PRINCIPAL REGISTER**

# ShearMix

BÜHLER AG (SWITZERLAND AKTIENGESELLSCHAFT)  
BAHNHOFSTRASSE  
CH-9240 UZWIL  
SWITZERLAND

FOR: VACCINE CRYSTALLIZATION INSTALLATIONS, NAMELY, PHARMACEUTICAL COOLING AND HEATING RECEPTACLES CONTAINING HEAT EXCHANGE FLUID FOR USE IN MAKING VACCINES, INDUSTRIAL DRYERS FOR HEATING AND DEHUMIDIFYING FOR USE IN MAKING VACCINES, IN CLASS 11 (U.S. CLS. 13, 21, 23, 31 AND 34).

FOR: PROVISION OF SERVICES IN THE FIELD OF SCIENCE AND TECHNOLOGY AS WELL AS PROVISION OF RELATED RESEARCH AND DEVELOPMENT SERVICES, NAMELY, RESEARCH AND DEVELOPMENT FOR NEW PRODUCTS FOR OTHERS, SCIENTIFIC RESEARCH AND DEVELOPMENT, RESEARCH AND DEVELOPMENT OF SEEDS; INDUSTRIAL RESEARCH AND ANALYSES, NAMELY, CHEMICAL AND BIOCHEMICAL RESEARCH AND ANALYSIS, TECHNICAL RESEARCH IN THE FIELD OF FOOD STORAGE

AND PROCESSING; PROJECT STUDIES AND DEVELOPMENT OF COMPUTERS AND COMPUTER PROGRAMS, NAMELY, CONDUCTING OF FEASIBILITY STUDIES, COMPUTER PROJECT MANAGEMENT SERVICES, DEVELOPMENT OF COMPUTER HARDWARE AND COMPUTER PROGRAMS; LEGAL COUNSELING AND REPRESENTATION, NAMELY, LEGAL SERVICES, IN CLASS 42 (U.S. CLS. 100 AND 101).

THE MARK CONSISTS OF STANDARD CHARACTERS WITHOUT CLAIM TO ANY PARTICULAR FONT, STYLE, SIZE, OR COLOR.

PRIORITY DATE OF 4-8-2005 IS CLAIMED.

OWNER OF INTERNATIONAL REGISTRATION 0866951 DATED 7-21-2005, EXPIRES 7-21-2015.

SER. NO. 79-017,118, FILED 7-21-2005.

MICHAEL TANNER, EXAMINING ATTORNEY

**Int. Cls.: 6, 39 and 42**

**Prior U.S. Cls.: 2, 12, 13, 14, 23, 25, 50, 100, 101 and 105**

**Reg. No. 3,570,136**

**United States Patent and Trademark Office**

**Registered Feb. 3, 2009**

**TRADEMARK  
SERVICE MARK  
PRINCIPAL REGISTER**



METINVEST INTERNATIONAL SA (SWITZERLAND SOCIÉTÉ ANONYME (SA))  
RUE VALLIN 2  
CH-1201 GENÈVE  
SWITZERLAND

FOR: COMMON METALS AND THEIR ALLOYS FOR FURTHER MANUFACTURING; TRANSPORTABLE METAL BUILDINGS; METAL MATERIALS FOR THE CONSTRUCTION OF RAILWAY TRACKS; NON-ELECTRIC CABLES AND WIRES OF METAL, NAMELY, METAL CABLE WIRE; LOCKSMITHS' GOODS, NAMELY, METAL LOCKS AND KEYS THEREFOR, METAL LOCK SETS; METAL PIPES AND TUBES; ORES, NAMELY, IRON ORES; CAST IRON, CAST IRON FOR MAKING STEEL, IRON ORE CONCENTRATE, PLUGS OF IRON ORE, STEEL AND STEEL ALLOYS; GOODS MADE FROM STEEL AND ALLOY STEEL, NAMELY, CABLES, CORDS, METALLIC GRATINGS AND WIRE MESH WEBS, PIPES, TUBES, SHEET METAL, SLABS, CLINKER, BARS, PROFILES, CHANNELS, SLAB, SQUARE AND ROUND BILLETS, ELBOWS, BEAMS, PLUGS, PEGS, WIRES, GRINDING BALLS, STRIPS, RAILS, SPOOLS, BUILDING PLATES FOR FURTHER MANUFACTURING; ALUMINUM PRODUCTS, NAMELY, ALUMINUM CABLE WIRES, IN CLASS 6 (U.S. CLS. 2, 12, 13, 14, 23, 25 AND 50).

FOR: MARITIME AND RIVER TRANSPORT BY BOAT AND GROUND TRANSPORT; GOODS STORAGE, NAMELY, STEEL MATERIAL STORAGE, PROVIDING STORAGE INFORMATION, WAREHOUSE RENTAL, RENTAL OF STORAGE CONTAINERS; BROKERAGE FOR FREIGHT, FOR MARITIME TRANSPORT, FREIGHTING, NAMELY, FREIGHT TRANSPORTATION SERVICES VIA

SHIPS, TRANSPORT OF GOODS, DELIVERY OF GOODS BY TRUCK AND RAILWAY, PROVIDING TRANSPORT INFORMATION, FREIGHT FORWARDING, PACKAGING OF GOODS FOR TRANSPORTATION, IN CLASS 39 (U.S. CLS. 100 AND 105).

FOR: CHEMICAL ANALYSIS, CHEMICAL RESEARCH; ENGINEERING, TECHNICAL RESEARCH IN THE FIELD OF STEEL MATERIAL, TECHNICAL PROJECT STUDIES, NAMELY, TECHNICAL RESEARCH IN THE FIELD OF STEEL, INDUSTRIAL DESIGN; PROSPECTING, NAMELY, STEEL MATERIAL, GEOLOGICAL SURVEYS AND RESEARCH; LEGAL RESEARCH, LEGAL SERVICES, LITIGATION SERVICES, NAMELY, LITIGATION SUPPORT SERVICES, ARBITRATION SERVICES; INSPECTION AND CONTROL, NAMELY, MATERIALS TESTING AND QUALITY CONTROL FOR OTHERS, IN CLASS 42 (U.S. CLS. 100 AND 101).

PRIORITY DATE OF 4-14-2005 IS CLAIMED.

OWNER OF INTERNATIONAL REGISTRATION 0881096 DATED 9-26-2005, EXPIRES 9-26-2015.

NO CLAIM IS MADE TO THE EXCLUSIVE RIGHT TO USE "COMMODITIES S.A.", APART FROM THE MARK AS SHOWN.

SER. NO. 79-022,409, FILED 9-26-2005.

MARLENE BELL, EXAMINING ATTORNEY

Int. Cl.: 16

Prior U.S. Cls.: 2, 5, 22, 23, 29, 37, 38 and 50

Reg. No. 3,570,137

United States Patent and Trademark Office

Registered Feb. 3, 2009

TRADEMARK  
PRINCIPAL REGISTER



3L-LUDVIGSEN A/S (DENMARK LIMITED LIABILITY COMPANY)  
VIBÆKVEJ 100, BRYLLE  
DK-5690 TOMMERUP  
DENMARK

FOR: OFFICE SUPPLIES, NAMELY, SELF-ADHESIVE STRIPS, STICKERS AND ADHESIVE LABELS FOR INDEX CARDS, DISPENSERS FOR DISPENSING DOUBLE-SIDED SELF-ADHESIVE TAPE FOR MOUNTING PHOTOGRAPHS, PAPER, IMAGES, PICTURES, DECORATIVE ELEMENTS AND ARTICLES USED IN SCRAPBOOK PROJECTS, DRAFTING SQUARES, DRAWING SQUARES, DRAWING RULERS, PROTRACTORS, ANGLE METERS PROTRACTORS, PAIRS OF COMPASSES IN THE NATURE OF DRAFTING COMPASSES, DRAWING INSTRUMENTS, DEVICE FOR POSITIONING DOCUMENTS, NAMELY, DISPENSERS FOR MOUNTING STRIPS FOR STATIONERY OR HOUSEHOLD USE AND DOCUMENT HOLDERS FOR MOUNTING OF ADHESIVE STRIPS, TRANSPARENT RINGS FOR REINFORCING HOLES FOR BINDER RINGS, TRANSPARENT SELF-ADHESIVE HOLDERS FOR BUSINESS AND VISITING CARDS, SELF-ADHESIVE LABEL HOLDERS AND ID CARD HOLDERS; LABELS, NAMELY, SELF-LAMINATING ADHESIVE LABELS AND BLANK CARDS, PHOTOGRAPH CORNERS, DOUBLE-SIDED ADHESIVE LABELS FOR PHOTOGRAPHS AND CLIPPINGS, DOUBLE-SIDED ADHESIVE TAPE FOR HOUSEHOLD OR STATIONERY USE, INCLUDING TAPE FOR PHOTOGRAPH MOUNTING; OFFICE SUPPLY KITS CONTAINING VARIOUS COMBINATIONS OF SELECTED OFFICE SUPPLIES, NAMELY, DRAWING RULERS, PROTRACTORS, PAIRS OF COMPASSES IN THE NATURE OF DRAFTING

COMPASSES, GRADUATED RULERS, SELF-ADHESIVE STRIPS, STICKERS AND ADHESIVE LABELS FOR INDEX CARDS, DISPENSERS FOR DISPENSING DOUBLE-SIDED SELF-ADHESIVE TAPE FOR MOUNTING PHOTOGRAPHS, PAPER, IMAGES, PICTURES, DECORATIVE ELEMENTS AND ARTICLES USED IN SCRAPBOOK PROJECTS, DRAFTING SQUARES, DRAWING SQUARES, ANGLE METERS PROTRACTORS, DRAWING INSTRUMENTS, DEVICE FOR POSITIONING DOCUMENTS, NAMELY, DISPENSERS FOR MOUNTING STRIPS FOR STATIONERY OR HOUSEHOLD USE AND DOCUMENT HOLDERS FOR MOUNTING OF ADHESIVE STRIPS, TRANSPARENT RINGS FOR REINFORCING HOLES FOR BINDER RINGS, TRANSPARENT SELF-ADHESIVE HOLDERS FOR BUSINESS AND VISITING CARDS, SELF-ADHESIVE LABEL HOLDERS AND ID CARD HOLDERS, LABELS, NAMELY, SELF-LAMINATING ADHESIVE LABELS AND BLANK CARDS, PHOTOGRAPH CORNERS, DOUBLE-SIDED ADHESIVE LABELS FOR PHOTOGRAPHS AND CLIPPINGS, DOUBLE-SIDED ADHESIVE TAPE FOR HOUSEHOLD OR STATIONERY USE, INCLUDING TAPE FOR PHOTOGRAPH MOUNTING, IN CLASS 16 (U.S. CLS. 2, 5, 22, 23, 29, 37, 38 AND 50).

OWNER OF INTERNATIONAL REGISTRATION  
0785518 DATED 7-9-2002, EXPIRES 7-9-2012.

OWNER OF U.S. REG. NO. 1,439,059.

SER. NO. 79-026,220, FILED 6-14-2006.

DOMINIC FATHY, EXAMINING ATTORNEY

**Int. Cls.: 3, 5, 16 and 21**

**Prior U.S. Cls.: 1, 2, 4, 5, 6, 13, 18, 22, 23, 29, 30, 33, 37, 38, 40, 44, 46, 50, 51 and 52**

**Reg. No. 3,570,138**

**United States Patent and Trademark Office**

**Registered Feb. 3, 2009**

**TRADEMARK  
PRINCIPAL REGISTER**

**BIANCI**

FIBIANCA GROUP INC (NEW JERSEY CORPORATION)  
691 STATE HIGHWAY 33  
TRENTON, NEW JERSEY 08619  
UNITED STATES

FOR: CLEANING PRODUCTS, NAMELY, ALL-PURPOSE CLEANERS, AUTOMOBILE CLEANERS, SHAMPOOS FOR AUTOMOBILES, WINDSHIELD CLEANER AND WASHER FLUIDS; CLEANING PREPARATIONS FOR USE ON VEHICLES, VEHICLE WHEELS, WHEEL COVERS, DASHBOARDS, GLASS AND MIRRORS; CARPET AND UPHOLSTERY CLEANERS; VEHICLE CARPET AND UPHOLSTERY CLEANERS; CARPET AND UPHOLSTERY CLEANERS WITH DEODORIZER; VEHICLE CARPET AND UPHOLSTERY CLEANERS WITH DEODORIZER; STRIPPING AND CLEANING PREPARATIONS FOR REMOVING WAX, OXIDATION AND LIGHT SCRATCHES FROM SURFACES OF VEHICLES; PRE-MOISTENED COSMETIC TISSUES; DISPOSABLE WIPES IMPREGNATED WITH CHEMICALS, COMPOUNDS, AND CLEANSERS FOR PERSONAL HYGIENE AND FOR CLEANING HANDS, IN CLASS 3 (U.S. CLS. 1, 4, 6, 50, 51 AND 52).

FOR: CAR DEODORANT, CAR DEODORIZER; SANITIZING WIPES AND HAND-SANITIZING PREPARATIONS; WIPES IMPREGNATED WITH DISINFECTANT; ALL PURPOSE DISINFECTING PREPARATIONS, IN CLASS 5 (U.S. CLS. 6, 18, 44, 46, 51 AND 52).

FOR: FACIAL AND HAND TISSUES; PAPER NAPKINS AND TOWELS AND DISPOSABLE NAPKINS AND PAPER TOWELS, ALL FOR PERSONAL CLEANING PURPOSES AND FOR CLEANING OF VEHICLES, IN CLASS 16 (U.S. CLS. 2, 5, 22, 23, 29, 37, 38 AND 50).

FOR: NON-WOVEN FABRIC WIPES PRE-MOISTENED WITH SOLUTIONS AND AGENTS FOR POLISHING AND CLEANING VEHICLES AND PARTS THEREOF; NON-WOVEN FABRIC COSMETIC WIPES, IN CLASS 21 (U.S. CLS. 2, 13, 23, 29, 30, 33, 40 AND 50).

THE MARK CONSISTS OF STANDARD CHARACTERS WITHOUT CLAIM TO ANY PARTICULAR FONT, STYLE, SIZE, OR COLOR.

PRIORITY DATE OF 11-3-2005 IS CLAIMED.

OWNER OF INTERNATIONAL REGISTRATION 0898327A DATED 4-28-2006, EXPIRES 4-28-2016.

SER. NO. 79-028,837, FILED 4-28-2006.

SUE LAWRENCE, EXAMINING ATTORNEY

**Int. Cl.: 9**

**Prior U.S. Cls.: 21, 23, 26, 36 and 38**

**United States Patent and Trademark Office**

**Reg. No. 3,570,139**

**Registered Feb. 3, 2009**

**TRADEMARK  
PRINCIPAL REGISTER**

**DRX**

MICRONAS GMBH (GERMAN DEM REP LIMITED LIABILITY COMPANY)  
HANS-BUNTE-STRASSE 19  
FREIBURG, FED REP GERMANY 79108

FOR: INTEGRATED CIRCUITS AND RELATED FIRMWARE, NAMELY MICROPROCESSORS, DIGITAL SIGNAL PROCESSORS AND MICROCONTROLLERS FOR VIDEO AND AUDIO MODULATORS AND DEMODULATORS FOR USE WITH TELEVISIONS, NONE BEING IDENTIFICATION SCANNERS OR APPARATUS UTILIZING SUCH SCANNERS FOR READING LABELS AND OTHER IDENTIFICATION MARKING ON GOODS AND PACKAGING OF GOODS TO FACILITATE INVENTORY CONTROL, TRACKING, SORTING, AND/OR DISTRIBUTION OF SUCH GOODS, IN CLASS 9 (U.S. CLS. 21, 23, 26, 36 AND 38).

THE MARK CONSISTS OF STANDARD CHARACTERS WITHOUT CLAIM TO ANY PARTICULAR FONT, STYLE, SIZE, OR COLOR.

PRIORITY DATE OF 5-20-2005 IS CLAIMED.

OWNER OF INTERNATIONAL REGISTRATION 0900821 DATED 11-16-2005, EXPIRES 11-16-2015.

SER. NO. 79-029,688, FILED 11-16-2005.

CURTIS FRENCH, EXAMINING ATTORNEY

**Int. Cls.: 7 and 9**

**Prior U.S. Cls.: 13, 19, 21, 23, 26, 31, 34, 35, 36 and 38**

**Reg. No. 3,570,140**

**United States Patent and Trademark Office**

**Registered Feb. 3, 2009**

**TRADEMARK  
PRINCIPAL REGISTER**

**HYBRID SIDE SHOOTER**

XAAR PLC (UNITED KINGDOM PRIVATE LIMITED COMPANY)  
UNIT 316, SCIENCE PARK  
CAMBRIDGE, UNITED KINGDOM CB4 0XR

FOR: PRINTING MACHINES; PRINT HEADS FOR PRINTING MACHINES; PRINTING INK SUPPLY SYSTEMS FOR USE WITH PRINTERS COMPOSED PRIMARILY OF INK RESERVOIRS, INK PUMPS AND INK CONNECTORS; FEEDING MACHINES FOR PAPER CUTTING AND PAPER FEEDING; STORAGE CONTAINERS FOR INK AND COLORED PRINTING INK FOR USE IN PRINTING MACHINES SOLD EMPTY; PARTS AND FITTINGS FOR THE AFORESAID GOODS, IN CLASS 7 (U.S. CLS. 13, 19, 21, 23, 31, 34 AND 35).

FOR: COMPUTER-CONTROLLED PRINTERS; INK-JET PRINTERS; COMPONENT PARTS FOR PRINTERS, NAMELY, PRINT HEADS, INK SUPPLY COMPONENTS FOR USE WITH PRINTERS, NAMELY, INK CONTROLLER UNIT FOR INK TEMPERATURE AND FLOW RATE REGULATION, INK CONDITIONING MODULE FOR FILTERING AND HEATING INK, AND A PRESSURE MODULE FOR

PROVIDING INPUTS TO THE INK CONTROLLER UNIT; CONNECTION CABLES; COMPUTER INTERFACE COMPONENTS FOR PRINTERS; ELECTRIC CHANGEOVER SWITCHES FOR PRINTERS; COMPUTER SOFTWARE FOR USE IN PRINTING OR IN CONNECTION WITH PRINTERS, IN CLASS 9 (U.S. CLS. 21, 23, 26, 36 AND 38).

PRIORITY DATE OF 1-23-2006 IS CLAIMED.

OWNER OF INTERNATIONAL REGISTRATION  
0902214 DATED 7-21-2006, EXPIRES 7-21-2016.

NO CLAIM IS MADE TO THE EXCLUSIVE RIGHT TO USE "HYBRID" AND "SHOOTER", APART FROM THE MARK AS SHOWN.

SER. NO. 79-030,399, FILED 7-21-2006.

CIMMERIAN COLEMAN, EXAMINING ATTORNEY

**Int. Cls.: 6, 7, 12 and 17**

**Prior U.S. Cls.: 1, 2, 5, 12, 13, 14, 19, 21, 23, 25, 31, 34, 35, 44 and 50**

**Reg. No. 3,570,141**

**United States Patent and Trademark Office**

**Registered Feb. 3, 2009**

**TRADEMARK  
PRINCIPAL REGISTER**



THE GATES CORPORATION (DELAWARE CORPORATION)  
1551 WEWATTA STREET  
DENVER, CO 80202

FOR: METAL HOSE CLAMPS FOR FLEXIBLE HOSES; METAL TUBES INCLUDING HYDRAULIC TUBES; FUEL TUBES, BRAIDED AND RIGID TUBES; METAL TUBES FOR TURBOCHARGERS; METAL TUBES FOR COOLING RADIATORS FOR MOTORS AND ENGINES, INCLUDING THOSE OF LAND VEHICLES; METAL TUBES FOR BRAKE LININGS FOR VEHICLES, IN CLASS 6 (U.S. CLS. 2, 12, 13, 14, 23, 25 AND 50).

FOR: POWER TRANSMISSION BELTS FOR LAND VEHICLE ENGINES INCLUDING VARIABLE SPEED BELTS; POWER TRANSMISSION BELTS FOR MACHINES, MOTORS AND ENGINES USED IN INDUSTRIAL APPLICATIONS INCLUDING VARIABLE SPEED BELTS; TIMING BELTS FOR ENGINES FOR LAND VEHICLES; TIMING BELTS FOR MACHINES, MOTORS AND ENGINES USED IN INDUSTRIAL APPLICATIONS; VACUUM CLEANER HOSES; SPROCKETS AND PULLEYS, VARIABLE DIAMETER PULLEYS, ADJUSTABLE PULLEYS, DUAL PULLEY TENSIONING SYSTEMS COMPRISING BELTS AND PULLEYS, BELT TENSIONERS, LOCKABLE TENSIONING DEVICES IN THE NATURE OF LOCKABLE TENSIONERS AND TENSIONING IDLER PULLEYS, ALL BEING PARTS OF ENGINES, MACHINES OR MOTORS, IN CLASS 7 (U.S. CLS. 13, 19, 21, 23, 31, 34 AND 35).

FOR: DRIVE BELTS AND POWER TRANSMISSION BELTS FOR LAND VEHICLES INCLUDING VARIABLE SPEED BELTS; LAND VEHICLE POWER TRANSMISSION AND STRUCTURAL PARTS FOR LAND VEHICLES OTHER THAN BELTS FOR LAND

VEHICLES, NAMELY, TENSIONERS, SPROCKETS AND PULLEYS, IN CLASS 12 (U.S. CLS. 19, 21, 23, 31, 35 AND 44).

FOR: FLEXIBLE TUBES OF RUBBER FOR LAND VEHICLES, INCLUDING HYDRAULIC HOSE, FUEL HOSE, BRAIDED HOSE AND RIGID TUBING; HOSE ASSEMBLIES MADE OF RUBBER FOR LAND VEHICLES; NON-METALLIC HOSE CLAMPING SLEEVES; NON-METALLIC TURBOCHARGER HOSE; NON-METALLIC HOSE FOR COOLING RADIATORS FOR MOTORS AND ENGINES, INCLUDING THOSE OF LAND VEHICLES; HYDRAULIC HOSE ASSEMBLIES MADE OF RUBBER; NON-METALLIC TUBES FOR BRAKE LININGS FOR VEHICLES; NON-METALLIC HOSE CLAMPS, IN CLASS 17 (U.S. CLS. 1, 5, 12, 13, 35 AND 50).

PRIORITY DATE OF 12-21-2005 IS CLAIMED.

OWNER OF INTERNATIONAL REGISTRATION  
0903481 DATED 6-15-2006, EXPIRES 6-15-2016.

NO CLAIM IS MADE TO THE EXCLUSIVE RIGHT TO USE "RACING" AS TO CLASSES 6, 12 AND 17 AND THE GOODS POWER TRANSMISSION BELTS FOR LAND VEHICLE ENGINES INCLUDING VARIABLE SPEED BELTS; TIMING BELTS FOR ENGINES FOR LAND VEHICLES; SPROCKETS AND PULLEYS, VARIABLE DIAMETER PULLEYS, ADJUSTABLE PULLEYS, DUAL PULLEY TENSIONING SYSTEMS COMPRISING BELTS AND PULLEYS, BELT TENSIONERS, LOCKABLE TENSIONING DEVICES IN THE NATURE OF LOCKABLE TENSIONERS AND TENSIONING IDLER PULLEYS, ALL BEING PARTS OF ENGINES, MA-



CHINES OR MOTORS IN CLASS 7, APART FROM  
THE MARK AS SHOWN.

SER. NO. 79-030,920, FILED 6-15-2006.

KRISTINA MORRIS, EXAMINING ATTORNEY

**Int. Cl.: 33**

**Prior U.S. Cls.: 47 and 49**

**United States Patent and Trademark Office**

**Reg. No. 3,570,142**

**Registered Feb. 3, 2009**

**TRADEMARK  
PRINCIPAL REGISTER**

**KANGARILLA ROAD**

ZINVIN PTY LTD (AUSTRALIA PROPRIETARY  
COMPANY LIMITED BY SHARES)  
C/- FINLAYSONS  
81 FLINDERS STREET  
ADELAIDE SA 5000, AUSTRALIA

PRIORITY DATE OF 10-25-2006 IS CLAIMED.

OWNER OF INTERNATIONAL REGISTRATION  
0906699 DATED 11-20-2006, EXPIRES 11-20-2016.

FOR: WINE, IN CLASS 33 (U.S. CLS. 47 AND 49).

THE MARK CONSISTS OF STANDARD CHAR-  
ACTERS WITHOUT CLAIM TO ANY PARTICULAR  
FONT, STYLE, SIZE, OR COLOR.

SER. NO. 79-032,179, FILED 11-20-2006.

DEBRA LEE, EXAMINING ATTORNEY

**Int. Cl.: 35**

**Prior U.S. Cls.: 100, 101 and 102**

**United States Patent and Trademark Office**

**Reg. No. 3,570,143**

**Registered Feb. 3, 2009**

**SERVICE MARK  
PRINCIPAL REGISTER**

**CRISCA**

BIBA GMBH (FED REP GERMANY PRIVATE  
LIMITED COMPANY)  
DAIMLERSTRASSE 3  
47167 DUISBURG, FED REP GERMANY

FOR: RETAIL STORE SERVICES WITH RESPECT  
TO CLOTHING, BELTS, FOOTWEAR AND HEAD-  
GEAR, GOODS MADE OF LEATHER AND IMITA-  
TIONS OF LEATHER, NAMELY, BAGS NOT  
ADAPTED TO THE PRODUCTS THEY ARE INTEN-  
DED TO CONTAIN AS WELL AS SMALL ARTICLES  
OF LEATHER, IN PARTICULAR PURSES, POCKET  
WALLETS, KEY CASES, TRUNKS AND TRAVEL-  
ING BAGS, UMBRELLAS, PARASOLS, JEWELRY,  
FASHION JEWELRY, PRECIOUS STONES, CLOCKS  
AND WATCHES, EYEGLASSES AND SUNGLASSES,  
PERFUMERIES, COSMETICS AND BODY CARE  
PRODUCTS, IN CLASS 35 (U.S. CLS. 100, 101 AND  
102).

THE MARK CONSISTS OF STANDARD CHAR-  
ACTERS WITHOUT CLAIM TO ANY PARTICULAR  
FONT, STYLE, SIZE, OR COLOR.

PRIORITY DATE OF 7-28-2006 IS CLAIMED.

OWNER OF INTERNATIONAL REGISTRATION  
0908046 DATED 11-14-2006, EXPIRES 11-14-2016.

OWNER OF U.S. REG. NO. 1,478,770.

SER. NO. 79-032,701, FILED 11-14-2006.

ELLEN B. AWRICH, EXAMINING ATTORNEY

**Int. Cl.: 25**

**Prior U.S. Cls.: 22 and 39**

**United States Patent and Trademark Office**

**Reg. No. 3,570,144**

**Registered Feb. 3, 2009**

**TRADEMARK  
PRINCIPAL REGISTER**



PM ONE S.R.L. (ITALY LIMITED LIABILITY COMPANY)  
VIA GIOVANNI FALCONE, 153  
I-25062 CONCESIO (BRESCIA)  
ITALY

FOR: CLOTHING FOR MEN, WOMEN AND CHILDREN, NAMELY, SUITS, DRESSES, PANTS, SHORTS, SKIRTS, SHIRTS, SWEATERS, BLOUSES, PULLOVERS, TRACK SUITS; JACKETS, COATS, WIND-RESISTANT JACKETS; SOCKS, TIGHTS, UNDERPANTS, PANTIES, BRAS, BRASSIERES, SINGLETS, LINGERIE, PAJAMAS, NIGHTGOWNS, NEGLIGEEES; HEADWEAR, NAMELY, BERETS, HATS, CAPS, BONNETS, BALACLAVAS, VISORS, HEADBANDS; SCARVES; FOULARDS; NECK BANDS; BANDANAS; GLOVES; SHOES AND BOOTS, IN CLASS 25 (U.S. CLS. 22 AND 39).

OWNER OF INTERNATIONAL REGISTRATION 0913525 DATED 12-1-2006, EXPIRES 12-1-2016.

NO CLAIM IS MADE TO THE EXCLUSIVE RIGHT TO USE "ITALIA", APART FROM THE MARK AS SHOWN.

THE TRADEMARK CONSISTS OF THE WORDING "GUASTO" WRITTEN WITH OUTLINED LETTERS AND IN A HALF STYLIZED FACE, ASSOCIATED TO WORDING "ITALIA" AND TO A TRICOLOR STRIP AND TO THE WORDING "HEAD EQUIPMENT".

THE FOREIGN WORDING "GUASTO" AND "ITALIA" CAN BE TRANSLATED INTO ENGLISH AS BREAKDOWN AND ITALY.

SER. NO. 79-034,583, FILED 12-1-2006.

DOMINIC J. FERRAIUOLO, EXAMINING ATTORNEY

**Int. Cl.: 30**

**Prior U.S. Cl.: 46**

**United States Patent and Trademark Office**

**Reg. No. 3,570,145**

**Registered Feb. 3, 2009**

**TRADEMARK  
PRINCIPAL REGISTER**



SOREMARTEC S.A. (BELGIUM SOCIÉTÉ ANON-  
YME)  
DRÈVE DE L'ARC-EN-CIEL 102  
B-6700 SCHOPPACH-ARLON  
BELGIUM

FOR: PASTRY AND CONFECTIONERY, NAME-  
LY, CANDIES, CHOCOLATE AND CHOCOLATE  
GOODS, NAMELY, CHOCOLATE BARS, CHOCO-  
LATE CAKES, CHOCOLATE COOKIES, CHOCO-  
LATE PASTES, CHOCOLATE COVERINGS,  
CHOCOLATE EGGS, CHOCOLATE CANDIES, IN  
CLASS 30 (U.S. CL. 46).

PRIORITY DATE OF 7-12-2006 IS CLAIMED.

OWNER OF INTERNATIONAL REGISTRATION  
0914862 DATED 1-10-2007, EXPIRES 1-10-2017.

OWNER OF U.S. REG. NOS. 2,637,970 AND  
2,697,090.

THE COLOR(S) GOLD AND DARK BROWN IS/  
ARE CLAIMED AS A FEATURE OF THE MARK.

THE MARK CONSISTS OF "FERRERO" IN  
BROWN LETTERS ON A GOLD BACKGROUND  
AND "MOMENTS" IN GOLD LETTERS ON A  
BROWN BACKGROUND.

THE MARK CONSISTS OF A RECTANGLE DIVI-  
DED IN HALF. THE TOP HALF FEATURES THE  
TERM "FERRERO" IN BROWN STYLIZED LET-  
TERS ON A GOLD BACKGROUND, AND THE  
BOTTOM HALF FEATURES THE TERM "MO-  
MENTS" IN GOLD STYLIZED LETTERS ON A  
BROWN BACKGROUND.

SER. NO. 79-035,003, FILED 1-10-2007.

SONYA STEPHENS, EXAMINING ATTORNEY

Int. Cl.: 33

Prior U.S. Cls.: 47 and 49

United States Patent and Trademark Office

Reg. No. 3,570,146

Registered Feb. 3, 2009

TRADEMARK  
PRINCIPAL REGISTER



OBSHCHESTVO S OGRANICHENNOY; OT-  
VETSTVENNOSTYU "DIAMANT ALKO"  
(RUSSIAN FED. LIMITED LIABILITY COM-  
PANY)  
STR. 13, 26 UL. LENINSKAYA SLOBODA  
RU-109280 MOSKVA, RUSSIAN FED.

FOR: VODKA, IN CLASS 33 (U.S. CLS. 47 AND 49).

OWNER OF INTERNATIONAL REGISTRATION  
0916481 DATED 12-18-2006, EXPIRES 12-18-2016.

OWNER OF U.S. REG. NOS. 3,093,398 AND  
3,251,964.

NO CLAIM IS MADE TO THE EXCLUSIVE  
RIGHT TO USE "PERVAYA VODKA" AND THE  
BOTTLE DESIGN, APART FROM THE MARK AS  
SHOWN.

THE COLOR(S) BLACK, RED, AND GRAY IS/  
ARE CLAIMED AS A FEATURE OF THE MARK.

THE MARK CONSISTS OF BOTTLE, WITH A  
RAISED DOME AS THE BASE, WHICH CONTAINS  
THE STYLIZED LETTERS "TK". THE FRONT OF  
THE BOTTLE CONTAINS THE CYRILLIC LETTER  
"A" IN RED WITH GRAY AND BLACK SHADOW-  
ING AND ABOVE THE LETTERS "[AZ]" IN BLACK  
CYRILLIC LETTERS. BELOW "[AZ]" ARE THE  
WORDS "PERVAYA VODKA" IN BLACK CYRILLIC  
LETTERS. THE BOTTLE DESIGN IS ONLY INTEN-  
DED TO INDICATE PLACEMENT OF THE MARK.

THE ENGLISH TRANSLATION OF THE WORD  
"PERVAYA" IN THE MARK IS PREMIER.

THE NON-LATIN CHARACTER(S) IN THE  
MARK TRANSLITERATES INTO "A [AZ] PERVAYA  
VODKA", AND THIS MEANS PREMIER VODKA IN  
ENGLISH.

SER. NO. 79-035,573, FILED 12-18-2006.

ALYSSA STEEL, EXAMINING ATTORNEY

**Int. Cl.: 7**

**Prior U.S. Cls.: 13, 19, 21, 23, 31, 34 and 35**

**United States Patent and Trademark Office**

**Reg. No. 3,570,147**

**Registered Feb. 3, 2009**

**TRADEMARK  
PRINCIPAL REGISTER**



HERRENKNECHT AG (FED REP GERMANY CORPORATION)  
SCHLEHENWEG 2  
SCHWANAU-ALLMANNSWEIER, FED REP GERMANY 77963

FOR: TUNNELING MACHINERY, NAMELY, TUNNEL BORING AND DRILLING MACHINES AND PERIPHERAL EQUIPMENT THEREFORE, NAMELY, CUTTER HEADS, DRILL PRESSES, NAVIGATION UNITS SOLD AS A COMPONENT OF TUNNEL BORING AND DRILLING MACHINES, CONTROL UNITS SOLD AS A COMPONENT OF TUNNEL BORING AND DRILLING MACHINES, SOLID AND FLUID SEPARATORS AND TRANSPORTERS SOLD AS A COMPONENT OF TUNNEL BORING AND DRILLING MACHINES FOR USE IN SEPARATING AND TRANSPORTING EXCAVATED MATERIALS, ALL FOR USE WITH TUNNEL BORING AND DRILLING MACHINES, IN CLASS 7 (U.S. CLS. 13, 19, 21, 23, 31, 34 AND 35).

OWNER OF INTERNATIONAL REGISTRATION 0919782 DATED 3-26-2007, EXPIRES 3-26-2017.

OWNER OF U.S. REG. NO. 2,943,698.

NO CLAIM IS MADE TO THE EXCLUSIVE RIGHT TO USE "TUNNELLING SYSTEMS", APART FROM THE MARK AS SHOWN.

THE COLOR(S) LIGHT GREEN, WHITE, DARK GREEN IS/ARE CLAIMED AS A FEATURE OF THE MARK.

THE MARK CONSISTS OF THE WORDING "TUNNELLING SYSTEMS" AND THE LETTER "H" ARE SHOWN IN DARK GREEN FONT. THE COLOR DARK GREEN ALSO APPEARS IN THE DESIGN AS SHADING FOR A GEOMETRIC FIGURE, WHICH ENCOMPASSES THE LETTER "H". THE WORDING "HERRENKNECHT" IS SHOWN IN WHITE FONT, AND THE COLOR WHITE ALSO APPEARS AS AN OUTLINE FOR THE LETTER "H", AS SHADING FOR THE GEOMETRIC FIGURE ENCOMPASSING THE LETTER "H", AND AS THE BACKGROUND FOR THE WORDING "TUNNELLING SYSTEMS". THE COLOR LIGHT GREEN APPEARS IN THE SQUARE BACKGROUND OF THE DESIGN.

SER. NO. 79-036,801, FILED 3-26-2007.

BRIAN CALLAGHAN, EXAMINING ATTORNEY

**Int. Cls.: 9, 12 and 37**

**Prior U.S. Cls.: 19, 21, 23, 26, 31, 35, 36, 38, 44, 100,  
103 and 106**

**Reg. No. 3,570,148**

**United States Patent and Trademark Office**

**Registered Feb. 3, 2009**

**TRADEMARK  
SERVICE MARK  
PRINCIPAL REGISTER**



FUELMATICS AB (SWEDEN PRIVATE LIMITED  
COMPANY)

BOX 24066

SE-104 51 STOCKHOLM, SWEDEN

FOR: PETROL PUMPS FOR PETROL STATIONS;  
REGISTERED COMPUTER SOFTWARE FOR CON-  
TROLLING AUTOMATIC FUEL PUMPS AND FOR  
USE WITH CARDS AND WITH DATA CARRIERS  
FOR MONETARY TRANSACTIONS; INFORMA-  
TION PROCESSING SYSTEM IN THE NATURE OF  
AUTOMATIC FUEL PUMPS AND FOR USE WITH  
CARDS AND WITH DATA CARRIERS FOR MONE-  
TARY TRANSACTIONS, IN CLASS 9 (U.S. CLS. 21,  
23, 26, 36 AND 38).

FOR: CAPS FOR VEHICLE PETROL TANKS, IN  
CLASS 12 (U.S. CLS. 19, 21, 23, 31, 35 AND 44).

FOR: VEHICLE SERVICE STATIONS FOR RE-  
FUELING, IN CLASS 37 (U.S. CLS. 100, 103 AND 106).

PRIORITY DATE OF 7-13-2006 IS CLAIMED.

OWNER OF INTERNATIONAL REGISTRATION  
0921184 DATED 1-12-2007, EXPIRES 1-12-2017.

SER. NO. 79-037,384, FILED 1-12-2007.

LAURIE KAUFMAN, EXAMINING ATTORNEY



Int. Cl.: 1

Prior U.S. Cls.: 1, 5, 6, 10, 26 and 46

United States Patent and Trademark Office

Reg. No. 3,570,149

Registered Feb. 3, 2009

TRADEMARK  
PRINCIPAL REGISTER



UAB "FERMENTAS" (LITHUANIA LIMITED  
LIABILITY COMPANY)  
V. GRAICIUNO G. 8  
LT-02241 VILNIUS  
LITHUANIA

FOR: CHEMICAL SUBSTANCES, NAMELY, ENZYMES FOR USE IN LABORATORIES NOT FOR MEDICAL OR VETERINARY PURPOSES; CHEMICAL PREPARATIONS FOR SCIENTIFIC PURPOSES NOT FOR MEDICAL OR VETERINARY USE; CHEMICAL REAGENTS NOT FOR MEDICAL OR VETERINARY PURPOSES; DIAGNOSTIC PREPARATIONS FOR USE IN LABORATORIES NOT FOR MEDICAL OR VETERINARY PURPOSES; BIOLOGICAL PREPARATIONS NOT FOR MEDICAL OR VETERINARY PURPOSES, IN CLASS 1 (U.S. CLS. 1, 5, 6, 10, 26 AND 46).

PRIORITY DATE OF 1-25-2007 IS CLAIMED.

OWNER OF INTERNATIONAL REGISTRATION  
0922282 DATED 1-30-2007, EXPIRES 1-30-2017.

THE COLOR(S) LIGHT BLUE, BLUE, RED AND WHITE IS/ARE CLAIMED AS A FEATURE OF THE MARK.

THE MARK CONSISTS OF THE WORD "FASTDIGEST" WITH A PARTIAL LIGHT BLUE OVAL AROUND LETTERS "FA" AND A BROKEN LIGHT BLUE LINE THAT FADES TO WHITE BELOW THE WORD "FASTDIGEST". THE LETTERS "FAST" ARE IN BLUE AND THE LETTERS "DIGEST" ARE IN RED.

SER. NO. 79-037,804, FILED 1-30-2007.

BENJAMIN OKEKE, EXAMINING ATTORNEY

**Int. Cl.: 1**

**Prior U.S. Cls.: 1, 5, 6, 10, 26 and 46**

**Reg. No. 3,570,150**

**United States Patent and Trademark Office**

**Registered Feb. 3, 2009**

**TRADEMARK  
PRINCIPAL REGISTER**



SINOCEM CORPORATION (CHINA CORPORATION)  
SINOCEM TOWER  
A2 FUXINGMENWAI DAJIE; BEIJING  
CHINA

FOR: CHEMICAL FERTILIZERS, VEGETABLE  
FERTILIZERS, ANIMAL FERTILIZERS, IN CLASS  
1 (U.S. CLS. 1, 5, 6, 10, 26 AND 46).

OWNER OF INTERNATIONAL REGISTRATION  
0923674 DATED 3-26-2007, EXPIRES 3-26-2017.

OWNER OF U.S. REG. NOS. 3,120,986, 3,398,704,  
AND 3,398,710.

THE WORDING "SINOCEM" HAS NO MEANING  
IN A FOREIGN LANGUAGE.

THE TRANSLITERATION OF THE NON-LATIN  
CHARACTERS IN THE MARK IS "ZHONG HUA"  
WHICH MEANS "MIDDLE" AND "CHANGE" RE-  
SPECTIVELY AND WHEN USED TOGETHER, IT  
DOES NOT HAVE ANY MEANING IN ENGLISH.

SER. NO. 79-038,313, FILED 3-26-2007.

DAVID MILLER, EXAMINING ATTORNEY

**Int. Cl.: 17**

**Prior U.S. Cls.: 1, 5, 12, 13, 35 and 50**

**Reg. No. 3,570,151**

**United States Patent and Trademark Office**

**Registered Feb. 3, 2009**

**TRADEMARK  
PRINCIPAL REGISTER**

---

**5Elem**

---

JIANGYANSHI WUXING; SHUIDAI YOUXIAN  
GONGSI (CHINA CORPORATION)  
JIANGSUSHENG JIANGYANZHEN  
TONGYANGXILU 73 HAO, CHINA

FOR: FIRE HOSES; CANVAS HOSE PIPES FOR  
USE IN IRRIGATION; HOSES OF TEXTILE MATE-  
RIAL, NAMELY, CANVAS HOSE PIPES FOR USE IN  
IRRIGATION; GARDEN HOSES; FLEXIBLE TUBES  
NOT OF METAL, NAMELY, PLASTIC TUBES FOR  
AGRICULTURAL USE, RUBBER TUBES; NON-ME-  
TAL, PLASTIC AND RUBBER HOSES FOR INDUS-

TRIAL APPLICATIONS; WATERING HOSES, IN  
CLASS 17 (U.S. CLS. 1, 5, 12, 13, 35 AND 50).

OWNER OF INTERNATIONAL REGISTRATION  
0924799 DATED 5-21-2007, EXPIRES 5-21-2017.

SER. NO. 79-038,712, FILED 5-21-2007.

MARCIE MILONE, EXAMINING ATTORNEY

**Int. Cls.: 9, 12 and 38**

**Prior U.S. Cls.: 19, 21, 23, 26, 31, 35, 36, 38, 44, 100,  
101 and 104**

**Reg. No. 3,570,152**

**United States Patent and Trademark Office**

**Registered Feb. 3, 2009**

**TRADEMARK  
SERVICE MARK  
PRINCIPAL REGISTER**

# **Making machines talk.**

TELIT COMMUNICATIONS S.P.A. (ITALY AK-  
TIENGESELLSCHAFT)  
VIA STAZIONE DI PROSECCO, 5/B  
I-34010 SGONICO (TS)  
ITALY

FOR: APPARATUS AND INSTRUMENTS FOR CONDUCTING, SWITCHING, TRANSFORMING, ACCUMULATING, REGULATING OR CONTROLLING ELECTRICITY, AND RELATED COMPONENTS, NAMELY, MODEMS, MODEMS FOR TRANSCEIVERS FOR WIRELESS TELECOMMUNICATIONS, AND INTEGRATED CIRCUIT MODULES FOR WIRELESS COMMUNICATIONS, ELECTRONIC MODULES, NAMELY, HARDWARE ELECTRONIC CHIPS WITH EMBEDDED SOFTWARE FOR PROVIDING TELECOMMUNICATION CAPABILITIES FOR EXCHANGING DATA OR SOUNDS, STILL OR ANIMATED IMAGES, MESSAGES, ESPECIALLY IN MOBILE TELEPHONY EQUIPMENT, IN A MOTOR VEHICLE, OR IN AN AUTOMATIC VENDING MACHINE; CD-PLAYERS, DVD-PLAYERS, MP3-PLAYERS; VENDING MACHINES; COMPUTERS; TELEPHONES; CELLULAR TELEPHONES; CORDLESS TELEPHONES; MOBILE PHONES; ACCESSORIES FOR TELEPHONES, MOBILE PHONES AND CORDLESS TELEPHONES, NAMELY, CARRYING CASES, BATTERY CHARGERS, BATTERY CHARGERS FOR USE IN VEHICLES, COVERS, EAR PHONES, HANDS FREE KITS, KEYBOARDS, PHONE STRAPS, DOWNLOADABLE RING TONES AND GRAPHICS FOR MOBILE PHONES; DEVICES FOR THE DISTANT REPRODUCTION OF DOCUMENTS VIA TELEPHONE, RADIO AND TELEVISION, NAMELY, PERSONAL DIGITAL ASSISTANTS FOR LOGISTICS AND GEOMEASURING SYSTEMS; FAX MACHINES; ENCODING AND DECODING APPARATUS; MODEMS; ELECTRONIC CALCULATORS, MICROELECTRONIC CIRCUITS; ELECTRONIC SEMICONDUCTORS, DIODES, TRANSISTORS. DEVICES FOR AUTOMATIC LOCATION, NAMELY, TRACING AND TRACKING DEVICES, NAMELY, ENCODED MICRO PARTICULATES, TAGS AND TAGGANTS

OF PLASTIC, METAL OR SILICATE FOR USE IN THE FIELD OF PASSING LABELING, TRACING OR TRACKING OF VEHICLES AND SATELLITES, COMPUTER HARDWARE AND SOFTWARE SYSTEM FOR TRACKING PEOPLE, VEHICLES, SATELLITES AND OTHER OBJECTS USING GPS DATA AND CELLULAR COMMUNICATIONS ON A DEVICE ON THE TRACKED PEOPLE, VEHICLES, SATELLITES AND OTHER OBJECTS, VEHICLE LOCATING, TRACKING AND SECURITY SYSTEM COMPRISED OF AN ANTENNA AND RADIO TRANSMITTER TO BE PLACED IN A VEHICLE, AND WIRELESS TRANSCEIVERS WITH COLLECTION AND DISPLAY TECHNOLOGY FOR THE STATUS AND TRACKING OF ALL VEHICLE TYPES IN LOCAL ENVIRONMENTS; DEVICES FOR AUTOMATIC LOCATION, NAMELY, FLEET MANAGEMENT SYSTEMS INTEGRATING A GLOBAL POSITIONING SYSTEM (GPS), A WIRELESS TRANSCEIVER, COMPUTER HARDWARE AND COMPUTER SOFTWARE WHICH PROVIDES ELECTRONIC INTELLIGENCE TO AND FROM VEHICLES, COMPUTER SOFTWARE FOR DATABASE MANAGEMENT OF FLEETS OF VEHICLES IN THE FIELD OF COMMERCIAL GROUND TRANSPORTATION; DEVICES FOR AUTOMATIC LOCATION, NAMELY, TOLL-COLLECT SYSTEMS, NAMELY, STATIONARY VEHICLE ELECTRONIC TAG IDENTITY READERS FOR PUBLIC AGENCIES AND AUTHORITIES FOR USE IN ELECTRONIC TOLL COLLECTION, MONITORING OF COMMERCIAL VEHICLE CREDENTIALS, AND TRAFFIC MONITORING, AND VEHICLE MOUNTED TRANSPONDERS FOR USE EXCLUSIVELY WITH SUCH STATIONARY VEHICLE ELECTRONIC TAG IDENTITY READERS; DEVICES FOR AUTOMATIC LOCATION, NAMELY, GLOBAL POSITIONING SYSTEM (GPS); DEVICES FOR AUTOMATIC LOCATION, NAMELY, SATELLITE-BASED SYSTEMS, NAMELY, SATELLITE AERIALS, SATELLITE NAVIGATIONAL SYSTEM, NAMELY, A GLOBAL POSITIONING SYSTEM (GPS), SATELLITE TRANSMITTERS AND RECEIVERS, SATELLITE RADIOS, SATELLITE AND MICROWAVE COMMU-

NICATIONS APPARATUS TO TRANSMIT COMMUNICATIONS FROM A VEHICLE TO ANOTHER VEHICLE, OR FROM A VEHICLE TO A SATELLITE. LOCATION-REPORTING DEVICE, NAMELY, TRACING AND TRACKING DEVICES, NAMELY, ENCODED MICRO PARTICULATES, TAGS AND TAGGANTS OF PLASTIC, METAL OR SILICATE FOR USE IN THE FIELD OF PASSING LABELING, TRACING OR TRACKING OF VEHICLES AND SATELLITES, COMPUTER HARDWARE AND SOFTWARE SYSTEM FOR TRACKING PEOPLE, VEHICLES, SATELLITES AND OTHER OBJECTS USING GPS DATA AND CELLULAR COMMUNICATIONS ON A DEVICE ON THE TRACKED PEOPLE, VEHICLES, SATELLITES AND OTHER OBJECTS, VEHICLE LOCATING, TRACKING AND SECURITY SYSTEM COMPRISED OF AN ANTENNA AND RADIO TRANSMITTER TO BE PLACED IN A VEHICLE, AND WIRELESS TRANSCEIVERS WITH COLLECTION AND DISPLAY TECHNOLOGY FOR THE STATUS AND TRACKING OF ALL VEHICLE TYPES IN LOCAL ENVIRONMENTS; LOCATION-REPORTING DEVICE, NAMELY, FLEET MANAGEMENT SYSTEMS INTEGRATING A GLOBAL POSITIONING SYSTEM (GPS), A WIRELESS TRANSCEIVER, COMPUTER HARDWARE AND COMPUTER SOFTWARE WHICH PROVIDES ELECTRONIC INTELLIGENCE TO AND FROM VEHICLES, COMPUTER SOFTWARE FOR DATABASE MANAGEMENT OF FLEETS OF VEHICLES IN THE FIELD OF COMMERCIAL GROUND TRANSPORTATION; LOCATION-REPORTING DEVICE, NAMELY, TOLL-COLLECT SYSTEMS, NAMELY, STATIONARY VEHICLE ELECTRONIC TAG READERS FOR PUBLIC AGENCIES AND AUTHORITIES FOR USE IN ELECTRONIC TOLL COLLECTION, MONITORING OF COMMERCIAL VEHICLE CREDENTIALS, AND TRAFFIC MONITORING, AND VEHICLE MOUNTED TRANSPONDERS FOR USE EXCLUSIVELY WITH SUCH STATIONARY VEHICLE ELECTRONIC TAG READERS; LOCATION-REPORTING DEVICE, NAMELY, GLOBAL POSITIONING SYSTEM (GPS); LOCATION-REPORTING DEVICE, NAMELY, SATELLITE-BASED SYSTEMS, NAMELY, SATELLITE AERIALS, SATELLITE NAVIGATIONAL SYSTEM, NAMELY, A GLOBAL POSITIONING SYSTEM (GPS), SATELLITE TRANSMITTERS AND RECEIVERS, SATELLITE RADIOS, SATELLITE AND MICROWAVE COMMUNICATIONS APPARATUS TO TRANSMIT COMMUNICATIONS FROM A VEHICLE TO ANOTHER VEHICLE, OR FROM A VEHICLE TO A SATELLITE; ELECTRONIC DEVICES FOR SATELLITE TRANSMISSION, NAMELY, SATELLITE TRANSMITTERS. COMMERCIAL AND CONSUMER SATELLITE NAVIGATION DEVICES NAMELY, GPS, INTEGRATED SIGNAL POSITIONING SYSTEMS COMPRISED OF A SATELLITE, GPS AND A CONTROL UNIT, SATELLITE COMMUNICATIONS TERRESTRIAL STATION COMMUNICATIONS EQUIPMENT, NAMELY, SATELLITE PROCESSORS AND VEHICLE COMMUNICATIONS EQUIPMENT FOR WIRELESS COMMUNICATION, NAMELY, VEHICLE LOCATING, TRACKING AND SECURITY SYSTEM COMPRISED OF AN ANTENNA AND RADIO TRANSMITTER TO BE PLACED IN A VEHICLE; APPLIANCES FOR RECORDING

DISTANCES, NAMELY, GPS AND GEO-MEASURING SYSTEMS TOOLS, NAMELY, INTEGRATED SIGNAL POSITIONING SYSTEMS COMPRISED OF A SATELLITE, GPS AND A CONTROL UNIT; DISTANCE MEASURING APPARATUS; NAVIGATION APPARATUS FOR VEHICLES IN THE NATURE OF ON-BOARD COMPUTERS; FREQUENCY METERS; SPEED CHECK DEVICES, NAMELY, SPEED INDICATORS, LASER SPEED DETECTORS AND ELECTRONIC SPEED CONTROLLERS; GEO-MEASURING TOOLS, NAMELY, INTEGRATED SIGNAL LOCATION AND POSITION MEASURING SYSTEMS COMPRISED OF A SATELLITE, GPS AND A CONTROL UNIT; INTERFACES FOR COMPUTERS; MICROPROCESSORS; TELECOMMUNICATIONS TRANSMITTERS, IN CLASS 9 (U.S. CLS. 21, 23, 26, 36 AND 38).

FOR: ANTI-THEFT ALARMS FOR VEHICLES, IN CLASS 12 (U.S. CLS. 19, 21, 23, 31, 35 AND 44).

FOR: TELECOMMUNICATIONS SERVICES, NAMELY, TRANSMISSION OF PODCASTS, TRANSMISSION OF WEBCASTS, LOCAL AND LONG DISTANCE TRANSMISSION OF VOICE, DATA, GRAPHICS AND VIDEO BY MEANS OF BROADBAND OPTICAL OR WIRELESS NETWORKS, PROVIDING INTERNET ACCESS VIA BROADBAND OPTICAL OR WIRELESS NETWORKS, LOCAL AND LONG DISTANCE TRANSMISSION OF VOICE, DATA, GRAPHICS AND VIDEO BY MEANS OF BROADBAND, COPPER AND OPTICAL OR WIRELESS NETWORKS, TRANSMISSION OF VOICE, DATA, GRAPHICS, SOUND AND VIDEO BY MEANS OF BROADBAND POWER LINE OR WIRELESS NETWORKS, WIRELESS TELEPHONE SERVICES, WIRELESS EXCHANGE OF DATA BETWEEN COMPUTER HARDWARE AND COMPUTERS, MACHINES, TECHNICAL EQUIPMENT AND TRANSPORTATION VEHICLES, TELECOMMUNICATION SERVICES IN THE NATURE OF PROVIDING TELEPHONE FEATURES, NAMELY, CALL WAITING, CALL IDENTIFICATION, CALL FORWARDING, AND MESSAGE WAITING, TELECOMMUNICATION SERVICES IN THE NATURE OF PROVIDING TELEPHONE SERVICES WITH VARIOUS TELEPHONE FEATURES, NAMELY, A DEDICATED TOLL-FREE NUMBER, VOICEMAIL, MULTIPLE MAILBOX EXTENSIONS, TELEPHONE MESSAGE NOTIFICATION, FAX CAPABILITIES, DETAILED CALL REPORTS, CALL WAITING, CALL IDENTIFICATION, CALL FORWARDING, AND MESSAGE WAITING, TELECOMMUNICATIONS BY E-MAIL; TELEPHONE CALL COMPLETION SERVICES FOR DIRECTORY ASSISTANCE CUSTOMERS; PROVIDING TELECOMMUNICATION CONNECTIONS TO A WORLD-WIDE COMPUTER NETWORK; TELECOMMUNICATIONS ROUTING AND JUNCTION SERVICES; MOBILE TELEPHONE COMMUNICATION SERVICE; SATELLITE TRANSMISSION; PROVIDING ACCESS TO A WORLD-WIDE COMPUTER NETWORK; COMMUNICATIONS VIA FIBER-OPTIC NETWORKS; WEBMESSAGING; PROVIDING ACCESS TO DATABASES, IN CLASS 38 (U.S. CLS. 100, 101 AND 104).

PRIORITY DATE OF 8-10-2006 IS CLAIMED.

SER. NO. 79-038,777, FILED 2-8-2007.

OWNER OF INTERNATIONAL REGISTRATION  
0924957 DATED 2-8-2007, EXPIRES 2-8-2017.

SHARON MEIER, EXAMINING ATTORNEY

**Int. Cls.: 1, 4, 9, 39, 40 and 42**

**Prior U.S. Cls.: 1, 5, 6, 10, 15, 21, 23, 26, 36, 38, 46,  
100, 101, 103, 105 and 106**

**Reg. No. 3,570,153**

**United States Patent and Trademark Office**

**Registered Feb. 3, 2009**

**TRADEMARK  
SERVICE MARK  
PRINCIPAL REGISTER**

**INBICON**

DONG ENERGY A/S (DENMARK CORPORATION)  
KRAFTVÆRKSVEJ 53  
DK-7000 FREDERICIA  
DENMARK

FOR: COMBUSTIBLE PREPARATIONS, NAME-  
LY, CHEMICAL ADDITIVES FOR MOTOR FUEL  
AND LUBRICANTS, IN CLASS 1 (U.S. CLS. 1, 5, 6, 10,  
26 AND 46).

FOR: INDUSTRIAL OILS AND GREASES; ALL  
PURPOSE AUTOMOTIVE LUBRICANTS; FUELS,  
NAMELY, MOTOR SPIRITS, NAMELY, GASOLINE,  
IN CLASS 4 (U.S. CLS. 1, 6 AND 15).

FOR: SOFTWARE FOR USE IN DATABASE MAN-  
AGEMENT IN THE FIELD OF DISTRIBUTION AND  
PRODUCTION OF ENERGY, DATA PROCESSING  
EQUIPMENT, NAMELY, PROCESSORS; APPARA-  
TUS AND INSTRUMENTS FOR CONDUCTING,  
SWITCHING, TRANSFORMING, ACCUMULAT-  
ING, REGULATING OR CONTROLLING ENERGY  
IN CONNECTION WITH DISTRIBUTION AND PRO-  
DUCTION OF ENERGY, NAMELY, TRANSFOR-  
MERS, SWITCHBOARDS, ELECTRIC  
CONDUCTORS, ELECTRONIC INDICATOR

BOARDS, IN CLASS 9 (U.S. CLS. 21, 23, 26, 36 AND  
38).

FOR: DISTRIBUTION OF ENERGY, UTILITY  
SERVICES, NAMELY, TRANSMISSION OF ENER-  
GY, IN CLASS 39 (U.S. CLS. 100 AND 105).

FOR: PRODUCTION OF ENERGY, IN CLASS 40  
(U.S. CLS. 100, 103 AND 106).

FOR: SCIENTIFIC AND TECHNOLOGICAL SER-  
VICES AND RESEARCH AND DESIGN RELATING  
THERETO IN CONNECTION WITH PRODUCTION  
AND DISTRIBUTION OF ENERGY, IN CLASS 42  
(U.S. CLS. 100 AND 101).

THE MARK CONSISTS OF STANDARD CHAR-  
ACTERS WITHOUT CLAIM TO ANY PARTICULAR  
FONT, STYLE, SIZE, OR COLOR.

OWNER OF INTERNATIONAL REGISTRATION  
0926015 DATED 4-16-2007, EXPIRES 4-16-2017.

SER. NO. 79-039,250, FILED 4-16-2007.

SANI KHOURI, EXAMINING ATTORNEY

**Int. Cls.: 9, 11 and 42**

**Prior U.S. Cls.: 13, 21, 23, 26, 31, 34, 36, 38, 100 and 101**

**Reg. No. 3,570,154**

**United States Patent and Trademark Office**

**Registered Feb. 3, 2009**

**TRADEMARK  
SERVICE MARK  
PRINCIPAL REGISTER**

**HENSEL**

HENSEL STUDIOTECHNIK GMBH & CO. KG  
(FED REP GERMANY LIMITED PARTNER-  
SHIP)

ROBERT-BUNSEN-STR. 3  
97076 WÜRZBURG  
FED REP GERMANY

FOR: PHOTOGRAPHIC, CINEMATOGRAPHIC,  
OPTICAL APPARATUS AND INSTRUMENTS,  
NAMELY, CAMERAS, EXPOSURE METERS, PHO-  
TOGRAPHIC FLASH UNITS, PHOTOGRAPHIC  
FLASHBULBS, PHOTOGRAPHIC AND CINEMATO-  
GRAPHIC PROJECTORS, OPTICAL MIRRORS;  
FLASH LAMPS; FLASHLIGHTS WITH LIGHT  
EMITTING DIODES FOR USE IN PHOTOGRAPHY;  
CAMERA CLOSURES AND FILTERS; PHOTO-  
GRAPHIC OBJECTIVES FOR CAMERAS AND OP-  
TICAL LENSES, LENS HOODS; SLIDE OR  
PHOTOGRAPHIC PROJECTION APPARATUS AND  
PROJECTION SCREENS; TRIPODS FOR CAMERAS,  
IN CLASS 9 (U.S. CLS. 21, 23, 26, 36 AND 38).

FOR: PERMANENT LIGHTS, NAMELY, HALO-  
GEN LIGHT BULBS; CEILING BAR SYSTEMS FOR  
LIGHTING INSTALLATIONS COMPRISED OF  
LIGHTING FIXTURES AND LIGHTING TRACKS;  
LAMPS; REFLECTORS FOR SHAPING AND DI-  
RECTING THE LIGHT, ALWAYS MOUNTED ON  
THE LIGHTSOURCE, NAMELY, THE LAMP, IN  
CLASS 11 (U.S. CLS. 13, 21, 23, 31 AND 34).

FOR: ENGINEERING; STYLING IN THE NAT-  
URE OF INDUSTRIAL DESIGN, IN CLASS 42 (U.S.  
CLS. 100 AND 101).

OWNER OF INTERNATIONAL REGISTRATION  
0867734 DATED 7-19-2005, EXPIRES 7-19-2015.

SEC. 2(F).

SER. NO. 79-039,875, FILED 6-13-2007.

DAVID MURRAY, EXAMINING ATTORNEY



**Int. Cl.: 29**

**Prior U.S. Cl.: 46**

**United States Patent and Trademark Office**

**Reg. No. 3,570,155**

**Registered Feb. 3, 2009**

**TRADEMARK  
PRINCIPAL REGISTER**

**SÖRGÅRDSOST**

MILKO EKONOMISK FÖRENING (SWEDEN  
ECONOMIC ASSOCIATION)

BOX 362

SE-831 25 ÖSTERSUND

SWEDEN

FOR: CHEESE, IN CLASS 29 (U.S. CL. 46).

THE MARK CONSISTS OF STANDARD CHAR-  
ACTERS WITHOUT CLAIM TO ANY PARTICULAR  
FONT, STYLE, SIZE, OR COLOR.

OWNER OF INTERNATIONAL REGISTRATION  
0928208 DATED 5-16-2007, EXPIRES 5-16-2017.

THE FOREIGN WORDING IN THE MARK  
TRANSLATES INTO ENGLISH AS CHEESE FROM  
THE FARM IN THE SOUTH.

SER. NO. 79-040,016, FILED 5-16-2007.

AMEETA JORDAN, EXAMINING ATTORNEY

**Int. Cls.: 19, 20, 24 and 37**

**Prior U.S. Cls.: 1, 2, 12, 13, 22, 25, 32, 33, 42, 50, 100,  
103 and 106**

**Reg. No. 3,570,156**

**United States Patent and Trademark Office**

**Registered Feb. 3, 2009**

**TRADEMARK  
SERVICE MARK  
PRINCIPAL REGISTER**



VKR HOLDING A/S  
BREELTEVEJ 18  
DK-2970 HØRSBOLM  
DENMARK

FOR: BUILDING MATERIALS NOT OF METAL, NAMELY, READY MOUNTABLE BUILDING PARTS, NAMELY, WINDOWS, SKYLIGHTS AND ROOF WINDOWS OF SYNTHETIC MATERIAL AND OF PLASTICS, WINDOW SECTIONS, NAMELY, FRAMES, ROOF TERRACES, ROOF BALCONIES, TUBULAR SKYLIGHTS, FLASHINGS, WINDOW LININGS, JALOUSIES, ROLLER JALOUSIES SHUTTERS, ROLLER SHUTTERS, OUTDOOR BLINDS; STRUCTURAL PARTS AND FITTINGS THEREFOR NOT MADE OF METAL, IN CLASS 19 (U.S. CLS. 1, 12, 33 AND 50).

FOR: VENETIAN BLINDS FOR INDOOR USE AND STRUCTURAL AND REPLACEMENT PARTS AND FITTINGS THEREFOR; INDOOR WINDOW SHADES, INDOOR ROLLER BLINDS OF WOOD, SYNTHETIC MATERIALS AND OF NON-TEXTILE MATERIALS, IN CLASS 20 (U.S. CLS. 2, 13, 22, 25, 32 AND 50).

FOR: READY MADE CURTAINS, SHADES AND BLINDS OF TEXTILE MATERIALS OR OF SYN-

THETIC MATERIALS FOR SKYLIGHTS AND ROOF WINDOWS, IN CLASS 24 (U.S. CLS. 42 AND 50).

FOR: INSTALLATION, MAINTENANCE AND REPAIR IN CONNECTION WITH WINDOWS, IN CLASS 37 (U.S. CLS. 100, 103 AND 106).

OWNER OF INTERNATIONAL REGISTRATION 0928560 DATED 3-28-2007, EXPIRES 3-28-2017.

OWNER OF U.S. REG. NOS. 1,091,446, 1,507,176 AND OTHERS.

THE COLOR(S) RED AND WHITE IS/ARE CLAIMED AS A FEATURE OF THE MARK.

THE COLOR RED IS FOR THE BACKGROUND AND WHITE IS FOR THE TEXT.

THE MARK HAS NO MEANING IN A FOREIGN LANGUAGE.

SER. NO. 79-040,146, FILED 3-28-2007.

WILLIAM ROSSMAN, EXAMINING ATTORNEY

**Int. Cls.: 3, 25 and 44**

**Prior U.S. Cls.: 1, 4, 6, 22, 39, 50, 51, 52, 100 and 101**

**Reg. No. 3,570,157**

**United States Patent and Trademark Office**

**Registered Feb. 3, 2009**

**TRADEMARK  
SERVICE MARK  
PRINCIPAL REGISTER**

**KAMISPA**

KAMI SPA S.R.L. (ITALY LIMITED LIABILITY COMPANY)  
VIA DEGLI AVIGNONESI, 12  
I-00187 ROME  
ITALY

FOR: AFTER SUN CREAMS, AFTER-SHAVE BALMS, AFTER-SHAVE CREAMS, AFTER-SHAVE EMULSIONS, AFTER-SHAVE GEL, AFTER-SHAVE LOTIONS, AFTER-SUN LOTIONS, AGE RETARDANT GEL, AGE RETARDANT LOTION, AGE SPOT REDUCING CREAMS, ALMOND SOAPS, ALOE VERA GEL FOR COSMETIC PURPOSES, ANTI-AGING CREAM, ANTI-FRECKLE CREAMS, ANTI-WRINKLE CREAMS, AROMATHERAPY CREAMS, AROMATHERAPY LOTIONS, AROMATHERAPY OILS, POTPOURRI INCORPORATED INTO AROMATHERAPY PILLOWS, ASTRINGENTS FOR COSMETIC PURPOSES, BATH CRYSTALS, BATH FOAMS, BATH GELS, BATH LOTION, BATH MILKS, BATH OILS, BATH OILS FOR COSMETIC PURPOSES, BATH PEARLS, BATH POWDER, BATH SALTS, NON-MEDICATED BATH SALTS, BATH SOAPS IN LIQUID, SOLID OR GEL FORM, BATHING LOTIONS, BEAUTY CREAMS, BEAUTY CREAMS FOR BODY CARE, BEAUTY GELS, BEAUTY LOTIONS, BEAUTY MASKS, BEAUTY MILKS, BEAUTY SERUMS, BODY AND BEAUTY CARE COSMETICS, BODY AND BEAUTY CARE PREPARATIONS, BODY CREAM, BODY CREAM SOAP, BODY CREAMS, BODY EMULSIONS, BODY LOTIONS, BODY MASK CREAM, BODY MASK LOTION, BODY MASK POWDER, BODY MASKS, BODY MILKS, BODY OILS, BODY POWDER, BODY SCRUB, BODY SPRAY USED AS A PERSONAL DEODORANT AND AS FRAGRANCE, CLEANSING CREAMS, CLEANSING MILK, COCOA BUTTER FOR COSMETIC PURPOSES, COLD CREAMS, COTTON BALLS FOR COSMETIC USE, COSMETIC CREAMS, COSMETIC CREAMS FOR SKIN CARE, COSMETIC FACIAL BLOTTERING PAPERS, COSMETIC MILKS, COSMETIC OILS, COSMETIC OILS FOR THE EPIDERMIS, COSMETIC PREPARATIONS FOR SKIN RENEWAL, COSMETIC PREPARATIONS

AGAINST SUNBURN, COSMETIC PREPARATIONS FOR BODY CARE, COSMETIC SOAPS, COSMETIC SUNTAN LOTIONS, COSMETIC SUN-PROTECTING PREPARATIONS, COSMETIC SUN-TANNING PREPARATIONS, COSMETICS, CREAM SOAPS, CREAM FOR CELLULITE REDUCTION, CREAMY FACE POWDER, CREAMY FOUNDATION, CREAMY ROUGES, CUTICLE CONDITIONERS, CUTICLE CREAM, CUTICLE REMOVING PREPARATIONS, DEODORANTS FOR PERSONAL USE, DEODORANT SOAP, DEODORANTS AND ANTIPERSPIRANTS, DEODORANTS FOR BODY CARE, DEODORANTS FOR CLOTHING OR TEXTILES, DEODORANTS FOR COLOGNE, EAU DE PERFUME, EAUX DE TOILETTE, EMULSIFYING PREPARATIONS FOR STRIPPING WAX FROM FLOORS, EPILATORY STRIPS, ESSENTIAL OILS, ESSENTIAL OILS FOR PERSONAL USE, EXFOLIANT CREAMS, EYE COMPRESSES FOR COSMETIC PURPOSES, EYE CREAM, EYE GELS, EYE LOTIONS, EYE MAKE UP REMOVER, EYEBROW COLORS, EYEBROW PENCILS, EYELINER PENCILS, EYELINERS, EYE MAKE-UP, EYE PENCILS, EYE SHADOWS, FACE AND BODY BEAUTY CREAMS, FACE AND BODY CREAMS, FACE AND BODY LOTIONS, FACE AND BODY MILK, FACE CREAMS, FACE CREAMS FOR COSMETIC USE, FACE MILK AND LOTIONS, FACE POWDER, FACE POWDER PASTE, FACE POWDER ON PAPER, FACIAL BEAUTY MASKS, FACIAL CLEANSERS, FACIAL CLEANSING MILK, FACIAL CONCEALER, FACIAL CREAMS, FACIAL EMULSIONS, FACIAL LOTION, FACIAL MAKE-UP, FACIAL SCRUBS, FACIAL WASHES, FEMININE DEODORANT SPRAYS, FRAGRANCES FOR PERSONAL USE, GEL EYE MASKS, HAIR BALSAM, HAIR CARE LOTIONS, HAIR CLEANING PREPARATIONS, HAIR CONDITIONERS, HAIR SHAMPOO, HAND CLEANING PREPARATIONS, HAND CREAMS, HAND LOTIONS, HAND SOAPS, INCENSE, INCENSE STICKS, LIP BALM, LIP CREAM, LIP GLOSS, LIP GLOSS PRODUCTS, LIPSTICKS, LIQUID SOAPS, LOTIONS FOR CELLULITE REDUCTION, LOTIONS FOR FACE AND BODY CARE, LOTIONS FOR STRENGTHENING THE NAILS, MAKE UP FOUNDATIONS, MAKE UP REMOVING

PREPARATIONS, MASSAGE OILS, MOISTURIZING MILKS, PERFUME OILS, PERFUME OILS FOR THE MANUFACTURE OF COSMETIC PREPARATIONS, PERFUMED CREAMS, PERFUMED PASTE, PERFUMED POWDERS, PERFUMED SOAPS, PERFUMED TALCUM POWDER, PERFUMERY, PERFUMES, PERFUMING SACHETS, SCENTED BODY SPRAY, SCENTED CERAMIC STONES, SCENTED LINEN SPRAYS, SCENTED LINEN WATER, SCENTED OILS USED TO PRODUCE AROMAS WHEN HEATED, SHAMPOOS, SHAMPOO-CONDITIONERS, SHAVING BALM, SHAVING CREAMS, SHAVING FOAM, SHAVING GELS, SHAVING LOTIONS, SHAVING MOUSSE, SHAVING PREPARATIONS, SHOWER GELS, SKIN CLARIFIERS, SKIN CLEANSERS, SKIN CLEANSING CREAM, SKIN CLEANSING LOTION, SKIN CONDITIONERS, SKIN CREAMS, SKIN CREAMS IN LIQUID AND IN SOLID FORM, SKIN EMOLLIENTS, SKIN GELS FOR ACCELERATING, ENHANCING OR EXTENDING TANS, SKIN LIGHTENERS, SKIN LIGHTENING CREAMS, SKIN LOTIONS, SKIN MASKS, SKIN MOISTURIZER, SKIN MOISTURIZER MASKS, SKIN POLISHING RICE BRAN, SKIN SOAP, SKIN TEXTURIZERS, SKIN TONERS, SKIN WHITENING CREAMS, SKIN WHITENING PREPARATIONS, SOAPS FOR BODY CARE, SUN BLOCK, SUN BLOCK PREPARATIONS, SUN CARE LOTIONS, SUN CREAMS, SUN SCREEN, SUN

SCREEN PREPARATIONS, SUN TAN GEL, SUN TAN LOTION, SUN TAN OIL, IN CLASS 3 (U.S. CLS. 1, 4, 6, 50, 51 AND 52).

FOR: BATH SLIPPERS, BATHROBES, JAPANESE-STYLE SANDALS, KIMONOS, IN CLASS 25 (U.S. CLS. 22 AND 39).

FOR: BEAUTY SALONS, HEALTH SPA SERVICES FOR HEALTH AND WELLNESS OF THE BODY AND SPIRIT OFFERED AT A HEALTH RESORT, HEALTH SPA SERVICES, NAMELY, COSMETIC BODY CARE SERVICES, IN CLASS 44 (U.S. CLS. 100 AND 101).

THE MARK CONSISTS OF STANDARD CHARACTERS WITHOUT CLAIM TO ANY PARTICULAR FONT, STYLE, SIZE, OR COLOR.

PRIORITY DATE OF 9-7-2006 IS CLAIMED.

OWNER OF INTERNATIONAL REGISTRATION 0928962 DATED 1-19-2007, EXPIRES 1-19-2017.

SER. NO. 79-040,324, FILED 1-19-2007.

CHRISIE B. KING, EXAMINING ATTORNEY

**Int. Cls.: 9, 41 and 42**

**Prior U.S. Cls.: 21, 23, 26, 36, 38, 100, 101 and 107**

**Reg. No. 3,570,158**

**United States Patent and Trademark Office**

**Registered Feb. 3, 2009**

**TRADEMARK  
SERVICE MARK  
PRINCIPAL REGISTER**

# MyMetier

METIER ACADEMY INTERNATIONAL AS  
(NORWAY AS (JOINT STOCK COMPANY))  
P.O. BOX 18  
N-0309 SMESTAD, OSLO  
NORWAY

FOR: COMPUTER PROGRAMS FOR DATABASE MANAGEMENT AND DOCUMENT MANAGEMENT, FOR USE IN PROVIDING SUPPORT AND TRAINING IN THE FIELDS OF MANAGEMENT, PROJECT MANAGEMENT, AND RISK MANAGEMENT, IN CLASS 9 (U.S. CLS. 21, 23, 26, 36 AND 38).

FOR: EDUCATIONAL SERVICES, NAMELY, PROVIDING TRAINING IN THE USE OF COMPUTER PROGRAMS IN THE FIELDS OF MANAGEMENT, PROJECT MANAGEMENT, HEALTH, AND SAFETY, IN CLASS 41 (U.S. CLS. 100, 101 AND 107).

FOR: PROVIDING TECHNICAL SUPPORT SERVICES FOR IMPLEMENTATION AND MAINTENANCE OF COMPUTER EQUIPMENT, COMPUTER SYSTEMS, AND SOFTWARE WITHIN SYSTEMS; COMPUTER CONSULTANCY SERVICES

IN THE FIELDS OF MANAGEMENT AND PROJECT MANAGEMENT; CONSULTANCY SERVICES, NAMELY, PROVIDING PROCEDURES AND TECHNIQUES FOR COMPUTER PROGRAMMING SERVICES IN THE FIELDS OF MANAGEMENT AND PROJECT MANAGEMENT, IN CLASS 42 (U.S. CLS. 100 AND 101).

THE MARK CONSISTS OF STANDARD CHARACTERS WITHOUT CLAIM TO ANY PARTICULAR FONT, STYLE, SIZE, OR COLOR.

PRIORITY DATE OF 1-30-2007 IS CLAIMED.

OWNER OF INTERNATIONAL REGISTRATION 0930298 DATED 2-27-2007, EXPIRES 2-27-2017.

SER. NO. 79-040,854, FILED 2-27-2007.

MARILYN IZZI, EXAMINING ATTORNEY

**Int. Cls.: 6, 7, 12, 17 and 42**

**Prior U.S. Cls.: 1, 2, 5, 12, 13, 14, 19, 21, 23, 25, 31, 34, 35, 44, 50, 100 and 101**

**Reg. No. 3,570,159**

**United States Patent and Trademark Office**

**Registered Feb. 3, 2009**

**TRADEMARK  
SERVICE MARK  
PRINCIPAL REGISTER**



MATADOR HOLDING, A.S. (SLOVAKIA JOINT STOCK COMPANY)  
STREZENICKÁ CESTA 45  
SK-020 01 PÚCHOV  
SLOVAKIA

FOR: METAL CONSTRUCTIONS, NAMELY, BUILDING CURTAIN WALLS MADE PRIMARILY OF METAL, FRAMEWORK OF METAL FOR BUILDING, CONSTRUCTION ELEMENTS MADE OF METAL, NAMELY, SHORES, SUPPORTS, BRACES, ANCHOR PLATES AND INGOTS OF COMMON METAL; METAL AND METAL ALLOYS AND GOODS MADE OF THESE MATERIALS INCLUDED IN THIS CLASS, NAMELY, METAL DOOR PANELS, METAL DOOR FRAMES, METAL DOOR UNITS, PAINT SPRAY BOOTHS OF METAL, METAL BINS, BASKETS OF COMMON METALS, METAL BOXES, SAFETY DEPOSIT BOXES, TOOL BOXES OF METAL, CONTAINERS OF METAL FOR TRANSPORT, METAL CHESTS, STORAGE PALLETS OF METAL, LOADING AND UNLOADING PALLETS OF METAL, POSTS OF METAL, METAL BELLS, METAL BEAMS; PRESSED PARTS, NAMELY, METAL TILES, METAL FLOOR TILES, METAL ROOFING TILES, SHEET METAL, SHEET METAL LININGS, STEEL IN SHEET, ROD, BAR LANDLORD BILLET FORM, ZINC-COATED STEEL SHEETS; METAL KEY BLANKS; FOUNDRY MOLDS OF METAL; FOUNDRY CHILL-MOLDS OF METAL, METALLIC MOULDS FOR METAL CASTING; METAL MOULDS FOR FORMING AND PRESSING OF METALS FOR AUTOMOBILE PARTS; METAL MOULDS FOR PRESSING RUBBER AND PLASTIC PRODUCTS, IN CLASS 6 (U.S. CLS. 2, 12, 13, 14, 23, 25 AND 50).

FOR: BELT CONVEYORS; CONVEYING BELTS; MACHINES FOR METAL WORKING, NAMELY,

GRINDERS, MILLING MACHINES, LATHES, POWER DRILLS; TOOLS AND PARTS OF METALWORKING MACHINES, NAMELY, HYDRAULIC PRESSES, MECHANICAL PRESSES, METAL EXTRUSION PRESSES, OIL HYDRAULIC PRESSES, PUNCHING PRESSES, STAMPING PRESSES, PLYWOOD PRESSES, PRESS DIES FOR METAL FORMING; CUTTERS AND CUTTING MACHINES, NAMELY, MILLING CUTTERS, GEAR CUTTERS, RECHARGEABLE HEDGE CUTTERS, TREE STUMP CUTTERS, TRENCH CUTTERS; MACHINES AND INSTALLATIONS FOR THE RUBBER INDUSTRY, NAMELY, INDUSTRIAL MACHINE PRESSES, MANIPULATORS FOR FORGING PRESSES AND FOR FORGING MACHINES, AGITATORS, TRIMMING MACHINES, AND ROLLING MILLS; MACHINES FOR PROCESSING RUBBER, NAMELY, MIXING MACHINES, GRINDING MACHINES CRUSHING MACHINES, SHREDDERS, VULCANIZATION MACHINES, TIRE BUILDING MACHINES, BEAD MAKING MACHINE USED IN PROCESS OF PRODUCTION OF TIRES, APEXING MACHINE IN PROCESS OF PRODUCTION OF TIRES; MACHINE TOOLS, NAMELY, BROACHES, CHASERS, GEAR CUTTERS, MILLING CUTTERS; RUBBER FORMING MACHINES AND INSTRUMENTS, IN CLASS 7 (U.S. CLS. 13, 19, 21, 23, 31, 34 AND 35).

FOR: PNEUMATIC TIRES FOR MOTOR CARS; LAND VEHICLES, THEIR PARTS AND SPARE PARTS, NAMELY, AUTOMOBILE CHASSIS, BODIES FOR VEHICLES, VEHICLES SEATS, MUDGUARDS OF MOTOR VEHICLES OR BICYCLES, DOORS FOR VEHICLES, BUMPERS FOR VEHICLES, UNDERCARRIAGES FOR VEHICLES, RIMS FOR VEHICLE WHEELS; PNEUMATIC TIRES OF ALL TYPES, IN CLASS 12 (U.S. CLS. 19, 21, 23, 31, 35 AND 44).

FOR: RAW OR SEMI -WORKED RUBBER; RUBBER USED IN THE MANUFACTURE AND RECAPING OF TIRES; SHOCK ABSORBING BUFFERS OF RUBBER FOR INDUSTRIAL MACHINERY AND VEHICLES; SYNTHETIC RUBBER; SEMI-WORKED PLASTICS IN THE FORM OF SHEETS, TUBES, BARS, PLATES, PROFILES TUBES OR RODS; GOODS OF SYNTHETIC MATERIAL INCLUDED IN THIS CLASS, NAMELY, SYNTHETIC PADDING AND STUFFING MATERIALS, NAMELY, PLASTIC WADDINGS; GOODS MADE OF SYNTHETIC RUBBER, FOAM RUBBER, ACRYLIC RUBBER, NATURAL RUBBER, RUBBER USED IN THE MANUFACTURE OF TIRES, LATEX RUBBER USED IN THE MANUFACTURE OF TIRES, RECLAIMED RUBBER, PLASTIC MATERIALS, NAMELY, ELECTRICAL INSULATING RUBBER PRODUCTS, GENERAL PURPOSE SILICONE RUBBER SEALANT, INDUSTRIAL PACKAGING CONTAINERS OF RUBBER, NON-METAL, PLASTIC AND RUBBER HOSES FOR INDUSTRIAL APPLICATIONS, RUBBER BAGS FOR MERCHANDISE PACKAGING, RUBBER BANDS FOR COMMERCIAL AND INDUSTRIAL USES, RUBBER BARS AND RODS, RUBBER SEALANT FOR CAULKING AND ADHESIVE PURPOSES, RUBBER SHEETS, RUBBER SHOCK ABSORBERS FOR INDUSTRIAL MACHINERY, RUBBER SLEEVES FOR PROTECTING PARTS OF MACHINERY, RUBBER THREAD NOT FOR TEXTILE USE, RUBBER TUBES AND PIPES, RUBBER WHEEL CHOCKS, STUFFING OF RUBBER, UNFITTED PROTECTIVE RUBBER SHEETS FOR AUTOMOBILE SEATS, VALVES OF RUBBER OR VULCANIZED FIBER NOT INCLUD-

ING MACHINE ELEMENTS, WASHERS OF RUBBER OR VULCANIZED FIBER, IN CLASS 17 (U.S. CLS. 1, 5, 12, 13, 35 AND 50).

FOR: CHEMICAL RESEARCH; MECHANICAL RESEARCH; SCIENTIFIC RESEARCH; INDUSTRIAL RESEARCH IN THE FIELD OF AUTOMOBILE INDUSTRY; RESEARCH AND DEVELOPMENT OF NEW PRODUCTS FOR THIRD PARTIES; INDUSTRIAL DESIGN; PROFESSIONAL ADVICE AND CONSULTING IN THE FIELD OF AUTOMOBILE DESIGN AND DEVELOPMENT IN THE AUTOMOBILE INDUSTRY AND CONSULTING IN THE FIELD OF MECHANICAL ENGINEERING, IN CLASS 42 (U.S. CLS. 100 AND 101).

OWNER OF INTERNATIONAL REGISTRATION 0932483 DATED 2-22-2007, EXPIRES 2-22-2017.

THE COLOR(S) RED AND BLACK IS/ARE CLAIMED AS A FEATURE OF THE MARK.

THE COLOR(S) RED APPEARS IN THE WORDING "MATADOR" AND IN A CURVE DESIGN TO THE LEFT OF THE WORDING. THE COLOR BLACK APPEARS IN TWO CURVE DESIGNS TO THE LEFT OF THE WORDING AND A BLACK OUTLINE.

SER. NO. 79-041,797, FILED 2-22-2007.

WILLIAM ROSSMAN, EXAMINING ATTORNEY

**Int. Cls.: 16 and 38**

**Prior U.S. Cls.: 2, 5, 22, 23, 29, 37, 38, 50, 100, 101 and 104**

**United States Patent and Trademark Office**

**Reg. No. 3,570,160**

**Registered Feb. 3, 2009**

**TRADEMARK  
SERVICE MARK  
PRINCIPAL REGISTER**

# HOME STICKERS

NOUVELLES IMAGES SA (FRANCE SOCIÉTÉ ANONYME À DIRECTOIRE ET CONSEIL DE SURVEILLANCE)  
LOMBREUIL  
F-45700 VILLEMANDEUR  
FRANCE

FOR: ADHESIVES FOR STATIONERY OR HOUSEHOLD PURPOSES, IN CLASS 16 (U.S. CLS. 2, 5, 22, 23, 29, 37, 38 AND 50).

FOR: TELECOMMUNICATIONS SERVICES, NAMELY, TRANSMISSION OF INFORMATION ABOUT TELECOMMUNICATIONS NETWORKS; COMMUNICATIONS BY COMPUTER TERMINALS OR VIA FIBRE-OPTIC NETWORKS; TELECOMMUNICATIONS SERVICES, NAMELY, THE TRANSMISSION OF DATA AND IMAGES VIA TELECOMMUNICATIONS NETWORKS FOR RE-

MOTE DISPLAY; CONNECTION BY TELECOMMUNICATIONS TO A GLOBAL COMPUTER NETWORK; PRESS AND INFORMATION NEWS AGENCIES, NAMELY, THE TRANSMISSION OF NEWS ITEMS TO NEWS REPORTING ORGANIZATIONS, IN CLASS 38 (U.S. CLS. 100, 101 AND 104).

PRIORITY DATE OF 11-23-2006 IS CLAIMED.

OWNER OF INTERNATIONAL REGISTRATION 0932550 DATED 5-3-2007, EXPIRES 5-3-2017.

SER. NO. 79-041,827, FILED 5-3-2007.

DEBRA LEE, EXAMINING ATTORNEY



Int. Cl.: 9

Prior U.S. Cls.: 21, 23, 26, 36 and 38

Reg. No. 3,570,161

United States Patent and Trademark Office

Registered Feb. 3, 2009

TRADEMARK  
PRINCIPAL REGISTER

A R T F O R T H E E A R

BURMESTER AUDIOSYSTEME GMBH (FED  
REP GERMANY GESELLSCHAFT MIT BES-  
CHRÄNKTER HAFTUNG (GMBH))  
KOLONNENSTRABE 30G  
10829 BERLIN  
FED REP GERMANY

FOR: ELECTRIC AND ELECTRONIC DEVICES,  
NAMELY, APPARATUS FOR SOUND RECORDING  
AND SOUND REPRODUCTION, AS WELL AS AC-  
CESSORIES FOR SOUND RECORDING AND RE-  
PRODUCTION APPARATUS, NAMELY, ELECTRIC  
CABLES AND ADAPTERS; ELECTRO-ACOUSTIC  
CONVERTERS; CD PLAYERS, CD DRIVES FOR  
COMPUTERS, DVD PLAYERS; DIGITAL ANALOG  
CONVERTERS; SURROUND DECODERS, NAME-  
LY, APPARATUS FOR GENERATING A SUR-  
ROUND SOUND SIGNAL; STEREO TUNERS,  
POWER CONDITIONERS, NAMELY, APPARATUS  
FOR ELIMINATING DC CURRENT COMPONENTS  
IN GRID VOLTAGE; AMPLIFIERS, NAMELY, PRE-  
AMPLIFIERS, POWER AMPLIFIERS; LOUD SPEAK-  
ERS, NAMELY, CENTER LOUDSPEAKERS AND  
SUBWOOFERS; REMOTE CONTROLS FOR THE  
AFOREMENTIONED GOODS, NAMELY, FOR AP-

PARATUS FOR SOUND RECORDING AND SOUND  
REPRODUCTION, ELECTRO-ACOUSTIC CONVER-  
TERS, CD PLAYERS, CD DRIVES FOR COMPU-  
TERS, DVD PLAYERS, DIGITAL ANALOG  
CONVERTERS, SURROUND DECODERS, NAME-  
LY, APPARATUS FOR GENERATING A SUR-  
ROUND SOUND SIGNAL, STEREO TUNERS,  
LOUD SPEAKERS, NAMELY, CENTER LOUDSPEA-  
KERS AND SUBWOOFERS, ALL FOR CARS AND/  
OR YACHTS; CDS, PHONOGRAPH RECORDS, AND  
DVDS FEATURING MUSIC AND MUSICAL PER-  
FORMANCES, IN CLASS 9 (U.S. CLS. 21, 23, 26, 36  
AND 38).

PRIORITY DATE OF 12-7-2006 IS CLAIMED.

OWNER OF INTERNATIONAL REGISTRATION  
0933157 DATED 5-30-2007, EXPIRES 5-30-2017.

SER. NO. 79-042,044, FILED 5-30-2007.

BERNICE MIDDLETON, EXAMINING ATTORNEY

**Int. Cls.: 35, 38 and 41**

**Prior U.S. Cls.: 100, 101, 102, 104 and 107**

**United States Patent and Trademark Office**

**Reg. No. 3,570,162**

**Registered Feb. 3, 2009**

**SERVICE MARK  
PRINCIPAL REGISTER**



PRÄSENZ SCHWEIZ (SWITZERLAND FEDERAL AGENCY)  
BUNDESGASSE 32  
CH-3003 BERN, SWITZERLAND

FOR: ADVERTISING SERVICES; BUSINESS MANAGEMENT, BUSINESS ADMINISTRATION AND MANAGEMENT, PROVIDING OFFICE FUNCTIONS, PUBLIC RELATIONS WORK PERTAINING TO THE ENCOURAGEMENT AND PROMOTION OF TRAINING, RESEARCH AND INNOVATION IN SWITZERLAND; ORGANISING AND HOLDING TRADE FAIRS AND BUSINESS CONFERENCES FOR ADVERTISING PURPOSES IN ORDER TO CONSTRUCT A NETWORK OF RELATIONSHIPS BETWEEN SWISS AND U.S. EDUCATIONAL INSTITUTIONS; ORGANIZING RECEPTIONS, PRESS CONFERENCES, AND EXHIBITIONS FOR COMMERCIAL OR ADVERTISING PURPOSES FOR CORPORATE BODIES, COMPANIES AND ORGANISATIONS IN THE FIELDS OF TRAINING, RESEARCH AND INNOVATION, IN CLASS 35 (U.S. CLS. 100, 101 AND 102).

FOR: TRANSMISSION OF NEWSLETTERS BY ELECTRONIC MAIL, IN CLASS 38 (U.S. CLS. 100, 101 AND 104).

FOR: EDUCATION, NAMELY, SPONSORING, DEVELOPING, AND CARRYING OUT INTERNATIONAL STUDENT EXCHANGE PROGRAMS; ORGANISING COMMUNITY SPORTING AND CULTURAL ACTIVITIES; PREPARATION AND

DISSEMINATION OF INFORMATION CONCERNING EDUCATION VIA THE INTERNET; ARRANGING CONFERENCES AND WORKSHOPS FOR CULTURAL OR EDUCATIONAL PURPOSES IN THE FIELDS OF RESEARCH, EDUCATION AND INNOVATION, PLANNING AND IMPLEMENTATION OF NETWORKING EVENTS FOR CULTURAL AND EDUCATIONAL PURPOSES, NAMELY, WORKSHOPS, RECEPTIONS, PRESS CONFERENCES, EXHIBITIONS IN THE FIELDS OF TRAINING, RESEARCH AND INNOVATION; ORGANISING WORKSHOPS FOR CORPORATE BODIES, COMPANIES AND ORGANISATIONS IN THE FIELD OF TRAINING, RESEARCH AND INNOVATION, IN CLASS 41 (U.S. CLS. 100, 101 AND 107).

PRIORITY DATE OF 12-12-2006 IS CLAIMED.

OWNER OF INTERNATIONAL REGISTRATION 0933315 DATED 4-30-2007, EXPIRES 4-30-2017.

NO CLAIM IS MADE TO THE EXCLUSIVE RIGHT TO USE "SWISS", APART FROM THE MARK AS SHOWN.

THE COLOR(S) RED AND WHITE IS/ARE CLAIMED AS A FEATURE OF THE MARK.

THE COLOR RED APPEARS IN THE WORDING "BRAINSTORM THE FUTURE" AND IN THE SPEECH BUBBLE. THE COLOR WHITE APPEARS IN THE WORDING "+ HINK SWISS" (WITHIN THE SPEECH BUBBLE).

SER. NO. 79-042,110, FILED 4-30-2007.

SUNG IN, EXAMINING ATTORNEY

Int. Cl.: 7

Prior U.S. Cls.: 13, 19, 21, 23, 31, 34 and 35

United States Patent and Trademark Office

Reg. No. 3,570,163

Registered Feb. 3, 2009

TRADEMARK  
PRINCIPAL REGISTER



PALMIERI S.P.A. (ITALY JOINT STOCK COMPANY)  
VIA DELL'INDUSTRIA, 58 -  
FRAZIONE SILLA; I-40040 GAGGIO MONTANO  
(BOLOGNA)  
ITALY

FOR: DRILLING MACHINES, PARTS AND ACCESSORIES FOR DRILLING MACHINES, NAMELY, DISC CUTTERS, CUTTER RINGS, CUTTING HEADS, AND VARIOUS ATTACHMENTS TO A TUNNEL-BORING MACHINE IN THE NATURE OF SCRAPER TOOLS, BREAKER TOOLS, RIPPER TOOLS, AND SHOE-TYPE SCRAPER TOOLS; DRILLING ROLLERS, NAMELY, BEARINGS USED IN DRILLING MACHINES; AND DRILLING HEADS, IN CLASS 7 (U.S. CLS. 13, 19, 21, 23, 31, 34 AND 35).

PRIORITY DATE OF 11-15-2006 IS CLAIMED.

OWNER OF INTERNATIONAL REGISTRATION  
0933317 DATED 4-16-2007, EXPIRES 4-16-2017.

"THE NAME(S), PORTRAIT(S), AND/OR SIGNATURE(S) SHOWN IN THE MARK IDENTIFIES PALMIERI SILVANO, WHOSE CONSENT(S) TO REGISTER IS SUBMITTED."

THE TRADEMARK CONSISTS OF THE WORD "PALMIERI" IN BLOCK CAPITAL LETTERS; THE LOWER PART OF THE LETTERS "ERI" COINCIDES WITH AND GIVES RISE TO A HORIZONTAL SEGMENT THAT EXTENDS TO THE RIGHT THEREOF AND IS IN A CONTRASTING SHADE THERETO; THE WORD "PALMIERI" IS PRECEDED BY THE REPRESENTATION OF AN OVAL WITH A LARGER VERTICAL AXIS, PLACED INSIDE WHICH IS THE STYLIZED REPRESENTATION OF A MILLER FOR A DRILL IN A CONTRASTING SHADE.

SER. NO. 79-042,111, FILED 4-16-2007.

SUNG IN, EXAMINING ATTORNEY

**Int. Cls.: 6, 7, 12, 17 and 42**

**Prior U.S. Cls.: 1, 2, 5, 12, 13, 14, 19, 21, 23, 25, 31, 34, 35, 44, 50, 100 and 101**

**Reg. No. 3,570,164**

**United States Patent and Trademark Office**

**Registered Feb. 3, 2009**

**TRADEMARK  
SERVICE MARK  
PRINCIPAL REGISTER**



MATADOR HOLDING, A.S. (SLOVAKIA JOINT STOCK COMPANY)  
STREENICKÁ CESTA 45  
SK-020 01 PÚCHOV  
SLOVAKIA

FOR: METAL CONSTRUCTIONS, NAMELY, BUILDING CURTAIN WALLS MADE PRIMARILY OF METAL, FRAMEWORK OF METAL FOR BUILDING, CONSTRUCTION ELEMENTS MADE OF METAL, NAMELY, SHORES, SUPPORTS, BRACES, ANCHOR PLATES AND INGOTS OF COMMON METAL; METAL AND METAL ALLOYS AND GOODS MADE OF THESE MATERIALS INCLUDED IN THIS CLASS, NAMELY, METAL DOOR PANELS, METAL DOOR FRAMES, METAL DOOR UNITS, PAINT SPRAY BOOTHS OF METAL, METAL BINS, BASKETS OF COMMON METALS, METAL BOXES, SAFETY DEPOSIT BOXES, TOOL BOXES OF METAL, CONTAINERS OF METAL FOR TRANSPORT, METAL CHESTS, STORAGE PALLETS OF METAL, LOADING AND UNLOADING PALLETS OF METAL, POSTS OF METAL, METAL BELLS, METAL BEAMS; PRESSED PARTS, NAMELY, METAL TILES, METAL FLOOR TILES, METAL ROOFING TILES, SHEET METAL, SHEET METAL LININGS, STEEL IN SHEET, ROD, BAR AND/OR BILLET FORM, ZINC-COATED STEEL SHEETS; METAL KEY BLANKS; FOUNDRY MOLDS OF METAL; FOUNDRY CHILL-MOULDs OF METAL, METALLIC MOULDs FOR METAL CASTING; METAL MOULDs FOR FORMING AND PRESSING OF METALS FOR AUTOMOBILE PARTS; METAL MOULDs FOR PRESSING RUBBER AND PLASTIC PRODUCTS, IN CLASS 6 (U.S. CLS. 2, 12, 13, 14, 23, 25 AND 50).

FOR: BELT CONVEYORS; CONVEYING BELTS; MACHINES FOR METAL WORKING, NAMELY, GRINDERS, MILLING MACHINES, LATHES, POWER DRILLS; TOOLS AND PARTS OF METALWORK-

ING MACHINES, NAMELY, HYDRAULIC PRESSES, MECHANICAL PRESSES, METAL EXTRUSION PRESSES, OIL HYDRAULIC PRESSES, PUNCHING PRESSES, STAMPING PRESSES, PLYWOOD PRESSES, PRESS DIES FOR METAL FORMING; CUTTERS AND CUTTING MACHINES, NAMELY, MILLING CUTTERS, GEAR CUTTERS, RECHARGEABLE HEDGE CUTTERS, TREE STUMP CUTTERS, TRENCH CUTTERS; MACHINES AND INSTALLATIONS FOR THE RUBBER INDUSTRY, NAMELY, INDUSTRIAL MACHINE PRESSES, MANIPULATORS FOR FORGING PRESSES AND FOR FORGING MACHINES, AGITATORS, TRIMMING MACHINES, AND ROLLING MILLS; MACHINES FOR PROCESSING RUBBER, NAMELY, MIXING MACHINES, GRINDING MACHINES, CRUSHING MACHINES, SHREDDERS, VULCANIZATION MACHINES, TIRE BUILDING MACHINES, BEADMaking MACHINE USED IN PROCESS OF PRODUCTION OF TIRES, APEXING MACHINE IN PROCESS OF PRODUCTION OF TIRES; MACHINE TOOLS, NAMELY, BROACHES, CHASERS, GEAR CUTTERS, MILLING CUTTERS; RUBBER FORMING MACHINES AND INSTRUMENTS, IN CLASS 7 (U.S. CLS. 13, 19, 21, 23, 31, 34 AND 35).

FOR: PNEUMATIC TIRES FOR MOTOR CARS; LAND VEHICLES, THEIR PARTS AND SPARE PARTS, NAMELY, AUTOMOBILE CHASSIS, BODIES FOR VEHICLES, VEHICLES SEATS, MUDGUARDS OF MOTOR VEHICLES OR BICYCLES, DOORS FOR VEHICLES, BUMPERS FOR VEHICLES, UNDERCARRIAGES FOR VEHICLES, RIMS FOR VEHICLE WHEELS; PNEUMATIC TIRES OF ALL TYPES, IN CLASS 12 (U.S. CLS. 19, 21, 23, 31, 35 AND 44).

FOR: RAW OR SEMI-WORKED RUBBER; RUBBER USED IN THE MANUFACTURE AND RECAPPING OF TIRES; SHOCK ABSORBING BUFFERS OF

RUBBER FOR INDUSTRIAL MACHINERY AND VEHICLES; SYNTHETIC RUBBER; SEMI-WORKED PLASTICS IN THE FORM OF SHEETS, TUBES, BARS, PLATES, PROFILES TUBES OR RODS; GOODS OF SYNTHETIC MATERIAL INCLUDED IN THIS CLASS, NAMELY, SYNTHETIC PADDING AND STUFFING MATERIALS, NAMELY, PLASTIC WADDINGS; GOODS MADE OF SYNTHETIC RUBBER, FOAM RUBBER, ACRYLIC RUBBER, NATURAL RUBBER, RUBBER USED IN THE MANUFACTURE OF TIRES, LATEX RUBBER USED IN THE MANUFACTURE OF TIRES, RECLAIMED RUBBER, PLASTIC MATERIALS, NAMELY, ELECTRICAL INSULATING RUBBER PRODUCTS, GENERAL PURPOSE SILICONE RUBBER SEALANT, INDUSTRIAL PACKAGING CONTAINERS OF RUBBER, NON-METAL, PLASTIC AND RUBBER HOSES FOR INDUSTRIAL APPLICATIONS, RUBBER BAGS FOR MERCHANDISE PACKAGING, RUBBER BANDS FOR COMMERCIAL AND INDUSTRIAL USES, RUBBER BARS AND RODS, RUBBER SEALANT FOR CAULKING AND ADHESIVE PURPOSES, RUBBER SHEETS, RUBBER SHOCK ABSORBERS FOR INDUSTRIAL MACHINERY, RUBBER SLEEVES FOR PROTECTING PARTS OF MACHINERY, RUBBER THREAD NOT FOR TEXTILE USE, RUBBER TUBES AND PIPES, RUBBER WHEEL CHOCKS, STUFFING OF RUBBER, UNFITTED PROTECTIVE RUBBER SHEETS FOR AUTOMOBILE SEATS, VALVES OF RUBBER OR VULCANIZED FIBER NOT INCLUDING MACHINE ELEMENTS, WASHERS OF RUBBER OR VULCANIZED FIBER, IN CLASS 17 (U.S. CLS. 1, 5, 12, 13, 35 AND 50).

FOR: CHEMICAL RESEARCH; MECHANICAL RESEARCH; SCIENTIFIC RESEARCH; INDUSTRIAL RESEARCH IN THE FIELD OF AUTOMOBILE INDUSTRY; RESEARCH AND DEVELOPMENT OF NEW PRODUCTS FOR THIRD PARTIES; INDUSTRIAL DESIGN; PROFESSIONAL ADVICE AND CONSULTING IN THE FIELD OF AUTOMOBILE DESIGN AND DEVELOPMENT IN THE AUTOMOBILE INDUSTRY AND CONSULTING IN THE FIELD OF MECHANICAL ENGINEERING, IN CLASS 42 (U.S. CLS. 100 AND 101).

PRIORITY DATE OF 11-16-2006 IS CLAIMED.

OWNER OF INTERNATIONAL REGISTRATION 0933734 DATED 4-12-2007, EXPIRES 4-12-2017.

THE COLOR(S) BLACK AND RED IS/ARE CLAIMED AS A FEATURE OF THE MARK.

THE COLOR(S) RED APPEARS IN THE WORDING "MATADOR" AND IN A CURVE DESIGN TO THE LEFT OF THE WORDING. THE COLOR BLACK APPEARS IN TWO CURVE DESIGNS TO THE LEFT OF THE WORDING AND THE WORDING "LEADING THE WAY".

SER. NO. 79-042,307, FILED 4-12-2007.

WILLIAM ROSSMAN, EXAMINING ATTORNEY

**Int. Cl.: 9**

**Prior U.S. Cls.: 21, 23, 26, 36 and 38**

**Reg. No. 3,570,165**

**United States Patent and Trademark Office**

**Registered Feb. 3, 2009**

**TRADEMARK  
PRINCIPAL REGISTER**

# QMEMS

EPSON TOYOCOM KABUSHIKI KAISHA; (EPSON TOYOCOM CORPORATION) (JAPAN CORPORATION)

421-8, HINO  
HINO-SHI  
TOKYO, JAPAN 1910012

FOR: CRYSTALLINE SYNTHETIC QUARTZ USED IN PIEZOELECTRIC DEVICES FOR OPTICAL APPARATUS AND DEVICES, MEASURING OR TESTING MACHINES AND INSTRUMENTS, ELECTRIC OR MAGNETIC METERS AND TESTERS, TELECOMMUNICATION MACHINES AND APPARATUS AND ELECTRONIC MACHINES AND APPARATUS; SYNTHETIC QUARTZ PROCESSED IN THE FORM OF WAFERS USED IN PIEZOELECTRIC DEVICES FOR OPTICAL APPARATUS AND DEVICES, MEASURING OR TESTING MACHINES AND INSTRUMENTS, ELECTRIC OR MAGNETIC METERS AND TESTERS, TELECOMMUNICATION MACHINES AND APPARATUS AND ELECTRONIC MACHINES AND APPARATUS; CRYSTAL SENSORS AND ELECTRONIC CIRCUIT DEVICES USING CRYSTAL SENSORS; PIEZOELECTRIC CRYSTAL OSCILLATORS; PIEZOELECTRIC CRYSTAL UNITS, NAMELY, TUNING FORK CRYSTAL UNITS, MEGAHERTZ RANGE CRYSTAL UNITS; AT CRYSTAL UNITS AND SURFACE ACOUSTIC WAVE RESONATORS; TELECOMMUNICATIONS MACHINES AND APPARATUS, NAMELY, AT CUT CRYSTAL RESONATORS; PIEZOELECTRIC CRYSTAL FILTERS; ATOMIC OSCILLATORS; OPTICAL GLASS; OPTICAL APPARATUS AND INSTRUMENTS, NAMELY, OPTICAL DEVICES IN THE NATURE OF OPTICAL FILTERS, OPTICAL WAVE PLATES, DICHROIC OPTICAL PRISMS, TRICHOIC OPTICAL PRISMS, POLARIZED BEAM SPLITTER PRISMS, P-POLARIZED AND S-POLARIZED CONVERTERS, AND CROSS PRISMS FOR LIQUID CRYSTAL DISPLAY PROJECTORS, VIDEO PROJECTORS, LIQUID CRYSTAL ON SILICON PROJECTORS, LIGHT EMITTING DIODE PROJECTORS AND CATHODE RAY TUBE PROJECTORS, OPTICAL PICKUPS, NAMELY, READ HEADS FOR

OPTICAL DRIVES, OPTICAL MIRRORS, OPTICAL FREQUENCY METROLOGY PLATES, OPTICAL GRATINGS UTILIZING A PERIODIC VARIATION OF THE REFRACTIVE INDEX ON OPTICAL GLASS USED IN OPTICAL PICKUPS FOR TRACKING SERVO SYSTEMS AND SPECTRAL ANALYZER AS DISPERSION ELEMENTS; OPTICAL APPARATUS AND INSTRUMENTS, NAMELY, OPTICAL LOW PASS FILTERS, HEAT SINKPLATES FOR LIQUID CRYSTAL DISPLAY PROJECTORS, VIDEO PROJECTORS, LIQUID CRYSTAL ON SILICON PROJECTORS, LIGHT EMITTING DIODE PROJECTORS AND CATHODE RAY TUBE PROJECTORS, AND ETALON OPTICAL FILTERS; ELECTRONIC MACHINES AND APPARATUS, NAMELY, OSCILLATORS, NAMELY, TEMPERATURE COMPENSATED CRYSTAL OSCILLATOR, VOLTAGE CONTROLLED CRYSTAL OSCILLATOR, OVEN CONTROLLED CRYSTAL OSCILLATOR, PROGRAMMABLE OSCILLATORS, CLOCK OSCILLATORS, AND ATOMIC OSCILLATORS, NAMELY, RUBIDIUM OSCILLATORS; ELECTRONIC MACHINES AND APPARATUS, NAMELY, CRYSTAL UNITS AND RESONATORS, NAMELY, TUNING FORK CRYSTAL RESONATORS AND AT CUT CRYSTAL RESONATORS; ELECTRONIC MACHINES AND APPARATUS, NAMELY, SURFACE ACOUSTIC WAVE DEVICES, NAMELY, SURFACE ACOUSTIC WAVE RESONATORS, AND SURFACE ACOUSTIC WAVE FILTERS; ELECTRONIC MACHINES AND APPARATUS, NAMELY, CRYSTAL FILTERS, NAMELY, MONOLITHIC CRYSTAL RESONATOR FILTERS; ELECTRONIC MACHINES AND APPARATUS, NAMELY, ELECTRONIC COMPONENTS AND PASSIVE ELECTRONIC COMPONENTS, NAMELY, SYNTHETIC QUARTZ CRYSTALS, LUMBERED QUARTZ CRYSTALS, AND CRYSTAL BLANKS, CRYSTALLINE SYNTHETIC QUARTZ USED IN PIEZOELECTRIC DEVICES FOR OPTICAL APPARATUS AND DEVICES, MEASURING OR TESTING MACHINES AND INSTRUMENTS, PIEZOELECTRIC OSCILLATORS, PIEZOELECTRIC CRYSTAL UNITS AND PIEZOELECTRIC FILTERS; ELECTRONIC MACHINES AND APPARATUS,

NAMELY, SYNTHETIC QUARTZ PROCESSED IN THE FORM OF WAFERS USED IN PIEZOELECTRIC DEVICES FOR OPTICAL APPARATUS AND DEVICES, MEASURING OR TESTING MACHINES AND INSTRUMENTS, PIEZOELECTRIC OSCILLATORS, PIEZOELECTRIC CRYSTAL UNITS AND PIEZOELECTRIC FILTERS, IN CLASS 9 (U.S. CLS. 21, 23, 26, 36 AND 38).

PRIORITY DATE OF 7-7-2006 IS CLAIMED.

OWNER OF INTERNATIONAL REGISTRATION 0934045 DATED 12-27-2006, EXPIRES 12-27-2016.

SER. NO. 79-042,429, FILED 12-27-2006.

RENEE SERVANCE, EXAMINING ATTORNEY



Int. Cls.: 16, 25 and 41

Prior U.S. Cls.: 2, 5, 22, 23, 29, 37, 38, 39, 50, 100, 101  
and 107

Reg. No. 3,570,166

United States Patent and Trademark Office

Registered Feb. 3, 2009

TRADEMARK  
SERVICE MARK  
PRINCIPAL REGISTER



NUEVO AGORA CENTRO DE ESTUDIOS, S.L.  
(SPAIN SOCIEDAD LIMITADA)  
CARRERA DE SAN JERÓNIMO, 44-1º A  
E-28014 MADRID, SPAIN

FOR: INSTRUCTIONAL AND TEACHING MATERIAL, NAMELY, BOOKS FOR TEACHING MATHEMATICS, SCIENCES, PHYSICS, CHEMISTRY, BIOLOGY, SOCIAL SCIENCES, GEOGRAPHY, FOREIGN LANGUAGES, HISTORY, ART, MUSIC, SPORTS, COMPUTING, PHILOSOPHY, RELIGION, EDUCATIONAL ACTIVITY BOOKS, EXERCISES BOOKS, BOOKS FOR LEARNING TO READ, EDUCATIONAL ACTIVITY CARDS; STATIONERY, NAMELY, EXERCISE BOOKS, FOLIOS FOR LOOSE-LEAF PAPER, GRADE BOOKS, AGENDAS, WRITING EXERCISE BOOKS, MATHEMATICS EXERCISE BOOKS, SCIENCE EXERCISE BOOKS, PHYSICS EXERCISE BOOKS, CHEMISTRY EXERCISE BOOKS, BIOLOGY NOTEBOOKS, SOCIAL SCIENCE EXERCISE BOOKS, GEOGRAPHY EXERCISE BOOKS, FOREIGN LANGUAGES EXERCISE BOOKS, HISTORY EXERCISE BOOKS, ART EXERCISE BOOKS, MUSIC EXERCISE BOOKS, SPORTS EXERCISE BOOKS, COMPUTING EXERCISE BOOKS, PHILOSOPHY EXERCISE BOOKS, RELIGION EXERCISE BOOKS, NOTEBOOKS, NOTEPADS, WRITING PADS, ALL WITH THE EXCLUSION OF MAGAZINES, IN CLASS 16 (U.S. CLS. 2, 5, 22, 23, 29, 37, 38 AND 50).

FOR: CLOTHING, FOOTWEAR AND HEADGEAR FOR BOYS AND GIRLS, WOMEN AND MEN, FOR USE AS COLLEGE, PRIMARY SCHOOL, KINDERGARTEN AND CRECHE UNIFORMS, NAMELY, JACKET COATS, JACKETS, JERSEYS, SWEATSHIRTS, SHIRTS, OVERALLS, TEE SHIRTS, WAISTCOATS, TROUSERS, SKIRTS, DRESSES,

JUMPERS, SHORT TROUSERS, BERMUDA SHORTS, TIES, BOW TIES, SOCKS, STOCKINGS, TRACK SUITS, POLO SHIRTS, SOCKS, SMOCKS, DRESSING GOWNS, SCARVES, BERETS, CAPS, BONNETS, HATS, SHOES; CLOTHING FOR GYMNASTICS, NAMELY, TEE SHIRTS, SWEATSHIRTS, TRACK SUITS, SPORTS TROUSERS, SHORT TROUSERS, TRAINING TROUSERS, SWIMMING COSTUMES, SPORTS SHOES, GYMNASTICS SHOES, IN CLASS 25 (U.S. CLS. 22 AND 39).

FOR: EDUCATIONAL SERVICES, NAMELY, PROVIDING COURSES AT THE NURSERY, PRIMARY, SECONDARY AND COLLEGE LEVELS, IN CLASS 41 (U.S. CLS. 100, 101 AND 107).

PRIORITY DATE OF 10-9-2006 IS CLAIMED.

OWNER OF INTERNATIONAL REGISTRATION  
0934060 DATED 4-3-2007, EXPIRES 4-3-2017.

NO CLAIM IS MADE TO THE EXCLUSIVE RIGHT TO USE "CENTROS EDUCATIVOS", APART FROM THE MARK AS SHOWN.

THE COLOR(S) BLACK, WHITE AND RED IS/ARE CLAIMED AS A FEATURE OF THE MARK.

THE MARK CONSISTS OF THE WORDS "CENTROS EDUCATIVOS AGORA NACE" ARE WRITTEN IN BLACK, WITH EXCEPTION OF THE LOWER PART OF THE FIRST "A" OF "AGORA", WHOSE LOWER PART IS A THICK RED LINE, AND THE "E" OF "NACE" WHICH IS WRITTEN IN WHITE OVER A RED DOT.

THE ENGLISH TRANSLATION OF THE FOREIGN WORD(S) IN THE MARK IS: EDUCATIVE CENTERS AGORA NACE, THE LAST TWO WORDS HAVE NO MEANING IN THIS SPECIFIC CONTEXT.

SER. NO. 79-042,433, FILED 4-3-2007.

JULIE GUTTADAURO, EXAMINING ATTORNEY

**Int. Cls.: 9, 41 and 42**

**Prior U.S. Cls.: 21, 23, 26, 36, 38, 100, 101 and 107**

**Reg. No. 3,570,167**

**United States Patent and Trademark Office**

**Registered Feb. 3, 2009**

**TRADEMARK  
SERVICE MARK  
PRINCIPAL REGISTER**

# Hall in One

FRAUNHOFER-GESELLSCHAFT ZUR; FÖRDERUNG DER ANGEWANDTEN FORSCHUNG E.V. (FED REP GERMANY INCORPORATED ASSOCIATION UNDER THE LAWS OF GERMANY)

HANSASTRASSE 27C  
80686 MÜNCHEN  
FED REP GERMANY

FOR: DETECTORS AND SENSORS, INCLUDING RADIO SENSORS, NAMELY, MAGNETIC FIELD SENSORS AND MAGNETIC HALL EFFECT SENSORS FOR THE DETERMINATION OF ONE DIMENSIONAL, TWO DIMENSIONAL AND THREE DIMENSIONAL MAGNETIC FIELDS, POSITIONS, ORIENTATIONS, ROTATIONS, SPEEDS, GEOMETRY AND MATERIAL PROPERTIES OF LIQUIDS, SOLIDS, ELECTRIC CURRENT AND ELECTRIC ENERGY; SCIENTIFIC, SURVEYING, PHOTOGRAPHIC, OPTICAL, WEIGHING, MEASURING, SIGNALING, CHECKING, LIFE-SAVING AND TEACHING APPARATUSES AND INSTRUMENTS, NAMELY, SURVEYING INSTRUMENTS, ELECTROMAGNETIC APPARATUS USED TO GENERATE OR MEASURE MAGNETIC FIELDS, WEIGHING APPARATUS AND INSTRUMENTS CONTAINING MAGNETIC FIELD SENSORS FOR THE DETERMINATION OF ONE DIMENSIONAL, TWO DIMENSIONAL AND THREE DIMENSIONAL MAGNETIC FIELDS, POSITIONS, ORIENTATIONS, ROTATIONS, SPEEDS, GEOMETRY AND MATERIAL PROPERTIES OF LIQUIDS, SOLIDS, ELECTRIC CURRENT AND ELECTRIC ENERGY FOR USE IN AUTOMOBILES, ROAD, RAIL AND WATER VEHICLES, AIR CRAFTS, HOME APPLIANCES AND INDUSTRIAL MACHINERY; TESTING APPARATUS AND DIAGNOSTIC APPARATUS, NOT FOR MEDICAL PURPOSES, NAMELY APPARATUS FOR TESTING LIQUIDS AND SOLIDS; APPARATUS AND INSTRUMENTS FOR THE CONDUCTING, SWITCHING, CONVERTING, STORAGE, REGULATING AND CONTROLLING OF ELECTRICITY BY MEANS OF MAGNETIC FIELD SENSORS, NAMELY, ELECTRIC CABLES, ELECTRICAL CON-

NECTORS, ELECTRIC SWITCHES, CIRCUIT BREAKERS, DC/AC AND AC/DC POWER CONVERTERS AND BATTERY MANAGEMENT DEVICES, NAMELY, ELECTRIC CONVERTERS, INTEGRATED BATTERY BACKUP SYSTEMS COMPRISING A BATTERY, AN ELECTRONIC MEASUREMENT APPARATUS FOR USE IN THE MEASUREMENT OF BATTERY HEALTH AND PERFORMANCE, AND A REMOTE COMPUTER SOFTWARE PROGRAM THAT USES THE FOREGOING DATA TO TREND, PREDICT, AND STORE DATA RELATED TO THE HEALTH OF THE BATTERY; APPARATUS FOR RECORDING, TRANSMISSION OR REPRODUCTION OF DATA, NAMELY, COMPUTERS; RADIO, TELEPHONE AND TELEVISION TRANSMITTERS AND RECEIVERS OF ELECTRONIC, ACOUSTIC OR OPTICAL SIGNALS; MEASURING APPARATUS AND PRECISION MEASURING APPARATUS, NAMELY, POSITION, ORIENTATION, ROTATION, AND SPEED MEASURING INSTRUMENTS, MAGNETIC FIELD METERS, ELECTRIC CURRENT METERS, ELECTRIC ENERGY METERS, MEASURING INSTRUMENTS FOR GEOMETRY AND MATERIAL PROPERTIES OF LIQUIDS AND SOLIDS; COMPONENT PARTS OF THE AFORESAID APPARATUSES, IN CLASS 9 (U.S. CLS. 21, 23, 26, 36 AND 38).

FOR: ORGANIZATION, ARRANGING AND CONDUCTING OF EDUCATIONAL COURSES, SEMINARS, WORKSHOPS, SYMPOSIA, CONGRESSES, CONFERENCES AND LECTURES IN THE FIELD OF MAGNETIC FIELD SENSORS, POSITION, ORIENTATION, ROTATION AND SPEED SENSORS, SENSORS FOR ELECTRIC CURRENT AND ELECTRIC ENERGY AND SENSORS FOR GEOMETRY AND THE MATERIAL PROPERTIES OF LIQUIDS AND SOLIDS, IN CLASS 41 (U.S. CLS. 100, 101 AND 107).

FOR: SURVEYING; SCIENTIFIC RESEARCH REGARDING THE DEVELOPMENT OF MEASURING AND TESTING METHODS, SENSORS AND APPA-

RATUSES IN THE FIELDS OF POSITION, ORIENTATION, ROTATION AND SPEED MEASUREMENT, MAGNETIC FIELD MEASUREMENT, ELECTRIC CURRENT AND ELECTRIC ENERGY MEASUREMENT AND MEASUREMENT OF GEOMETRY AND MATERIAL PROPERTIES OF LIQUIDS AND SOLIDS; MEASURING AND ANALYSIS SERVICES, NAMELY, MEASUREMENT EVALUATIONS OF GEOMETRIC AND MATERIAL PROPERTIES OF LIQUIDS AND SOLIDS; AND MATERIAL TESTING AND QUALITY CONTROL FOR OTHERS, IN CLASS 42 (U.S. CLS. 100 AND 101).

THE MARK CONSISTS OF STANDARD CHARACTERS WITHOUT CLAIM TO ANY PARTICULAR FONT, STYLE, SIZE, OR COLOR.

PRIORITY DATE OF 10-19-2006 IS CLAIMED.

OWNER OF INTERNATIONAL REGISTRATION 0934360 DATED 4-18-2007, EXPIRES 4-18-2017.

SER. NO. 79-042,568, FILED 4-18-2007.

DAYNA BROWNE, EXAMINING ATTORNEY

**Int. Cls.: 1, 3 and 5**

**Prior U.S. Cls.: 1, 4, 5, 6, 10, 18, 26, 44, 46, 50, 51 and 52**

**Reg. No. 3,570,168**

**United States Patent and Trademark Office**

**Registered Feb. 3, 2009**

**TRADEMARK  
PRINCIPAL REGISTER**

# Afterwash 2 Prevor

BLOMET JOËL.; C/O PREVOR INTERNATIONAL  
(FRANCE INDIVIDUAL)  
MOULIN DE VERVILLE  
F-95760 VALMONDOIS  
FRANCE

FOR: CHEMICALS FOR USE IN INDUSTRY, SCIENCE, AND PHOTOGRAPHY; CHEMICAL PREPARATIONS FOR USE IN AGRICULTURE, HORTICULTURE AND FORESTRY EXCEPT FUNGICIDES, HERBICIDES, INSECTICIDES AND PARASITICIDES, NAMELY, CHEMICAL SOLUTIONS USED FOR WASHING AND DETOXIFICATION; CHEMICAL PRODUCTS FOR USE IN MANUFACTURING WASHING SOLUTIONS FOR TREATING BURNS CAUSED BY ACIDS, ALKALIS, IRRITANTS OR CORROSIVES; CHEMICAL SOLUTIONS FOR USE IN MANUFACTURING WASHING SOLUTIONS FOR POST-WASHING TREATMENT OF CHEMICAL BURNS, IN CLASS 1 (U.S. CLS. 1, 5, 6, 10, 26 AND 46).

FOR: COSMETICS; COSMETIC PRODUCTS OR PROTECTION PRODUCTS INTENDED FOR BURN VICTIMS AND FOR USE IN DECONTAMINATION OR EMERGENCY WASHING OF BURNS CAUSED BY ACIDS OR ALKALIS OR FROM ANY OTHER CAUSE, NAMELY, NON-MEDICATED SKIN CLEANSERS, NAMELY, COMPACTS, PRE-MOISTENED COSMETIC TISSUES, PRE-MOISTENED COSMETIC TOWELS, PRE-MOISTENED COSMETIC WIPES, SKIN CLEANSING LOTIONS, SKIN CREAM, SKIN LOTIONS, FACIAL LOTIONS, BODY LOTIONS, MOISTURIZERS, SKIN AND FACIAL MOUSSE, NON-MEDICATED PATCHES CONTAINING BURN SCREEN AND BURN BLOCK FOR USE ON THE SKIN, SKIN EMOLLIENTS, AND SKIN MOISTURIZER MASKS; WASHING PRODUCTS, NAMELY, SKIN SOAP, FACIAL LOTIONS, BODY LOTIONS, COSMETIC TISSUES, PRE-MOISTENED COSMETIC TISSUES, PRE-MOISTENED COSMETIC TOWELS, PRE-MOISTENED COSMETIC WIPES, SKIN CLEANSING LOTION, SKIN CREAM, AND SKIN AND FACIAL MOUSSE; NON-MEDICATED DAILY CLEANSING PRODUCTS FOR HUMANS, NAMELY, BODY WASHES, COMPACTS, PRE-MOIS-

TENED COSMETIC TISSUES, PRE-MOISTENED COSMETIC TOWELS, PRE-MOISTENED COSMETIC WIPES, SKIN CLEANSING LOTION, SKIN CREAM, SKIN LOTIONS, FACIAL LOTIONS, BODY LOTIONS, MOISTURIZERS, SKIN AND FACIAL MOUSSE, NON-MEDICATED PATCHES CONTAINING BURN SCREEN AND BURN BLOCK FOR USE ON THE SKIN, SKIN EMOLLIENTS, SKIN MOISTURIZER MASKS, AND NON-MEDICATED SOOTHING PRODUCTS FOR TREATING THE SCALP OR HAIR, NAMELY, HAIR LOTIONS, SCALP TREATMENT CREAMS, HAIR CREAMS, HAIR GELS, AND SHAMPOOS; ANALGESICS ESPECIALLY FOR BURN VICTIMS; NON-MEDICATED COSMETIC WASHING SOLUTIONS FOR POST-WASHING USE ON SKIN CHEMICAL BURNS, IN CLASS 3 (U.S. CLS. 1, 4, 6, 50, 51 AND 52).

FOR: PHARMACEUTICAL PREPARATIONS FOR THE TREATMENT OF SKIN BURNS, EYE BURNS, BURNS SUFFERED AS THE RESULT OF INGESTION OR AS A RESULT OF INTOXICATION DUE TO CHEMICAL PRODUCTS; VETERINARY PREPARATIONS FOR USE IN THE TREATMENT OF SKIN BURNS, EYE BURNS, BURNS SUFFERED AS A RESULT OF INGESTION OR AS A RESULT OF INTOXICATION DUE TO CHEMICAL PRODUCTS; SANITARY PREPARATIONS, NAMELY, NAPKINS, PADS FOR USE IN THE TREATMENT OF SKIN BURNS, EYE BURNS, BURNS SUFFERED AS A RESULT OF INGESTION OR AS A RESULT OF INTOXICATION DUE TO CHEMICAL PRODUCTS; MEDICATED SKIN WASHING SOLUTIONS DESIGNED TO TREAT BURNS CAUSED BY ACIDS OR ALKALIS; PAINKILLER PRODUCTS FOR TREATING THE SCALP; MEDICATED PRODUCTS FOR USE BY BURN VICTIMS, NAMELY, COMPACTS, PRE-MOISTENED TISSUES, PRE-MOISTENED TOWELS, PRE-MOISTENED WIPES, SKIN LOTION, SKIN CREAM, FACIAL LOTIONS, BODY LOTIONS, MOISTURIZERS, SKIN AND FACIAL MOUSSE, MEDICATED PATCHES CONTAINING BURN SCREEN AND BURN BLOCK FOR USE ON THE SKIN, SKIN EMOLLIENTS, SKIN MOISTURIZER MASKS, NAPKINS, PADS, MEDICATED BATHING SOLUTIONS, BANDAGES, ADHESIVE

BANDAGES, BURN DRESSINGS, MOLESKIN FOR USE AS A MEDICAL BANDAGE, MEDICAL BANDAGES WITH CHEMICAL PRODUCTS IN GEL OR LOTION FORM; DISINFECTANTS, NAMELY, ALL PURPOSE DISINFECTANTS, PAINKILLER PRODUCTS FOR TREATING THE SCALP; MEDICATED DECONTAMINATION OR EMERGENCY WASHING PRODUCTS, NAMELY, SPRAYS, COMPACTS, TISSUES, TOWELS, WIPES, SKIN LOTIONS, SKIN CREAM, FACIAL LOTIONS, BODY LOTIONS, SKIN AND FACIAL MOUSSE, PATCHES, EMOLLIENTS, SKIN MOISTURIZERS, MASKS, NAPKINS, BATHING SOLUTIONS, DISINFECTANTS FOR USE IN PREVENTING AND TREATING BURNS CAUSED BY ACIDS OR ALKALIS OR FROM OTHER CAUSES; MEDICATED WASHING PRODUCTS, NAMELY, MEDICATED FACE WASHES, MEDICATED BODY WASHES, COMPACTS, TISSUES, TOWELS, WIPES, SKIN CLEANSING LOTIONS, SKIN CREAM, SKIN LOTIONS, FACIAL LOTIONS, BODY LOTIONS, MOISTURIZERS, SKIN AND FACIAL MOUSSE, PATCHES, SKIN EMOLLIENTS, SKIN MOISTURIZER MASKS, NAPKINS, PADS, BATHING SOLUTIONS, BANDAGES, MOLESKIN FOR USE AS A MEDICAL BANDAGE, PAINKILLER PRODUCTS FOR TREATING THE SCALP; DAILY MEDICATED CLEANSING PRODUCTS, NAMELY, COMPACTS, PRE-MOISTENED TISSUES, PRE-MOISTENED TOWELS, PRE-MOISTENED WIPES, SKIN LOTION, SKIN CREAM, FACIAL LOTIONS, BODY LOTIONS, MOISTURIZERS, SKIN AND FACIAL MOUSSE, MEDICATED PATCHES CONTAINING BURN SCREEN AND BURN BLOCK FOR USE ON THE SKIN, SKIN EMOLLIENTS, SKIN MOIST-

URIZER MASKS, NAPKINS, PADS, MEDICATED BATHING SOLUTIONS, BANDAGES, ADHESIVE BANDAGES, BURN DRESSINGS, MOLESKIN FOR USE AS A MEDICAL BANDAGE, MEDICAL BANDAGES WITH CHEMICAL PRODUCTS IN GEL OR LOTION FORM; DISINFECTANTS FOR HUMAN USE; ANALGESICS FOR BURN VICTIMS; MEDICATED OR PHARMACEUTICAL WASHING SOLUTIONS FOR THE POST-WASHING TREATMENT OF CHEMICAL BURNS, IN CLASS 5 (U.S. CLS. 6, 18, 44, 46, 51 AND 52).

THE MARK CONSISTS OF STANDARD CHARACTERS WITHOUT CLAIM TO ANY PARTICULAR FONT, STYLE, SIZE, OR COLOR.

PRIORITY DATE OF 11-2-2006 IS CLAIMED.

OWNER OF INTERNATIONAL REGISTRATION 0934454 DATED 4-13-2007, EXPIRES 4-13-2017.

OWNER OF U.S. REG. NOS. 2,855,442 AND 3,159,161.

NO CLAIM IS MADE TO THE EXCLUSIVE RIGHT TO USE "AFTERWASH", APART FROM THE MARK AS SHOWN.

SER. NO. 79-042,603, FILED 4-13-2007.

DAYNA BROWNE, EXAMINING ATTORNEY

**Int. Cl.: 10**

**Prior U.S. Cls.: 26, 39 and 44**

**United States Patent and Trademark Office**

**Reg. No. 3,570,169**

**Registered Feb. 3, 2009**

**TRADEMARK  
PRINCIPAL REGISTER**

**SONA**

SONOVA HOLDING AG (SWITZERLAND COR-  
PORATION)

LAUBISRÜTISTRASSE 28

CH-8712 STÄFA

SWITZERLAND

THE MARK CONSISTS OF STANDARD CHAR-  
ACTERS WITHOUT CLAIM TO ANY PARTICULAR  
FONT, STYLE, SIZE, OR COLOR.

OWNER OF INTERNATIONAL REGISTRATION  
0677868 DATED 7-28-1997, EXPIRES 7-28-2017.

FOR: HEARING AIDS AND STRUCTURAL  
PARTS THEREFORE, IN CLASS 10 (U.S. CLS. 26, 39  
AND 44).

SER. NO. 79-042,833, FILED 7-29-2007.

KELLEY WELLS, EXAMINING ATTORNEY

**Int. Cls.: 7 and 11**

**Prior U.S. Cls.: 13, 19, 21, 23, 31, 34 and 35**

**United States Patent and Trademark Office**

**Reg. No. 3,570,170**

**Registered Feb. 3, 2009**

**TRADEMARK  
PRINCIPAL REGISTER**

**CONSIGMA**

COLLETTE NV (BELGIUM LIMITED LIABILITY  
COMPANY)  
KEERBAAN 70  
B-2160 WOMMELGERN  
BELGIUM

FOR: GRANULATING MACHINES, SCREW  
GRANULATING MACHINES AND EXTRUDING  
MACHINES FOR GRANULATING AND EXTRUD-  
ING PHARMACEUTICALS, DRYING MACHINES  
FOR DRYING PHARMACEUTICALS, FLUID BED  
MACHINES FOR DRYING PHARMACEUTICALS,  
CONTINUOUS GRANULATING AND DRYING  
MACHINES FOR GRANULATING AND DRYING  
PHARMACEUTICALS. ALL THE AFOREMEN-  
TIONED FOR USE IN THE PHARMACEUTICAL  
INDUSTRY; PARTS FOR ALL THE AFOREMEN-  
TIONED, IN CLASS 7 (U.S. CLS. 13, 19, 21, 23, 31, 34  
AND 35).

FOR: DRYING APPARATUSES, NAMELY, IN-  
DUSTRIAL OR LABORATORY DRYERS FOR DRY-  
ING PHARMACEUTICALS, FLUID BED DRYERS  
FOR DRYING PHARMACEUTICALS, BOTH FOR  
USE IN THE PHARMACEUTICAL INDUSTRY , IN  
CLASS 11 (U.S. CLS. 13, 21, 23, 31 AND 34).

PRIORITY DATE OF 1-18-2007 IS CLAIMED.

OWNER OF INTERNATIONAL REGISTRATION  
0935199 DATED 7-17-2007, EXPIRES 7-17-2017.

SER. NO. 79-042,886, FILED 7-17-2007.

ANN E. SAPPENFIELD, EXAMINING ATTORNEY



**Int. Cl.: 9**

**Prior U.S. Cls.: 21, 23, 26, 36 and 38**

**United States Patent and Trademark Office**

**Reg. No. 3,570,171**

**Registered Feb. 3, 2009**

**TRADEMARK  
PRINCIPAL REGISTER**

# WinTool

WALTER GÖTSCHI (SWITZERLAND INDIVIDUAL)  
EICHWEIDSTRASSE 13B  
CH-8820 WÄDENSWIL  
SWITZERLAND

FOR: COMPUTER SOFTWARE FOR DATABASE MANAGEMENT AND MANUFACTURING PROCESS MANAGEMENT, IN CLASS 9 (U.S. CLS. 21, 23, 26, 36 AND 38).

THE MARK CONSISTS OF STANDARD CHARACTERS WITHOUT CLAIM TO ANY PARTICULAR FONT, STYLE, SIZE, OR COLOR.

PRIORITY DATE OF 5-5-2007 IS CLAIMED.

OWNER OF INTERNATIONAL REGISTRATION 0936474 DATED 8-16-2007, EXPIRES 8-16-2017.

SER. NO. 79-043,430, FILED 8-16-2007.

ELI HELLMAN, EXAMINING ATTORNEY

**Int. Cls.: 18 and 25**

**Prior U.S. Cls.: 1, 2, 3, 22, 39 and 41**

**Reg. No. 3,570,172**

**United States Patent and Trademark Office**

**Registered Feb. 3, 2009**

**TRADEMARK  
PRINCIPAL REGISTER**

# DUAL TREE

SELLERIE DE NONTRON (FRANCE SOCIÉTÉ  
PAR ACTIONS SIMPLIFIÉE)  
CHEMIN FONTAINE DE FANNY  
F-24300 NONTRON  
FRANCE

FOR: LEATHER AND IMITATION LEATHER;  
ANIMAL SKINS AND HIDES; TRUNKS; CHESTS,  
NAMELY, TRAVEL TRUNKS; SUITCASES; UM-  
BRELLAS, PARASOLS AND WALKING STICKS;  
WHIPS AND SADDLERY; SADDLE TREES BEING  
SADDLERY; FASTENINGS FOR SADDLES BEING  
SADDLERY; BELLY BANDS BEING SADDLERY;  
RIDING SADDLE UNDERPADS, NAMELY, SAD-  
DLER BLANKETS AND SHEETS; BRIDLES, NAME-  
LY, HARNESSSES; STIRRUP BARS; STIRRUP  
LEATHERS; STIRRUPS; HORSE COLLARS, HORSE  
BLANKETS, COVERS FOR HORSE SADDLES, SAD-  
DLER PADS FOR HORSES, HORSE HALTERS, RID-  
ING SADDLES; HARNESS FOR ANIMALS, RIDING  
CROPS, BITS FOR HARNESSING ANIMALS, HAR-  
NESS BLINKERS FOR ANIMALS, REINS; GAITERS,  
NAMELY, LEG BANDS, PROTECTIVE AND JUMP-  
ING BOOTS FOR HORSES; RUGS AND APPAREL  
FOR HORSES IN THE NATURE OF SADDLERY;  
PROTECTORS AND COVERINGS DESIGNED FOR  
HORSE HOOFS, NAMELY, HOOF GUARDS AND  
BOOTS FOR HORSES, IN CLASS 18 (U.S. CLS. 1, 2, 3,  
22 AND 41).

FOR: CLOTHING, NAMELY, TROUSERS, LEG-  
GINGS, TEE-SHIRTS, POLO SHIRTS, JUMPERS,  
SOCKS, WIND RESISTANT JACKETS, BLOUSON  
JACKETS, COMPETITION JACKETS; FOOTWEAR,  
EXCEPT ORTHOPEDIC FOOTWEAR; HEADWEAR;  
BOOTS, HALF-BOOTS; GLOVES, BELTS; GAITERS;  
TIES, SCARVES, IN CLASS 25 (U.S. CLS. 22 AND 39).

THE MARK CONSISTS OF STANDARD CHAR-  
ACTERS WITHOUT CLAIM TO ANY PARTICULAR  
FONT, STYLE, SIZE, OR COLOR.

PRIORITY DATE OF 11-22-2006 IS CLAIMED.

OWNER OF INTERNATIONAL REGISTRATION  
0937072 DATED 5-18-2007, EXPIRES 5-18-2017.

NO CLAIM IS MADE TO THE EXCLUSIVE  
RIGHT TO USE "TREE" FOR INTERNATIONAL  
CLASS 18, APART FROM THE MARK AS SHOWN.

SER. NO. 79-043,701, FILED 5-18-2007.

ROBERT STRUCK, EXAMINING ATTORNEY

**Int. Cl.: 2**

**Prior U.S. Cls.: 6, 11 and 16**

**United States Patent and Trademark Office**

**Reg. No. 3,570,173**

**Registered Feb. 3, 2009**

**TRADEMARK  
PRINCIPAL REGISTER**

**DECAFLEX**

LIQUID PLASTICS LIMITED (UNITED KING-  
DOM A COMPANY INCORPORATED UNDER  
THE LAWS OF ENGLAND AND WALES)  
IOTECH HOUSE, MILLER STREET  
PRESTON, LANCASHIRE PR1 1EA  
UNITED KINGDOM

FOR: PAINTS; COATINGS AND ENAMELS ALL  
IN THE NATURE OF PAINT; VARNISHES; PAIN-  
TERS' PAINT; DISTEMPERS; JAPANS; LACQUERS;  
PAINT AND VARNISH DRYING PREPARATIONS  
AND SUBSTANCES; WOOD PRESERVATIVES;  
WOOD STAINS; ANTI-CORROSIVE COATINGS;  
ANTI-FOULING COMPOSITIONS IN THE NATURE  
OF PAINT; WATERPROOFING PREPARATIONS

AND SUBSTANCES, ALL IN THE NATURE OF  
PAINT; THINNERS FOR ANY OF THE AFORESAID  
GOODS, IN CLASS 2 (U.S. CLS. 6, 11 AND 16).

PRIORITY DATE OF 5-19-2007 IS CLAIMED.

OWNER OF INTERNATIONAL REGISTRATION  
0937483 DATED 8-25-2007, EXPIRES 8-25-2017.

SER. NO. 79-043,852, FILED 8-25-2007.

WENDY GOODMAN, EXAMINING ATTORNEY

**Int. Cl.: 9**

**Prior U.S. Cls.: 21, 23, 26, 36 and 38**

**United States Patent and Trademark Office**

**Reg. No. 3,570,174**

**Registered Feb. 3, 2009**

**TRADEMARK  
PRINCIPAL REGISTER**

**SEITRON**

SEITRON S.R.L. (ITALY LIMITED LIABILITY  
COMPANY)  
VIA PROSDOCIMO 30  
I-36061 BASSANO DEL GRAPPA (VI)  
ITALY

FOR: ELECTRONIC APPLIANCES FOR REGULATING, MEASURING AND CONTROLLING ELECTRICITY, NAMELY, ELECTRIC CONTROL PANEL; TEMPERATURE CONTROL APPARATUS, NAMELY, CLIMATE CONTROL SYSTEMS CONSISTING OF DIGITAL THERMOSTATS FOR COOLING EQUIPMENT, AND A PROGRAMMABLE LOGIC CONTROLLER (PLC) WITH INPUT AND OUTPUT FEATURES FOR TEMPERATURE AND HUMIDITY, WHICH WORKS WITH A REMOTE DIGITAL READ OUT CONTROLLER; THERMOSTATS; GAS DETECTORS FOR DETECTING THE PRESENCE OF GAS, IN CLASS 9 (U.S. CLS. 21, 23, 26, 36 AND 38).

THE MARK CONSISTS OF STANDARD CHARACTERS WITHOUT CLAIM TO ANY PARTICULAR FONT, STYLE, SIZE, OR COLOR.

PRIORITY DATE OF 2-26-2007 IS CLAIMED.

OWNER OF INTERNATIONAL REGISTRATION  
0938372 DATED 5-15-2007, EXPIRES 5-15-2017.

THE WORDING "SEITRON" HAS NO MEANING  
IN FOREIGN LANGUAGE.

SER. NO. 79-044,169, FILED 5-15-2007.

DAYNA BROWNE, EXAMINING ATTORNEY

**Int. Cls.: 9 and 42**

**Prior U.S. Cls.: 21, 23, 26, 36, 38, 100 and 101**

**United States Patent and Trademark Office**

**Reg. No. 3,570,175**

**Registered Feb. 3, 2009**

**TRADEMARK  
SERVICE MARK  
PRINCIPAL REGISTER**

**nova**

ERSOL THIN FILM GMBH (FED REP GERMA-  
NY GMBH)  
SONNENTOR 2  
99098 ERFURT  
FED REP GERMANY

FOR: SOLAR CELLS FOR ELECTRICITY GEN-  
ERATION, SOLAR MODULES FOR ELECTRICITY  
GENERATION, SOLAR ELECTRICITY INSTALLA-  
TIONS, PHOTOVOLTAIC INSTALLATIONS FOR  
ELECTRICITY GENERATION; COMPONENTS  
AND SPARE PARTS FOR SOLAR POWER AND  
PHOTOVOLTAIC INSTALLATIONS, IN CLASS 9  
(U.S. CLS. 21, 23, 26, 36 AND 38).

FOR: TECHNICAL CONSULTANCY WITH RE-  
GARD TO THE CONSTRUCTION OF PHOTOVOL-  
TAIC INSTALLATIONS, TECHNICAL PLANNING  
OF PHOTOVOLTAIC INSTALLATIONS; RESEARCH

IN THE FIELD OF PHOTOVOLTAICS AND SOLAR  
TECHNOLOGY, IN PARTICULAR TECHNICAL DE-  
VELOPMENT OF COMPONENTS, EQUIPMENT  
AND SYSTEMS FOR PHOTOVOLTAICS AND FOR  
SOLAR POWER INSTALLATIONS, IN CLASS 42  
(U.S. CLS. 100 AND 101).

PRIORITY DATE OF 3-22-2007 IS CLAIMED.

OWNER OF INTERNATIONAL REGISTRATION  
0940251 DATED 9-14-2007, EXPIRES 9-14-2017.

SER. NO. 79-044,959, FILED 9-14-2007.

SHARON MEIER, EXAMINING ATTORNEY

**Int. Cls.: 9, 35, 38 and 41**

**Prior U.S. Cls.: 21, 23, 26, 36, 38, 100, 101, 102, 104  
and 107**

**Reg. No. 3,570,176**

**United States Patent and Trademark Office**

**Registered Feb. 3, 2009**

**TRADEMARK  
SERVICE MARK  
PRINCIPAL REGISTER**



EZMO AS (NORWAY CORPORATION)  
CHRISTIAN FREDRIKS PLASS 6  
N-0154 OSLO  
NORWAY

FOR: COMPUTER SOFTWARE FOR PROVIDING INTERACTIVE ENTERTAINMENT SOFTWARE FOR PLAYING COMPUTER GAMES AND COMPUTER UTILITY PROGRAMS ON COMPUTATIONAL DEVICES, COMPUTERS, MOBILE PHONES, PERSONAL DIGITAL ASSISTANTS, GAME CONSOLES, PERSONAL VIDEO RECORDERS, MEDIA PLAYERS AND NETWORK TERMINALS; COMPUTER SOFTWARE FOR PROVIDING REMOTE INFORMATION STORAGE SYNCHRONIZATION AND MULTIMEDIA STREAMING ON COMPUTATIONAL DEVICES, COMPUTERS, MOBILE PHONES, PERSONAL DIGITAL ASSISTANTS, GAME CONSOLES, PERSONAL VIDEO RECORDERS, MEDIA PLAYERS AND NETWORK TERMINALS; COMPUTER SOFTWARE FOR PROVIDING SOCIAL RECOMMENDATION AND COMMUNICATION SOFTWARE TO ACCESS DATA FOR COMPUTATIONAL DEVICES, COMPUTERS, MOBILE PHONES, PERSONAL DIGITAL ASSISTANTS, GAME CONSOLES, PERSONAL VIDEO RECORDERS, MEDIA PLAYERS AND NETWORK TERMINALS; COMPUTER SOFTWARE FOR PROVIDING MULTIMEDIA PLAYBACK AND OFFLINE INFORMATION ACCESS ON COMPUTATIONAL DEVICES, COMPUTERS, MOBILE PHONES, PERSONAL DIGITAL ASSISTANTS, GAME CONSOLES, PERSONAL VIDEO RECORDERS, MEDIA PLAYERS AND NETWORK TERMINALS, IN CLASS 9 (U.S. CLS. 21, 23, 26, 36 AND 38).

FOR: ONLINE RETAIL STORE SERVICES FEATURING DIGITAL PRODUCTS; DISTRIBUTION OF ELECTRONIC ADVERTISEMENTS FOR PROMOTIONAL AND ADVERTISING PURPOSES, IN CLASS 35 (U.S. CLS. 100, 101 AND 102).

FOR: ELECTRONIC TRANSMISSION OF DATA VIA PRIVATE, PUBLIC AND GLOBAL DATA COMMUNICATION NETWORKS, PARTICULARLY VIA COMPUTATIONAL DEVICES, INCLUDING COMPUTERS, MOBILE PHONES, PERSONAL DIGITAL ASSISTANTS, GAME CONSOLES, PERSONAL VIDEO RECORDERS, MEDIA PLAYERS AND NETWORK TERMINALS; TRANSMISSION OF DATA VIA COMMUNICATION NETWORKS, IN CLASS 38 (U.S. CLS. 100, 101 AND 104).

FOR: ENTERTAINMENT SERVICES PROVIDED VIA THE INTERNET, OTHER NETWORKS OR INDIVIDUAL COMPUTATIONAL DEVICES, NAMELY PROVIDING ON-LINE COMPUTER GAMES, IN CLASS 41 (U.S. CLS. 100, 101 AND 107).

THE MARK CONSISTS OF STANDARD CHARACTERS WITHOUT CLAIM TO ANY PARTICULAR FONT, STYLE, SIZE, OR COLOR.

PRIORITY DATE OF 2-20-2007 IS CLAIMED.

OWNER OF INTERNATIONAL REGISTRATION 0940381 DATED 3-21-2007, EXPIRES 3-21-2017.

SER. NO. 79-044,983, FILED 3-21-2007.

KAPIL BHANOT, EXAMINING ATTORNEY

**Int. Cls.: 16 and 35**

**Prior U.S. Cls.: 2, 5, 22, 23, 29, 37, 38, 50, 100, 101 and 102**

**United States Patent and Trademark Office**

**Reg. No. 3,570,177**

**Registered Feb. 3, 2009**

**TRADEMARK  
SERVICE MARK  
PRINCIPAL REGISTER**

**GANGSTER**

GANGSTER, S.R.O. (SLOVAKIA SOCIÉTÉ À RESPONSABILITÉ LIMITÉE)  
ZIMNÁ 18  
SK-040 01 KOICE  
SLOVAKIA

FOR: STATIONERY; PHOTOGRAPHS; NEWSPAPERS, IN CLASS 16 (U.S. CLS. 2, 5, 22, 23, 29, 37, 38 AND 50).

FOR: PUBLISHING, DISTRIBUTING ADVERTISING DOCUMENTATION, RENTAL OF ADVERTISING SPACE, RENTAL OF ADVERTISING MATERIAL, ADVERTISING BY POST, PUBLICATION OF ADVERTISING TEXTS, DISSEMINATION OF ADVERTISEMENTS, RESEARCH FOR BUSI-

NESS PURPOSES, BUSINESS INVESTIGATIONS, BUSINESS ORGANIZATION CONSULTANCY, ORGANIZATION OF EXHIBITIONS FOR COMMERCIAL OR ADVERTISING PURPOSES, PROFESSIONAL BUSINESS CONSULTING, IN CLASS 35 (U.S. CLS. 100, 101 AND 102).

OWNER OF INTERNATIONAL REGISTRATION 0941637 DATED 9-26-2007, EXPIRES 9-26-2017.

SER. NO. 79-045,443, FILED 9-26-2007.

MICHAEL WEBSTER, EXAMINING ATTORNEY

**Int. Cl.: 17**

**Prior U.S. Cls.: 1, 5, 12, 13, 35 and 50**

**United States Patent and Trademark Office**

**Reg. No. 3,570,178**

**Registered Feb. 3, 2009**

**TRADEMARK  
PRINCIPAL REGISTER**

# TRACTOR

MANULI RUBBER INDUSTRIES S.P.A. (ITALY  
JOINT STOCK COMPANY)  
PIAZZA DELLA REPUBBLICA, 14/16  
I-20124 MILANO  
ITALY

FOR: HYDRAULIC PIPES, NAMELY, HYDRAU-  
LIC HOSES MADE OF RUBBER, NOT TO BE USED  
IN CONNECTION WITH TRACTORS, IN CLASS 17  
(U.S. CLS. 1, 5, 12, 13, 35 AND 50).

THE MARK CONSISTS OF STANDARD CHAR-  
ACTERS WITHOUT CLAIM TO ANY PARTICULAR  
FONT, STYLE, SIZE, OR COLOR.

OWNER OF INTERNATIONAL REGISTRATION  
0942018 DATED 9-27-2007, EXPIRES 9-27-2017.

SER. NO. 79-045,626, FILED 9-27-2007.

ROBERT STRUCK, EXAMINING ATTORNEY



**Int. Cl.: 17**

**Prior U.S. Cls.: 1, 5, 12, 13, 35 and 50**

**Reg. No. 3,570,179**

**United States Patent and Trademark Office**

**Registered Feb. 3, 2009**

**TRADEMARK  
PRINCIPAL REGISTER**

**ETERNITY**

MANULI RUBBER INDUSTRIES S.P.A. (ITALY  
JOINT STOCK COMPANY)  
PIAZZA DELLA REPUBBLICA, 14/16  
I-20124 MILANO  
ITALY

FOR: FLEXIBLE PIPES, NOT OF METAL, FOR  
USE IN HYDRAULIC APPLICATIONS; REIN-  
FORCED RUBBER PIPES; FLEXIBLE PIPES AND  
HOSES MADE OF PLASTIC FOR HYDRAULIC  
APPARATUS AND FLUID CONVEYING APPLICA-  
TIONS; HYDRAULIC HOSES MADE OF REIN-  
FORCED RUBBER AND PLASTIC AND TUBES  
MADE OF RUBBER FOR HYDRAULIC APPLIAN-  
CES AND FLUID CONVEYING APPLICATIONS;

RUBBER TUBES AND HOSES FOR USE IN THE  
FIELD OF HYDRAULICS, IN CLASS 17 (U.S. CLS. 1,  
5, 12, 13, 35 AND 50).

PRIORITY DATE OF 6-18-2007 IS CLAIMED.

OWNER OF INTERNATIONAL REGISTRATION  
0942058 DATED 9-26-2007, EXPIRES 9-26-2017.

SER. NO. 79-045,636, FILED 9-26-2007.

ROBERT STRUCK, EXAMINING ATTORNEY

**Int. Cl.: 28**

**Prior U.S. Cls.: 22, 23, 38 and 50**

**United States Patent and Trademark Office**

**Reg. No. 3,570,180**

**Registered Feb. 3, 2009**

**TRADEMARK  
PRINCIPAL REGISTER**

**Variola**

SELECTA SPIELZEUG AG (FED REP GERMANY  
INCORPORATED COMPANY)  
RÖMERSTRASSE 1  
83533 EDLING  
FED REP GERMANY

FOR: WOODEN TOYS, NAMELY, A BALL AND  
TRACK SYSTEM COMPRISED OF WOODEN  
BUILDING BLOCKS, BALLS, MINIATURE WOO-  
DEN TOY FIGURES REPRESENTING PEOPLE,  
BELLS, AND A XYLOPHONE, ALL FOR CREATING  
A WOODEN TRACK FOR BALLS TO SLIDE DOWN,  
IN CLASS 28 (U.S. CLS. 22, 23, 38 AND 50).

THE MARK CONSISTS OF STANDARD CHAR-  
ACTERS WITHOUT CLAIM TO ANY PARTICULAR  
FONT, STYLE, SIZE, OR COLOR.

PRIORITY DATE OF 4-3-2007 IS CLAIMED.

OWNER OF INTERNATIONAL REGISTRATION  
0942748 DATED 10-1-2007, EXPIRES 10-1-2017.

SER. NO. 79-045,886, FILED 10-1-2007.

SHARON MEIER, EXAMINING ATTORNEY

**Int. Cl.: 9**

**Prior U.S. Cls.: 21, 23, 26, 36 and 38**

**United States Patent and Trademark Office**

**Reg. No. 3,570,181**

**Registered Feb. 3, 2009**

**TRADEMARK  
PRINCIPAL REGISTER**

**MIMESIS**

BCI CARTO (FRANCE SOCIÉTÉ ANONYME À  
CONSEIL D'ADMINISTRATION)  
3 RUE DU VELAY  
F-91090 LISSES  
FRANCE

FOR: CARTOGRAPHY AND GEOLOCALIZA-  
TION SOFTWARE; SOFTWARE FOR GEOGRAPHIC  
AND CARTOGRAPHIC MODELING, NAVIGATION  
AND GUIDANCE; TELEGUIDANCE APPARATUS,  
ALSO KNOWN AS A GLOBAL POSITIONING SYS-  
TEM; GRAPHICAL USER INTERFACE SOFTWARE;  
DATA PROCESSING AND COMPUTER EQUIP-  
MENT IN THE FIELD OF CARTOGRAPHY, IN  
CLASS 9 (U.S. CLS. 21, 23, 26, 36 AND 38).

THE MARK CONSISTS OF STANDARD CHAR-  
ACTERS WITHOUT CLAIM TO ANY PARTICULAR  
FONT, STYLE, SIZE, OR COLOR.

PRIORITY DATE OF 3-28-2007 IS CLAIMED.

OWNER OF INTERNATIONAL REGISTRATION  
0943276 DATED 9-17-2007, EXPIRES 9-17-2017.

SER. NO. 79-046,130, FILED 9-17-2007.

RONALD AIKENS, EXAMINING ATTORNEY

**Int. Cl.: 42**

**Prior U.S. Cls.: 100 and 101**

**United States Patent and Trademark Office**

**Reg. No. 3,570,182**

**Registered Feb. 3, 2009**

**SERVICE MARK  
PRINCIPAL REGISTER**

**seitz**

EUGEN SEITZ AG (SWITZERLAND JOINT  
STOCK COMPANY)  
SPITALSTRASSE 204  
CH-8623 KEMPTEN  
SWITZERLAND

FOR: MECHANICAL RESEARCH SERVICES; RE-  
SEARCH AND DESIGN SERVICES, IN PARTICU-  
LAR TECHNICAL RESEARCH AND TECHNICAL  
PROJECT STUDIES IN THE FIELDS OF MECHAN-  
ICAL ENGINEERING, PRODUCT TESTING, PRO-  
JECT MANAGEMENT AND TECHNICAL  
DOCUMENTATION, IN CLASS 42 (U.S. CLS. 100  
AND 101).

PRIORITY DATE OF 5-10-2007 IS CLAIMED.

OWNER OF INTERNATIONAL REGISTRATION  
0943624 DATED 10-19-2007, EXPIRES 10-19-2017.

SER. NO. 79-046,293, FILED 10-19-2007.

SUZANNE BLANE, EXAMINING ATTORNEY

**Int. Cl.: 7**

**Prior U.S. Cls.: 13, 19, 21, 23, 31, 34 and 35**

**Reg. No. 3,570,183**

**United States Patent and Trademark Office**

**Registered Feb. 3, 2009**

**TRADEMARK  
PRINCIPAL REGISTER**

**DEAIR**

TA-RO PROGETTI S.N.C. DI TAGLIATI RODOLFO E C. (ITALY GENERAL PARTNERSHIP)  
VIA MONTE GRAPPA, 59  
I-41042 FIORANO MODENESE (MO)  
ITALY

FOR: MACHINES FOR FORMING CERAMIC AND MASONRY TILES AND SLAB, NAMELY, DIE CUTTING AND STAMPING MACHINES; PRESS DIES FOR CERAMIC AND MASONRY FORMING; INDUSTRIAL MACHINE PRESSES; REPLACEMENT PARTS THEREFOR, IN CLASS 7 (U.S. CLS. 13, 19, 21, 23, 31, 34 AND 35).

THE MARK CONSISTS OF STANDARD CHARACTERS WITHOUT CLAIM TO ANY PARTICULAR FONT, STYLE, SIZE, OR COLOR.

PRIORITY DATE OF 6-13-2007 IS CLAIMED.

OWNER OF INTERNATIONAL REGISTRATION 0944140 DATED 10-19-2007, EXPIRES 10-19-2017.

SER. NO. 79-046,483, FILED 10-19-2007.

SUZANNE BLANE, EXAMINING ATTORNEY

**Int. Cl.: 7**

**Prior U.S. Cls.: 13, 19, 21, 23, 31, 34 and 35**

**Reg. No. 3,570,184**

**United States Patent and Trademark Office**

**Registered Feb. 3, 2009**

**TRADEMARK  
PRINCIPAL REGISTER**



CCVI INTERNATIONAL S.P.A. (ITALY JOINT  
STOCK COMPANY)  
VIA L.L. ZAMENHOF, 464  
I-36100 VICENZA  
ITALY

FOR: BALL BEARINGS FOR MACHINES, ROLLER BEARINGS AND NEEDLE ROLLER BEARINGS FOR MACHINES, HOUSED BEARING UNITS FOR MACHINES, SPHERICAL PLAIN BEARINGS FOR MACHINES, ROD ENDS FOR MACHINES, BUSHES FOR MACHINES, IN CLASS 7 (U.S. CLS. 13, 19, 21, 23, 31, 34 AND 35).

PRIORITY DATE OF 5-3-2007 IS CLAIMED.

OWNER OF INTERNATIONAL REGISTRATION  
0944185 DATED 6-7-2007, EXPIRES 6-7-2017.

NO CLAIM IS MADE TO THE EXCLUSIVE RIGHT TO USE "BEARING INDUSTRIES", APART FROM THE MARK AS SHOWN.

THE MARK CONSISTS OF THE LITERAL ELEMENT "CCVI BEARING INDUSTRIES" AND A DESIGN ELEMENT COMPRISING A SLOTTED GLOBE AND RECTANGLE. THE WORDING "CCVI" APPEARS IN THE RECTANGLE. THE GLOBE IS LOCATED TO THE RIGHT OF THE WORDING "CCVI". THE WORDING "BEARING INDUSTRIES" APPEARS UNDERNEATH THE RECTANGLE AND THE GLOBE.

SER. NO. 79-046,502, FILED 6-7-2007.

LAURIE KAUFMAN, EXAMINING ATTORNEY

**Int. Cls.: 16, 41 and 42**

**Prior U.S. Cls.: 2, 5, 22, 23, 29, 37, 38, 50, 100, 101 and 107**

**Reg. No. 3,570,185**

**United States Patent and Trademark Office**

**Registered Feb. 3, 2009**

**TRADEMARK  
SERVICE MARK  
PRINCIPAL REGISTER**

# VIA VINCI

PIETER A. PEENE (NETHERLANDS INDIVIDUAL)  
PADAKKER 77  
NL-4824 SW BREDA  
NETHERLANDS

FOR: PAPER; CARDBOARD; PRINTED MATTER, NAMELY, BROCHURES AND PUBLICATIONS IN THE NATURE OF BOOKS, HANDOUTS, WORKBOOKS, JOURNALS, AND TEACHING MATERIALS IN THE FIELDS OF THE HUMANITIES, SCIENCES, BUSINESS, LEADERSHIP, GOVERNANCE, MANAGEMENT, HEALTH CARE, ENGINEERING, ENVIRONMENTAL SCIENCES, ENVIRONMENTAL CONSERVATION, ENERGY, MATHEMATICS, AND LIBERAL ARTS; BOOKBINDING MATERIAL; PHOTOGRAPHS; STATIONERY; ADHESIVES FOR STATIONERY OR HOUSEHOLD PURPOSES; ARTISTS' MATERIALS, NAMELY, PAINT BRUSHES AND PAINTS; TYPEWRITERS; OFFICE REQUISITES, EXCEPT FURNITURE, NAMELY, PENHOLDERS, ENVELOPES, PLASTIC DOCUMENT COVERS, PLASTIC DOCUMENT SLEEVES, DOCUMENT CASES, AND PLASTIC COVERS FOR FILES; PRINTED INSTRUCTIONAL AND TEACHING MATERIALS IN THE FIELD OF EDUCATION; PLASTIC MATERIALS FOR PACKAGING, NAMELY, PLASTIC BAGS; PRINTERS' TYPE; PRINTING BLOCKS, IN CLASS 16 (U.S. CLS. 2, 5, 22, 23, 29, 37, 38 AND 50).

FOR: EDUCATIONAL SERVICES, NAMELY, PROVIDING COURSES OF INSTRUCTION AT THE COLLEGE AND GRADUATE SCHOOL LEVEL FOR BACHELORS, MASTERS, AND DOCTORATE DEGREES AND DISTRIBUTING COURSE MATERIAL IN CONNECTION THEREWITH; EDUCATION SERVICES, NAMELY, PROVIDING COURSES, TRAINING COURSES, SEMINARS, AND WORKSHOPS IN THE FIELD OF LEADERSHIP AND ENTREPRENEURSHIP; DEVELOPING AND PROVIDING IN-COMPANY EDUCATION PROGRAMS AND PROFESSIONAL EDUCATION-

AL PROGRAMS AND WORKSHOPS, ALL IN THE FIELDS OF THE HUMANITIES, SCIENCES, BUSINESS, LEADERSHIP, GOVERNANCE, MANAGEMENT, HEALTH CARE, ENGINEERING, ENVIRONMENTAL SCIENCES, ENVIRONMENTAL CONSERVATION, ENERGY, MATHEMATICS, AND LIBERAL ARTS; ORGANIZATION OF EDUCATIONAL CONGRESSES, CONFERENCES, SYMPOSIUMS, SEMINARS, AND LECTURES, ALL IN THE FIELDS OF THE HUMANITIES, SCIENCES, BUSINESS, LEADERSHIP, GOVERNANCE, MANAGEMENT, HEALTH CARE, ENGINEERING, ENVIRONMENTAL SCIENCES, ENVIRONMENTAL CONSERVATION, ENERGY, MATHEMATICS, AND LIBERAL ARTS; PUBLICATION BY ELECTRONIC MEANS OR BY OTHER MEANS OF BOOKS, MAGAZINES, NEWSLETTERS AND OTHER PRINTED MATTER FOR EDUCATIONAL PURPOSES; PROVIDING INFORMATION ON AND ABOUT EDUCATION; ORGANIZING COMMUNITY SPORTING AND CULTURAL EVENTS, IN CLASS 41 (U.S. CLS. 100, 101 AND 107).

FOR: DEVELOPMENT OF COMPUTER SOFTWARE IN THE FIELD OF EDUCATION, IN CLASS 42 (U.S. CLS. 100 AND 101).

THE MARK CONSISTS OF STANDARD CHARACTERS WITHOUT CLAIM TO ANY PARTICULAR FONT, STYLE, SIZE, OR COLOR.

PRIORITY DATE OF 12-28-2006 IS CLAIMED.

OWNER OF INTERNATIONAL REGISTRATION 0944355 DATED 6-27-2007, EXPIRES 6-27-2017.

THE WORDING "VIA VINCI" DOES NOT HAVE A LITERAL TRANSLATION. THE WORD "VIA" BY ITSELF MEANS BY WAY OF OR THROUGH. THE WORD "VINCI" IS MEANT TO CONNOTE THE

FAMOUS INVENTOR AND RENAISSANCE MAN,  
LEONARDO DA "VINCI", AND BY ITSELF IS THE  
PRESENT IMPERATIVE OF VINCERE IN ITALIAN,  
MEANING TO WIN. AS THE NAME OF THE  
INTERNATIONAL UNIVERSITY, THE MARK IS

MEANT TO BE SUGGESTIVE OF A RENAISSANCE  
SCHOOL OF THE WORLD.

SER. NO. 79-046,574, FILED 6-27-2007.

DEBRA LEE, EXAMINING ATTORNEY



**Int. Cls.: 9, 16 and 28**

**Prior U.S. Cls.: 2, 5, 21, 22, 23, 26, 29, 36, 37, 38 and 50**

**Reg. No. 3,570,186**

**United States Patent and Trademark Office**

**Registered Feb. 3, 2009**

**TRADEMARK  
PRINCIPAL REGISTER**

**WARDEVIL**

DIGI-GUYS LIMITED (UNITED KINGDOM A  
LIMITED COMPANY)  
EALING STUDIOS, EALING  
ESSEX W5 5EP  
UNITED KINGDOM

FOR: VIDEO GAMES SOFTWARE; COMPUTER  
GAME PROGRAMS; ELECTRONIC GAMES PRO-  
GRAMS; VIDEO GAME CARTRIDGES, COMPUTER  
GAME CARTRIDGES; BLANK COMPACT DISCS;  
COMPACT DISCS FEATURING VIDEO GAMES;  
CASSETTES AND CIRCUIT BOARDS CONTAINING  
GAME PROGRAMS FOR USE WITH HAND-HELD  
OR ARCADE VIDEO GAME MACHINES; HOME  
VIDEO GAMES MACHINES AND AMUSEMENT  
APPARATUS FOR USE WITH TELEVISION RECEI-  
VERS; COMPUTER PERIPHERAL DEVICES FOR  
USE WITH HOME VIDEO GAME MACHINES; CI-  
NEMATOGRAPHIC FILMS AND MOTION PIC-  
TURES IN THE FIELD OF ANIMATION, IN CLASS  
9 (U.S. CLS. 21, 23, 26, 36 AND 38).

FOR: SERIES OF BOOKS IN THE FIELD OF  
VIDEO GAMES; PRINTED INSTRUCTIONAL MAT-  
TER IN THE FIELD OF VIDEO GAMES; PRINTED

MATTER, NAMELY, VIDEO GAME INSTRUCTION  
MANUALS, IN CLASS 16 (U.S. CLS. 2, 5, 22, 23, 29, 37,  
38 AND 50).

FOR: STAND-ALONE ARCADE VIDEO GAME  
MACHINES; STAND-ALONE COIN, CARD OR  
COUNTER OPERATED GAME MACHINES AND  
AMUSEMENT APPARATUS, IN CLASS 28 (U.S. CLS.  
22, 23, 38 AND 50).

THE MARK CONSISTS OF STANDARD CHAR-  
ACTERS WITHOUT CLAIM TO ANY PARTICULAR  
FONT, STYLE, SIZE, OR COLOR.

PRIORITY DATE OF 6-13-2007 IS CLAIMED.

OWNER OF INTERNATIONAL REGISTRATION  
0945066 DATED 10-26-2007, EXPIRES 10-26-2017.

SER. NO. 79-046,841, FILED 10-26-2007.

EMILY CARLSEN, EXAMINING ATTORNEY

**Int. Cls.: 1 and 17**

**Prior U.S. Cls.: 1, 5, 6, 10, 12, 13, 26, 35, 46 and 50**

**United States Patent and Trademark Office**

**Reg. No. 3,570,187**

**Registered Feb. 3, 2009**

**TRADEMARK  
PRINCIPAL REGISTER**

**VISICO**

BOREALIS AG (AUSTRIA AKTIENGESELL-  
SCHAFT)  
IZD TOWER, WAGRAMERSTR. 17-19  
A-1220 VIENNA  
AUSTRIA

FOR: UNPROCESSED ARTIFICIAL OR SYN-  
THETIC RESINS; UNPROCESSED PLASTICS; UN-  
PROCESSED PLASTICS IN PELLET FORM;  
POLYETHYLENE RESINS; POLYPROPYLENE RE-  
SINS; POLYOLEFIN RESINS, IN CLASS 1 (U.S. CLS.  
1, 5, 6, 10, 26 AND 46).

FOR: SEMI-PROCESSED PLASTIC IN THE FORM  
OF FILMS, SHEETS, TUBES, BARS, RODS OR  
FIBRES; PLASTICS IN EXTRUDED FORM USED  
IN PRODUCTION OF PLASTIC PRODUCTS; SYN-

THETIC RESINS IN EXTRUDED FORM, OR IN  
BARS, BLOCKS, PELLETS, RODS, SHEETS AND  
TUBES, FOR GENERAL INDUSTRIAL USE; SEMI-  
FINISHED PRODUCTS, NAMELY, SEMI-FINISHED  
ACRYLIC MOLDED PLASTIC SUBSTANCE, FOR  
USE IN THE PLASTICS INDUSTRY, IN CLASS 17  
(U.S. CLS. 1, 5, 12, 13, 35 AND 50).

OWNER OF INTERNATIONAL REGISTRATION  
0946202 DATED 11-22-2007, EXPIRES 11-22-2017.

SER. NO. 79-047,255, FILED 11-22-2007.

SARA THOMAS, EXAMINING ATTORNEY

**Int. Cl.: 25**

**Prior U.S. Cls.: 22 and 39**

**United States Patent and Trademark Office**

**Reg. No. 3,570,188**

**Registered Feb. 3, 2009**

**TRADEMARK  
PRINCIPAL REGISTER**

**WESTROOPER**

DONG RUOLIN (CHINA INDIVIDUAL)  
RM. 1052, BUILDING NO. 2  
SHANGRI-LA GARDEN,; DAGUANG ROAD;  
210000NANJING  
CHINA

FOR: CLOTHING, NAMELY, GLOVES, BELTS OF  
LEATHER, AND PANTS, SHIRTS, COATS, TEE-  
SHIRTS, SKIRTS, UNDERWEAR; FOOTWEAR;  
HEADGEAR, NAMELY, HATS, CAPS; HOSIERY;  
SCARVES; WATERPROOF CLOTHING, NAMELY,  
WATERPROOF JACKETS AND WATERPROOF

PANTS; CYCLIST'S CLOTHING, NAMELY, CY-  
CLISTS' JERSEY AND SHOES; RAIN CAPES, IN  
CLASS 25 (U.S. CLS. 22 AND 39).

OWNER OF INTERNATIONAL REGISTRATION  
0946257 DATED 10-11-2007, EXPIRES 10-11-2017.

SER. NO. 79-047,282, FILED 10-11-2007.

HEATHER BIDDULPH, EXAMINING ATTORNEY

**Int. Cls.: 5, 10, 42 and 44**

**Prior U.S. Cls.: 6, 18, 26, 39, 44, 46, 51, 52, 100 and 101**

**United States Patent and Trademark Office**

**Reg. No. 3,570,189**

**Registered Feb. 3, 2009**

**TRADEMARK  
SERVICE MARK  
PRINCIPAL REGISTER**

# Invitalab

INVITALAB GMBH (FED REP GERMANY LIMITED COMPANY)  
HAMMFELDDAMM 6  
41460 NEUSS  
FED REP GERMANY

FOR: DIETETIC FOODS FOR MEDICAL USE; FOOD FOR BABIES; MEDICAL PLASTERS; MATERIALS, NAMELY, GAUZE AND BANDAGES FOR DRESSINGS; MATERIAL FOR STOPPING TEETH, DENTAL WAX; PREPARATIONS FOR DESTROYING VERMIN; FUNGICIDES, HERBICIDES, IN CLASS 5 (U.S. CLS. 6, 18, 44, 46, 51 AND 52).

FOR: SURGICAL APPARATUS AND INSTRUMENTS; ARTIFICIAL LIMBS, EYES AND TEETH; SUTURE MATERIALS, IN CLASS 10 (U.S. CLS. 26, 39 AND 44).

FOR: SCIENTIFIC RESEARCH; MEDICAL LABORATORIES; MEDICAL LABORATORY SERVICES; TECHNOLOGICAL RESEARCH IN THE FIELD OF MEDICAL TESTING; INDUSTRIAL ANALYSIS AND RESEARCH IN THE FIELD OF MEDICAL TESTING; DESIGN AND DEVELOPMENT OF COMPUTER HARDWARE AND SOFTWARE, IN CLASS 42 (U.S. CLS. 100 AND 101).

FOR: MEDICAL AND VETERINARY SERVICES; HEALTH AND BEAUTY CARE FOR HUMANS AND ANIMALS; MEDICAL DIAGNOSTIC TESTING, MONITORING AND REPORTING SERVICES; MEDICAL INFORMATION, NAMELY, CONSUMER-AUTHORIZED CLINICAL LABORATORY TESTING SERVICES THAT REPORT RESULTS DIRECTLY TO THE PATIENT; MEDICAL TESTING, IN CLASS 44 (U.S. CLS. 100 AND 101).

THE MARK CONSISTS OF STANDARD CHARACTERS WITHOUT CLAIM TO ANY PARTICULAR FONT, STYLE, SIZE, OR COLOR.

PRIORITY DATE OF 5-22-2007 IS CLAIMED.

OWNER OF INTERNATIONAL REGISTRATION 0946390 DATED 11-6-2007, EXPIRES 11-6-2017.

SER. NO. 79-047,330, FILED 11-6-2007.

JAMES GRIFFIN, EXAMINING ATTORNEY

**Int. Cl.: 12**

**Prior U.S. Cls.: 19, 21, 23, 31, 35 and 44**

**Reg. No. 3,570,190**

**United States Patent and Trademark Office**

**Registered Feb. 3, 2009**

**TRADEMARK  
PRINCIPAL REGISTER**

**SolidAir**

SOLIDEAL HOLDING S.A. (LUXEMBOURG SOCIÉTÉ ANONYME)  
23, AVENUE MONTEREY  
L-2086 LUXEMBOURG  
LUXEMBOURG

CARRYING AXLES, LOAD-CARRYING IDLERS, CHASSIS AND BRAKE PADS, ALL THESE GOODS FOR VEHICLES; LOAD-CARRYING IDLERS FOR TRACKED VEHICLES, IN CLASS 12 (U.S. CLS. 19, 21, 23, 31, 35 AND 44).

FOR: LAND VEHICLES AND THEIR STRUCTURAL PARTS; APPARATUS FOR LOCOMOTION BY LAND, AIR OR WATER, NAMELY, AUTOMOBILES, AIRPLANES, AND BOATS; TIRES, WHEEL RIMS, WHEELS, AXLES, CASINGS FOR PNEUMATIC TIRES; TRACKS, NAMELY, RUBBER TRACKS FOR MINI-EXCAVATORS, RUBBER TRACKS FOR SKID STEER TRACK SYSTEMS, OVER-THE TIRE TRACKS WHICH ARE FITTED OVER THE TIRES OF SKID STEER LOADERS, AND RUBBER TRACKS FOR AGRICULTURAL EQUIPMENT; DRIVING CHAINS, CHAIN SPROCKETS, LOAD-

PRIORITY DATE OF 3-27-2007 IS CLAIMED.

OWNER OF INTERNATIONAL REGISTRATION 0946598 DATED 7-24-2007, EXPIRES 7-24-2017.

SER. NO. 79-047,407, FILED 7-24-2007.

BERNICE MIDDLETON, EXAMINING ATTORNEY

Int. Cl.: 25

Prior U.S. Cls.: 22 and 39

United States Patent and Trademark Office

Reg. No. 3,570,191

Registered Feb. 3, 2009

TRADEMARK  
PRINCIPAL REGISTER

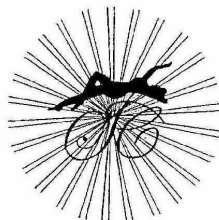

STAR CHIC  
*Easy Couture*

TUTTAITALIANA S.R.L. (ITALY LIMITED  
PARTNERSHIP COMPANY)  
VIA PRINCIPE AMEDEO, 3  
I-20121 MILANO  
ITALY

FOR: CLOTHING FOR MEN, WOMEN AND CHILDREN IN GENERAL, NAMELY, DRESSES MADE FROM SKINS; SHIRTS; BLOUSES; SKIRTS; SKIRT SUITS; JACKETS; TROUSERS; SHORTS; SINGLET; KNITWEAR; PYJAMAS; SOCKS; KNITTED UNDERWEAR; BODICES; GARTER BELTS; BRIEFS AND PANTS; BRASSIERES; SLIPS; HATS; HEAD SCARVES; TIES; WATERPROOF CLOTHING, NAMELY, WATERPROOF PANTS; OVERCOATS; COATS; BATHING SUITS; SPORTS OUTFITS, NAMELY, SPORTS JERSEYS; ANORAKS; SKI TROUSERS; BELTS; FURS; SCARVES; GLOVES; HOUSECOATS, SHOES IN GENERAL, NAMELY, SLIPPERS; SHOES; SPORTS SHOES; BOOTS AND SANDALS, IN CLASS 25 (U.S. CLS. 22 AND 39).

PRIORITY DATE OF 9-28-2007 IS CLAIMED.

OWNER OF INTERNATIONAL REGISTRATION  
0946842 DATED 11-19-2007, EXPIRES 11-19-2017.

NO CLAIM IS MADE TO THE EXCLUSIVE RIGHT TO USE "COUTURE", APART FROM THE MARK AS SHOWN.

THE MARK CONSISTS OF A SQUARE SHAPE WITH AT ITS CENTRE THE LETTERS "SC" IN SPECIAL FONT AND ABOVE, THE STYLIZED FORM OF A RECLINING WOMAN. THE LETTERS "SC" AND THE DRAWING OF THE WOMAN ARE SUPERIMPOSED ON A CIRCLE FROM WHICH A SERIES OF RAYS FAN OUTWARDS. UNDER THIS SHAPE THE WORDS "STAR CHIC EASY COUTURE" ARE IN SPECIAL FONT ON TWO LINES.

SER. NO. 79-047,511, FILED 11-19-2007.

SHANNON TWOHIG, EXAMINING ATTORNEY

Int. Cl.: 43

Prior U.S. Cls.: 100 and 101

United States Patent and Trademark Office

Reg. No. 3,570,192

Registered Feb. 3, 2009

SERVICE MARK  
PRINCIPAL REGISTER



MAIO S.R.L. (ITALY LIMITED LIABILITY COMPANY)

S.S. 230 VERCELLI BIELLA, 9

I-13040 CARISIO (VC)

ITALY

FOR: PROVISION OF FOOD AND DRINK; PROVISION OF TEMPORARY ACCOMMODATION, IN CLASS 43 (U.S. CLS. 100 AND 101).

PRIORITY DATE OF 10-23-2007 IS CLAIMED.

OWNER OF INTERNATIONAL REGISTRATION 0946996 DATED 11-21-2007, EXPIRES 11-21-2017.

THE TRADEMARK CONSISTS OF A QUADRILATERAL DARK IMPRINT INSIDE WHICH THERE IS THE WORD "MAIO".

THE ENGLISH TRANSLATION OF THE WORD "MAIO" IN THE MARK IS MAY.

SER. NO. 79-047,572, FILED 11-21-2007.

EMILY CARLSEN, EXAMINING ATTORNEY

**Int. Cls.: 3 and 5**

**Prior U.S. Cls.: 1, 4, 6, 18, 44, 46, 50, 51 and 52**

**Reg. No. 3,570,193**

**United States Patent and Trademark Office**

**Registered Feb. 3, 2009**

**TRADEMARK  
PRINCIPAL REGISTER**



R & H MINERALS BV (NETHERLANDS BESLO-  
TEN VENNOOTSCHAP)

MARNE 51

NL-9642 JX VEENDAM, NETHERLANDS

FOR: COSMETIC PRODUCTS, NAMELY, COS-  
METIC PRODUCTS IN THE FORM OF A SALT GEL  
OR SALT SCRUB-GEL FOR SKIN CARE, SALT  
CRYSTALS FOR SKIN CARE, SALT IN A WATER  
SOLUTION FOR SKIN CARE, COSMETICS; AND  
HAIR LOTIONS, IN CLASS 3 (U.S. CLS. 1, 4, 6, 50, 51  
AND 52).

FOR: PHARMACEUTICAL PRODUCTS FOR THE  
TREATMENT OF MAGNESIUM DEFICIENCY IN  
THE BODY, THE TREATMENT OF PSORIASIS AND  
OTHER SKIN DISEASES; ANIMAL HEALTH CARE  
PRODUCTS FOR THE TREATMENT OF MAGNE-  
SIUM DEFICIENCY IN THE BODY, THE TREAT-  
MENT OF SKIN DISEASES; HYGIENIC PRODUCTS  
FOR MEDICAL USE, NAMELY, HYGIENIC PRO-  
DUCTS FOR MEDICAL USE IN THE FORM OF A  
SALT SCRUB-GEL; DISINFECTANTS FOR HYGIE-  
NIC PURPOSES, IN CLASS 5 (U.S. CLS. 6, 18, 44, 46, 51  
AND 52).

PRIORITY DATE OF 6-8-2007 IS CLAIMED.

OWNER OF INTERNATIONAL REGISTRATION  
0947292 DATED 11-1-2007, EXPIRES 11-1-2017.

THE COLOR(S) BLACK, GREY, WHITE, BLUE IS/  
ARE CLAIMED AS A FEATURE OF THE MARK.

THE COLOR BLACK APPEARS IN THE WORD-  
ING "ZECHSTEIN INSIDE", AND THE OUTLINE OF  
THE RECTANGLE AND QUADRILATERAL, THE  
COLOR GRAY APPEARS AS WAVY LINES INSIDE  
THE RECTANGLE WITH A WHITE BACK-  
GROUND, THE COLORS WHITE AND BLUE AP-  
PEAR INSIDE THE QUADRILATERAL, AND THE  
COLOR BLUE APPEARS IN THE INSIDE OF THE  
LETTER "T" AND IN THE FOUNTAIN.

SER. NO. 79-047,646, FILED 11-1-2007.

TRICIA SONNEBORN, EXAMINING ATTORNEY



**Int. Cl.: 30**

**Prior U.S. Cl.: 46**

**United States Patent and Trademark Office**

**Reg. No. 3,570,194**

**Registered Feb. 3, 2009**

**TRADEMARK  
PRINCIPAL REGISTER**

**NYANGBO**

SONAFI (FRANCE SOCIÉTÉ PAR ACTIONS SIM-  
PLIFIÉE)  
42 RUE RIEUSSEC  
F-78220 VIROFLAY  
FRANCE

FOR: CHOCOLATE AND CANDY, IN CLASS 30  
(U.S. CL. 46).

PRIORITY DATE OF 5-24-2007 IS CLAIMED.

OWNER OF INTERNATIONAL REGISTRATION  
0947361 DATED 11-16-2007, EXPIRES 11-16-2017.

THE TERM NYANGBO HAS NO MEANING IN A  
FOREIGN LANGUAGE.

SER. NO. 79-047,672, FILED 11-16-2007.

ELI HELLMAN, EXAMINING ATTORNEY

**Int. Cls.: 32 and 33**

**Prior U.S. Cls.: 45, 46, 47, 48 and 49**

**United States Patent and Trademark Office**

**Reg. No. 3,570,195**

**Registered Feb. 3, 2009**

**TRADEMARK  
PRINCIPAL REGISTER**

**ROAD ONE**

HERAIL JEAN-PIERRE (BELGIUM JOINT  
STOCK COMPANY)  
AVENUE DE WALLONIE 128  
B-6180 COURCELLES  
BELGIUM

FOR: GRAPE JUICES; FRUIT JUICES, IN CLASS  
32 (U.S. CLS. 45, 46 AND 48).

FOR: WINES; SPIRITS; LIQUEURS, IN CLASS 33  
(U.S. CLS. 47 AND 49).

THE MARK CONSISTS OF STANDARD CHAR-  
ACTERS WITHOUT CLAIM TO ANY PARTICULAR  
FONT, STYLE, SIZE, OR COLOR.

OWNER OF INTERNATIONAL REGISTRATION  
0947372 DATED 11-14-2007, EXPIRES 11-14-2017.

SER. NO. 79-047,679, FILED 11-14-2007.

VERNA BETH RIRIE, EXAMINING ATTORNEY

Int. Cls.: 36 and 45

Prior U.S. Cls.: 100, 101 and 102

United States Patent and Trademark Office

Reg. No. 3,570,196

Registered Feb. 3, 2009

**SERVICE MARK  
PRINCIPAL REGISTER**



SOCIÉTÉ DE LA BOURSE DE LUXEMBOURG  
S.A. (LUXEMBOURG SOCIÉTÉ ANONYME  
(SA))

11 AVENUE DE LA PORTE-NEUVE  
L-2227 LUXEMBOURG

LUXEMBOURG AND  
EURONEXT N.V. (NETHERLANDS NAAMLOZE  
VENNOOTSCHAP (NV))

BEURSPLEIN 5  
NL-1012 JW AMSTERDAM  
NETHERLANDS

FOR: BANKING; INSURANCE SERVICES, NAMELY, INSURANCE BROKERAGE, INSURANCE UNDERWRITING, ELECTRONIC PROCESSING OF INSURANCE CLAIMS AND PAYMENT DATA, INSURANCE INFORMATION AND CONSULTANCY, INSURANCE PREMIUM RATE COMPUTING; FINANCIAL AFFAIRS SERVICES, NAMELY, BUSINESS FUND RAISING PROVIDED OVER A COMPUTER NETWORK SUCH AS THE INTERNET, PROVIDING FOR THE EXCHANGE OF FOREIGN CURRENCY, COMMODITIES, FINANCIAL DERIVATIVES, INTEREST RATE PRODUCTS, AND EQUITIES VIA THE INTERNET AND INTRANET SYSTEMS AS WELL AS PROVIDING INFORMATION THEREOF VIA THE INTERNET AND INTRANET SYSTEMS; MONETARY AFFAIRS SERVICES, NAMELY, MONETARY EXCHANGE AND MONETARY STRATEGY CONSULTATION AND RESEARCH; STOCK EXCHANGE SERVICES, NAMELY, PRICE QUOTATIONS, LISTING SERVICES, ORGANIZATION OF STOCK EXCHANGES FOR THE BENEFIT OF THE TRADE OF STOCKS AND OTHER FINANCIAL VALUES; CONSULTING AND INFORMATION ON BANKING, FINANCIAL, MONETARY AND STOCK EXCHANGE MATTERS; CONSULTING AND INFORMATION REGARDING INVESTMENT, IN PARTICULAR FINANCIAL IN-

VESTMENT; FINANCIAL TRANSACTIONS, NAMELY, INVESTMENT FUND TRANSFER AND TRANSACTIONS SERVICES, ELECTRONIC CASH TRANSACTIONS, FOREIGN EXCHANGE TRANSACTIONS; FINANCIAL TRUST OPERATIONS; ELECTRONIC FUNDS TRANSFER; INVESTMENT BY ELECTRONIC MEANS, NAMELY, ELECTRONIC TRANSFER OF SHARES, SECURITIES AND OTHER FINANCIAL PAPER; FINANCIAL SPONSORSHIP OF MARKETING PROMOTIONAL EVENTS, SPORTING AND CULTURAL EVENTS; BANKING; FOREIGN EXCHANGE TRANSACTIONS; FINANCIAL CLEARING HOUSE SERVICES, NAMELY, MONETARY, FINANCIAL AND STOCK EXCHANGE CLEARING OPERATIONS; FINANCIAL ANALYSIS; QUOTATION SERVICES FOR INVESTMENT FUNDS, SHARES, SECURITIES AND FINANCIAL PAPER IN THE NATURE OF EQUITY AND INSTALLMENT LOANS; SECURITIES, BUSINESS, INVESTMENT BROKERAGE; STOCK EXCHANGE QUOTATIONS; STOCK EXCHANGE BROKERAGE; INTERMEDIARY SERVICES WITH REGARD TO TRADING SHARES, SECURITIES AND OTHER FINANCIAL PAPER, NAMELY, INSURANCE AND FINANCIAL INFORMATION AND CONSULTANCY SERVICES; STOCK EXCHANGE SERVICES FOR QUOTATIONS AND EXCHANGING SHARES, SECURITIES AND FINANCIAL PAPER; REGISTRATION AND ADMISSION TO QUOTATION SERVICES FOR SHARES, SECURITIES AND FINANCIAL PAPER ON A STOCK EXCHANGE, NAMELY PROVIDING FOR STOCK EXCHANGE QUOTATION AND LISTING SERVICES; BROKERAGE SERVICES FOR SHARES, SECURITIES AND FINANCIAL PAPER IN THE NATURE OF EQUITY AND INSTALLMENT LOANS; INTERMEDIATION SERVICES WITH REGARD TO SHARES, SECURITIES AND FINANCIAL PAPER; INSTALLMENT LOANS; FISCAL VALUA-

TIONS AND ASSESSMENTS; CHARITABLE FUNDRAISING SERVICES, NAMELY, COLLECTIONS FOR CHARITY; INSURANCE UNDERWRITING SERVICES FOR NATURAL PERSONS AND CORPORATE ENTITIES AND FOR PROPERTY, AND ESPECIALLY INSURANCE UNDERWRITING SERVICES IN CONNECTION WITH FINANCIAL AND STOCK EXCHANGE TRANSACTIONS, IN CLASS 36 (U.S. CLS. 100, 101 AND 102).

FOR: LEGAL SERVICES; LEGAL AND JUDICIAL RESEARCH; LEGAL ANALYSES AND LEGAL SERVICES IN THE BANKING, FINANCIAL, MONE-

TARY AND STOCK EXCHANGE SECTORS, IN CLASS 45 (U.S. CLS. 100 AND 101).

PRIORITY DATE OF 3-20-2007 IS CLAIMED.

OWNER OF INTERNATIONAL REGISTRATION 0947688 DATED 7-27-2007, EXPIRES 7-27-2017.

SER. NO. 79-047,807, FILED 7-27-2007.

DEBRA LEE, EXAMINING ATTORNEY

**Int. Cls.: 9 and 15**

**Prior U.S. Cls.: 2, 21, 23, 26, 36 and 38**

**Reg. No. 3,570,197**

**United States Patent and Trademark Office**

**Registered Feb. 3, 2009**

**TRADEMARK  
PRINCIPAL REGISTER**



SCHALLER ELECTRONIC GMBH (FED REP  
GERMANY LIMITED LIABILITY COMPANY)  
AN DER HEIDE 15  
92353 POSTBAUER-HENG  
FED REP GERMANY

FOR: ELECTRICAL PICKUPS FOR PLUCKED  
AND BOWED STRING MUSICAL INSTRUMENTS;  
PRE-AMPLIFIERS FOR ELECTRICAL PICKUPS;  
SOUND CONTROLLERS FOR MANUAL OPERA-  
TION AND OPERATION BY FOOT, NAMELY,  
ELECTRONIC EFFECT PEDALS FOR USE WITH  
SOUND AMPLIFIERS; AMPLIFIER ELECTRICAL  
CABLES; MICROPHONE ELECTRICAL CABLES;  
LINEAR INSTRUMENT ELECTRICAL CABLES;  
ELECTRONIC TREMOLOS, NAMELY, ELECTRI-  
CAL SOUND EFFECT UNITS FOR USE WITH  
SOUND AMPLIFIERS IN THE NATURE OF TRE-  
MOLO PEDALS, IN CLASS 9 (U.S. CLS. 21, 23, 26, 36  
AND 38).

FOR: MACHINE HEADS, NAMELY, TUNERS  
FOR MUSICAL INSTRUMENTS FOR PLUCKED  
STRING MUSICAL INSTRUMENTS; BRIDGES

FOR PLUCKED STRING MUSICAL INSTRU-  
MENTS; TAILPIECES FOR PLUCKED MUSICAL  
INSTRUMENTS; TREMOLOS AS PARTS FOR GUI-  
TARS; ACCESSORIES FOR BOWED STRING MUSI-  
CAL INSTRUMENTS, NAMELY, PEGS,  
TAILPIECES, FINE TUNERS, VIOLIN BOWS AND  
PARTS THEREOF; PLECTRUMS FOR GUITARS  
AND STRINGED INSTRUMENTS, IN CLASS 15  
(U.S. CLS. 2, 21 AND 36).

PRIORITY DATE OF 6-4-2007 IS CLAIMED.

OWNER OF INTERNATIONAL REGISTRATION  
0947928 DATED 11-27-2007, EXPIRES 11-27-2017.

OWNER OF U.S. REG. NOS. 1,316,701 AND  
1,340,186.

SER. NO. 79-047,909, FILED 11-27-2007.

JAMES STEIN, EXAMINING ATTORNEY

**Int. Cls.: 1, 17 and 19**

**Prior U.S. Cls.: 1, 5, 6, 10, 12, 13, 26, 33, 35, 46 and 50**

**United States Patent and Trademark Office**

**Reg. No. 3,570,198**

**Registered Feb. 3, 2009**

**TRADEMARK  
PRINCIPAL REGISTER**

**BORSAFE**

BOREALIS AG (AUSTRIA AKTIENGESELL-  
SCHAFT (AG))  
IZD TOWER, WAGRAMERSTR. 17-19 A-1220  
VIENNA, AUSTRIA

FOR: UNPROCESSED ARTIFICIAL OR SYN-  
THETIC RESINS; UNPROCESSED PLASTICS; UN-  
PROCESSED PLASTICS IN PELLET FORM;  
POLYETHYLENE RESINS; POLYPROPYLENE RE-  
SINS; POLYOLEFIN RESINS, IN CLASS 1 (U.S. CLS.  
1, 5, 6, 10, 26 AND 46).

FOR: SEMI-PROCESSED PLASTIC IN THE FORM  
OF FILMS, SHEETS, TUBES, BARS, RODS OR  
FIBRES; PLASTICS IN EXTRUDED FORM USED  
IN PRODUCTION OF PLASTIC PRODUCTS; SYN-  
THETIC RESINS IN EXTRUDED FORM, OR IN  
BARS, BLOCKS, PELLETS, RODS, SHEETS AND

TUBES, AS SEMI-FINISHED PRODUCTS ALL FOR  
GENERAL INDUSTRIAL USE, IN CLASS 17 (U.S.  
CLS. 1, 5, 12, 13, 35 AND 50).

FOR: RIGID PIPES, NOT OF METAL; DRAIN  
PIPES, NOT OF METAL; GUTTER PIPES, NOT OF  
METAL; PENSTOCK PIPES, NOT OF METAL; WA-  
TER PIPES, NOT OF METAL, IN CLASS 19 (U.S. CLS.  
1, 12, 33 AND 50).

OWNER OF INTERNATIONAL REGISTRATION  
0948002 DATED 11-22-2007, EXPIRES 11-22-2017.

SER. NO. 79-047,942, FILED 11-22-2007.

ALYSSA STEEL, EXAMINING ATTORNEY

**Int. Cls.: 25 and 38**

**Prior U.S. Cls.: 22, 39, 100, 101 and 104**

**United States Patent and Trademark Office**

**Reg. No. 3,570,199**

**Registered Feb. 3, 2009**

**TRADEMARK  
SERVICE MARK  
PRINCIPAL REGISTER**



DALE ROSS ELLIOTT (AUSTRALIA INDIVIDUAL)  
43 CAPELLA DRIVE  
HALLETT COVE SA 5158  
AUSTRALIA

FOR: ARTICLES OF CLOTHING, NAMELY, T-SHIRTS, HATS AND JACKETS, IN CLASS 25 (U.S. CLS. 22 AND 39).

FOR: THE PROVISION OF ACCESS TO AN ONLINE SYSTEM, DATABASE, FORUM, AND CHAT ROOMS, FOR THE PROVISION OF PERSONAL CARE, SOCIAL SERVICES REMINDERS, SUPPORT, AND COMMUNICATION, INCLUDING FOR INDIVIDUALS TO COMMUNICATE AND PROVIDE PERSONAL SUPPORT, IN CLASS 38 (U.S. CLS. 100, 101 AND 104).

PRIORITY DATE OF 3-19-2007 IS CLAIMED.

OWNER OF INTERNATIONAL REGISTRATION  
0948123 DATED 9-7-2007, EXPIRES 9-7-2017.

NO CLAIM IS MADE TO THE EXCLUSIVE RIGHT TO USE ".COM.AU", APART FROM THE MARK AS SHOWN.

THE MARK IS COMPRISED OF THE WORDING "IMTHINKINGOFYOU" AND ".COM.AU", ABOVE WHICH IS A DESIGN ELEMENT FORMED BY TWO STYLIZED PEOPLE AND TWO HEART SHAPES.

SER. NO. 79-047,985, FILED 9-7-2007.

REBECCA POVARCHUK, EXAMINING ATTORNEY

Int. Cls.: 9 and 25

Prior U.S. Cls.: 21, 22, 23, 26, 36, 38 and 39

United States Patent and Trademark Office

Reg. No. 3,570,200

Registered Feb. 3, 2009

TRADEMARK  
PRINCIPAL REGISTER



OPTICOS SRL (ITALY LIMITED LIABILITY COMPANY)  
VIA G. TERZI SANT'AGATA, 2  
I-24030 BREMBATE DI SOPRA (BG)  
ITALY

FOR: HELMETS; PROTECTIVE HELMETS; SPORTS HELMETS; HELMETS FOR MOTORCYCLISTS; HELMETS FOR CYCLISTS; HELMETS FOR MOTORISTS; SPECTACLES; SPORTS SPECTACLES; SUNGLASSES; PROTECTIVE GLOVES AGAINST ACCIDENTS; PROTECTIVE GLOVES FOR SPORT; PROTECTIVE MASKS; PROTECTIVE CLOTHING, NAMELY, PROTECTIVE REINFORCEMENTS FOR ELBOWS, KNEES, LEGS AND ARMS AGAINST ACCIDENTS, IN CLASS 9 (U.S. CLS. 21, 23, 26, 36 AND 38).

FOR: CLOTHING, FOOTWEAR AND HEADGEAR, IN PARTICULAR, TRACK SUITS FOR SPORTS; JACKETS; WATERPROOF COATS AND TROUSERS; OVERCOATS; COATS; SKIRTS; SHIRTS; BLOUSES; UNDERWEAR; OUTER KNIT-

WEAR, NAMELY, VESTS AND JERSEYS; UNDERCLOTHING; PAJAMAS; TIES; FOULARDS; HATS; SOCKS; SHOES; SPORTS SHOES; MOUNTAINEERING SHOES; SKI BOOTS; SANDALS; BOOTS; SLIPPERS; TROUSERS; SWIMSUITS; SHORTS; TENNIS SHORTS; BELTS; SWEATSHIRTS; SWEATERS; SCARVES; GLOVES; ANORAKS WITH OR WITHOUT SLEEVES; WAISTCOATS; POLO SHIRTS; AND T-SHIRTS, IN CLASS 25 (U.S. CLS. 22 AND 39).

PRIORITY DATE OF 5-16-2007 IS CLAIMED.

OWNER OF INTERNATIONAL REGISTRATION  
0948507 DATED 8-27-2007, EXPIRES 8-27-2017.

SER. NO. 79-048,133, FILED 8-27-2007.

ALICE SUE CARRUTHERS, EXAMINING ATTORNEY



**Int. Cl.: 9**

**Prior U.S. Cls.: 21, 23, 26, 36 and 38**

**Reg. No. 3,570,201**

**United States Patent and Trademark Office**

**Registered Feb. 3, 2009**

**TRADEMARK  
PRINCIPAL REGISTER**



FIBOX OY AB (FINLAND LIMITED LIABILITY COMPANY)

P.O. BOX 16

FI-02421 JORVAS, FINLAND

FOR: HOUSINGS, CASINGS AND ENCLOSURES OF POLYCARBONATE AND ALUMINIUM FOR ELECTRIC AND ELECTRONIC COMPONENTS, ASSEMBLIES AND INSTALLATIONS, NAMELY, DISTRIBUTION BOARDS, METER AND FUSE BOXES, MACHINERY CONTROL PANELS, ELECTRICAL JUNCTION BOXES, TERMINAL WIRING BOXES, ELECTRICAL CONTROL BOXES, TERMINAL HOUSING, INSTRUMENT BOXES, PUSH BUTTON BOXES, SIGNAL LIGHT BOXES; HOUSINGS, CASINGS AND ENCLOSURES OF POLYCARBONATE AND ALUMINIUM FOR MEASURING AND CONTROL APPARATUS AND INSTRUMENTS, NAMELY, STARTERS, CONTROLLER AUTOMATION EQUIPMENT, ELECTRONIC TIMERS, CONTROLLERS, ELECTRICAL INSTRUMENTS, ELECTRICAL EQUIPMENT, TELEMETRY AND COMMUNICATION EQUIPMENT, SURVEILLANCE EQUIPMENT, SWITCHES, FUSES RELAYS, TERMINALS; PARTS AND FITTINGS FOR ALL THE AFORESAID

GOODS, NAMELY, CABLE INLETS, IN CLASS 9 (U.S. CLS. 21, 23, 26, 36 AND 38).

PRIORITY DATE OF 9-28-2007 IS CLAIMED.

OWNER OF INTERNATIONAL REGISTRATION 0949024 DATED 11-27-2007, EXPIRES 11-27-2017.

OWNER OF U.S. REG. NO. 1,933,410.

THE COLOR(S) BLUE, ORANGE AND WHITE IS/ ARE CLAIMED AS A FEATURE OF THE MARK.

THE MARK CONSISTS OF THE TERM "FIBOX" IN BLUE AND THE TERMS "ENCLOSING INNOVATIONS" IN ORANGE, ALL WITHIN A WHITE SQUARE DESIGN WITH THE PERIMETER IN BLUE AND THE LOWER RIGHT CORNER IN ORANGE.

SER. NO. 79-048,300, FILED 11-27-2007.

JAMES STEIN, EXAMINING ATTORNEY

**Int. Cls.: 1 and 3**

**Prior U.S. Cls.: 1, 4, 5, 6, 10, 26, 46, 50, 51 and 52**

**United States Patent and Trademark Office**

**Reg. No. 3,570,202**

**Registered Feb. 3, 2009**

**TRADEMARK  
PRINCIPAL REGISTER**

# Sensidin

SCHÜLKE & MAYR GMBH (FED REP GERMA-  
NY LIMITED LIABILITY COMPANY)  
ROBERT-KOCH-STRASSE 2  
22851 NORDERSTEDT  
FED REP GERMANY

FOR: CHEMICAL SUBSTANCES, NAMELY, CHE-  
MICAL ADDITIVES WITH SKIN CARE QUALITIES,  
ANTIMICROBIAL, ANTIMICROBIALY STABILIZ-  
ING, EMOLLIENT AND DEODORIZING PROPER-  
TIES FOR THE MANUFACTURE OF COSMETICS,  
IN CLASS 1 (U.S. CLS. 1, 5, 6, 10, 26 AND 46).

FOR: CLEANING PREPARATIONS FOR HOUSE-  
HOLD PURPOSES; SOAPS FOR HOUSEHOLD USE;  
HAND SOAPS; MEDICATED SOAPS; DISINFEC-  
TANT SOAPS; COSMETICS, IN CLASS 3 (U.S. CLS.  
1, 4, 6, 50, 51 AND 52).

THE MARK CONSISTS OF STANDARD CHAR-  
ACTERS WITHOUT CLAIM TO ANY PARTICULAR  
FONT, STYLE, SIZE, OR COLOR.

PRIORITY DATE OF 5-14-2007 IS CLAIMED.

OWNER OF INTERNATIONAL REGISTRATION  
0949043 DATED 11-13-2007, EXPIRES 11-13-2017.

SER. NO. 79-048,307, FILED 11-13-2007.

DAVID HOFFMAN, EXAMINING ATTORNEY

**Int. Cl.: 9**

**Prior U.S. Cls.: 21, 23, 26, 36 and 38**

**Reg. No. 3,570,203**

**United States Patent and Trademark Office**

**Registered Feb. 3, 2009**

**TRADEMARK  
PRINCIPAL REGISTER**



UBOWIRELESS PTY LIMITED (AUSTRALIA  
CORPORATION)

LEVEL 21

1 MARKET STREET

SYDNEY NSW 2000, AUSTRALIA

FOR: COMPUTER SOFTWARE, NAMELY, SOFTWARE FOR OPTIMIZING NETWORK, CUSTOMER AND COMMERCIAL OPERATIONS OF BUSINESSES, IN CLASS 9 (U.S. CLS. 21, 23, 26, 36 AND 38).

PRIORITY DATE OF 10-31-2007 IS CLAIMED.

OWNER OF INTERNATIONAL REGISTRATION  
0949058 DATED 12-3-2007, EXPIRES 12-3-2017.

THE COLOR(S) CYAN, MID BLUE AND DARK BLUE IS/ARE CLAIMED AS A FEATURE OF THE MARK.

THE MARK CONSISTS OF THE WORD "UBOWIRELESS" IN TWO COLOURS; THE LETTERS "UBO" IN DARK, BOLDED AND MID BLUE LOWER CASE LETTERS AND THE WORD "WIRELESS" IN DARK BLUE LOWER CASE LETTERING. AN ARRAY OF CYAN COLOURED DOTS FORM AN ELLIPSE APPEARING AS AN ORBIT SURROUNDING THE LETTERS "UBO" IN THE MARK. THE DOT ON THE LETTER "I" IN THE WORD "WIRELESS" IS IN THE COLOUR CYAN.

SER. NO. 79-048,312, FILED 12-3-2007.

JEFFERY COWARD, EXAMINING ATTORNEY

**Int. Cl.: 9**

**Prior U.S. Cls.: 21, 23, 26, 36 and 38**

**United States Patent and Trademark Office**

**Reg. No. 3,570,204**

**Registered Feb. 3, 2009**

**TRADEMARK  
PRINCIPAL REGISTER**

**uboWireless**

UBOWIRELESS PTY LIMITED (AUSTRALIA  
CORPORATION)  
LEVEL 21  
1 MARKET STREET  
SYDNEY NSW 2000, AUSTRALIA

OWNER OF INTERNATIONAL REGISTRATION  
0949059 DATED 12-3-2007, EXPIRES 12-3-2017.

FOR: COMPUTER SOFTWARE, NAMELY, SOFTWARE FOR OPTIMIZING NETWORK, CUSTOMER AND COMMERCIAL OPERATIONS OF BUSINESSES, IN CLASS 9 (U.S. CLS. 21, 23, 26, 36 AND 38).

SER. NO. 79-048,313, FILED 12-3-2007.

PRIORITY DATE OF 6-6-2007 IS CLAIMED.

JEFFERY COWARD, EXAMINING ATTORNEY

**Int. Cl.: 12**

**Prior U.S. Cls.: 19, 21, 23, 31, 35 and 44**

**Reg. No. 3,570,205**

**United States Patent and Trademark Office**

**Registered Feb. 3, 2009**

**TRADEMARK  
PRINCIPAL REGISTER**



***Van Nicholas***

EUROPEAN BICYCLE IMPORTS B.V. (NETHER-  
LANDS VENNOOTSCHAP ONDER FIRMA)  
ENERGIEWEG 23  
NL-3281 NH NUMANSDORP  
NETHERLANDS

OWNER OF INTERNATIONAL REGISTRATION  
0949116 DATED 11-22-2007, EXPIRES 11-22-2017.

OWNER OF U.S. REG. NO. 3,261,256.

FOR: BICYCLES AND BICYCLE PARTS, NAME-  
LY, BRAKES, CHAINS AND HANDLE BARS, IN  
CLASS 12 (U.S. CLS. 19, 21, 23, 31, 35 AND 44).

SER. NO. 79-048,330, FILED 11-22-2007.

KHANH LE, EXAMINING ATTORNEY

**Int. Cls.: 9, 16, 35, 37, 38 and 42**

**Prior U.S. Cls.: 2, 5, 21, 22, 23, 26, 29, 36, 37, 38, 50,  
100, 101, 102, 103, 104 and 106**

**Reg. No. 3,570,206**

**United States Patent and Trademark Office**

**Registered Feb. 3, 2009**

**TRADEMARK  
SERVICE MARK  
PRINCIPAL REGISTER**

**CMA CGM SYSTEMS**

CMA CGM (FRANCE SOCIÉTÉ ANONYME À  
DIRECTOIRE)  
4 QUAI D'ARENC  
F-13002 MARSEILLE  
FRANCE

FOR: COMPUTER HARDWARE, NAMELY, MEMORY AND MICROPROCESSOR CARDS, PRINTED CIRCUITS, BLANK FLOPPY DISCS, BLANK HARD DRIVES, COMPUTERS, COMPUTER PRINTERS, READING DEVICES FOR DATA PROCESSING USE, MODEMS, COMPUTER MEMORIES, COMPUTER PROGRAMS RECORDED ON DATA MEDIA FOR DATABASE MANAGEMENT IN THE MARITIME INDUSTRY, COMPUTER PERIPHERAL DEVICES, COMPUTER OPERATING PROGRAMS RECORDED ON DATA MEDIA, SCANNERS FOR COMPUTERS, AND COMPUTER SOFTWARE FOR DATABASE MANAGEMENT IN THE MARITIME INDUSTRY; SOFTWARE FOR CONTROLLING THE OPERATION AND EXECUTION OF PROGRAMS AND NETWORKS, NAMELY, LAN (LOCAL AREA NETWORK) AND USB (UNIVERSAL SERIAL BUS); SOFTWARE CONNECTING DISPARATE COMPUTER SYSTEMS, SERVERS AND STORAGE DEVICES FOR USE IN THE MARITIME INDUSTRY; INSTRUCTION MANUALS IN ELECTRONIC FORMAT SOLD THEREWITH; ALL OF THE FOREGOING GOODS ARE FOR USE IN THE MARITIME FIELD, IN CLASS 9 (U.S. CLS. 21, 23, 26, 36 AND 38).

FOR: INSTRUCTIONAL AND TEACHING MATERIALS, NAMELY, MANUALS IN THE FIELD OF COMPUTER PROGRAMMING; DOCUMENTATION AND PRINTED PUBLICATIONS, NAMELY, BOOKS, MAGAZINES, PERIODICALS, AND NEWSPAPERS REGARDING COMPUTERS AND COMPUTER PROGRAMS; BOOKS, MAGAZINES, PERIODICALS AND NEWSPAPERS RELATED TO COMPUTER HARDWARE, SOFTWARE AND COMPUTER SERVICES; ALL OF THE FOREGOING GOODS ARE FOR USE IN THE MARITIME FIELD, IN CLASS 16 (U.S. CLS. 2, 5, 22, 23, 29, 37, 38 AND 50).

FOR: ADVERTISING; BUSINESS MANAGEMENT AND CONSULTING; BUSINESS INFORMATION; DISTRIBUTION OF PROSPECTUSES; DISTRIBUTION OF SAMPLES; NEWSPAPER SUBSCRIPTION SERVICES FOR THIRD PARTIES; ACCOUNTING SERVICES; DOCUMENT REPRODUCTION; PROCESSING OF DATA MANAGEMENT, NAMELY, COMPILATION AND SYSTEMIZATION OF INFORMATION INTO COMPUTER DATABASES; ORGANIZATION OF EXHIBITIONS FOR COMMERCIAL OR ADVERTISING PURPOSES; COMMERCIAL ASSISTANCE IN BUSINESS MANAGEMENT; RETAIL STORE AND PROMOTIONAL SERVICES, EXCLUDING TRANSPORT, BY THE PROVISION OF A WEB SITE FOR THIRD-PARTY GOODS AND SERVICES, NAMELY, MEMORY AND MICROPROCESSOR CARDS, PRINTED CIRCUITS, FLOPPY DISCS, HARD DRIVES, COMPUTERS, COMPUTER PRINTERS, READING DEVICES FOR DATA PROCESSING, MODEMS, COMPUTER MEMORIES, RECORDED COMPUTER PROGRAMS, COMPUTER PERIPHERAL DEVICES, RECORDED COMPUTER OPERATING PROGRAMS, SCANNERS FOR COMPUTERS AND SOFTWARE; COMPUTER FILE MANAGEMENT; INSTALLATION, MAINTENANCE AND REPAIR OF COMPUTERS; COMPUTER SOFTWARE DEVELOPMENT, DESIGN AND UPDATING; RENTAL OF COMPUTER SOFTWARE; COMPUTER RENTAL; COMPUTER CONSULTING, NAMELY, BUSINESS CONSULTING SERVICES IN THE AREA OF COMPOSING, COMPILING AND SYSTEMIZATION OF WRITTEN COMMUNICATIONS; COMPUTER PROGRAMMING SERVICES; ALL OF THE FOREGOING SERVICES ARE FOR USE IN THE MARITIME FIELD, IN CLASS 35 (U.S. CLS. 100, 101 AND 102).

FOR: REPAIR, INSTALLATION AND MAINTENANCE OF COMPUTER HARDWARE; COMPUTER, ETHERNET AND WIRELESS NETWORKS MAINTENANCE; INSTALLING COMPUTER, ETHERNET AND WIRELESS NETWORKS; INSTALLATION, MAINTENANCE AND REPAIR OF COMPUTERS; ALL OF THE FOREGOING SERVICES

ARE FOR USE IN THE MARITIME FIELD, IN CLASS 37 (U.S. CLS. 100, 103 AND 106).

FOR: TELECOMMUNICATIONS SERVICES, NAMELY, THE RECEIPT AND DELIVERY OF MESSAGES, DOCUMENTS, IMAGES AND OTHER DATA BY ELECTRONIC TRANSMISSION; COMMUNICATIONS VIA COMPUTER TERMINALS; ELECTRONIC MAIL SERVICES; ELECTRONIC TRANSMISSION OF DATA AND DOCUMENTS VIA COMPUTER TERMINALS; PROVISION OF ACCESS TO A GLOBAL COMPUTER NETWORK; RENTAL OF ACCESS TIME TO COMPUTER DATABASE SERVERS; ALL OF THE FOREGOING SERVICES ARE FOR USE IN THE MARITIME FIELD, IN CLASS 38 (U.S. CLS. 100, 101 AND 104).

FOR: PROVISION OF COMPUTER SERVICES, NAMELY, COMPUTER SOFTWARE DEVELOPMENT, DESIGN AND UPDATING; RENTAL OF COMPUTER SOFTWARE; COMPUTER RENTAL; COMPUTER CONSULTING, NAMELY, CONSULTING AND TECHNICAL SUPPORT SERVICES IN THE FIELD OF THE DESIGN AND USE OF COMPUTER PROGRAMS, COMPUTERS, COMPUTER HARDWARE AND COMPUTER SYSTEMS; SERVICES PROVIDED BY COMPUTER PROGRAMMERS, NAMELY, COMPUTER PROGRAMMING SERVICES; COMPUTER SYSTEMS INTEGRATION SERVICES; COMPUTER SYSTEMS DESIGN SERVICES FOR THIRD PARTIES; COMPUTER SYSTEMS ANALYSIS; SOFTWARE INSTALLATION, UPDATING AND MAINTENANCE; ELECTRONIC COMPUTER PROGRAMMING FOR OTHERS; TECHNICAL PROJECT STUDIES IN THE FIELD OF COMPUTER HARDWARE AND SOFTWARE REGARDING SCIENTIFIC AND INDUSTRIAL RESEARCH; PROVIDING ADVICE ON COMPUTERS REGARDING INFORMATION CONCERNING COMPUTERS AND COMPUTER SOFTWARE OVER COMPUTER NETWORKS AND GLOBAL COMMUNICATION NETWORKS; RENTAL OF COMPUTERS AND OF

COMPUTER SOFTWARE; DUPLICATION OF COMPUTER PROGRAMS; SCIENTIFIC AND INDUSTRIAL RESEARCH SERVICES, NAMELY, ASSESSMENTS, ESTIMATES AND RESEARCH IN SCIENTIFIC AND TECHNOLOGICAL FIELDS REGARDING COMPUTER VIRUS PROTECTION SERVICES PROVIDED BY ENGINEERS; RESEARCH AND DEVELOPMENT OF NEW PRODUCTS; DESIGNING, UPDATING AND MAINTAINING WEB SITES ON THE INTERNET; ALL OF THE FOREGOING SERVICES ARE FOR USE IN THE MARITIME FIELD, IN CLASS 42 (U.S. CLS. 100 AND 101).

PRIORITY DATE OF 10-13-2006 IS CLAIMED.

OWNER OF INTERNATIONAL REGISTRATION 0949194 DATED 4-12-2007, EXPIRES 4-12-2017.

OWNER OF U.S. REG. NOS. 2,864,810 AND 2,868,249.

NO CLAIM IS MADE TO THE EXCLUSIVE RIGHT TO USE "SYSTEMS", APART FROM THE MARK AS SHOWN.

THE COLOR(S) BLUE AND RED IS/ARE CLAIMED AS A FEATURE OF THE MARK.

THE MARK CONSISTS OF THE WORDING "CMA CGM SYSTEMS" WITH THE ACRONYM "CMA" APPEARING IN RED CAPITAL LETTERS AND THE WORDING "CGM SYSTEMS" APPEARING IN BLUE CAPITAL LETTERS WITH THE "E" IN "SYSTEMS" APPEARING IN LOWER CASE, STYLIZED FORM.

SER. NO. 79-048,373, FILED 4-12-2007.

SHAILA SETTLES, EXAMINING ATTORNEY

**Int. Cls.: 7 and 8**

**Prior U.S. Cls.: 13, 19, 21, 23, 28, 31, 34, 35 and 44**

**United States Patent and Trademark Office**

**Reg. No. 3,570,207**

**Registered Feb. 3, 2009**

**TRADEMARK  
PRINCIPAL REGISTER**



PREALPINA DI ONGARO A. & G. S.N.C. (ITALY  
SOCIÉTÉ EN NOM COLLECTIF)  
VIALE VENEZIA, 50  
CONOGLIANO VENETO (TV), ITALY I31015

FOR: MACHINES, NAMELY, LATHES AND MACHINE TOOLS, NAMELY, MILLING CUTTERS; ELECTRIC DRILLS, AND MILLING MACHINES; INSTRUMENTS FOR MACHINE TOOLS, NAMELY, TOOL BITS, DIES FOR USE WITH MACHINE TOOLS; DRILL BITS AND MILLING ATTACHMENTS FOR POWER DRILLS; PARTS OF MACHINES, NAMELY, BLADES, BEARINGS; AND MACHINE TOOLS FOR REMOVING CHIPS, NAMELY, VACUUM CLEANERS, IN CLASS 7 (U.S. CLS. 13, 19, 21, 23, 31, 34 AND 35).

FOR: HAND-OPERATED TOOLS, NAMELY, DIES, CLAMPS, HAMMERS, DRILLS AND CHISELS, IN CLASS 8 (U.S. CLS. 23, 28 AND 44).

PRIORITY DATE OF 6-14-2007 IS CLAIMED.

OWNER OF INTERNATIONAL REGISTRATION  
0949245 DATED 10-16-2007, EXPIRES 10-16-2017.

THE MARK CONSISTS OF THE LITERAL ELEMENT "STARMILL" AND A DESIGN ELEMENT CONSISTING OF TWO CURVED LINES, THE FIRST CURVED LINE BEGINS SLIGHTLY BELOW THE LETTER "S" AND ARCHES OVER THE LETTERS "STARMIL", CONTINUES BEYOND AND BEHIND THE LETTER "L", ENDING IN A CENTER MASS BEHIND THE LETTERS "R" AND "M" WHERE THE FIRST CURVED LINE MEETS THE SECOND, AND WHEREIN FURTHER, THE SECOND CURVED LINE BEGINS SLIGHTLY ABOVE THE SECOND LETTER "L" AND ARCHES BELOW THE LETTERS "ARMILL", CONTINUES BEYOND AND BEHIND THE LETTER "A", ENDING IN THE SAME CENTER MASS BEHIND THE LETTERS "R" AND "M" WHERE THE SECOND CURVED LINE MEETS THE FIRST.

SER. NO. 79-048,400, FILED 10-16-2007.

RONALD DELGIZZI, EXAMINING ATTORNEY



**Int. Cl.: 45**

**Prior U.S. Cls.: 100 and 101**

**United States Patent and Trademark Office**

**Reg. No. 3,570,208**

**Registered Feb. 3, 2009**

**SERVICE MARK  
PRINCIPAL REGISTER**

**MEDINNOVA**

MEDINNOVA AS (NORWAY AS)  
RIKSHOSPITALET,  
SOGNSVANNSSVEIEN 20; N-0027 OSLO  
NORWAY

FOR: ADMINISTRATION OF AUTHOR RIGHTS  
AND INDUSTRIAL PROPERTY RIGHTS; LEGAL  
SERVICES; LICENSING OF INTELLECTUAL PROP-  
ERTY RIGHTS; LICENSING OF PROPERTY  
RIGHTS; MEDIATION SERVICES , IN CLASS 45  
(U.S. CLS. 100 AND 101).

THE MARK CONSISTS OF STANDARD CHAR-  
ACTERS WITHOUT CLAIM TO ANY PARTICULAR  
FONT, STYLE, SIZE, OR COLOR.

PRIORITY DATE OF 8-23-2007 IS CLAIMED.

OWNER OF INTERNATIONAL REGISTRATION  
0949250 DATED 10-10-2007, EXPIRES 10-10-2017.

SER. NO. 79-048,403, FILED 10-10-2007.

RONALD DELGIZZI, EXAMINING ATTORNEY

**Int. Cl.: 31**

**Prior U.S. Cls.: 1 and 46**

**United States Patent and Trademark Office**

**Reg. No. 3,570,209**

**Registered Feb. 3, 2009**

**TRADEMARK  
PRINCIPAL REGISTER**

# FRAGRANT RETURNS

MOLTER B.V. (NETHERLANDS BESLOTEN  
VENNOOTSCHAP MET BEP. AANSPRAKE-  
LIJKHEID)

LEIDSEVAART 133  
NL-2211 VS NOORDWIJKERHOUT  
NETHERLANDS

FOR: HORTICULTURE PRODUCTS, NAMELY,  
LIVE PLANTS AND FLOWERS; PLANT MATERIAL,  
NAMELY, PLANT SEEDS, LEAVES AND BUDS;  
SEEDS FOR SOWING; CUTTINGS AND TISSUE  
CULTURE MATERIALS FOR PLANT PROPAGA-  
TION, MULTIPLICATION AND REPRODUCTION;  
ALL THE AFOREMENTIONED GOODS IN PARTI-  
CULAR CONCERNING PERENNIALS, IN CLASS 31  
(U.S. CLS. 1 AND 46).

THE MARK CONSISTS OF STANDARD CHAR-  
ACTERS WITHOUT CLAIM TO ANY PARTICULAR  
FONT, STYLE, SIZE, OR COLOR.

PRIORITY DATE OF 11-7-2007 IS CLAIMED.

OWNER OF INTERNATIONAL REGISTRATION  
0949625 DATED 11-29-2007, EXPIRES 11-29-2017.

NO CLAIM IS MADE TO THE EXCLUSIVE  
RIGHT TO USE "FRAGRANT" , APART FROM  
THE MARK AS SHOWN.

SER. NO. 79-048,533, FILED 11-29-2007.

WARREN L. OLANDRIA, EXAMINING ATTOR-  
NEY

**Int. Cls.: 12, 28, 35 and 41**

**Prior U.S. Cls.: 19, 21, 22, 23, 31, 35, 38, 44, 50, 100,  
101, 102 and 107**

**Reg. No. 3,570,210**

**United States Patent and Trademark Office**

**Registered Feb. 3, 2009**

**TRADEMARK  
SERVICE MARK  
PRINCIPAL REGISTER**



DS-DESIGN, BESLOTEN VENNOOTSCHAP MET  
BEPERKTE; AANSPRAKELIJKHEID (BEL-  
GIUM BESLOTEN VENNOOTSCHAP MET BE-  
PERKTE AANSPRAKELIJKHEID)

WARESLAGESTRAAT 82  
B-9250 WAASMUNSTER  
BELGIUM

FOR: BICYCLES AND MOTORCYCLES, IN  
CLASS 12 (U.S. CLS. 19, 21, 23, 31, 35 AND 44).

FOR: GAMES, NAMELY, HAND HELD UNITS  
FOR PLAYING VIDEO GAMES; GYMNASTIC AP-  
PARATUS AND SPORTING GOODS, NAMELY,  
BODY-TRAINING APPARATUS, STATIONARY EX-  
ERCISE BICYCLES, NOT INCLUDED IN OTHER  
CLASSES, IN CLASS 28 (U.S. CLS. 22, 23, 38 AND 50).

FOR: PROMOTIONAL AND ADVERTISING SER-  
VICES; BUSINESS MANAGEMENT; BUSINESS AD-  
MINISTRATION; BUSINESS ADMINISTRATIVE  
SERVICES; DISTRIBUTION OF ADVERTISING  
MATTER, ADVERTISEMENTS AND PROMOTION-  
AL MATERIAL, ALSO IN THE INTERNET; ARRAN-  
GING AND CONDUCTING OF AUCTIONS AND  
PUBLIC AUCTION SALES; BUSINESS INFORMA-  
TION; MARKET STUDY, RESEARCH AND ANA-  
LYSIS; SHOP-WINDOW DISPLAY ARRANGEMENT  
SERVICES; ORGANISATIONAL AND BUSINESS  
CONSULTING; AGENCIES FOR PERSONNEL PLAC-  
EMENT AND CONSULTANCY ON PERSONNEL  
ISSUES; PLACEMENT OF TEMPORARY PERSON-  
NEL; LEASING OF OFFICE MACHINES; DOCU-  
MENTATION REPRODUCTION; PUBLIC  
RELATIONS; BUSINESS INTERMEDIATION SER-  
VICES IN THE FIELD OF WHOLESALE TRADING  
IN BICYCLES, MOTORCYCLES, GAMES, TOYS,  
SPORTING AND GYMNASTIC GOODS, BODY-  
TRAINING APPARATUS, STATIONARY EXERCISE

BICYCLES, AND PARTS THEREOF, CLOTHING,  
FOOTWEAR AND HEADGEAR, THE ABOVE-SER-  
VICES PROVIDED ONLINE OR NOT; BUSINESS  
RECORD MANAGEMENT; DATA PROCESSING;  
MARKETING SERVICES IN THE FIELD OF BI-  
CYCLES, MOTORCYCLES, GAMES, TOYS, SPORT-  
ING AND GYMNASTIC GOODS, BODY-TRAINING  
APPARATUS, STATIONARY EXERCISE BICYCLES,  
AND PARTS THEREOF, CLOTHING, FOOTWEAR  
AND HEADGEAR; RENTAL OF APPARATUS FOR  
DATA PROCESSING PURPOSES; CONSULTING  
WITH RESPECT TO DATA PROCESSING, IN CLASS  
35 (U.S. CLS. 100, 101 AND 102).

FOR: EDUCATION SERVICES, NAMELY, PRO-  
VIDING SEMINARS, WORKSHOPS IN THE FIELD  
OF SPORT AND TRAINING EQUIPMENT; ENTER-  
TAINMENT SERVICES, NAMELY, PROVIDING AN  
ON-GOING RADIO PROGRAM IN THE FIELD OF  
SPORT; ORGANISING SPORTING ACTIVITIES  
AND RECREATIONAL ACTIVITIES, NAMELY, FIT-  
NESS, AEROBIC, AND BODY-BUILDING EVENTS;  
TRAINING, NAMELY, STRENGTH AND CONDI-  
TIONAL TRAINING; PROVIDING OF SPORT  
TRAINING; PROVIDING SWIMMING POOLS AND  
SPA BATHS; OPERATING SPORTS FACILITIES;  
FITNESS CENTER SERVICES, NAMELY, PHYSI-  
CAL FITNESS CONSULTATION, CONDITIONING  
CLASSES AND FITNESS INSTRUCTION, IN CLASS  
41 (U.S. CLS. 100, 101 AND 107).

PRIORITY DATE OF 5-16-2007 IS CLAIMED.

OWNER OF INTERNATIONAL REGISTRATION  
0949727 DATED 9-18-2007, EXPIRES 9-18-2017.

NO CLAIM IS MADE TO THE EXCLUSIVE RIGHT TO USE "TECHNOLOGY", APART FROM THE MARK AS SHOWN.

THE COLOR(S) YELLOW, GREY AND BLACK IS/ ARE CLAIMED AS A FEATURE OF THE MARK.

THE COLOR GREY APPEARS IN THE WORDING "DKN", THE COLOR BLACK APPEARS IN THE WORDING "TECHNOLOGY" AND THE COLOR YELLOW APPEARS IN THE PULSE LINE

SER. NO. 79-048,573, FILED 9-18-2007.

KYLE PEETE, EXAMINING ATTORNEY

**Int. Cls.: 7, 9 and 11**

**Prior U.S. Cls.: 13, 19, 21, 23, 26, 31, 34, 35, 36 and 38**

**Reg. No. 3,570,211**

**United States Patent and Trademark Office**

**Registered Feb. 3, 2009**

**TRADEMARK  
PRINCIPAL REGISTER**



SYMACH S.R.L. (ITALY JOINT STOCK COMPANY WITH LIMITED LIABILITY)  
VIA CASOLETTA, 41/A  
I-40056 CREPELLANO (BOLOGNA)  
ITALY

FOR DRYING PAINTS, IN CLASS 11 (U.S. CLS. 13, 21, 23, 31 AND 34).

PRIORITY DATE OF 6-18-2007 IS CLAIMED.

FOR: INDUSTRIAL ROBOTS FOR AUTOMATIC POLISHING OF PAINTED PRODUCTS; MIXING MACHINES FOR AUTOMATIC MIXING OF PAINT, IN CLASS 7 (U.S. CLS. 13, 19, 21, 23, 31, 34 AND 35).

OWNER OF INTERNATIONAL REGISTRATION 0950017 DATED 12-6-2007, EXPIRES 12-6-2017.

FOR: COMPUTER SOFTWARE TO MANAGE THE COMPILATION AND SYSTEMIZATION OF INFORMATION IN DATABANKS; COMPUTER SOFTWARE FOR CREATING SEARCHABLE DATABASE OF INFORMATION AND DATA; COMPUTER SOFTWARE TO MANAGE AND TO CHECK PAINTING MIXING MACHINES; COMPUTER SOFTWARE TO MANAGE PAINTING MACHINES AND MACHINES TO POLISH PAINTED PRODUCTS, IN CLASS 9 (U.S. CLS. 21, 23, 26, 36 AND 38).

THE COLOR(S) LIGHT BLUE IS/ARE CLAIMED AS A FEATURE OF THE MARK.

THE MARK CONSISTS IN THE DENOMINATION "SYMACH" IN PARTICULAR LIGHT BLUE CHARACTERS.

THE WORDING "SYMACH" HAS NO MEANING IN A FOREIGN LANGUAGE.

FOR: APPARATUS FOR DRYING PAINTS, NAMELY, INFRARED DRYING STOVES, CABINS WITH AN INTEGRATED AUTOMATIC DRYING SYSTEM FOR PAINTS; INFRARED FLASH LIGHT

SER. NO. 79-048,698, FILED 12-6-2007.

LAURIE MAYES, EXAMINING ATTORNEY

**Int. Cls.: 7 and 12**

**Prior U.S. Cls.: 13, 19, 21, 23, 31, 34, 35 and 44**

**United States Patent and Trademark Office**

**Reg. No. 3,570,212**

**Registered Feb. 3, 2009**

**TRADEMARK  
PRINCIPAL REGISTER**



HONEYWELL B.V. (NETHERLANDS CORPORATION)  
LAARDERHOOGTWEG 18  
NL-1101 EA AMSTERDAM  
AMSTERDAM, NETHERLANDS

FOR: FILTERS, SPARK PLUGS, AND HYDRAULIC CONTROLS FOR MOTORS; IGNITION DEVICES FOR MOTORS OF LAND VEHICLES; TURBO COMPRESSORS FOR MOTORS OF LAND VEHICLES; AND AEROPLANE ENGINES, IN CLASS 7 (U.S. CLS. 13, 19, 21, 23, 31, 34 AND 35).

FOR: BRAKES FOR LAND VEHICLES, IN CLASS 12 (U.S. CLS. 19, 21, 23, 31, 35 AND 44).

OWNER OF INTERNATIONAL REGISTRATION  
0950358 DATED 11-29-2007, EXPIRES 11-29-2017.

SER. NO. 79-048,830, FILED 11-29-2007.

DAYNA BROWNE, EXAMINING ATTORNEY

**Int. Cls.: 18 and 25**

**Prior U.S. Cls.: 1, 2, 3, 22, 39 and 41**

**United States Patent and Trademark Office**

**Reg. No. 3,570,213**

**Registered Feb. 3, 2009**

**TRADEMARK  
PRINCIPAL REGISTER**



COTEC S.A. (LUXEMBOURG PLC)  
26, RUE PHILIPPE II  
L-2340 LUXEMBOURG  
LUXEMBOURG

FOR: LEATHER AND IMITATIONS OF LEATHER, AND GOODS MADE OF THESE MATERIALS, NAMELY, PURSES AND BAGS, ANIMAL SKINS AND HIDES; TRUNKS AND TRAVELING BAGS, UMBRELLAS, PARASOLS AND WALKING STICKS, WHIPS, HARNESS AND SADDLERY, IN CLASS 18 (U.S. CLS. 1, 2, 3, 22 AND 41).

FOR: CLOTHING, NAMELY, PANTS, BLOUSES AND SHIRTS; FOOTWEAR; HEADGEAR, NAMELY, HATS AND CAPS; BELTS IN LEATHER AND

LEATHER IMITATION, IN CLASS 25 (U.S. CLS. 22 AND 39).

PRIORITY DATE OF 7-4-2007 IS CLAIMED.

OWNER OF INTERNATIONAL REGISTRATION 0950582 DATED 12-19-2007, EXPIRES 12-19-2017.

OWNER OF U.S. REG. NO. 3,362,836.

SER. NO. 79-048,885, FILED 12-19-2007.

SHANNON TWOHIG, EXAMINING ATTORNEY

**Int. Cl.: 20**

**Prior U.S. Cls.: 2, 13, 22, 25, 32 and 50**

**Reg. No. 3,570,214**

**United States Patent and Trademark Office**

**Registered Feb. 3, 2009**

**TRADEMARK  
PRINCIPAL REGISTER**



TRI-PACK PLASTICS LTD (UNITED KINGDOM  
LIMITED COMPANY)  
ESTATE ROAD NO 1,  
SOUTH HUMBERSIDE INDUSTRIAL ESTATE,;  
GRIMSBY DN31 2TB  
UNITED KINGDOM

OWNER OF INTERNATIONAL REGISTRATION  
0950583 DATED 12-19-2007, EXPIRES 12-19-2017.

FOR: PLASTIC BOXES, IN CLASS 20 (U.S. CLS. 2,  
13, 22, 25, 32 AND 50).

SER. NO. 79-048,886, FILED 12-19-2007.

PRIORITY DATE OF 7-20-2007 IS CLAIMED.

SHANNON TWOHIG, EXAMINING ATTORNEY



**Int. Cls.: 18 and 25**

**Prior U.S. Cls.: 1, 2, 3, 22, 39 and 41**

**United States Patent and Trademark Office**

**Reg. No. 3,570,215**

**Registered Feb. 3, 2009**

**TRADEMARK  
PRINCIPAL REGISTER**



COTEC S.A. (LUXEMBOURG S.A.)  
26, RUE PHILIPPE II  
L-2340 LUXEMBOURG  
LUXEMBOURG

FOR: LEATHER AND IMITATIONS OF LEATHER, AND GOODS MADE OF THESE MATERIALS, NAMELY, PURSES AND BAGS, ANIMAL SKINS AND HIDES, TRUNKS AND TRAVELING BAGS, UMBRELLAS, PARASOLS AND WALKING STICKS, WHIPS, HARNESS AND SADDLERY, IN CLASS 18 (U.S. CLS. 1, 2, 3, 22 AND 41).

FOR: CLOTHING, NAMELY, PANTS, BLOUSES AND SHIRTS; FOOTWEAR; HEADGEAR, NAMELY, HATS AND CAPS; BELTS IN LEATHER AND

LEATHER IMITATION, IN CLASS 25 (U.S. CLS. 22 AND 39).

PRIORITY DATE OF 7-4-2007 IS CLAIMED.

OWNER OF INTERNATIONAL REGISTRATION 0950585 DATED 12-19-2007, EXPIRES 12-19-2017.

OWNER OF U.S. REG. NO. 3,362,836.

SER. NO. 79-048,888, FILED 12-19-2007.

SHANNON TWOHIG, EXAMINING ATTORNEY

**Int. Cls.: 18 and 25**

**Prior U.S. Cls.: 1, 2, 3, 22, 39 and 41**

**United States Patent and Trademark Office**

**Reg. No. 3,570,216**

**Registered Feb. 3, 2009**

**TRADEMARK  
PRINCIPAL REGISTER**

**D ♥ QUEEN**

COTEC S.A. (LUXEMBOURG S.A.)  
26, RUE PHILIPPE II  
L-2340 LUXEMBOURG  
LUXEMBOURG

FOR: LEATHER AND IMITATIONS OF LEATHER, AND GOODS MADE OF THESE MATERIALS, NAMELY, PURSES AND BAGS, ANIMAL SKINS AND HIDES, TRUNKS AND TRAVELING BAGS, UMBRELLAS, PARASOLS AND WALKING STICKS, WHIPS, HARNESS AND SADDLERY, IN CLASS 18 (U.S. CLS. 1, 2, 3, 22 AND 41).

FOR: CLOTHING, NAMELY, PANTS, BLOUSES AND SHIRTS; FOOTWEAR; HEADGEAR, NAMELY, HATS AND CAPS; BELTS IN LEATHER AND

LEATHER IMITATION, IN CLASS 25 (U.S. CLS. 22 AND 39).

PRIORITY DATE OF 7-4-2007 IS CLAIMED.

OWNER OF INTERNATIONAL REGISTRATION 0950586 DATED 12-19-2007, EXPIRES 12-19-2017.

OWNER OF U.S. REG. NO. 3,362,836.

SER. NO. 79-048,889, FILED 12-19-2007.

SHANNON TWOHIG, EXAMINING ATTORNEY

Int. Cls.: 9, 24 and 25

Prior U.S. Cls.: 21, 22, 23, 26, 36, 38, 39, 42 and 50

Reg. No. 3,570,217

United States Patent and Trademark Office

Registered Feb. 3, 2009

TRADEMARK  
PRINCIPAL REGISTER

# TIMPERO

LAINIERE DE PICARDIE BC (FRANCE SOCIETE  
PAR ACTIONS SIMPLIFIEE)  
BUIRE-COURCELLES  
F-80200 PERONNE  
FRANCE

FOR: CLOTHING FOR PROTECTION AGAINST ACCIDENTS, IRRADIATION AND FIRE; ASBESTOS GLOVES FOR PROTECTION AGAINST ACCIDENTS; ASBESTOS CLOTHING FOR PROTECTION AGAINST ACCIDENTS; PROTECTIVE SUITS FOR AVIATORS; SAFETY TARPULINS; DIVING SUITS; WORKMEN'S PROTECTIVE FACE-SHIELDS; GARMENTS FOR PROTECTION AGAINST FIRE; OPTICAL FIBERS; NETS FOR PROTECTION AGAINST ACCIDENTS; DIVING GLOVES; GLOVES FOR PROTECTION AGAINST X-RAYS FOR INDUSTRIAL USE; GLOVES FOR PROTECTION AGAINST ACCIDENTS; KNEE-PADS FOR WORKERS; SWIMMING JACKETS FOR PROTECTION AGAINST DROWNING; LIFE JACKETS, BULLET-PROOF VESTS; CLOTHING FOR PROTECTION AGAINST FIRE; SAFETY RESTRAINTS, OTHER THAN FOR VEHICLE SEATS OR SPORTS EQUIPMENT; PROTECTIVE MASKS FOR WORKMEN; SWIMMING BELTS FOR PROTECTION AGAINST DROWNING; DIVING OUTFITS; FACE MASKS FOR DIVING; PROTECTIVE HELMETS; PROTECTION DEVICES FOR PERSONAL USE AGAINST ACCIDENTS, NAMELY, FACE PROTECTION FIELD, FACE PROTECTION SHIELDS, GLOVES; PROTECTIVE DIVING SUITS, IN CLASS 9 (U.S. CLS. 21, 23, 26, 36 AND 38).

FOR: FABRICS FOR TEXTILE USE; BED OR TABLE COVERS, NAMELY, BED LINEN, BED SHEETS, TABLE LINEN; TEXTILE USED AS LININGS FOR CLOTHING; ADHESIVE FABRICS FOR APPLICATION BY HEAT; WOOLEN CLOTHS, WOOLEN FABRICS; LINEN FABRICS; SILK FABRICS; NON-WOVEN TEXTILE FABRICS; ELASTIC FABRICS FOR CLOTHING; FIBERGLASS FABRICS FOR TEXTILE USE; GUMMED CLOTHS OTHER THAN FOR STATIONERY; TICKING; PLASTIC MATERIALS, NAMELY, COVERINGS OF PLASTIC FOR FURNITURE, PLASTIC PLACE MATS; FABRICS

OF IMITATION ANIMAL SKINS; TAFFETAS; OIL-CLOTHS; UPHOLSTERY FABRICS, SLEEPING BAGS; BED COVERS; BEDSPREADS; MATTRESS COVERS; PILLOW CASES, COVERS FOR CUSHIONS; BED LINEN; BED BLANKETS; BED COVERS OF PAPER; BED LINENS IN THE NATURE OF BEDCLOTHES; MATTRESS COVERS; MOSQUITO NETS; LAP-ROBES; TRAVEL BLANKETS; PROTECTIVE COVERS FOR BEDCLOTHES; BEDDING ARTICLES, NAMELY, BED SHEETS, PILLOW CASES WITH SANITARY AND THERMOREGULATING PROPERTIES; COMFORTERS; SWEAT-ABSORBENT BED LINENS, IN CLASS 24 (U.S. CLS. 42 AND 50).

FOR: CLOTHING FOR MEN, WOMEN AND CHILDREN, NAMELY, PANTS, SHIRTS, JACKETS; FOOTWEAR; HEADWEAR; FINISHED TEXTILE LININGS FOR CLOTHING; LEISURE AND RECREATIONAL CLOTHING, NAMELY, SHIRTS, PANTS; CLOTHING FOR MOTORISTS, NAMELY, PANTS, JACKETS; COVERALLS; RAINCOATS; PARKAS; TROUSERS; SUITS; ONE-PIECE SKI SUITS; SWEAT-ABSORBENT UNDERWEAR; COATS, IN CLASS 25 (U.S. CLS. 22 AND 39).

THE MARK CONSISTS OF STANDARD CHARACTERS WITHOUT CLAIM TO ANY PARTICULAR FONT, STYLE, SIZE, OR COLOR.

PRIORITY DATE OF 6-25-2007 IS CLAIMED.

OWNER OF INTERNATIONAL REGISTRATION  
0950751 DATED 12-7-2007, EXPIRES 12-7-2017.

THE WORDING "TIMPERO" APPEARING IN THE MARK HAS NO MEANING IN A FOREIGN LANGUAGE.

SER. NO. 79-048,972, FILED 12-7-2007.

ELI HELLMAN, EXAMINING ATTORNEY

Int. Cl.: 33

Prior U.S. Cls.: 47 and 49

United States Patent and Trademark Office

Reg. No. 3,570,218

Registered Feb. 3, 2009

TRADEMARK  
PRINCIPAL REGISTER



LOUIS ROYER (FRANCE SOCIÉTÉ PAR AC-  
TIONS SIMPLIFIÉE)  
27 ET 29 RUE DU CHAIL  
F-16200 JARNAC  
FRANCE

FOR: COGNAC, IN CLASS 33 (U.S. CLS. 47 AND  
49).

PRIORITY DATE OF 6-15-2007 IS CLAIMED.

OWNER OF INTERNATIONAL REGISTRATION  
0950930 DATED 12-12-2007, EXPIRES 12-12-2017.

OWNER OF U.S. REG. NO. 1,383,635.

NO CLAIM IS MADE TO THE EXCLUSIVE  
RIGHT TO USE "COGNAC" AND THE SHAPE OF  
THE BOTTLE, APART FROM THE MARK AS  
SHOWN.

THE NAME OR SIGNATURE SHOWN IN THE  
MARK DOES NOT IDENTIFY A PARTICULAR  
LIVING INDIVIDUAL.

THE COLOR(S) WHITE, AMBER, BLUE, GRAY  
AND SILVER IS/ARE CLAIMED AS A FEATURE OF  
THE MARK.

THE MARK CONSISTS OF A CLEAR GLASS  
BOTTLE BEARING A SILVER LABEL, A SILVER  
BAND NEAR THE TOP, AND A SILVER TOP,  
SILVER NECK AND SILVER CAP. ON THE NECK  
OF THE BOTTLE IS THE GRAY TEXT "COGNAC  
GRANDE CHAMPAGNE EXTRA". ON THE BOT-  
TLE LABEL IS A SILVER RECTANGLE, A BLUE  
SHIELD, AND GRAY TEXT "COGNAC LOUIS ROY-  
ER EXTRA" WITH A GRAY LINE BELOW THE  
WORD "COGNAC". ON THE SILVER BAND IS THE  
UNDERLINED BLUE TEXT "LOUIS ROYER". AM-  
BER APPEARS IN THE LIQUID INSIDE THE BOT-  
TLE. THE COLOR GRAY APPEARING BEHIND  
THE BOTTLE IS MERELY BACKGROUND AND IS  
NOT PART OF THE MARK.

SER. NO. 79-049,022, FILED 12-12-2007.

REBECCA EISINGER, EXAMINING ATTORNEY

Int. Cl.: 7

Prior U.S. Cls.: 13, 19, 21, 23, 31, 34 and 35

Reg. No. 3,570,219

United States Patent and Trademark Office

Registered Feb. 3, 2009

TRADEMARK  
PRINCIPAL REGISTER



YANGZHOU XINJIANGZHENG TOOLS CO.,  
LTD. (CHINA CORPORATION)  
NO.10 OF FANRONGLU  
TANGTOUZHEN; JIANGDUSHI, JIANGSU  
CHINA

FOR: MACHINE TOOLS FOR MAKING HOLES;  
MACHINE TOOLS, NAMELY, IRON KNIVES FOR  
THE CUTTING OF MATERIALS; PNEUMATIC  
NAILERS; PNEUMATIC SCREWDRIVERS; POWER  
DRILLING BITS AS PARTS OF MACHINES, IN  
CLASS 7 (U.S. CLS. 13, 19, 21, 23, 31, 34 AND 35).

OWNER OF INTERNATIONAL REGISTRATION  
0951482 DATED 5-22-2007, EXPIRES 5-22-2017.

THE NAME "JIANG ZHENG" DOES NOT IDENTIFY A LIVING INDIVIDUAL.

THE ENGLISH TRANSLATION OF "JIANG" MEANS RIVER AND "ZHENG" MEANS CORRECTITUDE; THE COMBINATION OF THE TWO WORDS HAVE NO FOREIGN SIGNIFICANCE.

THE NON-LATIN CHARACTERS IN THE MARK TRANSLITERATE TO "JIANG ZHENG".

SER. NO. 79-049,182, FILED 5-22-2007.

DOMINIC FATHY, EXAMINING ATTORNEY

**Int. Cl.: 1**

**Prior U.S. Cls.: 1, 5, 6, 10, 26 and 46**

**Reg. No. 3,570,220**

**United States Patent and Trademark Office**

**Registered Feb. 3, 2009**

**TRADEMARK  
PRINCIPAL REGISTER**



SHANGHAI SUNNY; NEW TECHNOLOGY DE-  
VELOPMENT CORPORATION (CHINA COR-  
PORATION OF CHINA)  
MINGHANG DISTRICT  
NO. 378 HUMING ROAD  
201109 SHANGHAI, CHINA

OWNER OF INTERNATIONAL REGISTRATION  
0951510 DATED 1-10-2008, EXPIRES 1-10-2018.

SER. NO. 79-049,185, FILED 1-10-2008.

FOR: UNPROCESSED POLYETHYLENE PLAS-  
TICS IN THE FORM OF GRANULES OR POWDER,  
IN CLASS 1 (U.S. CLS. 1, 5, 6, 10, 26 AND 46).

MARK T. MULLEN, EXAMINING ATTORNEY

**Int. Cls.: 6 and 40**

**Prior U.S. Cls.: 2, 12, 13, 14, 23, 25, 50, 100, 103 and 106**

**Reg. No. 3,570,221**

**United States Patent and Trademark Office**

**Registered Feb. 3, 2009**

**TRADEMARK  
SERVICE MARK  
PRINCIPAL REGISTER**



AKTIEN-GESELLSCHAFT; DER DILLINGER  
HÜTTENWERKE (FED REP GERMANY  
STOCK CORPORATION)  
WERKSTRAÙE 1  
66763 DILLINGEN/SAAR  
FED REP GERMANY

FOR: BASE METALS AND THEIR ALLOYS; BUILDING MATERIALS MADE OF METAL, NAMELY, ANGLE IRONS, BANDS, BARS, BOARDS, BRACKETS FOR BUILDING, BUILDING FLASHING, BUILDING WALL FRAMINGS, CASINGS, CEILINGS, CHAINS, CHIMNEY POTS, CHIMNEY SHAFTS, CHIMNEYS, CLADDINGS FOR CONSTRUCTION AND BUILDING, COLUMNS, CORNICES, DECKINGS, DOOR, FENCE, FLOOR, ROOF AND WALL PANELS, DRAIN PIPES, DUCTS, FITTINGS, FLOORS, FRAMES FOR BUILDING, FRAMEWORKS FOR BUILDING, GIRDERS, GRATINGS, GUTTERS, HINGES, I-BEAMS, JOISTS, LADDERS, LATHS, LININGS, LINTELS, MASTS, MOLDINGS, PARTITIONS, PILLARS, PIPES, POSTS, RAILINGS FOR FENCES, BALCONIES AND BRIDGES, RAILS, PLUGS, POLES, ROOF AND WALL COVERINGS, ROOF FLASHING, SHEET PILES, SHUTTERING FOR CONCRETE, SHUTTERS, STAIR TREADS, STAIRWAYS, TILES, TRUSSES, TUBES, WAINSCOTING, WASHERS, WINDOWS, WIRE ROPES; TRANSPORTABLE SHELTER STRUCTURES MADE OF METAL; METAL REINFORCEMENT MATERIALS FOR BUILDINGS; JOINTS MADE OF METAL, NAMELY, METAL EXPANSION JOINTS FOR FLOORS, WALLS, PIPING AND DUCTING, PIPE COUPLING

JOINTS; CONSTRUCTION HARDWARE MADE OF METAL, NAMELY, BINDING SCREWS, BOLTS, BUCKLES, CLIPS FOR CABLES AND PIPES, COTTER PINS, COUPLINGS FOR CHAINS, CRAMPS, DOWELS, ELBOWS FOR PIPES, FLANGES, HOOKS, JUNCTIONS FOR PIPES, KARABINERS, MANIFOLDS FOR PIPES, NAILS, NUTS, PEGS, PINS, PIPE COLLARS, PIPE MUFFS, PULLEYS, RINGS, RIVETS, SCREWS, SEALING CAPS, SHIMS, SLEEVES, SPRINGS, VALVES, WALL PLUGS; SHEET METAL; SLABS OF METAL; WORKS OF ART MADE FROM BASE METALS; METAL REINFORCEMENTS FOR CONCRETE, NAMELY, MESHES, BEAMS, JOISTS, PLATES, RODS AND BARS; METAL PIPES; STEEL, UNWROUGHT OR PARTIALLY WROUGHT; STEEL PLATES; STEEL CASTINGS; STEEL BALLS; STEEL ALLOYS; STEEL PIPES, IN CLASS 6 (U.S. CLS. 2, 12, 13, 14, 23, 25 AND 50).

FOR: METALWORKING, NAMELY, METAL FABRICATION AND FINISHING SERVICES; OXYACETYLENE CUTTING OF METAL PARTS; ANNEALING OF METAL PARTS; STEEL SHOT BLASTING OF METAL PARTS; MILLING OF METAL PARTS; DRILLING OF METAL PARTS; WELDING OF METAL PARTS, IN CLASS 40 (U.S. CLS. 100, 103 AND 106).

PRIORITY DATE OF 6-15-2007 IS CLAIMED.

OWNER OF INTERNATIONAL REGISTRATION  
0951793 DATED 12-14-2007, EXPIRES 12-14-2017.

SER. NO. 79-049,310, FILED 12-14-2007.

MATTHEW MCDOWELL, EXAMINING ATTOR-  
NEY



**Int. Cls.: 18, 25 and 35**

**Prior U.S. Cls.: 1, 2, 3, 22, 39, 41, 100, 101 and 102**

**Reg. No. 3,570,222**

**United States Patent and Trademark Office**

**Registered Feb. 3, 2009**

**TRADEMARK  
SERVICE MARK  
PRINCIPAL REGISTER**

# G-STORE

G-STAR INTERNATIONAL B.V. (NETHERLANDS B.V.)  
KEIENBERGWEG 100  
NL-1101 GH AMSTERDAM  
NETHERLANDS

FOR: LEATHER AND IMITATIONS OF LEATHER, AND GOODS MADE OF THESE MATERIALS, NAMELY, LEATHER HANDBAGS, LEATHER KEY CASES, LEATHER WALLETS, LEATHER AND LEATHER BAGS; BAGS, NAMELY, HANDBAGS, PURSES, LEATHER SHOPPING BAGS, ALL PURPOSE ATHLETIC BAGS, BEACH BAGS, SHOULDER BAGS; RUCKSACKS AND WALLETS; TRUNKS, NAMELY, TRAVELING TRUNKS MADE OF LEATHER, LUGGAGE TRUNKS; TRAVELING BAGS; UMBRELLAS, IN CLASS 18 (U.S. CLS. 1, 2, 3, 22 AND 41).

FOR: CLOTHING, NAMELY, SHIRTS, T-SHIRTS, SWEATERS, JACKETS, WARM-UP SUITS, SHORTS, JEANS, TROUSERS, BLOUSES, BABY CLOTHING, NAMELY, INFANT WEAR, BEACHWEAR, CASUAL CHILDREN'S CLOTHING, NAMELY, CHILDREN'S GLOVES, CHILDREN'S MITTENS, CHILDREN'S CAPS, GIRL'S DRESSES, CHILDREN'S DUNGAREES, CHILDREN'S EAR MUFFS AND CHILDREN'S PLAY SUITS, GOLF WEAR, NAMELY, GOLF SHOES, GOLF PANTS, GOLF SHIRTS AND GOLF JACKETS, LOUNGEWEAR, SKI WEAR, SLEEPWEAR, SPORTS WEAR, NAMELY, ROBES, TOPS, PANTS, SWEAT PANTS, JOGGING SUITS, HOODED SWEATSHIRTS, HOODED PULLOVERS, GLOVES, PAJAMAS, FOULARDS, TIES, SUN VISORS, SKIRTS AND WRIST BANDS, UNDERGARMENTS, SOCKS, STOCKINGS, FOOTWEAR, HEADGEAR, NAMELY, HATS, BANDANNAS, CAPS, HEAD-SCARVES, SUNVISORS, CLOTHING BELTS, VESTS, IN CLASS 25 (U.S. CLS. 22 AND 39).

FOR: ADVERTISING SERVICES, NAMELY, DISSEMINATION OF ADVERTISEMENTS FOR THE SOAP, PERFUME, COSMETICS, LEATHER, CLOTHING, FOOTWEAR, HEADWEAR, CLOCK, SUN-

GLASSES, SPECTACLES, FRAMES FOR SPECTACLES, JEWELRY AND OTHER FASHION ACCESSORIES INDUSTRIES; BUSINESS MANAGEMENT; BUSINESS ADMINISTRATION; ADMINISTRATIVE SERVICES, NAMELY, BUSINESS ADMINISTRATION AND MANAGEMENT, BUSINESS ADMINISTRATION CONSULTANCY, BUSINESS ADMINISTRATIVE SERVICES PROVIDED IN THE NATURE OF CLOSING OF FRANCHISE AGREEMENTS FOR THE SOAP, PERFUME, COSMETICS, LEATHER, FOOTWEAR, HEADWEAR, CLOCK, SUNGLASSES, SPECTACLES, FRAMES FOR SPECTACLES, JEWELRY AND OTHER FASHION ACCESSORIES INDUSTRIES; RETAIL STORE SERVICES FEATURING SOAPS, PERFUMERY, ESSENTIAL OILS, COSMETICS, SUNTAN OILS, HAIR LOTIONS, GLASSES, SUNGLASSES AND SUNGLASS ACCESSORIES, CASES FOR GLASSES, CASES FOR SUNGLASSES, PRECIOUS METALS AND THEIR ALLOYS, JEWELRY, ORNAMENTS, PRECIOUS STONES, HOROLOGICAL AND CHRONOMETRIC INSTRUMENTS, WATCHES AND CLOCKS, LEATHER AND IMITATIONS OF LEATHER, LEATHER BAGS, RUCKSACKS AND WALLETS, TRUNKS AND TRAVELING BAGS, UMBRELLAS, FURNITURE, CLOTHING, FOOTWEAR, HEADGEAR, BELTS; FRANCHISING SERVICES, NAMELY, CONSULTATION ASSISTANCE IN BUSINESS MANAGEMENT, ORGANIZATION, PROMOTION AND ASSISTANCE IN THE ESTABLISHMENT AND OPERATION OF SHOPS SELLING SOAP, PERFUME, COSMETICS, LEATHER, CLOTHING, FOOTWEAR, HEADWEAR, CLOCK, SUNGLASSES, SPECTACLES, FRAMES FOR SPECTACLES, JEWELRY AND OTHER FASHION ACCESSORIES, IN CLASS 35 (U.S. CLS. 100, 101 AND 102).

THE MARK CONSISTS OF STANDARD CHARACTERS WITHOUT CLAIM TO ANY PARTICULAR FONT, STYLE, SIZE, OR COLOR.

PRIORITY DATE OF 6-25-2007 IS CLAIMED.

OWNER OF INTERNATIONAL REGISTRATION  
0951831 DATED 12-19-2007, EXPIRES 12-19-2017.

SER. NO. 79-049,327, FILED 12-19-2007.

MICHAEL TANNER, EXAMINING ATTORNEY

**Int. Cl.: 33**

**Prior U.S. Cls.: 47 and 49**

**United States Patent and Trademark Office**

**Reg. No. 3,570,223**

**Registered Feb. 3, 2009**

**TRADEMARK  
PRINCIPAL REGISTER**

**McGUIGAN**

MCGUIGAN SIMEON WINES LIMITED (AUSTRALIA CORPORATION)  
170 GREENHILL ROAD  
PARKSIDE SA 5063  
AUSTRALIA

FOR: WINE; TABLE WINE; SPARKLING WINES; WINE-BASED ALCOHOLIC BEVERAGES, NAME-  
LY, APERITIFS WITH WINE BASE; PREPARED  
WINE COCKTAILS; POTABLE SPIRITS; LIQUEURS,  
IN CLASS 33 (U.S. CLS. 47 AND 49).

THE MARK CONSISTS OF STANDARD CHAR-  
ACTERS WITHOUT CLAIM TO ANY PARTICULAR  
FONT, STYLE, SIZE, OR COLOR.

PRIORITY DATE OF 6-5-2007 IS CLAIMED.

OWNER OF INTERNATIONAL REGISTRATION  
0951913 DATED 12-5-2007, EXPIRES 12-5-2017.

SEC. 2(F).

SER. NO. 79-049,366, FILED 12-5-2007.

RENEE SERVANCE, EXAMINING ATTORNEY

**Int. Cl.: 41**

**Prior U.S. Cls.: 100, 101 and 107**

**United States Patent and Trademark Office**

**Reg. No. 3,570,224**

**Registered Feb. 3, 2009**

**SERVICE MARK  
PRINCIPAL REGISTER**



SELINA HARGRAVES (AUSTRALIA INDIVIDUAL)

16/75-85 ELM PARK DRIVE

HOPPERS CROSSING VIC 3029

AUSTRALIA AND

MICHAEL HARGRAVES (AUSTRALIA INDIVIDUAL)

16/75-85 ELM PARK DRIVE

HOPPERS CROSSING VIC 3029

AUSTRALIA

FOR: PROVIDING FITNESS FACILITIES, NAMELY, GYMS, IN CLASS 41 (U.S. CLS. 100, 101 AND 107).

OWNER OF INTERNATIONAL REGISTRATION 0951997 DATED 9-7-2007, EXPIRES 9-7-2017.

THE COLOR(S) RED, BLUE, WHITE IS/ARE CLAIMED AS A FEATURE OF THE MARK.

THE COLOR BLUE APPEARS IN THE WORD "FIT"; THE COLOR RED APPEARS IN THE WORDING "BOXING" AND IN THE RED EXTERIOR OUTLINING; THE COLOR WHITE APPEARS IN STRIPES OF THE OF THE LARGE "X" IN THE WORD "BOXING" AND IN THE SMALL LETTER "X" WHICH APPEARS OVER THE LARGER "X" IN "BOXING" AND IN THE INTERIOR BACKGROUND BEHIND THE WORDING AND CONTAINED IN THE RED OUTLINING.

SER. NO. 79-049,375, FILED 9-7-2007.

LAURA HAMMEL, EXAMINING ATTORNEY

**Int. Cls.: 36 and 38**

**Prior U.S. Cls.: 100, 101, 102 and 104**

**United States Patent and Trademark Office**

**Reg. No. 3,570,225**

**Registered Feb. 3, 2009**

**SERVICE MARK  
PRINCIPAL REGISTER**

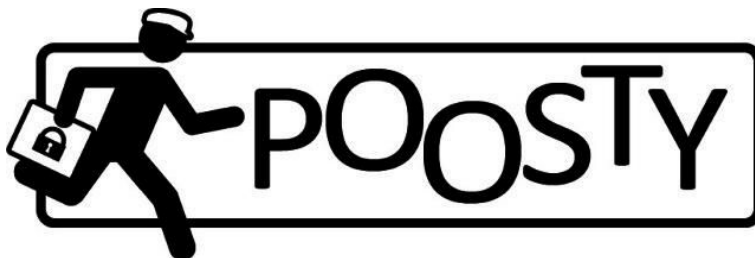

HEAVYPROJECT OU (ESTONIA LIMITED COMPANY)  
MAJAKA 52-1  
EE-11411 TALLINN, ESTONIA

FOR: FINANCIAL SERVICES IN THE NATURE OF ELECTRONIC PAYMENT SERVICES, NAMELY, ELECTRONIC TRANSMISSION OF BILL PAYMENT DATA, IN CLASS 36 (U.S. CLS. 100, 101 AND 102).

FOR: DATA COMMUNICATION, NAMELY, ELECTRONIC DATA TRANSMISSION; COMPUTER AIDED TRANSMISSION OF DIGITAL INFORMATION; ELECTRONIC MAIL SERVICES; CONCEALED AND PROTECTED ELECTRONIC MAIL SERVICES; PROVIDING ACCESS TO DATABASES;

PROVIDING ACCESS TO TELECOMMUNICATION NETWORKS AND INTERNET, IN CLASS 38 (U.S. CLS. 100, 101 AND 104).

PRIORITY DATE OF 11-23-2007 IS CLAIMED.

OWNER OF INTERNATIONAL REGISTRATION 0952143 DATED 12-10-2007, EXPIRES 12-10-2017.

SER. NO. 79-049,405, FILED 12-10-2007.

ALLISON HOLTZ, EXAMINING ATTORNEY

**Int. Cl.: 35**

**Prior U.S. Cls.: 100, 101 and 102**

**United States Patent and Trademark Office**

**Reg. No. 3,570,226**

**Registered Feb. 3, 2009**

**SERVICE MARK  
PRINCIPAL REGISTER**



SC ASESFT NET SRL (ROMANIA LIMITED  
LIABILITY COMPANY)  
STR MIHAI BRAVU NR 10  
100550 PLOIESTI, PRAHOVA  
ROMANIA

FOR: ADVERTISING; BUSINESS MANAGE-  
MENT; BUSINESS ADMINISTRATION; OFFICE  
FUNCTIONS, IN CLASS 35 (U.S. CLS. 100, 101 AND  
102).

OWNER OF INTERNATIONAL REGISTRATION  
0952265 DATED 11-20-2007, EXPIRES 11-20-2017.

OWNER OF U.S. REG. NO. 3,389,243.

NO CLAIM IS MADE TO THE EXCLUSIVE  
RIGHT TO USE "SHOP", APART FROM THE MARK  
AS SHOWN.

THE MARK CONSISTS OF THE WORDING,  
"SHOP MANIA" TO THE LEFT OF A DESIGN  
ELEMENT OF A SMILEY FACE THAT LOOKS LIKE  
A SHOPPING CART.

SER. NO. 79-049,461, FILED 11-20-2007.

GILBERT SWIFT, EXAMINING ATTORNEY

**Int. Cl.: 5**

**Prior U.S. Cls.: 6, 18, 44, 46, 51 and 52**

**Reg. No. 3,570,227**

**United States Patent and Trademark Office**

**Registered Feb. 3, 2009**

**TRADEMARK  
PRINCIPAL REGISTER**

**BRONCOSTAT**

HUNTER IMMUNOLOGY LIMITED (AUSTRALIA COMPANY)  
NEWCASTLE HOSPITAL  
LEVEL 4, DAVID MADDISON; CLINICAL SCIENCES BUILDING,; CORNER KING & WATT STREETS; NEWCASTLE NSW 2300  
AUSTRALIA

FOR: PHARMACEUTICAL PREPARATIONS FOR THE TREATMENT AND/OR ALLEVIATION OF RESPIRATORY DISEASES, IN CLASS 5 (U.S. CLS. 6, 18, 44, 46, 51 AND 52).

THE MARK CONSISTS OF STANDARD CHARACTERS WITHOUT CLAIM TO ANY PARTICULAR FONT, STYLE, SIZE, OR COLOR.

OWNER OF INTERNATIONAL REGISTRATION 0952306 DATED 12-21-2007, EXPIRES 12-21-2017.

SER. NO. 79-049,475, FILED 12-21-2007.

CHARISMA HAMPTON, EXAMINING ATTORNEY

**Int. Cl.: 18**

**Prior U.S. Cls.: 1, 2, 3, 22 and 41**

**United States Patent and Trademark Office**

**Reg. No. 3,570,228**

**Registered Feb. 3, 2009**

**TRADEMARK  
PRINCIPAL REGISTER**

**Hamish** McBeth 

HAZEL CLARKE (AUSTRALIA INDIVIDUAL)  
PO BOX 5091  
GOLD COAST MAIL CENTRE QLD 9726  
AUSTRALIA

FOR: COLLARS FOR ANIMALS, NAMELY, DOG  
AND CAT COLLARS; LEASHES AND LEADS FOR  
ANIMALS; CLOTHING FOR PETS, IN CLASS 18  
(U.S. CLS. 1, 2, 3, 22 AND 41).

OWNER OF INTERNATIONAL REGISTRATION  
0952485 DATED 1-18-2008, EXPIRES 1-18-2018.

THE NAME(S), PORTRAIT(S), AND/OR SIGNA-  
TURE(S) SHOWN IN THE MARK DOES NOT IDEN-  
TIFY A PARTICULAR LIVING INDIVIDUAL.

SER. NO. 79-049,545, FILED 1-18-2008.

RONALD DELGIZZI, EXAMINING ATTORNEY



**Int. Cl.: 9**

**Prior U.S. Cls.: 21, 23, 26, 36 and 38**

**Reg. No. 3,570,229**

**United States Patent and Trademark Office**

**Registered Feb. 3, 2009**

**TRADEMARK  
PRINCIPAL REGISTER**

**TØREAD**

DREAMSCO CO., LTD.  
DMC HI-TECH INDUSTRY CENTER 3F,  
SANGAM HOUSING SITE DEVELOPMENTDIS-  
TRICT G BLOCK IN 1580,, SANGAM-DONG,  
MAPO-GU, SEOUL 121-835  
REPUBLIC OF KOREA

FOR: TELESCOPES; CAMERA CASES; CAMCOR-  
DERS; EYEGASSES; SUNGLASSES; SWIMMING  
GOGGLES; EYEGLOSS CASES; EYEGLOSS  
FRAMES; TELEPHONES; RADIO RECEIVERS;  
RADIOS INCORPORATING CLOCKS; MUSICAL  
JUKE BOXES; CASSETTE PLAYERS; COMPACT  
DISC PLAYERS; BLANK VIDEOTAPES; ELECTRO-  
NIC AGENDAS; EXPOSED CINEMATOGRAPHIC  
FILM; EXPOSED CAMERA FILMS; VIDEO DISKS  
AND VIDEO TAPES WITH RECORDED ANIMATED  
CARTOONS; EXPOSED SLIDE FILMS; MOTION

PICTURE FILMS FEATURING COMEDY, DRAMA,  
ACTION, ADVENTURE AND ANIMATION, IN  
CLASS 9 (U.S. CLS. 21, 23, 26, 36 AND 38).

PRIORITY DATE OF 9-28-2007 IS CLAIMED.

OWNER OF INTERNATIONAL REGISTRATION  
0952892 DATED 1-14-2008, EXPIRES 1-14-2018.

OWNER OF U.S. REG. NOS. 3,440,948, 3,480,868  
AND OTHERS.

SER. NO. 79-049,712, FILED 1-14-2008.

KATHERINE E. HALMEN, EXAMINING ATTOR-  
NEY

**Int. Cls.: 2, 19 and 27**

**Prior U.S. Cls.: 1, 6, 11, 12, 16, 19, 20, 33, 37, 42 and 50**

**United States Patent and Trademark Office**

**Reg. No. 3,570,230**

**Registered Feb. 3, 2009**

**TRADEMARK  
PRINCIPAL REGISTER**

**REPOMA**

RPM/BELGIUM, NAAMLOZE VENNOOTSCHAP  
(BELGIUM NAAMLOZE VENNOOTSCHAP)  
INDUSTRIEPARK NOORD  
H. DUNANTSTRAAT 11B  
B-8700 TIELT, BELGIUM

FOR: RESINOUS COATINGS IN THE NATURE OF PAINTS DESIGNED FOR PROTECTING THE EXTERNAL PARTS OF BUILDINGS, CONSTRUCTIONS AND FLOORS AGAINST DETERIORATION, ABRASION, CHEMICAL CORROSION, UNDERMINING BY WATER, WATER PENETRATION, AS WELL AS AGAINST DETERIORATION DUE TO HEAVY VEHICLES, IN CLASS 2 (U.S. CLS. 6, 11 AND 16).

FOR: WATERPROOF ROOFING MEMBRANES; CONSTRUCTION MATERIALS, NAMELY, A NON-METAL SUB-FLOOR MEMBRANE FOR RESIDENTIAL AND COMMERCIAL SOUNDPROOFING USE, IN CLASS 19 (U.S. CLS. 1, 12, 33 AND 50).

FOR: FLOOR COVERINGS; INSULATING FLOOR COVERINGS; INDUSTRIAL FLOOR COVERINGS, IN CLASS 27 (U.S. CLS. 19, 20, 37, 42 AND 50).

THE MARK CONSISTS OF STANDARD CHARACTERS WITHOUT CLAIM TO ANY PARTICULAR FONT, STYLE, SIZE, OR COLOR.

OWNER OF INTERNATIONAL REGISTRATION 0781062 DATED 12-19-2001, EXPIRES 12-19-2011.

THE TERM REPOMA HAS NO MEANING IN A FOREIGN LANGUAGE.

SER. NO. 79-049,747, FILED 10-12-2007.

KRISTINA MORRIS, EXAMINING ATTORNEY

**Int. Cl.: 12**

**Prior U.S. Cls.: 19, 21, 23, 31, 35 and 44**

**Reg. No. 3,570,231**

**United States Patent and Trademark Office**

**Registered Feb. 3, 2009**

**TRADEMARK  
PRINCIPAL REGISTER**

**TEMSA**

**OPALIN**

TEMSA GLOBAL SANAYI VE TICARET ANONİM SİRKETİ  
MERSİN YOLU ÜZERİ, 10. KM  
SEYHAN-ADANA  
TURKEY

FOR: LAND VEHICLES, NAMELY, TRUCKS, VANS AND BUSES; SPARE PARTS FOR LAND VEHICLES, NAMELY, BRAKES, SHOCK ABSORBERS, SUSPENSION STRUTS, VIBRATION DAMPENERS IN THE NATURE OF SUSPENSION SPRINGS, STEERING WHEELS, BUMPERS, WHEEL RIMS, WHEEL CAPS, SUN VISORS, VEHICLE WINDOWS, WINDOW LIFTS IN THE NATURE OF VEHICLE WINDOW LIFTS, HEATED REAR WINDOWS, WINDSCREEN WIPERS, WINDSCREEN WIPING DEVICES IN THE NATURE OF WINDSHIELD WIPERS AND WINDSHIELD WIPER BLADES, SEATS, CONSOLES IN THE NATURE OF AUTOMOBILE INTERIOR ACCESSORY, NAMELY, DURABLE AND FLEXIBLE WEDGE, WHICH CAN BE EXPANDED OR CONTRACTED, TO FILL GAP BETWEEN FRONT SEAT AND CENTER CONSOLE OF AN AUTOMOBILE PREVENTING OBJECTS FROM DROPPING INTO GAP AND LAND VEHICLE CONSOLE PARTS, NAMELY, WIRING HARNESSSES FOR CONTROL, MONITORING AND PROTECTION OF INDUSTRIAL GASOLINE AND DIESEL ENGINES, RUBBER PARTS IN THE NATURE OF ADHESIVE RUBBER PATCHES FOR REPAIRING TUBES OR TIRES, AUTOMOTIVE EXTERIOR AND INTERIOR RUBBER DECORATIVE AND PROTECTIVE TRIM, AND FITTED PROTECTIVE RUBBER SHEETS FOR AUTOMOBILE SEATS; BODYWORK PARTS IN THE NATURE

OF STRUCTURAL PARTS OF AUTOMOBILES, V-BELTS, GEARSHIFT LEVERS; AIR PUMPS FOR MOTOR CARS; PROTECTIVE SKINS, HIDES, PELTS AND COVERS FOR MOTOR CAR SEATS; DOORS, BONNETS, MUDGUARDS AND SHOCK ABSORBERS AND BUMPERS; REARVIEW MIRRORS, GEARS AND CLUTCHES FOR LAND VEHICLES, AXLES FOR MOTOR CARS, HYDRAULIC BRAKING SYSTEMS COMPRISING FOR LAND VEHICLES AND THEIR POWER-ASSISTED PARTS, NAMELY, BRAKE ACTUATORS, DEVICES FOR INCREASING THE FORCE OF BRAKING, BRAKE LINES AND FLEXIBLE PIPES AS WELL AS BRAKES AND SPARE PARTS THEREFOR, NAMELY, DRUMS, DISCS, BLOCKS AND LININGS, CONTROL DEVICES FOR LAND VEHICLES AND SPARE PARTS THEREFOR, PARTICULARLY STEERING WHEELS, STEERING COLUMN TUBES, STEERING GEARS, STEERING LINKS AND LEVERS; SEATS AND SAFETY BELTS, IN CLASS 12 (U.S. CLS. 19, 21, 23, 31, 35 AND 44).

OWNER OF INTERNATIONAL REGISTRATION  
0817639 DATED 12-17-2003, EXPIRES 12-17-2013.

OWNER OF U.S. REG. NO. 3,462,440.

THE WORDING "TEMSA OPALIN" HAS NO MEANING IN A FOREIGN LANGUAGE.

SER. NO. 79-049,759, FILED 12-3-2007.

DAYNA BROWNE, EXAMINING ATTORNEY

**Int. Cl.: 14**

**Prior U.S. Cls.: 2, 27, 28 and 50**

**United States Patent and Trademark Office**

**Reg. No. 3,570,232**

**Registered Feb. 3, 2009**

**TRADEMARK  
PRINCIPAL REGISTER**



**ANDRE MOUCHE**

ANDRÉ MOUCHE S.A. (SWITZERLAND SOCI-  
ÉTÉ ANONYME (SA))  
RUE DE FRANCE 81A  
CH-2916 FAHY  
SWITZERLAND

FOR: PRECIOUS METALS AND THEIR ALLOYS;  
FANCY KEY-RINGS OF PRECIOUS METAL, AL-  
LOYED OR PLATED WITH PRECIOUS METALS;  
TIMEPIECES AND CHRONOMETRIC INSTRU-  
MENTS AND THEIR PARTS, IN CLASS 14 (U.S.  
CLS. 2, 27, 28 AND 50).

OWNER OF INTERNATIONAL REGISTRATION  
0889301 DATED 5-30-2006, EXPIRES 5-30-2016.

THE NAME(S), PORTRAIT(S), AND/OR SIGNA-  
TURE(S) SHOWN IN THE MARK DOES NOT IDEN-  
TIFY A PARTICULAR LIVING INDIVIDUAL.

SER. NO. 79-049,767, FILED 12-13-2007.

AMEETA JORDAN, EXAMINING ATTORNEY

**Int. Cl.: 35**

**Prior U.S. Cls.: 100, 101 and 102**

**United States Patent and Trademark Office**

**Reg. No. 3,570,233**

**Registered Feb. 3, 2009**

**SERVICE MARK  
PRINCIPAL REGISTER**

**KAREN MILLEN**

KAREN MILLEN LIMITED (UNITED KINGDOM  
PRIVATE LIMITED COMPANY)  
THE TRIANGLE  
STANTON HARCOURT INDUSTRIAL ESTATE,;  
STANTON HARCOURT; WITNEY, OXFORD-  
SHIRE OX29 5UT  
UNITED KINGDOM

FOR: RETAIL STORE SERVICES FEATURING  
WOMEN'S CLOTHING, SHOES, BAGS, LEATHER  
GOODS, JEWELLERY, WATCHES AND SUNGLAS-  
SES, IN CLASS 35 (U.S. CLS. 100, 101 AND 102).

THE MARK CONSISTS OF STANDARD CHAR-  
ACTERS WITHOUT CLAIM TO ANY PARTICULAR  
FONT, STYLE, SIZE, OR COLOR.

OWNER OF INTERNATIONAL REGISTRATION  
0952983 DATED 11-9-2007, EXPIRES 11-9-2017.

OWNER OF U.S. REG. NO. 2,806,908.

THE NAME(S), PORTRAIT(S), AND/OR SIGNA-  
TURE(S) SHOWN IN THE MARK IDENTIFIES  
"KAREN MILLEN", WHOSE CONSENT(S) TO REG-  
ISTER IS SUBMITTED.

SER. NO. 79-049,792, FILED 11-9-2007.

KRISTINA MORRIS, EXAMINING ATTORNEY

**Int. Cl.: 35**

**Prior U.S. Cls.: 100, 101 and 102**

**United States Patent and Trademark Office**

**Reg. No. 3,570,234**

**Registered Feb. 3, 2009**

**SERVICE MARK  
PRINCIPAL REGISTER**

# Altuïtion

ALTUÏTION B.V. (NETHERLANDS LIMITED  
LIABILITY COMPANY)  
ROMPERTSEBAAN 60  
NL-5231 GT 'S-HERTOGENBOSCH  
NETHERLANDS

FOR: EMPLOYMENT AGENCIES AND PERSON-  
NEL MANAGEMENT CONSULTANCY; COMPILA-  
TION OF STATISTICS; CONDUCTING BUSINESS  
AND MARKET RESEARCH SURVEYS, NAMELY,  
MARKETING CANVASSING, MARKETING RE-  
SEARCH, AND MARKETING ANALYSIS; PUBLIC  
OPINION POLLING; BUSINESS ORGANIZATION  
AND BUSINESS ECONOMICS CONSULTANCY, IN  
CLASS 35 (U.S. CLS. 100, 101 AND 102).

THE MARK CONSISTS OF STANDARD CHAR-  
ACTERS WITHOUT CLAIM TO ANY PARTICULAR  
FONT, STYLE, SIZE, OR COLOR.

OWNER OF INTERNATIONAL REGISTRATION  
0952992 DATED 9-6-2007, EXPIRES 9-6-2017.

THE WORDING "ALTUÏTION" APPEARING IN  
THE MARK HAS NO SIGNIFICANCE IN A FOR-  
EIGN LANGUAGE.

SER. NO. 79-049,795, FILED 9-6-2007.

ELI HELLMAN, EXAMINING ATTORNEY

**Int. Cl.: 3**

**Prior U.S. Cls.: 1, 4, 6, 50, 51 and 52**

**United States Patent and Trademark Office**

**Reg. No. 3,570,235**

**Registered Feb. 3, 2009**

**TRADEMARK  
PRINCIPAL REGISTER**

**LIGHT PROTECTOR**

CASTER (FRANCE SOCIETE PAR ACTIONS SIM-  
PLIFIEE)  
35 AVENUE FRANKLIN ROOSEVELT  
F-75008 PARIS  
FRANCE

FOR: SOAPS; PERFUMERY PRODUCTS, NAME-  
LY, PERFUME, EAU DE TOILETTE AND EAU DE  
COLOGNE; ESSENTIAL OILS, COSMETICS, NON-  
MEDICAL PREPARATIONS FOR THE CARE,  
MAINTENANCE AND BEAUTIFICATION OF THE  
SKIN, COSMETIC PREPARATIONS FOR REMOV-  
ING PIGMENTATION STAINS CAUSED BY THE  
SUN, BEAUTY MASKS, COSMETIC SUN-TANNING  
PREPARATIONS, COSMETIC PRODUCTS FOR  
AFTER-SUN SKIN CARE, NON-MEDICAL PRE-  
PARATIONS FOR HAIR CARE AND MAINTENANCE,  
IN CLASS 3 (U.S. CLS. 1, 4, 6, 50, 51 AND 52).

THE MARK CONSISTS OF STANDARD CHAR-  
ACTERS WITHOUT CLAIM TO ANY PARTICULAR  
FONT, STYLE, SIZE, OR COLOR.

PRIORITY DATE OF 7-13-2007 IS CLAIMED.

OWNER OF INTERNATIONAL REGISTRATION  
0953215 DATED 1-11-2008, EXPIRES 1-11-2018.

SER. NO. 79-049,867, FILED 1-11-2008.

ROBIN CHOSID, EXAMINING ATTORNEY

**Int. Cls.: 6 and 12**

**Prior U.S. Cls.: 2, 12, 13, 14, 19, 21, 23, 25, 31, 35, 44  
and 50**

**Reg. No. 3,570,236**

**United States Patent and Trademark Office**

**Registered Feb. 3, 2009**

---

**TRADEMARK  
PRINCIPAL REGISTER**

**PLAYMARKET**

PLAY, S.A. (SPAIN SOCIEDAD ANONIMA)  
POLÍGONO INDUSTRIAL RIERA DE CALDES  
RDA. BOADA VELL, 6; E-08184 PALAU DE PLEGA-  
MANS (BARCELONA)  
SPAIN

PRIORITY DATE OF 6-14-2007 IS CLAIMED.

OWNER OF INTERNATIONAL REGISTRATION  
0953569 DATED 12-13-2007, EXPIRES 12-13-2017.

FOR: STEPLADDERS MADE OF METAL, IN  
CLASS 6 (U.S. CLS. 2, 12, 13, 14, 23, 25 AND 50).

SER. NO. 79-049,997, FILED 12-13-2007.

FOR: SHOPPING TROLLEYS, IN CLASS 12 (U.S.  
CLS. 19, 21, 23, 31, 35 AND 44).

AMEETA JORDAN, EXAMINING ATTORNEY



**Int. Cls.: 20, 25 and 26**

**Prior U.S. Cls.: 2, 13, 22, 25, 32, 37, 39, 40, 42 and 50**

**United States Patent and Trademark Office**

**Reg. No. 3,570,237**

**Registered Feb. 3, 2009**

**TRADEMARK  
PRINCIPAL REGISTER**

# Heaven on Heels

DREAMWARE GMBH (FED REP GERMANY  
LIMITED LIABILITY COMPANY)  
WALDSTRASSE 3  
21521 WOHLTORF  
FED REP GERMANY

FOR: NUTS MADE OF PLASTICS; WASHERS  
MADE OF PLASTIC FOR BEARINGS, IN CLASS 20  
(U.S. CLS. 2, 13, 22, 25, 32 AND 50).

FOR: CLOTHING, NAMELY, FOOTWEAR,  
SHIRTS, SHORTS, AND GLOVES, IN CLASS 25  
(U.S. CLS. 22 AND 39).

FOR: SHOE ORNAMENTS MADE OF PLASTICS,  
IN CLASS 26 (U.S. CLS. 37, 39, 40, 42 AND 50).

THE MARK CONSISTS OF STANDARD CHAR-  
ACTERS WITHOUT CLAIM TO ANY PARTICULAR  
FONT, STYLE, SIZE, OR COLOR.

PRIORITY DATE OF 6-20-2007 IS CLAIMED.

OWNER OF INTERNATIONAL REGISTRATION  
0953789 DATED 12-7-2007, EXPIRES 12-7-2017.

SER. NO. 79-050,084, FILED 12-7-2007.

STEPHEN AQUILA, EXAMINING ATTORNEY

**Int. Cls.: 9, 12 and 42**

**Prior U.S. Cls.: 19, 21, 23, 26, 31, 35, 36, 38, 44, 100  
and 101**

**Reg. No. 3,570,238**

**United States Patent and Trademark Office**

**Registered Feb. 3, 2009**

**TRADEMARK  
SERVICE MARK  
PRINCIPAL REGISTER**

**WEDGETRONIC**

CONTINENTAL AUTOMOTIVE GMBH (FED  
REP GERMANY PRIVAT LIMITED COMPA-  
NY)  
VAHRENWALDER STRABE 9  
30165 HANNOVER  
FED REP GERMANY

FOR: ELECTRICAL OPEN AND CLOSED LOOP  
CONTROL DEVICES FOR MOTOR VEHICLE SAFE-  
TY APPLICATIONS; SEAT BELT BRAKING SYS-  
TEMS CONSISTING OF SENSORS AND  
COMPUTERS AND BELT RETRACTORS TO REG-  
ULATE SEAT BELT TENSION TO THE NEEDS OF  
THE SPECIFIC SITUATION; PARTS OF ALL THE  
APPARATUS AND DEVICES MENTIONED ABOVE;  
DATA PROCESSING COMPUTER PROGRAMS FOR  
OPERATING A SEAT BELT REGULATING SYS-  
TEM, IN CLASS 9 (U.S. CLS. 21, 23, 26, 36 AND 38).

FOR: ELECTROTECHNICAL EQUIPMENT,  
NAMELY, AN ADAPTIVE SEAT BELT FORCE  
LIMITER FOR USE AS COMPONENTS OF LAND  
VEHICLES, AIRCRAFT AND BOATS; SEAT BELTS  
FOR VEHICLES, IN CLASS 12 (U.S. CLS. 19, 21, 23, 31,  
35 AND 44).

FOR: ENGINEERING SERVICES, IN PARTICU-  
LAR, PLANNING AND DEVELOPMENT OF SAFE-  
TY CONCEPTS AND OF PASSIVE PASSENGER  
RESTRAINT SYSTEMS, IN PARTICULAR, FOR  
MOTOR VEHICLES, IN CLASS 42 (U.S. CLS. 100  
AND 101).

THE MARK CONSISTS OF STANDARD CHAR-  
ACTERS WITHOUT CLAIM TO ANY PARTICULAR  
FONT, STYLE, SIZE, OR COLOR.

PRIORITY DATE OF 7-19-2007 IS CLAIMED.

OWNER OF INTERNATIONAL REGISTRATION  
0953790 DATED 12-11-2007, EXPIRES 12-11-2017.

SER. NO. 79-050,085, FILED 12-11-2007.

LINDA ESTRADA, EXAMINING ATTORNEY

**Int. Cl.: 37**

**Prior U.S. Cls.: 100, 103 and 106**

**United States Patent and Trademark Office**

**Reg. No. 3,570,239**

**Registered Feb. 3, 2009**

**SERVICE MARK  
PRINCIPAL REGISTER**

**KERBMATE**

ALL KERB MACHINERY PTY LTD (AUSTRALIA  
CORPORATION)  
2A SPINE STREET  
SUMNER PARK QLD 4074  
AUSTRALIA

FOR: BUILDING CONSTRUCTION, MAINTENANCE AND REPAIR SERVICES, NAMELY, CONSTRUCTION OF CURBS, EDGES AND BORDERS AROUND BUILDINGS; BLOCK LAYING, NAMELY, LAYING CONCRETE STRIPS; RENTAL AND REPAIR OF CONSTRUCTION EQUIPMENT, NAMELY, MACHINES FOR MOULDING OR EXTRUDING CONCRETE, MACHINES PERFORMING CURBING, EDGING OR BORDERS, CURB LAYING MACHINES AND EDGE FORMING MACHINES

FOR LAWNS AND GARDENS, IN CLASS 37 (U.S. CLS. 100, 103 AND 106).

THE MARK CONSISTS OF STANDARD CHARACTERS WITHOUT CLAIM TO ANY PARTICULAR FONT, STYLE, SIZE, OR COLOR.

OWNER OF INTERNATIONAL REGISTRATION  
0953986 DATED 1-10-2008, EXPIRES 1-10-2018.

SER. NO. 79-050,181, FILED 1-10-2008.

SAIMA MAKHDOOM, EXAMINING ATTORNEY

**Int. Cls.: 9, 35, 38, 42 and 45**

**Prior U.S. Cls.: 21, 23, 26, 36, 38, 100, 101, 102 and 104**

**United States Patent and Trademark Office**

**Reg. No. 3,570,240**

**Registered Feb. 3, 2009**

**TRADEMARK  
SERVICE MARK  
PRINCIPAL REGISTER**



EMITALL SURVEILLANCE SA (SWITZERLAND  
SOCIÉTÉ ANONYME)  
RUE DU THÉÂTRE 5  
CH-1820 MONTREUX  
SWITZERLAND

FOR: ELECTRICAL MONITORING APPARATUS, NAMELY, DIGITAL CAMERAS, ACCESS CONTROL AND ALARM MONITORING SYSTEMS; COMPUTER SOFTWARE FOR PROVIDING AUTOMATIC INTRUSION DETECTION WITH ALARM VERIFICATION THROUGH INTERNET AND MOBILE NETWORK AND FOR SCRAMBLING AND UNSCRAMBLING IMAGES; SOFTWARE USED FOR MONITORING PEOPLE AND GOODS IN THE FIELD OF HOME AND SHOP SECURITY, BABY CARE, ELDERLY MONITORING AND POLICE SOLUTIONS; SOFTWARE USED FOR IMAGE AND DATE ANALYSIS, ENCODING, COMPRESSION AND JAMMING, IN CLASS 9 (U.S. CLS. 21, 23, 26, 36 AND 38).

FOR: BUSINESS MANAGEMENT CONSULTANCY AS WELL AS DEVELOPMENT OF PROCESSES FOR THE ANALYSIS AND THE IMPLEMENTATION OF STRATEGY PLANS AND MANAGEMENT PROJECTS; BUSINESS CONSULTATION IN THE FIELD OF HOME AND SHOP SECURITY, BABY CARE, ELDERLY MONITORING AND POLICE SOLUTIONS, IN CLASS 35 (U.S. CLS. 100, 101 AND 102).

FOR: COMMUNICATION SERVICES, NAMELY, TRANSMISSION OF VOICE, AUDIO, VISUAL IMAGES AND DATA BY TELECOMMUNICATIONS NETWORKS, WIRELESS COMMUNICATION NETWORKS, THE INTERNET, INFORMATION SERVICES NETWORKS AND DATA NETWORKS; COMPUTER AIDED TRANSMISSION OF INFORMATION AND IMAGES; ELECTRONIC, ELECTRIC, AND DIGITAL TRANSMISSION OF VOICE, DATA, IMAGES, SIGNALS, AND MESSAGES; TELECOMMUNICATION SERVICES, NAMELY, PROVIDING ACCESS TO PICTURES, VIDEO, ALARM STATUS, BUILDING PLANS AND OTHER BUILDING AND SECURITY INFORMATION AT A REMOTE STATION, IN CLASS 38 (U.S. CLS. 100, 101 AND 104).

FOR: COMPUTER SERVICES, NAMELY, MONITORING THE ACCESS TO COMPUTER NETWORKS OF OTHERS; SECURITY SERVICES, NAMELY, ONLINE PROTECTION OF COMPUTER NETWORKS AGAINST UNAUTHORIZED THIRD-PARTY ACCESS; SCIENTIFIC AND TECHNOLOGICAL RESEARCH AND DESIGN IN THE FIELD OF COMPUTER SOFTWARE FOR PROVIDING AUTOMATIC INTRUSION DETECTION WITH ALARM VERIFICATION THROUGH INTERNET AND MOBILE NETWORK AND FOR SCRAMBLING AND UNSCRAMBLING IMAGES, SOFTWARE USED FOR MONITORING PEOPLE AND GOODS IN THE FIELD OF HOME AND SHOP SECURITY, BABY CARE, ELDERLY MONITORING AND POLICE

SOLUTIONS, AND SOFTWARE USED FOR IMAGE AND DATE ANALYSIS, ENCODING, COMPRESSION AND JAMMING; INDUSTRIAL DESIGN; AND DESIGN AND DEVELOPMENT OF COMPUTER HARDWARE AND SOFTWARE, IN CLASS 42 (U.S. CLS. 100 AND 101).

FOR: CONSULTING AND LEGAL SERVICES IN THE FIELD OF PRIVACY AND SECURITY LAWS, REGULATIONS, AND REQUIREMENTS; HOME AND SHOP SECURITY MONITORING USING WIRELESS AND WIRED CAMERAS PERSONAL SECURITY CONSULTATION; MONITORING SECURITY SYSTEMS; SECURITY SERVICES, NAMELY, PROVIDING SECURITY ASSESSMENTS OF PHYSICAL LOCATIONS, INFORMATION SYSTEMS, AND WORKING ENVIRONMENTS; SECURITY SERVICES, NAMELY, PROVIDING ELECTRONIC ALERTS NOTIFYING OF A CHANGED STATUS OR CONDITION OF A SENSING DEVICE VIA THE INTERNET; ON-LINE MONITORING, NAMELY, VIDEO MONITORING OF FACILITIES, VIEWABLE THROUGH A GLOBAL COMPUTER NETWORK; ELECTRONIC MONITOR-

ING SERVICES FOR SECURITY PURPOSES IN THE FIELD OF ACCESS TO PRIVATE AND PUBLIC BUILDINGS AND PLANTS; MONITORING SECURITY SYSTEMS; PROVIDING A WEB SITE THAT FEATURES LIVE CAMERA IMAGES OF PEOPLE FOR PURPOSES OF ENSURING THEIR SAFETY AND WELL BEING, IN CLASS 45 (U.S. CLS. 100 AND 101).

PRIORITY DATE OF 7-3-2007 IS CLAIMED.

OWNER OF INTERNATIONAL REGISTRATION 0954077 DATED 12-24-2007, EXPIRES 12-24-2017.

THE MARK CONSISTS OF THE SILHOUETTE OF A STYLIZED MAN LOOKING THROUGH A CAMERA LENS.

SER. NO. 79-050,218, FILED 12-24-2007.

PATRICIA EVANKO, EXAMINING ATTORNEY

**Int. Cl.: 11**

**Prior U.S. Cls.: 13, 21, 23, 31 and 34**

**United States Patent and Trademark Office**

**Reg. No. 3,570,241**

**Registered Feb. 3, 2009**

**TRADEMARK  
PRINCIPAL REGISTER**

**TURBOMIX**

OTV SA (FRANCE SOCIÉTÉ ANONYME)  
IMMEUBLE L'AQUARÈNE -  
1, PLACE MONTGOLFIER; F-94410 SAINT-MAUR-  
ICE  
FRANCE

FOR: CHEMICAL REACTORS FOR USE IN WA-  
TER AND WASTEWATER TREATMENT INSTAL-  
LATIONS, IN CLASS 11 (U.S. CLS. 13, 21, 23, 31 AND  
34).

THE MARK CONSISTS OF STANDARD CHAR-  
ACTERS WITHOUT CLAIM TO ANY PARTICULAR  
FONT, STYLE, SIZE, OR COLOR.

PRIORITY DATE OF 4-27-2007 IS CLAIMED.

OWNER OF INTERNATIONAL REGISTRATION  
0954462 DATED 10-22-2007, EXPIRES 10-22-2017.

SER. NO. 79-050,326, FILED 10-22-2007.

WILLIAM ROSSMAN, EXAMINING ATTORNEY

**Int. Cls.: 9, 35, 38 and 42**

**Prior U.S. Cls.: 21, 23, 26, 36, 38, 100, 101, 102 and 104**

**United States Patent and Trademark Office**

**Reg. No. 3,570,242**

**Registered Feb. 3, 2009**

**TRADEMARK  
SERVICE MARK  
PRINCIPAL REGISTER**

**TEAM TRADE**

TEAM TRADE GROUPE (FRANCE SOCIÉTÉ ANONYME)  
43 RUE TAITBOUT  
F-75009 PARIS  
FRANCE

FOR: COMPUTER SOFTWARE FOR FINANCIAL, EVALUATION, HELP TO BUSINESS MANAGEMENT PURPOSES; COMPUTER SOFTWARE PACKAGES COMPRISING COMPUTER SOFTWARE FOR FINANCIAL, EVALUATION, HELP TO BUSINESS MANAGEMENT PURPOSES; RECORDED COMPUTER OPERATING PROGRAMS FOR FINANCIAL, EVALUATION, HELP TO BUSINESS MANAGEMENT PURPOSES; COMPUTER MONITORS; SOFTWARE FOR CONTROLLING AND MANAGING ACCESS COMPUTER SERVER APPLICATIONS; SOFTWARE FOR ELECTRONIC MAIL AND FOR ELECTRONIC INSTANT MESSAGING; NETWORK MANAGEMENT SOFTWARE; UTILITY PROGRAMS, NAMELY, PROGRAMS FOR FINANCIAL, EVALUATION, HELP TO BUSINESS MANAGEMENT PURPOSES; SOFTWARE FOR SECURITY AND AUTHENTICATION; BROWSER SOFTWARE FOR COMPUTER NETWORKS AND WIRELESS COMMUNICATION NETWORKS; COMPUTER PROGRAMS FOR MANAGING COMMUNICATIONS AND DATA AND INFORMATION EXCHANGE ON COMPUTER NETWORKS, WIRELESS NETWORKS AND GLOBAL COMMUNICATION NETWORKS; COMPUTER OPERATING SYSTEM SOFTWARE; SOFTWARE DEVELOPMENT PROGRAMS, IN CLASS 9 (U.S. CLS. 21, 23, 26, 36 AND 38).

FOR: BUSINESS MANAGEMENT CONSULTING; ASSISTANCE IN THE MANAGEMENT OF INDUSTRIAL AND COMMERCIAL COMPANIES; PROFESSIONAL BUSINESS CONSULTING; BUSINESS ORGANIZATION AND MANAGEMENT CONSULTING; MANAGEMENT CONSULTING; FACILITIES MANAGEMENT, NAMELY, MANAGEMENT OF COMPUTER INFRASTRUCTURES ON BEHALF OF INDUSTRIAL OR COMMERCIAL COMPANIES; BUSINESS ADVISORY SERVICES ON MANAGING INFORMATION SYSTEMS FOR COMPANIES; BUSI-

NESS ADVICE ON SETTING UP INFORMATION SYSTEMS; BUSINESS CONSULTING IN THE FIELDS OF INFORMATION AND COMPUTER TECHNOLOGY SYSTEMS MANAGEMENT; PERSONNEL CONSULTANCY, PERSONNEL RECRUITMENT, COMPUTER FILE MANAGEMENT; ORGANIZATION OF EXHIBITIONS FOR COMMERCIAL OR ADVERTISING PURPOSES; BUSINESS CONSULTANCY SERVICES AND INFORMATION SERVICES CONCERNING COMMERCIAL COMPANIES PROVIDED ONLINE FROM A COMPUTER DATABASE OR THE INTERNET; DESIGNING ADVERTISEMENTS USED AS WEB PAGES ON GLOBAL COMPUTER NETWORKS; ONLINE PRESENTATION OF ADVERTISING TEXTS, IN CLASS 35 (U.S. CLS. 100, 101 AND 102).

FOR: PROVIDING ACCESS TO AND RENTAL OF ACCESS TIME TO COMPUTER DATABASES; CONSULTING SERVICES IN THE FIELD OF TELECOMMUNICATIONS, IN CLASS 38 (U.S. CLS. 100, 101 AND 104).

FOR: CONSULTING IN THE FIELD OF COMPUTER INFORMATION SYSTEMS; COMPUTER TECHNOLOGY SERVICES, NAMELY, DEVELOPMENT OF DATA PROCESSING TECHNOLOGY STRATEGIES FOR COMPANIES; TECHNOLOGY CONSULTING AND ANALYSIS IN INFORMATION SYSTEMS AND IN DATA PROCESSING TECHNOLOGIES; COMPUTER PROGRAMMING; DESIGN AND DEVELOPMENT OF RECORDED SOFTWARE AND SOFTWARE PACKAGES; UPDATING SOFTWARE AND SOFTWARE PACKAGES; COMPUTER CONSULTING; TECHNICAL SUPPORT SERVICES, NAMELY, TROUBLESHOOTING OF COMPUTER HARDWARE AND SOFTWARE PROBLEMS; COMPUTER SERVICES, NAMELY, DEVELOPMENT OF DATA PROCESSING TECHNOLOGY FOR FINANCIAL, EVALUATION, AND BUSINESS MANAGEMENT STRATEGIES FOR COMPANIES; RENTAL OF SOFTWARE; CONSULTING SERVICES IN THE FIELD OF COMPUTERS, SOFTWARE, ELECTRONICS, COMPUTER SECURITY AND AUTHENTICATION; CONSULTING IN DESIGN AND

DEVELOPMENT OF INFORMATION SYSTEMS  
AND DATA PROCESSING TECHNOLOGIES; AD-  
VICE ON SETTING UP DATA PROCESSING TECH-  
NOLOGIES , IN CLASS 42 (U.S. CLS. 100 AND 101).

PRIORITY DATE OF 2-8-2007 IS CLAIMED.

OWNER OF INTERNATIONAL REGISTRATION  
0954623 DATED 7-19-2007, EXPIRES 7-19-2017.

SER. NO. 79-050,376, FILED 7-19-2007.

LAURIE KAUFMAN, EXAMINING ATTORNEY



Int. Cl.: 33

Prior U.S. Cls.: 47 and 49

United States Patent and Trademark Office

Reg. No. 3,570,243

Registered Feb. 3, 2009

TRADEMARK  
PRINCIPAL REGISTER



UNION AUBOISE DES PRODUCTEURS; DE VIN  
DE CHAMPAGNE (FRANCE COOPERATIVE  
SOCIETY)  
DOMAINE DE VILLENEUVE  
F-10110 BAR-SUR-SEINE  
FRANCE

FOR: WINES WITH CHAMPAGNE PROTECTED  
LABEL OF ORIGIN, IN CLASS 33 (U.S. CLS. 47 AND  
49).

PRIORITY DATE OF 8-7-2007 IS CLAIMED.

OWNER OF INTERNATIONAL REGISTRATION  
0954966 DATED 1-11-2008, EXPIRES 1-11-2018.

OWNER OF U.S. REG. NO. 1,561,253.

"VEUVE A. DEVAUX" DOES NOT IDENTIFY A  
LIVING INDIVIDUAL.

THE COLOR(S) GREY, GOLD AND BLACK IS/  
ARE CLAIMED AS A FEATURE OF THE MARK.

THE MARK CONSISTS OF THE WORDING "DE-  
VAUX" ACROSS THE CENTER OF THE MARK IN  
BLACK, AND THE WORDING "VEUVE A. DE-  
VAUX" IN THE CENTER OF A GOLD RECTANGLE,  
AT THE BOTTOM OF THE MARK. THE CENTER  
OF THE MARK CONTAINS A SHADED SQUARE IN  
LIGHT GOLD, OUTLINED BY A GREY LINE. IN  
THE UPPER PORTION OF THE LIGHT GOLD  
SQUARE IS A GOLD SHIELD DIVIDED INTO FOUR  
QUADRANTS APPEARING ABOVE THE WORD-  
ING "DEVEAUX". THE FOUR QUADRANTS OF  
THE SHIELD EACH CONTAIN ONE DESIGN, TO  
WIT, IN CLOCKWISE ORDER STARTING IN THE  
UPPER LEFT QUADRANT, A DESIGN OF A  
FLEUR-DE-LIS, A STAR, A LEAF, AND A SHIP'S  
WHEEL.

THE ENGLISH TRANSLATION OF THE WORD  
"VEUVE" IN THE MARK IS "WIDOW".

SER. NO. 79-050,490, FILED 1-11-2008.

MARK PILARO, EXAMINING ATTORNEY

**Int. Cl.: 3**

**Prior U.S. Cls.: 1, 4, 6, 50, 51 and 52**

**United States Patent and Trademark Office**

**Reg. No. 3,570,244**

**Registered Feb. 3, 2009**

**TRADEMARK  
PRINCIPAL REGISTER**

**COMFORT PEEL**

CASTER (FRANCE SOCIETE PAR ACTIONS SIM-  
PLIFIEE)  
35 AVENUE FRANKLIN ROOSEVELT  
F-75008 PARIS  
FRANCE

OWNER OF INTERNATIONAL REGISTRATION  
0936545 DATED 7-24-2007, EXPIRES 7-24-2017.

FOR: SOAPS, PERFUMERY, ESSENTIAL OILS,  
COSMETICS, COSMETIC PREPARATIONS FOR  
SKIN CARE FOR NON-MEDICAL PURPOSES,  
BEAUTY MASKS, HAIR LOTIONS , IN CLASS 3  
(U.S. CLS. 1, 4, 6, 50, 51 AND 52).

NO CLAIM IS MADE TO THE EXCLUSIVE  
RIGHT TO USE "PEEL", APART FROM THE MARK  
AS SHOWN.

SER. NO. 79-050,711, FILED 12-20-2007.

THE MARK CONSISTS OF STANDARD CHAR-  
ACTERS WITHOUT CLAIM TO ANY PARTICULAR  
FONT, STYLE, SIZE, OR COLOR.

ROBIN CHOSID, EXAMINING ATTORNEY

**Int. Cl.: 19**

**Prior U.S. Cls.: 1, 12, 33 and 50**

**United States Patent and Trademark Office**

**Reg. No. 3,570,245**

**Registered Feb. 3, 2009**

**TRADEMARK  
PRINCIPAL REGISTER**

# RE-BOUNCE

RECTICEL, NAAMLOZE VENNOOTSCHAP (BELGIUM LIMITED LIABILITY COMPANY)  
OLYMPIADENLAAN 2  
B-1140 BRUSSEL  
BELGIUM

FOR: NON-METAL BUILDING MATERIALS, NAMELY, SYNTHETIC MATERIALS, NAMELY, POLYMERS, POLYMER MIXTURES, POLYURETHANE AND POLYURETHANE MIXTURES FOR USE IN FLOORING, SUB-FLOORING, RACE TRACKS, ATHLETIC TRACKS AND SPORTS SURFACES; UNDERLAY MATERIALS, NAMELY, SYNTHETIC MATERIALS FOR ARTIFICIAL GRASS AND ARTIFICIAL GRASS MATS, FOR RACE TRACKS, ATHLETIC TRACKS AND SPORTS SURFACES; SHOCK-ABSORBENT NON-METAL BUILDING MATERIALS, NAMELY, SYNTHETIC MATERIALS FOR USE IN FLOORING, IN SUB-FLOORING, IN RACE TRACKS, IN ATHLETIC TRACKS, IN SPORTS SURFACES, IN UNDERLAYS FOR ARTIFICIAL GRASS, FOR ARTIFICIAL GRASS MATS, FOR RACE TRACKS, FOR ATHLETIC TRACKS AND FOR SPORTS SURFACES; NOISE-ABSORBENT NON-METAL BUILDING MATERI-

ALS, NAMELY, SYNTHETIC MATERIALS FOR USE IN FLOORING, IN SUB-FLOORING, IN RACE TRACKS, IN ATHLETIC TRACKS, IN SPORTS SURFACES, IN UNDERLAYS FOR ARTIFICIAL GRASS, FOR ARTIFICIAL GRASS MATS, FOR RACE TRACKS, FOR ATHLETIC TRACKS AND FOR SPORTS SURFACES, IN CLASS 19 (U.S. CLS. 1, 12, 33 AND 50).

THE MARK CONSISTS OF STANDARD CHARACTERS WITHOUT CLAIM TO ANY PARTICULAR FONT, STYLE, SIZE, OR COLOR.

PRIORITY DATE OF 7-5-2007 IS CLAIMED.

OWNER OF INTERNATIONAL REGISTRATION 0955933 DATED 12-28-2007, EXPIRES 12-28-2017.

SER. NO. 79-050,817, FILED 12-28-2007.

JILL C. ALT, EXAMINING ATTORNEY

Int. Cl.: 33

Prior U.S. Cls.: 47 and 49

United States Patent and Trademark Office

Reg. No. 3,570,246

Registered Feb. 3, 2009

TRADEMARK  
PRINCIPAL REGISTER



DISTILLERIE FRANCIACORTA S.P.A. (ITALY  
JOINT STOCK COMPANY)  
VIA MANDOLOSSA, 80  
I-25064 GUSSAGO (BS)  
ITALY

FOR: ALCOHOLIC BEVERAGES, EXCEPT  
BEERS, NAMELY, ALCOHOLIC BEVERAGES OF  
FRUIT, DISTILLED SPIRITS, DISTILLED LIQUORS,  
GRAPPA, AND WINE , IN CLASS 33 (U.S. CLS. 47  
AND 49).

PRIORITY DATE OF 12-13-2007 IS CLAIMED.

OWNER OF INTERNATIONAL REGISTRATION  
0956301 DATED 1-25-2008, EXPIRES 1-25-2018.

NO CLAIM IS MADE TO THE EXCLUSIVE  
RIGHT TO USE "DISTILLERIE FRANCIACORTA  
DAL 1901 DISTILLATORI IN FRANCIACORTA",  
APART FROM THE MARK AS SHOWN.

THE TRADEMARK CONSISTS OF THE WORDS  
"DISTILLERIE" AND "FRANCIACORTA" SEPARA-  
TED BY AN HORIZONTAL LINE AND WRITTEN  
IN FANCY CHARACTERS BENEATH WHICH  
THERE IS THE WORDING "DAL 1901 DISTILLA-  
TORI IN FRANCIACORTA" SEPARATED BY A  
SECOND HORIZONTAL LINE AND DISPOSED  
ABOVE A STYLIZED REPRESENTATION OF A  
LION'S HEAD, ALL THE ABOVE BEING DISPOSED  
INSIDE A FANCY GEOMETRIC FIGURE, AS IN  
THE ANNEXED EXAMPLE.

THE ENGLISH TRANSLATION OF THE FOR-  
EIGN WORD(S) IN THE MARK IS: DISTILLERIES  
FRANCIACORTA SINCE 1901 DISTILLERS IN  
FRANCIACORTA.

SER. NO. 79-050,944, FILED 1-25-2008.

LOURDES AYALA, EXAMINING ATTORNEY

**Int. Cls.: 12, 19 and 21**

**Prior U.S. Cls.: 1, 2, 12, 13, 19, 21, 23, 29, 30, 31, 33,  
35, 40, 44 and 50**

**Reg. No. 3,570,247**

**United States Patent and Trademark Office**

**Registered Feb. 3, 2009**

**TRADEMARK  
PRINCIPAL REGISTER**

***NordGlass***

JAAN AUTOMOTIVE GLASS SP. ZO.O (POLAND  
LIMITED LIABILITY COMPANY)  
UL. BOH. WARSZAWY 11  
KOSZALIN, POLAND PL75211

FOR: GLASS WINDOWS FOR VEHICLES; VEHI-  
CLE WINDSHIELDS, IN CLASS 12 (U.S. CLS. 19, 21,  
23, 31, 35 AND 44).

FOR: ALABASTER GLASS; SAFETY GLASS FOR  
BUILDING PURPOSES; BUILDING GLASS; GLASS  
BRICKS; GLASS BLOCKS FOR BUILDING; INSU-  
LATED GLASS; WINDOW GLASS; ROLLED SHEET  
GLASS FOR BUILDING, NAMELY, COLORED  
SHEET GLASS, COMMON SHEET GLASS, AND  
MODIFIED SHEET GLASS, IN CLASS 19 (U.S. CLS.  
1, 12, 33 AND 50).

FOR: GLASS WITH THIN ELECTRIC CONDUCT-  
TORS INSERTED; UNFINISHED GLASS FOR VEHI-  
CLE WINDOWS; OPAL GLASS; SEMI-FINISHED  
SAFETY GLASS; ROLLED, UNFINISHED SHEET  
GLASS NOT FOR BUILDING, NAMELY, COLORED  
SHEET GLASS, COMMON SHEET GLASS, AND  
MODIFIED SHEET GLASS, IN CLASS 21 (U.S. CLS.  
2, 13, 23, 29, 30, 33, 40 AND 50).

OWNER OF INTERNATIONAL REGISTRATION  
0956660 DATED 9-28-2007, EXPIRES 9-28-2017.

SER. NO. 79-051,087, FILED 9-28-2007.

CHRISTINE BLOMQUIST, EXAMINING ATTOR-  
NEY

**Int. Cls.: 9, 41 and 42**

**Prior U.S. Cls.: 21, 23, 26, 36, 38, 100, 101 and 107**

**Reg. No. 3,570,248**

**United States Patent and Trademark Office**

**Registered Feb. 3, 2009**

**TRADEMARK  
SERVICE MARK  
PRINCIPAL REGISTER**

# NAVYLEC

ANNECY ELECTRONIQUE (FRANCE SOCIETE  
PAR ACTIONS SIMPLIFIEE (S.A.S))  
Z.A. LES MARAIS  
F-74410 SAINT-JORIOZ  
FRANCE

FOR: SCIENTIFIC APPARATUS AND INSTRUMENTS AND ELECTRIC APPARATUS AND INSTRUMENTS, NAMELY, ELECTRIC APPARATUS AND INSTRUMENTS FOR MEASURING, TESTING, DISTRIBUTION, TRANSFORMATION, STORAGE OR CONTROL OF ELECTRIC CURRENT, ELECTRICITY DETECTORS, SWITCH CABINETS IN THE NATURE OF SPECIALLY ADAPTED CABINETS TO HOUSE ELECTRICAL FUSES, ELECTRIC LOSS INDICATORS, ELECTRIC MEASURING DEVICES, MEASURING INSTRUMENTS TO MEASURE ELECTRIC CURRENT, OHMMETERS, VOLT METERS, COMPUTERS, OSCILLOGRAPHS, VOLTAGE REGULATORS FOR VEHICLES, MEASURING AND CHECKING APPARATUS OF ELECTRIC CURRENT, SPEED CHECKING APPARATUS FOR VEHICLES, ANTI-THEFT WARNING DEVICES NOT FOR VEHICLES, VOLTAGE REGULATORS FOR VEHICLES, DATA PROCESSING APPARATUS, BATTERY CHARGERS, CURRENT RECTIFIERS, ELECTRICITY REDUCERS, CHARGERS FOR ELECTRIC BATTERIES, COMPUTER SOFTWARE FOR AUTOMATIC REGULATION OF ELECTRIC CURRENT, COMPUTER PERIPHERAL DEVICES, RECORDED COMPUTER PROGRAMS FOR AUTOMATIC REGULATION OF ELECTRIC CURRENT, SOFTWARE PACKAGES CONSISTING OF SOFTWARE FOR AUTOMATIC REGULATION OF ELECTRIC CURRENT, FURNITURE ESPECIALLY MADE FOR LABORATORIES, ELECTRONIC TEST BENCHES, IN CLASS 9 (U.S. CLS. 21, 23, 26, 36 AND 38).

FOR: EDUCATION, NAMELY, PROVIDING COURSES, SEMINARS IN THE FIELD OF ELECTRICAL ENGINEERING; PUBLICATION OF BOOKS, MAGAZINES; LENDING BOOKS, FILMS; ANIMAL TRAINING; RENTAL OF FILMS, VIDEO RECORDINGS; ARRANGING AND CONDUCTING OF EDUCATIONAL COLLOQUIUMS, CONFERENCES, CONGRESSES, ORGANIZATION OF EXHIBITIONS FOR CULTURAL OR EDUCATIONAL PURPOSES; RESERVATION OF SEATS FOR SHOWS, IN CLASS 41 (U.S. CLS. 100, 101 AND 107).

FOR: SCIENTIFIC RESEARCH; INDUSTRIAL RESEARCH IN THE FIELD OF ELECTRICAL ENGINEERING, COMPUTER PROGRAMMING; WORK OF ENGINEERS; PROFESSIONAL CONSULTANCY AND PLAN DRAFTING UNRELATED TO BUSINESS DEALINGS, NAMELY, DRAWING UP OF PLANS AND ENGINEERING DRAWINGS AND RELATED CONSULTATION, MATERIALS TESTING; ENGINEERING LABORATORIES; COMPUTER SOFTWARE DESIGN; INDUSTRIAL DESIGNS; CONDUCTING TECHNICAL PROJECT STUDIES IN THE FIELD OF ENGINEERING; MECHANICAL ENGINEERING RESEARCH, IN CLASS 42 (U.S. CLS. 100 AND 101).

OWNER OF INTERNATIONAL REGISTRATION  
0956900 DATED 11-26-2007, EXPIRES 11-26-2017.

SER. NO. 79-051,193, FILED 11-26-2007.

REBECCA POVARCHUK, EXAMINING ATTORNEY

**Int. Cl.: 9**

**Prior U.S. Cls.: 21, 23, 26, 36 and 38**

**Reg. No. 3,570,249**

**United States Patent and Trademark Office**

**Registered Feb. 3, 2009**

**TRADEMARK  
PRINCIPAL REGISTER**

**UGLY FISH**

AKBAR DARABI (AUSTRALIA INDIVIDUAL)  
UNIT 5  
6-8 RALPH BLACK DRIVE; NORTH WOLLON-  
GONGNSW 2519  
AUSTRALIA

FOR: OPTICAL FRAMES, SUNGLASSES AND  
ACCESSORIES FOR GLASSES AND SUNGLASSES,  
NAMELY, STRAPS, NECK CORDS, HEAD STRAPS  
THAT RESTRAIN EYEWEAR FROM MOVEMENT  
ON A WEARER, EYEWEAR CASES AND EYEWEAR  
RETAINERS, IN CLASS 9 (U.S. CLS. 21, 23, 26, 36  
AND 38).

THE MARK CONSISTS OF STANDARD CHAR-  
ACTERS WITHOUT CLAIM TO ANY PARTICULAR  
FONT, STYLE, SIZE, OR COLOR.

OWNER OF INTERNATIONAL REGISTRATION  
0957049 DATED 2-21-2008, EXPIRES 2-21-2018.

SER. NO. 79-051,266, FILED 2-21-2008.

LEIGH LOWRY, EXAMINING ATTORNEY

Int. Cls.: 29 and 30

Prior U.S. Cl.: 46

United States Patent and Trademark Office

Reg. No. 3,570,250

Registered Feb. 3, 2009

TRADEMARK  
PRINCIPAL REGISTER



INTERSNACK KNABBER-GEBAECK GMBH & CO.  
KG (FED REP GERMANY GMBH & CO. KG  
(LIMITED PARTNERSHIP))  
AACHENER STRASSE 1042  
50858 KÖLN  
FED REP GERMANY

PRIORITY DATE OF 11-7-2007 IS CLAIMED.

OWNER OF INTERNATIONAL REGISTRATION  
0957091 DATED 2-14-2008, EXPIRES 2-14-2018.

FOR: POTATO SNACK FOODS; ROASTED,  
DRIED, SALTED, SPICED AND SEASONED NUTS,  
IN CLASS 29 (U.S. CL. 46).

OWNER OF U.S. REG. NOS. 1,755,542 AND  
3,120,988.

FOR: TAPIOCA SNACK FOODS; RICE BASED  
SNACK FOODS; MANIOC BASED SNACK FOODS;  
CORN BASED SNACK FOODS; WHEAT BASED  
SNACK FOODS; CEREAL BASED SNACK FOODS;  
SAVOURY BISCUITS AND PRETZELS; MUESLI  
BARS, MAINLY CONSISTING OF NUTS, DRIED  
FRUITS, PROCESSED CEREAL GRAINS AND CHO-  
COLATE; SAUCES, IN CLASS 30 (U.S. CL. 46).

THE MARK CONSISTS OF A BEAR WITH A  
CROWN ENCLOSED IN A CIRCLE AND THE  
WORDING "POM-BAR" APPEARS BENEATH THE  
FIGURE OF THE BEAR AND CROWN.

SER. NO. 79-051,282, FILED 2-14-2008.

DANIEL CAPSHAW, EXAMINING ATTORNEY



**Int. Cl.: 9**

**Prior U.S. Cls.: 21, 23, 26, 36 and 38**

**United States Patent and Trademark Office**

**Reg. No. 3,570,251**

**Registered Feb. 3, 2009**

**TRADEMARK  
PRINCIPAL REGISTER**

**SUBEYE**

L3 COMMUNICATIONS ELAC NAUTIK GMBH  
(FED REP GERMANY LIMITED LIABILITY  
COMPANY)  
NEUFELDSTR. 10  
24118 KIEL  
FED REP GERMANY

FOR: NAUTICAL INSTRUMENTS, NAMELY, SO-  
NAR EMITTERS AND DETECTORS, ECHO SOUN-  
DERS, UNDERWATER SOUND VELOCITY  
PROBES, UNDERWATER DIGITAL DATA TRANS-  
MITTERS, USER INTERFACES FOR NAVIGATION-  
AL CONTROLS, AND NAUTICAL COMPUTERS  
AND COMPUTER SOFTWARE FOR NAVIGATION,  
UNDERWATER COMMUNICATION AND UNDER-

WATER DETECTION OF OBJECTS, IN CLASS 9 (U.S.  
CLS. 21, 23, 26, 36 AND 38).

PRIORITY DATE OF 1-7-2008 IS CLAIMED.

OWNER OF INTERNATIONAL REGISTRATION  
0957355 DATED 2-18-2008, EXPIRES 2-18-2018.

SER. NO. 79-051,374, FILED 2-18-2008.

ESTHER A. BORSUK, EXAMINING ATTORNEY

**Int. Cl.: 35**

**Prior U.S. Cls.: 100, 101 and 102**

**United States Patent and Trademark Office**

**Reg. No. 3,570,252**

**Registered Feb. 3, 2009**

**SERVICE MARK  
PRINCIPAL REGISTER**

**QOBLIQ**

QOBLIQ LIMITED (UNITED KINGDOM LIM-  
ITED COMPANY)  
100 NEW KINGS ROAD  
LONDON SW6 4LX  
UNITED KINGDOM

FOR: BUSINESS MARKETING SERVICES, IN  
CLASS 35 (U.S. CLS. 100, 101 AND 102).

THE MARK CONSISTS OF STANDARD CHAR-  
ACTERS WITHOUT CLAIM TO ANY PARTICULAR  
FONT, STYLE, SIZE, OR COLOR.

PRIORITY DATE OF 1-15-2008 IS CLAIMED.

OWNER OF INTERNATIONAL REGISTRATION  
0957438 DATED 3-10-2008, EXPIRES 3-10-2018.

SER. NO. 79-051,403, FILED 3-10-2008.

DAVID TOOLEY, EXAMINING ATTORNEY

**Int. Cls.: 30 and 32**

**Prior U.S. Cls.: 45, 46 and 48**

**United States Patent and Trademark Office**

**Reg. No. 3,570,253**

**Registered Feb. 3, 2009**

**TRADEMARK  
PRINCIPAL REGISTER**

# MIRADOR

INSTANTA SP. Z O.O. (POLAND LIMITED LIABILITY COMPANY)  
UL. KAWOWA 3  
PL-44-240 ZORY  
POLAND

FOR: COFFEE, TEA; COCOA; SUGAR; RICE; TAPIOCA, SAGO; ARTIFICIAL COFFEE, FLOUR AND CEREAL PRODUCTS; NAMELY, FLOUR FOR FOOD; CEREAL PRODUCTS FOR FOOD, NAMELY, OAT FLAKES, GROATS IN THE NATURE OF PROCESSED GRAINS, PROCESSED SEMOLINA, BREAKFAST CEREALS; BREAD; CONFECTIONERY, NAMELY, HARD CANDIES, FILLED CANDIES, CHOCOLATE COVERED FRUIT, CHOCOLATE COVERED NUTS, CHOCOLATES, FONDANTS; ICE-CREAM; SWEETS; HONEY; YEAST EXTRACTS; BAKING POWDER; SALT; MUSTARD; VINEGAR; SAUCES, FLAVOURINGS OTHER THAN ESSENTIAL OILS, FOR CAKES AND FOR BEVERAGES, DRINKS ON THE BASE OF COFFEE, TEA, COCOA OR CHOCOLATE, NAMELY, COFFEE BASED BEVERAGES, BEVERAGES MADE OF TEA, COCOA BASED BEVERAGES, CHOCOLATE BEVERAGES NOT BEING DAIRY BASED OR VEGETABLE BASED; PASTRY; CAKES; COOKIES; FLAVORS FOR DRINKS AND FLAVORS FOR PASTRY, NAMELY, FLAVOR ENHANCERS USED IN FOOD AND BEVERAGE PRODUCTS;

CANDIES; COFFEE AROMAS, NAMELY COFFEE EXTRACTS; VEGETAL PREPARATIONS FOR USE AS COFFEE SUBSTITUTES; KETCHUP; BISCUITS; WAFERS, IN CLASS 30 (U.S. CL. 46).

FOR: SUBSTANCES FOR DRINKS PRODUCTION, NAMELY, SYRUPS FOR MAKING SOFT DRINKS; ALCOHOL-FREE DRINKS, NAMELY, NON-ALCOHOLIC FRUIT JUICE BEVERAGES; TABLETS FOR EFFERVESCENT DRINKS, NAMELY, CONCENTRATES USED IN THE PREPARATION OF SOFT DRINKS; NON-ALCOHOLIC BEVERAGES CONTAINING FRUIT JUICES, BEER; TOMATO JUICE; FRUIT JUICES; WATERS CHARGED WITH GAS AND MINERAL, NAMELY, MINERAL AND CARBONATED WATERS; VEGETABLE JUICES, IN CLASS 32 (U.S. CLS. 45, 46 AND 48).

OWNER OF INTERNATIONAL REGISTRATION  
0957900 DATED 12-14-2007, EXPIRES 12-14-2017.

THE ENGLISH TRANSLATION OF THE WORD "MIRADOR" IN THE MARK IS "VIEWPOINT".

SER. NO. 79-051,582, FILED 12-14-2007.

ROBERT STRUCK, EXAMINING ATTORNEY

**Int. Cls.: 1, 3, 5 and 42**

**Prior U.S. Cls.: 1, 4, 5, 6, 10, 18, 26, 44, 46, 50, 51, 52,  
100 and 101**

**Reg. No. 3,570,254**

**United States Patent and Trademark Office**

**Registered Feb. 3, 2009**

**TRADEMARK  
SERVICE MARK  
PRINCIPAL REGISTER**



POLYPHOR AG (SWITZERLAND SOCIÉTÉ  
ANONYME)  
HEGENHEIMERMATTWEG 125  
CH-4123 ALLSCHWIL  
SWITZERLAND

FOR: CHEMICALS FOR USE IN INDUSTRY AND SCIENCE; CHEMICAL PREPARATIONS FOR USE IN AGRICULTURE, NAMELY, CHEMICAL PREPARATIONS FOR THE TREATMENT OF SEEDS; AND CHEMICAL PREPARATIONS FOR USE IN PHOTOGRAPHY, NAMELY, CHEMICAL DEVELOPERS; UNPROCESSED ARTIFICIAL RESINS AS RAW MATERIALS IN THE FORM OF POWDERS, LIQUIDS OR PASTES; UNPROCESSED PLASTICS FOR INDUSTRIAL USE; UNPROCESSED PLASTICS IN ALL FORMS; FERTILIZERS, NAMELY, MANURES; FIRE EXTINGUISHING COMPOSITIONS; TEMPERING CHEMICALS FOR USE IN METALWORKING OR SOLDERING; CHEMICAL SUBSTANCES FOR PRESERVING FOODSTUFFS; TANNING AGENTS FOR USE IN THE MANUFACTURE OF LEATHER, ADHESIVES FOR GENERAL INDUSTRIAL USE, IN CLASS 1 (U.S. CLS. 1, 5, 6, 10, 26 AND 46).

FOR: BLEACHING PREPARATIONS FOR HOUSEHOLD USE; GENERAL PURPOSE CLEANING, POLISHING, SCOURING AND ABRASIVE LIQUIDS AND POWDERS; SOAPS; PERFUMERY, ESSENTIAL OILS FOR PERSONAL USE AND FOR USE AS INGREDIENTS IN THE MANUFACTURE OF COSMETIC PREPARATIONS; COSMETICS; HAIR LOTIONS; DENTIFRICES, IN CLASS 3 (U.S. CLS. 1, 4, 6, 50, 51 AND 52).

FOR: PHARMACEUTICAL ANTI-ALLERGIC PREPARATIONS AND SUBSTANCES, PHARMACEUTICAL FOR THE TREATMENT OF ERECTILE DYSFUNCTION, PHARMACEUTICAL PREPARA-

TIONS, NAMELY, ANTICOAGULANTS, PHARMACEUTICAL PREPARATIONS, NAMELY, ANTIDEPRESSANTS, PHARMACEUTICAL PREPARATIONS, NAMELY, APPETITE SUPPRESSANTS, PHARMACEUTICAL PREPARATIONS FOR USE IN CHEMOTHERAPY, PHARMACEUTICAL PREPARATION FOR THE TREATMENT OF GOUT, PHARMACEUTICAL PREPARATIONS FOR THE TREATMENT OF HEART RHYTHM DISORDERS, PHARMACEUTICAL PREPARATIONS FOR THE TREATMENT OF STEM CELL MOBILIZATION, PHARMACEUTICAL PREPARATIONS FOR THE TREATMENT OF INFECTIOUS DISEASES, PHARMACEUTICAL PREPARATIONS ACTING ON THE CENTRAL NERVOUS SYSTEM, PHARMACEUTICAL PREPARATIONS AND SUBSTANCES FOR THE TREATMENT OF GASTRO-INTESTINAL DISEASES, PHARMACEUTICAL PREPARATIONS FOR ANIMAL SKINCARE, PHARMACEUTICAL PREPARATIONS FOR INHALATION FOR THE TREATMENT OF PULMONARY HYPERTENSION, PHARMACEUTICAL PREPARATIONS FOR OCULAR OR INTRAOCULAR SURGERY, PHARMACEUTICAL PREPARATIONS FOR THE TREATMENT OF HORMONAL DISORDERS AND THE PREVENTION OF OSTEOPOROSIS, PHARMACEUTICAL PREPARATIONS FOR TREATING ALLERGIC RHINITIS AND ASTHMA, PHARMACEUTICAL PREPARATIONS FOR TREATING DIABETES, PHARMACEUTICAL PREPARATIONS FOR TREATING SKIN DISORDERS, PHARMACEUTICAL PREPARATIONS FOR USE IN DERMATOLOGY, PHARMACEUTICAL PREPARATIONS FOR WOUNDS, PHARMACEUTICAL PREPARATIONS FOR USE IN UROLOGY, PHARMACEUTICAL PREPARATIONS, NAMELY, A BLOOD CLOTTING AID AND DELIVERY SYSTEM FOR USE IN HUMAN AND VETERINARY MEDICINE, PHARMACEUTICAL PRODUCTS AND PREPARATIONS AGAINST DRY SKIN CAUSED BY

PREGNANCY, PHARMACEUTICAL PRODUCTS AND PREPARATIONS FOR CHLOASMA, PHARMACEUTICAL PRODUCTS AND PREPARATIONS FOR HYDRATING THE SKIN DURING PREGNANCY, PHARMACEUTICAL PRODUCTS AND PREPARATIONS FOR PREGNANCY BLEMISHES, PHARMACEUTICAL PRODUCTS AND PREPARATIONS FOR PREVENTING SKIN BLEMISHES DURING PREGNANCY, PHARMACEUTICAL PRODUCTS AND PREPARATIONS TO PREVENT STRETCH MARKS, PHARMACEUTICAL PRODUCTS AND PREPARATIONS TO PREVENT SWELLING IN THE LEGS, PHARMACEUTICAL PRODUCTS FOR OPHTHALMOLOGICAL USE, PHARMACEUTICAL PRODUCTS FOR SKIN CARE FOR ANIMALS, PHARMACEUTICAL PRODUCTS FOR THE TREATMENT OF BONE DISEASES, PHARMACEUTICAL PRODUCTS FOR THE TREATMENT OF VIRAL AND INFECTIOUS DISEASES AND FOR THE TREATMENT OF CANCER, PHARMACEUTICAL PRODUCTS FOR TREATING RESPIRATORY DISEASES AND ASTHMA, PHARMACEUTICAL SKIN LOTIONS, PHARMACEUTICAL SOLUTIONS USED IN DIALYSIS, PHARMACEUTICALS, NAMELY, ANTIHELMINTICS, PHARMACEUTICALS, NAMELY, INDUCERS OF ERECTIONS, PHARMACEUTICALS, NAMELY, LIPID LOWERING AGENTS, PHARMACEUTICALS, NAMELY, PSYCHOTROPICS, PHARMACEUTICALS, NAMELY, ANTI-INFECTIVES; VETERINARY PREPARATIONS, NAMELY, PAIN RELIEF MEDICATION, VETERINARY PREPARATIONS FOR THE TREATMENT OF INTESTINAL BACTERIA, VETERINARY VACCINE FOR HORSES, VETER-

INARY VACCINES; SANITARY PREPARATIONS FOR MEDICAL PURPOSES; DIETETIC FOODS ADAPTED FOR MEDICAL USE, FOOD FOR BABIES; MEDICAL PLASTERS, DRESSINGS FOR WOUNDS, BURNS, SURGERY; DENTAL IMPRESSION MATERIALS; DISINFECTANTS FOR HYGIENIC PURPOSES; PREPARATIONS FOR DESTROYING VERMIN; FUNGICIDES AND HERBICIDES, IN CLASS 5 (U.S. CLS. 6, 18, 44, 46, 51 AND 52).

FOR: SCIENTIFIC AND TECHNOLOGICAL SERVICES IN THE NATURE OF RESEARCH IN THE FIELD OF AGROCHEMICALS, PHARMACEUTICALS AND BIO-CHEMISTRY AND DESIGN SERVICES RELATING THERETO, NAMELY, SCIENTIFIC AND TECHNOLOGICAL SERVICES RELATING TO PROPERTIES OF AGROCHEMICALS, PHARMACEUTICALS AND BIO-CHEMISTRY; INDUSTRIAL ANALYSIS AND RESEARCH SERVICES; DESIGN AND DEVELOPMENT OF COMPUTER HARDWARE AND SOFTWARE, IN CLASS 42 (U.S. CLS. 100 AND 101).

PRIORITY DATE OF 9-26-2007 IS CLAIMED.

OWNER OF INTERNATIONAL REGISTRATION 0958096 DATED 2-1-2008, EXPIRES 2-1-2018.

SER. NO. 79-051,641, FILED 2-1-2008.

LAURIE KAUFMAN, EXAMINING ATTORNEY

**Int. Cl.: 36**

**Prior U.S. Cls.: 100, 101 and 102**

**United States Patent and Trademark Office**

**Reg. No. 3,570,255**

**Registered Feb. 3, 2009**

**SERVICE MARK  
PRINCIPAL REGISTER**

**myf@c**

HANNOVER RÜCKVERSICHERUNG AG (FED  
REP GERMANY STOCK CORPORATION)  
KARL-WIECHERT-ALLEE 50  
30625 HANNOVER  
FED REP GERMANY

FOR: INSURANCE SERVICES, NAMELY, APPRAISALS OF INSURANCE POLICIES AND INSURANCE CONTRACTS; UNDERWRITING AND BROKERAGE OF ALL TYPES OF INSURANCE; DATA COMPILING AND ANALYZING IN ALL TYPES OF INSURANCE; FINANCIAL EVALUATION FOR ALL TYPES OF INSURANCE; PREMIUM RATE COMPUTING FOR ALL TYPES OF INSURANCE; PROVIDING INFORMATION IN ALL TYPES OF INSURANCE MATTERS; INSURANCE ADMINISTRATION IN ALL TYPES OF INSURANCE; CONSULTATION IN ALL TYPES OF INSURANCE; ACTUARIAL SCIENCE SERVICES FOR ALL TYPES OF INSURANCE PURPOSES AND CONSULTATION IN THE FIELD OF ACTUARIAL SCIENCE SERVICES FOR ALL TYPES OF INSURANCE PURPOSES; FINANCIAL RISK MANAGEMENT SERVICES IN ALL TYPES OF INSURANCE; CLAIMS SERVICES IN ALL TYPES OF INSURANCE, NAMELY, CLAIMS ADMINISTRATION AND PROCESSING; ACTUARIAL SCIENCE SERVICES AND CONSULTATION SERVICES IN ALL TYPES OF INSURANCE; INSURANCE CLAIMS EVALUATION SERVICES, NAMELY, CLAIMS ADJUSTMENT; INSURANCE CLAIMS SERVICES, NAMELY, INSURANCE CLAIMS ADMINISTRATION, INSURANCE CLAIMS PROCESSING AND INSURANCE CLAIMS ADJUSTMENT; REINSURANCE SERVICES, NAMELY, APPRAISALS OF REINSURANCE POLICIES AND REIN-

SURANCE CONTRACTS, UNDERWRITING AND BROKERAGE OF ALL TYPES OF REINSURANCE; DATA COMPILING AND ANALYZING IN ALL TYPES OF REINSURANCE; FINANCIAL EVALUATION FOR ALL TYPES OF REINSURANCE; PREMIUM RATE COMPUTING FOR ALL TYPES OF REINSURANCE; PROVIDING INFORMATION IN ALL TYPES OF REINSURANCE MATTERS; REINSURANCE ADMINISTRATION IN ALL TYPES OF REINSURANCE; CONSULTATION IN ALL TYPES OF REINSURANCE; ACTUARIAL SCIENCE SERVICES FOR ALL TYPES OF REINSURANCE PURPOSES AND CONSULTATION IN THE FIELD OF ACTUARIAL SCIENCE SERVICES FOR ALL TYPES OF REINSURANCE PURPOSES; FINANCIAL RISK MANAGEMENT SERVICES IN ALL TYPES OF REINSURANCE; CLAIMS SERVICES IN ALL TYPES OF REINSURANCE, NAMELY, CLAIMS AND ADMINISTRATION AND PROCESSING; ACTUARIAL SCIENCE SERVICES AND CONSULTATION SERVICES IN ALL TYPES OF REINSURANCE; REINSURANCE CLAIMS SERVICES, NAMELY, REINSURANCE CLAIMS ADMINISTRATION, REINSURANCE CLAIMS PROCESSING AND REINSURANCE CLAIMS ADJUSTMENT, IN CLASS 36 (U.S. CLS. 100, 101 AND 102).

OWNER OF INTERNATIONAL REGISTRATION  
0958932 DATED 6-22-2007, EXPIRES 6-22-2017.

SER. NO. 79-051,959, FILED 6-22-2007.

AISHA SALEM, EXAMINING ATTORNEY

**Int. Cl.: 16**

**Prior U.S. Cls.: 2, 5, 22, 23, 29, 37, 38 and 50**

**United States Patent and Trademark Office**

**Reg. No. 3,570,256**

**Registered Feb. 3, 2009**

**TRADEMARK  
PRINCIPAL REGISTER**

# Semikolon;

SEMIKOLON INTERNATIONAL INC. (CANADA CORPORATION)  
127 ST. PIERRE STREET  
MONTRAL, QUEBEC, H2Y 2L6  
CANADA

FOR: PAPER, CARDBOARD AND GOODS MADE OF THESE MATERIALS, NAMELY, PRESENTATION FOLDERS, PAPER EXPANDING FILES, FILE FOLDERS, NOTEPADS, BOXES OF CARDBOARD OR PAPER, FILE BOXES FOR STORAGE OF MAGAZINES, FILE BOXES FOR STORING OF BUSINESS AND PERSONAL RECORD, PHOTO STORAGE BOXES, GIFT BOXES, ADDRESS BOOKS, GUEST BOOKS, THREE-RING BINDERS, MECHANICAL BINDER SETS, COMPRISING DIVIDERS, BLANK JOURNAL BOOKS, BLANK WRITING JOURNALS; ALBUMS FOR PHOTO-

GRAPHS, SCRAPBOOK ALBUMS, WEDDING ALBUMS, PAPER PHOTO FRAMES, BINDERS, BINDER CLIPS, DOCUMENT FILE TRAYS; DESK BLOTTERS, IN CLASS 16 (U.S. CLS. 2, 5, 22, 23, 29, 37, 38 AND 50).

THE MARK CONSISTS OF STANDARD CHARACTERS WITHOUT CLAIM TO ANY PARTICULAR FONT, STYLE, SIZE, OR COLOR.

OWNER OF INTERNATIONAL REGISTRATION 0959235 DATED 5-23-2007, EXPIRES 5-23-2017.

SER. NO. 79-052,085, FILED 5-23-2007.

WILLIAM ROSSMAN, EXAMINING ATTORNEY

**Int. Cl.: 12**

**Prior U.S. Cls.: 19, 21, 23, 31, 35 and 44**

**Reg. No. 3,570,257**

**United States Patent and Trademark Office**

**Registered Feb. 3, 2009**

**TRADEMARK  
PRINCIPAL REGISTER**

**GREENWHEEL**

SHENZHEN GREENWHEEL; ELECTRIC VEHICLE CO., LTD (CHINA CORPORATION)  
F1, BUILDING 1  
BAIMANG GUANWAI XUSHENG INDUSTRIAL PARK.; XILI STREET, NANSHAN DISTRICT.; SHENZHEN CITY; GUANGDONG PROVINCE CHINA

FOR: AUTOMOBILES; ELECTRIC VEHICLES, NAMELY, ELECTRIC CARS, ELECTRIC TRUCKS AND ELECTRIC TRICYCLES; CLEANING TROLLEYS; MILITARY VEHICLES FOR TRANSPORT, NAMELY, CAISSONS VEHICLES; VEHICLES FOR LOCOMOTION BY LAND, AIR, WATER OR RAIL,

NAMELY, BUSES, BOATS, AEROPLANES AND TRAINS; FORK LIFT TRUCKS; MOTORCYCLE SIDECARS; CAMPING TRAILERS; MOTOR HOMES; SPORTS CARS, IN CLASS 12 (U.S. CLS. 19, 21, 23, 31, 35 AND 44).

OWNER OF INTERNATIONAL REGISTRATION 0960519 DATED 2-25-2008, EXPIRES 2-25-2018.

SER. NO. 79-052,506, FILED 2-25-2008.

JULIE VEPPUMTHARA, EXAMINING ATTORNEY



Int. Cl.: 7

Prior U.S. Cls.: 13, 19, 21, 23, 31, 34 and 35

Reg. No. 3,570,258

United States Patent and Trademark Office

Registered Feb. 3, 2009

TRADEMARK  
PRINCIPAL REGISTER

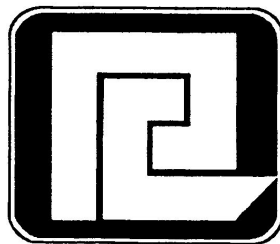

普利森  
PRECION

DEZHOU PRECION MACHINERY; MANUFACTURING CO., LTD.; (DEZHOU PULISEN JIXIE; ZHIZAO YOUXIAN GONGSI.) (CHINA CORPORATION)  
NO. 1 XIHUAN ROAD  
LING COUNTY ECONOMIC DEVELOPMENT ZONE; DEZHOU CITY; SHANDONG PROVINCE  
CHINA

FOR: MACHINE TOOLS, NAMELY, BROACHES, DIES, GEAR CUTTERS, DRILLING MACHINES, BORING MACHINES, GRINDING MACHINES FOR METALWORKING; LATHES; MILLING MACHINES; POWER DRILL PRESSES; BORING LATHES; CRUSHING MACHINES FOR USE IN MILLING; TOOLS AS PARTS OF MACHINES, NAMELY, TOOL BITS, DIES; OFFSET POINT MACHINE FOR PRINTING, IN CLASS 7 (U.S. CLS. 13, 19, 21, 23, 31, 34 AND 35).

OWNER OF INTERNATIONAL REGISTRATION  
0960691 DATED 2-25-2008, EXPIRES 2-25-2018.

THE MARK CONSISTS OF A ROUNDED, SHADDED RECTANGLE WITH A HEAVILY STYLIZED LETTER "P" AND "C" FORMING A SQUARE SHAPE IN THE CENTER. BELOW THAT ARE JAPANESE CHARACTERS PU LI SEN, AND BELOW THAT IS THE TERM "PRECION".

THE ENGLISH TRANSLATION OF THE FOREIGN WORD(S) IN THE MARK IS: "PU" MEANS COMMON; "LI" MEANS BENEFIT; "SEN" MEANS FOREST. THE WHOLE WORD HAS NO MEANING.

THE TRANSLITERATION OF THE NON-LATIN CHARACTERS IN THE MARK IS: PU LI SEN.

SER. NO. 79-052,563, FILED 2-25-2008.

RONALD DELGIZZI, EXAMINING ATTORNEY

**Int. Cls.: 35, 38 and 42**

**Prior U.S. Cls.: 100, 101, 102 and 104**

**United States Patent and Trademark Office**

**Reg. No. 3,570,259**

**Registered Feb. 3, 2009**

**SERVICE MARK  
PRINCIPAL REGISTER**

# Janubo

ANDREAS NIESSL (FED REP GERMANY INDIVIDUAL)  
WOLFSGANGSTRABE 24  
60322 FRANKFURT AM MAIN  
FRANKFURT, FED REP GERMANY

FOR: ONLINE BUSINESS NETWORKING SERVICES FOR SELF-EMPLOYED PERSONS; PROVIDING AN ONLINE COMMERCIAL INFORMATION DIRECTORY AND DATABASE IN THE FIELD OF SELF-EMPLOYED PERSONS' SERVICES TO ASSIST THEM IN ADVERTISING AND MARKETING THEIR SERVICES; AND INTERNET ADVERTISING AND MARKETING SERVICES FOR SELF-EMPLOYED PERSONS, IN CLASS 35 (U.S. CLS. 100, 101 AND 102).

FOR: PROVIDING MULTIPLE USER ACCESS TO PROPRIETARY COLLECTIONS OF INFORMATION ON SELF-EMPLOYED PERSONS VIA THE INTERNET, IN CLASS 38 (U.S. CLS. 100, 101 AND 104).

FOR: DATABASE DEVELOPMENT, COMPUTER PROGRAMMING SERVICES, AND SOFTWARE DE-

SIGN FOR OTHERS IN THE FIELD OF THE PROVISION OF INFORMATION AND DATA ON SELF-EMPLOYED PERSONS IN ORDER TO MARKET THEIR SERVICES, IN CLASS 42 (U.S. CLS. 100 AND 101).

THE MARK CONSISTS OF STANDARD CHARACTERS WITHOUT CLAIM TO ANY PARTICULAR FONT, STYLE, SIZE, OR COLOR.

PRIORITY DATE OF 2-1-2007 IS CLAIMED.

OWNER OF INTERNATIONAL REGISTRATION 0961267 DATED 7-25-2007, EXPIRES 7-25-2017.

THE WORDING "JANUBO" HAS NO MEANING IN ENGLISH.

SER. NO. 79-052,746, FILED 7-25-2007.

ELLEN B. AWRICH, EXAMINING ATTORNEY

**Int. Cl.: 7**

**Prior U.S. Cls.: 13, 19, 21, 23, 31, 34 and 35**

**Reg. No. 3,570,260**

**United States Patent and Trademark Office**

**Registered Feb. 3, 2009**

**TRADEMARK  
PRINCIPAL REGISTER**

**HGM**

NINGBO HGM FOOD MACHINERY CO., LTD  
(CHINA CORPORATION)  
NO.9 GANGXI ROAD  
XIZHOU INDUSTRIAL ESTATE,; XIANGSHAN;  
315721 NINGBO  
CHINA

FOR: BOTTLE WASHING MACHINES; ELECTRIC FOOD PROCESSORS; MECHANICAL DEVICES FOR THE CAN INDUSTRY, NAMELY, CAN WASHING MACHINES; FOOD PACKING MACHINES; CHURNING MACHINES; AERATED BEVERAGE MAKING MACHINES, NAMELY, BEER

BREWING MACHINES; AERATED BEVERAGES MAKING MACHINES; MINERAL WATER MAKING MACHINES, IN CLASS 7 (U.S. CLS. 13, 19, 21, 23, 31, 34 AND 35).

OWNER OF INTERNATIONAL REGISTRATION  
0961680 DATED 4-11-2008, EXPIRES 4-11-2018.

SER. NO. 79-052,904, FILED 4-11-2008.

MEGHAN REINHART, EXAMINING ATTORNEY

**Int. Cl.: 20**

**Prior U.S. Cls.: 2, 13, 22, 25, 32 and 50**

**Reg. No. 3,570,261**

**United States Patent and Trademark Office**

**Registered Feb. 3, 2009**

**TRADEMARK  
PRINCIPAL REGISTER**



HAORAN CHEN (CHINA INDIVIDUAL)  
VILLAGERS GROUP OF LIANTANG HUAXI  
ADMINISTRATIVE DISTRICT, LONGJIANG  
TOWN, SHUNDE CITY  
GUANDONG, CHINA

FOR: FURNITURE; MIRRORS; FURNITURE FIT-  
TINGS, NOT OF METAL; HANGERS FOR COATS;  
DECORATIONS OF PLASTIC FOR FOODSTUFFS;  
IDENTITY PLATES, NOT OF METAL; DECORA-  
TIVE ARTICLES MADE OF CORK, NAMELY PIC-  
TURE FRAMES OF CORK; DECORATIVE  
ARTICLES MADE OF BAMBOO OR WOOD, NAME-

LY DISPLAY STANDS MADE OF BAMBOO, PLA-  
QUES OF WOOD; PLASTIC TROUGHS FOR  
ORGANIZING CABLES AND WIRES OF HOME  
ELECTRONICS AND APPLIANCES, IN CLASS 20  
(U.S. CLS. 2, 13, 22, 25, 32 AND 50).

OWNER OF INTERNATIONAL REGISTRATION  
0962125 DATED 1-11-2008, EXPIRES 1-11-2018.

SER. NO. 79-053,054, FILED 1-11-2008.

APRIL ROACH, EXAMINING ATTORNEY

**Int. Cl.: 7**

**Prior U.S. Cls.: 13, 19, 21, 23, 31, 34 and 35**

**Reg. No. 3,570,262**

**United States Patent and Trademark Office**

**Registered Feb. 3, 2009**

**TRADEMARK  
PRINCIPAL REGISTER**

**EcoFuelKLEANZ**

TRUCKPROTECT LIMITED (UNITED KING-  
DOM LIMITED COMPANY)  
44 THE UPLANDS, DUKES WOOD  
GERRARDS CROSS, BUCKINGHAMSHIRE SL9 7JG  
UNITED KINGDOM

FOR: FUEL FILTERS; FUEL FILTERS FOR THE  
TREATMENT AND CONTROL OF MICROBIAL  
GROWTH IN DISTILLATE FUELS AND OILS; FUEL  
FILTERS BEING MAGNETIC FLUID CONDITION-  
ERS; FILTERS FOR LIQUID HYDROCARBONS IN  
ENGINES OR MOTORS; FILTERS FOR LUBRI-  
CANTS, NAMELY, FUEL FILTERS; FUEL FILTERS  
FOR INTERNAL COMBUSTION ENGINES; FIL-  
TERS FOR CLEANING THE LUBRICATING OILS  
IN ENGINES; FUEL FILTERS BEING PARTS OF  
ENGINES; PARTS AND FITTINGS FOR ALL THE

AFORESAID GOODS, IN CLASS 7 (U.S. CLS. 13, 19,  
21, 23, 31, 34 AND 35).

THE MARK CONSISTS OF STANDARD CHAR-  
ACTERS WITHOUT CLAIM TO ANY PARTICULAR  
FONT, STYLE, SIZE, OR COLOR.

PRIORITY DATE OF 2-29-2008 IS CLAIMED.

OWNER OF INTERNATIONAL REGISTRATION  
0962226 DATED 4-17-2008, EXPIRES 4-17-2018.

SER. NO. 79-053,090, FILED 4-17-2008.

JAMES STEIN, EXAMINING ATTORNEY

**Int. Cls.: 4, 31 and 44**

**Prior U.S. Cls.: 1, 6, 15, 46, 100 and 101**

**United States Patent and Trademark Office**

**Reg. No. 3,570,263**

**Registered Feb. 3, 2009**

**TRADEMARK  
SERVICE MARK  
PRINCIPAL REGISTER**

# JATROPOWER

JATROPOWER AG (SWITZERLAND CORPORATION)  
HALDENSTRASSE 5  
CH-6342 BAAR  
SWITZERLAND

FOR: INDUSTRIAL OILS AND GREASES; FUELS INCLUDING MOTOR SPIRIT, IN CLASS 4 (U.S. CLS. 1, 6 AND 15).

FOR: AGRICULTURAL AND FORESTRY PRODUCTS, NAMELY, LIVE PLANTS FOR BIOFUELS, BIOGAS AND FEED RAW MATERIAL, IN CLASS 31 (U.S. CLS. 1 AND 46).

FOR: SERVICES FOR AGRICULTURE AND FORESTRY, NAMELY, HORTICULTURAL SERVICES IN THE AREA OF RE-CULTIVATION OF UNUSED LANDS AIMED AT RESTORING ENVIRONMENTAL QUALITY AND GENERATING MARKET-

ABLE RESOURCES, IN CLASS 44 (U.S. CLS. 100 AND 101).

THE MARK CONSISTS OF STANDARD CHARACTERS WITHOUT CLAIM TO ANY PARTICULAR FONT, STYLE, SIZE, OR COLOR.

PRIORITY DATE OF 10-31-2007 IS CLAIMED.

OWNER OF INTERNATIONAL REGISTRATION 0962344 DATED 4-8-2008, EXPIRES 4-8-2018.

THE TERM "JATRO" HAS NO MEANING IN A FOREIGN LANGUAGE.

SER. NO. 79-053,135, FILED 4-8-2008.

DEIRDRE ROBERTSON, EXAMINING ATTORNEY

**Int. Cls.: 8, 9, 11, 17 and 19**

**Prior U.S. Cls.: 1, 5, 12, 13, 21, 23, 26, 28, 31, 33, 34,  
35, 36, 38, 44 and 50**

**Reg. No. 3,570,264**

**United States Patent and Trademark Office**

**Registered Feb. 3, 2009**

**TRADEMARK  
PRINCIPAL REGISTER**

**DEGUSSIT**

FRIATEC AKTIENGESELLSCHAFT (FED REP  
GERMANY JOINT STOCK COMPANY)  
STEINZEUGSTRASSE 50  
68229 MANNHEIM  
FED REP GERMANY

FOR: HAND TOOLS, NAMELY, MANUALLY  
OPERATED GRINDING WHEELS AND GRINDING  
DISCS; MANUALLY OPERATED MOUNTED  
POINTS FOR GRINDING ABRASIVE FILES AND  
WHETSTONES AND PROCESSING SURFACES OF  
GLASS-HARD MATERIALS, IN CLASS 8 (U.S. CLS.  
23, 28 AND 44).

FOR: LABORATORY EQUIPMENT, NAMELY,  
CRUCIBLES AND ADJUSTED PLATES AS COVERS  
FOR CRUCIBLES, IN CLASS 9 (U.S. CLS. 21, 23, 26, 36  
AND 38).

FOR: PORTABLE ELECTRIC HEATERS, COMPO-  
NENTS FOR USE IN ELECTRIC HEATERS, FUR-  
NACES AND MELTING FURNACES; HEAT  
DIFFUSION PLATES MADE OF ULTRA PURE  
ALUMINUM OXIDE USED AS BACKINGS DUR-  
ING THERMAL PROCESSES TO PREVENT CON-  
TACT REACTIONS IN FURNACES AND MELTING  
FURNACES, IN CLASS 11 (U.S. CLS. 13, 21, 23, 31  
AND 34).

FOR: INSULATING MATERIALS; INSULATING  
MATERIALS FOR HIGH TEMPERATURE FURNA-

CES AND FOR HIGH-TEMPERATURE MELTING  
FURNACES; INSULATING MATERIALS AND  
ELECTRICAL CERAMIC INSULATORS, IN CLASS  
17 (U.S. CLS. 1, 5, 12, 13, 35 AND 50).

FOR: PIPES, BARS AND CAPILLARIES MADE OF  
OXIDE CERAMICS FOR GENERAL USE IN HAND-  
CRAFT; PIPES, RODS, BARS, MADE OF OXIDE  
CERAMIC FOR USE IN MATERIAL TREATMENT  
AND TESTING IN HIGH TEMPERATURE RANGE  
AND HIGHEST TEMPERATURE RANGE, ELEC-  
TRIC INSULATION, CONDUCTION OF GAS INTO  
METAL AND GLASS MELTS, IN CLASS 19 (U.S. CLS.  
1, 12, 33 AND 50).

THE MARK CONSISTS OF STANDARD CHAR-  
ACTERS WITHOUT CLAIM TO ANY PARTICULAR  
FONT, STYLE, SIZE, OR COLOR.

OWNER OF INTERNATIONAL REGISTRATION  
0963013 DATED 10-2-2007, EXPIRES 10-2-2017.

THE WORDING "DEGUSSIT" APPEARING IN  
THE MARK HAS NO MEANING IN A FOREIGN  
LANGUAGE.

SER. NO. 79-053,373, FILED 10-2-2007.

KELLY MCCOY, EXAMINING ATTORNEY

**Int. Cls.: 9 and 38**

**Prior U.S. Cls.: 21, 23, 26, 36, 38, 100, 101 and 104**

**United States Patent and Trademark Office**

**Reg. No. 3,570,265**

**Registered Feb. 3, 2009**

**TRADEMARK  
SERVICE MARK  
PRINCIPAL REGISTER**



BOUCHAIB CHAKIR (FED REP GERMANY IN-  
DIVIDUAL)  
STUTTGARTER STRASSE 38  
73635 RUDERSBERG, FED REP GERMANY

FOR: SATELLITE RECEIVERS, SATELLITE AN-  
TENNAS, LNB CONVERTERS, IN CLASS 9 (U.S.  
CLS. 21, 23, 26, 36 AND 38).

FOR: TELECOMMUNICATIONS, NAMELY, SA-  
TELLITE TRANSMISSION AND SATELLITE COM-  
MUNICATION SERVICES, IN CLASS 38 (U.S. CLS.  
100, 101 AND 104).

OWNER OF INTERNATIONAL REGISTRATION  
0963064 DATED 4-10-2008, EXPIRES 4-10-2018.

THE COLOR(S) YELLOW, BLACK AND GREY IS/  
ARE CLAIMED AS A FEATURE OF THE MARK.

THE TRADEMARK CONSISTS OF THE COLORS  
YELLOW, GRAY AND BLACK, WITH THE COLOR  
YELLOW APPEARING IN THE STAR DESIGN, THE  
COLOR GRAY APPEARING IN THE OVAL DE-  
SIGN, AND THE WORDING "GOLDEN INTER-  
STAR" IN THE COLOR BLACK.

SER. NO. 79-053,395, FILED 4-10-2008.

PATRICIA EVANKO, EXAMINING ATTORNEY



**Int. Cl.: 32**

**Prior U.S. Cls.: 45, 46 and 48**

**United States Patent and Trademark Office**

**Reg. No. 3,570,266**

**Registered Feb. 3, 2009**

**TRADEMARK  
PRINCIPAL REGISTER**

**ELEPHANT**



CARLSBERG A/S (DENMARK CORPORATION)  
NY CARLSBERG VEJ 100  
DK-1760 COPENHAGEN V.  
DENMARK

THE COLOR(S) GREY, WHITE, BLACK AND  
GOLD IS/ARE CLAIMED AS A FEATURE OF THE  
MARK.

FOR: BEERS AND NON-ALCOHOLIC BEERS, IN  
CLASS 32 (U.S. CLS. 45, 46 AND 48).

THE MARK CONSISTS OF THE WORDING "ELE-  
PHANT" IN BLACK LETTERING OUTLINED IN  
GOLD, BELOW WHICH IS A GREY ELEPHANT  
LINED IN BLACK AND WITH WHITE TUSKS.

PRIORITY DATE OF 11-7-2007 IS CLAIMED.

OWNER OF INTERNATIONAL REGISTRATION  
0963952 DATED 4-29-2008, EXPIRES 4-29-2018.

SER. NO. 79-053,698, FILED 4-29-2008.

OWNER OF U.S. REG. NO. 906,899.

REBECCA POVARCHUK, EXAMINING ATTOR-  
NEY

**Int. Cl.: 32**

**Prior U.S. Cls.: 45, 46 and 48**

**United States Patent and Trademark Office**

**Reg. No. 3,570,267**

**Registered Feb. 3, 2009**

**TRADEMARK  
PRINCIPAL REGISTER**

**ELEPHANT**

CARLSBERG A/S (DENMARK CORPORATION)  
NY CARLSBERG VEJ 100  
DK-1760 COPENHAGEN V.  
DENMARK

FOR: BEERS AND NON-ALCOHOLIC BEERS, IN  
CLASS 32 (U.S. CLS. 45, 46 AND 48).

THE MARK CONSISTS OF STANDARD CHAR-  
ACTERS WITHOUT CLAIM TO ANY PARTICULAR  
FONT, STYLE, SIZE, OR COLOR.

OWNER OF INTERNATIONAL REGISTRATION  
0964129 DATED 4-29-2008, EXPIRES 4-29-2018.

OWNER OF U.S. REG. NO. 906,899.

SER. NO. 79-053,759, FILED 4-29-2008.

REBECCA POVARCHUK, EXAMINING ATTOR-  
NEY

**Int. Cl.: 17**

**Prior U.S. Cls.: 1, 5, 12, 13, 35 and 50**

**United States Patent and Trademark Office**

**Reg. No. 3,570,268**

**Registered Feb. 3, 2009**

**TRADEMARK  
PRINCIPAL REGISTER**

**MIGUTAN**

MIGUA FUGENSYSTEME GMBH & CO. KG  
(FED REP GERMANY K.G.)  
DIESELSTRASSE 20-24  
42489 WÜLFRATH, FED REP GERMANY

OWNER OF INTERNATIONAL REGISTRATION  
0525460 DATED 3-11-1988, EXPIRES 3-11-2018.

FOR: JOINT PACKINGS MADE OF RUBBER OR  
PLASTIC AND/OR METAL FOR USE IN CON-  
STRUCTION, IN CLASS 17 (U.S. CLS. 1, 5, 12, 13, 35  
AND 50).

SER. NO. 79-053,942, FILED 3-12-2008.

RON FAIRBANKS, EXAMINING ATTORNEY

**Int. Cl.: 33**

**Prior U.S. Cls.: 47 and 49**

**United States Patent and Trademark Office**

**Reg. No. 3,570,269**

**Registered Feb. 3, 2009**

**TRADEMARK  
PRINCIPAL REGISTER**

**JÈMA**

GERARDO CESARI S.P.A. (ITALY JOINT STOCK  
COMPANY)  
VIA L. CIOCCA, 35  
I-25027 QUINZANO D'OGGIO (BS)  
ITALY

FOR: WINES; SPIRITS; LIQUEURS; ALCOHOLIC  
BEVERAGES, NAMELY, SPARKLING WINE, AND  
PREPARED ALCOHOLIC COCKTAILS, IN CLASS 33  
(U.S. CLS. 47 AND 49).

THE MARK CONSISTS OF STANDARD CHAR-  
ACTERS WITHOUT CLAIM TO ANY PARTICULAR  
FONT, STYLE, SIZE, OR COLOR.

PRIORITY DATE OF 2-29-2008 IS CLAIMED.

OWNER OF INTERNATIONAL REGISTRATION  
0965394 DATED 4-7-2008, EXPIRES 4-7-2018.

THE WORDING "JEMA" HAS NO MEANING IN  
A FOREIGN LANGUAGE.

SER. NO. 79-054,267, FILED 4-7-2008.

LESLIE RICHARDS, EXAMINING ATTORNEY

**Int. Cl.: 9**

**Prior U.S. Cls.: 21, 23, 26, 36 and 38**

**Reg. No. 3,570,270**

**United States Patent and Trademark Office**

**Registered Feb. 3, 2009**

**TRADEMARK  
PRINCIPAL REGISTER**



GIO GOI BRANDS LIMITED  
13 MELVILLE STREET  
EDINBURGH EH3 7PE  
UNITED KINGDOM

FOR: PRE-RECORDED PHONOGRAPH RECORDS, COMPACT DISCS, AUDIO AND VIDEO TAPES, AUDIO AND VIDEO CASSETTES, AUDIO AND VIDEO CARTRIDGES, ALL BEARING SOUND RECORDINGS, VIDEO RECORDINGS, DATA, IMAGES, GAMES, GRAPHICS, TEXT, PROGRAMMES OR INFORMATION IN THE FIELDS OF FASHION, MUSIC, SPORT OR ENTERTAINMENT; DOWNLOADABLE ELECTRONIC PUBLICATIONS, NAMELY, NEWSLETTERS AND BROCHURES FEATURING FASHION, MUSIC, SPORT OR ENTERTAINMENT; MUSICAL SOUND AND VIDEO RECORDINGS; DIGITAL MUSIC DOWNLOADABLE FROM THE INTERNET; MOBILE PHONES; MOBILE PHONE COVERS; DOWNLOADABLE MOBILE PHONE ACCESSORIES, NAMELY, RINGTONES AND WALLPAPERS; PHONE CARDS,

NAMELY, PRE-PAID TELEPHONE CALLING CARDS, MAGNETICALLY ENCODED; CREDIT CARDS, NAMELY, MAGNETICALLY ENCODED CREDIT CARDS; CONTACT LENSES, SPECTACLES AND SUNGLASSES; EYEGGLASS CASES; GOGGLES FOR SPORTS; PROTECTIVE HELMETS, PROTECTIVE HELMETS FOR SPORTS, IN CLASS 9 (U.S. CLS. 21, 23, 26, 36 AND 38).

OWNER OF INTERNATIONAL REGISTRATION 0966300 DATED 4-3-2008, EXPIRES 4-3-2018.

OWNER OF U.S. REG. NOS. 3,250,144 AND 3,418,632.

THE MARK CONSISTS OF THE STYLIZED WORDS "GIO-GOI".

SER. NO. 79-054,579, FILED 4-3-2008.

ALYSSA STEEL, EXAMINING ATTORNEY

**Int. Cls.: 9, 10 and 42**

**Prior U.S. Cls.: 21, 23, 26, 36, 38, 39, 44, 100 and 101**

**Reg. No. 3,570,271**

**United States Patent and Trademark Office**

**Registered Feb. 3, 2009**

**TRADEMARK  
SERVICE MARK  
PRINCIPAL REGISTER**

**CNAA**

CNSYSTEMS MEDIZINTECHNIK AG (AUSTRIA  
PUBLIC LIMITED COMPANY)  
REININGHAUSSTRASSE 13  
A-8020 GRAZ  
AUSTRIA

FOR: SCIENTIFIC AND ELECTRONIC APPARATUSES AND INSTRUMENTS ESPECIALLY FOR PROCESSING OF ELECTRONIC SIGNALS, NAMELY, POLYGRAPHS; COMPUTER SOFTWARE, NAMELY, COMPUTER SOFTWARE STORED ON DATA CARRIERS FOR PROCESSING ELECTRONIC SIGNALS IN THE FIELD OF MEDICINE, IN CLASS 9 (U.S. CLS. 21, 23, 26, 36 AND 38).

FOR: MEDICAL APPARATUSES AND INSTRUMENTS, ESPECIALLY FOR THE MEASURING AND THE INTERPRETATION OF BIO-SIGNALS, NAMELY, BLOOD PRESSURE MEASURING APPARATUS, IMPEDANCE CARDIOGRAPHS, ELECTROCARDIOGRAPHS, PULSE OXIMETERS FOR THE ANALYSIS OF THE FUNCTION AND PATHOLOGY OF THE CIRCULATORY SYSTEM; MEDICAL DIAGNOSTIC MONITORING SYSTEM COMPRISED OF BLOOD PRESSURE MONITOR, IMPEDANCE CARDIOGRAPH, ELECTROCARDIOGRAPH, OSCILLOSCOPE AND OSCILLOMETRIC BLOOD PRESSURE MONITORS FOR THE MEASUREMENT AND RECORDATION OF HAEMODYNAMIC PARAME-

TERS, NAMELY, HEART RATE, STROKE VOLUME, CARDIAC OUTPUT, BLOOD PRESSURE, TOTAL PERIPHERAL RESISTANCE, BARORECEPTOR REFLEX SENSITIVITY, VAGAL AND SYMPATHETIC TONE; MEDICAL APPARATUS AND INSTRUMENTS, NAMELY, NON-INVASIVE DIAGNOSIS AIDING MONITORING UNIT FOR THE RECORDATION OF HAEMODYNAMIC PARAMETERS, IN CLASS 10 (U.S. CLS. 26, 39 AND 44).

FOR: MEDICAL RESEARCH, NAMELY, RESEARCHING THE DEVELOPMENT OF MEDICAL EQUIPMENT AND INSTRUMENTS; AND COMPUTER SOFTWARE DEVELOPMENT AND MAINTENANCE IN THE FIELD OF MEDICINE, IN CLASS 42 (U.S. CLS. 100 AND 101).

THE MARK CONSISTS OF STANDARD CHARACTERS WITHOUT CLAIM TO ANY PARTICULAR FONT, STYLE, SIZE, OR COLOR.

OWNER OF INTERNATIONAL REGISTRATION  
0966841 DATED 4-17-2008, EXPIRES 4-17-2018.

SER. NO. 79-054,747, FILED 4-17-2008.

FRANK LATTUCA, EXAMINING ATTORNEY

**Int. Cls.: 9, 10 and 42**

**Prior U.S. Cls.: 21, 23, 26, 36, 38, 39, 44, 100 and 101**

**United States Patent and Trademark Office**

**Reg. No. 3,570,272**

**Registered Feb. 3, 2009**

**TRADEMARK  
SERVICE MARK  
PRINCIPAL REGISTER**

**CNCO**

CNSYSTEMS MEDIZINTECHNIK AG (AUSTRIA  
PUBLIC LIMITED COMPANY)  
REININGHAUSSTRASSE 13  
A-8020 GRAZ  
AUSTRIA

FOR: SCIENTIFIC AND ELECTRONIC APPARATUSES AND INSTRUMENTS ESPECIALLY FOR PROCESSING OF ELECTRONIC SIGNALS, NAMELY, POLYGRAPHS; COMPUTER SOFTWARE, NAMELY, COMPUTER SOFTWARE STORED ON DATA CARRIERS FOR PROCESSING ELECTRONIC SIGNALS IN THE FIELD OF MEDICINE, IN CLASS 9 (U.S. CLS. 21, 23, 26, 36 AND 38).

FOR: MEDICAL APPARATUSES AND INSTRUMENTS, ESPECIALLY FOR THE MEASURING AND THE INTERPRETATION OF BIO-SIGNALS, NAMELY, BLOOD PRESSURE MEASURING APPARATUS, IMPEDANCE CARDIOGRAPHS, ELECTROCARDIOGRAPHS, PULSE OXIMETERS FOR THE ANALYSIS OF THE FUNCTION AND PATHOLOGY OF THE CIRCULATORY SYSTEM; MEDICAL DIAGNOSTIC MONITORING SYSTEM COMPRISED OF BLOOD PRESSURE MONITOR, IMPEDANCE CARDIOGRAPH, ELECTROCARDIOGRAPH, OSCILLOSCOPE AND OSCILLOMETRIC BLOOD PRESSURE MONITORS FOR THE MEASUREMENT AND RECORDATION OF HAEMODYNAMIC PARAME-

TERS, NAMELY, HEART RATE, STROKE VOLUME, CARDIAC OUTPUT, BLOOD PRESSURE, TOTAL PERIPHERAL RESISTANCE, BARORECEPTOR REFLEX SENSITIVITY, VAGAL AND SYMPATHETIC TONE; MEDICAL APPARATUS AND INSTRUMENTS, NAMELY, NON-INVASIVE DIAGNOSIS AIDING MONITORING UNIT FOR THE RECORDATION OF HAEMODYNAMIC PARAMETERS, IN CLASS 10 (U.S. CLS. 26, 39 AND 44).

FOR: MEDICAL RESEARCH, NAMELY, RESEARCHING THE DEVELOPMENT OF MEDICAL EQUIPMENT AND INSTRUMENTS; AND COMPUTER SOFTWARE DEVELOPMENT AND MAINTENANCE IN THE FIELD OF MEDICINE, IN CLASS 42 (U.S. CLS. 100 AND 101).

THE MARK CONSISTS OF STANDARD CHARACTERS WITHOUT CLAIM TO ANY PARTICULAR FONT, STYLE, SIZE, OR COLOR.

OWNER OF INTERNATIONAL REGISTRATION 0966842 DATED 4-17-2008, EXPIRES 4-17-2018.

SER. NO. 79-054,748, FILED 4-17-2008.

FRANK LATTUCA, EXAMINING ATTORNEY

**Int. Cl.: 1**

**Prior U.S. Cls.: 1, 5, 6, 10, 26 and 46**

**United States Patent and Trademark Office**

**Reg. No. 3,570,273**

**Registered Feb. 3, 2009**

**TRADEMARK  
PRINCIPAL REGISTER**



NOVOZYMES A/S (DENMARK CORPORATION)  
KROGSHOEJVEJ 36  
DK-2880 BAGSVAERD  
DENMARK

FOR: ENZYMES FOR USE IN THE PULP AND  
PAPER INDUSTRY, IN CLASS 1 (U.S. CLS. 1, 5, 6, 10,  
26 AND 46).

PRIORITY DATE OF 4-29-2008 IS CLAIMED.

OWNER OF INTERNATIONAL REGISTRATION  
0967610 DATED 5-19-2008, EXPIRES 5-19-2018.

OWNER OF U.S. REG. NO. 3,476,971.

THE MARK CONSISTS OF THE WORD "FIBER-  
CARE" IN STYLIZED FONT WITH A STYLIZED  
FOUR-LEAF CLOVER TO THE RIGHT.

SER. NO. 79-055,033, FILED 5-19-2008.

ADA HAN, EXAMINING ATTORNEY



Int. Cl.: 33

Prior U.S. Cls.: 47 and 49

**United States Patent and Trademark Office**

**Reg. No. 3,570,274**

Registered Feb. 3, 2009

**TRADEMARK  
PRINCIPAL REGISTER**

**LES TROIS COURONNES**

LOUIS MOUSSET SA; (SOCIÉTÉ ANONYME)  
(FRANCE SOCIÉTÉ ANONYME (SA))  
CHÂTEAU DES FINES ROCHES  
F-84230 CHATEAUNEUF DU PAPE  
FRANCE

THE FOREIGN WORDING IN THE MARK  
TRANSLATES INTO ENGLISH AS THE THREE  
CROWNS.

FOR: WINES, APERITIFS, IN CLASS 33 (U.S. CLS.  
47 AND 49).

SER. NO. 79-055,291, FILED 4-29-2008.

OWNER OF INTERNATIONAL REGISTRATION  
0239378 DATED 1-19-1961, EXPIRES 1-19-2011.

LAURIE KAUFMAN, EXAMINING ATTORNEY

**Int. Cl.: 5**

**Prior U.S. Cls.: 6, 18, 44, 46, 51 and 52**

**United States Patent and Trademark Office**

**Reg. No. 3,570,275**

**Registered Feb. 3, 2009**

**TRADEMARK  
PRINCIPAL REGISTER**

**DEXERYL**

PIERRE FABRE MEDICAMENT (FRANCE SOCI-  
ETE ANONYME)  
45, PLACE ABEL GANCE  
F-92100 BOULOGNE  
FRANCE

OWNER OF INTERNATIONAL REGISTRATION  
0713645 DATED 5-25-1999, EXPIRES 5-25-2009.

FOR: PHARMACEUTICAL PRODUCTS FOR  
TREATING HUMAN SKIN DRYNESS AND DER-  
MATOSES, IN CLASS 5 (U.S. CLS. 6, 18, 44, 46, 51 AND  
52).

THE WORDING "DEXERYL" HAS NO MEANING  
IN A FOREIGN LANGUAGE

THE MARK CONSISTS OF STANDARD CHAR-  
ACTERS WITHOUT CLAIM TO ANY PARTICULAR  
FONT, STYLE, SIZE, OR COLOR.

SER. NO. 79-055,616, FILED 3-3-2008.

MYRIAH HABEEB, EXAMINING ATTORNEY

**Int. Cls.: 35 and 36**

**Prior U.S. Cls.: 100, 101 and 102**

**United States Patent and Trademark Office**

**Reg. No. 3,570,276**

**Registered Feb. 3, 2009**

**SERVICE MARK  
PRINCIPAL REGISTER**



**Alexander von Humboldt**  
Stiftung/Foundation

ALEXANDER VON HUMBOLDT-STIFTUNG  
(FED REP GERMANY FOUNDATION)  
JEAN-PAUL-STRABE 12  
53173 BONN  
FED REP GERMANY

FOR: ADVERTISING SERVICES, BUSINESS MANAGEMENT, BUSINESS ADMINISTRATION AND OFFICE WORK, EACH IN CONNECTION WITH THE GRANTING OF RESEARCH SCHOLARSHIPS AND RESEARCH AWARDS FOR THE INTERNATIONAL PROMOTION OF SCIENCE AND RESEARCH, IN CLASS 35 (U.S. CLS. 100, 101 AND 102).

FOR: PROVISION OF FINANCIAL SUPPORT FOR THE GRANTING OF RESEARCH SCHOLARSHIPS AND RESEARCH AWARDS AS AN INTERNATIONAL PROMOTION OF SCIENCE AND RESEARCH, IN CLASS 36 (U.S. CLS. 100, 101 AND 102).

OWNER OF INTERNATIONAL REGISTRATION  
0969189 DATED 3-27-2008, EXPIRES 3-27-2018.

NO CLAIM IS MADE TO THE EXCLUSIVE RIGHT TO USE "STIFTUNG" AND "FOUNDATION", APART FROM THE MARK AS SHOWN.

THE NAME(S), PORTRAIT(S), AND/OR SIGNATURE(S) SHOWN IN THE MARK DOES NOT IDENTIFY A PARTICULAR LIVING INDIVIDUAL.

THE ENGLISH TRANSLATION OF "STIFTUNG" IN THE MARK IS "FOUNDATION".

SER. NO. 79-055,646, FILED 3-27-2008.

DOMINIC FATHY, EXAMINING ATTORNEY

**Int. Cl.: 5**

**Prior U.S. Cls.: 6, 18, 44, 46, 51 and 52**

**United States Patent and Trademark Office**

**Reg. No. 3,570,277**

**Registered Feb. 3, 2009**

**TRADEMARK  
PRINCIPAL REGISTER**

**VETORPHALE**

MEIJI SEIKA KAISHA, LTD. (JAPAN CORPORATION)  
NO. 4-16, KYOBASHI 2-CHOME  
CHUO-KU; TOKYO 104-8002  
JAPAN

PRIORITY DATE OF 6-5-2008 IS CLAIMED.

OWNER OF INTERNATIONAL REGISTRATION  
0969382 DATED 6-25-2008, EXPIRES 6-25-2018.

FOR: ANALGESICS FOR ANIMAL USE, IN  
CLASS 5 (U.S. CLS. 6, 18, 44, 46, 51 AND 52).

SER. NO. 79-055,731, FILED 6-25-2008.

THE MARK CONSISTS OF STANDARD CHARACTERS WITHOUT CLAIM TO ANY PARTICULAR FONT, STYLE, SIZE, OR COLOR.

EUGENIA MARTIN, EXAMINING ATTORNEY

**Int. Cl.: 5**

**Prior U.S. Cls.: 6, 18, 44, 46, 51 and 52**

**United States Patent and Trademark Office**

**Reg. No. 3,570,278**

**Registered Feb. 3, 2009**

**TRADEMARK  
PRINCIPAL REGISTER**

**WELLMATE**

MEIJI SEIKA KAISHA, LTD. (JAPAN CORPORATION)  
NO. 4-16, KYOBASHI 2-CHOME  
CHUO-KU; TOKYO 104-8002  
JAPAN

FOR: ANTIBIOTICS FOR ANIMAL USE, IN  
CLASS 5 (U.S. CLS. 6, 18, 44, 46, 51 AND 52).

THE MARK CONSISTS OF STANDARD CHARACTERS WITHOUT CLAIM TO ANY PARTICULAR FONT, STYLE, SIZE, OR COLOR.

PRIORITY DATE OF 6-5-2008 IS CLAIMED.

OWNER OF INTERNATIONAL REGISTRATION  
0969383 DATED 6-25-2008, EXPIRES 6-25-2018.

SER. NO. 79-055,732, FILED 6-25-2008.

EUGENIA MARTIN, EXAMINING ATTORNEY

**Int. Cl.: 30**

**Prior U.S. Cl.: 46**

**United States Patent and Trademark Office**

**Reg. No. 3,570,279**

**Registered Feb. 3, 2009**

**TRADEMARK  
PRINCIPAL REGISTER**

**FX10**

LAFFORT (FRANCE SAS)  
ZA DE LA JACQUOTTE,  
11 RUE ARISTIDE BERGÈS; F-33270 FLOIRAC  
FRANCE

OWNER OF INTERNATIONAL REGISTRATION  
0969962 DATED 6-18-2008, EXPIRES 6-18-2018.

FOR: YEASTS, IN CLASS 30 (U.S. CL. 46).

SER. NO. 79-055,950, FILED 6-18-2008.

THE MARK CONSISTS OF STANDARD CHAR-  
ACTERS WITHOUT CLAIM TO ANY PARTICULAR  
FONT, STYLE, SIZE, OR COLOR.

SUSAN RICHARDS, EXAMINING ATTORNEY

**Int. Cl.: 36**

**Prior U.S. Cls.: 100, 101 and 102**

**United States Patent and Trademark Office**

**Reg. No. 3,570,280**

**Registered Feb. 3, 2009**

**SERVICE MARK  
PRINCIPAL REGISTER**

**OSTIAN CAPITAL**

BRUNO GARDIEN (FRANCE INDIVIDUAL)  
39 MONT D'AZUR  
ROUTE DE BIOT; F-06560 VALBONNE  
FRANCE

OWNER OF INTERNATIONAL REGISTRATION  
0970301 DATED 4-4-2008, EXPIRES 4-4-2018.

FOR: FINANCIAL ANALYSIS; RAISING AND  
INVESTING CAPITAL FOR OTHERS; FINANCIAL  
CONSULTING, IN CLASS 36 (U.S. CLS. 100, 101 AND  
102).

NO CLAIM IS MADE TO THE EXCLUSIVE  
RIGHT TO USE "CAPITAL", APART FROM THE  
MARK AS SHOWN.

THE MARK CONSISTS OF STANDARD CHAR-  
ACTERS WITHOUT CLAIM TO ANY PARTICULAR  
FONT, STYLE, SIZE, OR COLOR.

THE WORDING "OSTIAN" HAS NO MEANING  
IN A FOREIGN LANGUAGE.

PRIORITY DATE OF 10-10-2007 IS CLAIMED.

SER. NO. 79-056,113, FILED 4-4-2008.

DAYNA BROWNE, EXAMINING ATTORNEY

**Int. Cl.: 20**

**Prior U.S. Cls.: 2, 13, 22, 25, 32 and 50**

**United States Patent and Trademark Office**

**Reg. No. 3,570,281**

**Registered Feb. 3, 2009**

**TRADEMARK  
PRINCIPAL REGISTER**

# **Frandiss**

DONGGUAN FUBAO; SOFA MANUFACTURING  
CO., LTD. (CHINA CORPORATION)  
SHIDA ROAD  
XIANGDONG INDUSTRIAL DISTRICT; DALING-  
SHAN TOWN; DONGGUAN CITY; GUANG-  
DONG  
CHINA

OWNER OF INTERNATIONAL REGISTRATION  
0970997 DATED 6-24-2008, EXPIRES 6-24-2018.

SER. NO. 79-056,375, FILED 6-24-2008.

FOR: FURNITURE, IN CLASS 20 (U.S. CLS. 2, 13,  
22, 25, 32 AND 50).

AISHA CLARKE, EXAMINING ATTORNEY



**Int. Cl.: 20**

**Prior U.S. Cls.: 2, 13, 22, 25, 32 and 50**

**United States Patent and Trademark Office**

**Reg. No. 3,570,282**

**Registered Feb. 3, 2009**

**TRADEMARK  
PRINCIPAL REGISTER**

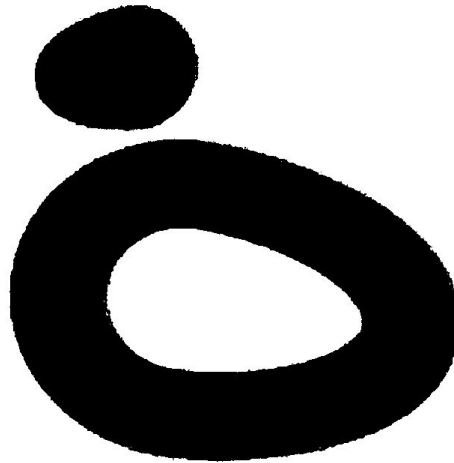

**NATUZZI S.P.A. (ITALY JOINT STOCK COMPAN-  
NY)**

**CORSO CAVOUR, 51**

**I-70121 BARI**

**ITALY**

**FOR: DIVANS, SOFA BEDS, ARMCHAIRS,  
POUFS BEING FURNITURE, CHAISE LONGUES,  
IN CLASS 20 (U.S. CLS. 2, 13, 22, 25, 32 AND 50).**

**PRIORITY DATE OF 1-4-2008 IS CLAIMED.**

**OWNER OF INTERNATIONAL REGISTRATION  
0971302 DATED 2-11-2008, EXPIRES 2-11-2018.**

**THE MARK CONSISTS OF A DESIGN OF TWO  
OVALS. THE BOTTOM OVAL SHAPE IS LARGER,  
UN-SHADED AND HAS BLURRED BORDERS. THE  
TOP OVAL SHAPE IS SMALLER, SHADED, AND  
HAS BLURRED BORDERS.**

**SER. NO. 79-056,486, FILED 2-11-2008.**

**DEBRA LEE, EXAMINING ATTORNEY**

**Int. Cls.: 7 and 12**

**Prior U.S. Cls.: 13, 19, 21, 23, 31, 34, 35 and 44**

**United States Patent and Trademark Office**

**Reg. No. 3,570,283**

**Registered Feb. 3, 2009**

**TRADEMARK  
PRINCIPAL REGISTER**



HANGZHOU TRUEMAX; MACHINERY & EQUIPMENT CO., LTD. (CHINA CORPORATION)  
1-23A GUODU DEVELOPMENT BUILDING,  
NO. 182 CHAOHUI ROAD,; XIACHENG,; HANGZHOU; ZHEJIANG  
CHINA

FOR: EARTH MOVING MACHINES; EXCAVATORS; LOADING AND UNLOADING MACHINES; LIFTING INSTALLATIONS FOR THE TRANSPORT OF PERSONS AND GOODS, IN CLASS 7 (U.S. CLS. 13, 19, 21, 23, 31, 34 AND 35).

FOR: FORK LIFT TRUCKS; CARS; CABLE CARS; WAGONS; AIR PUMPS OF AUTOMOBILES; TROLLEYS, IN CLASS 12 (U.S. CLS. 19, 21, 23, 31, 35 AND 44).

OWNER OF INTERNATIONAL REGISTRATION  
0972912 DATED 4-10-2008, EXPIRES 4-10-2018.

SER. NO. 79-057,192, FILED 4-10-2008.

JOHN WILKE, EXAMINING ATTORNEY

**Int. Cl.: 12**

**Prior U.S. Cls.: 19, 21, 23, 31, 35 and 44**

**Reg. No. 3,570,284**

**United States Patent and Trademark Office**

**Registered Feb. 3, 2009**

**TRADEMARK  
PRINCIPAL REGISTER**

**KODIAK**

OTTO BOCK HEALTHCARE GMBH (FED REP  
GERMANY LIMITED LIABILITY COMPANY)  
MAX-NÄEDER-STRASSE 15  
37115 DUDERSTADT  
FED REP GERMANY

FOR: WHEEL CHAIRS AND SUPPORTING  
FRAMES FOR WHEEL CHAIRS, IN CLASS 12 (U.S.  
CLS. 19, 21, 23, 31, 35 AND 44).

THE MARK CONSISTS OF STANDARD CHAR-  
ACTERS WITHOUT CLAIM TO ANY PARTICULAR  
FONT, STYLE, SIZE, OR COLOR.

PRIORITY DATE OF 5-2-2008 IS CLAIMED.

OWNER OF INTERNATIONAL REGISTRATION  
0972915 DATED 6-25-2008, EXPIRES 6-25-2018.

SER. NO. 79-057,195, FILED 6-25-2008.

SHAILA SETTLES, EXAMINING ATTORNEY

**Int. Cl.: 25**

**Prior U.S. Cls.: 22 and 39**

**United States Patent and Trademark Office**

**Reg. No. 3,570,285**

**Registered Feb. 3, 2009**

**TRADEMARK  
PRINCIPAL REGISTER**



KUBOTA SANGYO CO., LTD. (JAPAN CORPORATION)  
73, TAMACHI 4-CHOME  
AOI-KU.; SHIZUOKA-SHI; SHIZUOKA 420-0068  
JAPAN

OWNER OF INTERNATIONAL REGISTRATION  
0974333 DATED 2-22-2008, EXPIRES 2-22-2018.

SER. NO. 79-057,743, FILED 2-22-2008.

FOR: FOOTWEAR, NAMELY, SANDALS, SHOES,  
BOOTS, CANVAS SHOES; INSOLES FOR FOOT-  
WEAR, IN CLASS 25 (U.S. CLS. 22 AND 39).

LEIGH LOWRY, EXAMINING ATTORNEY

**Int. Cls.: 35 and 40**

**Prior U.S. Cls.: 100, 101, 102, 103, and 106**

**United States Patent and Trademark Office**

**Reg. No. 3,570,286**

**Registered Feb. 3, 2009**

**SERVICE MARK  
PRINCIPAL REGISTER**

**PETRO STAR**

PETRO STAR INC. (ALASKA CORPORATION)  
3900 C STREET, SUITE 802  
ANCHORAGE, AK 995035966

FOR: RETAIL STORES AND WHOLESALE DISTRIBUTORSHIPS FEATURING PETROLEUM PRODUCTS, NAMELY, FUEL OIL, GASOLINE, DIESEL FUEL, AND CRUDE OIL; RETAIL CONVENIENCE STORE SERVICES, IN CLASS 35 (U.S. CLS. 100, 101 AND 102).

FIRST USE 1-0-1986; IN COMMERCE 1-0-1986.

FOR: OIL AND FUEL REFINING SERVICES, IN CLASS 40 (U.S. CLS. 100, 103 AND 106).

FIRST USE 1-0-1986; IN COMMERCE 1-0-1986.

NO CLAIM IS MADE TO THE EXCLUSIVE RIGHT TO USE "PETRO", APART FROM THE MARK AS SHOWN.

SN 76-458,496, FILED 10-16-2002.

WILLIAM BRECKENFELD, EXAMINING ATTORNEY

**Int. Cls.: 24 and 25**

**Prior U.S. Cls.: 22, 39, 42, and 50**

**United States Patent and Trademark Office**

**Reg. No. 3,570,287**

**Registered Feb. 3, 2009**

**TRADEMARK  
PRINCIPAL REGISTER**

**ZERO DETECT**

BURSEY, WILLIAM S. (UNITED STATES INDIVIDUAL)  
725 COLLINSVILLE ROAD  
CROSS JUNCTION, VA 22625

FOR: FABRICS, NAMELY, COTTON FABRIC AND WATERPROOF FABRIC FOR USE IN THE MANUFACTURE OF CLOTHING, BACKPACKS AND HUNTERS BLINDS , IN CLASS 24 (U.S. CLS. 42 AND 50).

FIRST USE 9-11-2008; IN COMMERCE 9-11-2008.

FOR: CLOTHING, NAMELY, COATS, WIND-RESISTANT JACKETS, PARKAS, GLOVES, SHIRTS,

COVERALLS AND TROUSERS, IN CLASS 25 (U.S. CLS. 22 AND 39).

FIRST USE 9-11-2008; IN COMMERCE 9-11-2008.

THE MARK CONSISTS OF STANDARD CHARACTERS WITHOUT CLAIM TO ANY PARTICULAR FONT, STYLE, SIZE, OR COLOR.

SN 76-570,995, FILED 1-20-2004.

MICHAEL KEATING, EXAMINING ATTORNEY

**Int. Cl.: 8**

**Prior U.S. Cls.: 23, 28, and 44**

**Reg. No. 3,570,288**

**United States Patent and Trademark Office**

**Registered Feb. 3, 2009**

---

**TRADEMARK  
PRINCIPAL REGISTER**

**NSW**

THE GREAT AMERICAN TOOL COMPANY,  
INC. (DELAWARE CORPORATION)  
665 HERTEL AVENUE  
BUFFALO, NY 14207

THE MARK CONSISTS OF STANDARD CHAR-  
ACTERS WITHOUT CLAIM TO ANY PARTICULAR  
FONT, STYLE, SIZE, OR COLOR.

FOR: MILITARY FIXED BLADE AND FOLDING  
TACTICAL KNIVES, IN CLASS 8 (U.S. CLS. 23, 28  
AND 44).

SN 76-583,299, FILED 3-25-2004.

FIRST USE 12-5-2008; IN COMMERCE 12-5-2008.

IRA J. GOODSaid, EXAMINING ATTORNEY

**Int. Cl.: 42**

**Prior U.S. Cls.: 100 and 101**

**United States Patent and Trademark Office**

**Reg. No. 3,570,289**

**Registered Feb. 3, 2009**

**SERVICE MARK  
PRINCIPAL REGISTER**

**CARA**

THE CARA GROUP, INC. (ILLINOIS CORPORATION)  
ONE TOWER LANE, SUITE 1700  
OAK BROOK TERRACE, IL 60181

FOR: COMPUTER PROGRAMMING SERVICES FOR OTHERS; CONSULTING IN THE FIELDS OF COMPUTER SYSTEMS AND COMPUTER SOFTWARE; DESIGN FOR OTHERS OF COMPUTER SYSTEMS AND COMPUTER SOFTWARE; COMPUTER SERVICES, NAMELY, PROVIDING DATABASES FEATURING INFORMATION ON COMPUTERS AND COMPUTER SOFTWARE; INSTALLATION, IMPLEMENTATION, INTEGRATION AND MAINTENANCE OF COMPUTER SOFTWARE; DEVELOPMENT FOR OTHERS OF INTERNET AND EXTRANET SOFTWARE APPLI-

CATIONS; COMPUTER HELP DESK SERVICES FOR OTHERS, NAMELY, TROUBLESHOOTING COMPUTER SOFTWARE AND HARDWARE PROBLEMS; AND CONSULTING SERVICES RELATING TO THE FOREGOING, IN CLASS 42 (U.S. CLS. 100 AND 101).

FIRST USE 12-31-2003; IN COMMERCE 12-31-2003.

THE MARK CONSISTS OF STANDARD CHARACTERS WITHOUT CLAIM TO ANY PARTICULAR FONT, STYLE, SIZE, OR COLOR.

SN 76-583,549, FILED 3-26-2004.

ELLEN B. AWRICH, EXAMINING ATTORNEY



**Int. Cl.: 35**

**Prior U.S. Cls.: 100, 101, and 102**

**United States Patent and Trademark Office**

**Reg. No. 3,570,290**

**Registered Feb. 3, 2009**

**SERVICE MARK  
PRINCIPAL REGISTER**

**True**

TRUEBEGINNINGS, LLC (TEXAS LIMITED LIABILITY COMPANY)  
300 DECKER DRIVE  
IRVING, TX 75062

FOR: CAREER NETWORKING SERVICES, NAMELY, PROVIDING CAREER INFORMATION IN THE NATURE OF AN INDEX OF POTENTIAL EMPLOYEES BY MEANS OF GLOBAL COMPUTER NETWORKS; PERSONNEL PLACEMENT AND RECRUITMENT SERVICES, NAMELY, SCREENING AND SOURCING OF POTENTIAL JOB CANDIDATES FOR POTENTIAL EMPLOYERS VIA A GLOBAL COMPUTER NETWORK; EMPLOYMENT

AGENT AND COUNSELOR SERVICES, NAMELY, EMPLOYMENT RECRUITMENT SERVICES, CAREER DEVELOPMENT COUNSELING AND JOB PLACEMENT; REFERRAL SERVICES IN THE NATURE OF PROVIDING ROOMMATE MATCHING SERVICES FOR OTHERS, IN CLASS 35 (U.S. CLS. 100, 101 AND 102).

FIRST USE 6-1-2006; IN COMMERCE 6-1-2006.

SN 76-601,501, FILED 7-12-2004.

ANDREW RHIM, EXAMINING ATTORNEY

**Int. Cl.: 35**

**Prior U.S. Cls.: 100, 101, and 102**

**United States Patent and Trademark Office**

**Reg. No. 3,570,291**

**Registered Feb. 3, 2009**

**SERVICE MARK  
PRINCIPAL REGISTER**

**TRUE**

TRUEBEGINNINGS, LLC (TEXAS LIMITED LIABILITY COMPANY)  
300 DECKER DRIVE  
IRVING, TX 75062

FOR: REFERRAL SERVICES IN THE NATURE OF PROVIDING ROOMMATE MATCHING SERVICES FOR OTHERS, IN CLASS 35 (U.S. CLS. 100, 101 AND 102).

FIRST USE 6-1-2006; IN COMMERCE 6-1-2006.

THE MARK CONSISTS OF STANDARD CHARACTERS WITHOUT CLAIM TO ANY PARTICULAR FONT, STYLE, SIZE, OR COLOR.

SN 76-601,504, FILED 7-12-2004.

ANDREW RHIM, EXAMINING ATTORNEY

**Int. Cl.: 36**

**Prior U.S. Cls.: 100, 101, and 102**

**United States Patent and Trademark Office**

**Reg. No. 3,570,292**

**Registered Feb. 3, 2009**

**SERVICE MARK  
PRINCIPAL REGISTER**

**CON LOS SERVICIOS FINANCIEROS DE S.USA**

SBLI USA MUTUAL LIFE INSURANCE COMPAN-  
NY, INC. (NEW YORK CORPORATION)

460 WEST 34TH STREET

NEW YORK, NY 10001

FOR: INSURANCE AND FINANCIAL SERVICES,  
NAMELY, UNDERWRITING ANNUITIES AND UN-  
DERWRITING LIFE INSURANCE AND ACCIDENT  
AND HEALTH INSURANCE; BROKERAGE AND  
ADMINISTRATION SERVICES FOR ANNUITIES  
AND LIFE, HEALTH AND ACCIDENT INSUR-  
ANCE, IN CLASS 36 (U.S. CLS. 100, 101 AND 102).

FIRST USE 10-31-2005; IN COMMERCE 10-31-2005.

THE MARK CONSISTS OF STANDARD CHAR-  
ACTERS WITHOUT CLAIM TO ANY PARTICULAR  
FONT, STYLE, SIZE, OR COLOR.

NO CLAIM IS MADE TO THE EXCLUSIVE  
RIGHT TO USE "SERVICIOS FINANCIEROS" AND  
"USA", APART FROM THE MARK AS SHOWN.

THE ENGLISH TRANSLATION OF THE WORD  
"CON LOS SERVICIOS FINANCIEROS DE S.USA"  
IN THE MARK IS WITH FINANCIAL SERVICES  
FROM S.USA".

SN 76-605,700, FILED 8-5-2004.

FLORENTINA BLANDU, EXAMINING ATTORNEY

**Int. Cl.: 35**

**Prior U.S. Cls.: 100, 101, and 102**

**United States Patent and Trademark Office**

**Reg. No. 3,570,293**

**Registered Feb. 3, 2009**

**SERVICE MARK  
PRINCIPAL REGISTER**

**SEXPLORATION**

TRUEBEGINNINGS, LLC (TEXAS LIMITED LIABILITY COMPANY)  
300 DECKER DRIVE  
IRVING, TX 75039

THE MARK CONSISTS OF STANDARD CHARACTERS WITHOUT CLAIM TO ANY PARTICULAR FONT, STYLE, SIZE, OR COLOR.

FOR: ROOMMATE REFERRAL SERVICE, NAMELY, PROVIDING ROOMMATE MATCHING SERVICES FOR OTHERS, IN CLASS 35 (U.S. CLS. 100, 101 AND 102).

SN 76-610,016, FILED 9-3-2004.

FIRST USE 11-24-2008; IN COMMERCE 11-24-2008.

KAPIL BHANOT, EXAMINING ATTORNEY

**Int. Cl.: 41**

**Prior U.S. Cls.: 100, 101, and 107**

**United States Patent and Trademark Office**

**Reg. No. 3,570,294**

**Registered Feb. 3, 2009**

**SERVICE MARK  
PRINCIPAL REGISTER**

**FLIPSYDE**

FLIPSYDE ENTERTAINMENT LLC (ALABAMA  
LIMITED LIABILITY COMPANY)  
C/O SOUND MANAGEMENT  
ATTN: ROBERT HAYES 1525 SOUTH WINCHESTER  
BOULEVARD 1525 SOUTH WINCHESTER BOU-  
LEVARD  
SAN JOSE, CA 95128

FOR: ENTERTAINMENT IN THE NATURE OF  
PERFORMANCES BY A MUSICAL GROUP , IN  
CLASS 41 (U.S. CLS. 100, 101 AND 107).

FIRST USE 2-2-2005; IN COMMERCE 2-2-2005.

THE MARK CONSISTS OF STANDARD CHAR-  
ACTERS WITHOUT CLAIM TO ANY PARTICULAR  
FONT, STYLE, SIZE, OR COLOR.

SN 76-612,237, FILED 9-16-2004.

MARK RADEMACHER, EXAMINING ATTORNEY

**Int. Cl.: 5**

**Prior U.S. Cls.: 6, 18, 44, 46, 51, and 52**

**Reg. No. 3,570,295**

**United States Patent and Trademark Office**

**Registered Feb. 3, 2009**

**TRADEMARK  
PRINCIPAL REGISTER**

**VITALICA**

CAUDILL SEED & WAREHOUSE CO., INC.  
(KENTUCKY CORPORATION)  
1402 W. MAIN STREET  
LOUISVILLE, KY 40203

FIRST USE 1-1-2007; IN COMMERCE 1-1-2007.

FOR: PHARMACEUTICAL PREPARATIONS,  
NAMELY, VITAMIN AND MINERAL TABLETS  
OR LIQUIDS AS DIETARY FOOD SUPPLEMENTS,  
FOOD SUPPLEMENTS, NUTRITIONAL FOOD SUP-  
PLEMENTS , IN CLASS 5 (U.S. CLS. 6, 18, 44, 46, 51  
AND 52).

THE MARK CONSISTS OF STANDARD CHAR-  
ACTERS WITHOUT CLAIM TO ANY PARTICULAR  
FONT, STYLE, SIZE, OR COLOR.

SN 76-630,606, FILED 2-7-2005.

ANNE MADDEN, EXAMINING ATTORNEY

Int. Cl.: 41

Prior U.S. Cls.: 100, 101, and 107

Reg. No. 3,570,296

United States Patent and Trademark Office

Registered Feb. 3, 2009

**SERVICE MARK  
PRINCIPAL REGISTER**

*MOODYBEATS  
PRODUCTIONS LLC.*



MOODY BEATS PRODUCTION LLC. (D.C. LIMITED LIABILITY COMPANY)

3510 7TH STREET SE

WASHINGTON, DC 20032

FOR: MUSIC PRODUCTION SERVICES, IN CLASS 41 (U.S. CLS. 100, 101 AND 107).

FIRST USE 12-1-2003; IN COMMERCE 12-1-2003.

NO CLAIM IS MADE TO THE EXCLUSIVE RIGHT TO USE "PRODUCTIONS LLC", APART FROM THE MARK AS SHOWN.

THE MARK CONSISTS IN PART OF AN INK SPOT.

SN 76-638,930, FILED 5-19-2005.

SOPHIA S. KIM, EXAMINING ATTORNEY

**Int. Cl.: 8**

**Prior U.S. Cls.: 23, 28, and 44**

**United States Patent and Trademark Office**

**Reg. No. 3,570,297**

**Registered Feb. 3, 2009**

**TRADEMARK  
PRINCIPAL REGISTER**

**WHITEFORD TOOLS SAL**

WHITEFORD TOOLS, LLC (CONNECTICUT LIMITED LIABILITY COMPANY)

530 HIGHFIELD DR., P.O. BOX 587

ORANGE, CT 06477

FOR: HAND TOOLS, NAMELY, PLIERS, IN CLASS 8 (U.S. CLS. 23, 28 AND 44).

FIRST USE 11-13-2008; IN COMMERCE 11-13-2008.

THE MARK CONSISTS OF STANDARD CHARACTERS WITHOUT CLAIM TO ANY PARTICULAR FONT, STYLE, SIZE, OR COLOR.

NO CLAIM IS MADE TO THE EXCLUSIVE RIGHT TO USE "TOOLS", APART FROM THE MARK AS SHOWN.

SN 76-643,229, FILED 7-20-2005.

MARK PILARO, EXAMINING ATTORNEY



**Int. Cl.: 34**

**Prior U.S. Cls.: 2, 8, 9, and 17**

**United States Patent and Trademark Office**

**Reg. No. 3,570,298**

**Registered Feb. 3, 2009**

**TRADEMARK  
PRINCIPAL REGISTER**

**TRIPLE INFUSED FLAVOR**

REPUBLIC TOBACCO, L.P. (DELAWARE LIMITED PARTNERSHIP)

2301 RAVINE WAY

GLENVIEW, IL 60025

FOR: CIGARETTE ROLLING PAPERS, IN CLASS 34 (U.S. CLS. 2, 8, 9 AND 17).

FIRST USE 8-1-2005; IN COMMERCE 8-1-2005.

THE MARK CONSISTS OF STANDARD CHARACTERS WITHOUT CLAIM TO ANY PARTICULAR FONT, STYLE, SIZE, OR COLOR.

NO CLAIM IS MADE TO THE EXCLUSIVE RIGHT TO USE "INFUSED FLAVOR", APART FROM THE MARK AS SHOWN.

SN 76-643,375, FILED 7-22-2005.

GRETTA YAO, EXAMINING ATTORNEY

**Int. Cl.: 39**

**Prior U.S. Cls.: 100 and 105**

**United States Patent and Trademark Office**

**Reg. No. 3,570,299**

**Registered Feb. 3, 2009**

**SERVICE MARK  
PRINCIPAL REGISTER**

**DAIOHS FIRST CHOICE COFFEE  
SERVICES**

DAIOHS FIRST CHOICE SERVICES (CALIFORNIA CORPORATION)  
7373 EAST FLORES STREET  
DOWNEY, CA 902420211

OWNER OF U.S. REG. NOS. 2,122,284 AND 2,362,484.

FOR: OFFICE AND HOME DELIVERY OF COFFEE, BREWING EQUIPMENT, ACCOMPANIMENTS, AND RELATED PRODUCTS VIA TRUCK, IN CLASS 39 (U.S. CLS. 100 AND 105).

NO CLAIM IS MADE TO THE EXCLUSIVE RIGHT TO USE "COFFEE SERVICES", APART FROM THE MARK AS SHOWN.

FIRST USE 10-31-2006; IN COMMERCE 10-31-2006.

SN 76-655,342, FILED 4-26-2007.

THE MARK CONSISTS OF STANDARD CHARACTERS WITHOUT CLAIM TO ANY PARTICULAR FONT, STYLE, SIZE, OR COLOR.

FRANK LATTUCA, EXAMINING ATTORNEY

**Int. Cl.: 14**

**Prior U.S. Cls.: 2, 27, 28, and 50**

**United States Patent and Trademark Office**

**Reg. No. 3,570,300**

**Registered Feb. 3, 2009**

**TRADEMARK  
PRINCIPAL REGISTER**

**Stryker.**

D.P. GILLESPIE MARKETING, INC. (OREGON  
CORPORATION)  
20972 SW MEADOW WAY  
TUALATIN, OR 97062

THE MARK CONSISTS OF STANDARD CHAR-  
ACTERS WITHOUT CLAIM TO ANY PARTICULAR  
FONT, STYLE, SIZE, OR COLOR.

FOR: WATCHES FOR MILITARY, LAW ENFOR-  
CEMENT AND OUTDOOR USE, IN CLASS 14 (U.S.  
CLS. 2, 27, 28 AND 50).

SN 76-666,592, FILED 9-25-2006.

FIRST USE 10-29-2008; IN COMMERCE 10-29-2008.

BARBARA A. GOLD, EXAMINING ATTORNEY

**Int. Cl.: 37**

**Prior U.S. Cls.: 100, 103, and 106**

**United States Patent and Trademark Office**

**Reg. No. 3,570,301**

**Registered Feb. 3, 2009**

**SERVICE MARK  
PRINCIPAL REGISTER**

**MAKING AMERICA GREENER**

**ONE STATE AT A TIME**

UNITED SPORTS SURFACING OF AMERICA,  
INC. (CALIFORNIA CORPORATION)  
4000 BARRANCA PARKWAY, SUITE 250  
IRVINE, CA 92604

FOR: CONTRACTOR SERVICES FOR INSTALLA-  
TION OF RUBBER-BASED SIDEWALKS, IN CLASS  
37 (U.S. CLS. 100, 103 AND 106).

FIRST USE 9-0-2007; IN COMMERCE 9-0-2007.

THE MARK CONSISTS OF STANDARD CHAR-  
ACTERS WITHOUT CLAIM TO ANY PARTICULAR  
FONT, STYLE, SIZE, OR COLOR.

SN 76-668,956, FILED 11-13-2006.

TRACY WHITTAKER-BROWN, EXAMINING AT-  
TORNEY

**Int. Cl.: 7**

**Prior U.S. Cls.: 13, 19, 21, 23, 31, 34, and 35**

**Reg. No. 3,570,302**

**United States Patent and Trademark Office**

**Registered Feb. 3, 2009**

**TRADEMARK  
PRINCIPAL REGISTER**

The logo for "Wind Lift" features the word "Wind" in a bold, italicized, sans-serif font. A black arrow points upwards from the top of the letter "d". To the right of "Wind" is the word "Lift", also in a bold, italicized, sans-serif font, positioned slightly lower than "Wind".

FU, MEI CHENG (TAIWAN INDIVIDUAL)  
NO. 7, LANE 50, ZHIYUAN 3RD RD.  
BEITOU DISTRICT  
TAIPEI CITY, TAIWAN 112

GOODS, NAMELY, OVERHEAD TROLLEYS SUS-  
PENDED FROM OVERHEAD RAILS; WIRE HOISTS;  
CAR LIFTS; POWER WINCHES, IN CLASS 7 (U.S.  
CLS. 13, 19, 21, 23, 31, 34 AND 35).

FOR: HANGERS AS PARTS OF HANDLING  
MACHINES; CRANES; CRANES USED AS LIFTING  
AND HOISTING APPARATUSES; ELEVATORS; HO-  
ISTS; CHAIN HOISTS; LEVER HOISTS; WINCHES;  
HANDLING APPARATUSES FOR MOVING OTHER

FIRST USE 2-8-2004; IN COMMERCE 2-8-2004.

SN 76-670,833, FILED 12-26-2006.

DEZMONA MIZELLE, EXAMINING ATTORNEY

**Int. Cls.: 38 and 41**

**Prior U.S. Cls.: 100, 101, 104, and 107**

**United States Patent and Trademark Office**

**Reg. No. 3,570,303**

**Registered Feb. 3, 2009**

**SERVICE MARK  
PRINCIPAL REGISTER**

# SPORTINGNEWS

AMERICAN CITY BUSINESS JOURNALS, INC.  
(NORTH CAROLINA CORPORATION)  
120 WEST MOREHEAD STREET  
CHARLOTTE, NC 28202

FOR: WIRELESS COMMUNICATIONS SERVICES, NAMELY, TRANSMISSION OF TEXT AND GRAPHICS TO MOBILE TELEPHONES; WIRELESS ELECTRONIC TRANSMISSION OF VOICE SIGNALS, DATA, FACSIMILES, IMAGES AND INFORMATION; COMMUNICATIONS SERVICES, NAMELY, TRANSMITTING STREAMED VIDEO, SOUND AND AUDIO-VISUAL RECORDINGS VIA THE INTERNET, IN CLASS 38 (U.S. CLS. 100, 101 AND 104).

FIRST USE 10-1-2003; IN COMMERCE 10-1-2003.

FOR: PROVIDING INFORMATION IN THE FIELD OF SPORTS VIA THE INTERNET, SATEL-

LITE, CABLE AND WIRELESS NETWORKS, IN CLASS 41 (U.S. CLS. 100, 101 AND 107).

FIRST USE 10-1-2003; IN COMMERCE 10-1-2003.

THE MARK CONSISTS OF STANDARD CHARACTERS WITHOUT CLAIM TO ANY PARTICULAR FONT, STYLE, SIZE, OR COLOR.

OWNER OF U.S. REG. NOS. 2,133,802, 2,818,771, AND OTHERS.

SEC. 2(F).

SN 76-672,138, FILED 2-2-2007.

GRETTA YAO, EXAMINING ATTORNEY

**Int. Cl.: 25**

**Prior U.S. Cls.: 22 and 39**

**United States Patent and Trademark Office**

**Reg. No. 3,570,304**

**Registered Feb. 3, 2009**

**TRADEMARK  
PRINCIPAL REGISTER**

**WAZBEE**

SHERVINE BUNCH (CALIFORNIA SOLE PROPRIETORSHIP)  
21141 CANADA RD. #8D  
LAKE FOREST, CA 92630

THE MARK CONSISTS OF STANDARD CHARACTERS WITHOUT CLAIM TO ANY PARTICULAR FONT, STYLE, SIZE, OR COLOR.

FOR: CLOTHING, NAMELY, T-SHIRTS, IN CLASS 25 (U.S. CLS. 22 AND 39).

SN 76-673,632, FILED 3-5-2007.

FIRST USE 2-12-2006; IN COMMERCE 11-18-2006.

ELLEN BURNS, EXAMINING ATTORNEY

**Int. Cl.: 44**

**Prior U.S. Cls.: 100 and 101**

**United States Patent and Trademark Office**

**Reg. No. 3,570,305**

**Registered Feb. 3, 2009**

**SERVICE MARK  
PRINCIPAL REGISTER**

**RAYA**

ROSA WEST LABORATORIES, INC. (CALIFORNIA CORPORATION)  
10655 CHANDLER BOULEVARD  
NORTH HOLLYWOOD, CA 91601

FOR: SPA SERVICES, NAMELY, HEALTH SPA SERVICES FOR HEALTH AND WELLNESS OF BODY AND SPIRIT OFFERED AT THE HEALTH RESORT; SPA SERVICES, NAMELY, HEALTH SPA SERVICES, NAMELY, COSMETIC BODY CARE SERVICES; SALON SERVICES, NAMELY, NAIL CARE SALONS, SKIN CARE SALONS, HAIR STYLING, HAIR CUTTING, IN CLASS 44 (U.S. CLS. 100 AND 101).

FIRST USE 3-1-1980; IN COMMERCE 3-1-1980.

THE MARK CONSISTS OF STANDARD CHARACTERS WITHOUT CLAIM TO ANY PARTICULAR FONT, STYLE, SIZE, OR COLOR.

OWNER OF U.S. REG. NO. 2,329,355.

"RAYA" HAS NO MEANING IN A FOREIGN LANGUAGE.

SN 76-674,783, FILED 3-29-2007.

CHRISTINA SOBRAL, EXAMINING ATTORNEY



**Int. Cl.: 28**

**Prior U.S. Cls.: 22, 23, 38, and 50**

**United States Patent and Trademark Office**

**Reg. No. 3,570,306**

**Registered Feb. 3, 2009**

**TRADEMARK  
PRINCIPAL REGISTER**

**CARD BUGGY**

FEDRIGO, ALEX (UNITED STATES INDIVIDUAL)

36906 MARGARETA  
LIVONIA, MI 48152

FOR: WHEELED PLAYING CARD CADDIE FOR MOVING PLAYING CARDS AROUND A TABLE, IN CLASS 28 (U.S. CLS. 22, 23, 38 AND 50).

FIRST USE 11-1-2008; IN COMMERCE 11-1-2008.

THE MARK CONSISTS OF STANDARD CHARACTERS WITHOUT CLAIM TO ANY PARTICULAR FONT, STYLE, SIZE, OR COLOR.

NO CLAIM IS MADE TO THE EXCLUSIVE RIGHT TO USE "CARD", APART FROM THE MARK AS SHOWN.

SN 76-675,751, FILED 4-19-2007.

CHERYL CLAYTON, EXAMINING ATTORNEY

**Int. Cl.: 42**

**Prior U.S. Cls.: 100 and 101**

**United States Patent and Trademark Office**

**Reg. No. 3,570,307**

**Registered Feb. 3, 2009**

**SERVICE MARK  
PRINCIPAL REGISTER**

**AT LIPO, WE CALL THEM SCIENTISTS**

LIPO CHEMICALS, INC. (NEW JERSEY CORPORATION)  
207 19TH AVENUE  
PATERSON, NJ 07504

THE MARK CONSISTS OF STANDARD CHARACTERS WITHOUT CLAIM TO ANY PARTICULAR FONT, STYLE, SIZE, OR COLOR.

FOR: TECHNICAL AND SCIENTIFIC RESEARCH AND DEVELOPMENT IN THE FIELD OF COSMETICS AND PERFUMERY, NEW MIXTURES OF CHEMICAL COMPOUNDS, AND PHARMACEUTICAL TECHNOLOGY, IN CLASS 42 (U.S. CLS. 100 AND 101).

OWNER OF U.S. REG. NOS. 2,746,079 AND 3,200,147.

SN 76-676,684, FILED 5-11-2007.

FIRST USE 10-0-2006; IN COMMERCE 10-0-2006.

RON FAIRBANKS, EXAMINING ATTORNEY

**Int. Cl.: 28**

**Prior U.S. Cls.: 22, 23, 38, and 50**

**Reg. No. 3,570,308**

**United States Patent and Trademark Office**

**Registered Feb. 3, 2009**

**TRADEMARK  
PRINCIPAL REGISTER**

**PICTUREKA**

HASBRO, INC. (RHODE ISLAND CORPORATION)  
1027 NEWPORT AVENUE  
PAWTUCKET, RI 02862

THE MARK CONSISTS OF STANDARD CHARACTERS WITHOUT CLAIM TO ANY PARTICULAR FONT, STYLE, SIZE, OR COLOR.

FOR: GAMES, TOYS AND PLAYTHINGS, NAME-  
LY, BOARD GAMES, PARLOR GAMES, CARD  
GAMES, JIGSAW PUZZLES, IN CLASS 28 (U.S.  
CLS. 22, 23, 38 AND 50).

SN 76-676,782, FILED 5-14-2007.

FIRST USE 6-26-2007; IN COMMERCE 6-26-2007.

REBECCA POVARCHUK, EXAMINING ATTOR-  
NEY

Int. Cl.: 7

Prior U.S. Cls.: 13, 19, 21, 23, 31, 34, and 35

United States Patent and Trademark Office

Reg. No. 3,570,309

Registered Feb. 3, 2009

TRADEMARK  
PRINCIPAL REGISTER

*Suprolair*

GISON MACHINERY CO., LTD. (TAIWAN CORPORATION)  
NO. 15, JEN I STREET CHIEN CHU  
TSUEN WU JIN SHIANG  
TALCHUNG HSIEN, TAIWAN

FOR: POWER-OPERATED TOOLS AND POWER-OPERATED TOOL ACCESSORIES, NAMELY, AIR-POWERED AND ELECTRIC IMPACT WRENCHES, AIR-POWERED AND ELECTRIC RATCHET WRENCHES, AIR-POWERED AND ELECTRIC DRILLS, AIR-POWERED AND ELECTRIC METAL SHEARS, AIR-POWERED AND ELECTRIC SANDERS, AIR-POWERED AND ELECTRIC GRINDERS, AIR-POWERED AND ELECTRIC POLISHERS, AIR-POWERED AND ELECTRIC HAMMERS, AIR-POWERED AND ELECTRIC SCREWDRIVERS, AIR-POWERED AND ELECTRIC RIVET GUNS, AIR-POWERED AND ELECTRIC SAWS, AIR-POWERED AND ELECTRIC SPRAY GUNS, AIR-POWERED AND ELECTRIC STAPLER GUNS, AIR-

POWERED CHISELS, AIR-POWERED SOCKET WRENCHES, AIR-POWERED AND ELECTRIC MINI PUMP OILERS, AIR REGULATORS BEING PARTS OF MACHINES, AIR-POWERED AND ELECTRIC LUBRICANT DISPENSERS FOR MACHINES, COUPLINGS FOR MACHINES IN THE NATURE OF MECHANICAL QUICK JOINT COUPLINGS AND MECHANICAL TRIPLE COUPLINGS, IN CLASS 7 (U.S. CLS. 13, 19, 21, 23, 31, 34 AND 35).

FIRST USE 4-15-1996; IN COMMERCE 6-19-2008.

NO CLAIM IS MADE TO THE EXCLUSIVE RIGHT TO USE "AIR", APART FROM THE MARK AS SHOWN.

SN 76-677,435, FILED 5-25-2007.

MICHAEL TANNER, EXAMINING ATTORNEY

**Int. Cl.: 1**

**Prior U.S. Cls.: 1, 5, 6, 10, 26, and 46**

**United States Patent and Trademark Office**

**Reg. No. 3,570,310**

**Registered Feb. 3, 2009**

**TRADEMARK  
PRINCIPAL REGISTER**

**CYCLOSHIELD**

TEXAS STATE UNIVERSITY-SAN MARCOS  
(TEXAS STATE AGENCY)  
601 UNIVERSITY DRIVE  
SAN MARCOS, TX 78666

FOR: SYNTHETIC POLYMER AND NANOCOMPOSITE RESINOUS COMPOSITIONS FOR USE IN THE MANUFACTURE OF IMPACT RESISTANT GOODS, SUCH AS IMPACT RESISTANT WINDOWS, BULLET RESISTANT GLASS, BODY ARMOR, FACE SHIELDS, TRANSPARENT ARMOR AND SPORTS EQUIPMENT, IN CLASS 1 (U.S. CLS. 1, 5, 6, 10, 26 AND 46).

FIRST USE 11-16-2004; IN COMMERCE 11-16-2004.

THE MARK CONSISTS OF STANDARD CHARACTERS WITHOUT CLAIM TO ANY PARTICULAR FONT, STYLE, SIZE, OR COLOR.

SN 76-678,557, FILED 6-22-2007.

JAMES LOVELACE, EXAMINING ATTORNEY

**Int. Cls.: 10 and 20**

**Prior U.S. Cls.: 2, 13, 22, 25, 26, 32, 39, 44, and 50**

**United States Patent and Trademark Office**

**Reg. No. 3,570,311**

**Registered Feb. 3, 2009**

**TRADEMARK  
PRINCIPAL REGISTER**

**QUOLIS**

TAKARA BELMONT USA, INC. (NEW YORK CORPORATION)  
101 BELMONT DRIVE  
SOMERSET, NJ 08873

FOR: DENTAL EQUIPMENT, NAMELY, CHAIRS, AIR AND WATER DELIVERY UNITS, X-RAY UNITS, DENTAL EXAMINATION LIGHTS AND PARTS THEREOF, IN CLASS 10 (U.S. CLS. 26, 39 AND 44).

FIRST USE 9-26-2007; IN COMMERCE 9-26-2007.

FOR: DENTAL OFFICE FURNITURE, NAMELY, COUNTERS AND CABINETS, IN CLASS 20 (U.S. CLS. 2, 13, 22, 25, 32 AND 50).

FIRST USE 10-16-2007; IN COMMERCE 10-16-2007.

THE MARK CONSISTS OF STANDARD CHARACTERS WITHOUT CLAIM TO ANY PARTICULAR FONT, STYLE, SIZE, OR COLOR.

THE WORDING "QUOLIS" HAS NO MEANING IN ANY FOREIGN LANGUAGE.

SN 76-679,552, FILED 7-16-2007.

JENNIFER VASQUEZ, EXAMINING ATTORNEY

**Int. Cl.: 26**

**Prior U.S. Cls.: 37, 39, 40, 42, and 50**

**United States Patent and Trademark Office**

**Reg. No. 3,570,312**

**Registered Feb. 3, 2009**

**TRADEMARK  
PRINCIPAL REGISTER**

**FILLING THE HOLES  
IN YOUR HAT**

PERFECT CURVE, INC. (DELAWARE COR-  
PORATION)  
200 LINCOLN STREET, 5TH FLOOR  
BOSTON, MA 02111

THE MARK CONSISTS OF STANDARD CHAR-  
ACTERS WITHOUT CLAIM TO ANY PARTICULAR  
FONT, STYLE, SIZE, OR COLOR.

FOR: ORNAMENTAL BUTTONS WITH FASTEN-  
ERS USED IN DECORATING CAPS, IN CLASS 26  
(U.S. CLS. 37, 39, 40, 42 AND 50).

SN 76-679,701, FILED 7-19-2007.

FIRST USE 12-31-2007; IN COMMERCE 12-31-2007.

ANNE FARRELL, EXAMINING ATTORNEY

Int. Cl.: 15

Prior U.S. Cls.: 2, 21, and 36

United States Patent and Trademark Office

Reg. No. 3,570,313

Registered Feb. 3, 2009

TRADEMARK  
PRINCIPAL REGISTER

**C F M**

WANG, CHIH-HUNG (TAIWAN CORPORATION)  
3F., NO.21, ALLEY 6, LANE 118, SEC. 2  
HEPING E. RD., DA-AN DISTRICT  
TAIPEI, TAIWAN 106

FOR: MUSICAL INSTRUMENTS, NAMELY,  
TUNING FORKS, TONOMETERS, METRONOMES,  
ORGANS, PIANOS, GLOCKENSPIELS, XYLO-  
PHONES, HARPSICHORDS, ELECTRIC PIANO,  
SAXOPHONES, CLARINETS; MUSICAL INSTRU-  
MENTS, NAMELY, STRINGED INSTRUMENTS,  
COMETS, CARILLONS, GUITARS; AND PERCUS-

SION INSTRUMENTS, NAMELY, DRUMS, IN  
CLASS 15 (U.S. CLS. 2, 21 AND 36).

FIRST USE 4-14-2008; IN COMMERCE 4-14-2008.

THE MARK CONSISTS OF STANDARD CHAR-  
ACTERS WITHOUT CLAIM TO ANY PARTICULAR  
FONT, STYLE, SIZE, OR COLOR.

SN 76-680,295, FILED 8-3-2007.

ANNE E. GUSTASON, EXAMINING ATTORNEY



**Int. Cl.: 9**

**Prior U.S. Cls.: 21, 23, 26, 36, and 38**

**United States Patent and Trademark Office**

**Reg. No. 3,570,314**

**Registered Feb. 3, 2009**

**TRADEMARK  
PRINCIPAL REGISTER**

**THE TRUE MEASURE OF THE GAME**

SKYHAWKE TECHNOLOGIES, LLC (MISSISSIPPI LIMITED LIABILITY COMPANY)  
274 COMMERCE PARK DRIVE, SUITE M  
RIDGELAND, MS 39157

FOR: ELECTRONIC SATELLITE TRACKING AND INFORMATION SYSTEM COMPRISING COMPUTER HARDWARE AND COMPUTER SOFTWARE USED TO DETERMINE DISTANCES ON GOLF COURSES AND FOR ACCESSING RELEVANT DATA AND STATISTICS PERTINENT THERETO, IN CLASS 9 (U.S. CLS. 21, 23, 26, 36 AND 38).

FIRST USE 9-0-2007; IN COMMERCE 9-0-2007.

THE MARK CONSISTS OF STANDARD CHARACTERS WITHOUT CLAIM TO ANY PARTICULAR FONT, STYLE, SIZE, OR COLOR.

SN 76-681,129, FILED 8-24-2007.

APRIL HESIK, EXAMINING ATTORNEY

**Int. Cl.: 28**

**Prior U.S. Cls.: 22, 23, 38, and 50**

**Reg. No. 3,570,315**

**United States Patent and Trademark Office**

**Registered Feb. 3, 2009**

**TRADEMARK  
PRINCIPAL REGISTER**

**MUSHKINS**

JAY FRANCO & SONS, INC. (NEW YORK CORPORATION)  
295 FIFTH AVENUE, SUITE 312  
NEW YORK, NY 10016

THE MARK CONSISTS OF STANDARD CHARACTERS WITHOUT CLAIM TO ANY PARTICULAR FONT, STYLE, SIZE, OR COLOR.

FOR: STUFFED TOY ANIMALS, STUFFED TOY FIGURES, AND TOY PILLOWS, IN CLASS 28 (U.S. CLS. 22, 23, 38 AND 50).

SN 76-681,374, FILED 8-31-2007.

FIRST USE 10-0-2007; IN COMMERCE 10-0-2007.

JOHN DWYER, EXAMINING ATTORNEY

**Int. Cl.: 28**

**Prior U.S. Cls.: 22, 23, 38, and 50**

**United States Patent and Trademark Office**

**Reg. No. 3,570,316**

**Registered Feb. 3, 2009**

**TRADEMARK  
PRINCIPAL REGISTER**

**PILLOW TIME PALS**

JAY FRANCO & SONS, INC. (NEW YORK CORPORATION)

295 FIFTH AVENUE, SUITE 312

NEW YORK, NY 10016

FOR: PLUSH TOY ANIMALS AND STUFFED TOY FIGURES TO BE USED AS TOY PILLOWS, IN CLASS 28 (U.S. CLS. 22, 23, 38 AND 50).

FIRST USE 11-0-2006; IN COMMERCE 11-0-2006.

THE MARK CONSISTS OF STANDARD CHARACTERS WITHOUT CLAIM TO ANY PARTICULAR FONT, STYLE, SIZE, OR COLOR.

NO CLAIM IS MADE TO THE EXCLUSIVE RIGHT TO USE "PILLOW", APART FROM THE MARK AS SHOWN.

SN 76-681,564, FILED 9-6-2007.

JOHN DWYER, EXAMINING ATTORNEY

**Int. Cl.: 14**

**Prior U.S. Cls.: 2, 27, 28, and 50**

**Reg. No. 3,570,317**

**United States Patent and Trademark Office**

**Registered Feb. 3, 2009**

---

**TRADEMARK  
PRINCIPAL REGISTER**

**IONETIX**

IZZO GOLF INC. (DELAWARE CORPORATION)  
1635 COMMONS PARKWAY  
MACEDON, NY 145029191

THE MARK CONSISTS OF STANDARD CHAR-  
ACTERS WITHOUT CLAIM TO ANY PARTICULAR  
FONT, STYLE, SIZE, OR COLOR.

FOR: NECKLACES, BRACELETS, AND RINGS,  
IN CLASS 14 (U.S. CLS. 2, 27, 28 AND 50).

SN 76-682,878, FILED 10-11-2007.

FIRST USE 3-1-2008; IN COMMERCE 3-1-2008.

CARYN GLASSER, EXAMINING ATTORNEY

**Int. Cls.: 7 and 20**

**Prior U.S. Cls.: 2, 13, 19, 21, 22, 23, 25, 31, 32, 34, 35,  
and 50**

**Reg. No. 3,570,318**

**United States Patent and Trademark Office**

**Registered Feb. 3, 2009**

**TRADEMARK  
PRINCIPAL REGISTER**

**GREEN GORILLA**

FOREFRONT PRODUCT DESIGN, L.L.C. (PENN-  
SYLVANIA LIMITED LIABILITY COMPANY)  
300 PENN CENTER BOULEVARD  
PITTSBURGH, PA 15235

FOR: POWER OPERATED SPRAYERS AND  
ELECTRIC PUMPS FOR SPRAYERS, IN CLASS 7  
(U.S. CLS. 13, 19, 21, 23, 31, 34 AND 35).

FIRST USE 5-10-2008; IN COMMERCE 5-10-2008.

FOR: NON-METAL FLUID STORAGE TANKS, IN  
CLASS 20 (U.S. CLS. 2, 13, 22, 25, 32 AND 50).

FIRST USE 5-10-2008; IN COMMERCE 5-10-2008.

THE MARK CONSISTS OF STANDARD CHAR-  
ACTERS WITHOUT CLAIM TO ANY PARTICULAR  
FONT, STYLE, SIZE, OR COLOR.

SN 76-685,376, FILED 12-26-2007.

DAVID TOOLEY, EXAMINING ATTORNEY

**Int. Cl.: 9**

**Prior U.S. Cls.: 21, 23, 26, 36, and 38**

**United States Patent and Trademark Office**

**Reg. No. 3,570,319**

**Registered Feb. 3, 2009**

**TRADEMARK  
PRINCIPAL REGISTER**

**POLA SENSOR**

CLIFF WEIL, INC. (VIRGINIA CORPORATION)  
P.O. BOX 427  
MECHANICSVILLE, VA 23111

NO CLAIM IS MADE TO THE EXCLUSIVE  
RIGHT TO USE "SENSOR", APART FROM THE  
MARK AS SHOWN.

FOR: SUNGLASSES, IN CLASS 9 (U.S. CLS. 21, 23,  
26, 36 AND 38).

SN 76-688,129, FILED 3-27-2008.

FIRST USE 10-1-2007; IN COMMERCE 10-1-2007.

THE MARK CONSISTS OF STANDARD CHAR-  
ACTERS WITHOUT CLAIM TO ANY PARTICULAR  
FONT, STYLE, SIZE, OR COLOR.

JANICE L. MCMORROW, EXAMINING ATTOR-  
NEY

**Int. Cl.: 41**

**Prior U.S. Cls.: 100, 101, and 107**

**United States Patent and Trademark Office**

**Reg. No. 3,570,320**

**Registered Feb. 3, 2009**

**SERVICE MARK  
PRINCIPAL REGISTER**

**LIFETIME GAMES**

LIFETIME ENTERTAINMENT SERVICES (NEW  
YORK JOINT VENTURE)  
16TH FLOOR  
309 WEST 49TH STREET  
NEW YORK, NY 10019

FOR: ENTERTAINMENT SERVICES, NAMELY,  
PROVIDING ON-LINE COMPUTER GAMES, IN  
CLASS 41 (U.S. CLS. 100, 101 AND 107).

FIRST USE 1-31-2007; IN COMMERCE 1-31-2007.

THE MARK CONSISTS OF STANDARD CHAR-  
ACTERS WITHOUT CLAIM TO ANY PARTICULAR  
FONT, STYLE, SIZE, OR COLOR.

NO CLAIM IS MADE TO THE EXCLUSIVE  
RIGHT TO USE "GAMES", APART FROM THE  
MARK AS SHOWN.

SN 77-002,201, FILED 9-19-2006.

MICHAEL WEBSTER, EXAMINING ATTORNEY

**Int. Cl.: 3**

**Prior U.S. Cls.: 1, 4, 6, 50, 51, and 52**

**United States Patent and Trademark Office**

**Reg. No. 3,570,321**

**Registered Feb. 3, 2009**

**TRADEMARK  
PRINCIPAL REGISTER**

**DAMAGED BLONDE**

MBL/TIGI PRODUCTS (TEXAS LIMITED PART-  
NERSHIP)  
2311 MIDWAY ROAD  
CARROLLTON, TX 75006

THE MARK CONSISTS OF STANDARD CHAR-  
ACTERS WITHOUT CLAIM TO ANY PARTICULAR  
FONT, STYLE, SIZE, OR COLOR.

FOR: HAIR CARE PRODUCTS AND PREPARA-  
TIONS, NAMELY, HAIR CONDITIONER, IN CLASS  
3 (U.S. CLS. 1, 4, 6, 50, 51 AND 52).

SN 77-005,726, FILED 9-22-2006.

FIRST USE 9-1-2008; IN COMMERCE 9-1-2008.

JOHN WILKE, EXAMINING ATTORNEY



Int. Cl.: 12

Prior U.S. Cls.: 19, 21, 23, 31, 35, and 44

Reg. No. 3,570,322

United States Patent and Trademark Office

Registered Feb. 3, 2009

TRADEMARK  
PRINCIPAL REGISTER



COVERCRAFT INDUSTRIES, INC. (CALIFORNIA CORPORATION)  
100 ENTERPRISE BOULEVARD  
PAULS VALLEY, OK 73075

FOR: FITTED VEHICLE COVERS, IN CLASS 12  
(U.S. CLS. 19, 21, 23, 31, 35 AND 44).

FIRST USE 10-11-2006; IN COMMERCE 10-11-2006.

THE COLOR(S) BLACK, WHITE AND GREY IS/  
ARE CLAIMED AS A FEATURE OF THE MARK.

THE MARK CONSISTS OF THE WORDS "QWIK  
COVER" WITH A STYLIZED "Q" AND A STYLIZED

"C". THE COLOR BLACK APPEARS IN THE BACKGROUND OUTLINING THE WORDING "QWIK COVER"; THE COLOR WHITE APPEARS IN THE LETTERS "W", "I" AND "K" OF THE WORDING "QWIK", AND LETTERS "O", "V", "E" AND "R" OF THE WORDING "COVER"; THE COLOR GREY APPEARS IN THE LETTER "Q" OF THE WORDING "QWIK", AND THE LETTER "C" OF THE WORDING "COVER".

SN 77-009,546, FILED 9-28-2006.

SHAUNIA CARLYLE, EXAMINING ATTORNEY

**Int. Cl.: 36**

**Prior U.S. Cls.: 100, 101, and 102**

**United States Patent and Trademark Office**

**Reg. No. 3,570,323**

**Registered Feb. 3, 2009**

**SERVICE MARK  
PRINCIPAL REGISTER**

**FINEMARK NATIONAL BANK &  
TRUST**

FINEMARK HOLDINGS, INC. (FLORIDA CORPORATION)  
SUITE 100  
7800 UNIVERSITY POINTE DRIVE  
FR. MYERS, FL 33907

FOR: BANKING SERVICES; FINANCIAL SERVICES, NAMELY, OFFERING INDIVIDUAL RETIREMENT ACCOUNTS, FUNDS TRANSFERS, DEBIT AND CREDIT CARDS, WEALTH, RETIREMENT, ESTATE AND FINANCIAL PLANNING, INVESTMENT OF ROLLOVERS; PROVIDING ASSET MANAGEMENT ADVICE FOR INDIVIDUALS, FIDUCIARIES, QUALIFIED RETIREMENT PLANS AND FOUNDATIONS; TRUSTEESHIP SERVICES; ESTATE SETTLEMENT AND ASSET MANAGEMENT SERVICES AS COURT APPOINTED EXECUTOR OF ESTATES; AND ASSET MANAGEMENT

AND CUSTODIAL SERVICES AS APPOINTED BY THE COURT FOR WARDS OF THE STATE, IN CLASS 36 (U.S. CLS. 100, 101 AND 102).

FIRST USE 3-1-2007; IN COMMERCE 3-1-2007.

THE MARK CONSISTS OF STANDARD CHARACTERS WITHOUT CLAIM TO ANY PARTICULAR FONT, STYLE, SIZE, OR COLOR.

NO CLAIM IS MADE TO THE EXCLUSIVE RIGHT TO USE "NATIONAL BANK & TRUST", APART FROM THE MARK AS SHOWN.

SN 77-012,737, FILED 10-3-2006.

LINDA MICKLEBURGH, EXAMINING ATTORNEY

**Int. Cl.: 1**

**Prior U.S. Cls.: 1, 5, 6, 10, 26, and 46**

**Reg. No. 3,570,324**

**United States Patent and Trademark Office**

**Registered Feb. 3, 2009**

---

**TRADEMARK  
PRINCIPAL REGISTER**

**BW3250**

BRUSH WELLMAN INC. (OHIO CORPORATION)  
17876 ST. CLAIR AVENUE  
CLEVELAND, OH 44110

FIRST USE 1-22-2007; IN COMMERCE 1-22-2007.

FOR: CERAMIC MATERIALS IN THE NATURE  
OF SOLID SUBSTRATES OF BERYLLIUM OXIDE  
AND LANTHANUM FOR USE IN HIGH-HEAT  
DISSIPATION APPLICATIONS, IN CLASS 1 (U.S.  
CLS. 1, 5, 6, 10, 26 AND 46).

THE MARK CONSISTS OF STANDARD CHAR-  
ACTERS WITHOUT CLAIM TO ANY PARTICULAR  
FONT, STYLE, SIZE, OR COLOR.

SN 77-012,852, FILED 10-3-2006.

AMY HELLA, EXAMINING ATTORNEY

**Int. Cls.: 21, 25, and 28**

**Prior U.S. Cls.: 2, 13, 22, 23, 29, 30, 33, 38, 39, 40, and 50**

**Reg. No. 3,570,325**

**Registered Feb. 3, 2009**

**United States Patent and Trademark Office**

---

**TRADEMARK  
PRINCIPAL REGISTER**



PRATT & WHITNEY ROCKETDYNE INC. (DE-  
LAWARE CORPORATION)  
MC LA52  
6633 CANOGA AVENUE  
CANOGA PARK, CA 913097922

FOR: MUG, IN CLASS 21 (U.S. CLS. 2, 13, 23, 29, 30,  
33, 40 AND 50).

FIRST USE 7-1-2008; IN COMMERCE 7-1-2008.

FOR: CAP, IN CLASS 25 (U.S. CLS. 22 AND 39).

FIRST USE 7-1-2008; IN COMMERCE 7-1-2008.

FOR: GOLF BALL, IN CLASS 28 (U.S. CLS. 22, 23,  
38 AND 50).

FIRST USE 7-1-2008; IN COMMERCE 7-1-2008.

THE MARK CONSISTS OF A STYLIZED LETTER  
"R" THAT IS DISSECTED BY AN ASCENDING  
ROCKET DESIGN.

SN 77-015,823, FILED 10-6-2006.

JORDAN BAKER, EXAMINING ATTORNEY

**Int. Cl.: 5**

**Prior U.S. Cls.: 6, 18, 44, 46, 51, and 52**

**Reg. No. 3,570,326**

**United States Patent and Trademark Office**

**Registered Feb. 3, 2009**

**TRADEMARK  
PRINCIPAL REGISTER**

# GreenBiotics Plus

GOLDSHIELD GROUP PLC (UNITED KINGDOM CORPORATION)  
NO1 CROYDON (NLA TOWER)  
12-16 ADDISCOMBE ROAD  
CROYDON, SURREY, UNITED KINGDOM CR00XT

FOR: BEE POLLEN FOR USE AS A DIETARY FOOD SUPPLEMENT; CALCIUM SUPPLEMENTS; DIETARY AND NUTRITIONAL SUPPLEMENTS; DIETARY FOOD SUPPLEMENTS; DIETARY SUPPLEMENTAL DRINKS; DIETARY SUPPLEMENTS; DIETARY SUPPLEMENTS FOR ANIMALS; DIETARY SUPPLEMENTS FOR HUMAN CONSUMPTION; FOOD SUPPLEMENTS; FOOD SUPPLEMENTS, NAMELY, ANTI-OXIDANTS; GROUND FLAXSEED FIBER FOR USE AS A DIETARY SUPPLEMENT; HERBAL SUPPLEMENTS; HOMEOPATHIC SUPPLEMENTS; LECITHIN FOR USE AS A DIETARY SUPPLEMENT; MEAL REPLACEMENT AND DIETARY SUPPLEMENT DRINK MIXES; MINERAL NUTRITIONAL SUPPLEMENTS; MINERAL SUPPLEMENTS; NUTRACEUTICALS FOR USE AS A DIETARY SUPPLEMENT; NUTRITIONAL ADDITIVES FOR USE IN FOODS AND

DIETARY SUPPLEMENTS FOR HUMAN CONSUMPTION; NUTRITIONAL SUPPLEMENTS; NUTRITIONAL SUPPLEMENTS IN LOTION FORM SOLD AS A COMPONENT OF NUTRITIONAL SKIN CARE PRODUCTS; POWDERED NUTRITIONAL SUPPLEMENT DRINK MIX; VITAMIN AND MINERAL SUPPLEMENTS; VITAMIN SUPPLEMENT IN TABLET FORM FOR USE IN MAKING AN EFFERVESCENT BEVERAGE WHEN ADDED TO WATER; VITAMIN SUPPLEMENTS; WHEAT FOR USE AS A DIETARY SUPPLEMENT, IN CLASS 5 (U.S. CLS. 6, 18, 44, 46, 51 AND 52).

FIRST USE 12-14-2006; IN COMMERCE 12-14-2006.

THE MARK CONSISTS OF STANDARD CHARACTERS WITHOUT CLAIM TO ANY PARTICULAR FONT, STYLE, SIZE, OR COLOR.

SN 77-018,290, FILED 10-11-2006.

MIDGE BUTLER, EXAMINING ATTORNEY

**Int. Cl.: 44**

**Prior U.S. Cls.: 100 and 101**

**United States Patent and Trademark Office**

**Reg. No. 3,570,327**

**Registered Feb. 3, 2009**

**SERVICE MARK  
PRINCIPAL REGISTER**

**LINDORA HEALTH CLINIC**

LINDORA, INC. (CALIFORNIA CORPORATION)  
SUITE J-4  
3505 CADILLAC AVE.  
COSTA MESA, CA 92626

FOR: WEIGHT MANAGEMENT AND WEIGHT LOSS SERVICES, NAMELY, DIET PLANNING AND SUPERVISION SERVICES; PHYSICAL THERAPY; PHYSIOLOGICAL CONSULTATION; MEDICAL SCREENING; NUTRITIONAL COUNSELING; BEHAVIOR MODIFICATION IN THE FIELD OF WEIGHT LOSS AND WEIGHT MANAGEMENT; HEALTH CARE SERVICES; MEDICAL CLINICS; PHARMACEUTICAL CONSULTATION; COUNSELING REGARDING EATING DISORDERS, IN CLASS 44 (U.S. CLS. 100 AND 101).

FIRST USE 7-1-2007; IN COMMERCE 1-1-2008.

THE MARK CONSISTS OF STANDARD CHARACTERS WITHOUT CLAIM TO ANY PARTICULAR FONT, STYLE, SIZE, OR COLOR.

OWNER OF U.S. REG. NOS. 2,295,704, 2,484,443, AND 3,203,557.

NO CLAIM IS MADE TO THE EXCLUSIVE RIGHT TO USE "HEALTH CLINIC", APART FROM THE MARK AS SHOWN.

SN 77-018,771, FILED 10-11-2006.

LOURDES AYALA, EXAMINING ATTORNEY

**Int. Cls.: 35 and 39**

**Prior U.S. Cls.: 100, 101, 102, and 105**

**United States Patent and Trademark Office**

**Reg. No. 3,570,328**

**Registered Feb. 3, 2009**

**SERVICE MARK  
PRINCIPAL REGISTER**



KAWASAKI KISEN KAISHA, LTD. (JAPAN CORPORATION)  
MINATO-KU, TOKYO, JAPAN

FOR: TRANSPORTATION LOGISTICS SERVICES, NAMELY, ARRANGING, PLANNING AND SCHEDULING THE OCEAN, AIR AND LAND TRANSPORTATION OF GOODS FOR OTHERS IN UNITED STATES AND FOREIGN COMMERCE; ARRANGING AND COORDINATING PICK-UP OF CARGO AND OCEAN, AIR AND LAND TRANSPORTATION; ARRANGING WITH INLAND CARRIERS FOR THE PICK-UP AND DELIVERY OF SUCH CARGO BY TRUCK, AIR, OCEAN AND RAIL IN THE UNITED STATES IN CONNECTION THEREWITH, IN CLASS 35 (U.S. CLS. 100, 101 AND 102).

FIRST USE 5-1-2007; IN COMMERCE 5-1-2007.

FOR: WAREHOUSING AND CONSOLIDATION SERVICES, NAMELY, CONSOLIDATION OF CARGO, OCEAN, AIR AND LAND TRANSPORTATION; FURNISHING TRANSPORTATION OF CARGO BY OCEAN VESSELS BETWEEN THE UNITED STATES

AND FOREIGN COUNTRIES; SORTING, IDENTIFYING, STORING, DISTRIBUTING AND DELIVERING OF GOODS BY TRUCK, AIR, OCEAN AND RAIL IN THE UNITED STATES AND FOREIGN COMMERCE; BOAT RENTAL; BOAT STORAGE; BOAT TRANSPORT; FREIGHT BROKERAGE; TRANSPORT BROKERAGE; CAR TRANSPORT; MARINE TRANSPORT; PACKAGING OF GOODS FOR TRANSPORTATION; RENTAL OF PARKING SPACES; PORTERAGE; RAILWAY TRANSPORT; RENTAL OF WAREHOUSES; TRANSPORT RESERVATION; SHIP BROKERAGE; RENTAL OF STORAGE CONTAINERS; PROVIDING STORAGE INFORMATION TO OTHERS, IN CLASS 39 (U.S. CLS. 100 AND 105).

FIRST USE 5-1-2007; IN COMMERCE 5-1-2007.

THE MARK CONSISTS OF A STYLIZED "K" ABOVE A BAR ENCASING THE LETTERS "KLL".

SN 77-023,228, FILED 10-17-2006.

ANNE E. GUSTASON, EXAMINING ATTORNEY

**Int. Cls.: 35 and 39**

**Prior U.S. Cls.: 100, 101, 102, and 105**

**United States Patent and Trademark Office**

**Reg. No. 3,570,329**

**Registered Feb. 3, 2009**

**SERVICE MARK  
PRINCIPAL REGISTER**

**“K” LINE LOGISTICS**

KAWASAKI KISEN KAISHA, LTD. (JAPAN CORPORATION)  
MINATO-KU  
TOKYO, JAPAN

FOR: TRANSPORTATION LOGISTICS SERVICES, NAMELY, ARRANGING, PLANNING AND SCHEDULING THE OCEAN, AIR AND LAND TRANSPORTATION OF GOODS FOR OTHERS IN UNITED STATES AND FOREIGN COMMERCE; ARRANGING AND COORDINATING PICK-UP OF CARGO AND OCEAN, AIR AND LAND TRANSPORTATION; ARRANGING WITH INLAND CARRIERS FOR THE PICK-UP AND DELIVERY OF SUCH CARGO BY TRUCK, AIR, OCEAN AND RAIL IN THE UNITED STATES IN CONNECTION THEREWITH, IN CLASS 35 (U.S. CLS. 100, 101 AND 102).

FIRST USE 5-1-2007; IN COMMERCE 5-1-2007.

FOR: WAREHOUSING AND CONSOLIDATION SERVICES, NAMELY, CONSOLIDATION OF CARGO, OCEAN, AIR AND LAND TRANSPORTATION; FURNISHING TRANSPORTATION OF CARGO BY OCEAN VESSELS BETWEEN THE UNITED STATES AND FOREIGN COUNTRIES; SORTING, IDENTIFYING, STORING, DISTRIBUTING AND DELIVERING OF GOODS BY TRUCK, AIR, OCEAN AND RAIL IN THE UNITED STATES AND FOREIGN

COMMERCE; BOAT RENTAL; BOAT STORAGE; BOAT TRANSPORT; FREIGHT BROKERAGE; TRANSPORT BROKERAGE; CAR TRANSPORT; MARINE TRANSPORT; PACKAGING OF GOODS FOR TRANSPORTATION; RENTAL OF PARKING SPACES; PORTERAGE; RAILWAY TRANSPORT; RENTAL OF WAREHOUSES; TRANSPORT RESERVATION; SHIP BROKERAGE; RENTAL OF STORAGE CONTAINERS; PROVIDING STORAGE INFORMATION TO OTHERS, IN CLASS 39 (U.S. CLS. 100 AND 105).

FIRST USE 5-1-2007; IN COMMERCE 5-1-2007.

THE MARK CONSISTS OF STANDARD CHARACTERS WITHOUT CLAIM TO ANY PARTICULAR FONT, STYLE, SIZE, OR COLOR.

OWNER OF U.S. REG. NOS. 1,850,057 AND 2,744,225.

NO CLAIM IS MADE TO THE EXCLUSIVE RIGHT TO USE "LINE LOGISTICS", APART FROM THE MARK AS SHOWN.

SN 77-023,257, FILED 10-17-2006.

PAULA MAHONEY, EXAMINING ATTORNEY



**Int. Cl.: 41**

**Prior U.S. Cls.: 100, 101, and 107**

**United States Patent and Trademark Office**

**Reg. No. 3,570,330**

**Registered Feb. 3, 2009**

**SERVICE MARK  
PRINCIPAL REGISTER**



JIN PAL HAPKIDO MARTIAL ARTS ACADEMY,  
INC. (MARYLAND CORPORATION)  
7427 LINDBERGH DRIVE  
GAITHERSBURG, MD 20879

FOR: MARTIAL ARTS INSTRUCTION; OPERATING OF MARTIAL ARTS' SCHOOLS, IN CLASS 41 (U.S. CLS. 100, 101 AND 107).

FIRST USE 1-1-1999; IN COMMERCE 1-1-1999.

NO CLAIM IS MADE TO THE EXCLUSIVE RIGHT TO USE "HAPKIDO", APART FROM THE MARK AS SHOWN.

THE NAME(S), PORTRAIT(S), AND/OR SIGNATURE(S) SHOWN IN THE MARK IDENTIFIES JIN PAL KIM, WHOSE CONSENT(S) TO REGISTER IS SUBMITTED.

THE MARK CONSISTS OF A STYLIZED HUMAN FIGURE PRACTICING MARTIAL ARTS WITH NON-LATIN CHARACTERS POSITIONED VERTICALLY TO THE LEFT OF THE FIGURE, ENCLOSED BY A CIRCULAR CARRIER, SUPERIMPOSED ON A TRIANGULAR DESIGN BEARING THE WORDS "JIN PAL HAPKIDO" AT THE BASE OF THE TRIANGLE.

THE NON-LATIN CHARACTER(S) IN THE MARK TRANSLITERATES INTO "JIN PAL HAKIDO", MEANING "JIN PAL HAPKIDO" IN ENGLISH.

SN 77-024,915, FILED 10-19-2006.

ASMAT KHAN, EXAMINING ATTORNEY

**Int. Cl.: 44**

**Prior U.S. Cls.: 100 and 101**

**United States Patent and Trademark Office**

**Reg. No. 3,570,331**

**Registered Feb. 3, 2009**

**SERVICE MARK  
PRINCIPAL REGISTER**

**ISK INSTITUTE "SATISFYING  
ALL YOUR KNEEDS"**

SCOTT, W. NORMAN (UNITED STATES INDIVIDUAL)

4TH FLOOR

210 E 64TH STREET

NEW YORK, NY 10021

FOR: DIAGNOSIS AND TREATMENT OF ORTHOPEDIC AND SPORTS MEDICINE INJURIES, IN CLASS 44 (U.S. CLS. 100 AND 101).

FIRST USE 6-3-2008; IN COMMERCE 6-3-2008.

THE MARK CONSISTS OF STANDARD CHARACTERS WITHOUT CLAIM TO ANY PARTICULAR FONT, STYLE, SIZE, OR COLOR.

OWNER OF U.S. REG. NO. 2,947,548.

NO CLAIM IS MADE TO THE EXCLUSIVE RIGHT TO USE "INSTITUTE", APART FROM THE MARK AS SHOWN.

SN 77-027,718, FILED 10-24-2006.

CARYN GLASSER, EXAMINING ATTORNEY

**Int. Cl.: 45**

**Prior U.S. Cls.: 100 and 101**

**United States Patent and Trademark Office**

**Reg. No. 3,570,332**

**Registered Feb. 3, 2009**

**SERVICE MARK  
PRINCIPAL REGISTER**

**DEALER TEXT SOLUTIONS**

OCEAN MARKETING GROUP, LLC (ILLINOIS  
LIMITED LIABILITY COMPANY)  
9124 N. 66TH PLACE  
PARADISE VALLEY, AZ 85253

FOR: PROVIDING REMINDERS CONCERNING  
UPCOMING IMPORTANT DATES AND EVENTS  
VIA COMPUTER AND CELL PHONE, IN CLASS 45  
(U.S. CLS. 100 AND 101).

FIRST USE 2-9-2008; IN COMMERCE 2-9-2008.

THE MARK CONSISTS OF STANDARD CHAR-  
ACTERS WITHOUT CLAIM TO ANY PARTICULAR  
FONT, STYLE, SIZE, OR COLOR.

NO CLAIM IS MADE TO THE EXCLUSIVE  
RIGHT TO USE "DEALER TEXT", APART FROM  
THE MARK AS SHOWN.

SN 77-028,412, FILED 10-24-2006.

LINDA LAVACHE, EXAMINING ATTORNEY

**Int. Cl.: 41**

**Prior U.S. Cls.: 100, 101, and 107**

**United States Patent and Trademark Office**

**Reg. No. 3,570,333**

**Registered Feb. 3, 2009**

**SERVICE MARK  
PRINCIPAL REGISTER**

**SCARY MADISON**

HAPPY MADISON, INC. (NEW HAMPSHIRE  
CORPORATION)  
17 NORTH STREET  
MANCHESTER, NH 03104

FOR: MOTION PICTURE FILM PRODUCTION,  
IN CLASS 41 (U.S. CLS. 100, 101 AND 107).

FIRST USE 11-15-2008; IN COMMERCE 11-15-2008.

THE MARK CONSISTS OF STANDARD CHAR-  
ACTERS WITHOUT CLAIM TO ANY PARTICULAR  
FONT, STYLE, SIZE, OR COLOR.

OWNER OF U.S. REG. NO. 2,425,232.

SN 77-028,633, FILED 10-24-2006.

CHRISTINE COOPER, EXAMINING ATTORNEY

**Int. Cls.: 1, 5, 9, and 10**

**Prior U.S. Cls.: 1, 5, 6, 10, 18, 21, 23, 26, 36, 38, 39, 44, 46, 51, and 52**

**Reg. No. 3,570,334**

**United States Patent and Trademark Office**

**Registered Feb. 3, 2009**

**TRADEMARK  
PRINCIPAL REGISTER**



CYTYC CORPORATION (MASSACHUSETTS CORPORATION)  
250 CAMPUS DRIVE  
MARLBOROUGH, MA 01752

FOR: DIAGNOSTIC PREPARATIONS, REAGENTS AND CHEMICAL TEST KITS FOR SCIENTIFIC LABORATORY OR RESEARCH USE IN DETECTING CANCEROUS CONDITIONS, IN CLASS 1 (U.S. CLS. 1, 5, 6, 10, 26 AND 46).

FIRST USE 9-28-2007; IN COMMERCE 9-28-2007.

FOR: DIAGNOSTIC PREPARATIONS, REAGENTS AND TESTING KITS FOR CLINICAL OR MEDICAL LABORATORY USE IN DETECTING CANCEROUS CONDITIONS, IN CLASS 5 (U.S. CLS. 6, 18, 44, 46, 51 AND 52).

FIRST USE 9-28-2007; IN COMMERCE 9-28-2007.

FOR: APPARATUS, EQUIPMENT AND INSTRUMENTS FOR CYTOLOGY, HISTOLOGY AND PATHOLOGY LABORATORIES USED IN THE PREPARATION OF BIOLOGICAL HUMAN AND ANIMAL BIOLOGICAL SPECIMENS FOR CLINICAL DIAGNOSTIC PURPOSES AND FOR CYTOLOGY AND HISTOLOGY STUDY, NAMELY, SEMI-AUTOMATED CELL BLOCK PROCESSOR WITH

ALCOHOL REAGENTS, EOSIN REAGENTS, XYLENE REAGENTS AND PARAFFIN; CASSETTES FOR CAPTURING AND CONTAINING BIOLOGICAL SAMPLES FOR USE IN THE FOREGOING CELL BLOCK PROCESSOR; LABORATORY EQUIPMENT, NAMELY, CELL BLOCK FINISHING STATION WITH SURFACE FOR HEATING CELL BLOCKS, IN CLASS 9 (U.S. CLS. 21, 23, 26, 36 AND 38).

FIRST USE 9-28-2007; IN COMMERCE 9-28-2007.

FOR: MEDICAL DEVICES AND EQUIPMENT, NAMELY, CELL BLOCK APPARATUS FOR PREPARING HUMAN AND ANIMAL BIOLOGICAL SPECIMENS FOR CLINICAL MEDICAL OR VETERINARY DIAGNOSIS INCLUDING ONCOLOGY, IN CLASS 10 (U.S. CLS. 26, 39 AND 44).

FIRST USE 9-28-2007; IN COMMERCE 9-28-2007.

NO CLAIM IS MADE TO THE EXCLUSIVE RIGHT TO USE "AUTOMATED CELL BLOCK SYSTEM", APART FROM THE MARK AS SHOWN.

SN 77-028,817, FILED 10-25-2006.

G. MAYERSCHOFF, EXAMINING ATTORNEY

**Int. Cl.: 30**

**Prior U.S. Cl.: 46**

**United States Patent and Trademark Office**

**Reg. No. 3,570,335**

**Registered Feb. 3, 2009**

**TRADEMARK  
PRINCIPAL REGISTER**

**PIZZA NAVONA**

PIZZA NOVA RESTAURANTS LIMITED (CANADA CORPORATION)  
2247 MIDLAND AVENUE  
TORONTO, ONTARIO, CANADA M1P4R1

NO CLAIM IS MADE TO THE EXCLUSIVE RIGHT TO USE "PIZZA", APART FROM THE MARK AS SHOWN.

FOR: PIZZA, IN CLASS 30 (U.S. CL. 46).

FIRST USE 1-1-2008; IN COMMERCE 1-1-2008.

SN 77-028,872, FILED 10-25-2006.

THE MARK CONSISTS OF STANDARD CHARACTERS WITHOUT CLAIM TO ANY PARTICULAR FONT, STYLE, SIZE, OR COLOR.

SUZANNE BLANE, EXAMINING ATTORNEY

**Int. Cl.: 9**

**Prior U.S. Cls.: 21, 23, 26, 36, and 38**

**United States Patent and Trademark Office**

**Reg. No. 3,570,336**

**Registered Feb. 3, 2009**

**TRADEMARK  
PRINCIPAL REGISTER**

**PAN-TEAZ**

PAN-TEAZ IWEAR, INC. (INDIANA CORPORATION)  
3507 CANTERBURY DRIVE  
LAFAYETTE, IN 47909

FOR: SUNGLASSES, IN CLASS 9 (U.S. CLS. 21, 23,  
26, 36 AND 38).

FIRST USE 6-27-2008; IN COMMERCE 6-27-2008.

THE MARK CONSISTS OF STANDARD CHARACTERS WITHOUT CLAIM TO ANY PARTICULAR FONT, STYLE, SIZE, OR COLOR.

SN 77-029,333, FILED 10-25-2006.

JOHN SCHUYLER YARD, EXAMINING ATTORNEY

**Int. Cl.: 16**

**Prior U.S. Cls.: 2, 5, 22, 23, 29, 37, 38, and 50**

**Reg. No. 3,570,337**

**United States Patent and Trademark Office**

**Registered Feb. 3, 2009**

**TRADEMARK  
PRINCIPAL REGISTER**

**JoTeeny**

KUROKI, KAZ (UNITED STATES INDIVIDUAL)  
2640 HAMPSHIRE AVENUE S.  
SAINT LOUIS PARK, MN 55426

THE MARK CONSISTS OF STANDARD CHAR-  
ACTERS WITHOUT CLAIM TO ANY PARTICULAR  
FONT, STYLE, SIZE, OR COLOR.

FOR: HOLDERS FOR NOTEPADS, IN CLASS 16  
(U.S. CLS. 2, 5, 22, 23, 29, 37, 38 AND 50).

SN 77-029,522, FILED 10-25-2006.

FIRST USE 11-4-2006; IN COMMERCE 11-4-2006.

MICHAEL WEBSTER, EXAMINING ATTORNEY



Int. Cl.: 25

Prior U.S. Cls.: 22 and 39

United States Patent and Trademark Office

Reg. No. 3,570,338

Registered Feb. 3, 2009

TRADEMARK  
PRINCIPAL REGISTER

The image shows the word "Delirius" written in a cursive, handwritten style. A solid horizontal line is positioned above the word, and a solid black rectangular bar is positioned below it, partially obscuring the bottom of the letters.

BARRIO, ALDO (PERU INDIVIDUAL)  
164 EAST 100 STREET, APT.9  
NEW YORK, NY 10029

FOR: BELTS; BIBS NOT OF CLOTH OR PAPER; CAPS; CHILDREN'S AND INFANTS' CLOTH BIBS; CHILDREN'S CLOTH EATING BIBS; CLOTH BIBS; CLOTH BIBS FOR ADULT DINERS; CLOTH BIBS FOR USE BY SENIOR CITIZENS OR PHYSICALLY-OR MENTALLY-CHALLENGED PERSONS; CLOTH DIAPERS; CLOTHING FOR WEAR IN JUDO PRACTICES; CLOTHING FOR WEAR IN WRESTLING GAMES; CLOTHING, NAMELY, ARM WARMERS; CLOTHING, NAMELY, FOLK COSTUMES; CLOTHING, NAMELY, KNEE WARMERS; CLOTHING, NAMELY, NECK TUBES; CLOTHING, NAMELY, WRAP-AROUNDS; CORSETS; DUSTERS; FOU-LARDS; HOODS; INFANT AND TODDLER ONE PIECE CLOTHING; INFANT CLOTH DIAPERS;

JERSEYS; LEATHER BELTS; MANTLES; MUF-FLERS; NON-DISPOSABLE CLOTH TRAINING PANTS; PARTS OF CLOTHING, NAMELY, GUS-SETS FOR TIGHTS, GUSSETS FOR STOCKINGS, GUSSETS FOR BATHING SUITS, GUSSETS FOR UNDERWEAR, GUSSETS FOR LEOTARDS AND GUSSETS FOR FOOTLETS; PERSPIRATION AB-SORBENT UNDERWEAR CLOTHING; SHIFTS; SHORT SETS; SHOULDER PADS FOR CLOTHING; SHOULDER WRAPS; SWADDLING CLOTHES; TIES; TOPS; UNDERARM CLOTHING SHIELDS; WRAPS, IN CLASS 25 (U.S. CLS. 22 AND 39).

FIRST USE 11-30-2008; IN COMMERCE 11-30-2008.

SN 77-031,098, FILED 10-27-2006.

CHERYL CLAYTON, EXAMINING ATTORNEY

**Int. Cl.: 9**

**Prior U.S. Cls.: 21, 23, 26, 36, and 38**

**United States Patent and Trademark Office**

**Reg. No. 3,570,339**

**Registered Feb. 3, 2009**

**TRADEMARK  
PRINCIPAL REGISTER**

**BETTOR WAY CHANCE**

IGT (NEVADA CORPORATION)  
9295 PROTOTYPE DRIVE  
RENO, NV 895218986

THE MARK CONSISTS OF STANDARD CHAR-  
ACTERS WITHOUT CLAIM TO ANY PARTICULAR  
FONT, STYLE, SIZE, OR COLOR.

FOR: GAMING MACHINES, NAMELY, DEVICES  
WHICH ACCEPT A WAGER, IN CLASS 9 (U.S. CLS.  
21, 23, 26, 36 AND 38).

SN 77-033,697, FILED 10-31-2006.

FIRST USE 2-26-2007; IN COMMERCE 3-15-2007.

ROBIN MITTLER, EXAMINING ATTORNEY

**Int. Cl.: 9**

**Prior U.S. Cls.: 21, 23, 26, 36, and 38**

**United States Patent and Trademark Office**

**Reg. No. 3,570,340**

**Registered Feb. 3, 2009**

**TRADEMARK  
PRINCIPAL REGISTER**

**BETTOR CHANCE BONUS**

IGT (NEVADA CORPORATION)  
9295 PROTOTYPE DRIVE  
RENO, NV 895218986

THE MARK CONSISTS OF STANDARD CHAR-  
ACTERS WITHOUT CLAIM TO ANY PARTICULAR  
FONT, STYLE, SIZE, OR COLOR.

FOR: GAMING MACHINES, NAMELY, DEVICES  
WHICH ACCEPT A WAGER, IN CLASS 9 (U.S. CLS.  
21, 23, 26, 36 AND 38).

SN 77-033,700, FILED 10-31-2006.

FIRST USE 5-24-2007; IN COMMERCE 6-13-2007.

ROBIN MITTLER, EXAMINING ATTORNEY

**Int. Cl.: 9**

**Prior U.S. Cls.: 21, 23, 26, 36, and 38**

**United States Patent and Trademark Office**

**Reg. No. 3,570,341**

**Registered Feb. 3, 2009**

**TRADEMARK  
PRINCIPAL REGISTER**

**BETTOR BONUS CHANCE**

IGT (NEVADA CORPORATION)  
9295 PROTOTYPE DRIVE  
RENO, NV 895218986

THE MARK CONSISTS OF STANDARD CHAR-  
ACTERS WITHOUT CLAIM TO ANY PARTICULAR  
FONT, STYLE, SIZE, OR COLOR.

FOR: GAMING MACHINES, NAMELY, DEVICES  
WHICH ACCEPT A WAGER, IN CLASS 9 (U.S. CLS.  
21, 23, 26, 36 AND 38).

SN 77-033,702, FILED 10-31-2006.

FIRST USE 5-24-2007; IN COMMERCE 6-13-2007.

ROBIN MITTLER, EXAMINING ATTORNEY

**Int. Cl.: 9**

**Prior U.S. Cls.: 21, 23, 26, 36, and 38**

**Reg. No. 3,570,342**

**United States Patent and Trademark Office**

**Registered Feb. 3, 2009**

---

**TRADEMARK  
PRINCIPAL REGISTER**

**BLACK KNIGHT**

WMS GAMING INC. (DELAWARE CORPORATION)  
800 SOUTH NORTHPOINT BOULEVARD  
WAUKEGAN, IL 60085

FOR: GAMING MACHINES THAT GENERATE OR DISPLAY WAGER OUTCOMES; GAMING SOFTWARE THAT GENERATES OR DISPLAYS WAGER OUTCOMES OF GAMING MACHINES, IN CLASS 9 (U.S. CLS. 21, 23, 26, 36 AND 38).

FIRST USE 11-18-2008; IN COMMERCE 11-18-2008.

THE MARK CONSISTS OF STANDARD CHARACTERS WITHOUT CLAIM TO ANY PARTICULAR FONT, STYLE, SIZE, OR COLOR.

SN 77-048,609, FILED 11-21-2006.

ANNE FARRELL, EXAMINING ATTORNEY

**Int. Cl.: 9**

**Prior U.S. Cls.: 21, 23, 26, 36, and 38**

**United States Patent and Trademark Office**

**Reg. No. 3,570,343**

**Registered Feb. 3, 2009**

**TRADEMARK  
PRINCIPAL REGISTER**

**GRIFFIN'S GATE**

WMS GAMING INC. (DELAWARE CORPORATION)  
800 SOUTH NORTHPOINT BOULEVARD  
WAUKEGAN, IL 60085

FOR: GAMING MACHINES THAT GENERATE OR DISPLAY WAGER OUTCOMES; GAMING SOFTWARE THAT GENERATES OR DISPLAYS WAGER OUTCOMES OF GAMING MACHINES, IN CLASS 9 (U.S. CLS. 21, 23, 26, 36 AND 38).

FIRST USE 6-27-2008; IN COMMERCE 6-27-2008.

THE MARK CONSISTS OF STANDARD CHARACTERS WITHOUT CLAIM TO ANY PARTICULAR FONT, STYLE, SIZE, OR COLOR.

SN 77-053,695, FILED 11-30-2006.

MIDGE BUTLER, EXAMINING ATTORNEY

**Int. Cl.: 25**

**Prior U.S. Cls.: 22 and 39**

**United States Patent and Trademark Office**

**Reg. No. 3,570,344**

**Registered Feb. 3, 2009**

**TRADEMARK  
PRINCIPAL REGISTER**



GOTHAM GROUP CONCEPTS, LLC (NEW YORK  
LIMITED LIABILITY COMPANY)  
1820 INDUSTRIAL ST., STE. 240  
LOS ANGELES, CA 90021

FOR: CLOTHING, NAMELY, JEANS, TOPS,  
DRESSES, SKIRTS AND JACKETS, IN CLASS 25  
(U.S. CLS. 22 AND 39).

FIRST USE 10-0-2005; IN COMMERCE 10-0-2005.

THE MARK CONSISTS OF A STYLIZED CROSS.

SN 77-055,414, FILED 12-1-2006.

RON FAIRBANKS, EXAMINING ATTORNEY

**Int. Cl.: 10**

**Prior U.S. Cls.: 26, 39, and 44**

**United States Patent and Trademark Office**

**Reg. No. 3,570,345**

**Registered Feb. 3, 2009**

**TRADEMARK  
PRINCIPAL REGISTER**

**GEL-AIRE**

REGENCY INTERNATIONAL MARKETING,  
LLC (NEVADA LIMITED LIABILITY COMPA-  
NY)  
SUITE 174  
800 NORTH RAINBOW BOULEVARD  
LAS VEGAS, NV 89107

FOR: PRESSURE RELIEF CUSHIONS AND MAT-  
TRESSES FOR THERAPEUTIC PURPOSES, IN  
CLASS 10 (U.S. CLS. 26, 39 AND 44).

FIRST USE 11-15-2006; IN COMMERCE 11-15-2006.

THE MARK CONSISTS OF STANDARD CHAR-  
ACTERS WITHOUT CLAIM TO ANY PARTICULAR  
FONT, STYLE, SIZE, OR COLOR.

SN 77-056,727, FILED 12-4-2006.

ANNE E. GUSTASON, EXAMINING ATTORNEY



**Int. Cl.: 9**

**Prior U.S. Cls.: 21, 23, 26, 36, and 38**

**Reg. No. 3,570,346**

**United States Patent and Trademark Office**

**Registered Feb. 3, 2009**

---

**TRADEMARK  
PRINCIPAL REGISTER**

# RamTracer

OPTOTRACE TECHNOLOGIES, INC. (DELA-  
WARE CORPORATION)  
544 WEDDELL DRIVE, SUITE 7  
SUNNYVALE, CA 94089

FOR: SEMICONDUCTOR BASED SENSORS FOR  
SENSING TRACE CHEMICALS AND BIOLOGIC  
AGENTS, AND FOR IDENTIFYING CHEMICAL  
COMPOUNDS IN AIR OR LIQUID , IN CLASS 9  
(U.S. CLS. 21, 23, 26, 36 AND 38).

FIRST USE 3-10-2007; IN COMMERCE 3-10-2007.

THE MARK CONSISTS OF STANDARD CHAR-  
ACTERS WITHOUT CLAIM TO ANY PARTICULAR  
FONT, STYLE, SIZE, OR COLOR.

SN 77-057,339, FILED 12-5-2006.

PAUL CROWLEY, EXAMINING ATTORNEY

**Int. Cl.: 9**

**Prior U.S. Cls.: 21, 23, 26, 36, and 38**

**United States Patent and Trademark Office**

**Reg. No. 3,570,347**

**Registered Feb. 3, 2009**

**TRADEMARK  
PRINCIPAL REGISTER**

# The Treasure

WORLD MISSION (MICHIGAN CORPORATION)  
SUITE 6  
1701 PORTER SW  
WYOMING, MI 49519

THE MARK CONSISTS OF STANDARD CHAR-  
ACTERS WITHOUT CLAIM TO ANY PARTICULAR  
FONT, STYLE, SIZE, OR COLOR.

FOR: CD PLAYERS; DIGITAL AUDIO PLAYERS;  
MP3 PLAYERS, IN CLASS 9 (U.S. CLS. 21, 23, 26, 36  
AND 38).

SN 77-058,095, FILED 12-6-2006.

FIRST USE 1-1-2008; IN COMMERCE 1-1-2008.

DAVID HOFFMAN, EXAMINING ATTORNEY

**Int. Cl.: 9**

**Prior U.S. Cls.: 21, 23, 26, 36, and 38**

**United States Patent and Trademark Office**

**Reg. No. 3,570,348**

**Registered Feb. 3, 2009**

**TRADEMARK  
PRINCIPAL REGISTER**

# The Treasure Found

WORLD MISSION (MICHIGAN CORPORATION)  
SUITE 6  
1701 PORTER SW  
WYOMING, MI 49519

THE MARK CONSISTS OF STANDARD CHARACTERS WITHOUT CLAIM TO ANY PARTICULAR FONT, STYLE, SIZE, OR COLOR.

FOR: CD PLAYERS; DIGITAL AUDIO PLAYERS; MP3 PLAYERS; WEB CONSOLES, IN CLASS 9 (U.S. CLS. 21, 23, 26, 36 AND 38).

SN 77-058,114, FILED 12-6-2006.

FIRST USE 1-1-2008; IN COMMERCE 1-1-2008.

DAVID HOFFMAN, EXAMINING ATTORNEY

**Int. Cls.: 9 and 10**

**Prior U.S. Cls.: 21, 23, 26, 36, 38, 39, and 44**

**United States Patent and Trademark Office**

**Reg. No. 3,570,349**

**Registered Feb. 3, 2009**

**TRADEMARK  
PRINCIPAL REGISTER**

**CARESCAPE**

GENERAL ELECTRIC COMPANY (NEW YORK CORPORATION)  
1 RIVER ROAD  
SCHENECTADY, NY 12345

FOR: COMPUTER SOFTWARE FOR OPERATING PATIENT MONITORING EQUIPMENT; NETWORKING SOFTWARE, NAMELY, COMMUNICATIONS SOFTWARE FOR CONNECTING PATIENT MONITORS, THERAPY DEVICES, LIFE SUPPORT SYSTEMS, PERSONAL COMPUTERS, HANDHELD DEVICES, WIRELESS TELEPHONES AND PAGERS FOR USE IN DETECTING, ANALYZING, DIAGNOSING AND TREATING PATIENT HEALTH, IN CLASS 9 (U.S. CLS. 21, 23, 26, 36 AND 38).

FIRST USE 3-0-2008; IN COMMERCE 3-0-2008.

FOR: PATIENT MONITORING EQUIPMENT, NAMELY, PATIENT MONITORS FOR MONITORING PATIENT PHYSIOLOGICAL DATA; FETAL

AND NEONATAL MONITORING SYSTEMS COMPRISED OF INSTRUMENTS FOR MONITORING AND MEASURING FETAL AND HUMAN BODY REACTIONS; HEARTBEAT TRANSDUCERS AND ELECTRODES FOR USE WITH HEART RATE MONITORING DEVICES; TRANSPORT MONITORS; DEFIBRILLATORS; CARDIAC STRESS TEST INSTRUMENTS; AND PORTABLE ELECTROCARDIOGRAM, IN CLASS 10 (U.S. CLS. 26, 39 AND 44).

FIRST USE 3-0-2008; IN COMMERCE 3-0-2008.

THE MARK CONSISTS OF STANDARD CHARACTERS WITHOUT CLAIM TO ANY PARTICULAR FONT, STYLE, SIZE, OR COLOR.

SN 77-059,764, FILED 12-8-2006.

CAROLINE WOOD, EXAMINING ATTORNEY

**Int. Cl.: 36**

**Prior U.S. Cls.: 100, 101, and 102**

**United States Patent and Trademark Office**

**Reg. No. 3,570,350**

**Registered Feb. 3, 2009**

**SERVICE MARK  
PRINCIPAL REGISTER**

**MOUNTAIN BIZCAPITAL**

MOUNTAIN BIZWORKS, INC. (NORTH CAROLINA CORPORATION)

29 1/2 PAGE AVENUE

ASHEVILLE, NC 28801

FOR: FINANCING SERVICES, IN CLASS 36 (U.S. CLS. 100, 101 AND 102).

FIRST USE 1-30-2007; IN COMMERCE 1-30-2007.

THE MARK CONSISTS OF STANDARD CHARACTERS WITHOUT CLAIM TO ANY PARTICULAR FONT, STYLE, SIZE, OR COLOR.

NO CLAIM IS MADE TO THE EXCLUSIVE RIGHT TO USE "BUSINESS CAPITAL", APART FROM THE MARK AS SHOWN.

SN 77-063,587, FILED 12-13-2006.

SUZANNE BLANE, EXAMINING ATTORNEY

**Int. Cl.: 16**

**Prior U.S. Cls.: 2, 5, 22, 23, 29, 37, 38, and 50**

**Reg. No. 3,570,351**

**United States Patent and Trademark Office**

**Registered Feb. 3, 2009**

**TRADEMARK  
PRINCIPAL REGISTER**

**GOSIGN!**

BLAZER TECHNOLOGY LLC (MINNESOTA  
LIMITED LIABILITY COMPANY)  
1270 HELMO AVENUE  
OAKDALE, MN 55128

THE MARK CONSISTS OF STANDARD CHAR-  
ACTERS WITHOUT CLAIM TO ANY PARTICULAR  
FONT, STYLE, SIZE, OR COLOR.

FOR: ADHESIVE CRAFT PAPER; ADHESIVES  
FOR STATIONERY AND HOUSEHOLD USE; AND  
ADHESIVE COATED PAPER FOR USE IN SCRAP-  
BOOKING, IN CLASS 16 (U.S. CLS. 2, 5, 22, 23, 29, 37,  
38 AND 50).

OWNER OF U.S. REG. NO. 2,851,753.

SN 77-068,079, FILED 12-20-2006.

FIRST USE 6-12-2008; IN COMMERCE 6-12-2008.

SKYE YOUNG, EXAMINING ATTORNEY

**Int. Cl.: 35**

**Prior U.S. Cls.: 100, 101, and 102**

**United States Patent and Trademark Office**

**Reg. No. 3,570,352**

**Registered Feb. 3, 2009**

**SERVICE MARK  
PRINCIPAL REGISTER**

**Everything...Anytime!**

GOTTFURCHT, ELLIOT (UNITED STATES INDIVIDUAL)  
1018 HARTZELL STREET  
PACIFIC PALISADES, CA 90272

FOR: COMPUTERIZED ON-LINE ORDERING FEATURING GENERAL MERCHANDISE AND GENERAL CONSUMER GOODS AND SERVICES; OPERATING AN ONLINE SHOPPING SITE IN THE FIELDS OF GENERAL MERCHANDISE AND GENERAL CONSUMER GOODS AND SERVICES, NAMELY, MOVIES, SPORTS, GAMES, MUSIC, FAMILY, TELEVISION, THE INTERNET, EDUCATION

AND BUSINESS, IN CLASS 35 (U.S. CLS. 100, 101 AND 102).

FIRST USE 4-3-2007; IN COMMERCE 4-3-2007.

THE MARK CONSISTS OF STANDARD CHARACTERS WITHOUT CLAIM TO ANY PARTICULAR FONT, STYLE, SIZE, OR COLOR.

SN 77-075,106, FILED 1-3-2007.

RONALD MCMORROW, EXAMINING ATTORNEY

**Int. Cl.: 44**

**Prior U.S. Cls.: 100 and 101**

**United States Patent and Trademark Office**

**Reg. No. 3,570,353**

**Registered Feb. 3, 2009**

**SERVICE MARK  
PRINCIPAL REGISTER**

**THE MOST THOROUGH AND  
COMPLETE HEARING TEST**

MIRACLE-EAR, INC. (MINNESOTA CORPORATION)  
5000 CHESHIRE PARKWAY NORTH  
PLYMOUTH, MN 55446

FOR: MEDICAL SERVICES IN THE NATURE OF  
HEARING EVALUATION, IN CLASS 44 (U.S. CLS.  
100 AND 101).

FIRST USE 6-1-2007; IN COMMERCE 6-1-2007.

THE MARK CONSISTS OF STANDARD CHARACTERS WITHOUT CLAIM TO ANY PARTICULAR FONT, STYLE, SIZE, OR COLOR.

NO CLAIM IS MADE TO THE EXCLUSIVE RIGHT TO USE "HEARING TEST", APART FROM THE MARK AS SHOWN.

SN 77-075,262, FILED 1-3-2007.

ODESSA BIBBINS, EXAMINING ATTORNEY



**Int. Cl.: 9**

**Prior U.S. Cls.: 21, 23, 26, 36, and 38**

**United States Patent and Trademark Office**

**Reg. No. 3,570,354**

**Registered Feb. 3, 2009**

**TRADEMARK  
PRINCIPAL REGISTER**

**CONTRACTOR'S CHOICE**

BIG TIME HOLDINGS, INC. (GEORGIA CORPORATION)

2 WILBANKS ROAD

ROME, GA 30161

FOR: PROTECTIVE WORK GLOVES, IN CLASS 9  
(U.S. CLS. 21, 23, 26, 36 AND 38).

FIRST USE 10-15-2008; IN COMMERCE 10-15-2008.

THE MARK CONSISTS OF STANDARD CHARACTERS WITHOUT CLAIM TO ANY PARTICULAR FONT, STYLE, SIZE, OR COLOR.

NO CLAIM IS MADE TO THE EXCLUSIVE RIGHT TO USE "CONTRACTOR'S", APART FROM THE MARK AS SHOWN.

SN 77-078,054, FILED 1-8-2007.

BERNICE MIDDLETON, EXAMINING ATTORNEY

**Int. Cls.: 9 and 42**

**Prior U.S. Cls.: 21, 23, 26, 36, 38, 100, and 101**

**United States Patent and Trademark Office**

**Reg. No. 3,570,355**

**Registered Feb. 3, 2009**

**TRADEMARK  
SERVICE MARK  
PRINCIPAL REGISTER**

**JAZZ**

INTERNATIONAL BUSINESS MACHINES CORPORATION (NEW YORK CORPORATION)  
NEW ORCHARD ROAD  
ARMONK, NY 10504

FOR: COMPUTER SOFTWARE FOR COLLABORATIVE PRODUCT DESIGN AND DEVELOPMENT AND MANUALS SOLD AS A UNIT THEREWITH, IN CLASS 9 (U.S. CLS. 21, 23, 26, 36 AND 38).

FIRST USE 6-12-2007; IN COMMERCE 6-12-2007.

FOR: COMPUTER SOFTWARE SERVICES, NAMELY, A WEB SITE FEATURING INFORMATION ON SOFTWARE PROCESS AND APPLICATION FRAMEWORK TO FACILITATE COLLABORATIVE TEAM PRODUCT DESIGN AND DEVELOPMENT, INCLUDING DEVELOPMENT TOOLS, WHITEBOARDS, AWARENESS, COMMUNICATION AND COORDINATION

AMONG TEAMS; HOSTING COMPUTER SOFTWARE APPLICATIONS FOR OTHERS; TECHNICAL SUPPORT SERVICES, NAMELY, TROUBLESHOOTING OF COMPUTER SOFTWARE PROBLEMS; COMPUTER SOFTWARE DESIGN FOR OTHERS; INSTALLATION, UPDATING AND MAINTENANCE OF COMPUTER SOFTWARE; CONSULTING SERVICES IN THE FIELD OF COMPUTER SOFTWARE, IN CLASS 42 (U.S. CLS. 100 AND 101).

FIRST USE 6-12-2007; IN COMMERCE 6-12-2007.

THE MARK CONSISTS OF STANDARD CHARACTERS WITHOUT CLAIM TO ANY PARTICULAR FONT, STYLE, SIZE, OR COLOR.

SN 77-079,382, FILED 1-9-2007.

MYRIAH HABEEB, EXAMINING ATTORNEY

**Int. Cl.: 36**

**Prior U.S. Cls.: 100, 101, and 102**

**United States Patent and Trademark Office**

**Reg. No. 3,570,356**

**Registered Feb. 3, 2009**

**SERVICE MARK  
PRINCIPAL REGISTER**

**GENERATION CURES**

CHILDREN'S MEDICAL CENTER CORPORATION  
(MASSACHUSETTS CORPORATION)  
300 LONGWOOD AVENUE  
BOSTON, MA 02115

THE MARK CONSISTS OF STANDARD CHARACTERS WITHOUT CLAIM TO ANY PARTICULAR FONT, STYLE, SIZE, OR COLOR.

FOR: CHARITABLE FUNDRAISING SERVICES TO SUPPORT HOSPITAL-BASED PATIENT CARE AND RESEARCH PROGRAMS, IN CLASS 36 (U.S. CLS. 100, 101 AND 102).

SN 77-080,116, FILED 1-10-2007.

FIRST USE 8-20-2008; IN COMMERCE 8-20-2008.

JEFF DEFORD, EXAMINING ATTORNEY

**Int. Cl.: 25**

**Prior U.S. Cls.: 22 and 39**

**United States Patent and Trademark Office**

**Reg. No. 3,570,357**

**Registered Feb. 3, 2009**

**TRADEMARK  
PRINCIPAL REGISTER**

**ECOWEAVE**

ECO-BAGS PRODUCTS, INC. (NEW YORK CORPORATION)  
42 STONE AVENUE  
OSSINING, NY 10562

FOR: WEARING APPAREL FOR WOMEN AND MEN MADE OF NATURAL MATERIAL, RECYCLED MATERIAL, ORGANIC MATERIAL AND PLANT FIBERS, NAMELY, T-SHIRTS, POLO SHIRTS, SHIRTS, IN CLASS 25 (U.S. CLS. 22 AND 39).

FIRST USE 6-1-2000; IN COMMERCE 12-1-2000.

THE MARK CONSISTS OF STANDARD CHARACTERS WITHOUT CLAIM TO ANY PARTICULAR FONT, STYLE, SIZE, OR COLOR.

OWNER OF U.S. REG. NO. 2,601,167.

SN 77-082,231, FILED 1-12-2007.

MARILYN IZZI, EXAMINING ATTORNEY

**Int. Cl.: 29**

**Prior U.S. Cl.: 46**

**United States Patent and Trademark Office**

**Reg. No. 3,570,358**

**Registered Feb. 3, 2009**

**TRADEMARK  
PRINCIPAL REGISTER**

**TWIGGS**

MCCAIN FOODS USA, INC. (MAINE CORPORATION)  
2275 CABOT DRIVE  
LISLE, IL 605323653

THE MARK CONSISTS OF STANDARD CHARACTERS WITHOUT CLAIM TO ANY PARTICULAR FONT, STYLE, SIZE, OR COLOR.

FOR: FROZEN BREADED AND BATTERED VEGETABLE APPETIZERS, IN CLASS 29 (U.S. CL. 46).

SN 77-084,797, FILED 1-17-2007.

FIRST USE 12-29-2006; IN COMMERCE 12-29-2006.

SUZANNE BLANE, EXAMINING ATTORNEY

Int. Cl.: 44

Prior U.S. Cls.: 100 and 101

United States Patent and Trademark Office

Reg. No. 3,570,359

Registered Feb. 3, 2009

SERVICE MARK  
PRINCIPAL REGISTER



FEATHERS OF GRACE, LLC (MISSOURI LIMITED LIABILITY COMPANY)  
PMB 117, 14459 N. U.S. HWY. 169  
SMITHVILLE, MO 64089

THE MARK CONSISTS OF THE WORDS "FEATHERS OF GRACE" ABOVE THREE OVERLAPPING FEATHERS.

FOR: BREEDING OF EXOTIC BIRDS FOR PETS, IN CLASS 44 (U.S. CLS. 100 AND 101).

SN 77-085,778, FILED 1-18-2007.

FIRST USE 6-14-2007; IN COMMERCE 6-14-2007.

LAURIE KAUFMAN, EXAMINING ATTORNEY

**Int. Cl.: 25**

**Prior U.S. Cls.: 22 and 39**

**United States Patent and Trademark Office**

**Reg. No. 3,570,360**

**Registered Feb. 3, 2009**

**TRADEMARK  
PRINCIPAL REGISTER**

**STATE TEEZ**

OLSON, TIFFANY (UNITED STATES INDIVIDUAL)

1234 FALL CREEK ROAD

LINCOLN, NE 68510

FOR: SHIRTS; T-SHIRTS; TANK TOPS, IN CLASS 25 (U.S. CLS. 22 AND 39).

FIRST USE 8-19-2006; IN COMMERCE 1-12-2007.

THE MARK CONSISTS OF STANDARD CHARACTERS WITHOUT CLAIM TO ANY PARTICULAR FONT, STYLE, SIZE, OR COLOR.

NO CLAIM IS MADE TO THE EXCLUSIVE RIGHT TO USE "TEES", APART FROM THE MARK AS SHOWN.

SN 77-086,294, FILED 1-19-2007.

ROBIN MITTLER, EXAMINING ATTORNEY

**Int. Cl.: 16**

**Prior U.S. Cls.: 2, 5, 22, 23, 29, 37, 38, and 50**

**Reg. No. 3,570,361**

**United States Patent and Trademark Office**

**Registered Feb. 3, 2009**

**TRADEMARK  
PRINCIPAL REGISTER**

**GET GRINNING**

JENIFER JURDEN, LLC (MARYLAND LIMITED  
LIABILITY COMPANY)  
P.O. BOX 200  
BISHOPVILLE, MD 21813

THE MARK CONSISTS OF STANDARD CHAR-  
ACTERS WITHOUT CLAIM TO ANY PARTICULAR  
FONT, STYLE, SIZE, OR COLOR.

FOR: GREETING CARDS, IN CLASS 16 (U.S. CLS.  
2, 5, 22, 23, 29, 37, 38 AND 50).

SN 77-086,315, FILED 1-19-2007.

FIRST USE 4-0-2007; IN COMMERCE 4-0-2007.

SCOTT BIBB, EXAMINING ATTORNEY



**Int. Cl.: 9**

**Prior U.S. Cls.: 21, 23, 26, 36, and 38**

**United States Patent and Trademark Office**

**Reg. No. 3,570,362**

**Registered Feb. 3, 2009**

**TRADEMARK  
PRINCIPAL REGISTER**

**THE LEGEND OF KAGE**

KABUSHIKI KAISHA TAITO (JAPAN CORPORATION)  
3-22-7 YOYOGI, SHIBUYA-KU  
TOKYO, JAPAN 151-0053

FOR: DOWNLOADABLE SOFTWARE FOR USE AS GAME PROGRAMS ON MOBILE TELEPHONES; COMPUTER PROGRAMS FOR PLAYING GAMES RECORDED ON MOBILE TELEPHONES; AND ELECTRONIC GAME PROGRAMS; COMPUTER GAME PROGRAMS PRE-RECORDED ON CARTRIDGES, DISCS, AND CARDS; DOWNLOADABLE SOFTWARE FOR USE AS COMPUTER GAME PROGRAMS; INTERACTIVE MULTIMEDIA COMPUTER GAME PROGRAMS FEATURING DOWNLOADABLE SOUND AND DOWNLOADABLE DIGITAL MUSIC PROVIDED FROM THE INTERNET; DOWNLOADABLE SOFTWARE FOR USE AS SCREEN SAVERS FOR COMPUTERS OR MOBILE PHONES; DOWNLOADABLE SOFTWARE FOR USE AS RING TONES FOR MOBILE PHONES; PRE-RECORDED MAGNETIC DATA CARRIERS FEATURING GAMES; PRE-RECORDED DIGITAL VIDEO DISCS FEATURING GAMES; DOWNLOAD-

ABLE ELECTRONIC PUBLICATIONS IN THE NATURE OF ENTERTAINMENT IN THE FIELD OF ANIMATED CARTOONS OR ACTION/ADVENTURE ENTERTAINMENT; AND ELECTRONIC PUBLICATIONS, NAMELY, JOURNALS OR NEWSLETTERS IN THE FIELD OF ENTERTAINMENT FEATURING COMPUTER GAMES, VIDEO GAMES, CARTOONS OR GENERAL ENTERTAINMENT RECORDED ON COMPUTER MEDIA, IN CLASS 9 (U.S. CLS. 21, 23, 26, 36 AND 38).

FIRST USE 7-0-2006; IN COMMERCE 7-0-2006.

THE MARK CONSISTS OF STANDARD CHARACTERS WITHOUT CLAIM TO ANY PARTICULAR FONT, STYLE, SIZE, OR COLOR.

OWNER OF U.S. REG. NO. 1,420,219.

SN 77-087,222, FILED 1-19-2007.

WILLIAM P. SHANAHAN, EXAMINING ATTORNEY

**Int. Cl.: 10**

**Prior U.S. Cls.: 26, 39, and 44**

**United States Patent and Trademark Office**

**Reg. No. 3,570,363**

**Registered Feb. 3, 2009**

**TRADEMARK  
PRINCIPAL REGISTER**

**FAST1**

PYNG MEDICAL CORP. (CANADA CORPORATION)  
UNIT - 7-13511 CRESTWOOD PLACE  
RICHMOND, B.C., CANADA V6V 2E9

FOR: INTRAOSSEOUS INFUSION DEVICES, IN  
CLASS 10 (U.S. CLS. 26, 39 AND 44).

FIRST USE 7-25-2007; IN COMMERCE 7-25-2007.

THE MARK CONSISTS OF STANDARD CHARACTERS WITHOUT CLAIM TO ANY PARTICULAR FONT, STYLE, SIZE, OR COLOR.

PRIORITY CLAIMED UNDER SEC. 44(D) ON  
CANADA APPLICATION NO. 1322457, FILED 10-27-  
2006, REG. NO. 712912, DATED 4-25-2008, EXPIRES 4-  
25-2023.

OWNER OF U.S. REG. NO. 2,120,144.

SN 77-088,163, FILED 1-22-2007.

CHRISTINE COOPER, EXAMINING ATTORNEY

**Int. Cl.: 41**

**Prior U.S. Cls.: 100, 101, and 107**

**Reg. No. 3,570,364**

**United States Patent and Trademark Office**

**Registered Feb. 3, 2009**

**SERVICE MARK  
PRINCIPAL REGISTER**

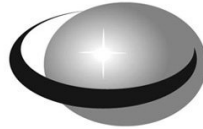

**mycareerplanet.com**

What do you want to be when you grow up?

MY CAREER PLANET, INC. (LOUISIANA CORPORATION)  
8500 JACKSON SQUARE, SUITE 6B  
SHREVEPORT, LA 71115

THE MARK CONSISTS OF A PLANET WITH A STARBURST POSITIONED SLIGHTLY LEFT OF CENTER WITH A SINGLE RING WHICH CIRCLES AROUND THE PLANET.

FOR: CAREER COUNSELING, IN CLASS 41 (U.S. CLS. 100, 101 AND 107).

SN 77-089,978, FILED 1-24-2007.

FIRST USE 10-1-2006; IN COMMERCE 5-26-2008.

ERNEST SHOSHO, EXAMINING ATTORNEY

**Int. Cl.: 42**

**Prior U.S. Cls.: 100 and 101**

**United States Patent and Trademark Office**

**Reg. No. 3,570,365**

**Registered Feb. 3, 2009**

**SERVICE MARK  
PRINCIPAL REGISTER**

**LIGHTS ON NETWORK**

CERNER INNOVATION, INC. (DELAWARE CORPORATION)  
10975 BENSON, SUITE 550  
12 CORPORATE WOODS  
OVERLAND PARK, KS 66210

FOR: COMPUTER SYSTEMS OPERATIONS SERVICES FOR OTHERS IN THE FIELD OF HEALTHCARE INFORMATION TECHNOLOGY, NAMELY, COMPUTER SYSTEMS ANALYSIS SERVICES AND REMOTE MANAGEMENT OF COMPUTER SYSTEMS; COMPUTER SYSTEMS OPERATIONS SERVICES FOR OTHERS IN THE FIELD OF HEALTHCARE INFORMATION TECHNOLOGY, NAMELY, CREATING AN ONLINE COMMUNITY FOR USERS TO COLLABORATE WITH THEIR

PEERS AND EXCHANGE OPERATIONAL DATA, IN CLASS 42 (U.S. CLS. 100 AND 101).

FIRST USE 6-1-2007; IN COMMERCE 6-1-2007.

THE MARK CONSISTS OF STANDARD CHARACTERS WITHOUT CLAIM TO ANY PARTICULAR FONT, STYLE, SIZE, OR COLOR.

NO CLAIM IS MADE TO THE EXCLUSIVE RIGHT TO USE "NETWORK", APART FROM THE MARK AS SHOWN.

SN 77-095,400, FILED 1-31-2007.

ALICIA COLLINS, EXAMINING ATTORNEY

**Int. Cl.: 11**

**Prior U.S. Cls.: 13, 21, 23, 31, and 34**

**United States Patent and Trademark Office**

**Reg. No. 3,570,366**

**Registered Feb. 3, 2009**

**TRADEMARK  
PRINCIPAL REGISTER**

**LA BLAC**

HOMER TLC, INC. (DELAWARE CORPORATION)  
1404 SOCIETY DRIVE  
CLAYMONT, DE 19703

FOR: CEILING FANS; ELECTRIC LIGHTING  
FIXTURES, IN CLASS 11 (U.S. CLS. 13, 21, 23, 31  
AND 34).

FIRST USE 4-0-2007; IN COMMERCE 4-0-2007.

THE MARK CONSISTS OF STANDARD CHARACTERS WITHOUT CLAIM TO ANY PARTICULAR FONT, STYLE, SIZE, OR COLOR.

THE WORDING "LA BLAC" IN THE MARK HAS NO MEANING IN A FOREIGN LANGUAGE.

SN 77-095,760, FILED 1-31-2007.

BERNICE MIDDLETON, EXAMINING ATTORNEY

**Int. Cl.: 36**

**Prior U.S. Cls.: 100, 101, and 102**

**United States Patent and Trademark Office**

**Reg. No. 3,570,367**

**Registered Feb. 3, 2009**

**SERVICE MARK  
PRINCIPAL REGISTER**



**COMMUNITY  
CAPITAL  
MANAGEMENT**

COMMUNITY CAPITAL MANAGEMENT, INC.  
(DELAWARE CORPORATION)  
2500 WESTON ROAD, SUITE #101  
WESTON, FL 33331

FOR: INVESTMENT ADVICE; INVESTMENT  
BANKING SERVICES; MUTUAL FUND MANAGE-  
MENT SERVICES, IN CLASS 36 (U.S. CLS. 100, 101  
AND 102).

FIRST USE 2-1-2007; IN COMMERCE 2-1-2007.

NO CLAIM IS MADE TO THE EXCLUSIVE  
RIGHT TO USE "COMMUNITY CAPITAL MAN-  
AGEMENT", APART FROM THE MARK AS  
SHOWN.

THE MARK CONSISTS OF AN OUTLINE OF A  
FENCE.

SN 77-099,563, FILED 2-5-2007.

TRACY CROSS, EXAMINING ATTORNEY

**Int. Cl.: 36**

**Prior U.S. Cls.: 100, 101, and 102**

**United States Patent and Trademark Office**

**Reg. No. 3,570,368**

**Registered Feb. 3, 2009**

**SERVICE MARK  
PRINCIPAL REGISTER**

# Revitalizing America

COMMUNITY CAPITAL MANAGEMENT, INC.  
(DELAWARE CORPORATION)  
2500 WESTON ROAD, SUITE #101  
WESTON, FL 33331

FOR: INVESTMENT ADVICE; INVESTMENT  
BANKING SERVICES; MUTUAL FUND MANAGE-  
MENT SERVICES, IN CLASS 36 (U.S. CLS. 100, 101  
AND 102).

FIRST USE 2-1-2007; IN COMMERCE 2-1-2007.

THE MARK CONSISTS OF STANDARD CHAR-  
ACTERS WITHOUT CLAIM TO ANY PARTICULAR  
FONT, STYLE, SIZE, OR COLOR.

NO CLAIM IS MADE TO THE EXCLUSIVE  
RIGHT TO USE "AMERICA", APART FROM THE  
MARK AS SHOWN.

SN 77-099,568, FILED 2-5-2007.

TRACY CROSS, EXAMINING ATTORNEY

**Int. Cl.: 16**

**Prior U.S. Cls.: 2, 5, 22, 23, 29, 37, 38, and 50**

**United States Patent and Trademark Office**

**Reg. No. 3,570,369**

**Registered Feb. 3, 2009**

**TRADEMARK  
PRINCIPAL REGISTER**

**CONNECT TO OWN**

BANK OF AMERICA CORPORATION (DELA-  
WARE CORPORATION)  
100 NORTH TRYON STREET  
CHARLOTTE, NC 28255

FOR: PRINTED MATERIALS, NAMELY, INVITA-  
TIONS, INFORMATIONAL FLYERS, FORMS, AND  
CONTRACTS ALL IN THE FIELD OF MORTGAGE  
LENDING, IN CLASS 16 (U.S. CLS. 2, 5, 22, 23, 29, 37,  
38 AND 50).

FIRST USE 6-0-2007; IN COMMERCE 6-0-2007.

THE MARK CONSISTS OF STANDARD CHAR-  
ACTERS WITHOUT CLAIM TO ANY PARTICULAR  
FONT, STYLE, SIZE, OR COLOR.

SN 77-101,163, FILED 2-7-2007.

PAUL CROWLEY, EXAMINING ATTORNEY



**Int. Cl.: 1**

**Prior U.S. Cls.: 1, 5, 6, 10, 26, and 46**

**Reg. No. 3,570,370**

**United States Patent and Trademark Office**

**Registered Feb. 3, 2009**

**TRADEMARK  
PRINCIPAL REGISTER**

**BIOSIL**

SÜD-CHEMIE AG (FED REP GERMANY CORPORATION)  
LENBACHPLATZ 6  
MUNICH, FED REP GERMANY 80333

FOR: CHEMICAL ADSORBENT AGENT FOR PURIFICATION OF BIODIESEL, FUELS, ETHANOL, SOLVENTS, VEGETABLE AND ANIMAL OILS AND FATS, AND BEVERAGES, IN CLASS 1 (U.S. CLS. 1, 5, 6, 10, 26 AND 46).

FIRST USE 11-0-2006; IN COMMERCE 11-0-2006.

THE MARK CONSISTS OF STANDARD CHARACTERS WITHOUT CLAIM TO ANY PARTICULAR FONT, STYLE, SIZE, OR COLOR.

PRIORITY CLAIMED UNDER SEC. 44(D) ON FED REP GERMANY APPLICATION NO. 30658500.6, FILED 9-21-2006, REG. NO. 30658500, DATED 4-16-2007, EXPIRES 9-30-2016.

SN 77-101,642, FILED 2-7-2007.

CAROLINE WOOD, EXAMINING ATTORNEY

Int. Cl.: 9

Prior U.S. Cls.: 21, 23, 26, 36, and 38

United States Patent and Trademark Office

Reg. No. 3,570,371

Registered Feb. 3, 2009

TRADEMARK  
PRINCIPAL REGISTER

icarecard

PINCHECK, L.C. (IOWA LIMITED LIABILITY  
COMPANY)  
338 SW 6TH STREET  
DES MOINES, IA 50309

FOR: MAGNETICALLY ENCODED DEBIT  
CARDS FOR USE IN DONATING A PORTION OF  
THE USER'S TRANSACTION FEE TO A CHARITA-  
BLE ORGANIZATION, IN CLASS 9 (U.S. CLS. 21, 23,  
26, 36 AND 38).

FIRST USE 5-31-2008; IN COMMERCE 5-31-2008.

THE MARK CONSISTS OF STANDARD CHAR-  
ACTERS WITHOUT CLAIM TO ANY PARTICULAR  
FONT, STYLE, SIZE, OR COLOR.

SN 77-102,848, FILED 2-8-2007.

ANDREW RHIM, EXAMINING ATTORNEY

**Int. Cl.: 35**

**Prior U.S. Cls.: 100, 101, and 102**

**United States Patent and Trademark Office**

**Reg. No. 3,570,372**

**Registered Feb. 3, 2009**

**SERVICE MARK  
PRINCIPAL REGISTER**

**PROJECT TRADES SOLUTIONS**

CLP RESOURCES, INC. (DELAWARE CORPORATION)  
200 S. VIRGINIA STREET, SUITE 600  
RENO, NV 89501

FOR: EMPLOYMENT AGENCY SERVICES; JOB PLACEMENT SERVICES, NAMELY, PROVIDING OF SKILLED TRADEPERSONS AND LABORERS TO OTHERS ON AN AS-NEEDED OR TEMPORARY BASIS, IN CLASS 35 (U.S. CLS. 100, 101 AND 102).

FIRST USE 1-1-2007; IN COMMERCE 1-1-2007.

THE MARK CONSISTS OF STANDARD CHARACTERS WITHOUT CLAIM TO ANY PARTICULAR FONT, STYLE, SIZE, OR COLOR.

SN 77-105,649, FILED 2-12-2007.

BARBARA BROWN, EXAMINING ATTORNEY

**Int. Cl.: 2**

**Prior U.S. Cls.: 6, 11, and 16**

**United States Patent and Trademark Office**

**Reg. No. 3,570,373**

**Registered Feb. 3, 2009**

**TRADEMARK  
PRINCIPAL REGISTER**

**INKIN**

POWERFUL WAY LIMITED (HONG KONG LIMITED LIABILITY COMPANY)  
101 KING'S ROAD  
ROOM 1701, 17TH FLOOR, SING PAO BUILDING  
NORTH POINT, HONG KONG

FOR: INKS FOR INK JET CARTRIDGES; COPYING INKS CONTAINED IN ROLLER CASSETTES; COPYING INKS CONTAINED IN CARTRIDGES; FILLED INK CARTRIDGES FOR INK-JET PRINTER; FILLED TONER CARTRIDGES FOR LASER PRINTERS; CARTRIDGES OF TONER FOR USE WITH COMPUTERS; CARTRIDGES FILLED WITH TONER; REFILLS FOR INKJET CARTRIDGES FOR

COMPUTER PRINTERS, IN CLASS 2 (U.S. CLS. 6, 11 AND 16).

FIRST USE 2-0-2007; IN COMMERCE 3-1-2008.

THE MARK CONSISTS OF STANDARD CHARACTERS WITHOUT CLAIM TO ANY PARTICULAR FONT, STYLE, SIZE, OR COLOR.

SN 77-106,045, FILED 2-13-2007.

AMEETA JORDAN, EXAMINING ATTORNEY

**Int. Cl.: 9**

**Prior U.S. Cls.: 21, 23, 26, 36, and 38**

**Reg. No. 3,570,374**

**United States Patent and Trademark Office**

**Registered Feb. 3, 2009**

**TRADEMARK  
PRINCIPAL REGISTER**

**30-INCH VIEW**

HUMANTECH, INC. (MICHIGAN CORPORATION)  
1161 OAK VALLEY DR.  
ANN ARBOR, MI 48108

THE MARK CONSISTS OF STANDARD CHARACTERS WITHOUT CLAIM TO ANY PARTICULAR FONT, STYLE, SIZE, OR COLOR.

FOR: COMPUTER PROGRAMS FOR DATABASE MANAGEMENT AND ANALYSIS IN HUMAN RESOURCES AND BUSINESS CONSULTATION, IN CLASS 9 (U.S. CLS. 21, 23, 26, 36 AND 38).

SN 77-106,592, FILED 2-13-2007.

FIRST USE 8-0-2008; IN COMMERCE 8-8-0208.

RICHARD WHITE, EXAMINING ATTORNEY

**Int. Cl.: 16**

**Prior U.S. Cls.: 2, 5, 22, 23, 29, 37, 38, and 50**

**Reg. No. 3,570,375**

**United States Patent and Trademark Office**

**Registered Feb. 3, 2009**

**TRADEMARK  
PRINCIPAL REGISTER**

# 30-INCH VIEW

HUMANTECH, INC. (MICHIGAN CORPORATION)  
1161 OAK VALLEY DR.  
ANN ARBOR, MI 48108

TEACHING MATERIALS IN THE FIELD OF HUMAN RESOURCES, BUSINESS CONSULTATION AND ERGONOMICS, IN CLASS 16 (U.S. CLS. 2, 5, 22, 23, 29, 37, 38 AND 50).

FOR: BOOKS IN THE FIELD OF HUMAN RESOURCES, BUSINESS CONSULTATION AND ERGONOMICS; BULLETINS CONCERNING HUMAN RESOURCES, BUSINESS CONSULTATION AND ERGONOMICS; MANUALS IN THE FIELD OF HUMAN RESOURCES, BUSINESS CONSULTATION AND ERGONOMICS; PRINTED INSTRUCTIONAL, EDUCATIONAL, AND TEACHING MATERIALS IN THE FIELD OF HUMAN RESOURCES, BUSINESS CONSULTATION AND ERGONOMICS; PUBLICATIONS, NAMELY, BROCHURES, BOOKLETS, AND

FIRST USE 10-30-2008; IN COMMERCE 10-30-2008.

THE MARK CONSISTS OF STANDARD CHARACTERS WITHOUT CLAIM TO ANY PARTICULAR FONT, STYLE, SIZE, OR COLOR.

SN 77-106,595, FILED 2-13-2007.

RICHARD WHITE, EXAMINING ATTORNEY

**Int. Cl.: 35**

**Prior U.S. Cls.: 100, 101, and 102**

**United States Patent and Trademark Office**

**Reg. No. 3,570,376**

**Registered Feb. 3, 2009**

**SERVICE MARK  
PRINCIPAL REGISTER**

# 30-INCH VIEW

HUMANTECH, INC. (MICHIGAN CORPORATION)  
1161 OAK VALLEY DR.  
ANN ARBOR, MI 48108

FOR: ADVERTISING AND MARKETING; ADVISORY SERVICE FOR ORGANIZATIONAL ISSUES AND BUSINESS ADMINISTRATION, WITH AND WITHOUT THE HELP OF ELECTRONIC DATA BASES; BUSINESS MANAGEMENT CONSULTANCY AND ADVISORY SERVICES; BUSINESS MANAGEMENT CONSULTANCY AS WELL AS DEVELOPMENT OF PROCESSES FOR THE ANALYSIS AND THE IMPLEMENTATION OF STRATEGY PLANS AND MANAGEMENT PROJECTS; BUSINESS MANAGEMENT CONSULTANCY SERVICES; BUSINESS MANAGEMENT CONSULTATION IN THE FIELD OF EXECUTIVE AND LEADERSHIP DEVELOPMENT; BUSINESS MANAGEMENT CONSULTING AND ADVISORY SERVICES; BUSINESS MANAGEMENT CONSULTING WITH RELATION TO STRATEGY, MARKETING, PRODUCTION, PERSONNEL AND RETAIL SALE MATTERS; BUSINESS MANAGEMENT PLANNING; BUSINESS OPERATION, BUSINESS ADMINISTRATION AND OFFICE FUNCTIONS; BUSINESS

ORGANIZATION ADVICE; BUSINESS ORGANIZATION AND OPERATION CONSULTANCY; BUSINESS ORGANIZATIONAL CONSULTATION; BUSINESS PLANNING; BUSINESS PROCESS RE-ENGINEERING SERVICES; CONSULTING SERVICES IN BUSINESS ORGANIZATION AND MANAGEMENT; CONSULTING SERVICES IN THE AREA OF SUSTAINABLE BUSINESS SOLUTIONS; CREATIVE MARKETING DESIGN SERVICES; DATA PROCESSING SERVICES; DESIGN OF ADVERTISING MATERIALS FOR OTHERS; PROVIDING BUSINESS INFORMATION, ALSO VIA INTERNET, THE CABLE NETWORK OR OTHER FORMS OF DATA TRANSFER, IN CLASS 35 (U.S. CLS. 100, 101 AND 102).

FIRST USE 10-30-2008; IN COMMERCE 10-30-2008.

THE MARK CONSISTS OF STANDARD CHARACTERS WITHOUT CLAIM TO ANY PARTICULAR FONT, STYLE, SIZE, OR COLOR.

SN 77-106,600, FILED 2-13-2007.

RICHARD WHITE, EXAMINING ATTORNEY

**Int. Cl.: 42**

**Prior U.S. Cls.: 100 and 101**

**United States Patent and Trademark Office**

**Reg. No. 3,570,377**

**Registered Feb. 3, 2009**

**SERVICE MARK  
PRINCIPAL REGISTER**

**30-INCH VIEW**

HUMANTECH, INC. (MICHIGAN CORPORATION)  
1161 OAK VALLEY DR.  
ANN ARBOR, MI 48108

FOR: COMPUTER SOFTWARE DEVELOPMENT;  
CONSULTING SERVICES IN THE FIELD OF DESIGN OF NEWSLETTERS; DESIGN OF HOME PAGES, COMPUTER SOFTWARE AND WEB SITES; DESIGN, CREATION, HOSTING, MAINTENANCE OF WEBSITES FOR OTHERS; DESIGN, DEVELOPMENT AND IMPLEMENTATION OF SOFTWARE; HOSTING OF DIGITAL CONTENT ON THE INTER-

NET; INDUSTRIAL DESIGN; WEB SITE HOSTING SERVICES, IN CLASS 42 (U.S. CLS. 100 AND 101).

FIRST USE 10-30-2008; IN COMMERCE 10-30-2008.

THE MARK CONSISTS OF STANDARD CHARACTERS WITHOUT CLAIM TO ANY PARTICULAR FONT, STYLE, SIZE, OR COLOR.

SN 77-106,602, FILED 2-13-2007.

RICHARD WHITE, EXAMINING ATTORNEY



**Int. Cls.: 35 and 42**

**Prior U.S. Cls.: 100, 101, and 102**

**United States Patent and Trademark Office**

**Reg. No. 3,570,378**

**Registered Feb. 3, 2009**

**SERVICE MARK  
PRINCIPAL REGISTER**

**SPOCK**

SPOCK NETWORKS, INC. (DELAWARE CORPORATION)  
1450 VETERANS BOULEVARD, SUITE 150  
REDWOOD CITY, CA 94063

FOR: PROVIDING AN ONLINE DIRECTORY INFORMATION SERVICE ON THE INTERNET FROM WHICH USERS CAN OBTAIN DATA AND INFORMATION REGARDING INDIVIDUALS AND ORGANIZATIONS; PROVIDING ONLINE DIRECTORY INFORMATION DATABASES AND INDEXES OF INFORMATION REGARDING INDIVIDUALS AND ORGANIZATIONS VIA A WEBSITE ON THE INTERNET, IN CLASS 35 (U.S. CLS. 100, 101 AND 102).

FIRST USE 8-8-2007; IN COMMERCE 8-8-2007.

FOR: COMPUTER SERVICES, NAMELY, PROVIDING A SEARCH ENGINE FOR OBTAINING

DATA AND INFORMATION REGARDING INDIVIDUALS AND ORGANIZATIONS VIA A GLOBAL COMPUTER NETWORK; PROVIDING TEMPORARY USE OF NON-DOWNLOADABLE COMPUTER SOFTWARE FOR OBTAINING DATA AND INFORMATION REGARDING INDIVIDUALS AND ORGANIZATIONS, IN CLASS 42 (U.S. CLS. 100 AND 101).

FIRST USE 8-8-2007; IN COMMERCE 8-8-2007.

THE MARK CONSISTS OF STANDARD CHARACTERS WITHOUT CLAIM TO ANY PARTICULAR FONT, STYLE, SIZE, OR COLOR.

SN 77-108,771, FILED 2-15-2007.

CAROLINE WOOD, EXAMINING ATTORNEY

**Int. Cls.: 9 and 11**

**Prior U.S. Cls.: 13, 21, 23, 26, 31, 34, 36, and 38**

**United States Patent and Trademark Office**

**Reg. No. 3,570,379**

**Registered Feb. 3, 2009**

**TRADEMARK  
PRINCIPAL REGISTER**

**CLARILITE CERTIFIED**

ENTEGRIS, INC. (DELAWARE CORPORATION)  
3500 LYMAN BOULEVARD  
CHASKA, MN 55318

FOR: RETICLE CARRIERS, NAMELY, BOXES FOR SECURING RETICLES FOR SEMICONDUCTOR MANUFACTURING, RETICLE CARRIER STOCKERS, NAMELY, STORAGE SYSTEMS FOR RETICLE CARRIERS, BARE RETICLE STOCKERS, NAMELY, STORAGE SYSTEMS FOR RETICLES, RETICLE CARRIER SIDE SCANNER RACKS, NAMELY, PURGE SYSTEMS FOR RETICLE CARRIERS, RETICLE CARRIER LIBRARIES, NAMELY, SYSTEMS FOR STORING SMALL QUANTITIES OF RETICLE CARRIERS IN SEMICONDUCTOR PROCESS TOOLS, IN CLASS 9 (U.S. CLS. 21, 23, 26, 36 AND 38).

FIRST USE 1-1-2007; IN COMMERCE 1-1-2007.

FOR: PURGE GAS PURIFIERS, PURGE GAS FILTERS, AIR FILTERS FOR REMOVING CHEMICAL AND MOLECULAR CONTAMINANTS, AIR FILTERS FOR REMOVING PARTICULATE CON-

TAMINANTS, AIR AND GAS PURIFIERS FOR USE IN RETICLE CARRIERS, AIR AND GAS PURIFIERS FOR USE IN RETICLE CARRIER RELATED ARTICLES, NAMELY, STOCKERS, SIDE SCANNER RACKS AND LIBRARIES, AIR AND GAS FILTERS FOR USE IN RETICLE CARRIERS, AIR AND GAS FILTERS FOR USE IN RETICLE CARRIER ACCESSORIES, NAMELY, STORAGE SYSTEMS AND PURGE SYSTEMS, IN CLASS 11 (U.S. CLS. 13, 21, 23, 31 AND 34).

FIRST USE 7-1-2007; IN COMMERCE 7-1-2007.

THE MARK CONSISTS OF STANDARD CHARACTERS WITHOUT CLAIM TO ANY PARTICULAR FONT, STYLE, SIZE, OR COLOR.

NO CLAIM IS MADE TO THE EXCLUSIVE RIGHT TO USE "CERTIFIED", APART FROM THE MARK AS SHOWN.

SN 77-110,097, FILED 2-16-2007.

KAREN SEVERSON, EXAMINING ATTORNEY

**Int. Cls.: 35 and 36**

**Prior U.S. Cls.: 100, 101, and 102**

**United States Patent and Trademark Office**

**Reg. No. 3,570,380**

**Registered Feb. 3, 2009**

**SERVICE MARK  
PRINCIPAL REGISTER**

**SIRN SECURE IDENTITY  
RESOURCE NETWORK**

FIRST ADVANTAGE CORPORATION (DELA-  
WARE CORPORATION)  
100 CARILLON PARKWAY  
ST. PETERSBURG, FL 33716

FOR: MONITORING CREDIT REPORTS AND  
PROVIDING NOTIFICATION TO CONSUMERS OF  
LOSS OR COMPROMISE OF IDENTIFICATION IN-  
FORMATION AND DAMAGE TO CREDIT STATUS  
, IN CLASS 35 (U.S. CLS. 100, 101 AND 102).

FIRST USE 8-16-2007; IN COMMERCE 8-16-2007.

FOR: CONSUMER CREDIT CONSULTING;  
CREDIT REPORTING SERVICES, IN CLASS 36  
(U.S. CLS. 100, 101 AND 102).

FIRST USE 8-16-2007; IN COMMERCE 8-16-2007.

THE MARK CONSISTS OF STANDARD CHAR-  
ACTERS WITHOUT CLAIM TO ANY PARTICULAR  
FONT, STYLE, SIZE, OR COLOR.

NO CLAIM IS MADE TO THE EXCLUSIVE  
RIGHT TO USE "SECURE IDENTITY RESOURCE  
NETWORK", APART FROM THE MARK AS  
SHOWN.

SN 77-112,610, FILED 2-21-2007.

KIM MONINGHOFF, EXAMINING ATTORNEY

**Int. Cls.: 9, 10, 21, 25, and 28**

**Prior U.S. Cls.: 2, 13, 21, 22, 23, 26, 29, 30, 33, 36, 38, 39, 40, 44, and 50**

**Reg. No. 3,570,381**

**United States Patent and Trademark Office**

**Registered Feb. 3, 2009**

**TRADEMARK  
PRINCIPAL REGISTER**



FOOT LEVELERS, INC. (VIRGINIA CORPORATION)  
518 POCAHONTAS AVE. N.E.  
ROANOKE, VA 240272611

FOR: DIGITAL SCANNING APPARATUS FOR OBTAINING AN IMAGE OF A PERSON'S FOOT, IN CLASS 9 (U.S. CLS. 21, 23, 26, 36 AND 38).

FIRST USE 2-28-2007; IN COMMERCE 2-28-2007.

FOR: THERAPEUTIC PILLOWS, ORTHOPEDIC PILLOWS, CUSTOM MADE CERVICAL PILLOWS FOR MEDICAL USE; ORTHOPEDIC FOOTWEAR, ORTHOTIC INSERTS FOR FOOTWEAR, ORTHOPEDIC ARCH SUPPORTS AND SPINAL/PELVIS STABILIZERS PRESCRIBED BY PHYSICIANS OR OTHER PRACTITIONERS FOR CORRECTING FOOT AND POSTURE PROBLEMS; CERVICAL REHABILITATION SYSTEM COMPRISED OF A NECK EXERCISER AND CERVICAL COLLAR; POSTURE ANALYSIS DEVICE, IN CLASS 10 (U.S. CLS. 26, 39 AND 44).

FIRST USE 2-28-2008; IN COMMERCE 2-28-2008.

FOR: MUGS, IN CLASS 21 (U.S. CLS. 2, 13, 23, 29, 30, 33, 40 AND 50).

FIRST USE 2-28-2007; IN COMMERCE 2-28-2007.

FOR: CLOTHING, NAMELY, T-SHIRTS AND HATS, IN CLASS 25 (U.S. CLS. 22 AND 39).

FIRST USE 2-28-2007; IN COMMERCE 2-28-2007.

FOR: EXERCISE EQUIPMENT, NAMELY, ELASTIC BANDS WITH FASTENERS FOR ATTACHMENT TO PARTS OF THE HUMAN BODY, IN CLASS 28 (U.S. CLS. 22, 23, 38 AND 50).

FIRST USE 2-28-2007; IN COMMERCE 2-28-2007.

OWNER OF U.S. REG. NOS. 805,279 AND 2,807,647.

NO CLAIM IS MADE TO THE EXCLUSIVE RIGHT TO USE "FOOT", APART FROM THE MARK AS SHOWN.

THE COLOR(S) WHITE, LIGHT BLUE, MEDIUM BLUE AND ROYAL BLUE IS/ARE CLAIMED AS A FEATURE OF THE MARK.

THE MARK CONSISTS OF A WHITE SIDE VIEW OF A HUMAN FOOT OUTLINED IN ROYAL BLUE SHOWN STANDING ON A SURFACE COLORED ROYAL BLUE WITH A LIGHT BLUE SURFACE UNDERNEATH; WHITE RAYS EXTEND OUTWARDLY FROM THE FOOT AND ARE SHADOWED IN A RAINBOW SHAPE IN MEDIUM AND LIGHT BLUE. THE BORDER IS RAINBOW-SHAPED COLORED ROYAL BLUE AND IS FLAT AT THE BOTTOM; A RECTANGULAR-SHAPED STRIP IS SHOWN UNDERNEATH IN ROYAL BLUE ENCLOSING THE WORDS "FOOT LEVELERS" IN WHITE.

SN 77-113,249, FILED 2-22-2007.

JOHN DALIER, EXAMINING ATTORNEY

**Int. Cls.: 16, 35, 41, and 44**

**Prior U.S. Cls.: 2, 5, 22, 23, 29, 37, 38, 50, 100, 101, 102, and 107**

**Reg. No. 3,570,382**

**United States Patent and Trademark Office**

**Registered Feb. 3, 2009**

**TRADEMARK  
SERVICE MARK  
PRINCIPAL REGISTER**



FOOT LEVELERS, INC. (VIRGINIA CORPORATION)  
518 POCAHONTAS AVE. N.E.  
ROANOKE, VA 240272611

FOR: PRINTED MATERIALS, NAMELY, BROCHURES, PAMPHLETS, EDUCATIONAL MAGAZINES, STATIONERY, BUSINESS CARDS; PENS AND PENCILS, IN CLASS 16 (U.S. CLS. 2, 5, 22, 23, 29, 37, 38 AND 50).

FIRST USE 2-28-2007; IN COMMERCE 2-28-2007.

FOR: ON-LINE RETAIL AND WHOLESALE STORE SERVICES FEATURING ORTHOTICS AND OTHER HEALTHCARE PRODUCTS; HEALTH CARE REFERRAL SERVICES, IN CLASS 35 (U.S. CLS. 100, 101 AND 102).

FIRST USE 2-28-2007; IN COMMERCE 2-28-2007.

FOR: EDUCATIONAL SERVICES, NAMELY, CONDUCTING LECTURES IN SEMINARS IN THE FIELD OF HEALTHCARE ON SETTING AND MEETING GOALS, OFFICE MANAGEMENT, RELATIONSHIPS WITH PATIENTS AND FINANCIAL MANAGEMENT, IN CLASS 41 (U.S. CLS. 100, 101 AND 107).

FIRST USE 2-28-2007; IN COMMERCE 2-28-2007.

FOR: MEDICAL SERVICES, NAMELY, PHYSICAL EXAMINATIONS PROVIDED BY A PRIMARY CARE DOCTOR; HEALTHCARE INFORMATION SERVICES TO HEALTH CARE PROFESSIONALS

AND TO THE GENERAL PUBLIC, HEALTH CARE INFORMATION SERVICES TO PROFESSIONALS AND THE GENERAL PUBLIC, IN CLASS 44 (U.S. CLS. 100 AND 101).

FIRST USE 2-28-2007; IN COMMERCE 2-28-2007.

OWNER OF U.S. REG. NOS. 805,279 AND 2,807,647.

NO CLAIM IS MADE TO THE EXCLUSIVE RIGHT TO USE "FOOT", APART FROM THE MARK AS SHOWN.

THE COLOR(S) WHITE, LIGHT BLUE, MEDIUM BLUE AND ROYAL BLUE IS/ARE CLAIMED AS A FEATURE OF THE MARK.

THE MARK CONSISTS OF A WHITE SIDE VIEW OF A HUMAN FOOT OUTLINED IN ROYAL BLUE SHOWN STANDING ON A SURFACE COLORED ROYAL BLUE WITH A LIGHT BLUE SURFACE UNDERNEATH; WHITE RAYS EXTEND OUTWARDLY FROM THE FOOT AND ARE SHADOWED IN A RAINBOW SHAPE IN MEDIUM AND LIGHT BLUE. THE BORDER IS RAINBOW-SHAPED COLORED ROYAL BLUE AND IS FLAT AT THE BOTTOM; A RECTANGULAR-SHAPED STRIP IS SHOWN UNDERNEATH IN ROYAL BLUE ENCLOSING THE WORDS "FOOT LEVELERS" IN WHITE.

SN 77-113,290, FILED 2-22-2007.

JOHN DALIER, EXAMINING ATTORNEY

**Int. Cls.: 35, 36, and 42**

**Prior U.S. Cls.: 100, 101, and 102**

**United States Patent and Trademark Office**

**Reg. No. 3,570,383**

**Registered Feb. 3, 2009**

**SERVICE MARK  
PRINCIPAL REGISTER**



**FI • MED**  
**THE PULSE OF YOUR PRACTICE**

FI-MED MANAGEMENT, INC. (WISCONSIN CORPORATION)  
2200 N MAYFAIR ROAD, STE 200  
WAUWATOSA, WI 53226

FOR: STATISTICAL ANALYSIS AND CONSULTING SERVICES IN THE FIELD OF FINANCIAL MEDICAL MANAGEMENT BY STANDARD BUSINESS POLICY REVIEW AND EFFICIENCY; BUSINESS AND INSURANCE COMPLIANCE ANALYSIS IN THE FIELD OF COMPLIANCE WITH FEDERAL AND STATE LAWS AND REGULATIONS; MEDICAL BILLING SUPPORT SERVICES, IN CLASS 35 (U.S. CLS. 100, 101 AND 102).

FIRST USE 3-0-2008; IN COMMERCE 3-0-2008.

FOR: FINANCIAL MEDICAL MANAGEMENT SERVICES, NAMELY, ACCOUNTS RECEIVABLES FINANCING MANAGEMENT; AND ELECTRONIC LOCK BOX SERVICES IN THE NATURE OF ELECTRONIC DEPOSIT SERVICES, IN CLASS 36 (U.S. CLS. 100, 101 AND 102).

FIRST USE 3-0-2008; IN COMMERCE 3-0-2008.

FOR: APPLICATION SERVICE PROVIDER FEATURING SOFTWARE FOR USE IN DATA CONNECTIVITY AND GENERAL PRACTICE MANAGEMENT IN THE FIELD OF MEDICAL MANAGEMENT FOR APPOINTMENT SCHEDULE

ING AND RECALLS, PATIENT DEMOGRAPHICS, ENCOUNTERS AND EXPLANATION OF BENEFITS, IN CLASS 42 (U.S. CLS. 100 AND 101).

FIRST USE 3-0-2008; IN COMMERCE 3-0-2008.

THE COLOR(S) BLUE, LIGHT GRAY, DARK GRAY, AND BLACK IS/ARE CLAIMED AS A FEATURE OF THE MARK.

THE MARK CONSISTS OF A CIRCULAR DESIGN WITH A BLUE AND GRAY DESIGN IN THE CENTER REPRESENTING A HEARTBEAT AS RECORDED ON A MONITOR. THE LEFT SIDE OF THE CIRCLE IS DARK GRAY AND THE RIGHT SIDE OF THE CIRCLE IS LIGHT GRAY WITH GRAY SHADING ON THE CIRCLE INDICATING DEPTH. THE INTERIOR OF THE CIRCLE IS DIVIDED INTO TWO SHADES OF GRAY WITH THE LEFT INTERIOR BEING A DARKER GRAY AND THE RIGHT INTERIOR BEING A LIGHTER GRAY. THE WORDS "FI MED" AND "THE PULSE OF YOUR PRACTICE" ARE BLACK AND APPEAR CENTERED BELOW THE CIRCULAR DESIGN. A LIGHT GRAY CIRCLE APPEARS BETWEEN THE LANGUAGE "FI" AND "MED".

SN 77-113,836, FILED 2-22-2007.

LYDIA BELZER, EXAMINING ATTORNEY

**Int. Cl.: 9**

**Prior U.S. Cls.: 21, 23, 26, 36, and 38**

**Reg. No. 3,570,384**

**United States Patent and Trademark Office**

**Registered Feb. 3, 2009**

**TRADEMARK  
PRINCIPAL REGISTER**



MEADWESTVACO CORPORATION (DELAWARE  
CORPORATION)  
MEADWESTVACO CORPORATE CENTER  
11013 WEST BROAD STREET  
GLEN ALLEN, VA 23060

FIRST USE 9-16-2007; IN COMMERCE 9-16-2007.

SN 77-119,273, FILED 3-1-2007.

FOR: AUDIO SPEAKERS, IN CLASS 9 (U.S. CLS.  
21, 23, 26, 36 AND 38).

TINA BROWN, EXAMINING ATTORNEY

**Int. Cl.: 9**

**Prior U.S. Cls.: 21, 23, 26, 36, and 38**

**Reg. No. 3,570,385**

**United States Patent and Trademark Office**

**Registered Feb. 3, 2009**

---

**TRADEMARK  
PRINCIPAL REGISTER**

**YETI**

TRIDENT SECURITY CONCEPTS, LLC (CALIFORNIA LIMITED LIABILITY COMPANY)  
1480 MEADOW VIEW LANE  
TEMPLETON, CA 93465

FOR: PORTABLE ELECTRONIC SECURITY DEVICE IN THE NATURE OF ELECTRONIC SENSORS FOR MONITORING AND DETECTING MOTION FEATURING SIRENS, FLASHING BEACONS AND NOISE ALERTING ALARMS, IN CLASS 9 (U.S. CLS. 21, 23, 26, 36 AND 38).

FIRST USE 3-2-2007; IN COMMERCE 11-12-2008.

THE MARK CONSISTS OF STANDARD CHARACTERS WITHOUT CLAIM TO ANY PARTICULAR FONT, STYLE, SIZE, OR COLOR.

SN 77-121,224, FILED 3-2-2007.

MORGAN WYNNE, EXAMINING ATTORNEY



**Int. Cl.: 9**

**Prior U.S. Cls.: 21, 23, 26, 36, and 38**

**Reg. No. 3,570,386**

**United States Patent and Trademark Office**

**Registered Feb. 3, 2009**

**TRADEMARK  
PRINCIPAL REGISTER**

**YETI**

TRIDENT SECURITY CONCEPTS, LLC (CALIFORNIA LIMITED LIABILITY COMPANY)  
1480 MEADOW VIEW LANE  
TEMPLETON, CA 93465

FIRST USE 3-2-2007; IN COMMERCE 11-12-2008.

FOR: PORTABLE ELECTRONIC SECURITY DEVICE IN THE NATURE OF ELECTRONIC SENSORS FOR MONITORING AND DETECTING MOTION FEATURING SIRENS, FLASHING BEACONS AND NOISE ALERTING ALARMS, IN CLASS 9 (U.S. CLS. 21, 23, 26, 36 AND 38).

THE MARK CONSISTS OF THE WORD "YETI" IN STYLIZED FONT.

SN 77-121,252, FILED 3-2-2007.

MORGAN WYNNE, EXAMINING ATTORNEY

**Int. Cl.: 41**

**Prior U.S. Cls.: 100, 101, and 107**

**United States Patent and Trademark Office**

**Reg. No. 3,570,387**

**Registered Feb. 3, 2009**

**SERVICE MARK  
PRINCIPAL REGISTER**

# HEALTH 2.0

HOLT, MATTHEW EDMUND (UNITED STATES INDIVIDUAL)  
650 DELANCEY STREET, #221  
SAN FRANCISCO, CA 94107

FOR: ARRANGING AND CONDUCTING EDUCATIONAL CONFERENCES; ARRANGING OF EXHIBITIONS, SEMINARS AND CONFERENCES; ARRANGING OF SEMINARS AND CONFERENCES; EDUCATION IN THE FIELD OF HEALTH CARE AND TECHNOLOGY RENDERED THROUGH VIDEO CONFERENCE; EDUCATIONAL SERVICES, NAMELY, CONDUCTING SEMINARS AND CONFERENCES IN THE FIELD OF HEALTH CARE AND TECHNOLOGY AND DISTRIBUTION OF COURSE MATERIAL IN CONNECTION THEREWITH; EDUCATIONAL SERVICES, NAMELY, DEVELOPING, ARRANGING, AND CONDUCTING EDUCATIONAL CONFERENCES AND PROGRAMS AND PROVIDING COURSES OF INSTRUCTION IN THE FIELD OF HEALTH CARE AND TECHNOLOGY; EDUCATIONAL SERVICES,

NAMELY, CONDUCTING SEMINARS AND CONFERENCES IN THE FIELD OF HEALTH CARE AND TECHNOLOGY; ORGANISATION OF CONFERENCES AND SYMPOSIA IN THE FIELD OF MEDICAL SCIENCE; EDITORIAL REPORTING SERVICES, IN CLASS 41 (U.S. CLS. 100, 101 AND 107).

FIRST USE 3-1-2007; IN COMMERCE 3-1-2007.

THE MARK CONSISTS OF STANDARD CHARACTERS WITHOUT CLAIM TO ANY PARTICULAR FONT, STYLE, SIZE, OR COLOR.

NO CLAIM IS MADE TO THE EXCLUSIVE RIGHT TO USE "HEALTH", APART FROM THE MARK AS SHOWN.

SN 77-122,908, FILED 3-6-2007.

LINDA LAVACHE, EXAMINING ATTORNEY

**Int. Cl.: 15**

**Prior U.S. Cls.: 2, 21, and 36**

**United States Patent and Trademark Office**

**Reg. No. 3,570,388**

**Registered Feb. 3, 2009**

**TRADEMARK  
PRINCIPAL REGISTER**

**FRANKLIN**

ENTERTAINMENT MUSIC MARKETING CORP.  
(NEW YORK CORPORATION)  
770-9 GRAND BLVD  
DEER PARK, NY 11746

FOR: MUSICAL INSTRUMENTS AND ACCESSORIES, NAMELY, CARRYING CASES FOR MUSICAL INSTRUMENTS, MUSICAL INSTRUMENT STANDS, BOWS FOR MUSICAL INSTRUMENTS, STRINGS FOR MUSICAL INSTRUMENTS; MOUTHPIECES FOR MUSICAL INSTRUMENTS, CORK GREASE AND OIL FOR MUSICAL INSTRUMENTS, AND ROSIN FOR STRINGED MUSICAL INSTRUMENTS, IN CLASS 15 (U.S. CLS. 2, 21 AND 36).

FIRST USE 11-1-2008; IN COMMERCE 11-1-2008.

THE MARK CONSISTS OF STANDARD CHARACTERS WITHOUT CLAIM TO ANY PARTICULAR FONT, STYLE, SIZE, OR COLOR.

THE NAME(S), PORTRAIT(S), AND/OR SIGNATURE(S) SHOWN IN THE MARK DOES NOT IDENTIFY A PARTICULAR LIVING INDIVIDUAL.

SN 77-123,375, FILED 3-6-2007.

SUZANNE BLANE, EXAMINING ATTORNEY

**Int. Cl.: 16**

**Prior U.S. Cls.: 2, 5, 22, 23, 29, 37, 38, and 50**

**Reg. No. 3,570,389**

**United States Patent and Trademark Office**

**Registered Feb. 3, 2009**

**TRADEMARK  
PRINCIPAL REGISTER**

**FOR THOSE OF US WHO ARE  
TIRED OF JUST BEING HUMAN**

JENIFER JURDEN, LLC (MARYLAND LIMITED  
LIABILITY COMPANY)  
P.O. BOX 200  
BISHOPVILLE, MD 21813

THE MARK CONSISTS OF STANDARD CHAR-  
ACTERS WITHOUT CLAIM TO ANY PARTICULAR  
FONT, STYLE, SIZE, OR COLOR.

FOR: PRINTED MATERIALS, NAMELY, GREET-  
ING CARDS, IN CLASS 16 (U.S. CLS. 2, 5, 22, 23, 29, 37,  
38 AND 50).

SN 77-124,160, FILED 3-7-2007.

FIRST USE 4-0-2007; IN COMMERCE 4-0-2007.

SCOTT BIBB, EXAMINING ATTORNEY

**Int. Cls.: 9 and 11**

**Prior U.S. Cls.: 13, 21, 23, 26, 31, 34, 36, and 38**

**United States Patent and Trademark Office**

**Reg. No. 3,570,390**

**Registered Feb. 3, 2009**

**TRADEMARK  
PRINCIPAL REGISTER**



CHIEN LUEN INDUSTRIES CO., LTD., INC.  
(FLORIDA CORPORATION)  
1967 NW 22ND STREET  
OAKLAND PARK, FL 33311

FOR: SOLAR CELLS, SOLAR CELL MODULES;  
APPARATUS FOR CONVERTING ELECTRONIC  
RADIATION TO ELECTRICAL ENERGY, NAMELY,  
PHOTOVOLTAIC ROOFING MEMBERS AND PHO-  
TOVOLTAIC SOLAR MODULES; PHOTOVOLTAIC  
GENERATORS COMPRISED OF SOLAR CELL  
MODULES, IN CLASS 9 (U.S. CLS. 21, 23, 26, 36  
AND 38).

FIRST USE 4-0-2007; IN COMMERCE 4-0-2007.

FOR: SOLAR POWERED INDOOR AND OUT-  
DOOR LIGHTS; SOLAR POWERED VENTILATING  
FANS, IN CLASS 11 (U.S. CLS. 13, 21, 23, 31 AND 34).

FIRST USE 4-0-2007; IN COMMERCE 4-0-2007.

THE COLOR(S) BLACK, WHITE AND YELLOW  
IS/ARE CLAIMED AS A FEATURE OF THE MARK.

THE MARK CONSISTS OF THE WORD "BRIGHT-  
WATTS" IN BLACK LETTERS WITH A SHADED  
YELLOW CIRCLE AROUND THE WORD  
"BRIGHT". THE YELLOW CIRCLE IS WHITE IN  
THE CENTER.

SN 77-124,785, FILED 3-7-2007.

REBECCA POVARCHUK, EXAMINING ATTOR-  
NEY

**Int. Cl.: 44**

**Prior U.S. Cls.: 100 and 101**

**United States Patent and Trademark Office**

**Reg. No. 3,570,391**

**Registered Feb. 3, 2009**

**SERVICE MARK  
PRINCIPAL REGISTER**

**DEO VOLENTE**

DEO VOLENTE FARMS, LLC (NEW JERSEY  
LIMITED LIABILITY COMPANY)  
8 POTTER LANE  
C/O MICHAEL GULOTTA  
LEBANON, NJ 088334539

THE MARK CONSISTS OF STANDARD CHAR-  
ACTERS WITHOUT CLAIM TO ANY PARTICULAR  
FONT, STYLE, SIZE, OR COLOR.

FOR: HORSE BREEDING AND STUD SERVICES,  
IN CLASS 44 (U.S. CLS. 100 AND 101).

SN 77-125,624, FILED 3-8-2007.

FIRST USE 4-15-2007; IN COMMERCE 4-15-2007.

BERNICE MIDDLETON, EXAMINING ATTORNEY

**Int. Cl.: 43**

**Prior U.S. Cls.: 100 and 101**

**United States Patent and Trademark Office**

**Reg. No. 3,570,392**

**Registered Feb. 3, 2009**

**SERVICE MARK  
PRINCIPAL REGISTER**

**AINA NALU**

IRONWOOD ASSOCIATES, LLC (VIRGINIA LIMITED LIABILITY COMPANY)  
SUITE 201  
900 FIFTH AVENUE  
SAN RAFAEL, CA 94901

FOR: HOTEL SERVICES, IN CLASS 43 (U.S. CLS. 100 AND 101).

FIRST USE 2-0-2005; IN COMMERCE 2-0-2005.

THE MARK CONSISTS OF STANDARD CHARACTERS WITHOUT CLAIM TO ANY PARTICULAR FONT, STYLE, SIZE, OR COLOR.

THE FOREIGN WORDING IN THE MARK TRANSLATES INTO ENGLISH AS LAND WAVE.

SN 77-126,291, FILED 3-8-2007.

JUDITH HELFMAN, EXAMINING ATTORNEY

**Int. Cl.: 1**

**Prior U.S. Cls.: 1, 5, 6, 10, 26, and 46**

**Reg. No. 3,570,393**

**United States Patent and Trademark Office**

**Registered Feb. 3, 2009**

**TRADEMARK  
PRINCIPAL REGISTER**

**VEGEPHOS**

MICHEL MERCIER PRODUCTS (NEW JERSEY CORPORATION), DBA M.M.P., INC.,  
3470 SOUTH CLINTON AVENUE  
SOUTH PLAINFIELD, NJ 07080

FIRST USE 1-26-2007; IN COMMERCE 1-26-2007.

FOR: CHEMICAL RAW MATERIALS USED IN THE MANUFACTURE OF COSMETIC, PERSONAL CARE, PHARMACEUTICAL AND NUTRITIONAL PRODUCTS, NAMELY EMULSIFIERS; DELIVERY AGENTS CONSISTING OF COMPOUNDS THAT FACILITATE DELIVERY OF A WIDE RANGE OF COSMETIC AND PHARMACEUTICAL INGREDIENTS, IN CLASS 1 (U.S. CLS. 1, 5, 6, 10, 26 AND 46).

THE MARK CONSISTS OF STANDARD CHARACTERS WITHOUT CLAIM TO ANY PARTICULAR FONT, STYLE, SIZE, OR COLOR.

SN 77-127,099, FILED 3-9-2007.

JANICE L. MCMORROW, EXAMINING ATTORNEY



**Int. Cl.: 35**

**Prior U.S. Cls.: 100, 101, and 102**

**United States Patent and Trademark Office**

**Reg. No. 3,570,394**

**Registered Feb. 3, 2009**

**SERVICE MARK  
PRINCIPAL REGISTER**

**FLAT EARTH IMPORTS**

FLAT EARTH IMPORTS LLC (MONTANA LIMITED LIABILITY COMPANY)  
2245 WEST KOCH, SUITE C  
BOZEMAN, MT 59718

FOR: IMPORT SERVICES IN THE FIELD OF DURABLE GOODS, FURNITURE, HOUSEWARES AND ACCESSORIES; WHOLESALE STORES FEATURING DURABLE GOODS, FURNITURE, HOUSEWARES AND ACCESSORIES, IN CLASS 35 (U.S. CLS. 100, 101 AND 102).

FIRST USE 10-1-2007; IN COMMERCE 10-1-2007.

THE MARK CONSISTS OF STANDARD CHARACTERS WITHOUT CLAIM TO ANY PARTICULAR FONT, STYLE, SIZE, OR COLOR.

NO CLAIM IS MADE TO THE EXCLUSIVE RIGHT TO USE "IMPORTS", APART FROM THE MARK AS SHOWN.

SN 77-127,753, FILED 3-10-2007.

DEZMONA MIZELLE, EXAMINING ATTORNEY

**Int. Cls.: 9, 10, 16, 41, and 44**

**Prior U.S. Cls.: 2, 5, 21, 22, 23, 26, 29, 36, 37, 38, 39, 44, 50, 100, 101, and 107**

**Reg. No. 3,570,395**

**United States Patent and Trademark Office**

**Registered Feb. 3, 2009**

**TRADEMARK  
SERVICE MARK  
PRINCIPAL REGISTER**

**DEVILBISS HEALTHCARE**

SUNRISE MEDICAL HHG INC. (CALIFORNIA CORPORATION)  
7477 EAST DRY CREEK PARKWAY  
LONGMONT, CO 80503

FOR: SOFTWARE FOR MONITORING PATIENTS FOR COMPLIANCE WITH PRESCRIBED RESPIRATORY THERAPY, IN CLASS 9 (U.S. CLS. 21, 23, 26, 36 AND 38).

FIRST USE 10-2-2007; IN COMMERCE 10-2-2007.

FOR: COMPRESSORS FOR MEDICAL PURPOSES; NEBULIZERS FOR RESPIRATION THERAPY; ATOMIZERS FOR MEDICAL PURPOSES; COMPRESSOR NEBULIZER SYSTEM, NAMELY, A COMPRESSED AIR OPERATED NEBULIZER AND A COMPRESSOR SOLD AS A UNIT FOR RESPIRATION THERAPY; PEAK EXPIRATORY AIR FLOW METERS; FLUID ASPIRATION PUMPS FOR MEDICAL APPLICATIONS AND COLLECTION BOTTLES FOR ASPIRATION PUMPS; OXYGEN CONCENTRATORS FOR MEDICAL APPLICATIONS; OXYGEN CONSERVERS FOR MEDICAL APPLICATIONS; OXYGEN COMPRESSOR SYSTEMS FOR TRANSFILLING PORTABLE METAL GAS CYLINDERS WITH PRESSURIZED OXYGEN FOR AMBULATORY PATIENT USE; PORTABLE MEDICAL OXYGEN STORAGE AND DELIVERY SYSTEM FOR AMBULATORY USE, NAMELY, A COMPRESSED OXYGEN CYLINDER, AN OXYGEN PRESSURE REGULATOR AND FLOW CONTROLLER, AND A CARRYING CASE SOLD AS A UNIT; OXYGEN APPARATUS FOR MEDICAL APPLICATIONS AND PARTS THEREFOR, NAMELY, OXYGEN CONCENTRATORS, AND REPLACEMENT SIEVE BEDS FOR OXYGEN CONCENTRATORS; OXYGEN CYLINDERS, OXYGEN CYLINDER CARTS, OXYGEN CYLINDER CARRYING CASES, OXYGEN CYLINDER REGULATOR VALVES, OXY-

GEN VALVE WRENCHES, OXYGEN TUBING, OXYGEN TUBING CONNECTORS, NASAL CANNULAS AND OXYGEN HUMIDIFIERS, ALL FOR MEDICAL APPLICATIONS; CONTINUOUS POSITIVE AIRWAY PRESSURE (CPAP) COMPRESSORS AND MONITORS FOR MEDICAL USE; BILEVEL POSITIVE AIRWAY PRESSURE COMPRESSORS AND MONITORS FOR MEDICAL USE; HUMIDIFIERS FOR USE IN CONNECTION WITH MEDICAL RESPIRATORY DEVICES, HUMIDIFIERS FOR PROVIDING MOISTURE TO PATIENTS' AIRWAYS; RESPIRATORY MASKS FOR MEDICAL PURPOSES AND PARTS THEREFORE, NAMELY, MASK CUSHIONS AND FOREHEAD PADS; APPARATUS FOR DIAGNOSING RESPIRATORY CONDITIONS; APPARATUS FOR TREATING RESPIRATORY CONDITIONS; APPARATUS FOR DIAGNOSING ABNORMAL SLEEP CONDITIONS, APPARATUS FOR MONITORING PATIENTS FOR COMPLIANCE WITH PRESCRIBED RESPIRATORY THERAPY, MEDICAL OXYGEN CONCENTRATION SENSORS FOR MONITORING THE CONCENTRATION OF OXYGEN USED BY PATIENTS, IN CLASS 10 (U.S. CLS. 26, 39 AND 44).

FIRST USE 10-2-2007; IN COMMERCE 10-2-2007.

FOR: NEWSLETTERS IN THE RESPIRATORY FIELD; PRINTED MANUALS, BROCHURES, NEWSLETTERS RELATING TO RESPIRATORY THERAPY FOR CHILDREN, PRINTED MEMBERSHIP CARDS, PRINTED CALENDARS AND PAPER DECALS, IN CLASS 16 (U.S. CLS. 2, 5, 22, 23, 29, 37, 38 AND 50).

FIRST USE 10-2-2007; IN COMMERCE 10-2-2007.

FOR: CONDUCTING SEMINARS IN THE FIELD OF RESPIRATORY THERAPY; CONDUCTING

SEMINARS IN THE FIELD OF RESPIRATORY THERAPY TREATMENT PRODUCTS AND IN THE MARKETING OF RESPIRATORY THERAPY TREATMENT PRODUCTS; EDUCATIONAL PROGRAMS FOR AEROSOL THERAPY FOR ASTHMA PATIENTS; EDUCATIONAL PROGRAMS FOR EDUCATING CHILDREN IN RESPIRATORY THERAPY TO PROMOTE COMPLIANCE WITH PHYSICIAN PRESCRIBED THERAPY, IN CLASS 41 (U.S. CLS. 100, 101 AND 107).

FIRST USE 10-2-2007; IN COMMERCE 10-2-2007.

FOR: REMOTE MONITORING SERVICES FOR MONITORING PATIENTS FOR COMPLIANCE WITH PRESCRIBED RESPIRATORY THERAPY AND REPORTING TO HEALTHCARE PROVIDERS, IN CLASS 44 (U.S. CLS. 100 AND 101).

FIRST USE 10-2-2007; IN COMMERCE 10-2-2007.

THE MARK CONSISTS OF STANDARD CHARACTERS WITHOUT CLAIM TO ANY PARTICULAR FONT, STYLE, SIZE, OR COLOR.

OWNER OF U.S. REG. NOS. 164,521, 1,871,284, AND OTHERS.

NO CLAIM IS MADE TO THE EXCLUSIVE RIGHT TO USE "HEALTHCARE", APART FROM THE MARK AS SHOWN.

SN 77-130,507, FILED 3-14-2007.

DOMINIC J. FERRAIUOLO, EXAMINING ATTORNEY

**Int. Cl.: 33**

**Prior U.S. Cls.: 47 and 49**

**United States Patent and Trademark Office**

**Reg. No. 3,570,396**

**Registered Feb. 3, 2009**

**TRADEMARK  
PRINCIPAL REGISTER**

**BONTEMPO**

SAN DONATO SRL (ITALY LIMITED LIABILITY  
COMPANY)  
LOC. SAN DONATO IN PERANO  
GAIOLE IN CHIANTI, ITALY 53013

FOR: RED WINE; TABLE WINES, IN CLASS 33  
(U.S. CLS. 47 AND 49).

FIRST USE 6-11-2007; IN COMMERCE 6-30-2007.

THE MARK CONSISTS OF STANDARD CHAR-  
ACTERS WITHOUT CLAIM TO ANY PARTICULAR  
FONT, STYLE, SIZE, OR COLOR.

SN 77-130,642, FILED 3-14-2007.

MATTHEW MCDOWELL, EXAMINING ATTOR-  
NEY

**Int. Cl.: 9**

**Prior U.S. Cls.: 21, 23, 26, 36, and 38**

**Reg. No. 3,570,397**

**United States Patent and Trademark Office**

**Registered Feb. 3, 2009**

---

**TRADEMARK  
PRINCIPAL REGISTER**

# MediaBand

D-LINK SYSTEMS, INC. (CALIFORNIA CORPORATION)  
17595 MT. HERRMANN ST.  
FOUNTAIN VALLEY, CA 92708

PRINT SERVERS AND INTERNET CAMERAS, IN CLASS 9 (U.S. CLS. 21, 23, 26, 36 AND 38).

FIRST USE 5-15-2007; IN COMMERCE 5-15-2007.

FOR: WIRELESS DATA NETWORKING BAND USED FOR INTERCONNECTING AND MANAGING COMPUTER HARDWARE, NAMELY, ROUTERS, WIRELESS ACCESS POINTS (WAP) DEVICES, NETWORK CLIENT ADAPTERS, COMPUTER NETWORK SWITCHES, GATEWAY ROUTERS IN THE NATURE OF COMPUTER CONTROL HARDWARE,

THE MARK CONSISTS OF STANDARD CHARACTERS WITHOUT CLAIM TO ANY PARTICULAR FONT, STYLE, SIZE, OR COLOR.

SN 77-130,735, FILED 3-14-2007.

DORITT L. CARROLL, EXAMINING ATTORNEY

**Int. Cls.: 16, 25, 28, and 41**

**Prior U.S. Cls.: 2, 5, 22, 23, 29, 37, 38, 39, 50, 100, 101,  
and 107**

**Reg. No. 3,570,398**

**United States Patent and Trademark Office**

**Registered Feb. 3, 2009**

**TRADEMARK  
SERVICE MARK  
PRINCIPAL REGISTER**

**AXBL**

LEE, SHUYEN (CANADA INDIVIDUAL)  
7155 TRANSCANADA, SAINT-LAURENT  
QUEBEC, CANADA H4T1A2

FOR: PROMOTIONAL ITEMS, NAMELY, POS-  
TERS AND STICKERS, IN CLASS 16 (U.S. CLS. 2, 5,  
22, 23, 29, 37, 38 AND 50).

FIRST USE 3-14-2007; IN COMMERCE 5-24-2007.

FOR: CLOTHING , NAMELY, SHIRTS, SHORTS,  
T-SHIRTS, SWEATSHIRTS, JERSEYS, HOODED  
JACKETS, JACKETS; HEADGEAR, NAMELY,  
HATS, BEENIES, CAPS, VISORS, HEAD BANDS,  
HEAD WRAPS, IN CLASS 25 (U.S. CLS. 22 AND 39).

FIRST USE 3-14-2007; IN COMMERCE 5-24-2007.

FOR: PAINTBALL EQUIPMENT, NAMELY,  
PAINTBALL BARREL BAGS SPECIALLY ADAPTED  
FOR HOLDING PAINTBALL BARRELS, PAINT  
BALLS, ENCAPSULATED PAINT IN GEL, IN CLASS  
28 (U.S. CLS. 22, 23, 38 AND 50).

FIRST USE 3-14-2007; IN COMMERCE 5-24-2007.

FOR: ENTERTAINMENT SERVICES, NAMELY,  
THE ORGANIZATION, SCHEDULING AND CON-  
DUCTING OF PAINTBALL COMPETITIONS; PRO-  
VIDING A WEBSITE THAT PROVIDES  
INFORMATION AND ENTERTAINMENT IN THE  
FIELD OF A PAINTBALL LEAGUE AS WELL AS  
RELATED PAINTBALL TOPICS, IN CLASS 41 (U.S.  
CLS. 100, 101 AND 107).

FIRST USE 3-14-2007; IN COMMERCE 5-24-2007.

THE MARK CONSISTS OF STANDARD CHAR-  
ACTERS WITHOUT CLAIM TO ANY PARTICULAR  
FONT, STYLE, SIZE, OR COLOR.

SN 77-130,901, FILED 3-14-2007.

JEAN IM, EXAMINING ATTORNEY

**Int. Cl.: 35**

**Prior U.S. Cls.: 100, 101, and 102**

**United States Patent and Trademark Office**

**Reg. No. 3,570,399**

**Registered Feb. 3, 2009**

**SERVICE MARK  
PRINCIPAL REGISTER**

**FREE RANGE HUMAN**

ZAMBRANO, TONIA M. (UNITED STATES IN-  
DIVIDUAL)  
2533 W 37TH AVENUE  
DENVER, CO 80211

FOR: MARKETING SERVICES, NAMELY, PRO-  
VIDING INFORMATIONAL WEB PAGES DE-  
SIGNER TO GENERATE SALES TRAFFIC VIA  
HYPERLINKS TO OTHER WEB SITES; PROMOT-  
ING THE GOODS AND SERVICES OF OTHERS BY  
PROVIDING HYPERTEXT LINKS TO THE WEB  
SITES OF OTHERS, IN CLASS 35 (U.S. CLS. 100, 101  
AND 102).

FIRST USE 1-13-2005; IN COMMERCE 1-15-2005.

THE MARK CONSISTS OF STANDARD CHAR-  
ACTERS WITHOUT CLAIM TO ANY PARTICULAR  
FONT, STYLE, SIZE, OR COLOR.

SN 77-131,204, FILED 3-14-2007.

ESTHER BELENKER, EXAMINING ATTORNEY

**Int. Cl.: 12**

**Prior U.S. Cls.: 19, 21, 23, 31, 35, and 44**

**Reg. No. 3,570,400**

**United States Patent and Trademark Office**

**Registered Feb. 3, 2009**

---

**TRADEMARK  
PRINCIPAL REGISTER**

**PHOENIX BOATS**

CJBBB, INC. (TENNESSEE CORPORATION)  
210 INDUSTRIAL BOULEVARD  
TULLAHOMA, TN 37388

FOR: FIBERGLASS POWER BOATS FOR USE IN  
FISHING, IN CLASS 12 (U.S. CLS. 19, 21, 23, 31, 35  
AND 44).

FIRST USE 9-2-2008; IN COMMERCE 9-2-2008.

THE MARK CONSISTS OF STANDARD CHAR-  
ACTERS WITHOUT CLAIM TO ANY PARTICULAR  
FONT, STYLE, SIZE, OR COLOR.

NO CLAIM IS MADE TO THE EXCLUSIVE  
RIGHT TO USE "BOATS", APART FROM THE  
MARK AS SHOWN.

SN 77-131,548, FILED 3-15-2007.

DAVID H. STINE, EXAMINING ATTORNEY



**Int. Cl.: 12**

**Prior U.S. Cls.: 19, 21, 23, 31, 35, and 44**

**Reg. No. 3,570,401**

**United States Patent and Trademark Office**

**Registered Feb. 3, 2009**

---

**TRADEMARK  
PRINCIPAL REGISTER**

**PHOENIX BASS BOATS**

CJBBB, INC. (TENNESSEE CORPORATION)  
210 INDUSTRIAL BOULEVARD  
TULLAHOMA, TN 37388

FOR: FIBERGLASS POWER BOATS FOR USE IN  
FISHING, IN CLASS 12 (U.S. CLS. 19, 21, 23, 31, 35  
AND 44).

FIRST USE 11-0-2007; IN COMMERCE 11-0-2007.

THE MARK CONSISTS OF STANDARD CHAR-  
ACTERS WITHOUT CLAIM TO ANY PARTICULAR  
FONT, STYLE, SIZE, OR COLOR.

NO CLAIM IS MADE TO THE EXCLUSIVE  
RIGHT TO USE "BASS BOATS", APART FROM  
THE MARK AS SHOWN.

SN 77-131,552, FILED 3-15-2007.

DAVID H. STINE, EXAMINING ATTORNEY

**Int. Cl.: 25**

**Prior U.S. Cls.: 22 and 39**

**United States Patent and Trademark Office**

**Reg. No. 3,570,402**

**Registered Feb. 3, 2009**

**TRADEMARK  
PRINCIPAL REGISTER**

**PTX**

HRBEK, VACLAV (CZECH REPUBLIC INDIVIDUAL)  
AUGUSTINOVA 2074  
PRAHA 4-CHODOV, CZECH REPUBLIC

THE MARK CONSISTS OF STANDARD CHARACTERS WITHOUT CLAIM TO ANY PARTICULAR FONT, STYLE, SIZE, OR COLOR.

FOR: FABRIC SOLD AS AN INTEGRAL COMPONENT OF CLOTHING ITEMS, NAMELY, JACKETS AND FOOTWEAR, IN CLASS 25 (U.S. CLS. 22 AND 39).

SN 77-131,567, FILED 3-15-2007.

FIRST USE 10-19-2005; IN COMMERCE 10-19-2005.

LINDA LAVACHE, EXAMINING ATTORNEY

**Int. Cl.: 16**

**Prior U.S. Cls.: 2, 5, 22, 23, 29, 37, 38, and 50**

**United States Patent and Trademark Office**

**Reg. No. 3,570,403**

**Registered Feb. 3, 2009**

**TRADEMARK  
PRINCIPAL REGISTER**



TRENDS INTERNATIONAL, LLC (DELAWARE  
LIMITED LIABILITY COMPANY)  
5188 WEST 74TH STREET  
INDIANAPOLIS, IN 46268

FOR: ARTS AND CRAFT PAINTING KITS; ARTS  
AND CRAFT COLORING KITS, CONTAINING CO-  
LORED PENCILS, CRAYONS, MARKERS, SE-  
QUINS, GLITTER GLUE, CRAFT AND ART SAND,  
POSTER BOARD, AND POSTERS, IN CLASS 16 (U.S.  
CLS. 2, 5, 22, 23, 29, 37, 38 AND 50).

FIRST USE 1-0-2007; IN COMMERCE 1-0-2007.

NO CLAIM IS MADE TO THE EXCLUSIVE  
RIGHT TO USE "ART", APART FROM THE MARK  
AS SHOWN.

SN 77-132,252, FILED 3-15-2007.

ESTHER BELENKER, EXAMINING ATTORNEY

**Int. Cl.: 30**

**Prior U.S. Cl.: 46**

**United States Patent and Trademark Office**

**Reg. No. 3,570,404**

**Registered Feb. 3, 2009**

**TRADEMARK  
PRINCIPAL REGISTER**

**RIGHTEOUSLY RAW**

EARTH SOURCE, INC. (CALIFORNIA CORPORATION)  
SUITE C  
1558 OSAGE STREET  
SAN MARCOS, CA 92128

FOR: CHOCOLATE BASED ORGANIC FOOD BARS, IN CLASS 30 (U.S. CL. 46).

FIRST USE 3-17-2008; IN COMMERCE 3-17-2008.

THE MARK CONSISTS OF STANDARD CHARACTERS WITHOUT CLAIM TO ANY PARTICULAR FONT, STYLE, SIZE, OR COLOR.

NO CLAIM IS MADE TO THE EXCLUSIVE RIGHT TO USE "RAW", APART FROM THE MARK AS SHOWN.

SN 77-132,450, FILED 3-15-2007.

MARK SPARACINO, EXAMINING ATTORNEY

**Int. Cls.: 9, 16, and 41**

**Prior U.S. Cls.: 2, 5, 21, 22, 23, 26, 29, 36, 37, 38, 50,  
100, 101, and 107**

**Reg. No. 3,570,405**

**United States Patent and Trademark Office**

**Registered Feb. 3, 2009**

**TRADEMARK  
SERVICE MARK  
PRINCIPAL REGISTER**



CHILDREN DESIRING GOD, LLC (MINNESOTA  
LIMITED LIABILITY COMPANY)  
2601 E FRANKLIN AVE  
MINNEAPOLIS, MN 55406

FOR: AUDIO RECORDINGS FEATURING CONTENT RELATED TO CHILD AND FAMILY RELIGIOUS EDUCATION, MINISTRY AND EVANGELISM; VIDEO RECORDINGS FEATURING CONTENT RELATED TO CHILD AND FAMILY RELIGIOUS EDUCATION, MINISTRY AND EVANGELISM; CHILDREN'S EDUCATIONAL SOFTWARE, IN CLASS 9 (U.S. CLS. 21, 23, 26, 36 AND 38).

FIRST USE 11-30-2007; IN COMMERCE 11-30-2007.

FOR: CHILDRENS INTERACTIVE EDUCATIONAL BOOKS; PRINTED INSTRUCTIONAL, EDUCATIONAL, AND TEACHING MATERIALS IN THE FIELD OF CHILD AND FAMILY RELIGIOUS EDUCATION, MINISTRY AND EVANGELISM, IN CLASS 16 (U.S. CLS. 2, 5, 22, 23, 29, 37, 38 AND 50).

FIRST USE 11-30-2007; IN COMMERCE 11-30-2007.

FOR: EDUCATIONAL SERVICES, NAMELY, DEVELOPING CURRICULUM FOR OTHERS IN THE FIELD OF CHILD AND FAMILY RELIGIOUS EDUCATION, MINISTRY AND EVANGELISM; EDUCATIONAL SERVICES, NAMELY, CONDUCTING CLASSES, SEMINARS, CONFERENCES AND WORKSHOPS IN THE FIELD OF CHILD AND FAMILY RELIGIOUS EDUCATION, MINISTRY AND EVANGELISM AND DISTRIBUTION OF COURSE MATERIAL IN CONNECTION THEREWITH; EDUCATIONAL SERVICES, NAMELY, PROVIDING A WEBSITE WITH INFORMATION AND RESOURCES IN THE FIELDS OF CHILD AND FAMILY RELIGIOUS EDUCATION; EDUCATIONAL SERVICES, NAMELY, DEVELOPING, ARRANGING, AND CONDUCTING EDUCATIONAL CONFERENCES AND PROGRAMS AND PROVIDING COURSES OF INSTRUCTION IN THE FIELD OF CHILD AND FAMILY RELIGIOUS EDUCATION, MINISTRY AND EVANGELISM, IN CLASS 41 (U.S. CLS. 100, 101 AND 107).

FIRST USE 3-30-2007; IN COMMERCE 4-30-2007.

THE MARK CONSISTS OF A HUMAN STICK FIGURE WITH OUTSTRETCHED LIMBS FORMING THE SHAPE OF AN ABSTRACTED CROSS, AND THE TERMS "CHILDREN DESIRING GOD".

SN 77-133,124, FILED 3-16-2007.

SUNG IN, EXAMINING ATTORNEY

**Int. Cl.: 16**

**Prior U.S. Cls.: 2, 5, 22, 23, 29, 37, 38, and 50**

**Reg. No. 3,570,406**

**United States Patent and Trademark Office**

**Registered Feb. 3, 2009**

**TRADEMARK  
PRINCIPAL REGISTER**

MY PERSONAL HEALTHCHART

SAWHNEY, AMRITA G. (UNITED STATES IN-  
DIVIDUAL)  
APT. 402  
21 TRINITY PLACE  
MONTCLAIR, NJ 07042

FOR: PERSONAL ORGANIZERS, IN CLASS 16  
(U.S. CLS. 2, 5, 22, 23, 29, 37, 38 AND 50).

FIRST USE 7-28-2008; IN COMMERCE 9-10-2008.

THE MARK CONSISTS OF STANDARD CHAR-  
ACTERS WITHOUT CLAIM TO ANY PARTICULAR  
FONT, STYLE, SIZE, OR COLOR.

NO CLAIM IS MADE TO THE EXCLUSIVE  
RIGHT TO USE "PERSONAL HEALTHCHART",  
APART FROM THE MARK AS SHOWN.

SN 77-134,391, FILED 3-19-2007.

STEVEN R. FOSTER, EXAMINING ATTORNEY

**Int. Cls.: 35 and 36**

**Prior U.S. Cls.: 100, 101, and 102**

**United States Patent and Trademark Office**

**Reg. No. 3,570,407**

**Registered Feb. 3, 2009**

**SERVICE MARK  
PRINCIPAL REGISTER**

**VISA INTELLILINK**

VISA INTERNATIONAL SERVICE ASSOCIATION  
(DELAWARE CORPORATION)  
900 METRO CENTER BOULEVARD, M1-11A  
FOSTER CITY, CA 94404

FOR: PROVIDING BROAD BASED FINANCIAL  
INFORMATION SERVICES, NAMELY, FINANCIAL  
RECORDS MANAGEMENT, IN CLASS 35 (U.S. CLS.  
100, 101 AND 102).

FIRST USE 9-2-2008; IN COMMERCE 9-2-2008.

FOR: CREDIT CARD SERVICES, DEBIT CARD  
SERVICES; PROVIDING CREDIT AND DEBIT PAY-  
MENT DATA AND REPORTS; FINANCIAL ASSES-  
SMENT AND RISK MANAGEMENT SERVICES;  
CREDIT MANAGEMENT SERVICES IN THE FIELD  
OF FINANCIAL ASSESSMENT AND RISK MAN-  
AGEMENT; DISSEMINATION OF FINANCIAL IN-

FORMATION VIA A GLOBAL COMPUTER  
NETWORK, FINANCIAL INFORMATION REN-  
DERED BY COMPUTER BY MEANS OF A SECURE  
INFORMATION COMPUTER NETWORK; ADVI-  
SORY SERVICES RELATING TO CREDIT AND  
DEBIT PAYMENT SERVICES, IN CLASS 36 (U.S.  
CLS. 100, 101 AND 102).

FIRST USE 9-2-2008; IN COMMERCE 9-2-2008.

THE MARK CONSISTS OF STANDARD CHAR-  
ACTERS WITHOUT CLAIM TO ANY PARTICULAR  
FONT, STYLE, SIZE, OR COLOR.

SN 77-134,915, FILED 3-19-2007.

EMILY CARLSEN, EXAMINING ATTORNEY

**Int. Cls.: 39, 41, and 43**

**Prior U.S. Cls.: 100, 101, 105, and 107**

**United States Patent and Trademark Office**

**Reg. No. 3,570,408**

**Registered Feb. 3, 2009**

**SERVICE MARK  
PRINCIPAL REGISTER**

**CARNIVAL SPLENDOR**

CARNIVAL CORPORATION (PANAMA CORPORATION)  
3655 N.W. 87 AVENUE  
MIAMI, FL 33178

FOR: CRUISE SHIP SERVICES, IN CLASS 39 (U.S. CLS. 100 AND 105).

FIRST USE 6-30-2008; IN COMMERCE 6-30-2008.

FOR: ENTERTAINMENT SERVICES, NAMELY, CASINO SERVICES, ORGANIZING AND CONDUCTING STAGE SHOWS, NIGHTCLUB SHOWS, CONTESTS, DANCES AND PARTIES, IN CLASS 41 (U.S. CLS. 100, 101 AND 107).

FIRST USE 6-30-2008; IN COMMERCE 6-30-2008.

FOR: HOTEL SERVICES AND RESTAURANT SERVICES, IN CLASS 43 (U.S. CLS. 100 AND 101).

FIRST USE 6-30-2008; IN COMMERCE 6-30-2008.

THE MARK CONSISTS OF STANDARD CHARACTERS WITHOUT CLAIM TO ANY PARTICULAR FONT, STYLE, SIZE, OR COLOR.

OWNER OF U.S. REG. NOS. 1,489,408, 1,591,384, AND OTHERS.

SN 77-136,775, FILED 3-21-2007.

MARCIE MILONE, EXAMINING ATTORNEY



Int. Cls.: 35, 37, 39, 40, 41, and 45

Prior U.S. Cls.: 100, 101, 102, 103, 105, 106, and 107

United States Patent and Trademark Office

Reg. No. 3,570,409

Registered Feb. 3, 2009

SERVICE MARK  
PRINCIPAL REGISTER



TOWN OF STRATFORD, CONNECTICUT (CONNECTICUT MUNICIPAL CORPORATION)

2725 MAIN STREET  
STRATFORD, CT 06615

FOR: LOBBYING SERVICES, NAMELY, PROMOTING THE INTERESTS OF THE CITIZENS OF STRATFORD, CONNECTICUT IN THE FIELD OF LEGISLATION, PROMOTING PUBLIC AWARENESS FOR LAND CONSERVATION AND PROTECTION; COMMERCIAL ADMINISTRATION OF LICENSING OF THE GOODS AND SERVICE OF OTHERS, NAMELY, REGULATING AND ISSUING LICENSES FOR INDIVIDUALS AND BUSINESSES IN THEIR CHOSEN FIELDS OF ENDEAVOR, IN CLASS 35 (U.S. CLS. 100, 101 AND 102).

FIRST USE 3-9-2007; IN COMMERCE 3-9-2007.

FOR: MUNICIPAL SERVICES, NAMELY, CONSTRUCTION PLANNING, AND STREET CONSTRUCTION AND MAINTENANCE, IN CLASS 37 (U.S. CLS. 100, 103 AND 106).

FIRST USE 3-9-2007; IN COMMERCE 3-9-2007.

FOR: MUNICIPAL GOVERNMENT SERVICES IN THE NATURE OF UTILITY SERVICES, WHERE WATER AND SEWER SERVICES ARE PROVIDED TO THE PUBLIC; PROVIDING PUBLIC TRANSPORTATION SERVICES VIA BUS, VAN, SHUTTLE, AUTOMOBILE, LIGHT RAIL, TRAIN, AND RAPID TRANSIT SYSTEMS, IN CLASS 39 (U.S. CLS. 100 AND 105).

FIRST USE 3-9-2007; IN COMMERCE 3-9-2007.

FOR: MUNICIPAL SERVICES, NAMELY, RECYCLING SERVICES, AND WASTE MANAGEMENT, IN CLASS 40 (U.S. CLS. 100, 103 AND 106).

FIRST USE 3-9-2007; IN COMMERCE 3-9-2007.

FOR: MUNICIPAL SERVICES, NAMELY, PUBLIC LIBRARIES, EDUCATIONAL SERVICES IN THE NATURE OF AN ANNUAL AWARDS PROGRAM TO RECOGNIZE THE EFFORTS OF INDIVIDUALS, GOVERNMENT AGENCIES, AND BUSINESSES WHO PROMOTE JOB CREATION AND ECONOMIC REVITALIZATION, CABLE TV PROGRAMMING, AND RECREATIONAL PARK SERVICES, IN CLASS 41 (U.S. CLS. 100, 101 AND 107).

FIRST USE 3-9-2007; IN COMMERCE 3-9-2007.

FOR: MUNICIPAL SERVICES, NAMELY, POLICE AND CIVIL PROTECTION SERVICES; MUNICIPAL GOVERNMENT SERVICES, NAMELY, ESTABLISHING AND ENFORCING BUILDING AND ZONING CODES, REGULATING DEVELOPMENT WITHIN THE CITY, REVIEWING STANDARDS AND PRACTICES TO ASSURE COMPLIANCE WITH LAWS AND REGULATIONS IN THE FIELDS OF UTILITIES, RESIDENTIAL AND COMMERCIAL BUILDING CONSTRUCTION, ROADS AND OPERATION OF BUSINESSES, IN CLASS 45 (U.S. CLS. 100 AND 101).

FIRST USE 3-9-2007; IN COMMERCE 3-9-2007.

NO CLAIM IS MADE TO THE EXCLUSIVE RIGHT TO USE "TOWN OF STRATFORD", APART FROM THE MARK AS SHOWN.

THE MARK CONSISTS OF A SHADED RECTANGLE DIVIDED IN HALF BY A VERTICAL S SHAPE; THREE WAVE DESIGNS APPEAR ON THE LEFT LOWER CORNER OF THE RECTANGLE AND THREE TREE DESIGNS APPEAR ON THE RIGHT UPPER CORNER OF THE RECTANGLE; TO THE RIGHT OF THE RECTANGLE ARE THE STYLIZED WORDS "TOWN OF STRATFORD" ALL IN UPPER

CASE LETTERS; CENTERED BELOW THESE ARE  
THE STYLIZED WORDS "OFFERING MORE FROM  
FOREST TO SHORE" ALL IN LOWER CASE LET-  
TERS.

SN 77-137,911, FILED 3-22-2007.

DAVID TAYLOR, EXAMINING ATTORNEY

**Int. Cl.: 28**

**Prior U.S. Cls.: 22, 23, 38, and 50**

**United States Patent and Trademark Office**

**Reg. No. 3,570,410**

**Registered Feb. 3, 2009**

**TRADEMARK  
PRINCIPAL REGISTER**



TOBIN, ARNOLD (UNITED STATES INDIVIDUAL)  
192-06 122 AVENUE  
SPRINGFIELD GARDENS, NY 11413

FOR: HAND STRENGTHENING DEVICE, NAME-  
LY, A GLOVE WITH BUILT-IN RESISTANCE ON  
EACH FINGER, IN CLASS 28 (U.S. CLS. 22, 23, 38  
AND 50).

FIRST USE 1-1-2007; IN COMMERCE 1-1-2007.

NO CLAIM IS MADE TO THE EXCLUSIVE  
RIGHT TO USE "THENAR", APART FROM THE  
MARK AS SHOWN.

THE MARK CONSISTS OF THE WORD "THE-  
NAR" WITH THE "N" IN THE SHAPE OF A LIGHT-  
NING BOLT.

SN 77-138,584, FILED 3-23-2007.

KATHERINE M. DUBRAY, EXAMINING ATTOR-  
NEY

Int. Cl.: 42

Prior U.S. Cls.: 100 and 101

United States Patent and Trademark Office

Reg. No. 3,570,411

Registered Feb. 3, 2009

SERVICE MARK  
PRINCIPAL REGISTER



Precision  
System  
Science  
USA Inc.

PRECISION SYSTEM SCIENCE CO., LTD. (JAPAN CORPORATION)  
88, KAMIHONGOU  
MATSUDO-SHI, JAPAN

FOR: TESTING OR RESEARCH OF LABORATORY APPARATUS AND INSTRUMENTS, MEASURING AND TESTING MACHINES AND INSTRUMENTS, ELECTRONIC MACHINES, APPARATUS AND THEIR PARTS, MEDICAL MACHINES AND APPARATUS, AND CHEMICAL PROCESSING MACHINES AND APPARATUS; TESTING, INSPECTION, OR RESEARCH OF CHEMICAL CARRIERS HAVING OLIGO-NUCLEOTIDES BONDED THEREWITH, AND KITS COMPRISED OF SUCH CARRIERS, FOR CLINICAL MEDICINE OR CLINICAL PROCEDURES, SUCH AS ANALYSIS OF DNA SEQUENCES, PHARMACEUTICALS, COSMETICS, OR FOODSTUFFS; DESIGNING OF MACHINES, APPARATUS, INSTRUMENTS AND PARTS THEREFOR AND SYSTEMS COMPOSED OF SUCH MACHINES, APPARATUS, AND INSTRUMENTS, FOR BIOCHEMICAL AND BIOLOGICAL ANALYSIS, TESTING, AND RESEARCH; RENTAL OF MEASURING APPARATUS, LABORATORY APPARA-

TUS, AND LABORATORY INSTRUMENTS, IN CLASS 42 (U.S. CLS. 100 AND 101).

FIRST USE 12-31-2002; IN COMMERCE 12-31-2002.

OWNER OF U.S. REG. NO. 3,142,333.

NO CLAIM IS MADE TO THE EXCLUSIVE RIGHT TO USE "SYSTEM", "SCIENCE", AND "USA INC.", APART FROM THE MARK AS SHOWN.

THE COLOR(S) GREEN AND BLACK IS/ARE CLAIMED AS A FEATURE OF THE MARK.

THE MARK CONSISTS OF THE WORDS "PSS" IN STYLIZED FONT AND IN THE COLOR GREEN ABOVE THE VERTICALLY STACKED WORDS "PRECISION", "SYSTEM", "SCIENCE", AND "USA INC." ALL OF WHICH APPEAR IN THE COLOR BLACK.

SN 77-139,932, FILED 3-26-2007.

LINDA POWELL, EXAMINING ATTORNEY

**Int. Cl.: 11**

**Prior U.S. Cls.: 13, 21, 23, 31, and 34**

**United States Patent and Trademark Office**

**Reg. No. 3,570,412**

**Registered Feb. 3, 2009**

**TRADEMARK  
PRINCIPAL REGISTER**

**OZONICS**

OZONICS, L.L.C. (TEXAS LIMITED LIABILITY  
COMPANY)  
62 SOUTH CALLALILY COURT  
LAKE JACKSON, TX 77566

THE MARK CONSISTS OF STANDARD CHAR-  
ACTERS WITHOUT CLAIM TO ANY PARTICULAR  
FONT, STYLE, SIZE, OR COLOR.

FOR: OZONE GENERATORS FOR PURIFYING  
AIR, IN CLASS 11 (U.S. CLS. 13, 21, 23, 31 AND 34).

SN 77-140,027, FILED 3-26-2007.

FIRST USE 12-12-2007; IN COMMERCE 12-12-2007.

DAVID MURRAY, EXAMINING ATTORNEY

**Int. Cl.: 11**

**Prior U.S. Cls.: 13, 21, 23, 31, and 34**

**United States Patent and Trademark Office**

**Reg. No. 3,570,413**

**Registered Feb. 3, 2009**

**TRADEMARK  
PRINCIPAL REGISTER**

**REVOLUTIONIZING SCENT  
CONTROL**

OZONICS, L.L.C. (TEXAS LIMITED LIABILITY  
COMPANY)

62 SOUTH CALLALILY COURT

LAKE JACKSON, TX 77566

FOR: OZONE GENERATORS FOR PURIFYING  
AIR, IN CLASS 11 (U.S. CLS. 13, 21, 23, 31 AND 34).

FIRST USE 12-12-2007; IN COMMERCE 12-12-2007.

THE MARK CONSISTS OF STANDARD CHAR-  
ACTERS WITHOUT CLAIM TO ANY PARTICULAR  
FONT, STYLE, SIZE, OR COLOR.

NO CLAIM IS MADE TO THE EXCLUSIVE  
RIGHT TO USE "SCENT CONTROL", APART FROM  
THE MARK AS SHOWN.

SN 77-140,030, FILED 3-26-2007.

MELVIN AXILBUND, EXAMINING ATTORNEY

**Int. Cl.: 12**

**Prior U.S. Cls.: 19, 21, 23, 31, 35, and 44**

**Reg. No. 3,570,414**

**United States Patent and Trademark Office**

**Registered Feb. 3, 2009**

**TRADEMARK  
PRINCIPAL REGISTER**

# Trailer Gator

PAPPALARDO, ADAM J. (UNITED STATES IN-  
DIVIDUAL)  
P.O. BOX 928  
ATKINSON, NH 03811

FOR: METAL LOCKING DEVICE FOR TRAILER  
COUPLER, IN CLASS 12 (U.S. CLS. 19, 21, 23, 31, 35  
AND 44).

FIRST USE 8-7-2008; IN COMMERCE 8-7-2008.

THE MARK CONSISTS OF STANDARD CHAR-  
ACTERS WITHOUT CLAIM TO ANY PARTICULAR  
FONT, STYLE, SIZE, OR COLOR.

NO CLAIM IS MADE TO THE EXCLUSIVE  
RIGHT TO USE "TRAILER", APART FROM THE  
MARK AS SHOWN.

SN 77-140,211, FILED 3-26-2007.

AMY ALFIERI, EXAMINING ATTORNEY

**Int. Cl.: 25**

**Prior U.S. Cls.: 22 and 39**

**United States Patent and Trademark Office**

**Reg. No. 3,570,415**

**Registered Feb. 3, 2009**

**TRADEMARK  
PRINCIPAL REGISTER**



SWEJJ, LLC (FLORIDA LIMITED LIABILITY  
COMPANY)  
4400 GULFSHORE BLVD N #603  
NAPLES, FL 34103

THE MARK CONSISTS OF DISTINCT STYLIZED  
FONT, NOT RESTRICTED TO COLOR.

FOR: CAPS; CAPS WITH VISORS; SHORT-  
SLEEVED OR LONG-SLEEVED T-SHIRTS; T-  
SHIRTS, IN CLASS 25 (U.S. CLS. 22 AND 39).

SN 77-142,056, FILED 3-27-2007.

FIRST USE 2-25-2008; IN COMMERCE 2-25-2008.

ARETHA SOMERVILLE, EXAMINING ATTORNEY



**Int. Cl.: 35**

**Prior U.S. Cls.: 100, 101, and 102**

**United States Patent and Trademark Office**

**Reg. No. 3,570,416**

**Registered Feb. 3, 2009**

**SERVICE MARK  
PRINCIPAL REGISTER**

**UPS FTZ FACILITATOR**

UNITED PARCEL SERVICE OF AMERICA, INC.  
(DELAWARE CORPORATION)  
55 GLENLAKE PARKWAY, NE  
ATLANTA, GA 30328

FOR: LOGISTICS MANAGEMENT IN THE FIELD OF TRANSPORTATION OF GOODS AND PERSONAL PROPERTY; PROVIDING COMPUTERIZED TRACKING AND TRACING OF PACKAGES IN TRANSIT; FOREIGN TRADE INFORMATION AND CONSULTATION; ADVISORY AND CONSULTANCY SERVICES RELATING TO EXPORT AND IMPORT; ADVISORY AND CONSULTANCY SERVICES RELATING TO EXPORT AND IMPORT PROMOTION INFORMATION AND SERVICES; CUSTOMS CLEARANCE SERVICES; AND TRANSPORTATION NETWORK MANAGEMENT SOLUTION SERVICES, IN CLASS 35 (U.S. CLS. 100, 101 AND 102).

FIRST USE 7-1-2007; IN COMMERCE 7-1-2007.

THE MARK CONSISTS OF STANDARD CHARACTERS WITHOUT CLAIM TO ANY PARTICULAR FONT, STYLE, SIZE, OR COLOR.

OWNER OF U.S. REG. NOS. 2,973,108, 2,981,794, AND 3,240,195.

NO CLAIM IS MADE TO THE EXCLUSIVE RIGHT TO USE "FTZ FACILITATOR", APART FROM THE MARK AS SHOWN.

SN 77-142,776, FILED 3-28-2007.

LINDA E. BLOHM, EXAMINING ATTORNEY

**Int. Cl.: 41**

**Prior U.S. Cls.: 100, 101, and 107**

**United States Patent and Trademark Office**

**Reg. No. 3,570,417**

**Registered Feb. 3, 2009**

**SERVICE MARK  
PRINCIPAL REGISTER**

# SOL CASINOS

PASCUA YAQUI TRIBE (UNITED STATES FED-  
ERALLY-RECOGNIZED INDIAN TRIBE)

7474 S. CAMINO DE OESTE

TUCSON, AZ 85746

FOR: PROVIDING CASINO FACILITIES; CASINO SERVICES; AND ENTERTAINMENT SERVICES, NAMELY, LIVE PERFORMANCES BY MUSICAL BANDS, LIVE MUSIC CONCERTS, LIVE APPEARANCES BY PROFESSIONAL ENTERTAINERS, AND LIVE SPORTING EVENTS IN THE NATURE OF BOXING AND CAGE FIGHTING, IN CLASS 41 (U.S. CLS. 100, 101 AND 107).

FIRST USE 5-1-2007; IN COMMERCE 5-1-2007.

THE MARK CONSISTS OF STANDARD CHARACTERS WITHOUT CLAIM TO ANY PARTICULAR FONT, STYLE, SIZE, OR COLOR.

OWNER OF U.S. REG. NOS. 2,800,090, 2,965,247, AND OTHERS.

NO CLAIM IS MADE TO THE EXCLUSIVE RIGHT TO USE "CASINOS", APART FROM THE MARK AS SHOWN.

THE ENGLISH TRANSLATION OF THE WORD "SOL CASINOS" IN THE MARK IS "SUN".

SN 77-144,496, FILED 3-30-2007.

DEBRA LEE, EXAMINING ATTORNEY

**Int. Cl.: 43**

**Prior U.S. Cls.: 100 and 101**

**United States Patent and Trademark Office**

**Reg. No. 3,570,418**

**Registered Feb. 3, 2009**

**SERVICE MARK  
PRINCIPAL REGISTER**

**SOL CASINOS**

PASCUA YAQUI TRIBE (UNITED STATES FED-  
ERALLY-RECOGNIZED INDIAN TRIBE)  
7474 S. CAMINO DE OESTE  
TUCSON, AZ 85746

OWNER OF U.S. REG. NOS. 2,800,090, 3,027,158,  
AND OTHERS.

FOR: RESTAURANT SERVICES, IN CLASS 43  
(U.S. CLS. 100 AND 101).

THE ENGLISH TRANSLATION OF THE WORD  
"SOL CASINOS" IN THE MARK IS "SUN".

FIRST USE 5-1-2007; IN COMMERCE 5-1-2007.

SN 77-144,500, FILED 3-30-2007.

THE MARK CONSISTS OF STANDARD CHAR-  
ACTERS WITHOUT CLAIM TO ANY PARTICULAR  
FONT, STYLE, SIZE, OR COLOR.

DEBRA LEE, EXAMINING ATTORNEY

**Int. Cl.: 9**

**Prior U.S. Cls.: 21, 23, 26, 36, and 38**

**Reg. No. 3,570,419**

**United States Patent and Trademark Office**

**Registered Feb. 3, 2009**

---

**TRADEMARK  
PRINCIPAL REGISTER**

**WiseCircu**

DAIHAN SCIENTIFIC CO., LTD. (REPUBLIC OF  
KOREA CORPORATION)  
24-4 SANGWOLGOK-DONG, SUNGBUK-GU  
SEOUL 136-120, REPUBLIC OF KOREA

FOR: LABORATORY EQUIPMENT AND SUP-  
PLIES, NAMELY, CONSTANT TEMPERATURE WA-  
TER CIRCULATION TANKS, HIGH  
TEMPERATURE CIRCULATORS, CIRCULATING  
WATER BATHS, REFRIGERATING CIRCULA-  
TORS, IN CLASS 9 (U.S. CLS. 21, 23, 26, 36 AND 38).

FIRST USE 8-10-2006; IN COMMERCE 8-10-2006.

THE MARK CONSISTS OF STANDARD CHAR-  
ACTERS WITHOUT CLAIM TO ANY PARTICULAR  
FONT, STYLE, SIZE, OR COLOR.

SN 77-146,390, FILED 4-2-2007.

IRA J. GOODSaid, EXAMINING ATTORNEY

**Int. Cl.: 24**

**Prior U.S. Cls.: 42 and 50**

**United States Patent and Trademark Office**

**Reg. No. 3,570,420**

**Registered Feb. 3, 2009**

**TRADEMARK  
PRINCIPAL REGISTER**

# FABSTRACT

PANGLIJIN, MARILYN (UNITED STATES INDIVIDUAL)  
406 WILLIAMS AVE NORTH  
RENTON, WA 98057

THE MARK CONSISTS OF STANDARD CHARACTERS WITHOUT CLAIM TO ANY PARTICULAR FONT, STYLE, SIZE, OR COLOR.

FOR: WORKS OF ART OF FABRIC, IN CLASS 24 (U.S. CLS. 42 AND 50).

SN 77-149,533, FILED 4-5-2007.

FIRST USE 1-19-2008; IN COMMERCE 1-19-2008.

ALYSSA STEEL, EXAMINING ATTORNEY

**Int. Cl.: 9**

**Prior U.S. Cls.: 21, 23, 26, 36, and 38**

**United States Patent and Trademark Office**

**Reg. No. 3,570,421**

**Registered Feb. 3, 2009**

**TRADEMARK  
PRINCIPAL REGISTER**

**BEYOND THE DESKTOP**

ICRON TECHNOLOGIES CORPORATION (CA-  
NADA CORPORATION)  
SUITE #221  
4664 LOUGHEED HWY  
BURNABY, CANADA V5C5T5

FOR: COMPUTER DATA COMMUNICATION  
HARDWARE, SOFTWARE AND FIRMWARE FOR  
USE IN THE FIELD OF COMPUTER COMMUNICA-  
TIONS FOR ENABLING DATA COMMUNICATION  
BETWEEN COMPUTERS AND COMPUTER RELA-  
TED PERIPHERAL DEVICES, IN CLASS 9 (U.S. CLS.  
21, 23, 26, 36 AND 38).

FIRST USE 11-25-2008; IN COMMERCE 11-25-2008.

THE MARK CONSISTS OF STANDARD CHAR-  
ACTERS WITHOUT CLAIM TO ANY PARTICULAR  
FONT, STYLE, SIZE, OR COLOR.

SN 77-149,753, FILED 4-5-2007.

JANICE L. MCMORROW, EXAMINING ATTOR-  
NEY

**Int. Cl.: 16**

**Prior U.S. Cls.: 2, 5, 22, 23, 29, 37, 38, and 50**

**Reg. No. 3,570,422**

**United States Patent and Trademark Office**

**Registered Feb. 3, 2009**

**TRADEMARK  
PRINCIPAL REGISTER**

**EASY WRAP**

NATIONAL ENVELOPE CORPORATION (NEW  
YORK CORPORATION)  
333 EARLE OVINGTON BOULEVARD  
SUITE 1035  
UNIONDALE, NY 11553

FOR: PAPER PRODUCTS AND PAPER-LIKE  
PRODUCTS, NAMELY, PAPER, ENVELOPES, DE-  
CORATED LETTERHEAD PAPER, WRITING PA-  
PER AND ENVELOPES FOR SPECIAL OCCASIONS,  
GREETING CARDS WITH AND WITHOUT ENVEL-  
OPES, NOTE CARDS WITH AND WITHOUT EN-  
VELOPES, ANNOUNCEMENT CARDS,  
PRESENTATION FOLDERS, DURABLE MAILERS

IN THE NATURE OF ENVELOPES, AND BOOKLET  
ENVELOPES, IN CLASS 16 (U.S. CLS. 2, 5, 22, 23, 29,  
37, 38 AND 50).

FIRST USE 10-0-2007; IN COMMERCE 10-0-2007.

THE MARK CONSISTS OF STANDARD CHAR-  
ACTERS WITHOUT CLAIM TO ANY PARTICULAR  
FONT, STYLE, SIZE, OR COLOR.

SN 77-149,955, FILED 4-5-2007.

JASON TURNER, EXAMINING ATTORNEY

**Int. Cl.: 20**

**Prior U.S. Cls.: 2, 13, 22, 25, 32, and 50**

**Reg. No. 3,570,423**

**United States Patent and Trademark Office**

**Registered Feb. 3, 2009**

**TRADEMARK  
PRINCIPAL REGISTER**

**QUINTETTE**

HUNTER DOUGLAS INC. (DELAWARE CORPORATION)  
2 PARK WAY & ROUTE 17 SOUTH  
UPPER SADDLE RIVER, NJ 07458

FOR: INTERIOR WINDOW AND DOOR BLINDS; INDOOR WINDOW AND DOOR SHADES; INTERIOR WINDOW COVERINGS, NAMELY, VERTICAL AND HORIZONTAL LOUVERS; ROOM DIVIDERS AND SCREENS AND PARTS AND FITTINGS THEREFOR; HARDWARE FOR WINDOW BLINDS, NAMELY, CLIPS, BRACKETS, VALANCES, RAILS, LOCKS, END CAPS, TRACKS, PINS, HANDLES, CLAMPS, HOOKS, KNOBS, RINGS, AND SUP-

PORTS, IN CLASS 20 (U.S. CLS. 2, 13, 22, 25, 32 AND 50).

FIRST USE 5-1-2007; IN COMMERCE 5-1-2007.

THE MARK CONSISTS OF STANDARD CHARACTERS WITHOUT CLAIM TO ANY PARTICULAR FONT, STYLE, SIZE, OR COLOR.

SN 77-150,132, FILED 4-5-2007.

CHARLES L. JENKINS, EXAMINING ATTORNEY



**Int. Cl.: 28**

**Prior U.S. Cls.: 22, 23, 38, and 50**

**United States Patent and Trademark Office**

**Reg. No. 3,570,424**

**Registered Feb. 3, 2009**

**TRADEMARK  
PRINCIPAL REGISTER**

**TRIVIATHON**

HERBERT BROTHERS ENTERTAINMENT, CO.  
(INDIANA CORPORATION)  
4950 E. MORRIS CHURCH ROAD  
BATESVILLE, IN 47006

THE MARK CONSISTS OF STANDARD CHAR-  
ACTERS WITHOUT CLAIM TO ANY PARTICULAR  
FONT, STYLE, SIZE, OR COLOR.

FOR: BOARD GAMES, IN CLASS 28 (U.S. CLS. 22,  
23, 38 AND 50).

SN 77-152,443, FILED 4-10-2007.

FIRST USE 12-29-2004; IN COMMERCE 5-30-2008.

MARY MUNSON, EXAMINING ATTORNEY

**Int. Cl.: 36**

**Prior U.S. Cls.: 100, 101, and 102**

**United States Patent and Trademark Office**

**Reg. No. 3,570,425**

**Registered Feb. 3, 2009**

**SERVICE MARK  
PRINCIPAL REGISTER**

bringing clarity to your  
future

FINANCIAL MODELING SOLUTIONS, INC.  
(GEORGIA CORPORATION)  
805 THORNBERRY DRIVE  
ALPHARETTA, GA 30022

FOR: ACCEPTING AND ADMINISTERING MONETARY CHARITABLE CONTRIBUTIONS; ACCIDENT INSURANCE UNDERWRITING; ACCOUNTS PAYABLE DEBITING SERVICES; ACCOUNTS RECEIVABLES FINANCING; ACQUISITION AND TRANSFER OF MONETARY CLAIMS; ACTUARIAL SERVICES; ADMINISTRATION OF EMPLOYEE BENEFIT PLANS; ADMINISTRATION OF EMPLOYEE PENSION PLANS; ADMINISTRATION OF EMPLOYEE WELFARE BENEFIT PLANS; ADMINISTRATION OF PRE-PAID HEALTH CARE PLANS; ADMINISTRATION OF PREFERRED PROVIDER PLANS IN THE FIELD OF FINANCE; ADMINISTRATION OF SAVINGS ACCOUNTS; ADVICE RELATING TO INVESTMENTS; AGENCIES FOR BROKERAGE OF SECURITIES TRADING IN OVERSEAS SECURITIES MARKETS AND OF TRANSACTIONS ON COMMISSION OF OVERSEAS MARKET SECURITIES FUTURES; AGENCIES FOR COMMODITY FUTURES TRADING; AGENCIES IN THE FIELD OF BONDS AND OTHER SECURITIES; AGENCIES IN THE FIELD OF CREDIT FOR FARMING; AGENCIES OR BROKERAGE FOR LEASING OR RENTING OF LAND; AGENCIES OR BROKERAGE FOR RENTING LAND; AGENCIES OR BROKERAGE FOR RENTING OF BUILDINGS; AGENCIES OR BROKERAGE FOR TRADING OF SECURITIES, SECURITIES INDEX FUTURES, SECURITIES OPTIONS, AND OVERSEAS MARKET SECURITIES FUTURES; AIRCRAFT BROKERAGE; ANNUITY UNDERWRITING; ANTIQUE APPRAISAL; APARTMENT HOUSE MANAGEMENT; APARTMENT LOCATING SERVICES FOR OTHERS; APPRAISAL OF REAL ESTATE; APPRAISALS FOR INSURANCE CLAIMS OF PERSONAL PROPERTY; APPRAISALS FOR INSURANCE CLAIMS OF REAL ESTATE; ART BROKERAGE; ASSESSMENT

AND MANAGEMENT OF REAL ESTATE; ASSUMING FINANCIAL RISK OF OTHERS BY ENTERING INTO OPTIONS AND SWAPS; AUTOMATED COIN COUNTING, SORTING AND CONVERTING SERVICES; AUTOMATED SECURITIES BROKERAGE; AUTOMATED TELLER MACHINE SERVICES; AUTOMOBILE APPRAISAL; BAIL BONDING; BANKING; BANKING CONSULTATION; BILL CONSOLIDATION SERVICES; BILL PAYMENT SERVICES; BONDING SERVICES; BROKERAGE FOR HIRE-PURCHASE; BROKERAGE HOUSES IN THE FIELD OF STOCKS, COMMODITIES, AND FUTURES; BROKERAGE OF ENERGY, NAMELY, GAS AND ELECTRICITY; BROKERAGE OF SHARES AND OTHER SECURITIES; BROKERAGE OF SHARES OR STOCKS AND OTHER SECURITIES; BUILDING LEASING; BUILDING MANAGEMENT; BUSINESS BROKERAGE; BUSINESS FINANCE PROCUREMENT SERVICES; BUSINESS LIQUIDATION SERVICES; BUSINESS, STOCK OPTION AND PENSION VALUATION SERVICES; CAPITAL INVESTMENT CONSULTATION; CASH AND FOREIGN EXCHANGE TRANSACTIONS; CASH MANAGEMENT; CASH REPLACEMENT RENDERED BY CREDIT CARD; CHARITABLE FUND RAISING; CHARITABLE FUND RAISING IN VIEW OF DISASTER PRECAUTIONS AND PREVENTION; CHARITABLE FUND RAISING SERVICES BY MEANS OF COLLECTING AND REDEEMING RECYCLABLES FOR DONATION OF REDEMPTION PROCEEDS TO CHARITABLE ORGANIZATIONS; CHARITABLE FUND RAISING SERVICES BY MEANS OF COLLECTING AND RESELLING USED AUTOMOBILES; CHARITABLE FUND RAISING SERVICES BY MEANS OF MUSICAL CONCERTS; CHARITABLE FUND RAISING SERVICES, NAMELY, SHARING PROFITS FROM NEWSPAPER SUBSCRIPTION SALES WITH NOT-FOR-PROFIT ORGANIZATIONS; CHECK CASHING; CHECK PROCESSING; CHECK RECOVERY SERVICES; CHECK VERIFICATION; CHECKING ACCOUNT SERVICES; CLAIMS ADJUSTMENT IN THE FIELD

OF INSURANCE; CLAIMS ADMINISTRATION IN THE FIELD OF WORKERS' COMPENSATION; COIN APPRAISAL; COLLECTING LICENSE FEES ON BEHALF OF INDEPENDENT WRITERS AND PUBLISHERS AND MAKING PAYMENTS TO THE COPYRIGHT OWNERS OF THE MUSIC; COLLECTION AGENCIES; COLLECTION OF DEBTS; COMMERCIAL LENDING SERVICES; COMMODITIES EXCHANGE SERVICES; COMMODITY BROKERAGE; COMMODITY EXCHANGE; COMMODITY INVESTMENT ADVICE; COMMODITY QUOTATIONS; COMMODITY TRADING FOR OTHERS; CONSULTANCY CONCERNING FINANCING OF ENERGY PROJECTS; CONSULTATION IN ART AS AN INVESTMENT; CONSULTATION RELATING TO THE APPRAISAL OF GOODS; CONSUMER CREDIT CONSULTATION; CONSUMER LENDING SERVICES; COOPERATIVE CREDIT ORGANIZATIONS; CORPORATE SAVINGS ACCOUNT SERVICES; CREDIT AGENCIES; CREDIT AGENCIES IN THE FIELD OF FARMING; CREDIT AND CASH CARD SERVICES; CREDIT AND FINANCIAL CONSULTATION; CREDIT BUREAUS; CREDIT CARD SERVICES; CREDIT CARD TRANSACTION PROCESSING SERVICES; CREDIT CARD VERIFICATION; CREDIT CONSULTATION; CREDIT INQUIRY AND CONSULTATION; CREDIT RATING SERVICES; CREDIT RECOVERY AND COLLECTION; CREDIT REPORTING AGENCY; CREDIT REPORTING SERVICES; CREDIT RISK MANAGEMENT; CREDIT UNIONS; CRUISE SHIP PROPERTY SERVICES, NAMELY, LISTING, LEASING, BROKERAGE, AND MANAGEMENT OF RESIDENTIAL AND COMMERCIAL UNITS ABOARD CRUISE SHIPS AND FINANCING OF SAME; CURRENCY EXCHANGE AND ADVICE; CUSTOMS BROKERAGE; DEBIT CARD SERVICES; DEBT CANCELLATION SERVICES USING PROCEEDS OF LIFE, DISABILITY AND UNEMPLOYMENT INSURANCE; DEBT COUNSELING SERVICES; DEBT MANAGEMENT CONSULTATION; DEBT RECOVERY AND COLLECTION AGENCIES; DENTAL HEALTH INSURANCE ADMINISTRATION; DENTAL HEALTH INSURANCE UNDERWRITING AND ADMINISTRATION; DISCOUNT BROKERAGE SERVICES; DUTY DRAWBACK SERVICES; ELECTRONIC CASH TRANSACTIONS; ELECTRONIC COMMERCE PAYMENT SERVICES, NAMELY, ESTABLISHING FUNDED ACCOUNTS USED TO PURCHASE GOODS AND SERVICES ON THE INTERNET; ELECTRONIC CREDIT CARD TRANSACTIONS; ELECTRONIC DEBIT TRANSACTIONS; ELECTRONIC FINANCIAL SERVICE FOR THE PURCHASE OF SAVINGS BONDS; ELECTRONIC FUNDS TRANSFER; ELECTRONIC FUNDS TRANSFER BY TELECOMMUNICATIONS; ELECTRONIC PAYMENT, NAMELY, ELECTRONIC PROCESSING AND TRANSMISSION OF BILL PAYMENT DATA; ELECTRONIC PROCESSING OF INSURANCE CLAIMS AND PAYMENT DATA; ELECTRONIC TOLL COLLECTION SERVICES; ELECTRONIC TRANSFER OF MONEY; ELECTRONIC TRANSFERS OF MONEY; ELEMOSYNARY SERVICES IN THE FIELD OF MONETARY DONATIONS; ENERGY BROKERAGE SERVICES; EQUIPMENT FINANCING SERVICES; EQUIPMENT MAINTENANCE CLAIMS PAYMENT SERVICE

FOR BUSINESS; EQUITY CAPITAL INVESTMENT; ESTABLISHING MUTUAL FUNDS FOR OTHERS; ESTATE PLANNING; ESTATE TRUST MANAGEMENT; EVALUATION OF CREDIT BUREAU DATA; EVALUATION OF REAL PROPERTY; EVALUATION OF THE CREDIT WORTHINESS OF COMPANIES AND PRIVATE INDIVIDUALS; FACILITATING AND ARRANGING FOR THE FINANCING OF DEBT; FACTORING AGENCIES; FIDUCIARY REPRESENTATIVES; FIDUCIARY TAX PAYMENT PROCESSING SERVICES; FINANCIAL ADMINISTRATION OF RETIREMENT PLANS; FINANCIAL ANALYSIS AND CONSULTATION; FINANCIAL CLEARING HOUSES; FINANCIAL CONSULTATION; FINANCIAL CONSULTATION IN THE FIELD OF FINANCE; FINANCIAL DUE DILIGENCE; FINANCIAL EVALUATION FOR INSURANCE PURPOSES; FINANCIAL EXCHANGE; FINANCIAL FORECASTING; FINANCIAL GUARANTEE AND SURETY; FINANCIAL INFORMATION IN THE NATURE OF RATES OF EXCHANGE; FINANCIAL INFORMATION PROCESSING; FINANCIAL INFORMATION PROVIDED BY ELECTRONIC MEANS; FINANCIAL INVESTMENT IN THE FIELD OF FINANCE; FINANCIAL LOAN CONSULTATION; FINANCIAL MANAGEMENT; FINANCIAL PLANNING; FINANCIAL PLANNING CONSULTATION; FINANCIAL PLANNING FOR RETIREMENT; FINANCIAL PLANNING, NAMELY THE CREATION OF PERSONALIZED STRATEGIES TO ACHIEVE FINANCIAL INDEPENDENCE; FINANCIAL PORTFOLIO MANAGEMENT; FINANCIAL RESEARCH; FINANCIAL RISK MANAGEMENT; FINANCIAL SERVICES IN THE FIELD OF MONEY LENDING; FINANCIAL SERVICES IN THE NATURE OF AN INVESTMENT SECURITY; FINANCIAL SERVICES, NAMELY, ASSISTING OTHERS WITH THE COMPLETION OF FINANCIAL TRANSACTIONS FOR STOCKS, BONDS, SECURITIES AND EQUITIES; FINANCIAL SERVICES, NAMELY, ESTATE SETTLEMENT SERVICES; FINANCIAL SERVICES, NAMELY, MONEY LENDING; FINANCIAL SERVICES, NAMELY, PROVIDING INFORMATION IN THE FIELDS OF FOREIGN CURRENCY, COMMODITIES, FINANCIAL DERIVATIVES, INTEREST RATE PRODUCTS, AND EQUITIES VIA THE INTERNET AND INTRANET SYSTEMS; FINANCIAL SERVICES, NAMELY, PROVIDING ON-LINE STORED VALUE ACCOUNTS IN AN ELECTRONIC ENVIRONMENT; FINANCIAL SERVICES, NAMELY, A TOTAL PORTFOLIO OFFERING FOR HIGH NET WORTH CLIENTS CONSISTING OF BOTH SEPARATE ACCOUNTS AND MUTUAL FUNDS FOR EQUITY AND FIXED INCOME INVESTMENTS; FINANCIAL SERVICES, NAMELY, INVESTMENT FUND TRANSFER AND TRANSACTION SERVICES; FINANCIAL SERVICES, NAMELY, ISSUANCE AND MANAGEMENT OF CERTIFICATES BACKED BY LOAN PORTFOLIOS WHICH ARE SUBSEQUENTLY MANAGED TO INSURE THE INTEGRITY OF THE CERTIFICATES; FINANCIAL SERVICES, NAMELY, MORTGAGE PLANNING; FINANCIAL SERVICES, NAMELY, PROVIDING A VIRTUAL CURRENCY FOR USE BY MEMBERS OF AN ONLINE COMMUNITY VIA A GLOBAL COMPUTER NETWORK; FINANCIAL

SERVICES, NAMELY, PROVIDING FOR THE EXCHANGE OF FOREIGN CURRENCY, COMMODITIES, FINANCIAL DERIVATIVES, INTEREST RATE PRODUCTS, AND EQUITIES VIA THE INTERNET AND INTRANET SYSTEMS; FINANCIAL SERVICES, NAMELY, SAVINGS PROGRAMS FOR YOUTHS; FINANCIAL SERVICES, NAMELY, THE PURCHASE OF RESIDENTIAL MORTGAGES ON BEHALF OF OTHERS AND THE ISSUANCE OF MORTGAGE-BACKED SECURITIES; FINANCIAL TRANSACTION SERVICES, NAMELY, PROVIDING SECURE COMMERCIAL TRANSACTIONS AND PAYMENT OPTIONS USING A MOBILE DEVICE AT A POINT OF SALE; FINANCIAL TRUST OPERATIONS; FINANCIAL VALUATION OF PERSONAL PROPERTY AND REAL ESTATE; FINANCIALLY-GUARANTEED FINANCING; FINANCING OF DEVELOPMENT AND OPERATION OF MEDICAL IMAGING CENTERS; FINANCING OF INDUSTRIAL ACTIVITIES; FINANCING OF PURCHASES; FINANCING RELATING TO AUTOMOBILES; FINANCING SERVICES; FIRE INSURANCE UNDERWRITING; FISCAL ASSESSMENT AND EVALUATION; FISCAL VALUATIONS AND ASSESSMENTS; FOREIGN EXCHANGE INFORMATION SERVICES; FORMATION, BROKERAGE AND MANAGEMENT OF TIME SHARE INTERESTS IN AIRCRAFT; FORMATION, OFFERING AND MANAGEMENT OF LIMITED PARTNERSHIPS; FUND INVESTMENT CONSULTATION; FUNDS INVESTMENT; FUTURES EXCHANGE SERVICES; GUARANTEE ASSURANCE UNDERWRITING; HEDGE FUND INVESTMENT SERVICES; HIGHWAY TOLL COLLECTION SERVICES; HOME APPRAISAL SERVICES; HOME EQUITY LOANS; HOUSING AGENCIES; HOUSING SERVICES, NAMELY, REAL PROPERTY ACQUISITION AND CONSUMER FINANCING TO FACILITATE HOME OWNERSHIP; INSTALLMENT LOANS; INSURANCE ACTUARIAL SERVICES; INSURANCE ADMINISTRATION; INSURANCE AGENCIES; INSURANCE AGENCY AND BROKERAGE; INSURANCE BROKERAGE; INSURANCE CARRIER SERVICES; INSURANCE CLAIMS ADMINISTRATION; INSURANCE CLAIMS PROCESSING; INSURANCE CONSULTATION; INSURANCE PREMIUM RATE COMPUTING; INSURANCE SERVICES, NAMELY, UNDERWRITING, ISSUING AND ADMINISTRATION OF LIFE INSURANCE; INSURANCE SERVICES, NAMELY, WRITING PROPERTY AND CASUALTY INSURANCE; INSURANCE SUBROGATION; INSURANCE SUBROGATION AND SALVAGE; INSURANCE UNDERWRITING CONSULTATION; INSURANCE UNDERWRITING SERVICES FOR ALL TYPES OF INSURANCE; INVESTMENT ADVICE; INVESTMENT ADVISORY SERVICES; INVESTMENT BANKING SERVICES; INVESTMENT BROKERAGE; INVESTMENT BY ELECTRONIC MEANS; INVESTMENT CLUBS; INVESTMENT CONSULTATION; INVESTMENT MANAGEMENT; INVESTMENT MANAGEMENT OF AND DISTRIBUTION OF VARIABLE ANNUITIES; INVESTMENT OF FUNDS FOR OTHERS; INVESTMENT SERVICES, NAMELY, ASSET ACQUISITION, CONSULTATION, DEVELOPMENT AND MANAGEMENT SERVICES; ISSUANCE AND ADMINISTRATION OF ANNU-

ITIES; ISSUANCE OF BANK CHECKS; ISSUE OF TRAVELLER'S CHEQUES; ISSUING CREDIT CARDS; ISSUING OF BANK CHEQUES; ISSUING OF CHECKS AND LETTERS OF CREDIT; ISSUING OF CHECKS; ISSUING STORED VALUE CARDS; JEWELRY APPRAISAL; LAND ACQUISITION, NAMELY, REAL ESTATE BROKERAGE; LAND LEASING; LAND VALUATION; LEASE SECURITIZATION; LEASE-PURCHASE FINANCING; LEASE-PURCHASE LOANS; LEASING OF APARTMENTS; LEASING OF FARMS; LEASING OF LAND; LEASING OF OFFICE SPACE; LEASING OF REAL ESTATE; LEASING OF REAL PROPERTY; LEASING OF SHOPPING MALL SPACE; LEASING OR RENTING OF BUILDINGS; LEVERAGED BUY OUTS AND INVESTMENTS IN FINANCIALLY DISTRESSED OR UNDERPERFORMING COMPANIES; LIFE INSURANCE BROKERAGE; LIFE INSURANCE UNDERWRITING; LOAN FINANCING; LOANS AND DISCOUNT OF BILLS; MAINTAINING ESCROW ACCOUNTS FOR INVESTMENTS; MAINTAINING MORTGAGE ESCROW ACCOUNTS; MAKING PAYMENTS ON PRE-PAID LONG DISTANCE CALLING CARDS FOR RECHARGING MINUTES; MANAGEMENT OF A CAPITAL INVESTMENT FUND; MANAGEMENT OF PORTFOLIOS COMPRISING SECURITIES; MANAGEMENT OF PORTFOLIOS OF TRANSFERABLE SECURITIES; MANAGEMENT OF PRIVATE EQUITY FUNDS; MARINE INSURANCE UNDERWRITING; MEDICAL INSURANCE UNDERWRITING; MEMORIAL FUND RAISING; MONETARY EXCHANGE; MONEY ORDER PAYMENT GUARANTEE SERVICES; MONEY ORDER SERVICES; MONEY TRANSFER; MORTGAGE BANKING; MORTGAGE BANKING SERVICES, NAMELY, ORIGINATION, ACQUISITION, SERVICING, SECURITIZATION AND BROKERAGE OF MORTGAGE LOANS; MORTGAGE BROKERAGE; MORTGAGE LENDING; MORTGAGE PROCUREMENT FOR OTHERS; MORTGAGE SERVICES, NAMELY, BUYER PRE-QUALIFICATION OF MORTGAGES FOR MORTGAGE BROKERS AND BANKS; MORTGAGING OF SECURITIES FOR OTHERS; MUTUAL FUND BROKERAGE; MUTUAL FUND DISTRIBUTION; MUTUAL FUND INVESTMENT; NUMISMATIC APPRAISAL; OFFERING AIRCRAFT FRACTIONAL OWNERSHIP PROGRAMS TO OTHERS; ON-LINE BANKING SERVICES; OPERATING MARKETPLACES FOR SELLERS OF GOODS AND/OR SERVICES; ORGANIZATION OF STOCK EXCHANGES FOR THE BENEFIT OF THE TRADE OF STOCKS AND OTHER FINANCIAL VALUES; ORGANIZING PRE-PAID HEALTH CARE PLANS; ORGANIZING PREFERRED PROVIDER PROGRAMS IN THE FIELD OF FINANCE; PAWN BROKERAGE; PAWN SHOPS; PAYROLL TAX DEBITING SERVICES; PHARMACEUTICAL BENEFIT MANAGEMENT SERVICES; PHARMACY BENEFIT MANAGEMENT SERVICES; PHILANTHROPIC SERVICES CONCERNING MONETARY DONATIONS; POLITICAL FUND RAISING SERVICES; PRE-PAID FUNERAL EXPENSE SERVICES; PRE-PAID PURCHASE CARD SERVICES NAMELY, PROCESSING ELECTRONIC PAYMENTS MADE THROUGH PREPAID CARDS; PRE-PAID PURCHASE CARD SERVICES, NAMELY, PROCESSING ELECTRONIC PAYMENTS

THROUGH PRE-PAID CARDS; PRECIOUS STONE APPRAISAL; PREPAID CARD SERVICES IN THE NATURE OF MAKING PAYMENT FOR ADDING AIRTIME TO PREPAID OR PAY-AS-YOU-GO WIRELESS SERVICES; PREPAID PREVENTIVE MAINTENANCE SERVICE PLANS FOR HEATING, VENTILATING AND AIR CONDITIONING SYSTEMS.; PREPAID TELECOMMUNICATIONS CALLING CARD SERVICES; PRIVATE EQUITY FUND INVESTMENT SERVICES; PROJECT FINANCING; PROVIDING A WEB SITE WHERE USERS CAN POST RATINGS, REVIEWS AND RECOMMENDATIONS ON STOCKS, BONDS, MUTUAL FUNDS AND OTHER FINANCIAL INSTRUMENTS; PROVIDING A WEBSITE THAT FEATURES INFORMATION ON THE OPTIONS MARKETS; PROVIDING AN ONLINE SEARCHABLE DATABASE FEATURING EDUCATION GRANTS; PROVIDING BANK ACCOUNT INFORMATION BY TELEPHONE; PROVIDING COLLEGE SCHOLARSHIPS; PROVIDING EDUCATIONAL SCHOLARSHIPS; PROVIDING ELECTRONIC PROCESSING OF CREDIT CARD TRANSACTIONS AND ELECTRONIC PAYMENTS VIA A GLOBAL COMPUTER NETWORK; PROVIDING FUND RAISING SERVICES FOR OTHERS VIA A GLOBAL COMPUTER NETWORK; PROVIDING INFORMATION IN INSURANCE MATTERS; PROVIDING INFORMATION IN THE FIELD OF REAL ESTATE BY MEANS OF LINKING THE WEB SITE TO OTHER WEB SITES FEATURING REAL ESTATE INFORMATION; PROVIDING INFORMATION IN THE FIELD OF REAL ESTATE VIA THE INTERNET; PROVIDING INFORMATION VIA A GLOBAL COMPUTER NETWORK ON THE SUBJECT OF NON-RESIDENTIAL BUILDING AND FACILITIES MANAGEMENT; PROVIDING LOANS SECURED BY COMMERCIAL PAPER; PROVIDING MULTIPLE PAYMENT OPTIONS BY MEANS OF CUSTOMER-OPERATED ELECTRONIC TERMINALS AVAILABLE ON-SITE IN RETAIL STORES; PROVIDING ON-LINE FINANCIAL CALCULATORS; PROVIDING ON-LINE NEWS IN THE FIELD OF FINANCE; PROVIDING ONLINE INFORMATION IN THE FIELD CHARITABLE MONETARY GIVING THROUGH FINANCIAL AND ESTATE PLANNING; PROVIDING REAL ESTATE LISTINGS AND REAL ESTATE INFORMATION VIA THE INTERNET; PROVIDING REBATES AT PARTICIPATING ESTABLISHMENTS OF OTHERS THROUGH USE OF A MEMBERSHIP CARD; PROVIDING STOCK MARKET INFORMATION; PROVIDING STOCK/SECURITIES MARKET INFORMATION; PROVIDING STUDENT LOAN INFORMATION; PROVIDING TEMPORARY LOANS; PROVIDING WORKING CAPITAL; PUBLIC EQUITY INVESTMENT MANAGEMENT; REAL ESTATE ACQUISITION SERVICES; REAL ESTATE AGENCIES; REAL ESTATE APPRAISAL; REAL ESTATE BROKERAGE; REAL ESTATE CONSULTANCY; REAL ESTATE CONSULTATION; REAL ESTATE EQUITY SHARING, NAMELY, MANAGING AND ARRANGING FOR CO-OWNERSHIP OF REAL ESTATE; REAL ESTATE ESCROW SERVICES; REAL ESTATE INVESTMENT; REAL ESTATE LENDING SERVICES; REAL ESTATE LISTING; REAL ESTATE MANAGEMENT; REAL ESTATE MANAGEMENT CONSULTATION; REAL ESTATE MULTIPLE LISTING SERVICES; REAL

ESTATE PROCUREMENT FOR OTHERS; REAL ESTATE SERVICES, NAMELY, RENTAL OF VACATION HOMES, CONDOMINIUMS, CABINS, AND VILLAS USING PAY PER CLICK ADVERTISING ON A GLOBAL COMPUTER NETWORK; REAL ESTATE SYNDICATION; REAL ESTATE TIME-SHARING; REAL ESTATE TRUSTEE SERVICES; REAL ESTATE VALUATION SERVICES; REAL ESTATE VALUATIONS; RECLAMATION OF IMPORT DUTIES FOR OTHERS; REINSURANCE UNDERWRITING; RENT COLLECTION AGENCIES; RENTAL OF APARTMENTS; RENTAL OF CABINS; RENTAL OF CASH DISPENSERS OR AUTOMATED-TELLER MACHINES; RENTAL OF OFFICE SPACE; REPAIR COST EVALUATION; REVOLVING LOANS; RISK MANAGEMENT; RISK MANAGEMENT CONSULTATION; SAFE DEPOSIT BOX SERVICES; SAFETY DEPOSIT BOX SERVICES; SAVINGS ACCOUNT SERVICES; SAVINGS AND LOAN ASSOCIATIONS; SAVINGS AND LOAN SERVICES; SAVINGS BANK SERVICES; SECURITIES ARBITRAGE SERVICES; SECURITIES TRADING AND INVESTING SERVICES FOR OTHERS VIA THE INTERNET; SECURITY BROKERAGE; SECURITY SERVICES, NAMELY, GUARANTEEING LOANS; SHOPPING CENTER SERVICES, NAMELY, RENTAL OF SHOPPING CENTER SPACE; STAMP APPRAISAL; STOCK BROKERAGE; STOCK EXCHANGE PRICE QUOTATIONS; STUDENT LOAN SERVICES; SURETY SERVICES; TAX PAYMENT PROCESSING SERVICES; TELECOMMUNICATIONS AIR TIME BROKERAGE SERVICES; TELECOMMUNICATIONS RESELLER SERVICES, NAMELY, TELECOMMUNICATIONS AIR TIME BROKERAGE SERVICES; TELEPHONE CALLING CARD SERVICES; TEMPORARY LOANS; TRANSFER AGENCY SERVICES RENDERED TO ISSUERS OF INVESTMENT SECURITIES; TRAVEL AGENCY SERVICES, NAMELY, ISSUING TRAVELER'S CHECKS; TRAVELERS' CHECK ISSUANCE; TRUST MANAGEMENT ACCOUNTS; TRUST SERVICES, NAMELY, INVESTMENT AND TRUST COMPANY SERVICES; TRUSTEESHIP REPRESENTATIVES; UNDERWRITING INSURANCE FOR PRE-PAID HEALTH CARE; UNDERWRITING INSURANCE FOR PRE-PAID LEGAL SERVICES; VACATION REAL ESTATE TIME SHARE EXCHANGE SERVICES; VACATION REAL ESTATE TIME-SHARING; VACATION REAL ESTATE TIMESHARE SERVICES; VENTURE CAPITAL FUNDING SERVICES TO EMERGING AND START-UP COMPANIES; VENTURE CAPITAL SERVICES, NAMELY, PROVIDING FINANCING TO EMERGING AND START-UP COMPANIES; VIATICAL SETTLEMENT SERVICES; WIRELESS TELEPHONE PAYMENT SERVICES, NAMELY, WIRELESS MOBILE TELEPHONE RATE PLANS; YACHT BROKERAGE, IN CLASS 36 (U.S. CLS. 100, 101 AND 102).

FIRST USE 4-1-2007; IN COMMERCE 4-1-2007.

THE MARK CONSISTS OF STANDARD CHARACTERS WITHOUT CLAIM TO ANY PARTICULAR FONT, STYLE, SIZE, OR COLOR.

SN 77-154,140, FILED 4-11-2007.

ANNE E. GUSTASON, EXAMINING ATTORNEY

Int. Cl.: 36

Prior U.S. Cls.: 100, 101, and 102

United States Patent and Trademark Office

Reg. No. 3,570,426

Registered Feb. 3, 2009

**SERVICE MARK  
PRINCIPAL REGISTER**



FINANCIAL MODELING SOLUTIONS, INC.  
(GEORGIA CORPORATION)

805 THORNBERRY DRIVE  
ALPHARETTA, GA 30022

FOR: ACCEPTING AND ADMINISTERING MONETARY CHARITABLE CONTRIBUTIONS; ACCIDENT INSURANCE UNDERWRITING; ACCOUNTS PAYABLE DEBITING SERVICES; ACCOUNTS RECEIVABLES FINANCING; ACQUISITION AND TRANSFER OF MONETARY CLAIMS; ACTUARIAL SERVICES; ADMINISTRATION OF EMPLOYEE BENEFIT PLANS; ADMINISTRATION OF EMPLOYEE PENSION PLANS; ADMINISTRATION OF EMPLOYEE WELFARE BENEFIT PLANS; ADMINISTRATION OF PRE-PAID HEALTH CARE PLANS; ADMINISTRATION OF PREFERRED PROVIDER PLANS IN THE FIELD OF FINANCE; ADMINISTRATION OF SAVINGS ACCOUNTS; ADVICE RELATING TO INVESTMENTS; AGENCIES FOR BROKERAGE OF SECURITIES TRADING IN OVERSEAS SECURITIES MARKETS AND OF TRANSACTIONS ON COMMISSION OF OVERSEAS MARKET SECURITIES FUTURES; AGENCIES FOR COMMODITY FUTURES TRADING; AGENCIES IN THE FIELD OF BONDS AND OTHER SECURITIES; AGENCIES IN THE FIELD OF CREDIT FOR FARMING; AGENCIES OR BROKERAGE FOR LEASING OR RENTING OF LAND; AGENCIES OR BROKERAGE FOR RENTING LAND; AGENCIES OR BROKERAGE FOR RENTING OF BUILDINGS; AGENCIES OR BROKERAGE FOR TRADING OF SECURITIES, SECURITIES INDEX FUTURES, SECURITIES OPTIONS, AND OVERSEAS MARKET SECURITIES FUTURES; AIRCRAFT BROKERAGE; ANNUITY UNDERWRITING; ANTIQUE APPRAI-

SAL; APARTMENT HOUSE MANAGEMENT; APARTMENT LOCATING SERVICES FOR OTHERS; APPRAISAL OF REAL ESTATE; APPRAISALS FOR INSURANCE CLAIMS OF PERSONAL PROPERTY; APPRAISALS FOR INSURANCE CLAIMS OF REAL ESTATE; ART BROKERAGE; ASSESSMENT AND MANAGEMENT OF REAL ESTATE; ASSUMING FINANCIAL RISK OF OTHERS BY ENTERING INTO OPTIONS AND SWAPS; AUTOMATED COIN COUNTING, SORTING AND CONVERTING SERVICES; AUTOMATED SECURITIES BROKERAGE; AUTOMATED TELLER MACHINE SERVICES; AUTOMOBILE APPRAISAL; BAIL BONDING; BANKING; BANKING CONSULTATION; BILL CONSOLIDATION SERVICES; BILL PAYMENT SERVICES; BONDING SERVICES; BROKERAGE FOR HIRE-PURCHASE; BROKERAGE HOUSES IN THE FIELD OF STOCKS, COMMODITIES, AND FUTURES; BROKERAGE OF ENERGY, NAMELY, GAS AND ELECTRICITY; BROKERAGE OF SHARES AND OTHER SECURITIES; BROKERAGE OF SHARES OR STOCKS AND OTHER SECURITIES; BUILDING LEASING; BUILDING MANAGEMENT; BUSINESS BROKERAGE; BUSINESS FINANCE PROCUREMENT SERVICES; BUSINESS LIQUIDATION SERVICES; BUSINESS, STOCK OPTION AND PENSION VALUATION SERVICES; CAPITAL INVESTMENT CONSULTATION; CASH AND FOREIGN EXCHANGE TRANSACTIONS; CASH MANAGEMENT; CASH REPLACEMENT RENDERED BY CREDIT CARD; CHARITABLE FUND RAISING; CHARITABLE FUND RAISING IN VIEW OF DISASTER PRECAUTIONS AND PREVENTION; CHARITABLE FUND RAISING SERVICES BY MEANS OF COLLECTING AND REDEEMING RECYCLABLES FOR DONATION OF REDEMPTION

PROCEEDS TO CHARITABLE ORGANIZATIONS; CHARITABLE FUND RAISING SERVICES BY MEANS OF COLLECTING AND RESELLING USED AUTOMOBILES; CHARITABLE FUND RAISING SERVICES BY MEANS OF MUSICAL CONCERTS; CHARITABLE FUND RAISING SERVICES, NAMELY, SHARING PROFITS FROM NEWSPAPER SUBSCRIPTION SALES WITH NOT-FOR-PROFIT ORGANIZATIONS; CHECK CASHING; CHECK PROCESSING; CHECK RECOVERY SERVICES; CHECK VERIFICATION; CHECKING ACCOUNT SERVICES; CLAIMS ADJUSTMENT IN THE FIELD OF INSURANCE; CLAIMS ADMINISTRATION IN THE FIELD OF WORKERS' COMPENSATION; COIN APPRAISAL; COLLECTING LICENSE FEES ON BEHALF OF INDEPENDENT WRITERS AND PUBLISHERS AND MAKING PAYMENTS TO THE COPYRIGHT OWNERS OF THE MUSIC; COLLECTION AGENCIES; COLLECTION OF DEBTS; COMMERCIAL LENDING SERVICES; COMMODITIES EXCHANGE SERVICES; COMMODITY BROKERAGE; COMMODITY EXCHANGE; COMMODITY INVESTMENT ADVICE; COMMODITY QUOTATIONS; COMMODITY TRADING FOR OTHERS; CONSULTANCY CONCERNING FINANCING OF ENERGY PROJECTS; CONSULTATION IN ART AS AN INVESTMENT; CONSULTATION RELATING TO THE APPRAISAL OF GOODS; CONSUMER CREDIT CONSULTATION; CONSUMER LENDING SERVICES; COOPERATIVE CREDIT ORGANIZATIONS; CORPORATE SAVINGS ACCOUNT SERVICES; CREDIT AGENCIES; CREDIT AGENCIES IN THE FIELD OF FARMING; CREDIT AND CASH CARD SERVICES; CREDIT AND FINANCIAL CONSULTATION; CREDIT BUREAUS; CREDIT CARD SERVICES; CREDIT CARD TRANSACTION PROCESSING SERVICES; CREDIT CARD VERIFICATION; CREDIT CONSULTATION; CREDIT INQUIRY AND CONSULTATION; CREDIT RATING SERVICES; CREDIT RECOVERY AND COLLECTION; CREDIT REPORTING AGENCY; CREDIT REPORTING SERVICES; CREDIT RISK MANAGEMENT; CREDIT UNIONS; CRUISE SHIP PROPERTY SERVICES, NAMELY, LISTING, LEASING, BROKERAGE, AND MANAGEMENT OF RESIDENTIAL AND COMMERCIAL UNITS ABOARD CRUISE SHIPS AND FINANCING OF SAME; CURRENCY EXCHANGE AND ADVICE; CUSTOMS BROKERAGE; DEBIT CARD SERVICES; DEBT CANCELLATION SERVICES USING PROCEEDS OF LIFE, DISABILITY AND UNEMPLOYMENT INSURANCE; DEBT COUNSELING SERVICES; DEBT MANAGEMENT CONSULTATION; DEBT RECOVERY AND COLLECTION AGENCIES; DENTAL HEALTH INSURANCE ADMINISTRATION; DENTAL HEALTH INSURANCE UNDERWRITING AND ADMINISTRATION; DISCOUNT BROKERAGE SERVICES; DUTY DRAWBACK SERVICES; ELECTRONIC CASH TRANSACTIONS; ELECTRONIC COMMERCE PAYMENT SERVICES, NAMELY, ESTABLISHING FUNDED ACCOUNTS USED TO PURCHASE GOODS AND SERVICES ON THE INTERNET; ELECTRONIC CREDIT CARD TRANSACTIONS; ELECTRONIC DEBIT TRANSACTIONS; ELECTRONIC FINANCIAL SERVICE FOR THE PURCHASE OF SAVINGS BONDS; ELECTRONIC FUNDS TRANSFER; ELECTRONIC FUNDS

TRANSFER BY TELECOMMUNICATIONS; ELECTRONIC PAYMENT, NAMELY, ELECTRONIC PROCESSING AND TRANSMISSION OF BILL PAYMENT DATA; ELECTRONIC PROCESSING OF INSURANCE CLAIMS AND PAYMENT DATA; ELECTRONIC TOLL COLLECTION SERVICES; ELECTRONIC TRANSFER OF MONEY; ELECTRONIC TRANSFERS OF MONEY; ELEEMOSYNARY SERVICES IN THE FIELD OF MONETARY DONATIONS; ENERGY BROKERAGE SERVICES; EQUIPMENT FINANCING SERVICES; EQUIPMENT MAINTENANCE CLAIMS PAYMENT SERVICE FOR BUSINESS; EQUITY CAPITAL INVESTMENT; ESTABLISHING MUTUAL FUNDS FOR OTHERS; ESTATE PLANNING; ESTATE TRUST MANAGEMENT; EVALUATION OF CREDIT BUREAU DATA; EVALUATION OF REAL PROPERTY; EVALUATION OF THE CREDIT WORTHINESS OF COMPANIES AND PRIVATE INDIVIDUALS; FACILITATING AND ARRANGING FOR THE FINANCING OF DEBT; FACTORING AGENCIES; FIDUCIARY REPRESENTATIVES; FIDUCIARY TAX PAYMENT PROCESSING SERVICES; FINANCIAL ADMINISTRATION OF RETIREMENT PLANS; FINANCIAL ANALYSIS AND CONSULTATION; FINANCIAL CLEARING HOUSES; FINANCIAL CONSULTATION; FINANCIAL CONSULTATION IN THE FIELD OF FINANCE; FINANCIAL DUE DILIGENCE; FINANCIAL EVALUATION FOR INSURANCE PURPOSES; FINANCIAL EXCHANGE; FINANCIAL FORECASTING; FINANCIAL GUARANTEE AND SURETY; FINANCIAL INFORMATION IN THE NATURE OF RATES OF EXCHANGE; FINANCIAL INFORMATION PROCESSING; FINANCIAL INFORMATION PROVIDED BY ELECTRONIC MEANS; FINANCIAL INVESTMENT IN THE FIELD OF FINANCE; FINANCIAL LOAN CONSULTATION; FINANCIAL MANAGEMENT; FINANCIAL PLANNING; FINANCIAL PLANNING CONSULTATION; FINANCIAL PLANNING FOR RETIREMENT; FINANCIAL PLANNING, NAMELY, THE CREATION OF PERSONALIZED STRATEGIES TO ACHIEVE FINANCIAL INDEPENDENCE; FINANCIAL PORTFOLIO MANAGEMENT; FINANCIAL RESEARCH; FINANCIAL RISK MANAGEMENT; FINANCIAL SERVICES IN THE FIELD OF MONEY LENDING; FINANCIAL SERVICES IN THE NATURE OF AN INVESTMENT SECURITY; FINANCIAL SERVICES, NAMELY, ASSISTING OTHERS WITH THE COMPLETION OF FINANCIAL TRANSACTIONS FOR STOCKS, BONDS, SECURITIES AND EQUITIES; FINANCIAL SERVICES, NAMELY, ESTATE SETTLEMENT SERVICES; FINANCIAL SERVICES, NAMELY, MONEY LENDING; FINANCIAL SERVICES, NAMELY, PROVIDING INFORMATION IN THE FIELDS OF FOREIGN CURRENCY, COMMODITIES, FINANCIAL DERIVATIVES, INTEREST RATE PRODUCTS, AND EQUITIES VIA THE INTERNET AND INTRANET SYSTEMS; FINANCIAL SERVICES, NAMELY, PROVIDING ON-LINE STORED VALUE ACCOUNTS IN AN ELECTRONIC ENVIRONMENT; FINANCIAL SERVICES, NAMELY, A TOTAL PORTFOLIO OFFERING FOR HIGH NET WORTH CLIENTS CONSISTING OF BOTH SEPARATE ACCOUNTS AND MUTUAL FUNDS FOR EQUITY AND FIXED INCOME INVEST-

MENTS; FINANCIAL SERVICES, NAMELY, INVESTMENT FUND TRANSFER AND TRANSACTION SERVICES; FINANCIAL SERVICES, NAMELY, ISSUANCE AND MANAGEMENT OF CERTIFICATES BACKED BY LOAN PORTFOLIOS WHICH ARE SUBSEQUENTLY MANAGED TO INSURE THE INTEGRITY OF THE CERTIFICATES; FINANCIAL SERVICES, NAMELY, MORTGAGE PLANNING; FINANCIAL SERVICES, NAMELY, PROVIDING A VIRTUAL CURRENCY FOR USE BY MEMBERS OF AN ONLINE COMMUNITY VIA A GLOBAL COMPUTER NETWORK; FINANCIAL SERVICES, NAMELY, PROVIDING FOR THE EXCHANGE OF FOREIGN CURRENCY, COMMODITIES, FINANCIAL DERIVATIVES, INTEREST RATE PRODUCTS, AND EQUITIES VIA THE INTERNET AND INTRANET SYSTEMS; FINANCIAL SERVICES, NAMELY, SAVINGS PROGRAMS FOR YOUTHS; FINANCIAL SERVICES, NAMELY, THE PURCHASE OF RESIDENTIAL MORTGAGES ON BEHALF OF OTHERS AND THE ISSUANCE OF MORTGAGE-BACKED SECURITIES; FINANCIAL TRANSACTION SERVICES, NAMELY, PROVIDING SECURE COMMERCIAL TRANSACTIONS AND PAYMENT OPTIONS USING A MOBILE DEVICE AT A POINT OF SALE; FINANCIAL TRUST OPERATIONS; FINANCIAL VALUATION OF PERSONAL PROPERTY AND REAL ESTATE; FINANCIALLY-GUARANTEED FINANCING; FINANCING OF DEVELOPMENT AND OPERATION OF MEDICAL IMAGING CENTERS; FINANCING OF INDUSTRIAL ACTIVITIES; FINANCING OF PURCHASES; FINANCING RELATING TO AUTOMOBILES; FINANCING SERVICES; FIRE INSURANCE UNDERWRITING; FISCAL ASSESSMENT AND EVALUATION; FISCAL VALUATIONS AND ASSESSMENTS; FOREIGN EXCHANGE INFORMATION SERVICES; FORMATION, BROKERAGE AND MANAGEMENT OF TIME SHARE INTERESTS IN AIRCRAFT; FORMATION, OFFERING AND MANAGEMENT OF LIMITED PARTNERSHIPS; FUND INVESTMENT CONSULTATION; FUNDS INVESTMENT; FUTURES EXCHANGE SERVICES; GUARANTEE ASSURANCE UNDERWRITING; HEDGE FUND INVESTMENT SERVICES; HIGHWAY TOLL COLLECTION SERVICES; HOME APPRAISAL SERVICES; HOME EQUITY LOANS; HOUSING AGENCIES; HOUSING SERVICES, NAMELY, REAL PROPERTY ACQUISITION AND CONSUMER FINANCING TO FACILITATE HOME OWNERSHIP; INSTALLMENT LOANS; INSURANCE ACTUARIAL SERVICES; INSURANCE ADMINISTRATION; INSURANCE AGENCIES; INSURANCE AGENCY AND BROKERAGE; INSURANCE BROKERAGE; INSURANCE CARRIER SERVICES; INSURANCE CLAIMS ADMINISTRATION; INSURANCE CLAIMS PROCESSING; INSURANCE CONSULTATION; INSURANCE PREMIUM RATE COMPUTING; INSURANCE SERVICES, NAMELY, UNDERWRITING, ISSUING AND ADMINISTRATION OF LIFE INSURANCE; INSURANCE SERVICES, NAMELY, WRITING PROPERTY AND CASUALTY INSURANCE; INSURANCE SUBROGATION; INSURANCE SUBROGATION AND SALVAGE; INSURANCE UNDERWRITING CONSULTATION; INSURANCE UNDERWRITING SERVICES FOR ALL TYPES OF

INSURANCE; INVESTMENT ADVICE; INVESTMENT ADVISORY SERVICES; INVESTMENT BANKING SERVICES; INVESTMENT BROKERAGE; INVESTMENT BY ELECTRONIC MEANS; INVESTMENT CLUBS; INVESTMENT CONSULTATION; INVESTMENT MANAGEMENT; INVESTMENT MANAGEMENT OF AND DISTRIBUTION OF VARIABLE ANNUITIES; INVESTMENT OF FUNDS FOR OTHERS; INVESTMENT SERVICES, NAMELY, ASSET ACQUISITION, CONSULTATION, DEVELOPMENT AND MANAGEMENT SERVICES; ISSUANCE AND ADMINISTRATION OF ANNUITIES; ISSUANCE OF BANK CHECKS; ISSUE OF TRAVELLER'S CHEQUES; ISSUING CREDIT CARDS; ISSUING OF BANK CHEQUES; ISSUING OF CHECKS AND LETTERS OF CREDIT; ISSUING OF CHEQUES; ISSUING STORED VALUE CARDS; JEWELRY APPRAISAL; LAND ACQUISITION, NAMELY, REAL ESTATE BROKERAGE; LAND LEASING; LAND VALUATION; LEASE SECURITIZATION; LEASE-PURCHASE FINANCING; LEASE-PURCHASE LOANS; LEASING OF APARTMENTS; LEASING OF FARMS; LEASING OF LAND; LEASING OF OFFICE SPACE; LEASING OF REAL ESTATE; LEASING OF REAL PROPERTY; LEASING OF SHOPPING MALL SPACE; LEASING OR RENTING OF BUILDINGS; LEVERAGED BUY OUTS AND INVESTMENTS IN FINANCIALLY DISTRESSED OR UNDERPERFORMING COMPANIES; LIFE INSURANCE BROKERAGE; LIFE INSURANCE UNDERWRITING; LOAN FINANCING; LOANS AND DISCOUNT OF BILLS; MAINTAINING ESCROW ACCOUNTS FOR INVESTMENTS; MAINTAINING MORTGAGE ESCROW ACCOUNTS; MAKING PAYMENTS ON PRE-PAID LONG DISTANCE CALLING CARDS FOR RECHARGING MINUTES; MANAGEMENT OF A CAPITAL INVESTMENT FUND; MANAGEMENT OF PORTFOLIOS COMPRISING SECURITIES; MANAGEMENT OF PORTFOLIOS OF TRANSFERABLE SECURITIES; MANAGEMENT OF PRIVATE EQUITY FUNDS; MARINE INSURANCE UNDERWRITING; MEDICAL INSURANCE UNDERWRITING; MEMORIAL FUND RAISING; MONETARY EXCHANGE; MONEY ORDER PAYMENT GUARANTEE SERVICES; MONEY ORDER SERVICES; MONEY TRANSFER; MORTGAGE BANKING; MORTGAGE BANKING SERVICES, NAMELY, ORIGINATION, ACQUISITION, SERVICING, SECURITIZATION AND BROKERAGE OF MORTGAGE LOANS; MORTGAGE BROKERAGE; MORTGAGE LENDING; MORTGAGE PROCUREMENT FOR OTHERS; MORTGAGE SERVICES, NAMELY, BUYER PRE-QUALIFICATION OF MORTGAGES FOR MORTGAGE BROKERS AND BANKS; MORTGAGING OF SECURITIES FOR OTHERS; MUTUAL FUND BROKERAGE; MUTUAL FUND DISTRIBUTION; MUTUAL FUND INVESTMENT; NUMISMATIC APPRAISAL; OFFERING AIRCRAFT FRACTIONAL OWNERSHIP PROGRAMS TO OTHERS; ON-LINE BANKING SERVICES; OPERATING MARKETPLACES FOR SELLERS OF GOODS AND/OR SERVICES; ORGANIZATION OF STOCK EXCHANGES FOR THE BENEFIT OF THE TRADE OF STOCKS AND OTHER FINANCIAL VALUES; ORGANIZING PRE-PAID HEALTH CARE PLANS; ORGANIZING PREFERRED PROVIDER PROGRAMS IN THE FIELD



OF FINANCE; PAWN BROKERAGE; PAWN SHOPS; PAYROLL TAX DEBITING SERVICES; PHARMACEUTICAL BENEFIT MANAGEMENT SERVICES; PHARMACY BENEFIT MANAGEMENT SERVICES; PHILANTHROPIC SERVICES CONCERNING MONETARY DONATIONS; POLITICAL FUND RAISING SERVICES; PRE-PAID FUNERAL EXPENSE SERVICES; PRE-PAID PURCHASE CARD SERVICES NAMELY, PROCESSING ELECTRONIC PAYMENTS MADE THROUGH PREPAID CARDS; PRE-PAID PURCHASE CARD SERVICES, NAMELY, PROCESSING ELECTRONIC PAYMENTS THROUGH PRE-PAID CARDS; PRECIOUS STONE APPRAISAL; PREPAID CARD SERVICES IN THE NATURE OF MAKING PAYMENT FOR ADDING AIRTIME TO PREPAID OR PAY-AS-YOU-GO WIRELESS SERVICES; PREPAID PREVENTIVE MAINTENANCE SERVICE PLANS FOR HEATING, VENTILATING AND AIR CONDITIONING SYSTEMS.; PREPAID TELECOMMUNICATIONS CALLING CARD SERVICES; PRIVATE EQUITY FUND INVESTMENT SERVICES; PROJECT FINANCING; PROVIDING A WEB SITE WHERE USERS CAN POST RATINGS, REVIEWS AND RECOMMENDATIONS ON STOCKS, BONDS, MUTUAL FUNDS AND OTHER FINANCIAL INSTRUMENTS; PROVIDING A WEBSITE THAT FEATURES INFORMATION ON THE OPTIONS MARKETS; PROVIDING AN ONLINE SEARCHABLE DATABASE FEATURING EDUCATION GRANTS; PROVIDING BANK ACCOUNT INFORMATION BY TELEPHONE; PROVIDING COLLEGE SCHOLARSHIPS; PROVIDING EDUCATIONAL SCHOLARSHIPS; PROVIDING ELECTRONIC PROCESSING OF CREDIT CARD TRANSACTIONS AND ELECTRONIC PAYMENTS VIA A GLOBAL COMPUTER NETWORK; PROVIDING FUND RAISING SERVICES FOR OTHERS VIA A GLOBAL COMPUTER NETWORK; PROVIDING INFORMATION IN INSURANCE MATTERS; PROVIDING INFORMATION IN THE FIELD OF REAL ESTATE BY MEANS OF LINKING THE WEB SITE TO OTHER WEB SITES FEATURING REAL ESTATE INFORMATION; PROVIDING INFORMATION IN THE FIELD OF REAL ESTATE VIA THE INTERNET; PROVIDING INFORMATION VIA A GLOBAL COMPUTER NETWORK ON THE SUBJECT OF NON-RESIDENTIAL BUILDING AND FACILITIES MANAGEMENT; PROVIDING LOANS SECURED BY COMMERCIAL PAPER; PROVIDING MULTIPLE PAYMENT OPTIONS BY MEANS OF CUSTOMER-OPERATED ELECTRONIC TERMINALS AVAILABLE ON-SITE IN RETAIL STORES; PROVIDING ON-LINE FINANCIAL CALCULATORS; PROVIDING ON-LINE NEWS IN THE FIELD OF FINANCE; PROVIDING ONLINE INFORMATION IN THE FIELD CHARITABLE MONETARY GIVING THROUGH FINANCIAL AND ESTATE PLANNING; PROVIDING REAL ESTATE LISTINGS AND REAL ESTATE INFORMATION VIA THE INTERNET; PROVIDING REBATES AT PARTICIPATING ESTABLISHMENTS OF OTHERS THROUGH USE OF A MEMBERSHIP CARD; PROVIDING STOCK MARKET INFORMATION; PROVIDING STOCK/SECURITIES MARKET INFORMATION; PROVIDING STUDENT LOAN INFORMATION; PROVIDING TEMPORARY LOANS; PROVIDING WORKING CAPITAL; PUBLIC EQUITY INVESTMENT MANAGE-

MENT; REAL ESTATE ACQUISITION SERVICES; REAL ESTATE AGENCIES; REAL ESTATE APPRAISAL; REAL ESTATE BROKERAGE; REAL ESTATE CONSULTANCY; REAL ESTATE CONSULTATION; REAL ESTATE EQUITY SHARING, NAMELY, MANAGING AND ARRANGING FOR CO-OWNERSHIP OF REAL ESTATE; REAL ESTATE ESCROW SERVICES; REAL ESTATE INVESTMENT; REAL ESTATE LENDING SERVICES; REAL ESTATE LISTING; REAL ESTATE MANAGEMENT; REAL ESTATE MANAGEMENT CONSULTATION; REAL ESTATE MULTIPLE LISTING SERVICES; REAL ESTATE PROCUREMENT FOR OTHERS; REAL ESTATE SERVICES, NAMELY, RENTAL OF VACATION HOMES, CONDOMINIUMS, CABINS, AND VILLAS USING PAY PER CLICK ADVERTISING ON A GLOBAL COMPUTER NETWORK; REAL ESTATE SYNDICATION; REAL ESTATE TIME-SHARING; REAL ESTATE TRUSTEE SERVICES; REAL ESTATE VALUATION SERVICES; REAL ESTATE VALUATION; RECLAMATION OF IMPORT DUTIES FOR OTHERS; REINSURANCE UNDERWRITING; RENT COLLECTION AGENCIES; RENTAL OF APARTMENTS; RENTAL OF CABINS; RENTAL OF CASH DISPENSERS OR AUTOMATED-TELLER MACHINES; RENTAL OF OFFICE SPACE; REPAIR COST EVALUATION; REVOLVING LOANS; RISK MANAGEMENT; RISK MANAGEMENT CONSULTATION; SAFE DEPOSIT BOX SERVICES; SAFETY DEPOSIT BOX SERVICES; SAVINGS ACCOUNT SERVICES; SAVINGS AND LOAN ASSOCIATIONS; SAVINGS AND LOAN SERVICES; SAVINGS BANK SERVICES; SECURITIES ARBITRAGE SERVICES; SECURITIES TRADING AND INVESTING SERVICES FOR OTHERS VIA THE INTERNET; SECURITY BROKERAGE; SECURITY SERVICES, NAMELY, GUARANTEEING LOANS; SHOPPING CENTER SERVICES, NAMELY, RENTAL OF SHOPPING CENTER SPACE; STAMP APPRAISAL; STOCK BROKERAGE; STOCK EXCHANGE PRICE QUOTATIONS; STUDENT LOAN SERVICES; SURETY SERVICES; TAX PAYMENT PROCESSING SERVICES; TELECOMMUNICATIONS AIR TIME BROKERAGE SERVICES; TELECOMMUNICATIONS RESELLER SERVICES, NAMELY, TELECOMMUNICATIONS AIR TIME BROKERAGE SERVICES; TELEPHONE CALLING CARD SERVICES; TEMPORARY LOANS; TRANSFER AGENCY SERVICES RENDERED TO ISSUERS OF INVESTMENT SECURITIES; TRAVEL AGENCY SERVICES, NAMELY, ISSUING TRAVELER'S CHECKS; TRAVELERS' CHECK ISSUANCE; TRUST MANAGEMENT ACCOUNTS; TRUST SERVICES, NAMELY, INVESTMENT AND TRUST COMPANY SERVICES; TRUSTEESHIP REPRESENTATIVES; UNDERWRITING INSURANCE FOR PRE-PAID HEALTH CARE; UNDERWRITING INSURANCE FOR PRE-PAID LEGAL SERVICES; VACATION REAL ESTATE TIME SHARE EXCHANGE SERVICES; VACATION REAL ESTATE TIME-SHARING; VACATION REAL ESTATE TIMESHARE SERVICES; VENTURE CAPITAL FUNDING SERVICES TO EMERGING AND START-UP COMPANIES; VENTURE CAPITAL SERVICES, NAMELY, PROVIDING FINANCING TO EMERGING AND START-UP COMPANIES; VIATICAL SETTLEMENT SERVICES; WIRELESS TELEPHONE PAYMENT SERVICES, NAMELY, WIRELESS MOBILE TELEPHONE

RATE PLANS; YACHT BROKERAGE, IN CLASS 36 (U.S. CLS. 100, 101 AND 102).

FIRST USE 4-1-2007; IN COMMERCE 4-1-2007.

THE COLOR(S) ORANGE, YELLOW, AND BLACK. IS/ARE CLAIMED AS A FEATURE OF THE MARK.

THE MARK CONSISTS OF THE MARK IS A FOUR (4) QUADRANT PUZZLE WITH ORANGE IN

THE TOP RIGHT QUADRANT AND YELLOW IN THE THREE (3) REMAINING QUADRANTS. IT IS FRAMED IN BLACK WITH THE FRAME NARROWING AT THE TOP RIGHT CORNER. A BLACK DIVIDER IS USED BETWEEN THE FOUR (4) QUADRANTS WITH EACH QUADRANT HAVING A MALE AND FEMALE PUZZLE NOTCH.

SN 77-154,626, FILED 4-11-2007.

ANNE E. GUSTASON, EXAMINING ATTORNEY

Int. Cl.: 7

Prior U.S. Cls.: 13, 19, 21, 23, 31, 34, and 35

Reg. No. 3,570,427

United States Patent and Trademark Office

Registered Feb. 3, 2009

TRADEMARK  
PRINCIPAL REGISTER

TIMED OXI

SEARS BRANDS, LLC (ILLINOIS LIMITED LIABILITY COMPANY)  
3333 BEVERLY ROAD  
HOFFMAN ESTATES, IL 60179

THE MARK CONSISTS OF STANDARD CHARACTERS WITHOUT CLAIM TO ANY PARTICULAR FONT, STYLE, SIZE, OR COLOR.

FOR: A FEATURE COMPONENT SOLD AS AN INTEGRAL PART OF CLOTHES WASHERS, WHICH FACILITATES THE RELEASE OF STAIN FIGHTERS OR COLOR-SAFE BLEACH FOR IMPROVED STAIN-FIGHTING PERFORMANCE, IN CLASS 7 (U.S. CLS. 13, 19, 21, 23, 31, 34 AND 35).

NO CLAIM IS MADE TO THE EXCLUSIVE RIGHT TO USE "TIMED", APART FROM THE MARK AS SHOWN.

SN 77-156,001, FILED 4-13-2007.

FIRST USE 8-0-2007; IN COMMERCE 8-0-2007.

FRED MANDIR, EXAMINING ATTORNEY

**Int. Cl.: 16**

**Prior U.S. Cls.: 2, 5, 22, 23, 29, 37, 38, and 50**

**Reg. No. 3,570,428**

**United States Patent and Trademark Office**

**Registered Feb. 3, 2009**

**TRADEMARK  
PRINCIPAL REGISTER**

**FIREW  RX**

BOISE WHITE PAPER, L.L.C. (DELAWARE LIMITED LIABILITY COMPANY)  
P.O. BOX 990050  
1111 W. JEFFERSON STREET, SUITE 200  
BOISE, ID 837990050

THE MARK CONSISTS OF THE WORD "FIREWORX" WITH A SUNBURST IN THE PLACE OF AN "O".

FOR: PAPER, NAMELY, PAPER SOLD IN LARGE QUANTITIES FOR OFFICE USE, IN CLASS 16 (U.S. CLS. 2, 5, 22, 23, 29, 37, 38 AND 50).

SN 77-156,680, FILED 4-13-2007.

FIRST USE 10-1-2007; IN COMMERCE 10-1-2007.

LOURDES AYALA, EXAMINING ATTORNEY

**Int. Cl.: 4**

**Prior U.S. Cls.: 1, 6, and 15**

**United States Patent and Trademark Office**

**Reg. No. 3,570,429**

**Registered Feb. 3, 2009**

**TRADEMARK  
PRINCIPAL REGISTER**



PROPEL BIOFUELS, INC. (WASHINGTON CORPORATION)  
4444 WOODLAND PARK AVE NORTH, SUITE 101  
SEATTLE, WA 98103

THE MARK CONSISTS OF A LEAF DESIGN PLACED ON THE UPPER LEFT CORNER OF THE WORDING "PROPEL".

FOR: FUEL FOR MOTOR VEHICLES, NAMELY, BIODIESEL; FUELS, IN CLASS 4 (U.S. CLS. 1, 6 AND 15).

SN 77-162,228, FILED 4-20-2007.

FIRST USE 10-10-2007; IN COMMERCE 12-1-2008.

KIMBERLY FRYE, EXAMINING ATTORNEY

**Int. Cl.: 35**

**Prior U.S. Cls.: 100, 101, and 102**

**United States Patent and Trademark Office**

**Reg. No. 3,570,430**

**Registered Feb. 3, 2009**

---

**SERVICE MARK  
PRINCIPAL REGISTER**

**APPAREL SOLUTIONS.  
DRIVEN BY TECHNOLOGY.**

NEJ, INC. (CONNECTICUT CORPORATION)  
170 PINESBRIDGE ROAD  
BEACON FALLS, CT 06403

FIRST USE 2-9-2007; IN COMMERCE 2-9-2007.

FOR: RETAIL STORE SERVICES FEATURING CLOTHING; ONLINE RETAIL STORE SERVICES FEATURING CLOTHING; CATALOG ORDERING SERVICES FEATURING CLOTHING; WHOLESALE DISTRIBUTORSHIPS FEATURING CLOTHING; LOGISTICS MANAGEMENT IN THE FIELD OF CLOTHING, IN CLASS 35 (U.S. CLS. 100, 101 AND 102).

THE MARK CONSISTS OF STANDARD CHARACTERS WITHOUT CLAIM TO ANY PARTICULAR FONT, STYLE, SIZE, OR COLOR.

SN 77-163,331, FILED 4-23-2007.

JESSICA A. POWERS, EXAMINING ATTORNEY

**Int. Cl.: 25**

**Prior U.S. Cls.: 22 and 39**

**United States Patent and Trademark Office**

**Reg. No. 3,570,431**

**Registered Feb. 3, 2009**

**TRADEMARK  
PRINCIPAL REGISTER**

**FUNCTION JEANS**

LANADO, INC. (CALIFORNIA CORPORATION)  
516 W. VERNON AVENUE  
LOS ANGELES, CA 90037

FOR: BELTS; BLOUSES; CAPS; COATS; COATS OF DENIM; DENIM JACKETS; DENIMS; SHIRTS; JACKETS; DRESSES; HATS; JEANS; MEN'S SUITS; WOMEN'S SUITS; NIGHTWEAR; PAJAMAS; PANTS; SHOES; SHORTS; SKIRT SUITS; SKIRTS; SLACKS; SOCKS; SWEAT PANTS; SWEAT SHIRTS; SWEAT SUITS; T-SHIRTS; TIES; TOPS, IN CLASS 25 (U.S. CLS. 22 AND 39).

FIRST USE 6-15-2008; IN COMMERCE 6-15-2008.

THE MARK CONSISTS OF STANDARD CHARACTERS WITHOUT CLAIM TO ANY PARTICULAR FONT, STYLE, SIZE, OR COLOR.

NO CLAIM IS MADE TO THE EXCLUSIVE RIGHT TO USE "JEANS", APART FROM THE MARK AS SHOWN.

SN 77-163,522, FILED 4-23-2007.

DAVID C. REIHNER, EXAMINING ATTORNEY

**Int. Cl.: 6**

**Prior U.S. Cls.: 2, 12, 13, 14, 23, 25, and 50**

**Reg. No. 3,570,432**

**United States Patent and Trademark Office**

**Registered Feb. 3, 2009**

---

**TRADEMARK  
PRINCIPAL REGISTER**

**UNI-GRIP**

WISDOM AUDIO (NEVADA CORPORATION)  
1572 COLLEGE PARKWAY, SUITE 164  
CARSON CITY, NV 89706

THE MARK CONSISTS OF STANDARD CHAR-  
ACTERS WITHOUT CLAIM TO ANY PARTICULAR  
FONT, STYLE, SIZE, OR COLOR.

FOR: METAL WALL MOUNTS FOR AUDIO  
SPEAKERS, IN CLASS 6 (U.S. CLS. 2, 12, 13, 14, 23,  
25 AND 50).

SN 77-164,691, FILED 4-24-2007.

FIRST USE 10-31-2008; IN COMMERCE 10-31-2008.

MICHAEL SOUDERS, EXAMINING ATTORNEY



**Int. Cl.: 11**

**Prior U.S. Cls.: 13, 21, 23, 31, and 34**

**United States Patent and Trademark Office**

**Reg. No. 3,570,433**

**Registered Feb. 3, 2009**

**TRADEMARK  
PRINCIPAL REGISTER**

**MAX.5**

ZELCO INDUSTRIES, INC. (NEW YORK COR-  
PORATION)  
65 HAVEN AVENUE  
MOUNT VERNON, NY 10553

THE MARK CONSISTS OF STANDARD CHAR-  
ACTERS WITHOUT CLAIM TO ANY PARTICULAR  
FONT, STYLE, SIZE, OR COLOR.

FOR: BOOKLIGHTS, IN CLASS 11 (U.S. CLS. 13, 21,  
23, 31 AND 34).

SN 77-165,396, FILED 4-25-2007.

FIRST USE 7-31-2007; IN COMMERCE 7-31-2007.

TIMOTHY FINNEGAN, EXAMINING ATTORNEY

**Int. Cl.: 9**

**Prior U.S. Cls.: 21, 23, 26, 36, and 38**

**United States Patent and Trademark Office**

**Reg. No. 3,570,434**

**Registered Feb. 3, 2009**

**TRADEMARK  
PRINCIPAL REGISTER**

**TRUVECTOR 360 COMPASS  
TECHNOLOGY**

LASER TECHNOLOGY, INC. (COLORADO CORPORATION)  
7070 S. TUCSON WAY  
CENTENNIAL, CO 80112 AND  
KAMA-TECH, HK LTD. (HONG KONG CORPORATION)  
9TH FLOOR, SUITE 4  
33 CANTON ROAD, TOWER 3  
TSIM SHA TSUI, HONG KONG

FOR: COMPASSES TO TAKE BEARING AND DISTANCE MEASUREMENTS; COMPASSES EMBEDDED IN LASERS TO TAKE BEARING AND DISTANCE MEASUREMENTS, IN CLASS 9 (U.S. CLS. 21, 23, 26, 36 AND 38).

FIRST USE 8-31-2007; IN COMMERCE 8-31-2007.

THE MARK CONSISTS OF STANDARD CHARACTERS WITHOUT CLAIM TO ANY PARTICULAR FONT, STYLE, SIZE, OR COLOR.

NO CLAIM IS MADE TO THE EXCLUSIVE RIGHT TO USE "360 COMPASS TECHNOLOGY", APART FROM THE MARK AS SHOWN.

SN 77-165,689, FILED 4-25-2007.

SCOTT BIBB, EXAMINING ATTORNEY

**Int. Cl.: 20**

**Prior U.S. Cls.: 2, 13, 22, 25, 32, and 50**

**United States Patent and Trademark Office**

**Reg. No. 3,570,435**

**Registered Feb. 3, 2009**

**TRADEMARK  
PRINCIPAL REGISTER**

# Eco Edge

SUNCAST CORPORATION (ILLINOIS CORPORATION)

701 N. KIRK ROAD

BATAVIA, IL 60510

FOR: PLASTIC LANDSCAPE EDGING, IN CLASS 20 (U.S. CLS. 2, 13, 22, 25, 32 AND 50).

FIRST USE 4-19-2006; IN COMMERCE 11-2-2006.

THE MARK CONSISTS OF STANDARD CHARACTERS WITHOUT CLAIM TO ANY PARTICULAR FONT, STYLE, SIZE, OR COLOR.

NO CLAIM IS MADE TO THE EXCLUSIVE RIGHT TO USE "EDGE", APART FROM THE MARK AS SHOWN.

SN 77-167,172, FILED 4-27-2007.

CAROLINE WOOD, EXAMINING ATTORNEY

**Int. Cl.: 41**

**Prior U.S. Cls.: 100, 101, and 107**

**United States Patent and Trademark Office**

**Reg. No. 3,570,436**

**Registered Feb. 3, 2009**

**SERVICE MARK  
PRINCIPAL REGISTER**

**RESOLVE THROUGH SHARING**

GUNDERSEN LUTHERAN MEDICAL CENTER,  
INC. (WISCONSIN CORPORATION)  
1836 SOUTH AVENUE  
LA CROSSE, WI 54601

FOR: EDUCATION SERVICES, NAMELY, ARRANGING AND PROVIDING CLASSES, SEMINARS, AND WORKSHOPS TO HEALTH CARE PROFESSIONALS IN THE FIELD OF DEATH, BEREAVEMENT, AND GRIEF COUNSELING, AND DISTRIBUTING COURSE MATERIALS IN CONNECTION THEREWITH; PROVIDING ONLINE TRAINING TO HEALTH CARE PROFESSIONALS IN THE FIELD OF DEATH, BEREAVEMENT, AND

GRIEF COUNSELING; PROVIDING CONTINUING EDUCATION FOR HEALTH CARE PROFESSIONALS, IN CLASS 41 (U.S. CLS. 100, 101 AND 107).

FIRST USE 8-0-2008; IN COMMERCE 8-0-2008.

THE MARK CONSISTS OF STANDARD CHARACTERS WITHOUT CLAIM TO ANY PARTICULAR FONT, STYLE, SIZE, OR COLOR.

SN 77-167,938, FILED 4-27-2007.

TINA BROWN, EXAMINING ATTORNEY

**Int. Cl.: 28**

**Prior U.S. Cls.: 22, 23, 38, and 50**

**United States Patent and Trademark Office**

**Reg. No. 3,570,437**

**Registered Feb. 3, 2009**

**TRADEMARK  
PRINCIPAL REGISTER**

**JEEZLE PETE'S!**

HERBERT BROTHERS ENTERTAINMENT, CO.  
(INDIANA CORPORATION)  
4950 E. MORRIS CHURCH RD.  
BATESVILLE, IN 47006

THE MARK CONSISTS OF STANDARD CHAR-  
ACTERS WITHOUT CLAIM TO ANY PARTICULAR  
FONT, STYLE, SIZE, OR COLOR.

FOR: BOARD GAMES, IN CLASS 28 (U.S. CLS. 22,  
23, 38 AND 50).

SN 77-168,504, FILED 4-29-2007.

FIRST USE 9-4-2006; IN COMMERCE 5-30-2008.

MARY MUNSON, EXAMINING ATTORNEY

**Int. Cl.: 13**

**Prior U.S. Cls.: 2 and 9**

**United States Patent and Trademark Office**

**Reg. No. 3,570,438**

**Registered Feb. 3, 2009**

**TRADEMARK  
PRINCIPAL REGISTER**

**Sentry**

STI INTERNATIONAL, INC (TEXAS CORPORATION)  
114 HALMAR COVE  
GEORGETOWN, TX 78628

THE MARK CONSISTS OF STANDARD CHARACTERS WITHOUT CLAIM TO ANY PARTICULAR FONT, STYLE, SIZE, OR COLOR.

FOR: FIREARMS, IN CLASS 13 (U.S. CLS. 2 AND 9).

SN 77-168,938, FILED 4-30-2007.

FIRST USE 12-1-2008; IN COMMERCE 12-1-2008.

BRENDAN REGAN, EXAMINING ATTORNEY

**Int. Cl.: 31**

**Prior U.S. Cls.: 1 and 46**

**United States Patent and Trademark Office**

**Reg. No. 3,570,439**

**Registered Feb. 3, 2009**

**TRADEMARK  
PRINCIPAL REGISTER**

**NUTRIST JELLY DE LUXE**

NUTRIST KG (FED REP GERMANY LIMITED  
LIABILITY COMPANY)

ROGGENKAMP 17

VERDEN, FED REP GERMANY 27283

FOR: NON-MEDICINAL ANIMAL FEED, NAME-  
LY, BEVERAGES FOR ANIMALS; ANIMAL LIT-  
TER, IN CLASS 31 (U.S. CLS. 1 AND 46).

FIRST USE 8-21-2007; IN COMMERCE 8-21-2007.

THE MARK CONSISTS OF STANDARD CHAR-  
ACTERS WITHOUT CLAIM TO ANY PARTICULAR  
FONT, STYLE, SIZE, OR COLOR.

NO CLAIM IS MADE TO THE EXCLUSIVE  
RIGHT TO USE "JELLY DE LUXE", APART FROM  
THE MARK AS SHOWN.

SN 77-170,806, FILED 5-2-2007.

MATTHEW MCDOWELL, EXAMINING ATTOR-  
NEY

Int. Cls.: 41 and 43

Prior U.S. Cls.: 100, 101, and 107

United States Patent and Trademark Office

Reg. No. 3,570,440

Registered Feb. 3, 2009

SERVICE MARK  
PRINCIPAL REGISTER



DETROIT ENTERTAINMENT, L.L.C. (MICHIGAN LIMITED LIABILITY COMPANY)  
2901 GRAND RIVER  
DETROIT, MI 48201

FOR: CASINO SERVICES; ENTERTAINMENT SERVICES, NAMELY, LIVE PERFORMANCES FEATURING LIVE AND RECORDED MUSIC, PRERECORDED VIDEO, VARIETY SHOWS, SINGERS, DANCERS, MAGICIANS, ACTORS, ACROBATS, AND COMEDIANS, IN CLASS 41 (U.S. CLS. 100, 101 AND 107).

FIRST USE 7-31-2007; IN COMMERCE 7-31-2007.

FOR: RESTAURANT, BAR AND LOUNGE SERVICES, IN CLASS 43 (U.S. CLS. 100 AND 101).

FIRST USE 7-31-2007; IN COMMERCE 7-31-2007.

OWNER OF U.S. REG. NOS. 3,085,795, 3,182,145, AND 3,190,362.

NO CLAIM IS MADE TO THE EXCLUSIVE RIGHT TO USE "CASINO HOTEL", APART FROM THE MARK AS SHOWN.

THE MARK CONSISTS OF THE STYLIZED WORDING "MOTORCITY" WITH THE WORDS "CASINO" AND "HOTEL" APPEARING BENEATH THE WORD "MOTOR".

SEC. 2(F) AS TO "MOTORCITY CASINO".

SN 77-171,376, FILED 5-2-2007.

JULIE WATSON, EXAMINING ATTORNEY



**Int. Cl.: 16**

**Prior U.S. Cls.: 2, 5, 22, 23, 29, 37, 38, and 50**

**United States Patent and Trademark Office**

**Reg. No. 3,570,441**

**Registered Feb. 3, 2009**

**TRADEMARK  
PRINCIPAL REGISTER**

**Viva Ecuador Powered by  
iBasis**

IBASIS, INC. (DELAWARE CORPORATION)  
20 SECOND AVENUE  
BURLINGTON, MA 01803

FOR: PRE-PAID TELEPHONE CALLING CARDS,  
NOT MAGNETICALLY ENCODED; TELEPHONE  
CALLING CARDS, NOT MAGNETICALLY ENCO-  
DED, IN CLASS 16 (U.S. CLS. 2, 5, 22, 23, 29, 37, 38  
AND 50).

FIRST USE 5-29-2008; IN COMMERCE 5-29-2008.

THE MARK CONSISTS OF STANDARD CHAR-  
ACTERS WITHOUT CLAIM TO ANY PARTICULAR  
FONT, STYLE, SIZE, OR COLOR.

OWNER OF U.S. REG. NOS. 2,446,999 AND  
2,494,853.

NO CLAIM IS MADE TO THE EXCLUSIVE  
RIGHT TO USE "ECUADOR", APART FROM THE  
MARK AS SHOWN.

SN 77-172,708, FILED 5-4-2007.

JORDAN BAKER, EXAMINING ATTORNEY

**Int. Cls.: 5 and 31**

**Prior U.S. Cls.: 1, 6, 18, 44, 46, 51, and 52**

**Reg. No. 3,570,442**

**United States Patent and Trademark Office**

**Registered Feb. 3, 2009**

**TRADEMARK  
PRINCIPAL REGISTER**

**DAZZLE**

NEWMAN, MATTHEW (UNITED STATES INDIVIDUAL)

2261 MORGANZA HIGHWAY

NEW ROADS, LA 70760

FOR: SUPPLEMENTS FOR DOMESTIC ANIMALS, NAMELY, FEED SUPPLEMENTS FOR HORSES, IN CLASS 5 (U.S. CLS. 6, 18, 44, 46, 51 AND 52).

FIRST USE 8-15-2007; IN COMMERCE 8-15-2007.

FOR: TREATS FOR DOMESTIC ANIMALS, NAMELY, EDIBLE HORSE TREATS, IN CLASS 31 (U.S. CLS. 1 AND 46).

FIRST USE 8-15-2007; IN COMMERCE 8-15-2007.

THE MARK CONSISTS OF STANDARD CHARACTERS WITHOUT CLAIM TO ANY PARTICULAR FONT, STYLE, SIZE, OR COLOR.

SN 77-172,900, FILED 5-4-2007.

INGRID C. EULIN, EXAMINING ATTORNEY

**Int. Cls.: 5 and 31**

**Prior U.S. Cls.: 1, 6, 18, 44, 46, 51, and 52**

**United States Patent and Trademark Office**

**Reg. No. 3,570,443**

**Registered Feb. 3, 2009**

**TRADEMARK  
PRINCIPAL REGISTER**

**MENTHOS**

NEWMAN, MATTHEW (UNITED STATES INDIVIDUAL)  
2261 MORGANZA HIGHWAY  
NEW ROADS, LA 70760

FOR: NUTRITIONAL AND VITAMIN SUPPLEMENTS FOR HORSES, IN CLASS 5 (U.S. CLS. 6, 18, 44, 46, 51 AND 52).

FIRST USE 8-16-2007; IN COMMERCE 8-16-2007.

FOR: EDIBLE HORSE TREATS, IN CLASS 31 (U.S. CLS. 1 AND 46).

FIRST USE 8-16-2007; IN COMMERCE 8-16-2007.

THE MARK CONSISTS OF STANDARD CHARACTERS WITHOUT CLAIM TO ANY PARTICULAR FONT, STYLE, SIZE, OR COLOR.

SN 77-173,211, FILED 5-4-2007.

INGRID C. EULIN, EXAMINING ATTORNEY

**Int. Cl.: 28**

**Prior U.S. Cls.: 22, 23, 38, and 50**

**United States Patent and Trademark Office**

**Reg. No. 3,570,444**

**Registered Feb. 3, 2009**

**TRADEMARK  
PRINCIPAL REGISTER**

**PET PLANET**

MATTEL, INC. (DELAWARE CORPORATION)  
M1-1518  
333 CONTINENTAL BLVD.  
EL SEGUNDO, CA 90245

FOR: TOYS, GAMES AND PLAYTHINGS, NAME-  
LY, HAND HELD UNIT FOR PLAYING ELECTRO-  
NIC GAMES, IN CLASS 28 (U.S. CLS. 22, 23, 38 AND  
50).

FIRST USE 12-4-2008; IN COMMERCE 12-4-2008.

THE MARK CONSISTS OF STANDARD CHAR-  
ACTERS WITHOUT CLAIM TO ANY PARTICULAR  
FONT, STYLE, SIZE, OR COLOR.

SN 77-176,205, FILED 5-9-2007.

SUSAN STIGLITZ, EXAMINING ATTORNEY

**Int. Cl.: 25**

**Prior U.S. Cls.: 22 and 39**

**United States Patent and Trademark Office**

**Reg. No. 3,570,445**

**Registered Feb. 3, 2009**

**TRADEMARK  
PRINCIPAL REGISTER**

**LEMLEM**

LIYA KEBEDE (ETHIOPIA INDIVIDUAL)  
548 WEST 28TH STREET, SUITE 538  
NEW YORK, NY 10001

SHIRTS, SLIPS, PAJAMAS, PANTIES, SHORTS  
AND BRIEFS, BODY SUITS, BATHING SUITS,  
BEACHWEAR, IN CLASS 25 (U.S. CLS. 22 AND 39).

FOR: CLOTHING FOR WOMEN AND CHILDREN, NAMELY, SKIRTS, PANTS, SHIRTS, T-SHIRTS, DRESSES, MINISKIRTS, DRESS SHIRTS, TROUSERS, SHORT-SLEEVED AND LONG-SLEEVED SHIRTS, TOPS, SWEAT PANTS, HALTER TOPS, TANK TOPS, BLOUSES, VESTS, SKORTS, HOODS, WRAPS, HEADWEAR, CARDIGANS, JACKETS, COATS, BLAZERS, SHAWLS, SCARVES, GYM SUITS, SUITS, SWEAT SUITS, SHOES, BELTS, SWEATERS, TUNICS, CAMISOLES, UNDER-

FIRST USE 1-31-2008; IN COMMERCE 1-31-2008.

THE MARK CONSISTS OF STANDARD CHARACTERS WITHOUT CLAIM TO ANY PARTICULAR FONT, STYLE, SIZE, OR COLOR.

SN 77-176,459, FILED 5-9-2007.

ALYSSA STEEL, EXAMINING ATTORNEY

**Int. Cl.: 21**

**Prior U.S. Cls.: 2, 13, 23, 29, 30, 33, 40, and 50**

**Reg. No. 3,570,446**

**United States Patent and Trademark Office**

**Registered Feb. 3, 2009**

**TRADEMARK  
PRINCIPAL REGISTER**

**SWEETBYTES**

EVRIHOLDER PRODUCTS, LLC (INDIANA LIMITED LIABILITY COMPANY)  
1530 S. LEWIS STREET  
ANAHEIM, CA 92805

FOR: SANDWICH SHAPERS, NAMELY, SANDWICH CUTTING MOLDS DESIGNED TO CUT BREAD INTO FANCIFUL SHAPES AND TO CUT CRUSTS FROM BREAD, IN CLASS 21 (U.S. CLS. 2, 13, 23, 29, 30, 33, 40 AND 50).

FIRST USE 12-14-2006; IN COMMERCE 12-14-2006.

THE MARK CONSISTS OF STANDARD CHARACTERS WITHOUT CLAIM TO ANY PARTICULAR FONT, STYLE, SIZE, OR COLOR.

SN 77-177,329, FILED 5-10-2007.

PAUL F. GAST, EXAMINING ATTORNEY

Int. Cl.: 30

Prior U.S. Cl.: 46

**United States Patent and Trademark Office**

**Reg. No. 3,570,447**

Registered Feb. 3, 2009

**TRADEMARK  
PRINCIPAL REGISTER**



DR. LUCY'S LLC (VIRGINIA LIMITED LIABILITY COMPANY)  
SUITE 1  
7420 CENTRAL BUSINESS PARK DRIVE  
NORFOLK, VA 23513

THE MARK CONSISTS OF A SHADED OVAL OUTLINED ON THE INSIDE WITH A BROKEN LINE. THE WORD "LUCY'S" IS INSIDE THE OVAL. THE APOSTROPHE IS REPRESENTED BY A FLOWER WITH FIVE SHADED ROUNDED PETALS AND A CENTRAL CIRCLE.

FOR: COOKIES, IN CLASS 30 (U.S. CL. 46).

SN 77-177,364, FILED 5-10-2007.

FIRST USE 9-25-2007; IN COMMERCE 12-15-2007.

HENRY S. ZAK, EXAMINING ATTORNEY

**Int. Cls.: 35 and 42**

**Prior U.S. Cls.: 100, 101, and 102**

**United States Patent and Trademark Office**

**Reg. No. 3,570,448**

**Registered Feb. 3, 2009**

**SERVICE MARK  
PRINCIPAL REGISTER**

**GUMTREE**

KIJIJI INTERNATIONAL LIMITED (IRELAND CORPORATION)  
BLANCHARDSTOWN CORPORATE PARK, UNIT 6  
DUBLIN 15, IRELAND

FOR: PROVIDING AN ONLINE COMPUTER DATABASE AND ON-LINE SEARCHABLE DATABASE FEATURING CLASSIFIED AD LISTINGS, IN CLASS 35 (U.S. CLS. 100, 101 AND 102).

FIRST USE 8-14-2007; IN COMMERCE 8-14-2007.

FOR: COMPUTER SERVICES, NAMELY, HOSTING ONLINE WEB FACILITIES FOR OTHERS FOR ORGANIZING AND CONDUCTING ONLINE MEETINGS, GATHERINGS, AND INTERACTIVE DISCUSSIONS; COMPUTER SERVICES IN THE

NATURE OF PROVIDING CUSTOMIZED WEB PAGES FEATURING USER-DEFINED INFORMATION, PERSONAL PROFILES AND INFORMATION, IN CLASS 42 (U.S. CLS. 100 AND 101).

FIRST USE 8-17-2007; IN COMMERCE 8-17-2007.

THE MARK CONSISTS OF STANDARD CHARACTERS WITHOUT CLAIM TO ANY PARTICULAR FONT, STYLE, SIZE, OR COLOR.

SN 77-177,799, FILED 5-10-2007.

JASON LOTT, EXAMINING ATTORNEY



**Int. Cl.: 42**

**Prior U.S. Cls.: 100 and 101**

**United States Patent and Trademark Office**

**Reg. No. 3,570,449**

**Registered Feb. 3, 2009**

**SERVICE MARK  
PRINCIPAL REGISTER**

**FUSIONIQ**

FUSION ANALYTICS SOFTWARE DEVELOPMENT PARTNERS LLC (DELAWARE LIMITED LIABILITY COMPANY)

SUITE 1700  
300 PARK AVENUE  
NEW YORK, NY 10022

FOR: PROVIDING TEMPORARY USE OF NON-DOWNLOADABLE WEB-BASED SOFTWARE APPLICATION USED TO RESEARCH COMPREHENSIVE QUANTITATIVE STOCK AND INDUSTRY GROUP RANKINGS FOR USE IN TRADING AND

PORTFOLIO ANALYTICS APPLICATIONS, IN CLASS 42 (U.S. CLS. 100 AND 101).

FIRST USE 12-12-2007; IN COMMERCE 12-12-2007.

THE MARK CONSISTS OF STANDARD CHARACTERS WITHOUT CLAIM TO ANY PARTICULAR FONT, STYLE, SIZE, OR COLOR.

SN 77-180,014, FILED 5-14-2007.

ANNE E. GUSTASON, EXAMINING ATTORNEY

**Int. Cl.: 29**

**Prior U.S. Cl.: 46**

**Reg. No. 3,570,450**

**United States Patent and Trademark Office**

**Registered Feb. 3, 2009**

---

**TRADEMARK  
PRINCIPAL REGISTER**

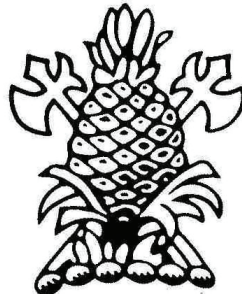

DIAGEO BRANDS B.V. (NETHERLANDS PRIVATE LIMITED COMPANY)  
MOLENWERF 10-12  
1014 BG AMSTERDAM, NETHERLANDS

THE MARK CONSISTS OF A DESIGN OF A PINEAPPLE AND TWO AXES SITTING ON TOP OF LEAVES ON A BASE.

FOR: PROCESSED OLIVES; COCKTAIL ONIONS, IN CLASS 29 (U.S. CL. 46).

SN 77-180,323, FILED 5-14-2007.

FIRST USE 2-29-2008; IN COMMERCE 2-29-2008.

NAKIA HENRY, EXAMINING ATTORNEY

**Int. Cl.: 5**

**Prior U.S. Cls.: 6, 18, 44, 46, 51, and 52**

**Reg. No. 3,570,451**

**United States Patent and Trademark Office**

**Registered Feb. 3, 2009**

**TRADEMARK  
PRINCIPAL REGISTER**

**WOLVERINE**

BAYER AKTIENGESELLSCHAFT (FED REP  
GERMANY AKTIENGESELLSCHAFT)  
D-51368  
LEVERKUSEN-BAYERWERK, FED REP GERMA-  
NY

FOR: PREPARATIONS FOR KILLING WEEDS  
AND DESTROYING VERMIN; INSECTICIDES,  
HERBICIDES, FUNGICIDES, IN CLASS 5 (U.S. CLS.  
6, 18, 44, 46, 51 AND 52).

FIRST USE 4-27-2008; IN COMMERCE 4-27-2008.

THE MARK CONSISTS OF STANDARD CHAR-  
ACTERS WITHOUT CLAIM TO ANY PARTICULAR  
FONT, STYLE, SIZE, OR COLOR.

SN 77-182,139, FILED 5-16-2007.

THEODORE MCBRIDE, EXAMINING ATTORNEY

**Int. Cl.: 22**

**Prior U.S. Cls.: 1, 2, 7, 19, 22, 42, and 50**

**Reg. No. 3,570,452**

**United States Patent and Trademark Office**

**Registered Feb. 3, 2009**

---

**TRADEMARK  
PRINCIPAL REGISTER**

**ZIPFRAME**

NORTH POLE LIMITED (HONG KONG CORPORATION)  
UNIT A905, DRAGON INDUSTRIAL BUILDING  
NO. 93 KING LAM STREET, CHEUNG SHA WAN  
KOWLOON, HONG KONG

THE MARK CONSISTS OF STANDARD CHARACTERS WITHOUT CLAIM TO ANY PARTICULAR FONT, STYLE, SIZE, OR COLOR.

FOR: PORTABLE SHELTERS, NAMELY, CANVAS CANOPIES, IN CLASS 22 (U.S. CLS. 1, 2, 7, 19, 22, 42 AND 50).

SN 77-186,336, FILED 5-21-2007.

FIRST USE 7-0-2008; IN COMMERCE 7-0-2008.

MICHAEL TANNER, EXAMINING ATTORNEY

**Int. Cl.: 31**

**Prior U.S. Cls.: 1 and 46**

**United States Patent and Trademark Office**

**Reg. No. 3,570,453**

**Registered Feb. 3, 2009**

**TRADEMARK  
PRINCIPAL REGISTER**

**SoyChoice**

WENGER'S FEED MILL, INC. (PENNSYLVANIA  
CORPORATION)  
101 WEST HARRISBURG AVENUE  
RHEEMS, PA 17570

THE MARK CONSISTS OF STANDARD CHAR-  
ACTERS WITHOUT CLAIM TO ANY PARTICULAR  
FONT, STYLE, SIZE, OR COLOR.

FOR: ANIMAL FEED, IN CLASS 31 (U.S. CLS. 1  
AND 46).

SN 77-186,488, FILED 5-21-2007.

FIRST USE 8-28-2008; IN COMMERCE 10-27-2008.

FRANK LATTUCA, EXAMINING ATTORNEY

**Int. Cls.: 35 and 41**

**Prior U.S. Cls.: 100, 101, 102, and 107**

**United States Patent and Trademark Office**

**Reg. No. 3,570,454**

**Registered Feb. 3, 2009**

**SERVICE MARK  
PRINCIPAL REGISTER**

# EXPLORAMANIA

SUNSCHEINE WORLD, LLC (DELAWARE LIMITED LIABILITY COMPANY)  
SUITE 737  
13014 N. DALE MARBRY HWY  
TAMPA, FL 33618

FOR: COMPUTERIZED ON-LINE RETAIL STORE SERVICES AND RETAIL STORE SERVICES FEATURING EDUCATIONAL GAMES, BOOKS AND AUDIOVISUAL PROGRAMMING STORED FOR PLAYBACK ON VIDEO TAPE, VIDEO DISC, CD-ROM, DVD OR DOWNLOADABLE DIGITAL FILES, NAMELY, FOR LEARNING SUBJECTS WHILE PERFORMING GYMNASTICS, EXERCISE AND SENSORY-MOTOR PLAY ROUTINES AND PROGRAMS, IN CLASS 35 (U.S. CLS. 100, 101 AND 102).

FIRST USE 10-31-2008; IN COMMERCE 12-10-2008.

FOR: PROVIDING EDUCATIONAL AND LEISURE ACTIVITIES FOR CHILDREN AND ADULTS, NAMELY, PROVIDING INSTRUCTION AND CONDUCTING EDUCATIONAL CONFERENCES AND CONVENTIONS IN THE FIELD OF MATHEMATICS AND COMPUTER SCIENCE, NATURAL SCIENCE, SOCIAL STUDIES, LANGUAGE ARTS, CREATIVE

AND PERFORMING ARTS AND HEALTH AND FITNESS, WHILE PERFORMING GYMNASTICS, EXERCISE AND SENSORY-MOTOR PLAY ROUTINES AND PROGRAMS; ORGANIZING AND CONDUCTING CHILDREN'S AND ADULTS' EDUCATIONAL AND ENTERTAINMENT EVENTS, NAMELY, EDUCATIONAL AND MOTIVATIONAL SPEAKER EVENTS, KEY NOTE ADDRESSES, HEALTH AND FITNESS PERFORMANCES, FASHION SHOWS, BOOK SIGNINGS, AND PRODUCTION OF TELEVISION SHOWS; PROVIDING INFORMATION IN THE FIELD OF EDUCATIONAL AND LEISURE ACTIVITIES FOR CHILDREN AND ADULTS, IN CLASS 41 (U.S. CLS. 100, 101 AND 107).

FIRST USE 10-31-2008; IN COMMERCE 12-10-2008.

THE MARK CONSISTS OF STANDARD CHARACTERS WITHOUT CLAIM TO ANY PARTICULAR FONT, STYLE, SIZE, OR COLOR.

SN 77-187,658, FILED 5-22-2007.

DANIEL BRODY, EXAMINING ATTORNEY

**Int. Cls.: 28 and 41**

**Prior U.S. Cls.: 22, 23, 38, 50, 100, 101, and 107**

**Reg. No. 3,570,455**

**United States Patent and Trademark Office**

**Registered Feb. 3, 2009**

**TRADEMARK  
SERVICE MARK  
PRINCIPAL REGISTER**

**UH-OHS**

NATIONAL FIRE PROTECTION ASSOCIATION,  
INC. (MASSACHUSETTS CORPORATION)  
1 BATTERYMARCH PARK  
QUINCY, MA 02169

FOR: TOY FIGURES, IN CLASS 28 (U.S. CLS. 22,  
23, 38 AND 50).

FIRST USE 9-0-2008; IN COMMERCE 9-0-2008.

FOR: PROVIDING A WEB SITE FEATURING  
ENTERTAINMENT IN THE NATURE OF GAMES,  
DEPICTIONS OF FICTIONAL CHARACTERS AND

INTERACTIVE ACTIVITIES FOR CHILDREN, IN  
CLASS 41 (U.S. CLS. 100, 101 AND 107).

FIRST USE 9-0-2008; IN COMMERCE 9-0-2008.

THE MARK CONSISTS OF STANDARD CHAR-  
ACTERS WITHOUT CLAIM TO ANY PARTICULAR  
FONT, STYLE, SIZE, OR COLOR.

SN 77-189,663, FILED 5-24-2007.

MYRIAH HABEEB, EXAMINING ATTORNEY

**Int. Cls.: 28 and 41**

**Prior U.S. Cls.: 22, 23, 38, 50, 100, 101, and 107**

**United States Patent and Trademark Office**

**Reg. No. 3,570,456**

**Registered Feb. 3, 2009**

**TRADEMARK  
SERVICE MARK  
PRINCIPAL REGISTER**

# THE UH-OHS

NATIONAL FIRE PROTECTION ASSOCIATION,  
INC. (MASSACHUSETTS CORPORATION)  
1 BATTERYMARCH PARK  
QUINCY, MA 02169

FOR: TOY FIGURES, IN CLASS 28 (U.S. CLS. 22,  
23, 38 AND 50).

FIRST USE 9-0-2008; IN COMMERCE 9-0-2008.

FOR: PROVIDING A WEB SITE FEATURING  
ENTERTAINMENT IN THE NATURE OF GAMES,  
DEPICTIONS OF FICTIONAL CHARACTERS AND

INTERACTIVE ACTIVITIES FOR CHILDREN, IN  
CLASS 41 (U.S. CLS. 100, 101 AND 107).

FIRST USE 9-0-2008; IN COMMERCE 9-0-2008.

THE MARK CONSISTS OF STANDARD CHAR-  
ACTERS WITHOUT CLAIM TO ANY PARTICULAR  
FONT, STYLE, SIZE, OR COLOR.

SN 77-190,376, FILED 5-25-2007.

MYRIAH HABEEB, EXAMINING ATTORNEY



Int. Cl.: 30

Prior U.S. Cl.: 46

United States Patent and Trademark Office

Reg. No. 3,570,457

Registered Feb. 3, 2009

TRADEMARK  
PRINCIPAL REGISTER



EL MAIZITO, LLC (TEXAS LIMITED LIABILITY  
COMPANY)  
SUITE F  
4912 AIRLINE DRIVE  
HOUSTON, TX 77022

FOR: TORTILLAS, SALSA, TOSTADAS, TACOS,  
TACO SHELLS, TACO CHIPS, TORTILLA CHIPS,  
TORTILLA SHELLS, NACHOS, DOUGH FOR TOR-  
TILLAS, DOUGH FOR TAMALES, IN CLASS 30 (U.S.  
CL. 46).

FIRST USE 6-1-2007; IN COMMERCE 6-1-2007.

THE COLOR(S) YELLOW, LIGHT AND DARK  
GREEN, RED, WHITE, BLACK AND ORANGE IS/  
ARE CLAIMED AS A FEATURE OF THE MARK.

THE MARK CONSISTS OF A CIRCLE OUTLINED  
IN BLACK, WITH A RED AND ORANGE DIAGON-  
ALLY-STRIPED BACKGROUND PATTERN. WITH-  
IN THE CIRCLE IS AN ORANGE AND YELLOW-  
SHADED CORN COB WITH A LIGHT AND DARK  
GREEN HUSK PEELING BACK, AND WITH HU-  
MAN FEATURES, NAMELY, BLACK HAIR, EYES,  
NOSE, MUSTACHE AND MOUTH WITH WHITE  
TEETH AND RED TONGUE, WEARING A BROWN  
SOMBRERO, OUTLINED IN BLACK, AND WITH A  
GREEN ZIGZAG DESIGN THEREON.

SN 77-192,272, FILED 5-29-2007.

LAURA KOVALSKY, EXAMINING ATTORNEY

**Int. Cls.: 20 and 21**

**Prior U.S. Cls.: 2, 13, 22, 23, 25, 29, 30, 32, 33, 40, and 50**

**Reg. No. 3,570,458**

**United States Patent and Trademark Office**

**Registered Feb. 3, 2009**

**TRADEMARK  
PRINCIPAL REGISTER**

**SWOOPCUP**

HALO CUPS, INC. (ARIZONA CORPORATION)  
1937 W. PUMPKIN RIDGE LANE  
ANTHEM, AZ 85083

FIRST USE 4-30-2005; IN COMMERCE 4-30-2005.

FOR: PLASTIC CUP LIDS, IN CLASS 20 (U.S. CLS. 2, 13, 22, 25, 32 AND 50).

THE MARK CONSISTS OF STANDARD CHARACTERS WITHOUT CLAIM TO ANY PARTICULAR FONT, STYLE, SIZE, OR COLOR.

FIRST USE 4-30-2005; IN COMMERCE 4-30-2005.

SN 77-194,903, FILED 5-31-2007.

FOR: PLASTIC CUPS, IN CLASS 21 (U.S. CLS. 2, 13, 23, 29, 30, 33, 40 AND 50).

DOMINIC J. FERRAIUOLO, EXAMINING ATTORNEY

Int. Cl.: 25

Prior U.S. Cls.: 22 and 39

United States Patent and Trademark Office

Reg. No. 3,570,459

Registered Feb. 3, 2009

**TRADEMARK  
PRINCIPAL REGISTER**

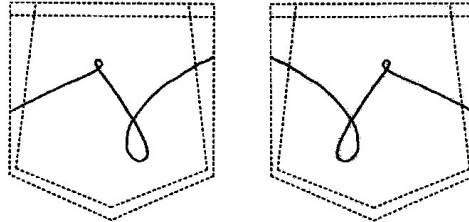

HBI BRANDED APPAREL ENTERPRISES, LLC  
(DELAWARE LIMITED LIABILITY COMPAN-  
NY)  
1000 EAST HANES MILL ROAD  
WINSTON-SALEM, NC 27105

FOR: JEANS; PANTS, IN CLASS 25 (U.S. CLS. 22  
AND 39).

FIRST USE 7-31-2008; IN COMMERCE 7-31-2008.

THE MARK CONSISTS OF J DESIGN-THIS  
MARK CONSISTS OF A DECORATIVE DESIGN

PLACED ON THE LEFT BACK POCKET AND ITS  
MIRROR IMAGE ON THE RIGHT POCKET OF THE  
GOODS; NO CLAIM IS MADE IN THE OUTLINE OR  
DESIGN OF A POCKET, BUT SUCH IS INCLUDED  
MERELY TO SHOW THE PLACEMENT OF THE  
MARK ON THE GOODS.

SN 77-195,131, FILED 6-1-2007.

JASON TURNER, EXAMINING ATTORNEY

**Int. Cl.: 35**

**Prior U.S. Cls.: 100, 101, and 102**

**United States Patent and Trademark Office**

**Reg. No. 3,570,460**

**Registered Feb. 3, 2009**

**SERVICE MARK  
PRINCIPAL REGISTER**

# LIQUID FOCUS

LIQUID FOCUS INC. (CONNECTICUT CORPORATION)  
1335 WOOD AVENUE  
BRIDGEPORT, CT 06604

FOR: ELECTRONIC COMMERCE SERVICES, NAMELY, PROVIDING INFORMATION ABOUT PRODUCTS VIA TELECOMMUNICATION NETWORKS FOR ADVERTISING AND SALES PURPOSES; DIRECT MARKETING SERVICES, IN CLASS 35 (U.S. CLS. 100, 101 AND 102).

FIRST USE 6-11-2007; IN COMMERCE 9-30-2007.

THE MARK CONSISTS OF STANDARD CHARACTERS WITHOUT CLAIM TO ANY PARTICULAR FONT, STYLE, SIZE, OR COLOR.

SN 77-196,626, FILED 6-4-2007.

LAURA HAMMEL, EXAMINING ATTORNEY

**Int. Cls.: 39, 41, 43, and 44**

**Prior U.S. Cls.: 100, 101, 105, and 107**

**United States Patent and Trademark Office**

**Reg. No. 3,570,461**

**Registered Feb. 3, 2009**

**SERVICE MARK  
PRINCIPAL REGISTER**

**RUBY PRINCESS**

PRINCESS CRUISE LINES, LTD. (BERMUDA CORPORATION)  
LEGAL DEPT.  
24305 TOWN CENTER DRIVE  
SANTA CLARITA, CA 91355

FOR: CRUISE SHIP SERVICES; TRANSPORTATION OF PASSENGERS BY SHIP; TRAVEL AND TOUR ARRANGEMENT SERVICES, IN CLASS 39 (U.S. CLS. 100 AND 105).

FIRST USE 11-4-2008; IN COMMERCE 11-4-2008.

FOR: SPORTS AND ENTERTAINMENT SERVICES, NAMELY, PROVIDING RECREATIONAL SERVICES IN THE NATURE OF SWIMMING, PADDLE TENNIS, PING PONG, BASKETBALL, VOLLEYBALL AND GOLF, PROVIDING FACILITIES FOR RECREATIONAL ACTIVITIES, NAMELY, MOVIES, DANCING, POOLSIDE AND WATER ACTIVITIES; ENTERTAINMENT, NAMELY, LIVE MUSICAL PERFORMANCES, LIVE CABARET PERFORMANCES, LIVE COMEDY PERFORMANCES AND LIVE VARIETY PERFORMANCES; EDUCATIONAL SERVICES, NAMELY, CONDUCTING CLASSES, DEMONSTRATIONS AND WORKSHOPS IN THE FIELDS OF PHYSICAL FITNESS TRAINING AND THE ARTS; CASINO AND GAMBLING SERVICES ON BOARD A CRUISE SHIP OR IN CONNECTION WITH CRUISE SHIP TRAVEL SERVICES, IN CLASS 41 (U.S. CLS. 100, 101 AND 107).

FIRST USE 11-4-2008; IN COMMERCE 11-4-2008.

FOR: RESTAURANT AND BAR SERVICES ON BOARD A CRUISE SHIP OR IN CONNECTION WITH CRUISE SHIP TRAVEL SERVICES, IN CLASS 43 (U.S. CLS. 100 AND 101).

FIRST USE 11-4-2008; IN COMMERCE 11-4-2008.

FOR: HAIRDRESSING, MASSAGE AND HEALTH SPA SERVICES ON BOARD A CRUISE SHIP OR IN CONNECTION WITH CRUISE SHIP TRAVEL SERVICES, NAMELY, COSMETIC BODY CARE SERVICES, IN CLASS 44 (U.S. CLS. 100 AND 101).

FIRST USE 11-4-2008; IN COMMERCE 11-4-2008.

THE MARK CONSISTS OF STANDARD CHARACTERS WITHOUT CLAIM TO ANY PARTICULAR FONT, STYLE, SIZE, OR COLOR.

OWNER OF U.S. REG. NOS. 2,186,199, 2,757,656, AND OTHERS.

NO CLAIM IS MADE TO THE EXCLUSIVE RIGHT TO USE "RUBY", APART FROM THE MARK AS SHOWN.

SN 77-198,092, FILED 6-5-2007.

JANICE KIM, EXAMINING ATTORNEY

**Int. Cl.: 35**

**Prior U.S. Cls.: 100, 101, and 102**

**United States Patent and Trademark Office**

**Reg. No. 3,570,462**

**Registered Feb. 3, 2009**

**SERVICE MARK  
PRINCIPAL REGISTER**

**MAHOGANY HOUSE**

MAHOGANY & ASSOCIATES, INC. (NORTH  
CAROLINA CORPORATION)  
240 DEPOT STREET  
WAYNESVILLE, NC 28786

FOR: RETAIL FURNITURE STORES, IN CLASS 35  
(U.S. CLS. 100, 101 AND 102).

FIRST USE 7-15-2007; IN COMMERCE 7-15-2007.

OWNER OF U.S. REG. NO. 3,521,674.

NO CLAIM IS MADE TO THE EXCLUSIVE  
RIGHT TO USE "MAHOGANY", APART FROM  
THE MARK AS SHOWN.

THE COLOR(S) BROWN AND WHITE IS/ARE  
CLAIMED AS A FEATURE OF THE MARK.

THE MARK CONSISTS OF THE WORDS "MAHO-  
GANY HOUSE" IN WHITE LETTERING UPON A  
BROWN BACKGROUND.

SN 77-200,153, FILED 6-7-2007.

MARCIE MILONE, EXAMINING ATTORNEY

**Int. Cl.: 45**

**Prior U.S. Cls.: 100 and 101**

**United States Patent and Trademark Office**

**Reg. No. 3,570,463**

**Registered Feb. 3, 2009**

**SERVICE MARK  
PRINCIPAL REGISTER**

**FIRSTPASS ADVISOR**

TARGUS INFORMATION CORPORATION (DE-  
LAWARE CORPORATION)  
8010 TOWERS CRESCENT DRIVE, FIFTH FLOOR  
VIENNA, VA 22182

FOR: PROVIDING USER AUTHENTICATION  
SERVICES TO BUSINESSES IN E-COMMERCE  
TRANSACTIONS, NAMELY, AUTHENTICATING  
CUSTOMER USER PROVIDED INFORMATION IN  
THE NATURE OF PERSONAL IDENTIFICATION  
INFORMATION, OBTAINED FROM CUSTOMER  
REGISTRATION FORMS, IN CLASS 45 (U.S. CLS.  
100 AND 101).

FIRST USE 3-15-2007; IN COMMERCE 3-15-2007.

THE MARK CONSISTS OF STANDARD CHAR-  
ACTERS WITHOUT CLAIM TO ANY PARTICULAR  
FONT, STYLE, SIZE, OR COLOR.

NO CLAIM IS MADE TO THE EXCLUSIVE  
RIGHT TO USE "ADVISOR", APART FROM THE  
MARK AS SHOWN.

SN 77-201,262, FILED 6-8-2007.

LINDA ESTRADA, EXAMINING ATTORNEY

Int. Cl.: 9

Prior U.S. Cls.: 21, 23, 26, 36, and 38

Reg. No. 3,570,464

United States Patent and Trademark Office

Registered Feb. 3, 2009

TRADEMARK  
PRINCIPAL REGISTER



MCAHON, DAVID (UNITED STATES INDIVIDUAL)  
4529 CEDAR PATH DRIVE  
DALLAS, TX 75211

THE MARK CONSISTS OF THE WORDS "DAVIDCHICKEN.COM" OVERLAID ON A CHICKEN DESIGN.

FOR: AUDIO RECORDINGS FEATURING CHILDREN'S MUSIC AND FAMILY MUSIC, IN CLASS 9 (U.S. CLS. 21, 23, 26, 36 AND 38).

SN 77-204,708, FILED 6-13-2007.

FIRST USE 1-1-2001; IN COMMERCE 1-1-2001.

HOWARD B. LEVINE, EXAMINING ATTORNEY



**Int. Cl.: 30**

**Prior U.S. Cl.: 46**

**United States Patent and Trademark Office**

**Reg. No. 3,570,465**

**Registered Feb. 3, 2009**

**TRADEMARK  
PRINCIPAL REGISTER**



SWEET SHOP CANDIES, INC. (TEXAS CORPORATION)  
1316 INDUSTRIAL ROAD  
MOUNT PLEASANT, TX 75455

FOR: CHOCOLATE CANDIES, IN CLASS 30 (U.S. CL. 46).

FIRST USE 6-0-2007; IN COMMERCE 6-0-2007.

THE MARK CONSISTS OF STYLIZED S.

SN 77-204,802, FILED 6-13-2007.

INGA ERVIN, EXAMINING ATTORNEY

**Int. Cl.: 25**

**Prior U.S. Cls.: 22 and 39**

**United States Patent and Trademark Office**

**Reg. No. 3,570,466**

**Registered Feb. 3, 2009**

**TRADEMARK  
PRINCIPAL REGISTER**

**Outlaw Farmer**

HOSKINS, MATT L. (UNITED STATES INDIVIDUAL)  
PO BOX 97  
KIRKLIN, IN 46050

THE MARK CONSISTS OF STANDARD CHARACTERS WITHOUT CLAIM TO ANY PARTICULAR FONT, STYLE, SIZE, OR COLOR.

FOR: CAPS WITH VISORS; HATS; SHIRT FRONTS; SHIRTS; T-SHIRTS, IN CLASS 25 (U.S. CLS. 22 AND 39).

SN 77-206,667, FILED 6-14-2007.

FIRST USE 10-15-2007; IN COMMERCE 3-1-2008.

JESSICA A. POWERS, EXAMINING ATTORNEY

**Int. Cl.: 16**

**Prior U.S. Cls.: 2, 5, 22, 23, 29, 37, 38, and 50**

**Reg. No. 3,570,467**

**United States Patent and Trademark Office**

**Registered Feb. 3, 2009**

**TRADEMARK  
PRINCIPAL REGISTER**

**XPANZ**

MEADWESTVACO CORPORATION (DELAWARE CORPORATION)

MEADWESTVACO CORPORATE CENTER

11013 WEST BROAD STREET

GLEN ALLEN, VA 23060

FOR: CLIPBOARDS; ZIPPERED POUCHES USED TO STORE ITEMS SUCH AS PENS, PENCILS, HIGHLIGHTERS AND NOTEPADS , IN CLASS 16 (U.S. CLS. 2, 5, 22, 23, 29, 37, 38 AND 50).

FIRST USE 11-12-2002; IN COMMERCE 11-12-2002.

THE MARK CONSISTS OF STANDARD CHARACTERS WITHOUT CLAIM TO ANY PARTICULAR FONT, STYLE, SIZE, OR COLOR.

OWNER OF U.S. REG. NOS. 2,541,267 AND 2,541,268.

NO CLAIM IS MADE TO THE EXCLUSIVE RIGHT TO USE "EXPANDS", APART FROM THE MARK AS SHOWN.

SN 77-207,288, FILED 6-15-2007.

RON FAIRBANKS, EXAMINING ATTORNEY

**Int. Cl.: 43**

**Prior U.S. Cls.: 100 and 101**

**United States Patent and Trademark Office**

**Reg. No. 3,570,468**

**Registered Feb. 3, 2009**

**SERVICE MARK  
PRINCIPAL REGISTER**

# SLS Hotels

SBE ENTERTAINMENT GROUP, LLC (CALIFORNIA LIMITED LIABILITY COMPANY)  
8000 BEVERLY BOULEVARD  
LOS ANGELES, CA 90048

FOR: HOTEL SERVICES; HOTEL SERVICES FOR PREFERRED CUSTOMERS; HOTEL, BAR AND RESTAURANT SERVICES; HOTELS; RESORT HOTELS, IN CLASS 43 (U.S. CLS. 100 AND 101).

FIRST USE 6-24-2008; IN COMMERCE 11-1-2008.

THE MARK CONSISTS OF STANDARD CHARACTERS WITHOUT CLAIM TO ANY PARTICULAR FONT, STYLE, SIZE, OR COLOR.

NO CLAIM IS MADE TO THE EXCLUSIVE RIGHT TO USE "HOTELS", APART FROM THE MARK AS SHOWN.

SN 77-207,312, FILED 6-15-2007.

MIDGE BUTLER, EXAMINING ATTORNEY

**Int. Cl.: 3**

**Prior U.S. Cls.: 1, 4, 6, 50, 51, and 52**

**Reg. No. 3,570,469**

**United States Patent and Trademark Office**

**Registered Feb. 3, 2009**

---

**TRADEMARK  
PRINCIPAL REGISTER**

**COLORGENIUS**

NOXELL CORPORATION (MARYLAND COR-  
PORATION)  
11050 YORK ROAD  
HUNT VALLEY, MD 21030

THE MARK CONSISTS OF STANDARD CHAR-  
ACTERS WITHOUT CLAIM TO ANY PARTICULAR  
FONT, STYLE, SIZE, OR COLOR.

FOR: COSMETICS, IN CLASS 3 (U.S. CLS. 1, 4, 6, 50,  
51 AND 52).

SN 77-210,762, FILED 6-20-2007.

FIRST USE 6-9-2008; IN COMMERCE 6-9-2008.

SHAUNIA CARLYLE, EXAMINING ATTORNEY

**Int. Cls.: 16 and 21**

**Prior U.S. Cls.: 2, 5, 13, 22, 23, 29, 30, 33, 37, 38, 40,  
and 50**

**Reg. No. 3,570,470**

**United States Patent and Trademark Office**

**Registered Feb. 3, 2009**

**TRADEMARK  
PRINCIPAL REGISTER**



GEORGIA-PACIFIC CONSUMER PRODUCTS LP  
(DELAWARE LIMITED PARTNERSHIP)

GA030-41N

133 PEACHTREE STREET NE

ATLANTA, GA 30303

FOR: PAPER TOWELS, IN CLASS 16 (U.S. CLS. 2, 5,  
22, 23, 29, 37, 38 AND 50).

FIRST USE 7-1-2008; IN COMMERCE 7-1-2008.

FOR: DISPENSERS FOR PAPER TOWELS, IN  
CLASS 21 (U.S. CLS. 2, 13, 23, 29, 30, 33, 40 AND 50).

FIRST USE 7-1-2008; IN COMMERCE 7-1-2008.

THE MARK CONSISTS OF THE WORD "ASIO" IN  
A STYLIZED FORMAT.

SN 77-212,262, FILED 6-21-2007.

ROBERT C. CLARK JR., EXAMINING ATTORNEY

**Int. Cl.: 28**

**Prior U.S. Cls.: 22, 23, 38, and 50**

**Reg. No. 3,570,471**

**United States Patent and Trademark Office**

**Registered Feb. 3, 2009**

**TRADEMARK  
PRINCIPAL REGISTER**



NATIONAL HARBOUR LIMITED (HONG KONG  
LIMITED LIABILITY COMPANY)  
UNIT A14, 7/F., BLK. A  
3-5 WANG TAI RD, HOPLITE INDUSTRIAL CTR  
KOWLOON BAY, HONG KONG

FOR: CARD GAMES; CHILDREN'S MULTIPLE  
ACTIVITY TOYS; ELECTRONIC LEARNING TOYS;  
INFANT TOYS; CHECKER SETS; BALLS FOR  
GAMES; EXERCISE EQUIPMENT, NAMELY, VIR-  
TUAL REALITY TRAINING CYCLES; BODY  
BOARDS; CHESS SETS; PUZZLES; CHRISTMAS

TREE ORNAMENTS; FISHING TACKLE; TOY MO-  
BILES, IN CLASS 28 (U.S. CLS. 22, 23, 38 AND 50).

FIRST USE 8-1-2007; IN COMMERCE 11-26-2008.

NO CLAIM IS MADE TO THE EXCLUSIVE  
RIGHT TO USE "TOY", APART FROM THE MARK  
AS SHOWN.

SN 77-215,147, FILED 6-25-2007.

ELI HELLMAN, EXAMINING ATTORNEY

**Int. Cl.: 28**

**Prior U.S. Cls.: 22, 23, 38, and 50**

**United States Patent and Trademark Office**

**Reg. No. 3,570,472**

**Registered Feb. 3, 2009**

**TRADEMARK  
PRINCIPAL REGISTER**



NATIONAL HARBOUR LIMITED (HONG KONG  
LIMITED LIABILITY COMPANY)  
UNIT A14, 7/F., BLK. A  
3-5 WANG TAI RD, HOPLITE INDUSTRIAL CTR  
KOWLOON BAY, HONG KONG

FOR: CARD GAMES; CHILDREN'S MULTIPLE  
ACTIVITY TOYS; ELECTRONIC LEARNING TOYS;  
INFANT TOYS; CHECKER SETS; BALLS FOR  
GAMES; EXERCISE EQUIPMENT, NAMELY, VIR-  
TUAL REALITY TRAINING CYCLES; BODY  
BOARDS; CHESS SETS; PUZZLES; CHRISTMAS

TREE ORNAMENTS; FISHING TACKLE; TOY MO-  
BILES, IN CLASS 28 (U.S. CLS. 22, 23, 38 AND 50).

FIRST USE 8-1-2007; IN COMMERCE 11-26-2008.

NO CLAIM IS MADE TO THE EXCLUSIVE  
RIGHT TO USE "TOY", APART FROM THE MARK  
AS SHOWN.

SN 77-215,152, FILED 6-25-2007.

ELI HELLMAN, EXAMINING ATTORNEY



**Int. Cl.: 35**

**Prior U.S. Cls.: 100, 101, and 102**

**United States Patent and Trademark Office**

**Reg. No. 3,570,473**

**Registered Feb. 3, 2009**

**SERVICE MARK  
PRINCIPAL REGISTER**

**Maximizing.....ROIT  
Return on Invested Time.**

FUSCO, GERARD (UNITED STATES INDIVIDUAL)  
15406 STONE GABLES LANE  
HOUSTON, TX 77044

FOR: PROVIDING CONSULTING SERVICES TO THE MANUFACTURING SECTOR, SPECIFICALLY, PROVIDING ASSISTANCE IN THE MANAGEMENT OF BUSINESS ACTIVITIES, IN CLASS 35 (U.S. CLS. 100, 101 AND 102).

FIRST USE 7-11-2007; IN COMMERCE 7-11-2007.

THE MARK CONSISTS OF STANDARD CHARACTERS WITHOUT CLAIM TO ANY PARTICULAR FONT, STYLE, SIZE, OR COLOR.

SN 77-218,474, FILED 6-28-2007.

RICHARD WHITE, EXAMINING ATTORNEY

**Int. Cl.: 3**

**Prior U.S. Cls.: 1, 4, 6, 50, 51, and 52**

**United States Patent and Trademark Office**

**Reg. No. 3,570,474**

**Registered Feb. 3, 2009**

**TRADEMARK  
PRINCIPAL REGISTER**

**DROP 'N GO**

MILLIKEN & COMPANY (DELAWARE CORPORATION)  
920 MILLIKEN ROAD  
M495  
SPARTANBURG, SC 29303

THE MARK CONSISTS OF STANDARD CHARACTERS WITHOUT CLAIM TO ANY PARTICULAR FONT, STYLE, SIZE, OR COLOR.

FOR: ALL PURPOSE CLEANING PREPARATIONS, IN CLASS 3 (U.S. CLS. 1, 4, 6, 50, 51 AND 52).

SN 77-219,349, FILED 6-29-2007.

FIRST USE 3-15-2007; IN COMMERCE 3-15-2007.

JULIE VEPPUMTHARA, EXAMINING ATTORNEY

**Int. Cl.: 9**

**Prior U.S. Cls.: 21, 23, 26, 36, and 38**

**Reg. No. 3,570,475**

**United States Patent and Trademark Office**

**Registered Feb. 3, 2009**

---

**TRADEMARK  
PRINCIPAL REGISTER**

# The Next Wave

SCUBA SONICS, INC. (TEXAS CORPORATION)  
1501 PLANTATION DRIVE  
SOUTHLAKE, TX 76092

FIRST USE 2-10-2008; IN COMMERCE 2-10-2008.

FOR: SIGNALING DEVICES, NAMELY, RAT-  
TLES AND ELECTRONIC SOUND-GENERATING  
DEVICES WITH AND WITHOUT LIGHTS, BOTH  
EMERGENCY AND NON-EMERGENCY, USED BY  
SCUBA DIVERS, BOTH BETWEEN INDIVIDUAL  
DIVERS AND AMONG GROUPS OF DIVERS, IN  
CLASS 9 (U.S. CLS. 21, 23, 26, 36 AND 38).

THE MARK CONSISTS OF STANDARD CHAR-  
ACTERS WITHOUT CLAIM TO ANY PARTICULAR  
FONT, STYLE, SIZE, OR COLOR.

SN 77-221,109, FILED 7-3-2007.

DEZMONA MIZELLE, EXAMINING ATTORNEY

**Int. Cl.: 25**

**Prior U.S. Cls.: 22 and 39**

**United States Patent and Trademark Office**

**Reg. No. 3,570,476**

**Registered Feb. 3, 2009**

**TRADEMARK  
PRINCIPAL REGISTER**

**ARISTOC**

MAGELLAN TEXTILE HOLDINGS LIMITED  
(HONG KONG CORPORATION)  
UNIT 1001, 10TH FLOOR, STAR HOUSE  
3 SALISBURY ROAD  
TSIMSHATSUI, HONG KONG

FOR: HOSIERY, LINGERIE, STOCKINGS,  
TIGHTS, SOCKS, PANTYHOSE, AND KNEE HIGHS,  
IN CLASS 25 (U.S. CLS. 22 AND 39).

FIRST USE 7-31-2008; IN COMMERCE 7-31-2008.

THE MARK CONSISTS OF STANDARD CHAR-  
ACTERS WITHOUT CLAIM TO ANY PARTICULAR  
FONT, STYLE, SIZE, OR COLOR.

THE WORDING "ARISTOC" HAS NO MEANING  
IN A FOREIGN LANGUAGE.

SN 77-222,671, FILED 7-5-2007.

AMOS T. MATTHEWS, JR., EXAMINING ATTOR-  
NEY

**Int. Cl.: 9**

**Prior U.S. Cls.: 21, 23, 26, 36, and 38**

**Reg. No. 3,570,477**

**United States Patent and Trademark Office**

**Registered Feb. 3, 2009**

**TRADEMARK  
PRINCIPAL REGISTER**

**OV**

OLYMPUS CORPORATION (JAPAN JOINT  
STOCK COMPANY)  
43-2, HATAGAYA 2-CHOME, SHIBUYA-KU  
TOKYO, JAPAN

FOR: IMAGING SYSTEM COMPRISED OF CAM-  
ERAS AND MICROSCOPIC AND MACROSCOPIC  
APPARATUSES FOR OBSERVING ANIMALS, TIS-  
SUES AND CELLS IN A RESEARCH LABORATORY  
ENVIRONMENT , IN CLASS 9 (U.S. CLS. 21, 23, 26, 36  
AND 38).

FIRST USE 4-2-2006; IN COMMERCE 4-2-2006.

THE MARK CONSISTS OF STANDARD CHAR-  
ACTERS WITHOUT CLAIM TO ANY PARTICULAR  
FONT, STYLE, SIZE, OR COLOR.

THE WORDING " OV" HAS NO MEANING IN A  
FOREIGN LANGUAGE.

SN 77-223,564, FILED 7-6-2007.

EDWARD NELSON, EXAMINING ATTORNEY

**Int. Cl.: 44**

**Prior U.S. Cls.: 100 and 101**

**United States Patent and Trademark Office**

**Reg. No. 3,570,478**

**Registered Feb. 3, 2009**

**SERVICE MARK  
PRINCIPAL REGISTER**

**CARIS COHEN DX**

CARIS DIAGNOSTICS, INC. (DELAWARE CORPORATION)  
8400 ESTERS BOULEVARD, SUITE 190  
IRVING, TX 75063

FOR: MEDICAL DIAGNOSTIC AND ANALYSIS SERVICES, NAMELY, PATHOLOGY DIAGNOSTIC SERVICE, IN CLASS 44 (U.S. CLS. 100 AND 101).

FIRST USE 8-1-2007; IN COMMERCE 8-1-2007.

THE MARK CONSISTS OF STANDARD CHARACTERS WITHOUT CLAIM TO ANY PARTICULAR FONT, STYLE, SIZE, OR COLOR.

NO CLAIM IS MADE TO THE EXCLUSIVE RIGHT TO USE "DX", APART FROM THE MARK AS SHOWN.

SN 77-226,088, FILED 7-10-2007.

ELLEN BURNS, EXAMINING ATTORNEY

**Int. Cl.: 44**

**Prior U.S. Cls.: 100 and 101**

**United States Patent and Trademark Office**

**Reg. No. 3,570,479**

**Registered Feb. 3, 2009**

**SERVICE MARK  
PRINCIPAL REGISTER**



CARIS DIAGNOSTICS, INC. (DELAWARE CORPORATION)  
8400 ESTERS BOULEVARD, SUITE 190  
IRVING, TX 75063

FOR: MEDICAL DIAGNOSTIC AND ANALYSIS SERVICES, NAMELY, PATHOLOGY DIAGNOSTIC SERVICES, IN CLASS 44 (U.S. CLS. 100 AND 101).

FIRST USE 8-1-2007; IN COMMERCE 8-1-2007.

NO CLAIM IS MADE TO THE EXCLUSIVE RIGHT TO USE "DX", APART FROM THE MARK AS SHOWN.

THE STIPPLING IS FOR SHADING PURPOSES ONLY.

SN 77-226,090, FILED 7-10-2007.

ELLEN BURNS, EXAMINING ATTORNEY

Int. Cl.: 44

Prior U.S. Cls.: 100 and 101

United States Patent and Trademark Office

Reg. No. 3,570,480

Registered Feb. 3, 2009

SERVICE MARK  
PRINCIPAL REGISTER



NORTH BROWARD HOSPITAL DISTRICT  
(FLORIDA SPECIAL TAXING DISTRICT CRE-  
ATED UNDER THE LAWS OF THE STATE OF  
FLORIDA)

303 S.E. 17TH STREET  
FORT LAUDERDALE, FL 33316

FOR: HEALTH CARE; PHYSICIAN SERVICES;  
MEDICAL SERVICES, NAMELY, MEDICAL DIAG-  
NOSTIC AND TREATMENT SERVICES; AND MED-  
ICAL CLINICS IN THE NATURE OF A WALK-IN  
CLINIC, IN CLASS 44 (U.S. CLS. 100 AND 101).

THE PORTION OF THE MARK COMPRISED OF  
A PLUS SIGN DESIGN IS NOT DISPLAYED IN THE  
COLOR RED OR A COLORABLE IMITATION  
THEREOF. APPLICANT DOES NOT USE AND WILL  
NOT USE THE PLUS SIGN DESIGN THAT APPEARS  
IN ITS MARK IN THE COLOR RED OR A COLOR-  
ABLE IMITATION THEREOF.

SN 77-226,558, FILED 7-11-2007.

FIRST USE 12-13-2007; IN COMMERCE 12-13-2007.

JANET LEE, EXAMINING ATTORNEY



**Int. Cl.: 31**

**Prior U.S. Cls.: 1 and 46**

**United States Patent and Trademark Office**

**Reg. No. 3,570,481**

**Registered Feb. 3, 2009**

**TRADEMARK  
PRINCIPAL REGISTER**

**PREMIUM GRAND PET BRAND 4  
LIFE**

MULTISERVICIOS 2001 S.A. DE C.V. (MEXICO  
CORPORATION)  
CIUDAD MANUEL DOBLADO S/N  
KM 1 CARRETERA LA PIEDAD  
SANTA ANA PACUECO, MEXICO 36910(MEX

FOR: PET FOOD; DOG FOOD, IN CLASS 31 (U.S.  
CLS. 1 AND 46).

FIRST USE 1-1-2006; IN COMMERCE 10-16-2008.

THE MARK CONSISTS OF STANDARD CHAR-  
ACTERS WITHOUT CLAIM TO ANY PARTICULAR  
FONT, STYLE, SIZE, OR COLOR.

NO CLAIM IS MADE TO THE EXCLUSIVE  
RIGHT TO USE "PREMIUM GRAND PET BRAND",  
APART FROM THE MARK AS SHOWN.

SN 77-226,907, FILED 7-11-2007.

JIM RINGLE, EXAMINING ATTORNEY

**Int. Cl.: 16**

**Prior U.S. Cls.: 2, 5, 22, 23, 29, 37, 38, and 50**

**United States Patent and Trademark Office**

**Reg. No. 3,570,482**

**Registered Feb. 3, 2009**

**TRADEMARK  
PRINCIPAL REGISTER**

INDIAN COUNTRY GAMING TODAY

FOUR DIRECTIONS, INC. (NEW YORK CORPORATION)  
2037 DREAM CATCHER PLAZA  
ONEIDA, NY 13421

OWNER OF U.S. REG. NOS. 2,886,105 AND 3,215,527.

FOR: MAGAZINES IN THE FIELD OF INDIAN GAMING, IN CLASS 16 (U.S. CLS. 2, 5, 22, 23, 29, 37, 38 AND 50).

NO CLAIM IS MADE TO THE EXCLUSIVE RIGHT TO USE "INDIAN COUNTRY GAMING", APART FROM THE MARK AS SHOWN.

FIRST USE 11-10-2008; IN COMMERCE 11-10-2008.

SN 77-227,639, FILED 7-12-2007.

THE MARK CONSISTS OF STANDARD CHARACTERS WITHOUT CLAIM TO ANY PARTICULAR FONT, STYLE, SIZE, OR COLOR.

KATHY DE JONGE, EXAMINING ATTORNEY

**Int. Cl.: 33**

**Prior U.S. Cls.: 47 and 49**

**United States Patent and Trademark Office**

**Reg. No. 3,570,483**

**Registered Feb. 3, 2009**

**TRADEMARK  
PRINCIPAL REGISTER**

**ADUENTUS**

O. PEIRO, HORACIO (UNITED STATES INDIVIDUAL)

8356 N.W. 30 TERRACE

DORAL, FL 33122

FOR: WINES, IN CLASS 33 (U.S. CLS. 47 AND 49).

FIRST USE 1-30-2008; IN COMMERCE 2-15-2008.

THE MARK CONSISTS OF STANDARD CHARACTERS WITHOUT CLAIM TO ANY PARTICULAR FONT, STYLE, SIZE, OR COLOR.

THE ENGLISH TRANSLATION OF THE LATIN WORD "ADUENTUS" IS A NEW ARRIVAL.

SN 77-227,713, FILED 7-12-2007.

BARBARA A. GOLD, EXAMINING ATTORNEY

**Int. Cl.: 16**

**Prior U.S. Cls.: 2, 5, 22, 23, 29, 37, 38, and 50**

**United States Patent and Trademark Office**

**Reg. No. 3,570,484**

**Registered Feb. 3, 2009**

**TRADEMARK  
PRINCIPAL REGISTER**

**JUST YOU & ME**

COPELAND, P. TAYLOR (UNITED STATES IN-  
DIVIDUAL)  
P. O. BOX 12260  
SAN LUIS OBISPO, CA 93406

FOR: CHILDREN'S BOOKS; A SERIES OF BOOKS  
ON CHILDREN AND FAMILY, IN CLASS 16 (U.S.  
CLS. 2, 5, 22, 23, 29, 37, 38 AND 50).

FIRST USE 7-28-2008; IN COMMERCE 7-28-2008.

THE MARK CONSISTS OF STANDARD CHAR-  
ACTERS WITHOUT CLAIM TO ANY PARTICULAR  
FONT, STYLE, SIZE, OR COLOR.

OWNER OF U.S. REG. NO. 3,074,051.

SN 77-232,031, FILED 7-17-2007.

DAVID TOOLEY, EXAMINING ATTORNEY

**Int. Cl.: 29**

**Prior U.S. Cl.: 46**

**United States Patent and Trademark Office**

**Reg. No. 3,570,485**

**Registered Feb. 3, 2009**

**TRADEMARK  
PRINCIPAL REGISTER**

**ONION CREEK FARMS**

ONION CREEK FARMS LLC (NEW YORK LIMITED LIABILITY COMPANY)  
15 CUTTER DRIVE  
ROCHESTER, NY 14624

FOR: HOT PEPPER JELLY, PICKLED JALAPENOS, PICKLES WITH PROCESSED HOT PEPPERS AND PROCESSED SHALLOTS; PROCESSED HOT PEPPERS, PEPPER SPREAD, PROCESSED PEANUTS, PICKLED SAUSAGES , IN CLASS 29 (U.S. CL. 46).

FIRST USE 9-18-2008; IN COMMERCE 9-18-2008.

THE MARK CONSISTS OF STANDARD CHARACTERS WITHOUT CLAIM TO ANY PARTICULAR FONT, STYLE, SIZE, OR COLOR.

NO CLAIM IS MADE TO THE EXCLUSIVE RIGHT TO USE "FARMS", APART FROM THE MARK AS SHOWN.

SN 77-232,233, FILED 7-18-2007.

CARYN GLASSER, EXAMINING ATTORNEY

**Int. Cl.: 41**

**Prior U.S. Cls.: 100, 101, and 107**

**United States Patent and Trademark Office**

**Reg. No. 3,570,486**

**Registered Feb. 3, 2009**

**SERVICE MARK  
PRINCIPAL REGISTER**

**BEHAVIORAL ARCHITECT**

CALIFORNIA UNIFIED SERVICE PROVIDERS,  
L.L.C. (CALIFORNIA LIMITED LIABILITY  
COMPANY)

SUITE 201  
3868 CARSON STREET  
TORRANCE, CA 90503

FOR: EDUCATIONAL SERVICES, NAMELY,  
PROVIDING INDIVIDUAL INSTRUCTION AND  
CONDUCTING CLASSES, SEMINARS, CONFEREN-  
CES AND WORKSHOPS IN THE FIELDS OF AUT-  
ISM, DEVELOPMENTAL DISABILITIES,  
LEARNING DISORDERS AND RELATED DISOR-  
DERS; REMEDIAL EDUCATIONAL SERVICES,  
NAMELY, PROVIDING INDIVIDUAL INSTRU-  
CTION AND CONDUCTING CLASSES, SEMINARS,  
CONFERENCES AND WORKSHOPS IN THE  
FIELDS OF AUTISM, DEVELOPMENTAL DISABIL-  
ITIES, LEARNING DISORDERS AND RELATED  
DISORDERS; PROVIDING COUNSELING FOR

LEARNING DISORDERS, IN CLASS 41 (U.S. CLS.  
100, 101 AND 107).

FIRST USE 11-5-2008; IN COMMERCE 11-5-2008.

THE MARK CONSISTS OF STANDARD CHAR-  
ACTERS WITHOUT CLAIM TO ANY PARTICULAR  
FONT, STYLE, SIZE, OR COLOR.

OWNER OF U.S. REG. NO. 3,293,652.

NO CLAIM IS MADE TO THE EXCLUSIVE  
RIGHT TO USE "BEHAVIORAL", APART FROM  
THE MARK AS SHOWN.

SN 77-232,246, FILED 7-18-2007.

KIMBERLY FRYE, EXAMINING ATTORNEY

**Int. Cl.: 36**

**Prior U.S. Cls.: 100, 101, and 102**

**United States Patent and Trademark Office**

**Reg. No. 3,570,487**

**Registered Feb. 3, 2009**

**SERVICE MARK  
PRINCIPAL REGISTER**

**PUT US TO WORK FOR YOU**

BANK OF AMERICA CORPORATION (DELA-  
WARE CORPORATION)  
100 NORTH TRYON STREET  
CHARLOTTE, NC 28255

FOR: BANKING SERVICES, NAMELY, CHECK-  
ING ACCOUNT SERVICES, OVERDRAFT PROTEC-  
TION SERVICES, CREDIT CARD AND CHECK  
CARD SERVICES, ON-LINE BANKING SERVICES,  
MERCHANT CARD PROCESSING SERVICES, DI-  
RECT PAYMENT SERVICES, AND ACCOUNT  
MANAGEMENT SERVICES, IN CLASS 36 (U.S.  
CLS. 100, 101 AND 102).

FIRST USE 11-0-2007; IN COMMERCE 11-0-2007.

THE MARK CONSISTS OF STANDARD CHAR-  
ACTERS WITHOUT CLAIM TO ANY PARTICULAR  
FONT, STYLE, SIZE, OR COLOR.

SN 77-234,944, FILED 7-20-2007.

TINA BROWN, EXAMINING ATTORNEY

**Int. Cl.: 19**

**Prior U.S. Cls.: 1, 12, 33, and 50**

**United States Patent and Trademark Office**

**Reg. No. 3,570,488**

**Registered Feb. 3, 2009**

**TRADEMARK  
PRINCIPAL REGISTER**



KING, SAMUEL L. (UNITED STATES INDIVIDUAL)  
678 GRANDVIEW LANE  
LOYSVILLE, PA 17047

FOR: NON-METAL BUILDING PRODUCTS, NAMELY, CONCRETE RETAINING WALL BLOCKS, RETAINING WALL BLOCKS, STONE VENEERS, ARCHITECTURAL STONE VENEERS, LEDGE STONE VENEERS, MOUNTAIN STONE VENEERS, COBBLE STONE VENEERS AND ARCHITECTURAL STONE VENEERS MADE OF CONCRETE, IN CLASS 19 (U.S. CLS. 1, 12, 33 AND 50).

FIRST USE 9-10-2008; IN COMMERCE 9-10-2008.

THE MARK CONSISTS OF A HAMMER AND CHISEL POSITIONED SUCH THAT A PORTION OF THE HAMMER CROSSES A PORTION OF THE CHISEL.

SN 77-237,394, FILED 7-24-2007.

JANICE L. MCMORROW, EXAMINING ATTORNEY



**Int. Cl.: 18**

**Prior U.S. Cls.: 1, 2, 3, 22, and 41**

**United States Patent and Trademark Office**

**Reg. No. 3,570,489**

**Registered Feb. 3, 2009**

**TRADEMARK  
PRINCIPAL REGISTER**



TIVERTON TRADING COMPANY, LLC (CALI-  
FORNIA LIMITED LIABILITY COMPANY)  
P. O. BOX 963  
LITTLE COMPTON, RI 02837

FOR: TOTE BAGS AND PURSES, IN CLASS 18  
(U.S. CLS. 1, 2, 3, 22 AND 41).

FIRST USE 11-7-2008; IN COMMERCE 11-7-2008.

THE MARK CONSISTS OF THE STYLIZED LET-  
TER "N" WITHIN A CIRCLE.

SN 77-238,450, FILED 7-25-2007.

TRICIA SONNEBORN, EXAMINING ATTORNEY

**Int. Cl.: 41**

**Prior U.S. Cls.: 100, 101, and 107**

**United States Patent and Trademark Office**

**Reg. No. 3,570,490**

**Registered Feb. 3, 2009**

**SERVICE MARK  
PRINCIPAL REGISTER**

**THE SEARCH FOR THE NEXT  
ELVIRA**

TWENTIETH CENTURY FOX FILM CORPORATION (DELAWARE CORPORATION)  
10201 WEST PICO BOULEVARD  
LOS ANGELES, CA 90035

FOR: ENTERTAINMENT SERVICES IN THE NATURE OF A TELEVISION SERIES IN THE REALITY GENRE, IN CLASS 41 (U.S. CLS. 100, 101 AND 107).

FIRST USE 10-13-2007; IN COMMERCE 10-13-2007.

THE MARK CONSISTS OF STANDARD CHARACTERS WITHOUT CLAIM TO ANY PARTICULAR FONT, STYLE, SIZE, OR COLOR.

"THE NAME(S), PORTRAIT(S), AND/OR SIGNATURE(S) SHOWN IN THE MARK IDENTIFIES "ELVIRA", WHOSE CONSENT(S) TO REGISTER IS SUBMITTED."

SN 77-242,310, FILED 7-30-2007.

RON FAIRBANKS, EXAMINING ATTORNEY

**Int. Cl.: 43**

**Prior U.S. Cls.: 100 and 101**

**United States Patent and Trademark Office**

**Reg. No. 3,570,491**

**Registered Feb. 3, 2009**

**SERVICE MARK  
PRINCIPAL REGISTER**



TAZINOS, INC. (WISCONSIN CORPORATION)  
SUITE 300  
400 W. BELL CT.  
OAK CREEK, WI 53154

THE MARK CONSISTS OF THE WORD "TAZINOS" WITH A CIRCLE AROUND THE LETTERS "T" AND "A".

FOR: RESTAURANT SERVICES, IN CLASS 43  
(U.S. CLS. 100 AND 101).

SN 77-245,494, FILED 8-2-2007.

FIRST USE 10-17-2008; IN COMMERCE 10-24-2008.

KIMBERLY PERRY, EXAMINING ATTORNEY

**Int. Cl.: 18**

**Prior U.S. Cls.: 1, 2, 3, 22, and 41**

**United States Patent and Trademark Office**

**Reg. No. 3,570,492**

**Registered Feb. 3, 2009**

**TRADEMARK  
PRINCIPAL REGISTER**

**GRETA CAVAZZONI**

GRETA CAVAZZONI LLC (NEW YORK LIMITED LIABILITY COMPANY)

4D

111 FOURTH AVENUE

NEW YORK, NY 10003

FOR: EVENING HANDBAGS; HANDBAG FRAMES; HANDBAGS; LEATHER HANDBAGS; STRAPS FOR HANDBAGS; WALLETS, IN CLASS 18 (U.S. CLS. 1, 2, 3, 22 AND 41).

FIRST USE 9-1-2007; IN COMMERCE 9-1-2007.

THE MARK CONSISTS OF STANDARD CHARACTERS WITHOUT CLAIM TO ANY PARTICULAR FONT, STYLE, SIZE, OR COLOR.

THE NAME(S), PORTRAIT(S), AND/OR SIGNATURE(S) SHOWN IN THE MARK IDENTIFIES "GRETA CAVAZZONI", WHOSE CONSENT(S) TO REGISTER IS SUBMITTED.

SN 77-248,421, FILED 8-6-2007.

DAVID TOOLEY, EXAMINING ATTORNEY

**Int. Cl.: 18**

**Prior U.S. Cls.: 1, 2, 3, 22, and 41**

**United States Patent and Trademark Office**

**Reg. No. 3,570,493**

**Registered Feb. 3, 2009**

**TRADEMARK  
PRINCIPAL REGISTER**

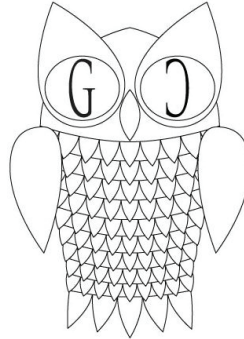

GRETA CAVAZZONI LLC (NEW YORK LIMITED LIABILITY COMPANY)

4D

111 FOURTH AVENUE  
NEW YORK, NY 10003

FOR: EVENING HANDBAGS; HANDBAG FRAMES; HANDBAGS; LEATHER HANDBAGS; STRAPS FOR HANDBAGS; WALLETS, IN CLASS 18 (U.S. CLS. 1, 2, 3, 22 AND 41).

FIRST USE 9-1-2007; IN COMMERCE 9-1-2007.

THE MARK CONSISTS OF AN OWL WITH THE LETTER "G" AND BACKWARDS LETTER "C" AS THE EYEBALLS.

SN 77-248,435, FILED 8-6-2007.

DAVID TOOLEY, EXAMINING ATTORNEY

**Int. Cl.: 9**

**Prior U.S. Cls.: 21, 23, 26, 36, and 38**

**United States Patent and Trademark Office**

**Reg. No. 3,570,494**

**Registered Feb. 3, 2009**

**TRADEMARK  
PRINCIPAL REGISTER**

# Animal Kingdom

MOTO DESIGN CO., LTD. (JAPAN CORPORATION)  
2F HIGASHIKANDA IN BLDG.  
2-10-17 HIGASHIKANDA  
CHIYODA-KU, TOKYO, JAPAN 101-0031

FOR: APPARATUS FOR SPEECH RECORDING AND REPLAYING; CALCULATORS; COMPUTER MOUSE; COMPUTER MOUSE, NAMELY, TOUCH-PADS, IN CLASS 9 (U.S. CLS. 21, 23, 26, 36 AND 38).

FIRST USE 7-10-2007; IN COMMERCE 9-19-2008.

THE MARK CONSISTS OF STANDARD CHARACTERS WITHOUT CLAIM TO ANY PARTICULAR FONT, STYLE, SIZE, OR COLOR.

SN 77-248,697, FILED 8-7-2007.

REBECCA SMITH, EXAMINING ATTORNEY

**Int. Cls.: 9 and 16**

**Prior U.S. Cls.: 2, 5, 21, 22, 23, 26, 29, 36, 37, 38, and 50**

**Reg. No. 3,570,495**

**United States Patent and Trademark Office**

**Registered Feb. 3, 2009**

**TRADEMARK  
PRINCIPAL REGISTER**

**FINGERTIP LAW**

FINGERTIP ENTERPRISES LLC (FLORIDA LIMITED LIABILITY COMPANY)  
9121 NORTH MILITARY TRAIL  
SUITE 107  
PALM BEACH GARDENS, FL 33410

FOR: ELECTRONIC PUBLICATIONS, NAMELY, GUIDES, BOOKS, MANUALS AND FORMS FEATURING BUSINESS AND LEGAL MATERIAL RECORDED ON COMPUTER MEDIA, IN CLASS 9 (U.S. CLS. 21, 23, 26, 36 AND 38).

FIRST USE 1-17-2008; IN COMMERCE 1-17-2008.

FOR: PRINTED GUIDES FOR BUSINESSES FOR USE IN BUSINESS MANAGEMENT, BUSINESS OPERATIONS, HUMAN RESOURCES, FINANCE, FRANCHISING AND DOING BUSINESS IN THE

UNITED STATES OF AMERICA, IN CLASS 16 (U.S. CLS. 2, 5, 22, 23, 29, 37, 38 AND 50).

FIRST USE 1-17-2008; IN COMMERCE 1-17-2008.

THE MARK CONSISTS OF STANDARD CHARACTERS WITHOUT CLAIM TO ANY PARTICULAR FONT, STYLE, SIZE, OR COLOR.

NO CLAIM IS MADE TO THE EXCLUSIVE RIGHT TO USE "LAW", APART FROM THE MARK AS SHOWN.

SN 77-250,452, FILED 8-8-2007.

KAREN BRACEY, EXAMINING ATTORNEY

**Int. Cls.: 9 and 16**

**Prior U.S. Cls.: 2, 5, 21, 22, 23, 26, 29, 36, 37, 38, and 50**

**Reg. No. 3,570,496**

**United States Patent and Trademark Office**

**Registered Feb. 3, 2009**

**TRADEMARK  
PRINCIPAL REGISTER**

**AT YOUR FINGERTIP**

FINGERTIP ENTERPRISES LLC (FLORIDA LIMITED LIABILITY COMPANY)  
SUITE 107  
9121 NORTH MILITARY TRAIL  
PALM BEACH GARDENS, FL 33410

FOR: ELECTRONIC PUBLICATIONS, NAMELY, GUIDES, BOOKS, MANUALS AND FORMS FEATURING BUSINESS AND LEGAL MATERIAL RECORDED ON COMPUTER MEDIA, IN CLASS 9 (U.S. CLS. 21, 23, 26, 36 AND 38).

FIRST USE 1-17-2008; IN COMMERCE 1-17-2008.

FOR: PRINTED GUIDES FOR BUSINESSES FOR USE IN BUSINESS MANAGEMENT, BUSINESS OP-

ERATIONS, HUMAN RESOURCES, FINANCE, FRANCHISING AND DOING BUSINESS IN THE UNITED STATES OF AMERICA, IN CLASS 16 (U.S. CLS. 2, 5, 22, 23, 29, 37, 38 AND 50).

FIRST USE 1-17-2008; IN COMMERCE 1-17-2008.

THE MARK CONSISTS OF STANDARD CHARACTERS WITHOUT CLAIM TO ANY PARTICULAR FONT, STYLE, SIZE, OR COLOR.

SN 77-250,727, FILED 8-8-2007.

KAREN BRACEY, EXAMINING ATTORNEY



**Int. Cl.: 11**

**Prior U.S. Cls.: 13, 21, 23, 31, and 34**

**United States Patent and Trademark Office**

**Reg. No. 3,570,497**

**Registered Feb. 3, 2009**

**TRADEMARK  
PRINCIPAL REGISTER**

**SONG**

**Bath & Kitchen Masterpieces  
The Leader in Style and Price**

SONG BATH LLC (CONNECTICUT LIMITED  
LIABILITY COMPANY)  
146 OLD KINGS HIGHWAY  
NEW CANAAN, CT 06840

FOR: BATHTUBS, SINKS, BATHTUB LEGS, AND  
BATHTUB DRAIN ASSEMBLIES, IN CLASS 11 (U.S.  
CLS. 13, 21, 23, 31 AND 34).

FIRST USE 7-7-2006; IN COMMERCE 7-7-2006.

NO CLAIM IS MADE TO THE EXCLUSIVE  
RIGHT TO USE "BATH & KITCHEN" AND "THE  
LEADER IN STYLE AND PRICE", APART FROM  
THE MARK AS SHOWN.

THE COLOR(S) RED IS/ARE CLAIMED AS A  
FEATURE OF THE MARK.

THE MARK CONSISTS OF THE WORD "SONG"  
IN CAPITAL RED LETTERS, ABOVE THE PHRASES  
"BATH & KITCHEN MASTERPIECES" AND "THE  
LEADER IN STYLE AND PRICE" IN BLACK LET-  
TERS.

SN 77-251,453, FILED 8-9-2007.

ALLISON HOLTZ, EXAMINING ATTORNEY

**Int. Cl.: 11**

**Prior U.S. Cls.: 13, 21, 23, 31, and 34**

**United States Patent and Trademark Office**

**Reg. No. 3,570,498**

**Registered Feb. 3, 2009**

**TRADEMARK  
PRINCIPAL REGISTER**

**Bath & Kitchen Masterpieces**

SONG BATH LLC (CONNECTICUT LIMITED  
LIABILITY COMPANY)  
146 OLD KINGS HIGHWAY  
NEW CANAAN, CT 06840

FOR: BATHTUBS, SINKS, BATHTUB LEGS, AND  
BATHTUB DRAIN ASSEMBLIES, IN CLASS 11 (U.S.  
CLS. 13, 21, 23, 31 AND 34).

FIRST USE 7-7-2006; IN COMMERCE 7-7-2006.

THE MARK CONSISTS OF STANDARD CHAR-  
ACTERS WITHOUT CLAIM TO ANY PARTICULAR  
FONT, STYLE, SIZE, OR COLOR.

NO CLAIM IS MADE TO THE EXCLUSIVE  
RIGHT TO USE "BATH & KITCHEN", APART  
FROM THE MARK AS SHOWN.

SN 77-251,469, FILED 8-9-2007.

ALLISON HOLTZ, EXAMINING ATTORNEY

**Int. Cl.: 25**

**Prior U.S. Cls.: 22 and 39**

**United States Patent and Trademark Office**

**Reg. No. 3,570,499**

**Registered Feb. 3, 2009**

**TRADEMARK  
PRINCIPAL REGISTER**

**DIVINE RIGHTS OF DENIM**

PHOENIX TEXTILE, INC. (CALIFORNIA CORPORATION)  
14600 SOUTH BROADWAY  
ATTN: JOSEPH TSE  
GARDENA, CA 90248

FOR: WOMEN'S CLOTHING, NAMELY, PANTS, JEANS, SKIRTS, SHORTS, DRESSES, JACKETS, COATS, T-SHIRTS, IN CLASS 25 (U.S. CLS. 22 AND 39).

FIRST USE 10-26-2007; IN COMMERCE 10-26-2007.

THE MARK CONSISTS OF STANDARD CHARACTERS WITHOUT CLAIM TO ANY PARTICULAR FONT, STYLE, SIZE, OR COLOR.

SN 77-252,646, FILED 8-10-2007.

GIANCARLO CASTRO, EXAMINING ATTORNEY

**Int. Cl.: 9**

**Prior U.S. Cls.: 21, 23, 26, 36, and 38**

**Reg. No. 3,570,500**

**United States Patent and Trademark Office**

**Registered Feb. 3, 2009**

---

**TRADEMARK  
PRINCIPAL REGISTER**

**LUCIDIUM**

NUVISION U.S., INC. (DELAWARE CORPORATION)  
SUITE A  
7901 E. PIERCE  
SCOTTSDALE, AZ 85257

FOR: HOME THEATRE PRODUCTS, NAMELY, TELEVISIONS, LCD TELEVISIONS, PLASMA TELEVISIONS AND FLAT PANEL TELEVISIONS, IN CLASS 9 (U.S. CLS. 21, 23, 26, 36 AND 38).

FIRST USE 9-6-2007; IN COMMERCE 1-3-2008.

THE MARK CONSISTS OF STANDARD CHARACTERS WITHOUT CLAIM TO ANY PARTICULAR FONT, STYLE, SIZE, OR COLOR.

SN 77-254,178, FILED 8-13-2007.

REBECCA SMITH, EXAMINING ATTORNEY

**Int. Cl.: 28**

**Prior U.S. Cls.: 22, 23, 38, and 50**

**United States Patent and Trademark Office**

**Reg. No. 3,570,501**

**Registered Feb. 3, 2009**

**TRADEMARK  
PRINCIPAL REGISTER**

**BLUE DESTROYER**

STROKIN, LLC (MINNESOTA LIMITED LIABILITY COMPANY)  
8085 CENTURY BOULEVARD  
CHASKA, MN 55318

THE MARK CONSISTS OF STANDARD CHARACTERS WITHOUT CLAIM TO ANY PARTICULAR FONT, STYLE, SIZE, OR COLOR.

FOR: GOLF CLUBS, IN CLASS 28 (U.S. CLS. 22, 23, 38 AND 50).

SN 77-254,422, FILED 8-14-2007.

FIRST USE 8-20-2007; IN COMMERCE 8-20-2007.

INGRID C. EULIN, EXAMINING ATTORNEY

**Int. Cl.: 14**

**Prior U.S. Cls.: 2, 27, 28, and 50**

**Reg. No. 3,570,502**

**United States Patent and Trademark Office**

**Registered Feb. 3, 2009**

---

**TRADEMARK  
PRINCIPAL REGISTER**

**IKTYS**

SWISS TIME CORPORATION (TEXAS COR-  
PORATION)  
3200 CURTIS DR.  
SUITE 200  
FORT WORTH, TX 76116

FOR: MECHANICAL AND AUTOMATIC  
WATCHES; TIMEPIECES AND CHRONOMETRIC  
INSTRUMENTS; JEWELRY WATCHES, IN CLASS 14  
(U.S. CLS. 2, 27, 28 AND 50).

FIRST USE 9-0-2008; IN COMMERCE 11-0-2008.

THE MARK CONSISTS OF STANDARD CHAR-  
ACTERS WITHOUT CLAIM TO ANY PARTICULAR  
FONT, STYLE, SIZE, OR COLOR.

SN 77-255,828, FILED 8-15-2007.

MARIAM MAHMOUDI, EXAMINING ATTORNEY

**Int. Cls.: 35 and 41**

**Prior U.S. Cls.: 100, 101, 102, and 107**

**United States Patent and Trademark Office**

**Reg. No. 3,570,503**

**Registered Feb. 3, 2009**

**SERVICE MARK  
PRINCIPAL REGISTER**



ROSENBERG & ASSOCIATES, INC. (NEW JERSEY CORPORATION)  
SUITE 201  
425 EAGLE ROCK AVENUE  
ROSELAND, NJ 07068

FOR: STENOGRAPHIC TRANSCRIPTION, IN CLASS 35 (U.S. CLS. 100, 101 AND 102).

FIRST USE 8-26-2008; IN COMMERCE 8-26-2008.

FOR: PHOTOGRAPHIC AND VIDEO SERVICES, NAMELY, PHOTOGRAPHIC AND VIDEO CAPTURE, IN CLASS 41 (U.S. CLS. 100, 101 AND 107).

FIRST USE 4-1-2008; IN COMMERCE 4-1-2008.

THE COLOR(S) MAGENTA AND WHITE IS/ARE CLAIMED AS A FEATURE OF THE MARK.

THE MARK CONSISTS OF ALL LOWER CASE; SINGLE TERM "DEPOCAST" WHERE "DEPO" APPEARS IN MAGENTA AGAINST A WHITE BACKGROUND AND "CAST" APPEARS IN WHITE AGAINST A MAGENTA BACKGROUND. APPEARING ON THE LINE BENEATH DEPOCAST AND ON THE RIGHT OF THE VERTICAL OF THE "P" IN THAT TERM ARE THE ITALICIZED WORDS "SYNCHRONIZED DEPOSITIONS FOR YOUR VIDEO MP3 PLAYER" (NO QUOTES) IN MAGENTA AGAINST A WHITE BACKGROUND.

SN 77-256,692, FILED 8-16-2007.

BARBARA BROWN, EXAMINING ATTORNEY

**Int. Cl.: 30**

**Prior U.S. Cl.: 46**

**United States Patent and Trademark Office**

**Reg. No. 3,570,504**

**Registered Feb. 3, 2009**

**TRADEMARK  
PRINCIPAL REGISTER**

**TERRA NOSTRA ORGANIC**

FLORES, KARLO (CANADA INDIVIDUAL), DBA  
KFM FOODS INTERNATIONAL,  
2385 BURRARD STREET  
VANCOUVER, CANADA V6J3J2

FOR: CANDY WITH COCOA; CHOCOLATE CANDIES; CHOCOLATE; CHOCOLATE BARS; CHOCOLATE COVERED NUTS; CHOCOLATE TRUFFLES; MILK CHOCOLATE, IN CLASS 30 (U.S. CL. 46).

FIRST USE 8-30-2001; IN COMMERCE 8-30-2001.

THE MARK CONSISTS OF STANDARD CHARACTERS WITHOUT CLAIM TO ANY PARTICULAR FONT, STYLE, SIZE, OR COLOR.

NO CLAIM IS MADE TO THE EXCLUSIVE RIGHT TO USE "ORGANIC", APART FROM THE MARK AS SHOWN.

THE FOREIGN WORDING IN THE MARK TRANSLATES INTO ENGLISH AS OUR LAND .

SN 77-258,492, FILED 8-17-2007.

JEFF DEFORD, EXAMINING ATTORNEY



**Int. Cl.: 35**

**Prior U.S. Cls.: 100, 101, and 102**

**United States Patent and Trademark Office**

**Reg. No. 3,570,505**

**Registered Feb. 3, 2009**

**SERVICE MARK  
PRINCIPAL REGISTER**

**GLOBAL LEGACY**

HUNTER, DENNIS R. (UNITED STATES INDIVIDUAL)  
520 MENDOCINO AVENUE  
SUITE 261  
SANTA ROSA, CA 954015255

FOR: ECONOMIC CONSULTING AND INFORMATION FOR THE INDUSTRIAL AND COMMERCIAL SECTORS FOR PLANNING, ORGANIZING, MONITORING AND CARRYING OUT UNIQUE AND COMPLEX PROJECTS IN DIFFERENT SECTORS OF ONE OR SEVERAL COMPANIES, IN CLASS 35 (U.S. CLS. 100, 101 AND 102).

FIRST USE 9-22-2007; IN COMMERCE 9-22-2007.

THE MARK CONSISTS OF STANDARD CHARACTERS WITHOUT CLAIM TO ANY PARTICULAR FONT, STYLE, SIZE, OR COLOR.

NO CLAIM IS MADE TO THE EXCLUSIVE RIGHT TO USE "GLOBAL", APART FROM THE MARK AS SHOWN.

SN 77-259,333, FILED 8-20-2007.

SETH A. RAPPAPORT, EXAMINING ATTORNEY

**Int. Cl.: 9**

**Prior U.S. Cls.: 21, 23, 26, 36, and 38**

**United States Patent and Trademark Office**

**Reg. No. 3,570,506**

**Registered Feb. 3, 2009**

**TRADEMARK  
PRINCIPAL REGISTER**

**REEL ESTATE TYCOON**

WMS GAMING INC. (DELAWARE CORPORATION)

800 SOUTH NORTHPOINT BOULEVARD

WAUKEGAN, IL 60085

FOR: GAMING MACHINES THAT GENERATE OR DISPLAY WAGER OUTCOMES; GAMING SOFTWARE THAT GENERATES OR DISPLAYS WAGER OUTCOMES OF GAMING MACHINES, IN CLASS 9 (U.S. CLS. 21, 23, 26, 36 AND 38).

FIRST USE 11-18-2008; IN COMMERCE 11-18-2008.

THE MARK CONSISTS OF STANDARD CHARACTERS WITHOUT CLAIM TO ANY PARTICULAR FONT, STYLE, SIZE, OR COLOR.

OWNER OF U.S. REG. NO. 2,319,796.

NO CLAIM IS MADE TO THE EXCLUSIVE RIGHT TO USE "TYCOON", APART FROM THE MARK AS SHOWN.

SN 77-259,461, FILED 8-20-2007.

ALEXANDER L. POWERS, EXAMINING ATTORNEY

**Int. Cl.: 41**

**Prior U.S. Cls.: 100, 101, and 107**

**United States Patent and Trademark Office**

**Reg. No. 3,570,507**

**Registered Feb. 3, 2009**

**SERVICE MARK  
PRINCIPAL REGISTER**

**ATHLETE UP**

ACCELERATION PRODUCTS, INC. (NORTH DA-  
KOTA CORPORATION)  
2301 25TH STREET SOUTH  
SUITE E  
FARGO, ND 58103

FOR: EDUCATIONAL SERVICES, NAMELY,  
CONDUCTING SEMINARS IN THE FIELD OF EX-  
ERCISE AND SPORT TRAINING; SPORT SKILLS  
TRAINING INSTRUCTION; PHYSICAL FITNESS  
INSTRUCTION, IN CLASS 41 (U.S. CLS. 100, 101  
AND 107).

FIRST USE 7-18-2007; IN COMMERCE 7-18-2007.

THE MARK CONSISTS OF STANDARD CHAR-  
ACTERS WITHOUT CLAIM TO ANY PARTICULAR  
FONT, STYLE, SIZE, OR COLOR.

SN 77-260,835, FILED 8-21-2007.

ALLISON SCHRODY, EXAMINING ATTORNEY

**Int. Cl.: 5**

**Prior U.S. Cls.: 6, 18, 44, 46, 51, and 52**

**Reg. No. 3,570,508**

**United States Patent and Trademark Office**

**Registered Feb. 3, 2009**

---

**TRADEMARK  
PRINCIPAL REGISTER**

# Slentiva

METAGENICS, INC. (DELAWARE CORPORATION)  
100 AVENIDA LA PATA  
SAN CLEMENTE, CA 92673

THE MARK CONSISTS OF STANDARD CHARACTERS WITHOUT CLAIM TO ANY PARTICULAR FONT, STYLE, SIZE, OR COLOR.

FOR: DIETARY SUPPLEMENTS, IN CLASS 5 (U.S. CLS. 6, 18, 44, 46, 51 AND 52).

SN 77-262,196, FILED 8-22-2007.

FIRST USE 12-17-2007; IN COMMERCE 12-17-2007.

ALICIA COLLINS, EXAMINING ATTORNEY

**Int. Cl.: 37**

**Prior U.S. Cls.: 100, 103, and 106**

**United States Patent and Trademark Office**

**Reg. No. 3,570,509**

**Registered Feb. 3, 2009**

**SERVICE MARK  
PRINCIPAL REGISTER**

**PASO ROBLES**

CARMA PASO ROBLES LLC (TEXAS LIMITED  
LIABILITY COMPANY)  
9737 GREAT HILLS TRAIL, SUITE 260  
AUSTIN, TX 78759

FOR: REAL ESTATE DEVELOPMENT SERVICES  
AND DEVELOPMENT OF MASTER PLANNED  
COMMERCIAL AND RESIDENTIAL COMMUNI-  
TIES, IN CLASS 37 (U.S. CLS. 100, 103 AND 106).

FIRST USE 2-7-2007; IN COMMERCE 2-7-2007.

THE MARK CONSISTS OF STANDARD CHAR-  
ACTERS WITHOUT CLAIM TO ANY PARTICULAR  
FONT, STYLE, SIZE, OR COLOR.

THE FOREIGN WORDING IN THE MARK  
TRANSLATES INTO ENGLISH AS PASS IN THE  
OAKS.

SN 77-262,773, FILED 8-23-2007.

SARA THOMAS, EXAMINING ATTORNEY

Int. Cl.: 9

Prior U.S. Cls.: 21, 23, 26, 36, and 38

United States Patent and Trademark Office

Reg. No. 3,570,510

Registered Feb. 3, 2009

TRADEMARK  
PRINCIPAL REGISTER



POOLE PRODUCTIONS, LLC (TEXAS LIMITED LIABILITY COMPANY)  
P.O. BOX 16686  
SUGAR LAND, TX 77496

FOR: CHILDREN'S EDUCATIONAL MUSIC CDS AND DVDS, IN CLASS 9 (U.S. CLS. 21, 23, 26, 36 AND 38).

FIRST USE 11-1-2008; IN COMMERCE 11-18-2008.

THE COLOR(S) GREEN, RED, LIGHT BLUE, DARK BLUE, PINK, YELLOW, ORANGE, BROWN, BEIGE, BLACK, WHITE, PURPLE, AND PINK IS/ARE CLAIMED AS A FEATURE OF THE MARK.

THE MARK CONSISTS OF, ON THE LEFT, BALLOONS OF RED, LIGHT BLUE (FRONTMOST), GREEN (BACKMOST), AND PURPLE, AND A CASCADE OF FLOWERS BEING PINK, YELLOW, LIGHT BLUE, YELLOW, LIGHT BLUE, RED, DARK BLUE, PURPLE, LIGHT BLUE, THREE RED/DARK-BLUE PAIRS, AND LIGHT BLUE FROM TOP CENTER TO BOTTOM RIGHT, WITH GREEN LEAVES

BEING MIXED THEREIN, AND A PINK BANNER IN THE BACKGROUND. AT BOTTOM CENTER IS A HORSE AND ROOSTER IN A YELLOW BALLOON. THE HORSE IS MOSTLY BROWN, WITH BEIGE AROUND EARS AND SNOUT, WHITE EYES, AND PINK LIPS, WITH DARK BLUE, RED, YELLOW, AND PURPLE MANE HAIR. THE ROOSTER IS BEIGE WITH WHITE EYES, ORANGE BEAK, AND RED JOWLS AND MULTICOLORED COMB BEING RED, DARK BLUE, YELLOW, AND PURPLE. BOTH HORSE AND ROOSTER HAVE BLACK PUPILS. "APRENDAMOS INGLÉS" IS WHITE; "SPANISH" IS YELLOW; "Y" IS WHITE; "FRANK Y PACO" IS BLACK. THE BACKGROUND IS A YELLOW-TO-PINK (TOP-TO-BOTTOM) GRADUATED FILL.

THE ENGLISH TRANSLATION OF "APRENDAMOS INGLÉS CON FRANK Y PACO" IS LET'S LEARN ENGLISH WITH FRANK AND PACO.

SN 77-264,946, FILED S.R. 8-27-2007; AM. P.R. 12-6-2007.

BRENDAN REGAN, EXAMINING ATTORNEY

**Int. Cl.: 35**

**Prior U.S. Cls.: 100, 101, and 102**

**United States Patent and Trademark Office**

**Reg. No. 3,570,511**

**Registered Feb. 3, 2009**

**SERVICE MARK  
PRINCIPAL REGISTER**

**ECOFOOD**

SPECIALTY NUTRITION GROUP INC. (FLORIDA CORPORATION)  
2971 N.E. 27TH AVENUE  
LIGHTHOUSE POINT, FL 33064

FOR: ON-LINE RETAIL STORE SERVICES FEATURING ORGANICALLY GROWN AND ENVIRONMENTALLY CONSCIOUS FOOD PRODUCTS; WHOLESALE STORES FEATURING ORGANICALLY GROWN AND ENVIRONMENTALLY CONSCIOUS FOOD PRODUCTS, IN CLASS 35 (U.S. CLS. 100, 101 AND 102).

FIRST USE 4-30-2008; IN COMMERCE 10-30-2008.

THE MARK CONSISTS OF STANDARD CHARACTERS WITHOUT CLAIM TO ANY PARTICULAR FONT, STYLE, SIZE, OR COLOR.

SN 77-265,302, FILED 8-27-2007.

MICHAEL TANNER, EXAMINING ATTORNEY

**Int. Cl.: 38**

**Prior U.S. Cls.: 100, 101, and 104**

**United States Patent and Trademark Office**

**Reg. No. 3,570,512**

**Registered Feb. 3, 2009**

**SERVICE MARK  
PRINCIPAL REGISTER**

**IN THE BAND**

HEALEY, THOMAS (UNITED STATES INDIVIDUAL)  
7025 GREATWOOD TRAIL  
ALPHARETTA, GA 30005

FOR: BROADCASTING SERVICES, NAMELY, WEBCASTING AND STREAMING OF AUDIO, VIDEO AND MULTIMEDIA CONTENT VIA THE INTERNET, IN CLASS 38 (U.S. CLS. 100, 101 AND 104).

FIRST USE 11-15-2007; IN COMMERCE 11-15-2007.

THE MARK CONSISTS OF STANDARD CHARACTERS WITHOUT CLAIM TO ANY PARTICULAR FONT, STYLE, SIZE, OR COLOR.

SN 77-266,497, FILED 8-28-2007.

ANNE MADDEN, EXAMINING ATTORNEY



**Int. Cl.: 39**

**Prior U.S. Cls.: 100 and 105**

**United States Patent and Trademark Office**

**Reg. No. 3,570,513**

**Registered Feb. 3, 2009**

**SERVICE MARK  
PRINCIPAL REGISTER**



ZILBERBERG, MENDEL (UNITED STATES INDIVIDUAL)  
6619 THIRTEENTH AVENUE  
BROOKLYN, NY 11219

FOR: MEDICAL TOURISM SERVICES, NAMELY, MAKING TRANSPORTATION RESERVATIONS AND BOOKINGS FOR TRAVEL TO ANOTHER COUNTRY IN ORDER TO OBTAIN HEALTH CARE, IN CLASS 39 (U.S. CLS. 100 AND 105).

FIRST USE 9-1-2007; IN COMMERCE 9-1-2007.

NO CLAIM IS MADE TO THE EXCLUSIVE RIGHT TO USE "YOUR JOURNEY TO QUALITY MEDICAL CARE", APART FROM THE MARK AS SHOWN.

THE COLOR(S) RED AND GREY IS/ARE CLAIMED AS A FEATURE OF THE MARK.

THE MARK CONSISTS OF A STYLIZED DESIGN OF A HUMAN BEING CONSISTING OF TWO CURVED, GREY LINES THAT CONVERGE AROUND THEIR CENTERS TO FORM A TORSO AND LIMBS, A RED DOT SYMBOLIZING THE HEAD, AND TWO PARALLEL, RED CIRCLES IN FRONT OF THE GREY LINES, WITH THE ENDS OF EACH CIRCLE FADING NEXT TO THE GREY LINES TO GIVE THE IMPRESSION THAT THE CIRCLES GO AROUND THE LINES; THE WORD "BESTMED" IN RED; THE WORD "JOURNEYS" IN GREY WITH THE LETTER "J" REPLACED BY A GREY STHETOSCOPE; AND THE WORDS "YOUR JOURNEY TO QUALITY MEDICAL CARE" IN GREY, ALL IN A CLEAR, TRANSPARENT BACKGROUND.

SN 77-266,508, FILED 8-28-2007.

MICHAEL WEBSTER, EXAMINING ATTORNEY

**Int. Cl.: 19**

**Prior U.S. Cls.: 1, 12, 33, and 50**

**United States Patent and Trademark Office**

**Reg. No. 3,570,514**

**Registered Feb. 3, 2009**

**TRADEMARK  
PRINCIPAL REGISTER**

**LUMBERMAN**

BRADLEY, SEAN (UNITED STATES INDIVIDUAL)  
4221 LOMBARD STREET  
DULUTH, MN 55804

THE MARK CONSISTS OF STANDARD CHARACTERS WITHOUT CLAIM TO ANY PARTICULAR FONT, STYLE, SIZE, OR COLOR.

FOR: FLOOR BOARDS, IN CLASS 19 (U.S. CLS. 1, 12, 33 AND 50).

SN 77-267,245, FILED 8-29-2007.

FIRST USE 9-15-2008; IN COMMERCE 9-15-2008.

RICHARD A. STRASER, EXAMINING ATTORNEY

**Int. Cl.: 36**

**Prior U.S. Cls.: 100, 101, and 102**

**United States Patent and Trademark Office**

**Reg. No. 3,570,515**

**Registered Feb. 3, 2009**

**SERVICE MARK  
PRINCIPAL REGISTER**

**WINDGENERATIONS**

SIERRA PACIFIC POWER COMPANY (NEVADA  
CORPORATION)  
6100 NEIL ROAD  
RENO, NV 89520

FOR: PROVIDING REBATES AS INCENTIVES  
FOR THE PURCHASE AND INSTALLATION OF  
ENERGY-EFFICIENT RENEWABLE ENERGY DE-  
VICES AND COMPONENTS, IN CLASS 36 (U.S. CLS.  
100, 101 AND 102).

FIRST USE 8-0-2007; IN COMMERCE 9-4-2008.

THE MARK CONSISTS OF STANDARD CHAR-  
ACTERS WITHOUT CLAIM TO ANY PARTICULAR  
FONT, STYLE, SIZE, OR COLOR.

OWNER OF U.S. REG. NO. 3,092,582.

SN 77-267,376, FILED 8-29-2007.

REBECCA SMITH, EXAMINING ATTORNEY

**Int. Cl.: 36**

**Prior U.S. Cls.: 100, 101, and 102**

**United States Patent and Trademark Office**

**Reg. No. 3,570,516**

**Registered Feb. 3, 2009**

**SERVICE MARK  
PRINCIPAL REGISTER**

**HYDROGENERATIONS**

SIERRA PACIFIC POWER COMPANY (NEVADA  
CORPORATION)  
6100 NEIL ROAD  
RENO, NV 89520

FOR: PROVIDING REBATES AS INCENTIVES  
FOR THE PURCHASE AND INSTALLATION OF  
ENERGY-EFFICIENT RENEWABLE ENERGY DE-  
VICES AND COMPONENTS, IN CLASS 36 (U.S. CLS.  
100, 101 AND 102).

FIRST USE 8-0-2007; IN COMMERCE 9-4-2008.

THE MARK CONSISTS OF STANDARD CHAR-  
ACTERS WITHOUT CLAIM TO ANY PARTICULAR  
FONT, STYLE, SIZE, OR COLOR.

OWNER OF U.S. REG. NO. 3,092,582.

SN 77-267,412, FILED 8-29-2007.

REBECCA SMITH, EXAMINING ATTORNEY

**Int. Cls.: 35 and 37**

**Prior U.S. Cls.: 100, 101, 102, 103, and 106**

**United States Patent and Trademark Office**

**Reg. No. 3,570,517**

**Registered Feb. 3, 2009**

**SERVICE MARK  
PRINCIPAL REGISTER**

WATER HOUSE ON MAIN STREET

MAIN STREET STATION BRECKENRIDGE (DE-  
LAWARE LIMITED LIABILITY COMPANY)  
100 E. THOMAS PLACE  
P.O. BOX 2770; ATTENTION SHARON COLE  
AVON, CO 81620

FOR: REAL ESTATE MARKETING SERVICES IN  
THE FIELD OF CONDOMINIUMS, APARTMENTS  
AND LOFTS , IN CLASS 35 (U.S. CLS. 100, 101 AND  
102).

FIRST USE 4-1-2008; IN COMMERCE 4-1-2008.

FOR: REAL ESTATE DEVELOPMENT, IN CLASS  
37 (U.S. CLS. 100, 103 AND 106).

FIRST USE 4-1-2008; IN COMMERCE 4-1-2008.

THE MARK CONSISTS OF STANDARD CHAR-  
ACTERS WITHOUT CLAIM TO ANY PARTICULAR  
FONT, STYLE, SIZE, OR COLOR.

SN 77-267,493, FILED 8-29-2007.

SUSAN STIGLITZ, EXAMINING ATTORNEY

**Int. Cl.: 1**

**Prior U.S. Cls.: 1, 5, 6, 10, 26, and 46**

**Reg. No. 3,570,518**

**United States Patent and Trademark Office**

**Registered Feb. 3, 2009**

---

**TRADEMARK  
PRINCIPAL REGISTER**

**ACCELL**

DHARMACON, INC. (DELAWARE CORPORATION)  
2650 CRESCENT DRIVE, SUITE 100  
LAFAYETTE, CO 80026

THE MARK CONSISTS OF STANDARD CHARACTERS WITHOUT CLAIM TO ANY PARTICULAR FONT, STYLE, SIZE, OR COLOR.

FOR: REAGENTS, NAMELY, RNAI REAGENTS USED IN LIFE SCIENCE RESEARCH AND DEVELOPMENT, NOT FOR DIAGNOSTIC USE, IN CLASS 1 (U.S. CLS. 1, 5, 6, 10, 26 AND 46).

SN 77-268,468, FILED 8-30-2007.

FIRST USE 5-0-2008; IN COMMERCE 5-0-2008.

GIANCARLO CASTRO, EXAMINING ATTORNEY

**Int. Cl.: 42**

**Prior U.S. Cls.: 100 and 101**

**United States Patent and Trademark Office**

**Reg. No. 3,570,519**

**Registered Feb. 3, 2009**

**SERVICE MARK  
PRINCIPAL REGISTER**

**CHALLENGE**

CHALLENGE INC. (DELAWARE CORPORATION)  
#319  
1474 NORTH POINT VILLAGE CENTER  
RESTON, VA 20194

FOR: COMPUTER SERVICES, NAMELY, CREATING AN ONLINE COMMUNITY FOR REGISTERED USERS TO PARTICIPATE IN COMPETITIONS, SHOWCASE THEIR SKILLS, GET FEEDBACK FROM THEIR PEERS, FORM VIRTUAL COMMUNITIES, ENGAGE IN SOCIAL NETWORKING AND

IMPROVE THEIR TALENT, IN CLASS 42 (U.S. CLS. 100 AND 101).

FIRST USE 3-17-2007; IN COMMERCE 3-18-2008.

THE MARK CONSISTS OF STANDARD CHARACTERS WITHOUT CLAIM TO ANY PARTICULAR FONT, STYLE, SIZE, OR COLOR.

SN 77-268,957, FILED 8-31-2007.

ELI HELLMAN, EXAMINING ATTORNEY

**Int. Cl.: 16**

**Prior U.S. Cls.: 2, 5, 22, 23, 29, 37, 38, and 50**

**Reg. No. 3,570,520**

**United States Patent and Trademark Office**

**Registered Feb. 3, 2009**

**TRADEMARK  
PRINCIPAL REGISTER**

**WorkSpace**

SCHOLASTIC INC. (NEW YORK CORPORATION)  
557 BROADWAY  
NEW YORK, NY 10012

THE MARK CONSISTS OF THE WORD "WORKSPACE" WITH THE "W" AND THE "S" CAPITALIZED AND THE "ORK" AND "PACE" IN LOWER CASE LETTERS.

FOR: A SERIES OF CONSUMABLE STUDENT WORKBOOKS IN THE FIELD OF MATHEMATICS EDUCATION, IN CLASS 16 (U.S. CLS. 2, 5, 22, 23, 29, 37, 38 AND 50).

SN 77-269,353, FILED 8-31-2007.

FIRST USE 10-1-2007; IN COMMERCE 10-1-2007.

FLORENTINA BLANDU, EXAMINING ATTORNEY



**Int. Cl.: 41**

**Prior U.S. Cls.: 100, 101, and 107**

**United States Patent and Trademark Office**

**Reg. No. 3,570,521**

**Registered Feb. 3, 2009**

**SERVICE MARK  
PRINCIPAL REGISTER**

# THE MOTIONS

SILVERMAN, STEVE I. (UNITED STATES INDIVIDUAL)  
17TH FLOOR  
201 S. BISCAYNE BLVD.  
MIAMI, FL 33131 AND  
MANOS, TOM (UNITED STATES INDIVIDUAL)  
17TH FLOOR  
201 S. BISCAYNE BLVD.  
MIAMI, FL 33131

FOR: ENTERTAINMENT SERVICES IN THE NATURE OF LIVE MUSIC OF A VOCAL AND INSTRUMENTAL GROUP THROUGH PERSONAL

APPEARANCES, IN CLASS 41 (U.S. CLS. 100, 101 AND 107).

FIRST USE 12-0-2007; IN COMMERCE 12-0-2007.

THE MARK CONSISTS OF STANDARD CHARACTERS WITHOUT CLAIM TO ANY PARTICULAR FONT, STYLE, SIZE, OR COLOR.

SN 77-269,749, FILED 8-31-2007.

ROSELLE HERRERA, EXAMINING ATTORNEY

Int. Cls.: 4, 12, 24, and 26

Prior U.S. Cls.: 1, 6, 15, 19, 21, 23, 31, 35, 37, 39, 40,  
42, 44, and 50

Reg. No. 3,570,522

Registered Feb. 3, 2009

**United States Patent and Trademark Office**

---

**TRADEMARK  
PRINCIPAL REGISTER**

**NEIGHBORHOOD**

NEIGHBORHOOD CO., LTD. (JAPAN CORPORATION)  
2-9-1 NH BLDG., SENDAGAYA, SHIBUYA-KU  
TOKYO, JAPAN 151-0051

FOR: CANDLES, IN CLASS 4 (U.S. CLS. 1, 6 AND 15).

FIRST USE 3-5-2008; IN COMMERCE 3-5-2008.

FOR: AUTOMOBILES AND STRUCTURAL PARTS AND FITTINGS THEREFORE; TWO-WHEELED MOTOR VEHICLES; BICYCLES, IN CLASS 12 (U.S. CLS. 19, 21, 23, 31, 35 AND 44).

FIRST USE 3-5-2008; IN COMMERCE 3-5-2008.

FOR: WOVEN FABRICS, IN CLASS 24 (U.S. CLS. 42 AND 50).

FIRST USE 3-5-2008; IN COMMERCE 3-5-2008.

FOR: BUTTONS, NAMELY, BUTTONS FOR CLOTHING, IN CLASS 26 (U.S. CLS. 37, 39, 40, 42 AND 50).

FIRST USE 3-5-2008; IN COMMERCE 3-5-2008.

THE MARK CONSISTS OF STANDARD CHARACTERS WITHOUT CLAIM TO ANY PARTICULAR FONT, STYLE, SIZE, OR COLOR.

SN 77-271,808, FILED 9-5-2007.

SUZANNE BLANE, EXAMINING ATTORNEY

**Int. Cl.: 9**

**Prior U.S. Cls.: 21, 23, 26, 36, and 38**

**Reg. No. 3,570,523**

**United States Patent and Trademark Office**

**Registered Feb. 3, 2009**

---

**TRADEMARK  
PRINCIPAL REGISTER**

**ARLINK**

PIRACLE, INC. (UTAH CORPORATION)  
2302 SOUTH PRESIDENTS DRIVE, SUITE B  
SALT LAKE CITY, UT 84120

FIRST USE 7-10-2007; IN COMMERCE 7-10-2007.

FOR: COMPUTER SOFTWARE WHICH ENABLE  
THE SECURE MOVEMENT OF FINANCIAL PAY-  
MENT DATA FROM ONE LOCATION TO AN-  
OTHER, AND WHICH CREATES, RECORDS,  
SHARES AND TRANSMITS PAYMENTS AND PAY-  
MENT INFORMATION, IN CLASS 9 (U.S. CLS. 21, 23,  
26, 36 AND 38).

THE MARK CONSISTS OF STANDARD CHAR-  
ACTERS WITHOUT CLAIM TO ANY PARTICULAR  
FONT, STYLE, SIZE, OR COLOR.

SN 77-272,379, FILED 9-5-2007.

ANNE MADDEN, EXAMINING ATTORNEY

**Int. Cl.: 38**

**Prior U.S. Cls.: 100, 101, and 104**

**United States Patent and Trademark Office**

**Reg. No. 3,570,524**

**Registered Feb. 3, 2009**

**SERVICE MARK  
PRINCIPAL REGISTER**

**Be Neighborly**

FRIEDMAN, MAURY (UNITED STATES INDIVIDUAL)  
29480 BERTRAND DR.  
AGOURA HILLS, CA 91301

FOR: PROVIDING ON-LINE ELECTRONIC BULLETIN BOARDS FOR TRANSMISSION OF MESSAGES AMONG COMPUTER USERS CONCERNING LOCAL NEWS, ACTIVITIES, AND EVENTS; ELECTRONIC MAIL SERVICES; ELECTRONIC TRANSMISSION OF MESSAGES AND DATA, IN CLASS 38 (U.S. CLS. 100, 101 AND 104).

FIRST USE 1-14-2008; IN COMMERCE 1-14-2008.

THE MARK CONSISTS OF STANDARD CHARACTERS WITHOUT CLAIM TO ANY PARTICULAR FONT, STYLE, SIZE, OR COLOR.

SN 77-273,576, FILED 9-6-2007.

JEAN IM, EXAMINING ATTORNEY

**Int. Cl.: 9**

**Prior U.S. Cls.: 21, 23, 26, 36, and 38**

**United States Patent and Trademark Office**

**Reg. No. 3,570,525**

**Registered Feb. 3, 2009**

**TRADEMARK  
PRINCIPAL REGISTER**

**DRAGON CRYSTAL**

KONAMI GAMING, INC. (NEVADA CORPORATION)  
585 TRADE CENTER DRIVE  
LAS VEGAS, NV 89119

FOR: ELECTRONIC GAME PROGRAMS; GAMING EQUIPMENT, NAMELY, SLOT MACHINES WITH OR WITHOUT VIDEO OUTPUT; GAMING MACHINES; MACHINES FOR PLAYING GAMES OF CHANCE; SLOT MACHINES, IN CLASS 9 (U.S. CLS. 21, 23, 26, 36 AND 38).

FIRST USE 8-14-2007; IN COMMERCE 8-14-2007.

THE MARK CONSISTS OF STANDARD CHARACTERS WITHOUT CLAIM TO ANY PARTICULAR FONT, STYLE, SIZE, OR COLOR.

OWNER OF U.S. REG. NOS. 2,865,249 AND 2,929,804.

SN 77-273,718, FILED 9-7-2007.

JENNIFER MARTIN, EXAMINING ATTORNEY

**Int. Cl.: 9**

**Prior U.S. Cls.: 21, 23, 26, 36, and 38**

**Reg. No. 3,570,526**

**United States Patent and Trademark Office**

**Registered Feb. 3, 2009**

**TRADEMARK  
PRINCIPAL REGISTER**

**THUNDER WARRIOR**

KONAMI GAMING, INC. (NEVADA CORPORATION)  
585 TRADE CENTER DRIVE  
LAS VEGAS, NV 89119

FOR: ELECTRONIC GAME PROGRAMS; GAMING EQUIPMENT, NAMELY, SLOT MACHINES WITH OR WITHOUT VIDEO OUTPUT; GAMING MACHINES; MACHINES FOR PLAYING GAMES OF CHANCE; SLOT MACHINES, IN CLASS 9 (U.S. CLS. 21, 23, 26, 36 AND 38).

FIRST USE 10-23-2007; IN COMMERCE 10-23-2007.

THE MARK CONSISTS OF STANDARD CHARACTERS WITHOUT CLAIM TO ANY PARTICULAR FONT, STYLE, SIZE, OR COLOR.

SN 77-273,723, FILED 9-7-2007.

JENNIFER MARTIN, EXAMINING ATTORNEY

**Int. Cl.: 28**

**Prior U.S. Cls.: 22, 23, 38, and 50**

**Reg. No. 3,570,527**

**United States Patent and Trademark Office**

**Registered Feb. 3, 2009**

---

**TRADEMARK  
PRINCIPAL REGISTER**

**VR**

NIKE, INC. (OREGON CORPORATION)  
ONE BOWERMAN DRIVE  
BEAVERTON, OR 97005

THE MARK CONSISTS OF STANDARD CHAR-  
ACTERS WITHOUT CLAIM TO ANY PARTICULAR  
FONT, STYLE, SIZE, OR COLOR.

FOR: GOLF CLUBS, GOLF CLUB HEADS, GOLF  
CLUB SHAFTS, GOLF CLUB GRIPS, IN CLASS 28  
(U.S. CLS. 22, 23, 38 AND 50).

SN 77-274,685, FILED 9-7-2007.

FIRST USE 11-1-2008; IN COMMERCE 11-1-2008.

LINDA ORNDORFF, EXAMINING ATTORNEY

**Int. Cl.: 14**

**Prior U.S. Cls.: 2, 27, 28, and 50**

**United States Patent and Trademark Office**

**Reg. No. 3,570,528**

**Registered Feb. 3, 2009**

**TRADEMARK  
PRINCIPAL REGISTER**

**FROM THE HEART**

JB-DM JEWELRY, LLC (CALIFORNIA LIMITED  
LIABILITY COMPANY)  
1623 ALLESANDRO STREET  
LOS ANGELES, CA 90026

FOR: JEWELRY, IN CLASS 14 (U.S. CLS. 2, 27, 28  
AND 50).

FIRST USE 2-14-2008; IN COMMERCE 2-14-2008.

THE MARK CONSISTS OF STANDARD CHAR-  
ACTERS WITHOUT CLAIM TO ANY PARTICULAR  
FONT, STYLE, SIZE, OR COLOR.

SN 77-274,736, FILED 9-7-2007.

ALICE SUE CARRUTHERS, EXAMINING ATTOR-  
NEY



**Int. Cls.: 16, 21, and 24**

**Prior U.S. Cls.: 2, 5, 13, 22, 23, 29, 30, 33, 37, 38, 40,  
42, and 50**

**Reg. No. 3,570,529**

**United States Patent and Trademark Office**

**Registered Feb. 3, 2009**

**TRADEMARK  
PRINCIPAL REGISTER**

**Pethany  Larsen**

PETHANY DESIGN STUDIO (TAIWAN LIMITED  
LIABILITY COMPANY)  
5F., NO. 57, MIN-SHENG E. RD. SEC. 3  
TAIPEI CITY, TAIWAN 104

FOR: BOOKMARKS; CHRISTMAS CARDS; DESK  
CALENDARS; FOLDERS; GREETING CARDS; GIFT  
CARDS; HOLIDAY CARDS; INVITATION CARDS;  
NOTEBOOKS; PAPER BAGS; PAPER CONTAINERS;  
PAPER FOLDERS; PAPER GIFT BAGS; POST-  
CARDS; SKETCHBOOKS; WRAPPING PAPER, IN  
CLASS 16 (U.S. CLS. 2, 5, 22, 23, 29, 37, 38 AND 50).

FIRST USE 4-21-2006; IN COMMERCE 4-21-2006.

FOR: (BASED ON USE IN COMMERCE) CANDLE  
HOLDERS; CHOPSTICKS; COFFEE CUPS; COM-  
MEMORATIVE PLATES; CUPS; DINNERWARE;  
FABRIC BOXES FOR STORING GREETING  
CARDS; FLOWER VASES AND BOWLS; MUGS;  
NAPKIN HOLDERS; NAPKIN RINGS; PLATES;  
PORCELAIN KNOBS; PORCELAIN MUGS; SOUVE-  
NIR PLATES; TOOTHBRUSH HOLDERS, BOWLS;  
GLASS BOWLS; SALAD BOWLS, IN CLASS 21 (U.S.  
CLS. 2, 13, 23, 29, 30, 33, 40 AND 50).

FIRST USE 4-21-2006; IN COMMERCE 4-21-2006.

FOR: BATH TOWELS; BED BLANKETS; CHIL-  
DREN'S BLANKETS; CHILDREN'S TOWELS;  
BEACH TOWELS; BED LINEN; BED SHEETS; BED  
SPREADS; BLANKET THROWS; CASHMERE FAB-  
RIC; COMFORTERS; COTTON FABRIC; DUVET  
COVERS; DUVETS; FACE TOWELS; FELTS; HAND  
TOWELS; HOODED TOWELS; KITCHEN TOWELS;  
MATTRESS COVERS; PILLOW CASES; PILLOW  
COVERS; SHOWER CURTAINS; SILK BED BLAN-  
KETS; TABLE LINEN; TEXTILE NAPKINS;  
THROWS; TOWEL SETS; TOWELS; WASHCLOTHS;  
WOOLLEN BLANKETS, IN CLASS 24 (U.S. CLS. 42  
AND 50).

FIRST USE 4-21-2006; IN COMMERCE 4-21-2006.

SN 77-275,523, FILED 9-10-2007.

JOHN WILKE, EXAMINING ATTORNEY

**Int. Cl.: 32**

**Prior U.S. Cls.: 45, 46, and 48**

**Reg. No. 3,570,530**

**United States Patent and Trademark Office**

**Registered Feb. 3, 2009**

---

**TRADEMARK  
PRINCIPAL REGISTER**

**for peace, tranquility and  
unconditional love**

ROUDA, KAIRA (UNITED STATES INDIVIDUAL)  
2285 YORKSHIRE ROAD  
COLUMBUS, OH 43221

THE MARK CONSISTS OF STANDARD CHARACTERS WITHOUT CLAIM TO ANY PARTICULAR FONT, STYLE, SIZE, OR COLOR.

FOR: BOTTLED DRINKING WATER; BOTTLED WATER; FLAVORED WATERS; FLAVOURED WATERS, IN CLASS 32 (U.S. CLS. 45, 46 AND 48).

SN 77-275,783, FILED 9-10-2007.

FIRST USE 8-13-2007; IN COMMERCE 10-2-2008.

DANIEL BRODY, EXAMINING ATTORNEY

**Int. Cl.: 9**

**Prior U.S. Cls.: 21, 23, 26, 36, and 38**

**United States Patent and Trademark Office**

**Reg. No. 3,570,531**

**Registered Feb. 3, 2009**

**TRADEMARK  
PRINCIPAL REGISTER**

**ROCK THE DENIM**

MOWRY, BRADLEY A. (UNITED STATES INDIVIDUAL)  
23259 LEA COURT  
VALENCIA, CA 91354

FOR: DOWNLOADABLE MUSICAL SOUND RECORDINGS; DOWNLOADABLE VIDEO RECORDINGS FEATURING MUSIC; SOUND RECORDINGS FEATURING MUSIC; VIDEO RECORDINGS FEATURING MUSIC; DOWNLOADABLE MP3 FILES, MP3 RECORDINGS, ONLINE DISCUSSION BOARDS, WEBCASTS AND PODCASTS FEATURING MUSIC, AUDIO BOOKS AND NEWS BROADCASTS; DIGITAL MEDIA, NAMELY, CDS, DVDS, DOWNLOADABLE AUDIO FILES FEATURING

MUSIC; PRE-RECORDED CDS, VIDEO TAPES, LASER DISKS AND DVDS FEATURING MUSIC, IN CLASS 9 (U.S. CLS. 21, 23, 26, 36 AND 38).

FIRST USE 2-5-2008; IN COMMERCE 2-5-2008.

THE MARK CONSISTS OF STANDARD CHARACTERS WITHOUT CLAIM TO ANY PARTICULAR FONT, STYLE, SIZE, OR COLOR.

SN 77-276,045, FILED 9-10-2007.

JENNIFER VASQUEZ, EXAMINING ATTORNEY

Int. Cl.: 35

Prior U.S. Cls.: 100, 101, and 102

United States Patent and Trademark Office

Reg. No. 3,570,532

Registered Feb. 3, 2009

SERVICE MARK  
PRINCIPAL REGISTER



KABUSHIKI KAISHA NTT DOCOMO (JAPAN  
JOINT STOCK COMPANY), DBA NTT DOCO-  
MO, INC.,  
11-1, NAGATACHO 2-CHOME  
CHIYODA-KU TOKYO, JAPAN 100-6150

FOR: PROMOTING THE GOODS AND SERVICES  
OF OTHERS BY PROVIDING DOWNLOADABLE  
CONSUMER COUPONS VIA CELLULAR TELE-  
PHONE , IN CLASS 35 (U.S. CLS. 100, 101 AND 102).

FIRST USE 6-1-2008; IN COMMERCE 7-11-2008.

THE MARK CONSISTS OF THE DESIGNATION  
"DOCOMO", JAPANESE KATAKANA CHARAC-  
TERS, AND DESIGN.

THE FOREIGN WORDING IN THE MARK  
TRANSLATES INTO ENGLISH AS PREMIUM  
CLUB.

SN 77-276,179, FILED 9-11-2007.

INGRID C. EULIN, EXAMINING ATTORNEY

**Int. Cl.: 35**

**Prior U.S. Cls.: 100, 101, and 102**

**United States Patent and Trademark Office**

**Reg. No. 3,570,533**

**Registered Feb. 3, 2009**

**SERVICE MARK  
PRINCIPAL REGISTER**



THE CODEMASTERS SOFTWARE COMPANY  
LIMITED (UNITED KINGDOM LIMITED  
COMPANY (LTD.))

SOUTHAM

LOWER FARM, STONEYTHORPE

WARWICKSHIRE, UNITED KINGDOM CV472DL

FOR: ELECTRONIC CATALOG SERVICES FEATURING COMPUTER SOFTWARE, GAMES, VIDEO GAMES, ELECTRONIC GAME SOFTWARE, AND DIGITAL MATERIALS, NAMELY, CD'S AND DATA

CARRIERS FEATURING COMPUTER GAMES, IN CLASS 35 (U.S. CLS. 100, 101 AND 102).

FIRST USE 11-1-2008; IN COMMERCE 11-1-2008.

THE MARK CONSISTS OF INTERLOCKING BLOCK LETTERS "C" AND "M".

SN 77-276,514, FILED 9-11-2007.

ANNE MADDEN, EXAMINING ATTORNEY

**Int. Cl.: 7**

**Prior U.S. Cls.: 13, 19, 21, 23, 31, 34, and 35**

**Reg. No. 3,570,534**

**United States Patent and Trademark Office**

**Registered Feb. 3, 2009**

**TRADEMARK  
PRINCIPAL REGISTER**

# GraverSmith

GLENDON CORPORATION (KANSAS CORPORATION)  
900 OVERLANDER ROAD  
EMPORIA, KS 66801

FOR: ENGRAVING MACHINES; ELECTRIC AND PNEUMATIC ENGRAVING TOOLS AND COMPONENT PARTS THEREOF, IN CLASS 7 (U.S. CLS. 13, 19, 21, 23, 31, 34 AND 35).

FIRST USE 9-11-2007; IN COMMERCE 1-16-2008.

THE MARK CONSISTS OF STANDARD CHARACTERS WITHOUT CLAIM TO ANY PARTICULAR FONT, STYLE, SIZE, OR COLOR.

OWNER OF U.S. REG. NOS. 1,468,824, 3,120,802, AND OTHERS.

SN 77-276,524, FILED 9-11-2007.

ROBERT LAVACHE, EXAMINING ATTORNEY

**Int. Cl.: 9**

**Prior U.S. Cls.: 21, 23, 26, 36, and 38**

**Reg. No. 3,570,535**

**United States Patent and Trademark Office**

**Registered Feb. 3, 2009**

**TRADEMARK  
PRINCIPAL REGISTER**

**ROVIO**

WOWWEE GROUP LIMITED (HONG KONG  
CORPORATION)  
ENERGY PLAZA, UNIT 301-C  
92 GRANVILLE ROAD  
TSIM SHA TSUI EAST, KOWLOON, HONG KONG

THE MARK CONSISTS OF STANDARD CHAR-  
ACTERS WITHOUT CLAIM TO ANY PARTICULAR  
FONT, STYLE, SIZE, OR COLOR.

FOR: COMPUTER PERIPHERALS; WEBCAMS, IN  
CLASS 9 (U.S. CLS. 21, 23, 26, 36 AND 38).

SN 77-276,725, FILED 9-11-2007.

FIRST USE 8-29-2008; IN COMMERCE 8-29-2008.

SHARON MEIER, EXAMINING ATTORNEY

**Int. Cls.: 38 and 39**

**Prior U.S. Cls.: 100, 101, 104, and 105**

**United States Patent and Trademark Office**

**Reg. No. 3,570,536**

**Registered Feb. 3, 2009**

**SERVICE MARK  
PRINCIPAL REGISTER**



EHEALTH SOLUTIONS, INC. (DELAWARE CORPORATION)  
SUITE 302  
360 WEST 31ST STREET  
NEW YORK, NY 10001

FOR: ELECTRONIC TRANSMISSION OF CLINICAL, ADMINISTRATIVE AND FINANCIAL DATA FILES AND DOCUMENTS VIA COMPUTER TERMINALS; PROVISION OF ACCESS TO DATA OR DOCUMENTS STORED ELECTRONICALLY IN CENTRAL FILES FOR REMOTE CONSULTATION, IN CLASS 38 (U.S. CLS. 100, 101 AND 104).

FIRST USE 12-13-2007; IN COMMERCE 12-13-2007.

FOR: ELECTRONIC STORAGE OF CLINICAL, ADMINISTRATIVE AND FINANCIAL FILES AND DOCUMENTS FOR ARCHIVING AND RETRIEVAL PURPOSES, IN CLASS 39 (U.S. CLS. 100 AND 105).

FIRST USE 12-13-2007; IN COMMERCE 12-13-2007.

THE MARK CONSISTS OF THE WORDS "SIGMA" AND "SAFE" NEXT TO A CIRCLE WITH THE GREEK LETTER SIGMA IN IT.

SN 77-276,853, FILED 9-11-2007.

ELI HELLMAN, EXAMINING ATTORNEY



**Int. Cl.: 41**

**Prior U.S. Cls.: 100, 101, and 107**

**United States Patent and Trademark Office**

**Reg. No. 3,570,537**

**Registered Feb. 3, 2009**

**SERVICE MARK  
PRINCIPAL REGISTER**

**SEEDS OF COMPASSION**

KIRLIN CHARITABLE FOUNDATION (WA-  
SHINGTON NON-PROFIT CORPORATION)  
SUITE 1550  
10500 NE 8TH STREET  
BELLEVUE, WA 98004

FOR: EDUCATIONAL SERVICES, NAMELY, DE-  
VELOPING, ARRANGING, AND CONDUCTING  
EDUCATIONAL CONFERENCES AND PROGRAMS  
IN THE FIELD OF SOCIAL AND EMOTIONAL  
DEVELOPMENT, IN CLASS 41 (U.S. CLS. 100, 101  
AND 107).

FIRST USE 2-1-2008; IN COMMERCE 2-1-2008.

THE MARK CONSISTS OF STANDARD CHAR-  
ACTERS WITHOUT CLAIM TO ANY PARTICULAR  
FONT, STYLE, SIZE, OR COLOR.

SN 77-276,895, FILED 9-11-2007.

CIMMERIAN COLEMAN, EXAMINING ATTOR-  
NEY

**Int. Cl.: 41**

**Prior U.S. Cls.: 100, 101, and 107**

**United States Patent and Trademark Office**

**Reg. No. 3,570,538**

**Registered Feb. 3, 2009**

**SERVICE MARK  
PRINCIPAL REGISTER**



KIRLIN CHARITABLE FOUNDATION (WA-  
SHINGTON NON-PROFIT CORPORATION)  
SUITE 1550  
10500 NE 8TH STREET  
BELLEVUE, WA 98004

FOR: EDUCATIONAL SERVICES, NAMELY, DE-  
VELOPING, ARRANGING, AND CONDUCTING  
EDUCATIONAL CONFERENCES AND PROGRAMS  
IN THE FIELD OF SOCIAL AND EMOTIONAL  
DEVELOPMENT, IN CLASS 41 (U.S. CLS. 100, 101  
AND 107).

FIRST USE 1-1-2008; IN COMMERCE 1-1-2008.

THE MARK CONSISTS OF AN OVAL CONTAIN-  
ING TWO HANDS WITH THE FINGER AND  
THUMB OF RIGHT HAND HOLDING A SEED  
WITH A STYLIZED HUMAN FIGURE WITH ARMS  
OUTSTRETCHED SPROUTING FROM THE SEED.  
STYLIZED FLOWERS AND LEAVES ARE BEHIND  
THE HUMAN FIGURE.

SN 77-276,900, FILED 9-11-2007.

CIMMERIAN COLEMAN, EXAMINING ATTOR-  
NEY

**Int. Cl.: 10**

**Prior U.S. Cls.: 26, 39, and 44**

**United States Patent and Trademark Office**

**Reg. No. 3,570,539**

**Registered Feb. 3, 2009**

**TRADEMARK  
PRINCIPAL REGISTER**

**CLEARFIELD**

DENOVO DENTAL, INC. (CALIFORNIA CORPORATION)  
5130 COMMERCE DRIVE  
BALDWIN PARK, CA 91706

FOR: DENTAL DEVICE THAT EXPANDS THE MOUTH TO IMPROVE THE FIELD OF VIEW INSIDE THE MOUTH, AND EXTRACTS SALIVA FROM THE WORK AREA INSIDE THE MOUTH, IN CLASS 10 (U.S. CLS. 26, 39 AND 44).

FIRST USE 1-0-2008; IN COMMERCE 1-0-2008.

THE MARK CONSISTS OF STANDARD CHARACTERS WITHOUT CLAIM TO ANY PARTICULAR FONT, STYLE, SIZE, OR COLOR.

SN 77-277,152, FILED 9-11-2007.

GISELLE AGOSTO, EXAMINING ATTORNEY

**Int. Cl.: 7**

**Prior U.S. Cls.: 13, 19, 21, 23, 31, 34, and 35**

**Reg. No. 3,570,540**

**United States Patent and Trademark Office**

**Registered Feb. 3, 2009**

**TRADEMARK  
PRINCIPAL REGISTER**

**Nitro**

SMARTPOOL INCORPORATED (DELAWARE  
CORPORATION)  
687 PROSPECT ST.  
LAKEWOOD, NJ 08701

THE MARK CONSISTS OF STANDARD CHAR-  
ACTERS WITHOUT CLAIM TO ANY PARTICULAR  
FONT, STYLE, SIZE, OR COLOR.

FOR: ROBOTIC POOL CLEANERS, IN CLASS 7  
(U.S. CLS. 13, 19, 21, 23, 31, 34 AND 35).

SN 77-277,337, FILED 9-12-2007.

FIRST USE 10-0-2007; IN COMMERCE 10-0-2007.

BERYL GARDNER, EXAMINING ATTORNEY

**Int. Cl.: 14**

**Prior U.S. Cls.: 2, 27, 28, and 50**

**United States Patent and Trademark Office**

**Reg. No. 3,570,541**

**Registered Feb. 3, 2009**

**TRADEMARK  
PRINCIPAL REGISTER**

**OPOGEE**

GOEBEL, MARISA (UNITED STATES INDIVIDUAL), DBA ATELIER MARISA,  
#308  
139 S BEVERLY HILLS DRIVE  
BEVERLY HILLS, CA 90212

FOR: EARRINGS, JEWELRY, IN CLASS 14 (U.S. CLS. 2, 27, 28 AND 50).

FIRST USE 8-0-2008; IN COMMERCE 8-0-2008.

THE MARK CONSISTS OF STANDARD CHARACTERS WITHOUT CLAIM TO ANY PARTICULAR FONT, STYLE, SIZE, OR COLOR.

SN 77-278,837, FILED 9-13-2007.

MATTHEW MCDOWELL, EXAMINING ATTORNEY

**Int. Cl.: 14**

**Prior U.S. Cls.: 2, 27, 28, and 50**

**United States Patent and Trademark Office**

**Reg. No. 3,570,542**

**Registered Feb. 3, 2009**

**TRADEMARK  
PRINCIPAL REGISTER**

**EUROCOMFORT FIT**

TOSYALI INTERNATIONAL INC. (ALABAMA  
CORPORATION)

P.O. BOX 2929

TUSCALOOSA, AL 35403

FOR: JEWELRY, IN CLASS 14 (U.S. CLS. 2, 27, 28  
AND 50).

FIRST USE 2-0-2008; IN COMMERCE 2-0-2008.

THE MARK CONSISTS OF STANDARD CHAR-  
ACTERS WITHOUT CLAIM TO ANY PARTICULAR  
FONT, STYLE, SIZE, OR COLOR.

NO CLAIM IS MADE TO THE EXCLUSIVE  
RIGHT TO USE "FIT", APART FROM THE MARK  
AS SHOWN.

SN 77-279,566, FILED 9-14-2007.

ROBIN MITTLER, EXAMINING ATTORNEY

Int. Cl.: 31

Prior U.S. Cls.: 1 and 46

United States Patent and Trademark Office

Reg. No. 3,570,543

Registered Feb. 3, 2009

TRADEMARK  
PRINCIPAL REGISTER

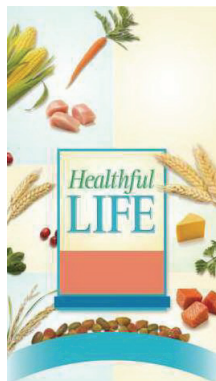

SOCIETE DES PRODUITS NESTLE S.A. (SWITZERLAND SOCIÉTÉ ANONYME (SA))  
CASE POSTALE 353  
INTELLECTUAL PROPERTY DEPARTMENT  
VEVEY, SWITZERLAND 1800

FOR: PET FOOD, IN CLASS 31 (U.S. CLS. 1 AND 46).

FIRST USE 2-15-2008; IN COMMERCE 2-15-2008.

NO CLAIM IS MADE TO THE EXCLUSIVE RIGHT TO USE "HEALTHFUL", APART FROM THE MARK AS SHOWN.

THE COLOR(S) WHITE, LIGHT BLUE, TEAL, BLUE, PINK, GREEN, ORANGE, YELLOW, BEIGE, BROWN, RED, LIGHT GREEN, LIGHT YELLOW, LIGHT PINK AND DARK PINK IS/ARE CLAIMED AS A FEATURE OF THE MARK.

THE MARK CONSISTS OF THE WORDING "HEALTHFUL LIFE", WHEREIN THE WORD "HEALTHFUL" IS IN GREEN LETTERS HAVING A NARROW WHITE BORDER, AND THE WORD "LIFE" IS IN TEAL LETTERS HAVING A NARROW WHITE BORDER; A BACKGROUND DESIGN HAVING LIGHT BLUE, LIGHT GREEN & LIGHT YELLOW PANELS ARRANGED IN A CHECKERBOARD PATTERN; A PANEL DESIGN POSITIONED OVER THE CHECKERBOARD BACKGROUND, THE PA-

NEL DESIGN HAVING A SQUARE FIELD THAT IS LIGHT YELLOW IN COLOR WITH THE WORDING "HEALTHFUL LIFE" POSITIONED THEREIN, A RECTANGULAR FIELD THAT IS ORANGE IN COLOR POSITIONED BELOW THE SQUARE FIELD, A NARROW BORDER THAT IS TEAL IN COLOR AND WHICH SURROUNDS THE SQUARE AND RECTANGULAR FIELDS, A HORIZONTAL BAND THAT IS BLUE IN COLOR AND EXTENDS ALONG THE BOTTOM OF THE PANEL DESIGN, AND A NARROW HORIZONTAL BAND THAT IS TEAL IN COLOR POSITIONED BELOW THE HORIZONTAL BLUE BAND; AN ARC BAND THAT IS TEAL IN COLOR AND POSITIONED BELOW THE PANEL DESIGN; DEPICTIONS OF MEATS, CHEESE AND VEGETABLES THAT APPEAR TO FLOAT OVER THE CHECKERBOARD BACKGROUND AND SURROUND THE PANEL DESIGN, IN PARTICULAR, CORN APPEARS IN YELLOW WITH GREEN LEAVES, A CARROT APPEARS IN ORANGE WITH GREEN LEAVES, CHICKEN APPEARS IN LIGHT PINK, WHEAT APPEARS IN BEIGE, CHEESE APPEARS IN YELLOW & ORANGE, PARSLEY AND SPINACH APPEAR IN GREEN, FISH APPEARS IN DARK PINK, BERRIES APPEAR IN RED, AND KIBBLE APPEARS IN BROWN, GREEN, AND BEIGE.

SN 77-279,873, FILED 9-14-2007.

HEATHER THOMPSON, EXAMINING ATTORNEY

Int. Cl.: 31

Prior U.S. Cls.: 1 and 46

United States Patent and Trademark Office

Reg. No. 3,570,544

Registered Feb. 3, 2009

TRADEMARK  
PRINCIPAL REGISTER



SOCIETE DES PRODUITS NESTLE S.A. (SWITZERLAND SOCIÉTÉ ANONYME (SA))  
CASE POSTALE 353  
INTELLECTUAL PROPERTY DEPARTMENT  
VEVEY, SWITZERLAND 1800

FOR: PET FOOD, IN CLASS 31 (U.S. CLS. 1 AND 46).

FIRST USE 2-15-2008; IN COMMERCE 2-15-2008.

THE COLOR(S) WHITE, LIGHT BLUE, TEAL, BLUE, PINK, GREEN, ORANGE, YELLOW, BEIGE, BROWN, RED, LIGHT GREEN, LIGHT YELLOW, LIGHT PINK AND DARK PINK IS/ARE CLAIMED AS A FEATURE OF THE MARK.

THE MARK CONSISTS OF A BACKGROUND DESIGN HAVING LIGHT BLUE, LIGHT GREEN AND LIGHT YELLOW PANELS ARRANGED IN A CHECKERBOARD PATTERN; A PANEL DESIGN POSITIONED OVER THE CHECKERBOARD BACKGROUND, THE PANEL DESIGN HAVING A SQUARE FIELD THAT IS LIGHT YELLOW IN COLOR, A RECTANGULAR FIELD THAT IS ORANGE IN COLOR POSITIONED BELOW THE

SQUARE FIELD, A NARROW BORDER THAT IS TEAL IN COLOR AND WHICH SURROUNDS THE SQUARE AND RECTANGULAR FIELDS, A HORIZONTAL BAND THAT IS BLUE IN COLOR AND EXTENDS ALONG THE BOTTOM OF THE PANEL DESIGN, AND A NARROW HORIZONTAL BAND THAT IS TEAL IN COLOR POSITIONED BELOW THE HORIZONTAL BLUE BAND; AN ARC BAND THAT IS TEAL IN COLOR AND POSITIONED BELOW THE PANEL DESIGN; DEPICTIONS OF MEATS, CHEESE AND VEGETABLES THAT APPEAR TO FLOAT OVER THE CHECKERBOARD BACKGROUND AND SURROUND THE PANEL DESIGN, IN PARTICULAR, CORN APPEARS IN YELLOW WITH GREEN LEAVES, A CARROT APPEARS IN ORANGE WITH GREEN LEAVES, CHICKEN APPEARS IN PINK, WHEAT APPEARS IN BEIGE, CHEESE APPEARS IN YELLOW AND ORANGE, PARSLEY AND SPINACH APPEAR IN GREEN, FISH APPEARS IN DARK PINK, BERRIES APPEAR IN RED, AND KIBBLE APPEARS IN BROWN, GREEN, AND BEIGE.

SN 77-279,885, FILED 9-14-2007.

HEATHER THOMPSON, EXAMINING ATTORNEY



**Int. Cl.: 3**

**Prior U.S. Cls.: 1, 4, 6, 50, 51, and 52**

**United States Patent and Trademark Office**

**Reg. No. 3,570,545**

**Registered Feb. 3, 2009**

**TRADEMARK  
PRINCIPAL REGISTER**

**SEASOURCE DETOX SPA**

ARBONNE INTERNATIONAL, LLC (DELAWARE  
LIMITED LIABILITY COMPANY)  
9400 JERONIMO ROAD  
IRVINE, CA 92618

FOR: COSMETICS; NON-MEDICATED SKIN  
CARE PREPARATIONS; HAIR CARE PREPARA-  
TIONS, IN CLASS 3 (U.S. CLS. 1, 4, 6, 50, 51 AND 52).

FIRST USE 4-1-2008; IN COMMERCE 4-1-2008.

THE MARK CONSISTS OF STANDARD CHAR-  
ACTERS WITHOUT CLAIM TO ANY PARTICULAR  
FONT, STYLE, SIZE, OR COLOR.

NO CLAIM IS MADE TO THE EXCLUSIVE  
RIGHT TO USE "DETOX SPA", APART FROM THE  
MARK AS SHOWN.

SN 77-280,403, FILED 9-14-2007.

KIMBERLY FRYE, EXAMINING ATTORNEY

**Int. Cl.: 5**

**Prior U.S. Cls.: 6, 18, 44, 46, 51, and 52**

**United States Patent and Trademark Office**

**Reg. No. 3,570,546**

**Registered Feb. 3, 2009**

**TRADEMARK  
PRINCIPAL REGISTER**

**SEASOURCE DETOX SPA**

ARBONNE INTERNATIONAL, LLC (DELAWARE  
LIMITED LIABILITY COMPANY)  
9400 JERONIMO ROAD  
IRVINE, CA 92618

FOR: HERBAL TEA FOR NUTRITIONAL AND  
DIETETIC PURPOSES; NUTRITIONAL SUPPLE-  
MENTS; AIR FRESHENERS, IN CLASS 5 (U.S. CLS.  
6, 18, 44, 46, 51 AND 52).

FIRST USE 4-1-2008; IN COMMERCE 4-1-2008.

THE MARK CONSISTS OF STANDARD CHAR-  
ACTERS WITHOUT CLAIM TO ANY PARTICULAR  
FONT, STYLE, SIZE, OR COLOR.

NO CLAIM IS MADE TO THE EXCLUSIVE  
RIGHT TO USE "DETOX SPA", APART FROM THE  
MARK AS SHOWN.

SN 77-280,407, FILED 9-14-2007.

KIMBERLY FRYE, EXAMINING ATTORNEY

**Int. Cl.: 30**

**Prior U.S. Cl.: 46**

**United States Patent and Trademark Office**

**Reg. No. 3,570,547**

**Registered Feb. 3, 2009**

**TRADEMARK  
PRINCIPAL REGISTER**

MICHAELITA'S FINE PRODUCTS

MICHAELITA'S FINE PRODUCTS, INC. (TEXAS  
CORPORATION)  
6305 BRADLEY LANE  
PLANO, TX 75023

FOR: SALSA, IN CLASS 30 (U.S. CL. 46).

FIRST USE 10-7-2008; IN COMMERCE 10-7-2008.

THE MARK CONSISTS OF STANDARD CHAR-  
ACTERS WITHOUT CLAIM TO ANY PARTICULAR  
FONT, STYLE, SIZE, OR COLOR.

NO CLAIM IS MADE TO THE EXCLUSIVE  
RIGHT TO USE "FINE PRODUCTS", APART FROM  
THE MARK AS SHOWN.

THE NAME(S), PORTRAIT(S), AND/OR SIGNA-  
TURE(S) SHOWN IN THE MARK IDENTIFIES A  
LIVING INDIVIDUAL.

THE FOREIGN WORDING IN THE MARK  
TRANSLATES INTO ENGLISH AS LITTLE MI-  
CHELLE'S FINE PRODUCTS.

SN 77-280,905, FILED 9-17-2007.

ANTHONY RINKER, EXAMINING ATTORNEY

**Int. Cl.: 3**

**Prior U.S. Cls.: 1, 4, 6, 50, 51, and 52**

**United States Patent and Trademark Office**

**Reg. No. 3,570,548**

**Registered Feb. 3, 2009**

**TRADEMARK  
PRINCIPAL REGISTER**

**ezLIQUID**

ALUTA, INC. (OHIO CORPORATION)  
7650 CAMARGO ROAD  
CINCINNATI, OH 45243

THE MARK CONSISTS OF THE LETTERS AND  
WORD "EZ LIQUID" IN A STYLIZED FORMAT.

FOR: SKIN SOAP, IN CLASS 3 (U.S. CLS. 1, 4, 6, 50,  
51 AND 52).

SN 77-281,066, FILED 9-17-2007.

FIRST USE 9-30-2008; IN COMMERCE 9-30-2008.

KEVON CHISOLM, EXAMINING ATTORNEY

**Int. Cl.: 35**

**Prior U.S. Cls.: 100, 101, and 102**

**United States Patent and Trademark Office**

**Reg. No. 3,570,549**

**Registered Feb. 3, 2009**

**SERVICE MARK  
PRINCIPAL REGISTER**

**EATONCARE**

EATON CORPORATION (OHIO CORPORATION)  
1111 SUPERIOR AVENUE  
CLEVELAND, OH 44114

FOR: ELECTRICAL ADVERTISING SERVICES FOR OTHERS, NAMELY, ADVERTISING OF BUSINESSES IN THE FIELDS OF COMMERCIAL SERVICES, TECHNICAL SERVICES, SUPPORT SERVICES FOR THE COMMERCIAL, INDUSTRIAL, AND RESIDENTIAL MARKETS, TROUBLE SHOOTING SERVICES, PRICING SERVICES, ORDER STATUS REPORT SERVICES, LOGISTICAL SUPPORT SERVICES, VALUE ENGINEERING SERVICES, TECHNICAL PRODUCT SUPPORT SERVICES, GENERAL APPLICATION SUPPORT SERVICES,

TROUBLESHOOTING SUPPORT SERVICES, AFTERMARKET SUPPORT SERVICES, AND MARKET ANALYSIS SUPPORT SERVICES, IN CLASS 35 (U.S. CLS. 100, 101 AND 102).

FIRST USE 9-30-2007; IN COMMERCE 9-30-2007.

THE MARK CONSISTS OF STANDARD CHARACTERS WITHOUT CLAIM TO ANY PARTICULAR FONT, STYLE, SIZE, OR COLOR.

SN 77-281,140, FILED 9-17-2007.

SHARON MEIER, EXAMINING ATTORNEY

**Int. Cl.: 9**

**Prior U.S. Cls.: 21, 23, 26, 36, and 38**

**Reg. No. 3,570,550**

**United States Patent and Trademark Office**

**Registered Feb. 3, 2009**

**TRADEMARK  
PRINCIPAL REGISTER**

# FRACTURE

LUCASFILM ENTERTAINMENT COMPANY  
LTD. (CALIFORNIA CORPORATION)  
P.O. BOX 29919  
SAN FRANCISCO, CA 94129

FOR: PRE-RECORDED CD-ROMS AND DVDS  
FEATURING MUSIC; PRE-RECORDED CD-ROMS  
AND DVDS FEATURING GAMES, MUSIC AND  
FILMS; GAME SOFTWARE FOR WIRELESS DEVI-  
CES; PRE-RECORDED ELECTRONIC MEDIA FEA-  
TURING MUSIC; PRE-RECORDED ELECTRONIC  
MEDIA FEATURING GAMES; PRE-RECORDED

ELECTRONIC MEDIA FEATURING FILMS, IN  
CLASS 9 (U.S. CLS. 21, 23, 26, 36 AND 38).

FIRST USE 10-7-2008; IN COMMERCE 10-7-2008.

THE MARK CONSISTS OF STANDARD CHAR-  
ACTERS WITHOUT CLAIM TO ANY PARTICULAR  
FONT, STYLE, SIZE, OR COLOR.

SN 77-281,627, FILED 9-17-2007.

MARY MUNSON, EXAMINING ATTORNEY

**Int. Cl.: 9**

**Prior U.S. Cls.: 21, 23, 26, 36, and 38**

**Reg. No. 3,570,551**

**United States Patent and Trademark Office**

**Registered Feb. 3, 2009**

**TRADEMARK  
PRINCIPAL REGISTER**

# Shear Luck

MULTIMEDIA GAMES, INC. (TEXAS CORPORATION)  
206 WILD BASIN RD.  
BLDG B - 4TH FLR  
AUSTIN, TX 78746

FOR: GAMING MACHINES, NAMELY, ELECTRONIC SLOT AND BINGO MACHINES; VIDEO LOTTERY TERMINALS, IN CLASS 9 (U.S. CLS. 21, 23, 26, 36 AND 38).

FIRST USE 11-13-2007; IN COMMERCE 11-13-2007.

THE MARK CONSISTS OF STANDARD CHARACTERS WITHOUT CLAIM TO ANY PARTICULAR FONT, STYLE, SIZE, OR COLOR.

SN 77-281,713, FILED 9-17-2007.

DAVID YONTEF, EXAMINING ATTORNEY

**Int. Cl.: 9**

**Prior U.S. Cls.: 21, 23, 26, 36, and 38**

**Reg. No. 3,570,552**

**United States Patent and Trademark Office**

**Registered Feb. 3, 2009**

**TRADEMARK  
PRINCIPAL REGISTER**

**FASTRACK**

NATIONAL AERONAUTICS AND SPACE AD-  
MINISTRATION (UNITED STATES FEDERAL  
AGENCY)  
300 E. STREET S.W.  
WASHINGTON, DC 20546

FOR: SPACE EXPERIMENT TESTING LABORA-  
TORY EQUIPMENT, NAMELY, RACKS FOR USE  
WITH DRAWERS AND LOCKERS WHICH HOUSE  
EXPERIMENT SPECIMENS, INSTRUMENTS, AND  
ELECTRICAL POWER AND DATA RECORDING  
DEVICES FOR SERVICING THE EXPERIMENTS, IN  
CLASS 9 (U.S. CLS. 21, 23, 26, 36 AND 38).

FIRST USE 9-9-2008; IN COMMERCE 9-9-2008.

THE MARK CONSISTS OF STANDARD CHAR-  
ACTERS WITHOUT CLAIM TO ANY PARTICULAR  
FONT, STYLE, SIZE, OR COLOR.

SN 77-282,043, FILED 9-18-2007.

COLLEEN DOMBROW, EXAMINING ATTORNEY



**Int. Cl.: 9**

**Prior U.S. Cls.: 21, 23, 26, 36, and 38**

**Reg. No. 3,570,553**

**United States Patent and Trademark Office**

**Registered Feb. 3, 2009**

---

**TRADEMARK  
PRINCIPAL REGISTER**

**psychpartner**

PSYCHIATRIC HEALTH CORPORATION (OKLAHOMA CORPORATION)  
10101 S PENNSYLVANIA AVE., SUITE A  
OKLAHOMA CITY, OK 73159

FOR: COMPUTER SOFTWARE FOR USE IN PSYCHIATRIC AND MEDICAL OFFICES AND FACILITIES FOR PATIENT'S MEDICAL RECORDS, PRACTICE MANAGEMENT, SCHEDULING, AND BILLING, IN CLASS 9 (U.S. CLS. 21, 23, 26, 36 AND 38).

FIRST USE 1-1-2008; IN COMMERCE 6-1-2008.

THE MARK CONSISTS OF STANDARD CHARACTERS WITHOUT CLAIM TO ANY PARTICULAR FONT, STYLE, SIZE, OR COLOR.

SN 77-282,067, FILED 9-18-2007.

KELLY BOULTON, EXAMINING ATTORNEY

**Int. Cls.: 24 and 25**

**Prior U.S. Cls.: 22, 39, 42, and 50**

**United States Patent and Trademark Office**

**Reg. No. 3,570,554**

**Registered Feb. 3, 2009**

**TRADEMARK  
PRINCIPAL REGISTER**

**BAMBINI PICCOLINI**

BAMBINI CARINI INC. (NEW YORK CORPORATION)  
PO BOX 202  
CEDARHURST, NY 11516

FOR: BURP CLOTHS; CHILDREN'S BLANKETS;  
TOWELS, IN CLASS 24 (U.S. CLS. 42 AND 50).

FIRST USE 4-1-2008; IN COMMERCE 5-1-2008.

FOR: BABY BIBS NOT OF PAPER; BIB OVER-ALLS; BOOTIES; CAPS; CHILDREN'S HEADWEAR; CLOTH BIBS; HATS; HEADWEAR; INFANT AND TODDLER ONE PIECE CLOTHING; INFANTWEAR; LOUNGEWEAR; ROBES, IN CLASS 25 (U.S. CLS. 22 AND 39).

FIRST USE 4-1-2008; IN COMMERCE 5-1-2008.

THE MARK CONSISTS OF STANDARD CHARACTERS WITHOUT CLAIM TO ANY PARTICULAR FONT, STYLE, SIZE, OR COLOR.

NO CLAIM IS MADE TO THE EXCLUSIVE RIGHT TO USE "BAMBINI", APART FROM THE MARK AS SHOWN.

THE ENGLISH TRANSLATION OF "BAMBINI PICCOLINI" IS LITTLE CHILDREN.

SN 77-282,464, FILED 9-18-2007.

TOBY BULLOFF, EXAMINING ATTORNEY

**Int. Cl.: 21**

**Prior U.S. Cls.: 2, 13, 23, 29, 30, 33, 40, and 50**

**United States Patent and Trademark Office**

**Reg. No. 3,570,555**

**Registered Feb. 3, 2009**

**TRADEMARK  
PRINCIPAL REGISTER**

**Body Up Brush System**

PURVIS, JONNA M. (UNITED STATES INDIVIDUAL)

3212 ANGUS DR.

PRESCOTT, AZ 86305

FOR: HAIR BRUSHES, IN CLASS 21 (U.S. CLS. 2, 13, 23, 29, 30, 33, 40 AND 50).

FIRST USE 11-11-2008; IN COMMERCE 11-11-2008.

THE MARK CONSISTS OF STANDARD CHARACTERS WITHOUT CLAIM TO ANY PARTICULAR FONT, STYLE, SIZE, OR COLOR.

NO CLAIM IS MADE TO THE EXCLUSIVE RIGHT TO USE "BRUSH SYSTEM", APART FROM THE MARK AS SHOWN.

SN 77-282,825, FILED 9-18-2007.

THEODORE MCBRIDE, EXAMINING ATTORNEY

**Int. Cl.: 9**

**Prior U.S. Cls.: 21, 23, 26, 36, and 38**

**United States Patent and Trademark Office**

**Reg. No. 3,570,556**

**Registered Feb. 3, 2009**

**TRADEMARK  
PRINCIPAL REGISTER**

**ECOSLIM**

PTG, LLC (MAINE LIMITED LIABILITY COMPANY)  
16 LANDRY STREET  
BIDDEFORD, ME 04005

THE MARK CONSISTS OF STANDARD CHARACTERS WITHOUT CLAIM TO ANY PARTICULAR FONT, STYLE, SIZE, OR COLOR.

FOR: HOLDERS FOR CDS, DVDS AND BLANK DISCS, IN CLASS 9 (U.S. CLS. 21, 23, 26, 36 AND 38).

SN 77-283,003, FILED 9-19-2007.

FIRST USE 5-2-2008; IN COMMERCE 5-2-2008.

PAM WILLIS, EXAMINING ATTORNEY

**Int. Cl.: 36**

**Prior U.S. Cls.: 100, 101, and 102**

**United States Patent and Trademark Office**

**Reg. No. 3,570,557**

**Registered Feb. 3, 2009**

**SERVICE MARK  
PRINCIPAL REGISTER**

**PAY 'N PAK**

DOUGLASS, HARLEY C. (UNITED STATES IN-  
DIVIDUAL)  
P.O. BOX 234  
COLBERT, WA 99005

FOR: REAL ESTATE SERVICES, NAMELY, LEAS-  
ING, RENTING, AND MANAGEMENT OF CONDO-  
MINIUM STORAGE UNITS; REAL ESTATE  
BROKERAGE, NAMELY, PROVIDING BROKER-  
AGE FOR CONDOMINIUM STORAGE UNITS,  
CONDOMINIUM UNITS FOR STORAGE, AND  
CONDOMINIUM GARAGE UNITS FOR STORAGE,  
IN CLASS 36 (U.S. CLS. 100, 101 AND 102).

FIRST USE 7-1-2008; IN COMMERCE 7-1-2008.

THE MARK CONSISTS OF STANDARD CHAR-  
ACTERS WITHOUT CLAIM TO ANY PARTICULAR  
FONT, STYLE, SIZE, OR COLOR.

SN 77-283,908, FILED 9-19-2007.

JAY FLOWERS, EXAMINING ATTORNEY

**Int. Cl.: 36**

**Prior U.S. Cls.: 100, 101, and 102**

**United States Patent and Trademark Office**

**Reg. No. 3,570,558**

**Registered Feb. 3, 2009**

**SERVICE MARK  
PRINCIPAL REGISTER**

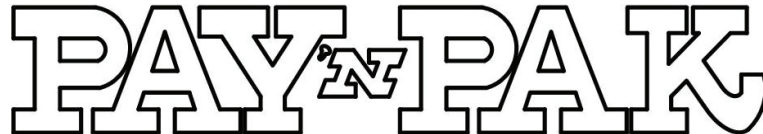
The logo consists of the words "PAY" and "PARK" in a bold, outlined, sans-serif font. A stylized ampersand (&) is positioned between the two words, also in an outlined font. The letters are thick and have a double-line outline.

DOUGLASS, HARLEY C. (UNITED STATES IN-  
DIVIDUAL)  
P.O. BOX 234  
COLBERT, WA 99005

FOR: REAL ESTATE SERVICES, NAMELY, LEAS-  
ING, RENTING, AND MANAGEMENT OF CONDO-  
MINIUM STORAGE UNITS; REAL ESTATE  
BROKERAGE, NAMELY, PROVIDING BROKER-  
AGE FOR CONDOMINIUM STORAGE UNITS,  
CONDOMINIUM UNITS FOR STORAGE, AND

CONDOMINIUM GARAGE UNITS FOR STORAGE,  
IN CLASS 36 (U.S. CLS. 100, 101 AND 102).

FIRST USE 7-1-2008; IN COMMERCE 7-1-2008.

THE MARK CONSISTS OF STYLIZED WORD(S)  
AND/OR LETTER(S).

SN 77-284,297, FILED 9-20-2007.

JAY FLOWERS, EXAMINING ATTORNEY

**Int. Cl.: 41**

**Prior U.S. Cls.: 100, 101, and 107**

**United States Patent and Trademark Office**

**Reg. No. 3,570,559**

**Registered Feb. 3, 2009**

**SERVICE MARK  
PRINCIPAL REGISTER**

**HIplet**

CHICAGO MULTI-CULTURAL DANCE CENTER  
(ILLINOIS NON-PROFIT CORPORATION)  
806 SOUTH PLYMOUTH COURT  
CHICAGO, IL 60605

THE MARK CONSISTS OF STANDARD CHAR-  
ACTERS WITHOUT CLAIM TO ANY PARTICULAR  
FONT, STYLE, SIZE, OR COLOR.

FOR: ENTERTAINMENT SERVICES, NAMELY,  
PERFORMANCE AND CREATION OF DANCE  
CHOREOGRAPHY, IN CLASS 41 (U.S. CLS. 100, 101  
AND 107).

SN 77-285,343, FILED 9-21-2007.

FIRST USE 6-14-2008; IN COMMERCE 6-14-2008.

CHERYL CLAYTON, EXAMINING ATTORNEY

**Int. Cl.: 9**

**Prior U.S. Cls.: 21, 23, 26, 36, and 38**

**Reg. No. 3,570,560**

**United States Patent and Trademark Office**

**Registered Feb. 3, 2009**

---

**TRADEMARK  
PRINCIPAL REGISTER**

**SKUA**

PARADIGM GEOPHYSICAL ,LUXEMBOURG  
SARL (LUXEMBOURG SOCIÉTÉ A RESPONSABILITÉ LIMITÉE (SARL))  
CARRE BONN  
RUE DE LA POSTE 20, LUXEMBOURG L-2346

FOR: COMPUTER SOFTWARE, NAMELY, COMPUTER PROGRAMS FOR USE IN RELATION TO EXPLORATION AND PRODUCTION OF OIL AND GAS , IN CLASS 9 (U.S. CLS. 21, 23, 26, 36 AND 38).

FIRST USE 9-27-2007; IN COMMERCE 9-27-2007.

THE MARK CONSISTS OF STANDARD CHARACTERS WITHOUT CLAIM TO ANY PARTICULAR FONT, STYLE, SIZE, OR COLOR.

SN 77-285,620, FILED 9-21-2007.

SANJEEV VOHRA, EXAMINING ATTORNEY



**Int. Cl.: 28**

**Prior U.S. Cls.: 22, 23, 38, and 50**

**United States Patent and Trademark Office**

**Reg. No. 3,570,561**

**Registered Feb. 3, 2009**

**TRADEMARK  
PRINCIPAL REGISTER**

**HI**

CLAWSON CUSTOM CUES, INC (FLORIDA  
CORPORATION)  
5055-5 ST AUGUSTINE RD  
JACKSONVILLE, FL 32207

THE MARK CONSISTS OF STANDARD CHAR-  
ACTERS WITHOUT CLAIM TO ANY PARTICULAR  
FONT, STYLE, SIZE, OR COLOR.

FOR: BILLIARD CUES, IN CLASS 28 (U.S. CLS. 22,  
23, 38 AND 50).

SN 77-285,963, FILED 9-21-2007.

FIRST USE 10-24-2007; IN COMMERCE 10-24-2007.

ANTHONY RINKER, EXAMINING ATTORNEY

**Int. Cl.: 28**

**Prior U.S. Cls.: 22, 23, 38, and 50**

**United States Patent and Trademark Office**

**Reg. No. 3,570,562**

**Registered Feb. 3, 2009**

**TRADEMARK  
PRINCIPAL REGISTER**

The image shows the letters 'HD' in a large, bold, serif font. The letters are black and centered on the page. The 'H' and 'D' are connected at the top and bottom, with a slight gap in the middle of the 'H'.

CLAWSON CUSTOM CUES,INC (FLORIDA CORPORATION)  
5055-5 ST AUGUSTINE RD  
JACKSONVILLE, FL 32207

THE MARK CONSISTS OF STANDARD CHARACTERS WITHOUT CLAIM TO ANY PARTICULAR FONT, STYLE, SIZE, OR COLOR.

FOR: BILLIARD CUES, IN CLASS 28 (U.S. CLS. 22, 23, 38 AND 50).

SN 77-286,093, FILED 9-21-2007.

FIRST USE 10-24-2007; IN COMMERCE 10-24-2007.

ANTHONY RINKER, EXAMINING ATTORNEY

**Int. Cl.: 28**

**Prior U.S. Cls.: 22, 23, 38, and 50**

**Reg. No. 3,570,563**

**United States Patent and Trademark Office**

**Registered Feb. 3, 2009**

---

**TRADEMARK  
PRINCIPAL REGISTER**

**GTX**

CLAWSON CUSTOM CUES,INC (FLORIDA COR-  
PORATION)  
5055-5 ST AUGUSTINE RD  
JACKSONVILLE, FL 32207

THE MARK CONSISTS OF STANDARD CHAR-  
ACTERS WITHOUT CLAIM TO ANY PARTICULAR  
FONT, STYLE, SIZE, OR COLOR.

FOR: BILLIARD CUES, IN CLASS 28 (U.S. CLS. 22,  
23, 38 AND 50).

SN 77-286,137, FILED 9-21-2007.

FIRST USE 10-24-2007; IN COMMERCE 10-24-2007.

ANTHONY RINKER, EXAMINING ATTORNEY

**Int. Cl.: 30**

**Prior U.S. Cl.: 46**

**United States Patent and Trademark Office**

**Reg. No. 3,570,564**

**Registered Feb. 3, 2009**

**TRADEMARK  
PRINCIPAL REGISTER**



MILTON'S BAKING COMPANY, LLC (DELA-  
WARE LIMITED LIABILITY COMPANY)  
SUITE 202  
3702 VIA DE LA VALLE  
DEL MAR, CA 92014

FOR: BAKED GOODS, NAMELY, CRACKERS, IN  
CLASS 30 (U.S. CL. 46).

FIRST USE 3-31-2008; IN COMMERCE 3-31-2008.

THE MARK CONSISTS OF THE LETTER "M".

SN 77-286,541, FILED 9-23-2007.

RUDY R. SINGLETON, EXAMINING ATTORNEY

**Int. Cl.: 3**

**Prior U.S. Cls.: 1, 4, 6, 50, 51, and 52**

**United States Patent and Trademark Office**

**Reg. No. 3,570,565**

**Registered Feb. 3, 2009**

**TRADEMARK  
PRINCIPAL REGISTER**

**SUN FRESH**

NEUTROGENA CORPORATION (DELAWARE  
CORPORATION)  
5760 WEST 96TH STREET  
LOS ANGELES, CA 90045

FOR: SUNLESS TANNING LOTIONS AND  
FOAMS, IN CLASS 3 (U.S. CLS. 1, 4, 6, 50, 51 AND 52).

FIRST USE 11-7-2007; IN COMMERCE 11-7-2007.

THE MARK CONSISTS OF STANDARD CHAR-  
ACTERS WITHOUT CLAIM TO ANY PARTICULAR  
FONT, STYLE, SIZE, OR COLOR.

SN 77-287,034, FILED 9-24-2007.

DOMINIC J. FERRAIUOLO, EXAMINING ATTOR-  
NEY

**Int. Cl.: 9**

**Prior U.S. Cls.: 21, 23, 26, 36, and 38**

**Reg. No. 3,570,566**

**United States Patent and Trademark Office**

**Registered Feb. 3, 2009**

**TRADEMARK  
PRINCIPAL REGISTER**

**FREEDOM SWITCH**

ENERGY FOCUS, INC. (DELAWARE CORPORATION)  
32000 AURORA ROAD  
OLON, OH 44139

FOR: JUNCTION BOXES AND WIRELESS TRANSMITTERS FOR USE IN CONTROLLING SWIMMING POOL LIGHTS; SWIMMING POOL LIGHTING CONTROLLERS, IN CLASS 9 (U.S. CLS. 21, 23, 26, 36 AND 38).

FIRST USE 11-27-2007; IN COMMERCE 11-27-2007.

THE MARK CONSISTS OF STANDARD CHARACTERS WITHOUT CLAIM TO ANY PARTICULAR FONT, STYLE, SIZE, OR COLOR.

NO CLAIM IS MADE TO THE EXCLUSIVE RIGHT TO USE "SWITCH", APART FROM THE MARK AS SHOWN.

SN 77-287,335, FILED 9-24-2007.

JOHN DWYER, EXAMINING ATTORNEY

**Int. Cls.: 29 and 30**

**Prior U.S. Cl.: 46**

**United States Patent and Trademark Office**

**Reg. No. 3,570,567**

**Registered Feb. 3, 2009**

**TRADEMARK  
PRINCIPAL REGISTER**

**MIXIT**

CUISINE SOLUTIONS, INC. (DELAWARE CORPORATION)  
SUITE 600  
85 SOUTH BRAGG STREET  
ALEXANDRIA, VA 22312

FOR: FROZEN AND REFRIGERATED ENTREES CONSISTING PRIMARILY OF MEAT, FISH, POULTRY, OR VEGETABLES, COOKED EITHER REGULAR STYLE OR UNDER VACUUM BY THE SOUS VIDE PROCESS; FRUIT SALAD, GARDEN SALAD AND VEGETABLE SALAD, IN CLASS 29 (U.S. CL. 46).

FIRST USE 11-1-2008; IN COMMERCE 11-1-2008.

FOR: FROZEN AND REFRIGERATED ENTRES CONSISTING PRIMARILY OF PASTA AND RICE,

COOKED EITHER REGULAR STYLE OR UNDER VACUUM BY THE SOUS VIDE PROCESS; MACARONI SALAD, PASTA SALAD, AND RICE SALAD, IN CLASS 30 (U.S. CL. 46).

FIRST USE 11-1-2008; IN COMMERCE 11-1-2008.

THE MARK CONSISTS OF STANDARD CHARACTERS WITHOUT CLAIM TO ANY PARTICULAR FONT, STYLE, SIZE, OR COLOR.

SN 77-289,259, FILED 9-26-2007.

VIVIAN MICZNIK FIRST, EXAMINING ATTORNEY

**Int. Cl.: 42**

**Prior U.S. Cls.: 100 and 101**

**United States Patent and Trademark Office**

**Reg. No. 3,570,568**

**Registered Feb. 3, 2009**

**SERVICE MARK  
PRINCIPAL REGISTER**

**BOARDVISION**

BOARDROOM SOFTWARE, INC. (TEXAS CORPORATION)  
SUITE 2350  
4120 INTERNATIONAL PARKWAY  
CARROLLTON, TX 75007

FOR: PROVIDING ON-LINE NON-DOWNLOADABLE SOFTWARE FOR FACILITATING COMMUNICATIONS FOR MEETINGS VIA THE INTERNET, IN CLASS 42 (U.S. CLS. 100 AND 101).

FIRST USE 12-0-2007; IN COMMERCE 12-0-2007.

THE MARK CONSISTS OF STANDARD CHARACTERS WITHOUT CLAIM TO ANY PARTICULAR FONT, STYLE, SIZE, OR COLOR.

SN 77-289,920, FILED 9-26-2007.

JASON LOTT, EXAMINING ATTORNEY



Int. Cl.: 36

Prior U.S. Cls.: 100, 101, and 102

United States Patent and Trademark Office

Reg. No. 3,570,569

Registered Feb. 3, 2009

SERVICE MARK  
PRINCIPAL REGISTER



HUNTSVILLE HOSPITAL FOUNDATION (ALABAMA NON-PROFIT ORGANIZATION)  
101 SIVLEY ROAD  
HUNTSVILLE, AL 35801

FOR: CHARITABLE DONATIONS SERVICES; CHARITABLE FUND RAISING SERVICES, NAMELY, BY PROVIDING DONORS WITH THE INFORMATION AND OPPORTUNITY TO MAKE MONETARY DONATIONS TO THEIR FAVORITE CHARITY; ACCEPTING AND ADMINISTERING MONETARY CHARITABLE DONATIONS, IN CLASS 36 (U.S. CLS. 100, 101 AND 102).

FIRST USE 10-1-2007; IN COMMERCE 10-1-2007.

NO CLAIM IS MADE TO THE EXCLUSIVE RIGHT TO USE "ONLINE" AND "GIFTS", APART FROM THE MARK AS SHOWN.

THE MARK CONSISTS OF THE WORDS "ONLINE LIFELINE" SEPARATED BY A HEART-PULSE TYPE LINE THAT RUNS UNDERNEATH BOTH WORDS AND JUTS UP BETWEEN THEM. THE LINE IS SIMILAR TO A HEART RHYTHM MONITOR LINE. THE WORDS "GIFTS THAT HEAL" ARE LOCATED BELOW THAT LINE.

SN 77-290,060, FILED 9-27-2007.

ADA HAN, EXAMINING ATTORNEY

**Int. Cl.: 25**

**Prior U.S. Cls.: 22 and 39**

**United States Patent and Trademark Office**

**Reg. No. 3,570,570**

**Registered Feb. 3, 2009**

**TRADEMARK  
PRINCIPAL REGISTER**

**FLOPOLOGY**

MYERS, PAMELA (UNITED STATES INDIVIDUAL)  
18135 STONY POINT DR.  
STRONGSVILLE, OH 44136

THE MARK CONSISTS OF STANDARD CHARACTERS WITHOUT CLAIM TO ANY PARTICULAR FONT, STYLE, SIZE, OR COLOR.

FOR: FOOTWEAR, IN CLASS 25 (U.S. CLS. 22 AND 39).

SN 77-290,704, FILED 9-27-2007.

FIRST USE 4-1-2008; IN COMMERCE 4-1-2008.

JAY FLOWERS, EXAMINING ATTORNEY

**Int. Cl.: 17**

**Prior U.S. Cls.: 1, 5, 12, 13, 35, and 50**

**United States Patent and Trademark Office**

**Reg. No. 3,570,571**

**Registered Feb. 3, 2009**

**TRADEMARK  
PRINCIPAL REGISTER**

**AQUABLOWN MIDFLEX**

ENERGYSEAL AIR BARRIER SYSTEMS (IDAHO  
LIMITED LIABILITY COMPANY)  
PO BOX 1404  
MCCALL, ID 83638

THE MARK CONSISTS OF STANDARD CHAR-  
ACTERS WITHOUT CLAIM TO ANY PARTICULAR  
FONT, STYLE, SIZE, OR COLOR.

FOR: URETHANE SPRAY FOAMS APPLIED AS  
INSULATION TO HOMES, COMMERCIAL BUILD-  
INGS, AND INDUSTRIAL APPLICATIONS, IN  
CLASS 17 (U.S. CLS. 1, 5, 12, 13, 35 AND 50).

SN 77-291,261, FILED 9-28-2007.

FIRST USE 10-25-2008; IN COMMERCE 10-25-2008.

BRIAN PINO, EXAMINING ATTORNEY

**Int. Cl.: 42**

**Prior U.S. Cls.: 100 and 101**

**United States Patent and Trademark Office**

**Reg. No. 3,570,572**

**Registered Feb. 3, 2009**

**SERVICE MARK  
PRINCIPAL REGISTER**

RELIABLE HOME INSPECTION

RELIABLE HOME INSPECTION INC. (NEW JERSEY CORPORATION)  
152 HICKSON DRIVE  
NEW PROVIDENCE, NJ 07974

FOR: INSPECTIONS OF HOMES, INSPECTIONS OF HOMES FOR TERMITES, AND RADON TESTING, IN CLASS 42 (U.S. CLS. 100 AND 101).

FIRST USE 1-3-1993; IN COMMERCE 6-15-1995.

THE MARK CONSISTS OF STANDARD CHARACTERS WITHOUT CLAIM TO ANY PARTICULAR FONT, STYLE, SIZE, OR COLOR.

NO CLAIM IS MADE TO THE EXCLUSIVE RIGHT TO USE "HOME INSPECTION", APART FROM THE MARK AS SHOWN.

SN 77-291,262, FILED 9-28-2007.

ANDREW RHIM, EXAMINING ATTORNEY

**Int. Cl.: 30**

**Prior U.S. Cl.: 46**

**United States Patent and Trademark Office**

**Reg. No. 3,570,573**

**Registered Feb. 3, 2009**

**TRADEMARK  
PRINCIPAL REGISTER**

**CUSTOM MELTS**

SARGENTO FOODS, INC. (WISCONSIN CORPORATION)

ONE PERSNICKETY PLACE

PLYMOUTH, WI 53073

FOR: SAUCES; CHEESE SAUCE, IN CLASS 30 (U.S. CL. 46).

FIRST USE 4-2-2008; IN COMMERCE 4-2-2008.

THE MARK CONSISTS OF STANDARD CHARACTERS WITHOUT CLAIM TO ANY PARTICULAR FONT, STYLE, SIZE, OR COLOR.

NO CLAIM IS MADE TO THE EXCLUSIVE RIGHT TO USE "MELTS", APART FROM THE MARK AS SHOWN.

SN 77-291,445, FILED 9-28-2007.

G. MAYERSCHOFF, EXAMINING ATTORNEY

Int. Cls.: 29, 30, and 32

Prior U.S. Cls.: 45, 46, and 48

United States Patent and Trademark Office

Reg. No. 3,570,574

Registered Feb. 3, 2009

TRADEMARK  
PRINCIPAL REGISTER

やがて、いのちが変わるもの。

KABUSHIKI KAISHA MITSUKAN GROUP HON-  
SHA (JAPAN CORPORATION)  
2-6, NAKAMURA-CHO, HANDA-SHI  
AICHI-KEN, JAPAN 475-8585

FOR: FERMENTED SOY BEANS, PREPARED  
VEGETABLES FOR GOMOKU CHIRASHI SUSHI,  
IN CLASS 29 (U.S. CL. 46).

FIRST USE 6-1-2004; IN COMMERCE 1-1-2008.

FOR: VINEGAR, SUSHI SEASONING, SALAD  
DRESSING; AND SEASONED POWDER CONSIST-  
ING PRIMARILY OF DRIED SEAWEED AND  
DRIED EGG WITH SESAME SEEDS FOR SPRINK-  
LING ON RICE (FURI-KAKE), IN CLASS 30 (U.S. CL.  
46).

FIRST USE 6-1-2004; IN COMMERCE 1-1-2008.

FOR: NON-ALCOHOLIC VINEGAR BASED BEV-  
ERAGES CONTAINING A DILUENT SUCH AS

LIQUID SUGAR, SODA WATER, FRUIT JUICE,  
HONEY, OR WATER, INTENDED FOR CONSUMP-  
TION OR FOR FURTHER DILUTION PRIOR TO  
CONSUMPTION, IN CLASS 32 (U.S. CLS. 45, 46 AND  
48).

FIRST USE 6-1-2004; IN COMMERCE 1-1-2008.

THE MARK CONSISTS OF JAPANESE CHARAC-  
TERS IN STYLIZED LETTERING.

THE NON-LATIN CHARACTER(S) IN THE  
MARK TRANSLITERATE INTO YAGATEINOCHI-  
NIKAWARUMONO, AND THIS MEANS "SOME-  
THING THAT WILL EVENTUALLY CHANGE TO  
LIFE" IN ENGLISH.

SN 77-291,585, FILED 9-28-2007.

MARK T. MULLEN, EXAMINING ATTORNEY

**Int. Cl.: 29**

**Prior U.S. Cl.: 46**

**United States Patent and Trademark Office**

**Reg. No. 3,570,575**

**Registered Feb. 3, 2009**

**TRADEMARK  
PRINCIPAL REGISTER**

**NOGÜRT**

RICH AND WHOLESOME FOODS, LLC (COLOR-  
ADO LIMITED LIABILITY COMPANY)  
SUITE 313  
637B BROADWAY  
BOULDER, CO 80305

THE MARK CONSISTS OF STANDARD CHAR-  
ACTERS WITHOUT CLAIM TO ANY PARTICULAR  
FONT, STYLE, SIZE, OR COLOR.

FOR: DAIRY AND SOY FREE YOGURT, IN  
CLASS 29 (U.S. CL. 46).

SN 77-291,859, FILED 9-28-2007.

FIRST USE 11-25-2008; IN COMMERCE 11-25-2008.

STEVEN JACKSON, EXAMINING ATTORNEY

**Int. Cl.: 9**

**Prior U.S. Cls.: 21, 23, 26, 36, and 38**

**Reg. No. 3,570,576**

**United States Patent and Trademark Office**

**Registered Feb. 3, 2009**

---

**TRADEMARK  
PRINCIPAL REGISTER**

**DYNAMAX**

PANAVISION IMAGING, LLC (DELAWARE LIMITED LIABILITY COMPANY)  
ONE TECHNOLOGY PLACE  
HOMER, NY 13077

THE MARK CONSISTS OF STANDARD CHARACTERS WITHOUT CLAIM TO ANY PARTICULAR FONT, STYLE, SIZE, OR COLOR.

FOR: INTEGRATED CIRCUITS FOR USE IN DIGITAL IMAGING SENSORS AND DIGITAL IMAGING EQUIPMENT, IN CLASS 9 (U.S. CLS. 21, 23, 26, 36 AND 38).

SN 77-291,918, FILED 9-28-2007.

FIRST USE 5-0-2006; IN COMMERCE 1-13-2008.

ELLEN BURNS, EXAMINING ATTORNEY



**Int. Cl.: 36**

**Prior U.S. Cls.: 100, 101, and 102**

**United States Patent and Trademark Office**

**Reg. No. 3,570,577**

**Registered Feb. 3, 2009**

**SERVICE MARK  
PRINCIPAL REGISTER**

# SwiftCollect

SWIFTCOLLECT LLC (DELAWARE LIMITED  
LIABILITY COMPANY)  
SUITE 373  
527 3RD AVENUE  
NEW YORK, NY 10016

FOR: COLLECTION OF DEBTS; COLLECTION  
AGENCIES; CREDIT RECOVERY AND COLLEC-  
TION; DEBT RECOVERY AND COLLECTION  
AGENCIES; DEBT COUNSELING SERVICES; DEBT  
MANAGEMENT CONSULTATION, IN CLASS 36  
(U.S. CLS. 100, 101 AND 102).

FIRST USE 10-6-2007; IN COMMERCE 10-6-2007.

THE MARK CONSISTS OF STANDARD CHAR-  
ACTERS WITHOUT CLAIM TO ANY PARTICULAR  
FONT, STYLE, SIZE, OR COLOR.

SN 77-292,560, FILED 10-1-2007.

BRENDAN MCCAULEY, EXAMINING ATTORNEY

**Int. Cl.: 16**

**Prior U.S. Cls.: 2, 5, 22, 23, 29, 37, 38, and 50**

**Reg. No. 3,570,578**

**United States Patent and Trademark Office**

**Registered Feb. 3, 2009**

---

**TRADEMARK  
PRINCIPAL REGISTER**

**BLOCK HEAD**

PROFORM TECHNOLOGIES, INC. (WYOMING  
CORPORATION)  
315 RAILROAD AVENUE  
RIVERTON, WY 82501

THE MARK CONSISTS OF STANDARD CHAR-  
ACTERS WITHOUT CLAIM TO ANY PARTICULAR  
FONT, STYLE, SIZE, OR COLOR.

FOR: PAINT BRUSHES, IN CLASS 16 (U.S. CLS. 2,  
5, 22, 23, 29, 37, 38 AND 50).

SN 77-292,863, FILED 10-1-2007.

FIRST USE 1-25-2008; IN COMMERCE 1-25-2008.

ESTHER A. BORSUK, EXAMINING ATTORNEY

**Int. Cl.: 9**

**Prior U.S. Cls.: 21, 23, 26, 36, and 38**

**Reg. No. 3,570,579**

**United States Patent and Trademark Office**

**Registered Feb. 3, 2009**

**TRADEMARK  
PRINCIPAL REGISTER**

The logo for AvRamp features a stylized, bold letter 'A' on the left. The top of the 'A' is curved and ends in an arrowhead pointing upwards and to the right. To the right of this 'A' is the word 'vRamp' in a bold, sans-serif font. The 'v' is lowercase, and 'Ramp' is uppercase.

I.D. SYSTEMS, INC. (DELAWARE CORPORATION)  
ONE UNIVERSITY PLAZA DRIVE  
6TH FLOOR  
HACKENSACK, NJ 07601

FOR: WIRELESS TRANSMITTERS AND RECEIVERS FOR USE WITH AIRCRAFT GROUND SUPPORT EQUIPMENT AND OPERATORS OF AIRCRAFT GROUND SUPPORT EQUIPMENT; COMPUTER HARDWARE AND SOFTWARE FOR WIRELESSLY MANAGING, MONITORING, ANALYZING, AND TRACKING AIRCRAFT GROUND SUPPORT EQUIPMENT AND OPERATORS OF AIR-

CRAFT GROUND SUPPORT EQUIPMENT, IN CLASS 9 (U.S. CLS. 21, 23, 26, 36 AND 38).

FIRST USE 6-30-2008; IN COMMERCE 6-30-2008.

THE MARK CONSISTS OF THE LITERAL ELEMENT "AVRAMP" WITH A STYLIZED INITIAL LETTER "A" DEPICTING AN AIRPLANE IN FLIGHT.

SN 77-292,941, FILED 10-1-2007.

BARBARA A. GOLD, EXAMINING ATTORNEY

**Int. Cl.: 9**

**Prior U.S. Cls.: 21, 23, 26, 36, and 38**

**Reg. No. 3,570,580**

**United States Patent and Trademark Office**

**Registered Feb. 3, 2009**

**TRADEMARK  
PRINCIPAL REGISTER**

The logo for "WiFree" features the word "WiFree" in a bold, sans-serif font. Above the letter "i" in "Wi", there are three curved lines of increasing size, resembling a Wi-Fi signal icon.

I.D. SYSTEMS, INC. (DELAWARE CORPORATION)  
ONE UNIVERSITY PLAZA DRIVE  
6TH FLOOR  
HACKENSACK, NJ 07601

TRUCKS, TOW TRACTORS, CRANES, AIRCRAFT GROUND SUPPORT EQUIPMENT, LETTERS, RAIL CARS, PACKAGES, LUGGAGE, PALLETS, CONTAINERS, AND DRIVERS, IN CLASS 9 (U.S. CLS. 21, 23, 26, 36 AND 38).

FOR: RADIO FREQUENCY TRANSMITTERS AND RECEIVERS FOR USE WITH VEHICLES, POWERED AND NON-POWERED ASSETS, NAMELY, FORKLIFTS, LIFT TRUCKS, TOW TRUCKS, CRANES, AIRCRAFT GROUND SUPPORT EQUIPMENT, LETTERS, RAIL CARS, PACKAGES, LUGGAGE, PALLETS, AND CONTAINERS; COMPUTER HARDWARE AND SOFTWARE FOR MANAGING, MONITORING, ANALYZING, AND TRACKING ENTERPRISE ASSETS, NAMELY, MOBILE POWER EQUIPMENT, VEHICLES, FORKLIFTS, LIFT

FIRST USE 10-31-2007; IN COMMERCE 10-31-2007.

THE MARK CONSISTS OF THE LITERAL ELEMENTS "WIFREE" WITH THREE PARTIAL, CIRCULAR SHAPES POSITIONED ABOVE THE LETTER "I" .

SN 77-292,948, FILED 10-1-2007.

BARBARA A. GOLD, EXAMINING ATTORNEY

**Int. Cl.: 37**

**Prior U.S. Cls.: 100, 103, and 106**

**United States Patent and Trademark Office**

**Reg. No. 3,570,581**

**Registered Feb. 3, 2009**

**SERVICE MARK  
PRINCIPAL REGISTER**

**ANTS ON FIRE**

ANTS ON FIRE, INC. (VIRGINIA CORPORATION)  
1177 PINE RIDGE DR  
FRONT ROYAL, VA 22630

FOR: PEST CONTROL; PEST CONTROL AND EXTERMINATION OTHER THAN FOR AGRICULTURAL PURPOSES, IN CLASS 37 (U.S. CLS. 100, 103 AND 106).

FIRST USE 9-0-2008; IN COMMERCE 9-0-2008.

THE MARK CONSISTS OF STANDARD CHARACTERS WITHOUT CLAIM TO ANY PARTICULAR FONT, STYLE, SIZE, OR COLOR.

NO CLAIM IS MADE TO THE EXCLUSIVE RIGHT TO USE "ANTS", APART FROM THE MARK AS SHOWN.

SN 77-293,391, FILED 10-1-2007.

ANDREA HACK, EXAMINING ATTORNEY

**Int. Cls.: 11 and 24**

**Prior U.S. Cls.: 13, 21, 23, 31, 34, 42, and 50**

**United States Patent and Trademark Office**

**Reg. No. 3,570,582**

**Registered Feb. 3, 2009**

**TRADEMARK  
PRINCIPAL REGISTER**

**SUPERSTAR MONKEY**

IDEA NUOVA, INC. (NEW YORK CORPORATION)  
302 FIFTH AVENUE  
NEW YORK, NY 10001

FOR: LAMPS, IN CLASS 11 (U.S. CLS. 13, 21, 23, 31 AND 34).

FIRST USE 11-25-2008; IN COMMERCE 11-25-2008.

FOR: BEDDING, NAMELY, BLANKETS, QUILTS, COVERLETS, BLANKET THROWS, BED SKIRTS, DUST RUFFLES, PILLOW SHAMS, PILLOW CASES,

SHEET AND SHEET SETS, DUVETS, COMFORTER, BED CANOPIES, IN CLASS 24 (U.S. CLS. 42 AND 50).

FIRST USE 7-1-2007; IN COMMERCE 12-17-2007.

THE MARK CONSISTS OF STANDARD CHARACTERS WITHOUT CLAIM TO ANY PARTICULAR FONT, STYLE, SIZE, OR COLOR.

SN 77-293,547, FILED 10-2-2007.

JANICE KIM, EXAMINING ATTORNEY

**Int. Cl.: 45**

**Prior U.S. Cls.: 100 and 101**

**United States Patent and Trademark Office**

**Reg. No. 3,570,583**

**Registered Feb. 3, 2009**

**SERVICE MARK  
PRINCIPAL REGISTER**



WINSTEAD PC (TEXAS CORPORATION), DBA  
WINSTEAD SECHREST & MINICK P.C.,  
5400 RENAISSANCE TOWER, 1201 ELM STREET  
DALLAS, TX 75270

FOR: LEGAL SERVICES, IN CLASS 45 (U.S. CLS.  
100 AND 101).

FIRST USE 9-5-2007; IN COMMERCE 9-5-2007.

THE COLOR(S) GREY, WHITE AND BLACK IS/  
ARE CLAIMED AS A FEATURE OF THE MARK.

THE MARK CONSISTS OF A RECTANGULAR  
LOGO FORMED FROM TWO ADJACENT RECTAN-  
GLES, A FIRST, GREY, ON THE LEFT, A SECOND,  
WHITE, ON THE RIGHT, WITH THE WORD "WIN-  
STEAD" IN BLACK PRINT, "WIN" IN THE GREY  
RECTANGLE, "STEAD" IN THE WHITE RECTAN-  
GLE.

SN 77-294,059, FILED 10-2-2007.

VIVIAN MICZNIK FIRST, EXAMINING ATTOR-  
NEY

**Int. Cl.: 45**

**Prior U.S. Cls.: 100 and 101**

**United States Patent and Trademark Office**

**Reg. No. 3,570,584**

**Registered Feb. 3, 2009**

**SERVICE MARK  
PRINCIPAL REGISTER**



WINSTEAD PC (TEXAS CORPORATION), DBA  
WINSTEAD SECHREST & MINICK P.C.,  
5400 RENAISSANCE TOWER, 1201 ELM STREET  
DALLAS, TX 75270

FOR: LEGAL SERVICES, IN CLASS 45 (U.S. CLS.  
100 AND 101).

FIRST USE 9-5-2007; IN COMMERCE 9-5-2007.

THE COLOR(S) YELLOW, BLACK AND WHITE  
IS/ARE CLAIMED AS A FEATURE OF THE MARK.

THE MARK CONSISTS OF A RECTANGULAR  
LOGO FORMED FROM A FIRST, YELLOW, REC-  
TANGLE IN THE UPPER LEFT QUADRANT OF A  
SECOND, LARGER, BLACK, RECTANGLE, WITH  
THE WORD "WINSTEAD" IN WHITE PRINT, "WIN"  
IN THE BOTTOM RIGHT QUADRANT OF THE  
YELLOW RECTANGLE, "STEAD" CONTINUING  
INTO THE BLACK RECTANGLE.

SN 77-294,069, FILED 10-2-2007.

VIVIAN MICZNIK FIRST, EXAMINING ATTOR-  
NEY



**Int. Cls.: 17, 21, and 27**

**Prior U.S. Cls.: 1, 2, 5, 12, 13, 19, 20, 23, 29, 30, 33, 35,  
37, 40, 42, and 50**

**Reg. No. 3,570,585**

**United States Patent and Trademark Office**

**Registered Feb. 3, 2009**

**TRADEMARK  
PRINCIPAL REGISTER**

**FAT MAT**

NEW PENDULUM CORP. (DELAWARE COR-  
PORATION)  
STE 1300  
1105 N. MARKET ST  
WILMINGTON, DE 19801

FOR: TEXTILES SOLD IN ROLLS AND PADS  
FOR ABSORBING INDUSTRIAL OIL, COOLANT  
AND SOLVENT SPILLS, IN CLASS 17 (U.S. CLS. 1, 5,  
12, 13, 35 AND 50).

FIRST USE 10-11-2007; IN COMMERCE 10-11-2007.

FOR: CLEANING PADS AND WIPES MADE OF  
SYNTHETIC AND NATURAL ABSORBENT TEX-  
TILES FOR ABSORBING INDUSTRIAL LIQUIDS,  
IN CLASS 21 (U.S. CLS. 2, 13, 23, 29, 30, 33, 40 AND 50).

FIRST USE 10-11-2007; IN COMMERCE 10-11-2007.

FOR: TEXTILE FLOOR MATS FOR ABSORBING  
LIQUID SPILLS FOR INDUSTRIAL AND COMMER-

CIAL USE, IN CLASS 27 (U.S. CLS. 19, 20, 37, 42 AND  
50).

FIRST USE 10-11-2007; IN COMMERCE 10-11-2007.

THE MARK CONSISTS OF STANDARD CHAR-  
ACTERS WITHOUT CLAIM TO ANY PARTICULAR  
FONT, STYLE, SIZE, OR COLOR.

OWNER OF U.S. REG. NOS. 2,240,173 AND  
2,679,781.

NO CLAIM IS MADE TO THE EXCLUSIVE  
RIGHT TO USE "MAT", APART FROM THE MARK  
AS SHOWN.

SN 77-294,098, FILED 10-2-2007.

BENJAMIN ALLEN, EXAMINING ATTORNEY

**Int. Cl.: 9**

**Prior U.S. Cls.: 21, 23, 26, 36, and 38**

**Reg. No. 3,570,586**

**United States Patent and Trademark Office**

**Registered Feb. 3, 2009**

**TRADEMARK  
PRINCIPAL REGISTER**



HEARING ENHANCEMENT GROUP, LLC (CALIFORNIA LIMITED LIABILITY COMPANY)  
P. O. BOX 6968  
THOUSAND OAKS, CA 91359

FIRST USE 9-15-2008; IN COMMERCE 9-15-2008.

SN 77-294,302, FILED 10-2-2007.

FOR: HEADPHONES, IN CLASS 9 (U.S. CLS. 21, 23, 26, 36 AND 38).

SHANNON TWOHIG, EXAMINING ATTORNEY

**Int. Cl.: 10**

**Prior U.S. Cls.: 26, 39, and 44**

**United States Patent and Trademark Office**

**Reg. No. 3,570,587**

**Registered Feb. 3, 2009**

**TRADEMARK  
PRINCIPAL REGISTER**



HEARING ENHANCEMENT GROUP, LLC (CALIFORNIA LIMITED LIABILITY COMPANY)  
P. O. BOX 6968  
THOUSAND OAKS, CA 91359

FIRST USE 9-15-2008; IN COMMERCE 9-15-2008.

SN 77-294,328, FILED 10-2-2007.

FOR: HEARING AIDS, IN CLASS 10 (U.S. CLS. 26, 39 AND 44).

SHANNON TWOHIG, EXAMINING ATTORNEY

**Int. Cls.: 29, 30, and 32**

**Prior U.S. Cls.: 45, 46, and 48**

**United States Patent and Trademark Office**

**Reg. No. 3,570,588**

**Registered Feb. 3, 2009**

**TRADEMARK  
PRINCIPAL REGISTER**

# Supreme Choice

SHOPKO STORES OPERATING CO., LLC (DELA-  
WARE LIMITED LIABILITY COMPANY)

700 PILGRIM WAY  
GREEN BAY, WI 54304

FOR: PROCESSED NUTS; DRIED FRUITS; POTATO CHIPS, SNACK MIX CONSISTING PRIMARILY OF PROCESSED FRUITS, PROCESSED NUTS AND/OR RAISINS , IN CLASS 29 (U.S. CL. 46).

FIRST USE 1-1-1997; IN COMMERCE 1-1-1997.

FOR: CHOCOLATE CANDIES; CANDY, SNACK MIX CONSISTING PRIMARILY OF CRACKERS, PRETZELS, CANDIED NUTS AND/OR POPPED POPCORN, IN CLASS 30 (U.S. CL. 46).

FIRST USE 5-25-2001; IN COMMERCE 5-25-2001.

FOR: SPRING WATER, IN CLASS 32 (U.S. CLS. 45, 46 AND 48).

FIRST USE 12-11-1998; IN COMMERCE 12-11-1998.

THE MARK CONSISTS OF STANDARD CHARACTERS WITHOUT CLAIM TO ANY PARTICULAR FONT, STYLE, SIZE, OR COLOR.

OWNER OF U.S. REG. NOS. 2,497,155 AND 2,625,405.

NO CLAIM IS MADE TO THE EXCLUSIVE RIGHT TO USE "SUPREME", APART FROM THE MARK AS SHOWN.

SN 77-294,494, FILED 10-2-2007.

HELENE LIWINSKI, EXAMINING ATTORNEY

**Int. Cl.: 16**

**Prior U.S. Cls.: 2, 5, 22, 23, 29, 37, 38, and 50**

**United States Patent and Trademark Office**

**Reg. No. 3,570,589**

**Registered Feb. 3, 2009**

**TRADEMARK  
PRINCIPAL REGISTER**

ENTERPRISE POSTAL ADVANTAGE

DOMTAR PAPER COMPANY, LLC (DELAWARE  
LIMITED LIABILITY COMPANY)  
100 KINGSLEY PARK DRIVE  
FORT MILL, SC 297156476

OWNER OF U.S. REG. NOS. 2,597,056, 2,927,947,  
AND 2,928,882.

FOR: PAPER, IN CLASS 16 (U.S. CLS. 2, 5, 22, 23, 29,  
37, 38 AND 50).

NO CLAIM IS MADE TO THE EXCLUSIVE  
RIGHT TO USE "POSTAL", APART FROM THE  
MARK AS SHOWN.

FIRST USE 2-0-2008; IN COMMERCE 2-0-2008.

SN 77-295,347, FILED 10-3-2007.

THE MARK CONSISTS OF STANDARD CHAR-  
ACTERS WITHOUT CLAIM TO ANY PARTICULAR  
FONT, STYLE, SIZE, OR COLOR.

DAVID MURRAY, EXAMINING ATTORNEY

**Int. Cl.: 41**

**Prior U.S. Cls.: 100, 101, and 107**

**United States Patent and Trademark Office**

**Reg. No. 3,570,590**

**Registered Feb. 3, 2009**

**SERVICE MARK  
PRINCIPAL REGISTER**

**BARWORKS**

YOGA WORKS, INC. (CALIFORNIA CORPORATION)  
2215 MAIN STREET  
SANTA MONICA, CA 90405

FOR: YOGA INSTRUCTION; PHYSICAL FITNESS  
CONDITIONING CLASSES, IN CLASS 41 (U.S. CLS.  
100, 101 AND 107).

FIRST USE 9-15-2008; IN COMMERCE 9-15-2008.

THE MARK CONSISTS OF STANDARD CHARACTERS WITHOUT CLAIM TO ANY PARTICULAR FONT, STYLE, SIZE, OR COLOR.

OWNER OF U.S. REG. NOS. 2,066,984, 2,075,873,  
AND 2,991,794.

SN 77-295,616, FILED 10-3-2007.

ANNE E. GUSTASON, EXAMINING ATTORNEY

**Int. Cl.: 6**

**Prior U.S. Cls.: 2, 12, 13, 14, 23, 25, and 50**

**Reg. No. 3,570,591**

**United States Patent and Trademark Office**

**Registered Feb. 3, 2009**

---

**TRADEMARK  
PRINCIPAL REGISTER**

**CARRIAGE HOUSE**

GARDEN ZONE, LLC (DELAWARE LIMITED  
LIABILITY COMPANY)  
1431 HIGHWAY 101 SOUTH  
GREER, SC 29651

THE MARK CONSISTS OF STANDARD CHAR-  
ACTERS WITHOUT CLAIM TO ANY PARTICULAR  
FONT, STYLE, SIZE, OR COLOR.

FOR: METAL GARDEN PRODUCTS, NAMELY,  
FENCES, FENCE PANELS, FENCE POSTS, FEN-  
CING, GATES, AND WIRE FENCES, IN CLASS 6  
(U.S. CLS. 2, 12, 13, 14, 23, 25 AND 50).

SN 77-296,930, FILED 10-5-2007.

FIRST USE 2-8-2008; IN COMMERCE 2-8-2008.

LAURIE MAYES, EXAMINING ATTORNEY

**Int. Cl.: 36**

**Prior U.S. Cls.: 100, 101, and 102**

**United States Patent and Trademark Office**

**Reg. No. 3,570,592**

**Registered Feb. 3, 2009**

---

**SERVICE MARK  
PRINCIPAL REGISTER**

**TRIPLE-Y**

THE BEAR STEARNS COMPANIES LLC. (DELA-  
WARE CORPORATION)  
383 MADISON AVENUE  
NEW YORK, NY 10179

THE MARK CONSISTS OF STANDARD CHAR-  
ACTERS WITHOUT CLAIM TO ANY PARTICULAR  
FONT, STYLE, SIZE, OR COLOR.

FOR: FINANCIAL SERVICES, NAMELY, INVEST-  
MENT MANAGEMENT AND FUND INVESTMENT  
SERVICES, IN CLASS 36 (U.S. CLS. 100, 101 AND 102).

SN 77-297,555, FILED 10-5-2007.

FIRST USE 3-10-2008; IN COMMERCE 3-10-2008.

ROBIN CHOSID, EXAMINING ATTORNEY



Int. Cl.: 32

Prior U.S. Cls.: 45, 46, and 48

United States Patent and Trademark Office

Reg. No. 3,570,593

Registered Feb. 3, 2009

TRADEMARK  
PRINCIPAL REGISTER

MANGO PLUS

TRAVIS BELL (CANADA INDIVIDUAL)  
579 HANCOCK WAY  
MISSISSAUGA, ONTARIO, CANADA L5H4L5

FOR: SMOOTHIES; FRUIT DRINKS; FRUIT JUICES; NON-ALCOHOLIC FRUIT JUICE BEVERAGES, IN CLASS 32 (U.S. CLS. 45, 46 AND 48).

FIRST USE 12-0-2007; IN COMMERCE 9-0-2008.

THE MARK CONSISTS OF STANDARD CHARACTERS WITHOUT CLAIM TO ANY PARTICULAR FONT, STYLE, SIZE, OR COLOR.

NO CLAIM IS MADE TO THE EXCLUSIVE RIGHT TO USE "MANGO", APART FROM THE MARK AS SHOWN.

SN 77-298,279, FILED 10-8-2007.

IRA J. GOODSaid, EXAMINING ATTORNEY

**Int. Cl.: 32**

**Prior U.S. Cls.: 45, 46, and 48**

**United States Patent and Trademark Office**

**Reg. No. 3,570,594**

**Registered Feb. 3, 2009**

**TRADEMARK  
PRINCIPAL REGISTER**

**STRAWBERRY RAINFOREST**

TRAVIS BELL (CANADA INDIVIDUAL)  
579 HANCOCK WAY  
MISSISSAUGA, ONTARIO, CANADA L5H4L5

FOR: SMOOTHIES; FRUIT DRINKS; FRUIT JUICES; NON-ALCOHOLIC FRUIT JUICE BEVERAGES, IN CLASS 32 (U.S. CLS. 45, 46 AND 48).

FIRST USE 12-0-2007; IN COMMERCE 9-0-2008.

THE MARK CONSISTS OF STANDARD CHARACTERS WITHOUT CLAIM TO ANY PARTICULAR FONT, STYLE, SIZE, OR COLOR.

NO CLAIM IS MADE TO THE EXCLUSIVE RIGHT TO USE "STRAWBERRY", APART FROM THE MARK AS SHOWN.

SN 77-298,282, FILED 10-8-2007.

MATTHEW MCDOWELL, EXAMINING ATTORNEY

**Int. Cl.: 25**

**Prior U.S. Cls.: 22 and 39**

**United States Patent and Trademark Office**

**Reg. No. 3,570,595**

**Registered Feb. 3, 2009**

**TRADEMARK  
PRINCIPAL REGISTER**

**& DANIELLE NEW YORK**

VIOLETTA, LLC (NEW YORK LIMITED LIABILITY COMPANY)  
C/O PRYOR CASHMAN LLP  
410 PARK AVENUE  
NEW YORK, NY 10022

FOR: CLOTHING, NAMELY, T-SHIRTS, PANTS, TROUSERS, JEANS, STRETCH PANTS, DENIM JEANS, TOPS, TANK TOPS, BLOUSES, SKIRTS, DRESSES, JACKETS, BLAZERS, IN CLASS 25 (U.S. CLS. 22 AND 39).

FIRST USE 1-0-2005; IN COMMERCE 1-0-2005.

THE MARK CONSISTS OF STANDARD CHARACTERS WITHOUT CLAIM TO ANY PARTICULAR FONT, STYLE, SIZE, OR COLOR.

NO CLAIM IS MADE TO THE EXCLUSIVE RIGHT TO USE "NEW YORK", APART FROM THE MARK AS SHOWN.

SN 77-298,712, FILED 10-8-2007.

REBECCA GILBERT, EXAMINING ATTORNEY

**Int. Cl.: 11**

**Prior U.S. Cls.: 13, 21, 23, 31, and 34**

**United States Patent and Trademark Office**

**Reg. No. 3,570,596**

**Registered Feb. 3, 2009**

**TRADEMARK  
PRINCIPAL REGISTER**

**COMFORTMATE**

THETFORD CORPORATION (DELAWARE COR-  
PORATION)  
7101 JACKSON ROAD  
ANN ARBOR, MI 48106

THE MARK CONSISTS OF STANDARD CHAR-  
ACTERS WITHOUT CLAIM TO ANY PARTICULAR  
FONT, STYLE, SIZE, OR COLOR.

FOR: TOILETS, IN CLASS 11 (U.S. CLS. 13, 21, 23, 31  
AND 34).

SN 77-299,328, FILED 10-9-2007.

FIRST USE 9-16-2008; IN COMMERCE 9-16-2008.

THEODORE MCBRIDE, EXAMINING ATTORNEY

**Int. Cl.: 10**

**Prior U.S. Cls.: 26, 39, and 44**

**United States Patent and Trademark Office**

**Reg. No. 3,570,597**

**Registered Feb. 3, 2009**

**TRADEMARK  
PRINCIPAL REGISTER**

**HEMOHEEL PREEMIE**

HELENA LABORATORIES CORPORATION  
(TEXAS CORPORATION)  
1530 LINDBERGH DRIVE  
BEAUMONT, TX 777040752

FOR: MEDICAL DEVICES, NAMELY, A DEVICE  
USED FOR MAKING AN INCISION ON A BABY'S  
HEEL TO FACILITATE OBTAINING A BLOOD  
SPECIMEN, IN CLASS 10 (U.S. CLS. 26, 39 AND 44).

FIRST USE 9-21-2007; IN COMMERCE 11-17-2008.

THE MARK CONSISTS OF STANDARD CHAR-  
ACTERS WITHOUT CLAIM TO ANY PARTICULAR  
FONT, STYLE, SIZE, OR COLOR.

NO CLAIM IS MADE TO THE EXCLUSIVE  
RIGHT TO USE "PREEMIE", APART FROM THE  
MARK AS SHOWN.

SN 77-299,636, FILED 10-9-2007.

JULIE WATSON, EXAMINING ATTORNEY

**Int. Cl.: 9**

**Prior U.S. Cls.: 21, 23, 26, 36, and 38**

**Reg. No. 3,570,598**

**United States Patent and Trademark Office**

**Registered Feb. 3, 2009**

**TRADEMARK  
PRINCIPAL REGISTER**

TENNRICH ELECTRONICS (SHENZHEN) CO.,  
LTD. (CHINA CORPORATION)  
THE 3RD BLDG, FUHAI INDUSTRIAL PARK C1  
FUHAI ROAD, FUYONG TOWN, BAO'AN DIST  
SHENZHEN, CHINA

FOR: BATTERIES; BATTERY CHARGERS; SO-  
LAR CELLS; BATTERIES FOR VEHICLES; CASES  
FOR POCKET CALCULATORS; ELECTRIC SOCK-  
ETS; ELECTRIC PLUGS; ELECTRIC CONNECTORS;  
ELECTRICAL TRANSFORMERS; CARRYING  
CASES FOR CELL PHONES, IN CLASS 9 (U.S. CLS.  
21, 23, 26, 36 AND 38).

FIRST USE 5-1-2008; IN COMMERCE 11-1-2008.

THE MARK CONSISTS OF THE WORD "ORICE".

THE WORDING "ORICE" HAS NO MEANING IN  
A FOREIGN LANGUAGE.

SN 77-301,207, FILED 10-10-2007.

CURTIS FRENCH, EXAMINING ATTORNEY

**Int. Cl.: 9**

**Prior U.S. Cls.: 21, 23, 26, 36, and 38**

**Reg. No. 3,570,599**

**United States Patent and Trademark Office**

**Registered Feb. 3, 2009**

**TRADEMARK  
PRINCIPAL REGISTER**

**Roller - Shady**

EYE CARE AND CURE CORP. (ARIZONA CORPORATION)  
4646 S. OVERLAND DRIVE  
TUCSON, AZ 85714

FIRST USE 9-1-2007; IN COMMERCE 11-29-2007.

SN 77-302,277, FILED 10-11-2007.

FOR: DISPOSABLE EYEGLASSES TO MITIGATE THE EFFECTS OF A DILATED PUPIL, IN CLASS 9 (U.S. CLS. 21, 23, 26, 36 AND 38).

JULIE WATSON, EXAMINING ATTORNEY

**Int. Cl.: 3**

**Prior U.S. Cls.: 1, 4, 6, 50, 51, and 52**

**Reg. No. 3,570,600**

**United States Patent and Trademark Office**

**Registered Feb. 3, 2009**

**TRADEMARK  
PRINCIPAL REGISTER**

**HEMPHATIC**

DESIGNER SKIN, LLC (ARIZONA LIMITED  
LIABILITY COMPANY)  
6270 CORPORATE DRIVE  
INDIANAPOLIS, IN 46278

FOR: COSMETICS, NAMELY, CLEANSERS FOR  
SKIN AND FACE; MOISTURIZERS FOR SKIN AND  
FACE, NAMELY, LOTIONS AND CREAMS; FACIAL  
MAKE-UP; NAIL CARE PREPARATIONS; HAIR  
CARE PREPARATIONS; DEODORANTS AND  
ANTI-PERSPIRANTS; PERFUME, COLOGNE AND  
AFTER-SHAVE LOTION; SHAVING CREAM; BATH  
OIL; SUNTANNING PREPARATIONS, NAMELY,  
SUN BLOCK, SUN SCREEN, SUN TAN OIL AND  
LOTION, AFTER SUN LOTION, BRONZER, SELF-  
TANNING LOTIONS AND SPRAY, SUNLESS TAN-

NING LOTION AND SPRAY, INDOOR TANNING  
PREPARATION, AND LOTION TO ACCELERATE,  
EXTEND AND/OR ENHANCE TANS, IN CLASS 3  
(U.S. CLS. 1, 4, 6, 50, 51 AND 52).

FIRST USE 11-0-2007; IN COMMERCE 11-0-2007.

THE MARK CONSISTS OF STANDARD CHAR-  
ACTERS WITHOUT CLAIM TO ANY PARTICULAR  
FONT, STYLE, SIZE, OR COLOR.

SN 77-302,315, FILED 10-11-2007.

GINA HAYES, EXAMINING ATTORNEY



Int. Cl.: 25

Prior U.S. Cls.: 22 and 39

United States Patent and Trademark Office

Reg. No. 3,570,601

Registered Feb. 3, 2009

TRADEMARK  
PRINCIPAL REGISTER

sandgirls

CHRISTINE MIKIKO WHITNEY (UNITED STATES INDIVIDUAL)  
45959 CORTE CARMELLO  
TEMECULA, CA 92592

FOR: BERMUDA SHORTS; BOARD SHORTS; BOXER SHORTS; FLEECE SHORTS; GYM SHORTS; SWEAT SHORTS; SWEAT PANTS; SWEAT SHIRTS; SWEAT SUITS; CAMP SHIRTS; GOLF SHIRTS; LONG-SLEEVED SHIRTS; OPEN-NECKED SHIRTS; PIQUE SHIRTS; POLO SHIRTS; SHORT-SLEEVED OR LONG-SLEEVED T-SHIRTS; SHORT-SLEEVED

SHIRTS; SPORT SHIRTS; JACKETS; SWIMSUITS, IN CLASS 25 (U.S. CLS. 22 AND 39).

FIRST USE 9-28-2008; IN COMMERCE 9-28-2008.

THE MARK CONSISTS OF STANDARD CHARACTERS WITHOUT CLAIM TO ANY PARTICULAR FONT, STYLE, SIZE, OR COLOR.

SN 77-302,377, FILED 10-11-2007.

MARK SPARACINO, EXAMINING ATTORNEY

**Int. Cl.: 25**

**Prior U.S. Cls.: 22 and 39**

**United States Patent and Trademark Office**

**Reg. No. 3,570,602**

**Registered Feb. 3, 2009**

**TRADEMARK  
PRINCIPAL REGISTER**

**sandgirlz**

CHRISTINE MIKIKO WHITNEY (UNITED STATES INDIVIDUAL)  
45959 CORTE CARMELLO  
TEMECULA, CA 92592

THE MARK CONSISTS OF STANDARD CHARACTERS WITHOUT CLAIM TO ANY PARTICULAR FONT, STYLE, SIZE, OR COLOR.

FOR: HATS; BASEBALL CAPS; SHIRTS; SHORTS; SWEAT PANTS; SWEAT SHIRTS; SWEAT SHORTS; SWEAT SUITS; SWIMSUITS, IN CLASS 25 (U.S. CLS. 22 AND 39).

SN 77-302,424, FILED 10-12-2007.

FIRST USE 9-28-2008; IN COMMERCE 9-28-2008.

MARK SPARACINO, EXAMINING ATTORNEY

Int. Cl.: 25

Prior U.S. Cls.: 22 and 39

United States Patent and Trademark Office

Reg. No. 3,570,603

Registered Feb. 3, 2009

TRADEMARK  
PRINCIPAL REGISTER



DON'T LET UP, INC (CALIFORNIA CORPORATION)  
542 TORNGA  
RIPON, CA 95366

FOR: TOPS; JEANS; SHIRTS; PANTS, IN CLASS 25  
(U.S. CLS. 22 AND 39).

FIRST USE 1-1-2008; IN COMMERCE 1-1-2008.

THE COLOR(S) BLACK, PURPLE AND GREY IS/  
ARE CLAIMED AS A FEATURE OF THE MARK.

THE MARK CONSISTS OF THE TERMS "DLU",  
WITH THE LETTERS "D" AND "U" IN BLACK AND  
THE LETTER "L" IN PURPLE. THE TERMS "TTA  
DESIGNS INC." REPEATED IN THE BACK-  
GROUND IN THE COLOR GRAY.

SN 77-303,302, FILED 10-12-2007.

CAROLINE WOOD, EXAMINING ATTORNEY

**Int. Cl.: 9**

**Prior U.S. Cls.: 21, 23, 26, 36, and 38**

**United States Patent and Trademark Office**

**Reg. No. 3,570,604**

**Registered Feb. 3, 2009**

**TRADEMARK  
PRINCIPAL REGISTER**

**PHARAOH'S CONQUEST**

KONAMI GAMING, INC. (NEVADA CORPORATION)  
585 TRADE CENTER DRIVE  
LAS VEGAS, NV 89119

FOR: ELECTRONIC GAME PROGRAMS; GAMING EQUIPMENT, NAMELY, SLOT MACHINES WITH OR WITHOUT VIDEO OUTPUT; GAMING MACHINES; MACHINES FOR PLAYING GAMES OF CHANCE; SLOT MACHINES, IN CLASS 9 (U.S. CLS. 21, 23, 26, 36 AND 38).

FIRST USE 10-23-2007; IN COMMERCE 10-23-2007.

THE MARK CONSISTS OF STANDARD CHARACTERS WITHOUT CLAIM TO ANY PARTICULAR FONT, STYLE, SIZE, OR COLOR.

SN 77-303,673, FILED 10-14-2007.

ZACHARY BELLO, EXAMINING ATTORNEY

**Int. Cl.: 41**

**Prior U.S. Cls.: 100, 101, and 107**

**United States Patent and Trademark Office**

**Reg. No. 3,570,605**

**Registered Feb. 3, 2009**

**SERVICE MARK  
PRINCIPAL REGISTER**

The logo for "filedby" features the word "filedby" in a lowercase, sans-serif font. Above the letter "i" are four small, grey, circular dots arranged in a slightly curved pattern.

FILEDBY, INC. (DELAWARE CORPORATION)  
28 WHITE BRIDGE ROAD  
SUITE 209  
NASHVILLE, TN 37205

FIRST USE 12-12-2008; IN COMMERCE 12-12-2008.

SN 77-303,895, FILED 10-15-2007.

FOR: PROVIDING INFORMATION ON-LINE RE-  
GARDING WRITERS, AUTHORS AND THEIR  
WORKS, IN CLASS 41 (U.S. CLS. 100, 101 AND 107).

H. M. FISHER, EXAMINING ATTORNEY

**Int. Cl.: 21**

**Prior U.S. Cls.: 2, 13, 23, 29, 30, 33, 40, and 50**

**United States Patent and Trademark Office**

**Reg. No. 3,570,606**

**Registered Feb. 3, 2009**

**TRADEMARK  
PRINCIPAL REGISTER**

**SMART LIDZ**

JORDAN DREW CORPORATION (NEW YORK CORPORATION)  
C/O SAS GROUP, INC., 220 WHITE PLAINS RD  
TARRYTOWN, NY 10591

FOR: SET OF UNIVERSAL LIDS FOR HOUSEHOLD USE THAT COVER BOWLS, CONTAINERS AND POTS, IN CLASS 21 (U.S. CLS. 2, 13, 23, 29, 30, 33, 40 AND 50).

FIRST USE 1-21-2008; IN COMMERCE 1-21-2008.

THE MARK CONSISTS OF STANDARD CHARACTERS WITHOUT CLAIM TO ANY PARTICULAR FONT, STYLE, SIZE, OR COLOR.

NO CLAIM IS MADE TO THE EXCLUSIVE RIGHT TO USE "LIDS", APART FROM THE MARK AS SHOWN.

SN 77-303,993, FILED 10-15-2007.

ROSELLE HERRERA, EXAMINING ATTORNEY

**Int. Cl.: 43**

**Prior U.S. Cls.: 100 and 101**

**United States Patent and Trademark Office**

**Reg. No. 3,570,607**

**Registered Feb. 3, 2009**

**SERVICE MARK  
PRINCIPAL REGISTER**



JAW RESTAURANT MANAGEMENT, LLC (CALIFORNIA LIMITED LIABILITY COMPANY)  
8571 HIGUERA STREET  
CULVER CITY, CA 90232

THE MARK CONSISTS OF AN EXTENDED "C".

FOR: RESTAURANT SERVICES, IN CLASS 43  
(U.S. CLS. 100 AND 101).

SN 77-304,028, FILED 10-15-2007.

FIRST USE 3-0-2007; IN COMMERCE 8-20-2007.

SHAUNIA CARLYLE, EXAMINING ATTORNEY

Int. Cl.: 25

Prior U.S. Cls.: 22 and 39

United States Patent and Trademark Office

Reg. No. 3,570,608

Registered Feb. 3, 2009

TRADEMARK  
PRINCIPAL REGISTER



KIM, CHRISTNA (UNITED STATES INDIVIDUAL)

8100 ORANGEWOOD AVE. APT. #20

STANTON, CA 90680

FOR: SHORTS; SHIRTS; JACKETS; SWEAT SHIRTS; SWEAT PANTS; TANK TOPS; MARTIAL ARTS UNIFORMS; JERSEYS; ROBES; BOARD SHORTS, IN CLASS 25 (U.S. CLS. 22 AND 39).

FIRST USE 12-1-2007; IN COMMERCE 12-1-2007.

NO CLAIM IS MADE TO THE EXCLUSIVE RIGHT TO USE "FIGHT GEAR", APART FROM THE MARK AS SHOWN.

THE MARK CONSISTS OF THE WORDS "BRAVADO FIGHT GEAR SHOW 'EM UP KNOCK 'EM OUT" IN STYLIZED TEXT. THE LETTERS "B" AND "O" ARE LARGER IN SIZE. THERE IS A STAR TO THE LEFT AND RIGHT OF THE TEXT.

SN 77-304,607, FILED 10-15-2007.

FRED MANDIR, EXAMINING ATTORNEY



**Int. Cl.: 9**

**Prior U.S. Cls.: 21, 23, 26, 36, and 38**

**Reg. No. 3,570,609**

**United States Patent and Trademark Office**

**Registered Feb. 3, 2009**

---

**TRADEMARK  
PRINCIPAL REGISTER**

**AFRICAN DIAMOND: JEWELS OF  
THE WILD**

KONAMI GAMING, INC. (NEVADA CORPORATION)  
585 TRADE CENTER DRIVE  
LAS VEGAS, NV 89119

FOR: ELECTRONIC GAME PROGRAMS; GAMING EQUIPMENT, NAMELY, SLOT MACHINES WITH OR WITHOUT VIDEO OUTPUT; GAMING MACHINES; MACHINES FOR PLAYING GAMES OF CHANCE; SLOT MACHINES, IN CLASS 9 (U.S. CLS. 21, 23, 26, 36 AND 38).

FIRST USE 1-3-2008; IN COMMERCE 1-3-2008.

THE MARK CONSISTS OF STANDARD CHARACTERS WITHOUT CLAIM TO ANY PARTICULAR FONT, STYLE, SIZE, OR COLOR.

SN 77-304,799, FILED 10-16-2007.

ZACHARY BELLO, EXAMINING ATTORNEY

**Int. Cl.: 9**

**Prior U.S. Cls.: 21, 23, 26, 36, and 38**

**Reg. No. 3,570,610**

**United States Patent and Trademark Office**

**Registered Feb. 3, 2009**

---

**TRADEMARK  
PRINCIPAL REGISTER**

**SECRETS OF EGYPT**

KONAMI GAMING, INC. (NEVADA CORPORATION)  
585 TRADE CENTER DRIVE  
LAS VEGAS, NV 89119

FOR: ELECTRONIC GAME PROGRAMS; GAMING EQUIPMENT, NAMELY, SLOT MACHINES WITH OR WITHOUT VIDEO OUTPUT; GAMING MACHINES; MACHINES FOR PLAYING GAMES OF CHANCE; SLOT MACHINES, IN CLASS 9 (U.S. CLS. 21, 23, 26, 36 AND 38).

FIRST USE 4-23-2008; IN COMMERCE 4-23-2008.

THE MARK CONSISTS OF STANDARD CHARACTERS WITHOUT CLAIM TO ANY PARTICULAR FONT, STYLE, SIZE, OR COLOR.

SN 77-304,800, FILED 10-16-2007.

ZACHARY BELLO, EXAMINING ATTORNEY

**Int. Cl.: 25**

**Prior U.S. Cls.: 22 and 39**

**United States Patent and Trademark Office**

**Reg. No. 3,570,611**

**Registered Feb. 3, 2009**

**TRADEMARK  
PRINCIPAL REGISTER**

**GREENIACS**

WASHINGTON REALTY GROUP, INC. (DELA-  
WARE CORPORATION), DBA GREENIACS,  
SUITE #107, 153 2ND STREET  
LOS ALTOS, CA 94022

FOR: TOPS; HEADWEAR, IN CLASS 25 (U.S. CLS.  
22 AND 39).

FIRST USE 9-15-2007; IN COMMERCE 4-0-2008.

THE MARK CONSISTS OF STANDARD CHAR-  
ACTERS WITHOUT CLAIM TO ANY PARTICULAR  
FONT, STYLE, SIZE, OR COLOR.

OWNER OF U.S. REG. NO. 3,473,041.

SN 77-305,318, FILED 10-16-2007.

BRIAN CALLAGHAN, EXAMINING ATTORNEY

**Int. Cl.: 9**

**Prior U.S. Cls.: 21, 23, 26, 36, and 38**

**Reg. No. 3,570,612**

**United States Patent and Trademark Office**

**Registered Feb. 3, 2009**

**TRADEMARK  
PRINCIPAL REGISTER**

**OPTI-KAN**

I.D. SYSTEMS, INC. (DELAWARE CORPORATION)  
ONE UNIVERSITY PLAZA DRIVE  
6TH FLOOR  
HACKENSACK, NJ 07601

FOR: PARTS REPLENISHMENT SYSTEM COMPRISED OF WIRELESS TRANSMITTERS, WIRELESS RECEIVERS, COMPUTER HARDWARE AND SOFTWARE FOR AUTOMATING AND OPTIMIZING MATERIAL HANDLING TASKS FOR MANUFACTURING AND INDUSTRIAL PRODUCTION LINES, IN CLASS 9 (U.S. CLS. 21, 23, 26, 36 AND 38).

FIRST USE 9-1-2007; IN COMMERCE 9-1-2007.

THE MARK CONSISTS OF STANDARD CHARACTERS WITHOUT CLAIM TO ANY PARTICULAR FONT, STYLE, SIZE, OR COLOR.

SN 77-306,610, FILED 10-17-2007.

BARBARA A. GOLD, EXAMINING ATTORNEY

**Int. Cl.: 25**

**Prior U.S. Cls.: 22 and 39**

**United States Patent and Trademark Office**

**Reg. No. 3,570,613**

**Registered Feb. 3, 2009**

**TRADEMARK  
PRINCIPAL REGISTER**

**THE SWEETEST, SOFTEST  
LAMBIE SLIPPERS ON EARTH**

BATH & BODY WORKS BRAND MANAGE-  
MENT, INC. (DELAWARE CORPORATION)  
7 LIMITED PARKWAY EAST  
REYNOLDSBURG, OH 43068

FOR: SLIPPERS, IN CLASS 25 (U.S. CLS. 22 AND  
39).

FIRST USE 10-1-2007; IN COMMERCE 10-1-2007.

THE MARK CONSISTS OF STANDARD CHAR-  
ACTERS WITHOUT CLAIM TO ANY PARTICULAR  
FONT, STYLE, SIZE, OR COLOR.

OWNER OF U.S. REG. NOS. 3,248,428 AND  
3,354,364.

SN 77-306,614, FILED 10-17-2007.

HEATHER THOMPSON, EXAMINING ATTORNEY

**Int. Cl.: 43**

**Prior U.S. Cls.: 100 and 101**

**United States Patent and Trademark Office**

**Reg. No. 3,570,614**

**Registered Feb. 3, 2009**

**SERVICE MARK  
PRINCIPAL REGISTER**



DANIEL OZIOLI (UNITED STATES INDIVIDUAL)  
SUITE 100  
205 VAN BUREN STREET  
HERNDON, VA 20170

FOR: RESTAURANT, CAFE AND CATERING SERVICES, IN CLASS 43 (U.S. CLS. 100 AND 101).

FIRST USE 5-17-2007; IN COMMERCE 5-17-2007.

THE COLOR(S) TAN, BLACK, PURPLE, GREEN, BROWN, ORANGE, BLUE AND YELLOW IS/ARE CLAIMED AS A FEATURE OF THE MARK.

THE MARK CONSISTS OF A TAN ARCHWAY WITH BLACK SHADOWING TOPPED BY A BUNCH OF PURPLE GRAPES WITH GREEN LEAVES THROUGH WHICH IS SEEN A TAN AND BROWN HOUSE SET AMONG GREEN HILLS AND TREES AND GREEN AND ORANGE BUSHES WITH A BLUE SKY AND YELLOW SETTING SUN IN THE BACKGROUND.

SN 77-306,995, FILED 10-18-2007.

DAVID YONTEF, EXAMINING ATTORNEY

**Int. Cl.: 10**

**Prior U.S. Cls.: 26, 39, and 44**

**Reg. No. 3,570,615**

**United States Patent and Trademark Office**

**Registered Feb. 3, 2009**

**TRADEMARK  
PRINCIPAL REGISTER**

**TRANSCATHETER  
EXTRACTOR**

TRAN HOLDINGS, LLC (FLORIDA LIMITED  
LIABILITY COMPANY)  
390 N. ORANGE AVENUE  
SUITE 1500  
ORLANDO, FL 32801

FOR: SURGICAL APPARATUS, NAMELY, CATHETER EXTRACTORS, IN CLASS 10 (U.S. CLS. 26, 39 AND 44).

FIRST USE 1-31-2007; IN COMMERCE 9-14-2007.

NO CLAIM IS MADE TO THE EXCLUSIVE RIGHT TO USE "EXTRACTOR", APART FROM THE MARK AS SHOWN.

THE MARK CONSISTS OF THE WORDS "TRANSCATHETER EXTRACTOR" WITH A STYLIZED CATHETER BETWEEN THE TWO WORDS.

SN 77-307,570, FILED 10-18-2007.

WON TEAK OH, EXAMINING ATTORNEY

**Int. Cl.: 38**

**Prior U.S. Cls.: 100, 101, and 104**

**United States Patent and Trademark Office**

**Reg. No. 3,570,616**

**Registered Feb. 3, 2009**

**SERVICE MARK  
PRINCIPAL REGISTER**



VIACOM INTERNATIONAL INC. (DELAWARE  
CORPORATION)  
1515 BROADWAY  
NEW YORK, NY 10036

FIRST USE 12-31-2007; IN COMMERCE 12-31-2007.

SN 77-307,693, FILED 10-18-2007.

FOR: TELEVISION BROADCASTING SERVICES  
VIA CABLE, SATELLITE AND OTHER MEANS, IN  
CLASS 38 (U.S. CLS. 100, 101 AND 104).

JILL C. ALT, EXAMINING ATTORNEY



Int. Cl.: 41

Prior U.S. Cls.: 100, 101, and 107

United States Patent and Trademark Office

Reg. No. 3,570,617

Registered Feb. 3, 2009

SERVICE MARK  
PRINCIPAL REGISTER



VIACOM INTERNATIONAL INC. (DELAWARE CORPORATION)  
1515 BROADWAY  
NEW YORK, NY 10036

FOR: ENTERTAINMENT SERVICES IN THE NATURE OF ONGOING TELEVISION PROGRAMS IN THE FIELD OF LIVE ACTION, COMEDY, DRAMA AND ANIMATION; PROVIDING INFORMATION IN THE FIELD OF ENTERTAINMENT, NAMELY, TELEVISION PROGRAMMING, REN-

DERED VIA COMPUTER BY MEANS OF A GLOBAL COMPUTER NETWORK, IN CLASS 41 (U.S. CLS. 100, 101 AND 107).

FIRST USE 12-31-2007; IN COMMERCE 12-31-2007.

SN 77-307,697, FILED 10-18-2007.

JILL C. ALT, EXAMINING ATTORNEY

**Int. Cl.: 16**

**Prior U.S. Cls.: 2, 5, 22, 23, 29, 37, 38, and 50**

**Reg. No. 3,570,618**

**United States Patent and Trademark Office**

**Registered Feb. 3, 2009**

**TRADEMARK  
PRINCIPAL REGISTER**

**POLAR BEAR PLUS**

HANKUK PAPER MFG. CO., LTD. (REPUBLIC  
OF KOREA CORPORATION)  
1358-6, SEOCHO-DONG, SEOCHO-KU  
SEOUL, REPUBLIC OF KOREA

FOR: PAPER PRODUCTS AND PRINTED MAT-  
TER, NAMELY, PRINTING PAPER, DUPLICATING  
PAPER, NEWSPRINT PAPER, WATERPROOF PA-  
PER, NAPKIN PAPER, TOILET PAPER, MEMO  
PAPER, BOXES MADE OF PAPER, PAPER SACKS  
FOR WRAPPING, AND CATALOGUES IN THE  
FIELD OF PAPER PRODUCTS, IN CLASS 16 (U.S.  
CLS. 2, 5, 22, 23, 29, 37, 38 AND 50).

FIRST USE 6-10-2004; IN COMMERCE 9-1-2004.

THE MARK CONSISTS OF STANDARD CHAR-  
ACTERS WITHOUT CLAIM TO ANY PARTICULAR  
FONT, STYLE, SIZE, OR COLOR.

OWNER OF U.S. REG. NO. 2,109,653.

SN 77-307,815, FILED 10-18-2007.

LESLEY LAMOTHE, EXAMINING ATTORNEY

Int. Cl.: 9

Prior U.S. Cls.: 21, 23, 26, 36, and 38

Reg. No. 3,570,619

United States Patent and Trademark Office

Registered Feb. 3, 2009

TRADEMARK  
PRINCIPAL REGISTER

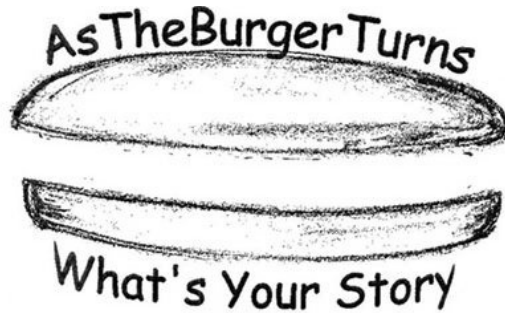

ASTHEBURGERTURNS HOLDINGS, LLC (ALABAMA LIMITED LIABILITY COMPANY)

P. O. BOX 55726

BIRMINGHAM, AL 35255

FOR: DVDS FEATURING TRAINING MATERIALS FOR RESTAURANT MANAGERS, EMPLOYEES AND POTENTIAL EMPLOYEES IN THE FIELD OF RESTAURANT SERVICES; DOWNLOADABLE PODCASTS FOR RESTAURANT MANAGERS, EMPLOYEES AND POTENTIAL EMPLOYEES IN THE FIELD OF RESTAURANT SERVICES, IN CLASS 9 (U.S. CLS. 21, 23, 26, 36 AND 38).

FIRST USE 8-10-2007; IN COMMERCE 11-26-2008.

THE MARK CONSISTS OF DRAWN IMAGE OF TOP HALF AND BOTTOM HALF OF HAMBURGER BUN SEPARATED WITH THE WORDS, "AS THE BURGER TURNS", ABOVE THE TOP HALF OF THE BUN AND THE WORDS, "WHAT'S YOUR STORY", BELOW THE BOTTOM HALF OF THE BUN.

SN 77-308,179, FILED 10-19-2007.

SHANNON TWOHIG, EXAMINING ATTORNEY

**Int. Cl.: 2**

**Prior U.S. Cls.: 6, 11, and 16**

**United States Patent and Trademark Office**

**Reg. No. 3,570,620**

**Registered Feb. 3, 2009**

**TRADEMARK  
PRINCIPAL REGISTER**

**CEREUS**

PERFORMANCE INDICATOR, LLC (DELAWARE  
LIMITED LIABILITY COMPANY)  
116 JOHN STREET, SOUTH MILL  
LOWELL, MA 01852

FOR: CAMOUFLAGE PAINTS FOR MILITARY  
EQUIPMENT; COATING COMPOSITIONS IN THE  
NATURE OF PAINT FOR INDUSTRIAL APPLICA-  
TIONS; COLORANTS, PAINTS AND DYES FOR  
GENERAL INDUSTRIAL USE; FLUORESCENT  
PAINTS; PAINT FOR INDUSTRIAL EQUIPMENT  
AND MACHINERY; PAINTS; PAINTS FOR IDENTI-  
FICATION; PAVEMENT MARKING PAINT; PAVE-

MENT STRIPING PAINT, IN CLASS 2 (U.S. CLS. 6, 11  
AND 16).

FIRST USE 4-28-2008; IN COMMERCE 4-28-2008.

THE MARK CONSISTS OF STANDARD CHAR-  
ACTERS WITHOUT CLAIM TO ANY PARTICULAR  
FONT, STYLE, SIZE, OR COLOR.

SN 77-308,271, FILED 10-19-2007.

LINDA MICKLEBURGH, EXAMINING ATTORNEY

**Int. Cls.: 21 and 25**

**Prior U.S. Cls.: 2, 13, 22, 23, 29, 30, 33, 39, 40, and 50**

**Reg. No. 3,570,621**

**United States Patent and Trademark Office**

**Registered Feb. 3, 2009**

**TRADEMARK  
PRINCIPAL REGISTER**



WASHINGTON REALTY GROUP, INC. (DELA-  
WARE CORPORATION), DBA GREENIACS,  
SUITE #107  
153 2ND STREET  
LOS ALTOS, CA 94022

FOR: PLASTIC WATER BOTTLES SOLD EMPTY,  
IN CLASS 21 (U.S. CLS. 2, 13, 23, 29, 30, 33, 40 AND 50).

FIRST USE 9-15-2007; IN COMMERCE 11-12-2008.

FOR: TOPS; HEAD WEAR, IN CLASS 25 (U.S. CLS.  
22 AND 39).

FIRST USE 9-15-2007; IN COMMERCE 4-0-2008.

THE MARK CONSISTS OF THE HEAD OF A  
FROG-LIKE CHARACTER.

SN 77-308,660, FILED 10-19-2007.

BRIAN CALLAGHAN, EXAMINING ATTORNEY

**Int. Cl.: 24**

**Prior U.S. Cls.: 42 and 50**

**United States Patent and Trademark Office**

**Reg. No. 3,570,622**

**Registered Feb. 3, 2009**

**TRADEMARK  
PRINCIPAL REGISTER**

**FollowMeFlags**

HICKEY, MARGARET (UNITED STATES INDIVIDUAL)  
3312 FOX SQUIRREL LANE  
VALRICO, FL 33594

THE MARK CONSISTS OF STANDARD CHARACTERS WITHOUT CLAIM TO ANY PARTICULAR FONT, STYLE, SIZE, OR COLOR.

FOR: FABRIC FLAGS, IN CLASS 24 (U.S. CLS. 42 AND 50).

SN 77-308,996, FILED 10-19-2007.

FIRST USE 11-10-2008; IN COMMERCE 11-10-2008.

MELVIN AXILBUND, EXAMINING ATTORNEY

**Int. Cl.: 9**

**Prior U.S. Cls.: 21, 23, 26, 36, and 38**

**Reg. No. 3,570,623**

**United States Patent and Trademark Office**

**Registered Feb. 3, 2009**

**TRADEMARK  
PRINCIPAL REGISTER**

**TRUSCAN**

SYMANTEC CORPORATION (DELAWARE CORPORATION)  
20330 STEVENS CREEK BOULEVARD  
CUPERTINO, CA 95014

THE MARK CONSISTS OF STANDARD CHARACTERS WITHOUT CLAIM TO ANY PARTICULAR FONT, STYLE, SIZE, OR COLOR.

FOR: FEATURE OF SECURITY SOFTWARE;  
FEATURE OF COMPUTER SOFTWARE FOR DETECTING MALWARE, IN CLASS 9 (U.S. CLS. 21, 23, 26, 36 AND 38).

SN 77-308,999, FILED 10-19-2007.

FIRST USE 12-0-2007; IN COMMERCE 12-0-2007.

MARK T. MULLEN, EXAMINING ATTORNEY

**Int. Cl.: 35**

**Prior U.S. Cls.: 100, 101, and 102**

**United States Patent and Trademark Office**

**Reg. No. 3,570,624**

**Registered Feb. 3, 2009**

**SERVICE MARK  
PRINCIPAL REGISTER**

**ENVIRONMENTAL HOME**

ABBAY CARPET CO., INC. (FLORIDA CORPORATION)  
3741 BONITA BAY BOULEVARD  
BONITA SPRINGS, FL 34134

THE MARK CONSISTS OF STANDARD CHARACTERS WITHOUT CLAIM TO ANY PARTICULAR FONT, STYLE, SIZE, OR COLOR.

FOR: RETAIL STORE SERVICES, FEATURING FLOOR COVERINGS, IN CLASS 35 (U.S. CLS. 100, 101 AND 102).

SN 77-309,166, FILED 10-20-2007.

FIRST USE 2-21-2008; IN COMMERCE 2-21-2008.

REGINA DRUMMOND, EXAMINING ATTORNEY



**Int. Cl.: 35**

**Prior U.S. Cls.: 100, 101, and 102**

**United States Patent and Trademark Office**

**Reg. No. 3,570,625**

**Registered Feb. 3, 2009**

**SERVICE MARK  
PRINCIPAL REGISTER**

**IT'S A GIRL CELEBRATION  
EVERY DAY!**

AMERICAN GIRL, LLC (DELAWARE LIMITED  
LIABILITY COMPANY)  
M1-1518  
333 CONTINENTAL BLVD.  
EL SEGUNDO, CA 90245

FOR: RETAIL STORE SERVICES, ONLINE RE-  
TAIL STORE SERVICES AND DIRECT MAIL CAT-  
ALOG SERVICES FEATURING, DOLLS, DOLL  
CLOTHING, DOLL ACCESSORIES, DOLL FURNI-  
TURE, STUFFED TOYS AND ACCESSORIES AND  
FURNITURE FOR STUFFED TOYS, BOOKS, CHIL-  
DREN'S CLOTHING, NAMELY, PANTS, CAPS,  
HATS, JACKETS, SWEATSHIRTS, T-SHIRTS, TOTE  
BAGS, BACKPACKS, PERSONAL CARE PRO-

DUCTS, NAMELY, BODY CARE, SKIN CARE, NAIL  
CARE AND HAIR CARE ITEMS, IN CLASS 35 (U.S.  
CLS. 100, 101 AND 102).

FIRST USE 8-17-2007; IN COMMERCE 8-17-2007.

THE MARK CONSISTS OF STANDARD CHAR-  
ACTERS WITHOUT CLAIM TO ANY PARTICULAR  
FONT, STYLE, SIZE, OR COLOR.

SN 77-310,450, FILED 10-22-2007.

TOBY BULLOFF, EXAMINING ATTORNEY

**Int. Cl.: 11**

**Prior U.S. Cls.: 13, 21, 23, 31, and 34**

**United States Patent and Trademark Office**

**Reg. No. 3,570,626**

**Registered Feb. 3, 2009**

**TRADEMARK  
PRINCIPAL REGISTER**

**FLAT FIRE**

FC INDUSTRIES, LLC (GEORGIA LIMITED LIABILITY COMPANY)  
112 KROG STREET, NE  
SUITE 17  
ATLANTA, GA 30307

FOR: FIRE PITTS, IN CLASS 11 (U.S. CLS. 13, 21, 23, 31 AND 34).

FIRST USE 11-17-2007; IN COMMERCE 11-17-2007.

THE MARK CONSISTS OF STANDARD CHARACTERS WITHOUT CLAIM TO ANY PARTICULAR FONT, STYLE, SIZE, OR COLOR.

NO CLAIM IS MADE TO THE EXCLUSIVE RIGHT TO USE "FIRE", APART FROM THE MARK AS SHOWN.

SN 77-310,688, FILED 10-23-2007.

RICHARD WHITE, EXAMINING ATTORNEY

**Int. Cl.: 11**

**Prior U.S. Cls.: 13, 21, 23, 31, and 34**

**Reg. No. 3,570,627**

**United States Patent and Trademark Office**

**Registered Feb. 3, 2009**

**TRADEMARK  
PRINCIPAL REGISTER**



FC INDUSTRIES, LLC (GEORGIA LIMITED LIABILITY COMPANY)  
112 KROG STREET, NE  
SUITE 17  
ATLANTA, GA 30307

FOR: FIRE PITS, IN CLASS 11 (U.S. CLS. 13, 21, 23, 31 AND 34).

FIRST USE 11-17-2007; IN COMMERCE 11-17-2007.

OWNER OF U.S. REG. NO. 3,176,124.

NO CLAIM IS MADE TO THE EXCLUSIVE RIGHT TO USE "FIRE", APART FROM THE MARK AS SHOWN.

THE MARK CONSISTS OF THE WORDS "ORION FLAT FIRE" WITHIN A STYLIZED OVAL. AN ARROW IS BEHIND THE WORD "ORION".

SN 77-310,694, FILED 10-23-2007.

RICHARD WHITE, EXAMINING ATTORNEY

**Int. Cl.: 3**

**Prior U.S. Cls.: 1, 4, 6, 50, 51, and 52**

**United States Patent and Trademark Office**

**Reg. No. 3,570,628**

**Registered Feb. 3, 2009**

**TRADEMARK  
PRINCIPAL REGISTER**

**KRAZZY HAIR**

DISTRIBUIDORA DE ALIMENTOS NATURALES  
Y NUTRICIONALES, S.A. DE C.V. (MEXICO  
CORPORATION)  
MANUEL AVILA CAMACHO # 44-A  
MEXICO, MEXICO 09570

FOR: BATH GELS; BATH SOAPS IN LIQUID,  
SOLID OR GEL FORM; BEAUTY GELS; GEL FOR  
HAIR; HAIR CARE CREAMS; HAIR GEL; HAIR  
GELS; HAIR OILS; HAIR SHAMPOO; HAIR STY-  
LING GEL; HAIR STYLING SPRAY; SHOWER AND  
BATH GEL; SHOWER GEL; SHOWER GELS; STY-  
LING GELS; TANNING GELS, IN CLASS 3 (U.S. CLS.  
1, 4, 6, 50, 51 AND 52).

FIRST USE 10-10-2008; IN COMMERCE 10-10-2008.

THE MARK CONSISTS OF STANDARD CHAR-  
ACTERS WITHOUT CLAIM TO ANY PARTICULAR  
FONT, STYLE, SIZE, OR COLOR.

NO CLAIM IS MADE TO THE EXCLUSIVE  
RIGHT TO USE "HAIR", APART FROM THE MARK  
AS SHOWN.

SN 77-310,898, FILED 10-23-2007.

KAREN K. BUSH, EXAMINING ATTORNEY

**Int. Cl.: 9**

**Prior U.S. Cls.: 21, 23, 26, 36, and 38**

**Reg. No. 3,570,629**

**United States Patent and Trademark Office**

**Registered Feb. 3, 2009**

---

**TRADEMARK  
PRINCIPAL REGISTER**

**NEWOTRAK**

ABI TREATMENT SOFTWARE SOLUTIONS INC.  
(COLORADO CORPORATION)  
1602 S. PARKER ROAD, SUITE 110  
DENVER, CO 80231

FIRST USE 8-1-2008; IN COMMERCE 8-1-2008.

FOR: COMPUTER SOFTWARE FOR MONITORING CLIENTS, SCHEDULING CLIENT ACTIVITIES AND EVENTS, AND GENERATING REPORTS ON CLIENT MONITORING AND CLIENT EVENTS AND ACTIVITIES, IN CLASS 9 (U.S. CLS. 21, 23, 26, 36 AND 38).

THE MARK CONSISTS OF STANDARD CHARACTERS WITHOUT CLAIM TO ANY PARTICULAR FONT, STYLE, SIZE, OR COLOR.

SN 77-310,904, FILED 10-23-2007.

H. M. FISHER, EXAMINING ATTORNEY

**Int. Cls.: 16 and 21**

**Prior U.S. Cls.: 2, 5, 13, 22, 23, 29, 30, 33, 37, 38, 40,  
and 50**

**Reg. No. 3,570,630**

**United States Patent and Trademark Office**

**Registered Feb. 3, 2009**

**TRADEMARK  
PRINCIPAL REGISTER**

**FRESH SHIELD**

S. C. JOHNSON HOME STORAGE, INC. (DELA-  
WARE CORPORATION)  
1525 HOWE STREET  
RACINE, WI 53403

FIRST USE 10-15-2008; IN COMMERCE 10-15-2008.

FOR: PLASTIC FOOD STORAGE BAGS FOR  
HOUSEHOLD USE, IN CLASS 16 (U.S. CLS. 2, 5, 22,  
23, 29, 37, 38 AND 50).

THE MARK CONSISTS OF STANDARD CHAR-  
ACTERS WITHOUT CLAIM TO ANY PARTICULAR  
FONT, STYLE, SIZE, OR COLOR.

FIRST USE 10-15-2008; IN COMMERCE 10-15-2008.

SN 77-311,066, FILED 10-23-2007.

FOR: PLASTIC STORAGE CONTAINERS FOR  
DOMESTIC USE, IN CLASS 21 (U.S. CLS. 2, 13, 23,  
29, 30, 33, 40 AND 50).

CHERYL CLAYTON, EXAMINING ATTORNEY

**Int. Cl.: 29**

**Prior U.S. Cl.: 46**

**United States Patent and Trademark Office**

**Reg. No. 3,570,631**

**Registered Feb. 3, 2009**

**TRADEMARK  
PRINCIPAL REGISTER**

**TRUST THE TASTE**

JONMOR INVESTMENTS, INC. (DELAWARE  
CORPORATION)  
103 BAYNARD BUILDING  
3411 SILVERSIDE ROAD  
WILMINGTON, DE 19810

FOR: MEAT; PROCESSED MEATS; LUNCHEON  
MEATS; PREPARED ENTREES AND MEALS CON-  
SISTING PRIMARILY OF MEAT, POULTRY, OR  
VEGETABLES, IN CLASS 29 (U.S. CL. 46).

FIRST USE 6-1-2007; IN COMMERCE 6-1-2007.

THE MARK CONSISTS OF STANDARD CHAR-  
ACTERS WITHOUT CLAIM TO ANY PARTICULAR  
FONT, STYLE, SIZE, OR COLOR.

SN 77-311,323, FILED 10-23-2007.

PAUL E. FAHRENKOPF, EXAMINING ATTORNEY

**Int. Cl.: 12**

**Prior U.S. Cls.: 19, 21, 23, 31, 35, and 44**

**Reg. No. 3,570,632**

**United States Patent and Trademark Office**

**Registered Feb. 3, 2009**

**TRADEMARK  
PRINCIPAL REGISTER**

**FRONTIER**

BRITAX CHILD SAFETY, INC. (SOUTH CAROLINA CORPORATION)  
13501 SOUTH RIDGE DRIVE  
CHARLOTTE, NC 28273

FIRST USE 3-18-2008; IN COMMERCE 3-18-2008.

FOR: CHILD SAFETY SEATS FOR USE IN CARS AND VEHICLES; CHILD SAFETY HARNESSSES FOR THE SEATS OF VEHICLES; CHILD SAFETY BELTS FOR THE SEATS OF VEHICLES; CHILD RESTRAINTS FOR USE IN VEHICLES; REPLACEMENT PARTS AND REPLACEMENT FITTINGS FOR ALL OF THE AFORESAID GOODS, IN CLASS 12 (U.S. CLS. 19, 21, 23, 31, 35 AND 44).

THE MARK CONSISTS OF STANDARD CHARACTERS WITHOUT CLAIM TO ANY PARTICULAR FONT, STYLE, SIZE, OR COLOR.

SN 77-312,076, FILED 10-24-2007.

KAREN SEVERSON, EXAMINING ATTORNEY



**Int. Cl.: 9**

**Prior U.S. Cls.: 21, 23, 26, 36, and 38**

**Reg. No. 3,570,633**

**United States Patent and Trademark Office**

**Registered Feb. 3, 2009**

**TRADEMARK  
PRINCIPAL REGISTER**



EUREKA, INC. (REPUBLIC OF KOREA CORPORATION)  
260-3 GALSAN-DONG, DALSUH-GU  
DAEGU-SI, REPUBLIC OF KOREA

FOR: ANTIREFLECTION COATED EYEGLASSES; EYEGLOSS CASES; EYEGLOSS CHAINS; EYEGLOSS FRAMES; EYEGLOSS LENSES; EYEGLOSSES; PROTECTIVE EYEGLOSSES; READING EYEGLOSSES; SIDE GUARDS FOR EYEGLOSSES; SPECTACLES; SPORTS TRAINING EYEGLOSSES; CASES FOR SPECTACLES AND SUNGLASSES; FRAMES FOR SPECTACLES AND SUNGLASSES; LENSES FOR SUNGLASSES; NOSE GUARDS WHICH CAN BE WORN BY ATTACHMENT TO EYEWEAR SUCH AS SUNGLASSES AND

SKI GOGGLES; SUNGLASS LENSES; SUNGLASSES; DIVING GOGGLES; GOGGLES FOR SPORTS; SAFETY GOGGLES; SCUBA GOGGLES; SKI GOGGLES; SNOW GOGGLES; SWIMMING GOGGLES, IN CLASS 9 (U.S. CLS. 21, 23, 26, 36 AND 38).

FIRST USE 11-15-2007; IN COMMERCE 11-15-2007.

THE MARK CONSISTS OF THE WORD "EUREKA" TO THE RIGHT OF A SYMBOL THAT RESEMBLES A STYLIZED "E".

SN 77-312,083, FILED 10-24-2007.

KAREN SEVERSON, EXAMINING ATTORNEY

**Int. Cl.: 9**

**Prior U.S. Cls.: 21, 23, 26, 36, and 38**

**United States Patent and Trademark Office**

**Reg. No. 3,570,634**

**Registered Feb. 3, 2009**

**TRADEMARK  
PRINCIPAL REGISTER**

**KWIKTAG CONNECT**

IMAGETAG, INC. (ARIZONA CORPORATION)  
7201 WEST OAKLAND, SUITE 2  
CHANDLER, AZ 85226

OWNER OF U.S. REG. NOS. 2,660,204, 2,660,219,  
AND 2,684,282.

FOR: COMPUTER SOFTWARE DEVELOPMENT  
TOOLS, IN CLASS 9 (U.S. CLS. 21, 23, 26, 36 AND 38).

NO CLAIM IS MADE TO THE EXCLUSIVE  
RIGHT TO USE "CONNECT", APART FROM THE  
MARK AS SHOWN.

FIRST USE 11-1-2008; IN COMMERCE 11-1-2008.

SN 77-312,757, FILED 10-24-2007.

THE MARK CONSISTS OF STANDARD CHAR-  
ACTERS WITHOUT CLAIM TO ANY PARTICULAR  
FONT, STYLE, SIZE, OR COLOR.

JAMES STEIN, EXAMINING ATTORNEY

**Int. Cl.: 41**

**Prior U.S. Cls.: 100, 101, and 107**

**United States Patent and Trademark Office**

**Reg. No. 3,570,635**

**Registered Feb. 3, 2009**

**SERVICE MARK  
PRINCIPAL REGISTER**

**THE M WORD**

SACKLER, LORI R. (UNITED STATES INDIVIDUAL)  
238 ENGLE STREET  
TENAFLY, NJ 07670

FOR: EDUCATIONAL AND ENTERTAINMENT SERVICES, NAMELY, A CONTINUING PROGRAM ABOUT FINANCE, WEALTH MANAGEMENT, WEALTH COMMUNICATION AND TRANSFER ACROSS GENERATIONS, ACCESSIBLE BY RADIO, TELEVISION, SATELLITE, AUDIO, VIDEO AND COMPUTER NETWORKS, IN CLASS 41 (U.S. CLS. 100, 101 AND 107).

FIRST USE 10-1-2008; IN COMMERCE 11-2-2008.

THE MARK CONSISTS OF STANDARD CHARACTERS WITHOUT CLAIM TO ANY PARTICULAR FONT, STYLE, SIZE, OR COLOR.

SN 77-313,569, FILED 10-25-2007.

MARY CRAWFORD, EXAMINING ATTORNEY

**Int. Cl.: 3**

**Prior U.S. Cls.: 1, 4, 6, 50, 51, and 52**

**Reg. No. 3,570,636**

**United States Patent and Trademark Office**

**Registered Feb. 3, 2009**

**TRADEMARK  
PRINCIPAL REGISTER**

**ULTRA CHERRY**

ILLINOIS TOOL WORKS INC. (DELAWARE  
CORPORATION)  
3600 WEST LAKE AVENUE  
GLENVIEW, IL 60026

FOR: HAND CLEANING PREPARATIONS HAV-  
ING A CHERRY SCENT; CLEANING PREPARA-  
TIONS HAVING A CHERRY SCENT, IN CLASS 3  
(U.S. CLS. 1, 4, 6, 50, 51 AND 52).

FIRST USE 3-19-2008; IN COMMERCE 3-19-2008.

THE MARK CONSISTS OF STANDARD CHAR-  
ACTERS WITHOUT CLAIM TO ANY PARTICULAR  
FONT, STYLE, SIZE, OR COLOR.

NO CLAIM IS MADE TO THE EXCLUSIVE  
RIGHT TO USE "CHERRY", APART FROM THE  
MARK AS SHOWN.

SN 77-313,638, FILED 10-25-2007.

JAY BESCH, EXAMINING ATTORNEY

**Int. Cl.: 16**

**Prior U.S. Cls.: 2, 5, 22, 23, 29, 37, 38, and 50**

**Reg. No. 3,570,637**

**United States Patent and Trademark Office**

**Registered Feb. 3, 2009**

**TRADEMARK  
PRINCIPAL REGISTER**

**AIRWAVE**

STAPLES THE OFFICE SUPERSTORE, LLC (DE-  
LAWARE LIMITED LIABILITY COMPANY)  
500 STAPLES DRIVE  
FRAMINGHAM, MA 01702

THE MARK CONSISTS OF STANDARD CHAR-  
ACTERS WITHOUT CLAIM TO ANY PARTICULAR  
FONT, STYLE, SIZE, OR COLOR.

FOR: WRITING INSTRUMENTS, IN CLASS 16  
(U.S. CLS. 2, 5, 22, 23, 29, 37, 38 AND 50).

SN 77-314,565, FILED 10-26-2007.

FIRST USE 12-0-2007; IN COMMERCE 12-0-2007.

DOMINICK J. SALEMI, EXAMINING ATTORNEY

**Int. Cl.: 16**

**Prior U.S. Cls.: 2, 5, 22, 23, 29, 37, 38, and 50**

**Reg. No. 3,570,638**

**United States Patent and Trademark Office**

**Registered Feb. 3, 2009**

**TRADEMARK  
PRINCIPAL REGISTER**

**METRIX**

STAPLES THE OFFICE SUPERSTORE, LLC (DE-  
LAWARE LIMITED LIABILITY COMPANY)  
500 STAPLES DRIVE  
FRAMINGHAM, MA 01702

THE MARK CONSISTS OF STANDARD CHAR-  
ACTERS WITHOUT CLAIM TO ANY PARTICULAR  
FONT, STYLE, SIZE, OR COLOR.

FOR: WRITING INSTRUMENTS, IN CLASS 16  
(U.S. CLS. 2, 5, 22, 23, 29, 37, 38 AND 50).

SN 77-314,569, FILED 10-26-2007.

FIRST USE 12-0-2007; IN COMMERCE 12-0-2007.

DOMINICK J. SALEMI, EXAMINING ATTORNEY

**Int. Cl.: 21**

**Prior U.S. Cls.: 2, 13, 23, 29, 30, 33, 40, and 50**

**United States Patent and Trademark Office**

**Reg. No. 3,570,639**

**Registered Feb. 3, 2009**

**TRADEMARK  
PRINCIPAL REGISTER**

**ZAK! SNAPS**

ZAK DESIGNS, INC. (WASHINGTON CORPORATION)  
P.O. BOX 19188  
SPOKANE, WA 99219

OWNER OF U.S. REG. NOS. 1,806,163, 3,334,730,  
AND OTHERS.

FOR: PLASTIC FOOD STORAGE CONTAINERS,  
IN CLASS 21 (U.S. CLS. 2, 13, 23, 29, 30, 33, 40 AND 50).

NO CLAIM IS MADE TO THE EXCLUSIVE  
RIGHT TO USE "SNAPS", APART FROM THE  
MARK AS SHOWN.

FIRST USE 1-1-2008; IN COMMERCE 1-1-2008.

SN 77-314,904, FILED 10-26-2007.

THE MARK CONSISTS OF STANDARD CHARACTERS WITHOUT CLAIM TO ANY PARTICULAR FONT, STYLE, SIZE, OR COLOR.

KAPIL BHANOT, EXAMINING ATTORNEY

**Int. Cl.: 43**

**Prior U.S. Cls.: 100 and 101**

**United States Patent and Trademark Office**

**Reg. No. 3,570,640**

**Registered Feb. 3, 2009**

**SERVICE MARK  
PRINCIPAL REGISTER**

THE GREENBRIER CENTER FOR  
HEALTHY LIVING

CSX IA, INC. (DELAWARE CORPORATION)  
500 WATER STREET  
JACKSONVILLE, FL 32202

FOR: HEALTH RESORT SERVICES, NAMELY,  
PROVIDING FOOD AND LODGING THAT SPECIALIZE  
IN PROMOTING PATRONS' GENERAL HEALTH  
AND WELL-BEING, IN CLASS 43 (U.S. CLS.  
100 AND 101).

FIRST USE 1-2-2008; IN COMMERCE 1-2-2008.

THE MARK CONSISTS OF STANDARD CHARACTERS  
WITHOUT CLAIM TO ANY PARTICULAR FONT,  
STYLE, SIZE, OR COLOR.

OWNER OF U.S. REG. NOS. 2,754,408, 2,940,022,  
AND OTHERS.

NO CLAIM IS MADE TO THE EXCLUSIVE  
RIGHT TO USE "CENTER FOR HEALTHY LIVING",  
APART FROM THE MARK AS SHOWN.

SN 77-315,616, FILED 10-29-2007.

ELLEN BURNS, EXAMINING ATTORNEY



**Int. Cl.: 24**

**Prior U.S. Cls.: 42 and 50**

**United States Patent and Trademark Office**

**Reg. No. 3,570,641**

**Registered Feb. 3, 2009**

**TRADEMARK  
PRINCIPAL REGISTER**

**INSPIRATIONS BY WAMSUTTA**

SPRINGS GLOBAL US, INC. (DELAWARE CORPORATION)  
205 NORTH WHITE STREET  
FORT MILL, SC 29715

FOR: BATH TOWELS; HAND TOWELS; TOWELS;  
WASHCLOTHS, IN CLASS 24 (U.S. CLS. 42 AND 50).

FIRST USE 2-0-2008; IN COMMERCE 2-0-2008.

THE MARK CONSISTS OF STANDARD CHARACTERS WITHOUT CLAIM TO ANY PARTICULAR FONT, STYLE, SIZE, OR COLOR.

OWNER OF U.S. REG. NOS. 1,233,623, 1,909,067,  
AND 3,029,557.

SN 77-315,936, FILED 10-29-2007.

DAVID TAYLOR, EXAMINING ATTORNEY

**Int. Cl.: 3**

**Prior U.S. Cls.: 1, 4, 6, 50, 51, and 52**

**United States Patent and Trademark Office**

**Reg. No. 3,570,642**

**Registered Feb. 3, 2009**

**TRADEMARK  
PRINCIPAL REGISTER**



RDM MULTI-ENTERPRISES, INCORPORATED  
(MONTANA CORPORATION)  
105 NORTH SILVER ST  
ANACONDA, MT 59711

FOR: GRANULATED COPPER FURNACE SMEL-  
TER SLAG USED AS SANDBLASTING MEDIA;  
INDUSTRIAL ABRASIVES USED FOR MANUFAC-  
TURE OF ROOFING SHINGLES , IN CLASS 3 (U.S.  
CLS. 1, 4, 6, 50, 51 AND 52).

FIRST USE 7-1-2003; IN COMMERCE 7-1-2003.

NO CLAIM IS MADE TO THE EXCLUSIVE  
RIGHT TO USE "BLAST", APART FROM THE  
MARK AS SHOWN.

SN 77-316,375, FILED 10-29-2007.

MELVIN AXILBUND, EXAMINING ATTORNEY

**Int. Cl.: 5**

**Prior U.S. Cls.: 6, 18, 44, 46, 51, and 52**

**Reg. No. 3,570,643**

**United States Patent and Trademark Office**

**Registered Feb. 3, 2009**

---

**TRADEMARK  
PRINCIPAL REGISTER**

**STAR SLIM**

STARBODIES, INC. (FLORIDA CORPORATION)  
9835-16 LAKE WORTH ROAD  
LAKE WORTH, FL 33467

FOR: DIETARY SUPPLEMENTS, IN CLASS 5 (U.S.  
CLS. 6, 18, 44, 46, 51 AND 52).

FIRST USE 11-21-2007; IN COMMERCE 1-18-2008.

THE MARK CONSISTS OF STANDARD CHAR-  
ACTERS WITHOUT CLAIM TO ANY PARTICULAR  
FONT, STYLE, SIZE, OR COLOR.

NO CLAIM IS MADE TO THE EXCLUSIVE  
RIGHT TO USE "SLIM", APART FROM THE MARK  
AS SHOWN.

SN 77-316,972, FILED 10-30-2007.

CHRISTINA SOBRAL, EXAMINING ATTORNEY

**Int. Cl.: 35**

**Prior U.S. Cls.: 100, 101, and 102**

**United States Patent and Trademark Office**

**Reg. No. 3,570,644**

**Registered Feb. 3, 2009**

**SERVICE MARK  
PRINCIPAL REGISTER**

REAL ESTATE OUT IN THE OPEN

RANDI THORNTON (UNITED STATES INDIVIDUAL)  
192 2ND STREET  
EXCELSIOR, MN 55331

FOR: MATCHING CONSUMERS WITH REAL ESTATE PROFESSIONALS IN THE FIELD OF REAL ESTATE SERVICES VIA COMPUTER NETWORK; PROVIDING REAL ESTATE LEADS FOR PROSPECTIVE PURCHASERS; REAL ESTATE ADVERTISING SERVICES; REAL ESTATE MARKETING SERVICES IN THE FIELD OF HOMES; REAL ESTATE MARKETING SERVICES, NAMELY, ON-LINE SERVICES FEATURING TOURS OF RESIDENTIAL AND COM-

MERCIAL REAL ESTATE, IN CLASS 35 (U.S. CLS. 100, 101 AND 102).

FIRST USE 8-1-2008; IN COMMERCE 8-1-2008.

THE MARK CONSISTS OF STANDARD CHARACTERS WITHOUT CLAIM TO ANY PARTICULAR FONT, STYLE, SIZE, OR COLOR.

SN 77-317,025, FILED 10-30-2007.

JESSICA A. POWERS, EXAMINING ATTORNEY

**Int. Cl.: 9**

**Prior U.S. Cls.: 21, 23, 26, 36, and 38**

**United States Patent and Trademark Office**

**Reg. No. 3,570,645**

**Registered Feb. 3, 2009**

**TRADEMARK  
PRINCIPAL REGISTER**

**PACK A WEIGH**

INGENIOUS DESIGNS LLC (DELAWARE LIMITED LIABILITY COMPANY)  
LEGAL DEPARTMENT  
1 HSN DRIVE  
ST. PETERSBURG, FL 33629

THE MARK CONSISTS OF STANDARD CHARACTERS WITHOUT CLAIM TO ANY PARTICULAR FONT, STYLE, SIZE, OR COLOR.

FOR: SCALES, IN CLASS 9 (U.S. CLS. 21, 23, 26, 36 AND 38).

SN 77-318,789, FILED 11-1-2007.

FIRST USE 10-1-2007; IN COMMERCE 10-1-2007.

SHARON MEIER, EXAMINING ATTORNEY

**Int. Cl.: 3**

**Prior U.S. Cls.: 1, 4, 6, 50, 51, and 52**

**Reg. No. 3,570,646**

**United States Patent and Trademark Office**

**Registered Feb. 3, 2009**

**TRADEMARK  
PRINCIPAL REGISTER**

**Peptoxyl**

MANA PRODUCTS, INC. (NEW YORK COR-  
PORATION)  
32-02 QUEENS BOULEVARD  
LONG ISLAND CITY, NY 11101

THE MARK CONSISTS OF STANDARD CHAR-  
ACTERS WITHOUT CLAIM TO ANY PARTICULAR  
FONT, STYLE, SIZE, OR COLOR.

FOR: COSMETICS AND NON-MEDICATED  
SKINCARE PREPARATIONS, IN CLASS 3 (U.S.  
CLS. 1, 4, 6, 50, 51 AND 52).

SN 77-318,902, FILED 11-1-2007.

FIRST USE 11-1-2008; IN COMMERCE 11-1-2008.

LAURIE MAYES, EXAMINING ATTORNEY

**Int. Cl.: 3**

**Prior U.S. Cls.: 1, 4, 6, 50, 51, and 52**

**Reg. No. 3,570,647**

**United States Patent and Trademark Office**

**Registered Feb. 3, 2009**

**TRADEMARK  
PRINCIPAL REGISTER**

**Liptoxyl**

MANA PRODUCTS, INC. (NEW YORK COR-  
PORATION)  
32-02 QUEENS BOULEVARD  
LONG ISLAND CITY, NY 11101

THE MARK CONSISTS OF STANDARD CHAR-  
ACTERS WITHOUT CLAIM TO ANY PARTICULAR  
FONT, STYLE, SIZE, OR COLOR.

FOR: COSMETICS AND NON-MEDICATED  
SKINCARE PREPARATIONS, IN CLASS 3 (U.S.  
CLS. 1, 4, 6, 50, 51 AND 52).

SN 77-318,921, FILED 11-1-2007.

FIRST USE 11-1-2008; IN COMMERCE 11-1-2008.

LAURIE MAYES, EXAMINING ATTORNEY

Int. Cl.: 25

Prior U.S. Cls.: 22 and 39

United States Patent and Trademark Office

Reg. No. 3,570,648

Registered Feb. 3, 2009

TRADEMARK  
PRINCIPAL REGISTER



PINKERTON, JONATHAN J. (UNITED STATES  
INDIVIDUAL)  
124 TIMBERLANE DRIVE  
PITTSBURGH, PA 15229

THE MARK CONSISTS OF THE REPRESENTATION OF BRASS KNUCKLES WITH A BANNER INTERTWINED THAT READS "TRUE TILL THE END BROTHERHOOD".

FOR: JERSEYS, IN CLASS 25 (U.S. CLS. 22 AND 39).

SN 77-319,021, FILED 11-1-2007.

FIRST USE 1-17-2008; IN COMMERCE 1-17-2008.

RON FAIRBANKS, EXAMINING ATTORNEY



**Int. Cl.: 10**

**Prior U.S. Cls.: 26, 39, and 44**

**United States Patent and Trademark Office**

**Reg. No. 3,570,649**

**Registered Feb. 3, 2009**

**TRADEMARK  
PRINCIPAL REGISTER**

**DIGNICARE**

C. R. BARD, INC. (NEW JERSEY CORPORATION)  
730 CENTRAL AVENUE  
MURRAY HILL, NJ 07974

FOR: MEDICAL DEVICES AND APPARATUS, NAMELY, STOOL MANAGEMENT SYSTEM PRIMARILY CONSISTING OF A CATHETER, CONNECTORS, DRAINAGE TUBE, COLLECTION BAG AND PLUG, SYRINGES, INFLATION AND RETENTION CUFF, MEDICAL PORTS, AND PARTS AND FITTINGS THEREFOR, IN CLASS 10 (U.S. CLS. 26, 39 AND 44).

FIRST USE 8-31-2008; IN COMMERCE 8-31-2008.

THE MARK CONSISTS OF STANDARD CHARACTERS WITHOUT CLAIM TO ANY PARTICULAR FONT, STYLE, SIZE, OR COLOR.

SN 77-319,233, FILED 11-1-2007.

MAUREEN DALL, EXAMINING ATTORNEY

**Int. Cl.: 35**

**Prior U.S. Cls.: 100, 101, and 102**

**United States Patent and Trademark Office**

**Reg. No. 3,570,650**

**Registered Feb. 3, 2009**

**SERVICE MARK  
PRINCIPAL REGISTER**

**PROMISE SHOP**

THE SUSAN G. KOMEN BREAST CANCER  
FOUNDATION, INC. (TEXAS NON-PROFIT  
CORPORATION)  
5005 LBJ FREEWAY, SUITE 250  
DALLAS, TX 75244

FOR: RETAIL STORE SERVICES IN THE NAT-  
URE OF BOOTHS AND KIOSKS AND ONLINE  
RETAIL SERVICES FEATURING A WIDE VARIETY  
OF GENERAL CONSUMER MERCHANDISE PRO-  
DUCTS AND EDUCATIONAL INFORMATION  
AND MATERIALS RELATED TO BREAST CANCER  
FOR THE PURPOSE OF RAISING MONEY FOR  
BREAST CANCER RESEARCH AND RAISING  
BREAST CANCER AWARENESS, IN CLASS 35  
(U.S. CLS. 100, 101 AND 102).

FIRST USE 10-0-2007; IN COMMERCE 10-0-2007.

THE MARK CONSISTS OF STANDARD CHAR-  
ACTERS WITHOUT CLAIM TO ANY PARTICULAR  
FONT, STYLE, SIZE, OR COLOR.

NO CLAIM IS MADE TO THE EXCLUSIVE  
RIGHT TO USE "SHOP", APART FROM THE MARK  
AS SHOWN.

SN 77-321,233, FILED 11-5-2007.

SUSAN STIGLITZ, EXAMINING ATTORNEY

**Int. Cl.: 30**

**Prior U.S. Cl.: 46**

**United States Patent and Trademark Office**

**Reg. No. 3,570,651**

**Registered Feb. 3, 2009**

**TRADEMARK  
PRINCIPAL REGISTER**

**MICHAELITA'S**

MICHAELITA'S FINE PRODUCTS, INC. (TEXAS  
CORPORATION)  
6305 BRADLEY LANE  
PLANO, TX 75023

THE MARK CONSISTS OF STANDARD CHAR-  
ACTERS WITHOUT CLAIM TO ANY PARTICULAR  
FONT, STYLE, SIZE, OR COLOR.

FOR: SALSA, IN CLASS 30 (U.S. CL. 46).

SN 77-322,600, FILED 11-6-2007.

FIRST USE 10-7-2008; IN COMMERCE 10-7-2008.

ANTHONY RINKER, EXAMINING ATTORNEY

**Int. Cl.: 11**

**Prior U.S. Cls.: 13, 21, 23, 31, and 34**

**United States Patent and Trademark Office**

**Reg. No. 3,570,652**

**Registered Feb. 3, 2009**

**TRADEMARK  
PRINCIPAL REGISTER**

**Clara**

STORMWATERX LLC (OREGON LIMITED LIABILITY COMPANY)  
122 SE 27TH AVENUE  
PORTLAND, OR 97214

THE MARK CONSISTS OF STANDARD CHARACTERS WITHOUT CLAIM TO ANY PARTICULAR FONT, STYLE, SIZE, OR COLOR.

FOR: WATER FILTERING UNITS FOR COMMERCIAL AND INDUSTRIAL USE, IN CLASS 11 (U.S. CLS. 13, 21, 23, 31 AND 34).

SN 77-323,015, FILED 11-6-2007.

FIRST USE 4-1-2008; IN COMMERCE 4-1-2008.

MARY MUNSON, EXAMINING ATTORNEY

**Int. Cl.: 41**

**Prior U.S. Cls.: 100, 101, and 107**

**United States Patent and Trademark Office**

**Reg. No. 3,570,653**

**Registered Feb. 3, 2009**

**SERVICE MARK  
PRINCIPAL REGISTER**

**FIT 4 U**

REDCATS USA, L.P. (DELAWARE LIMITED  
PARTNERSHIP)  
2300 SOUTHEASTERN AVE.  
INDIANAPOLIS, IN 46201

THE MARK CONSISTS OF STANDARD CHAR-  
ACTERS WITHOUT CLAIM TO ANY PARTICULAR  
FONT, STYLE, SIZE, OR COLOR.

FOR: PROVIDING ONLINE CHARTS IN THE  
FIELD OF CLOTHES SIZE DETERMINATION, IN  
CLASS 41 (U.S. CLS. 100, 101 AND 107).

SN 77-323,324, FILED 11-7-2007.

FIRST USE 10-21-2008; IN COMMERCE 10-21-2008.

KEVIN DINALLO, EXAMINING ATTORNEY

**Int. Cl.: 18**

**Prior U.S. Cls.: 1, 2, 3, 22, and 41**

**United States Patent and Trademark Office**

**Reg. No. 3,570,654**

**Registered Feb. 3, 2009**

**TRADEMARK  
PRINCIPAL REGISTER**

**PURSELING**

PRUZHANSKY, MILANA (UNITED STATES IN-  
DIVIDUAL)

# B-128

9500 SW 3RD STREET  
BOCA RATON, FL 33428

FOR: LUGGAGE; PURSES; WALLETS, IN CLASS  
18 (U.S. CLS. 1, 2, 3, 22 AND 41).

FIRST USE 2-1-2008; IN COMMERCE 2-1-2008.

THE MARK CONSISTS OF STANDARD CHAR-  
ACTERS WITHOUT CLAIM TO ANY PARTICULAR  
FONT, STYLE, SIZE, OR COLOR.

SN 77-323,494, FILED 11-7-2007.

SAMUEL E. SHARPER JR., EXAMINING ATTOR-  
NEY

**Int. Cl.: 36**

**Prior U.S. Cls.: 100, 101, and 102**

**United States Patent and Trademark Office**

**Reg. No. 3,570,655**

**Registered Feb. 3, 2009**

**SERVICE MARK  
PRINCIPAL REGISTER**

**WACHOVIA BLUEPRINT**

WACHOVIA CORPORATION (NORTH CAROLINA CORPORATION)  
ONE WACHOVIA CENTER  
301 S. COLLEGE STREET, 30TH FLOOR NC0630  
CHARLOTTE, NC 282880630

FOR: DEBT MANAGEMENT CONSULTATION,  
AND DEBT CONSOLIDATION LENDING SERVICES,  
IN CLASS 36 (U.S. CLS. 100, 101 AND 102).

FIRST USE 1-4-2008; IN COMMERCE 1-4-2008.

THE MARK CONSISTS OF STANDARD CHARACTERS WITHOUT CLAIM TO ANY PARTICULAR FONT, STYLE, SIZE, OR COLOR.

OWNER OF U.S. REG. NOS. 883,259, 1,735,242,  
AND OTHERS.

SN 77-323,601, FILED 11-7-2007.

RONALD MCMORROW, EXAMINING ATTORNEY

**Int. Cl.: 25**

**Prior U.S. Cls.: 22 and 39**

**United States Patent and Trademark Office**

**Reg. No. 3,570,656**

**Registered Feb. 3, 2009**

**TRADEMARK  
PRINCIPAL REGISTER**

**JACK HEIGHTS**

MPC PROPERTIES, LLC (NEW YORK LIMITED  
LIABILITY COMPANY)  
82-11 37TH AVENUE, SUITE 605  
JACKSON HEIGHTS, NY 11372

FOR: TEE SHIRTS AND HATS, IN CLASS 25 (U.S.  
CLS. 22 AND 39).

FIRST USE 12-1-2008; IN COMMERCE 12-1-2008.

THE MARK CONSISTS OF STANDARD CHAR-  
ACTERS WITHOUT CLAIM TO ANY PARTICULAR  
FONT, STYLE, SIZE, OR COLOR.

THE NAME "JACK HEIGHTS" DOES NOT IDEN-  
TIFY A LIVING INDIVIDUAL.

SN 77-323,819, FILED 11-7-2007.

GILBERT SWIFT, EXAMINING ATTORNEY



**Int. Cl.: 36**

**Prior U.S. Cls.: 100, 101, and 102**

**United States Patent and Trademark Office**

**Reg. No. 3,570,657**

**Registered Feb. 3, 2009**

**SERVICE MARK  
PRINCIPAL REGISTER**

# JACK HEIGHTS

MPC PROPERTIES, LLC (NEW YORK LIMITED LIABILITY COMPANY)  
82-11 37TH AVENUE, SUITE 605  
JACKSON HEIGHTS, NY 11372

FOR: ASSESSMENT AND MANAGEMENT OF REAL ESTATE; FINANCIAL INVESTMENT IN THE FIELD OF REAL ESTATE; FINANCIAL VALUATION OF REAL ESTATE; LEASING OF REAL ESTATE; OPERATING MARKETPLACES FOR SELLERS OF GOODS AND/OR SERVICES IN CONNECTION WITH REAL ESTATE; PROVIDING INFORMATION IN THE FIELD OF REAL ESTATE BY MEANS OF LINKING THE WEB SITE TO OTHER WEB SITES FEATURING REAL ESTATE INFORMATION; REAL ESTATE ACQUISITION SERVICES; REAL ESTATE AGENCIES; REAL ESTATE BROKERAGE; REAL ESTATE CONSULTATION; REAL ESTATE EQUITY SHARING, NAMELY, MANAGING AND ARRANGING FOR CO-OWNERSHIP OF REAL ESTATE; REAL ESTATE INVEST-

MENT; REAL ESTATE LISTING; REAL ESTATE MANAGEMENT; REAL ESTATE MANAGEMENT CONSULTATION; REAL ESTATE PROCUREMENT FOR OTHERS; REAL ESTATE SYNDICATION; REAL ESTATE VALUATION SERVICES, IN CLASS 36 (U.S. CLS. 100, 101 AND 102).

FIRST USE 4-1-2008; IN COMMERCE 11-24-2008.

THE MARK CONSISTS OF STANDARD CHARACTERS WITHOUT CLAIM TO ANY PARTICULAR FONT, STYLE, SIZE, OR COLOR.

THE NAME "JACK HEIGHTS" DOES NOT IDENTIFY A LIVING INDIVIDUAL.

SN 77-323,872, FILED 11-7-2007.

GILBERT SWIFT, EXAMINING ATTORNEY

**Int. Cl.: 5**

**Prior U.S. Cls.: 6, 18, 44, 46, 51, and 52**

**Reg. No. 3,570,658**

**United States Patent and Trademark Office**

**Registered Feb. 3, 2009**

**TRADEMARK  
PRINCIPAL REGISTER**

**CADET**

FMC CORPORATION (DELAWARE CORPORATION)  
1735 MARKET STREET  
PHILADELPHIA, PA 19103

THE MARK CONSISTS OF STANDARD CHARACTERS WITHOUT CLAIM TO ANY PARTICULAR FONT, STYLE, SIZE, OR COLOR.

FOR: PESTICIDES FOR USE IN AGRICULTURE,  
IN CLASS 5 (U.S. CLS. 6, 18, 44, 46, 51 AND 52).

SN 77-324,493, FILED 11-8-2007.

FIRST USE 6-9-2008; IN COMMERCE 6-9-2008.

ALYSSA STEEL, EXAMINING ATTORNEY

**Int. Cl.: 29**

**Prior U.S. Cl.: 46**

**United States Patent and Trademark Office**

**Reg. No. 3,570,659**

**Registered Feb. 3, 2009**

**TRADEMARK  
PRINCIPAL REGISTER**

**FEED YOUR NEED FOR SPEED**

JONMOR INVESTMENTS, INC. (DELAWARE  
CORPORATION)  
103 BAYNARD BUILDING  
3411 SILVERSIDE ROAD  
WILMINGTON, DE 19810

FOR: MEAT; PROCESSED MEATS; LUNCHEON  
MEATS; PREPARED ENTREES AND MEALS CON-  
SISTING PRIMARILY OF MEAT, POULTRY, OR  
VEGETABLES, IN CLASS 29 (U.S. CL. 46).

FIRST USE 6-1-2007; IN COMMERCE 6-1-2007.

THE MARK CONSISTS OF STANDARD CHAR-  
ACTERS WITHOUT CLAIM TO ANY PARTICULAR  
FONT, STYLE, SIZE, OR COLOR.

SN 77-324,855, FILED 11-8-2007.

PAUL E. FAHRENKOPF, EXAMINING ATTORNEY

**Int. Cl.: 28**

**Prior U.S. Cls.: 22, 23, 38, and 50**

**United States Patent and Trademark Office**

**Reg. No. 3,570,660**

**Registered Feb. 3, 2009**

**TRADEMARK  
PRINCIPAL REGISTER**

**KNOOBIES**

SASHA'S TREE L.L.C. (NEW YORK LIMITED  
LIABILITY COMPANY)

#22

34-35 82ND STREET

JACKSON HEIGHTS, NY 11372

THE MARK CONSISTS OF STANDARD CHAR-  
ACTERS WITHOUT CLAIM TO ANY PARTICULAR  
FONT, STYLE, SIZE, OR COLOR.

FOR: COTTON-TERRY KNEEPADS FOR TOD-  
DLERS FOR USE IN ACTIVE PLAY, IN CLASS 28  
(U.S. CLS. 22, 23, 38 AND 50).

SN 77-325,860, FILED 11-9-2007.

FIRST USE 6-2-2008; IN COMMERCE 6-10-2008.

ALYSSA STEEL, EXAMINING ATTORNEY

**Int. Cl.: 19**

**Prior U.S. Cls.: 1, 12, 33, and 50**

**United States Patent and Trademark Office**

**Reg. No. 3,570,661**

**Registered Feb. 3, 2009**

**TRADEMARK  
PRINCIPAL REGISTER**

**EARTH REFLECTED**

LEE MASONRY PRODUCTS, INC. (KENTUCKY CORPORATION), DBA LEE BRICK + BLOCK, 4301 INDUSTRIAL DRIVE BOWLING GREEN, KY 42101

THE MARK CONSISTS OF STANDARD CHARACTERS WITHOUT CLAIM TO ANY PARTICULAR FONT, STYLE, SIZE, OR COLOR.

FOR: CONCRETE BUILDING MATERIALS, NAMELY, VENEER MASONRY, IN CLASS 19 (U.S. CLS. 1, 12, 33 AND 50).

SN 77-326,021, FILED 11-9-2007.

FIRST USE 10-15-2008; IN COMMERCE 10-15-2008.

PAUL E. FAHRENKOPF, EXAMINING ATTORNEY

**Int. Cl.: 36**

**Prior U.S. Cls.: 100, 101, and 102**

**United States Patent and Trademark Office**

**Reg. No. 3,570,662**

**Registered Feb. 3, 2009**

**SERVICE MARK  
PRINCIPAL REGISTER**

**S.O.U.L. SANCTITY OF  
UNBORN LIFE**

S.O.U.L., INC. (CALIFORNIA CORPORATION)  
5630 ARLINGTON AVE.  
RIVERSIDE, CA 92504

THE MARK CONSISTS OF STANDARD CHAR-  
ACTERS WITHOUT CLAIM TO ANY PARTICULAR  
FONT, STYLE, SIZE, OR COLOR.

FOR: CHARITABLE FUND RAISING AND ON-  
LINE CHARITABLE FUND RAISING FOR PREG-  
NANCY COUNSELING CENTERS, IN CLASS 36  
(U.S. CLS. 100, 101 AND 102).

SN 77-327,484, FILED 11-12-2007.

FIRST USE 9-1-2008; IN COMMERCE 9-1-2008.

ROBERT C. CLARK JR., EXAMINING ATTORNEY

**Int. Cl.: 14**

**Prior U.S. Cls.: 2, 27, 28, and 50**

**United States Patent and Trademark Office**

**Reg. No. 3,570,663**

**Registered Feb. 3, 2009**

**TRADEMARK  
PRINCIPAL REGISTER**

**OUR EMERALDS MAKE DIAMONDS  
GREEN WITH ENVY**

EMERALDS INTERNATIONAL, LLC (FLORIDA  
LIMITED LIABILITY COMPANY)  
104 DUVAL STREET  
KEY WEST, FL 33040

THE MARK CONSISTS OF STANDARD CHAR-  
ACTERS WITHOUT CLAIM TO ANY PARTICULAR  
FONT, STYLE, SIZE, OR COLOR.

FOR: EMERALD JEWELRY, IN CLASS 14 (U.S.  
CLS. 2, 27, 28 AND 50).

SN 77-328,993, FILED 11-14-2007.

FIRST USE 5-0-2006; IN COMMERCE 5-0-2006.

MELISSA VALLILLO, EXAMINING ATTORNEY

**Int. Cl.: 12**

**Prior U.S. Cls.: 19, 21, 23, 31, 35, and 44**

**Reg. No. 3,570,664**

**United States Patent and Trademark Office**

**Registered Feb. 3, 2009**

**TRADEMARK  
PRINCIPAL REGISTER**

**HITCH ARTZ**

SIMPLE WISHES, INC. (DELAWARE CORPORATION)  
5850 KIYOT WAY  
PLAYA VISTA, CA 90094

THE MARK CONSISTS OF STANDARD CHARACTERS WITHOUT CLAIM TO ANY PARTICULAR FONT, STYLE, SIZE, OR COLOR.

FOR: AUTOMOTIVE AFTERMARKET PARTS, NAMELY, ACCESSORIES FOR ENHANCING THE APPEARANCE OF LAND VEHICLES IN THE NATURE OF ELECTRICAL DECORATIONS ATTACHED TO VEHICLE TOW BARS, IN CLASS 12 (U.S. CLS. 19, 21, 23, 31, 35 AND 44).

NO CLAIM IS MADE TO THE EXCLUSIVE RIGHT TO USE "HITCH", APART FROM THE MARK AS SHOWN.

SN 77-329,307, FILED 11-14-2007.

FIRST USE 8-0-2008; IN COMMERCE 11-4-2008.

ELLEN PERKINS, EXAMINING ATTORNEY



**Int. Cl.: 9**

**Prior U.S. Cls.: 21, 23, 26, 36, and 38**

**Reg. No. 3,570,665**

**United States Patent and Trademark Office**

**Registered Feb. 3, 2009**

**TRADEMARK  
PRINCIPAL REGISTER**

# HiBot

JWIN ELECTRONICS CORP. (NEW YORK CORPORATION)  
2 HARBOR PARK DRIVE  
PORT WASHINGTON, NY 11050

FOR: LABORATORY ROBOTS; MANIPULATORS FOR THE REMOTE OPERATION OF ROBOTIC ARMS; ROBOTIC EXOSKELETON SUITS WORN BY HUMANS FOR THE PURPOSE OF ENHANCING THE STRENGTH AND ENDURANCE OF THE PERSON WEARING THE SUIT; ROBOTS FOR PERSONAL OR HOBBY USE; ABDOMINAL BELT CONTAINING BUILT-IN SPEAKERS FOR PURPOSES OF TRANSMITTING MUSIC/SOUNDS/EDUCATIONAL MATERIAL TO A FETUS AND A BUILT-IN POCKETS IN WHICH TO CARRY AUDIO TRANSMITTERS; AUDIO AMPLIFIERS; AUDIO AND VIDEO CASSETTE RECORDERS; AUDIO CASSETTE AND CD PLAYERS; AUDIO CASSETTE DECKS FOR AUTOMOBILES; AUDIO CASSETTE PLAYERS; AUDIO CASSETTE RECORDERS; AUDIO CIRCUIT BOARDS; AUDIO ELECTRONIC COMPONENTS, NAMELY, SURROUND SOUND SYSTEMS; AUDIO EQUIPMENT FOR VEHICLES, NAMELY, SUBWOOFERS; AUDIO EQUIPMENT FOR VEHICLES, NAMELY, STEREOS, SPEAKERS, AMPLIFIERS, EQUALIZERS, CROSSOVERS AND SPEAKER HOUSINGS; AUDIO MIXERS; AUDIO PROCESSING EQUIPMENT, NAMELY, LIMITERS AND COMPRESSORS; BLANK RECORDABLE DVDS; CHILDREN'S EDUCATIONAL MUSIC CDS AND DVDS; DVD BURNERS; DVD CASES; DVD DRIVES; DVD MACHINES; DVD PLAYERS; DVD RECORDING APPARATUS; DVD SLEEVES; PLASTIC CASE USED AS A SECURITY DEVICE FOR PROTECTING AND SECURING DVDS AND OTHER MAGNETIC AND ELECTRONIC MEDIA FROM THEFT; PORTABLE DVD PLAYERS; AUDIO-VIDEO RECEIVERS; BLANK CD-ROMS FOR SOUND OR VIDEO RECORDING; BLANK VIDEO CASSETTES; BLANK VIDEO TAPES; BUILDING SECURITY SYSTEMS

COMPRISING SOFTWARE AND HARDWARE FOR PROVIDING PICTURE, VIDEO, ALARM STATUS, BUILDING PLANS, AND OTHER INFORMATION TO A REMOTE STATION; CAR VIDEO RECORDERS; CHILDREN'S VIDEO TAPES; COMBINATION VIDEO PLAYERS AND RECORDERS; COMPUTER PROGRAMS FOR EDITING IMAGES, SOUND AND VIDEO; COMPUTER PROGRAMS FOR VIDEO AND COMPUTER GAMES; COMPUTER SOFTWARE AND FIRMWARE FOR GAMES OF CHANCE ON ANY COMPUTERIZED PLATFORM, INCLUDING DEDICATED GAMING CONSOLES, VIDEO BASED SLOT MACHINES, REEL BASED SLOT MACHINES, AND VIDEO LOTTERY TERMINALS; COMPUTER SOFTWARE FOR USE IN THE ENCRYPTION AND DECRYPTION OF DIGITAL FILES, INCLUDING AUDIO, VIDEO, TEXT, BINARY, STILL IMAGES, GRAPHICS AND MULTIMEDIA FILES; COMPUTER SOFTWARE FOR USE IN THE SAFEGUARDING OF DIGITAL FILES, INCLUDING AUDIO, VIDEO, TEXT, BINARY, STILL IMAGES, GRAPHICS AND MULTIMEDIA FILES; COMPUTERIZED VIDEO GAME TABLES FOR GAMING PURPOSES, NAMELY, A COMPUTERIZED VIDEO CRAPS GAME TABLE; COMPUTERIZED VIDEO TABLE GAMES FOR GAMING PURPOSES; DIGITAL PHOTO FRAMES FOR DISPLAYING DIGITAL PICTURES, VIDEO CLIPS AND MUSIC, IN CLASS 9 (U.S. CLS. 21, 23, 26, 36 AND 38).

FIRST USE 11-20-2007; IN COMMERCE 11-20-2007.

THE MARK CONSISTS OF STANDARD CHARACTERS WITHOUT CLAIM TO ANY PARTICULAR FONT, STYLE, SIZE, OR COLOR.

SN 77-329,459, FILED 11-14-2007.

NATALIE POLZER, EXAMINING ATTORNEY

**Int. Cl.: 7**

**Prior U.S. Cls.: 13, 19, 21, 23, 31, 34, and 35**

**United States Patent and Trademark Office**

**Reg. No. 3,570,666**

**Registered Feb. 3, 2009**

**TRADEMARK  
PRINCIPAL REGISTER**

**GREEN THUMB**

TRUE VALUE COMPANY (DELAWARE CORPORATION)  
8600 WEST BRYN MAWR AVENUE  
CHICAGO, IL 606313505

FOR: LAWN MOWERS, IN CLASS 7 (U.S. CLS. 13, 19, 21, 23, 31, 34 AND 35).

FIRST USE 10-0-2007; IN COMMERCE 10-0-2007.

THE MARK CONSISTS OF STANDARD CHARACTERS WITHOUT CLAIM TO ANY PARTICULAR FONT, STYLE, SIZE, OR COLOR.

OWNER OF U.S. REG. NOS. 581,301, 3,068,228, AND OTHERS.

SN 77-330,407, FILED 11-15-2007.

JUDITH HELFMAN, EXAMINING ATTORNEY

**Int. Cls.: 25 and 41**

**Prior U.S. Cls.: 22, 39, 100, 101, and 107**

**Reg. No. 3,570,667**

**United States Patent and Trademark Office**

**Registered Feb. 3, 2009**

**TRADEMARK  
SERVICE MARK  
PRINCIPAL REGISTER**

**WTE**

RIVER GORGE ENTERPRISES, INC. (TENNESSEE CORPORATION), DBA MUSIC JUNKIE RECORDS,  
4116 WESTLIN AVE.  
SHERMAN OAKS, CA 91423

FOR: CLOTHING, NAMELY, T-SHIRTS, LONG SLEEVE SHIRTS, TANK TOPS, SHORT SLEEVE SHIRTS, 3/4 SLEEVE SHIRTS, BUTTON DOWN SHIRTS, SWEATSHIRTS, HOODED SWEATSHIRTS, JACKETS, SLEEVELESS JACKETS, PANTS, JEANS, CAPRIS, SWEAT PANTS, CARGO SHORTS, SHORTS, SKIRTS, DRESSES, BRAS, PANTIES, UNDERWEAR, HATS, KNIT HATS, BEANIE CAPS, BANDANAS, DO RAGS, SWEATBANDS, SOCKS, BELTS AND SHOES, IN CLASS 25 (U.S. CLS. 22 AND 39).

FIRST USE 5-11-2007; IN COMMERCE 1-23-2008.

FOR: ENTERTAINMENT SERVICES, NAMELY, LIVE PERFORMANCES BY A MUSICAL GROUP, IN CLASS 41 (U.S. CLS. 100, 101 AND 107).

FIRST USE 5-11-2007; IN COMMERCE 1-23-2008.

THE MARK CONSISTS OF STANDARD CHARACTERS WITHOUT CLAIM TO ANY PARTICULAR FONT, STYLE, SIZE, OR COLOR.

SN 77-330,502, FILED 11-15-2007.

REBECCA EISINGER, EXAMINING ATTORNEY

**Int. Cl.: 16**

**Prior U.S. Cls.: 2, 5, 22, 23, 29, 37, 38, and 50**

**Reg. No. 3,570,668**

**United States Patent and Trademark Office**

**Registered Feb. 3, 2009**

**TRADEMARK  
PRINCIPAL REGISTER**

**LIFE WELL SHARED**

THE READER'S DIGEST ASSOCIATION, INC.  
(DELAWARE CORPORATION)  
READER'S DIGEST ROAD  
PLEASANTVILLE, NY 10570

THE MARK CONSISTS OF STANDARD CHARACTERS WITHOUT CLAIM TO ANY PARTICULAR FONT, STYLE, SIZE, OR COLOR.

FOR: GENERAL FEATURE MAGAZINES, IN CLASS 16 (U.S. CLS. 2, 5, 22, 23, 29, 37, 38 AND 50).

SN 77-331,163, FILED 11-16-2007.

FIRST USE 12-18-2007; IN COMMERCE 12-18-2007.

CIMMERIAN COLEMAN, EXAMINING ATTORNEY

**Int. Cl.: 41**

**Prior U.S. Cls.: 100, 101, and 107**

**United States Patent and Trademark Office**

**Reg. No. 3,570,669**

**Registered Feb. 3, 2009**

**SERVICE MARK  
PRINCIPAL REGISTER**



**GRAMMY  
MUSEUM**

NATIONAL ACADEMY OF RECORDING ARTS  
& SCIENCES, INC. (DELAWARE CORPORATION)

3402 PICO BOULEVARD  
SANTA MONICA, CA 90405

FOR: MUSEUM SERVICES, IN CLASS 41 (U.S.  
CLS. 100, 101 AND 107).

FIRST USE 12-3-2008; IN COMMERCE 12-3-2008.

OWNER OF U.S. REG. NOS. 2,630,880, 3,202,214,  
AND OTHERS.

NO CLAIM IS MADE TO THE EXCLUSIVE  
RIGHT TO USE "MUSEUM", APART FROM THE  
MARK AS SHOWN.

THE MARK CONSISTS OF AN OUTLINE OF A  
RECTANGLE WITH A SILHOUETTE OF GRAMO-  
PHONE INSIDE OF THE OUTLINE WITH THE  
LITERAL ELEMENT OF THE MARK APPEARING  
OUTSIDE OF THE OUTLINE ACROSS THE BOT-  
TOM OF THE DESIGN.

SN 77-331,791, FILED 11-16-2007.

NATALIE POLZER, EXAMINING ATTORNEY

**Int. Cl.: 41**

**Prior U.S. Cls.: 100, 101, and 107**

**United States Patent and Trademark Office**

**Reg. No. 3,570,670**

**Registered Feb. 3, 2009**

**SERVICE MARK  
PRINCIPAL REGISTER**



NATIONAL ACADEMY OF RECORDING ARTS  
& SCIENCES, INC. (DELAWARE CORPORATION)  
3402 PICO BOULEVARD  
SANTA MONICA, CA 90405

FOR: MUSEUM SERVICES, IN CLASS 41 (U.S.  
CLS. 100, 101 AND 107).

FIRST USE 12-3-2008; IN COMMERCE 12-3-2008.

OWNER OF U.S. REG. NOS. 1,018,537, 3,068,324,  
AND OTHERS.

THE MARK CONSISTS OF AN OUTLINE OF A  
RECTANGLE WITH A SILHOUETTE OF GRAMO-  
PHONE INSIDE OF THE OUTLINE.

SN 77-331,794, FILED 11-16-2007.

NATALIE POLZER, EXAMINING ATTORNEY

**Int. Cl.: 5**

**Prior U.S. Cls.: 6, 18, 44, 46, 51, and 52**

**Reg. No. 3,570,671**

**United States Patent and Trademark Office**

**Registered Feb. 3, 2009**

**TRADEMARK  
PRINCIPAL REGISTER**

**HOPSACTIV**

NATUREX, INC. (DELAWARE CORPORATION)  
375 HUYLER STREET  
SOUTH HACKENSACK, NJ 07606

THE MARK CONSISTS OF STANDARD CHARACTERS WITHOUT CLAIM TO ANY PARTICULAR FONT, STYLE, SIZE, OR COLOR.

FOR: DIETETIC SUBSTANCES ADAPTED FOR MEDICAL USE; FOOD SUPPLEMENTS FOR MEDICAL USE; MINERAL FOOD SUPPLEMENTS, IN CLASS 5 (U.S. CLS. 6, 18, 44, 46, 51 AND 52).

SN 77-333,357, FILED 11-19-2007.

FIRST USE 11-0-2007; IN COMMERCE 11-0-2007.

BRENDAN REGAN, EXAMINING ATTORNEY

**Int. Cl.: 9**

**Prior U.S. Cls.: 21, 23, 26, 36, and 38**

**Reg. No. 3,570,672**

**United States Patent and Trademark Office**

**Registered Feb. 3, 2009**

**TRADEMARK  
PRINCIPAL REGISTER**

**SUNLYTE**

PTG, LLC (MAINE LIMITED LIABILITY COMPANY)  
16 LANDRY STREET  
BIDDEFORD, ME 04005

THE MARK CONSISTS OF STANDARD CHARACTERS WITHOUT CLAIM TO ANY PARTICULAR FONT, STYLE, SIZE, OR COLOR.

FOR: HOLDERS FOR CDS, DVDS AND BLANK DISCS, IN CLASS 9 (U.S. CLS. 21, 23, 26, 36 AND 38).

SN 77-334,859, FILED 11-21-2007.

FIRST USE 2-12-2008; IN COMMERCE 2-12-2008.

PAM WILLIS, EXAMINING ATTORNEY



Int. Cl.: 9

Prior U.S. Cls.: 21, 23, 26, 36, and 38

United States Patent and Trademark Office

Reg. No. 3,570,673

Registered Feb. 3, 2009

TRADEMARK  
PRINCIPAL REGISTER

NANOVUE

GE HEALTHCARE UK LIMITED (UNITED  
KINGDOM LIMITED COMPANY (LTD.))  
AMERSHAM PLACE, LITTLE CHALFONT  
BUCKINGHAMSHIRE, UNITED KINGDOM  
HP79NA

FOR: SCIENTIFIC APPARATUS, NAMELY, SPEC-  
TROPHOTOMETER FOR MEASURING RELATIVE  
DNA/RNA AND PROTEIN , IN CLASS 9 (U.S. CLS.  
21, 23, 26, 36 AND 38).

FIRST USE 12-0-2007; IN COMMERCE 12-0-2007.

THE MARK CONSISTS OF STANDARD CHAR-  
ACTERS WITHOUT CLAIM TO ANY PARTICULAR  
FONT, STYLE, SIZE, OR COLOR.

SN 77-337,692, FILED 11-27-2007.

HOWARD B. LEVINE, EXAMINING ATTORNEY

**Int. Cls.: 16 and 45**

**Prior U.S. Cls.: 2, 5, 22, 23, 29, 37, 38, 50, 100, and 101**

**United States Patent and Trademark Office**

**Reg. No. 3,570,674**

**Registered Feb. 3, 2009**

**TRADEMARK  
SERVICE MARK  
PRINCIPAL REGISTER**

# Antitrust Intelligence

PEIXOTO, BRUNO DE VILHENA L (BRAZIL  
INDIVIDUAL)  
14 ANDAR  
RUA SERGIPE 925  
BELO HORIZONTE, BRAZIL 30130-171

FOR: LAW REPORTS, IN CLASS 16 (U.S. CLS. 2, 5,  
22, 23, 29, 37, 38 AND 50).

FIRST USE 11-27-2008; IN COMMERCE 11-27-2008.

FOR: LEGAL SERVICES; PROVIDING INFOR-  
MATION RELATING TO LEGAL AFFAIRS, IN  
CLASS 45 (U.S. CLS. 100 AND 101).

FIRST USE 11-27-2008; IN COMMERCE 11-27-2008.

THE MARK CONSISTS OF STANDARD CHAR-  
ACTERS WITHOUT CLAIM TO ANY PARTICULAR  
FONT, STYLE, SIZE, OR COLOR.

NO CLAIM IS MADE TO THE EXCLUSIVE  
RIGHT TO USE "ANTITRUST", APART FROM  
THE MARK AS SHOWN.

SN 77-340,089, FILED 11-29-2007.

SANJEEV VOHRA, EXAMINING ATTORNEY

**Int. Cl.: 25**

**Prior U.S. Cls.: 22 and 39**

**United States Patent and Trademark Office**

**Reg. No. 3,570,675**

**Registered Feb. 3, 2009**

**TRADEMARK  
PRINCIPAL REGISTER**

**GEARS OF WAR**

EPIC GAMES, INC. (NORTH CAROLINA CORPORATION)  
620 CROSSROADS BOULEVARD  
CARY, NC 27518

FOR: FOOTWEAR, IN CLASS 25 (U.S. CLS. 22 AND 39).

FIRST USE 6-1-2008; IN COMMERCE 6-1-2008.

THE MARK CONSISTS OF STANDARD CHARACTERS WITHOUT CLAIM TO ANY PARTICULAR FONT, STYLE, SIZE, OR COLOR.

OWNER OF U.S. REG. NOS. 3,022,153, 3,327,331, AND OTHERS.

SN 77-340,754, FILED 11-30-2007.

RON FAIRBANKS, EXAMINING ATTORNEY

**Int. Cl.: 42**

**Prior U.S. Cls.: 100 and 101**

**United States Patent and Trademark Office**

**Reg. No. 3,570,676**

**Registered Feb. 3, 2009**

**SERVICE MARK  
PRINCIPAL REGISTER**

**FINDING THE NEXT STEP  
TOGETHER**

PFIZER INC. (DELAWARE CORPORATION)  
235 EAST 42ND STREET  
NEW YORK, NY 10017

FOR: MEDICAL AND SCIENTIFIC RESEARCH,  
NAMELY, CONDUCTING CLINICAL TRIALS FOR  
PHARMACEUTICAL PREPARATIONS FOR THE  
TREATMENT OF BIPOLAR DEPRESSION, IN  
CLASS 42 (U.S. CLS. 100 AND 101).

FIRST USE 8-31-2007; IN COMMERCE 8-31-2007.

THE MARK CONSISTS OF STANDARD CHAR-  
ACTERS WITHOUT CLAIM TO ANY PARTICULAR  
FONT, STYLE, SIZE, OR COLOR.

SN 77-341,191, FILED 11-30-2007.

CHRISTINE COOPER, EXAMINING ATTORNEY

**Int. Cls.: 29 and 30**

**Prior U.S. Cl.: 46**

**United States Patent and Trademark Office**

**Reg. No. 3,570,677**

**Registered Feb. 3, 2009**

**TRADEMARK  
PRINCIPAL REGISTER**

ABOVE ALL, A BETTER TOMATO

TRADEMARK MANAGEMENT COMPANY (DE-  
LAWARE CORPORATION)  
SUITE 100  
2541 NORTH STOKESBERRY PLACE  
MERIDIAN, ID 83646

FOR: PROCESSED TOMATOES AND TOMATO  
PASTE, IN CLASS 29 (U.S. CL. 46).

FIRST USE 11-1-2005; IN COMMERCE 11-1-2005.

FOR: PIZZA SAUCE, TOMATO SAUCE AND  
PASTA SAUCE, IN CLASS 30 (U.S. CL. 46).

FIRST USE 11-1-2005; IN COMMERCE 11-1-2005.

THE MARK CONSISTS OF STANDARD CHAR-  
ACTERS WITHOUT CLAIM TO ANY PARTICULAR  
FONT, STYLE, SIZE, OR COLOR.

NO CLAIM IS MADE TO THE EXCLUSIVE  
RIGHT TO USE "A BETTER TOMATO", APART  
FROM THE MARK AS SHOWN.

SN 77-342,101, FILED 12-3-2007.

LYDIA BELZER, EXAMINING ATTORNEY

**Int. Cls.: 35 and 41**

**Prior U.S. Cls.: 100, 101, 102, and 107**

**United States Patent and Trademark Office**

**Reg. No. 3,570,678**

**Registered Feb. 3, 2009**

**SERVICE MARK  
PRINCIPAL REGISTER**

**WHY-WHAT-WHEN**

PARTNERS IN LEADERSHIP IP II, LLC (NEVADA LIMITED LIABILITY COMPANY)  
27555 YNEZ ROAD, SUITE 300  
TEMECULA, CA 92591

FOR: BUSINESS SERVICES, NAMELY, BUSINESS CONSULTATION SERVICES AND BUSINESS MANAGEMENT SERVICES, IN CLASS 35 (U.S. CLS. 100, 101 AND 102).

FIRST USE 6-2-2008; IN COMMERCE 8-15-2008.

FOR: EDUCATIONAL AND TRAINING SERVICES, NAMELY, CONSULTING SEMINARS, WORKSHOPS AND ONE-ON-ONE TRAINING IN THE

FIELDS OF BUSINESS MANAGEMENT AND BUSINESS OPERATIONS AND DISTRIBUTION OF COURSE MATERIAL IN CONNECTION THEREWITH, IN CLASS 41 (U.S. CLS. 100, 101 AND 107).

FIRST USE 6-2-2008; IN COMMERCE 8-15-2008.

THE MARK CONSISTS OF STANDARD CHARACTERS WITHOUT CLAIM TO ANY PARTICULAR FONT, STYLE, SIZE, OR COLOR.

SN 77-343,024, FILED 12-3-2007.

KELLY MCCOY, EXAMINING ATTORNEY

**Int. Cls.: 35 and 42**

**Prior U.S. Cls.: 100, 101, and 102**

**United States Patent and Trademark Office**

**Reg. No. 3,570,679**

**Registered Feb. 3, 2009**

**SERVICE MARK  
PRINCIPAL REGISTER**

# DEXTRYS

DARWIN PARTNERS, INC. (MASSACHUSETTS CORPORATION)  
SUITE 225  
201 EDGEWATER DRIVE  
WAKEFIELD, MA 01880

FOR: BUSINESS CONSULTING SERVICES RELATED TO INFORMATION TECHNOLOGY, SYSTEMS MANAGEMENT AND INTEGRATION, PRODUCT DEVELOPMENT AND SUPPORT, AND SOFTWARE ENGINEERING, OUTSOURCING SERVICES IN THE FIELD OF INFORMATION TECHNOLOGY, SYSTEMS MANAGEMENT AND INTEGRATION, PRODUCT DEVELOPMENT AND SUPPORT, AND SOFTWARE ENGINEERING; BUSINESS PROCESS ENGINEERING SERVICES, IN CLASS 35 (U.S. CLS. 100, 101 AND 102).

FIRST USE 2-1-2008; IN COMMERCE 2-1-2008.

FOR: COMPUTER CONSULTING SERVICES; COMPUTER SOFTWARE DESIGN AND DEVELOP-

MENT SERVICES FOR OTHERS; INSTALLATION, MAINTENANCE AND UPDATING OF COMPUTER SOFTWARE; TECHNICAL SUPPORT SERVICES, NAMELY, TROUBLESHOOTING OF COMPUTER HARDWARE AND SOFTWARE PROBLEMS IN PERSON, VIA TELEPHONE AND VIA ELECTRONIC AND OPTICAL COMMUNICATIONS NETWORKS; INTEGRATION OF COMPUTER SYSTEMS AND NETWORKS, IN CLASS 42 (U.S. CLS. 100 AND 101).

FIRST USE 2-1-2008; IN COMMERCE 2-1-2008.

THE MARK CONSISTS OF STANDARD CHARACTERS WITHOUT CLAIM TO ANY PARTICULAR FONT, STYLE, SIZE, OR COLOR.

SN 77-344,051, FILED 12-4-2007.

ELLEN PERKINS, EXAMINING ATTORNEY

**Int. Cl.: 10**

**Prior U.S. Cls.: 26, 39, and 44**

**Reg. No. 3,570,680**

**United States Patent and Trademark Office**

**Registered Feb. 3, 2009**

---

**TRADEMARK  
PRINCIPAL REGISTER**

**UPLIF**

VERTEBRAL TECHNOLOGIES, INC. (MINNESOTA CORPORATION)  
SUITE 550  
5909 BAKER ROAD  
MINNETONKA, MN 55345

FOR: MEDICAL AND SURGICAL APPARATUS AND INSTRUMENTS, NAMELY, ORTHOPEDIC FIXATION DEVICE USED IN ORTHOPEDIC TRANSPLANT AND/OR IMPLANT SURGERY , IN CLASS 10 (U.S. CLS. 26, 39 AND 44).

FIRST USE 12-3-2008; IN COMMERCE 12-3-2008.

THE MARK CONSISTS OF STANDARD CHARACTERS WITHOUT CLAIM TO ANY PARTICULAR FONT, STYLE, SIZE, OR COLOR.

SN 77-344,514, FILED 12-5-2007.

MICHAEL GAAFAR, EXAMINING ATTORNEY



**Int. Cls.: 16 and 28**

**Prior U.S. Cls.: 2, 5, 22, 23, 29, 37, 38, and 50**

**United States Patent and Trademark Office**

**Reg. No. 3,570,681**

**Registered Feb. 3, 2009**

**TRADEMARK  
PRINCIPAL REGISTER**

**ZENITH OF THE HIVE**

TC DIGITAL GAMES LLC (DELAWARE LIMITED LIABILITY COMPANY)  
108 WEST 13TH STREET  
WILMINGTON, DE 19801

FOR: TRADING CARDS; PLAYER GUIDE BOOKS, IN CLASS 16 (U.S. CLS. 2, 5, 22, 23, 29, 37, 38 AND 50).

FIRST USE 4-0-2008; IN COMMERCE 4-0-2008.

FOR: CARD GAMES AND PRINTED INSTRUCTIONS SOLD THEREWITH, IN CLASS 28 (U.S. CLS. 22, 23, 38 AND 50).

FIRST USE 4-0-2008; IN COMMERCE 4-0-2008.

THE MARK CONSISTS OF STANDARD CHARACTERS WITHOUT CLAIM TO ANY PARTICULAR FONT, STYLE, SIZE, OR COLOR.

SN 77-346,596, FILED 12-7-2007.

SARA THOMAS, EXAMINING ATTORNEY

**Int. Cl.: 27**

**Prior U.S. Cls.: 19, 20, 37, 42, and 50**

**Reg. No. 3,570,682**

**United States Patent and Trademark Office**

**Registered Feb. 3, 2009**

**TRADEMARK  
PRINCIPAL REGISTER**



COLUMBIA INSURANCE COMPANY (NEBRASKA CORPORATION)  
3024 HARNEY STREET  
OMAHA, NE 68131

THE MARK CONSISTS OF THE WORDS "THE NEW PATCRAFT & DESIGNWEAVE" INSIDE A STYLIZED QUOTATION MARK.

FOR: CARPET TILES; CARPETING, IN CLASS 27 (U.S. CLS. 19, 20, 37, 42 AND 50).

SN 77-346,920, FILED 12-7-2007.

FIRST USE 1-1-2008; IN COMMERCE 1-1-2008.

CHERYL CLAYTON, EXAMINING ATTORNEY

**Int. Cl.: 30**

**Prior U.S. Cl.: 46**

**United States Patent and Trademark Office**

**Reg. No. 3,570,683**

**Registered Feb. 3, 2009**

**TRADEMARK  
PRINCIPAL REGISTER**



COMPANY, STEVEN, LEO (UNITED STATES  
INDIVIDUAL)  
P.O.BOX 4056  
DEERFIELD BEACH, FL 334424056

FOR: TEA; TEA BAGS, IN CLASS 30 (U.S. CL. 46).

FIRST USE 1-19-2006; IN COMMERCE 6-1-2007.

NO CLAIM IS MADE TO THE EXCLUSIVE  
RIGHT TO USE "TEA", APART FROM THE MARK  
AS SHOWN.

THE COLOR(S) RED, BLACK, WHITE AND  
GREEN IS/ARE CLAIMED AS A FEATURE OF  
THE MARK.

THE MARK CONSISTS OF THE COLOR GREEN  
APPEARS IN THE "TEA" AND INSIDE THE TRIAN-  
GLE; THE COLOR RED APPEARS IN "TAMEBULL"  
AND IN THE TRIANGLE; THE COLOR WHITE  
APPEARS IN THE TRIANGLE, THE COLOR BLACK  
APPEARS IN THE BACKGROUND.

SN 77-351,968, FILED 12-14-2007.

ANNE MADDEN, EXAMINING ATTORNEY

**Int. Cl.: 42**

**Prior U.S. Cls.: 100 and 101**

**United States Patent and Trademark Office**

**Reg. No. 3,570,684**

**Registered Feb. 3, 2009**

**SERVICE MARK  
PRINCIPAL REGISTER**

**NETWORKEVERYWOMAN**

NETWORK EVERY WOMAN LLC (CALIFORNIA  
LIMITED LIABILITY COMPANY)  
P.O. BOX 1488  
FOLSOM, CA 957631488

FOR: COMPUTER SERVICES, NAMELY, HOST-  
ING ON-LINE WEB FACILITIES FOR OTHERS FOR  
ORGANIZING AND CONDUCTING ONLINE  
MEETINGS, GATHERINGS, AND INTERACTIVE  
DISCUSSIONS; COMPUTER SERVICES IN THE  
NATURE OF CUSTOMIZED WEB PAGES FEATUR-  
ING USER-DEFINED INFORMATION, PERSONAL

PROFILES AND INFORMATION, IN CLASS 42 (U.S.  
CLS. 100 AND 101).

FIRST USE 3-1-2008; IN COMMERCE 9-18-2008.

THE MARK CONSISTS OF STANDARD CHAR-  
ACTERS WITHOUT CLAIM TO ANY PARTICULAR  
FONT, STYLE, SIZE, OR COLOR.

SN 77-352,329, FILED 12-14-2007.

DEZMONA MIZELLE, EXAMINING ATTORNEY

**Int. Cl.: 33**

**Prior U.S. Cls.: 47 and 49**

**United States Patent and Trademark Office**

**Reg. No. 3,570,685**

**Registered Feb. 3, 2009**

**TRADEMARK  
PRINCIPAL REGISTER**

**HARNEY LANE WINERY**

METTLER & SON, INC. (CALIFORNIA CORPORATION)  
8848 E. HARNEY LN.  
LODI, CA 95240

FOR: WINES, IN CLASS 33 (U.S. CLS. 47 AND 49).

FIRST USE 9-3-2008; IN COMMERCE 9-3-2008.

THE MARK CONSISTS OF STANDARD CHARACTERS WITHOUT CLAIM TO ANY PARTICULAR FONT, STYLE, SIZE, OR COLOR.

NO CLAIM IS MADE TO THE EXCLUSIVE RIGHT TO USE "WINERY", APART FROM THE MARK AS SHOWN.

THE NAME "HARNEY LANE" DOES NOT IDENTIFY A LIVING INDIVIDUAL.

SN 77-352,887, FILED 12-14-2007.

SKYE YOUNG, EXAMINING ATTORNEY

**Int. Cls.: 10 and 25**

**Prior U.S. Cls.: 22, 26, 39, and 44**

**United States Patent and Trademark Office**

**Reg. No. 3,570,686**

**Registered Feb. 3, 2009**

**TRADEMARK  
PRINCIPAL REGISTER**

**ZOLES**

Z-TECH, INC. (NEW MEXICO CORPORATION)  
6932 4TH STREET, N.W.  
ALBUQUERQUE, NM 87107

FOR: ORTHOPEDIC INSOLE FOR FOOTWEAR,  
IN CLASS 10 (U.S. CLS. 26, 39 AND 44).

FIRST USE 10-1-2008; IN COMMERCE 10-1-2008.

FOR: INSOLE FOR FOOTWEAR , IN CLASS 25  
(U.S. CLS. 22 AND 39).

FIRST USE 10-1-2008; IN COMMERCE 10-1-2008.

THE MARK CONSISTS OF STANDARD CHAR-  
ACTERS WITHOUT CLAIM TO ANY PARTICULAR  
FONT, STYLE, SIZE, OR COLOR.

SN 77-353,073, FILED 12-15-2007.

MARK SPARACINO, EXAMINING ATTORNEY

**Int. Cl.: 35**

**Prior U.S. Cls.: 100, 101, and 102**

**United States Patent and Trademark Office**

**Reg. No. 3,570,687**

**Registered Feb. 3, 2009**

**SERVICE MARK  
PRINCIPAL REGISTER**

**snösmart**

DETRICK, OSA (UNITED STATES INDIVIDUAL)  
1426 G STREET  
ANCHORAGE, AK 99501

THE MARK CONSISTS OF STANDARD CHAR-  
ACTERS WITHOUT CLAIM TO ANY PARTICULAR  
FONT, STYLE, SIZE, OR COLOR.

FOR: DISTRIBUTORSHIP SERVICES IN THE  
FIELD OF CLOTHING AND APPAREL, IN CLASS  
35 (U.S. CLS. 100, 101 AND 102).

SN 77-353,643, FILED 12-17-2007.

FIRST USE 8-13-2007; IN COMMERCE 8-13-2007.

INGA ERVIN, EXAMINING ATTORNEY

**Int. Cl.: 35**

**Prior U.S. Cls.: 100, 101, and 102**

**United States Patent and Trademark Office**

**Reg. No. 3,570,688**

**Registered Feb. 3, 2009**

**SERVICE MARK  
PRINCIPAL REGISTER**

**VETSTREET**

VETINSITE.COM, INC. (DELAWARE CORPORATION)  
1110 BONIFANT STREET #401  
SILVER SPRINGS, MD 20910

FOR: PROVIDING CUSTOMIZED ADMINISTRATIVE INFORMATIONAL SERVICES VIA THE INTERNET IN THE FIELD OF VETERINARY OFFICES, NAMELY, APPOINTMENT SCHEDULING, REVIEW OF CUSTOMER RECORDS, AND ADMINISTRATIVE COMMUNICATION BETWEEN BUSINESS AND CUSTOMER, IN CLASS 35 (U.S. CLS. 100, 101 AND 102).

FIRST USE 1-0-2008; IN COMMERCE 1-0-2008.

THE MARK CONSISTS OF STANDARD CHARACTERS WITHOUT CLAIM TO ANY PARTICULAR FONT, STYLE, SIZE, OR COLOR.

SN 77-355,413, FILED 12-19-2007.

DARRYL SPRUILL, EXAMINING ATTORNEY



**Int. Cl.: 35**

**Prior U.S. Cls.: 100, 101, and 102**

**United States Patent and Trademark Office**

**Reg. No. 3,570,689**

**Registered Feb. 3, 2009**

**SERVICE MARK  
PRINCIPAL REGISTER**

**INDIVISUALIZE YOUR  
CREDENTIALS**

IACOVONE, MATTHEW R. (UNITED STATES  
INDIVIDUAL)  
6 MARY DRIVE  
WEST BOYLSTON, MA 015831615

FOR: DESIGN OF ADVERTISING MATERIALS  
FOR OTHERS; ADVERTISING AND PROMOTION  
SERVICES AND RELATED CONSULTING; RE-  
SUME PREPARATION; PROVIDING AN INTERAC-  
TIVE WEBSITE THAT FACILITATES THE  
PREPARATION OF RESUMES, IN CLASS 35 (U.S.  
CLS. 100, 101 AND 102).

FIRST USE 11-20-2008; IN COMMERCE 11-20-2008.

THE MARK CONSISTS OF STANDARD CHAR-  
ACTERS WITHOUT CLAIM TO ANY PARTICULAR  
FONT, STYLE, SIZE, OR COLOR.

SN 77-358,324, FILED 12-21-2007.

ELLEN B. AWRICH, EXAMINING ATTORNEY

**Int. Cl.: 35**

**Prior U.S. Cls.: 100, 101, and 102**

**United States Patent and Trademark Office**

**Reg. No. 3,570,690**

**Registered Feb. 3, 2009**

**SERVICE MARK  
PRINCIPAL REGISTER**

**INDIVISUALIZE**

IACOVONE, MATTHEW R. (UNITED STATES  
INDIVIDUAL)  
6 MARY DRIVE  
WEST BOYLSTON, MA 015831615

FOR: DESIGN OF ADVERTISING MATERIALS  
FOR OTHERS; ADVERTISING AND PROMOTION  
SERVICES AND RELATED CONSULTING; RE-  
SUME PREPARATION; PROVIDING AN INTERAC-  
TIVE WEBSITE THAT FACILITATES THE  
PREPARATION OF RESUMES, IN CLASS 35 (U.S.  
CLS. 100, 101 AND 102).

FIRST USE 11-20-2008; IN COMMERCE 11-20-2008.

THE MARK CONSISTS OF STANDARD CHAR-  
ACTERS WITHOUT CLAIM TO ANY PARTICULAR  
FONT, STYLE, SIZE, OR COLOR.

SN 77-358,330, FILED 12-21-2007.

ELLEN B. AWRICH, EXAMINING ATTORNEY

**Int. Cl.: 7**

**Prior U.S. Cls.: 13, 19, 21, 23, 31, 34, and 35**

**Reg. No. 3,570,691**

**United States Patent and Trademark Office**

**Registered Feb. 3, 2009**

---

**TRADEMARK  
PRINCIPAL REGISTER**

**easymotion**

BANSBACH EASYLIFT OF NORTH AMERICA,  
INC. (GEORGIA CORPORATION)  
50 WEST DRIVE  
MELBOURNE, FL 32904

FOR: INDUSTRIAL MACHINE PARTS, NAMELY,  
SYNCHRONOUSLY ACTUATED MULTIPLE AD-  
JUSTMENT HYDRAULIC CYLINDERS FOR MA-  
CHINES, IN CLASS 7 (U.S. CLS. 13, 19, 21, 23, 31, 34  
AND 35).

FIRST USE 8-11-2006; IN COMMERCE 8-11-2006.

THE MARK CONSISTS OF STANDARD CHAR-  
ACTERS WITHOUT CLAIM TO ANY PARTICULAR  
FONT, STYLE, SIZE, OR COLOR.

SN 77-358,472, FILED 12-21-2007.

SANJEEV VOHRA, EXAMINING ATTORNEY

**Int. Cls.: 35, 36, and 45**

**Prior U.S. Cls.: 100, 101, and 102**

**United States Patent and Trademark Office**

**Reg. No. 3,570,692**

**Registered Feb. 3, 2009**

**SERVICE MARK  
PRINCIPAL REGISTER**



THE RISK ADVISORY GROUP PLC (UNITED KINGDOM COMPANY)  
10-11 RUSSELL SQUARE  
RUSSELL SQUARE HOUSE  
LONDON, UNITED KINGDOM WC1B5EH

FOR: BUSINESS ADVISORY SERVICES, NAME-  
LY, BUSINESS RISK MANAGEMENT AND CON-  
SULTATION; BUSINESS INVESTIGATION AND  
INTELLIGENCE SERVICES; BUSINESS CONSUL-  
TATION SERVICES, NAMELY, POLITICAL RISK  
ANALYSIS, IN CLASS 35 (U.S. CLS. 100, 101 AND  
102).

FIRST USE 10-0-2007; IN COMMERCE 10-0-2007.

FOR: FINANCIAL AND INVESTMENT CONSUL-  
TANCY; FINANCIAL RISK MANAGEMENT; FI-  
NANCIAL RISK MANAGEMENT CONSULTANCY  
SERVICES, IN CLASS 36 (U.S. CLS. 100, 101 AND 102).

FIRST USE 10-0-2007; IN COMMERCE 10-0-2007.

FOR: SECURITY ASSESSMENT OF RISKS; AD-  
VISORY SERVICES IN ASSESSMENT OF RISKS

RELATING TO GUARDING, PROTECTION OR  
SECURITY OF PERSONS; GUARDING, PROTEC-  
TION OR SECURITY OF PROPERTY, IN CLASS 45  
(U.S. CLS. 100 AND 101).

FIRST USE 10-0-2007; IN COMMERCE 10-0-2007.

NO CLAIM IS MADE TO THE EXCLUSIVE  
RIGHT TO USE "RISK ADVISORY", APART FROM  
THE MARK AS SHOWN.

THE COLOR(S) BLUE, WHITE AND BLACK IS/  
ARE CLAIMED AS A FEATURE OF THE MARK.

THE MARK CONSISTS OF THE COLORS BLUE,  
WHITE AND BLACK THAT APPEAR IN THE DE-  
SIGN AND THE COLOR BLACK THAT APPEARS IN  
THE WORDING.

SN 77-358,492, FILED 12-21-2007.

SANJEEV VOHRA, EXAMINING ATTORNEY

**Int. Cls.: 35, 36, and 45**

**Prior U.S. Cls.: 100, 101, and 102**

**United States Patent and Trademark Office**

**Reg. No. 3,570,693**

**Registered Feb. 3, 2009**

**SERVICE MARK  
PRINCIPAL REGISTER**



THE RISK ADVISORY GROUP PLC (UNITED KINGDOM COMPANY)  
10-11 RUSSELL SQUARE  
RUSSELL SQUARE HOUSE  
LONDON, UNITED KINGDOM WC1B5EH

FOR: BUSINESS ADVISORY SERVICES, NAME-  
LY, BUSINESS RISK MANAGEMENT AND CON-  
SULTATION; BUSINESS INVESTIGATION AND  
INTELLIGENCE SERVICES; BUSINESS CONSUL-  
TATION SERVICES, NAMELY, POLITICAL RISK  
ANALYSIS, IN CLASS 35 (U.S. CLS. 100, 101 AND  
102).

FIRST USE 10-0-2007; IN COMMERCE 10-0-2007.

FOR: FINANCIAL AND INVESTMENT CONSUL-  
TANCY; FINANCIAL RISK MANAGEMENT; FI-  
NANCIAL RISK MANAGEMENT CONSULTANCY  
SERVICES, IN CLASS 36 (U.S. CLS. 100, 101 AND 102).

FIRST USE 10-0-2007; IN COMMERCE 10-0-2007.

FOR: SECURITY ASSESSMENT OF RISKS; AD-  
VISORY SERVICES IN ASSESSMENT OF RISKS  
RELATING TO GUARDING, PROTECTION OR  
SECURITY OF PERSONS; GUARDING, PROTEC-  
TION OR SECURITY OF PROPERTY, IN CLASS 45  
(U.S. CLS. 100 AND 101).

FIRST USE 10-0-2007; IN COMMERCE 10-0-2007.

THE COLOR(S) BLUE, WHITE AND BLACK IS/  
ARE CLAIMED AS A FEATURE OF THE MARK.

THE MARK CONSISTS OF THE COLORS BLUE,  
WHITE AND BLACK THAT APPEAR IN THE DE-  
SIGN AND THE COLOR BLACK THAT APPEARS IN  
THE WORDING.

SN 77-358,508, FILED 12-21-2007.

SANJEEV VOHRA, EXAMINING ATTORNEY

**Int. Cls.: 33 and 35**

**Prior U.S. Cls.: 47, 49, 100, 101, and 102**

**United States Patent and Trademark Office**

**Reg. No. 3,570,694**

**Registered Feb. 3, 2009**

**TRADEMARK  
SERVICE MARK  
PRINCIPAL REGISTER**

**ALTUS**

THE FOLEY WINE GROUP, LP (DELAWARE  
LIMITED PARTNERSHIP)  
SUITE 210  
4050 CALLE REAL  
SANTA BARBARA, CA 93110

FOR: WINES, IN CLASS 33 (U.S. CLS. 47 AND 49).

FIRST USE 6-0-2008; IN COMMERCE 6-0-2008.

FOR: MAIL ORDER SERVICES FEATURING  
WINES, IN CLASS 35 (U.S. CLS. 100, 101 AND 102).

FIRST USE 6-0-2008; IN COMMERCE 6-0-2008.

THE MARK CONSISTS OF STANDARD CHAR-  
ACTERS WITHOUT CLAIM TO ANY PARTICULAR  
FONT, STYLE, SIZE, OR COLOR.

SN 77-360,199, FILED 12-27-2007.

JOHN GARTNER, EXAMINING ATTORNEY

**Int. Cl.: 20**

**Prior U.S. Cls.: 2, 13, 22, 25, 32, and 50**

**United States Patent and Trademark Office**

**Reg. No. 3,570,695**

**Registered Feb. 3, 2009**

**TRADEMARK  
PRINCIPAL REGISTER**

**DIMA**

NIU, ZHIGANG (UNITED STATES INDIVIDUAL)  
1580 ONTARIO DR. #9  
SUNNYVALE, CA 94087

THE MARK CONSISTS OF STANDARD CHAR-  
ACTERS WITHOUT CLAIM TO ANY PARTICULAR  
FONT, STYLE, SIZE, OR COLOR.

FOR: SOFAS, IN CLASS 20 (U.S. CLS. 2, 13, 22, 25, 32  
AND 50).

SN 77-360,556, FILED 12-27-2007.

FIRST USE 8-19-2008; IN COMMERCE 8-19-2008.

BARBARA BROWN, EXAMINING ATTORNEY

**Int. Cl.: 20**

**Prior U.S. Cls.: 2, 13, 22, 25, 32, and 50**

**Reg. No. 3,570,696**

**United States Patent and Trademark Office**

**Registered Feb. 3, 2009**

---

**TRADEMARK  
PRINCIPAL REGISTER**

**DEVITA**

NIU, ZHIGANG (UNITED STATES INDIVIDUAL)  
1580 ONTARIO DR. #9  
SUNNYVALE, CA 94087

THE MARK CONSISTS OF STANDARD CHAR-  
ACTERS WITHOUT CLAIM TO ANY PARTICULAR  
FONT, STYLE, SIZE, OR COLOR.

FOR: SOFAS, IN CLASS 20 (U.S. CLS. 2, 13, 22, 25, 32  
AND 50).

SN 77-360,575, FILED 12-27-2007.

FIRST USE 8-19-2008; IN COMMERCE 8-19-2008.

BARBARA BROWN, EXAMINING ATTORNEY



**Int. Cl.: 25**

**Prior U.S. Cls.: 22 and 39**

**United States Patent and Trademark Office**

**Reg. No. 3,570,697**

**Registered Feb. 3, 2009**

**TRADEMARK  
PRINCIPAL REGISTER**

**AQUACHUNK**

KARMAN, INC. (COLORADO CORPORATION),  
DBA ROPER APPAREL AND FOOTWEAR,  
14707 E. 2ND AVENUE SUITE 300  
AURORA, CO 80011

THE MARK CONSISTS OF STANDARD CHAR-  
ACTERS WITHOUT CLAIM TO ANY PARTICULAR  
FONT, STYLE, SIZE, OR COLOR.

FOR: FOOTWEAR, IN CLASS 25 (U.S. CLS. 22 AND  
39).

SN 77-362,179, FILED 12-31-2007.

FIRST USE 8-4-2008; IN COMMERCE 8-4-2008.

ERNEST SHOSHO, EXAMINING ATTORNEY

Int. Cl.: 36

Prior U.S. Cls.: 100, 101, and 102

United States Patent and Trademark Office

Reg. No. 3,570,698

Registered Feb. 3, 2009

SERVICE MARK  
PRINCIPAL REGISTER



VISKUP, JR., JOHN C. (UNITED STATES INDIVIDUAL)

10701 EAST 126TH STREET, NORTH  
COLLINSVILLE, OK 74021 AND

VISKUP, LESLIE DAILE (UNITED STATES INDIVIDUAL)

10701 EAST 126TH STREET, NORTH  
COLLINSVILLE, OK 74021

FOR: REAL ESTATE INVESTMENT, INVESTMENT ADVICE, LAND LEASING, FINANCIAL INVESTMENT IN THE FIELD OF REAL ESTATE, LEASING OF REAL ESTATE, IN CLASS 36 (U.S. CLS. 100, 101 AND 102).

FIRST USE 9-0-2007; IN COMMERCE 9-0-2007.

NO CLAIM IS MADE TO THE EXCLUSIVE RIGHT TO USE "INVESTMENTS", APART FROM THE MARK AS SHOWN.

THE COLOR(S) PURPLE AND TEAL IS/ARE CLAIMED AS A FEATURE OF THE MARK.

THE COLOR PURPLE APPEARS IN THE SUN DESIGN AND THE WORD "INVESTMENTS", AND THE COLOR TEAL APPEARS IN THE NUMBER "212".

SN 77-362,665, FILED 1-2-2008.

WILLIAM P. SHANAHAN, EXAMINING ATTORNEY

**Int. Cl.: 5**

**Prior U.S. Cls.: 6, 18, 44, 46, 51, and 52**

**United States Patent and Trademark Office**

**Reg. No. 3,570,699**

**Registered Feb. 3, 2009**

**TRADEMARK  
PRINCIPAL REGISTER**

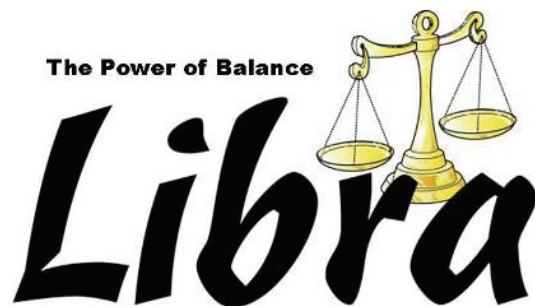

NOURICHE NUTRITION LTD (MISSOURI CORPORATION)  
21 NORMANDY DRIVE  
LAKE ST. LOUIS, MO 63367

FOR: ANIMAL FEED SUPPLEMENTS; NUTRITIONAL ADDITIVES FOR LIVESTOCK FEED FOR MEDICAL PURPOSES; ELECTROLYTE REPLACEMENT SOLUTIONS, IN CLASS 5 (U.S. CLS. 6, 18, 44, 46, 51 AND 52).

FIRST USE 9-1-2008; IN COMMERCE 10-15-2008.

THE COLOR(S) BLACK AND YELLOW IS/ARE CLAIMED AS A FEATURE OF THE MARK.

THE MARK CONSISTS OF THE STYLIZED WORDING "LIBRA THE POWER OF BALANCE" AND THE DESIGN OF SCALES OF JUSTICE. THE COLOR BLACK IS IN THE WORDING "LIBRA THE POWER OF BALANCE" AND IN THE OUTLINE OF THE DESIGN OF THE SCALES OF JUSTICE. THE COLOR YELLOW IS IN THE DESIGN OF THE SCALES OF JUSTICE. THE COLOR WHITE IS NOT CLAIMED AS A FEATURE OF THE MARK AND REPRESENTS BACKGROUND.

SN 77-363,343, FILED 1-3-2008.

MARGARET POWER, EXAMINING ATTORNEY

**Int. Cl.: 42**

**Prior U.S. Cls.: 100 and 101**

**United States Patent and Trademark Office**

**Reg. No. 3,570,700**

**Registered Feb. 3, 2009**

**SERVICE MARK  
PRINCIPAL REGISTER**

**VISIBLECHOICE**

INSURANCE TECHNOLOGIES, LLC (DELA-  
WARE LIMITED LIABILITY COMPANY)  
TWO SOUTH CASCADE AVENUE, SUITE 200  
COLORADO SPRINGS, CO 80903

FOR: PROVIDING ONLINE NON-DOWNLOAD-  
ABLE SOFTWARE FOR USE IN PROVIDING COM-  
PARISONS, NEEDS ANALYSIS, ILLUSTRATIONS  
AND ENHANCED SUITABILITY ANALYSIS OF  
LIFE AND ANNUITY PRODUCTS, IN CLASS 42  
(U.S. CLS. 100 AND 101).

FIRST USE 5-8-2008; IN COMMERCE 7-25-2008.

THE MARK CONSISTS OF STANDARD CHAR-  
ACTERS WITHOUT CLAIM TO ANY PARTICULAR  
FONT, STYLE, SIZE, OR COLOR.

SN 77-364,713, FILED 1-4-2008.

BRENDAN REGAN, EXAMINING ATTORNEY

**Int. Cl.: 29**

**Prior U.S. Cl.: 46**

**United States Patent and Trademark Office**

**Reg. No. 3,570,701**

**Registered Feb. 3, 2009**

**TRADEMARK  
PRINCIPAL REGISTER**



FIGO FOODS SENDIRIAN BERHAD (MALAYSIA  
SENDIRIAN BERHAD (SDN BHD))  
TAMAN UNIVERSITI INDUSTRIAL PARK  
23 & 25, JALAN PERDAGANGAN 16  
SKUDAI, JOHOR, MALAYSIA 81300

FOR: FISH, CRAYFISH, FISH FILLETS, PRAWNS,  
TUNAFISH, SHRIMP, AND SHELLFISH ALL SOLD  
FROZEN; FROZEN FOOD PRODUCTS MADE  
FROM FISH, NAMELY, FISH CHIPS; FISHBALLS  
AND CUTTLEFISH BALLS, IN CLASS 29 (U.S. CL.  
46).

FIRST USE 6-4-2004; IN COMMERCE 5-31-2007.

THE MARK CONSISTS OF THE WORD "FIGO"  
APPEARING WITHIN A CIRCLE WHICH HAS A  
SHADED LOWER PORTION AND AN UPPER POR-  
TION WHICH INCLUDES AN ABSTRACT DESIGN.

SN 77-365,175, FILED 1-7-2008.

DAVID MURRAY, EXAMINING ATTORNEY

**Int. Cl.: 25**

**Prior U.S. Cls.: 22 and 39**

**United States Patent and Trademark Office**

**Reg. No. 3,570,702**

**Registered Feb. 3, 2009**

**TRADEMARK  
PRINCIPAL REGISTER**

**SGT KAMO**

SFC USA, INC. (NEVADA CORPORATION)  
6540 HINSON STREET  
LAS VEGAS, NV 89118

FIRST USE 1-15-2008; IN COMMERCE 1-15-2008.

FOR: APRONS; ATHLETIC UNIFORMS; BABY BIBS NOT OF PAPER; BANDANAS; BASEBALL CAPS; BATHING SUITS; BOXER BRIEFS; BOXER SHORTS; CAPS; CLOTHING FOR WEAR IN WRESTLING GAMES; COATS; CREEPERS; GOLF SHIRTS; GYM SUITS; HALTER TOPS; HEADWEAR; JACKETS; JERSEYS; JOGGING SUITS; PAJAMAS; PANTS; POLO SHIRTS; PULLOVERS; ROBES; SCHOOL UNIFORMS; SHIRTS; SHORTS; SINGLETS; SOCKS; SWEAT PANTS; SWEAT SHIRTS; SWEAT SUITS; T-SHIRTS; TANK TOPS, IN CLASS 25 (U.S. CLS. 22 AND 39).

THE MARK CONSISTS OF STANDARD CHARACTERS WITHOUT CLAIM TO ANY PARTICULAR FONT, STYLE, SIZE, OR COLOR.

NO CLAIM IS MADE TO THE EXCLUSIVE RIGHT TO USE "CAMO" , APART FROM THE MARK AS SHOWN.

SN 77-365,334, FILED 1-7-2008.

CAROLINE WOOD, EXAMINING ATTORNEY

**Int. Cl.: 7**

**Prior U.S. Cls.: 13, 19, 21, 23, 31, 34, and 35**

**Reg. No. 3,570,703**

**United States Patent and Trademark Office**

**Registered Feb. 3, 2009**

**TRADEMARK  
PRINCIPAL REGISTER**



R2C PERFORMANCE PRODUCTS, LLC (ILLINOIS LIMITED LIABILITY COMPANY)  
521 HASTINGS RD  
LAKE FOREST, IL 60045

FOR: AIR FILTERS FOR MOTOR VEHICLE MOTORS AND ENGINES, INCLUDING LIGHT TRUCKS, IN CLASS 7 (U.S. CLS. 13, 19, 21, 23, 31, 34 AND 35).

FIRST USE 10-1-2008; IN COMMERCE 10-1-2008.

THE COLOR(S) SILVER AND BLACK IS/ARE CLAIMED AS A FEATURE OF THE MARK.

THE MARK CONSISTS OF THE WORDS "R2C MAXXFLOW" IN SILVER LETTERS OUTLINED IN BLACK.

SN 77-367,328, FILED 1-9-2008.

LINDA M. KING, EXAMINING ATTORNEY

**Int. Cl.: 29**

**Prior U.S. Cl.: 46**

**United States Patent and Trademark Office**

**Reg. No. 3,570,704**

**Registered Feb. 3, 2009**

**TRADEMARK  
PRINCIPAL REGISTER**

**Verdant Hills**

HARRAH'S LICENSE COMPANY, LLC (TENNESSEE LIMITED LIABILITY COMPANY)  
ONE HARRAH'S COURT  
LAS VEGAS, NV 89119

FOR: EGG SUBSTITUTE; EGGS, IN CLASS 29 (U.S. CL. 46).

FIRST USE 3-31-2008; IN COMMERCE 3-31-2008.

THE MARK CONSISTS OF STANDARD CHARACTERS WITHOUT CLAIM TO ANY PARTICULAR FONT, STYLE, SIZE, OR COLOR.

OWNER OF U.S. REG. NO. 3,226,009.

SN 77-367,424, FILED 1-9-2008.

MICHAEL SOUDERS, EXAMINING ATTORNEY



**Int. Cl.: 9**

**Prior U.S. Cls.: 21, 23, 26, 36, and 38**

**United States Patent and Trademark Office**

**Reg. No. 3,570,705**

**Registered Feb. 3, 2009**

**TRADEMARK  
PRINCIPAL REGISTER**

BETTER HOMES AND GARDENS

MEREDITH CORPORATION (IOWA CORPORATION)  
1716 LOCUST STREET  
DES MOINES, IA 503093023

FOR: MUSICAL SOUND RECORDINGS, IN  
CLASS 9 (U.S. CLS. 21, 23, 26, 36 AND 38).

FIRST USE 9-15-2008; IN COMMERCE 9-15-2008.

THE MARK CONSISTS OF STANDARD CHARACTERS WITHOUT CLAIM TO ANY PARTICULAR FONT, STYLE, SIZE, OR COLOR.

OWNER OF U.S. REG. NOS. 754,656, 1,573,340,  
AND OTHERS.

SN 77-367,747, FILED 1-9-2008.

ELLEN PERKINS, EXAMINING ATTORNEY

**Int. Cl.: 18**

**Prior U.S. Cls.: 1, 2, 3, 22, and 41**

**United States Patent and Trademark Office**

**Reg. No. 3,570,706**

**Registered Feb. 3, 2009**

**TRADEMARK  
PRINCIPAL REGISTER**

The logo consists of the letters 'Z', '&', and 'A' in a bold, black, sans-serif font. The 'Z' is on the left, the '&' is in the middle, and the 'A' is on the right. The letters are closely spaced and have a slightly irregular, hand-drawn appearance.

WEIQIN, ZHU (CHINA INDIVIDUAL)  
NO.298 EAST XUMIN ROAD  
XUJING TOWN, QINGPU DISTRICT  
SHANGHAI, CHINA

FOR: PURSES; HANDBAGS; LEATHER BAGS  
FOR MERCHANDISE PACKAGING; LEATHER  
AND IMITATION LEATHER BAGS; LEATHER  
STRAPS; FUR; UMBRELLAS; CANES; GUT FOR

MAKING SAUSAGE CASINGS, IN CLASS 18 (U.S.  
CLS. 1, 2, 3, 22 AND 41).

FIRST USE 7-31-2004; IN COMMERCE 5-5-2008.

SN 77-371,581, FILED 1-14-2008.

JOHN WILKE, EXAMINING ATTORNEY

**Int. Cl.: 21**

**Prior U.S. Cls.: 2, 13, 23, 29, 30, 33, 40, and 50**

**United States Patent and Trademark Office**

**Reg. No. 3,570,707**

**Registered Feb. 3, 2009**

**TRADEMARK  
PRINCIPAL REGISTER**

# The Chiller Shot

FANTASTIC FABRICS AND PROMOTIONS, INC.  
(NEW YORK CORPORATION)

4R BETHPAGE COURT

HICKSVILLE, NY 11801

FOR: GLASS BEVERAGeware, IN CLASS 21  
(U.S. CLS. 2, 13, 23, 29, 30, 33, 40 AND 50).

FIRST USE 12-6-2007; IN COMMERCE 12-6-2007.

THE MARK CONSISTS OF STANDARD CHARACTERS WITHOUT CLAIM TO ANY PARTICULAR FONT, STYLE, SIZE, OR COLOR.

NO CLAIM IS MADE TO THE EXCLUSIVE RIGHT TO USE "SHOT", APART FROM THE MARK AS SHOWN.

SN 77-374,256, FILED 1-17-2008.

SANJEEV VOHRA, EXAMINING ATTORNEY

**Int. Cl.: 5**

**Prior U.S. Cls.: 6, 18, 44, 46, 51, and 52**

**United States Patent and Trademark Office**

**Reg. No. 3,570,708**

**Registered Feb. 3, 2009**

**TRADEMARK  
PRINCIPAL REGISTER**

**VAZOPREN**

NUTRASCI INC (FLORIDA CORPORATION)  
1025 N. FLORIDA MANGO RD, STE 5  
WEST PALM BEACH, FL 33409

FOR: DIETARY AND NUTRITIONAL SUPPLE-  
MENTS, IN CLASS 5 (U.S. CLS. 6, 18, 44, 46, 51 AND  
52).

FIRST USE 2-1-2008; IN COMMERCE 4-1-2008.

THE MARK CONSISTS OF STANDARD CHAR-  
ACTERS WITHOUT CLAIM TO ANY PARTICULAR  
FONT, STYLE, SIZE, OR COLOR.

SN 77-376,323, FILED 1-21-2008.

JANICE L. MCMORROW, EXAMINING ATTOR-  
NEY

**Int. Cl.: 3**

**Prior U.S. Cls.: 1, 4, 6, 50, 51, and 52**

**Reg. No. 3,570,709**

**United States Patent and Trademark Office**

**Registered Feb. 3, 2009**

**TRADEMARK  
PRINCIPAL REGISTER**

**Cucina Divina**

LA DOLCE DIVA, INC. (GEORGIA CORPORATION)  
2305 BRANDON CT.  
MARIETTA, GA 30066

NO CLAIM IS MADE TO THE EXCLUSIVE RIGHT TO USE "CUCINA", APART FROM THE MARK AS SHOWN.

FOR: BATH AND BODY CARE PRODUCTS, NAMELY, BODY LOTION AND HAND SOAP, IN CLASS 3 (U.S. CLS. 1, 4, 6, 50, 51 AND 52).

THE FOREIGN WORDING IN THE MARK TRANSLATES INTO ENGLISH AS KITCHEN DIVA.

FIRST USE 1-15-2008; IN COMMERCE 2-15-2008.

SN 77-376,477, FILED 1-21-2008.

THE MARK CONSISTS OF STANDARD CHARACTERS WITHOUT CLAIM TO ANY PARTICULAR FONT, STYLE, SIZE, OR COLOR.

JEFF DEFORD, EXAMINING ATTORNEY

**Int. Cl.: 10**

**Prior U.S. Cls.: 26, 39, and 44**

**United States Patent and Trademark Office**

**Reg. No. 3,570,710**

**Registered Feb. 3, 2009**

**TRADEMARK  
PRINCIPAL REGISTER**

**SPA-KINI**

SPA-KINI.COM, LLC (CALIFORNIA LIMITED  
LIABILITY COMPANY)  
410 FAIR STREET  
PETALUMA, CA 94952

THE MARK CONSISTS OF STANDARD CHAR-  
ACTERS WITHOUT CLAIM TO ANY PARTICULAR  
FONT, STYLE, SIZE, OR COLOR.

FOR: MASSAGE APPARATUS, IN CLASS 10 (U.S.  
CLS. 26, 39 AND 44).

SN 77-376,822, FILED 1-21-2008.

FIRST USE 3-1-2008; IN COMMERCE 3-1-2008.

DAVID MURRAY, EXAMINING ATTORNEY

**Int. Cl.: 10**

**Prior U.S. Cls.: 26, 39, and 44**

**United States Patent and Trademark Office**

**Reg. No. 3,570,711**

**Registered Feb. 3, 2009**

**TRADEMARK  
PRINCIPAL REGISTER**

**SPAKINI**

SPA-KINI.COM, LLC (CALIFORNIA LIMITED  
LIABILITY COMPANY)  
410 FAIR STREET  
PETALUMA, CA 94952

THE MARK CONSISTS OF STANDARD CHAR-  
ACTERS WITHOUT CLAIM TO ANY PARTICULAR  
FONT, STYLE, SIZE, OR COLOR.

FOR: MASSAGE APPARATUS, IN CLASS 10 (U.S.  
CLS. 26, 39 AND 44).

SN 77-376,838, FILED 1-21-2008.

FIRST USE 3-1-2008; IN COMMERCE 3-1-2008.

DAVID MURRAY, EXAMINING ATTORNEY

**Int. Cl.: 16**

**Prior U.S. Cls.: 2, 5, 22, 23, 29, 37, 38, and 50**

**Reg. No. 3,570,712**

**United States Patent and Trademark Office**

**Registered Feb. 3, 2009**

**TRADEMARK  
PRINCIPAL REGISTER**

# COMBIFILE

ESSELTE CORPORATION (NEW YORK CORPORATION)  
48 SOUTH SERVICE ROAD  
MELVILLE, NY 11747

THE MARK CONSISTS OF STANDARD CHARACTERS WITHOUT CLAIM TO ANY PARTICULAR FONT, STYLE, SIZE, OR COLOR.

FOR: FILE POCKETS WITH A FOLD OUT STRIP FOR SECURING POCKETS INTO A THREE-RING BINDER, IN CLASS 16 (U.S. CLS. 2, 5, 22, 23, 29, 37, 38 AND 50).

SN 77-377,361, FILED 1-22-2008.

FIRST USE 10-31-2008; IN COMMERCE 10-31-2008.

FLORENTINA BLANDU, EXAMINING ATTORNEY



**Int. Cl.: 30**

**Prior U.S. Cl.: 46**

**United States Patent and Trademark Office**

**Reg. No. 3,570,713**

**Registered Feb. 3, 2009**

**TRADEMARK  
PRINCIPAL REGISTER**

**GARRETT MIX**

GARRETT BRANDS LLC (DELAWARE LIMITED  
LIABILITY COMPANY)  
401 N. MICHIGAN AVENUE SUITE 1700  
CHICAGO, IL 60611

OWNER OF U.S. REG. NOS. 2,000,754, 2,033,329,  
AND 3,106,045.

FOR: POPPED POPCORN; FLAVORED POPPED  
POPCORN; FLAVORED POPPED POPCORN WITH  
PROCESSED NUTS; PROCESSED POPCORN BALLS,  
IN CLASS 30 (U.S. CL. 46).

NO CLAIM IS MADE TO THE EXCLUSIVE  
RIGHT TO USE "MIX", APART FROM THE MARK  
AS SHOWN.

FIRST USE 11-5-2008; IN COMMERCE 11-5-2008.

SN 77-378,814, FILED 1-23-2008.

THE MARK CONSISTS OF STANDARD CHAR-  
ACTERS WITHOUT CLAIM TO ANY PARTICULAR  
FONT, STYLE, SIZE, OR COLOR.

GIANCARLO CASTRO, EXAMINING ATTORNEY

**Int. Cls.: 16 and 41**

**Prior U.S. Cls.: 2, 5, 22, 23, 29, 37, 38, 50, 100, 101, and 107**

**Reg. No. 3,570,714**

**United States Patent and Trademark Office**

**Registered Feb. 3, 2009**

**TRADEMARK  
SERVICE MARK  
PRINCIPAL REGISTER**

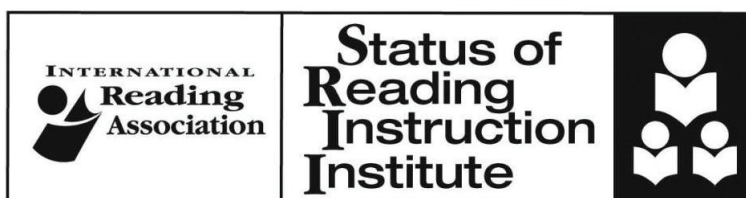

INTERNATIONAL READING ASSOCIATION  
(DELAWARE CORPORATION)  
800 BARKSDALE ROAD  
P.O. BOX 8139  
NEWARK, DE 19714

FOR: EDUCATIONAL PUBLICATIONS, NAME-  
LY, PAMPHLETS, BOOKS, REPORTS, STUDIES,  
AND RESEARCH SUMMARIES ON READING IN  
THE FIELDS OF EDUCATION AND LITERACY, IN  
CLASS 16 (U.S. CLS. 2, 5, 22, 23, 29, 37, 38 AND 50).

FIRST USE 10-30-2008; IN COMMERCE 10-30-2008.

FOR: EDUCATIONAL SERVICES, NAME-  
LY, PROVIDING PRESENTATIONS TO PROFESSIONAL  
EDUCATORS IN THE FIELDS OF EDUCATION  
AND LITERACY, IN CLASS 41 (U.S. CLS. 100, 101  
AND 107).

FIRST USE 11-7-2007; IN COMMERCE 11-7-2007.

NO CLAIM IS MADE TO THE EXCLUSIVE  
RIGHT TO USE "INTERNATIONAL READING AS-  
SOCIATION" OR "STATUS OF READING INSTRU-  
CTION INSTITUTE", APART FROM THE MARK AS  
SHOWN.

THE MARK CONSISTS OF A RECTANGLE DIVI-  
DED INTO THIRDS. THE FIRST PORTION CON-  
TAINS THE STYLIZED WORDING "INTERNATIONAL READING ASSOCIATION"  
ABOVE AND NEXT TO AN IMAGE OF A SHADED  
CIRCLE REPRESENTING A HEAD OVER AN OPEN  
BOOK. THE SECOND PORTION OF THE RECTAN-  
GLE CONTAINS THE STYLIZED WORDING "STA-  
TUS OF READING INSTRUCTION INSTITUTE".  
THE THIRD PORTION CONTAINS THREE CIR-  
CLES REPRESENTING HEADS, EACH OVER AN  
OPEN BOOK.

SN 77-379,464, FILED 1-24-2008.

LYDIA BELZER, EXAMINING ATTORNEY

Int. Cl.: 41

Prior U.S. Cls.: 100, 101, and 107

United States Patent and Trademark Office

Reg. No. 3,570,715

Registered Feb. 3, 2009

**SERVICE MARK  
PRINCIPAL REGISTER**



BETTA PLACE, INC. (GEORGIA CORPORATION)  
436 IVY ST.  
JESUP, GA 31546

FOR: EDUCATION SERVICES, NAMELY, WORKSHOPS IN THE FIELD OF TRAINING TEACHERS AND ADMINISTRATORS HOW TO INCORPORATE A SPECIFIC CURRICULUM INTO THE SCHOOL AND CLASSROOM, NAMELY, TEACHING STUDENTS TO USE THEIR GIFTS TO HELP OTHERS BY ENCOURAGING SERVICE, AND TO COMMUNICATE IN A POSITIVE WAY THAT ELIMINATES BULLYING, AND TO RESOURCE INNER STRENGTH THROUGH QUIET TIME, AND TO SET GOALS BY PICTURING A POSITIVE FUTURE,

AND DISTRIBUTING COURSE MATERIALS IN CONNECTION THEREWITH, IN CLASS 41 (U.S. CLS. 100, 101 AND 107).

FIRST USE 1-24-2008; IN COMMERCE 1-24-2008.

THE MARK CONSISTS OF A STYLIZED GLOBE WITH A FIVE LINE MUSIC STAFF SWIRLING AROUND IT WITH 2 NOTES ON THE RIGHT AND 2 NOTES ON THE LEFT.

SN 77-379,639, FILED 1-24-2008.

ERNEST SHOSHO, EXAMINING ATTORNEY

**Int. Cl.: 41**

**Prior U.S. Cls.: 100, 101, and 107**

**United States Patent and Trademark Office**

**Reg. No. 3,570,716**

**Registered Feb. 3, 2009**

**SERVICE MARK  
PRINCIPAL REGISTER**

# Betta Place, Inc.

BETTA PLACE, INC. (GEORGIA CORPORATION)  
436 IVY ST.  
JESUP, GA 31546

FOR: EDUCATION SERVICES, NAMELY, WORKSHOPS IN THE FIELD OF TRAINING TEACHERS AND ADMINISTRATORS HOW TO INCORPORATE A SPECIFIC CURRICULUM INTO THE SCHOOL AND CLASSROOM, NAMELY, TEACHING STUDENTS TO USE THEIR GIFTS TO HELP OTHERS BY ENCOURAGING SERVICE, AND TO COMMUNICATE IN A POSITIVE WAY THAT ELIMINATES BULLYING, AND TO RESOURCE INNER STRENGTH THROUGH QUIET TIME, AND TO SET GOALS BY PICTURING A POSITIVE FUTURE, AND DISTRIBUTING COURSE MATERIALS IN

CONNECTION THEREWITH, IN CLASS 41 (U.S. CLS. 100, 101 AND 107).

FIRST USE 1-24-2008; IN COMMERCE 1-24-2008.

THE MARK CONSISTS OF STANDARD CHARACTERS WITHOUT CLAIM TO ANY PARTICULAR FONT, STYLE, SIZE, OR COLOR.

NO CLAIM IS MADE TO THE EXCLUSIVE RIGHT TO USE "INC.", APART FROM THE MARK AS SHOWN.

SN 77-379,667, FILED 1-24-2008.

ERNEST SHOSHO, EXAMINING ATTORNEY

Int. Cl.: 41

Prior U.S. Cls.: 100, 101, and 107

**United States Patent and Trademark Office**

**Reg. No. 3,570,717**

Registered Feb. 3, 2009

**SERVICE MARK  
PRINCIPAL REGISTER**

Live the song in your  
heart.

BETTA PLACE, INC. (GEORGIA CORPORATION)  
436 IVY ST.  
JESUP, GA 31546

FOR: EDUCATION SERVICES, NAMELY, WORKSHOPS IN THE FIELD OF TRAINING TEACHERS AND ADMINISTRATORS HOW TO INCORPORATE A SPECIFIC CURRICULUM INTO THE SCHOOL AND CLASSROOM, NAMELY, TEACHING STUDENTS TO USE THEIR GIFTS TO HELP OTHERS BY ENCOURAGING SERVICE, AND TO COMMUNICATE IN A POSITIVE WAY THAT ELIMINATES BULLYING, AND TO RESOURCE INNER STRENGTH THROUGH QUIET TIME, AND TO

SET GOALS BY PICTURING A POSITIVE FUTURE, AND DISTRIBUTING COURSE MATERIALS IN CONNECTION THEREWITH, IN CLASS 41 (U.S. CLS. 100, 101 AND 107).

FIRST USE 4-30-2008; IN COMMERCE 4-30-2008.

THE MARK CONSISTS OF STANDARD CHARACTERS WITHOUT CLAIM TO ANY PARTICULAR FONT, STYLE, SIZE, OR COLOR.

SN 77-379,684, FILED 1-24-2008.

ERNEST SHOSHO, EXAMINING ATTORNEY

**Int. Cl.: 16**

**Prior U.S. Cls.: 2, 5, 22, 23, 29, 37, 38, and 50**

**Reg. No. 3,570,718**

**United States Patent and Trademark Office**

**Registered Feb. 3, 2009**

**TRADEMARK  
PRINCIPAL REGISTER**



FOCUS ON THE FAMILY (CALIFORNIA CORPORATION)  
8605 EXPLORER DRIVE  
COLORADO SPRINGS, CO 80920

OWNER OF U.S. REG. NOS. 1,104,503, 2,671,827,  
AND OTHERS.

FOR: PRINTED MATERIALS, NAMELY, A SERIES OF FICTION AND NON-FICTION BOOKS, PAMPHLETS, BROCHURES, NEWSLETTERS AND MAGAZINES FEATURING INFORMATION RELATED TO FAMILY MATTERS, IN CLASS 16 (U.S. CLS. 2, 5, 22, 23, 29, 37, 38 AND 50).

THE MARK CONSISTS OF A SILHOUETTE OF A CHILD WALKING HAND-IN-HAND WITH TWO ADULTS WITH THE WORDS "FOCUS ON THE FAMILY" IN A SIDE-BY-SIDE FASHION.

SN 77-383,119, FILED 1-29-2008.

FIRST USE 3-10-2008; IN COMMERCE 3-10-2008.

LINDA MICKLEBURGH, EXAMINING ATTORNEY

**Int. Cl.: 24**

**Prior U.S. Cls.: 42 and 50**

**United States Patent and Trademark Office**

**Reg. No. 3,570,719**

**Registered Feb. 3, 2009**

**TRADEMARK  
PRINCIPAL REGISTER**

**AMPLITUDE**

MILLIKEN & COMPANY (DELAWARE CORPORATION)  
920 MILLIKEN ROAD  
SPARTANBURG, SC 29303

THE MARK CONSISTS OF STANDARD CHARACTERS WITHOUT CLAIM TO ANY PARTICULAR FONT, STYLE, SIZE, OR COLOR.

FOR: TEXTILE FABRICS FOR THE MANUFACTURE OF CLOTHING, IN CLASS 24 (U.S. CLS. 42 AND 50).

SN 77-384,423, FILED 1-30-2008.

FIRST USE 7-17-2008; IN COMMERCE 7-17-2008.

EVELYN BRADLEY, EXAMINING ATTORNEY

**Int. Cl.: 25**

**Prior U.S. Cls.: 22 and 39**

**United States Patent and Trademark Office**

**Reg. No. 3,570,720**

**Registered Feb. 3, 2009**

**TRADEMARK  
PRINCIPAL REGISTER**

**SIGNATURE NATURALIZER**

BROWN SHOE COMPANY, INC. (NEW YORK  
CORPORATION)  
8300 MARYLAND AVENUE  
ST. LOUIS, MO 63105

FOR: FOOTWEAR, IN CLASS 25 (U.S. CLS. 22 AND  
39).

FIRST USE 2-28-2007; IN COMMERCE 2-28-2007.

THE MARK CONSISTS OF STANDARD CHAR-  
ACTERS WITHOUT CLAIM TO ANY PARTICULAR  
FONT, STYLE, SIZE, OR COLOR.

OWNER OF U.S. REG. NOS. 3,149,878, 3,236,960,  
AND OTHERS.

SN 77-385,067, FILED 1-31-2008.

ANNE FARRELL, EXAMINING ATTORNEY



**Int. Cl.: 35**

**Prior U.S. Cls.: 100, 101, and 102**

**United States Patent and Trademark Office**

**Reg. No. 3,570,721**

**Registered Feb. 3, 2009**

**SERVICE MARK  
PRINCIPAL REGISTER**

**MIKIHOUSE**

MIKI SHOKO CO., LTD. (JAPAN CORPORATION)  
76-2, WAKABAYASHI-CHO 1-CHOME  
YAO-SHI, OSAKA, JAPAN

FOR: RETAIL STORE AND WHOLESALE DISTRIBUTORSHIP SERVICES FEATURING CLOTHING, SHOES, BAGS, POUCHES, TOYS, DOLLS AND PERSONAL ARTICLES OF WOVEN TEXTILES, IN CLASS 35 (U.S. CLS. 100, 101 AND 102).

FIRST USE 4-0-1984; IN COMMERCE 6-22-2005.

OWNER OF U.S. REG. NOS. 1,853,690, 2,354,973, AND 3,262,330.

THE MARK CONSISTS OF THE WORD "MIKIHOUSE" IN STYLIZED LETTERS.

SN 77-385,382, FILED 1-31-2008.

MARTHA FROMM, EXAMINING ATTORNEY

Int. Cl.: 9

Prior U.S. Cls.: 21, 23, 26, 36, and 38

Reg. No. 3,570,722

United States Patent and Trademark Office

Registered Feb. 3, 2009

TRADEMARK  
PRINCIPAL REGISTER

# the Safety Girls

SULLIVAN, JACQUIE S. (UNITED STATES INDIVIDUAL), DBA SAFETY GIRLS,  
2233 N. SUREE ELLEN LANE  
ALTADENA, CA 91001

FOR: AUDIO RECORDINGS FEATURING MUSIC FOR CHILDREN, TEENAGERS AND ADULTS; DIGITAL MEDIA, NAMELY, PRE-RECORDED VIDEO CASSETTES, DIGITAL VIDEO DISCS, DIGITAL VERSATILE DISCS, DOWNLOADABLE AUDIO AND VIDEO RECORDINGS, DVDS, AND HIGH DEFINITION DIGITAL DISKS FEATURING MUSIC FOR CHILDREN, TEENAGERS AND ADULTS; DOWNLOADABLE MP3 FILES, MP3 RECORDINGS, ONLINE DISCUSSION BOARDS, WEBCASTS AND PODCASTS FEATURING MUSIC, AUDIO BOOKS AND NEWS BROADCASTS; DOWNLOADABLE MUSICAL SOUND RECORDINGS; DOWNLOADABLE VIDEO RECORDINGS FEATURING MUSIC FOR CHILDREN, TEENAGERS AND ADULTS; ELECTRONIC PUBLICATIONS, NAMELY, MAGAZINE FEATURING MUSIC FOR CHILDREN, TEENAGERS AND ADULTS RECORDED ON COMPUTER MEDIA; MULTIMEDIA SOFTWARE RECORDED ON CD-ROM FEATURING MUSIC FOR CHILDREN, TEENAGERS AND ADULTS; MUSICAL SOUND RECORDINGS; MUSICAL VIDEO RECORDINGS; PRE-RECORDED CDS, VIDEO TAPES, LASER DISKS AND DVDS FEATURING

MUSIC FOR CHILDREN, TEENAGERS AND ADULTS; PRE-RECORDED DIGITAL MEDIA FEATURING MUSIC FOR CHILDREN, TEENAGERS AND ADULTS; PRE-RECORDED ELECTRONIC MEDIA FEATURING MUSIC FOR CHILDREN, TEENAGERS AND ADULTS; SOUND RECORDINGS FEATURING MUSIC FOR CHILDREN, TEENAGERS AND ADULTS; VIDEO MAGAZINE RECORDED ON ELECTRONIC MEDIA FEATURING MUSIC FOR CHILDREN, TEENAGERS AND ADULTS; VIDEO RECORDINGS FEATURING MUSIC FOR CHILDREN, TEENAGERS AND ADULTS; VIDEOTAPES AND VIDEO DISKS RECORDED WITH ANIMATION; VISUAL RECORDINGS AND AUDIO VISUAL RECORDINGS FEATURING MUSIC AND ANIMATION, IN CLASS 9 (U.S. CLS. 21, 23, 26, 36 AND 38).

FIRST USE 8-27-2008; IN COMMERCE 8-27-2008.

THE MARK CONSISTS OF STANDARD CHARACTERS WITHOUT CLAIM TO ANY PARTICULAR FONT, STYLE, SIZE, OR COLOR.

SN 77-386,030, FILED 1-31-2008.

RON FAIRBANKS, EXAMINING ATTORNEY

**Int. Cl.: 36**

**Prior U.S. Cls.: 100, 101, and 102**

**United States Patent and Trademark Office**

**Reg. No. 3,570,723**

**Registered Feb. 3, 2009**

**SERVICE MARK  
PRINCIPAL REGISTER**



ALPHACLONE, LLC (CALIFORNIA LIMITED  
LIABILITY COMPANY)  
999 GREEN STREET  
SAN FRANCISCO, CA 94133

FOR: STOCK MARKET RESEARCH SERVICES  
THAT ALLOW USERS TO ANALYZE AND TRACK  
THE INDIVIDUAL AND COLLECTIVE INVEST-  
MENT BEHAVIOR OF PROFESSIONAL MONEY  
MANAGERS, IN CLASS 36 (U.S. CLS. 100, 101 AND  
102).

FIRST USE 11-25-2008; IN COMMERCE 11-25-2008.

THE MARK CONSISTS OF THE WORD "ALPHA"  
IN ALL LOWER CASE AND THE WORD "CLONE"  
IN ALL UPPERCASE. THE TWO WORDS "ALPHA"  
AND "CLONE" ARE PRESENTED AS ONE WORD  
"ALPHACLONE". THERE IS A SWOOSH MARK  
ABOVE THE WORD "CLONE" COMPRISED OF  
THREE CURVED LINES.

SN 77-388,307, FILED 2-4-2008.

KATHERINE M. DUBRAY, EXAMINING ATTOR-  
NEY

**Int. Cl.: 16**

**Prior U.S. Cls.: 2, 5, 22, 23, 29, 37, 38, and 50**

**Reg. No. 3,570,724**

**United States Patent and Trademark Office**

**Registered Feb. 3, 2009**

**TRADEMARK  
PRINCIPAL REGISTER**

# Blue Cat Pies

ANY BABY CAN OF SAN ANTONIO, INC.  
(TEXAS CORPORATION)  
217 HOWARD STREET  
SAN ANTONIO, TX 78212

THE MARK CONSISTS OF STANDARD CHARACTERS WITHOUT CLAIM TO ANY PARTICULAR FONT, STYLE, SIZE, OR COLOR.

FOR: PRINTED INSTRUCTIONAL, EDUCATIONAL, AND TEACHING MATERIALS IN THE FIELD OF PRIMARY AND SECONDARY EDUCATION, IN CLASS 16 (U.S. CLS. 2, 5, 22, 23, 29, 37, 38 AND 50).

SN 77-389,927, FILED 2-6-2008.

FIRST USE 12-9-2008; IN COMMERCE 12-9-2008.

CYNTHIA SLOAN, EXAMINING ATTORNEY

**Int. Cl.: 29**

**Prior U.S. Cl.: 46**

**United States Patent and Trademark Office**

**Reg. No. 3,570,725**

**Registered Feb. 3, 2009**

**TRADEMARK  
PRINCIPAL REGISTER**

**MOMMY'S  
Readymeals  
Just Heat & Eat**

SHEIKH, MUDASSAR ANJUM (CANADA INDIVIDUAL)  
2782 WESTBURY COURT  
MISSISSAUGA ONTARIO, CANADA L5M6B4

FOR: COMBINATION MEAL CONSISTING PRIMARILY OF A MEAT OR VEGETABLE-BASED ENTREE AND A SOUP OR SALAD FOR CONSUMPTION ON OR OFF THE PREMISES; PREPARED AND PACKAGED MEALS CONSISTING PRIMARILY OF MEAT, FISH, POULTRY OR VEGETABLES, IN CLASS 29 (U.S. CL. 46).

FIRST USE 11-30-2006; IN COMMERCE 6-1-2007.

THE MARK CONSISTS OF STANDARD CHARACTERS WITHOUT CLAIM TO ANY PARTICULAR FONT, STYLE, SIZE, OR COLOR.

NO CLAIM IS MADE TO THE EXCLUSIVE RIGHT TO USE "HEAT & EAT", APART FROM THE MARK AS SHOWN.

SN 77-393,559, FILED 2-11-2008.

SETH A. RAPPAPORT, EXAMINING ATTORNEY

**Int. Cl.: 35**

**Prior U.S. Cls.: 100, 101, and 102**

**United States Patent and Trademark Office**

**Reg. No. 3,570,726**

**Registered Feb. 3, 2009**

**SERVICE MARK  
PRINCIPAL REGISTER**

# HYPERLOCAL

HELLO METRO, INC. (INDIANA CORPORATION)  
455 SOUTH 4TH STREET  
LOUISVILLE, KY 40202

FOR: ADVERTISING AND COMMERCIAL INFORMATION SERVICES, VIA THE INTERNET; ADVERTISING AND MARKETING; ADVERTISING SERVICES; ELECTRONIC COMMERCE SERVICES, NAMELY, PROVIDING INFORMATION ABOUT PRODUCTS VIA TELECOMMUNICATION NETWORKS FOR ADVERTISING AND SALES PURPOSES; INTERNET ADVERTISING SERVICES; PROVIDING INFORMATION ABOUT COMMERCIAL BUSINESS AND COMMERCIAL INFORMATION VIA THE GLOBAL COMPUTER NETWORK;

PROVIDING INFORMATION ABOUT THE GOODS AND SERVICES OF OTHERS VIA THE GLOBAL COMPUTER NETWORK, IN CLASS 35 (U.S. CLS. 100, 101 AND 102).

FIRST USE 1-0-2008; IN COMMERCE 1-0-2008.

THE MARK CONSISTS OF STANDARD CHARACTERS WITHOUT CLAIM TO ANY PARTICULAR FONT, STYLE, SIZE, OR COLOR.

SN 77-394,671, FILED 2-12-2008.

CHERYL CLAYTON, EXAMINING ATTORNEY

**Int. Cl.: 16**

**Prior U.S. Cls.: 2, 5, 22, 23, 29, 37, 38, and 50**

**Reg. No. 3,570,727**

**United States Patent and Trademark Office**

**Registered Feb. 3, 2009**

**TRADEMARK  
PRINCIPAL REGISTER**

**THE GERM-O-TRON**

PROFESSIONAL DISPOSABLES INTERNATIONAL, INC. (DELAWARE CORPORATION)  
TWO NICE-PAK PARK  
ORANGEBURG, NY 109621376

THE MARK CONSISTS OF STANDARD CHARACTERS WITHOUT CLAIM TO ANY PARTICULAR FONT, STYLE, SIZE, OR COLOR.

FOR: PRINTED PUBLICATIONS, NAMELY, CHILDREN'S BOOKS AND EDUCATIONAL MATERIALS IN THE FIELD OF PERSONAL HYGIENE, IN CLASS 16 (U.S. CLS. 2, 5, 22, 23, 29, 37, 38 AND 50).

SN 77-402,080, FILED 2-20-2008.

FIRST USE 2-14-2008; IN COMMERCE 2-14-2008.

ESTHER A. BORSUK, EXAMINING ATTORNEY

**Int. Cl.: 35**

**Prior U.S. Cls.: 100, 101, and 102**

**United States Patent and Trademark Office**

**Reg. No. 3,570,728**

**Registered Feb. 3, 2009**

**SERVICE MARK  
PRINCIPAL REGISTER**

**Leadership CAT Scan**

ECSTASIS, LLC. (CALIFORNIA LIMITED LIABILITY COMPANY)  
SUITE A252 31441 SANTA MARGARITA PARKWAY  
RANCHO SANTA MARGARITA, CA 92688

FOR: BUSINESS MANAGEMENT CONSULTATION IN THE FIELD OF EXECUTIVE AND LEADERSHIP DEVELOPMENT, IN CLASS 35 (U.S. CLS. 100, 101 AND 102).

FIRST USE 11-1-2008; IN COMMERCE 11-1-2008.

THE MARK CONSISTS OF STANDARD CHARACTERS WITHOUT CLAIM TO ANY PARTICULAR FONT, STYLE, SIZE, OR COLOR.

NO CLAIM IS MADE TO THE EXCLUSIVE RIGHT TO USE "LEADERSHIP", APART FROM THE MARK AS SHOWN.

SN 77-405,111, FILED 2-25-2008.

VERNA BETH RIRIE, EXAMINING ATTORNEY



**Int. Cl.: 5**

**Prior U.S. Cls.: 6, 18, 44, 46, 51, and 52**

**United States Patent and Trademark Office**

**Reg. No. 3,570,729**

**Registered Feb. 3, 2009**

**TRADEMARK  
PRINCIPAL REGISTER**

**LITTLE REMEDIES**

MEDTECH PRODUCTS INC. (DELAWARE CORPORATION)  
90 NORTH BROADWAY  
IRVINGTON, NY 10533

OWNER OF U.S. REG. NO. 2,030,332.

FOR: NON-MEDICATED NASAL PREPARATIONS FOR THE RELIEF OF COLD SYMPTOMS, IN CLASS 5 (U.S. CLS. 6, 18, 44, 46, 51 AND 52).

NO CLAIM IS MADE TO THE EXCLUSIVE RIGHT TO USE "REMEDIES", APART FROM THE MARK AS SHOWN.

FIRST USE 7-1-2000; IN COMMERCE 7-1-2000.

SN 77-406,141, FILED 2-26-2008.

THE MARK CONSISTS OF STANDARD CHARACTERS WITHOUT CLAIM TO ANY PARTICULAR FONT, STYLE, SIZE, OR COLOR.

JASON LOTT, EXAMINING ATTORNEY

**Int. Cl.: 5**

**Prior U.S. Cls.: 6, 18, 44, 46, 51, and 52**

**United States Patent and Trademark Office**

**Reg. No. 3,570,730**

**Registered Feb. 3, 2009**

**TRADEMARK  
PRINCIPAL REGISTER**

**WE MAKE IT ALL BETTER!**

MEDTECH PRODUCTS INC. (DELAWARE CORPORATION)  
90 NORTH BROADWAY  
IRVINGTON, NY 10533

FOR: NON-MEDICATED NASAL PREPARATIONS FOR THE RELIEF OF COLD SYMPTOMS, IN CLASS 5 (U.S. CLS. 6, 18, 44, 46, 51 AND 52).

FIRST USE 7-1-2000; IN COMMERCE 7-1-2000.

THE MARK CONSISTS OF STANDARD CHARACTERS WITHOUT CLAIM TO ANY PARTICULAR FONT, STYLE, SIZE, OR COLOR.

OWNER OF U.S. REG. NO. 2,523,530.

SN 77-406,154, FILED 2-26-2008.

JASON LOTT, EXAMINING ATTORNEY

**Int. Cl.: 5**

**Prior U.S. Cls.: 6, 18, 44, 46, 51, and 52**

**Reg. No. 3,570,731**

**United States Patent and Trademark Office**

**Registered Feb. 3, 2009**

**TRADEMARK  
PRINCIPAL REGISTER**

**GLUC-O-BAR**

AMERICAN PHARMACEUTICAL INNOVATIONS COMPANY (ILLINOIS LIMITED LIABILITY COMPANY)  
8117 SOUTH LEMONT ROAD, SUITE #6  
DARIEN, IL 60561

FOR: MEDICAL FOOD PRODUCTS, NAMELY, SLOW RELEASE CARBOHYDRATE MEAL REPLACEMENT BARS AND NUTRITIONAL ENERGY BARS FOR USE AS A MEAL SUBSTITUTE; NUTRITIONAL SUPPLEMENTS, IN CLASS 5 (U.S. CLS. 6, 18, 44, 46, 51 AND 52).

FIRST USE 10-10-2008; IN COMMERCE 10-10-2008.

THE MARK CONSISTS OF STANDARD CHARACTERS WITHOUT CLAIM TO ANY PARTICULAR FONT, STYLE, SIZE, OR COLOR.

SN 77-406,339, FILED 2-26-2008.

DAVID YONTEF, EXAMINING ATTORNEY

**Int. Cl.: 24**

**Prior U.S. Cls.: 42 and 50**

**United States Patent and Trademark Office**

**Reg. No. 3,570,732**

**Registered Feb. 3, 2009**

**TRADEMARK  
PRINCIPAL REGISTER**

**HALO**

MASSIF MOUNTAIN GEAR COMPANY, L.L.C.  
(OREGON LIMITED LIABILITY COMPANY)  
415 WILLIAMSON WAY, SUITE 1  
ASHLAND, OR 97520

THE MARK CONSISTS OF STANDARD CHAR-  
ACTERS WITHOUT CLAIM TO ANY PARTICULAR  
FONT, STYLE, SIZE, OR COLOR.

FOR: FIRE RESISTANT TEXTILE FABRICS FOR  
THE MANUFACTURE OF CLOTHING, IN CLASS 24  
(U.S. CLS. 42 AND 50).

SN 77-411,592, FILED 3-3-2008.

FIRST USE 7-0-2007; IN COMMERCE 7-0-2007.

SIMON TENG, EXAMINING ATTORNEY

**Int. Cl.: 6**

**Prior U.S. Cls.: 2, 12, 13, 14, 23, 25, and 50**

**United States Patent and Trademark Office**

**Reg. No. 3,570,733**

**Registered Feb. 3, 2009**

**TRADEMARK  
PRINCIPAL REGISTER**

**CARABEAN**

P FOR C, LLC (CALIFORNIA LIMITED LIABILITY COMPANY)  
3366 MCLAUGHLIN AVENUE  
LOS ANGELES, CA 90066

THE MARK CONSISTS OF STANDARD CHARACTERS WITHOUT CLAIM TO ANY PARTICULAR FONT, STYLE, SIZE, OR COLOR.

FOR: METAL HARDWARE, NAMELY, CARABINERS OF METAL, IN CLASS 6 (U.S. CLS. 2, 12, 13, 14, 23, 25 AND 50).

SN 77-415,009, FILED 3-6-2008.

FIRST USE 7-16-2008; IN COMMERCE 7-19-2008.

CHRISTINE COOPER, EXAMINING ATTORNEY

**Int. Cl.: 6**

**Prior U.S. Cls.: 2, 12, 13, 14, 23, 25, and 50**

**United States Patent and Trademark Office**

**Reg. No. 3,570,734**

**Registered Feb. 3, 2009**

**TRADEMARK  
PRINCIPAL REGISTER**

**MOMMY TOOLBOX**

P FOR C, LLC (CALIFORNIA LIMITED LIABILITY COMPANY)  
3366 MCLAUGHLIN AVENUE  
LOS ANGELES, CA 90066

THE MARK CONSISTS OF STANDARD CHARACTERS WITHOUT CLAIM TO ANY PARTICULAR FONT, STYLE, SIZE, OR COLOR.

FOR: METAL HARDWARE, NAMELY, CARABINERS OF METAL, IN CLASS 6 (U.S. CLS. 2, 12, 13, 14, 23, 25 AND 50).

SN 77-415,013, FILED 3-6-2008.

FIRST USE 7-16-2008; IN COMMERCE 7-19-2008.

CHRISTINE COOPER, EXAMINING ATTORNEY

**Int. Cl.: 11**

**Prior U.S. Cls.: 13, 21, 23, 31, and 34**

**United States Patent and Trademark Office**

**Reg. No. 3,570,735**

**Registered Feb. 3, 2009**

**TRADEMARK  
PRINCIPAL REGISTER**

**TRIBUTE**

COOPER TECNOLOGIES COMPANY (DELA-  
WARE CORPORATION)  
600 TRAVIS, SUITE 5600  
HOUSTON, TX 77002

FOR: LIGHTING FIXTURES, NAMELY, LUMI-  
NAIRES USED PRIMARILY FOR OUTDOOR AP-  
PLICATIONS, NAMELY, WALKWAYS, PARKING  
LOTS, ROADWAYS, BRIDGES, OVERPASSES,  
LOADING DOCKS, AND BUILDING AREAS; LU-  
MINAIRES FOR USE IN SECURITY LIGHTING  
APPLICATIONS, IN CLASS 11 (U.S. CLS. 13, 21, 23,  
31 AND 34).

FIRST USE 1-22-2008; IN COMMERCE 1-22-2008.

THE MARK CONSISTS OF STANDARD CHAR-  
ACTERS WITHOUT CLAIM TO ANY PARTICULAR  
FONT, STYLE, SIZE, OR COLOR.

SN 77-418,425, FILED 3-11-2008.

SCOTT BIBB, EXAMINING ATTORNEY

**Int. Cl.: 5**

**Prior U.S. Cls.: 6, 18, 44, 46, 51, and 52**

**Reg. No. 3,570,736**

**United States Patent and Trademark Office**

**Registered Feb. 3, 2009**

---

**TRADEMARK  
PRINCIPAL REGISTER**

**ANABOLIC AXIS**

MAXIMUM HUMAN PERFORMANCE, INC.  
(NEW JERSEY CORPORATION)  
21 DWIGHT PLACE  
FAIRFIELD, NJ 07004

NO CLAIM IS MADE TO THE EXCLUSIVE  
RIGHT TO USE "ANABOLIC", APART FROM THE  
MARK AS SHOWN.

FOR: DIETARY SUPPLEMENTS, IN CLASS 5 (U.S.  
CLS. 6, 18, 44, 46, 51 AND 52).

SN 77-422,537, FILED 3-14-2008.

FIRST USE 2-1-2008; IN COMMERCE 2-1-2008.

THE MARK CONSISTS OF STANDARD CHAR-  
ACTERS WITHOUT CLAIM TO ANY PARTICULAR  
FONT, STYLE, SIZE, OR COLOR.

AMOS T. MATTHEWS, JR., EXAMINING ATTOR-  
NEY



Int. Cl.: 40

Prior U.S. Cls.: 100, 103, and 106

United States Patent and Trademark Office

Reg. No. 3,570,737

Registered Feb. 3, 2009

**SERVICE MARK  
PRINCIPAL REGISTER**



BENSON, STEVEN V. (UNITED STATES INDIVIDUAL)  
64 MEDICI  
SAN ANTONIO, TX 78258

FOR: CUSTOMIZED PRINTING OF COMPANY NAMES AND LOGOS FOR PROMOTIONAL AND ADVERTISING PURPOSES ON THE GOODS OF OTHERS, IN CLASS 40 (U.S. CLS. 100, 103 AND 106).

FIRST USE 4-1-2008; IN COMMERCE 6-15-2008.

NO CLAIM IS MADE TO THE EXCLUSIVE RIGHT TO USE "IMAGE, LLC", APART FROM THE MARK AS SHOWN.

THE COLOR(S) BLUE, LIGHT BLUE AND BLACK IS/ARE CLAIMED AS A FEATURE OF THE MARK.

THE MARK CONSISTS OF A BLUE FINGERPRINT IMAGE AND PARTIAL REFLECTION BELOW THE FINGERPRINT IN LIGHT BLUE; TO THE RIGHT OF THE IMAGE, THE WORDING "DISTINCTIVE IMAGE, LLC" APPEARS IN BLACK.

SN 77-425,145, FILED 3-18-2008.

ELLEN PERKINS, EXAMINING ATTORNEY

**Int. Cl.: 33**

**Prior U.S. Cls.: 47 and 49**

**United States Patent and Trademark Office**

**Reg. No. 3,570,738**

**Registered Feb. 3, 2009**

**TRADEMARK  
PRINCIPAL REGISTER**

**THREE COINS**

LAWER FAMILY WINERY, INC. (CALIFORNIA  
CORPORATION)  
1273 BANNISTER DRIVE  
ANCHORAGE, AK 99508

THE MARK CONSISTS OF STANDARD CHAR-  
ACTERS WITHOUT CLAIM TO ANY PARTICULAR  
FONT, STYLE, SIZE, OR COLOR.

FOR: WINES, IN CLASS 33 (U.S. CLS. 47 AND 49).

SN 77-428,390, FILED 3-21-2008.

FIRST USE 9-12-2008; IN COMMERCE 9-12-2008.

SANJEEV VOHRA, EXAMINING ATTORNEY

**Int. Cl.: 10**

**Prior U.S. Cls.: 26, 39, and 44**

**United States Patent and Trademark Office**

**Reg. No. 3,570,739**

**Registered Feb. 3, 2009**

**TRADEMARK  
PRINCIPAL REGISTER**

**SMARTMETAL**

TORNIER, INC. (DELAWARE CORPORATION)  
3601 WEST 76TH STREET, SUITE 200  
EDINA, MN 55435

FOR: MEDICAL DEVICES AND INSTRUMENTS  
COMPRISED WHOLLY OR IN PART OF NITINOL,  
NAMELY, IMPLANTS, SCREWS, FASTENERS, AND  
ANCHORS FOR FIXATION OF TISSUE, TENDON,  
LIGAMENT, SYNTHETICS, SUTURES, SOFT TIS-  
SUE AND/OR BONE IN ORTHOPAEDIC SURGICAL  
PROCEDURES, IN CLASS 10 (U.S. CLS. 26, 39 AND  
44).

FIRST USE 6-30-2008; IN COMMERCE 6-30-2008.

THE MARK CONSISTS OF STANDARD CHAR-  
ACTERS WITHOUT CLAIM TO ANY PARTICULAR  
FONT, STYLE, SIZE, OR COLOR.

SN 77-432,820, FILED 3-27-2008.

WILLIAM BRECKENFELD, EXAMINING ATTOR-  
NEY

**Int. Cl.: 21**

**Prior U.S. Cls.: 2, 13, 23, 29, 30, 33, 40, and 50**

**Reg. No. 3,570,740**

**United States Patent and Trademark Office**

**Registered Feb. 3, 2009**

---

**TRADEMARK  
PRINCIPAL REGISTER**

**MODKAT**

MODPRODUCTS, LLC (NEW YORK LIMITED  
LIABILITY COMPANY)  
PH2  
139 FULTON STREET  
NEW YORK, NY 10038

THE MARK CONSISTS OF STANDARD CHAR-  
ACTERS WITHOUT CLAIM TO ANY PARTICULAR  
FONT, STYLE, SIZE, OR COLOR.

SN 77-437,834, FILED 4-2-2008.

FOR: CAT LITTER BOXES, IN CLASS 21 (U.S. CLS.  
2, 13, 23, 29, 30, 33, 40 AND 50).

FIRST USE 11-15-2008; IN COMMERCE 11-15-2008.

JANICE L. MCMORROW, EXAMINING ATTOR-  
NEY

**Int. Cl.: 5**

**Prior U.S. Cls.: 6, 18, 44, 46, 51, and 52**

**United States Patent and Trademark Office**

**Reg. No. 3,570,741**

**Registered Feb. 3, 2009**

**TRADEMARK  
PRINCIPAL REGISTER**

**PLASMAPUMP**

MAXIMUM HUMAN PERFORMANCE, INC.  
(NEW JERSEY CORPORATION)  
21 DWIGHT PLACE  
FAIRFIELD, NJ 07004

FOR: DIETARY SUPPLEMENTS, IN CLASS 5 (U.S.  
CLS. 6, 18, 44, 46, 51 AND 52).

FIRST USE 3-1-2008; IN COMMERCE 3-1-2008.

THE MARK CONSISTS OF STANDARD CHAR-  
ACTERS WITHOUT CLAIM TO ANY PARTICULAR  
FONT, STYLE, SIZE, OR COLOR.

SN 77-440,196, FILED 4-4-2008.

AMOS T. MATTHEWS, JR., EXAMINING ATTOR-  
NEY

**Int. Cl.: 33**

**Prior U.S. Cls.: 47 and 49**

**United States Patent and Trademark Office**

**Reg. No. 3,570,742**

**Registered Feb. 3, 2009**

**TRADEMARK  
PRINCIPAL REGISTER**

# Belle Joli

JACKSON WINERY AND VINEYARDS, L.L.C.  
(SOUTH DAKOTA LIMITED LIABILITY COMPANY)

1108 8TH AVENUE

BELLE FOURCHE, SD 57717

FOR: WINES, IN CLASS 33 (U.S. CLS. 47 AND 49).

FIRST USE 11-24-2008; IN COMMERCE 11-24-2008.

THE MARK CONSISTS OF STANDARD CHARACTERS WITHOUT CLAIM TO ANY PARTICULAR FONT, STYLE, SIZE, OR COLOR.

THE ENGLISH TRANSLATION OF "BELLE JOLI" IS "BEAUTIFUL PRETTY".

SN 77-440,231, FILED 4-4-2008.

WILLIAM P. SHANAHAN, EXAMINING ATTORNEY

**Int. Cl.: 5**

**Prior U.S. Cls.: 6, 18, 44, 46, 51, and 52**

**United States Patent and Trademark Office**

**Reg. No. 3,570,743**

**Registered Feb. 3, 2009**

**TRADEMARK  
PRINCIPAL REGISTER**



BIOTECH TRADING PARTNERS, LLC (CALIFORNIA LIMITED LIABILITY COMPANY)  
1042B N. EL CAMINO REAL, STE 341  
ENCINITAS, CA 92024

FOR: DIAGNOSTIC PREPARATIONS FOR MEDICAL AND VETERINARY USE, IN CLASS 5 (U.S. CLS. 6, 18, 44, 46, 51 AND 52).

FIRST USE 5-1-2008; IN COMMERCE 7-1-2008.

THE COLOR(S) BROWN, TAN, YELLOW-GOLD, GOLD, AND TEAL IS/ARE CLAIMED AS A FEATURE OF THE MARK.

THE MARK CONSISTS OF A STYLIZED MONKEY IN A CLIMBING DOWN POSITION. THE MONKEY HAS A BROWN BODY COLOR, A TAN COLORED FACE WITH BROWN COLORED EYES, AND A YELLOW-GOLD COLOR TAIL. THE MONKEY IS WEARING A TEAL COLORED GRADUATION CAP WITH A GOLD COLORED TASSLE.

SN 77-441,589, FILED 4-7-2008.

VERNA BETH RIRIE, EXAMINING ATTORNEY

**Int. Cl.: 42**

**Prior U.S. Cls.: 100 and 101**

**United States Patent and Trademark Office**

**Reg. No. 3,570,744**

**Registered Feb. 3, 2009**

**SERVICE MARK  
PRINCIPAL REGISTER**

**Making The Internet Safer  
One Website at a Time**

ANIRBAN BANERJEE (INDIA INDIVIDUAL)  
180 W BIG SPRINGS RD., #21  
RIVERSIDE, CA 92507

FOR: COMPUTER SERVICES, NAMELY, ONLINE SCANNING, DETECTING, QUARANTINING AND ELIMINATING VIRUSES, WORMS, TROJANS, SPYWARE, ADWARE, MALWARE AND UNAUTHORIZED DATA AND PROGRAMS ON COMPUTERS AND ELECTRONIC DEVICES, IN CLASS 42 (U.S. CLS. 100 AND 101).

FIRST USE 8-15-2008; IN COMMERCE 10-14-2008.

THE MARK CONSISTS OF STANDARD CHARACTERS WITHOUT CLAIM TO ANY PARTICULAR FONT, STYLE, SIZE, OR COLOR.

SN 77-443,795, FILED 4-9-2008.

JANICE L. MCMORROW, EXAMINING ATTORNEY



**Int. Cl.: 9**

**Prior U.S. Cls.: 21, 23, 26, 36, and 38**

**United States Patent and Trademark Office**

**Reg. No. 3,570,745**

**Registered Feb. 3, 2009**

**TRADEMARK  
PRINCIPAL REGISTER**

**PICTOIMAGE**

KABUSHIKI KAISHA SEGA (JAPAN CORPORATION), DBA SEGA CORPORATION,  
2-12, HANEDA 1-CHOME  
OHTA-KU, TOKYO, JAPAN

FOR: VIDEO GAME SOFTWARE, IN CLASS 9  
(U.S. CLS. 21, 23, 26, 36 AND 38).

FIRST USE 9-2-2008; IN COMMERCE 9-2-2008.

THE MARK CONSISTS OF STANDARD CHARACTERS WITHOUT CLAIM TO ANY PARTICULAR FONT, STYLE, SIZE, OR COLOR.

SN 77-444,648, FILED 4-10-2008.

JANICE L. MCMORROW, EXAMINING ATTORNEY

**Int. Cl.: 35**

**Prior U.S. Cls.: 100, 101, and 102**

**United States Patent and Trademark Office**

**Reg. No. 3,570,746**

**Registered Feb. 3, 2009**

**SERVICE MARK  
PRINCIPAL REGISTER**

**RS CONSULTING USA**

THE RICHMARK GROUP, INC. (ILLINOIS CORPORATION)  
5TH FLOOR  
39 S. LASALLE STREET  
CHICAGO, IL 60603

FOR: MARKET RESEARCH; BUSINESS CONSULTATION; AND, BUSINESS MARKETING CONSULTING SERVICES, IN CLASS 35 (U.S. CLS. 100, 101 AND 102).

FIRST USE 6-0-2008; IN COMMERCE 6-0-2008.

THE MARK CONSISTS OF STANDARD CHARACTERS WITHOUT CLAIM TO ANY PARTICULAR FONT, STYLE, SIZE, OR COLOR.

NO CLAIM IS MADE TO THE EXCLUSIVE RIGHT TO USE "CONSULTING USA", APART FROM THE MARK AS SHOWN.

SN 77-448,606, FILED 4-15-2008.

LINDA E. BLOHM, EXAMINING ATTORNEY

**Int. Cl.: 38**

**Prior U.S. Cls.: 100, 101, and 104**

**United States Patent and Trademark Office**

**Reg. No. 3,570,747**

**Registered Feb. 3, 2009**

**SERVICE MARK  
PRINCIPAL REGISTER**

**NEWTALK**

THE COMMON GOOD INSTITUTE, INC. (NEW  
YORK NON-PROFIT CORPORATION)  
SUITE 308  
1730 RHODE ISLAND AVENUE, NW  
WASHINGTON, DC 20036

FOR: PROVIDING ON-LINE DISCUSSION FOR-  
UMS FOR TRANSMISSION OF MESSAGES AMONG  
COMPUTER USERS CONCERNING PUBLIC POL-  
ICY ISSUES AND REFORM OF AMERICA'S LEGAL  
SYSTEM, IN CLASS 38 (U.S. CLS. 100, 101 AND 104).

FIRST USE 6-10-2008; IN COMMERCE 6-10-2008.

THE MARK CONSISTS OF STANDARD CHAR-  
ACTERS WITHOUT CLAIM TO ANY PARTICULAR  
FONT, STYLE, SIZE, OR COLOR.

SN 77-452,229, FILED 4-18-2008.

LAURIE KAUFMAN, EXAMINING ATTORNEY

Int. Cl.: 41

Prior U.S. Cls.: 100, 101, and 107

United States Patent and Trademark Office

Reg. No. 3,570,748

Registered Feb. 3, 2009

SERVICE MARK  
PRINCIPAL REGISTER



PEPSICO, INC. (NORTH CAROLINA CORPORATION)  
700 ANDERSON HILL ROAD  
PURCHASE, NY 10577

FOR: ENTERTAINMENT SERVICES, NAMELY, AN ON-GOING ANIMATED COMEDY SERIES PROVIDED THROUGH THE INTERNET, IN CLASS 41 (U.S. CLS. 100, 101 AND 107).

FIRST USE 6-0-2008; IN COMMERCE 6-0-2008.

THE COLOR(S) GREEN, YELLOW, WHITE, BLACK AND BLUE IS/ARE CLAIMED AS A FEATURE OF THE MARK.

THE MARK CONSISTS OF THE WORDS "ON THE BUBBLE" IN STYLIZED LETTERS. THE LETTERS CONTAIN THE COLORS LIGHT GREEN, YELLOW AND WHITE. THE OUTLINE OF THE LETTERS CONTAIN THE COLORS GREEN AND BLACK. THE BACKGROUND IS BLUE WITH YELLOW BUBBLE AND STAR DESIGNS.

SN 77-452,706, FILED 4-19-2008.

DAVID MURRAY, EXAMINING ATTORNEY

**Int. Cl.: 29**

**Prior U.S. Cl.: 46**

**United States Patent and Trademark Office**

**Reg. No. 3,570,749**

**Registered Feb. 3, 2009**

**TRADEMARK  
PRINCIPAL REGISTER**

**IN A CLASS BY ITSELF**

LB BRANDS, LLC (MAINE LIMITED LIABILITY  
COMPANY)  
PO BOX 239  
PORT CLYDE, ME 04855

THE MARK CONSISTS OF STANDARD CHAR-  
ACTERS WITHOUT CLAIM TO ANY PARTICULAR  
FONT, STYLE, SIZE, OR COLOR.

FOR: LOBSTERS, SHELL FISH, SEAFOOD, IN  
CLASS 29 (U.S. CL. 46).

SN 77-453,592, FILED 4-21-2008.

FIRST USE 10-31-2008; IN COMMERCE 10-31-2008.

TINA BROWN, EXAMINING ATTORNEY

**Int. Cls.: 36 and 42**

**Prior U.S. Cls.: 100, 101, and 102**

**United States Patent and Trademark Office**

**Reg. No. 3,570,750**

**Registered Feb. 3, 2009**

**SERVICE MARK  
PRINCIPAL REGISTER**



AGER GROUP INC. (MASSACHUSETTS CORPORATION)  
275 GROVE STREET, SUITE 2-400  
NEWTON, MA 02466

FOR: REAL ESTATE CONSULTANCY; REAL ESTATE CONSULTATION, IN CLASS 36 (U.S. CLS. 100, 101 AND 102).

FIRST USE 10-31-2008; IN COMMERCE 10-31-2008.

FOR: LANDSCAPE ARCHITECTURAL DESIGN; LANDSCAPE LIGHTING DESIGN; LAND USE PLANNING SERVICES; ARCHITECTURAL AND ENGINEERING SERVICES; ARCHITECTURAL CONSULTANCY; ARCHITECTURAL CONSULTATION; ARCHITECTURAL DESIGN; CONSULTING IN THE FIELDS OF ENGINEERING AND ARCHITECTURE; CONSULTING SERVICES IN THE FIELD OF ARCHITECTURAL DESIGN; CIVIL ENGINEER-

ING; URBAN PLANNING; ENVIRONMENTAL SERVICES, NAMELY, TECHNICAL CONSULTATION IN THE FIELD OF ENVIRONMENTAL SCIENCE, ENGINEERING SERVICES, DESIGN FOR OTHERS IN THE FIELD OF ENVIRONMENTAL ENGINEERING, DESIGNING AND TESTING OF NEW ENVIRONMENTALLY FRIENDLY PRODUCTS FOR OTHERS; INTERIOR DESIGN SERVICES, IN CLASS 42 (U.S. CLS. 100 AND 101).

FIRST USE 10-31-2008; IN COMMERCE 10-31-2008.

NO CLAIM IS MADE TO THE EXCLUSIVE RIGHT TO USE "GROUP", APART FROM THE MARK AS SHOWN.

SN 77-455,899, FILED 4-23-2008.

JORDAN BAKER, EXAMINING ATTORNEY

**Int. Cl.: 32**

**Prior U.S. Cls.: 45, 46, and 48**

**United States Patent and Trademark Office**

**Reg. No. 3,570,751**

**Registered Feb. 3, 2009**

**TRADEMARK  
PRINCIPAL REGISTER**

**IF IT'S NOT WHET IT'S NOT  
WATER**

ENTREPRENEURIAL VENTURES CAPITAL CO  
LLC (PENNSYLVANIA LIMITED LIABILITY  
COMPANY)  
SUITE 1212  
429 FORBES AVENUE  
PITTSBURGH, PA 15219

FOR: BOTTLED DRINKING WATER; BOTTLED  
WATER; DRINKING WATER; SPRING WATER;  
TABLE WATER, IN CLASS 32 (U.S. CLS. 45, 46 AND  
48).

FIRST USE 8-21-2008; IN COMMERCE 8-21-2008.

THE MARK CONSISTS OF STANDARD CHAR-  
ACTERS WITHOUT CLAIM TO ANY PARTICULAR  
FONT, STYLE, SIZE, OR COLOR.

SN 77-456,436, FILED 4-23-2008.

KATINA MISTER, EXAMINING ATTORNEY

**Int. Cl.: 32**

**Prior U.S. Cls.: 45, 46, and 48**

**United States Patent and Trademark Office**

**Reg. No. 3,570,752**

**Registered Feb. 3, 2009**

**TRADEMARK  
PRINCIPAL REGISTER**

**YOU'RE THIRSTY. IT'S WHET.**

ENTREPRENEURIAL VENTURES CAPITAL CO  
LLC (PENNSYLVANIA LIMITED LIABILITY  
COMPANY)  
SUITE 1212  
429 FORBES AVENUE  
PITTSBURGH, PA 15219

FOR: BOTTLED DRINKING WATER; BOTTLED  
WATER; DRINKING WATER; SPRING WATER;  
TABLE WATER, IN CLASS 32 (U.S. CLS. 45, 46 AND  
48).

FIRST USE 8-21-2008; IN COMMERCE 8-21-2008.

THE MARK CONSISTS OF STANDARD CHAR-  
ACTERS WITHOUT CLAIM TO ANY PARTICULAR  
FONT, STYLE, SIZE, OR COLOR.

SN 77-456,438, FILED 4-23-2008.

KATINA MISTER, EXAMINING ATTORNEY



**Int. Cl.: 25**

**Prior U.S. Cls.: 22 and 39**

**United States Patent and Trademark Office**

**Reg. No. 3,570,753**

**Registered Feb. 3, 2009**

**TRADEMARK  
PRINCIPAL REGISTER**

**TOVO**

DANIEL, SAYO ISAAC (UNITED STATES INDIVIDUAL)  
848 BRICKELL KEY DRIVE, #3904  
MIAMI, FL 33131

THE MARK CONSISTS OF STANDARD CHARACTERS WITHOUT CLAIM TO ANY PARTICULAR FONT, STYLE, SIZE, OR COLOR.

FOR: SHOES, FOOTWEAR, T-SHIRTS, SPORTS SHIRTS, SPORTS JERSEYS, SPORTS JACKETS, SPORTS PANTS, TRACK PANTS, SPORTS FLEECE PULLOVERS, IN CLASS 25 (U.S. CLS. 22 AND 39).

SN 77-460,185, FILED 4-28-2008.

FIRST USE 3-31-2008; IN COMMERCE 3-31-2008.

DOUGLAS LEE, EXAMINING ATTORNEY

**Int. Cl.: 21**

**Prior U.S. Cls.: 2, 13, 23, 29, 30, 33, 40, and 50**

**Reg. No. 3,570,754**

**United States Patent and Trademark Office**

**Registered Feb. 3, 2009**

**TRADEMARK  
PRINCIPAL REGISTER**

**HERB 'N ICE**

AEROGROW INTERNATIONAL, INC. (NEVADA  
CORPORATION)

6075 LONGBOW DRIVE SUITE 200

BOULDER, CO 80301

FOR: ICE CUBE MOLDS, IN CLASS 21 (U.S. CLS. 2,  
13, 23, 29, 30, 33, 40 AND 50).

FIRST USE 5-16-2008; IN COMMERCE 11-12-2008.

THE MARK CONSISTS OF STANDARD CHAR-  
ACTERS WITHOUT CLAIM TO ANY PARTICULAR  
FONT, STYLE, SIZE, OR COLOR.

NO CLAIM IS MADE TO THE EXCLUSIVE  
RIGHT TO USE "ICE", APART FROM THE MARK  
AS SHOWN.

SN 77-476,610, FILED 5-16-2008.

STEVEN JACKSON, EXAMINING ATTORNEY

**Int. Cl.: 10**

**Prior U.S. Cls.: 26, 39, and 44**

**United States Patent and Trademark Office**

**Reg. No. 3,570,755**

**Registered Feb. 3, 2009**

**TRADEMARK  
PRINCIPAL REGISTER**

**CYCLONE**

NORTH AMERICAN RESCUE PRODUCTS, INC.  
(DELAWARE CORPORATION), DBA NORTH  
AMERICAN RESCUE,  
35 TEDWALL CT.  
GREER, SC 29650

THE MARK CONSISTS OF STANDARD CHAR-  
ACTERS WITHOUT CLAIM TO ANY PARTICULAR  
FONT, STYLE, SIZE, OR COLOR.

FOR: BAG-VALVE-MASK RESUSCITATOR, IN  
CLASS 10 (U.S. CLS. 26, 39 AND 44).

SN 77-480,338, FILED 5-21-2008.

FIRST USE 6-1-2008; IN COMMERCE 6-1-2008.

RENEE SERVANCE, EXAMINING ATTORNEY

**Int. Cl.: 10**

**Prior U.S. Cls.: 26, 39, and 44**

**United States Patent and Trademark Office**

**Reg. No. 3,570,756**

**Registered Feb. 3, 2009**

**TRADEMARK  
PRINCIPAL REGISTER**

**ARS**

NORTH AMERICAN RESCUE PRODUCTS, INC.  
(DELAWARE CORPORATION), DBA NORTH  
AMERICAN RESCUE,  
35 TEDWALL CT.  
GREER, SC 29650

THE MARK CONSISTS OF STANDARD CHAR-  
ACTERS WITHOUT CLAIM TO ANY PARTICULAR  
FONT, STYLE, SIZE, OR COLOR.

FOR: NEEDLES FOR MEDICAL PURPOSES, IN  
CLASS 10 (U.S. CLS. 26, 39 AND 44).

SN 77-482,092, FILED 5-23-2008.

FIRST USE 7-1-2008; IN COMMERCE 7-1-2008.

RENEE SERVANCE, EXAMINING ATTORNEY

**Int. Cl.: 28**

**Prior U.S. Cls.: 22, 23, 38, and 50**

**United States Patent and Trademark Office**

**Reg. No. 3,570,757**

**Registered Feb. 3, 2009**

**TRADEMARK  
PRINCIPAL REGISTER**

**PET 'N' PLAY PALZ**

ZIZZLE, LLC (DELAWARE LIMITED LIABILITY  
COMPANY)  
1500 SOUTH LAKESIDE DRIVE  
BANNOCKBURN, IL 60015

FOR: HAND HELD UNIT FOR PLAYING ELEC-  
TRONIC GAMES; HAND-HELD GAMES WITH LI-  
QUID CRYSTAL DISPLAYS; TOY, NAMELY,  
BATTERY-POWERED COMPUTER GAME WITH  
LCD SCREEN WHICH FEATURES ANIMATION  
AND SOUND EFFECTS, IN CLASS 28 (U.S. CLS. 22,  
23, 38 AND 50).

FIRST USE 11-10-2008; IN COMMERCE 11-10-2008.

THE MARK CONSISTS OF STANDARD CHAR-  
ACTERS WITHOUT CLAIM TO ANY PARTICULAR  
FONT, STYLE, SIZE, OR COLOR.

SN 77-482,863, FILED 5-23-2008.

TEJBIR SINGH, EXAMINING ATTORNEY

**Int. Cl.: 3**

**Prior U.S. Cls.: 1, 4, 6, 50, 51, and 52**

**United States Patent and Trademark Office**

**Reg. No. 3,570,758**

**Registered Feb. 3, 2009**

**TRADEMARK  
PRINCIPAL REGISTER**



VIDAL, GLORIA L. (VENEZUELA INDIVIDUAL)  
522 CALLIPPE CT.  
BRISBANE, CA 94005

FOR: COSMETIC CREAMS FOR SKIN CARE;  
FACIAL CREAMS, IN CLASS 3 (U.S. CLS. 1, 4, 6, 50,  
51 AND 52).

FIRST USE 1-1-2005; IN COMMERCE 1-1-2005.

THE COLOR(S) GREEN, PASTEL GREEN IS/ARE  
CLAIMED AS A FEATURE OF THE MARK.

THE MARK CONSISTS OF THE WORD "BELLA",  
THE NUMBER "13" AND THE UNDERLINE IN  
GREEN, AND THE OVAL IN PASTEL GREEN. THE  
NUMBER "13" AND A PART OF THE UNDERLINE  
ARE INSIDE THE OVAL.

THE FOREIGN WORDING IN THE MARK  
TRANSLATES INTO ENGLISH AS BEAUTIFUL.

SN 77-975,256, FILED 8-17-2007.

JEFF DEFORD, EXAMINING ATTORNEY

**Int. Cls.: 25 and 28**

**Prior U.S. Cls.: 22, 23, 38, 39, and 50**

**United States Patent and Trademark Office**

**Reg. No. 3,570,759**

**Registered Feb. 3, 2009**

**TRADEMARK  
PRINCIPAL REGISTER**

**BUMMER HIGH**

BURWELL, SCOTT (UNITED STATES INDIVIDUAL)  
226 WOODCREST LANE  
ALISO VIEJO, CA 92656

FOR: T-SHIRTS; SWEAT SHIRTS; HATS, IN CLASS 25 (U.S. CLS. 22 AND 39).

FIRST USE 5-12-2008; IN COMMERCE 5-12-2008.

FOR: BALL BEARINGS FOR SKATEBOARDS; NUTS AND BOLTS FOR SKATEBOARDS; SKATEBOARD DECKS; SKATEBOARD GRIP TAPES; SKATEBOARD RAILS; SKATEBOARD RISER PADS;

SKATEBOARD TRUCKS; SKATEBOARD WHEELS; SKATEBOARDS, IN CLASS 28 (U.S. CLS. 22, 23, 38 AND 50).

FIRST USE 5-12-2008; IN COMMERCE 5-12-2008.

THE MARK CONSISTS OF STANDARD CHARACTERS WITHOUT CLAIM TO ANY PARTICULAR FONT, STYLE, SIZE, OR COLOR.

SN 77-975,622, FILED 7-17-2007.

JAY FLOWERS, EXAMINING ATTORNEY

**Int. Cls.: 5 and 42**

**Prior U.S. Cls.: 6, 18, 44, 46, 51, 52, 100, and 101**

**United States Patent and Trademark Office**

**Reg. No. 3,570,760**

**Registered Feb. 3, 2009**

**TRADEMARK  
SERVICE MARK  
PRINCIPAL REGISTER**

**COLDSTREAM LABORATORIES  
INC.**

COLDSTREAM LABORATORIES INC. (KENTUCKY CORPORATION)  
1500 BULL LEA RD., STE. 250  
LEXINGTON, KY 40511

FOR: PHARMACEUTICAL PREPARATIONS FOR USE IN DERMATOLOGY, ONCOLOGY AND OPHTHALMOLOGY; PHARMACEUTICAL PREPARATIONS FOR USE IN CHEMOTHERAPY, IN CLASS 5 (U.S. CLS. 6, 18, 44, 46, 51 AND 52).

FIRST USE 7-9-2007; IN COMMERCE 7-9-2007.

FOR: RESEARCH AND DEVELOPMENT IN THE FIELD OF PHARMACEUTICALS, IN CLASS 42 (U.S. CLS. 100 AND 101).

FIRST USE 5-6-2007; IN COMMERCE 5-6-2007.

THE MARK CONSISTS OF STANDARD CHARACTERS WITHOUT CLAIM TO ANY PARTICULAR FONT, STYLE, SIZE, OR COLOR.

NO CLAIM IS MADE TO THE EXCLUSIVE RIGHT TO USE "LABORATORIES INC.", APART FROM THE MARK AS SHOWN.

SN 77-976,237, FILED 3-27-2007.

DEZMONA MIZELLE, EXAMINING ATTORNEY



**Int. Cls.: 18 and 25**

**Prior U.S. Cls.: 1, 2, 3, 22, 39, and 41**

**United States Patent and Trademark Office**

**Reg. No. 3,570,761**

**Registered Feb. 3, 2009**

**TRADEMARK  
PRINCIPAL REGISTER**

# MILES TO GO

ROBERT LEWIS PORTER, JR. (UNITED STATES  
INDIVIDUAL)

5129 7TH COURT SOUTH

BIRMINGHAM, AL 35212

FOR: LUGGAGE; LUGGAGE TAGS; ALL PURPOSE SPORT BAGS; CARRY-ALL BAGS; TRAVEL BAGS; WHEELED TOTE BAGS, IN CLASS 18 (U.S. CLS. 1, 2, 3, 22 AND 41).

FIRST USE 11-3-2008; IN COMMERCE 11-3-2008.

FOR: COATS; FOOTWEAR; GLOVES; HEADWEAR; NECKWEAR; PANTS; SHIRTS; SHORTS; SKIRTS, IN CLASS 25 (U.S. CLS. 22 AND 39).

FIRST USE 11-3-2008; IN COMMERCE 11-3-2008.

THE MARK CONSISTS OF STANDARD CHARACTERS WITHOUT CLAIM TO ANY PARTICULAR FONT, STYLE, SIZE, OR COLOR.

SN 77-976,272, FILED 9-11-2007.

ELLEN BURNS, EXAMINING ATTORNEY

**Int. Cl.: 5**

**Prior U.S. Cls.: 6, 18, 44, 46, 51, and 52**

**Reg. No. 3,570,762**

**United States Patent and Trademark Office**

**Registered Feb. 3, 2009**

---

**TRADEMARK  
PRINCIPAL REGISTER**

**NUFIX**

NUFIX, INC. (ALABAMA CORPORATION)  
174 OXMOOR ROAD  
BIRMINGHAM, AL 35209

FIRST USE 3-1-2007; IN COMMERCE 3-1-2007.

FOR: SURGICAL IMPLANTS COMPRISING AL-  
LOGRAFT OR OTHER PROCESSED HUMAN OR  
ANIMAL TISSUE AND ASSOCIATED SURGICAL  
INSTRUMENT SETS, IN CLASS 5 (U.S. CLS. 6, 18, 44,  
46, 51 AND 52).

THE MARK CONSISTS OF STANDARD CHAR-  
ACTERS WITHOUT CLAIM TO ANY PARTICULAR  
FONT, STYLE, SIZE, OR COLOR.

SN 77-976,311, FILED 2-6-2008.

MARY CRAWFORD, EXAMINING ATTORNEY

**Int. Cl.: 36**

**Prior U.S. Cls.: 100, 101, and 102**

**United States Patent and Trademark Office**

**Reg. No. 3,570,763**

**Registered Feb. 3, 2009**

**SERVICE MARK  
PRINCIPAL REGISTER**

**THE OPTIONS PLAYBOOK**

KANE REID SECURITIES GROUP, INC. (DELA-  
WARE CORPORATION)  
5455 NORTH FEDERAL HIGHWAY, SUITE E  
BOCA RATON, FL 33487

FOR: FINANCIAL CONSULTING SERVICES IN  
THE FIELD OF INVESTMENTS AND TRADING  
STRATEGIES, IN CLASS 36 (U.S. CLS. 100, 101 AND  
102).

FIRST USE 8-0-2007; IN COMMERCE 8-0-2007.

THE MARK CONSISTS OF STANDARD CHAR-  
ACTERS WITHOUT CLAIM TO ANY PARTICULAR  
FONT, STYLE, SIZE, OR COLOR.

NO CLAIM IS MADE TO THE EXCLUSIVE  
RIGHT TO USE "OPTIONS", APART FROM THE  
MARK AS SHOWN.

SN 77-976,313, FILED 6-8-2007.

LESLEY LAMOTHE, EXAMINING ATTORNEY

**Int. Cl.: 35**

**Prior U.S. Cls.: 100, 101, and 102**

**United States Patent and Trademark Office**

**Reg. No. 3,570,764**

**Registered Feb. 3, 2009**

**SERVICE MARK  
PRINCIPAL REGISTER**

**NEW CONVERSATIONS**

THE SAINT PAUL FOUNDATION, INCORPORATED (MINNESOTA NON-PROFIT CORPORATION)  
SUITE 600  
55 FIFTH STREET  
ST. PAUL, MN 55101

FOR: PROMOTING AWARENESS OF RACISM AND THE PREVENTION AND ELIMINATION OF RACISM, AND DISTRIBUTING PRINTED MATERIALS IN CONNECTION THEREWITH, IN CLASS 35 (U.S. CLS. 100, 101 AND 102).

FIRST USE 2-7-2006; IN COMMERCE 2-7-2006.

THE MARK CONSISTS OF STANDARD CHARACTERS WITHOUT CLAIM TO ANY PARTICULAR FONT, STYLE, SIZE, OR COLOR.

SN 77-976,320, FILED 2-14-2007.

ALICE SUE CARRUTHERS, EXAMINING ATTORNEY

**Int. Cl.: 41**

**Prior U.S. Cls.: 100, 101, and 107**

**United States Patent and Trademark Office**

**Reg. No. 3,570,765**

**Registered Feb. 3, 2009**

**SERVICE MARK  
PRINCIPAL REGISTER**

**TELL IT TO YOUR FACE**

TELL IT TO YOUR FACE LLC (WYOMING  
LIMITED LIABILITY COMPANY)  
P.O. BOX 5642  
SOUTH SAN FRANCISCO, CA 94080

FOR: CONDUCTING WORKSHOPS AND SEMI-  
NARS IN PERSONAL AND SPIRITUAL GROWTH  
AND SELF-AWARENESS, IN CLASS 41 (U.S. CLS.  
100, 101 AND 107).

FIRST USE 8-23-2008; IN COMMERCE 8-23-2008.

THE MARK CONSISTS OF STANDARD CHAR-  
ACTERS WITHOUT CLAIM TO ANY PARTICULAR  
FONT, STYLE, SIZE, OR COLOR.

SN 77-976,372, FILED 9-20-2007.

ALEXANDER L. POWERS, EXAMINING ATTOR-  
NEY

**Int. Cl.: 12**

**Prior U.S. Cls.: 19, 21, 23, 31, 35, and 44**

**United States Patent and Trademark Office**

**Reg. No. 3,570,766**

**Registered Feb. 3, 2009**

**TRADEMARK  
PRINCIPAL REGISTER**

**DING DEFENSE**

CANO, LARRY R. (UNITED STATES INDIVIDUAL)  
92 HARTFORD DRIVE  
NEWPORT BEACH, CA 92660

FOR: REMOVABLE, MAGNETIZED, COMPATIBLE, PLASTIC, PROTECTIVE VEHICLE SIDE MOLDING, IN CLASS 12 (U.S. CLS. 19, 21, 23, 31, 35 AND 44).

FIRST USE 12-5-2008; IN COMMERCE 12-5-2008.

SN 78-174,293, FILED 10-14-2002.

KIMBERLY FRYE, EXAMINING ATTORNEY

**Int. Cl.: 25**

**Prior U.S. Cls.: 22 and 39**

**United States Patent and Trademark Office**

**Reg. No. 3,570,767**

**Registered Feb. 3, 2009**

**TRADEMARK  
PRINCIPAL REGISTER**

**TURN BACK THE CLOCK**

MAJOR LEAGUE BASEBALL PROPERTIES, INC.  
(NEW YORK CORPORATION)  
245 PARK AVENUE  
NEW YORK, NY 10167

FIRST USE 8-19-2006; IN COMMERCE 8-19-2006.

SN 78-184,291, FILED 11-12-2002.

FOR: CLOTHING, NAMELY, SHIRTS, T-SHIRTS,  
BASEBALL UNIFORMS, JERSEYS, IN CLASS 25  
(U.S. CLS. 22 AND 39).

BERYL GARDNER, EXAMINING ATTORNEY

**Int. Cl.: 28**

**Prior U.S. Cls.: 22, 23, 38, and 50**

**United States Patent and Trademark Office**

**Reg. No. 3,570,768**

**Registered Feb. 3, 2009**

**TRADEMARK  
PRINCIPAL REGISTER**



SCAPEQUEST PTY LTD (AUSTRALIA CORPORATION)  
1/47 MUSGRAVE ROAD, COOPER PLAINS  
QUEENSLAND 4108, AUSTRALIA

FOR: LASER SKIRMISH SPORTING EQUIPMENT, NAMELY TOY WEAPONS AND LASER WEAPONS WHICH EMIT AND/OR DETECT AND RECORD AND RECEIVE INFRA-RED BEAMS, NAMELY, AUTOMATIC AND SEMI-AUTOMATIC PISTOLS, RIFLES, MINES AND ROCKET PROPELLED GRENADES AND PARTS THEREFOR, NAMELY KITS COMPRISED OF SPARE ELECTRONIC PARTS AND ACCESSORIES THEREFOR, NAMELY GUN AND RIFLE SCOPES, RIFLE SLINGS, CARRYING CASES, SOUND CHIPS, AND BATTERIES AND BATTERY CHARGERS, SOLD AS A UNIT WITH THE LASER SKIRMISH SPORTING EQUIPMENT, IN CLASS 28 (U.S. CLS. 22, 23, 38 AND 50).

FIRST USE 4-15-2002; IN COMMERCE 4-15-2002.

PRIORITY CLAIMED UNDER SEC. 44(D) ON AUSTRALIA APPLICATION NO. 912556, FILED 2-28-2003.

NO CLAIM IS MADE TO THE EXCLUSIVE RIGHT TO USE "SPORTS.COM", APART FROM THE MARK AS SHOWN.

THE MARK CONSISTS OF OCTAGONAL TAG WITH THE WORDS "BATTLEFIELD SPORTS.-COM".

SN 78-257,916, FILED 6-3-2003.

ELLEN B. AWRICH, EXAMINING ATTORNEY



**Int. Cl.: 25**

**Prior U.S. Cls.: 22 and 39**

**United States Patent and Trademark Office**

**Reg. No. 3,570,769**

**Registered Feb. 3, 2009**

**TRADEMARK  
PRINCIPAL REGISTER**

**KICKFLIP**

RAJAN IMPORTS LIMITED (UNITED KING-  
DOM CORPORATION)  
61 GREAT DUCIE STREET  
MANCHESTER, UNITED KINGDOM M3 1RR

FIRST USE 0-0-2002; IN COMMERCE 7-0-2007.

SN 78-258,921, FILED 6-5-2003.

FOR: ARTICLES OF CLOTHING, NAMELY,  
JACKETS, IN CLASS 25 (U.S. CLS. 22 AND 39).

DEZMONA MIZELLE, EXAMINING ATTORNEY

**Int. Cl.: 32**

**Prior U.S. Cls.: 45, 46, and 48**

**United States Patent and Trademark Office**

**Reg. No. 3,570,770**

**Registered Feb. 3, 2009**

**TRADEMARK  
PRINCIPAL REGISTER**

**SONNY'S**

FALCON FOOD DISTRIBUTORS INC. (NEW  
YORK CORPORATION)  
2 COLONY ROAD  
JERSEY CITY, NJ 07305

THE MARK CONSISTS OF STANDARD CHAR-  
ACTERS WITHOUT CLAIM TO ANY PARTICULAR  
FONT, STYLE, SIZE, OR COLOR.

FOR: POWDERED MIXTURES FOR THE PRE-  
PARATION OF SOFT DRINKS, IN CLASS 32 (U.S.  
CLS. 45, 46 AND 48).

SN 78-355,724, FILED 1-22-2004.

FIRST USE 6-1-2004; IN COMMERCE 6-1-2004.

REBECCA SMITH, EXAMINING ATTORNEY

**Int. Cl.: 9**

**Prior U.S. Cls.: 21, 23, 26, 36, and 38**

**United States Patent and Trademark Office**

**Reg. No. 3,570,771**

**Registered Feb. 3, 2009**

**TRADEMARK  
PRINCIPAL REGISTER**

**IDPOS**

DRESSER, INC. (DELAWARE CORPORATION)  
11TH FLOOR, MILLENNIUM 1  
15455 DALLAS PARKWAY  
ADDISON, TX 75001

FOR: FUEL DISPENSERS FOR SERVICE STATIONS; FUEL DISPENSING SYSTEMS COMPRISED OF COMPUTER HARDWARE AND SOFTWARE FOR CONTROLLING AND MONITORING FUEL DISPENSERS, CREDIT, DEBIT AND SMART CARD PROCESSING, ELECTRONIC CASH REGISTERS, VIDEO SECURITY CAMERAS, CAR WASH MA-

CHINERY AND UNDERGROUND TANK MONITORING, IN CLASS 9 (U.S. CLS. 21, 23, 26, 36 AND 38).

FIRST USE 11-14-2008; IN COMMERCE 11-14-2008.

THE MARK CONSISTS OF STANDARD CHARACTERS WITHOUT CLAIM TO ANY PARTICULAR FONT, STYLE, SIZE, OR COLOR.

SN 78-379,375, FILED 3-5-2004.

JEFF DEFORD, EXAMINING ATTORNEY

**Int. Cl.: 41**

**Prior U.S. Cls.: 100, 101, and 107**

**United States Patent and Trademark Office**

**Reg. No. 3,570,772**

**Registered Feb. 3, 2009**

**SERVICE MARK  
PRINCIPAL REGISTER**

**WORLD SERIES OF  
TRADING**

TREND FUND, LLC (NEW YORK LIMITED  
LIABILITY COMPANY)

20 RIVER TERRACE

#8M

NEW YORK, NY 10282

FOR: ENTERTAINMENT SERVICES, NAMELY,  
AN ONLINE FANTASY STOCK TRADING GAME,  
IN CLASS 41 (U.S. CLS. 100, 101 AND 107).

FIRST USE 11-25-2008; IN COMMERCE 11-25-2008.

THE MARK CONSISTS OF STANDARD CHAR-  
ACTERS WITHOUT CLAIM TO ANY PARTICULAR  
FONT, STYLE, SIZE, OR COLOR.

NO CLAIM IS MADE TO THE EXCLUSIVE  
RIGHT TO USE "TRADING", APART FROM THE  
MARK AS SHOWN.

SN 78-399,043, FILED 4-8-2004.

WILLIAM BRECKENFELD, EXAMINING ATTOR-  
NEY

**Int. Cl.: 3**

**Prior U.S. Cls.: 1, 4, 6, 50, 51, and 52**

**United States Patent and Trademark Office**

**Reg. No. 3,570,773**

**Registered Feb. 3, 2009**

**TRADEMARK  
PRINCIPAL REGISTER**

**FASHION CHIC**

TUPPERWARE PRODUCTS S.A. (SWITZERLAND  
CORPORATION)  
ROUTE DU JURA 37  
FRIBOURG, SWITZERLAND CH-1700

FOR: PERFUMERY, FRAGRANCES FOR PERSONAL USE, IN CLASS 3 (U.S. CLS. 1, 4, 6, 50, 51 AND 52).

FIRST USE 6-14-2008; IN COMMERCE 6-14-2008.

THE MARK CONSISTS OF STANDARD CHARACTERS WITHOUT CLAIM TO ANY PARTICULAR FONT, STYLE, SIZE, OR COLOR.

SN 78-436,365, FILED 6-16-2004.

GEOFFREY FOSDICK, EXAMINING ATTORNEY

**Int. Cl.: 36**

**Prior U.S. Cls.: 100, 101, and 102**

**United States Patent and Trademark Office**

**Reg. No. 3,570,774**

**Registered Feb. 3, 2009**

**SERVICE MARK  
PRINCIPAL REGISTER**



MILEMETER, INC. (DELAWARE CORPORATION)  
1700 PACIFIC AVENUE, SUITE 2400  
DALLAS, TX 75201

FOR: INSURANCE UNDERWRITING AND BROKERAGE IN THE FIELD OF ACCIDENT INSURANCE FOR VEHICLES; INSURANCE UNDERWRITING AND BROKERAGE OF DIRECT SALES INSURANCE IN THE FIELD OF ACCIDENT INSURANCE FOR VEHICLES, IN CLASS 36 (U.S. CLS. 100, 101 AND 102).

FIRST USE 10-31-2008; IN COMMERCE 10-31-2008.

THE MARK CONSISTS OF THE WORD MARK "MILEMETER" IN A STYLIZED FORMAT WITH EACH INDIVIDUAL CHARACTER BEING PLACED IN A RECTANGLE.

SN 78-446,424, FILED 7-6-2004.

INGA ERVIN, EXAMINING ATTORNEY

**Int. Cls.: 3, 5, 35, and 44**

**Prior U.S. Cls.: 1, 4, 6, 18, 44, 46, 50, 51, 52, 100, 101,  
and 102**

**Reg. No. 3,570,775**

**Registered Feb. 3, 2009**

**United States Patent and Trademark Office**

---

**TRADEMARK  
SERVICE MARK  
PRINCIPAL REGISTER**

**SURACELL**

SURACELL INC. (DELAWARE CORPORATION)  
87 VALLEY ROAD  
MONTCLAIR, NJ 07042

FOR: COSMETICS; SKIN CLEANSERS; FACIAL  
LOTIONS; BODY LOTIONS; BATHING LOTIONS,  
IN CLASS 3 (U.S. CLS. 1, 4, 6, 50, 51 AND 52).

FIRST USE 11-30-2006; IN COMMERCE 11-30-2006.

FOR: PHARMACEUTICAL SKIN LOTIONS;  
DIETARY AND NUTRITIONAL SUPPLEMENTS;  
VITAMINS, IN CLASS 5 (U.S. CLS. 6, 18, 44, 46, 51  
AND 52).

FIRST USE 12-31-2004; IN COMMERCE 12-31-2004.

FOR: DISTRIBUTORSHIP, RETAIL AND ONLINE  
RETAIL STORE SERVICES FEATURING COSMET-

ICS, SKIN CLEANSERS, LOTIONS, DIETARY AND  
NUTRITIONAL SUPPLEMENTS AND VITAMINS,  
IN CLASS 35 (U.S. CLS. 100, 101 AND 102).

FIRST USE 12-31-2004; IN COMMERCE 12-31-2004.

FOR: DIETARY AND NUTRITIONAL COUNSEL-  
ING; MEDICAL TESTING AND MEDICAL COUN-  
SELING, IN CLASS 44 (U.S. CLS. 100 AND 101).

FIRST USE 12-31-2004; IN COMMERCE 12-31-2004.

THE MARK CONSISTS OF STANDARD CHAR-  
ACTERS WITHOUT CLAIM TO ANY PARTICULAR  
FONT, STYLE, SIZE, OR COLOR.

SN 78-480,968, FILED 9-9-2004.

BRENDAN MCCAULEY, EXAMINING ATTORNEY

**Int. Cls.: 2 and 5**

**Prior U.S. Cls.: 6, 11, 16, 18, 44, 46, 51, and 52**

**United States Patent and Trademark Office**

**Reg. No. 3,570,776**

**Registered Feb. 3, 2009**

**TRADEMARK  
PRINCIPAL REGISTER**

**BIOLUT**

BIOLUT S.A. DE C.V. (MEXICO CORPORATION)  
PASEO DE CELAYA NO. 14  
COL. JARDINES DE CELAYA 1A SECCIONCE-  
LAYACELAYA  
GUANAJUATO, MEXICO 38080

FOR: COLORANTS FOR USE IN THE MANU-  
FACTURE OF BEVERAGES, IN CLASS 2 (U.S. CLS. 6,  
11 AND 16).

FIRST USE 0-0-2006; IN COMMERCE 8-1-2003.

FOR: DIETARY SUPPLEMENTS, IN PILL OR  
LIQUID FORM; AND DIETARY SUPPLEMENTS

AS AN ADDITIVE TO FOOD PRODUCTS, IN CLASS  
5 (U.S. CLS. 6, 18, 44, 46, 51 AND 52).

FIRST USE 0-0-2006; IN COMMERCE 8-1-2003.

THE MARK CONSISTS OF STANDARD CHAR-  
ACTERS WITHOUT CLAIM TO ANY PARTICULAR  
FONT, STYLE, SIZE, OR COLOR.

SN 78-489,337, FILED 9-24-2004.

EVELYN BRADLEY, EXAMINING ATTORNEY



**Int. Cls.: 35 and 36**

**Prior U.S. Cls.: 100, 101, and 102**

**United States Patent and Trademark Office**

**Reg. No. 3,570,777**

**Registered Feb. 3, 2009**

**SERVICE MARK  
PRINCIPAL REGISTER**

**REAL ESTATE AROUND  
THE WORLD**

THE REAL ESTATE SHOW.TV LLC (INDIANA LIMITED LIABILITY COMPANY)  
300 S. MADISON AVE., SUITE 401  
GREENWOOD, IN 46142

FOR: REAL ESTATE MARKETING, ADVERTISING AND PROMOTING; PROVIDING ADVERTISING AND COMMERCIAL INFORMATION RELATING TO SERVICES OF THIRD PARTIES PERTAINING TO REAL ESTATE TRANSACTIONS, NAMELY, TRANSMISSION OF ADVERTISING MATERIAL AND DISSEMINATION OF ADVERTISING MESSAGES VIA A GLOBAL COMPUTER NETWORK; OPERATING ON-LINE MARKETPLACES FOR BUYERS AND SELLERS OF REAL ESTATE, IN CLASS 35 (U.S. CLS. 100, 101 AND 102).

FIRST USE 5-31-2008; IN COMMERCE 5-31-2008.

FOR: REAL ESTATE SERVICES, NAMELY, REAL ESTATE MANAGEMENT SERVICES, REAL ESTATE APPRAISAL SERVICES, REAL ESTATE BROKERAGE SERVICES, REAL ESTATE CONSULTATION, REAL ESTATE LISTING SERVICES, REAL

ESTATE ACQUISITION SERVICES, REAL ESTATE LEASING SERVICES, REAL ESTATE ESCROW SERVICES, REAL ESTATE INVESTMENT SERVICES, OPERATING PHYSICAL MARKETPLACES FOR BUYERS AND SELLERS OF REAL ESTATE, PROVIDING INFORMATION TO THE PUBLIC IN THE FIELD OF REAL ESTATE BY MEANS OF A GLOBAL COMPUTER NETWORK, IN CLASS 36 (U.S. CLS. 100, 101 AND 102).

FIRST USE 5-31-2008; IN COMMERCE 5-31-2008.

THE MARK CONSISTS OF STANDARD CHARACTERS WITHOUT CLAIM TO ANY PARTICULAR FONT, STYLE, SIZE, OR COLOR.

NO CLAIM IS MADE TO THE EXCLUSIVE RIGHT TO USE "REAL ESTATE", APART FROM THE MARK AS SHOWN.

SN 78-494,148, FILED 10-4-2004.

H. M. FISHER, EXAMINING ATTORNEY

**Int. Cl.: 25**

**Prior U.S. Cls.: 22 and 39**

**United States Patent and Trademark Office**

**Reg. No. 3,570,778**

**Registered Feb. 3, 2009**

---

**TRADEMARK  
PRINCIPAL REGISTER**

**OAK ICE**

COLUMBIA INSURANCE COMPANY (NEBRASKA CORPORATION)  
3024 HARNEY STREET  
OMAHA, NE 68131

THE MARK CONSISTS OF STANDARD CHARACTERS WITHOUT CLAIM TO ANY PARTICULAR FONT, STYLE, SIZE, OR COLOR.

FOR: FOOTWEAR, IN CLASS 25 (U.S. CLS. 22 AND 39).

SN 78-498,924, FILED 10-13-2004.

FIRST USE 6-0-2006; IN COMMERCE 6-0-2006.

RICHARD A. STRASER, EXAMINING ATTORNEY

**Int. Cl.: 9**

**Prior U.S. Cls.: 21, 23, 26, 36, and 38**

**Reg. No. 3,570,779**

**United States Patent and Trademark Office**

**Registered Feb. 3, 2009**

**TRADEMARK  
PRINCIPAL REGISTER**



SUN MICROSYSTEMS, INC. (DELAWARE CORPORATION)  
4150 NETWORK CIRCLE  
SANTA CLARA, CA 95054

FOR: COMPUTER OPERATING SYSTEMS; COMPUTER PROGRAMS FOR USE IN COMPUTER NETWORKING; COMPUTER PROGRAMS FOR USE IN COMPUTER SECURITY; COMPUTER OPERATING SYSTEM PROGRAMS; DOWNLOADABLE ELECTRONIC PUBLICATIONS IN THE FIELDS OF COMPUTING, COMPUTER NETWORK-

ING, AND INFORMATION TECHNOLOGY, IN CLASS 9 (U.S. CLS. 21, 23, 26, 36 AND 38).

FIRST USE 10-30-2008; IN COMMERCE 10-30-2008.

OWNER OF U.S. REG. NOS. 1,648,740, 2,778,104, AND OTHERS.

SN 78-507,734, FILED 10-28-2004.

JEFF DEFORD, EXAMINING ATTORNEY

**Int. Cl.: 10**

**Prior U.S. Cls.: 26, 39, and 44**

**United States Patent and Trademark Office**

**Reg. No. 3,570,780**

**Registered Feb. 3, 2009**

**TRADEMARK  
PRINCIPAL REGISTER**

**IPOSTURE**

SCHNAPP, MOACIR (UNITED STATES INDIVIDUAL)  
55 HUMPHREYS BLVD. SUITE 200  
MEMPHIS, TN 38120

FOR: SPINAL ORIENTATION MONITOR FOR MEASURING, RECORDING AND SIGNALING DEVIATION OF THE SPINE FROM AN ANATOMICAL NORM, IN CLASS 10 (U.S. CLS. 26, 39 AND 44).

FIRST USE 11-8-2008; IN COMMERCE 11-8-2008.

THE MARK CONSISTS OF STANDARD CHARACTERS WITHOUT CLAIM TO ANY PARTICULAR FONT, STYLE, SIZE, OR COLOR.

SN 78-516,997, FILED 11-15-2004.

G. MAYERSCHOFF, EXAMINING ATTORNEY

**Int. Cl.: 5**

**Prior U.S. Cls.: 6, 18, 44, 46, 51, and 52**

**Reg. No. 3,570,781**

**United States Patent and Trademark Office**

**Registered Feb. 3, 2009**

---

**TRADEMARK  
PRINCIPAL REGISTER**

**NAPALM**

FIZOGEN PRECISION TECHNOLOGIES (FLOR-  
IDA CORPORATION)  
3133 FORTUNE WAY #4  
WELLINGTON, FL 33414

THE MARK CONSISTS OF STANDARD CHAR-  
ACTERS WITHOUT CLAIM TO ANY PARTICULAR  
FONT, STYLE, SIZE, OR COLOR.

FOR: DIETARY SUPPLEMENTS, IN CLASS 5 (U.S.  
CLS. 6, 18, 44, 46, 51 AND 52).

SN 78-527,025, FILED 12-3-2004.

FIRST USE 11-15-2008; IN COMMERCE 11-15-2008.

TRACY CROSS, EXAMINING ATTORNEY

Int. Cl.: 3

Prior U.S. Cls.: 1, 4, 6, 50, 51, and 52

Reg. No. 3,570,782

United States Patent and Trademark Office

Registered Feb. 3, 2009

**TRADEMARK  
PRINCIPAL REGISTER**



PLAYBOY ENTERPRISES INTERNATIONAL,  
INC. (DELAWARE CORPORATION)  
680 N. LAKE SHORE DRIVE  
CHICAGO, IL 60611

FOR: MAKE-UP FOR THE FACE AND BODY, IN  
CLASS 3 (U.S. CLS. 1, 4, 6, 50, 51 AND 52).

FIRST USE 11-9-2005; IN COMMERCE 11-5-2005.

THE MARK CONSISTS OF A THREE DIMEN-  
SIONAL BUNNY COSTUME WORN BY A WOMAN  
USED AS A POINT OF SALE DISPLAY. THE COS-  
TUME INCLUDES A CORSETED BODICE, BUNNY  
EARS WORN ON THE HEAD, A BUNNY TAIL ON

THE BACK OF THE BODICE, A NAME TAG ON  
THE FRONT OF THE BODICE, WRIST CUFFS AND  
A BOW TIE COLLAR. THE DOTTED OUTLINE OF A  
WOMAN IS NOT A PART OF THE MARK BUT IS  
MERELY INTENDED TO SHOW THE POSITION OF  
THE COSTUME.

SEC. 2(F).

SN 78-554,553, FILED 1-26-2005.

AISHA SALEM, EXAMINING ATTORNEY

**Int. Cls.: 7 and 9**

**Prior U.S. Cls.: 13, 19, 21, 23, 26, 31, 34, 35, 36, and 38**

**United States Patent and Trademark Office**

**Reg. No. 3,570,783**

**Registered Feb. 3, 2009**

**TRADEMARK  
PRINCIPAL REGISTER**

**SOLAR GROVE**

KYOCERA SOLAR, INC. (DELAWARE CORPORATION)  
7812 EAST ACOMA DRIVE  
SCOTTSDALE, AZ 85260

FOR: SOLAR POWERED ELECTRIC GENERATORS, IN CLASS 7 (U.S. CLS. 13, 19, 21, 23, 31, 34 AND 35).

FIRST USE 8-0-2004; IN COMMERCE 8-0-2006.

FOR: MULTIPLE CARPORT SYSTEMS COMPRISED OF PHOTOVOLTAIC MODULES, ELECTRICAL INVERTERS, AND SUPPORTING STRUCTURES FOR GENERATING ELECTRIC POWER FROM SOLAR RADIATION AND FOR

PROVIDING SHADE FOR VEHICLES, IN CLASS 9 (U.S. CLS. 21, 23, 26, 36 AND 38).

FIRST USE 8-0-2004; IN COMMERCE 8-0-2006.

THE MARK CONSISTS OF STANDARD CHARACTERS WITHOUT CLAIM TO ANY PARTICULAR FONT, STYLE, SIZE, OR COLOR.

NO CLAIM IS MADE TO THE EXCLUSIVE RIGHT TO USE "SOLAR", APART FROM THE MARK AS SHOWN.

SN 78-564,619, FILED 2-10-2005.

INGA ERVIN, EXAMINING ATTORNEY

**Int. Cls.: 6 and 7**

**Prior U.S. Cls.: 2, 12, 13, 14, 19, 21, 23, 25, 31, 34, 35,  
and 50**

**Reg. No. 3,570,784**

**United States Patent and Trademark Office**

**Registered Feb. 3, 2009**

**TRADEMARK  
PRINCIPAL REGISTER**

**SAMICK**

SAMICK PRECISION IND. CO., LTD. (REPUBLIC  
OF KOREA LIMITED LIABILITY COMPANY)  
925-2 WULAM-DONG, DALSEO-GU  
DAEGU, REPUBLIC OF KOREA 704-320

FOR: METAL HARDWARE, NAMELY, SPRINGS;  
STEEL RAILS, IN CLASS 6 (U.S. CLS. 2, 12, 13, 14, 23,  
25 AND 50).

FIRST USE 10-1-1997; IN COMMERCE 10-1-1997.

FOR: MACHINE PARTS, NAMELY, BALL BEAR-  
INGS, BUSHINGS, SHAFT COUPLINGS, COU-  
PLINGS, LINEAR BEARINGS, BALL SCREWS,  
BALL BUSH, LINEAR BUSHING; BRAKES FOR

MACHINES, IN CLASS 7 (U.S. CLS. 13, 19, 21, 23, 31,  
34 AND 35).

FIRST USE 10-1-1997; IN COMMERCE 10-1-1997.

THE MARK CONSISTS OF STANDARD CHAR-  
ACTERS WITHOUT CLAIM TO ANY PARTICULAR  
FONT, STYLE, SIZE, OR COLOR.

SN 78-597,316, FILED 3-29-2005.

WARREN L. OLANDRIA, EXAMINING ATTOR-  
NEY



**Int. Cl.: 5**

**Prior U.S. Cls.: 6, 18, 44, 46, 51, and 52**

**United States Patent and Trademark Office**

**Reg. No. 3,570,785**

**Registered Feb. 3, 2009**

**TRADEMARK  
PRINCIPAL REGISTER**

# RITE DOSE

HOLOPACK INTERNATIONAL CORP. (SOUTH  
CAROLINA CORPORATION)  
CAROLINA RESEARCH PARK  
ONE TECHNOLOGY CIRCLE  
COLUMBIA, SC 29203

FOR: PRE-FILLED, SINGLE DOSE, CONTAINERS  
FOR LIQUID OR WASHES, NAMELY, PHARMA-  
CEUTICALS FOR THE TREATMENT OF COLDS,  
ALLERGIES, COUGHS, SINUS AILMENTS, PAIN,  
GASTROINTESTINAL AILMENTS, OR FEVER, NU-  
TRITIONAL SUPPLEMENTS, NAMELY, VITAMINS  
OR HERBS, AND LIQUID WASHES, NAMELY, EYE  
WASHES OR EAR WASHES, IN CLASS 5 (U.S. CLS. 6,  
18, 44, 46, 51 AND 52).

FIRST USE 8-1-2007; IN COMMERCE 8-1-2007.

THE MARK CONSISTS OF STANDARD CHAR-  
ACTERS WITHOUT CLAIM TO ANY PARTICULAR  
FONT, STYLE, SIZE, OR COLOR.

NO CLAIM IS MADE TO THE EXCLUSIVE  
RIGHT TO USE "DOSE", APART FROM THE MARK  
AS SHOWN.

SN 78-611,150, FILED 4-18-2005.

MATTHEW KLINE, EXAMINING ATTORNEY

**Int. Cl.: 3**

**Prior U.S. Cls.: 1, 4, 6, 50, 51, and 52**

**Reg. No. 3,570,786**

**United States Patent and Trademark Office**

**Registered Feb. 3, 2009**

**TRADEMARK  
PRINCIPAL REGISTER**

**SUPERWEAR**

MANA PRODUCTS, INC. (NEW YORK COR-  
PORATION)  
32-02 QUEENS BOULEVARD  
LONG ISLAND CITY, NY 111012341

THE MARK CONSISTS OF STANDARD CHAR-  
ACTERS WITHOUT CLAIM TO ANY PARTICULAR  
FONT, STYLE, SIZE, OR COLOR.

FOR: COSMETICS, IN CLASS 3 (U.S. CLS. 1, 4, 6, 50,  
51 AND 52).

SN 78-644,490, FILED 6-6-2005.

FIRST USE 7-31-2005; IN COMMERCE 7-31-2005.

DARRYL SPRUILL, EXAMINING ATTORNEY

**Int. Cl.: 9**

**Prior U.S. Cls.: 21, 23, 26, 36, and 38**

**Reg. No. 3,570,787**

**United States Patent and Trademark Office**

**Registered Feb. 3, 2009**

---

**TRADEMARK  
PRINCIPAL REGISTER**

**NEMO**

ENHANCED VISION SYSTEMS, INC. (CALIFORNIA CORPORATION)  
5882 MACHINE DRIVE  
HUNTINGTON BEACH, CA 92649

FIRST USE 10-30-2006; IN COMMERCE 10-30-2006.

FOR: ELECTRONIC DEVICE WITH A LIQUID CRYSTAL DISPLAY AND CAMERA, THAT MAGNIFIES AND ENHANCES AN IMAGE, USED FOR READING, WRITING, AND LOOKING AT PICTURES, IN CLASS 9 (U.S. CLS. 21, 23, 26, 36 AND 38).

THE MARK CONSISTS OF STANDARD CHARACTERS WITHOUT CLAIM TO ANY PARTICULAR FONT, STYLE, SIZE, OR COLOR.

SN 78-669,933, FILED 7-13-2005.

PAUL CROWLEY, EXAMINING ATTORNEY

Int. Cl.: 33

Prior U.S. Cls.: 47 and 49

Reg. No. 3,570,788

United States Patent and Trademark Office

Registered Feb. 3, 2009

TRADEMARK  
PRINCIPAL REGISTER



THE TRUSTEES OF THE COPPOLA FAMILY TRUST, THE TRUSTEES COMPRISING FRANCIS FORD COPPOLA, A U.S. CITIZEN AND ELEANOR COPPOLA, A U.S. CITIZEN (CALIFORNIA TRUST)  
1991 ST. HELENA HIGHWAY  
RUTHERFORD, CA 94573

NO CLAIM IS MADE TO THE EXCLUSIVE RIGHT TO USE "ESTATE FOUNDED 1880 RUBICON ESTATE CASK CABERNET RUTHERFORD ESTATE GROWN PRODUCED BOTTLED CABERNET SAUVIGNON NAPA VALLEY", APART FROM THE MARK AS SHOWN.

FOR: WINE, IN CLASS 33 (U.S. CLS. 47 AND 49).

SN 78-684,079, FILED 8-2-2005.

FIRST USE 9-1-1998; IN COMMERCE 9-1-1998.

SALLY SHIH, EXAMINING ATTORNEY

**Int. Cl.: 10**

**Prior U.S. Cls.: 26, 39, and 44**

**United States Patent and Trademark Office**

**Reg. No. 3,570,789**

**Registered Feb. 3, 2009**

**TRADEMARK  
PRINCIPAL REGISTER**

**V-GRIP**

MICROVENTION, INC. (DELAWARE CORPORATION)  
75 COLUMBIA, SUITE A  
ALISO VIEJO, CA 92656

FOR: MEDICAL APPARATUS AND INSTRUMENTS, NAMELY, DEVICES USED TO CONTROL THE DELIVERY OF AN IMPLANT INTO THE VASCULATURE OF A HUMAN PATIENT, IN CLASS 10 (U.S. CLS. 26, 39 AND 44).

FIRST USE 9-30-2005; IN COMMERCE 9-30-2005.

THE MARK CONSISTS OF STANDARD CHARACTERS WITHOUT CLAIM TO ANY PARTICULAR FONT, STYLE, SIZE, OR COLOR.

SN 78-688,601, FILED 8-9-2005.

MICHAEL WEBSTER, EXAMINING ATTORNEY

**Int. Cls.: 35, 37, and 39**

**Prior U.S. Cls.: 100, 101, 102, 103, 105, and 106**

**United States Patent and Trademark Office**

**Reg. No. 3,570,790**

**Registered Feb. 3, 2009**

**SERVICE MARK  
PRINCIPAL REGISTER**

**SOUTH BAY EXPRESSWAY**

CALIFORNIA TRANSPORTATION VENTURES,  
INC. (CALIFORNIA CORPORATION)  
1129 LA MEDIA ROAD  
SAN DIEGO, CA 92154

FOR: CUSTOMER SERVICES IN THE FIELDS OF  
HIGHWAY TOLL COLLECTION AND THE MAIN-  
TENANCE AND OPERATION OF HIGHWAYS AND  
ROADS, IN CLASS 35 (U.S. CLS. 100, 101 AND 102).

FIRST USE 11-19-2007; IN COMMERCE 11-19-2007.

FOR: DEVELOPMENT, CONSTRUCTION, RE-  
PAIR, AND MAINTENANCE OF HIGHWAYS AND  
ROADS, IN CLASS 37 (U.S. CLS. 100, 103 AND 106).

FIRST USE 11-19-2007; IN COMMERCE 11-19-2007.

FOR: TRANSPORTATION SERVICES, NAMELY,  
OPERATION OF HIGHWAYS AND ROADS, IN  
CLASS 39 (U.S. CLS. 100 AND 105).

FIRST USE 11-19-2007; IN COMMERCE 11-19-2007.

THE MARK CONSISTS OF STANDARD CHAR-  
ACTERS WITHOUT CLAIM TO ANY PARTICULAR  
FONT, STYLE, SIZE, OR COLOR.

NO CLAIM IS MADE TO THE EXCLUSIVE  
RIGHT TO USE "EXPRESSWAY", APART FROM  
THE MARK AS SHOWN.

SN 78-691,965, FILED 8-12-2005.

MICHELE SWAIN, EXAMINING ATTORNEY

**Int. Cl.: 44**

**Prior U.S. Cls.: 100 and 101**

**United States Patent and Trademark Office**

**Reg. No. 3,570,791**

**Registered Feb. 3, 2009**

**SERVICE MARK  
PRINCIPAL REGISTER**

**Lasik ProVision**

LASER PROVISION INC. (CANADA CORPORATION)  
73 TRANBY AVE.  
TORONTO, CANADA M5R 1N4

FOR: MEDICAL CLINICS FOR CONSUMERS  
SPECIALIZING IN SURGICAL TECHNIQUES FOR  
THE CORRECTION OF REFRACTIVE DISORDERS  
OF THE EYE, IN CLASS 44 (U.S. CLS. 100 AND 101).

FIRST USE 12-31-2006; IN COMMERCE 12-31-2006.

THE MARK CONSISTS OF STANDARD CHARACTERS WITHOUT CLAIM TO ANY PARTICULAR FONT, STYLE, SIZE, OR COLOR.

NO CLAIM IS MADE TO THE EXCLUSIVE RIGHT TO USE "LASIK", APART FROM THE MARK AS SHOWN.

SN 78-693,913, FILED 8-16-2005.

JASON TURNER, EXAMINING ATTORNEY

**Int. Cl.: 29**

**Prior U.S. Cl.: 46**

**Reg. No. 3,570,792**

**Registered Feb. 3, 2009**

**United States Patent and Trademark Office**

---

**TRADEMARK  
PRINCIPAL REGISTER**



RICE FIELD CORPORATION (CALIFORNIA CORPORATION)  
14500 EAST VALLEY BLVD.  
CITY OF INDUSTRY, CA 91746

FOR: FOOD PRODUCTS, NAMELY, MEAT, FISH, POULTRY AND GAME, MEAT EXTRACTS; PRESERVED AND COOKED FRUITS AND VEGETA-

BLES; FROZEN SEAFOOD AND FRESH SEAFOOD, IN CLASS 29 (U.S. CL. 46).

FIRST USE 5-1-1997; IN COMMERCE 5-1-1997.

SN 78-704,793, FILED 8-31-2005.

JOHN GARTNER, EXAMINING ATTORNEY



**Int. Cl.: 36**

**Prior U.S. Cls.: 100, 101, and 102**

**United States Patent and Trademark Office**

**Reg. No. 3,570,793**

**Registered Feb. 3, 2009**

**SERVICE MARK  
PRINCIPAL REGISTER**

**ViVOnfc**

VIVOTECH (CALIFORNIA CORPORATION)  
451 EL CAMINO REAL  
SANTA CLARA, CA 95050

FOR: ELECTRONIC CREDIT CARD TRANSACTION PROCESSING, DEBIT CARD SERVICES, PRE-PAID PURCHASE CARD SERVICES, NAMELY, PROCESSING ELECTRONIC PAYMENTS MADE THROUGH PREPAID CARDS AND PROCESSING ELECTRONIC PAYMENT THROUGH PRE-PAID CARDS, PROCESSING ELECTRONIC PAYMENTS MADE THROUGH LOYALTY CARDS; ELECTRONIC PAYMENT, NAMELY, ELECTRONIC PROCESSING AND TRANSMISSION OF CREDIT CARD TRANSACTIONS, WIRELESS WALLETS, MOBILE WALLETS, ELECTRONIC WALLETS, WIRELESS

CREDIT, DEBIT AND PREPARED CARD TRANSACTIONS, CREDIT CARD AND TRANSACTION PROCESSING TERMINAL SERVICES USING NFC-NEAR FIELD COMMUNICATION TECHNOLOGY, IN CLASS 36 (U.S. CLS. 100, 101 AND 102).

FIRST USE 10-31-2005; IN COMMERCE 10-31-2005.

THE MARK CONSISTS OF STANDARD CHARACTERS WITHOUT CLAIM TO ANY PARTICULAR FONT, STYLE, SIZE, OR COLOR.

SN 78-719,719, FILED 9-23-2005.

SAMUEL E. SHARPER JR., EXAMINING ATTORNEY

Int. Cls.: 6, 11, 20, and 21

Prior U.S. Cls.: 2, 12, 13, 14, 21, 22, 23, 25, 29, 30, 31,  
32, 33, 34, 40, and 50

Reg. No. 3,570,794

United States Patent and Trademark Office

Registered Feb. 3, 2009

TRADEMARK  
PRINCIPAL REGISTER

# MEMOIRS

KOHLER CO. (WISCONSIN CORPORATION)  
444 HIGHLAND DRIVE  
KOHLER, WI 53044

FOR: METAL ROBE HOOKS; METAL HAND  
SHOWER WALL-MOUNT BRACKETS; AND METAL  
HAND SHOWER WALL-MOUNT SUPPLY EL-  
BOWS, IN CLASS 6 (U.S. CLS. 2, 12, 13, 14, 23, 25 AND  
50).

FIRST USE 4-0-2001; IN COMMERCE 4-0-2001.

FOR: BATHTUBS; WHIRLPOOL BATHTUBS;  
SHOWERS; SHOWER DOORS; SHOWER HEADS;  
SHOWER RECEPTORS; HAND SHOWERS; HAND  
SHOWER HOSES; HAND SHOWER HOLDERS; BI-  
DETS; BIDET FAUCET AND HANDLE SETS; LA-  
VATORIES; LAVATORY PEDESTALS; FAUCETS;  
FAUCET HANDLES; TOILETS; TOILET TANKS;  
TOILET BOWLS; TOILET TRIP LEVERS; LEVER  
HANDLES FOR SHOWERS, WHIRLPOOL BATH-  
TUBS, BATHTUBS, FAUCETS AND BIDETS; BATH-  
TUB SPOUTS; BATHTUB FAUCET AND HANDLE  
SETS; BATH VALVES; BATHROOM FITTINGS,  
NAMELY, SHOWER FAUCET TRIM, BATHTUB  
FAUCET TRIM, SHOWER SLIDE BAR TRIM, TRIM  
FOR SHOWERS, BATHTUBS AND WHIRLPOOL  
BATHTUBS, NAMELY, TRANSFER VALVE TRIM,

THERMOSTATIC VALVE TRIM, VOLUME CON-  
TROL VALVE TRIM AND PRESSURE BALANCE  
TRIM, IN CLASS 11 (U.S. CLS. 13, 21, 23, 31 AND 34).

FIRST USE 4-0-1996; IN COMMERCE 4-0-1996.

FOR: FURNITURE PARTS, NAMELY, METAL  
CONSOLE TABLE LEGS; LAVATORY CONSOLE  
TABLES; GLASS SHELVES, IN CLASS 20 (U.S. CLS.  
2, 13, 22, 25, 32 AND 50).

FIRST USE 4-0-2001; IN COMMERCE 4-0-2001.

FOR: TOWEL RINGS; TOWEL BARS; AND TOI-  
LET TISSUE HOLDERS, IN CLASS 21 (U.S. CLS. 2, 13,  
23, 29, 30, 33, 40 AND 50).

FIRST USE 4-0-2001; IN COMMERCE 4-0-2001.

THE MARK CONSISTS OF STANDARD CHAR-  
ACTERS WITHOUT CLAIM TO ANY PARTICULAR  
FONT, STYLE, SIZE, OR COLOR.

OWNER OF U.S. REG. NO. 2,686,617.

SN 78-734,712, FILED 10-17-2005.

AMY C. KEAN, EXAMINING ATTORNEY

Int. Cl.: 43

Prior U.S. Cls.: 100 and 101

United States Patent and Trademark Office

Reg. No. 3,570,795

Registered Feb. 3, 2009

SERVICE MARK  
PRINCIPAL REGISTER



GRUPO ROCA, LLC. (GEORGIA LIMITED LIABILITY COMPANY)  
SUITE 510  
5901-A PEACHTREE DUNWOODY ROAD  
ATLANTA, GA 30328

FOR: RESTAURANTS, IN CLASS 43 (U.S. CLS. 100 AND 101).

FIRST USE 9-22-2005; IN COMMERCE 1-15-2007.

THE COLORS, BLUE, PURPLE, ORANGE, RED, YELLOW, GREEN, BLACK AND WHITE ARE CLAIMED AS A FEATURE OF THE MARK.

THE MARK CONSISTS OF A CARTOON RENDITION OF A PANDA SMILING WITH OPEN ARMS WITH "EL MUNDO MAGICO DE PANDY" WRITTEN BENEATH HIS ARMS. THE COLOR BLUE APPEARS ON THE PANDA'S ARMS AND EARS, AROUND THE PANDA'S EYES AND IN THE

WORDS "EL MUNDO" AND "DE PANDY"; THE COLOR PURPLE APPEARS IN THE LETTER "C"; THE COLOR ORANGE APPEARS IN THE LETTER "A"; THE COLOR RED APPEARS IN THE LETTER "M" OF "MAGICO" AND ON THE PANDA'S TONGUE; THE COLOR YELLOW APPEARS IN THE LETTER "G" AND IN THE BACKGROUND DESIGN BEHIND THE WORDING; THE COLOR GREEN APPEARS IN THE LETTER "I"; THE COLOR BLACK APPEARS IN THE PANDA'S EYEBALLS AND NOSE; THE COLOR WHITE APPEARS ON THE PANDA'S HEAD AND SURROUNDING ITS EYEBALLS.

THE ENGLISH TRANSLATION OF THE SPANISH WORDING "EL MUNDO MAGICO DE PANDY" IS "THE MAGICAL WORLD OF PANDY."

SN 78-737,143, FILED 10-20-2005.

RONALD MCMORROW, EXAMINING ATTORNEY

**Int. Cl.: 9**

**Prior U.S. Cls.: 21, 23, 26, 36, and 38**

**United States Patent and Trademark Office**

**Reg. No. 3,570,796**

**Registered Feb. 3, 2009**

**TRADEMARK  
PRINCIPAL REGISTER**

**SHARP OSA**

SHARP KABUSHIKI KAISHA (JAPAN CORPORATION), TA SHARP CORPORATION,  
22-22 NAGAIKE-CHO, ABENO-KU  
OSAKA, JAPAN 545-8522

OWNER OF U.S. REG. NOS. 1,405,542, 1,985,630,  
AND OTHERS.

FOR: COPYING MACHINES, PRINTERS, FACSIMILE MACHINES, SCANNERS, AND COMBINATIONS OF THE ABOVE-MENTIONED PRODUCTS, IN CLASS 9 (U.S. CLS. 21, 23, 26, 36 AND 38).

NO CLAIM IS MADE TO THE EXCLUSIVE RIGHT TO USE "OSA", APART FROM THE MARK AS SHOWN.

FIRST USE 5-30-2006; IN COMMERCE 5-30-2006.

SN 78-751,121, FILED 11-10-2005.

THE MARK CONSISTS OF STANDARD CHARACTERS WITHOUT CLAIM TO ANY PARTICULAR FONT, STYLE, SIZE, OR COLOR.

LEIGH CAROLINE CASE, EXAMINING ATTORNEY

**Int. Cls.: 9 and 25**

**Prior U.S. Cls.: 21, 22, 23, 26, 36, 38, and 39**

**United States Patent and Trademark Office**

**Reg. No. 3,570,797**

**Registered Feb. 3, 2009**

**TRADEMARK  
PRINCIPAL REGISTER**

**SOMNIO**

SULLIVAN, SEAN (UNITED STATES INDIVIDUAL)  
P.O. BOX 983  
APTOS, CA 95003

FOR: ATHLETIC SPORTING GOODS, NAMELY, ATHLETIC MEASUREMENT DEVICES IN THE NATURE OF COMPUTERIZED LASER ALIGNMENT APPARATUS FOR PERFORMANCE RELATED ATHLETIC MEASUREMENT; ELECTRONIC POWER METERS USED TO MEASURE POWER OUTPUT IN THE NATURE OF ENERGY EXPENDED AND APPLIED FORCE DURING ATHLETIC ACTIVITY; PEDOMETERS; ATHLETIC GPS SYSTEMS CONSISTING OF COMPUTERS, COMPUTER SOFTWARE, TRANSMITTERS, RECEIVERS, AND NETWORK INTERFACE DEVICES; ATHLETIC TIMERS, IN CLASS 9 (U.S. CLS. 21, 23, 26, 36 AND 38).

FIRST USE 11-1-2008; IN COMMERCE 11-1-2008.

FOR: ATHLETIC FOOTWEAR; HEADWEAR; CLOTHING, NAMELY, ATHLETIC UNIFORMS, JACKETS, SHIRTS, PANTS, SHORTS, IN CLASS 25 (U.S. CLS. 22 AND 39).

FIRST USE 11-1-2008; IN COMMERCE 11-1-2008.

THE MARK CONSISTS OF STANDARD CHARACTERS WITHOUT CLAIM TO ANY PARTICULAR FONT, STYLE, SIZE, OR COLOR.

SN 78-754,142, FILED 11-15-2005.

BARBARA RUTLAND, EXAMINING ATTORNEY

**Int. Cls.: 9 and 25**

**Prior U.S. Cls.: 21, 22, 23, 26, 36, 38, and 39**

**United States Patent and Trademark Office**

**Reg. No. 3,570,798**

**Registered Feb. 3, 2009**

**TRADEMARK  
PRINCIPAL REGISTER**



SULLIVAN, SEAN (UNITED STATES INDIVIDUAL)  
P.O. BOX 983  
APTOS, CA 95001

FOR: ATHLETIC SPORTING GOODS, NAMELY, ATHLETIC MEASUREMENT DEVICES IN THE NATURE OF COMPUTERIZED LASER ALIGNMENT APPARATUS FOR PERFORMANCE RELATED ATHLETIC MEASUREMENT; ELECTRONIC POWER METERS USED TO MEASURE POWER OUTPUT IN THE NATURE OF ENERGY EXPENDED AND APPLIED FORCE DURING ATHLETIC ACTIVITY; PEDOMETERS; ATHLETIC GPS SYSTEMS CONSISTING OF COMPUTERS, COMPUTER SOFTWARE, TRANSMITTERS, RECEIVERS, AND

NETWORK INTERFACE DEVICES; ATHLETIC TIMERS, IN CLASS 9 (U.S. CLS. 21, 23, 26, 36 AND 38).

FIRST USE 11-1-2008; IN COMMERCE 11-1-2008.

FOR: ATHLETIC FOOTWEAR; HEADWEAR; CLOTHING, NAMELY, ATHLETIC UNIFORMS, JACKETS, SHIRTS, PANTS, SHORTS, IN CLASS 25 (U.S. CLS. 22 AND 39).

FIRST USE 11-1-2008; IN COMMERCE 11-1-2008.

SN 78-754,172, FILED 11-15-2005.

BARBARA RUTLAND, EXAMINING ATTORNEY

**Int. Cl.: 42**

**Prior U.S. Cls.: 100 and 101**

**United States Patent and Trademark Office**

**Reg. No. 3,570,799**

**Registered Feb. 3, 2009**

**SERVICE MARK  
PRINCIPAL REGISTER**



ENERGY CONVERSION DEVICES, INC. (DELA-  
WARE CORPORATION)

2956 WATERVIEW DRIVE  
ROCHESTER HILLS, MI 48309

FOR: RESEARCH AND DEVELOPMENT SERVI-  
CES FEATURING MATERIALS, CHEMICALS, PRO-  
DUCTS AND PROCESSES USED IN THE  
MANUFACTURE, PRODUCTION, AND DISTRIBUTION  
OF FUEL CELLS TO END USERS, RETAI-  
LERS, INTERMEDIATES, WHOLESALERS AND  
ORIGINAL EQUIPMENT MANUFACTURERS, IN  
CLASS 42 (U.S. CLS. 100 AND 101).

FIRST USE 6-1-2008; IN COMMERCE 6-1-2008.

OWNER OF U.S. REG. NOS. 2,752,727, 2,918,342,  
AND OTHERS.

NO CLAIM IS MADE TO THE EXCLUSIVE  
RIGHT TO USE "FUEL CELL", APART FROM THE  
MARK AS SHOWN.

THE COLOR(S) ORANGE, WHITE AND GRAY IS/  
ARE CLAIMED AS A FEATURE OF THE MARK.

THE MARK CONSISTS OF THE WORD "OVONIC  
FUEL CELL" AND THE DESIGN OF MULTIPLE  
POLYGONS REPRESENTING FUEL CELLS AP-  
PEAR IN WHITE, THE WORD "SOLUTIONS" AP-  
PEARS IN GRAY, THE MARKS HAS A SMALLER  
SQUARE BACKGROUND AND A LARGER SINGLE  
LINE SQUARE BORDER THAT APPEAR IN OR-  
ANGE.

SN 78-759,580, FILED 11-22-2005.

ELLEN PERKINS, EXAMINING ATTORNEY

**Int. Cls.: 7, 9, and 11**

**Prior U.S. Cls.: 13, 19, 21, 23, 26, 31, 34, 35, 36, and 38**

**United States Patent and Trademark Office**

**Reg. No. 3,570,800**

**Registered Feb. 3, 2009**

**TRADEMARK  
PRINCIPAL REGISTER**

**EUCO**

SCHMACK BIOGAS AG (FED REP GERMANY CORPORATION)

AM BAYERNWERK 8

92421 SCHWANDORF, FED REP GERMANY

FOR: STARTER MOTORS; ENGINES AND MOTORS FOR THE GENERATION OF ELECTRICITY; AGITATORS FOR CIRCULATING LIQUID MEDIA; CONVEYORS; MACHINES FOR GAS UTILIZATION AND GAS DISPOSAL, IN PARTICULAR FLARE INSTALLATIONS; CATALYTIC CONVERTERS; ELECTRIC GENERATORS; COMPRESSORS FOR MACHINES; GAS AND STEAM TURBINES; ENGINES AND MOTORS FOR MODEL VEHICLES, AIRCRAFT AND BOATS, NAMELY, COMBUSTION ENGINES; TRANSMISSION GEARS FOR MACHINES, NAMELY, COUPLINGS, GEAR WHEELS, GEARS, SHAFTS, BELT AND CHAIN DRIVES; MACHINES AND INSTALLATIONS, NAMELY FERMENTERS, NAMELY, CONTINUOUS-FLOW FERMENTER SAND MINE STORAGE FERMENTERS; ELECTRIC EGG BEATERS; WASTE CRUSHING MACHINES; REGULATORS BEING PART OF MACHINES; AGRICULTURAL MACHINES, NAMELY, MACHINES AND INSTALLATIONS FOR THE PRODUCTION OF RAW MATERIALS FOR EXTRACTING BIOGAS; ENDLESS SCREWS FOR MOVING SOLIDS; HEAT EXCHANGERS BEING PART OF MACHINES; STARTER ALTERNATORS; HEAT EXCHANGERS BEING PART OF MACHINES; CENTRIFUGAL GRINDING MACHINES; FUEL PUMPS FOR LAND VEHICLES AND WATER PUMPS FOR LAND VEHICLES; AGITATORS, NAMELY, AGITATORS FOR BIOGAS INSTALLATIONS, LARGE-BLADE AGITATORS; SUBMERSIBLE MOTOR-DRIVEN AGITATORS PADDLE AGITATORS; MACHINE CRUSHERS, NAMELY CRUSHERS FOR CRUSHERS SUBSTRATES FOR BIOGAS INSTALLATIONS; MACHINES FOR AUTOMATIC DOSING OF SOLIDS; GAS CONDENSERS, IN CLASS 7 (U.S. CLS. 13, 19, 21, 23, 31, 34 AND 35).

FIRST USE 11-6-2008; IN COMMERCE 11-6-2008.

FOR: ELECTRIC CONTROLS FOR MACHINES AND ENGINES, NAMELY, ELECTRIC GENERATORS; SECONDARY FERMENTERS, CONTROLLED VOLUME PUMPS; MACHINES FOR DISPENSING PRE-DETERMINED DOSAGES OF MEDICATION; FUEL CELLS FOR HYDROGEN, NATURAL GAS, SEWAGE GAS, BIOGAS, LAND-FILL GAS AND HYDROCARBON VAPORS, IN CLASS 9 (U.S. CLS. 21, 23, 26, 36 AND 38).

FIRST USE 11-6-2008; IN COMMERCE 11-6-2008.

FOR: WATER PUMPS; HEATING SYSTEMS COMPRISED PRIMARILY OF TUBES, PIPES AND PRE-ASSEMBLED MANIFOLDS THROUGH WHICH COLD OR LOW TEMPERATURE WATER CIRCULATES; REFRIGERATING MACHINES; ELECTRIC CLOTHES DRYING MACHINES FOR HOUSEHOLD PURPOSES; HEAT SINKS FOR USE IN HEATING, COOLING AND VENTILATING APPARATUS; BOILER MACHINES, NAMELY, HEATING, STEAM, WASTE AND GAS BOILER MACHINES; AND STEAM GENERATORS; GAS DESULFURIZATION INSTALLATIONS, NAMELY, GAS DESULFURIZATION INSTALLATIONS COMPRISING DESULFURIZING BACTERIA; WATER PURIFICATION INSTALLATIONS FOR WASTE WATER AND SEWAGE CONSISTING OF CURTAINS AND TEXTILE FABRICS; FLARE STACKS FOR USE IN RELEASE OF GASES; WASTE WATER SEWAGE PURIFICATION UNITS; STEAM BOILERS; GAS BURNERS FOR INDUSTRIAL, COMMERCIAL AND DOMESTIC USE; ELECTROCHEMICAL GAS GENERATORS; GAS BOILERS; ELECTRO-CHEMICAL FLUE GAS SCRUBBING MACHINES; AIR PURIFICATION UNITS; REGULATING ACCESSORIES FOR WATER SUPPLY, NAMELY, METERED VALVES AND PIPES; EVAPORATORS FOR CHEMICAL PROCESSING; HYDRO-GENERATION EQUIPMENT AND COMPONENTS, NAMELY,



HYDROGEN GENERATORS, HYDROGEN PURIFIERS, HYDROGEN PURIFICATION MEMBRANES, FUEL PROCESSORS AND STEAM REFORMERS; BLOCK-TYPE THERMAL POWER PLANTS; GAS REGULATORS; EQUIPMENT FOR THE UTILIZATION OF BIOGAS, NAMELY, GAS BURNERS, HEATING APPARATUS, HEATING INSTALLATIONS, BLOCK-TYPE THERMAL POWER STATIONS, HEAT PUMPS, HEAT REGENERATORS, HEAT ACCUMULATORS AND HEAT EXCHANGERS; WASTE TREATMENT INSTALLATIONS FOR SUBSTRATES FERMENTED IN BIOGAS INSTALLATIONS, IN CLASS 11 (U.S. CLS. 13, 21, 23, 31 AND 34).

FIRST USE 11-6-2008; IN COMMERCE 11-6-2008.

THE MARK CONSISTS OF STANDARD CHARACTERS WITHOUT CLAIM TO ANY PARTICULAR FONT, STYLE, SIZE, OR COLOR.

THE WORDING "EUCO" IN THE MARK HAS NO MEANING IN A FOREIGN LANGUAGE.

SN 78-764,585, FILED 12-1-2005.

INGA ERVIN, EXAMINING ATTORNEY

**Int. Cls.: 7, 9, and 11**

**Prior U.S. Cls.: 13, 19, 21, 23, 26, 31, 34, 35, 36, and 38**

**Reg. No. 3,570,801**

**United States Patent and Trademark Office**

**Registered Feb. 3, 2009**

**TRADEMARK  
PRINCIPAL REGISTER**

**COCCUS**

SCHMACK BIOGAS AG (FED REP GERMANY CORPORATION)

AM BAYERNWERK 8

92421 SCHWANDORF, FED REP GERMANY

FOR: STARTER MOTORS; ENGINES AND MOTORS FOR THE GENERATION OF ELECTRICITY; AGITATORS FOR CIRCULATING LIQUID MEDIA; CONVEYORS; MACHINES FOR GAS UTILIZATION AND GAS DISPOSAL, IN PARTICULAR FLARE INSTALLATIONS; CATALYTIC CONVERTERS; ELECTRIC GENERATORS; COMPRESSORS FOR MACHINES; GAS AND STEAM TURBINES; ENGINES AND MOTORS FOR MODEL VEHICLES, AIRCRAFT AND BOATS, NAMELY, COMBUSTION ENGINES; TRANSMISSION GEARS FOR MACHINES, NAMELY, COUPLINGS, GEAR WHEELS, GEARS, SHAFTS, BELT AND CHAIN DRIVES; MACHINES AND INSTALLATIONS, NAMELY, FERMENTERS, NAMELY, CONTINUOUS-FLOW FERMENTER SAND MINE STORAGE FERMENTERS; ELECTRIC EGG BEATERS; WASTE CRUSHING MACHINES; REGULATORS BEING PART OF MACHINES; AGRICULTURAL MACHINES, NAMELY, MACHINES AND INSTALLATIONS FOR THE PRODUCTION OF RAW MATERIALS FOR EXTRACTING BIOGAS; ENDLESS SCREWS FOR MOVING SOLIDS; HEAT EXCHANGERS BEING PART OF MACHINES; STARTER ALTERNATORS; HEAT EXCHANGERS BEING PART OF MACHINES; CENTRIFUGAL GRINDING MACHINES; FUEL PUMPS FOR LAND VEHICLES AND WATER PUMPS FOR LAND VEHICLES; AGITATORS, NAMELY, AGITATORS FOR BIOGAS INSTALLATIONS, LARGE-BLADE AGITATORS; SUBMERSIBLE MOTOR-DRIVEN AGITATORS PADDLE AGITATORS; MACHINE CRUSHERS, NAMELY, CRUSHERS FOR CRUSHERS SUBSTRATES FOR BIOGAS INSTALLATIONS; MACHINES FOR AUTOMATIC DOSING OF SOLIDS; GAS CONDENSERS, IN CLASS 7 (U.S. CLS. 13, 19, 21, 23, 31, 34 AND 35).

FIRST USE 11-6-2008; IN COMMERCE 11-6-2008.

FOR: ELECTRIC CONTROLS FOR MACHINES AND ENGINES, NAMELY, ELECTRIC GENERATORS; SECONDARY FERMENTERS, CONTROLLED VOLUME PUMPS; MACHINES FOR DISPENSING PRE-DETERMINED DOSAGES OF MEDICATION; FUEL CELLS FOR HYDROGEN, NATURAL GAS, SEWAGE GAS, BIOGAS, LAND-FILL GAS AND HYDROCARBON VAPORS, IN CLASS 9 (U.S. CLS. 21, 23, 26, 36 AND 38).

FIRST USE 11-6-2008; IN COMMERCE 11-6-2008.

FOR: WATER PUMPS; HEATING SYSTEMS COMPRISED PRIMARILY OF TUBES, PIPES AND PRE-ASSEMBLED MANIFOLDS THROUGH WHICH COLD OR LOW TEMPERATURE WATER CIRCULATES; REFRIGERATING MACHINES; ELECTRIC CLOTHES DRYING MACHINES FOR HOUSEHOLD PURPOSES; HEAT SINKS FOR USE IN HEATING, COOLING AND VENTILATING APPARATUS; BOILER MACHINES, NAMELY, HEATING, STEAM, WASTE AND GAS BOILER MACHINES; AND STEAM GENERATORS; GAS DESULFURIZATION INSTALLATIONS, NAMELY, GAS DESULFURIZATION INSTALLATIONS COMPRISING DESULFURIZING BACTERIA; WATER PURIFICATION INSTALLATIONS FOR WASTE WATER AND SEWAGE CONSISTING OF CURTAINS AND TEXTILE FABRICS; FLARE STACKS FOR USE IN RELEASE OF GASES; WASTE WATER SEWAGE PURIFICATION UNITS; STEAM BOILERS; GAS BURNERS FOR INDUSTRIAL, COMMERCIAL AND DOMESTIC USE; ELECTROCHEMICAL GAS GENERATORS; GAS BOILERS; ELECTRO-CHEMICAL FLUE GAS SCRUBBING MACHINES; AIR PURIFICATION UNITS; REGULATING ACCESSORIES FOR WATER SUPPLY, NAMELY, METERED VALVES AND PIPES; EVAPORATORS FOR CHEMICAL PROCESSING; HYDRO-GENERATION EQUIPMENT AND COMPONENTS, NAMELY,

HYDROGEN GENERATORS, HYDROGEN PURIFIERS, HYDROGEN PURIFICATION MEMBRANES, FUEL PROCESSORS AND STEAM REFORMERS; BLOCK-TYPE THERMAL POWER PLANTS; GAS REGULATORS; EQUIPMENT FOR THE UTILIZATION OF BIOGAS, NAMELY, GAS BURNERS, HEATING APPARATUS, HEATING INSTALLATIONS, BLOCK-TYPE THERMAL POWER STATIONS, HEAT PUMPS, HEAT REGENERATORS, HEAT ACCUMULATORS AND HEAT EXCHANGERS; WASTE TREATMENT INSTALLATIONS FOR SUBSTRATES FERMENTED IN BIOGAS IN-

STALLATIONS, IN CLASS 11 (U.S. CLS. 13, 21, 23, 31 AND 34).

FIRST USE 11-6-2008; IN COMMERCE 11-6-2008.

THE MARK CONSISTS OF STANDARD CHARACTERS WITHOUT CLAIM TO ANY PARTICULAR FONT, STYLE, SIZE, OR COLOR.

SN 78-764,598, FILED 12-1-2005.

INGA ERVIN, EXAMINING ATTORNEY

**Int. Cl.: 9**

**Prior U.S. Cls.: 21, 23, 26, 36, and 38**

**Reg. No. 3,570,802**

**United States Patent and Trademark Office**

**Registered Feb. 3, 2009**

**TRADEMARK  
PRINCIPAL REGISTER**

**ENTERPRISE PATROL**

ACE\*COMM CORPORATION (MARYLAND CORPORATION)  
704 QUINCE ORCHARD ROAD  
GAITHERSBURG, MD 20878

THE MARK CONSISTS OF STANDARD CHARACTERS WITHOUT CLAIM TO ANY PARTICULAR FONT, STYLE, SIZE, OR COLOR.

FOR: COMPUTER SOFTWARE, HARDWARE AND INSTRUCTION MANUALS SOLD THEREWITH AS A UNIT, FOR PROVIDING INTERACTIVE SERVICE TO SPECIFY AND ENFORCE REAL-TIME CALLING PROFILE AND COST CONTROL RESTRICTIONS FOR MOBILE VOICE AND DATA MOBILE SERVICES FOR CORPORATE WORK FORCES, IN CLASS 9 (U.S. CLS. 21, 23, 26, 36 AND 38).

NO CLAIM IS MADE TO THE EXCLUSIVE RIGHT TO USE "ENTERPRISE", APART FROM THE MARK AS SHOWN.

SN 78-770,559, FILED 12-9-2005.

FIRST USE 3-30-2007; IN COMMERCE 3-30-2007.

JASON TURNER, EXAMINING ATTORNEY

**Int. Cl.: 9**

**Prior U.S. Cls.: 21, 23, 26, 36, and 38**

**Reg. No. 3,570,803**

**United States Patent and Trademark Office**

**Registered Feb. 3, 2009**

**TRADEMARK  
PRINCIPAL REGISTER**

**THE SUITE LIFE OF ZACK &  
CODY**

DISNEY ENTERPRISES, INC. (DELAWARE CORPORATION)  
500 SOUTH BUENA VISTA STREET  
BURBANK, CA 91521

FOR: COMPUTER GAME CARTRIDGES; COMPUTER SOFTWARE, FEATURING GAMES FOR CHILDREN; PRE-RECORDED DVDS, DIGITAL VERSATILE DISCS, DIGITAL VIDEO DISCS, FEATURING LIVE ACTION ENTERTAINMENT FOR CHILDREN; VIDEO GAME CARTRIDGES, IN CLASS 9 (U.S. CLS. 21, 23, 26, 36 AND 38).

FIRST USE 7-18-2006; IN COMMERCE 7-18-2006.

THE MARK CONSISTS OF STANDARD CHARACTERS WITHOUT CLAIM TO ANY PARTICULAR FONT, STYLE, SIZE, OR COLOR.

SN 78-774,675, FILED 12-15-2005.

SHAUNIA CARLYLE, EXAMINING ATTORNEY

**Int. Cl.: 9**

**Prior U.S. Cls.: 21, 23, 26, 36, and 38**

**Reg. No. 3,570,804**

**United States Patent and Trademark Office**

**Registered Feb. 3, 2009**

**TRADEMARK  
PRINCIPAL REGISTER**

**TENXC**

TENXC WIRELESS INC. (CANADA CORPORATION)  
SUITE 200  
11 HINES ROAD  
OTTAWA, ONTARIO, CANADA K2K 2X1

FOR: RADIO FREQUENCY (RF) SPECTRALLY EFFICIENT AND PERFORMANCE ENHANCING SYSTEMS AND TECHNOLOGY FOR WIRELESS ACCESS NETWORKS, NAMELY, ELECTRONIC CARDS FOR ADAPTOR SPATIAL PROCESSING IN RADIO FREQUENCY SYSTEMS FOR SIGNAL TRANSMISSION, RECEPTION AND PROCESSING IN FIXED AND MOBILE WIRELESS ACCESS BASE STATIONS AND ACCESS POINTS; ANTENNAS AND ANTENNA ARRAYS FOR WIRELESS NETWORK ACCESS; COMPUTER SOFTWARE FOR USE

IN CONTROLLING, OPERATING, MANAGING AND MAINTAINING THE FOREGOING WIRELESS COMMUNICATIONS SYSTEMS AND WIRELESS INFRASTRUCTURE EQUIPMENT, ANTENNAS AND ANTENNA ARRAYS, IN CLASS 9 (U.S. CLS. 21, 23, 26, 36 AND 38).

FIRST USE 7-0-2007; IN COMMERCE 7-0-2007.

THE MARK CONSISTS OF STANDARD CHARACTERS WITHOUT CLAIM TO ANY PARTICULAR FONT, STYLE, SIZE, OR COLOR.

SN 78-778,338, FILED 12-21-2005.

STEVEN R. FOSTER, EXAMINING ATTORNEY

**Int. Cls.: 35 and 42**

**Prior U.S. Cls.: 100, 101, and 102**

**United States Patent and Trademark Office**

**Reg. No. 3,570,805**

**Registered Feb. 3, 2009**

**SERVICE MARK  
PRINCIPAL REGISTER**

**MSI**

MEDIA STRATEGIES INTERNATIONAL, INC.  
(CALIFORNIA CORPORATION)  
814 SOUTH WESTGATE AVENUE, SUITE 250  
LOS ANGELES, CA 90049

FOR: BUSINESS CONSULTING SERVICES RELATING TO THE MOTION PICTURE, TELEVISION, ENTERTAINMENT, MEDIA, AND COMMUNICATIONS INDUSTRIES; BUSINESS SERVICES, NAMELY, MATCHING FUNDING SOURCES WITH BUSINESSES IN THE MOTION PICTURE, TELEVISION, ENTERTAINMENT, MEDIA, AND COMMUNICATIONS INDUSTRIES, IN CLASS 35 (U.S. CLS. 100, 101 AND 102).

FIRST USE 5-1-2007; IN COMMERCE 5-1-2007.

FOR: LICENSING OF INTELLECTUAL PROPERTY RELATING TO THE MOTION PICTURE, TELE-

VISION, ENTERTAINMENT, MEDIA, AND COMMUNICATIONS INDUSTRIES; PROVIDING LEGAL SERVICES IN THE MOTION PICTURE, TELEVISION, ENTERTAINMENT, MEDIA, AND COMMUNICATIONS INDUSTRIES, IN CLASS 42 (U.S. CLS. 100 AND 101).

FIRST USE 5-1-2007; IN COMMERCE 5-1-2007.

THE MARK CONSISTS OF STANDARD CHARACTERS WITHOUT CLAIM TO ANY PARTICULAR FONT, STYLE, SIZE, OR COLOR.

SN 78-782,645, FILED 12-29-2005.

AMEETA JORDAN, EXAMINING ATTORNEY

**Int. Cl.: 9**

**Prior U.S. Cls.: 21, 23, 26, 36, and 38**

**Reg. No. 3,570,806**

**United States Patent and Trademark Office**

**Registered Feb. 3, 2009**

**TRADEMARK  
PRINCIPAL REGISTER**

**RITECORD**

APOLLO NORTH AMERICA, INC. (INDIANA  
CORPORATION)  
SUITE 600  
17406 TILLER COURT  
WESTFIELD, IN 46074

THE MARK CONSISTS OF STANDARD CHAR-  
ACTERS WITHOUT CLAIM TO ANY PARTICULAR  
FONT, STYLE, SIZE, OR COLOR.

FOR: ELECTRICAL POWER EXTENSION  
CORDS, IN CLASS 9 (U.S. CLS. 21, 23, 26, 36 AND 38).

SN 78-794,637, FILED 1-19-2006.

FIRST USE 8-2-2005; IN COMMERCE 9-18-2008.

DAVID MILLER, EXAMINING ATTORNEY



**Int. Cl.: 32**

**Prior U.S. Cls.: 45, 46, and 48**

**United States Patent and Trademark Office**

**Reg. No. 3,570,807**

**Registered Feb. 3, 2009**

**TRADEMARK  
PRINCIPAL REGISTER**

**MOXIE ENERGY**

CORNUCOPIA BEVERAGES, INC. (NEW HAMP-  
SHIRE CORPORATION)  
ONE EXECUTIVE PARK DRIVE  
SUITE 330  
BEDFORD, NH 03110

FOR: CARBONATED SOFT DRINKS, IN CLASS 32  
(U.S. CLS. 45, 46 AND 48).

FIRST USE 10-16-2008; IN COMMERCE 10-20-2008.

THE MARK CONSISTS OF STANDARD CHAR-  
ACTERS WITHOUT CLAIM TO ANY PARTICULAR  
FONT, STYLE, SIZE, OR COLOR.

OWNER OF U.S. REG. NOS. 189,066 AND 1,399,370.

NO CLAIM IS MADE TO THE EXCLUSIVE  
RIGHT TO USE "ENERGY", APART FROM THE  
MARK AS SHOWN.

SN 78-800,015, FILED 1-26-2006.

LAURA KOVALSKY, EXAMINING ATTORNEY

**Int. Cl.: 35**

**Prior U.S. Cls.: 100, 101, and 102**

**United States Patent and Trademark Office**

**Reg. No. 3,570,808**

**Registered Feb. 3, 2009**

**SERVICE MARK  
PRINCIPAL REGISTER**

**WHOLE GOAL**

EXECUTIVE LEADERSHIP GROUP, INC. (COLORADO CORPORATION)  
14390 BRAUN RD.  
GOLDEN, CO 80401

FOR: BUSINESS MANAGEMENT CONSULTATION, NAMELY, ADVISING IN THE FIELD OF ORGANIZATIONAL STRUCTURE AND GOAL IMPLEMENTATION, IN CLASS 35 (U.S. CLS. 100, 101 AND 102).

FIRST USE 10-0-2005; IN COMMERCE 10-0-2005.

THE MARK CONSISTS OF STANDARD CHARACTERS WITHOUT CLAIM TO ANY PARTICULAR FONT, STYLE, SIZE, OR COLOR.

NO CLAIM IS MADE TO THE EXCLUSIVE RIGHT TO USE "GOAL", APART FROM THE MARK AS SHOWN.

SN 78-804,202, FILED 2-1-2006.

RUDY R. SINGLETON, EXAMINING ATTORNEY

**Int. Cl.: 3**

**Prior U.S. Cls.: 1, 4, 6, 50, 51, and 52**

**Reg. No. 3,570,809**

**United States Patent and Trademark Office**

**Registered Feb. 3, 2009**

**TRADEMARK  
PRINCIPAL REGISTER**

**SHEERTAN**

SHEERESQUE, INC. (TEXAS CORPORATION)  
3225 TURTLE CREEK BOULEVARD, SUITE 1111  
DALLAS, TX 75219

SKIN COLORATION AND SKIN CARE, IN CLASS 3  
(U.S. CLS. 1, 4, 6, 50, 51 AND 52).

FIRST USE 7-7-2008; IN COMMERCE 7-7-2008.

FOR: SUNLESS TANNING, NAMELY, SELF-TANNING PREPARATIONS; COLORANTS, NAMELY, COLORING PREPARATIONS FOR FACE AND BODY COSMETIC PURPOSES; COSMETIC PREPARATIONS, NAMELY, BODY AND BEAUTY CARE, COSMETIC SELF-TANNING, SUN PROTECTING, FACIAL MAKE-UP; COSMETIC COLORANT PRODUCTS IN THE FORM OF AEROSOL FOR

THE MARK CONSISTS OF STANDARD CHARACTERS WITHOUT CLAIM TO ANY PARTICULAR FONT, STYLE, SIZE, OR COLOR.

SN 78-806,506, FILED 2-3-2006.

INGRID C. EULIN, EXAMINING ATTORNEY

**Int. Cl.: 35**

**Prior U.S. Cls.: 100, 101, and 102**

**United States Patent and Trademark Office**

**Reg. No. 3,570,810**

**Registered Feb. 3, 2009**

**SERVICE MARK  
PRINCIPAL REGISTER**

**NEXT STREET**

NEXT STREET FINANCIAL LLC (DELAWARE  
LIMITED LIABILITY COMPANY)  
SUITE 200  
184 DUDLEY STREET  
ROXBURY, MA 02119

FOR: BUSINESS SERVICES, NAMELY, BUSINESS  
PLANNING SERVICES, MERGERS AND ACQUISI-  
TIONS CONSULTING SERVICES, BUSINESS MAN-  
AGEMENT, BUSINESS PROJECT MANAGEMENT  
SERVICES, BUSINESS MANAGEMENT CONSUL-  
TANCY RELATED TO DEVELOPMENT OF CAP-  
ABILITIES FOR ANALYSIS AND  
IMPLEMENTATION OF BUSINESS STRATEGY  
AND MANAGEMENT PROJECTS, BUSINESS CON-  
SULTING SERVICES, BUSINESS ADVISORY SER-

VICES, AND IMPLEMENTATION SERVICES,  
NAMELY, PROVIDING BUSINESS MANAGEMENT  
CONSULTATION TO ASSIST IN THE IMPLEMEN-  
TATION OF BUSINESS AND STRATEGIC PLANS,  
IN CLASS 35 (U.S. CLS. 100, 101 AND 102).

FIRST USE 10-0-2005; IN COMMERCE 11-0-2007.

THE MARK CONSISTS OF STANDARD CHAR-  
ACTERS WITHOUT CLAIM TO ANY PARTICULAR  
FONT, STYLE, SIZE, OR COLOR.

SN 78-808,133, FILED 2-6-2006.

MARY MUNSON, EXAMINING ATTORNEY

**Int. Cl.: 11**

**Prior U.S. Cls.: 13, 21, 23, 31, and 34**

**United States Patent and Trademark Office**

**Reg. No. 3,570,811**

**Registered Feb. 3, 2009**

**TRADEMARK  
PRINCIPAL REGISTER**

**GRAND SLAM**

GREGG, DOUG (UNITED STATES INDIVIDUAL)  
24522 VERONICA COURT  
MISSION VIEJO, CA 92691

THE MARK CONSISTS OF STANDARD CHAR-  
ACTERS WITHOUT CLAIM TO ANY PARTICULAR  
FONT, STYLE, SIZE, OR COLOR.

FOR: LIGHTING FIXTURES, IN CLASS 11 (U.S.  
CLS. 13, 21, 23, 31 AND 34).

SN 78-813,364, FILED 2-13-2006.

FIRST USE 9-18-2008; IN COMMERCE 9-18-2008.

LINDA ESTRADA, EXAMINING ATTORNEY

**Int. Cl.: 43**

**Prior U.S. Cls.: 100 and 101**

**United States Patent and Trademark Office**

**Reg. No. 3,570,812**

**Registered Feb. 3, 2009**

**SERVICE MARK  
PRINCIPAL REGISTER**

**AROMA BUENA CATERING  
HISPANO WORLD CUISINE**

AROMA BUENA CATERING, INC (CALIFORNIA CORPORATION)  
236 WEST PORTAL AVENUE # 460  
SAN FRANCISCO, CA 941271427

FOR: CATERING, IN CLASS 43 (U.S. CLS. 100 AND 101).

FIRST USE 1-24-2006; IN COMMERCE 5-20-2008.

THE MARK CONSISTS OF STANDARD CHARACTERS WITHOUT CLAIM TO ANY PARTICULAR FONT, STYLE, SIZE, OR COLOR.

NO CLAIM IS MADE TO THE EXCLUSIVE RIGHT TO USE "BUENA CATERING HISPANO WORLD CUISINE", APART FROM THE MARK AS SHOWN.

THE FOREIGN WORDING IN THE MARK TRANSLATES INTO ENGLISH AS "GOOD" FOR THE WORD "BUENA", AND THE FOREIGN WORDING IN THE MARK TRANSLATES INTO ENGLISH AS "HISPANIC" FOR THE WORD "HISPANO".

SN 78-813,994, FILED 2-14-2006.

SHANNON TWOHIG, EXAMINING ATTORNEY

**Int. Cl.: 9**

**Prior U.S. Cls.: 21, 23, 26, 36, and 38**

**Reg. No. 3,570,813**

**United States Patent and Trademark Office**

**Registered Feb. 3, 2009**

**TRADEMARK  
PRINCIPAL REGISTER**

**SEEUV**

INTERTEST, INC. (NEW JERSEY CORPORATION)  
303 ROUTE 94  
COLUMBIA, NJ 07832

FOR: ULTRA-VIOLET INSPECTION TOOLS,  
NAMELY, MAGNETIC PENETRANT TESTING  
TOOLS FOR FINDING FLAWS IN METAL, IN  
CLASS 9 (U.S. CLS. 21, 23, 26, 36 AND 38).

FIRST USE 10-1-2007; IN COMMERCE 10-1-2007.

THE MARK CONSISTS OF STANDARD CHARACTERS WITHOUT CLAIM TO ANY PARTICULAR FONT, STYLE, SIZE, OR COLOR.

SN 78-815,289, FILED 2-15-2006.

MATTHEW MCDOWELL, EXAMINING ATTORNEY

**Int. Cl.: 41**

**Prior U.S. Cls.: 100, 101, and 107**

**Reg. No. 3,570,814**

**United States Patent and Trademark Office**

**Registered Feb. 3, 2009**

**SERVICE MARK  
PRINCIPAL REGISTER**

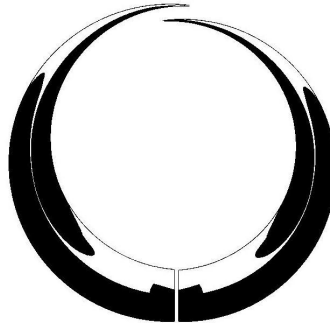

**OUTRAGEOUS  
RECORDS**

OUTRAGEOUS RECORDS (CALIFORNIA PART-  
NERSHIP)  
849 ROSE AVE  
LONG BEACH, CA 90813

NO CLAIM IS MADE TO THE EXCLUSIVE  
RIGHT TO USE "RECORDS", APART FROM THE  
MARK AS SHOWN.

FOR: MUSIC WRITING AND PRODUCTION, IN  
CLASS 41 (U.S. CLS. 100, 101 AND 107).

SN 78-844,978, FILED 3-23-2006.

FIRST USE 1-2-2008; IN COMMERCE 1-2-2008.

CAROLYN CATALDO, EXAMINING ATTORNEY



**Int. Cl.: 10**

**Prior U.S. Cls.: 26, 39, and 44**

**United States Patent and Trademark Office**

**Reg. No. 3,570,815**

**Registered Feb. 3, 2009**

**TRADEMARK  
PRINCIPAL REGISTER**

**FEELBUCK**

KAIN, MELISSA MIA (UNITED STATES INDIVIDUAL)  
P.O. BOX 2694  
LAKELAND, FL 338062694

THE MARK CONSISTS OF STANDARD CHARACTERS WITHOUT CLAIM TO ANY PARTICULAR FONT, STYLE, SIZE, OR COLOR.

FOR: ADULT SEXUAL AIDS, NAMELY, DILDOS,  
IN CLASS 10 (U.S. CLS. 26, 39 AND 44).

SN 78-846,132, FILED 3-25-2006.

FIRST USE 5-6-2007; IN COMMERCE 5-7-2007.

JOHN DWYER, EXAMINING ATTORNEY

**Int. Cls.: 35 and 42**

**Prior U.S. Cls.: 100, 101, and 102**

**United States Patent and Trademark Office**

**Reg. No. 3,570,816**

**Registered Feb. 3, 2009**

**SERVICE MARK  
PRINCIPAL REGISTER**

**SIMTANO**

SIMTANO, INC. (CALIFORNIA CORPORATION)  
3956 LOST SPRINGS DRIVE  
CALABASAS, CA 91301

FOR: SERVICES CONSISTING OF THE REGISTRATION, COLLECTION, TRANSCRIPTION, COMPILATION AND SYSTEMIZATION OF MATHEMATICAL, TECHNICAL AND STATISTICAL WRITTEN COMMUNICATIONS AND DATA, IN CLASS 35 (U.S. CLS. 100, 101 AND 102).

FIRST USE 8-26-2005; IN COMMERCE 5-3-2007.

FOR: SCIENTIFIC AND TECHNOLOGICAL RESEARCH AND DEVELOPMENT; RESEARCH IN THE FIELD OF INDUSTRIAL ANALYSIS; DESIGN AND DEVELOPMENT OF COMPUTER HARD-

WARE AND SOFTWARE, IN CLASS 42 (U.S. CLS. 100 AND 101).

FIRST USE 8-26-2005; IN COMMERCE 5-3-2007.

THE MARK CONSISTS OF STANDARD CHARACTERS WITHOUT CLAIM TO ANY PARTICULAR FONT, STYLE, SIZE, OR COLOR.

PRIORITY CLAIMED UNDER SEC. 44(D) ON NORWAY APPLICATION NO. 200510139, FILED 9-29-2005.

SN 78-848,549, FILED 3-29-2006.

KAPIL BHANOT, EXAMINING ATTORNEY

**Int. Cl.: 7**

**Prior U.S. Cls.: 13, 19, 21, 23, 31, 34, and 35**

**Reg. No. 3,570,817**

**United States Patent and Trademark Office**

**Registered Feb. 3, 2009**

---

**TRADEMARK  
PRINCIPAL REGISTER**

**VISION**

STERIS INC. (DELAWARE CORPORATION)  
43425 BUSINESS PARK DRIVE  
TEMECULA, CA 92590

THE MARK CONSISTS OF STANDARD CHAR-  
ACTERS WITHOUT CLAIM TO ANY PARTICULAR  
FONT, STYLE, SIZE, OR COLOR.

FOR: AUTOMATED WASHERS FOR SURGICAL,  
MEDICAL AND LABORATORY EQUIPMENT, IN  
CLASS 7 (U.S. CLS. 13, 19, 21, 23, 31, 34 AND 35).

SN 78-849,033, FILED 3-29-2006.

FIRST USE 5-31-2007; IN COMMERCE 5-31-2007.

MICHAEL GAAFAR, EXAMINING ATTORNEY

**Int. Cl.: 19**

**Prior U.S. Cls.: 1, 12, 33, and 50**

**United States Patent and Trademark Office**

**Reg. No. 3,570,818**

**Registered Feb. 3, 2009**

---

**TRADEMARK  
PRINCIPAL REGISTER**

**Save Wood, Buy Grass**

MCGOVERN CAPITAL LLC (DELAWARE SOLE  
PROPRIETORSHIP)  
14 E. 60TH STREET, SUITE 606  
NEW YORK, NY 10022

THE MARK CONSISTS OF STANDARD CHAR-  
ACTERS WITHOUT CLAIM TO ANY PARTICULAR  
FONT, STYLE, SIZE, OR COLOR.

FOR: BUILDING MATERIALS, NAMELY, HARD-  
WOOD AND ENGINEERED BOARDS, IN CLASS 19  
(U.S. CLS. 1, 12, 33 AND 50).

SN 78-849,718, FILED 3-30-2006.

FIRST USE 7-10-2008; IN COMMERCE 7-10-2008.

INGA ERVIN, EXAMINING ATTORNEY

**Int. Cl.: 33**

**Prior U.S. Cls.: 47 and 49**

**United States Patent and Trademark Office**

**Reg. No. 3,570,819**

**Registered Feb. 3, 2009**

**TRADEMARK  
PRINCIPAL REGISTER**

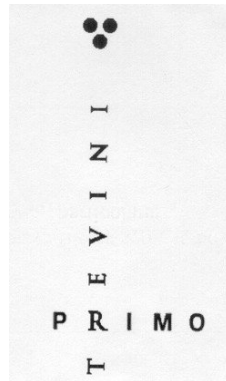

MGM MONDO DEL VINO S.R.L. (ITALY SOCIE-  
TA A RESPONSABILITA LIMITATA)  
VIA SEGANTI 73/F  
FORLI' (FORLI' CESENA), ITALY

FOR: RED WINE; WHITE WINE, IN CLASS 33  
(U.S. CLS. 47 AND 49).

FIRST USE 10-31-2003; IN COMMERCE 9-30-2008.

THE ENGLISH TRANSLATION OF THE WORD  
"PRIMO" IN THE MARK IS FIRST.

SN 78-852,370, FILED 4-3-2006.

HANNO RITTNER, EXAMINING ATTORNEY

**Int. Cl.: 25**

**Prior U.S. Cls.: 22 and 39**

**United States Patent and Trademark Office**

**Reg. No. 3,570,820**

**Registered Feb. 3, 2009**

**TRADEMARK  
PRINCIPAL REGISTER**

**TEVROW + CHASE**

TEVROW + CHASE INC. (CANADA CORPORATION)

41 FRASER AVENUE

TORONTO, ONTARIO, CANADA M6K 1Y7

FOR: WOMEN'S CLOTHING, NAMELY, SHIRTS, PANTS, SWEATERS, SPORTS JACKETS, COATS AND T-SHIRTS, IN CLASS 25 (U.S. CLS. 22 AND 39).

FIRST USE 9-30-2006; IN COMMERCE 9-30-2006.

THE MARK CONSISTS OF STANDARD CHARACTERS WITHOUT CLAIM TO ANY PARTICULAR FONT, STYLE, SIZE, OR COLOR.

PRIORITY CLAIMED UNDER SEC. 44(D) ON CANADA APPLICATION NO. 1296096, FILED 3-30-2006.

SN 78-863,711, FILED 4-18-2006.

NORA BUCHANAN WILL, EXAMINING ATTORNEY

**Int. Cl.: 29**

**Prior U.S. Cl.: 46**

**United States Patent and Trademark Office**

**Reg. No. 3,570,821**

**Registered Feb. 3, 2009**

**TRADEMARK  
PRINCIPAL REGISTER**

**STEAK FILETS**

OBERTO SAUSAGE COMPANY (WASHINGTON  
CORPORATION)  
P.O. BOX 429  
KENT, WA 98035

FOR: PROCESSED MEAT, NAMELY, DRIED  
MEAT; PROCESSED AND DRIED MEAT-BASED  
SNACKS, NAMELY, BEEF JERKY, DRIED AND  
SMOKED BEEF, CHICKEN, TURKEY AND PORK,  
IN CLASS 29 (U.S. CL. 46).

FIRST USE 8-31-2007; IN COMMERCE 8-31-2007.

THE MARK CONSISTS OF STANDARD CHAR-  
ACTERS WITHOUT CLAIM TO ANY PARTICULAR  
FONT, STYLE, SIZE, OR COLOR.

SN 78-863,910, FILED 4-18-2006.

CHRISTOPHER BUONGIORNO, EXAMINING AT-  
TORNEY

**Int. Cls.: 6, 37, and 42**

**Prior U.S. Cls.: 2, 12, 13, 14, 23, 25, 50, 100, 101, 103,  
and 106**

**Reg. No. 3,570,822**

**Registered Feb. 3, 2009**

**United States Patent and Trademark Office**

---

**TRADEMARK  
SERVICE MARK  
PRINCIPAL REGISTER**



O'HAGIN'S, INC. (CALIFORNIA CORPORATION)  
210 CLASSIC COURT  
ROHNERT PARK, CA 94928

FOR: METAL ROOF VENTS FOR COMMERCIAL AND RESIDENTIAL BUILDINGS, IN CLASS 6 (U.S. CLS. 2, 12, 13, 14, 23, 25 AND 50).

FIRST USE 12-31-1992; IN COMMERCE 12-31-1992.

FOR: CONSULTATION SERVICES IN THE FIELD OF COMMERCIAL BUILDING AND RESIDENTIAL VENTS AND VENTILATION SYSTEMS; REPAIR, AND MAINTENANCE OF COMMERCIAL BUILDING AND RESIDENTIAL VENTS AND VENTILA-

TION SYSTEMS, IN CLASS 37 (U.S. CLS. 100, 103 AND 106).

FIRST USE 3-31-1978; IN COMMERCE 3-31-1978.

FOR: CUSTOM DESIGN OF COMMERCIAL BUILDING AND RESIDENTIAL VENTS AND VENTILATION SYSTEMS, IN CLASS 42 (U.S. CLS. 100 AND 101).

FIRST USE 3-31-1978; IN COMMERCE 3-31-1978.

SN 78-864,273, FILED 4-18-2006.

EMILY CARLSEN, EXAMINING ATTORNEY



Int. Cl.: 2

Prior U.S. Cls.: 6, 11, and 16

United States Patent and Trademark Office

Reg. No. 3,570,823

Registered Feb. 3, 2009

TRADEMARK  
PRINCIPAL REGISTER



SPACE COATINGS

FENG, PEISHEN (UNITED STATES INDIVIDUAL)

2035 HARPER ST.  
EL CERRITO, CA 94530

FOR: ANTICORROSIVE PAINTS; BACTERICIDAL PAINTS; CAMOUFLAGE PAINTS FOR MILITARY EQUIPMENT; CHEMICALPROOF PAINTS; CLEAR AND PIGMENTED COATINGS USED IN THE NATURE OF PAINT; CLEAR COATING PROTECTANT FOR VEHICLES; COATING COMPOSITION IN THE NATURE OF PAINT FOR INDUSTRIAL APPLICATIONS; COATING COMPOSITIONS IN THE NATURE OF PAINT FOR INDUSTRIAL APPLICATIONS; COATINGS IN THE NATURE OF CONDUCTIVE INKS FOR USE IN THE MANUFACTURE OF PRINTED CIRCUIT BOARDS; COATINGS IN THE NATURE OF FINISHES FOR STAINLESS STEEL SHEET, STRIP, AND PLATE, WHICH PROVIDES A DECORATIVE APPEARANCE; COATINGS USED FOR FURNITURE FINISHING; COATINGS, NAMELY, STAINS AND CLEAR FINISHES FOR EXTERIOR AND INTERIOR USE ON A VARIETY OF SUBSTRATES; COLORANT DISPERSIONS FOR USE IN SURFACE COATING COMPOSITIONS; COLORANTS FOR USE IN THE MANUFACTURE OF PAINT; COLORANTS, PAINTS AND DYES FOR GENERAL INDUSTRIAL USE; CONCRETE MOISTURE BARRIER COATING; CORROSION INHIBITANTS IN THE NATURE OF A COATING; CORROSION INHIBITING PAINT TYPE COATINGS FOR COMMERCIAL MARINE USE; CORROSION INHIBITING PAINT TYPE COATINGS FOR USE IN THE OIL AND/OR GAS DRILLING INDUSTRY; DECORATIVE SPRAY COATING; ELASTOMERIC-BASED COATINGS FOR USE ON ROOFS, WALLS AND BUILDING FOUNDATIONS; ENAMEL PAINTS; EPOXY COATING FOR USE ON CONCRETE INDUSTRIAL FLOORS; EXTERIOR PAINT; FABRIC PAINTS; FIRE RETARDANT

PAINTS; FIREPROOF PAINTS; FLUORESCENT PAINTS; GLAZES ; LACQUERS FOR COATING PAPERS; LACQUERS IN THE NATURE OF A COATING; LOWER HULL PAINTS; NONSTICK COATING FOR COOKWARE AND PORTABLE ELECTRIC APPLIANCES; OIL PAINTS; OPTICAL COATINGS; PAINT FOR CONCRETE FLOORS; PAINT FOR INDUSTRIAL EQUIPMENT AND MACHINERY; PAINT FOR MODEL AIRPLANES, MODEL CARS AND THE LIKE; PAINT FOR USE IN THE MANUFACTURE OF AUTOMOBILES; PAINT FOR USE IN THE MANUFACTURE OF CERAMICS; PAINT PRIMERS; PAINT SEALERS; PAINT THINNER; PAINT THINNERS; PAINTS; PAINTS FOR ELECTRONICS; PAVEMENT MARKING PAINT; PAVEMENT STRIPING PAINT; PRESERVATIVE COATINGS FOR INSULATION, DRYWALL, AND MASONRY; PRESERVATIVE COATINGS FOR PAPER AND WOOD SURFACES; PRIMERS FOR PREPARING SURFACES TO BE PAINTED; PRINTING INKS, COATINGS, PIGMENTS AND DISPERSIONS FOR USE IN THE GRAPHIC ARTS INDUSTRY; RUST PRESERVATIVES IN THE NATURE OF A COATING; RUST PREVENTATIVES IN THE NATURE OF A COATING; SEALER COATINGS FOR USE IN INDUSTRIAL INSULATION; SHELLAC FOR USE AS A SURFACE COATING; SYNTHETIC RESIN PAINTS; THERMOPLASTIC PAINT MATERIALS FOR USE IN MARKING ROAD SURFACES; TINTS FOR ARCHITECTURAL PAINTS AND PIGMENTED COATINGS FOR INTERIOR AND EXTERIOR USE; UNDERCOATING FOR SURFACES TO BE PAINTED; WATER BASED FIRE RETARDANT COATINGS FOR BUILDING CONSTRUCTION MATERIALS; WATER REPELLENT PAINTS; WATER-PROOF PAINTS , IN CLASS 2 (U.S. CLS. 6, 11 AND 16).

FIRST USE 9-19-2007; IN COMMERCE 9-19-2007.

NO CLAIM IS MADE TO THE EXCLUSIVE RIGHT TO USE "SPACE COATINGS", APART FROM THE MARK AS SHOWN.

THE COLOR(S) WHITE AND BLUE IS/ARE CLAIMED AS A FEATURE OF THE MARK.

THE MARK CONSISTS OF THE COLOR BLUE APPEARS ON THE WORDING "SPACE COATINGS",

AND ON THE STYLIZED DESIGN OF A SPACECRAFT. THE COLOR WHITE APPEARS ON THE THREE CIRCLES ON THE BACK OF THE SPACECRAFT, AND ON THE LINE SEPARATING THE WING OF THE SPACECRAFT FROM THE BODY OF THE SPACECRAFT.

SN 78-866,360, FILED 4-20-2006.

COLLEEN DOMBROW, EXAMINING ATTORNEY

Int. Cl.: 25

Prior U.S. Cls.: 22 and 39

United States Patent and Trademark Office

Reg. No. 3,570,824

Registered Feb. 3, 2009

TRADEMARK  
PRINCIPAL REGISTER



AMANDA ADAMS COUTURE, LLC (FLORIDA CORPORATION)  
STE. 904  
201 S. NARCISSUS AVENUE  
WEST PALM BEACH, FL 33410

FOR: CLOTHING, NAMELY, DENIM JEANS, DENIM JACKETS, WOMEN'S TOPS AND SHIRTS, AND SKIRTS, IN CLASS 25 (U.S. CLS. 22 AND 39).

FIRST USE 1-30-2006; IN COMMERCE 11-15-2006.

NO CLAIM IS MADE TO THE EXCLUSIVE RIGHT TO USE "COUTURE", APART FROM THE MARK AS SHOWN.

THE NAME "AMANDA ADAMS" IDENTIFIES A LIVING INDIVIDUAL WHOSE CONSENT IS OF RECORD.

THE COLOR(S) RED AND BLACK IS/ARE CLAIMED AS A FEATURE OF THE MARK.

THE COLOR RED APPEARS IN THE DIAMONDS UNDER THE TWO "A"'S, WHILE THE WRITING IS IN BLACK.

SN 78-866,427, FILED 4-21-2006.

INGA ERVIN, EXAMINING ATTORNEY

**Int. Cls.: 36, 37, and 42**

**Prior U.S. Cls.: 100, 101, 102, 103, and 106**

**United States Patent and Trademark Office**

**Reg. No. 3,570,825**

**Registered Feb. 3, 2009**

**SERVICE MARK  
PRINCIPAL REGISTER**



COAST TO COAST DEALER SERVICES INC.  
(CANADA CORPORATION)  
1945 KING STREET EAST, SUITE 100  
HAMILTON, CANADA L8K 1W2

FOR: AFTERMARKET EXTENDED WARRANTY PLANS AND PROVIDING VEHICLE REPAIR AND MAINTENANCE SERVICE PLANS FOR LAND VEHICLES, NAMELY, AUTOMOBILES, VANS, TRUCKS, RECREATIONAL VEHICLES, MOTOR HOMES, MOTORCYCLES AND MOTORBIKES, TRAILERS, AND WATERCRAFT, NAMELY, BOATS, JET BOATS AND WATER SCOOTERS, IN CLASS 36 (U.S. CLS. 100, 101 AND 102).

FIRST USE 8-1-2006; IN COMMERCE 8-1-2006.

FOR: INSTALLING THEFT PREVENTION DEVICES FOR LAND VEHICLES, NAMELY, AUTOMOBILES, VANS, TRUCKS, RECREATIONAL VEHICLES, MOTOR HOMES, MOTORCYCLES AND MOTORBIKES, TRAILERS, AND WATERCRAFT, NAMELY, BOATS, JET BOATS AND WA-

TER SCOOTERS , IN CLASS 37 (U.S. CLS. 100, 103 AND 106).

FIRST USE 8-1-2006; IN COMMERCE 8-1-2006.

FOR: PROVIDING VEHICLE INSPECTION SERVICE PLANS FOR LAND VEHICLES, NAMELY, AUTOMOBILES, VANS, TRUCKS, RECREATIONAL VEHICLES, MOTOR HOMES, MOTORCYCLES AND MOTORBIKES, TRAILERS, AND WATERCRAFT, NAMELY, BOATS, JET BOATS AND WATER SCOOTERS, IN CLASS 42 (U.S. CLS. 100 AND 101).

FIRST USE 8-1-2006; IN COMMERCE 8-1-2006.

THE MARK CONSISTS OF THE WORDS "ASSURE-A-CAR" INSIDE A FRAMED BOX WITH ROUNDED CORNERS.

SN 78-868,262, FILED 4-24-2006.

KATHERINE M. DUBRAY, EXAMINING ATTORNEY

Int. Cls.: 9, 36, 37, and 42

Prior U.S. Cls.: 21, 23, 26, 36, 38, 100, 101, 102, 103,  
and 106

Reg. No. 3,570,826

United States Patent and Trademark Office

Registered Feb. 3, 2009

TRADEMARK  
SERVICE MARK  
PRINCIPAL REGISTER



COAST TO COAST DEALER SERVICES INC.  
(CANADA CORPORATION)  
1945 KING STREET EAST, SUITE 100  
HAMILTON, CANADA L8K 1W2

FOR: COMPUTER SOFTWARE, NAMELY, COMPUTER SOFTWARE FOR FINANCIAL COMPUTATION, SCHEDULING, INVENTORY MAINTENANCE AND SALES FOR BUSINESSES ENGAGED IN THE SALE AND RENTAL OF LAND VEHICLES, NAMELY, AUTOMOBILES, VANS, TRUCKS, RECREATIONAL VEHICLES, MOTOR HOMES, MOTORCYCLES AND MOTORBIKES, TRAILERS, AND WATERCRAFT, NAMELY, BOATS, JET BOATS AND WATER SCOOTERS, IN CLASS 9 (U.S. CLS. 21, 23, 26, 36 AND 38).

FIRST USE 7-31-2006; IN COMMERCE 7-31-2006.

FOR: AFTERMARKET EXTENDED WARRANTY PLANS AND PROVIDING VEHICLE REPAIR AND MAINTENANCE SERVICE PLANS FOR LAND VEHICLES, NAMELY, AUTOMOBILES, VANS, TRUCKS, RECREATIONAL VEHICLES, MOTOR HOMES, MOTORCYCLES AND MOTORBIKES, TRAILERS, AND WATERCRAFT, NAMELY, BOATS, JET BOATS AND WATER SCOOTERS, IN CLASS 36 (U.S. CLS. 100, 101 AND 102).

FIRST USE 7-31-2006; IN COMMERCE 7-31-2006.

FOR: INSTALLING THEFT PREVENTION DEVICES FOR LAND VEHICLES, NAMELY, AUTOMOBILES, VANS, TRUCKS, RECREATIONAL VEHICLES, MOTOR HOMES, MOTORCYCLES AND MOTORBIKES, TRAILERS, AND WATERCRAFT, NAMELY, BOATS, JET BOATS AND WATER SCOOTERS, IN CLASS 37 (U.S. CLS. 100, 103 AND 106).

FIRST USE 7-31-2006; IN COMMERCE 7-31-2006.

FOR: PROVIDING VEHICLE INSPECTION SERVICE PLANS FOR LAND VEHICLES, NAMELY, AUTOMOBILES, VANS, TRUCKS, RECREATIONAL VEHICLES, MOTOR HOMES, MOTORCYCLES AND MOTORBIKES, TRAILERS, AND WATERCRAFT, NAMELY, BOATS, JET BOATS AND WATER SCOOTERS, IN CLASS 42 (U.S. CLS. 100 AND 101).

FIRST USE 7-31-2006; IN COMMERCE 7-31-2006.

NO CLAIM IS MADE TO THE EXCLUSIVE RIGHT TO USE "DEALER SERVICES", APART FROM THE MARK AS SHOWN.

THE MARK CONSISTS OF THE WORDS "COAST TO COAST DEALER SERVICES" WRITTEN OVER AND ACROSS A GLOBE WITH FIVE STARS UNDERNEATH.

SN 78-868,322, FILED 4-24-2006.

KATHERINE M. DUBRAY, EXAMINING ATTOR-  
NEY

**Int. Cl.: 3**

**Prior U.S. Cls.: 1, 4, 6, 50, 51, and 52**

**Reg. No. 3,570,827**

**United States Patent and Trademark Office**

**Registered Feb. 3, 2009**

**TRADEMARK  
PRINCIPAL REGISTER**

**SMART COLOUR**

SMART BEAUTY HOLDINGS LIMITED (UNI-  
TED KINGDOM PRIVATE LIMITED COMPA-  
NY)  
PLACE ROAD  
FERNLEITH HOUSE  
DOUGLAS, UNITED KINGDOM IM2 4LB

FOR: HAIR CARE PREPARATIONS; HAIR LO-  
TIONS; NON-MEDICATED PREPARATIONS FOR  
THE HAIR AND SCALP; HAIR COLOURANTS;  
HAIR BLEACHING PREPARATIONS; HAIR DYE-  
ING PREPARATIONS; SHAMPOO, CONDITIONER;  
HAIR SHEEN, RINSE, GEL, MOUSSE, SPRAY AND  
OIL, IN CLASS 3 (U.S. CLS. 1, 4, 6, 50, 51 AND 52).

FIRST USE 1-31-2007; IN COMMERCE 1-31-2007.

THE MARK CONSISTS OF STANDARD CHAR-  
ACTERS WITHOUT CLAIM TO ANY PARTICULAR  
FONT, STYLE, SIZE, OR COLOR.

NO CLAIM IS MADE TO THE EXCLUSIVE  
RIGHT TO USE "COLOUR", APART FROM THE  
MARK AS SHOWN.

SN 78-870,128, FILED 4-26-2006.

LAURIE KAUFMAN, EXAMINING ATTORNEY

Int. Cl.: 1

Prior U.S. Cls.: 1, 5, 6, 10, 26, and 46

United States Patent and Trademark Office

Reg. No. 3,570,828

Registered Feb. 3, 2009

TRADEMARK  
PRINCIPAL REGISTER

Firmenich | INSPIRING

FIRMENICH S.A. (SWITZERLAND SOCIETE ANONYME)  
I.P. DEPT.; 1, ROUTE DES JEUNES  
GENEVE, SWITZERLAND CH-1211

FOR: CHEMICAL ADDITIVES AND PREPARATIONS FOR USE IN THE MANUFACTURE OF PERFUMES, FLAVORS, AND OTHER INTERMEDIATE PRODUCTS USED IN THE FRAGRANCE AND FLAVOR INDUSTRY, IN CLASS 1 (U.S. CLS. 1, 5, 6, 10, 26 AND 46).

FIRST USE 3-1-2006; IN COMMERCE 3-1-2006.

PRIORITY CLAIMED UNDER SEC. 44(D) ON SWITZERLAND APPLICATION NO. 007532006,

FILED 4-6-2006, REG. NO. 548091, DATED 4-6-2006, EXPIRES 4-6-2016.

OWNER OF U.S. REG. NO. 2,571,897.

THE MARK CONSISTS OF THE WORD "FIRMENICH" IN STYLIZED LETTERS, A VERTICAL BAR, AND THE WORD "INSPIRING" IN BLOCK CAPITAL LETTERS.

SN 78-871,723, FILED 4-27-2006.

JASON TURNER, EXAMINING ATTORNEY



**Int. Cl.: 3**

**Prior U.S. Cls.: 1, 4, 6, 50, 51, and 52**

**Reg. No. 3,570,829**

**United States Patent and Trademark Office**

**Registered Feb. 3, 2009**

---

**TRADEMARK  
PRINCIPAL REGISTER**

# The Fill Monty

SOAP & GLORY LIMITED (UNITED KINGDOM  
LIMITED LIABILITY JOINT STOCK COMPA-  
NY)  
167-169 KENSINGTON HIGH STREET  
FIRST FLOOR  
LONDON, UNITED KINGDOM W8 6SH

FOR: COSMETICS, NAMELY, WRINKLE FIL-  
LERS AND LINE FILLERS, IN CLASS 3 (U.S. CLS.  
1, 4, 6, 50, 51 AND 52).

FIRST USE 3-15-2008; IN COMMERCE 3-15-2008.

THE MARK CONSISTS OF STANDARD CHAR-  
ACTERS WITHOUT CLAIM TO ANY PARTICULAR  
FONT, STYLE, SIZE, OR COLOR.

SN 78-871,763, FILED 4-28-2006.

SANJEEV VOHRA, EXAMINING ATTORNEY

**Int. Cl.: 10**

**Prior U.S. Cls.: 26, 39, and 44**

**United States Patent and Trademark Office**

**Reg. No. 3,570,830**

**Registered Feb. 3, 2009**

**TRADEMARK  
PRINCIPAL REGISTER**

**VALECOR**

CORNOVA, INC. (DELAWARE CORPORATION)  
21 A STREET  
BURLINGTON, MA 01803

THE MARK CONSISTS OF STANDARD CHAR-  
ACTERS WITHOUT CLAIM TO ANY PARTICULAR  
FONT, STYLE, SIZE, OR COLOR.

FOR: CARDIOVASCULAR MEDICAL DEVICES,  
NAMELY STENTS AND STENT SYSTEMS COM-  
PRISING CATHETERS, GUIDE WIRES, AND  
STENTS, IN CLASS 10 (U.S. CLS. 26, 39 AND 44).

SN 78-873,582, FILED 5-1-2006.

FIRST USE 2-28-2006; IN COMMERCE 2-28-2006.

DARRYL SPRUILL, EXAMINING ATTORNEY

**Int. Cls.: 37 and 42**

**Prior U.S. Cls.: 100, 101, 103, and 106**

**United States Patent and Trademark Office**

**Reg. No. 3,570,831**

**Registered Feb. 3, 2009**

**SERVICE MARK  
PRINCIPAL REGISTER**

**DEVINECUSTOM**

DEVINE COLORS, INC. (OREGON CORPORATION)  
1551 LAKE FRONT ROAD  
LAKE OSWEGO, OR 97034

FOR: HOUSE PAINTING, IN CLASS 37 (U.S. CLS. 100, 103 AND 106).

FIRST USE 1-1-2007; IN COMMERCE 1-1-2007.

FOR: COLOR SELECTION CONSULTING SERVICES, IN CLASS 42 (U.S. CLS. 100 AND 101).

FIRST USE 1-1-2007; IN COMMERCE 1-1-2007.

THE MARK CONSISTS OF STANDARD CHARACTERS WITHOUT CLAIM TO ANY PARTICULAR FONT, STYLE, SIZE, OR COLOR.

OWNER OF U.S. REG. NOS. 2,650,258 AND 2,972,541.

SN 78-874,393, FILED 5-2-2006.

RON FAIRBANKS, EXAMINING ATTORNEY

**Int. Cl.: 20**

**Prior U.S. Cls.: 2, 13, 22, 25, 32, and 50**

**Reg. No. 3,570,832**

**United States Patent and Trademark Office**

**Registered Feb. 3, 2009**

---

**TRADEMARK  
PRINCIPAL REGISTER**

**WYNN DREAM BED**

WYNN RESORTS HOLDINGS, LLC (NEVADA  
LIMITED LIABILITY COMPANY)

3131 LAS VEGAS BLVD. SOUTH

LAS VEGAS, NV 89109

FOR: BEDS; MATTRESSES, IN CLASS 20 (U.S.  
CLS. 2, 13, 22, 25, 32 AND 50).

FIRST USE 4-29-2005; IN COMMERCE 4-29-2005.

THE MARK CONSISTS OF STANDARD CHAR-  
ACTERS WITHOUT CLAIM TO ANY PARTICULAR  
FONT, STYLE, SIZE, OR COLOR.

NO CLAIM IS MADE TO THE EXCLUSIVE  
RIGHT TO USE "BED", APART FROM THE MARK  
AS SHOWN.

SN 78-885,153, FILED 5-16-2006.

SANJEEV VOHRA, EXAMINING ATTORNEY

**Int. Cl.: 16**

**Prior U.S. Cls.: 2, 5, 22, 23, 29, 37, 38, and 50**

**United States Patent and Trademark Office**

**Reg. No. 3,570,833**

**Registered Feb. 3, 2009**

**TRADEMARK  
PRINCIPAL REGISTER**

**CHANNEL ADVISOR**

INGRAM MICRO INC. (DELAWARE CORPORATION)  
1600 EAST ST. ANDREW PLACE  
SANTA ANA, CA 92705

FOR: PRINTED MATERIALS, NAMELY, MAGAZINES ON THE TOPICS OF INFORMATION TECHNOLOGY AND COMPUTERS, IN CLASS 16 (U.S. CLS. 2, 5, 22, 23, 29, 37, 38 AND 50).

FIRST USE 5-0-2006; IN COMMERCE 5-0-2006.

THE MARK CONSISTS OF STANDARD CHARACTERS WITHOUT CLAIM TO ANY PARTICULAR FONT, STYLE, SIZE, OR COLOR.

SN 78-888,215, FILED 5-19-2006.

ANGELA GAW, EXAMINING ATTORNEY

**Int. Cl.: 14**

**Prior U.S. Cls.: 2, 27, 28, and 50**

**United States Patent and Trademark Office**

**Reg. No. 3,570,834**

**Registered Feb. 3, 2009**

**TRADEMARK  
PRINCIPAL REGISTER**

**RENE CAOVI**

RENÉ CAOVI S.P.A. (ITALY JOINT STOCK COMPANY)

VIA PARADISI 1 I-30032 FIESSO D'ARTICO (VENEZIA), ITALY

FOR: JEWELRY; SHOE ORNAMENTS IN PRECIOUS METAL, THEIR ALLOYS OR COATED THEREWITH; PRECIOUS STONES; HOROLOGICAL AND CHRONOMETRIC INSTRUMENTS, IN CLASS 14 (U.S. CLS. 2, 27, 28 AND 50).

FIRST USE 12-17-2007; IN COMMERCE 2-21-2008.

THE MARK CONSISTS OF STANDARD CHARACTERS WITHOUT CLAIM TO ANY PARTICULAR FONT, STYLE, SIZE, OR COLOR.

OWNER OF U.S. REG. NO. 3,035,999.

THE NAME "RENE CAOVI" SHOWN IN THE MARK IDENTIFIES A LIVING INDIVIDUAL WHOSE CONSENT IS OF RECORD.

SN 78-889,140, FILED 5-22-2006.

DEBRA LEE, EXAMINING ATTORNEY

**Int. Cl.: 9**

**Prior U.S. Cls.: 21, 23, 26, 36, and 38**

**Reg. No. 3,570,835**

**United States Patent and Trademark Office**

**Registered Feb. 3, 2009**

**TRADEMARK  
PRINCIPAL REGISTER**

**OEXtra**

STANDARD MOTOR PRODUCTS, INC. (NEW YORK CORPORATION)  
37-18 NORTHERN BLVD.  
LONG ISLAND CITY, NY 11101

FOR: LAND VEHICLE PARTS, NAMELY, OXYGEN SENSORS FOR EMISSION REDUCTION FOR MOTORS AND ENGINES AND ELECTRONIC CONTROLS FOR MOTORS; OXYGEN SENSORS, EXHAUST GAS OXYGEN SENSORS, AIR FUEL SENSORS, AIR FUEL RATIO SENSORS, PLANAR SENSORS, WIDE BAND SENSORS FOR AUTOMOBILE, WIDE RANGE SENSORS FOR AUTOMOBILES, AND TITANIA SENSORS FOR

AUTOMOBILES, IN CLASS 9 (U.S. CLS. 21, 23, 26, 36 AND 38).

FIRST USE 8-31-2006; IN COMMERCE 8-31-2006.

THE MARK CONSISTS OF STANDARD CHARACTERS WITHOUT CLAIM TO ANY PARTICULAR FONT, STYLE, SIZE, OR COLOR.

SN 78-908,424, FILED 6-14-2006.

EDWARD NELSON, EXAMINING ATTORNEY

**Int. Cls.: 10 and 11**

**Prior U.S. Cls.: 13, 21, 23, 26, 31, 34, 39, and 44**

**United States Patent and Trademark Office**

**Reg. No. 3,570,836**

**Registered Feb. 3, 2009**

**TRADEMARK  
PRINCIPAL REGISTER**

# Jaguar Pedispa

TON, QUY THAT (UNITED STATES INDIVIDUAL)  
3131 DALRYMPLE DRIVE  
BATON ROUGE, LA 70808

FOR: MASSAGE CHAIR AND FOOTBATHS SOLD AS A UNIT THEREWITH, IN CLASS 10 (U.S. CLS. 26, 39 AND 44).

FIRST USE 7-16-2008; IN COMMERCE 7-16-2008.

FOR: FOOTBATHS FOR USE IN PEDICURE SALONS AND DAY SPAS, IN CLASS 11 (U.S. CLS. 13, 21, 23, 31 AND 34).

FIRST USE 7-16-2006; IN COMMERCE 7-16-2006.

THE MARK CONSISTS OF STANDARD CHARACTERS WITHOUT CLAIM TO ANY PARTICULAR FONT, STYLE, SIZE, OR COLOR.

NO CLAIM IS MADE TO THE EXCLUSIVE RIGHT TO USE "PEDI SPA", APART FROM THE MARK AS SHOWN.

SN 78-912,274, FILED 6-20-2006.

EMILY CARLSEN, EXAMINING ATTORNEY



**Int. Cls.: 11 and 37**

**Prior U.S. Cls.: 13, 21, 23, 31, 34, 100, 103, and 106**

**United States Patent and Trademark Office**

**Reg. No. 3,570,837**

**Registered Feb. 3, 2009**

**TRADEMARK  
SERVICE MARK  
PRINCIPAL REGISTER**



INNOVATIVE STEAM TECHNOLOGIES INC.  
(CANADA CORPORATION)  
549 CONESTOGA BOULEVARD  
CAMBRIDGE, ONTARIO N1R 7P4

FOR: STEAM GENERATORS AND ASSOCIATED  
FURNACE BOILERS, IN CLASS 11 (U.S. CLS. 13, 21,  
23, 31 AND 34).

FIRST USE 9-0-2008; IN COMMERCE 9-0-2008.

FOR: MAINTENANCE AND SERVICING OF  
STEAM GENERATORS, IN CLASS 37 (U.S. CLS.  
100, 103 AND 106).

FIRST USE 9-0-2008; IN COMMERCE 9-0-2008.

PRIORITY CLAIMED UNDER SEC. 44(D) ON  
CANADA APPLICATION NO. 1,297,595, FILED 4-12-  
2006.

OWNER OF U.S. REG. NO. 2,427,853.

SN 78-914,775, FILED 6-22-2006.

JEFF DEFORD, EXAMINING ATTORNEY

**Int. Cl.: 9**

**Prior U.S. Cls.: 21, 23, 26, 36, and 38**

**Reg. No. 3,570,838**

**United States Patent and Trademark Office**

**Registered Feb. 3, 2009**

**TRADEMARK  
PRINCIPAL REGISTER**

**LOADVUE**

LOADSTAR SENSORS, INC. (CALIFORNIA CORPORATION)  
48089 FREMONT BLVD.  
FREMONT, CA 94538

FOR: ELECTRICAL AND SCIENTIFIC GOODS, NAMELY, CAPACITIVE SENSORS AND ELECTRONIC MEASURING INSTRUMENTS FOR MEASURING LOADS, FORCES, PRESSURES AND WEIGHTS, NAMELY, SCALES AND BALANCES, SPRING SCALE, STRAIN GAUGE SCALE, HYDRAULIC SCALE, ANALYTICAL SCALE, SUPERMARKET SCALE, DYNAMOMETER, BAROMETER, BARO-

GRAPH, MICROBAROMETERS, IN CLASS 9 (U.S. CLS. 21, 23, 26, 36 AND 38).

FIRST USE 1-1-2007; IN COMMERCE 1-1-2007.

THE MARK CONSISTS OF STANDARD CHARACTERS WITHOUT CLAIM TO ANY PARTICULAR FONT, STYLE, SIZE, OR COLOR.

SN 78-915,203, FILED 6-23-2006.

HEATHER THOMPSON, EXAMINING ATTORNEY

**Int. Cl.: 10**

**Prior U.S. Cls.: 26, 39, and 44**

**United States Patent and Trademark Office**

**Reg. No. 3,570,839**

**Registered Feb. 3, 2009**

**TRADEMARK  
PRINCIPAL REGISTER**

**SENO MEDICAL INSTRUMENTS**

SENO MEDICAL INSTRUMENTS, INC. (TEXAS  
CORPORATION)  
3838 MEDICAL DRIVE, SUITE 101  
SAN ANTONIO, TX 78229

FOR: OPTOACOUSTIC MEDICAL DEVICE FOR  
IMAGING SOFT TISSUE STRUCTURES, IN CLASS  
10 (U.S. CLS. 26, 39 AND 44).

FIRST USE 11-16-2007; IN COMMERCE 11-16-2007.

THE MARK CONSISTS OF STANDARD CHAR-  
ACTERS WITHOUT CLAIM TO ANY PARTICULAR  
FONT, STYLE, SIZE, OR COLOR.

NO CLAIM IS MADE TO THE EXCLUSIVE  
RIGHT TO USE "MEDICAL INSTRUMENTS",  
APART FROM THE MARK AS SHOWN.

THE FOREIGN WORDING IN THE MARK  
TRANSLATES INTO ENGLISH AS BOSOM OR  
BREAST.

SN 78-916,910, FILED 6-26-2006.

PRISCILLA MILTON, EXAMINING ATTORNEY

**Int. Cl.: 19**

**Prior U.S. Cls.: 1, 12, 33, and 50**

**United States Patent and Trademark Office**

**Reg. No. 3,570,840**

**Registered Feb. 3, 2009**

**TRADEMARK  
PRINCIPAL REGISTER**

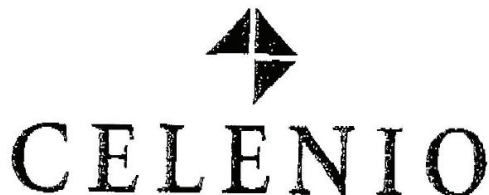

HAMBERGER INDUSTRIEWERKE GMBH (FED  
REP GERMANY GMBH)  
ROHRDORFER STR. 133  
STEPHANSKIRCHEN, FED REP GERMANY 83071

FOR: BUILDING MATERIALS NOT OF METAL,  
NAMELY, WALL, FLOOR AND CEILING TILES  
MADE OF VEGETABLE FIBERS AND WOOD FI-  
BERS; SHAPED ARTICLES COMPRISED OF VEGE-  
TABLE FIBERS AND WOOD FIBERS, NAMELY,  
STRUCTURAL AND ARCHITECTURAL MEMBERS

FORMED OF PRESSED WOOF FIBERS; AND RE-  
SUMABLE WALL, FLOOR, CEILING TILES COM-  
PRISED OF VEGETABLE FIBERS, IN CLASS 19 (U.S.  
CLS. 1, 12, 33 AND 50).

FIRST USE 12-22-2003; IN COMMERCE 8-4-2005.

SN 78-921,261, FILED 6-30-2006.

DAYNA BROWNE, EXAMINING ATTORNEY

**Int. Cl.: 33**

**Prior U.S. Cls.: 47 and 49**

**United States Patent and Trademark Office**

**Reg. No. 3,570,841**

**Registered Feb. 3, 2009**

**TRADEMARK  
PRINCIPAL REGISTER**

# Pantheon Cellars

SIKEOTIS, NICHOLAS J (UNITED STATES IN-  
DIVIDUAL)  
1618 TIMBERLAKE CIRCLE  
LODI, CA 95242

NO CLAIM IS MADE TO THE EXCLUSIVE  
RIGHT TO USE "CELLARS", APART FROM THE  
MARK AS SHOWN.

FOR: WINE, IN CLASS 33 (U.S. CLS. 47 AND 49).

FIRST USE 4-1-2006; IN COMMERCE 10-16-2008.

SN 78-921,634, FILED 7-1-2006.

THE MARK CONSISTS OF STANDARD CHAR-  
ACTERS WITHOUT CLAIM TO ANY PARTICULAR  
FONT, STYLE, SIZE, OR COLOR.

MYRIAH HABEEB, EXAMINING ATTORNEY

**Int. Cl.: 35**

**Prior U.S. Cls.: 100, 101, and 102**

**United States Patent and Trademark Office**

**Reg. No. 3,570,842**

**Registered Feb. 3, 2009**

**SERVICE MARK  
PRINCIPAL REGISTER**

**BERRYWEBSMART**

AT&T INTELLECTUAL PROPERTY II, L.P. (NE-  
VADA LIMITED PARTNERSHIP)  
645 EAST PLUMB LANE  
RENO, NV 89502

FOR: BUSINESS MARKETING CONSULTING  
SERVICES; MARKET RESEARCH SERVICES,  
NAMELY, MARKET ANALYSIS AND COMPILA-  
TION; MARKET DATA RESEARCH SERVICES,  
NAMELY, AD RESPONSE TRACKING AND MON-  
ITORING SERVICES; INTERACTIVE BUSINESS  
MARKETING SERVICES, NAMELY, PROVIDING  
USER CUSTOMIZABLE REPORTS WHICH MAN-  
AGE, TRACK AND REPORT CALL AND CLICK  
RELATED DATA, NAMELY, CUSTOMER PRO-

FILES AND CONTACT INFORMATION, TO TRACK  
ADVERTISING EFFECTIVENESS, AND IMPROVE  
SALES, IN CLASS 35 (U.S. CLS. 100, 101 AND 102).

FIRST USE 4-0-2004; IN COMMERCE 4-0-2004.

THE MARK CONSISTS OF STANDARD CHAR-  
ACTERS WITHOUT CLAIM TO ANY PARTICULAR  
FONT, STYLE, SIZE, OR COLOR.

SN 78-923,295, FILED 7-6-2006.

JANICE L. MCMORROW, EXAMINING ATTOR-  
NEY

**Int. Cl.: 28**

**Prior U.S. Cls.: 22, 23, 38, and 50**

**Reg. No. 3,570,843**

**United States Patent and Trademark Office**

**Registered Feb. 3, 2009**

**TRADEMARK  
PRINCIPAL REGISTER**

**NIGHT GUARDIANS**

IDEA VAULT, LLC (WYOMING LIMITED LIABILITY COMPANY)  
P.O. BOX 2869  
JACKSON, WY 83001

FOR: TOYS, NAMELY, ELECTRIC ACTION TOYS, BATTERY OPERATED ACTION TOYS, PLUSH TOYS, STUFFED TOYS, TALKING TOYS, INTERACTIVE TOYS, NAMELY, INTERACTIVE PLUSH TOYS AND INTERACTIVE TALKING TOYS, ANIMATED TALKING TOY FIGURES, ANIMATED TALKING TOY FIGURES SOLD AS A UNIT WITH

BOOKS AND DISCS, IN CLASS 28 (U.S. CLS. 22, 23, 38 AND 50).

FIRST USE 11-10-2008; IN COMMERCE 11-10-2008.

THE MARK CONSISTS OF STANDARD CHARACTERS WITHOUT CLAIM TO ANY PARTICULAR FONT, STYLE, SIZE, OR COLOR.

SN 78-923,758, FILED 7-6-2006.

JULIE WATSON, EXAMINING ATTORNEY

**Int. Cl.: 30**

**Prior U.S. Cl.: 46**

**United States Patent and Trademark Office**

**Reg. No. 3,570,844**

**Registered Feb. 3, 2009**

**TRADEMARK  
PRINCIPAL REGISTER**

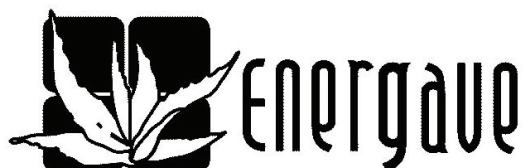

GALLARDO, SHANTALL (MEXICO INDIVIDUAL)  
PABLO NERUDA 2989 COL. PROVIDENCIA  
GUADALAJARA, MEXICO 44630

FOR: BAKERY DESSERTS; BAKERY GOODS; BAKERY PRODUCTS; BAKERY PRODUCTS, NAMELY, SWEET BAKERY GOODS; CEREAL BASED SNACK FOOD; CEREAL-BASED SNACK FOODS; COOKIES; FLAVORING SYRUP; GRANOLA SNACKS; GRANOLA-BASED SNACK BARS; HONEY SUBSTITUTES; PANCAKE SYRUP; SUGAR SUBSTITUTES, IN CLASS 30 (U.S. CL. 46).

FIRST USE 5-24-2005; IN COMMERCE 6-22-2007.

THE MARK CONSISTS OF AN AGAVE PLANT OVER FOUR SQUARES NEXT TO THE STYLIZED WORD "ENERGAVE" AT THE RIGHT.

SN 78-924,330, FILED 7-7-2006.

CHRISTINE COOPER, EXAMINING ATTORNEY



**Int. Cl.: 35**

**Prior U.S. Cls.: 100, 101, and 102**

**United States Patent and Trademark Office**

**Reg. No. 3,570,845**

**Registered Feb. 3, 2009**

**SERVICE MARK  
PRINCIPAL REGISTER**

**SNOOZAPALOOZA**

YOUNG, RANDALL K. (UNITED STATES INDIVIDUAL)  
134 LAKEWOOD ROAD  
GREENSBURG, PA 15601

FOR: RETAIL STORES FEATURING MATTRESSES, BOX SPRINGS, BED FRAMES, FUTONS, MATTRESS PADS AND HEAD BOARDS, IN CLASS 35 (U.S. CLS. 100, 101 AND 102).

FIRST USE 7-1-2008; IN COMMERCE 7-1-2008.

THE MARK CONSISTS OF STANDARD CHARACTERS WITHOUT CLAIM TO ANY PARTICULAR FONT, STYLE, SIZE, OR COLOR.

SN 78-928,979, FILED 7-13-2006.

JORDAN BAKER, EXAMINING ATTORNEY

**Int. Cl.: 17**

**Prior U.S. Cls.: 1, 5, 12, 13, 35, and 50**

**United States Patent and Trademark Office**

**Reg. No. 3,570,846**

**Registered Feb. 3, 2009**

**TRADEMARK  
PRINCIPAL REGISTER**

**FILM OF TOMORROW**

PINNACLE FILMS, INC. (NORTH CAROLINA CORPORATION)  
10701-A SOUTH COMMERCE BOULEVARD  
CHARLOTTE, NC 28273

FOR: FILM USED AS AN INDUSTRIAL OR COMMERCIAL PACKING, IN CLASS 17 (U.S. CLS. 1, 5, 12, 13, 35 AND 50).

FIRST USE 2-1-2008; IN COMMERCE 2-1-2008.

THE MARK CONSISTS OF STANDARD CHARACTERS WITHOUT CLAIM TO ANY PARTICULAR FONT, STYLE, SIZE, OR COLOR.

NO CLAIM IS MADE TO THE EXCLUSIVE RIGHT TO USE "FILM", APART FROM THE MARK AS SHOWN.

SN 78-931,054, FILED 7-17-2006.

BARBARA BROWN, EXAMINING ATTORNEY

**Int. Cls.: 9 and 16**

**Prior U.S. Cls.: 2, 5, 21, 22, 23, 26, 29, 36, 37, 38, and 50**

**United States Patent and Trademark Office**

**Reg. No. 3,570,847**

**Registered Feb. 3, 2009**

**TRADEMARK  
PRINCIPAL REGISTER**

# PUZZLE PLAY

SCHOOL ZONE PUBLISHING COMPANY (MICHIGAN CORPORATION)  
1819 INDUSTRIAL DRIVE  
GRAND HAVEN, MI 49417

FOR: PRERECORDED AUDIO CD-ROMS, COMPUTER GAME SOFTWARE IN THE FIELD OF EDUCATIONAL ACTIVITIES FOR CHILDREN; EDUCATIONAL SOFTWARE FOR SCHOOL AGED CHILDREN, IN CLASS 9 (U.S. CLS. 21, 23, 26, 36 AND 38).

FIRST USE 8-31-2006; IN COMMERCE 8-31-2006.

FOR: EDUCATIONAL AND LEARNING PUBLICATIONS, NAMELY, CHILDREN'S ACTIVITY BOOKS, PUZZLE BOOKS, AND CHILDREN'S INTERACTIVE EDUCATIONAL WORK BOOKS;

WORK BOOKS IN THE FIELD OF ELEMENTARY AND SECONDARY EDUCATION SUBJECTS, IN CLASS 16 (U.S. CLS. 2, 5, 22, 23, 29, 37, 38 AND 50).

FIRST USE 8-31-2006; IN COMMERCE 8-31-2006.

THE MARK CONSISTS OF STANDARD CHARACTERS WITHOUT CLAIM TO ANY PARTICULAR FONT, STYLE, SIZE, OR COLOR.

NO CLAIM IS MADE TO THE EXCLUSIVE RIGHT TO USE "PUZZLE", APART FROM THE MARK AS SHOWN.

SN 78-931,564, FILED 7-18-2006.

TOBY BULLOFF, EXAMINING ATTORNEY

**Int. Cls.: 9, 35, 36, 40, 41, and 42**

**Prior U.S. Cls.: 21, 23, 26, 36, 38, 100, 101, 102, 103, 106, and 107**

**Reg. No. 3,570,848**

**United States Patent and Trademark Office**

**Registered Feb. 3, 2009**

**TRADEMARK  
SERVICE MARK  
PRINCIPAL REGISTER**

**MINX**

CORPORATION FOR NATIONAL RESEARCH INITIATIVES (D.C. CORPORATION)  
1895 PRESTON WHITE DRIVE  
RESTON, VA 22091

FOR: DOWNLOADABLE COMPUTER SOFTWARE FOR PROJECT AND FOUNDRY MANAGEMENT IN THE FIELD OF NANOSCALE AND MICROSCALE SYSTEMS AND DEVICES, IN CLASS 9 (U.S. CLS. 21, 23, 26, 36 AND 38).

FIRST USE 11-10-2008; IN COMMERCE 11-10-2008.

FOR: PACKAGING OF NANOSCALE AND MICROSCALE SYSTEMS AND DEVICES TO THE ORDER AND SPECIFICATION OF OTHERS; PROVIDING INFORMATION ABOUT SILICON WAFERS FOR SALE BY MEANS OF THE INTERNET; BUSINESS MANAGEMENT FOR OTHERS IN THE FIELD OF DESIGNING, TESTING, AND DEVELOPING NANOSCALE AND MICROSCALE FABRICATION SYSTEMS AND DEVICES, IN CLASS 35 (U.S. CLS. 100, 101 AND 102).

FIRST USE 11-10-2008; IN COMMERCE 11-10-2008.

FOR: BROKERAGE SERVICES IN THE FIELD OF NANOSCALE AND MICROSCALE SYSTEMS AND DEVICES; BROKERAGE OF THE MANUFACTURING OF NANOSCALE AND MICROSCALE SYSTEMS AND DEVICES, IN CLASS 36 (U.S. CLS. 100, 101 AND 102).

FIRST USE 11-10-2008; IN COMMERCE 11-10-2008.

FOR: PROVIDING AN ONLINE DATABASE THAT IDENTIFIES PROCESSES AND FOUNDRY AND FABRICATION FACILITIES IN THE FIELD OF NANOSCALE AND MICROSCALE SYSTEMS AND DEVICES; FABRICATION FOR OTHERS OF NA-

NOSCALE AND MICROSCALE SYSTEMS AND DEVICES AND MASK WORKS; CONSULTING SERVICES IN THE FIELD OF FABRICATION AND MANUFACTURING OF NANOSCALE AND MICROSCALE SYSTEMS AND DEVICES AND MASK WORKS; MANUFACTURING SERVICES FOR OTHERS IN THE FIELD OF NANOSCALE AND MICROSCALE SYSTEMS AND DEVICES AND MASK WORKS; PROVIDING INFORMATION ABOUT THE MANUFACTURING OF NANOSCALE AND MICROSCALE SYSTEMS AND DEVICES AND MASK WORKS, IN CLASS 40 (U.S. CLS. 100, 103 AND 106).

FIRST USE 11-10-2008; IN COMMERCE 11-10-2008.

FOR: EDUCATIONAL SERVICES, NAMELY, CONDUCTING WORKSHOPS AND SEMINARS IN THE FIELD OF MANUFACTURING OF NANOSCALE AND MICROSCALE SYSTEMS AND DEVICES AND MASK WORKS, IN CLASS 41 (U.S. CLS. 100, 101 AND 107).

FIRST USE 11-10-2008; IN COMMERCE 11-10-2008.

FOR: PROVIDING QUALITY CONTROL SERVICES FOR OTHERS IN THE FIELD OF NANOSCALE AND MICROSCALE SYSTEMS AND DEVICES; PROVIDING TESTING AND MATERIAL PROPERTY MEASUREMENT SERVICES IN THE FIELD OF NANOSCALE AND MICROSCALE SYSTEMS AND DEVICES; TECHNICAL CONSULTING FOR OTHERS IN THE FIELD OF DESIGNING, TESTING, AND DEVELOPING NANOSCALE AND MICROSCALE FABRICATION SYSTEMS AND DEVICES; RESEARCH AND DEVELOPMENT FOR OTHERS OF PRODUCTS, FABRICATION PROCESSES AND OPERATIONAL PROCEDURES IN THE FIELD OF NANOSCALE AND MICROSCALE SYSTEMS AND

DEVICES; PACKAGING DESIGN SERVICES FOR OTHERS OF NANOSCALE AND MICROSCALE SYSTEMS AND DEVICES; PROVIDING TECHNICAL INFORMATION ABOUT NANOSCALE AND MICROSCALE SYSTEMS AND DEVICES AND MASK WORKS; TECHNICAL CONSULTING SERVICES IN THE FIELD OF NANOSCALE AND MICROSCALE SYSTEMS AND DEVICES; AND SCIENTIFIC RESEARCH AND DEVELOPMENT, NAMELY, DESIGNING FOR OTHERS NANOSCALE AND MICROSCALE SYSTEMS AND DEVI-

CES AND MASK WORKS, IN CLASS 42 (U.S. CLS. 100 AND 101).

FIRST USE 11-10-2008; IN COMMERCE 11-10-2008.

THE MARK CONSISTS OF STANDARD CHARACTERS WITHOUT CLAIM TO ANY PARTICULAR FONT, STYLE, SIZE, OR COLOR.

SN 78-933,840, FILED 7-20-2006.

MARILYN IZZI, EXAMINING ATTORNEY

**Int. Cls.: 9, 35, 36, 40, 41, and 42**

**Prior U.S. Cls.: 21, 23, 26, 36, 38, 100, 101, 102, 103, 106, and 107**

**Reg. No. 3,570,849**

**United States Patent and Trademark Office**

**Registered Feb. 3, 2009**

**TRADEMARK  
SERVICE MARK  
PRINCIPAL REGISTER**

**MX**

CORPORATION FOR NATIONAL RESEARCH INITIATIVES (D.C. CORPORATION)  
1895 PRESTON WHITE DRIVE  
RESTON, VA 22091

FOR: DOWNLOADABLE COMPUTER SOFTWARE FOR PROJECT AND FOUNDRY MANAGEMENT IN THE FIELD OF NANOSCALE AND MICROSCALE SYSTEMS AND DEVICES, IN CLASS 9 (U.S. CLS. 21, 23, 26, 36 AND 38).

FIRST USE 11-10-2008; IN COMMERCE 11-10-2008.

FOR: PACKAGING OF NANOSCALE AND MICROSCALE SYSTEMS AND DEVICES TO THE ORDER AND SPECIFICATION OF OTHERS; PROVIDING INFORMATION ABOUT SILICON WAFERS FOR SALE BY MEANS OF THE INTERNET; BUSINESS MANAGEMENT FOR OTHERS IN THE FIELD OF DESIGNING, TESTING, AND DEVELOPING NANOSCALE AND MICROSCALE FABRICATION SYSTEMS AND DEVICES, IN CLASS 35 (U.S. CLS. 100, 101 AND 102).

FIRST USE 11-10-2008; IN COMMERCE 11-10-2008.

FOR: BROKERAGE SERVICES IN THE FIELD OF NANOSCALE AND MICROSCALE SYSTEMS AND DEVICES ; BROKERAGE OF THE MANUFACTURING OF NANOSCALE AND MICROSCALE SYSTEMS AND DEVICES, IN CLASS 36 (U.S. CLS. 100, 101 AND 102).

FIRST USE 11-10-2008; IN COMMERCE 11-10-2008.

FOR: PROVIDING AN ONLINE DATABASE THAT IDENTIFIES PROCESSES AND FOUNDRY AND FABRICATION FACILITIES IN THE FIELD OF NANOSCALE AND MICROSCALE SYSTEMS AND DEVICES; FABRICATION FOR OTHERS OF NA-

NOSCALE AND MICROSCALE SYSTEMS AND DEVICES AND MASK WORKS; CONSULTING SERVICES IN THE FIELD OF FABRICATION AND MANUFACTURING OF NANOSCALE AND MICROSCALE SYSTEMS AND DEVICES AND MASK WORKS; MANUFACTURING SERVICES FOR OTHERS IN THE FIELD OF NANOSCALE AND MICROSCALE SYSTEMS AND DEVICES AND MASK WORKS; PROVIDING INFORMATION ABOUT THE MANUFACTURING OF NANOSCALE AND MICROSCALE SYSTEMS AND DEVICES AND MASK WORKS, IN CLASS 40 (U.S. CLS. 100, 103 AND 106).

FIRST USE 11-10-2008; IN COMMERCE 11-10-2008.

FOR: EDUCATIONAL SERVICES, NAMELY, CONDUCTING WORKSHOPS AND SEMINARS IN THE FIELD OF MANUFACTURING OF NANOSCALE AND MICROSCALE SYSTEMS AND DEVICES AND MASK WORKS, IN CLASS 41 (U.S. CLS. 100, 101 AND 107).

FIRST USE 11-10-2008; IN COMMERCE 11-10-2008.

FOR: PROVIDING QUALITY CONTROL SERVICES FOR OTHERS IN THE FIELD OF NANOSCALE AND MICROSCALE SYSTEMS AND DEVICES; PROVIDING TESTING AND MATERIAL PROPERTY MEASUREMENT SERVICES IN THE FIELD OF NANOSCALE AND MICROSCALE SYSTEMS AND DEVICES; TECHNICAL CONSULTING FOR OTHERS IN THE FIELD OF DESIGNING, TESTING, AND DEVELOPING NANOSCALE AND MICROSCALE FABRICATION SYSTEMS AND DEVICES; RESEARCH AND DEVELOPMENT FOR OTHERS OF PRODUCTS, FABRICATION PROCESSES AND OPERATIONAL PROCEDURES IN THE FIELD OF NANOSCALE AND MICROSCALE SYSTEMS AND

DEVICES; PACKAGING DESIGN SERVICES FOR OTHERS OF NANOSCALE AND MICROSCALE SYSTEMS AND DEVICES; PROVIDING TECHNICAL INFORMATION ABOUT NANOSCALE AND MICROSCALE SYSTEMS AND DEVICES AND MASK WORKS; TECHNICAL CONSULTING SERVICES IN THE FIELD OF NANOSCALE AND MICROSCALE SYSTEMS AND DEVICES; AND SCIENTIFIC RESEARCH AND DEVELOPMENT, NAMELY, DESIGNING FOR OTHERS NANOSCALE AND MICROSCALE SYSTEMS AND DEVI-

CES AND MASK WORKS, IN CLASS 42 (U.S. CLS. 100 AND 101).

FIRST USE 11-10-2008; IN COMMERCE 11-10-2008.

THE MARK CONSISTS OF STANDARD CHARACTERS WITHOUT CLAIM TO ANY PARTICULAR FONT, STYLE, SIZE, OR COLOR.

SN 78-933,852, FILED 7-20-2006.

MARILYN IZZI, EXAMINING ATTORNEY

**Int. Cl.: 5**

**Prior U.S. Cls.: 6, 18, 44, 46, 51, and 52**

**Reg. No. 3,570,850**

**United States Patent and Trademark Office**

**Registered Feb. 3, 2009**

**TRADEMARK  
PRINCIPAL REGISTER**

**MEDIKA MAMBA**

MEDS AND FOOD FOR KIDS (MISSOURI NON-  
PROFIT ORGANIZATION)  
SUITE 230  
4488 FOREST PARK AVENUE  
ST. LOUIS, MO 63108

FOR: NUTRITIONAL SUPPLEMENTS IN THE  
NATURE OF READY TO EAT BARS AND PASTES  
CONTAINING VITAMINS, MINERALS, PROTEINS  
AND ANTI-OXIDANTS , IN CLASS 5 (U.S. CLS. 6, 18,  
44, 46, 51 AND 52).

FIRST USE 1-1-2006; IN COMMERCE 1-1-2006.

THE MARK CONSISTS OF STANDARD CHAR-  
ACTERS WITHOUT CLAIM TO ANY PARTICULAR  
FONT, STYLE, SIZE, OR COLOR.

THE NAME "MEDIKA MAMBA" DOES NOT  
IDENTIFY A LIVING INDIVIDUAL.

SN 78-933,921, FILED 7-20-2006.

ALLISON HOLTZ, EXAMINING ATTORNEY



**Int. Cl.: 11**

**Prior U.S. Cls.: 13, 21, 23, 31, and 34**

**United States Patent and Trademark Office**

**Reg. No. 3,570,851**

**Registered Feb. 3, 2009**

**TRADEMARK  
PRINCIPAL REGISTER**

**CASH-FLO**

RELIANCE WORLDWIDE CORPORATION,  
THROUGH ITS DIVISION CASH ACME (DE-  
LAWARE CORPORATION)  
2400 SEVENTH AVENUE, SW  
CULLMAN, AL 35055

FOR: PLUMBING FITTINGS, NAMELY, BACK-  
FLOW PREVENTION VALVES AND VALVE AS-  
SEMBLY, IN CLASS 11 (U.S. CLS. 13, 21, 23, 31 AND  
34).

FIRST USE 1-18-2007; IN COMMERCE 1-18-2007.

THE MARK CONSISTS OF STANDARD CHAR-  
ACTERS WITHOUT CLAIM TO ANY PARTICULAR  
FONT, STYLE, SIZE, OR COLOR.

SN 78-934,217, FILED 7-20-2006.

ANTHONY RINKER, EXAMINING ATTORNEY

**Int. Cl.: 3**

**Prior U.S. Cls.: 1, 4, 6, 50, 51, and 52**

**United States Patent and Trademark Office**

**Reg. No. 3,570,852**

**Registered Feb. 3, 2009**

**TRADEMARK  
PRINCIPAL REGISTER**

**QUINTESSENCE SKIN SYSTEMS**

INTERNATIONAL COSMECEUTICALS, INC.  
(FLORIDA CORPORATION)

9750 N.W. 17 STREET

SUITE 1

MIAMI, FL 33172

FOR: SKIN CARE PRODUCTS, NAMELY, LOTIONS, CREAMS, AND BEAUTY SERUMS; COSMETICS, IN CLASS 3 (U.S. CLS. 1, 4, 6, 50, 51 AND 52).

FIRST USE 8-20-2008; IN COMMERCE 8-20-2008.

THE MARK CONSISTS OF STANDARD CHARACTERS WITHOUT CLAIM TO ANY PARTICULAR FONT, STYLE, SIZE, OR COLOR.

OWNER OF U.S. REG. NO. 3,251,524.

NO CLAIM IS MADE TO THE EXCLUSIVE RIGHT TO USE "SKIN SYSTEMS", APART FROM THE MARK AS SHOWN.

SN 78-935,648, FILED 7-24-2006.

PAUL CROWLEY, EXAMINING ATTORNEY

**Int. Cl.: 25**

**Prior U.S. Cls.: 22 and 39**

**United States Patent and Trademark Office**

**Reg. No. 3,570,853**

**Registered Feb. 3, 2009**

**TRADEMARK  
PRINCIPAL REGISTER**

**akaMeat**

HENRY CHEESEMAN (UNITED STATES INDIVIDUAL)  
USC MARSHALL SCHOOL OF BUSINESS - FBE  
701 EXPOSITION BLVD.  
LOS ANGELES, CA 90089

THE MARK CONSISTS OF STANDARD CHARACTERS WITHOUT CLAIM TO ANY PARTICULAR FONT, STYLE, SIZE, OR COLOR.

FOR: MEN'S AND WOMEN'S CLOTHING, NAMELY, SHIRTS, PANTS, JEANS AND HATS, IN CLASS 25 (U.S. CLS. 22 AND 39).

SN 78-941,294, FILED 7-31-2006.

FIRST USE 11-1-2008; IN COMMERCE 11-1-2008.

JENNIFER DIXON, EXAMINING ATTORNEY

**Int. Cls.: 18 and 25**

**Prior U.S. Cls.: 1, 2, 3, 22, 39, and 41**

**Reg. No. 3,570,854**

**United States Patent and Trademark Office**

**Registered Feb. 3, 2009**

**TRADEMARK  
PRINCIPAL REGISTER**

**PRÜNE**

PRUNE S.A. (ARGENTINA SOCIETE ANONYME)  
GROUND FLOOR 2  
SINCLAIR 2936  
BUENOS AIRES, ARGENTINA 1425

FOR: HANDBAGS, ATTACHE CASES, BARREL BAGS, BEACH BAGS, BILLFOLDS, BOOK BAGS, BRIEFCASES, BUSINESS CASES, COIN PURSES, CREDIT CARD CASES, GARMENT BAGS FOR TRAVEL, KEY CASES, SUITCASES, WALLETS; SADDLERY; UMBRELLAS, IN CLASS 18 (U.S. CLS. 1, 2, 3, 22 AND 41).

FIRST USE 3-4-1999; IN COMMERCE 9-13-2008.

FOR: LEATHER COATS, LEATHER JACKETS, FUR COATS, FUR JACKETS, FUR STOLES, BELTS, FOOTWEAR, MOCCASINS, SANDALS, BOOTS, SHOES, ATHLETIC FOOTWEAR, GLOVES, PONCHOS, SHAWLS, SCARVES, HEADWEAR, HATS, IN CLASS 25 (U.S. CLS. 22 AND 39).

FIRST USE 3-4-1999; IN COMMERCE 9-13-2008.

THE MARK CONSISTS OF STANDARD CHARACTERS WITHOUT CLAIM TO ANY PARTICULAR FONT, STYLE, SIZE, OR COLOR.

SN 78-943,089, FILED 8-2-2006.

H. M. FISHER, EXAMINING ATTORNEY

**Int. Cls.: 16 and 35**

**Prior U.S. Cls.: 2, 5, 22, 23, 29, 37, 38, 50, 100, 101, and 102**

**Reg. No. 3,570,855**

**United States Patent and Trademark Office**

**Registered Feb. 3, 2009**

**TRADEMARK  
SERVICE MARK  
PRINCIPAL REGISTER**

# TAKE CARE

HIGH COUNTRY BEVERAGE CORP. (COLORADO CORPORATION)  
5706 WRIGHT DRIVE  
LOVELAND, CO 80538

FOR: INFORMATIONAL MANUALS, BROCHURES, FLYERS, POSTERS AND BUMPER STICKERS FOR USE IN TRAINING AND EDUCATING OTHERS ABOUT THE RESPONSIBLE USE OF ALCOHOL, THE PREVENTION OF THE ILLEGAL USE OF ALCOHOL AND DRUGS, AND THE ABUSE OF ALCOHOL, DRUGS AND TOBACCO, IN CLASS 16 (U.S. CLS. 2, 5, 22, 23, 29, 37, 38 AND 50).

FIRST USE 11-30-2004; IN COMMERCE 6-13-2006.

FOR: PROMOTING PUBLIC AWARENESS ABOUT RESPONSIBLE ALCOHOL CONSUMPTION, THE PREVENTION OF ILLEGAL USE OF ALCOHOL AND DRUGS, AND THE ABUSE OF ALCOHOL, DRUGS AND TOBACCO, IN CLASS 35 (U.S. CLS. 100, 101 AND 102).

FIRST USE 11-30-2004; IN COMMERCE 6-13-2006.

THE MARK CONSISTS OF STANDARD CHARACTERS WITHOUT CLAIM TO ANY PARTICULAR FONT, STYLE, SIZE, OR COLOR.

SN 78-946,678, FILED 8-7-2006.

PAUL E. FAHRENKOPF, EXAMINING ATTORNEY

**Int. Cl.: 35**

**Prior U.S. Cls.: 100, 101, and 102**

**United States Patent and Trademark Office**

**Reg. No. 3,570,856**

**Registered Feb. 3, 2009**

**SERVICE MARK  
PRINCIPAL REGISTER**

**REDFLY MOTORSPORTS**

REDFLY MOTORSPORTS, INC. (NEVADA CORPORATION)  
P.O. BOX 152  
VIROQUA, WI 54665

FOR: ONLINE RETAIL STORE SERVICES FEATURING AUTOMOBILE RACING AND AFTER-MARKET RACING AND PERFORMANCE AUTOMOBILE PRODUCTS AND ACCESSORIES THEREFOR, AND ACCESSORIES FOR AUTOMOBILE RACING, NAMELY, WATCHES, BACKPACKS, HELMET BAGS, ATHLETIC BAGS, OVERNIGHT BAGS, HELMETS AND UMBRELLAS, ALL OF WHICH ARE RELATED TO AUTOMOBILE RACING, IN CLASS 35 (U.S. CLS. 100, 101 AND 102).

FIRST USE 12-1-2008; IN COMMERCE 12-1-2008.

THE MARK CONSISTS OF STANDARD CHARACTERS WITHOUT CLAIM TO ANY PARTICULAR FONT, STYLE, SIZE, OR COLOR.

NO CLAIM IS MADE TO THE EXCLUSIVE RIGHT TO USE "MOTORSPORTS", APART FROM THE MARK AS SHOWN.

SN 78-949,390, FILED 8-10-2006.

ANDREA BUTLER, EXAMINING ATTORNEY

**Int. Cls.: 35, 36, and 43**

**Prior U.S. Cls.: 100, 101, and 102**

**United States Patent and Trademark Office**

**Reg. No. 3,570,857**

**Registered Feb. 3, 2009**

**SERVICE MARK  
PRINCIPAL REGISTER**

**SLEEPING WITH THE ENEMY**

SLEEPING WITH THE ENEMY PTY LTD (AUSTRALIA CORPORATION)  
54 DARLINGHURST ROAD  
KINGS CROSS, SYDNEY NS, AUSTRALIA 2011

FOR: ADVERTISING SERVICES, DISSEMINATION OF ADVERTISING MATERIAL, BUSINESS MANAGEMENT ASSISTANCE, BUSINESS ADVICE AND INFORMATION, MANAGEMENT OF HOTELS FOR OTHERS, COMPILATION OF INFORMATION INTO COMPUTER DATABASES, ONLINE ADVERTISING ON A COMPUTER NETWORK, IN CLASS 35 (U.S. CLS. 100, 101 AND 102).

FIRST USE 0-0-2005; IN COMMERCE 8-0-2007.

FOR: LEASING OF REAL ESTATE, REAL ESTATE MANAGEMENT, RENT COLLECTION AGENCIES, FINANCIAL SERVICES, NAMELY, CASH TRANSFER AND TRANSACTION SERVICES, IN CLASS 36 (U.S. CLS. 100, 101 AND 102).

FIRST USE 0-0-2005; IN COMMERCE 8-0-2007.

FOR: ACCOMMODATION BUREAU, NAMELY, BOARDING HOUSES, ACCOMMODATION RENTAL, NAMELY, ARRANGING AND PROVIDING TEMPORARY HOUSING ACCOMMODATIONS, ACCOMMODATION RESERVATIONS FOR OTHERS, BOARDING HOUSE BOOKINGS FOR OTHERS, TOURIST HOMES, IN CLASS 43 (U.S. CLS. 100 AND 101).

FIRST USE 0-0-2005; IN COMMERCE 8-0-2007.

THE MARK CONSISTS OF STANDARD CHARACTERS WITHOUT CLAIM TO ANY PARTICULAR FONT, STYLE, SIZE, OR COLOR.

SN 78-949,463, FILED 8-10-2006.

KATHERINE CONNOLLY, EXAMINING ATTORNEY

**Int. Cls.: 6, 7, 9, 37, and 40**

**Prior U.S. Cls.: 2, 12, 13, 14, 19, 21, 23, 25, 26, 31, 34,  
35, 36, 38, 50, 100, 103, and 106**

**Reg. No. 3,570,858**

**United States Patent and Trademark Office**

**Registered Feb. 3, 2009**

**TRADEMARK  
SERVICE MARK  
PRINCIPAL REGISTER**



CURTISS-WRIGHT FLOW CONTROL CORPORATION (NEW YORK CORPORATION)  
2941 FAIRVIEW PARK DRIVE, SUITE 850  
FALLS CHURCH, VA 22042

FOR: METAL SLIDE VALVES, IN CLASS 6 (U.S. CLS. 2, 12, 13, 14, 23, 25 AND 50).

FIRST USE 8-0-2006; IN COMMERCE 8-0-2006.

FOR: OIL REFINERY AND NUCLEAR REACTOR EQUIPMENT AND PARTS, NAMELY, NON-METAL MANUALLY OPERATED BUTTERFLY VALVES; HYDRAULIC, LINEAR AND PNEUMATIC ACTUATORS, IN CLASS 7 (U.S. CLS. 13, 19, 21, 23, 31, 34 AND 35).

FIRST USE 8-0-2006; IN COMMERCE 8-0-2006.

FOR: AUTOMATICALLY OPERATED BUTTERFLY VALVES AND SLIDE VALVES, ELECTRIC ACTUATORS AND CONTROLS FOR FLUID CATALYTIC CRACKING UNITS, IN CLASS 9 (U.S. CLS. 21, 23, 26, 36 AND 38).

FIRST USE 8-0-2006; IN COMMERCE 8-0-2006.

FOR: REMANUFACTURE AND REPAIR OF CRITICAL SERVICE EQUIPMENT, NAMELY, VALVES, ACTUATORS AND CONTROLLERS USED IN PETROLEUM REFINING; CUSTOM MODIFICATION OF CRITICAL SERVICE EQUIPMENT, NAMELY, VALVES, ACTUATORS AND CONTROLLERS USED IN PETROLEUM REFINING TO THE ORDER AND SPECIFICATION OF OTHERS, IN CLASS 37 (U.S. CLS. 100, 103 AND 106).

FIRST USE 8-0-2006; IN COMMERCE 8-0-2006.

FOR: CUSTOM FABRICATION OF PRESSURE VESSELS, REACTORS, COLUMNS AND TOWERS USED IN PETROLEUM REFINERIES TO THE ORDER AND SPECIFICATION OF OTHERS, IN CLASS 40 (U.S. CLS. 100, 103 AND 106).

FIRST USE 8-0-2006; IN COMMERCE 8-0-2006.

NO CLAIM IS MADE TO THE EXCLUSIVE RIGHT TO USE "INTERNATIONAL", APART FROM THE MARK AS SHOWN.

SN 78-951,813, FILED 8-14-2006.

ANTHONY RINKER, EXAMINING ATTORNEY



**Int. Cls.: 29 and 30**

**Prior U.S. Cl.: 46**

**United States Patent and Trademark Office**

**Reg. No. 3,570,859**

**Registered Feb. 3, 2009**

**TRADEMARK  
PRINCIPAL REGISTER**

**GOURMET WITHOUT GUILT**

R.A.B. FOOD GROUP LLC (DELAWARE LIMITED LIABILITY COMPANY)  
ONE HARMON PLAZA  
SECAUCUS, NJ 07094

FOR: BEAN DIPS AND HUMMUS, IN CLASS 29 (U.S. CL. 46).

FIRST USE 7-1-2008; IN COMMERCE 7-1-2008.

FOR: BAKING MIXES, NAMELY, CAKE, BROWNIES AND OTHER BAKERY GOODS, IN CLASS 30 (U.S. CL. 46).

FIRST USE 5-1-2006; IN COMMERCE 5-1-2006.

THE MARK CONSISTS OF STANDARD CHARACTERS WITHOUT CLAIM TO ANY PARTICULAR FONT, STYLE, SIZE, OR COLOR.

OWNER OF U.S. REG. NO. 2,043,300.

NO CLAIM IS MADE TO THE EXCLUSIVE RIGHT TO USE "GOURMET", APART FROM THE MARK AS SHOWN.

SN 78-957,319, FILED 8-22-2006.

NAKIA HENRY, EXAMINING ATTORNEY

**Int. Cl.: 41**

**Prior U.S. Cls.: 100, 101, and 107**

**United States Patent and Trademark Office**

**Reg. No. 3,570,860**

**Registered Feb. 3, 2009**

**SERVICE MARK  
PRINCIPAL REGISTER**

**JIMMY WANG YANG**

WORLD WRESTLING ENTERTAINMENT, INC.  
(DELAWARE CORPORATION)  
1241 EAST MAIN STREET  
STAMFORD, CT 06902

FOR: ENTERTAINMENT SERVICES, NAMELY, WRESTLING EXHIBITS AND PERFORMANCES BY A PROFESSIONAL WRESTLER AND ENTERTAINER; PROVIDING WRESTLING NEWS AND INFORMATION VIA A GLOBAL COMPUTER NETWORK, IN CLASS 41 (U.S. CLS. 100, 101 AND 107).

FIRST USE 8-25-2006; IN COMMERCE 8-25-2006.

THE MARK CONSISTS OF STANDARD CHARACTERS WITHOUT CLAIM TO ANY PARTICULAR FONT, STYLE, SIZE, OR COLOR.

THE NAME(S), PORTRAIT(S), AND/OR SIGNATURE(S) SHOWN IN THE MARK DOES NOT IDENTIFY A PARTICULAR LIVING INDIVIDUAL.

SN 78-958,644, FILED 8-23-2006.

BERNICE MIDDLETON, EXAMINING ATTORNEY

**Int. Cl.: 9**

**Prior U.S. Cls.: 21, 23, 26, 36, and 38**

**Reg. No. 3,570,861**

**United States Patent and Trademark Office**

**Registered Feb. 3, 2009**

**TRADEMARK  
PRINCIPAL REGISTER**

**ICE'D**

SCOSCHE INDUSTRIES, INC. (CALIFORNIA  
CORPORATION)  
1550 PACIFIC AVENUE  
OXNARD, CA 93033

FIRST USE 2-26-2007; IN COMMERCE 2-26-2007.

FOR: AUDIO EQUIPMENT FOR VEHICLES,  
NAMELY, STEREOS, AMPLIFIERS, TUNERS,  
SPEAKERS, WIRING KITS CONSISTING ESSEN-  
TIALY OF WIRES AND CONNECTORS FOR IN-  
STALLING AUDIO EQUIPMENT IN  
AUTOMOBILES, IN CLASS 9 (U.S. CLS. 21, 23, 26, 36  
AND 38).

THE MARK CONSISTS OF STANDARD CHAR-  
ACTERS WITHOUT CLAIM TO ANY PARTICULAR  
FONT, STYLE, SIZE, OR COLOR.

SN 78-961,029, FILED 8-25-2006.

JOHN E. MICHOS, EXAMINING ATTORNEY

**Int. Cl.: 9**

**Prior U.S. Cls.: 21, 23, 26, 36, and 38**

**Reg. No. 3,570,862**

**United States Patent and Trademark Office**

**Registered Feb. 3, 2009**

**TRADEMARK  
PRINCIPAL REGISTER**

**ICED AUDIO**

SCOSCHE INDUSTRIES, INC. (CALIFORNIA CORPORATION)  
1550 PACIFIC AVENUE  
OXNARD, CA 93033

THE MARK CONSISTS OF STANDARD CHARACTERS WITHOUT CLAIM TO ANY PARTICULAR FONT, STYLE, SIZE, OR COLOR.

FOR: AUDIO EQUIPMENT FOR VEHICLES, NAMELY, STEREOS, AMPLIFIERS, TUNERS, SPEAKERS, WIRING KITS CONSISTING ESSENTIALLY OF WIRES AND CONNECTORS FOR INSTALLING AUDIO EQUIPMENT IN AUTOMOBILES, IN CLASS 9 (U.S. CLS. 21, 23, 26, 36 AND 38).

NO CLAIM IS MADE TO THE EXCLUSIVE RIGHT TO USE "AUDIO", APART FROM THE MARK AS SHOWN.

SN 78-961,033, FILED 8-25-2006.

FIRST USE 2-26-2007; IN COMMERCE 2-26-2007.

JOHN E. MICHOS, EXAMINING ATTORNEY

**Int. Cl.: 9**

**Prior U.S. Cls.: 21, 23, 26, 36, and 38**

**Reg. No. 3,570,863**

**United States Patent and Trademark Office**

**Registered Feb. 3, 2009**

**TRADEMARK  
PRINCIPAL REGISTER**

**PRIVAFONE**

ASHBURN, STEPHEN P. (UNITED STATES IN-  
DIVIDUAL)  
9 CUSTER AVENUE  
P.O. BOX 300  
FORT MEADE, SD 57741

FIRST USE 11-9-2008; IN COMMERCE 11-9-2008.

THE MARK CONSISTS OF STANDARD CHAR-  
ACTERS WITHOUT CLAIM TO ANY PARTICULAR  
FONT, STYLE, SIZE, OR COLOR.

FOR: COMPUTER TELEPHONY SOFTWARE  
AND HARDWARE FOR ENCRYPTION OF VOICE  
AND DATA COMMUNICATIONS BY INTERNET,  
RADIO, LANDLINE AND OTHER MODES , IN  
CLASS 9 (U.S. CLS. 21, 23, 26, 36 AND 38).

SN 78-962,266, FILED 8-28-2006.

INGRID C. EULIN, EXAMINING ATTORNEY

**Int. Cl.: 35**

**Prior U.S. Cls.: 100, 101, and 102**

**United States Patent and Trademark Office**

**Reg. No. 3,570,864**

**Registered Feb. 3, 2009**

**SERVICE MARK  
PRINCIPAL REGISTER**

**TOTAL VENTURE ECOSYSTEM**

SCIENCE CENTER (PENNSYLVANIA CORPORATION)  
3711 MARKET STREET  
SUITE 800  
PHILADELPHIA, PA 19104

FOR: BUSINESS DEVELOPMENT SERVICES, NAMELY, PROVIDING START-UP SUPPORT FOR BUSINESSES OF OTHERS IN FIELDS OF LIFE SCIENCE AND TECHNOLOGY , IN CLASS 35 (U.S. CLS. 100, 101 AND 102).

FIRST USE 12-20-2005; IN COMMERCE 12-20-2005.

THE MARK CONSISTS OF STANDARD CHARACTERS WITHOUT CLAIM TO ANY PARTICULAR FONT, STYLE, SIZE, OR COLOR.

NO CLAIM IS MADE TO THE EXCLUSIVE RIGHT TO USE "VENTURE ECOSYSTEM", APART FROM THE MARK AS SHOWN.

SN 78-967,827, FILED 9-6-2006.

SCOTT BIBB, EXAMINING ATTORNEY

**Int. Cls.: 16 and 25**

**Prior U.S. Cls.: 2, 5, 22, 23, 29, 37, 38, 39, and 50**

**Reg. No. 3,570,865**

**United States Patent and Trademark Office**

**Registered Feb. 3, 2009**

**TRADEMARK  
PRINCIPAL REGISTER**

**Zasuu**

OSADETE, GREGORY (CANADA INDIVIDUAL)  
C/O ZASUU DESIGNS LIMITED  
3700 CANTERRA TOWER 400 3RD AVE SW  
CALGARY, CANADA T2P 4H2

FOR: ADULT'S BOOKS, NAMELY, BOOKS FEATURING TRIVIA, QUIZZES AND PUZZLES; SERIES OF FICTION BOOKS AND COMIC BOOKS; CHILDREN'S BOOKS, NAMELY, GAMES BOOKS FEATURING TRIVIA, QUIZZES AND PUZZLES; SERIES OF FICTION BOOKS AND COMIC BOOKS, IN CLASS 16 (U.S. CLS. 2, 5, 22, 23, 29, 37, 38 AND 50).

FIRST USE 6-15-2006; IN COMMERCE 6-15-2006.

FOR: MEN'S, WOMEN'S AND CHILDREN'S CLOTHING, NAMELY, SHIRTS, PANTS, DRESSES, SKIRTS, HATS AND FOOTWEAR, IN CLASS 25 (U.S. CLS. 22 AND 39).

FIRST USE 7-20-2006; IN COMMERCE 7-20-2006.

THE MARK CONSISTS OF STANDARD CHARACTERS WITHOUT CLAIM TO ANY PARTICULAR FONT, STYLE, SIZE, OR COLOR.

SN 78-971,573, FILED 9-11-2006.

PAUL CROWLEY, EXAMINING ATTORNEY

**Int. Cls.: 42 and 44**

**Prior U.S. Cls.: 100 and 101**

**United States Patent and Trademark Office**

**Reg. No. 3,570,866**

**Registered Feb. 3, 2009**

**SERVICE MARK  
PRINCIPAL REGISTER**



THE REGENTS OF THE UNIVERSITY OF CALIFORNIA (CALIFORNIA CORPORATION)  
1111 FRANKLIN STREET  
OAKLAND, CA 94607

FOR: MEDICAL RESEARCH, IN CLASS 42 (U.S. CLS. 100 AND 101).

FIRST USE 10-0-2006; IN COMMERCE 10-0-2006.

FOR: HEALTH CARE SERVICES , IN CLASS 44 (U.S. CLS. 100 AND 101).

FIRST USE 10-0-2006; IN COMMERCE 10-0-2006.

SN 78-971,923, FILED 9-11-2006.

H. M. FISHER, EXAMINING ATTORNEY



**Int. Cl.: 16**

**Prior U.S. Cls.: 2, 5, 22, 23, 29, 37, 38, and 50**

**Reg. No. 3,570,867**

**United States Patent and Trademark Office**

**Registered Feb. 3, 2009**

**TRADEMARK  
PRINCIPAL REGISTER**

**THE NAKED WALLET**

THE NAKED WALLET, INC. (CALIFORNIA CORPORATION)  
2753 CAMINO CAPISTRANO, SUITE A-100  
SAN CLEMENTE, CA 92672

FOR: MONEY CLIP; CURRENCY BAND; BAND FOR HOLDING MONEY; BAND FOR HOLDING MONEY AND CREDIT CARDS; BAND FOR HOLDING MONEY, CREDIT CARDS AND IDENTIFICATION CARDS; BAND FOR HOLDING MONEY, CREDIT CARDS, IDENTIFICATION CARDS AND PERSONAL PAPERS; ELASTIC STRIP FOR HOLDING MONEY; ELASTIC STRIP FOR HOLDING MONEY AND CREDIT CARDS; ELASTIC STRIP FOR HOLDING MONEY, CREDIT CARDS AND IDENTIFICATION CARDS; ELASTIC STRIP FOR HOLDING MONEY, CREDIT CARDS, IDENTIFICATION CARDS AND PERSONAL PAPERS; EXPANDABLE STRIP FOR HOLDING MONEY; EXPANDABLE STRIP FOR HOLDING MONEY AND CREDIT CARDS; EXPANDABLE STRIP FOR

HOLDING MONEY, CREDIT CARDS AND IDENTIFICATION CARDS; EXPANDABLE STRIP FOR HOLDING MONEY, CREDIT CARDS, IDENTIFICATION CARDS AND PERSONAL PAPERS, IN CLASS 16 (U.S. CLS. 2, 5, 22, 23, 29, 37, 38 AND 50).

FIRST USE 12-4-2008; IN COMMERCE 12-8-2008.

THE MARK CONSISTS OF STANDARD CHARACTERS WITHOUT CLAIM TO ANY PARTICULAR FONT, STYLE, SIZE, OR COLOR.

NO CLAIM IS MADE TO THE EXCLUSIVE RIGHT TO USE "WALLET", APART FROM THE MARK AS SHOWN.

SN 78-974,573, FILED 9-14-2006.

BRIAN PINO, EXAMINING ATTORNEY

**Int. Cl.: 45**

**Prior U.S. Cls.: 100 and 101**

**United States Patent and Trademark Office**

**Reg. No. 3,570,868**

**Registered Feb. 3, 2009**

**SERVICE MARK  
PRINCIPAL REGISTER**

**PRIVACYFIRST**

BANK OF AMERICA CORPORATION (DELA-  
WARE CORPORATION)  
100 NORTH TRYON STREET  
CHARLOTTE, NC 28255

FOR: PROVIDING CUSTOMER IDENTIFICA-  
TION AND AUTHENTICATION SERVICES FOR  
ACCESS TO ONLINE BANKING, IN CLASS 45 (U.S.  
CLS. 100 AND 101).

FIRST USE 11-24-2006; IN COMMERCE 11-24-2006.

THE MARK CONSISTS OF STANDARD CHAR-  
ACTERS WITHOUT CLAIM TO ANY PARTICULAR  
FONT, STYLE, SIZE, OR COLOR.

SN 78-974,709, FILED 9-14-2006.

RON FAIRBANKS, EXAMINING ATTORNEY

**Int. Cl.: 11**

**Prior U.S. Cls.: 13, 21, 23, 31, and 34**

**United States Patent and Trademark Office**

**Reg. No. 3,570,869**

**Registered Feb. 3, 2009**

**TRADEMARK  
PRINCIPAL REGISTER**

**PURATRON**

SUAREZ CORPORATION INDUSTRIES (OHIO  
CORPORATION)  
7800 WHIPPLE AVENUE, N.W.  
NORTH CANTON, OH 44720

THE MARK CONSISTS OF STANDARD CHAR-  
ACTERS WITHOUT CLAIM TO ANY PARTICULAR  
FONT, STYLE, SIZE, OR COLOR.

FOR: AIR PURIFIERS; WATER PURIFIERS, IN  
CLASS 11 (U.S. CLS. 13, 21, 23, 31 AND 34).

SN 78-980,806, FILED 1-10-2006.

FIRST USE 12-20-2005; IN COMMERCE 12-20-2005.

DEZMONA MIZELLE, EXAMINING ATTORNEY

**Int. Cl.: 36**

**Prior U.S. Cls.: 100, 101, and 102**

**United States Patent and Trademark Office**

**Reg. No. 3,570,870**

**Registered Feb. 3, 2009**

**SERVICE MARK  
SUPPLEMENTAL REGISTER**

**QUANTICO  
CORPORATE CENTER  
AT STAFFORD, VIRGINIA**

SILVER IP RIGHTS, INC. (VIRGINIA LIMITED  
LIABILITY COMPANY)  
1001 EAST TELECOM DRIVE  
BACA RATON, FL 33431

FOR: REAL ESTATE BROKERAGE; REAL ES-  
TATE INVESTMENT; REAL ESTATE MANAGE-  
MENT; REAL ESTATE LEASING OF OFFICE  
SPACE, RETAIL SHOPS, RESTAURANTS, THEA-  
TERS AND HEALTH AND FITNESS CLUBS, IN  
CLASS 36 (U.S. CLS. 100, 101 AND 102).

FIRST USE 4-0-2006; IN COMMERCE 7-0-2006.

THE MARK CONSISTS OF STANDARD CHAR-  
ACTERS WITHOUT CLAIM TO ANY PARTICULAR  
FONT, STYLE, SIZE, OR COLOR.

NO CLAIM IS MADE TO THE EXCLUSIVE  
RIGHT TO USE "CORPORATE CENTER", APART  
FROM THE MARK AS SHOWN.

SER. NO. 76-658,317, FILED P.R. 4-12-2006; AM. S.R.  
10-31-2008.

ELLEN PERKINS, EXAMINING ATTORNEY

**Int. Cl.: 7**

**Prior U.S. Cls.: 13, 19, 21, 23, 31, 34, and 35**

**United States Patent and Trademark Office**

**Reg. No. 3,570,871**

**Registered Feb. 3, 2009**

**TRADEMARK  
SUPPLEMENTAL REGISTER**

**ROLLERDRIVE**

SANKYO MANUFACTURING CO., LTD. (JAPAN  
JOINT STOCK COMPANY)  
37-3, TABATA-SHINMACHI 3-CHOME, KITA-KU  
TOKYO, JAPAN

FOR: PARTS AND ELEMENTS OF METAL  
WORKING MACHINES, NAMELY, CAM-DRIVEN  
INDEXING TABLE UNITS OPERATED BY COMPU-  
TER NUMERICAL CONTROL (CMC) FOR POSI-  
TIONING OF WORKPIECES, BUT THAT ARE NOT  
USED IN OR IN MANUFACTURING MACHINES  
THAT ARE CONVEYORS OR THAT CONTAIN  
CONVEYORS OR THAT ARE USED IN CONNEC-  
TION WITH CONVEYORS, IN CLASS 7 (U.S. CLS. 13,  
19, 21, 23, 31, 34 AND 35).

FIRST USE 5-31-2006; IN COMMERCE 10-10-2006.

THE MARK CONSISTS OF STANDARD CHAR-  
ACTERS WITHOUT CLAIM TO ANY PARTICULAR  
FONT, STYLE, SIZE, OR COLOR.

PRIORITY CLAIMED UNDER SEC. 44(D) ON  
JAPAN APPLICATION NO. 2007-19547, FILED 3-7-  
2007, REG. NO. 5116647, DATED 3-7-2008, EXPIRES 3-  
7-2018.

SER. NO. 76-679,667, FILED P.R. 7-19-2007; AM. S.R.  
12-4-2008.

AMY C. KEAN, EXAMINING ATTORNEY

**Int. Cl.: 3**

**Prior U.S. Cls.: 1, 4, 6, 50, 51, and 52**

**United States Patent and Trademark Office**

**Reg. No. 3,570,872**

**Registered Feb. 3, 2009**

**TRADEMARK  
SUPPLEMENTAL REGISTER**

**CONNECTICUT NATURAL SOAPWORKS**

SUNFLOWER FARM OF ORANGE, LLC (CON-  
NECTICUT CORPORATION)

767 DERBY MILFORD RD.

ORANGE, CT 06477

FOR: SOAPS, NAMELY, SCENTED AND UN-  
SCENTED SOAPS FOR PERSONAL USE, IN CLASS  
3 (U.S. CLS. 1, 4, 6, 50, 51 AND 52).

FIRST USE 3-28-2008; IN COMMERCE 3-28-2008.

THE MARK CONSISTS OF STANDARD CHAR-  
ACTERS WITHOUT CLAIM TO ANY PARTICULAR  
FONT, STYLE, SIZE, OR COLOR.

NO CLAIM IS MADE TO THE EXCLUSIVE  
RIGHT TO USE "NATURAL SOAPWORKS", APART  
FROM THE MARK AS SHOWN.

SER. NO. 76-688,417, FILED P.R. 4-7-2008; AM. S.R.  
10-10-2008.

NANCY CLARKE, EXAMINING ATTORNEY

**Int. Cl.: 5**

**Prior U.S. Cls.: 6, 18, 44, 46, 51, and 52**

**United States Patent and Trademark Office**

**Reg. No. 3,570,873**

**Registered Feb. 3, 2009**

**TRADEMARK  
SUPPLEMENTAL REGISTER**

**PROSTATE COMPLETE**

GREEK ISLAND LABS, LLC (ARIZONA LIMITED LIABILITY COMPANY)  
7620 EAST MCKELLIPS ROAD, SUITE 4  
PMB 86  
SCOTTSDALE, AZ 85257

THE MARK CONSISTS OF STANDARD CHARACTERS WITHOUT CLAIM TO ANY PARTICULAR FONT, STYLE, SIZE, OR COLOR.

FOR: DIETARY SUPPLEMENTS; FOOD SUPPLEMENTS; AND HERBAL SUPPLEMENTS, IN CLASS 5 (U.S. CLS. 6, 18, 44, 46, 51 AND 52).

SER. NO. 76-689,829, FILED P.R. 5-20-2008; AM. S.R. 11-6-2008.

FIRST USE 5-10-2008; IN COMMERCE 5-10-2008.

ANNE E. GUSTASON, EXAMINING ATTORNEY

**Int. Cl.: 25**

**Prior U.S. Cls.: 22 and 39**

**United States Patent and Trademark Office**

**Reg. No. 3,570,874**

**Registered Feb. 3, 2009**

**TRADEMARK  
SUPPLEMENTAL REGISTER**

**QUEEN OF THE GHETTO**

ROBINSON, SEKENNIA RUTH (UNITED STATES  
INDIVIDUAL)  
7820 BAIRD AVE #5  
RESEDA, CA 91335

THE MARK CONSISTS OF STANDARD CHAR-  
ACTERS WITHOUT CLAIM TO ANY PARTICULAR  
FONT, STYLE, SIZE, OR COLOR.

FOR: T-SHIRTS, IN CLASS 25 (U.S. CLS. 22 AND  
39).

SER. NO. 76-692,923, FILED P.R. 9-17-2008; AM. S.R.  
12-24-2008.

FIRST USE 3-23-2005; IN COMMERCE 7-13-2005.

HOWARD SMIGA, EXAMINING ATTORNEY



**Int. Cl.: 36**

**Prior U.S. Cls.: 100, 101, and 102**

**United States Patent and Trademark Office**

**Reg. No. 3,570,875**

**Registered Feb. 3, 2009**

**SERVICE MARK  
SUPPLEMENTAL REGISTER**

**The Town Center At Alamo  
Ranch**

151 ALAMO RANCH, LTD. (TEXAS LIMITED  
PARTNERSHIP)  
7800 IH-10 WEST, SUITE 800  
SAN ANTONIO, TX 78230

FOR: REAL ESTATE SERVICES, NAMELY, THE  
LISTING, LEASING, AND MANAGEMENT OF  
COMMERCIAL REAL ESTATE PROPERTY; AND  
REAL ESTATE MANAGEMENT SERVICES FOR  
COMMERCIAL MIXED USE PROPERTY, IN CLASS  
36 (U.S. CLS. 100, 101 AND 102).

FIRST USE 5-1-2008; IN COMMERCE 5-1-2008.

THE MARK CONSISTS OF STANDARD CHAR-  
ACTERS WITHOUT CLAIM TO ANY PARTICULAR  
FONT, STYLE, SIZE, OR COLOR.

SER. NO. 77-025,648, FILED P.R. 10-20-2006; AM.  
S.R. 9-17-2007.

ALLISON HOLTZ, EXAMINING ATTORNEY

**Int. Cl.: 37**

**Prior U.S. Cls.: 100, 103, and 106**

**United States Patent and Trademark Office**

**Reg. No. 3,570,876**

**Registered Feb. 3, 2009**

**SERVICE MARK  
SUPPLEMENTAL REGISTER**

**The Town Center At Alamo  
Ranch**

151 ALAMO RANCH, LTD. (TEXAS LIMITED  
PARTNERSHIP)  
7800 IH-10 WEST, SUITE 800  
SAN ANTONIO, TX 78230

FOR: COMMERCIAL REAL ESTATE DEVELOPMENT; REAL ESTATE DEVELOPMENT SERVICES, NAMELY, PLANNING, LAYING-OUT, AND MANAGING THE DEVELOPMENT OF MIXED-USE REAL ESTATE PROPERTY; AND MASTER-PLAN MIXED-USE REAL ESTATE DEVELOPMENT SERVICES, IN CLASS 37 (U.S. CLS. 100, 103 AND 106).

FIRST USE 5-1-2008; IN COMMERCE 5-1-2008.

THE MARK CONSISTS OF STANDARD CHARACTERS WITHOUT CLAIM TO ANY PARTICULAR FONT, STYLE, SIZE, OR COLOR.

SER. NO. 77-025,666, FILED P.R. 10-20-2006; AM. S.R. 9-17-2007.

ALLISON HOLTZ, EXAMINING ATTORNEY

**Int. Cl.: 7**

**Prior U.S. Cls.: 13, 19, 21, 23, 31, 34, and 35**

**United States Patent and Trademark Office**

**Reg. No. 3,570,877**

**Registered Feb. 3, 2009**

**TRADEMARK  
SUPPLEMENTAL REGISTER**

**GRIPPER CHAIN**

U.S. TSUBAKI, INC. (ILLINOIS CORPORATION)  
301 E. MARQUARDT DRIVE  
WHEELING, IL 60090

FOR: CHAIN CONVEYORS, NAMELY, ROLLER  
CHAIN AND SPROCKETS FOR INDUSTRIAL AP-  
PLICATIONS, IN CLASS 7 (U.S. CLS. 13, 19, 21, 23, 31,  
34 AND 35).

FIRST USE 9-0-2006; IN COMMERCE 9-0-2006.

THE MARK CONSISTS OF STANDARD CHAR-  
ACTERS WITHOUT CLAIM TO ANY PARTICULAR  
FONT, STYLE, SIZE, OR COLOR.

NO CLAIM IS MADE TO THE EXCLUSIVE  
RIGHT TO USE "CHAIN", APART FROM THE  
MARK AS SHOWN.

SER. NO. 77-035,181, FILED P.R. 11-2-2006; AM. S.R.  
12-30-2008.

FRED MANDIR, EXAMINING ATTORNEY

**Int. Cl.: 44**

**Prior U.S. Cls.: 100 and 101**

**United States Patent and Trademark Office**

**Reg. No. 3,570,878**

**Registered Feb. 3, 2009**

**SERVICE MARK  
SUPPLEMENTAL REGISTER**

**Cosmetic and Family  
Dentistry of North Texas**

JEAN A. TUGGEY D.D.S., P. C. (TEXAS CORPORATION)

1361 CROSS TIMBER

SOUTHLAKE, TX 76092

FOR: DENTIST SERVICES, IN CLASS 44 (U.S. CLS. 100 AND 101).

FIRST USE 9-1-2006; IN COMMERCE 9-1-2006.

THE MARK CONSISTS OF STANDARD CHARACTERS WITHOUT CLAIM TO ANY PARTICULAR FONT, STYLE, SIZE, OR COLOR.

NO CLAIM IS MADE TO THE EXCLUSIVE RIGHT TO USE "COSMETIC AND FAMILY DENTISTRY", APART FROM THE MARK AS SHOWN.

SER. NO. 77-077,302, FILED P.R. 1-5-2007; AM. S.R. 10-1-2007.

LINDA ESTRADA, EXAMINING ATTORNEY

**Int. Cls.: 35 and 41**

**Prior U.S. Cls.: 100, 101, 102, and 107**

**United States Patent and Trademark Office**

**Reg. No. 3,570,879**

**Registered Feb. 3, 2009**

**SERVICE MARK  
SUPPLEMENTAL REGISTER**

**TICKETDEALS NETWORK**

TICKETMASTER CORPORATION (ILLINOIS CORPORATION)  
8800 SUNSET BOULEVARD  
WEST HOLLYWOOD, CA 90069

FOR: PROMOTION OF VENUES, MUSICAL PERFORMERS, SPORTING EVENTS, MUSICAL CONCERTS AND OTHER ENTERTAINMENT EVENTS OF OTHERS, IN CLASS 35 (U.S. CLS. 100, 101 AND 102).

FIRST USE 5-0-2004; IN COMMERCE 5-0-2004.

FOR: TICKET PURCHASING AGENCY SERVICES AND TICKET INFORMATION FOR VENUES, SPORTING EVENTS, MUSICAL CONCERTS AND

OTHER ENTERTAINMENT EVENTS, RENDERED ONLINE, IN CLASS 41 (U.S. CLS. 100, 101 AND 107).

FIRST USE 5-0-2004; IN COMMERCE 5-0-2004.

THE MARK CONSISTS OF STANDARD CHARACTERS WITHOUT CLAIM TO ANY PARTICULAR FONT, STYLE, SIZE, OR COLOR.

NO CLAIM IS MADE TO THE EXCLUSIVE RIGHT TO USE "NETWORK" , APART FROM THE MARK AS SHOWN.

SER. NO. 77-116,005, FILED P.R. 2-26-2007; AM. S.R. 12-11-2008.

KAPIL BHANOT, EXAMINING ATTORNEY

**Int. Cl.: 25**

**Prior U.S. Cls.: 22 and 39**

**United States Patent and Trademark Office**

**Reg. No. 3,570,880**

**Registered Feb. 3, 2009**

**TRADEMARK  
SUPPLEMENTAL REGISTER**

LIFE IS ABOUT SOLVING FOR X

LESCARBEAU, JANE T. (UNITED STATES INDIVIDUAL)  
9981 DAKOTA ROAD  
BLOOMINGTON, MN 55438

FOR: CLOTHING, NAMELY, SHIRTS, IN CLASS 25 (U.S. CLS. 22 AND 39).

FIRST USE 4-30-2006; IN COMMERCE 4-30-2006.

THE MARK CONSISTS OF STANDARD CHARACTERS WITHOUT CLAIM TO ANY PARTICULAR FONT, STYLE, SIZE, OR COLOR.

SER. NO. 77-182,199, FILED P.R. 5-16-2007; AM. S.R. 12-18-2008.

DAVID TOOLEY, EXAMINING ATTORNEY

**Int. Cls.: 5, 35, and 42**

**Prior U.S. Cls.: 6, 18, 44, 46, 51, 52, 100, 101, and 102**

**United States Patent and Trademark Office**

**Reg. No. 3,570,881**

**Registered Feb. 3, 2009**

**TRADEMARK  
SERVICE MARK  
SUPPLEMENTAL REGISTER**

**MAKING FOODS FUNCTIONAL**

NUTRAGENESIS, LLC (VERMONT LIMITED LIABILITY COMPANY)  
167 MAIN STREET, #208  
BRATTLEBORO, VT 05301

FOR: FOOD SUPPLEMENTS AND DIETARY SUPPLEMENTS, NAMELY, FUNCTIONAL INGREDIENTS COMPRISED OF BOTANICAL EXTRACTS FOR ENHANCING HEALTH, NAMELY, BOTANICAL PREPARATIONS FOR ENHANCING IMMUNITY, ENERGY, ENDURANCE, CARDIOVASCULAR HEALTH, COGNITIVE FUNCTION, STRESS MANAGEMENT, WEIGHT MANAGEMENT, BLOOD GLUCOSE MANAGEMENT, AND FOR REDUCING THE EFFECTS OF AGING, IN CLASS 5 (U.S. CLS. 6, 18, 44, 46, 51 AND 52).

FIRST USE 9-1-2005; IN COMMERCE 9-1-2005.

FOR: WHOLESALE DISTRIBUTORSHIP SERVICES FEATURING INGREDIENTS IN THE NATURE OF RAW MATERIALS SOLD IN BULK QUANTITIES, WHICH INGREDIENTS ARE SOLD TO MANUFACTURERS OF COSMETICS, COSMECEUTICALS, DIETARY SUPPLEMENTS, NUTRACEUTICALS, FOODS AND BEVERAGES AND ARE USED IN THE MANUFACTURE OF COSMETICS, COSMECEUTICALS, DIETARY SUPPLEMENTS, NUTRACEUTICALS, FOODS AND

BEVERAGES, IN CLASS 35 (U.S. CLS. 100, 101 AND 102).

FIRST USE 7-15-2003; IN COMMERCE 7-15-2003.

FOR: PRODUCT DEVELOPMENT SERVICES FEATURING INGREDIENTS IN THE NATURE OF RAW MATERIALS INTENDED FOR SALE IN BULK QUANTITIES, WHICH SERVICES ARE RENDERED TO MANUFACTURERS OF COSMETICS, COSMECEUTICALS, DIETARY SUPPLEMENTS, NUTRACEUTICALS, FOODS AND BEVERAGES, AND WHICH INGREDIENTS ARE USED IN THE MANUFACTURE OF COSMETICS, COSMECEUTICALS, DIETARY SUPPLEMENTS, NUTRACEUTICALS, FOODS AND BEVERAGES, IN CLASS 42 (U.S. CLS. 100 AND 101).

FIRST USE 7-15-2003; IN COMMERCE 7-15-2003.

THE MARK CONSISTS OF STANDARD CHARACTERS WITHOUT CLAIM TO ANY PARTICULAR FONT, STYLE, SIZE, OR COLOR.

SER. NO. 77-207,191, FILED P.R. 6-15-2007; AM. S.R. 10-13-2008.

ROBERT C. CLARK JR., EXAMINING ATTORNEY

**Int. Cl.: 43**

**Prior U.S. Cls.: 100 and 101**

**United States Patent and Trademark Office**

**Reg. No. 3,570,882**

**Registered Feb. 3, 2009**

**SERVICE MARK  
SUPPLEMENTAL REGISTER**

**1-888-33-CANAD**

CANAD CORPORATION OF MANITOBA LTD.  
(CANADA CORPORATION)  
930 JEFFERSON AVENUE  
3RD FLOOR  
WINNIPEG, MANITOBA, CANADA R2P1W1

FOR: PROVISION OF HOTEL, RESTAURANT  
AND BAR SERVICES; PROVIDING BANQUET  
AND SOCIAL FUNCTION FACILITIES FOR SPE-  
CIAL OCCASIONS, IN CLASS 43 (U.S. CLS. 100 AND  
101).

THE MARK CONSISTS OF STANDARD CHAR-  
ACTERS WITHOUT CLAIM TO ANY PARTICULAR  
FONT, STYLE, SIZE, OR COLOR.

PRIORITY CLAIMED UNDER SEC. 44(D) ON  
CANADA APPLICATION NO. 1354498, FILED 7-4-  
2007, REG. NO. TMA715021, DATED 5-23-2008, EX-  
PIRES 5-23-2023.

OWNER OF U.S. REG. NOS. 2,812,042 AND  
3,012,869.

SER. NO. 77-222,685, FILED P.R. 7-5-2007; AM. S.R.  
12-15-2008.

MELISSA VALLILLO, EXAMINING ATTORNEY



**Int. Cl.: 29**

**Prior U.S. Cl.: 46**

**United States Patent and Trademark Office**

**Reg. No. 3,570,883**

**Registered Feb. 3, 2009**

**TRADEMARK  
SUPPLEMENTAL REGISTER**

**PREMIUM PRODUCTS FRESH  
FROM THE FARM**

WALTER P. RAWL & SONS, INC. (SOUTH CAROLINA CORPORATION)  
824 FAIRVIEW ROAD  
PELION, SC 29123

FOR: FRESH CUT VEGETABLES, IN CLASS 29 (U.S. CL. 46).

FIRST USE 12-1-2007; IN COMMERCE 12-1-2007.

THE MARK CONSISTS OF STANDARD CHARACTERS WITHOUT CLAIM TO ANY PARTICULAR FONT, STYLE, SIZE, OR COLOR.

SER. NO. 77-228,954, FILED P.R. 7-13-2007; AM. S.R. 12-15-2008.

DEZMONA MIZELLE, EXAMINING ATTORNEY

**Int. Cl.: 41**

**Prior U.S. Cls.: 100, 101, and 107**

**United States Patent and Trademark Office**

**Reg. No. 3,570,884**

**Registered Feb. 3, 2009**

**SERVICE MARK  
SUPPLEMENTAL REGISTER**

**UNITED STATES OPEN DANCE  
CHAMPIONSHIPS**

AMERICAN BALLROOM COMPANY, INC.  
(FLORIDA CORPORATION)  
49 SANTA CRUZ  
ROLLING HILLS ESTATES, CA 90274

FOR: ORGANIZING, OPERATING AND CON-  
DUCTING DANCE CONTEST EVENTS, IN CLASS  
41 (U.S. CLS. 100, 101 AND 107).

FIRST USE 2-0-2008; IN COMMERCE 2-0-2008.

THE MARK CONSISTS OF STANDARD CHAR-  
ACTERS WITHOUT CLAIM TO ANY PARTICULAR  
FONT, STYLE, SIZE, OR COLOR.

OWNER OF U.S. REG. NOS. 1,237,714, 1,533,676,  
AND OTHERS.

NO CLAIM IS MADE TO THE EXCLUSIVE  
RIGHT TO USE "OPEN DANCE CHAMPIONSHIPS",  
APART FROM THE MARK AS SHOWN.

SER. NO. 77-236,499, FILED P.R. 7-23-2007; AM. S.R.  
11-25-2008.

CHARLES L. JENKINS, EXAMINING ATTORNEY

**Int. Cl.: 41**

**Prior U.S. Cls.: 100, 101, and 107**

**United States Patent and Trademark Office**

**Reg. No. 3,570,885**

**Registered Feb. 3, 2009**

**SERVICE MARK  
SUPPLEMENTAL REGISTER**

**WORLD PROFESSIONAL DANCE  
CHAMPIONSHIPS**

AMERICAN BALLROOM COMPANY, INC.  
(FLORIDA CORPORATION)  
49 SANTA CRUZ  
ROLLING HILLS ESTATES, CA 90274

FOR: ORGANIZING, OPERATING AND CON-  
DUCTING DANCE CONTEST EVENTS, IN CLASS  
41 (U.S. CLS. 100, 101 AND 107).

FIRST USE 2-0-2008; IN COMMERCE 2-0-2008.

THE MARK CONSISTS OF STANDARD CHAR-  
ACTERS WITHOUT CLAIM TO ANY PARTICULAR  
FONT, STYLE, SIZE, OR COLOR.

OWNER OF U.S. REG. NOS. 2,233,056 AND  
2,236,234.

NO CLAIM IS MADE TO THE EXCLUSIVE  
RIGHT TO USE "PROFESSIONAL DANCE CHAM-  
PIONSHIPS", APART FROM THE MARK AS  
SHOWN.

SER. NO. 77-236,521, FILED P.R. 7-23-2007; AM. S.R.  
11-25-2008.

CHARLES L. JENKINS, EXAMINING ATTORNEY

**Int. Cl.: 45**

**Prior U.S. Cls.: 100 and 101**

**United States Patent and Trademark Office**

**Reg. No. 3,570,886**

**Registered Feb. 3, 2009**

**SERVICE MARK  
SUPPLEMENTAL REGISTER**

**CERTIFIED BIKER**

SUCCESSFULMATCH.COM (CALIFORNIA CORPORATION)  
800 WEST EL CAMINO REAL #180  
MOUNTAIN VIEW, CA 94040

FOR: COMPUTER DATING AND INTRODUCTION SERVICES; INTERNET BASED SOCIAL NETWORKING, INTRODUCTION AND DATING SERVICES, NAMELY, PROVIDING AN ONLINE DATABASE OF PERSONAL ADS TO FACILITATE ON-LINE DATING AND INTRODUCTIONS AND INFORMATION REGARDING ON-LINE PERSONALS, SOCIAL INTRODUCTION AND SOCIAL NETWORKING ACTIVITIES AND SERVICES, PROVIDING INFORMATION IN THE FIELD OF DATING AND INTRODUCTION SERVICES, AND

CERTIFYING PARTICULAR CHARACTERISTICS AND QUALIFICATIONS OF INDIVIDUALS FOR PURPOSES OF DATING, INTRODUCTION, AND SOCIAL NETWORKING, IN CLASS 45 (U.S. CLS. 100 AND 101).

FIRST USE 1-1-2008; IN COMMERCE 1-1-2008.

THE MARK CONSISTS OF STANDARD CHARACTERS WITHOUT CLAIM TO ANY PARTICULAR FONT, STYLE, SIZE, OR COLOR.

SER. NO. 77-244,466, FILED P.R. 8-1-2007; AM. S.R. 12-5-2008.

LINDA ESTRADA, EXAMINING ATTORNEY

**Int. Cl.: 39**

**Prior U.S. Cls.: 100 and 105**

**United States Patent and Trademark Office**

**Reg. No. 3,570,887**

**Registered Feb. 3, 2009**

**SERVICE MARK  
SUPPLEMENTAL REGISTER**

**DOWNEAST ENERGY & BUILDING  
SUPPLY**

DOWNEAST ENERGY CORP. (MAINE COR-  
PORATION)

18 SPRING STREET

BRUNSWICK, ME 04011

FOR: TRANSPORTATION AND STORAGE OF  
FUELS, IN CLASS 39 (U.S. CLS. 100 AND 105).

FIRST USE 12-31-1998; IN COMMERCE 12-31-2006.

THE MARK CONSISTS OF STANDARD CHAR-  
ACTERS WITHOUT CLAIM TO ANY PARTICULAR  
FONT, STYLE, SIZE, OR COLOR.

NO CLAIM IS MADE TO THE EXCLUSIVE  
RIGHT TO USE "ENERGY & BUILDING SUPPLY",  
APART FROM THE MARK AS SHOWN.

SER. NO. 77-253,740, FILED P.R. 8-13-2007; AM. S.R.  
12-8-2008.

DAVID TOOLEY, EXAMINING ATTORNEY

**Int. Cl.: 6**

**Prior U.S. Cls.: 2, 12, 13, 14, 23, 25, and 50**

**United States Patent and Trademark Office**

**Reg. No. 3,570,888**

**Registered Feb. 3, 2009**

**TRADEMARK  
SUPPLEMENTAL REGISTER**

**bannerhinge**

KICHER & CO. (OHIO CORPORATION)  
2920 CANTERBURY COURT  
WILLOUGHBY HILLS, OH 44092

THE MARK CONSISTS OF STANDARD CHAR-  
ACTERS WITHOUT CLAIM TO ANY PARTICULAR  
FONT, STYLE, SIZE, OR COLOR.

FOR: METAL HINGE LIKE DEVICE USED TO  
MOUNT BANNERS ON LIGHTPOLES THAT WILL  
MINIMIZE THE DAMAGING EFFECTS OF WIND,  
IN CLASS 6 (U.S. CLS. 2, 12, 13, 14, 23, 25 AND 50).

SER. NO. 77-254,478, FILED P.R. 8-14-2007; AM. S.R.  
12-17-2008.

FIRST USE 1-1-2008; IN COMMERCE 1-1-2008.

RAMONA ORTIGA, EXAMINING ATTORNEY

**Int. Cl.: 34**

**Prior U.S. Cls.: 2, 8, 9, and 17**

**United States Patent and Trademark Office**

**Reg. No. 3,570,889**

**Registered Feb. 3, 2009**

**TRADEMARK  
SUPPLEMENTAL REGISTER**

**Certified Vintage Cigars**

SANTA CLARA, INC. (NORTH CAROLINA CORPORATION)

C/O MC MANAGEMENT, INC.

301 ROUTE 10 EAST

WHIPPANY, NJ 07981

FOR: CIGARS, IN CLASS 34 (U.S. CLS. 2, 8, 9 AND 17).

FIRST USE 1-1-2008; IN COMMERCE 1-1-2008.

THE MARK CONSISTS OF STANDARD CHARACTERS WITHOUT CLAIM TO ANY PARTICULAR FONT, STYLE, SIZE, OR COLOR.

NO CLAIM IS MADE TO THE EXCLUSIVE RIGHT TO USE "VINTAGE CIGARS", APART FROM THE MARK AS SHOWN.

SER. NO. 77-263,486, FILED P.R. 8-24-2007; AM. S.R. 12-18-2008.

KATHERINE E. HALMEN, EXAMINING ATTORNEY

**Int. Cl.: 16**

**Prior U.S. Cls.: 2, 5, 22, 23, 29, 37, 38, and 50**

**United States Patent and Trademark Office**

**Reg. No. 3,570,890**

**Registered Feb. 3, 2009**

**TRADEMARK  
SUPPLEMENTAL REGISTER**

# HowToAchieve

HOWTOACHIEVE, LLC (TEXAS LIMITED LIABILITY COMPANY)  
7210 FRANCISCAN CT  
MISSOURI CITY, TX 77459

FOR: BOOKS IN THE FIELD OF SELF-IMPROVEMENT, ACHIEVEMENT AND SUCCESS; PRINTED GUIDES FOR SELF-IMPROVEMENT, ACHIEVEMENT AND SUCCESS; STUDY GUIDES; EDUCATIONAL PUBLICATIONS, NAMELY, TRAINING MANUALS IN THE FIELD OF SELF-IMPROVEMENT, ACHIEVEMENT AND SUCCESS; MANUALS IN THE FIELD OF SELF-IMPROVEMENT,

ACHIEVEMENT AND SUCCESS, IN CLASS 16 (U.S. CLS. 2, 5, 22, 23, 29, 37, 38 AND 50).

FIRST USE 7-0-2008; IN COMMERCE 7-0-2008.

THE MARK CONSISTS OF STANDARD CHARACTERS WITHOUT CLAIM TO ANY PARTICULAR FONT, STYLE, SIZE, OR COLOR.

SER. NO. 77-264,251, FILED P.R. 8-24-2007; AM. S.R. 12-14-2008.

KATHY DE JONGE, EXAMINING ATTORNEY



Int. Cls.: 24 and 25

Prior U.S. Cls.: 22, 39, 42, and 50

United States Patent and Trademark Office

Reg. No. 3,570,891

Registered Feb. 3, 2009

TRADEMARK  
SUPPLEMENTAL REGISTER



LE GALL, JEAN CLAUDE (FRANCE INDIVIDUAL)  
LA RÉUNION  
15 RUE DES BRISANTS  
SAINT GILLES LES BAINS, FRANCE 94435

FOR: FABRICS HAVING A TEXTILE USE, IN CLASS 24 (U.S. CLS. 42 AND 50).

FOR: READY TO WEAR GARMENTS, NAMELY, T-SHIRTS, SHIRTS, POLOSHIRTS, DRESSES, SHORTS, PANTS, DJELABAS, SWEATSHIRTS AND

SWIMSHORTS; CAPS AND HATS; FLIP-FLOPS; AND PAREOS, IN CLASS 25 (U.S. CLS. 22 AND 39).

OWNER OF FRANCE REG. NO. FR95597715, DATED 11-15-1995, EXPIRES 7-5-2015.

THE MARK CONSISTS OF AN ABSTRACT HUMAN FIGURE.

SER. NO. 77-278,634, FILED 9-13-2007.

STEPHANIE ALI, EXAMINING ATTORNEY

Int. Cl.: 40

Prior U.S. Cls.: 100, 103, and 106

United States Patent and Trademark Office

Reg. No. 3,570,892

Registered Feb. 3, 2009

SERVICE MARK  
SUPPLEMENTAL REGISTER

*bio*trauma

BIOTRAUMA, INC. (GEORGIA CORPORATION)  
999 CHESTNUT STREET  
GAINESVILLE, GA 30501

THE MARK CONSISTS OF THE STYLIZED  
WORD "BIOTRAUMA".

FOR: DECONTAMINATION AND DEODORIZA-  
TION OF CRIME AND TRAUMA SCENES, IN  
CLASS 40 (U.S. CLS. 100, 103 AND 106).

SER. NO. 77-289,203, FILED P.R. 9-26-2007; AM. S.R.  
6-3-2008.

FIRST USE 2-1-2007; IN COMMERCE 2-1-2007.

MICHAEL WEBSTER, EXAMINING ATTORNEY

**Int. Cl.: 19**

**Prior U.S. Cls.: 1, 12, 33, and 50**

**United States Patent and Trademark Office**

**Reg. No. 3,570,893**

**Registered Feb. 3, 2009**

**TRADEMARK  
SUPPLEMENTAL REGISTER**

# Gutter Edge

DEHART, JIMMY (PENNSYLVANIA SOLE PROPRIETORSHIP), DBA GUTTER EDGE,  
446 CHAMBERS ROCK RD  
LANDENBERG, PA 19350

THE MARK CONSISTS OF STANDARD CHARACTERS WITHOUT CLAIM TO ANY PARTICULAR FONT, STYLE, SIZE, OR COLOR.

FOR: NON-METAL EDGE THAT CLIPS ON THE FRONT OF A HOUSE GUTTER TO PREVENT STAINING, IN CLASS 19 (U.S. CLS. 1, 12, 33 AND 50).

SER. NO. 77-289,814, FILED P.R. 9-26-2007; AM. S.R. 12-15-2008.

FIRST USE 8-12-2007; IN COMMERCE 8-12-2007.

KIMBERLY FRYE, EXAMINING ATTORNEY

**Int. Cl.: 43**

**Prior U.S. Cls.: 100 and 101**

**United States Patent and Trademark Office**

**Reg. No. 3,570,894**

**Registered Feb. 3, 2009**

**SERVICE MARK  
SUPPLEMENTAL REGISTER**

# Branzino

LAMB, PETER (UNITED STATES INDIVIDUAL)  
2516 12TH AVE. W.  
SEATTLE, WA 98119

FOR: RESTAURANT AND BAR SERVICES, IN  
CLASS 43 (U.S. CLS. 100 AND 101).

FIRST USE 6-4-2008; IN COMMERCE 6-4-2008.

THE MARK CONSISTS OF STANDARD CHAR-  
ACTERS WITHOUT CLAIM TO ANY PARTICULAR  
FONT, STYLE, SIZE, OR COLOR.

SER. NO. 77-293,247, FILED P.R. 10-1-2007; AM. S.R.  
12-8-2008.

ROBIN MITTLER, EXAMINING ATTORNEY

**Int. Cl.: 40**

**Prior U.S. Cls.: 100, 103, and 106**

**United States Patent and Trademark Office**

**Reg. No. 3,570,895**

**Registered Feb. 3, 2009**

**SERVICE MARK  
SUPPLEMENTAL REGISTER**

**biotrauma**

BIOTRAUMA, INC. (GEORGIA CORPORATION)  
999 CHESTNUT STREET  
GAINESVILLE, GA 30501

FOR: DECONTAMINATION AND DEODORIZATION OF CRIME AND TRAUMA SCENES, IN CLASS 40 (U.S. CLS. 100, 103 AND 106).

FIRST USE 2-1-2007; IN COMMERCE 2-1-2007.

THE MARK CONSISTS OF STANDARD CHARACTERS WITHOUT CLAIM TO ANY PARTICULAR FONT, STYLE, SIZE, OR COLOR.

SER. NO. 77-299,277, FILED P.R. 10-9-2007; AM. S.R. 6-3-2008.

MICHAEL WEBSTER, EXAMINING ATTORNEY

**Int. Cl.: 3**

**Prior U.S. Cls.: 1, 4, 6, 50, 51, and 52**

**Reg. No. 3,570,896**

**United States Patent and Trademark Office**

**Registered Feb. 3, 2009**

**TRADEMARK  
SUPPLEMENTAL REGISTER**

**SPORTOWEL**

WOODWARD, ROBERT G. SR. (UNITED STATES  
INDIVIDUAL)  
1000 JOHNSON STREET  
KEY WEST, FL 33040 AND  
WIMER, ALLAN H. (UNITED STATES INDIVI-  
DUAL)  
POST OFFICE BOX 1317  
KEY WEST, FL 33040

FOR: COSMETIC TOWELS AND TOWELETTES  
FOR COOLING THE BODY IMPREGNATED WITH  
CHEMICAL OR NATURAL SUBSTANCE THAT

SELF-COOLS ON ACTIVATION, IN CLASS 3 (U.S.  
CLS. 1, 4, 6, 50, 51 AND 52).

FIRST USE 1-25-2007; IN COMMERCE 1-25-2007.

THE MARK CONSISTS OF STANDARD CHAR-  
ACTERS WITHOUT CLAIM TO ANY PARTICULAR  
FONT, STYLE, SIZE, OR COLOR.

SER. NO. 77-302,733, FILED P.R. 10-12-2007; AM.  
S.R. 11-18-2008.

ANNE E. GUSTASON, EXAMINING ATTORNEY

**Int. Cl.: 41**

**Prior U.S. Cls.: 100, 101, and 107**

**United States Patent and Trademark Office**

**Reg. No. 3,570,897**

**Registered Feb. 3, 2009**

**SERVICE MARK  
SUPPLEMENTAL REGISTER**

**THE CAREER INSTITUTE**

ADVANCED CAREER TECHNOLOGIES, INC.  
(MASSACHUSETTS CORPORATION)  
SUITE 530  
175 CROSSING BLVD  
FRAMINGHAM, MA 01702

FOR: EDUCATIONAL SERVICES, NAMELY,  
PROVIDING COURSES OF INSTRUCTION IN THE  
HEALTHCARE, DIGITAL MEDIA AND INFORMA-  
TION TECHNOLOGY FIELDS , IN CLASS 41 (U.S.  
CLS. 100, 101 AND 107).

FIRST USE 10-30-2007; IN COMMERCE 10-30-2007.

THE MARK CONSISTS OF STANDARD CHAR-  
ACTERS WITHOUT CLAIM TO ANY PARTICULAR  
FONT, STYLE, SIZE, OR COLOR.

NO CLAIM IS MADE TO THE EXCLUSIVE  
RIGHT TO USE "INSTITUTE", APART FROM THE  
MARK AS SHOWN.

SER. NO. 77-318,112, FILED P.R. 10-31-2007; AM.  
S.R. 10-15-2008.

KELLEY WELLS, EXAMINING ATTORNEY

**Int. Cl.: 12**

**Prior U.S. Cls.: 19, 21, 23, 31, 35, and 44**

**United States Patent and Trademark Office**

**Reg. No. 3,570,898**

**Registered Feb. 3, 2009**

**TRADEMARK  
SUPPLEMENTAL REGISTER**

**LINX SET**

CHAIN REVOLUTION (WASHINGTON LIMITED  
LIABILITY COMPANY)  
3141 N. FERDINAND ST.  
TACOMA, WA 98407

THE MARK CONSISTS OF STANDARD CHAR-  
ACTERS WITHOUT CLAIM TO ANY PARTICULAR  
FONT, STYLE, SIZE, OR COLOR.

FOR: BICYCLE PARTS, NAMELY, DRIVE  
CHAINS, IN CLASS 12 (U.S. CLS. 19, 21, 23, 31, 35  
AND 44).

SER. NO. 77-319,546, FILED P.R. 11-1-2007; AM. S.R.  
12-17-2008.

FIRST USE 1-11-2007; IN COMMERCE 12-5-2008.

ALLISON HOLTZ, EXAMINING ATTORNEY



**Int. Cl.: 9**

**Prior U.S. Cls.: 21, 23, 26, 36, and 38**

**Reg. No. 3,570,899**

**United States Patent and Trademark Office**

**Registered Feb. 3, 2009**

---

**TRADEMARK  
SUPPLEMENTAL REGISTER**

# Internet Cleanroom

SECURE COMMAND, LLC (VIRGINIA LIMITED  
LIABILITY COMPANY)  
4972 MARSHALL CROWN RD  
CENTREVILLE, VA 20120

THE MARK CONSISTS OF STANDARD CHAR-  
ACTERS WITHOUT CLAIM TO ANY PARTICULAR  
FONT, STYLE, SIZE, OR COLOR.

FOR: COMPUTER SOFTWARE FOR THE CREA-  
TION OF FIREWALLS, IN CLASS 9 (U.S. CLS. 21, 23,  
26, 36 AND 38).

SER. NO. 77-323,505, FILED P.R. 11-7-2007; AM. S.R.  
12-17-2008.

FIRST USE 3-15-2006; IN COMMERCE 9-15-2006.

FRED MANDIR, EXAMINING ATTORNEY

**Int. Cl.: 41**

**Prior U.S. Cls.: 100, 101, and 107**

**United States Patent and Trademark Office**

**Reg. No. 3,570,900**

**Registered Feb. 3, 2009**

**SERVICE MARK  
SUPPLEMENTAL REGISTER**

# Book in a Day

ALEXANDER, EDWARD C. (UNITED STATES INDIVIDUAL), DBA ALEXANDER, KWAME, 1396 CRANES BILL WAY WOODBRIDGE, VA 22191

FOR: EDUCATION SERVICES, NAMELY, PROVIDING CLASSES, SEMINARS, WORKSHOPS, TUTORING, AND MENTORING IN THE FIELD OF MIDDLE AND HIGH SCHOOL REFORM; EDUCATION SERVICES, NAMELY, PROVIDING LIVE AND ON-LINE CLASSES, WORKSHOPS, TRAININGS, SEMINARS, CONFERENCES IN THE FIELD OF

POETRY, LITERATURE, AND PUBLISHING, IN CLASS 41 (U.S. CLS. 100, 101 AND 107).

FIRST USE 5-20-2006; IN COMMERCE 6-19-2006.

THE MARK CONSISTS OF STANDARD CHARACTERS WITHOUT CLAIM TO ANY PARTICULAR FONT, STYLE, SIZE, OR COLOR.

SER. NO. 77-323,713, FILED P.R. 11-7-2007; AM. S.R. 12-12-2008.

NATALIE POLZER, EXAMINING ATTORNEY

**Int. Cl.: 41**

**Prior U.S. Cls.: 100, 101, and 107**

**United States Patent and Trademark Office**

**Reg. No. 3,570,901**

**Registered Feb. 3, 2009**

**SERVICE MARK  
SUPPLEMENTAL REGISTER**

**Surf Dog SURF-A-THON**

HELEN WOODWARD ANIMAL CENTER (CALI-  
FORNIA CORPORATION)

6461 EL APAJO ROAD P.O. BOX 64

RANCHO SANTA FE, CA 92067

FOR: ORGANIZING AND CONDUCTING A  
SURFING EVENT TO RAISE FUNDS FOR CHAR-  
ITY, IN CLASS 41 (U.S. CLS. 100, 101 AND 107).

FIRST USE 9-17-2006; IN COMMERCE 9-17-2006.

THE MARK CONSISTS OF STANDARD CHAR-  
ACTERS WITHOUT CLAIM TO ANY PARTICULAR  
FONT, STYLE, SIZE, OR COLOR.

NO CLAIM IS MADE TO THE EXCLUSIVE  
RIGHT TO USE "SURF-A-THON", APART FROM  
THE MARK AS SHOWN.

SER. NO. 77-339,492, FILED P.R. 11-28-2007; AM.  
S.R. 12-18-2008.

JANICE L. MCMORROW, EXAMINING ATTOR-  
NEY

**Int. Cl.: 41**

**Prior U.S. Cls.: 100, 101, and 107**

**United States Patent and Trademark Office**

**Reg. No. 3,570,902**

**Registered Feb. 3, 2009**

**SERVICE MARK  
SUPPLEMENTAL REGISTER**

**BOUNCE, SLIDE & PLAY!**

KIRBY ASH ENTERPRISES, INC. (MISSOURI  
CORPORATION)  
7807 NORTH OAK TRAFFICWAY  
KANSAS CITY, MO 64118

FOR: ENTERTAINMENT AND RECREATION  
SERVICES, NAMELY, PROVIDING FACILITIES  
WITH LARGE INFLATABLE PLAY STRUCTURES,  
IN CLASS 41 (U.S. CLS. 100, 101 AND 107).

FIRST USE 7-31-2007; IN COMMERCE 7-31-2007.

THE MARK CONSISTS OF STANDARD CHAR-  
ACTERS WITHOUT CLAIM TO ANY PARTICULAR  
FONT, STYLE, SIZE, OR COLOR.

SER. NO. 77-354,505, FILED P.R. 12-18-2007; AM.  
S.R. 12-1-2008.

KAREN SEVERSON, EXAMINING ATTORNEY

**Int. Cl.: 8**

**Prior U.S. Cls.: 23, 28, and 44**

**United States Patent and Trademark Office**

**Reg. No. 3,570,903**

**Registered Feb. 3, 2009**

**TRADEMARK  
SUPPLEMENTAL REGISTER**

The logo for "Snap N Slice" features the word "Snap" in a stylized, italicized serif font with horizontal motion lines to its left. A large, bold, sans-serif "N" is positioned between "Snap" and "Slice". The word "Slice" is in a bold, sans-serif font with a horizontal underline beneath it.

REPAC, CEDOMIR (SLOVENIA INDIVIDUAL)  
FLIEDERWEG 24  
BRECHEN, FED REP GERMANY D-65611

FOR: HAND-OPERATED CUTTING INSTRUMENTS FOR FOOD, IN PARTICULAR FOR FRUIT AND VEGETABLES, IN THE NATURE OF FOOD SLICERS, WEDGE CUTTERS, KNIFE BLADE INSERTS, FOOD GUIDE BLADES , IN CLASS 8 (U.S. CLS. 23, 28 AND 44).

FIRST USE 9-5-2007; IN COMMERCE 9-5-2007.

PRIORITY CLAIMED UNDER SEC. 44(D) ON FED REP GERMANY APPLICATION NO. 30745020.1/2, FILED 7-10-2007, REG. NO. 30745020, DATED 10-31-2007, EXPIRES 7-31-2017.

SER. NO. 77-368,503, FILED P.R. 1-10-2008; AM. S.R. 12-18-2008.

MARK RADEMACHER, EXAMINING ATTORNEY

**Int. Cl.: 8**

**Prior U.S. Cls.: 23, 28, and 44**

**United States Patent and Trademark Office**

**Reg. No. 3,570,904**

**Registered Feb. 3, 2009**

**TRADEMARK  
SUPPLEMENTAL REGISTER**

**SNAP N SLICE**

REPAC, CEDOMIR (SLOVENIA INDIVIDUAL)  
FLIEDERWEG 24  
BRECHEN, FED REP GERMANY D-65611

FOR: HAND-OPERATED CUTTING INSTRUMENTS FOR FOOD, IN PARTICULAR FOR FRUIT AND VEGETABLES, IN THE NATURE OF FOOD SLICERS, WEDGE CUTTERS, KNIFE BLADE INSERTS, FOOD GUIDE BLADES , IN CLASS 8 (U.S. CLS. 23, 28 AND 44).

FIRST USE 9-5-2007; IN COMMERCE 9-5-2007.

THE MARK CONSISTS OF STANDARD CHARACTERS WITHOUT CLAIM TO ANY PARTICULAR FONT, STYLE, SIZE, OR COLOR.

PRIORITY CLAIMED UNDER SEC. 44(D) ON FED REP GERMANY APPLICATION NO. 30745032.5/2, FILED 7-10-2007, REG. NO. 30745032, DATED 11-22-2007, EXPIRES 7-31-2017.

SER. NO. 77-368,544, FILED P.R. 1-10-2008; AM. S.R. 12-18-2008.

MARK RADEMACHER, EXAMINING ATTORNEY

**Int. Cl.: 41**

**Prior U.S. Cls.: 100, 101, and 107**

**United States Patent and Trademark Office**

**Reg. No. 3,570,905**

**Registered Feb. 3, 2009**

**SERVICE MARK  
SUPPLEMENTAL REGISTER**

**The Chicago Teen Museum**

CHICAGO TEEN MUSEUM, THE (ILLINOIS  
NON-PROFIT ORGANIZATION)

1451 WEST SUMMERDALE AVENUE

CHICAGO, IL 60640

FOR: MUSEUMS, IN CLASS 41 (U.S. CLS. 100, 101  
AND 107).

FIRST USE 5-1-2008; IN COMMERCE 5-1-2008.

THE MARK CONSISTS OF STANDARD CHAR-  
ACTERS WITHOUT CLAIM TO ANY PARTICULAR  
FONT, STYLE, SIZE, OR COLOR.

NO CLAIM IS MADE TO THE EXCLUSIVE  
RIGHT TO USE "MUSEUM", APART FROM THE  
MARK AS SHOWN.

SER. NO. 77-377,438, FILED P.R. 1-22-2008; AM. S.R.  
11-25-2008.

DAVID YONTEF, EXAMINING ATTORNEY

**Int. Cl.: 43**

**Prior U.S. Cls.: 100 and 101**

**United States Patent and Trademark Office**

**Reg. No. 3,570,906**

**Registered Feb. 3, 2009**

**SERVICE MARK  
SUPPLEMENTAL REGISTER**

# CancunVacaciones

PASTOR INNERARITY, JOSE MARIA (MEXICO  
INDIVIDUAL)  
CAPRICORNIO, L. 2-14, C-16, SM 41, M 3  
CANCUN, MEXICO

FOR: TRAVEL AGENCY SERVICES, NAMELY,  
MAKING RESERVATIONS AND BOOKING FOR  
TEMPORARY LODGING; PROVIDING TEMPOR-  
ARY LODGING SERVICES IN THE NATURE OF A  
CONDOMINIUM HOTEL; HOTEL AND RESTAU-  
RANT RESERVATION SERVICES; PROVIDING AD-  
VICE TO TOURISTS AND BUSINESS TRAVELERS  
ON HOTEL AND RESTAURANT DESTINATIONS;  
PROVIDING PERSONALIZED INFORMATION  
ABOUT HOTELS AND TEMPORARY ACCOMMO-  
DATIONS FOR TRAVEL VIA THE INTERNET;  
PROVIDING TRAVEL LODGING INFORMATION

SERVICES AND TRAVEL LODGING BOOKING  
AGENCY SERVICES FOR TRAVELERS, IN CLASS  
43 (U.S. CLS. 100 AND 101).

FIRST USE 2-8-2002; IN COMMERCE 1-1-2007.

THE MARK CONSISTS OF STANDARD CHAR-  
ACTERS WITHOUT CLAIM TO ANY PARTICULAR  
FONT, STYLE, SIZE, OR COLOR.

THE ENGLISH TRANSLATION OF "VACA-  
CIONES" IN THE MARK IS VACATIONS.

SER. NO. 77-388,010, FILED 2-4-2008.

RONALD DELGIZZI, EXAMINING ATTORNEY



**Int. Cl.: 43**

**Prior U.S. Cls.: 100 and 101**

**United States Patent and Trademark Office**

**Reg. No. 3,570,907**

**Registered Feb. 3, 2009**

**SERVICE MARK  
SUPPLEMENTAL REGISTER**

**FASHION FURNITURE RENTAL**

FASHION FURNITURE RENTAL, INC. (CALI-  
FORNIA CORPORATION)

10075 MESA RIM ROAD

SAN DIEGO, CA 92121

FOR: FURNITURE RENTAL AND LEASING  
SERVICES, IN CLASS 43 (U.S. CLS. 100 AND 101).

FIRST USE 10-1-1985; IN COMMERCE 6-1-1996.

THE MARK CONSISTS OF STANDARD CHAR-  
ACTERS WITHOUT CLAIM TO ANY PARTICULAR  
FONT, STYLE, SIZE, OR COLOR.

NO CLAIM IS MADE TO THE EXCLUSIVE  
RIGHT TO USE "FURNITURE RENTAL", APART  
FROM THE MARK AS SHOWN.

SER. NO. 77-396,234, FILED P.R. 2-13-2008; AM. S.R.  
12-11-2008.

BRIAN CALLAGHAN, EXAMINING ATTORNEY

**Int. Cl.: 10**

**Prior U.S. Cls.: 26, 39, and 44**

**United States Patent and Trademark Office**

**Reg. No. 3,570,908**

**Registered Feb. 3, 2009**

**TRADEMARK  
SUPPLEMENTAL REGISTER**

**MULTI-PURPOSE RESTORATIVE  
APPLIANCE**

LIECHTUNG, MARC. M., DMD, PC (NEW YORK CORPORATION)  
SUITE 200 1995 BROADWAY  
NEW YORK, NY 10023

FOR: DENTAL APPLIANCE, NAMELY, HOLLOW TEETH IN THE FORM OF A DENTAL ARCH CORRESPONDING TO AND MOUNTABLE ON THE SURFACE OF A PERSON'S EXISTING TEETH, IN CLASS 10 (U.S. CLS. 26, 39 AND 44).

FIRST USE 12-1-2004; IN COMMERCE 12-1-2004.

THE MARK CONSISTS OF STANDARD CHARACTERS WITHOUT CLAIM TO ANY PARTICULAR FONT, STYLE, SIZE, OR COLOR.

NO CLAIM IS MADE TO THE EXCLUSIVE RIGHT TO USE "APPLIANCE", APART FROM THE MARK AS SHOWN.

SER. NO. 77-401,660, FILED P.R. 2-20-2008; AM. S.R. 12-9-2008.

BERNICE MIDDLETON, EXAMINING ATTORNEY

**Int. Cl.: 37**

**Prior U.S. Cls.: 100, 103, and 106**

**United States Patent and Trademark Office**

**Reg. No. 3,570,909**

**Registered Feb. 3, 2009**

**SERVICE MARK  
SUPPLEMENTAL REGISTER**

**WILD ZONES**

DAVID HAWKINS AND KAREN PAYNE (UNI-  
TED STATES INDIVIDUAL)  
1800 ARCH STREET  
BERKELEY, CA 94709

FOR: PROVIDING CONSULTING IN THE FIELD  
OF DESIGN AND DEVELOPMENT OF RECREA-  
TIONAL SITES AND PLAYGROUNDS THAT FOS-  
TER ECOLOGICAL RESPONSIBILITY AND  
DIVERSITY AND BUILD COMMUNITY, IN CLASS  
37 (U.S. CLS. 100, 103 AND 106).

FIRST USE 12-1-2005; IN COMMERCE 4-1-2006.

THE MARK CONSISTS OF STANDARD CHAR-  
ACTERS WITHOUT CLAIM TO ANY PARTICULAR  
FONT, STYLE, SIZE, OR COLOR.

SER. NO. 77-408,036, FILED P.R. 2-27-2008; AM. S.R.  
12-1-2008.

FLORENTINA BLANDU, EXAMINING ATTORNEY

**Int. Cl.: 7**

**Prior U.S. Cls.: 13, 19, 21, 23, 31, 34, and 35**

**Reg. No. 3,570,910**

**United States Patent and Trademark Office**

**Registered Feb. 3, 2009**

**TRADEMARK  
SUPPLEMENTAL REGISTER**

**BIND-UP CONTROL**

BLACK & DECKER CORPORATION, THE  
(MARYLAND CORPORATION)  
TW199  
701 E. JOPPA ROAD  
TOWSON, MD 21286

FOR: POWER TOOLS, NAMELY, DRILLS, DRIVERS, SAWS AND HAMMERS, IN CLASS 7 (U.S. CLS. 13, 19, 21, 23, 31, 34 AND 35).

FIRST USE 11-1-2008; IN COMMERCE 11-1-2008.

THE MARK CONSISTS OF STANDARD CHARACTERS WITHOUT CLAIM TO ANY PARTICULAR FONT, STYLE, SIZE, OR COLOR.

SER. NO. 77-408,309, FILED P.R. 2-28-2008; AM. S.R. 11-26-2008.

TRACY WHITTAKER-BROWN, EXAMINING ATTORNEY

**Int. Cl.: 42**

**Prior U.S. Cls.: 100 and 101**

**United States Patent and Trademark Office**

**Reg. No. 3,570,911**

**Registered Feb. 3, 2009**

**SERVICE MARK  
SUPPLEMENTAL REGISTER**

**ANDA IP**

SPEIER, GARY J. (UNITED STATES INDIVIDUAL)  
P.O. BOX 2938  
MINNEAPOLIS, MN 55402

FOR: A WEBSITE PROVIDING INFORMATION ON US PHARMACEUTICALS, PATENT INFORMATION RELATING TO US PHARMACEUTICALS, REGULATORY INFORMATION RELATING TO US PHARMACEUTICALS, AND TECHNICAL INFORMATION RELATING TO US PHARMACEUTICALS, IN CLASS 42 (U.S. CLS. 100 AND 101).

FIRST USE 4-30-2008; IN COMMERCE 4-30-2008.

THE MARK CONSISTS OF STANDARD CHARACTERS WITHOUT CLAIM TO ANY PARTICULAR FONT, STYLE, SIZE, OR COLOR.

SER. NO. 77-410,067, FILED P.R. 2-29-2008; AM. S.R. 12-4-2008.

WILLIAM BRECKENFELD, EXAMINING ATTORNEY

**Int. Cl.: 3**

**Prior U.S. Cls.: 1, 4, 6, 50, 51, and 52**

**Reg. No. 3,570,912**

**United States Patent and Trademark Office**

**Registered Feb. 3, 2009**

**TRADEMARK  
SUPPLEMENTAL REGISTER**

**ULTRA CONCENTRATE CREAM  
FOR THE HANDS.**

KLEIN-BECKER IP HOLDINGS, LLC (WYOM-  
ING LIMITED LIABILITY COMPANY)

1000 EAST WILLIAM STREET

CARSON CITY, NV 89701

FOR: COSMETICS, IN CLASS 3 (U.S. CLS. 1, 4, 6, 50,  
51 AND 52).

FIRST USE 3-23-2006; IN COMMERCE 3-23-2006.

THE MARK CONSISTS OF STANDARD CHAR-  
ACTERS WITHOUT CLAIM TO ANY PARTICULAR  
FONT, STYLE, SIZE, OR COLOR.

NO CLAIM IS MADE TO THE EXCLUSIVE  
RIGHT TO USE "CREAM", APART FROM THE  
MARK AS SHOWN.

SER. NO. 77-416,489, FILED P.R. 3-7-2008; AM. S.R.  
12-15-2008.

AMY HELLA, EXAMINING ATTORNEY

**Int. Cl.: 5**

**Prior U.S. Cls.: 6, 18, 44, 46, 51, and 52**

**United States Patent and Trademark Office**

**Reg. No. 3,570,913**

**Registered Feb. 3, 2009**

**TRADEMARK  
SUPPLEMENTAL REGISTER**

**Açaí Energy**

BRAZILIAN BASICS LLC (FLORIDA LIMITED  
LIABILITY COMPANY)  
4532 W KENNEDY BLVD  
#324  
TAMPA, FL 33609

THE MARK CONSISTS OF STANDARD CHAR-  
ACTERS WITHOUT CLAIM TO ANY PARTICULAR  
FONT, STYLE, SIZE, OR COLOR.

FOR: DIETARY SUPPLEMENTS, IN CLASS 5 (U.S.  
CLS. 6, 18, 44, 46, 51 AND 52).

SER. NO. 77-418,584, FILED P.R. 3-11-2008; AM. S.R.  
11-26-2008.

FIRST USE 7-1-2007; IN COMMERCE 8-1-2007.

MATTHEW EINSTEIN, EXAMINING ATTORNEY

**Int. Cl.: 16**

**Prior U.S. Cls.: 2, 5, 22, 23, 29, 37, 38, and 50**

**United States Patent and Trademark Office**

**Reg. No. 3,570,914**

**Registered Feb. 3, 2009**

**TRADEMARK  
SUPPLEMENTAL REGISTER**

**PUZZLES & PRIZES**

THE READER'S DIGEST ASSOCIATION, INC.  
(DELAWARE CORPORATION)  
READER'S DIGEST ROAD  
PLEASANTVILLE, NY 10570

THE MARK CONSISTS OF STANDARD CHAR-  
ACTERS WITHOUT CLAIM TO ANY PARTICULAR  
FONT, STYLE, SIZE, OR COLOR.

FOR: PRINTED PERIODICALS IN THE FIELD OF  
PUZZLES, IN CLASS 16 (U.S. CLS. 2, 5, 22, 23, 29, 37, 38  
AND 50).

SER. NO. 77-420,651, FILED P.R. 3-13-2008; AM. S.R.  
12-5-2008.

FIRST USE 11-11-2008; IN COMMERCE 11-11-2008.

PRISCILLA MILTON, EXAMINING ATTORNEY



**Int. Cl.: 9**

**Prior U.S. Cls.: 21, 23, 26, 36, and 38**

**United States Patent and Trademark Office**

**Reg. No. 3,570,915**

**Registered Feb. 3, 2009**

**TRADEMARK  
SUPPLEMENTAL REGISTER**

# ViewerStatistician

DELBO SYSTEMS (PENNSYLVANIA SOLE PROPRIETORSHIP)  
180 MOSER RD.  
DANVILLE, PA 17821

FOR: COMPUTER HARDWARE AND SOFTWARE PROGRAMS FOR COLLECTING TV CHANNEL DATA FROM WITHIN A HOME AND TRANSMIT THE DATA LOGS TO LICENSED CLIENTS WHO THEN REQUEST FIXED STATISTICAL REPORTS ON VARIOUS TIME SEGMENTS OF THE DATA, THE STATISTICAL REPORTS ARE INTERACTIVE AND ANALYZE TV STATION MARKET

SHARES FOR THE COLLECTED DATA LOGS, IN CLASS 9 (U.S. CLS. 21, 23, 26, 36 AND 38).

FIRST USE 7-1-2008; IN COMMERCE 7-20-2008.

THE MARK CONSISTS OF STANDARD CHARACTERS WITHOUT CLAIM TO ANY PARTICULAR FONT, STYLE, SIZE, OR COLOR.

SER. NO. 77-425,218, FILED P.R. 3-18-2008; AM. S.R. 12-16-2008.

KEVON CHISOLM, EXAMINING ATTORNEY

**Int. Cl.: 42**

**Prior U.S. Cls.: 100 and 101**

**United States Patent and Trademark Office**

**Reg. No. 3,570,916**

**Registered Feb. 3, 2009**

**SERVICE MARK  
SUPPLEMENTAL REGISTER**

**Advanced Virtual Technology**

ADVANCED VIRTUAL TECHNOLOGY INC. (MI-  
CHIGAN CORPORATION)  
SUITE 100  
17340 12 MILE ROAD  
SOUTHFIELD, MI 48076

FOR: DEVELOPING CUSTOM AUDIO VIRTUAL  
INTERACTIVE WEBSITES TO CREATE A VIRTUAL  
REALITY, IN CLASS 42 (U.S. CLS. 100 AND 101).

FIRST USE 3-21-2008; IN COMMERCE 3-21-2008.

THE MARK CONSISTS OF STANDARD CHAR-  
ACTERS WITHOUT CLAIM TO ANY PARTICULAR  
FONT, STYLE, SIZE, OR COLOR.

NO CLAIM IS MADE TO THE EXCLUSIVE  
RIGHT TO USE "VIRTUAL TECHNOLOGY",  
APART FROM THE MARK AS SHOWN.

SER. NO. 77-444,979, FILED P.R. 4-10-2008; AM. S.R.  
12-16-2008.

ANGELA GAW, EXAMINING ATTORNEY

**Int. Cl.: 16**

**Prior U.S. Cls.: 2, 5, 22, 23, 29, 37, 38, and 50**

**United States Patent and Trademark Office**

**Reg. No. 3,570,917**

**Registered Feb. 3, 2009**

**TRADEMARK  
SUPPLEMENTAL REGISTER**

**WORKPLACE MOTIVATORS**

TARGET TRAINING INTERNATIONAL, LTD  
(IOWA CORPORATION)  
17785 N. PACESETTER WAY  
SCOTTSDALE, AZ 85255

FOR: PRINTED REPORTS FEATURING INFORMATION REGARDING THE PERSONAL INTERESTS, ATTITUDES, AND VALUES REQUIRED FOR SUCCESSFUL JOB PERFORMANCE; INFORMATIONAL FLYERS FEATURING PERSONAL INTERESTS, ATTITUDES AND VALUES FOR SUCCESSFUL JOB PERFORMANCE, IN CLASS 16 (U.S. CLS. 2, 5, 22, 23, 29, 37, 38 AND 50).

FIRST USE 3-17-2004; IN COMMERCE 3-17-2004.

THE MARK CONSISTS OF STANDARD CHARACTERS WITHOUT CLAIM TO ANY PARTICULAR FONT, STYLE, SIZE, OR COLOR.

SER. NO. 77-449,724, FILED P.R. 4-16-2008; AM. S.R. 12-16-2008.

LINDA LAVACHE, EXAMINING ATTORNEY

**Int. Cls.: 35, 38, and 41**

**Prior U.S. Cls.: 100, 101, 102, 104, and 107**

**United States Patent and Trademark Office**

**Reg. No. 3,570,918**

**Registered Feb. 3, 2009**

**SERVICE MARK  
SUPPLEMENTAL REGISTER**

# iProgram

IPROGRAM LLC (NEW YORK LIMITED LIABILITY COMPANY)

220 EAST 65TH STREET, SUITE 20H  
NEW YORK, NY 10021

FOR: MARKETING SERVICES, NAMELY, PROMOTING THE GOODS AND SERVICES OF OTHERS BY PROVIDING LINKS WEBSITES OF OTHERS FEATURING MARKETING CONTENT IN THE NATURE OF TEXT, GRAPHICS, AUDIO AND VIDEO MARKETING CONTENT BY MOBILE DEVICE CONNECTIONS, IN CLASS 35 (U.S. CLS. 100, 101 AND 102).

FIRST USE 6-13-2006; IN COMMERCE 6-13-2006.

FOR: WIRELESS COMMUNICATION SERVICES, NAMELY, TRANSMISSION OF GRAPHICS TO MOBILE DEVICES; MOBILE MEDIA SERVICES IN THE NATURE OF ELECTRONIC TRANSMISSION OF

ENTERTAINMENT MEDIA CONTENT, IN CLASS 38 (U.S. CLS. 100, 101 AND 104).

FIRST USE 6-13-2006; IN COMMERCE 6-13-2006.

FOR: PROVIDING LINKS TO ENTERTAINMENT WEBSITES FEATURING TEXT, GRAPHICS, AUDIO AND VIDEO CONTENT, IN CLASS 41 (U.S. CLS. 100, 101 AND 107).

FIRST USE 6-13-2006; IN COMMERCE 6-13-2006.

THE MARK CONSISTS OF STANDARD CHARACTERS WITHOUT CLAIM TO ANY PARTICULAR FONT, STYLE, SIZE, OR COLOR.

SER. NO. 77-458,107, FILED P.R. 4-25-2008; AM. S.R. 11-13-2008.

CHRISTINE BLOMQUIST, EXAMINING ATTORNEY

**Int. Cl.: 11**

**Prior U.S. Cls.: 13, 21, 23, 31, and 34**

**United States Patent and Trademark Office**

**Reg. No. 3,570,919**

**Registered Feb. 3, 2009**

**TRADEMARK  
SUPPLEMENTAL REGISTER**

# CleanWater

CONAIR CORPORATION (DELAWARE CORPORATION)  
ONE CUMMINGS POINT ROAD  
STAMFORD, CT 06902

FOR: COUNTERTOP WATER PURIFICATION  
AND FILTRATION APPARATUS, IN CLASS 11  
(U.S. CLS. 13, 21, 23, 31 AND 34).

FIRST USE 10-1-2007; IN COMMERCE 10-1-2007.

THE MARK CONSISTS OF STANDARD CHARACTERS WITHOUT CLAIM TO ANY PARTICULAR FONT, STYLE, SIZE, OR COLOR.

SER. NO. 77-458,310, FILED P.R. 4-25-2008; AM. S.R. 12-16-2008.

CHRISTINA SOBRAL, EXAMINING ATTORNEY

**Int. Cl.: 35**

**Prior U.S. Cls.: 100, 101, and 102**

**United States Patent and Trademark Office**

**Reg. No. 3,570,920**

**Registered Feb. 3, 2009**

**SERVICE MARK  
SUPPLEMENTAL REGISTER**

**Over60Exchange**

OVER60EXCHANGE, LLC. (FLORIDA LIMITED  
LIABILITY COMPANY)  
1624 AVIATION CENTER PKWY.  
DAYTONA BEACH, FL 32114

FOR: PROVIDING A WEB SITE FEATURING  
EMPLOYMENT AND JOB SEARCH SERVICES  
FOR PEOPLE OVER AGE 55, IN CLASS 35 (U.S.  
CLS. 100, 101 AND 102).

FIRST USE 1-1-2008; IN COMMERCE 1-1-2008.

THE MARK CONSISTS OF STANDARD CHAR-  
ACTERS WITHOUT CLAIM TO ANY PARTICULAR  
FONT, STYLE, SIZE, OR COLOR.

SER. NO. 77-462,702, FILED P.R. 5-1-2008; AM. S.R.  
12-8-2008.

ESTHER BELENKER, EXAMINING ATTORNEY

**Int. Cl.: 35**

**Prior U.S. Cls.: 100, 101, and 102**

**United States Patent and Trademark Office**

**Reg. No. 3,570,921**

**Registered Feb. 3, 2009**

**SERVICE MARK  
SUPPLEMENTAL REGISTER**

# DeliverMed

DELIVERMED HOLDINGS, LLC (ILLINOIS LIMITED LIABILITY COMPANY), DBA DELIVERMED,  
220 MELROSE AVENUE  
KENILWORTH, IL 60043

FOR: RETAIL PHARMACY SERVICES, IN CLASS 35 (U.S. CLS. 100, 101 AND 102).

FIRST USE 2-1-2005; IN COMMERCE 2-1-2005.

THE MARK CONSISTS OF STANDARD CHARACTERS WITHOUT CLAIM TO ANY PARTICULAR FONT, STYLE, SIZE, OR COLOR.

SER. NO. 77-465,265, FILED P.R. 5-4-2008; AM. S.R. 12-11-2008.

CHRISTINE BLOMQUIST, EXAMINING ATTORNEY

**Int. Cl.: 42**

**Prior U.S. Cls.: 100 and 101**

**United States Patent and Trademark Office**

**Reg. No. 3,570,922**

**Registered Feb. 3, 2009**

**SERVICE MARK  
SUPPLEMENTAL REGISTER**

**Collaborative Learning Maps**

COLLECTIVE NEXT, LLC (MASSACHUSETTS  
LIMITED LIABILITY COMPANY)  
129 SOUTH STREET, FLOOR 2  
BOSTON, MA 02111

FOR: CUSTOM DESIGN SERVICES IN THE NATURE OF THE DRAWING AND CREATION OF COLLABORATIVE MAPS USED FOR THE SHORT AND LONG TERM TRAINING OF PEOPLE IN BUSINESS SITUATIONS, IN CLASS 42 (U.S. CLS. 100 AND 101).

FIRST USE 1-1-2008; IN COMMERCE 1-1-2008.

THE MARK CONSISTS OF STANDARD CHARACTERS WITHOUT CLAIM TO ANY PARTICULAR FONT, STYLE, SIZE, OR COLOR.

NO CLAIM IS MADE TO THE EXCLUSIVE RIGHT TO USE "MAPS", APART FROM THE MARK AS SHOWN.

SER. NO. 77-467,781, FILED P.R. 5-7-2008; AM. S.R. 12-12-2008.

ERIN FALK, EXAMINING ATTORNEY



**Int. Cl.: 42**

**Prior U.S. Cls.: 100 and 101**

**United States Patent and Trademark Office**

**Reg. No. 3,570,923**

**Registered Feb. 3, 2009**

**SERVICE MARK  
SUPPLEMENTAL REGISTER**

**Collaborative Learning Map**

COLLECTIVE NEXT, LLC (MASSACHUSETTS  
LIMITED LIABILITY COMPANY)  
129 SOUTH STREET, FLOOR 2  
BOSTON, MA 02111

FOR: CUSTOM DESIGN SERVICES IN THE NATURE OF THE DRAWING AND CREATION OF COLLABORATIVE MAPS USED FOR THE SHORT AND LONG TERM TRAINING OF PEOPLE IN BUSINESS SITUATIONS, IN CLASS 42 (U.S. CLS. 100 AND 101).

FIRST USE 1-1-2008; IN COMMERCE 1-1-2008.

THE MARK CONSISTS OF STANDARD CHARACTERS WITHOUT CLAIM TO ANY PARTICULAR FONT, STYLE, SIZE, OR COLOR.

NO CLAIM IS MADE TO THE EXCLUSIVE RIGHT TO USE "MAP", APART FROM THE MARK AS SHOWN.

SER. NO. 77-467,802, FILED P.R. 5-7-2008; AM. S.R. 12-12-2008.

ERIN FALK, EXAMINING ATTORNEY

**Int. Cl.: 7**

**Prior U.S. Cls.: 13, 19, 21, 23, 31, 34, and 35**

**Reg. No. 3,570,924**

**United States Patent and Trademark Office**

**Registered Feb. 3, 2009**

**TRADEMARK  
SUPPLEMENTAL REGISTER**

**ECELL**

LINCOLN GLOBAL, INC. (DELAWARE COR-  
PORATION)  
17721 RAILROAD STREET  
CITY OF INDUSTRY, CA 91748

THE MARK CONSISTS OF STANDARD CHAR-  
ACTERS WITHOUT CLAIM TO ANY PARTICULAR  
FONT, STYLE, SIZE, OR COLOR.

FOR: ELECTRIC ARC WELDING MACHINES;  
ROBOTIC WELDING MACHINES, IN CLASS 7 (U.S.  
CLS. 13, 19, 21, 23, 31, 34 AND 35).

SER. NO. 77-474,107, FILED P.R. 5-14-2008; AM. S.R.  
12-9-2008.

FIRST USE 8-1-2007; IN COMMERCE 8-1-2007.

BARBARA BROWN, EXAMINING ATTORNEY

Int. Cl.: 9

Prior U.S. Cls.: 21, 23, 26, 36, and 38

Reg. No. 3,570,925

United States Patent and Trademark Office

Registered Feb. 3, 2009

TRADEMARK  
SUPPLEMENTAL REGISTER

e-range

KANE'S DISTRIBUTING LTD. (CANADA LIMITED COMPANY (LTD.))  
115 DIEPPE ROAD  
ST. CATHARINES, CANADA L2M7N6

FOR: CASHLESS PERIPHERAL DEVICE AND COMPUTER SOFTWARE SYSTEM THAT INSTALLS INTO A GOLF BALL DISPENSING MACHINE ALLOWING GOLF RANGE OWNERS TO CREATE PREPAID ACCOUNTS FOR CUSTOMERS, IN CLASS 9 (U.S. CLS. 21, 23, 26, 36 AND 38).

FIRST USE 1-31-2001; IN COMMERCE 1-31-2001.

THE MARK CONSISTS OF STANDARD CHARACTERS WITHOUT CLAIM TO ANY PARTICULAR FONT, STYLE, SIZE, OR COLOR.

SER. NO. 77-476,085, FILED P.R. 5-15-2008; AM. S.R. 12-4-2008.

CORY BOONE, EXAMINING ATTORNEY

**Int. Cl.: 30**

**Prior U.S. Cl.: 46**

**United States Patent and Trademark Office**

**Reg. No. 3,570,926**

**Registered Feb. 3, 2009**

**TRADEMARK  
SUPPLEMENTAL REGISTER**

**ULTIMATE CUPCAKE**

ULTIMATE CUPCAKE LLC (TEXAS LIMITED  
LIABILITY COMPANY)  
3205 INSPIRATION DRIVE  
HUDSON OAKS, TX 76087

NO CLAIM IS MADE TO THE EXCLUSIVE  
RIGHT TO USE "CUPCAKE", APART FROM THE  
MARK AS SHOWN.

FOR: CUP CAKES, IN CLASS 30 (U.S. CL. 46).

FIRST USE 10-0-2007; IN COMMERCE 10-0-2007.

THE MARK CONSISTS OF STANDARD CHAR-  
ACTERS WITHOUT CLAIM TO ANY PARTICULAR  
FONT, STYLE, SIZE, OR COLOR.

SER. NO. 77-482,665, FILED P.R. 5-23-2008; AM. S.R.  
12-2-2008.

TASNEEM HUSSAIN, EXAMINING ATTORNEY

**Int. Cl.: 2**

**Prior U.S. Cls.: 6, 11, and 16**

**United States Patent and Trademark Office**

**Reg. No. 3,570,927**

**Registered Feb. 3, 2009**

**TRADEMARK  
SUPPLEMENTAL REGISTER**

**SQUEEZABLES**

CRAYOLA PROPERTIES, INC. (DELAWARE  
CORPORATION)  
2035 EDGEWOOD AVENUE  
EASTON, PA 18042

FOR: PAINTS, IN CLASS 2 (U.S. CLS. 6, 11 AND 16).

FIRST USE 1-22-2007; IN COMMERCE 1-22-2007.

THE MARK CONSISTS OF STANDARD CHAR-  
ACTERS WITHOUT CLAIM TO ANY PARTICULAR  
FONT, STYLE, SIZE, OR COLOR.

SER. NO. 77-486,228, FILED P.R. 5-29-2008; AM. S.R.  
12-15-2008.

MARTHA FROMM, EXAMINING ATTORNEY

**Int. Cl.: 5**

**Prior U.S. Cls.: 6, 18, 44, 46, 51, and 52**

**United States Patent and Trademark Office**

**Reg. No. 3,570,928**

**Registered Feb. 3, 2009**

**TRADEMARK  
SUPPLEMENTAL REGISTER**

**Himalayan Salt Inhaler**

6247164 CANADA INC. (CANADA CORPORATION), DBA NATURE'S ARTIFACTS,  
2554 CAWTHRA ROAD  
UNIT #27  
MISSISSAUGA, CANADA L5A3P1

FOR: INHALERS FILLED WITH SALT FOR ENHANCING AIR QUALITY WHEN BREATHING, IN CLASS 5 (U.S. CLS. 6, 18, 44, 46, 51 AND 52).

FIRST USE 5-1-2007; IN COMMERCE 5-1-2007.

THE MARK CONSISTS OF STANDARD CHARACTERS WITHOUT CLAIM TO ANY PARTICULAR FONT, STYLE, SIZE, OR COLOR.

NO CLAIM IS MADE TO THE EXCLUSIVE RIGHT TO USE "SALT INHALER", APART FROM THE MARK AS SHOWN.

SER. NO. 77-493,922, FILED P.R. 6-9-2008; AM. S.R. 11-13-2008.

ANNE MADDEN, EXAMINING ATTORNEY

**Int. Cl.: 45**

**Prior U.S. Cls.: 100 and 101**

**United States Patent and Trademark Office**

**Reg. No. 3,570,929**

**Registered Feb. 3, 2009**

**SERVICE MARK  
SUPPLEMENTAL REGISTER**

**CHRIST INNER HEALING  
MINISTRIES**

CHRIST INNER HEALING MINISTRIES, LLC  
(KANSAS LIMITED LIABILITY COMPANY)

5741 MARION STREET

SHAWNEE, KS 66218

FOR: MINISTERIAL SERVICES, IN CLASS 45 (U.S.  
CLS. 100 AND 101).

FIRST USE 6-17-2007; IN COMMERCE 6-17-2007.

THE MARK CONSISTS OF STANDARD CHAR-  
ACTERS WITHOUT CLAIM TO ANY PARTICULAR  
FONT, STYLE, SIZE, OR COLOR.

NO CLAIM IS MADE TO THE EXCLUSIVE  
RIGHT TO USE "MINISTRIES", APART FROM  
THE MARK AS SHOWN.

SER. NO. 77-494,885, FILED P.R. 6-10-2008; AM. S.R.  
12-17-2008.

JEFF DEFORD, EXAMINING ATTORNEY

**Int. Cl.: 35**

**Prior U.S. Cls.: 100, 101, and 102**

**United States Patent and Trademark Office**

**Reg. No. 3,570,930**

**Registered Feb. 3, 2009**

**SERVICE MARK  
SUPPLEMENTAL REGISTER**

**Radicati Market Quadrant**

THE RADICATI GROUP, INC. (CALIFORNIA CORPORATION)  
595 LYTTON AVE  
PALO ALTO, CA 94301

FOR: MARKET ANALYSIS; MARKET REPORTS AND STUDIES; MARKET RESEARCH SERVICES; MARKET RESEARCH STUDIES; MARKET SEGMENTATION CONSULTATION, IN CLASS 35 (U.S. CLS. 100, 101 AND 102).

FIRST USE 2-20-2005; IN COMMERCE 2-20-2005.

THE MARK CONSISTS OF STANDARD CHARACTERS WITHOUT CLAIM TO ANY PARTICULAR FONT, STYLE, SIZE, OR COLOR.

NO CLAIM IS MADE TO THE EXCLUSIVE RIGHT TO USE "MARKET QUADRANT", APART FROM THE MARK AS SHOWN.

SER. NO. 77-498,368, FILED 6-13-2008.

SANI KHOURI, EXAMINING ATTORNEY



**Int. Cl.: 20**

**Prior U.S. Cls.: 2, 13, 22, 25, 32, and 50**

**United States Patent and Trademark Office**

**Reg. No. 3,570,931**

**Registered Feb. 3, 2009**

**TRADEMARK  
SUPPLEMENTAL REGISTER**

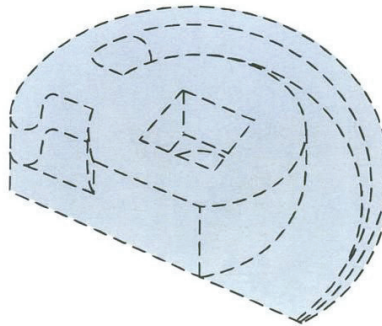

LAWRENCE INDUSTRIES, INC. (NORTH CAROLINA CORPORATION)  
7246 WRIGHT ROAD  
THOMASVILLE, NC 27361

FOR: NON-METAL WINDOW HARDWARE, NAMELY, PLASTIC SASH CAMS FOR USE IN WINDOW LATCHES, IN CLASS 20 (U.S. CLS. 2, 13, 22, 25, 32 AND 50).

FIRST USE 7-15-2008; IN COMMERCE 7-15-2008.

THE COLOR(S) GRAY IS/ARE CLAIMED AS A FEATURE OF THE MARK.

THE MARK CONSISTS OF THE COLOR GRAY AS APPLIED TO WINDOW CAM LATCHES IN ITS ENTIRETY. THE DOTTED OUTLINE OF THE GOODS IS INTENDED TO SHOW THE POSITION OF THE MARK ON THE GOODS IS NOT PART OF THE MARK.

SER. NO. 77-549,173, FILED P.R. 8-18-2008; AM. S.R. 11-24-2008.

LEIGH LOWRY, EXAMINING ATTORNEY

**Int. Cl.: 36**

**Prior U.S. Cls.: 100, 101, and 102**

**United States Patent and Trademark Office**

**Reg. No. 3,570,932**

**Registered Feb. 3, 2009**

**SERVICE MARK  
SUPPLEMENTAL REGISTER**

**INSTANT INSURANCE**

INSTANT INSURANCE SERVICE, LLC (OHIO  
LIMITED LIABILITY COMPANY)

SUITE 1430

ONE SOUTH MAIN STREET

DAYTON, OH 45402

FOR: INSURANCE AGENCY AND BROKERAGE,  
IN CLASS 36 (U.S. CLS. 100, 101 AND 102).

FIRST USE 4-1-2008; IN COMMERCE 4-1-2008.

THE MARK CONSISTS OF STANDARD CHAR-  
ACTERS WITHOUT CLAIM TO ANY PARTICULAR  
FONT, STYLE, SIZE, OR COLOR.

NO CLAIM IS MADE TO THE EXCLUSIVE  
RIGHT TO USE "INSURANCE", APART FROM  
THE MARK AS SHOWN.

SER. NO. 77-553,762, FILED P.R. 8-22-2008; AM. S.R.  
12-16-2008.

JIM RINGLE, EXAMINING ATTORNEY

**Int. Cl.: 35**

**Prior U.S. Cls.: 100, 101, and 102**

**United States Patent and Trademark Office**

**Reg. No. 3,570,933**

**Registered Feb. 3, 2009**

**SERVICE MARK  
SUPPLEMENTAL REGISTER**

**THE NATIONAL HISPANIC  
RETIRES ASSOCIATION**

NATIONAL HISPANIC RETIREES ASSOCIATION, LLC (TEXAS LIMITED LIABILITY COMPANY)  
SUITE 195  
10998 S. WILCREST BOULEVARD  
HOUSTON, TX 77099

FOR: ASSOCIATION SERVICES, NAMELY, PROMOTING THE INTERESTS OF MATURE PERSONS AND PERSONS PREPARING FOR RETIREMENT, IN CLASS 35 (U.S. CLS. 100, 101 AND 102).

FIRST USE 8-20-2008; IN COMMERCE 8-20-2008.

THE MARK CONSISTS OF STANDARD CHARACTERS WITHOUT CLAIM TO ANY PARTICULAR FONT, STYLE, SIZE, OR COLOR.

NO CLAIM IS MADE TO THE EXCLUSIVE RIGHT TO USE "ASSOCIATION", APART FROM THE MARK AS SHOWN.

SER. NO. 77-557,507, FILED P.R. 8-27-2008; AM. S.R. 12-10-2008.

AMEEN IMAM, EXAMINING ATTORNEY

**Int. Cl.: 6**

**Prior U.S. Cls.: 2, 12, 13, 14, 23, 25, and 50**

**Reg. No. 3,570,934**

**United States Patent and Trademark Office**

**Registered Feb. 3, 2009**

---

**TRADEMARK  
SUPPLEMENTAL REGISTER**

**HOODNUTZ**

PIESTER, CHAD (UNITED STATES INDIVIDUAL)  
802 CENTERWOOD CT.  
BRANDON, FL 33511

FOR: METAL FASTENERS, NAMELY, CONNECTORS FOR USE ON WELDING MASKS AND FACE-PROTECTION SHIELDS; METAL THREADED FASTENERS, IN CLASS 6 (U.S. CLS. 2, 12, 13, 14, 23, 25 AND 50).

FIRST USE 1-8-2008; IN COMMERCE 1-8-2008.

THE MARK CONSISTS OF STANDARD CHARACTERS WITHOUT CLAIM TO ANY PARTICULAR FONT, STYLE, SIZE, OR COLOR.

SER. NO. 77-559,014, FILED P.R. 8-29-2008; AM. S.R. 12-15-2008.

BARBARA RUTLAND, EXAMINING ATTORNEY

**Int. Cl.: 42**

**Prior U.S. Cls.: 100 and 101**

**United States Patent and Trademark Office**

**Reg. No. 3,570,935**

**Registered Feb. 3, 2009**

**SERVICE MARK  
SUPPLEMENTAL REGISTER**

**2-MINUTE TRAINER**

THE NATIONAL RESTAURANT ASSOCIATION  
EDUCATIONAL FOUNDATION (ILLINOIS  
CORPORATION)

SUITE 1500

175 W. JACKSON BOULEVARD

CHICAGO, IL 606042814

FOR: PROVIDING TEMPORARY USE OF NON-DOWNLOADABLE SOFTWARE AND PROGRAMS TO ALLOW INSTRUCTORS TO REVIEW WEBINARS, SEMINARS AND OTHER TRAINING PRESENTATIONS AND EDUCATIONAL MATERIALS IN THE FIELDS OF TRAINING, EDUCATION, INSTRUCTOR TECHNIQUES, ICEBREAKERS AND

INSTRUCTOR METHODOLOGY, IN CLASS 42 (U.S. CLS. 100 AND 101).

FIRST USE 3-0-2008; IN COMMERCE 3-0-2008.

THE MARK CONSISTS OF STANDARD CHARACTERS WITHOUT CLAIM TO ANY PARTICULAR FONT, STYLE, SIZE, OR COLOR.

SER. NO. 77-561,058, FILED P.R. 9-3-2008; AM. S.R. 12-16-2008.

DANNEAN HETZEL, EXAMINING ATTORNEY

**Int. Cl.: 13**

**Prior U.S. Cls.: 2 and 9**

**United States Patent and Trademark Office**

**Reg. No. 3,570,936**

**Registered Feb. 3, 2009**

**TRADEMARK  
SUPPLEMENTAL REGISTER**

**GUN CADDIE**

GUNHIDE PROPERTIES, LLC (NEW YORK LIMITED LIABILITY COMPANY)

431 BAYVIEW AVENUE

AMITYVILLE, NY 11701

FOR: HOLSTERS, IN CLASS 13 (U.S. CLS. 2 AND 9).

FIRST USE 0-0-1999; IN COMMERCE 0-0-1999.

THE MARK CONSISTS OF STANDARD CHARACTERS WITHOUT CLAIM TO ANY PARTICULAR FONT, STYLE, SIZE, OR COLOR.

NO CLAIM IS MADE TO THE EXCLUSIVE RIGHT TO USE "GUN", APART FROM THE MARK AS SHOWN.

SER. NO. 77-567,256, FILED P.R. 9-10-2008; AM. S.R. 12-17-2008.

DAVID TOOLEY, EXAMINING ATTORNEY

**Int. Cl.: 42**

**Prior U.S. Cls.: 100 and 101**

**United States Patent and Trademark Office**

**Reg. No. 3,570,937**

**Registered Feb. 3, 2009**

**SERVICE MARK  
SUPPLEMENTAL REGISTER**

**SYRACUSE.COM**

SYRACUSE ONLINE, LLC (NEW YORK LIMITED LIABILITY COMPANY)  
5795 WIDEWATERS PARKWAY  
DEWITT, NY 13214

FOR: COMPUTER SERVICES, NAMELY, PROVIDING ON-LINE DATABASES FEATURING NEWS IN THE NATURE OF CURRENT EVENT REPORTING AND INTERNET NEWS PORTAL FEATURING STORIES ON WEATHER, ENTERTAINMENT, BUSINESS AND SPORTS, IN CLASS 42 (U.S. CLS. 100 AND 101).

FIRST USE 1-25-2001; IN COMMERCE 1-25-2001.

THE MARK CONSISTS OF STANDARD CHARACTERS WITHOUT CLAIM TO ANY PARTICULAR FONT, STYLE, SIZE, OR COLOR.

OWNER OF U.S. REG. NO. 2,543,532.

SER. NO. 77-571,010, FILED 9-16-2008.

SAMUEL E. SHARPER JR., EXAMINING ATTORNEY

**Int. Cl.: 36**

**Prior U.S. Cls.: 100, 101, and 102**

**United States Patent and Trademark Office**

**Reg. No. 3,570,938**

**Registered Feb. 3, 2009**

**SERVICE MARK  
SUPPLEMENTAL REGISTER**

**FIRST MARINE DIVISION  
FOUNDATION, INC.**

FIRST MARINE DIVISION FOUNDATION, INC.  
(MARYLAND CORPORATION)

400

575 S. CHARLES STREET  
BALTIMORE, MD 21201

FOR: ACCEPTING AND ADMINISTERING  
MONETARY CHARITABLE CONTRIBUTIONS, IN  
CLASS 36 (U.S. CLS. 100, 101 AND 102).

FIRST USE 12-17-2007; IN COMMERCE 12-17-2007.

THE MARK CONSISTS OF STANDARD CHAR-  
ACTERS WITHOUT CLAIM TO ANY PARTICULAR  
FONT, STYLE, SIZE, OR COLOR.

NO CLAIM IS MADE TO THE EXCLUSIVE  
RIGHT TO USE "FOUNDATION, INC.", APART  
FROM THE MARK AS SHOWN.

SER. NO. 77-572,136, FILED P.R. 9-17-2008; AM. S.R.  
12-17-2008.

JEFFERY COWARD, EXAMINING ATTORNEY



Int. Cl.: 18

Prior U.S. Cls.: 1, 2, 3, 22, and 41

United States Patent and Trademark Office

Reg. No. 3,570,939

Registered Feb. 3, 2009

**TRADEMARK  
SUPPLEMENTAL REGISTER**

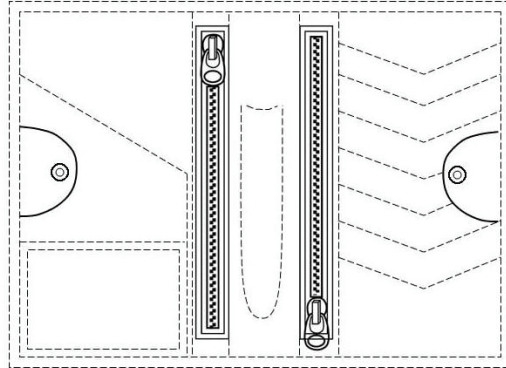

VALLAVISTA CORPORATION (CALIFORNIA CORPORATION)  
3541 WILKINSON LANE  
LAFAYETTE, CA 94549

FOR: WALLETS, IN CLASS 18 (U.S. CLS. 1, 2, 3, 22 AND 41).

FIRST USE 7-1-2006; IN COMMERCE 7-1-2006.

OWNER OF U.S. REG. NO. 3,542,191.

THE MARK CONSISTS OF THE CONFIGURATION OF THE INTERIOR OF A BIFOLD WALLET

FEATURING: (1) TWO PARALLEL ZIPPERS NEAR THE CENTER CREASE WITH OPENING TAGS PLACED SUCH THAT THE ZIPPERS OPEN IN OPPOSING DIRECTIONS; AND (2) TWO HALF MOON SHAPED TABS ON OPPOSING EDGES. THE REMAINDER OF THE INTERIOR OF THE WALLET IS NOT CLAIMED AS A FEATURE OF THE MARK.

SER. NO. 77-579,209, FILED P.R. 9-25-2008; AM. S.R. 12-30-2008.

REBECCA GILBERT, EXAMINING ATTORNEY

**Int. Cl.: 30**

**Prior U.S. Cl.: 46**

**United States Patent and Trademark Office**

**Reg. No. 3,570,940**

**Registered Feb. 3, 2009**

**TRADEMARK  
SUPPLEMENTAL REGISTER**

**LEMONADE BLENDS**

JUST BORN, INC. (PENNSYLVANIA CORPORATION)  
1300 STEFKO BOULEVARD  
BETHLEHAM, PA 18017

FOR: CANDY, IN CLASS 30 (U.S. CL. 46).

FIRST USE 3-1-2008; IN COMMERCE 3-1-2008.

THE MARK CONSISTS OF STANDARD CHARACTERS WITHOUT CLAIM TO ANY PARTICULAR FONT, STYLE, SIZE, OR COLOR.

SER. NO. 77-592,975, FILED 10-15-2008.

COURTNEY MCCORMICK, EXAMINING ATTORNEY

**Int. Cl.: 10**

**Prior U.S. Cls.: 26, 39, and 44**

**United States Patent and Trademark Office**

**Reg. No. 3,570,941**

**Registered Feb. 3, 2009**

**TRADEMARK  
SUPPLEMENTAL REGISTER**

**E-POLY**

BIOMET MANUFACTURING CORP. (INDIANA  
CORPORATION)  
P.O. BOX 587  
WARSAW, IN 46581

FOR: PLASTIC ENHANCED WITH VITAMIN E  
FOR OXIDATION RESISTANCE AS AN INTEGRAL  
COMPONENT OF ORTHOPEDIC IMPLANTS AND  
PROSTHESES, IN CLASS 10 (U.S. CLS. 26, 39 AND 44).

FIRST USE 7-23-2007; IN COMMERCE 7-23-2007.

THE MARK CONSISTS OF STANDARD CHAR-  
ACTERS WITHOUT CLAIM TO ANY PARTICULAR  
FONT, STYLE, SIZE, OR COLOR.

SER. NO. 78-474,171, FILED P.R. 8-26-2004; AM. S.R.  
4-28-2008.

MARK RADEMACHER, EXAMINING ATTORNEY