

**Int. Cl.: 16**

**Prior U.S. Cls.: 2, 5, 22, 23, 29, 37, 38 and 50**

**United States Patent and Trademark Office**

**Reg. No. 3,497,461**

**Registered Sep. 9, 2008**

**TRADEMARK  
PRINCIPAL REGISTER**

**INTERNET INDUSTRY WORLD**

INTERNATIONAL DATA GROUP, INC. (MASSACHUSETTS CORPORATION)  
5 SPEEN STREET  
FRAMINGHAM, MA 01701

FOR: NEWSLETTERS AND NEWSLETTER SUPPLEMENTS IN THE FIELD OF INFORMATION TECHNOLOGY, IN CLASS 16 (U.S. CLS. 2, 5, 22, 23, 29, 37, 38 AND 50).

FIRST USE 4-15-1997; IN COMMERCE 4-15-1997.

NO CLAIM IS MADE TO THE EXCLUSIVE RIGHT TO USE "INTERNET INDUSTRY", APART FROM THE MARK AS SHOWN.

SER. NO. 75-262,367, FILED 3-21-1997.

JULIE GUTTADAURO, EXAMINING ATTORNEY

**Int. Cl.: 42**

**Prior U.S. Cls.: 100 and 101**

**United States Patent and Trademark Office**

**Reg. No. 3,497,462**

**Registered Sep. 9, 2008**

**SERVICE MARK  
PRINCIPAL REGISTER**

**WEBPARTNER**

VERTICALSOFTWARE.COM, INC. (DELAWARE CORPORATION)  
20410 TOWN CENTER LANE, SUITE 220  
CUPERTINO, CA 95014

FOR: WEB AND SOFTWARE BASED WEB SITE PERFORMANCE MANAGEMENT SERVICES THAT MONITOR WEB SITES, CREATE ALERTS, AND REPORTS VIA A GLOBAL COMPUTER INFORMA-

TION NETWORK , IN CLASS 42 (U.S. CLS. 100 AND 101).

FIRST USE 3-4-1999; IN COMMERCE 3-4-1999.

SER. NO. 75-814,796, FILED 9-27-1999.

FLORENTINA BLANDU, EXAMINING ATTORNEY

**Int. Cls.: 16, 18 and 25**

**Prior U.S. Cls.: 1, 2, 3, 5, 22, 23, 29, 37, 38, 39, 41 and 50**

**Reg. No. 3,497,463**

**United States Patent and Trademark Office**

**Registered Sep. 9, 2008**

**TRADEMARK  
PRINCIPAL REGISTER**

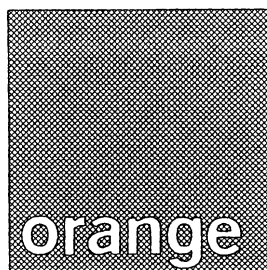

ORANGE PERSONAL COMMUNICATIONS SERVICES LIMITED (UNITED KINGDOM COMPANY)  
ST. JAMES COURT, GREAT PARK ROAD  
ALMONDSBURY PARK, BRADLEY STOKE  
BRISTOL BS12 4QJ, UNITED KINGDOM

FOR: PRINTED MATTER, NAMELY POSTERS; LEAFLETS, BROCHURES, BOOKLETS, INSTRUCTION MANUALS AND INFORMATIONAL FLYERS ALL RELATING TO TELECOMMUNICATIONS, COMPUTERS, THE INTERNET, MOTOR RACING, THE ARTS, BUSINESS PRODUCT PROMOTION, REAL ESTATE, STOCKS AND SHARES, MAINTENANCE AND PRODUCT REPAIR OF PROPERTY, HOUSEHOLD ITEMS, VEHICLES, MAINTENANCE AND REPAIR OF TELECOMMUNICATIONS INSTALLATIONS, NETWORKS, TELEPHONES AND COMPUTER EQUIPMENT, TRAVEL, ENTERTAINMENT, SPORTS, NOT INCLUDING THE PRESENTATION OF COLLEGE LEVEL SPORTING EVENTS, CULTURAL EVENTS, TRAVEL AND RESTAURANTS; BOOKS, MAGAZINES, NEWSPAPER AND MAGAZINE PERIODICALS, NEWSLETTERS RELATING TO THE SUBJECT OF TELECOMMUNICATIONS AND COMPUTING, NOT INCLUDING ANY OF THE AFORESAID GOODS RELATING TO ORANGES, IN CLASS 16 (U.S. CLS. 2, 5, 22, 23, 29, 37, 38 AND 50).

FOR: GOODS MADE FROM LEATHER OR IMITATION LEATHER, NAMELY DUFFEL BAGS,

TOTE BAGS, HAND BAGS, ATHLETIC BAGS, BEACH BAGS, BOOK BAGS, CARRY-ON BAGS, DIAPER BAGS, GYM BAGS, OVERNIGHT BAGS, MESH BAGS, SCHOOL BAGS, SHOULDER BAGS, LEATHER SHOPPING BAGS, MESH SHOPPING BAGS, TEXTILE SHOPPING BAGS, ATTACHE CASES, BUSINESS CARD CASES, CALLING CARD CASES, CREDIT CARD CASES, DOCUMENT CASES, KEY CASES, OVERNIGHT CASES, SUITCASES; UMBRELLAS AND PARASOLS, IN CLASS 18 (U.S. CLS. 1, 2, 3, 22 AND 41).

FOR: HATS; TIES; T-SHIRTS; SWEAT SHIRTS; POLO SHIRTS; GOLF SHIRTS; UNDER SHIRTS; NIGHT SHIRTS; KNIT SHIRTS; GYM SHORTS; SWEAT SHORTS; FLEECE JACKETS; WIND RESISTANT JACKETS; LEATHER JACKETS; LONG SLEEVE SWEAT SHIRTS; SHIRTS; BASEBALL CAPS; HATS; HEAD BANDS; HEAD WEAR; RAIN COATS; BELTS, IN CLASS 25 (U.S. CLS. 22 AND 39).

OWNER OF UNITED KINGDOM REG. NO. 2283049, DATED 10-12-2001, EXPIRES 10-12-2011.

OWNER OF UNITED KINGDOM REG. NO. 2256498, DATED 12-21-2000, EXPIRES 12-21-2010.

SER. NO. 75-981,190, FILED 6-16-1999.

JAMES A. RAUEN, EXAMINING ATTORNEY

**Int. Cls.: 30 and 43**

**Prior U.S. Cls.: 46, 100 and 101**

**United States Patent and Trademark Office**

**Reg. No. 3,497,464**

**Registered Sep. 9, 2008**

**TRADEMARK  
SERVICE MARK  
PRINCIPAL REGISTER**

**EXTREME. NOT MAINSTREAM.**

OOO INC. (CALIFORNIA CORPORATION), DBA  
EXTREME PIZZA

C/O TODD PARENT

1730 FILLMORE STREET

SAN FRANCISCO, CA 94115

FOR: GOURMET PIZZA, IN CLASS 30 (U.S. CL.  
46).

FIRST USE 11-0-1995; IN COMMERCE 11-0-1995.

FOR: RESTAURANT AND CARRY OUT SERVI-  
CES FEATURING PIZZA, IN CLASS 43 (U.S. CLS. 100  
AND 101).

FIRST USE 11-0-1995; IN COMMERCE 11-0-1995.

OWNER OF U.S. REG. NOS. 2,187,758 AND  
2,187,793.

SER. NO. 76-121,884, FILED 9-6-2000.

AISHA CLARKE, EXAMINING ATTORNEY

**Int. Cls.: 16, 41 and 42**

**Prior U.S. Cls.: 2, 5, 22, 23, 29, 37, 38, 50, 100, 101 and 107**

**Reg. No. 3,497,465**

**United States Patent and Trademark Office**

**Registered Sep. 9, 2008**

**TRADEMARK  
SERVICE MARK  
PRINCIPAL REGISTER**

**MDTV**

VOICE OF THE ARAB WORLD, INC. (MASSACHUSETTS CHARITABLE CORPORATION)  
BOX 390883  
CAMBRIDGE, MA 02139

FOR: PERIODICALS IN THE FIELD OF MEDICINE FOR WITH DISTANCE LEARNING EDUCATIONAL SERVICES TO THE ARAB AND MUSLIM WORLD, IN CLASS 16 (U.S. CLS. 2, 5, 22, 23, 29, 37, 38 AND 50).

FIRST USE 12-31-1989; IN COMMERCE 12-31-1989.

FOR: EDUCATIONAL SERVICES; NAMELY, PROVIDING DISTANCE LEARNING PRESENTATIONS IN THE FIELD OF MEDICINE VIA RADIO, TV, SATELLITE BROADCAST AND THE INTER-

NET TO THE ARAB AND MUSLIM WORLD, IN CLASS 41 (U.S. CLS. 100, 101 AND 107).

FIRST USE 12-31-1989; IN COMMERCE 12-31-1989.

FOR: PROVIDING INFORMATION IN THE FIELD OF MEDICINE VIA RADIO, TV, SATELLITE BROADCAST AND THE INTERNET TO THE ARAB AND MUSLIM WORLD, IN CLASS 42 (U.S. CLS. 100 AND 101).

FIRST USE 12-31-1989; IN COMMERCE 12-31-1989.

SER. NO. 76-135,402, FILED 9-25-2000.

PAUL F. GAST, EXAMINING ATTORNEY

**Int. Cl.: 35**

**Prior U.S. Cls.: 100, 101 and 102**

**United States Patent and Trademark Office**

**Reg. No. 3,497,466**

**Registered Sep. 9, 2008**

**SERVICE MARK  
PRINCIPAL REGISTER**



STEELBUILDING ACQUISITION, INC. (DELA-  
WARE CORPORATION)  
10943 NORTH SAM HOUSTON PARKWAY WES  
HOUSTON, TX 77064

FOR: COMPUTERIZED ON-LINE RETAIL SER-  
VICES IN THE FIELD OF PRE-ENGINEERED  
STEEL BUILDINGS AND ROOFING SYSTEMS, IN  
CLASS 35 (U.S. CLS. 100, 101 AND 102).

FIRST USE 6-1-2000; IN COMMERCE 9-29-2000.

THE STIPPLING IN THE DRAWING DOES NOT  
INDICATE COLOR.

THE MARK CONSISTS IN PART OF A STYLIZED  
DEPICTION OF A ROOF AND THE TOP OF A BOLT.

SEC. 2(F) AS TO "STEELBUILDING.COM".

SER. NO. 76-280,389, FILED 7-3-2001.

KHANH LE, EXAMINING ATTORNEY

**Int. Cls.: 9, 16, 28, 35, 36, 37, 38, 39, 40, 41 and 42**

**Prior U.S. Cls.: 2, 5, 21, 22, 23, 26, 29, 36, 37, 38, 50, 100, 101, 102, 103, 104, 105, 106 and 107**

**Reg. No. 3,497,467**

**United States Patent and Trademark Office**

**Registered Sep. 9, 2008**

**TRADEMARK  
SERVICE MARK  
PRINCIPAL REGISTER**

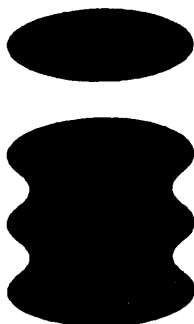

KABUSHIKI KAISHA NTT DOCOMO (JAPAN CORPORATION), DBA NTT DOCOMO, INC.  
11-1, NAGATACHO 2-CHOME  
CHIYODA-KU  
TOKYO, JAPAN

FOR: VIDEO OUTPUT GAME MACHINES FOR USE WITH TELEVISIONS AND OVER THE GLOBAL COMMUNICATION NETWORK; ELECTRONIC GAMES ADAPTED FOR USE WITH TELEVISION RECEIVERS ONLY ENABLING THE USERS TO COMMUNICATE WITH EACH OTHER VIA TELECOMMUNICATION NETWORK, IN CLASS 9 (U.S. CLS. 21, 23, 26, 36 AND 38).

FOR: ATLASES; BLUE PRINT PAPER; BOOKLETS RELATING TO COMMUNICATION, HANDHELD COMPUTERS, PERSONAL COMPUTERS, PDA, COMPUTER SOFTWARE MUSIC AND MOVIES; COMIC BOOKS; PAPER CONTROL TOKENS FOR FOREIGN EXCHANGE AND FOR USE AS ADMISSION PASSES; GRAPHIC PRINTS ART PRODUCTIONS; PRINTED TIMETABLES; INSTRUCTION MANUALS FOR USE IN THE FIELD OF COMMUNICATION, HANDHELD COMPUTERS, PERSONAL COMPUTERS, PDA, COMPUTER SOFTWARE, MUSIC AND MOVIES; PERIODICALS RELATING TO COMMUNICATION, HANDHELD COMPUTERS, PERSONAL COMPUTERS, PDA, COMPUTER SOFTWARE, MUSIC AND MOVIES; PRINTED PLANS AND ARCHITECTURAL PLANS; POSTERS; PRINTED PUBLICATIONS, NAMELY, LEAFLETS AND BROCHURES RELATING TO COMMUNICATION, HANDHELD COMPUTERS,

PERSONAL COMPUTERS, PDA, COMPUTER SOFTWARE, MUSIC AND MOVIES NEWSLETTERS RELATING TO COMMUNICATION, HANDHELD COMPUTERS, PERSONAL COMPUTERS, PDA, COMPUTER SOFTWARE, MUSIC AND MOVIES; PROSPECTUSES RELATING TO COMMUNICATION, HANDHELD COMPUTERS, PERSONAL COMPUTERS, PDA, COMPUTER SOFTWARE, MUSIC AND MOVIES; PRINTED INSTRUCTIONAL TEACHING MATERIALS RELATING TO COMMUNICATION, HANDHELD COMPUTERS, PERSONAL COMPUTERS, PDA, COMPUTER SOFTWARE, MUSIC AND MOVIES; TEAR-OFF CALENDARS, IN CLASS 16 (U.S. CLS. 2, 5, 22, 23, 29, 37, 38 AND 50).

FOR: GAMES, NAMELY, COIN-OPERATED VIDEO GAMES, ELECTRONIC DART GAMES AND HANDHELD UNITS FOR PLAYING ELECTRONIC GAMES; TOYS, NAMELY, INFANT DEVELOPMENT TOYS, MECHANICAL TOYS AND PET TOYS, DOLLS; DOMINOS; BILLIARD MARKERS; TOY MOBILES; PARLOR GAMES, NAMELY, GO GAMES, JAPANESE CHESS (SHOGI), DICE, JAPANESE DICE GAMES (SUGOROKU), CHESS GAMES AND CHECKER SETS; PLAY BALLOONS; TOY ROBOTS FOR ENTERTAINMENT USE, IN CLASS 28 (U.S. CLS. 22, 23, 38 AND 50).

FOR: PROVIDING BUSINESS DIRECTORY INFORMATION RELATING TO ADVERTISEMENTS, TO THE SALE OF GOODS, AND TO SHOPS CLASSIFIED BY THE TYPE OF BUSINESS, VIA WIRE-

LESS COMMUNICATION SERVICES; PROVIDING BUSINESS INFORMATION RELATING TO SALES VOLUME TRACKING AND COMMERCIAL INFORMATION VIA WIRELESS COMMUNICATION SERVICES; ADVERTISING AGENCIES; DISSEMINATION OF ADVERTISING MATTER; PREPARING ADVERTISEMENTS FOR OTHERS; PROMOTING THE GOODS AND SERVICES OF OTHERS BY MEANS OF OPERATING AN ONLINE SHOPPING MALL WITH LINKS TO THE WEBSITES OF OTHERS VIA MOBILE TELEPHONES AND COMPUTER TELEPHONES; MANAGEMENT OF TRADE SHOW AND BUSINESS EXHIBITIONS FOR ADVERTISING PURPOSES IN THE FIELD OF TELECOMMUNICATIONS AND COMPUTERS; RENTAL OF ADVERTISING SPACE; MARKET RESEARCH VIA A COMPUTER DATA BASE; PLANNING OF SALES PROMOTION AND ADVERTISING FOR COMMUNICATION TERMINALS AND TELECOMMUNICATION SERVICES; BUSINESS ADMINISTRATION, NAMELY, MANAGEMENT OF HOTELS FOR OTHERS; BUSINESS MANAGEMENT CONSULTANCY; BUSINESS ORGANIZATION CONSULTANCY; BUSINESS MANAGEMENT CONSULTING; BUSINESS APPRAISALS OF BUILDINGS AND LAND; BUSINESS RESEARCH, NAMELY, MARKET RESEARCH; EFFICIENCY EXPERTS; ADVISORY SERVICES FOR BUSINESS MANAGEMENT; PROMOTING THE GOODS AND SERVICES OF OTHERS BY PREPARING AND PLACING ADVERTISEMENTS IN AN ELECTRONIC MAGAZINE ACCESSED THROUGH A GLOBAL COMPUTER NETWORK AND INFORMATION SERVICES RELATING THERETO; PROVIDING AUCTION SERVICES VIA A GLOBAL COMPUTER NETWORK; MONITORING SERVICES IN THE NATURE OF PROVIDING TRACKING INFORMATION INVOLVING THE USE OF TWO-WAY WIRELESS COMMUNICATION SYSTEMS, GLOBAL POSITIONING SYSTEMS, AND COMPUTER INTEGRATION SYSTEMS, TO ASCERTAIN THE GEOGRAPHIC LOCATIONS OF MOVABLE OBJECTS, NAMELY, MOTOR VEHICLES, FOR COMMERCIAL PURPOSES, IN CLASS 35 (U.S. CLS. 100, 101 AND 102).

FOR: CREDIT CARD VERIFICATION SERVICES IN THE NATURE OF PROVIDING VERIFICATION OF ACCOUNTS ON BEHALF OF CREDIT CARD HOLDERS, DEBIT CARD HOLDERS, CREDIT CARD COMPANIES AND ELECTRONIC MONEY USERS; PROVIDING INFORMATION RELATING TO INSURANCE ACTUARIAL SERVICES; BANKING SERVICES, NAMELY, ACCEPTANCE OF DEPOSITS, SUBSTITUTE BONDS AND FIXED INTERVAL INSTALLMENT DEPOSITS VIA A GLOBAL COMPUTER NETWORK; ELECTRONIC MONEY TRANSFER; ISSUANCE OF PRE-PAID DEBIT CARDS FOR CELL-PHONE AND LAND-LINE AIR TIME; COLLECTION AGENCY SERVICES FOR OTHERS IN THE FIELD OF ELECTRONIC COMMERCE VIA WIRELESS COMMUNICATION SERVICES; AGENCY IN THE FIELD OF COLLECTING BILLS, NAMELY, COLLECTING LIABILITIES FOR OTHERS BY PROVIDING INFORMATION OVER COMPUTERS; ELECTRONIC FUNDS TRANSFERS AND TRANSACTIONS; PROVIDING ELECTRONIC

BANKING SERVICES, NAMELY, ACCEPTANCE OF DEPOSITS, SUBSTITUTE BONDS AND FIXED INTERVAL INSTALLMENT DEPOSITS VIA A GLOBAL COMPUTER NETWORK; COMPUTERIZED FINANCIAL AND INSURANCE INFORMATION PROVIDED VIA WIRELESS COMMUNICATION SERVICES IN THE FIELD OF INSURANCE ACTUARIAL SERVICES AND STOCK MARKET INFORMATION; ONLINE BANKING SERVICES, NAMELY, ACCEPTANCE OF DEPOSITS, SUBSTITUTE BONDS AND FIXED INTERVAL INSTALLMENT DEPOSITS VIA A GLOBAL COMPUTER NETWORK, IN CLASS 36 (U.S. CLS. 100, 101 AND 102).

FOR: MAINTENANCE AND REPAIR OF TELECOMMUNICATION NETWORKS; MAINTENANCE AND REPAIR OF TELECOMMUNICATION EQUIPMENT; REPAIR OF TELECOMMUNICATION APPARATUS; REPAIR OF COMPUTER HARDWARE; REPAIR AND MAINTENANCE OF COMPUTERS; REPAIR AND MAINTENANCE OF POWER CABLES AND TELECOMMUNICATION CABLES FOR SUBMARINES; BUILDING CONSTRUCTION; CONSTRUCTION OF COMMUNICATION PLANTS; UNDERGROUND CONSTRUCTION; RENTAL AND LEASING OF CONSTRUCTION EQUIPMENT, CIVIL ENGINEERING MACHINERY, EARTH MOVING EQUIPMENT AND EXCAVATORS; PROVIDING INFORMATION RELATING TO CONSTRUCTION OF BUILDINGS; CONSULTATION IN THE FIELD OF CONSTRUCTION AND CIVIL ENGINEERING WORKS; MAINTENANCE OF ELECTRICAL BUILDING EQUIPMENT INSTALLED IN BUILDINGS, AND OF BUILDING FACILITIES; DISINFECTING TELEPHONE SETS, IN CLASS 37 (U.S. CLS. 100, 103 AND 106).

FOR: PROVIDING CHAT ROOMS FOR TRANSMISSION OF MESSAGES AMONG COMPUTER USERS CONCERNING ENTERTAINMENT, EDUCATION, TECHNOLOGY, CULTURE, MUSIC, SPORTS, FASHION, LANGUAGE, PERSONAL COMPUTERS, IT RELATED MATTER, CURRENT EVENTS AND LIFESTYLES; STREAMING OF AUDIO MATERIAL ON THE INTERNET, IN CLASS 38 (U.S. CLS. 100, 101 AND 104).

FOR: TRANSPORTATION OF PASSENGERS AND/OR GOODS BY AIR, RAIL, BOATS AND VEHICLES; MERCHANDISE PACKAGING FOR TRANSPORTATION AND WAREHOUSE STORAGE OF GOODS; PROVIDING TRAVEL AND TRANSPORTATION INFORMATION, SPECIFICALLY INFORMATION RELATING TO SERVICE RECORD REGARDING TRANSPORT BY VEHICLES, INFORMATION RELATING TO THE LOCATION OF VEHICLES ON THE ROAD, INFORMATION RELATING TO THE TRANSPORT OF GOODS AND FREIGHT SERVICES, INFORMATION RELATING TO THE MANAGEMENT OF VEHICLE TRANSPORT SERVICES AND KEEPING TRACK OF THE VEHICLE TRANSPORT SITUATION, ROAD AND TRAFFIC INFORMATION, AND ROAD ROUTE INFORMATION, IN CLASS 39 (U.S. CLS. 100 AND 105).



FOR: CHEMICAL TREATMENT OF CLOTHING; PAPER FINISHING; ELECTRO-PLATING FOR METALS; FOOD TREATMENT FOR STORAGE; CERAMIC BURNING; GOLD-PLATING; PROVIDING INFORMATION IN THE FIELD OF TREATMENT OF MATERIALS, PROVIDED VIA WIRELESS COMMUNICATION SERVICES FROM A COMPUTER DATABASE OR A GLOBAL COMPUTER NETWORK, IN CLASS 40 (U.S. CLS. 100, 103 AND 106).

FOR: DISSEMINATION OF EDUCATIONAL MATERIALS FOR OTHERS, IN THE FIELDS OF MATH, SCIENCE, LITERATURE, TECHNOLOGY AND CULTURE TO CHILDREN USING COMPUTER TERMINALS; PROVIDING INFORMATION RELATING TO ENTERTAINMENT, MOVIES, SPORTS, SCENIC SPOTS, PLACES OF HISTORIC INTEREST, AND RECREATION; PUBLISHING OF ELECTRONIC PUBLICATIONS IN THE NATURE OF BOOKS AND MAGAZINES; PROVIDING A COMPUTER GAME PLAYED BY USING COMPUTER TERMINAL TELECOMMUNICATION; EDUCATION, NAMELY CLASSES, SEMINARS, CONFERENCES, AND WORKSHOPS PROVIDED BY TELEPHONE, IN THE FIELD OF SALES TECHNIQUE; ARRANGING AND CONDUCTING EDUCATIONAL CONFERENCES VIA COMPUTER TERMINALS IN THE FIELD OF ENTERTAINMENT, EDUCATION, TECHNOLOGY AND CULTURE; PROVIDING INFORMATION IN THE FIELDS OF ENTERTAINMENT AND EDUCATION, PROVIDED VIA WIRELESS COMMUNICATION SERVICES FROM COMPUTER TERMINALS; PROVIDING ONLINE COMPUTER GAMES PROVIDED BY MEANS OF A GLOBAL COMPUTER NETWORK VIA COMPUTER TERMINALS; ELECTRONIC LIBRARY SERVICES, NAMELY, PROVIDING INFORMATION RELAT-

ING TO THE DISPLAY OF BOOKS AND DOCUMENTARY RECORDS, SPECIFICALLY NEWSPAPERS, MAGAZINES, PHOTOGRAPHS AND PICTURES, VIA COMPUTER NETWORK; COMPUTER SERVICES, NAMELY PROVIDING ON-LINE PUBLICATIONS, NAMELY BOOKS, NEWSLETTERS AND MAGAZINES IN THE FIELD OF ENTERTAINMENT, EDUCATION, TECHNOLOGY AND CULTURE VIA WIRELESS COMMUNICATION SERVICES, IN CLASS 41 (U.S. CLS. 100, 101 AND 107).

FOR: PROVIDING FACILITIES FOR EXHIBITIONS FOR ADVERTISING PURPOSES; COMPUTER SERVICES, NAMELY, PROVIDING ON-LINE PUBLICATIONS AND MAGAZINES IN THE FIELD OF ENTERTAINMENT, EDUCATION, TECHNOLOGY AND CULTURE VIA WIRELESS COMMUNICATION SERVICES; MONITORING SERVICES, NAMELY, TWO WAY WIRELESS COMMUNICATION SYSTEMS MONITORING, GLOBAL POSITIONING SYSTEMS ELECTRONIC MONITORING SERVICES AND COMPUTER INTEGRATION SERVICES TO ASCERTAIN THE GEOGRAPHIC LOCATIONS OF MOVABLE OBJECTS, IN CLASS 42 (U.S. CLS. 100 AND 101).

OWNER OF JAPAN REG. NO. 4887104, DATED 8-12-2005, EXPIRES 8-12-2015.

THE MARK CONSISTS OF A DESIGN LETTER "I".

SER. NO. 76-303,158, FILED 8-22-2001.

ADA HAN, EXAMINING ATTORNEY

**Int. Cls.: 7 and 11**

**Prior U.S. Cls.: 13, 19, 21, 23, 31, 34 and 35**

**United States Patent and Trademark Office**

**Reg. No. 3,497,468**

**Registered Sep. 9, 2008**

**TRADEMARK  
PRINCIPAL REGISTER**

# **DynoFlash**

ATLAS-STORD NORWAY AS (NORWAY CORPORATION)  
SANDSLIMARKA 251  
P.O. BOX 9 SANDSLI  
N-5861 BERGEN, NORWAY

FOR: DRYING MACHINES FOR INDUSTRIAL USE, AND MACHINES FOR USE IN INDUSTRIAL DRYING SYSTEMS; MOTORS AND ENGINES FOR DRYING MACHINES, IN CLASS 7 (U.S. CLS. 13, 19, 21, 23, 31, 34 AND 35).

FOR: DRYING SYSTEMS FOR INDUSTRIAL USE COMPRISED OF NON-ELECTRIC INDUSTRIAL DRYERS FOR HEATING PRODUCT AND EVAPORATING MOISTURE AND ELECTRONIC CONTROL-

TERS AND COMPUTER HARDWARE AND SOFTWARE USED IN DRYING SYSTEMS FOR PROCESS CONTROL AND MONITORING; INDUSTRIAL DRYERS FOR HEATING AND DEHUMIDIFYING, IN CLASS 11 (U.S. CLS. 13, 21, 23, 31 AND 34).

PRIORITY CLAIMED UNDER SEC. 44(D) ON NORWAY APPLICATION NO. 200105064, FILED 4-20-2001, REG. NO. 226930, DATED 6-8-2005, EXPIRES 6-8-2015.

SER. NO. 76-316,789, FILED 9-20-2001.

THEODORE MCBRIDE, EXAMINING ATTORNEY

Int. Cl.: 41

Prior U.S. Cls.: 100, 101 and 107

United States Patent and Trademark Office

Reg. No. 3,497,469

Registered Sep. 9, 2008

SERVICE MARK  
PRINCIPAL REGISTER



FRANCIS MARION UNIVERSITY (SOUTH CAROLINA CORPORATION)  
P. O. BOX 100547  
FLORENCE, SC 295010547

FOR: ENTERTAINMENT SERVICES, NAMELY, COLLEGIATE SPORTS AND SPORTS EXHIBITIONS IN THE NATURE OF BASKETBALL, BASEBALL, CROSS COUNTRY, GOLF, SOCCER, SOFTBALL,

TENNIS, TRACK AND FIELD AND VOLLEYBALL GAMES, IN CLASS 41 (U.S. CLS. 100, 101 AND 107).

FIRST USE 8-24-2001; IN COMMERCE 8-24-2001.

SER. NO. 76-383,186, FILED 3-18-2002.

JAMES MACFARLANE, EXAMINING ATTORNEY

**Int. Cl.: 20**

**Prior U.S. Cls.: 2, 13, 22, 25, 32 and 50**

**United States Patent and Trademark Office**

**Reg. No. 3,497,470**

**Registered Sep. 9, 2008**

**TRADEMARK  
PRINCIPAL REGISTER**



KNIGHT INTERNATIONAL TRADE LLC (NEW YORK LIMITED LIABILITY COMPANY)  
280 MADISON AVENUE, STE. 1110  
NEW YORK, NY 10016

FOR: FURNITURE; MIRRORS; PICTURE FRAMES; AND SOFAS AND ARMCHAIRS, DAVENPORTS, CHAIRS AND CHAIR LOUNGES, SEATS, STOOLS, AND TABLES OF WOOD, CORK, REED, CANE, WICKER, HORN, BONE, IVORY, WHALE-BONE, SHELL, AMBER, MOTHER-OF-PEARL, MEERSCHAUM AND SUBSTITUTES FOR ALL OF

THE ABOVE MATERIALS, OR OF PLASTICS, IN CLASS 20 (U.S. CLS. 2, 13, 22, 25, 32 AND 50).

FIRST USE 10-0-2001; IN COMMERCE 10-0-2001.

NO CLAIM IS MADE TO THE EXCLUSIVE RIGHT TO USE "DESIGN", APART FROM THE MARK AS SHOWN.

SER. NO. 76-432,652, FILED 7-22-2002.

JAMES A. RAUEN, EXAMINING ATTORNEY

**Int. Cl.: 9**

**Prior U.S. Cls.: 21, 23, 26, 36 and 38**

**United States Patent and Trademark Office**

**Reg. No. 3,497,471**

**Registered Sep. 9, 2008**

**TRADEMARK  
PRINCIPAL REGISTER**

**SEASON TICKET**

INFOGRAMES, INC. (DELAWARE CORPORATION)  
417 FIFTH AVENUE  
NEW YORK, NY 10016

FIRST USE 6-0-2001; IN COMMERCE 6-0-2001.

SER. NO. 76-442,168, FILED 8-15-2002.

FOR: INTERACTIVE MULTIMEDIA GAME SOFTWARE FOR USE ON PERSONAL COMPUTERS AND ELECTRONIC GAME-PLAYING UNITS, IN CLASS 9 (U.S. CLS. 21, 23, 26, 36 AND 38).

GINA FINK, EXAMINING ATTORNEY

**Int. Cls.: 3, 6, 8, 9, 14, 16, 18, 20, 21, 24, 25, 26, 28, 29, 30, 32, 33, 34, 35, 41 and 43**

**Prior U.S. Cls.: 1, 2, 3, 4, 5, 6, 8, 9, 12, 13, 14, 17, 21, 22, 23, 25, 26, 27, 28, 29, 30, 32, 33, 36, 37, 38, 39, 40, 41, 42, 44, 45, 46, 47, 48, 49, 50, 51, 52, 100, 101, 102 and 107**

**Reg. No. 3,497,472**

**Registered Sep. 9, 2008**

**United States Patent and Trademark Office**

**TRADEMARK  
SERVICE MARK  
PRINCIPAL REGISTER**

**GUIDO E ANGELINA**

GUIDO & ANGELINA ENTERTAINMENT ENTERPRISES INC. (CANADA CORPORATION)  
BUREAU 2000  
300 RUE LEO-PARISEAU  
MONTREAL, QUEBEC, CANADA H2X 4B3

FOR: PERFUMES AND ESSENTIAL OILS FOR PERSONAL USE, IN CLASS 3 (U.S. CLS. 1, 4, 6, 50, 51 AND 52).

FOR: METAL KEY RINGS, IN CLASS 6 (U.S. CLS. 2, 12, 13, 14, 23, 25 AND 50).

FOR: SOUVENIER COLLECTOR SPOONS, IN CLASS 8 (U.S. CLS. 23, 28 AND 44).

FOR: SUNGLASSES; COMPUTER SOFTWARE, NAMELY, SERIES OF INTERACTIVE SOFTWARE PROGRAMS FEATURING ANIMATED CHARACTERS; COMPUTER PROGRAMS FOR CREATING, EDITING AND DISPLAYING ANIMATED CHARACTERS IN THE USER INTERFACE OF OTHER COMPUTER PROGRAMS AND WEB SITES; COMPUTER GAME SOFTWARE; CD-ROMS, NAMELY, BLANK CD-ROMS AND SERIES OF INTERACTIVE PRE-RECORDED CD-ROMS FEATURING ANIMATED CHARACTERS; COMPACT DISCS, NAMELY, BLANK COMPACT DISCS AND SERIES OF COMPACT DISCS FEATURING ANIMATED CHARACTERS; SERIES OF PRE-RECORDED AUDIO CASSETTES FEATURING ANIMATED CHARACTERS; BLANK AUDIO CASSETTES; SERIES OF PRE-RECORDED VIDEO CASSETTES FEATURING ANIMATED CHARACTERS; BLANK VIDEO CASSETTES; DECORATIVE MAGNETS; VIDEO GAME SOFTWARE, IN CLASS 9 (U.S. CLS. 21, 23, 26, 36 AND 38).

FOR: JEWELRY, WATCHES, CLOCKS, CIGARETTE LIGHTERS OF PRECIOUS METAL, ASHTRAYS OF PRECIOUS METAL, DECORATIVE PINS, IN CLASS 14 (U.S. CLS. 2, 27, 28 AND 50).

FOR: ARTWORK PRINTS, PHOTOGRAPHS, POSTERS, PENS, PENCILS, PAPER COASTERS; BOOKS, NAMELY, SERIES OF BOOKS FEATURING STORIES ABOUT ANIMATED CHARACTERS; COMIC BOOKS, COOK BOOKS, SCHOOL BOOKS, ILLUSTRATION BOOKS, COLORING BOOKS, DRAWING BOOKS, IN CLASS 16 (U.S. CLS. 2, 5, 22, 23, 29, 37, 38 AND 50).

FOR: WALLETS, ALL PURPOSE SPORT BAGS, TRAVEL BAGS, TOTE BAGS AND BACK PACKS, IN CLASS 18 (U.S. CLS. 1, 2, 3, 22 AND 41).

FOR: NON-METAL KEY RINGS, PICTURE FRAMES, CORKS FOR BOTTLES, IN CLASS 20 (U.S. CLS. 2, 13, 22, 25, 32 AND 50).

FOR: SPORT BOTTLES SOLD EMPTY, BOTTLE OPENERS, PLASTIC COASTERS; DECORATIVE PLATES, DECORATIVE BEVERAGE WARE, IN CLASS 21 (U.S. CLS. 2, 13, 23, 29, 30, 33, 40 AND 50).

FOR: TOWELS, BLANKETS, PILLOW CASES, IN CLASS 24 (U.S. CLS. 42 AND 50).

FOR: CLOTHING, NAMELY, DRESSES, SUITS, SWEATERS, SKIRTS, HALTER TOPS, BLOUSES, SHIRTS, T-SHIRTS, PANTS, SHORTS, JACKETS, JUMPSUITS, JUMPERS, VESTS, COATS, JEANS, BATHING SUITS, PYJAMAS, NIGHTGOWNS, UNDERWEAR, SOCKS, GLOVES, MITTENS, WRISTBANDS, LINGERIE, KITCHEN UNIFORMS,

RESTAURANT UNIFORMS, HATS, CAPS, BELTS, TIES, SCARVES, IN CLASS 25 (U.S. CLS. 22 AND 39).

FOR: EMBROIDERED EMBLEMS , IN CLASS 26 (U.S. CLS. 37, 39, 40, 42 AND 50).

FOR: GAMES, NAMELY, BOARD GAMES, PARLOR GAMES, CARD GAMES, WORD GAMES, VIDEO GAMES, NAMELY, ARCADE-TYPE ELECTRONIC VIDEO GAMES, HAND HELD UNITS FOR PLAYING VIDEO GAMES, STAND ALONE VIDEO GAME MACHINES; TOYS, NAMELY, JIGSAW PUZZLES, STUFFED AND INFLATABLE TOYS, NAMELY, PLUSH TOYS AND FLAT FABRIC TOYS DEPICTING ANIMATED CHARACTERS; PLUSH TOYS AND FLAT FABRIC TOYS, NAMELY, INFLATABLE FIGURES, DOLLS, PUPPETS; BALLS OF ALL KINDS, NAMELY, ACTION BALLS, NAMELY, BEACH BALLS, AND SPORT BALLS, NAMELY, SOCCER BALLS AND GOLF BALLS; SAVING BANKS, SNOWBOARDS, PLAYING CARDS, IN CLASS 28 (U.S. CLS. 22, 23, 38 AND 50).

FOR: FOOD PRODUCTS, NAMELY, READY-MADE MEALS, FROZEN, PREPARED OR PACKAGED, PRIMARILY MADE OF MEAT, POULTRY, FISH, CHEESE, VEGETABLES; DELI MEATS, SAUSAGES; PREPARED GARDEN SALADS; PREPARED VEGETABLE SALADS, EXCEPT MACARONI, RICE, AND PASTA SALADS; SOUPS, STEWS, CHEESE; FRUIT SAUCE, NAMELY, CRANBERRY SAUCE; APPLESAUCE, PICKLED VEGETABLES, PEANUT BUTTER, POTATO CHIPS; PRESERVED, DRIED, AND COOKED FRUITS AND VEGETABLES; OLIVE OIL, SUN DRIED TOMATOES, EDIBLE OILS, COOKING OIL, SALAD OIL, VEGETABLE OIL, CANOLA OIL, SOYA OIL, SHORTENING, CANNED TOMATOES, TOMATO PASTE, CANNED AND DRIED BEANS, PEAS, LENTILS, CANNED AND JARRED FRUITS, VEGETABLE DIPS AND SPREADS, PROCESSED NUTS, PROCESSED PEANUTS, SARDINES; CANNED AND BOTTLED FRUITS AND VEGETABLES, NAMELY, ARTICHOKES, OLIVES, PEPPERS, HOT PEPPER RINGS, MUSHROOMS, MIXED VEGETABLES; CANNED SEAFOOD, NAMELY, TUNA, MACKEREL, SARDINES, SHRIMP, CLAMS AND ANCHOVIES; JAMS, MARMALADES, JELLIES, PICKLES, EGGS, MILK; MILK PRODUCTS, NAMELY, BUTTER, CHEESE, CREAM, YOGURT, POWDERED MILK; CHOCOLATE-BASED BEVERAGES, NAMELY, DAIRY-BASED CHOCOLATE FOOD BEVERAGES AND VEGETABLE-BASED CHOCOLATE FOOD BEVERAGES, IN CLASS 29 (U.S. CL. 46).

FOR: FOOD PRODUCTS, NAMELY, RICE, PRE-COOKED PASTA MEALS, PIZZA, SANDWICHES, QUICHES, LASAGNA; FROZEN, FRESH OR DRIED PASTA, NAMELY, RAVIOLI, LASAGNA, TORTELLINI, MACARONI, RIGATONI, EGG NEST NOODLES, EGG NOODLES, GNOCCHI, SPAGHETTI, NOODLES; PIZZA SAUCE, PASTA SAUCE; PASTA SAUCE WITH MEAT, VEGETABLE OR CHEESE; CHEESE SAUCE, MEAT SAUCE; SAUCES, NAMELY, SALSA, BARBECUE, SPAGHETTI, SEAFOOD, STEAK, HORSERADISH; MAYONNAISE, DESSERT SAUCE, MUSTARD, VINEGAR, RELISH, CATSUP,

MARINADES, SALAD DRESSINGS, HONEY; SYRUPS, NAMELY, MAPLE SYRUP, CHOCOLATE SYRUP, PANCAKE SYRUP, CORN SYRUP, FLAVOURING SYRUP, TABLE SYRUP; SPICES, SEASONINGS, BALSAMIC VINEGAR, BREAKFAST CEREAL, FLOURS, CROUTONS, BREAD CRUMBS, PITA, FOCACCIA, BAGELS, TORTILLAS, CRUMPETS, MUFFINS, SNACKING CRACKERS, ICE CREAM; FROZEN DESSERTS, NAMELY, SORBET, FROZEN YOGURT; DESSERTS, NAMELY, CAKES, PUDDINGS, SHORTBREAD, CRISPS; CAKE MIXES, PIES, BISCUITS, COOKIES, TARTS, WAFFLES, CROISSANTS, BREAD, BUNS, COFFEE AND INSTANT COFFEE, TEA, ICED TEA, COFFEE-BASED BEVERAGES CONTAINING MILK, COCOA, SUGAR, MOLASSES, TAPIOCA, CHOCOLATE, CANDIES; MACARONI, RICE AND PASTA SALADS; SALTY SNACKS, NAMELY, PRETZELS; BEVERAGES MADE PRIMARILY WITH MILK, NAMELY, MILK SHAKES, IN CLASS 30 (U.S. CL. 46).

FOR: BEVERAGES, NAMELY, NON-ALCOHOLIC BEVERAGES COMPRISING ENERGY DRINKS, TOMATO JUICES, VEGETABLE JUICES, FRUIT JUICES, FRUIT DRINKS; FLAVOURED BEVERAGES, NAMELY, CARBONATED AND NON-CARBONATED FRUIT FLAVORED BEVERAGES; CARBONATED BEVERAGES, NAMELY, MINERAL WATER; FRUIT PUNCHES, NECTARS, LEMONADES, BOTTLED DRINKING WATER, MINERAL WATER, FLAVOURED WATERS, BEER, NON-ALCOHOLIC COFFEE BASED BEVERAGES NOT CONTAINING MILK, IN CLASS 32 (U.S. CLS. 45, 46 AND 48).

FOR: WINES, WINE COOLERS, DISTILLED SPIRITS, IN CLASS 33 (U.S. CLS. 47 AND 49).

FOR: CIGARETTE LIGHTERS NOT OF PRECIOUS METAL, MATCHES, ASHTRAYS NOT OF PRECIOUS METAL, IN CLASS 34 (U.S. CLS. 2, 8, 9 AND 17).

FOR: BOUTIQUES, NAMELY, RETAIL BOUTIQUES OFFERING A VARIETY OF PRODUCTS, NAMELY, SOUVENIRS, FINE FOOD, COOKWARE, HOUSEWARE PRODUCTS, CLOTHING, SPORTS EQUIPMENT, VIDEOCASSETTES, MAGAZINES, CIGARS, CIGAR ACCESSORIES, BIRTHDAY CARDS, CALENDARS, AGENDAS, PENS, PENCILS, WRITING PAPERS AND ART SUPPLIES, IN CLASS 35 (U.S. CLS. 100, 101 AND 102).

FOR: NIGHTCLUBS; ENTERTAINMENT, NAMELY, LIVE MUSIC CONCERTS, IN CLASS 41 (U.S. CLS. 100, 101 AND 107).

FOR: RESTAURANT AND BAR SERVICES, PIZZA RESTAURANT SERVICES, IN CLASS 43 (U.S. CLS. 100 AND 101).

THE MARK CONSISTS OF STANDARD CHARACTERS WITHOUT CLAIM TO ANY PARTICULAR FONT, STYLE, SIZE, OR COLOR.

PRIORITY CLAIMED UNDER SEC. 44(D) ON CANADA APPLICATION NO. 1149778, FILED 8-14-

2002, REG. NO. TMA687704, DATED 5-14-2007, EX-PIRES 5-14-2017.

SER. NO. 76-458,696, FILED 10-8-2002.

THE NAME "GUIDO ANGELINA" DOES NOT IDENTIFY A LIVING INDIVIDUAL.

PAUL F. GAST, EXAMINING ATTORNEY



**Int. Cl.: 9**

**Prior U.S. Cls.: 21, 23, 26, 36 and 38**

**United States Patent and Trademark Office**

**Reg. No. 3,497,473**

**Registered Sep. 9, 2008**

**TRADEMARK  
PRINCIPAL REGISTER**

**EXCELEVERYWHERE**

FRAMTIDSFORUM I & M AB (SWEDEN COR-  
PORATION)  
HALLBYGATAN 34A  
752 28 UPPSALA, SWEDEN

FIRST USE 6-17-2002; IN COMMERCE 6-17-2002.

SER. NO. 76-485,998, FILED 1-29-2003.

FOR: COMPUTER PROGRAMS FOR MAKING  
SPREADSHEETS AVAILABLE ON COMPUTING  
DEVICES, IN CLASS 9 (U.S. CLS. 21, 23, 26, 36 AND  
38).

GINA FINK, EXAMINING ATTORNEY

**Int. Cl.: 5**

**Prior U.S. Cls.: 6, 18, 44, 46, 51 and 52**

**United States Patent and Trademark Office**

**Reg. No. 3,497,474**

**Registered Sep. 9, 2008**

**TRADEMARK  
PRINCIPAL REGISTER**

**HOMACTON**

FERRING B.V. (NETHERLANDS CORPORATION)  
POLARIS AVENUE 144  
2132 JX HOOFFDORP, NETHERLANDS

OWNER OF IRELAND REG. NO. 205077, DATED  
3-4-1997, RENEWED AS REG. NO. 205077, DATED 3-  
2-2007, EXPIRES 3-4-2017.

FOR: PHARMACEUTICAL PREPARATIONS  
AND SUBSTANCES USED IN THE FIELD OF  
ENDOCRINOLOGY, IN CLASS 5 (U.S. CLS. 6, 18,  
44, 46, 51 AND 52).

SER. NO. 76-540,465, FILED 8-27-2003.

BRIAN NEVILLE, EXAMINING ATTORNEY

**Int. Cl.: 1**

**Prior U.S. Cls.: 1, 5, 6, 10, 26 and 46**

**United States Patent and Trademark Office**

**Reg. No. 3,497,475**

**Registered Sep. 9, 2008**

**TRADEMARK  
PRINCIPAL REGISTER**

**POL-E-FLAKE**

WELDRIL HOLDINGS, LLC (OKLAHOMA CORPORATION)  
10624 SOUTH LAKEWOOD  
TULSA, OK 74137

FOR: LOST CIRCULATION ADDITIVES CONSISTING OF FLAKES MADE FROM POLYESTER FILM, USED IN OIL AND GAS DRILLING AND COMPLETION OPERATIONS, IN CLASS 1 (U.S. CLS. 1, 5, 6, 10, 26 AND 46).

FIRST USE 1-1-1984; IN COMMERCE 1-1-1984.

THE MARK CONSISTS OF STANDARD CHARACTERS WITHOUT CLAIM TO ANY PARTICULAR FONT, STYLE, SIZE, OR COLOR.

SER. NO. 76-571,224, FILED 1-21-2004.

PATRICIA EVANKO, EXAMINING ATTORNEY

**Int. Cl.: 30**

**Prior U.S. Cl.: 46**

**United States Patent and Trademark Office**

**Reg. No. 3,497,476**

**Registered Sep. 9, 2008**

**TRADEMARK  
PRINCIPAL REGISTER**

**GIOVANNI'S PIZZA**

NORTHLAND FROZEN PIZZA, INC. (MINNESOTA CORPORATION)  
121 NE WASHINGTON ST.  
BRainerd, MN 56401

FOR: FROZEN PIZZA SOLD THROUGH GROCERY STORES, THROUGH CONVENIENCE STORES OR VIA SHIPMENT TO THE CUSTOMER, IN CLASS 30 (U.S. CL. 46).

FIRST USE 4-26-1995; IN COMMERCE 4-26-1995.

THE MARK CONSISTS OF STANDARD CHARACTERS WITHOUT CLAIM TO ANY PARTICULAR FONT, STYLE, SIZE, OR COLOR.

NO CLAIM IS MADE TO THE EXCLUSIVE RIGHT TO USE "PIZZA", APART FROM THE MARK AS SHOWN.

SER. NO. 76-582,697, FILED 3-23-2004.

MELISSA VALLILLO, EXAMINING ATTORNEY

**Int. Cl.: 25**

**Prior U.S. Cls.: 22 and 39**

**United States Patent and Trademark Office**

**Reg. No. 3,497,477**

**Registered Sep. 9, 2008**

**TRADEMARK  
PRINCIPAL REGISTER**

**SanSara**

PHILHOBAR DESIGN CANADA LTD. (CANADA  
COMPANY)  
365 LOUVAIN QUEST  
MONTREAL, QUEBEC, CANADA H2N 2J1

FOR: LADIES', MEN'S, GIRLS, BOYS' AND CHILDREN'S CLOTHING; NAMELY, POLO SHIRTS, SWEATERS, SHIRTS, BLOUSES, PANTS, OVERALLS, SHORTS, SKIRTS, COATS, JACKETS, VESTS, TURTLENECKS; ACTIVE WEAR, NAMELY, SHORTS, SWEAT PANTS, T-SHIRTS, SWEAT SHIRTS; UNDERGARMENTS, SLEEPWEAR, ROBES, IN CLASS 25 (U.S. CLS. 22 AND 39).

THE MARK CONSISTS OF STANDARD CHARACTERS WITHOUT CLAIM TO ANY PARTICULAR FONT, STYLE, SIZE, OR COLOR.

PRIORITY CLAIMED UNDER SEC. 44(D) ON CANADA APPLICATION NO. 1209688, FILED 3-15-2004, REG. NO. TMA707118, DATED 2-12-2008, EXPIRES 2-12-2023.

SER. NO. 76-593,637, FILED 5-24-2004.

MARY ROSSMAN, EXAMINING ATTORNEY

**Int. Cl.: 35**

**Prior U.S. Cls.: 100, 101 and 102**

**United States Patent and Trademark Office**

**Reg. No. 3,497,478**

**Registered Sep. 9, 2008**

**SERVICE MARK  
PRINCIPAL REGISTER**

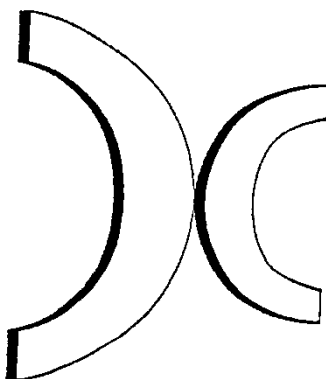

JIWIRE, INC. (DELAWARE CORPORATION)  
220 SANSOME STREET  
SAN FRANCISCO, CA 94104

FOR: PROVIDING CONSUMER PRODUCT AND SERVICE INFORMATION RELATING TO THE WIRELESS INDUSTRY VIA THE INTERNET; PROVIDING BUYING GUIDE INFORMATION ABOUT THE GOODS AND SERVICES OF OTHERS IN THE WIRELESS INDUSTRY VIA THE INTERNET; PROVIDING AN ONLINE BUSINESS DIRECTORY FEATURING PROVIDERS OF WIRELESS GOODS AND WIRELESS SERVICES; PROMOTING THE GOODS AND SERVICES OF OTHERS IN THE WIRELESS

INDUSTRY BY PROVIDING A WEB SITE AT WHICH USERS CAN LINK TO PROVIDERS OF WIRELESS GOODS AND SERVICES, IN CLASS 35 (U.S. CLS. 100, 101 AND 102).

FIRST USE 8-15-2003; IN COMMERCE 8-15-2003.

THE MARK CONSISTS OF BACK-TO-BACK SEMI-CIRCLES, THE LEFT LARGER THAN THE RIGHT.

SER. NO. 76-617,493, FILED 10-25-2004.

JILL C. ALT, EXAMINING ATTORNEY

**Int. Cl.: 35**

**Prior U.S. Cls.: 100, 101 and 102**

**United States Patent and Trademark Office**

**Reg. No. 3,497,479**

**Registered Sep. 9, 2008**

**SERVICE MARK  
PRINCIPAL REGISTER**

**HUXLEY ASSOCIATES**

HUXLEY ASSOCIATES LIMITED (UNITED  
KINGDOM COMPANY)  
2ND FLOOR  
VENTURE HOUSE 27-29 GLASSHOUSE STREET  
LONDON W1B 5DF, UNITED KINGDOM

FOR: PERSONNEL RECRUITMENT SERVICES;  
PERSONNEL RECRUITMENT SERVICES IN CON-  
NECTION WITH PERSONNEL FOR THE MANAGE-  
MENT, CONSTRUCTION PROGRAMMING, OR  
OPERATION OF COMPUTERS; CONSULTATION  
WITH RESPECT TO THE RECRUITMENT OF PER-  
SONNEL; COUNSELING WITH RESPECT TO THE  
SEEKING OF EMPLOYMENT; PERSONNEL MAN-  
AGEMENT CONSULTANCY SERVICES; SERVICES  
IN THE NATURE OF FINANCIAL INTRODUCTION  
SERVICES, NAMELY, REFERRING CONTRAC-  
TORS TO FINANCIAL ADVISORS WHO PROVIDE  
FINANCIAL CONSULTATION, TAX CONSULTA-

TION AND PORTFOLIO MANAGEMENT, IN CLASS  
35 (U.S. CLS. 100, 101 AND 102).

FIRST USE 9-12-2002; IN COMMERCE 9-12-2002.

THE MARK CONSISTS OF STANDARD CHAR-  
ACTERS WITHOUT CLAIM TO ANY PARTICULAR  
FONT, STYLE, SIZE, OR COLOR.

NO CLAIM IS MADE TO THE EXCLUSIVE  
RIGHT TO USE "ASSOCIATES", APART FROM  
THE MARK AS SHOWN.

SEC. 2(F).

SER. NO. 76-639,560, FILED 5-25-2005.

KELLY BOULTON, EXAMINING ATTORNEY

**Int. Cl.: 41**

**Prior U.S. Cls.: 100, 101 and 107**

**United States Patent and Trademark Office**

**Reg. No. 3,497,480**

**Registered Sep. 9, 2008**

**SERVICE MARK  
PRINCIPAL REGISTER**

**UTAH GRIZZLIES**

GRIZZLIES HOCKEY CLUB, INC. (UTAH CORPORATION)  
CENTENNIAL MANAGEMENT  
3200 DECKER LAKE BLVD.  
WEST VALLEY CITY, UT 84119

FOR: ENTERTAINMENT SERVICES, NAMELY PROFESSIONAL HOCKEY GAMES AND EXHIBITIONS, IN CLASS 41 (U.S. CLS. 100, 101 AND 107).

FIRST USE 7-5-2000; IN COMMERCE 7-5-2000.

THE MARK CONSISTS OF STANDARD CHARACTERS WITHOUT CLAIM TO ANY PARTICULAR FONT, STYLE, SIZE, OR COLOR.

NO CLAIM IS MADE TO THE EXCLUSIVE RIGHT TO USE UTAH, APART FROM THE MARK AS SHOWN.

SER. NO. 76-648,444, FILED 10-13-2005.

JORDAN BAKER, EXAMINING ATTORNEY



**Int. Cl.: 26**

**Prior U.S. Cls.: 37, 39, 40, 42 and 50**

**Reg. No. 3,497,481**

**United States Patent and Trademark Office**

**Registered Sep. 9, 2008**

**TRADEMARK  
PRINCIPAL REGISTER**



**P R I M A**

SIU, LAI KAM (CHINA INDIVIDUAL)  
561 10TH AVENUE, APT 24J  
NEW YORK, NY 10036

AND ZIPPER PULLS, IN CLASS 26 (U.S. CLS. 37, 39,  
40, 42 AND 50).

FIRST USE 1-1-2006; IN COMMERCE 1-1-2006.

FOR: ZIPPERS, NAMELY, METAL ZIPPERS, NY-  
LON ZIPPERS, MOULDED ZIPPERS, INVISIBLE  
ZIPPERS, ZIPPER FASTENERS, ZIPPER SLIDERS,

SER. NO. 76-657,478, FILED 3-24-2006.

ALLISON SCHRODY, EXAMINING ATTORNEY

**Int. Cl.: 9**

**Prior U.S. Cls.: 21, 23, 26, 36 and 38**

**Reg. No. 3,497,482**

**United States Patent and Trademark Office**

**Registered Sep. 9, 2008**

**TRADEMARK  
PRINCIPAL REGISTER**



SEVEN FREEDOMS MUSIC, LLC (NEW YORK  
LIMITED LIABILITY COMPANY)

P.O BOX 424

GRAHAMSVILLE, NY 127400424

FOR: PRE-RECORDED CD'S FEATURING MU-  
SIC, IN CLASS 9 (U.S. CLS. 21, 23, 26, 36 AND 38).

FIRST USE 11-22-2004; IN COMMERCE 11-24-2004.

THE COLOR(S) GREEN, BLUE, PURPLE, GREY  
AND WHITE IS/ARE CLAIMED AS A FEATURE OF  
THE MARK.

THE MARK CONSISTS OF A GRAPHIC OF A  
STYLIZED ASTERISK WITH A WHITE CENTER  
AND PROGRESSING OUTWARD FROM PURPLE  
TO GREEN TO PURPLE. THE BRANCHES OF THE  
ASTERISK ARE CONNECTED BY A LIGHT BLUE  
CIRCLE. ABOVE THE GRAPHIC IS THE WORD  
"SEVEN" AND BELOW THE GRAPHIC IS THE  
WORD "FREEDOMS", BOTH OF WHICH ARE  
WRITTEN IN PURPLE AND SHADED WITH DAR-  
KER PURPLE. THE ENTIRE MARK IS ON A BLUE  
RECTANGULAR BACKGROUND.

SER. NO. 76-657,757, FILED 4-3-2006.

ALYSSA PALADINO, EXAMINING ATTORNEY

**Int. Cls.: 41 and 42**

**Prior U.S. Cls.: 100, 101 and 107**

**United States Patent and Trademark Office**

**Reg. No. 3,497,483**

**Registered Sep. 9, 2008**

**SERVICE MARK  
PRINCIPAL REGISTER**



POTION DESIGN, LLC (NEW YORK LIMITED LIABILITY COMPANY)  
264 CANAL STREET  
SUITE 6E  
NEW YORK, NY 10013

FOR: FILM AND VIDEO PRODUCTION FOR OTHERS, IN CLASS 41 (U.S. CLS. 100, 101 AND 107).

FIRST USE 2-23-2005; IN COMMERCE 7-1-2005.

FOR: RESEARCH AND DESIGN SERVICES IN THE AREAS OF ENVIRONMENTAL DESIGN, NAMELY, DESIGN OF SPECIALTY INTERIOR AND EXTERIOR ENVIRONMENT SETTINGS; GRAPHIC ART DESIGN IN THE FIELD OF MOTION GRAPHICS, COMPUTER GRAPHICS, AND

GRAPHIC ILLUSTRATION SERVICES FOR OTHERS; WEBSITE DEVELOPMENT SERVICES; DESIGN OF INTERACTIVE EXHIBIT INSTALLATIONS FOR OTHERS AND COMPUTER SOFTWARE DEVELOPMENT, IN CLASS 42 (U.S. CLS. 100 AND 101).

FIRST USE 2-23-2005; IN COMMERCE 7-1-2005.

THE DESIGN COMPRISES THE WORD "POTION" WITH BUBBLES ARISING FROM THE LETTER "I".

SER. NO. 76-657,840, FILED 4-4-2006.

STEVEN PEREZ, EXAMINING ATTORNEY

**Int. Cl.: 41**

**Prior U.S. Cls.: 100, 101 and 107**

**United States Patent and Trademark Office**

**Reg. No. 3,497,484**

**Registered Sep. 9, 2008**

**SERVICE MARK  
PRINCIPAL REGISTER**

**EL VENADITO ESTRADA**

SAUCEDO, MARIA (MEXICO INDIVIDUAL)  
8560 VINEYARD AVE. SUITE 107  
RANCHO CUCAMONGA, CA 91730

FOR: ENTERTAINMENT SERVICES IN THE  
NATURE OF LIVE MUSICAL PERFORMANCES,  
IN CLASS 41 (U.S. CLS. 100, 101 AND 107).

FIRST USE 9-15-1998; IN COMMERCE 9-15-1998.

THE MARK CONSISTS OF STANDARD CHAR-  
ACTERS WITHOUT CLAIM TO ANY PARTICULAR  
FONT, STYLE, SIZE, OR COLOR.

THE ENGLISH TRANSLATION OF "EL VENADI-  
TO ESTRADA" IS "THE LITTLE DEER ESTRADA".

SER. NO. 76-661,637, FILED 6-15-2006.

JAMES LOVELACE, EXAMINING ATTORNEY

**Int. Cls.: 24 and 25**

**Prior U.S. Cls.: 22, 39, 42 and 50**

**United States Patent and Trademark Office**

**Reg. No. 3,497,485**

**Registered Sep. 9, 2008**

**TRADEMARK  
PRINCIPAL REGISTER**

**OY VEY IT'S HOT**

GIFTWARE INTERNATIONAL (PENNSYLVANIA CORPORATION)  
1280 INDUSTRIAL BOULEVARD  
SOUTHAMPTON, PA 18966

FOR: HOUSEHOLD AND KITCHEN PRODUCTS, NAMELY, OVEN MITTS AND POTHOLDERS, IN CLASS 24 (U.S. CLS. 42 AND 50).

FIRST USE 6-15-1985; IN COMMERCE 6-15-1985.

FOR: HOUSEHOLD AND KITCHEN PRODUCTS, NAMELY, APRONS, IN CLASS 25 (U.S. CLS. 22 AND 39).

FIRST USE 1-0-1986; IN COMMERCE 1-0-1986.

THE MARK CONSISTS OF STANDARD CHARACTERS WITHOUT CLAIM TO ANY PARTICULAR FONT, STYLE, SIZE, OR COLOR.

THE ENGLISH TRANSLATION OF THE YIDDISH PHRASE "OY VEY" IS OH MY GOD.

SER. NO. 76-662,270, FILED 6-28-2006.

STEPHANIE ALI, EXAMINING ATTORNEY

**Int. Cl.: 35**

**Prior U.S. Cls.: 100, 101 and 102**

**United States Patent and Trademark Office**

**Reg. No. 3,497,486**

**Registered Sep. 9, 2008**

**SERVICE MARK  
PRINCIPAL REGISTER**

**DISCOUNTED WHEEL WAREHOUSE**

USA WHEEL AND TIRE OUTLET #2, INC.  
(CALIFORNIA CORPORATION)  
1301 BURTON ROAD  
FULLERTON, CA 92831

FOR: ELECTRONIC ONLINE INTERNET CATALOG SERVICES, MAIL ORDER CATALOG, WHOLESALE STORE SERVICES, AND RETAIL STORE SERVICES, ALL FEATURING AUTOMOTIVE WHEELS AND TIRES, IN CLASS 35 (U.S. CLS. 100, 101 AND 102).

FIRST USE 11-1-2003; IN COMMERCE 11-1-2003.

THE MARK CONSISTS OF STANDARD CHARACTERS WITHOUT CLAIM TO ANY PARTICULAR FONT, STYLE, SIZE, OR COLOR.

NO CLAIM IS MADE TO THE EXCLUSIVE RIGHT TO USE "WHEEL", APART FROM THE MARK AS SHOWN.

SEC. 2(F).

SER. NO. 76-663,170, FILED 7-17-2006.

BARNEY CHARLON, EXAMINING ATTORNEY

**Int. Cl.: 35**

**Prior U.S. Cls.: 100, 101 and 102**

**United States Patent and Trademark Office**

**Reg. No. 3,497,487**

**Registered Sep. 9, 2008**

**SERVICE MARK  
PRINCIPAL REGISTER**

**THE WHEEL CLUB**

USA WHEEL AND TIRE OUTLET #2, INC.  
(CALIFORNIA CORPORATION)  
1301 BURTON ROAD  
FULLERTON, CA 92831

FOR: ELECTRONIC ONLINE INTERNET CATALOG SERVICES, MAIL ORDER CATALOG, WHOLESALE STORE SERVICES, AND RETAIL STORE SERVICES, ALL FEATURING AUTOMOTIVE WHEELS AND TIRES, IN CLASS 35 (U.S. CLS. 100, 101 AND 102).

FIRST USE 11-1-2003; IN COMMERCE 11-1-2003.

THE MARK CONSISTS OF STANDARD CHARACTERS WITHOUT CLAIM TO ANY PARTICULAR FONT, STYLE, SIZE, OR COLOR.

NO CLAIM IS MADE TO THE EXCLUSIVE RIGHT TO USE "WHEEL", APART FROM THE MARK AS SHOWN.

SEC. 2(F).

SER. NO. 76-663,217, FILED 7-17-2006.

BARNEY CHARLON, EXAMINING ATTORNEY

**Int. Cls.: 6 and 20**

**Prior U.S. Cls.: 2, 12, 13, 14, 22, 23, 25, 32 and 50**

**Reg. No. 3,497,488**

**United States Patent and Trademark Office**

**Registered Sep. 9, 2008**

**TRADEMARK  
PRINCIPAL REGISTER**

**W N**

WWN, LTD. (TEXAS LIMITED PARTNERSHIP)  
1519 FULTON ST.  
HOUSTON, TX 77009

FOR: METAL FASTENERS, NAMELY, ENGINEERED SPECIAL FASTENERS AND MACHINED COMPONENTS, NAMELY, METAL THREADED FASTENERS, PINS, AND STUDS; PRECISION SHEER SCREWS AND PINS, NUTS, BOLTS, SCREWS, STUDS; METAL SHEER SCREWS AND COTTER PINS, AND WASHERS, NAMELY, WASHERS USED IN THE ASSEMBLY OF OEM (ORIGINAL EQUIPMENT MANUFACTURER) UNITS ASSOCIATED WITH OILFIELD, NATURAL GAS, AND ELECTRICAL INDUSTRIES, IN CLASS 6 (U.S. CLS. 2, 12, 13, 14, 23, 25 AND 50).

FIRST USE 12-31-1986; IN COMMERCE 12-31-1986.

FOR: NON-METAL FASTENERS AND PLASTIC WASHERS, NAMELY, WASHERS USED IN THE ASSEMBLY OF OEM (ORIGINAL EQUIPMENT MANUFACTURER) UNITS ASSOCIATED WITH OILFIELD, NATURAL GAS, AND ELECTRICAL INDUSTRIES, IN CLASS 20 (U.S. CLS. 2, 13, 22, 25, 32 AND 50).

FIRST USE 12-31-1986; IN COMMERCE 12-31-1986.

THE MARK CONSISTS OF STANDARD CHARACTERS WITHOUT CLAIM TO ANY PARTICULAR FONT, STYLE, SIZE, OR COLOR.

SER. NO. 76-663,442, FILED 7-20-2006.

KELLY BOULTON, EXAMINING ATTORNEY



**Int. Cls.: 6 and 20**

**Prior U.S. Cls.: 2, 12, 13, 14, 22, 23, 25, 32 and 50**

**United States Patent and Trademark Office**

**Reg. No. 3,497,489**

**Registered Sep. 9, 2008**

**TRADEMARK  
PRINCIPAL REGISTER**

**TEXAS SCREW PRODUCTS**

WWN, LTD. (TEXAS LIMITED PARTNERSHIP)  
1519 FULTON ST.  
HOUSTON, TX 77009

FOR: METAL FASTENERS, NAMELY, ENGINEERED SPECIAL FASTENERS AND MACHINED COMPONENTS, NAMELY, METAL THREADED FASTENERS, PINS, AND STUDS; PRECISION SHEER SCREWS AND PINS, NUTS, BOLTS, SCREWS, STUDS; METAL SHEER SCREWS AND COTTER PINS, AND WASHERS, NAMELY, WASHERS USED IN THE ASSEMBLY OF OEM (ORIGINAL EQUIPMENT MANUFACTURER) UNITS ASSOCIATED WITH OILFIELD, NATURAL GAS, AND ELECTRICAL INDUSTRIES, IN CLASS 6 (U.S. CLS. 2, 12, 13, 14, 23, 25 AND 50).

FIRST USE 12-31-1986; IN COMMERCE 12-31-1986.

FOR: NON-METAL FASTENERS AND PLASTIC WASHERS, NAMELY, WASHERS USED IN THE

ASSEMBLY OF "OEM" (ORIGINAL EQUIPMENT MANUFACTURER) UNITS ASSOCIATED WITH OILFIELD, NATURAL GAS, AND ELECTRICAL INDUSTRIES, IN CLASS 20 (U.S. CLS. 2, 13, 22, 25, 32 AND 50).

FIRST USE 12-31-1986; IN COMMERCE 12-31-1986.

THE MARK CONSISTS OF STANDARD CHARACTERS WITHOUT CLAIM TO ANY PARTICULAR FONT, STYLE, SIZE, OR COLOR.

NO CLAIM IS MADE TO THE EXCLUSIVE RIGHT TO USE "SCREW PRODUCTS", APART FROM THE MARK AS SHOWN.

SEC. 2(F).

SER. NO. 76-663,443, FILED 7-20-2006.

KELLY BOULTON, EXAMINING ATTORNEY

Int. Cl.: 25

Prior U.S. Cls.: 22 and 39

United States Patent and Trademark Office

Reg. No. 3,497,490

Registered Sep. 9, 2008

TRADEMARK  
PRINCIPAL REGISTER

*MC Oasis*

MAY YANG DAILY (OREGON SOLE PROPRIETORSHIP), DBA MC OASIS  
1118 SW 162ND AVE.  
BEAVERTON, OR 97006

FIRST USE 8-0-2006; IN COMMERCE 8-0-2006.

SER. NO. 76-666,582, FILED 9-25-2006.

FOR: SHIRTS, SKIRTS, JACKETS, SCARVES,  
HATS, IN CLASS 25 (U.S. CLS. 22 AND 39).

CHERYL CLAYTON, EXAMINING ATTORNEY

**Int. Cls.: 16 and 25**

**Prior U.S. Cls.: 2, 5, 22, 23, 29, 37, 38, 39 and 50**

**United States Patent and Trademark Office**

**Reg. No. 3,497,491**

**Registered Sep. 9, 2008**

**TRADEMARK  
PRINCIPAL REGISTER**

**THE JUNK HUNK**

FRIEDMAN AND SOLIMAN ENTERPRISES LLC  
(MARYLAND LIMITED LIABILITY COMPAN-  
NY), DBA COLLEGE HUNKS HAULING  
JUNK  
4800 HAMPDEN LANE, 7TH FLOOR  
BETHESDA, MD 20814

FOR: CALENDARS, PENS, BANNERS OF PAPER,  
NOTE PADS, AND PENCILS , IN CLASS 16 (U.S. CLS.  
2, 5, 22, 23, 29, 37, 38 AND 50).

FIRST USE 3-1-2006; IN COMMERCE 3-1-2006.

FOR: SHIRTS, HATS, BASEBALL CAPS, T-  
SHIRTS, POLO SHIRTS, SWEAT SHIRTS, TANK  
TOPS AND JACKETS, IN CLASS 25 (U.S. CLS. 22  
AND 39).

FIRST USE 3-1-2006; IN COMMERCE 3-1-2006.

THE MARK CONSISTS OF STANDARD CHAR-  
ACTERS WITHOUT CLAIM TO ANY PARTICULAR  
FONT, STYLE, SIZE, OR COLOR.

OWNER OF U.S. REG. NO. 3,382,970.

NO CLAIM IS MADE TO THE EXCLUSIVE  
RIGHT TO USE "JUNK" , APART FROM THE  
MARK AS SHOWN.

SER. NO. 76-668,142, FILED 10-26-2006.

THOMAS MANOR, EXAMINING ATTORNEY

**Int. Cl.: 16**

**Prior U.S. Cls.: 2, 5, 22, 23, 29, 37, 38 and 50**

**Reg. No. 3,497,492**

**United States Patent and Trademark Office**

**Registered Sep. 9, 2008**

**TRADEMARK  
PRINCIPAL REGISTER**

**NETTECH**

GRAYMARK INTERNATIONAL, INC. (NEW  
JERSEY CORPORATION)  
P.O. BOX 205  
TUSTIN, CA 92781

FIRST USE 1-22-1997; IN COMMERCE 1-22-1997.

FOR: PRINTED EDUCATIONAL PUBLICATIONS, NAMELY, INSTRUCTION GUIDES, STUDENT MANUALS, REFERENCE AND DEMONSTRATION BOOKS SOLD TO SCHOOLS IN THE FIELD OF NETWORK TECHNOLOGY TO BE USED IN CONJUNCTION WITH COURSE INSTRUCTION, IN CLASS 16 (U.S. CLS. 2, 5, 22, 23, 29, 37, 38 AND 50).

THE MARK CONSISTS OF STANDARD CHARACTERS WITHOUT CLAIM TO ANY PARTICULAR FONT, STYLE, SIZE, OR COLOR.

SEC. 2(F).

SER. NO. 76-668,203, FILED 10-27-2006.

DAVID HOFFMAN, EXAMINING ATTORNEY

**Int. Cl.: 9**

**Prior U.S. Cls.: 21, 23, 26, 36 and 38**

**United States Patent and Trademark Office**

**Reg. No. 3,497,493**

**Registered Sep. 9, 2008**

**TRADEMARK  
PRINCIPAL REGISTER**

**CEF Series**

TDK CORPORATION (JAPAN CORPORATION)  
13-1, NIHONBASHI 1-CHOME  
CHUO-KU, TOKYO, JAPAN

FOR: ELECTRIC CAPACITORS, CAPACITORS,  
CERAMIC CAPACITORS, IN CLASS 9 (U.S. CLS. 21,  
23, 26, 36 AND 38).

THE MARK CONSISTS OF STANDARD CHAR-  
ACTERS WITHOUT CLAIM TO ANY PARTICULAR  
FONT, STYLE, SIZE, OR COLOR.

PRIORITY CLAIMED UNDER SEC. 44(D) ON  
JAPAN APPLICATION NO. 2006-096363, FILED 10-  
17-2006, REG. NO. 5085299, DATED 10-17-2007, EX-  
PIRES 10-17-2017.

NO CLAIM IS MADE TO THE EXCLUSIVE  
RIGHT TO USE "SERIES", APART FROM THE  
MARK AS SHOWN.

SER. NO. 76-668,889, FILED 11-13-2006.

KATHRYN COWARD, EXAMINING ATTORNEY

**Int. Cl.: 29**

**Prior U.S. Cl.: 46**

**United States Patent and Trademark Office**

**Reg. No. 3,497,494**

**Registered Sep. 9, 2008**

**TRADEMARK  
PRINCIPAL REGISTER**

**HOFFY**

SQUARE-H BRANDS, INC. (DELAWARE CORPORATION), DBA SQUARE-H BRANDS  
2731 SOUTH SOTO STREET  
LOS ANGELES, CA 90023

FOR: MEAT PRODUCTS—NAMELY, SMOKED SAUSAGE, LIVER SAUSAGE, PORK SAUSAGE, POLISH SAUSAGE, PORTUGUESE SAUSAGE, PASTRAMI, KNOCKWURST, CANADIAN STYLE BACON, CANNED HAMS, SMOKED HAMS-WHOLE AND BONELESS, HAM HOCKS, HAM SHANKS, SPARE RIBS, BACK RIBS, PORK LOINS, PORK BELLIES, BEEF BRISKETS, BEEF RIB EYES, BEEF BALL TIPS, AND BEEF TENDERS, FRANKFURTERS, PACKAGED MEATS, NAMELY, SALAMI,

MEAT LOAF, LUNCHEON MEAT, BOLOGNA, CHILI CON CARNE, HAM, BACON, BACON SQUARES, PORK SHOULDER, PORK LOINS, IN CLASS 29 (U.S. CL. 46).

FIRST USE 1-1-1973; IN COMMERCE 1-1-1973.

THE MARK CONSISTS OF STANDARD CHARACTERS WITHOUT CLAIM TO ANY PARTICULAR FONT, STYLE, SIZE, OR COLOR.

SER. NO. 76-669,470, FILED 11-24-2006.

BENJAMIN OKEKE, EXAMINING ATTORNEY

**Int. Cls.: 35 and 41**

**Prior U.S. Cls.: 100, 101, 102 and 107**

**United States Patent and Trademark Office**

**Reg. No. 3,497,495**

**Registered Sep. 9, 2008**

**SERVICE MARK  
PRINCIPAL REGISTER**

The logo for PAINTBOX is displayed in a large, bold, sans-serif font. The letters 'P', 'A', 'I', 'N', 'T', 'B', and 'O' are in a dark grey color, while the 'X' is in a lighter grey color. The 'X' is composed of two overlapping shapes that form the letter.

PAINTBOX LABORATORIES, LLC (NEW YORK  
LIMITED LIABILITY COMPANY)  
535 WEST 34TH STREET  
NEW YORK, NY 10001

EXHIBITIONS NAMELY FOR EDUCATIONAL,  
CULTURAL, SPORTING, OR ENTERTAINMENT  
PURPOSES, IN CLASS 41 (U.S. CLS. 100, 101 AND  
107).

FOR: ADVICE IN THE FIELDS OF BUSINESS  
MANAGEMENT, AND PRODUCT MARKETING,  
IN CLASS 35 (U.S. CLS. 100, 101 AND 102).

FIRST USE 10-13-2005; IN COMMERCE 1-24-2006.

FIRST USE 10-13-2005; IN COMMERCE 1-24-2006.

SER. NO. 76-669,635, FILED 11-28-2006.

FOR: ENTERTAINMENT SERVICES NAMELY  
DEVELOPING LIVE EVENTS, AND ORGANIZING

DOMINICK J. SALEMI, EXAMINING ATTORNEY

**Int. Cl.: 25**

**Prior U.S. Cls.: 22 and 39**

**United States Patent and Trademark Office**

**Reg. No. 3,497,496**

**Registered Sep. 9, 2008**

**TRADEMARK  
PRINCIPAL REGISTER**

**ATLANTIS**

THE ROCKHOPPER GROUP LLC (MASSACHU-  
SETTS LIMITED LIABILITY COMPANY)  
89 FRONT STREET  
MARBLEHEAD, MA 01945

FOR: RAINWEAR, PANTS, JACKETS, HATS,  
SHIRTS AND SWEATERS FOR PROTECTIVE PUR-  
POSES IN MARINE AND LEISURE SPORTS, IN  
CLASS 25 (U.S. CLS. 22 AND 39).

FIRST USE 2-20-1973; IN COMMERCE 5-25-1973.

THE MARK CONSISTS OF STANDARD CHAR-  
ACTERS WITHOUT CLAIM TO ANY PARTICULAR  
FONT, STYLE, SIZE, OR COLOR.

OWNER OF U.S. REG. NO. 1,212,225.

SER. NO. 76-670,671, FILED 12-22-2006.

ALYSSA PALADINO, EXAMINING ATTORNEY



**Int. Cl.: 36**

**Prior U.S. Cls.: 100, 101 and 102**

**United States Patent and Trademark Office**

**Reg. No. 3,497,497**

**Registered Sep. 9, 2008**

**SERVICE MARK  
PRINCIPAL REGISTER**

**BULLDOG, REALTORS**

BULLDOG ESTATES, INC. (CALIFORNIA CORPORATION)  
1209 ABBOT KINNEY BOULEVARD  
VENICE, CA 90291

THE MARK CONSISTS OF STANDARD CHARACTERS WITHOUT CLAIM TO ANY PARTICULAR FONT, STYLE, SIZE, OR COLOR.

FOR: RESIDENTIAL AND COMMERCIAL REAL ESTATE BROKERAGE SERVICES, IN CLASS 36 (U.S. CLS. 100, 101 AND 102).

SER. NO. 76-670,901, FILED 12-28-2006.

FIRST USE 3-1-1997; IN COMMERCE 8-1-1997.

AMY MCMENAMIN, EXAMINING ATTORNEY

**Int. Cls.: 41 and 43**

**Prior U.S. Cls.: 100, 101 and 107**

**United States Patent and Trademark Office**

**Reg. No. 3,497,498**

**Registered Sep. 9, 2008**

**SERVICE MARK  
PRINCIPAL REGISTER**

**Where America . . . Plays at Night!**

GRAHAM BROTHERS PARTNERSHIP (TEXAS  
GENERAL PARTNERSHIP)  
6999 EAST HIGHWAY 90  
ODESSA, TX 79762

FOR: NIGHTCLUB SERVICES, IN CLASS 41 (U.S.  
CLS. 100, 101 AND 107).

FIRST USE 3-0-1992; IN COMMERCE 3-0-1992.

FOR: RESTAURANT SERVICES , IN CLASS 43  
(U.S. CLS. 100 AND 101).

FIRST USE 3-0-1992; IN COMMERCE 3-0-1992.

THE MARK CONSISTS OF STANDARD CHAR-  
ACTERS WITHOUT CLAIM TO ANY PARTICULAR  
FONT, STYLE, SIZE, OR COLOR.

OWNER OF U.S. REG. NO. 2,282,552.

SER. NO. 76-670,916, FILED 12-29-2006.

AMY HELLA, EXAMINING ATTORNEY

**Int. Cl.: 28**

**Prior U.S. Cls.: 22, 23, 38 and 50**

**United States Patent and Trademark Office**

**Reg. No. 3,497,499**

**Registered Sep. 9, 2008**

**TRADEMARK  
PRINCIPAL REGISTER**



LEDESMA, ROBERT (UNITED STATES INDIVIDUAL)  
535 RIVER ROAD  
FELTON, CA 95060

NO CLAIM IS MADE TO THE EXCLUSIVE RIGHT TO USE "SURF AND SANTA CRUZ", APART FROM THE MARK AS SHOWN.

FOR: SPORTING ARTICLES, NAMELY, SURFBOARDS, IN CLASS 28 (U.S. CLS. 22, 23, 38 AND 50).

SER. NO. 76-671,823, FILED 1-25-2007.

FIRST USE 5-31-2005; IN COMMERCE 7-31-2005.

JOHN WILKE, EXAMINING ATTORNEY

**Int. Cl.: 25**

**Prior U.S. Cls.: 22 and 39**

**United States Patent and Trademark Office**

**Reg. No. 3,497,500**

**Registered Sep. 9, 2008**

**TRADEMARK  
PRINCIPAL REGISTER**



LEDESMA, ROBERT (UNITED STATES INDIVIDUAL)  
535 RIVER ROAD  
FELTON, CA 95060

NO CLAIM IS MADE TO THE EXCLUSIVE RIGHT TO USE "SANTA CRUZ", APART FROM THE MARK AS SHOWN.

FOR: CLOTHING, NAMELY, SHIRTS, T-SHIRTS, SWEAT SHIRTS, HATS, AND PANTS, IN CLASS 25 (U.S. CLS. 22 AND 39).

SER. NO. 76-671,824, FILED 1-25-2007.

FIRST USE 9-16-2005; IN COMMERCE 10-1-2005.

JOHN WILKE, EXAMINING ATTORNEY

**Int. Cl.: 35**

**Prior U.S. Cls.: 100, 101 and 102**

**United States Patent and Trademark Office**

**Reg. No. 3,497,501**

**Registered Sep. 9, 2008**

**SERVICE MARK  
PRINCIPAL REGISTER**

**The Commercial Traffic Company**

THE COMMERCIAL TRAFFIC COMPANY (OHIO  
CORPORATION)  
12487 PLAZA DRIVE  
PARMA, OH 44130

NO CLAIM IS MADE TO THE EXCLUSIVE  
RIGHT TO USE "COMPANY", APART FROM THE  
MARK AS SHOWN.

FOR: AUDITING AND BOOKKEEPING SERVI-  
CES FOR COMMERCIAL SHIPPERS, IN CLASS 35  
(U.S. CLS. 100, 101 AND 102).

SEC. 2(F).

FIRST USE 6-1-1970; IN COMMERCE 6-1-1970.

SER. NO. 76-671,914, FILED 1-29-2007.

THE MARK CONSISTS OF STANDARD CHAR-  
ACTERS WITHOUT CLAIM TO ANY PARTICULAR  
FONT, STYLE, SIZE, OR COLOR.

CAROLYN CATALDO, EXAMINING ATTORNEY

**Int. Cl.: 24**

**Prior U.S. Cls.: 42 and 50**

**United States Patent and Trademark Office**

**Reg. No. 3,497,502**

**Registered Sep. 9, 2008**

**TRADEMARK  
PRINCIPAL REGISTER**

**Luv-a-Lily**

BON MARKETING, INC. (CALIFORNIA CORPORATION)  
4901 PATATA STREET, UNIT 301  
CUDAHY, CA 90201

FIRST USE 3-14-2007; IN COMMERCE 3-14-2007.

SER. NO. 76-674,670, FILED 3-27-2007.

FOR: BEDDING NAMELY, BLANKETS, IN CLASS 24 (U.S. CLS. 42 AND 50).

BRIAN NEVILLE, EXAMINING ATTORNEY

**Int. Cl.: 41**

**Prior U.S. Cls.: 100, 101 and 107**

**United States Patent and Trademark Office**

**Reg. No. 3,497,503**

**Registered Sep. 9, 2008**

**SERVICE MARK  
PRINCIPAL REGISTER**

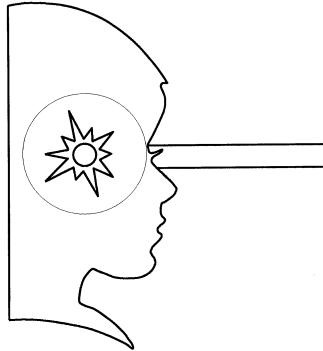

BRIGHT FUTURES LEARNING, INC. (SOUTH  
CAROLINA CORPORATION)  
516 S. COIT STREET  
FLORENCE, SC 29501

FOR: EDUCATION SERVICES, NAMELY, TU-  
TORING IN THE FIELDS OF READING, MATHE-  
MATICS, WRITING, AND STUDY STRATEGIES AT  
GRADE LEVELS PRE-KINDERGARTEN TO  
TWELFTH GRADE, USING COMBINED ACA-  
DEMIC AND SENSORY INTEGRATION STRATE-

GIES, NAMELY, IN SMALL GROUP CLASSES AND  
ONE-ON-ONE INSTRUCTION, IN CLASS 41 (U.S.  
CLS. 100, 101 AND 107).

FIRST USE 6-27-2003; IN COMMERCE 6-27-2003.

SER. NO. 76-674,844, FILED 3-30-2007.

SUZANNE BLANE, EXAMINING ATTORNEY

**Int. Cl.: 35**

**Prior U.S. Cls.: 100, 101 and 102**

**United States Patent and Trademark Office**

**Reg. No. 3,497,504**

**Registered Sep. 9, 2008**

**SERVICE MARK  
PRINCIPAL REGISTER**

**Scuderia O<sub>2</sub>**  
Oxygen Rich Marketing Ideas

SCUDERIA O2, LLC (NEW YORK LIMITED LIABILITY COMPANY)  
49 WEST 27 STREET  
NEW YORK, NY 10001

FOR: ADVERTISING SERVICES, NAMELY, PROMOTING AND MARKETING THE GOODS AND SERVICES OF OTHERS THROUGH ALL PUBLIC COMMUNICATION MEANS, IN CLASS 35 (U.S. CLS. 100, 101 AND 102).

FIRST USE 8-8-2005; IN COMMERCE 8-8-2005.

THE ENGLISH TRANSLATION OF "SCUDERIA" IS "STABLE".

SER. NO. 76-674,941, FILED 4-3-2007.

JOHN GARTNER, EXAMINING ATTORNEY



**Int. Cl.: 44**

**Prior U.S. Cls.: 100 and 101**

**United States Patent and Trademark Office**

**Reg. No. 3,497,505**

**Registered Sep. 9, 2008**

**SERVICE MARK  
PRINCIPAL REGISTER**



COLORADO SLEEP CENTER OF THE ROCKIES,  
LLC (COLORADO LIMITED LIABILITY COM-  
PANY)  
2500 ROCKY MOUNTAIN AVENUE, SUITE 310  
LOVELAND, CO 80538

NO CLAIM IS MADE TO THE EXCLUSIVE  
RIGHT TO USE "SLEEP CENTER OF THE ROCK-  
IES", APART FROM THE MARK AS SHOWN.

FOR: MEDICAL SERVICES, NAMELY, CONSUL-  
TATION, DIAGNOSIS, AND TREATMENT OF  
SLEEP DISORDERS, IN CLASS 44 (U.S. CLS. 100  
AND 101).

SER. NO. 76-675,442, FILED S.R. 4-13-2007 AM. P.R.  
12-19-2007.

FIRST USE 4-12-2007; IN COMMERCE 4-12-2007.

SANI KHOURI, EXAMINING ATTORNEY

**Int. Cls.: 35, 38 and 42**

**Prior U.S. Cls.: 100, 101, 102 and 104**

**Reg. No. 3,497,506**

**United States Patent and Trademark Office**

**Registered Sep. 9, 2008**

**SERVICE MARK  
PRINCIPAL REGISTER**

**HOWWAS**

MITCHELL, WILLIAM (UNITED KINGDOM INDIVIDUAL)  
HAZELSIDE DOUGLAS  
LANARK, UNITED KINGDOM ML11 OSD

FOR: BUSINESS ADVISORY, CONSULTANCY, RESEARCH AND INFORMATION SERVICES; COMPILATION, PROVISION, STORAGE AND RETRIEVAL OF BUSINESS AND COMMERCIAL INFORMATION; MARKETING, PROMOTIONAL AND ADVERTISING SERVICES; DATA PROCESSING AND DATABASE MANAGEMENT SERVICES; PRODUCTION, PREPARATION AND PRESENTATION OF ADVERTISING MATTER; COMPILATION OF BUSINESS DIRECTORIES; COMPILATION AND TRANSCRIPTION OF BUSINESS DATA; SALES PROMOTION; DATABASE MANAGEMENT SERVICES; PROVIDING DATABASES, ONLINE AND INTERNET INFORMATION; VOTING AND PUBLIC OPINION POLLING SERVICES PROVIDED VIA TELEPHONE AND WIRELESS COMMUNICATIONS DEVICES; ON-LINE AND WIRELESS COLLECTION AND DISSEMINATION OF CONSUMER INFORMATION, REVIEWS AND FEED BACK; ONLINE AND WIRELESS DATABASE SERVICES, NAMELY, GATHERING, ANALYSIS AND UPDATING OF DATA AND INFORMATION IN THE FIELDS OF BUSINESS INFORMATION, MARKETING, DATABASE MANAGEMENT AND ADVERTISING; ARRANGING AND PROVIDING CONSUMER REVIEWS, CONSUMER FEEDBACK, CONSUMER RESEARCH, MARKET ANALYSIS AND RESEARCH; PROVISION OF TELEPHONE DIRECTORY SERVICES; PROVIDING ACCESS TO A DATABASE AND DIRECTORY SERVICES AVAILABLE ON THE INTERNET TO HELP LOCATE PEOPLE, PLACES AND ORGANIZATIONS; ADVISORY AND CONSULTANCY SERVICES, ALL RELATING TO MARKETING, DATABASE MANAGEMENT AND ADVERTISING; BUSINESS, ADVERTISING AND COMMERCIAL INFORMATION PROVIDED ONLINE FROM A COMPUTER

DATABASE OR THE INTERNET, IN CLASS 35 (U.S. CLS. 100, 101 AND 102).

FOR: COMMUNICATIONS AND TELECOMMUNICATIONS SERVICES, NAMELY, DATA TRANSMISSION, TRANSMISSION OF MESSAGES, SOUND AND IMAGES; MOBILE PHONE MESSAGING SERVICES; TRANSMISSION OF INFORMATION BY ELECTRONIC MEANS; RECEIVING AND EXCHANGE OF INFORMATION, MESSAGES, IMAGES AND DATA; MESSAGE SENDING; PROVIDING COMMUNICATIONS ACCESS TO A COMPUTERIZED DATABASE; PROVISION OF ACCESS TO TELECOMMUNICATIONS NETWORKS FOR ACCESSING AND RETRIEVAL OF SOUND, IMAGES, TEXT, INFORMATION AND DATA; COMMUNICATIONS BY TELEPHONE, LINE, CABLE, WIRE OR FIBER; PROVIDING SERVICES IN CONNECTION WITH ONLINE SERVICES, NAMELY, THE TRANSMISSION OF MESSAGES AND INFORMATION OF ALL KINDS; TELEPHONE INFORMATION SERVICES, IN PARTICULAR, DIRECT CONNECTION TO THE REQUIRED CONNECTION, COMMUNICATION OF TELEPHONE NUMBERS, ADDRESSES, FAX NUMBERS; MOBILE TELECOMMUNICATIONS SERVICES; E-MAIL AND TEXT MESSAGING SERVICES; CELLULAR TELEPHONE COMMUNICATION; SERVICES FOR RECEIVING VOICE AND TEXT MESSAGES BETWEEN WIRELESS MOBILE COMMUNICATIONS DEVICES; AND TRANSMISSION OF BUSINESS INFORMATION FOR COMMERCIAL PURPOSES FROM A COMPUTER-STORED DATABANK, IN CLASS 38 (U.S. CLS. 100, 101 AND 104).

FOR: COMPUTER SERVICES, NAMELY, UPDATING AND DESIGN OF COMPUTER SOFTWARE; DATABASE, INTERACTIVE DATABASE, ON-LINE AND INTERNET INFORMATION, ADVISORY AND CONSULTANCY SERVICES, ALL RELATING TO UPDATING AND DESIGN OF COMPUTER SOFT-

WARE; DESIGN OF INTERACTIVE COMPUTERIZED CONSUMER FEEDBACK AND VOTING SYSTEMS; AND DESIGN AND DEVELOPMENT OF SOFTWARE RELATED TO INTERACTIVE CONSUMER FEEDBACK AND VOTING SYSTEMS, IN CLASS 42 (U.S. CLS. 100 AND 101).

THE MARK CONSISTS OF STANDARD CHARACTERS WITHOUT CLAIM TO ANY PARTICULAR FONT, STYLE, SIZE, OR COLOR.

PRIORITY CLAIMED UNDER SEC. 44(D) ON UNITED KINGDOM APPLICATION NO. 005423371, FILED 10-27-2006, REG. NO. 5423371, DATED 10-18-2007, EXPIRES 10-27-2016.

SER. NO. 76-676,140, FILED 4-27-2007.

HOWARD B. LEVINE, EXAMINING ATTORNEY

**Int. Cl.: 35**

**Prior U.S. Cls.: 100, 101 and 102**

**United States Patent and Trademark Office**

**Reg. No. 3,497,507**

**Registered Sep. 9, 2008**

**SERVICE MARK  
PRINCIPAL REGISTER**



**Dawson County  
Chamber Of Commerce**

DAWSON COUNTY CHAMBER OF COMMERCE  
(GEORGIA CHARITABLE, NON-PROFIT COR-  
PORATION)  
P.O. BOX 299  
DAWSONVILLE, GA 30534

FOR: BUSINESS INFORMATION SERVICES, IN  
CLASS 35 (U.S. CLS. 100, 101 AND 102).

FIRST USE 6-6-1986; IN COMMERCE 6-6-1986.

NO CLAIM IS MADE TO THE EXCLUSIVE  
RIGHT TO USE "DAWSON COUNTY CHAMBER  
OF COMMERCE" OR THE PICTORIAL REPRESENTATION  
OF DAWSON COUNTY, GA, APART  
FROM THE MARK AS SHOWN.

THE COLOR(S) RED, BLACK AND WHITE IS/  
ARE CLAIMED AS A FEATURE OF THE MARK.

THE MARK CONSISTS OF THE COLOR RED IN  
THE SCOTTY DOG'S BOWTIE, THE COLOR BLACK  
APPEARS IN THE OUTLINE OF THE PICTORIAL  
REPRESENTATION OF DAWSON COUNTY, IN-  
SIDE THE DOG DESIGN, INSIDE THE BOWTIE  
DESIGN, AND INSIDE THE WORDING "DAWSON  
COUNTY CHAMBER OF COMMERCE", AND THE  
COLOR WHITE APPEARS INSIDE THE DOG DE-  
SIGN AND INSIDE THE PICTORIAL REPRESENTATION  
OF DAWSON COUNTY.

SER. NO. 76-676,232, FILED 4-30-2007.

SETH A. RAPPAPORT, EXAMINING ATTORNEY

**Int. Cls.: 9 and 41**

**Prior U.S. Cls.: 21, 23, 26, 36, 38, 100, 101 and 107**

**Reg. No. 3,497,508**

**United States Patent and Trademark Office**

**Registered Sep. 9, 2008**

**TRADEMARK  
SERVICE MARK  
PRINCIPAL REGISTER**

**CODEBLACK ENTERTAINMENT**

CODEBLACK ENTERPRISES, LLC (CALIFORNIA LIMITED LIABILITY CORPORATION)  
15260 VENTURA BOULEVARD, SUITE 840  
SHERMAN OAKS, CA 91403

FOR: PRERECORDED DVD'S, HIGH-DEFINITION DVD'S, CD ROMS AND VIDEO CASSETTES AND DIGITAL AND DOWNLOADABLE AUDIO-VISUAL CONTENT FILES FEATURING DRAMATIC, COMEDIC, DOCUMENTARY, ACTION-ADVENTURE, THEATRICAL AND STAGE PERFORMANCES, GAMES AND SPORTS RELATED PROGRAMS FOR CABLE, SATELLITE, AND BROADCAST TELEVISION AND WIRELESS, MOBILE AND CELLULAR TRANSMISSION; MOTION PICTURE FILMS IN THE FIELD OF DRAMA, COMEDY, DOCUMENTARIES, ACTION-ADVENTURES; DIGITAL AUDIO AND VISUAL RECORDERS AND PLAYERS; DOWNLOADABLE GRAPHICS AND RINGTONES VIA WIRELESS DEVICES, IN CLASS 9 (U.S. CLS. 21, 23, 26, 36 AND 38).

FIRST USE 5-1-2005; IN COMMERCE 5-1-2005.

FOR: POPULAR CULTURE, URBAN, AND INTERNATIONAL ENTERTAINMENT SERVICES;

NAMELY, THE PRODUCTION AND DISTRIBUTION OF MOTION PICTURES, TELEVISION PROGRAMS AND LIVE PERFORMANCES; SCRIPT WRITING AND SCRIPT EDITING SERVICES; EDITING SERVICES, NAMELY, FILM, PHOTO, CINEMAGRAPHIC, AND WRITTEN TEXTS EDITING AND POST PRODUCTION EDITING SERVICES IN THE FIELD OF VIDEOS AND FILMS, IN CLASS 41 (U.S. CLS. 100, 101 AND 107).

FIRST USE 5-1-2005; IN COMMERCE 5-1-2005.

THE MARK CONSISTS OF STANDARD CHARACTERS WITHOUT CLAIM TO ANY PARTICULAR FONT, STYLE, SIZE, OR COLOR.

NO CLAIM IS MADE TO THE EXCLUSIVE RIGHT TO USE "ENTERTAINMENT", APART FROM THE MARK AS SHOWN.

SER. NO. 76-676,866, FILED 5-14-2007.

ELLEN PERKINS, EXAMINING ATTORNEY

**Int. Cls.: 35 and 40**

**Prior U.S. Cls.: 100, 101, 102, 103 and 106**

**United States Patent and Trademark Office**

**Reg. No. 3,497,509**

**Registered Sep. 9, 2008**

**SERVICE MARK  
PRINCIPAL REGISTER**

**INGREDIENT SOLUTIONS THAT  
IMPROVE YOUR BOTTOM LINE**

ALL AMERICAN FOODS, INC. (MINNESOTA  
CORPORATION)  
121 MOHR DRIVE  
MANKATO, MN 56002

FOR: PACKAGING DRIED FOOD ITEMS TO THE  
ORDER AND SPECIFICATION OF OTHERS, IN  
CLASS 35 (U.S. CLS. 100, 101 AND 102).

FIRST USE 3-0-2005; IN COMMERCE 3-0-2005.

FOR: MIXING, GRINDING, SIFTING AND LI-  
QUID SPRAYING OF DRIED FOOD INGREDI-  
ENTS, IN CLASS 40 (U.S. CLS. 100, 103 AND 106).

FIRST USE 3-0-2005; IN COMMERCE 3-0-2005.

THE MARK CONSISTS OF STANDARD CHAR-  
ACTERS WITHOUT CLAIM TO ANY PARTICULAR  
FONT, STYLE, SIZE, OR COLOR.

SER. NO. 76-677,217, FILED 5-21-2007.

RON FAIRBANKS, EXAMINING ATTORNEY

**Int. Cls.: 35 and 40**

**Prior U.S. Cls.: 100, 101, 102, 103 and 106**

**United States Patent and Trademark Office**

**Reg. No. 3,497,510**

**Registered Sep. 9, 2008**

**SERVICE MARK  
PRINCIPAL REGISTER**

**FUNCTIONALITY AT ITS BEST  
IMPROVES YOUR BOTTOM LINE**

ALL AMERICAN FOODS, INC. (MINNESOTA  
CORPORATION)  
121 MOHR DRIVE  
MANKATO, MN 56002

FOR: PACKAGING DRIED FOOD ITEMS TO THE  
ORDER AND SPECIFICATION OF OTHERS, IN  
CLASS 35 (U.S. CLS. 100, 101 AND 102).

FIRST USE 3-0-2005; IN COMMERCE 3-0-2005.

FOR: MIXING, GRINDING, SIFTING AND LI-  
QUID SPRAYING OF DRIED FOOD INGREDI-  
ENTS, IN CLASS 40 (U.S. CLS. 100, 103 AND 106).

FIRST USE 3-0-2005; IN COMMERCE 3-0-2005.

THE MARK CONSISTS OF STANDARD CHAR-  
ACTERS WITHOUT CLAIM TO ANY PARTICULAR  
FONT, STYLE, SIZE, OR COLOR.

SER. NO. 76-677,218, FILED 5-21-2007.

RON FAIRBANKS, EXAMINING ATTORNEY

Int. Cl.: 42

Prior U.S. Cls.: 100 and 101

**United States Patent and Trademark Office**

**Reg. No. 3,497,511**

Registered Sep. 9, 2008

**SERVICE MARK  
PRINCIPAL REGISTER**



NYTE LLC (CALIFORNIA LIMITED LIABILITY COMPANY)  
1501 SECRET RAVINE PARKWAY, #1925  
ROSEVILLE, CA 95661

FOR: COMPUTER SERVICES, NAMELY HOSTING AND MAINTAINING AN ONLINE WEBSITE FOR OTHERS TO UPLOAD, EXCHANGE AND SHARE PHOTOS AND ENGAGE IN SOCIAL NETWORKING, IN CLASS 42 (U.S. CLS. 100 AND 101).

FIRST USE 6-1-2007; IN COMMERCE 6-1-2007.

NO CLAIM IS MADE TO THE EXCLUSIVE RIGHT TO USE "SCRAPBOOKS", APART FROM THE MARK AS SHOWN.

SER. NO. 76-677,511, FILED 5-29-2007.

CARYN GLASSER, EXAMINING ATTORNEY



**Int. Cl.: 33**

**Prior U.S. Cls.: 47 and 49**

**United States Patent and Trademark Office**

**Reg. No. 3,497,512**

**Registered Sep. 9, 2008**

**TRADEMARK  
PRINCIPAL REGISTER**

**GV**

GARGIULO VINEYARDS, LLC (CALIFORNIA  
LIMITED LIABILITY COMPANY)  
575 OAKVILLE CROSSROAD  
NAPA, CA 94558

THE MARK CONSISTS OF STANDARD CHAR-  
ACTERS WITHOUT CLAIM TO ANY PARTICULAR  
FONT, STYLE, SIZE, OR COLOR.

FOR: WINE, IN CLASS 33 (U.S. CLS. 47 AND 49).

SER. NO. 76-677,530, FILED 5-29-2007.

FIRST USE 12-1-2001; IN COMMERCE 3-1-2002.

ANDREA BUTLER, EXAMINING ATTORNEY

**Int. Cl.: 33**

**Prior U.S. Cls.: 47 and 49**

**United States Patent and Trademark Office**

**Reg. No. 3,497,513**

**Registered Sep. 9, 2008**

**TRADEMARK  
PRINCIPAL REGISTER**



GARGIULO VINEYARDS, LLC (CALIFORNIA  
LIMITED LIABILITY COMPANY)  
575 OAKVILLE CROSSROAD  
NAPA, CA 94558

FIRST USE 12-1-2001; IN COMMERCE 3-1-2002.

SER. NO. 76-677,531, FILED 5-29-2007.

FOR: WINE, IN CLASS 33 (U.S. CLS. 47 AND 49).

ANDREA BUTLER, EXAMINING ATTORNEY

**Int. Cl.: 33**

**Prior U.S. Cls.: 47 and 49**

**United States Patent and Trademark Office**

**Reg. No. 3,497,514**

**Registered Sep. 9, 2008**

**TRADEMARK  
PRINCIPAL REGISTER**

**CASA MADERO**

AGENCIA MADERO, S.A. (MEXICO CORPORATION)  
INDUSTRIALES DEL PONIENTE 2000-A  
SANATA CATARINA, N.L., MEXICO 66350

FOR: WINE, IN CLASS 33 (U.S. CLS. 47 AND 49).

FIRST USE 0-0-1982; IN COMMERCE 0-0-1982.

THE MARK CONSISTS OF STANDARD CHARACTERS WITHOUT CLAIM TO ANY PARTICULAR FONT, STYLE, SIZE, OR COLOR.

OWNER OF U.S. REG. NOS. 1,331,184, 2,718,745 AND OTHERS.

THE MARK CAN BE TRANSLATED AS "CASA" MEANING "HOUSE" AND "MADERO" MEANING "BEAM" OR "PIECE OF WOOD".

SER. NO. 76-678,144, FILED 6-12-2007.

BERNICE MIDDLETON, EXAMINING ATTORNEY

**Int. Cl.: 9**

**Prior U.S. Cls.: 21, 23, 26, 36 and 38**

**United States Patent and Trademark Office**

**Reg. No. 3,497,515**

**Registered Sep. 9, 2008**

**TRADEMARK  
PRINCIPAL REGISTER**

**STAR TRON**

OPTICAL SYSTEMS TECHNOLOGY, INC.  
(PENNSYLVANIA CORPORATION)  
110 KOUNTZ LANE  
FREEPORT, PA 16229

FOR: ELECTRO-OPTICAL IMAGE AND LIGHT  
INTENSIFYING DEVICES, NAMELY, LENSES,  
NON-VISIBLE ILLUMINATORS, IMAGE STABILIZERS,  
AND SENSORS FOR NIGHT VISION PRODUCTS,  
IN CLASS 9 (U.S. CLS. 21, 23, 26, 36 AND 38).

FIRST USE 1-7-1971; IN COMMERCE 1-19-1971.

THE MARK CONSISTS OF STANDARD CHARACTERS  
WITHOUT CLAIM TO ANY PARTICULAR FONT,  
STYLE, SIZE, OR COLOR.

SER. NO. 76-678,202, FILED 6-14-2007.

ESTHER BELENKER, EXAMINING ATTORNEY

**Int. Cls.: 43 and 45**

**Prior U.S. Cls.: 100 and 101**

**United States Patent and Trademark Office**

**Reg. No. 3,497,516**

**Registered Sep. 9, 2008**

**SERVICE MARK  
PRINCIPAL REGISTER**



SAVOY LINEN SERVICES, INC. (CONNECTICUT CORPORATION)  
895 WOODEND ROAD  
STRATFORD, CT 06615

FOR: RENTAL OF BED, BATH AND TABLE LINENS, IN CLASS 43 (U.S. CLS. 100 AND 101).

FIRST USE 12-31-1924; IN COMMERCE 12-31-1950.

FOR: RENTAL OF UNIFORMS, IN CLASS 45 (U.S. CLS. 100 AND 101).

FIRST USE 12-31-1924; IN COMMERCE 12-31-1950.

THE MARK CONSISTS OF A SHIELD DESIGN DIVIDED IN THE MIDDLE WITH ONE SIDE CONTAINING THE LETTER S AND THE OPPOSITE SIDE CONTAINING THE LETTER L.

SER. NO. 76-678,564, FILED 6-22-2007.

EDWARD NELSON, EXAMINING ATTORNEY

**Int. Cl.: 16**

**Prior U.S. Cls.: 2, 5, 22, 23, 29, 37, 38 and 50**

**United States Patent and Trademark Office**

**Reg. No. 3,497,517**

**Registered Sep. 9, 2008**

**TRADEMARK  
PRINCIPAL REGISTER**

**THE MANAGER'S JOURNEY**

EDTREK, INC. (FLORIDA CORPORATION)  
1314 EAST LAS OLAS BLVD., SUITE 415  
FT. LAUDERDALE, FL 33301

FOR: PAPER GOODS AND PRINTED MATTER  
IN THE NATURE OF INSTRUCTIONAL AND  
TEACHING MATERIALS IN THE FIELD OF MAN-  
AGER TRAINING, IN CLASS 16 (U.S. CLS. 2, 5, 22, 23,  
29, 37, 38 AND 50).

FIRST USE 8-6-2006; IN COMMERCE 8-6-2006.

THE MARK CONSISTS OF STANDARD CHAR-  
ACTERS WITHOUT CLAIM TO ANY PARTICULAR  
FONT, STYLE, SIZE, OR COLOR.

NO CLAIM IS MADE TO THE EXCLUSIVE  
RIGHT TO USE "MANAGER'S", APART FROM  
THE MARK AS SHOWN.

SER. NO. 76-678,661, FILED 6-25-2007.

ARETHA SOMERVILLE, EXAMINING ATTORNEY

**Int. Cl.: 26**

**Prior U.S. Cls.: 37, 39, 40, 42 and 50**

**United States Patent and Trademark Office**

**Reg. No. 3,497,518**

**Registered Sep. 9, 2008**

**TRADEMARK  
PRINCIPAL REGISTER**

**BRIM TRIM**

DOMINOCUS DESIGNS, LLC (NEW YORK LIMITED LIABILITY COMPANY)

4 ASHTON ROAD

KATONAH, NY 10536

FOR: HAT ORNAMENT NOT OF PRECIOUS METAL, IN CLASS 26 (U.S. CLS. 37, 39, 40, 42 AND 50).

FIRST USE 3-16-2008; IN COMMERCE 3-16-2008.

THE MARK CONSISTS OF STANDARD CHARACTERS WITHOUT CLAIM TO ANY PARTICULAR FONT, STYLE, SIZE, OR COLOR.

NO CLAIM IS MADE TO THE EXCLUSIVE RIGHT TO USE "BRIM", APART FROM THE MARK AS SHOWN.

SER. NO. 76-679,102, FILED 7-5-2007.

STEVEN R. FINE, EXAMINING ATTORNEY

**Int. Cl.: 7**

**Prior U.S. Cls.: 13, 19, 21, 23, 31, 34 and 35**

**United States Patent and Trademark Office**

**Reg. No. 3,497,519**

**Registered Sep. 9, 2008**

**TRADEMARK  
PRINCIPAL REGISTER**

**SETGA**

LIU, DAVID (UNITED STATES INDIVIDUAL)  
20627 GOLDEN SPRINGS DRIVE  
SUITE 1-C  
DIAMOND BAR, CA 91789

FOR: POWER TOOLS, NAMELY, DRILL  
PRESSES, GRINDERS, LOAD BINDERS AND TILE  
SAWS, IN CLASS 7 (U.S. CLS. 13, 19, 21, 23, 31, 34 AND  
35).

FIRST USE 5-24-2007; IN COMMERCE 5-24-2007.

THE MARK CONSISTS OF STANDARD CHAR-  
ACTERS WITHOUT CLAIM TO ANY PARTICULAR  
FONT, STYLE, SIZE, OR COLOR.

SER. NO. 76-679,489, FILED 7-13-2007.

SETH A. RAPPAPORT, EXAMINING ATTORNEY



**Int. Cl.: 35**

**Prior U.S. Cls.: 100, 101 and 102**

**United States Patent and Trademark Office**

**Reg. No. 3,497,520**

**Registered Sep. 9, 2008**

**SERVICE MARK  
PRINCIPAL REGISTER**

**RAC<sup>2</sup>E**

ADVANCED GLOBAL SCIENTIFIC MANAGE-  
MENT, INC. (CALIFORNIA CORPORATION)  
21520 YORBA LINDA BOULEVARD, SUITE G288  
YORBA LINDA, CA 92887

FOR: BUSINESS MANAGEMENT CONSULTING  
SERVICES, NAMELY, CONSULTING ON IMPLE-  
MENTATION OF RISK MANAGEMENT FOR

HEALTH PRODUCTS AND PROCESSES, IN CLASS  
35 (U.S. CLS. 100, 101 AND 102).

FIRST USE 6-0-2003; IN COMMERCE 11-0-2004.

SER. NO. 76-679,775, FILED 7-23-2007.

LINDA ESTRADA, EXAMINING ATTORNEY

**Int. Cl.: 44**

**Prior U.S. Cls.: 100 and 101**

**United States Patent and Trademark Office**

**Reg. No. 3,497,521**

**Registered Sep. 9, 2008**

**SERVICE MARK  
PRINCIPAL REGISTER**

**MARK SLICKER SALONS**

MARK SLICKER SALONS, LLC (CALIFORNIA CORPORATION)  
7600 HOLLYWOOD BLVD., NO. 201  
LOS ANGELES, CA 90046

NO CLAIM IS MADE TO THE EXCLUSIVE RIGHT TO USE "SALONS", APART FROM THE MARK AS SHOWN.

FOR: PROVIDING HAIR CUTTING AND HAIR STYLING SERVICES AND OTHER BEAUTICIAN SERVICES, NAMELY, HAIR CUTTING, HAIR STYLING, HAIR COLORING, WAXING AND HAIR EXTENSIONS, IN CLASS 44 (U.S. CLS. 100 AND 101).

THE NAME "MARK SLICKER" IDENTIFIES A LIVING INDIVIDUAL WHOSE CONSENT IS OF RECORD.

FIRST USE 2-0-2007; IN COMMERCE 2-0-2007.

SER. NO. 76-680,041, FILED 7-30-2007.

THE MARK CONSISTS OF STANDARD CHARACTERS WITHOUT CLAIM TO ANY PARTICULAR FONT, STYLE, SIZE, OR COLOR.

INGA ERVIN, EXAMINING ATTORNEY

**Int. Cls.: 36 and 37**

**Prior U.S. Cls.: 100, 101, 102, 103 and 106**

**United States Patent and Trademark Office**

**Reg. No. 3,497,522**

**Registered Sep. 9, 2008**

**SERVICE MARK  
PRINCIPAL REGISTER**

**CLIFFS COMMUNITIES**

THE CLIFFS COMMUNITIES, INC. (SOUTH  
CAROLINA CORPORATION)  
3598 HIGHWAY 11  
TRAVELERS REST, SC 29690

FOR: REAL ESTATE BROKERAGE, IN CLASS 36  
(U.S. CLS. 100, 101 AND 102).

FIRST USE 1-1-1991; IN COMMERCE 1-1-1991.

FOR: REAL ESTATE DEVELOPMENT, CON-  
STRUCTION SERVICES IN THE FIELD OF RESI-  
DENTIAL BUILDING, AND PLANNING, AND  
LAYING OUT OF RESIDENTIAL COMMUNITIES,  
IN CLASS 37 (U.S. CLS. 100, 103 AND 106).

FIRST USE 1-1-1991; IN COMMERCE 1-1-1991.

THE MARK CONSISTS OF STANDARD CHAR-  
ACTERS WITHOUT CLAIM TO ANY PARTICULAR  
FONT, STYLE, SIZE, OR COLOR.

OWNER OF U.S. REG. NOS. 2,689,951, 3,217,373  
AND OTHERS.

NO CLAIM IS MADE TO THE EXCLUSIVE  
RIGHT TO USE "COMMUNITIES", APART FROM  
THE MARK AS SHOWN.

SER. NO. 76-680,501, FILED 8-9-2007.

LEIGH CAROLINE CASE, EXAMINING ATTOR-  
NEY

**Int. Cls.: 36, 41, 44 and 45**

**Prior U.S. Cls.: 100, 101, 102 and 107**

**United States Patent and Trademark Office**

**Reg. No. 3,497,523**

**Registered Sep. 9, 2008**

**SERVICE MARK  
PRINCIPAL REGISTER**

# **FAMILYMEANS**

FAMILYMEANS CORPORATION (MINNESOTA CORPORATION)

1875 NORTHWESTERN AVE. S.  
STILLWATER, MN 550827534

FOR: COUNSELING IN THE FIELDS OF BANKRUPTCY, BUDGETING, CASH MANAGEMENT, CREDIT, DEBT REPAYMENT, AND FINANCIAL PLANNING; CONSUMER CREDIT CONSULTATION; DEBT CONSULTATION; DEBT MANAGEMENT CONSULTATION; FINANCIAL PLANNING CONSULTATION; FINANCIAL ANALYSIS AND CONSULTATION; EVALUATION OF THE CREDIT WORTHINESS OF PRIVATE INDIVIDUALS; AND PROVIDING CONSULTATION AND SUPPORT SERVICES IN THE NATURE OF TECHNICAL ADVICE TO PRIVATE INDIVIDUALS IN THE AREA OF CREDIT COUNSELING, IN CLASS 36 (U.S. CLS. 100, 101 AND 102).

FIRST USE 4-24-1999; IN COMMERCE 4-24-1999.

FOR: EDUCATION SERVICES, NAMELY, PROVIDING CLASSES, SEMINARS, AND WORKSHOPS IN THE FIELDS OF BANKRUPTCY, BUDGETING, CREDIT, DEBT REPAYMENT, AND FINANCIAL PLANNING; CAREGIVER EDUCATION SERVICES, NAMELY, PROVIDING CLASSES, SEMINARS, AND WORKSHOPS IN THE FIELD OF ELDERCARE AND HEALTHCARE AND CONCERNING TOPICS OF AGING, ANGER MANAGEMENT, DISABILITIES, DOCTOR VISITS, FAMILY HEALTH, FAMILY COMMUNICATIONS, FAMILY RELATIONSHIPS, HUMOR, MARRIAGE, MEDICAL FORMS, PARENTING AND SUBSTANCE ABUSE, IN CLASS 41 (U.S. CLS. 100, 101 AND 107).

FIRST USE 4-24-1999; IN COMMERCE 4-24-1999.

FOR: MENTAL HEALTH COUNSELING AND PSYCHOTHERAPY AS IT RELATES TO RELATIONSHIPS; PSYCHOTHERAPY SERVICES; PSYCHOTHERAPY COUNSELING FOR CHILDREN AND ADULTS IN INDIVIDUAL AND FAMILY SESSIONS; CONSULTING SERVICES IN THE FIELD OF MEN-

TAL FITNESS; CONSULTING SERVICES IN THE FIELD OF MENTAL HEALTH AND WELLNESS; CONSULTING SERVICES IN THE FIELD OF WOMEN'S HEALTH; CONSULTING SERVICES IN THE FIELD OF MEN'S HEALTH; CONSULTING SERVICES IN THE FIELD OF MENTAL HEALTH AND WELLNESS; CONSULTING SERVICES IN THE FIELD OF MENTAL FITNESS; PSYCHOLOGICAL TESTING; PSYCHOLOGICAL COUNSELING; PSYCHOLOGICAL CONSULTATION; PROVIDING WELLNESS SERVICES, NAMELY, PERSONAL ASSESSMENTS, PERSONALIZED ROUTINES, MAINTENANCE SCHEDULES; PROVIDING CONSULTATION AND SUPPORT SERVICES IN THE NATURE OF TECHNICAL ADVICE TO PRIVATE INDIVIDUALS AND BUSINESSES IN THE AREA OF MENTAL HEALTH AND DRUG TESTING FOR SUBSTANCE ABUSE; CAREGIVER SERVICES, NAMELY, HOME HEALTH CARE SERVICES; HYGIENIC CARE; AND RESPITE CARE, IN CLASS 44 (U.S. CLS. 100 AND 101).

FIRST USE 4-24-1999; IN COMMERCE 4-24-1999.

FOR: CAREGIVER SUPPORT AND COUNSELING, NAMELY, ORGANIZING AND CONDUCTING SUPPORT GROUPS IN THE FIELD OF FAMILY CARE; ORGANIZING AND PROVIDING COMMUNITY BASED CAREGIVER SUPPORT, NAMELY, HELPING TO BUILD RELATIONSHIPS BETWEEN CAREGIVERS AND BETWEEN CAREGIVERS AND THE COMMUNITY AND PROVIDING INFORMATION OF ORGANIZATIONS AND AGENCIES THAT HELP CAREGIVERS; PROVIDING PERSONAL SUPPORT SERVICES FOR CAREGIVERS TO THE ELDERLY, INFIRM, AND INDIVIDUALS WITH LIFE THREATENING DISORDERS OR DEBILITATING ILLNESSES OR INJURIES, NAMELY, COMPANIONSHIP, HELP WITH MEDICAL FORMS, COUNSELING, AND EMOTIONAL SUPPORT; PROVIDING INFORMATION IN THE FIELD OF PARENTING CONCERNING INTRA-FAMILY RELATIONSHIPS; AND PROVIDING MARRIAGE COUNSELING, IN CLASS 45 (U.S. CLS. 100 AND 101).

FIRST USE 4-24-1999; IN COMMERCE 4-24-1999.

OWNER OF U.S. REG. NO. 2,497,739.

THE MARK CONSISTS OF STANDARD CHARACTERS WITHOUT CLAIM TO ANY PARTICULAR FONT, STYLE, SIZE, OR COLOR.

SER. NO. 76-680,637, FILED 8-13-2007.

BARBARA RUTLAND, EXAMINING ATTORNEY

**Int. Cl.: 35**

**Prior U.S. Cls.: 100, 101 and 102**

**United States Patent and Trademark Office**

**Reg. No. 3,497,524**

**Registered Sep. 9, 2008**

**SERVICE MARK  
PRINCIPAL REGISTER**

**ZOOMERZ**

ZOOMERZ, INC. (TENNESSEE CORPORATION)  
1634 WEST 1ST NORTH STREET  
MORRISTOWN, TN 37816

FOR: RETAIL CONVENIENCE STORE SERVICES;  
AND SELF-SERVICE FILLING STATION SERVICES,  
NAMELY, RETAIL GASOLINE AND DIESEL SUP-  
PLY SERVICES, IN CLASS 35 (U.S. CLS. 100, 101 AND  
102).

FIRST USE 10-17-1996; IN COMMERCE 10-17-1996.

THE MARK CONSISTS OF STANDARD CHAR-  
ACTERS WITHOUT CLAIM TO ANY PARTICULAR  
FONT, STYLE, SIZE, OR COLOR.

OWNER OF U.S. REG. NO. 2,092,163.

SER. NO. 76-680,657, FILED 8-13-2007.

TARAH HARDY, EXAMINING ATTORNEY

**Int. Cls.: 35 and 41**

**Prior U.S. Cls.: 100, 101, 102 and 107**

**United States Patent and Trademark Office**

**Reg. No. 3,497,525**

**Registered Sep. 9, 2008**

**SERVICE MARK  
PRINCIPAL REGISTER**

**ROOKIE**  **driver**

MARYLAND MOTOR VEHICLE ADMINISTRATION (MARYLAND STATE AGENCY)  
6601 RITCHIE HIGHWAY, N.E.  
GLEN BURNIE, MD 21062

FOR: PROMOTING PUBLIC AWARENESS OF THE NEED FOR SAFE DRIVING BY NEW DRIVERS, IN CLASS 35 (U.S. CLS. 100, 101 AND 102).

FIRST USE 7-31-1998; IN COMMERCE 7-31-1998.

FOR: EDUCATIONAL SERVICES, NAMELY, CONDUCTING GRADUATED DRIVER'S LICENSE PROGRAMS AND CLASSES DISCUSSING THE RE-

QUIREMENTS OF OBTAINING A DRIVER'S LICENSE, DRIVING SKILLS AND VISION TESTING, SUPERVISED DRIVING, AND THE SUSPENSION OR REVOCATION OF LICENSES AND DRIVER IMPROVEMENT, IN CLASS 41 (U.S. CLS. 100, 101 AND 107).

FIRST USE 7-31-1998; IN COMMERCE 7-31-1998.

SER. NO. 76-681,321, FILED 8-29-2007.

CHARISMA HAMPTON, EXAMINING ATTORNEY

**Int. Cl.: 16**

**Prior U.S. Cls.: 2, 5, 22, 23, 29, 37, 38 and 50**

**United States Patent and Trademark Office**

**Reg. No. 3,497,526**

**Registered Sep. 9, 2008**

**TRADEMARK  
PRINCIPAL REGISTER**

**US MARKERBOARD**

BRITE VISUAL PRODUCTS, INC. (MASSACHU-  
SETTS CORPORATION)  
270 CENTRE STREET, UNIT F  
HOLBROOK, MA 02343

FOR: BLACKBOARDS, CHALKBOARDS, BULLE-  
TIN BOARDS, AND WHITEBOARDS USED BY  
INDIVIDUALS AND BUSINESS FOR THE PRESEN-  
TATION OF INFORMATION , IN CLASS 16 (U.S.  
CLS. 2, 5, 22, 23, 29, 37, 38 AND 50).

FIRST USE 7-14-1999; IN COMMERCE 7-14-1999.

THE MARK CONSISTS OF STANDARD CHAR-  
ACTERS WITHOUT CLAIM TO ANY PARTICULAR  
FONT, STYLE, SIZE, OR COLOR.

NO CLAIM IS MADE TO THE EXCLUSIVE  
RIGHT TO USE "MARKERBOARD", APART FROM  
THE MARK AS SHOWN.

SEC. 2(F).

SER. NO. 76-681,875, FILED 9-14-2007.

DOMINICK J. SALEMI, EXAMINING ATTORNEY



**Int. Cl.: 35**

**Prior U.S. Cls.: 100, 101 and 102**

**United States Patent and Trademark Office**

**Reg. No. 3,497,527**

**Registered Sep. 9, 2008**

**SERVICE MARK  
PRINCIPAL REGISTER**

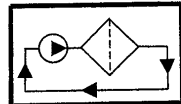

**OIL FILTRATION SYSTEMS, INC.**

OIL FILTRATION SYSTEMS, INC. (TEXAS CORPORATION)  
111 PARKWAY DRIVE  
BOERNE, TX 78006

NO CLAIM IS MADE TO THE EXCLUSIVE RIGHT TO USE "OIL FILTRATION SYSTEMS, INC.", APART FROM THE MARK AS SHOWN.

FOR: CUSTOMER SERVICE IN THE FIELD OF OIL FILTRATION AND FLUID ANALYSIS, IN CLASS 35 (U.S. CLS. 100, 101 AND 102).

SER. NO. 76-681,961, FILED 9-17-2007.

FIRST USE 7-31-1999; IN COMMERCE 7-31-1999.

RONALD MCMORROW, EXAMINING ATTORNEY

Int. Cl.: 11

Prior U.S. Cls.: 13, 21, 23, 31 and 34

Reg. No. 3,497,528

United States Patent and Trademark Office

Registered Sep. 9, 2008

**TRADEMARK  
PRINCIPAL REGISTER**

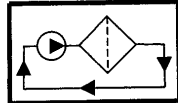

**OIL FILTRATION SYSTEMS, INC.**

OIL FILTRATION SYSTEMS, INC. (TEXAS CORPORATION)  
111 PARKWAY DRIVE  
BOERNE, TX 78006

FOR: PORTABLE AND FIXED, HIGH AND LOW FLOW FILTRATION UNITS FOR FILTERING HYDRAULIC, LUBRICATION, AND DIELECTRIC FLUIDS; VACUUM DEHYDRATION OIL PURIFIERS; VACUUM DEHYDRATORS; COALESCER FLUID PURIFIERS; HIGH VACUUM TRANSFORMER OIL PURIFIERS; AND BEARING LUBE OIL

FILTRATION ASSEMBLIES, IN CLASS 11 (U.S. CLS. 13, 21, 23, 31 AND 34).

FIRST USE 7-31-1999; IN COMMERCE 7-31-1999.

NO CLAIM IS MADE TO THE EXCLUSIVE RIGHT TO USE "OIL FILTRATION SYSTEMS, INC.", APART FROM THE MARK AS SHOWN.

SER. NO. 76-681,965, FILED 9-17-2007.

RONALD MCMORROW, EXAMINING ATTORNEY

Int. Cl.: 40

Prior U.S. Cls.: 100, 103 and 106

Reg. No. 3,497,529

United States Patent and Trademark Office

Registered Sep. 9, 2008

SERVICE MARK  
PRINCIPAL REGISTER

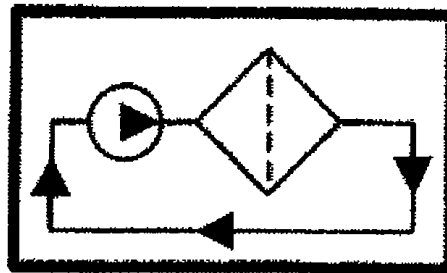

OIL FILTRATION SYSTEMS, INC. (TEXAS CORPORATION)  
111 PARKWAY DRIVE  
BOERNE, TX 78006

FIRST USE 7-31-1999; IN COMMERCE 7-31-1999.

SER. NO. 76-681,966, FILED 9-17-2007.

FOR: OIL RECLAMATION SERVICES, AND LEASING AND RENTAL OF OIL FILTRATION SYSTEMS, IN CLASS 40 (U.S. CLS. 100, 103 AND 106).

RONALD MCMORROW, EXAMINING ATTORNEY

Int. Cl.: 37

Prior U.S. Cls.: 100, 103 and 106

United States Patent and Trademark Office

Reg. No. 3,497,530

Registered Sep. 9, 2008

**SERVICE MARK  
PRINCIPAL REGISTER**

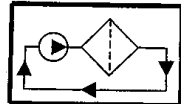

**OIL FILTRATION SYSTEMS, INC.**

OIL FILTRATION SYSTEMS, INC. (TEXAS CORPORATION)  
111 PARKWAY DRIVE  
BOERNE, TX 78006

FOR: OIL FLUSHING SERVICES, NAMELY, MAINTENANCE OF INDUSTRIAL ROTATIONAL EQUIPMENT, HYDRAULIC CONTROL PANELS, AND HYDRAULIC POWER UNITS BY CIRCULATION OF HOT OIL OR FLUSHING FLUID THROUGH THE PIPING OF A SYSTEM, IN CLASS 37 (U.S. CLS. 100, 103 AND 106).

FIRST USE 7-31-1999; IN COMMERCE 7-31-1999.

NO CLAIM IS MADE TO THE EXCLUSIVE RIGHT TO USE "OIL FILTRATION SYSTEMS, INC.", APART FROM THE MARK AS SHOWN.

SER. NO. 76-681,968, FILED 9-17-2007.

RONALD MCMORROW, EXAMINING ATTORNEY

Int. Cl.: 7

Prior U.S. Cls.: 13, 19, 21, 23, 31, 34 and 35

Reg. No. 3,497,531

United States Patent and Trademark Office

Registered Sep. 9, 2008

TRADEMARK  
PRINCIPAL REGISTER

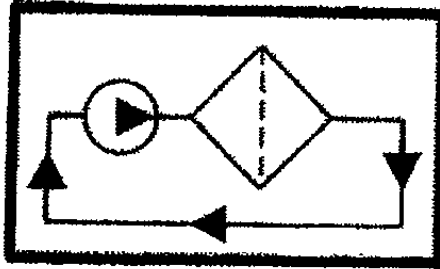

OIL FILTRATION SYSTEMS, INC. (TEXAS CORPORATION)  
111 PARKWAY DRIVE  
BOERNE, TX 78006

FILTER HOUSINGS, COALESCER HOUSINGS, AND BULK TANK BREATHERS AND DESICCANT AIR BREATHERS, IN CLASS 7 (U.S. CLS. 13, 19, 21, 23, 31, 34 AND 35).

FOR: PORTABLE LIQUID PUMPS FOR REMOVING PARTICULATE FROM A WIDE VARIETY OF LIQUIDS FOR INDUSTRIAL AND COMMERCIAL USE; OIL SEPARATORS; INDUSTRIAL FILTRATION MACHINE PARTS, NAMELY, SINGLE AND MULTI-ELEMENT FILTER HOUSINGS AND FILTER CARTRIDGES, SPIN-ON FILTER HEADS, BAG

FIRST USE 7-31-1999; IN COMMERCE 7-31-1999.

SER. NO. 76-681,969, FILED 9-17-2007.

RONALD MCMORROW, EXAMINING ATTORNEY

**Int. Cl.: 7**

**Prior U.S. Cls.: 13, 19, 21, 23, 31, 34 and 35**

**Reg. No. 3,497,532**

**United States Patent and Trademark Office**

**Registered Sep. 9, 2008**

**TRADEMARK  
PRINCIPAL REGISTER**

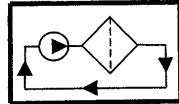

**OIL FILTRATION SYSTEMS, INC.**

OIL FILTRATION SYSTEMS, INC. (TEXAS CORPORATION)  
111 PARKWAY DRIVE  
BOERNE, TX 78006

FOR: PORTABLE LIQUID PUMPS FOR REMOVING PARTICULATE FROM A WIDE VARIETY OF LIQUIDS FOR INDUSTRIAL AND COMMERCIAL USE; OIL SEPARATORS; INDUSTRIAL FILTRATION MACHINE PARTS, NAMELY, SINGLE AND MULTI-ELEMENT FILTER HOUSINGS AND FILTER CARTRIDGES, SPIN-ON FILTER HEADS, BAG FILTER HOUSINGS, COALESCER HOUSINGS, AND BULK TANK BREATHERS AND DESICCANT

AIR BREATHERS, IN CLASS 7 (U.S. CLS. 13, 19, 21, 23, 31, 34 AND 35).

FIRST USE 7-31-1999; IN COMMERCE 7-31-1999.

NO CLAIM IS MADE TO THE EXCLUSIVE RIGHT TO USE "OIL FILTRATION SYSTEMS, INC.", APART FROM THE MARK AS SHOWN.

SER. NO. 76-681,971, FILED 9-17-2007.

RONALD MCMORROW, EXAMINING ATTORNEY

**Int. Cl.: 35**

**Prior U.S. Cls.: 100, 101 and 102**

**United States Patent and Trademark Office**

**Reg. No. 3,497,533**

**Registered Sep. 9, 2008**

**SERVICE MARK  
PRINCIPAL REGISTER**

**DOLLAR DOG KIDS CLUB**

MARKETING PARTNERS, INC. (PENNSYLVANIA CORPORATION)  
6583 RUCH ROAD  
BETHLEHEM, PA 18017

FOR: MARKETING CONSULTING, IN CLASS 35  
(U.S. CLS. 100, 101 AND 102).

FIRST USE 1-7-2002; IN COMMERCE 1-7-2002.

THE MARK CONSISTS OF STANDARD CHARACTERS WITHOUT CLAIM TO ANY PARTICULAR FONT, STYLE, SIZE, OR COLOR.

NO CLAIM IS MADE TO THE EXCLUSIVE RIGHT TO USE "KIDS CLUB", APART FROM THE MARK AS SHOWN.

SER. NO. 76-682,286, FILED 9-25-2007.

CHRISTOPHER BUONGIORNO, EXAMINING ATTORNEY

**Int. Cls.: 16, 17 and 40**

**Prior U.S. Cls.: 1, 2, 5, 12, 13, 22, 23, 29, 35, 37, 38, 50,  
100, 103 and 106**

**Reg. No. 3,497,534**

**United States Patent and Trademark Office**

**Registered Sep. 9, 2008**

**TRADEMARK  
SERVICE MARK  
PRINCIPAL REGISTER**

# IDEAL JACOBS

IDEAL JACOBS CORP. (NEW JERSEY CORPORATION)  
515 VALLEY STREET  
MAPLEWOOD, NJ 07040

FOR: ADHESIVE LABELS; BAR CODE LABELS; PAPER LABELS; PRINTED PAPER LABELS; SHIPPING LABELS; PRINTED PRESSURE SENSITIVE GRAPHICS LABELS FOR APPLICATION TO AUTOMOBILES; BRAILLE IMPRINTED DECALS, IN CLASS 16 (U.S. CLS. 2, 5, 22, 23, 29, 37, 38 AND 50).

FIRST USE 10-1-1995; IN COMMERCE 10-1-1995.

FOR: ADHESIVE-BACKED PLASTIC FILMS FOR USE IN THE MANUFACTURE OF DURABLE LABELS AND NAMEPLATES; CLEAR PLASTIC ADHESIVE SHEETS FOR REMOVAL AND LAMINATION OF LABELS ON BOTTLES, IN CLASS 17 (U.S. CLS. 1, 5, 12, 13, 35 AND 50).

FIRST USE 10-1-1995; IN COMMERCE 10-1-1995.

FOR: PRINTING; PORTRAIT PRINTING; CUSTOMIZED PRINTING OF COMPANY NAMES AND LOGOS FOR PROMOTIONAL AND ADVERTISING PURPOSES ON THE GOODS OF OTHERS; DESIGN PRINTING FOR OTHERS; IMPRINTING MESSAGES ON T-SHIRTS, NAMELY, SCREEN PRINTING; PORTRAIT PRINTING; SILK SCREEN PRINTING; STATIONERY PRINTING SERVICES, IN CLASS 40 (U.S. CLS. 100, 103 AND 106).

FIRST USE 10-1-1995; IN COMMERCE 10-1-1995.

THE MARK CONSISTS OF STANDARD CHARACTERS WITHOUT CLAIM TO ANY PARTICULAR FONT, STYLE, SIZE, OR COLOR.

SER. NO. 76-682,401, FILED 9-28-2007.

JESSICA A. POWERS, EXAMINING ATTORNEY



**Int. Cls.: 9, 16, 38 and 41**

**Prior U.S. Cls.: 2, 5, 21, 22, 23, 26, 29, 36, 37, 38, 50,  
100, 101, 104 and 107**

**Reg. No. 3,497,535**

**United States Patent and Trademark Office**

**Registered Sep. 9, 2008**

**TRADEMARK  
SERVICE MARK  
PRINCIPAL REGISTER**

**ARTSEGE**

THE JOHN F. KENNEDY CENTER FOR THE  
PERFORMING ARTS (D.C. TRUST)  
P.O. BOX 101510  
ARLINGTON, VA 22210

FOR: PRERECORDED CDS, VIDEOTAPES, AND DVDS FEATURING MUSIC, VIDEO AND EDUCATIONAL MATERIALS; PRERECORDED DIGITAL MEDIA FEATURING MUSIC, VIDEO AND EDUCATIONAL MATERIALS; DOWNLOADABLE VIDEO AND AUDIO RECORDINGS FEATURING MUSIC, VIDEO AND EDUCATIONAL MATERIALS AVAILABLE VIA THE INTERNET; DOWNLOADABLE COMPUTER SOFTWARE IN THE FIELD OF ARTS EDUCATION FOR STUDENT AND EDUCATOR USE; PRERECORDED VIDEO TAPES AND DVDS FEATURING LECTURES, IN CLASS 9 (U.S. CLS. 21, 23, 26, 36 AND 38).

FIRST USE 2-0-1999; IN COMMERCE 2-0-1999.

FOR: PRINTED MATTER, NAMELY, INFORMATIONAL BROCHURES, STUDY GUIDES AND THEATRICAL GUIDES IN THE FIELD OF ARTS EDUCATION, IN CLASS 16 (U.S. CLS. 2, 5, 22, 23, 29, 37, 38 AND 50).

FIRST USE 1-28-1994; IN COMMERCE 1-28-1994.

FOR: BROADCAST SERVICES VIA TELEVISION AND RADIO; STREAMING OF AUDIO AND VIDEO MATERIAL ON THE INTERNET; PROVIDING AN ONLINE BULLETIN BOARD IN THE FIELD OF ARTS EDUCATION AND THE PERFORMING ARTS, NAMELY, MUSIC, DANCE, THEATER, DE-

SIGN, VISUAL ARTS, FOLK ARTS, LITERARY ARTS, AND MEDIA AND FILM, IN CLASS 38 (U.S. CLS. 100, 101 AND 104).

FIRST USE 1-28-1999; IN COMMERCE 1-28-1999.

FOR: PROVIDING INFORMATION IN THE FIELDS OF ARTS EDUCATION AND THE PERFORMING ARTS, NAMELY, MUSIC, DANCE, THEATER, AND OTHER CREATIVE ACCOMPLISHMENTS; PROVIDING A WEBSITE FEATURING AUDIO AND VIDEO PRESENTATIONS OF LIVE LECTURES FOR EDUCATIONAL AND ENTERTAINMENT PURPOSES VIA GLOBAL COMPUTER NETWORKS; PROVIDING DATABASES FEATURING MUSIC, DANCE, THEATRE, DESIGN, VISUAL ARTS, FOLK ARTS, LITERARY ARTS, AND MEDIA AND FILM IN THE FIELDS OF ARTS EDUCATION AND THE PERFORMING ARTS; PUBLICATION OF ELECTRONIC MAGAZINES IN THE FIELDS OF ARTS EDUCATION AND THE PERFORMING ARTS, IN CLASS 41 (U.S. CLS. 100, 101 AND 107).

FIRST USE 1-28-1994; IN COMMERCE 1-28-1994.

THE MARK CONSISTS OF STANDARD CHARACTERS WITHOUT CLAIM TO ANY PARTICULAR FONT, STYLE, SIZE, OR COLOR.

SER. NO. 76-682,519, FILED 10-2-2007.

GINA HAYES, EXAMINING ATTORNEY

**Int. Cl.: 35**

**Prior U.S. Cls.: 100, 101 and 102**

**United States Patent and Trademark Office**

**Reg. No. 3,497,536**

**Registered Sep. 9, 2008**

**SERVICE MARK  
PRINCIPAL REGISTER**

**LAST CALL AUTO PARTS**

PROLIANCE INTERNATIONAL, INC (DELA-  
WARE CORPORATION)  
100 GANDO DRIVE  
NEW HAVEN, CT 06513

FOR: RETAIL STORE SERVICES VIA A GLOBAL  
COMPUTER NETWORK FEATURING THE SALE  
OF AUTOMOTIVE PARTS, NAMELY, REPLACE-  
MENT HEAT EXCHANGERS AND AIR CONDI-  
TIONING PARTS, INCLUDING RADIATORS,  
CONDENSERS, HEATER CORES, COMPRESSORS,  
EVAPORATORS AND ACCUMULATORS FOR AU-  
TOMOBILE AND LIGHT TRUCK APPLICATIONS,  
IN CLASS 35 (U.S. CLS. 100, 101 AND 102).

FIRST USE 9-30-2007; IN COMMERCE 9-30-2007.

THE MARK CONSISTS OF STANDARD CHAR-  
ACTERS WITHOUT CLAIM TO ANY PARTICULAR  
FONT, STYLE, SIZE, OR COLOR.

NO CLAIM IS MADE TO THE EXCLUSIVE  
RIGHT TO USE "AUTO PARTS", APART FROM  
THE MARK AS SHOWN.

SER. NO. 76-682,931, FILED 10-15-2007.

AISHA CLARKE, EXAMINING ATTORNEY

**Int. Cl.: 35**

**Prior U.S. Cls.: 100, 101 and 102**

**United States Patent and Trademark Office**

**Reg. No. 3,497,537**

**Registered Sep. 9, 2008**

**SERVICE MARK  
PRINCIPAL REGISTER**

**ALLYTICS**

ALLY MARKETING, INC. (WASHINGTON CORPORATION)  
8518 154TH AVE. NE  
REDMOND, WA 98052

FOR: BUSINESS ANALYSIS AND REPORTING SERVICES, NAMELY, SCORECARD DEVELOPMENT IN THE NATURE OF BUSINESS PERFORMANCE MEASUREMENT USED TO MONITOR ORGANIZATION PERFORMANCE AGAINST STRATEGIC GOALS; WEB BASED ANALYTICAL REPORTS FEATURING FINANCIAL STATEMENTS, MARKET ANALYSIS, AND ORGANIZATIONAL PERFORMANCE, INTERPRETING AND REPORTING BUSINESS INTELLIGENCE FOR OTH-

ERS, BUSINESS INTELLIGENCE ANALYSIS FOR OTHERS, AND PROVIDING BUSINESS MARKETING, COLLATERAL DESIGN AND CREATION, IN CLASS 35 (U.S. CLS. 100, 101 AND 102).

FIRST USE 9-0-2006; IN COMMERCE 10-23-2006.

THE MARK CONSISTS OF STANDARD CHARACTERS WITHOUT CLAIM TO ANY PARTICULAR FONT, STYLE, SIZE, OR COLOR.

SER. NO. 76-683,497, FILED 10-30-2007.

AISHA CLARKE, EXAMINING ATTORNEY

**Int. Cl.: 24**

**Prior U.S. Cls.: 42 and 50**

**United States Patent and Trademark Office**

**Reg. No. 3,497,538**

**Registered Sep. 9, 2008**

**TRADEMARK  
PRINCIPAL REGISTER**

**MANAR**

AWAD MANUFACTURING, INC. (CALIFORNIA  
CORPORATION)

5201 SOUTH SANTA FE AVENUE

VERNON, CA 90058

FOR: BEDDING AND LINENS, NAMELY, BLANKETS, IN CLASS 24 (U.S. CLS. 42 AND 50).

FIRST USE 8-1-2003; IN COMMERCE 8-1-2003.

THE MARK CONSISTS OF STANDARD CHARACTERS WITHOUT CLAIM TO ANY PARTICULAR FONT, STYLE, SIZE, OR COLOR.

THE FOREIGN WORDING IN THE MARK TRANSLATES INTO ENGLISH AS BEACON IN ARABIC.

SER. NO. 76-683,520, FILED 10-31-2007.

DORITT L. CARROLL, EXAMINING ATTORNEY

**Int. Cl.: 21**

**Prior U.S. Cls.: 2, 13, 23, 29, 30, 33, 40 and 50**

**Reg. No. 3,497,539**

**United States Patent and Trademark Office**

**Registered Sep. 9, 2008**

**TRADEMARK  
PRINCIPAL REGISTER**



ONE STOP BRUSH, INC. (CALIFORNIA CORPORATION)  
7891 BARBI LANE  
LA PALMA, CA 90623

THE MARK CONSISTS OF THE LETTER "C", THE NUMBER "1", AND THE LETTER "W", ALL IN A STYLIZED FONT, WHICH APPEAR INSIDE AN OCTAGON SHAPE.

FOR: BRUSHES USED FOR WASHING CARS AND OTHER HOUSEHOLD CLEANING NEEDS, IN CLASS 21 (U.S. CLS. 2, 13, 23, 29, 30, 33, 40 AND 50).

SER. NO. 76-683,848, FILED 11-8-2007.

FIRST USE 10-1-2006; IN COMMERCE 10-1-2006.

KAREN SEVERSON, EXAMINING ATTORNEY

**Int. Cl.: 42**

**Prior U.S. Cls.: 100 and 101**

**United States Patent and Trademark Office**

**Reg. No. 3,497,540**

**Registered Sep. 9, 2008**

**SERVICE MARK  
PRINCIPAL REGISTER**

**RESEARCH & REVIEW**

CHASE MEDICAL COMMUNICATIONS, INC.  
(CONNECTICUT CORPORATION)

65 OLD RIDGEFIELD ROAD

WILTON, CT 06897

FOR: PROVIDING MEDICAL INFORMATION  
VIA THE INTERNET, IN CLASS 42 (U.S. CLS. 100  
AND 101).

FIRST USE 6-0-2007; IN COMMERCE 6-0-2007.

THE MARK CONSISTS OF STANDARD CHAR-  
ACTERS WITHOUT CLAIM TO ANY PARTICULAR  
FONT, STYLE, SIZE, OR COLOR.

OWNER OF U.S. REG. NOS. 2,354,170, 3,409,687  
AND OTHERS.

SEC. 2(F) AS TO "RESEARCH AND REVIEW".

SER. NO. 76-683,894, FILED 11-9-2007.

ELIZABETH KAJUBI, EXAMINING ATTORNEY

**Int. Cl.: 32**

**Prior U.S. Cls.: 45, 46 and 48**

**United States Patent and Trademark Office**

**Reg. No. 3,497,541**

**Registered Sep. 9, 2008**

**TRADEMARK  
PRINCIPAL REGISTER**

**BAYBUTT**

HAWKINS, KEVIN (UNITED STATES INDIVIDUAL)  
200 PLYMOUTH STREET  
SILVER SPRING, MD 20901 AND  
HAWKINS, MONICA (UNITED STATES INDIVIDUAL)  
200 PLYMOUTH STREET  
SILVER SPRING, MD 20901  
DBA BAYBUTT

FIRST USE 8-6-2005; IN COMMERCE 8-6-2005.

THE MARK CONSISTS OF STANDARD CHARACTERS WITHOUT CLAIM TO ANY PARTICULAR FONT, STYLE, SIZE, OR COLOR.

SER. NO. 76-683,913, FILED 11-9-2007.

FOR: FRESH FRUIT AND VEGETABLE JUICES  
FOR CONSUMPTION ON OR OFF THE PREMISES,  
IN CLASS 32 (U.S. CLS. 45, 46 AND 48).

CHRISTOPHER BUONGIORNO, EXAMINING ATTORNEY

**Int. Cl.: 32**

**Prior U.S. Cls.: 45, 46 and 48**

**United States Patent and Trademark Office**

**Reg. No. 3,497,542**

**Registered Sep. 9, 2008**

**TRADEMARK  
PRINCIPAL REGISTER**

**THE WIGMORE**

HAWKINS, KEVIN (UNITED STATES INDIVIDUAL)  
200 PLYMOUTH STREET  
SILVER SPRING, MD 20901 AND  
HAWKINS, MONICA (UNITED STATES INDIVIDUAL)  
200 PLYMOUTH STREET  
SILVER SPRING, MD 20901  
DBA THE WIGMORE

FIRST USE 8-6-2005; IN COMMERCE 8-6-2005.

THE MARK CONSISTS OF STANDARD CHARACTERS WITHOUT CLAIM TO ANY PARTICULAR FONT, STYLE, SIZE, OR COLOR.

SER. NO. 76-683,914, FILED 11-9-2007.

FOR: FRESH FRUIT AND VEGETABLE JUICES  
FOR CONSUMPTION ON OR OFF THE PREMISES,  
IN CLASS 32 (U.S. CLS. 45, 46 AND 48).

CHRISTOPHER BUONGIORNO, EXAMINING ATTORNEY



**Int. Cl.: 32**

**Prior U.S. Cls.: 45, 46 and 48**

**United States Patent and Trademark Office**

**Reg. No. 3,497,543**

**Registered Sep. 9, 2008**

**TRADEMARK  
PRINCIPAL REGISTER**

**GEZER SMART**

HAWKINS, KEVIN (UNITED STATES INDIVIDUAL)  
200 PLYMOUTH STREET  
SILVER SPRING, MD 20901 AND  
HAWKINS, MONICA (UNITED STATES INDIVIDUAL)  
200 PLYMOUTH STREET  
SILVER SPRING, MD 20901  
DBA GEZER SMART

FOR: FRESH FRUIT AND VEGETABLE JUICES  
FOR CONSUMPTION ON OR OFF THE PREMISES,  
IN CLASS 32 (U.S. CLS. 45, 46 AND 48).

FIRST USE 8-6-2005; IN COMMERCE 8-6-2005.

THE MARK CONSISTS OF STANDARD CHARACTERS WITHOUT CLAIM TO ANY PARTICULAR FONT, STYLE, SIZE, OR COLOR.

SER. NO. 76-683,915, FILED 11-9-2007.

CHRISTOPHER BUONGIORNO, EXAMINING ATTORNEY

**Int. Cl.: 32**

**Prior U.S. Cls.: 45, 46 and 48**

**Reg. No. 3,497,544**

**United States Patent and Trademark Office**

**Registered Sep. 9, 2008**

**TRADEMARK  
PRINCIPAL REGISTER**

**TRUE VINE**

HAWKINS, KEVIN (UNITED STATES INDIVIDUAL)  
200 PLYMOUTH STREET  
SILVER SPRING, MD 20901 AND  
HAWKINS, MONICA (UNITED STATES INDIVIDUAL)  
200 PLYMOUTH STREET  
SILVER SPRING, MD 20901  
DBA TRUE VINE

FIRST USE 8-6-2005; IN COMMERCE 8-6-2005.

THE MARK CONSISTS OF STANDARD CHARACTERS WITHOUT CLAIM TO ANY PARTICULAR FONT, STYLE, SIZE, OR COLOR.

SER. NO. 76-683,916, FILED 11-9-2007.

FOR: FRESH FRUIT AND VEGETABLE JUICES  
FOR CONSUMPTION ON OR OFF THE PREMISES,  
IN CLASS 32 (U.S. CLS. 45, 46 AND 48).

CHRISTOPHER BUONGIORNO, EXAMINING ATTORNEY

**Int. Cl.: 32**

**Prior U.S. Cls.: 45, 46 and 48**

**United States Patent and Trademark Office**

**Reg. No. 3,497,545**

**Registered Sep. 9, 2008**

**TRADEMARK  
PRINCIPAL REGISTER**

**JO JO**

HAWKINS, KEVIN (UNITED STATES INDIVIDUAL)  
200 PLYMOUTH STREET  
SILVER SPRING, MD 20901 AND  
HAWKINS, MONICA (UNITED STATES INDIVIDUAL)  
200 PLYMOUTH STREET  
SILVER SPRING, MD 20901  
DBA JO JO

FOR: FRESH FRUIT AND VEGETABLE JUICES  
FOR CONSUMPTION ON OR OFF THE PREMISES,  
IN CLASS 32 (U.S. CLS. 45, 46 AND 48).

FIRST USE 8-6-2005; IN COMMERCE 8-6-2005.

THE MARK CONSISTS OF STANDARD CHARACTERS WITHOUT CLAIM TO ANY PARTICULAR FONT, STYLE, SIZE, OR COLOR.

SER. NO. 76-683,917, FILED 11-9-2007.

CHRISTOPHER BUONGIORNO, EXAMINING ATTORNEY

**Int. Cl.: 32**

**Prior U.S. Cls.: 45, 46 and 48**

**United States Patent and Trademark Office**

**Reg. No. 3,497,546**

**Registered Sep. 9, 2008**

**TRADEMARK  
PRINCIPAL REGISTER**

**IT'S NO OXIDANT**

HAWKINS, KEVIN (UNITED STATES INDIVIDUAL)  
200 PLYMOUTH STREET  
SILVER SPRING, MD 20901 AND  
HAWKINS, MONICA (UNITED STATES INDIVIDUAL)  
200 PLYMOUTH STREET  
SILVER SPRING, MD 20901  
DBA IT S NO OXIDANT

FIRST USE 8-6-2005; IN COMMERCE 8-6-2005.

THE MARK CONSISTS OF STANDARD CHARACTERS WITHOUT CLAIM TO ANY PARTICULAR FONT, STYLE, SIZE, OR COLOR.

SER. NO. 76-683,918, FILED 11-9-2007.

FOR: FRESH FRUIT AND VEGETABLE JUICES  
FOR CONSUMPTION ON OR OFF THE PREMISES,  
IN CLASS 32 (U.S. CLS. 45, 46 AND 48).

CHRISTOPHER BUONGIORNO, EXAMINING ATTORNEY

**Int. Cl.: 35**

**Prior U.S. Cls.: 100, 101 and 102**

**United States Patent and Trademark Office**

**Reg. No. 3,497,547**

**Registered Sep. 9, 2008**

**SERVICE MARK  
PRINCIPAL REGISTER**

**GREENWICH WORKSHOP GALLERY**

GREENWICH WORKSHOP, INC. (CONNECTI-  
CUT CORPORATION)  
151 MAIN STREET  
SEYMOUR, CT 06483

FOR: ART GALLERY SERVICES, IN CLASS 35  
(U.S. CLS. 100, 101 AND 102).

FIRST USE 12-31-1998; IN COMMERCE 12-31-1998.

THE MARK CONSISTS OF STANDARD CHAR-  
ACTERS WITHOUT CLAIM TO ANY PARTICULAR  
FONT, STYLE, SIZE, OR COLOR.

OWNER OF U.S. REG. NO. 1,896,012.

NO CLAIM IS MADE TO THE EXCLUSIVE  
RIGHT TO USE "GALLERY", APART FROM THE  
MARK AS SHOWN.

SER. NO. 76-684,042, FILED 11-15-2007.

MICHAEL WIENER, EXAMINING ATTORNEY

**Int. Cl.: 41**

**Prior U.S. Cls.: 100, 101 and 107**

**United States Patent and Trademark Office**

**Reg. No. 3,497,548**

**Registered Sep. 9, 2008**

**SERVICE MARK  
PRINCIPAL REGISTER**



TAUB, KEN (UNITED STATES INDIVIDUAL)  
242 CEDAR STREET  
SAINT JAMES, NY 11780

FIRST USE 10-8-2007; IN COMMERCE 10-8-2007.

FOR: PROVIDING A WEBSITE FOR FEMALE ATHLETES AND WOMEN WHO WANT TO REMAIN FIT FEATURING INFORMATION ON SPORTS AND FITNESS AND PHOTOGRAPHS IN THE FIELD OF SPORTS AND FITNESS , IN CLASS 41 (U.S. CLS. 100, 101 AND 107).

NO CLAIM IS MADE TO THE EXCLUSIVE RIGHT TO USE "WOMEN", APART FROM THE MARK AS SHOWN.

SER. NO. 76-684,060, FILED 11-15-2007.

KRISTINA MORRIS, EXAMINING ATTORNEY

**Int. Cl.: 35**

**Prior U.S. Cls.: 100, 101 and 102**

**United States Patent and Trademark Office**

**Reg. No. 3,497,549**

**Registered Sep. 9, 2008**

**SERVICE MARK  
PRINCIPAL REGISTER**

**POWERED BY NIAGARA**

NIAGARA CONSERVATION CORP. (NEW JERSEY CORPORATION)  
45 HORSEHILL ROAD  
CEDAR KNOLLS, NJ 07927

FOR: DISTRIBUTORSHIP SERVICES FEATURING WATER CONSERVATION PRODUCTS, NAMELY, SHOWER HEADS, FAUCET AERATORS, WATER FLOW METERS, SHOWERHEAD TIMERS, PRE-RINSE AUTOMATIC NOZZLES, DRIP GAUGES, TOILETS, TOILET WATER SAVER COMPONENTS, FLAPPERS FOR TOILET TANKS, AUTOMATED IRRIGATION SYSTEMS AND COMPONENTS THEREOF, INCLUDING ELECTRONIC TIMERS; LIGHT BULBS, LAMPS, FLORESCENT LIGHTING, AND ELECTRIC LIGHTING FIXTURES; MERCHANDISE PACKAGING OF SAID

CONSERVATION PRODUCTS IN COMBINATION, IN CLASS 35 (U.S. CLS. 100, 101 AND 102).

FIRST USE 11-7-2007; IN COMMERCE 11-7-2007.

THE MARK CONSISTS OF STANDARD CHARACTERS WITHOUT CLAIM TO ANY PARTICULAR FONT, STYLE, SIZE, OR COLOR.

OWNER OF U.S. REG. NOS. 2,198,698, 2,887,101 AND OTHERS.

SER. NO. 76-684,190, FILED 11-19-2007.

JENNIFER VASQUEZ, EXAMINING ATTORNEY

**Int. Cl.: 6**

**Prior U.S. Cls.: 2, 12, 13, 14, 23, 25 and 50**

**Reg. No. 3,497,550**

**United States Patent and Trademark Office**

**Registered Sep. 9, 2008**

**TRADEMARK  
PRINCIPAL REGISTER**

**BUILT TO THE EXTREME**

GRELA, LARRY MITCHELL (UNITED STATES  
INDIVIDUAL)  
12926 NORTHLAND DR.  
PLAINFIELD, IL 60585

THE MARK CONSISTS OF STANDARD CHAR-  
ACTERS WITHOUT CLAIM TO ANY PARTICULAR  
FONT, STYLE, SIZE, OR COLOR.

FOR: METAL TOOL BOXES, IN CLASS 6 (U.S.  
CLS. 2, 12, 13, 14, 23, 25 AND 50).

SER. NO. 76-684,212, FILED 11-19-2007.

FIRST USE 10-30-2007; IN COMMERCE 10-30-2007.

ALLISON HOLTZ, EXAMINING ATTORNEY



**Int. Cl.: 9**

**Prior U.S. Cls.: 21, 23, 26, 36 and 38**

**Reg. No. 3,497,551**

**United States Patent and Trademark Office**

**Registered Sep. 9, 2008**

**TRADEMARK  
PRINCIPAL REGISTER**



QD TECHNOLOGY LLC (DELAWARE LIMITED  
LIABILITY COMPANY)  
29 CRESTHILL AVENUE  
CLIFTON, NJ 07012

NO CLAIM IS MADE TO THE EXCLUSIVE  
RIGHT TO USE "TECHNOLOGY", APART FROM  
THE MARK AS SHOWN.

FOR: COMPUTER SOFTWARE, NAMELY, RELATIONAL  
DATABASE SOFTWARE, IN CLASS 9 (U.S.  
CLS. 21, 23, 26, 36 AND 38).

SER. NO. 76-684,276, FILED 11-23-2007.

FIRST USE 12-31-2006; IN COMMERCE 12-31-2006.

ALLISON HOLTZ, EXAMINING ATTORNEY

**Int. Cl.: 36**

**Prior U.S. Cls.: 100, 101 and 102**

**United States Patent and Trademark Office**

**Reg. No. 3,497,552**

**Registered Sep. 9, 2008**

**SERVICE MARK  
PRINCIPAL REGISTER**

**EURO VAT REFUND**

EURO VAT REFUND, INC. (CALIFORNIA CORPORATION)  
5161 OVERLAND AVENUE  
CULVER CITY, CA 902304913

NO CLAIM IS MADE TO THE EXCLUSIVE RIGHT TO USE "VAT REFUND", APART FROM THE MARK AS SHOWN.

FOR: FINANCIAL MANAGEMENT, IN CLASS 36 (U.S. CLS. 100, 101 AND 102).

SER. NO. 76-684,278, FILED 11-23-2007.

FIRST USE 8-7-1992; IN COMMERCE 8-11-1992.

ALLISON HOLTZ, EXAMINING ATTORNEY

**Int. Cls.: 41, 44 and 45**

**Prior U.S. Cls.: 100, 101 and 107**

**United States Patent and Trademark Office**

**Reg. No. 3,497,553**

**Registered Sep. 9, 2008**

**SERVICE MARK  
PRINCIPAL REGISTER**

**OHI**

THE FREE SACRED TRINITY CHURCH (CALIFORNIA CORPORATION)  
9655 GRANITE RIDGE DRIVE, SUITE 550  
SAN DIEGO, CA 92123

FOR: EDUCATION SERVICES, NAMELY, PROVIDING LIVE AND ON LINE CLASSES, SEMINARS AND WORKSHOPS IN THE FIELDS OF SPIRITUALITY, HOLISTIC HEALTH CARE, DIET AND NUTRITION, STRESS MANAGEMENT, ADDICTION AND DRUG REHABILITATION AND TREATMENT OPTIONS, SMOKING CESSATION TREATMENT OPTIONS AND PERSONAL SCHEDULES, AND COUNSELING OPTIONS, IN CLASS 41 (U.S. CLS. 100, 101 AND 107).

FIRST USE 12-1-1984; IN COMMERCE 12-1-1984.

FOR: PROVIDING DIET AND NUTRITION COUNSELING, STRESS MANAGEMENT COUNSELING, ADDICTION AND DRUG REHABILITATION COUNSELING AND TREATMENT

SERVICES, SMOKING CESSATION TREATMENT SERVICES AND PERSONAL MAINTENANCE SCHEDULES AND COUNSELING, IN CLASS 44 (U.S. CLS. 100 AND 101).

FIRST USE 12-1-1984; IN COMMERCE 12-1-1984.

FOR: PROVIDING HOLISTIC SPIRITUAL COUNSELING SERVICES, IN CLASS 45 (U.S. CLS. 100 AND 101).

FIRST USE 12-1-1984; IN COMMERCE 12-1-1984.

THE MARK CONSISTS OF STANDARD CHARACTERS WITHOUT CLAIM TO ANY PARTICULAR FONT, STYLE, SIZE, OR COLOR.

SER. NO. 76-684,294, FILED 11-26-2007.

KYLE PEETE, EXAMINING ATTORNEY

**Int. Cl.: 3**

**Prior U.S. Cls.: 1, 4, 6, 50, 51 and 52**

**Reg. No. 3,497,554**

**United States Patent and Trademark Office**

**Registered Sep. 9, 2008**

**TRADEMARK  
PRINCIPAL REGISTER**

**STOP NAIL**

KIM, LAWRENCE (UNITED STATES INDIVIDUAL)  
819 SOUTH GLADYS AVENUE  
LOS ANGELES, CA 90021

FOR: ARTIFICIAL FINGERNAILS; NAIL GROOMING PRODUCTS, NAMELY, GLUE ON NAILS, SELF-STICK NAILS, NAIL-TIPS, NAIL ACRYLIC POWDER, NAIL ACRYLIC LIQUID; NAIL CARE PREPARATIONS, NAMELY, NAIL WRAPS, IN CLASS 3 (U.S. CLS. 1, 4, 6, 50, 51 AND 52).

FIRST USE 8-1-2002; IN COMMERCE 8-1-2002.

THE MARK CONSISTS OF STANDARD CHARACTERS WITHOUT CLAIM TO ANY PARTICULAR FONT, STYLE, SIZE, OR COLOR.

NO CLAIM IS MADE TO THE EXCLUSIVE RIGHT TO USE "NAIL", APART FROM THE MARK AS SHOWN.

SER. NO. 76-684,614, FILED 12-4-2007.

JENNIFER MARTIN, EXAMINING ATTORNEY

**Int. Cl.: 16**

**Prior U.S. Cls.: 2, 5, 22, 23, 29, 37, 38 and 50**

**United States Patent and Trademark Office**

**Reg. No. 3,497,555**

**Registered Sep. 9, 2008**

**TRADEMARK  
PRINCIPAL REGISTER**

# The Affluent Artist

DIBIASIO, RICHARD J. (UNITED STATES INDIVIDUAL)

3704 WINTER GARDEN VINELAND RD.

WINTER GARDEN, FL 34787

FOR: BOOKS IN THE FIELD OF FINANCIAL ADVISORY SERVICES, IN CLASS 16 (U.S. CLS. 2, 5, 22, 23, 29, 37, 38 AND 50).

FIRST USE 9-1-2007; IN COMMERCE 9-1-2007.

THE MARK CONSISTS OF STANDARD CHARACTERS WITHOUT CLAIM TO ANY PARTICULAR FONT, STYLE, SIZE, OR COLOR.

NO CLAIM IS MADE TO THE EXCLUSIVE RIGHT TO USE "ARTIST", APART FROM THE MARK AS SHOWN.

SER. NO. 76-684,737, FILED 12-7-2007.

MARK PILARO, EXAMINING ATTORNEY

**Int. Cl.: 12**

**Prior U.S. Cls.: 19, 21, 23, 31, 35 and 44**

**Reg. No. 3,497,556**

**United States Patent and Trademark Office**

**Registered Sep. 9, 2008**

**TRADEMARK  
PRINCIPAL REGISTER**

# **Xtreme Vent**

FINANCIAL ANALYSTS CONSULTANTS, INC.  
(ARIZONA CORPORATION)  
24060B NORTH 195TH AVENUE  
SURPRISE, AZ 85387

FOR: RECREATIONAL VEHICLE VENTS WHICH  
SUCTION AND REMOVE UNPLEASANT SEWAGE  
HOLDING TANK ODORS, IN CLASS 12 (U.S. CLS.  
19, 21, 23, 31, 35 AND 44).

FIRST USE 12-20-2003; IN COMMERCE 12-20-2003.

THE MARK CONSISTS OF STANDARD CHAR-  
ACTERS WITHOUT CLAIM TO ANY PARTICULAR  
FONT, STYLE, SIZE, OR COLOR.

NO CLAIM IS MADE TO THE EXCLUSIVE  
RIGHT TO USE "VENT", APART FROM THE MARK  
AS SHOWN.

SER. NO. 76-684,741, FILED 12-7-2007.

COLLEEN KEARNEY, EXAMINING ATTORNEY

Int. Cl.: 29

Prior U.S. Cl.: 46

United States Patent and Trademark Office

Reg. No. 3,497,557

Registered Sep. 9, 2008

TRADEMARK  
PRINCIPAL REGISTER



SEA MERCHANTS INC. (CANADA CORPORATION)  
55 VANSO ROAD  
TORONTO, ONTARIO, CANADA M5C 2V9

FOR: FRESH AND FROZEN SOLE, FRESH AND FROZEN HADDOCK, FRESH AND FROZEN COD, FRESH AND FROZEN ORANGE ROUGHY, FRESH AND FROZEN RED COD, FRESH AND FROZEN POLLOCK, FRESH AND FROZEN OCEAN PERCH, FRESH AND FROZEN SNAPPER, FRESH AND FROZEN PACIFIC SALMON, FRESH AND FROZEN ATLANTIC SALMON, FRESH AND FROZEN TILAPIA, FRESH AND FROZEN TUNA, FRESH AND FROZEN SWORDFISH, FRESH AND FROZEN SEA BASS, FRESH AND FROZEN HALIBUT, FRESH AND FROZEN MONKFISH AND FRESH AND FROZEN MAHI MAHI; FRESH AND FROZEN

WARM WATER SHRIMP, FRESH AND FROZEN COLD WATER SHRIMP, FRESH AND FROZEN SCALLOPS AND FRESH AND FROZEN MUSSELS, IN CLASS 29 (U.S. CL. 46).

FIRST USE 1-0-2007; IN COMMERCE 1-0-2007.

PRIORITY CLAIMED UNDER SEC. 44(D) ON CANADA APPLICATION NO. 1355899, FILED 7-12-2007.

SEA MERCHANTS & BOAT DESIGN

SER. NO. 76-684,813, FILED 12-11-2007.

JERI J. FICKES, EXAMINING ATTORNEY

Int. Cl.: 5

Prior U.S. Cls.: 6, 18, 44, 46, 51 and 52

Reg. No. 3,497,558

United States Patent and Trademark Office

Registered Sep. 9, 2008

TRADEMARK  
PRINCIPAL REGISTER



e-Drink  
*Plus*

E-DRINK PLUS DISTRIBUTING, INC. (CALI-  
FORNIA CORPORATION)  
2018 N. LEE AVE.  
SOUTH EL MONTE, CA 91733

FOR: NUTRITIONAL SUPPLEMENTS CONTAIN-  
ING ENZYMES, IN CLASS 5 (U.S. CLS. 6, 18, 44, 46, 51  
AND 52).

FIRST USE 5-15-2007; IN COMMERCE 5-15-2007.

THE STIPPLING IS FOR SHADING PURPOSES  
ONLY.

THE MARK CONSISTS OF THE FIRST LETTER IS  
A LOWER CASE "E" FOLLOW BY A DASH AND  
THE WORK "DRINK". THERE ARE TWO BUBBLES  
ON THE LETTER "I" IN "DRINK" AND ONE  
LARGER BUBBLE ON THE LETTER "N". UNDER  
THE LETTERS "INK" OF "DRINK", THERE IS THE  
WORD "PLUS".

SER. NO. 76-685,276, FILED 12-26-2007.

PAM WILLIS, EXAMINING ATTORNEY



**Int. Cl.: 3**

**Prior U.S. Cls.: 1, 4, 6, 50, 51 and 52**

**United States Patent and Trademark Office**

**Reg. No. 3,497,559**

**Registered Sep. 9, 2008**

**TRADEMARK  
PRINCIPAL REGISTER**

**CONDITION AND SCULPT**

CARTER, JANE (UNITED STATES INDIVIDUAL)  
161 GROVE ROAD  
SOUTH ORANGE, NJ 07059

FOR: HAIR CARE PREPARATIONS, NAMELY,  
HAIR CONDITIONER IN GEL FORM, AND HAIR  
GEL, IN CLASS 3 (U.S. CLS. 1, 4, 6, 50, 51 AND 52).

FIRST USE 10-21-1995; IN COMMERCE 10-21-1995.

THE MARK CONSISTS OF STANDARD CHAR-  
ACTERS WITHOUT CLAIM TO ANY PARTICULAR  
FONT, STYLE, SIZE, OR COLOR.

NO CLAIM IS MADE TO THE EXCLUSIVE  
RIGHT TO USE "CONDITION", APART FROM  
THE MARK AS SHOWN.

SER. NO. 76-685,855, FILED 1-16-2008.

JOHN WILKE, EXAMINING ATTORNEY

**Int. Cl.: 9**

**Prior U.S. Cls.: 21, 23, 26, 36 and 38**

**United States Patent and Trademark Office**

**Reg. No. 3,497,560**

**Registered Sep. 9, 2008**

**TRADEMARK  
PRINCIPAL REGISTER**

**RENT MANAGER**

LONDON COMPUTER SYSTEMS, INC. (OHIO  
CORPORATION)  
1007 COTTONWOOD DRIVE  
LOVELAND, OH 45140

FOR: COMPUTER SOFTWARE TO ASSIST LAND-  
LORDS WITH THEIR RESIDENTIAL PROPERTIES,  
IN CLASS 9 (U.S. CLS. 21, 23, 26, 36 AND 38).

FIRST USE 1-31-1988; IN COMMERCE 1-31-1988.

THE MARK CONSISTS OF STANDARD CHAR-  
ACTERS WITHOUT CLAIM TO ANY PARTICULAR  
FONT, STYLE, SIZE, OR COLOR.

SEC. 2(F).

SER. NO. 76-686,009, FILED 1-22-2008.

LIEF MARTIN, EXAMINING ATTORNEY

**Int. Cl.: 35**

**Prior U.S. Cls.: 100, 101 and 102**

**United States Patent and Trademark Office**

**Reg. No. 3,497,561**

**Registered Sep. 9, 2008**

**SERVICE MARK  
PRINCIPAL REGISTER**

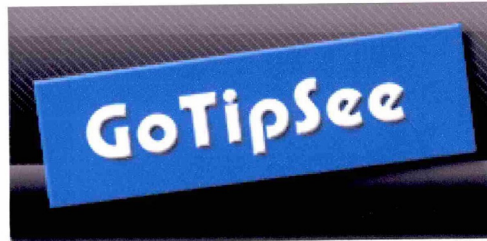

KASSIM, KAID (UNITED STATES INDIVIDUAL)  
3706 S.W. 12TH AVENUE  
CAPE CORAL, FL 33914

FOR: ADVERTISING VIA INTERNET, IN CLASS  
35 (U.S. CLS. 100, 101 AND 102).

FIRST USE 8-15-2007; IN COMMERCE 8-15-2007.

THE COLOR(S) WHITE, BLUE, GRAY AND  
BLACK IS/ARE CLAIMED AS A FEATURE OF  
THE MARK.

THE WORDING "GOTIPSEE" IS WHITE INSIDE A  
BLUE RECTANGLE, WHICH RESTS ON A GRAY  
AND BLACK BACKGROUND.

SER. NO. 76-686,037, FILED 1-23-2008.

ALICE SUE CARRUTHERS, EXAMINING ATTOR-  
NEY

**Int. Cl.: 35**

**Prior U.S. Cls.: 100, 101 and 102**

**United States Patent and Trademark Office**

**Reg. No. 3,497,562**

**Registered Sep. 9, 2008**

**SERVICE MARK  
PRINCIPAL REGISTER**

**MONERGY**

MONERGY, LLC (WISCONSIN LIMITED LIABILITY COMPANY)  
210 SOUTH MAIN STREET  
THIENSVILLE, WI 530921905

THE MARK CONSISTS OF STANDARD CHARACTERS WITHOUT CLAIM TO ANY PARTICULAR FONT, STYLE, SIZE, OR COLOR.

FOR: PROVIDING A WEB SITE FEATURING PUBLIC POLICY INFORMATION IN THE FIELDS OF ENERGY, ECONOMICS, AND POLITICS, IN CLASS 35 (U.S. CLS. 100, 101 AND 102).

SER. NO. 76-686,080, FILED 1-24-2008.

FIRST USE 3-23-2001; IN COMMERCE 3-23-2001.

DORITT L. CARROLL, EXAMINING ATTORNEY

**Int. Cl.: 27**

**Prior U.S. Cls.: 19, 20, 37, 42 and 50**

**United States Patent and Trademark Office**

**Reg. No. 3,497,563**

**Registered Sep. 9, 2008**

**TRADEMARK  
PRINCIPAL REGISTER**

**CARPET-PRO**

BROADWAY KLEER-GUARD CORP. (NEW JERSEY CORPORATION)  
53 BRUNSWICK AVENUE  
EDISON, NJ 08817

FOR: MATS AND RUNNERS, MADE OF PLASTIC FILM, FOR USE ON TOP OF CARPETING FOR PROTECTING CARPETS AGAINST DUST, STAINS AND DIRT, IN CLASS 27 (U.S. CLS. 19, 20, 37, 42 AND 50).

FIRST USE 4-0-2006; IN COMMERCE 4-0-2006.

THE MARK CONSISTS OF STANDARD CHARACTERS WITHOUT CLAIM TO ANY PARTICULAR FONT, STYLE, SIZE, OR COLOR.

SER. NO. 76-686,196, FILED 1-28-2008.

RUSS HERMAN, EXAMINING ATTORNEY

Int. Cl.: 36

Prior U.S. Cls.: 100, 101 and 102

United States Patent and Trademark Office

Reg. No. 3,497,564

Registered Sep. 9, 2008

SERVICE MARK  
PRINCIPAL REGISTER



WOODBOURNE INVESTMENT MANAGEMENT  
LLC (DELAWARE LIMITED LIABILITY COM-  
PANY)  
1919 14TH STREET  
SUITE 300  
BOULDER, CO 80302

FOR: FINANCIAL SERVICES, NAMELY, INVEST-  
MENT MANAGEMENT SERVICES, AND FINAN-  
CIAL INVESTMENTS IN THE FIELD OF  
INVESTMENT FUNDS, IN CLASS 36 (U.S. CLS. 100,  
101 AND 102).

FIRST USE 1-4-2008; IN COMMERCE 1-4-2008.

THE MARK CONSISTS OF THE TERM "WOOD-  
BOURNE" APPEARING VERTICALLY IN A STY-  
LIZED FONT IMMEDIATELY TO THE LEFT OF A  
SQUARE STYLIZED DESIGN DEPICTING THE  
LETTER "W" CENTERED THEREIN IN A STY-  
LIZED FONT.

SER. NO. 76-686,209, FILED 1-28-2008.

ANDREA K. NADELMAN, EXAMINING ATTOR-  
NEY

**Int. Cl.: 30**

**Prior U.S. Cl.: 46**

**United States Patent and Trademark Office**

**Reg. No. 3,497,565**

**Registered Sep. 9, 2008**

**TRADEMARK  
PRINCIPAL REGISTER**

**BEER BARREL MAIN EVENT BURGER**

DENNY'S BEER BARREL PUB INCORPORATED  
(PENNSYLVANIA CORPORATION)

1452 WOODLAND ROAD

CLEARFIELD, PA 16830

FOR: HAMBURGER SANDWICHES, IN CLASS 30  
(U.S. CL. 46).

FIRST USE 2-24-2007; IN COMMERCE 2-24-2007.

THE MARK CONSISTS OF STANDARD CHAR-  
ACTERS WITHOUT CLAIM TO ANY PARTICULAR  
FONT, STYLE, SIZE, OR COLOR.

NO CLAIM IS MADE TO THE EXCLUSIVE  
RIGHT TO USE "BURGER", APART FROM THE  
MARK AS SHOWN.

SER. NO. 76-686,246, FILED 1-28-2008.

APRIL HESIK, EXAMINING ATTORNEY

**Int. Cl.: 15**

**Prior U.S. Cls.: 2, 21 and 36**

**United States Patent and Trademark Office**

**Reg. No. 3,497,566**

**Registered Sep. 9, 2008**

**TRADEMARK  
PRINCIPAL REGISTER**

**V-ACCORDION**

ROLAND CORPORATION (JAPAN CORPORATION)

2036-1, NAKAGAWA, HOSOE-CHO, KITA-KU  
HAMAMATSU, SHIZUOKA-KEN 431, JAPAN

FOR: ACCORDIONS, IN CLASS 15 (U.S. CLS. 2, 21  
AND 36).

FIRST USE 6-22-2004; IN COMMERCE 8-0-2004.

THE MARK CONSISTS OF STANDARD CHARACTERS WITHOUT CLAIM TO ANY PARTICULAR FONT, STYLE, SIZE, OR COLOR.

OWNER OF U.S. REG. NOS. 2,188,455, 2,784,673  
AND OTHERS.

SER. NO. 76-686,300, FILED 1-29-2008.

KELLY MCCOY, EXAMINING ATTORNEY



**Int. Cl.: 41**

**Prior U.S. Cls.: 100, 101 and 107**

**United States Patent and Trademark Office**

**Reg. No. 3,497,567**

**Registered Sep. 9, 2008**

**SERVICE MARK  
PRINCIPAL REGISTER**

# **WORKSPACEK12**

NAVIANCE, INC. (DELAWARE CORPORATION)  
910 17TH STREET NW, SUITE 1000  
WASHINGTON, DC 20006

FOR: PROVIDING INFORMATION OVER A GLOBAL COMPUTER NETWORK RELATING TO SELECTING A COLLEGE OR VOCATIONAL SCHOOL; PROVIDING INFORMATION OVER A GLOBAL COMPUTER NETWORK RELATING TO SELECTING COURSES TO MEET GRADUATION REQUIREMENTS AND EDUCATIONAL GOALS, IN CLASS 41 (U.S. CLS. 100, 101 AND 107).

FIRST USE 7-15-2005; IN COMMERCE 7-15-2005.

THE MARK CONSISTS OF STANDARD CHARACTERS WITHOUT CLAIM TO ANY PARTICULAR FONT, STYLE, SIZE, OR COLOR.

OWNER OF U.S. REG. NO. 3,106,872.

SER. NO. 76-686,335, FILED 1-31-2008.

ALICIA COLLINS, EXAMINING ATTORNEY

**Int. Cl.: 41**

**Prior U.S. Cls.: 100, 101 and 107**

**United States Patent and Trademark Office**

**Reg. No. 3,497,568**

**Registered Sep. 9, 2008**

**SERVICE MARK  
PRINCIPAL REGISTER**

**NAVIANCE**

NAVIANCE, INC. (DELAWARE CORPORATION)  
910 17TH STREET NW, SUITE 1000  
WASHINGTON, DC 20006

FOR: PROVIDING INFORMATION OVER A GLOBAL COMPUTER NETWORK RELATING TO SELECTING A COLLEGE OR VOCATIONAL SCHOOL; PROVIDING INFORMATION OVER A GLOBAL COMPUTER NETWORK RELATING TO SELECTING COURSES TO MEET GRADUATION REQUIREMENTS AND EDUCATIONAL GOALS, IN CLASS 41 (U.S. CLS. 100, 101 AND 107).

FIRST USE 6-13-2001; IN COMMERCE 6-13-2001.

THE MARK CONSISTS OF STANDARD CHARACTERS WITHOUT CLAIM TO ANY PARTICULAR FONT, STYLE, SIZE, OR COLOR.

OWNER OF U.S. REG. NO. 2,663,392.

SER. NO. 76-686,336, FILED 1-31-2008.

ALICIA COLLINS, EXAMINING ATTORNEY

**Int. Cl.: 19**

**Prior U.S. Cls.: 1, 12, 33 and 50**

**United States Patent and Trademark Office**

**Reg. No. 3,497,569**

**Registered Sep. 9, 2008**

**TRADEMARK  
PRINCIPAL REGISTER**

**ENVIROSCAPE**

ENVIROGLAS, LLC (TEXAS LIMITED LIABILITY COMPANY)  
5048 TENNYSON PKWY, SUITE 202  
PLANO, TX 75024

FOR: BUILDING MATERIALS, NAMELY, GLASS AND PORCELAIN AGGREGATE USED IN LANDSCAPING, AQUARIUMS AND FOUNTAINS, USED BOTH RESIDENTIALLY AND COMMERCIALY, IN CLASS 19 (U.S. CLS. 1, 12, 33 AND 50).

FIRST USE 8-12-2005; IN COMMERCE 8-12-2005.

THE MARK CONSISTS OF STANDARD CHARACTERS WITHOUT CLAIM TO ANY PARTICULAR FONT, STYLE, SIZE, OR COLOR.

SER. NO. 76-686,345, FILED 1-31-2008.

DAVID ELTON, EXAMINING ATTORNEY

**Int. Cl.: 6**

**Prior U.S. Cls.: 2, 12, 13, 14, 23, 25 and 50**

**Reg. No. 3,497,570**

**United States Patent and Trademark Office**

**Registered Sep. 9, 2008**

**TRADEMARK  
PRINCIPAL REGISTER**

**106**

THE EASTERN COMPANY (CONNECTICUT CORPORATION), DBA EBERHARD MANUFACTURING COMPANY  
112 BRIDGE STREET  
NAUGATUCK, CT 06770

FOR: LATCHES, LOCKS AND PARTS THEREFOR FOR CLOSURES MADE PRIMARILY OF METAL, IN CLASS 6 (U.S. CLS. 2, 12, 13, 14, 23, 25 AND 50).

FIRST USE 6-24-1988; IN COMMERCE 6-24-1988.

THE MARK CONSISTS OF STANDARD CHARACTERS WITHOUT CLAIM TO ANY PARTICULAR FONT, STYLE, SIZE, OR COLOR.

OWNER OF U.S. REG. NOS. 1,455,909, 1,601,879 AND OTHERS.

SER. NO. 76-686,395, FILED 2-1-2008.

KOURTNEE HODGES, EXAMINING ATTORNEY

**Int. Cl.: 37**

**Prior U.S. Cls.: 100, 103 and 106**

**United States Patent and Trademark Office**

**Reg. No. 3,497,571**

**Registered Sep. 9, 2008**

**SERVICE MARK  
PRINCIPAL REGISTER**

**ICEFIGHTERS**

NICHOLAS J. MURANO LLC (CONNECTICUT  
LIMITED LIABILITY COMPANY)  
219 CHURCH STREET  
YALESVILLE, CT 06492

FOR: SNOW REMOVAL SERVICES; COMMERCIAL/RESIDENTIAL SNOW PLOWING; PROPERTY MAINTENANCE SERVICES FOR SNOW AND ICE REMOVAL, IN CLASS 37 (U.S. CLS. 100, 103 AND 106).

FIRST USE 12-2-2006; IN COMMERCE 12-2-2006.

THE MARK CONSISTS OF STANDARD CHARACTERS WITHOUT CLAIM TO ANY PARTICULAR FONT, STYLE, SIZE, OR COLOR.

SER. NO. 76-686,464, FILED 2-4-2008.

EMILY CARLSEN, EXAMINING ATTORNEY

**Int. Cls.: 30 and 43**

**Prior U.S. Cls.: 46, 100 and 101**

**United States Patent and Trademark Office**

**Reg. No. 3,497,572**

**Registered Sep. 9, 2008**

**TRADEMARK  
SERVICE MARK  
PRINCIPAL REGISTER**



P.D.K.D. ENTERPRISES, INC. (MASSACHU-  
SETTS CORPORATION)  
120 LINCOLN AVENUE  
SAUGUS, MA 01906

FOR: DONUTS AND BAKERY PRODUCTS, IN  
CLASS 30 (U.S. CL. 46).

FIRST USE 0-0-1955; IN COMMERCE 0-0-1955.

FOR: RESTAURANT AND CARRYOUT SERVI-  
CES, IN CLASS 43 (U.S. CLS. 100 AND 101).

FIRST USE 0-0-1955; IN COMMERCE 0-0-1955.

NO CLAIM IS MADE TO THE EXCLUSIVE  
RIGHT TO USE "DONUTS", APART FROM THE  
MARK AS SHOWN.

SEC. 2(F).

SER. NO. 76-686,541, FILED 2-4-2008.

KIMBERLY PERRY, EXAMINING ATTORNEY

**Int. Cl.: 12**

**Prior U.S. Cls.: 19, 21, 23, 31, 35 and 44**

**Reg. No. 3,497,573**

**United States Patent and Trademark Office**

**Registered Sep. 9, 2008**

**TRADEMARK  
PRINCIPAL REGISTER**

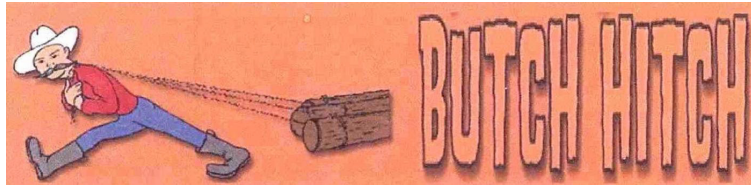

CBR DESIGN & MACHINE, LLC (PENNSYLVANIA LIMITED LIABILITY COMPANY)  
1050 BROAD STREET, SUITE 10  
MONTOURSVILLE, PA 17754

THE COLOR(S) BLACK, WHITE, PEACH, RED, BLUE, BROWN, AND ORANGE IS/ARE CLAIMED AS A FEATURE OF THE MARK.

FOR: SMALL ITEMS OF METAL HARDWARE, NAMELY, DRAWBAR HITCH DEVICES USED TO CONNECT MULTIPLE CHAINS TO A SINGLE HITCH PLATE, IN CLASS 12 (U.S. CLS. 19, 21, 23, 31, 35 AND 44).

THE MARK CONSISTS OF THE WORDS "BUTCH HITCH" IN BLACK OUTLINED LETTERS WITH A BLACK SHADOW TO THE RIGHT OF A STYLIZED MAN WITH A WHITE COWBOY HAT, A RED SHIRT, BLUE PANTS, A PEACH FACE, PEACH HANDS, A BROWN MUSTACHE AND BROWN BOOTS PULLING THREE BROWN LOGS WITH BLACK CHAINS OVER THE MAN'S SHOULDER, ALL ON AN ORANGE BACKGROUND.

FIRST USE 12-5-2007; IN COMMERCE 12-5-2007.

SER. NO. 76-686,551, FILED 2-1-2008.

NO CLAIM IS MADE TO THE EXCLUSIVE RIGHT TO USE "HITCH", APART FROM THE MARK AS SHOWN.

DAVID TOOLEY, EXAMINING ATTORNEY

**Int. Cl.: 30**

**Prior U.S. Cl.: 46**

**United States Patent and Trademark Office**

**Reg. No. 3,497,574**

**Registered Sep. 9, 2008**

**TRADEMARK  
PRINCIPAL REGISTER**

**BUTT BURNIN'  
HOT SAUCE**

FUZZY'S TACO HOLDINGS, LLC (TEXAS LIMITED LIABILITY COMPANY)  
248 N. BAILEY  
FORT WORTH, TX 76107

NO CLAIM IS MADE TO THE EXCLUSIVE RIGHT TO USE "HOT SAUCE" , APART FROM THE MARK AS SHOWN.

FOR: CONDIMENT, NAMELY, READY-MADE HOT SAUCE, IN CLASS 30 (U.S. CL. 46).

SER. NO. 76-686,554, FILED 2-5-2008.

FIRST USE 2-15-2001; IN COMMERCE 2-15-2001.

HEATHER SAPP, EXAMINING ATTORNEY



Int. Cl.: 44

Prior U.S. Cls.: 100 and 101

United States Patent and Trademark Office

Reg. No. 3,497,575

Registered Sep. 9, 2008

SERVICE MARK  
PRINCIPAL REGISTER



GREAT SALONS, INC. (TEXAS CORPORATION),  
DBA COMEDY CLIPS  
112 PR 2218  
DECATUR, TX 76234

FOR: HAIRDRESSING SALONS SERVICES,  
NAMELY, HAIRCUTTING, STYLING, AND  
HEALTH AND BEAUTY CARE, AND BEAUTY  
SALON SERVICES, IN CLASS 44 (U.S. CLS. 100  
AND 101).

FIRST USE 9-29-2006; IN COMMERCE 9-29-2006.

NO CLAIM IS MADE TO THE EXCLUSIVE  
RIGHT TO USE "CLIPS", APART FROM THE MARK  
AS SHOWN.

SER. NO. 76-686,555, FILED 2-5-2008.

HEATHER SAPP, EXAMINING ATTORNEY

**Int. Cl.: 35**

**Prior U.S. Cls.: 100, 101 and 102**

**United States Patent and Trademark Office**

**Reg. No. 3,497,576**

**Registered Sep. 9, 2008**

**SERVICE MARK  
PRINCIPAL REGISTER**

JEG SEARCH, LLC (CONNECTICUT LIMITED  
LIABILITY COMPANY)  
2 HOLLY PLACE  
WILTON, CT 06897

THE MARK CONSISTS OF STANDARD CHAR-  
ACTERS WITHOUT CLAIM TO ANY PARTICULAR  
FONT, STYLE, SIZE, OR COLOR.

FOR: EXECUTIVE SEARCH SERVICES, IN CLASS  
35 (U.S. CLS. 100, 101 AND 102).

SER. NO. 76-686,565, FILED 2-6-2008.

FIRST USE 10-1-2006; IN COMMERCE 10-1-2006.

EMILY CARLSEN, EXAMINING ATTORNEY

**Int. Cl.: 18**

**Prior U.S. Cls.: 1, 2, 3, 22 and 41**

**Reg. No. 3,497,577**

**United States Patent and Trademark Office**

**Registered Sep. 9, 2008**

**TRADEMARK  
PRINCIPAL REGISTER**

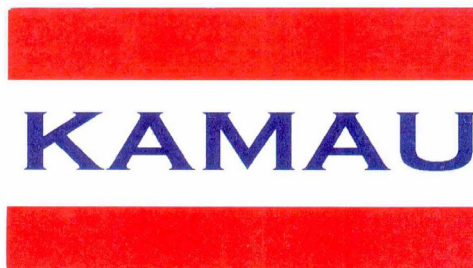

REGINALD HOLMES C/O. KAMAU CLOTHING  
LLC. (TEXAS LIMITED LIABILITY COMP-  
NY)

2102 SEVEN PINES ST.  
SAN ANTONIO, TX 78245

FOR: LUGGAGE; ALL-PURPOSE SPORT BAGS,  
NAMELY, BACKPACKS, ATHLETE BAGS, DUFFEL  
BAGS, BOOK BAGS, HANDBAGS, TOTE BAGS,  
TRAVEL KIT BAGS SOLD EMPTY, BRIEFCASES,  
WALLETS, PURSES, MESSENGER BAGS, AND  
COSMETIC CASES SOLD EMPTY, IN CLASS 18  
(U.S. CLS. 1, 2, 3, 22 AND 41).

FIRST USE 12-20-2002; IN COMMERCE 2-1-2008.

OWNER OF U.S. REG. NO. 2,924,201.

THE COLOR(S) RED, WHITE AND BLUE IS/ARE  
CLAIMED AS A FEATURE OF THE MARK.

THE MARK CONSISTS OF THE COLOR RED IS  
DEPICTED AT THE TOP AND BOTTOM OF THE  
BARS WHICH IS A DESIGN ELEMENT OF A FLAG.  
THE COLOR WHITE IS DEPICTED IN A WHITE  
BLOCK THAT IS LOCATED BETWEEN THE TOP  
AND BOTTOM OF THE TWO RED BARS WHICH IS  
A DESIGN ELEMENT OF A FLAG. THE COLOR  
BLUE IS DEPICTED IN THE MARK "KAMAU"  
WHICH IS LOCATED IN THE MIDDLE SECTION  
OF THE WHITE BLOCK THAT IS LOCATED BE-  
TWEEN THE TOP AND BOTTOM RED BARS THAT  
ARE A DESIGN ELEMENT OF A FLAG.

SER. NO. 76-686,574, FILED 2-6-2008.

JOHN WILKE, EXAMINING ATTORNEY

**Int. Cl.: 7**

**Prior U.S. Cls.: 13, 19, 21, 23, 31, 34 and 35**

**Reg. No. 3,497,578**

**United States Patent and Trademark Office**

**Registered Sep. 9, 2008**

**TRADEMARK  
PRINCIPAL REGISTER**

**SUZLON**

SUZLON WIND ENERGY CORPORATION (DE-  
LAWARE CORPORATION)  
8750 WEST BRYN MAWR AVENUE  
SUITE 720  
CHICAGO, IL 60631

FIRST USE 5-1-2003; IN COMMERCE 5-1-2003.

OWNER OF U.S. REG. NO. 2,811,396.

FOR: WIND TURBINES AND THEIR COMPO-  
NENTS, NAMELY, NACELLE, GEARBOX, GEN-  
ERATOR, CONTROL SYSTEM, HUB, TOWER,  
AND BLADES, IN CLASS 7 (U.S. CLS. 13, 19, 21, 23,  
31, 34 AND 35).

SER. NO. 76-686,593, FILED 2-6-2008.

JOHN HWANG, EXAMINING ATTORNEY

**Int. Cl.: 40**

**Prior U.S. Cls.: 100, 103 and 106**

**United States Patent and Trademark Office**

**Reg. No. 3,497,579**

**Registered Sep. 9, 2008**

**SERVICE MARK  
PRINCIPAL REGISTER**

**CITRINE**

FRAC TECH SERVICES LTD. (TEXAS LIMITED  
PARTNERSHIP)  
16858 INTERSTATE 20  
CISCO, TX 76437

FOR: OIL AND GAS WELL STIMULATION SERVICES, NAMELY, HYDRAULIC FRACTURING AND COMPLETION SERVICES USING SPECIALIZED FORMULATIONS OF AQUEOUS POLYMER COMPOUND SOLUTIONS, IN CLASS 40 (U.S. CLS. 100, 103 AND 106).

FIRST USE 11-15-2007; IN COMMERCE 11-15-2007.

THE MARK CONSISTS OF STANDARD CHARACTERS WITHOUT CLAIM TO ANY PARTICULAR FONT, STYLE, SIZE, OR COLOR.

SER. NO. 76-686,614, FILED 2-7-2008.

VIVIAN MICZNIK FIRST, EXAMINING ATTORNEY

**Int. Cl.: 14**

**Prior U.S. Cls.: 2, 27, 28 and 50**

**United States Patent and Trademark Office**

**Reg. No. 3,497,580**

**Registered Sep. 9, 2008**

**TRADEMARK  
PRINCIPAL REGISTER**

**SUPER TECHNO**

RODEO OF NY INC. (NEW YORK CORPORATION)  
62 WEST 47TH STREET, SUITE 14A2  
NEW YORK, NY 10036

FIRST USE 7-1-2007; IN COMMERCE 7-1-2007.

SER. NO. 76-686,641, FILED 2-8-2008.

FOR: WATCHES, NAMELY, WRISTWATCHES,  
POCKET WATCHES, DIVING WATCHES, CLOCKS  
AND WATCH CASES, IN CLASS 14 (U.S. CLS. 2, 27, 28  
AND 50).

BRIAN CALLAGHAN, EXAMINING ATTORNEY

**Int. Cl.: 41**

**Prior U.S. Cls.: 100, 101 and 107**

**United States Patent and Trademark Office**

**Reg. No. 3,497,581**

**Registered Sep. 9, 2008**

**SERVICE MARK  
PRINCIPAL REGISTER**

**WOMENCREATE**

EMPIRE ROAD PRODUCTIONS, LLC (UTAH  
LIMITED LIABILITY COMPANY)  
215 25TH STREET  
OGDEN, UT 84401

FOR: CONDUCTING WORKSHOPS, SEMINARS,  
SYMPOSIUMS, AND CLASSES IN ARTS, CRAFTS,  
SCRAPBOOKING, KNITTING, STAINED GLASS  
MAKING, AND SMALL BUSINESS DEVELOP-  
MENT, IN CLASS 41 (U.S. CLS. 100, 101 AND 107).

FIRST USE 4-0-2005; IN COMMERCE 4-0-2005.

THE MARK CONSISTS OF STANDARD CHAR-  
ACTERS WITHOUT CLAIM TO ANY PARTICULAR  
FONT, STYLE, SIZE, OR COLOR.

SER. NO. 76-686,655, FILED 2-8-2008.

MICHAEL TANNER, EXAMINING ATTORNEY

**Int. Cl.: 9**

**Prior U.S. Cls.: 21, 23, 26, 36 and 38**

**United States Patent and Trademark Office**

**Reg. No. 3,497,582**

**Registered Sep. 9, 2008**

**TRADEMARK  
PRINCIPAL REGISTER**

**GET RHYTHM**

SUN INTERNATIONAL CORPORATION (TEN-  
NESSEE CORPORATION)  
3106 BELMONT BOULEVARD  
NASHVILLE, TN 37212

THE MARK CONSISTS OF STANDARD CHAR-  
ACTERS WITHOUT CLAIM TO ANY PARTICULAR  
FONT, STYLE, SIZE, OR COLOR.

FOR: DECORATIVE MAGNETS, IN CLASS 9 (U.S.  
CLS. 21, 23, 26, 36 AND 38).

SER. NO. 76-686,668, FILED 2-8-2008.

FIRST USE 11-30-2007; IN COMMERCE 11-30-2007.

ANTHONY RINKER, EXAMINING ATTORNEY



**Int. Cl.: 25**

**Prior U.S. Cls.: 22 and 39**

**United States Patent and Trademark Office**

**Reg. No. 3,497,583**

**Registered Sep. 9, 2008**

**TRADEMARK  
PRINCIPAL REGISTER**

**BABY BLOSSOM**

KIM, JONG SUH (UNITED STATES INDIVIDUAL)

3215 WEST PICO BOULEVARD, #115

LOS ANGELES, CA 90019

FOR: CLOTHING, NAMELY, DRESSES, SHIRTS, JACKETS, PANTS, JUMPSUITS, SHOES, SOCKS AND HATS, IN CLASS 25 (U.S. CLS. 22 AND 39).

FIRST USE 2-1-2008; IN COMMERCE 2-1-2008.

THE MARK CONSISTS OF STANDARD CHARACTERS WITHOUT CLAIM TO ANY PARTICULAR FONT, STYLE, SIZE, OR COLOR.

NO CLAIM IS MADE TO THE EXCLUSIVE RIGHT TO USE "BABY", APART FROM THE MARK AS SHOWN.

SER. NO. 76-686,702, FILED 2-11-2008.

ALICE BENMAMAN, EXAMINING ATTORNEY

Int. Cl.: 29

Prior U.S. Cl.: 46

United States Patent and Trademark Office

Reg. No. 3,497,584

Registered Sep. 9, 2008

TRADEMARK  
PRINCIPAL REGISTER



POWERS, JOHN WILLIAM (UNITED STATES INDIVIDUAL)  
214 S. MAGNOLIA STREET  
ELMWOOD, IL 61529

FOR: SMOKED BEEF, PORK, TURKEY AND BEEF JERKY ALL SEALED IN VACUUM BAGS, IN CLASS 29 (U.S. CL. 46).

FIRST USE 1-21-1998; IN COMMERCE 7-27-2007.

NO CLAIM IS MADE TO THE EXCLUSIVE RIGHT TO USE "HILLBILLY STYLE" AND "PRODUCTS", APART FROM THE MARK AS SHOWN.

THE COLOR(S) YELLOW, PINK, ORANGE, BROWN, BLACK, WHITE, BLUE, TAN, RED AND DARK BLUE IS/ARE CLAIMED AS A FEATURE OF THE MARK.

THE COLORS YELLOW, PINK, ORANGE AND BROWN APPEAR IN THE RINGED CIRCLE DESIGN THAT FORMS THE BACK GROUND TO THE ENTIRE MARK. THE COLOR BLACK APPEARS IN THE WORDING "J & J PRODUCTS", "HILLBILLY

STYLE", THE OUTLINE OF THE INNER SQUARE DESIGN, THE OUTLINE OF THE SIGNS, THE OUTLINE OF THE HAT, EYES AND BEARD OF THE MAN DESIGN, THE LINES INDICATING MOVEMENT BEHIND THE MAN DESIGN, THE SHADOW OF THE MAN DESIGN'S LEFT FOOT, THE SPIT, THE OUTLINE OF THE COW DESIGN, FIRE AND LOGS; THE COLOR WHITE APPEARS IN THE LINES INDICATING MOVEMENT BEHIND THE MAN DESIGN; THE COLOR BLUE APPEARS AS THE BACK GROUND TO THE AREA INSIDE THE SQUARE DESIGN; THE COLOR TAN APPEARS IN THE COW DESIGN AND THE MAN DESIGN; THE COLOR RED APPEARS IN THE MAN DESIGN'S SHIRT; THE COLOR DARK BLUE APPEARS IN THE MAN DESIGN'S OVERALLS; THE COLORS ORANGE, YELLOW AND RED APPEAR IN THE FIRE DESIGN; THE COLOR YELLOW APPEARS IN THE HALO AROUND THE FIRE DESIGN; THE COLOR BROWN APPEARS IN THE LOGS.

SER. NO. 76-686,708, FILED 2-11-2008.

DAVID MURRAY, EXAMINING ATTORNEY

**Int. Cl.: 29**

**Prior U.S. Cl.: 46**

**United States Patent and Trademark Office**

**Reg. No. 3,497,585**

**Registered Sep. 9, 2008**

**TRADEMARK  
PRINCIPAL REGISTER**

**J & J PRODUCTS HILLBILLY STYLE**

POWERS, JOHN WILLIAM (UNITED STATES  
INDIVIDUAL)  
214 S. MAGNOLIA STREET  
ELMWOOD, IL 61529

FOR: SMOKED BEEF, PORK, TURKEY AND  
BEEF JERKY ALL SEALED IN VACUUM BAGS,  
IN CLASS 29 (U.S. CL. 46).

FIRST USE 1-21-1998; IN COMMERCE 7-27-2007.

THE MARK CONSISTS OF STANDARD CHAR-  
ACTERS WITHOUT CLAIM TO ANY PARTICULAR  
FONT, STYLE, SIZE, OR COLOR.

NO CLAIM IS MADE TO THE EXCLUSIVE  
RIGHT TO USE "PRODUCTS HILLBILLY STYLE",  
APART FROM THE MARK AS SHOWN.

SER. NO. 76-686,709, FILED 2-11-2008.

DAVID MURRAY, EXAMINING ATTORNEY

**Int. Cl.: 29**

**Prior U.S. Cl.: 46**

**United States Patent and Trademark Office**

**Reg. No. 3,497,586**

**Registered Sep. 9, 2008**

**TRADEMARK  
PRINCIPAL REGISTER**



NORMAN W. FRIES, INC. (GEORGIA CORPORATION)  
P.O. BOX 428  
CLAXTON, GA 30417

NO CLAIM IS MADE TO THE EXCLUSIVE RIGHT TO USE "CHICKEN", APART FROM THE MARK AS SHOWN.

SEC. 2(F) AS TO "CLAXTON".

FOR: POULTRY, IN CLASS 29 (U.S. CL. 46).

SER. NO. 76-687,197, FILED 2-28-2008.

FIRST USE 4-29-1982; IN COMMERCE 4-29-1982.

MARK T. MULLEN, EXAMINING ATTORNEY

**Int. Cl.: 35**

**Prior U.S. Cls.: 100, 101 and 102**

**United States Patent and Trademark Office**

**Reg. No. 3,497,587**

**Registered Sep. 9, 2008**

**SERVICE MARK  
PRINCIPAL REGISTER**

**ACCUFILL**

ACADEMY CORPORATION (NEW MEXICO CORPORATION)  
5520 MIDWAY PARK PLACE NE  
ALBUQUERQUE, NM 87109

FOR: DISTRIBUTORSHIPS IN THE FIELD OF AUTOMATED INK CARTRIDGE REFILLING MACHINES AND APPARATUS, AND RELATED EQUIPMENT AND PRODUCTS, NAMELY, REFILLABLE INK CARTRIDGES, WEIGHING SCALES, VACUUM WANDS, LOW TORQUE DRILLS, VACUUM BOXES, COLOR TOUCH-SCREEN INTERFACES, ATOMIZERS, AND CENTRIFUGES, AT LEAST SOME OF WHICH ARE AN INTEGRAL PART OF THE AUTOMATED INK CARTRIDGE REFILLING MACHINES, ALL OF WHICH ARE USED IN CONNECTION WITH INKJET PRINTERS; ADVERTISING AND MARKETING OF AUTOMATED INK CARTRIDGE REFILLING MACHINES AND APPARATUS, AND RELATED EQUIPMENT AND PRODUCTS, NAMELY, REFILLABLE INK CARTRIDGES, WEIGHING SCALES, VACUUM

WANDS, LOW TORQUE DRILLS, VACUUM BOXES, COLOR TOUCH-SCREEN INTERFACES, ATOMIZERS, AND CENTRIFUGES, AT LEAST SOME OF WHICH ARE AN INTEGRAL PART OF THE AUTOMATED INK CARTRIDGE REFILLING MACHINES, ALL OF WHICH ARE USED IN CONNECTION WITH INKJET PRINTERS, IN CLASS 35 (U.S. CLS. 100, 101 AND 102).

FIRST USE 2-26-2006; IN COMMERCE 2-26-2006.

THE MARK CONSISTS OF STANDARD CHARACTERS WITHOUT CLAIM TO ANY PARTICULAR FONT, STYLE, SIZE, OR COLOR.

OWNER OF U.S. REG. NOS. 3,273,234 AND 3,328,221.

SER. NO. 76-687,266, FILED 3-3-2008.

BARBARA RUTLAND, EXAMINING ATTORNEY

**Int. Cl.: 37**

**Prior U.S. Cls.: 100, 103 and 106**

**United States Patent and Trademark Office**

**Reg. No. 3,497,588**

**Registered Sep. 9, 2008**

**SERVICE MARK  
PRINCIPAL REGISTER**

**ACCUFILL**

ACADEMY CORPORATION (NEW MEXICO CORPORATION)  
5520 MIDWAY PARK PLACE NE  
ALBUQUERQUE, NM 87109

FOR: REPAIR AND MAINTENANCE OF AUTOMATED INK CARTRIDGE REFILLING MACHINES AND APPARATUS, INCLUDING RELATED EQUIPMENT AND PRODUCTS, NAMELY, REFILLABLE INK CARTRIDGES, WEIGHING SCALES, VACUUM WANDS, LOW TORQUE DRILLS, VACUUM BOXES, COLOR TOUCH-SCREEN INTERFACES, ATOMIZERS, AND CENTRIFUGES, AT LEAST SOME OF WHICH ARE AN INTEGRAL PART OF THE AUTOMATED INK CARTRIDGE REFILLING MACHINES, ALL OF WHICH ARE USED IN

CONNECTION WITH INKJET PRINTERS, IN CLASS 37 (U.S. CLS. 100, 103 AND 106).

FIRST USE 2-26-2006; IN COMMERCE 2-26-2006.

THE MARK CONSISTS OF STANDARD CHARACTERS WITHOUT CLAIM TO ANY PARTICULAR FONT, STYLE, SIZE, OR COLOR.

OWNER OF U.S. REG. NOS. 3,273,234 AND 3,328,221.

SER. NO. 76-687,268, FILED 3-3-2008.

BARBARA RUTLAND, EXAMINING ATTORNEY

**Int. Cl.: 3**

**Prior U.S. Cls.: 1, 4, 6, 50, 51 and 52**

**United States Patent and Trademark Office**

**Reg. No. 3,497,589**

**Registered Sep. 9, 2008**

**TRADEMARK  
PRINCIPAL REGISTER**

**C E FERULIC**

L'OREAL USA CREATIVE, INC. (DELAWARE  
CORPORATION)  
575 FIFTH AVENUE  
NEW YORK, NY 10017

FOR: FACIAL SERUM, IN CLASS 3 (U.S. CLS. 1, 4,  
6, 50, 51 AND 52).

FIRST USE 2-15-2005; IN COMMERCE 2-15-2005.

THE MARK CONSISTS OF STANDARD CHAR-  
ACTERS WITHOUT CLAIM TO ANY PARTICULAR  
FONT, STYLE, SIZE, OR COLOR.

OWNER OF U.S. REG. NO. 3,185,073.

SEC. 2(F).

SER. NO. 76-688,456, FILED 4-7-2008.

HENRY S. ZAK, EXAMINING ATTORNEY

**Int. Cl.: 42**

**Prior U.S. Cls.: 100 and 101**

**United States Patent and Trademark Office**

**Reg. No. 3,497,590**

**Registered Sep. 9, 2008**

**SERVICE MARK  
PRINCIPAL REGISTER**

**RESENE**

RESENE PAINTS LIMITED (NEW ZEALAND  
LIMITED LIABILITY COMPANY)  
32-50 VOGEL STREET  
NAENAE, LOWER HUTT, NEW ZEALAND

OWNER OF NEW ZEALAND REG. NO. 2999042,  
DATED 9-30-1998, EXPIRES 9-30-2015.

FOR: PRODUCT DEVELOPMENT SERVICES  
FOR OTHERS RELATING TO FORMULATION OF  
PAINT AND PAINT COLORS, IN CLASS 42 (U.S.  
CLS. 100 AND 101).

SER. NO. 76-977,836, FILED 3-7-2001.

TRACY FLETCHER, EXAMINING ATTORNEY



**Int. Cl.: 11**

**Prior U.S. Cls.: 13, 21, 23, 31 and 34**

**United States Patent and Trademark Office**

**Reg. No. 3,497,591**

**Registered Sep. 9, 2008**

**TRADEMARK  
PRINCIPAL REGISTER**

# ConCordia

PRESSALIT GROUP A/S (DENMARK CORPORATION)  
PRESSALITVEJ 1  
RY, DENMARK 8680

FOR: SANITARY WARE, NAMELY, TOILET SEATS, IN CLASS 11 (U.S. CLS. 13, 21, 23, 31 AND 34).

FIRST USE 1-0-2007; IN COMMERCE 6-0-2007.

THE MARK CONSISTS OF STANDARD CHARACTERS WITHOUT CLAIM TO ANY PARTICULAR FONT, STYLE, SIZE, OR COLOR.

PRIORITY CLAIMED UNDER SEC. 44(D) ON ERPN CMNTY TM OFC APPLICATION NO. 005653605, FILED 9-13-2006.

THE WORDING "CONCORDIA" HAS NO MEANING OR SIGNIFICANCE IN ANY FOREIGN LANGUAGE.

SER. NO. 77-003,425, FILED 9-20-2006.

HENRY S. ZAK, EXAMINING ATTORNEY

**Int. Cl.: 43**

**Prior U.S. Cls.: 100 and 101**

**United States Patent and Trademark Office**

**Reg. No. 3,497,592**

**Registered Sep. 9, 2008**

**SERVICE MARK  
PRINCIPAL REGISTER**



THE BRAMBLES RESTAURANT, INC. (CALIFORNIA CORPORATION)  
5520 OAKHURST DRIVE  
CAMBRIA, CA 93428

FOR: FOOD PREPARATION; PREPARATION OF FOOD AND BEVERAGES; PROVIDING A DATABASE IN THE FIELD OF RECIPES AND COOKING INFORMATION; RESTAURANT AND BAR SERVICES; RESTAURANT SERVICES; RESTAURANTS;

SERVING FOOD AND DRINKS; SERVING OF FOOD AND DRINK/BEVERAGES, IN CLASS 43 (U.S. CLS. 100 AND 101).

FIRST USE 10-12-1982; IN COMMERCE 10-12-1982.

SER. NO. 77-003,752, FILED 9-20-2006.

WENDY GOODMAN, EXAMINING ATTORNEY

Int. Cl.: 36

Prior U.S. Cls.: 100, 101 and 102

United States Patent and Trademark Office

Reg. No. 3,497,593

Registered Sep. 9, 2008

SERVICE MARK  
PRINCIPAL REGISTER



NEWS INSURANCE SERVICES, INC. (CALIFORNIA CORPORATION)  
1501 WEST CLIFF DRIVE, SUITE 301  
NEWPORT BEACH, CA 92660

FOR: INSURANCE SERVICES, NAMELY, WRITING PROPERTY, CASUALTY, LIFE, DISABILITY, AND COMMERCIAL INSURANCE, IN CLASS 36 (U.S. CLS. 100, 101 AND 102).

FIRST USE 11-1-2005; IN COMMERCE 11-1-2005.

NO CLAIM IS MADE TO THE EXCLUSIVE RIGHT TO USE "INSURANCE SERVICES PROVID-

ING COVERAGE NATIONWIDE", APART FROM THE MARK AS SHOWN.

THE MARK CONSISTS OF A COMPASS WITH THE WORDS GOING AROUND IT SAYING "NEWS INSURANCE SERVICES PROVIDING COVERAGE NATIONWIDE".

SER. NO. 77-006,413, FILED 9-25-2006.

JULIE WATSON, EXAMINING ATTORNEY

**Int. Cl.: 36**

**Prior U.S. Cls.: 100, 101 and 102**

**United States Patent and Trademark Office**

**Reg. No. 3,497,594**

**Registered Sep. 9, 2008**

**SERVICE MARK  
PRINCIPAL REGISTER**

**COINS THAT CARE**

IDAHO CENTRAL CREDIT UNION (IDAHO  
CORPORATION)  
4425 BURLEY DRIVE  
CHUBBUCK, ID 83202

THE MARK CONSISTS OF STANDARD CHAR-  
ACTERS WITHOUT CLAIM TO ANY PARTICULAR  
FONT, STYLE, SIZE, OR COLOR.

FOR: BANKING SERVICES, IN CLASS 36 (U.S.  
CLS. 100, 101 AND 102).

SER. NO. 77-010,828, FILED 9-29-2006.

FIRST USE 1-30-2006; IN COMMERCE 1-30-2006.

RON FAIRBANKS, EXAMINING ATTORNEY

**Int. Cls.: 16, 35 and 44**

**Prior U.S. Cls.: 2, 5, 22, 23, 29, 37, 38, 50, 100, 101 and 102**

**Reg. No. 3,497,595**

**United States Patent and Trademark Office**

**Registered Sep. 9, 2008**

**TRADEMARK  
SERVICE MARK  
PRINCIPAL REGISTER**

**CAMPAIGN BOOSTER**

INFOMEDICS, INC. (DELAWARE CORPORATION)  
12 GILL STREET  
WOBBURN, MA 01801

FOR: PRINTED MATERIAL, NAMELY, REPORTS RELATED TO PATIENT CONDITIONS AND PATIENT CARE TO FACILITATE PATIENT FEEDBACK REGARDING PHARMACEUTICALS, MEDICAL DEVICES, AND MEDICAL CARE; PRINTED MATERIAL, NAMELY, REPORTS OF SURVEY RESPONSE SUMMARIES FOR PHARMACEUTICAL COMPANIES RELATED TO TREATMENT PATTERNS, PRACTICE AND DIAGNOSTIC TRENDS AND PATIENT SATISFACTION, IN CLASS 16 (U.S. CLS. 2, 5, 22, 23, 29, 37, 38 AND 50).

FIRST USE 12-0-2005; IN COMMERCE 12-0-2005.

FOR: DATA COLLECTION SERVICES, NAMELY, TRANSCRIPTION, COMPILATION AND SYSTEMIZATION OF WRITTEN COMMUNICATIONS AND DATA FOR OTHERS RELATED TO PATIENT CONDITIONS AND PATIENT CARE TO FACILITATE PATIENT FEEDBACK REGARDING PHARMACEUTICALS, MEDICAL DEVICES, AND MEDICAL

CARE; DATA COLLECTION AND REPORTING SERVICES THAT FACILITATE PATIENT FEEDBACK REGARDING PHARMACEUTICAL, MEDICAL DEVICE OR MEDICAL CARE, NAMELY, CONDUCTING SURVEYS FOR OTHERS, IN CLASS 35 (U.S. CLS. 100, 101 AND 102).

FIRST USE 12-0-2005; IN COMMERCE 12-0-2005.

FOR: PROVIDING DATABASES IN THE FIELD OF HEALTH CARE TREATMENT AND FOR INPUTTING AND COLLECTION OF DATA AND INFORMATION ALL FOR TREATMENT AND DIAGNOSTIC PURPOSES, IN CLASS 44 (U.S. CLS. 100 AND 101).

FIRST USE 12-0-2005; IN COMMERCE 12-0-2005.

THE MARK CONSISTS OF STANDARD CHARACTERS WITHOUT CLAIM TO ANY PARTICULAR FONT, STYLE, SIZE, OR COLOR.

SER. NO. 77-011,972, FILED 10-2-2006.

INGRID C. EULIN, EXAMINING ATTORNEY

**Int. Cls.: 16, 35 and 44**

**Prior U.S. Cls.: 2, 5, 22, 23, 29, 37, 38, 50, 100, 101 and 102**

**United States Patent and Trademark Office**

**Reg. No. 3,497,596**

**Registered Sep. 9, 2008**

**TRADEMARK  
SERVICE MARK  
PRINCIPAL REGISTER**

**TREATMENT EDUCATOR**

INFOMEDICS, INC. (DELAWARE CORPORATION)  
12 GILL STREET  
WOBURN, MA 01801

FOR: PRINTED MATERIAL, NAMELY, REPORTS RELATED TO PATIENT CONDITIONS AND PATIENT CARE TO FACILITATE PATIENT FEEDBACK REGARDING PHARMACEUTICALS, MEDICAL DEVICES, AND MEDICAL CARE; PRINTED MATERIAL, NAMELY, REPORTS OF SURVEY RESPONSE SUMMARIES FOR PHARMACEUTICAL COMPANIES RELATED TO TREATMENT PATTERNS, PRACTICE AND DIAGNOSTIC TRENDS AND PATIENT SATISFACTION, IN CLASS 16 (U.S. CLS. 2, 5, 22, 23, 29, 37, 38 AND 50).

FIRST USE 12-0-2005; IN COMMERCE 12-0-2005.

FOR: DATA COLLECTION SERVICES, NAMELY, TRANSCRIPTION, COMPILATION AND SYSTEMIZATION OF WRITTEN COMMUNICATIONS AND DATA FOR OTHERS RELATED TO PATIENT CONDITIONS AND PATIENT CARE TO FACILITATE PATIENT FEEDBACK REGARDING PHARMACEUTICALS, MEDICAL DEVICES, AND MEDICAL CARE; DATA COLLECTION AND REPORTING SERVICES THAT FACILITATE PATIENT FEED-

BACK REGARDING PHARMACEUTICAL, MEDICAL DEVICE OR MEDICAL CARE, NAMELY, CONDUCTING SURVEYS FOR OTHERS, IN CLASS 35 (U.S. CLS. 100, 101 AND 102).

FIRST USE 12-0-2005; IN COMMERCE 12-0-2005.

FOR: PROVIDING DATABASES IN THE FIELD OF HEALTH CARE TREATMENT AND FOR INPUTTING AND COLLECTION OF DATA AND INFORMATION ALL FOR TREATMENT AND DIAGNOSTIC PURPOSES, IN CLASS 44 (U.S. CLS. 100 AND 101).

FIRST USE 12-0-2005; IN COMMERCE 12-0-2005.

THE MARK CONSISTS OF STANDARD CHARACTERS WITHOUT CLAIM TO ANY PARTICULAR FONT, STYLE, SIZE, OR COLOR.

NO CLAIM IS MADE TO THE EXCLUSIVE RIGHT TO USE "TREATMENT", APART FROM THE MARK AS SHOWN.

SER. NO. 77-011,975, FILED 10-2-2006.

INGRID C. EULIN, EXAMINING ATTORNEY

**Int. Cl.: 14**

**Prior U.S. Cls.: 2, 27, 28 and 50**

**United States Patent and Trademark Office**

**Reg. No. 3,497,597**

**Registered Sep. 9, 2008**

**TRADEMARK  
PRINCIPAL REGISTER**

**AMEDEO**

RENAISSANCE COLLECTION CORP. (NEW  
YORK CORPORATION)  
5 EAST 57TH STREET  
NEW YORK, NY 10022

FOR: JEWELRY AND WATCHES, IN CLASS 14  
(U.S. CLS. 2, 27, 28 AND 50).

FIRST USE 6-0-2002; IN COMMERCE 6-0-2002.

THE MARK CONSISTS OF STANDARD CHAR-  
ACTERS WITHOUT CLAIM TO ANY PARTICULAR  
FONT, STYLE, SIZE, OR COLOR.

SEC. 2(F).

SER. NO. 77-013,710, FILED 10-4-2006.

SETH A. RAPPAPORT, EXAMINING ATTORNEY

**Int. Cl.: 35**

**Prior U.S. Cls.: 100, 101 and 102**

**United States Patent and Trademark Office**

**Reg. No. 3,497,598**

**Registered Sep. 9, 2008**

**SERVICE MARK  
PRINCIPAL REGISTER**



GLEE, INCORPORATED (MASSACHUSETTS CORPORATION)  
29 WEST STREET  
BEVERLY, MA 01915

FOR: ON-LINE RETAIL STORE SERVICES FEATURING CLOTHING; RETAIL APPAREL STORES; RETAIL CLOTHING BOUTIQUES; RETAIL CLOTHING STORES, IN CLASS 35 (U.S. CLS. 100, 101 AND 102).

FIRST USE 3-1-2003; IN COMMERCE 4-1-2003.

THE COLOR(S) ORANGE, WHITE, AND PINK IS/ ARE CLAIMED AS A FEATURE OF THE MARK.

THE MARK CONSISTS OF ORANGE CIRCLE CONTAINING, IN LOWER CASE LETTERS, SLANTING UPWARD FROM LEFT TO RIGHT, THE WORD "GLEE" IN WHITE, WITH A PINK DOT BENEATH THE LETTER "L".

SER. NO. 77-014,624, FILED 10-5-2006.

DAVID HOFFMAN, EXAMINING ATTORNEY



Int. Cl.: 41

Prior U.S. Cls.: 100, 101 and 107

United States Patent and Trademark Office

Reg. No. 3,497,599

Registered Sep. 9, 2008

SERVICE MARK  
PRINCIPAL REGISTER



CREATIVE LEARNING 4 KIDS, INC. (TEXAS CORPORATION)

6705 PATRICK

PLANO, TX 75093

FOR: EDUCATION SERVICES, NAMELY, PROVIDING TUTORING IN THE FIELD OF GENERAL EDUCATION FOR STUDENTS FROM KINDERGARTEN THROUGH GRADE 12, IN CLASS 41 (U.S. CLS. 100, 101 AND 107).

FIRST USE 7-8-2006; IN COMMERCE 9-14-2006.

NO CLAIM IS MADE TO THE EXCLUSIVE RIGHT TO USE "CREATIVE LEARNING FOR KIDS", APART FROM THE MARK AS SHOWN.

THE MARK CONSISTS OF A CHILD CLIMBING A LADDER WHICH IS LEANING AGAINST A TREE, ALL OF WHICH HAS A CIRCLE BOUNDARY. UNDERNEATH THE DESIGN IS THE STYLIZED WORDING "CREATIVE" AND THE WORDING "LEARNING 4 KIDS".

SER. NO. 77-015,037, FILED 10-5-2006.

SCOTT BIBB, EXAMINING ATTORNEY

Int. Cl.: 35

Prior U.S. Cls.: 100, 101 and 102

United States Patent and Trademark Office

Reg. No. 3,497,600

Registered Sep. 9, 2008

**SERVICE MARK  
PRINCIPAL REGISTER**



*Government Purchasers Saving You Money*

HB CAPITAL RESOURCES, LTD. (CALIFORNIA CORPORATION)  
SUITE 700  
2033 N. MAIN STREET  
WALNUT CREEK, CA 94596

FOR: PROCUREMENT SERVICES FOR OTHERS, NAMELY, PURCHASING OFFICE SUPPLIES, OFFICE FURNITURE, OFFICE MACHINES, SCHOOL SUPPLIES, SCHOOL FURNITURE, TECHNOLOGY PRODUCTS, TECHNOLOGY HARDWARE AND SOFTWARE, ELECTRICAL AND TELECOMMUNICATIONS EQUIPMENT, JANITORIAL SUPPLIES, CARPET AND FLOORING, PARK AND PLAYGROUND MATERIALS AND SUPPLIES, PHYSICAL EDUCATION SUPPLIES, MAINTENANCE AND HARDWARE SUPPLIES, HOMELAND SECURITY AND PUBLIC SAFETY SUPPLIES, ROOFING SUPPLIES AND SERVICES, AND AUTO PARTS AND ACCESSORIES, FOR OTHERS, IN CLASS 35 (U.S. CLS. 100, 101 AND 102).

FIRST USE 12-31-1999; IN COMMERCE 12-31-1999.

NO CLAIM IS MADE TO THE EXCLUSIVE RIGHT TO USE "GOVERNMENT PURCHASING ALLIANCE" AND "GOVERNMENT PURCHASERS SAVING YOU MONEY", APART FROM THE MARK AS SHOWN.

THE MARK CONSISTS OF THE WORDS "GOVERNMENT PURCHASING ALLIANCE" SURROUNDING A STYLIZED "U" ALL ABOVE THE WORD "U.S." ABOVE THE WORD "COMMUNITIES" ABOVE THE WORDS "GOVERNMENT PURCHASERS SAVING YOU MONEY".

SEC. 2(F) "U.S. COMMUNITIES".

SER. NO. 77-016,819, FILED 10-9-2006.

CHARLOTTE CORWIN, EXAMINING ATTORNEY

**Int. Cl.: 3**

**Prior U.S. Cls.: 1, 4, 6, 50, 51 and 52**

**United States Patent and Trademark Office**

**Reg. No. 3,497,601**

**Registered Sep. 9, 2008**

**TRADEMARK  
PRINCIPAL REGISTER**

**REVELAR DE NATURA**

NATURA COSMÉTICOS S/A (BRAZIL CORPORATION)  
RODOVIA RÉGIS BITTENCOURT, S/Nº KM 293  
ITAPECERICA DA SERRA, BRAZIL 06850

FOR: PERFUMERY; BODY SPRAYS; FRAGRANCES FOR PERSONAL USE; SCENTED BODY SPRAY; TOILET WATER; LAVENDER SCENTED TOILET WATER; NON-MEDICATED TOILETRIES, IN CLASS 3 (U.S. CLS. 1, 4, 6, 50, 51 AND 52).

THE MARK CONSISTS OF STANDARD CHARACTERS WITHOUT CLAIM TO ANY PARTICULAR FONT, STYLE, SIZE, OR COLOR.

OWNER OF BRAZIL REG. NO. 821717448, DATED 10-28-2003, EXPIRES 10-28-2013.

OWNER OF U.S. REG. NO. 2,164,917.

"NATURA" IS A LATIN WORD, WHICH PRIMARILY MEANS "NATURE", BUT ALSO MAY REFER TO THE "ELEMENT" OR "SUBSTANCE" OF SOMETHING, OR ITS "NATURAL PARTS". "REVELAR" MEANS "REVEAL."

SER. NO. 77-017,698, FILED 10-10-2006.

THOMAS MANOR, EXAMINING ATTORNEY

Int. Cls.: 9 and 42

Prior U.S. Cls.: 21, 23, 26, 36, 38, 100 and 101

United States Patent and Trademark Office

Reg. No. 3,497,602

Registered Sep. 9, 2008

TRADEMARK  
SERVICE MARK  
PRINCIPAL REGISTER

# PROGNOST-*Genuit*

PROGNOST SYSTEMS GMBH (FED REP GER-  
MANY GMBH)  
177 BIRKENALLEE  
48432 RHEINE, FED REP GERMANY

FOR: EQUIPMENT AND DEVICES TO CONDUCT, CONNECT, TRANSFORM, STORE ELECTRICITY AND/OR THE CONDITION OF MACHINES, NAMELY, CONDENSERS; DEVICES FOR PROCESSING ELECTRONIC DATA, NAMELY, ELECTRONIC DATA RELAYS FOR SENSORS, COMPUTERS; COMPUTER SYSTEMS CONSISTING OF COMPUTER HARDWARE AND COMPUTER SOFTWARE FOR MONITORING, INSPECTING AND TESTING THE CONDITION OF MACHINES, ENGINES AND COMPRESSORS; DEVICES FOR COLLECTION OF OPERATION DATA OR DEVICES FOR THE CONTROL AND MONITORING OF PROCESSES THROUGH APPLICATION OF SENSORS, MATHEMATICAL UNITS, STORAGE UNITS AS WELL AS DATA TRANSFER UNITS VIA CABLE AND VIA RADIO, NAMELY, DATA ACCESS PORTS FOR USE WITH ELECTRICAL CONTROL PANELS FOR CONNECTING MULTIPLE DATA AND ELECTRICAL DEVICES, GATEWAY ROUTERS IN THE NATURE OF COMPUTER CONTROL HARDWARE AND ELECTRICAL CONTROLLING DEVICES; ELECTRONIC DATABASE IN THE FIELD OF MONITORING, INSPECTING AND TESTING THE CONDITION OF MACHINES, ENGINES AND COMPRESSORS RECORDED ON COMPUTER MEDIA; BLANK MAGNETIC DATA CARRIERS; BLANK CD-ROM DISCS FOR PERMANENT STORAGE; STORED COMPUTER PROGRAMS FOR MONITORING, INSPECTING AND TESTING THE CONDITION OF MACHINES, ENGINES AND COMPRESSORS; COMPUTER STORAGE DEVICES, NAMELY, FLASH DRIVES; COMPUTER SOFTWARE FOR THE STORAGE OF DATA AND INFORMATION; TIME RECORDING DEVICES, NAMELY, TIME CLOCKS, CHRONOGRAPHS FOR USE AS SPECIALIZED TIME RECORDING APPARATUS; CENTRAL PROCESSING UNITS FOR PROCESSING DATA; BLANK OPTICAL DISCS

AND OPTICAL DISCS FEATURING ENGINE MONITORING DATA; OPTICAL DISC DRIVES; OPTICAL FIBERS SOLD AS A COMPONENT OF FIBER OPTIC CABLES; ELECTRICAL AND OPTICAL COMMUNICATIONS INSTRUMENTS AND COMPONENTS, NAMELY, OPTICAL DATA LINKS; ENCODED SMART CARDS CONTAINING PROGRAMMING TO MONITOR, INSPECT AND TEST THE CONDITION OF MACHINES, ENGINES AND COMPRESSORS; STORED COMPUTER SOFTWARE FOR ENCRYPTION; DOWNLOADABLE COMPUTER PROGRAMS FOR USE IN DATABASE MANAGEMENT FOR DATA RELATED TO MONITORING, INSPECTING AND TESTING THE CONDITION OF MACHINES, ENGINES AND COMPRESSORS; COMPUTER OPERATING PROGRAMS; STORED COMPUTER SOFTWARE, NAMELY, COMPUTER SOFTWARE FOR USE IN DATABASE MANAGEMENT FOR DATA RELATED TO MONITORING, INSPECTING AND TESTING THE CONDITION OF MACHINES, ENGINES AND COMPRESSORS; INTERFACES FOR DETECTORS; COMPUTER DEVICES OR PROGRAMS FOR INTERFACES, NAMELY, COMPUTER INTERFACE BOARDS AND GRAPHICAL USER INTERFACE SOFTWARE; COMPUTER PERIPHERAL DEVICES; ELECTRIC AND ELECTRONIC MEASURING INSTRUMENT, NAMELY, LENGTH, PRESSURE AND TEMPERATURE MEASURING GAUGES; LASER MEASURING SYSTEMS; COMPUTER MONITORS; COMPUTER SOFTWARE TO MONITOR AND TEST PERFORMANCE DATA OF ENGINES AND COMPRESSORS; DATA INDICATORS AND INDICATOR TABLES, NAMELY, ELECTRONIC INDICATOR BOARDS, ELECTRONIC INDICATOR PANELS, IN CLASS 9 (U.S. CLS. 21, 23, 26, 36 AND 38).

FIRST USE 4-5-2006; IN COMMERCE 4-5-2006.

FOR: TECHNICAL MONITORING, INSPECTING AND TESTING THE CONDITION OF MACHINES, ENGINES AND EQUIPMENT USING COMPUTERS, ELECTRONIC DATA PROCESSING EQUIPMENT,

DEVICES OR SYSTEMS FOR MONITORING OR MEASURING DATA ACQUISITION, DEVICES OR SYSTEMS FOR MONITORING THE CONDITION OF MACHINES, DEVICES OR SYSTEMS FOR MEASURING PARAMETERS AND CONDITIONS AT REMOTE LOCATIONS, DEVICES OR SYSTEMS FOR MONITORING COMPRESSORS, BLOWERS, SUPERCHARGERS, CONDENSERS, COMPRESSOR TURBINES, DATABASES FOR COMPRESSOR DATA, DATABASES AND SOFTWARE FOR MAINTAINING, UPKEEPING AND SERVICING DEVICES OR SYSTEMS FOR MONITORING RECIPROCATING ENGINES, PUMPS, COMPRESSORS AND DATABASES FOR RECIPROCATING ENGINES, PUMP AND COMPRESSOR DATA; DRAFTING DRAWINGS, PLANS, LAYOUTS, AND CONSTRUCTIVE DESIGNS; CONSULTATION IN THE FIELD OF PHYSICS; ENGINEERING IN THE NATURE OF

ADVICE, SERVICES OF TECHNICAL CONSULTING AND SERVICES OF CONSULTING ENGINEERS; PROGRAMMING OF COMPUTERS AND PROGRAMMING OF AND FOR DATA PROCESSING MACHINES FOR OTHERS; MATERIAL TESTING IN THE NATURE OF TESTING MATERIALS, RESEARCHING OF MATERIALS AND CARRYING OUT SPECIFICATION TESTS, IN CLASS 42 (U.S. CLS. 100 AND 101).

FIRST USE 4-5-2006; IN COMMERCE 4-5-2006.

OWNER OF U.S. REG. NO. 2,661,192.

SER. NO. 77-019,516, FILED 10-12-2006.

KATHERINE M. DUBRAY, EXAMINING ATTORNEY

**Int. Cl.: 35**

**Prior U.S. Cls.: 100, 101 and 102**

**United States Patent and Trademark Office**

**Reg. No. 3,497,603**

**Registered Sep. 9, 2008**

**SERVICE MARK  
PRINCIPAL REGISTER**

**FAST Mover Advantage**

TAYLOR, DOUGLAS B (UNITED STATES INDIVIDUAL)  
11 CAVALLINI DRIVE  
NOKOMIS, FL 34275

FOR: BUSINESS TO BUSINESS MANAGEMENT ADVISORY SERVICES IN THE AREAS OF MARKETING, SALES, STRATEGIC PLANNING AND REVENUE GENERATION FOR FINANCIAL SERVICES COMPANIES, IN CLASS 35 (U.S. CLS. 100, 101 AND 102).

FIRST USE 5-5-2006; IN COMMERCE 5-8-2006.

THE MARK CONSISTS OF STANDARD CHARACTERS WITHOUT CLAIM TO ANY PARTICULAR FONT, STYLE, SIZE, OR COLOR.

NO CLAIM IS MADE TO THE EXCLUSIVE RIGHT TO USE "ADVANTAGE", APART FROM THE MARK AS SHOWN.

SER. NO. 77-019,946, FILED 10-12-2006.

ELIZABETH KAJUBI, EXAMINING ATTORNEY

**Int. Cl.: 35**

**Prior U.S. Cls.: 100, 101 and 102**

**United States Patent and Trademark Office**

**Reg. No. 3,497,604**

**Registered Sep. 9, 2008**

**SERVICE MARK  
PRINCIPAL REGISTER**

**PEAK IMPACT**

PEAK IMPACT INC. (CANADA CORPORATION)  
2 BEAVERBROOK ROAD, SUITE 204  
OTTAWA, ONTARIO, CANADA K2K1L1

FOR: ELECTRONIC COMMERCE SERVICES, NAMELY, THE OPERATION OF AN ON-LINE MARKETING AGENCY TO ASSIST POTENTIAL BUYERS OF COMMODITIES OR SERVICES OF ANY KIND IN FINDING SELLERS THEREOF IN THE NATURE OF PROVIDING BUSINESS LEADS AND TO PROVIDE BUSINESS INFORMATION RELATED TO LEAD GENERATION, EXCLUDING SUCH SERVICES AS THEY RELATE TO THE CONSTRUCTION INDUSTRY; MARKETING SERVICES, NAMELY, THE GENERATION, MANAGEMENT AND DELIVERY OF BUSINESS OPPORTUNITY LEADS FOR THIRD PARTIES, EXCLUDING SUCH SERVICES AS THEY RELATE TO THE CONSTRUCTION INDUSTRY; BUSINESS CONSULTING SERVICES IN THE FIELD OF ON-LINE BUSINESS,

NAMELY, INCREASING BUSINESS PROFITABILITY AND REVENUES BY PROVIDING ADVICE WITH RESPECT TO WEBSITE DESIGN, INCREASING ON-LINE ADVERTISEMENT AND INCREASING TRAFFIC, IN CLASS 35 (U.S. CLS. 100, 101 AND 102).

THE MARK CONSISTS OF STANDARD CHARACTERS WITHOUT CLAIM TO ANY PARTICULAR FONT, STYLE, SIZE, OR COLOR.

PRIORITY CLAIMED UNDER SEC. 44(D) ON CANADA APPLICATION NO. 1313669, FILED 8-16-2006, REG. NO. TMA703795, DATED 12-21-2007, EXPIRES 12-21-2022.

SER. NO. 77-020,572, FILED 10-13-2006.

DOMINIC FATHY, EXAMINING ATTORNEY

**Int. Cl.: 11**

**Prior U.S. Cls.: 13, 21, 23, 31 and 34**

**United States Patent and Trademark Office**

**Reg. No. 3,497,605**

**Registered Sep. 9, 2008**

**TRADEMARK  
PRINCIPAL REGISTER**

**DC AIRCO**

THE DC AIRCO COMPANY (NETHERLANDS  
CORPORATION)  
FLEMINGSTRAAT 17  
HEERHUGOWAARD, NETHERLANDS 1704SL

FOR: AIR CONDITIONERS FOR VEHICLES,  
NAMELY, AN ANTI-IDLING AIR CONDITIONER  
FOR OVER-THE-ROAD TRUCKS WHICH COOLS  
THE DRIVER WITH THE ENGINE OFF , IN CLASS  
11 (U.S. CLS. 13, 21, 23, 31 AND 34).

FIRST USE 1-31-2004; IN COMMERCE 1-31-2004.

THE MARK CONSISTS OF STANDARD CHAR-  
ACTERS WITHOUT CLAIM TO ANY PARTICULAR  
FONT, STYLE, SIZE, OR COLOR.

SER. NO. 77-021,686, FILED 10-16-2006.

KATHERINE M. DUBRAY, EXAMINING ATTOR-  
NEY



**Int. Cl.: 25**

**Prior U.S. Cls.: 22 and 39**

**United States Patent and Trademark Office**

**Reg. No. 3,497,606**

**Registered Sep. 9, 2008**

**TRADEMARK  
PRINCIPAL REGISTER**

**HALEY & KATE**

JV/CHINA TING, LLC (NEW YORK LIMITED  
LIABILITY COMPANY)  
16TH FLOOR  
525 5TH AVENUE  
NEW YORK, NY 10018

FOR: BLOUSES, SKIRTS, PANTS, JACKETS,  
VESTS, SHRUGS; COATS, RAINCOATS, BELTS,  
GLOVES, SCARVES, HATS, LINGERIE, IN CLASS  
25 (U.S. CLS. 22 AND 39).

FIRST USE 5-6-2006; IN COMMERCE 5-6-2006.

THE MARK CONSISTS OF STANDARD CHAR-  
ACTERS WITHOUT CLAIM TO ANY PARTICULAR  
FONT, STYLE, SIZE, OR COLOR.

THE NAME HALEY & KATE DOES NOT IDEN-  
TIFY A LIVING INDIVIDUAL.

SER. NO. 77-022,499, FILED 10-17-2006.

KIMBERLY PERRY, EXAMINING ATTORNEY

**Int. Cl.: 25**

**Prior U.S. Cls.: 22 and 39**

**United States Patent and Trademark Office**

**Reg. No. 3,497,607**

**Registered Sep. 9, 2008**

**TRADEMARK  
PRINCIPAL REGISTER**

**TREVAN**

JV/CHINA TING, LLC (NEW YORK LIMITED  
LIABILITY COMPANY)  
16TH FLOOR  
525 5TH AVENUE  
NEW YORK, NY 10017

FOR: BLOUSES, SKIRTS, PANTS, JACKETS,  
VESTS, SHRUGS; COATS, RAINCOATS, BELTS,  
GLOVES, SCARVES, HATS, LINGERIE, IN CLASS  
25 (U.S. CLS. 22 AND 39).

FIRST USE 8-0-2006; IN COMMERCE 8-0-2006.

THE MARK CONSISTS OF STANDARD CHAR-  
ACTERS WITHOUT CLAIM TO ANY PARTICULAR  
FONT, STYLE, SIZE, OR COLOR.

SER. NO. 77-022,512, FILED 10-17-2006.

KIMBERLY PERRY, EXAMINING ATTORNEY

**Int. Cl.: 25**

**Prior U.S. Cls.: 22 and 39**

**United States Patent and Trademark Office**

**Reg. No. 3,497,608**

**Registered Sep. 9, 2008**

**TRADEMARK  
PRINCIPAL REGISTER**

**FELICIA & COMPANY**

JV/CHINA TING, LLC (NEW YORK LIMITED  
LIABILITY COMPANY)

16TH FLOOR

525 5TH AVENUE

NEW YORK, NY 10018

FOR: BLOUSES, SKIRTS, PANTS, JACKETS,  
VESTS, SHRUGS; COATS, RAINCOATS, BELTS,  
GLOVES, SCARVES, HATS, LINGERIE, IN CLASS  
25 (U.S. CLS. 22 AND 39).

FIRST USE 6-6-2006; IN COMMERCE 6-6-2006.

THE MARK CONSISTS OF STANDARD CHAR-  
ACTERS WITHOUT CLAIM TO ANY PARTICULAR  
FONT, STYLE, SIZE, OR COLOR.

NO CLAIM IS MADE TO THE EXCLUSIVE  
RIGHT TO USE "COMPANY", APART FROM THE  
MARK AS SHOWN.

THE NAME FELICIA DOES NOT IDENTIFY A  
LIVING INDIVIDUAL.

SER. NO. 77-022,555, FILED 10-17-2006.

KIMBERLY PERRY, EXAMINING ATTORNEY

**Int. Cls.: 3 and 10**

**Prior U.S. Cls.: 1, 4, 6, 26, 39, 44, 50, 51 and 52**

**United States Patent and Trademark Office**

**Reg. No. 3,497,609**

**Registered Sep. 9, 2008**

**TRADEMARK  
PRINCIPAL REGISTER**



THE F.A.C.E. COMPANY, L.L.C. (DELAWARE  
LIMITED LIABILITY COMPANY)  
P. O. BOX 4603  
WILMINGTON, DE 19807

FOR: SKIN CREAMS, IN CLASS 3 (U.S. CLS. 1, 4, 6,  
50, 51 AND 52).

FIRST USE 11-1-2002; IN COMMERCE 11-1-2002.

FOR: MEDICAL APPARATUS, NAMELY, A NEU-  
ROMUSCULAR ELECTRICAL STIMULATOR, IN  
CLASS 10 (U.S. CLS. 26, 39 AND 44).

FIRST USE 10-0-1994; IN COMMERCE 10-0-1994.

THE MARK CONSISTS OF A STYLIZED DRAW-  
ING OF A WOMAN'S FACE.

SER. NO. 77-024,035, FILED 10-18-2006.

DEZMONA MIZELLE, EXAMINING ATTORNEY

**Int. Cl.: 35**

**Prior U.S. Cls.: 100, 101 and 102**

**United States Patent and Trademark Office**

**Reg. No. 3,497,610**

**Registered Sep. 9, 2008**

**SERVICE MARK  
PRINCIPAL REGISTER**

**DOKSHOP**

PRISMA GRAPHIC CORPORATION (ARIZONA CORPORATION)  
2937 E. BROADWAY RD., #11  
PHOENIX, AZ 85040

FOR: PROVIDING MARKETING SERVICES FOR OTHERS, NAMELY, ONLINE ORDERING OF CUSTOMIZABLE BUSINESS FORMS, STATIONERY PRODUCTS, AND MARKETING MATERIALS; MANAGEMENT, TRACKING, INVENTORY CONTROL, AND USAGE REPORTING OF CUSTOMER BUSINESS FORMS, STATIONERY PRODUCTS, AND MARKETING MATERIALS; ORDER FULFILLMENT SERVICES IN THE FIELD OF DISTRIBUTION AND WAREHOUSING, PRINTING, DOCUMENT PRODUCTION, DECAL PRODUCTION, PRINT MANAGEMENT AND GRAPHIC ARTS DESIGN, IN CLASS 35 (U.S. CLS. 100, 101 AND 102).

TION, PRINT MANAGEMENT AND GRAPHIC ARTS DESIGN, IN CLASS 35 (U.S. CLS. 100, 101 AND 102).

FIRST USE 8-21-2002; IN COMMERCE 8-21-2002.

THE MARK CONSISTS OF STANDARD CHARACTERS WITHOUT CLAIM TO ANY PARTICULAR FONT, STYLE, SIZE, OR COLOR.

SEC. 2(F).

SER. NO. 77-024,413, FILED 10-18-2006.

LINDA ESTRADA, EXAMINING ATTORNEY

**Int. Cls.: 9, 14, 18 and 25**

**Prior U.S. Cls.: 1, 2, 3, 21, 22, 23, 26, 27, 28, 36, 38, 39, 41 and 50**

**Reg. No. 3,497,611**

**United States Patent and Trademark Office**

**Registered Sep. 9, 2008**

**TRADEMARK  
PRINCIPAL REGISTER**



ONETRUESAXON LIMITED (UNITED KINGDOM COMPANY)  
8 MANCHESTER SQUARE  
LONDON, UNITED KINGDOM W1U3PH

FOR: TELEPHONES, CELLULAR, WIRELESS AND MOBILE TELEPHONES, PAGERS AND PORTABLE TELECOMMUNICATION INSTANT MESSAGING DEVICES; ELECTRONIC ORGANIZERS; SPECTACLES, SPECTACLE FRAMES, SPECTACLE CASES, SUNGLASSES, SUNGLASSES FRAMES, SUNGLASSES CASES; TELEPHONES, CELLULAR, WIRELESS AND MOBILE TELEPHONES, PAGERS AND OTHER PORTABLE COMMUNICATIONS DEVICES; ELECTRONIC ORGANIZERS; RELATED ACCESSORIES FOR THE FOREGOING GOODS, NAMELY, TELEPHONE HEADSETS, MICROPHONES, AUDIO SPEAKERS, CARRIERS AND HOLDERS, BATTERIES AND BATTERY CHARGERS; POWER ADAPTERS; DOWNLOADABLE MOBILE PHONE CONTENT, NAMELY, RINGTONES, MUSIC VIDEOS AND AUDIO MUSIC FILES; MP3 PLAYERS; BAGS AND CASES ADAPTED OR SHAPED TO CONTAIN MP3 PLAYERS; HEADPHONES; AUDIO SPEAKERS; CHARGERS FOR ELECTRIC BATTERIES; SOLID STATE MEMORY APPARATUS, NAMELY MEMORY CARDS, IN CLASS 9 (U.S. CLS. 21, 23, 26, 36 AND 38).

FOR: ANKLE BRACELETS; BADGES OF PRECIOUS METAL; BELT BUCKLES OF PRECIOUS METAL; BODY-PIERCING RINGS AND STUDS; JEWELRY, NAMELY, BRACELETS; BRACELETS OF PRECIOUS METAL; BROOCHES; CIGARETTE CASES OF PRECIOUS METAL; CIGARETTE LIGHTERS OF PRECIOUS METAL; COSTUME JEWELRY;

CUFF-LINKS; EARRINGS; FANCY KEYRINGS OF PRECIOUS METAL; GEMSTONES; JEWELRY, NAMELY, IDENTITY BRACELETS; JEWELRY; JEWELRY CHAINS; JEWELRY WATCHES; NECKLACES; ORNAMENTAL PINS; RINGS; TIE CLIPS AND TIE PINS; ALARM CLOCKS; APPARATUS FOR TIMING SPORTING EVENTS; BOXES FOR TIMEPIECES; BUCKLES FOR WATCHSTRAPS; CASES FOR CLOCK AND WATCH-MAKING; CASES FOR WATCHES AND CLOCKS; CHRONOGRAPHS FOR USE AS WATCHES AND TIMEPIECES; CLOCK AND WATCH HANDS; CLOCKS; DIVING WATCHES; HOROLOGICAL AND CHRONOMETRIC INSTRUMENTS AND CASES AND PARTS THEREFOR; PARTS FOR CLOCKS AND WATCHES; SMALL CLOCKS; STOP WATCHES; TIMEPIECES; WALL CLOCKS; WATCH BANDS AND STRAPS; WATCH STRAPS; WATCHES; WATCHES FOR OUTDOOR USE; WRIST WATCHES, IN CLASS 14 (U.S. CLS. 2, 27, 28 AND 50).

FOR: LEATHER AND IMITATIONS OF LEATHER, NAMELY LEATHER AND IMITATION LEATHER BAGS, SUITCASES AND WALLETS; ANIMAL SKINS, HIDES; TRUNKS AND TRAVELLING BAGS; UMBRELLAS, PARASOLS AND WALKING STICKS; WHIPS, HARNESS AND SADDLERY; CLUTCH BAGS, TOTE BAGS, HANDBAGS, PURSES; RUCKSACKS, BACKPACKS, KNAPSACKS, SACHELS, ATTACHÉ CASES, CARRYING CASES, WALLETS, TRAVELING BAGS, HOLDALLS, DUFFLE BAGS, SPORT BAGS, GARMENT CARRIERS, IN CLASS 18 (U.S. CLS. 1, 2, 3, 22 AND 41).

FOR: CLOTHING, NAMELY, ANORAKS, ATHLETIC UNIFORMS, BATHING COSTUMES, BATH-

ING SUITS, BATHING TRUNKS, BATHROBES, BEACHWEAR, BELTS, BERMUDA SHORTS, BICYCLE GLOVES, BIKINIS, BLAZERS, BLOUSES, BOARD SHORTS, BOXER BRIEFS, BOXER SHORTS, BRIEFS, CARDIGANS, COATS, DRESSES, DRESSING GOWNS, FLEECE JACKETS, FLEECE PULLOVERS, FLEECE SHORTS, FOUL WEATHER GEAR, FOUNDATION GARMENTS, GAITERS, GALOSHES, GLOVES, GREATCOATS, GYM SHORTS, GYM SUITS, HEAVY JACKETS, HOSIERY, INSOLES, JACKETS, JEANS, JERKINS, JERSEYS, JOGGING PANTS, JOGGING SUITS, JUMPERS, JUMPSUITS, KNICKERS, KNIT SHIRTS, LIGHT REFLECTING COATS AND JACKETS, LOUNGEWEAR, MITTENS, NIGHTWEAR, OVERCOATS, PYJAMAS, PANTIES, PANTS, PARKAS, POLO SHIRTS, PULLOVERS, RAINWEAR, RUGBY SHORTS, RUGBY TOPS, SCARVES, SHIRTS, SHORTS, SHORT-SLEEVED OR LONG-SLEEVED T-SHIRTS, SHORT-SLEEVED SHIRTS, SINGLET, SKI WEAR, SKI JACKETS, SKI PANTS, SKI SUITS, SKIRTS, SLEEPWEAR, SOCKS, SPORT COATS, SPORTS JACKETS, SPORTS SHIRTS, STOCKINGS, SUITS, SURF WEAR, SWEAT SHIRTS, SWEAT SHORTS, SWEAT PANTS, SWIM WEAR, TANK TOPS, TIGHTS, TOP COATS, TRACK PANTS, TRACK SUITS, TROUSERS, TRUNKS, T-SHIRTS, UNDERCLOTHES, UNDERPANTS, UNDERSHIRTS, UNDERWEAR, VESTS, WAISTCOATS, WALKING SHORTS, WARM UP SUITS, WATERPROOF JACKETS AND PANTS,

WIND COATS, WIND RESISTANT JACKETS, WIND CHEATERS; FOOTWEAR, NAMELY, ATHLETIC FOOTWEAR, ATHLETIC SHOES, BASEBALL SHOES, BASKETBALL SNEAKERS; BEACH FOOTWEAR, BEACH SHOES, BOOTS, CANVAS SHOES, CLEATS FOR ATTACHMENTS TO SPORTS SHOES, CLIMBING BOOTS, NAMELY, MOUNTAINEERING BOOTS, FOOTBALL SHOES, GYMNASTIC SHOES, HIKING BOOTS, OVERSHOES, PUMPS, RAIN BOOTS, RUBBER SHOES, RUNNING SHOES, SHOES, SHOE SOLES, SKI BOOTS, SLIPPERS, SNEAKERS, SOCCER BOOTS, TRAINING SHOES; HEADGEAR, NAMELY, BANDANAS, BASEBALL CAPS, BEANIES, CAPS, HATS, HEAD SCARVES, HEADWEAR, WOOLLY HATS, IN CLASS 25 (U.S. CLS. 22 AND 39).

OWNER OF ERPN CMNTY TM OFC REG. NO. 004966404, DATED 4-11-2007, EXPIRES 3-17-2016.

OWNER OF ERPN CMNTY TM OFC REG. NO. 005355797, DATED 10-4-2007, EXPIRES 10-4-2016.

THE MARK CONSISTS OF A DOG STANDING UPON A TRIANGLE.

SER. NO. 77-024,968, FILED 10-19-2006.

AISHA SALEM, EXAMINING ATTORNEY

**Int. Cl.: 41**

**Prior U.S. Cls.: 100, 101 and 107**

**United States Patent and Trademark Office**

**Reg. No. 3,497,612**

**Registered Sep. 9, 2008**

**SERVICE MARK  
PRINCIPAL REGISTER**

# Friendango

FRIENDANGO CORPORATION (WYOMING  
CORPORATION)  
10 DURLSTON WAY  
LADERA RANCH, CA 92694

FOR: ENTERTAINMENT SERVICES NAMELY,  
PROVIDING A WEBSITE FEATURING, PHOTO-  
GRAPHIC, AUDIO, VIDEO AND PROSE PRESEN-  
TATIONS FEATURING SOCIAL NETWORKING, IN  
CLASS 41 (U.S. CLS. 100, 101 AND 107).

FIRST USE 7-1-2006; IN COMMERCE 7-1-2006.

THE MARK CONSISTS OF STANDARD CHAR-  
ACTERS WITHOUT CLAIM TO ANY PARTICULAR  
FONT, STYLE, SIZE, OR COLOR.

SER. NO. 77-026,521, FILED 10-21-2006.

TINA L. SNAPP, EXAMINING ATTORNEY



**Int. Cl.: 25**

**Prior U.S. Cls.: 22 and 39**

**United States Patent and Trademark Office**

**Reg. No. 3,497,613**

**Registered Sep. 9, 2008**

**TRADEMARK  
PRINCIPAL REGISTER**

**Little Miami Panthers**

LITTLE MIAMI ATHLETIC BOOSTER CLUB  
(OHIO NON-PROFIT ASSOCIATION)  
3001 US RT 22 & 3  
MORROW, OH 45152

FOR: COATS; GLOVES; HATS; SCARVES;  
SHORTS; SWEAT PANTS; SWEAT SHIRTS; T-  
SHIRTS; VESTS, IN CLASS 25 (U.S. CLS. 22 AND 39).

FIRST USE 8-0-2000; IN COMMERCE 8-1-2002.

THE MARK CONSISTS OF STANDARD CHAR-  
ACTERS WITHOUT CLAIM TO ANY PARTICULAR  
FONT, STYLE, SIZE, OR COLOR.

NO CLAIM IS MADE TO THE EXCLUSIVE  
RIGHT TO USE "MIAMI", APART FROM THE  
MARK AS SHOWN.

SER. NO. 77-028,402, FILED 10-24-2006.

EMILY CARLSEN, EXAMINING ATTORNEY

Prior U.S. Cl.: 200

United States Patent and Trademark Office

Reg. No. 3,497,614

Registered Sep. 9, 2008

COLLECTIVE MEMBERSHIP  
PRINCIPAL REGISTER



THE REAL ESTATE BOARD OF NEW YORK,  
INC. (NEW YORK CORPORATION)  
570 LEXINGTON AVENUE  
NEW YORK, NY 10022

FOR: INDICATING MEMBERSHIP IN AN ASSO-  
CIATION OF REAL ESTATE PROFESSIONALS, IN  
CLASS 200 (U.S. CL. 200).

FIRST USE 12-11-2006; IN COMMERCE 12-11-2006.

OWNER OF U.S. REG. NO. 3,187,048.

NO CLAIM IS MADE TO THE EXCLUSIVE  
RIGHT TO USE "REAL ESTATE BOARD OF NY",  
APART FROM THE MARK AS SHOWN.

THE COLOR(S) BLACK, GOLD AND RED IS/ARE  
CLAIMED AS A FEATURE OF THE MARK.

THE MARK CONSISTS OF THE COLOR BLACK  
APPEARS IN THE WORDING "REAL ESTATE  
BOARD OF NY" AND IN THE OVAL DESIGN  
AND RECTANGULAR DESIGNS; THE COLOR  
GOLD APPEARS IN THE WORDING "MEMBER"  
AND IN THE SEMI-CIRCULAR DESIGN; THE COL-  
OR RED APPEARS IN THE LETTER "R".

SER. NO. 77-029,019, FILED 10-25-2006.

BARNEY CHARLON, EXAMINING ATTORNEY

**Int. Cl.: 35**

**Prior U.S. Cls.: 100, 101 and 102**

**United States Patent and Trademark Office**

**Reg. No. 3,497,615**

**Registered Sep. 9, 2008**

**SERVICE MARK  
PRINCIPAL REGISTER**

**BACON OF THE MONTH CLUB**

THE GRATEFUL PALATE, INC. (CALIFORNIA CORPORATION)  
SUITE 210  
701 DEL NORTE BLVD.  
OXNARD, CA 93030

FOR: ON-LINE RETAIL STORE SERVICES FEATURING FOOD PRODUCTS; MAIL ORDER SERVICES FEATURING FOOD PRODUCTS; ON-LINE BUYING CLUB SERVICES FEATURING FOOD PRODUCTS, IN CLASS 35 (U.S. CLS. 100, 101 AND 102).

FIRST USE 10-1-1999; IN COMMERCE 10-1-1999.

THE MARK CONSISTS OF STANDARD CHARACTERS WITHOUT CLAIM TO ANY PARTICULAR FONT, STYLE, SIZE, OR COLOR.

OWNER OF U.S. REG. NOS. 2,644,829 AND 2,933,151.

NO CLAIM IS MADE TO THE EXCLUSIVE RIGHT TO USE "CLUB", APART FROM THE MARK AS SHOWN.

SEC. 2(F).

SER. NO. 77-030,530, FILED 10-26-2006.

LINDA ORNDORFF, EXAMINING ATTORNEY

**Int. Cl.: 31**

**Prior U.S. Cls.: 1 and 46**

**United States Patent and Trademark Office**

**Reg. No. 3,497,616**

**Registered Sep. 9, 2008**

**TRADEMARK  
PRINCIPAL REGISTER**

**SUBARASHII KUDAMONO**

SUBARASHII KUDAMONO COMPANY, INC.  
(PENNSYLVANIA CORPORATION)  
1506 PLEASANT VIEW ROAD  
COOPERSBURG, PA 18036

FOR: FRESH PEARS, IN CLASS 31 (U.S. CLS. 1  
AND 46).

FIRST USE 9-20-1995; IN COMMERCE 9-20-1995.

THE MARK CONSISTS OF STANDARD CHAR-  
ACTERS WITHOUT CLAIM TO ANY PARTICULAR  
FONT, STYLE, SIZE, OR COLOR.

OWNER OF U.S. REG. NOS. 2,046,815 AND  
2,195,765.

NO CLAIM IS MADE TO THE EXCLUSIVE  
RIGHT TO USE "KUDAMONO", APART FROM  
THE MARK AS SHOWN.

"THE FOREIGN WORDING IN THE MARK  
TRANSLATES INTO ENGLISH AS WONDERFUL  
FRUIT."

SEC. 2(F) "SUBARASHII HAS BECOME DISTINC-  
TIVE OF THE GOODS/SERVICES THROUGH THE  
APPLICANT'S SUBSTANTIALLY EXCLUSIVE AND  
CONTINUOUS USE IN COMMERCE FOR AT  
LEAST THE FIVE YEARS IMMEDIATELY BEFORE  
THE DATE OF THIS STATEMENT." .

SER. NO. 77-033,939, FILED 11-1-2006.

DEIRDRE ROBERTSON, EXAMINING ATTORNEY

**Int. Cl.: 20**

**Prior U.S. Cls.: 2, 13, 22, 25, 32 and 50**

**Reg. No. 3,497,617**

**United States Patent and Trademark Office**

**Registered Sep. 9, 2008**

**TRADEMARK  
PRINCIPAL REGISTER**

**AVENIR**

WINPAK (PENNSYLVANIA CORPORATION)  
828A NEWTOWN-YARDLEY RD, SU. 101  
NEWTOWN, PA 189401785

THE MARK CONSISTS OF STANDARD CHARACTERS WITHOUT CLAIM TO ANY PARTICULAR FONT, STYLE, SIZE, OR COLOR.

FOR: LID STOCK FOR CONTAINERS, PARTICULARLY, LIDDING FORMED OF LAMINATED RESINS WHICH MAY BE SEALED TO A CONTAINER AND SUBSEQUENTLY PEELED OPEN BY THE CONSUMER, IN CLASS 20 (U.S. CLS. 2, 13, 22, 25, 32 AND 50).

THE ENGLISH TRANSLATION OF "AVENIR" IS "FUTURE".

SER. NO. 77-034,099, FILED 11-1-2006.

FIRST USE 10-29-2006; IN COMMERCE 10-29-2006.

TRICIA SONNEBORN, EXAMINING ATTORNEY

**Int. Cls.: 35 and 41**

**Prior U.S. Cls.: 100, 101, 102 and 107**

**United States Patent and Trademark Office**

**Reg. No. 3,497,618**

**Registered Sep. 9, 2008**

**SERVICE MARK  
PRINCIPAL REGISTER**

# CATAPULT

U.S. DEVELOPMENT PARTNERS, LLC (DELA-  
WARE LIMITED LIABILITY COMPANY)  
303 HIGHLAND TERRACE  
WOODSIDE, CA 94062

FOR: ORGANIZING AND CONDUCTING BUSI-  
NESS CONFERENCES IN THE FIELDS OF BUSI-  
NESS STRATEGY, BUSINESS DEVELOPMENT,  
PRODUCT LICENSING, LEGALITIES, FUND RAIS-  
ING, MARKETING AND SALES AND PERSONNEL  
TO COMPANIES, INVESTORS, ENTREPRENEURS  
AND SERVICE PROVIDERS, IN CLASS 35 (U.S. CLS.  
100, 101 AND 102).

FIRST USE 8-1-2006; IN COMMERCE 8-1-2006.

FOR: ORGANIZING AND CONDUCTING EDU-  
CATIONAL CONFERENCES AND WORKSHOPS IN

THE FIELDS OF BUSINESS STRATEGY, BUSINESS  
DEVELOPMENT, PRODUCT LICENSING, LEGAL-  
ITIES, FUND RAISING, MARKETING AND SALES  
AND PERSONNEL TO COMPANIES, INVESTORS,  
ENTREPRENEURS AND SERVICE PROVIDERS, IN  
CLASS 41 (U.S. CLS. 100, 101 AND 107).

FIRST USE 8-1-2006; IN COMMERCE 8-1-2006.

THE MARK CONSISTS OF STANDARD CHAR-  
ACTERS WITHOUT CLAIM TO ANY PARTICULAR  
FONT, STYLE, SIZE, OR COLOR.

SER. NO. 77-034,259, FILED 11-1-2006.

ASMAT KHAN, EXAMINING ATTORNEY

**Int. Cl.: 36**

**Prior U.S. Cls.: 100, 101 and 102**

**United States Patent and Trademark Office**

**Reg. No. 3,497,619**

**Registered Sep. 9, 2008**

**SERVICE MARK  
PRINCIPAL REGISTER**

**CAMBRIDGE PAYMENT SYSTEMS**

JAMES NAFSO (UNITED STATES INDIVIDUAL)  
43155 MAIN ST.  
NO. 2208  
NOVI, MI 48375

FOR: CREDIT CARD TRANSACTION PROCES-  
SING SERVICES FOR COMMERCIAL BUSINESS  
ENTITIES TO ENABLE CONSUMERS TO USE  
CREDIT CARDS WITH THOSE BUSINESSES, IN  
CLASS 36 (U.S. CLS. 100, 101 AND 102).

FIRST USE 6-15-2004; IN COMMERCE 7-13-2004.

THE MARK CONSISTS OF STANDARD CHAR-  
ACTERS WITHOUT CLAIM TO ANY PARTICULAR  
FONT, STYLE, SIZE, OR COLOR.

NO CLAIM IS MADE TO THE EXCLUSIVE  
RIGHT TO USE "PAYMENT SYSTEMS", APART  
FROM THE MARK AS SHOWN.

SER. NO. 77-034,856, FILED 11-2-2006.

JEAN IM, EXAMINING ATTORNEY

**Int. Cls.: 35, 41 and 42**

**Prior U.S. Cls.: 100, 101, 102 and 107**

**United States Patent and Trademark Office**

**Reg. No. 3,497,620**

**Registered Sep. 9, 2008**

**SERVICE MARK  
PRINCIPAL REGISTER**

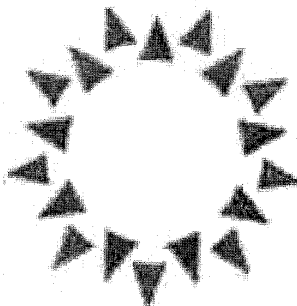

MITRATECH HOLDINGS, INC. (DELAWARE CORPORATION)  
SUITE 1500  
5900 WILSHIRE BOULEVARD  
LOS ANGELES, CA 90036

FOR: BUSINESS CONSULTATION SERVICES IN THE FIELD OF COMPUTER SOFTWARE, PROCESS REENGINEERING, WORKFLOW ANALYSIS, DESIGN WORKSHOP, AND NEED ANALYSIS, IN CLASS 35 (U.S. CLS. 100, 101 AND 102).

FIRST USE 0-0-1987; IN COMMERCE 0-0-1987.

FOR: EDUCATIONAL SERVICES, NAMELY, CONDUCTING CLASSES, SEMINARS, CONFERENCES, AND WORKSHOPS IN THE FIELD OF COMPUTERS AND COMPUTER SOFTWARE, IN CLASS 41 (U.S. CLS. 100, 101 AND 107).

FIRST USE 0-0-1987; IN COMMERCE 0-0-1987.

FOR: COMPUTER SOFTWARE DEVELOPMENT, DESIGN, AND CUSTOMIZATION FOR OTHERS; CONSULTING SERVICES IN THE FIELD OF DESIGN, SELECTION, IMPLEMENTATION AND USE OF COMPUTER SOFTWARE SYSTEMS FOR OTHERS; DESIGN AND DEVELOPMENT OF COMPUTER NETWORKS; DEVELOPING OF COMPUTER

SOFTWARE FOR USE IN DOCUMENT MANAGEMENT AND ELECTRONIC BILLING MANAGEMENT RELATING TO CORPORATE LEGAL MANAGEMENT, RISK MANAGEMENT, COMPLIANCE MANAGEMENT, AND OTHER MANAGEMENT PURPOSES; TECHNICAL SUPPORT SERVICES, NAMELY, TROUBLESHOOTING OF COMPUTER SOFTWARE PROBLEMS; IMPLEMENTATION OF COMPUTER SOFTWARE FOR OTHERS; INSTALLATION, MAINTENANCE AND UPDATING OF COMPUTER SOFTWARE FOR OTHERS; PROVIDING ON-LINE NON-DOWNLOADABLE SOFTWARE FOR DOCUMENT MANAGEMENT AND MANIPULATION TO PERMIT REAL-TIME COMMUNICATIONS, MANIPULATION AND COOPERATION ON ELECTRONIC FILES AND DATA, AND FOR ELECTRONIC BILLING, IN CLASS 42 (U.S. CLS. 100 AND 101).

FIRST USE 0-0-1987; IN COMMERCE 0-0-1987.

THE MARK CONSISTS OF TWO CONCENTRIC CIRCLES, EACH COMPRISED OF NINE SMALL TRIANGLES POINTING OUTWARD.

SER. NO. 77-035,506, FILED 11-2-2006.

MICHAEL SOUDERS, EXAMINING ATTORNEY



**Int. Cls.: 35 and 41**

**Prior U.S. Cls.: 100, 101, 102 and 107**

**United States Patent and Trademark Office**

**Reg. No. 3,497,621**

**Registered Sep. 9, 2008**

**SERVICE MARK  
PRINCIPAL REGISTER**

**MITRATECH**

MITRATECH HOLDINGS, INC. (DELAWARE CORPORATION)  
SUITE 1500  
5900 WILSHIRE BOULEVARD  
LOS ANGELES, CA 90036

FOR: BUSINESS CONSULTATION SERVICES IN THE FIELD OF COMPUTER SOFTWARE, PROCESS REENGINEERING, WORKFLOW ANALYSIS, DESIGN WORKSHOP, AND NEED ANALYSIS, IN CLASS 35 (U.S. CLS. 100, 101 AND 102).

FIRST USE 0-0-1987; IN COMMERCE 0-0-1987.

FOR: EDUCATIONAL SERVICES, NAMELY, CONDUCTING CLASSES, SEMINARS, CONFEREN-

CES, AND WORKSHOPS IN THE FIELD OF COMPUTERS AND COMPUTER SOFTWARE, IN CLASS 41 (U.S. CLS. 100, 101 AND 107).

FIRST USE 0-0-1987; IN COMMERCE 0-0-1987.

THE MARK CONSISTS OF STANDARD CHARACTERS WITHOUT CLAIM TO ANY PARTICULAR FONT, STYLE, SIZE, OR COLOR.

SER. NO. 77-035,515, FILED 11-2-2006.

MICHAEL SOUDERS, EXAMINING ATTORNEY

**Int. Cls.: 9 and 42**

**Prior U.S. Cls.: 21, 23, 26, 36, 38, 100 and 101**

**Reg. No. 3,497,622**

**United States Patent and Trademark Office**

**Registered Sep. 9, 2008**

**TRADEMARK  
SERVICE MARK  
PRINCIPAL REGISTER**

# BINGOLAND

GAME PARK TRADING LIMITED (BR.VIRGIN ISLANDS CORPORATION)  
ST. GEORGE'S COURT, UPPER CHURCH STREET  
DOUGLAS, ISLE OF MAN

FOR: COMPUTER SOFTWARE PLATFORM FOR INCORPORATING SINGLE OR MULTIPLE APPLICATIONS FEATURING FUNCTIONAL AND GRAPHICAL ELEMENTS IN THE GAMBLING FIELD; COMPUTER SOFTWARE FOR THE PROVISION OF MANAGEMENT, USE AND ACCESS OF PARTICIPANTS TO ON-LINE MULTIMEDIA ACTIVITIES IN THE ON-LINE GAMBLING FIELD; COMPUTER APPLICATION SOFTWARE FOR MOBILE PHONES IN THE ON-LINE GAMBLING FIELD; COMPUTER HARDWARE; ELECTRONIC COMPONENTS FOR COMPUTERS; COMPUTER PERIPHERAL EQUIPMENT; ELECTRIC APPARATUS AND INSTRUMENTS, NAMELY, SLOT MACHINES, JUKEBOXES, GAMING MACHINES AND GAMBLING MACHINES; AUTOMATIC VENDING MACHINES AND MECHANISMS FOR COIN-OPERATED APPARATUS IN THE GAMBLING FIELD, IN CLASS 9 (U.S. CLS. 21, 23, 26, 36 AND 38).

FOR: COMPUTER SOFTWARE RESEARCH, DEVELOPMENT AND DESIGN IN CONNECTION WITH COMPUTER UNIFIED SOFTWARE PLATFORM INCORPORATING SINGLE OR MULTIPLE APPLICATIONS FEATURING FUNCTIONAL AND

GRAPHICAL ELEMENTS IN THE GAMBLING FIELD; PROVIDING TEMPORARY USE OF NON-DOWNLOADABLE COMPUTER SOFTWARE FOR THE PROVISION OF MANAGEMENT, USE AND ACCESS OF PARTICIPANTS TO ON-LINE MULTIMEDIA ACTIVITIES IN THE ON-LINE GAMBLING FIELD; PROVIDING TEMPORARY USE OF NON-DOWNLOADABLE COMPUTER APPLICATION SOFTWARE FOR MOBILE PHONES IN THE ON-LINE GAMBLING FIELD; APPLICATION SERVICE PROVIDER FEATURING SOFTWARE FOR THE PROVISION OF MANAGEMENT, USE AND ACCESS OF PARTICIPANTS TO ON-LINE MULTIMEDIA ACTIVITIES IN THE ON-LINE GAMBLING FIELD; APPLICATION SERVICE PROVIDER FEATURING COMPUTER APPLICATION SOFTWARE FOR MOBILE PHONES IN THE ON-LINE GAMBLING FIELD, IN CLASS 42 (U.S. CLS. 100 AND 101).

THE MARK CONSISTS OF STANDARD CHARACTERS WITHOUT CLAIM TO ANY PARTICULAR FONT, STYLE, SIZE, OR COLOR.

OWNER OF ERPN CMNTY TM OFC REG. NO. 005510086, DATED 2-6-2008, EXPIRES 11-29-2016.

SER. NO. 77-038,143, FILED 11-7-2006.

DAVID TAYLOR, EXAMINING ATTORNEY

**Int. Cls.: 9 and 42**

**Prior U.S. Cls.: 21, 23, 26, 36, 38, 100 and 101**

**United States Patent and Trademark Office**

**Reg. No. 3,497,623**

**Registered Sep. 9, 2008**

**TRADEMARK  
SERVICE MARK  
PRINCIPAL REGISTER**



GAME PARK TRADING LIMITED (BR.VIRGIN ISLANDS CORPORATION)  
ST. GEORGE'S COURT, UPPER CHURCH STREET  
DOUGLAS, ISLE OF MAN

FOR: COMPUTER SOFTWARE PLATFORM FOR INCORPORATING SINGLE OR MULTIPLE APPLICATIONS FEATURING FUNCTIONAL AND GRAPHICAL ELEMENTS IN THE GAMBLING FIELD; COMPUTER SOFTWARE FOR THE PROVISION OF MANAGEMENT, USE AND ACCESS OF PARTICIPANTS TO ON-LINE MULTIMEDIA ACTIVITIES IN THE ON-LINE GAMBLING FIELD; COMPUTER APPLICATION SOFTWARE FOR MOBILE PHONES IN THE ON-LINE GAMBLING FIELD; COMPUTER HARDWARE; ELECTRONIC COMPONENTS FOR COMPUTERS; COMPUTER PERIPHERAL EQUIPMENT; ELECTRIC APPARATUS AND INSTRUMENTS, NAMELY, SLOT MACHINES, JUKEBOXES, GAMING MACHINES AND GAMBLING MACHINES; AUTOMATIC VENDING MACHINES AND MECHANISMS FOR COIN-OPERATED APPARATUS IN THE GAMBLING FIELD, IN CLASS 9 (U.S. CLS. 21, 23, 26, 36 AND 38).

FOR: COMPUTER SOFTWARE RESEARCH, DEVELOPMENT AND DESIGN IN CONNECTION WITH COMPUTER UNIFIED SOFTWARE PLATFORM INCORPORATING SINGLE OR MULTIPLE APPLICATIONS FEATURING FUNCTIONAL AND GRAPHICAL ELEMENTS IN THE GAMBLING FIELD; PROVIDING TEMPORARY USE OF NON-DOWNLOADABLE COMPUTER SOFTWARE FOR THE PROVISION OF MANAGEMENT, USE AND

ACCESS OF PARTICIPANTS TO ON-LINE MULTIMEDIA ACTIVITIES IN THE ON-LINE GAMBLING FIELD; PROVIDING TEMPORARY USE OF NON-DOWNLOADABLE COMPUTER APPLICATION SOFTWARE FOR MOBILE PHONES IN THE ON-LINE GAMBLING FIELD; APPLICATION SERVICE PROVIDER FEATURING SOFTWARE FOR THE PROVISION OF MANAGEMENT, USE AND ACCESS OF PARTICIPANTS TO ON-LINE MULTIMEDIA ACTIVITIES IN THE ON-LINE GAMBLING FIELD; APPLICATION SERVICE PROVIDER FEATURING COMPUTER APPLICATION SOFTWARE FOR MOBILE PHONES IN THE ON-LINE GAMBLING FIELD, IN CLASS 42 (U.S. CLS. 100 AND 101).

OWNER OF ERPN CMNTY TM OFC REG. NO. 5448411, DATED 10-26-2007, EXPIRES 11-8-2016.

THE COLOR(S) YELLOW, GOLD AND BLUE IS/ ARE CLAIMED AS A FEATURE OF THE MARK.

THE MARK CONSISTS OF THE STYLIZED LETTERS "BING" IN GOLD OUTLINED IN BLUE, FOLLOWED BY A BALL MADE OF GOLD-YELLOW STRIPE WITH BLUE BACKGROUND AND THE STYLIZED WORD "LAND" IN GOLD OUTLINED IN BLUE.

SER. NO. 77-038,144, FILED 11-7-2006.

DAVID TAYLOR, EXAMINING ATTORNEY

**Int. Cls.: 9 and 42**

**Prior U.S. Cls.: 21, 23, 26, 36, 38, 100 and 101**

**Reg. No. 3,497,624**

**United States Patent and Trademark Office**

**Registered Sep. 9, 2008**

**TRADEMARK  
SERVICE MARK  
PRINCIPAL REGISTER**



GAME PARK TRADING LIMITED (BR.VIRGIN ISLANDS CORPORATION)  
ST. GEORGE'S COURT, UPPER CHURCH STREET  
DOUGLAS, ISLE OF MAN

FOR: COMPUTER SOFTWARE PLATFORM FOR INCORPORATING SINGLE OR MULTIPLE APPLICATIONS FEATURING FUNCTIONAL AND GRAPHICAL ELEMENTS IN THE GAMBLING FIELD; COMPUTER SOFTWARE FOR THE PROVISION OF MANAGEMENT, USE AND ACCESS OF PARTICIPANTS TO ON-LINE MULTIMEDIA ACTIVITIES IN THE ON-LINE GAMBLING FIELD; COMPUTER APPLICATION SOFTWARE FOR MOBILE PHONES IN THE ON-LINE GAMBLING FIELD; COMPUTER HARDWARE; ELECTRONIC COMPONENTS FOR COMPUTERS; COMPUTER PERIPHERAL EQUIPMENT; ELECTRIC APPARATUS AND INSTRUMENTS, NAMELY, SLOT MACHINES, JUKEBOXES, GAMING MACHINES AND GAMBLING MACHINES; AUTOMATIC VENDING MACHINES AND MECHANISMS FOR COIN-OPERATED APPARATUS IN THE GAMBLING FIELD, IN CLASS 9 (U.S. CLS. 21, 23, 26, 36 AND 38).

FOR: COMPUTER SOFTWARE RESEARCH, DEVELOPMENT AND DESIGN IN CONNECTION WITH COMPUTER UNIFIED SOFTWARE PLATFORM INCORPORATING SINGLE OR MULTIPLE APPLICATIONS FEATURING FUNCTIONAL AND GRAPHICAL ELEMENTS IN THE GAMBLING FIELD; PROVIDING TEMPORARY USE OF NON-DOWNLOADABLE COMPUTER SOFTWARE FOR THE PROVISION OF MANAGEMENT, USE AND ACCESS OF PARTICIPANTS TO ON-LINE MULTIMEDIA ACTIVITIES IN THE ON-LINE GAMBLING

FIELD; PROVIDING TEMPORARY USE OF NON-DOWNLOADABLE COMPUTER APPLICATION SOFTWARE FOR MOBILE PHONES IN THE ON-LINE GAMBLING FIELD; APPLICATION SERVICE PROVIDER FEATURING SOFTWARE FOR THE PROVISION OF MANAGEMENT, USE AND ACCESS OF PARTICIPANTS TO ON-LINE MULTIMEDIA ACTIVITIES IN THE ON-LINE GAMBLING FIELD; APPLICATION SERVICE PROVIDER FEATURING COMPUTER APPLICATION SOFTWARE FOR MOBILE PHONES IN THE ON-LINE GAMBLING FIELD, IN CLASS 42 (U.S. CLS. 100 AND 101).

OWNER OF ERPN CMNTY TM OFC REG. NO. 5448105, DATED 10-19-2007, EXPIRES 8-11-2016.

NO CLAIM IS MADE TO THE EXCLUSIVE RIGHT TO USE "IPOKER NETWORK", APART FROM THE MARK AS SHOWN.

THE COLOR(S) RED AND BLACK IS/ARE CLAIMED AS A FEATURE OF THE MARK.

THE MARK CONSISTS OF THE STYLIZED COMBINATION "IPOKER", WITH THE LETTER "I" IN RED AND THE TERM "POKER" AND THE TERM "NETWORK" IN BLACK BELOW THE TERM "POKER", AND A CIRCLE LOGO IN BLACK WHICH CONNECTS TO THE LETTER "O" AND SURROUNDS THE LETTERS "I" AND "P".

SER. NO. 77-038,148, FILED 11-7-2006.

DAVID TAYLOR, EXAMINING ATTORNEY

**Int. Cl.: 36**

**Prior U.S. Cls.: 100, 101 and 102**

**United States Patent and Trademark Office**

**Reg. No. 3,497,625**

**Registered Sep. 9, 2008**

**SERVICE MARK  
PRINCIPAL REGISTER**



A QUICK SALE LIMITED (ENGLAND LIMITED COMPANY)  
67 MOOR LANE  
YORK, UNITED KINGDOM YO242QX

FOR: FINANCIAL VALUATION OF REAL PROPERTY; ARRANGING OR FACILITATING THE LEASING OR RENTAL OF REAL PROPERTY; REAL ESTATE AGENCIES; REAL ESTATE PROPERTY BROKERAGE, IN CLASS 36 (U.S. CLS. 100, 101 AND 102).

OWNER OF UNITED KINGDOM REG. NO. 2417243, DATED 3-21-2006, EXPIRES 3-21-2016.

NO CLAIM IS MADE TO THE EXCLUSIVE RIGHT TO USE "A QUICK SALE", APART FROM THE MARK AS SHOWN.

THE MARK CONSISTS OF A HOUSE DESIGN OVER THE WORDS "A QUICK SALE".

SER. NO. 77-039,359, FILED 11-8-2006.

CHRISIE B. KING, EXAMINING ATTORNEY

**Int. Cl.: 6**

**Prior U.S. Cls.: 2, 12, 13, 14, 23, 25 and 50**

**Reg. No. 3,497,626**

**United States Patent and Trademark Office**

**Registered Sep. 9, 2008**

**TRADEMARK  
PRINCIPAL REGISTER**



MILLENNIUM GARAGE DOORS, INC. (CALIFORNIA CORPORATION)  
555 SOUTH PROMENADE AVENUE, SUITE 103  
CORONA, CA 92879

FOR: METAL GARAGE DOORS WITH DESIGNER METAL WINDOW FRAMES AND GLASS PANE OPTIONS, SOLD AS A UNIT, IN CLASS 6 (U.S. CLS. 2, 12, 13, 14, 23, 25 AND 50).

FIRST USE 9-27-1999; IN COMMERCE 9-27-1999.

NO CLAIM IS MADE TO THE EXCLUSIVE RIGHT TO USE "GARAGE DOORS", APART FROM THE MARK AS SHOWN.

THE COLOR(S) BLUE AND RED IS/ARE CLAIMED AS A FEATURE OF THE MARK.

THE MARK CONSISTS OF WORDS, "MGD" AND "MILLENNIUM GARAGE DOORS", ARE UPPER CASE AND BLUE COLORED. THE LETTERS "MGD" ARE LINKED TOGETHER WITH A RED COLORED SHOOTING STAR CROSSED OVER THE LETTERS. THE WORD "MILLENNIUM" APPEARS UNDER "MGD". THE WORDS "GARAGE DOORS" APPEAR UNDERNEATH "MILLENNIUM".

SEC. 2(F).

SER. NO. 77-039,760, FILED 11-8-2006.

ZACHARY BELLO, EXAMINING ATTORNEY

**Int. Cls.: 5, 41 and 44**

**Prior U.S. Cls.: 6, 18, 44, 46, 51, 52, 100, 101 and 107**

**Reg. No. 3,497,627**

**United States Patent and Trademark Office**

**Registered Sep. 9, 2008**

**TRADEMARK  
SERVICE MARK  
PRINCIPAL REGISTER**



BODY IMAGE SOLUTIONS, LLC (LOUISIANA  
LIMITED LIABILITY COMPANY)  
7865 JEFFERSON HWY  
BATON ROUGE, LA 70809

FOR: DIETARY AND NUTRITIONAL SUPPLE-  
MENTS; DIETARY SUPPLEMENTS; NUTRITIONAL  
SUPPLEMENTS; STIMULATORY MEDICATIONS  
FOR USE IN WEIGHT REDUCTION PROGRAMS,  
IN CLASS 5 (U.S. CLS. 6, 18, 44, 46, 51 AND 52).

FIRST USE 6-1-2005; IN COMMERCE 6-1-2005.

FOR: PERSONAL TRAINER SERVICES, IN CLASS  
41 (U.S. CLS. 100, 101 AND 107).

FIRST USE 6-1-2005; IN COMMERCE 6-1-2005.

FOR: COSMETIC AND PLASTIC SURGERY;  
DIETARY AND NUTRITIONAL GUIDANCE; PRO-  
VIDING INFORMATION ABOUT DIETARY SUP-

PLEMENTS AND NUTRITION; WEIGHT  
REDUCTION DIET PLANNING AND SUPERVI-  
SION, IN CLASS 44 (U.S. CLS. 100 AND 101).

FIRST USE 6-1-2005; IN COMMERCE 6-1-2005.

NO CLAIM IS MADE TO THE EXCLUSIVE  
RIGHT TO USE "SOLUTIONS", APART FROM  
THE MARK AS SHOWN.

THE MARK CONSISTS OF A MALE FIGURE  
OVER THE CREST OF A WAVE ON THE LEFT SIDE  
OF THE PHRASE "BODY IMAGE SOLUTIONS"  
AND A FEMALE FIGURE OVER THE CREST OF  
THE A WAVE ON THE RIGHT SIDE OF THE  
PHRASE.

SER. NO. 77-039,892, FILED 11-8-2006.

CHRISTINA SOBRAL, EXAMINING ATTORNEY

**Int. Cl.: 9**

**Prior U.S. Cls.: 21, 23, 26, 36 and 38**

**Reg. No. 3,497,628**

**United States Patent and Trademark Office**

**Registered Sep. 9, 2008**

**TRADEMARK  
PRINCIPAL REGISTER**

**solio**

BETTER ENERGY SYSTEMS LIMITED (CALIFORNIA LIMITED LIABILITY COMPANY)  
1508 SIXTH STREET  
BERKELEY, CA 94710

FOR: SOLAR POWERED BATTERY; SOLAR POWERED BATTERY CHARGERS; SOLAR POWERED AUXILIARY POWER SUPPLIES FOR ELECTRONIC DEVICES; APPARATUS FOR CONVERTING ELECTRONIC RADIATION TO ELECTRICAL ENERGY, NAMELY, PHOTOVOLTAIC SOLAR MODULES; DRY CELLS; PHOTOVOLTAIC CELLS; SOLAR BATTERIES; CAPACITORS; CHARGERS FOR ELECTRIC BATTERIES; STORAGE BATTERY CHARGERS; ALL AFORESAID FOR USE WITH PORTABLE ELECTRONIC DEVICES, NAMELY, MOBILE PHONES, PORTABLE MUSIC PLAYERS, DIGITAL CAMERAS, MOBILE PHONE ACCESSORIES, BATTERY CHARGERS, COMPUTERS, PERSONAL DEVICE ACCESSORIES; MOBILE PHONE ACCESSORIES, NAMELY, HANDS FREE KITS FOR PHONES, WIRELESS HEADSETS

FOR PHONES AND DEVICES FOR HANDS FREE USE OF MOBILE PHONES; BATTERY CHARGERS; SOLAR ENERGY BATTERY AND AC CHARGERS FOR USE WITH PORTABLE ELECTRONIC DEVICES; COMPUTER HARDWARE; MOBILE TELEPHONES; DIGITAL CAMERAS; ELECTRONIC PERSONAL ORGANIZERS; COMPUTER SOFTWARE FOR USE IN OPERATING SOLAR POWERED DEVICES, IN CLASS 9 (U.S. CLS. 21, 23, 26, 36 AND 38).

FIRST USE 5-1-2002; IN COMMERCE 5-1-2002.

THE MARK CONSISTS OF STANDARD CHARACTERS WITHOUT CLAIM TO ANY PARTICULAR FONT, STYLE, SIZE, OR COLOR.

SER. NO. 77-040,086, FILED 11-8-2006.

LEIGH LOWRY, EXAMINING ATTORNEY



**Int. Cl.: 35**

**Prior U.S. Cls.: 100, 101 and 102**

**United States Patent and Trademark Office**

**Reg. No. 3,497,629**

**Registered Sep. 9, 2008**

**SERVICE MARK  
PRINCIPAL REGISTER**

**eTouches**

GLOBAL EXECUTIVE BUSINESS SERVICES, INC  
(NEW YORK CORPORATION)  
90 GROVE STREET, SUITE 01  
RIDGFIELD, CT 06877

THE MARK CONSISTS OF STANDARD CHAR-  
ACTERS WITHOUT CLAIM TO ANY PARTICULAR  
FONT, STYLE, SIZE, OR COLOR.

FOR: ON-LINE EVENT REGISTRATION FOR  
ATTENDEES OF SEMINARS, MEETINGS AND  
SEMINARS PERFORMED VIA THE INTERNET, IN  
CLASS 35 (U.S. CLS. 100, 101 AND 102).

SER. NO. 77-040,206, FILED 11-9-2006.

FIRST USE 6-1-2005; IN COMMERCE 6-1-2005.

PAM WILLIS, EXAMINING ATTORNEY

**Int. Cl.: 9**

**Prior U.S. Cls.: 21, 23, 26, 36 and 38**

**Reg. No. 3,497,630**

**United States Patent and Trademark Office**

**Registered Sep. 9, 2008**

**TRADEMARK  
PRINCIPAL REGISTER**

# Verification Experts

VEEX INC (CALIFORNIA CORPORATION)  
2255 MARTIN AVE, SUITE G  
SANTA CLARA, CA 95050

FIRST USE 4-1-2006; IN COMMERCE 10-1-2006.

FOR: ELECTRONIC TELECOMMUNICATIONS AND DATA COMMUNICATIONS TESTING EQUIPMENT, NAMELY, HAND-HELD PORTABLE AND RACK MOUNTED TESTING EQUIPMENT USED TO TEST AND VERIFY LINK QUALITY, SIGNAL STRENGTH, VOICE QUALITY, THROUGHPUT, VIDEO QUALITY, DATA INTEGRITY ON DSL LINKS, CABLE TV LINKS, ETHERNET LINKS, AND COMPUTER SOFTWARE FOR USE THEREWITH, IN CLASS 9 (U.S. CLS. 21, 23, 26, 36 AND 38).

THE MARK CONSISTS OF STANDARD CHARACTERS WITHOUT CLAIM TO ANY PARTICULAR FONT, STYLE, SIZE, OR COLOR.

NO CLAIM IS MADE TO THE EXCLUSIVE RIGHT TO USE "VERIFICATION", APART FROM THE MARK AS SHOWN.

SER. NO. 77-041,770, FILED 11-10-2006.

MAUREEN DALL, EXAMINING ATTORNEY

**Int. Cls.: 11, 20 and 24**

**Prior U.S. Cls.: 2, 13, 21, 22, 23, 25, 31, 32, 34, 42 and 50**

**United States Patent and Trademark Office**

**Reg. No. 3,497,631**

**Registered Sep. 9, 2008**

**TRADEMARK  
PRINCIPAL REGISTER**

**PUMMER**

NATURAL BY DESIGN, LTD. (CANADA CORPORATION)  
1 LEE VALLEY DRIVE  
PORT CARLING, CANADA POB1J0

FOR: LIGHTING FIXTURES, IN CLASS 11 (U.S. CLS. 13, 21, 23, 31 AND 34).

FIRST USE 0-0-1998; IN COMMERCE 0-0-1998.

FOR: FURNITURE AND FURNITURE ACCESSORIES, IN CLASS 20 (U.S. CLS. 2, 13, 22, 25, 32 AND 50).

FIRST USE 0-0-1998; IN COMMERCE 0-0-1998.

FOR: TEXTILES, NAMELY, TEXTILE FABRICS FOR HOME AND COMMERCIAL INTERIORS, IN CLASS 24 (U.S. CLS. 42 AND 50).

FIRST USE 0-0-1998; IN COMMERCE 0-0-1998.

THE MARK CONSISTS OF STANDARD CHARACTERS WITHOUT CLAIM TO ANY PARTICULAR FONT, STYLE, SIZE, OR COLOR.

SEC. 2(F).

SER. NO. 77-044,407, FILED 11-15-2006.

JOHN WILKE, EXAMINING ATTORNEY

**Int. Cls.: 9 and 41**

**Prior U.S. Cls.: 21, 23, 26, 36, 38, 100, 101 and 107**

**Reg. No. 3,497,632**

**United States Patent and Trademark Office**

**Registered Sep. 9, 2008**

**TRADEMARK  
SERVICE MARK  
PRINCIPAL REGISTER**

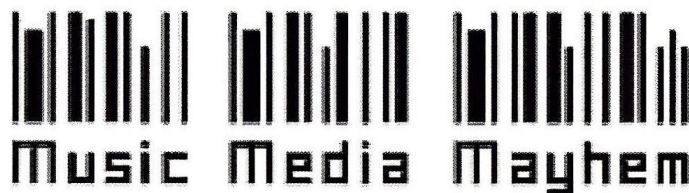

RUCKUS NETWORK, INC. (DELAWARE CORPORATION)  
SUITE 700  
12901 WORLDGATE DRIVE  
HERNDON, VA 20170

FOR: COMPUTER SOFTWARE FOR THE TRANSMISSION OF MUSIC, MOVIES, TELEVISION PROGRAMMING, VIDEOS, SPORTING EVENTS, GAMES AND NATIONAL, LOCAL AND CAMPUS CONTENT IN THE FORM OF ARTICLES, DOCUMENTS, NEWS AND INFORMATION VIA COLLEGE AND UNIVERSITY INTRANETS, IN CLASS 9 (U.S. CLS. 21, 23, 26, 36 AND 38).

FIRST USE 7-0-2006; IN COMMERCE 7-0-2006.

FOR: ENTERTAINMENT SERVICES, NAMELY, PROVIDING NON-DOWNLOADABLE PRE-RECORDED MUSIC AND LIVE MUSIC PERFORMANCES, MOVIES, TELEVISION PROGRAMMING, VIDEOS, AND ON-LINE COMPUTER GAMES AND NATIONAL, LOCAL AND CAMPUS CONTENT IN THE FORM OF ON-LINE PUBLICATIONS IN THE NATURE OF ARTICLES AND DOCUMENTS IN THE FIELDS OF BUSINESS, POLITICS, GOVERNMENT,

FINANCE, FINANCIAL PLANNING, FINANCIAL RESEARCH, INVESTING, STOCK QUOTES, SECURITIES, SECURITIES MARKETS, ECONOMICS, BANKRUPTCY, REAL ESTATE, HOME IMPROVEMENT, AUTOMOTIVE MAINTENANCE AND REPAIR, SPORTS, ENTERTAINMENT, EDUCATION, CULTURE, ART, MUSIC, MOVIES, THEATRE, BOOKS, GAMING, CURRENT NATIONAL AND INTERNATIONAL EVENTS, HISTORY, WEATHER, LAW, ENVIRONMENT, SCIENCE, TECHNOLOGY, COMPUTERS, COMPUTER SOFTWARE, DEFENSE, SECURITY, FASHION, CURRENT NATIONAL AND INTERNATIONAL NEWS AND EVENTS VIA COLLEGE AND UNIVERSITY INTRANETS, IN CLASS 41 (U.S. CLS. 100, 101 AND 107).

FIRST USE 7-0-2006; IN COMMERCE 7-0-2006.

NO CLAIM IS MADE TO THE EXCLUSIVE RIGHT TO USE "MUSIC" AND "MEDIA", APART FROM THE MARK AS SHOWN.

SER. NO. 77-044,459, FILED 11-15-2006.

KELLY BOULTON, EXAMINING ATTORNEY

**Int. Cl.: 30**

**Prior U.S. Cl.: 46**

**United States Patent and Trademark Office**

**Reg. No. 3,497,633**

**Registered Sep. 9, 2008**

**TRADEMARK  
PRINCIPAL REGISTER**

**GOURMANTRA**

GOURMANTRA FOODS INC. (CANADA CORPORATION)  
95 SILVER ROSE CRESCENT  
MARKHAM, ONTARIO L9C 1W6

FOR: INDIAN AND ASIAN MEAL KITS COMPRISED PRIMARILY OF RICE, SPICES AND SAUCES, SOLD AS A UNIT, IN CLASS 30 (U.S. CL. 46).

THE MARK CONSISTS OF STANDARD CHARACTERS WITHOUT CLAIM TO ANY PARTICULAR FONT, STYLE, SIZE, OR COLOR.

PRIORITY CLAIMED UNDER SEC. 44(D) ON CANADA APPLICATION NO. 1,321,222, FILED 10-23-2006, REG. NO. TMA708974, DATED 3-6-2008, EXPIRES 3-6-2023.

SER. NO. 77-045,368, FILED 11-16-2006.

MARTHA FROMM, EXAMINING ATTORNEY

**Int. Cls.: 5 and 40**

**Prior U.S. Cls.: 6, 18, 44, 46, 51, 52, 100, 103 and 106**

**Reg. No. 3,497,634**

**United States Patent and Trademark Office**

**Registered Sep. 9, 2008**

**TRADEMARK  
SERVICE MARK  
PRINCIPAL REGISTER**



HYALURON, INC. (MASSACHUSETTS CORPORATION)  
SUITE 2  
99 SOUTH BEDFORD STREET  
BURLINGTON, MA 01803

FOR: BIOMEDICAL PREPARATIONS CONTAINING HYALURONIC ACID, HYALURONATE OLIGOSACCHARIDES, AND BULK HYALURONATE FOR USE IN THE TREATMENT OF OSTEOARTHRITIS, EYE SURGERY, AND CANCER, IN CLASS 5 (U.S. CLS. 6, 18, 44, 46, 51 AND 52).

FIRST USE 6-7-2005; IN COMMERCE 6-7-2005.

FOR: CONTRACT MANUFACTURING IN THE FIELD OF PHARMACEUTICALS AND BIOPHARMACEUTICALS; CONTRACT MANUFACTURING IN THE FIELD OF ASEPTICALLY FILLED LIQUID PARENTERAL VIALS, SYRINGES, MEDICAL VIALS, AND CONTAINERS; ASSEMBLING OF PRODUCT FOR OTHERS, NAMELY, FILLING OF VIALS, SYRINGES, AND CUSTOM CONTAINERS FOR OTHERS IN THE FIELD OF PHARMACEUTI-

CAL PRODUCTS OF LIQUID, SEMI-SOLID, OR SOLID KIND, IN CLASS 40 (U.S. CLS. 100, 103 AND 106).

FIRST USE 6-7-2005; IN COMMERCE 6-7-2005.

NO CLAIM IS MADE TO THE EXCLUSIVE RIGHT TO USE "CONTRACT MANUFACTURING", APART FROM THE MARK AS SHOWN.

THE COLOR(S) BLUE AND PURPLE IS/ARE CLAIMED AS A FEATURE OF THE MARK.

THE COLOR BLUE APPEARS IN THE DESIGN AND WORDING "HCM" AND "CONTRACT MANUFACTURING" OF THE MARK; THE COLOR PURPLE APPEARS IN THE WORDING "HYALURON" OF THE MARK.

SER. NO. 77-047,143, FILED 11-17-2006.

DAWN HAN, EXAMINING ATTORNEY

**Int. Cl.: 9**

**Prior U.S. Cls.: 21, 23, 26, 36 and 38**

**United States Patent and Trademark Office**

**Reg. No. 3,497,635**

**Registered Sep. 9, 2008**

**TRADEMARK  
PRINCIPAL REGISTER**

**SARIN COLOR TECHNOLOGIES**

SARIN COLOR TECHNOLOGIES LTD. (ISRAEL  
CORPORATION)  
4 HAHILAZON STREET  
RAMAT-GAN, ISRAEL 52522

PRIORITY CLAIMED UNDER SEC. 44(D) ON  
ISRAEL APPLICATION NO. 191750, FILED 7-13-  
2006, REG. NO. 191750, DATED 2-14-2008, EXPIRES  
7-13-2016.

FOR: COMPUTER HARDWARE, SOFTWARE,  
CAMERAS, SPECTROMETERS AND LIGHT SEN-  
SORS ALL FOR MEASURING, ANALYZING, PRE-  
DICTING, VISUALLY REPRESENTING,  
EVALUATING, GRADING AND REPORTING COL-  
OR AND FLUORESCENCE OF DIAMONDS AND  
GEMSTONES, IN CLASS 9 (U.S. CLS. 21, 23, 26, 36  
AND 38).

NO CLAIM IS MADE TO THE EXCLUSIVE  
RIGHT TO USE "COLOR TECHNOLOGIES", APART  
FROM THE MARK AS SHOWN.

SER. NO. 77-047,468, FILED 11-20-2006.

THE MARK CONSISTS OF STANDARD CHAR-  
ACTERS WITHOUT CLAIM TO ANY PARTICULAR  
FONT, STYLE, SIZE, OR COLOR.

NATALIE POLZER, EXAMINING ATTORNEY

**Int. Cl.: 20**

**Prior U.S. Cls.: 2, 13, 22, 25, 32 and 50**

**United States Patent and Trademark Office**

**Reg. No. 3,497,636**

**Registered Sep. 9, 2008**

**TRADEMARK  
PRINCIPAL REGISTER**



W.J. TRADING ENTERPRISE, INC. (TEXAS CORPORATION)  
8634 WESTPARK DRIVE  
HOUSTON, TX 77063

FIRST USE 2-28-2006; IN COMMERCE 2-28-2006.

SER. NO. 77-047,903, FILED 11-20-2006.

FOR: MATTRESSES AND PILLOWS, IN CLASS 20  
(U.S. CLS. 2, 13, 22, 25, 32 AND 50).

FRED CARL, EXAMINING ATTORNEY



Int. Cl.: 35

Prior U.S. Cls.: 100, 101 and 102

United States Patent and Trademark Office

Reg. No. 3,497,637

Registered Sep. 9, 2008

**SERVICE MARK  
PRINCIPAL REGISTER**



HEARTS ACROSS THE MILES (COLORADO CORPORATION)  
P.O. BOX 471297  
AURORA, CO 80047

FOR: CHARITABLE SERVICES, NAMELY, COORDINATING, PROCURING AND DISTRIBUTING DONATIONS OF GOODS AND CORRESPONDENCE TO DEPLOYED MILITARY PERSONNEL, IN CLASS 35 (U.S. CLS. 100, 101 AND 102).

FIRST USE 1-14-2005; IN COMMERCE 1-14-2005.

THE MARK CONSISTS OF THE WORDS "HEARTS ACROSS THE MILES" OVER THE TOP OF A GLOBE WITH AN EQUATOR OF HEARTS.

SER. NO. 77-048,584, FILED 11-21-2006.

SUSAN RICHARDS, EXAMINING ATTORNEY

Int. Cl.: 36

Prior U.S. Cls.: 100, 101 and 102

United States Patent and Trademark Office

Reg. No. 3,497,638

Registered Sep. 9, 2008

**SERVICE MARK  
PRINCIPAL REGISTER**



HEARTS ACROSS THE MILES (COLORADO CORPORATION)  
P.O. BOX 471297  
AURORA, CO 80047

THE MARK CONSISTS OF THE WORDS "HEARTS ACROSS THE MILES" AND A DESIGN OF A GLOBE WITH AN EQUATOR OF HEARTS.

FOR: CHARITABLE FUNDRAISING TO AID AND ASSIST DEPLOYED MILITARY PERSONNEL AND THEIR FAMILIES, IN CLASS 36 (U.S. CLS. 100, 101 AND 102).

SER. NO. 77-048,604, FILED 11-21-2006.

FIRST USE 1-14-2005; IN COMMERCE 1-14-2005.

SUSAN RICHARDS, EXAMINING ATTORNEY

**Int. Cls.: 37 and 44**

**Prior U.S. Cls.: 100, 101, 103 and 106**

**United States Patent and Trademark Office**

**Reg. No. 3,497,639**

**Registered Sep. 9, 2008**

**SERVICE MARK  
PRINCIPAL REGISTER**

**OPERATION SECOND CHANCE**

OPERATION SECOND CHANCE, INC. (MARY-  
LAND CORPORATION)  
227808 BIRCHCREST LANE  
CLARKSBURG, MD 20871

FOR: CHARITABLE SERVICES, NAMELY, AS-  
SISTING IN THE MODIFICATION OF HOUSING TO  
ACCOMMODATE DISABLED VETERANS, IN  
CLASS 37 (U.S. CLS. 100, 103 AND 106).

FIRST USE 10-31-2006; IN COMMERCE 10-31-2006.

FOR: FACILITATING THE TRANSITION OF  
WOUNDED SERVICEMEN AND SERVICEWOMEN  
BACK INTO CIVILIAN SOCIETY, NAMELY, PRO-  
VIDING CARE PACKAGES CONSISTING PRIMAR-

ILY OF PERSONAL CARE ITEMS TO WOUNDED  
SERVICEMEN, WOUNDED SERVICEWOMEN,  
AND THEIR FAMILIES, IN CLASS 44 (U.S. CLS. 100  
AND 101).

FIRST USE 10-31-2006; IN COMMERCE 10-31-2006.

THE MARK CONSISTS OF STANDARD CHAR-  
ACTERS WITHOUT CLAIM TO ANY PARTICULAR  
FONT, STYLE, SIZE, OR COLOR.

SER. NO. 77-048,986, FILED 11-21-2006.

COLLEEN KEARNEY, EXAMINING ATTORNEY

**Int. Cl.: 20**

**Prior U.S. Cls.: 2, 13, 22, 25, 32 and 50**

**United States Patent and Trademark Office**

**Reg. No. 3,497,640**

**Registered Sep. 9, 2008**

**TRADEMARK  
PRINCIPAL REGISTER**

**Coffee Kiss Travel PLug**

KELLER, ROBERT C. (UNITED STATES INDIVIDUAL)

1344 AVALON AVE.

BEAUMONT, CA 92223

FOR: NON-METALLIC BOTTLE STOPPERS, IN CLASS 20 (U.S. CLS. 2, 13, 22, 25, 32 AND 50).

FIRST USE 10-27-2006; IN COMMERCE 10-30-2006.

THE MARK CONSISTS OF STANDARD CHARACTERS WITHOUT CLAIM TO ANY PARTICULAR FONT, STYLE, SIZE, OR COLOR.

NO CLAIM IS MADE TO THE EXCLUSIVE RIGHT TO USE "TRAVEL PLUG", APART FROM THE MARK AS SHOWN.

SER. NO. 77-051,308, FILED 11-27-2006.

GISELLE AGOSTO, EXAMINING ATTORNEY

**Int. Cls.: 3, 4, 5, 9 and 18**

**Prior U.S. Cls.: 1, 2, 3, 4, 6, 15, 18, 21, 22, 23, 26, 36, 38, 41, 44, 46, 50, 51 and 52**

**Reg. No. 3,497,641**

**United States Patent and Trademark Office**

**Registered Sep. 9, 2008**

**TRADEMARK  
PRINCIPAL REGISTER**

**HEALING YOUR PETS BODY,  
MIND & SPIRIT**

A TOUCH OF LOVE INC. (CANADA CORPORATION)  
R.R. #1, 1025 NORTH MORRISON LAKE ROAD  
KILWORTHY, CANADA P0E1G0

FOR: SHAMPOO AND SHAMPOO BARS FOR PETS, NON-MEDICATED COAT/HAIR TREATMENTS FOR PETS, NAMELY, CONDITIONERS AND DETANGLING SPRAYS, PET PAW BALMS, SCENTED PET REFRESHING FRAGRANCE SPRAYS, AROMATIC PRODUCTS, NAMELY, INCENSE STICKS, IN CLASS 3 (U.S. CLS. 1, 4, 6, 50, 51 AND 52).

FOR: SCENTED AND/OR FRAGRANCED CANDLES, IN CLASS 4 (U.S. CLS. 1, 6 AND 15).

FOR: INSECT REPELLENT FOR USE ON PETS, IN CLASS 5 (U.S. CLS. 6, 18, 44, 46, 51 AND 52).

FOR: PRE-RECORDED MUSIC CDS FEATURING TRANQUIL SOUNDS, IN CLASS 9 (U.S. CLS. 21, 23, 26, 36 AND 38).

FOR: PET APPAREL, NAMELY, ROBES AND SPA JACKETS, IN CLASS 18 (U.S. CLS. 1, 2, 3, 22 AND 41).

THE MARK CONSISTS OF STANDARD CHARACTERS WITHOUT CLAIM TO ANY PARTICULAR FONT, STYLE, SIZE, OR COLOR.

PRIORITY CLAIMED UNDER SEC. 44(D) ON CANADA APPLICATION NO. 1325120, FILED 11-21-2006, REG. NO. TMA708035, DATED 2-21-2008, EXPIRES 2-21-2023.

NO CLAIM IS MADE TO THE EXCLUSIVE RIGHT TO USE "PETS", APART FROM THE MARK AS SHOWN.

SER. NO. 77-052,035, FILED 11-28-2006.

MARK PILARO, EXAMINING ATTORNEY

**Int. Cl.: 42**

**Prior U.S. Cls.: 100 and 101**

**United States Patent and Trademark Office**

**Reg. No. 3,497,642**

**Registered Sep. 9, 2008**

**SERVICE MARK  
PRINCIPAL REGISTER**

**COVERITY CERTIFIED**

COVERITY, INC. (CALIFORNIA CORPORATION)  
185 BERRY STREET, STE. 2400  
SAN FRANCISCO, CA 94107

FOR: PROVIDING QUALITY ASSURANCE SERVICES IN THE FIELD OF COMPUTER SOFTWARE, IN CLASS 42 (U.S. CLS. 100 AND 101).

FIRST USE 4-30-2006; IN COMMERCE 4-30-2006.

THE MARK CONSISTS OF STANDARD CHARACTERS WITHOUT CLAIM TO ANY PARTICULAR FONT, STYLE, SIZE, OR COLOR.

NO CLAIM IS MADE TO THE EXCLUSIVE RIGHT TO USE "CERTIFIED", APART FROM THE MARK AS SHOWN.

SER. NO. 77-052,394, FILED 11-28-2006.

DAVID C. REIHNER, EXAMINING ATTORNEY

Int. Cl.: 9

Prior U.S. Cls.: 21, 23, 26, 36 and 38

Reg. No. 3,497,643

United States Patent and Trademark Office

Registered Sep. 9, 2008

TRADEMARK  
PRINCIPAL REGISTER



SMK CORPORATION (JAPAN CORPORATION)  
5-5, TOGOSHI 6-CHOME, SHINAGAWA-KU  
TOKYO, JAPAN 142-8511

FOR: MOBILE TELEPHONES; LAN HARDWARE, LAN SOFTWARE; TELEPHONE ANSWERING MACHINES; FACSIMILE MACHINES; WIRELESS NETWORK DEVICES, NAMELY, WIRELESS NETWORK UNIVERSAL SERIAL BUS DONGLES, HEADSETS FOR USE WITH WIRELESS NETWORKED TELEPHONES, WIRELESS NETWORK SERIAL PORT ADAPTORS AND WIRELESS NETWORK BASE STATIONS; LIQUID CRYSTAL DISPLAYS; COMPUTER HARD DISC DRIVES; DVD PLAYERS; COMPUTER MONITORS; COMPUTERS; COMPUTER POINTING DEVICES, NAMELY, MICE AND TOUCH PADS; COMPUTER KEYBOARDS UNITS; COMPUTER MEMBRANE-KEYBOARD UNITS; COMPUTER NETWORK ROUTERS; MODEMS; PERSONAL DIGITAL ASSISTANTS; AUDIO AND VIDEO DEVICES, NAMELY, STEREO RECEIVERS, CD PLAYERS, RADIO SPEAKERS, AUDIO CASSETTE PLAYERS, DIGITAL AUDIO PLAYERS, MP3 PLAYERS; FLAT PANEL DISPLAY SCREENS; PDP PLASMA DISPLAY PANEL; LCD LARGE-SCREEN DISPLAYS; PHOTOCOPIERS; PORTABLE INFORMATION TERMINAL DEVICES, NAMELY WALKIE-TALKIES AND TWO-WAY RADIOS; AUDIO-VISUAL EQUIPMENT, NAMELY, MOVIE PROJECTORS, VIDEO PROJECTORS, SLIDE PROJECTORS, DIGITAL VIDEO CAMERAS; DIGITAL STILL CAMERAS; TELEVISIONS; DIGITAL TELEVISIONS; CAR NAVIGATION COMPUTERS; RADIOS; AUDIO EQUIPMENT FOR VEHICLES, NAMELY, STEREOS, SPEAKERS, AMPLIFIERS, EQUALIZERS, CROSSEOVERS AND SPEAKER HOUSINGS; WIRELESS POS DEVICES; AUTOMATED TELLER MACHINES (ATM); ELECTRONIC VENDING MACHINES FOR THE ISSUING OF TICKETS; HOME THEATER SYSTEMS, COMPRISING TELEVISIONS, LCD MONITORS, PLASMA MONITORS, DVD PLAYERS AND CD PLAYERS; HARD DISK DRIVE RECOR-

DERS; DVD RECORDERS; BLANK DIGITAL VERSATILE DISKS; HEADSETS FOR TELEPHONES; HEADSETS FOR USE WITH COMPUTERS; WIRELESS COMMUNICATION HANDSETS; BARCODE SCANNERS; SCANNERS; FULL LINE OF ELECTRICAL COMPONENTS, NAMELY, KEYBOARD SWITCHES, SWITCHES, SOCKETS, CONNECTORS, TOUCH PANELS, FERRULES, ELECTRIC CARD ASSEMBLIES, ANTENNAS, TERMINAL BOARDS, CONTROL PANELS, TELEPHONE AND COMPUTER JACKS, MINI JACKS, POWER SUPPLY JACKS, PIN JACKS, AND MODULAR JACKS; CONNECTIVE ELECTRICAL TERMINALS FOR USE IN AUDIO AND VIDEO DEVICES; SPEAKER TERMINALS, FOR USE IN CONNECTING SPEAKERS OF AN AUDIO SYSTEM; SCREW-TYPE TERMINALS, CONNECTIVE TERMINALS WITH SCREW-TYPE CONNECTIVE PARTS, USED TO CONNECT AUDIO AND VIDEO DEVICES; PUSH AND LEVER TERMINALS, USED TO CONNECT AUDIO AND VIDEO DEVICES; VOLTAGE MONITOR MODULES; VOLTAGE STABILIZERS; CAMERA MODULES, NAMELY, A MODULAR COMPONENT INCORPORATED INTO MOBILE DEVICES SUCH AS CELL PHONES, AND IS CAPABLE OF PROCESSING IMAGES TAKEN VIA ITS LENS AND OUTPUTTING THEM THROUGH ELECTRONIC SIGNALS; POWER LINE COMMUNICATIONS MODULE, FOR USE IN CONVERTING POWER LINES INTO TRANSMISSION PATHS FOR NETWORK DATA COMMUNICATIONS AND THE CONTROL OF HOUSEHOLD APPLIANCES; ELECTRIC PLUGS, LASER POINTERS, REMOTE CONTROL UNITS FOR TELEVISIONS, STEREOS, DVD PLAYERS, CD PLAYERS, VIDEOCASSETTE PLAYERS AND AUDIO CASSETTE PLAYERS; BATTERY AND ELECTRONIC DEVICE CHARGERS, NAMELY, ALTERNATING CURRENT CHARGERS AND DIRECT CURRENT CHARGERS, CHARGER STANDS; CURRENT CONVERTERS, CURRENT MODULATORS, VIDEO GAME INTERACTIVE REMOTE CONTROL UNITS, MICROPHONES; RADIO FREQUENCY IDENTIFI-

CATION TAG READERS; LIGHT EMITTING DIODE DISPLAYS; FUSE HOLDERS; ELECTRONIC POWER USAGE CONTROLLERS FOR USE IN LIMITING POWER CONSUMPTION IN HOUSEHOLD APPLIANCES WHEN NOT IN USE; CELLULAR PHONE ACCESSORIES, NAMELY ELECTRICAL MOUNTING CRADLES FOR USE IN MOUNTING CELLULAR PHONES FOR CHARGING; DIGITAL CAMERA ACCESSORIES, NAMELY, ELECTRICAL MOUNTING CRADLES FOR USE IN MOUNTING DIGITAL CAMERAS FOR CHARGING; PORTABLE AUDIO DEVICE ACCESSORIES, NAMELY, ELECTRICAL MOUNTING CRADLES FOR USE IN MOUNTING PORTABLE AUDIO DEVICES FOR CHARGING; POWER SWITCHES, WHICH SERVE TO SELECT THE DESIRED ELECTRICAL VOLTAGE FOR ELECTRONIC GOODS AND APPLIANCES, IN CLASS 9 (U.S. CLS. 21, 23, 26, 36 AND 38).

FIRST USE 2-1-1985; IN COMMERCE 2-1-1985.

OWNER OF U.S. REG. NOS. 1,408,284 AND 1,837,777.

THE COLOR(S) BLUE AND RED IS/ARE CLAIMED AS A FEATURE OF THE MARK.

THE MARK CONSISTS OF THE CAPITAL LETTERS "SMK," IN THE COLOR BLUE, WHICH ARE BORDERED BY A SERIES OF EIGHT (8) RED DOTS.

SER. NO. 77-052,420, FILED 11-28-2006.

FRED CARL, EXAMINING ATTORNEY



**Int. Cls.: 16, 35, 41 and 42**

**Prior U.S. Cls.: 2, 5, 22, 23, 29, 37, 38, 50, 100, 101, 102  
and 107**

**Reg. No. 3,497,644**

**Registered Sep. 9, 2008**

**United States Patent and Trademark Office**

**TRADEMARK  
SERVICE MARK  
PRINCIPAL REGISTER**



NATIONAL ASSOCIATION OF BOARDS OF  
PHARMACY (KENTUCKY CORPORATION)  
1600 FEEHANVILLE DRIVE  
MOUNT PROSPECT, IL 60056

FOR: PRINTED GUIDES FOR PHARMACY IN-  
DUSTRY PROFESSIONALS; NEWSLETTERS IN  
THE FIELD OF PHARMACY, IN CLASS 16 (U.S.  
CLS. 2, 5, 22, 23, 29, 37, 38 AND 50).

FIRST USE 0-0-1973; IN COMMERCE 0-0-1973.

FOR: ASSOCIATION SERVICES, NAMELY, PRO-  
MOTING THE INTERESTS OF AND ASSISTING  
STATE AGENCIES RESPONSIBLE FOR REGULAT-  
ING AND LICENSING PHARMACY PRACTICE, IN  
CLASS 35 (U.S. CLS. 100, 101 AND 102).

FIRST USE 0-0-1973; IN COMMERCE 0-0-1973.

FOR: EDUCATIONAL SERVICES, NAMELY,  
PROVIDING CLASSES, SEMINARS, WORKSHOPS  
AND ONLINE KNOWLEDGE ASSESSMENTS PRO-  
GRAMS IN THE FIELD OF PHARMACY; PREPAR-  
ING, ADMINISTERING, AND SCORING  
STANDARD TESTS, NAMELY, PHARMACY LI-  
CENSURE EXAMINATIONS; PROVIDING NEWS-

LETTERS IN THE FIELD OF PHARMACY VIA  
EMAIL, IN CLASS 41 (U.S. CLS. 100, 101 AND 107).

FIRST USE 0-0-1973; IN COMMERCE 0-0-1973.

FOR: ACCREDITATION SERVICES, NAMELY,  
DEVELOPING EVALUATING AND TESTING  
STANDARDS FOR PHARMACY LICENSURE AC-  
CREDITATION, IN CLASS 42 (U.S. CLS. 100 AND  
101).

FIRST USE 4-0-1973; IN COMMERCE 4-0-1973.

OWNER OF U.S. REG. NOS. 1,162,334, 2,270,607  
AND OTHERS.

NO CLAIM IS MADE TO THE EXCLUSIVE  
RIGHT TO USE "1904", APART FROM THE MARK  
AS SHOWN.

SEC. 2(F) AS TO "NATIONAL ASSOCIATION OF  
BOARDS OF PHARMACY".

SER. NO. 77-054,541, FILED 11-30-2006.

AISHA SALEM, EXAMINING ATTORNEY

**Int. Cl.: 36**

**Prior U.S. Cls.: 100, 101 and 102**

**United States Patent and Trademark Office**

**Reg. No. 3,497,645**

**Registered Sep. 9, 2008**

**SERVICE MARK  
PRINCIPAL REGISTER**

**STEAMBOAT RESORTS**

THE RESORT COMPANY LLC (DELAWARE  
LIMITED LIABILITY COMPANY)

1847 TIME SQUARE DRIVE

STEAMBOAT SPRINGS, CO 80487

FOR: REAL ESTATE MANAGEMENT SERVICES,  
NAMELY, RENTAL OF HOMES, CONDOMINIUMS,  
AND HOTEL AND RESORT ACCOMMODATIONS,  
IN CLASS 36 (U.S. CLS. 100, 101 AND 102).

FIRST USE 0-0-1982; IN COMMERCE 0-0-1982.

THE MARK CONSISTS OF STANDARD CHAR-  
ACTERS WITHOUT CLAIM TO ANY PARTICULAR  
FONT, STYLE, SIZE, OR COLOR.

NO CLAIM IS MADE TO THE EXCLUSIVE  
RIGHT TO USE "RESORTS", APART FROM THE  
MARK AS SHOWN.

SEC. 2(F).

SER. NO. 77-054,889, FILED 12-1-2006.

MONIQUE MILLER, EXAMINING ATTORNEY

**Int. Cl.: 12**

**Prior U.S. Cls.: 19, 21, 23, 31, 35 and 44**

**Reg. No. 3,497,646**

**United States Patent and Trademark Office**

**Registered Sep. 9, 2008**

**TRADEMARK  
PRINCIPAL REGISTER**

**BIGGRIGGS**

RUPP MARINE, INC. (FLORIDA CORPORATION)  
P.O. DRAWER F  
4761 ANCHOR AVENUE  
PORT SALERNO, FL 34992

FOR: STRUCTURAL PARTS AND ACCESSORIES FOR FISHING BOATS, NAMELY, ANTENNA MOUNTINGS, ROD AND REEL HANGERS; OUTRIGGERS AND PARTS THEREOF; ACCESSORIES FOR FISHING BOAT OUTRIGGERS, NAMELY, RELEASE CLIPS, LAY DOWN HOOKS, SPACER BLOCKS, HOLD-IN ARMS, AND CLAMP-ON FITTINGS; STRUCTURAL PARTS FOR FISHING BOATS, NAMELY, OUTRIGGER POLES, POLE BASES, POLE MOUNTINGS, TOWER MOUNTS,

ROD HOLDERS, POLE SETTERS; STRUCTURAL PARTS FOR BOATS, NAMELY, COLLAPSIBLE BACK BARS; HULL FITTINGS, NAMELY, CLEATS AND BAILERS, IN CLASS 12 (U.S. CLS. 19, 21, 23, 31, 35 AND 44).

FIRST USE 1-1-2002; IN COMMERCE 1-1-2003.

THE MARK CONSISTS OF STANDARD CHARACTERS WITHOUT CLAIM TO ANY PARTICULAR FONT, STYLE, SIZE, OR COLOR.

SER. NO. 77-055,668, FILED 12-1-2006.

SETH A. RAPPAPORT, EXAMINING ATTORNEY

Int. Cl.: 30

Prior U.S. Cl.: 46

United States Patent and Trademark Office

Reg. No. 3,497,647

Registered Sep. 9, 2008

TRADEMARK  
PRINCIPAL REGISTER



BERKSHIRE BARK, INC. (MASSACHUSETTS CORPORATION)  
10 CRISSEY RD.  
GREAT BARRINGTON, MA 01230

FOR: CANDY; CANDY BARS, IN CLASS 30 (U.S. CL. 46).

FIRST USE 11-9-2006; IN COMMERCE 11-9-2006.

NO CLAIM IS MADE TO THE EXCLUSIVE RIGHT TO USE "CHOCOLATE" , APART FROM THE MARK AS SHOWN.

THE COLOR(S) DARK BROWN AND LIGHT BROWN IS/ARE CLAIMED AS A FEATURE OF THE MARK.

THE MARK CONSISTS OF THE WORD "BERKSHIRE" APPEARS IN DARK BROWN. THE WORD "CHOCOLATE" APPEARS IN LIGHT BROWN AND THE BACKGROUND APPEARS IN LIGHT BROWN.

SER. NO. 77-055,933, FILED 12-2-2006.

GINA HAYES, EXAMINING ATTORNEY

Int. Cl.: 35

Prior U.S. Cls.: 100, 101 and 102

United States Patent and Trademark Office

Reg. No. 3,497,648

Registered Sep. 9, 2008

**SERVICE MARK  
PRINCIPAL REGISTER**



PARATRADE, LLC (FLORIDA LIMITED LIABILITY COMPANY)

SUITE 770

10800 BISCAYNE BOULEVARD

MIAMI, FL 33161

FOR: INDEPENDENT SALES REPRESENTATIVES IN THE FIELD OF ORGANIC SUGARS, FOOD SWEETENERS AND NUTRITIONAL AND NATURAL INGREDIENTS; PROCUREMENT, NAMELY, PURCHASING ORGANIC SUGARS, SWEETENERS AND SUGAR SUBSTITUTES AS WELL AS ORGANIC NUTRITIONAL AND NATURAL FOOD INGREDIENTS FOR OTHERS; WHOLESALE ORGANIC DISTRIBUTORSHIPS FEATURING ORGANIC SUGARS, SWEETENERS, SUGAR SUBSTITUTES AND NUTRITIONAL FOOD INGREDIENTS, IN CLASS 35 (U.S. CLS. 100, 101 AND 102).

FIRST USE 10-30-2006; IN COMMERCE 10-30-2006.

NO CLAIM IS MADE TO THE EXCLUSIVE RIGHT TO USE "ORGANIC", APART FROM THE MARK AS SHOWN.

THE COLOR(S) PINK, GREEN, GRAY, BLUE, BLACK, WHITE AND BROWN IS/ARE CLAIMED AS A FEATURE OF THE MARK.

THE MARK CONSISTS OF THE BLACK LETTERS "OC" OUTLINED IN WHITE, APPEARING ON A BLUE STRIPED BACKGROUND WITH SHADES OF PINK AND WHITE CLOUDS APPEARING WITHIN THE BLUE, WITH A FIELD OF GREENS TOUCHING AND OVERLAPPING THE LETTERS, ALSO CONTAINING STRIPES IN GREEN, PINK AND BROWN, ALL ENCLOSED WITHIN A THICK CIRCULAR BORDER OF OLIVE GREENS AND BROWNS WITH THE WORD "ORGANIC" APPEARING IN WHITE LETTERS AT THE TOP OF THE CIRCLE AND THE WORD "CULTURE" APPEARING AS WHITE LETTERS OUTLINED IN BLACK WITHIN A GRAY BANNER WITH A PINK TINGE AT THE BOTTOM OF THE CIRCLE WITH GREEN LEAF LIKE ILLUSTRATIONS EMERGING FROM BOTH SIDES OF THE CIRCULAR DESIGN.

SER. NO. 77-056,070, FILED 12-4-2006.

TANYA AMOS, EXAMINING ATTORNEY

Int. Cl.: 28

Prior U.S. Cls.: 22, 23, 38 and 50

Reg. No. 3,497,649

United States Patent and Trademark Office

Registered Sep. 9, 2008

TRADEMARK  
PRINCIPAL REGISTER

*Markwort*

MARKWORT SPORTING GOODS COMPANY  
(MISSOURI CORPORATION)  
1101 RESEARCH BLVD.  
ST. LOUIS, MO 63132

FOR: FOOT BAGS; BOCCE LAWN BOWLING GAMES; WATER POLO BALLS; HORSE SHOE GAMES; BASES FOR BASEBALL AND SOFTBALL; UMPIRE INDICATORS FOR RECORDING BALLS, STRIKES, OUTS AND SCORE; ROSIN USED BY ATHLETES, NAMELY, ATHLETIC ROSIN BAGS; PINE TAR USED BY ATHLETES, NAMELY, ATHLETIC PINE TAR RAGS AND ATHLETIC PINE TAR STICKS; BALLS FOR GAMES, NAMELY, PLAY GROUND BALLS; TETHERBALLS; BADMINTON RACKETS; WEIGHT LIFTING BELTS; JUMP ROPES, NAMELY, SKIP ROPES; HAND WEIGHTS; MEDICINE BALLS; EXERCISE BARS, NAMELY, PUSH UP BARS; MANUALLY OPERATED RESISTIVE EXERCISE STRETCH TUBING; NETS FOR TENNIS, SOCCER GOALS, LACROSSE GOALS, AND VOLLEY BALL; SPORTING GOODS AND EQUIPMENT FOR SOCCER, NAMELY, SOCCER CONES AND DISCS; SHIN GUARDS FOR SOCCER; RUGBY BALLS; FOOTBALL SHOULDER PADS; KICKING TEES; INFLATORS AND PUMPS FOR INFLATING SPORTSBALLS; ATHLETIC MOUTHGUARDS; SIDELINE EQUIPMENT FOR FOOTBALL

FIELDS, NAMELY, SIDELINE MARKERS, GOAL LINE AND END ZONE MARKERS, AND LINEMAN SETS USED TO MARK THE LINE OF SCRIMMAGE AND THE FIRST DOWN; TENNIS RACKETS; TENNIS RACKET COVERS; BADMINTON RACKETS; BADMINTON SETS; BASEBALL EQUIPMENT, NAMELY, BATS, BALLS, GLOVES, MITTS, BASEBALL BODY PROTECTORS, CATCHERS', BATTERS', FIELDERS' AND UMPIRES' MASKS; BASKETBALLS; BASKETBALL GOAL NETS; BILLIARD CUES; CORKBALLS; CORKBALL BATS; FOOTBALLS; RACKETS AND PROTECTIVE COVERS FOR RACKETS FOR A BALL GAME PLAYED WITH A RACKET; SOCCER BALLS; SOFTBALL BATS; SOFTBALLS; TABLE TENNIS PADDLES; AND VOLLEYBALLS, IN CLASS 28 (U.S. CLS. 22, 23, 38 AND 50).

FIRST USE 0-0-1937; IN COMMERCE 0-0-1937.

OWNER OF U.S. REG. NOS. 1,057,126 AND 2,526,578.

SER. NO. 77-056,640, FILED 12-4-2006.

LINDSEY RUBIN, EXAMINING ATTORNEY

Int. Cl.: 35

Prior U.S. Cls.: 100, 101 and 102

United States Patent and Trademark Office

Reg. No. 3,497,650

Registered Sep. 9, 2008

SERVICE MARK  
PRINCIPAL REGISTER



WEBSITE PROS, INC. (DELAWARE CORPORATION)  
SUITE 1000  
12735 GRAN BAY PARKWAY WEST, BLDG. 200  
JACKSONVILLE, FL 32258

FOR: ADVERTISING BY TRANSMISSION OF ONLINE PUBLICITY FOR THIRD PARTIES THROUGH ELECTRONIC COMMUNICATIONS NETWORKS; ADVERTISING, NAMELY, PROMOTION OF THE SALE OF ARTICLES AND SERVICES OF THIRD PARTIES BY THE TRANSMISSION OF ADVERTISING MATERIALS AND THE DISSEMINATION OF ADVERTISING MESSAGES ON COMPUTER NETWORKS; COOPERATIVE ADVERTISING AND MARKETING SERVICES BY WAY OF SOLICITATION, CUSTOMER SERVICE, AND PROVIDING MARKETING INFORMATION VIA WEBSITES ON A GLOBAL COMPUTER NETWORK; DISSEMINATION OF ADVERTISING FOR OTHERS VIA THE INTERNET; PROMOTING, ADVERTISING, AND MARKETING OF THE ON-LINE

WEBSITES OF OTHERS, IN CLASS 35 (U.S. CLS. 100, 101 AND 102).

FIRST USE 8-15-2006; IN COMMERCE 8-15-2006.

OWNER OF U.S. REG. NO. 2,262,495.

THE COLOR(S) GRAY, ORANGE AND WHITE ARE CLAIMED AS A FEATURE OF THE MARK IS/ ARE CLAIMED AS A FEATURE OF THE MARK.

THE MARK CONSISTS OF THE TERM "SMART" IS GRAY. AN ORANGE RECTANGULAR CARRIER DESIGN CONTAINS THE TERM "CLICKS" WHICH IS WHITE AND IS UNDERLINED IN LIGHT ORANGE. THE POINTING HAND DESIGN IS WHITE WITH A THIN GRAY OUTLINE.

SER. NO. 77-058,273, FILED 12-6-2006.

NELSON SNYDER, EXAMINING ATTORNEY

**Int. Cl.: 41**

**Prior U.S. Cls.: 100, 101 and 107**

**United States Patent and Trademark Office**

**Reg. No. 3,497,651**

**Registered Sep. 9, 2008**

**SERVICE MARK  
PRINCIPAL REGISTER**

**MIKE IN BRAZIL**

RK NETMEDIA, INC. (FLORIDA CORPORATION)  
3RD FLOOR  
705 WASHINGTON AVENUE  
MIAMI BEACH, FL 33139

FOR: ENTERTAINMENT SERVICES IN THE NATURE OF PHOTOGRAPHIC IMAGES, PICTURES, VIDEO AND AUDIO RECORDINGS, AND INFORMATION INVOLVING ADULT ORIENTED SUBJECT MATTER TRANSMITTED THROUGH A GLOBAL COMPUTER NETWORK, IN CLASS 41 (U.S. CLS. 100, 101 AND 107).

FIRST USE 6-14-2002; IN COMMERCE 6-14-2002.

THE MARK CONSISTS OF STANDARD CHARACTERS WITHOUT CLAIM TO ANY PARTICULAR FONT, STYLE, SIZE, OR COLOR.

NO CLAIM IS MADE TO THE EXCLUSIVE RIGHT TO USE "BRAZIL", APART FROM THE MARK AS SHOWN.

SER. NO. 77-059,928, FILED 12-8-2006.

KAREN SEVERSON, EXAMINING ATTORNEY



**Int. Cl.: 41**

**Prior U.S. Cls.: 100, 101 and 107**

**United States Patent and Trademark Office**

**Reg. No. 3,497,652**

**Registered Sep. 9, 2008**

**SERVICE MARK  
PRINCIPAL REGISTER**

**TRANNY SURPRISE**

RK NETMEDIA, INC. (FLORIDA CORPORATION)  
3RD FLOOR  
705 WASHINGTON AVENUE  
MIAMI BEACH, FL 33139

FOR: ENTERTAINMENT SERVICES IN THE NATURE OF PHOTOGRAPHIC IMAGES, PICTURES, VIDEO AND AUDIO RECORDINGS, AND INFORMATION INVOLVING ADULT ORIENTED SUBJECT MATTER TRANSMITTED THROUGH A GLOBAL COMPUTER NETWORK, IN CLASS 41 (U.S. CLS. 100, 101 AND 107).

FIRST USE 4-18-2001; IN COMMERCE 4-18-2001.

THE MARK CONSISTS OF STANDARD CHARACTERS WITHOUT CLAIM TO ANY PARTICULAR FONT, STYLE, SIZE, OR COLOR.

NO CLAIM IS MADE TO THE EXCLUSIVE RIGHT TO USE "TRANNY", APART FROM THE MARK AS SHOWN.

SER. NO. 77-060,451, FILED 12-8-2006.

KAREN SEVERSON, EXAMINING ATTORNEY

**Int. Cl.: 25**

**Prior U.S. Cls.: 22 and 39**

**United States Patent and Trademark Office**

**Reg. No. 3,497,653**

**Registered Sep. 9, 2008**

**TRADEMARK  
PRINCIPAL REGISTER**

**"iller"**

TORBERT, JAMES (UNITED STATES INDIVIDUAL)  
9792 EDMONDS WAY #245  
EDMONDS, WA 98020

FOR: PULLOVERS; T-SHIRTS, IN CLASS 25 (U.S. CLS. 22 AND 39).

FIRST USE 8-0-2004; IN COMMERCE 8-0-2004.

THE MARK CONSISTS OF STANDARD CHARACTERS WITHOUT CLAIM TO ANY PARTICULAR FONT, STYLE, SIZE, OR COLOR.

SER. NO. 77-060,651, FILED 12-8-2006.

KATHERINE CONNOLLY, EXAMINING ATTORNEY

**Int. Cls.: 9, 25 and 28**

**Prior U.S. Cls.: 21, 22, 23, 26, 36, 38, 39 and 50**

**United States Patent and Trademark Office**

**Reg. No. 3,497,654**

**Registered Sep. 9, 2008**

**TRADEMARK  
PRINCIPAL REGISTER**

**FEEL THE RUSH**

EBSCO INDUSTRIES, INC. (DELAWARE CORPORATION)  
5724 HIGHWAY 280 EAST  
BIRMINGHAM, AL 35242

FOR: HUNTING SHOOTING AIDS, NAMELY, HUNTING VIDEO TAPES; REMOTE CONTROLLED LOCATOR LIGHT; WIND DIRECTION INDICATORS, NAMELY, A HOUSING CONTAINING FUZZ OR FIBROUS MATERIAL TO JUDGE WIND DIRECTION, IN CLASS 9 (U.S. CLS. 21, 23, 26, 36 AND 38).

FIRST USE 9-30-2006; IN COMMERCE 9-30-2006.

FOR: HUNTING APPAREL, NAMELY, SHIRTS, GLOVES AND CAPS FOR HUNTING, IN CLASS 25 (U.S. CLS. 22 AND 39).

FIRST USE 9-30-2006; IN COMMERCE 9-30-2006.

FOR: HUNTING GAME CALLS; CAMOUFLAGE TAPE USED IN HUNTING, IN CLASS 28 (U.S. CLS. 22, 23, 38 AND 50).

FIRST USE 9-30-2006; IN COMMERCE 9-30-2006.

THE MARK CONSISTS OF STANDARD CHARACTERS WITHOUT CLAIM TO ANY PARTICULAR FONT, STYLE, SIZE, OR COLOR.

SER. NO. 77-061,489, FILED 12-11-2006.

ARETHA SOMERVILLE, EXAMINING ATTORNEY

**Int. Cl.: 35**

**Prior U.S. Cls.: 100, 101 and 102**

**United States Patent and Trademark Office**

**Reg. No. 3,497,655**

**Registered Sep. 9, 2008**

**SERVICE MARK  
PRINCIPAL REGISTER**



RAT CITY ROLLERGIRLS, LLC (WASHINGTON  
LIMITED LIABILITY COMPANY)  
PO BOX 4698  
SEATTLE, WA 98194

OWNER OF U.S. REG. NO. 3,305,666.

FOR: COORDINATION OF RECREATIONAL  
SPORTING OPPORTUNITIES FOR INDIVIDUALS  
WHO WISH TO PARTICIPATE IN TEAM LEAGUE  
SPORTS; PROMOTING SPORTS COMPETITIONS  
AND/OR EVENTS OF OTHERS, IN CLASS 35 (U.S.  
CLS. 100, 101 AND 102).

NO CLAIM IS MADE TO THE EXCLUSIVE  
RIGHT TO USE "ROLLERGIRLS", APART FROM  
THE MARK AS SHOWN.

SER. NO. 77-063,762, FILED 12-13-2006.

FIRST USE 5-1-2004; IN COMMERCE 5-1-2004.

AISHA SALEM, EXAMINING ATTORNEY

**Int. Cl.: 9**

**Prior U.S. Cls.: 21, 23, 26, 36 and 38**

**United States Patent and Trademark Office**

**Reg. No. 3,497,656**

**Registered Sep. 9, 2008**

**TRADEMARK  
PRINCIPAL REGISTER**

**COM DEV**

COM DEV LTD. (CANADA CORPORATION)  
155 SHELDON DRIVE  
CAMBRIDGE, ONTARIO, CANADA N1R7H6

FOR: HIGH TECHNOLOGY COMMUNICATIONS EQUIPMENT, NAMELY, MICROWAVE/MILLIMETER MULTIPLEXERS, CO-AXIAL AND WAVEGUIDE RF AND MICROWAVE SWITCHES, ELECTRONICS IN THE NATURE OF RF AND MICROWAVE/MILLIMETER-WAVE RECEIVERS, TRANSMITTERS AND SIGNAL PROCESSING ELECTRONICS, SURFACE ACOUSTIC WAVE DEVICES (SAW) DEVICES COMPRISING RF FILTERING RECEIVERS, TRANSMITTERS AND SENSORS, HIGH TECHNOLOGY SCIENTIFIC INSTRUMENTS, SENSORS AND MECHANISMS FOR ASTRONOMICAL, REMOTE SENSING, ENVIRONMENTAL AND CLIMATOLOGY APPLICATIONS FOR THE SPACE, AEROSPACE AND MILITARY MARKETS, NAMELY, OPTICAL AND IR RECEIVERS AND PROCESSING ELECTRONICS,

SPECTROMETERS, ION RECEIVING INSTRUMENTS, OPTICAL GUIDANCE SENSORS, AND RADAR TRANSCEIVERS, IN CLASS 9 (U.S. CLS. 21, 23, 26, 36 AND 38).

FIRST USE 1-2-1975; IN COMMERCE 1-2-1975.

THE MARK CONSISTS OF STANDARD CHARACTERS WITHOUT CLAIM TO ANY PARTICULAR FONT, STYLE, SIZE, OR COLOR.

NO CLAIM IS MADE TO THE EXCLUSIVE RIGHT TO USE "COM", APART FROM THE MARK AS SHOWN.

SEC. 2(F).

SER. NO. 77-063,999, FILED 12-14-2006.

JENNIFER HETU, EXAMINING ATTORNEY

Int. Cl.: 9

Prior U.S. Cls.: 21, 23, 26, 36 and 38

United States Patent and Trademark Office

Reg. No. 3,497,657

Registered Sep. 9, 2008

TRADEMARK  
PRINCIPAL REGISTER



MAUI JIM, INC. (ILLINOIS CORPORATION)  
ONE ALOHA LANE  
PEORIA, IL 61615

THE COLOR(S) RED, ORANGE, YELLOW, GREEN, BLUE, PURPLE, PINK AND BLACK IS/ ARE CLAIMED AS A FEATURE OF THE MARK.

FOR: SUNGLASSES AND PRESCRIPTION AND NON-PRESCRIPTION SUNGLASS LENSES, IN CLASS 9 (U.S. CLS. 21, 23, 26, 36 AND 38).

THE MARK IS COMPRISED OF THE WORDS "POLARIZED PLUS 2" CENTERED BETWEEN TWO CRESCENTS AND CIRCLED BY THE WORDS "ADVANCED PERFORMANCE ONLY" BY "MAUI JIM". THE NUMBER "2" APPEARS IN A RED, ORANGE, YELLOW, GREEN, BLUE, PURPLE, AND PINK RAINBOW COMBINATION. THE OTHER WORDS AND ELEMENTS APPEAR IN BLACK.

FIRST USE 1-31-2004; IN COMMERCE 1-31-2004.

OWNER OF U.S. REG. NOS. 1,781,170, 3,010,769 AND OTHERS.

SER. NO. 77-066,759, FILED 12-18-2006.

THE NAME "MAUI JIM" DOES NOT IDENTIFY A LIVING INDIVIDUAL.

ELISSA GARBER KON, EXAMINING ATTORNEY

**Int. Cls.: 9 and 41**

**Prior U.S. Cls.: 21, 23, 26, 36, 38, 100, 101 and 107**

**Reg. No. 3,497,658**

**United States Patent and Trademark Office**

**Registered Sep. 9, 2008**

**TRADEMARK  
SERVICE MARK  
PRINCIPAL REGISTER**

**SCT**

SCT PERFORMANCE, LLC (NORTH CAROLINA  
LIMITED LIABILITY COMPANY)  
975 FLORIDA CENTRAL PARKWAY, SUITE 1900  
LONGWOOD, FL 32750

FOR: ELECTRONIC AUTOMOTIVE TUNING DE-  
VICE, NAMELY, ELECTRONIC CONTROL HARD-  
WARE UNIT WHICH INTERFACES WITH A CAR'S  
DRIVE-TRAIN COMPUTER SYSTEM AND REPRO-  
GRAMS THE CAR'S MICROCHIP TO MAKE IT GO  
FASTER, HAVE MORE HORSE POWER AND GET  
BETTER GAS MILEAGE, IN CLASS 9 (U.S. CLS. 21,  
23, 26, 36 AND 38).

FIRST USE 3-1-2004; IN COMMERCE 3-1-2004.

FOR: EDUCATIONAL SERVICES, NAMELY,  
PROVIDING CLASSES FEATURING TRAINING IN  
THE FIELD OF AUTOMOTIVE PERFORMANCE  
ENHANCEMENT, IN CLASS 41 (U.S. CLS. 100, 101  
AND 107).

FIRST USE 3-1-2004; IN COMMERCE 3-1-2004.

THE MARK CONSISTS OF STANDARD CHAR-  
ACTERS WITHOUT CLAIM TO ANY PARTICULAR  
FONT, STYLE, SIZE, OR COLOR.

SER. NO. 77-067,042, FILED 12-19-2006.

ROBERT LAVACHE, EXAMINING ATTORNEY

**Int. Cls.: 9 and 41**

**Prior U.S. Cls.: 21, 23, 26, 36, 38, 100, 101 and 107**

**Reg. No. 3,497,659**

**United States Patent and Trademark Office**

**Registered Sep. 9, 2008**

**TRADEMARK  
SERVICE MARK  
PRINCIPAL REGISTER**



SCT PERFORMANCE, LLC (NORTH CAROLINA  
LIMITED LIABILITY COMPANY)  
975 FLORIDA CENTRAL PARKWAY, SUITE 1900  
LONGWOOD, FL 32750

FOR: ELECTRONIC AUTOMOTIVE TUNING DE-  
VICE, NAMELY, ELECTRONIC CONTROL HARD-  
WARE UNIT WHICH INTERFACES WITH A CAR'S  
DRIVE-TRAIN COMPUTER SYSTEM AND REPRO-  
GRAMS THE CAR'S MICROCHIP TO MAKE IT GO  
FASTER, HAVE MORE HORSE POWER AND GET  
BETTER GAS MILEAGE, IN CLASS 9 (U.S. CLS. 21,  
23, 26, 36 AND 38).

FIRST USE 3-1-2004; IN COMMERCE 3-1-2004.

FOR: EDUCATIONAL SERVICES, NAMELY,  
PROVIDING CLASSES FEATURING TRAINING IN  
THE FIELD OF AUTOMOTIVE PERFORMANCE  
ENHANCEMENT, IN CLASS 41 (U.S. CLS. 100, 101  
AND 107).

FIRST USE 3-1-2004; IN COMMERCE 3-1-2004.

THE MARK CONSISTS OF THE LETTERS "SCT".  
THERE ARE FLAMES EXTENDING FROM THE  
LETTER "S" AND THE LETTER "T" HAS AN  
ARROW EXTENDING FROM IT.

SER. NO. 77-067,094, FILED 12-19-2006.

ROBERT LAVACHE, EXAMINING ATTORNEY



**Int. Cls.: 5, 29, 30 and 31**

**Prior U.S. Cls.: 1, 6, 18, 44, 46, 51 and 52**

**Reg. No. 3,497,660**

**United States Patent and Trademark Office**

**Registered Sep. 9, 2008**

**TRADEMARK  
PRINCIPAL REGISTER**



PHOENIX INTANGIBLES HOLDING COMPANY  
(DELAWARE CORPORATION)  
TWO GREENVILLE CROSSING  
4005 KENNETT PIKE, SUITE 220  
GREENVILLE, DE 19807

FOR: BABY FOOD, IN CLASS 5 (U.S. CLS. 6, 18, 44,  
46, 51 AND 52).

FIRST USE 11-0-2004; IN COMMERCE 11-0-2004.

FOR: OLIVE OIL; EGGS; PEANUT BUTTER;  
MILK; SOYMILK; AND POTATO CHIPS, IN CLASS  
29 (U.S. CL. 46).

FIRST USE 8-0-2004; IN COMMERCE 8-0-2004.

FOR: PASTA; SALAD DRESSINGS; BREAKFAST  
CEREALS; SPAGHETTI SAUCE; TORTILLA CHIPS;  
POPCORN; AND PRETZELS, IN CLASS 30 (U.S. CL.  
46).

FIRST USE 9-0-2004; IN COMMERCE 9-0-2004.

FOR: FRESH VEGETABLES, NAMELY, CAR-  
ROTS, EGGPLANT, TOMATOES, PEPPERS, YAMS,  
ZUCCHINI, SPINACH, CUCUMBERS, GARLIC,  
SQUASH, SWEET POTATOES, PEAS AND BEANS ,  
IN CLASS 31 (U.S. CLS. 1 AND 46).

FIRST USE 10-0-2004; IN COMMERCE 10-0-2004.

OWNER OF U.S. REG. NOS. 1,287,433, 1,949,612  
AND OTHERS.

NO CLAIM IS MADE TO THE EXCLUSIVE  
RIGHT TO USE "ORGANIC", APART FROM THE  
MARK AS SHOWN.

SER. NO. 77-067,416, FILED 12-19-2006.

LINDA ORNDORFF, EXAMINING ATTORNEY

**Int. Cls.: 9 and 42**

**Prior U.S. Cls.: 21, 23, 26, 36, 38, 100 and 101**

**Reg. No. 3,497,661**

**United States Patent and Trademark Office**

**Registered Sep. 9, 2008**

**TRADEMARK  
SERVICE MARK  
PRINCIPAL REGISTER**

# BLUE RIDGE

BLUE RIDGE NETWORKS, INC. (DELAWARE CORPORATION)  
14120 PARKE LONG CT., #103  
CHANTILLY, VA 20151

FOR: EQUIPMENT THAT PROVIDES USER AUTHENTICATION, NETWORK SECURITY, AND INFORMATION AND DATA SECURITY IN THE FIELDS OF COMPUTER OR TELECOMMUNICATIONS FOR OTHERS, NAMELY, COMPUTER HARDWARE; COMPUTER SOFTWARE FOR USER AUTHENTICATION, NETWORK SECURITY, AND INFORMATION AND DATA SECURITY; COMPUTER FIRMWARE FOR USER AUTHENTICATION, NETWORK SECURITY, AND INFORMATION AND DATA SECURITY; COMPUTER HARDWARE THAT PROVIDES USER AUTHENTICATION, NETWORK SECURITY, AND INFORMATION AND DATA SECURITY; VIRTUAL PRIVATE NETWORK HARDWARE AND OPERATING SOFTWARE; COMPUTER HARDWARE, NAMELY, CRYPTOGRAPHIC SERVERS AND PROPRIETARY PRIVACY DATA SOFTWARE FOR REMOTE AND MOBILE USERS TO HAVE SECURE ACCESS TO PRIVATE NETWORKS, IN CLASS 9 (U.S. CLS. 21, 23, 26, 36 AND 38).

FIRST USE 3-31-1998; IN COMMERCE 3-31-1998.

FOR: MANAGED SERVICES IN THE FIELD OF COMPUTER OR TELECOMMUNICATIONS NETWORK SECURITY SYSTEM FOR OTHERS, NAMELY, COMPUTER CONSULTATION IN THE FIELD OF COMPUTER SECURITY, COMPUTER SECURITY SERVICE, NAMELY, RESTRICTING ACCESS TO AND BY COMPUTER NETWORKS TO AND OF UNDESIRE WEB SITES, MEDIA AND INDIVIDUALS AND FACILITIES; AND COMPUTER CONSULTATION SERVICES IN THE FIELD OF DESIGN AND IMPLEMENTATION OF COMPUTER HARDWARE AND SOFTWARE AS PART OF A NETWORK SECURITY SYSTEM FOR OTHERS, IN CLASS 42 (U.S. CLS. 100 AND 101).

FIRST USE 3-31-1998; IN COMMERCE 3-31-1998.

THE MARK CONSISTS OF STANDARD CHARACTERS WITHOUT CLAIM TO ANY PARTICULAR FONT, STYLE, SIZE, OR COLOR.

OWNER OF U.S. REG. NO. 2,799,564.

SER. NO. 77-067,638, FILED 12-19-2006.

KATHERINE E. HALMEN, EXAMINING ATTORNEY

**Int. Cl.: 9**

**Prior U.S. Cls.: 21, 23, 26, 36 and 38**

**Reg. No. 3,497,662**

**United States Patent and Trademark Office**

**Registered Sep. 9, 2008**

**TRADEMARK  
PRINCIPAL REGISTER**

**BORDERGUARD**

BLUE RIDGE NETWORKS, INC. (DELAWARE CORPORATION)  
14120 PARKE LONG CT., #103  
CHANTILLY, VA 20151

FOR: EQUIPMENT THAT PROVIDES USER VALIDATION, NETWORK SECURITY, AND INFORMATION AND DATA SECURITY IN THE FIELDS OF COMPUTER AND TELECOMMUNICATIONS, NAMELY, COMPUTER HARDWARE; COMPUTER FIRMWARE FOR USER VALIDATION, NETWORK SECURITY, AND INFORMATION AND DATA SECURITY; VIRTUAL PRIVATE NETWORK HARDWARE AND OPERATING SOFTWARE; COMPUTER HARDWARE AND SOFTWARE SOLD AS A UNIT FOR PROVIDING ROUTING AND SWITCHING IN COMPUTER COMMUNICATION SYSTEMS; COMPUTER HARDWARE THAT PROVIDES USER VALIDATION, NETWORK SECURITY, AND INFORMATION AND DATA SECURITY; AND COMPUTER HARDWARE, NAMELY, CRYPT-

TOGRAPHIC SERVERS AND PROPRIETARY PRIVACY DATA SOFTWARE FOR REMOTE AND MOBILE USERS TO HAVE SECURE ACCESS TO PRIVATE NETWORKS, IN CLASS 9 (U.S. CLS. 21, 23, 26, 36 AND 38).

FIRST USE 10-31-1994; IN COMMERCE 3-31-1995.

THE MARK CONSISTS OF STANDARD CHARACTERS WITHOUT CLAIM TO ANY PARTICULAR FONT, STYLE, SIZE, OR COLOR.

OWNER OF U.S. REG. NOS. 2,954,505 AND 2,954,506.

SER. NO. 77-067,670, FILED 12-19-2006.

KATHERINE E. HALMEN, EXAMINING ATTORNEY

**Int. Cl.: 36**

**Prior U.S. Cls.: 100, 101 and 102**

**United States Patent and Trademark Office**

**Reg. No. 3,497,663**

**Registered Sep. 9, 2008**

**SERVICE MARK  
PRINCIPAL REGISTER**

**INTERNATIONAL FELLOWSHIP  
OF CHRISTIANS AND JEWS**

INTERNATIONAL FELLOWSHIP OF CHRIS-  
TIAN & JEWS, INC. (ILLINOIS NON-PROFIT  
CORPORATION)

30 N. LASALLE STREET, SUITE 2600  
CHICAGO, IL 60602

FOR: CHARITABLE FUNDRAISING SERVICES;  
PROVIDING MONETARY GRANTS TO CHARITA-  
BLE RELIGIOUS ORGANIZATIONS, IN CLASS 36  
(U.S. CLS. 100, 101 AND 102).

FIRST USE 8-28-1991; IN COMMERCE 8-28-1991.

THE MARK CONSISTS OF STANDARD CHAR-  
ACTERS WITHOUT CLAIM TO ANY PARTICULAR  
FONT, STYLE, SIZE, OR COLOR.

NO CLAIM IS MADE TO THE EXCLUSIVE  
RIGHT TO USE "FELLOWSHIP", APART FROM  
THE MARK AS SHOWN.

SEC. 2(F).

SER. NO. 77-068,483, FILED 12-20-2006.

SEAN CROWLEY, EXAMINING ATTORNEY

**Int. Cls.: 41 and 45**

**Prior U.S. Cls.: 100, 101 and 107**

**United States Patent and Trademark Office**

**Reg. No. 3,497,664**

**Registered Sep. 9, 2008**

**SERVICE MARK  
PRINCIPAL REGISTER**

**INTERNATIONAL FELLOWSHIP  
OF CHRISTIANS AND JEWS**

INTERNATIONAL FELLOWSHIP OF CHRISTIANS & JEWS, INC. (ILLINOIS NON-PROFIT CORPORATION)  
30 N. LASALLE STREET, SUITE 2600  
CHICAGO, IL 60602

FOR: RELIGIOUS EDUCATIONAL SERVICES, NAMELY, CONDUCTING SEMINARS, MEETINGS AND CONFERENCES, AND DISTRIBUTING COURSE MATERIALS IN THE NATURE OF TAPES, NEWSLETTERS, BOOKS, PAMPHLETS, LEAFLETS; PROVIDING INFORMATION VIA A GLOBAL COMMUNICATIONS NETWORK IN THE FIELD OF ISRAELI HISTORY, IN CLASS 41 (U.S. CLS. 100, 101 AND 107).

FIRST USE 8-28-1991; IN COMMERCE 8-28-1991.

FOR: PROVIDING INFORMATION VIA A GLOBAL COMMUNICATIONS NETWORK IN THE

FIELD OF JUDAISM, CHRISTIANITY, RELIGION AND ISRAELI CULTURE, IN CLASS 45 (U.S. CLS. 100 AND 101).

FIRST USE 2-4-1998; IN COMMERCE 2-4-1998.

THE MARK CONSISTS OF STANDARD CHARACTERS WITHOUT CLAIM TO ANY PARTICULAR FONT, STYLE, SIZE, OR COLOR.

NO CLAIM IS MADE TO THE EXCLUSIVE RIGHT TO USE "FELLOWSHIP", APART FROM THE MARK AS SHOWN.

SEC. 2(F).

SER. NO. 77-068,500, FILED 12-20-2006.

SEAN CROWLEY, EXAMINING ATTORNEY

**Int. Cls.: 35 and 42**

**Prior U.S. Cls.: 100, 101 and 102**

**United States Patent and Trademark Office**

**Reg. No. 3,497,665**

**Registered Sep. 9, 2008**

**SERVICE MARK  
PRINCIPAL REGISTER**

**PEOPLEAHEAD**

PEOPLEAHEAD, INC. (DELAWARE CORPORATION)  
BABSON PARK  
103 BLANK CENTER  
WELLESLEY, MA 02457

FOR: PROVIDING AN ON-LINE SEARCHABLE DATABASE FEATURING CLASSIFIED JOB LISTINGS AND EMPLOYMENT OPPORTUNITIES VIA ADS AND ON-LINE RESUMES; ON-LINE EMPLOYMENT PLACEMENT SERVICES, NAMELY, ON-LINE EMPLOYMENT HIRING, RECRUITING, PLACEMENT, STAFFING AND CAREER NETWORKING SERVICES; DISSEMINATION OF ADVERTISING MATTER, IN CLASS 35 (U.S. CLS. 100, 101 AND 102).

FIRST USE 4-10-2007; IN COMMERCE 4-10-2007.

FOR: CREATING AND MAINTAINING WEBSITES FOR OTHERS VIA A GLOBAL COMPUTER NETWORK, IN CLASS 42 (U.S. CLS. 100 AND 101).

FIRST USE 4-10-2007; IN COMMERCE 4-10-2007.

THE MARK CONSISTS OF STANDARD CHARACTERS WITHOUT CLAIM TO ANY PARTICULAR FONT, STYLE, SIZE, OR COLOR.

SER. NO. 77-069,782, FILED 12-21-2006.

KAPIL BHANOT, EXAMINING ATTORNEY

**Int. Cl.: 3**

**Prior U.S. Cls.: 1, 4, 6, 50, 51 and 52**

**United States Patent and Trademark Office**

**Reg. No. 3,497,666**

**Registered Sep. 9, 2008**

**TRADEMARK  
PRINCIPAL REGISTER**

**DIRTY CLEAN**

L'OREAL (FRANCE SOCIETE ANONYME)  
14 RUE ROYALE  
PARIS, FRANCE 75008

FOR: SHAMPOOS; CONDITIONERS; GELS,  
SPRAYS, MOUSSES AND BALMS FOR THE HAIR  
STYLING AND HAIR CARE; HAIR LACQUERS;  
HAIR COLOURING AND HAIR DECOLORANT  
PREPARATIONS; PERMANENT WAVING AND  
CURLING PREPARATIONS, IN CLASS 3 (U.S. CLS.  
1, 4, 6, 50, 51 AND 52).

THE MARK CONSISTS OF STANDARD CHAR-  
ACTERS WITHOUT CLAIM TO ANY PARTICULAR  
FONT, STYLE, SIZE, OR COLOR.

PRIORITY CLAIMED UNDER SEC. 44(D) ON  
FRANCE APPLICATION NO. 063468760, FILED 12-  
12-2006, REG. NO. 063468760, DATED 12-12-2006,  
EXPIRES 12-12-2016.

SER. NO. 77-070,489, FILED 12-22-2006.

LINDSEY RUBIN, EXAMINING ATTORNEY

**Int. Cl.: 21**

**Prior U.S. Cls.: 2, 13, 23, 29, 30, 33, 40 and 50**

**Reg. No. 3,497,667**

**United States Patent and Trademark Office**

**Registered Sep. 9, 2008**

**TRADEMARK  
PRINCIPAL REGISTER**



BPONG, LLC (ILLINOIS LIMITED LIABILITY  
COMPANY)  
PO BOX 10609  
CHICAGO, IL 606100609

THE MARK CONSISTS OF A DESIGN CONSIST-  
ING, IN PART, OF THE STYLIZED SILHOUETTE  
OF A BALL PLAYER.

FOR: CUPS, IN CLASS 21 (U.S. CLS. 2, 13, 23, 29, 30,  
33, 40 AND 50).

SER. NO. 77-071,121, FILED 12-25-2006.

FIRST USE 12-19-2006; IN COMMERCE 12-19-2006.

OWNER OF U.S. REG. NO. 3,201,910.

KELLY BOULTON, EXAMINING ATTORNEY



**Int. Cl.: 20**

**Prior U.S. Cls.: 2, 13, 22, 25, 32 and 50**

**United States Patent and Trademark Office**

**Reg. No. 3,497,668**

**Registered Sep. 9, 2008**

**TRADEMARK  
PRINCIPAL REGISTER**

**CREATEENS**

SPOTLIGHT PTY LTD (AUSTRALIA LIMITED  
LIABILITY COMPANY)  
100 MARKET STREET  
SOUTH MELBOURNE, AUSTRALIA 3205VIC

FOR: FURNITURE; MIRRORS; PICTURE  
FRAMES NOT MADE OF PRECIOUS METAL;  
AND GOODS MADE OF WOOD AND PLASTICS  
AND SUBSTITUTES FOR THESE MATERIALS,  
NAMELY, WOOD BOXES, PLASTIC BOXES, PLAS-  
TIC TUBS, FIGURINES, MINIATURE FURNITURE  
MADE OF WOODS OR PLASTIC, ORNAMENTS  
MADE OF WOOD OR PLASTIC, FIGURES OF  
PLASTIC AND WOOD FOR PAINTING; PLASTIC  
MESH FOR NEEDLEPOINT; PLASTIC AND WOOD  
NEEDLEPOINT FRAMES, IN CLASS 20 (U.S. CLS. 2,  
13, 22, 25, 32 AND 50).

THE MARK CONSISTS OF STANDARD CHAR-  
ACTERS WITHOUT CLAIM TO ANY PARTICULAR  
FONT, STYLE, SIZE, OR COLOR.

PRIORITY CLAIMED UNDER SEC. 44(D) ON  
AUSTRALIA APPLICATION NO. 1149992, FILED  
12-1-2006, REG. NO. 1149992, DATED 12-1-2006, EX-  
PIRES 12-1-2016.

OWNER OF U.S. REG. NOS. 3,390,857, 3,390,859  
AND OTHERS.

SER. NO. 77-071,968, FILED 12-27-2006.

PAUL MORENO, EXAMINING ATTORNEY

**Int. Cl.: 21**

**Prior U.S. Cls.: 2, 13, 23, 29, 30, 33, 40 and 50**

**United States Patent and Trademark Office**

**Reg. No. 3,497,669**

**Registered Sep. 9, 2008**

**TRADEMARK  
PRINCIPAL REGISTER**

# CREATEENS

SPOTLIGHT PTY LTD (AUSTRALIA LIMITED  
LIABILITY COMPANY)  
100 MARKET STREET  
SOUTH MELBOURNE, AUSTRALIA 3205VIC

FOR: HOUSEHOLD AND KITCHEN UTENSILS, NAMELY, ROLLING PINS, MIXING BOWLS, CUTTING BOARDS, MIXING SPOONS, MOLDS, NAMELY, CAKE MOLDS, CONFECTIONERS' MOLDS AND GELATIN MOLDS, SPATULAS; CONTAINERS FOR HOUSEHOLD AND KITCHEN USE; COMBS; SPONGES, NAMELY, BATH SPONGES AND KITCHEN SPONGES; BRUSHES, NAMELY, BAKERS' BRUSHES, HAIR BRUSHES, MAKE UP BRUSHES; BRUSH MAKING MATERIALS; UNWORKED OR SEMI-WORKED GLASS; GLASSWARE, NAMELY, BEVERAGE GLASSWARE, BAKING DISHES MADE OF GLASS, DECORATIVE ARTICLES MADE OF GLASS NOT FOR BUILDING, GLASS BOTTLES SOLD EMPTY, GLASS BOWLS, GLASS MOSAICS NOT FOR BUILDING, GLASS VASES, FIGURES OF GLASS FOR PAINTING; PORCELAIN, NAMELY, PORCELAIN MUGS; PORCELAIN BAKING CONTAINERS AND DISHES, NAMELY, BAKING DISHES AND BAKING CUPS;

FIGURES OF PORCELAIN FOR PAINTING, PORCELAIN VASES; EARTHENWARE, NAMELY, EARTHENWARE MUGS; EARTHENWARE BAKING CONTAINERS AND DISHES, NAMELY, BAKING DISHES AND BAKING CUPS; FIGURES OF EARTHENWARE FOR PAINTING, IN CLASS 21 (U.S. CLS. 2, 13, 23, 29, 30, 33, 40 AND 50).

THE MARK CONSISTS OF STANDARD CHARACTERS WITHOUT CLAIM TO ANY PARTICULAR FONT, STYLE, SIZE, OR COLOR.

PRIORITY CLAIMED UNDER SEC. 44(D) ON AUSTRALIA APPLICATION NO. 1149992, FILED 12-1-2006, REG. NO. 1149992, DATED 12-1-2006, EXPIRES 12-1-2016.

OWNER OF U.S. REG. NOS. 3,390,857, 3,390,859 AND OTHERS.

SER. NO. 77-071,972, FILED 12-27-2006.

PAUL MORENO, EXAMINING ATTORNEY

**Int. Cls.: 1, 9 and 11**

**Prior U.S. Cls.: 1, 5, 6, 10, 13, 21, 23, 26, 31, 34, 36, 38  
and 46**

**Reg. No. 3,497,670**

**United States Patent and Trademark Office**

**Registered Sep. 9, 2008**

**TRADEMARK  
PRINCIPAL REGISTER**

**YINGLI**

MIAO, LIAN SHENG (CHINA INDIVIDUAL)  
NO. 3055 MIDDLE FUXING ROAD  
BAODING, CHINA 071051

FOR: PURE SILICON SOLD IN INGOTS, PURE  
SILICON SOLD IN BLOCKS, IN CLASS 1 (U.S. CLS. 1,  
5, 6, 10, 26 AND 46).

FOR: PHOTOVOLTAIC SOLAR MODULES, SO-  
LAR CELLS, SOLAR MODULES, SILICON CHIPS,  
SILICON WAFERS, MULTI-CRYSTALLINE PHOTO-  
VOLTAIC CELLS, IN CLASS 9 (U.S. CLS. 21, 23, 26, 36  
AND 38).

FOR: SOLAR COLLECTORS FOR GENERATING  
ENERGY, IN PARTICULAR ELECTRICITY, IN  
CLASS 11 (U.S. CLS. 13, 21, 23, 31 AND 34).

THE MARK CONSISTS OF STANDARD CHAR-  
ACTERS WITHOUT CLAIM TO ANY PARTICULAR  
FONT, STYLE, SIZE, OR COLOR.

PRIORITY CLAIMED UNDER SEC. 44(D) ON  
ERPNTY TM OFC APPLICATION NO.  
005194402, FILED 7-12-2006, REG. NO. 005194402,  
DATED 6-21-2007, EXPIRES 7-12-2016.

THE WORD "YINGLI" HAS NO MEANING IN A  
FOREIGN LANGUAGE.

SER. NO. 77-072,583, FILED 12-28-2006.

JUDITH HELFMAN, EXAMINING ATTORNEY

**Int. Cl.: 18**

**Prior U.S. Cls.: 1, 2, 3, 22 and 41**

**United States Patent and Trademark Office**

**Reg. No. 3,497,671**

**Registered Sep. 9, 2008**

**TRADEMARK  
PRINCIPAL REGISTER**



RHEINGOLD, RACHEL, JENNIFER (UNITED STATES INDIVIDUAL)  
740 CARROLL STREET  
BROOKLYN, NY 11215 AND  
BERICK, MICHAEL, ADAM (UNITED STATES INDIVIDUAL)  
740 CARROLL STREET  
BROOKLYN, NY 11215

FOR: ALL PURPOSE SPORT BAGS; ALL-PURPOSE ATHLETIC BAGS; ALL-PURPOSE CARRYING BAGS; BEACH BAGS; BOOK BAGS; CARRY-ALL BAGS; CARRY-ON BAGS; GYM BAGS; OVER-NIGHT BAGS; SCHOOL BAGS; SCHOOL BOOK BAGS; SHOULDER BAGS; SMALL BAGS FOR MEN; SOUVENIR BAGS; TEXTILE SHOPPING BAGS; TOTE BAGS; TRAVEL BAGS; TRAVELING BAGS; WINE BAGS WITH HANDLES FOR CARRY-

ING OR HOLDING WINE, IN CLASS 18 (U.S. CLS. 1, 2, 3, 22 AND 41).

FIRST USE 11-1-2006; IN COMMERCE 12-1-2006.

THE MARK CONSISTS OF THE LOGO AND NAME OF OUR COMPANY WHICH IS THE WORD MAPTOTE WITH AN ARROW BELOW POINTING TO THE RIGHT. THE WORD MAPTOTE AND THE ARROW WILL BE ONE SOLID COLOR. THOUGH THE COLOR MAY VARY FROM THE PRODUCT TO THE HANGTAG TO OUR WEBSITE, ETC BUT WILL REMAIN AS ONE COLOR.

SER. NO. 77-073,041, FILED 12-28-2006.

SIMON TENG, EXAMINING ATTORNEY

**Int. Cl.: 35**

**Prior U.S. Cls.: 100, 101 and 102**

**United States Patent and Trademark Office**

**Reg. No. 3,497,672**

**Registered Sep. 9, 2008**

**SERVICE MARK  
PRINCIPAL REGISTER**

**Yes I Advertise**

MILLER, KEVIN PAUL (UNITED STATES INDIVIDUAL)  
528-A 13TH AVE  
SANTA CRUZ, CA 95062

FOR: PROVIDING SPACE AT A WEB SITE FOR THE ADVERTISEMENT OF THE GOODS AND SERVICES OF OTHERS, IN CLASS 35 (U.S. CLS. 100, 101 AND 102).

FIRST USE 6-22-1999; IN COMMERCE 6-22-1999.

THE MARK CONSISTS OF STANDARD CHARACTERS WITHOUT CLAIM TO ANY PARTICULAR FONT, STYLE, SIZE, OR COLOR.

NO CLAIM IS MADE TO THE EXCLUSIVE RIGHT TO USE "I ADVERTISE", APART FROM THE MARK AS SHOWN.

SER. NO. 77-073,066, FILED 12-29-2006.

LOURDES AYALA, EXAMINING ATTORNEY

**Int. Cl.: 41**

**Prior U.S. Cls.: 100, 101 and 107**

**United States Patent and Trademark Office**

**Reg. No. 3,497,673**

**Registered Sep. 9, 2008**

**SERVICE MARK  
PRINCIPAL REGISTER**

# Join the Elite

ROMMANIA, INC. (CALIFORNIA CORPORATION)  
355 N. LANTANA STREET, #562  
CAMARILLO, CA 930106083

FOR: PROVIDING INCENTIVES BY WAY OF AWARDS AND AWARD CERTIFICATES TO MEMBERS OF JOIN THE ELITE WHO USE EDUCATIONAL SPEED READING SOFTWARE IN ORDER TO DEMONSTRATE EXCELLENCE IN THE FIELD OF EDUCATIONAL SPEED READING, IN CLASS 41 (U.S. CLS. 100, 101 AND 107).

FIRST USE 10-16-2005; IN COMMERCE 10-16-2005.

THE MARK CONSISTS OF STANDARD CHARACTERS WITHOUT CLAIM TO ANY PARTICULAR FONT, STYLE, SIZE, OR COLOR.

SER. NO. 77-073,871, FILED 12-31-2006.

LAURA HAMMEL, EXAMINING ATTORNEY

**Int. Cl.: 43**

**Prior U.S. Cls.: 100 and 101**

**United States Patent and Trademark Office**

**Reg. No. 3,497,674**

**Registered Sep. 9, 2008**

**SERVICE MARK  
PRINCIPAL REGISTER**

# Keating House Inn

SCOTT, DOUGLAS BRYCE (CALIFORNIA PART-  
NERSHIP)  
2331 SECOND AVENUE  
SAN DIEGO, CA 92101 AND  
BALTIC, BENJAMIN FRANKLIN (CALIFORNIA  
PARTNERSHIP)  
2331 SECOND AVENUE  
SAN DIEGO, CA 92101

THE MARK CONSISTS OF STANDARD CHAR-  
ACTERS WITHOUT CLAIM TO ANY PARTICULAR  
FONT, STYLE, SIZE, OR COLOR.

NO CLAIM IS MADE TO THE EXCLUSIVE  
RIGHT TO USE "HOUSE INN", APART FROM  
THE MARK AS SHOWN.

FOR: HOTELS, IN CLASS 43 (U.S. CLS. 100 AND  
101).

SER. NO. 77-073,973, FILED 12-31-2006.

FIRST USE 8-29-1985; IN COMMERCE 8-29-1985.

AMEETA JORDAN, EXAMINING ATTORNEY

**Int. Cl.: 5**

**Prior U.S. Cls.: 6, 18, 44, 46, 51 and 52**

**United States Patent and Trademark Office**

**Reg. No. 3,497,675**

**Registered Sep. 9, 2008**

**TRADEMARK  
PRINCIPAL REGISTER**

# Multifibren

DADE BEHRING MARBURG GMBH (FED REP  
GERMANY GMBH)  
EMIL-VON-BEHRING-STR. 76  
MARBURG, FED REP GERMANY 35041

OWNER OF FED REP GERMANY REG. NO.  
749758, DATED 6-9-1961, RENEWED AS REG. NO.  
749758, DATED 11-3-2000, EXPIRES 11-30-2010.

FOR: DIAGNOSTIC REAGENTS FOR CLINICAL  
OR MEDICAL LABORATORY USE, IN CLASS 5  
(U.S. CLS. 6, 18, 44, 46, 51 AND 52).

SER. NO. 77-075,239, FILED 1-3-2007.

THE MARK CONSISTS OF STANDARD CHAR-  
ACTERS WITHOUT CLAIM TO ANY PARTICULAR  
FONT, STYLE, SIZE, OR COLOR.

HEATHER SAPP, EXAMINING ATTORNEY



**Int. Cl.: 5**

**Prior U.S. Cls.: 6, 18, 44, 46, 51 and 52**

**United States Patent and Trademark Office**

**Reg. No. 3,497,676**

**Registered Sep. 9, 2008**

**TRADEMARK  
PRINCIPAL REGISTER**

# Berichrom

DADE BEHRING MARBURG GMBH (FED REP  
GERMANY GMBH)  
EMIL-VON-BEHRING-STR. 76  
MARBURG, FED REP GERMANY 35041

OWNER OF GERMAN DEM REP REG. NO.  
986538, DATED 6-13-1979, RENEWED AS REG. NO.  
986538, DATED 5-31-2008, EXPIRES 5-31-2018.

FOR: DIAGNOSTIC REAGENTS FOR CLINICAL  
OR MEDICAL LABORATORY USE, IN CLASS 5  
(U.S. CLS. 6, 18, 44, 46, 51 AND 52).

SER. NO. 77-075,366, FILED 1-3-2007.

THE MARK CONSISTS OF STANDARD CHAR-  
ACTERS WITHOUT CLAIM TO ANY PARTICULAR  
FONT, STYLE, SIZE, OR COLOR.

HEATHER SAPP, EXAMINING ATTORNEY

**Int. Cl.: 25**

**Prior U.S. Cls.: 22 and 39**

**United States Patent and Trademark Office**

**Reg. No. 3,497,677**

**Registered Sep. 9, 2008**

**TRADEMARK  
PRINCIPAL REGISTER**

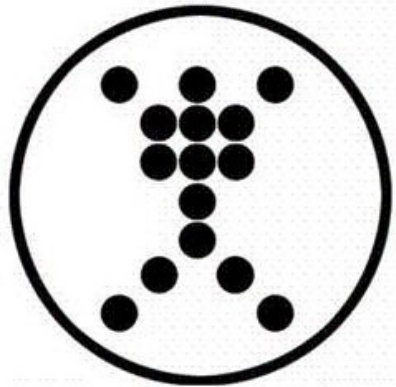

POWERED TRIANGLE LIMITED (UNITED  
KINGDOM CORPORATION)  
34 HATLEY CLOSE  
LONDON, UNITED KINGDOM N113LN

FOR: SHOE INSOLES, OTHER THAN FOR OR-  
THOPAEDIC USE; SOFT INSOLES, OTHER THAN  
FOR ORTHOPAEDIC USE; INSOLES FOR BOOTS;  
INSOLES FOR FOOTWEAR; SPORTS SHOES; ATH-  
LETIC SHOES; CASUAL SHOES; LEISURE SHOES;  
BOOTS, IN CLASS 25 (U.S. CLS. 22 AND 39).

PRIORITY CLAIMED UNDER SEC. 44(D) ON  
UNITED KINGDOM APPLICATION NO. 2426698,  
FILED 7-10-2006, REG. NO. 2426698, DATED 1-5-2007,  
EXPIRES 7-10-2016.

THE MARK CONSISTS OF A STICK MAN  
DRAWN FROM A PLURALITY OF DOTS AND  
SURROUNDED BY A CIRCLE.

SER. NO. 77-076,512, FILED 1-5-2007.

KEVON CHISOLM, EXAMINING ATTORNEY

**Int. Cl.: 25**

**Prior U.S. Cls.: 22 and 39**

**United States Patent and Trademark Office**

**Reg. No. 3,497,678**

**Registered Sep. 9, 2008**

**TRADEMARK  
PRINCIPAL REGISTER**

**LET THE WALK DO THE TALK**

POWERED TRIANGLE LIMITED (UNITED  
KINGDOM CORPORATION)  
34 HATLEY CLOSE  
LONDON, UNITED KINGDOM N113LN

FOR: SHOE INSOLES, OTHER THAN FOR OR-  
THOPAEDIC USE; SOFT INSOLES, OTHER THAN  
FOR ORTHOPAEDIC USE; INSOLES FOR BOOTS;  
INSOLES FOR FOOTWEAR; SPORTS SHOES; ATH-  
LETIC SHOES; CASUAL SHOES; LEISURE SHOES;  
BOOTS, IN CLASS 25 (U.S. CLS. 22 AND 39).

THE MARK CONSISTS OF STANDARD CHAR-  
ACTERS WITHOUT CLAIM TO ANY PARTICULAR  
FONT, STYLE, SIZE, OR COLOR.

PRIORITY CLAIMED UNDER SEC. 44(D) ON  
UNITED KINGDOM APPLICATION NO. 2426726,  
FILED 7-10-2006, REG. NO. 2426726, DATED 1-5-2007,  
EXPIRES 7-10-2016.

SER. NO. 77-076,517, FILED 1-5-2007.

KEVON CHISOLM, EXAMINING ATTORNEY

**Int. Cls.: 9 and 40**

**Prior U.S. Cls.: 21, 23, 26, 36, 38, 100, 103 and 106**

**United States Patent and Trademark Office**

**Reg. No. 3,497,679**

**Registered Sep. 9, 2008**

**TRADEMARK  
SERVICE MARK  
PRINCIPAL REGISTER**

**PRIMAWAVE**

WAVEFRONT ENERGY AND ENVIRONMENTAL SERVICES INC. (CANADA CORPORATION)

SUITE 100

17608 - 103 AVENUE

EDMONTON, CANADA T5S1J9

FOR: SOFTWARE FOR THE ANALYSIS, TREATMENT AND ELIMINATION OF HAZARDOUS CHEMICALS FOR USE IN GROUND WATER REMEDIATION, IN CLASS 9 (U.S. CLS. 21, 23, 26, 36 AND 38).

FOR: ENVIRONMENTAL REMEDIATION SERVICES, NAMELY, GROUND WATER REMEDIA-

TION SERVICES, IN CLASS 40 (U.S. CLS. 100, 103 AND 106).

THE MARK CONSISTS OF STANDARD CHARACTERS WITHOUT CLAIM TO ANY PARTICULAR FONT, STYLE, SIZE, OR COLOR.

OWNER OF CANADA REG. NO. TMA177955, DATED 4-15-2008, EXPIRES 4-15-2023.

SER. NO. 77-076,918, FILED 1-5-2007.

PAUL CROWLEY, EXAMINING ATTORNEY

**Int. Cl.: 39**

**Prior U.S. Cls.: 100 and 105**

**United States Patent and Trademark Office**

**Reg. No. 3,497,680**

**Registered Sep. 9, 2008**

**SERVICE MARK  
PRINCIPAL REGISTER**



SEAJET EXPRESS, INC. (MASSACHUSETTS CORPORATION)

46 ARLINGTON STREET  
CHELSEA, MA 02150

FOR: FREIGHT FORWARDING; FREIGHT TRANSPORTATION BY LAND, AIR AND SEA, IN CLASS 39 (U.S. CLS. 100 AND 105).

FIRST USE 12-11-1987; IN COMMERCE 12-11-1987.

THE COLOR(S) BLUE IS/ARE CLAIMED AS A FEATURE OF THE MARK.

THE MARK CONSISTS OF THE WORD "SEAJET" AND IS PRECEDED BY A STYLIZED WAVE AND FOLLOWED BY A STYLIZED WING; THE LETTERS "S" AND "J" ARE ENLARGED. THE WORD "EXPRESS" FOLLOWS THE WORD "SEAJET" AND IS IN ALL CAPITAL LETTERS. ALL LETTERS ARE COLORED BLUE. BOTH THE STYLIZED WAVE AND WING ARE COLORED BLUE. THE MARK IS IN THE HORIZONTAL POSITION.

SEC. 2(F) AS TO "EXPRESS".

SER. NO. 77-077,100, FILED 1-5-2007.

SARA THOMAS, EXAMINING ATTORNEY

Int. Cl.: 33

Prior U.S. Cls.: 47 and 49

United States Patent and Trademark Office

Reg. No. 3,497,681

Registered Sep. 9, 2008

TRADEMARK  
PRINCIPAL REGISTER



BARÓN DE VILLACAMPA

BARON DE VILLACAMPA SL. (SPAIN CORPORATION)  
CARRETERA SARINENA S/N TORRE BORAU  
HUESCA, SPAIN 22005

FOR: GRAPE WINE; RED WINE; TABLE WINES;  
WHITE WINE; WINE; WINES, IN CLASS 33 (U.S.  
CLS. 47 AND 49).

FIRST USE 6-21-2005; IN COMMERCE 6-21-2005.

OWNER OF ERPN CMNTY TM OFC REG. NO.  
003704442, DATED 6-21-2005, EXPIRES 6-21-2015.

OWNER OF U.S. REG. NO. 370,442.

THE NAME "BARON DE VILLACAMPA" DOES  
NOT IDENTIFY A LIVING INDIVIDUAL.

THE COLOR(S) SILVER, BLACK, RED, GOLD,  
DARK BLUE AND WHITE IS/ARE CLAIMED AS A  
FEATURE OF THE MARK.

THE LOGO IS CROWNED KNIGHT FACING  
FORWARD, HOLDING A LONG SPEAR WITH HIS  
RIGHT ARM, AND OBLONG SHIELD, BEARING  
THE KNIGHT'S ARMS WITH HIS LEFT HAND,  
THE LOWER TIP OF THE SHIELD REST ON THE  
FLOOR IN FRONT OF KNIGHT LEFT FOOT. THE  
COLOUR SILVER APPEARS AS A HIGHLIGHTING  
COLOUR IN THE KNIGHT'S IN THE KNIGHT'S  
ARMOUR, IN THE KNIGHT'S SPEAR AND THE  
KNIGHT'S SHIELD, IT ALSO APPEARS ON THE  
OUTSIDE OF TWO TOWER CASTLE WALLS AND  
ITS TOWERS. THE COLOUR BLACK APPEARS

OVERALL THE KNIGHT'S ARMOUR, HELMET,  
CROWN, SHIELD AND SPEAR. THE COLOUR  
RED APPEARS ON THE KILT OF KNIGHT AND  
ON THE ARCHED DOOR BEHIND THE KNIGHT  
GUARDING ENTRANCE TO CASTLE AND IN THE  
WINDOWS OF SAME. THE COLOUR GOLD AP-  
PEARS HIGHLIGHTING THE KNIGHT'S CROWN,  
THE PERIMETER OF HIS SHIELD AND ON THE  
TRIMMING OF THE KILT WORN BY SAID  
KNIGHT. A DARK BLUE COLOUR IS FOUND AS  
A BACKGROUND COLOUR BEHIND THE TWO  
TOWER SILVER CASTLE AND BEHIND THE  
WHITE WINGED ANGEL, SINCE IT IS SPREADING  
ITS WINGS OVER THE WATERS SEPARATE AND  
UNDER KNIGHT'S FIGURE AND SLIGHTLY OFF-  
CENTRE THE WORDING IN BLACK CAPS "BARON  
DE VILLACAMPA" (THE KNIGHT'S NAME), THE  
ARMS WITHIN OR ON THE KNIGHT'S SHIELD  
ARE DIVIDED INTO TWO SECTIONS: THE UPPER  
SECTION OCCUPIES ABOUT 2/3 OF SHIELD AND  
IT CONTAINS: A TWO TOWER SILVER CASTLE,  
ON A DARK BLUE BACKGROUND, A RED BACK-  
GROUND COLOUR APPEARS IN THE TWO LOW-  
ER WINDOWS, IN THE TWO UPPER WINDOWS  
AND IN THE ARCHED FRONT DOORWAY (AL-  
READY DESCRIBED ABOVE IN THE COLOURS  
LOCATION STATEMENT) WHERE THE KNIGHT  
STANDS ON GUARD ON THE LOWER 1/3, AT THE  
FOOT OF CASTLES DOOR, THERE IS A STAIRCASE  
WHICH LEADS TO A LAKE (REPRESENTED BY  
THE DARK BLUE COLOUR BEHIND THE ANGEL'S  
WINGS AND HEAD) ON SAID LAKE WE FIND A  
WHITE WINGED ANGEL SPREADING ITS WHITE  
WINGS OVER THE WATERS OF LAKE.

THE GOLD PERIMETER OF THE OBLONG  
SHAPED SHIELD CONTAINS THE WORDS IN  
LATIN "IN DEO MEO TRANSGREDIAR MVRVM"  
WHICH MEANS "WITH GOD'S HELP WE WILL  
CONQUER THE WALLS".

SER. NO. 77-077,705, FILED 1-8-2007.

DAWN FELDMAN, EXAMINING ATTORNEY

**Int. Cl.: 43**

**Prior U.S. Cls.: 100 and 101**

**United States Patent and Trademark Office**

**Reg. No. 3,497,682**

**Registered Sep. 9, 2008**

**SERVICE MARK  
PRINCIPAL REGISTER**

**BRAZZAZ**

BRAZZAZ, LLC (ILLINOIS LIMITED LIABILITY  
COMPANY)  
514 ANDERSON DR.  
LAKE IN THE HILLS, IL 60156

FOR: RESTAURANT AND BAR SERVICES; RES-  
TAURANT SERVICES, IN CLASS 43 (U.S. CLS. 100  
AND 101).

FIRST USE 5-1-2005; IN COMMERCE 5-1-2005.

THE MARK CONSISTS OF STANDARD CHAR-  
ACTERS WITHOUT CLAIM TO ANY PARTICULAR  
FONT, STYLE, SIZE, OR COLOR.

OWNER OF U.S. REG. NO. 3,036,850.

SER. NO. 77-079,488, FILED 1-10-2007.

JERI J. FICKES, EXAMINING ATTORNEY



**Int. Cl.: 25**

**Prior U.S. Cls.: 22 and 39**

**United States Patent and Trademark Office**

**Reg. No. 3,497,683**

**Registered Sep. 9, 2008**

**TRADEMARK  
PRINCIPAL REGISTER**

**WHAT 4 ?!**

SHENANDOAH TRADING CO., LTD. (TAIWAN  
LIMITED LIABILITY COMPANY)  
NO. 40, ZHOH SHI, DIN SHI LI, HUWET TOWN  
YUU LIN HSIEN, TAIWAN

FOR: SUITS, JACKETS, DRESSES, SKIRTS, UN-  
DERWEAR, SWIMSUITS, T-SHIRTS, PARKAS,  
SPORTS UNIFORMS, SHORTS, SHOES, BOOTS,  
SPORTS SHOES, SANDALS, HATS, SOCKS,  
GLOVES, BELTS, TIES, NECKERCHIEFS, IN CLASS  
25 (U.S. CLS. 22 AND 39).

THE MARK CONSISTS OF STANDARD CHAR-  
ACTERS WITHOUT CLAIM TO ANY PARTICULAR  
FONT, STYLE, SIZE, OR COLOR.

OWNER OF CHINA REG. NO. 01290152, DATED  
12-1-2007, EXPIRES 11-30-2017.

SER. NO. 77-079,827, FILED 1-10-2007.

MIDGE BUTLER, EXAMINING ATTORNEY

**Int. Cl.: 35**

**Prior U.S. Cls.: 100, 101 and 102**

**United States Patent and Trademark Office**

**Reg. No. 3,497,684**

**Registered Sep. 9, 2008**

**SERVICE MARK  
PRINCIPAL REGISTER**

**WHAT 4 ?!**

SHENANDOAH TRADING CO., LTD. (TAIWAN  
LIMITED LIABILITY COMPANY)  
NO. 40, ZHOH SHI, DIN SHI LI, HUWET TOWN  
YUU LIN HSIEN, TAIWAN

FOR: IMPORT AND EXPORT AGENCIES; SALE  
PROMOTION FOR OTHERS; RETAIL STORE, COM-  
PUTERIZED ONLINE RETAIL AND RETAIL DIS-  
TRIBUTORSHIP SERVICES ALL FEATURING  
TRAVELING BAGS, TRUNKS, HANDBAGS, AT-  
TACHÉ CASES, UMBRELLAS, PARASOLS, SUITS,  
JACKETS, DRESSES, SKIRTS, UNDERWEAR,  
SWIMSUITS, T-SHIRTS, PARKAS, SPORTS UNI-  
FORMS, SHORTS, SHOES, BOOTS, SPORTS SHOES,  
SANDALS, HATS, SOCKS, GLOVES, BELTS, TIES

AND NECKERCHIEFS, IN CLASS 35 (U.S. CLS. 100,  
101 AND 102).

THE MARK CONSISTS OF STANDARD CHAR-  
ACTERS WITHOUT CLAIM TO ANY PARTICULAR  
FONT, STYLE, SIZE, OR COLOR.

OWNER OF CHINA REG. NO. 01286170, DATED  
11-1-2007, EXPIRES 10-31-2017.

SER. NO. 77-079,834, FILED 1-10-2007.

MIDGE BUTLER, EXAMINING ATTORNEY

Int. Cl.: 31

Prior U.S. Cls.: 1 and 46

United States Patent and Trademark Office

Reg. No. 3,497,685

Registered Sep. 9, 2008

TRADEMARK  
PRINCIPAL REGISTER



THE HONEST KITCHEN, INC. (CALIFORNIA CORPORATION)  
145 14TH STREET  
SAN DIEGO, CA 92101

FOR: DOG FOOD, IN CLASS 31 (U.S. CLS. 1 AND 46).

FIRST USE 8-20-2003; IN COMMERCE 8-20-2003.

OWNER OF U.S. REG. NO. 2,908,697.

NO CLAIM IS MADE TO THE EXCLUSIVE RIGHT TO USE "DEHYDRATED RAW DOG FOOD FOR ADULT MAINTENANCE", APART FROM THE MARK AS SHOWN.

THE COLOR(S) GREEN AND WHITE IS/ARE CLAIMED AS A FEATURE OF THE MARK.

THE COLOR RED APPEARS IN THE TWO DOGS, RECTANGLES AND THE WORDING "THE HONEST KITCHEN", THE COLORS ORANGE AND YELLOW APPEAR IN RECTANGLES, THE COLOR GREEN APPEARS IN THE DOG, RECTANGLES AND BACKGROUND AND THE COLOR WHITE APPEARS IN THE WORDING "FORCE DEHYDRATED RAW DOG FOOD FOR ADULT MAINTENANCE" AND THE RECTANGLE BAR ACROSS THE MARK.

THE MARK CONSISTS OF WHITE WRITING ON GREEN BACKGROUND WITH DOG BEHIND.

SER. NO. 77-080,360, FILED 1-10-2007.

SALLY SHIH, EXAMINING ATTORNEY

**Int. Cls.: 16 and 41**

**Prior U.S. Cls.: 2, 5, 22, 23, 29, 37, 38, 50, 100, 101 and 107**

**United States Patent and Trademark Office**

**Reg. No. 3,497,686**

**Registered Sep. 9, 2008**

**TRADEMARK  
SERVICE MARK  
PRINCIPAL REGISTER**

**WICKED WORDS**

VIRGIN BOOKS LIMITED (UNITED KINGDOM  
LIMITED CORPORATION)  
120 CAMPDEN HILL ROAD  
LONDON, UNITED KINGDOM W87AR

FOR: BOOKS IN THE FIELD OF ADULT ENTERTAINMENT; PRINTED MATTER, NAMELY, MAGAZINES AND NEWSLETTERS IN THE FIELD OF ADULT ENTERTAINMENT, IN CLASS 16 (U.S. CLS. 2, 5, 22, 23, 29, 37, 38 AND 50).

FOR: PUBLICATION OF BOOKS, IN CLASS 41 (U.S. CLS. 100, 101 AND 107).

THE MARK CONSISTS OF STANDARD CHARACTERS WITHOUT CLAIM TO ANY PARTICULAR FONT, STYLE, SIZE, OR COLOR.

PRIORITY CLAIMED UNDER SEC. 44(D) ON UNITED KINGDOM APPLICATION NO. 2426798, FILED 7-11-2006, REG. NO. 2426798, DATED 7-11-2006, EXPIRES 7-11-2016.

SER. NO. 77-080,874, FILED 1-11-2007.

KATHY DE JONGE, EXAMINING ATTORNEY

**Int. Cl.: 20**

**Prior U.S. Cls.: 2, 13, 22, 25, 32 and 50**

**United States Patent and Trademark Office**

**Reg. No. 3,497,687**

**Registered Sep. 9, 2008**

**TRADEMARK  
PRINCIPAL REGISTER**

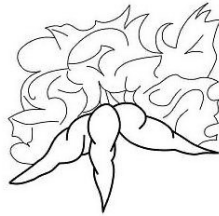

MARSHALL STREET DEPOT AND CO. (TEXAS CORPORATION), DBA PLENTY'S HORN  
15 CR 2210  
PO BOX 869  
PITTSBURGH, TX 75686

FOR: FURNITURE; CHILDREN'S FURNITURE; BEDROOM FURNITURE; ARMOIRE; CRIB; NON-METAL CHESTS; FURNITURE MIRRORS; FURNITURE TABLES; FURNITURE PILLOWS, CHAIRS, DESKS; STOOLS; HAMPERS; OTTOMANS; DOG BED; CURTAIN ROD; TOY CHESTS; FURNITURE TOY BOXES; SHELF SETS; AND FURNITURE

PARTS, NAMELY, HEADBOARDS, FOOTBOARDS, AND FLATBOARDS, IN CLASS 20 (U.S. CLS. 2, 13, 22, 25, 32 AND 50).

FIRST USE 11-1-1996; IN COMMERCE 11-1-1996.

THE MARK CONSISTS OF A CARROT DESIGN.

SER. NO. 77-081,714, FILED 1-12-2007.

ALLISON HOLTZ, EXAMINING ATTORNEY

**Int. Cls.: 35 and 41**

**Prior U.S. Cls.: 100, 101, 102 and 107**

**United States Patent and Trademark Office**

**Reg. No. 3,497,688**

**Registered Sep. 9, 2008**

**SERVICE MARK  
PRINCIPAL REGISTER**

**INTERNATIONAL SOCIETY FOR  
CLINICAL DENSITOMETRY**

INTERNATIONAL SOCIETY FOR CLINICAL  
DENSITOMETRY (NEW YORK CORPORATION)  
342 NORTH MAIN STREET  
WEST HARTFORD, CT 061172507

FOR: ASSOCIATION SERVICES, NAMELY, PROMOTING THE INTERESTS OF PROFESSIONALS IN THE FIELD OF DENSITOMETRY AND THE SCIENCES RELATED TO THE ASSESSMENT OF SKELETAL HEALTH, IN CLASS 35 (U.S. CLS. 100, 101 AND 102).

FIRST USE 5-29-2001; IN COMMERCE 5-29-2001.

FOR: EDUCATIONAL SERVICES, NAMELY, ARRANGING AND CONDUCTING CLASSES, SEMINARS, WORKSHOPS, SYMPOSIA AND EDUCATIONAL CONFERENCES IN THE FIELD OF DENSITOMETRY AND THE SCIENCES RELA-

TED TO THE ASSESSMENT OF SKELETAL HEALTH; EDUCATIONAL SERVICES, NAMELY, PREPARING, ADMINISTERING AND SCORING OF EXAMINATIONS IN THE FIELD OF DENSITOMETRY AND THE SCIENCES RELATED TO THE ASSESSMENT OF SKELETAL HEALTH, IN CLASS 41 (U.S. CLS. 100, 101 AND 107).

FIRST USE 5-29-2001; IN COMMERCE 5-29-2001.

THE MARK CONSISTS OF STANDARD CHARACTERS WITHOUT CLAIM TO ANY PARTICULAR FONT, STYLE, SIZE, OR COLOR.

SEC. 2(F).

SER. NO. 77-082,058, FILED 1-12-2007.

KAPIL BHANOT, EXAMINING ATTORNEY

**Int. Cl.: 3**

**Prior U.S. Cls.: 1, 4, 6, 50, 51 and 52**

**United States Patent and Trademark Office**

**Reg. No. 3,497,689**

**Registered Sep. 9, 2008**

**TRADEMARK  
PRINCIPAL REGISTER**



UNION COUNTY MEDICAL CENTER, P.C. (NEW MEXICO CORPORATION)  
314 NORTH THIRD STREET  
CLAYTON, NM 88415

FOR: BODY AND FACIAL CLEANSERS, NAME-  
LY, LOTIONS, MISTS, FOAMS, GELS AND SCRUBS,  
AND KITS CONSISTING PRIMARILY OF THESE  
GOODS; BODY AND FACIAL MOISTURIZERS,  
NAMELY, LOTIONS, CREAMS, SALVES, GELS,  
GELEES, RUBS, AND SERUMS, AND KITS CON-  
SISTING PRIMARILY OF THESE GOODS; BODY  
AND FACIAL EXFOLIATORS, NAMELY, LOTIONS,  
SCRUBS, GELS, WASHES, CREAMS, PEELS, MASKS  
AND SERUMS, AND KITS CONSISTING PRIMAR-  
ILY OF THESE GOODS; BODY AND FACIAL  
TONERS, AND KITS CONSISTING PRIMARILY  
OF THESE GOODS; BODY AND FACIAL MASQUES,  
AND KITS CONSISTING PRIMARILY OF THESE  
GOODS; BODY AND FACIAL MASKS, AND KITS  
CONSISTING PRIMARILY OF THESE GOODS;  
BODY AND FACIAL PREPARATIONS, NAMELY  
NON-MEDICATED SKIN SERUMS AND KITS CON-  
SISTING PRIMARILY OF THESE GOODS; SHAV-  
ING PRODUCTS, NAMELY, GELS AND AFTER-  
SHAVE, AND KITS CONSISTING PRIMARILY OF  
THESE GOODS; MAKE-UP, INCLUDING BROW  
TINTS AND GELS, MASCARAS, EYE PENCILS,

FOUNDATIONS, TINTED LOTIONS, BLUSHES, LIP-  
STICKS, LIP GLAZES, LIP SHEENS, LIP PENCILS,  
MAKE-UP REMOVERS, AND KITS CONSISTING  
PRIMARILY OF THESE GOODS; NON-MEDICA-  
TED LIP CARE PREPARATIONS, INCLUDING  
BALMS; BODY AND FACIAL POWDERS; SUN-  
BLOCK PREPARATIONS, INCLUDING LOTIONS  
AND CREAMS, AND KITS CONSISTING PRIMAR-  
ILY OF THESE GOODS; SELF-TANNING PRE-  
PARATIONS, INCLUDING FOAMS; SKIN  
LIGHTENING CREAMS AND GELS, AND KITS  
CONSISTING PRIMARILY OF THESE GOODS;  
NON-MEDICATED ANTI-BLEMISH CLEANSERS,  
LOTIONS AND GELS; ANTI-WRINKLE SKIN CARE  
PREPARATIONS, INCLUDING LOTIONS,  
CREAMS, SERUMS, GELS AND OINTMENTS,  
AND KITS CONSISTING PRIMARILY OF THESE  
GOODS, IN CLASS 3 (U.S. CLS. 1, 4, 6, 50, 51 AND 52).

FIRST USE 4-20-2004; IN COMMERCE 4-20-2004.

THE MARK CONSISTS OF A STYLIZED LETTER  
"G".

SER. NO. 77-082,122, FILED 1-12-2007.

ANNE MADDEN, EXAMINING ATTORNEY

**Int. Cl.: 12**

**Prior U.S. Cls.: 19, 21, 23, 31, 35 and 44**

**Reg. No. 3,497,690**

**United States Patent and Trademark Office**

**Registered Sep. 9, 2008**

**TRADEMARK  
PRINCIPAL REGISTER**

**CORECON**

CORECON, INC. (ILLINOIS CORPORATION)  
775 DUVICK AVE.  
SANDWICH, IL 60548

CLUTCHES, AND THRUSTERS, IN CLASS 12 (U.S.  
CLS. 19, 21, 23, 31, 35 AND 44).

FIRST USE 10-28-1992; IN COMMERCE 10-28-1992.

FOR: AUTOMATED GUIDED VEHICLES; SPARE  
PARTS FOR AUTOMATED GUIDED VEHICLES,  
NAMELY, HORNS, BACK-UP WARNING ALARMS,  
ANTI-THEFT ALARMS, SHOCK ABSORBING  
SPRINGS, WHEELS, GEAR LEVER KNOBS, DOOR  
HANDLES, COUPLINGS, GEARS, BUMPERS,  
SHOCK ABSORBERS, GAS TANK GROMMETS,  
BRAKES, WHEEL SPROCKETS, DRIVE BELTS,

THE MARK CONSISTS OF STANDARD CHAR-  
ACTERS WITHOUT CLAIM TO ANY PARTICULAR  
FONT, STYLE, SIZE, OR COLOR.

SER. NO. 77-082,314, FILED 1-12-2007.

PATRICIA EVANKO, EXAMINING ATTORNEY



**Int. Cls.: 3 and 35**

**Prior U.S. Cls.: 1, 4, 6, 50, 51, 52, 100, 101 and 102**

**Reg. No. 3,497,691**

**United States Patent and Trademark Office**

**Registered Sep. 9, 2008**

**TRADEMARK  
SERVICE MARK  
PRINCIPAL REGISTER**



ATLANTIC INNOVATIONS, LLC (MASSACHUSETTS LIMITED LIABILITY COMPANY)  
21B OLYMPIA AVENUE  
WOBURN, MA 01801

FIRST USE 3-1-2006; IN COMMERCE 3-1-2006.

FOR: MASSAGE OIL, IN CLASS 3 (U.S. CLS. 1, 4, 6, 50, 51 AND 52).

NO CLAIM IS MADE TO THE EXCLUSIVE RIGHT TO USE "COMPANY", APART FROM THE MARK AS SHOWN.

FIRST USE 3-1-2006; IN COMMERCE 3-1-2006.

SER. NO. 77-083,208, FILED 1-15-2007.

FOR: COMPUTERIZED ON-LINE RETAIL STORE SERVICES IN THE FIELD OF ADULT SEXUAL AIDS, IN CLASS 35 (U.S. CLS. 100, 101 AND 102).

SIMON TENG, EXAMINING ATTORNEY

**Int. Cl.: 35**

**Prior U.S. Cls.: 100, 101 and 102**

**United States Patent and Trademark Office**

**Reg. No. 3,497,692**

**Registered Sep. 9, 2008**

**SERVICE MARK  
PRINCIPAL REGISTER**

**VIPdesk Connect**

VIPDESK.COM, INC. (DELAWARE CORPORATION)  
324 N FAIRFAX STREET  
ALEXANDRIA, VA 22314

FOR: OPERATION OF TELEPHONE CALL CENTERS FOR OTHERS, IN CLASS 35 (U.S. CLS. 100, 101 AND 102).

FIRST USE 7-1-2006; IN COMMERCE 7-1-2006.

THE MARK CONSISTS OF STANDARD CHARACTERS WITHOUT CLAIM TO ANY PARTICULAR FONT, STYLE, SIZE, OR COLOR.

OWNER OF U.S. REG. NO. 2,661,282.

SER. NO. 77-084,893, FILED 1-17-2007.

STEVEN PEREZ, EXAMINING ATTORNEY

**Int. Cls.: 4 and 6**

**Prior U.S. Cls.: 1, 2, 6, 12, 13, 14, 15, 23, 25 and 50**

**United States Patent and Trademark Office**

**Reg. No. 3,497,693**

**Registered Sep. 9, 2008**

**TRADEMARK  
PRINCIPAL REGISTER**

**MIPRO**

CALEDON PROPANE INC. (CANADA CORPORATION)  
1 BETOMAT COURT, P.O. BOX 400  
BOLTON, CANADA L7E5T3

FOR: PROPANE GAS SOLD IN TANKS FOR BARBECUES AND FORKLIFTS, IN CLASS 4 (U.S. CLS. 1, 6 AND 15).

FOR: METAL TANKS FOR PROPANE GAS, SOLD EMPTY, FOR BARBECUES AND FORKLIFTS, IN CLASS 6 (U.S. CLS. 2, 12, 13, 14, 23, 25 AND 50).

THE MARK CONSISTS OF STANDARD CHARACTERS WITHOUT CLAIM TO ANY PARTICULAR FONT, STYLE, SIZE, OR COLOR.

PRIORITY CLAIMED UNDER SEC. 44(D) ON CANADA APPLICATION NO. 1331844, FILED 1-18-2007, REG. NO. TMA707213, DATED 2-12-2008, EXPIRES 2-12-2023.

SER. NO. 77-085,881, FILED 1-18-2007.

CAROLYN CATALDO, EXAMINING ATTORNEY

**Int. Cl.: 16**

**Prior U.S. Cls.: 2, 5, 22, 23, 29, 37, 38 and 50**

**United States Patent and Trademark Office**

**Reg. No. 3,497,694**

**Registered Sep. 9, 2008**

**TRADEMARK  
PRINCIPAL REGISTER**

**AMERICA'S TRUCK PARTS  
PROFESSIONALS**

TRUCKPRO, INC. (DELAWARE CORPORATION)  
8110 CORDOVA ROAD, SUITE 116  
CORDOVA, TN 38018

FOR: CALENDARS, IN CLASS 16 (U.S. CLS. 2, 5,  
22, 23, 29, 37, 38 AND 50).

FIRST USE 12-1-2007; IN COMMERCE 12-1-2007.

THE MARK CONSISTS OF STANDARD CHAR-  
ACTERS WITHOUT CLAIM TO ANY PARTICULAR  
FONT, STYLE, SIZE, OR COLOR.

SEC. 2(F).

SER. NO. 77-086,588, FILED 1-19-2007.

DAVID H. STINE, EXAMINING ATTORNEY

Int. Cl.: 30

Prior U.S. Cl.: 46

United States Patent and Trademark Office

Reg. No. 3,497,695

Registered Sep. 9, 2008

TRADEMARK  
PRINCIPAL REGISTER



HILL & VALLEY, INC. (ILLINOIS CORPORATION)  
3915 9TH STREET  
ROCK ISLAND, IL 61201

FOR: BAKERY GOODS, NAMELY, PRE-BAKED, FROZEN PIES, QUICHES, CAKES, MUFFINS, COOKIES, AND BROWNIES; UNBAKED, FROZEN PIES AND QUICHES; AND, ICING, IN CLASS 30 (U.S. CL. 46).

FIRST USE 8-1-2006; IN COMMERCE 8-1-2006.

OWNER OF U.S. REG. NO. 2,911,676.

NO CLAIM IS MADE TO THE EXCLUSIVE RIGHT TO USE "PREMIUM BAKERY", APART FROM THE MARK AS SHOWN.

"THE COLOR(S) DARK BLUE, GOLD, BEIGE AND WHITE IS/ARE CLAIMED AS A FEATURE OF THE MARK."

"THE MARK CONSISTS OF A DARK BLUE OVAL BACKGROUND DESIGN CIRCUMSCRIBED BY A GOLD SCALLOPED BORDER, IN WHICH THE LITERAL ELEMENT "HILL & VALLEY" APPEARS IN WHITE LETTERING. ALSO WITHIN THE DARK BLUE OVAL BACKGROUND APPEARS A DEPICTION OF A PIE IN BEIGE WITH A DARK BLUE PIE PLATE. THE DEPICTION OF VAPOR OR STEAM EMANATING FROM THE PIE APPEARS IN WHITE. DIRECTLY BELOW THE GOLD SCALLOPED BORDER AND DARK BLUE OVAL DESIGN IS A BANNER WHICH APPEARS IN SHADES OF GOLD AND SUPERIMPOSED UPON THE BANNER IS THE WORDING "PREMIUM BAKERY" WHICH APPEARS IN DARK BLUE LETTERING."

SER. NO. 77-089,778, FILED 1-24-2007.

ERIN FALK, EXAMINING ATTORNEY

**Int. Cls.: 39 and 42**

**Prior U.S. Cls.: 100, 101 and 105**

**United States Patent and Trademark Office**

**Reg. No. 3,497,696**

**Registered Sep. 9, 2008**

**SERVICE MARK  
PRINCIPAL REGISTER**

# Endura Vault

NET IMPRESSIONS, LTD. (NEVADA LIMITED  
LIABILITY COMPANY)

#462

3540 WEST SAHARA AVENUE  
LAS VEGAS, NV 89102

FOR: ELECTRONIC STORAGE OF FILES AND  
DOCUMENTS, IN CLASS 39 (U.S. CLS. 100 AND 105).

FIRST USE 11-18-2005; IN COMMERCE 11-18-2005.

FOR: CONVERSION OF DATA OR DOCUMENTS  
FROM PHYSICAL TO ELECTRONIC MEDIA, IN  
CLASS 42 (U.S. CLS. 100 AND 101).

FIRST USE 11-18-2005; IN COMMERCE 11-18-2005.

THE MARK CONSISTS OF STANDARD CHAR-  
ACTERS WITHOUT CLAIM TO ANY PARTICULAR  
FONT, STYLE, SIZE, OR COLOR.

SER. NO. 77-089,824, FILED 1-24-2007.

SEAN CROWLEY, EXAMINING ATTORNEY

**Int. Cl.: 45**

**Prior U.S. Cls.: 100 and 101**

**United States Patent and Trademark Office**

**Reg. No. 3,497,697**

**Registered Sep. 9, 2008**

**SERVICE MARK  
PRINCIPAL REGISTER**



CENTRA-LARM MONITORING, INC. (NEW HAMPSHIRE CORPORATION)  
994 CANDIA ROAD  
MANCHESTER, NH 03109

FOR: ALARM MONITORING SERVICES, IN CLASS 45 (U.S. CLS. 100 AND 101).

FIRST USE 0-0-2001; IN COMMERCE 0-0-2001.

THE COLOR(S) BLUE AND GRAY IS/ARE CLAIMED AS A FEATURE OF THE MARK.

THE MARK CONSISTS OF THE LETTER "I" AND CIRCULAR DESIGNS REVOLVING AROUND THE LETTER "I"; THE BASE OF THE LETTER "I" IS GRAY AND THE DOT OF THE LETTER "I" APPEARS IN VARIOUS SHADES OF BLUE AND GRAY AND THE SIDES AND BOTTOM OF THE BASE OF SAID LETTER ARE OUTLINED IN BLUE; THE CIRCULAR DESIGNS REVOLVING AROUND THE LETTER "I" APPEAR IN VARIOUS SHADES OF BLUE.

SER. NO. 77-090,177, FILED 1-24-2007.

MATTHEW PAPPAS, EXAMINING ATTORNEY

**Int. Cls.: 42 and 45**

**Prior U.S. Cls.: 100 and 101**

**United States Patent and Trademark Office**

**Reg. No. 3,497,698**

**Registered Sep. 9, 2008**

**SERVICE MARK  
PRINCIPAL REGISTER**

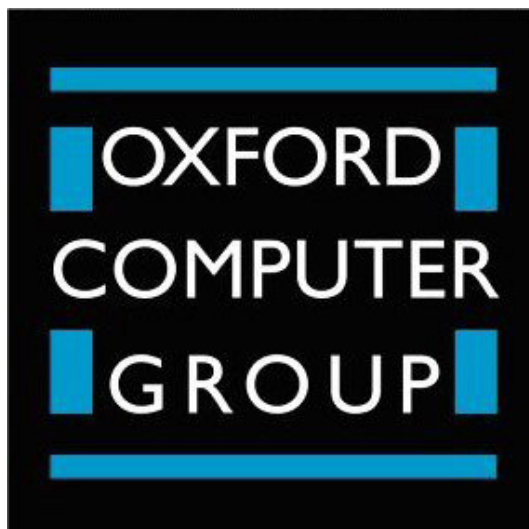

OXFORD COMPUTER GROUP LIMITED (UNITED KINGDOM LIMITED LIABILITY COMPANY)

THE STABLES, BIGNELL PARK BARNS  
CHESTERTON

OXFORDSHIRE, UNITED KINGDOM OX261TD

FOR: IDENTITY MANAGEMENT SERVICES, NAMELY, COMPUTER SECURITY SERVICES, NAMELY, RESTRICTING ACCESS TO AND BY COMPUTER NETWORKS TO AND OF UNDESIRE WEB SITES, MEDIA AND INDIVIDUALS AND FACILITIES, IN CLASS 42 (U.S. CLS. 100 AND 101).

FIRST USE 1-1-2003; IN COMMERCE 1-1-2003.

FOR: ACCESS MANAGEMENT SERVICES, NAMELY, MONITORING OF COMPUTER SYSTEMS FOR SECURITY PURPOSES; IDENTITY AND ACCESS MANAGEMENT SERVICES, NAMELY, IDENTIFICATION VERIFICATION SERVICES, NAMELY, PROVIDING AUTHENTICATION OF

PERSONAL IDENTIFICATION SERVICES, IN CLASS 45 (U.S. CLS. 100 AND 101).

FIRST USE 1-1-2003; IN COMMERCE 1-1-2003.

NO CLAIM IS MADE TO THE EXCLUSIVE RIGHT TO USE "OXFORD COMPUTER GROUP", APART FROM THE MARK AS SHOWN.

THE COLOR(S) WHITE, BLACK AND BLUE IS/ ARE CLAIMED AS A FEATURE OF THE MARK.

THE MARK CONSISTS OF THE WORDS "OXFORD COMPUTER GROUP" APPEARING IN THE COLOR WHITE, WITH RANDOM BLUE BANDS ON A BLACK SQUARE BACKGROUND.

SER. NO. 77-091,269, FILED 1-25-2007.

TASHIA BUNCH, EXAMINING ATTORNEY



**Int. Cl.: 9**

**Prior U.S. Cls.: 21, 23, 26, 36 and 38**

**Reg. No. 3,497,699**

**United States Patent and Trademark Office**

**Registered Sep. 9, 2008**

**TRADEMARK  
PRINCIPAL REGISTER**

**CEBIX**

APPLIED PHYSICS TECHNOLOGIES, INC. (OREGON CORPORATION)  
1600 NE MILLER STREET, SUITE 105A  
MCMINNVILLE, OR 97128

FOR: CATHODES AND ELECTRON SOURCES, NAMELY, THERMIONIC AND FIELD EMISSION CATHODES FOR USE IN MICROSCOPY, METROLOGY, LITHOGRAPHY AND WAFER INSPECTION, IN CLASS 9 (U.S. CLS. 21, 23, 26, 36 AND 38).

FIRST USE 1-0-1993; IN COMMERCE 1-0-1993.

THE MARK CONSISTS OF STANDARD CHARACTERS WITHOUT CLAIM TO ANY PARTICULAR FONT, STYLE, SIZE, OR COLOR.

THE TERM "CEBIX" HAS NO MEANING IN A FOREIGN LANGUAGE.

SER. NO. 77-093,403, FILED 1-29-2007.

MICHAEL KEATING, EXAMINING ATTORNEY

**Int. Cl.: 9**

**Prior U.S. Cls.: 21, 23, 26, 36 and 38**

**United States Patent and Trademark Office**

**Reg. No. 3,497,700**

**Registered Sep. 9, 2008**

**TRADEMARK  
PRINCIPAL REGISTER**

**CELLCRYPT**

CELLFIRE SECURITY TECHNOLOGIES, LTD.  
(GREAT BRITAIN CORPORATION)  
32 DUNELM STREET  
LONDON, GREAT BRITAIN E10QQ

FOR: COMPUTER HARDWARE, SOFTWARE AND FIRMWARE FOR ENCRYPTION; COMPUTER HARDWARE, SOFTWARE AND FIRMWARE FOR ENCRYPTING TELECOMMUNICATIONS; PRE-RECORDED MEDIA AND DATA CARRIERS ENCODED WITH COMPUTER SOFTWARE FOR ENCRYPTING TELECOMMUNICATIONS; CODING AND DECODING APPARATUS, NAMELY, ELECTRONIC CODING UNITS; ENCRYPTION AND DECRYPTION APPARATUS, NAMELY, ELECTRONIC ENCRYPTION AND DECRYPTION UNITS; STRUCTURAL PARTS AND FITTINGS FOR ALL

THE AFORESAID GOODS, IN CLASS 9 (U.S. CLS. 21, 23, 26, 36 AND 38).

THE MARK CONSISTS OF STANDARD CHARACTERS WITHOUT CLAIM TO ANY PARTICULAR FONT, STYLE, SIZE, OR COLOR.

PRIORITY CLAIMED UNDER SEC. 44(D) ON ERPN CMNTY TM OFC APPLICATION NO. 005649157, FILED 1-29-2007, REG. NO. 005649157, DATED 2-6-2008, EXPIRES 1-29-2017.

SER. NO. 77-093,958, FILED 1-29-2007.

BRIAN CALLAGHAN, EXAMINING ATTORNEY

**Int. Cls.: 9 and 42**

**Prior U.S. Cls.: 21, 23, 26, 36, 38, 100 and 101**

**United States Patent and Trademark Office**

**Reg. No. 3,497,701**

**Registered Sep. 9, 2008**

**TRADEMARK  
SERVICE MARK  
PRINCIPAL REGISTER**

**XMOS**

XMOS LTD (UNITED KINGDOM LIMITED LIABILITY COMPANY)  
UNIVERSITY GATE EAST, PARK ROW  
BRISTOL, UNITED KINGDOM BS15UB

FOR: COMPUTER SOFTWARE DEVELOPMENT TOOLS; SEMICONDUCTOR CHIPS; SEMICONDUCTOR DEVICES, IN CLASS 9 (U.S. CLS. 21, 23, 26, 36 AND 38).

FOR: DESIGN AND DEVELOPMENT OF SOFTWARE, IN CLASS 42 (U.S. CLS. 100 AND 101).

THE MARK CONSISTS OF STANDARD CHARACTERS WITHOUT CLAIM TO ANY PARTICULAR FONT, STYLE, SIZE, OR COLOR.

PRIORITY CLAIMED UNDER SEC. 44(D) ON UNITED KINGDOM APPLICATION NO. 2445131, FILED 1-30-2007, REG. NO. 2445131, DATED 1-30-2007, EXPIRES 1-30-2017.

SER. NO. 77-094,178, FILED 1-30-2007.

SARA THOMAS, EXAMINING ATTORNEY

**Int. Cl.: 35**

**Prior U.S. Cls.: 100, 101 and 102**

**United States Patent and Trademark Office**

**Reg. No. 3,497,702**

**Registered Sep. 9, 2008**

**SERVICE MARK  
PRINCIPAL REGISTER**

**ZMAG**

INNOVATIVE AUTOMOTIVE GROUP, LLC (DE-  
LAWARE LIMITED LIABILITY COMPANY)  
14405 NORTH SCOTTSDALE ROAD, SUITE A  
SCOTTSDALE, AZ 85254

FOR: WHOLESALE DISTRIBUTORSHIPS FEATURING INTERIOR AND EXTERIOR STYLING COMPONENTS AND ACCESSORIES FOR CARS AND TRUCKS, NAMELY, FUEL DOORS, MINI GRILLS, DOOR BRACKETS, DOOR PULLS, CARGO DOOR PULLS, HOOD HANDLES, HOOD PANELS, HOOD LATCHES, TAIL VENTS, SIDE VENTS, LIGHT BEZEL SETS, MARKER LIGHT COVERS, ROOF RACKS, CIGARETTE LIGHTERS, AND EN-

GINE TUNING SOFTWARE, IN CLASS 35 (U.S. CLS. 100, 101 AND 102).

FIRST USE 1-0-2003; IN COMMERCE 1-0-2003.

THE MARK CONSISTS OF STANDARD CHARACTERS WITHOUT CLAIM TO ANY PARTICULAR FONT, STYLE, SIZE, OR COLOR.

SER. NO. 77-094,946, FILED 1-30-2007.

LOURDES AYALA, EXAMINING ATTORNEY

**Int. Cl.: 19**

**Prior U.S. Cls.: 1, 12, 33 and 50**

**United States Patent and Trademark Office**

**Reg. No. 3,497,703**

**Registered Sep. 9, 2008**

**TRADEMARK  
PRINCIPAL REGISTER**

**MILLSTONE**

SINGER, RALPH, M. (UNITED STATES INDIVIDUAL)  
19321 E. WALNUT DRIVE NORTH  
CITY OF INDUSTRY, CA 91748

FOR: FLOOR MATERIAL, NAMELY, FLOOR  
BOARDS AND FLOOR TILES OF HARDWOOD  
AND SOLID WOOD, IN CLASS 19 (U.S. CLS. 1, 12,  
33 AND 50).

FIRST USE 11-7-2004; IN COMMERCE 11-7-2004.

THE MARK CONSISTS OF STANDARD CHARACTERS WITHOUT CLAIM TO ANY PARTICULAR FONT, STYLE, SIZE, OR COLOR.

SER. NO. 77-095,513, FILED 1-31-2007.

COLLEEN DOMBROW, EXAMINING ATTORNEY

Int. Cl.: 31

Prior U.S. Cls.: 1 and 46

United States Patent and Trademark Office

Reg. No. 3,497,704

Registered Sep. 9, 2008

TRADEMARK  
PRINCIPAL REGISTER

***Fubon***

ANGEL YEAST CO., LTD. (CHINA CORPORATION)  
NO. 24, ZHONGNAN ROAD, YICHANG CITY  
HUBEI PROVINCE, CHINA

FOR: FODDER FOR USE AS ANIMAL FEED, NAMELY, MIXED ANIMAL FEED, LIVESTOCK FEED, ANIMAL FEED, ANIMAL FOODSTUFFS, FISH MEAL AS ANIMAL FEED; ADDITIVES FOR FODDER NOT FOR MEDICAL PURPOSES; YEAST FOR USE AS ANIMAL FEED; ANIMAL FOODSTUFFS; PROTEIN BEING FOODSTUFFS FOR AN-

IMAL CONSUMPTION, IN CLASS 31 (U.S. CLS. 1 AND 46).

FIRST USE 0-0-2003; IN COMMERCE 11-0-2006.

THE FOREIGN WORDING IN THE MARK TRANSLATES INTO ENGLISH AS PROSPEROUS NATION.

SER. NO. 77-098,514, FILED 2-2-2007.

KAPIL BHANOT, EXAMINING ATTORNEY

Int. Cl.: 41

Prior U.S. Cls.: 100, 101 and 107

Reg. No. 3,497,705

United States Patent and Trademark Office

Registered Sep. 9, 2008

**SERVICE MARK  
PRINCIPAL REGISTER**

# Kenya

BERROA, CAROLINA TESS (UNITED STATES INDIVIDUAL)  
5034 PALOMAR DR.  
TARZANA, CA 91356

FOR: ENTERTAINMENT IN THE NATURE OF LIVE PERFORMANCES BY MUSICAL ARTIST, MUSICAL GROUP OR MUSICAL BAND; ENTERTAINMENT IN THE NATURE OF THEATER PRODUCTIONS; ENTERTAINMENT IN THE NATURE OF VISUAL AND AUDIO PERFORMANCES, AND MUSICAL, VARIETY, NEWS AND COMEDY SHOWS; ENTERTAINMENT IN THE NATURE OF VISUAL AND AUDIO PERFORMANCES, NAMELY, MUSICAL BAND, ROCK GROUP, GYMNASTIC, DANCE, AND BALLET PERFORMANCES; ENTERTAINMENT, NAMELY, LIVE PERFORMANCES BY A MUSICAL BAND; ENTERTAINMENT SERVICES, NAMELY, LIVE, TELEVISED AND MOVIE APPEARANCES BY A PROFESSIONAL ENTERTAINER; ENTERTAINMENT SERVICES, NAMELY, PERSONAL APPEARANCES BY A MUSICIAN, MUSICAL GROUP OR MUSICAL BAND; ENTERTAINMENT SERVICES, NAMELY, PROVIDING A WEB SITE FEATURING MUSICAL PERFORMANCES, MUSICAL VIDEOS, RELATED FILM CLIPS, PHO-

TOGRAPHS, AND OTHER MULTIMEDIA MATERIALS; ENTERTAINMENT SERVICES, NAMELY, PROVIDING PRERECORDED MUSIC, INFORMATION IN THE FIELD OF MUSIC, AND COMMENTARY AND ARTICLES ABOUT MUSIC, ALL ONLINE VIA A GLOBAL COMPUTER NETWORK; ENTERTAINMENT, NAMELY, LIVE MUSIC CONCERTS; ENTERTAINMENT, NAMELY, LIVE PERFORMANCES BY MUSICAL BANDS; ENTERTAINMENT, NAMELY, LIVE PERFORMANCES BY ROCK GROUPS, IN CLASS 41 (U.S. CLS. 100, 101 AND 107).

FIRST USE 4-15-2001; IN COMMERCE 4-15-2001.

THE MARK CONSISTS OF STANDARD CHARACTERS WITHOUT CLAIM TO ANY PARTICULAR FONT, STYLE, SIZE, OR COLOR.

THE WORDING "KENYA" HAS NO MEANING IN A FOREIGN LANGUAGE.

SER. NO. 77-099,150, FILED 2-5-2007.

ROBIN MITTLER, EXAMINING ATTORNEY

Int. Cls.: 9, 16 and 41

Prior U.S. Cls.: 2, 5, 21, 22, 23, 26, 29, 36, 37, 38, 50,  
100, 101 and 107

Reg. No. 3,497,706

United States Patent and Trademark Office

Registered Sep. 9, 2008

TRADEMARK  
SERVICE MARK  
PRINCIPAL REGISTER



TRAINING | CONSULTING | TEAM BUILDING

BOLD COMPANIES CREATED ONE PERSON AT A TIME

CONSCIOUS DYNAMICS LLC (OHIO LIMITED  
LIABILITY COMPANY)  
114 WELLINGTON PLACE  
CINCINNATI, OH 45219

FOR: DIGITAL MATERIALS, NAMELY, PRE-RECORDED CDS, VIDEOTAPES, LASER DISKS, AND DVDS FEATURING TRAINING, CONSULTING, AND TEAM BUILDING MATERIALS BASED UPON INDIVIDUAL PERSONALITY TRAITS TO CREATE HIGH PERFORMANCE TEAMS, TO MAXIMIZE SKILLS, TO IMPROVE COMMUNICATION, TO PREVENT AND RESOLVE CONFLICTS, TO PROVIDE CONSTRUCTIVE FEEDBACK, TO IMPROVE AND FOSTER CREATIVITY, BUSINESS DEVELOPMENT, DIGITAL MATERIALS, NAMELY, PRE-RECORDED CDS, VIDEOTAPES, LASER DISKS, AND DVDS FEATURING TRAINING, CONSULTING, AND TEAM BUILDING MATERIALS BASED UPON INDIVIDUAL PERSONALITY TRAITS TO CREATE HIGH PERFORMANCE TEAMS, TO MAXIMIZE SKILLS, TO IMPROVE COMMUNICATION, TO PREVENT AND RESOLVE CONFLICTS, TO PROVIDE CONSTRUCTIVE FEEDBACK, TO IMPROVE AND FOSTER CREATIVITY, BUSINESS DEVELOPMENT, BUSINESS PLANNING, MANAGEMENT SKILLS, BUSINESS INNOVATION AND COMMUNICATION. ELECTRONIC PUBLICATIONS, NAMELY, BOOKS, MAGAZINES, MANUALS, NEWSLETTERS FEATURING TRAINING, CONSULTING, AND TEAM BUILDING MATERIALS BASED UPON INDIVIDUAL PERSONALITY TRAITS TO CREATE HIGH PERFORMANCE TEAMS, TO MAXIMIZE SKILLS, TO IMPROVE COMMUNICATION, TO PREVENT AND RESOLVE CONFLICTS, AND TO PROVIDE CON-

STRUCTIVE FEEDBACK, TO IMPROVE AND FOSTER CREATIVITY, BUSINESS DEVELOPMENT, BUSINESS PLANNING, MANAGEMENT SKILLS, BUSINESS INNOVATION AND COMMUNICATION RECORDED ON COMPUTER MEDIA. PROVIDING ON-LINE ELECTRONIC NEWSLETTERS IN THE FIELD OF BUSINESS DEVELOPMENT AND BUSINESS IMPROVEMENT BASED UPON INDIVIDUAL PERSONALITY TRAITS TO CREATE HIGH PERFORMANCE TEAMS, TO MAXIMIZE SKILLS, TO IMPROVE COMMUNICATION, TO PREVENT AND RESOLVE CONFLICTS, AND TO PROVIDE CONSTRUCTIVE FEEDBACK, TO IMPROVE AND FOSTER CREATIVITY, BUSINESS DEVELOPMENT, BUSINESS PLANNING, MANAGEMENT SKILLS, BUSINESS INNOVATION AND COMMUNICATION, IN CLASS 9 (U.S. CLS. 21, 23, 26, 36 AND 38).

FIRST USE 10-4-2006; IN COMMERCE 12-1-2006.

FOR: EDUCATIONAL BOOKS AND NEWSLETTERS FEATURING TRAINING, CONSULTING, AND TEAM BUILDING MATERIALS USING INDIVIDUAL PERSONALITY TRAITS TO CREATE HIGH PERFORMANCE TEAMS, TO MAXIMIZE SKILLS, TO IMPROVE COMMUNICATION, TO PREVENT AND RESOLVE CONFLICTS, TO PROVIDE CONSTRUCTIVE FEEDBACK, TO IMPROVE AND FOSTER CREATIVITY, BUSINESS DEVELOPMENT, BUSINESS PLANNING, MANAGEMENT SKILLS, BUSINESS INNOVATION AND COMMUNICATION, IN CLASS 16 (U.S. CLS. 2, 5, 22, 23, 29, 37, 38 AND 50).

FIRST USE 10-4-2006; IN COMMERCE 12-1-2006.



FOR: PROVIDING ONLINE TRAINING AND EDUCATIONAL SERVICES BY CONDUCTING WORKSHOPS AND SEMINARS IN BUSINESS DEVELOPMENT AND BUSINESS IMPROVEMENT USING INDIVIDUAL PERSONALITY TRAITS FOR TRAINING, CONSULTING, AND TEAM BUILDING TO CREATE HIGH PERFORMANCE TEAMS, TO MAXIMIZE SKILLS, TO IMPROVE COMMUNICATION, TO PREVENT AND RESOLVE CONFLICTS, TO PROVIDE CONSTRUCTIVE FEEDBACK, TO IMPROVE AND FOSTER CREATIVITY, BUSINESS DEVELOPMENT, BUSINESS PLANNING, MANAGEMENT SKILLS, BUSINESS INNOVATION AND COMMUNICATION, IN CLASS 41 (U.S. CLS. 100, 101 AND 107).

FIRST USE 10-4-2006; IN COMMERCE 12-1-2006.

NO CLAIM IS MADE TO THE EXCLUSIVE RIGHT TO USE "TRAINING CONSULTING TEAM BUILDING", APART FROM THE MARK AS SHOWN.

THE COLOR(S) YELLOW, GREY, BLACK AND WHITE IS/ARE CLAIMED AS A FEATURE OF THE MARK.

THE MARK CONSISTS OF THE WORDS "CONSCIOUS DYNAMICS" IN ALL CAPITALS WITH A

LOGO BETWEEN THE WORDS "CONSCIOUS" AND "DYNAMICS", WITH THE WORDS "TRAINING CONSULTING TEAM BUILDING" UNDERNEATH IN SMALL CAPITALS WITH EACH WORD SEPARATED BY A VERTICAL LINE OF THE SAME SIZE, AND THE WORDS "BOLD COMPANIES CREATED ONE PERSON AT A TIME" IN SMALL CAPITAL LETTERS UNDERNEATH. THE LOGO BETWEEN THE WORDS "CONSCIOUS" AND "DYNAMICS" CONSISTS OF A SHADED CIRCLE WITH A SHADED OUTLINE AROUND IT WITH A CHEVRON OR PARTIAL CIRCLE SEGMENT AROUND EACH HALF OF THE CIRCLE. THE COLOR YELLOW APPEARS IN THE TWO CIRCLE SEGMENTS OR CHEVRONS SURROUNDING THE SHADED CIRCLE. THE COLOR GREY APPEARS IN THE SHADED CIRCLE, THE SHADOW IN THE LINES AROUND THE SHADED CIRCLE, AND THE WORDING "CONSCIOUS", "DYNAMIC", AND "BOLD COMPANIES CREATED ONE PERSON AT A TIME". THE COLOR BLACK APPEARS IN THE WORDING "TRAINING CONSULTING TEAM BUILDING" AND THE VERTICAL LINES IN THE MARK. THE COLOR WHITE APPEARS IN THE CIRCLE, THE LINES SURROUNDING THE CIRCLE AND THE BACKGROUND OF THE MARK.

SER. NO. 77-100,121, FILED 2-6-2007.

CHRISTINE COOPER, EXAMINING ATTORNEY

**Int. Cl.: 25**

**Prior U.S. Cls.: 22 and 39**

**United States Patent and Trademark Office**

**Reg. No. 3,497,707**

**Registered Sep. 9, 2008**

**TRADEMARK  
PRINCIPAL REGISTER**

**ANNIKKI KARVINEN**

OY ANNIKKI KARVINEN, LTD. (FINLAND  
CORPORATION)

VASARAKATU 9A RAK B

40320 JYVASKYLA, FINLAND

FOR: WOMEN'S DESIGNER CLOTHING, NAME-  
LY, COATS, JACKETS, CAPES, BOLEROS, VESTS,  
DRESSES, SKIRTS, PANTS, SHIRTS, CARDIGANS,  
SWEATERS, SCARVES, AND HATS, IN CLASS 25  
(U.S. CLS. 22 AND 39).

FIRST USE 1-1-1980; IN COMMERCE 1-1-1980.

THE MARK CONSISTS OF STANDARD CHAR-  
ACTERS WITHOUT CLAIM TO ANY PARTICULAR  
FONT, STYLE, SIZE, OR COLOR.

THE NAME "ANNIKKI KARVINEN" IDENTI-  
FIES A LIVING INDIVIDUAL WHOSE CONSENT  
IS OF RECORD.

THE MARK HAS NO MEANING IN A FOREIGN  
LANGUAGE.

SER. NO. 77-100,348, FILED 2-6-2007.

LANA PHAM, EXAMINING ATTORNEY

**Int. Cl.: 9**

**Prior U.S. Cls.: 21, 23, 26, 36 and 38**

**United States Patent and Trademark Office**

**Reg. No. 3,497,708**

**Registered Sep. 9, 2008**

**TRADEMARK  
PRINCIPAL REGISTER**

**BUTTERFLY DELIGHT**

ARISTOCRAT TECHNOLOGIES AUSTRALIA  
PTY LTD (AUSTRALIA CORPORATION)  
71 LONGUEVILLE ROAD  
LANE COVE, AUSTRALIA NSW 2066

OWNER OF AUSTRALIA REG. NO. 700458, DA-  
TED 1-9-1996, EXPIRES 1-9-2016.

FOR: GAMING MACHINES, IN CLASS 9 (U.S.  
CLS. 21, 23, 26, 36 AND 38).

SER. NO. 77-100,790, FILED 2-6-2007.

THE MARK CONSISTS OF STANDARD CHAR-  
ACTERS WITHOUT CLAIM TO ANY PARTICULAR  
FONT, STYLE, SIZE, OR COLOR.

WILLIAM ROSSMAN, EXAMINING ATTORNEY

**Int. Cl.: 35**

**Prior U.S. Cls.: 100, 101 and 102**

**United States Patent and Trademark Office**

**Reg. No. 3,497,709**

**Registered Sep. 9, 2008**

**SERVICE MARK  
PRINCIPAL REGISTER**

**TRINITYONE**  
**W O R L D W I D E**

TRINITYONE INC. (MASSACHUSETTS CORPORATION)  
SUITE 303  
1661 WORCESTER ROAD  
FRAMINGHAM, MA 01701

FOR: PROVIDING ADVERTISING, MARKETING, PROMOTIONAL, SPONSORSHIP GENERATION AND PRODUCT PLACEMENT SERVICES, AND RELATED CONSULTING, AND NEGOTIATION AND SETTLEMENT OF COMMERCIAL TRANSACTIONS FOR SPORTS TEAMS, ENTERTAINMENT ENTITIES, MEDIA ORGANIZATIONS,

ATHLETES, PERSONALITIES AND COMPANIES, IN CLASS 35 (U.S. CLS. 100, 101 AND 102).

FIRST USE 4-7-2006; IN COMMERCE 4-7-2006.

NO CLAIM IS MADE TO THE EXCLUSIVE RIGHT TO USE "WORLDWIDE", APART FROM THE MARK AS SHOWN.

SER. NO. 77-102,964, FILED 2-8-2007.

AISHA CLARKE, EXAMINING ATTORNEY

**Int. Cl.: 41**

**Prior U.S. Cls.: 100, 101 and 107**

**United States Patent and Trademark Office**

**Reg. No. 3,497,710**

**Registered Sep. 9, 2008**

**SERVICE MARK  
PRINCIPAL REGISTER**

**DOMINIONSAP**

RODERICK COLLINS (UNITED STATES INDIVIDUAL)  
5680 HIGHWAY 6, # 144  
MISSOURI CITY, TX 77459

THE MARK CONSISTS OF STANDARD CHARACTERS WITHOUT CLAIM TO ANY PARTICULAR FONT, STYLE, SIZE, OR COLOR.

FOR: COMPUTER EDUCATION TRAINING, IN CLASS 41 (U.S. CLS. 100, 101 AND 107).

SER. NO. 77-104,330, FILED 2-10-2007.

FIRST USE 9-15-2006; IN COMMERCE 9-15-2006.

ANTHONY RINKER, EXAMINING ATTORNEY

**Int. Cl.: 45**

**Prior U.S. Cls.: 100 and 101**

**United States Patent and Trademark Office**

**Reg. No. 3,497,711**

**Registered Sep. 9, 2008**

**SERVICE MARK  
PRINCIPAL REGISTER**

**THE FINGERPRINT MAN**

ANTHONY'S MOBILE FINGERPRINTING, INC.  
(ILLINOIS CORPORATION)  
10 SOUTH RIVERSIDE PLAZA  
CHICAGO, IL 60606

FOR: PRE-EMPLOYMENT BACKGROUND INVESTIGATION SERVICES; PRE-EMPLOYMENT BACKGROUND SCREENING, IN CLASS 45 (U.S. CLS. 100 AND 101).

FIRST USE 11-15-2005; IN COMMERCE 11-1-2006.

THE MARK CONSISTS OF STANDARD CHARACTERS WITHOUT CLAIM TO ANY PARTICULAR FONT, STYLE, SIZE, OR COLOR.

NO CLAIM IS MADE TO THE EXCLUSIVE RIGHT TO USE "FINGERPRINT", APART FROM THE MARK AS SHOWN.

SER. NO. 77-105,126, FILED 2-12-2007.

JASON TURNER, EXAMINING ATTORNEY

**Int. Cl.: 25**

**Prior U.S. Cls.: 22 and 39**

**United States Patent and Trademark Office**

**Reg. No. 3,497,712**

**Registered Sep. 9, 2008**

**TRADEMARK  
PRINCIPAL REGISTER**

**Jeffrey D.**

BRONX FOOT FASHION INC. (NEW YORK  
CORPORATION)  
1632 EAST 7TH STREET  
BROOKLYN, NY 11230

FOR: BELTS; BLOUSES; BRAS; COATS; DRESSES;  
FOOTWEAR; HOSIERY; JACKETS; JEANS; SHOES;  
SOCKS; SWEATERS; UNDERGARMENTS; UNDER-  
WEAR, IN CLASS 25 (U.S. CLS. 22 AND 39).

FIRST USE 6-1-2004; IN COMMERCE 6-1-2004.

THE MARK CONSISTS OF STANDARD CHAR-  
ACTERS WITHOUT CLAIM TO ANY PARTICULAR  
FONT, STYLE, SIZE, OR COLOR.

THE NAME "JEFFREY D." IDENTIFIES A LIV-  
ING INDIVIDUAL WHOSE CONSENT IS OF RE-  
CORD.

SER. NO. 77-107,226, FILED 2-14-2007.

SOPHIA S. KIM, EXAMINING ATTORNEY

**Int. Cl.: 41**

**Prior U.S. Cls.: 100, 101 and 107**

**Reg. No. 3,497,713**

**United States Patent and Trademark Office**

**Registered Sep. 9, 2008**

**SERVICE MARK  
PRINCIPAL REGISTER**



FUNKY PEOPLE, LLC (NEW JERSEY LIMITED LIABILITY COMPANY)  
28 W. 3RD STR, STE #2319  
SOUTH ORANGE, NJ 070791788

FOR: ENTERTAINMENT SERVICES, NAMELY, LIVE MUSIC CONCERTS, CONDUCTING NETWORKING PARTIES FOR THE PURPOSE OF DATING AND SOCIAL INTRODUCTION FOR ADULTS; EDUCATIONAL SERVICES, NAMELY, CONDUCTING COURSES OF INSTRUCTION IN THE FIELDS OF ENTREPRENEURSHIP, FINANCIAL INVESTMENT, BUSINESS, AND CAREER DEVELOPMENT, USING ON-LINE ACTIVITIES AND INTERACTIVE EXHIBITS, AND PRINTABLE MATERIALS DISTRIBUTED THEREWITH; ENTERTAINMENT, NAMELY, MUSIC PRODUCTION SERVICES, PRODUCTION OF VIDEO CASSETTES AND MOTION PICTURE FILMS; ENTERTAINMENT SERVICES, NAMELY, PROVIDING PRERECORDED MUSIC, INFORMATION IN THE FIELD OF MUSIC, AND COMMENTARY AND ARTICLES ABOUT MUSIC, ALL ON-LINE VIA A GLOBAL COMPUTER NET-

WORK; ENTERTAINMENT, NAMELY, A CONTINUING MUSIC, AND VARIETY SHOW BROADCAST OVER TELEVISION, SATELLITE, AUDIO, AND VIDEO MEDIA; PROVIDING A WEB SITE WHERE USERS CAN POST RATINGS, REVIEWS AND RECOMMENDATIONS ON EVENTS AND ACTIVITIES IN THE FIELD OF ENTERTAINMENT AND EDUCATION; RADIO ENTERTAINMENT PRODUCTION; RADIO ENTERTAINMENT SERVICES, NAMELY, RADIO PROGRAMS FEATURING PERFORMANCES BY A DEE JAY OR PERSONALITY, IN CLASS 41 (U.S. CLS. 100, 101 AND 107).

FIRST USE 3-1-2006; IN COMMERCE 3-1-2006.

THE MARK CONSISTS OF THE BLACK COLORING IS IN THE FONT STYLE OF THE IMAGE.

SER. NO. 77-107,527, FILED 2-14-2007.

SUSAN LESLIE DUBOIS, EXAMINING ATTORNEY



**Int. Cl.: 41**

**Prior U.S. Cls.: 100, 101 and 107**

**United States Patent and Trademark Office**

**Reg. No. 3,497,714**

**Registered Sep. 9, 2008**

**SERVICE MARK  
PRINCIPAL REGISTER**

**Funky People**

FUNKY PEOPLE, LLC (NEW JERSEY LIMITED LIABILITY COMPANY)  
28 W. 3RD STR, STE #2319  
SOUTH ORANGE, NJ 070791788

FOR: ENTERTAINMENT SERVICES, NAMELY, LIVE MUSIC CONCERTS, CONDUCTING NETWORKING PARTIES FOR THE PURPOSE OF DATING AND SOCIAL INTRODUCTION FOR ADULTS; EDUCATIONAL SERVICES, NAMELY, CONDUCTING COURSES OF INSTRUCTION IN THE FIELDS OF ENTREPRENEURSHIP, FINANCIAL INVESTMENT, BUSINESS, AND CAREER DEVELOPMENT, USING ON-LINE ACTIVITIES AND INTERACTIVE EXHIBITS, AND PRINTABLE MATERIALS DISTRIBUTED THEREWITH; ENTERTAINMENT, NAMELY, MUSIC PRODUCTION SERVICES, PRODUCTION OF VIDEO CASSETTES AND MOTION PICTURE FILMS; ENTERTAINMENT SERVICES, NAMELY, PROVIDING PRERECORDED MUSIC, INFORMATION IN THE FIELD OF MUSIC, AND COMMENTARY AND ARTICLES ABOUT MUSIC, ALL ON-LINE VIA A GLOBAL COMPUTER NETWORK; ENTERTAINMENT, NAMELY, A CONTINUING MUSIC, AND VARIETY SHOW

BROADCAST OVER TELEVISION, SATELLITE, AUDIO, AND VIDEO MEDIA; PROVIDING A WEB SITE WHERE USERS CAN POST RATINGS, REVIEWS AND RECOMMENDATIONS ON EVENTS AND ACTIVITIES IN THE FIELD OF ENTERTAINMENT AND EDUCATION; RADIO ENTERTAINMENT PRODUCTION; RADIO ENTERTAINMENT SERVICES, NAMELY, RADIO PROGRAMS FEATURING PERFORMANCES BY A DEE JAY OR PERSONALITY, IN CLASS 41 (U.S. CLS. 100, 101 AND 107).

FIRST USE 3-1-2006; IN COMMERCE 3-1-2006.

THE COLOR(S) BLACK IS/ARE CLAIMED AS A FEATURE OF THE MARK.

THE MARK CONSISTS OF THE BLACK COLORING IS IN THE FONT STYLE OF THE IMAGE.

SER. NO. 77-107,546, FILED 2-14-2007.

SUSAN LESLIE DUBOIS, EXAMINING ATTORNEY

**Int. Cl.: 3**

**Prior U.S. Cls.: 1, 4, 6, 50, 51 and 52**

**United States Patent and Trademark Office**

**Reg. No. 3,497,715**

**Registered Sep. 9, 2008**

**TRADEMARK  
PRINCIPAL REGISTER**

**MIDNIGHT ELIXIR  
ELIXIR DE MINUIT**

LANCOME PARFUMS ET BEAUTE & CIE  
(FRANCE SOCIETE EN NOM COLLECTIF)  
29, RUE DU FAUBOURG SAINT-HONORE  
PARIS, FRANCE 75008

FOR: PERFUMERY PRODUCTS, NAMELY, PERFUMES, EAU DE COLOGNE, PERFUMED WATER, SKIN LOTIONS, SOAPS, BATH AND SHOWER FOAMING COMPOSITIONS AND GELS; COSMETICS, NAMELY, CREAMS, GELS, MILKS, POWDERS AND LOTIONS FOR THE FACE, BODY AND HANDS; MAKE-UP PRODUCTS, NAMELY, MASCARA, EYELINER, EYE SHADOW, EYEBROW PENCIL, LIPSTICKS, NAIL POLISH, BLUSH, FOUNDATION CREAMS AND POWDER, BODY DEODERANTS; SUN CARE PREPARATIONS, NAMELY, TANNING AND AFTER-SUN MILKS, GELS AND OILS, IN CLASS 3 (U.S. CLS. 1, 4, 6, 50, 51 AND 52).

THE MARK CONSISTS OF STANDARD CHARACTERS WITHOUT CLAIM TO ANY PARTICULAR FONT, STYLE, SIZE, OR COLOR.

PRIORITY CLAIMED UNDER SEC. 44(D) ON ERPN CMNTY TM OFC APPLICATION NO. 5665427, FILED 2-5-2007, REG. NO. 5665427, DATED 2-5-2007, EXPIRES 2-5-2017.

NO CLAIM IS MADE TO THE EXCLUSIVE RIGHT TO USE "ELIXIR", APART FROM THE MARK AS SHOWN.

SER. NO. 77-109,065, FILED 2-16-2007.

BRIAN PINO, EXAMINING ATTORNEY

Int. Cl.: 43

Prior U.S. Cls.: 100 and 101

United States Patent and Trademark Office

Reg. No. 3,497,716

Registered Sep. 9, 2008

SERVICE MARK  
PRINCIPAL REGISTER



NEW VISIONS, NEW VENTURES, INC. (VIRGINIA CORPORATION)  
801 E. MAIN STREET, SUITE 1102  
RICHMOND, VA 23219

FOR: CATERING SERVICES, NAMELY, PROVIDING CATERING OF FOOD AND BEVERAGES; PROVIDING LOW-INCOME PERSONNEL WITH INFORMATION AND ADVICE RELATING TO COOKING AND CATERING SERVICES, IN CLASS 43 (U.S. CLS. 100 AND 101).

FIRST USE 1-17-2007; IN COMMERCE 1-17-2007.

THE MARK CONSISTS OF THE WORD "BREADWINNERS" IN STYLIZED LETTERING, WITH A CHEF'S CAP ABOVE THE CAPITAL LETTER "B," TILTED TO THE LEFT.

SER. NO. 77-110,678, FILED 2-19-2007.

KEVON CHISOLM, EXAMINING ATTORNEY

Int. Cls.: 41, 42, 43 and 44

Prior U.S. Cls.: 100, 101 and 107

United States Patent and Trademark Office

Reg. No. 3,497,717

Registered Sep. 9, 2008

SERVICE MARK  
PRINCIPAL REGISTER

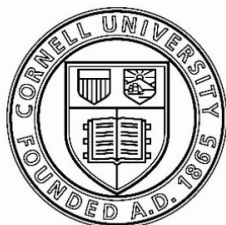

Cornell University

CORNELL UNIVERSITY (NEW YORK EDUCATIONAL CORPORATION)  
DAY HALL  
ITHACA, NY 14853

FOR: EDUCATIONAL SERVICES, NAMELY, PROVIDING COURSES OF INSTRUCTION AT THE UNDERGRADUATE, GRADUATE, POST-GRADUATE, AND PROFESSIONAL LEVELS; PROVIDING CONTINUING EDUCATION COURSES IN THE FIELDS OF MEDICINE, LAW, MANAGEMENT, ENGINEERING, HOSPITALITY, AND VETERINARY MEDICINE; CONDUCTING DISTANCE LEARNING INSTRUCTION AT THE UNDERGRADUATE, GRADUATE, AND POST-GRADUATE LEVELS; ORGANIZING AND CONDUCTING SUMMER CAMPS AND SPORTS CAMPS; ACADEMIC EDUCATIONAL RESEARCH; ARRANGING AND CONDUCTING EDUCATIONAL CONFERENCES; COOPERATIVE EXTENSION PROGRAMS PROVIDED TO COMMUNITY MEMBERS, NAMELY, CLASSES AND WORKSHOPS, IN THE FIELDS OF AGRICULTURE AND FOOD SYSTEMS, ENVIRONMENT AND NATURAL RESOURCES, NUTRITION, HEALTH, COMMUNITY AND ECONOMIC DEVELOPMENT, FAMILY AND YOUTH, GARDENING, AND FINANCIAL MANAGEMENT; LIBRARIES; MUSEUMS; ENTERTAINMENT SERVICES, NAMELY, PRESENTATION OF ATHLETIC EVENTS INCLUDING INTERCOLLEGIATE COMPETITIONS; EDUCATIONAL AND ENTERTAINMENT SERVICES, NAMELY, PROVIDING EDUCATIONAL SPEAKERS AND LECTURERS, LIVE CONCERTS, FINE ART EXHIBITIONS, DRAMATIC THEATER PRODUCTIONS, LIVE PERFORMANCES BY MUSI-

CAL GROUPS, AND LIVE DANCE PERFORMANCES; PUBLISHING OF BOOKS, JOURNALS, MAGAZINES, AND SCIENTIFIC PAPERS, IN CLASS 41 (U.S. CLS. 100, 101 AND 107).

FIRST USE 11-0-2004; IN COMMERCE 11-0-2004.

FOR: RESEARCH IN THE FIELDS OF SCIENCE, ENGINEERING, ARCHITECTURE, HUMAN ECOLOGY, MEDICINE, ART, HUMANITIES AND VETERINARY SCIENCE IN AN ACADEMIC SETTING, IN CLASS 42 (U.S. CLS. 100 AND 101).

FIRST USE 11-0-2004; IN COMMERCE 11-0-2004.

FOR: RESTAURANTS; HOTELS, IN CLASS 43 (U.S. CLS. 100 AND 101).

FIRST USE 11-0-2004; IN COMMERCE 11-0-2004.

FOR: VETERINARY SERVICES, IN CLASS 44 (U.S. CLS. 100 AND 101).

FIRST USE 11-0-2004; IN COMMERCE 11-0-2004.

OWNER OF U.S. REG. NO. 2,757,826.

NO CLAIM IS MADE TO THE EXCLUSIVE RIGHT TO USE "UNIVERSITY" AND "FOUNDED A.D. 1865", APART FROM THE MARK AS SHOWN.

SER. NO. 77-111,290, FILED 2-20-2007.

CHERYL CLAYTON, EXAMINING ATTORNEY

**Int. Cls.: 3, 5, 26, 35 and 44**

**Prior U.S. Cls.: 1, 4, 6, 18, 37, 39, 40, 42, 44, 46, 50, 51,  
52, 100, 101 and 102**

**Reg. No. 3,497,718**

**United States Patent and Trademark Office**

**Registered Sep. 9, 2008**

**TRADEMARK  
SERVICE MARK  
PRINCIPAL REGISTER**

**LIFELIKE**

WELLINGTON POINT, L.L.C. (MISSOURI LIMITED LIABILITY COMPANY)  
2255 N.W. VIVION ROAD  
KANSAS CITY, MO 64150

FOR: HAIR CARE PREPARATIONS, NAMELY, HAIR CLEANER, SHAMPOO, CONDITIONER, HAIR SPRAY, HAIR STYLING MOUSSE, HAIRPIECE CLEANER, HAIRPIECE REMOVER AND HAIRPIECE ADHESIVE REMOVER; SKIN LOTION; AND COLOGNE, IN CLASS 3 (U.S. CLS. 1, 4, 6, 50, 51 AND 52).

FIRST USE 3-11-1999; IN COMMERCE 3-11-1999.

FOR: VITAMINS, MINERALS SUPPLEMENTS AND DIETARY SUPPLEMENTS, IN CLASS 5 (U.S. CLS. 6, 18, 44, 46, 51 AND 52).

FIRST USE 3-11-1999; IN COMMERCE 3-11-1999.

FOR: HAIRPIECES AND HAIRPIECE TAPE, IN CLASS 26 (U.S. CLS. 37, 39, 40, 42 AND 50).

FIRST USE 4-5-1967; IN COMMERCE 4-20-1967.

FOR: RETAIL STORE SERVICES IN THE FIELD OF HAIR CARE PREPARATIONS, SKIN LOTIONS,

COLOGNES, WIGS, TOUPEES, AND OTHER TYPES OF HAIRPIECES, IN CLASS 35 (U.S. CLS. 100, 101 AND 102).

FIRST USE 4-5-1967; IN COMMERCE 4-20-1967.

FOR: HAIR STYLING SALON SERVICES; AND HAIR REPLACEMENT SERVICES, IN CLASS 44 (U.S. CLS. 100 AND 101).

FIRST USE 4-5-1967; IN COMMERCE 4-20-1967.

THE MARK CONSISTS OF STANDARD CHARACTERS WITHOUT CLAIM TO ANY PARTICULAR FONT, STYLE, SIZE, OR COLOR.

OWNER OF U.S. REG. NO. 1,685,429.

SEC. 2(F).

THE 2(F) CLAIM IS RESTRICTED TO CLASS(ES) 26, 35, AND 44

SER. NO. 77-115,217, FILED 2-23-2007.

LESLIE RICHARDS, EXAMINING ATTORNEY

**Int. Cl.: 17**

**Prior U.S. Cls.: 1, 5, 12, 13, 35 and 50**

**United States Patent and Trademark Office**

**Reg. No. 3,497,719**

**Registered Sep. 9, 2008**

**TRADEMARK  
PRINCIPAL REGISTER**

**BARRICADE**

COVALENCE SPECIALTY COATINGS LLC (DE-  
LAWARE LIMITED LIABILITY COMPANY)  
25 FORGE PARKWAY  
FRANKLIN, MA 02038

FOR: CONSTRUCTION BUILDINGWRAP AND  
HOUSEWRAP TO BE USED FOR MOISTURE MAN-  
AGEMENT, NAMELY, POLYOLEFIN FILM MADE  
OF PLASTIC OR FIBERS FOR USE IN SEALING  
AND PROTECTING THE EXTERIOR OF BUILD-  
INGS AND STRUCTURES, IN CLASS 17 (U.S. CLS. 1,  
5, 12, 13, 35 AND 50).

FIRST USE 6-1-1985; IN COMMERCE 6-1-1985.

THE MARK CONSISTS OF STANDARD CHAR-  
ACTERS WITHOUT CLAIM TO ANY PARTICULAR  
FONT, STYLE, SIZE, OR COLOR.

OWNER OF U.S. REG. NO. 1,004,819.

SER. NO. 77-115,937, FILED 2-26-2007.

CAROL SPILS, EXAMINING ATTORNEY

**Int. Cl.: 13**

**Prior U.S. Cls.: 2 and 9**

**United States Patent and Trademark Office**

**Reg. No. 3,497,720**

**Registered Sep. 9, 2008**

**TRADEMARK  
PRINCIPAL REGISTER**

**KENT CARTRIDGE**

KENT-GAMEBORE CORPORATION (DELA-  
WARE CORPORATION)  
727 HITE ROAD  
KEARNEYSVILLE, WV 25430

FOR: SHOTGUN SHELLS, IN CLASS 13 (U.S. CLS.  
2 AND 9).

FIRST USE 6-30-2002; IN COMMERCE 6-30-2002.

THE MARK CONSISTS OF STANDARD CHAR-  
ACTERS WITHOUT CLAIM TO ANY PARTICULAR  
FONT, STYLE, SIZE, OR COLOR.

PRIORITY CLAIMED UNDER SEC. 44(D) ON  
CANADA APPLICATION NO. 1337501, FILED 2-23-  
2007, REG. NO. TMA709799, DATED 3-18-2008, EX-  
PIRES 3-18-2023.

OWNER OF U.S. REG. NO. 2,477,825.

NO CLAIM IS MADE TO THE EXCLUSIVE  
RIGHT TO USE "CARTRIDGE", APART FROM  
THE MARK AS SHOWN.

SER. NO. 77-116,436, FILED 2-26-2007.

CAROLINE WOOD, EXAMINING ATTORNEY

**Int. Cl.: 7**

**Prior U.S. Cls.: 13, 19, 21, 23, 31, 34 and 35**

**United States Patent and Trademark Office**

**Reg. No. 3,497,721**

**Registered Sep. 9, 2008**

**TRADEMARK  
PRINCIPAL REGISTER**

**BISOMAC210**

NIHON BISOH CO., LTD. (JAPAN CORPORATION)  
4-15-33, SHIBAURA  
MINATO-KU, TOKYO, JAPAN

THE MARK CONSISTS OF STANDARD CHARACTERS WITHOUT CLAIM TO ANY PARTICULAR FONT, STYLE, SIZE, OR COLOR.

FOR: TRACTION HOIST, IN CLASS 7 (U.S. CLS. 13, 19, 21, 23, 31, 34 AND 35).

SER. NO. 77-118,059, FILED 2-28-2007.

FIRST USE 11-24-2006; IN COMMERCE 11-24-2006.

SAIMA MAKHDOOM, EXAMINING ATTORNEY



Int. Cl.: 41

Prior U.S. Cls.: 100, 101 and 107

United States Patent and Trademark Office

Reg. No. 3,497,722

Registered Sep. 9, 2008

**SERVICE MARK  
PRINCIPAL REGISTER**



MYHUNTINGROOM (CALIFORNIA LIMITED LIABILITY COMPANY)  
1210 MISSION DRIVE D  
SOLVANG, CA 93463

FOR: PROVIDING INFORMATION IN THE FIELD OF OUTDOOR RECREATION VIA A WEBSITE, NAMELY, PROVIDING INFORMATION ABOUT HUNTING AND FISHING EVENTS AND HUNTING AND FISHING ORGANIZATIONS, IN CLASS 41 (U.S. CLS. 100, 101 AND 107).

FIRST USE 1-15-2007; IN COMMERCE 1-23-2007.

THE MARK CONSISTS OF A SHIELD SHAPED PLAQUE WITH A MALE DEER'S (A BUCK'S) HEAD AND ANTLERS, SHADOWED. THE ANTLERS AND THE EARS OF THE DEER EXTEND ABOVE THE

SHIELD'S TOP EDGE. TO THE LEFT OF THE BUCK AND CONTACTING THE TOP LEFT OF THE SHIELD'S EDGE IS A CANADIAN GOOSE, SHADOWED. TO THE RIGHT OF THE BUCK AND CONTACTING THE TOP RIGHT OF THE SHIELD'S EDGE IS A RAINBOW TROUT, SHADOWED. BELOW AND CONTACTING THE NECK OF THE BUCK IS A BANNER THAT EXTENDS BOTH LEFT AND RIGHT PAST THE SHIELD'S EDGES AND READS "MYHUNTINGROOM.COM". BELOW THE BANNER AND ENTIRELY WITHIN THE SHIELD ARE THE WORDS "BRING YOUR GAME!".

SER. NO. 77-118,229, FILED 2-28-2007.

REBECCA SMITH, EXAMINING ATTORNEY

**Int. Cls.: 2, 11, 20 and 21**

**Prior U.S. Cls.: 2, 6, 11, 13, 16, 21, 22, 23, 25, 29, 30,  
31, 32, 33, 34, 40 and 50**

**Reg. No. 3,497,723**

**United States Patent and Trademark Office**

**Registered Sep. 9, 2008**

**TRADEMARK  
PRINCIPAL REGISTER**

# MARY CAROL

NELL HILLS CORPORATION (MISSOURI CORPORATION)  
501 COMMERCIAL STREET  
ATCHISON, KS 66002

FOR: PAINTS AND PAINT PRIMERS, IN CLASS 2 (U.S. CLS. 6, 11 AND 16).

FIRST USE 12-1-2005; IN COMMERCE 12-1-2005.

FOR: LAMPS, IN CLASS 11 (U.S. CLS. 13, 21, 23, 31 AND 34).

FIRST USE 1-31-2007; IN COMMERCE 1-31-2007.

FOR: FURNITURE FOR THE HOME; MIRRORS; PICTURE FRAMES; BOOK BOXES OF WOOD, IN CLASS 20 (U.S. CLS. 2, 13, 22, 25, 32 AND 50).

FIRST USE 10-1-2003; IN COMMERCE 10-1-2003.

FOR: HOME ACCESSORIES MADE OF METAL, NAMELY, DESSERT TRAYS, DESSERT STANDS, CANDLE HOLDERS, SERVING TRAYS, COASTERS, AND HOLDERS FOR PLATES; HOME ACCESSORIES MADE OF WOOD, NAMELY, SERVING TRAYS, IN CLASS 21 (U.S. CLS. 2, 13, 23, 29, 30, 33, 40 AND 50).

FIRST USE 1-31-2007; IN COMMERCE 1-31-2007.

THE MARK CONSISTS OF STANDARD CHARACTERS WITHOUT CLAIM TO ANY PARTICULAR FONT, STYLE, SIZE, OR COLOR.

THE NAME SHOWN IN THE MARK IDENTIFIES "MARY CAROL GARRITY" WHOSE CONSENT IS OF RECORD.

SER. NO. 77-120,040, FILED 3-1-2007.

DANIEL BRODY, EXAMINING ATTORNEY

**Int. Cl.: 11**

**Prior U.S. Cls.: 13, 21, 23, 31 and 34**

**United States Patent and Trademark Office**

**Reg. No. 3,497,724**

**Registered Sep. 9, 2008**

**TRADEMARK  
PRINCIPAL REGISTER**

# Vitashower

VITASHOWER CORPORATION (NEVADA CORPORATION)  
2657 WINMILL PKWY, #213  
HENDERSON, NV 89074

THE MARK CONSISTS OF STANDARD CHARACTERS WITHOUT CLAIM TO ANY PARTICULAR FONT, STYLE, SIZE, OR COLOR.

FOR: VITAMIN C FILTER FOR WATER DE-CHLORINATION, IN CLASS 11 (U.S. CLS. 13, 21, 23, 31 AND 34).

SER. NO. 77-122,794, FILED 3-5-2007.

FIRST USE 11-22-2002; IN COMMERCE 11-22-2002.

ALEX KEAM, EXAMINING ATTORNEY

**Int. Cl.: 35**

**Prior U.S. Cls.: 100, 101 and 102**

**United States Patent and Trademark Office**

**Reg. No. 3,497,725**

**Registered Sep. 9, 2008**

**SERVICE MARK  
PRINCIPAL REGISTER**

**ANESTHETIX**

ANESTHETIX HOLDINGS, LLC (DELAWARE  
LIMITED LIABILITY COMPANY)  
9000 BURMA ROAD, SUITE 107  
PALM BEACH GARDENS, FL 33403

FOR: BUSINESS MANAGEMENT SERVICES,  
NAMELY, DEVELOPMENT, MANAGEMENT, BILL-  
ING, RECRUITING AND BUSINESS OVERSIGHT  
OF OPERATIONS OF MEDICAL PRACTICE  
GROUPS IN THE FIELD OF ANESTHESIA AND  
PAIN MANAGEMENT, IN CLASS 35 (U.S. CLS. 100,  
101 AND 102).

FIRST USE 2-27-2007; IN COMMERCE 2-27-2007.

NO CLAIM IS MADE TO THE EXCLUSIVE  
RIGHT TO USE "ANESTHETICS", APART FROM  
THE MARK AS SHOWN.

THE MARK CONSISTS OF THE WORD "ANES-  
THETIX" IN STYLIZED FORM WITH "ANES" DAR-  
KER AND "THETIX" LIGHTER, WITH A PLUS (+)  
SYMBOL IN THE DOT OF THE LETTER "I" AND  
THE "X" AT THE END HAVING A STYLIZED  
CURVE.

SER. NO. 77-124,067, FILED 3-7-2007.

HOWARD B. LEVINE, EXAMINING ATTORNEY

**Int. Cl.: 5**

**Prior U.S. Cls.: 6, 18, 44, 46, 51 and 52**

**United States Patent and Trademark Office**

**Reg. No. 3,497,726**

**Registered Sep. 9, 2008**

**TRADEMARK  
PRINCIPAL REGISTER**

**ALLERGEAZE**

SMARTHEALTH, INC. (ARIZONA CORPORATION)  
3400 EAST MCDOWELL  
PHOENIX, AZ 85008

FOR: PATCH TEST SYSTEMS COMPRISING EPICUTANEOUS CONTACT ALLERGENS, PATCH TEST CHAMBERS, CHAMBER COVERS, READING GUIDES, SKIN MARKERS, CLINIC BOXES, PATCH TRAYS, DATA COLLECTION FORMS AND ALLERGY HEALTH HISTORY FORMS ALL USED FOR DIAGNOSTIC ALLERGY TESTS IN THE FIELD OF

DERMATOLOGY, IN CLASS 5 (U.S. CLS. 6, 18, 44, 46, 51 AND 52).

FIRST USE 1-31-2007; IN COMMERCE 1-31-2007.

THE MARK CONSISTS OF STANDARD CHARACTERS WITHOUT CLAIM TO ANY PARTICULAR FONT, STYLE, SIZE, OR COLOR.

SER. NO. 77-124,190, FILED 3-7-2007.

DAVID COLLIER, EXAMINING ATTORNEY

**Int. Cl.: 12**

**Prior U.S. Cls.: 19, 21, 23, 31, 35 and 44**

**United States Patent and Trademark Office**

**Reg. No. 3,497,727**

**Registered Sep. 9, 2008**

**TRADEMARK  
PRINCIPAL REGISTER**

**POWERSTOP**

POWER STOP LLC (ILLINOIS LIMITED LIABILITY COMPANY)  
6312 WEST 74TH STREET  
BEDFORD PARK, IL 60638

FIRST USE 8-0-2005; IN COMMERCE 8-0-2005.

FOR: BRAKE PARTS FOR AUTOMOBILES, TRUCKS AND SUVS UP TO 1 TON, NAMELY, BRAKE ROTORS, BRAKE PADS, BRAKE CALIPERS, BIG BRAKE KITS, NAMELY, BRAKE HARDWARE FOR VEHICLES, BRAKE DRUMS AND BRAKE SHOES, IN CLASS 12 (U.S. CLS. 19, 21, 23, 31, 35 AND 44).

THE MARK CONSISTS OF STANDARD CHARACTERS WITHOUT CLAIM TO ANY PARTICULAR FONT, STYLE, SIZE, OR COLOR.

SER. NO. 77-124,736, FILED 3-7-2007.

KYLE PEETE, EXAMINING ATTORNEY

**Int. Cl.: 9**

**Prior U.S. Cls.: 21, 23, 26, 36 and 38**

**Reg. No. 3,497,728**

**United States Patent and Trademark Office**

**Registered Sep. 9, 2008**

**TRADEMARK  
PRINCIPAL REGISTER**

**CUSTOM PROTECT EAR**

CUSTOM PROTECT EAR INC. (CANADA CORPORATION)  
SUITE 681  
7789 134TH STREET  
SURREY, B.C., CANADA V3W9E9

FOR: HEARING PROTECTORS, NAMELY, HEARING PROTECTION EARPIECES AND HEADSETS NOT FOR MEDICAL USE AND EAR PLUGS FOR SOUNDPROOFING , IN CLASS 9 (U.S. CLS. 21, 23, 26, 36 AND 38).

FIRST USE 0-0-1995; IN COMMERCE 0-0-1995.

THE MARK CONSISTS OF STANDARD CHARACTERS WITHOUT CLAIM TO ANY PARTICULAR FONT, STYLE, SIZE, OR COLOR.

OWNER OF CANADA REG. NO. TMA498751, DATED 8-17-1998, EXPIRES 8-17-2013.

SER. NO. 77-125,625, FILED 3-8-2007.

INGRID C. EULIN, EXAMINING ATTORNEY

**Int. Cls.: 3, 26 and 44**

**Prior U.S. Cls.: 1, 4, 6, 37, 39, 40, 42, 50, 51, 52, 100  
and 101**

**Reg. No. 3,497,729**

**United States Patent and Trademark Office**

**Registered Sep. 9, 2008**

**TRADEMARK  
SERVICE MARK  
PRINCIPAL REGISTER**

# SCALP OPTIX

APOLLO PRODUCTS, INC. (MISSOURI CORPORATION)  
2255 N.W. VIVION ROAD  
KANSAS CITY, MO 64150

FOR: HAIR CARE PREPARATIONS, NAMELY, HAIR CLEANER, SHAMPOO, HAIR CONDITIONER, HAIR SPRAY, HAIR STYLING MOUSSE, HAIRPIECE CLEANER, HAIRPIECE REMOVER AND HAIR PIECE ADHESIVE REMOVER; SKIN LOTION; AND COLOGNE, IN CLASS 3 (U.S. CLS. 1, 4, 6, 50, 51 AND 52).

FIRST USE 2-27-2007; IN COMMERCE 2-27-2007.

FOR: HAIRPIECES AND HAIRPIECE TAPE, IN CLASS 26 (U.S. CLS. 37, 39, 40, 42 AND 50).

FIRST USE 2-27-2007; IN COMMERCE 2-27-2007.

FOR: HAIR STYLING SALON SERVICES; AND HAIR REPLACEMENT SERVICES, IN CLASS 44 (U.S. CLS. 100 AND 101).

FIRST USE 2-27-2007; IN COMMERCE 2-27-2007.

THE MARK CONSISTS OF STANDARD CHARACTERS WITHOUT CLAIM TO ANY PARTICULAR FONT, STYLE, SIZE, OR COLOR.

OWNER OF U.S. REG. NOS. 2,308,253 AND 2,844,511.

NO CLAIM IS MADE TO THE EXCLUSIVE RIGHT TO USE "SCALP", APART FROM THE MARK AS SHOWN.

SER. NO. 77-125,658, FILED 3-8-2007.

BRENDAN REGAN, EXAMINING ATTORNEY



Int. Cl.: 35

Prior U.S. Cls.: 100, 101 and 102

United States Patent and Trademark Office

Reg. No. 3,497,730

Registered Sep. 9, 2008

SERVICE MARK  
PRINCIPAL REGISTER



SOUTHERN BAPTIST HOSPITAL OF FLORIDA,  
INC. (FLORIDA CORPORATION)  
800 PRUDENTIAL DRIVE  
JACKSONVILLE, FL 32207

FOR: PROMOTING PUBLIC AWARENESS IN  
THE FIELD OF BREAST CANCER, AND THE NEED  
TO ENCOURAGE WOMEN TO CONDUCT MONTH-  
LY SELF BREAST EXAMS , IN CLASS 35 (U.S. CLS.  
100, 101 AND 102).

FIRST USE 4-28-1992; IN COMMERCE 4-28-1992.

THE MARK CONSISTS OF THE WORD "BUDDY"  
IN CAPITAL LETTERS, CRADLED INSIDE A  
CHECKMARK.

SER. NO. 77-125,832, FILED 3-8-2007.

AMOS T. MATTHEWS, JR., EXAMINING ATTOR-  
NEY

**Int. Cl.: 44**

**Prior U.S. Cls.: 100 and 101**

**United States Patent and Trademark Office**

**Reg. No. 3,497,731**

**Registered Sep. 9, 2008**

**SERVICE MARK  
PRINCIPAL REGISTER**



WYETH (DELAWARE CORPORATION)  
FIVE GIRALDA FARMS  
MADISON, NJ 07940

FOR: PROVIDING INFORMATION REGARDING  
ACID REFLUX DISEASE, IN CLASS 44 (U.S. CLS. 100  
AND 101).

FIRST USE 4-28-2006; IN COMMERCE 4-28-2006.

THE MARK CONSISTS OF THE WORD "IN-  
TOUCH" WITH A FINGERPRINT DESIGN AND  
TABLET SHAPED CIRCLE REPRESENTING THE  
LETTER "O"; GRAY IS INTENDED TO SHOW  
SHADING OR CONTRAST ONLY.

SER. NO. 77-126,441, FILED 3-9-2007.

SAIMA MAKHDOOM, EXAMINING ATTORNEY

Int. Cls.: 30, 35 and 43

Prior U.S. Cls.: 46, 100, 101 and 102

United States Patent and Trademark Office

Reg. No. 3,497,732

Registered Sep. 9, 2008

**TRADEMARK  
SERVICE MARK  
PRINCIPAL REGISTER**

# Viva Chcolato!

CHOCOGELATIER, LLC (DELAWARE LIMITED LIABILITY COMPANY)  
8408 BIG TIMBER  
AUSTIN, TX 78735

FOR: CHOCOLATE, COFFEE, TEA, COCOA, PREPARED COFFEE AND COFFEE-BASED BEVERAGES; PREPARED COCOA AND COCOA-BASED BEVERAGES; PREPARED ICE CREAM AND ICE CREAM-BASED BEVERAGES; BEVERAGES MADE OF TEA; POWDERED CHOCOLATE AND VANILLA; CHOCOLATE AND CANDY, NAMELY, CHOCOLATES, CHOCOLATE BARS, CHOCOLATE-COVERED FRUITS, CHOCOLATE-COVERED NUTS, CHOCOLATE-COVERED DRIED FRUITS, CHOCOLATE-COVERED CRACKERS, CHOCOLATE TRUFFLES, AND CHOCOLATE TOPPINGS; CHOCOLATE FONDUE; CHOCOLATE FOOD BEVERAGES NOT BEING DAIRY-BASED OR VEGETABLE BASED WITH COFFEE FLAVORS; POWDERED FLAVORING ADDITIVES FOR NON-NUTRITIONAL PURPOSES; COCOA PRODUCTS, NAMELY, COCOA MIXES AND COCOA POWDERS; CHOCOLATE POWDER; HOT CHOCOLATE; COCOA BEVERAGES WITH MILK; ICE CREAM, ICE CREAM DRINKS, ICE CREAM MIXES, ICE CREAM POWDER, ICE CREAM SUBSTITUTES; GELATO; ICE CREAM AND CHOCOLATE-BASED DESSERTS, NAMELY, CHOCOLATE MOUSSE, CHOCOLATE FONDUE, CHOCOLATE CREPES AND WAFFLES, CHOCOLATE CAKES, AND CHOCOLATE SUNDAES; GIFT BASKETS CONTAINING CANDY, IN CLASS 30 (U.S. CL. 46).

FIRST USE 1-1-2007; IN COMMERCE 1-1-2007.

FOR: ON-LINE ORDERING SERVICES FEATURING FOOD, INCLUDING CHOCOLATES, CANDIES

AND CANDY-BASED GIFT BASKETS; RESTAURANT FRANCHISING, NAMELY, FRANCHISING CHOCOLATE AND GELATO STORES AND CAFES; FRANCHISING SERVICES, NAMELY, OFFERING TECHNICAL ASSISTANCE IN THE ESTABLISHMENT AND/OR OPERATION OF CHOCOLATE AND GELATO STORES AND CAFES; SERVICES FOR PROVIDING FOOD AND DRINK, NAMELY, FOOD KIOSK SERVICES, IN CLASS 35 (U.S. CLS. 100, 101 AND 102).

FIRST USE 1-1-2007; IN COMMERCE 1-1-2007.

FOR: SERVICES FOR PROVIDING FOOD AND DRINK, NAMELY, RESTAURANTS, CAFES, AND COFFEE SHOPS; CAFÉ-RESTAURANTS FEATURING CHOCOLATES, COFFEE, CANDY GIFTS, ICE CREAM PRODUCTS, DESSERTS, PREPARED DRINKS AND BEVERAGES; CATERING FOR THE PROVISION OF FOOD AND BEVERAGES, IN CLASS 43 (U.S. CLS. 100 AND 101).

FIRST USE 1-1-2007; IN COMMERCE 1-1-2007.

THE MARK CONSISTS OF STANDARD CHARACTERS WITHOUT CLAIM TO ANY PARTICULAR FONT, STYLE, SIZE, OR COLOR.

THE FOREIGN WORDING IN THE MARK TRANSLATES INTO ENGLISH AS LONG LIVE CHOCOLATE!

SER. NO. 77-126,831, FILED 3-9-2007.

ROSELLE HERRERA, EXAMINING ATTORNEY

**Int. Cl.: 29**

**Prior U.S. Cl.: 46**

**United States Patent and Trademark Office**

**Reg. No. 3,497,733**

**Registered Sep. 9, 2008**

**TRADEMARK  
PRINCIPAL REGISTER**



GENIUS FOOD IDEAS S.R.L. (ITALY LIMITED LIABILITY COMPANY)

VIA CIAVARELLA ANGELO, 2

PARMA, ITALY 43100

FOR: VEGETABLES PRESERVED IN OIL, PRESERVED IN VINEGAR, AND PRESERVED UNDER SWEET AND SOUR SAUCE; PRESERVED, DRIED, COOKED AND FROZEN FRUITS AND VEGETABLES; EDIBLE OILS AND FATS; PRESERVES AND PULP OF VEGETABLES; PICKLES; PRESERVES OF LEGUMES; MEAT, FISH, POULTRY AND GAME; MEAT EXTRACTS; MEAT JELLIES; JELLIES IN THE NATURE OF BREAD SPREADS; JAMS; MILK; DAIRY PRODUCTS, EXCLUDING ICE CREAM, ICE MILK, AND FROZEN YOGURT; CHEESE; CHARCUTERIE, IN CLASS 29 (U.S. CL. 46).

PRIORITY CLAIMED UNDER SEC. 44(D) ON ERPN CMNTY TM OFC APPLICATION NO. 5731526, FILED 3-5-2007.

OWNER OF ERPN CMNTY TM OFC REG. NO. 005731526, DATED 3-10-2008, EXPIRES 3-5-2017.

NO CLAIM IS MADE TO THE EXCLUSIVE RIGHT TO USE "AUTENTICO", APART FROM THE MARK AS SHOWN.

THE COLOR(S) DARK GREEN, LIGHT GREEN, RED, WHITE, AND YELLOW IS/ARE CLAIMED AS A FEATURE OF THE MARK.

THE MARK CONSISTS OF THE COLOR DARK GREEN APPEARING IN THE WORD "AUTENTICO" WRITTEN BELOW A TRI-COLORED HORIZONTAL RIBBON OUTLINED IN WHITE WITH LIGHT GREEN, WHITE, AND RED STRIPES; A RED CIRCLE WITH A CURVED WHITE LINE EXTENDS FROM A SINGLE RED BAR, IS DECORATED WITH A YELLOW BOW, AND APPEARS IN THE CENTER OF THE RIBBON.

THE FOREIGN WORDING IN THE MARK TRANSLATES INTO ENGLISH AS AUTHENTIC.

SER. NO. 77-127,326, FILED 3-9-2007.

KATHERINE M. DUBRAY, EXAMINING ATTORNEY

**Int. Cl.: 41**

**Prior U.S. Cls.: 100, 101 and 107**

**United States Patent and Trademark Office**

**Reg. No. 3,497,734**

**Registered Sep. 9, 2008**

**SERVICE MARK  
PRINCIPAL REGISTER**



TOWN HALL LOS ANGELES (CALIFORNIA  
NON-PROFIT ORGANIZATION)  
SUITE 1650  
515 S. FLOWER STREET  
LOS ANGELES, CA 900712201

FOR: EDUCATIONAL AND ENTERTAINMENT  
SERVICES, NAMELY, PROVIDING MOTIVATION-  
AL AND EDUCATIONAL SPEAKERS, IN CLASS 41  
(U.S. CLS. 100, 101 AND 107).

FIRST USE 2-28-2007; IN COMMERCE 2-28-2007.

NO CLAIM IS MADE TO THE EXCLUSIVE  
RIGHT TO USE "LA", APART FROM THE MARK  
AS SHOWN.

THE COLOR(S) DARK RED, YELLOW, DARK  
ORANGE, MEDIUM RED, AND MEDIUM ORANGE

AND BLACK IS/ARE CLAIMED AS A FEATURE OF  
THE MARK.

THE MARK CONSISTS OF "CREATIVE LA IT  
STARTS HERE" IN FOUR COLORS: "C" IN DARK  
RED IN A CIRCLE OF DARK RED; "R" IN YELLOW;  
"E" IN DARK ORANGE; "A" IN MEDIUM RED; "T"  
IN DARK ORANGE, "I" IN MEDIUM ORANGE; "V"  
IN DARK RED; "E" IN YELLOW; "L" IN MEDIUM  
ORANGE; "A" IN DARK RED; "IT STARTS HERE"  
IN BLACK.

SER. NO. 77-127,482, FILED 3-9-2007.

BRIAN NEVILLE, EXAMINING ATTORNEY

**Int. Cl.: 28**

**Prior U.S. Cls.: 22, 23, 38 and 50**

**United States Patent and Trademark Office**

**Reg. No. 3,497,735**

**Registered Sep. 9, 2008**

**TRADEMARK  
PRINCIPAL REGISTER**

**BIG POWER FOR LITTLE ONES**

MATTEL, INC. (DELAWARE CORPORATION)  
M1-1518  
333 CONTINENTAL BLVD.  
EL SEGUNDO, CA 90245

FOR: TOYS, GAMES AND PLAYTHINGS, NAME-  
LY, TOY ACTION FIGURES, TOY FIGURES, TOY  
VEHICLES, AND ACCESSORIES FOR ALL OF THE  
FOREGOING, IN CLASS 28 (U.S. CLS. 22, 23, 38 AND  
50).

FIRST USE 6-20-2007; IN COMMERCE 6-20-2007.

THE MARK CONSISTS OF STANDARD CHAR-  
ACTERS WITHOUT CLAIM TO ANY PARTICULAR  
FONT, STYLE, SIZE, OR COLOR.

SER. NO. 77-128,077, FILED 3-12-2007.

MARK RADEMACHER, EXAMINING ATTORNEY

**Int. Cl.: 41**

**Prior U.S. Cls.: 100, 101 and 107**

**United States Patent and Trademark Office**

**Reg. No. 3,497,736**

**Registered Sep. 9, 2008**

**SERVICE MARK  
PRINCIPAL REGISTER**



**wavegeneration**

LEON, CAMILLE (UNITED STATES INDIVIDUAL)  
PO BOX 66880  
LOS ANGELES, CA 900660880

FIRST USE 5-11-2000; IN COMMERCE 4-29-2001.

FOR: EDUCATION, NAMELY, PROVIDING TRAINING IN THE FIELD OF RISK-TAKING AND PERSONAL ACCOMPLISHMENT; RECREATIONAL CAMPS THAT FEATURE EVENTS PROMOTING RISK TAKING AND PERSONAL ACCOMPLISHMENT; ORGANIZING COMMUNITY SPORTING AND CULTURAL EVENTS DESIGNED TO PUSH PARTICIPANTS OUTSIDE THEIR COMFORT ZONES, IN CLASS 41 (U.S. CLS. 100, 101 AND 107).

THE MARK CONSISTS OF A STYLIZED LETTER "W" ABOVE THE WORDING "WAVEGENERATION".

SER. NO. 77-128,078, FILED 3-12-2007.

KATHERINE M. DUBRAY, EXAMINING ATTORNEY

**Int. Cl.: 5**

**Prior U.S. Cls.: 6, 18, 44, 46, 51 and 52**

**United States Patent and Trademark Office**

**Reg. No. 3,497,737**

**Registered Sep. 9, 2008**

**TRADEMARK  
PRINCIPAL REGISTER**

**JOVOYCE**

GLAXO GROUP LIMITED (ENGLAND CORPORATION)  
GLAXO WELLCOME HOUSE  
BERKELEY AVENUE  
GREENFORD, MIDDLESEX, UNITED KINGDOM  
UB60NN

FOR: PHARMACEUTICAL PREPARATIONS AND SUBSTANCES FOR THE TREATMENT OF INFECTIOUS DISEASES, BLOOD DISORDERS, PAIN, INFLAMMATION, SEPSIS, ALOPECIA AND OBESITY, AND FOR THE TREATMENT OF VIRAL, METABOLIC, ENDOCRINE, MUSCULOSKELETAL, CARDIOVASCULAR, CARDIOPULMONARY, GENITOURINARY, SEXUAL DYSFUNCTION, ONCOLOGICAL, HEPATOLOGICAL, OPHTHALMOLOGICAL, RESPIRATORY, NEUROLOGICAL, GASTROINTESTINAL, HORMONAL,

DERMATOLOGICAL AND PSYCHIATRIC RELATED DISEASES AND DISORDERS, AND FOR THE TREATMENT OF DAMAGED SKIN AND TISSUE; AND FOR VACCINES, IN CLASS 5 (U.S. CLS. 6, 18, 44, 46, 51 AND 52).

THE MARK CONSISTS OF STANDARD CHARACTERS WITHOUT CLAIM TO ANY PARTICULAR FONT, STYLE, SIZE, OR COLOR.

OWNER OF UNITED KINGDOM REG. NO. 2449338, DATED 3-13-2007, EXPIRES 3-13-2017.

SER. NO. 77-129,553, FILED 3-13-2007.

WILLIAM BRECKENFELD, EXAMINING ATTORNEY



**Int. Cl.: 5**

**Prior U.S. Cls.: 6, 18, 44, 46, 51 and 52**

**Reg. No. 3,497,738**

**United States Patent and Trademark Office**

**Registered Sep. 9, 2008**

**TRADEMARK  
PRINCIPAL REGISTER**

**KURTROVA**

GLAXO GROUP LIMITED (ENGLAND CORPORATION)  
GLAXO WELLCOME HOUSE  
BERKELEY AVENUE  
GREENFORD, MIDDLESEX, UNITED KINGDOM  
UB60NN

FOR: PHARMACEUTICAL PREPARATIONS AND SUBSTANCES FOR THE TREATMENT OF INFECTIOUS DISEASES, BLOOD DISORDERS, PAIN, INFLAMMATION, SEPSIS, ALOPECIA AND OBESITY, AND FOR THE TREATMENT OF VIRAL, METABOLIC, ENDOCRINE, MUSCULOSKELETAL, CARDIOVASCULAR, CARDIOPULMONARY, GENITOURINARY, SEXUAL DYSFUNCTION, ONCOLOGICAL, HEPATOLOGICAL, OPHTHALMOLOGICAL, RESPIRATORY, NEUROLOGICAL, GASTROINTESTINAL, HORMONAL,

DERMATOLOGICAL AND PSYCHIATRIC RELATED DISEASES AND DISORDERS, AND FOR THE TREATMENT OF DAMAGED SKIN AND TISSUE; AND FOR VACCINES, IN CLASS 5 (U.S. CLS. 6, 18, 44, 46, 51 AND 52).

THE MARK CONSISTS OF STANDARD CHARACTERS WITHOUT CLAIM TO ANY PARTICULAR FONT, STYLE, SIZE, OR COLOR.

OWNER OF UNITED KINGDOM REG. NO. 2449339, DATED 3-13-2007, EXPIRES 3-13-2017.

SER. NO. 77-129,557, FILED 3-13-2007.

WILLIAM BRECKENFELD, EXAMINING ATTORNEY

**Int. Cl.: 5**

**Prior U.S. Cls.: 6, 18, 44, 46, 51 and 52**

**Reg. No. 3,497,739**

**United States Patent and Trademark Office**

**Registered Sep. 9, 2008**

**TRADEMARK  
PRINCIPAL REGISTER**

**NORJURE**

GLAXO GROUP LIMITED (ENGLAND CORPORATION)  
GLAXO WELLCOME HOUSE  
BERKELEY AVENUE  
GREENFORD, MIDDLESEX, UNITED KINGDOM  
UB60NN

FOR: PHARMACEUTICAL PREPARATIONS AND SUBSTANCES FOR THE TREATMENT OF INFECTIOUS DISEASES, BLOOD DISORDERS, PAIN, INFLAMMATION, SEPSIS, ALOPECIA AND OBESITY, AND FOR THE TREATMENT OF VIRAL, METABOLIC, ENDOCRINE, MUSCULOSKELETAL, CARDIOVASCULAR, CARDIOPULMONARY, GENITOURINARY, SEXUAL DYSFUNCTION, ONCOLOGICAL, HEPATOLOGICAL, OPHTHALMOLOGICAL, RESPIRATORY, NEUROLOGICAL, GASTROINTESTINAL, HORMONAL,

DERMATOLOGICAL AND PSYCHIATRIC RELATED DISEASES AND DISORDERS, AND FOR THE TREATMENT OF DAMAGED SKIN AND TISSUE; AND FOR VACCINES, IN CLASS 5 (U.S. CLS. 6, 18, 44, 46, 51 AND 52).

THE MARK CONSISTS OF STANDARD CHARACTERS WITHOUT CLAIM TO ANY PARTICULAR FONT, STYLE, SIZE, OR COLOR.

OWNER OF UNITED KINGDOM REG. NO. 2449340, DATED 3-13-2007, EXPIRES 3-13-2017.

SER. NO. 77-129,568, FILED 3-13-2007.

WILLIAM BRECKENFELD, EXAMINING ATTORNEY

Int. Cl.: 14

Prior U.S. Cls.: 2, 27, 28 and 50

United States Patent and Trademark Office

Reg. No. 3,497,740

Registered Sep. 9, 2008

TRADEMARK  
PRINCIPAL REGISTER

The logo features the word "Elini" in a large, elegant, black cursive script. Below it, the word "BAROKAS" is written in a smaller, black, all-caps, sans-serif font.

ELINI NV (BELGIUM CORPORATION)  
VESTINGSTRAAT 49-P.O.B.-35  
ANTWERPEN, BELGIUM B-2018

OWNER OF BENELUX REG. NO. 0815306, DATED  
3-7-2007, EXPIRES 12-14-2016.

OWNER OF U.S. REG. NO. 3,260,116.

FOR: JEWELRY, NAMELY, GOLD JEWELRY,  
GOLD JEWELRY SET WITH CUBIC ZIRCON, GOLD  
JEWELRY SET WITH DIAMONDS, GOLD JEWEL-  
RY SET WITH GEM STONES, GOLD JEWELRY SET  
WITH PEARLS; RINGS, EARRINGS, PENDANTS,  
BRACELETS, BANGLES, NECKLACES, BROO-  
CHES, CUFFLINKS, AND JEWELRY CHAINS;  
WATCHES, GOLD WATCHES, GOLD WATCHES  
SET WITH DIAMONDS, GOLD WATCHES SET  
WITH CUBIC ZIRCON, GOLD WATCHES SET WITH  
PEARLS, STEEL WATCHES, IN CLASS 14 (U.S. CLS.  
2, 27, 28 AND 50).

THE NAME(S), PORTRAIT(S), AND/OR SIGNA-  
TURE(S) SHOWN IN THE MARK IDENTIFIES  
"ELINI BAROKAS", WHOSE CONSENT(S) TO REG-  
ISTER IS MADE OF RECORD.

SER. NO. 77-130,165, FILED 3-13-2007.

KATHERINE M. DUBRAY, EXAMINING ATTOR-  
NEY

Int. Cl.: 42

Prior U.S. Cls.: 100 and 101

United States Patent and Trademark Office

Reg. No. 3,497,741

Registered Sep. 9, 2008

SERVICE MARK  
PRINCIPAL REGISTER



THE PERSONAL MARKETING COMPANY, INC.  
(TEXAS CORPORATION)  
11843 WEST 83RD TERRACE  
LENEXA, KS 66214

FOR: PROVIDING TEMPORARY USE OF ON-  
LINE NON-DOWNLOADABLE SOFTWARE FOR  
DATABASE MANAGEMENT SOFTWARE FOR  
USE IN MANAGING DIRECT MARKETING EMAIL  
CONTACTS AND DIRECT MAIL ONLINE, IN  
CLASS 42 (U.S. CLS. 100 AND 101).

FIRST USE 11-10-2006; IN COMMERCE 11-10-2006.

NO CLAIM IS MADE TO THE EXCLUSIVE  
RIGHT TO USE THE ONE-TO-ONE MARKETING  
SYSTEM, APART FROM THE MARK AS SHOWN.

SER. NO. 77-132,012, FILED 3-15-2007.

STEPHANIE ALI, EXAMINING ATTORNEY

**Int. Cl.: 29**

**Prior U.S. Cl.: 46**

**United States Patent and Trademark Office**

**Reg. No. 3,497,742**

**Registered Sep. 9, 2008**

**TRADEMARK  
PRINCIPAL REGISTER**

**KNEIP**

JONMOR INVESTMENTS, INC. (DELAWARE  
CORPORATION)

103 BAYNARD BUILDING

3411 SILVERSIDE ROAD

WILMINGTON, DE 19810

FOR: MEAT, IN CLASS 29 (U.S. CL. 46).

FIRST USE 1-0-1973; IN COMMERCE 0-0-1973.

THE MARK CONSISTS OF STANDARD CHAR-  
ACTERS WITHOUT CLAIM TO ANY PARTICULAR  
FONT, STYLE, SIZE, OR COLOR.

OWNER OF U.S. REG. NO. 980,454.

SEC. 2(F).

SER. NO. 77-132,039, FILED 3-15-2007.

NAAKWAMA ANKRAH, EXAMINING ATTORNEY

**Int. Cls.: 9, 14 and 25**

**Prior U.S. Cls.: 2, 21, 22, 23, 26, 27, 28, 36, 38, 39 and 50**

**Reg. No. 3,497,743**

**United States Patent and Trademark Office**

**Registered Sep. 9, 2008**

**TRADEMARK  
PRINCIPAL REGISTER**

**BENGALS**

CINCINNATI BENGALS, INC. (OHIO CORPORATION)  
ONE PAUL BROWN STADIUM  
CINCINNATI, OH 45202

FOR: FOOTBALL HELMETS, MAGNETICALLY ENCODED CREDIT CARDS, DECORATIVE MAGNETS, PRERECORDED COMPACT DISCS CONTAINING MUSIC AND AUDIO TRACKS FEATURING THE SPORT OF FOOTBALL, COMPUTER GAME SOFTWARE AND DISCS, AND VIDEO GAME CARTRIDGES; NOT PROVIDED BY OR USED IN CONNECTION WITH A UNIVERSITY, IN CLASS 9 (U.S. CLS. 21, 23, 26, 36 AND 38).

FIRST USE 9-0-1987; IN COMMERCE 9-0-1987.

FOR: JEWELRY, WATCHES, CLOCKS, ORNAMENTAL PINS, EARRINGS, NECKLACES, CHARMS, COLLECTIBLE AND COMMEMORATIVE COINS MADE OF PRECIOUS METAL, PENDANTS AND KEY CHAINS MADE OF PRECIOUS METAL; NOT PROVIDED BY OR USED IN CONNECTION WITH A UNIVERSITY, IN CLASS 14 (U.S. CLS. 2, 27, 28 AND 50).

FIRST USE 9-0-1987; IN COMMERCE 9-0-1987.

FOR: MEN'S, WOMEN'S AND CHILDREN'S CLOTHING, NAMELY, FLEECE TOPS AND BOTTOMS, HEADWEAR, CAPS, KNIT HATS, T-SHIRTS, SWEATSHIRTS, SHORTS, TANK TOPS, PANTS, JACKETS, GOLF SHIRTS, KNIT SHIRTS, JERSEYS, GLOVES AND APRONS; NOT PROVIDED BY OR USED IN CONNECTION WITH A UNIVERSITY, IN CLASS 25 (U.S. CLS. 22 AND 39).

FIRST USE 9-0-1987; IN COMMERCE 9-0-1987.

THE MARK CONSISTS OF STANDARD CHARACTERS WITHOUT CLAIM TO ANY PARTICULAR FONT, STYLE, SIZE, OR COLOR.

OWNER OF U.S. REG. NOS. 940,763, 1,861,765 AND OTHERS.

SER. NO. 77-132,222, FILED 3-15-2007.

STEVEN PEREZ, EXAMINING ATTORNEY

**Int. Cl.: 41**

**Prior U.S. Cls.: 100, 101 and 107**

**United States Patent and Trademark Office**

**Reg. No. 3,497,744**

**Registered Sep. 9, 2008**

**SERVICE MARK  
PRINCIPAL REGISTER**

**GAMEFIESTA**

TRAFFIX, INC. (DELAWARE CORPORATION)  
5TH FLOOR  
1 BLUE HILL PLAZA  
PEARL RIVER, NY 06514

FOR: ENTERTAINMENT SERVICES, NAMELY, PROVIDING ON-LINE COMPUTER GAMES; PROVIDING AN ONLINE COMPUTER DATABASE IN THE FIELD OF COMPUTER GAMES; PROVIDING A WEBSITE FEATURING ONLINE COMPUTER GAMES; ELECTRONIC PUBLISHING SERVICES, NAMELY, PUBLICATION OF ONLINE COMPUTER GAMES, NAMELY, ELECTRONIC, TEXT, GRAPHIC AND MULTIMEDIA WORKS OF OTHERS OVER A GLOBAL COMMUNICATIONS NETWORK; ALL OF

THE AFOREMENTIONED DO NOT INCLUDE CASINO SERVICES OR COMPUTER GAMES INVOLVING MONEY, IN CLASS 41 (U.S. CLS. 100, 101 AND 107).

FIRST USE 9-22-2004; IN COMMERCE 9-22-2004.

THE MARK CONSISTS OF STANDARD CHARACTERS WITHOUT CLAIM TO ANY PARTICULAR FONT, STYLE, SIZE, OR COLOR.

SER. NO. 77-133,336, FILED 3-16-2007.

JACQUELINE A. LAVINE, EXAMINING ATTORNEY

**Int. Cl.: 43**

**Prior U.S. Cls.: 100 and 101**

**United States Patent and Trademark Office**

**Reg. No. 3,497,745**

**Registered Sep. 9, 2008**

**SERVICE MARK  
PRINCIPAL REGISTER**



PLANET HOLLYWOOD (REGION IV), INC.  
(MINNESOTA CORPORATION)  
7598 W. SAND LAKE ROAD  
ORLANDO, FL 32819

FOR: COFFEE SHOPS, IN CLASS 43 (U.S. CLS. 100  
AND 101).

FIRST USE 2-1-2007; IN COMMERCE 2-1-2007.

NO CLAIM IS MADE TO THE EXCLUSIVE  
RIGHT TO USE "PLANET" , APART FROM THE  
MARK AS SHOWN.

THE COLOR(S) RED AND WHITE IS/ARE  
CLAIMED AS A FEATURE OF THE MARK.

THE MARK CONSISTS OF THE WORDS "PLA-  
NET DAILIES" IN WHITE LETTERS INSIDE OF A  
RED RECTANGLE WITH A DESIGN CONSISTING  
OF MISCELLANEOUS INTERSECTING LINES.  
THERE IS ALSO A WHITE BORDER SET WITHIN  
THE RED RECTANGLE.

SER. NO. 77-135,698, FILED 3-20-2007.

STEVEN JACKSON, EXAMINING ATTORNEY



**Int. Cl.: 42**

**Prior U.S. Cls.: 100 and 101**

**United States Patent and Trademark Office**

**Reg. No. 3,497,746**

**Registered Sep. 9, 2008**

**SERVICE MARK  
PRINCIPAL REGISTER**



NAVITAR, INC. (NEW YORK CORPORATION)  
200 COMMERCE DRIVE  
ROCHESTER, NY 14623

THE COLOR(S) ORANGE AND BROWN IS/ARE  
CLAIMED AS A FEATURE OF THE MARK.

FOR: TECHNICAL SERVICES, NAMELY, PRO-  
VIDING AN ON-LINE AUTOMATED SYSTEM FOR  
INDICATING APPROPRIATE OPTICAL LENSES  
AND APPARATUS FOR ELECTRONIC IMAGING  
AND OPTICAL MACHINES ACCORDING TO USER  
INPUT, IN CLASS 42 (U.S. CLS. 100 AND 101).

THE COLOR ORANGE APPEARS IN THE OUTER  
CIRCLE IN THE MARK AND IN THE INNER HALF  
CIRCLE IN THE MARK. THE COLOR BROWN  
APPEARS IN THE WORDING "OPTICAL WIZARD".

FIRST USE 1-1-2006; IN COMMERCE 4-3-2006.

SER. NO. 77-137,748, FILED 3-22-2007.

NO CLAIM IS MADE TO THE EXCLUSIVE  
RIGHT TO USE "OPTICAL", APART FROM THE  
MARK AS SHOWN.

KELLEY WELLS, EXAMINING ATTORNEY

**Int. Cl.: 25**

**Prior U.S. Cls.: 22 and 39**

**United States Patent and Trademark Office**

**Reg. No. 3,497,747**

**Registered Sep. 9, 2008**

**TRADEMARK  
PRINCIPAL REGISTER**

**BLUENOTCH**

NHO, JUNG HO (REPUBLIC OF KOREA INDIVIDUAL)  
110-1202 OKSU-SAMSUNG APT., 250 OKSUDONG  
SEONGDONG-GU, SEOUL, REPUBLIC OF KOREA

FOR: CLOTHING, NAMELY, BLUE JEANS, BUTTON-FRONT ALOHA SHIRTS, BELTS, BLOUSES, BRASSIERES, BUSINESS SUITS, CARDIGANS, COATS, DRESSES, DRESS SHIRTS, GLOVES, JACKETS, JUMPERS, NECKTIES, PANTS, PARKAS, POLO SHIRTS, SCARVES, SHIRTS, SKIRTS, SOCKS, STOCKINGS, SUITS, SWEATERS, TROUSERS, T-SHIRTS, UNDERPANTS, UNIFORMS, UNDERWEAR, FOOTWEAR, AND HEADWEAR; CHILDREN'S CLOTHING, NAMELY, SHIRTS, TOPS,

PANTS, SHORTS, SOCKS, COATS, JACKETS, AND UNDERWEAR, IN CLASS 25 (U.S. CLS. 22 AND 39).

THE MARK CONSISTS OF STANDARD CHARACTERS WITHOUT CLAIM TO ANY PARTICULAR FONT, STYLE, SIZE, OR COLOR.

PRIORITY CLAIMED UNDER SEC. 44(D) ON REPUBLIC OF KOREA APPLICATION NO. 2007-0008510, FILED 2-13-2007, REG. NO. 0742398, DATED 4-1-2008, EXPIRES 4-1-2018.

SER. NO. 77-138,580, FILED 3-23-2007.

VERNA BETH RIRIE, EXAMINING ATTORNEY

**Int. Cl.: 39**

**Prior U.S. Cls.: 100 and 105**

**United States Patent and Trademark Office**

**Reg. No. 3,497,748**

**Registered Sep. 9, 2008**

**SERVICE MARK  
PRINCIPAL REGISTER**

**Your Journey, Your Way**

BOLDER ADVENTURES, INC. (COLORADO CORPORATION)  
2995 CENTER GREEN COURT  
BOULDER, CO 80301

FOR: ARRANGING INTERNATIONAL TRAVEL TOURS; ARRANGING FOR TRAVEL VISAS, PASSPORTS AND TRAVEL DOCUMENTS FOR PERSONS TRAVELING ABROAD, IN CLASS 39 (U.S. CLS. 100 AND 105).

FIRST USE 1-1-2004; IN COMMERCE 1-1-2004.

THE MARK CONSISTS OF STANDARD CHARACTERS WITHOUT CLAIM TO ANY PARTICULAR FONT, STYLE, SIZE, OR COLOR.

SER. NO. 77-138,693, FILED 3-23-2007.

JACQUELINE A. LAVINE, EXAMINING ATTORNEY

**Int. Cls.: 25 and 26**

**Prior U.S. Cls.: 22, 37, 39, 40, 42 and 50**

**United States Patent and Trademark Office**

**Reg. No. 3,497,749**

**Registered Sep. 9, 2008**

**TRADEMARK  
PRINCIPAL REGISTER**



DEPALMA'S ACTION KARATE, LLC (ARIZONA  
LIMITED LIABILITY COMPANY)

1234 S. POWER RD., SUITE 150

MESA, AZ 85206

FOR: KARATE SUITS; MARTIAL ARTS UNI-  
FORMS, IN CLASS 25 (U.S. CLS. 22 AND 39).

FIRST USE 2-1-1997; IN COMMERCE 2-1-1997.

FOR: EMBROIDERED PATCHES FOR KARATE  
SUITS AND MARTIAL ARTS UNIFORMS, IN  
CLASS 26 (U.S. CLS. 37, 39, 40, 42 AND 50).

FIRST USE 2-1-1997; IN COMMERCE 2-1-1997.

THE MARK CONSISTS OF KICKER WITH BALL.

SER. NO. 77-139,464, FILED 3-23-2007.

KAREN K. BUSH, EXAMINING ATTORNEY

**Int. Cl.: 16**

**Prior U.S. Cls.: 2, 5, 22, 23, 29, 37, 38 and 50**

**United States Patent and Trademark Office**

**Reg. No. 3,497,750**

**Registered Sep. 9, 2008**

**TRADEMARK  
PRINCIPAL REGISTER**

**Knowledge into Practice**

ENNA PRODUCTS INCORPORATION (CANADA  
CORPORATION)  
1306 CAROLINA STREET, UNIT B-3  
BELLINGHAM, WA 98229

FOR: A SERIES OF PRINTED INSTRUCTIONAL  
AND TEACHING MATERIALS, NAMELY, BOOKS,  
WORKSHEETS, IDENTIFYING PAPER TAGS, PHOTOGRAPHS,  
AND INDUSTRIAL BOOK MANUALS,  
ALL IN THE FIELD OF BUSINESS IMPROVEMENT  
AND PROCESS IMPROVEMENT, IN CLASS 16 (U.S.  
CLS. 2, 5, 22, 23, 29, 37, 38 AND 50).

FIRST USE 12-20-2004; IN COMMERCE 5-4-2005.

THE MARK CONSISTS OF STANDARD CHARACTERS  
WITHOUT CLAIM TO ANY PARTICULAR  
FONT, STYLE, SIZE, OR COLOR.

SER. NO. 77-139,713, FILED 3-25-2007.

PAUL E. FAHRENKOPF, EXAMINING ATTORNEY

**Int. Cls.: 35 and 41**

**Prior U.S. Cls.: 100, 101, 102 and 107**

**United States Patent and Trademark Office**

**Reg. No. 3,497,751**

**Registered Sep. 9, 2008**

**SERVICE MARK  
PRINCIPAL REGISTER**

**THE JAMESTOWN PROJECT**

THE JAMESTOWN PROJECT (D.C. NON-PROFIT CORPORATION)  
1140 CHAPEL STREET SUITE 301  
NEW HAVEN, CT 06510

FOR: THINK TANK SERVICES, NAMELY, CONDUCTING BUSINESS AND PUBLIC POLICY RESEARCH DIRECTED TO THE STUDY OF THE HISTORY OF DEMOCRACY IN AMERICA; PUBLIC ADVOCACY TO PROMOTE AWARENESS OF DEMOCRATIC PRINCIPLES THROUGH MEDIA RELATIONS, GOVERNMENT RELATIONS, ADVERTISING, PUBLICATIONS, AND OUTREACH AND GRASSROOTS EDUCATION, IN CLASS 35 (U.S. CLS. 100, 101 AND 102).

FIRST USE 10-0-2005; IN COMMERCE 10-0-2005.

FOR: THINK TANK SERVICES, NAMELY, CONDUCTING MEETINGS, SEMINARS, AND CONFER-

ENCES DIRECTED TO THE STUDY OF THE HISTORY OF DEMOCRACY IN AMERICA, IN CLASS 41 (U.S. CLS. 100, 101 AND 107).

FIRST USE 10-0-2005; IN COMMERCE 10-0-2005.

THE MARK CONSISTS OF STANDARD CHARACTERS WITHOUT CLAIM TO ANY PARTICULAR FONT, STYLE, SIZE, OR COLOR.

NO CLAIM IS MADE TO THE EXCLUSIVE RIGHT TO USE "PROJECT", APART FROM THE MARK AS SHOWN.

SER. NO. 77-140,121, FILED 3-26-2007.

KELLY BOULTON, EXAMINING ATTORNEY

**Int. Cls.: 35 and 41**

**Prior U.S. Cls.: 100, 101, 102 and 107**

**United States Patent and Trademark Office**

**Reg. No. 3,497,752**

**Registered Sep. 9, 2008**

**SERVICE MARK  
PRINCIPAL REGISTER**



THE JAMESTOWN PROJECT (D.C. CORPORATION)  
1140 CHAPEL STREET SUITE 301  
NEW HAVEN, CT 06510

FOR: THINK TANK SERVICES, NAMELY, CONDUCTING BUSINESS AND PUBLIC POLICY RESEARCH DIRECTED TO THE STUDY OF THE HISTORY OF DEMOCRACY IN AMERICA; PUBLIC ADVOCACY TO PROMOTE AWARENESS OF DEMOCRATIC PRINCIPLES THROUGH MEDIA RELATIONS, GOVERNMENT RELATIONS, ADVERTISING, PUBLICATIONS, AND OUTREACH AND GRASSROOTS EDUCATION, IN CLASS 35 (U.S. CLS. 100, 101 AND 102).

FIRST USE 10-0-2005; IN COMMERCE 10-0-2005.

FOR: THINK TANK SERVICES, NAMELY, CONDUCTING MEETINGS, SEMINARS, AND CONFER-

ENCES DIRECTED TO THE STUDY OF THE HISTORY OF DEMOCRACY IN AMERICA, IN CLASS 41 (U.S. CLS. 100, 101 AND 107).

FIRST USE 10-0-2005; IN COMMERCE 10-0-2005.

NO CLAIM IS MADE TO THE EXCLUSIVE RIGHT TO USE "PROJECT", APART FROM THE MARK AS SHOWN.

THE MARK CONSISTS OF THE WORDS "THE JAMESTOWN PROJECT" WITH A LOGO RESEMBLING A COMPASS.

SER. NO. 77-140,135, FILED 3-26-2007.

KELLY BOULTON, EXAMINING ATTORNEY

**Int. Cl.: 11**

**Prior U.S. Cls.: 13, 21, 23, 31 and 34**

**United States Patent and Trademark Office**

**Reg. No. 3,497,753**

**Registered Sep. 9, 2008**

**TRADEMARK  
PRINCIPAL REGISTER**

**INDEPENDENCE LINE**

CLARION BATHWARE, INC. (PENNSYLVANIA  
CORPORATION)  
44 AMSLER AVENUE  
SHIPPENVILLE, PA 16254

FOR: SHOWERS, TUBS AND INSERTS FOR CON-  
VERTING SHOWERS TO TUBS, IN CLASS 11 (U.S.  
CLS. 13, 21, 23, 31 AND 34).

FIRST USE 6-1-1999; IN COMMERCE 6-1-1999.

THE MARK CONSISTS OF STANDARD CHAR-  
ACTERS WITHOUT CLAIM TO ANY PARTICULAR  
FONT, STYLE, SIZE, OR COLOR.

NO CLAIM IS MADE TO THE EXCLUSIVE  
RIGHT TO USE "LINE", APART FROM THE MARK  
AS SHOWN.

SER. NO. 77-140,974, FILED 3-27-2007.

LOURDES AYALA, EXAMINING ATTORNEY



**Int. Cl.: 44**

**Prior U.S. Cls.: 100 and 101**

**United States Patent and Trademark Office**

**Reg. No. 3,497,754**

**Registered Sep. 9, 2008**

**SERVICE MARK  
PRINCIPAL REGISTER**



NUTRECO CANADA INC. (CANADA CORPORATION)  
150 RESEARCH LANE  
SUITE 200  
GUELPH, CANADA N1G 4T2

FOR: ASSISTING CATTLE FARMERS BY PROVIDING NUTRITIONAL RECOMMENDATIONS, NAMELY, PROVIDING COMPUTER-GENERATED FEEDING STRATEGIES BASED ON TECHNOLOGY AND RESEARCH PERTAINING TO THE LIVESTOCK INDUSTRY, IN CLASS 44 (U.S. CLS. 100 AND 101).

PRIORITY CLAIMED UNDER SEC. 44(D) ON CANADA APPLICATION NO. 1340862, FILED 3-26-2007, REG. NO. TMA713292, DATED 5-1-2008, EXPIRES 5-1-2023.

OWNER OF U.S. REG. NOS. 734,810, 2,014,032 AND OTHERS.

SER. NO. 77-141,493, FILED 3-27-2007.

KATHERINE CONNOLLY, EXAMINING ATTORNEY

**Int. Cl.: 37**

**Prior U.S. Cls.: 100, 103 and 106**

**United States Patent and Trademark Office**

**Reg. No. 3,497,755**

**Registered Sep. 9, 2008**

**SERVICE MARK  
PRINCIPAL REGISTER**

THEHOMEWARRANTYEXCHANGE.COM

SCJ VENDING CORP. (DELAWARE CORPORATION)  
80 EAGLE CHASE  
WOODBURY, NY 11797

FOR: PROVIDING INFORMATION CONCERNING HOME HABITABILITY GUARANTEES, IN CLASS 37 (U.S. CLS. 100, 103 AND 106).

FIRST USE 1-31-2007; IN COMMERCE 1-31-2007.

THE MARK CONSISTS OF STANDARD CHARACTERS WITHOUT CLAIM TO ANY PARTICULAR FONT, STYLE, SIZE, OR COLOR.

SER. NO. 77-141,976, FILED 3-27-2007.

CAROLINE WOOD, EXAMINING ATTORNEY

**Int. Cl.: 9**

**Prior U.S. Cls.: 21, 23, 26, 36 and 38**

**United States Patent and Trademark Office**

**Reg. No. 3,497,756**

**Registered Sep. 9, 2008**

**TRADEMARK  
PRINCIPAL REGISTER**

**Demand-Driven Workforce**

REDPRAIRIE CORPORATION (DELAWARE  
CORPORATION)  
20700 SWENSON DRIVE  
WAUKESHA, WI 53186

FOR: DOWNLOADABLE ELECTRONIC PUBLI-  
CATIONS AND DOCUMENTATION IN THE NAT-  
URE OF NEWSLETTERS AND ARTICLES IN THE  
FIELD OF SUPPLY CHAIN MANAGEMENT AND  
INTEGRATION, IN CLASS 9 (U.S. CLS. 21, 23, 26, 36  
AND 38).

FIRST USE 1-13-2006; IN COMMERCE 1-13-2006.

THE MARK CONSISTS OF STANDARD CHAR-  
ACTERS WITHOUT CLAIM TO ANY PARTICULAR  
FONT, STYLE, SIZE, OR COLOR.

SER. NO. 77-143,743, FILED 3-29-2007.

H. M. FISHER, EXAMINING ATTORNEY

**Int. Cl.: 12**

**Prior U.S. Cls.: 19, 21, 23, 31, 35 and 44**

**United States Patent and Trademark Office**

**Reg. No. 3,497,757**

**Registered Sep. 9, 2008**

**TRADEMARK  
PRINCIPAL REGISTER**



ONE STOP UNDERCAR, INC. (CALIFORNIA CORPORATION)  
2938 SOUTH DAIMLER STREET  
SANTA ANA, CA 92705

NO CLAIM IS MADE TO THE EXCLUSIVE RIGHT TO USE "PROFESSIONAL QUALITY DRUMS & ROTORS", APART FROM THE MARK AS SHOWN.

FOR: AUTOMOTIVE PARTS AND ACCESSORIES, NAMELY, BRAKE ROTORS AND BRAKE DRUMS, IN CLASS 12 (U.S. CLS. 19, 21, 23, 31, 35 AND 44).

SER. NO. 77-143,975, FILED 3-29-2007.

FIRST USE 11-30-2005; IN COMMERCE 11-30-2005.

OWNER OF U.S. REG. NO. 2,564,222.

ZACHARY BELLO, EXAMINING ATTORNEY

**Int. Cl.: 3**

**Prior U.S. Cls.: 1, 4, 6, 50, 51 and 52**

**Reg. No. 3,497,758**

**United States Patent and Trademark Office**

**Registered Sep. 9, 2008**

**TRADEMARK  
PRINCIPAL REGISTER**

**PureFlex**

B.E.N. TRADING (NEW YORK CORPORATION)  
280 DOUGLASS STREET  
BROOKLYN, NY 11217

FIRST USE 3-23-2007; IN COMMERCE 3-23-2007.

FOR: AEROSOL SPRAY CLEANING PRODUCTS,  
NAMELY, SPRAY LAUNDRY STARCH, OVEN  
AND GRILL CLEANER, CARPET CLEANER  
SPRAY, CARPET REFRESHER SPRAY, FURNI-  
TURE POLISH, GLASS CLEANER, NON-DISIN-  
FECTING BATHROOM CLEANER, NON-  
DISINFECTING TOILET BOWL CLEANER, IN  
CLASS 3 (U.S. CLS. 1, 4, 6, 50, 51 AND 52).

THE MARK CONSISTS OF STANDARD CHAR-  
ACTERS WITHOUT CLAIM TO ANY PARTICULAR  
FONT, STYLE, SIZE, OR COLOR.

SER. NO. 77-144,488, FILED 3-30-2007.

RENEE SERVANCE, EXAMINING ATTORNEY

**Int. Cl.: 33**

**Prior U.S. Cls.: 47 and 49**

**United States Patent and Trademark Office**

**Reg. No. 3,497,759**

**Registered Sep. 9, 2008**

**TRADEMARK  
PRINCIPAL REGISTER**

**volé**

MOHOLT-SIEBERT, MELISSA J. (UNITED STATES INDIVIDUAL)  
319 S.W. WASHINGTON, #812  
PORTLAND, OR 97204

FOR: WINES, IN CLASS 33 (U.S. CLS. 47 AND 49).

FIRST USE 5-3-2007; IN COMMERCE 7-2-2007.

THE MARK CONSISTS OF STANDARD CHARACTERS WITHOUT CLAIM TO ANY PARTICULAR FONT, STYLE, SIZE, OR COLOR.

THE ENGLISH TRANSLATION OF THE MARK IS FLOWN OR STOLEN.

SER. NO. 77-145,077, FILED 3-30-2007.

STEVEN PEREZ, EXAMINING ATTORNEY

**Int. Cl.: 35**

**Prior U.S. Cls.: 100, 101 and 102**

**United States Patent and Trademark Office**

**Reg. No. 3,497,760**

**Registered Sep. 9, 2008**

**SERVICE MARK  
PRINCIPAL REGISTER**

**HOTHYDRO**

TOLEDO HYDROPONICS LTD (OHIO LIMITED  
LIABILITY COMPANY)  
855 S HOLLAND SYLVANIA RD #2  
TOLEDO, OH 43615

THE MARK CONSISTS OF STANDARD CHAR-  
ACTERS WITHOUT CLAIM TO ANY PARTICULAR  
FONT, STYLE, SIZE, OR COLOR.

FOR: ON-LINE RETAIL STORE SERVICES FEA-  
TURING GARDENING SUPPLIES AND EQUIP-  
MENT; RETAIL LAWN, GARDEN AND NURSERY  
STORES, IN CLASS 35 (U.S. CLS. 100, 101 AND 102).

SER. NO. 77-145,538, FILED 3-31-2007.

FIRST USE 7-5-2005; IN COMMERCE 1-1-2006.

RON FAIRBANKS, EXAMINING ATTORNEY

**Int. Cl.: 6**

**Prior U.S. Cls.: 2, 12, 13, 14, 23, 25 and 50**

**Reg. No. 3,497,761**

**United States Patent and Trademark Office**

**Registered Sep. 9, 2008**

**TRADEMARK  
PRINCIPAL REGISTER**

**The Mobile Decorative  
Hardware Store**

PUSH PULL OPEN CLOSE INCORPORATED  
(TEXAS CORPORATION)  
P.O. BOX 41706  
AUSTIN, TX 78704

FOR: COMMON METAL DRAWER PULLS; METAL BATHROOM HARDWARE, NAMELY, PULLS; METAL PULLS FOR DRAWERS, CABINETS AND FURNITURE; METAL HANDLES FOR DOORS, NAMELY, DOORKNOBS; METAL LATCHES; METAL DOOR TRIM; METAL KNOBS, IN CLASS 6 (U.S. CLS. 2, 12, 13, 14, 23, 25 AND 50).

FIRST USE 1-5-2005; IN COMMERCE 1-5-2005.

THE MARK CONSISTS OF STANDARD CHARACTERS WITHOUT CLAIM TO ANY PARTICULAR FONT, STYLE, SIZE, OR COLOR.

NO CLAIM IS MADE TO THE EXCLUSIVE RIGHT TO USE "DECORATIVE HARDWARE STORE", APART FROM THE MARK AS SHOWN.

SER. NO. 77-146,608, FILED 4-2-2007.

TASHIA BUNCH, EXAMINING ATTORNEY



**Int. Cl.: 33**

**Prior U.S. Cls.: 47 and 49**

**United States Patent and Trademark Office**

**Reg. No. 3,497,762**

**Registered Sep. 9, 2008**

**TRADEMARK  
PRINCIPAL REGISTER**

**BOURBONCRAFT**

ALLIED LOMAR, INC. (CALIFORNIA CORPORATION)  
1199 HOWARD AVE. SUITE 350  
BURLINGAME, CA 94010

THE MARK CONSISTS OF STANDARD CHARACTERS WITHOUT CLAIM TO ANY PARTICULAR FONT, STYLE, SIZE, OR COLOR.

FOR: LIQUOR, IN CLASS 33 (U.S. CLS. 47 AND 49).

SER. NO. 77-147,563, FILED 4-3-2007.

FIRST USE 3-28-2007; IN COMMERCE 3-28-2007.

JIM RINGLE, EXAMINING ATTORNEY

**Int. Cls.: 16 and 20**

**Prior U.S. Cls.: 2, 5, 13, 22, 23, 25, 29, 32, 37, 38 and 50**

**United States Patent and Trademark Office**

**Reg. No. 3,497,763**

**Registered Sep. 9, 2008**

**TRADEMARK  
PRINCIPAL REGISTER**

# DOGS RULE

MARS, INCORPORATED (DELAWARE CORPORATION)  
6885 ELM STREET  
MCLEAN, VA 221013883

FOR: CALENDARS, IN CLASS 16 (U.S. CLS. 2, 5, 22, 23, 29, 37, 38 AND 50).

FIRST USE 10-0-2006; IN COMMERCE 10-0-2006.

FOR: PICTURE FRAMES, PICTURE FRAMES WITH MAGNETIZED BACKING FOR MOUNTING, IN CLASS 20 (U.S. CLS. 2, 13, 22, 25, 32 AND 50).

FIRST USE 9-0-2006; IN COMMERCE 9-0-2006.

THE MARK CONSISTS OF STANDARD CHARACTERS WITHOUT CLAIM TO ANY PARTICULAR FONT, STYLE, SIZE, OR COLOR.

OWNER OF U.S. REG. NO. 2,969,041.

SER. NO. 77-148,970, FILED 4-4-2007.

LYDIA BELZER, EXAMINING ATTORNEY

**Int. Cl.: 16**

**Prior U.S. Cls.: 2, 5, 22, 23, 29, 37, 38 and 50**

**Reg. No. 3,497,764**

**United States Patent and Trademark Office**

**Registered Sep. 9, 2008**

**TRADEMARK  
PRINCIPAL REGISTER**

**UROK**

BIG PICTURE MANAGEMENT PTY LIMITED  
(AUSTRALIA CORPORATION)  
SUITE 105B NEXUS TOWERS  
105 SCARBOROUGH STREET  
SOUTHPORT, AUSTRALIA 4215

FOR: PUBLICATIONS, NAMELY, BROCHURES, BOOKLETS, ARTICLES AND JOURNALS IN THE FIELD OF PERSONAL DEVELOPMENT, PERSONAL GROWTH AND CHANGE MANAGEMENT, BUSINESS DEVELOPMENT, BUSINESS STRATEGY, BUSINESS GROWTH AND CHANGE MANAGEMENT, INTERPERSONAL RELATIONSHIPS AND COMMUNICATION MANAGEMENT, GOAL SETTING AND PLANNING SOLUTIONS; MAGAZINES FEATURING LIFESTYLES, PERSONAL DEVELOPMENT, PERSONAL GROWTH AND CHANGE MANAGEMENT, BUSINESS DEVELOPMENT, BUSINESS STRATEGY, BUSINESS GROWTH AND CHANGE MANAGEMENT, INTERPERSONAL RELATIONSHIPS AND COMMUNICATION MANAGEMENT, GOAL SETTING AND PLANNING SOLUTIONS, ENTERTAINMENT, SPORT, CULTURES AND MUSIC; SERIES OF FICTION AND NON-FICTION BOOKS IN THE FIELD OF PERSONAL DEVELOPMENT, PERSONAL GROWTH AND CHANGE MANAGEMENT, BUSINESS DEVELOPMENT, BUSINESS STRATEGY, BUSINESS GROWTH AND CHANGE MANAGEMENT, INTERPERSONAL RELATIONSHIPS AND COMMUNICATION MANAGEMENT, GOAL SETTING AND PLANNING SOLUTIONS, ENTERTAINMENT, SPORT, CULTURES AND MUSIC; NEWSPAPERS; NEWSLETTERS IN THE FIELD OF PERSONAL DEVELOPMENT, PERSONAL GROWTH AND CHANGE MANAGEMENT, BUSINESS DEVELOPMENT, BUSINESS STRATEGY, BUSINESS GROWTH AND CHANGE MANAGEMENT, INTERPERSONAL RELATIONSHIPS AND COMMUNICATION MANAGEMENT, GOAL SETTING AND PLANNING SOLUTIONS, ENTERTAINMENT, SPORT, CULTURES AND MUSIC;

TEXTBOOKS IN THE FIELD OF PERSONAL DEVELOPMENT, PERSONAL GROWTH AND CHANGE MANAGEMENT, BUSINESS DEVELOPMENT, BUSINESS STRATEGY, BUSINESS GROWTH AND CHANGE MANAGEMENT, INTERPERSONAL RELATIONSHIPS AND COMMUNICATION MANAGEMENT, GOAL SETTING AND PLANNING SOLUTIONS, ENTERTAINMENT, SPORT, CULTURES AND MUSIC; SCRAPBOOKS; INFORMATION BOOKS IN THE FIELD OF PERSONAL DEVELOPMENT, PERSONAL GROWTH AND CHANGE MANAGEMENT, BUSINESS DEVELOPMENT, BUSINESS STRATEGY, BUSINESS GROWTH AND CHANGE MANAGEMENT, INTERPERSONAL RELATIONSHIPS AND COMMUNICATION MANAGEMENT, GOAL SETTING AND PLANNING SOLUTIONS, ENTERTAINMENT, SPORT, CULTURES AND MUSIC; INSTRUCTION BOOKLETS IN THE FIELD OF PERSONAL DEVELOPMENT, PERSONAL GROWTH AND CHANGE MANAGEMENT, BUSINESS DEVELOPMENT, BUSINESS STRATEGY, BUSINESS GROWTH AND CHANGE MANAGEMENT, INTERPERSONAL RELATIONSHIPS AND COMMUNICATION MANAGEMENT, GOAL SETTING AND PLANNING SOLUTIONS, ENTERTAINMENT, SPORT, CULTURES AND MUSIC; PRINTED GUIDES FEATURING INFORMATION ABOUT PERSONAL DEVELOPMENT, PERSONAL GROWTH AND CHANGE MANAGEMENT, BUSINESS DEVELOPMENT, BUSINESS STRATEGY, BUSINESS GROWTH AND CHANGE MANAGEMENT, INTERPERSONAL RELATIONSHIPS AND COMMUNICATION MANAGEMENT, GOAL SETTING AND PLANNING SOLUTIONS, ENTERTAINMENT, SPORT, CULTURES AND MUSIC; MAPS; CITY DIRECTORIES; LEDGER BOOKS; DIARIES; LOG BOOKS; TRAVEL BOOKS; LOOSE-LEAF NOTEBOOKS; PRINTED INVITATIONS; MEMO PADS AND BOOKS; NOTEBOOKS; PHOTO ALBUMS; DOCUMENT PORTFOLIOS; FOLDERS; DATE BOOKS; HARD BOUND BOOKS FOR EDUCATION

PURPOSES FEATURING INFORMATION ABOUT PERSONAL DEVELOPMENT, PERSONAL GROWTH AND CHANGE MANAGEMENT, BUSINESS DEVELOPMENT, BUSINESS STRATEGY, BUSINESS GROWTH AND CHANGE MANAGEMENT, INTERPERSONAL RELATIONSHIPS AND COMMUNICATION MANAGEMENT, GOAL SETTING AND PLANNING SOLUTIONS, ENTERTAINMENT, SPORT, CULTURES AND MUSIC; BOOKMARKS; COMIC BOOKS; COMIC STRIPS; STUDENT DAY PLANNERS; BOOK BINDERS; BOOK COVERING MATERIALS; BOOK BINDING MATERIALS; BOOKENDS; BINDERS FOR MAGAZINES; COMPANY MAGAZINES FEATURING PERSONAL DEVELOPMENT, PERSONAL GROWTH AND CHANGE MANAGEMENT, BUSINESS DEVELOPMENT, BUSINESS STRATEGY, BUSINESS GROWTH AND CHANGE MANAGEMENT, INTERPERSONAL RELATIONSHIPS AND COMMUNICATION MANAGEMENT, GOAL SETTING AND PLANNING SOLUTIONS, ENTERTAINMENT, SPORT, CULTURES AND MUSIC; COVERING MATERIALS FOR MAGAZINES; COVERS FOR MAGAZINES; MAGAZINES FEATURING PERSONAL DEVELOPMENT, PERSONAL GROWTH AND CHANGE MANAGEMENT, BUSINESS DEVELOPMENT, BUSINESS STRATEGY, BUSINESS GROWTH AND CHANGE MANAGEMENT, INTERPERSONAL RELATIONSHIPS AND COMMUNICATION MANAGEMENT, GOAL SETTING AND PLANNING SOLUTIONS, ENTERTAINMENT, SPORT, CULTURES AND MUSIC INCORPORATING POSTERS; MAGAZINE BINDERS; MAGAZINE COLLECTORS FOR EDUCATION PURPOSES, NAMELY, MAGAZINE COVERS; PRINTED VISUALS IN THE NATURE OF PROMOTIONAL MA-

TERIALS; ADVERTISING PAMPHLETS; EVENTS PROGRAMMES; PRINTED VOUCHERS AND COUPONS; CALENDARS; BLANK JOURNALS; LOOSE-LEAF PUBLICATIONS, NAMELY, BROCHURES, BOOKLETS, AND TEACHING MATERIALS IN THE FIELD OF PERSONAL DEVELOPMENT, PERSONAL GROWTH AND CHANGE MANAGEMENT, BUSINESS DEVELOPMENT, BUSINESS STRATEGY, BUSINESS GROWTH AND CHANGE MANAGEMENT, INTERPERSONAL RELATIONSHIPS AND COMMUNICATION MANAGEMENT, GOAL SETTING AND PLANNING SOLUTIONS, ENTERTAINMENT, SPORT, CULTURES AND MUSIC; POSTERS; JACKETS OF PAPER FOR MAGAZINES; JACKETS OF PLASTIC FOR MAGAZINES; PAPER BAGS; MERCHANDISE BAGS; PAPER BANNERS; CARDBOARD GOODS NAMELY, BOXES, FILES AND FILE COVERS; CARDBOARD FOLDERS; CARDBOARD SHEETS; CARDBOARD TUBES; CARD FILES; DESKTOP BUSINESS CARD HOLDERS; BUSINESS CARDS; ANNOUNCEMENT CARDS; GREETING CARDS; STICKERS; POST CARDS; ENVELOPES; LETTERHEAD PAPER; BANNERS OF CARDBOARD; PENS; PENCILS, IN CLASS 16 (U.S. CLS. 2, 5, 22, 23, 29, 37, 38 AND 50).

THE MARK CONSISTS OF STANDARD CHARACTERS WITHOUT CLAIM TO ANY PARTICULAR FONT, STYLE, SIZE, OR COLOR.

OWNER OF AUSTRALIA REG. NO. 994724, DATED 4-24-2004, EXPIRES 4-24-2014.

SER. NO. 77-149,059, FILED 4-5-2007.

DAVID HOFFMAN, EXAMINING ATTORNEY

Int. Cl.: 30

Prior U.S. Cl.: 46

United States Patent and Trademark Office

Reg. No. 3,497,765

Registered Sep. 9, 2008

TRADEMARK  
PRINCIPAL REGISTER

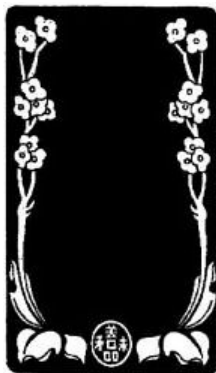

TIEN CHU (HONG KONG) COMPANY LIMITED,  
THE (HONG KONG CORPORATION)  
BLOCK B, TIEN CHU (TSING YI) INDUS. CNTR  
52-62 TSING YI ROAD  
TSING YI, NT, HONG KONG

FOR: PROCESSED GRAINS, NAMELY, DUMPLINGS, FLOUR, READY TO EAT CEREAL DERIVED FOOD BARS, GRANOLA BASED SNACK BARS, MACARONI, NOODLES AND OATMEAL; MIXES IN THE NATURE OF CRYSTALLIZED POWDERS IN PREPARATION OF TEA BASED BEVERAGES, GRAIN BASED BEVERAGES, HERBAL FOOD BEVERAGES NOT BEING VEGETABLE BASED; AND FOOD FLAVORING, NAMELY, MONOSODIUM GLUTAMATE, ALMOND PASTE, BARBECUE SAUCES, GARLIC POWDERS, CRYSTALLIZED GINGER, NUTMEG AND SAGE, IN CLASS 30 (U.S. CL. 46).

FIRST USE 1-1-1995; IN COMMERCE 1-1-1995.

NO CLAIM IS MADE TO THE EXCLUSIVE RIGHT TO USE THE NON-LATIN CHARACTERS THAT MEAN "GOOD TASTE AND QUALITY" , APART FROM THE MARK AS SHOWN.

THE MARK CONSISTS OF FLOWERS AND FLOWER BLOSSOMS FORMING A BORDER DESIGN.

THE NON-LATIN CHARACTERS IN THE MARK TRANSLITERATE TO "SHANG FU, BIAO SHOU, SHAN, HE WEI, PIN" AND THIS MEANS "TRADE BUDDHA, MARK HAND, BENIGN, GOOD TASTE, QUALITY" IN ENGLISH.

SER. NO. 77-149,159, FILED 4-5-2007.

ELLEN PERKINS, EXAMINING ATTORNEY

**Int. Cls.: 9 and 41**

**Prior U.S. Cls.: 21, 23, 26, 36, 38, 100, 101 and 107**

**Reg. No. 3,497,766**

**United States Patent and Trademark Office**

**Registered Sep. 9, 2008**

**TRADEMARK  
SERVICE MARK  
PRINCIPAL REGISTER**

# Sharpe's Point

SHARPE MEDIA, LLC (VIRGINIA LIMITED LIABILITY COMPANY)  
4519 34TH STREET S.  
ARLINGTON, VA 222061914

FOR: PROVIDING DOWNLOADABLE ELECTRONIC NEWSLETTERS IN THE FIELD OF OCCUPATIONAL SAFETY AND HEALTH , IN CLASS 9 (U.S. CLS. 21, 23, 26, 36 AND 38).

FIRST USE 8-1-2005; IN COMMERCE 8-1-2005.

FOR: PROVIDING NEWSLETTERS IN THE FIELD OF OCCUPATIONAL SAFETY AND

HEALTH VIA E-MAIL AND INTERNET, IN CLASS 41 (U.S. CLS. 100, 101 AND 107).

FIRST USE 8-1-2005; IN COMMERCE 8-1-2005.

THE MARK CONSISTS OF STANDARD CHARACTERS WITHOUT CLAIM TO ANY PARTICULAR FONT, STYLE, SIZE, OR COLOR.

SER. NO. 77-149,441, FILED 4-5-2007.

MICHAEL SOUDERS, EXAMINING ATTORNEY

**Int. Cls.: 25 and 33**

**Prior U.S. Cls.: 22, 39, 47 and 49**

**United States Patent and Trademark Office**

**Reg. No. 3,497,767**

**Registered Sep. 9, 2008**

**TRADEMARK  
PRINCIPAL REGISTER**

**TEMPLETON RYE**

TEMPLETON RYE SPIRITS, LLC (IOWA LIMITED LIABILITY COMPANY)  
2800 BERKSHIRE DRIVE  
NORWALK, IA 50211

FOR: MEN'S AND WOMEN'S CLOTHING, NAMELY, T-SHIRTS, SHIRTS, AND HATS, IN CLASS 25 (U.S. CLS. 22 AND 39).

FIRST USE 8-0-2005; IN COMMERCE 8-0-2005.

FOR: DISTILLED SPIRITS, IN CLASS 33 (U.S. CLS. 47 AND 49).

FIRST USE 10-27-2006; IN COMMERCE 10-27-2006.

THE MARK CONSISTS OF STANDARD CHARACTERS WITHOUT CLAIM TO ANY PARTICULAR FONT, STYLE, SIZE, OR COLOR.

NO CLAIM IS MADE TO THE EXCLUSIVE RIGHT TO USE "RYE", APART FROM THE MARK AS SHOWN.

SER. NO. 77-151,059, FILED 4-6-2007.

GIANCARLO CASTRO, EXAMINING ATTORNEY

**Int. Cl.: 44**

**Prior U.S. Cls.: 100 and 101**

**United States Patent and Trademark Office**

**Reg. No. 3,497,768**

**Registered Sep. 9, 2008**

**SERVICE MARK  
PRINCIPAL REGISTER**

**FLUFFY PUPS**

FLUFFY PUPS, INC. (NEW YORK CORPORATION)  
2054 GOSHEN TURNPIKE  
MIDDLETOWN, NY 10941

FOR: PET CARE SERVICES, NAMELY, NON-MEDICATED GROOMING, BATHING, DESHEDDING, SKIN CARE, COAT CARE; MOBILE CANINE NON-MEDICATED GROOMING, GROOM TRAINING, NAMELY, PROVIDING INFORMATION ABOUT CANINE GROOMING, CANINE SALON SERVICES, NAMELY, CANINE FUR AND HAIR CUTTING, COLORING AND STYLING, PAW CARE AND NAIL CLIPPING, FILING, AND POLISHING, CANINE TOOTH BRUSHING AND MOUTH CLEANING, IN CLASS 44 (U.S. CLS. 100 AND 101).

FIRST USE 3-16-2005; IN COMMERCE 3-16-2005.

THE MARK CONSISTS OF STANDARD CHARACTERS WITHOUT CLAIM TO ANY PARTICULAR FONT, STYLE, SIZE, OR COLOR.

NO CLAIM IS MADE TO THE EXCLUSIVE RIGHT TO USE "PUPS", APART FROM THE MARK AS SHOWN.

SER. NO. 77-151,756, FILED 4-9-2007.

DAVID I, EXAMINING ATTORNEY



**Int. Cl.: 41**

**Prior U.S. Cls.: 100, 101 and 107**

**United States Patent and Trademark Office**

**Reg. No. 3,497,769**

**Registered Sep. 9, 2008**

**SERVICE MARK  
COLLECTIVE SERVICE MARK  
PRINCIPAL REGISTER**

**Filly's Gentlemen's Club**

JUSTICE, EVERETT G. (UNITED STATES INDIVIDUAL)  
8155 NC HWY 47  
LEXINGTON, NC 29272

FOR: PRESENTATION OF LIVE SHOW PERFORMANCES, NAMELY, A GENTLEMEN'S CLUB FEATURING EXOTIC DANCERS, IN CLASS 41 (U.S. CLS. 100, 101 AND 107).

FIRST USE 4-30-1985; IN COMMERCE 4-30-1985.

THE MARK CONSISTS OF STANDARD CHARACTERS WITHOUT CLAIM TO ANY PARTICULAR FONT, STYLE, SIZE, OR COLOR.

NO CLAIM IS MADE TO THE EXCLUSIVE RIGHT TO USE "GENTLEMEN'S CLUB", APART FROM THE MARK AS SHOWN.

SER. NO. 77-153,780, FILED 4-11-2007.

STEVEN PEREZ, EXAMINING ATTORNEY

**Int. Cl.: 3**

**Prior U.S. Cls.: 1, 4, 6, 50, 51 and 52**

**United States Patent and Trademark Office**

**Reg. No. 3,497,770**

**Registered Sep. 9, 2008**

**TRADEMARK  
PRINCIPAL REGISTER**

**MAGISTRALE**

LANCOME PARFUMS ET BEAUTE & CIE  
(FRANCE SOCIETE EN NOM COLLECTIF)  
29, RUE DU FAUBOURG SAINT-HONORE  
PARIS, FRANCE 75008

FOR: COSMETICS, NAMELY, CREAMS, GELS,  
LOTIONS, MILKS FOR ANTI-CELLULITE AND  
FOR BODY CARE, IN CLASS 3 (U.S. CLS. 1, 4, 6, 50,  
51 AND 52).

THE MARK CONSISTS OF STANDARD CHAR-  
ACTERS WITHOUT CLAIM TO ANY PARTICULAR  
FONT, STYLE, SIZE, OR COLOR.

PRIORITY CLAIMED UNDER SEC. 44(D) ON  
ERPN CMNTY TM OFC APPLICATION NO.  
5824545, FILED 4-11-2007, REG. NO. 5824545, DATED  
3-27-2008, EXPIRES 4-11-2017.

THE ENGLISH TRANSLATION OF THE WORD  
"MAGISTRALE" IN THE MARK IS MAGISTERIAL  
AND AUTHORITATIVE.

SER. NO. 77-155,862, FILED 4-13-2007.

JOHN WILKE, EXAMINING ATTORNEY

**Int. Cl.: 5**

**Prior U.S. Cls.: 6, 18, 44, 46, 51 and 52**

**United States Patent and Trademark Office**

**Reg. No. 3,497,771**

**Registered Sep. 9, 2008**

**TRADEMARK  
PRINCIPAL REGISTER**



JAMES LAM (UNITED STATES INDIVIDUAL)  
PO BOX 818  
NEWTOWN, CT 06470

FOR: ANCIENT CHINESE MEDICINAL HERBS FOR EXTERNAL PAIN RELIEF, RELIEF OF ACHES AND PAINS OF JOINTS AND MUSCLES ASSOCIATED WITH ARTHRITIS, MUSCLES ASSOCIATED WITH ARTHRITIS, MUSCLE AND BACK PAIN, TENDONITIS, MUSCLE SPRAINS, STRAINS, BRUISES AND CRAMPS, IN CLASS 5 (U.S. CLS. 6, 18, 44, 46, 51 AND 52).

FIRST USE 1-1-2007; IN COMMERCE 1-1-2007.

THE COLOR(S) BLUE AND BLACK IS/ARE CLAIMED AS A FEATURE OF THE MARK.

THE COLOR BLACK APPEARS IN THE CHINESE CHARACTERS AND THE HORIZONTAL LINE. THE COLOR BLUE APPEARS IN THE WORD "ACUSA" AND THE BURST DESIGN TO THE LEFT OF THE WORD "ACUSA".

THE NON-LATIN CHARACTER IN THE MARK TRANSLITERATES TO "YI JIA SHA", AND THIS DOES NOT HAVE ANY MEANING IN ENGLISH.

SER. NO. 77-156,290, FILED S.R. 4-13-2007 AM. P.R. 9-24-2007.

BRIAN PINO, EXAMINING ATTORNEY

**Int. Cl.: 30**

**Prior U.S. Cl.: 46**

**United States Patent and Trademark Office**

**Reg. No. 3,497,772**

**Registered Sep. 9, 2008**

**TRADEMARK  
PRINCIPAL REGISTER**

**OX**

COLOMBINA S.A. (COLOMBIA CORPORATION)  
LA PAILA  
ZARZAL, VALLE, COLOMBIA

OWNER OF COLOMBIA REG. NO. 348772, DATED 1-8-2008, EXPIRES 1-8-2018.

FOR: CANDY, CANDY MINTS AND CHEWING GUM, IN CLASS 30 (U.S. CL. 46).

SER. NO. 77-156,766, FILED 4-13-2007.

THE MARK CONSISTS OF STANDARD CHARACTERS WITHOUT CLAIM TO ANY PARTICULAR FONT, STYLE, SIZE, OR COLOR.

WILLIAM BRECKENFELD, EXAMINING ATTORNEY

Int. Cl.: 33

Prior U.S. Cls.: 47 and 49

United States Patent and Trademark Office

Reg. No. 3,497,773

Registered Sep. 9, 2008

TRADEMARK  
PRINCIPAL REGISTER



LORA PRODUCTIONS, INC (CALIFORNIA CORPORATION)  
8560 VINEYARD AVE STE 107  
RANCHO CUCAMONGA, CA 91730

FOR: MEZCAL, CREAM MEZCALS, DISTILLED AGAVE, PULQUE AND TEQUILA, IN CLASS 33 (U.S. CLS. 47 AND 49).

FIRST USE 12-7-2006; IN COMMERCE 12-7-2006.

NO CLAIM IS MADE TO THE EXCLUSIVE RIGHT TO USE "MEZCAL" OR "38 AÑOS", APART FROM THE MARK AS SHOWN.

THE MARK CONSISTS OF THE WORDS "EL TRI" THE NUMBER "38" AND THE WORDS "MEZCAL" AND "AÑOS" ALL IN STYLIZED LETTER.

"THE FOREIGN WORDING IN THE MARK TRANSLATES INTO THE FOLLOWING: THE WORDING "EL" IN THE MARK IS THE; AND AÑOS IS YEARS."

SER. NO. 77-157,140, FILED 4-16-2007.

BENJAMIN OKEKE, EXAMINING ATTORNEY

**Int. Cls.: 5 and 30**

**Prior U.S. Cls.: 6, 18, 44, 46, 51 and 52**

**United States Patent and Trademark Office**

**Reg. No. 3,497,774**

**Registered Sep. 9, 2008**

**TRADEMARK  
PRINCIPAL REGISTER**

**VITASAFE**

LESAFFRE ET COMPAGNIE (FRANCE CORPORATION)  
41, RUE ETIENNE MARCEL  
PARIS, FRANCE 75001

FOR: BREAD MIXES FORMULATED FOR DIETETIC OR MEDICAL PURPOSES, IN CLASS 5 (U.S. CLS. 6, 18, 44, 46, 51 AND 52).

FOR: YEAST; PRE-MIXES AND MIXES FOR MAKING BAKERY PRODUCTS; BREAD IMPROVERS, NAMELY, FOOD ADDITIVES FOR NON-NUTRITIONAL PURPOSES FOR USE AS A FLAVORING IN PREPARING AND IMPROVING BREAD; INGREDIENTS FOR USE IN PREPARING AND IMPROVING BREAD, NAMELY, FLAVOR ENHANCERS; BREAD MIXES, INCLUDING

BREAD MIXES FORMULATED FOR HEALTH AND NUTRITIONAL PURPOSES, IN CLASS 30 (U.S. CL. 46).

THE MARK CONSISTS OF STANDARD CHARACTERS WITHOUT CLAIM TO ANY PARTICULAR FONT, STYLE, SIZE, OR COLOR.

PRIORITY CLAIMED UNDER SEC. 44(D) ON ERPN CMNTY TM OFC APPLICATION NO. 005639364, FILED 1-24-2007, REG. NO. 005639364, DATED 11-26-2007, EXPIRES 1-24-2017.

SER. NO. 77-157,510, FILED 4-16-2007.

CHRISTINE COOPER, EXAMINING ATTORNEY

**Int. Cl.: 35**

**Prior U.S. Cls.: 100, 101 and 102**

**United States Patent and Trademark Office**

**Reg. No. 3,497,775**

**Registered Sep. 9, 2008**

**SERVICE MARK  
PRINCIPAL REGISTER**



**GORGEOUS  
GARAGE**

GORGEOUS GARAGE LLC (IDAHO LIMITED  
LIABILITY COMPANY)  
3941 W. MOUNTAIN VIEW DRIVE  
REXBURG, ID 83440

FOR: FRANCHISE SERVICES, NAMELY, OFFER-  
ING TECHNICAL AND BUSINESS MANAGEMENT  
ASSISTANCE IN THE ESTABLISHMENT AND OP-  
ERATION OF RETAIL AND CONSTRUCTION; AS-  
SISTANCE IN BUSINESS MANAGEMENT AND  
PRODUCT COMMERCIALIZATION, WITHIN THE  
FRAMEWORK OF A FRANCHISE CONTRACT, IN  
CLASS 35 (U.S. CLS. 100, 101 AND 102).

FIRST USE 3-1-2007; IN COMMERCE 3-1-2007.

OWNER OF U.S. REG. NO. 2,831,729.

NO CLAIM IS MADE TO THE EXCLUSIVE  
RIGHT TO USE "GARAGE", APART FROM THE  
MARK AS SHOWN.

THE MARK CONSISTS OF TWO "G'S" FACING  
EACH OTHER WITH AN ARROW ON TOP OF  
THEM. "GORGEOUS GARAGE" SITS UNDER-  
NEATH THIS LOGO.

SER. NO. 77-159,520, FILED 4-18-2007.

BRIDGETT SMITH, EXAMINING ATTORNEY

**Int. Cl.: 9**

**Prior U.S. Cls.: 21, 23, 26, 36 and 38**

**Reg. No. 3,497,776**

**United States Patent and Trademark Office**

**Registered Sep. 9, 2008**

---

**TRADEMARK  
PRINCIPAL REGISTER**

**ZEAL**

ZEAL OPTICS, INC. (UTAH CORPORATION)  
375 SOUTH MAIN # 143  
MOAB, UT 84532

THE MARK CONSISTS OF STANDARD CHARACTERS WITHOUT CLAIM TO ANY PARTICULAR FONT, STYLE, SIZE, OR COLOR.

FOR: SPORT GOGGLES FOR USE IN SKIING, SNOWBOARDING AND SNOWMOBILING; SUNGLASSES; SPORTS EYEWEAR, IN CLASS 9 (U.S. CLS. 21, 23, 26, 36 AND 38).

OWNER OF U.S. REG. NO. 2,159,264.

SER. NO. 77-160,094, FILED 4-18-2007.

FIRST USE 8-0-2006; IN COMMERCE 8-0-2006.

ALICE BENMAMAN, EXAMINING ATTORNEY



**Int. Cls.: 36 and 37**

**Prior U.S. Cls.: 100, 101, 102, 103 and 106**

**United States Patent and Trademark Office**

**Reg. No. 3,497,777**

**Registered Sep. 9, 2008**

**SERVICE MARK  
PRINCIPAL REGISTER**

**HUFFINES COMMUNITIES**

HUFFINES MANAGEMENT PARTNERS, L.P.  
(TEXAS CORPORATION)  
8200 DOUGLAS AVENUE  
SUITE 300  
DALLAS, TX 752255923

FOR: REAL ESTATE MANAGEMENT SERVICES,  
IN CLASS 36 (U.S. CLS. 100, 101 AND 102).

FIRST USE 1-31-2003; IN COMMERCE 8-4-2003.

FOR: REAL ESTATE DEVELOPMENT SERVICES,  
IN CLASS 37 (U.S. CLS. 100, 103 AND 106).

FIRST USE 1-31-2003; IN COMMERCE 8-4-2003.

THE MARK CONSISTS OF STANDARD CHAR-  
ACTERS WITHOUT CLAIM TO ANY PARTICULAR  
FONT, STYLE, SIZE, OR COLOR.

NO CLAIM IS MADE TO THE EXCLUSIVE  
RIGHT TO USE "COMMUNITIES", APART FROM  
THE MARK AS SHOWN.

SEC. 2(F).

SER. NO. 77-160,426, FILED 4-19-2007.

KYLE PEETE, EXAMINING ATTORNEY

**Int. Cl.: 9**

**Prior U.S. Cls.: 21, 23, 26, 36 and 38**

**Reg. No. 3,497,778**

**United States Patent and Trademark Office**

**Registered Sep. 9, 2008**

**TRADEMARK  
PRINCIPAL REGISTER**

**DISNEY MIX CLIP**

DISNEY ENTERPRISES, INC. (DELAWARE CORPORATION)  
500 SOUTH BUENA VISTA STREET  
BURBANK, CA 91521

OWNER OF U.S. REG. NOS. 2,573,544, 3,242,910  
AND OTHERS.

FOR: AUDIO RECORDINGS FEATURING MUSIC, STORIES, AND ACTIVITIES IN THE NATURE OF ENTERTAINMENT FOR CHILDREN, IN CLASS 9 (U.S. CLS. 21, 23, 26, 36 AND 38).

NO CLAIM IS MADE TO THE EXCLUSIVE RIGHT TO USE "CLIP", APART FROM THE MARK AS SHOWN.

FIRST USE 8-1-2005; IN COMMERCE 8-1-2005.

SER. NO. 77-160,904, FILED 4-19-2007.

THE MARK CONSISTS OF STANDARD CHARACTERS WITHOUT CLAIM TO ANY PARTICULAR FONT, STYLE, SIZE, OR COLOR.

BRIDGETT SMITH, EXAMINING ATTORNEY

**Int. Cl.: 16**

**Prior U.S. Cls.: 2, 5, 22, 23, 29, 37, 38 and 50**

**Reg. No. 3,497,779**

**United States Patent and Trademark Office**

**Registered Sep. 9, 2008**

**TRADEMARK  
PRINCIPAL REGISTER**

**CELEBRITY SOCIETY**

CELEBRITY SOCIETY, INC. (CALIFORNIA CORPORATION)  
9606 SANTA MONICA BLVD., THIRD FLOOR  
BEVERLY HILLS, CA 90210

FOR: MAGAZINES FEATURING LUXURY LIFESTYLE AND COVERAGE OF PHILANTHROPIC EVENTS, IN CLASS 16 (U.S. CLS. 2, 5, 22, 23, 29, 37, 38 AND 50).

FIRST USE 1-1-1972; IN COMMERCE 1-1-1972.

THE MARK CONSISTS OF STANDARD CHARACTERS WITHOUT CLAIM TO ANY PARTICULAR FONT, STYLE, SIZE, OR COLOR.

SEC. 2(F).

SER. NO. 77-161,252, FILED 4-19-2007.

JOHN SCHUYLER YARD, EXAMINING ATTORNEY

**Int. Cl.: 35**

**Prior U.S. Cls.: 100, 101 and 102**

**United States Patent and Trademark Office**

**Reg. No. 3,497,780**

**Registered Sep. 9, 2008**

**SERVICE MARK  
PRINCIPAL REGISTER**

**FREE ZONE**

FREE ZONE MEDIA, LLC (VIRGINIA LIMITED  
LIABILITY COMPANY)  
10810 TRADE ROAD  
RICHMOND, VA 23236

FOR: ON-LINE ADVERTISING AND MARKET-  
ING SERVICES, BY WHICH CONSUMERS EARN  
FREE GOODS AND SERVICES BY PARTICIPATING  
IN A SET NUMBER OF SPONSORED OFFERS, IN  
CLASS 35 (U.S. CLS. 100, 101 AND 102).

FIRST USE 5-1-2006; IN COMMERCE 5-1-2006.

THE MARK CONSISTS OF STANDARD CHAR-  
ACTERS WITHOUT CLAIM TO ANY PARTICULAR  
FONT, STYLE, SIZE, OR COLOR.

NO CLAIM IS MADE TO THE EXCLUSIVE  
RIGHT TO USE "FREE", APART FROM THE MARK  
AS SHOWN.

SER. NO. 77-161,651, FILED 4-20-2007.

THOMAS MANOR, EXAMINING ATTORNEY

**Int. Cl.: 41**

**Prior U.S. Cls.: 100, 101 and 107**

**United States Patent and Trademark Office**

**Reg. No. 3,497,781**

**Registered Sep. 9, 2008**

**SERVICE MARK  
PRINCIPAL REGISTER**

**THE HORROR DRUNX**

HULD, ANDREW J. (UNITED STATES INDIVIDUAL), DBA MORTIMER A. LONDON  
2024 PRIMROSE AVE.  
SOUTH PASADENA, CA 91030

THE MARK CONSISTS OF STANDARD CHARACTERS WITHOUT CLAIM TO ANY PARTICULAR FONT, STYLE, SIZE, OR COLOR.

FOR: FAN CLUBS, IN CLASS 41 (U.S. CLS. 100, 101 AND 107).

SER. NO. 77-162,527, FILED 4-22-2007.

FIRST USE 12-9-2002; IN COMMERCE 10-31-2003.

BILL DAWE, EXAMINING ATTORNEY

**Int. Cl.: 25**

**Prior U.S. Cls.: 22 and 39**

**United States Patent and Trademark Office**

**Reg. No. 3,497,782**

**Registered Sep. 9, 2008**

**TRADEMARK  
PRINCIPAL REGISTER**

**GOT COWGIRL?**

DESHAW, JASON (UNITED STATES INDIVIDUAL)  
920 W 1ST AVE  
PLENTYWOOD, MT 59254

FOR: CLOTHING, NAMELY, T-SHIRTS, SHIRTS, CAPS, JACKETS, PANTS, UNDERSHIRTS, CAMISOLES, UNDERWEAR, VESTS, COATS, SHORTS, SWEATSHIRTS, SWEAT PANTS, GLOVES, SHOES, BOOTS, BANDANAS, SOCKS, SCARFS AND BELTS, IN CLASS 25 (U.S. CLS. 22 AND 39).

FIRST USE 3-1-2003; IN COMMERCE 3-25-2005.

THE MARK CONSISTS OF STANDARD CHARACTERS WITHOUT CLAIM TO ANY PARTICULAR FONT, STYLE, SIZE, OR COLOR.

SER. NO. 77-162,641, FILED 4-22-2007.

NATALIE POLZER, EXAMINING ATTORNEY

**Int. Cl.: 41**

**Prior U.S. Cls.: 100, 101 and 107**

**United States Patent and Trademark Office**

**Reg. No. 3,497,783**

**Registered Sep. 9, 2008**

**SERVICE MARK  
PRINCIPAL REGISTER**



OH BABY! FITNESS LLC (GEORGIA LIMITED  
LIABILITY COMPANY)  
116 DREXEL AVE.  
DECATUR, GA 30030

FOR: PRENATAL AND POSTNATAL PHYSICAL  
FITNESS INSTRUCTION, IN CLASS 41 (U.S. CLS.  
100, 101 AND 107).

FIRST USE 6-1-2005; IN COMMERCE 6-1-2005.

NO CLAIM IS MADE TO THE EXCLUSIVE  
RIGHT TO USE "FITNESS", APART FROM THE  
MARK AS SHOWN.

THE COLOR(S) GREEN, WHITE AND GRAY IS/  
ARE CLAIMED AS A FEATURE OF THE MARK.

THE MARK CONSISTS OF THE WORD "OH" IN  
WHITE, SUPERIMPOSED UPON A DEPICTION OF  
A GREEN CIRCLE WITH THE WORDS "BABY"  
AND AN EXCLAMATION POINT IN GREEN NEXT  
TO THE CIRCLE. THE WORD "FITNESS" IS BELOW  
IN GRAY.

SER. NO. 77-163,979, FILED 4-24-2007.

SETH A. RAPPAPORT, EXAMINING ATTORNEY

**Int. Cl.: 26**

**Prior U.S. Cls.: 37, 39, 40, 42 and 50**

**Reg. No. 3,497,784**

**United States Patent and Trademark Office**

**Registered Sep. 9, 2008**

**TRADEMARK  
PRINCIPAL REGISTER**

**EZ Weft**

BEAUTY PLUS TRADING CO., INC (NEW JERSEY CORPORATION)

210 W. COMMERCIAL AVE

MOONACHIE, NJ 07074

FOR: HAIR EXTENSIONS, IN CLASS 26 (U.S. CLS. 37, 39, 40, 42 AND 50).

FIRST USE 12-1-2005; IN COMMERCE 12-1-2005.

THE MARK CONSISTS OF STANDARD CHARACTERS WITHOUT CLAIM TO ANY PARTICULAR FONT, STYLE, SIZE, OR COLOR.

NO CLAIM IS MADE TO THE EXCLUSIVE RIGHT TO USE "WEFT", APART FROM THE MARK AS SHOWN.

SER. NO. 77-165,224, FILED 4-25-2007.

ELIZABETH BEYER, EXAMINING ATTORNEY



**Int. Cls.: 25, 36, 38 and 41**

**Prior U.S. Cls.: 22, 39, 100, 101, 102, 104 and 107**

**United States Patent and Trademark Office**

**Reg. No. 3,497,785**

**Registered Sep. 9, 2008**

**TRADEMARK  
SERVICE MARK  
PRINCIPAL REGISTER**

**PARKINSON'S UNITY WALK**

PARKINSON'S UNITY WALK (NEW YORK  
NON-PROFIT CORPORATION)  
P.O. BOX 275  
KINGSTON, NJ 08528

FOR: CLOTHING, NAMELY, T-SHIRTS, IN  
CLASS 25 (U.S. CLS. 22 AND 39).

FIRST USE 9-0-1994; IN COMMERCE 9-0-1994.

FOR: CHARITABLE FUNDRAISING FOR PAR-  
KINSON'S DISEASE BY MEANS OF ORGANIZING  
AND CONDUCTING ATHLETIC EVENTS, IN  
CLASS 36 (U.S. CLS. 100, 101 AND 102).

FIRST USE 9-0-1994; IN COMMERCE 9-0-1994.

FOR: PROVIDING ON-LINE ELECTRONIC BUL-  
LETIN BOARDS FOR TRANSMISSION OF MESSA-  
GES AMONG COMPUTER USERS CONCERNING  
PARKINSON'S DISEASE, IN CLASS 38 (U.S. CLS. 100,  
101 AND 104).

FIRST USE 9-0-2002; IN COMMERCE 9-0-2002.

FOR: PROVIDING ON-LINE PUBLICATIONS IN  
THE NATURE OF ELECTRONIC NEWSLETTERS  
IN THE FIELD OF PARKINSON'S DISEASE, IN  
CLASS 41 (U.S. CLS. 100, 101 AND 107).

FIRST USE 9-0-2002; IN COMMERCE 9-0-2002.

THE MARK CONSISTS OF STANDARD CHAR-  
ACTERS WITHOUT CLAIM TO ANY PARTICULAR  
FONT, STYLE, SIZE, OR COLOR.

NO CLAIM IS MADE TO THE EXCLUSIVE  
RIGHT TO USE "PARKINSON'S" IN ALL CLASSES  
AND "WALK" IN CLASS 36 ONLY, APART FROM  
THE MARK AS SHOWN.

SER. NO. 77-167,309, FILED 4-27-2007.

JAMES LOVELACE, EXAMINING ATTORNEY

**Int. Cl.: 9**

**Prior U.S. Cls.: 21, 23, 26, 36 and 38**

**Reg. No. 3,497,786**

**United States Patent and Trademark Office**

**Registered Sep. 9, 2008**

**TRADEMARK  
PRINCIPAL REGISTER**

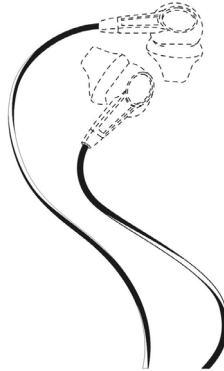

BOSE CORPORATION (DELAWARE CORPORATION)  
THE MOUNTAIN  
FRAMINGHAM, MA 017019168

FOR: HEADPHONES, IN CLASS 9 (U.S. CLS. 21, 23, 26, 36 AND 38).

FIRST USE 3-15-2007; IN COMMERCE 3-15-2007.

THE COLOR(S) BLACK AND WHITE IS/ARE CLAIMED AS A FEATURE OF THE MARK.

THE MARK CONSISTS OF THE COLOR WHITE INTERWOVEN WITH THE COLOR BLACK THROUGHOUT THE LENGTH OF THE CORDS ATTACHED TO HEADPHONES. NO CLAIM IS MADE TO THE SHAPE OF THE CORDS OR THE HEADPHONES.

SEC. 2(F).

SER. NO. 77-168,672, FILED 4-30-2007.

JACQUELINE A. LAVINE, EXAMINING ATTORNEY

**Int. Cl.: 30**

**Prior U.S. Cl.: 46**

**United States Patent and Trademark Office**

**Reg. No. 3,497,787**

**Registered Sep. 9, 2008**

**TRADEMARK  
PRINCIPAL REGISTER**

**DECADENCE GOURMET  
CHEESECAKES**

DECADENCE L.L.C. (COLORADO LIMITED LIABILITY COMPANY)

2591 B 3/4 ROAD

GRAND JUNCTION, CO 81503

FOR: CHEESECAKE; CAKES; PASTRIES, IN CLASS 30 (U.S. CL. 46).

FIRST USE 1-1-2006; IN COMMERCE 1-1-2006.

THE MARK CONSISTS OF STANDARD CHARACTERS WITHOUT CLAIM TO ANY PARTICULAR FONT, STYLE, SIZE, OR COLOR.

NO CLAIM IS MADE TO THE EXCLUSIVE RIGHT TO USE "GOURMET CHEESECAKES", APART FROM THE MARK AS SHOWN.

SER. NO. 77-169,360, FILED 4-30-2007.

MARY MUNSON, EXAMINING ATTORNEY

**Int. Cl.: 36**

**Prior U.S. Cls.: 100, 101 and 102**

**United States Patent and Trademark Office**

**Reg. No. 3,497,788**

**Registered Sep. 9, 2008**

**SERVICE MARK  
PRINCIPAL REGISTER**

**AFC**

AFC FUNDING, INC. (DELAWARE CORPORATION)  
SUITE 501  
350 SOUTH FIGUEROA STREET  
LOS ANGELES, CA 90071

FOR: COMMERCIAL LENDING SERVICES, ACCOUNTS RECEIVABLE FINANCING AND INVENTORY FINANCING IN THE AGRICULTURAL AND FOOD INDUSTRIES, IN CLASS 36 (U.S. CLS. 100, 101 AND 102).

FIRST USE 2-18-2008; IN COMMERCE 2-18-2008.

THE MARK CONSISTS OF STANDARD CHARACTERS WITHOUT CLAIM TO ANY PARTICULAR FONT, STYLE, SIZE, OR COLOR.

SER. NO. 77-171,117, FILED 5-2-2007.

JENNIFER VASQUEZ, EXAMINING ATTORNEY

**Int. Cls.: 41 and 45**

**Prior U.S. Cls.: 100, 101 and 107**

**United States Patent and Trademark Office**

**Reg. No. 3,497,789**

**Registered Sep. 9, 2008**

**SERVICE MARK  
PRINCIPAL REGISTER**

**GIGI'S PLAYHOUSE**

GIGI'S PLAYHOUSE, INC. (ILLINOIS NON-  
PROFIT CORPORATION)  
1069 WEST GOLF ROAD  
HOFFMAN ESTATES, IL 60194

FOR: EDUCATIONAL SERVICES, NAMELY,  
CLASSES, WORKSHOPS AND SEMINARS FOR  
CHILDREN AND FAMILIES OF CHILDREN WITH  
DOWN SYNDROME, IN CLASS 41 (U.S. CLS. 100, 101  
AND 107).

FIRST USE 10-0-2003; IN COMMERCE 10-0-2003.

FOR: ORGANIZING AND CONDUCTING SUP-  
PORT GROUPS FOR CHILDREN AND FAMILIES

OF CHILDREN WITH DOWN SYNDROME, IN  
CLASS 45 (U.S. CLS. 100 AND 101).

FIRST USE 10-0-2003; IN COMMERCE 10-0-2003.

THE MARK CONSISTS OF STANDARD CHAR-  
ACTERS WITHOUT CLAIM TO ANY PARTICULAR  
FONT, STYLE, SIZE, OR COLOR.

SER. NO. 77-171,173, FILED 5-2-2007.

MICHAEL KAZAZIAN, EXAMINING ATTORNEY

**Int. Cl.: 41**

**Prior U.S. Cls.: 100, 101 and 107**

**United States Patent and Trademark Office**

**Reg. No. 3,497,790**

**Registered Sep. 9, 2008**

**SERVICE MARK  
PRINCIPAL REGISTER**

# Bamboo Women

FISHER, JEANETTE S. (UNITED STATES INDIVIDUAL)  
18475 GRAND AVENUE  
LAKE ELSINORE, CA 92530

FOR: PROVIDING EDUCATIONAL MENTORING SERVICES AND PROGRAMS SELF-ESTEEM FOR WOMEN, IN CLASS 41 (U.S. CLS. 100, 101 AND 107).

FIRST USE 2-15-2007; IN COMMERCE 4-5-2007.

THE MARK CONSISTS OF STANDARD CHARACTERS WITHOUT CLAIM TO ANY PARTICULAR FONT, STYLE, SIZE, OR COLOR.

NO CLAIM IS MADE TO THE EXCLUSIVE RIGHT TO USE "WOMEN", APART FROM THE MARK AS SHOWN.

SER. NO. 77-171,530, FILED 5-2-2007.

ARETHA SOMERVILLE, EXAMINING ATTORNEY

**Int. Cl.: 11**

**Prior U.S. Cls.: 13, 21, 23, 31 and 34**

**Reg. No. 3,497,791**

**United States Patent and Trademark Office**

**Registered Sep. 9, 2008**

**TRADEMARK  
PRINCIPAL REGISTER**

**COBRA**

MOFFAT PTY LIMITED (AUSTRALIA CORPORATION)  
740 SPRINGVALE ROAD  
MULGRAVE, VICTORIA, AUSTRALIA 3170

FOR: MACHINES, APPARATUS AND APPLIANCES FOR COOKING AND HEATING FOOD, NAMELY, ELECTRIC STOVES, BAKING OVENS, COOKING RANGES, ELECTRIC COOK-TOPS, ELECTRIC FRYERS, ELECTRIC GRIDDLES, ELECTRIC FOOD WARMERS, ELECTRIC SANDWICH MAKERS, ELECTRIC BREAD MAKERS, ELECTRIC WAFFLE BAKERS, PASTRY OVENS, ELECTRIC FOOD STEAMERS, PIZZA OVENS, ELECTRIC TOASTERS AND HOT FOOD DISPLAY CABINETS FOR MIXING, DIVIDING, PREFORMING, THAWING AND PROVING DOUGH; COMMERCIAL OVENS FOR BAKING FOOD; FOOD DISPLAY AND SERVERY UNITS, NAMELY, HEATED MERCHANDISE DISPLAY CASES, REFRIGERATED MERCHANDISE DISPLAY CASES, STORING APPARATUS USING HEAT, NAMELY, ELECTRIC WARMING TRAYS; ELECTRIC FOOD WARMERS;

ELECTRIC FOOD WARMING PLATES; GRILL ACCESSORIES, NAMELY, ELECTRIC TRAYS; HEATED CABINETS AND ELECTRIC CABINETS USED TO CONTROL TEMPERATURE AND HUMIDITY FOR HEATING AND PROVING DOUGH; ELECTRIC HEATED TROLLEYS FOR KEEPING FOOD WARM, IN CLASS 11 (U.S. CLS. 13, 21, 23, 31 AND 34).

THE MARK CONSISTS OF STANDARD CHARACTERS WITHOUT CLAIM TO ANY PARTICULAR FONT, STYLE, SIZE, OR COLOR.

PRIORITY CLAIMED UNDER SEC. 44(D) ON AUSTRALIA APPLICATION NO. 1172948, FILED 4-26-2007, REG. NO. 1172948, DATED 4-26-2007, EXPIRES 4-26-2017.

SER. NO. 77-171,963, FILED 5-3-2007.

EDWARD FENNESSY, EXAMINING ATTORNEY

Int. Cl.: 27

Prior U.S. Cls.: 19, 20, 37, 42 and 50

United States Patent and Trademark Office

Reg. No. 3,497,792

Registered Sep. 9, 2008

TRADEMARK  
PRINCIPAL REGISTER



SOROUGH, BAHRAM (UNITED STATES INDIVIDUAL)  
4519 DORSET AVE.  
CHEVY CHASE, MD 20815 AND  
SOROUGH, MIRIAM (UNITED STATES INDIVIDUAL)  
4519 DORSET AVE.  
CHEVY CHASE, MD 20815

FOR: CARPETING, CARPETS, CARPET PADDING, CLOTH WALL COVERINGS, FLOOR COVERINGS, RUGS, WALLCOVERINGS, IN CLASS 27 (U.S. CLS. 19, 20, 37, 42 AND 50).

FIRST USE 2-1-1992; IN COMMERCE 2-1-1992.

THE MARK CONSISTS OF A WINGED FLYING LION INCORPORATED INTO THE LAST "O" IN "SOROUGH" WITH A WORLD GLOBE INSIDE THE "O".

SER. NO. 77-171,981, FILED 5-3-2007.

JAMES STEIN, EXAMINING ATTORNEY



**Int. Cl.: 9**

**Prior U.S. Cls.: 21, 23, 26, 36 and 38**

**United States Patent and Trademark Office**

**Reg. No. 3,497,793**

**Registered Sep. 9, 2008**

**TRADEMARK  
PRINCIPAL REGISTER**

**MAILDEPOT**

ECOMPEX, INC. (VIRGINIA CORPORATION)  
7926 JONES BRANCH DRIVE, SUITE 560  
MCLEAN, VA 22102

THE MARK CONSISTS OF STANDARD CHAR-  
ACTERS WITHOUT CLAIM TO ANY PARTICULAR  
FONT, STYLE, SIZE, OR COLOR.

FOR: COMPUTER PROGRAMMES FOR DOCU-  
MENT MANAGEMENT, IN CLASS 9 (U.S. CLS. 21,  
23, 26, 36 AND 38).

SER. NO. 77-173,336, FILED 5-4-2007.

FIRST USE 1-1-2007; IN COMMERCE 1-1-2007.

JASON TURNER, EXAMINING ATTORNEY

Int. Cls.: 35, 41, 43 and 45

Prior U.S. Cls.: 100, 101, 102 and 107

United States Patent and Trademark Office

Reg. No. 3,497,794

Registered Sep. 9, 2008

**SERVICE MARK  
PRINCIPAL REGISTER**



*Gabriel Project*

ARCHDIOCESE OF GALVESTON-HOUSTON  
(TEXAS SECTION 501(C)(3) RELIGIOUS OR-  
GANIZATION)  
ATTN: JOHN A. SIEGER, GENERAL COUNSEL  
1700 SAN JACINTO STREET  
HOUSTON, TX 77002

FOR: PARISH BASED PASTORAL CARE, NAME-  
LY, REFERRALS IN THE FIELD OF MEDICAL  
CARE, ADOPTION, AND FOSTER CARE FOR WO-  
MEN IN DIFFICULT OR CRISIS PREGNANCY  
CIRCUMSTANCES, IN CLASS 35 (U.S. CLS. 100, 101  
AND 102).

FIRST USE 12-31-1993; IN COMMERCE 12-31-1995.

FOR: PARISH BASED PASTORAL CARE, NAME-  
LY, EDUCATION IN THE FIELD OF PRE-NATAL  
CARE, CHILD CARE, AND NATURAL FAMILY  
PLANNING FOR WOMEN IN DIFFICULT OR CRI-  
SIS PREGNANCY CIRCUMSTANCES PROVIDED  
VIA ONE ON ONE MENTORING, IN CLASS 41 (U.S.  
CLS. 100, 101 AND 107).

FIRST USE 12-31-1993; IN COMMERCE 12-31-1995.

FOR: PARISH BASED PASTORAL CARE, NAME-  
LY, SUPPORT FOR WOMEN IN DIFFICULT OR  
CRISIS PREGNANCY CIRCUMSTANCES, NAME-  
LY, PROVIDING FOOD AND TEMPORARY HOUS-  
ING, IN CLASS 43 (U.S. CLS. 100 AND 101).

FIRST USE 12-31-1993; IN COMMERCE 12-31-1995.

FOR: PARISH BASED PASTORAL CARE, NAME-  
LY, SUPPORT FOR WOMEN IN DIFFICULT OR  
CRISIS PREGNANCY CIRCUMSTANCES, NAME-  
LY, PROVIDING CLOTHING, IN CLASS 45 (U.S.  
CLS. 100 AND 101).

FIRST USE 12-31-1993; IN COMMERCE 12-31-1995.

THE COLOR(S) BLACK, WHITE, GRAY, TAN ,  
BROWN, BLUE AND GOLD IS/ARE CLAIMED AS A  
FEATURE OF THE MARK.

THE MARK CONSISTS OF THE WORDS "GAB-  
RIEL PROJECT" IN BLACK AND A REPRESENTA-  
TION OF A MOTHER AND CHILD ON A GRAY  
BACKGROUND. THE SKIN AND FEATURES OF  
THE MOTHER AND CHILD ARE IN SHADES OF  
TAN AND BROWN. THE EYES, EYEBROWS AND  
HAIR OF THE MOTHER ARE BLACK, WHILE THE  
CHILD'S EYEBROWS ARE BLACK. THE CHILD  
WEARS A WHITE GOWN, THE MOTHER IS WEAR-  
ING BLUE CLOTHING AND A GOLD BONNET.  
THE WORDS AND PICTURE ARE SUPERIMPOSED  
ON A WHITE BACKGROUND.

SER. NO. 77-173,565, FILED 5-4-2007.

EUGENIA MARTIN, EXAMINING ATTORNEY

**Int. Cl.: 9**

**Prior U.S. Cls.: 21, 23, 26, 36 and 38**

**Reg. No. 3,497,795**

**United States Patent and Trademark Office**

**Registered Sep. 9, 2008**

**TRADEMARK  
PRINCIPAL REGISTER**

**ENERGOV.NET**

ENERGOV SOLUTIONS, LLC (GEORGIA LIMITED LIABILITY COMPANY)  
SUITE 220  
2763 MEADOW CHURCH ROAD  
DULUTH, GA 30097

FOR: COMPUTER SOFTWARE SUITE OF APPLICATIONS USED TO AUTOMATE AND STREAMLINE GOVERNMENT AGENCY OPERATIONS BY PROVIDING ACCESS TO AND FEATURING INFORMATION ABOUT AND MANAGING DATABASES IN THE FIELD OF COMMUNITY DEVELOPMENT SERVICES, INSPECTION SCHEDULING, PERMIT APPLICATIONS AND PERMIT STATUS UPDATES, LICENSING AND CODE ENFORCEMENT FORMS AND INFORMATION AND ENTERPRISE LAND MANAGEMENT USED FOR COMMUNITY DEVELOPMENT OPERATIONS;

COMPUTER SOFTWARE USED IN PLANNING AND ZONING CASE AND WORKFLOW MANAGEMENT; GEOGRAPHIC DATA MANAGEMENT, CODE ENFORCEMENT DATA MANAGEMENT AND LICENSING AND PERMIT DATA MANAGEMENT, IN CLASS 9 (U.S. CLS. 21, 23, 26, 36 AND 38).

FIRST USE 11-0-2003; IN COMMERCE 1-0-2004.

THE MARK CONSISTS OF STANDARD CHARACTERS WITHOUT CLAIM TO ANY PARTICULAR FONT, STYLE, SIZE, OR COLOR.

SER. NO. 77-174,041, FILED 5-7-2007.

KELLEY WELLS, EXAMINING ATTORNEY

**Int. Cl.: 20**

**Prior U.S. Cls.: 2, 13, 22, 25, 32 and 50**

**United States Patent and Trademark Office**

**Reg. No. 3,497,796**

**Registered Sep. 9, 2008**

**TRADEMARK  
PRINCIPAL REGISTER**

**ENCORE**

CRYSTAL CABINET WORKS, INC. (MINNESOTA  
CORPORATION)  
1100 CRYSTAL DRIVE  
PRINCETON, MN 55371

THE MARK CONSISTS OF STANDARD CHAR-  
ACTERS WITHOUT CLAIM TO ANY PARTICULAR  
FONT, STYLE, SIZE, OR COLOR.

FOR: KITCHEN AND BATHROOM CABINETS  
FOR RESIDENTIAL USE, IN CLASS 20 (U.S. CLS. 2,  
13, 22, 25, 32 AND 50).

SER. NO. 77-174,292, FILED 5-7-2007.

FIRST USE 8-0-2007; IN COMMERCE 8-0-2007.

DOMINICK J. SALEMI, EXAMINING ATTORNEY

**Int. Cl.: 36**

**Prior U.S. Cls.: 100, 101 and 102**

**United States Patent and Trademark Office**

**Reg. No. 3,497,797**

**Registered Sep. 9, 2008**

**SERVICE MARK  
PRINCIPAL REGISTER**



INVESTATE HOLDINGS CO. (INDIANA CORPORATION)

#200

6302 ILLINOIS ROAD  
FORT WAYNE, IN 46804

FOR: REAL ESTATE ACQUISITION SERVICES;  
REAL ESTATE PROCUREMENT FOR OTHERS;  
INVESTMENT SERVICES, NAMELY, ASSET AC-  
QUISITION, CONSULTATION, DEVELOPMENT  
AND MANAGEMENT SERVICES; LOAN FINAN-  
CING; REAL ESTATE VALUATION SERVICES;  
PROVIDING INFORMATION IN THE FIELD OF

REAL ESTATE VIA THE INTERNET, IN CLASS 36  
(U.S. CLS. 100, 101 AND 102).

FIRST USE 12-23-2003; IN COMMERCE 12-23-2003.

THE MARK CONSISTS OF THE STYLIZED LET-  
TERS "EZ" AND A TRIANGLE FORMING A SHAPE  
OF A BUILDING AND THE TEXT "EZHOMEBUY-  
ERS".

SER. NO. 77-175,322, FILED 5-8-2007.

DAVID TOOLEY, EXAMINING ATTORNEY

**Int. Cl.: 45**

**Prior U.S. Cls.: 100 and 101**

**United States Patent and Trademark Office**

**Reg. No. 3,497,798**

**Registered Sep. 9, 2008**

**SERVICE MARK  
PRINCIPAL REGISTER**



M. LEE SMITH PUBLISHERS, LLC (TENNESSEE  
LIMITED LIABILITY COMPANY)  
5201 VIRGINIA WAY  
BRENTWOOD, TN 37024

FOR: REVIEW AND REPORTING ON LAWS,  
STANDARDS AND PRACTICES IN THE FIELD OF  
EMPLOYMENT LAW; AND LEGAL RESEARCH, IN  
CLASS 45 (U.S. CLS. 100 AND 101).

FIRST USE 6-1-1996; IN COMMERCE 6-1-1996.

NO CLAIM IS MADE TO THE EXCLUSIVE  
RIGHT TO USE "PUBLISHER HR", APART FROM  
THE MARK AS SHOWN.

THE NAME "M. LEE SMITH" IDENTIFIES A  
LIVING INDIVIDUAL WHOSE CONSENT IS OF  
RECORD.

SER. NO. 77-176,170, FILED 5-9-2007.

AMOS T. MATTHEWS, JR., EXAMINING ATTOR-  
NEY

**Int. Cl.: 42**

**Prior U.S. Cls.: 100 and 101**

**United States Patent and Trademark Office**

**Reg. No. 3,497,799**

**Registered Sep. 9, 2008**

**SERVICE MARK  
PRINCIPAL REGISTER**

# Cash For Virtual

MARKO, ANASTASOV (CYPRUS INDIVIDUAL)  
38 ANDREA ARAOUZOU  
NICOSIA, CYPRUS 1687

FIRST USE 4-29-2007; IN COMMERCE 4-29-2007.

FOR: COMPUTER SERVICES, NAMELY, CREATING AN ONLINE COMMUNITY FOR REGISTERED USERS TO PARTICIPATE IN COMPETITIONS, SHOWCASE THEIR SKILLS, GET FEEDBACK FROM THEIR PEERS, FORM VIRTUAL COMMUNITIES, ENGAGE IN SOCIAL NETWORKING AND IMPROVE THEIR TALENT, IN CLASS 42 (U.S. CLS. 100 AND 101).

THE MARK CONSISTS OF STANDARD CHARACTERS WITHOUT CLAIM TO ANY PARTICULAR FONT, STYLE, SIZE, OR COLOR.

SER. NO. 77-177,097, FILED 5-9-2007.

KAREN K. BUSH, EXAMINING ATTORNEY

**Int. Cl.: 12**

**Prior U.S. Cls.: 19, 21, 23, 31, 35 and 44**

**United States Patent and Trademark Office**

**Reg. No. 3,497,800**

**Registered Sep. 9, 2008**

**TRADEMARK  
PRINCIPAL REGISTER**



SKODA AUTO A.S. (CZECH REPUBLIC CORPORATION)

TR. VACLAVA KLEMENTA 869

293 60 MLADA BOLESLAV, CZECH REPUBLIC

FOR: PASSENGER AUTOMOBILES AND THEIR MODIFICATIONS, SPARE PARTS, ACCESSORIES, EQUIPMENT AND COMPONENTS FOR AUTOMOBILES, NAMELY, SPOILERS, TOWING EQUIPMENT AND COUPLINGS IN THE NATURE OF HITCHES AND BALL MOUNTS FOR ATTACHMENT TO VEHICLES FOR TOWING TRAILERS, HOOKS, TOW BARS AND TOWING HITCHES, ALLOY WHEELS, TILTING SUN ROOFS, FOLD AWAY ROOFS, ROOF LUGGAGE CARRIERS, AND COMBUSTION ENGINES FOR PASSENGER VEHICLES, IN CLASS 12 (U.S. CLS. 19, 21, 23, 31, 35 AND 44).

OWNER OF CZECH REPUBLIC REG. NO. 153355A, DATED 2-5-1992, EXPIRES 4-4-2018.

OWNER OF U.S. REG. NOS. 2,471,201, 2,475,252, AND 2,959,005.

THE MARK CONSISTS OF THE WORDING "SKODA" TO THE RIGHT OF A STYLIZED REPRESENTATION OF A WINGED ARROW IN A CIRCLE.

SER. NO. 77-178,820, FILED 5-11-2007.

PATRICIA EVANKO, EXAMINING ATTORNEY



**Int. Cl.: 35**

**Prior U.S. Cls.: 100, 101 and 102**

**United States Patent and Trademark Office**

**Reg. No. 3,497,801**

**Registered Sep. 9, 2008**

**SERVICE MARK  
PRINCIPAL REGISTER**

# Guiding Light Video

GUIDING LIGHT VIDEO (PENNSYLVANIA  
SOLE PROPRIETORSHIP)  
3649 MILL RD  
COLLEGEVILLE, PA 19426

FOR: COMPUTERIZED ON-LINE WHOLESALE  
AND RETAIL DISTRIBUTORSHIP FEATURING  
CHRISTIAN BOOKS, VIDEOS, DVD'S, MUSICAL  
PLAY KITS, SOFTWARE, GAMES, AUDIO RE-  
CORDINGS, T-SHIRTS AND CAPS, IN CLASS 35  
(U.S. CLS. 100, 101 AND 102).

FIRST USE 1-1-1996; IN COMMERCE 1-1-1996.

THE MARK CONSISTS OF STANDARD CHAR-  
ACTERS WITHOUT CLAIM TO ANY PARTICULAR  
FONT, STYLE, SIZE, OR COLOR.

NO CLAIM IS MADE TO THE EXCLUSIVE  
RIGHT TO USE "VIDEO", APART FROM THE  
MARK AS SHOWN.

SER. NO. 77-180,992, FILED 5-15-2007.

JAMES LOVELACE, EXAMINING ATTORNEY

**Int. Cl.: 35**

**Prior U.S. Cls.: 100, 101 and 102**

**United States Patent and Trademark Office**

**Reg. No. 3,497,802**

**Registered Sep. 9, 2008**

**SERVICE MARK  
PRINCIPAL REGISTER**

**HOOSIER BASKET**

THE CREATIVE CONCEPT (INDIANA CORPORATION)  
PO BOX 8326  
FORT WAYNE, IN 46898

FOR: COMPUTERIZED ON-LINE RETAIL STORE SERVICES IN THE FIELD OF CANDLES, POTPOURRI, BASKETS, HOUSEWARES, APPAREL, FOODS AND DOLLS, IN CLASS 35 (U.S. CLS. 100, 101 AND 102).

FIRST USE 3-17-2002; IN COMMERCE 3-17-2002.

THE MARK CONSISTS OF STANDARD CHARACTERS WITHOUT CLAIM TO ANY PARTICULAR FONT, STYLE, SIZE, OR COLOR.

NO CLAIM IS MADE TO THE EXCLUSIVE RIGHT TO USE "BASKET", APART FROM THE MARK AS SHOWN.

SEC. 2(F).

SER. NO. 77-181,176, FILED 5-15-2007.

INGRID C. EULIN, EXAMINING ATTORNEY

**Int. Cl.: 16**

**Prior U.S. Cls.: 2, 5, 22, 23, 29, 37, 38 and 50**

**Reg. No. 3,497,803**

**United States Patent and Trademark Office**

**Registered Sep. 9, 2008**

**TRADEMARK  
PRINCIPAL REGISTER**

THE RELIZON COMPANY (DELAWARE CORPORATION)  
220 E. MONUMENT AVENUE  
DAYTON, OH 45402

THE MARK CONSISTS OF THE WORD WILMER. THE LETTER "L" IS A TWO-PART SHADED TRIANGLE WITH CURVED CORNERS LOOPING UNDER THE LETTER "M"..

FOR: BUSINESS AND ACCOUNTING FORMS, IN CLASS 16 (U.S. CLS. 2, 5, 22, 23, 29, 37, 38 AND 50).

SER. NO. 77-182,428, FILED 5-16-2007.

FIRST USE 8-31-2005; IN COMMERCE 8-31-2005.

OWNER OF U.S. REG. NO. 1,208,210.

ANTHONY RINKER, EXAMINING ATTORNEY

**Int. Cls.: 9 and 42**

**Prior U.S. Cls.: 21, 23, 26, 36, 38, 100 and 101**

**United States Patent and Trademark Office**

**Reg. No. 3,497,804**

**Registered Sep. 9, 2008**

**TRADEMARK  
SERVICE MARK  
PRINCIPAL REGISTER**

**P<sup>2</sup>RMIS**

CONSTELLA GROUP, LLC (NORTH CAROLINA  
LIMITED LIABILITY COMPANY)  
4300 FAIR LAKES COURT  
KAY PATTERSON - FLS-518  
FAIRFAX, VA 22033

FOR: COMPUTER PROGRAMS FOR PEER RE-  
VIEW PROGRAM MANAGEMENT IN THE BIO-  
MEDICAL FIELD, IN CLASS 9 (U.S. CLS. 21, 23, 26, 36  
AND 38).

FIRST USE 8-0-1996; IN COMMERCE 8-0-1996.

FOR: PROVIDING ON-LINE NON-DOWNLOAD-  
ABLE COMPUTER PROGRAMS FOR PEER RE-

VIEW PROGRAM MANAGEMENT IN THE BIO-  
MEDICAL FIELD, IN CLASS 42 (U.S. CLS. 100 AND  
101).

FIRST USE 8-0-1996; IN COMMERCE 8-0-1996.

THE WORDING "P<sup>2</sup>RMIS" HAS NO MEANING IN  
A FOREIGN LANGUAGE.

SER. NO. 77-182,510, FILED 5-16-2007.

HOWARD SMIGA, EXAMINING ATTORNEY

**Int. Cl.: 19**

**Prior U.S. Cls.: 1, 12, 33 and 50**

**United States Patent and Trademark Office**

**Reg. No. 3,497,805**

**Registered Sep. 9, 2008**

**TRADEMARK  
PRINCIPAL REGISTER**

**SHADOWGROOVE**

OUTDOOR TECHNOLOGIES INC. (DELAWARE  
CORPORATION)  
1576 MAGNOLIA DRIVE  
MACON, MS 39341

FOR: NON-METAL GATES AND FENCES;  
BUILDING MATERIALS, NAMELY, FENCE  
BOARDS, IN CLASS 19 (U.S. CLS. 1, 12, 33 AND 50).

FIRST USE 9-1-2006; IN COMMERCE 9-1-2006.

THE MARK CONSISTS OF STANDARD CHAR-  
ACTERS WITHOUT CLAIM TO ANY PARTICULAR  
FONT, STYLE, SIZE, OR COLOR.

SER. NO. 77-182,922, FILED 5-16-2007.

LINDA ESTRADA, EXAMINING ATTORNEY

**Int. Cl.: 35**

**Prior U.S. Cls.: 100, 101 and 102**

**United States Patent and Trademark Office**

**Reg. No. 3,497,806**

**Registered Sep. 9, 2008**

**SERVICE MARK  
PRINCIPAL REGISTER**

**ADAPTIVEMALL.COM**

ADAPTIVEMALL.COM, LLC (NEW YORK LIMITED LIABILITY COMPANY)  
15 SECOND STREET  
DOLGEVILLE, NY 13329

FOR: PROVIDING CONSUMER PRODUCT INFORMATION VIA THE INTERNET; COMPUTERIZED ON-LINE RETAIL STORE SERVICES IN THE FIELD OF EQUIPMENT AND SUPPLIES FOR INDIVIDUALS WITH PHYSICAL DISABILITIES, IN CLASS 35 (U.S. CLS. 100, 101 AND 102).

FIRST USE 3-10-1999; IN COMMERCE 3-10-1999.

THE MARK CONSISTS OF STANDARD CHARACTERS WITHOUT CLAIM TO ANY PARTICULAR FONT, STYLE, SIZE, OR COLOR.

OWNER OF U.S. REG. NO. 2,501,139.

SEC. 2(F).

SER. NO. 77-183,517, FILED 5-17-2007.

RONALD MCMORROW, EXAMINING ATTORNEY

**Int. Cls.: 1 and 11**

**Prior U.S. Cls.: 1, 5, 6, 10, 13, 21, 23, 26, 31, 34 and 46**

**United States Patent and Trademark Office**

**Reg. No. 3,497,807**

**Registered Sep. 9, 2008**

**TRADEMARK  
PRINCIPAL REGISTER**

**TANNER**

TANNER SYSTEMS, INC. (MINNESOTA CORPORATION)  
PO BOX 488  
ST. JOSEPH, MN 56374

FOR: ANTIFREEZE, IN CLASS 1 (U.S. CLS. 1, 5, 6, 10, 26 AND 46).

FIRST USE 11-1-1933; IN COMMERCE 11-1-1933.

FOR: ELECTRIC VAPORIZERS , IN CLASS 11 (U.S. CLS. 13, 21, 23, 31 AND 34).

FIRST USE 11-1-1933; IN COMMERCE 11-1-1933.

THE MARK CONSISTS OF STANDARD CHARACTERS WITHOUT CLAIM TO ANY PARTICULAR FONT, STYLE, SIZE, OR COLOR.

SER. NO. 77-183,623, FILED 5-17-2007.

ARETHA SOMERVILLE, EXAMINING ATTORNEY

**Int. Cl.: 11**

**Prior U.S. Cls.: 13, 21, 23, 31 and 34**

**Reg. No. 3,497,808**

**United States Patent and Trademark Office**

**Registered Sep. 9, 2008**

**TRADEMARK  
PRINCIPAL REGISTER**

**CHILL**

CHILL COOLING TOWELS INTERNATIONAL  
LLC (FLORIDA LIMITED LIABILITY COMPA-  
NY)  
626 WILLIAM STREET  
KEY WEST, FL 33040

FOR: PRE-MOISTENED, NON-MEDICATED DIS-  
POSABLE TOWELS CONTAINING A COOLING  
SUBSTANCE TO COOL THE USER, IN CLASS 11  
(U.S. CLS. 13, 21, 23, 31 AND 34).

FIRST USE 1-25-2007; IN COMMERCE 1-25-2007.

THE MARK CONSISTS OF STANDARD CHAR-  
ACTERS WITHOUT CLAIM TO ANY PARTICULAR  
FONT, STYLE, SIZE, OR COLOR.

SER. NO. 77-184,767, FILED 5-18-2007.

PETER B. BROMAGHIM, EXAMINING ATTORNEY



**Int. Cl.: 9**

**Prior U.S. Cls.: 21, 23, 26, 36 and 38**

**Reg. No. 3,497,809**

**United States Patent and Trademark Office**

**Registered Sep. 9, 2008**

**TRADEMARK  
PRINCIPAL REGISTER**

# SigniShell

CSSN, INC (CALIFORNIA CORPORATION), DBA  
CARD SCANNING SOLUTION  
SUITE 330  
10350 SANTA MONICA BLVD  
LOS ANGELES, CA 90025

FOR: COMPUTER HARDWARE, NAMELY,  
ELECTRONIC SIGNATURE CAPTURE PADS SOLD  
AS A UNIT WITH BIOMETRIC SIGNATURE AU-  
THENTICATION SOFTWARE THAT CAPTURES  
THE SIGNATURE, IN CLASS 9 (U.S. CLS. 21, 23, 26,  
36 AND 38).

FIRST USE 11-5-2005; IN COMMERCE 11-5-2005.

THE MARK CONSISTS OF STANDARD CHAR-  
ACTERS WITHOUT CLAIM TO ANY PARTICULAR  
FONT, STYLE, SIZE, OR COLOR.

SER. NO. 77-184,852, FILED 5-18-2007.

TANYA AMOS, EXAMINING ATTORNEY

**Int. Cl.: 41**

**Prior U.S. Cls.: 100, 101 and 107**

**United States Patent and Trademark Office**

**Reg. No. 3,497,810**

**Registered Sep. 9, 2008**

**SERVICE MARK  
PRINCIPAL REGISTER**

**WealthSTRONG**

RYAN, EVONNE, I (UNITED STATES INDIVIDUAL)  
C/O CFC-SERVICES  
5944 S. KIPLING #302  
LITTLETON, CO 80127 AND  
WEST, SCOTT S (UNITED STATES INDIVIDUAL)  
C/O CFC-SERVICES  
5944 S. KIPLING #302  
LITTLETON, CO 80127

FOR: EDUCATIONAL SERVICES, NAMELY, ORGANIZING AND CONDUCTING CONFERENCES IN THE FIELD OF FINANCIAL COACHING AND

WEALTH EMPOWERMENT, IN CLASS 41 (U.S. CLS. 100, 101 AND 107).

FIRST USE 5-1-2007; IN COMMERCE 5-12-2007.

THE MARK CONSISTS OF STANDARD CHARACTERS WITHOUT CLAIM TO ANY PARTICULAR FONT, STYLE, SIZE, OR COLOR.

SER. NO. 77-185,397, FILED 5-19-2007.

LEIGH CAROLINE CASE, EXAMINING ATTORNEY

**Int. Cl.: 12**

**Prior U.S. Cls.: 19, 21, 23, 31, 35 and 44**

**Reg. No. 3,497,811**

**United States Patent and Trademark Office**

**Registered Sep. 9, 2008**

**TRADEMARK  
PRINCIPAL REGISTER**

# Roadstercycle

FLEMING, JACK M. (UNITED STATES INDIVIDUAL)  
17252 HAWTHORNE BLVD. 222  
TORRANCE, CA 90504

THE MARK CONSISTS OF STANDARD CHARACTERS WITHOUT CLAIM TO ANY PARTICULAR FONT, STYLE, SIZE, OR COLOR.

FOR: MOTORCYCLES AND STRUCTURAL PARTS THEREFOR, IN CLASS 12 (U.S. CLS. 19, 21, 23, 31, 35 AND 44).

SER. NO. 77-185,578, FILED 5-20-2007.

FIRST USE 5-10-1997; IN COMMERCE 8-5-1997.

KYLE PEETE, EXAMINING ATTORNEY

**Int. Cl.: 45**

**Prior U.S. Cls.: 100 and 101**

**United States Patent and Trademark Office**

**Reg. No. 3,497,812**

**Registered Sep. 9, 2008**

**SERVICE MARK  
PRINCIPAL REGISTER**



KCT PARTNERS, LLC (NEW JERSEY LIMITED  
LIABILITY COMPANY)  
76 NINTH AVENUE, SUITE 1531  
NEW YORK, NY 10011

FOR: INTERNET BASED SOCIAL NETWORK-  
ING, INTRODUCTION, AND DATING SERVICES,  
IN CLASS 45 (U.S. CLS. 100 AND 101).

FIRST USE 3-1-2006; IN COMMERCE 3-1-2006.

THE MARK CONSISTS OF A RECTANGLE WITH  
A SQUARE SHAPE WHICH HAS THREE ROUNDED  
CORNERS, THE BOTTOM RIGHT CORNER IS NOT  
ROUNDED, THERE IS A FIVE POINTED STAR IN  
THE SQUARE, THE STYLIZED LETTERS DLIST  
ARE TO THE RIGHT OF THE SQUARE SHAPE.

SER. NO. 77-185,991, FILED 5-21-2007.

JOHN SCHUYLER YARD, EXAMINING ATTOR-  
NEY

**Int. Cl.: 35**

**Prior U.S. Cls.: 100, 101 and 102**

**United States Patent and Trademark Office**

**Reg. No. 3,497,813**

**Registered Sep. 9, 2008**

**SERVICE MARK  
PRINCIPAL REGISTER**

**The key to unlocking your  
global potential  
PSD Global**

PSD GLOBAL, LLC (VIRGINIA LIMITED LIABILITY COMPANY)  
505 NORTH MANSFIELD STREET  
ALEXANDRIA, VA 22304

FOR: BUSINESS ADVISORY AND CONSULTANCY SERVICES RELATING TO EXPORT, EXPORT SERVICES, EXPORT PROMOTION INFORMATION AND SERVICES AND GLOBAL ACQUISITION AND MERGER CONSULTATION; EXPORT AND IMPORT AGENCY SERVICES, IN CLASS 35 (U.S. CLS. 100, 101 AND 102).

FIRST USE 5-5-2002; IN COMMERCE 1-1-2004.

THE MARK CONSISTS OF STANDARD CHARACTERS WITHOUT CLAIM TO ANY PARTICULAR FONT, STYLE, SIZE, OR COLOR.

NO CLAIM IS MADE TO THE EXCLUSIVE RIGHT TO USE "GLOBAL", APART FROM THE MARK AS SHOWN.

SER. NO. 77-187,736, FILED 5-22-2007.

HOWARD B. LEVINE, EXAMINING ATTORNEY

**Int. Cl.: 25**

**Prior U.S. Cls.: 22 and 39**

**United States Patent and Trademark Office**

**Reg. No. 3,497,814**

**Registered Sep. 9, 2008**

**TRADEMARK  
PRINCIPAL REGISTER**

**CT KIDZ**

NORTHPEAK INTERNATIONAL INC. (CANADA  
CORPORATION)  
8300 COTE DE LIESSE SUITE 104  
VILLE SAINT LAURENT, CANADA H4T1G7

FOR: BATHING SUITS; BIKINIS; CAPS; COATS;  
GLOVES; JACKETS; JOGGING PANTS; JOGGING  
SUITS; PARKAS; RAIN COATS; RAIN JACKETS;  
SKI AND SNOW GLOVES; SKI AND SNOW JACK-  
ETS; SKI AND SNOW PANTS; SKI AND SNOW BIBS;  
SKI AND SNOW SUITS; SNOWBOARD GLOVES;  
SNOWBOARD JACKETS; SNOWBOARD PANTS;  
SWIM TRUNKS; SWIM WEAR; SYSTEM JACKETS,  
NAMELY, 3-IN-1 JACKETS AND 4-IN-1 JACKETS;  
TRACK SUITS; VESTS, IN CLASS 25 (U.S. CLS. 22  
AND 39).

FIRST USE 12-1-1986; IN COMMERCE 12-1-1986.

THE MARK CONSISTS OF STANDARD CHAR-  
ACTERS WITHOUT CLAIM TO ANY PARTICULAR  
FONT, STYLE, SIZE, OR COLOR.

NO CLAIM IS MADE TO THE EXCLUSIVE  
RIGHT TO USE "KIDS" , APART FROM THE MARK  
AS SHOWN.

SER. NO. 77-187,901, FILED 5-23-2007.

MICHAEL KAZAZIAN, EXAMINING ATTORNEY

**Int. Cl.: 5**

**Prior U.S. Cls.: 6, 18, 44, 46, 51 and 52**

**Reg. No. 3,497,815**

**United States Patent and Trademark Office**

**Registered Sep. 9, 2008**

**TRADEMARK  
PRINCIPAL REGISTER**

**MYSTIC SCENT**

GREEN PLANET, INC. (CALIFORNIA CORPORATION)  
424 BOYD STREET  
LOS ANGELES, CA 90013

FOR: AIR FRESHENERS, NAMELY, LIQUID FOR USE IN VAPORIZERS PRODUCING VARIOUS SCENTS, IN CLASS 5 (U.S. CLS. 6, 18, 44, 46, 51 AND 52).

FIRST USE 4-14-2007; IN COMMERCE 4-14-2007.

THE MARK CONSISTS OF STANDARD CHARACTERS WITHOUT CLAIM TO ANY PARTICULAR FONT, STYLE, SIZE, OR COLOR.

NO CLAIM IS MADE TO THE EXCLUSIVE RIGHT TO USE "SCENT", APART FROM THE MARK AS SHOWN.

SER. NO. 77-188,645, FILED 5-23-2007.

BRENDAN REGAN, EXAMINING ATTORNEY

**Int. Cls.: 18 and 25**

**Prior U.S. Cls.: 1, 2, 3, 22, 39 and 41**

**United States Patent and Trademark Office**

**Reg. No. 3,497,816**

**Registered Sep. 9, 2008**

**TRADEMARK  
PRINCIPAL REGISTER**

**LIVING DEAD SOULS**

SILVER STOP (UK) LTD. (UNITED KINGDOM  
LIMITED LIABILITY COMPANY)  
96 COMMERCIAL ROAD  
LONDON, UNITED KINGDOM E11NU

FOR: CHANGE PURSES, ALL-PURPOSE ATHLETIC BAGS, BOOK BAGS, CARRY-ON BAGS, OVERNIGHT BAGS, DUFFEL BAGS, SHOE BAGS FOR TRAVEL, HANDBAGS, SHOULDER BAGS, HOLDALLS, WALLETS, BILLFOLDS, BELT BAGS, PURSES, CREDIT CARD CASES, WALLETS, CASES INCORPORATING CHEQUE BOOK HOLDERS, ARTICLES OF LUGGAGE, LUGGAGE TAGS, BRIEF-CASES, BUSINESS CARD CASES, KEY CASES, GYM BAGS, TEXTILE SHOPPING BAGS, TRAVELING BAGS, LEATHER SHOPPING BAGS, MESH SHOPPING BAGS, TRUNKS, SUITCASES, SATCHELS, HAVERSACKS, RUCKSACKS, KNAPSACKS, BACKPACKS, BEACH BAGS, HUNTERS' GAME BAGS, TOTE BAGS, UMBRELLAS AND PARASOLS, UNFITTED VANITY CASES, TOILETRY BAGS SOLD EMPTY; COSMETIC BAGS SOLD EMPTY; INTEGRAL PARTS AND FITTINGS FOR THE AFORE-

SAID GOODS, IN CLASS 18 (U.S. CLS. 1, 2, 3, 22 AND 41).

FOR: CLOTHING, NAMELY, PANTS, SHIRTS, T-SHIRTS, SHORTS, SWEATERS, SUITS, BATHING SUITS, BATHROBES, COATS, JACKETS, DRESSES, SHOES, SOCKS, RAINCOATS, SKIRTS, BLOUSES, SWEATSHIRTS, SWEATPANTS, UNDERWEAR, ATHLETIC FOOTWEAR, HEADGEAR, NAMELY, CAPS, HATS AND HEADBANDS, IN CLASS 25 (U.S. CLS. 22 AND 39).

THE MARK CONSISTS OF STANDARD CHARACTERS WITHOUT CLAIM TO ANY PARTICULAR FONT, STYLE, SIZE, OR COLOR.

OWNER OF UNITED KINGDOM REG. NO. 2390646, DATED 12-2-2005, EXPIRES 4-28-2015.

SER. NO. 77-188,704, FILED 5-23-2007.

PAUL F. GAST, EXAMINING ATTORNEY



**Int. Cl.: 3**

**Prior U.S. Cls.: 1, 4, 6, 50, 51 and 52**

**United States Patent and Trademark Office**

**Reg. No. 3,497,817**

**Registered Sep. 9, 2008**

**TRADEMARK  
PRINCIPAL REGISTER**

**DIPPITY-DO**

CENTURA BRANDS INC. (CANADA CORPORATION)  
1200 AEROWOOD DRIVE, UNIT 50  
MISSISSAUGA, CANADA L4W2S7

FOR: HAIR CARE PREPARATIONS, IN CLASS 3  
(U.S. CLS. 1, 4, 6, 50, 51 AND 52).

FIRST USE 0-0-1959; IN COMMERCE 0-0-1959.

THE MARK CONSISTS OF STANDARD CHARACTERS WITHOUT CLAIM TO ANY PARTICULAR FONT, STYLE, SIZE, OR COLOR.

PRIORITY CLAIMED UNDER SEC. 44(D) ON CANADA APPLICATION NO. 1347825, FILED 5-17-2007, REG. NO. TMA709831, DATED 3-18-2008, EXPIRES 3-18-2023.

OWNER OF U.S. REG. NO. 694,682.

SER. NO. 77-189,402, FILED 5-24-2007.

AISHA SALEM, EXAMINING ATTORNEY

**Int. Cl.: 36**

**Prior U.S. Cls.: 100, 101 and 102**

**United States Patent and Trademark Office**

**Reg. No. 3,497,818**

**Registered Sep. 9, 2008**

**SERVICE MARK  
PRINCIPAL REGISTER**

**DEVELOPING PARADISE**

ALRIGHT THEN, LLC (FLORIDA LIMITED LIABILITY COMPANY)  
34507 LOCKE AVE.  
FREMONT, CA 94555

FOR: LAND ACQUISITION, NAMELY, REAL ESTATE BROKERAGE; PROVIDING INFORMATION IN THE FIELD OF REAL ESTATE BY MEANS OF LINKING THE WEB SITE TO OTHER WEB SITES FEATURING REAL ESTATE INFORMATION; PROVIDING REAL ESTATE LISTINGS AND REAL ESTATE INFORMATION VIA THE INTERNET; REAL ESTATE ACQUISITION SERVICES; REAL ESTATE AGENCIES; REAL ESTATE BROKERAGE; REAL ESTATE CONSULTATION; REAL ESTATE EQUITY SHARING, NAMELY, MANAGING AND ARRANGING FOR CO-OWNERSHIP OF REAL ESTATE; REAL ESTATE INVESTMENT; REAL ESTATE INVESTMENT SERVICES IN THE NATURE OF PURCHASING AND SELLING OF REAL ES-

TATE FOR OTHERS; REAL ESTATE LISTING; REAL ESTATE MANAGEMENT CONSULTATION; REAL ESTATE PROCUREMENT FOR OTHERS; REAL ESTATE SERVICES, NAMELY, RENTAL OF VACATION HOMES, CONDOMINIUMS, CABINS, AND VILLAS USING PAY PER CLICK ADVERTISING ON A GLOBAL COMPUTER NETWORK; REAL ESTATE TIME-SHARING; REAL ESTATE VALUATIONS, IN CLASS 36 (U.S. CLS. 100, 101 AND 102).

FIRST USE 9-0-2006; IN COMMERCE 9-0-2006.

THE MARK CONSISTS OF STANDARD CHARACTERS WITHOUT CLAIM TO ANY PARTICULAR FONT, STYLE, SIZE, OR COLOR.

SER. NO. 77-189,710, FILED 5-24-2007.

CAROLYN CATALDO, EXAMINING ATTORNEY

**Int. Cl.: 7**

**Prior U.S. Cls.: 13, 19, 21, 23, 31, 34 and 35**

**Reg. No. 3,497,819**

**United States Patent and Trademark Office**

**Registered Sep. 9, 2008**

**TRADEMARK  
PRINCIPAL REGISTER**

**PGS**

ASM TECHNOLOGY SINGAPORE PTE LTD (SINGAPORE CORPORATION)  
2 YISHUN AVENUE 7  
SINGAPORE, SINGAPORE 768924

FOR: MOLDING MACHINES AND MOLDS THEREOF FOR USE IN THE MANUFACTURE OF INTEGRATED CIRCUIT PACKAGES AND SEMICONDUCTOR DEVICES; MACHINES FOR TRANSFER-MOLDING OF SEMICONDUCTOR DEVICES, IN CLASS 7 (U.S. CLS. 13, 19, 21, 23, 31, 34 AND 35).

THE MARK CONSISTS OF STANDARD CHARACTERS WITHOUT CLAIM TO ANY PARTICULAR FONT, STYLE, SIZE, OR COLOR.

OWNER OF SINGAPORE REG. NO. T02/04610Z, DATED 4-11-2002, EXPIRES 4-11-2012.

SER. NO. 77-190,696, FILED 5-25-2007.

ZACHARY BELLO, EXAMINING ATTORNEY

**Int. Cls.: 37, 40 and 42**

**Prior U.S. Cls.: 100, 101, 103 and 106**

**United States Patent and Trademark Office**

**Reg. No. 3,497,820**

**Registered Sep. 9, 2008**

**SERVICE MARK  
PRINCIPAL REGISTER**

# BLUE MEDIA

BBCW, INC (ARIZONA CORPORATION)  
1725 WEST 3RD STREET  
TEMPE, AZ 85281

FOR: APPLICATION OF GRAPHICS TO VEHICLE BODIES; INSTALLATION OF INDOOR AND OUTDOOR SIGNAGE, IN CLASS 37 (U.S. CLS. 100, 103 AND 106).

FIRST USE 8-8-1999; IN COMMERCE 8-8-1999.

FOR: LARGE FORMAT DIGITAL PRINTING; PRINTING OF VEHICLE GRAPHICS; PRINTING OF INDOOR AND OUTDOOR SIGNAGE, IN CLASS 40 (U.S. CLS. 100, 103 AND 106).

FIRST USE 8-8-1999; IN COMMERCE 8-8-1999.

FOR: GRAPHIC DESIGN, IN CLASS 42 (U.S. CLS. 100 AND 101).

FIRST USE 8-8-1999; IN COMMERCE 8-8-1999.

THE MARK CONSISTS OF STANDARD CHARACTERS WITHOUT CLAIM TO ANY PARTICULAR FONT, STYLE, SIZE, OR COLOR.

NO CLAIM IS MADE TO THE EXCLUSIVE RIGHT TO USE "MEDIA" , APART FROM THE MARK AS SHOWN.

SER. NO. 77-190,828, FILED 5-25-2007.

KAREN SEVERSON, EXAMINING ATTORNEY

**Int. Cls.: 35 and 42**

**Prior U.S. Cls.: 100, 101 and 102**

**United States Patent and Trademark Office**

**Reg. No. 3,497,821**

**Registered Sep. 9, 2008**

**SERVICE MARK  
PRINCIPAL REGISTER**

**ACCREDITED STAGING  
PROFESSIONAL**

BARB, INC. DBA STAGED HOMES (WASHINGTON CORPORATION)  
4807 CLAYTON RD. SUITE #200  
CONCORD, CA 94521

FOR: ASSOCIATION SERVICES, NAMELY, PROMOTING THE INTERESTS OF MEMBERS AND OTHERS IN THE FIELD OF HOME RENOVATION, DESIGN AND DECORATING , IN CLASS 35 (U.S. CLS. 100, 101 AND 102).

FIRST USE 1-31-2000; IN COMMERCE 1-31-2000.

FOR: ACCREDITATION SERVICES, NAMELY, DEVELOPING, EVALUATING, AND TESTING STANDARDS FOR THE FIELD OF HOME RENO-

VATION, DESIGN AND DECORATION FOR THE PURPOSE OF ACCREDITATION, IN CLASS 42 (U.S. CLS. 100 AND 101).

FIRST USE 1-31-2000; IN COMMERCE 1-31-2000.

THE MARK CONSISTS OF STANDARD CHARACTERS WITHOUT CLAIM TO ANY PARTICULAR FONT, STYLE, SIZE, OR COLOR.

SEC. 2(F).

SER. NO. 77-191,280, FILED 5-26-2007.

DORITT L. CARROLL, EXAMINING ATTORNEY

**Int. Cls.: 20, 37 and 42**

**Prior U.S. Cls.: 2, 13, 22, 25, 32, 50, 100, 101, 103 and 106**

**Reg. No. 3,497,822**

**United States Patent and Trademark Office**

**Registered Sep. 9, 2008**

**TRADEMARK  
SERVICE MARK  
PRINCIPAL REGISTER**

# CHEMISTRY

RICHMOND SOLUTIONS LIMITED (UNITED KINGDOM COMPANY)  
BAIRD HOUSE, 15-17 ST. CROSS STREET  
LONDON, UNITED KINGDOM EC1N8UW

FOR: OFFICE FURNITURE; FURNITURE; DESKS; SEATS AND SEATING; FURNITURE FOR STORAGE; PARTS AND FITTINGS FOR ALL THE AFORESAID GOODS, IN CLASS 20 (U.S. CLS. 2, 13, 22, 25, 32 AND 50).

FOR: INSTALLATION OF OFFICE FURNITURE AND FURNITURE, IN CLASS 37 (U.S. CLS. 100, 103 AND 106).

FOR: OFFICE FURNITURE AND FURNITURE DESIGN; DESIGN OF LAYOUTS FOR OFFICE FURNITURE AND FURNITURE; DESIGNING AND PLANNING THE LAYOUT, FURNISHING

AND DECORATION OF OFFICES AND OF OFFICE SPACE; INTERIOR DESIGN SERVICES; WORK-PLACE DESIGN SERVICES; INTERIOR OFFICE SPACE PLANNING, IN CLASS 42 (U.S. CLS. 100 AND 101).

THE MARK CONSISTS OF STANDARD CHARACTERS WITHOUT CLAIM TO ANY PARTICULAR FONT, STYLE, SIZE, OR COLOR.

PRIORITY CLAIMED UNDER SEC. 44(D) ON UNITED KINGDOM APPLICATION NO. 2454957, FILED 5-9-2007, REG. NO. 2454957, DATED 5-9-2007, EXPIRES 5-9-2017.

SER. NO. 77-191,870, FILED 5-29-2007.

KATINA MISTER, EXAMINING ATTORNEY

**Int. Cl.: 35**

**Prior U.S. Cls.: 100, 101 and 102**

**United States Patent and Trademark Office**

**Reg. No. 3,497,823**

**Registered Sep. 9, 2008**

**SERVICE MARK  
PRINCIPAL REGISTER**

**truevue**

SPECTRUM NETWORKS, INC. (OHIO CORPORATION)  
9145 GOVERNORS WAY  
CINCINNATI, OH 45249

FOR: PROVIDING PROJECT MANAGEMENT AND CONSULTATION REGARDING CUSTOMERS' TELECOMMUNICATIONS ASSETS, SERVICES AND INVOICING, NAMELY, PROVIDING BUSINESS CONSULTATION IN THE FIELD OF TELECOMMUNICATIONS EXPENSE AND ASSET MANAGEMENT, TELECOMMUNICATIONS ACCOUNT AND USAGE AUDITING, AND INVENTORY MANAGEMENT IN THE FIELD OF

TELECOMMUNICATIONS EQUIPMENT, IN CLASS 35 (U.S. CLS. 100, 101 AND 102).

FIRST USE 10-31-2006; IN COMMERCE 10-31-2006.

THE MARK CONSISTS OF STANDARD CHARACTERS WITHOUT CLAIM TO ANY PARTICULAR FONT, STYLE, SIZE, OR COLOR.

SER. NO. 77-192,120, FILED 5-29-2007.

MARTHA FROMM, EXAMINING ATTORNEY

**Int. Cl.: 35**

**Prior U.S. Cls.: 100, 101 and 102**

**United States Patent and Trademark Office**

**Reg. No. 3,497,824**

**Registered Sep. 9, 2008**

**SERVICE MARK  
PRINCIPAL REGISTER**

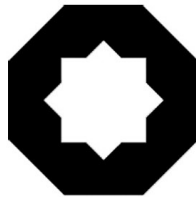

**CNBM**

CHINA NATIONAL BUILDING MATERIAL  
GROUP CORPORATION (CHINA CORPORATION)  
NO. 2 ZIZHUYUAN SOUTH ROAD  
BEIJING, CHINA 100044

FOR: GENERAL BUSINESS MERCHANDISING  
SERVICES, NAMELY, MARKETING, GOODS IMPORT-EXPORT AGENCIES, AND WHOLESALE ORDERING SERVICES AND DISTRIBUTORSHIPS IN THE FIELD OF BUILDING MATERIALS, IN CLASS 35 (U.S. CLS. 100, 101 AND 102).

FIRST USE 12-31-1984; IN COMMERCE 6-10-2005.

THE MARK CONSISTS OF A STYLIZED LETTERING "CNBM" UNDER AN OCTANGLE INSIDE A OCTAGON.

SER. NO. 77-192,192, FILED 5-29-2007.

KATHERINE M. DUBRAY, EXAMINING ATTORNEY



**Int. Cl.: 35**

**Prior U.S. Cls.: 100, 101 and 102**

**United States Patent and Trademark Office**

**Reg. No. 3,497,825**

**Registered Sep. 9, 2008**

**SERVICE MARK  
PRINCIPAL REGISTER**



CHINA NATIONAL BUILDING MATERIAL  
GROUP CORPORATION (CHINA CORPORA-  
TION)  
NO. 2 ZIZHUYUAN SOUTH ROAD  
BEIJING, CHINA 100044

FOR: GENERAL BUSINESS MERCHANDISING  
SERVICES, NAMELY, MARKETING, GOODS IM-  
PORT-EXPORT AGENCIES, AND WHOLESALE OR-  
DERING SERVICES AND DISTRIBUTORSHIPS IN

THE FIELD OF BUILDING MATERIALS, IN CLASS  
35 (U.S. CLS. 100, 101 AND 102).

FIRST USE 12-31-1984; IN COMMERCE 6-10-2005.

SER. NO. 77-192,203, FILED 5-29-2007.

SIMON TENG, EXAMINING ATTORNEY

**Int. Cl.: 7**

**Prior U.S. Cls.: 13, 19, 21, 23, 31, 34 and 35**

**Reg. No. 3,497,826**

**United States Patent and Trademark Office**

**Registered Sep. 9, 2008**

**TRADEMARK  
PRINCIPAL REGISTER**

**AXO**

AXO SHREDDERS LTD (NEW ZEALAND LIMITED LIABILITY COMPANY)  
PO BOX 12088  
WELLINGTON, NEW ZEALAND 6144

THE MARK CONSISTS OF STANDARD CHARACTERS WITHOUT CLAIM TO ANY PARTICULAR FONT, STYLE, SIZE, OR COLOR.

FOR: SHREDDING MACHINES, IN CLASS 7 (U.S. CLS. 13, 19, 21, 23, 31, 34 AND 35).

SER. NO. 77-192,512, FILED 5-29-2007.

FIRST USE 3-31-2003; IN COMMERCE 3-31-2003.

LANA PHAM, EXAMINING ATTORNEY

**Int. Cl.: 9**

**Prior U.S. Cls.: 21, 23, 26, 36 and 38**

**Reg. No. 3,497,827**

**United States Patent and Trademark Office**

**Registered Sep. 9, 2008**

**TRADEMARK  
PRINCIPAL REGISTER**

**FLASH**

AIRLOGICA CORPORATION (TEXAS CORPORATION)  
SUITE 615, 275 W. CAMPBELL ROAD  
RICHARDSON, TX 75080

FOR: COMPUTER SOFTWARE EXCLUSIVELY FOR THE AIRLINE AND TRAVEL INDUSTRIES FOR PROVIDING A DATABASE IN THE FIELD OF RESERVATION TRANSACTION PROCESSING TO LOAN TRANSACTIONAL DATA, PROVIDE STATISTICAL ANALYSIS, AND PRODUCE NOTIFICATIONS AND REPORTS FOR PRODUCT DISTRIBUTION AND REVENUE INTEGRITY; COMPUTER SOFTWARE EXCLUSIVELY FOR THE AIRLINE AND TRAVEL INDUSTRIES FOR THE COLLECTION, EDITING, ORGANIZING,

MODIFYING, TRANSMISSION, STORAGE AND SHARING OF RESERVATION DATA AND INFORMATION FOR PRODUCT DISTRIBUTION AND REVENUE INTEGRITY, IN CLASS 9 (U.S. CLS. 21, 23, 26, 36 AND 38).

FIRST USE 1-1-1995; IN COMMERCE 1-1-1995.

THE MARK CONSISTS OF STANDARD CHARACTERS WITHOUT CLAIM TO ANY PARTICULAR FONT, STYLE, SIZE, OR COLOR.

SER. NO. 77-193,356, FILED 5-30-2007.

GISELLE AGOSTO, EXAMINING ATTORNEY

**Int. Cl.: 9**

**Prior U.S. Cls.: 21, 23, 26, 36 and 38**

**Reg. No. 3,497,828**

**United States Patent and Trademark Office**

**Registered Sep. 9, 2008**

**TRADEMARK  
PRINCIPAL REGISTER**

**AUDIOGEAR FOR THE 21ST  
CENTURY CLASSROOM**

LOGICAL CHOICE TECHNOLOGIES, INC.  
(GEORGIA CORPORATION)  
SUITE 200  
3305 BRECKINRIDGE BLVD.  
DULUTH, GA 30096

FOR: PUBLIC-ADDRESS SYSTEMS CONSISTING OF AUDIO AMPLIFIERS, AUDIO MIXERS, AUDIO SPEAKERS, AUDIO RECEIVERS, AUDIO TRANSMITTERS, AUDIO EQUALIZERS, AND MICROPHONES, USED AS A PERIPHERAL DEVICE TO AND IN CONJUNCTION WITH ELECTRONIC WHITEBOARDS, FOR USE BY EDUCATIONAL INSTITUTIONS IN CLASSROOMS, IN CLASS 9 (U.S. CLS. 21, 23, 26, 36 AND 38).

FIRST USE 10-1-2006; IN COMMERCE 11-10-2006.

THE MARK CONSISTS OF STANDARD CHARACTERS WITHOUT CLAIM TO ANY PARTICULAR FONT, STYLE, SIZE, OR COLOR.

NO CLAIM IS MADE TO THE EXCLUSIVE RIGHT TO USE "AUDIO GEAR", APART FROM THE MARK AS SHOWN.

SER. NO. 77-193,419, FILED 5-30-2007.

TINA BROWN, EXAMINING ATTORNEY

**Int. Cl.: 35**

**Prior U.S. Cls.: 100, 101 and 102**

**United States Patent and Trademark Office**

**Reg. No. 3,497,829**

**Registered Sep. 9, 2008**

**SERVICE MARK  
PRINCIPAL REGISTER**



THE FIZIX INC. (DELAWARE CORPORATION)  
577 S. RANCHO SANTE FE ROAD, STE. 103  
SAN MARCOS, CA 92078

FOR: RETAIL CLOTHING STORES, IN CLASS 35  
(U.S. CLS. 100, 101 AND 102).

FIRST USE 5-1-2007; IN COMMERCE 5-1-2007.

THE MARK CONSISTS OF BLOCK LETTERS  
SPELLING "THE FIZIX" WHEREIN THE LETTERS

IN "FIZIX" ARE CONNECTED BY THE LARGER  
THAN NORMAL LETTER "Z" AND WHEREIN THE  
"THE" RUNS PERPENDICULAR ALONG AND IN  
FRONT OF THE LETTER "F" IN A FONT SIZE  
THAT IS ABOUT HALF THE SIZE OF THE FONT  
SIZED USED IN "FIZIX"

SER. NO. 77-193,429, FILED 5-30-2007.

JORDAN BAKER, EXAMINING ATTORNEY

**Int. Cl.: 10**

**Prior U.S. Cls.: 26, 39 and 44**

**United States Patent and Trademark Office**

**Reg. No. 3,497,830**

**Registered Sep. 9, 2008**

**TRADEMARK  
PRINCIPAL REGISTER**

**BEAUTÉ**

WIDEX A/S (DENMARK CORPORATION)  
NY VESTERGAARDSVEJ 25  
VAERLOESE, DENMARK DK-3500

FOR: HEARING AIDS AND PARTS THEREOF, IN  
CLASS 10 (U.S. CLS. 26, 39 AND 44).

THE MARK CONSISTS OF STANDARD CHAR-  
ACTERS WITHOUT CLAIM TO ANY PARTICULAR  
FONT, STYLE, SIZE, OR COLOR.

PRIORITY CLAIMED UNDER SEC. 44(D) ON  
DENMARK APPLICATION NO. VA200604887,  
FILED 12-7-2006, REG. NO. VR20070174, DATED 6-  
8-2007, EXPIRES 6-8-2017.

THE ENGLISH TRANSLATION OF THE WORD  
"BEAUTÉ" IN THE MARK IS BEAUTY.

SER. NO. 77-194,066, FILED 5-31-2007.

KYLE PEETE, EXAMINING ATTORNEY

**Int. Cl.: 25**

**Prior U.S. Cls.: 22 and 39**

**United States Patent and Trademark Office**

**Reg. No. 3,497,831**

**Registered Sep. 9, 2008**

**TRADEMARK  
PRINCIPAL REGISTER**



FALCON, RIVERA JR (UNITED STATES INDIVIDUAL)  
2417 STARGAZE WAY  
CHULA VISTA, CA 91915

THE MARK CONSISTS OF A FIST OF MONEY WITH "MEAN HUSTLE" ABOVE "ENTERTAINMENT" BELOW.

FOR: SHORT SLEEVED OR LONG SLEEVED T-SHIRTS; T-SHIRTS, IN CLASS 25 (U.S. CLS. 22 AND 39).

SER. NO. 77-195,006, FILED 5-31-2007.

FIRST USE 1-1-2004; IN COMMERCE 1-1-2004.

JOHN WILKE, EXAMINING ATTORNEY

**Int. Cls.: 41 and 43**

**Prior U.S. Cls.: 100, 101 and 107**

**United States Patent and Trademark Office**

**Reg. No. 3,497,832**

**Registered Sep. 9, 2008**

**SERVICE MARK  
PRINCIPAL REGISTER**



BTB SERVICE CORP. (NEW YORK CORPORATION)  
250 WEST 54TH STREET  
NEW YORK, NY 10019

FOR: PARTY PLANNING SERVICES; PARTY PLANNING CONSULTATION, IN CLASS 41 (U.S. CLS. 100, 101 AND 107).

FIRST USE 8-15-1989; IN COMMERCE 8-15-1989.

FOR: CATERING , IN CLASS 43 (U.S. CLS. 100 AND 101).

FIRST USE 8-15-1989; IN COMMERCE 8-15-1989.

THE COLOR(S) BLACK, RED AND WHITE IS/ ARE CLAIMED AS A FEATURE OF THE MARK.

THE MARK CONSISTS OF A DEPICTION OF A TUXEDO TOP, CONSISTING OF TWO BLACK LAPELS, A WHITE TUXEDO SHIRT, A RED FLOWER, A BLACK BOW TIE AND BLACK BUTTONS.

SER. NO. 77-195,434, FILED 6-1-2007.

LAURA HAMMEL, EXAMINING ATTORNEY



**Int. Cls.: 5 and 32**

**Prior U.S. Cls.: 6, 18, 44, 45, 46, 48, 51 and 52**

**United States Patent and Trademark Office**

**Reg. No. 3,497,833**

**Registered Sep. 9, 2008**

**TRADEMARK  
PRINCIPAL REGISTER**



MCINTYRE, MICHAEL R (UNITED STATES INDIVIDUAL)  
1543 CLIFFTOP AVENUE  
SAN MARCOS, CA 92078

FOR: DIETARY DRINK MIX FOR USE AS A MEAL REPLACEMENT; DIETARY SUPPLEMENTAL DRINKS; ENERGY BOOSTING MOUTH DISSOLVABLE FLAVORED EDIBLE FILMS; MEAL REPLACEMENT AND DIETARY SUPPLEMENT DRINK MIXES; MEAL REPLACEMENT DRINKS; NUTRITIONAL DRINK MIX FOR USE AS A MEAL REPLACEMENT; NUTRITIONAL ENERGY BARS FOR USE AS A MEAL SUBSTITUTE; POWDERED NUTRITIONAL SUPPLEMENT DRINK MIX; SOY PROTEIN FOR USE AS A NUTRITIONAL INGREDIENT IN VARIOUS POWDERED AND READY-TO-DRINK BEVERAGES; AMINO ACIDS FOR NUTRITIONAL PURPOSES; CALCIUM SUPPLEMENTS; DIETARY AND NUTRITIONAL SUPPLEMENTS; DIETARY FOOD SUPPLEMENTS; DIETARY SUPPLEMENTS; DIETARY SUPPLEMENTS FOR HUMAN CONSUMPTION; FOOD SUPPLEMENTS; FOOD SUPPLEMENTS, NAMELY, ANTI-OXIDANTS; GROUND FLAXSEED FIBER FOR USE AS A DIETARY SUPPLEMENT; HERBAL SUPPLEMENTS; HOMEOPATHIC SUPPLEMENTS; MINERAL NUTRITIONAL SUPPLEMENTS; MINERAL SUPPLEMENTS; NUTRITIONAL SHAKES FOR USE AS A MEAL SUBSTITUTE; NUTRITIONAL SUPPLEMENTS; VITAMIN AND MINERAL SUPPLEMENTS; VITAMIN SUPPLEMENTS; WHEAT FOR USE AS A DIETARY SUPPLEMENT; ELEC-

TROLYTE REPLACEMENT SOLUTIONS; MEAL REPLACEMENT BARS; MEAL REPLACEMENT POWDERS; MEAL REPLACEMENT SHAKES; VITAMIN AND MINERAL FORMED AND PACKAGED AS BARS, IN CLASS 5 (U.S. CLS. 6, 18, 44, 46, 51 AND 52).

FIRST USE 7-18-2007; IN COMMERCE 7-18-2007.

FOR: ALOE VERA DRINKS; ENERGY DRINKS; FRUIT DRINKS; FRUIT-FLAVORED DRINKS; SPORTS DRINKS; NON-ALCOHOLIC BEVERAGES CONTAINING FRUIT JUICES; NON-ALCOHOLIC BEVERAGES WITH TEA FLAVOR; NON-ALCOHOLIC FRUIT JUICE BEVERAGES, IN CLASS 32 (U.S. CLS. 45, 46 AND 48).

FIRST USE 7-18-2007; IN COMMERCE 7-18-2007.

OWNER OF U.S. REG. NO. 3,241,751.

THE MARK CONSISTS OF THE DESIGN OF AN ANVIL IN THE SHAPE OF A STYLIZED LETTER "T", WITH THE WORD "THROWDOWN" APPEARING DIRECTLY ABOVE THE DESIGN AND BEING APPROXIMATELY THE SAME LENGTH AS THE TOP BAR OF THE "T".

SER. NO. 77-195,751, FILED 6-1-2007.

MATTHEW PAPPAS, EXAMINING ATTORNEY

**Int. Cls.: 16, 35 and 40**

**Prior U.S. Cls.: 2, 5, 22, 23, 29, 37, 38, 50, 100, 101, 102, 103 and 106**

**Reg. No. 3,497,834**

**Registered Sep. 9, 2008**

**United States Patent and Trademark Office**

---

**TRADEMARK  
SERVICE MARK  
PRINCIPAL REGISTER**

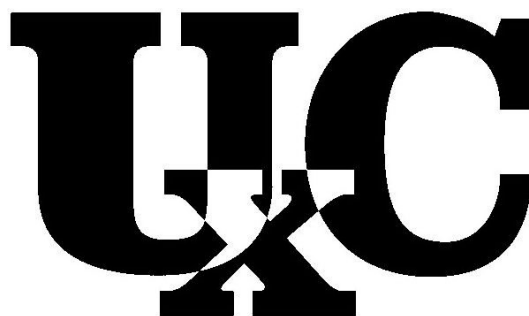

THE UX CONSULTING COMPANY, LLC (GEORGIA LIMITED LIABILITY COMPANY)  
1401 MACY DRIVE  
ROSWELL, GA 30076

FOR: PUBLICATIONS, NAMELY, PRINTED REPORTS, PRINTED STUDY GUIDES AND PRINTED PERIODICALS IN THE FIELD OF NUCLEAR ENERGY, IN CLASS 16 (U.S. CLS. 2, 5, 22, 23, 29, 37, 38 AND 50).

FIRST USE 9-6-2004; IN COMMERCE 9-6-2004.

FOR: ECONOMIC FORECASTING AND ANALYSIS IN THE FIELD OF NUCLEAR ENERGY; PROVIDING GOODS AND SERVICES PRICE QUOTATIONS IN THE FIELD OF NUCLEAR ENERGY; AND COMMERCIAL CONSULTANCY IN THE FIELD OF NUCLEAR ENERGY, IN CLASS 35 (U.S. CLS. 100, 101 AND 102).

FIRST USE 9-6-2004; IN COMMERCE 9-6-2004.

FOR: PROVIDING INFORMATION IN THE FIELD OF NUCLEAR ENERGY GENERATION AND PRODUCTION, IN CLASS 40 (U.S. CLS. 100, 103 AND 106).

FIRST USE 9-6-2004; IN COMMERCE 9-6-2004.

THE MARK CONSISTS OF CAPITAL LETTERS U AND C WITH A LOWER CASE SUBSCRIPT LETTER X BETWEEN THE U AND C.

SER. NO. 77-198,107, FILED 6-5-2007.

MICHAEL WEBSTER, EXAMINING ATTORNEY

**Int. Cl.: 41**

**Prior U.S. Cls.: 100, 101 and 107**

**United States Patent and Trademark Office**

**Reg. No. 3,497,835**

**Registered Sep. 9, 2008**

**SERVICE MARK  
PRINCIPAL REGISTER**



MACNEIL LEHRER PRODUCTIONS (VIRGINIA  
PARTNERSHIP)  
SUITE 250  
2700 SOUTH QUINCY STREET  
ARLINGTON, VA 22206

FOR: PROVIDING A WEBSITE FEATURING  
NEWS IN THE NATURE OF CURRENT EVENT  
REPORTING, IN CLASS 41 (U.S. CLS. 100, 101 AND  
107).

FIRST USE 9-5-1983; IN COMMERCE 9-5-1983.

NO CLAIM IS MADE TO THE EXCLUSIVE  
RIGHT TO USE "ONLINE", APART FROM THE  
MARK AS SHOWN.

THE MARK CONSISTS OF THE WORDS "THE  
ONLINE" IN WHITE BLOCK PRINT LETTERING  
APPEARING TO THE LEFT OF A WHITE WIRE-  
FRAME GLOBE, WHICH IS FOLLOWED BY THE  
WORD "NEWSHOUR", ALSO IN WHITE BLOCK  
PRINT LETTERING, ALL ON A BLACK BACK-  
GROUND. THE WORDS "ONLINE" AND "NEWS-  
HOUR" APPEAR IN BOLD.

SER. NO. 77-198,171, FILED 6-5-2007.

PAULA MAHONEY, EXAMINING ATTORNEY

**Int. Cl.: 3**

**Prior U.S. Cls.: 1, 4, 6, 50, 51 and 52**

**United States Patent and Trademark Office**

**Reg. No. 3,497,836**

**Registered Sep. 9, 2008**

**TRADEMARK  
PRINCIPAL REGISTER**



BELLA ROMA BATH & BEAUTY, INC. (FLORIDA CORPORATION)  
5105 W. POE AVE.  
TAMPA, FL 33629

FOR: BAR SOAP; BATH SOAPS; BATH SOAPS IN LIQUID, SOLID OR GEL FORM; BODY CREAM SOAP; COSMETIC SOAPS; CREAM SOAPS; HAND SOAPS; LIQUID BATH SOAPS; LIQUID SOAP; LIQUID SOAPS; LIQUID SOAPS FOR HANDS AND FACE; LIQUID SOAPS FOR HANDS, FACE AND BODY; PERFUMED SOAP; PERFUMED SOAPS; SKIN SOAP; SOAPS FOR BODY CARE; SOAPS FOR PERSONAL USE, IN CLASS 3 (U.S. CLS. 1, 4, 6, 50, 51 AND 52).

FIRST USE 5-1-2007; IN COMMERCE 6-7-2007.

THE COLOR(S) GREEN AND BROWN IS/ARE CLAIMED AS A FEATURE OF THE MARK.

THE MARK CONSISTS OF THE WORDS "BELLA ROMA" SEPARATED BY AN OLIVE BRANCH. THE COLOR GREEN APPEARS IN THE LETTERING FOR THE WORDING "BELLA ROMA" AND IN THE GREEN LEAVES AND OLIVES ON THE BRANCH DESIGN. THE COLOR BROWN APPEARS IN THE BRANCH IN THE DESIGN ELEMENT.

THE ENGLISH TRANSLATION OF THE WORD "BELLA ROMA" IN THE MARK IS BEAUTIFUL ROME.

SER. NO. 77-198,300, FILED 6-5-2007.

SETH A. RAPPAPORT, EXAMINING ATTORNEY

**Int. Cl.: 40**

**Prior U.S. Cls.: 100, 103 and 106**

**United States Patent and Trademark Office**

**Reg. No. 3,497,837**

**Registered Sep. 9, 2008**

**SERVICE MARK  
PRINCIPAL REGISTER**

**SOD.R.( Sensory Overload  
Dominican Republic)**

STEVEN TAYLOR (GEORGIA LIMITED LIABILITY COMPANY)  
2343 BERNARD RD NW  
ATLANTA, GA 30318

THE MARK CONSISTS OF STANDARD CHARACTERS WITHOUT CLAIM TO ANY PARTICULAR FONT, STYLE, SIZE, OR COLOR.

FOR: IMPRINTING MESSAGES ON WEARING APPAREL, ACCESSORIES AND MUGS, IN CLASS 40 (U.S. CLS. 100, 103 AND 106).

SER. NO. 77-198,778, FILED 6-6-2007.

FIRST USE 7-1-2006; IN COMMERCE 7-1-2006.

DAWN FELDMAN, EXAMINING ATTORNEY

**Int. Cl.: 36**

**Prior U.S. Cls.: 100, 101 and 102**

**United States Patent and Trademark Office**

**Reg. No. 3,497,838**

**Registered Sep. 9, 2008**

**SERVICE MARK  
PRINCIPAL REGISTER**



JULIAN A.L. ALLEN (UNITED KINGDOM IN-  
DIVIDUAL)  
7 GLEN DRIVE  
MILL VALLEY, CA 94941

FOR: HEDGE FUND INVESTMENT SERVICES;  
MANAGEMENT OF PRIVATE EQUITY FUNDS;  
PRIVATE EQUITY FUND INVESTMENT SERVICES;  
VENTURE CAPITAL FUNDING SERVICES TO  
EMERGING AND START-UP COMPANIES; IN-  
VESTMENT MANAGEMENT; MANAGEMENT OF  
PORTFOLIOS COMPRISING SECURITIES; PUBLIC  
EQUITY INVESTMENT MANAGEMENT; INVEST-  
MENT ADVISORY SERVICES; LEVERAGED BUY  
OUTS AND INVESTMENTS IN FINANCIALLY DIS-  
TRESSED OR UNDERPERFORMING COMPANIES,  
IN CLASS 36 (U.S. CLS. 100, 101 AND 102).

FIRST USE 4-19-2007; IN COMMERCE 4-19-2007.

NO CLAIM IS MADE TO THE EXCLUSIVE  
RIGHT TO USE "CAPITAL LLC", APART FROM  
THE MARK AS SHOWN.

THE COLOR(S) GREEN AND BLACK IS/ARE  
CLAIMED AS A FEATURE OF THE MARK.

THE COLOR GREEN APPEARS IN THE AIR-  
PLANE, AND THE COLOR BLACK APPEARS IN  
THE WORDING "SPITFIRE CAPITAL LLC".

SER. NO. 77-199,092, FILED 6-6-2007.

MARCIE MILONE, EXAMINING ATTORNEY

**Int. Cl.: 35**

**Prior U.S. Cls.: 100, 101 and 102**

**United States Patent and Trademark Office**

**Reg. No. 3,497,839**

**Registered Sep. 9, 2008**

**SERVICE MARK  
PRINCIPAL REGISTER**

**T · · Home ·**

DEUTSCHE TELEKOM AG (FED REP GERMA-  
NY CORPORATION)  
FRIEDRICH-EBERT-ALLEE 140  
BONN, FED REP GERMANY 53113

FOR: TELEPHONE DIRECTORY ASSISTANCE SERVICES; ADVERTISING SERVICES, NAMELY, PREPARING AND PLACING ADVERTISEMENTS FOR OTHERS PROMOTING THE GOODS AND SERVICES OF OTHERS THROUGH PRINTED ADVERTISING, PRINTED DIRECTORIES, THROUGH ENCODED MEDIA, THROUGH THE DISSEMINATION OF PROMOTIONAL MATERIALS, THROUGH DIRECT MAIL ADVERTISING, THROUGH ELECTRONIC BILLBOARD ADVERTISING, PREPARING AUDIO-VISUAL PRESENTATIONS FOR USE IN ADVERTISING; BUSINESS MANAGEMENT SERVICES, NAMELY, BUSINESS APPRAISALS, BUSINESS AUDITING, PROVIDING BUSINESS INFORMATION, NAMELY, PREPARING BUSINESS REPORTS AND CONDUCTING BUSINESS RESEARCH, ANALYSIS AND SURVEYS, BUSINESS MANAGEMENT PLANNING, BUSINESS MANAGEMENT CONSULTATION, BUSINESS MANAGEMENT SUPERVISION, CONDUCTING

BUSINESS NETWORKING FOR OTHERS; BUSINESS MANAGEMENT AND CONSULTING SERVICES, EXCLUDING AGRICULTURAL BUSINESS MANAGEMENT AND CONSULTING SERVICES; PROVIDING INFORMATION VIA THE TELEPHONE AND THE GLOBAL COMMUNICATION NETWORKS IN THE FIELD OF ADVERTISING AND BUSINESS MARKETING; PROFESSIONAL CONSULTANCY IN THE FIELD OF DATA PROCESSING; RENTAL OF DATA PROCESSING EQUIPMENT, IN CLASS 35 (U.S. CLS. 100, 101 AND 102).

PRIORITY CLAIMED UNDER SEC. 44(D) ON FED REP GERMANY APPLICATION NO. 30675591238, FILED 12-8-2006, REG. NO. 30675591, DATED 5-31-2007, EXPIRES 12-31-2016.

OWNER OF U.S. REG. NOS. 2,911,878, 3,008,493 AND OTHERS.

SER. NO. 77-199,348, FILED 6-6-2007.

ROBIN MITTLER, EXAMINING ATTORNEY

**Int. Cl.: 9**

**Prior U.S. Cls.: 21, 23, 26, 36 and 38**

**United States Patent and Trademark Office**

**Reg. No. 3,497,840**

**Registered Sep. 9, 2008**

**TRADEMARK  
PRINCIPAL REGISTER**

**PJIMPACT**

ORC MANUFACTURING CO., LTD. (JAPAN  
CORPORATION)  
MACHIDA-SHI  
9-6, OYAMAGAOKA 3-CHOME  
TOKYO, JAPAN

FOR: EXPOSURE DEVICE, NAMELY, AN EXPO-  
SURE DEVICE TO FORM PATTERNS ON THE  
PHOTO-RESISTANT COATED SURFACE OF A SUB-  
STRATE BY USING ULTRAVIOLET LIGHT DUR-  
ING EXPOSURE, WASHING AND DRYING  
PROCESSES, IN CLASS 9 (U.S. CLS. 21, 23, 26, 36  
AND 38).

THE MARK CONSISTS OF STANDARD CHAR-  
ACTERS WITHOUT CLAIM TO ANY PARTICULAR  
FONT, STYLE, SIZE, OR COLOR.

PRIORITY CLAIMED UNDER SEC. 44(D) ON  
JAPAN APPLICATION NO. 2007-053039, FILED 5-28-  
2007, REG. NO. 5113033, DATED 2-22-2008, EXPIRES  
2-22-2018.

SER. NO. 77-200,527, FILED 6-7-2007.

STEPHANIE ALI, EXAMINING ATTORNEY



**Int. Cl.: 28**

**Prior U.S. Cls.: 22, 23, 38 and 50**

**Reg. No. 3,497,841**

**United States Patent and Trademark Office**

**Registered Sep. 9, 2008**

**TRADEMARK  
PRINCIPAL REGISTER**

**CYBER WIRED MAX**

MATTEL, INC. (DELAWARE CORPORATION)  
M1-1518  
333 CONTINENTAL BLVD.  
EL SEGUNDO, CA 90245

FIRST USE 4-24-2008; IN COMMERCE 4-24-2008.

THE MARK CONSISTS OF STANDARD CHARACTERS WITHOUT CLAIM TO ANY PARTICULAR FONT, STYLE, SIZE, OR COLOR.

FOR: TOYS, GAMES AND PLAYTHINGS, NAME-  
LY, TOY ACTION FIGURES, TOY FIGURES, AND  
ACCESSORIES FOR ALL OF THE FOREGOING, IN  
CLASS 28 (U.S. CLS. 22, 23, 38 AND 50).

SER. NO. 77-200,832, FILED 6-7-2007.

INGA ERVIN, EXAMINING ATTORNEY

**Int. Cl.: 19**

**Prior U.S. Cls.: 1, 12, 33 and 50**

**United States Patent and Trademark Office**

**Reg. No. 3,497,842**

**Registered Sep. 9, 2008**

**TRADEMARK  
PRINCIPAL REGISTER**

**WILLOW CREEK**

KILTIE CORPORATION (MINNESOTA CORPORATION)  
6348 HWY. 36 BLVD., SUITE 1  
OAKDALE, MN 55128

FOR: OUTDOOR CONCRETE LANDSCAPING PRODUCTS, NAMELY, CONCRETE PAVING STONES RETAINING WALLS, IN CLASS 19 (U.S. CLS. 1, 12, 33 AND 50).

FIRST USE 12-31-2003; IN COMMERCE 1-8-2004.

THE MARK CONSISTS OF STANDARD CHARACTERS WITHOUT CLAIM TO ANY PARTICULAR FONT, STYLE, SIZE, OR COLOR.

SER. NO. 77-201,589, FILED 6-8-2007.

WARREN L. OLANDRIA, EXAMINING ATTORNEY

Int. Cl.: 35

Prior U.S. Cls.: 100, 101 and 102

United States Patent and Trademark Office

Reg. No. 3,497,843

Registered Sep. 9, 2008

**SERVICE MARK  
PRINCIPAL REGISTER**



PROFESSIONAL SERVICES MARKETING, INC.  
(MINNESOTA CORPORATION)  
806 12TH AVENUE NORTHWEST  
NEW BRIGHTON, MN 55112

FOR: ADVERTISING, MARKETING AND PROMOTION CONSULTING SERVICES IN THE FIELDS OF PROFESSIONAL LEGAL SERVICES, IN CLASS 35 (U.S. CLS. 100, 101 AND 102).

FIRST USE 2-26-2004; IN COMMERCE 2-26-2004.

NO CLAIM IS MADE TO THE EXCLUSIVE RIGHT TO USE "PROFESSIONAL SERVICES MARKETING, INC." AND "TARGETED STRATEGIES FOR BUSINESS GROWTH", APART FROM THE MARK AS SHOWN.

THE COLOR(S) ORANGE, BLUE, WHITE AND BLACK IS/ARE CLAIMED AS A FEATURE OF THE MARK.

THE MARK CONSISTS OF THE WORDS "PROFESSIONAL SERVICES MARKETING, INC." IN BLACK LETTERING ON A RECTANGULAR-SHAPED GRADATED WHITE AND ORANGE BACKGROUND WHICH GRADUALLY CHANGES FROM WHITE TO ORANGE. UNDERNEATH THE GRADATED WHITE AND ORANGE BACKGROUND IS A NARROW RECTANGULAR-SHAPED BLACK BACKGROUND THAT CONTAINS THE WORDS "TARGETED STRATEGIES FOR BUSINESS GROWTH" IN WHITE LETTERING. A BLUE SPHERE IS SUPERIMPOSED OVER BOTH BACKGROUNDS ON THE FAR LEFT. THE BLUE SPHERE CONTAINS A SUNBURST DESIGN COMPRISED OF SEVEN GRADATED RAYS EMANATING FROM THE BLUE SPHERE. EACH OF THE GRADATED RAYS GRADUALLY CHANGES FROM WHITE TO ORANGE.

SER. NO. 77-201,666, FILED 6-8-2007.

SONYA STEPHENS, EXAMINING ATTORNEY

**Int. Cl.: 35**

**Prior U.S. Cls.: 100, 101 and 102**

**United States Patent and Trademark Office**

**Reg. No. 3,497,844**

**Registered Sep. 9, 2008**

**SERVICE MARK  
PRINCIPAL REGISTER**



PROFESSIONAL SERVICES MARKETING, INC.  
(MINNESOTA CORPORATION)  
806 12TH AVENUE NORTHWEST  
NEW BRIGHTON, MN 55112

FOR: ADVERTISING, MARKETING AND PROMOTION SERVICES; ADVICE IN THE FIELD OF BUSINESS MANAGEMENT AND MARKETING; BUSINESS MARKETING CONSULTING SERVICES; BUSINESS MARKETING SERVICES; CREATION OF MARKETING TOOLS DESIGNED TO INCREASE A CLIENT COMPANY'S KNOWLEDGE OF CUSTOMER NEEDS, AND ITS COMPETITORS' PRODUCTS AND SERVICES, PRICING, ADVERTISING STRATEGY AND SALES STRATEGY; DEVELOPMENT OF MARKETING STRATEGIES AND CONCEPTS; MARKETING CONSULTATION IN THE FIELD OF LEGAL PRACTICE; MARKETING CONSULTING; MARKETING PLAN DEVELOPMENT, IN CLASS 35 (U.S. CLS. 100, 101 AND 102).

FIRST USE 6-1-2007; IN COMMERCE 6-1-2007.

NO CLAIM IS MADE TO THE EXCLUSIVE RIGHT TO USE "MARKETYOURLAWPRACTICE.COM" AND "YOUR VIRTUAL MARKETING COACH", APART FROM THE MARK AS SHOWN.

THE COLOR(S) ORANGE, BLACK, BLUE AND WHITE IS/ARE CLAIMED AS A FEATURE OF THE MARK.

THE MARK CONSISTS OF THE WORDING "MARKETYOURLAWPRACTICE.COM" IN BLACK LETTERING WITH A HORIZONTAL BLACK LINE UNDERNEATH THE SAME ON AN ORANGE RECTANGULAR-SHAPED BACKGROUND WITH A CURVED TOP RIGHT SIDE AND BOTTOM LEFT SIDE. A NARROW BLACK, HORIZONTAL RECTANGLE APPEARS ACROSS THE BOTTOM OF THE ORANGE BACKGROUND EXTENDING PAST THE LEFT AND RIGHT SIDE OF THE ORANGE BACKGROUND. THE WORDING "YOUR VIRTUAL MARKETING COACH" APPEARS IN WHITE LETTERING IN THE LEFT SIDE OF THE BLACK RECTANGLE. A BLUE OVAL APPEARS AT THE RIGHT END OF THE HORIZONTAL BLACK LINE THAT IS UNDERNEATH THE WORDING "MARKETYOURLAWPRACTICE.COM." TWO BLUE CURVED BARS, SIGNIFYING WATER, APPEAR ON THE RIGHT SIDE OF THE BLUE OVAL.

SER. NO. 77-201,687, FILED 6-8-2007.

SONYA STEPHENS, EXAMINING ATTORNEY

**Int. Cl.: 36**

**Prior U.S. Cls.: 100, 101 and 102**

**United States Patent and Trademark Office**

**Reg. No. 3,497,845**

**Registered Sep. 9, 2008**

**SERVICE MARK  
PRINCIPAL REGISTER**



GATEWAY PARK, LLC (MASSACHUSETTS LIMITED LIABILITY COMPANY)  
100 INSTITUTE ROAD  
WORCESTER, MA 01609

FOR: LEASING AND MANAGEMENT OF LAB SPACE AND OFFICE SPACE IN A BIOTECHNOLOGY AND LIFE SCIENCES RESEARCH PARK, IN CLASS 36 (U.S. CLS. 100, 101 AND 102).

FIRST USE 2-22-2007; IN COMMERCE 2-22-2007.

THE COLOR(S) DARK GREEN, LIGHT GREEN AND WHITE IS/ARE CLAIMED AS A FEATURE OF THE MARK.

THE COLOR DARK GREEN APPEARS IN THE TOP PORTION OF THE STYLIZED LEAF DESIGN; THE COLOR LIGHT GREEN APPEARS IN THE BOTTOM PORTION OF THE STYLIZED LEAF DESIGN; THE COLOR WHITE APPEARS IN THE DNA STRAND OR HELIX THAT CONNECTS THE TOP AND BOTTOM PORTIONS OF THE STYLIZED LEAF DESIGN.

SER. NO. 77-202,872, FILED 6-11-2007.

MYRIAH HABEEB, EXAMINING ATTORNEY

**Int. Cl.: 36**

**Prior U.S. Cls.: 100, 101 and 102**

**United States Patent and Trademark Office**

**Reg. No. 3,497,846**

**Registered Sep. 9, 2008**

**SERVICE MARK  
PRINCIPAL REGISTER**



GATEWAY PARK, LLC (MASSACHUSETTS LIMITED LIABILITY COMPANY)  
100 INSTITUTE ROAD  
WORCESTER, MA 01609

FOR: LEASING AND MANAGEMENT OF LAB SPACE AND OFFICE SPACE IN A BIOTECHNOLOGY AND LIFE SCIENCES RESEARCH PARK, IN CLASS 36 (U.S. CLS. 100, 101 AND 102).

FIRST USE 2-22-2007; IN COMMERCE 2-22-2007.

NO CLAIM IS MADE TO THE EXCLUSIVE RIGHT TO USE "PARK", APART FROM THE MARK AS SHOWN.

THE COLOR(S) DARK GREEN, LIGHT GREEN AND WHITE IS/ARE CLAIMED AS A FEATURE OF THE MARK.

THE COLOR DARK GREEN APPEARS IN THE TOP PORTION OF THE STYLIZED LEAF DESIGN AND IN THE PHRASE "GATEWAY PARK" TO THE RIGHT OF THE LEAF THE COLOR LIGHT GREEN APPEARS IN THE BOTTOM PORTION OF THE STYLIZED LEAF DESIGN; THE COLOR WHITE APPEARS IN THE DNA STRAND OR HELIX THAT CONNECTS THE TOP AND BOTTOM PORTIONS OF THE STYLIZED LEAF DESIGN.

SER. NO. 77-202,880, FILED 6-11-2007.

MYRIAH HABEEB, EXAMINING ATTORNEY

**Int. Cl.: 42**

**Prior U.S. Cls.: 100 and 101**

**United States Patent and Trademark Office**

**Reg. No. 3,497,847**

**Registered Sep. 9, 2008**

**SERVICE MARK  
PRINCIPAL REGISTER**

**CollegeAnywhere**

COLLEGEANYWHERE, INC. (PENNSYLVANIA  
NON-PROFIT CORPORATION)  
150 N. 6TH STREET  
PHILADELPHIA, PA 19106

FOR: TECHNOLOGY TO SUPPORT INSTRUCTION BY INSTITUTIONS OF HIGHER EDUCATION, NAMELY, PROVIDING TEMPORARY USE OF ON-LINE NON-DOWNLOADABLE COMPUTER SOFTWARE FOR USE IN CREATING AND DELIVERING COURSES OF INSTRUCTION AT THE COLLEGE LEVEL; TROUBLESHOOTING OF COMPUTER HARDWARE AND SOFTWARE FOR COLLEGES TO SUPPORT ONLINE INSTRUCTION BY

INSTITUTIONS OF HIGHER EDUCATION, IN CLASS 42 (U.S. CLS. 100 AND 101).

FIRST USE 11-13-2006; IN COMMERCE 11-13-2006.

THE MARK CONSISTS OF STANDARD CHARACTERS WITHOUT CLAIM TO ANY PARTICULAR FONT, STYLE, SIZE, OR COLOR.

SER. NO. 77-202,940, FILED 6-11-2007.

ELLEN PERKINS, EXAMINING ATTORNEY

**Int. Cl.: 34**

**Prior U.S. Cls.: 2, 8, 9 and 17**

**United States Patent and Trademark Office**

**Reg. No. 3,497,848**

**Registered Sep. 9, 2008**

**TRADEMARK  
PRINCIPAL REGISTER**

**WINSTON CHURCHILL No. 10**

CHURCHILL, WINSTON S. (UNITED KINGDOM  
INDIVIDUAL)

4 BELGRAVE SQUARE

LONDON, UNITED KINGDOM SW1X 8PH

FOR: CIGARS, IN CLASS 34 (U.S. CLS. 2, 8, 9 AND  
17).

FIRST USE 11-14-2007; IN COMMERCE 11-14-2007.

THE MARK CONSISTS OF STANDARD CHAR-  
ACTERS WITHOUT CLAIM TO ANY PARTICULAR  
FONT, STYLE, SIZE, OR COLOR.

THE NAME(S), PORTRAIT(S), AND/OR SIGNA-  
TURE(S) SHOWN IN THE MARK DOES NOT IDEN-  
TIFY A PARTICULAR LIVING INDIVIDUAL.

SER. NO. 77-203,670, FILED 6-12-2007.

PAM WILLIS, EXAMINING ATTORNEY



**Int. Cl.: 34**

**Prior U.S. Cls.: 2, 8, 9 and 17**

**United States Patent and Trademark Office**

**Reg. No. 3,497,849**

**Registered Sep. 9, 2008**

**TRADEMARK  
PRINCIPAL REGISTER**

WINSTON CHURCHILL CHEQUERS

CHURCHILL, WINSTON S. (UNITED KINGDOM  
INDIVIDUAL)

4 BELGRAVE SQUARE

LONDON, UNITED KINGDOM SW1X 8PH

FOR: CIGARS, IN CLASS 34 (U.S. CLS. 2, 8, 9 AND  
17).

FIRST USE 11-14-2007; IN COMMERCE 11-14-2007.

THE MARK CONSISTS OF STANDARD CHAR-  
ACTERS WITHOUT CLAIM TO ANY PARTICULAR  
FONT, STYLE, SIZE, OR COLOR.

THE NAME(S), PORTRAIT(S), AND/OR SIGNA-  
TURE(S) SHOWN IN THE MARK DOES NOT IDENTI-  
FY A PARTICULAR LIVING INDIVIDUAL.

SER. NO. 77-203,697, FILED 6-12-2007.

PAM WILLIS, EXAMINING ATTORNEY

**Int. Cls.: 9, 16, 41 and 45**

**Prior U.S. Cls.: 2, 5, 21, 22, 23, 26, 29, 36, 37, 38, 50,  
100, 101 and 107**

**Reg. No. 3,497,850**

**United States Patent and Trademark Office**

**Registered Sep. 9, 2008**

**TRADEMARK  
SERVICE MARK  
PRINCIPAL REGISTER**

# Gloria Copeland

COPELAND, GLORIA J. (UNITED STATES INDIVIDUAL)  
ATTN: KIM COWLEY/TRADEMARK ADMINISTRATOR  
P.O. BOX 728  
NEWARK, TX 760710728

FOR: PRE-RECORDED CDS, VIDEO TAPES, LASER DISKS AND DVDS FEATURING RELIGIOUS MATERIALS, IN CLASS 9 (U.S. CLS. 21, 23, 26, 36 AND 38).

FIRST USE 5-9-1968; IN COMMERCE 5-9-1968.

FOR: RELIGIOUS BOOKS; MAGAZINES FEATURING RELIGIOUS ARTICLES, IN CLASS 16 (U.S. CLS. 2, 5, 22, 23, 29, 37, 38 AND 50).

FIRST USE 5-9-1968; IN COMMERCE 5-9-1968.

FOR: EDUCATION SERVICES, NAMELY, PROVIDING CLASSES, SEMINARS AND CONFERENCES IN THE FIELDS OF RELIGION, IN CLASS 41 (U.S. CLS. 100, 101 AND 107).

FIRST USE 5-9-1968; IN COMMERCE 5-9-1968.

FOR: EVANGELISTIC AND MINISTERIAL SERVICES, IN CLASS 45 (U.S. CLS. 100 AND 101).

FIRST USE 5-9-1968; IN COMMERCE 5-9-1968.

THE MARK CONSISTS OF STANDARD CHARACTERS WITHOUT CLAIM TO ANY PARTICULAR FONT, STYLE, SIZE, OR COLOR.

THE NAME(S), PORTRAIT(S), AND/OR SIGNATURE(S) SHOWN IN THE MARK IDENTIFIES "GLORIA COPELAND", WHOSE CONSENT(S) TO REGISTER IS MADE OF RECORD.

SEC. 2(F).

SER. NO. 77-203,978, FILED 6-12-2007.

CAROL SPILS, EXAMINING ATTORNEY

**Int. Cl.: 5**

**Prior U.S. Cls.: 6, 18, 44, 46, 51 and 52**

**Reg. No. 3,497,851**

**United States Patent and Trademark Office**

**Registered Sep. 9, 2008**

**TRADEMARK  
PRINCIPAL REGISTER**

**KLERITEA**

LEONARD HARDY (CANADA INDIVIDUAL)  
P.O. BOX 9  
GHARB, MALTA GRB100

THE MARK CONSISTS OF STANDARD CHAR-  
ACTERS WITHOUT CLAIM TO ANY PARTICULAR  
FONT, STYLE, SIZE, OR COLOR.

FOR: HERBAL TEAS FOR MEDICINAL PURPOSES,  
IN CLASS 5 (U.S. CLS. 6, 18, 44, 46, 51 AND 52).

SER. NO. 77-204,294, FILED 6-12-2007.

FIRST USE 1-15-1998; IN COMMERCE 4-1-1998.

JAY BESCH, EXAMINING ATTORNEY

**Int. Cls.: 12 and 25**

**Prior U.S. Cls.: 19, 21, 22, 23, 31, 35, 39 and 44**

**United States Patent and Trademark Office**

**Reg. No. 3,497,852**

**Registered Sep. 9, 2008**

**TRADEMARK  
PRINCIPAL REGISTER**

**PROTRUCK**

PROTRUCK RACING ORGANIZATION, INC.  
(NEVADA CORPORATION)  
14402 BOND COURT  
EL CAJON, CA 92021

FOR: TRUCKS AND PARTS THEREFORE,  
NAMELY, TRUCK WHEELS, SEATS AND SEAT  
BELTS, IN CLASS 12 (U.S. CLS. 19, 21, 23, 31, 35 AND  
44).

FIRST USE 10-30-1995; IN COMMERCE 10-30-1995.

FOR: CLOTHING, NAMELY, SHIRTS, PANTS,  
SHORTS, CAPS, HATS, VESTS, DRESSES, BLOUSES,

COATS, DRIVING SUITS, SHOES AND SANDALS,  
IN CLASS 25 (U.S. CLS. 22 AND 39).

FIRST USE 10-30-1995; IN COMMERCE 10-30-1995.

THE MARK CONSISTS OF STANDARD CHAR-  
ACTERS WITHOUT CLAIM TO ANY PARTICULAR  
FONT, STYLE, SIZE, OR COLOR.

SER. NO. 77-205,003, FILED 6-13-2007.

VIVIAN MICZNIK FIRST, EXAMINING ATTOR-  
NEY

**Int. Cl.: 41**

**Prior U.S. Cls.: 100, 101 and 107**

**United States Patent and Trademark Office**

**Reg. No. 3,497,853**

**Registered Sep. 9, 2008**

**SERVICE MARK  
PRINCIPAL REGISTER**

**SOLSTICE IN TIMES SQUARE**

TIMES SQUARE BUSINESS IMPROVEMENT DIS-  
TRICT (NEW YORK CORPORATION)  
1560 BROADWAY, SUITE 800  
NEW YORK, NY 10036

FOR: ENTERTAINMENT IN THE NATURE OF A  
FESTIVAL. ORGANIZING COMMUNITY FESTI-  
VALS FEATURING A VARIETY OF ACTIVITIES,  
NAMELY, SPORTING EVENTS, ART EXHIBITIONS,  
FLEA MARKETS, ETHNIC DANCES AND THE  
LIKE, IN CLASS 41 (U.S. CLS. 100, 101 AND 107).

FIRST USE 6-30-2003; IN COMMERCE 6-30-2003.

THE MARK CONSISTS OF STANDARD CHAR-  
ACTERS WITHOUT CLAIM TO ANY PARTICULAR  
FONT, STYLE, SIZE, OR COLOR.

NO CLAIM IS MADE TO THE EXCLUSIVE  
RIGHT TO USE "TIMES SQUARE", APART FROM  
THE MARK AS SHOWN.

SER. NO. 77-205,030, FILED 6-13-2007.

HEATHER THOMPSON, EXAMINING ATTORNEY

**Int. Cl.: 35**

**Prior U.S. Cls.: 100, 101 and 102**

**United States Patent and Trademark Office**

**Reg. No. 3,497,854**

**Registered Sep. 9, 2008**

**SERVICE MARK  
PRINCIPAL REGISTER**

**AMERICAN HERITAGE**

AMERICAN HERITAGE DATA CORPORATION  
(CALIFORNIA CORPORATION)  
1336 MOORPARK ROAD, UNIT 329  
THOUSAND OAKS, CA 91360

FOR: DIRECT MARKETING SERVICES, NAME-  
LY, PROVIDING SALES LEADS, PREPARING  
MAILING LISTS AND PROVIDING BUSINESS  
AND CONSUMER MARKETING INFORMATION  
FOR DIRECT MARKETING CAMPAIGNS; BUSI-  
NESS MARKETING AND DIRECT MAIL CON-  
SULTING SERVICES; MANAGEMENT AND  
COMPILATION OF COMPUTERIZED DATABASES;  
PROVIDING BUSINESS INFORMATION IN THE  
FIELD OF COMPANY PROFILES, COMPANY AND  
CONTACT NAMES, TELEPHONE NUMBERS, AND  
ADDRESSES VIA A GLOBAL COMPUTER NET-  
WORK; PROVIDING SALES AND MARKET RE-  
PORTS TO THE ORDER AND/OR SPECIFICATION  
OF OTHERS; PROVIDING GENERAL BUSINESS

INFORMATION CONCERNING SALES, SIZE AND  
POSITION; PROVIDING BUSINESS INFORMATION  
SERVICES PERTAINING TO MARKETING, DEMO-  
GRAPHICS AND STATISTICAL FIELDS; SUPPLY-  
ING SALES AND MARKETING INFORMATION  
CONCERNING THE BUSINESS COMMUNITY AC-  
CORDING TO THE REQUIREMENT OF CUSTO-  
MERS, MAILING LISTS PREPARATION SERVICES,  
IN CLASS 35 (U.S. CLS. 100, 101 AND 102).

FIRST USE 9-21-2006; IN COMMERCE 9-21-2006.

THE MARK CONSISTS OF STANDARD CHAR-  
ACTERS WITHOUT CLAIM TO ANY PARTICULAR  
FONT, STYLE, SIZE, OR COLOR.

SER. NO. 77-205,474, FILED 6-13-2007.

JUSTINE D. PARKER, EXAMINING ATTORNEY

**Int. Cl.: 45**

**Prior U.S. Cls.: 100 and 101**

**United States Patent and Trademark Office**

**Reg. No. 3,497,855**

**Registered Sep. 9, 2008**

**SERVICE MARK  
PRINCIPAL REGISTER**

**SERIOUS LAWYERS FOR  
SERIOUS INJURIES**

ELK & ELK CO., LTD. (OHIO LIMITED LIABILITY COMPANY)  
6110 PARKLAND BOULEVARD  
MAYFIELD HEIGHTS, OH 44124

THE MARK CONSISTS OF STANDARD CHARACTERS WITHOUT CLAIM TO ANY PARTICULAR FONT, STYLE, SIZE, OR COLOR.

FOR: LEGAL SERVICES, IN CLASS 45 (U.S. CLS. 100 AND 101).

SER. NO. 77-206,349, FILED 6-14-2007.

FIRST USE 7-31-1998; IN COMMERCE 7-31-1998.

KIMBERLY PERRY, EXAMINING ATTORNEY

**Int. Cls.: 37 and 40**

**Prior U.S. Cls.: 100, 103 and 106**

**United States Patent and Trademark Office**

**Reg. No. 3,497,856**

**Registered Sep. 9, 2008**

**SERVICE MARK  
PRINCIPAL REGISTER**



STINGER WELLHEAD PROTECTION, INC.  
(TEXAS CORPORATION)  
4301 WILL ROGERS PARKWAY, SUITE 600-700  
OKLAHOMA CITY, OK 73108

FOR: RENTAL OF OIL AND GAS WELL EQUIPMENT, NAMELY, FRACHEADS, COIL TUBING FRACHEADS, FRACSTACKS, WELLHEAD ISOLATION TOOLS, FULL-BORE WELL STIMULATION TOOLS, GATE VALVES, PLUG VALVES, BALL-DROP VALVES, FLANGES, WEDGES, DRILLING CROSSOVERS, FLOW TEES, SPACER SPOOLS AND SPOOLS, IN CLASS 37 (U.S. CLS. 100, 103 AND 106).

FIRST USE 10-1-1988; IN COMMERCE 10-1-1988.

FOR: OIL AND GAS WELL TREATMENT SERVICES, IN CLASS 40 (U.S. CLS. 100, 103 AND 106).

FIRST USE 10-31-1988; IN COMMERCE 10-31-1988.

NO CLAIM IS MADE TO THE EXCLUSIVE RIGHT TO USE "WELLHEAD PROTECTION INC.", APART FROM THE MARK AS SHOWN.

THE MARK CONSISTS OF A DARK BOX WITH TWO PARALLEL WHITE LINES, ONE ABOVE THE OTHER, INTERSECTING IN THE MIDDLE OF THE BOX AT A DOWN POINTING ARROW COMPRISING THE LEFT SIDE AND THE UNDERLINED WORD "STINGER" WITH THE WORDS "WELLHEAD PROTECTION, INC." APPEARING UNDERNEATH COMPRISING THE RIGHT SIDE.

SER. NO. 77-207,577, FILED 6-15-2007.

KAPIL BHANOT, EXAMINING ATTORNEY



Int. Cl.: 19

Prior U.S. Cls.: 1, 12, 33 and 50

United States Patent and Trademark Office

Reg. No. 3,497,857

Registered Sep. 9, 2008

TRADEMARK  
PRINCIPAL REGISTER

THE BASEMENT  
**TUXEDO**

JACKSON, TODD L/ (UNITED STATES INDIVIDUAL)  
40195 JUDD RD  
BELLEVILLE, MI 48111

FOR: WALL PANELS NOT OF METAL, IN CLASS 19 (U.S. CLS. 1, 12, 33 AND 50).

FIRST USE 5-1-2007; IN COMMERCE 5-1-2007.

NO CLAIM IS MADE TO THE EXCLUSIVE RIGHT TO USE "BASEMENT" , APART FROM THE MARK AS SHOWN.

THE MARK CONSISTS OF THE WORD "THE BASEMENT" IN UPPER CASE LETTERS, ABOVE "TUXEDO" IN BOLD, UPPERCASE LETTERS WITH THE LETTER "X" DEPICTED AS STYLIZED TUXEDO.

SER. NO. 77-207,631, FILED 6-15-2007.

ELISSA GARBER KON, EXAMINING ATTORNEY

**Int. Cls.: 16 and 41**

**Prior U.S. Cls.: 2, 5, 22, 23, 29, 37, 38, 50, 100, 101 and 107**

**Reg. No. 3,497,858**

**United States Patent and Trademark Office**

**Registered Sep. 9, 2008**

**TRADEMARK  
SERVICE MARK  
PRINCIPAL REGISTER**

**KLEIN GROUP INSTRUMENT**

ROBERT R. KLEIN (UNITED STATES INDIVIDUAL)  
56 BRAINARD ROAD  
WILBRAHAM, MA 01095

FOR: PRINTED MATERIAL, NAMELY, REPORTS, MANUALS AND ASSESSMENT TOOLS FOR USE IN TEAMS, WORK GROUPS AND ORGANIZATIONS FOR THE PURPOSE OF TEAM BUILDING, IMPROVING TEAM PERFORMANCE AND PRODUCTIVITY, LEADERSHIP AND ORGANIZATIONAL DEVELOPMENT, IN CLASS 16 (U.S. CLS. 2, 5, 22, 23, 29, 37, 38 AND 50).

FIRST USE 1-1-2007; IN COMMERCE 1-8-2007.

FOR: EDUCATIONAL SERVICES, NAMELY, PROVIDING WORKSHOPS AND COURSES OF INSTRUCTION GEARED TO HELP PEOPLE IN THEIR PLACE OF BUSINESS WITH TEAM BUILDING, IMPROVING TEAM PERFORMANCE AND PRODUCTIVITY, LEADERSHIP AND ORGANIZATION-

AL DEVELOPMENT, IN CLASS 41 (U.S. CLS. 100, 101 AND 107).

FIRST USE 1-1-2007; IN COMMERCE 1-8-2007.

THE MARK CONSISTS OF STANDARD CHARACTERS WITHOUT CLAIM TO ANY PARTICULAR FONT, STYLE, SIZE, OR COLOR.

NO CLAIM IS MADE TO THE EXCLUSIVE RIGHT TO USE "GROUP INSTRUMENT", APART FROM THE MARK AS SHOWN.

THE NAME "ROBERT R. KLEIN" IDENTIFIES A LIVING INDIVIDUAL WHOSE CONSENT IS OF RECORD.

SER. NO. 77-208,572, FILED 6-18-2007.

WANDA KAY PRICE, EXAMINING ATTORNEY

**Int. Cl.: 39**

**Prior U.S. Cls.: 100 and 105**

**United States Patent and Trademark Office**

**Reg. No. 3,497,859**

**Registered Sep. 9, 2008**

**SERVICE MARK  
PRINCIPAL REGISTER**

**CROWN**

CROWN MELBOURE LIMITED (AUSTRALIA  
CORPORATION)  
8 WHITEMAN STREET  
SOUTHBANK, MELBOURNE, AUSTRALIA 3006

THE MARK CONSISTS OF STANDARD CHAR-  
ACTERS WITHOUT CLAIM TO ANY PARTICULAR  
FONT, STYLE, SIZE, OR COLOR.

FOR: TRAVEL AND TOUR TICKET RESERVA-  
TION SERVICES; ARRANGING TRAVEL TOURS;  
TRAVEL AND TOUR INFORMATION SERVICES,  
IN CLASS 39 (U.S. CLS. 100 AND 105).

SER. NO. 77-208,867, FILED 6-18-2007.

FIRST USE 1-31-1994; IN COMMERCE 7-31-2002.

CYNTHIA SLOAN, EXAMINING ATTORNEY

**Int. Cl.: 5**

**Prior U.S. Cls.: 6, 18, 44, 46, 51 and 52**

**United States Patent and Trademark Office**

**Reg. No. 3,497,860**

**Registered Sep. 9, 2008**

**TRADEMARK  
PRINCIPAL REGISTER**

# DynaClose

CANICA DESIGN INC. (CANADA CORPORATION)  
36 MILL STREET  
ALMONTE, CANADA K0A1A0

FOR: SURGICAL TAPE FOR THE NON-INVASIVE APPROXIMATION OF SKIN, IN CLASS 5 (U.S. CLS. 6, 18, 44, 46, 51 AND 52).

THE MARK CONSISTS OF STANDARD CHARACTERS WITHOUT CLAIM TO ANY PARTICULAR FONT, STYLE, SIZE, OR COLOR.

PRIORITY CLAIMED UNDER SEC. 44(D) ON CANADA APPLICATION NO. 1351753, FILED 6-15-2007, REG. NO. TMA711,924, DATED 4-25-2008, EXPIRES 4-25-2023.

SER. NO. 77-209,356, FILED 6-19-2007.

ANDREA K. NADELMAN, EXAMINING ATTORNEY

**Int. Cl.: 44**

**Prior U.S. Cls.: 100 and 101**

**United States Patent and Trademark Office**

**Reg. No. 3,497,861**

**Registered Sep. 9, 2008**

**SERVICE MARK  
PRINCIPAL REGISTER**

**LASER & SKIN SURGERY  
CENTER OF NEW YORK**

ROY G. GERONEMUS, M.D., P.C. (NEW YORK CORPORATION), DBA LASER & SKIN SURGERY CENTER OF NEW YORK

317 EAST 34 STREET  
NEW YORK, NY 10016

FOR: MEDICAL SERVICES, NAMELY, DERMATOLOGICAL AND COSMETIC SERVICES; MEDICAL AND COSMETIC SURGERY SERVICES, IN CLASS 44 (U.S. CLS. 100 AND 101).

FIRST USE 5-10-1993; IN COMMERCE 5-10-1993.

THE MARK CONSISTS OF STANDARD CHARACTERS WITHOUT CLAIM TO ANY PARTICULAR FONT, STYLE, SIZE, OR COLOR.

NO CLAIM IS MADE TO THE EXCLUSIVE RIGHT TO USE "LASER & SKIN SURGERY CENTER", APART FROM THE MARK AS SHOWN.

SEC. 2(F).

SER. NO. 77-210,705, FILED 6-20-2007.

PAUL E. FAHRENKOPF, EXAMINING ATTORNEY

**Int. Cl.: 16**

**Prior U.S. Cls.: 2, 5, 22, 23, 29, 37, 38 and 50**

**Reg. No. 3,497,862**

**United States Patent and Trademark Office**

**Registered Sep. 9, 2008**

**TRADEMARK  
PRINCIPAL REGISTER**

**EAST WEST AFRICA**

DPE LABEL HOLDING CORP. (NEW YORK  
CORPORATION)  
232 BROADWAY  
BROOKLYN, NY 11211

FOR: PRE-PAID TELEPHONE CALLING CARDS,  
NOT MAGNETICALLY ENCODED, IN CLASS 16  
(U.S. CLS. 2, 5, 22, 23, 29, 37, 38 AND 50).

FIRST USE 12-31-2004; IN COMMERCE 12-31-2004.

THE MARK CONSISTS OF STANDARD CHAR-  
ACTERS WITHOUT CLAIM TO ANY PARTICULAR  
FONT, STYLE, SIZE, OR COLOR.

NO CLAIM IS MADE TO THE EXCLUSIVE  
RIGHT TO USE "AFRICA", APART FROM THE  
MARK AS SHOWN.

SER. NO. 77-211,484, FILED 6-21-2007.

JOHN KELLY, EXAMINING ATTORNEY

**Int. Cl.: 7**

**Prior U.S. Cls.: 13, 19, 21, 23, 31, 34 and 35**

**Reg. No. 3,497,863**

**United States Patent and Trademark Office**

**Registered Sep. 9, 2008**

**TRADEMARK  
PRINCIPAL REGISTER**

**HPC AUTOMATION**

HACKETT PRECISION COMPANY, INC. (TENNESSEE CORPORATION)  
1001 W. KIRKLAND AVE.  
NASHVILLE, TN 37216

FOR: CUSTOM DESIGNED MACHINERY FEATURING AUTOMATION AND ROBOTICS FOR USE IN THE ASSEMBLY OR SUBASSEMBLY OF MANUFACTURED GOODS, NAMELY, EQUIPMENT THAT PERMITS CUSTOM INTEGRATION OF MANUFACTURING FACILITIES FOR ASSEMBLY OR SUBASSEMBLY OF GOODS, AUTOMATED ASSEMBLY AND TEST SYSTEMS, AUTOMATED WELDING SYSTEMS, AUTOMATED METAL REMOVAL SYSTEMS, AUTOMATED MATERIAL HANDING MACHINERY, NAMELY, PALLETIZERS, CASE ELEVATORS, AUTOMATIC PALLET DISPENSING MACHINES AND AUTOMATIC SLIP SHEET DISPENSING MACHINES, MACHINERY THAT PERMITS AUTOMATION AND INTEGRATION OF PROCESSES IN MANUFACTURING FACILITIES, ROBOTIC ASSEMBLY AND PACKAGING

MACHINERY, TOOLING MACHINERY, AND FIXTURING EQUIPMENT, NAMELY, EQUIPMENT UTILIZING CUSTOM ENGINEERED EQUIPMENT OR ROBOTICS FOR THE ASSEMBLY OR SUBASSEMBLY OF MANUFACTURE GOODS, IN CLASS 7 (U.S. CLS. 13, 19, 21, 23, 31, 34 AND 35).

FIRST USE 6-21-2007; IN COMMERCE 6-21-2007.

THE MARK CONSISTS OF STANDARD CHARACTERS WITHOUT CLAIM TO ANY PARTICULAR FONT, STYLE, SIZE, OR COLOR.

NO CLAIM IS MADE TO THE EXCLUSIVE RIGHT TO USE "AUTOMATION", APART FROM THE MARK AS SHOWN.

SER. NO. 77-211,803, FILED 6-21-2007.

MARY ROSSMAN, EXAMINING ATTORNEY

**Int. Cls.: 7, 9, 16, 35, 37, 41 and 42**

**Prior U.S. Cls.: 2, 5, 13, 19, 21, 22, 23, 26, 29, 31, 34,  
35, 36, 37, 38, 50, 100, 101, 102, 103, 106 and 107**

**Reg. No. 3,497,864**

**United States Patent and Trademark Office**

**Registered Sep. 9, 2008**

**TRADEMARK  
SERVICE MARK  
PRINCIPAL REGISTER**

**THINK USTER - THINK QUALITY**

USTER TECHNOLOGIES AG (SWITZERLAND CORPORATION)  
11 WILSTRASSE  
USTER, SWITZERLAND 8610

FOR: TEXTILE-SPINNING MACHINES AND PARTS THEREOF, NAMELY, FRONT PANELS AND DISPLAYS; SPINDLES AND WINDING POSITIONS BEING PARTS OF MACHINES; POWER WINDING MACHINES FOR YARN; POWER LOOMS AND PARTS THEREOF, NAMELY, FRONT PANELS AND DISPLAYS; MACHINE PARTS IN THE NATURE OF REELS AND BOBBINS FOR LOOMS; MACHINE PARTS IN THE NATURE OF SHUTTLES FOR LOOMS; POWER KNITTING MACHINES AND PARTS THEREOF, NAMELY, FRONT PANELS AND DISPLAYS; KNIVES BEING PARTS OF MACHINES, IN CLASS 7 (U.S. CLS. 13, 19, 21, 23, 31, 34 AND 35).

FOR: TEXTILE TESTING MACHINES, NAMELY, MACHINES FOR DETERMINING PROPERTIES OF TEXTILE MATERIALS AND PRODUCTS, AND AUTOMATIC YARN STRENGTH TESTERS, AND NEP TESTER MACHINES; MEASURING, WEIGHING, TESTING AND ANALYZING APPARATUS AND INSTRUMENTS, NAMELY, DEVICES FOR MONITORING AND TESTING OF TEXTILE MATERIALS AND OF TEXTILE PRODUCTS, DEVICES FOR TESTING OF TEXTILE FIBERS, DEVICES FOR MONITORING AND TESTING TEXTILE SLIVER AND ROVING; TESTERS IN THE NATURE OF YARN DETECTORS AND YARN CLEARERS, YARN TESTERS AND DEVICES FOR MONITORING AND TESTING WOVEN AND KNITTED FABRICS; DIAGNOSTIC APPARATUS, NOT FOR MEDICAL PURPOSES, NAMELY, FOR SERVICING AND CALIBRATION OF MACHINES FOR USE IN THE TEXTILE INDUSTRY; BLANK MAGNETIC, OPTICAL, ELECTRIC OR MAGNETO-OPTICAL

DATA CARRIERS, AND PRERECORDED MAGNETIC, OPTICAL, ELECTRIC OR MAGNETO-OPTICAL DATA CARRIERS FEATURING INFORMATION AND DATA RELATED TO THE TEXTILE INDUSTRY; DATA PROCESSORS; COMPUTERS; COMPUTER PROGRAMS AND SOFTWARE FOR MACHINE CONTROL, PROCESS CONTROL, DATA EVALUATION, REPRESENTATION OF DATA AND QUALITY MANAGEMENT IN THE TEXTILE FIELD, IN CLASS 9 (U.S. CLS. 21, 23, 26, 36 AND 38).

FOR: PRINTED MATTER, NAMELY, MAGAZINES FEATURING TEXTILE MATERIALS, TEXTILE PRODUCTS AND TEXTILE QUALITY CONTROL, AND SERIES OF NONFICTION BOOKS FEATURING TEXTILE MATERIALS, TEXTILE PRODUCTS AND TEXTILE QUALITY CONTROL, AWARDS, CHARTS, EMBLEMS, FORMS, GUIDES FOR TEXTILE MATERIALS, TEXTILE PRODUCTS AND TEXTILE QUALITY CONTROL, INVITATIONS, PAPER LABELS, MAIL RESPONSE CARDS RELATING TO TEXTILE MATERIALS, TEXTILE PRODUCTS AND TEXTILE QUALITY CONTROL, SEMINAR NOTES, SURVEY ANSWER SHEETS, TABLES CONCERNING TEXTILE MATERIALS, TEXTILE PRODUCTS AND TEXTILE QUALITY CONTROL; GRAPHIC REPRESENTATIONS IN THE NATURE OF PRINTED CHARTS OF STATISTICAL DATA RELATED TO TEXTILE MATERIALS, TEXTILE PRODUCTS AND TEXTILE QUALITY CONTROL; PRINTED INSTRUCTIONAL AND TEACHING MATERIAL FOR TEXTILE MATERIALS, TEXTILE PRODUCTS AND TEXTILE QUALITY CONTROL; JOURNALS CONCERNING TEXTILE MATERIALS, TEXTILE PRODUCTS AND TEXTILE QUALITY CONTROL, NEWSLETTERS, MANUALS AND CATALOGUES, ALL RELATED



TO THE TEXTILE INDUSTRY; WRAPPING PAPER, IN CLASS 16 (U.S. CLS. 2, 5, 22, 23, 29, 37, 38 AND 50).

FOR: BUSINESS CONSULTING, BUSINESS AUDITING AND BUSINESS MANAGEMENT ASSISTANCE, ALL RELATED TO TEXTILE MILLS; COMPILATION OF STATISTICS RELATED TO TEXTILE MATERIALS AND PRODUCTS; COMPILATION OF INFORMATION RELATED TO TEXTILE MATERIALS AND PRODUCTS INTO COMPUTER DATABASES, IN CLASS 35 (U.S. CLS. 100, 101 AND 102).

FOR: INSTALLATION, MAINTENANCE, SUPPORT IN THE NATURE OF PROVIDING TECHNICAL ADVICE, AND REPAIR OF TEXTILE MACHINES AND APPARATUS; INSTALLATION, MAINTENANCE, SUPPORT IN THE NATURE OF PROVIDING TECHNICAL ADVICE, AND REPAIR OF MEASURING, WEIGHING, TESTING AND ANALYZING APPARATUS AND INSTRUMENTS IN THE FIELD OF TEXTILES; INSTALLATION, MAINTENANCE, SUPPORT IN THE NATURE OF PROVIDING TECHNICAL ADVICE, AND REPAIR OF DEVICES FOR MONITORING AND TESTING TEXTILE MATERIALS AND PRODUCTS; INSTALLATION, MAINTENANCE, SUPPORT IN THE NATURE OF PROVIDING TECHNICAL ADVICE, AND REPAIR OF COMPUTER HARDWARE, IN CLASS 37 (U.S. CLS. 100, 103 AND 106).

FOR: EDUCATIONAL SERVICES, NAMELY, CONDUCTING CLASSES, SEMINARS, CONFERENCES AND WORKSHOPS IN THE FIELD OF TEXTILES, AND TRAINING SERVICES IN THE FIELD OF TEXTILES; INSTRUCTION AND TEACHING IN THE TEXTILE FIELD; ARRANGING AND CONDUCTING OF WORKSHOPS, COLLOQUIUMS AND CONFERENCES IN THE TEXTILE FIELD; PUBLI-

CATION OF BOOKS, OF TEXTS, AND OF PRINTED MATTER FEATURING STATISTICAL DATA AND GRAPHIC REPRESENTATIONS; PUBLICATION OF ELECTRONIC BOOKS, OF ELECTRONIC TEXTS, AND OF ELECTRONIC MATTER FEATURING STATISTICAL DATA AND GRAPHIC REPRESENTATIONS, IN CLASS 41 (U.S. CLS. 100, 101 AND 107).

FOR: ANALYSIS AND TESTING FOR OTHERS OF TEXTILE MATERIALS AND PRODUCTS; QUALITY CONTROL FOR OTHERS IN THE TEXTILE FIELD; TEXTILE TESTING; EVALUATION, GRADING AND CLASSIFICATION OF TEXTILE MATERIALS AND PRODUCTS, NAMELY, QUALITY TESTING FOR OTHERS; COMPUTER SOFTWARE CONSULTANCY; COMPUTER SOFTWARE DESIGN AND DEVELOPMENT; INSTALLATION, MAINTENANCE, SUPPORT AND UPDATING OF COMPUTER SOFTWARE; CONSULTANCY IN THE FIELD OF COMPUTER HARDWARE; CALIBRATION IN THE NATURE OF ADJUSTMENT AND INCHING OF APPARATUS FOR THE TEXTILE INDUSTRY, IN CLASS 42 (U.S. CLS. 100 AND 101).

THE MARK CONSISTS OF STANDARD CHARACTERS WITHOUT CLAIM TO ANY PARTICULAR FONT, STYLE, SIZE, OR COLOR.

PRIORITY CLAIMED UNDER SEC. 44(D) ON SWITZERLAND APPLICATION NO. 52134/2007, FILED 2-26-2007, REG. NO. 560421, DATED 7-20-2007, EXPIRES 2-26-2017.

OWNER OF U.S. REG. NOS. 1,189,773 AND 1,738,081.

SER. NO. 77-212,952, FILED 6-22-2007.

BRENDAN REGAN, EXAMINING ATTORNEY

**Int. Cl.: 10**

**Prior U.S. Cls.: 26, 39 and 44**

**United States Patent and Trademark Office**

**Reg. No. 3,497,865**

**Registered Sep. 9, 2008**

**TRADEMARK  
PRINCIPAL REGISTER**

**FLESHJACK**

SHUBIN, STEVE (UNITED STATES INDIVIDUAL)  
300 TEXAS LONGHORN TRAIL  
DRIPPING SPRINGS, TX 78620

FOR: ADULT SEXUAL AIDS, NAMELY, MASTURBATION SLEEVES THAT ALLOW FOR THE DISCREET COLLECTION OF HUMAN SPERM, IN CLASS 10 (U.S. CLS. 26, 39 AND 44).

FIRST USE 4-26-2007; IN COMMERCE 4-26-2007.

THE MARK CONSISTS OF STANDARD CHARACTERS WITHOUT CLAIM TO ANY PARTICULAR FONT, STYLE, SIZE, OR COLOR.

SER. NO. 77-213,165, FILED 6-22-2007.

JASON LOTT, EXAMINING ATTORNEY

**Int. Cl.: 10**

**Prior U.S. Cls.: 26, 39 and 44**

**United States Patent and Trademark Office**

**Reg. No. 3,497,866**

**Registered Sep. 9, 2008**

**TRADEMARK  
PRINCIPAL REGISTER**

SHUBIN, STEVE (UNITED STATES INDIVIDUAL)  
300 TEXAS LONGHORN TRAIL  
DRIPPING SPRINGS, TX 78620

FIRST USE 4-26-2007; IN COMMERCE 4-26-2007.

SER. NO. 77-213,769, FILED 6-22-2007.

FOR: ADULT SEXUAL AIDS, NAMELY, MASTURBATION SLEEVES THAT ALLOW FOR THE DISCREET COLLECTION OF HUMAN SPERM, IN CLASS 10 (U.S. CLS. 26, 39 AND 44).

JASON LOTT, EXAMINING ATTORNEY

**Int. Cls.: 9, 38, 40 and 42**

**Prior U.S. Cls.: 21, 23, 26, 36, 38, 100, 101, 103, 104  
and 106**

**Reg. No. 3,497,867**

**United States Patent and Trademark Office**

**Registered Sep. 9, 2008**

**TRADEMARK  
SERVICE MARK  
PRINCIPAL REGISTER**

# PutPlace

SECANTHUS LIMITED (IRELAND LIMITED  
LIABILITY COMPANY)  
THE DIGITAL DEPOT, 4 ROE LANE  
DUBLIN, IRELAND 8

FOR: COMPUTER PROGRAMMES FOR DOCUMENT MANAGEMENT; COMPUTER JOYSTICKS; COMPUTER DATABASE MANAGEMENT SOFTWARE FOR USE IN PERSONALIZING THE CONTENT OF EMAIL COMMUNICATIONS; COMPUTER GROUPWARE FOR SHARING DIGITAL CONTENT; COMPUTER HARDWARE; COMPUTER PROGRAMS FOR EDITING IMAGES, SOUND AND VIDEO; COMPUTER PROGRAMS FOR SEARCHING THE CONTENTS OF COMPUTERS AND COMPUTER NETWORKS BY REMOTE CONTROL; COMPUTER SEARCH ENGINE SOFTWARE; COMPUTER SOFTWARE FOR ACCESSING INFORMATION DIRECTORIES THAT MAY BE DOWNLOADED FROM THE GLOBAL COMPUTER NETWORK; COMPUTER SOFTWARE FOR APPLICATION AND DATABASE INTEGRATION; COMPUTER SOFTWARE FOR COMMUNICATING WITH USERS OF HAND-HELD COMPUTERS; COMPUTER SOFTWARE FOR CREATING SEARCHABLE DATABASES OF INFORMATION AND DATA; COMPUTER SOFTWARE FOR MANIPULATING DIGITAL AUDIO INFORMATION FOR USE IN AUDIO MEDIA APPLICATIONS; COMPUTER SOFTWARE FOR PROCESSING DIGITAL MUSIC FILES; COMPUTER SOFTWARE FOR THE COLLECTION, EDITING, ORGANIZING, MODIFYING, BOOK MARKING, TRANSMISSION, STORAGE AND SHARING OF DATA AND INFORMATION; COMPUTER SOFTWARE FOR USE IN RELATION TO DIGITAL ANIMATION AND SPECIAL EFFECTS OF IMAGES; COMPUTER SOFTWARE FOR USE IN THE ENCRYPTION AND DECRYPTION OF DIGITAL FILES, INCLUDING AUDIO, VIDEO, TEXT, BINARY, STILL IMAGES,

GRAPHICS AND MULTIMEDIA FILES; COMPUTER SOFTWARE FOR USE IN THE SAFEGUARDING OF DIGITAL FILES, INCLUDING AUDIO, VIDEO, TEXT, BINARY, STILL IMAGES, GRAPHICS AND MULTIMEDIA FILES; COMPUTER SOFTWARE FOR ENCRYPTION AND DECRYPTION OF, AND RETRIEVING AND/OR PUBLISHING OF, DIGITAL CONTENT THAT MAY BE DOWNLOADED FROM A GLOBAL COMPUTER NETWORK; COMPUTER SOFTWARE TO ENABLE THE TRANSMISSION OF PHOTOGRAPHS TO MOBILE TELEPHONES; COMPUTER SOFTWARE TO ENHANCE THE AUDIO-VISUAL CAPABILITIES OF MULTIMEDIA APPLICATIONS, NAMELY, FOR THE INTEGRATION OF TEXT, AUDIO, GRAPHICS, STILL IMAGES AND MOVING PICTURES; COMPUTER STORAGE DEVICES, NAMELY, FLASH DRIVES; COMPUTER STORAGE DEVICES, NAMELY, COMPUTER FLASH DRIVES; COMPUTER STORAGE DEVICES, NAMELY, THUMB DRIVES; DATABASE MANAGEMENT SOFTWARE FOR DIGITAL CONTENT; DESKTOP PUBLISHING SOFTWARE; ENTERTAINMENT SYSTEM COMPRISING A COMPUTER, MULTIPLE DISPLAY DISPLAY SCREEN, MULTIPLE INPUT DEVICES AND A PRINTER; INTERACTIVE MULTIMEDIA COMPUTER PROGRAM FOR DIGITAL CONTENT SHARING AND MANAGEMENT; SOFTWARE FOR PROCESSING DIGITAL IMAGES OF THE ANATOMY FOR DIAGNOSIS AND TREATMENT; SOFTWARE FOR PROCESSING IMAGES, GRAPHICS AND TEXT, IN CLASS 9 (U.S. CLS. 21, 23, 26, 36 AND 38).

FIRST USE 7-14-2006; IN COMMERCE 7-14-2006.

FOR: COMMUNICATION SERVICES, NAMELY, ELECTRONIC TRANSMISSION OF DATA AND DOCUMENTS AMONG USERS OF COMPUTERS;

COMMUNICATIONS BY COMPUTER TERMINALS; ELECTRONIC DELIVERY OF IMAGES AND PHOTOGRAPHS VIA A GLOBAL COMPUTER NETWORK; ELECTRONIC TRANSMISSION OF DATA AND DOCUMENTS VIA COMPUTER TERMINALS; ON-LINE DOCUMENT DELIVERY VIA A GLOBAL COMPUTER NETWORK; PROVIDING MULTIPLE USE ACCESS TO GLOBAL COMPUTER INFORMATION NETWORKS FOR THE TRANSFER AND DISSEMINATION OF A WIDE RANGE OF INFORMATION; PROVIDING MULTIPLE-USER ACCESS TO A GLOBAL COMPUTER INFORMATION NETWORK; PROVIDING ON-LINE CHAT ROOMS FOR TRANSMISSION OF MESSAGES AMONG COMPUTER USERS CONCERNING DIGITAL CONTENT; PROVIDING ON-LINE ELECTRONIC BULLETIN BOARDS FOR TRANSMISSION OF MESSAGES AMONG COMPUTER USERS CONCERNING DIGITAL CONTENT; PROVIDING ON-LINE FORUMS FOR TRANSMISSION OF MESSAGES AMONG COMPUTER USERS CONCERNING DIGITAL CONTENT; PROVIDING ON-LINE LISTSERVERS FOR TRANSMISSION OF MESSAGES AMONG COMPUTER USERS CONCERNING DIGITAL CONTENT; PROVIDING PRIVATE AND SECURE REAL TIME ELECTRONIC COMMUNICATION OVER A COMPUTER NETWORK; RENTAL OF ACCESS TIME TO GLOBAL COMPUTER NETWORKS; RENTAL OF TELEPROCESSING AND COMPUTER COMMUNICATION APPARATUS AND INSTRUMENTS; TRANSMISSION OF INFORMATION VIA COMPUTERS CONNECTED TO THE SAME TELEMATIC NETWORK, IN CLASS 38 (U.S. CLS. 100, 101 AND 104).

FIRST USE 7-14-2006; IN COMMERCE 7-14-2006.

FOR: DIGITAL COMPRESSION OF DIGITAL CONTENT; ELECTRONIC DIGITIZING OF PHOTOGRAPHS INTO A COMPUTER READABLE MEDIA; PHOTOGRAPHIC COMPUTER IMAGING, IN CLASS 40 (U.S. CLS. 100, 103 AND 106).

FIRST USE 7-14-2006; IN COMMERCE 7-14-2006.

FOR: ADVISORY SERVICES IN THE FIELD OF PRODUCT DEVELOPMENT AND QUALITY IMPROVEMENT OF SOFTWARE; APPLICATION SERVICE PROVIDER (ASP) FEATURING SOFTWARE FOR USE IN SHARING AND MANAGING DIGITAL CONTENT; APPLICATION SERVICE PROVIDER (ASP), NAMELY, HOSTING COMPUTER SOFTWARE APPLICATIONS OF OTHERS; COMPUTER CONSULTATION; COMPUTER DISASTER RECOVERY PLANNING; COMPUTER GRAPHICS SERVICES; COMPUTER SERVICES, NAMELY, MONITORING AND REPORTING ON THE PERFORMANCE, AVAILABILITY, AND ERRORS OF WEBSITES OF OTHERS; COMPUTER SERVICES, NAMELY, COMPUTER SYSTEM ADMINISTRATION FOR OTHERS; COMPUTER SERVICES,

NAMELY, CREATING AN ONLINE COMMUNITY FOR REGISTERED USERS TO PARTICIPATE IN COMPETITIONS, SHOWCASE THEIR SKILLS, GET FEEDBACK FROM THEIR PEERS, FORM VIRTUAL COMMUNITIES, ENGAGE IN SOCIAL NETWORKING AND IMPROVE THEIR TALENT; COMPUTER SERVICES, NAMELY, CREATING AND MAINTAINING WEB SITES FOR OTHERS; COMPUTER SERVICES, NAMELY, DATA RECOVERY SERVICES; COMPUTER SERVICES, NAMELY, DESIGNING AND IMPLEMENTING NETWORK WEB PAGES FOR OTHERS; COMPUTER SERVICES, NAMELY, DESIGNING AND IMPLEMENTING WEB SITES FOR OTHERS; COMPUTER SERVICES, NAMELY, HOSTING ON-LINE WEB FACILITIES FOR OTHERS FOR ORGANIZING AND CONDUCTING ONLINE MEETINGS, GATHERINGS, AND INTERACTIVE DISCUSSIONS; COMPUTER SERVICES, NAMELY, PROVIDING SEARCH ENGINES FOR OBTAINING DATA ON A GLOBAL COMPUTER NETWORK; COMPUTER SERVICES, NAMELY, UPLOADING MUSIC TO THE INTERNET FOR OTHERS; COMPUTER SOFTWARE CONSULTANCY; COMPUTER SOFTWARE CONSULTATION; COMPUTER SOFTWARE DESIGN FOR OTHERS; DATA CONVERSION OF COMPUTER PROGRAM DATA OR INFORMATION; DESIGN, DEVELOPMENT AND IMPLEMENTATION OF SOFTWARE; DEVELOPMENT, UPDATING AND MAINTENANCE OF SOFTWARE AND DATA BASES; DISPLAYING THE WEB SITES AND IMAGES OF OTHERS ON A COMPUTER SERVER; DOCUMENT DATA TRANSFER FROM ONE COMPUTER FORMAT TO ANOTHER; DUPLICATING COMPUTER PROGRAMS; DUPLICATION OF COMPUTER PROGRAMS; IMAGE PROCESSING SOFTWARE DESIGN; INSTALLATION OF COMPUTER SOFTWARE; MAINTENANCE OF COMPUTER SOFTWARE; PROVIDING ON-LINE NON-DOWNLOADABLE SOFTWARE FOR DIGITAL CONTENT SHARING AND MANAGEMENT; RECOVERY OF COMPUTER DATA; TECHNICAL SUPPORT SERVICES, NAMELY, TROUBLESHOOTING OF COMPUTER HARDWARE AND SOFTWARE PROBLEMS; TECHNICAL SUPPORT SERVICES, NAMELY, TROUBLESHOOTING OF COMPUTER SOFTWARE PROBLEMS; TECHNICAL SUPPORT, NAMELY, PROVIDING BACK-UP COMPUTER PROGRAMS AND FACILITIES, IN CLASS 42 (U.S. CLS. 100 AND 101).

FIRST USE 7-14-2006; IN COMMERCE 7-14-2006.

THE MARK CONSISTS OF STANDARD CHARACTERS WITHOUT CLAIM TO ANY PARTICULAR FONT, STYLE, SIZE, OR COLOR.

SER. NO. 77-215,232, FILED 6-26-2007.

JUDITH HELFMAN, EXAMINING ATTORNEY

Int. Cl.: 29

Prior U.S. Cl.: 46

United States Patent and Trademark Office

Reg. No. 3,497,868

Registered Sep. 9, 2008

TRADEMARK  
PRINCIPAL REGISTER



OCEAN GOURMET SEAFOOD INC. (DELA-  
WARE CORPORATION)  
4400 ROUTE 9 S STE 1000  
FREEHOLD, NJ 077281383

FOR: FROZEN SEAFOOD, NAMELY, FISH  
STEAKS, FILLETS OF FISH, SCALLOPS, SHRIMP,  
PRE-PACKAGED DINNERS CONSISTING PRI-  
MARILY OF SEAFOOD, IN CLASS 29 (U.S. CL. 46).

FIRST USE 12-6-2007; IN COMMERCE 12-6-2007.

NO CLAIM IS MADE TO THE EXCLUSIVE  
RIGHT TO USE "GOURMET SEAFOOD", APART  
FROM THE MARK AS SHOWN.

SER. NO. 77-215,685, FILED 6-26-2007.

CHRISTOPHER BUONGIORNO, EXAMINING AT-  
TORNEY

**Int. Cl.: 16**

**Prior U.S. Cls.: 2, 5, 22, 23, 29, 37, 38 and 50**

**United States Patent and Trademark Office**

**Reg. No. 3,497,869**

**Registered Sep. 9, 2008**

**TRADEMARK  
PRINCIPAL REGISTER**

**WAY UP**

KONECRANES PLC (FINLAND PUBLIC LIMITED COMPANY (PLC))  
KONEENKATU 8  
FI-05830 HYVINKÄÄ, FINLAND

PRIORITY CLAIMED UNDER SEC. 44(D) ON  
ERPN CMNTY TM OFC APPLICATION NO.  
005931548, FILED 5-24-2007, REG. NO. 005931548,  
DATED 3-4-2008, EXPIRES 5-24-2017.

FOR: HOUSE ORGANS, IN CLASS 16 (U.S. CLS. 2,  
5, 22, 23, 29, 37, 38 AND 50).

SER. NO. 77-216,959, FILED 6-27-2007.

THE MARK CONSISTS OF STANDARD CHARACTERS WITHOUT CLAIM TO ANY PARTICULAR FONT, STYLE, SIZE, OR COLOR.

JUSTINE D. PARKER, EXAMINING ATTORNEY

**Int. Cls.: 35 and 39**

**Prior U.S. Cls.: 100, 101, 102 and 105**

**United States Patent and Trademark Office**

**Reg. No. 3,497,870**

**Registered Sep. 9, 2008**

**SERVICE MARK  
PRINCIPAL REGISTER**

**AJC INTERNATIONAL**

AJC INTERNATIONAL, INC. (GEORGIA CORPORATION)  
5188 ROSWELL ROAD  
ATLANTA, GA 30342

FOR: BUSINESS CONSULTING IN THE FIELD OF FOOD PRODUCTS AND EXPORT AND IMPORT DISTRIBUTION SERVICES IN THE FIELD OF FOOD PRODUCTS, IN CLASS 35 (U.S. CLS. 100, 101 AND 102).

FIRST USE 8-3-1987; IN COMMERCE 8-3-1987.

FOR: PROVIDING OCEAN TRANSPORTATION, STORAGE AND DELIVERY SERVICES; TRANSPORTATION LOGISTICS SERVICES, NAMELY, ARRANGING THE TRANSPORTATION OF GOODS FOR OTHERS; AND PROVIDING NON-VESSEL

OPERATING COMMON CARRIER (NVOCC) SERVICES, IN CLASS 39 (U.S. CLS. 100 AND 105).

FIRST USE 4-28-2003; IN COMMERCE 4-28-2003.

THE MARK CONSISTS OF STANDARD CHARACTERS WITHOUT CLAIM TO ANY PARTICULAR FONT, STYLE, SIZE, OR COLOR.

OWNER OF U.S. REG. NO. 2,083,131.

NO CLAIM IS MADE TO THE EXCLUSIVE RIGHT TO USE "INTERNATIONAL", APART FROM THE MARK AS SHOWN.

SER. NO. 77-217,070, FILED 6-27-2007.

KIMBERLY KREHELY, EXAMINING ATTORNEY



**Int. Cl.: 36**

**Prior U.S. Cls.: 100, 101 and 102**

**United States Patent and Trademark Office**

**Reg. No. 3,497,871**

**Registered Sep. 9, 2008**

**SERVICE MARK  
PRINCIPAL REGISTER**

PROVIDENCE BY HOMETOWN  
AMERICA

HOMETOWN AMERICA, L.L.C. (DELAWARE  
LIMITED LIABILITY COMPANY)

SUITE 2800

150 NORTH WACKER DRIVE

CHICAGO, IL 60606

FOR: REAL ESTATE MANAGEMENT, NAMELY,  
MANAGEMENT OF MANUFACTURED HOUSING  
COMMUNITIES, IN CLASS 36 (U.S. CLS. 100, 101  
AND 102).

FIRST USE 11-1-2003; IN COMMERCE 11-1-2003.

THE MARK CONSISTS OF STANDARD CHAR-  
ACTERS WITHOUT CLAIM TO ANY PARTICULAR  
FONT, STYLE, SIZE, OR COLOR.

OWNER OF U.S. REG. NOS. 2,337,580, 3,210,433,  
AND 3,214,947.

NO CLAIM IS MADE TO THE EXCLUSIVE  
RIGHT TO USE "AMERICA", APART FROM THE  
MARK AS SHOWN.

SER. NO. 77-217,076, FILED 6-27-2007.

PATRICIA EVANKO, EXAMINING ATTORNEY

Int. Cl.: 43

Prior U.S. Cls.: 100 and 101

United States Patent and Trademark Office

Reg. No. 3,497,872

Registered Sep. 9, 2008

SERVICE MARK  
PRINCIPAL REGISTER



JAMAICO, INC. (GUAM CORPORATION)  
SUITE 800 - AIRPORT INDUSTRIAL CENTER  
165 SKYLINE DRIVE  
TAMUNING, GUAM 96913

FOR: RESTAURANTS, CATERING, BAR SERVICES, IN CLASS 43 (U.S. CLS. 100 AND 101).

FIRST USE 6-1-2003; IN COMMERCE 6-1-2003.

OWNER OF U.S. REG. NO. 3,384,957.

NO CLAIM IS MADE TO THE EXCLUSIVE RIGHT TO USE "GRILL" AND "GUAM", APART FROM THE MARK AS SHOWN.

THE COLOR(S) DARK BROWN, LIGHT BROWN, TAN, DARK BLUE, LIGHT BLUE, WHITE, DARK YELLOW, LIGHT YELLOW, DARK GREEN, LIGHT GREEN, RED, PINK, ORANGE, DARK GREY, LIGHT GREY, AND BLACK IS/ARE CLAIMED AS A FEATURE OF THE MARK.

THE MARK CONSISTS OF A MAN WITH LIGHT BROWN SKIN, DARK BROWN HAIR, DARK BROWN EYEBROWS, WHITE TEETH, WHITE AND BLACK EYES, BLACK LINES ON HIS FACE, WEARING A RED SHIRT WITH WHITE WRITING ON IT THAT READS "GUAM" AND BLUE SHORTS WITH GREEN AND WHITE DESIGNS ON IT, A TAN NECKLACE, BLUE AND WHITE SANDALS, WHITE BRACELET, AND A RED HAT WITH BLACK,

GREEN, AND YELLOW DESIGNS. THE MAN IS STANDING ON A TAN SAND BEACH WITH A DARK BLUE OCEAN AND LIGHT BLUE SKY WITH WHITE CLOUDS AND A YELLOW SETTING SUN IN THE BACKGROUND WITH DARK YELLOW AND ORANGE RAYS. THE MAN IS HOLDING LIGHT GREY TONGS AND IS STANDING IN FRONT OF A GRILL THAT IS DARK AND LIGHT GREY WITH WHITE OUTLINING, HAS DARK BROWN LEGS AND A PINK TOP WITH A BLACK GRILL SHAPE, WITH A LIGHT AND DARK BLUE FISH, A LIGHT BROWN, DARK BROWN, AND TAN CHICKEN LEG, AND RED AND DARK BROWN RIBS. THERE IS A WATERMELON WITH LIGHT AND DARK GREEN SKIN, RED INSIDE, AND BLACK AND WHITE SEEDS, A LIGHT BROWN, LIGHT GREEN, AND DARK GREEN PINEAPPLE WITH BLACK SPECS ON IT, AND A BUNCH OF YELLOW BANANAS ON THE SAND. THE WORD "JAMAICAN" APPEARS IN LIGHT AND DARK GREEN, FADING TO YELLOW AT THE EDGES OF THE LETTERS "J", "A", AND "N", OUTLINED IN BLACK. THE WORD "GRILL" APPEARS IN RED, FADING TO ORANGE AT THE TOP OF EACH LETTER, OUTLINED IN BLACK. THE PHRASE "YA MON" APPEARS IN BLACK IN A WHITE BALLOON OUTLINED IN BLACK TO THE MAN'S RIGHT. THE ENTIRE MARK IS OUTLINED IN BLACK WITH A THICK WHITE INNER BORDER AND A THIN BLACK BORDER WITHIN THE WHITE BORDER.

SEC. 2(F) AS TO "JAMAICAN".

SER. NO. 77-217,335, FILED 6-27-2007.

LINDSEY RUBIN, EXAMINING ATTORNEY

Int. Cl.: 43

Prior U.S. Cls.: 100 and 101

United States Patent and Trademark Office

Reg. No. 3,497,873

Registered Sep. 9, 2008

SERVICE MARK  
PRINCIPAL REGISTER



HARMAN, PETER (UNITED STATES INDIVIDUAL), DBA FOOD GURU  
610 N 4TH STREET, SUITE 400  
BURLINGTON, IA 52601

NO CLAIM IS MADE TO THE EXCLUSIVE RIGHT TO USE "FOOD", APART FROM THE MARK AS SHOWN.

FOR: RESTAURANT, BAR AND COCKTAIL LOUNGE SERVICES, IN CLASS 43 (U.S. CLS. 100 AND 101).

SER. NO. 77-219,229, FILED 6-29-2007.

FIRST USE 3-1-2007; IN COMMERCE 3-1-2007.

ODESSA BIBBINS, EXAMINING ATTORNEY

Int. Cl.: 2

Prior U.S. Cls.: 6, 11 and 16

United States Patent and Trademark Office

Reg. No. 3,497,874

Registered Sep. 9, 2008

TRADEMARK  
PRINCIPAL REGISTER



SAFE FOR  
PEOPLE



SAFE FOR  
PETS



SAFE FOR  
*the* EARTH

SOUTHERN DIVERSIFIED PRODUCTS, LLC  
(MISSISSIPPI LIMITED LIABILITY COMPAN-  
NY)  
2714 HARDY STREET  
HATTIESBURG, MS 39401

FOR: PAINTS; INTERIOR PAINT; EXTERIOR  
PAINT; HOUSE PAINT, IN CLASS 2 (U.S. CLS. 6, 11  
AND 16).

FIRST USE 6-22-2007; IN COMMERCE 6-22-2007.

NO CLAIM IS MADE TO THE EXCLUSIVE  
RIGHT TO USE "SAFE FOR PEOPLE", "SAFE FOR

PETS" OR "SAFE FOR THE EARTH", APART FROM  
THE MARK AS SHOWN.

THE MARK CONSISTS OF THE WORDS "SAFE  
FOR PEOPLE SAFE FOR PETS SAFE FOR THE  
EARTH" TOGETHER WITH DRAWINGS OF A  
CHILD WEARING A CAP, A PET ANIMAL AND A  
GLOBE.

SER. NO. 77-219,382, FILED 6-29-2007.

VERNA BETH RIRIE, EXAMINING ATTORNEY

**Int. Cl.: 2**

**Prior U.S. Cls.: 6, 11 and 16**

**United States Patent and Trademark Office**

**Reg. No. 3,497,875**

**Registered Sep. 9, 2008**

**TRADEMARK  
PRINCIPAL REGISTER**

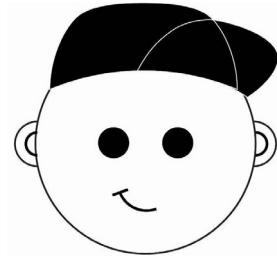

**SAFE FOR  
PEOPLE**

SOUTHERN DIVERSIFIED PRODUCTS, LLC  
(MISSISSIPPI LIMITED LIABILITY COMPAN-  
NY)  
2714 HARDY STREET  
HATTIESBURG, MS 39401

FOR: PAINTS; INTERIOR PAINT; EXTERIOR  
PAINT; HOUSE PAINT, IN CLASS 2 (U.S. CLS. 6, 11  
AND 16).

FIRST USE 6-22-2007; IN COMMERCE 6-22-2007.

NO CLAIM IS MADE TO THE EXCLUSIVE  
RIGHT TO USE "SAFE FOR PEOPLE", APART  
FROM THE MARK AS SHOWN.

THE MARK CONSISTS OF THE WORDS "SAFE  
FOR PEOPLE" TOGETHER WITH A DRAWING OF  
A CHILD WEARING A CAP.

SER. NO. 77-219,384, FILED 6-29-2007.

VERNA BETH RIRIE, EXAMINING ATTORNEY

**Int. Cl.: 2**

**Prior U.S. Cls.: 6, 11 and 16**

**United States Patent and Trademark Office**

**Reg. No. 3,497,876**

**Registered Sep. 9, 2008**

**TRADEMARK  
PRINCIPAL REGISTER**



SOUTHERN DIVERSIFIED PRODUCTS, LLC  
(MISSISSIPPI LIMITED LIABILITY COMPAN-  
NY)  
2714 HARDY STREET  
HATTIESBURG, MS 39401

FOR: PAINTS; INTERIOR PAINT; EXTERIOR  
PAINT; HOUSE PAINT, IN CLASS 2 (U.S. CLS. 6, 11  
AND 16).

FIRST USE 6-22-2007; IN COMMERCE 6-22-2007.

NO CLAIM IS MADE TO THE EXCLUSIVE  
RIGHT TO USE "SAFE FOR PETS", APART FROM  
THE MARK AS SHOWN.

THE MARK CONSISTS OF THE WORDS "SAFE  
FOR PETS" TOGETHER WITH A DRAWING OF A  
PET ANIMAL.

SER. NO. 77-219,386, FILED 6-29-2007.

VERNA BETH RIRIE, EXAMINING ATTORNEY

**Int. Cl.: 2**

**Prior U.S. Cls.: 6, 11 and 16**

**United States Patent and Trademark Office**

**Reg. No. 3,497,877**

**Registered Sep. 9, 2008**

**TRADEMARK  
PRINCIPAL REGISTER**



**SAFE FOR  
*the* EARTH**

SOUTHERN DIVERSIFIED PRODUCTS, LLC  
(MISSISSIPPI LIMITED LIABILITY COMPAN-  
NY)  
2714 HARDY STREET  
HATTIESBURG, MS 39401

FOR: PAINTS; INTERIOR PAINT; EXTERIOR  
PAINT; HOUSE PAINT, IN CLASS 2 (U.S. CLS. 6, 11  
AND 16).

FIRST USE 6-22-2007; IN COMMERCE 6-22-2007.

NO CLAIM IS MADE TO THE EXCLUSIVE  
RIGHT TO USE "SAFE FOR THE EARTH", APART  
FROM THE MARK AS SHOWN.

THE MARK CONSISTS OF THE WORDS "SAFE  
FOR THE EARTH" TOGETHER WITH A DRAWING  
OF A GLOBE.

SER. NO. 77-219,387, FILED 6-29-2007.

VERNA BETH RIRIE, EXAMINING ATTORNEY



**Int. Cl.: 41**

**Prior U.S. Cls.: 100, 101 and 107**

**United States Patent and Trademark Office**

**Reg. No. 3,497,878**

**Registered Sep. 9, 2008**

**SERVICE MARK  
PRINCIPAL REGISTER**

HAMILTON BEHIND THE CAMERA  
AWARDS

THE SWATCH GROUP (U.S.) INC. (DELAWARE  
CORPORATION)  
1200 HARBOR BOULEVARD, 7TH FLOOR  
WEEHAWKEN, NJ 07087

FOR: CULTURAL ACTIVITIES IN THE NATURE  
OF CONDUCTING COMPETITIONS OF EXHIBI-  
TIONS AND ORGANIZING AWARD CEREMONIES,  
IN CLASS 41 (U.S. CLS. 100, 101 AND 107).

FIRST USE 11-12-2006; IN COMMERCE 11-12-2006.

THE MARK CONSISTS OF STANDARD CHAR-  
ACTERS WITHOUT CLAIM TO ANY PARTICULAR  
FONT, STYLE, SIZE, OR COLOR.

NO CLAIM IS MADE TO THE EXCLUSIVE  
RIGHT TO USE "AWARDS", APART FROM THE  
MARK AS SHOWN.

SER. NO. 77-219,418, FILED 6-29-2007.

JULIE GUTTADAURO, EXAMINING ATTORNEY

**Int. Cl.: 41**

**Prior U.S. Cls.: 100, 101 and 107**

**United States Patent and Trademark Office**

**Reg. No. 3,497,879**

**Registered Sep. 9, 2008**

**SERVICE MARK  
PRINCIPAL REGISTER**

**SPORTSLINK**

DAKTRONICS, INC. (SOUTH DAKOTA COR-  
PORATION)  
331 32ND AVENUE  
P.O. BOX 5128  
BROOKINGS, SD 570065128

FOR: PROVIDING INFORMATION IN THE  
FIELD OF SPORTS VIA THE INTERNET FOR  
LARGE SCREEN VIDEO AND ELECTRONIC DIS-  
PLAYS, IN CLASS 41 (U.S. CLS. 100, 101 AND 107).

FIRST USE 6-21-2007; IN COMMERCE 6-21-2007.

THE MARK CONSISTS OF STANDARD CHAR-  
ACTERS WITHOUT CLAIM TO ANY PARTICULAR  
FONT, STYLE, SIZE, OR COLOR.

OWNER OF U.S. REG. NO. 2,607,429.

SER. NO. 77-220,641, FILED 7-2-2007.

WANDA KAY PRICE, EXAMINING ATTORNEY

**Int. Cl.: 41**

**Prior U.S. Cls.: 100, 101 and 107**

**United States Patent and Trademark Office**

**Reg. No. 3,497,880**

**Registered Sep. 9, 2008**

**SERVICE MARK  
PRINCIPAL REGISTER**

**Villabrille-Largusa Kali  
System**

KALI ASSOCIATION OF AMERICA (CALIFORNIA NON-PROFIT ORGANIZATION)  
P.O. BOX 8185  
FREMONT, CA 94537

FOR: EDUCATIONAL SERVICES, NAMELY, INSTRUCTIONAL CLASSES THAT TEACH, PROMOTE AND PRESERVE THE FUNDAMENTAL FORMS, STANCES, PRINCIPLES, AND THEORY OF THE FILIPINO MARTIAL ART OF KALI BY DEMONSTRATING TECHNIQUES DEVELOPED BY EARLIER GRANDMASTERS, IN CLASS 41 (U.S. CLS. 100, 101 AND 107).

FIRST USE 1-27-1973; IN COMMERCE 1-27-1973.

THE MARK CONSISTS OF STANDARD CHARACTERS WITHOUT CLAIM TO ANY PARTICULAR FONT, STYLE, SIZE, OR COLOR.

NO CLAIM IS MADE TO THE EXCLUSIVE RIGHT TO USE "KALI SYSTEM", APART FROM THE MARK AS SHOWN.

SEC. 2(F).

SER. NO. 77-221,490, FILED 7-3-2007.

JAMES A. RAUEN, EXAMINING ATTORNEY

**Int. Cl.: 41**

**Prior U.S. Cls.: 100, 101 and 107**

**United States Patent and Trademark Office**

**Reg. No. 3,497,881**

**Registered Sep. 9, 2008**

**SERVICE MARK  
PRINCIPAL REGISTER**

**KALI ASSOCIATION OF AMERICA  
FOUNDED IN JANUARY 1973  
VILLABRILLE-LARGUSA KALI  
SYSTEM**

KALI ASSOCIATION OF AMERICA (CALIFORNIA NON-PROFIT ORGANIZATION)  
P.O. BOX 8185  
FREMONT, CA 94537

FOR: EDUCATIONAL SERVICES, NAMELY, INSTRUCTIONAL CLASSES WHICH TEACH, PROMOTE AND PRESERVE THE FILIPINO MARTIAL ART AS THE VILLABRILLE-LARGUSA KALI SYSTEM PROVIDES UNIFORM FUNDAMENTAL FORMS, STANCES, PRINCIPLES AND THEORY IN THE TEACHING, APPLICATION AND DEMONSTRATION OF SPECIFIC TECHNIQUES DEVELOPED BY GRANDMASTERS VILLABRILLE AND LARGUSA, IN CLASS 41 (U.S. CLS. 100, 101 AND 107).

FIRST USE 1-27-1973; IN COMMERCE 1-27-1973.

THE MARK CONSISTS OF STANDARD CHARACTERS WITHOUT CLAIM TO ANY PARTICULAR FONT, STYLE, SIZE, OR COLOR.

NO CLAIM IS MADE TO THE EXCLUSIVE RIGHT TO USE "KALI ASSOCIATION OF AMERICA FOUNDED IN JANUARY 1973" AND "KALI SYSTEM" , APART FROM THE MARK AS SHOWN.

SEC. 2(F).

SER. NO. 77-221,504, FILED 7-3-2007.

JAMES A. RAUEN, EXAMINING ATTORNEY

**Int. Cls.: 35 and 45**

**Prior U.S. Cls.: 100, 101 and 102**

**United States Patent and Trademark Office**

**Reg. No. 3,497,882**

**Registered Sep. 9, 2008**

**SERVICE MARK  
PRINCIPAL REGISTER**

**WE MEAN SECURITY**

NEXUM, INC. (ILLINOIS CORPORATION)  
190 S. LASALLE ST., SUITE 1450  
CHICAGO, IL 60603

FOR: VALUE-ADDED RESELLER SERVICES,  
NAMELY, DISTRIBUTORSHIP SERVICES FEATURING  
COMPUTER SECURITY AND INFORMATION TECHNOLOGY  
PRODUCTS; CONSULTING SERVICES FOR BUSINESS  
RISK MANAGEMENT IN THE FIELD OF COMPUTER  
SECURITY, IN CLASS 35 (U.S. CLS. 100, 101 AND 102).

FIRST USE 3-21-2007; IN COMMERCE 3-21-2007.

FOR: MONITORING OF COMPUTER SYSTEMS  
FOR SECURITY PURPOSES, IN CLASS 45 (U.S. CLS.  
100 AND 101).

FIRST USE 3-21-2007; IN COMMERCE 3-21-2007.

THE MARK CONSISTS OF STANDARD CHARACTERS  
WITHOUT CLAIM TO ANY PARTICULAR FONT,  
STYLE, SIZE, OR COLOR.

NO CLAIM IS MADE TO THE EXCLUSIVE  
RIGHT TO USE "SECURITY", APART FROM THE  
MARK AS SHOWN.

SER. NO. 77-221,608, FILED 7-3-2007.

GILBERT SWIFT, EXAMINING ATTORNEY

**Int. Cls.: 35, 41 and 45**

**Prior U.S. Cls.: 100, 101, 102 and 107**

**United States Patent and Trademark Office**

**Reg. No. 3,497,883**

**Registered Sep. 9, 2008**

**SERVICE MARK  
PRINCIPAL REGISTER**

**NEXUM**

NEXUM, INC. (ILLINOIS CORPORATION)  
190 S. LASALLE ST., SUITE 1450  
CHICAGO, IL 60603

FOR: VALUE-ADDED RESELLER SERVICES,  
NAMELY, DISTRIBUTORSHIP SERVICES FEATURING  
COMPUTER SECURITY AND INFORMATION TECHNOLOGY  
PRODUCTS; CONSULTING SERVICES FOR BUSINESS  
RISK MANAGEMENT IN THE FIELD OF COMPUTER  
SECURITY, IN CLASS 35 (U.S. CLS. 100, 101 AND 102).

FIRST USE 4-0-2001; IN COMMERCE 4-0-2001.

FOR: TRAINING SERVICES IN THE FIELD OF  
COMPUTER SECURITY, IN CLASS 41 (U.S. CLS. 100,  
101 AND 107).

FIRST USE 2-0-2003; IN COMMERCE 2-0-2003.

FOR: MONITORING OF COMPUTER SYSTEMS  
FOR SECURITY PURPOSES, IN CLASS 45 (U.S. CLS.  
100 AND 101).

FIRST USE 4-0-2001; IN COMMERCE 4-0-2001.

THE MARK CONSISTS OF STANDARD CHARACTERS  
WITHOUT CLAIM TO ANY PARTICULAR FONT,  
STYLE, SIZE, OR COLOR.

SER. NO. 77-221,612, FILED 7-3-2007.

GILBERT SWIFT, EXAMINING ATTORNEY

**Int. Cls.: 35, 41 and 45**

**Prior U.S. Cls.: 100, 101, 102 and 107**

**United States Patent and Trademark Office**

**Reg. No. 3,497,884**

**Registered Sep. 9, 2008**

**SERVICE MARK  
PRINCIPAL REGISTER**



NEXUM, INC. (ILLINOIS CORPORATION)  
190 S. LASALLE ST., SUITE 1450  
CHICAGO, IL 60603

FOR: VALUE-ADDED RESELLER SERVICES, NAMELY, DISTRIBUTORSHIP SERVICES FEATURING COMPUTER SECURITY AND INFORMATION TECHNOLOGY PRODUCTS; CONSULTING SERVICES FOR BUSINESS RISK MANAGEMENT IN THE FIELD OF COMPUTER SECURITY, IN CLASS 35 (U.S. CLS. 100, 101 AND 102).

FIRST USE 6-0-2005; IN COMMERCE 6-0-2005.

FOR: TRAINING SERVICES IN THE FIELD OF COMPUTER SECURITY, IN CLASS 41 (U.S. CLS. 100, 101 AND 107).

FIRST USE 6-0-2005; IN COMMERCE 6-0-2005.

FOR: MONITORING OF COMPUTER SYSTEMS FOR SECURITY PURPOSES, IN CLASS 45 (U.S. CLS. 100 AND 101).

FIRST USE 6-0-2005; IN COMMERCE 6-0-2005.

THE MARK CONSISTS OF "NEXUM" AND STAR DESIGN.

SER. NO. 77-221,614, FILED 7-3-2007.

GILBERT SWIFT, EXAMINING ATTORNEY

**Int. Cl.: 25**

**Prior U.S. Cls.: 22 and 39**

**United States Patent and Trademark Office**

**Reg. No. 3,497,885**

**Registered Sep. 9, 2008**

**TRADEMARK  
PRINCIPAL REGISTER**

**Dynamic Suspension System**

AURA LLC (NEW YORK LIMITED LIABILITY  
COMPANY)  
82-11 160TH AVENUE  
HOWARD BEACH, NY 11414

NO CLAIM IS MADE TO THE EXCLUSIVE  
RIGHT TO USE "SUSPENSION SYSTEM", APART  
FROM THE MARK AS SHOWN.

FOR: ATHLETIC SHOES, IN CLASS 25 (U.S. CLS.  
22 AND 39).

SEC. 2(F).

FIRST USE 8-26-2002; IN COMMERCE 8-26-2002.

SER. NO. 77-223,090, FILED 7-5-2007.

THE MARK CONSISTS OF STANDARD CHAR-  
ACTERS WITHOUT CLAIM TO ANY PARTICULAR  
FONT, STYLE, SIZE, OR COLOR.

CARYN GLASSER, EXAMINING ATTORNEY



**Int. Cls.: 1, 17 and 40**

**Prior U.S. Cls.: 1, 5, 6, 10, 12, 13, 26, 35, 46, 50, 100,  
103 and 106**

**Reg. No. 3,497,886**

**United States Patent and Trademark Office**

**Registered Sep. 9, 2008**

**TRADEMARK  
SERVICE MARK  
PRINCIPAL REGISTER**

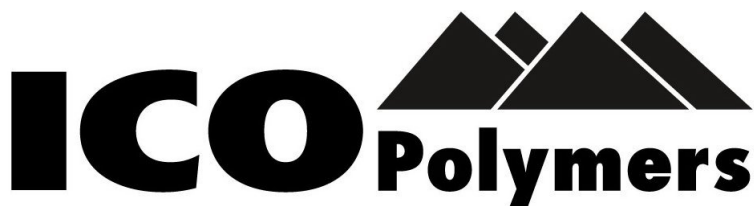

ICO TECHNOLOGY, INC. (DELAWARE COR-  
PORATION)  
SUITE 200  
1811 BERING DRIVE  
HOUSTON, TX 77057

FOR: PLASTIC MOLDING COMPOUNDS FOR  
USE IN THE MANUFACTURE OF MOLDED PLAS-  
TIC ARTICLES; PLASTIC MOLDING COMPOUNDS  
FOR USE IN THE MANUFACTURE OF PLASTIC  
SHEETS AND FILMS; UNPROCESSED PLASTIC IN  
THE FORM OF POWDER OR GRANULES, IN  
CLASS 1 (U.S. CLS. 1, 5, 6, 10, 26 AND 46).

FIRST USE 8-14-2002; IN COMMERCE 8-14-2002.

FOR: PLASTIC IN POWDERED FORM, IN CLASS  
17 (U.S. CLS. 1, 5, 12, 13, 35 AND 50).

FIRST USE 8-14-2002; IN COMMERCE 8-14-2002.

FOR: CONTRACT MANUFACTURING, NAME-  
LY, SIZE REDUCTION AND COMPOUNDING OF  
PLASTIC, RUBBER AND WAX INTO POWDER,  
GRANULES OR PELLETS; MANUFACTURE OF  
PLASTIC POWDERS AND COMPOUNDS TO OR-  
DER AND/OR SPECIFICATION OF OTHERS, IN  
CLASS 40 (U.S. CLS. 100, 103 AND 106).

FIRST USE 8-14-2002; IN COMMERCE 8-14-2002.

NO CLAIM IS MADE TO THE EXCLUSIVE  
RIGHT TO USE "POLYMERS", APART FROM THE  
MARK AS SHOWN.

THE MARK CONSISTS OF "ICO POLYMERS"  
WITH 4 INTERLOCKING TRIANGLES ABOVE THE  
WORD "POLYMERS".

SER. NO. 77-223,354, FILED 7-6-2007.

LESLIE RICHARDS, EXAMINING ATTORNEY

**Int. Cl.: 42**

**Prior U.S. Cls.: 100 and 101**

**United States Patent and Trademark Office**

**Reg. No. 3,497,887**

**Registered Sep. 9, 2008**

**SERVICE MARK  
PRINCIPAL REGISTER**

# Authentage

BOLAND, DEAN (UNITED STATES INDIVIDUAL)  
2070 BROWN ROAD  
LAKEWOOD, OH 44107

FOR: AUTHENTICATION IN THE FIELD OF ELECTRONICALLY STORED INFORMATION, IN CLASS 42 (U.S. CLS. 100 AND 101).

FIRST USE 6-1-2007; IN COMMERCE 6-15-2007.

THE MARK CONSISTS OF STANDARD CHARACTERS WITHOUT CLAIM TO ANY PARTICULAR FONT, STYLE, SIZE, OR COLOR.

SER. NO. 77-224,219, FILED 7-8-2007.

CURTIS FRENCH, EXAMINING ATTORNEY

**Int. Cl.: 41**

**Prior U.S. Cls.: 100, 101 and 107**

**United States Patent and Trademark Office**

**Reg. No. 3,497,888**

**Registered Sep. 9, 2008**

**SERVICE MARK  
PRINCIPAL REGISTER**



ROBERT TAKAC (UNITED STATES INDIVIDUAL)  
C/O MICHAEL LEE JACKSON SUITE 603  
70 WEST CHIPPEWA ST.  
BUFFALO, NY 14202

FOR: ENTERTAINMENT SERVICES, NAMELY, PROVIDING PRERECORDED MUSIC, INFORMATION IN THE FIELD OF MUSIC, AND COMMENTARY AND ARTICLES ABOUT MUSIC, ALL ONLINE VIA A GLOBAL COMPUTER NETWORK, IN CLASS 41 (U.S. CLS. 100, 101 AND 107).

FIRST USE 11-18-2005; IN COMMERCE 11-18-2005.

THE NAME "ROBBY TAKAC" IDENTIFIES A LIVING INDIVIDUAL WHOSE CONSENT IS OF RECORD.

"THE COLOR(S) RED, BLACK, BLUE, PURPLE, WHITE, TAN AND GRAY IS/ARE CLAIMED AS A FEATURE OF THE MARK."

THE MARK CONSISTS OF A CARICATURE OF THE APPLICANT SHOWING RED, BLACK, BLUE AND PURPLE STRIPED HAIR, WITH A TAN FACE, PLAYING A BLACK AND GRAY GUITAR, WITH THE WORDS "ROBBY'S LOBBY" IN BLACK TO THE RIGHT AND THE NAME "TRENDY" SPELLED PHONETICALLY IN JAPANESE TO THE RIGHT OF "ROBBY'S LOBBY" IN A RED CIRCLE.

THE NON-LATIN CHARACTER(S) IN THE MARK TRANSLITERATES INTO "TRENDY", AND THIS MEANS "COOL" IN ENGLISH.

SER. NO. 77-224,253, FILED 7-8-2007.

KAREN K. BUSH, EXAMINING ATTORNEY

**Int. Cls.: 36 and 41**

**Prior U.S. Cls.: 100, 101, 102 and 107**

**United States Patent and Trademark Office**

**Reg. No. 3,497,889**

**Registered Sep. 9, 2008**

**SERVICE MARK  
PRINCIPAL REGISTER**

# INNOVASSION

INNOVASSION, LLC (OHIO LIMITED LIABILITY  
COMPANY)  
625 CANAL ROAD  
WATERVILLE, OH 43566

FOR: CHARITABLE FUNDRAISING; AND  
CHARITABLE FUND RAISING SERVICES, NAME-  
LY, PROVIDING INDIVIDUALS, FAMILIES, AND  
COMPANIES WITH THE INFORMATION AND OP-  
PORTUNITY TO MAKE MONETARY DONATIONS  
TO CHARITIES, IN CLASS 36 (U.S. CLS. 100, 101 AND  
102).

FIRST USE 5-0-2007; IN COMMERCE 5-0-2007.

FOR: PERSONAL COACHING SERVICES FOR  
EXECUTIVES OF NOT-FOR-PROFIT ORGANIZA-  
TIONS IN THE FIELD OF CHARITABLE FUND  
RAISING, IN CLASS 41 (U.S. CLS. 100, 101 AND 107).

FIRST USE 5-0-2007; IN COMMERCE 5-0-2007.

THE MARK CONSISTS OF STANDARD CHAR-  
ACTERS WITHOUT CLAIM TO ANY PARTICULAR  
FONT, STYLE, SIZE, OR COLOR.

SER. NO. 77-225,066, FILED 7-9-2007.

NANCY CLARKE, EXAMINING ATTORNEY

**Int. Cl.: 12**

**Prior U.S. Cls.: 19, 21, 23, 31, 35 and 44**

**United States Patent and Trademark Office**

**Reg. No. 3,497,890**

**Registered Sep. 9, 2008**

**TRADEMARK  
PRINCIPAL REGISTER**

# EVOLUTION

H-D MICHIGAN, INC. (MICHIGAN CORPORATION)  
315 W. HURON, SUITE 400  
ANN ARBOR, MI 48103

FOR: MOTORCYCLE ENGINES, IN CLASS 12  
(U.S. CLS. 19, 21, 23, 31, 35 AND 44).

FIRST USE 7-0-1983; IN COMMERCE 7-0-1983.

THE MARK CONSISTS OF STANDARD CHARACTERS WITHOUT CLAIM TO ANY PARTICULAR FONT, STYLE, SIZE, OR COLOR.

OWNER OF U.S. REG. NO. 1,459,152.

SER. NO. 77-225,437, FILED 7-10-2007.

NAAKWAMA ANKRAH, EXAMINING ATTORNEY

Int. Cl.: 11

Prior U.S. Cls.: 13, 21, 23, 31 and 34

Reg. No. 3,497,891

United States Patent and Trademark Office

Registered Sep. 9, 2008

TRADEMARK  
PRINCIPAL REGISTER



INDEL B S.P.A. (ITALY CORPORATION)  
SANT'AGATA FELTRIA  
LOCALITA CA' BALDONE  
PESARO URBINO, ITALY

FOR: REFRIGERATORS; REFRIGERATION EQUIPMENT, NAMELY, FOOD AND BEVERAGE CHILLING UNITS; ELECTRIC REFRIGERATORS, FOR HOUSEHOLD PURPOSES; ICE-COOLING REFRIGERATORS, FOR HOUSEHOLD PURPOSES; REFRIGERATOR SHELVING, DRAWERS, BINS AND TRAYS; REFRIGERATING MACHINES; REFRIGERATING OR FREEZING SHOWCASES; FREEZERS; ELECTRIC FREEZERS, FOR HOUSEHOLD PURPOSES; WALK-IN FREEZERS; ICE-CREAM FREEZERS, ELECTRIC OR NON-ELECTRIC; WALK-IN COOLERS; REFRIGERATED BEVERAGE DISPENSING UNITS; REFRIGERATED MERCHANDISE DISPLAY CASES; REFRIGERATED SHIPPING CONTAINERS; REFRIGERATORS AND FREEZERS FOR VEHICLES; REFRIGERATORS AND FREEZERS FOR HOTELS; AIR CONDITIONERS; AIR CONDITIONING UNITS; AIR-

CONDITIONING APPARATUS, FOR INDUSTRIAL PURPOSES; CENTRAL AIR-CONDITIONING INSTALLATIONS, FOR INDUSTRIAL PURPOSES; COMPONENTS FOR AIR CONDITIONING AND COOLING SYSTEMS, NAMELY, EVAPORATIVE AIR COOLERS; AIR FILTERS FOR AIR CONDITIONING UNITS; AIR PURIFIERS; DEHUMIDIFIERS; HAIR DRYERS, FOR HOUSEHOLD PURPOSES; HAIR DRYING MACHINES FOR BEAUTY SALON USE, IN CLASS 11 (U.S. CLS. 13, 21, 23, 31 AND 34).

FIRST USE 7-31-1996; IN COMMERCE 12-31-1996.

THE MARK CONSISTS OF THE TERM "INDEL" IN LOWER CASE LETTERS AND AN UPPER CASE LETTER "B" ALL WITHIN AN OVAL. AT THE TOP OF THE OVAL, ABOVE THE LETTERS "DEL" ARE FIVE STARS.

SER. NO. 77-225,989, FILED 7-10-2007.

JORDAN BAKER, EXAMINING ATTORNEY

**Int. Cl.: 3**

**Prior U.S. Cls.: 1, 4, 6, 50, 51 and 52**

**United States Patent and Trademark Office**

**Reg. No. 3,497,892**

**Registered Sep. 9, 2008**

**TRADEMARK  
PRINCIPAL REGISTER**

**SILK FOAM**

FRANCO IMPORTING CO., INC. (NEW YORK CORPORATION)

6288 RUNNING RIDGE ROAD

NORTH SYRACUSE, NY 13212

FOR: HAIR MOUSSE, IN CLASS 3 (U.S. CLS. 1, 4, 6, 50, 51 AND 52).

FIRST USE 5-1-2007; IN COMMERCE 5-1-2007.

THE MARK CONSISTS OF STANDARD CHARACTERS WITHOUT CLAIM TO ANY PARTICULAR FONT, STYLE, SIZE, OR COLOR.

NO CLAIM IS MADE TO THE EXCLUSIVE RIGHT TO USE "FOAM", APART FROM THE MARK AS SHOWN.

SER. NO. 77-226,044, FILED 7-10-2007.

MARY CRAWFORD, EXAMINING ATTORNEY

**Int. Cl.: 44**

**Prior U.S. Cls.: 100 and 101**

**United States Patent and Trademark Office**

**Reg. No. 3,497,893**

**Registered Sep. 9, 2008**

**SERVICE MARK  
PRINCIPAL REGISTER**



1ST ADVANTAGE PHYSICAL THERAPY (INDIANA CORPORATION)  
1516 N MAIN ST.  
CROWN POINT, IN 46307

FOR: PHYSICAL REHABILITATION; PHYSICAL THERAPY, IN CLASS 44 (U.S. CLS. 100 AND 101).

FIRST USE 4-1-2005; IN COMMERCE 4-1-2005.

NO CLAIM IS MADE TO THE EXCLUSIVE RIGHT TO USE "PHYSICAL THERAPY", APART FROM THE MARK AS SHOWN.

THE COLOR(S) BLACK AND GREEN IS/ARE CLAIMED AS A FEATURE OF THE MARK.

THE MARK CONSISTS OF "FIRST ADVANTAGE" IS IN BLACK THE "1" AND "PHYSICAL THERAPY" IS IN GREEN.

SER. NO. 77-226,446, FILED 7-10-2007.

SHANNON TWOHIG, EXAMINING ATTORNEY



**Int. Cl.: 35**

**Prior U.S. Cls.: 100, 101 and 102**

**United States Patent and Trademark Office**

**Reg. No. 3,497,894**

**Registered Sep. 9, 2008**

**SERVICE MARK  
PRINCIPAL REGISTER**

**USMD**

USMD INC. (TEXAS CORPORATION)  
SUITE 200  
6333 N. STATE HIGHWAY 161  
IRVING, TX 75038

THE MARK CONSISTS OF STANDARD CHAR-  
ACTERS WITHOUT CLAIM TO ANY PARTICULAR  
FONT, STYLE, SIZE, OR COLOR.

FOR: MANAGEMENT AND BUSINESS CON-  
SULTING SERVICES IN THE FIELD OF HEALTH  
CARE, IN CLASS 35 (U.S. CLS. 100, 101 AND 102).

SER. NO. 77-226,589, FILED 7-11-2007.

FIRST USE 11-20-2006; IN COMMERCE 1-1-2007.

REBECCA EISINGER, EXAMINING ATTORNEY

**Int. Cl.: 35**

**Prior U.S. Cls.: 100, 101 and 102**

**United States Patent and Trademark Office**

**Reg. No. 3,497,895**

**Registered Sep. 9, 2008**

**SERVICE MARK  
PRINCIPAL REGISTER**

**FINANCIAL PERSONALITIES**

FIRST MANHATTAN CONSULTING GROUP,  
INC. (DELAWARE CORPORATION)  
90 PARK AVENUE  
NEW YORK, NY 10016

FOR: MARKET ANALYSIS, RESEARCH AND  
RESEARCH CONSULTATION TO FINANCIAL SER-  
VICE PROVIDERS, IN CLASS 35 (U.S. CLS. 100, 101  
AND 102).

FIRST USE 1-0-2001; IN COMMERCE 1-0-2001.

THE MARK CONSISTS OF STANDARD CHAR-  
ACTERS WITHOUT CLAIM TO ANY PARTICULAR  
FONT, STYLE, SIZE, OR COLOR.

OWNER OF U.S. REG. NOS. 2,652,870 AND  
3,211,373.

NO CLAIM IS MADE TO THE EXCLUSIVE  
RIGHT TO USE "FINANCIAL", APART FROM  
THE MARK AS SHOWN.

SEC. 2(F).

SER. NO. 77-226,626, FILED 7-11-2007.

HEATHER BIDDULPH, EXAMINING ATTORNEY

**Int. Cl.: 35**

**Prior U.S. Cls.: 100, 101 and 102**

**United States Patent and Trademark Office**

**Reg. No. 3,497,896**

**Registered Sep. 9, 2008**

**SERVICE MARK  
PRINCIPAL REGISTER**

**USMD Inc.**

USMD INC. (TEXAS CORPORATION)  
SUITE 200  
6333 N. STATE HIGHWAY 161  
IRVING, TX 75038

FOR: MANAGEMENT AND BUSINESS CONSULTING SERVICES IN THE FIELD OF HEALTH CARE, IN CLASS 35 (U.S. CLS. 100, 101 AND 102).

FIRST USE 11-20-2006; IN COMMERCE 1-1-2007.

THE MARK CONSISTS OF STANDARD CHARACTERS WITHOUT CLAIM TO ANY PARTICULAR FONT, STYLE, SIZE, OR COLOR.

NO CLAIM IS MADE TO THE EXCLUSIVE RIGHT TO USE "INC.", APART FROM THE MARK AS SHOWN.

SER. NO. 77-226,641, FILED 7-11-2007.

REBECCA EISINGER, EXAMINING ATTORNEY

**Int. Cl.: 35**

**Prior U.S. Cls.: 100, 101 and 102**

**United States Patent and Trademark Office**

**Reg. No. 3,497,897**

**Registered Sep. 9, 2008**

**SERVICE MARK  
PRINCIPAL REGISTER**



USMD INC. (TEXAS CORPORATION)  
SUITE 200  
6333 N. STATE HIGHWAY 161  
IRVING, TX 75038

FOR: MANAGEMENT AND BUSINESS CONSULTING SERVICES IN THE FIELD OF HEALTH CARE, IN CLASS 35 (U.S. CLS. 100, 101 AND 102).

FIRST USE 11-20-2006; IN COMMERCE 1-1-2007.

THE COLOR(S) BLUE, RED, BLACK, AND GRAY IS/ARE CLAIMED AS A FEATURE OF THE MARK.

THE MARK CONSISTS OF NINE CURVED, PARALLEL LINES IN THE GENERAL SHAPE OF A GREEK CROSS, WITH THREE LINES APPEARING IN RED AND SIX APPEARING IN BLUE. NEXT TO THE DESIGN IS THE TEXT "USMD" WITH "US" IN BLACK AND "MD" IN BLUE. SHADING FOR THE DESIGN AND TEXT APPEARS IN GRAY.

SER. NO. 77-226,666, FILED 7-11-2007.

REBECCA EISINGER, EXAMINING ATTORNEY

Int. Cl.: 37

Prior U.S. Cls.: 100, 103 and 106

Reg. No. 3,497,898

United States Patent and Trademark Office

Registered Sep. 9, 2008

SERVICE MARK  
PRINCIPAL REGISTER



AAL CONSTRUCTION CO., INC. (CALIFORNIA CORPORATION)  
13252 SERENITY TRAIL  
CHINO, CA 91710

NO CLAIM IS MADE TO THE EXCLUSIVE RIGHT TO USE "REMODELING", APART FROM THE MARK AS SHOWN.

FOR: REMODELING OF BATHROOMS AND KITCHENS; AND CONSTRUCTION OF ROOM ADDITIONS, IN CLASS 37 (U.S. CLS. 100, 103 AND 106).

SER. NO. 77-226,894, FILED 7-11-2007.

FIRST USE 6-5-2007; IN COMMERCE 6-5-2007.

KATHERINE CHANG, EXAMINING ATTORNEY

**Int. Cls.: 1, 2, 3 and 5**

**Prior U.S. Cls.: 1, 4, 5, 6, 10, 11, 16, 18, 26, 44, 46, 50,  
51 and 52**

**Reg. No. 3,497,899**

**United States Patent and Trademark Office**

**Registered Sep. 9, 2008**

**TRADEMARK  
PRINCIPAL REGISTER**

**BITREX**

JOHNSON MATTHEY PUBLIC LIMITED COMPANY (UNITED KINGDOM PUBLIC LIMITED COMPANY (PLC))  
40-42 HATTON GARDEN  
LONDON, UNITED KINGDOM EC1N8EE

FOR: CHEMICAL PREPARATIONS AND OTHER SUBSTANCES USED TO DENATURE OTHER CHEMICAL SUBSTANCES BY RENDERING THEM UNSUITABLE FOR HUMAN CONSUMPTION; CHEMICAL PREPARATIONS AND OTHER SUBSTANCES USED TO DENATURE OTHER CHEMICAL SUBSTANCES BY RENDERING THEM UNSUITABLE FOR HUMAN CONSUMPTION SOLD AS AN INTEGRAL COMPONENT OF ANTIFREEZE; CHEMICAL PREPARATIONS AND OTHER SUBSTANCES USED TO DENATURE OTHER CHEMICAL SUBSTANCES BY RENDERING THEM UNSUITABLE FOR HUMAN CONSUMPTION SOLD AS AN INTEGRAL COMPONENT OF FERTILIZERS, IN CLASS 1 (U.S. CLS. 1, 5, 6, 10, 26 AND 46).

FIRST USE 0-0-1962; IN COMMERCE 0-0-1962.

FOR: CHEMICAL PREPARATIONS AND OTHER SUBSTANCES USED TO DENATURE OTHER CHEMICAL SUBSTANCES BY RENDERING THEM UNSUITABLE FOR HUMAN CONSUMPTION SOLD AS AN INTEGRAL COMPONENT OF EVAPORATIVE COATING USED TO SHAPE CAULKED JOINTS; CHEMICAL PREPARATIONS AND OTHER SUBSTANCES USED TO DENATURE OTHER CHEMICAL SUBSTANCES BY RENDERING THEM UNSUITABLE FOR HUMAN CONSUMPTION SOLD AS AN INTEGRAL COMPONENT OF ENCAPSULATING COATING USED AS A BARRIER BETWEEN LEAD-BASED PAINT AND THE ENVIRONMENT, IN CLASS 2 (U.S. CLS. 6, 11 AND 16).

FIRST USE 0-0-1991; IN COMMERCE 0-0-1991.

FOR: CHEMICAL PREPARATIONS AND OTHER SUBSTANCES USED TO DENATURE OTHER CHEMICAL SUBSTANCES BY RENDERING THEM UNSUITABLE FOR HUMAN CONSUMPTION SOLD AS AN INTEGRAL COMPONENT OF ALL-PURPOSE CLEANERS; CHEMICAL PREPARATIONS AND OTHER SUBSTANCES USED TO DENATURE OTHER CHEMICAL SUBSTANCES BY RENDERING THEM UNSUITABLE FOR HUMAN CONSUMPTION SOLD AS AN INTEGRAL COMPONENT OF CLEANER FOR USE ON WALLS AND WOODWORK; CHEMICAL PREPARATIONS AND OTHER SUBSTANCES USED TO DENATURE OTHER CHEMICAL SUBSTANCES BY RENDERING THEM UNSUITABLE FOR HUMAN CONSUMPTION SOLD AS AN INTEGRAL COMPONENT OF WINDSHIELD CLEANER FLUIDS; CHEMICAL PREPARATIONS AND OTHER SUBSTANCES USED TO DENATURE OTHER CHEMICAL SUBSTANCES BY RENDERING THEM UNSUITABLE FOR HUMAN CONSUMPTION SOLD AS AN INTEGRAL COMPONENT OF CLEANER FOR REMOVING GREASE AND OIL, NAMELY CLEANER FOR USE ON ASPHALT, CONCRETE, MACHINERY, OUTDOOR EQUIPMENT, AND TOOLS; CHEMICAL PREPARATIONS AND OTHER SUBSTANCES USED TO DENATURE OTHER CHEMICAL SUBSTANCES BY RENDERING THEM UNSUITABLE FOR HUMAN CONSUMPTION SOLD AS AN INTEGRAL COMPONENT OF DETERGENT SOAP; CHEMICAL PREPARATIONS AND OTHER SUBSTANCES USED TO DENATURE OTHER CHEMICAL SUBSTANCES BY RENDERING THEM UNSUITABLE FOR HUMAN CONSUMPTION SOLD AS AN INTEGRAL COMPONENT OF NAIL POLISH REMOVER; CHEMICAL PREPARATIONS AND OTHER SUBSTANCES USED TO DENATURE OTHER CHEMICAL SUBSTANCES BY RENDERING THEM UNSUITABLE FOR HUMAN CONSUMPTION SOLD AS AN INTEGRAL COMPONENT OF LAUNDRY DETER-

GENT; CHEMICAL PREPARATIONS AND OTHER SUBSTANCES USED TO DENATURE OTHER CHEMICAL SUBSTANCES BY RENDERING THEM UNSUITABLE FOR HUMAN CONSUMPTION SOLD AS AN INTEGRAL COMPONENT OF FRAGRANCES, IN CLASS 3 (U.S. CLS. 1, 4, 6, 50, 51 AND 52).

FIRST USE 0-0-1991; IN COMMERCE 0-0-1991.

FOR: CHEMICAL PREPARATIONS AND OTHER SUBSTANCES USED TO DENATURE OTHER CHEMICAL SUBSTANCES BY RENDERING THEM UNSUITABLE FOR HUMAN CONSUMPTION SOLD AS AN INTEGRAL COMPONENT OF REPELLANTS FOR USE IN DETERRING ANIMALS FROM GRAZING, EATING OR DAMAGING PLANTS; CHEMICAL PREPARATIONS AND OTHER SUBSTANCES USED TO DENATURE OTHER CHEMICAL SUBSTANCES BY RENDERING THEM UNSUITABLE FOR HUMAN CONSUMPTION SOLD AS AN INTE-

GRAL COMPONENT OF PREPARATIONS FOR REPELLING ANIMALS; CHEMICAL PREPARATIONS AND OTHER SUBSTANCES USED TO DENATURE OTHER CHEMICAL SUBSTANCES BY RENDERING THEM UNSUITABLE FOR HUMAN CONSUMPTION SOLD AS AN INTEGRAL COMPONENT OF PESTICIDES, IN CLASS 5 (U.S. CLS. 6, 18, 44, 46, 51 AND 52).

FIRST USE 0-0-2000; IN COMMERCE 0-0-2000.

THE MARK CONSISTS OF STANDARD CHARACTERS WITHOUT CLAIM TO ANY PARTICULAR FONT, STYLE, SIZE, OR COLOR.

OWNER OF U.S. REG. NOS. 738,448 AND 1,751,753.

SER. NO. 77-226,987, FILED 7-11-2007.

ELLEN PERKINS, EXAMINING ATTORNEY

**Int. Cl.: 30**

**Prior U.S. Cl.: 46**

**United States Patent and Trademark Office**

**Reg. No. 3,497,900**

**Registered Sep. 9, 2008**

**TRADEMARK  
PRINCIPAL REGISTER**

MEDURI NUTTY PEACH CAKE

MEDURI FARMS, INC. (OREGON CORPORATION)  
P.O. BOX 636  
DALLAS, OR 97338

OWNER OF U.S. REG. NO. 1,878,769.

FOR: FRUIT CAKES, IN CLASS 30 (U.S. CL. 46).

NO CLAIM IS MADE TO THE EXCLUSIVE RIGHT TO USE "NUTTY PEACH CAKE", APART FROM THE MARK AS SHOWN.

FIRST USE 9-0-2007; IN COMMERCE 9-0-2007.

SER. NO. 77-227,270, FILED 7-11-2007.

THE MARK CONSISTS OF STANDARD CHARACTERS WITHOUT CLAIM TO ANY PARTICULAR FONT, STYLE, SIZE, OR COLOR.

KIMBERLY FRYE, EXAMINING ATTORNEY



**Int. Cls.: 14 and 19**

**Prior U.S. Cls.: 1, 2, 12, 27, 28, 33 and 50**

**United States Patent and Trademark Office**

**Reg. No. 3,497,901**

**Registered Sep. 9, 2008**

**TRADEMARK  
PRINCIPAL REGISTER**

**KENZIE'S CORNER**

KENZIE'S CORNER (UTAH SOLE PROPRIETOR-  
SHIP)  
2814 W. 400 S.  
LEHI, UT 84043

FOR: CLOCKS AND CLOCK PARTS, NAMELY,  
CLOCK AND WATCH HANDS, CLOCK HOUSINGS,  
CLOCK DIALS, SMALL CLOCKS, TABLE CLOCKS,  
AND WALL CLOCKS, IN CLASS 14 (U.S. CLS. 2, 27,  
28 AND 50).

FIRST USE 10-15-2004; IN COMMERCE 10-15-2004.

FOR: NON-LUMINOUS, NON-MECHANICAL  
SIGNS NOT OF METAL, NAMELY, VINYL SIGNS

WITH ADHESIVE BACK FOR USE IN ADVERTIS-  
ING AND /OR PROMOTIONS, IN CLASS 19 (U.S.  
CLS. 1, 12, 33 AND 50).

FIRST USE 10-15-2004; IN COMMERCE 10-15-2004.

THE MARK CONSISTS OF STANDARD CHAR-  
ACTERS WITHOUT CLAIM TO ANY PARTICULAR  
FONT, STYLE, SIZE, OR COLOR.

SER. NO. 77-227,412, FILED 7-11-2007.

KAPIL BHANOT, EXAMINING ATTORNEY

**Int. Cl.: 44**

**Prior U.S. Cls.: 100 and 101**

**United States Patent and Trademark Office**

**Reg. No. 3,497,902**

**Registered Sep. 9, 2008**

**SERVICE MARK  
PRINCIPAL REGISTER**



SLATE DENTAL CORPORATION (CALIFORNIA CORPORATION)  
6512 LONETREE BLVD  
ROCKLIN, CA 95765

FOR: DENTISTRY, IN CLASS 44 (U.S. CLS. 100 AND 101).

FIRST USE 1-29-2007; IN COMMERCE 1-29-2007.

NO CLAIM IS MADE TO THE EXCLUSIVE RIGHT TO USE "DENTISTRY" , APART FROM THE MARK AS SHOWN.

THE COLOR(S) ORANGE, PANTONE 158C, BABY BLUE, PANTONE 2985C, BROWN, PANTONE 161C, AND WHITE IS/ARE CLAIMED AS A FEATURE OF THE MARK.

THE MARK CONSISTS OF A WHITE RECTANGULAR BOX OUTLINED IN THE COLOR BROWN. THERE IS A THREE-STEMMED LEAF IN WHITE OVERLAYING FOUR COLORED SMALLER BOXES. THE FOUR BOXES ARE COLORED, ORANGE IN THE UPPER LEFT, BROWN IN THE UPPER RIGHT AND LOWER LEFT, AND BABY BLUE IN THE LOWER RIGHT. UNDER THE LEAF OVERLAY ARE THE WORDS "PURE" WITH "DENTISTRY" IMMEDIATELY UNDER BOTH IN THE COLOR BROWN.

SER. NO. 77-227,504, FILED 7-11-2007.

LINDA E. BLOHM, EXAMINING ATTORNEY

**Int. Cl.: 42**

**Prior U.S. Cls.: 100 and 101**

**United States Patent and Trademark Office**

**Reg. No. 3,497,903**

**Registered Sep. 9, 2008**

**SERVICE MARK  
PRINCIPAL REGISTER**



NATIONAL WEATHER SERVICE (UNITED STATES AGENCY OF THE UNITED STATES GOVERNMENT)  
1325 EAST-WEST HIGHWAY  
SILVER SPRING, MD 20910

FOR: PROVISION OF WEATHER AND EMERGENCY ALERT INFORMATION BY RADIO AND COMPUTER NETWORKS, IN CLASS 42 (U.S. CLS. 100 AND 101).

FIRST USE 4-17-2007; IN COMMERCE 4-17-2007.

NO CLAIM IS MADE TO THE EXCLUSIVE RIGHT TO USE "ALL HAZARDS, WEATHER RADIO, AND NATIONAL WEATHER SERVICE", APART FROM THE MARK AS SHOWN.

SER. NO. 77-227,674, FILED 7-12-2007.

ALICIA COLLINS, EXAMINING ATTORNEY

Prior U.S. Cl.: A

United States Patent and Trademark Office

Reg. No. 3,497,904

Registered Sep. 9, 2008

CERTIFICATION MARK  
PRINCIPAL REGISTER



NATIONAL WEATHER SERVICE (UNITED STATES AGENCY OF THE UNITED STATES GOVERNMENT)  
1325 EAST-WEST HIGHWAY  
SILVER SPRING, MD 20910

FOR: ALL HAZARDS RADIO RECEIVERS, IN CLASS A (U.S. CL. A).

FIRST USE 4-17-2007; IN COMMERCE 4-17-2007.

NO CLAIM IS MADE TO THE EXCLUSIVE RIGHT TO USE "ALL HAZARDS AND WEATHER

RADIO AND NATIONAL WEATHER SERVICE", APART FROM THE MARK AS SHOWN.

THE CERTIFICATION MARK, AS USED BY AUTHORIZED PERSONS, CERTIFIES THE CERTIFIED RADIOS MEET OR EXCEED THE CURRENT NOAA WEATHER RADIO ALL HAZARDS STANDARDS.

SER. NO. 77-227,681, FILED 7-12-2007.

ALICIA COLLINS, EXAMINING ATTORNEY

**Int. Cl.: 25**

**Prior U.S. Cls.: 22 and 39**

**United States Patent and Trademark Office**

**Reg. No. 3,497,905**

**Registered Sep. 9, 2008**

**TRADEMARK  
PRINCIPAL REGISTER**

**SKILZ**

HEADLEE, LANCE (UNITED STATES INDIVIDUAL)  
39832 N. IRON HORSE WAY  
ANTHEM, AZ 85086

FOR: PRINTED, SILKSCREEN OR EMBROIDERY  
GARMENTS, NAMELY, SHIRTS, PANTS, SHORTS,  
JACKETS, HATS, IN CLASS 25 (U.S. CLS. 22 AND 39).

FIRST USE 9-23-1999; IN COMMERCE 11-3-1999.

THE MARK CONSISTS OF STANDARD CHARACTERS WITHOUT CLAIM TO ANY PARTICULAR FONT, STYLE, SIZE, OR COLOR.

OWNER OF U.S. REG. NO. 2,800,605.

SER. NO. 77-227,803, FILED 7-12-2007.

ALYSSA PALADINO, EXAMINING ATTORNEY

**Int. Cl.: 9**

**Prior U.S. Cls.: 21, 23, 26, 36 and 38**

**United States Patent and Trademark Office**

**Reg. No. 3,497,906**

**Registered Sep. 9, 2008**

**TRADEMARK  
PRINCIPAL REGISTER**

**GETTING FULLY ENGAGED**

LGE PERFORMANCE SYSTEMS, INC. DBA HUMAN PERFORMANCE INSTITUTE (FLORIDA CORPORATION)  
9757 LAKE NONA ROAD  
ORLANDO, FL 32827

FOR: ELECTRONIC MEDIA PRODUCTS, NAME-  
LY, AUDIOTAPES, VIDEO TAPES, CDS, DVDS, AND  
EDUCATIONAL SOFTWARE, ALL IN THE FIELDS  
OF IMPROVING PERSONAL AND BUSINESS  
SKILLS, ABILITIES AND PERFORMANCE, IN  
CLASS 9 (U.S. CLS. 21, 23, 26, 36 AND 38).

FIRST USE 12-31-2002; IN COMMERCE 12-31-2002.

THE MARK CONSISTS OF STANDARD CHAR-  
ACTERS WITHOUT CLAIM TO ANY PARTICULAR  
FONT, STYLE, SIZE, OR COLOR.

OWNER OF U.S. REG. NOS. 2,863,417, 2,927,200,  
AND 2,935,371.

SER. NO. 77-227,943, FILED 7-12-2007.

BARBARA GAYNOR, EXAMINING ATTORNEY

**Int. Cl.: 16**

**Prior U.S. Cls.: 2, 5, 22, 23, 29, 37, 38 and 50**

**Reg. No. 3,497,907**

**United States Patent and Trademark Office**

**Registered Sep. 9, 2008**

**TRADEMARK  
PRINCIPAL REGISTER**

**GETTING FULLY ENGAGED**

LGE PERFORMANCE SYSTEMS, INC. DBA HUMAN PERFORMANCE INSTITUTE (FLORIDA CORPORATION)  
9757 LAKE NONA ROAD  
ORLANDO, FL 32827

FOR: PUBLICATIONS AND PRINTED MATERIALS, NAMELY, BOOKS, BOOKLETS, WORKBOOKS, MANUALS, PAPER AND/OR PLASTIC OVERHEAD TRANSPARENCIES, CHARTS, TABLES, HANDOUTS, NAMELY, INSTRUCTION GUIDES, AND PAMPHLETS, ALL IN THE FIELD OF IMPROVING PERSONAL AND BUSINESS SKILLS, ABILITIES AND PERFORMANCE, IN CLASS 16 (U.S. CLS. 2, 5, 22, 23, 29, 37, 38 AND 50).

FIRST USE 12-31-2002; IN COMMERCE 12-31-2002.

THE MARK CONSISTS OF STANDARD CHARACTERS WITHOUT CLAIM TO ANY PARTICULAR FONT, STYLE, SIZE, OR COLOR.

OWNER OF U.S. REG. NOS. 2,777,720, 2,863,417, AND 2,927,200.

SER. NO. 77-227,977, FILED 7-12-2007.

BARBARA GAYNOR, EXAMINING ATTORNEY

**Int. Cl.: 20**

**Prior U.S. Cls.: 2, 13, 22, 25, 32 and 50**

**United States Patent and Trademark Office**

**Reg. No. 3,497,908**

**Registered Sep. 9, 2008**

**TRADEMARK  
PRINCIPAL REGISTER**

**BIG RED FLEXITANK**

ENVIRONMENTAL PACKAGING TECHNOLOGIES LIMITED (HONG KONG CORPORATION)  
2200 POST OAK BLVD., SUITE 325  
HOUSTON, TX 77056

FOR: STACKABLE AND COLLAPSIBLE BULK PACKING PLASTIC CONTAINERS FOR COMMERCIAL AND INDUSTRIAL USE, NAMELY, FOR STORING AND SHIPPING NON-HAZARDOUS, HAZARDOUS AND FOOD GRADE PRODUCTS IN THE FORM OF LIQUIDS, SLURRYS OR FLUIDS, IN CLASS 20 (U.S. CLS. 2, 13, 22, 25, 32 AND 50).

FIRST USE 5-1-2007; IN COMMERCE 5-1-2007.

THE MARK CONSISTS OF STANDARD CHARACTERS WITHOUT CLAIM TO ANY PARTICULAR FONT, STYLE, SIZE, OR COLOR.

NO CLAIM IS MADE TO THE EXCLUSIVE RIGHT TO USE "FLEXITANK", APART FROM THE MARK AS SHOWN.

SER. NO. 77-228,271, FILED 7-12-2007.

SETH A. RAPPAPORT, EXAMINING ATTORNEY



**Int. Cl.: 22**

**Prior U.S. Cls.: 1, 2, 7, 19, 22, 42 and 50**

**Reg. No. 3,497,909**

**United States Patent and Trademark Office**

**Registered Sep. 9, 2008**

**TRADEMARK  
PRINCIPAL REGISTER**



***PROCORD***

CORDEX-COMPANHIA INDUSTRIAL TEXTIL,  
SA (PORTUGAL SOCIEDAD ANONIMA)  
RUA DA ESTRADA NOVA, 785  
ESMORIZ, PORTUGAL 3885-456

FOR: SISAL BALER TWINE FOR AGRICULTURAL USE; SYNTHETIC BALER TWINE FOR AGRICULTURAL USE; SISAL AND SYNTHETIC TWINES FOR COMMERCIAL USE, NAMELY, PACKING;

SISAL AND SYNTHETIC ROPES AND COMMERCIAL NETS FOR AGRICULTURE, IN CLASS 22 (U.S. CLS. 1, 2, 7, 19, 22, 42 AND 50).

FIRST USE 9-1-2006; IN COMMERCE 9-1-2006.

SER. NO. 77-228,315, FILED 7-12-2007.

AMY MCMENAMIN, EXAMINING ATTORNEY

Int. Cl.: 22

Prior U.S. Cls.: 1, 2, 7, 19, 22, 42 and 50

Reg. No. 3,497,910

United States Patent and Trademark Office

Registered Sep. 9, 2008

TRADEMARK  
PRINCIPAL REGISTER

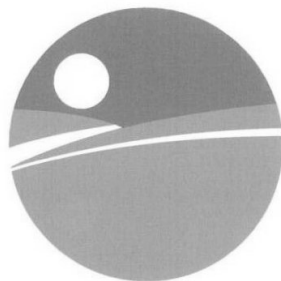

*baleCORD*

CORDEX-COMPANHIA INDUSTRIAL TEXTIL,  
SA (PORTUGAL SOCIEDAD ANONIMA)  
RUA DA ESTRADA NOVA, 785  
ESMORIZ, PORTUGAL 3885-456

FOR: SISAL BALER TWINE FOR AGRICULTURAL USE; SYNTHETIC BALER TWINE FOR AGRICULTURAL USE; SISAL AND SYNTHETIC TWINES FOR COMMERCIAL USE, NAMELY, PACKING; SISAL AND SYNTHETIC ROPES AND COMMERCIAL NETS FOR AGRICULTURE, IN CLASS 22 (U.S. CLS. 1, 2, 7, 19, 22, 42 AND 50).

FIRST USE 9-1-2006; IN COMMERCE 9-1-2006.

NO CLAIM IS MADE TO THE EXCLUSIVE RIGHT TO USE "BALECORD", APART FROM THE MARK AS SHOWN.

THE MARK CONSISTS OF THE WORDING "BALECORD" UNDERNEATH OF A CIRCLE BORDER ENCOMPASSING THE DESIGN OF TWO HILLS WITH ONE ROAD RUNNING BETWEEN THE HILLS AND ONE ROAD RUNNING ACROSS THE HILL TO THE RIGHT. THE DESIGN OF A SUN APPEARS OVER THE HILL ON THE RIGHT.

SER. NO. 77-228,316, FILED 7-12-2007.

AMY MCMENAMIN, EXAMINING ATTORNEY

**Int. Cl.: 9**

**Prior U.S. Cls.: 21, 23, 26, 36 and 38**

**Reg. No. 3,497,911**

**United States Patent and Trademark Office**

**Registered Sep. 9, 2008**

**TRADEMARK  
PRINCIPAL REGISTER**



THERAPEUTIC RESEARCH CENTER, INC. (CALIFORNIA CORPORATION)  
3120 W. MARCH LANE  
STOCKTON, CA 95219

NO CLAIM IS MADE TO THE EXCLUSIVE RIGHT TO USE "LETTER", APART FROM THE MARK AS SHOWN.

FOR: PROVIDING DOWNLOADABLE ELECTRONIC NEWSLETTERS FOR PHARMACY TECHNICIANS, IN CLASS 9 (U.S. CLS. 21, 23, 26, 36 AND 38).

SEC. 2(F) AS TO "PHARMACY TECHNICIAN'S".

FIRST USE 8-15-2007; IN COMMERCE 8-15-2007.

SER. NO. 77-228,485, FILED 7-12-2007.

OWNER OF U.S. REG. NOS. 2,283,188 AND 2,306,236.

ANDREA SAUNDERS, EXAMINING ATTORNEY

**Int. Cl.: 41**

**Prior U.S. Cls.: 100, 101 and 107**

**United States Patent and Trademark Office**

**Reg. No. 3,497,912**

**Registered Sep. 9, 2008**

**SERVICE MARK  
PRINCIPAL REGISTER**



THERAPEUTIC RESEARCH CENTER, INC. (CALIFORNIA CORPORATION)  
3120 W. MARCH LANE  
STOCKTON, CA 95219

NO CLAIM IS MADE TO THE EXCLUSIVE RIGHT TO USE "JOURNAL CLUB", APART FROM THE MARK AS SHOWN.

FOR: PROVIDING CONTINUING MEDICAL, NURSING, AND PHARMACY EDUCATION PROGRAMS, IN CLASS 41 (U.S. CLS. 100, 101 AND 107).

SER. NO. 77-228,570, FILED 7-12-2007.

FIRST USE 12-1-2004; IN COMMERCE 12-1-2004.

ANDREA SAUNDERS, EXAMINING ATTORNEY

**Int. Cls.: 20, 24 and 25**

**Prior U.S. Cls.: 2, 13, 22, 25, 32, 39, 42 and 50**

**United States Patent and Trademark Office**

**Reg. No. 3,497,913**

**Registered Sep. 9, 2008**

**TRADEMARK  
PRINCIPAL REGISTER**

**ANDREW MORGAN COLLECTION**

MORGAN COLLECTION INC. (NEW YORK CORPORATION)  
31 SOUTH STREET , ROOM 2N4  
MOUNT VERNON, NY 10550

FOR: PILLOWS AND BOLSTERS, IN CLASS 20 (U.S. CLS. 2, 13, 22, 25, 32 AND 50).

FIRST USE 12-1-2006; IN COMMERCE 12-1-2006.

FOR: PILLOW SHAMS, THROWS, BLANKET THROWS, THROWS DESIGNED TO BE WRAPPED AROUND A PERSON, BED BLANKETS, BLANKETS FOR OUTDOOR USE, IN CLASS 24 (U.S. CLS. 42 AND 50).

FIRST USE 12-1-2006; IN COMMERCE 12-1-2006.

FOR: ROBES, IN CLASS 25 (U.S. CLS. 22 AND 39).

FIRST USE 12-1-2006; IN COMMERCE 12-1-2006.

THE MARK CONSISTS OF STANDARD CHARACTERS WITHOUT CLAIM TO ANY PARTICULAR FONT, STYLE, SIZE, OR COLOR.

NO CLAIM IS MADE TO THE EXCLUSIVE RIGHT TO USE "COLLECTION", APART FROM THE MARK AS SHOWN.

THE NAME(S), PORTRAIT(S), AND/OR SIGNATURE(S) SHOWN IN THE MARK IDENTIFIES "ANDREW MORGAN", WHOSE CONSENT(S) TO REGISTER IS SUBMITTED.

SER. NO. 77-228,956, FILED 7-13-2007.

MELVIN AXILBUND, EXAMINING ATTORNEY

**Int. Cl.: 25**

**Prior U.S. Cls.: 22 and 39**

**United States Patent and Trademark Office**

**Reg. No. 3,497,914**

**Registered Sep. 9, 2008**

**TRADEMARK  
PRINCIPAL REGISTER**



WILD DAWG GEAR, LLC (NORTH CAROLINA  
LIMITED LIABILITY COMPANY)  
29 BERMUDA LANDING PL  
N. TOPSAIL BEACH, NC 28460

FIRST USE 8-7-2007; IN COMMERCE 8-7-2007.

FOR: CLOTHING, NAMELY, SHORTS, JERSEYS,  
FLEECE PULLOVERS, T-SHIRTS, POLO SHIRTS,  
SWEATSHIRTS, HEADWEAR, HATS, CAPS, BEA-  
NIES, VISORS , IN CLASS 25 (U.S. CLS. 22 AND 39).

SER. NO. 77-229,331, FILED 7-13-2007.

KATHERINE CHANG, EXAMINING ATTORNEY

**Int. Cl.: 35**

**Prior U.S. Cls.: 100, 101 and 102**

**United States Patent and Trademark Office**

**Reg. No. 3,497,915**

**Registered Sep. 9, 2008**

**SERVICE MARK  
PRINCIPAL REGISTER**

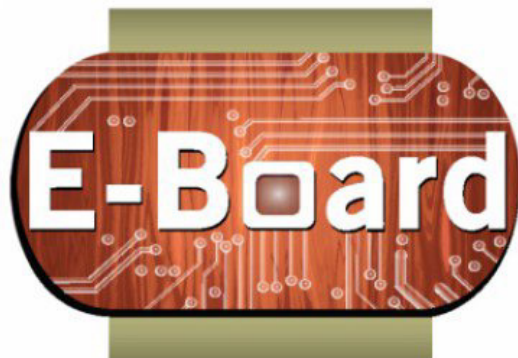

REX WYON SERVICES, INC. (NEW YORK CORPORATION)

420 LEXINGTON AVENUE  
NEW YORK, NY 10170

FIRST USE 11-1-2001; IN COMMERCE 9-1-2004.

THE COLOR(S) WHITE, GRAY, BLACK, BROWN, AND OLIVE IS/ARE CLAIMED AS A FEATURE OF THE MARK.

FOR: BUSINESS INFORMATION MANAGEMENT; BUSINESS RECORDS MANAGEMENT; COLLECTION, PREPARATION, COMPOSITION, STORAGE, PROCESSING, ACQUISITION AND PROVISION OF BUSINESS INFORMATION, DATA, STATISTICS AND INDICES; COMPUTERIZED AND CENTRAL FILE MANAGEMENT AND BUSINESS FILE MANAGEMENT; FINANCIAL RECORDS MANAGEMENT; INFORMATION, ADVISORY AND CONSULTANCY SERVICES RELATING TO BUSINESS AND MANAGEMENT OR BUSINESS ADMINISTRATION, INCLUDING SUCH SERVICES PROVIDED ON LINE OR VIA THE INTERNET; ONLINE BUSINESS NETWORKING SERVICES; PROVIDING INFORMATION ABOUT COMMERCIAL BUSINESS AND COMMERCIAL INFORMATION VIA THE GLOBAL COMPUTER NETWORK; SERVICES COMPRISING THE RECORDING, TRANSCRIPTION, COMPOSITION, COMPILATION AND SYSTEMATIZATION OF WRITTEN COMMUNICATIONS AND RECORDINGS, AS WELL AS THE COMPILATION OF MATHEMATICAL OR STATISTICAL DATA; SERVICES CONSISTING OF THE REGISTRATION, COLLECTION, TRANSCRIPTION, COMPILATION AND SYSTEMIZATION OF WRITTEN COMMUNICATIONS AND DATA; SERVICES INCLUDING RECORDING, TRANSCRIPTION, TRANSFORMATION, COMPOSITION, COMPILATION AND SYSTEMIZATION OF INFORMATION USED IN ELECTRONIC TRANSMISSIONS, IN CLASS 35 (U.S. CLS. 100, 101 AND 102).

THE MARK CONSISTS OF THE WORDING "E-BOARD" PLACED INSIDE AN ELLIPTICAL GEOMETRIC FIGURE FEATURING DESIGN ELEMENTS RESEMBLING COMPUTER CIRCUITS INSIDE THE ELLIPTICAL GEOMETRIC FIGURE AND RECTANGLES ON THE UPPER AND LOWER EDGES OF THE ELLIPTICAL GEOMETRIC FIGURE. THE COLOR WHITE APPEARS IN THE WORDING "E-BOARD," IN THE LIGHTEST AREAS OF THE CIRCUIT DESIGNS, AND IN THE LIGHTEST SHADED AREA INSIDE THE LETTER "O"; THE COLOR GRAY APPEARS IN THE SECOND LIGHTEST SHADED AREAS OF THE CIRCUIT DESIGNS AND IN THE SECOND DARKEST SHADED AREA INSIDE THE LETTER "O"; THE COLOR BLACK APPEARS IN THE DARK BORDERS AROUND THE WORDING "E-BOARD," AND IN THE DARK BORDER ON THE RIGHT, LEFT, AND LOWER EDGES OF THE ELLIPTICAL GEOMETRIC DESIGN; THE COLOR BROWN APPEARS IN THE BACKGROUND OF THE ELLIPTICAL GEOMETRIC FIGURE, IN THE DARKEST SHADED AREA INSIDE THE LETTER "O," AND IN THE DARKEST SHADED AREAS OF THE CIRCUIT DESIGNS; THE COLOR OLIVE APPEARS IN THE RECTANGLES ON THE UPPER AND LOWER EDGES OF THE ELLIPTICAL GEOMETRIC FIGURE.

SER. NO. 77-229,350, FILED 7-13-2007.

MICHAEL GAAFAR, EXAMINING ATTORNEY



**Int. Cl.: 35**

**Prior U.S. Cls.: 100, 101 and 102**

**United States Patent and Trademark Office**

**Reg. No. 3,497,916**

**Registered Sep. 9, 2008**

**SERVICE MARK  
PRINCIPAL REGISTER**

**VOXOPOLIS**

IG INSIGHTGLOBAL, INC. (CALIFORNIA CORPORATION)  
11TH FLOOR  
4695 MACARTHUR COURT  
NEWPORT BEACH, CA 92660

FOR: PROVIDING AN ONLINE SERVICE FOR INDIVIDUALS AND ORGANIZATIONS TO CONDUCT BUSINESS, ORGANIZATIONAL, AND MARKET RESEARCH FEATURING INTERACTIVE ANONYMOUS FEEDBACK THROUGH THE INTERNET; AND PROVIDING ONLINE ADVERTISING FOR OTHERS, NAMELY, PROMOTION, ADVERTISING AND MARKETING OF THEIR PRO-

DUCTS AND SERVICES, IN CLASS 35 (U.S. CLS. 100, 101 AND 102).

FIRST USE 11-9-2006; IN COMMERCE 11-9-2006.

THE MARK CONSISTS OF STANDARD CHARACTERS WITHOUT CLAIM TO ANY PARTICULAR FONT, STYLE, SIZE, OR COLOR.

SER. NO. 77-230,290, FILED 7-16-2007.

GIANCARLO CASTRO, EXAMINING ATTORNEY

**Int. Cl.: 28**

**Prior U.S. Cls.: 22, 23, 38 and 50**

**Reg. No. 3,497,917**

**United States Patent and Trademark Office**

**Registered Sep. 9, 2008**

---

**TRADEMARK  
PRINCIPAL REGISTER**

**V-LOCK**

OUT O' SITE, LLC (MISSOURI LIMITED LIABILITY COMPANY)  
2500 EAST KEARNEY  
SPRINGFIELD, MO 65898

THE MARK CONSISTS OF STANDARD CHARACTERS WITHOUT CLAIM TO ANY PARTICULAR FONT, STYLE, SIZE, OR COLOR.

FOR: TREE STANDS FOR HUNTING, IN CLASS 28 (U.S. CLS. 22, 23, 38 AND 50).

SER. NO. 77-230,646, FILED 7-16-2007.

FIRST USE 6-0-2001; IN COMMERCE 6-0-2001.

ELI HELLMAN, EXAMINING ATTORNEY

**Int. Cl.: 41**

**Prior U.S. Cls.: 100, 101 and 107**

**United States Patent and Trademark Office**

**Reg. No. 3,497,918**

**Registered Sep. 9, 2008**

**SERVICE MARK  
PRINCIPAL REGISTER**



COLORADO WOMEN'S ROLLER DERBY (COL-  
ORADO CORPORATION), DBA DENVER  
ROLLER DOLLS  
3627 W. 33RD AVE  
DENVER, CO 80211

FOR: ENTERTAINMENT IN THE NATURE OF  
ROLLER SKATING COMPETITIONS, IN CLASS 41  
(U.S. CLS. 100, 101 AND 107).

FIRST USE 3-16-2006; IN COMMERCE 3-16-2006.

NO CLAIM IS MADE TO THE EXCLUSIVE  
RIGHT TO USE "DENVER", APART FROM THE  
MARK AS SHOWN.

THE MARK CONSISTS OF SILHOUETTE OF  
FEMALE WITH PIGTAILS ON ROLLER SKATES  
WITH STYLIZED LETTERS.

SER. NO. 77-230,776, FILED 7-16-2007.

KYLE PEETE, EXAMINING ATTORNEY

**Int. Cls.: 9, 38 and 41**

**Prior U.S. Cls.: 21, 23, 26, 36, 38, 100, 101, 104 and 107**

**United States Patent and Trademark Office**

**Reg. No. 3,497,919**

**Registered Sep. 9, 2008**

**TRADEMARK  
SERVICE MARK  
PRINCIPAL REGISTER**

**The audience is never wrong**

B-SIDE ENTERTAINMENT, INC. (TEXAS CORPORATION)  
SUITE 300  
815 BRAZOS STREET  
AUSTIN, TX 78701

FOR: DIGITAL MATERIALS, NAMELY, DVDS AND DOWNLOADABLE VIDEO FILES FEATURING INDEPENDENT FILMS, IN CLASS 9 (U.S. CLS. 21, 23, 26, 36 AND 38).

FIRST USE 10-11-2005; IN COMMERCE 10-11-2005.

FOR: PROVIDING ONLINE AND MOBILE FORUMS FOR TRANSMISSION OF TEXT-BASED AND VIDEO-BASED MESSAGES AMONG COMPUTER USERS CONCERNING INDEPENDENT FILMS; STREAMING OF VIDEO MATERIAL ON THE INTERNET, IN CLASS 38 (U.S. CLS. 100, 101 AND 104).

FIRST USE 10-11-2005; IN COMMERCE 10-11-2005.

FOR: ENTERTAINMENT SERVICES, NAMELY, COLLECTING AND PROVIDING ONLINE REVIEWS OF INDEPENDENT FILMS; ONLINE JOURNALS, NAMELY, BLOGS FEATURING INDEPENDENT FILM INFORMATION AND AUDIENCE OPINIONS; FILM DISTRIBUTION SERVICES, NAMELY, DISTRIBUTION OF INDEPENDENT FILMS; CONDUCTING ENTERTAINMENT EXHIBITIONS IN THE NATURE OF INDEPENDENT FILMS, IN CLASS 41 (U.S. CLS. 100, 101 AND 107).

FIRST USE 10-11-2005; IN COMMERCE 10-11-2005.

THE MARK CONSISTS OF STANDARD CHARACTERS WITHOUT CLAIM TO ANY PARTICULAR FONT, STYLE, SIZE, OR COLOR.

SER. NO. 77-230,891, FILED 7-16-2007.

KAREN SEVERSON, EXAMINING ATTORNEY

**Int. Cls.: 44 and 45**

**Prior U.S. Cls.: 100 and 101**

**United States Patent and Trademark Office**

**Reg. No. 3,497,920**

**Registered Sep. 9, 2008**

**SERVICE MARK  
PRINCIPAL REGISTER**



OCCUSCREEN, LLC. (OREGON LIMITED LIABILITY COMPANY)  
215 W 12TH STREET  
VANCOUVER, WA 98660

FOR: MEDICAL SERVICES, NAMELY, PRE-EMPLOYMENT DRUG SCREENING AND PHYSICAL EXAMINATIONS, IN CLASS 44 (U.S. CLS. 100 AND 101).

FIRST USE 7-0-1999; IN COMMERCE 7-0-1999.

FOR: PRE-EMPLOYMENT BACKGROUND SCREENING, IN CLASS 45 (U.S. CLS. 100 AND 101).

FIRST USE 7-0-1999; IN COMMERCE 7-0-1999.

THE COLOR(S) YELLOW AND BLACK IS/ARE CLAIMED AS A FEATURE OF THE MARK.

THE MARK CONSISTS OF A SPIRAL DESIGN IN BLACK WITH A YELLOW CENTER AND THE WORD "OCCUSCREEN" APPEARING IN BLACK TO THE RIGHT OF THE DESIGN.

SER. NO. 77-231,674, FILED 7-17-2007.

CHRISTINE COOPER, EXAMINING ATTORNEY

**Int. Cl.: 35**

**Prior U.S. Cls.: 100, 101 and 102**

**United States Patent and Trademark Office**

**Reg. No. 3,497,921**

**Registered Sep. 9, 2008**

**SERVICE MARK  
PRINCIPAL REGISTER**

**CHAD ALLISON**

CHAD ALLISON CORP. (DELAWARE CORPORATION)  
SUITE # 904  
576 5TH AVENUE  
NEW YORK, NY 10036

FOR: RETAIL AND WHOLESALE STORE AND  
ONLINE RETAIL AND WHOLESALE STORE SERVICES  
FEATURING JEWELRY, IN CLASS 35 (U.S.  
CLS. 100, 101 AND 102).

FIRST USE 9-21-1999; IN COMMERCE 9-21-1999.

THE MARK CONSISTS OF STANDARD CHARACTERS  
WITHOUT CLAIM TO ANY PARTICULAR FONT,  
STYLE, SIZE, OR COLOR.

OWNER OF U.S. REG. NO. 2,885,903.

THE NAME "CHAD ALLISON" IN THE MARK  
DOES NOT IDENTIFY A LIVING INDIVIDUAL.

SER. NO. 77-232,348, FILED 7-18-2007.

CHRIS WELLS, EXAMINING ATTORNEY

**Int. Cl.: 9**

**Prior U.S. Cls.: 21, 23, 26, 36 and 38**

**Reg. No. 3,497,922**

**United States Patent and Trademark Office**

**Registered Sep. 9, 2008**

---

**TRADEMARK  
PRINCIPAL REGISTER**

**CODA**

PANIC INC (OREGON CORPORATION)  
425 NW 10TH AVE STE 301  
PORTLAND, OR 97209

THE MARK CONSISTS OF STANDARD CHAR-  
ACTERS WITHOUT CLAIM TO ANY PARTICULAR  
FONT, STYLE, SIZE, OR COLOR.

FOR: WEB SITE DEVELOPMENT SOFTWARE, IN  
CLASS 9 (U.S. CLS. 21, 23, 26, 36 AND 38).

SER. NO. 77-232,875, FILED 7-18-2007.

FIRST USE 4-23-2007; IN COMMERCE 4-23-2007.

DEIRDRE ROBERTSON, EXAMINING ATTORNEY

**Int. Cl.: 9**

**Prior U.S. Cls.: 21, 23, 26, 36 and 38**

**United States Patent and Trademark Office**

**Reg. No. 3,497,923**

**Registered Sep. 9, 2008**

**TRADEMARK  
PRINCIPAL REGISTER**

**GHOSTS 'N GOBLINS**

CAPCOM CO., LTD. (JAPAN CORPORATION)  
3-1-3 UCHIHIRANOMACHI, CHUO-KU  
OSAKA, JAPAN

FOR: COMPUTER GAME SOFTWARE; COMPUTER GAME IN THE FORM OF CARTRIDGES, CASSETTES, DISCS OR TAPES; VIDEO GAME CARTRIDGES; VIDEO GAME MACHINES FOR USE WITH TELEVISION RECEIVERS, IN CLASS 9 (U.S. CLS. 21, 23, 26, 36 AND 38).

FIRST USE 9-19-1985; IN COMMERCE 9-19-1985.

THE MARK CONSISTS OF STANDARD CHARACTERS WITHOUT CLAIM TO ANY PARTICULAR FONT, STYLE, SIZE, OR COLOR.

SER. NO. 77-232,920, FILED 7-18-2007.

LINDA MICKLEBURGH, EXAMINING ATTORNEY



**Int. Cl.: 41**

**Prior U.S. Cls.: 100, 101 and 107**

**United States Patent and Trademark Office**

**Reg. No. 3,497,924**

**Registered Sep. 9, 2008**

**SERVICE MARK  
PRINCIPAL REGISTER**

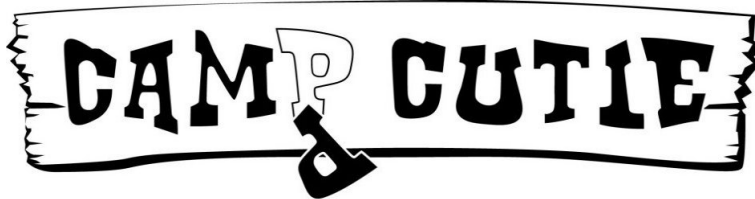

KICK ASS PICTURES, INC. (CALIFORNIA CORPORATION)  
710 IVY ST.  
GLENDALE, CA 91204

FIRST USE 7-6-2006; IN COMMERCE 8-1-2006.

FOR: ENTERTAINMENT SERVICES, NAMELY, PROVIDING A WEBSITE FEATURING, PHOTOGRAPHIC, AUDIO, VIDEO AND PROSE PRESENTATIONS FEATURING ADULT ORIENTED ENTERTAINMENT, IN CLASS 41 (U.S. CLS. 100, 101 AND 107).

THE MARK CONSISTS OF THE WORDS "CAMP" AND "CUTIE" IN A SIGN FORMAT.

SER. NO. 77-234,250, FILED 7-19-2007.

MARK SPARACINO, EXAMINING ATTORNEY

**Int. Cls.: 35, 38, 41 and 42**

**Prior U.S. Cls.: 100, 101, 102, 104 and 107**

**United States Patent and Trademark Office**

**Reg. No. 3,497,925**

**Registered Sep. 9, 2008**

**SERVICE MARK  
PRINCIPAL REGISTER**

# Zstreet

CINCINNATI BELL, INC. (OHIO CORPORATION)  
221 EAST FOURTH STREET  
CINCINNATI, OH 45202

FOR: ADVERTISING AND ADVERTISEMENT, PROMOTION AND MARKETING SERVICES FOR PROVIDING ELECTRONIC MEDIA OR INFORMATION OVER THE INTERNET OR OTHER COMMUNICATIONS NETWORK; DISSEMINATION OF ADVERTISING FOR OTHERS VIA A GLOBAL COMMUNICATIONS NETWORK; ONLINE ADVERTISING SERVICES FOR OTHERS, NAMELY, PROVIDING ADVERTISING SPACE ON INTERNET WEB SITES, IN CLASS 35 (U.S. CLS. 100, 101 AND 102).

FIRST USE 4-5-2007; IN COMMERCE 4-5-2007.

FOR: PROVIDING REMOTE INTERNET ACCESS TO INFORMATION, AUDIO, AND VIDEO VIA WEBSITES, ONLINE FORUMS, CHAT ROOMS, LISTSERVERS AND BLOGS; PROVIDING ON-LINE CHAT ROOMS AND ELECTRONIC BULLETIN BOARDS FOR TRANSMISSION OF MESSAGES AMONG USERS IN THE FIELD OF GENERAL INTEREST AND CLASSIFIED ADVERTISEMENTS, IN CLASS 38 (U.S. CLS. 100, 101 AND 104).

FIRST USE 4-5-2007; IN COMMERCE 4-5-2007.

FOR: PROVIDING EDUCATION AND ENTERTAINMENT INFORMATION IN AUDIO CLIPS, VIDEO CLIPS, MUSICAL PERFORMANCES,

MUSICAL VIDEOS, FILM CLIPS, PHOTOGRAPHS, AND OTHER MULTIMEDIA MATERIALS VIA A WEBSITE; BLOGS FEATURING INFORMATION IN THE FIELD OF AUDIO CLIPS, VIDEO CLIPS, MUSICAL PERFORMANCES, MUSICAL VIDEOS, FILM CLIPS, PHOTOGRAPHS, AND OTHER MULTIMEDIA MATERIALS, IN CLASS 41 (U.S. CLS. 100, 101 AND 107).

FIRST USE 4-5-2007; IN COMMERCE 4-5-2007.

FOR: APPLICATION SERVICE PROVIDER (ASP) FEATURING SOFTWARE TO ENABLE UPLOADING, POSTING, SHOWING, DISPLAYING, TAGGING, BLOGGING, SHARING OR OTHERWISE PROVIDING ELECTRONIC MEDIA OR INFORMATION OVER THE INTERNET OR OTHER COMMUNICATIONS NETWORK; PROVIDING A WEBSITE THAT ALLOWS COMPUTER USERS THE ABILITY TO UPLOADING, POSTING, SHOWING, DISPLAYING, TAGGING AND ELECTRONICALLY TRANSMITTING INFORMATION, AUDIO, AND VIDEO CLIPS, IN CLASS 42 (U.S. CLS. 100 AND 101).

FIRST USE 4-5-2007; IN COMMERCE 4-5-2007.

THE MARK CONSISTS OF STANDARD CHARACTERS WITHOUT CLAIM TO ANY PARTICULAR FONT, STYLE, SIZE, OR COLOR.

SER. NO. 77-234,294, FILED 7-19-2007.

ANGELA M. MICHELI, EXAMINING ATTORNEY

Int. Cl.: 35

Prior U.S. Cls.: 100, 101 and 102

United States Patent and Trademark Office

Reg. No. 3,497,926

Registered Sep. 9, 2008

**SERVICE MARK  
PRINCIPAL REGISTER**



PETMED EXPRESS, INC. (FLORIDA CORPORATION)  
1441 SW 29TH AVENUE  
POMPANO BEACH, FL 33069

FOR: ONLINE ORDERING SERVICES USING A GLOBAL COMPUTER NETWORK, TELEPHONE ORDERING SERVICES, AND MAIL ORDER SERVICES, ALL FEATURING VETERINARY PHARMACEUTICALS FOR PETS, PET SUPPLIES, AND PET NUTRITIONAL PRODUCTS, IN CLASS 35 (U.S. CLS. 100, 101 AND 102).

FIRST USE 7-6-2007; IN COMMERCE 7-6-2007.

OWNER OF U.S. REG. NO. 2,895,150.

NO CLAIM IS MADE TO THE EXCLUSIVE RIGHT TO USE "100% PRODUCT GUARANTEE" AND "BETTER THAN A MANUFACTURER'S GUARANTEE, IT'S 100% SATISFACTION", APART FROM THE MARK AS SHOWN.

THE COLOR(S) BLUE, RED, WHITE, AND BLACK IS/ARE CLAIMED AS A FEATURE OF THE MARK.

THE COLOR BLUE APPEARS IN THE PRIZE SEAL CONTAINING THE NUMBER "100%." THE COLOR WHITE APPEARS IN THE NUMBER "100%" AND IN THE WORDING "PRODUCT GUARANTEE." THE COLOR RED APPEARS IN THE NARROW RECTANGLE CONTAINING THE WORDS "PRODUCT GUARANTEE." THE COLOR BLACK APPEARS IN THE WORDS "1-800-PETMEDS," AND "BETTER THAN A MANUFACTURER'S GUARANTEE, IT'S 100% SATISFACTION."

SEC. 2(F) AS TO "1-800-PETMEDS".

SER. NO. 77-234,386, FILED 7-20-2007.

EVELYN BRADLEY, EXAMINING ATTORNEY

**Int. Cl.: 25**

**Prior U.S. Cls.: 22 and 39**

**United States Patent and Trademark Office**

**Reg. No. 3,497,927**

**Registered Sep. 9, 2008**

**TRADEMARK  
PRINCIPAL REGISTER**

**SOUL PATROL**

HICKS, TAYLOR REUBEN (UNITED STATES  
INDIVIDUAL)  
P.O. BOX 43219  
3800 COLONNADE PARKWAY, SUITE 650  
BIRMINGHAM, AL 35243

FOR: CLOTHING; NAMELY, TEE SHIRTS, CAPS,  
SWEATSHIRTS, AND TANK TOPS DISTRIBUTED  
IN CONNECTION WITH MUSICAL CONCERTS  
AND MUSICAL SOUND RECORDINGS , IN CLASS  
25 (U.S. CLS. 22 AND 39).

FIRST USE 4-1-2006; IN COMMERCE 4-1-2006.

THE MARK CONSISTS OF STANDARD CHAR-  
ACTERS WITHOUT CLAIM TO ANY PARTICULAR  
FONT, STYLE, SIZE, OR COLOR.

SER. NO. 77-234,885, FILED 7-20-2007.

BARBARA RUTLAND, EXAMINING ATTORNEY

**Int. Cl.: 25**

**Prior U.S. Cls.: 22 and 39**

**United States Patent and Trademark Office**

**Reg. No. 3,497,928**

**Registered Sep. 9, 2008**

**TRADEMARK  
PRINCIPAL REGISTER**

**MODERN WHOMP**

HICKS, TAYLOR REUBEN (UNITED STATES  
INDIVIDUAL)  
P.O. BOX 43219  
3800 COLONNADE PARKWAY, SUITE 650  
BIRMINGHAM, AL 35243

FOR: CLOTHING; NAMELY, TEE SHIRTS,  
SWEATSHIRTS, TANK TOPS, AND CAPS DISTRIB-  
UTED IN CONNECTION WITH MUSICAL CON-  
CERTS AND MUSICAL SOUND RECORDINGS , IN  
CLASS 25 (U.S. CLS. 22 AND 39).

FIRST USE 2-14-2006; IN COMMERCE 2-14-2006.

THE MARK CONSISTS OF STANDARD CHAR-  
ACTERS WITHOUT CLAIM TO ANY PARTICULAR  
FONT, STYLE, SIZE, OR COLOR.

SER. NO. 77-235,001, FILED 7-20-2007.

BARBARA RUTLAND, EXAMINING ATTORNEY

**Int. Cls.: 30, 35 and 43**

**Prior U.S. Cls.: 46, 100, 101 and 102**

**United States Patent and Trademark Office**

**Reg. No. 3,497,929**

**Registered Sep. 9, 2008**

**TRADEMARK  
SERVICE MARK  
PRINCIPAL REGISTER**

**BONE DADDY'S**

BONE DADDY'S, INC. (TEXAS CORPORATION)  
SUITE 806W  
5080 SPECTRUM DRIVE  
ADDISON, TX 75001

FOR: BARBECUE SAUCE, IN CLASS 30 (U.S. CL. 46).

FIRST USE 9-0-2005; IN COMMERCE 9-0-2005.

FOR: ONLINE RETAIL STORE SERVICES FEATURING FOOD, CLOTHING, AND GIFT CARDS, IN CLASS 35 (U.S. CLS. 100, 101 AND 102).

FIRST USE 9-0-2005; IN COMMERCE 9-0-2005.

FOR: RESTAURANT SERVICES; CATERING SERVICES, IN CLASS 43 (U.S. CLS. 100 AND 101).

FIRST USE 1-0-2000; IN COMMERCE 1-0-2000.

THE MARK CONSISTS OF STANDARD CHARACTERS WITHOUT CLAIM TO ANY PARTICULAR FONT, STYLE, SIZE, OR COLOR.

OWNER OF U.S. REG. NOS. 2,471,883, 2,478,567, AND 2,947,123.

SER. NO. 77-235,091, FILED 7-20-2007.

FLORENTINA BLANDU, EXAMINING ATTORNEY

**Int. Cl.: 16**

**Prior U.S. Cls.: 2, 5, 22, 23, 29, 37, 38 and 50**

**United States Patent and Trademark Office**

**Reg. No. 3,497,930**

**Registered Sep. 9, 2008**

**TRADEMARK  
PRINCIPAL REGISTER**

**MACHINEGUN**

EIKON DEVICE INC. (CANADA CORPORATION)  
692 MCKAY STREET  
KINGSTON, CANADA K7M7G2

FOR: MAGAZINES FEATURING TECHNICAL  
AND MECHANICAL ASPECTS OF TATTOOING,  
IN CLASS 16 (U.S. CLS. 2, 5, 22, 23, 29, 37, 38 AND 50).

FIRST USE 6-0-2001; IN COMMERCE 6-0-2001.

THE MARK CONSISTS OF STANDARD CHAR-  
ACTERS WITHOUT CLAIM TO ANY PARTICULAR  
FONT, STYLE, SIZE, OR COLOR.

PRIORITY CLAIMED UNDER SEC. 44(D) ON  
CANADA APPLICATION NO. 1350524, FILED 6-6-  
2007.

SER. NO. 77-235,136, FILED 7-20-2007.

AHSEN KHAN, EXAMINING ATTORNEY

**Int. Cl.: 42**

**Prior U.S. Cls.: 100 and 101**

**United States Patent and Trademark Office**

**Reg. No. 3,497,931**

**Registered Sep. 9, 2008**

**SERVICE MARK  
PRINCIPAL REGISTER**

**BUSINESS CLARITY**

DATA CRAFT, INC. (ILLINOIS CORPORATION)  
120 WEST STATE STREET, SUITE 302  
ROCKFORD, IL 61101

FOR: PROVIDING CONSULTING SERVICES IN  
THE FIELD OF SELECTION, IMPLEMENTATION  
AND OPERATION OF COMPUTER ACCOUNTING  
SOFTWARE, IN CLASS 42 (U.S. CLS. 100 AND 101).

FIRST USE 7-9-2007; IN COMMERCE 7-9-2007.

THE MARK CONSISTS OF STANDARD CHAR-  
ACTERS WITHOUT CLAIM TO ANY PARTICULAR  
FONT, STYLE, SIZE, OR COLOR.

NO CLAIM IS MADE TO THE EXCLUSIVE  
RIGHT TO USE "BUSINESS", APART FROM THE  
MARK AS SHOWN.

SER. NO. 77-235,404, FILED 7-21-2007.

DOMINICK J. SALEMI, EXAMINING ATTORNEY



**Int. Cl.: 5**

**Prior U.S. Cls.: 6, 18, 44, 46, 51 and 52**

**Reg. No. 3,497,932**

**United States Patent and Trademark Office**

**Registered Sep. 9, 2008**

---

**TRADEMARK  
PRINCIPAL REGISTER**

**NO Xtreme**

EST NUTRITION LLC (FLORIDA LIMITED LIABILITY COMPANY), DBA EST NUTRITION INC

SUITE 114

7217 EAST COLONIAL DRIVE

ORLANDO, FL 32807

FOR: DIETARY SUPPLEMENTS, IN CLASS 5 (U.S. CLS. 6, 18, 44, 46, 51 AND 52).

FIRST USE 6-1-2004; IN COMMERCE 6-1-2004.

THE MARK CONSISTS OF STANDARD CHARACTERS WITHOUT CLAIM TO ANY PARTICULAR FONT, STYLE, SIZE, OR COLOR.

NO CLAIM IS MADE TO THE EXCLUSIVE RIGHT TO USE "NO", APART FROM THE MARK AS SHOWN.

SER. NO. 77-235,904, FILED S.R. 7-23-2007 AM. P.R. 7-23-2007.

KATINA MISTER, EXAMINING ATTORNEY

**Int. Cl.: 9**

**Prior U.S. Cls.: 21, 23, 26, 36 and 38**

**Reg. No. 3,497,933**

**United States Patent and Trademark Office**

**Registered Sep. 9, 2008**

**TRADEMARK  
PRINCIPAL REGISTER**

**ACQUIRO**

UNITED SPACE ALLIANCE, LLC (DELAWARE  
LIMITED LIABILITY COMPANY)  
1150 GEMINI  
HOUSTON, TX 77058

FOR: ELECTRONIC SYSTEMS CONSISTING PRIMARILY OF COMPUTER SOFTWARE AND HARDWARE FOR USE IN SPATIAL LOCATION, DATA INTEGRATION AND MANIPULATION IN THE FIELDS OF SPACE OPERATIONS, SPACE FLIGHT AND SPACE EXPLORATION AND IN THE FIELDS OF NATURAL RESOURCE EXPLORATION, EXTRACTION AND PROCESSING, IN CLASS 9 (U.S. CLS. 21, 23, 26, 36 AND 38).

FIRST USE 4-7-2006; IN COMMERCE 4-7-2006.

THE MARK CONSISTS OF STANDARD CHARACTERS WITHOUT CLAIM TO ANY PARTICULAR FONT, STYLE, SIZE, OR COLOR.

THE MARK TRANSLATES INTO ENGLISH AS "TO ACQUIRE".

SER. NO. 77-236,168, FILED 7-23-2007.

ROBERT C. CLARK JR., EXAMINING ATTORNEY

**Int. Cl.: 5**

**Prior U.S. Cls.: 6, 18, 44, 46, 51 and 52**

**United States Patent and Trademark Office**

**Reg. No. 3,497,934**

**Registered Sep. 9, 2008**

**TRADEMARK  
PRINCIPAL REGISTER**

**DESIGNER LINER FOR THE  
ACTIVE GIRL**

OWENS, JEANNIE (CANADA INDIVIDUAL)  
P. O. BOX 9606  
SAN DIEGO, CA 92169 AND  
RICHARDSON, DEBBIE (UNITED STATES INDIVIDUAL)  
P. O. BOX 9606  
SAN DIEGO, CA 92169

FOR: PERSPIRATION ABSORBENT PANTY LINERS, IN CLASS 5 (U.S. CLS. 6, 18, 44, 46, 51 AND 52).

FIRST USE 7-5-2007; IN COMMERCE 7-5-2007.

THE MARK CONSISTS OF STANDARD CHARACTERS WITHOUT CLAIM TO ANY PARTICULAR FONT, STYLE, SIZE, OR COLOR.

NO CLAIM IS MADE TO THE EXCLUSIVE RIGHT TO USE "DESIGNER LINER", APART FROM THE MARK AS SHOWN.

SER. NO. 77-236,169, FILED 7-23-2007.

ROBERT C. CLARK JR., EXAMINING ATTORNEY

**Int. Cl.: 41**

**Prior U.S. Cls.: 100, 101 and 107**

**Reg. No. 3,497,935**

**United States Patent and Trademark Office**

**Registered Sep. 9, 2008**

**SERVICE MARK  
PRINCIPAL REGISTER**

**BREAST CANCER RECOVERY  
FOUNDATION**

BREAST CANCER RECOVERY FOUNDATION,  
INC. (WISCONSIN NON-STOCK CORPORATION)  
4200 COUNTY M  
MIDDLETON, WI 53562

FOR: EDUCATIONAL SERVICES, NAMELY, CONDUCTING SEMINARS, CONFERENCES, WORKSHOPS AND RETREATS FOR PATIENTS AND SURVIVORS OF BREAST CANCER IN THE FIELDS OF NUTRITION, EXERCISE, AND HEALING TECHNIQUES; EDUCATIONAL SERVICES, NAMELY, CONDUCTING SEMINARS, CONFERENCES, WORKSHOPS AND RETREATS FOR BREAST CANCER PATIENTS AND SURVIVORS, FAMILY MEMBERS AND FRIENDS OF BREAST CANCER PATIENTS AND SURVIVORS, INDIVIDUALS WITH A FAMILY HISTORY OF BREAST CANCER, CARE GIVERS, CERTIFIED NURSES, NURSING STUDENTS, AND HEALTH CARE PROFESSIONALS FEATURING INFORMATION CONCERNING BREAST CANCER, BREAST CANCER TREATMENTS, BREAST CANCER DIAGNOSIS, BREAST CANCER RESEARCH, AND BREAST CANCER SURVIVAL, MANAGEMENT AND RECOVERY; EDUCATIONAL SERVICES, NAMELY, CONDUCTING SEMINARS, CONFERENCES AND

WORKSHOPS DESIGNED TO NURTURE, ENHANCE AND AID IN THE PHYSICAL, EMOTIONAL AND SPIRITUAL RECOVERY OF INDIVIDUALS WHO HAVE BEEN DIAGNOSED WITH BREAST CANCER; AND EDUCATIONAL SERVICES, NAMELY, CONDUCTING RETREATS DESIGNED TO NURTURE, ENHANCE AND AID IN THE PHYSICAL, EMOTIONAL AND SPIRITUAL RECOVERY OF INDIVIDUALS WHO HAVE BEEN DIAGNOSED WITH BREAST CANCER THROUGH PARTICIPATION IN DISCUSSION GROUPS, CREATIVE ARTS ACTIVITIES, AND OUTDOOR PHYSICAL AND RECREATIONAL ACTIVITIES, IN CLASS 41 (U.S. CLS. 100, 101 AND 107).

FIRST USE 9-0-1997; IN COMMERCE 1-0-1998.

THE MARK CONSISTS OF STANDARD CHARACTERS WITHOUT CLAIM TO ANY PARTICULAR FONT, STYLE, SIZE, OR COLOR.

SEC. 2(F).

SER. NO. 77-236,231, FILED 7-23-2007.

INGA ERVIN, EXAMINING ATTORNEY

**Int. Cl.: 41**

**Prior U.S. Cls.: 100, 101 and 107**

**Reg. No. 3,497,936**

**United States Patent and Trademark Office**

**Registered Sep. 9, 2008**

**SERVICE MARK  
PRINCIPAL REGISTER**

  
**Breast Cancer Recovery Foundation, Inc.**

BREAST CANCER RECOVERY FOUNDATION,  
INC. (WISCONSIN NON-STOCK CORPORATION)  
4200 COUNTY M  
MIDDLETON, WI 53562

FOR: EDUCATIONAL SERVICES, NAMELY, CONDUCTING SEMINARS, CONFERENCES, WORKSHOPS AND RETREATS FOR PATIENTS AND SURVIVORS OF BREAST CANCER IN THE FIELDS OF NUTRITION, EXERCISE, AND HEALING TECHNIQUES; EDUCATIONAL SERVICES, NAMELY, CONDUCTING SEMINARS, CONFERENCES, WORKSHOPS AND RETREATS FOR BREAST CANCER PATIENTS AND SURVIVORS, FAMILY MEMBERS AND FRIENDS OF BREAST CANCER PATIENTS AND SURVIVORS, INDIVIDUALS WITH A FAMILY HISTORY OF BREAST CANCER, CARE GIVERS, CERTIFIED NURSES, NURSING STUDENTS, AND HEALTH CARE PROFESSIONALS FEATURING INFORMATION CONCERNING BREAST CANCER, BREAST CANCER TREATMENTS, BREAST CANCER DIAGNOSIS, BREAST CANCER RESEARCH, AND BREAST CANCER SURVIVAL, MANAGEMENT AND RECOVERY; EDUCATIONAL SERVICES, NAMELY,

CONDUCTING SEMINARS, CONFERENCES AND WORKSHOPS DESIGNED TO NURTURE, ENHANCE AND AID IN THE PHYSICAL, EMOTIONAL AND SPIRITUAL RECOVERY OF INDIVIDUALS WHO HAVE BEEN DIAGNOSED WITH BREAST CANCER; AND EDUCATIONAL SERVICES, NAMELY, CONDUCTING RETREATS DESIGNED TO NURTURE, ENHANCE AND AID IN THE PHYSICAL, EMOTIONAL AND SPIRITUAL RECOVERY OF INDIVIDUALS WHO HAVE BEEN DIAGNOSED WITH BREAST CANCER THROUGH PARTICIPATION IN DISCUSSION GROUPS, CREATIVE ARTS ACTIVITIES, AND OUTDOOR PHYSICAL AND RECREATIONAL ACTIVITIES, IN CLASS 41 (U.S. CLS. 100, 101 AND 107).

FIRST USE 9-0-1997; IN COMMERCE 1-0-1998.

SEC. 2(F) AS TO "BREAST CANCER RECOVERY FOUNDATION, INC."

SER. NO. 77-236,315, FILED 7-23-2007.

INGA ERVIN, EXAMINING ATTORNEY

Int. Cl.: 44

Prior U.S. Cls.: 100 and 101

United States Patent and Trademark Office

Reg. No. 3,497,937

Registered Sep. 9, 2008

**SERVICE MARK  
PRINCIPAL REGISTER**



BREAST CANCER RECOVERY FOUNDATION,  
INC. (WISCONSIN NON-STOCK CORPORATION)  
2800 ROYAL AVENUE, SUITE 306  
MADISON, WI 53713

FOR: COUNSELING AND SUPPORT SERVICES  
FOR BREAST CANCER PATIENTS AND BREAST  
CANCER SURVIVORS; PROVIDING INFORMA-  
TION IN THE FIELDS OF BREAST CANCER,  
BREAST CANCER TREATMENTS, BREAST CAN-  
CER DIAGNOSIS, BREAST CANCER RESEARCH,  
AND BREAST CANCER SURVIVAL, MANAGE-

MENT AND RECOVERY; AND PROVIDING  
HEALTH AND WELLNESS INFORMATION TO  
BREAST CANCER PATIENTS AND BREAST CAN-  
CER SURVIVORS IN THE FIELDS OF NUTRITION,  
EXERCISE, AND HEALING TECHNIQUES, IN  
CLASS 44 (U.S. CLS. 100 AND 101).

FIRST USE 9-0-1997; IN COMMERCE 1-0-1998.

SER. NO. 77-236,424, FILED 7-23-2007.

INGA ERVIN, EXAMINING ATTORNEY

**Int. Cl.: 35**

**Prior U.S. Cls.: 100, 101 and 102**

**United States Patent and Trademark Office**

**Reg. No. 3,497,938**

**Registered Sep. 9, 2008**

**SERVICE MARK  
PRINCIPAL REGISTER**



RED TOMATO, INC. (MASSACHUSETTS NON-PROFIT CORPORATION)  
1033 TURNPIKE STREET  
CANTON, MA 02021

FOR: CONSULTING REGARDING THE MARKETING OF AGRICULTURAL PRODUCTS; MARKETING SERVICES, NAMELY, ASSISTING OTHERS WITH THE MARKETING OF AGRICULTURAL PRODUCTS, IN CLASS 35 (U.S. CLS. 100, 101 AND 102).

FIRST USE 12-31-1996; IN COMMERCE 12-31-1996.

THE MARK CONSISTS OF A TOMATO WITH AN ARROW AROUND IT.

SER. NO. 77-236,789, FILED 7-24-2007.

KRISTIN DAHLING, EXAMINING ATTORNEY

**Int. Cl.: 35**

**Prior U.S. Cls.: 100, 101 and 102**

**United States Patent and Trademark Office**

**Reg. No. 3,497,939**

**Registered Sep. 9, 2008**

**SERVICE MARK  
PRINCIPAL REGISTER**

**BORN AND RAISED HERE**

RED TOMATO, INC. (MASSACHUSETTS NON-  
PROFIT CORPORATION)  
1033 TURNPIKE STREET  
CANTON, MA 02021

FOR: CONSULTING REGARDING THE MAR-  
KETING OF AGRICULTURAL PRODUCTS; MAR-  
KETING SERVICES, NAMELY, ASSISTING  
OTHERS WITH THE MARKETING OF AGRICUL-  
TURAL PRODUCTS, IN CLASS 35 (U.S. CLS. 100, 101  
AND 102).

FIRST USE 12-31-2003; IN COMMERCE 12-31-2003.

THE MARK CONSISTS OF STANDARD CHAR-  
ACTERS WITHOUT CLAIM TO ANY PARTICULAR  
FONT, STYLE, SIZE, OR COLOR.

SER. NO. 77-236,801, FILED 7-24-2007.

KRISTIN DAHLING, EXAMINING ATTORNEY



**Int. Cl.: 39**

**Prior U.S. Cls.: 100 and 105**

**United States Patent and Trademark Office**

**Reg. No. 3,497,940**

**Registered Sep. 9, 2008**

**SERVICE MARK  
PRINCIPAL REGISTER**

**BEE-LINE**

BEE-LINE DELIVERY SERVICE, INC. (TEXAS  
CORPORATION)  
P.O. BOX 571267  
HOUSTON, TX 772571267

THE MARK CONSISTS OF STANDARD CHAR-  
ACTERS WITHOUT CLAIM TO ANY PARTICULAR  
FONT, STYLE, SIZE, OR COLOR.

FOR: TRUCK HAULING, NAMELY, FREIGHT  
HAULING AND TRACTOR TRAILER SERVICES;  
FREIGHT BROKERAGE, IN CLASS 39 (U.S. CLS. 100  
AND 105).

SER. NO. 77-237,039, FILED 7-24-2007.

FIRST USE 4-24-1972; IN COMMERCE 11-0-1995.

INGA ERVIN, EXAMINING ATTORNEY

**Int. Cls.: 36 and 41**

**Prior U.S. Cls.: 100, 101, 102 and 107**

**United States Patent and Trademark Office**

**Reg. No. 3,497,941**

**Registered Sep. 9, 2008**

**SERVICE MARK  
PRINCIPAL REGISTER**

**SUNSET GOWER STUDIOS**

GI PARTNERS STUDIO, LLC (DELAWARE LIMITED LIABILITY COMPANY)  
1438 NORTH GOWER STREET, BOX 21  
BUILDING 1, SUITE 248  
HOLLYWOOD, CA 90028

FOR: RENTAL OF OFFICE SPACE FACILITIES, IN CLASS 36 (U.S. CLS. 100, 101 AND 102).

FIRST USE 0-0-1977; IN COMMERCE 0-0-1977.

FOR: CINEMA, FILM, TELEVISION AND MOVIE STUDIO SERVICES; OPERATING OF FILM STUDIOS; RENTAL OF STAGE FACILITIES, IN CLASS 41 (U.S. CLS. 100, 101 AND 107).

FIRST USE 0-0-1977; IN COMMERCE 0-0-1977.

THE MARK CONSISTS OF STANDARD CHARACTERS WITHOUT CLAIM TO ANY PARTICULAR FONT, STYLE, SIZE, OR COLOR.

NO CLAIM IS MADE TO THE EXCLUSIVE RIGHT TO USE "STUDIOS", APART FROM THE MARK AS SHOWN.

SER. NO. 77-237,042, FILED 7-24-2007.

CHRISTINA SOBRAL, EXAMINING ATTORNEY

**Int. Cl.: 45**

**Prior U.S. Cls.: 100 and 101**

**United States Patent and Trademark Office**

**Reg. No. 3,497,942**

**Registered Sep. 9, 2008**

**SERVICE MARK  
PRINCIPAL REGISTER**

# The Better Solution

NATIONAL ARBITRATION AND MEDIATION,  
INC. (NEW YORK CORPORATION)

990 STEWART AVENUE

GARDEN CITY, NY 11530

FOR: ALTERNATIVE DISPUTE RESOLUTION, IN  
CLASS 45 (U.S. CLS. 100 AND 101).

FIRST USE 3-0-2006; IN COMMERCE 3-0-2006.

THE MARK CONSISTS OF STANDARD CHAR-  
ACTERS WITHOUT CLAIM TO ANY PARTICULAR  
FONT, STYLE, SIZE, OR COLOR.

NO CLAIM IS MADE TO THE EXCLUSIVE  
RIGHT TO USE "SOLUTION", APART FROM THE  
MARK AS SHOWN.

SER. NO. 77-237,044, FILED 7-24-2007.

MELVIN AXILBUND, EXAMINING ATTORNEY

**Int. Cls.: 25 and 35**

**Prior U.S. Cls.: 22, 39, 100, 101 and 102**

**United States Patent and Trademark Office**

**Reg. No. 3,497,943**

**Registered Sep. 9, 2008**

**TRADEMARK  
SERVICE MARK  
PRINCIPAL REGISTER**

**WORK SMARTER...NOT HARDER!**

KUCHTA, ROBERT M. (UNITED STATES INDIVIDUAL)  
368 OAK GROVE ROAD  
PITTSTOWN, NJ 08867

FOR: HATS; JACKETS; KNIT SHIRTS; SHIRTS; SWEATERS; WIND RESISTANT JACKETS, IN CLASS 25 (U.S. CLS. 22 AND 39).

FIRST USE 4-15-1990; IN COMMERCE 4-15-1992.

FOR: MARKETING CONSULTING; BUSINESS CONSULTATION; BUSINESS CONSULTATION SERVICES, IN CLASS 35 (U.S. CLS. 100, 101 AND 102).

FIRST USE 4-15-1990; IN COMMERCE 4-15-1992.

THE MARK CONSISTS OF STANDARD CHARACTERS WITHOUT CLAIM TO ANY PARTICULAR FONT, STYLE, SIZE, OR COLOR.

SER. NO. 77-237,271, FILED 7-24-2007.

MATTHEW PAPPAS, EXAMINING ATTORNEY

**Int. Cls.: 35 and 42**

**Prior U.S. Cls.: 100, 101 and 102**

**United States Patent and Trademark Office**

**Reg. No. 3,497,944**

**Registered Sep. 9, 2008**

**SERVICE MARK  
PRINCIPAL REGISTER**

**AMINI'S**

AMINI'S BILLIARDS AND BARSTOOLS INC.  
(KANSAS CORPORATION)  
10595 METCALF  
OVERLAND PARK, KS 66212

FOR: RETAIL STORE SERVICES FEATURING  
POOL TABLES, GAME TABLES, BARS, SHUFFLE  
BOARDS, AIR HOCKEY, FOOSBALL, VIDEO  
GAMES, PINBALL, CASINO GAMES, PING PONG  
TABLES, AREA RUGS, THEATER SEATING,  
STOOLS, AND RELATED FURNISHINGS, EQUIP-  
MENT, AND ACCESSORIES, IN CLASS 35 (U.S. CLS.  
100, 101 AND 102).

FIRST USE 11-0-1983; IN COMMERCE 11-0-1983.

FOR: GAME AND THEATER ROOM DESIGN  
SERVICES; CONSULTATION SERVICES IN THE  
FIELD OF GAME AND THEATER ROOM DESIGN,  
IN CLASS 42 (U.S. CLS. 100 AND 101).

FIRST USE 11-0-1983; IN COMMERCE 11-0-1983.

THE MARK CONSISTS OF STANDARD CHAR-  
ACTERS WITHOUT CLAIM TO ANY PARTICULAR  
FONT, STYLE, SIZE, OR COLOR.

SEC. 2(F).

SER. NO. 77-237,332, FILED 7-24-2007.

THOMAS MANOR, EXAMINING ATTORNEY

**Int. Cl.: 9**

**Prior U.S. Cls.: 21, 23, 26, 36 and 38**

**Reg. No. 3,497,945**

**United States Patent and Trademark Office**

**Registered Sep. 9, 2008**

**TRADEMARK  
PRINCIPAL REGISTER**

**VALO**

DAKTRONICS, INC. (SOUTH DAKOTA CORPORATION)  
331 32ND AVENUE  
P.O. BOX 5128  
BROOKINGS, SD 570065128

FIRST USE 5-15-2007; IN COMMERCE 5-15-2007.

FOR: DIGITAL BILLBOARDS FOR DISPLAYING ADVERTISEMENTS, PUBLIC SERVICE ANNOUNCEMENTS, PUBLIC ALERTS, NAMELY, SAFETY ALERTS, AMBER ALERTS, CRIME FIGHTING ALERTS, WEATHER ALERTS, TRAFFIC ALERTS, HOMELAND SECURITY ALERTS, IN CLASS 9 (U.S. CLS. 21, 23, 26, 36 AND 38).

THE MARK CONSISTS OF STANDARD CHARACTERS WITHOUT CLAIM TO ANY PARTICULAR FONT, STYLE, SIZE, OR COLOR.

SER. NO. 77-237,456, FILED 7-24-2007.

WANDA KAY PRICE, EXAMINING ATTORNEY

**Int. Cl.: 9**

**Prior U.S. Cls.: 21, 23, 26, 36 and 38**

**United States Patent and Trademark Office**

**Reg. No. 3,497,946**

**Registered Sep. 9, 2008**

**TRADEMARK  
PRINCIPAL REGISTER**

**V1: AGILE ENTERPRISE**

VERSIONONE, INC. (DELAWARE CORPORATION)  
6220 SHILOH ROAD, SUITE 400  
ALPHARETTA, GA 30005

FOR: COMPUTER SOFTWARE FOR MANAGEMENT OF COMPUTER SOFTWARE DEVELOPMENT AND RELEASE BY OTHERS THAT MAY BE DOWNLOADED FROM A GLOBAL COMPUTER NETWORK, IN CLASS 9 (U.S. CLS. 21, 23, 26, 36 AND 38).

FIRST USE 2-0-2006; IN COMMERCE 2-0-2006.

THE MARK CONSISTS OF STANDARD CHARACTERS WITHOUT CLAIM TO ANY PARTICULAR FONT, STYLE, SIZE, OR COLOR.

NO CLAIM IS MADE TO THE EXCLUSIVE RIGHT TO USE "AGILE", APART FROM THE MARK AS SHOWN.

SER. NO. 77-237,698, FILED 7-24-2007.

KATHY DE JONGE, EXAMINING ATTORNEY

**Int. Cl.: 9**

**Prior U.S. Cls.: 21, 23, 26, 36 and 38**

**Reg. No. 3,497,947**

**United States Patent and Trademark Office**

**Registered Sep. 9, 2008**

**TRADEMARK  
PRINCIPAL REGISTER**

**V1: AGILE COMMUNITY**

VERSIONONE, INC. (DELAWARE CORPORATION)  
6220 SHILOH ROAD, SUITE 400  
ALPHARETTA, GA 30005

FOR: COMPUTER SOFTWARE FOR MANAGEMENT OF COMPUTER SOFTWARE DEVELOPMENT AND RELEASE BY OTHERS; COMPUTER SOFTWARE FOR MANAGEMENT OF COMPUTER SOFTWARE DEVELOPMENT AND RELEASE BY OTHERS THAT MAY BE DOWNLOADED FROM A GLOBAL COMPUTER NETWORK, IN CLASS 9 (U.S. CLS. 21, 23, 26, 36 AND 38).

FIRST USE 4-0-2007; IN COMMERCE 4-0-2007.

THE MARK CONSISTS OF STANDARD CHARACTERS WITHOUT CLAIM TO ANY PARTICULAR FONT, STYLE, SIZE, OR COLOR.

NO CLAIM IS MADE TO THE EXCLUSIVE RIGHT TO USE "AGILE", APART FROM THE MARK AS SHOWN.

SER. NO. 77-237,719, FILED 7-24-2007.

KATHY DE JONGE, EXAMINING ATTORNEY



**Int. Cl.: 25**

**Prior U.S. Cls.: 22 and 39**

**United States Patent and Trademark Office**

**Reg. No. 3,497,948**

**Registered Sep. 9, 2008**

**TRADEMARK  
PRINCIPAL REGISTER**



SKINNER, JEFF (UNITED STATES INDIVIDUAL)  
10900 VINEDALE ST.  
SUN VALLEY, CA 91352 AND  
GARCIA, EDDIE (UNITED STATES INDIVIDUAL)  
15922 VALERIO ST.  
VAN NUYS, CA 91406 AND  
MACK, THOMAS (UNITED STATES INDIVIDUAL)  
#105  
10755 KLING ST.  
NORTH HOLLYWOOD, CA 91602

FOR: CLOTHING, NAMELY, SHIRTS, SWEATSHIRTS, HATS, SCARVES, JACKETS, MEN'S AND WOMEN'S UNDERWEAR, IN CLASS 25 (U.S. CLS. 22 AND 39).

FIRST USE 6-1-2002; IN COMMERCE 6-1-2002.

THE MARK CONSISTS OF A STYLIZED DEPICTION OF A MAN WEARING HELMET AND GAS MASK.

THE FOREIGN WORDING IN THE MARK TRANSLATES INTO ENGLISH AS I CAME, I DRANK, I CONQUERED.

SER. NO. 77-237,754, FILED 7-24-2007.

ELLEN PERKINS, EXAMINING ATTORNEY

**Int. Cls.: 6, 7 and 8**

**Prior U.S. Cls.: 2, 12, 13, 14, 19, 21, 23, 25, 28, 31, 34,  
35, 44 and 50**

**Reg. No. 3,497,949**

**United States Patent and Trademark Office**

**Registered Sep. 9, 2008**

**TRADEMARK  
PRINCIPAL REGISTER**

# BROOKLINE

ADVANCED GROUP LTD. (NEVADA CORPORATION)  
2021 SOUTH WABASH AVENUE  
CHICAGO, IL 60616

FOR: HARDWARE ITEMS FOR DOORS, NAME-  
LY, METAL PULL HANDLES, METAL KICK  
PLATES, METAL DOOR STOPS, METAL FINGER  
PLATES, METAL DOOR EDGE PULL HANDLES,  
METAL SIGNAGE PLATES, NAMELY, METAL  
NAME PLATES, METAL DOOR KNOCKERS, ME-  
TAL DOOR HOLDERS AND METAL FLUSH BOLTS;  
METAL HARDWARE ITEMS FOR WINDOWS,  
NAMELY, HINGES, WINDOW HINGES, CONTINU-  
OUS HINGES, WINDOW PULLS, WINDOW OPERA-  
TORS, WINDOW SLIDING TRACK, NAMELY,  
WINDOW TRIM; METAL LOCKS, IN CLASS 6 (U.S.  
CLS. 2, 12, 13, 14, 23, 25 AND 50).

FIRST USE 9-10-1998; IN COMMERCE 9-10-1998.

FOR: POWER TOOLS, NAMELY, BUFFERS AND  
GRINDERS, IN CLASS 7 (U.S. CLS. 13, 19, 21, 23, 31, 34  
AND 35).

FIRST USE 9-10-1998; IN COMMERCE 9-10-1998.

FOR: HAND TOOLS, NAMELY, HAMMERS, IN  
CLASS 8 (U.S. CLS. 23, 28 AND 44).

FIRST USE 9-10-1998; IN COMMERCE 9-10-1998.

THE MARK CONSISTS OF STANDARD CHAR-  
ACTERS WITHOUT CLAIM TO ANY PARTICULAR  
FONT, STYLE, SIZE, OR COLOR.

SER. NO. 77-238,183, FILED 7-25-2007.

KIMBERLY FRYE, EXAMINING ATTORNEY

**Int. Cl.: 9**

**Prior U.S. Cls.: 21, 23, 26, 36 and 38**

**Reg. No. 3,497,950**

**United States Patent and Trademark Office**

**Registered Sep. 9, 2008**

**TRADEMARK  
PRINCIPAL REGISTER**

# SafeTap

DIXIE IRON WORKS, LTD (TEXAS LIMITED  
PARTNERSHIP)  
300 WEST MAIN STREET  
ALICE, TX 78332

FIRST USE 5-9-2003; IN COMMERCE 5-13-2003.

FOR: COMPONENTS FOR CONTROL VALVES  
USED FOR REGULATING THE FLOW OF GASES  
AND LIQUIDS, NAMELY, NON-PRESSURE SEAL-  
ING THREAD FITTING USED TO ADD GREASE TO  
CONTROL VALVES USED FOR REGULATING THE  
FLOW OF GASES AND LIQUIDS, IN CLASS 9 (U.S.  
CLS. 21, 23, 26, 36 AND 38).

THE MARK CONSISTS OF STANDARD CHAR-  
ACTERS WITHOUT CLAIM TO ANY PARTICULAR  
FONT, STYLE, SIZE, OR COLOR.

SER. NO. 77-238,357, FILED 7-25-2007.

ADA HAN, EXAMINING ATTORNEY

**Int. Cls.: 21, 24, 29, 30, 31 and 32**

**Prior U.S. Cls.: 1, 2, 13, 23, 29, 30, 33, 40, 42, 45, 46, 48  
and 50**

**Reg. No. 3,497,951**

**United States Patent and Trademark Office**

**Registered Sep. 9, 2008**

**TRADEMARK  
PRINCIPAL REGISTER**

**LUNDS & BYERLYS**

LUND FOOD HOLDINGS, INC. (MINNESOTA CORPORATION)  
SUITE 2100  
4100 WEST 50TH STREET  
EDINA, MN 55424

FOR: WOOD COOKING PLANKS AND THERMAL INSULATED WRAPS FOR GRILLING, IN CLASS 21 (U.S. CLS. 2, 13, 23, 29, 30, 33, 40 AND 50).

FIRST USE 5-0-2005; IN COMMERCE 5-0-2005.

FOR: KITCHEN TEXTILES, IN CLASS 24 (U.S. CLS. 42 AND 50).

FIRST USE 6-0-2006; IN COMMERCE 6-0-2006.

FOR: KETTLE POTATO CHIPS; GRAPESEED OIL; OLIVE OIL; EDIBLE DIPPING OILS; PROCESSED NUTS; SNACK MIXES CONSISTING PRIMARILY OF PROCESSED FRUITS, PROCESSED NUTS, PROCESSED EDIBLE SEEDS, PROCESSED WASABI DRIED PEAS, SESAME STICKS OR RAISINS; PROCESSED ORGANIC SNACK NUTS; CUT FRUITS AND VEGETABLES; NATURAL PEANUT BUTTER; NATURAL APPLESAUCE; JAMS; MILK; ORGANIC MILK; ORGANIC EGGS; SPECIALTY CHEESES; SOUPS; HASH BROWN POTATOES; VEGETABLE CHIPS; SLICED MEATS; NATURAL BEEF; NATURAL CHICKEN; BEEF PATTIES; BAGGED SHRIMP; SMOKED FISH; SIRLOIN BEEF STEAKS; BACON; SAUSAGE; FROZEN APPETIZERS CONSISTING PRIMARILY OF MEAT, CHEESE, POULTRY OR VEGETABLES; HAM; TURKEYS; BRUSCHETTA TOPPING; DIPS; POTATO CHIPS, IN CLASS 29 (U.S. CL. 46).

FIRST USE 9-0-2002; IN COMMERCE 9-0-2002.

FOR: SPICES AND SEASONINGS; SAUCES; SALAD DRESSINGS; ORGANIC SALAD DRESSINGS;

SALSA; BARBEQUE AND GRILLING SAUCES; DIPPING SAUCES; STEAK AND WORCESTERSHIRE SAUCE; MUSTARD; SEAFOOD COCKTAIL SAUCE; PASTA AND PASTA SAUCES; SAVORY JAMS; VINEGARS; BALSAMIC VINEGAR; WILD RICE; MAPLE SYRUP; COOKIES; BISCOTTI; CRACKERS; ORGANIC TORTILLA CHIPS; CROSTINI; SNACKING GRANOLA; BREADS; APPLE CRISP AND APPLE PIE; CAKES; GINGERBREAD HOUSES; CARAMEL APPLES; LASAGNA; PIZZA; COFFEE; ORGANIC COFFEE; TEA; GELATO; FROZEN DESERTS CONSISTING OF FRUIT AND CREAM; ICE CREAM TOPPINGS, NAMELY, CHOCOLATE TOPPING, CARAMEL TOPPING, BUTTERSCOTCH TOPPING; CONFECTIONS, NAMELY, CANDY; CHOCOLATES; CHOCOLATE BARS; POPCORN; FROZEN ENTREES CONSISTING PRIMARILY OF PASTA OR RICE; LEFSE, IN CLASS 30 (U.S. CL. 46).

FIRST USE 10-0-2002; IN COMMERCE 10-0-2002.

FOR: FRESH POTATOES; FRESH PEPPERS; FRESH ONIONS, IN CLASS 31 (U.S. CLS. 1 AND 46).

FIRST USE 9-0-2006; IN COMMERCE 9-0-2006.

FOR: DRINKING WATER; ORANGE AND GRAPEFRUIT JUICE, IN CLASS 32 (U.S. CLS. 45, 46 AND 48).

FIRST USE 4-0-2006; IN COMMERCE 4-0-2006.

THE MARK CONSISTS OF STANDARD CHARACTERS WITHOUT CLAIM TO ANY PARTICULAR FONT, STYLE, SIZE, OR COLOR.

SER. NO. 77-238,695, FILED 7-25-2007.

JILL PRATER, EXAMINING ATTORNEY

**Int. Cl.: 41**

**Prior U.S. Cls.: 100, 101 and 107**

**United States Patent and Trademark Office**

**Reg. No. 3,497,952**

**Registered Sep. 9, 2008**

**SERVICE MARK  
PRINCIPAL REGISTER**



KIMC INVESTMENTS, INC. (DELAWARE CORPORATION)  
1401 FORUM WAY  
6TH FLOOR  
WEST PALM BEACH, FL 33401

FOR: EDUCATIONAL SERVICES, NAMELY, PROVIDING COURSES OF INSTRUCTION IN THE FIELDS OF NURSING PRACTICES, MEDICAL LABORATORY TECHNOLOGY, MEDICAL RECORDS MANAGEMENT AND MEDICAL OFFICE ADMINISTRATION; TRAINING SERVICES IN THE FIELD OF NURSING PRACTICES, MEDICAL LABORATORY TECHNOLOGY, MEDICAL RECORDS MANAGEMENT AND MEDICAL OFFICE

ADMINISTRATION, IN CLASS 41 (U.S. CLS. 100, 101 AND 107).

FIRST USE 7-1-2007; IN COMMERCE 7-1-2007.

OWNER OF U.S. REG. NO. 2,548,056.

NO CLAIM IS MADE TO THE EXCLUSIVE RIGHT TO USE "INSTITUTE", APART FROM THE MARK AS SHOWN.

SER. NO. 77-239,090, FILED 7-26-2007.

RONALD MCMORROW, EXAMINING ATTORNEY

Int. Cls.: 35 and 40

Prior U.S. Cls.: 100, 101, 102, 103 and 106

United States Patent and Trademark Office

Reg. No. 3,497,953

Registered Sep. 9, 2008

**SERVICE MARK  
PRINCIPAL REGISTER**

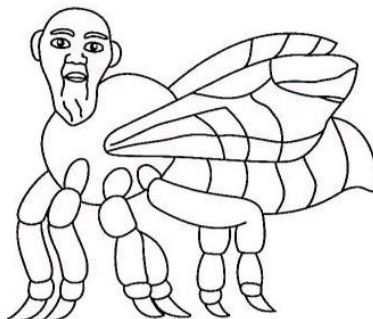

**Kelley The Bee Man**

THE WALTER T. KELLEY CO. (KENTUCKY CORPORATION)

807 WEST MAIN STREET

CLARKSON, KY 42726

FOR: RETAIL STORE SERVICES FEATURING BEEKEEPING SUPPLIES; CATALOG ORDERING SERVICES FEATURING BEEKEEPING SUPPLIES, IN CLASS 35 (U.S. CLS. 100, 101 AND 102).

FIRST USE 1-1-1938; IN COMMERCE 1-1-1938.

FOR: CUSTOM MANUFACTURING OF BEEKEEPING SUPPLIES FOR OTHERS, IN CLASS 40 (U.S. CLS. 100, 103 AND 106).

FIRST USE 1-1-1938; IN COMMERCE 1-1-1938.

THE LIKENESS (OR, "PORTRAIT") IN THE MARK DOES NOT IDENTIFY A LIVING INDIVIDUAL.

SER. NO. 77-239,166, FILED 7-26-2007.

SIMON TENG, EXAMINING ATTORNEY

**Int. Cls.: 35 and 36**

**Prior U.S. Cls.: 100, 101 and 102**

**United States Patent and Trademark Office**

**Reg. No. 3,497,954**

**Registered Sep. 9, 2008**

**SERVICE MARK  
PRINCIPAL REGISTER**

# TAP PROJECT

UNITED STATES FUND FOR UNICEF (NEW  
YORK CORPORATION)  
333 EAST 38TH STREET  
NEW YORK, NY 10016

FOR: PROMOTING PUBLIC AWARENESS  
ABOUT CHILDREN IN DEVELOPING COUNTRIES  
AND LIVING CONDITIONS FOR CHILDREN IN  
DEVELOPING COUNTRIES, IN CLASS 35 (U.S. CLS.  
100, 101 AND 102).

FIRST USE 1-31-2006; IN COMMERCE 1-31-2006.

FOR: CHARITABLE FUNDRAISING SERVICES,  
NAMELY, ACTIVITIES TO RAISE FUNDS FOR  
CHILDREN IN DEVELOPING COUNTRIES TO IM-

PROVE THE CONDITIONS IN WHICH THEY LIVE,  
IN CLASS 36 (U.S. CLS. 100, 101 AND 102).

FIRST USE 1-31-2006; IN COMMERCE 1-31-2006.

THE MARK CONSISTS OF STANDARD CHAR-  
ACTERS WITHOUT CLAIM TO ANY PARTICULAR  
FONT, STYLE, SIZE, OR COLOR.

NO CLAIM IS MADE TO THE EXCLUSIVE  
RIGHT TO USE "PROJECT", APART FROM THE  
MARK AS SHOWN.

SER. NO. 77-239,217, FILED 7-26-2007.

ZACHARY BELLO, EXAMINING ATTORNEY

**Int. Cl.: 42**

**Prior U.S. Cls.: 100 and 101**

**United States Patent and Trademark Office**

**Reg. No. 3,497,955**

**Registered Sep. 9, 2008**

**SERVICE MARK  
PRINCIPAL REGISTER**

**MYMAILBOXMANAGER**

INTERMEDIA, INC. (MINNESOTA CORPORATION)  
156 WEST 56TH STREET  
SUITE 1601  
NEW YORK, MN 10019

FOR: MANAGEMENT AND CONTROL OF SOFTWARE APPLICATIONS HOSTED ON COMPUTER SERVERS ACCESSIBLE VIA THE INTERNET FEATURING HOSTED E-MAIL AND OTHER HOSTED COMMUNICATION AND COLLABORATION TOOLS RELATED TO E-MAIL MANAGEMENT, IN CLASS 42 (U.S. CLS. 100 AND 101).

FIRST USE 1-7-1999; IN COMMERCE 1-7-1999.

THE MARK CONSISTS OF STANDARD CHARACTERS WITHOUT CLAIM TO ANY PARTICULAR FONT, STYLE, SIZE, OR COLOR.

SER. NO. 77-239,270, FILED 7-26-2007.

JILL C. ALT, EXAMINING ATTORNEY



**Int. Cls.: 35 and 36**

**Prior U.S. Cls.: 100, 101 and 102**

**United States Patent and Trademark Office**

**Reg. No. 3,497,956**

**Registered Sep. 9, 2008**

**SERVICE MARK  
PRINCIPAL REGISTER**

**SECOVA**

SECOVA (DELAWARE CORPORATION)  
535 ANTON BLVD., 2ND FLOOR  
COSTA MESA, CA 926267109

FOR: ADMINISTRATION OF EMPLOYEE BENEFIT PLANS CONCERNING PRIMARY AND VOLUNTARY HEALTH AND WELFARE BENEFIT PLANS, PROVIDING EMPLOYEES WITH BENEFITS PLAN INFORMATION, ADMINISTRATION SERVICES CONCERNING PRIMARY AND VOLUNTARY HEALTH AND WELFARE BENEFIT PLANS, AND OUTSOURCING AND RELATED CONSULTING SERVICES IN THE FIELD OF ADMINISTRATION OF EMPLOYEE BENEFIT PLANS PROVIDED VIA A GLOBAL COMPUTER NETWORK USING COMPREHENSIVE BENEFITS ADMINISTRATION TOOLS, IN CLASS 35 (U.S. CLS. 100, 101 AND 102).

FIRST USE 4-2-2007; IN COMMERCE 5-4-2007.

FOR: ADMINISTRATION OF EMPLOYEE BENEFIT PLANS CONCERNING FITNESS REIMBURSEMENT, TUITION REIMBURSEMENT, BROADBAND ACCESS REIMBURSEMENT AND OTHER ADMINISTRATIVE EMPLOYEE REIMBURSEMENT PROGRAMS, IN CLASS 36 (U.S. CLS. 100, 101 AND 102).

FIRST USE 4-2-2007; IN COMMERCE 5-4-2007.

THE MARK CONSISTS OF STANDARD CHARACTERS WITHOUT CLAIM TO ANY PARTICULAR FONT, STYLE, SIZE, OR COLOR.

SER. NO. 77-239,882, FILED 7-26-2007.

JANICE L. MCMORROW, EXAMINING ATTORNEY

**Int. Cls.: 3, 5 and 44**

**Prior U.S. Cls.: 1, 4, 6, 18, 44, 46, 50, 51, 52, 100 and 101**

**Reg. No. 3,497,957**

**United States Patent and Trademark Office**

**Registered Sep. 9, 2008**

**TRADEMARK  
SERVICE MARK  
PRINCIPAL REGISTER**



BLUE OAK AYURVEDA, INC (CALIFORNIA CORPORATION)  
4993 KNOLL LANE  
CATHEYS VALLEY, CA 95306

FOR: BODY OILS, IN CLASS 3 (U.S. CLS. 1, 4, 6, 50, 51 AND 52).

FIRST USE 5-2-2006; IN COMMERCE 5-2-2006.

FOR: HERBAL TEAS FOR MEDICINAL PURPOSES, IN CLASS 5 (U.S. CLS. 6, 18, 44, 46, 51 AND 52).

FIRST USE 5-2-2006; IN COMMERCE 5-2-2006.

FOR: MEDICAL SERVICES, NAMELY, AYURVEDA MEDICAL SERVICES, IN CLASS 44 (U.S. CLS. 100 AND 101).

FIRST USE 5-2-2006; IN COMMERCE 5-2-2006.

NO CLAIM IS MADE TO THE EXCLUSIVE RIGHT TO USE "AYURVEDA", APART FROM THE MARK AS SHOWN.

THE COLOR(S) BLUE, BLACK AND WHITE IS/ ARE CLAIMED AS A FEATURE OF THE MARK.

THE COLOR BLACK APPEARS IN THE WORDING "BLUE OAK AYURVEDA", WHICH WORDS APPEAR TO THE RIGHT OF THE DESIGN, AND THE DESIGN IS COMPRISED OF A BLUE LEAF SHAPE WITH CURVED, WHITE CUT-OUT SHAPES IN THE CENTER OF THE BLUE LEAF SHAPE.

SER. NO. 77-239,895, FILED 7-26-2007.

MARK T. MULLEN, EXAMINING ATTORNEY

**Int. Cl.: 25**

**Prior U.S. Cls.: 22 and 39**

**United States Patent and Trademark Office**

**Reg. No. 3,497,958**

**Registered Sep. 9, 2008**

**TRADEMARK  
PRINCIPAL REGISTER**

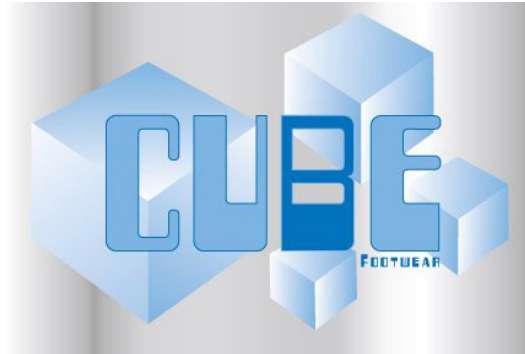

SJ & B1 HOLDING CORP. (NEW YORK CORPORATION)  
6814 BAY PARKWAY  
SUITE 1A  
NEW YORK, NY 11204

FOR: MEN'S, WOMEN'S AND CHILDREN'S FOOTWEAR, IN CLASS 25 (U.S. CLS. 22 AND 39).

FIRST USE 5-1-2007; IN COMMERCE 5-1-2007.

NO CLAIM IS MADE TO THE EXCLUSIVE RIGHT TO USE "FOOTWEAR", APART FROM THE MARK AS SHOWN.

THE COLOR(S) LIGHT BLUE, DARK BLUE, WHITE AND GRAY IS/ARE CLAIMED AS A FEATURE OF THE MARK.

THE MARK CONSISTS OF THE STYLIZED WORD "CUBE" IN SHADES OF BLUE ABOVE THE STYLIZED WORD "FOOTWEAR" IN BLUE. BEHIND THESE WORDS ARE FOUR 3-DIMENSIONAL CUBES IN WHITE AND BLUE. ALL THIS IS ON A GRAY BACKGROUND.

SER. NO. 77-240,053, FILED 7-26-2007.

ZACHARY BELLO, EXAMINING ATTORNEY

**Int. Cl.: 38**

**Prior U.S. Cls.: 100, 101 and 104**

**United States Patent and Trademark Office**

**Reg. No. 3,497,959**

**Registered Sep. 9, 2008**

**SERVICE MARK  
PRINCIPAL REGISTER**

**MUN-E**

RUDOLPH UNIVERSAL, INC. (FLORIDA CORPORATION)  
SUITE 806  
255 DOLPHIN POINT ROAD  
CLEARWATER, FL 33767

THE MARK CONSISTS OF STANDARD CHARACTERS WITHOUT CLAIM TO ANY PARTICULAR FONT, STYLE, SIZE, OR COLOR.

FOR: LED CAPTIONED MOBILE RADIO BROADCASTING FOR THE HEARING IMPAIRED, IN CLASS 38 (U.S. CLS. 100, 101 AND 104).

SER. NO. 77-240,246, FILED 7-27-2007.

FIRST USE 4-1-2007; IN COMMERCE 4-1-2007.

CAROLYN CATALDO, EXAMINING ATTORNEY

**Int. Cl.: 11**

**Prior U.S. Cls.: 13, 21, 23, 31 and 34**

**United States Patent and Trademark Office**

**Reg. No. 3,497,960**

**Registered Sep. 9, 2008**

**TRADEMARK  
PRINCIPAL REGISTER**

**NINETY**

LUXO ASA (NORWAY CORPORATION)  
DRAMMENSVEIEN 175  
OSLO, NORWAY 0277

FOR: ELECTRIC LIGHT FIXTURES AND ELECTRIC LAMPS MOUNTED ON FIXED BRACKETS, MOVABLE BASES AND STANDS, AND ELECTRIC LAMPS SUPPORTED BY SPRING-ARM ASSEMBLIES AND COMPONENTS THEREOF, IN CLASS 11 (U.S. CLS. 13, 21, 23, 31 AND 34).

THE MARK CONSISTS OF STANDARD CHARACTERS WITHOUT CLAIM TO ANY PARTICULAR FONT, STYLE, SIZE, OR COLOR.

PRIORITY CLAIMED UNDER SEC. 44(D) ON NORWAY APPLICATION NO. 200707645, FILED 7-3-2007, REG. NO. 2422200, DATED 11-12-2007, EXPIRES 11-12-2017.

SER. NO. 77-240,799, FILED 7-27-2007.

TOBY BULLOFF, EXAMINING ATTORNEY

**Int. Cl.: 12**

**Prior U.S. Cls.: 19, 21, 23, 31, 35 and 44**

**Reg. No. 3,497,961**

**United States Patent and Trademark Office**

**Registered Sep. 9, 2008**

**TRADEMARK  
PRINCIPAL REGISTER**



TA SHING YACHT BUILDING CO., LTD. (TAI-  
WAN CORPORATION)  
AN-PING INDUSTRIAL DISTRICT  
4, SHING YIH ROAD  
TAINAN, TAIWAN

FIRST USE 0-0-1996; IN COMMERCE 0-0-1996.

SER. NO. 77-241,197, FILED 7-27-2007.

FOR: YACHTS AND BOATS, IN CLASS 12 (U.S.  
CLS. 19, 21, 23, 31, 35 AND 44).

SAIMA MAKHDOOM, EXAMINING ATTORNEY

Int. Cl.: 25

Prior U.S. Cls.: 22 and 39

United States Patent and Trademark Office

Reg. No. 3,497,962

Registered Sep. 9, 2008

TRADEMARK  
PRINCIPAL REGISTER

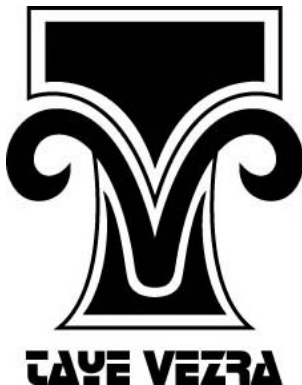

GREGG, TERRY D., JR. (CALIFORNIA SOLE  
PROPRIETORSHIP)

APT. 302

460 WINSTON DR.

SAN FRANCISCO, CA 94132

FOR: T-SHIRTS; SWEAT PANTS; SWEAT SHIRTS;  
JERSEYS; SLEEVELESS JERSEYS; SPORTS JER-  
SEYS; TANK TOPS; SHORTS; JEANS; JACKETS;  
COATS; HATS; SHOES; BELTS MADE OF LEATHER;  
UNDERWEAR, IN CLASS 25 (U.S. CLS. 22 AND 39).

FIRST USE 10-28-2006; IN COMMERCE 10-28-2006.

THE NAME(S), PORTRAIT(S), AND/OR SIGNA-  
TURE(S) SHOWN IN THE MARK DOES NOT IDEN-  
TIFY A PARTICULAR LIVING INDIVIDUAL.

THE MARK CONSISTS OF THE STYLIZED LET-  
TERS "T" AND "V" FORMING A RAM WITH A  
CROWN ON ITS HEAD OVER THE WORDING  
"TAYE VEZRA".

THE TERM "TAYE VEZRA" HAS NO MEANING  
IN A FOREIGN LANGUAGE.

SER. NO. 77-241,589, FILED 7-30-2007.

AMY HELLA, EXAMINING ATTORNEY

**Int. Cl.: 13**

**Prior U.S. Cls.: 2 and 9**

**United States Patent and Trademark Office**

**Reg. No. 3,497,963**

**Registered Sep. 9, 2008**

**TRADEMARK  
PRINCIPAL REGISTER**

**AUTO-5**

BROWNING (UTAH CORPORATION)  
ONE BROWNING PLACE  
MORGAN, UT 84050

THE MARK CONSISTS OF STANDARD CHAR-  
ACTERS WITHOUT CLAIM TO ANY PARTICULAR  
FONT, STYLE, SIZE, OR COLOR.

FOR: FIREARMS, IN CLASS 13 (U.S. CLS. 2 AND  
9).

SER. NO. 77-242,130, FILED 7-30-2007.

FIRST USE 1-1-1943; IN COMMERCE 1-1-1946.

LAURIE KAUFMAN, EXAMINING ATTORNEY



**Int. Cls.: 8 and 16**

**Prior U.S. Cls.: 2, 5, 22, 23, 28, 29, 37, 38, 44 and 50**

**United States Patent and Trademark Office**

**Reg. No. 3,497,964**

**Registered Sep. 9, 2008**

**TRADEMARK  
PRINCIPAL REGISTER**

**ZUTTER INNOVATIVE PRODUCTS**

FELIPE ANGEL (UNITED STATES INDIVIDUAL)  
25752 DILLON RD.  
LAGUNA HILLS, CA 92653

FOR: HAND-OPERATED BOOK-BINDING MACHINES, IN CLASS 8 (U.S. CLS. 23, 28 AND 44).

FIRST USE 1-27-2007; IN COMMERCE 1-27-2007.

FOR: PAPER, BOOK COVERS, AND WIRE BINDINGS FOR BINDING LOOSE SHEETS, IN CLASS 16 (U.S. CLS. 2, 5, 22, 23, 29, 37, 38 AND 50).

FIRST USE 1-27-2007; IN COMMERCE 1-27-2007.

THE MARK CONSISTS OF STANDARD CHARACTERS WITHOUT CLAIM TO ANY PARTICULAR FONT, STYLE, SIZE, OR COLOR.

NO CLAIM IS MADE TO THE EXCLUSIVE RIGHT TO USE "PRODUCTS", APART FROM THE MARK AS SHOWN.

SER. NO. 77-242,302, FILED 7-30-2007.

LINDA E. BLOHM, EXAMINING ATTORNEY

**Int. Cl.: 5**

**Prior U.S. Cls.: 6, 18, 44, 46, 51 and 52**

**Reg. No. 3,497,965**

**United States Patent and Trademark Office**

**Registered Sep. 9, 2008**

**TRADEMARK  
PRINCIPAL REGISTER**

# SCRIPT EASE

WELLFOUNT, CORPORATION (INDIANA CORPORATION)  
5704 W. 79TH STREET  
INDIANAPOLIS, IN 46278

FOR: CONTAINERS IN THE NATURE OF PLASTIC SLIDE BLISTERS AND CARDBOARD BACKING FILLED WITH PHARMACEUTICAL PREPARATIONS FOR THE PREVENTION AND TREATMENT OF AUTOIMMUNE DISEASE, CARDIAC DISEASE, ENDOCRINE DISEASE, GASTROINTESTINAL DISEASE, GENETIC DISEASE, HEMATOLOGICAL DISEASE, INFECTIOUS DISEASE, NEUROLOGIC DISEASE, ONCOLOGIC DIS-

EASE, PERINATAL DISEASE, PULMONARY DISEASE AND RENAL DISEASE, IN CLASS 5 (U.S. CLS. 6, 18, 44, 46, 51 AND 52).

FIRST USE 9-18-2006; IN COMMERCE 9-18-2006.

THE MARK CONSISTS OF STANDARD CHARACTERS WITHOUT CLAIM TO ANY PARTICULAR FONT, STYLE, SIZE, OR COLOR.

SER. NO. 77-242,329, FILED 7-30-2007.

SKYE YOUNG, EXAMINING ATTORNEY

**Int. Cl.: 41**

**Prior U.S. Cls.: 100, 101 and 107**

**United States Patent and Trademark Office**

**Reg. No. 3,497,966**

**Registered Sep. 9, 2008**

**SERVICE MARK  
PRINCIPAL REGISTER**

# IVG Photography

IVO VELAZCO (UNITED STATES INDIVIDUAL)  
18 HUMMINGBIRD LANE  
DANVILLE, NH 03819

FOR: AERIAL PHOTOGRAPHY; PHOTOGRAPHY SERVICES; PORTRAIT PHOTOGRAPHY; PROVIDING FACILITIES FOR PRODUCING VIDEO, CINEMA AND PHOTOGRAPHY PRODUCTIONS, IN CLASS 41 (U.S. CLS. 100, 101 AND 107).

FIRST USE 3-1-1999; IN COMMERCE 6-1-2002.

THE MARK CONSISTS OF STANDARD CHARACTERS WITHOUT CLAIM TO ANY PARTICULAR FONT, STYLE, SIZE, OR COLOR.

NO CLAIM IS MADE TO THE EXCLUSIVE RIGHT TO USE "PHOTOGRAPHY", APART FROM THE MARK AS SHOWN.

SER. NO. 77-242,361, FILED 7-30-2007.

ATTIYA MALIK, EXAMINING ATTORNEY

**Int. Cl.: 25**

**Prior U.S. Cls.: 22 and 39**

**United States Patent and Trademark Office**

**Reg. No. 3,497,967**

**Registered Sep. 9, 2008**

**TRADEMARK  
PRINCIPAL REGISTER**



INSPIRED CULTURE, INC. (CALIFORNIA CORPORATION)  
24231 MIMOSA  
LAGUNA NIGUEL, CA 92677

FOR: FOOTWEAR; HEADWEAR; SWIMWEAR; T-SHIRTS; SHIRTS AND CASUAL TOPS WITH LONG AND SHORT SLEEVES; SLEEVELESS SHIRTS AND TOPS; SLEEVELESS TOPS; JERSEYS; SWEAT TOPS; SWEAT HOODED PARKAS; JACKETS; WIND RESISTANT JACKETS; SHORTS; BOARD SHORTS; WALK SHORTS; VOLLEY SHORTS; LONG PANTS; TROUSERS; SLACKS; JEANS; UNDERWEAR; BANDANNAS; BEANIES; HEADBANDS; HATS; VISORS;

CAPES;CAPS; ATHLETIC SHOES; BOOTS; SHOES; BEACH SHOES; THONGED AND STRAPPED SANDALS, IN CLASS 25 (U.S. CLS. 22 AND 39).

FIRST USE 11-21-2004; IN COMMERCE 11-21-2004.

THE MARK CONSISTS OF A HEAD WITH ANGEL WINGS CONNECTED TO THE BACK OF THE HEAD.

SER. NO. 77-242,596, FILED 7-30-2007.

ANN E. SAPPENFIELD, EXAMINING ATTORNEY

**Int. Cl.: 14**

**Prior U.S. Cls.: 2, 27, 28 and 50**

**United States Patent and Trademark Office**

**Reg. No. 3,497,968**

**Registered Sep. 9, 2008**

**TRADEMARK  
PRINCIPAL REGISTER**

**PLUMPLIPS**

SPECCHIO CO., LTD. (JAPAN CORPORATION)  
3-3-22, KOMABA MEGURO-KU  
TOKYO, JAPAN 153-0041

FOR: GOODS MADE OF PRECIOUS METAL, NAMELY, KEY HOLDERS, JEWELRY BOXES, COMMEMORATED STATUARY CUPS, COMMEMORATIVE PLAQUES, SHOE ORNAMENTS, UNWROUGHT AND SEMI-PRECIOUS GEMSTONES AND IMITATION GEMS; CLOCKS; JEWELRY WATCHES; JEWELRY, NAMELY, EARRINGS, NECKLACES, BRACELETS, PENDANTS, JEWEL

PENDANT, AND RINGS BEING JEWELRY, IN CLASS 14 (U.S. CLS. 2, 27, 28 AND 50).

THE MARK CONSISTS OF STANDARD CHARACTERS WITHOUT CLAIM TO ANY PARTICULAR FONT, STYLE, SIZE, OR COLOR.

OWNER OF JAPAN REG. NO. 4829955, DATED 1-7-2005, EXPIRES 1-7-2015.

SER. NO. 77-242,774, FILED 7-31-2007.

STEVEN JACKSON, EXAMINING ATTORNEY

**Int. Cl.: 9**

**Prior U.S. Cls.: 21, 23, 26, 36 and 38**

**Reg. No. 3,497,969**

**United States Patent and Trademark Office**

**Registered Sep. 9, 2008**

**TRADEMARK  
PRINCIPAL REGISTER**

# INTOXIMETERS

INTOXIMETERS, INC. (MISSOURI CORPORATION)  
8110 LACKLAND ROAD  
ST. LOUIS, MO 63114

FOR: BREATH ALCOHOL ANALYZERS AND RELATED ACCESSORIES AND SUPPLIES, SOLD AS A UNIT, NAMELY, CARRYING CASES AND HOLSTERS, PRINTED INSTRUCTIONAL AND TRAINING MANUAL, INSTRUCTIONAL AND TRAINING VIDEO RECORDINGS, PRINTERS FOR USE WITH BREATH ALCOHOL ANALYZERS, REGULATORS FOR USE WITH BREATH ALCOHOL ANALYZERS; ACCESSORIES AND SUPPLIES FOR BREATH ALCOHOL ANALYZERS, NAMELY, STRUCTURAL PARTS, DISPOSABLE MOUTH PIE-

CES, GAS REGULATORS, DISPOSABLE STRAWS, IN CLASS 9 (U.S. CLS. 21, 23, 26, 36 AND 38).

FIRST USE 0-0-1945; IN COMMERCE 0-0-1945.

THE MARK CONSISTS OF STANDARD CHARACTERS WITHOUT CLAIM TO ANY PARTICULAR FONT, STYLE, SIZE, OR COLOR.

OWNER OF U.S. REG. NO. 1,338,927.

SER. NO. 77-243,047, FILED 7-31-2007.

KELLY BOULTON, EXAMINING ATTORNEY

**Int. Cl.: 9**

**Prior U.S. Cls.: 21, 23, 26, 36 and 38**

**United States Patent and Trademark Office**

**Reg. No. 3,497,970**

**Registered Sep. 9, 2008**

**TRADEMARK  
PRINCIPAL REGISTER**

**ALCOMONITOR CC**

INTOXIMETERS, INC. (MISSOURI CORPORATION)  
8110 LACKLAND ROAD  
ST. LOUIS, MO 63114

FOR: BREATH ANALYZERS AND RELATED ACCESSORIES AND SUPPLIES SOLD AS A UNIT, NAMELY, CARRYING CASES, PRINTED INSTRUCTIONAL AND TRAINING MANUALS, AND INSTRUCTIONAL AND TRAINING VIDEO RECORDINGS, IN CLASS 9 (U.S. CLS. 21, 23, 26, 36 AND 38).

FIRST USE 12-15-1993; IN COMMERCE 12-15-1993.

THE MARK CONSISTS OF STANDARD CHARACTERS WITHOUT CLAIM TO ANY PARTICULAR FONT, STYLE, SIZE, OR COLOR.

SER. NO. 77-243,062, FILED 7-31-2007.

KELLY BOULTON, EXAMINING ATTORNEY

**Int. Cl.: 9**

**Prior U.S. Cls.: 21, 23, 26, 36 and 38**

**Reg. No. 3,497,971**

**United States Patent and Trademark Office**

**Registered Sep. 9, 2008**

**TRADEMARK  
PRINCIPAL REGISTER**

**INTOX EC/IR**

INTOXIMETERS, INC. (MISSOURI CORPORATION)  
8110 LACKLAND ROAD  
ST. LOUIS, MO 63114

FOR: BREATH ALCOHOL ANALYZERS AND RELATED ACCESSORIES AND SUPPLIES SOLD AS A UNIT, NAMELY, CARRYING CASE, PRINTED INSTRUCTIONAL AND TRAINING MANUAL, INSTRUCTIONAL AND TRAINING VIDEO RECORDING, IN CLASS 9 (U.S. CLS. 21, 23, 26, 36 AND 38).

FIRST USE 6-21-1994; IN COMMERCE 6-21-1994.

THE MARK CONSISTS OF STANDARD CHARACTERS WITHOUT CLAIM TO ANY PARTICULAR FONT, STYLE, SIZE, OR COLOR.

SER. NO. 77-243,076, FILED 7-31-2007.

KELLY BOULTON, EXAMINING ATTORNEY



**Int. Cl.: 5**

**Prior U.S. Cls.: 6, 18, 44, 46, 51 and 52**

**United States Patent and Trademark Office**

**Reg. No. 3,497,972**

**Registered Sep. 9, 2008**

**TRADEMARK  
PRINCIPAL REGISTER**

**TYPHERIX**

GLAXOSMITHKLINE BIOLOGICALS, S.A. (BELGIUM CORPORATION)

RUE DE L'INSTITUT 89

RIXENSART, BELGIUM B-1330

FOR: PHARMACEUTICAL AND MEDICINAL PREPARATIONS AND SUBSTANCES, NAMELY, VACCINES, IN CLASS 5 (U.S. CLS. 6, 18, 44, 46, 51 AND 52).

THE MARK CONSISTS OF STANDARD CHARACTERS WITHOUT CLAIM TO ANY PARTICULAR FONT, STYLE, SIZE, OR COLOR.

OWNER OF BENELUX REG. NO. 620677, DATED 11-7-1997, EXPIRES 11-7-2018.

SER. NO. 77-243,077, FILED 7-31-2007.

KARANENDRA S. CHHINA, EXAMINING ATTORNEY

Int. Cl.: 44

Prior U.S. Cls.: 100 and 101

United States Patent and Trademark Office

Reg. No. 3,497,973

Registered Sep. 9, 2008

SERVICE MARK  
PRINCIPAL REGISTER

The logo for ZenTric is a stylized, cursive script. The letter 'Z' is large and features a prominent loop on its left side. The letters 'e', 'n', 't', 'r', and 'i' are connected in a fluid, handwritten style. The final 'c' is a simple, rounded cursive flourish. The entire word is written in black ink with some texture, suggesting a brush or marker.

EZENTRIC LLC (HAWAII LIMITED LIABILITY  
COMPANY)  
918 SMITH STREET, SUITE F  
HONOLULU, HI 96817

FOR: BEAUTY SALON AND SPA SERVICES,  
NAMELY, HAIR CARE AND STYLING SERVICES,  
HAIR CUTTING SERVICES, HAIR COLORING SER-  
VICES, FACIALS, MASSAGE AND THERAPEUTIC  
SHIATSU MASSAGE, MANICURE SERVICES, PED-  
ICURE SERVICES, BODY TREATMENT SERVICES,  
NAMELY, COSMETIC PEELS, MICRODERMABRA-  
SION, NAMELY, A TOPICAL SKIN TREATMENT  
INVOLVING ABRASION OF THE SKIN WITH A  
HIGH-PRESSURE FLOW OF CRYSTALS, BODY  
WAXING SERVICES, CHEMICAL PEELS, BODY  
WRAPS, EXFOLIATION, PURIFICATION IN THE  
NATURE OF COLONIC TREATMENTS, NAMELY,  
IRRIGATION OF THE COLON FOR CLEANSING

PURPOSES BY INJECTING LARGE AMOUNTS OF  
FLUID HIGH INTO THE COLON, REFLEXOLOGY  
SERVICES, SKIN LIGHTENING AND PEELING,  
ACNE TREATMENT SERVICES, EYEBROW AND  
EYELASH TINTING; BEAUTY CONSULTATION,  
NAMELY, PROVIDING GUIDANCE IN THE SELEC-  
TION AND USE OF PERSONAL CARE PRODUCTS,  
COSMETICS, FRAGRANCES, SKIN CARE PRO-  
DUCTS AND HAIR CARE PRODUCTS, IN CLASS  
44 (U.S. CLS. 100 AND 101).

FIRST USE 8-1-2005; IN COMMERCE 8-1-2005.

THE MARK CONSISTS OF STYLIZED LETTERS.

SER. NO. 77-243,133, FILED 7-31-2007.

PAUL F. GAST, EXAMINING ATTORNEY

**Int. Cl.: 16**

**Prior U.S. Cls.: 2, 5, 22, 23, 29, 37, 38 and 50**

**Reg. No. 3,497,974**

**United States Patent and Trademark Office**

**Registered Sep. 9, 2008**

**TRADEMARK  
PRINCIPAL REGISTER**

**UMC**

INTERNATIONAL ASSOCIATION OF PLUMBING AND MECHANICAL OFFICIALS (CALIFORNIA NON-PROFIT CORPORATION)  
5001 EAST PHILADELPHIA STREET  
ONTARIO, CA 91731

FOR: BOOKS, MANUALS, STUDY GUIDES, AND TRAINING GUIDES IN THE FIELD OF MECHANICAL STANDARDS, IN CLASS 16 (U.S. CLS. 2, 5, 22, 23, 29, 37, 38 AND 50).

FIRST USE 0-0-1967; IN COMMERCE 0-0-1967.

THE MARK CONSISTS OF STANDARD CHARACTERS WITHOUT CLAIM TO ANY PARTICULAR FONT, STYLE, SIZE, OR COLOR.

SEC. 2(F).

SER. NO. 77-243,147, FILED 7-31-2007.

NAAKWAMA ANKRAH, EXAMINING ATTORNEY

Int. Cl.: 28

Prior U.S. Cls.: 22, 23, 38 and 50

United States Patent and Trademark Office

Reg. No. 3,497,975

Registered Sep. 9, 2008

TRADEMARK  
PRINCIPAL REGISTER



BRETT BROTHERS SPORTS INTERNATIONAL,  
INC. (WASHINGTON CORPORATION)  
9514 EAST MONTGOMERY, BUILDING 14  
SPOKANE VALLEY, WA 99206

FOR: BASEBALL BATS; BASEBALL GLOVES;  
BASEBALLS, IN CLASS 28 (U.S. CLS. 22, 23, 38 AND  
50).

FIRST USE 6-11-2007; IN COMMERCE 6-11-2007.

THE NAME(S), PORTRAIT(S), AND/OR SIGNA-  
TURE(S) SHOWN IN THE MARK IDENTIFIES

"GARY WULF", WHOSE CONSENT(S) TO REGIS-  
TER IS SUBMITTED.

THE MARK CONSISTS OF THE WORDS "WULF  
MAN" IN UPPERCASE, THE WORDS "GARY  
WULF" IN SCRIPT, AND A WOLF'S HEAD.

SER. NO. 77-243,641, FILED 7-31-2007.

AMY MCMENAMIN, EXAMINING ATTORNEY

**Int. Cl.: 36**

**Prior U.S. Cls.: 100, 101 and 102**

**United States Patent and Trademark Office**

**Reg. No. 3,497,976**

**Registered Sep. 9, 2008**

**SERVICE MARK  
PRINCIPAL REGISTER**

**PATRIOT GOLF DAY**

FALLEN HEROES FOUNDATION (DELAWARE  
NON-PROFIT CORPORATION)  
1608 W. MONTPELIER STREET  
BROKEN ARROW, OK 74012

FOR: CHARITABLE FUNDRAISING SERVICES  
BY MEANS OF AN ENTERTAINMENT EVENT IN  
THE NATURE OF GOLF EVENTS TO BENEFIT U.S.  
VETERANS AND THEIR FAMILIES , IN CLASS 36  
(U.S. CLS. 100, 101 AND 102).

FIRST USE 5-1-2007; IN COMMERCE 5-1-2007.

THE MARK CONSISTS OF STANDARD CHAR-  
ACTERS WITHOUT CLAIM TO ANY PARTICULAR  
FONT, STYLE, SIZE, OR COLOR.

NO CLAIM IS MADE TO THE EXCLUSIVE  
RIGHT TO USE "GOLF", APART FROM THE MARK  
AS SHOWN.

SER. NO. 77-243,855, FILED 8-1-2007.

EMILY CHUO, EXAMINING ATTORNEY

**Int. Cls.: 40 and 41**

**Prior U.S. Cls.: 100, 101, 103, 106 and 107**

**United States Patent and Trademark Office**

**Reg. No. 3,497,977**

**Registered Sep. 9, 2008**

**SERVICE MARK  
PRINCIPAL REGISTER**

# HERO

HERO IMAGE ARTS, INC. (OREGON CORPORATION)  
4949 SE 25TH AVENUE  
PORTLAND, OR 97202

FOR: ELECTRONIC IMAGING, SCANNING, DIGITIZING, ALTERATION AND/OR RETOUCHING OF PHOTOGRAPHIC IMAGES; PHOTOGRAPHIC COMPUTER IMAGING; PHOTOGRAPHIC ENLARGING, IN CLASS 40 (U.S. CLS. 100, 103 AND 106).

FIRST USE 1-0-2006; IN COMMERCE 1-0-2006.

FOR: PHOTOGRAPHY SERVICES, IN CLASS 41 (U.S. CLS. 100, 101 AND 107).

FIRST USE 1-0-2006; IN COMMERCE 1-0-2006.

THE MARK CONSISTS OF STANDARD CHARACTERS WITHOUT CLAIM TO ANY PARTICULAR FONT, STYLE, SIZE, OR COLOR.

SER. NO. 77-244,084, FILED 8-1-2007.

JESSICA FATHY, EXAMINING ATTORNEY

**Int. Cls.: 40 and 41**

**Prior U.S. Cls.: 100, 101, 103, 106 and 107**

**United States Patent and Trademark Office**

**Reg. No. 3,497,978**

**Registered Sep. 9, 2008**

**SERVICE MARK  
PRINCIPAL REGISTER**



HERO IMAGE ARTS, INC. (OREGON CORPORATION)  
4949 SE 25TH AVENUE  
PORTLAND, OR 97202

FOR: ELECTRONIC IMAGING, SCANNING, DIGITIZING, ALTERATION AND/OR RETOUCHING OF PHOTOGRAPHIC IMAGES; PHOTOGRAPHIC COMPUTER IMAGING; PHOTOGRAPHIC ENLARGING, IN CLASS 40 (U.S. CLS. 100, 103 AND 106).

FIRST USE 1-0-2006; IN COMMERCE 1-0-2006.

FOR: PHOTOGRAPHY SERVICES, IN CLASS 41 (U.S. CLS. 100, 101 AND 107).

FIRST USE 1-0-2006; IN COMMERCE 1-0-2006.

NO CLAIM IS MADE TO THE EXCLUSIVE RIGHT TO USE "IMAGE ARTS", APART FROM THE MARK AS SHOWN.

THE MARK CONSISTS OF THE WORDS "HERO IMAGE ARTS" OVER A STAR SHAPE IMAGE.

SER. NO. 77-244,130, FILED 8-1-2007.

JESSICA FATHY, EXAMINING ATTORNEY

**Int. Cls.: 9, 16, 25 and 41**

**Prior U.S. Cls.: 2, 5, 21, 22, 23, 26, 29, 36, 37, 38, 39,  
50, 100, 101 and 107**

**Reg. No. 3,497,979**

**United States Patent and Trademark Office**

**Registered Sep. 9, 2008**

**TRADEMARK  
SERVICE MARK  
PRINCIPAL REGISTER**

**REVOLUTION MOTHER**

REVOLUTION MOTHER LLC (CALIFORNIA  
LIMITED LIABILITY COMPANY)

#476

2892 NORTH BELL FLOWER BOULEVARD  
LONG BEACH, CA 90815

FOR: PRERECORDED AUDIO DISCS, TAPES  
AND PHONOGRAPHIC RECORDS FEATURING  
MUSIC, DIGITAL MEDIA, NAMELY, DOWNLOAD-  
ABLE AUDIO FILES FEATURING MUSICAL RE-  
CORDINGS VIA A GLOBAL COMPUTER  
NETWORK, IN CLASS 9 (U.S. CLS. 21, 23, 26, 36  
AND 38).

FIRST USE 6-26-2007; IN COMMERCE 6-26-2007.

FOR: POSTERS; STICKERS; BOOK COVERS;  
BOOKS IN THE FIELD OF MUSIC AND ENTER-  
TAINMENT; COFFEE TABLE BOOKS FEATURING  
MUSIC AND ENTERTAINMENT; COMPOSITION  
BOOKS; GIFT BOOKS FEATURING MUSIC AND  
ENTERTAINMENT; PICTURE BOOKS; SERIES OF  
NON-FICTION BOOKS IN THE FIELD OF MUSIC  
AND ENTERTAINMENT; SONG BOOKS; SOUVE-  
NIR PROGRAMS CONCERNING A MUSICAL  
GROUP, IN CLASS 16 (U.S. CLS. 2, 5, 22, 23, 29, 37,  
38 AND 50).

FIRST USE 6-26-2007; IN COMMERCE 6-26-2007.

FOR: CLOTHING; NAMELY, TEE SHIRTS,  
SWEATSHIRTS, TANK TOPS, CAPS, POLO SHIRTS,  
DRESS SHIRTS, SUIT JACKETS, JACKETS, COATS,  
PANTS, WIND RESISTANT COATS, SHORT PANTS,  
SWEAT SUITS, SWEAT PANTS, SKIRTS, BLOUSES,  
UNDERGARMENTS, BELTS, WRISTBANDS AND  
VISORS, IN CLASS 25 (U.S. CLS. 22 AND 39).

FIRST USE 6-26-2007; IN COMMERCE 6-26-2007.

FOR: ENTERTAINMENT SERVICES, NAMELY,  
PERFORMANCES BY A LIVE MUSICAL GROUP  
AND PROVIDING PRERECORDED MUSIC ON-  
LINE AND INFORMATION REGARDING A MUSI-  
CAL GROUP ONLINE VIA A GLOBAL COMPUTER  
NETWORK, IN CLASS 41 (U.S. CLS. 100, 101 AND  
107).

FIRST USE 6-26-2007; IN COMMERCE 6-26-2007.

THE MARK CONSISTS OF STANDARD CHAR-  
ACTERS WITHOUT CLAIM TO ANY PARTICULAR  
FONT, STYLE, SIZE, OR COLOR.

SER. NO. 77-244,298, FILED 8-1-2007.

BRIAN PINO, EXAMINING ATTORNEY



**Int. Cl.: 36**

**Prior U.S. Cls.: 100, 101 and 102**

**United States Patent and Trademark Office**

**Reg. No. 3,497,980**

**Registered Sep. 9, 2008**

**SERVICE MARK  
PRINCIPAL REGISTER**

**APPLIED BONUS SAVINGS**

APPLIED BANK (DELAWARE CORPORATION)  
601 DELAWARE AVENUE  
WILMINGTON, DE 19801

FOR: BANKING; SAVINGS ACCOUNT SERVICES; SAVINGS BANK SERVICES; ON-LINE BANKING SERVICES, IN CLASS 36 (U.S. CLS. 100, 101 AND 102).

FIRST USE 5-19-2007; IN COMMERCE 5-19-2007.

THE MARK CONSISTS OF STANDARD CHARACTERS WITHOUT CLAIM TO ANY PARTICULAR FONT, STYLE, SIZE, OR COLOR.

NO CLAIM IS MADE TO THE EXCLUSIVE RIGHT TO USE "BONUS SAVINGS", APART FROM THE MARK AS SHOWN.

SER. NO. 77-244,367, FILED 8-1-2007.

JOHN DALIER, EXAMINING ATTORNEY

**Int. Cl.: 36**

**Prior U.S. Cls.: 100, 101 and 102**

**United States Patent and Trademark Office**

**Reg. No. 3,497,981**

**Registered Sep. 9, 2008**

**SERVICE MARK  
PRINCIPAL REGISTER**

**APPLIED BONUS FOR YOUNG  
SAVERS**

APPLIED BANK (DELAWARE CORPORATION)  
601 DELAWARE AVENUE  
WILMINGTON, DE 19801

FOR: ON-LINE BANKING SERVICES; SAVINGS  
BANK SERVICES; BANKING; FINANCIAL SERVI-  
CES, NAMELY, SAVINGS PROGRAMS FOR  
YOUTHS, IN CLASS 36 (U.S. CLS. 100, 101 AND 102).

FIRST USE 5-19-2007; IN COMMERCE 5-19-2007.

THE MARK CONSISTS OF STANDARD CHAR-  
ACTERS WITHOUT CLAIM TO ANY PARTICULAR  
FONT, STYLE, SIZE, OR COLOR.

NO CLAIM IS MADE TO THE EXCLUSIVE  
RIGHT TO USE "BONUS FOR YOUNG SAVERS",  
APART FROM THE MARK AS SHOWN.

SER. NO. 77-244,380, FILED 8-1-2007.

JOHN DALIER, EXAMINING ATTORNEY

**Int. Cl.: 33**

**Prior U.S. Cls.: 47 and 49**

**United States Patent and Trademark Office**

**Reg. No. 3,497,982**

**Registered Sep. 9, 2008**

**TRADEMARK  
PRINCIPAL REGISTER**

# Platinum Bay

RODRIGUEZ, EZEQUIEL (UNITED STATES INDIVIDUAL)  
811 10TH AVE.  
SAN MATEO, CA 94402 AND  
RODRIGUEZ, CARMEN (UNITED STATES INDIVIDUAL)  
811 10TH AVE.  
SAN MATEO, CA 94402 AND  
RODRIGUEZ, ARTHUR (UNITED STATES INDIVIDUAL)  
811 TENTH AVE.  
SAN MATEO, CA 94402 AND  
RODRIGUEZ, CRISTINA (UNITED STATES INDIVIDUAL)  
811 10TH AVE.  
SAN MATEO, CA 94402

FOR: ALCOHOLIC BEVERAGES, NAMELY, TEQUILA; TEQUILA, IN CLASS 33 (U.S. CLS. 47 AND 49).

FIRST USE 7-20-2007; IN COMMERCE 12-19-2007.

THE MARK CONSISTS OF STANDARD CHARACTERS WITHOUT CLAIM TO ANY PARTICULAR FONT, STYLE, SIZE, OR COLOR.

SER. NO. 77-244,641, FILED 8-1-2007.

KATHERINE CONNOLLY, EXAMINING ATTORNEY

Int. Cl.: 3

Prior U.S. Cls.: 1, 4, 6, 50, 51 and 52

United States Patent and Trademark Office

Reg. No. 3,497,983

Registered Sep. 9, 2008

TRADEMARK  
PRINCIPAL REGISTER

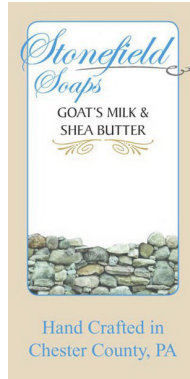

BUTCHKOSKI, JAMES A (PENNSYLVANIA LIMITED LIABILITY COMPANY)  
1550 YELLOW SPRINGS ROAD  
CHESTER SPRINGS, PA 19425 AND  
BUTCHKOSKI, PAMELA B (PENNSYLVANIA LIMITED LIABILITY COMPANY)  
1550 YELLOW SPRINGS ROAD  
CHESTER SPRINGS, PA 19425

FOR: BAR SOAP; BATH SOAPS; HAND SOAPS, IN CLASS 3 (U.S. CLS. 1, 4, 6, 50, 51 AND 52).

FIRST USE 10-1-2006; IN COMMERCE 9-15-2007.

NO CLAIM IS MADE TO THE EXCLUSIVE RIGHT TO USE "SOAPS" AND "GOAT'S MILK & SHEA BUTTER" AND "HAND CRAFTED IN CHESTER COUNTY, PA", APART FROM THE MARK AS SHOWN.

THE COLOR(S) BLUE, BLACK, BEIGE, GOLD, WHITE, GRAY IS/ARE CLAIMED AS A FEATURE OF THE MARK.

THE MARK CONSISTS OF A BEIGE OUTER LABEL, THE WORDING "GOAT'S MILK & SHEA BUTTER" IN BLACK, THE WORDING "STONEFIELD SOAPS" AND "HAND CRAFTED IN CHESTER COUNTY, PA" IN BLUE, A GOLD EMBOSSED DESIGN, THE INSIDE LABEL BACKGROUND IS WHITE, WITH A GRAY STONE WALL.

SER. NO. 77-244,882, FILED 8-1-2007.

KELLY BOULTON, EXAMINING ATTORNEY

**Int. Cl.: 43**

**Prior U.S. Cls.: 100 and 101**

**United States Patent and Trademark Office**

**Reg. No. 3,497,984**

**Registered Sep. 9, 2008**

**SERVICE MARK  
PRINCIPAL REGISTER**

**THREEBEEES**

JOHNNY'S LUNCH FRANCHISE LLC (OHIO  
LIMITED LIABILITY COMPANY)  
9TH FLOOR  
ONE SEAGATE  
TOLEDO, OH 43604

THE MARK CONSISTS OF STANDARD CHAR-  
ACTERS WITHOUT CLAIM TO ANY PARTICULAR  
FONT, STYLE, SIZE, OR COLOR.

FOR: RESTAURANT SERVICES, IN CLASS 43  
(U.S. CLS. 100 AND 101).

SER. NO. 77-245,142, FILED 8-2-2007.

FIRST USE 0-0-1972; IN COMMERCE 0-0-1972.

EMILY CHUO, EXAMINING ATTORNEY

**Int. Cl.: 10**

**Prior U.S. Cls.: 26, 39 and 44**

**United States Patent and Trademark Office**

**Reg. No. 3,497,985**

**Registered Sep. 9, 2008**

**TRADEMARK  
PRINCIPAL REGISTER**



**LUMIport**

LUMIPOINT, LLC (UTAH LIMITED LIABILITY  
COMPANY)  
5255 N. EDGEWOOD DR., SUITE 235  
PROVO, UT 84604

OWNER OF U.S. REG. NO. 3,244,005.

FOR: PHOTOTHERAPEUTIC APPARATUS,  
NAMELY, A LED (LIGHT-EMITTING DIODE)  
LIGHT SOURCE FOR TRANSMITTING LIGHT  
ONTO A USER'S BODY FOR MEDICAL AND  
AESTHETIC SKIN TREATMENTS , IN CLASS 10  
(U.S. CLS. 26, 39 AND 44).

THE MARK CONSISTS OF THE WORD "LUMI-  
PORT" WITH A STYLIZED PICTURE OF A SUN  
OVER THE "I".

SER. NO. 77-245,193, FILED 8-2-2007.

FIRST USE 3-15-2005; IN COMMERCE 3-15-2005.

ALEX KEAM, EXAMINING ATTORNEY

**Int. Cl.: 25**

**Prior U.S. Cls.: 22 and 39**

**United States Patent and Trademark Office**

**Reg. No. 3,497,986**

**Registered Sep. 9, 2008**

**TRADEMARK  
PRINCIPAL REGISTER**

**MEXI-MOUSE**

HANSON, STEPHEN (UNITED STATES INDIVIDUAL)  
1647 COLLINGWOOD DRIVE  
SAN DIEGO, CA 92109

THE MARK CONSISTS OF STANDARD CHARACTERS WITHOUT CLAIM TO ANY PARTICULAR FONT, STYLE, SIZE, OR COLOR.

FOR: CLOTHING, NAMELY, HATS, T-SHIRTS AND BIBS, IN CLASS 25 (U.S. CLS. 22 AND 39).

SER. NO. 77-245,341, FILED 8-2-2007.

FIRST USE 9-30-2007; IN COMMERCE 10-31-2007.

CAROLYN CATALDO, EXAMINING ATTORNEY

**Int. Cl.: 31**

**Prior U.S. Cls.: 1 and 46**

**United States Patent and Trademark Office**

**Reg. No. 3,497,987**

**Registered Sep. 9, 2008**

**TRADEMARK  
PRINCIPAL REGISTER**

**Paw-Metto Love**

DAVID MCNULTY (UNITED STATES INDIVIDUAL)  
4151 SOUTHERN AVENUE #204  
CAPITAL HEIGHTS, MD 20743

THE MARK CONSISTS OF STANDARD CHARACTERS WITHOUT CLAIM TO ANY PARTICULAR FONT, STYLE, SIZE, OR COLOR.

FOR: DOG TREATS, IN CLASS 31 (U.S. CLS. 1 AND 46).

SER. NO. 77-245,480, FILED 8-2-2007.

FIRST USE 12-14-2005; IN COMMERCE 12-14-2005.

SKYE YOUNG, EXAMINING ATTORNEY



**Int. Cl.: 41**

**Prior U.S. Cls.: 100, 101 and 107**

**United States Patent and Trademark Office**

**Reg. No. 3,497,988**

**Registered Sep. 9, 2008**

**SERVICE MARK  
PRINCIPAL REGISTER**



ADVANCED ACADEMICS, INC. (DELAWARE CORPORATION)  
100 EAST CALIFORNIA AVENUE, SUITE 200  
OKLAHOMA CITY, OK 73104

FOR: EDUCATIONAL SERVICES, NAMELY, THE PROVISION OF ON-LINE COURSES OF INSTRUCTION AT THE HIGH SCHOOL LEVEL AND RELATED EDUCATIONAL TESTING AND ACADEMIC EVALUATION TO STUDENTS THROUGH AN INTERACTIVE WEB SITE ACCESSIBLE VIA THE INTERNET, IN CLASS 41 (U.S. CLS. 100, 101 AND 107).

FIRST USE 8-0-2006; IN COMMERCE 8-0-2006.

NO CLAIM IS MADE TO THE EXCLUSIVE RIGHT TO USE "OKLAHOMA VIRTUAL HIGH SCHOOL", APART FROM THE MARK AS SHOWN.

SER. NO. 77-245,493, FILED 8-2-2007.

MELISSA VALLILLO, EXAMINING ATTORNEY

**Int. Cl.: 41**

**Prior U.S. Cls.: 100, 101 and 107**

**United States Patent and Trademark Office**

**Reg. No. 3,497,989**

**Registered Sep. 9, 2008**

**SERVICE MARK  
PRINCIPAL REGISTER**

**GOLD CIRCLE**

GOLD CIRCLE FILMS, LLC (SOUTH DAKOTA  
LIMITED LIABILITY COMPANY)  
SUITE 600N  
2000 AVENUE OF THE STARS  
LOS ANGELES, CA 90067

FOR: ENTERTAINMENT SERVICES, NAMELY,  
THE DEVELOPMENT, PRODUCTION, AND DIS-  
TRIBUTION OF MOTION PICTURES, IN CLASS 41  
(U.S. CLS. 100, 101 AND 107).

FIRST USE 9-13-2001; IN COMMERCE 9-13-2001.

THE MARK CONSISTS OF STANDARD CHAR-  
ACTERS WITHOUT CLAIM TO ANY PARTICULAR  
FONT, STYLE, SIZE, OR COLOR.

SER. NO. 77-245,512, FILED 8-2-2007.

KELLEY WELLS, EXAMINING ATTORNEY

**Int. Cl.: 41**

**Prior U.S. Cls.: 100, 101 and 107**

**Reg. No. 3,497,990**

**United States Patent and Trademark Office**

**Registered Sep. 9, 2008**

**SERVICE MARK  
PRINCIPAL REGISTER**



ADVANCED ACADEMICS, INC. (DELAWARE CORPORATION)  
100 EAST CALIFORNIA AVENUE, SUITE 200  
OKLAHOMA CITY, OK 73104

FIRST USE 12-0-2006; IN COMMERCE 12-0-2006.

FOR: EDUCATIONAL SERVICES, NAMELY, THE PROVISION OF ON-LINE COURSES OF INSTRUCTION AT THE HIGH SCHOOL LEVEL AND RELATED EDUCATIONAL TESTING AND ACADEMIC EVALUATION TO STUDENTS THROUGH AN INTERACTIVE WEB SITE ACCESSIBLE VIA THE INTERNET, IN CLASS 41 (U.S. CLS. 100, 101 AND 107).

NO CLAIM IS MADE TO THE EXCLUSIVE RIGHT TO USE "MINNESOTA VIRTUAL HIGH SCHOOL", APART FROM THE MARK AS SHOWN.

SER. NO. 77-245,521, FILED 8-2-2007.

MELISSA VALLILLO, EXAMINING ATTORNEY

**Int. Cl.: 28**

**Prior U.S. Cls.: 22, 23, 38 and 50**

**Reg. No. 3,497,991**

**United States Patent and Trademark Office**

**Registered Sep. 9, 2008**

**TRADEMARK  
PRINCIPAL REGISTER**



SHINNECOCK HILLS GOLF CLUB (NEW YORK  
NON-PROFIT CORPORATION)

200 TUCKAHOE ROAD  
SOUTHAMPTON, NY 11968

FOR: SPORTING GOODS, NAMELY, GOLF  
BAGS, GOLF BALLS, AND GOLF GLOVES, IN  
CLASS 28 (U.S. CLS. 22, 23, 38 AND 50).

FIRST USE 12-31-2005; IN COMMERCE 12-31-2005.

OWNER OF U.S. REG. NOS. 1,447,929 AND  
2,739,914.

NO CLAIM IS MADE TO THE EXCLUSIVE  
RIGHT TO USE "1891", APART FROM THE MARK  
AS SHOWN.

THE MARK IS CONSISTS OF A SHIELD DESIGN  
WITH CROSSED GOLF CLUBS IN THE SHIELD  
AND "1891" AT THE TOP OUTSIDE OF THE SHIELD  
AND THE WORDS "SHINNECOCK" IN A BANNER  
BELOW THE SHIELD.

SEC. 2(F) AS TO "SHINNECOCK".

SER. NO. 77-245,551, FILED 8-2-2007.

JENNY PARK, EXAMINING ATTORNEY

**Int. Cl.: 41**

**Prior U.S. Cls.: 100, 101 and 107**

**United States Patent and Trademark Office**

**Reg. No. 3,497,992**

**Registered Sep. 9, 2008**

**SERVICE MARK  
PRINCIPAL REGISTER**



GOLD CIRCLE FILMS, LLC (SOUTH DAKOTA  
LIMITED LIABILITY COMPANY)  
SUITE 600N  
2000 AVENUE OF THE STARS  
LOS ANGELES, CA 90067

FOR: ENTERTAINMENT SERVICES, NAMELY,  
THE DEVELOPMENT, PRODUCTION, AND DIS-  
TRIBUTION OF MOTION PICTURES, IN CLASS 41  
(U.S. CLS. 100, 101 AND 107).

FIRST USE 9-13-2001; IN COMMERCE 9-13-2001.

THE MARK CONSISTS OF A RING WITH A  
SHADOW OF THE RING.

SER. NO. 77-245,572, FILED 8-2-2007.

KELLEY WELLS, EXAMINING ATTORNEY

**Int. Cl.: 41**

**Prior U.S. Cls.: 100, 101 and 107**

**United States Patent and Trademark Office**

**Reg. No. 3,497,993**

**Registered Sep. 9, 2008**

**SERVICE MARK  
PRINCIPAL REGISTER**



**GOLD CIRCLE FILMS, LLC (SOUTH DAKOTA  
LIMITED LIABILITY COMPANY)  
SUITE 600N  
2000 AVENUE OF THE STARS  
LOS ANGELES, CA 90067**

**FOR: ENTERTAINMENT SERVICES, NAMELY,  
THE DEVELOPMENT, PRODUCTION, AND DIS-  
TRIBUTION OF MOTION PICTURES, IN CLASS 41  
(U.S. CLS. 100, 101 AND 107).**

**FIRST USE 9-13-2001; IN COMMERCE 9-13-2001.**

**THE MARK CONSISTS OF WORDS "GOLD CIR-  
CLE" UNDER A CIRCLE AND A SHADOW BEHIND  
THE CIRCLE.**

**SER. NO. 77-245,606, FILED 8-2-2007.**

**KELLEY WELLS, EXAMINING ATTORNEY**

**Int. Cl.: 16**

**Prior U.S. Cls.: 2, 5, 22, 23, 29, 37, 38 and 50**

**United States Patent and Trademark Office**

**Reg. No. 3,497,994**

**Registered Sep. 9, 2008**

**TRADEMARK  
PRINCIPAL REGISTER**

**enviropak**

ENVIROPAK CORPORATION (MISSOURI CORPORATION)  
4135 GALLEY COURT  
ST. LOUIS, MO 63045

THE MARK CONSISTS OF STANDARD CHARACTERS WITHOUT CLAIM TO ANY PARTICULAR FONT, STYLE, SIZE, OR COLOR.

FOR: INDUSTRIAL PACKAGING CONTAINERS OF PAPER, IN CLASS 16 (U.S. CLS. 2, 5, 22, 23, 29, 37, 38 AND 50).

SER. NO. 77-245,693, FILED 8-2-2007.

FIRST USE 1-1-1996; IN COMMERCE 1-1-1996.

JAMES LOVELACE, EXAMINING ATTORNEY

**Int. Cl.: 41**

**Prior U.S. Cls.: 100, 101 and 107**

**United States Patent and Trademark Office**

**Reg. No. 3,497,995**

**Registered Sep. 9, 2008**

**SERVICE MARK  
PRINCIPAL REGISTER**



ADVANCED ACADEMICS, INC. (DELAWARE CORPORATION)  
100 EAST CALIFORNIA AVENUE, SUITE 200  
OKLAHOMA CITY, OK 73104

FOR: EDUCATIONAL SERVICES, NAMELY, THE PROVISION OF ON-LINE COURSES OF INSTRUCTION AT THE HIGH SCHOOL LEVEL AND RELATED EDUCATIONAL TESTING AND ACADEMIC EVALUATION TO STUDENTS THROUGH AN INTERACTIVE WEB SITE ACCESSIBLE VIA THE INTERNET, IN CLASS 41 (U.S. CLS. 100, 101 AND 107).

FIRST USE 8-0-2006; IN COMMERCE 8-0-2006.

NO CLAIM IS MADE TO THE EXCLUSIVE RIGHT TO USE "WASHINGTON VIRTUAL HIGH SCHOOL", APART FROM THE MARK AS SHOWN.

SER. NO. 77-245,908, FILED 8-2-2007.

MELISSA VALLILLO, EXAMINING ATTORNEY



**Int. Cl.: 25**

**Prior U.S. Cls.: 22 and 39**

**United States Patent and Trademark Office**

**Reg. No. 3,497,996**

**Registered Sep. 9, 2008**

**TRADEMARK  
PRINCIPAL REGISTER**

**WEAR IT 'TIL IT STINKS**

THE DIRTBAG CLOTHING COMPANY (CALI-  
FORNIA CORPORATION)  
1135 GARNET AVENUE, UNIT # U  
SAN DIEGO, CA 92109

FOR: CASUAL AND INFORMAL CLOTHING,  
NAMELY, AS SHIRTS, BLOUSES, PANTS, SHORTS,  
UNDERWEAR, SHOES, SOCKS, HATS AND CAPS,  
IN CLASS 25 (U.S. CLS. 22 AND 39).

FIRST USE 1-1-1999; IN COMMERCE 1-1-1999.

THE MARK CONSISTS OF STANDARD CHAR-  
ACTERS WITHOUT CLAIM TO ANY PARTICULAR  
FONT, STYLE, SIZE, OR COLOR.

SER. NO. 77-245,972, FILED 8-2-2007.

KRISTIN DAHLING, EXAMINING ATTORNEY

**Int. Cls.: 35 and 38**

**Prior U.S. Cls.: 100, 101, 102 and 104**

**United States Patent and Trademark Office**

**Reg. No. 3,497,997**

**Registered Sep. 9, 2008**

**SERVICE MARK  
PRINCIPAL REGISTER**

# WEBCRAWLER

INFOSPACE, INC. (DELAWARE CORPORATION)  
SUITE 1200  
601 - 108TH AVENUE NE  
BELLEVUE, WA 98004

FOR: PROMOTING THE GOODS AND SERVICES OF OTHERS BY PROVIDING A WEBSITE AT WHICH USERS CAN LINK TO A VARIETY OF SUBJECTS, NAMELY, ENTERTAINMENT, LIFESTYLE, EMPLOYMENT, FINANCE, TECHNOLOGY, TRAVEL AND GENERAL INTEREST, IN CLASS 35 (U.S. CLS. 100, 101 AND 102).

FIRST USE 12-26-1996; IN COMMERCE 12-26-1996.

FOR: COMPUTER TELECOMMUNICATIONS SERVICES, NAMELY, PROVIDING ON-LINE GATE-

WAY LINKS FOR ATTRACTING USERS AND SEARCH ENGINES TO WEBSITES FOR ENTERTAINMENT SERVICES AND FINANCIAL, SPORTS AND GENERAL INFORMATION, IN CLASS 38 (U.S. CLS. 100, 101 AND 104).

FIRST USE 10-23-1996; IN COMMERCE 10-23-1996.

THE MARK CONSISTS OF STANDARD CHARACTERS WITHOUT CLAIM TO ANY PARTICULAR FONT, STYLE, SIZE, OR COLOR.

OWNER OF U.S. REG. NO. 2,007,916.

SER. NO. 77-245,974, FILED 8-2-2007.

KATHERINE CHANG, EXAMINING ATTORNEY

**Int. Cl.: 35**

**Prior U.S. Cls.: 100, 101 and 102**

**United States Patent and Trademark Office**

**Reg. No. 3,497,998**

**Registered Sep. 9, 2008**

**SERVICE MARK  
PRINCIPAL REGISTER**

**ZEPHYR**

ZEPHYR GAS SERVICES, LP (TEXAS LIMITED  
PARTNERSHIP)  
11433 BRITTMOORE PARK DRIVE  
HOUSTON, TX 77041

FOR: RETAIL SERVICES BY DIRECT SOLICITA-  
TION BY SALES AGENTS IN THE FIELD OF  
PRODUCTION, TREATMENT AND TRANSMIS-  
SION EQUIPMENT FOR THE GAS INDUSTRY , IN  
CLASS 35 (U.S. CLS. 100, 101 AND 102).

FIRST USE 1-0-2007; IN COMMERCE 1-0-2007.

THE MARK CONSISTS OF STANDARD CHAR-  
ACTERS WITHOUT CLAIM TO ANY PARTICULAR  
FONT, STYLE, SIZE, OR COLOR.

SER. NO. 77-245,997, FILED 8-2-2007.

MICHAEL KAZAZIAN, EXAMINING ATTORNEY

**Int. Cls.: 39 and 40**

**Prior U.S. Cls.: 100, 103, 105 and 106**

**United States Patent and Trademark Office**

**Reg. No. 3,497,999**

**Registered Sep. 9, 2008**

**SERVICE MARK  
PRINCIPAL REGISTER**

**ZEPHYR**

ZEPHYR GAS SERVICES, LP (TEXAS LIMITED  
PARTNERSHIP)  
11433 BRITTMOORE PARK DRIVE  
HOUSTON, TX 77041

FOR: RENTAL OF OIL AND GAS TRANSMIS-  
SION PIPELINE EQUIPMENT FOR THE GAS IN-  
DUSTRY, IN CLASS 39 (U.S. CLS. 100 AND 105).

FIRST USE 1-0-2007; IN COMMERCE 1-0-2007.

FOR: RENTAL OF OIL AND GAS WELL TREAT-  
MENT AND COOLING EQUIPMENT FOR THE GAS

INDUSTRY, IN CLASS 40 (U.S. CLS. 100, 103 AND  
106).

FIRST USE 1-0-2007; IN COMMERCE 1-0-2007.

THE MARK CONSISTS OF STANDARD CHAR-  
ACTERS WITHOUT CLAIM TO ANY PARTICULAR  
FONT, STYLE, SIZE, OR COLOR.

SER. NO. 77-246,001, FILED 8-2-2007.

MICHAEL KAZAZIAN, EXAMINING ATTORNEY

**Int. Cls.: 39 and 40**

**Prior U.S. Cls.: 100, 103, 105 and 106**

**United States Patent and Trademark Office**

**Reg. No. 3,498,000**

**Registered Sep. 9, 2008**

**SERVICE MARK  
PRINCIPAL REGISTER**



ZEPHYR GAS SERVICES, LP (TEXAS LIMITED  
PARTNERSHIP)  
11433 BRITTMOORE PARK DRIVE  
HOUSTON, TX 77041

FOR: RENTAL OF OIL AND GAS TRANSMIS-  
SION PIPELINE EQUIPMENT FOR THE GAS IN-  
DUSTRY, IN CLASS 39 (U.S. CLS. 100 AND 105).

FIRST USE 1-0-2007; IN COMMERCE 1-0-2007.

FOR: RENTAL OF OIL AND GAS WELL TREAT-  
MENT AND COOLING EQUIPMENT FOR THE GAS  
INDUSTRY, IN CLASS 40 (U.S. CLS. 100, 103 AND  
106).

FIRST USE 1-0-2007; IN COMMERCE 1-0-2007.

THE MARK CONSISTS OF THE WORD "ZEPH-  
YR" IN STYLIZED FORM WITH THE BOTTOM OF  
THE LETTER "Z" CONTINUING UNDER THE  
LETTERS "EPHY" AND ENDING AT THE END OF  
THE LETTER "R".

SER. NO. 77-246,004, FILED 8-2-2007.

MICHAEL KAZAZIAN, EXAMINING ATTORNEY

**Int. Cl.: 35**

**Prior U.S. Cls.: 100, 101 and 102**

**United States Patent and Trademark Office**

**Reg. No. 3,498,001**

**Registered Sep. 9, 2008**

**SERVICE MARK  
PRINCIPAL REGISTER**

**NO ONE SHOULD FEEL ALONE**

LIFE CENTER FOR AUTISM FOUNDATION  
(OHIO NON-PROFIT CORPORATION)  
INNER OFFICE B  
10035 BROADVIEW ROAD  
BROADVIEW HEIGHTS, OH 44147

FOR: CHARITABLE SERVICES FOR PROMOTING THE PUBLIC INTEREST AND AWARENESS IN AUTISM RESEARCH AND EDUCATION; PROMOTING THE INTERESTS OF AUTISTIC INDIVIDUALS AND THEIR FAMILIES, IN CLASS 35 (U.S. CLS. 100, 101 AND 102).

FIRST USE 0-0-2007; IN COMMERCE 0-0-2007.

THE MARK CONSISTS OF STANDARD CHARACTERS WITHOUT CLAIM TO ANY PARTICULAR FONT, STYLE, SIZE, OR COLOR.

SER. NO. 77-246,193, FILED 8-3-2007.

MICHAEL KAZAZIAN, EXAMINING ATTORNEY

**Int. Cl.: 35**

**Prior U.S. Cls.: 100, 101 and 102**

**Reg. No. 3,498,002**

**United States Patent and Trademark Office**

**Registered Sep. 9, 2008**

**SERVICE MARK  
PRINCIPAL REGISTER**



LIFE CENTER FOR AUTISM FOUNDATION  
(OHIO NON-PROFIT CORPORATION)  
INNER OFFICE B  
10035 BROADVIEW ROAD  
BROADVIEW HEIGHTS, OH 44147

FOR: CHARITABLE SERVICES FOR PROMOT-  
ING THE PUBLIC INTEREST AND AWARENESS IN  
AUTISM RESEARCH AND EDUCATION; PROMOT-  
ING THE INTERESTS OF AUTISTIC INDIVIDUALS

AND THEIR FAMILIES, IN CLASS 35 (U.S. CLS. 100,  
101 AND 102).

FIRST USE 0-0-2007; IN COMMERCE 0-0-2007.

SER. NO. 77-246,194, FILED 8-3-2007.

MICHAEL KAZAZIAN, EXAMINING ATTORNEY

Int. Cl.: 35

Prior U.S. Cls.: 100, 101 and 102

United States Patent and Trademark Office

Reg. No. 3,498,003

Registered Sep. 9, 2008

SERVICE MARK  
PRINCIPAL REGISTER



LIFE CENTER FOR AUTISM FOUNDATION  
(OHIO NON-PROFIT CORPORATION)  
INNER OFFICE B  
10035 BROADVIEW ROAD  
BROADVIEW HEIGHTS, OH 44147

FOR: CHARITABLE SERVICES FOR PROMOTING THE PUBLIC INTEREST AND AWARENESS IN AUTISM RESEARCH AND EDUCATION; PROMOTING THE INTERESTS OF AUTISTIC INDIVIDUALS AND THEIR FAMILIES, IN CLASS 35 (U.S. CLS. 100, 101 AND 102).

FIRST USE 0-0-2007; IN COMMERCE 0-0-2007.

NO CLAIM IS MADE TO THE EXCLUSIVE RIGHT TO USE "CENTER FOR AUTISM", APART FROM THE MARK AS SHOWN.

THE COLOR(S) ORANGE AND TEAL. IS/ARE CLAIMED AS A FEATURE OF THE MARK.

THE MARK CONSISTS OF A DESIGN OF THREE BODY FIGURES AND THE WORDING "LIFE CENTER FOR AUTISM NO ONE SHOULD FEEL ALONE". THE COLOR ORANGE APPEARS IN THE FIRST AND THIRD BODY FIGURES AND IN THE WORDING "LIFE CENTER" AND "NO ONE SHOULD FEEL ALONE". THE COLOR TEAL APPEARS IN THE SECOND BODY AND IN THE TERM "FOR AUTISM".

SER. NO. 77-246,195, FILED 8-3-2007.

MICHAEL KAZAZIAN, EXAMINING ATTORNEY



**Int. Cl.: 41**

**Prior U.S. Cls.: 100, 101 and 107**

**United States Patent and Trademark Office**

**Reg. No. 3,498,004**

**Registered Sep. 9, 2008**

**SERVICE MARK  
PRINCIPAL REGISTER**

**GOLD CIRCLE FILMS**

GOLD CIRCLE FILMS, LLC (SOUTH DAKOTA  
LIMITED LIABILITY COMPANY)  
SUITE 600N  
2000 AVENUE OF THE STARS  
LOS ANGELES, CA 90067

FOR: ENTERTAINMENT SERVICES, NAMELY,  
THE DEVELOPMENT, PRODUCTION, AND DIS-  
TRIBUTION OF MOTION PICTURES, IN CLASS 41  
(U.S. CLS. 100, 101 AND 107).

FIRST USE 9-13-2001; IN COMMERCE 9-13-2001.

THE MARK CONSISTS OF STANDARD CHAR-  
ACTERS WITHOUT CLAIM TO ANY PARTICULAR  
FONT, STYLE, SIZE, OR COLOR.

NO CLAIM IS MADE TO THE EXCLUSIVE  
RIGHT TO USE "FILMS", APART FROM THE  
MARK AS SHOWN.

SER. NO. 77-246,196, FILED 8-3-2007.

KELLEY WELLS, EXAMINING ATTORNEY

Int. Cl.: 37

Prior U.S. Cls.: 100, 103 and 106

United States Patent and Trademark Office

Reg. No. 3,498,005

Registered Sep. 9, 2008

**SERVICE MARK  
PRINCIPAL REGISTER**



KANSAS CITY MASTER COMPANIES, INC.  
(MISSOURI CORPORATION)  
13501 ARRINGTON ROAD  
GRANDVIEW, MO 64030

FOR: BUILDING MAINTENANCE AND REPAIR,  
IN CLASS 37 (U.S. CLS. 100, 103 AND 106).

FIRST USE 7-24-2007; IN COMMERCE 7-24-2007.

OWNER OF U.S. REG. NO. 2,662,807.

NO CLAIM IS MADE TO THE EXCLUSIVE  
RIGHT TO USE "PIER", APART FROM THE MARK  
AS SHOWN.

THE COLOR(S) BRIGHT BLUE, GRAY, WHITE IS/  
ARE CLAIMED AS A FEATURE OF THE MARK.

THE MARK CONSISTS OF WHITE LEANING  
TOWER ENCASED IN A BRIGHT BLUE CIRCLE  
SITTING TO THE LEFT OF THE WORD "PIER" IN  
THE COLOR GRAY AND BELOW "PIER" THE  
WORD "MASTERS" IN BRIGHT BLUE UNDER-  
NEATH "MASTERS" ARE THE WORDS "ENGI-  
NEERED EXCELLENCE" IN GRAY.

SER. NO. 77-246,375, FILED 8-3-2007.

KIMBERLY FRYE, EXAMINING ATTORNEY

Int. Cl.: 42

Prior U.S. Cls.: 100 and 101

United States Patent and Trademark Office

Reg. No. 3,498,006

Registered Sep. 9, 2008

SERVICE MARK  
PRINCIPAL REGISTER

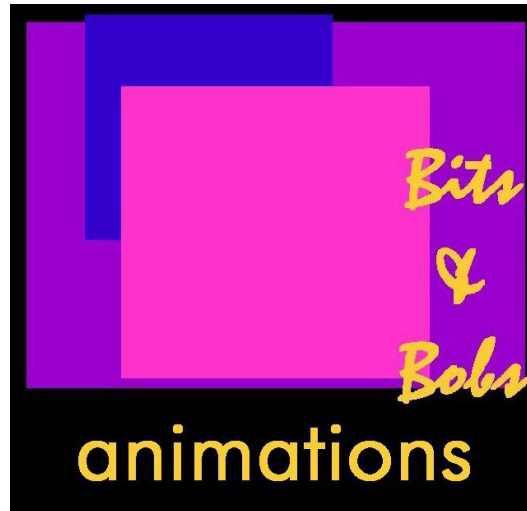

MEAD, CHRISTOPHER (GREAT BRITAIN INDIVIDUAL)  
5 SCHOOL ROAD, FRITTON  
NORWICH, GREAT BRITAIN NR152QN

FOR: ANIMATION SERVICES, NAMELY PROVIDING TO OTHERS TEMPORARY USE OF NON-DOWNLOADABLE SOFTWARE FOR ANIMATING THREE-DIMENSIONAL VIRTUAL CHARACTERS WITHIN A VIRTUAL COMPUTER ENVIRONMENT, NAMELY A COMPUTER-BASED SIMULATED ENVIRONMENT IN WHICH USERS INHABIT THE SPACE AND INTERACT BY WAY OF AN AVATAR, IN CLASS 42 (U.S. CLS. 100 AND 101).

FIRST USE 2-25-2005; IN COMMERCE 2-25-2005.

NO CLAIM IS MADE TO THE EXCLUSIVE RIGHT TO USE "ANIMATIONS", APART FROM THE MARK AS SHOWN.

"THE COLOR(S) GOLD, PURPLE, BLUE, FUCHSIA AND BLACK IS/ARE CLAIMED AS A FEATURE OF THE MARK."

THE MARK CONSISTS OF A LARGE PURPLE SQUARE WITH A SMALLER BLUE SQUARE ON IT AND A MEDIUM FUCHSIA SQUARE ON TOP OF THE PURPLE AND BLUE SQUARES WITH THE STYLIZED WORDS BITS & BOBS IN GOLD, TO THE RIGHT SIDE OF THE OF THE PURPLE SQUARE WITH THE WORD ANIMATIONS BELOW THE PURPLE SQUARE IN GOLD ALL AGAINST A BLACK BACKGROUND.

SER. NO. 77-246,710, FILED 8-3-2007.

DAVID I, EXAMINING ATTORNEY

Int. Cl.: 35

Prior U.S. Cls.: 100, 101 and 102

United States Patent and Trademark Office

Reg. No. 3,498,007

Registered Sep. 9, 2008

**SERVICE MARK  
PRINCIPAL REGISTER**



LATINVIDEOMUSIC (CALIFORNIA LIMITED  
LIABILITY COMPANY)  
SUITE 394  
211 S. STATE COLLEGE BLVD.  
ANAHEIM, CA 92806

FOR: ADVERTISING, MARKETING AND PRO-  
MOTION SERVICES; ON-LINE RETAIL STORE  
SERVICES FEATURING DOWNLOADABLE PRE-  
RECORDED MUSIC AND VIDEO, IN CLASS 35 (U.S.  
CLS. 100, 101 AND 102).

FIRST USE 6-0-2007; IN COMMERCE 6-0-2007.

NO CLAIM IS MADE TO THE EXCLUSIVE  
RIGHT TO USE "LATINVIDEOMUSIC.COM",  
APART FROM THE MARK AS SHOWN.

THE COLOR(S) RED, WHITE, BLUE, TAN,  
GREEN, YELLOW, BROWN, IS/ARE CLAIMED AS  
A FEATURE OF THE MARK.

THE MARK CONSISTS OF A RED/WHITE MA  
CAW PERCH ON BLUE BOTTLES OF WINE WITH  
WHITE LABELS AND TAN CORKS AND DRINK-  
ING OUT OF A TAN CUP WITH A WHITE STRAW  
WITH GREEN/YELLOW/RED FRUIT, AND WEAR-  
ING A TAN/BROWN HAT AND YELLOW/WHITE/  
RED FLOWER SHIRT AND YELLOW SHORTS.

SER. NO. 77-247,777, FILED 8-6-2007.

DOMINICK J. SALEMI, EXAMINING ATTORNEY

**Int. Cls.: 35 and 36**

**Prior U.S. Cls.: 100, 101 and 102**

**United States Patent and Trademark Office**

**Reg. No. 3,498,008**

**Registered Sep. 9, 2008**

**SERVICE MARK  
PRINCIPAL REGISTER**

**UNITED ONE**

UNITED ONE GROUP, INC. (GEORGIA CORPORATION)  
221-A CLEVELAND AVENUE  
ATLANTA, GA 30315

FOR: TAX PREPARATION, IN CLASS 35 (U.S. CLS. 100, 101 AND 102).

FIRST USE 8-1-2007; IN COMMERCE 8-1-2007.

FOR: MONEY ORDER SERVICES AND TRAVELERS' CHECK ISSUANCE SERVICES RENDERED

IN CONVENIENCE STORES AND RETAIL STORE OUTLETS, IN CLASS 36 (U.S. CLS. 100, 101 AND 102).

FIRST USE 8-1-2007; IN COMMERCE 8-1-2007.

THE MARK CONSISTS OF STANDARD CHARACTERS WITHOUT CLAIM TO ANY PARTICULAR FONT, STYLE, SIZE, OR COLOR.

SER. NO. 77-248,028, FILED 8-6-2007.

BARBARA A. GOLD, EXAMINING ATTORNEY

**Int. Cls.: 11, 16, 20 and 21**

**Prior U.S. Cls.: 2, 5, 13, 21, 22, 23, 25, 29, 30, 31, 32,  
33, 34, 37, 38, 40 and 50**

**Reg. No. 3,498,009**

**United States Patent and Trademark Office**

**Registered Sep. 9, 2008**

**TRADEMARK  
PRINCIPAL REGISTER**

**BRIDGEBLUE SOURCING  
PARTNERS**

TAYLOR-MARTIN GROUP, LLC (MISSOURI  
LIMITED LIABILITY COMPANY)  
405 N. WASHINGTON, SUITE A  
SPRINGFIELD, MO 65806

FOR: LAMPS; ORNAMENTAL FOUNTAINS; WA-  
TER FOUNTAINS, LANTERNS, IN CLASS 11 (U.S.  
CLS. 13, 21, 23, 31 AND 34).

FIRST USE 2-17-2003; IN COMMERCE 2-25-2003.

FOR: ART PRINTS; PAINTINGS, IN CLASS 16  
(U.S. CLS. 2, 5, 22, 23, 29, 37, 38 AND 50).

FIRST USE 2-17-2003; IN COMMERCE 2-25-2003.

FOR: TABLES, CONSOLE TABLES, ARMOIRES,  
PICTURE FRAMES, BOOKCASES; UMBRELLA  
STANDS, FURNITURE CHESTS, ENTERTAIN-  
MENT CENTERS; BENCHES, CHAIRS, OTTOMANS;  
MIRRORS, DESKS, PILLOWS, WINE RACKS;

SCULPTURES OF RESIN, IN CLASS 20 (U.S. CLS. 2,  
13, 22, 25, 32 AND 50).

FIRST USE 2-17-2003; IN COMMERCE 2-25-2003.

FOR: VASES; BASKETS OF ROPE; DECORATIVE  
TRAYS; DECORATIVE SERVING PLATTERS;  
SCULPTURES OF PORCELAIN; BIRD BATHS; CAN-  
DLE HOLDERS, IN CLASS 21 (U.S. CLS. 2, 13, 23, 29,  
30, 33, 40 AND 50).

FIRST USE 2-17-2003; IN COMMERCE 2-25-2003.

THE MARK CONSISTS OF STANDARD CHAR-  
ACTERS WITHOUT CLAIM TO ANY PARTICULAR  
FONT, STYLE, SIZE, OR COLOR.

SER. NO. 77-248,075, FILED 8-6-2007.

SANJEEV VOHRA, EXAMINING ATTORNEY

Int. Cls.: 11, 16, 20 and 21

Prior U.S. Cls.: 2, 5, 13, 21, 22, 23, 25, 29, 30, 31, 32,  
33, 34, 37, 38, 40 and 50

Reg. No. 3,498,010

Registered Sep. 9, 2008

**United States Patent and Trademark Office**

---

TRADEMARK  
PRINCIPAL REGISTER



TAYLOR-MARTIN GROUP, LLC (MISSOURI  
LIMITED LIABILITY COMPANY)  
405 N. WASHINGTON, SUITE A  
SPRINGFIELD, MO 65806

FOR: LAMPS; ORNAMENTAL FOUNTAINS; WA-  
TER FOUNTAINS, LANTERNS, IN CLASS 11 (U.S.  
CLS. 13, 21, 23, 31 AND 34).

FIRST USE 2-17-2003; IN COMMERCE 2-25-2003.

FOR: ART PRINTS; PAINTINGS, IN CLASS 16  
(U.S. CLS. 2, 5, 22, 23, 29, 37, 38 AND 50).

FIRST USE 2-17-2003; IN COMMERCE 2-25-2003.

FOR: TABLES, CONSOLE TABLES, ARMOIRES,  
PICTURE FRAMES, BOOKCASES; UMBRELLA  
STANDS, FURNITURE CHESTS, ENTERTAIN-  
MENT CENTERS; BENCHES, CHAIRS, OTTOMANS;  
MIRRORS, DESKS, PILLOWS, WINE RACKS;

SCULPTURES OF RESIN, IN CLASS 20 (U.S. CLS. 2,  
13, 22, 25, 32 AND 50).

FIRST USE 2-17-2003; IN COMMERCE 2-25-2003.

FOR: VASES; BASKETS OF ROPE; DECORATIVE  
TRAYS; DECORATIVE SERVING PLATTERS;  
SCULPTURES OF PORCELAIN; BIRD BATHS; CAN-  
DLE HOLDERS, IN CLASS 21 (U.S. CLS. 2, 13, 23, 29,  
30, 33, 40 AND 50).

FIRST USE 2-17-2003; IN COMMERCE 2-25-2003.

THE MARK CONSISTS OF THE WORDING  
"BRIDGEBLUE SOURCING PARTNERS" ABOVE  
THE IMAGE OF A BRIDGE IN A SHADED SQUARE.

SER. NO. 77-248,111, FILED 8-6-2007.

SANJEEV VOHRA, EXAMINING ATTORNEY

**Int. Cl.: 9**

**Prior U.S. Cls.: 21, 23, 26, 36 and 38**

**United States Patent and Trademark Office**

**Reg. No. 3,498,011**

**Registered Sep. 9, 2008**

**TRADEMARK  
PRINCIPAL REGISTER**

**CALABRIO VISION**

CALABRIO, INC. (DELAWARE CORPORATION)  
605 HIGHWAY 169 NORTH  
MINNEAPOLIS, MN 55441

FOR: COMPUTER SOFTWARE FOR USE IN THE  
FIELDS OF TELEPHONE CALL CENTERS, CUSTOMER  
CONTACT CENTERS AND RELATED COMPUTER  
TELEPHONY NETWORKS, NAMELY,  
DATABASE MANAGEMENT SOFTWARE, STAFF  
SCHEDULING SOFTWARE, EMPLOYEE PERFORMANCE  
DATA COMPILATION SOFTWARE, AND

COMPUTER TELEPHONY SOFTWARE, IN CLASS 9  
(U.S. CLS. 21, 23, 26, 36 AND 38).

FIRST USE 3-0-2007; IN COMMERCE 3-0-2007.

THE MARK CONSISTS OF STANDARD CHARACTERS  
WITHOUT CLAIM TO ANY PARTICULAR FONT,  
STYLE, SIZE, OR COLOR.

SER. NO. 77-248,600, FILED 8-7-2007.

G. MAYERSCHOFF, EXAMINING ATTORNEY



**Int. Cls.: 9, 35, 41 and 42**

**Prior U.S. Cls.: 21, 23, 26, 36, 38, 100, 101, 102 and 107**

**United States Patent and Trademark Office**

**Reg. No. 3,498,012**

**Registered Sep. 9, 2008**

**TRADEMARK  
SERVICE MARK  
PRINCIPAL REGISTER**

**THERE'S NO END TO BETTER.**

CALABRIO, INC. (DELAWARE CORPORATION)  
605 HIGHWAY 169 NORTH  
MINNEAPOLIS, MN 55441

FOR: COMPUTER SOFTWARE FOR USE IN THE FIELDS OF TELEPHONE CALL CENTERS, CUSTOMER CONTACT CENTERS AND RELATED COMPUTER TELEPHONY NETWORKS, NAMELY, DATABASE MANAGEMENT SOFTWARE, STAFF SCHEDULING SOFTWARE, EMPLOYEE PERFORMANCES DATA COMPILATION SOFTWARE, AND COMPUTER TELEPHONY SOFTWARE, IN CLASS 9 (U.S. CLS. 21, 23, 26, 36 AND 38).

FIRST USE 3-0-2007; IN COMMERCE 3-0-2007.

FOR: CONSULTING SERVICES IN THE FIELD OF THE OPERATION OF TELEPHONE CALL CENTERS AND CUSTOMER CONTACT CENTERS, IN CLASS 35 (U.S. CLS. 100, 101 AND 102).

FIRST USE 3-0-2007; IN COMMERCE 3-0-2007.

FOR: TRAINING IN THE USE AND OPERATIONS OF TELEPHONE CALL CENTERS, CUSTOMER

CONTACT CENTERS AND RELATED COMPUTER TELEPHONY NETWORKS, IN CLASS 41 (U.S. CLS. 100, 101 AND 107).

FIRST USE 3-0-2007; IN COMMERCE 3-0-2007.

FOR: TECHNICAL SUPPORT SERVICES, NAMELY, TROUBLESHOOTING OF COMPUTER SOFTWARE PROBLEMS IN THE FIELDS OF TELEPHONE CALL CENTERS, CUSTOMER CONTACT CENTERS AND RELATED COMPUTER TELEPHONY NETWORKS, IN CLASS 42 (U.S. CLS. 100 AND 101).

FIRST USE 3-0-2007; IN COMMERCE 3-0-2007.

THE MARK CONSISTS OF STANDARD CHARACTERS WITHOUT CLAIM TO ANY PARTICULAR FONT, STYLE, SIZE, OR COLOR.

SER. NO. 77-248,614, FILED 8-7-2007.

G. MAYERSCHOFF, EXAMINING ATTORNEY

**Int. Cls.: 9, 35, 41 and 42**

**Prior U.S. Cls.: 21, 23, 26, 36, 38, 100, 101, 102 and 107**

**United States Patent and Trademark Office**

**Reg. No. 3,498,013**

**Registered Sep. 9, 2008**

**TRADEMARK  
SERVICE MARK  
PRINCIPAL REGISTER**

**calabrio**

CALABRIO, INC. (DELAWARE CORPORATION)  
605 HIGHWAY 169 NORTH  
MINNEAPOLIS, MN 55441

FOR: COMPUTER SOFTWARE FOR USE IN THE FIELDS OF TELEPHONE CALL CENTERS, CUSTOMER CONTACT CENTERS AND RELATED COMPUTER TELEPHONY NETWORKS, NAMELY, DATABASE MANAGEMENT SOFTWARE, STAFF SCHEDULING SOFTWARE, EMPLOYEE PERFORMANCE DATA COMPILATION SOFTWARE AND COMPUTER TELEPHONY SOFTWARE, IN CLASS 9 (U.S. CLS. 21, 23, 26, 36 AND 38).

FIRST USE 3-0-2007; IN COMMERCE 3-0-2007.

FOR: CONSULTING SERVICES IN THE FIELD OF THE OPERATION OF TELEPHONE CALL CENTERS AND CUSTOMER CONTACT CENTERS, IN CLASS 35 (U.S. CLS. 100, 101 AND 102).

FIRST USE 3-0-2007; IN COMMERCE 3-0-2007.

FOR: TRAINING IN THE USE AND OPERATIONS OF TELEPHONE CALL CENTERS, CUSTOMER CONTACT CENTERS AND RELATED COMPUTER TELEPHONY NETWORKS, IN CLASS 41 (U.S. CLS. 100, 101 AND 107).

FIRST USE 3-0-2007; IN COMMERCE 3-0-2007.

FOR: TECHNICAL SUPPORT SERVICES, NAMELY, TROUBLESHOOTING OF COMPUTER SOFTWARE PROBLEMS IN THE FIELDS OF TELEPHONE CALL CENTERS, CUSTOMER CONTACT CENTERS AND RELATED COMPUTER TELEPHONY NETWORKS, IN CLASS 42 (U.S. CLS. 100 AND 101).

FIRST USE 3-0-2007; IN COMMERCE 3-0-2007.

THE MARK CONSISTS OF THE WORD "CALABRIO" IN FANCIFUL FORM.

SER. NO. 77-248,628, FILED 8-7-2007.

G. MAYERSCHOFF, EXAMINING ATTORNEY

**Int. Cl.: 35**

**Prior U.S. Cls.: 100, 101 and 102**

**United States Patent and Trademark Office**

**Reg. No. 3,498,014**

**Registered Sep. 9, 2008**

**SERVICE MARK  
PRINCIPAL REGISTER**

**S&P GLOBAL THEMATIC INDICES**

THE MCGRAW-HILL COMPANIES, INC. (NEW  
YORK CORPORATION)

1221 AVENUE OF THE AMERICAS

NEW YORK, NY 10020

FOR: PROVIDING A FINANCIAL INDEX CON-  
SISTING OF STOCKS THAT REFLECT THE PER-  
FORMANCE OF MARKETS THE INDEX  
MEASURES, IN CLASS 35 (U.S. CLS. 100, 101 AND  
102).

FIRST USE 5-0-2007; IN COMMERCE 5-0-2007.

THE MARK CONSISTS OF STANDARD CHAR-  
ACTERS WITHOUT CLAIM TO ANY PARTICULAR  
FONT, STYLE, SIZE, OR COLOR.

OWNER OF U.S. REG. NOS. 2,475,074, 3,290,686  
AND OTHERS.

NO CLAIM IS MADE TO THE EXCLUSIVE  
RIGHT TO USE "GLOBAL THEMATIC INDICES",  
APART FROM THE MARK AS SHOWN.

SER. NO. 77-248,859, FILED 8-7-2007.

MICHAEL TANNER, EXAMINING ATTORNEY

**Int. Cl.: 38**

**Prior U.S. Cls.: 100, 101 and 104**

**United States Patent and Trademark Office**

**Reg. No. 3,498,015**

**Registered Sep. 9, 2008**

**SERVICE MARK  
PRINCIPAL REGISTER**

**DIRTBAG BLAB**

DIRTBAG MUSIC, INC. (DELAWARE CORPORATION)  
1135 GARNET AVENUE, UNIT #U  
SAN DIEGO, CA 92109

FOR: VOICE OVER INTERNET PROTOCOL SERVICES; SESSION INITIATED PROTOCOL; LIVE VIDEO BROADCASTING; VOICE CHAT SERVICES; BROADCASTING VIDEO MESSAGES; POD CASTING; PROVIDING VOICE MULTIPOINT WEB CONFERENCING SERVICES; INSTANT MESSAGING SERVICES; INSTANT MESSAGING VIDEO, TEXT AND MOBILE ENHANCED EMAIL VIA INSTANT MESSAGING SERVICES; PROVIDING VIDEO

ELECTRONIC MAIL SERVICES SET IN AN ONLINE SOCIAL NETWORK SITE, IN CLASS 38 (U.S. CLS. 100, 101 AND 104).

FIRST USE 7-20-2007; IN COMMERCE 7-20-2007.

THE MARK CONSISTS OF STANDARD CHARACTERS WITHOUT CLAIM TO ANY PARTICULAR FONT, STYLE, SIZE, OR COLOR.

SER. NO. 77-248,972, FILED 8-7-2007.

INGRID C. EULIN, EXAMINING ATTORNEY

**Int. Cl.: 41**

**Prior U.S. Cls.: 100, 101 and 107**

**United States Patent and Trademark Office**

**Reg. No. 3,498,016**

**Registered Sep. 9, 2008**

**SERVICE MARK  
PRINCIPAL REGISTER**

**42 ENTERTAINMENT**

42 ENTERTAINMENT LLC (CALIFORNIA LIMITED LIABILITY COMPANY)  
SUITE 200  
1 SOUTH FAIR OAKS AVENUE  
PASADENA, CA 91105

FOR: MOBILE MEDIA AND ENTERTAINMENT SERVICES IN THE NATURE OF CONTENT PREPARATION FOR CELL PHONE, MOBILE DEVICES AND THE INTERNET; FILM PRODUCTION, IN CLASS 41 (U.S. CLS. 100, 101 AND 107).

FIRST USE 7-20-2005; IN COMMERCE 7-20-2005.

THE MARK CONSISTS OF STANDARD CHARACTERS WITHOUT CLAIM TO ANY PARTICULAR FONT, STYLE, SIZE, OR COLOR.

NO CLAIM IS MADE TO THE EXCLUSIVE RIGHT TO USE "ENTERTAINMENT", APART FROM THE MARK AS SHOWN.

SER. NO. 77-249,039, FILED 8-7-2007.

ANDREA HACK, EXAMINING ATTORNEY

**Int. Cl.: 40**

**Prior U.S. Cls.: 100, 103 and 106**

**United States Patent and Trademark Office**

**Reg. No. 3,498,017**

**Registered Sep. 9, 2008**

**SERVICE MARK  
PRINCIPAL REGISTER**

**ESPOSITO SAUSAGE**

ELMGANG ENTERPRISES I, INC. (NEW YORK CORPORATION), DBA D/B/A ESPOSITO'S FINEST QUALITY SAUSAGE PRODUCTS

GROUND FLOOR FACTORY

354 WEST 38TH STREET

NEW YORK, NY 10018

FOR: MANUFACTURING SERVICES FOR OTHERS IN THE FIELD OF SAUSAGE PRODUCTS, IN CLASS 40 (U.S. CLS. 100, 103 AND 106).

FIRST USE 12-30-1982; IN COMMERCE 12-30-1982.

THE MARK CONSISTS OF STANDARD CHARACTERS WITHOUT CLAIM TO ANY PARTICULAR FONT, STYLE, SIZE, OR COLOR.

NO CLAIM IS MADE TO THE EXCLUSIVE RIGHT TO USE "SAUSAGE", APART FROM THE MARK AS SHOWN.

SEC. 2(F).

SER. NO. 77-249,187, FILED 8-7-2007.

NAAKWAMA ANKRAH, EXAMINING ATTORNEY

**Int. Cl.: 7**

**Prior U.S. Cls.: 13, 19, 21, 23, 31, 34 and 35**

**Reg. No. 3,498,018**

**United States Patent and Trademark Office**

**Registered Sep. 9, 2008**

**TRADEMARK  
PRINCIPAL REGISTER**

# JOBSITE

EASTWAY FAIR COMPANY LIMITED (BERMUDA CORPORATION)  
P. O. BOX 146, TORTOLA  
ROAD TOWN, BR. VIRGIN ISLANDS

FOR: HAND-HELD POWER TOOLS, NAMELY, DRILLS, IMPACT DRIVERS, TORQUE DRIVERS, NAIL DRIVERS AND SOCKET DRIVERS, IN CLASS 7 (U.S. CLS. 13, 19, 21, 23, 31, 34 AND 35).

FIRST USE 10-7-1997; IN COMMERCE 10-7-1997.

THE MARK CONSISTS OF STANDARD CHARACTERS WITHOUT CLAIM TO ANY PARTICULAR FONT, STYLE, SIZE, OR COLOR.

OWNER OF U.S. REG. NO. 2,482,921.

SER. NO. 77-249,271, FILED 8-7-2007.

JAY FLOWERS, EXAMINING ATTORNEY

**Int. Cl.: 35**

**Prior U.S. Cls.: 100, 101 and 102**

**United States Patent and Trademark Office**

**Reg. No. 3,498,019**

**Registered Sep. 9, 2008**

**SERVICE MARK  
PRINCIPAL REGISTER**

**THE ORIGINAL DENTAL  
REFERRAL SERVICE**

FUTURE DONTICS, INC. (CALIFORNIA CORPORATION)  
6060 CENTER DRIVE, 7TH FLOOR  
LOS ANGELES, CA 90045

NO CLAIM IS MADE TO THE EXCLUSIVE RIGHT TO USE "DENTAL REFERRAL SERVICE", APART FROM THE MARK AS SHOWN.

FOR: DENTIST REFERRAL SERVICES, IN CLASS 35 (U.S. CLS. 100, 101 AND 102).

SEC. 2(F).

FIRST USE 8-21-1998; IN COMMERCE 8-21-1998.

SER. NO. 77-249,353, FILED 8-7-2007.

THE MARK CONSISTS OF STANDARD CHARACTERS WITHOUT CLAIM TO ANY PARTICULAR FONT, STYLE, SIZE, OR COLOR.

AISHA CLARKE, EXAMINING ATTORNEY



**Int. Cl.: 7**

**Prior U.S. Cls.: 13, 19, 21, 23, 31, 34 and 35**

**United States Patent and Trademark Office**

**Reg. No. 3,498,020**

**Registered Sep. 9, 2008**

**TRADEMARK  
PRINCIPAL REGISTER**

**COOL CLEAN**

COOL CLEAN TECHNOLOGIES, INC. (MINNESOTA CORPORATION)  
SUITE 11  
915 BLUE GENTIAN RD  
EAGAN, MN 55121

FOR: INDUSTRIAL MACHINES FOR TREATING SUBSTRATE SURFACES WITH CARBON DIOXIDE IN VARIOUS STATES, NAMELY, GASEOUS CARBON DIOXIDE, LIQUID CARBON DIOXIDE, SOLID CARBON DIOXIDE OR CARBON DIOXIDE PLASMA, AND ANY COMBINATION THEREOF, IN CLASS 7 (U.S. CLS. 13, 19, 21, 23, 31, 34 AND 35).

FIRST USE 2-1-2002; IN COMMERCE 2-1-2002.

THE MARK CONSISTS OF STANDARD CHARACTERS WITHOUT CLAIM TO ANY PARTICULAR FONT, STYLE, SIZE, OR COLOR.

OWNER OF U.S. REG. NOS. 2,696,413, 3,011,931, AND 3,083,206.

SEC. 2(F).

SER. NO. 77-249,548, FILED 8-7-2007.

JAMES LOVELACE, EXAMINING ATTORNEY

**Int. Cl.: 41**

**Prior U.S. Cls.: 100, 101 and 107**

**United States Patent and Trademark Office**

**Reg. No. 3,498,021**

**Registered Sep. 9, 2008**

**SERVICE MARK  
PRINCIPAL REGISTER**

**DEATH HUNTER**

JAY AXEL ALFALLA (UNITED STATES INDIVIDUAL)  
23-43 125 STREET  
COLLEGE POINT, NY 11356

FOR: AN ONGOING MOTION PICTURE SERIES OF EPISODES ON WEBSITES IN THE FIELD OF DRAMA, SCIENCE FICTION AND HORROR, IN CLASS 41 (U.S. CLS. 100, 101 AND 107).

FIRST USE 0-0-2003; IN COMMERCE 0-0-2003.

THE MARK CONSISTS OF STANDARD CHARACTERS WITHOUT CLAIM TO ANY PARTICULAR FONT, STYLE, SIZE, OR COLOR.

SER. NO. 77-249,612, FILED 8-7-2007.

MICHAEL ENGEL, EXAMINING ATTORNEY

**Int. Cl.: 14**

**Prior U.S. Cls.: 2, 27, 28 and 50**

**Reg. No. 3,498,022**

**United States Patent and Trademark Office**

**Registered Sep. 9, 2008**

**TRADEMARK  
PRINCIPAL REGISTER**

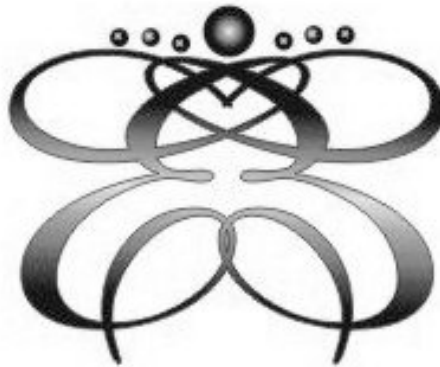

ELIZABETH JEWELRY INC. (NEW YORK COR-  
PORATION)  
FIFTH FLOOR  
13 WEST 36TH STREET  
NEW YORK, NY 10018

THE MARK CONSISTS OF A MISCELLANEOUS  
IMAGE OF INTERLOCKING CURVES, WITH SE-  
VEN SPHERES LOCATED ABOVE SAID IMAGE.

FOR: JEWELRY, IN CLASS 14 (U.S. CLS. 2, 27, 28  
AND 50).

SER. NO. 77-249,620, FILED 8-8-2007.

FIRST USE 7-0-2007; IN COMMERCE 7-0-2007.

SUNG IN, EXAMINING ATTORNEY

**Int. Cl.: 39**

**Prior U.S. Cls.: 100 and 105**

**United States Patent and Trademark Office**

**Reg. No. 3,498,023**

**Registered Sep. 9, 2008**

**SERVICE MARK  
PRINCIPAL REGISTER**

**CRUISEDEALS.COM**

B4 TRAVEL GROUP, INC. (CALIFORNIA CORPORATION)  
6442 CITY WEST PARKWAY  
EDEN PRAIRIE, MN 55344

FOR: ARRANGEMENT OF TRAVEL, EXCURSIONS AND CRUISES FOR OTHERS; TRAVEL AGENCY SERVICES, NAMELY, MAKING RESERVATIONS AND BOOKINGS FOR TRANSPORTATION, CRUISES AND TRAVEL TOURS, IN CLASS 39 (U.S. CLS. 100 AND 105).

FIRST USE 3-0-2003; IN COMMERCE 3-0-2003.

THE MARK CONSISTS OF STANDARD CHARACTERS WITHOUT CLAIM TO ANY PARTICULAR FONT, STYLE, SIZE, OR COLOR.

OWNER OF U.S. REG. NO. 3,185,959.

SEC. 2(F).

SER. NO. 77-249,676, FILED 8-8-2007.

BARBARA RUTLAND, EXAMINING ATTORNEY

**Int. Cl.: 42**

**Prior U.S. Cls.: 100 and 101**

**United States Patent and Trademark Office**

**Reg. No. 3,498,024**

**Registered Sep. 9, 2008**

**SERVICE MARK  
PRINCIPAL REGISTER**

## Spirit Drilling Fluids

SPIRIT DRILLING FLUIDS, GP, LLC (TEXAS  
LIMITED LIABILITY COMPANY)  
SUITE 400  
12941 N. FRWY.  
HOUSTON, TX 77060

FOR: DESIGN AND TESTING FOR NEW PRO-  
DUCT DEVELOPMENT; DESIGN FOR OTHERS IN  
THE FIELD OF OIL AND GAS EXPLORATION;  
ENGINEERING SERVICES, NAMELY, ENGINEER-  
ING FOR THE OIL AND GAS EXPLORATION  
INDUSTRY; PRODUCT RESEARCH AND DEVEL-  
OPMENT, IN CLASS 42 (U.S. CLS. 100 AND 101).

FIRST USE 4-15-2002; IN COMMERCE 4-15-2002.

THE MARK CONSISTS OF STANDARD CHAR-  
ACTERS WITHOUT CLAIM TO ANY PARTICULAR  
FONT, STYLE, SIZE, OR COLOR.

NO CLAIM IS MADE TO THE EXCLUSIVE  
RIGHT TO USE "DRILLING FLUIDS", APART  
FROM THE MARK AS SHOWN.

SER. NO. 77-249,863, FILED 8-8-2007.

STEVEN JACKSON, EXAMINING ATTORNEY

Int. Cl.: 37

Prior U.S. Cls.: 100, 103 and 106

United States Patent and Trademark Office

Reg. No. 3,498,025

Registered Sep. 9, 2008

**SERVICE MARK  
PRINCIPAL REGISTER**



FORTMAN INDUSTRIES, LLC (TEXAS LIMITED  
LIABILITY COMPANY)  
1606 WILLOW LANE  
MCKINNEY, TX 75070

FOR: HOUSE PAINTING; PAINTING, IN CLASS  
37 (U.S. CLS. 100, 103 AND 106).

FIRST USE 5-0-2007; IN COMMERCE 6-0-2007.

NO CLAIM IS MADE TO THE EXCLUSIVE  
RIGHT TO USE "PAINT TO SELL", APART FROM  
THE MARK AS SHOWN.

THE MARK CONSISTS OF A SLANTED YARD  
SIGN WITH THE WORDS "PAINT" ON THE TOP  
HALF AND "TO SELL" ON THE BETTOM, ALSO TO  
THE RIGHT A PAINT BRUSH COMBINED WITH A  
HOUSE IMAGE.

SER. NO. 77-249,926, FILED 8-8-2007.

REBECCA SMITH, EXAMINING ATTORNEY

Int. Cl.: 35

Prior U.S. Cls.: 100, 101 and 102

United States Patent and Trademark Office

Reg. No. 3,498,026

Registered Sep. 9, 2008

SERVICE MARK  
PRINCIPAL REGISTER

**Shipping LIVE!**

WAREHOUSE MANAGEMENT SOLUTIONS,  
INC. (KANSAS CORPORATION)  
9708 WEST 128TH STREET  
OVERLAND PARK, KS 66213

FOR: INFORMATION MANAGEMENT SERVICES, NAMELY, SHIPMENT PROCESSING, PREPARING SHIPPING DOCUMENTS AND INVOICES, TRACKING DOCUMENTS, PACKAGES AND FREIGHT OVER COMPUTER NETWORKS, INTRANETS AND INTERNETS, IN CLASS 35 (U.S. CLS. 100, 101 AND 102).

FIRST USE 4-30-2007; IN COMMERCE 4-30-2007.

OWNER OF U.S. REG. NO. 7,719,262.

NO CLAIM IS MADE TO THE EXCLUSIVE RIGHT TO USE "SHIPPING", APART FROM THE MARK AS SHOWN.

THE MARK CONSISTS OF THE ALPHANUMERIC PHRASE "SHIPPING LIVE", WITH "LIVE" REPRESENTED IN A STYLIZED FORMAT.

SER. NO. 77-249,978, FILED 8-8-2007.

ALLISON HOLTZ, EXAMINING ATTORNEY

**Int. Cl.: 30**

**Prior U.S. Cl.: 46**

**Reg. No. 3,498,027**

**United States Patent and Trademark Office**

**Registered Sep. 9, 2008**

**TRADEMARK  
PRINCIPAL REGISTER**



WEISS, WILLIAM J. (UNITED STATES INDIVIDUAL)  
7677 HAWKS LANDING DRIVE  
WEST PALM BEACH, FL 33412

FOR: TACOS; FRESH PIZZA; CHICKEN WING SAUCE; SALAD DRESSINGS; SANDWICHES, IN CLASS 30 (U.S. CL. 46).

FIRST USE 8-0-2006; IN COMMERCE 8-0-2006.

NO CLAIM IS MADE TO THE EXCLUSIVE RIGHT TO USE "PIZZA", APART FROM THE MARK AS SHOWN.

THE COLOR(S) YELLOW, ORANGE AND WHITE IS/ARE CLAIMED AS A FEATURE OF THE MARK.

THE MARK CONSISTS OF THE DESIGN OF A PIZZA SLICE IN THE COLORS YELLOW AND ORANGE AND THE LITERAL TERMS "SLICERS PIZZA EXPRESS" IN THE COLOR WHITE. THE ENTIRE MARK HAS AN ORANGE BACKGROUND.

SER. NO. 77-250,092, FILED 8-8-2007.

KAPIL BHANOT, EXAMINING ATTORNEY



**Int. Cl.: 7**

**Prior U.S. Cls.: 13, 19, 21, 23, 31, 34 and 35**

**Reg. No. 3,498,028**

**United States Patent and Trademark Office**

**Registered Sep. 9, 2008**

**TRADEMARK  
PRINCIPAL REGISTER**

**ACCUNIP**

PFE ROLLS, INC. (WISCONSIN CORPORATION)  
1035 BREEZEWOOD LANE, P.O. BOX 1026  
NEENAH, WI 549571026

FIRST USE 9-12-1973; IN COMMERCE 9-12-1973.

FOR: INDUSTRIAL MACHINERY, NAMELY,  
SQUEEZE ROLL MACHINES FOR COATING, CA-  
LENDARING, LAMINATING, PERFORATING,  
SQUEEZING, AND STOPPING CONTINUOUS  
NON-METALLIC SHEET MATERIALS, IN CLASS 7  
(U.S. CLS. 13, 19, 21, 23, 31, 34 AND 35).

THE MARK CONSISTS OF STANDARD CHAR-  
ACTERS WITHOUT CLAIM TO ANY PARTICULAR  
FONT, STYLE, SIZE, OR COLOR.

SER. NO. 77-250,342, FILED 8-8-2007.

CHRISTINE COOPER, EXAMINING ATTORNEY

**Int. Cl.: 25**

**Prior U.S. Cls.: 22 and 39**

**United States Patent and Trademark Office**

**Reg. No. 3,498,029**

**Registered Sep. 9, 2008**

**TRADEMARK  
PRINCIPAL REGISTER**

**MIC MAC**

SOCIETE GUY LAROCHE (FRANCE SOCIETE  
PAR ACTIONS SIMPLIFIEE)  
35, RUE FRANÇOIS LER  
PARIS, FRANCE 75008

FOR: CLOTHING FOR MEN AND WOMEN,  
NAMELY, UNDERWEAR, SHIRTS, POLO SHIRTS,  
JACKETS, SUITS, TROUSERS, DRESSES, SKIRTS,  
COATS, SCARVES, TIES, BELTS, SOCKS, PAJAMAS,  
LOUNGE WEAR, AND FUR COATS; CLOTHING IN  
THE NATURE OF KNITTED WEAR, NAMELY,  
SHIRTS, POLO SHIRTS, SKIRTS, AND DRESSES;  
CLOTHING IN THE NATURE OF LEATHER WEAR,  
NAMELY, TROUSERS, SKIRTS, DRESSES, JACK-

ETS AND COATS; BOOTS; SHOES; SLIPPERS; AND  
HEADWEAR, IN CLASS 25 (U.S. CLS. 22 AND 39).

THE MARK CONSISTS OF STANDARD CHAR-  
ACTERS WITHOUT CLAIM TO ANY PARTICULAR  
FONT, STYLE, SIZE, OR COLOR.

OWNER OF FRANCE REG. NO. 1575437, DATED  
2-14-1990, EXPIRES 2-14-2010.

SER. NO. 77-250,348, FILED 8-8-2007.

ELLEN PERKINS, EXAMINING ATTORNEY

**Int. Cl.: 41**

**Prior U.S. Cls.: 100, 101 and 107**

**United States Patent and Trademark Office**

**Reg. No. 3,498,030**

**Registered Sep. 9, 2008**

**SERVICE MARK  
PRINCIPAL REGISTER**

# KNOWLEDGE

SMITH ABRASIVES, INC. (DELAWARE CORPORATION)  
1700 SLEEPY VALLEY ROAD  
HOT SPRINGS, AR 71901

FOR: EDUCATIONAL SERVICES, PROVIDING LIVE IN-STORE PRESENTATIONS AND CONDUCTING INFORMAL ON-LINE PROGRAMS IN THE FIELDS OF MANUAL AND ELECTRIC SHARPENING FOR KNIVES, SCISSORS AND OTHER TOOLS, AND PRINTABLE MATERIALS DISTRIBUTED THEREWITH ACCESSIBLE BY PRINT, VIDEO,

INTERNET AND DVD, IN CLASS 41 (U.S. CLS. 100, 101 AND 107).

FIRST USE 10-31-2006; IN COMMERCE 10-31-2006.

THE MARK CONSISTS OF STANDARD CHARACTERS WITHOUT CLAIM TO ANY PARTICULAR FONT, STYLE, SIZE, OR COLOR.

SER. NO. 77-250,574, FILED 8-8-2007.

BRIAN NEVILLE, EXAMINING ATTORNEY

**Int. Cl.: 14**

**Prior U.S. Cls.: 2, 27, 28 and 50**

**United States Patent and Trademark Office**

**Reg. No. 3,498,031**

**Registered Sep. 9, 2008**

**TRADEMARK  
PRINCIPAL REGISTER**

# Sauer

AMSTERDAM SAUER JOALHEIROS LTDA  
(BRAZIL LIMITED LIABILITY COMPANY)

250/6 ANDAR PARTE  
RUA VISCONDE DE PIRAJA  
RIO DE JANEIRO, BRAZIL 22410

FOR: GEMSTONES; JEWELRY; SCULPTURES  
MADE OF PRECIOUS METAL; WATCHES, IN  
CLASS 14 (U.S. CLS. 2, 27, 28 AND 50).

FIRST USE 11-10-1953; IN COMMERCE 11-10-1953.

OWNER OF BRAZIL REG. NO. 007023472, DATED  
11-10-1979, EXPIRES 11-10-2009.

SER. NO. 77-250,664, FILED 8-8-2007.

DAVID COLLIER, EXAMINING ATTORNEY

**Int. Cls.: 12 and 40**

**Prior U.S. Cls.: 19, 21, 23, 31, 35, 44, 100, 103 and 106**

**Reg. No. 3,498,032**

**United States Patent and Trademark Office**

**Registered Sep. 9, 2008**

**TRADEMARK  
SERVICE MARK  
PRINCIPAL REGISTER**

# Maxey

MAXEY COMPANIES, INC. (COLORADO CORPORATION)  
2101 AIRWAY AVE.  
FORT COLLINS, CO 80524

FOR: SNOW GROOMING EQUIPMENT, NAME-  
LY, LAND VEHICLES FOR USE ON SNOW IN THE  
NATURE OF TRAIL GROOMING, IN CLASS 12 (U.S.  
CLS. 19, 21, 23, 31, 35 AND 44).

FIRST USE 6-1-1969; IN COMMERCE 8-31-1970.

FOR: CUSTOM MANUFACTURE OF FABRICA-  
TED STEEL PRODUCTS TO THE ORDER AND  
SPECIFICATION OF OTHERS, NAMELY, TRUCK-  
BEDS, TRAILERS, HITCHES, SNOW GROOMING

EQUIPMENT, SNOW REMOVAL EQUIPMENT,  
AND SNOW MELTING EQUIPMENT, IN CLASS 40  
(U.S. CLS. 100, 103 AND 106).

FIRST USE 6-1-1969; IN COMMERCE 8-31-1970.

THE MARK CONSISTS OF STANDARD CHAR-  
ACTERS WITHOUT CLAIM TO ANY PARTICULAR  
FONT, STYLE, SIZE, OR COLOR.

SEC. 2(F).

SER. NO. 77-251,237, FILED 8-9-2007.

ADA HAN, EXAMINING ATTORNEY

**Int. Cl.: 9**

**Prior U.S. Cls.: 21, 23, 26, 36 and 38**

**United States Patent and Trademark Office**

**Reg. No. 3,498,033**

**Registered Sep. 9, 2008**

**TRADEMARK  
PRINCIPAL REGISTER**



LEGAL FILES SOFTWARE, INC. (ILLINOIS CORPORATION)  
801 S. DURKIN DRIVE  
SPRINGFIELD, IL 62704

FOR: COMPUTER SOFTWARE FOR LEGAL CASE MANAGEMENT, IN CLASS 9 (U.S. CLS. 21, 23, 26, 36 AND 38).

FIRST USE 8-1-1998; IN COMMERCE 8-1-1998.

OWNER OF U.S. REG. NO. 2,742,368.

NO CLAIM IS MADE TO THE EXCLUSIVE RIGHT TO USE "LEGAL FILES", APART FROM THE MARK AS SHOWN.

THE COLOR(S) BLACK, WHITE AND BLUE IS/ ARE CLAIMED AS A FEATURE OF THE MARK.

THE MARK CONSISTS OF THE WORD LEGAL IN BLACK, THE WORD FILES IN WHITE, AND A STYLIZED IMAGE OF A BLUE FOLDER .

SER. NO. 77-251,429, FILED 8-9-2007.

LINDA E. BLOHM, EXAMINING ATTORNEY

**Int. Cl.: 25**

**Prior U.S. Cls.: 22 and 39**

**United States Patent and Trademark Office**

**Reg. No. 3,498,034**

**Registered Sep. 9, 2008**

**TRADEMARK  
PRINCIPAL REGISTER**

**ELEVATED IMPACT**

JOHNSON, RYAN (UNITED STATES INDIVIDUAL)  
A118  
8300 NORTH HAYDEN ROAD  
SCOTTSDALE, AZ 85258

FOR: SHIRTS; HATS; PANTS; JACKETS, IN CLASS 25 (U.S. CLS. 22 AND 39).

FIRST USE 7-7-2007; IN COMMERCE 7-7-2007.

THE MARK CONSISTS OF STANDARD CHARACTERS WITHOUT CLAIM TO ANY PARTICULAR FONT, STYLE, SIZE, OR COLOR.

SER. NO. 77-251,460, FILED 8-9-2007.

KEVON CHISOLM, EXAMINING ATTORNEY

**Int. Cl.: 10**

**Prior U.S. Cls.: 26, 39 and 44**

**Reg. No. 3,498,035**

**United States Patent and Trademark Office**

**Registered Sep. 9, 2008**

**TRADEMARK  
PRINCIPAL REGISTER**



RESTORE MEDICAL, INC. (MINNESOTA CORPORATION)  
2800 PATTON ROAD  
ST. PAUL, MN 55113

FOR: MEDICAL DEVICES, NAMELY, UPPER AIRWAY IMPLANTS, IN CLASS 10 (U.S. CLS. 26, 39 AND 44).

FIRST USE 5-0-2003; IN COMMERCE 5-0-2003.

OWNER OF U.S. REG. NO. 2,885,136.

NO CLAIM IS MADE TO THE EXCLUSIVE RIGHT TO USE "MEDICAL", APART FROM THE MARK AS SHOWN.

SER. NO. 77-251,463, FILED 8-9-2007.

SONYA STEPHENS, EXAMINING ATTORNEY



**Int. Cls.: 9 and 42**

**Prior U.S. Cls.: 21, 23, 26, 36, 38, 100 and 101**

**Reg. No. 3,498,036**

**United States Patent and Trademark Office**

**Registered Sep. 9, 2008**

**TRADEMARK  
SERVICE MARK  
PRINCIPAL REGISTER**

# APIAN

APIAN SOFTWARE, INC. (CALIFORNIA CORPORATION)  
SUITE 204  
115 N 85TH STREET  
SEATTLE, WA 98103

FOR: COMPUTER SOFTWARE FOR CONDUCTING AND MANAGING A SURVEY, NAMELY, SOFTWARE FOR GENERATING SURVEY FORMS, SOFTWARE FOR RECORDING INFORMATION OBTAINED IN THE SURVEY, SOFTWARE FOR ACCESSING THE INFORMATION, SOFTWARE FOR EVALUATING AND ANALYZING THE INFORMATION, AND SOFTWARE FOR GENERATING A REPORT BASED ON THE INFORMATION, ITS EVALUATION OR ITS ANALYSIS, IN CLASS 9 (U.S. CLS. 21, 23, 26, 36 AND 38).

FIRST USE 12-19-1986; IN COMMERCE 12-19-1986.

FOR: HOSTING WEBSITES FOR OTHERS FOR CONDUCTING AND MANAGING A SURVEY; PROVIDING TECHNICAL SUPPORT SERVICES, NAMELY, TROUBLESHOOTING COMPUTER SOFTWARE PROBLEMS RELATED TO SURVEY SOFTWARE AND DECISION ANALYSIS SOFTWARE, IN CLASS 42 (U.S. CLS. 100 AND 101).

FIRST USE 12-19-1986; IN COMMERCE 12-19-1986.

THE MARK CONSISTS OF STANDARD CHARACTERS WITHOUT CLAIM TO ANY PARTICULAR FONT, STYLE, SIZE, OR COLOR.

SER. NO. 77-251,676, FILED 8-9-2007.

MARIAM MAHMOUDI, EXAMINING ATTORNEY

Int. Cl.: 16

Prior U.S. Cls.: 2, 5, 22, 23, 29, 37, 38 and 50

United States Patent and Trademark Office

Reg. No. 3,498,037

Registered Sep. 9, 2008

TRADEMARK  
PRINCIPAL REGISTER



SAITO, JOHN (UNITED STATES INDIVIDUAL)  
5309 BRIARCREST CIRCLE,  
TEMPLE, TX 76502

FOR: GRAPHIC NOVELS, IN CLASS 16 (U.S. CLS.  
2, 5, 22, 23, 29, 37, 38 AND 50).

FIRST USE 7-29-2005; IN COMMERCE 1-24-2007.

NO CLAIM IS MADE TO THE EXCLUSIVE  
RIGHT TO USE CREATED BY, APART FROM THE  
MARK AS SHOWN.

THE COLOR(S) RED, YELLOW, BLUE, AND  
BLACK IS/ARE CLAIMED AS A FEATURE OF  
THE MARK.

THE MARK CONSISTS OF THE TERM "JOHNNY  
AND THE" IN THE COLOR RED AND OUTLINED  
IN THE COLOR BLACK. THE TERM "MAGIC  
PAINT BRUSH" IS IN THE COLOR YELLOW AND  
OUTLINED IN THE COLOR BLACK. THE TERM  
"CREATED BY JOHN SAITO, M.D. IS IN THE  
COLOR BLACK, ALL WITHIN A BLACK BORDER  
AGAINST A BLUE BACKGROUND.

SER. NO. 77-251,956, FILED 8-10-2007.

EMILY CHUO, EXAMINING ATTORNEY

**Int. Cls.: 35, 38 and 41**

**Prior U.S. Cls.: 100, 101, 102, 104 and 107**

**United States Patent and Trademark Office**

**Reg. No. 3,498,038**

**Registered Sep. 9, 2008**

**SERVICE MARK  
PRINCIPAL REGISTER**

# CROSSROADS

C & S WHOLESALE GROCERS, INC. (VERMONT CORPORATION)  
47 OLD FERRY ROAD  
BRATTLEBORO, VT 05301

FOR: INFORMATION MANAGEMENT SERVICES, NAMELY, COLLECTING AND PROVIDING INFORMATION TO VENDORS IN THE FIELD OF GROCERY WHOLESALING REGARDING THE SHIPMENT OF THEIR PRODUCTS BASED ON PRODUCT TYPE OR THE IDENTITY OF THE RETAILER RECEIVING THE PRODUCTS; PROVIDING CUSTOMER RELATIONSHIP MANAGEMENT SERVICES TO VENDORS OF GROCERY PRODUCTS IN THE FIELD OF GROCERY WHOLESALING; PROVIDING SUPPLY CHAIN INFORMATION SERVICES TO VENDORS, NAMELY, PROVIDING CONTINUOUS INVENTORY REPLENISHMENT PROGRAM AND VENDOR MANAGED INVENTORY SUPPLY CHAIN MANAGEMENT SERVICES; PREPARING FINANCIAL REPORTS FOR OTHERS REGARDING PAYMENT, INVOICE, BILL-BACK AND DEDUCTION INFORMATION IN THE GROCERY WHOLESALING FIELD, IN CLASS 35 (U.S. CLS. 100, 101 AND 102).

FIRST USE 1-1-2004; IN COMMERCE 1-1-2004.

FOR: ELECTRONIC DATA INTERCHANGE (EDI) SERVICES, NAMELY, PROVIDING PRODUCT AC-

TIVITY INVENTORY DATA TO VENDORS AND VENDOR BROKERS THROUGH ELECTRONIC DATA INTERCHANGE (EDI 852) TRANSACTIONS, IN CLASS 38 (U.S. CLS. 100, 101 AND 104).

FIRST USE 1-1-2004; IN COMMERCE 1-1-2004.

FOR: EDUCATIONAL SERVICES, NAMELY, CONDUCTING SEMINARS, CONFERENCES AND WORKSHOPS FOR THE PURPOSE OF EDUCATING VENDORS IN THE FIELD OF GROCERY WHOLESALING, NAMELY, HOW TO EVALUATE AND USE THEIR BUSINESS WHOLESALE GROCERY INVENTORY DATA, IN CLASS 41 (U.S. CLS. 100, 101 AND 107).

FIRST USE 1-1-2004; IN COMMERCE 1-1-2004.

THE MARK CONSISTS OF STANDARD CHARACTERS WITHOUT CLAIM TO ANY PARTICULAR FONT, STYLE, SIZE, OR COLOR.

OWNER OF U.S. REG. NO. 1,952,962.

SER. NO. 77-252,043, FILED 8-10-2007.

HOWARD SMIGA, EXAMINING ATTORNEY

**Int. Cls.: 9 and 41**

**Prior U.S. Cls.: 21, 23, 26, 36, 38, 100, 101 and 107**

**United States Patent and Trademark Office**

**Reg. No. 3,498,039**

**Registered Sep. 9, 2008**

**TRADEMARK  
SERVICE MARK  
PRINCIPAL REGISTER**

**CASSIE**

CVENTURA, INC. (NEW YORK CORPORATION)  
SUITE 1  
3665 MERRICK ROAD  
SEAFORD, NY 11783

FOR: A SERIES OF MUSICAL SOUND RECORDINGS; MUSICAL VIDEO RECORDINGS; DOWNLOADABLE MUSIC AND MUSIC VIDEO RECORDINGS, IN CLASS 9 (U.S. CLS. 21, 23, 26, 36 AND 38).

FIRST USE 2-10-2006; IN COMMERCE 2-10-2006.

FOR: ENTERTAINMENT SERVICES, NAMELY, LIVE PERFORMANCES BY A MUSICAL ARTIST, IN CLASS 41 (U.S. CLS. 100, 101 AND 107).

FIRST USE 2-10-2006; IN COMMERCE 2-10-2006.

THE MARK CONSISTS OF STANDARD CHARACTERS WITHOUT CLAIM TO ANY PARTICULAR FONT, STYLE, SIZE, OR COLOR.

THE NAME(S), PORTRAIT(S), AND/OR SIGNATURE(S) SHOWN IN THE MARK IDENTIFIES "CASSIE VENTURA", WHOSE CONSENT(S) TO REGISTER IS MADE OF RECORD.

SER. NO. 77-252,079, FILED 8-10-2007.

ESTHER A. BORSUK, EXAMINING ATTORNEY

**Int. Cl.: 42**

**Prior U.S. Cls.: 100 and 101**

**United States Patent and Trademark Office**

**Reg. No. 3,498,040**

**Registered Sep. 9, 2008**

**SERVICE MARK  
PRINCIPAL REGISTER**



AMBRIEL TECHNOLOGIES (VIRGINIA LIMITED LIABILITY COMPANY)  
126 N. KENT STREET  
WINCHESTER, VA 22601

FOR: TECHNOLOGY CONSULTING, RESEARCH, DEVELOPMENT IN THE FIELD OF INTERNET AND NETWORK PROTOCOL TECHNOLOGY, IN CLASS 42 (U.S. CLS. 100 AND 101).

FIRST USE 1-8-2007; IN COMMERCE 1-8-2007.

NO CLAIM IS MADE TO THE EXCLUSIVE RIGHT TO USE "TECHNOLOGIES", APART FROM THE MARK AS SHOWN.

THE COLOR(S) BLUE AND TAN IS/ARE CLAIMED AS A FEATURE OF THE MARK.

THE MARK CONSISTS OF ALL LETTERS IN THE WORD "AMBRIEL" IN DARK BLUE, THE LETTER "A" HAVING A TAN COLOR SWOOSH GOING UPWARD FROM THE LEFT SIDE OF THE LETTER, SEEMING TO ENCIRCLE THE RIGHT SIDE OF THE LETTER. THE LETTER "A" IS CAPITALIZED, THE LETTERS "M", "B", "R", "I", "E", AND "L" ARE LOWER CASE. ALL LETTERS IN THE WORD "TECHNOLOGIES" ARE CAPITALIZED AND IN TAN COLOR, WITH THE WORD "TECHNOLOGIES" POSITIONED UNDERNEATH THE WORD "AMBRIEL".

SER. NO. 77-252,231, FILED 8-10-2007.

SHAUNIA CARLYLE, EXAMINING ATTORNEY

**Int. Cl.: 16**

**Prior U.S. Cls.: 2, 5, 22, 23, 29, 37, 38 and 50**

**Reg. No. 3,498,041**

**United States Patent and Trademark Office**

**Registered Sep. 9, 2008**

**TRADEMARK  
PRINCIPAL REGISTER**

# Magical Windhorses

TELANO, DEAN A. (UNITED STATES INDIVIDUAL)  
27 STONYWOOD ROAD  
COMMACK, NY 11725

FOR: PRINTED CHARTS; EDUCATIONAL PUBLICATIONS, NAMELY, TRAINING MANUALS IN THE FIELD OF YOGA, MEDITATION, HEALING TECHNIQUES, IN CLASS 16 (U.S. CLS. 2, 5, 22, 23, 29, 37, 38 AND 50).

FIRST USE 1-10-2005; IN COMMERCE 1-10-2005.

THE MARK CONSISTS OF STANDARD CHARACTERS WITHOUT CLAIM TO ANY PARTICULAR FONT, STYLE, SIZE, OR COLOR.

SER. NO. 77-252,568, FILED 8-10-2007.

TINA BROWN, EXAMINING ATTORNEY

**Int. Cl.: 36**

**Prior U.S. Cls.: 100, 101 and 102**

**United States Patent and Trademark Office**

**Reg. No. 3,498,042**

**Registered Sep. 9, 2008**

**SERVICE MARK  
PRINCIPAL REGISTER**

**Working Hard For Working  
People**

AMALGAMATED BANK OF NEW YORK (NEW  
YORK CORPORATION)  
15 UNION SQUARE  
NEW YORK, NY 10003

THE MARK CONSISTS OF STANDARD CHAR-  
ACTERS WITHOUT CLAIM TO ANY PARTICULAR  
FONT, STYLE, SIZE, OR COLOR.

FOR: RETAIL BANKING SERVICES; FINANCIAL  
PLANNING AND INVESTMENT ADVISORY SER-  
VICES; FINANCIAL TRUST OPERATIONS, IN  
CLASS 36 (U.S. CLS. 100, 101 AND 102).

SER. NO. 77-252,581, FILED 8-10-2007.

FIRST USE 11-1-2006; IN COMMERCE 11-1-2006.

RENEE MCCRAY, EXAMINING ATTORNEY

**Int. Cl.: 41**

**Prior U.S. Cls.: 100, 101 and 107**

**United States Patent and Trademark Office**

**Reg. No. 3,498,043**

**Registered Sep. 9, 2008**

**SERVICE MARK  
PRINCIPAL REGISTER**

**Soul Incorporated**

LEVENTHAL, SHARON RICH (UNITED STATES  
INDIVIDUAL), DBA SHARON RICH  
11700 NATIONAL BL., ST. L, #106  
LOS ANGELES, CA 90064

FOR: LIFE COACHING SERVICES IN THE FIELD  
OF LIFE PERSONAL AND BUSINESS IMPROVE-  
MENT; PERSONAL COACHING SERVICES IN THE  
FIELD OF LIFE AND BUSINESS IMPROVEMENT;  
PROFESSIONAL COACHING SERVICES IN THE  
FIELD OF LIFE AND BUSINESS IMPROVEMENT,  
IN CLASS 41 (U.S. CLS. 100, 101 AND 107).

FIRST USE 11-9-2005; IN COMMERCE 5-1-2006.

THE MARK CONSISTS OF STANDARD CHAR-  
ACTERS WITHOUT CLAIM TO ANY PARTICULAR  
FONT, STYLE, SIZE, OR COLOR.

NO CLAIM IS MADE TO THE EXCLUSIVE  
RIGHT TO USE "INCORPORATED", APART FROM  
THE MARK AS SHOWN.

SER. NO. 77-253,061, FILED 8-11-2007.

ANDREA BUTLER, EXAMINING ATTORNEY



**Int. Cl.: 16**

**Prior U.S. Cls.: 2, 5, 22, 23, 29, 37, 38 and 50**

**Reg. No. 3,498,044**

**United States Patent and Trademark Office**

**Registered Sep. 9, 2008**

**TRADEMARK  
PRINCIPAL REGISTER**

# Windhorse

TELANO, DEAN A. (UNITED STATES INDIVIDUAL)  
27 STONYWOOD ROAD  
COMMACK, NY 11725

FOR: EDUCATIONAL PUBLICATIONS, NAME-  
LY, EDUCATIONAL LEARNING CARDS, FLASH  
CARDS, ACTIVITY CARDS, WORKBOOKS, TEXT-  
BOOKS, ACTIVITY BOOKS, STORY BOOKS, PUZ-  
ZLE BOOKS, PUZZLES, TEACHER GUIDES,  
MANUALS, POSTERS, EDUCATIONAL CARD  
GAMES AND EDUCATIONAL BOOKLETS IN THE  
FIELD OF YOGA, MEDITATION, WELLNESS; EDU-  
CATIONAL PUBLICATIONS, NAMELY, TRAINING

MANUALS IN THE FIELD OF YOGA, MEDITA-  
TION, WELLNESS, IN CLASS 16 (U.S. CLS. 2, 5, 22, 23,  
29, 37, 38 AND 50).

FIRST USE 1-1-2005; IN COMMERCE 1-1-2005.

THE MARK CONSISTS OF STANDARD CHAR-  
ACTERS WITHOUT CLAIM TO ANY PARTICULAR  
FONT, STYLE, SIZE, OR COLOR.

SER. NO. 77-253,152, FILED 8-12-2007.

TINA BROWN, EXAMINING ATTORNEY

**Int. Cl.: 25**

**Prior U.S. Cls.: 22 and 39**

**United States Patent and Trademark Office**

**Reg. No. 3,498,045**

**Registered Sep. 9, 2008**

**TRADEMARK  
PRINCIPAL REGISTER**

The logo for Vivahora features the word "vivahora" in a lowercase, sans-serif font. The letter "a" is significantly larger than the other letters and has three dots positioned directly beneath it.

VIVAHORA, LLC (FLORIDA LIMITED LIABILITY COMPANY)  
SUITE 78  
1521 ALTON ROAD  
MIAMI BEACH, FL 33180

"A" LARGER THAN THE OTHER LETTERS AND HAVING THREE DOTS BENEATH THE FIRST LETTER "A" AND ALIGNED IN A ROW PARALLEL TO THE TEXT.

FOR: SPORTSWEAR, NAMELY, T-SHIRTS AND TANK TOPS, IN CLASS 25 (U.S. CLS. 22 AND 39).

THE FOREIGN WORDING IN THE MARK TRANSLATES INTO ENGLISH AS HOORAY NOW.

FIRST USE 12-31-2006; IN COMMERCE 12-31-2006.

SER. NO. 77-253,312, FILED 8-13-2007.

THE MARK CONSISTS OF "VIVAHORA" WRITTEN IN LOWER CASE WITH THE FIRST LETTER

CURTIS FRENCH, EXAMINING ATTORNEY

**Int. Cl.: 20**

**Prior U.S. Cls.: 2, 13, 22, 25, 32 and 50**

**Reg. No. 3,498,046**

**United States Patent and Trademark Office**

**Registered Sep. 9, 2008**

**TRADEMARK  
PRINCIPAL REGISTER**

**RACCOON**

BANDSUNIQUE LLC (NORTH CAROLINA LIMITED LIABILITY COMPANY)  
7305 FOXFORD AVENUE NW  
ALBUQUERQUE, NM 87120

THE MARK CONSISTS OF STANDARD CHARACTERS WITHOUT CLAIM TO ANY PARTICULAR FONT, STYLE, SIZE, OR COLOR.

FOR: NON-METAL IDENTIFICATION BANDS USED ON CONTAINERS, IN CLASS 20 (U.S. CLS. 2, 13, 22, 25, 32 AND 50).

SER. NO. 77-253,335, FILED 8-13-2007.

FIRST USE 8-3-2007; IN COMMERCE 8-8-2007.

INGA ERVIN, EXAMINING ATTORNEY

**Int. Cl.: 29**

**Prior U.S. Cl.: 46**

**United States Patent and Trademark Office**

**Reg. No. 3,498,047**

**Registered Sep. 9, 2008**

**TRADEMARK  
PRINCIPAL REGISTER**



ELMGANG ENTERPRISES I, INC. (NEW YORK CORPORATION), DBA ESPOSITO'S FINEST QUALITY SAUSAGE PRODUCTS  
GROUND FLOOR FACTORY  
354 WEST 38TH STREET  
NEW YORK, NY 10018

THE MARK CONSISTS OF THE WORD "ESPOSITO'S" AND A DESIGN OF A PIG'S HEAD WITH HOOVES.

SER. NO. 77-253,481, FILED 8-13-2007.

FOR: SAUSAGES, IN CLASS 29 (U.S. CL. 46).

FIRST USE 12-30-1982; IN COMMERCE 12-30-1982.

NAAKWAMA ANKRAH, EXAMINING ATTORNEY

**Int. Cls.: 41 and 45**

**Prior U.S. Cls.: 100, 101 and 107**

**United States Patent and Trademark Office**

**Reg. No. 3,498,048**

**Registered Sep. 9, 2008**

**SERVICE MARK  
PRINCIPAL REGISTER**

**THE IRREVERENT WIDOW**

SILVER CRAYON STUDIOS (MAINE CORPORATION)  
3 AVON ROAD  
CAPE ELIZABETH, ME 04107

FOR: ORGANIZING WORKSHOPS, SEMINARS AND ART EXHIBITS FEATURING INFORMATION AND MULTIMEDIA CONTENT RELATED TO LOVE, DEATH AND DATING, IN CLASS 41 (U.S. CLS. 100, 101 AND 107).

FIRST USE 10-22-2007; IN COMMERCE 10-22-2007.

FOR: ENTERTAINMENT AND EDUCATION SERVICES, NAMELY, PROVIDING A WEB SITE

FEATURING INFORMATION AND MULTIMEDIA CONTENT RELATED TO LOVE, DEATH AND DATING, IN CLASS 45 (U.S. CLS. 100 AND 101).

FIRST USE 10-22-2007; IN COMMERCE 10-22-2007.

THE MARK CONSISTS OF STANDARD CHARACTERS WITHOUT CLAIM TO ANY PARTICULAR FONT, STYLE, SIZE, OR COLOR.

SER. NO. 77-253,546, FILED 8-13-2007.

SANI KHOURI, EXAMINING ATTORNEY

**Int. Cl.: 40**

**Prior U.S. Cls.: 100, 103 and 106**

**United States Patent and Trademark Office**

**Reg. No. 3,498,049**

**Registered Sep. 9, 2008**

**SERVICE MARK  
PRINCIPAL REGISTER**

**ESPOSITO'S  
FINEST QUALITY  
SAUSAGE**



ELMGANG ENTERPRISES I, INC. (NEW YORK CORPORATION), DBA D/B/A ESPOSITO'S FINEST QUALITY SAUSAGE PRODUCTS  
GROUND FLOOR FACTORY  
354 WEST 38TH STREET  
NEW YORK, NY 10018

FOR: MANUFACTURING SERVICES FOR OTHERS IN THE FIELD OF SAUSAGE PRODUCTS, IN CLASS 40 (U.S. CLS. 100, 103 AND 106).

FIRST USE 12-30-1982; IN COMMERCE 12-30-1982.

NO CLAIM IS MADE TO THE EXCLUSIVE RIGHT TO USE "FINEST QUALITY SAUSAGE", APART FROM THE MARK AS SHOWN.

THE NAME(S), PORTRAIT(S), AND/OR SIGNATURE(S) SHOWN IN THE MARK IDENTIFIES GIOVANNI ESPOSITO WITH HIS SON, WHOSE CONSENT(S) TO REGISTER IS MADE OF RECORD.

THE MARK CONSISTS OF THE WORDS" ESPOSITO'S FINEST QUALITY SAUSAGE" AND A DESIGN OF A PIG'S HEAD WITH HOOVES AND THE PORTRAITS OF GIOVANNI ESPOSITO AND ONE OF HIS SONS.

SER. NO. 77-253,560, FILED 8-13-2007.

NAAKWAMA ANKRAH, EXAMINING ATTORNEY

**Int. Cl.: 35**

**Prior U.S. Cls.: 100, 101 and 102**

**United States Patent and Trademark Office**

**Reg. No. 3,498,050**

**Registered Sep. 9, 2008**

**SERVICE MARK  
PRINCIPAL REGISTER**

**DOWNEAST ENERGY**

DOWNEAST ENERGY CORP. (MAINE CORPORATION)  
18 SPRING STREET  
BRUNSWICK, ME 04011

FOR: RETAIL STORE SERVICES FEATURING LUMBER AND A VARIETY OF OTHER BUILDING MATERIALS, PAINTS AND ITEMS USED IN HOME BUILDING, REMODELING AND/OR IMPROVEMENT, SUCH AS KITCHEN AND BATHROOM MATERIALS AND APPLIANCES, FLOORING, WINDOWS, DOORS AND HARDWARE, IN CLASS 35 (U.S. CLS. 100, 101 AND 102).

FIRST USE 12-31-1980; IN COMMERCE 12-31-2006.

THE MARK CONSISTS OF STANDARD CHARACTERS WITHOUT CLAIM TO ANY PARTICULAR FONT, STYLE, SIZE, OR COLOR.

NO CLAIM IS MADE TO THE EXCLUSIVE RIGHT TO USE "ENERGY", APART FROM THE MARK AS SHOWN.

SER. NO. 77-253,642, FILED 8-13-2007.

KELLEY WELLS, EXAMINING ATTORNEY

**Int. Cl.: 35**

**Prior U.S. Cls.: 100, 101 and 102**

**United States Patent and Trademark Office**

**Reg. No. 3,498,051**

**Registered Sep. 9, 2008**

**SERVICE MARK  
PRINCIPAL REGISTER**

**DOWNEAST ENERGY & BUILDING  
SUPPLY**

DOWNEAST ENERGY CORP. (MAINE COR-  
PORATION)  
18 SPRING STREET  
BRUNSWICK, ME 04011

FOR: RETAIL STORE SERVICES FEATURING  
LUMBER AND A VARIETY OF OTHER BUILDING  
MATERIALS, PAINTS AND ITEMS USED IN HOME  
BUILDING, REMODELING AND/OR IMPROVE-  
MENT, SUCH AS KITCHEN AND BATHROOM  
MATERIALS AND APPLIANCES, FLOORING, WIN-  
DOWS, DOORS AND HARDWARE, IN CLASS 35  
(U.S. CLS. 100, 101 AND 102).

FIRST USE 12-31-1980; IN COMMERCE 12-31-2006.

THE MARK CONSISTS OF STANDARD CHAR-  
ACTERS WITHOUT CLAIM TO ANY PARTICULAR  
FONT, STYLE, SIZE, OR COLOR.

NO CLAIM IS MADE TO THE EXCLUSIVE  
RIGHT TO USE "ENERGY & BUILDING SUPPLY",  
APART FROM THE MARK AS SHOWN.

SER. NO. 77-253,646, FILED 8-13-2007.

KELLEY WELLS, EXAMINING ATTORNEY



Int. Cl.: 35

Prior U.S. Cls.: 100, 101 and 102

United States Patent and Trademark Office

Reg. No. 3,498,052

Registered Sep. 9, 2008

**SERVICE MARK  
PRINCIPAL REGISTER**



**DOWNEAST ENERGY  
& BUILDING SUPPLY**

*Good Friends For All Seasons*

DOWNEAST ENERGY CORP. (MAINE CORPORATION)  
18 SPRING STREET  
BRUNSWICK, ME 04011

FOR: RETAIL STORE SERVICES FEATURING LUMBER AND A VARIETY OF OTHER BUILDING MATERIALS, PAINTS AND ITEMS USED IN HOME BUILDING, REMODELING AND/OR IMPROVEMENT, SUCH AS KITCHEN AND BATHROOM MATERIALS AND APPLIANCES, FLOORING, WINDOWS, DOORS AND HARDWARE, IN CLASS 35 (U.S. CLS. 100, 101 AND 102).

FIRST USE 12-31-1980; IN COMMERCE 12-31-2006.

NO CLAIM IS MADE TO THE EXCLUSIVE RIGHT TO USE "ENERGY & BUILDING SUPPLY", APART FROM THE MARK AS SHOWN.

THE MARK CONSISTS OF A FANCIFUL DEPICTION OF A PUFFIN WITHIN A CIRCLE ABOVE THE PHRASES "DOWNEAST ENERGY & BUILDING SUPPLY GOOD FRIENDS FOR ALL SEASONS".

SER. NO. 77-253,655, FILED 8-13-2007.

KELLEY WELLS, EXAMINING ATTORNEY

**Int. Cls.: 35 and 42**

**Prior U.S. Cls.: 100, 101 and 102**

**United States Patent and Trademark Office**

**Reg. No. 3,498,053**

**Registered Sep. 9, 2008**

**SERVICE MARK  
PRINCIPAL REGISTER**

**OLDRIDE.COM**

OLDRIDE LLC (WASHINGTON LIMITED LIABILITY COMPANY)  
P.O. BOX 801  
LYNDEN, WA 98264

FOR: PROVIDING A WEB SITE THAT ENABLES USERS TO POST CLASSIC AND VINTAGE VEHICLES FOR SALE THROUGH ON-LINE CLASSIFIED ADVERTISEMENTS, IN CLASS 35 (U.S. CLS. 100, 101 AND 102).

FIRST USE 5-1-2004; IN COMMERCE 5-1-2004.

FOR: HOSTING AN ONLINE COMMUNITY WEBSITE FEATURING GENERAL INFORMATION

ABOUT CLASSIC AND VINTAGE VEHICLES AND INFORMATION ABOUT EVENTS AND CLUBS RELATED TO CLASSIC AND VINTAGE VEHICLES, IN CLASS 42 (U.S. CLS. 100 AND 101).

FIRST USE 5-1-2004; IN COMMERCE 5-1-2004.

THE MARK CONSISTS OF STANDARD CHARACTERS WITHOUT CLAIM TO ANY PARTICULAR FONT, STYLE, SIZE, OR COLOR.

SER. NO. 77-253,766, FILED 8-13-2007.

KELLEY WELLS, EXAMINING ATTORNEY

**Int. Cl.: 5**

**Prior U.S. Cls.: 6, 18, 44, 46, 51 and 52**

**Reg. No. 3,498,054**

**United States Patent and Trademark Office**

**Registered Sep. 9, 2008**

**TRADEMARK  
PRINCIPAL REGISTER**

# FabricAide

CRAIG ANDREWS (UNITED STATES INDIVIDUAL)  
2849 PRODUCT DRIVE  
ROCHESTER HILLS, MI 48309

THE MARK CONSISTS OF STANDARD CHARACTERS WITHOUT CLAIM TO ANY PARTICULAR FONT, STYLE, SIZE, OR COLOR.

FOR: ANTIMICROBIAL COATINGS TO TREAT THE GROWTH OF MOLD, MILDEW, BACTERIA AND FUNGUS ON VARIOUS SURFACES, IN CLASS 5 (U.S. CLS. 6, 18, 44, 46, 51 AND 52).

SER. NO. 77-253,823, FILED 8-13-2007.

FIRST USE 7-1-2006; IN COMMERCE 7-1-2006.

ELLEN PERKINS, EXAMINING ATTORNEY

**Int. Cl.: 25**

**Prior U.S. Cls.: 22 and 39**

**United States Patent and Trademark Office**

**Reg. No. 3,498,055**

**Registered Sep. 9, 2008**

**TRADEMARK  
PRINCIPAL REGISTER**



AUGER, SAVANNAH GRACE (UNITED STATES  
INDIVIDUAL), DBA LIBERTAS  
623 SUNSET AVE.  
VENICE, CA 90291

THE MARK CONSISTS OF A STYLIZED DEPICTION OF A MAGPIE BIRD.

FOR: FOOTWEAR; SHOES; SANDALS, IN CLASS  
25 (U.S. CLS. 22 AND 39).

SER. NO. 77-253,858, FILED 8-13-2007.

FIRST USE 8-4-2005; IN COMMERCE 8-4-2005.

STEVEN R. FOSTER, EXAMINING ATTORNEY

**Int. Cl.: 27**

**Prior U.S. Cls.: 19, 20, 37, 42 and 50**

**Reg. No. 3,498,056**

**United States Patent and Trademark Office**

**Registered Sep. 9, 2008**

**TRADEMARK  
PRINCIPAL REGISTER**



JNJ GREENS, LLC (NEW JERSEY LIMITED  
LIABILITY COMPANY), DBA GOLF GREENS  
FORE U  
119 SHREWSBURY AVE  
RED BANK, NJ 07701

NO CLAIM IS MADE TO THE EXCLUSIVE  
RIGHT TO USE "TURF", APART FROM THE MARK  
AS SHOWN.

FOR: ARTIFICIAL TURF, IN CLASS 27 (U.S. CLS.  
19, 20, 37, 42 AND 50).

SER. NO. 77-253,914, FILED 8-13-2007.

FIRST USE 8-1-2007; IN COMMERCE 8-1-2007.

MORGAN WYNNE, EXAMINING ATTORNEY

**Int. Cls.: 38, 41 and 42**

**Prior U.S. Cls.: 100, 101, 104 and 107**

**United States Patent and Trademark Office**

**Reg. No. 3,498,057**

**Registered Sep. 9, 2008**

**SERVICE MARK  
PRINCIPAL REGISTER**

# AUTHORBYTES

S.J. BENNETT & COMPANY, INC. (MASSACHUSETTS CORPORATION)  
29 COGSWELL AVENUE  
CAMBRIDGE, MA 02140

FOR: PODCASTING SERVICES FOR AUTHORS AND PUBLISHERS, IN CLASS 38 (U.S. CLS. 100, 101 AND 104).

FIRST USE 2-21-2003; IN COMMERCE 2-21-2003.

FOR: MULTIMEDIA ENTERTAINMENT SERVICES IN THE NATURE OF RECORDING, PRODUCTION, AND POST-PRODUCTION SERVICES IN THE FIELDS OF MUSIC, VIDEO, AND FILMS FOR AUTHORS AND PUBLISHERS; WEB AUDIO PRODUCTION SERVICES, IN CLASS 41 (U.S. CLS. 100, 101 AND 107).

FIRST USE 2-21-2003; IN COMMERCE 2-21-2003.

FOR: DESIGN, CREATION, HOSTING, AND MAINTENANCE OF WEB SITES FOR AUTHORS AND PUBLISHERS, IN CLASS 42 (U.S. CLS. 100 AND 101).

FIRST USE 2-21-2003; IN COMMERCE 2-21-2003.

THE MARK CONSISTS OF STANDARD CHARACTERS WITHOUT CLAIM TO ANY PARTICULAR FONT, STYLE, SIZE, OR COLOR.

SER. NO. 77-253,937, FILED 8-13-2007.

WILLIAM ROSSMAN, EXAMINING ATTORNEY

**Int. Cl.: 9**

**Prior U.S. Cls.: 21, 23, 26, 36 and 38**

**Reg. No. 3,498,058**

**United States Patent and Trademark Office**

**Registered Sep. 9, 2008**

**TRADEMARK  
PRINCIPAL REGISTER**

**INNOVATE MOTORSPORTS**

INNOVATE! TECHNOLOGY, INC. (DELAWARE CORPORATION)  
5 JENNER STREET, SUITE 100  
IRVINE, CA 92618

FOR: AUTOMOTIVE MEASURING INSTRUMENTS, NAMELY, PRESSURE, TEMPERATURE, AIR FUEL/RATIO AND MEASURING GAUGES FOR HIGH PERFORMANCE AUTOMOTIVE AND RACING APPLICATIONS, IN CLASS 9 (U.S. CLS. 21, 23, 26, 36 AND 38).

FIRST USE 5-1-2004; IN COMMERCE 5-1-2004.

THE MARK CONSISTS OF STANDARD CHARACTERS WITHOUT CLAIM TO ANY PARTICULAR FONT, STYLE, SIZE, OR COLOR.

NO CLAIM IS MADE TO THE EXCLUSIVE RIGHT TO USE "MOTORSPORTS", APART FROM THE MARK AS SHOWN.

SER. NO. 77-254,176, FILED 8-13-2007.

FRED MANDIR, EXAMINING ATTORNEY

**Int. Cl.: 42**

**Prior U.S. Cls.: 100 and 101**

**United States Patent and Trademark Office**

**Reg. No. 3,498,059**

**Registered Sep. 9, 2008**

**SERVICE MARK  
PRINCIPAL REGISTER**

**Geeks On The Go**

GEEKS ON THE GO, LLC (VIRGINIA LIMITED  
LIABILITY COMPANY)  
2413 FELBRIDGE CT.  
MIDLOTHIAN, VA 23113

FOR: TECHNICAL SUPPORT SERVICES, NAME-  
LY, TROUBLESHOOTING OF COMPUTER HARD-  
WARE AND SOFTWARE PROBLEMS, IN CLASS 42  
(U.S. CLS. 100 AND 101).

FIRST USE 3-0-2001; IN COMMERCE 3-0-2001.

THE MARK CONSISTS OF STANDARD CHAR-  
ACTERS WITHOUT CLAIM TO ANY PARTICULAR  
FONT, STYLE, SIZE, OR COLOR.

SER. NO. 77-254,234, FILED 8-13-2007.

DOMINICK J. SALEMI, EXAMINING ATTORNEY



**Int. Cl.: 5**

**Prior U.S. Cls.: 6, 18, 44, 46, 51 and 52**

**Reg. No. 3,498,060**

**United States Patent and Trademark Office**

**Registered Sep. 9, 2008**

**TRADEMARK  
PRINCIPAL REGISTER**

# ENDENVO

GLAXO GROUP LIMITED (ENGLAND CORPORATION)  
GLAXO WELLCOME HOUSE  
BERKELEY AVENUE  
GREENFORD, MIDDLESEX, ENGLAND UB60NN

FOR: PHARMACEUTICAL PREPARATIONS AND SUBSTANCES FOR THE TREATMENT OF INFECTIOUS DISEASES, BLOOD DISORDERS, PAIN, INFLAMMATION, SEPSIS, ALOPECIA AND OBESITY, AND FOR THE TREATMENT OF VIRAL, METABOLIC, ENDOCRINE, MUSCULOSKELETAL, CARDIOVASCULAR, CARDIOPULMONARY, GENITOURINARY, SEXUAL DYSFUNCTION, ONCOLOGICAL, HEPATOLOGICAL, OPHTHALMOLOGICAL, RESPIRATORY, NEUROLOGICAL, GASTROINTESTINAL, HORMONAL, DERMATOLOGICAL AND PSYCHIATRIC RELATED DISEASES AND DISORDERS, AND FOR THE

TREATMENT OF DAMAGED SKIN AND TISSUE; AND FOR VACCINES, IN CLASS 5 (U.S. CLS. 6, 18, 44, 46, 51 AND 52).

THE MARK CONSISTS OF STANDARD CHARACTERS WITHOUT CLAIM TO ANY PARTICULAR FONT, STYLE, SIZE, OR COLOR.

OWNER OF UNITED KINGDOM REG. NO. 2463351, DATED 8-6-2007, EXPIRES 8-6-2017.

THE WORDING "ENDENVO" HAS NO MEANING IN A FOREIGN LANGUAGE.

SER. NO. 77-254,866, FILED 8-14-2007.

SETH A. RAPPAPORT, EXAMINING ATTORNEY

**Int. Cl.: 35**

**Prior U.S. Cls.: 100, 101 and 102**

**United States Patent and Trademark Office**

**Reg. No. 3,498,061**

**Registered Sep. 9, 2008**

**SERVICE MARK  
PRINCIPAL REGISTER**



CARDINAL HEALTH TECHNOLOGIES, LLC  
(NEVADA LIMITED LIABILITY COMPANY)  
SUITE 100  
7660 WEST CHEYENNE AVENUE  
LAS VEGAS, NV 89129

FOR: DISTRIBUTORSHIP SERVICES TO HOSPITALS, DRUG STORES, PHARMACIES, CLINICS AND OTHER HEALTH PRODUCT RETAILERS IN THE PHARMACEUTICAL, RADIOPHARMACEUTICAL, HEALTH AND BEAUTY AIDS, HEALTH CARE PRODUCTS, MEDICAL PRODUCTS AND SURGICAL PRODUCTS FIELDS; BUSINESS MANAGEMENT SUPPORT AND CONSULTING SERVICES FOR DRUG STORES, HOSPITALS, CLINICS, ALTERNATE CARE CENTERS, PHARMACY DEPARTMENTS OF MERCHANDISERS AND PROMOTIONAL SUPPORT PROGRAMS, STORE LAYOUT ASSISTANCE, COUPON REDEMPTION AND PROCUREMENT, NAMELY, EQUIPMENT SPECIFICATION AND PURCHASING; PHARMACY MANAGEMENT SERVICES; ELECTRONIC CUSTOMER ORDERING SERVICES FOR MEDICAL, SURGICAL, LABORATORY SUPPLIES AND EQUIPMENT; ELECTRONIC CUSTOMER ORDERING SERVICES FOR PHARMACEUTICALS, MEDICAL, SURGICAL AND LABORATORY SUPPLIES AND EQUIPMENT; ONLINE PRODUCT CATALOG

SERVICES FEATURING A FULL LINE OF PHARMACEUTICALS, MEDICAL, SURGICAL AND LABORATORY SUPPLIES AND EQUIPMENT; INVENTORY CONTROL OF HOSPITAL EQUIPMENT; INVENTORY CONTROL OF HOSPITAL LINENS; MEDICATION MANAGEMENT SERVICES, NAMELY, ASSESS TOTAL MEDICATION USE, COSTS AND PRIORITIZE SPECIFIC OPPORTUNITIES FOR OVERALL COST-REDUCTION; MANAGEMENT AND OPERATION OF HEALTH CARE FACILITIES FOR OTHERS; COMPUTERIZED PHARMACEUTICAL RECORD KEEPING AND PHARMACEUTICAL INVENTORY SERVICES, NAMELY, PHARMACEUTICAL RECORD KEEPING AND PHARMACEUTICAL INVENTORY PROGRAMS, IN CLASS 35 (U.S. CLS. 100, 101 AND 102).

FIRST USE 1-1-2003; IN COMMERCE 1-1-2003.

OWNER OF U.S. REG. NOS. 2,938,876, 3,002,534 AND OTHERS.

THE MARK CONSISTS OF WINGS DESIGN.

SER. NO. 77-254,920, FILED 8-14-2007.

ANDREA BUTLER, EXAMINING ATTORNEY

**Int. Cl.: 25**

**Prior U.S. Cls.: 22 and 39**

**United States Patent and Trademark Office**

**Reg. No. 3,498,062**

**Registered Sep. 9, 2008**

**TRADEMARK  
PRINCIPAL REGISTER**

The logo for the trademark "MOTHBALLS" is displayed in a large, bold, black, hand-drawn style font. The word "MOTHBALLS" is written in all capital letters. The letter "O" is significantly larger than the other letters and contains a silhouette of a moth inside it, positioned in the center of the "O".

BREADANDBUTTER DESIGNS INC (CALIFORNIA CORPORATION)  
12611 W. WASHINGTON BLVD.  
LOS ANGELES, CA 90006

THE MARK CONSISTS OF THE WORD "MOTHBALLS" IN WHICH A DESIGN OF A MOTH APPEARS INSIDE THE LETTER "O".

FOR: DRESSES; TOPS; VESTS; SWEATERS, IN CLASS 25 (U.S. CLS. 22 AND 39).

SER. NO. 77-255,275, FILED 8-14-2007.

FIRST USE 6-15-2001; IN COMMERCE 3-15-2004.

SUSAN STIGLITZ, EXAMINING ATTORNEY

**Int. Cl.: 38**

**Prior U.S. Cls.: 100, 101 and 104**

**United States Patent and Trademark Office**

**Reg. No. 3,498,063**

**Registered Sep. 9, 2008**

**SERVICE MARK  
PRINCIPAL REGISTER**

# TAP TIP

YAHOO! INC. (DELAWARE CORPORATION)  
701 FIRST AVE.  
SUNNYVALE, CA 94089

FIRST USE 9-12-2007; IN COMMERCE 9-12-2007.

FOR: TELECOMMUNICATIONS SERVICES,  
NAMELY, PROVIDING INFORMATION ABOUT  
TELECOMMUNICATION IN THE NATURE OF  
SHORTCUTS REGARDING USE OF WIRELESS  
TELECOMMUNICATION SERVICES ON HAND-  
HELD MOBILE DIGITAL ELECTRONIC DEVICES,  
IN CLASS 38 (U.S. CLS. 100, 101 AND 104).

THE MARK CONSISTS OF STANDARD CHAR-  
ACTERS WITHOUT CLAIM TO ANY PARTICULAR  
FONT, STYLE, SIZE, OR COLOR.

SER. NO. 77-255,372, FILED 8-14-2007.

ROBIN CHOSID, EXAMINING ATTORNEY

**Int. Cls.: 39 and 43**

**Prior U.S. Cls.: 100, 101 and 105**

**United States Patent and Trademark Office**

**Reg. No. 3,498,064**

**Registered Sep. 9, 2008**

**SERVICE MARK  
PRINCIPAL REGISTER**

**INDIA IN LUXURY**

SITA WORLD TOURS, INC. (CALIFORNIA CORPORATION)  
6250 VENTURA BLVD., SUITE 300  
ENCINO, CA 91436

FOR: TRAVEL AGENCY SERVICES, NAMELY, ARRANGING AND CONDUCTING TRAVEL TOURS, ARRANGING TRAVEL TOURS FOR TRAVEL AGENTS, ARRANGING TRAVEL TOURS FOR CONSUMERS, MAKING RESERVATIONS AND BOOKINGS FOR TRANSPORTATION, CERTIFIED TOUR GUIDE SERVICES, ORGANIZATION OF SIGHTSEEING TOURS AND EXCURSIONS, TRAVEL AND TOUR INFORMATION SERVICES, TRAVEL AND TOUR TICKET RESERVATION SERVICE, IN CLASS 39 (U.S. CLS. 100 AND 105).

FIRST USE 12-31-2001; IN COMMERCE 12-31-2001.

FOR: TRAVEL AGENCY SERVICES, NAMELY, MAKING RESERVATIONS AND BOOKINGS FOR TEMPORARY LODGING AND ACCOMMODATION, MAKING RESERVATIONS AND BOOKINGS FOR RESTAURANTS AND MEALS , IN CLASS 43 (U.S. CLS. 100 AND 101).

FIRST USE 12-31-2001; IN COMMERCE 12-31-2001.

THE MARK CONSISTS OF STANDARD CHARACTERS WITHOUT CLAIM TO ANY PARTICULAR FONT, STYLE, SIZE, OR COLOR.

SEC. 2(F).

SER. NO. 77-255,384, FILED 8-14-2007.

LINDA M. KING, EXAMINING ATTORNEY

**Int. Cl.: 35**

**Prior U.S. Cls.: 100, 101 and 102**

**United States Patent and Trademark Office**

**Reg. No. 3,498,065**

**Registered Sep. 9, 2008**

**SERVICE MARK  
PRINCIPAL REGISTER**

**QRECS**

QUATRRO BPO SOLUTIONS (P) LTD. (INDIA  
CORPORATION)  
267 UDYOG VIHAR PHASE II  
GURGAON, HARYANA 12201, INDIA

FOR: BUSINESS MANAGEMENT, ACCOUNT-  
ING, ADMINISTRATION AND RECONCILIATION  
OF ACCOUNTS ON BEHALF OF OTHERS; RE-  
CORDS MANAGEMENT SERVICES, NAMELY,  
DOCUMENT INDEXING FOR OTHERS; CUSTO-  
MER DATABASE MANAGEMENT, FINANCIAL  
RECONCILIATION OF ACCOUNTS ON BEHALF  
OF OTHERS, NAMELY, COMPARING INFORMA-  
TION THAT EXISTS IN MULTIPLE SYSTEMS OR

LOCATIONS SO THAT THE INFORMATION IS  
ACCURATELY PRESENTED, IN CLASS 35 (U.S.  
CLS. 100, 101 AND 102).

FIRST USE 7-1-2007; IN COMMERCE 7-1-2007.

THE MARK CONSISTS OF STANDARD CHAR-  
ACTERS WITHOUT CLAIM TO ANY PARTICULAR  
FONT, STYLE, SIZE, OR COLOR.

SER. NO. 77-255,617, FILED 8-15-2007.

SANJEEV VOHRA, EXAMINING ATTORNEY

**Int. Cl.: 42**

**Prior U.S. Cls.: 100 and 101**

**United States Patent and Trademark Office**

**Reg. No. 3,498,066**

**Registered Sep. 9, 2008**

**SERVICE MARK  
PRINCIPAL REGISTER**

**NO DRAWING-SENSORY MARK**

HOWSTUFFWORKS, INC. (DELAWARE CORPORATION)  
SUITE 1500  
ONE CAPITAL CITY PLZA; 3350 PEACHTREE RD  
ATLANTA, GA 30326

FOR: PROVIDING A WIDE RANGE OF INFORMATION IN THE FIELDS OF SCIENCE AND TECHNOLOGY VIA A GLOBAL COMPUTER NETWORK, IN CLASS 42 (U.S. CLS. 100 AND 101).

FIRST USE 2-1-2001; IN COMMERCE 2-1-2001.

THE MARK CONSISTS OF A SOUND COMPRISING AN ORIENTAL WIND INSTRUMENT PLAYING AN A4 QUARTER NOTE OVER THE SOUND OF A FAX MACHINE LOGON SOUND, AN F#4 QUARTER NOTE OVER THE SOUND OF AN AIR RATCHET, AND A D4 QUARTER NOTE OVER THE SOUND OF A HAMMER STRIKING METAL.

SER. NO. 77-255,913, FILED 8-15-2007.

JASON BLAIR, EXAMINING ATTORNEY

**Int. Cl.: 35**

**Prior U.S. Cls.: 100, 101 and 102**

**United States Patent and Trademark Office**

**Reg. No. 3,498,067**

**Registered Sep. 9, 2008**

**SERVICE MARK  
PRINCIPAL REGISTER**

**PRIME FINDINGS**

PRIME FINDINGS, LLC (CONNECTICUT LIMITED LIABILITY COMPANY)  
248 WOOD HOUSE ROAD  
FAIRFIELD, CT 06824

FOR: PROMOTION AND MARKETING SERVICES AND RELATED CONSULTING RENDERED ON BEHALF OF LUXURIOUS HOTELS, SPAS AND CASINOS LOCATED IN EUROPE , IN CLASS 35 (U.S. CLS. 100, 101 AND 102).

FIRST USE 5-1-2003; IN COMMERCE 5-1-2003.

THE MARK CONSISTS OF STANDARD CHARACTERS WITHOUT CLAIM TO ANY PARTICULAR FONT, STYLE, SIZE, OR COLOR.

SER. NO. 77-256,179, FILED 8-15-2007.

KELLEY WELLS, EXAMINING ATTORNEY



Int. Cl.: 35

Prior U.S. Cls.: 100, 101 and 102

United States Patent and Trademark Office

Reg. No. 3,498,068

Registered Sep. 9, 2008

**SERVICE MARK  
PRINCIPAL REGISTER**



PRIME FINDINGS, LLC (CONNECTICUT LIMITED LIABILITY COMPANY)  
248 WOOD HOUSE ROAD  
FAIRFIELD, CT 06824

FOR: PROMOTION AND MARKETING SERVICES AND RELATED CONSULTING RENDERED ON BEHALF OF LUXURIOUS HOTELS, SPAS AND CASINOS LOCATED IN EUROPE, IN CLASS 35 (U.S. CLS. 100, 101 AND 102).

FIRST USE 5-1-2003; IN COMMERCE 5-1-2003.

THE MARK CONSISTS OF A COAT OF ARMS COMPRISED OF TWO LIONS OPPOSITE ONE ANOTHER AND STANDING ON THEIR HIND LEGS WITH AN ORNAMENTAL DESIGN UNDER THEIR HIND PAWS, WITH THEIR UPPER PAWS EMBRA-

CING AN UPRIGHT OVAL THAT CONTAINS ANOTHER LION STANDING ON ITS HIND LEGS AND FACING THE LEFT AND THREE CIRCLES ABOVE THE LION AND TWO SEPARATE BACKGROUND SECTIONS, AND FURTHER COMPRISED OF A CROWN ABOVE THE OVAL WITH AN ORNAMENTAL DESIGN UNDERNEATH THE CROWN, AND FURTHER COMPRISED OF AN ORNAMENTAL CROSS UNDERNEATH THE OVAL, AND FURTHER COMPRISED OF A BANNER AT THE BOTTOM OF THE COAT OF ARMS THAT CONTAINS THE WORDS "FORTITUDO EST IN CARITATE".

SER. NO. 77-256,181, FILED 8-15-2007.

KELLEY WELLS, EXAMINING ATTORNEY

**Int. Cl.: 35**

**Prior U.S. Cls.: 100, 101 and 102**

**United States Patent and Trademark Office**

**Reg. No. 3,498,069**

**Registered Sep. 9, 2008**

**SERVICE MARK  
PRINCIPAL REGISTER**

# DIABLO BATS

FILIP, INC. (ARIZONA CORPORATION), DBA  
DIABLO BATS  
STE O  
320 E 10TH DR  
MESA, AZ 85210

FOR: COMPUTERIZED ON-LINE RETAIL STORE  
SERVICES IN THE FIELD OF BASEBALL EQUIP-  
MENT; RETAIL SPORTING GOODS STORES; RE-  
TAIL STORE SERVICES FEATURING BASEBALL  
EQUIPMENT, IN CLASS 35 (U.S. CLS. 100, 101 AND  
102).

FIRST USE 6-0-2003; IN COMMERCE 6-0-2003.

THE MARK CONSISTS OF STANDARD CHAR-  
ACTERS WITHOUT CLAIM TO ANY PARTICULAR  
FONT, STYLE, SIZE, OR COLOR.

NO CLAIM IS MADE TO THE EXCLUSIVE  
RIGHT TO USE "BATS", APART FROM THE MARK  
AS SHOWN.

THE FOREIGN WORDING IN THE MARK  
TRANSLATES INTO ENGLISH AS DEVIL.

SER. NO. 77-256,208, FILED 8-15-2007.

ERNEST SHOSHO, EXAMINING ATTORNEY

**Int. Cl.: 41**

**Prior U.S. Cls.: 100, 101 and 107**

**Reg. No. 3,498,070**

**United States Patent and Trademark Office**

**Registered Sep. 9, 2008**

**SERVICE MARK  
PRINCIPAL REGISTER**



**BOREDAT, INC. (CALIFORNIA CORPORATION)  
635 TENNESSEE STREET, APT. 404  
SAN FRANCISCO, CA 94107**

**THE FIELD OF CURRENT EVENTS RELATING TO  
COLLEGIATE LIFE, IN CLASS 41 (U.S. CLS. 100, 101  
AND 107).**

**FOR: ELECTRONIC PUBLISHING SERVICES,  
NAMELY, ONLINE PUBLICATION OF TEXT, GRA-  
PHICS, AUDIO, VIDEO AND MULTIMEDIA  
WORKS FOR OTHERS FEATURING USER-CRE-  
ATED CONTENT IN THE FIELD OF COLLEGIATE  
LIFE; PROVIDING ONLINE JOURNALS, NAMELY,  
BLOGS FEATURING USER-CREATED CONTENT  
IN THE FIELD OF COLLEGIATE LIFE; PROVIDING  
INFORMATION, NEWS AND COMMENTARY IN**

**FIRST USE 8-8-2007; IN COMMERCE 8-8-2007.**

**THE MARK CONSISTS OF THE LETTER "B" IN  
LOWERCASE SURROUNDED BY CIRCULAR  
LINE.**

**SER. NO. 77-256,336, FILED 8-15-2007.**

**FRED MANDIR, EXAMINING ATTORNEY**

**Int. Cl.: 12**

**Prior U.S. Cls.: 19, 21, 23, 31, 35 and 44**

**United States Patent and Trademark Office**

**Reg. No. 3,498,071**

**Registered Sep. 9, 2008**

**TRADEMARK  
PRINCIPAL REGISTER**



WALKER BAY BOATS, INC. (WASHINGTON CORPORATION)  
717 BUTTERFIELD RD  
YAKIMA, WA 98901

FOR: BOATS AND STRUCTURAL PARTS THEREOF, NAMELY, BOAT TOPS, MASTS AND BOOMS; BOAT ACCESSORIES, NAMELY, FITTED BOAT COVERS, BOAT DOLLIES, BOAT TRAILERS, AUXILIARY FLOTATION TANKS FOR BOATS AND BOAT RACKS FOR USE ON VEHICLES, OARS AND BOAT SEAT CUSHIONS; INFLATABLE KAYAKS, DINGHIES, SAILBOATS, RIB BOATS, RECREATIONAL WATERCRAFT, NAMELY, SMALL POWERBOATS, PERSONAL JET BOATS, WATER SCOOTERS AND PADDLE BOATS; BOAT ACCESSORIES, NAMELY, OARS, IN CLASS 12 (U.S. CLS. 19, 21, 23, 31, 35 AND 44).

FIRST USE 11-1-2005; IN COMMERCE 11-1-2005.

THE COLOR(S) NAVY, TEAL AND WHITE IS/ARE CLAIMED AS A FEATURE OF THE MARK.

THE MARK CONSISTS OF A TEAL-COLORED SKY BACKGROUND ABOVE A WHITE WAVE RESEMBLING A "W" OVER A DARKER NAVY BLUE PORTION RESEMBLING WATER. THE WHITE "W" CONNECTS WITH A WHITE OVAL.

SER. NO. 77-256,824, FILED 8-16-2007.

KELLEY WELLS, EXAMINING ATTORNEY

Int. Cl.: 12

Prior U.S. Cls.: 19, 21, 23, 31, 35 and 44

Reg. No. 3,498,072

United States Patent and Trademark Office

Registered Sep. 9, 2008

TRADEMARK  
PRINCIPAL REGISTER

***WALKER BAY***

WALKER BAY BOATS, INC. (WASHINGTON CORPORATION)  
717 BUTTERFIELD RD  
YAKIMA, WA 98901

FOR: BOATS AND STRUCTURAL PARTS THEREOF, NAMELY, BOAT TOPS, MASTS AND BOOMS; BOAT ACCESSORIES, NAMELY, FITTED BOAT COVERS, BOAT DOLLIES, BOAT TRAILERS, AUXILIARY FLOTATION TANKS FOR BOATS AND BOAT RACKS FOR USE ON VEHICLES, OARS AND BOAT SEAT CUSHIONS; INFLATABLE KAYAKS, DINGHIES, SAILBOATS, RIB BOATS, RECREATIONAL WATERCRAFT, NAMELY, SMALL POWERBOATS, PERSONAL JET BOATS, WATER SCOOTERS AND PADDLE BOATS; BOAT

ACCESSORIES, NAMELY, OARS, IN CLASS 12 (U.S. CLS. 19, 21, 23, 31, 35 AND 44).

FIRST USE 11-1-2005; IN COMMERCE 11-1-2005.

OWNER OF U.S. REG. NO. 2,421,824.

THE MARK CONSISTS OF THE LETTERS IN THE WORD MARK "WALKER BAY" BEING CAPITALIZED LETTERS HAVING A CURVACEOUS FORM.

SER. NO. 77-256,847, FILED 8-16-2007.

KELLEY WELLS, EXAMINING ATTORNEY

**Int. Cls.: 9 and 41**

**Prior U.S. Cls.: 21, 23, 26, 36, 38, 100, 101 and 107**

**United States Patent and Trademark Office**

**Reg. No. 3,498,073**

**Registered Sep. 9, 2008**

**TRADEMARK  
SERVICE MARK  
PRINCIPAL REGISTER**

**TRUCKS GONE WILD**

TGW PRODUCTIONS INC. (FLORIDA CORPORATION)  
100 W. LIVINGSTON ST.  
ORLANDO, FL 32801

FOR: PRE-RECORDED CDS, VIDEO TAPES, LASER DISKS AND DVDS FEATURING MOTOR SPORTING EVENTS AND TOPICS OF INTEREST TO AUTOMOBILE ENTHUSIASTS, INCLUDING CAR, TRUCK, MOTORCYCLE AND ATV COMPETITIONS, DEMONSTRATIONS AND EXHIBITIONS, IN CLASS 9 (U.S. CLS. 21, 23, 26, 36 AND 38).

FIRST USE 9-1-2004; IN COMMERCE 1-28-2005.

FOR: ENTERTAINMENT SERVICES, NAMELY, ARRANGING AND CONDUCTING OF COMPETITIONS FOR MOTOR SPORTING EVENTS, INCLUDING CAR, TRUCK AND MOTORCYCLE RACING, AND DEMONSTRATIONS AND EXHIBITIONS; ENTERTAINMENT, NAMELY, PRODUCTION OF ON-

GOING TELEVISION PROGRAMS AND VIDEOS IN THE FIELD OF AUTOMOBILES, MOTOR SPORTING EVENTS, RACING AND TOPICS OF INTEREST FOR THE AUTOMOTIVE ENTHUSIAST, IN CLASS 41 (U.S. CLS. 100, 101 AND 107).

FIRST USE 9-1-2004; IN COMMERCE 1-23-2005.

THE MARK CONSISTS OF STANDARD CHARACTERS WITHOUT CLAIM TO ANY PARTICULAR FONT, STYLE, SIZE, OR COLOR.

NO CLAIM IS MADE TO THE EXCLUSIVE RIGHT TO USE "TRUCKS", APART FROM THE MARK AS SHOWN.

SER. NO. 77-256,869, FILED 8-16-2007.

AHSEN KHAN, EXAMINING ATTORNEY

**Int. Cl.: 16**

**Prior U.S. Cls.: 2, 5, 22, 23, 29, 37, 38 and 50**

**Reg. No. 3,498,074**

**United States Patent and Trademark Office**

**Registered Sep. 9, 2008**

**TRADEMARK  
PRINCIPAL REGISTER**

# Artful Blogging

STAMPINGTON & COMPANY, LLC (CALIFORNIA LIMITED LIABILITY COMPANY)  
22992 MILL CREEK, SUITE B  
LAGUNA HILLS, CA 92653

FOR: ART AND PHOTOGRAPH PORTFOLIO CASES; ART PAPER; ART PICTURES; ART PRINTS; GRAPHIC ART REPRODUCTIONS; LOG BOOKS; PAPER FOR USE IN THE GRAPHIC ARTS INDUSTRY; PRINTED ART REPRODUCTIONS; WORKS OF ART MADE FROM CUSTOM MANUFACTURED PAPER; BLANK ART JOURNAL BOOKS CONCERNING BLOGGING; BLANK JOURNALS CONCERNING BLOGGING; BLANK WRITING JOURNALS CONCERNING BLOGGING; JOURNALS CONCERNING BLOGGING; ARTS AND CRAFT PAINT KITS; PAPERS FOR USE IN THE GRAPHIC ARTS INDUSTRY; PRINTED PERIODICALS IN THE FIELD OF FIGURATIVE ARTS; ART

ETCHINGS; ART MOUNTS; PHOTOGRAPHIC OR ART MOUNTS, IN CLASS 16 (U.S. CLS. 2, 5, 22, 23, 29, 37, 38 AND 50).

FIRST USE 8-1-2007; IN COMMERCE 8-1-2007.

THE MARK CONSISTS OF STANDARD CHARACTERS WITHOUT CLAIM TO ANY PARTICULAR FONT, STYLE, SIZE, OR COLOR.

NO CLAIM IS MADE TO THE EXCLUSIVE RIGHT TO USE "BLOGGING", APART FROM THE MARK AS SHOWN.

SER. NO. 77-256,976, FILED 8-16-2007.

KIMBERLY PERRY, EXAMINING ATTORNEY

**Int. Cls.: 9 and 41**

**Prior U.S. Cls.: 21, 23, 26, 36, 38, 100, 101 and 107**

**United States Patent and Trademark Office**

**Reg. No. 3,498,075**

**Registered Sep. 9, 2008**

**TRADEMARK  
SERVICE MARK  
PRINCIPAL REGISTER**

**DON OMAR**

LANDRON, WILLIAM (UNITED STATES INDIVIDUAL)  
C/O LATIN ENTERTAINMENT MANAGEMENT  
166 WATERBURY ROAD  
PROSPECT, CT 06712

FOR: CDS, DVDS, AUDIOCASSETTES, AND VIDEOCASSETTES FEATURING PRERECORDED MUSIC; DOWNLOADABLE MUSICAL SOUND RECORDINGS, IN CLASS 9 (U.S. CLS. 21, 23, 26, 36 AND 38).

FIRST USE 8-31-2002; IN COMMERCE 8-31-2002.

FOR: LIVE PERFORMANCES FEATURING MUSIC; ENTERTAINMENT, NAMELY, PERSONAL APPEARANCES BY A MUSICIAN, IN CLASS 41 (U.S. CLS. 100, 101 AND 107).

FIRST USE 1-31-2002; IN COMMERCE 1-31-2002.

THE MARK CONSISTS OF STANDARD CHARACTERS WITHOUT CLAIM TO ANY PARTICULAR FONT, STYLE, SIZE, OR COLOR.

THE NAME(S), PORTRAIT(S), AND/OR SIGNATURE(S) SHOWN IN THE MARK IDENTIFIES THE STAGE NAME OF OWNER, WHOSE CONSENT(S) TO REGISTER IS SUBMITTED.

SER. NO. 77-257,267, FILED 8-16-2007.

DORITT L. CARROLL, EXAMINING ATTORNEY



**Int. Cl.: 40**

**Prior U.S. Cls.: 100, 103 and 106**

**United States Patent and Trademark Office**

**Reg. No. 3,498,076**

**Registered Sep. 9, 2008**

**SERVICE MARK  
PRINCIPAL REGISTER**

**Elevator Remodeling  
Simplified**

BOSTOCK COMPANY, INC. (PENNSYLVANIA  
CORPORATION)  
175 TITUS AVENUE, SUITE 200  
WARRINGTON, PA 18976

FOR: CUSTOM MANUFACTURE AND CON-  
STRUCTION OF ELEVATOR CABIN INTERIORS,  
IN CLASS 40 (U.S. CLS. 100, 103 AND 106).

FIRST USE 9-28-2004; IN COMMERCE 9-28-2004.

THE MARK CONSISTS OF STANDARD CHAR-  
ACTERS WITHOUT CLAIM TO ANY PARTICULAR  
FONT, STYLE, SIZE, OR COLOR.

NO CLAIM IS MADE TO THE EXCLUSIVE  
RIGHT TO USE "ELEVATOR REMODELING",  
APART FROM THE MARK AS SHOWN.

SER. NO. 77-257,517, FILED 8-16-2007.

CHRIS DONINGER, EXAMINING ATTORNEY

**Int. Cl.: 3**

**Prior U.S. Cls.: 1, 4, 6, 50, 51 and 52**

**Reg. No. 3,498,077**

**United States Patent and Trademark Office**

**Registered Sep. 9, 2008**

**TRADEMARK  
PRINCIPAL REGISTER**

**LA FRESH**

LA FRESH GROUP, INC. (CALIFORNIA CORPORATION)  
SUITE B  
4200 EAST MISSION BLVD.  
ONTARIO, CA 91761

FOR: DISPOSABLE WIPES IMPREGNATED WITH CHEMICALS OR COMPOUNDS FOR PERSONAL HYGIENE, MAKEUP REMOVAL, PERSONAL DEODORIZING, SKIN MOISTURIZING, SUNSCREEN, HAND SANITIZING, PERSONAL LENS AND SCREEN CLEANING, SHOE POLISHING, SHAVING, HAIR STYLING, AND NAIL POLISH

REMOVAL, IN CLASS 3 (U.S. CLS. 1, 4, 6, 50, 51 AND 52).

FIRST USE 4-1-1994; IN COMMERCE 4-1-1994.

THE MARK CONSISTS OF STANDARD CHARACTERS WITHOUT CLAIM TO ANY PARTICULAR FONT, STYLE, SIZE, OR COLOR.

SER. NO. 77-257,522, FILED 8-16-2007.

H. M. FISHER, EXAMINING ATTORNEY

**Int. Cl.: 36**

**Prior U.S. Cls.: 100, 101 and 102**

**United States Patent and Trademark Office**

**Reg. No. 3,498,078**

**Registered Sep. 9, 2008**

**SERVICE MARK  
PRINCIPAL REGISTER**



RANDOLPH-BROOKS FEDERAL CREDIT UNION (UNITED STATES FEDERALLY CHARTERED CREDIT UNION)  
CHIEF FINANCIAL OFFICER  
ONE RANDOLPH BROOKS PARKWAY  
LIVE OAK, TX 78233

FOR: CREDIT UNIONS, IN CLASS 36 (U.S. CLS. 100, 101 AND 102).

FIRST USE 1-15-2005; IN COMMERCE 1-15-2005.

NO CLAIM IS MADE TO THE EXCLUSIVE RIGHT TO USE "TITLE COMPANY, LLC", APART FROM THE MARK AS SHOWN.

THE COLOR(S) BLUE, RED AND WHITE IS/ARE CLAIMED AS A FEATURE OF THE MARK.

THE MARK CONSISTS OF TO THE FAR LEFT IS A LARGE RED STAR WITH A BLUE SHAPE OF TEXAS SET INSIDE OF IT WITH A WHITE STAR INSIDE THE SHAPE OF TEXAS THEN TO THE RIGHT IN LARGE BLUE LETTERS IS "RANDOLPH BROOKS" WITH A SMALL BLUE STAR BETWEEN "RANDOLPH" AND "BROOKS" THEN UNDERNEATH THAT IS A BIG BLUE LINE GOING HALF-WAY ACROSS FOLLOWED BY "TITLE COMPANY, LLC" IN SMALLER BLUE LETTERS.

SER. NO. 77-257,572, FILED 8-16-2007.

JENNIFER MARTIN, EXAMINING ATTORNEY

Int. Cl.: 35

Prior U.S. Cls.: 100, 101 and 102

United States Patent and Trademark Office

Reg. No. 3,498,079

Registered Sep. 9, 2008

SERVICE MARK  
PRINCIPAL REGISTER



JackiesBaskets.com

JACKIE'S BASKETS (NEW YORK PARTNER-SHIP), DBA JACKIE'S BASKET  
761 COTTAGE STREET  
UNIONDALE, NY 11553

FOR: COMPUTERIZED ON-LINE GIFT ORDERING SERVICE WHICH MATCHES THE GIFT GIVER'S REQUIREMENTS WITH THE GIFT RECIPIENT'S WANTS AND NEEDS; RETAIL GIFT SHOPS; RETAIL SHOPS FEATURING GIFT BASKETS, FRUIT BASKETS, IN CLASS 35 (U.S. CLS. 100, 101 AND 102).

FIRST USE 11-13-2001; IN COMMERCE 11-13-2001.

NO CLAIM IS MADE TO THE EXCLUSIVE RIGHT TO USE "BASKETS", APART FROM THE MARK AS SHOWN.

THE COLOR(S) MUSTARD, YELLOW, BLACK, WHITE IS/ARE CLAIMED AS A FEATURE OF THE MARK.

THE COLOR YELLOW APPEARS IN THE VERTICAL OVAL BACKGROUND OF THE LADY IN PORTRAIT. THE COLOR YELLOW ALSO APPEARS IN THE LARGER HORIZONTAL OVAL SHAPE. THIS YELLOW COLOR FILLS IN THE OUTSIDE

BORDER AROUND THE BLACK OVAL DESIGN, AND IN THE TWO BOWS LOCATED TO THE RIGHT AND LEFT OF THE PORTRAIT. THE COLOR MUSTARD APPEARS IN THE OUTERMOST OUTLINES OF THE ENTIRE DRAWING. THIS MUSTARD COLOR APPEARS ON THE OUTSIDE BORDER OF THE PORTRAIT, FILLS IN SOME SPACES AROUND THE LEFT AND RIGHT BOWS AND CONTINUES AROUND THE ENTIRE DRAWING. THE COLOR WHITE APPEARS IN THE SCRIPT WORDS JACKIE'S BASKETS LOCATED IN THE LARGE HORIZONTAL BLACK OVAL. THE INNER SPACING BETWEEN THE BLACK FILLED OVAL AND YELLOW PORTION IS FILLED WITH WHITE COLOR. THE COLOR WHITE ALSO APPEARS IN THE DRAWING OF THE PORTRAIT. THE COLOR BLACK APPEARS IN THE OVAL BACKGROUND WHERE THE SCRIPT WORDS JACKIE'S BASKETS IS ETCHED IN. THE COLOR BLACK ALSO APPEARS IN THE OUTLINE OF THE BOWS LOCATED LEFT AND RIGHT OF THE PORTRAIT. THE PORTRAIT IS ALSO CONTAINS SOME COLOR BLACK. THE WORDS JACKIESBASKETS.COM IS ALSO IN COLOR BLACK.

SER. NO. 77-258,535, FILED 8-17-2007.

ALEX KEAM, EXAMINING ATTORNEY

**Int. Cl.: 28**

**Prior U.S. Cls.: 22, 23, 38 and 50**

**United States Patent and Trademark Office**

**Reg. No. 3,498,080**

**Registered Sep. 9, 2008**

**TRADEMARK  
PRINCIPAL REGISTER**

**we play—we learn**

KIDDIE'S PARADISE INC. (TAIWAN CORPORATION)  
9FL, NO. 70, SEC. 5 NAN KING EAST RD.  
TAIPEI, TAIWAN

FOR: CHILDREN'S MULTIPLE ACTIVITY EDUCATIONAL TOYS; PLAYGROUND EQUIPMENT, NAMELY, CLIMBERS, SWINGS, SAND AND WATER TABLES ; GYM EQUIPMENT, NAMELY, GYM BALLS, GYM ROLLS, JUMPING BALLS, VAULTING BOXES AND EXERCISE MATS; TOYS; TOY SCOOTERS, IN CLASS 28 (U.S. CLS. 22, 23, 38 AND 50).

FIRST USE 1-1-2006; IN COMMERCE 1-1-2006.

THE MARK CONSISTS OF STANDARD CHARACTERS WITHOUT CLAIM TO ANY PARTICULAR FONT, STYLE, SIZE, OR COLOR.

SER. NO. 77-258,586, FILED 8-17-2007.

RONALD AIKENS, EXAMINING ATTORNEY

**Int. Cl.: 41**

**Prior U.S. Cls.: 100, 101 and 107**

**United States Patent and Trademark Office**

**Reg. No. 3,498,081**

**Registered Sep. 9, 2008**

**SERVICE MARK  
PRINCIPAL REGISTER**

**FastTrack Racing Challenge**

1080 EDUCATION INC. (NEW YORK CORPORATION), DBA TEN80 EDUCATION  
105 CEMETERY AVE  
SCHUYLERVILLE, NY 12871

FOR: EDUCATIONAL SERVICES, NAMELY, CONDUCTING WORKSHOPS, COURSES AND SEMINARS IN THE FIELD OF SCIENCE, TECHNOLOGY, ENGINEERING AND MATHEMATICS EDUCATION AND DISTRIBUTION OF COURSE MATERIAL IN CONNECTION THEREWITH; ENTERTAINMENT SERVICES, NAMELY, ARRANGING AND CONDUCTING OF COMPETITIONS FOR SCIENCE, TECHNOLOGY, ENGINEERING AND MATHEMATICS EDUCATION; MULTIMEDIA PUBLISHING OF BOOKS, MAGAZINES, JOURNALS, SOFTWARE, GAMES, MUSIC, AND

ELECTRONIC PUBLICATIONS, IN CLASS 41 (U.S. CLS. 100, 101 AND 107).

FIRST USE 2-19-2007; IN COMMERCE 2-23-2007.

THE MARK CONSISTS OF STANDARD CHARACTERS WITHOUT CLAIM TO ANY PARTICULAR FONT, STYLE, SIZE, OR COLOR.

NO CLAIM IS MADE TO THE EXCLUSIVE RIGHT TO USE "RACING CHALLENGE", APART FROM THE MARK AS SHOWN.

SER. NO. 77-258,717, FILED 8-18-2007.

CHERYL CLAYTON, EXAMINING ATTORNEY

**Int. Cl.: 37**

**Prior U.S. Cls.: 100, 103 and 106**

**United States Patent and Trademark Office**

**Reg. No. 3,498,082**

**Registered Sep. 9, 2008**

**SERVICE MARK  
PRINCIPAL REGISTER**

**NATURESWAY THE GREENER  
CARPET CLEANER**

OXYMAGIC FRANCHISE DEVELOPMENT CORP  
(OKLAHOMA CORPORATION)  
PO BOX 2378  
OWASSO, OK 74055

FOR: CARPET AND RUG CLEANING, IN CLASS  
37 (U.S. CLS. 100, 103 AND 106).

FIRST USE 2-21-1999; IN COMMERCE 2-21-1999.

THE MARK CONSISTS OF STANDARD CHAR-  
ACTERS WITHOUT CLAIM TO ANY PARTICULAR  
FONT, STYLE, SIZE, OR COLOR.

SEC. 2(F) AS TO "GREENER CARPET CLEANER".

SER. NO. 77-259,367, FILED 8-20-2007.

ALYSSA PALADINO, EXAMINING ATTORNEY

**Int. Cl.: 16**

**Prior U.S. Cls.: 2, 5, 22, 23, 29, 37, 38 and 50**

**Reg. No. 3,498,083**

**United States Patent and Trademark Office**

**Registered Sep. 9, 2008**

**TRADEMARK  
PRINCIPAL REGISTER**

**SIDVIEW WINDOW**

PPG INDUSTRIES OHIO, INC. (DELAWARE  
CORPORATION)  
3800 WEST 143RD STREET  
CLEVELAND, OH 44111

FOR: FEATURE OF PRINTED COLOR CARDS,  
SWATCHBOOKS AND FORMULA BOOKS FOR  
SELECTING, COORDINATING AND MATCHING  
VEHICLE REFINISH PAINTS IN THE NATURE OF  
A CUT OUT WITHIN THE PAGE FOR COLOR  
COMPARISON, IN CLASS 16 (U.S. CLS. 2, 5, 22, 23,  
29, 37, 38 AND 50).

FIRST USE 9-30-2007; IN COMMERCE 9-30-2007.

THE MARK CONSISTS OF STANDARD CHAR-  
ACTERS WITHOUT CLAIM TO ANY PARTICULAR  
FONT, STYLE, SIZE, OR COLOR.

NO CLAIM IS MADE TO THE EXCLUSIVE  
RIGHT TO USE "WINDOW", APART FROM THE  
MARK AS SHOWN.

SER. NO. 77-259,537, FILED 8-20-2007.

B. PARADEWELAI, EXAMINING ATTORNEY



**Int. Cl.: 41**

**Prior U.S. Cls.: 100, 101 and 107**

**United States Patent and Trademark Office**

**Reg. No. 3,498,084**

**Registered Sep. 9, 2008**

**SERVICE MARK  
PRINCIPAL REGISTER**

# THROWDOWN

TELEVISION FOOD NETWORK, G.P. (DELA-  
WARE PARTNERSHIP)  
1180 AVENUE OF THE AMERICAS  
NEW YORK, NY 10036

FOR: ENTERTAINMENT SERVICES, NAMELY,  
AN ONGOING AUDIO AND VISUAL PROGRAM  
DISTRIBUTED OVER TELEVISION, SATELLITE,  
WIRELESS, AUDIO AND VIDEO MEDIA, FIBER  
OPTICS, CABLE AND A GLOBAL COMPUTER  
NETWORK IN THE FIELDS OF COOKING, IN  
CLASS 41 (U.S. CLS. 100, 101 AND 107).

FIRST USE 3-3-2006; IN COMMERCE 3-3-2006.

THE MARK CONSISTS OF STANDARD CHAR-  
ACTERS WITHOUT CLAIM TO ANY PARTICULAR  
FONT, STYLE, SIZE, OR COLOR.

SER. NO. 77-259,538, FILED 8-20-2007.

JOHN E. MICHOS, EXAMINING ATTORNEY

**Int. Cl.: 29**

**Prior U.S. Cl.: 46**

**United States Patent and Trademark Office**

**Reg. No. 3,498,085**

**Registered Sep. 9, 2008**

**TRADEMARK  
PRINCIPAL REGISTER**

**NATURESOURCE**

US SOY LLC (ILLINOIS LIMITED LIABILITY  
COMPANY)  
2808 THOMASON DRIVE  
MATTOON, IL 61938

THE MARK CONSISTS OF STANDARD CHAR-  
ACTERS WITHOUT CLAIM TO ANY PARTICULAR  
FONT, STYLE, SIZE, OR COLOR.

FOR: DRIED SOYBEANS, NAMELY, DRIED SOY-  
BEAN SOLD IN BULK BAGS FOR FOOD ADDITIVE  
PROCESSING AND FOR FURTHER USE BY THE  
FOOD INDUSTRY, IN CLASS 29 (U.S. CL. 46).

SER. NO. 77-259,556, FILED 8-20-2007.

FIRST USE 7-29-2007; IN COMMERCE 7-29-2007.

JAY BESCH, EXAMINING ATTORNEY

**Int. Cl.: 25**

**Prior U.S. Cls.: 22 and 39**

**United States Patent and Trademark Office**

**Reg. No. 3,498,086**

**Registered Sep. 9, 2008**

**TRADEMARK  
PRINCIPAL REGISTER**

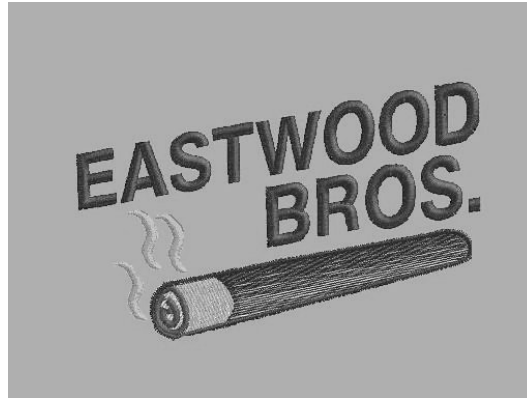

FULTON, MARK D (UNITED STATES INDIVIDUAL)  
12510 E. VIA DE ARBOLES  
CHANDLER, AZ 85249

FOR: CAPS; TOPS, IN CLASS 25 (U.S. CLS. 22 AND 39).

FIRST USE 1-12-2002; IN COMMERCE 1-12-2002.

NO CLAIM IS MADE TO THE EXCLUSIVE RIGHT TO USE "BROS." , APART FROM THE MARK AS SHOWN.

THE MARK CONSISTS OF THE WORD "EASTWOOD" SLIGHTLY DIAGONALLY LOWER LEFT TO UPPER, RIGHT, THE WORD "BROS." UNDER THE "WOOD" PORTION OF THE WORD EASTWOOD AND A SMOKING LIT CIGAR UNDERLINING BOTH WORDS, WITH THE LIT END TO THE LEFT.

SER. NO. 77-259,972, FILED 8-20-2007.

MICHAEL ENGEL, EXAMINING ATTORNEY

**Int. Cl.: 41**

**Prior U.S. Cls.: 100, 101 and 107**

**United States Patent and Trademark Office**

**Reg. No. 3,498,087**

**Registered Sep. 9, 2008**

**SERVICE MARK  
PRINCIPAL REGISTER**

**Looking for America with  
Jed Taylor**

RINZIVILLO, JED (UNITED STATES INDIVIDUAL)  
80 SOMERSET DRIVE  
PATTERSON, NY 12563

FOR: ENTERTAINMENT IN THE NATURE OF AN ONGOING RADIO SHOW IN THE FIELD OF MUSIC INTERVIEWS, IN CLASS 41 (U.S. CLS. 100, 101 AND 107).

FIRST USE 11-1-2006; IN COMMERCE 11-1-2006.

THE MARK CONSISTS OF STANDARD CHARACTERS WITHOUT CLAIM TO ANY PARTICULAR FONT, STYLE, SIZE, OR COLOR.

THE NAME(S), PORTRAIT(S), AND/OR SIGNATURE(S) SHOWN IN THE MARK IDENTIFIES "JED RINZIVILLO", WHOSE CONSENT(S) TO REGISTER IS SUBMITTED.

SER. NO. 77-260,031, FILED 8-20-2007.

BARBARA BROWN, EXAMINING ATTORNEY

**Int. Cls.: 37 and 40**

**Prior U.S. Cls.: 100, 103 and 106**

**United States Patent and Trademark Office**

**Reg. No. 3,498,088**

**Registered Sep. 9, 2008**

**SERVICE MARK  
PRINCIPAL REGISTER**

**METALMEN**

METALMEN INC. (NEVADA CORPORATION)  
5845 WYNN ROAD  
LAS VEGAS, NV 89118

FOR: CONSTRUCTION, INSTALLATION AND DISMANTLING OF COMMERCIAL SPACE FACILITIES, NAMELY, SPECIAL EVENT FACILITIES FEATURING PRODUCT SHOWROOMS AND DISPLAYS FOR TRADE SHOW EXHIBITS THAT CONSIST OF METAL PARTS, RAILINGS, CANOPIES, AWNINGS, BANISTERS, AND FIXTURES; METAL CONSTRUCTION OF SPECIAL EVENT FACILITIES, HOTELS AND COMMERCIAL OFFICE BUILDINGS, IN CLASS 37 (U.S. CLS. 100, 103 AND 106).

FIRST USE 1-31-2007; IN COMMERCE 1-31-2007.

FOR: METAL FABRICATION AND FINISHING SERVICES OF METAL PARTS FOR TRADE SHOW EXHIBIT DISPLAYS, SPECIAL EVENT FACILITIES, HOTELS, AND COMMERCIAL OFFICE BUILDINGS, IN CLASS 40 (U.S. CLS. 100, 103 AND 106).

FIRST USE 1-31-2007; IN COMMERCE 1-31-2007.

THE MARK CONSISTS OF STANDARD CHARACTERS WITHOUT CLAIM TO ANY PARTICULAR FONT, STYLE, SIZE, OR COLOR.

SER. NO. 77-260,795, FILED 8-21-2007.

SIMON TENG, EXAMINING ATTORNEY

**Int. Cl.: 9**

**Prior U.S. Cls.: 21, 23, 26, 36 and 38**

**United States Patent and Trademark Office**

**Reg. No. 3,498,089**

**Registered Sep. 9, 2008**

**TRADEMARK  
PRINCIPAL REGISTER**



CTL, INC. (CONNECTICUT CORPORATION)  
SUITE 300  
375 BRIDGEPORT AVE.  
SHELTON, CT 06484

FOR: COMPUTER SOFTWARE PLATFORMS FOR CALENDAR-BASED SCHEDULING THAT PROVIDE AUTOMATIC NOTIFICATION WITH INTERACTIVE CONFIRMATION VIA VOICE TO WIRED AND WIRELESS TELEPHONES, VOICE AND TEXT TO MOBILE PHONES, EMAIL, AND/OR FAX, IN CLASS 9 (U.S. CLS. 21, 23, 26, 36 AND 38).

FIRST USE 8-6-2007; IN COMMERCE 8-6-2007.

THE COLOR(S) ORANGE, BLACK, AND WHITE IS/ARE CLAIMED AS A FEATURE OF THE MARK.

THE MARK CONSISTS OF THE WORDING "CONFIRM-IT" IN THE COLOR BLACK SUPERIMPOSED OVER A CALENDAR THAT IS ORANGE, BLACK, AND WHITE. THE DOT OVER THE LETTER "I" IN THE WORD "IT" IS A BLACK CIRCLE WITH AN ORANGE CHECK MARK ON IT. THERE IS ALSO A LARGE LETTER "C" THAT ENCOMPASSES THE LEFT SIDE OF THE CALENDAR WHICH IS ORANGE. A BLACK CELL PHONE WITH ORANGE FEATURES AND AN ORANGE SCREEN IS TO THE RIGHT OF THE LARGE LETTER "C".

SER. NO. 77-260,849, FILED 8-21-2007.

BARBARA GAYNOR, EXAMINING ATTORNEY

**Int. Cl.: 9**

**Prior U.S. Cls.: 21, 23, 26, 36 and 38**

**United States Patent and Trademark Office**

**Reg. No. 3,498,090**

**Registered Sep. 9, 2008**

**TRADEMARK  
PRINCIPAL REGISTER**

**MAGNA•LATCH**

D & D GROUP PTY LTD (AUSTRALIA CORPORATION)  
UNIT 6, 4-6 AQUATIC DRIVE  
FRENCHS FOREST, NSW, AUSTRALIA 2086

FOR: ELECTRONICALLY OPERATED LATCHES,  
IN CLASS 9 (U.S. CLS. 21, 23, 26, 36 AND 38).

PRIORITY CLAIMED UNDER SEC. 44(D) ON  
AUSTRALIA APPLICATION NO. 1189801, FILED 7-

27-2007, REG. NO. 1189801, DATED 7-27-2007, EXPIRES 7-27-2017.

THE MARK CONSISTS OF THE WORDS "MAGNA LATCH" WITH A LARGE DOT PLACED BETWEEN THE WORDS.

SER. NO. 77-261,037, FILED 8-21-2007.

NAAKWAMA ANKRAH, EXAMINING ATTORNEY

**Int. Cl.: 45**

**Prior U.S. Cls.: 100 and 101**

**United States Patent and Trademark Office**

**Reg. No. 3,498,091**

**Registered Sep. 9, 2008**

**SERVICE MARK  
PRINCIPAL REGISTER**

**JIM ADLER THE TOUGH,  
SMART LAWYER**

JIM S. ADLER, P.C. (TEXAS CORPORATION)  
1900 WEST LOOP SOUTH, 20TH FLOOR  
HOUSTON, TX 770273214

FOR: LEGAL SERVICES, IN CLASS 45 (U.S. CLS.  
100 AND 101).

FIRST USE 8-2-2002; IN COMMERCE 8-2-2002.

THE MARK CONSISTS OF STANDARD CHAR-  
ACTERS WITHOUT CLAIM TO ANY PARTICULAR  
FONT, STYLE, SIZE, OR COLOR.

THE PHRASE "JIM ADLER" IDENTIFIES A LIV-  
ING INDIVIDUAL WHOSE CONSENT IS OF RE-  
CORD.

SER. NO. 77-261,157, FILED 8-21-2007.

MARK RADEMACHER, EXAMINING ATTORNEY



**Int. Cl.: 45**

**Prior U.S. Cls.: 100 and 101**

**United States Patent and Trademark Office**

**Reg. No. 3,498,092**

**Registered Sep. 9, 2008**

**SERVICE MARK  
PRINCIPAL REGISTER**

**JIM S. ADLER & ASSOCIATES  
THE TOUGH, SMART LAWYERS**

JIM S. ADLER, P.C. (TEXAS CORPORATION)  
1900 WEST LOOP SOUTH, 20TH FLOOR  
HOUSTON, TX 770273214

FOR: LEGAL SERVICES, IN CLASS 45 (U.S. CLS.  
100 AND 101).

FIRST USE 8-2-2002; IN COMMERCE 8-2-2002.

THE MARK CONSISTS OF STANDARD CHAR-  
ACTERS WITHOUT CLAIM TO ANY PARTICULAR  
FONT, STYLE, SIZE, OR COLOR.

NO CLAIM IS MADE TO THE EXCLUSIVE  
RIGHT TO USE "ASSOCIATES", APART FROM  
THE MARK AS SHOWN.

THE PHRASE "JIM S. ADLER" IDENTIFIES A  
LIVING INDIVIDUAL WHOSE CONSENT IS OF  
RECORD.

SER. NO. 77-261,173, FILED 8-21-2007.

MARK RADEMACHER, EXAMINING ATTORNEY

**Int. Cl.: 3**

**Prior U.S. Cls.: 1, 4, 6, 50, 51 and 52**

**Reg. No. 3,498,093**

**United States Patent and Trademark Office**

**Registered Sep. 9, 2008**

**TRADEMARK  
PRINCIPAL REGISTER**

**SUPER JUICIES SHIMMER**

BEAUTY HOLDING LLC (DELAWARE LIMITED  
LIABILITY COMPANY)

3001 COLORADO BOULEVARD

DENTON, TX 76210

FOR: LIP GLOSS, IN CLASS 3 (U.S. CLS. 1, 4, 6, 50,  
51 AND 52).

FIRST USE 12-31-2003; IN COMMERCE 12-31-2003.

THE MARK CONSISTS OF STANDARD CHAR-  
ACTERS WITHOUT CLAIM TO ANY PARTICULAR  
FONT, STYLE, SIZE, OR COLOR.

NO CLAIM IS MADE TO THE EXCLUSIVE  
RIGHT TO USE "SUPER" AND "SHIMMER", APART  
FROM THE MARK AS SHOWN.

SER. NO. 77-261,725, FILED 8-22-2007.

LOURDES AYALA, EXAMINING ATTORNEY

**Int. Cl.: 19**

**Prior U.S. Cls.: 1, 12, 33 and 50**

**Reg. No. 3,498,094**

**United States Patent and Trademark Office**

**Registered Sep. 9, 2008**

**TRADEMARK  
PRINCIPAL REGISTER**

**SYMPHONY**

CERTAINEED CORPORATION (DELAWARE  
CORPORATION)  
750 E. SWEDESFORD ROAD  
VALLEY FORGE, PA 194820101

THE MARK CONSISTS OF STANDARD CHAR-  
ACTERS WITHOUT CLAIM TO ANY PARTICULAR  
FONT, STYLE, SIZE, OR COLOR.

FOR: NON-METAL BUILDING MATERIALS,  
NAMELY, ROOFING SHINGLES, IN CLASS 19  
(U.S. CLS. 1, 12, 33 AND 50).

SER. NO. 77-262,347, FILED 8-23-2007.

FIRST USE 5-29-2007; IN COMMERCE 5-29-2007.

RICHARD A. STRASER, EXAMINING ATTORNEY

**Int. Cl.: 35**

**Prior U.S. Cls.: 100, 101 and 102**

**United States Patent and Trademark Office**

**Reg. No. 3,498,095**

**Registered Sep. 9, 2008**

**SERVICE MARK  
PRINCIPAL REGISTER**



AUTOLADY, INC. (ALABAMA CORPORATION)  
2912 GLENSTONE CIRCLE  
BIRMINGHAM, AL 35242

FOR: INDEPENDENT SALES REPRESENTATIVES IN THE FIELD OF AFTER MARKET PRODUCTS RELATED TO AUTOMOTIVE INDUSTRY, IN CLASS 35 (U.S. CLS. 100, 101 AND 102).

FIRST USE 10-2-2004; IN COMMERCE 10-2-2004.

THE MARK CONSISTS OF A CURSIVE COMBINATION OF THE LETTERS "A" & "L" SURROUNDED IN A FRAME/SHAPE OF A CAR TAG. IT SYMBOLIZES THE WORD AUTOLADY.

SER. NO. 77-263,252, FILED 8-23-2007.

AMY GEARIN, EXAMINING ATTORNEY

**Int. Cls.: 19, 37 and 42**

**Prior U.S. Cls.: 1, 12, 33, 50, 100, 101, 103 and 106**

**Reg. No. 3,498,096**

**United States Patent and Trademark Office**

**Registered Sep. 9, 2008**

**TRADEMARK  
SERVICE MARK  
PRINCIPAL REGISTER**

**LYTAG**

HARGREAVES BUILDING PRODUCTS LIMITED  
(UNITED KINGDOM LIMITED COMPANY)  
ESH WINNING  
WEST TERRACE  
DURHAM, UNITED KINGDOM DH7 9PT

FOR: NON-METALLIC BUILDING MATERIALS, NAMELY, FLY ASH, COMPOSITE PANELS COMPOSED PRIMARILY OF NON-METALLIC MATERIALS; CONCRETE BUILDING MATERIALS IN THE FORM OF BLOCKS, BRICKS, POSTS, SLATES AND PANELS; LIGHT WEIGHT AGGREGATE BUILDING MATERIALS COMPOSED OF FLY ASH, CEMENT, SAND, STONES AND GRAVEL, IN CLASS 19 (U.S. CLS. 1, 12, 33 AND 50).

FOR: CONSULTING SERVICES RELATING TO THE BUILDING AND CONSTRUCTION SERVICES; INFORMATION SERVICES RELATING TO THE INSTALLATION OF BUILDING MATERIALS; TECHNICAL CONSULTING REGARDING BUILDING MATERIALS, IN CLASS 37 (U.S. CLS. 100, 103 AND 106).

FOR: CIVIL ENGINEERING SERVICES RELATING TO LAND; SCIENTIFIC AND RESEARCH SERVICES AND DESIGN SERVICES REGARDING

BUILDING MATERIALS; INDUSTRIAL ANALYSIS AND RESEARCH SERVICES IN THE FIELD OF BUILDING MATERIALS; TECHNOLOGY CONSULTATION SERVICES, NAMELY, PROVISION OF TECHNICAL ADVICE RELATING TO BUILDING TECHNOLOGY AND THE TECHNOLOGY OF MANUFACTURING BUILDING MATERIALS; INFORMATION SERVICES RELATING TO BUILDING TECHNOLOGY AND THE TECHNOLOGY OF MANUFACTURING BUILDING MATERIALS; TECHNICAL SUPPORT SERVICES, NAMELY, PROVISION OF TECHNICAL ENGINEERING ADVICE RELATING TO BUILDING MATERIALS, IN CLASS 42 (U.S. CLS. 100 AND 101).

THE MARK CONSISTS OF STANDARD CHARACTERS WITHOUT CLAIM TO ANY PARTICULAR FONT, STYLE, SIZE, OR COLOR.

OWNER OF ERPN CMNTY TM OFC REG. NO. 003937653, DATED 10-21-2005, EXPIRES 7-7-2014.

SER. NO. 77-263,776, FILED 8-24-2007.

AMY HELLA, EXAMINING ATTORNEY

**Int. Cl.: 35**

**Prior U.S. Cls.: 100, 101 and 102**

**United States Patent and Trademark Office**

**Reg. No. 3,498,097**

**Registered Sep. 9, 2008**

**SERVICE MARK  
PRINCIPAL REGISTER**

# Peter Glenn

GREEN MOUNTAIN CORPORATION (FLORIDA CORPORATION), DBA PETER GLENN SKI & SPORTS

2901 W. OAKLAND PARK BLVD. #B12  
FT. LAUDERDALE, FL 33311

FOR: RETAIL SPORTING GOODS STORES, IN CLASS 35 (U.S. CLS. 100, 101 AND 102).

FIRST USE 1-1-1965; IN COMMERCE 1-1-1965.

THE MARK CONSISTS OF STANDARD CHARACTERS WITHOUT CLAIM TO ANY PARTICULAR FONT, STYLE, SIZE, OR COLOR.

THE NAME "PETER GLENN" IDENTIFIES A LIVING INDIVIDUAL WHOSE CONSENT IS OF RECORD.

SER. NO. 77-263,853, FILED 8-24-2007.

BRENDAN MCCAULEY, EXAMINING ATTORNEY

**Int. Cl.: 41**

**Prior U.S. Cls.: 100, 101 and 107**

**United States Patent and Trademark Office**

**Reg. No. 3,498,098**

**Registered Sep. 9, 2008**

**SERVICE MARK  
PRINCIPAL REGISTER**



LEHR, PAMELA R. (UNITED STATES INDIVIDUAL), DBA 10/01/69/PAMELA R. OWENS  
214 BRAEBURN DR.  
MARTINSBURG, WV 25403

FOR: EDUCATION SERVICES, NAMELY, PROVIDING CLASSES IN THE FIELD OF MUSIC, IN CLASS 41 (U.S. CLS. 100, 101 AND 107).

FIRST USE 8-1-2007; IN COMMERCE 8-1-2007.

THE MARK CONSISTS OF THE WORD "KINDERPRAISE", WITH THE LETTER "D" IN THE SHAPE OF AN EIGHT NOTE WITH A SMILEY FACE, WITH A 5 LINE MUSICAL STAFF AS THE BACKGROUND.

SER. NO. 77-264,483, FILED 8-26-2007.

ANNE MADDEN, EXAMINING ATTORNEY

Int. Cl.: 41

Prior U.S. Cls.: 100, 101 and 107

United States Patent and Trademark Office

Reg. No. 3,498,099

Registered Sep. 9, 2008

**SERVICE MARK  
PRINCIPAL REGISTER**



TRIGGER BOXING LLC (MICHIGAN LIMITED  
LIABILITY COMPANY)

# D

1220 WOODMERE  
TRAVERSE CITY, MI 49686

FOR: MARTIAL ARTS INSTRUCTION, IN CLASS  
41 (U.S. CLS. 100, 101 AND 107).

FIRST USE 5-19-2002; IN COMMERCE 5-19-2002.

NO CLAIM IS MADE TO THE EXCLUSIVE  
RIGHT TO USE "BOXING", APART FROM THE  
MARK AS SHOWN.

THE MARK CONSISTS OF A LOGO CONSISTING  
OF A CHARACTER IN A BOXING STANCE. THE  
CHARACTER IS WEARING A HOODED SWEAT-  
SHIRT AND BOXING GLOVES, AND ITS FACE IS  
HALF DARK AND HALF LIGHT. THE HOODED  
SWEATSHIRT HAS "TRIGGER" IMPRINTED ON  
THE CREST OF THE HOOD.

SER. NO. 77-265,384, FILED 8-27-2007.

LINDA MICKLEBURGH, EXAMINING ATTORNEY



**Int. Cls.: 40 and 42**

**Prior U.S. Cls.: 100, 101, 103 and 106**

**United States Patent and Trademark Office**

**Reg. No. 3,498,100**

**Registered Sep. 9, 2008**

**SERVICE MARK  
PRINCIPAL REGISTER**

**SERIAL INVENTOR**

GEBHARD, ALBERT (UNITED STATES INDIVIDUAL)  
2101 EAST ALAMEDA  
DENVER, CO 80209

FOR: CONSULTING IN THE FIELD OF MANUFACTURING, IN CLASS 40 (U.S. CLS. 100, 103 AND 106).

FIRST USE 1-1-2007; IN COMMERCE 1-1-2007.

FOR: DESIGN FOR OTHERS IN THE FIELD OF PRODUCT ENGINEERING, DESIGN OF NEW PRODUCTS FOR OTHERS AND ENGINEERING SERVICES, IN CLASS 42 (U.S. CLS. 100 AND 101).

FIRST USE 1-1-2007; IN COMMERCE 1-1-2007.

THE MARK CONSISTS OF STANDARD CHARACTERS WITHOUT CLAIM TO ANY PARTICULAR FONT, STYLE, SIZE, OR COLOR.

NO CLAIM IS MADE TO THE EXCLUSIVE RIGHT TO USE "INVENTOR", APART FROM THE MARK AS SHOWN.

SER. NO. 77-265,398, FILED 8-27-2007.

CHRISTINE COOPER, EXAMINING ATTORNEY

**Int. Cl.: 28**

**Prior U.S. Cls.: 22, 23, 38 and 50**

**Reg. No. 3,498,101**

**United States Patent and Trademark Office**

**Registered Sep. 9, 2008**

**TRADEMARK  
PRINCIPAL REGISTER**

The trademark consists of the letters 'I.O.U.' in a bold, rounded, sans-serif font. The letter 'I' is on the left, 'O' is in the middle, and 'U' is on the right. A small heart is positioned at the bottom center of the 'I', and another small heart is positioned at the bottom center of the 'U'. The 'O' is a simple circle with no heart below it.

BALL & CHAIN LLC (WASHINGTON LIMITED  
LIABILITY COMPANY)  
1110 R STREET NW  
AUBURN, WA 98001

FOR: CARD GAMES, IN CLASS 28 (U.S. CLS. 22,  
23, 38 AND 50).

FIRST USE 11-11-2003; IN COMMERCE 11-11-2003.

THE MARK CONSISTS OF STYLIZED LETTERS  
"I", "O" AND "U" WITH SMALL HEARTS AT THE  
BOTTOM OF AND BETWEEN THE LETTERS "I"  
AND "O" AND BETWEEN THE LETTERS "O" AND  
"U".

SER. NO. 77-265,536, FILED 8-27-2007.

LINDA MICKLEBURGH, EXAMINING ATTORNEY

**Int. Cl.: 25**

**Prior U.S. Cls.: 22 and 39**

**United States Patent and Trademark Office**

**Reg. No. 3,498,102**

**Registered Sep. 9, 2008**

**TRADEMARK  
PRINCIPAL REGISTER**

**SNAPPER ROCK**

ELIZABETH JEAN EGLINTON (MARYLAND  
CORPORATION)  
1146 MAINSAIL DR  
ANNAPOLIS, MD 21403

FOR: SWIMWEAR; BOARD SHORTS; CHILDREN'S HEADWEAR; CARGO PANTS; WET SUITS; RASH GUARDS; BEACH COVER-UPS; BEACH SHOES; BEACHWEAR; CAPRI PANTS, IN CLASS 25 (U.S. CLS. 22 AND 39).

FIRST USE 10-29-2003; IN COMMERCE 10-29-2003.

THE MARK CONSISTS OF STANDARD CHARACTERS WITHOUT CLAIM TO ANY PARTICULAR FONT, STYLE, SIZE, OR COLOR.

SER. NO. 77-265,666, FILED 8-28-2007.

HOWARD SMIGA, EXAMINING ATTORNEY

**Int. Cl.: 35**

**Prior U.S. Cls.: 100, 101 and 102**

**United States Patent and Trademark Office**

**Reg. No. 3,498,103**

**Registered Sep. 9, 2008**

**SERVICE MARK  
PRINCIPAL REGISTER**

**Miss Kitty's Barn**

MCCUE, CATHERINE (UNITED STATES INDIVIDUAL)  
143 BOZRAH ST.  
BOZRAH, CT 06334

THE MARK CONSISTS OF STANDARD CHARACTERS WITHOUT CLAIM TO ANY PARTICULAR FONT, STYLE, SIZE, OR COLOR.

FOR: RETAIL GIFT SHOPS, IN CLASS 35 (U.S. CLS. 100, 101 AND 102).

SER. NO. 77-265,729, FILED 8-28-2007.

FIRST USE 8-28-2007; IN COMMERCE 8-28-2007.

JEAN IM, EXAMINING ATTORNEY

**Int. Cl.: 35**

**Prior U.S. Cls.: 100, 101 and 102**

**United States Patent and Trademark Office**

**Reg. No. 3,498,104**

**Registered Sep. 9, 2008**

**SERVICE MARK  
PRINCIPAL REGISTER**



UNCLAIMED PROPERTY PROFESSIONALS ORGANIZATION, INC. (DELAWARE CORPORATION)

#0080

110 WALL STREET, 11TH FLOOR  
NEW YORK, NY 100053111

FOR: BUSINESS INFORMATION IN THE FIELD OF UNCLAIMED PROPERTY, IN CLASS 35 (U.S. CLS. 100, 101 AND 102).

FIRST USE 8-8-2007; IN COMMERCE 8-8-2007.

THE MARK CONSISTS OF A FIGURE OF A MAN STANDING ON A HILL LOOKING THROUGH A TELESCOPE.

SER. NO. 77-265,801, FILED 8-28-2007.

PAUL CROWLEY, EXAMINING ATTORNEY

**Int. Cl.: 35**

**Prior U.S. Cls.: 100, 101 and 102**

**United States Patent and Trademark Office**

**Reg. No. 3,498,105**

**Registered Sep. 9, 2008**

**SERVICE MARK  
PRINCIPAL REGISTER**

**UPPO**

UNCLAIMED PROPERTY PROFESSIONALS ORGANIZATION, INC. (DELAWARE CORPORATION)

#0080

110 WALL STREET, 11TH FLOOR  
NEW YORK, NY 100053111

FOR: BUSINESS INFORMATION IN THE FIELD OF UNCLAIMED PROPERTY, IN CLASS 35 (U.S. CLS. 100, 101 AND 102).

FIRST USE 8-8-2007; IN COMMERCE 8-8-2007.

THE MARK CONSISTS OF STANDARD CHARACTERS WITHOUT CLAIM TO ANY PARTICULAR FONT, STYLE, SIZE, OR COLOR.

SER. NO. 77-265,817, FILED 8-28-2007.

PAUL CROWLEY, EXAMINING ATTORNEY

**Int. Cl.: 18**

**Prior U.S. Cls.: 1, 2, 3, 22 and 41**

**Reg. No. 3,498,106**

**United States Patent and Trademark Office**

**Registered Sep. 9, 2008**

**TRADEMARK  
PRINCIPAL REGISTER**

**THE ATLANTIC PARANORMAL  
SOCIETY**

HAWES, JASON (UNITED STATES INDIVIDUAL), DBA THE ATLANTIC PARANORMAL SOCIETY

611 BROADWAY, SUITE 741  
NEW YORK, NY 10012 AND

WILSON, GRANT (UNITED STATES INDIVIDUAL),  
DBA THE ATLANTIC PARANORMAL SOCIETY

611 BROADWAY, SUITE 741  
NEW YORK, NY 10012

FOR: DUFFEL BAGS, MESSENGER BAGS,  
SHOULDER BAGS AND TRAVEL BAGS, IN CLASS  
18 (U.S. CLS. 1, 2, 3, 22 AND 41).

FIRST USE 12-9-2005; IN COMMERCE 12-9-2005.

THE MARK CONSISTS OF STANDARD CHARACTERS WITHOUT CLAIM TO ANY PARTICULAR FONT, STYLE, SIZE, OR COLOR.

SER. NO. 77-266,018, FILED 8-28-2007.

NELSON SNYDER, EXAMINING ATTORNEY

Int. Cl.: 34

Prior U.S. Cls.: 2, 8, 9 and 17

United States Patent and Trademark Office

Reg. No. 3,498,107

Registered Sep. 9, 2008

**TRADEMARK  
PRINCIPAL REGISTER**

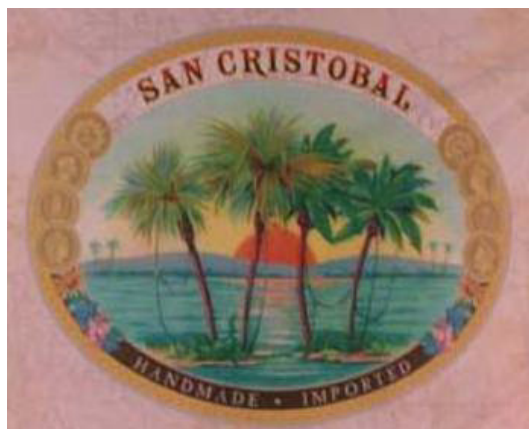

HOLT'S COMPANY (DELAWARE CORPORATION)  
12270 TOWNSEND ROAD  
PHILADELPHIA, PA 19154

FOR: CIGARS, CIGAR CASES AND CIGAR BOXES, IN CLASS 34 (U.S. CLS. 2, 8, 9 AND 17).

FIRST USE 8-14-2007; IN COMMERCE 8-14-2007.

OWNER OF U.S. REG. NO. 2,062,586.

NO CLAIM IS MADE TO THE EXCLUSIVE RIGHT TO USE "HANDMADE OR IMPORTED", APART FROM THE MARK AS SHOWN.

THE COLOR(S) PEACH, GRAY, RED, BROWN, WHITE, BLUE, GREEN, GOLD, PINK AND ORANGE IS/ARE CLAIMED AS A FEATURE OF THE MARK.

THE MARK CONSISTS OF A SCENE OF A BAY WITH A BLUE SKY, AN ORANGE SUN SETTING BEHIND BLUE MOUNTAINS, BLUE WATER, GREEN AND BROWN PALM TREES. THE SCENE IS ENCIRCLED WITH A GOLD OVAL WITH GOLD AND BROWN COINS, PINK, ORANGE AND BLUE FLOWERS ON EACH SIDE, A BROWN BANNER WITH THE WORDS "HANDMADE" AND "IMPORTED" IN GOLD LETTERING ALONG THE BOTTOM. DIRECTLY ABOVE THE PALM TREES THE WORDS "SAN CRISTOBAL" APPEAR IN BROWN AND RED LETTERING, WITH GOLD OUTLINES. THE ENTIRE DESIGN IS SUPERIMPOSED OVER A PEACH BACKGROUND WITH FAINT MAP LINES IN GRAY.

SER. NO. 77-266,119, FILED 8-28-2007.

SUSAN LESLIE DUBOIS, EXAMINING ATTORNEY



**Int. Cl.: 41**

**Prior U.S. Cls.: 100, 101 and 107**

**United States Patent and Trademark Office**

**Reg. No. 3,498,108**

**Registered Sep. 9, 2008**

**SERVICE MARK  
PRINCIPAL REGISTER**

# Game Tight Recordz

MCCORMACK, SEAN (UNITED STATES INDIVIDUAL)  
PMB #90 526 N. WEST AVE.  
ARLINGTON, WA 98223

FOR: MUSIC PRODUCTION SERVICES, PRODUCTION OF SOUND RECORDINGS AND PROVIDING AUDIO OR VIDEO STUDIOS, IN CLASS 41 (U.S. CLS. 100, 101 AND 107).

FIRST USE 1-1-2007; IN COMMERCE 1-1-2007.

THE MARK CONSISTS OF STANDARD CHARACTERS WITHOUT CLAIM TO ANY PARTICULAR FONT, STYLE, SIZE, OR COLOR.

NO CLAIM IS MADE TO THE EXCLUSIVE RIGHT TO USE "RECORDS", APART FROM THE MARK AS SHOWN.

SER. NO. 77-266,852, FILED 8-29-2007.

DEIRDRE ROBERTSON, EXAMINING ATTORNEY

**Int. Cl.: 6**

**Prior U.S. Cls.: 2, 12, 13, 14, 23, 25 and 50**

**Reg. No. 3,498,109**

**United States Patent and Trademark Office**

**Registered Sep. 9, 2008**

**TRADEMARK  
PRINCIPAL REGISTER**



**Usang**

USANG INDUSTRIAL CO., LTD. (TAIWAN CORPORATION)  
3F-4, NO. 65, SEC. 2, FU HSING S. ROAD  
TAIPEI, TAIWAN

FOR: METAL CHAIN ACCESSORIES MADE OF METAL, NAMELY, CLEVIS GRAB HOOKS, CONNECTING LINKS, NAMELY, CHAIN FITTINGS FOR OVERHEAD LIFTING; METAL D-RINGS FOR FALL PROTECTION HARNESS; METAL QUICK LINKS; METAL CARABINEER HOOKS FOR FALL PROTECTION LANYARDS; METAL ROPE HOOKS; METAL ROPE GRABS, IN CLASS 6 (U.S. CLS. 2, 12, 13, 14, 23, 25 AND 50).

FIRST USE 1-31-1978; IN COMMERCE 8-21-1978.

THE MARK CONSISTS OF THE WORD "USANG" AND A CIRCLE CONTAINING A "U" AND A STYLIZED REVERSE "V".

THE WORDING "USANG" HAS NO MEANING IN A FOREIGN LANGUAGE.

SER. NO. 77-267,068, FILED 8-29-2007.

BILL DAWE, EXAMINING ATTORNEY

**Int. Cl.: 37**

**Prior U.S. Cls.: 100, 103 and 106**

**United States Patent and Trademark Office**

**Reg. No. 3,498,110**

**Registered Sep. 9, 2008**

**SERVICE MARK  
PRINCIPAL REGISTER**



QUALITY CONTROL INSPECTION, INC. (OHIO CORPORATION)  
40 TARBELL AVE.  
BEDFORD, OH 44146

FOR: CONSTRUCTION MANAGEMENT; CONSTRUCTION SUPERVISION; CONSULTATION IN BUILDING CONSTRUCTION SUPERVISION, IN CLASS 37 (U.S. CLS. 100, 103 AND 106).

FIRST USE 1-31-1994; IN COMMERCE 1-31-1994.

NO CLAIM IS MADE TO THE EXCLUSIVE RIGHT TO USE "QCI", APART FROM THE MARK AS SHOWN.

THE MARK CONSISTS OF THE LETTERS "QCI" INSIDE A CIRCLE.

SER. NO. 77-268,036, FILED 8-30-2007.

ANDREA BUTLER, EXAMINING ATTORNEY

Int. Cl.: 3

Prior U.S. Cls.: 1, 4, 6, 50, 51 and 52

Reg. No. 3,498,111

United States Patent and Trademark Office

Registered Sep. 9, 2008

TRADEMARK  
PRINCIPAL REGISTER

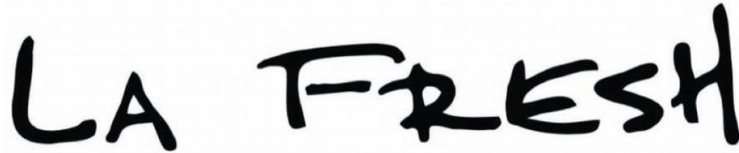
The logo consists of the words "LA FRESH" written in a bold, black, handwritten-style font. The letters are slightly irregular and spaced out, with a casual, sketchy appearance.

LA FRESH GROUP, INC. (CALIFORNIA CORPORATION)  
SUITE B  
4200 EAST MISSION BLVD.  
ONTARIO, CA 91761

FOR: DISPOSABLE WIPES IMPREGNATED WITH CHEMICALS OR COMPOUNDS FOR PERSONAL HYGIENE, MAKEUP REMOVAL, PERSONAL DEODORIZING, SKIN MOISTURIZING, SUNSCREEN, HAND SANITIZING, PERSONAL LENS AND SCREEN CLEANING, SHOE POLISHING, SHAVING, HAIR STYLING, AND NAIL POLISH

REMOVAL, IN CLASS 3 (U.S. CLS. 1, 4, 6, 50, 51 AND 52).

FIRST USE 4-1-1994; IN COMMERCE 4-1-1994.

THE MARK CONSISTS OF STYLIZED WORDS "LA FRESH".

SER. NO. 77-268,750, FILED 8-30-2007.

H. M. FISHER, EXAMINING ATTORNEY

Int. Cls.: 35 and 41

Prior U.S. Cls.: 100, 101, 102 and 107

United States Patent and Trademark Office

Reg. No. 3,498,112

Registered Sep. 9, 2008

SERVICE MARK  
PRINCIPAL REGISTER



LOS ANGELES COUNTY FAIR ASSOCIATION  
(CALIFORNIA CORPORATION)  
1101 MCKINLEY AVE  
POMONA, CA 91768

FOR: ADVERTISING AND BUSINESS SERVICES, NAMELY, ARRANGING AND CONDUCTING TRADE SHOWS IN THE NATURE OF BUSINESS COMPETITIONS IN THE FIELD OF WINE FOR EXHIBITORS, OFFICIALS, AND PROFESSIONAL ORGANIZATIONS IN THE INTERNATIONAL WINE AND SPIRITS INDUSTRIES, IN CLASS 35 (U.S. CLS. 100, 101 AND 102).

FIRST USE 5-16-2007; IN COMMERCE 5-16-2007.

FOR: ENTERTAINMENT SERVICES, NAMELY, WINE TASTINGS FOR EXHIBITORS, OFFICIALS, PROFESSIONAL ORGANIZATIONS, IN THE INTERNATIONAL WINE AND SPIRITS INDUSTRIES, AND THE PUBLIC, IN CLASS 41 (U.S. CLS. 100, 101 AND 107).

FIRST USE 5-16-2007; IN COMMERCE 5-16-2007.

NO CLAIM IS MADE TO THE EXCLUSIVE RIGHT TO USE "LOS ANGELES INTERNATIONAL WINE & SPIRITS COMPETITION", APART FROM THE MARK AS SHOWN.

THE MARK CONSISTS OF IN ADDITION TO THE LITERAL ELEMENT OF THE MARK, "LOS ANGELES INTERNATIONAL WINE & SPIRITS COMPETITION", THE DESIGN OF A SKYSCAPE OF TALL BUILDINGS, MOUNTAINS, SUNSHINE AND A PALM TREE, AND A DESIGN OF A WINE BOTTLE, WINE GLASS, WITH GRAPES ON A VINE.

SER. NO. 77-269,447, FILED 8-31-2007.

LAURA HAMMEL, EXAMINING ATTORNEY

**Int. Cl.: 41**

**Prior U.S. Cls.: 100, 101 and 107**

**United States Patent and Trademark Office**

**Reg. No. 3,498,113**

**Registered Sep. 9, 2008**

**SERVICE MARK  
PRINCIPAL REGISTER**

**PROJECTS ARE PEOPLE**

THE LEWIS INSTITUTE, INC. (VIRGINIA CORPORATION)  
302 CHESTNUT MOUNTAIN DRIVE  
VINTON, VA 24179

FOR: EDUCATIONAL SERVICES, NAMELY, WORKSHOPS AND SEMINARS OFFERING TRAINING IN PROJECT MANAGEMENT, PLANNING, ANALYSIS, IMPLEMENTATION AND COMPLETION, IN CLASS 41 (U.S. CLS. 100, 101 AND 107).

FIRST USE 12-15-2001; IN COMMERCE 12-15-2001.

THE MARK CONSISTS OF STANDARD CHARACTERS WITHOUT CLAIM TO ANY PARTICULAR FONT, STYLE, SIZE, OR COLOR.

SER. NO. 77-270,415, FILED 9-3-2007.

MELVIN AXILBUND, EXAMINING ATTORNEY

**Int. Cl.: 36**

**Prior U.S. Cls.: 100, 101 and 102**

**United States Patent and Trademark Office**

**Reg. No. 3,498,114**

**Registered Sep. 9, 2008**

**SERVICE MARK  
PRINCIPAL REGISTER**



RANDOLPH-BROOKS FEDERAL CREDIT UNION (UNITED STATES FEDERALLY CHARTERED CREDIT UNION)  
CHIEF FINANCIAL OFFICER  
ONE RANDOLPH BROOKS PARKWAY  
LIVE OAK, TX 78233

FOR: CREDIT UNIONS; INSURANCE AGENCIES,  
IN CLASS 36 (U.S. CLS. 100, 101 AND 102).

FIRST USE 1-15-2006; IN COMMERCE 1-15-2006.

NO CLAIM IS MADE TO THE EXCLUSIVE RIGHT TO USE "INSURANCE AGENCY, LLC", APART FROM THE MARK AS SHOWN.

THE COLOR(S) BLUE, RED AND WHITE IS/ARE CLAIMED AS A FEATURE OF THE MARK.

THE MARK CONSISTS OF TO THE FAR LEFT IS A WAVY FLAG WITH A BLUE FIELD THEN ONE WHITE STAR THEN THREE RED STRIPES AND TWO WHITE STRIPES FOLLOWED BY THE WORDS "RANDOLPH BROOKS" IN BLUE WITH THE WORDS "INSURANCE AGENCY, LLC" UNDERNEATH IN SMALLER RED LETTERS.

SER. NO. 77-270,609, FILED 9-4-2007.

JENNIFER MARTIN, EXAMINING ATTORNEY

**Int. Cl.: 36**

**Prior U.S. Cls.: 100, 101 and 102**

**United States Patent and Trademark Office**

**Reg. No. 3,498,115**

**Registered Sep. 9, 2008**

**SERVICE MARK  
PRINCIPAL REGISTER**



RANDOLPH-BROOKS FEDERAL CREDIT UNION (UNITED STATES FEDERALLY CHARTERED CREDIT UNION)  
CHIEF FINANCIAL OFFICER  
ONE RANDOLPH BROOKS PARKWAY  
LIVE OAK, TX 78233

FOR: CREDIT UNIONS, IN CLASS 36 (U.S. CLS. 100, 101 AND 102).

FIRST USE 3-15-2001; IN COMMERCE 3-15-2001.

NO CLAIM IS MADE TO THE EXCLUSIVE RIGHT TO USE "SERVICES GROUP, LLC", APART FROM THE MARK AS SHOWN.

THE COLOR(S) BLUE, RED AND WHITE IS/ARE CLAIMED AS A FEATURE OF THE MARK.

THE MARK CONSISTS OF TO THE FAR LEFT IS A WAVY FLAG WITH A BLUE FIELD THEN ONE WHITE STAR THEN THREE RED STRIPES AND TWO WHITE STRIPES FOLLOWED BY THE WORDS "RANDOLPH BROOKS" IN BLUE WITH THE WORDS "SERVICES GROUP, LLC" UNDERNEATH IN SMALLER RED LETTERS.

SER. NO. 77-270,702, FILED 9-4-2007.

JENNIFER MARTIN, EXAMINING ATTORNEY



**Int. Cl.: 9**

**Prior U.S. Cls.: 21, 23, 26, 36 and 38**

**United States Patent and Trademark Office**

**Reg. No. 3,498,116**

**Registered Sep. 9, 2008**

**TRADEMARK  
PRINCIPAL REGISTER**



MAGYAROK VILAGSZOVETSEGE (HUNGARY  
NON-PROFIT ORGANIZATION)

SEMELWEIS U. 1-3

1052 BUDAPEST, HUNGARY AND

BUDAI ISTVAN LASZLO (HUNGARY INDIVIDUAL)

JASZAI M. U. 22

9700 SZOMBATHELY, HUNGARY AND

BUDAI ISTVAN ZSOLT (HUNGARY INDIVIDUAL)

JASZAI M. U. 22

9700 SZOMBATHELY, HUNGARY

FOR: CAMERA EQUIPMENT, NAMELY, LIGHT DIRECTORS AND DIFFUSERS FOR USE WITH PHOTOGRAPHIC LIGHTING EQUIPMENT FOR PROFESSIONAL AND HIGH-END PHOTOGRAPHY, IN CLASS 9 (U.S. CLS. 21, 23, 26, 36 AND 38).

PRIORITY CLAIMED UNDER SEC. 44(D) ON HUNGARY APPLICATION NO. M0700744, FILED 3-6-2007, REG. NO. 191007, DATED 9-5-2007, EXPIRES 3-6-2017.

NO CLAIM IS MADE TO THE EXCLUSIVE RIGHT TO USE "NEW"; "QUALITY OF LIGHT"

AND "ONE SIZE FITS ALL" , APART FROM THE MARK AS SHOWN.

THE COLOR(S) YELLOW, BLACK AND WHITE IS/ARE CLAIMED AS A FEATURE OF THE MARK.

THE MARK CONSISTS OF THE WORD "WAKELITE" IN WHITE ON A TOP PANEL, AND A SPACE IN THE SHAPE OF A LIGHTBULB IN WHITE ON A BOTTOM PANEL. THE TOP PANEL IS BLACK, AND THE BOTTOM PANEL IS YELLOW. THE LEFT SIDE OF THE BOTTOM PANEL HAS THE WORDS "QUALITY OF LIGHT!" IN BLACK AND THE WORD "NEW" IN RED. THE RIGHT SIDE OF THE BOTTOM PANEL HAS THE WORDS "ONE SIZE FITS ALL!" IN BLACK. THE TOP RIGHT OF THE BOTTOM PANEL HAS A CAMERA IN BLACK WITH A LIGHT DIFFUSER IN WHITE. THE LIGHT DIFFUSER OVERLAPS THE RIGHT SIDE OF THE TOP PANEL.

SER. NO. 77-270,729, FILED 9-4-2007.

INGA ERVIN, EXAMINING ATTORNEY

**Int. Cl.: 21**

**Prior U.S. Cls.: 2, 13, 23, 29, 30, 33, 40 and 50**

**United States Patent and Trademark Office**

**Reg. No. 3,498,117**

**Registered Sep. 9, 2008**

**TRADEMARK  
PRINCIPAL REGISTER**

**CLEAN BEAUTIFULLY!**

HI-LOOK, INC. (CALIFORNIA CORPORATION)  
SUITE 8-C  
12155 MAGNOLIA AVENUE  
RIVERSIDE, CA 92503 AND  
KYUNG-HYUN, YU (REPUBLIC OF KOREA INDI-  
VIDUAL)  
#39  
3738 HARRISON STREET  
RIVERSIDE, CA 92503

FIRST USE 1-1-2006; IN COMMERCE 1-1-2006.

THE MARK CONSISTS OF STANDARD CHAR-  
ACTERS WITHOUT CLAIM TO ANY PARTICULAR  
FONT, STYLE, SIZE, OR COLOR.

SER. NO. 77-270,772, FILED S.R. 9-4-2007 AM. P.R.  
5-5-2008.

FOR: CLEANING CLOTHS, IN CLASS 21 (U.S.  
CLS. 2, 13, 23, 29, 30, 33, 40 AND 50).

CHRIS DONINGER, EXAMINING ATTORNEY

**Int. Cl.: 41**

**Prior U.S. Cls.: 100, 101 and 107**

**United States Patent and Trademark Office**

**Reg. No. 3,498,118**

**Registered Sep. 9, 2008**

**SERVICE MARK  
PRINCIPAL REGISTER**



humankind  
media for the global citizen

NAFF, CHRISTINE L. (UNITED STATES INDIVIDUAL), DBA QOE MANAGEMENT CONSULTING, INC.

5 VISTA LANE  
ALAMO, CA 94507

FOR: ON-LINE JOURNALS, NAMELY, BLOGS FEATURING NEWS AND INFORMATION ABOUT PEOPLE AND ORGANIZATIONS WHO ARE HEALING THE WORLD WITH THEIR WORKS AND IDEAS, IN CLASS 41 (U.S. CLS. 100, 101 AND 107).

FIRST USE 9-4-2007; IN COMMERCE 9-4-2007.

THE COLOR(S) BROWN, BLUE, AND GRAY IS/ARE CLAIMED AS A FEATURE OF THE MARK.

THE MARK CONSISTS OF THE WORD HUMAN-KIND IN STYLIZED, LOWER CASE FONT, WITH "HUMAN" IN BROWN AND "KIND" IN BLUE, WITH THE WORDS "MEDIA FOR THE GLOBAL CITIZEN" IN STYLIZED, LOWER CASE FONT IN GRAY BENEATH "KIND".

SER. NO. 77-271,115, FILED 9-4-2007.

ELISSA GARBER KON, EXAMINING ATTORNEY

**Int. Cl.: 28**

**Prior U.S. Cls.: 22, 23, 38 and 50**

**United States Patent and Trademark Office**

**Reg. No. 3,498,119**

**Registered Sep. 9, 2008**

**TRADEMARK  
PRINCIPAL REGISTER**

**Gambling on love –  
everybody wins!**

JOAN P. PALMER (UNITED STATES INDIVIDUAL)  
ONE DAMON WAY  
360 PROSPECT STREET  
NORWELL, MA 020611116

FOR: DICE GAMES; BOARD GAMES; CARD GAMES; EQUIPMENT SOLD AS A UNIT FOR PLAYING CARD GAMES, IN CLASS 28 (U.S. CLS. 22, 23, 38 AND 50).

FIRST USE 6-21-2006; IN COMMERCE 8-8-2007.

THE MARK CONSISTS OF STANDARD CHARACTERS WITHOUT CLAIM TO ANY PARTICULAR FONT, STYLE, SIZE, OR COLOR.

SER. NO. 77-271,198, FILED 9-4-2007.

SUSAN RICHARDS, EXAMINING ATTORNEY

**Int. Cls.: 38 and 44**

**Prior U.S. Cls.: 100, 101 and 104**

**United States Patent and Trademark Office**

**Reg. No. 3,498,120**

**Registered Sep. 9, 2008**

**SERVICE MARK  
PRINCIPAL REGISTER**

**CANCERCOMPASS**

RISING TIDE KFT., BUDAPEST, SCHAFFHAUSEN BRANCH (HUNGARY LIMITED LIABILITY COMPANY)

HERRENACKER 15

8200 SCHAFFHAUSEN, SWITZERLAND

FOR: PROVIDING ONLINE CHAT ROOMS AND ELECTRONIC BULLETIN BOARDS FOR TRANSMISSION OF MESSAGES AMONG USERS ON TOPICS RELATED TO CANCER, IN CLASS 38 (U.S. CLS. 100, 101 AND 104).

FIRST USE 1-0-2002; IN COMMERCE 1-0-2002.

FOR: PROVIDING A WEBSITE AND AN ONLINE DATABASE FEATURING INFORMATION ON TOPICS RELATED TO CANCER, IN CLASS 44 (U.S. CLS. 100 AND 101).

FIRST USE 1-0-2002; IN COMMERCE 1-0-2002.

THE MARK CONSISTS OF STANDARD CHARACTERS WITHOUT CLAIM TO ANY PARTICULAR FONT, STYLE, SIZE, OR COLOR.

SER. NO. 77-271,258, FILED 9-4-2007.

LESLEY LAMOTHE, EXAMINING ATTORNEY

**Int. Cl.: 21**

**Prior U.S. Cls.: 2, 13, 23, 29, 30, 33, 40 and 50**

**United States Patent and Trademark Office**

**Reg. No. 3,498,121**

**Registered Sep. 9, 2008**

**TRADEMARK  
PRINCIPAL REGISTER**



**ANCHOR PACKAGING, INC. (MISSOURI CORPORATION)**

**SUITE 100**

**13515 BARRETT PARKWAY DRIVE**

**BALLWIN, MO 63021**

**FOR: PLASTIC TAKE-OUT CONTAINERS FOR FOOD, IN CLASS 21 (U.S. CLS. 2, 13, 23, 29, 30, 33, 40 AND 50).**

**FIRST USE 8-13-2007; IN COMMERCE 8-13-2007.**

**NO CLAIM IS MADE TO THE EXCLUSIVE RIGHT TO USE RE-USE, APART FROM THE MARK AS SHOWN.**

**THE MARK CONSISTS OF THE WORD "RE-USE" WITH A CURVED, RIGHT DIRECTIONAL ARROW ON TOP AND A CURVED, LEFT DIRECTIONAL ARROW ON BOTTOM FORMING AN INCOMPLETE CIRCLE.**

**SER. NO. 77-272,128, FILED 9-5-2007.**

**HOWARD B. LEVINE, EXAMINING ATTORNEY**

**Int. Cls.: 35 and 43**

**Prior U.S. Cls.: 100, 101 and 102**

**United States Patent and Trademark Office**

**Reg. No. 3,498,122**

**Registered Sep. 9, 2008**

**SERVICE MARK  
PRINCIPAL REGISTER**



EMDECE GROUP S.A. (ARGENTINA CORPORATION)  
FLORIDA 935  
BUENOS AIRES, ARGENTINA C1005AAS

FOR: ADMINISTRATIVE HOTEL MANAGEMENT; BUSINESS MANAGEMENT OF HOTELS FOR OTHERS; HOTEL MANAGEMENT FOR OTHERS; MANAGEMENT OF HOTEL INCENTIVE PROGRAMS OF OTHERS; MANAGING AND OPERATING RESORT HOTELS AND BUSINESS CONFERENCE CENTERS OF OTHERS; PROVIDING HOTEL RATE COMPARISON INFORMATION, IN CLASS 35 (U.S. CLS. 100, 101 AND 102).

FIRST USE 3-1-2007; IN COMMERCE 3-1-2007.

FOR: HOTEL SERVICES; HOTEL SERVICES FOR PREFERRED CUSTOMERS; HOTEL, BAR AND RESTAURANT SERVICES; HOTELS; MAKING HOTEL RESERVATIONS FOR OTHERS; PROVIDING

ADVICE TO TOURISTS AND BUSINESS TRAVELERS ON HOTEL AND RESTAURANT DESTINATIONS; PROVIDING ON-LINE REVIEWS OF RESTAURANTS AND HOTELS; RESERVATION OF HOTEL ROOMS FOR TRAVELERS; RESORT HOTELS, IN CLASS 43 (U.S. CLS. 100 AND 101).

FIRST USE 3-1-2007; IN COMMERCE 3-1-2007.

THE MARK CONSISTS OF THE WORDING "UNIQUE ECO EXPERIENCES" IN WHICH THE FIRST AND THE LAST WORD ARE IN STANDARD CHARACTERS WHILE THE SECOND WORD IS IN STYLIZED CHARACTERS.

SER. NO. 77-272,370, FILED 9-5-2007.

KATHLEEN M. VANSTON, EXAMINING ATTORNEY

Int. Cl.: 28

Prior U.S. Cls.: 22, 23, 38 and 50

Reg. No. 3,498,123

United States Patent and Trademark Office

Registered Sep. 9, 2008

TRADEMARK  
PRINCIPAL REGISTER

The logo consists of the letters 'I.O.U.' in a highly stylized, calligraphic font. The 'I' is a simple vertical line with a dot. The 'O's are large, rounded, and feature decorative swirls at their top and bottom. The 'U' is also large and rounded, with a decorative swirl at its top.

BALL & CHAIN LLC (WASHINGTON LIMITED  
LIABILITY COMPANY)  
1110 R STREET NW  
AUBURN, WA 98001

THE MARK CONSISTS OF STYLIZED LETTERS  
"I", "O" AND "U" WITH PERIODS FOLLOWING  
THE "I" AND THE "O".

FOR: CARD GAMES, IN CLASS 28 (U.S. CLS. 22,  
23, 38 AND 50).

SER. NO. 77-272,456, FILED 9-5-2007.

FIRST USE 1-30-2007; IN COMMERCE 1-30-2007.

LINDA MICKLEBURGH, EXAMINING ATTORNEY



**Int. Cl.: 35**

**Prior U.S. Cls.: 100, 101 and 102**

**United States Patent and Trademark Office**

**Reg. No. 3,498,124**

**Registered Sep. 9, 2008**

**SERVICE MARK  
PRINCIPAL REGISTER**



LUMING SCIENCE & TECHNOLOGY GROUP  
CO., LTD. (CHINA LIMITED LIABILITY COM-  
PANY)

QIXIANLING HI-TECH INDUSTRIAL ZONE  
NO. 1 GAONENG STREET  
DALIAN, CHINA

FOR: ADVERTISING AND ADVERTISEMENT  
SERVICES; ADVERTISING SERVICES OF A RADIO  
AND TELEVISION ADVERTISING AGENCY; PRO-  
VIDING TELEVISION ADVERTISING FOR OTH-  
ERS; ADVERTISING SERVICES, NAMELY,  
PROMOTING AND MARKETING THE GOODS  
AND SERVICES OF OTHERS THROUGH ALL PUB-  
LIC COMMUNICATION MEANS; BUSINESS MAN-  
AGEMENT ASSISTANCE TO INDUSTRIAL OR  
COMMERCIAL COMPANIES; SALES PROMOTION  
SERVICES; RETAIL DEPARTMENT STORES; PUR-  
CHASING AGENTS; MOVING AND RELOCATION  
SERVICES, NAMELY PLANNING AND IMPLE-  
MENTING MOVES OF HOMES AND OFFICES;  
COMPUTERIZED DATABASE MANAGEMENT; IN-

VOICING SERVICES; ACCOUNTING SERVICES, IN  
CLASS 35 (U.S. CLS. 100, 101 AND 102).

OWNER OF CHINA REG. NO. 3256287, DATED 6-  
21-2002, EXPIRES 6-20-2012.

OWNER OF CHINA REG. NO. 1794232, DATED 6-  
21-2002, EXPIRES 6-20-2012.

THE TERM "LUMING" HAS NO MEANING IN  
ENGLISH.

THE NON-LATIN CHARACTERS IN THE MARK  
TRANSLITERATE TO "LUMING" AND THIS TERM  
HAS NO MEANING IN ENGLISH

SER. NO. 77-272,611, FILED 9-6-2007.

ERNEST SHOSHO, EXAMINING ATTORNEY

**Int. Cl.: 9**

**Prior U.S. Cls.: 21, 23, 26, 36 and 38**

**Reg. No. 3,498,125**

**United States Patent and Trademark Office**

**Registered Sep. 9, 2008**

**TRADEMARK  
PRINCIPAL REGISTER**

# Explorer

RUDOLPH TECHNOLOGIES, INC. (DELAWARE CORPORATION)  
PO BOX 1000  
ONE RUDOLPH ROAD  
FLANDERS, NJ 07836

FOR: SYSTEM FOR OPTICAL SEMICONDUCTOR WAFER INSPECTION COMPRISING INTERCHANGEABLE MODULES, EACH MODULE BEING DESIGNED FOR A SEPARATE TYPE OF OPTICAL SEMICONDUCTOR WAFER INSPECTION AND COMPRISED OF BRIGHTFIELD AND DARKFIELD ILLUMINATORS, SUBSTRATE MOVING ARMS, COMPUTERS, SOFTWARE FOR CON-

TROLLING THE OPERATION THEREOF AND EVALUATES RESULTS THEREFROM, IN CLASS 9 (U.S. CLS. 21, 23, 26, 36 AND 38).

FIRST USE 7-16-2007; IN COMMERCE 8-7-2007.

THE MARK CONSISTS OF STANDARD CHARACTERS WITHOUT CLAIM TO ANY PARTICULAR FONT, STYLE, SIZE, OR COLOR.

SER. NO. 77-273,013, FILED 9-6-2007.

KATHERINE CHANG, EXAMINING ATTORNEY

**Int. Cl.: 12**

**Prior U.S. Cls.: 19, 21, 23, 31, 35 and 44**

**United States Patent and Trademark Office**

**Reg. No. 3,498,126**

**Registered Sep. 9, 2008**

**TRADEMARK  
PRINCIPAL REGISTER**

**NOVATECK**

PIRELLI TYRE S.P.A. (ITALY SOCIETA PER  
AZIONI), DBA PIRELLI PNEUMATICI S.P.A.  
VIALE SARCA 222  
MILANO (MI), ITALY I-20126

FOR: TIRES, PNEUMATIC, SEMI-PNEUMATIC  
AND SOLID TIRES FOR VEHICLE WHEELS,  
WHEELS FOR VEHICLES, INNER TUBES, WHEEL  
RIMS, AND STRUCTURAL PARTS FOR ALL THE  
AFORESAID GOODS, IN CLASS 12 (U.S. CLS. 19, 21,  
23, 31, 35 AND 44).

THE MARK CONSISTS OF STANDARD CHAR-  
ACTERS WITHOUT CLAIM TO ANY PARTICULAR  
FONT, STYLE, SIZE, OR COLOR.

OWNER OF ERPN CMNTY TM OFC REG. NO.  
896100, DATED 1-4-2000, EXPIRES 7-30-2018.

SER. NO. 77-273,930, FILED 9-7-2007.

WILLIAM VERHOSEK, EXAMINING ATTORNEY

**Int. Cls.: 35 and 45**

**Prior U.S. Cls.: 100, 101 and 102**

**United States Patent and Trademark Office**

**Reg. No. 3,498,127**

**Registered Sep. 9, 2008**

**SERVICE MARK  
PRINCIPAL REGISTER**



SONNENBERG, FRED (FED REP GERMANY  
INDIVIDUAL)  
VOLKAETSTRABE 80  
80634 MUNICH, FED REP GERMANY AND  
FORTMANN, CHRISTIAN (FED REP GERMANY  
INDIVIDUAL)  
HEIMGARTENSTR. 37A  
82319 STARNBERG, FED REP GERMANY

FOR: BUSINESS CONSULTANCY , IN CLASS 35  
(U.S. CLS. 100, 101 AND 102).

FOR: LEGAL SERVICES, INCLUDING PATENT  
LAWYERS AND LEGAL PRACTITIONERS; PA-  
TENT AND INDUSTRIAL PROPERTY CONSULTA-  
TION, IN CLASS 45 (U.S. CLS. 100 AND 101).

PRIORITY CLAIMED UNDER SEC. 44(D) ON  
ERPNTM CMNTY TM OFC APPLICATION NO.

005738241, FILED 7-3-2007, REG. NO. 005738241,  
DATED 7-3-2007, EXPIRES 7-3-2017.

OWNER OF U.S. REG. NO. 2,468,966.

NO CLAIM IS MADE TO THE EXCLUSIVE  
RIGHT TO USE "LAW GROUP", APART FROM  
THE MARK AS SHOWN.

THE MARK CONSISTS OF A SQUARE WITH A  
CIRCLE IN THE LOWER RIGHT CORNER, "24IP"  
IN THE UPPER RIGHT CORNER, AND "LAW  
GROUP" IN THE LOWER RIGHT CORNER.

SER. NO. 77-273,994, FILED 9-7-2007.

LINDA E. BLOHM, EXAMINING ATTORNEY

**Int. Cl.: 36**

**Prior U.S. Cls.: 100, 101 and 102**

**United States Patent and Trademark Office**

**Reg. No. 3,498,128**

**Registered Sep. 9, 2008**

**SERVICE MARK  
PRINCIPAL REGISTER**



**DUNHAM FUNDS**

DUNHAM & ASSOCIATES INVESTMENT COUN-  
SEL, INC. (CALIFORNIA CORPORATION)  
SUITE 200  
10251 VISTA SORRENTO PARKWAY  
SAN DIEGO, CA 92121

FOR: MUTUAL FUND INVESTMENT SERVICES,  
IN CLASS 36 (U.S. CLS. 100, 101 AND 102).

FIRST USE 8-8-2007; IN COMMERCE 8-8-2007.

NO CLAIM IS MADE TO THE EXCLUSIVE  
RIGHT TO USE "FUNDS", APART FROM THE  
MARK AS SHOWN.

THE MARK CONSISTS OF, IN PART, AN AB-  
STRACT DESIGN OF A SAIL.

SER. NO. 77-274,233, FILED 9-7-2007.

STEVEN R. FOSTER, EXAMINING ATTORNEY

Int. Cl.: 44

Prior U.S. Cls.: 100 and 101

United States Patent and Trademark Office

Reg. No. 3,498,129

Registered Sep. 9, 2008

SERVICE MARK  
PRINCIPAL REGISTER

jupiter  
2 SALON

JUPITER SALON INC. (LOUISIANA CORPORATION)  
1101 TCHOUPITOULAS STREET  
NEW ORLEANS, LA 70130

FOR: BEAUTY SALONS; HAIR SALON SERVICES; HAIR SALON SERVICES, NAMELY, HAIR CUTTING, STYLING, COLORING, AND HAIR EXTENSION SERVICES; HAIR SALON SERVICES, NAMELY, TREATMENTS TO PROTECT HAIR FROM AFFECTS OF EXPOSURE TO SUNLIGHT, HEAT, HUMIDITY AND CHLORINATED WATER;

HAIRDRESSING SALONS, IN CLASS 44 (U.S. CLS. 100 AND 101).

FIRST USE 10-7-1998; IN COMMERCE 9-5-2000.

NO CLAIM IS MADE TO THE EXCLUSIVE RIGHT TO USE "SALON", APART FROM THE MARK AS SHOWN.

SER. NO. 77-274,916, FILED 9-8-2007.

ELLEN PERKINS, EXAMINING ATTORNEY

**Int. Cl.: 35**

**Prior U.S. Cls.: 100, 101 and 102**

**United States Patent and Trademark Office**

**Reg. No. 3,498,130**

**Registered Sep. 9, 2008**

**SERVICE MARK  
PRINCIPAL REGISTER**

# Convergent HRS

LEE D. FLOWERS (UNITED STATES INDIVIDUAL)  
3100 PADDOCK ROAD  
WESTON, FL 33331

FOR: MANAGEMENT AND BUSINESS CONSULTING SERVICES IN THE FIELD OF PRODUCTIVITY, SAFETY AND ERROR REDUCTION, IN CLASS 35 (U.S. CLS. 100, 101 AND 102).

FIRST USE 9-12-2007; IN COMMERCE 9-12-2007.

THE MARK CONSISTS OF STANDARD CHARACTERS WITHOUT CLAIM TO ANY PARTICULAR FONT, STYLE, SIZE, OR COLOR.

SER. NO. 77-277,802, FILED 9-12-2007.

SKYE YOUNG, EXAMINING ATTORNEY

**Int. Cl.: 1**

**Prior U.S. Cls.: 1, 5, 6, 10, 26 and 46**

**Reg. No. 3,498,131**

**United States Patent and Trademark Office**

**Registered Sep. 9, 2008**

**TRADEMARK  
PRINCIPAL REGISTER**

**SUPRA COOLANT**

KL TEXAS, L.P. (DELAWARE LIMITED PART-  
NERSHIP), DBA SUMMIT INDUSTRIAL PRO-  
DUCTS

9010 CR 2120  
TYLER, TX 75707

FOR: SYNTHETIC COOLANT FOR ROTARY  
SCREW COMPRESSORS, IN CLASS 1 (U.S. CLS. 1,  
5, 6, 10, 26 AND 46).

FIRST USE 11-30-1988; IN COMMERCE 11-30-1988.

THE MARK CONSISTS OF STANDARD CHAR-  
ACTERS WITHOUT CLAIM TO ANY PARTICULAR  
FONT, STYLE, SIZE, OR COLOR.

NO CLAIM IS MADE TO THE EXCLUSIVE  
RIGHT TO USE "COOLANT", APART FROM THE  
MARK AS SHOWN.

SER. NO. 77-277,968, FILED 9-12-2007.

DOMINICK J. SALEMI, EXAMINING ATTORNEY



**Int. Cls.: 20 and 21**

**Prior U.S. Cls.: 2, 13, 22, 23, 25, 29, 30, 32, 33, 40 and 50**

**United States Patent and Trademark Office**

**Reg. No. 3,498,132**

**Registered Sep. 9, 2008**

**TRADEMARK  
PRINCIPAL REGISTER**

**HOWARD ELLIOTT COLLECTION**

THE HOWARD ELLIOTT COLLECTION, INC.  
(ILLINOIS CORPORATION)  
489 MISSION STREET  
CAROL STREAM, IL 60188

FOR: MIRRORS; OTTOMANS; TABLES, IN CLASS  
20 (U.S. CLS. 2, 13, 22, 25, 32 AND 50).

FIRST USE 1-31-2002; IN COMMERCE 1-31-2002.

FOR: VASES, IN CLASS 21 (U.S. CLS. 2, 13, 23, 29,  
30, 33, 40 AND 50).

FIRST USE 1-31-2002; IN COMMERCE 1-31-2002.

THE MARK CONSISTS OF STANDARD CHAR-  
ACTERS WITHOUT CLAIM TO ANY PARTICULAR  
FONT, STYLE, SIZE, OR COLOR.

NO CLAIM IS MADE TO THE EXCLUSIVE  
RIGHT TO USE "COLLECTION", APART FROM  
THE MARK AS SHOWN.

THE NAME "HOWARD ELLIOTT" DOES NOT  
IDENTIFY A LIVING INDIVIDUAL.

SER. NO. 77-278,087, FILED 9-12-2007.

TINA BROWN, EXAMINING ATTORNEY

**Int. Cl.: 35**

**Prior U.S. Cls.: 100, 101 and 102**

**United States Patent and Trademark Office**

**Reg. No. 3,498,133**

**Registered Sep. 9, 2008**

**SERVICE MARK  
PRINCIPAL REGISTER**

**THE HOWARD ELLIOTT  
COLLECTION**

THE HOWARD ELLIOTT COLLECTION, INC.  
(ILLINOIS CORPORATION)  
489 MISSION STREET  
CAROL STREAM, IL 60188

NO CLAIM IS MADE TO THE EXCLUSIVE  
RIGHT TO USE "COLLECTION", APART FROM  
THE MARK AS SHOWN.

FOR: WHOLESALE DISTRIBUTION SERVICES,  
NAMELY, WHOLESALE ORDERING SERVICES  
FEATURING FURNITURE, MIRRORS AND VASES,  
IN CLASS 35 (U.S. CLS. 100, 101 AND 102).

THE NAME "HOWARD ELLIOTT" DOES NOT  
IDENTIFY A LIVING INDIVIDUAL.

FIRST USE 1-31-2002; IN COMMERCE 1-31-2002.

SER. NO. 77-278,089, FILED 9-12-2007.

THE MARK CONSISTS OF STANDARD CHAR-  
ACTERS WITHOUT CLAIM TO ANY PARTICULAR  
FONT, STYLE, SIZE, OR COLOR.

TINA BROWN, EXAMINING ATTORNEY

**Int. Cl.: 41**

**Prior U.S. Cls.: 100, 101 and 107**

**United States Patent and Trademark Office**

**Reg. No. 3,498,134**

**Registered Sep. 9, 2008**

**SERVICE MARK  
PRINCIPAL REGISTER**

**THE HATER**

ONION, INC. (WISCONSIN CORPORATION)  
10TH FLOOR  
536 BROADWAY  
NEW YORK, NY 10012

FOR: PROVIDING ON-LINE PUBLICATIONS IN  
THE NATURE OF NEWSPAPERS IN THE FIELD OF  
HUMOR AND ENTERTAINMENT, IN CLASS 41  
(U.S. CLS. 100, 101 AND 107).

FIRST USE 4-6-2006; IN COMMERCE 4-6-2006.

THE MARK CONSISTS OF STANDARD CHAR-  
ACTERS WITHOUT CLAIM TO ANY PARTICULAR  
FONT, STYLE, SIZE, OR COLOR.

SER. NO. 77-278,157, FILED 9-12-2007.

CHARLES L. JENKINS, EXAMINING ATTORNEY

**Int. Cl.: 36**

**Prior U.S. Cls.: 100, 101 and 102**

**United States Patent and Trademark Office**

**Reg. No. 3,498,135**

**Registered Sep. 9, 2008**

**SERVICE MARK  
PRINCIPAL REGISTER**

**CADOGAN TATE**

CADOGAN TATE GROUP LIMITED (UNITED  
KINGDOM LIMITED COMPANY (LTD.))  
CADOGAN HOUSE  
239 ACTON LANE  
LONDON, UNITED KINGDOM NW107NP

FOR: INSURANCE INFORMATION AND CON-  
SULTATION, IN CLASS 36 (U.S. CLS. 100, 101 AND  
102).

FIRST USE 12-31-1997; IN COMMERCE 12-31-1997.

THE MARK CONSISTS OF STANDARD CHAR-  
ACTERS WITHOUT CLAIM TO ANY PARTICULAR  
FONT, STYLE, SIZE, OR COLOR.

OWNER OF ERPN CMNTY TM OFC REG. NO.  
005769328, DATED 2-22-2008, EXPIRES 3-19-2017.

SER. NO. 77-278,398, FILED 9-12-2007.

JOHN SCHUYLER YARD, EXAMINING ATTOR-  
NEY

**Int. Cl.: 33**

**Prior U.S. Cls.: 47 and 49**

**United States Patent and Trademark Office**

**Reg. No. 3,498,136**

**Registered Sep. 9, 2008**

**TRADEMARK  
PRINCIPAL REGISTER**

**DRAGÓN DE AGAVE**

AGROINDUSTRIAS CASA RAMÍREZ, S.A. DE  
C.V. (MEXICO CORPORATION)  
CARR LEÓN-MANUEL DOBLADO KM. 38  
PURÍSIMA DEL RINCÓN, MEXICO

FOR: TEQUILA, IN CLASS 33 (U.S. CLS. 47 AND  
49).

FIRST USE 8-15-2007; IN COMMERCE 8-15-2007.

THE MARK CONSISTS OF STANDARD CHAR-  
ACTERS WITHOUT CLAIM TO ANY PARTICULAR  
FONT, STYLE, SIZE, OR COLOR.

NO CLAIM IS MADE TO THE EXCLUSIVE  
RIGHT TO USE "DE AGAVE", APART FROM THE  
MARK AS SHOWN.

THE FOREIGN WORDING IN THE MARK  
TRANSLATES INTO ENGLISH AS DRAGON OF  
AGAVE.

SER. NO. 77-278,546, FILED 9-13-2007.

ESTHER A. BORSUK, EXAMINING ATTORNEY

**Int. Cls.: 1 and 4**

**Prior U.S. Cls.: 1, 5, 6, 10, 15, 26 and 46**

**Reg. No. 3,498,137**

**United States Patent and Trademark Office**

**Registered Sep. 9, 2008**

**TRADEMARK  
PRINCIPAL REGISTER**



MITSUBISHI SHOJI KAISHA, LTD. (JAPAN CORPORATION)  
3-1, MARUNOUCHI 2-CHOME, CHIYODA-KU  
TOKYO, JAPAN

FOR: HIGHER FATTY ACIDS, NAMELY, STEARIC ACIDS AND OLEIC ACIDS, USED AS RAW MATERIALS IN THE MANUFACTURE OF SOAPS, CANDLES, COSMETICS, POLISHING AGENTS AND CHEMICAL AGENTS, IN CLASS 1 (U.S. CLS. 1, 5, 6, 10, 26 AND 46).

FOR: FUELS, NAMELY, COALS, COKES, CRUDE OILS, GASOLINE, KEROSENE, LIGHT OILS, HEAVY OILS, NATURAL GAS, AND LIQUIFIED PETROLEUM GAS FOR HEATING AND FOR PROVIDING POWER SOURCES; GAS FUELS, NAMELY, COAL, USED AS A RAW MATERIAL FOR THE MANUFACTURE OF CHEMICAL PRODUCTS; WAXES, NAMELY, BEESWAXES AND PARAFFIN WAXES FOR USE AS RAW MATERIALS FOR THE MANUFACTURE OF SOAPS, CANDLES, COSMETICS, POLISHING AGENTS, AND CHEMICAL AGENTS; LIQUIFIED PETROLEUM GAS AS A RAW MATERIAL FOR USE IN THE MANUFACTURE OF CHEMICAL PRODUCTS, NAMELY, ETHANE, ETHYLENE, PROPANE, PROPYLENE, BUTANE, BUTYLENE AND BUTADIENE; INED-

IBLE OILS, NAMELY, ANIMAL, VEGETABLE, FISH AND PROCESSED OILS, BUT NOT ESSENTIAL OILS, FOR USE AS RAW MATERIALS IN THE MANUFACTURE OF PAINTS, SOAPS, COSMETICS AND CHEMICAL AGENTS; INEDIBLE FATS, NAMELY, ANIMAL, VEGETABLE AND PROCESSED FATS FOR USE AS RAW MATERIALS IN THE MANUFACTURE OF PAINTS, SOAPS, COSMETICS AND CHEMICAL AGENTS, IN CLASS 4 (U.S. CLS. 1, 6 AND 15).

OWNER OF JAPAN REG. NO. 4319476, DATED 10-1-1999, EXPIRES 10-1-2009.

OWNER OF U.S. REG. NOS. 1,637,308 AND 3,236,530.

THE COLOR(S) RED IS/ARE CLAIMED AS A FEATURE OF THE MARK.

THE MARK CONSISTS OF A DESIGN OF THREE DIAMONDS COLORED RED.

SER. NO. 77-279,496, FILED 9-14-2007.

ZACHARY BELLO, EXAMINING ATTORNEY

**Int. Cls.: 1 and 4**

**Prior U.S. Cls.: 1, 5, 6, 10, 15, 26 and 46**

**Reg. No. 3,498,138**

**United States Patent and Trademark Office**

**Registered Sep. 9, 2008**

**TRADEMARK  
PRINCIPAL REGISTER**

**MITSUBISHI**

MITSUBISHI SHOJI KAISHA, LTD. (JAPAN CORPORATION)  
3-1, MARUNOUCHI 2-CHOME, CHIYODA-KU  
TOKYO, JAPAN

FOR: HIGHER FATTY ACIDS, NAMELY, STEARIC ACIDS AND OLEIC ACIDS, USED AS RAW MATERIALS IN THE MANUFACTURE OF SOAPS, CANDLES, COSMETICS, POLISHING AGENTS AND CHEMICAL AGENTS, IN CLASS 1 (U.S. CLS. 1, 5, 6, 10, 26 AND 46).

FOR: FUELS, NAMELY, COALS, COKES, CRUDE OILS, GASOLINE, KEROSENE, LIGHT OILS, HEAVY OILS, NATURAL GAS, AND LIQUIFIED PETROLEUM GAS FOR HEATING AND FOR PROVIDING POWER SOURCES; GAS FUELS, NAMELY, COAL, USED AS A RAW MATERIAL FOR THE MANUFACTURE OF CHEMICAL PRODUCTS; WAXES, NAMELY, BEESWAXES AND PARAFFIN WAXES FOR USE AS RAW MATERIALS FOR THE MANUFACTURE OF SOAPS, CANDLES, COSMETICS, POLISHING AGENTS, AND CHEMICAL AGENTS; LIQUIFIED PETROLEUM GAS AS A RAW MATERIAL FOR USE IN THE MANUFACTURE OF CHEMICAL PRODUCTS, NAMELY, ETHANE, ETHYLENE, PROPANE, PROPYLENE,

BUTANE, BUTYLENE AND BUTADIENE; INEDIBLE OILS, NAMELY, ANIMAL, VEGETABLE, FISH AND PROCESSED OILS, BUT NOT ESSENTIAL OILS, FOR USE AS RAW MATERIALS IN THE MANUFACTURE OF PAINTS, SOAPS, COSMETICS AND CHEMICAL AGENTS; INEDIBLE FATS, NAMELY, ANIMAL, VEGETABLE AND PROCESSED FATS FOR USE AS RAW MATERIALS IN THE MANUFACTURE OF PAINTS, SOAPS, COSMETICS AND CHEMICAL AGENTS, IN CLASS 4 (U.S. CLS. 1, 6 AND 15).

THE MARK CONSISTS OF STANDARD CHARACTERS WITHOUT CLAIM TO ANY PARTICULAR FONT, STYLE, SIZE, OR COLOR.

OWNER OF JAPAN REG. NO. 4319478, DATED 10-1-1999, EXPIRES 10-1-2009.

THE ENGLISH TRANSLATION OF THE WORD "MITSUBISHI" IN THE MARK IS "THREE RHOMBOIDS".

SER. NO. 77-279,524, FILED 9-14-2007.

ZACHARY BELLO, EXAMINING ATTORNEY

**Int. Cls.: 29, 30, 31, 32 and 33**

**Prior U.S. Cls.: 1, 45, 46, 47, 48 and 49**

**Reg. No. 3,498,139**

**United States Patent and Trademark Office**

**Registered Sep. 9, 2008**

**TRADEMARK  
PRINCIPAL REGISTER**

**MITSUBISHI**

MITSUBISHI SHOJI KAISHA, LTD. (JAPAN CORPORATION)  
3-1, MARUNOUCHI 2-CHOME, CHIYODA-KU  
TOKYO, JAPAN

FOR: EDIBLE OILS AND FATS, DAIRY PRODUCTS EXCLUDING ICE CREAM, ICE MILK AND FROZEN YOGURT; MEAT; EGGS; FISHES AND SHELLFISHES, NAMELY SALMONS, TUNAS, SARDINES, OYSTERS, SHRIMPS AND CRABS; PROCESSED FOODS, NAMELY FRUITS, VEGETABLES, MEATS, FISHES AND SHELLFISHES, AND JAMS, PULSES, NAMELY, SOYBEANS FOR EATING, IN CLASS 29 (U.S. CL. 46).

FOR: TEA, COFFEE, UNROASTED COFFEE BEANS, COCOA, ICE; CONFECTIONERY, NAMELY, WAFERS, CHOCOLATES, CAKES, COOKIES AND CANDIES, BISCUITS; CHEWING GUM; CRACKERS, BREAD AND BUNS; SEASONINGS; SPICES; PROCESSED GRAINS; FLOUR, IN CLASS 30 (U.S. CL. 46).

FOR: FRESH FRUIT AND VEGETABLES; ANIMAL FEED; LIVE PLANTS AND ANIMALS; UNPROCESSED GRAINS FOR EATING AND AGRICULTURAL GRAINS FOR PLANTING; SEEDS, NAMELY, FLOWER SEEDS AND BULBS, VEGETABLE SEEDS, TREE AND SHRUB SEEDS, LAWN GRASS SEEDS, RAPE OIL SEEDS, SOYBEAN OIL SEEDS, SESAME OIL SEEDS, PEANUT OIL SEEDS, GRASS SODS FOR LAWNS AND GARDENS, FLOWERS, SEEDLINGS, SAPLINGS, TREES; LIVESTOCK, NAMELY, CATTLE, PIGS, HORSES, SHEEP,

RABBITS, CHICKENS, DUCKS, QUAILS AND TURKEYS, BIRDS, FISH, INSECTS, BREEDING COCOONS, SILK-WORM EGGS, EGGS OF CHICKEN, QUAIL, DUCK AND TURKEY FOR HATCHING; PULSES, NAMELY, SOYBEANS FOR PLANTING OR AGRICULTURAL PURPOSES, IN CLASS 31 (U.S. CLS. 1 AND 46).

FOR: VEGETABLE JUICES AND BEERS, IN CLASS 32 (U.S. CLS. 45, 46 AND 48).

FOR: ALCOHOLIC BEVERAGES, NAMELY, WINES, WHISKEY AND BRANDIES, IN CLASS 33 (U.S. CLS. 47 AND 49).

THE MARK CONSISTS OF STANDARD CHARACTERS WITHOUT CLAIM TO ANY PARTICULAR FONT, STYLE, SIZE, OR COLOR.

OWNER OF JAPAN REG. NO. 4319478, DATED 10-1-1999, EXPIRES 10-1-2009.

OWNER OF U.S. REG. NOS. 1,003,293 AND 3,241,672.

THE ENGLISH TRANSLATION OF THE WORD "MITSUBISHI" IN THE MARK IS "THREE RHOMBIDS".

SER. NO. 77-279,571, FILED 9-14-2007.

ZACHARY BELLO, EXAMINING ATTORNEY



**Int. Cls.: 29, 30, 31, 32 and 33**

**Prior U.S. Cls.: 1, 45, 46, 47, 48 and 49**

**Reg. No. 3,498,140**

**United States Patent and Trademark Office**

**Registered Sep. 9, 2008**

**TRADEMARK  
PRINCIPAL REGISTER**



MITSUBISHI SHOJI KAISHA, LTD. (JAPAN CORPORATION)  
3-1, MARUNOUCHI 2-CHOME, CHIYODA-KU  
TOKYO, JAPAN

FOR: EDIBLE OILS AND FATS, DAIRY PRODUCTS EXCLUDING ICE CREAM, ICE MILK AND FROZEN YOGURT; MEAT; EGGS; FISHES AND SHELLFISHES, NAMELY, SALMONS, TUNAS, SARDINES, OYSTERS, SHRIMPS AND CRABS; JAMS; PULSES, NAMELY, SOYBEANS, IN CLASS 29 (U.S. CL. 46).

FOR: TEA, COFFEE, UNROASTED COFFEE BEANS, COCOA, ICE, CONFECTIONERY, NAMELY, WAFERS, CHOCOLATES, CAKES, COOKIES AND CANDIES, BISCUITS; CHEWING GUM; CRACKERS, BREAD AND BUNS; SEASONINGS; SPICES; PROCESSED GRAINS; FLOUR, IN CLASS 30 (U.S. CL. 46).

FOR: FRESH FRUIT AND VEGETABLES; ANIMAL FEED; LIVE PLANTS AND ANIMALS; UNPROCESSED GRAINS FOR EATING AND AGRICULTURAL GRAINS FOR PLANTING; SEEDS, NAMELY, FLOWER SEEDS AND BULBS, VEGETABLE SEEDS, TREE AND SHRUB SEEDS, LAWN GRASS SEEDS, OIL SEEDS, NAMELY, RAPE OIL SEEDS, SOYBEAN OIL SEEDS, SESAME OIL SEEDS AND PEANUT OIL SEEDS; GRASS SODS FOR LAWNS AND GARDENS, FLOWERS, SEEDLINGS, SAPLINGS, TREES; LIVESTOCK, NAMELY,

CATTLE, PIGS, HORSES, SHEEP, RABBITS, CHICKENS, DUCKS, QUAILS AND TURKEYS, BIRDS, FISH, INSECTS, BREEDING COCOONS, SILKWORM EGGS, EGGS OF CHICKEN, QUAIL, DUCK AND TURKEY FOR HATCHING; PULSES, NAMELY, SOYBEANS FOR PLANTING OR AGRICULTURAL PURPOSES, IN CLASS 31 (U.S. CLS. 1 AND 46).

FOR: VEGETABLE JUICES, BEER, IN CLASS 32 (U.S. CLS. 45, 46 AND 48).

FOR: ALCOHOLIC BEVERAGES, NAMELY, WINES, WHISKEYS, BRANDIES, IN CLASS 33 (U.S. CLS. 47 AND 49).

OWNER OF JAPAN REG. NO. 4319476, DATED 10-1-1999, EXPIRES 10-1-2009.

OWNER OF U.S. REG. NO. 1,637,308.

THE COLOR(S) RED IS/ARE CLAIMED AS A FEATURE OF THE MARK.

THE MARK CONSISTS OF A DESIGN OF THREE DIAMONDS COLORED RED.

SER. NO. 77-279,598, FILED 9-14-2007.

ZACHARY BELLO, EXAMINING ATTORNEY

**Int. Cls.: 3 and 18**

**Prior U.S. Cls.: 1, 2, 3, 4, 6, 22, 41, 50, 51 and 52**

**Reg. No. 3,498,141**

**United States Patent and Trademark Office**

**Registered Sep. 9, 2008**

**TRADEMARK  
PRINCIPAL REGISTER**

**ANIMALI BELLI**

HEALTHY AGING LIVING ORGANICS, INC.  
(WASHINGTON CORPORATION), DBA HALO,  
INC.  
10011 E. TALLMAN ROAD  
CHATTAROY, WA 99003

FOR: PET SHAMPOO; PET ODOR REMOVERS;  
DEODORIZERS FOR PETS; PET CREME, NAMELY,  
NON-MEDICATED SKIN CARE PREPARATIONS  
FOR PETS, IN CLASS 3 (U.S. CLS. 1, 4, 6, 50, 51  
AND 52).

FIRST USE 11-30-2006; IN COMMERCE 11-30-2006.

FOR: COLLARS FOR PETS; LEASHES FOR ANI-  
MALS; ANIMAL CARRIERS, IN CLASS 18 (U.S. CLS.  
1, 2, 3, 22 AND 41).

FIRST USE 11-30-2006; IN COMMERCE 11-30-2006.

THE MARK CONSISTS OF STANDARD CHAR-  
ACTERS WITHOUT CLAIM TO ANY PARTICULAR  
FONT, STYLE, SIZE, OR COLOR.

NO CLAIM IS MADE TO THE EXCLUSIVE  
RIGHT TO USE "ANIMALI", APART FROM THE  
MARK AS SHOWN.

THE FOREIGN WORDING IN THE MARK  
TRANSLATES INTO ENGLISH AS BEAUTIFUL  
ANIMALS.

SER. NO. 77-279,892, FILED 9-14-2007.

SAMUEL E. SHARPER JR., EXAMINING ATTOR-  
NEY

**Int. Cl.: 24**

**Prior U.S. Cls.: 42 and 50**

**United States Patent and Trademark Office**

**Reg. No. 3,498,142**

**Registered Sep. 9, 2008**

**TRADEMARK  
PRINCIPAL REGISTER**

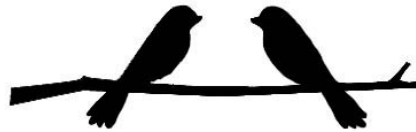

SERENA & LILY (CALIFORNIA CORPORATION)  
SUITE 115  
475 GATE 5 ROAD  
SAUSALITO, CA 94965

FOR: FABRIC, LINENS, AND TEXTILES FOR CHILDREN'S ROOMS, NAMELY, BUMPERS, SHEETS, BED SKIRTS, MATCHING COTTON FABRICS FOR FURNITURE, PILLOWS, AND DUVETS, IN CLASS 24 (U.S. CLS. 42 AND 50).

FIRST USE 5-1-2004; IN COMMERCE 5-1-2004.

THE MARK CONSISTS OF TWO BIRDS IN SILHOUETTE SITTING ON A BRANCH FACING EACH OTHER. COLOR IS NOT CLAIMED.

SER. NO. 77-279,896, FILED 9-14-2007.

KEVON CHISOLM, EXAMINING ATTORNEY

**Int. Cl.: 35**

**Prior U.S. Cls.: 100, 101 and 102**

**United States Patent and Trademark Office**

**Reg. No. 3,498,143**

**Registered Sep. 9, 2008**

**SERVICE MARK  
PRINCIPAL REGISTER**

**MALCOLM OUT LOUD**

SCREAMINEYES, LLC (FLORIDA LIMITED LIABILITY COMPANY)  
SUITE 320  
405 N. REO STREET  
TAMPA, FL 33609

FOR: BUSINESS MARKETING CONSULTING SERVICES, IN CLASS 35 (U.S. CLS. 100, 101 AND 102).

FIRST USE 4-15-2005; IN COMMERCE 4-15-2005.

THE MARK CONSISTS OF STANDARD CHARACTERS WITHOUT CLAIM TO ANY PARTICULAR FONT, STYLE, SIZE, OR COLOR.

THE NAME SHOWN IN THE MARK IDENTIFIES "MALCOLM TEASDALE" WHOSE CONSENT IS OF RECORD.

SER. NO. 77-280,059, FILED 9-14-2007.

KELLY BOULTON, EXAMINING ATTORNEY

**Int. Cl.: 2**

**Prior U.S. Cls.: 6, 11 and 16**

**United States Patent and Trademark Office**

**Reg. No. 3,498,144**

**Registered Sep. 9, 2008**

**TRADEMARK  
PRINCIPAL REGISTER**



RENNER HERRMANN S/A (BRAZIL SOCIEDAD  
ANONIMA (SA))  
AV. ASSIS BRASIL  
PORTO ALEGRE RS, BRAZIL 3966

FOR: PAINTS FOR INTERIOR AND EXTERIOR  
WOOD OBJECTS AND SURFACES, SUCH AS  
FLOORS, WALLS, STAIRS AND FURNITURE, IN  
CLASS 2 (U.S. CLS. 6, 11 AND 16).

FIRST USE 1-0-2006; IN COMMERCE 1-0-2006.

THE MARK CONSISTS OF A HORSE AND THE  
WORDS "RENNER".

SER. NO. 77-280,114, FILED 9-14-2007.

HOWARD SMIGA, EXAMINING ATTORNEY

**Int. Cl.: 36**

**Prior U.S. Cls.: 100, 101 and 102**

**United States Patent and Trademark Office**

**Reg. No. 3,498,145**

**Registered Sep. 9, 2008**

**SERVICE MARK  
PRINCIPAL REGISTER**

**MEREBIS**

MEREBIS CAPITAL MANAGEMENT LLP (UNI-  
TED KINGDOM CORPORATION)  
7 SAVILE ROW  
LONDON, UNITED KINGDOM W1S3PE

FOR: INVESTMENT ADVISORY SERVICES, IN-  
VESTMENT MANAGEMENT SERVICES; FUND IN-  
VESTMENT SERVICES; ASSET MANAGEMENT  
FOR PRIVATE, INSTITUTIONAL AND CORPO-  
RATE CLIENTS; HEDGE FUND INVESTMENT  
SERVICES; PROVIDING FINANCIAL ADVISORY,  
CONSULTANCY AND INFORMATION, ALL RE-  
LATING TO ALL OF THE AFORESAID SERVICES,  
IN CLASS 36 (U.S. CLS. 100, 101 AND 102).

THE MARK CONSISTS OF STANDARD CHAR-  
ACTERS WITHOUT CLAIM TO ANY PARTICULAR  
FONT, STYLE, SIZE, OR COLOR.

PRIORITY CLAIMED UNDER SEC. 44(D) ON  
ERPNTY CMNTY TM OFC APPLICATION NO.  
5848262, FILED 4-20-2007, REG. NO. 005848262, DA-  
TED 1-30-2008, EXPIRES 4-20-2017.

SER. NO. 77-280,764, FILED 9-17-2007.

JOHN SCHUYLER YARD, EXAMINING ATTOR-  
NEY

**Int. Cl.: 35**

**Prior U.S. Cls.: 100, 101 and 102**

**United States Patent and Trademark Office**

**Reg. No. 3,498,146**

**Registered Sep. 9, 2008**

**SERVICE MARK  
PRINCIPAL REGISTER**

**LOAF'N JUG**

THE KROGER CO. OF MICHIGAN (MICHIGAN CORPORATION)  
18334 LAUREL PARK DRIVE NORTH  
LIVONIA, MI 481522686

FOR: RETAIL CONVENIENCE STORE SERVICES AND RETAIL GAS STATION SERVICES FEATURING GASOLINE PUMPS, IN CLASS 35 (U.S. CLS. 100, 101 AND 102).

FIRST USE 1-1-2007; IN COMMERCE 1-1-2007.

THE MARK CONSISTS OF STANDARD CHARACTERS WITHOUT CLAIM TO ANY PARTICULAR FONT, STYLE, SIZE, OR COLOR.

OWNER OF U.S. REG. NOS. 1,580,693 AND 2,614,360.

SER. NO. 77-282,531, FILED 9-18-2007.

ARETHA SOMERVILLE, EXAMINING ATTORNEY

**Int. Cl.: 43**

**Prior U.S. Cls.: 100 and 101**

**United States Patent and Trademark Office**

**Reg. No. 3,498,147**

**Registered Sep. 9, 2008**

**SERVICE MARK  
PRINCIPAL REGISTER**

**Gardski's Loft**

GARDSKI'S LOFT, INC. (TEXAS CORPORATION)  
1302 AVENUE Q  
LUBBOCK, TX 79401

FOR: RESTAURANT AND BAR SERVICES, IN  
CLASS 43 (U.S. CLS. 100 AND 101).

FIRST USE 1-1-1976; IN COMMERCE 1-1-1976.

THE MARK CONSISTS OF STANDARD CHARACTERS WITHOUT CLAIM TO ANY PARTICULAR FONT, STYLE, SIZE, OR COLOR.

OWNER OF U.S. REG. NO. 1,300,011.

SER. NO. 77-284,627, FILED 9-20-2007.

H. M. FISHER, EXAMINING ATTORNEY



**Int. Cl.: 29**

**Prior U.S. Cl.: 46**

**United States Patent and Trademark Office**

**Reg. No. 3,498,148**

**Registered Sep. 9, 2008**

**TRADEMARK  
PRINCIPAL REGISTER**

**CASCADE PRIDE**

FFX, INC. (CALIFORNIA CORPORATION)  
1000 AMES AVENUE, SUITE C-30  
MILPITAS, CA 95035

FOR: FROZEN POTATO PRODUCTS, NAMELY,  
FRENCH FRYING POTATOES AND FROZEN PRO-  
CESSED POTATOES, IN CLASS 29 (U.S. CL. 46).

FIRST USE 7-31-2007; IN COMMERCE 7-31-2007.

THE MARK CONSISTS OF STANDARD CHAR-  
ACTERS WITHOUT CLAIM TO ANY PARTICULAR  
FONT, STYLE, SIZE, OR COLOR.

NO CLAIM IS MADE TO THE EXCLUSIVE  
RIGHT TO USE "CASCADE", APART FROM THE  
MARK AS SHOWN.

SER. NO. 77-284,884, FILED 9-20-2007.

BARBARA BROWN, EXAMINING ATTORNEY

**Int. Cl.: 29**

**Prior U.S. Cl.: 46**

**United States Patent and Trademark Office**

**Reg. No. 3,498,149**

**Registered Sep. 9, 2008**

**TRADEMARK  
PRINCIPAL REGISTER**

**CASCADE GOLD**

FFX, INC. (CALIFORNIA CORPORATION)  
1000 AMES AVENUE, SUITE C-30  
MILPITAS, CA 95035

FOR: FROZEN POTATO PRODUCTS, NAMELY,  
FRENCH FRYING POTATOES AND FROZEN PRO-  
CESSED POTATOES, IN CLASS 29 (U.S. CL. 46).

FIRST USE 3-30-2007; IN COMMERCE 3-30-2007.

THE MARK CONSISTS OF STANDARD CHAR-  
ACTERS WITHOUT CLAIM TO ANY PARTICULAR  
FONT, STYLE, SIZE, OR COLOR.

NO CLAIM IS MADE TO THE EXCLUSIVE  
RIGHT TO USE "CASCADE", APART FROM THE  
MARK AS SHOWN.

SER. NO. 77-284,886, FILED 9-20-2007.

BARBARA BROWN, EXAMINING ATTORNEY

**Int. Cl.: 44**

**Prior U.S. Cls.: 100 and 101**

**United States Patent and Trademark Office**

**Reg. No. 3,498,150**

**Registered Sep. 9, 2008**

**SERVICE MARK  
PRINCIPAL REGISTER**

**DreamVision Sleep Center**

MALLI, DIPAKKUMAR P. (UNITED STATES  
INDIVIDUAL)  
1416 SPRUCE AVENUE  
VOORHEES, NJ 08043

FOR: MEDICAL SERVICES, NAMELY, CON-  
DUCTING SLEEP STUDIES TO ASSESS AND  
TREAT SLEEP DISORDERS, IN CLASS 44 (U.S.  
CLS. 100 AND 101).

FIRST USE 11-21-2006; IN COMMERCE 11-21-2006.

THE MARK CONSISTS OF STANDARD CHAR-  
ACTERS WITHOUT CLAIM TO ANY PARTICULAR  
FONT, STYLE, SIZE, OR COLOR.

NO CLAIM IS MADE TO THE EXCLUSIVE  
RIGHT TO USE "SLEEP CENTER", APART FROM  
THE MARK AS SHOWN.

SER. NO. 77-287,712, FILED 9-24-2007.

CIMMERIAN COLEMAN, EXAMINING ATTOR-  
NEY

**Int. Cl.: 21**

**Prior U.S. Cls.: 2, 13, 23, 29, 30, 33, 40 and 50**

**United States Patent and Trademark Office**

**Reg. No. 3,498,151**

**Registered Sep. 9, 2008**

**TRADEMARK  
PRINCIPAL REGISTER**

**DINING STONES**

RED OAK WORKSHOP, INC. (IOWA CORPORATION)  
P.O. BOX 182  
BATAVIA, IA 52533

FOR: NON-ELECTRIC PLATES OF SLATE AND GRANITE TO BE PLACED IN THE OVEN, OR IN A FREEZER OR COOLER, WHICH MAINTAIN TEMPERATURE LONG AFTER BEING REMOVED FOR USE AS DINNER PLATE WARMERS AND CHILLERS, IN CLASS 21 (U.S. CLS. 2, 13, 23, 29, 30, 33, 40 AND 50).

FIRST USE 9-20-2007; IN COMMERCE 9-20-2007.

THE MARK CONSISTS OF STANDARD CHARACTERS WITHOUT CLAIM TO ANY PARTICULAR FONT, STYLE, SIZE, OR COLOR.

NO CLAIM IS MADE TO THE EXCLUSIVE RIGHT TO USE "STONES", APART FROM THE MARK AS SHOWN.

SER. NO. 77-288,057, FILED 9-25-2007.

AISHA CLARKE, EXAMINING ATTORNEY

**Int. Cl.: 35**

**Prior U.S. Cls.: 100, 101 and 102**

**United States Patent and Trademark Office**

**Reg. No. 3,498,152**

**Registered Sep. 9, 2008**

**SERVICE MARK  
PRINCIPAL REGISTER**

THE KWAKU AKYEAMPONG  
APPROACH TO EARNED VALUE  
MANAGEMENT EXCELLENCE

AKYEAMPONG, KWAKU APPIAH NUAMAH  
(GHANA INDIVIDUAL)  
P.O. BOX 25132  
ARLINGTON, VA 222029032

FOR: BUSINESS MANAGEMENT CONSULTING,  
IN CLASS 35 (U.S. CLS. 100, 101 AND 102).

FIRST USE 9-2-1999; IN COMMERCE 9-2-1999.

THE MARK CONSISTS OF STANDARD CHAR-  
ACTERS WITHOUT CLAIM TO ANY PARTICULAR  
FONT, STYLE, SIZE, OR COLOR.

NO CLAIM IS MADE TO THE EXCLUSIVE  
RIGHT TO USE "EARNED VALUE MANAGE-  
MENT", APART FROM THE MARK AS SHOWN.

THE NAME(S), PORTRAIT(S), AND/OR SIGNA-  
TURE(S) SHOWN IN THE MARK IDENTIFIES  
"KWAKU APPIAH NUAMAH AKYEAMPONG",  
WHOSE CONSENT(S) TO REGISTER IS MADE OF  
RECORD.

SER. NO. 77-288,064, FILED 9-25-2007.

MARILYN IZZI, EXAMINING ATTORNEY

**Int. Cl.: 35**

**Prior U.S. Cls.: 100, 101 and 102**

**United States Patent and Trademark Office**

**Reg. No. 3,498,153**

**Registered Sep. 9, 2008**

**SERVICE MARK  
PRINCIPAL REGISTER**

**THE KWAKU AKYEAMPONG 7  
KEYS TO EFFECTIVE EARNED  
VALUE MANAGEMENT**

AKYEAMPONG, KWAKU APPIAH NUAMAH  
(GHANA INDIVIDUAL)  
P.O. BOX 25132  
ARLINGTON, VA 222029032

FOR: BUSINESS MANAGEMENT CONSULTING,  
IN CLASS 35 (U.S. CLS. 100, 101 AND 102).

FIRST USE 9-2-1999; IN COMMERCE 9-2-1999.

THE MARK CONSISTS OF STANDARD CHAR-  
ACTERS WITHOUT CLAIM TO ANY PARTICULAR  
FONT, STYLE, SIZE, OR COLOR.

NO CLAIM IS MADE TO THE EXCLUSIVE  
RIGHT TO USE "EARNED VALUE MANAGE-  
MENT", APART FROM THE MARK AS SHOWN.

THE NAME(S), PORTRAIT(S), AND/OR SIGNA-  
TURE(S) SHOWN IN THE MARK IDENTIFIES  
"KWAKU APPIAH NUAMAH AKYEAMPONG",  
WHOSE CONSENT(S) TO REGISTER IS MADE OF  
RECORD.

SER. NO. 77-288,066, FILED 9-25-2007.

MARILYN IZZI, EXAMINING ATTORNEY

**Int. Cl.: 41**

**Prior U.S. Cls.: 100, 101 and 107**

**United States Patent and Trademark Office**

**Reg. No. 3,498,154**

**Registered Sep. 9, 2008**

**SERVICE MARK  
PRINCIPAL REGISTER**

**invested.**

INVESTTOOLS INC. (DELAWARE CORPORATION)  
13947 S. MINUTEMAN DRIVE  
DRAPER, UT 84020

FOR: PROVIDING ON-LINE NON-DOWNLOADABLE PUBLICATIONS IN THE NATURE OF NEWSLETTERS IN THE FIELD OF EDUCATION FOR INVESTORS AND MARKET COMMENTARY, IN CLASS 41 (U.S. CLS. 100, 101 AND 107).

FIRST USE 9-1-2007; IN COMMERCE 9-1-2007.

THE MARK CONSISTS OF STANDARD CHARACTERS WITHOUT CLAIM TO ANY PARTICULAR FONT, STYLE, SIZE, OR COLOR.

SER. NO. 77-288,238, FILED 9-25-2007.

JERI J. FICKES, EXAMINING ATTORNEY

**Int. Cls.: 3 and 39**

**Prior U.S. Cls.: 1, 4, 6, 50, 51, 52, 100 and 105**

**United States Patent and Trademark Office**

**Reg. No. 3,498,155**

**Registered Sep. 9, 2008**

**TRADEMARK  
SERVICE MARK  
PRINCIPAL REGISTER**



OH DISTRIBUTORS (NORTH CAROLINA CORPORATION), DBA APU  
722 PARK AVENUE  
YOUNGSVILLE, NC 27596

FOR: GLASS CLEANERS, IN CLASS 3 (U.S. CLS. 1, 4, 6, 50, 51 AND 52).

FIRST USE 1-1-2005; IN COMMERCE 1-1-2005.

FOR: WAREHOUSING SERVICES, NAMELY, STORAGE, DISTRIBUTION, PICK-UP, AND PACKING FOR SHIPMENT OF DOCUMENTS, PACKAGES, RAW MATERIALS, AND OTHER FREIGHT FOR OTHERS, IN CLASS 39 (U.S. CLS. 100 AND 105).

FIRST USE 10-1-2005; IN COMMERCE 10-1-2005.

THE COLOR(S) RED (PANTONE 17.97) AND GRAY (SCALE) IS/ARE CLAIMED AS A FEATURE OF THE MARK.

THE MARK CONSISTS OF OVAL SHAPED BORDER, GRAY SCALE, GRADIENT APPLICATION "APU" (SERPENTINE FONT, GRAY SCALE, HORIZONTAL GRADIENT) CENTERED INSIDE OVAL; "A" POKING OUTSIDE OVAL ON BOTTOM LEFT, AND "U" POKING OUTSIDE OVAL ON TOP RIGHT INTERIOR OF OVAL AND AROUND "APU" FILLED IN RED (PANTONE 17.97).

SER. NO. 77-288,424, FILED 9-25-2007.

WANDA KAY PRICE, EXAMINING ATTORNEY



**Int. Cl.: 3**

**Prior U.S. Cls.: 1, 4, 6, 50, 51 and 52**

**Reg. No. 3,498,156**

**United States Patent and Trademark Office**

**Registered Sep. 9, 2008**

**TRADEMARK  
PRINCIPAL REGISTER**

**D'ORGANIQUES ORIGINAL  
SPROUT**

THE ORIGINAL LITTLE SPROUT, LLC (CALIFORNIA LIMITED LIABILITY COMPANY)  
13615 OLD MORRO ROAD  
ATASCADERO, CA 93422

FOR: HAIR AND SKIN CARE PRODUCTS, NAMELY, BABY, CHILDREN'S AND ADULT SHAMPOOS, HAIR DETANGLERS, SKIN LOTIONS, SKIN CREAMS, HAIR CONDITIONERS, HAIR GEL, HAIR CARE PREPARATIONS, NAMELY, HAIR RELAXER, BATH WASH, NAMELY, BATH FOAM, BODY WASH, BODY BALMS, AROMA THERAPY PRODUCTS, NAMELY, SHOWER GELS AND BODY LOTION, BAR SOAP, BATH GELS, BATH OILS, BATH SALTS, BLUSH, BLUSHERS, BODY MISTS, BODY MOISTURIZERS, BUBBLE BATH, COLD CREAM, COLOGNES, COLOR COSMETICS, HAIR CONDITIONERS, SKIN CREAMS, DEODORANT SOAP, DEPILATORY CREAMS, ESSENTIAL OILS FOR PERSONAL USE, EYE MAKEUP REMOVER, EYE MAKEUP, EYE PENCILS, EYE SHADOW, EYEBROW PENCILS, EYELINERS, FACE POWDERS, FACIAL MASKS, FACIAL SCRUBS, FOOT CARE PRODUCTS, NAMELY, NON-MEDICATED FOOT CREAM, FOUNDATION MAKEUP, GLYCERIN SOAP, HAIR DYE, HAIR GELS, HAIR LIGHTENERS, HAIR REMOVING CREAM, HAIR RINSES, HAIR SPRAY, HAIR STYLING PREPARATIONS, HAND CREAMS, LIP BALMS, LIP GLOSS, PENCILS FOR COSMETIC PURPOSES, NAMELY, LIP PENCILS, LIPSTICK, LIQUID SOAP, SKIN LOTIONS, MAKE UP BASES, MAKEUP, MASCARA, SKIN MOISTURIZERS, HAIR MOUSSE, MOUTHWASH, NAIL LACQUER AND GLITTER, NAIL POLISH TOP COAT, NAIL POLISH, NIGHT CREAM, NON-MEDICATED HAIR CARE PREPARATIONS, NON-MEDI-

CATED LIP BALM, PERFUMES, PERSONAL DEODORANTS, POMADE, ROUGE, SHAVING CREAM, SHAVING GEL, SHOWER GELS, SKIN CLARIFIERS, SKIN CLEANSING CREAM, SKIN CLEANSING LOTIONS, SKIN SOAP, SKIN TONERS, BODY SOAPS, TALCUM POWDER, TOOTHPASTE, TOOTH POWDERS, VANISHING CREAMS, WRINKLE REMOVING SKIN CARE PREPARATIONS, SUN CARE PRODUCTS, NAMELY, SUN BLOCK LOTIONS, SUN TANNING PREPARATIONS, HAIR GELS, SKIN LOTIONS, HAIR SPRAYS, AFTER SUN LOTION SUNSCREEN, NON MEDICATED PET SHAMPOO AND BODY SPRAY, ALL MADE FROM ORGANIC INGREDIENTS, IN CLASS 3 (U.S. CLS. 1, 4, 6, 50, 51 AND 52).

FIRST USE 4-2-2007; IN COMMERCE 4-2-2007.

THE MARK CONSISTS OF STANDARD CHARACTERS WITHOUT CLAIM TO ANY PARTICULAR FONT, STYLE, SIZE, OR COLOR.

OWNER OF U.S. REG. NO. 3,021,733.

NO CLAIM IS MADE TO THE EXCLUSIVE RIGHT TO USE "D'ORGANIQUES ORIGINAL", APART FROM THE MARK AS SHOWN.

"THE FOREIGN WORDING IN THE MARK TRANSLATES INTO ENGLISH AS WITH ORGANICS."

SER. NO. 77-288,849, FILED 9-25-2007.

ESTHER BELENKER, EXAMINING ATTORNEY

**Int. Cl.: 7**

**Prior U.S. Cls.: 13, 19, 21, 23, 31, 34 and 35**

**United States Patent and Trademark Office**

**Reg. No. 3,498,157**

**Registered Sep. 9, 2008**

**TRADEMARK  
PRINCIPAL REGISTER**

**VON WEISE**

TECUMSEH CANADA HOLDING COMPANY  
(DELAWARE CORPORATION)  
402 E. HAVEN STREET  
EATON RAPIDS, MI 48827

THE MARK CONSISTS OF STANDARD CHAR-  
ACTERS WITHOUT CLAIM TO ANY PARTICULAR  
FONT, STYLE, SIZE, OR COLOR.

FOR: ELECTRIC MOTORS; DC ELECTRIC MO-  
TORS FOR AUTOMOTIVE SEAT ACTUATORS,  
GASOLINE ENGINE STARTER MOTORS AND  
GEAR MOTORS, IN CLASS 7 (U.S. CLS. 13, 19, 21,  
23, 31, 34 AND 35).

SEC. 2(F).

SER. NO. 77-289,576, FILED 9-26-2007.

FIRST USE 0-0-1952; IN COMMERCE 0-0-1952.

JOHN DALIER, EXAMINING ATTORNEY

**Int. Cl.: 5**

**Prior U.S. Cls.: 6, 18, 44, 46, 51 and 52**

**United States Patent and Trademark Office**

**Reg. No. 3,498,158**

**Registered Sep. 9, 2008**

**TRADEMARK  
PRINCIPAL REGISTER**

**ALKYL TRANSFACTOR**

SEABIOTICS, INC. (TEXAS CORPORATION)  
1000 HIGH WILLOW DRIVE  
PROSPER, TX 75078

FOR: DIETARY AND NUTRITIONAL SUPPLEMENTS; DIETARY FOOD SUPPLEMENTS; DIETARY SUPPLEMENTAL DRINKS, IN CLASS 5 (U.S. CLS. 6, 18, 44, 46, 51 AND 52).

FIRST USE 9-10-2003; IN COMMERCE 9-10-2003.

THE MARK CONSISTS OF STANDARD CHARACTERS WITHOUT CLAIM TO ANY PARTICULAR FONT, STYLE, SIZE, OR COLOR.

NO CLAIM IS MADE TO THE EXCLUSIVE RIGHT TO USE "ALKYL", APART FROM THE MARK AS SHOWN.

THE WORDING "ALKYL" HAS NO MEANING IN A FOREIGN LANGUAGE.

SER. NO. 77-289,924, FILED 9-26-2007.

AMY GEARIN, EXAMINING ATTORNEY

**Int. Cl.: 10**

**Prior U.S. Cls.: 26, 39 and 44**

**United States Patent and Trademark Office**

**Reg. No. 3,498,159**

**Registered Sep. 9, 2008**

**TRADEMARK  
PRINCIPAL REGISTER**

TRANSCATHETER EXTRACTOR

TRAN HOLDINGS, LLC (FLORIDA LIMITED  
LIABILITY COMPANY)  
SUITE 1500  
390 N. ORANGE AVENUE  
ORLANDO, FL 32801

FOR: SURGICAL APPARATUS, NAMELY, CA-  
THETER EXTRACTORS, IN CLASS 10 (U.S. CLS. 26,  
39 AND 44).

FIRST USE 1-0-2007; IN COMMERCE 1-0-2007.

THE MARK CONSISTS OF STANDARD CHAR-  
ACTERS WITHOUT CLAIM TO ANY PARTICULAR  
FONT, STYLE, SIZE, OR COLOR.

NO CLAIM IS MADE TO THE EXCLUSIVE  
RIGHT TO USE "EXTRACTOR", APART FROM  
THE MARK AS SHOWN.

SER. NO. 77-290,353, FILED 9-27-2007.

WON TEAK OH, EXAMINING ATTORNEY

**Int. Cls.: 9 and 41**

**Prior U.S. Cls.: 21, 23, 26, 36, 38, 100, 101 and 107**

**Reg. No. 3,498,160**

**United States Patent and Trademark Office**

**Registered Sep. 9, 2008**

**TRADEMARK  
SERVICE MARK  
PRINCIPAL REGISTER**

# Spiritual Adulthood

LANDAU, MARIANGELA PINO (UNITED STATES INDIVIDUAL)  
PO BOX 386  
SPRINGDALE, UT 84767

FOR: DIGITAL MEDIA, NAMELY, CDS, DVDS, DOWNLOADABLE AUDIO, MULTIMEDIA, AND VIDEO FILES, AND DOWNLOADABLE PODCASTS, FEATURING WORKSHOPS, CONFERENCES, LECTURES, SEMINARS IN THE FIELDS OF SPIRITUALITY, RELIGION, PHILOSOPHY, AND SELF-IMPROVEMENT; PRE-RECORDED CDS, VIDEO TAPES, LASER DISKS AND DVDS FEATURING WORKSHOPS, CONFERENCES, LECTURES, SEMINARS IN THE FIELDS OF SPIRITUALITY, RELIGION, PHILOSOPHY, AND SELF-IMPROVEMENT; DOWNLOADABLE ELECTRONIC PUBLICATIONS IN THE NATURE OF WORKSHOPS, CONFERENCES, LECTURES, SEMINARS IN THE FIELD OF SPIRITUALITY; DOWNLOADABLE WEBCASTS IN THE FIELD OF SPIRITUALITY, IN CLASS 9 (U.S. CLS. 21, 23, 26, 36 AND 38).

FIRST USE 9-21-2007; IN COMMERCE 9-21-2007.

FOR: EDUCATION SERVICES, NAMELY, PROVIDING LIVE AND ON-LINE WORKSHOPS, CONFERENCES, LECTURES, SEMINARS IN THE FIELD

OF SPIRITUALITY; EDUCATIONAL SERVICES, NAMELY, PROVIDING WORKSHOPS, CONFERENCES, LECTURES, SEMINARS IN THE FIELDS OF SPIRITUALITY, SELF IMPROVEMENT, PHILOSOPHY, AND RELIGION; EDUCATIONAL SERVICES, NAMELY, CONDUCTING WORKSHOPS, CONFERENCES, LECTURES, SEMINARS IN THE FIELD OF SPIRITUALITY, AND DISTRIBUTION OF COURSE MATERIAL IN CONNECTION THEREWITH; PROVIDING ON-LINE PUBLICATIONS IN THE NATURE OF WORKSHOPS, CONFERENCES, LECTURES, SEMINARS IN THE FIELD OF SPIRITUALITY, IN CLASS 41 (U.S. CLS. 100, 101 AND 107).

FIRST USE 9-21-2007; IN COMMERCE 9-21-2007.

THE MARK CONSISTS OF STANDARD CHARACTERS WITHOUT CLAIM TO ANY PARTICULAR FONT, STYLE, SIZE, OR COLOR.

NO CLAIM IS MADE TO THE EXCLUSIVE RIGHT TO USE "SPIRITUAL", APART FROM THE MARK AS SHOWN.

SER. NO. 77-290,753, FILED 9-27-2007.

JORDAN BAKER, EXAMINING ATTORNEY

**Int. Cl.: 22**

**Prior U.S. Cls.: 1, 2, 7, 19, 22, 42 and 50**

**Reg. No. 3,498,161**

**United States Patent and Trademark Office**

**Registered Sep. 9, 2008**

**TRADEMARK  
PRINCIPAL REGISTER**

**BUTTON-LOK**

THERMO MANUFACTURING, INC. (OHIO CORPORATION)  
3709 COLUMBUS RD. NE  
CANTON, OH 44705

FOR: PLASTIC HANGER STRAPS, NAMELY, ALL-PURPOSE STRAPS OF PLASTIC, IN CLASS 22 (U.S. CLS. 1, 2, 7, 19, 22, 42 AND 50).

FIRST USE 9-21-2007; IN COMMERCE 9-21-2007.

THE MARK CONSISTS OF STANDARD CHARACTERS WITHOUT CLAIM TO ANY PARTICULAR FONT, STYLE, SIZE, OR COLOR.

OWNER OF U.S. REG. NO. 2,495,356.

SER. NO. 77-290,780, FILED 9-27-2007.

SEAN CROWLEY, EXAMINING ATTORNEY

**Int. Cl.: 3**

**Prior U.S. Cls.: 1, 4, 6, 50, 51 and 52**

**United States Patent and Trademark Office**

**Reg. No. 3,498,162**

**Registered Sep. 9, 2008**

**TRADEMARK  
PRINCIPAL REGISTER**

**RITMIX**

L'OREAL (FRANCE SOCIÉTÉ ANONYME (SA))  
14 RUE ROYALE  
PARIS, FRANCE 75008

FOR: SHAMPOOS; GELS, SPRAYS, MOUSSES  
AND BALMS FOR THE HAIR STYLING AND HAIR  
CARE; HAIR LACQUERS; HAIR COLOURING AND  
HAIR DECOLORANT PREPARATIONS; PERMA-  
NENT HAIR WAVING AND HAIR CURLING PRE-  
PARATIONS; ESSENTIAL OILS FOR PERSONAL  
USE, IN CLASS 3 (U.S. CLS. 1, 4, 6, 50, 51 AND 52).

THE MARK CONSISTS OF STANDARD CHAR-  
ACTERS WITHOUT CLAIM TO ANY PARTICULAR  
FONT, STYLE, SIZE, OR COLOR.

PRIORITY CLAIMED UNDER SEC. 44(D) ON  
FRANCE APPLICATION NO. 073493424, FILED 4-6-  
2007, REG. NO. 073493424, DATED 4-6-2007, EXPIRES  
4-6-2017.

SER. NO. 77-291,174, FILED 9-28-2007.

CHRIS DONINGER, EXAMINING ATTORNEY

**Int. Cls.: 41 and 44**

**Prior U.S. Cls.: 100, 101 and 107**

**United States Patent and Trademark Office**

**Reg. No. 3,498,163**

**Registered Sep. 9, 2008**

**SERVICE MARK  
PRINCIPAL REGISTER**

**WE'LL BE THERE WHEN YOU  
CAN'T**

CRAWFORD & COMPANY (GEORGIA CORPORATION)  
1001 SUMMIT BLVD,  
ATLANTA, GA 30319

FOR: TRAINING SERVICES IN THE FIELD OF CARING FOR THE AGING AND DISABLED PERSONS, IN CLASS 41 (U.S. CLS. 100, 101 AND 107).

FIRST USE 1-1-2004; IN COMMERCE 1-1-2004.

FOR: PROVIDING HEALTH CARE CONSULTATION SERVICES FOR INDIVIDUALS AND FAMILIES SEEKING LONG TERM CARE FOR GERIATRIC AND DISABLED PERSONS, IN THE NATURE OF

ASSESSMENT, PLACEMENT IN LONG TERM CARE FACILITIES, AND MONITORING OF MEDICAL NEEDS, IN CLASS 44 (U.S. CLS. 100 AND 101).

FIRST USE 1-1-2004; IN COMMERCE 1-1-2004.

THE MARK CONSISTS OF STANDARD CHARACTERS WITHOUT CLAIM TO ANY PARTICULAR FONT, STYLE, SIZE, OR COLOR.

SER. NO. 77-291,537, FILED 9-28-2007.

VERNA BETH RIRIE, EXAMINING ATTORNEY



**Int. Cl.: 28**

**Prior U.S. Cls.: 22, 23, 38 and 50**

**United States Patent and Trademark Office**

**Reg. No. 3,498,164**

**Registered Sep. 9, 2008**

**TRADEMARK  
PRINCIPAL REGISTER**

**BATTLE BOARD**

MATTEL, INC. (DELAWARE CORPORATION)  
M1-1518  
333 CONTINENTAL BLVD.  
EL SEGUNDO, CA 90245

FOR: TOYS, GAMES AND PLAYTHINGS, NAME-  
LY, TOY VEHICLES, TOY FIGURES, AND ACCES-  
SORIES FOR ALL OF THE FOREGOING, IN CLASS  
28 (U.S. CLS. 22, 23, 38 AND 50).

FIRST USE 4-18-2008; IN COMMERCE 4-18-2008.

THE MARK CONSISTS OF STANDARD CHAR-  
ACTERS WITHOUT CLAIM TO ANY PARTICULAR  
FONT, STYLE, SIZE, OR COLOR.

OWNER OF U.S. REG. NO. 2,958,030.

SER. NO. 77-291,569, FILED 9-28-2007.

LINDA MICKLEBURGH, EXAMINING ATTORNEY

Int. Cl.: 45

Prior U.S. Cls.: 100 and 101

**United States Patent and Trademark Office**

**Reg. No. 3,498,165**

Registered Sep. 9, 2008

**SERVICE MARK  
PRINCIPAL REGISTER**



CIRELLO & VESSICCHIO, LLC (CONNECTICUT  
LIMITED LIABILITY COMPANY)  
142 TEMPLE ST., 2ND FLOOR  
NEW HAVEN, CT 06510

FOR: LEGAL SERVICES AND LEGAL CONSULTATION, IN CLASS 45 (U.S. CLS. 100 AND 101).

FIRST USE 9-15-2007; IN COMMERCE 9-15-2007.

NO CLAIM IS MADE TO THE EXCLUSIVE RIGHT TO USE "LAWYER", APART FROM THE MARK AS SHOWN.

THE MARK CONSISTS OF THE STYLIZED WORD "LAWYER", THE STYLIZED WORD "YOU" SURROUNDED BY A CIRCLE, AND THE DESIGN OF A SCALE.

SER. NO. 77-292,186, FILED 9-28-2007.

EMILY CARLSEN, EXAMINING ATTORNEY

**Int. Cl.: 14**

**Prior U.S. Cls.: 2, 27, 28 and 50**

**United States Patent and Trademark Office**

**Reg. No. 3,498,166**

**Registered Sep. 9, 2008**

**TRADEMARK  
PRINCIPAL REGISTER**

# Finn Jules Jewelry

KIRKLAND, PATRICIA (UNITED STATES INDIVIDUAL), DBA FINN JULES JEWELRY  
SUITE 600B  
195 CHRYSYIE STREET  
NEW YORK, NY 10002

FOR: JEWELRY, NAMELY, RINGS, NECKLACES, CUFF LINKS, EARRINGS AND PENDANTS, IN CLASS 14 (U.S. CLS. 2, 27, 28 AND 50).

FIRST USE 1-5-2005; IN COMMERCE 5-29-2007.

THE MARK CONSISTS OF STANDARD CHARACTERS WITHOUT CLAIM TO ANY PARTICULAR FONT, STYLE, SIZE, OR COLOR.

NO CLAIM IS MADE TO THE EXCLUSIVE RIGHT TO USE "JEWELRY", APART FROM THE MARK AS SHOWN.

THE NAME "FINN JULES" IDENTIFIES A LIVING INDIVIDUAL WHOSE CONSENT IS OF RECORD.

SER. NO. 77-292,258, FILED 9-29-2007.

ADA HAN, EXAMINING ATTORNEY

**Int. Cls.: 9 and 41**

**Prior U.S. Cls.: 21, 23, 26, 36, 38, 100, 101 and 107**

**Reg. No. 3,498,167**

**United States Patent and Trademark Office**

**Registered Sep. 9, 2008**

**TRADEMARK  
SERVICE MARK  
PRINCIPAL REGISTER**

# Karmic Conspiracy

LANDAU, MARIANGELA PINO (UNITED STATES INDIVIDUAL)  
PO BOX 386  
SPRINGDALE, UT 84767 AND  
THE CENTER FOR TRUE NORTH, LLC (UTAH LIMITED LIABILITY COMPANY)  
P.O. BOX 386  
SPRINGDALE, UT 84767

FOR: DIGITAL MEDIA, NAMELY, CDS, DVDS, ON-LINE DOWNLOADS, PODCASTS FEATURING WORKSHOPS, CONFERENCES, LECTURES, SEMINARS IN THE FIELDS OF SPIRITUALITY, RELIGION, PHILOSOPHY, AND SELF-IMPROVEMENT; PRE-RECORDED CDS, VIDEO TAPES, LASER DISKS AND DVDS FEATURING WORKSHOPS, CONFERENCES, LECTURES, SEMINARS IN THE FIELDS OF SPIRITUALITY, RELIGION, PHILOSOPHY, AND SELF-IMPROVEMENT; DOWNLOADABLE ELECTRONIC PUBLICATIONS IN THE NATURE OF WORKSHOPS, CONFERENCES, LECTURES, SEMINARS IN THE FIELD OF SPIRITUALITY; DOWNLOADABLE WEBCASTS IN THE FIELD OF SPIRITUALITY, IN CLASS 9 (U.S. CLS. 21, 23, 26, 36 AND 38).

FIRST USE 9-21-2007; IN COMMERCE 9-21-2007.

FOR: EDUCATION SERVICES, NAMELY, PROVIDING LIVE AND ON-LINE WORKSHOPS, CONFERENCES, LECTURES, SEMINARS IN THE FIELD OF SPIRITUALITY; EDUCATIONAL SERVICES, NAMELY, PROVIDING WORKSHOPS, CONFERENCES, LECTURES, SEMINARS IN THE FIELDS OF SPIRITUALITY, SELF IMPROVEMENT, PHILOSOPHY, AND RELIGION; EDUCATIONAL SERVICES, NAMELY, CONDUCTING WORKSHOPS, CONFERENCES, LECTURES, SEMINARS IN THE FIELD OF SPIRITUALITY AND DISTRIBUTION OF COURSE MATERIAL IN CONNECTION THEREWITH; PROVIDING ON-LINE PUBLICATIONS IN THE NATURE OF WORKSHOPS, CONFERENCES, LECTURES, SEMINARS IN THE FIELD OF SPIRITUALITY, IN CLASS 41 (U.S. CLS. 100, 101 AND 107).

FIRST USE 9-21-2007; IN COMMERCE 9-21-2007.

THE MARK CONSISTS OF STANDARD CHARACTERS WITHOUT CLAIM TO ANY PARTICULAR FONT, STYLE, SIZE, OR COLOR.

SER. NO. 77-292,278, FILED 9-29-2007.

JORDAN BAKER, EXAMINING ATTORNEY

**Int. Cl.: 34**

**Prior U.S. Cls.: 2, 8, 9 and 17**

**United States Patent and Trademark Office**

**Reg. No. 3,498,168**

**Registered Sep. 9, 2008**

**TRADEMARK  
PRINCIPAL REGISTER**

**ALIADOS**

PUROS INDIOS CIGARS, INC. (FLORIDA CORPORATION)  
114 N.W. 22ND AVENUE  
MIAMI, FL 33125

FOR: CIGARS, IN CLASS 34 (U.S. CLS. 2, 8, 9 AND 17).

FIRST USE 8-1-1957; IN COMMERCE 6-15-1978.

THE MARK CONSISTS OF STANDARD CHARACTERS WITHOUT CLAIM TO ANY PARTICULAR FONT, STYLE, SIZE, OR COLOR.

OWNER OF U.S. REG. NO. 2,039,757.

THE FOREIGN WORDING IN THE MARK TRANSLATES INTO ENGLISH AS UNITED.

SER. NO. 77-292,533, FILED 10-1-2007.

TINA BROWN, EXAMINING ATTORNEY

**Int. Cl.: 26**

**Prior U.S. Cls.: 37, 39, 40, 42 and 50**

**United States Patent and Trademark Office**

**Reg. No. 3,498,169**

**Registered Sep. 9, 2008**

**TRADEMARK  
PRINCIPAL REGISTER**

**Hair Addictionz  
get addicted**

HAIR ADDICTIONZ, LLC (ARIZONA LIMITED  
LIABILITY COMPANY)

15045 W. WINDSOR AVE.

GOODYEAR, AZ 85395

FOR: HAIR EXTENSIONS, IN CLASS 26 (U.S. CLS.  
37, 39, 40, 42 AND 50).

FIRST USE 5-28-2007; IN COMMERCE 5-28-2007.

THE MARK CONSISTS OF STANDARD CHAR-  
ACTERS WITHOUT CLAIM TO ANY PARTICULAR  
FONT, STYLE, SIZE, OR COLOR.

NO CLAIM IS MADE TO THE EXCLUSIVE  
RIGHT TO USE "HAIR", APART FROM THE MARK  
AS SHOWN.

SER. NO. 77-292,917, FILED 10-1-2007.

KIMBERLY PERRY, EXAMINING ATTORNEY

**Int. Cl.: 35**

**Prior U.S. Cls.: 100, 101 and 102**

**United States Patent and Trademark Office**

**Reg. No. 3,498,170**

**Registered Sep. 9, 2008**

**SERVICE MARK  
PRINCIPAL REGISTER**

**VOYAGE**

VOYAGE IP, LLC (FLORIDA LIMITED LIABILITY COMPANY)  
SUITE 2051  
1485 INTERNATIONAL PARKWAY  
HEATHROW, FL 32746

FOR: INTERNET-BASED RECRUITING, PLACEMENT AND STAFFING OF PERSONNEL ON A TEMPORARY CONTRACTUAL BASIS IN THE FIELDS OF REHABILITATIVE THERAPY, INCLUDING PHYSICAL THERAPY, OCCUPATIONAL THERAPY, AND SPEECH THERAPY, NURSING, PHYSICIAN ASSISTANTS, MEDICAL ASSISTANTS, DIAGNOSTIC IMAGING, RESPIRATORY, SLEEP TECHNICIANS, PHARMACISTS, PHARMACY TECHNICIANS, FINANCE PROFESSIONALS, ACCOUNTANTS AND ACCOUNTING ASSISTANTS AND CLERKS, BUSINESS MANAGERS AND EXECUTIVES, INFORMATION TECHNOLOGY PRO-

FESSIONALS, COMPUTER PROGRAMMERS, WEBSITE CODING AND DESIGN PROFESSIONALS, LIGHT INDUSTRIAL AND WAREHOUSE WORKERS, CONVENTION STAFFING, ADMINISTRATIVE PROFESSIONALS, ASSISTANTS AND CLERKS, EXECUTIVE ASSISTANTS, LAWYERS, PARALEGALS, AND LEGAL SECRETARIES, IN CLASS 35 (U.S. CLS. 100, 101 AND 102).

FIRST USE 6-30-2006; IN COMMERCE 6-30-2006.

THE MARK CONSISTS OF STANDARD CHARACTERS WITHOUT CLAIM TO ANY PARTICULAR FONT, STYLE, SIZE, OR COLOR.

SER. NO. 77-293,392, FILED 10-1-2007.

TAMARA FRAZIER, EXAMINING ATTORNEY

Int. Cl.: 35

Prior U.S. Cls.: 100, 101 and 102

United States Patent and Trademark Office

Reg. No. 3,498,171

Registered Sep. 9, 2008

**SERVICE MARK  
PRINCIPAL REGISTER**



COLLINS, TIMOTHY T. (UNITED STATES INDIVIDUAL)  
CALLE PRINCIPAL # 4  
PALMER, PUERTO RICO 00721

FOR: MAIL ORDER CATALOG, ONLINE RETAIL STORE, RETAIL GIFT SHOP, AND RETAIL STORE SERVICES ALL FEATURING ARTS AND CRAFTS ITEMS, BOOKS, TOYS, FOOD PRODUCTS, NAMELY, HERBS, SPICES, TEA, COFFEE, CONDIMENTS, SAUCES, CANDIES, COSMETICS, FRAGRANCES, HAIR CARE PRODUCTS, AND SKIN CARE PRODUCTS, IN CLASS 35 (U.S. CLS. 100, 101 AND 102).

FIRST USE 6-1-2005; IN COMMERCE 6-1-2005.

OWNER OF U.S. REG. NO. 3,077,309.

NO CLAIM IS MADE TO THE EXCLUSIVE RIGHT TO USE "CARIBBEAN TRADING COMPANY", APART FROM THE MARK AS SHOWN.

THE MARK CONSISTS OF A YELLOW SUN SURROUNDED BY BLUE WAVES IN AN OVAL SHAPE WITH GREEN PALM TREE AND MOUNTAINS CONTAINED WITHIN PLACED ON A BROWN SCROLL THAT RESTS ON TOP OF A BROWN SHIP'S WHEEL WITH THE BLACK WORDS "CARIBBEAN TRADING COMPANY" IN A SEMI CIRCLE SURROUNDING THE IMAGE.

SER. NO. 77-293,629, FILED 10-2-2007.

KELLY BOULTON, EXAMINING ATTORNEY



**Int. Cl.: 3**

**Prior U.S. Cls.: 1, 4, 6, 50, 51 and 52**

**United States Patent and Trademark Office**

**Reg. No. 3,498,172**

**Registered Sep. 9, 2008**

**TRADEMARK  
PRINCIPAL REGISTER**

**SUTERA**

PEEKAY, INC. (WASHINGTON CORPORATION)  
901 W. MAIN  
SUITE A  
AUBURN, WA 980015280

FOR: CLEANING LIQUID FOR ADULT SEXUAL  
STIMULATION DEVICES AND INCENSE, IN CLASS  
3 (U.S. CLS. 1, 4, 6, 50, 51 AND 52).

FIRST USE 3-1-2006; IN COMMERCE 3-1-2006.

THE MARK CONSISTS OF STANDARD CHAR-  
ACTERS WITHOUT CLAIM TO ANY PARTICULAR  
FONT, STYLE, SIZE, OR COLOR.

OWNER OF U.S. REG. NO. 3,283,605.

SEC. 2(F).

SER. NO. 77-293,736, FILED 10-2-2007.

JOHN SCHUYLER YARD, EXAMINING ATTOR-  
NEY

**Int. Cl.: 16**

**Prior U.S. Cls.: 2, 5, 22, 23, 29, 37, 38 and 50**

**Reg. No. 3,498,173**

**United States Patent and Trademark Office**

**Registered Sep. 9, 2008**

**TRADEMARK  
PRINCIPAL REGISTER**



LEISURE PUBLISHING, LLC (FLORIDA LIMITED LIABILITY COMPANY)

7598 W. SAND LAKE ROAD

ORLANDO, FL 32819

FOR: MAGAZINES FEATURING CELEBRITIES AND ENTERTAINMENT, IN CLASS 16 (U.S. CLS. 2, 5, 22, 23, 29, 37, 38 AND 50).

FIRST USE 2-1-2002; IN COMMERCE 2-1-2002.

NO CLAIM IS MADE TO THE EXCLUSIVE RIGHT TO USE "POP STAR", APART FROM THE MARK AS SHOWN.

THE MARK CONSISTS OF A SINGLE FIVE POINT STAR ON TOP OF A CIRCLE DESIGN WITH THE TERM "POPSTAR!" ON TOP OF THE STAR AND CIRCLE DESIGN.

SER. NO. 77-293,991, FILED 10-2-2007.

ERNEST SHOSHO, EXAMINING ATTORNEY

**Int. Cl.: 35**

**Prior U.S. Cls.: 100, 101 and 102**

**United States Patent and Trademark Office**

**Reg. No. 3,498,174**

**Registered Sep. 9, 2008**

**SERVICE MARK  
PRINCIPAL REGISTER**

# Fox Run Tools

FOX RUN TOOLS LLC (NEW HAMPSHIRE LIMITED LIABILITY COMPANY)  
3 FOX RUN RD  
AMHERST, NH 03031

FOR: ON-LINE RETAIL STORE SERVICES FEATURING AUTOMOTIVE AND INDUSTRIAL TOOLS; RETAIL SERVICES BY DIRECT SOLICITATION BY SALES AGENTS IN THE FIELD OF AUTOMOTIVE AND INDUSTRIAL TOOLS, IN CLASS 35 (U.S. CLS. 100, 101 AND 102).

FIRST USE 6-30-2005; IN COMMERCE 6-30-2005.

THE MARK CONSISTS OF STANDARD CHARACTERS WITHOUT CLAIM TO ANY PARTICULAR FONT, STYLE, SIZE, OR COLOR.

NO CLAIM IS MADE TO THE EXCLUSIVE RIGHT TO USE "TOOLS", APART FROM THE MARK AS SHOWN.

SER. NO. 77-294,218, FILED 10-2-2007.

BARBARA GAYNOR, EXAMINING ATTORNEY

**Int. Cl.: 5**

**Prior U.S. Cls.: 6, 18, 44, 46, 51 and 52**

**Reg. No. 3,498,175**

**United States Patent and Trademark Office**

**Registered Sep. 9, 2008**

**TRADEMARK  
PRINCIPAL REGISTER**

**ISO-pax**

NEXT PROTEINS, INC. (CALIFORNIA CORPORATION)  
SUITE 350  
5050 AVENIDA ENCINAS  
CARLSBAD, CA 92008

FOR: NUTRITIONAL SUPPLEMENT PREPARATIONS, NAMELY, PROTEIN SUPPLEMENT BEVERAGES AND PROTEIN SUPPLEMENT BEVERAGE CONCENTRATED POWDERS FOR USE AS A SUPPLEMENT DRINK MIX, NAMELY, PREPACKAGED INDIVIDUAL SERVING PROTEIN SUPPLEMENT BEVERAGE CONCENTRATED POWDERS, BULK PACKAGED PROTEIN SUPPLEMENT BEVERAGE CONCENTRATED POWDERS, AND MULTI-PACKS OF PREPACKAGED INDIVIDUAL SERVING PROTEIN SUPPLEMENT BEVERAGE CONCENTRATED POWDERS; AND NUTRITIONAL SUPPLEMENTS IN THE FORM OF PROTEIN SUPPLEMENT CONCENTRATED SYR-

UPS FOR ADDITION TO OTHER DRINKS, NAMELY, PREPACKAGED INDIVIDUAL SERVING PROTEIN SUPPLEMENT BEVERAGE CONCENTRATED SYRUPS, BULK PACKAGED PROTEIN SUPPLEMENT BEVERAGE CONCENTRATED SYRUPS, AND MULTI-PACKS OF PREPACKAGED INDIVIDUAL SERVING PROTEIN SUPPLEMENT BEVERAGE CONCENTRATED SYRUPS, IN CLASS 5 (U.S. CLS. 6, 18, 44, 46, 51 AND 52).

FIRST USE 5-2-2007; IN COMMERCE 5-2-2007.

THE MARK CONSISTS OF STANDARD CHARACTERS WITHOUT CLAIM TO ANY PARTICULAR FONT, STYLE, SIZE, OR COLOR.

SER. NO. 77-294,258, FILED 10-2-2007.

ZACHARY BELLO, EXAMINING ATTORNEY

**Int. Cls.: 37 and 42**

**Prior U.S. Cls.: 100, 101, 103 and 106**

**United States Patent and Trademark Office**

**Reg. No. 3,498,176**

**Registered Sep. 9, 2008**

**SERVICE MARK  
PRINCIPAL REGISTER**

**GLOBAL ENGINEERING  
SOLUTIONS**

GLOBAL ENGINEERING SOLUTIONS, INC.  
(MARYLAND CORPORATION)  
SUITE 360  
1355 PICCARD DRIVE  
ROCKVILLE, MD 20850

FOR: GENERAL BUILDING CONSTRUCTION MANAGEMENT, MASTER CONSTRUCTION PLANNING, DESIGN-BUILD CONSTRUCTION MANAGEMENT, CONSTRUCTION CONSULTATION AND CONSTRUCTION CONSULTATION FEATURING FEASIBILITY STUDIES; REPAIR AND RESTORATION OF HISTORIC BUILDINGS, IN CLASS 37 (U.S. CLS. 100, 103 AND 106).

FIRST USE 6-27-2002; IN COMMERCE 6-27-2002.

FOR: ENGINEERING SERVICES IN THE FIELD OF MECHANICAL, ELECTRICAL, PLUMBING AND FIRE PROTECTION FOR THE CONSTRUCTION, RENOVATION AND RESTORATION OF BUILDINGS; DESIGN FOR OTHERS IN THE FIELD OF NEW COMMERCIAL, RESIDENTIAL AND GOVERNMENT BUILDINGS; DESIGN FOR OTHERS IN THE FIELD OF MECHANICAL, ELECTRICAL, PLUMBING AND FIRE PROTECTION SYSTEMS FOR BUILDINGS, IN CLASS 42 (U.S. CLS. 100 AND 101).

FIRST USE 6-27-2002; IN COMMERCE 6-27-2002.

THE MARK CONSISTS OF STANDARD CHARACTERS WITHOUT CLAIM TO ANY PARTICULAR FONT, STYLE, SIZE, OR COLOR.

SER. NO. 77-295,062, FILED 10-3-2007.

DAWN HAN, EXAMINING ATTORNEY

**Int. Cl.: 35**

**Prior U.S. Cls.: 100, 101 and 102**

**United States Patent and Trademark Office**

**Reg. No. 3,498,177**

**Registered Sep. 9, 2008**

**SERVICE MARK  
PRINCIPAL REGISTER**

**JOHN HANCOCK ROLLOVER  
REWARDS**

JOHN HANCOCK LIFE INSURANCE COMPANY  
(U.S.A.) (MICHIGAN CORPORATION)  
601 CONGRESS STREET  
BOSTON, MA 02210

FOR: BUSINESS MARKETING SERVICES; PROVIDING BUSINESS MARKETING INFORMATION; PROVIDING AN INCENTIVE AWARD PROGRAM FOR QUALIFIED FINANCIAL AGENTS FOR THE PURPOSE OF PROMOTING AND REWARDING AGENT LOYALTY, AND FOR THE PURPOSE OF PROMOTING THE AVAILABILITY FOR RETIREMENT PLAN PARTICIPANTS OF INFORMATION AND EDUCATION SERVICES RELATING TO RETIREMENT PLANS, IN CLASS 35 (U.S. CLS. 100, 101 AND 102).

FIRST USE 11-5-2007; IN COMMERCE 11-5-2007.

THE MARK CONSISTS OF STANDARD CHARACTERS WITHOUT CLAIM TO ANY PARTICULAR FONT, STYLE, SIZE, OR COLOR.

OWNER OF U.S. REG. NO. 1,287,236.

NO CLAIM IS MADE TO THE EXCLUSIVE RIGHT TO USE "ROLLOVER REWARDS", APART FROM THE MARK AS SHOWN.

SER. NO. 77-296,962, FILED 10-5-2007.

MATTHEW MCDOWELL, EXAMINING ATTORNEY

Int. Cl.: 41

Prior U.S. Cls.: 100, 101 and 107

United States Patent and Trademark Office

Reg. No. 3,498,178

Registered Sep. 9, 2008

SERVICE MARK  
PRINCIPAL REGISTER



SPANISH CLUBHOUSE FOR KIDS (MISSOURI  
LIMITED LIABILITY COMPANY)

# 134

112 W. JEFFERSON  
KIRKWOOD, MO 63122

FOR: EDUCATIONAL SERVICES, NAMELY,  
PROVIDING CLASSES IN THE FIELDS OF FOR-  
EIGN LANGUAGES, IN CLASS 41 (U.S. CLS. 100, 101  
AND 107).

FIRST USE 1-1-2007; IN COMMERCE 1-1-2007.

THE MARK CONSISTS OF A CIRCULAR DE-  
SIGN. THE STYLIZED TAGLINE "FLUENT IN

FUN!" IS PLACED ABOVE THE LEFT HAND SIDE  
OF THE CIRCULAR LOGO. THERE IS A STAR FOR  
THE DOT ON THE LETTER "I" IN "IN". THERE ARE  
TWO FACES THAT PEEK OUT OF THE TYPE OF  
THE STYLIZED WORDS "SPANISH CLUBHOUSE  
FOR KIDS". THE FACES ARE CIRCULAR AND  
REPRESENT A GIRL AND A BOY. "CLUBHOUSE"  
IS PLACED BELOW THE WORD "SPANISH". THE  
STYLIZED WORDS "FOR KIDS" SITS BELOW THE  
CIRCLE.

SER. NO. 77-298,780, FILED 10-8-2007.

BRENDAN REGAN, EXAMINING ATTORNEY

Int. Cl.: 9

Prior U.S. Cls.: 21, 23, 26, 36 and 38

Reg. No. 3,498,179

United States Patent and Trademark Office

Registered Sep. 9, 2008

TRADEMARK  
PRINCIPAL REGISTER

The logo for "Mega Power" features the word "Mega" in a bold, outlined, sans-serif font above the word "Power", which is also in a bold, outlined, sans-serif font. The letters are thick and have a double-line outline.

GRUPO MEDIATICO REFORMA NORTE, S.A.  
DE C.V. (MEXICO CORPORATION)  
AMADO NERVO # 204 LADRÓN DE GUEVARA  
GUADALAJARA, MEXICO 44680

FOR: DIGITAL MEDIA PRODUCTS, NAME-  
LY, CDS, DVDS, DOWNLOADABLE AUDIO FILES FEATURING MOVIES, MUSIC; DIGITAL MEDIA PRODUCTS, NAME-  
LY, BLANK DIGITAL STORAGE MEDIA; UNRECORDED OPTICAL MEDIA, NAME-  
LY, BLANK OPTICAL DISK; BLANK DVDS AND CD-RS; FLASH MEMORY CARD; OPTICAL MEDIA PRODUCTS, NAME-  
LY, CDS, DVDS, DOWNLOAD-

ABLE AUDIO FILES FEATURING MOVIES, MUSIC,  
IN CLASS 9 (U.S. CLS. 21, 23, 26, 36 AND 38).

FIRST USE 3-5-2007; IN COMMERCE 3-5-2007.

THE MARK CONSISTS OF TWO WORDS, THE  
FIRST IS "MEGA" WHICH IS OVER THE SECOND  
WORD "POWER"..

SER. NO. 77-299,189, FILED 10-9-2007.

AISHA CLARKE, EXAMINING ATTORNEY



Int. Cl.: 35

Prior U.S. Cls.: 100, 101 and 102

United States Patent and Trademark Office

Reg. No. 3,498,180

Registered Sep. 9, 2008

**SERVICE MARK  
PRINCIPAL REGISTER**

**MONEY TONIC**

DOLLAR EXPRESS, INC. (CALIFORNIA CORPORATION)

#139

2934 1/2 BEVERLY GLEN CIRCLE

LOS ANGELES, CA 90077

FOR: OPERATING AN ON-LINE MARKET-PLACE FEATURING PRE-OWNED AND NEW GIFT CARDS, IN CLASS 35 (U.S. CLS. 100, 101 AND 102).

FIRST USE 10-9-2007; IN COMMERCE 10-9-2007.

THE MARK CONSISTS OF STANDARD CHARACTERS WITHOUT CLAIM TO ANY PARTICULAR FONT, STYLE, SIZE, OR COLOR.

OWNER OF U.S. REG. NO. 3,320,741.

NO CLAIM IS MADE TO THE EXCLUSIVE RIGHT TO USE "MONEY", APART FROM THE MARK AS SHOWN.

SER. NO. 77-299,508, FILED 10-9-2007.

DANIEL CAPSHAW, EXAMINING ATTORNEY

Int. Cl.: 31

Prior U.S. Cls.: 1 and 46

United States Patent and Trademark Office

Reg. No. 3,498,181

Registered Sep. 9, 2008

**TRADEMARK  
PRINCIPAL REGISTER**



INCREDIBLE EDIBLE BOUQUET, LLC (GEORGIA LIMITED LIABILITY COMPANY)  
SUITE A  
165 BRADFORD SQUARE  
FAYETTEVILLE, GA 30215

FOR: FRESH FRUITS, IN CLASS 31 (U.S. CLS. 1 AND 46).

FIRST USE 1-1-1998; IN COMMERCE 4-1-1998.

"THE COLOR(S) RED, BURGUNDY, YELLOW, BLACK, PURPLE, GREEN, BROWN, AND BEIGE IS/ARE CLAIMED AS A FEATURE OF THE MARK."

THE COLOR RED APPEARS IN THE STRAWBERRIES. THE COLOR BURGUNDY APPEARS IN THE CHERRIES. THE COLOR YELLOW APPEARS

IN THE STAR FRUIT, AND A LIGHTER SHADE OF YELLOW APPEARS IN BOTH THE STAR FRUIT AND THE CANTALOUPE. THE COLOR BLACK APPEARS IN THE OUTLINING OF THE FRUIT AND THE FRUIT BOWL, AND ALSO IN THE DOTS ON THE STRAWBERRIES. THE COLOR PURPLE APPEARS IN THE BLACKBERRIES. THE COLOR GREEN APPEARS IN THE LEAF OF THE GRAPE BUNCH AND IN THE STEMS OF THE STRAWBERRIES. A LIGHTER SHADE OF GREEN APPEARS IN THE GRAPES. THE COLOR BROWN APPEARS IN THE STEM OF THE GRAPES. THE COLOR BEIGE APPEARS ON THE FRUIT BOWL AND ON THE HULL OF THE CANTALOUPE.

SER. NO. 77-299,684, FILED 10-9-2007.

JENNIFER MARTIN, EXAMINING ATTORNEY

**Int. Cl.: 41**

**Prior U.S. Cls.: 100, 101 and 107**

**United States Patent and Trademark Office**

**Reg. No. 3,498,182**

**Registered Sep. 9, 2008**

**SERVICE MARK  
PRINCIPAL REGISTER**

# Sandler Training

SANDLER SYSTEMS, INC. (MARYLAND CORPORATION)  
300 RED BROOK BOULEVARD, SUITE 400  
OWINGS MILLS, MD 21117

FOR: EDUCATIONAL SERVICES, NAMELY, CONDUCTING TRAINING THROUGH SEMINARS, MEETINGS, WORKSHOPS AND ON-LINE PRESENTATIONS IN THE FIELD OF INCREASING THE EFFECTIVENESS OF PERSONS WHOSE GOAL IS TO EFFECTUATE PURCHASES OF PRODUCTS OR SERVICES, AND DISTRIBUTION OF COURSE MATERIAL IN CONNECTION THEREWITH, IN CLASS 41 (U.S. CLS. 100, 101 AND 107).

FIRST USE 10-4-2007; IN COMMERCE 10-4-2007.

THE MARK CONSISTS OF STANDARD CHARACTERS WITHOUT CLAIM TO ANY PARTICULAR FONT, STYLE, SIZE, OR COLOR.

OWNER OF U.S. REG. NOS. 1,774,492, 3,132,831 AND OTHERS.

NO CLAIM IS MADE TO THE EXCLUSIVE RIGHT TO USE "TRAINING", APART FROM THE MARK AS SHOWN.

SEC. 2(F) "SANDLER" HAS BECOME DISTINCTIVE OF THE GOODS/SERVICES AS EVIDENCED BY THE OWNERSHIP ON THE PRINCIPAL REGISTER FOR THE SAME MARK FOR RELATED GOODS OR SERVICES OF U.S. REGISTRATION NO(S)1774492, 1835750, 2654595, 2957236, 2077423, 3132831, 3120050, 1814148, 2494343, 2498251, 3044634, 2561465, 2663420, 2943833, 2862743 .".

SER. NO. 77-299,686, FILED 10-9-2007.

BRIAN NEVILLE, EXAMINING ATTORNEY

**Int. Cl.: 17**

**Prior U.S. Cls.: 1, 5, 12, 13, 35 and 50**

**United States Patent and Trademark Office**

**Reg. No. 3,498,183**

**Registered Sep. 9, 2008**

**TRADEMARK  
PRINCIPAL REGISTER**

**Greenix**

SIP SUPPLY, LLC (GEORGIA LIMITED LIABILITY COMPANY)  
205 STARLING DRIVE  
EASTMAN, GA 31023

THE MARK CONSISTS OF STANDARD CHARACTERS WITHOUT CLAIM TO ANY PARTICULAR FONT, STYLE, SIZE, OR COLOR.

FOR: STRUCTURAL INSULATED CONSTRUCTION PANELS, IN CLASS 17 (U.S. CLS. 1, 5, 12, 13, 35 AND 50).

SER. NO. 77-300,135, FILED 10-10-2007.

FIRST USE 8-30-2006; IN COMMERCE 8-30-2006.

BARBARA A. GOLD, EXAMINING ATTORNEY

**Int. Cl.: 25**

**Prior U.S. Cls.: 22 and 39**

**United States Patent and Trademark Office**

**Reg. No. 3,498,184**

**Registered Sep. 9, 2008**

**TRADEMARK  
PRINCIPAL REGISTER**

**KOMBI**

KOMBI LIMITED (CONNECTICUT CORPORATION)  
67 THOMPSON DRIVE  
ESSEX JUNCTION, VT 05451

FOR: CAPS; CREWNECK SWEATERS; CREW-NECKS; CROSS-COUNTRY GLOVES; CROSS-COUNTRY MITTENS; HATS; MITTENS; MOCK TURTLE-NECK SWEATERS; MOCKNECKS; OUTDOOR GLOVES; OUTDOOR MITTENS; SNOWBOARD GLOVES; SNOWBOARD MITTENS; SOCKS; TURTLENECK SWEATERS; TURTLE-NECKS; UNDERWEAR, IN CLASS 25 (U.S. CLS. 22 AND 39).

FIRST USE 11-2-1972; IN COMMERCE 11-2-1972.

THE MARK CONSISTS OF STANDARD CHARACTERS WITHOUT CLAIM TO ANY PARTICULAR FONT, STYLE, SIZE, OR COLOR.

OWNER OF U.S. REG. NO. 1,354,195.

THE FOREIGN WORDING IN THE MARK TRANSLATES INTO ENGLISH AS COMBINATION.

SER. NO. 77-300,203, FILED 10-10-2007.

AMY MCMENAMIN, EXAMINING ATTORNEY

**Int. Cls.: 9, 41 and 42**

**Prior U.S. Cls.: 21, 23, 26, 36, 38, 100, 101 and 107**

**United States Patent and Trademark Office**

**Reg. No. 3,498,185**

**Registered Sep. 9, 2008**

**TRADEMARK  
SERVICE MARK  
PRINCIPAL REGISTER**

# ExtremeTransactions

PARDON, GUY (BELGIUM INDIVIDUAL)  
HOVENIERSSTRAAT 39/1  
MECHELEN, BELGIUM B-2800

FOR: COMPUTER SOFTWARE FOR MIDDLEWARE FOR USE IN ENTERPRISE RESOURCE PLANNING, ENTERPRISE APPLICATION INTEGRATION, SERVICE-ORIENTED ARCHITECTURE, EVENT-DRIVEN ARCHITECTURES, AND ENTERPRISE SERVICE BUS SYSTEMS, IN THE AREAS OF FINANCE, INSURANCE, ONLINE COMMERCE, ELECTRONIC BUSINESS, AND TELECOMMUNICATIONS, THAT MAY BE DOWNLOADED FROM A GLOBAL COMPUTER NETWORK, IN CLASS 9 (U.S. CLS. 21, 23, 26, 36 AND 38).

FIRST USE 10-9-2007; IN COMMERCE 10-9-2007.

FOR: TRAINING SERVICES IN THE FIELD OF FINANCE, INSURANCE, ONLINE COMMERCE, ELECTRONIC BUSINESS, AND TELECOMMUNI-

CATIONS SOFTWARE, IN CLASS 41 (U.S. CLS. 100, 101 AND 107).

FIRST USE 10-9-2007; IN COMMERCE 10-9-2007.

FOR: CONSULTANCY IN THE FIELD OF SOFTWARE DESIGN; TECHNICAL SUPPORT SERVICES, NAMELY, TROUBLESHOOTING OF COMPUTER HARDWARE AND SOFTWARE PROBLEMS, IN CLASS 42 (U.S. CLS. 100 AND 101).

FIRST USE 10-9-2007; IN COMMERCE 10-9-2007.

THE MARK CONSISTS OF STANDARD CHARACTERS WITHOUT CLAIM TO ANY PARTICULAR FONT, STYLE, SIZE, OR COLOR.

SER. NO. 77-300,381, FILED 10-10-2007.

ANDREA BUTLER, EXAMINING ATTORNEY

**Int. Cl.: 9**

**Prior U.S. Cls.: 21, 23, 26, 36 and 38**

**United States Patent and Trademark Office**

**Reg. No. 3,498,186**

**Registered Sep. 9, 2008**

**TRADEMARK  
PRINCIPAL REGISTER**



GRUPO MEDIATICO REFORMA NORTE, S.A.  
DE C.V. (MEXICO CORPORATION)  
AMADO NERVO # 204 LADRÓN DE GUEVARA  
GUADALAJARA, MEXICO 44680

FOR: DIGITAL MEDIA PRODUCTS, NAMELY,  
CDS, DVDS, DOWNLOADABLE AUDIO FILES FEATURING  
MOVIES, MUSIC; DIGITAL MEDIA PRODUCTS,  
NAMELY, BLANK DIGITAL STORAGE MEDIA;  
UNRECORDED OPTICAL MEDIA, NAMELY,  
BLANK OPTICAL DISK; BLANK DVDS AND  
CD-RS; FLASH MEMORY CARD; OPTICAL MEDIA  
PRODUCTS, NAMELY, CDS, DVDS, DOWNLOADABLE  
AUDIO FILES FEATURING MOVIES, MUSIC,  
IN CLASS 9 (U.S. CLS. 21, 23, 26, 36 AND 38).

FIRST USE 2-19-2007; IN COMMERCE 2-19-2007.

THE MARK CONSISTS OF THE WORDS "MAGIC"  
AND "SOUND" WRITTEN IN A SEMI CIRCLE  
FORM, AND BETWEEN THEM THERE IS A MUSICAL  
KEY. BOTH WORDS ARE WRITTEN WITH THE  
FIRST LETTER IN CAPITAL AND THE REST OF  
THEM IN SMALL LETTER.

SER. NO. 77-300,438, FILED 10-10-2007.

AISHA CLARKE, EXAMINING ATTORNEY

**Int. Cl.: 9**

**Prior U.S. Cls.: 21, 23, 26, 36 and 38**

**Reg. No. 3,498,187**

**United States Patent and Trademark Office**

**Registered Sep. 9, 2008**

**TRADEMARK  
PRINCIPAL REGISTER**

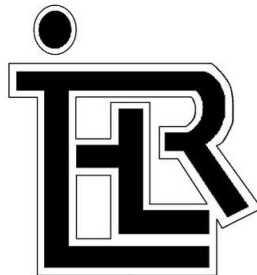

MCNEILL, AARON M. (UNITED STATES INDIVIDUAL)  
3406 BEACON BEND CT.  
PEARLAND, TX 77584

FOR: AUDIO AND VIDEO RECORDINGS FEATURING MUSICAL PERFORMANCES; MUSICAL SOUND RECORDINGS; MUSICAL VIDEO RECORDINGS; PRE-RECORDED CDS, VIDEO TAPES, LASER DISKS AND DVDS FEATURING MUSICAL PERFORMANCES; VIDEO RECORDINGS FEATUR-

ING MUSIC; VISUAL RECORDINGS AND AUDIO VISUAL RECORDINGS FEATURING MUSIC AND ANIMATION, IN CLASS 9 (U.S. CLS. 21, 23, 26, 36 AND 38).

FIRST USE 9-18-2002; IN COMMERCE 9-18-2002.

SER. NO. 77-303,355, FILED 10-12-2007.

CARRIE GENOVESE, EXAMINING ATTORNEY



**Int. Cls.: 11, 18, 20, 21, 24 and 27**

**Prior U.S. Cls.: 1, 2, 3, 13, 19, 20, 21, 22, 23, 25, 29, 30, 31, 32, 33, 34, 37, 40, 41, 42 and 50**

**Reg. No. 3,498,188**

**United States Patent and Trademark Office**

**Registered Sep. 9, 2008**

**TRADEMARK  
PRINCIPAL REGISTER**

**LIORA MANNE**

M G K GROUP INC. (NEW YORK CORPORATION)  
210 11TH AVENUE, 7TH FLOOR  
NEW YORK, NY 10001

FOR: LAMPS AND LAMP SHADES, IN CLASS 11 (U.S. CLS. 13, 21, 23, 31 AND 34).

FIRST USE 10-0-2003; IN COMMERCE 10-0-2003.

FOR: HANDBAGS; TOTE BAGS; COSMETIC CASES SOLD EMPTY; UMBRELLAS; LUGGAGE, IN CLASS 18 (U.S. CLS. 1, 2, 3, 22 AND 41).

FIRST USE 10-0-2003; IN COMMERCE 10-0-2003.

FOR: DECORATIVE PILLOWS, IN CLASS 20 (U.S. CLS. 2, 13, 22, 25, 32 AND 50).

FIRST USE 10-0-2003; IN COMMERCE 10-0-2003.

FOR: BOWLS AND COASTERS, NOT OF PAPER AND NOT BEING OF LINEN, IN CLASS 21 (U.S. CLS. 2, 13, 23, 29, 30, 33, 40 AND 50).

FIRST USE 10-0-2003; IN COMMERCE 10-0-2003.

FOR: SYNTHETIC FIBER FELTING USED IN BED COVERS, DECORATIVE BLANKETS, PLACEMATS AND DECORATIVE PILLOWS; PLACEMATS NOT BEING PAPER AND NOT BEING TABLE LINEN; TEXTILE WALL HANGINGS, IN CLASS 24 (U.S. CLS. 42 AND 50).

FIRST USE 10-0-2003; IN COMMERCE 10-0-2003.

FOR: CARPETS AND RUGS, IN CLASS 27 (U.S. CLS. 19, 20, 37, 42 AND 50).

FIRST USE 10-0-2003; IN COMMERCE 10-0-2003.

THE MARK CONSISTS OF STANDARD CHARACTERS WITHOUT CLAIM TO ANY PARTICULAR FONT, STYLE, SIZE, OR COLOR.

THE NAME "LIORA MANNE" IDENTIFIES A LIVING INDIVIDUAL WHOSE CONSENT IS OF RECORD.

SER. NO. 77-304,923, FILED 10-16-2007.

CORY BOONE, EXAMINING ATTORNEY

**Int. Cl.: 36**

**Prior U.S. Cls.: 100, 101 and 102**

**United States Patent and Trademark Office**

**Reg. No. 3,498,189**

**Registered Sep. 9, 2008**

**SERVICE MARK  
PRINCIPAL REGISTER**

**ATTICUS**

ATTICUS MANAGEMENT LLC (DELAWARE  
LIMITED LIABILITY COMPANY)  
767 FIFTH AVENUE  
NEW YORK, NY 10153

FOR: CHARITABLE SERVICES, NAMELY, AC-  
CEPTING AND ADMINISTERING MONETARY  
CHARITABLE CONTRIBUTIONS, IN CLASS 36  
(U.S. CLS. 100, 101 AND 102).

FIRST USE 1-1-1998; IN COMMERCE 1-1-1998.

THE MARK CONSISTS OF STANDARD CHAR-  
ACTERS WITHOUT CLAIM TO ANY PARTICULAR  
FONT, STYLE, SIZE, OR COLOR.

OWNER OF U.S. REG. NOS. 2,098,746 AND  
3,388,189.

SER. NO. 77-305,208, FILED 10-16-2007.

JULIE WATSON, EXAMINING ATTORNEY

**Int. Cl.: 35**

**Prior U.S. Cls.: 100, 101 and 102**

**United States Patent and Trademark Office**

**Reg. No. 3,498,190**

**Registered Sep. 9, 2008**

**SERVICE MARK  
PRINCIPAL REGISTER**

**WE LOOK FORWARD TO  
SERVICING YOUR AUDIO NEEDS**

AERIELLE TECHNOLOGIES, INC. (CALIFORNIA CORPORATION)  
625 ELLIS STREET, SUITE 206  
MOUNTAIN VIEW, CA 94043

FOR: RETAIL STORE SERVICES FEATURING ELECTRONIC DEVICES, NAMELY, RADIO FREQUENCY ELECTRONIC TRANSMITTERS, RADIO FREQUENCY ELECTRONIC TRANSCEIVERS, POWER SUPPLIES FOR BOTH TRANSMITTERS AND TRANSCEIVERS, PRINTED CIRCUIT BOARD ASSEMBLIES, APPLICATION-SPECIFIC INTEGRATED CIRCUITS FOR USE WITH MP3 PLAYERS, COMPACT DISC PLAYERS, MINI-DISC PLAYERS, AND CASSETTE TAPE PLAYERS, IN CLASS 35 (U.S. CLS. 100, 101 AND 102).

FIRST USE 2-8-2007; IN COMMERCE 2-8-2007.

THE MARK CONSISTS OF STANDARD CHARACTERS WITHOUT CLAIM TO ANY PARTICULAR FONT, STYLE, SIZE, OR COLOR.

NO CLAIM IS MADE TO THE EXCLUSIVE RIGHT TO USE "SERVICING YOUR AUDIO NEEDS", APART FROM THE MARK AS SHOWN.

SER. NO. 77-305,603, FILED 10-16-2007.

SUSAN STIGLITZ, EXAMINING ATTORNEY

**Int. Cls.: 9 and 41**

**Prior U.S. Cls.: 21, 23, 26, 36, 38, 100, 101 and 107**

**Reg. No. 3,498,191**

**United States Patent and Trademark Office**

**Registered Sep. 9, 2008**

**TRADEMARK  
SERVICE MARK  
PRINCIPAL REGISTER**

# STOCKUMENTARY

STOCKWIRE RESEARCH GROUP, INC. (FLORIDA CORPORATION)  
1781 SW 69TH AVENUE  
PLANTATION, FL 33317

FOR: DVDS FEATURING INFORMATION IN THE FIELDS OF CORPORATE FINANCE, STOCKS, AND BUSINESS, NAMELY, RESEARCH, DATA, REPORTS, ANALYSIS, FORECASTS, INTERVIEWS, NEWS, PRICING, INFORMATION ON ADVERTISING, MARKETING INFORMATION, INFORMATION ON PROMOTIONAL MATERIALS, AND MULTIMEDIA PRESENTATIONS IN THE FIELDS OF CORPORATE FINANCE, STOCKS AND BUSINESS; DIGITAL MATERIALS, NAMELY, DVDS AND DOWNLOADABLE VIDEO FILES FEATURING MULTIMEDIA PRESENTATIONS CONTAINING RESEARCH, DATA, REPORTS, ANALYSIS, FORECASTS, INTERVIEWS, NEWS, PRICING, ADVERTISING INFORMATION, MARKETING INFORMATION, AND INFORMATION ON PROMOTIONAL MATERIALS IN THE FIELDS OF CORPORATE FINANCE, STOCKS AND BUSINESS; DIGITAL MEDIA, NAMELY, DOWNLOADABLE VIDEO FILES, DOWNLOADABLE AUDIO FILES, DVDS, AND COMPACT DISCS FEATURING INFORMATION IN THE FIELDS OF CORPORATE FINANCE, STOCKS, AND BUSINESS, NAMELY, RESEARCH, DATA, REPORTS, ANALYSIS, FORECASTS, INTERVIEWS, NEWS, PRICING, ADVERTISING INFORMATION, MARKETING INFORMATION, INFORMATION ON PROMOTIONAL MATERIALS, AND MULTIMEDIA PRESENTATIONS IN THE FIELDS OF CORPORATE FINANCE, STOCKS AND BUSINESS; PRE-RECORDED CDS, VIDEO TAPES, LASER DISKS AND DVDS FEATURING INFORMATION IN THE FIELDS OF CORPORATE FINANCE, STOCKS, AND BUSINESS, NAMELY, RESEARCH, DATA, REPORTS, ANALYSIS, FORECASTS, INTERVIEWS, NEWS, PRICING, ADVERTISING INFORMATION, MARKETING IN-

FORMATION, INFORMATION ON PROMOTIONAL MATERIALS, AND MULTIMEDIA PRESENTATIONS IN THE FIELDS OF CORPORATE FINANCE, STOCKS AND BUSINESS; DOWNLOADABLE FILMS AND TELEVISION PROGRAMS FEATURING INFORMATION IN THE FIELDS OF CORPORATE FINANCE, STOCKS, AND BUSINESS, NAMELY, RESEARCH, DATA, REPORTS, ANALYSIS, FORECASTS, INTERVIEWS, NEWS, PRICING, ADVERTISING INFORMATION, MARKETING INFORMATION, INFORMATION ON PROMOTIONAL MATERIALS, MULTIMEDIA PRESENTATIONS, AND INFORMATION ON BUSINESS SOFTWARE IN THE FIELDS OF CORPORATE FINANCE, STOCKS AND BUSINESS, PROVIDED VIA A VIDEO-ON-DEMAND SERVICE; DOWNLOADABLE VIDEO RECORDINGS FEATURING INFORMATION IN THE FIELDS OF CORPORATE FINANCE, STOCKS, AND BUSINESS, NAMELY, RESEARCH, DATA, REPORTS, ANALYSIS, FORECASTS, INTERVIEWS, NEWS, PRICING, ADVERTISING INFORMATION, MARKETING INFORMATION, INFORMATION ON PROMOTIONAL MATERIALS, MULTIMEDIA PRESENTATIONS, AND INFORMATION ON BUSINESS SOFTWARE; COMPUTER SOFTWARE PROGRAMS FOR THE INTEGRATION OF TEXT, AUDIO, GRAPHICS, STILL IMAGES AND MOVING PICTURES INTO AN INTERACTIVE DELIVERY FOR MULTIMEDIA APPLICATIONS FOR USE IN THE FIELDS OF CORPORATE FINANCE, STOCKS, AND BUSINESS, RECORDED ON DVDS; EDUCATIONAL SOFTWARE FEATURING INSTRUCTION IN THE FIELDS OF BUSINESS, STOCK MARKETS, AND CORPORATE FINANCE; EDUCATIONAL SOFTWARE FEATURING INSTRUCTION IN THE FIELDS OF BUSINESS, STOCK MARKETS, AND CORPORATE FINANCE, RECORDED ON DVDS AND COMPACT DISCS; EDUCATIONAL SOFTWARE FEATURING INSTRUCTION IN THE FIELDS OF BUSINESS, STOCK MARKETS, AND CORPORATE FINANCE, RECORDED ON DVDS,

LASER DISCS AND COMPACT DISCS, IN CLASS 9 (U.S. CLS. 21, 23, 26, 36 AND 38).

FIRST USE 5-24-2006; IN COMMERCE 5-24-2006.

FOR: ELECTRONIC PUBLISHING SERVICES, NAMELY, PUBLICATION OF TEXT AND GRAPHIC WORKS OF OTHERS ON DVDS, COMPACT DISCS AND ONLINE IN THE FIELDS OF CORPORATE FINANCE, STOCKS, AND BUSINESS, FEATURING RESEARCH, DATA, REPORTS, ANALYSIS, FORECASTS, INTERVIEWS, NEWS, PRICING, ADVERTISING, MARKETING INFORMATION, PROMOTIONAL INFORMATION, INFORMATION ON MULTIMEDIA PRESENTATIONS, AND INFORMATION ON BUSINESS SOFTWARE; PRODUCTION OF DVDS, VIDEOTAPES AND TELEVISION PROGRAMS IN THE FIELDS OF CORPORATE FINANCE, STOCKS, AND BUSINESS, FEATURING RESEARCH, DATA, REPORTS, ANALYSIS, FORECASTS, INTERVIEWS, NEWS, PRICING, INFORMATION ON ADVERTISING, MARKETING INFORMATION, INFORMATION ON PROMOTIONAL MATERIALS, MULTIMEDIA PRESENTATIONS AND INFORMATION ON BUSINESS SOFTWARE; PRODUCTION OF VIDEO AND CREATION OF VISUAL EFFECTS FOR OTHERS FOR USE IN DVDS, TELEVISION PROGRAMS AND ON WEBSITES; PRODUCTION OF VISUAL EFFECTS FOR VIDEOS, DVDS, TELEVISION AND FOR INTERNET WEBSITES; DIGITAL VIDEO, AUDIO, AND MULTIMEDIA PUBLISHING SERVICES; EDUCATIONAL AND ENTERTAINMENT SERVICES, NAMELY, A CONTINUING PROGRAM ABOUT CORPORATE

FINANCE, STOCKS, AND BUSINESS, FEATURING RESEARCH, DATA, REPORTS, ANALYSIS, FORECASTS, INTERVIEWS, NEWS, PRICING, INFORMATION ON ADVERTISING, MARKETING INFORMATION, PROMOTION INFORMATION, MULTIMEDIA PRESENTATIONS, AND INFORMATION ON BUSINESS SOFTWARE, ACCESSIBLE BY RADIO, TELEVISION, SATELLITE, AUDIO, VIDEO AND COMPUTER NETWORKS; MULTIMEDIA ENTERTAINMENT SERVICES IN THE NATURE OF RECORDING, PRODUCTION AND POST-PRODUCTION SERVICES IN THE FIELDS OF MUSIC, VIDEO, AND FILMS; OPERATION OF VIDEO EQUIPMENT OR AUDIO EQUIPMENT ETC. FOR PRODUCTION OF RADIO OR TELEVISION PROGRAMS; PRODUCTION OF VIDEO DISCS AND TAPES; PROVIDING A WEBSITE FEATURING NON-DOWNLOADABLE INSTRUCTIONAL VIDEOS IN THE FIELD OF FINANCE; PROVISION OF NON-DOWNLOADABLE FILMS AND TELEVISION PROGRAMS VIA A VIDEO-ON-DEMAND SERVICE; VIDEO EDITING; VIDEO MASTERING SERVICES; VIDEO TAPE RECORDING FOR OTHERS, IN CLASS 41 (U.S. CLS. 100, 101 AND 107).

FIRST USE 5-24-2006; IN COMMERCE 5-24-2006.

THE MARK CONSISTS OF STANDARD CHARACTERS WITHOUT CLAIM TO ANY PARTICULAR FONT, STYLE, SIZE, OR COLOR.

SER. NO. 77-305,834, FILED 10-17-2007.

MICHAEL GAAFAR, EXAMINING ATTORNEY

**Int. Cl.: 36**

**Prior U.S. Cls.: 100, 101 and 102**

**United States Patent and Trademark Office**

**Reg. No. 3,498,192**

**Registered Sep. 9, 2008**

**SERVICE MARK  
PRINCIPAL REGISTER**

**ELEGANT HOMES**

GMAC HOME SERVICES, LLC (DELAWARE  
LIMITED LIABILITY COMPANY)  
SUITE 300  
2021 SPRING ROAD  
OAK BROOK, IL 60523

FOR: REAL ESTATE BROKERAGE, IN CLASS 36  
(U.S. CLS. 100, 101 AND 102).

FIRST USE 10-1-1975; IN COMMERCE 10-1-1978.

THE MARK CONSISTS OF STANDARD CHAR-  
ACTERS WITHOUT CLAIM TO ANY PARTICULAR  
FONT, STYLE, SIZE, OR COLOR.

NO CLAIM IS MADE TO THE EXCLUSIVE  
RIGHT TO USE "HOMES", APART FROM THE  
MARK AS SHOWN.

SEC. 2(F).

SER. NO. 77-305,874, FILED 10-17-2007.

VIVIAN MICZNIK FIRST, EXAMINING ATTOR-  
NEY

**Int. Cl.: 42**

**Prior U.S. Cls.: 100 and 101**

**United States Patent and Trademark Office**

**Reg. No. 3,498,193**

**Registered Sep. 9, 2008**

**SERVICE MARK  
PRINCIPAL REGISTER**

**PROMISE**

CF INDUSTRIES, INC. (DELAWARE CORPORATION)  
SUITE 400  
4 PARKWAY NORTH  
DEERFIELD, IL 60015

FOR: PROVIDING TEMPORARY USE OF ONLINE NON-DOWNLOADABLE SOFTWARE FOR MANAGING CONTRACTS AND ORDERS FOR NITROGEN FERTILIZERS INCLUDING AMMONIATED PHOSPHATE AND MONOAMMONIUM PHOSPHATE FERTILIZERS, IN CLASS 42 (U.S. CLS. 100 AND 101).

FIRST USE 8-16-2003; IN COMMERCE 8-16-2003.

THE MARK CONSISTS OF STANDARD CHARACTERS WITHOUT CLAIM TO ANY PARTICULAR FONT, STYLE, SIZE, OR COLOR.

SER. NO. 77-306,492, FILED 10-17-2007.

STEVEN PEREZ, EXAMINING ATTORNEY

**Int. Cl.: 9**

**Prior U.S. Cls.: 21, 23, 26, 36 and 38**

**United States Patent and Trademark Office**

**Reg. No. 3,498,194**

**Registered Sep. 9, 2008**

**TRADEMARK  
PRINCIPAL REGISTER**

**SMOKE CHECK**

HSI FIRE & SAFETY GROUP LLC (ILLINOIS  
LIMITED LIABILITY COMPANY)  
107 GARLISCH DRIVE  
ELK GROVE VILLAGE, IL 60007

FOR: ALARM TESTING DEVICE USED TO  
CHECK THE FUNCTION AND EFFECTIVENESS  
OF SMOKE DETECTORS, IN CLASS 9 (U.S. CLS. 21,  
23, 26, 36 AND 38).

FIRST USE 11-1-2001; IN COMMERCE 4-1-2002.

THE MARK CONSISTS OF STANDARD CHAR-  
ACTERS WITHOUT CLAIM TO ANY PARTICULAR  
FONT, STYLE, SIZE, OR COLOR.

OWNER OF U.S. REG. NOS. 2,641,325 AND  
2,787,095.

SEC. 2(F).

SER. NO. 77-306,518, FILED 10-17-2007.

STEVEN JACKSON, EXAMINING ATTORNEY



**Int. Cl.: 35**

**Prior U.S. Cls.: 100, 101 and 102**

**United States Patent and Trademark Office**

**Reg. No. 3,498,195**

**Registered Sep. 9, 2008**

**SERVICE MARK  
PRINCIPAL REGISTER**



LOGO DESIGN GURU (DELAWARE CORPORATION), DBA LOGO SNAP  
SUITE A-3  
19 SOUTH MAIN STREET  
YARDLEY, PA 19067

FOR: ADVERTISING SERVICES, NAMELY, CREATING CORPORATE LOGOS FOR OTHERS, IN CLASS 35 (U.S. CLS. 100, 101 AND 102).

FIRST USE 3-4-2005; IN COMMERCE 4-27-2005.

NO CLAIM IS MADE TO THE EXCLUSIVE RIGHT TO USE .COM, APART FROM THE MARK AS SHOWN.

THE COLOR(S) BLUE AND ORANGE IS/ARE CLAIMED AS A FEATURE OF THE MARK.

THE MARK CONSISTS OF A TWO PART WAVE DESIGN AND THE TEXT OF THE MARK; THE COLOR BLUE APPEARS IN THE TEXT LOGO AND IN HALF OF THE WAVE DESIGN, AND THE COLOR ORANGE APPEARS IN THE TEXT SNAP .COM AND IN THE BALANCE OF THE WAVE DESIGN. .

SER. NO. 77-307,082, FILED 10-18-2007.

PAUL E. FAHRENKOPF, EXAMINING ATTORNEY

**Int. Cls.: 16 and 40**

**Prior U.S. Cls.: 2, 5, 22, 23, 29, 37, 38, 50, 100, 103 and 106**

**Reg. No. 3,498,196**

**United States Patent and Trademark Office**

**Registered Sep. 9, 2008**

**TRADEMARK  
SERVICE MARK  
PRINCIPAL REGISTER**

**BLOCK GRAPHICS**

BLOCK GRAPHICS, INC. (OREGON CORPORATION)  
2441 PRESIDENTIAL PARKWAY  
MIDLOTHIAN, TX 76065

THE MARK CONSISTS OF STANDARD CHARACTERS WITHOUT CLAIM TO ANY PARTICULAR FONT, STYLE, SIZE, OR COLOR.

FOR: PRINTED MATTER, NAMELY, CUSTOM FORMS PRINTED TO CUSTOMER SPECIFICATIONS, IN CLASS 16 (U.S. CLS. 2, 5, 22, 23, 29, 37, 38 AND 50).

NO CLAIM IS MADE TO THE EXCLUSIVE RIGHT TO USE "GRAPHICS", APART FROM THE MARK AS SHOWN.

FIRST USE 7-1-1990; IN COMMERCE 7-1-1990.

SEC. 2(F).

FOR: PRINTING CUSTOM FORMS TO CUSTOMER SPECIFICATIONS, IN CLASS 40 (U.S. CLS. 100, 103 AND 106).

SER. NO. 77-307,440, FILED 10-18-2007.

FIRST USE 7-1-1990; IN COMMERCE 7-1-1990.

MICHAEL LITZAU, EXAMINING ATTORNEY

Int. Cl.: 35

Prior U.S. Cls.: 100, 101 and 102

United States Patent and Trademark Office

Reg. No. 3,498,197

Registered Sep. 9, 2008

**SERVICE MARK  
PRINCIPAL REGISTER**



FASTGRAPHIX, INC. (MISSOURI CORPORATION)  
1325 W SUNSHINE STREET #525  
SPRINGFIELD, MO 65807

FOR: PROVIDING ONLINE INFORMATION, NAMELY, SEARCHABLE DIRECTORIES AND DATABASES ABOUT BUSINESSES AND INDIVIDUALS, IN CLASS 35 (U.S. CLS. 100, 101 AND 102).

FIRST USE 12-1-1997; IN COMMERCE 4-15-2003.

NO CLAIM IS MADE TO THE EXCLUSIVE RIGHT TO USE "GAY SOUTHFLORIDA.COM", APART FROM THE MARK AS SHOWN.

THE COLOR(S) RED, ORANGE, YELLOW, GREEN, BLUE, PURPLE, GOLD AND WHITE IS/ARE CLAIMED AS A FEATURE OF THE MARK.

THE MARK CONSISTS OF SIX PALM TREES IN A ROW, EACH HAVING A DIFFERENT COLOR, FROM THE LEFT, RED, ORANGE, YELLOW, GREEN, BLUE AND PURPLE WITH THE WORDS "GAY SOUTH FLORIDA.COM" IN GOLD WITH WHITE EFFECTS AND TWO HORIZONTAL LINES ALSO IN GOLD WITH WHITE EFFECT.

SER. NO. 77-307,757, FILED 10-18-2007.

HENRY S. ZAK, EXAMINING ATTORNEY

**Int. Cls.: 3 and 5**

**Prior U.S. Cls.: 1, 4, 6, 18, 44, 46, 50, 51 and 52**

**United States Patent and Trademark Office**

**Reg. No. 3,498,198**

**Registered Sep. 9, 2008**

**TRADEMARK  
PRINCIPAL REGISTER**



MARTINEZ, ROBERTO J. (UNITED STATES IN-  
DIVIDUAL)  
UNIT 88  
18501 52ND AVE. WEST  
LYNNWOOD, WA 980374519

FOR: PET SHAMPOO MADE WITH NATURAL  
CEDAR OIL, IN CLASS 3 (U.S. CLS. 1, 4, 6, 50, 51 AND  
52).

FIRST USE 1-1-1985; IN COMMERCE 1-1-2005.

FOR: ANTI-INSECT SPRAY MADE WITH NAT-  
URAL CEDAR OIL, IN CLASS 5 (U.S. CLS. 6, 18, 44,  
46, 51 AND 52).

FIRST USE 1-1-1985; IN COMMERCE 1-1-1985.

NO CLAIM IS MADE TO THE EXCLUSIVE  
RIGHT TO USE "THE ORIGINAL", APART FROM  
THE MARK AS SHOWN.

"THE COLOR(S) GREEN, ORANGE AND WHITE  
IS/ARE CLAIMED AS A FEATURE OF THE MARK."

THE WORDS "THE ORIGINAL" ARE IN OR-  
ANGE. THE WORDING "CEDAR-AL" IS IN GREEN  
WITH TWO ORANGE DOTS ABOVE THE LETTER  
"A" IN "AL". BELOW ARE TWO CEDAR LEAVES IN  
GREEN WITH WHITE HIGHLIGHTS. BETWEEN  
THE LEAVES IS A CONE IN ORANGE WITH WHITE  
HIGHLIGHTS.

SER. NO. 77-308,269, FILED 10-19-2007.

STEVEN R. FOSTER, EXAMINING ATTORNEY

**Int. Cl.: 31**

**Prior U.S. Cls.: 1 and 46**

**United States Patent and Trademark Office**

**Reg. No. 3,498,199**

**Registered Sep. 9, 2008**

**TRADEMARK  
PRINCIPAL REGISTER**



"DAN" FLOWER FARM (ISRAEL PARTNER-  
SHIP)  
MOSHAV MISHMAR HASHIVA  
BEIT DAGAN, ISRAEL 50297

FOR: LIVE PLANTS, NAMELY, GYPSOPHILA, IN  
CLASS 31 (U.S. CLS. 1 AND 46).

FIRST USE 1-15-1995; IN COMMERCE 1-15-1995.

THE MARK CONSISTS OF HEAVY BLOCK LET-  
TERS FOR THE "F" AND THE "L." ALL OTHER  
LETTERS ARE A THIN FONT. A SIMPLE DOT AND  
LINE DESIGN OF A BOUQUET OF FLOWERS  
APPEARING OVER THE LETTER "V" WITHIN  
THE MARK.

SER. NO. 77-308,688, FILED 10-19-2007.

DORITT L. CARROLL, EXAMINING ATTORNEY

**Int. Cl.: 41**

**Prior U.S. Cls.: 100, 101 and 107**

**United States Patent and Trademark Office**

**Reg. No. 3,498,200**

**Registered Sep. 9, 2008**

**SERVICE MARK  
PRINCIPAL REGISTER**

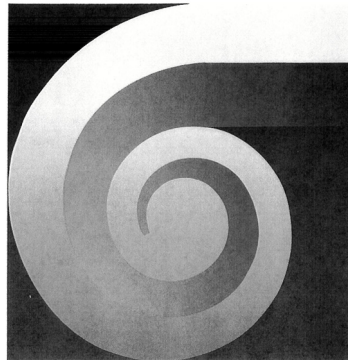

ARIES INSTITUTE OF TECHNOLOGY, INC. (ARIZONA CORPORATION)  
1445 WEST 12TH PLACE  
TEMPE, AZ 85281

FOR: ON-LINE EDUCATIONAL COURSES AND TRAINING IN THE FIELDS OF COMPUTER HARDWARE AND SOFTWARE; PROVIDING AN EDUCATIONAL WEBSITE OFFERING TRAINING IN THE FIELDS OF COMPUTER HARDWARE AND COMPUTER SOFTWARE, IN CLASS 41 (U.S. CLS. 100, 101 AND 107).

FIRST USE 8-30-2007; IN COMMERCE 8-30-2007.

THE MARK CONSISTS OF A SPIRAL WITH A STRAIGHT TAIL.

SER. NO. 77-309,035, FILED 10-19-2007.

LINDA E. BLOHM, EXAMINING ATTORNEY

Int. Cls.: 25 and 41

Prior U.S. Cls.: 22, 39, 100, 101 and 107

United States Patent and Trademark Office

Reg. No. 3,498,201

Registered Sep. 9, 2008

TRADEMARK  
SERVICE MARK  
PRINCIPAL REGISTER



DRAKE UNIVERSITY (IOWA CORPORATION)  
2507 UNIVERSITY AVENUE  
DES MOINES, IA 50311

FOR: CLOTHING FOR MEN, WOMEN AND CHILDREN, NAMELY, SHIRTS, SHORTS, T-SHIRTS, HATS, CAPS, SOCKS, JACKETS, PANTS, SWEATSUITS, SWEATSHIRTS, SWEATPANTS, SLEEPWEAR, RAINWEAR, SWEATERS AND VISORS, IN CLASS 25 (U.S. CLS. 22 AND 39).

FIRST USE 8-12-2005; IN COMMERCE 8-12-2005.

FOR: ENTERTAINMENT AND EDUCATIONAL SERVICES, NAMELY, CONDUCTING COLLEGIATE EDUCATIONAL PROGRAMS LEADING TO

UNDERGRADUATE, POSTGRADUATE, AND PROFESSIONAL DEGREES, AND CONDUCTING COLLEGIATE SPORTING EVENTS, NAMELY, FOOTBALL, BASEBALL, SOFTBALL, TENNIS, SOCCER, CREW, CROSS COUNTRY, GOLF, VOLLEYBALL, BASKETBALL, AND TRACK EVENTS, IN CLASS 41 (U.S. CLS. 100, 101 AND 107).

FIRST USE 8-12-2005; IN COMMERCE 8-12-2005.

OWNER OF U.S. REG. NOS. 1,296,052, 2,830,020 AND OTHERS.

SER. NO. 77-309,570, FILED 10-22-2007.

MARK PILARO, EXAMINING ATTORNEY

**Int. Cls.: 21, 25 and 41**

**Prior U.S. Cls.: 2, 13, 22, 23, 29, 30, 33, 39, 40, 50, 100,  
101 and 107**

**Reg. No. 3,498,202**

**United States Patent and Trademark Office**

**Registered Sep. 9, 2008**

**TRADEMARK  
SERVICE MARK  
PRINCIPAL REGISTER**



DRAKE UNIVERSITY (IOWA CORPORATION)  
2507 UNIVERSITY AVENUE  
DES MOINES, IA 50311

FOR: BEVERAGE CONTAINERS, NAMELY, COFFEE MUGS; DRINKING GLASSES, STEINS, STEAMWARE, SHOT GLASSES, SIPPY CUPS; WATER BOTTLES SOLD EMPTY; TRAVEL MUGS; THERMAL INSULATED CONTAINERS FOR BEVERAGES, SERVING BOWLS, INSULATED SLEEVE-HOLDERS FOR BEVERAGE CONTAINERS; ORNAMENTS OF CHINA, CRYSTAL, GLASS, PORCELAIN NOT BEING CHRISTMAS TREE ORNAMENTS; CERAMIC FIGURES; COASTERS NOT OF PAPER AND NOT BEING TABLE LINEN, IN CLASS 21 (U.S. CLS. 2, 13, 23, 29, 30, 33, 40 AND 50).

FIRST USE 8-12-2005; IN COMMERCE 8-12-2005.

FOR: CLOTHING FOR MEN, WOMEN AND CHILDREN, NAMELY, SHIRTS, SHORTS, T-SHIRTS, HATS, CAPS, SOCKS, JACKETS, PANTS,

SWEATSUITS, SWEATSHIRTS, SWEATPANTS, SLEEPWEAR, RAINWEAR, SWEATERS AND VISORS, IN CLASS 25 (U.S. CLS. 22 AND 39).

FIRST USE 8-12-2005; IN COMMERCE 8-12-2005.

FOR: ENTERTAINMENT AND EDUCATIONAL SERVICES, NAMELY, CONDUCTING COLLEGIATE EDUCATIONAL PROGRAMS LEADING TO UNDERGRADUATE, POSTGRADUATE, AND PROFESSIONAL DEGREES, AND CONDUCTING COLLEGIATE SPORTING EVENTS, NAMELY, FOOTBALL, BASEBALL, SOFTBALL, TENNIS, SOCCER, CREW, CROSS COUNTRY, GOLF, VOLLEYBALL, BASKETBALL, AND TRACK EVENTS, IN CLASS 41 (U.S. CLS. 100, 101 AND 107).

FIRST USE 8-12-2005; IN COMMERCE 8-12-2005.

SER. NO. 77-309,671, FILED 10-22-2007.

MARK PILARO, EXAMINING ATTORNEY



**Int. Cls.: 21, 25 and 41**

**Prior U.S. Cls.: 2, 13, 22, 23, 29, 30, 33, 39, 40, 50, 100,  
101 and 107**

**Reg. No. 3,498,203**

**United States Patent and Trademark Office**

**Registered Sep. 9, 2008**

**TRADEMARK  
SERVICE MARK  
PRINCIPAL REGISTER**



DRAKE UNIVERSITY (IOWA CORPORATION)  
2507 UNIVERSITY AVENUE  
DES MOINES, IA 50311

FOR: BEVERAGE CONTAINERS, NAMELY, COFFEE MUGS; DRINKING GLASSES, STEINS, STEAMWARE, SHOT GLASSES, SIPPY CUPS; WATER BOTTLES SOLD EMPTY; TRAVEL MUGS; THERMAL INSULATED CONTAINERS FOR BEVERAGES, SERVING BOWLS, INSULATED SLEEVE-HOLDERS FOR BEVERAGE CONTAINERS; ORNAMENTS OF CHINA, CRYSTAL, GLASS, PORCELAIN NOT BEING CHRISTMAS TREE ORNAMENTS; CERAMIC FIGURES; COASTERS NOT OF PAPER AND NOT BEING TABLE LINEN, IN CLASS 21 (U.S. CLS. 2, 13, 23, 29, 30, 33, 40 AND 50).

FIRST USE 8-12-2005; IN COMMERCE 8-12-2005.

FOR: CLOTHING FOR MEN, WOMEN AND CHILDREN, NAMELY, SHIRTS, SHORTS, T-SHIRTS, HATS, CAPS, SOCKS, JACKETS, PANTS,

SWEATSUITS, SWEATSHIRTS, SWEATPANTS, SLEEPWEAR, RAINWEAR, SWEATERS AND VISORS, IN CLASS 25 (U.S. CLS. 22 AND 39).

FIRST USE 8-12-2005; IN COMMERCE 8-12-2005.

FOR: ENTERTAINMENT AND EDUCATIONAL SERVICES, NAMELY, CONDUCTING COLLEGIATE EDUCATIONAL PROGRAMS LEADING TO UNDERGRADUATE, POSTGRADUATE, AND PROFESSIONAL DEGREES, AND CONDUCTING COLLEGIATE SPORTING EVENTS, NAMELY, FOOTBALL, BASEBALL, SOFTBALL, TENNIS, SOCCER, CREW, CROSS COUNTRY, GOLF, VOLLEYBALL, BASKETBALL, AND TRACK EVENTS, IN CLASS 41 (U.S. CLS. 100, 101 AND 107).

FIRST USE 8-12-2005; IN COMMERCE 8-12-2005.

SER. NO. 77-309,775, FILED 10-22-2007.

MARK PILARO, EXAMINING ATTORNEY

**Int. Cls.: 21, 25 and 41**

**Prior U.S. Cls.: 2, 13, 22, 23, 29, 30, 33, 39, 40, 50, 100,  
101 and 107**

**Reg. No. 3,498,204**

**United States Patent and Trademark Office**

**Registered Sep. 9, 2008**

**TRADEMARK  
SERVICE MARK  
PRINCIPAL REGISTER**



DRAKE UNIVERSITY (IOWA CORPORATION)  
2507 UNIVERSITY AVENUE  
DES MOINES, IA 50311

FOR: BEVERAGE CONTAINERS, NAMELY, COFFEE MUGS; DRINKING GLASSES, STEINS, STEAMWARE, SHOT GLASSES, SIPPY CUPS; WATER BOTTLES SOLD EMPTY; TRAVEL MUGS; THERMAL INSULATED CONTAINERS FOR BEVERAGES, SERVING BOWLS, INSULATED SLEEVE-HOLDERS FOR BEVERAGE CONTAINERS; ORNAMENTS OF CHINA, CRYSTAL, GLASS, PORCELAIN NOT BEING CHRISTMAS TREE ORNAMENTS; CERAMIC FIGURES; COASTERS NOT OF PAPER AND NOT BEING TABLE LINEN, IN CLASS 21 (U.S. CLS. 2, 13, 23, 29, 30, 33, 40 AND 50).

FIRST USE 8-12-2005; IN COMMERCE 8-12-2005.

FOR: CLOTHING FOR MEN, WOMEN AND CHILDREN, NAMELY, SHIRTS, SHORTS, T-SHIRTS, HATS, CAPS, SOCKS, JACKETS, PANTS, SWEATSUITS, SWEATSHIRTS, SWEATPANTS,

SLEEPWEAR, RAINWEAR, SWEATERS AND VISORS, IN CLASS 25 (U.S. CLS. 22 AND 39).

FIRST USE 8-12-2005; IN COMMERCE 8-12-2005.

FOR: ENTERTAINMENT AND EDUCATIONAL SERVICES, NAMELY, CONDUCTING COLLEGIATE EDUCATIONAL PROGRAMS LEADING TO UNDERGRADUATE, POSTGRADUATE, AND PROFESSIONAL DEGREES, AND CONDUCTING COLLEGIATE SPORTING EVENTS, NAMELY, FOOTBALL, BASEBALL, SOFTBALL, TENNIS, SOCCER, CREW, CROSS COUNTRY, GOLF, VOLLEYBALL, BASKETBALL, AND TRACK EVENTS, IN CLASS 41 (U.S. CLS. 100, 101 AND 107).

FIRST USE 8-12-2005; IN COMMERCE 8-12-2005.

OWNER OF U.S. REG. NOS. 1,296,052, 2,830,020 AND OTHERS.

SER. NO. 77-310,019, FILED 10-22-2007.

MARK PILARO, EXAMINING ATTORNEY

Int. Cl.: 25

Prior U.S. Cls.: 22 and 39

United States Patent and Trademark Office

Reg. No. 3,498,205

Registered Sep. 9, 2008

TRADEMARK  
PRINCIPAL REGISTER



MCMANUS, RACHELLE L (UNITED STATES INDIVIDUAL), DBA RODEO HO  
9738 VISTA CACHE COURT  
LAS VEGAS, NV 89148

FOR: TANK-TOPS; DRESS SHIRTS; NIGHT SHIRTS; OPEN-NECKED SHIRTS; SHIRTS; SHORT-SLEEVED OR LONG-SLEEVED T-SHIRTS; SHORT-SLEEVED SHIRTS; SLEEP SHIRTS; SPORT SHIRTS; SWEAT SHIRTS; TEE SHIRTS; DENIM JACKETS; DENIMS; FLEECE PULLOVERS; PULLOVERS; BRIEFS; LADIES' UNDERWEAR; LONG UNDERWEAR; THONGS; UNDERWEAR; UNDERWEAR, NAMELY, BOY SHORTS; WOMEN'S UNDERWEAR; PANTIES, SHORTS AND BRIEFS; JEANS; JACKETS;

HATS; BANDANAS; BELTS; LEATHER BELTS; SOCKS; GLOVES, IN CLASS 25 (U.S. CLS. 22 AND 39).

FIRST USE 11-1-2006; IN COMMERCE 11-5-2006.

THE MARK CONSISTS OF A STYLIZED WOMAN IN A SITTING POSITION WEARING A COWBOY HAT AND COWBOY BOOTS; UNDERNEATH THE DESIGN IS THE STYLIZED WORDING "RODEO HO".

SER. NO. 77-310,358, FILED 10-22-2007.

CHRISTOPHER BUONGIORNO, EXAMINING ATTORNEY

**Int. Cl.: 25**

**Prior U.S. Cls.: 22 and 39**

**United States Patent and Trademark Office**

**Reg. No. 3,498,206**

**Registered Sep. 9, 2008**

**TRADEMARK  
PRINCIPAL REGISTER**



MCMANUS, RACHELLE L (UNITED STATES  
INDIVIDUAL), DBA RODEO HO  
9738 VISTA CACHE COURT  
LAS VEGAS, NV 89148

JACKETS; HATS; BANDANAS; BELTS; BELTS  
MADE OF LEATHER; SOCKS; GLOVES, IN CLASS  
25 (U.S. CLS. 22 AND 39).

FOR: TANK TOPS; SHORT-SLEEVED OR LONG-  
SLEEVED T-SHIRTS; T-SHIRTS; DRESS SHIRTS;  
LONG-SLEEVED SHIRTS; NIGHT SHIRTS; OPEN-  
NECKED SHIRTS; SHIRTS; SHORT-SLEEVED  
SHIRTS; SLEEP SHIRTS; SPORT SHIRTS; SWEAT  
SHIRTS; TEE SHIRTS; DENIM JACKETS; DENIMS;  
FLEECE PULLOVERS; FLEECE VESTS; PULL-  
OVERS; BRIEFS; LADIES' UNDERWEAR; LONG  
UNDERWEAR; THONGS; UNDERWEAR; UNDER-  
WEAR, NAMELY, BOY SHORTS; WOMEN'S UN-  
DERWEAR; PANTIES; PANTIES, SHORTS AND  
BRIEFS; BOXER SHORTS; SHORTS; JEANS; PANTS;

FIRST USE 11-1-2006; IN COMMERCE 11-5-2006.

THE MARK CONSISTS OF A STYLIZED WORD-  
ING "RODEO PIMP" WITH A DESIGN OF A COW-  
BOY FORMING THE LETTER "I" IN THE TERM  
"PIMP".

SER. NO. 77-310,385, FILED 10-22-2007.

CHRISTOPHER BUONGIORNO, EXAMINING AT-  
TORNEY

**Int. Cl.: 1**

**Prior U.S. Cls.: 1, 5, 6, 10, 26 and 46**

**United States Patent and Trademark Office**

**Reg. No. 3,498,207**

**Registered Sep. 9, 2008**

**TRADEMARK  
PRINCIPAL REGISTER**



ENVIRONMENTAL RESOURCE ASSOCIATES,  
INC. (COLORADO CORPORATION)  
6000 WEST 54TH AVENUE  
ARVADA, CO 80002

FOR: ENVIRONMENTAL QUALITY CONTROL  
FLUID, SOLID, AND GAS SAMPLES FOR CALCULATING  
STANDARDS FOR TESTING AND VERIFYING THE  
QUALITY OF AIR, IN CLASS 1 (U.S. CLS. 1, 5, 6, 10, 26 AND 46).

FIRST USE 7-20-2007; IN COMMERCE 7-20-2007.

THE MARK CONSISTS OF A DEPICTION OF A  
BUILDING WITH SMOKESTACKS, CONTAINED  
WITHIN A CIRCLE.

SER. NO. 77-310,705, FILED 10-23-2007.

MORGAN WYNNE, EXAMINING ATTORNEY

**Int. Cl.: 44**

**Prior U.S. Cls.: 100 and 101**

**United States Patent and Trademark Office**

**Reg. No. 3,498,208**

**Registered Sep. 9, 2008**

**SERVICE MARK  
PRINCIPAL REGISTER**

**SilverAdvantAGE**

SILVERCREST PROPERTIES, LLC (MINNESOTA  
LIMITED LIABILITY COMPANY)  
3601 PARK CENTER BLVD., SUITE 210  
ST. LOUIS PARK, MN 55146

FOR: CONSULTING SERVICES IN THE FIELD  
OF WOMEN'S HEALTH; COUNSELING SERVICES  
IN THE FIELDS OF HEALTH, NUTRITION AND  
LIFESTYLE WELLNESS; HEALTH CARE; HEALTH  
CARE SERVICES, NAMELY, WELLNESS PRO-  
GRAMS; HEALTH SPA SERVICES FOR HEALTH  
AND WELLNESS OF THE MIND, BODY AND  
SPIRIT OFFERED IN OR FROM A REMOTE, MO-  
BILE OR TEMPORARY ON-SITE LOCATION;  
HOME HEALTH CARE SERVICES; MUSIC THER-

APY FOR PHYSICAL, PSYCHOLOGICAL AND  
COGNITIVE PURPOSES; PHYSICAL REHABILITA-  
TION; PHYSICAL THERAPY, IN CLASS 44 (U.S. CLS.  
100 AND 101).

FIRST USE 10-2-2007; IN COMMERCE 10-2-2007.

THE MARK CONSISTS OF STANDARD CHAR-  
ACTERS WITHOUT CLAIM TO ANY PARTICULAR  
FONT, STYLE, SIZE, OR COLOR.

SER. NO. 77-311,320, FILED 10-23-2007.

SANJEEV VOHRA, EXAMINING ATTORNEY

Int. Cl.: 20

Prior U.S. Cls.: 2, 13, 22, 25, 32 and 50

Reg. No. 3,498,209

United States Patent and Trademark Office

Registered Sep. 9, 2008

TRADEMARK  
PRINCIPAL REGISTER



COSTCO WHOLESALE CORPORATION (WASHINGTON CORPORATION)  
999 LAKE DRIVE  
ISSAQUAH, WA 98027

FOR: MATTRESSES; PILLOWS; FURNITURE; CUSHIONS; PET BEDS; DECORATIVE CHRISTMAS/HOLIDAY-THEME ARTICLES MADE PRIMARILY OF PLASTIC, RESIN, FABRIC, OR WOOD, NAMELY, FIGURINES, STATUETTES, AND ORNAMENTS, IN CLASS 20 (U.S. CLS. 2, 13, 22, 25, 32 AND 50).

FIRST USE 9-30-1995; IN COMMERCE 9-30-1995.

OWNER OF U.S. REG. NOS. 2,133,426, 2,264,258, AND 2,780,567.

THE COLOR(S) RED, WHITE, BLACK IS/ARE CLAIMED AS A FEATURE OF THE MARK.

THE MARK CONSISTS OF THE WORDS "KIRKLAND SIGNATURE" IN STYLIZED LETTERING WITH "KIRKLAND" IN WHITE (EXCEPT FOR THE CROSS-HATCH OF THE "A" IN "KIRKLAND", WHICH IS IN RED) OVER "SIGNATURE" IN RED, ALL IN A BLACK RECTANGULAR BOX.

SER. NO. 77-312,458, FILED 10-24-2007.

SANJEEV VOHRA, EXAMINING ATTORNEY

Int. Cl.: 21

Prior U.S. Cls.: 2, 13, 23, 29, 30, 33, 40 and 50

United States Patent and Trademark Office

Reg. No. 3,498,210

Registered Sep. 9, 2008

TRADEMARK  
PRINCIPAL REGISTER



COSTCO WHOLESALE CORPORATION (WASHINGTON CORPORATION)  
999 LAKE DRIVE  
ISSAQUAH, WA 98027

FOR: DISPOSABLE GLOVES FOR HOME AND GENERAL USE; CORK SCREWS; DECORATIVE CHRISTMAS/HOLIDAY-THEME ARTICLES MADE PRIMARILY OF CERAMICS, PORCELAIN OR GLASS, NAMELY, FIGURINES, STATUETTES, ORNAMENTAL SCULPTURES, ORNAMENTS; HOLIDAY ORNAMENTS MADE PRIMARILY OF CERAMICS, PORCELAIN OR GLASS, NAMELY, MINIATURE VILLAGES, NATIVITY SETS, IN CLASS 21 (U.S. CLS. 2, 13, 23, 29, 30, 33, 40 AND 50).

FIRST USE 9-30-1995; IN COMMERCE 9-30-1995.

OWNER OF U.S. REG. NOS. 2,105,724, 2,264,258 AND OTHERS.

THE COLOR(S) RED, WHITE, BLACK IS/ARE CLAIMED AS A FEATURE OF THE MARK.

THE MARK CONSISTS OF THE WORDS "KIRKLAND SIGNATURE" IN STYLIZED LETTERING WITH "KIRKLAND" IN WHITE (EXCEPT FOR THE CROSS-HATCH OF THE "A" IN "KIRKLAND", WHICH IS IN RED) OVER "SIGNATURE" IN RED, ALL IN A BLACK RECTANGULAR BOX.

SER. NO. 77-312,477, FILED 10-24-2007.

SANJEEV VOHRA, EXAMINING ATTORNEY



**Int. Cls.: 3 and 25**

**Prior U.S. Cls.: 1, 4, 6, 22, 39, 50, 51 and 52**

**United States Patent and Trademark Office**

**Reg. No. 3,498,211**

**Registered Sep. 9, 2008**

**TRADEMARK  
PRINCIPAL REGISTER**



STEVEN M. BAILEY (CANADA INDIVIDUAL)  
BOX 1585  
3592 APPLETON SIDE ROAD  
CARLETON PLACE, CANADA K7C4M3

FOR: PERFUME, COLOGNE, EAU DE TOILETTE,  
PERFUME OIL, BODY SPRAY, PERFUME SPRAY,  
BODY LOTION, SHOWER GEL, IN CLASS 3 (U.S.  
CLS. 1, 4, 6, 50, 51 AND 52).

FIRST USE 4-19-2006; IN COMMERCE 4-19-2006.

FOR: CLOTHING, NAMELY, T-SHIRTS, IN  
CLASS 25 (U.S. CLS. 22 AND 39).

FIRST USE 4-19-2006; IN COMMERCE 4-19-2006.

PRIORITY CLAIMED UNDER SEC. 44(D) ON  
CANADA APPLICATION NO. 1366867, FILED 10-9-  
2007.

OWNER OF U.S. REG. NO. 1,804,019.

NO CLAIM IS MADE TO THE EXCLUSIVE  
RIGHT TO USE "FEMME", APART FROM THE  
MARK AS SHOWN.

THE MARK CONSISTS OF THE STYLIZED  
WORD "SEXUAL" FEATURING ACCENTS ON  
THE LETTERS "E" AND "U" ABOVE THE WORD  
"FEMME".

THE FOREIGN WORDING IN THE MARK  
TRANSLATES INTO ENGLISH AS WOMAN.

SER. NO. 77-312,837, FILED 10-25-2007.

RAUL CORDOVA, EXAMINING ATTORNEY

**Int. Cl.: 43**

**Prior U.S. Cls.: 100 and 101**

**United States Patent and Trademark Office**

**Reg. No. 3,498,212**

**Registered Sep. 9, 2008**

**SERVICE MARK  
PRINCIPAL REGISTER**

**RIMEL'S ROTISSERIE & LOCAL  
SEAFOOD**

MATTHEW AND JACQUELINE RIMEL (UNITED STATES INDIVIDUAL)  
6823 DRAPER AVE  
LA JOLLA, CA 92037

NO CLAIM IS MADE TO THE EXCLUSIVE RIGHT TO USE "ROTISSERIE & LOCAL SEAFOOD", APART FROM THE MARK AS SHOWN.

FOR: RESTAURANT, CATERING AND TAKE-OUT SERVICES, IN CLASS 43 (U.S. CLS. 100 AND 101).

SEC. 2(F).

FIRST USE 6-1-1994; IN COMMERCE 6-1-1994.

SER. NO. 77-313,280, FILED 10-25-2007.

THE MARK CONSISTS OF STANDARD CHARACTERS WITHOUT CLAIM TO ANY PARTICULAR FONT, STYLE, SIZE, OR COLOR.

AISHA CLARKE, EXAMINING ATTORNEY

Int. Cl.: 36

Prior U.S. Cls.: 100, 101 and 102

United States Patent and Trademark Office

Reg. No. 3,498,213

Registered Sep. 9, 2008

SERVICE MARK  
PRINCIPAL REGISTER

精 算 子

TONG LUO (CHINA INDIVIDUAL)  
2077 ARAPAHO PLACE  
FREMONT, CA 94539

FOR: FINANCIAL LOAN CONSULTATION SERVICES, IN CLASS 36 (U.S. CLS. 100, 101 AND 102).

FIRST USE 1-1-2003; IN COMMERCE 1-1-2003.

THE MARK CONSISTS OF 3 CHINESE CHARACTERS THAT LOOSELY TRANSLATE TO SMART CALCULATOR IN ENGLISH.

THE FOREIGN WORDING IN THE MARK TRANSLATES INTO ENGLISH AS SMART CALCULATOR.

THE NON-LATIN CHARACTER(S) IN THE MARK TRANSLITERATES INTO "JING SUAN ZI", AND THIS MEANS SMART CALCULATOR IN ENGLISH.

SER. NO. 77-313,530, FILED 10-25-2007.

JANICE KIM, EXAMINING ATTORNEY

**Int. Cl.: 35**

**Prior U.S. Cls.: 100, 101 and 102**

**United States Patent and Trademark Office**

**Reg. No. 3,498,214**

**Registered Sep. 9, 2008**

**SERVICE MARK  
PRINCIPAL REGISTER**

**CALLING ALL MEN  
SINCE 1923!**

BARNEY'S, INC. (NEW YORK CORPORATION)  
11TH FLOOR  
575 FIFTH AVENUE  
NEW YORK, NY 10017

THE MARK CONSISTS OF STANDARD CHAR-  
ACTERS WITHOUT CLAIM TO ANY PARTICULAR  
FONT, STYLE, SIZE, OR COLOR.

FOR: RETAIL STORE SERVICES IN THE FIELD  
OF MENS' CLOTHING, IN CLASS 35 (U.S. CLS. 100,  
101 AND 102).

SER. NO. 77-313,545, FILED 10-25-2007.

FIRST USE 10-1-2007; IN COMMERCE 10-1-2007.

ASMAT KHAN, EXAMINING ATTORNEY

**Int. Cl.: 35**

**Prior U.S. Cls.: 100, 101 and 102**

**United States Patent and Trademark Office**

**Reg. No. 3,498,215**

**Registered Sep. 9, 2008**

**SERVICE MARK  
PRINCIPAL REGISTER**

**HILL PARTNER**

DAVID COLANGELO (UNITED STATES INDIVIDUAL)  
P.O. BOX 11546  
SYRACUSE, NY 13218

FOR: LOBBYING SERVICES, NAMELY, PROMOTING THE INTERESTS OF COMMERCIAL BUSINESSES AND ORGANIZATIONS, GOVERNMENTAL ENTITIES, OTHER ENTITIES OR GROUPS IN THE FIELDS OF LEGISLATION AND REGULATION; STRATEGIC AND POLITICAL CONSULTING IN THE FIELD OF COALITION

BUILDING AND GRASSROOTS ORGANIZING, IN CLASS 35 (U.S. CLS. 100, 101 AND 102).

FIRST USE 11-27-2004; IN COMMERCE 11-27-2004.

THE MARK CONSISTS OF STANDARD CHARACTERS WITHOUT CLAIM TO ANY PARTICULAR FONT, STYLE, SIZE, OR COLOR.

SER. NO. 77-313,736, FILED 10-25-2007.

DANIEL CAPSHAW, EXAMINING ATTORNEY

**Int. Cl.: 33**

**Prior U.S. Cls.: 47 and 49**

**United States Patent and Trademark Office**

**Reg. No. 3,498,216**

**Registered Sep. 9, 2008**

**TRADEMARK  
PRINCIPAL REGISTER**

**BIONATURA**

UNION DES COOPERATIVES AGRICOLES LES  
VIGNERONS DES GARRIGUES (FRANCE UN-  
ION DE COOPERATIVES AGRICOLES)  
Z.I. SAINT CÉSAIRE, CHEMIN DU CHAI  
NIMES, FRANCE 30900

OWNER OF FRANCE REG. NO. 063464557, DA-  
TED 11-22-2006, EXPIRES 11-22-2016.

FOR: WINES, IN CLASS 33 (U.S. CLS. 47 AND 49).

SER. NO. 77-314,157, FILED 10-26-2007.

THE MARK CONSISTS OF STANDARD CHAR-  
ACTERS WITHOUT CLAIM TO ANY PARTICULAR  
FONT, STYLE, SIZE, OR COLOR.

KAREN K. BUSH, EXAMINING ATTORNEY

**Int. Cls.: 5 and 42**

**Prior U.S. Cls.: 6, 18, 44, 46, 51, 52, 100 and 101**

**United States Patent and Trademark Office**

**Reg. No. 3,498,217**

**Registered Sep. 9, 2008**

**TRADEMARK  
SERVICE MARK  
PRINCIPAL REGISTER**



OSMOTICA HOLDINGS CORPORATION (PANAMA CORPORATION)  
EDIFICIO AFRA  
AVENIDA SAMUEL LEWIS Y CALLE 54  
PANAMA 5, PANAMA

FOR: PHARMACEUTICAL PRODUCTS AND PREPARATIONS FOR THE PREVENTION AND TREATMENT OF CENTRAL NERVOUS SYSTEM, CARDIAC, AND GASTROINTESTINAL DISORDERS USING CONTROLLED RELEASE DRUG DELIVERY TECHNOLOGIES, IN CLASS 5 (U.S. CLS. 6, 18, 44, 46, 51 AND 52).

FIRST USE 1-31-2006; IN COMMERCE 1-31-2006.

FOR: CONSULTATION SERVICES REGARDING CONTROLLED RELEASE DRUG DELIVERY TECH-

NOLOGY FOR PHARMACEUTICAL COMPANIES, IN CLASS 42 (U.S. CLS. 100 AND 101).

FIRST USE 6-30-2000; IN COMMERCE 6-30-2000.

NO CLAIM IS MADE TO THE EXCLUSIVE RIGHT TO USE "PHARMACEUTICAL", APART FROM THE MARK AS SHOWN.

THE STIPPLING IS A FEATURE OF THE MARK.

THE MARK CONSISTS OF A STYLIZED LETTER "O" WITH THE WORDS "OSMOTICA PHARMACEUTICAL" BESIDE THE LETTER "O".

SER. NO. 77-314,483, FILED 10-26-2007.

LOURDES AYALA, EXAMINING ATTORNEY

**Int. Cls.: 16, 41, 44 and 45**

**Prior U.S. Cls.: 2, 5, 22, 23, 29, 37, 38, 50, 100, 101 and 107**

**Reg. No. 3,498,218**

**United States Patent and Trademark Office**

**Registered Sep. 9, 2008**

**TRADEMARK  
SERVICE MARK  
PRINCIPAL REGISTER**

# PROCOVERY

PROCOVERY INSTITUTE LLC (CALIFORNIA LIMITED LIABILITY COMPANY)  
P.O. BOX 351663  
LOS ANGELES, CA 90035

FOR: SERIES OF BOOKS AND BOOKLETS, PAMPHLETS, PRINTED CARDS, AND PRINTED TRAINING AND INSTRUCTIONAL MATERIALS IN THE FIELDS OF PERSONAL GROWTH, WELLNESS AND RECOVERY FROM LOSS, AND CARE AND TREATMENT OF MENTAL ILLNESS AND SERIOUS AND CHRONIC ILLNESSES, TRAUMAS AND ADDICTION; PENS; POSTERS, IN CLASS 16 (U.S. CLS. 2, 5, 22, 23, 29, 37, 38 AND 50).

FIRST USE 10-0-1996; IN COMMERCE 10-0-1996.

FOR: EDUCATIONAL SERVICES, NAMELY, CONDUCTING WORKSHOPS, SEMINARS AND COURSES OF INSTRUCTION IN THE FIELDS OF PERSONAL GROWTH, WELLNESS AND RECOVERY FROM LOSS, AND CARE AND TREATMENT OF MENTAL ILLNESS AND SERIOUS AND CHRONIC ILLNESSES, TRAUMAS AND ADDICTION; PROVIDING TRAINING IN THE FIELD OF ORGANIZING AND CONDUCTING SUPPORT GROUPS IN THE FIELDS OF PERSONAL GROWTH, WELLNESS AND RECOVERY FROM LOSS, AND CARE AND TREATMENT OF MENTAL ILLNESS AND SERIOUS AND CHRONIC ILLNESSES, TRAUMAS AND ADDICTION, IN CLASS 41 (U.S. CLS. 100, 101 AND 107).

FIRST USE 10-0-1996; IN COMMERCE 10-0-1996.

FOR: PROVIDING INFORMATION VIA THE INTERNET IN THE FIELDS OF LIFESTYLE WELL-BEING, EMOTIONAL AND HEALTH WELL-BEING, SUPPORT FOR THE PHYSICAL, MENTAL, EMOTIONAL AND PSYCHOLOGICAL RECOVERY FROM LOSS, AND CARE AND TREATMENT OF MENTAL ILLNESS AND SERIOUS AND CHRONIC ILLNESSES, TRAUMAS AND ADDICTION, IN CLASS 44 (U.S. CLS. 100 AND 101).

FIRST USE 6-0-2000; IN COMMERCE 6-0-2000.

FOR: ORGANIZING, CONDUCTING AND FACILITATING SUPPORT GROUPS IN THE FIELDS OF PERSONAL GROWTH, WELLNESS AND RECOVERY FROM LOSS, AND CARE AND TREATMENT OF MENTAL ILLNESS AND SERIOUS AND CHRONIC ILLNESSES, TRAUMAS AND ADDICTION; PROVIDING INFORMATION VIA THE INTERNET IN THE FIELD OF PERSONAL GROWTH, IN CLASS 45 (U.S. CLS. 100 AND 101).

FIRST USE 10-0-2001; IN COMMERCE 10-0-2001.

THE MARK CONSISTS OF STANDARD CHARACTERS WITHOUT CLAIM TO ANY PARTICULAR FONT, STYLE, SIZE, OR COLOR.

OWNER OF U.S. REG. NO. 3,256,127.

SER. NO. 77-314,869, FILED 10-26-2007.

DAVID MILLER, EXAMINING ATTORNEY



**Int. Cl.: 32**

**Prior U.S. Cls.: 45, 46 and 48**

**Reg. No. 3,498,219**

**United States Patent and Trademark Office**

**Registered Sep. 9, 2008**

---

**TRADEMARK  
PRINCIPAL REGISTER**

**PARLE**

PARLE AGTO PVT.LTD (INDIA LIMITED LIABILITY COMPANY)  
CHAKALA  
WESTERN EXPRESS HIGHWAY, ANDHERI EAST  
MUMBAI, INDIA

THE MARK CONSISTS OF STANDARD CHARACTERS WITHOUT CLAIM TO ANY PARTICULAR FONT, STYLE, SIZE, OR COLOR.

FOR: FRUIT JUICE AND DRINKING WATER, IN CLASS 32 (U.S. CLS. 45, 46 AND 48).

SER. NO. 77-315,491, FILED 10-29-2007.

FIRST USE 1-1-1965; IN COMMERCE 1-1-1965.

MORGAN WYNNE, EXAMINING ATTORNEY

**Int. Cls.: 41, 42 and 44**

**Prior U.S. Cls.: 100, 101 and 107**

**United States Patent and Trademark Office**

**Reg. No. 3,498,220**

**Registered Sep. 9, 2008**

**SERVICE MARK  
PRINCIPAL REGISTER**

**MISSOURI BAPTIST MEDICAL  
CENTER**

MISSOURI BAPTIST MEDICAL CENTER (MISSOURI CORPORATION)  
3015 N. BALLAS ROAD  
ST. LOUIS, MO 63131

FOR: EDUCATIONAL SERVICES, NAMELY, CONDUCTING CLASSES, SEMINARS, TRAINING PROGRAMS, WORKSHOPS AND CONFERENCES, ALL IN THE FIELDS OF MEDICINE AND BIOMEDICAL SCIENCES, AND DISTRIBUTING EDUCATIONAL COURSE MATERIALS IN CONNECTION THEREWITH, IN CLASS 41 (U.S. CLS. 100, 101 AND 107).

FIRST USE 10-27-1987; IN COMMERCE 10-27-1987.

FOR: MEDICAL RESEARCH SERVICES, IN CLASS 42 (U.S. CLS. 100 AND 101).

FIRST USE 10-27-1987; IN COMMERCE 10-27-1987.

FOR: MEDICAL AND HOSPITAL SERVICES, IN CLASS 44 (U.S. CLS. 100 AND 101).

FIRST USE 10-27-1987; IN COMMERCE 10-27-1987.

THE MARK CONSISTS OF STANDARD CHARACTERS WITHOUT CLAIM TO ANY PARTICULAR FONT, STYLE, SIZE, OR COLOR.

NO CLAIM IS MADE TO THE EXCLUSIVE RIGHT TO USE "MEDICAL CENTER", APART FROM THE MARK AS SHOWN.

SEC. 2(F).

SER. NO. 77-316,169, FILED 10-29-2007.

TRICIA SONNEBORN, EXAMINING ATTORNEY

**Int. Cl.: 42**

**Prior U.S. Cls.: 100 and 101**

**United States Patent and Trademark Office**

**Reg. No. 3,498,221**

**Registered Sep. 9, 2008**

**SERVICE MARK  
PRINCIPAL REGISTER**

**ABK-Soft**

RUDAKOV DMITRY VLADIMIROVICH (RUSSIAN FED. INDIVIDUAL)  
ZELENAYA 4-42  
VLADIMIR, RUSSIAN FED. 600017

THE MARK CONSISTS OF STANDARD CHARACTERS WITHOUT CLAIM TO ANY PARTICULAR FONT, STYLE, SIZE, OR COLOR.

FOR: SOFTWARE DEVELOPMENT IN THE FIELD OF DATING, SOCIAL NETWORKING AND COMMUNITY WEBSITES, IN CLASS 42 (U.S. CLS. 100 AND 101).

SER. NO. 77-316,724, FILED 10-30-2007.

FIRST USE 6-1-2006; IN COMMERCE 6-1-2006.

LINDA ORNDORFF, EXAMINING ATTORNEY

**Int. Cl.: 29**

**Prior U.S. Cl.: 46**

**United States Patent and Trademark Office**

**Reg. No. 3,498,222**

**Registered Sep. 9, 2008**

**TRADEMARK  
PRINCIPAL REGISTER**



MING HONG INTERNATIONAL (CALIFORNIA CORPORATION)  
13285 AMAR ROAD  
CITY OF INDUSTRY, CA 91746

FOR: NORI (DRY SEAWEED), IN CLASS 29 (U.S. CL. 46).

FIRST USE 6-15-1996; IN COMMERCE 6-15-1996.

NO CLAIM IS MADE TO THE EXCLUSIVE RIGHT TO USE "TOKYO" AND "NORI" AND THE NON-LATIN CHARACTERS MEANING "TOKYO" AND "NORI", APART FROM THE MARK AS SHOWN.

THE MARK CONSISTS IN PART OF A DESIGN OF OCEAN WAVES.

THE NON-LATIN CHARACTERS IN THE MARK ARE BOTH TRANSLITERATED AND TRANSLATED AS "TOKYO NORI".

SER. NO. 77-316,785, FILED 10-30-2007.

STEVEN R. FINE, EXAMINING ATTORNEY

**Int. Cls.: 16 and 41**

**Prior U.S. Cls.: 2, 5, 22, 23, 29, 37, 38, 50, 100, 101 and 107**

**Reg. No. 3,498,223**

**United States Patent and Trademark Office**

**Registered Sep. 9, 2008**

**TRADEMARK  
SERVICE MARK  
PRINCIPAL REGISTER**

# Vinland Press

COONS SUSAN A. (UNITED STATES INDIVIDUAL)  
PO BOX 927  
NORTH BEND, OR 97459

THE MARK CONSISTS OF STANDARD CHARACTERS WITHOUT CLAIM TO ANY PARTICULAR FONT, STYLE, SIZE, OR COLOR.

FOR: CHILDREN'S BOOKS, IN CLASS 16 (U.S. CLS. 2, 5, 22, 23, 29, 37, 38 AND 50).

NO CLAIM IS MADE TO THE EXCLUSIVE RIGHT TO USE "PRESS", APART FROM THE MARK AS SHOWN.

FIRST USE 4-1-1976; IN COMMERCE 4-1-1976.

FOR: PUBLISHING OF BOOKS, IN CLASS 41 (U.S. CLS. 100, 101 AND 107).

SER. NO. 77-317,087, FILED 10-30-2007.

FIRST USE 4-1-1976; IN COMMERCE 4-1-1976.

KELLEY WELLS, EXAMINING ATTORNEY

Int. Cl.: 9

Prior U.S. Cls.: 21, 23, 26, 36 and 38

United States Patent and Trademark Office

Reg. No. 3,498,224

Registered Sep. 9, 2008

TRADEMARK  
PRINCIPAL REGISTER

sewing ideas 

KSIN LUXEMBOURG III, S.AR.L. (LUXEMBOURG CORPORATION)  
1, RUE DES GLACIS  
L-1628, LUXEMBOURG

FOR: DIGITAL MATERIALS, NAMELY, DOWNLOADABLE GRAPHICS FILES FEATURING DESIGNS FOR EMBROIDERING; DOWNLOADABLE ELECTRONIC PUBLICATIONS IN THE NATURE OF INSTRUCTION GUIDES IN THE FIELD OF SEWING AND EMBROIDERY, IN CLASS 9 (U.S. CLS. 21, 23, 26, 36 AND 38).

FIRST USE 8-15-2007; IN COMMERCE 8-15-2007.

NO CLAIM IS MADE TO THE EXCLUSIVE RIGHT TO USE "SEWING IDEAS", APART FROM THE MARK AS SHOWN.

THE MARK CONSISTS OF THE WORDS "SEWING IDEAS" WITH A STARBURST ABOVE AND TO THE RIGHT OF THE WORD "IDEAS".

SER. NO. 77-317,705, FILED 10-31-2007.

CAROLYN CATALDO, EXAMINING ATTORNEY

**Int. Cl.: 40**

**Prior U.S. Cls.: 100, 103 and 106**

**United States Patent and Trademark Office**

**Reg. No. 3,498,225**

**Registered Sep. 9, 2008**

**SERVICE MARK  
PRINCIPAL REGISTER**

# MIMviewer

MIMVISTA CORP. (OHIO CORPORATION)  
SUITE 200  
25200 CHAGRIN BLVD.  
CLEVELAND, OH 44122

FOR: DIGITAL ENHANCEMENT AND MANIPULATION OF RADIOLOGICAL DATA BY MEANS OF COMPUTERIZED SOFTWARE FOR USE IN THE FIELD OF RADIOLOGY, IN CLASS 40 (U.S. CLS. 100, 103 AND 106).

FIRST USE 12-12-2005; IN COMMERCE 12-12-2005.

THE MARK CONSISTS OF STANDARD CHARACTERS WITHOUT CLAIM TO ANY PARTICULAR FONT, STYLE, SIZE, OR COLOR.

SER. NO. 77-318,809, FILED 11-1-2007.

CHRIS WELLS, EXAMINING ATTORNEY

**Int. Cl.: 3**

**Prior U.S. Cls.: 1, 4, 6, 50, 51 and 52**

**United States Patent and Trademark Office**

**Reg. No. 3,498,226**

**Registered Sep. 9, 2008**

**TRADEMARK  
PRINCIPAL REGISTER**

**GOOD DOGMA**

GOOD DOGMA PRODUCTS, INC. (OREGON  
CORPORATION)  
P.O. BOX 1754  
BEAVERTON, OR 97075

FOR: AROMATHERAPY OILS; DEODORIZERS  
FOR PETS IN THE NATURE OF SPRITZERS; PET  
ODOR REMOVERS; NON-MEDICATED GROOM-  
ING PREPARATIONS FOR PETS, NAMELY, SPRIT-  
ZERS AND BAR SOAPS, IN CLASS 3 (U.S. CLS. 1, 4, 6,  
50, 51 AND 52).

FIRST USE 6-30-1996; IN COMMERCE 6-30-1996.

THE MARK CONSISTS OF STANDARD CHAR-  
ACTERS WITHOUT CLAIM TO ANY PARTICULAR  
FONT, STYLE, SIZE, OR COLOR.

OWNER OF U.S. REG. NO. 3,306,796.

SER. NO. 77-318,928, FILED 11-1-2007.

ANDREA BUTLER, EXAMINING ATTORNEY



**Int. Cl.: 16**

**Prior U.S. Cls.: 2, 5, 22, 23, 29, 37, 38 and 50**

**Reg. No. 3,498,227**

**United States Patent and Trademark Office**

**Registered Sep. 9, 2008**

**TRADEMARK  
PRINCIPAL REGISTER**

**STEELMASTER**

BLOCK AND COMPANY, INC. (ILLINOIS CORPORATION)  
1111 SOUTH WHEELING ROAD  
WHEELING, IL 60090

FOR: OFFICE PRODUCTS, DESK ACCESSORIES AND FILING SUPPLIES, NAMELY, DESK TOP VERTICAL ORGANIZERS, DESK TOP HORIZONTAL ORGANIZERS, DESK TOP FORM AND STATIONERY HOLDERS, DESK TOP CABINETS FOR STORING DOCUMENTS AND STATIONERY, DESK LETTER TRAYS, CHART HOLDERS, PERSONAL DOCUMENT FILES, BOOKENDS, DESK TOP CARD

FILES AND BUSINESS CARD FILES, IN CLASS 16 (U.S. CLS. 2, 5, 22, 23, 29, 37, 38 AND 50).

FIRST USE 4-1-1994; IN COMMERCE 4-1-1994.

THE MARK CONSISTS OF STANDARD CHARACTERS WITHOUT CLAIM TO ANY PARTICULAR FONT, STYLE, SIZE, OR COLOR.

SER. NO. 77-319,280, FILED 11-1-2007.

VIVIAN MICZNIK FIRST, EXAMINING ATTORNEY

**Int. Cl.: 9**

**Prior U.S. Cls.: 21, 23, 26, 36 and 38**

**Reg. No. 3,498,228**

**United States Patent and Trademark Office**

**Registered Sep. 9, 2008**

---

**TRADEMARK  
PRINCIPAL REGISTER**

**PrecipiCalc**

QUESTEK INNOVATIONS LLC (DELAWARE  
LIMITED LIABILITY COMPANY)  
1820 RIDGE AVENUE  
EVANSTON, IL 60201

THE MARK CONSISTS OF STANDARD CHAR-  
ACTERS WITHOUT CLAIM TO ANY PARTICULAR  
FONT, STYLE, SIZE, OR COLOR.

FOR: COMPUTER SOFTWARE PROGRAMS FOR  
DESIGNING METAL ALLOYS, IN CLASS 9 (U.S.  
CLS. 21, 23, 26, 36 AND 38).

SER. NO. 77-319,443, FILED 11-1-2007.

FIRST USE 3-0-2001; IN COMMERCE 12-0-2004.

JESSICA FATHY, EXAMINING ATTORNEY

**Int. Cl.: 35**

**Prior U.S. Cls.: 100, 101 and 102**

**United States Patent and Trademark Office**

**Reg. No. 3,498,229**

**Registered Sep. 9, 2008**

**SERVICE MARK  
PRINCIPAL REGISTER**

**HAWAIIMEETINGS.COM**

PACIFIC MOTIVATION ADVISORS INC. (HAWAII CORPORATION), DBA HAWAII MEETING BUILDERS  
33 N. MARKET STREET, SUITE 300  
WAILUKU, HI 96793

FOR: BUSINESS MANAGEMENT AND CONSULTING SERVICES IN THE FIELD OF TRAVEL DESTINATION MANAGEMENT AND EVENT PRODUCTION, IN CLASS 35 (U.S. CLS. 100, 101 AND 102).

FIRST USE 1-2-1997; IN COMMERCE 1-2-1997.

THE MARK CONSISTS OF STANDARD CHARACTERS WITHOUT CLAIM TO ANY PARTICULAR FONT, STYLE, SIZE, OR COLOR.

SEC. 2(F).

SER. NO. 77-319,501, FILED 11-1-2007.

JIM RINGLE, EXAMINING ATTORNEY

Int. Cl.: 25

Prior U.S. Cls.: 22 and 39

United States Patent and Trademark Office

Reg. No. 3,498,230

Registered Sep. 9, 2008

TRADEMARK  
PRINCIPAL REGISTER



WILLIAMS, CLARENCE JR. (UNITED STATES  
INDIVIDUAL)  
37371 WILD TREE ST.  
PALMDALE, CA 93550

FOR: CLOTHING, NAMELY, PANTS, SHIRTS,  
JACKETS, BELTS, IN CLASS 25 (U.S. CLS. 22 AND  
39).

FIRST USE 2-1-2008; IN COMMERCE 2-1-2008.

NO CLAIM IS MADE TO THE EXCLUSIVE  
RIGHT TO USE "APPAREL", APART FROM THE  
MARK AS SHOWN.

THE COLOR(S) BLACK, GRAY, AND RED IS/  
ARE CLAIMED AS A FEATURE OF THE MARK.

THE MARK CONSISTS OF THE WORD "CODE"  
IN BLACK LETTERING WITH A GRAY BORDER,  
AND THE WORD "X" IN RED WITH A GRAY  
BORDER.

SER. NO. 77-319,635, FILED 11-2-2007.

CHARLES L. JENKINS, EXAMINING ATTORNEY

**Int. Cls.: 6, 11 and 17**

**Prior U.S. Cls.: 1, 2, 5, 12, 13, 14, 21, 23, 25, 31, 34, 35  
and 50**

**Reg. No. 3,498,231**

**United States Patent and Trademark Office**

**Registered Sep. 9, 2008**

**TRADEMARK  
PRINCIPAL REGISTER**



QUICK FITTING, INC. (RHODE ISLAND COR-  
PORATION)  
P.O. BOX 164  
TIVERTON, RI 02878

FOR: METAL PIPE FITTINGS FOR COPPER  
PIPES, PVC PIPES, PEX TUBING AND STAINLESS  
STEEL TUBING, AND METAL STRUCTURAL  
PARTS THEREFOR , IN CLASS 6 (U.S. CLS. 2, 12,  
13, 14, 23, 25 AND 50).

FIRST USE 8-0-2005; IN COMMERCE 8-0-2005.

FOR: PLUMBING FITTINGS, NAMELY, VALVES,  
COUPLERS, REDUCERS, PLUMBING T-PIPE FIT-  
TINGS BEING COUPLERS OR VALVES, PLASTIC  
PLUMBING PIPE FITTING END RETAINING CAPS,  
INSERT SLEEVES, THREADED END FITTINGS  
AND SOLDERED END FITTINGS, IN CLASS 11  
(U.S. CLS. 13, 21, 23, 31 AND 34).

FIRST USE 8-0-2005; IN COMMERCE 8-0-2005.

FOR: PLASTIC INSERTS FOR USE WITH METAL  
PIPE FITTINGS AND PLUMBING FITTINGS,  
NAMELY, PIPE GASKETS, O-RING PIPE SEALS,  
PACKING GLANDS FOR SEALING PIPES; PLASTIC  
PIPE FITTING END RETAINING CAPS; KITS COM-  
POSED OF PIPE FITTINGS CONSISTING OF PIPE  
GASKETS, O-RING PIPE SEALS, PACKING  
GLANDS FOR SEALING PIPES, PIPE FITTING  
END RETAINING CAPS AND REMOVAL TOOLS  
FOR REMOVING PIPE INSERTS FROM PIPE FIT-  
TINGS, IN CLASS 17 (U.S. CLS. 1, 5, 12, 13, 35 AND 50).

FIRST USE 8-0-2005; IN COMMERCE 8-0-2005.

OWNER OF U.S. REG. NO. 3,240,465.

SER. NO. 77-319,866, FILED 11-2-2007.

DOMINIC FATHY, EXAMINING ATTORNEY

**Int. Cls.: 35 and 41**

**Prior U.S. Cls.: 100, 101, 102 and 107**

**United States Patent and Trademark Office**

**Reg. No. 3,498,232**

**Registered Sep. 9, 2008**

**SERVICE MARK  
PRINCIPAL REGISTER**

**The San Francisco Fall  
Antiques Show**

ENTERPRISE FOR HIGH SCHOOL STUDENTS  
(CALIFORNIA CORPORATION)  
200 PINE STREET, SUITE 600  
SAN FRANCISCO, CA 94104

FOR: ARRANGING AND CONDUCTING TRADE  
SHOW EXHIBITIONS IN THE FIELD OF AN-  
TIQUES, IN CLASS 35 (U.S. CLS. 100, 101 AND 102).

FIRST USE 11-0-1982; IN COMMERCE 11-0-1982.

FOR: ARRANGING OF SEMINARS; ARRAN-  
GING EDUCATIONAL CONFERENCES, IN CLASS  
41 (U.S. CLS. 100, 101 AND 107).

FIRST USE 11-0-1982; IN COMMERCE 11-0-1982.

THE MARK CONSISTS OF STANDARD CHAR-  
ACTERS WITHOUT CLAIM TO ANY PARTICULAR  
FONT, STYLE, SIZE, OR COLOR.

NO CLAIM IS MADE TO THE EXCLUSIVE  
RIGHT TO USE "FALL ANTIQUES SHOW", APART  
FROM THE MARK AS SHOWN.

SEC. 2(F).

SER. NO. 77-320,286, FILED 11-2-2007.

WANDA KAY PRICE, EXAMINING ATTORNEY

**Int. Cl.: 35**

**Prior U.S. Cls.: 100, 101 and 102**

**United States Patent and Trademark Office**

**Reg. No. 3,498,233**

**Registered Sep. 9, 2008**

**SERVICE MARK  
PRINCIPAL REGISTER**

**UNIFIED MARKET SIMULATOR**

TVG, INC. (DELAWARE CORPORATION), DBA  
TVG MARKETING RESEARCH & CONSULT-  
ING  
SUITE 3100  
200 DRYDEN ROAD  
DRESHER, PA 19025

FOR: MARKETING RESEARCH SERVICES,  
NAMELY, USING KNOWLEDGE OF CUSTOMER  
PREFERENCES, CUSTOMER POLLS AND MAR-  
KETING STUDIES TO ADVISE CLIENTS, IN CLASS  
35 (U.S. CLS. 100, 101 AND 102).

FIRST USE 2-1-2007; IN COMMERCE 3-6-2007.

THE MARK CONSISTS OF STANDARD CHAR-  
ACTERS WITHOUT CLAIM TO ANY PARTICULAR  
FONT, STYLE, SIZE, OR COLOR.

NO CLAIM IS MADE TO THE EXCLUSIVE  
RIGHT TO USE "MARKET SIMULATOR", APART  
FROM THE MARK AS SHOWN.

SER. NO. 77-321,521, FILED 11-5-2007.

MATTHEW MCDOWELL, EXAMINING ATTOR-  
NEY

**Int. Cl.: 35**

**Prior U.S. Cls.: 100, 101 and 102**

**United States Patent and Trademark Office**

**Reg. No. 3,498,234**

**Registered Sep. 9, 2008**

**SERVICE MARK  
PRINCIPAL REGISTER**

**MESSAGE MAX**

TVG, INC. (DELAWARE CORPORATION), DBA  
TVG MARKETING RESEARCH & CONSULT-  
ING  
SUITE 3100  
200 DRYDEN ROAD  
DRESHER, PA 19025

FOR: MARKETING RESEARCH SERVICES,  
NAMELY, DEVELOPING PRODUCT MESSAGES  
FOR OTHERS, IN CLASS 35 (U.S. CLS. 100, 101  
AND 102).

FIRST USE 3-1-2007; IN COMMERCE 4-10-2007.

THE MARK CONSISTS OF STANDARD CHAR-  
ACTERS WITHOUT CLAIM TO ANY PARTICULAR  
FONT, STYLE, SIZE, OR COLOR.

NO CLAIM IS MADE TO THE EXCLUSIVE  
RIGHT TO USE "MESSAGE", APART FROM THE  
MARK AS SHOWN.

SER. NO. 77-321,631, FILED 11-5-2007.

MATTHEW MCDOWELL, EXAMINING ATTOR-  
NEY



Int. Cl.: 25

Prior U.S. Cls.: 22 and 39

United States Patent and Trademark Office

Reg. No. 3,498,235

Registered Sep. 9, 2008

TRADEMARK  
PRINCIPAL REGISTER

# Jimmy Snaps

CURRY, DAVID (FLORIDA SOLE PROPRIETOR-SHIP), DBA DESIGN LATITUDES  
161 NE 106TH STREET  
MIAMI SHORES, FL 331382036

FOR: BEACHWEAR; BASEBALL CAPS; BELTS; BIKINIS; BOXER SHORTS; BOXER BRIEFS; CAPS; CAPS WITH VISORS; DENIM JACKETS; DENIMS; DO RAGS; DRESSES; FOOTWEAR; GLOVES; GOLF CAPS; GOLF SHIRTS; HATS; HEADBANDS; HOODS; JACKETS; JEANS; LEOTARDS; LINGERIE; LOUNGEWEAR; MEN AND WOMEN JACKETS; COATS, TROUSERS, VESTS; NECKWEAR; NIGHTWEAR; PAJAMAS; PANTIES, SHORTS AND BRIEFS; PANTS; PANTYHOSE; POLO SHIRTS; RAINWEAR; ROBES; SHAWLS AND HEADSCARVES; SHIRTS; SHORT-SLEEVED OR LONG-SLEEVED T-SHIRTS; SHORT-SLEEVED SHIRTS; SHORTS; SILK SCARVES; SKIRTS; SMOKING JACKETS; SOCKS AND STOCKINGS; STOLE; SURF WEAR; SWEAT BANDS; SWEAT PANTS; SWEAT SHIRTS; SWEAT SHORTS; SWEAT SUITS; SWEATSOCKS; SWIM CAPS; SWIM TRUNKS; SWIMWEAR; T-SHIRTS;

TANK TOPS; THONGS; TIES; TIGHTS; TRACK SUITS; TRAINING SUITS; TURTLENECK SWEATERS; TUXEDO BELTS; TUXEDOS; UNDERSHIRTS; UNDERWEAR; VISORS; WARM UP SUITS; WIND-JACKETS; WIND COATS; WIND PANTS; WRISTBANDS, IN CLASS 25 (U.S. CLS. 22 AND 39).

FIRST USE 11-1-2007; IN COMMERCE 11-1-2007.

THE MARK CONSISTS OF STANDARD CHARACTERS WITHOUT CLAIM TO ANY PARTICULAR FONT, STYLE, SIZE, OR COLOR.

THE NAME(S), PORTRAIT(S), AND/OR SIGNATURE(S) SHOWN IN THE MARK "JIMMY SNAPS" DOES NOT IDENTIFY A PARTICULAR LIVING INDIVIDUAL.

SER. NO. 77-321,981, FILED 11-5-2007.

MARY BOAGNI, EXAMINING ATTORNEY

**Int. Cl.: 36**

**Prior U.S. Cls.: 100, 101 and 102**

**United States Patent and Trademark Office**

**Reg. No. 3,498,236**

**Registered Sep. 9, 2008**

**SERVICE MARK  
PRINCIPAL REGISTER**

**spa and share**

MARIO TRICOCI HAIR SALONS & DAY SPAS  
(ARIZONA CORPORATION)  
273 E. HELLEN ROAD  
PALATINE, IL 60067

FOR: CHARITABLE FUNDRAISING FOR NON-PROFIT CHARITABLE AND SERVICE ORGANIZATIONS RENDERED THROUGH THE DONATION OF PROCEEDS GENERATED FROM PROVIDING HAIR SALON SERVICES AND DAY SPA SERVICES, IN CLASS 36 (U.S. CLS. 100, 101 AND 102).

FIRST USE 3-26-2007; IN COMMERCE 3-26-2007.

THE MARK CONSISTS OF STANDARD CHARACTERS WITHOUT CLAIM TO ANY PARTICULAR FONT, STYLE, SIZE, OR COLOR.

NO CLAIM IS MADE TO THE EXCLUSIVE RIGHT TO USE "SPA", APART FROM THE MARK AS SHOWN.

SER. NO. 77-322,722, FILED 11-6-2007.

SETH A. RAPPAPORT, EXAMINING ATTORNEY

**Int. Cl.: 36**

**Prior U.S. Cls.: 100, 101 and 102**

**United States Patent and Trademark Office**

**Reg. No. 3,498,237**

**Registered Sep. 9, 2008**

**SERVICE MARK  
PRINCIPAL REGISTER**

**Texas Rx**

SCOTT AND WHITE HEALTH PLAN (TEXAS  
NON-PROFIT CORPORATION)  
2401 SOUTH 31ST STREET  
TEMPLE, TX 76508

FOR: INSURANCE HEALTH PLAN ADMINIS-  
TRATION, ISSUING AND SERVICING, IN CLASS 36  
(U.S. CLS. 100, 101 AND 102).

FIRST USE 10-0-2005; IN COMMERCE 10-0-2005.

THE MARK CONSISTS OF STANDARD CHAR-  
ACTERS WITHOUT CLAIM TO ANY PARTICULAR  
FONT, STYLE, SIZE, OR COLOR.

NO CLAIM IS MADE TO THE EXCLUSIVE  
RIGHT TO USE "TEXAS", APART FROM THE  
MARK AS SHOWN.

SER. NO. 77-323,027, FILED 11-6-2007.

SHAUNIA CARLYLE, EXAMINING ATTORNEY

Int. Cl.: 44

Prior U.S. Cls.: 100 and 101

United States Patent and Trademark Office

Reg. No. 3,498,238

Registered Sep. 9, 2008

SERVICE MARK  
PRINCIPAL REGISTER



AIHARA, LIANE (UNITED STATES INDIVIDUAL)  
765 DANFORTH TERRACE  
SUNNYVALE, CA 94087 AND  
WOLFFS, DAVID (UNITED STATES INDIVIDUAL)  
223 KILLDEER COURT  
FOSTER CITY, CA 94404 AND  
JENSEN, JANE (UNITED STATES INDIVIDUAL)  
1279 31ST AVENUE  
SAN MATEO, CA 94403 AND  
FORD, MARGIE (UNITED STATES INDIVIDUAL)  
691 DRUCILLA DRIVE  
MOUNTAIN VIEW, CA 94040

FOR: PROVIDING ALTERNATIVE HEALTH THERAPY IN THE NATURE OF ENERGY THERAPIES, NAMELY, BODY WORK, HEALING TOUCH, REIKI, AND MASSAGE, IN CLASS 44 (U.S. CLS. 100 AND 101).

FIRST USE 2-1-2007; IN COMMERCE 2-1-2007.

NO CLAIM IS MADE TO THE EXCLUSIVE RIGHT TO USE "HEALTH AND HEALING", APART FROM THE MARK AS SHOWN.

THE MARK CONSISTS OF THE PHRASE "RADIATING HEALTH AND HEALING" WRAPPED AROUND THE PICTURE OF TWO HANDS CUSPING A HEART. THE PICTURE IS OUTLINED WITH A RECTANGLE.

SER. NO. 77-323,087, FILED 11-6-2007.

STEVEN R. FINE, EXAMINING ATTORNEY

Int. Cl.: 35

Prior U.S. Cls.: 100, 101 and 102

United States Patent and Trademark Office

Reg. No. 3,498,239

Registered Sep. 9, 2008

SERVICE MARK  
PRINCIPAL REGISTER



RED DINGO GMBH (SWITZERLAND CORPORATION)

ROEHLIBERG 20

CH-6330 CHAM, SWITZERLAND

FOR: WHOLESALE DISTRIBUTORSHIPS AND  
RETAIL STORE SERVICES FEATURING PET IDENTIFICATION TAGS, IN CLASS 35 (U.S. CLS. 100, 101 AND 102).

OWNER OF AUSTRALIA REG. NO. 952819, DATED 5-7-2003, EXPIRES 5-7-2023.

THE MARK CONSISTS OF STYLIZED WORDS "RED DINGO" WITH AN IMAGE OF A DOG IN A CIRCLE IN THE MIDDLE OF THE TWO WORDS.

SER. NO. 77-323,110, FILED 11-6-2007.

MARK PILARO, EXAMINING ATTORNEY

**Int. Cl.: 35**

**Prior U.S. Cls.: 100, 101 and 102**

**United States Patent and Trademark Office**

**Reg. No. 3,498,240**

**Registered Sep. 9, 2008**

**SERVICE MARK  
PRINCIPAL REGISTER**



WESTERN SPORT SHOP, INC. (CALIFORNIA CORPORATION)

902 THIRD STREET  
SAN RAFAEL, CA 94901

FOR: ON-LINE RETAIL STORE SERVICES FEATURING HUNTING, FISHING, FLY FISHING AND OUTDOOR SPORTING GOODS AND RELATED BOOKS; RETAIL SHOPS FEATURING HUNTING, FISHING, FLY FISHING AND OUTDOOR SPORTING GOODS AND RELATED BOOKS, IN CLASS 35 (U.S. CLS. 100, 101 AND 102).

FIRST USE 12-31-1967; IN COMMERCE 2-28-2001.

NO CLAIM IS MADE TO THE EXCLUSIVE RIGHT TO USE "SPORTSHOP INC.", APART FROM THE MARK AS SHOWN.

THE MARK CONSISTS OF THE WORDS "WESTERN SPORTSHOP INC.", AND AN IMAGE OF A FISH WITH A CURVED TAIL-FIN. THE WORD "WESTERN" APPEARS ON THE BODY OF THE FISH. THE WORDS "SPORTSHOP" APPEAR JUST BELOW THE BODY OF THE FISH INSIDE THE CURVE OF THE TAIL-FIN.

SER. NO. 77-323,688, FILED 11-7-2007.

JASON TURNER, EXAMINING ATTORNEY

**Int. Cl.: 6**

**Prior U.S. Cls.: 2, 12, 13, 14, 23, 25 and 50**

**Reg. No. 3,498,241**

**United States Patent and Trademark Office**

**Registered Sep. 9, 2008**

**TRADEMARK  
PRINCIPAL REGISTER**

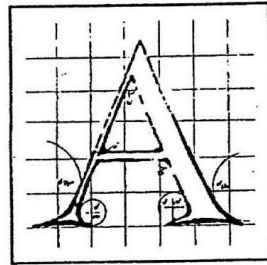

**arkita**

TREFIMETAUX S.A. (FRANCE CORPORATION)  
11 BIS, RUE DE L'HOTEL DE VILLE  
92400 COURBEVOIE, FRANCE

OWNER OF FRANCE REG. NO. 99/781517, DA-  
TED 3-18-1999, EXPIRES 3-17-2009.

FOR: FINISHED AND UNFINISHED COPPER  
AND COPPER ALLOY SHEETS, RODS AND BARS  
FOR USE IN ARCHITECTURE AND INTERIOR  
DECORATION OF COMMERCIAL AND PRIVATE  
BUILDINGS, IN CLASS 6 (U.S. CLS. 2, 12, 13, 14, 23, 25  
AND 50).

OWNER OF U.S. REG. NO. 2,337,154.

SER. NO. 77-324,398, FILED 11-8-2007.

BARBARA RUTLAND, EXAMINING ATTORNEY

**Int. Cls.: 17 and 27**

**Prior U.S. Cls.: 1, 5, 12, 13, 19, 20, 35, 37, 42 and 50**

**United States Patent and Trademark Office**

**Reg. No. 3,498,242**

**Registered Sep. 9, 2008**

**TRADEMARK  
PRINCIPAL REGISTER**

**MONOGRASS**

DR. WETEKAM & CO. KG (FED REP GERMANY  
LIMITED PARTNERSHIP)  
NURNBERGER STRASSE 30-32  
34212 MELSUNGEN, FED REP GERMANY

FOR: SEMI-PROCESSED PLASTICS FOR FURTHER FABRICATION AND MANUFACTURING, NAMELY, PLASTIC YARNS, FILAMENTS, FIBERS, BANDS, FABRICS AND FLEECES, ALL FOR NON-TEXTILE USE, IN CLASS 17 (U.S. CLS. 1, 5, 12, 13, 35 AND 50).

FOR: ARTIFICIAL TURF, IN CLASS 27 (U.S. CLS. 19, 20, 37, 42 AND 50).

THE MARK CONSISTS OF STANDARD CHARACTERS WITHOUT CLAIM TO ANY PARTICULAR FONT, STYLE, SIZE, OR COLOR.

OWNER OF FED REP GERMANY REG. NO. DE30729985, DATED 7-19-2007, EXPIRES 5-10-2017.

SER. NO. 77-324,819, FILED 11-8-2007.

STEVEN PEREZ, EXAMINING ATTORNEY



**Int. Cl.: 31**

**Prior U.S. Cls.: 1 and 46**

**United States Patent and Trademark Office**

**Reg. No. 3,498,243**

**Registered Sep. 9, 2008**

**TRADEMARK  
PRINCIPAL REGISTER**

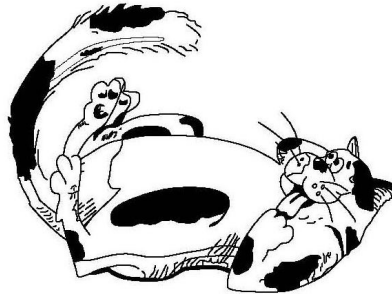

MARS, INCORPORATED (DELAWARE CORPORATION)  
6885 ELM STREET  
MCLEAN, VA 22101

THE MARK CONSISTS OF A STYLIZED CAT  
LYING ON HIS BACK.

FOR: PET SNACKS AND TREATS, IN CLASS 31  
(U.S. CLS. 1 AND 46).

SER. NO. 77-324,849, FILED 11-8-2007.

FIRST USE 1-0-2001; IN COMMERCE 1-0-2001.

WENDY GOODMAN, EXAMINING ATTORNEY

**Int. Cl.: 12**

**Prior U.S. Cls.: 19, 21, 23, 31, 35 and 44**

**Reg. No. 3,498,244**

**United States Patent and Trademark Office**

**Registered Sep. 9, 2008**

**TRADEMARK  
PRINCIPAL REGISTER**

**TOMCAT**

B. FOSTER AND COMPANY, INC. (PENNSYLVANIA CORPORATION)  
PO BOX 188, 6806 ANTHONY HIGHWAY  
WAYNESBORO, PA 17268

THE MARK CONSISTS OF STANDARD CHARACTERS WITHOUT CLAIM TO ANY PARTICULAR FONT, STYLE, SIZE, OR COLOR.

FOR: FIRE AND RESCUE VEHICLE IN THE NATURE OF A TRUCK FOR CARRYING AN ON-BOARD ELECTRICAL GENERATOR, IN CLASS 12 (U.S. CLS. 19, 21, 23, 31, 35 AND 44).

SER. NO. 77-325,308, FILED 11-8-2007.

FIRST USE 11-8-2007; IN COMMERCE 11-8-2007.

MARK SPARACINO, EXAMINING ATTORNEY

**Int. Cl.: 42**

**Prior U.S. Cls.: 100 and 101**

**United States Patent and Trademark Office**

**Reg. No. 3,498,245**

**Registered Sep. 9, 2008**

**SERVICE MARK  
PRINCIPAL REGISTER**

**MIKE TRUESE CREATIONS**

MIKE TRUESE CREATIONS INC. (NEW JERSEY CORPORATION)  
85 VAN REYPEN STREET  
JERSEY CITY, NJ 07306

FOR: DESIGN OF HOME PAGES, WEB SITES AND INTRANETS; CREATING OR MAINTAINING WEB SITES AND INTRANETS FOR OTHERS; COMPUTER SERVICES, NAMELY, MANAGING WEB SITES AND INTRANETS FOR OTHERS; ELABORATION AND MAINTENANCE OF WEB SITES AND INTRANETS FOR THIRD PARTIES; INTRANET AND WEB SITE HOSTING SERVICES FOR OTHERS; DEVELOPMENT OF WEBSITE CODING AND

SCRIPTS; CONSULTING SERVICES IN CONNECTION WITH THE FOREGOING, IN CLASS 42 (U.S. CLS. 100 AND 101).

FIRST USE 10-18-2007; IN COMMERCE 10-18-2007.

THE MARK CONSISTS OF STANDARD CHARACTERS WITHOUT CLAIM TO ANY PARTICULAR FONT, STYLE, SIZE, OR COLOR.

SER. NO. 77-326,591, FILED 11-10-2007.

AISHA CLARKE, EXAMINING ATTORNEY

**Int. Cl.: 9**

**Prior U.S. Cls.: 21, 23, 26, 36 and 38**

**Reg. No. 3,498,246**

**United States Patent and Trademark Office**

**Registered Sep. 9, 2008**

**TRADEMARK  
PRINCIPAL REGISTER**



SEMANTRA, INC. (TEXAS CORPORATION)  
5055 KELLER SPRINGS ROAD  
LIBERTY PLAZA 1, SUITE 550  
ADDISON, TX 75002

FOR: COMPUTER SEARCH ENGINE SOFTWARE; ENTERPRISE SOFTWARE IN THE NATURE OF A DATABASE FOR NON-TRANSACTIONAL DATA AND A SEARCH ENGINE FOR DATABASE

CONTENT , IN CLASS 9 (U.S. CLS. 21, 23, 26, 36 AND 38).

FIRST USE 8-15-2007; IN COMMERCE 9-30-2007.

SER. NO. 77-326,775, FILED 11-12-2007.

HANNO RITTNER, EXAMINING ATTORNEY

**Int. Cl.: 42**

**Prior U.S. Cls.: 100 and 101**

**United States Patent and Trademark Office**

**Reg. No. 3,498,247**

**Registered Sep. 9, 2008**

**SERVICE MARK  
PRINCIPAL REGISTER**

**PIEmatrix**

PIEMATRIX INC. (DELAWARE CORPORATION)  
120 PINE ST.  
BURLINGTON, VT 05401

FOR: COMPUTER SERVICES, NAMELY, INTERACTIVE HOSTING SERVICES WHICH ALLOW USERS TO PUBLISH AND SHARE THEIR OWN CONTENT AND IMAGES ONLINE; PROVIDING TEMPORARY USE OF ON-LINE NON-DOWNLOADABLE SOFTWARE FOR DEFINING AND MANAGING PROCESS STEPS; COMPUTER PRO-

JECT MANAGEMENT SERVICES, IN CLASS 42 (U.S. CLS. 100 AND 101).

FIRST USE 10-1-2006; IN COMMERCE 10-31-2007.

THE MARK CONSISTS OF STANDARD CHARACTERS WITHOUT CLAIM TO ANY PARTICULAR FONT, STYLE, SIZE, OR COLOR.

SER. NO. 77-327,170, FILED 11-12-2007.

DAVID C. REIHNER, EXAMINING ATTORNEY

Int. Cl.: 25

Prior U.S. Cls.: 22 and 39

United States Patent and Trademark Office

Reg. No. 3,498,248

Registered Sep. 9, 2008

TRADEMARK  
PRINCIPAL REGISTER



RITCH JEANS INC (PENNSYLVANIA CORPORATION), DBA RITCH DESIGNER FASHIONS  
2148 BIRCH DRIVE  
LAFAYETTE HILL, PA 19444

FOR: JEANS, IN CLASS 25 (U.S. CLS. 22 AND 39).

FIRST USE 3-1-2007; IN COMMERCE 7-1-2007.

OWNER OF U.S. REG. NO. 2,769,072.

NO CLAIM IS MADE TO THE EXCLUSIVE RIGHT TO USE "JEANS, UPSCALE FASHION" AND "DESIGNER APPAREL", APART FROM THE MARK AS SHOWN.

THE MARK CONSISTS OF THE WORD "RITCH" IN THREE DIFFERENT STYLES OR ART DESIGN, MIXED IN WITH ARTISTIC SWIRLS, AND THE WORDING "RITCH DESIGNER APPAREL" AND "UPSCALE FASHION AVEC ATTITUDE" CLEARLY PRINTED AT THE BOTTOM RIGHT.

THE FOREIGN WORDING IN THE MARK TRANSLATES INTO ENGLISH AS WITH ATTITUDE.

SER. NO. 77-327,237, FILED 11-12-2007.

STEVEN R. FINE, EXAMINING ATTORNEY

**Int. Cls.: 7 and 17**

**Prior U.S. Cls.: 1, 5, 12, 13, 19, 21, 23, 31, 34, 35 and 50**

**United States Patent and Trademark Office**

**Reg. No. 3,498,249**

**Registered Sep. 9, 2008**

**TRADEMARK  
PRINCIPAL REGISTER**

# EGC PLASTICS

CDI SEALS, INC. (TEXAS CORPORATION)  
8103 RANKIN ROAD  
HUMBLE, TX 77396

FOR: MACHINE PARTS, NAMELY, BEARINGS, BUSHINGS, FLUID PUMPS AND FITTINGS FOR THE AFORESAID GOODS, IN CLASS 7 (U.S. CLS. 13, 19, 21, 23, 31, 34 AND 35).

FIRST USE 10-1-2006; IN COMMERCE 10-1-2006.

FOR: SEALS COMPRISED OF ELASTOMERS, PLASTIC AND THERMOPLASTIC USED TO RETAIN OR SEPARATE LIQUIDS AND GASES BY MEANS OF SEALING PUMPS, COMPRESSORS AND VALVES; FLUROPLASTIC AND THERMOPLASTIC GOODS, NAMELY, RODS, TUBING, CONTAINERS AND FLEXIBLE DIAPHRAGMS FOR USE IN THE MANUFACTURE OF OTHER GOODS; EXPANSION JOINT FILLERS COMPRISED OF

FLUROPLASTIC.; THERMOPLASTIC WOUND STRUCTURES AND CARBON FILAMENT WOUND STRUCTURES IN THE FORM OF PELLETS, SHEETS, BOARDS AND RODS FOR USE IN MANUFACTURING, IN CLASS 17 (U.S. CLS. 1, 5, 12, 13, 35 AND 50).

FIRST USE 10-1-2006; IN COMMERCE 10-1-2006.

THE MARK CONSISTS OF STANDARD CHARACTERS WITHOUT CLAIM TO ANY PARTICULAR FONT, STYLE, SIZE, OR COLOR.

NO CLAIM IS MADE TO THE EXCLUSIVE RIGHT TO USE "PLASTICS", APART FROM THE MARK AS SHOWN.

SER. NO. 77-327,936, FILED 11-13-2007.

DANNEAN HETZEL, EXAMINING ATTORNEY

**Int. Cl.: 35**

**Prior U.S. Cls.: 100, 101 and 102**

**United States Patent and Trademark Office**

**Reg. No. 3,498,250**

**Registered Sep. 9, 2008**

**SERVICE MARK  
PRINCIPAL REGISTER**

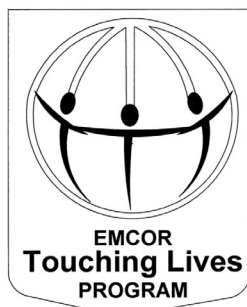

EMCOR GROUP, INC. (DELAWARE CORPORATION)  
301 MERRITT SEVEN - 7TH FLOOR  
NORWALK, CT 06851

FOR: CHARITABLE SERVICES, NAMELY, ORGANIZING AND CONDUCTING VOLUNTEER PROGRAMS AND COMMUNITY SERVICE PROJECTS, IN CLASS 35 (U.S. CLS. 100, 101 AND 102).

FIRST USE 6-24-2004; IN COMMERCE 6-24-2004.

OWNER OF U.S. REG. NOS. 2,562,923, 2,575,099, AND 3,202,939.

NO CLAIM IS MADE TO THE EXCLUSIVE RIGHT TO USE "PROGRAM", APART FROM THE MARK AS SHOWN.

THE MARK CONSISTS OF A DESIGN OF A GLOBE CONTAINING THREE LATITUDE LINES, THE BOTTOM HALF OF EACH LATITUDE LINE BEING A STICK FIGURE WITH ARMS OUTSTRETCHED FORMING ONE LONGITUDINAL LINE.

SER. NO. 77-327,945, FILED 11-13-2007.

MICHAEL LITZAU, EXAMINING ATTORNEY



**Int. Cl.: 35**

**Prior U.S. Cls.: 100, 101 and 102**

**United States Patent and Trademark Office**

**Reg. No. 3,498,251**

**Registered Sep. 9, 2008**

**SERVICE MARK  
PRINCIPAL REGISTER**

**SF WORKS BREAKTHROUGH  
WORKFORCE SOLUTIONS**

THE SAN FRANCISCO CHAMBER OF COM-  
MERCE FOUNDATION (CALIFORNIA COR-  
PORATION)  
235 MONTGOMERY STREET  
12TH FLOOR  
SAN FRANCISCO, CA 94104

FOR: PROMOTING PUBLIC AWARENESS OF  
EMPLOYMENT ISSUES AND WORKPLACE POLI-  
CIES, IN CLASS 35 (U.S. CLS. 100, 101 AND 102).

FIRST USE 7-20-2007; IN COMMERCE 7-20-2007.

THE MARK CONSISTS OF STANDARD CHAR-  
ACTERS WITHOUT CLAIM TO ANY PARTICULAR  
FONT, STYLE, SIZE, OR COLOR.

NO CLAIM IS MADE TO THE EXCLUSIVE  
RIGHT TO USE "WORKFORCE SOLUTIONS",  
APART FROM THE MARK AS SHOWN.

SER. NO. 77-328,044, FILED 11-13-2007.

VERNA BETH RIRIE, EXAMINING ATTORNEY

**Int. Cl.: 7**

**Prior U.S. Cls.: 13, 19, 21, 23, 31, 34 and 35**

**Reg. No. 3,498,252**

**United States Patent and Trademark Office**

**Registered Sep. 9, 2008**

---

**TRADEMARK  
PRINCIPAL REGISTER**

**FGX**

FGX SEPTECH, LLC (KENTUCKY LIMITED  
LIABILITY COMPANY)  
1018 EAST NEW CIRCLE ROAD  
LEXINGTON, KY 40505

FOR: COAL SEPARATION SYSTEMS, NAMELY,  
DRY COAL SEPARATING MACHINES FEATUR-  
ING A FLUIDIZED AIR STREAM AND A VIBRAT-  
ING SEPARATION DECK , IN CLASS 7 (U.S. CLS. 13,  
19, 21, 23, 31, 34 AND 35).

FIRST USE 5-1-2003; IN COMMERCE 5-1-2003.

THE MARK CONSISTS OF STANDARD CHAR-  
ACTERS WITHOUT CLAIM TO ANY PARTICULAR  
FONT, STYLE, SIZE, OR COLOR.

SER. NO. 77-328,508, FILED 11-13-2007.

JAMES LOVELACE, EXAMINING ATTORNEY

**Int. Cl.: 20**

**Prior U.S. Cls.: 2, 13, 22, 25, 32 and 50**

**United States Patent and Trademark Office**

**Reg. No. 3,498,253**

**Registered Sep. 9, 2008**

**TRADEMARK  
PRINCIPAL REGISTER**

**ELASTISNAP**

BEDFORD INDUSTRIES, INC. (SOUTH DAKOTA  
CORPORATION)  
1659 ROWE AVENUE  
WORTHINGTON, MN 56187

FOR: NON-TEXTILE PLASTIC HANG TAGS  
HAVING A PLASTIC FASTENER, IN CLASS 20  
(U.S. CLS. 2, 13, 22, 25, 32 AND 50).

FIRST USE 12-4-2007; IN COMMERCE 12-4-2007.

THE MARK CONSISTS OF STANDARD CHAR-  
ACTERS WITHOUT CLAIM TO ANY PARTICULAR  
FONT, STYLE, SIZE, OR COLOR.

OWNER OF U.S. REG. NOS. 2,894,933, 3,060,059,  
AND 3,327,803.

SER. NO. 77-328,694, FILED 11-13-2007.

BRIAN NEVILLE, EXAMINING ATTORNEY

**Int. Cl.: 41**

**Prior U.S. Cls.: 100, 101 and 107**

**United States Patent and Trademark Office**

**Reg. No. 3,498,254**

**Registered Sep. 9, 2008**

**SERVICE MARK  
PRINCIPAL REGISTER**

# The D Spot

CAMPBELL, LAURA M (UNITED STATES INDIVIDUAL)  
22 WALKER LANE  
WOODBIDGE, CT 06525

THE MARK CONSISTS OF STANDARD CHARACTERS WITHOUT CLAIM TO ANY PARTICULAR FONT, STYLE, SIZE, OR COLOR.

FOR: LIFE COACHING SERVICES IN THE FIELD OF LIFE TRANSITIONS, IN CLASS 41 (U.S. CLS. 100, 101 AND 107).

SER. NO. 77-328,967, FILED 11-14-2007.

FIRST USE 11-1-2007; IN COMMERCE 11-14-2007.

LINDSEY RUBIN, EXAMINING ATTORNEY

**Int. Cl.: 6**

**Prior U.S. Cls.: 2, 12, 13, 14, 23, 25 and 50**

**United States Patent and Trademark Office**

**Reg. No. 3,498,255**

**Registered Sep. 9, 2008**

**TRADEMARK  
PRINCIPAL REGISTER**

**TRACTOR SUPPLY CO.**

TRACTOR SUPPLY CO. OF TEXAS, LP (TEXAS  
LIMITED PARTNERSHIP)  
200 POWELL PLACE  
BRENTWOOD, TN 37027

FOR: LIVESTOCK, FARM AND RANCH EQUIP-  
MENT, NAMELY, METAL GATES AND FENCING,  
SOLD SEPARATELY AND AS PART OF LIVE-  
STOCK HANDLING SYSTEMS COMPRISED OF  
CHUTES, PENS AND ALLEYS, IN CLASS 6 (U.S.  
CLS. 2, 12, 13, 14, 23, 25 AND 50).

FIRST USE 8-4-2007; IN COMMERCE 8-4-2007.

THE MARK CONSISTS OF STANDARD CHAR-  
ACTERS WITHOUT CLAIM TO ANY PARTICULAR  
FONT, STYLE, SIZE, OR COLOR.

OWNER OF U.S. REG. NOS. 1,846,015 AND  
3,039,473.

NO CLAIM IS MADE TO THE EXCLUSIVE  
RIGHT TO USE "CO.", APART FROM THE MARK  
AS SHOWN.

SER. NO. 77-329,581, FILED 11-14-2007.

H. M. FISHER, EXAMINING ATTORNEY

**Int. Cl.: 9**

**Prior U.S. Cls.: 21, 23, 26, 36 and 38**

**Reg. No. 3,498,256**

**United States Patent and Trademark Office**

**Registered Sep. 9, 2008**

**TRADEMARK  
PRINCIPAL REGISTER**



**EdgeMagic**

CYBRA CORPORATION (NEW YORK COR-  
PORATION)  
1 EXECUTIVE BOULEVARD  
YONKERS, NY 107016804

FOR: SOFTWARE FOR MANAGEMENT OF  
RADIO FREQUENCY IDENTIFICATION (RFID)  
SYSTEM MANAGEMENT AND RELATED DEVI-  
CES, NAMELY, READERS, SENSORS, DIVERTERS,  
AND LIGHT STACKS, IN CLASS 9 (U.S. CLS. 21, 23,  
26, 36 AND 38).

FIRST USE 2-1-2007; IN COMMERCE 2-1-2007.

THE MARK CONSISTS OF THE WORD "EDGE-  
MAGIC" UNDER A CIRCLE CONTAINING A  
SWIRLED DESIGN.

SER. NO. 77-329,594, FILED 11-14-2007.

JOHN SCHUYLER YARD, EXAMINING ATTOR-  
NEY

**Int. Cl.: 41**

**Prior U.S. Cls.: 100, 101 and 107**

**United States Patent and Trademark Office**

**Reg. No. 3,498,257**

**Registered Sep. 9, 2008**

**SERVICE MARK  
PRINCIPAL REGISTER**



THE TUTORING CENTER, INC. (CALIFORNIA CORPORATION)  
SUITE 510  
4300 LONG BEACH BLVD.  
LONG BEACH, CA 90807

FOR: EDUCATION SERVICES, NAMELY, PROVIDING TUTORIAL SESSIONS IN THE FIELDS OF READING, MATH AND WRITING FOR CHILDREN, IN CLASS 41 (U.S. CLS. 100, 101 AND 107).

FIRST USE 9-1-1994; IN COMMERCE 9-1-1994.

NO CLAIM IS MADE TO THE EXCLUSIVE RIGHT TO USE "TUTORING CENTER", APART FROM THE MARK AS SHOWN.

THE COLOR(S) TEAL, WHITE AND GOLD IS/ARE CLAIMED AS A FEATURE OF THE MARK.

THE MARK CONSISTS OF A WHITE HUMAN FIGURE WITH A TEAL BACKGROUND AND WHITE AND GOLD STAR SHAPES IN AN ARBITRARY PATTERN NEXT TO THE WORDS "THE TUTORING CENTER" UNDERLINED IN GOLD.

SEC. 2(F).

SER. NO. 77-329,813, FILED 11-14-2007.

BRIAN NEVILLE, EXAMINING ATTORNEY

**Int. Cl.: 12**

**Prior U.S. Cls.: 19, 21, 23, 31, 35 and 44**

**Reg. No. 3,498,258**

**United States Patent and Trademark Office**

**Registered Sep. 9, 2008**

**TRADEMARK  
PRINCIPAL REGISTER**

**ULTRA LEVEL**

LIPPERT COMPONENTS, INC. (INDIANA CORPORATION)  
2766 COLLEGE AVENUE  
GOSHEN, IN 46528

FOR: HYDRAULIC LEVELING SYSTEM FOR RECREATIONAL VEHICLES CONSISTING OF HYDRAULIC POWER UNITS AND HYDRAULIC LEVELS, IN CLASS 12 (U.S. CLS. 19, 21, 23, 31, 35 AND 44).

FIRST USE 2-11-2008; IN COMMERCE 2-11-2008.

THE MARK CONSISTS OF STANDARD CHARACTERS WITHOUT CLAIM TO ANY PARTICULAR FONT, STYLE, SIZE, OR COLOR.

NO CLAIM IS MADE TO THE EXCLUSIVE RIGHT TO USE "LEVEL", APART FROM THE MARK AS SHOWN.

SER. NO. 77-330,314, FILED S.R. 11-15-2007 AM.  
P.R. 4-10-2008.

JESSICA FATHY, EXAMINING ATTORNEY



**Int. Cl.: 40**

**Prior U.S. Cls.: 100, 103 and 106**

**United States Patent and Trademark Office**

**Reg. No. 3,498,259**

**Registered Sep. 9, 2008**

**SERVICE MARK  
PRINCIPAL REGISTER**



CENVEO CORPORATION (DELAWARE CORPORATION)  
ONE CANTERBURY GREEN  
201 BROAD STREET, 6TH FLOOR  
STAMFORD, CT 06901

FOR: CUSTOM PRINTING TO THE SPECIFICATION OF OTHERS; CUSTOMIZED PRINTING OF COMPANY NAMES AND LOGOS FOR BUSINESS COMMUNICATIONS, TRANSACTIONS, PROMOTIONAL AND ADVERTISING PURPOSES, IN CLASS 40 (U.S. CLS. 100, 103 AND 106).

FIRST USE 2-0-2000; IN COMMERCE 2-0-2000.

THE MARK CONSISTS OF THE STYLIZED LETTER "X" WITH A SERIES OF SIX HORIZONTAL LINES ON THE LEFT SIDE OF THE LETTER "X".

SER. NO. 77-330,478, FILED 11-15-2007.

MARK RADEMACHER, EXAMINING ATTORNEY

**Int. Cl.: 44**

**Prior U.S. Cls.: 100 and 101**

**United States Patent and Trademark Office**

**Reg. No. 3,498,260**

**Registered Sep. 9, 2008**

**SERVICE MARK  
PRINCIPAL REGISTER**



SYNCHRONICITY MINDFUL BODY WORK,  
LLC (VIRGINIA LIMITED LIABILITY COM-  
PANY)  
14415 FOWLERS MILL DRIVE  
GAINESVILLE, VA 20155

FOR: MASSAGE, IN CLASS 44 (U.S. CLS. 100 AND  
101).

FIRST USE 8-4-2007; IN COMMERCE 11-10-2007.

NO CLAIM IS MADE TO THE EXCLUSIVE  
RIGHT TO USE "BODY WORK, LLC", APART  
FROM THE MARK AS SHOWN.

THE COLOR(S) GREEN, GREENISH-BLUE, BLUE  
AND GRAY IS/ARE CLAIMED AS A FEATURE OF  
THE MARK.

THE MARK CONSISTS OF A DESIGN OF FIVE  
LAYERED TEARDROPS WITH THE MIDDLE ONE  
IN FRONT AND GREEN, THE NEXT LAYER OF  
TWO ARE GREENISH-BLUE, AND THE TWO IN  
THE FINAL DISTANT LAYER ARE BLUE, ALL  
FANNED LIKE A PEACOCK'S TAIL. BENEATH  
THE DESIGN IS A THIN GREEN DIAMOND-  
SHAPED SHADOW OF THE DESIGN, AND BE-  
NEATH THIS IS THE WORD "SYNCHRONICITY"  
IN GRAY, AND BENEATH THIS WORD IS THE  
WORDING "MINDFUL BODY WORKS, LLC" IN  
GREEN.

SER. NO. 77-331,298, FILED 11-16-2007.

GIANCARLO CASTRO, EXAMINING ATTORNEY

**Int. Cls.: 29 and 30**

**Prior U.S. Cl.: 46**

**United States Patent and Trademark Office**

**Reg. No. 3,498,261**

**Registered Sep. 9, 2008**

**TRADEMARK  
PRINCIPAL REGISTER**

**Harvest the Power of Nature**

CALBEE FOODS CO., LTD. (JAPAN CORPORATION)  
1-20-1, AKABANE-MINAMI, KITA-KU  
TOKYO, JAPAN

FOR: POTATO CHIPS, POTATO CRISPS; SWEET POTATO CHIPS, SWEET POTATO CRISPS; SHRIMP BASED SNACK FOOD, NAMELY, SHRIMP CHIPS; VEGETABLE BASED SNACK FOOD; POTATO BASED SNACK FOOD; BEAN BASED SNACK FOOD; PEA BASED SNACK FOOD; FRUIT BASED SNACK FOOD, IN CLASS 29 (U.S. CL. 46).

FOR: CORN BASED SNACK FOOD; WHEAT FLOUR BASED SNACK FOOD; CEREAL BASED SNACK FOOD; ICE CREAM; CANDIES; BISCUITS AND COOKIES; CHOCOLATES; CHEWING GUMS; PASTRIES AND BREAD; CORN FLAKES; BREAK-

FAST CEREALS, PROCESSED CEREALS, READY-TO-EAT CEREALS, CEREAL BARS; WHEAT FLOUR; COFFEE; COCOA; TEA, IN CLASS 30 (U.S. CL. 46).

THE MARK CONSISTS OF STANDARD CHARACTERS WITHOUT CLAIM TO ANY PARTICULAR FONT, STYLE, SIZE, OR COLOR.

PRIORITY CLAIMED UNDER SEC. 44(D) ON JAPAN APPLICATION NO. 2007-54689, FILED 5-31-2007, REG. NO. 5103420, DATED 1-11-2008, EXPIRES 5-31-2017.

SER. NO. 77-331,350, FILED 11-16-2007.

MICHAEL TANNER, EXAMINING ATTORNEY

**Int. Cl.: 43**

**Prior U.S. Cls.: 100 and 101**

**United States Patent and Trademark Office**

**Reg. No. 3,498,262**

**Registered Sep. 9, 2008**

**SERVICE MARK  
PRINCIPAL REGISTER**

# Tarallucci e Vino

ABRUZZO DOCG, INC. (NEW YORK CORPORATION)  
15 EAST 18TH STREET  
NEW YORK, NY 10003

FOR: RESTAURANT AND BAR SERVICES, IN CLASS 43 (U.S. CLS. 100 AND 101).

FIRST USE 7-29-2001; IN COMMERCE 7-29-2001.

THE MARK CONSISTS OF STANDARD CHARACTERS WITHOUT CLAIM TO ANY PARTICULAR FONT, STYLE, SIZE, OR COLOR.

NO CLAIM IS MADE TO THE EXCLUSIVE RIGHT TO USE "VINO", APART FROM THE MARK AS SHOWN.

THE FOREIGN WORDING IN THE MARK TRANSLATES INTO ENGLISH AS SEMOLINA FLOUR COOKIES AND WINE.

SER. NO. 77-331,582, FILED 11-16-2007.

JULIE WATSON, EXAMINING ATTORNEY

**Int. Cl.: 43**

**Prior U.S. Cls.: 100 and 101**

**United States Patent and Trademark Office**

**Reg. No. 3,498,263**

**Registered Sep. 9, 2008**

**SERVICE MARK  
PRINCIPAL REGISTER**



ABRUZZO DOCG, INC. (NEW YORK CORPORATION)  
15 EAST 18TH STREET  
NEW YORK, NY 10011

FOR: RESTAURANT AND BAR SERVICES, IN CLASS 43 (U.S. CLS. 100 AND 101).

FIRST USE 11-1-2005; IN COMMERCE 11-1-2005.

NO CLAIM IS MADE TO THE EXCLUSIVE RIGHT TO USE "VINO", APART FROM THE MARK AS SHOWN.

THE MARK CONSISTS OF A VERTICAL RECTANGLE CONTAINING A LARGE LETTER "T" IN

BLOCK FONT WITH A STEM OF GRAPES TO THE LOWER LEFT SIDE OF THE LETTER "T" AND A SWIRL SYMBOL TO THE LOWER RIGHT SIDE OF THE LETTER "T" AND THE WORDS "TARALLUCCI E VINO" BENEATH THEM.

THE FOREIGN WORDING IN THE MARK TRANSLATES INTO ENGLISH AS SEMOLINA FLOUR COOKIES AND WINE.

SER. NO. 77-331,601, FILED 11-16-2007.

JULIE WATSON, EXAMINING ATTORNEY

**Int. Cl.: 12**

**Prior U.S. Cls.: 19, 21, 23, 31, 35 and 44**

**United States Patent and Trademark Office**

**Reg. No. 3,498,264**

**Registered Sep. 9, 2008**

**TRADEMARK  
PRINCIPAL REGISTER**

**MCT**

DAIMLER AG (FED REP GERMANY CORPORATION)  
MERCEDSSTRASSE 137  
D-70327 STUTTGART, FED REP GERMANY

OWNER OF FED REP GERMANY REG. NO.  
30707973, DATED 3-5-2007, EXPIRES 2-5-2017.

FOR: TRANSMISSIONS FOR AUTOMOBILES, IN  
CLASS 12 (U.S. CLS. 19, 21, 23, 31, 35 AND 44).

SER. NO. 77-331,830, FILED 11-16-2007.

THE MARK CONSISTS OF STANDARD CHARACTERS WITHOUT CLAIM TO ANY PARTICULAR FONT, STYLE, SIZE, OR COLOR.

RON FAIRBANKS, EXAMINING ATTORNEY

**Int. Cl.: 20**

**Prior U.S. Cls.: 2, 13, 22, 25, 32 and 50**

**United States Patent and Trademark Office**

**Reg. No. 3,498,265**

**Registered Sep. 9, 2008**

**TRADEMARK  
PRINCIPAL REGISTER**

**BUILD-A-BEAR WORKSHOP**

BUILD-A-BEAR RETAIL MANAGEMENT, INC.  
(DELAWARE CORPORATION)  
1954 INNERBELT BUSINESS CENTER DRIVE  
ST. LOUIS, MO 631145760

FOR: FURNITURE; NAMELY, FURNITURE FOR  
JUVENILES, IN CLASS 20 (U.S. CLS. 2, 13, 22, 25, 32  
AND 50).

FIRST USE 11-1-2006; IN COMMERCE 11-1-2006.

THE MARK CONSISTS OF STANDARD CHAR-  
ACTERS WITHOUT CLAIM TO ANY PARTICULAR  
FONT, STYLE, SIZE, OR COLOR.

OWNER OF U.S. REG. NOS. 2,553,748, 2,756,424  
AND OTHERS.

SER. NO. 77-332,012, FILED 11-16-2007.

HEATHER BIDDULPH, EXAMINING ATTORNEY

**Int. Cl.: 35**

**Prior U.S. Cls.: 100, 101 and 102**

**United States Patent and Trademark Office**

**Reg. No. 3,498,266**

**Registered Sep. 9, 2008**

**SERVICE MARK  
PRINCIPAL REGISTER**

**g3 Direct Mail  
Advertising, Inc.**

G3 DIRECT MAIL ADVERTISING, INC. (TEXAS  
CORPORATION)  
SUITE 110  
25700 INTERSTATE 45 N  
SPRING, TX 77386

FOR: MAILING LIST PREPARATION; PREPAR-  
ING MAILING LISTS; DIRECT MAIL CONSULTING  
SERVICES; DIRECT MAIL ADVERTISING; DIRECT  
MARKETING ADVERTISING FOR OTHERS; DI-  
RECT MARKETING CONSULTING SERVICES; DI-  
RECT MARKETING SERVICES, IN CLASS 35 (U.S.  
CLS. 100, 101 AND 102).

FIRST USE 7-17-2003; IN COMMERCE 7-17-2003.

THE MARK CONSISTS OF STANDARD CHAR-  
ACTERS WITHOUT CLAIM TO ANY PARTICULAR  
FONT, STYLE, SIZE, OR COLOR.

NO CLAIM IS MADE TO THE EXCLUSIVE  
RIGHT TO USE "DIRECT MAIL ADVERTISING,  
INC.", APART FROM THE MARK AS SHOWN.

SER. NO. 77-332,030, FILED 11-16-2007.

CURTIS FRENCH, EXAMINING ATTORNEY



**Int. Cl.: 3**

**Prior U.S. Cls.: 1, 4, 6, 50, 51 and 52**

**United States Patent and Trademark Office**

**Reg. No. 3,498,267**

**Registered Sep. 9, 2008**

**TRADEMARK  
PRINCIPAL REGISTER**



GELDERMANN, LINDA L. (UNITED STATES  
INDIVIDUAL)  
W1119 TRIESTE DR.  
LAKE GENEVA, WI 53147

FOR: SKIN CLARIFIERS; SKIN CLEANSERS;  
SKIN CLEANSING LOTION; SKIN CONDITION-  
ERS; SKIN CREAM; SKIN LOTION; SKIN LOTIONS;  
SKIN MOISTURIZER; SKIN WHITENING CREAMS;  
SUN CARE LOTIONS, IN CLASS 3 (U.S. CLS. 1, 4, 6,  
50, 51 AND 52).

FIRST USE 11-16-2007; IN COMMERCE 12-3-2007.

NO CLAIM IS MADE TO THE EXCLUSIVE  
RIGHT TO USE "SPORTS SKIN CARE", APART  
FROM THE MARK AS SHOWN.

THE MARK CONSISTS OF 5 LETTERS: "BEND S"  
AND THREE STACKED CIRCLES IN PLACE OF  
THE LETTER "I" (BECAUSE COMPANY NAME IS  
"BENDIS").

SER. NO. 77-332,515, FILED S.R. 11-18-2007 AM.  
P.R. 5-5-2008.

KHANH LE, EXAMINING ATTORNEY

**Int. Cl.: 21**

**Prior U.S. Cls.: 2, 13, 23, 29, 30, 33, 40 and 50**

**Reg. No. 3,498,268**

**United States Patent and Trademark Office**

**Registered Sep. 9, 2008**

**TRADEMARK  
PRINCIPAL REGISTER**

**TANKS FOR THE MEMORIES**

GREEN, TIMOTHY O. (UNITED STATES INDIVIDUAL)  
2147 SOUTH 15TH STREET  
SPRINGFIELD, IL 62703

FOR: HOUSEWARES, NAMELY, TOILET PAPER HOLDERS, PAPER TOWEL HOLDERS, TOWEL HOLDERS, AND STORAGE CONTAINERS FOR HOUSEHOLD USE, IN CLASS 21 (U.S. CLS. 2, 13, 23, 29, 30, 33, 40 AND 50).

FIRST USE 2-21-1998; IN COMMERCE 2-21-1998.

THE MARK CONSISTS OF STANDARD CHARACTERS WITHOUT CLAIM TO ANY PARTICULAR FONT, STYLE, SIZE, OR COLOR.

SER. NO. 77-332,681, FILED 11-19-2007.

JENNIFER VASQUEZ, EXAMINING ATTORNEY

**Int. Cls.: 16, 35 and 41**

**Prior U.S. Cls.: 2, 5, 22, 23, 29, 37, 38, 50, 100, 101, 102  
and 107**

**Reg. No. 3,498,269**

**United States Patent and Trademark Office**

**Registered Sep. 9, 2008**

**TRADEMARK  
SERVICE MARK  
PRINCIPAL REGISTER**

# CAREERFIRSTS

FEDERATION EMPLOYMENT AND GUIDANCE  
SERVICE, INC. (F.E.G.S.) (NEW YORK NON-  
PROFIT CORPORATION)  
315 HUDSON STREET  
NEW YORK, NY 10013

FOR: PUBLICATIONS, NAMELY, BROCHURES,  
BOOKLETS, AND TEACHING MATERIALS IN THE  
FIELD OF PROFESSIONAL DEVELOPMENT, IN  
CLASS 16 (U.S. CLS. 2, 5, 22, 23, 29, 37, 38 AND 50).

FIRST USE 10-15-2007; IN COMMERCE 10-15-2007.

FOR: PROVIDING ON-LINE EMPLOYMENT  
PLACEMENT, JOB LISTING AND TRACKING SER-  
VICES, AND LISTING AND TRACKING SERVICES  
FOR INTERNSHIPS FOR BUSINESS PURPOSES, IN  
CLASS 35 (U.S. CLS. 100, 101 AND 102).

FIRST USE 10-15-2007; IN COMMERCE 10-15-2007.

FOR: PROVIDING AN ONLINE COMPUTER DA-  
TABASE IN THE FIELD OF EDUCATIONAL IN-  
TERNSHIPS, FEATURING LISTING AND  
TRACKING SERVICES, IN CLASS 41 (U.S. CLS. 100,  
101 AND 107).

FIRST USE 10-15-2007; IN COMMERCE 10-15-2007.

THE MARK CONSISTS OF STANDARD CHAR-  
ACTERS WITHOUT CLAIM TO ANY PARTICULAR  
FONT, STYLE, SIZE, OR COLOR.

SER. NO. 77-332,730, FILED 11-19-2007.

AMY ALFIERI, EXAMINING ATTORNEY

**Int. Cl.: 29**

**Prior U.S. Cl.: 46**

**United States Patent and Trademark Office**

**Reg. No. 3,498,270**

**Registered Sep. 9, 2008**

**TRADEMARK  
PRINCIPAL REGISTER**

**EMERALD COCOA ROAST**

DIAMOND FOODS, INC. (DELAWARE CORPORATION)  
1050 S. DIAMOND STREET  
STOCKTON, CA 95205

FOR: PROCESSED NUTS, IN CLASS 29 (U.S. CL. 46).

FIRST USE 3-0-2008; IN COMMERCE 3-0-2008.

THE MARK CONSISTS OF STANDARD CHARACTERS WITHOUT CLAIM TO ANY PARTICULAR FONT, STYLE, SIZE, OR COLOR.

OWNER OF U.S. REG. NOS. 639,432 AND 728,907.

NO CLAIM IS MADE TO THE EXCLUSIVE RIGHT TO USE "COCOA ROAST", APART FROM THE MARK AS SHOWN.

SER. NO. 77-333,559, FILED 11-19-2007.

MARGERY A. TIERNEY, EXAMINING ATTORNEY

**Int. Cl.: 35**

**Prior U.S. Cls.: 100, 101 and 102**

**United States Patent and Trademark Office**

**Reg. No. 3,498,271**

**Registered Sep. 9, 2008**

**SERVICE MARK  
PRINCIPAL REGISTER**

**LAUNCH PLAYBOOK**

CAMPBELL ALLIANCE GROUP, INC. (NORTH  
CAROLINA CORPORATION)  
SUITE 500  
8045 ARCO CORPORATE DRIVE  
RALEIGH, NC 27617

FOR: BUSINESS MANAGEMENT CONSULTING  
SERVICES, NAMELY, PROVIDING PROJECT MAN-  
AGEMENT TOOLS AND ADVICE RELATED TO  
THE MARKET INTRODUCTION OF NEW PRO-  
DUCTS OR INDICATIONS IN THE PHARMACEU-  
TICAL AND BIOTECHNOLOGY INDUSTRIES, IN  
CLASS 35 (U.S. CLS. 100, 101 AND 102).

FIRST USE 1-16-2004; IN COMMERCE 1-16-2004.

THE MARK CONSISTS OF STANDARD CHAR-  
ACTERS WITHOUT CLAIM TO ANY PARTICULAR  
FONT, STYLE, SIZE, OR COLOR.

NO CLAIM IS MADE TO THE EXCLUSIVE  
RIGHT TO USE "LAUNCH", APART FROM THE  
MARK AS SHOWN.

SER. NO. 77-333,859, FILED 11-20-2007.

ROBERT C. CLARK JR., EXAMINING ATTORNEY

Int. Cl.: 35

Prior U.S. Cls.: 100, 101 and 102

United States Patent and Trademark Office

Reg. No. 3,498,272

Registered Sep. 9, 2008

SERVICE MARK  
PRINCIPAL REGISTER



G3 DIRECT MAIL ADVERTISING, INC. (TEXAS CORPORATION)

SUITE 110

25700 INTERSTATE 45 N

SPRING, TX 77386

FOR: DIRECT MAIL ADVERTISING; DIRECT MARKETING ADVERTISING FOR OTHERS; MAILING LIST PREPARATION; PREPARING MAILING LISTS; DIRECT MAIL CONSULTING SERVICES; DIRECT MARKETING CONSULTING SERVICES; DIRECT MARKETING SERVICES, IN CLASS 35 (U.S. CLS. 100, 101 AND 102).

FIRST USE 7-17-2003; IN COMMERCE 7-17-2003.

NO CLAIM IS MADE TO THE EXCLUSIVE RIGHT TO USE "DIRECTMAIL ADVERTISING, INC.", APART FROM THE MARK AS SHOWN.

THE COLOR(S) RED, BLUE, AND BLACK IS/ARE CLAIMED AS A FEATURE OF THE MARK.

THE MARK CONSISTS OF A STYLIZED LOWER CASE LETTER G IN RED, A STYLIZED NUMBER "3" IN BLUE, THE WORDS DIRECTMAIL ADVERTISING INC. IN BLACK EXCEPT FOR MAIL WHICH IS IN BLUE.

SER. NO. 77-333,922, FILED 11-20-2007.

CURTIS FRENCH, EXAMINING ATTORNEY

**Int. Cls.: 35, 38 and 41**

**Prior U.S. Cls.: 100, 101, 102, 104 and 107**

**United States Patent and Trademark Office**

**Reg. No. 3,498,273**

**Registered Sep. 9, 2008**

**SERVICE MARK  
PRINCIPAL REGISTER**

# TRACK SHACK

HOUSE OF HANSEN PRODUCTIONS, LLC (CALIFORNIA LIMITED LIABILITY COMPANY)  
4920 PHELPS CT.  
CARMICHAEL, CA 95608

FOR: RETAIL STORE SERVICES IN THE FIELD OF ENTERTAINMENT, NAMELY, MUSICAL AND AUDIOVISUAL WORKS AND RELATED MERCHANDISE, PROVIDED VIA THE INTERNET AND OTHER COMPUTER AND ELECTRONIC COMMUNICATION NETWORKS; RETAIL STORE SERVICES IN THE FIELD OF ENTERTAINMENT FEATURING PRE-RECORDED AUDIO AND AUDIOVISUAL WORKS AND RELATED MERCHANDISE, PROVIDED VIA THE INTERNET AND OTHER COMPUTER AND ELECTRONIC COMMUNICATION NETWORKS, IN CLASS 35 (U.S. CLS. 100, 101 AND 102).

FIRST USE 11-21-2007; IN COMMERCE 11-21-2007.

FOR: STREAMING OF AUDIO MATERIAL ON THE INTERNET, IN CLASS 38 (U.S. CLS. 100, 101 AND 104).

FIRST USE 11-21-2007; IN COMMERCE 11-21-2007.

FOR: ENTERTAINMENT SERVICES, NAMELY, PROVIDING A WEBSITE FEATURING AUDIO MATERIAL, NAMELY, RECORDED MUSIC WITH DISTINCT MUSICAL PATTERNS, GROOVES, RIFFS, LOOPS, AND LICKS FROM A VARIETY OF SOURCES, NAMELY, MP3, VIDEO, ELECTRONIC SYNTHESIZER, AND RECORDED TRACKS WHERE THE USER MAY CREATE AN ORIGINAL FINISHED SONG, IN CLASS 41 (U.S. CLS. 100, 101 AND 107).

FIRST USE 11-21-2007; IN COMMERCE 11-21-2007.

THE MARK CONSISTS OF STANDARD CHARACTERS WITHOUT CLAIM TO ANY PARTICULAR FONT, STYLE, SIZE, OR COLOR.

NO CLAIM IS MADE TO THE EXCLUSIVE RIGHT TO USE "TRACK", APART FROM THE MARK AS SHOWN.

SER. NO. 77-335,519, FILED 11-21-2007.

PAULA MAHONEY, EXAMINING ATTORNEY

**Int. Cl.: 42**

**Prior U.S. Cls.: 100 and 101**

**United States Patent and Trademark Office**

**Reg. No. 3,498,274**

**Registered Sep. 9, 2008**

**SERVICE MARK  
PRINCIPAL REGISTER**

THE ART & SCIENCE OF BEAUTY

PHOENIX CHEMICAL INC. (NEW JERSEY COR-  
PORATION)  
60 FOURTH STREET  
SOMERVILLE, NJ 08876

FOR: DEVELOPMENT OF RAW MATERIALS  
FOR USE IN PERSONAL CARE AND COSMETIC  
PRODUCTS FOR OTHERS AND CONSULTATION  
SERVICES THEREFORE, IN CLASS 42 (U.S. CLS. 100  
AND 101).

FIRST USE 4-1-1997; IN COMMERCE 4-1-1997.

THE MARK CONSISTS OF STANDARD CHAR-  
ACTERS WITHOUT CLAIM TO ANY PARTICULAR  
FONT, STYLE, SIZE, OR COLOR.

NO CLAIM IS MADE TO THE EXCLUSIVE  
RIGHT TO USE "BEAUTY", APART FROM THE  
MARK AS SHOWN.

SER. NO. 77-336,760, FILED 11-26-2007.

TINA KUAN, EXAMINING ATTORNEY



**Int. Cl.: 39**

**Prior U.S. Cls.: 100 and 105**

**United States Patent and Trademark Office**

**Reg. No. 3,498,275**

**Registered Sep. 9, 2008**

**SERVICE MARK  
PRINCIPAL REGISTER**

**MONTANA RAIL LINK**

MONTANA RAIL LINK, INC. (MONTANA CORPORATION)  
101 INTERNATIONAL WAY, P.O. BOX 16390  
MISSOULA, MT 59808

NO CLAIM IS MADE TO THE EXCLUSIVE RIGHT TO USE "RAIL LINK", APART FROM THE MARK AS SHOWN.

FOR: TRANSPORTATION OF PASSENGERS AND GOODS BY RAIL, IN CLASS 39 (U.S. CLS. 100 AND 105).

SEC. 2(F).

FIRST USE 10-30-1987; IN COMMERCE 10-30-1987.

SER. NO. 77-338,021, FILED 11-27-2007.

THE MARK CONSISTS OF STANDARD CHARACTERS WITHOUT CLAIM TO ANY PARTICULAR FONT, STYLE, SIZE, OR COLOR.

JENNY PARK, EXAMINING ATTORNEY

**Int. Cls.: 11, 21 and 25**

**Prior U.S. Cls.: 2, 13, 21, 22, 23, 29, 30, 31, 33, 34, 39,  
40 and 50**

**Reg. No. 3,498,276**

**United States Patent and Trademark Office**

**Registered Sep. 9, 2008**

**TRADEMARK  
PRINCIPAL REGISTER**

**SIKES COOKERS**

SIKES COOKERS AND GRILLS, INC. (GEORGIA  
CORPORATION)  
337 COMMERCE LOOP  
VIDALIA, GA 30474

FOR: GAS COOKERS, IN CLASS 11 (U.S. CLS. 13,  
21, 23, 31 AND 34).

FIRST USE 1-1-2002; IN COMMERCE 1-1-2002.

FOR: COOKING UTENSILS, NAMELY, GRILLS,  
GRILL COVERS, WIRE BASKETS, COOKING  
PLATES, COOKING SCREENS, SPATULAS, TURN-  
ERS, MEAT FORKS, TONGS, SKEWERS, IN CLASS  
21 (U.S. CLS. 2, 13, 23, 29, 30, 33, 40 AND 50).

FIRST USE 1-1-2002; IN COMMERCE 1-1-2002.

FOR: CLOTHING, NAMELY, HATS, SHIRTS,  
CLOTH BIBS, AND APRONS, IN CLASS 25 (U.S.  
CLS. 22 AND 39).

FIRST USE 1-1-2002; IN COMMERCE 1-1-2002.

THE MARK CONSISTS OF STANDARD CHAR-  
ACTERS WITHOUT CLAIM TO ANY PARTICULAR  
FONT, STYLE, SIZE, OR COLOR.

NO CLAIM IS MADE TO THE EXCLUSIVE  
RIGHT TO USE "COOKERS", APART FROM THE  
MARK AS SHOWN.

SEC. 2(F).

SER. NO. 77-338,087, FILED 11-27-2007.

MARK T. MULLEN, EXAMINING ATTORNEY

**Int. Cl.: 9**

**Prior U.S. Cls.: 21, 23, 26, 36 and 38**

**Reg. No. 3,498,277**

**United States Patent and Trademark Office**

**Registered Sep. 9, 2008**

**TRADEMARK  
PRINCIPAL REGISTER**



HOWETT, GREG (UNITED KINGDOM INDIVIDUAL)  
SUITE 12  
GROVE BUSINESS PARK, WHITE WALTHAM  
MAIDENHEAD, UNITED KINGDOM SL66NP

FOR: COMPUTER HARDWARE, IN CLASS 9 (U.S. CLS. 21, 23, 26, 36 AND 38).

FIRST USE 1-21-2002; IN COMMERCE 1-21-2002.

THE COLOR(S) BLUE AND DARK BLUE IS/ARE CLAIMED AS A FEATURE OF THE MARK.

THE COLOR LIGHT BLUE APPEARS IN THE WORDING "JET" AND IN THE DESIGN OF AN ORBITING PLANET; THE COLOR DARK BLUE APPEARS IN THE WORDING "NEXUS" AND IN THE DESIGN OF THE ORBIT OF THE ORBITING PLANET.

SER. NO. 77-338,739, FILED 11-28-2007.

SEAN CROWLEY, EXAMINING ATTORNEY

**Int. Cl.: 35**

**Prior U.S. Cls.: 100, 101 and 102**

**United States Patent and Trademark Office**

**Reg. No. 3,498,278**

**Registered Sep. 9, 2008**

**SERVICE MARK  
PRINCIPAL REGISTER**



COVENANT COLLEGE, INC. (GEORGIA CORPORATION)

14049 SCENIC HIGHWAY

LOOKOUT MOUNTAIN, GA 30750

FOR: ASSOCIATION SERVICES, NAMELY, PROMOTING THE INTERESTS OF THE COLLEGE AND ITS ALUMNI, IN CLASS 35 (U.S. CLS. 100, 101 AND 102).

FIRST USE 6-15-2004; IN COMMERCE 6-15-2004.

NO CLAIM IS MADE TO THE EXCLUSIVE RIGHT TO USE "ALUMNI", APART FROM THE MARK AS SHOWN.

"THE COLOR(S) DARK BLUE, LIGHT BLUE AND WHITE IS/ARE CLAIMED AS A FEATURE OF THE MARK."

THE MARK CONSISTS OF A DARK BLUE SHIELD WITH THE WORD "ALUMNI" IN WHITE DISPOSED AT THE TOP CENTER OF THE SHIELD SYMBOL AND A SCOTTISH THISTLE IN WHITE DISPOSED IN THE MIDDLE LEFT OF THE SHIELD SYMBOL AND LIGHT BLUE DIAGONAL STRIPES ON THE RIGHT SIDE OF THE SHIELD.

SER. NO. 77-339,350, FILED 11-28-2007.

KATHERINE CONNOLLY, EXAMINING ATTORNEY

**Int. Cls.: 25 and 28**

**Prior U.S. Cls.: 22, 23, 38, 39 and 50**

**United States Patent and Trademark Office**

**Reg. No. 3,498,279**

**Registered Sep. 9, 2008**

**TRADEMARK  
PRINCIPAL REGISTER**

# Cold Avenger

TALUS OUTDOOR TECHNOLOGIES, LLC (MONTANA LIMITED LIABILITY COMPANY)  
648 E. SUSSEX  
MISSOULA, MT 59801

FOR: CLOTHING, NAMELY, FOUL WEATHER GEAR, JACKETS, HEAD WEAR, VESTS, SKI WEAR AND SKI MASKS, IN CLASS 25 (U.S. CLS. 22 AND 39).

FIRST USE 6-16-2007; IN COMMERCE 10-26-2007.

FOR: PLASTIC FACE MASKS INCORPORATING FABRIC FOR SKIING AND INCLEMENT WEATH-

ER OUTDOOR SPORTS, IN CLASS 28 (U.S. CLS. 22, 23, 38 AND 50).

FIRST USE 6-16-2007; IN COMMERCE 10-26-2007.

THE MARK CONSISTS OF STANDARD CHARACTERS WITHOUT CLAIM TO ANY PARTICULAR FONT, STYLE, SIZE, OR COLOR.

SER. NO. 77-340,079, FILED 11-29-2007.

MICHELLE DUBOIS, EXAMINING ATTORNEY

**Int. Cl.: 41**

**Prior U.S. Cls.: 100, 101 and 107**

**United States Patent and Trademark Office**

**Reg. No. 3,498,280**

**Registered Sep. 9, 2008**

**SERVICE MARK  
PRINCIPAL REGISTER**

**withleather.com**

RYAN PERRY ENTERPRISES, INC. (ARIZONA  
CORPORATION)  
1234 S. POWER ROAD, SUITE 206  
MESA, AZ 85206

THE MARK CONSISTS OF STANDARD CHAR-  
ACTERS WITHOUT CLAIM TO ANY PARTICULAR  
FONT, STYLE, SIZE, OR COLOR.

FOR: PROVIDING A WEBSITE FEATURING  
SPORTING INFORMATION, IN CLASS 41 (U.S.  
CLS. 100, 101 AND 107).

SER. NO. 77-341,054, FILED 11-30-2007.

FIRST USE 9-4-2006; IN COMMERCE 10-31-2006.

KYLE PEETE, EXAMINING ATTORNEY

**Int. Cl.: 5**

**Prior U.S. Cls.: 6, 18, 44, 46, 51 and 52**

**Reg. No. 3,498,281**

**United States Patent and Trademark Office**

**Registered Sep. 9, 2008**

**TRADEMARK  
PRINCIPAL REGISTER**

**JU-LYN**

NATURAL ODOR TECHNOLOGIES, LLC (IDAHO LIMITED LIABILITY COMPANY)  
4606 E. OAK  
NAMPA, ID 83687

FOR: ODOR NEUTRALIZING PREPARATIONS FOR THE PREVENTION OF UNPLEASANT ODORS IN TOILETS, ARTICLES OF CLOTHING, CARPETS, VEHICLES INCLUDING BOATS, AIRPLANES, AUTOMOBILES AND COMMERCIAL VEHICLES, STORAGE TANKS OF RVs AND HOUSEBOATS AND OTHER CONFINED AREAS; AIR FRESHENERS; DEODORIZER FOR USE IN ANIMAL LITTER, IN CLASS 5 (U.S. CLS. 6, 18, 44, 46, 51 AND 52).

FIRST USE 11-15-2007; IN COMMERCE 11-15-2007.

THE MARK CONSISTS OF STANDARD CHARACTERS WITHOUT CLAIM TO ANY PARTICULAR FONT, STYLE, SIZE, OR COLOR.

"THE NAME(S), PORTRAIT(S), AND/OR SIGNATURE(S) SHOWN IN THE MARK DOES NOT IDENTIFY A PARTICULAR LIVING INDIVIDUAL."

SER. NO. 77-341,057, FILED 11-30-2007.

CARYN GLASSER, EXAMINING ATTORNEY

**Int. Cl.: 41**

**Prior U.S. Cls.: 100, 101 and 107**

**United States Patent and Trademark Office**

**Reg. No. 3,498,282**

**Registered Sep. 9, 2008**

**SERVICE MARK  
PRINCIPAL REGISTER**

**wwtdd.com**

RYAN PERRY ENTERPRISES, INC. (ARIZONA  
CORPORATION)  
1234 S. POWER ROAD, SUITE 206  
MESA, AZ 85206

FOR: ENTERTAINMENT SERVICES, NAMELY,  
PROVIDING A WEBSITE FEATURING PHOTO-  
GRAPHIC, AUDIO, VIDEO AND PROSE PRESEN-  
TATIONS FEATURING CELEBRITY GOSSIP, IN  
CLASS 41 (U.S. CLS. 100, 101 AND 107).

FIRST USE 7-5-2005; IN COMMERCE 7-15-2005.

THE MARK CONSISTS OF STANDARD CHAR-  
ACTERS WITHOUT CLAIM TO ANY PARTICULAR  
FONT, STYLE, SIZE, OR COLOR.

SER. NO. 77-341,060, FILED 11-30-2007.

KYLE PEETE, EXAMINING ATTORNEY



**Int. Cl.: 18**

**Prior U.S. Cls.: 1, 2, 3, 22 and 41**

**United States Patent and Trademark Office**

**Reg. No. 3,498,283**

**Registered Sep. 9, 2008**

**TRADEMARK  
PRINCIPAL REGISTER**

**HORSE SENSE**

EQUINE VENTURES, L.L.C. (IOWA LIMITED  
LIABILITY COMPANY)  
955 S.E. OLSON DRIVE  
WAUKEE, IA 50263

THE MARK CONSISTS OF STANDARD CHAR-  
ACTERS WITHOUT CLAIM TO ANY PARTICULAR  
FONT, STYLE, SIZE, OR COLOR.

FOR: HORSE FLY VEILS; ANIMAL CLOTHING,  
NAMELY, GAIL SOCKS; HORSE BLANKETS, IN  
CLASS 18 (U.S. CLS. 1, 2, 3, 22 AND 41).

SER. NO. 77-341,548, FILED 11-30-2007.

FIRST USE 1-1-1995; IN COMMERCE 1-1-1995.

JAMES A. RAUEN, EXAMINING ATTORNEY

**Int. Cl.: 29**

**Prior U.S. Cl.: 46**

**United States Patent and Trademark Office**

**Reg. No. 3,498,284**

**Registered Sep. 9, 2008**

**TRADEMARK  
PRINCIPAL REGISTER**

**UN COOPED**

HICKMAN'S EGG RANCH, INC. (ARIZONA  
CORPORATION)  
6515 SOUTH JACKRABBIT TRAIL  
BUCKEYE, AZ 85326

THE MARK CONSISTS OF STANDARD CHAR-  
ACTERS WITHOUT CLAIM TO ANY PARTICULAR  
FONT, STYLE, SIZE, OR COLOR.

FOR: EGGS, IN CLASS 29 (U.S. CL. 46).

SER. NO. 77-341,586, FILED 11-30-2007.

FIRST USE 12-15-2007; IN COMMERCE 1-5-2008.

JENNIFER MARTIN, EXAMINING ATTORNEY

**Int. Cl.: 37**

**Prior U.S. Cls.: 100, 103 and 106**

**United States Patent and Trademark Office**

**Reg. No. 3,498,285**

**Registered Sep. 9, 2008**

**SERVICE MARK  
PRINCIPAL REGISTER**

**We Install Peace of Mind**

WILLIAM LAROQUE INSTALLERS, INC. (FLOR-  
IDA CORPORATION)  
601 NORTH 44TH AVENUE  
HOLLYWOOD, FL 33021

THE MARK CONSISTS OF STANDARD CHAR-  
ACTERS WITHOUT CLAIM TO ANY PARTICULAR  
FONT, STYLE, SIZE, OR COLOR.

FOR: BUILDING CONSTRUCTION SERVICES, IN  
CLASS 37 (U.S. CLS. 100, 103 AND 106).

SER. NO. 77-341,948, FILED 12-2-2007.

FIRST USE 7-21-1993; IN COMMERCE 7-21-1993.

ANNE FARRELL, EXAMINING ATTORNEY

Int. Cl.: 3

Prior U.S. Cls.: 1, 4, 6, 50, 51 and 52

Reg. No. 3,498,286

United States Patent and Trademark Office

Registered Sep. 9, 2008

TRADEMARK  
PRINCIPAL REGISTER

ACCEN  
澳雪

CIDORE HOLDING LIMITED (BR.VIRGIN ISLANDS LIMITED LIABILITY COMPANY)  
OFFSHORE INCORPORATIONS CTR  
PO BOX 957  
ROAD TOWN, TORTOLA, BR.VIRGIN ISLANDS

FOR: BLEACHING PREPARATIONS AND LAUNDRY DETERGENTS; CLEANING, POLISHING, SCOURING AND ABRASIVE PREPARATIONS; SOAPS; PERFUMERY, ESSENTIAL OILS, COSMETICS, HAIR LOTIONS; DENTIFRICES; NON-MEDICAL CLEANSING PREPARATIONS FOR SKIN; FACIAL CLEANSING MILK; FACIAL CLEANSING SOAP; FACIAL CLEANSING CREAM; BATH LIQUID GEL, BATH SOAPS IN LIQUID FORM; PREPARATIONS FOR USE IN SHOWER AND BATH, NAMELY, SHOWER AND BATH GEL AND FOAM; NON-MEDICATED SKIN CARE PREPARATIONS AND NON-MEDICATED SKIN PROTECTION PREPARATIONS IN THE NATURE OF DAY CREAM AND NIGHT CREAM; SKIN CARE MOISTURIZERS; SKIN TONERS; NON-MEDICATED SKIN CARE PREPARATIONS FOR SENSITIVE SKIN AND NON-MEDICATED SKIN PROTECTION PREPARATIONS FOR SENSITIVE SKIN IN THE NATURE OF DAY CREAM AND NIGHT CREAM; NON-MEDICATED PREPARATIONS FOR MASSAGE IN THE NATURE OF MASSAGE CREAMS AND OILS; DEODORANT PREPARATIONS FOR PERSONAL USE; COSMETIC ANTIPERSPIRANTS FOR PERSONAL USE; PORE ASTRINGENT CREAMS FOR COSMETIC PURPOSES; COSMETIC ANTI-WRINKLE CREAM; COSMETIC PREPARATIONS FOR KERATOSIS REMOVAL; NON-MEDICATED BODY POWDER; COSMETIC PREPARATIONS FOR AGE

SPOT REDUCTION; COSMETIC PREPARATIONS FOR WHITENING THE SKIN; SKIN AND BODY MASKS; COSMETIC SUNSCREEN AND SUN-BLOCK PREPARATIONS; BODY MASSAGE OILS; BODY MASSAGE CREAMS; COSMETIC PREPARATIONS FOR CARE OF BUST; COSMETIC BUST BEAUTIFYING AND FIRING SKIN CARE CREAMS AND LOTIONS; AROMATIC LIQUID FOR PERSONAL USE; NON-MEDICATED BABIES SKIN CARE PREPARATIONS; NON-MEDICATED PREPARATIONS FOR CARE OF THE EYES IN THE NATURE OF EYE CREAM; EYE MASKS; COSMETIC EYE TREATMENT PREPARATIONS IN THE NATURE OF EYE CREAMS TO TREAT WRINKLES; EYE CREAMS FOR FIRING SKIN AROUND EYES; NON-MEDICATED ACNE CARE PREPARATIONS; NON-MEDICAL ACNE REMOVING PREPARATIONS; COSMETICS FOR MAKING-UP THE FACE; ESSENCES FOR COSMETIC PURPOSES, NAMELY, WHITENING ESSENCES FOR SKIN, OIL CONTROL ESSENCES FOR SKIN, MOISTURIZING ESSENCES FOR SKIN; LIP STICK; NON-MEDICAL PREPARATIONS FOR CARE OF LIPS; MAKE-UP REMOVERS; COSMETIC PREPARATIONS FOR SLIMMING PURPOSES; COSMETIC PREPARATIONS FOR SKIN CARE; MAKE-UP; NON MEDICATED PREPARATIONS FOR CARE OF HAIR; HAIR SHAMPOOS; HAIR CLEANSING PREPARATIONS; HAIR CLEANSING GELS; HAIR CONDITIONERS; OILS FOR THE CARE OF HAIR; NON-MEDICATED PREPARATIONS FOR THE REGENERATION OF HAIR, NOT BEING HAIR GROWTH STIMULANTS; NON-MEDICATED SCALP TREATMENT PREPARATIONS; NON-MEDICATED HAIR PRESERVATION PREPARATIONS; PREPARA-

TIONS FOR HAIR WAVING; PREPARATIONS FOR HAIR COLOURING; NON-MEDICATED PREPARATIONS FOR USE IN ORAL HYGIENE, NAMELY, MOUTHWASHES AND BREATH SPRAY; PREPARATIONS FOR CLEANING TEETH; NON-MEDICATED PREPARATIONS FOR CARE OF HANDS; NON-MEDICATED HAND TREATMENT PREPARATIONS; COSMETIC PREPARATIONS FOR NAILS, NAMELY, NAIL POLISH, NAIL VARNISH, AND NAIL ENAMELS; PREPARATIONS FOR CARE OF NAILS; NON-MEDICATED PREPARATIONS FOR CARE OF FOOT; HAIR REMOVAL PREPARATIONS; SHAVE CREAMS; NON-MEDICATED PREPARATIONS FOR USE BEFORE SHAVING AND AFTER SHAVING, IN CLASS 3 (U.S. CLS. 1, 4, 6, 50, 51 AND 52).

FIRST USE 1-1-1994; IN COMMERCE 1-1-2005.

THE COLOR(S) DARK BLUE IS/ARE CLAIMED AS A FEATURE OF THE MARK.

THE MARK CONSISTS OF A WORD "ACCEN" AND TWO CHINESE CHARACTERS AND ALL OF THEM ARE DARK BLUE IN COLOR.

THE WORDING "ACCEN" IN THE MARK HAS NO MEANING IN A FOREIGN LANGUAGE

THE NON-LATIN CHARACTER(S) IN THE MARK TRANSLITERATES INTO AO XUE, AND THIS HAS NO MEANING IN ENGLISH

SER. NO. 77-342,096, FILED 12-3-2007.

JEAN IM, EXAMINING ATTORNEY

**Int. Cl.: 20**

**Prior U.S. Cls.: 2, 13, 22, 25, 32 and 50**

**United States Patent and Trademark Office**

**Reg. No. 3,498,287**

**Registered Sep. 9, 2008**

**TRADEMARK  
PRINCIPAL REGISTER**

**ARSTAR**

ARSTAR, S. A. DE C. V. (MEXICO CORPORATION)  
CHAPULTEPEC 1840 OTE  
COL. BUENOS AIRES, MEXICO 64800

FOR: KITCHEN AND BATHROOM COMPONENTS FORMED OF MOLDED RESIN MATERIALS IN THE NATURE OF FURNITURE PARTS, NAMELY, MOLDED COUNTERTOPS AND VANITY TOPS; AND MOLDED RESIN TRIM FOR SAID MOLDED COUNTERTOPS AND VANITY TOPS, IN CLASS 20 (U.S. CLS. 2, 13, 22, 25, 32 AND 50).

FIRST USE 3-14-2003; IN COMMERCE 3-14-2003.

THE MARK CONSISTS OF STANDARD CHARACTERS WITHOUT CLAIM TO ANY PARTICULAR FONT, STYLE, SIZE, OR COLOR.

SER. NO. 77-342,127, FILED 12-3-2007.

AMEETA JORDAN, EXAMINING ATTORNEY

**Int. Cl.: 40**

**Prior U.S. Cls.: 100, 103 and 106**

**United States Patent and Trademark Office**

**Reg. No. 3,498,288**

**Registered Sep. 9, 2008**

**SERVICE MARK  
PRINCIPAL REGISTER**

**HP MILE**

H.P. MILE, INC. (NEW YORK CORPORATION)  
225 WILKINSON STREET  
SYRACUSE, NY 13204

FOR: MANUFACTURING OF LABELS, BAR-CODES, AND RADIO FREQUENCY IDENTIFICATION (RFID) TAGS TO THE ORDER AND SPECIFICATION OF OTHERS, IN CLASS 40 (U.S. CLS. 100, 103 AND 106).

FIRST USE 3-0-2002; IN COMMERCE 3-0-2002.

THE MARK CONSISTS OF STANDARD CHARACTERS WITHOUT CLAIM TO ANY PARTICULAR FONT, STYLE, SIZE, OR COLOR.

SER. NO. 77-342,543, FILED 12-3-2007.

LYDIA BELZER, EXAMINING ATTORNEY

**Int. Cl.: 35**

**Prior U.S. Cls.: 100, 101 and 102**

**United States Patent and Trademark Office**

**Reg. No. 3,498,289**

**Registered Sep. 9, 2008**

**SERVICE MARK  
PRINCIPAL REGISTER**



SID BHATTI (UNITED STATES INDIVIDUAL)  
1020 NORTH MAIN STREET  
EDGERTON, WI 53534

FOR: RETAIL STORE SERVICES FEATURING  
CONVENIENCE STORE ITEMS AND GASOLINE, IN  
CLASS 35 (U.S. CLS. 100, 101 AND 102).

FIRST USE 6-15-2007; IN COMMERCE 6-15-2007.

THE MARK CONSISTS OF THE WORD "SIDBE"  
IN A DIAMOND SHAPE.

SER. NO. 77-343,139, FILED S.R. 12-4-2007 AM. P.R.  
5-8-2008.

JACQUELINE A. LAVINE, EXAMINING ATTOR-  
NEY



**Int. Cl.: 6**

**Prior U.S. Cls.: 2, 12, 13, 14, 23, 25 and 50**

**Reg. No. 3,498,290**

**United States Patent and Trademark Office**

**Registered Sep. 9, 2008**

**TRADEMARK  
PRINCIPAL REGISTER**

**ORIGINAL Safe & Vault Inc.**

ORIGINAL SAFE & VAULT INC. (NEW JERSEY CORPORATION), DBA ORIGINAL SAFE & VAULT CO., ORIGINAL SAFE CO.  
3709 PARK AVENUE  
UNION CITY, NJ 07087

NO CLAIM IS MADE TO THE EXCLUSIVE RIGHT TO USE "SAFE & VAULT INC.", APART FROM THE MARK AS SHOWN.

FOR: METAL SAFES, IN CLASS 6 (U.S. CLS. 2, 12, 13, 14, 23, 25 AND 50).

SEC. 2(F).

FIRST USE 4-10-1986; IN COMMERCE 4-10-1986.

SER. NO. 77-343,433, FILED 12-4-2007.

THE MARK CONSISTS OF STANDARD CHARACTERS WITHOUT CLAIM TO ANY PARTICULAR FONT, STYLE, SIZE, OR COLOR.

BARBARA RUTLAND, EXAMINING ATTORNEY

**Int. Cl.: 42**

**Prior U.S. Cls.: 100 and 101**

**United States Patent and Trademark Office**

**Reg. No. 3,498,291**

**Registered Sep. 9, 2008**

**SERVICE MARK  
PRINCIPAL REGISTER**

**PERI**

PERI SOFTWARE SOLUTIONS, INC. (NEW JERSEY CORPORATION)  
26 JOURNAL SQUARE, 2ND FLOOR  
JERSEY CITY, NJ 07306

FOR: DESIGN, DEVELOPMENT AND MAINTENANCE OF COMPUTER SOFTWARE FOR OTHERS; TECHNICAL CONSULTATION IN THE FIELD OF DESIGN, DEVELOPMENT AND MAINTENANCE OF COMPUTER SOFTWARE, IN CLASS 42 (U.S. CLS. 100 AND 101).

FIRST USE 2-1-1999; IN COMMERCE 2-1-1999.

THE MARK CONSISTS OF STANDARD CHARACTERS WITHOUT CLAIM TO ANY PARTICULAR FONT, STYLE, SIZE, OR COLOR.

SER. NO. 77-343,799, FILED 12-4-2007.

STEVEN R. FINE, EXAMINING ATTORNEY

**Int. Cl.: 9**

**Prior U.S. Cls.: 21, 23, 26, 36 and 38**

**Reg. No. 3,498,292**

**United States Patent and Trademark Office**

**Registered Sep. 9, 2008**

**TRADEMARK  
PRINCIPAL REGISTER**

**MANAGEPRO**

PERFORMANCE SOLUTIONS TECHNOLOGY,  
LLC (CALIFORNIA LIMITED LIABILITY  
COMPANY)

301 NAUTICAL HEIGHTS ROAD  
SMITH RIVER, CA 95567

FOR: DOWNLOADABLE COMPUTER PRO-  
GRAM FOR PROJECT MANAGEMENT; DOWN-  
LOADABLE COMPUTER PROGRAM FOR  
PROJECT TASK PRIORITIZATION, GOAL MAN-  
AGEMENT, PERFORMANCE MANAGEMENT  
AND EMPLOYEE COMMUNICATION, ALL IN

THE FIELD OF PERSONNEL MANAGEMENT, IN  
CLASS 9 (U.S. CLS. 21, 23, 26, 36 AND 38).

FIRST USE 6-24-1992; IN COMMERCE 6-24-1992.

THE MARK CONSISTS OF STANDARD CHAR-  
ACTERS WITHOUT CLAIM TO ANY PARTICULAR  
FONT, STYLE, SIZE, OR COLOR.

SER. NO. 77-343,983, FILED 12-4-2007.

AISHA CLARKE, EXAMINING ATTORNEY

**Int. Cl.: 35**

**Prior U.S. Cls.: 100, 101 and 102**

**United States Patent and Trademark Office**

**Reg. No. 3,498,293**

**Registered Sep. 9, 2008**

**SERVICE MARK  
PRINCIPAL REGISTER**

**United Networker\$**

TRUST DEED OF CALIFORNIA FINANCIAL,  
INC (CALIFORNIA CORPORATION)  
3575 CAHUENGA BLVD W #125  
LOS ANGELES, CA 90068

FOR: GENERAL BUSINESS NETWORKING RE-  
FERRAL SERVICES, NAMELY, PROMOTING THE  
GOODS AND SERVICES OF OTHERS BY PASSING  
BUSINESS LEADS AND REFERRALS AMONG  
GROUP MEMBERS; BUSINESS NETWORKING, IN  
CLASS 35 (U.S. CLS. 100, 101 AND 102).

FIRST USE 6-1-2006; IN COMMERCE 6-1-2006.

THE MARK CONSISTS OF STANDARD CHAR-  
ACTERS WITHOUT CLAIM TO ANY PARTICULAR  
FONT, STYLE, SIZE, OR COLOR.

SER. NO. 77-344,049, FILED 12-4-2007.

ELLEN PERKINS, EXAMINING ATTORNEY

**Int. Cl.: 28**

**Prior U.S. Cls.: 22, 23, 38 and 50**

**Reg. No. 3,498,294**

**United States Patent and Trademark Office**

**Registered Sep. 9, 2008**

---

**TRADEMARK  
PRINCIPAL REGISTER**

**SKY SHOOTER**

MATTEL, INC. (DELAWARE CORPORATION)  
M1-1518  
333 CONTINENTAL BLVD.  
EL SEGUNDO, CA 90245

FIRST USE 4-18-2008; IN COMMERCE 4-18-2008.

FOR: TOYS, GAMES AND PLAYTHINGS, NAME-  
LY, TOY VEHICLES, TOY FIGURES, AND ACCES-  
SORIES FOR ALL OF THE FOREGOING, IN CLASS  
28 (U.S. CLS. 22, 23, 38 AND 50).

THE MARK CONSISTS OF STANDARD CHAR-  
ACTERS WITHOUT CLAIM TO ANY PARTICULAR  
FONT, STYLE, SIZE, OR COLOR.

SER. NO. 77-344,172, FILED 12-4-2007.

SAIMA MAKHDOOM, EXAMINING ATTORNEY

**Int. Cl.: 9**

**Prior U.S. Cls.: 21, 23, 26, 36 and 38**

**United States Patent and Trademark Office**

**Reg. No. 3,498,295**

**Registered Sep. 9, 2008**

**TRADEMARK  
PRINCIPAL REGISTER**

**BLEEDING ON DEMAND**

O2MICRO, INC. (CALIFORNIA CORPORATION)  
3118 PATRICK HENRY DRIVE  
SANTA CLARA, CA 95054

FOR: ELECTRONIC INTEGRATED CIRCUITS,  
COMPUTER SOFTWARE, NAMELY, COMPUTER  
ARCHITECTURE FOR POWER MANAGEMENT IN  
ELECTRONIC VEHICLES, IN PORTABLE ELEC-  
TRONIC DEVICES AND EQUIPMENT, IN POWER  
ADAPTERS AND BATTERY CHARGERS, IN CLASS  
9 (U.S. CLS. 21, 23, 26, 36 AND 38).

FIRST USE 5-5-2008; IN COMMERCE 5-5-2008.

THE MARK CONSISTS OF STANDARD CHAR-  
ACTERS WITHOUT CLAIM TO ANY PARTICULAR  
FONT, STYLE, SIZE, OR COLOR.

THE WORDING "BLEEDING ON DEMAND" HAS  
NO MEANING IN A FOREIGN LANGUAGE.

SER. NO. 77-344,562, FILED 12-5-2007.

NATALIE POLZER, EXAMINING ATTORNEY

**Int. Cl.: 41**

**Prior U.S. Cls.: 100, 101 and 107**

**Reg. No. 3,498,296**

**United States Patent and Trademark Office**

**Registered Sep. 9, 2008**

**SERVICE MARK  
PRINCIPAL REGISTER**

# FUNNY JOINTS

FUNNY JOINTS, LLC (FLORIDA LIMITED LIABILITY COMPANY)  
2921 WESTON TERRACE  
PALM HARBOR, FL 34685

FOR: TELEVISION PRODUCTION SERVICES; EDUCATIONAL AND ENTERTAINMENT SERVICES IN THE NATURE OF VISUAL AND AUDIO PERFORMANCES, AND MUSICAL, VARIETY, NEWS, AND COMEDY SHOWS; ENTERTAINMENT SERVICES, NAMELY, PROVIDING TELEVISION, SATELLITE, AUDIO AND VIDEO PROGRAMS IN THE FIELD OF NEWS, COMEDY, AND DRAMA; ENTERTAINMENT SERVICES, NAMELY, LIVE MUSICAL CONCERTS AND TELEVISION NEWS SHOWS; PROVIDING INFORMATION IN THE FIELD OF TELEVISION, CABLE AND SATELLITE PROGRAMS; ENTERTAINMENT SERVICES IN THE NATURE OF COMEDY SHOWS, GAME SHOWS, DANCE SHOWS, MUSIC SHOWS, AND AWARD SHOWS VIA TELEVISION, CABLE AND SATELLITE; ENTERTAINMENT IN THE NATURE OF TELEVISION COMEDY SHOWS, GAME SHOWS, MUSIC SHOWS AND AWARD SHOWS BEFORE LIVE AUDIENCES WHICH ARE BROADCAST LIVE OR TAPED FOR LATER BROADCAST; ENTERTAINMENT IN THE NATURE OF TELEVISION NEWS SHOWS AND COMEDY SHOWS VIA A

GLOBAL COMPUTER NETWORK; PROVIDING ON-LINE DATABASE SERVICES IN THE FIELDS OF ENTERTAINMENT, EDUCATION, HISTORICAL AND BIOGRAPHICAL INFORMATION REGARDING NEWS, COMEDY, DRAMA, MUSICAL CONCERTS, AND TELEVISION; ENTERTAINMENT SERVICES, NAMELY, PROVIDING A WEBSITE FEATURING COMIC MATERIAL IN THE FORM OF AUDIO AND VIDEO CLIPS, WRITTEN MATERIAL, TELEVISION CLIPS, MOVIE CLIPS, COMMERCIALS AND OTHER MULTIMEDIA MATERIALS; ENTERTAINMENT SERVICES, NAMELY, PROVIDING WEBCASTS AND PODCASTS IN THE FIELD OF NEWS, COMEDY, AND DRAMA, IN CLASS 41 (U.S. CLS. 100, 101 AND 107).

FIRST USE 3-1-2007; IN COMMERCE 3-1-2007.

THE MARK CONSISTS OF STANDARD CHARACTERS WITHOUT CLAIM TO ANY PARTICULAR FONT, STYLE, SIZE, OR COLOR.

SER. NO. 77-344,592, FILED 12-5-2007.

CIMMERIAN COLEMAN, EXAMINING ATTORNEY

**Int. Cl.: 41**

**Prior U.S. Cls.: 100, 101 and 107**

**United States Patent and Trademark Office**

**Reg. No. 3,498,297**

**Registered Sep. 9, 2008**

**SERVICE MARK  
PRINCIPAL REGISTER**

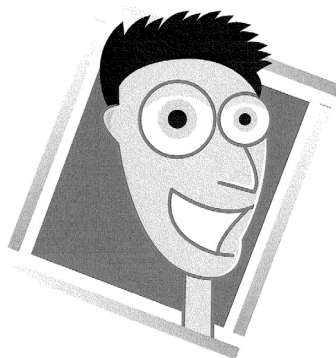

FUNNY JOINTS, LLC (FLORIDA LIMITED LIABILITY COMPANY)  
2921 WESTON TERRACE  
PALM HARBOR, FL 34685

FOR: TELEVISION PRODUCTION SERVICES; EDUCATIONAL AND ENTERTAINMENT SERVICES IN THE NATURE OF VISUAL AND AUDIO PERFORMANCES, AND MUSICAL, VARIETY, NEWS, AND COMEDY SHOWS; ENTERTAINMENT SERVICES, NAMELY, PROVIDING TELEVISION, SATELLITE, AUDIO AND VIDEO PROGRAMS IN THE FIELD OF NEWS, COMEDY, AND DRAMA; ENTERTAINMENT SERVICES, NAMELY, LIVE MUSICAL CONCERTS AND TELEVISION NEWS SHOWS; PROVIDING INFORMATION IN THE FIELD OF TELEVISION, CABLE AND SATELLITE PROGRAMS; ENTERTAINMENT SERVICES IN THE NATURE OF COMEDY SHOWS, GAME SHOWS, DANCE SHOWS, MUSIC SHOWS, AND AWARD SHOWS VIA TELEVISION, CABLE AND SATELLITE; ENTERTAINMENT IN THE NATURE OF TELEVISION COMEDY SHOWS, GAME SHOWS, MUSIC SHOWS AND AWARD SHOWS BEFORE LIVE AUDIENCES WHICH ARE BROADCAST LIVE OR TAPED FOR LATER BROADCAST; ENTERTAINMENT IN THE NATURE OF TELEVISION NEWS SHOWS AND COMEDY SHOWS VIA A

GLOBAL COMPUTER NETWORK; PROVIDING ON-LINE DATABASE SERVICES IN THE FIELDS OF ENTERTAINMENT, EDUCATION, HISTORICAL AND BIOGRAPHICAL INFORMATION REGARDING NEWS, COMEDY, DRAMA, MUSICAL CONCERTS, AND TELEVISION; ENTERTAINMENT SERVICES, NAMELY, PROVIDING A WEBSITE FEATURING COMIC MATERIAL IN THE FORM OF AUDIO AND VIDEO CLIPS, WRITTEN MATERIAL, TELEVISION CLIPS, MOVIE CLIPS, COMMERCIALS AND OTHER MULTIMEDIA MATERIALS; ENTERTAINMENT SERVICES, NAMELY, PROVIDING WEBCASTS AND PODCASTS IN THE FIELD OF NEWS, COMEDY, AND DRAMA, IN CLASS 41 (U.S. CLS. 100, 101 AND 107).

FIRST USE 3-1-2007; IN COMMERCE 3-1-2007.

THE MARK CONSISTS OF CARTOON ILLUSTRATION OF A MAN WITH LARGE EYES AND A BIG SMILE INSIDE A BOX.

SER. NO. 77-344,642, FILED 12-5-2007.

CIMMERIAN COLEMAN, EXAMINING ATTORNEY



**Int. Cl.: 35**

**Prior U.S. Cls.: 100, 101 and 102**

**United States Patent and Trademark Office**

**Reg. No. 3,498,298**

**Registered Sep. 9, 2008**

**SERVICE MARK  
PRINCIPAL REGISTER**



RUSCO, CLARK (UNITED STATES INDIVIDUAL)  
3016 BROADWAY  
GREAT BEND, KS 67530 AND  
RUSCO, JEREMY (UNITED STATES INDIVIDUAL)  
3016 BROADWAY  
GREAT BEND, KS 67530

FOR: ON-LINE RETAIL STORE SERVICES FEATURING CLOTHING, DISCS AND DISC GOLF ACCESSORIES , IN CLASS 35 (U.S. CLS. 100, 101 AND 102).

FIRST USE 3-1-2005; IN COMMERCE 8-1-2006.

NO CLAIM IS MADE TO THE EXCLUSIVE RIGHT TO USE "DISCS", APART FROM THE MARK AS SHOWN.

THE MARK CONSISTS OF THE STYLIZED WORDS "DD DYNAMIC DISCS". THE FIRST "D" IS A BACKWARDS FOLLOWED BY A "D". THE WORDS "DYNAMIC DISCS" ARE BELOW THE TWO "D'S". THERE IS A CROWN OVER THE TWO "D'S".

SER. NO. 77-345,596, FILED 12-6-2007.

DAVID H. STINE, EXAMINING ATTORNEY

**Int. Cl.: 35**

**Prior U.S. Cls.: 100, 101 and 102**

**United States Patent and Trademark Office**

**Reg. No. 3,498,299**

**Registered Sep. 9, 2008**

**SERVICE MARK  
PRINCIPAL REGISTER**

**SHOP WELL. BE WELL. T.J.  
MAXX**

NBC FOURTH REALTY CORP. (NEVADA CORPORATION)  
4100 EAST LONE MOUNTAIN ROAD  
NORTH LAS VEGAS, NV 89031

FOR: RETAIL DEPARTMENT STORE SERVICES,  
IN CLASS 35 (U.S. CLS. 100, 101 AND 102).

FIRST USE 9-24-2007; IN COMMERCE 9-24-2007.

THE MARK CONSISTS OF STANDARD CHARACTERS WITHOUT CLAIM TO ANY PARTICULAR FONT, STYLE, SIZE, OR COLOR.

OWNER OF U.S. REG. NOS. 1,199,126, 1,637,243  
AND OTHERS.

THE NAME(S), PORTRAIT(S), AND/OR SIGNATURE(S) SHOWN IN THE MARK DOES NOT IDENTIFY A PARTICULAR LIVING INDIVIDUAL.

SER. NO. 77-345,784, FILED 12-6-2007.

DANIEL BRODY, EXAMINING ATTORNEY

**Int. Cls.: 35 and 36**

**Prior U.S. Cls.: 100, 101 and 102**

**United States Patent and Trademark Office**

**Reg. No. 3,498,300**

**Registered Sep. 9, 2008**

**SERVICE MARK  
PRINCIPAL REGISTER**

**RESOURCES FOR ENRICHING  
LIVES**

CHS INC. (MINNESOTA CORPORATION)  
5500 CENEX DRIVE  
INVER GROVE HEIGHTS, MN 55077

FOR: COOPERATIVE BUSINESS MANAGEMENT AND CONSULTATION SERVICES IN THE FOOD, AGRICULTURAL AND UTILITIES INDUSTRIES; COOPERATIVE ADVERTISING AND MARKETING SERVICES, NAMELY, CONSULTATION SERVICES IN THE DEVELOPMENT OF ADVERTISEMENTS AND SALES PROMOTIONS; DISTRIBUTORSHIP SERVICES FEATURING AGRICULTURAL, FOOD AND UTILITIES PRODUCTS AND SUPPLIES; ASSOCIATION SERVICES, NAMELY, PROMOTING THE INTERESTS OF AGRICULTURAL COOPERATIVES, FARMERS AND AGRICULTURAL COOPERATIVES ORIENTED PARTIES, IN CLASS 35 (U.S. CLS. 100, 101 AND 102).

FIRST USE 9-1-2003; IN COMMERCE 9-1-2003.

FOR: GRAIN, UTILITY AND COMMODITY BROKERAGE SERVICES, IN CLASS 36 (U.S. CLS. 100, 101 AND 102).

FIRST USE 9-1-2003; IN COMMERCE 9-1-2003.

THE MARK CONSISTS OF STANDARD CHARACTERS WITHOUT CLAIM TO ANY PARTICULAR FONT, STYLE, SIZE, OR COLOR.

OWNER OF U.S. REG. NO. 2,937,335.

SER. NO. 77-346,481, FILED 12-7-2007.

GILBERT SWIFT, EXAMINING ATTORNEY

**Int. Cl.: 37**

**Prior U.S. Cls.: 100, 103 and 106**

**United States Patent and Trademark Office**

**Reg. No. 3,498,301**

**Registered Sep. 9, 2008**

**SERVICE MARK  
PRINCIPAL REGISTER**

**J.R. MCKINLEY CONSTRUCTION**

J.R. MCKINLEY CONSTRUCTION, LLC (TEXAS  
LIMITED LIABILITY COMPANY)  
1 EAST MARKET STREET, SUITE 201  
YORK, ANDORRA 17401

FOR: CONSTRUCTION OF RESIDENTIAL, COM-  
MERCIAL, INDUSTRIAL, INSTITUTIONAL AND  
RECREATIONAL BUILDINGS, IN CLASS 37 (U.S.  
CLS. 100, 103 AND 106).

FIRST USE 11-9-2006; IN COMMERCE 11-9-2006.

THE MARK CONSISTS OF STANDARD CHAR-  
ACTERS WITHOUT CLAIM TO ANY PARTICULAR  
FONT, STYLE, SIZE, OR COLOR.

NO CLAIM IS MADE TO THE EXCLUSIVE  
RIGHT TO USE "CONSTRUCTION", APART FROM  
THE MARK AS SHOWN.

THE NAME "J.R. MCKINLEY" DOES NOT IDEN-  
TIFY A LIVING INDIVIDUAL.

SER. NO. 77-346,626, FILED 12-7-2007.

RONALD MCMORROW, EXAMINING ATTORNEY

**Int. Cl.: 31**

**Prior U.S. Cls.: 1 and 46**

**United States Patent and Trademark Office**

**Reg. No. 3,498,302**

**Registered Sep. 9, 2008**

**TRADEMARK  
PRINCIPAL REGISTER**

**SUPER MANGO**

AMEX DISTRIBUTING CO., INC. (ARIZONA  
CORPORATION)  
RIO RICO INDUSTRIAL PARK  
5 CALLE CRISTINA  
RIO RICO, AZ 85648

FOR: FRESH FRUIT, NAMELY, MANGOS, IN  
CLASS 31 (U.S. CLS. 1 AND 46).

FIRST USE 0-0-1987; IN COMMERCE 0-0-1987.

THE MARK CONSISTS OF STANDARD CHAR-  
ACTERS WITHOUT CLAIM TO ANY PARTICULAR  
FONT, STYLE, SIZE, OR COLOR.

NO CLAIM IS MADE TO THE EXCLUSIVE  
RIGHT TO USE "MANGO", APART FROM THE  
MARK AS SHOWN.

THE WORD "SUPER" HAS NO VARIETAL SIG-  
NIFICANCE.

SEC. 2(F).

SER. NO. 77-346,834, FILED 12-7-2007.

CAROL SPILS, EXAMINING ATTORNEY

**Int. Cl.: 25**

**Prior U.S. Cls.: 22 and 39**

**United States Patent and Trademark Office**

**Reg. No. 3,498,303**

**Registered Sep. 9, 2008**

**TRADEMARK  
PRINCIPAL REGISTER**

**JOE BANG**

STACEY, K. LAWRENCE (UNITED STATES IN-  
DIVIDUAL)

412 1ST AVENUE WEST

HENDERSONVILLE, NC 28739

FOR: TEE SHIRTS, IN CLASS 25 (U.S. CLS. 22 AND  
39).

FIRST USE 7-3-2007; IN COMMERCE 7-3-2007.

THE MARK CONSISTS OF STANDARD CHAR-  
ACTERS WITHOUT CLAIM TO ANY PARTICULAR  
FONT, STYLE, SIZE, OR COLOR.

"THE NAME(S), PORTRAIT(S), AND/OR SIGNA-  
TURE(S) SHOWN IN THE MARK DOES NOT IDEN-  
TIFY A PARTICULAR LIVING INDIVIDUAL."

SER. NO. 77-346,846, FILED 12-7-2007.

ANDREA SAUNDERS, EXAMINING ATTORNEY

**Int. Cl.: 28**

**Prior U.S. Cls.: 22, 23, 38 and 50**

**United States Patent and Trademark Office**

**Reg. No. 3,498,304**

**Registered Sep. 9, 2008**

**TRADEMARK  
PRINCIPAL REGISTER**

**JOE BANG**

STACEY, K. LAWRENCE (UNITED STATES IN-  
DIVIDUAL)

412 1ST AVENUE WEST

HENDERSONVILLE, NC 28739

FOR: SKATEBOARDS, IN CLASS 28 (U.S. CLS. 22,  
23, 38 AND 50).

FIRST USE 7-3-2007; IN COMMERCE 7-3-2007.

THE MARK CONSISTS OF STANDARD CHAR-  
ACTERS WITHOUT CLAIM TO ANY PARTICULAR  
FONT, STYLE, SIZE, OR COLOR.

THE NAME(S), PORTRAIT(S), AND/OR SIGNA-  
TURE(S) SHOWN IN THE MARK DOES NOT IDEN-  
TIFY A PARTICULAR LIVING INDIVIDUAL.

SER. NO. 77-346,875, FILED 12-7-2007.

ANDREA SAUNDERS, EXAMINING ATTORNEY

**Int. Cl.: 16**

**Prior U.S. Cls.: 2, 5, 22, 23, 29, 37, 38 and 50**

**Reg. No. 3,498,305**

**United States Patent and Trademark Office**

**Registered Sep. 9, 2008**

**TRADEMARK  
PRINCIPAL REGISTER**

**FRUSTRATED ACCOMPANIST**

JANSSEN, CAROL LEYBOURN (UNITED STATES INDIVIDUAL)  
622 E. LINDBERGH STREET  
APPLETON, WI 549112836

FOR: PRINTED MUSICAL ARRANGEMENTS, NAMELY, CONCERTO ORCHESTRAL REDUCTIONS FOR A PIANIST WHICH INCLUDES THE SOLO LINES FOR A MUSICIAN PLAYING ANOTHER INSTRUMENT, IN CLASS 16 (U.S. CLS. 2, 5, 22, 23, 29, 37, 38 AND 50).

FIRST USE 12-7-2005; IN COMMERCE 12-7-2005.

THE MARK CONSISTS OF STANDARD CHARACTERS WITHOUT CLAIM TO ANY PARTICULAR FONT, STYLE, SIZE, OR COLOR.

NO CLAIM IS MADE TO THE EXCLUSIVE RIGHT TO USE "ACCOMPANIST", APART FROM THE MARK AS SHOWN.

SER. NO. 77-347,050, FILED 12-7-2007.

TAMARA FRAZIER, EXAMINING ATTORNEY



**Int. Cl.: 16**

**Prior U.S. Cls.: 2, 5, 22, 23, 29, 37, 38 and 50**

**Reg. No. 3,498,306**

**United States Patent and Trademark Office**

**Registered Sep. 9, 2008**

**TRADEMARK  
PRINCIPAL REGISTER**



JANSSEN, CAROL LEYBOURN (UNITED STATES INDIVIDUAL)

622 E. LINDBERGH STREET

APPLETON, WI 549112836

FOR: PRINTED MUSICAL ARRANGEMENTS, NAMELY, CONCERTO ORCHESTRAL REDUCTIONS FOR A PIANIST WHICH INCLUDES THE SOLO LINES FOR A MUSICIAN PLAYING ANOTHER INSTRUMENT, IN CLASS 16 (U.S. CLS. 2, 5, 22, 23, 29, 37, 38 AND 50).

FIRST USE 7-30-2007; IN COMMERCE 7-30-2007.

NO CLAIM IS MADE TO THE EXCLUSIVE RIGHT TO USE "ACCOMPANIST", APART FROM THE MARK AS SHOWN.

THE MARK CONSISTS OF TWO CONCENTRIC CIRCLES, WITH THE FIRST CIRCLE BEING SMALLER THAN THE SECOND CIRCLE. THE WORDS "FRUSTRATED ACCOMPANIST" ARE LOCATED BETWEEN THE FIRST AND SECOND CIRCLES. INSIDE THE FIRST CIRCLE IS A SMILEY FACE WITH HAIR, OVERLAPPING A MUSIC NOTE.

SER. NO. 77-347,124, FILED 12-7-2007.

TAMARA FRAZIER, EXAMINING ATTORNEY

**Int. Cl.: 41**

**Prior U.S. Cls.: 100, 101 and 107**

**United States Patent and Trademark Office**

**Reg. No. 3,498,307**

**Registered Sep. 9, 2008**

**SERVICE MARK  
PRINCIPAL REGISTER**

# Alive Day

ARRECIS, DANIEL (UNITED STATES INDIVIDUAL)  
2333 NORTH KILBOURN  
CHICAGO, IL 60639

FOR: ENTERTAINMENT IN THE NATURE OF LIVE PERFORMANCES BY MUSICAL GROUP; ENTERTAINMENT IN THE NATURE OF VISUAL AND AUDIO PERFORMANCES, NAMELY, MUSICAL BAND, ROCK GROUP, GYMNASTIC, DANCE, AND BALLET PERFORMANCES; ENTERTAINMENT IN THE NATURE OF MUSICAL GROUP; ENTERTAINMENT, NAMELY, LIVE PERFORMANCES BY A MUSICAL BAND; ENTERTAINMENT, NAMELY, LIVE MUSIC CONCERTS; ENTERTAIN-

MENT, NAMELY, LIVE PERFORMANCES BY MUSICAL BANDS; ENTERTAINMENT, NAMELY, LIVE PERFORMANCES BY ROCK GROUPS, IN CLASS 41 (U.S. CLS. 100, 101 AND 107).

FIRST USE 11-1-2005; IN COMMERCE 11-1-2005.

THE MARK CONSISTS OF STANDARD CHARACTERS WITHOUT CLAIM TO ANY PARTICULAR FONT, STYLE, SIZE, OR COLOR.

SER. NO. 77-347,444, FILED 12-8-2007.

SUSAN RICHARDS, EXAMINING ATTORNEY

**Int. Cl.: 33**

**Prior U.S. Cls.: 47 and 49**

**United States Patent and Trademark Office**

**Reg. No. 3,498,308**

**Registered Sep. 9, 2008**

**TRADEMARK  
PRINCIPAL REGISTER**

**CONTREBANDE**

SARGENTON-CALLARD, LOUIS (UNITED STATES INDIVIDUAL)  
10 HERITAGE WAY  
BARKHAMSTED, CT 06063

FOR: DISTILLED SPIRITS; ALCOHOLIC BEVERAGES, NAMELY, RUM; PUNCH CONTAINING ALCOHOL, IN CLASS 33 (U.S. CLS. 47 AND 49).

FIRST USE 2-15-2007; IN COMMERCE 9-15-2007.

THE MARK CONSISTS OF STANDARD CHARACTERS WITHOUT CLAIM TO ANY PARTICULAR FONT, STYLE, SIZE, OR COLOR.

THE ENGLISH TRANSLATION OF "CONTREBANDE" IS CONTRABAND.

SER. NO. 77-347,625, FILED 12-9-2007.

KEVIN DINALLO, EXAMINING ATTORNEY

**Int. Cl.: 40**

**Prior U.S. Cls.: 100, 103 and 106**

**United States Patent and Trademark Office**

**Reg. No. 3,498,309**

**Registered Sep. 9, 2008**

**SERVICE MARK  
PRINCIPAL REGISTER**



DEMMMER CORPORATION (MICHIGAN CORPORATION)  
1600 N. LARCH  
LANSING, MI 48906

FOR: CUSTOM MANUFACTURING SERVICES, NAMELY, FABRICATION, ASSEMBLY, TOOLING, MACHINING, VEHICLE SYSTEMS INTEGRATION, KITTING AND STAMPING OF ARMORED AND NON-ARMORED PARTS OR COMPONENTS TO THE SPECIFICATIONS OF OTHERS FOR THE DEFENSE, AEROSPACE, COMMERCIAL AND AUTOMOTIVE INDUSTRIES, IN CLASS 40 (U.S. CLS. 100, 103 AND 106).

FIRST USE 10-16-2007; IN COMMERCE 10-16-2007.

NO CLAIM IS MADE TO THE EXCLUSIVE RIGHT TO USE "CORPORATION", APART FROM THE MARK AS SHOWN.

THE MARK CONSISTS OF A SOLID RECTANGLE WITH THE LITERAL ELEMENT WITHIN.

SER. NO. 77-347,701, FILED 12-10-2007.

PAM WILLIS, EXAMINING ATTORNEY

Int. Cl.: 35

Prior U.S. Cls.: 100, 101 and 102

United States Patent and Trademark Office

Reg. No. 3,498,310

Registered Sep. 9, 2008

**SERVICE MARK  
PRINCIPAL REGISTER**



INTERNATIONAL RETT SYNDROME FOUNDATION (OHIO NON-PROFIT CORPORATION)  
4600 DEVITT DRIVE  
CINCINNATI, OH 45246

FOR: PROMOTING PUBLIC AWARENESS OF THE EFFECTS OF RETT SYNDROME DISEASE; DISTRIBUTING ADVERTISING MATERIAL FOR PROMOTING PUBLIC AWARENESS IN THE FIELD OF RETT SYNDROME DISEASE; PUBLIC ADVOCACY TO PROMOTE PUBLIC AWARENESS OF THE EFFECTS OF RETT SYNDROME DISEASE, IN CLASS 35 (U.S. CLS. 100, 101 AND 102).

FIRST USE 12-17-2007; IN COMMERCE 12-17-2007.

OWNER OF U.S. REG. NO. 3,348,455.

NO CLAIM IS MADE TO THE EXCLUSIVE RIGHT TO USE "INTERNATIONAL RETT SYNDROME FOUNDATION", APART FROM THE MARK AS SHOWN.

THE MARK CONSISTS OF REARVIEW IMAGE OF A GIRL HOLDING A STAR, LOOKING AT A STAR TO THE LEFT OF THE WORDS "IRSF INTERNATIONAL RETT SYNDROME FOUNDATION".

SER. NO. 77-348,250, FILED 12-10-2007.

WILLIAM ROSSMAN, EXAMINING ATTORNEY

**Int. Cl.: 42**

**Prior U.S. Cls.: 100 and 101**

**United States Patent and Trademark Office**

**Reg. No. 3,498,311**

**Registered Sep. 9, 2008**

**SERVICE MARK  
PRINCIPAL REGISTER**

**Aeaea**

AEAEA CORPORATION (COLORADO CORPORATION), DBA AEAEA  
3025 BROADWAY 39  
BOULDER, CO 80304 AND  
BARBOUR, JOHN THOMAS (UNITED STATES INDIVIDUAL)  
3025 BROADWAY 39  
BOULDER, CO 80304

FOR: ARCHITECTURAL DESIGN; CONSULTING SERVICES IN THE FIELD OF ARCHITECTURAL DESIGN; DESIGN AND TESTING FOR NEW PRODUCT DEVELOPMENT; DESIGN AND TESTING OF NEW PRODUCTS FOR OTHERS; DESIGNING THEME GRAPHICS AND MULTIMEDIA SHOWS FOR CONVENTIONS, PRODUCT LAUNCHES, TRADE SHOWS, KEY NOTE ADDRESSES AND AWARD CEREMONIES FOR OTHERS; ENVIRONMENTAL SERVICES, NAMELY, TECHNICAL CONSULTATION IN THE FIELD OF ENVIRONMENTAL SCIENCE, ENGINEERING SERVICES, DESIGN FOR OTHERS IN THE FIELD OF ENVIRONMENTAL

ENGINEERING, DESIGNING AND TESTING OF NEW ENVIRONMENTALLY FRIENDLY PRODUCTS FOR OTHERS; FURNITURE DESIGN SERVICES; GRAPHIC ART DESIGN; GRAPHIC ARTS DESIGNING; GRAPHIC DESIGN; GRAPHIC DESIGN SERVICES; INDUSTRIAL DESIGN; INDUSTRIAL DESIGN SERVICES; INTERIOR DESIGN SERVICES; PACKAGING DESIGN; PLANNING AND LAYOUT DESIGN FOR THE INTERIOR SPACE OF RETAIL BUSINESS ESTABLISHMENTS, IN CLASS 42 (U.S. CLS. 100 AND 101).

FIRST USE 11-20-2007; IN COMMERCE 11-30-2007.

THE MARK CONSISTS OF STANDARD CHARACTERS WITHOUT CLAIM TO ANY PARTICULAR FONT, STYLE, SIZE, OR COLOR.

SER. NO. 77-348,576, FILED 12-11-2007.

CAROLYN CATALDO, EXAMINING ATTORNEY

**Int. Cl.: 29**

**Prior U.S. Cl.: 46**

**United States Patent and Trademark Office**

**Reg. No. 3,498,312**

**Registered Sep. 9, 2008**

**TRADEMARK  
PRINCIPAL REGISTER**

FARMER-OWNED, COW-APPROVED

UPSTATE NIAGARA COOPERATIVE, INC. (NEW  
YORK CORPORATION)  
25 ANDERSON ROAD  
BUFFALO, NY 14225

NO CLAIM IS MADE TO THE EXCLUSIVE  
RIGHT TO USE "FARMER-OWNED", APART  
FROM THE MARK AS SHOWN.

FOR: MILK, IN CLASS 29 (U.S. CL. 46).

FIRST USE 9-1-2007; IN COMMERCE 9-1-2007.

SER. NO. 77-348,711, FILED 12-11-2007.

THE MARK CONSISTS OF STANDARD CHAR-  
ACTERS WITHOUT CLAIM TO ANY PARTICULAR  
FONT, STYLE, SIZE, OR COLOR.

EUGENIA MARTIN, EXAMINING ATTORNEY

**Int. Cl.: 9**

**Prior U.S. Cls.: 21, 23, 26, 36 and 38**

**Reg. No. 3,498,313**

**United States Patent and Trademark Office**

**Registered Sep. 9, 2008**

**TRADEMARK  
PRINCIPAL REGISTER**

# MEDTEST

ASSOCIATED RESEARCH, INC. (ILLINOIS CORPORATION)  
13860 WEST LAUREL DRIVE  
LAKE FOREST, IL 60045

FOR: ELECTRONIC TEST SYSTEMS COMPRISED PRIMARILY OF PRINTED CIRCUIT BOARDS, COMPUTER SOFTWARE IN THE FIELD OF TESTING ELECTRONIC EQUIPMENT, HOUSINGS, TRANSFORMERS, LIQUID CRYSTAL DISPLAYS ALSO KNOWN AS LCDS, ELECTRICAL INSTRUMENTS USED TO TEST COMMERCIAL PRODUCTS ON A VARIETY OF ELECTRICAL SAFETY SPECIFICATIONS INCLUDING TESTS FOR AC HIPOT, DC HIPOT, INSULATION RESISTANCE, GROUND BOND, FUNCTIONAL RUN AND LINE ELECTRICITY LEAKAGE TEST, ELECTRICAL INSTRUMENTS USED TO PERFORM ELECTRICITY LEAKAGE TESTS ON COMMERCIAL PRODUCTS, ELECTRICAL INSTRUMENTS USED TO APPLY PRESELECTED ELECTRICAL POWER LOADS TO SIMULATE POSSIBLE POWER LOADS WHEN USING THE PRODUCTS BEING TESTED, AND ELECTRICAL INSTRUMENTS USED TO SIMULATE FAULT CONDITIONS WHILE TESTS ARE IN PROCESS; SYSTEMS FOR TESTING ELECTRONIC EQUIPMENT COMPRISED PRIMARILY OF PRINTED CIRCUIT BOARDS, COMPUTER SOFTWARE IN THE FIELD OF TESTING ELECTRONIC EQUIPMENT, HOUSINGS, TRANSFORMERS, LIQUID CRYSTAL DISPLAYS ALSO KNOWN AS LCDS, ELECTRICAL INSTRUMENTS USED TO

TEST COMMERCIAL PRODUCTS ON A VARIETY OF ELECTRICAL SAFETY SPECIFICATIONS INCLUDING TESTS FOR AC HIPOT, DC HIPOT, INSULATION RESISTANCE, GROUND BOND, FUNCTIONAL RUN AND LINE ELECTRICITY LEAKAGE TEST, ELECTRICAL INSTRUMENTS USED TO PERFORM ELECTRICITY LEAKAGE TESTS ON COMMERCIAL PRODUCTS, ELECTRICAL INSTRUMENTS USED TO APPLY PRESELECTED ELECTRICAL POWER LOADS TO SIMULATE POSSIBLE POWER LOADS WHEN USING THE PRODUCTS BEING TESTED, AND ELECTRICAL INSTRUMENTS USED TO SIMULATE FAULT CONDITIONS WHILE TESTS ARE IN PROCESS; ELECTRONIC TESTERS USED IN TESTING MEDICAL EQUIPMENT; COMPUTER SOFTWARE FOR ELECTRONIC TESTING OF MEDICAL EQUIPMENT; ELECTRONIC TESTERS FOR ELECTRONIC MEDICAL EQUIPMENT, IN CLASS 9 (U.S. CLS. 21, 23, 26, 36 AND 38).

FIRST USE 10-29-2007; IN COMMERCE 10-29-2007.

THE MARK CONSISTS OF STANDARD CHARACTERS WITHOUT CLAIM TO ANY PARTICULAR FONT, STYLE, SIZE, OR COLOR.

SER. NO. 77-348,778, FILED 12-11-2007.

HOWARD B. LEVINE, EXAMINING ATTORNEY



**Int. Cl.: 9**

**Prior U.S. Cls.: 21, 23, 26, 36 and 38**

**Reg. No. 3,498,314**

**United States Patent and Trademark Office**

**Registered Sep. 9, 2008**

---

**TRADEMARK  
PRINCIPAL REGISTER**

**EN-SPEC**

RIDGEWAY, RANDY H. (UNITED STATES INDIVIDUAL), DBA ENGINE ROOM INTERNATIONAL  
1680 MILLERSBURG ROAD  
UTICA, OH 43080

FIRST USE 11-14-1978; IN COMMERCE 11-14-1978.

THE MARK CONSISTS OF STANDARD CHARACTERS WITHOUT CLAIM TO ANY PARTICULAR FONT, STYLE, SIZE, OR COLOR.

FOR: PORTABLE ELECTRONIC RECORDER FOR MEASURING AND RECORDING MULTIPLE VOLTAGE, CURRENT AND THERMOCOUPLE READINGS FROM VARIOUS TRANSDUCERS , IN CLASS 9 (U.S. CLS. 21, 23, 26, 36 AND 38).

SER. NO. 77-349,030, FILED 12-11-2007.

IRA J. GOODSaid, EXAMINING ATTORNEY

**Int. Cl.: 20**

**Prior U.S. Cls.: 2, 13, 22, 25, 32 and 50**

**United States Patent and Trademark Office**

**Reg. No. 3,498,315**

**Registered Sep. 9, 2008**

**TRADEMARK  
PRINCIPAL REGISTER**

# FigurePrints

FIGUREPRINTS, LLC (WASHINGTON LIMITED  
LIABILITY COMPANY)  
7629 NE CHAMPAGNE POINT PLACE  
KIRKLAND, WA 98034

THE MARK CONSISTS OF STANDARD CHAR-  
ACTERS WITHOUT CLAIM TO ANY PARTICULAR  
FONT, STYLE, SIZE, OR COLOR.

FOR: FIGURINES OF PLASTER, IN CLASS 20  
(U.S. CLS. 2, 13, 22, 25, 32 AND 50).

SER. NO. 77-349,549, FILED 12-11-2007.

FIRST USE 8-17-2007; IN COMMERCE 8-17-2007.

BARBARA A. GOLD, EXAMINING ATTORNEY

**Int. Cl.: 35**

**Prior U.S. Cls.: 100, 101 and 102**

**United States Patent and Trademark Office**

**Reg. No. 3,498,316**

**Registered Sep. 9, 2008**

**SERVICE MARK  
PRINCIPAL REGISTER**

# AutoLady

AUTOLADY, INC. (ALABAMA CORPORATION),  
DBA AUTOLADY, INC.  
2912 GLENSTONE CIRCLE  
BIRMINGHAM, AL 35242

FOR: INDEPENDENT SALES REPRESENTA-  
TIVES IN THE FIELD OF AFTERMARKET PRO-  
DUCTS RELATED TO THE AUTOMOTIVE  
INDUSTRY, IN CLASS 35 (U.S. CLS. 100, 101 AND  
102).

FIRST USE 10-2-2004; IN COMMERCE 10-2-2004.

THE MARK CONSISTS OF STANDARD CHAR-  
ACTERS WITHOUT CLAIM TO ANY PARTICULAR  
FONT, STYLE, SIZE, OR COLOR.

SER. NO. 77-349,619, FILED 12-11-2007.

CHARLES L. JENKINS, EXAMINING ATTORNEY

**Int. Cl.: 35**

**Prior U.S. Cls.: 100, 101 and 102**

**United States Patent and Trademark Office**

**Reg. No. 3,498,317**

**Registered Sep. 9, 2008**

**SERVICE MARK  
PRINCIPAL REGISTER**

**MAINE AT ITS BEST**

DOWN EAST ENTERPRISE, INC. (MAINE CORPORATION)  
PO 679  
CAMDEN, ME 04843

FOR: OPERATING AN ONLINE SHOPPING SITE IN THE FIELD OF BOOKS, MAGAZINES, COMPACT DISKS AND VIDEOS, IN CLASS 35 (U.S. CLS. 100, 101 AND 102).

FIRST USE 7-18-2007; IN COMMERCE 7-18-2007.

THE MARK CONSISTS OF STANDARD CHARACTERS WITHOUT CLAIM TO ANY PARTICULAR FONT, STYLE, SIZE, OR COLOR.

NO CLAIM IS MADE TO THE EXCLUSIVE RIGHT TO USE "MAINE", APART FROM THE MARK AS SHOWN.

SER. NO. 77-349,711, FILED 12-12-2007.

LAURIE KAUFMAN, EXAMINING ATTORNEY

**Int. Cls.: 16 and 40**

**Prior U.S. Cls.: 2, 5, 22, 23, 29, 37, 38, 50, 100, 103 and 106**

**Reg. No. 3,498,318**

**United States Patent and Trademark Office**

**Registered Sep. 9, 2008**

**TRADEMARK  
SERVICE MARK  
PRINCIPAL REGISTER**

**MEATINGPLACE**

MARKETING & TECHNOLOGY GROUP, INC.  
(ILLINOIS CORPORATION)  
1415 NORTH DAYTON STREET  
CHICAGO, IL 60622

FOR: PERIODICAL TRADE PUBLICATIONS,  
NAMELY, MAGAZINES IN THE FIELD OF MEAT  
AND POULTRY PROCESSING , IN CLASS 16 (U.S.  
CLS. 2, 5, 22, 23, 29, 37, 38 AND 50).

FIRST USE 1-0-1997; IN COMMERCE 1-0-1997.

FOR: PROVIDING ON-LINE NEWS AND INFOR-  
MATION IN THE MEAT AND POULTRY PROCES-

SING INDUSTRY, IN CLASS 40 (U.S. CLS. 100, 103  
AND 106).

FIRST USE 6-0-1996; IN COMMERCE 6-0-1996.

THE MARK CONSISTS OF STANDARD CHAR-  
ACTERS WITHOUT CLAIM TO ANY PARTICULAR  
FONT, STYLE, SIZE, OR COLOR.

SER. NO. 77-350,409, FILED 12-12-2007.

DAVID COLLIER, EXAMINING ATTORNEY

**Int. Cls.: 35 and 36**

**Prior U.S. Cls.: 100, 101 and 102**

**United States Patent and Trademark Office**

**Reg. No. 3,498,319**

**Registered Sep. 9, 2008**

**SERVICE MARK  
PRINCIPAL REGISTER**

**COST U LESS**

KEENAN HOLDINGS, INC. (DELAWARE CORPORATION)  
2701 CITRUS ROAD, STE. A  
RANCHO CORDOVA, CA 95742

FOR: PROMOTING THE GOODS AND SERVICES OF OTHERS BY ARRANGING AND DISSEMINATING INFORMATION OF PROPERTY AND CASUALTY INSURANCE CARRIERS INDICATING SAID CARRIERS MEET CERTAIN CRITERIA, DONE THROUGH ALL PUBLIC COMMUNICATION MEANS, IN CLASS 35 (U.S. CLS. 100, 101 AND 102).

FIRST USE 1-10-1994; IN COMMERCE 1-10-1994.

FOR: FINANCIAL AND INSURANCE SERVICES AND CONSULTATION, NAMELY, INSURANCE BROKERAGE, ALL IN THE FIELDS OF PROPERTY AND CASUALTY INSURANCE, IN CLASS 36 (U.S. CLS. 100, 101 AND 102).

FIRST USE 1-10-1994; IN COMMERCE 1-10-1994.

THE MARK CONSISTS OF STANDARD CHARACTERS WITHOUT CLAIM TO ANY PARTICULAR FONT, STYLE, SIZE, OR COLOR.

OWNER OF U.S. REG. NO. 3,171,136.

NO CLAIM IS MADE TO THE EXCLUSIVE RIGHT TO USE "COST", APART FROM THE MARK AS SHOWN.

SEC. 2(F).

SER. NO. 77-350,528, FILED 12-12-2007.

FRED CARL, EXAMINING ATTORNEY

**Int. Cl.: 16**

**Prior U.S. Cls.: 2, 5, 22, 23, 29, 37, 38 and 50**

**Reg. No. 3,498,320**

**United States Patent and Trademark Office**

**Registered Sep. 9, 2008**

**TRADEMARK  
PRINCIPAL REGISTER**

**SCRIPTURE PRESS**

COOK COMMUNICATIONS MINISTRIES (ILLINOIS CORPORATION)  
4050 LEE VANCE VIEW  
COLORADO SPRINGS, CO 80918

FOR: STUDY GUIDES; EDUCATIONAL PUBLICATIONS, NAMELY, EDUCATIONAL LEARNING CARDS, FLASH CARDS, ACTIVITY CARDS, WORKBOOKS, TEXTBOOKS, ACTIVITY BOOKS, STORY BOOKS, PUZZLE BOOKS, PUZZLES, TEACHER GUIDES, MANUALS, POSTERS, EDUCATIONAL CARD GAMES AND EDUCATIONAL BOOKLETS IN THE FIELD OF CHRISTIAN FAITH; PRINTED INSTRUCTIONAL, EDUCATIONAL, AND TEACHING MATERIALS IN THE FIELD OF CHRISTIAN FAITH, IN CLASS 16 (U.S. CLS. 2, 5, 22, 23, 29, 37, 38 AND 50).

FIRST USE 1-1-1951; IN COMMERCE 1-1-1951.

THE MARK CONSISTS OF STANDARD CHARACTERS WITHOUT CLAIM TO ANY PARTICULAR FONT, STYLE, SIZE, OR COLOR.

NO CLAIM IS MADE TO THE EXCLUSIVE RIGHT TO USE "PRESS", APART FROM THE MARK AS SHOWN.

SEC. 2(F).

SER. NO. 77-351,000, FILED 12-13-2007.

RAUL CORDOVA, EXAMINING ATTORNEY

**Int. Cl.: 35**

**Prior U.S. Cls.: 100, 101 and 102**

**United States Patent and Trademark Office**

**Reg. No. 3,498,321**

**Registered Sep. 9, 2008**

**SERVICE MARK  
PRINCIPAL REGISTER**

**CARTOON ENCYCLOPEDIA**

ONE SUPER GUIDE, INC. PRESIDENT: JONSAN,  
IBRAHIM (NEW YORK CORPORATION)  
P.O. BOX 99  
YONKERS, NY 10702

FOR: PROVIDING AN ON-LINE COMMERCIAL  
INFORMATION DIRECTORY ON THE INTERNET;  
PROVIDING ON-LINE DIRECTORY INFORMAT-  
ION SERVICES ALSO FEATURING HYPERLINKS  
TO OTHER WEB SITES, IN CLASS 35 (U.S. CLS. 100,  
101 AND 102).

FIRST USE 10-2-1998; IN COMMERCE 10-2-1998.

THE MARK CONSISTS OF STANDARD CHAR-  
ACTERS WITHOUT CLAIM TO ANY PARTICULAR  
FONT, STYLE, SIZE, OR COLOR.

NO CLAIM IS MADE TO THE EXCLUSIVE  
RIGHT TO USE "ENCYCLOPEDIA", APART FROM  
THE MARK AS SHOWN.

SEC. 2(F).

SER. NO. 77-351,019, FILED 12-13-2007.

INGRID C. EULIN, EXAMINING ATTORNEY



Int. Cl.: 44

Prior U.S. Cls.: 100 and 101

United States Patent and Trademark Office

Reg. No. 3,498,322

Registered Sep. 9, 2008

SERVICE MARK  
PRINCIPAL REGISTER



EZA CORPORATION (KANSAS CORPORATION)  
6356 CARTER AVENUE  
MERRIAM, KS 66203

FOR: HAIR CUTTING SALON SERVICES, IN  
CLASS 44 (U.S. CLS. 100 AND 101).

FIRST USE 11-11-2007; IN COMMERCE 11-11-2007.

NO CLAIM IS MADE TO THE EXCLUSIVE  
RIGHT TO USE "GENTLEMEN HAIRCUTS" ,  
APART FROM THE MARK AS SHOWN.

THE MARK CONSISTS OF A MAN'S TOP HAT  
POSITIONED TO THE LEFT OF THE WORDS  
"GENTLEMEN HAIRCUTS" AND A FANCIFUL  
WAVE POSITIONED TO THE RIGHT OF THE  
WORDS. THE WORD "GENTLEMEN" APPEARS  
ABOVE THE WORD "HAIRCUTS".

SER. NO. 77-351,630, FILED 12-13-2007.

STEPHANIE ALI, EXAMINING ATTORNEY

**Int. Cl.: 36**

**Prior U.S. Cls.: 100, 101 and 102**

**United States Patent and Trademark Office**

**Reg. No. 3,498,323**

**Registered Sep. 9, 2008**

**SERVICE MARK  
PRINCIPAL REGISTER**

# Knock-Out Abuse

ROBERT, JILL SORENSEN (UNITED STATES  
INDIVIDUAL)  
1127 BELLVIEW ROAD  
MCLEAN, VA 22101 AND  
MASRI, CHERYL DAVIS (UNITED STATES INDIVI-  
DUAL)  
1901 24TH STREET, N.W.  
WASHINGTON, D.C., DC 20008

FOR: CHARITABLE FUND RAISING IN THE  
NATURE OF FUND RAISING PROGRAMS TO  
COMBAT DOMESTIC VIOLENCE, IN CLASS 36  
(U.S. CLS. 100, 101 AND 102).

FIRST USE 11-1-1993; IN COMMERCE 11-1-1993.

THE MARK CONSISTS OF STANDARD CHAR-  
ACTERS WITHOUT CLAIM TO ANY PARTICULAR  
FONT, STYLE, SIZE, OR COLOR.

OWNER OF U.S. REG. NO. 2,178,362.

SER. NO. 77-351,994, FILED 12-14-2007.

PAULA MAHONEY, EXAMINING ATTORNEY

**Int. Cl.: 36**

**Prior U.S. Cls.: 100, 101 and 102**

**United States Patent and Trademark Office**

**Reg. No. 3,498,324**

**Registered Sep. 9, 2008**

**SERVICE MARK  
PRINCIPAL REGISTER**

# Knock Out Abuse

ROBERT, JILL SORENSEN (UNITED STATES  
INDIVIDUAL)  
1127 BELLVIEW ROAD  
MCLEAN, VA 22101 AND  
MASRI, CHERYL DAVIS (UNITED STATES INDIVI-  
DUAL)  
1901 24TH STREET, N.W.  
WASHINGTON, D.C., DC 20008

FOR: CHARITABLE FUND RAISING IN THE  
NATURE OF FUND RAISING PROGRAMS TO  
COMBAT DOMESTIC VIOLENCE, IN CLASS 36  
(U.S. CLS. 100, 101 AND 102).

FIRST USE 11-1-1993; IN COMMERCE 11-1-1993.

THE MARK CONSISTS OF STANDARD CHAR-  
ACTERS WITHOUT CLAIM TO ANY PARTICULAR  
FONT, STYLE, SIZE, OR COLOR.

OWNER OF U.S. REG. NO. 2,178,362.

SER. NO. 77-352,008, FILED 12-14-2007.

PAULA MAHONEY, EXAMINING ATTORNEY

**Int. Cl.: 41**

**Prior U.S. Cls.: 100, 101 and 107**

**United States Patent and Trademark Office**

**Reg. No. 3,498,325**

**Registered Sep. 9, 2008**

**SERVICE MARK  
PRINCIPAL REGISTER**

**RED CARPET WINE CLUB**

KHAYAT-TOUBIA, RITA (UNITED STATES IN-  
DIVIDUAL)  
6876 SANTA TERESA BLVD.  
SAN JOSE, CA 95119

FOR: ORGANIZING AND CONDUCTING WINE  
AND FOOD TASTING EVENTS, IN CLASS 41 (U.S.  
CLS. 100, 101 AND 107).

FIRST USE 3-0-2007; IN COMMERCE 3-0-2007.

THE MARK CONSISTS OF STANDARD CHAR-  
ACTERS WITHOUT CLAIM TO ANY PARTICULAR  
FONT, STYLE, SIZE, OR COLOR.

NO CLAIM IS MADE TO THE EXCLUSIVE  
RIGHT TO USE "WINE CLUB", APART FROM  
THE MARK AS SHOWN.

SER. NO. 77-352,360, FILED 12-14-2007.

GINA HAYES, EXAMINING ATTORNEY

**Int. Cls.: 37 and 42**

**Prior U.S. Cls.: 100, 101, 103 and 106**

**United States Patent and Trademark Office**

**Reg. No. 3,498,326**

**Registered Sep. 9, 2008**

**SERVICE MARK  
PRINCIPAL REGISTER**



TIBURON DIVERS, INC. (TEXAS CORPORATION)

25227 GROGANS MILL RD., SUITE 222

THE WOODLANDS, TX 77380 AND

TIBURON MARINE, LLC (TEXAS LIMITED LIABILITY COMPANY)

25227 GROGANS MILL RD., SUITE 222

THE WOODLANDS, TX 77380 AND

TIBURON DIVERS USA, LLC (TEXAS LIMITED LIABILITY COMPANY)

25227 GROGANS MILL RD., SUITE 222

THE WOODLANDS, TX 77380 AND

TIBURON CARIBE, SRL (BARBADOS SOCIEDAD DE RESPONSABILIDAD LIMITADA (SRL))

25227 GROGANS MILL RD., SUITE 222

THE WOODLANDS, TX 77380 AND

TIBURON DIVERS PACIFICA, PTE, LTD. (SINGAPORE PRIVATE LIMITED COMPANY)

25227 GROGANS MILL RD., SUITE 222

THE WOODLANDS, TX 77380

FOR: UNDERWATER BUILDING AND CONSTRUCTION; UNDERWATER REPAIR, IN CLASS 37 (U.S. CLS. 100, 103 AND 106).

FIRST USE 1-1-2008; IN COMMERCE 1-1-2008.

FOR: UNDERWATER EXPLORATION; UNDERWATER STRUCTURAL INSPECTION SERVICES, IN CLASS 42 (U.S. CLS. 100 AND 101).

FIRST USE 1-1-2008; IN COMMERCE 1-1-2008.

NO CLAIM IS MADE TO THE EXCLUSIVE RIGHT TO USE "DIVER'S", APART FROM THE MARK AS SHOWN.

THE COLOR(S) GRAY, BLUE, YELLOW, BLACK, WHITE IS/ARE CLAIMED AS A FEATURE OF THE MARK.

THE MARK CONSISTS OF A DIVER'S HEAD WITH GRAY AND BLACK GOGGLES AND A BLUE AND YELLOW HEADCOVER TOPPED BY A CAMERA LENS RISING FROM A BLUE AND WHITE WATER LINE ALL ENCIRCLED BY A GRAY SHIP PORTAL. ATTACHED TO THE PORTAL IS A GRAY NAMEPLATE THAT CONTAINS THE LITERAL ELEMENT, "DIVER'S EYE" IN BLACK, CAPITAL LETTERS.

SER. NO. 77-352,813, FILED 12-14-2007.

CARRIE GENOVESE, EXAMINING ATTORNEY

**Int. Cl.: 39**

**Prior U.S. Cls.: 100 and 105**

**United States Patent and Trademark Office**

**Reg. No. 3,498,327**

**Registered Sep. 9, 2008**

**SERVICE MARK  
PRINCIPAL REGISTER**



NOTHERN NEW ENGLAND PASSENGER RAIL  
AUTHORITY (MAINE CORPORATION)  
SUITE 104  
75 WEST COMMERCIAL STREET  
PORTLAND, ME 04101

FOR: TRANSPORTATION SERVICES, NAMELY  
PASSENGER RAIL SERVICES, IN CLASS 39 (U.S.  
CLS. 100 AND 105).

FIRST USE 12-1-2003; IN COMMERCE 12-1-2003.

NO CLAIM IS MADE TO THE EXCLUSIVE  
RIGHT TO USE "6 TIX", APART FROM THE MARK  
AS SHOWN.

THE MARK CONSISTS OF THE WORDS "6 TIX"  
INSIDE A RIGHTWARD DIRECTING ARROW. THE  
WORD "COLLEGE" APPEARS ABOVE THE AR-  
ROW.

SER. NO. 77-353,918, FILED 12-17-2007.

STEVEN R. FINE, EXAMINING ATTORNEY

**Int. Cl.: 30**

**Prior U.S. Cl.: 46**

**United States Patent and Trademark Office**

**Reg. No. 3,498,328**

**Registered Sep. 9, 2008**

**TRADEMARK  
PRINCIPAL REGISTER**

**LiquiSea**

SEA MINERALS WATER, INC. (GEORGIA CORPORATION)  
15 FIRST AVE  
NEWNAN, GA 30263

THE MARK CONSISTS OF STANDARD CHARACTERS WITHOUT CLAIM TO ANY PARTICULAR FONT, STYLE, SIZE, OR COLOR.

FOR: MINERAL SALT FOR HUMAN CONSUMPTION; COOKING SALT; EDIBLE SALT, IN CLASS 30 (U.S. CL. 46).

SER. NO. 77-354,463, FILED 12-18-2007.

FIRST USE 10-18-2007; IN COMMERCE 10-18-2007.

KELLY BOULTON, EXAMINING ATTORNEY

**Int. Cl.: 44**

**Prior U.S. Cls.: 100 and 101**

**United States Patent and Trademark Office**

**Reg. No. 3,498,329**

**Registered Sep. 9, 2008**

**SERVICE MARK  
PRINCIPAL REGISTER**

**GOOD HEALTH GATEWAY**

ABACUS MANAGEMENT TECHNOLOGIES,  
LLC. (RHODE ISLAND LIMITED LIABILITY  
COMPANY)  
1210 PONTIAC AVE.  
CRANSTON, RI 02920

FOR: HEALTH-CARE INFORMATION SERVI-  
CES, NAMELY, PROVIDING ON-LINE CUSTO-  
MIZED HEALTH-CARE INFORMATION VIA A  
WEBSITE WHERE USERS CAN REGISTER AND  
MONITOR THEIR PROGRESS IN THE FIELDS OF  
CUSTOMIZED HEALTH PROGRAMS, WELLNESS  
PROGRAMS, HEALTH-IMPROVEMENT PLANS,  
AND REFERENCES TO OTHER ON-LINE  
HEALTH-CARE RESOURCES, IN CLASS 44 (U.S.  
CLS. 100 AND 101).

FIRST USE 12-17-2007; IN COMMERCE 12-17-2007.

THE MARK CONSISTS OF STANDARD CHAR-  
ACTERS WITHOUT CLAIM TO ANY PARTICULAR  
FONT, STYLE, SIZE, OR COLOR.

NO CLAIM IS MADE TO THE EXCLUSIVE  
RIGHT TO USE "HEALTH GATEWAY", APART  
FROM THE MARK AS SHOWN.

SER. NO. 77-354,596, FILED 12-18-2007.

REBECCA SMITH, EXAMINING ATTORNEY



**Int. Cl.: 36**

**Prior U.S. Cls.: 100, 101 and 102**

**United States Patent and Trademark Office**

**Reg. No. 3,498,330**

**Registered Sep. 9, 2008**

**SERVICE MARK  
PRINCIPAL REGISTER**

# Bright Pink

BRIGHT PINK (ILLINOIS CHARITABLE, NON-  
PROFIT CORPORATION)  
P.O. BOX 10915  
CHICAGO, IL 60610

FOR: CHARITABLE FUND RAISING SERVICES,  
IN CLASS 36 (U.S. CLS. 100, 101 AND 102).

FIRST USE 2-20-2007; IN COMMERCE 2-20-2007.

THE MARK CONSISTS OF STANDARD CHAR-  
ACTERS WITHOUT CLAIM TO ANY PARTICULAR  
FONT, STYLE, SIZE, OR COLOR.

SER. NO. 77-354,796, FILED 12-19-2007.

MATTHEW MCDOWELL, EXAMINING ATTOR-  
NEY

**Int. Cl.: 25**

**Prior U.S. Cls.: 22 and 39**

**United States Patent and Trademark Office**

**Reg. No. 3,498,331**

**Registered Sep. 9, 2008**

**TRADEMARK  
PRINCIPAL REGISTER**

**Sommer  
Designs**

SOMMER DESIGNS, LLC (CALIFORNIA LIMITED LIABILITY COMPANY)

29316 STONECREST ROAD

ROLLING HILLS ESTATES, CA 90274

FOR: APRONS, IN CLASS 25 (U.S. CLS. 22 AND 39).

FIRST USE 1-1-2003; IN COMMERCE 1-1-2003.

NO CLAIM IS MADE TO THE EXCLUSIVE RIGHT TO USE "DESIGNS" , APART FROM THE MARK AS SHOWN.

THE MARK CONSISTS OF THE 'O' IN SOMMER IS REPLACED WITH A FLOWER .

SER. NO. 77-355,177, FILED 12-18-2007.

YONG KIM, EXAMINING ATTORNEY

Int. Cl.: 35

Prior U.S. Cls.: 100, 101 and 102

United States Patent and Trademark Office

Reg. No. 3,498,332

Registered Sep. 9, 2008

SERVICE MARK  
PRINCIPAL REGISTER

The logo for AMP3 PUBLIC RELATIONS. The word "amp3" is in a bold, lowercase, sans-serif font. The "3" is stylized with three horizontal lines extending to the right. Below "amp3" is the word "public relations" in a smaller, lowercase, sans-serif font.

ARTIST MEDIA PRODUCTIONS (NEW YORK  
LIMITED LIABILITY COMPANY), DBA  
AMP3 PUBLIC RELATIONS  
SUITE 801  
928 BROADWAY  
NEW YORK, NY 10010

FOR: ADVERTISING SERVICES, PUBLIC RELATIONS AND MARKETING SERVICES, NAMELY, PROMOTING AND MARKETING THE GOODS AND SERVICES OF OTHERS THROUGH ALL PUBLIC COMMUNICATION MEANS, IN CLASS 35 (U.S. CLS. 100, 101 AND 102).

FIRST USE 9-1-2006; IN COMMERCE 10-1-2006.

NO CLAIM IS MADE TO THE EXCLUSIVE RIGHT TO USE "PUBLIC RELATIONS", APART FROM THE MARK AS SHOWN.

THE MARK CONSISTS OF "AMP3" FOLLOWED BY THREE HORIZONTAL LINES, THE SHORTEST AT THE BOTTOM, THE LONGEST AT THE TOP, AND THE WORDS "PUBLIC RELATIONS" LOCATED BELOW.

SER. NO. 77-355,202, FILED 12-18-2007.

JILL C. ALT, EXAMINING ATTORNEY

**Int. Cl.: 9**

**Prior U.S. Cls.: 21, 23, 26, 36 and 38**

**Reg. No. 3,498,333**

**United States Patent and Trademark Office**

**Registered Sep. 9, 2008**

**TRADEMARK  
PRINCIPAL REGISTER**



MARIUS MOREL FRANCE SAS (FRANCE SOCIÉTÉ PAR ACTIONS SIMPLIFIÉE (SAS))  
117 ROUTE DES BUCLETS  
39400 MORBIER, FRANCE

FOR: SPECTACLES; SUNGLASSES; NON-IMPLANTABLE OPHTHALMIC LENSES; LENSES FOR SPECTACLES; COATED LENSES FOR SPECTACLES; LENSES FOR SUNGLASSES; TINTED LENSES FOR SPECTACLES; PHOTSENSITIVE LENSES FOR SPECTACLES; SPECTACLE LENS BLANKS; SPECTACLE FRAMES; CASES FOR SPECTACLES, CASES FOR SUNGLASSES, CASES FOR OPHTHALMIC LENSES, CASES FOR COATED LENSES FOR SPECTACLES, CASES FOR LENSES FOR SUNGLASSES CASES FOR TINTED LENSES FOR

SPECTACLES, CASES FOR PHOTSENSITIVE LENSES FOR SPECTACLES, CASES FOR SPECTACLE LENS BLANKS, CASES FOR SPECTACLE FRAMES, IN CLASS 9 (U.S. CLS. 21, 23, 26, 36 AND 38).

FIRST USE 10-0-2006; IN COMMERCE 10-0-2006.

OWNER OF U.S. REG. NO. 2,509,264.

THE MARK CONSISTS OF "LT LIGHTTEC" STYLIZED.

SER. NO. 77-355,539, FILED 12-19-2007.

SEAN CROWLEY, EXAMINING ATTORNEY

**Int. Cl.: 41**

**Prior U.S. Cls.: 100, 101 and 107**

**United States Patent and Trademark Office**

**Reg. No. 3,498,334**

**Registered Sep. 9, 2008**

**SERVICE MARK  
PRINCIPAL REGISTER**

**The Center for  
Professional Innovation &  
Education**

THE CENTER FOR PROFESSIONAL INNOVATION & EDUCATION, INC. (PENNSYLVANIA CORPORATION)  
7 GREAT VALLEY PARKWAY  
SUITE 128  
MALVERN, PA 19355

FOR: DEVELOPMENT AND ADMINISTRATION OF EDUCATIONAL TESTING FOR THE PHARMACEUTICAL INDUSTRY, AND TRAINING PROGRAMS FOR CERTIFICATION OF PERSONS IN THE MEDICAL AND HEALTHCARE FIELDS, AND PROVIDING PHARMACEUTICAL BIOTECH AND MEDICAL DEVICE TRAINING COURSES, IN CLASS 41 (U.S. CLS. 100, 101 AND 107).

FIRST USE 12-30-2001; IN COMMERCE 12-30-2001.

THE MARK CONSISTS OF STANDARD CHARACTERS WITHOUT CLAIM TO ANY PARTICULAR FONT, STYLE, SIZE, OR COLOR.

NO CLAIM IS MADE TO THE EXCLUSIVE RIGHT TO USE "CENTER," "PROFESSIONAL" AND "EDUCATION", APART FROM THE MARK AS SHOWN.

SER. NO. 77-355,583, FILED 12-19-2007.

AISHA CLARKE, EXAMINING ATTORNEY

Int. Cl.: 41

Prior U.S. Cls.: 100, 101 and 107

United States Patent and Trademark Office

Reg. No. 3,498,335

Registered Sep. 9, 2008

**SERVICE MARK  
PRINCIPAL REGISTER**

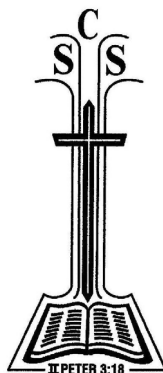

CATHOLIC SCRIPTURE STUDY, INC. (TEXAS CORPORATION)  
1604 NEWSOM CT.  
PANTEGO, TX 76013

FOR: EDUCATIONAL SERVICES, NAMELY, OFFERING BIBLE STUDY COURSES IN THE FIELD OF CHRISTIAN RELIGION AND THEOLOGY, IN CLASS 41 (U.S. CLS. 100, 101 AND 107).

FIRST USE 0-0-1985; IN COMMERCE 0-0-1985.

NO CLAIM IS MADE TO THE EXCLUSIVE RIGHT TO USE "II PETER 3:18", APART FROM THE MARK AS SHOWN.

THE MARK CONSISTS OF AN ELONGATED CROSS CENTERED ABOVE AN OPEN BIBLE THAT IS PARTIALLY ENCOMPASSED BY LINES THAT

EXTEND AROUND THE BIBLE AND UPWARD ON EACH SIDE OF THE CROSS, THEN DIVERGE TO THE LEFT AND RIGHT ABOVE THE CROSS. A SECOND SET OF DIVERGING LINES, PLACED INSIDE THE FIRST SET, BEGIN AT THE BASE OF THE CROSS AND EXTEND FURTHER ABOVE THE FIRST SET OF DIVERGING LINES. ABOVE AND IN THE CENTER OF THE FOUR DIVERGING LINES IS THE LETTER "C", AND IN BETWEEN THE TWO SETS OF DIVERGING LINES IS THE LETTER "S" ON BOTH THE LEFT AND THE RIGHT. CENTERED BENEATH THE BIBLE IS THE REFERENCE TO THE SCRIPTURE "II PETER 3:18".

SER. NO. 77-356,157, FILED 12-19-2007.

WILLIAM BRECKENFELD, EXAMINING ATTORNEY

**Int. Cls.: 39 and 43**

**Prior U.S. Cls.: 100, 101 and 105**

**United States Patent and Trademark Office**

**Reg. No. 3,498,336**

**Registered Sep. 9, 2008**

**SERVICE MARK  
PRINCIPAL REGISTER**

TRAVEL AGENTS INTERNATIONAL

TRAVEL FRANCHISE GROUP, INC., THE (MINNESOTA CORPORATION)  
6442 CITY WEST PARKWAY  
EDEN PRAIRIE, MN 55344

FOR: TRAVEL AGENCY SERVICES, NAMELY, MAKING RESERVATIONS AND BOOKINGS FOR TRANSPORTATION, AND MAKING CRUISE RESERVATIONS FOR INDIVIDUALS AND GROUPS, IN CLASS 39 (U.S. CLS. 100 AND 105).

FIRST USE 6-0-1981; IN COMMERCE 6-0-1981.

FOR: TRAVEL AGENCY SERVICES, NAMELY, MAKING RESERVATIONS AND BOOKINGS FOR TEMPORARY LODGING, IN CLASS 43 (U.S. CLS. 100 AND 101).

FIRST USE 6-0-1981; IN COMMERCE 6-0-1981.

THE MARK CONSISTS OF STANDARD CHARACTERS WITHOUT CLAIM TO ANY PARTICULAR FONT, STYLE, SIZE, OR COLOR.

OWNER OF U.S. REG. NO. 1,598,936.

NO CLAIM IS MADE TO THE EXCLUSIVE RIGHT TO USE "TRAVEL AGENTS", APART FROM THE MARK AS SHOWN.

SEC. 2(F).

SER. NO. 77-356,845, FILED 12-20-2007.

KEVON CHISOLM, EXAMINING ATTORNEY

**Int. Cls.: 39 and 43**

**Prior U.S. Cls.: 100, 101 and 105**

**United States Patent and Trademark Office**

**Reg. No. 3,498,337**

**Registered Sep. 9, 2008**

**SERVICE MARK  
PRINCIPAL REGISTER**

**ALL ABOARD TRAVEL**

B4 TRAVEL GROUP, INC. (CALIFORNIA CORPORATION)  
6442 CITY WEST PARKWAY  
EDEN PRAIRIE, MN 55344

FOR: ORGANIZING AND ARRANGING VACATION TRIPS, TRAVEL TOURS AND SIGHTSEEING TOURS, NAMELY, ORGANIZING AND ARRANGING CUSTOM AND PACKAGED VACATION TRIPS, TRAVEL TOURS AND SIGHTSEEING TOURS, AND ACTIVITIES PACKAGES; WHOLESALE AND RETAIL TRAVEL AGENCY SERVICES, NAMELY, MAKING RESERVATIONS AND BOOKINGS FOR AIR, GROUND AND SEA TRANSPORTATION SERVICES; PROVIDING TRAVEL INFORMATION BY MEANS OF A WEB SITE IN THE FIELDS OF TRAVEL TRANSPORTATION, TOURS AND VACATION TRAVEL PACKAGES FEATURING TRANSPORTATION, IN CLASS 39 (U.S. CLS. 100 AND 105).

FIRST USE 9-0-2005; IN COMMERCE 9-0-2005.

FOR: WHOLESALE AND RETAIL TRAVEL AGENCY SERVICES, NAMELY, MAKING RESERVATIONS AND BOOKINGS FOR TEMPORARY LODGING; PROVIDING TRAVEL INFORMATION BY MEANS OF A WEB SITE IN THE FIELDS OF ACCOMMODATIONS AND LODGING, AND VACATION TRAVEL PACKAGES FEATURING ACCOMMODATIONS, IN CLASS 43 (U.S. CLS. 100 AND 101).

FIRST USE 9-0-2005; IN COMMERCE 9-0-2005.

THE MARK CONSISTS OF STANDARD CHARACTERS WITHOUT CLAIM TO ANY PARTICULAR FONT, STYLE, SIZE, OR COLOR.

NO CLAIM IS MADE TO THE EXCLUSIVE RIGHT TO USE "TRAVEL", APART FROM THE MARK AS SHOWN.

SER. NO. 77-356,852, FILED 12-20-2007.

KEVON CHISOLM, EXAMINING ATTORNEY



Int. Cl.: 30

Prior U.S. Cl.: 46

United States Patent and Trademark Office

Reg. No. 3,498,338

Registered Sep. 9, 2008

TRADEMARK  
PRINCIPAL REGISTER



SINCE 1950

MING TEH FOOD INDUSTRY CO., LTD. (TAI-  
WAN CORPORATION)  
NO. 46, TONG SHIAW ROAD  
KANG SHAN JHEN, TAIWAN

FOR: ALLSPICE; BEAN MEAL; CHOW-CHOW  
CONDIMENT; CHUTNEYS CONDIMENTS; FARI-  
NACEOUS FOOD PASTES FOR HUMAN CON-  
SUMPTION; PRESERVED GARDEN HERBS  
SEASONINGS; POWDERED OR PRESERVED GIN-  
GER SPICE; HONEY; MUSTARD; PASTA; SOYA  
BEAN PASTE CONDIMENT; PEPPER SPICE; REL-  
ISH CONDIMENT; SAUCE CONDIMENTS; SEA-  
SONINGS; SOYA SAUCE; SPICES; VINEGAR, IN  
CLASS 30 (U.S. CL. 46).

FIRST USE 9-7-2007; IN COMMERCE 11-8-2007.

NO CLAIM IS MADE TO THE EXCLUSIVE  
RIGHT TO USE "SINCE 1950", APART FROM THE  
MARK AS SHOWN.

THE ENGLISH TRANSLATION OF THE NON-  
LATIN CHARACTERS IS ("MING" PORTION OF  
THE MARK) BRIGHT; CLEAR; OVER; CLEAR-  
SIGHTED; TO UNDERSTAND AND ("DE" POR-  
TION OF THE MARK) VIRTUE; HEART; FAVOR;  
KINDNESS; MIND.

THE NON-LATIN CHARACTER(S) IN THE  
MARK TRANSLITERATES INTO "MING DE".

SER. NO. 77-356,898, FILED 12-20-2007.

BRIAN PINO, EXAMINING ATTORNEY

**Int. Cl.: 41**

**Prior U.S. Cls.: 100, 101 and 107**

**United States Patent and Trademark Office**

**Reg. No. 3,498,339**

**Registered Sep. 9, 2008**

**SERVICE MARK  
PRINCIPAL REGISTER**



AVNET, INC. (NEW YORK CORPORATION)  
2211 SOUTH 47TH STREET  
PHOENIX, AZ 85034

NO CLAIM IS MADE TO THE EXCLUSIVE  
RIGHT TO USE "DESIGN WORKSHOPS", APART  
FROM THE MARK AS SHOWN.

FOR: EDUCATIONAL SERVICES, NAMELY,  
PROVIDING WORKSHOPS IN THE FIELDS OF  
COMPUTER HARDWARE AND SOFTWARE, IN  
CLASS 41 (U.S. CLS. 100, 101 AND 107).

SER. NO. 77-356,907, FILED 12-20-2007.

FIRST USE 5-21-2003; IN COMMERCE 5-21-2003.

DAWN HAN, EXAMINING ATTORNEY

**Int. Cl.: 7**

**Prior U.S. Cls.: 13, 19, 21, 23, 31, 34 and 35**

**United States Patent and Trademark Office**

**Reg. No. 3,498,340**

**Registered Sep. 9, 2008**

**TRADEMARK  
PRINCIPAL REGISTER**

**XTREME**

ENIDINE INCORPORATED (DELAWARE COR-  
PORATION)  
7 CENTRE DRIVE  
ORCHARD PARK, NY 14127

THE MARK CONSISTS OF STANDARD CHAR-  
ACTERS WITHOUT CLAIM TO ANY PARTICULAR  
FONT, STYLE, SIZE, OR COLOR.

FOR: INDUSTRIAL HYDRAULIC SHOCK AB-  
SORBERS FOR MACHINES, IN CLASS 7 (U.S. CLS.  
13, 19, 21, 23, 31, 34 AND 35).

SER. NO. 77-357,011, FILED 12-20-2007.

FIRST USE 11-24-2004; IN COMMERCE 11-24-2004.

HENRY S. ZAK, EXAMINING ATTORNEY

**Int. Cl.: 35**

**Prior U.S. Cls.: 100, 101 and 102**

**United States Patent and Trademark Office**

**Reg. No. 3,498,341**

**Registered Sep. 9, 2008**

**SERVICE MARK  
PRINCIPAL REGISTER**



SISC, L.L.C. (NEVADA LIMITED LIABILITY  
COMPANY)  
111 CENTER STREET  
SUITE 2110  
LITTLE ROCK, AR 72201

FOR: EMPLOYMENT AGENCY, RECRUITMENT  
AND PERSONNEL PLACEMENT SERVICES IN THE  
INDUSTRIAL, COMMERCIAL AND BUSINESS  
CONSULTING INDUSTRIES , IN CLASS 35 (U.S.  
CLS. 100, 101 AND 102).

FIRST USE 5-22-2000; IN COMMERCE 5-22-2000.

OWNER OF U.S. REG. NOS. 2,098,379 AND  
2,942,098.

THE MARK CONSISTS OF A STYLIZED LEAP-  
ING FIGURE, WHICH CASTS AN OVAL SHADOW,  
TO THE RIGHT OF THE WORDING "STAFF-  
MARK".

SER. NO. 77-357,157, FILED 12-20-2007.

LYDIA BELZER, EXAMINING ATTORNEY

**Int. Cl.: 1**

**Prior U.S. Cls.: 1, 5, 6, 10, 26 and 46**

**Reg. No. 3,498,342**

**United States Patent and Trademark Office**

**Registered Sep. 9, 2008**

**TRADEMARK  
PRINCIPAL REGISTER**

**ENDUROSOLV RESPONSIBLE  
WATER TREATMENT**

AP TECH GROUP, INC. (OHIO CORPORATION)  
6 KOVACH DRIVE, SUITE 612  
CINCINNATI, OH 46215

FOR: SOLID WATER TREATMENT CHEMICALS  
FOR USE IN BOILERS AND COOLING TOWERS, IN  
CLASS 1 (U.S. CLS. 1, 5, 6, 10, 26 AND 46).

FIRST USE 10-10-2007; IN COMMERCE 10-10-2007.

THE MARK CONSISTS OF STANDARD CHAR-  
ACTERS WITHOUT CLAIM TO ANY PARTICULAR  
FONT, STYLE, SIZE, OR COLOR.

NO CLAIM IS MADE TO THE EXCLUSIVE  
RIGHT TO USE "RESPONSIBLE WATER TREAT-  
MENT", APART FROM THE MARK AS SHOWN.

SER. NO. 77-357,213, FILED 12-20-2007.

LESLEY LAMOTHE, EXAMINING ATTORNEY

**Int. Cl.: 45**

**Prior U.S. Cls.: 100 and 101**

**United States Patent and Trademark Office**

**Reg. No. 3,498,343**

**Registered Sep. 9, 2008**

**SERVICE MARK  
PRINCIPAL REGISTER**

**ACE**

WEBMAGIC VENTURES, LLC (CALIFORNIA  
LIMITED LIABILITY COMPANY)  
87 N. RAYMOND AVE. STE 850  
PASADENA, CA 91103

FOR: FASHION INFORMATION; PROVIDING  
FASHION INFORMATION; PROVIDING A WEB-  
SITE FEATURING INFORMATION AND CONTENT  
IN THE FIELDS OF PERSONAL RELATIONSHIPS,  
DATING AND FASHION; PROVIDING HORO-  
SCOPE INFORMATION VIA COMPUTER NET-  
WORKS; PROVIDING INFORMATION RELATING  
TO LEGAL AFFAIRS; PROVIDING ON-LINE IN-  
FORMATION IN THE FIELD OF SPIRITUALITY,  
SELF-HELP, AND PERSONAL EMPOWERMENT  
SUBJECT MATTERS; PROVISION OF A WEBSITE

FEATURING INFORMATION ON LIFESTYLES;  
ONLINE SOCIAL NETWORKING SERVICES, IN  
CLASS 45 (U.S. CLS. 100 AND 101).

FIRST USE 5-15-2000; IN COMMERCE 5-15-2000.

THE MARK CONSISTS OF STANDARD CHAR-  
ACTERS WITHOUT CLAIM TO ANY PARTICULAR  
FONT, STYLE, SIZE, OR COLOR.

OWNER OF U.S. REG. NO. 2,831,789.

SER. NO. 77-357,416, FILED 12-20-2007.

SONYA STEPHENS, EXAMINING ATTORNEY

**Int. Cl.: 37**

**Prior U.S. Cls.: 100, 103 and 106**

**United States Patent and Trademark Office**

**Reg. No. 3,498,344**

**Registered Sep. 9, 2008**

**SERVICE MARK  
PRINCIPAL REGISTER**

**Desert Foothills Handyman  
Service**

DESERT FOOTHILLS HANDYMAN SERVICE,  
INC. (ARIZONA CORPORATION)  
P. O. BOX 1849  
CAVE CREEK, AZ 85327

FOR: CLEANING OF SEWER DRAINS; PREVENTATIVE MAINTENANCE AND REPAIR OF AIR CONDITIONING AND HEATING SYSTEMS AND UNITS; ELECTRICAL REPAIRS AND INSTALLATIONS OF ELECTRIC LIGHTING APPARATUS, ELECTRICAL SYSTEMS AND APPLIANCES; PLUMBING REPAIRS AND INSTALLATIONS; INSTALLATION AND MAINTENANCE OF IRRIGATION SYSTEMS; REPAIR OR MAINTENANCE OF ELECTRIC LIGHTING APPARATUS; DRYWALL REPAIRS; CARPENTRY; PAINTING, IN CLASS 37 (U.S. CLS. 100, 103 AND 106).

FIRST USE 1-23-2004; IN COMMERCE 1-23-2004.

THE MARK CONSISTS OF STANDARD CHARACTERS WITHOUT CLAIM TO ANY PARTICULAR FONT, STYLE, SIZE, OR COLOR.

NO CLAIM IS MADE TO THE EXCLUSIVE RIGHT TO USE "HANDYMAN SERVICE", APART FROM THE MARK AS SHOWN.

SER. NO. 77-357,838, FILED 12-21-2007.

ELLEN PERKINS, EXAMINING ATTORNEY

**Int. Cl.: 9**

**Prior U.S. Cls.: 21, 23, 26, 36 and 38**

**Reg. No. 3,498,345**

**United States Patent and Trademark Office**

**Registered Sep. 9, 2008**

**TRADEMARK  
PRINCIPAL REGISTER**

**TEAM R SINAL**

TEAMRSINAL INC. (NEW YORK CORPORATION)  
APT. 5H  
1734 MADISON AVE.  
NEW YORK, NY 10029

THE MARK CONSISTS OF STANDARD CHARACTERS WITHOUT CLAIM TO ANY PARTICULAR FONT, STYLE, SIZE, OR COLOR.

FOR: PRE-RECORDED CDS, VIDEO TAPES, LASER DISKS AND DVDS FEATURING HIP-HOP MUSIC, IN CLASS 9 (U.S. CLS. 21, 23, 26, 36 AND 38).

SER. NO. 77-357,858, FILED 12-21-2007.

FIRST USE 11-1-2005; IN COMMERCE 11-1-2005.

CHRIS WELLS, EXAMINING ATTORNEY



**Int. Cls.: 41 and 44**

**Prior U.S. Cls.: 100, 101 and 107**

**United States Patent and Trademark Office**

**Reg. No. 3,498,346**

**Registered Sep. 9, 2008**

**SERVICE MARK  
PRINCIPAL REGISTER**

**THE FITNESS SOLUTION FOR  
AMERICA'S YOUTH**

ENERGY FITNESS, LLC (NEW JERSEY LIMITED  
LIABILITY COMPANY)  
566 BROAD STREET  
GLEN ROCK, NJ 07452

FOR: HEALTH CLUB SERVICES, NAMELY, PERSONAL FITNESS TRAINING CIRCUIT PROGRAM FOR ADULTS AND CHILDREN USING INTERACTIVE VIDEO AND ELECTRONIC GAMES RESULTING IN MEASURABLE PHYSICAL EXERTION, IN CLASS 41 (U.S. CLS. 100, 101 AND 107).

FIRST USE 11-1-2007; IN COMMERCE 12-8-2007.

FOR: CONDUCTING MEDICALLY ENGINEERED FITNESS EVALUATION TEST TO MEASURE SUCCESS IN FLEXIBILITY, STRENGTH, COORDINATION AND CARDIOVASCULAR FITNESS FROM PARTICIPATION IN THE PERSONAL

FITNESS CIRCUIT TRAINING PROGRAM; PHYSICAL FITNESS TESTING, NAMELY, ADMINISTERING OBJECTIVE TESTS TO MEASURE CHANGES IN FITNESS AND SELF IMAGE FROM PARTICIPATION IN PERSONAL FITNESS CIRCUIT TRAINING PROGRAM AND RECORDING RESULTS, IN CLASS 44 (U.S. CLS. 100 AND 101).

FIRST USE 11-1-2007; IN COMMERCE 12-8-2007.

THE MARK CONSISTS OF STANDARD CHARACTERS WITHOUT CLAIM TO ANY PARTICULAR FONT, STYLE, SIZE, OR COLOR.

SER. NO. 77-358,667, FILED 12-21-2007.

JOHN GARTNER, EXAMINING ATTORNEY

**Int. Cl.: 41**

**Prior U.S. Cls.: 100, 101 and 107**

**United States Patent and Trademark Office**

**Reg. No. 3,498,347**

**Registered Sep. 9, 2008**

**SERVICE MARK  
PRINCIPAL REGISTER**

# I'AMedia

I'AMEDIA LTD. (OHIO LIMITED LIABILITY COMPANY), DBA I'AMEDIA  
441 E MOUND STREET  
COLUMBUS, OH 43215

FOR: DIGITAL VIDEO, AUDIO, AND MULTIMEDIA PUBLISHING SERVICES; EDUCATIONAL AND ENTERTAINMENT SERVICES, NAMELY, A CONTINUING PROGRAM ABOUT THE HOME AND GARDEN INDUSTRY ACCESSIBLE BY RADIO, TELEVISION, SATELLITE, AUDIO, VIDEO AND COMPUTER NETWORKS; ENTERTAINMENT IN THE NATURE OF AN ON-GOING SPECIAL VARIETY, NEWS, MUSIC OR COMEDY SHOW FEATURING THE HOME AND GARDEN INDUSTRY BROADCAST OVER TELEVISION, SATELLITE, AUDIO, AND VIDEO MEDIA; FILM AND VIDEO FILM PRODUCTION; FILM AND VIDEO PRODUCTION; MEDIA PRODUCTION SERVICES, NAMELY, VIDEO AND FILM PRODUCTION; MULTIMEDIA ENTERTAINMENT SERVICES IN THE NATURE OF RECORDING, PRODUCTION AND POST-PRODUCTION SERVICES IN THE FIELDS OF MUSIC, VIDEO, AND FILMS; POST-PRODUCTION EDITING SERVICES IN THE FIELD OF MUSIC, VIDEOS AND FILMS; PRODUCTION OF SOUND

AND MUSIC VIDEO RECORDINGS; PRODUCTION OF VIDEO AND CREATION OF VISUAL EFFECTS FOR OTHERS FOR USE IN DVDS, TELEVISION PROGRAMS AND ON WEBSITES; PRODUCTION OF VISUAL EFFECTS FOR VIDEOS, DVDS, TELEVISION AND FOR INTERNET WEBSITES; PROVIDING AUDIO OR VIDEO STUDIOS; PROVIDING FACILITIES FOR PRODUCING VIDEO, CINEMA AND PHOTOGRAPHY PRODUCTIONS; SPECIAL EFFECTS ANIMATION SERVICES FOR FILM AND VIDEO; VIDEO EDITING; VIDEO MASTERING SERVICES; VIDEO TAPE EDITING; VIDEO TAPE FILM PRODUCTION, IN CLASS 41 (U.S. CLS. 100, 101 AND 107).

FIRST USE 12-1-2003; IN COMMERCE 12-1-2003.

THE MARK CONSISTS OF STANDARD CHARACTERS WITHOUT CLAIM TO ANY PARTICULAR FONT, STYLE, SIZE, OR COLOR.

SER. NO. 77-358,825, FILED 12-22-2007.

JEFFERY COWARD, EXAMINING ATTORNEY

**Int. Cl.: 9**

**Prior U.S. Cls.: 21, 23, 26, 36 and 38**

**Reg. No. 3,498,348**

**United States Patent and Trademark Office**

**Registered Sep. 9, 2008**

---

**TRADEMARK  
PRINCIPAL REGISTER**

**THE INFERNAL GATE**

RC GENERAL ENTERPRISES, INC. (NEW YORK  
CORPORATION)  
1254 HOLLYWOOD AVE. #2  
BRONX, NY 10461

THE MARK CONSISTS OF STANDARD CHAR-  
ACTERS WITHOUT CLAIM TO ANY PARTICULAR  
FONT, STYLE, SIZE, OR COLOR.

FOR: DIGITAL MEDIA, NAMELY, CDS, DVDS,  
AND DOWNLOADABLE AUDIO FILES FEATUR-  
ING MUSIC, IN CLASS 9 (U.S. CLS. 21, 23, 26, 36 AND  
38).

SER. NO. 77-358,875, FILED 12-23-2007.

FIRST USE 12-22-2007; IN COMMERCE 12-22-2007.

SUNG IN, EXAMINING ATTORNEY

**Int. Cl.: 35**

**Prior U.S. Cls.: 100, 101 and 102**

**United States Patent and Trademark Office**

**Reg. No. 3,498,349**

**Registered Sep. 9, 2008**

**SERVICE MARK  
PRINCIPAL REGISTER**

**Small Business Specialists**

TARTONI, DONALD A. (UNITED STATES INDIVIDUAL)

PARKWAY 4, SUITE 100

2697 INTERNATIONAL PARKWAY

VIRGINIA BEACH, VA 23452 AND

TARTONI, JAN (UNITED STATES INDIVIDUAL)

PARKWAY 4, SUITE 100

2697 INTERNATIONAL PARKWAY

VIRGINIA BEACH, VA 23452

FOR: ACCOUNTING CONSULTATION; ACCOUNTING SERVICES; BUSINESS INFORMATION AND ACCOUNTING ADVISORY SERVICES; COMPUTERIZED ACCOUNTING SERVICES; BOOKKEEPING; TAX AND TAXATION PLANNING, ADVICE, INFORMATION AND CONSULTANCY SERVICES; TAX PREPARATION; PAYROLL PREPARATION; PAYROLL PROCESSING SERVICES, IN CLASS 35 (U.S. CLS. 100, 101 AND 102).

FIRST USE 4-1-1986; IN COMMERCE 4-1-1986.

THE MARK CONSISTS OF STANDARD CHARACTERS WITHOUT CLAIM TO ANY PARTICULAR FONT, STYLE, SIZE, OR COLOR.

NO CLAIM IS MADE TO THE EXCLUSIVE RIGHT TO USE "SMALL BUSINESS", APART FROM THE MARK AS SHOWN.

SEC. 2(F).

SER. NO. 77-359,035, FILED 12-24-2007.

KARANENDRA S. CHHINA, EXAMINING ATTORNEY

**Int. Cl.: 33**

**Prior U.S. Cls.: 47 and 49**

**United States Patent and Trademark Office**

**Reg. No. 3,498,350**

**Registered Sep. 9, 2008**

**TRADEMARK  
PRINCIPAL REGISTER**

**OF THE STONES**

CALEB FOSTER WINES, L.L.C. (WASHINGTON  
LIMITED LIABILITY COMPANY)  
535 CESSNA AVENUE  
WALLA WALLA, WA 99362

THE MARK CONSISTS OF STANDARD CHAR-  
ACTERS WITHOUT CLAIM TO ANY PARTICULAR  
FONT, STYLE, SIZE, OR COLOR.

FOR: WINES, IN CLASS 33 (U.S. CLS. 47 AND 49).

SER. NO. 77-359,123, FILED 12-24-2007.

FIRST USE 11-1-2004; IN COMMERCE 11-1-2004.

SUNG IN, EXAMINING ATTORNEY

**Int. Cl.: 30**

**Prior U.S. Cl.: 46**

**United States Patent and Trademark Office**

**Reg. No. 3,498,351**

**Registered Sep. 9, 2008**

**TRADEMARK  
PRINCIPAL REGISTER**

**RUTTER'S DAIRY**

RUTTER'S HOLDINGS, INC. (PENNSYLVANIA  
CORPORATION)  
2100 N. GEORGE STREET  
YORK, PA 17404

FOR: DAIRY PRODUCTS, NAMELY, ICE CREAM  
AND ICE MILK, IN CLASS 30 (U.S. CL. 46).

FIRST USE 1-21-1921; IN COMMERCE 1-21-1921.

THE MARK CONSISTS OF STANDARD CHAR-  
ACTERS WITHOUT CLAIM TO ANY PARTICULAR  
FONT, STYLE, SIZE, OR COLOR.

NO CLAIM IS MADE TO THE EXCLUSIVE  
RIGHT TO USE "DAIRY", APART FROM THE  
MARK AS SHOWN.

SEC. 2(F).

SER. NO. 77-359,226, FILED 12-26-2007.

KELLY BOULTON, EXAMINING ATTORNEY

**Int. Cl.: 38**

**Prior U.S. Cls.: 100, 101 and 104**

**United States Patent and Trademark Office**

**Reg. No. 3,498,352**

**Registered Sep. 9, 2008**

**SERVICE MARK  
PRINCIPAL REGISTER**

The logo for Phone.com features a large, stylized black location pin icon above the word "Phone.com" in a bold, sans-serif font. The dot of the location pin is a solid black circle, and the tail of the pin is a curved shape pointing downwards and to the left.

PHONE.COM LLC (DELAWARE LIMITED LIABILITY COMPANY)  
123 NEWBURY STREET  
BOSTON, MA 02111

FOR: TELECOMMUNICATIONS SERVICES, NAMELY, THE PROVISION OF VOICE OVER INTERNET PROTOCOL (VOIP) SERVICES; THE PROVISION OF VIRTUAL PRIVATE BRANCH EXCHANGE (PBX) SERVICES, NAMELY, AUTOMATED CALL HANDLING AND ROUTING SERVICES, IN CLASS 38 (U.S. CLS. 100, 101 AND 104).

FIRST USE 9-24-2007; IN COMMERCE 9-24-2007.

NO CLAIM IS MADE TO THE EXCLUSIVE RIGHT TO USE "PHONE.COM", APART FROM THE MARK AS SHOWN.

SER. NO. 77-359,241, FILED 12-26-2007.

SKYE YOUNG, EXAMINING ATTORNEY

Int. Cl.: 42

Prior U.S. Cls.: 100 and 101

United States Patent and Trademark Office

Reg. No. 3,498,353

Registered Sep. 9, 2008

SERVICE MARK  
PRINCIPAL REGISTER



THE COMPUTER SUPPORT PEOPLE, LLC (CONNECTICUT LIMITED LIABILITY COMPANY)  
P.O. BOX 17186  
STAMFORD, CT 06907

FOR: TECHNICAL SUPPORT SERVICES, NAME-  
LY, TROUBLESHOOTING OF COMPUTER HARD-  
WARE AND SOFTWARE PROBLEMS; COMPUTER  
PROGRAMMING AND MAINTENANCE OF COM-  
PUTER PROGRAMS; COMPUTER PROGRAM-  
MING AND SOFTWARE DESIGN; COMPUTER  
PROGRAMMING IN THE MEDICAL FIELD, IN  
CLASS 42 (U.S. CLS. 100 AND 101).

FIRST USE 7-25-1989; IN COMMERCE 7-25-1989.

NO CLAIM IS MADE TO THE EXCLUSIVE  
RIGHT TO USE "COMPUTERS" AND "202-653-4643"  
AND "WWW.THECOMPUTERSUPPORTPEOPLE-  
COM" AND "SINCE 1989", APART FROM THE  
MARK AS SHOWN.

THE COLOR(S) RED, YELLOW, GOLD, WHITE  
AND BLACK IS/ARE CLAIMED AS A FEATURE OF  
THE MARK.

THE MARK CONSISTS OF THE WORDING  
"COMPUTERS" AND "203-653-4643" CUTTING  
ACROSS AND INSIDE A RECTANGLE. IN THE  
MIDDLE, THE WORDING "YOU BREAK IT, WE  
FIX IT" APPEARS. THE LOWER RECTANGLE

CONTAINS THE WORDING WWW.THECOMPU-  
TERSUPPORTPEOPLE.COM AND THE WORDING  
"SINCE 1989". THE MARK CONSISTS OF THE  
COLORS RED, YELLOW, GOLD, WHITE, AND  
BLACK WITH THE COLOR RED APPEARING IN  
THE WORDING "COMPUTERS" AND IN THE LET-  
TERS "T", "C", "S", AND "P" IN THE WORDING  
"WWW.THECOMPUTERSUPPORTPEOPLE.COM",  
WITH THE COLOR YELLOW APPEARING IN THE  
RECTANGLES AT THE TOP AND BOTTOM OF THE  
MARK AND IN THE LETTERING FOR THE WORD-  
ING "IT" IN "WE FIX IT", WITH THE COLOR GOLD  
APPEARING IN THE LETTERING FOR THE  
WORDING "IT" IN "YOU BREAK IT", WITH THE  
COLOR WHITE APPEARING IN THE BACK-  
GROUND OF THE MARK, AND WITH THE COLOR  
BLACK APPEARING INSIDE "203-653-4643", INSIDE  
THE WORDING "YOU BREAK IT", INSIDE THE  
WORDING "WE FIX" IN "WE FIX IT", IN THE  
OUTLINING FOR THE WORDING "COMPUTERS",  
IN THE OUTLINING OF THE RECTANGLES, IN  
THE OUTLINING OF THE TWO "IT'S", IN THE  
LETTERING "WWW.", "HE", "OMPUTER", "UP-  
PORT", AND "EOPLE" IN THE WORDING  
"WWW.THECOMPUTERSUPPORTPEOPLE.COM",  
AND IN THE LETTERING FOR THE WORDING  
"SINCE 1989".

SER. NO. 77-359,366, FILED 12-26-2007.

SETH A. RAPPAPORT, EXAMINING ATTORNEY



**Int. Cl.: 9**

**Prior U.S. Cls.: 21, 23, 26, 36 and 38**

**Reg. No. 3,498,354**

**United States Patent and Trademark Office**

**Registered Sep. 9, 2008**

**TRADEMARK  
PRINCIPAL REGISTER**

The logo for APPEON features the word "APPEON" in a bold, sans-serif font. The letters "A", "P", "P", "E", and "O" are blue, while the letter "E" is orange. The "N" is also blue. The letters are closely spaced and have a slight shadow effect.

APPEON CORPORATION (HK) LIMITED (HONG  
KONG CORPORATION)  
1/F SHELL INDUSTRIAL BUILDING  
12 LEE CHUNG STREET  
CHAI WAN, HONG KONG

FOR: COMPUTER SOFTWARE FOR PROGRAM-  
MING ENTERPRISE SOFTWARE APPLICATIONS,  
IN CLASS 9 (U.S. CLS. 21, 23, 26, 36 AND 38).

FIRST USE 5-16-2004; IN COMMERCE 5-16-2004.

OWNER OF U.S. REG. NO. 2,850,331.

THE COLOR(S) BLUE AND ORANGE IS/ARE  
CLAIMED AS A FEATURE OF THE MARK.

THE MARK CONSISTS OF THE COLOR BLUE IN  
THE WORD "APPEON"; THE COLOR ORANGE  
APPEARS IN THE LETTER "E".

SER. NO. 77-359,382, FILED 12-26-2007.

LEIGH LOWRY, EXAMINING ATTORNEY

**Int. Cls.: 14, 20, 25 and 26**

**Prior U.S. Cls.: 2, 13, 22, 25, 27, 28, 32, 37, 39, 40, 42  
and 50**

**Reg. No. 3,498,355**

**United States Patent and Trademark Office**

**Registered Sep. 9, 2008**

**TRADEMARK  
PRINCIPAL REGISTER**

# Dillon Rogers

DILLON ROGERS, INC. (CALIFORNIA CORPORATION)  
165 S. FAIRFAX AVE.  
LOS ANGELES, CA 90036

FOR: ANKLE BRACELETS; BRACELETS; BRACELETS OF PRECIOUS METAL; IDENTIFICATION BRACELETS; CHARMS; JEWELRY AND IMITATION JEWELRY; LEATHER JEWELRY AND ACCESSORY BOXES; NECKLACES; JEWEL PENDANTS; PENDANTS, IN CLASS 14 (U.S. CLS. 2, 27, 28 AND 50).

FIRST USE 1-28-2002; IN COMMERCE 1-28-2002.

FOR: NON-METAL KEY RINGS, IN CLASS 20 (U.S. CLS. 2, 13, 22, 25, 32 AND 50).

FIRST USE 1-27-2005; IN COMMERCE 1-27-2005.

FOR: BELTS; LEATHER BELTS; SHORT-SLEEVED OR LONG-SLEEVED T-SHIRTS; T-SHIRTS; TOPS, IN CLASS 25 (U.S. CLS. 22 AND 39).

FIRST USE 1-30-2003; IN COMMERCE 1-30-2003.

FOR: BELT BUCKLES; BELT BUCKLES NOT OF PRECIOUS METAL; HAIR BANDS, IN CLASS 26 (U.S. CLS. 37, 39, 40, 42 AND 50).

FIRST USE 1-30-2003; IN COMMERCE 1-30-2003.

THE MARK CONSISTS OF STANDARD CHARACTERS WITHOUT CLAIM TO ANY PARTICULAR FONT, STYLE, SIZE, OR COLOR.

THE NAME(S), PORTRAIT(S), AND/OR SIGNATURE(S) SHOWN IN THE MARK DOES NOT IDENTIFY A PARTICULAR LIVING INDIVIDUAL.

SER. NO. 77-359,683, FILED 12-26-2007.

KELLY BOULTON, EXAMINING ATTORNEY

**Int. Cl.: 5**

**Prior U.S. Cls.: 6, 18, 44, 46, 51 and 52**

**Reg. No. 3,498,356**

**United States Patent and Trademark Office**

**Registered Sep. 9, 2008**

**TRADEMARK  
PRINCIPAL REGISTER**

**OXY-CAPS**

MATRIX HEALTH PRODUCTS INC. (WASHING-  
TON CORPORATION)  
1101 NE 144TH ST. #109  
VANCOUVER, WA 98685

THE MARK CONSISTS OF STANDARD CHAR-  
ACTERS WITHOUT CLAIM TO ANY PARTICULAR  
FONT, STYLE, SIZE, OR COLOR.

FOR: DIETARY AND NUTRITIONAL SUPPLE-  
MENTS NOT FOR SKIN OR ACNE CARE, IN CLASS  
5 (U.S. CLS. 6, 18, 44, 46, 51 AND 52).

SER. NO. 77-359,696, FILED 12-26-2007.

FIRST USE 2-1-1994; IN COMMERCE 2-1-1994.

MICHAEL WEBSTER, EXAMINING ATTORNEY

**Int. Cl.: 9**

**Prior U.S. Cls.: 21, 23, 26, 36 and 38**

**Reg. No. 3,498,357**

**United States Patent and Trademark Office**

**Registered Sep. 9, 2008**

**TRADEMARK  
PRINCIPAL REGISTER**

**MG-33**

PULSED POWER TECHNOLOGIES, LLC (WYOM-  
ING LIMITED LIABILITY COMPANY)  
122 SUMMERVILLE DR. #101  
MOORESVILLE, NC 28115

THE MARK CONSISTS OF STANDARD CHAR-  
ACTERS WITHOUT CLAIM TO ANY PARTICULAR  
FONT, STYLE, SIZE, OR COLOR.

FOR: ELECTROMAGNETIC APPARATUS USED  
TO GENERATE OR MEASURE MAGNETIC  
FIELDS, IN CLASS 9 (U.S. CLS. 21, 23, 26, 36 AND 38).

SER. NO. 77-359,800, FILED 12-26-2007.

FIRST USE 12-1-2007; IN COMMERCE 12-1-2007.

ANDREA SAUNDERS, EXAMINING ATTORNEY

**Int. Cls.: 7 and 12**

**Prior U.S. Cls.: 13, 19, 21, 23, 31, 34, 35 and 44**

**United States Patent and Trademark Office**

**Reg. No. 3,498,358**

**Registered Sep. 9, 2008**

**TRADEMARK  
PRINCIPAL REGISTER**

**ROMAC**

NORNDA PTY LTD (AUSTRALIA PROPRIETARY LIMITED COMPANY (P/L OR PTY. LTD.))  
25-31 INNES ROAD  
WINDSOR GARDENS, AUSTRALIA 5087

FOR: HARMONIC BALANCERS FOR ENGINES, TIMING CHAIN SETS COMPRISING CHAINS AND GEARS, AND TIMING BELT SETS COMPRISING BELTS AND GEARS, IN CLASS 7 (U.S. CLS. 13, 19, 21, 23, 31, 34 AND 35).

FOR: AUTOMOTIVE PARTS AND COMPONENTS, NAMELY, ENGINE, TRANSMISSION AND FINAL DRIVE ASSEMBLIES FOR LAND VEHICLES; LAND VEHICLE PARTS AND COMPO-

NENTS, NAMELY, AXLES, HUB ASSEMBLIES, BRAKE DISC ROTORS, IN CLASS 12 (U.S. CLS. 19, 21, 23, 31, 35 AND 44).

THE MARK CONSISTS OF STANDARD CHARACTERS WITHOUT CLAIM TO ANY PARTICULAR FONT, STYLE, SIZE, OR COLOR.

OWNER OF AUSTRALIA REG. NO. 925250, DATED 8-29-2002, EXPIRES 8-30-2012.

SER. NO. 77-359,850, FILED 12-27-2007.

STEVEN JACKSON, EXAMINING ATTORNEY

Int. Cl.: 41

Prior U.S. Cls.: 100, 101 and 107

Reg. No. 3,498,359

United States Patent and Trademark Office

Registered Sep. 9, 2008

SERVICE MARK  
PRINCIPAL REGISTER



THE COLUMBUS ZOOLOGICAL PARK ASSO-  
CIATION (OHIO NON-PROFIT CORPORA-  
TION)

9990 RIVERSIDE DRIVE  
P.O. BOX 400  
POWELL, OH 430650400

FOR: PROVIDING ZOOLOGICAL SERVICES  
AND AQUARIUM SERVICES TO THE PUBLIC, IN  
CLASS 41 (U.S. CLS. 100, 101 AND 107).

FIRST USE 12-6-2007; IN COMMERCE 12-6-2007.

NO CLAIM IS MADE TO THE EXCLUSIVE  
RIGHT TO USE "COLUMBUS ZOO AND AQUA-  
RIUM", APART FROM THE MARK AS SHOWN.

THE MARK CONSISTS OF THE WORDS "CO-  
LUMBUS ZOO AND AQUARIUM" WITH THE  
WORD "ZOO" COMPOSED OF LETTERS IN THE  
FORM OF ANIMALS IN LARGE PRINT IN A  
RECTANGULAR BLOCK, THE WORD "COLUM-  
BUS" ABOVE THE BLOCK AND THE WORDS "AND  
AQUARIUM" BELOW THE BLOCK.

SER. NO. 77-360,018, FILED 12-27-2007.

TASHIA BUNCH, EXAMINING ATTORNEY

**Int. Cl.: 35**

**Prior U.S. Cls.: 100, 101 and 102**

**United States Patent and Trademark Office**

**Reg. No. 3,498,360**

**Registered Sep. 9, 2008**

**SERVICE MARK  
PRINCIPAL REGISTER**

**travelscream**

TRAVELSCREAM, INC. (COLORADO CORPORATION)  
P O BOX 3851  
AVON, CO 81620

THE MARK CONSISTS OF STANDARD CHARACTERS WITHOUT CLAIM TO ANY PARTICULAR FONT, STYLE, SIZE, OR COLOR.

FOR: ON-LINE STORE FOR APPAREL, NAMELY, SHIRTS, AND MUGS, MOUSE PADS, NOTE PADS AND TOTE BAGS, IN CLASS 35 (U.S. CLS. 100, 101 AND 102).

SER. NO. 77-360,076, FILED 12-27-2007.

FIRST USE 7-0-2007; IN COMMERCE 7-0-2007.

SUNG IN, EXAMINING ATTORNEY

Int. Cl.: 9

Prior U.S. Cls.: 21, 23, 26, 36 and 38

Reg. No. 3,498,361

United States Patent and Trademark Office

Registered Sep. 9, 2008

TRADEMARK  
PRINCIPAL REGISTER



BACKYARD FREEDOM LLC (TEXAS LIMITED LIABILITY COMPANY)  
4748 SUGAR MILL ROAD  
DALLAS, TX 75244

FOR: OUTDOOR AUTOMATED MIST SYSTEM FOR INSECT AND PEST CONTROL COMPRISING OF A BATTERY OPERATED TIMER AND INDUSTRIAL GRADE CHECK VALVE THAT ATTACHES TO AN OUTDOOR WATER FAUCET AND WORKS OFF OF THE HOME'S WATER PRESSURE TO DELIVER A FINE MIST OF INSECTICIDE FORMULATION AT PRE-SET TIME INTERVALS WHICH HELPS ELIMINATE A WIDE RANGE OF FLYING INSECTS IN AND AROUND RESIDENTIAL OUTDOOR SPACES, IN CLASS 9 (U.S. CLS. 21, 23, 26, 36 AND 38).

FIRST USE 3-15-2008; IN COMMERCE 3-15-2008.

THE COLOR(S) BLACK, BLUE, YELLOW, RED, GRAY, WHITE IS/ARE CLAIMED AS A FEATURE OF THE MARK.

THE MARK CONSISTS OF THE WORD "BACKYARD" IN BLUE WITH BLACK OUTLINE AND YELLOW OUTLINE, THE WORD "FREEDOM" IN RED WITH BLACK OUTLINE AND YELLOW OUTLINE, THE WORDS "WIN THE WAR AGAINST MOSQUITOES!" IN BLACK WITH YELLOW OUTLINE. BETWEEN THE TWO LINES OF TEXT, THERE IS A STICK FIGURE FAMILY IN BLACK, FROM LEFT TO RIGHT, FATHER, SON, DAUGHTER AND MOTHER, OUTLINED IN YELLOW. TO THE LEFT OF THE STICK FIGURE FAMILY ARE THREE RED STARS THAT INCREASE IN SIZE FROM LEFT TO RIGHT. ON THE RIGHT OF THE STICK FIGURE FAMILY ARE THREE BLUE STARS THAT DECREASE IN SIZE FROM LEFT TO RIGHT. AROUND THE ENTIRE MARK ARE CARTOON MOSQUITOES IN BLACK AND GRAY IN VARYING SIZES AND FACING VARYING DIRECTIONS.

SER. NO. 77-360,253, FILED 12-27-2007.

JERI J. FICKES, EXAMINING ATTORNEY



Int. Cl.: 36

Prior U.S. Cls.: 100, 101 and 102

United States Patent and Trademark Office

Reg. No. 3,498,362

Registered Sep. 9, 2008

SERVICE MARK  
PRINCIPAL REGISTER



ORIGEN FINANCIAL, INC. (VIRGINIA CORPORATION)  
27777 FRANKLIN RD., SUITE 1700  
SOUTHFIELD, MI 48034

FOR: FINANCING SERVICES, IN CLASS 36 (U.S. CLS. 100, 101 AND 102).

FIRST USE 5-23-2005; IN COMMERCE 5-23-2005.

OWNER OF U.S. REG. NO. 2,544,859.

THE COLOR(S) BLUE, GOLD, TAN AND WHITE IS/ARE CLAIMED AS A FEATURE OF THE MARK.

THE MARK CONSISTS OF AN OVAL BROKEN IN HALF VERTICALLY WITH THE WORDS "SPEED -

CONVENIENCE - SAVINGS" WRITTEN IN WHITE IN THE LEFT HALF OF THE OVAL WHICH IS OTHERWISE BLUE AND THE WORDS "INCREASED APPROVALS" WRITTEN IN WHITE ON THE RIGHT HALF OF THE OVAL WHICH IS OTHERWISE GOLD; AND THE WORDS "ORIGEN FOCUS" IN THE CENTER OF THE OVAL AND WRITTEN IN BLUE EXCEPT FOR THE STYLIZED "O" IN "FOCUS" WHICH IS GOLD WITH A TAN ARROW POINTING TO ITS CENTER.

SER. NO. 77-360,306, FILED 12-27-2007.

KATHERINE M. DUBRAY, EXAMINING ATTORNEY

**Int. Cl.: 9**

**Prior U.S. Cls.: 21, 23, 26, 36 and 38**

**Reg. No. 3,498,363**

**United States Patent and Trademark Office**

**Registered Sep. 9, 2008**

**TRADEMARK  
PRINCIPAL REGISTER**

**NO-FOG**

MARTIN, TOM (UNITED STATES INDIVIDUAL)  
N9488 SPIRIT LAKE ROAD  
RIB LAKE, WI 54470

FOR: PROTECTIVE FACE MASKS TO COVER  
THE FACE, CHIN AND NECK, SPECIFICALLY FOR  
USE IN OIL DRILLING, IN CLASS 9 (U.S. CLS. 21, 23,  
26, 36 AND 38).

FIRST USE 2-23-1980; IN COMMERCE 2-29-1980.

THE MARK CONSISTS OF STANDARD CHAR-  
ACTERS WITHOUT CLAIM TO ANY PARTICULAR  
FONT, STYLE, SIZE, OR COLOR.

OWNER OF U.S. REG. NO. 3,050,876.

SEC. 2(F).

SER. NO. 77-360,414, FILED 12-27-2007.

BARBARA A. GOLD, EXAMINING ATTORNEY

**Int. Cl.: 35**

**Prior U.S. Cls.: 100, 101 and 102**

**United States Patent and Trademark Office**

**Reg. No. 3,498,364**

**Registered Sep. 9, 2008**

**SERVICE MARK  
PRINCIPAL REGISTER**

# Bruce Clay

BRUCE CLAY, INC. (CALIFORNIA CORPORATION)  
SUITE 277  
207 W. LOS ANGELES AVENUE  
MOORPARK, CA 93021

FOR: INTERNET ADVERTISING AND MARKETING SERVICES, NAMELY, ONLINE ADVERTISING AND MARKETING WITH AN EMPHASIS ON SEARCH ENGINE OPTIMIZATION; ADVERTISING OF BUSINESS WEB SITES, IN CLASS 35 (U.S. CLS. 100, 101 AND 102).

FIRST USE 11-1-1996; IN COMMERCE 11-1-1996.

THE MARK CONSISTS OF STANDARD CHARACTERS WITHOUT CLAIM TO ANY PARTICULAR FONT, STYLE, SIZE, OR COLOR.

THE NAME "BRUCE CLAY" IDENTIFIES A LIVING INDIVIDUAL WHOSE CONSENT IS OF RECORD.

SER. NO. 77-360,434, FILED 12-27-2007.

SUNG IN, EXAMINING ATTORNEY

Int. Cl.: 36

Prior U.S. Cls.: 100, 101 and 102

United States Patent and Trademark Office

Reg. No. 3,498,365

Registered Sep. 9, 2008

SERVICE MARK  
PRINCIPAL REGISTER



NATIONAL BREAST CANCER FOUNDATION,  
INC. (TEXAS CORPORATION)  
2600 NETWORK BOULEVARD  
SUITE 300  
FRISCO, TX 75034

FOR: CHARITABLE FUND-RAISING SERVICES, NAMELY, RAISING MONEY FOR BREAST CANCER PUBLIC AWARENESS PROGRAMS, BREAST CANCER EDUCATION PROGRAMS, BREAST CANCER DETECTION PROGRAMS, AND BREAST CANCER RESEARCH PROGRAMS, AND FOR SUBSIDIZING MAMMOGRAMS FOR UNDERSERVED WOMEN, IN CLASS 36 (U.S. CLS. 100, 101 AND 102).

FIRST USE 10-0-2007; IN COMMERCE 10-0-2007.

NO CLAIM IS MADE TO THE EXCLUSIVE RIGHT TO USE "BREAST CANCER", APART FROM THE MARK AS SHOWN.

THE COLOR(S) BLACK AND PINK IS/ARE CLAIMED AS A FEATURE OF THE MARK.

THE MARK CONSISTS OF THE STYLIZED WORD "CASUAL" WRITTEN HORIZONTALLY, THE STYLIZED WORD "UP" WRITTEN VERTICALLY DOWNWARD FROM THE SHARED "U" OF "CASUAL" AND THE WORDS "FOR", "BREAST" AND "CANCER" WRITTEN HORIZONTALLY IN A SMALLER FONT IN VERTICALLY STACKED ROWS BELOW THE "AL" OF "CASUAL" AND TO THE RIGHT OF THE "P" OF "UP". A VERTICAL LINE IS POSITIONED BETWEEN THE "P" OF "UP" AND THE WORDS "FOR", "BREAST" AND "CANCER". THE SHARED "U" HAS AN UPWARD-POINTING ARROW ON THE LEFT BRANCH AND A RIBBON IS TIED AROUND THE RIGHT-EXTENDING LEG OF THE LETTER "L" OF THE WORD "CASUAL". THE COLOR BLACK APPEARS IN THE LETTERS "CAS" AND "AL" OF THE WORD "CASUAL", IN THE VERTICAL LINE, AND IN THE WORDS "FOR", "BREAST" AND "CANCER". THE COLOR PINK APPEARS IN THE WORD "UP" INCLUDING THE SHARED "U" AND IN THE RIBBON.

SER. NO. 77-360,818, FILED 12-28-2007.

MARK SPARACINO, EXAMINING ATTORNEY

Int. Cl.: 37

Prior U.S. Cls.: 100, 103 and 106

United States Patent and Trademark Office

Reg. No. 3,498,366

Registered Sep. 9, 2008

SERVICE MARK  
PRINCIPAL REGISTER



CHARLTON, NICHOLAS THOMAS (UNITED STATES INDIVIDUAL)  
47 HARRINGTON AVENUE  
CONCORD, MA 017423907

FOR: CLEANING OF COMMERCIAL AND RESIDENTIAL BUILDINGS, IN CLASS 37 (U.S. CLS. 100, 103 AND 106).

FIRST USE 1-1-1979; IN COMMERCE 1-1-1979.

NO CLAIM IS MADE TO THE EXCLUSIVE RIGHT TO USE "CLEANING COMPANY", APART FROM THE MARK AS SHOWN.

THE MARK CONSISTS OF THE LEFT TOP SIDE OF THE LOGO WITH THE LETTER "L", THE MIDDLE TOP OF THE LOGO HOLDS THE LETTER "T" AND THE RIGHT SIDE OF THE LOGO ENDS

WITH THE LETTER "C". THE THREE LETTERS "L"- "T"- "C" FORM TOGETHER TO CREATE THE SHAPE OF A STANDARD HOUSE-FRONT, WITH A "DOUBLE HUNG WINDOW" FIT BETWEEN THE LETTERS "L" AND "T" AND ANOTHER "DOUBLE HUNG WINDOW" FIT INSIDE OF THE LETTER "C" BUTTRESSING THE RIGHT SIDE THE LOGO. THERE IS ALSO A 13 WINDOW-PANE DOOR, 4 OF THE PANES ARE IN AN ARCH DESIGN AT THE TOP OF THE DOOR, WHICH FITS UNDER THE RIGHT HORIZONTAL END OF THE LETTER "T" AND AGAINST THE BOTTOM LEFT SIDE OF THE LETTER "C". BELOW THE "L"- "T"- "C" DESIGN, THE WORDS "CLEANING COMPANY".

SER. NO. 77-361,732, FILED 12-31-2007.

REBECCA GILBERT, EXAMINING ATTORNEY

Int. Cl.: 6

Prior U.S. Cls.: 2, 12, 13, 14, 23, 25 and 50

Reg. No. 3,498,367

United States Patent and Trademark Office

Registered Sep. 9, 2008

TRADEMARK  
PRINCIPAL REGISTER



EZR PRODUCTS, INC. (NEW YORK CORPORATION)  
49 WEST STREET  
NORTHPORT, NY 11768

FOR: METAL PICTURE HANGERS, IN CLASS 6  
(U.S. CLS. 2, 12, 13, 14, 23, 25 AND 50).

FIRST USE 10-24-2005; IN COMMERCE 10-24-2005.

NO CLAIM IS MADE TO THE EXCLUSIVE  
RIGHT TO USE "PUSH & HANG", APART FROM  
THE MARK AS SHOWN.

"THE STIPPLING IS A FEATURE OF THE  
MARK."

THE COLOR(S) RED, BLACK AND GRAY IS/ARE  
CLAIMED AS A FEATURE OF THE MARK.

THE MARK CONSISTS OF THE WORD "PUSH"  
IN RED OVER THE "&" SIGN AND THE WORD  
"HANG" AND THE "&" SIGN ARE BOTH IN BLACK  
WITH A RED OUTLINE AND A "SHADOW" BACK-  
DROP. THE WORD "PUSH" HAS TWO BLACK  
LINES LEADING TO THE DESIGN OF A PICTURE  
HANGER IN GRAY. THE TWO LINES REPRESENT  
A GRAPHIC IMAGE OF A WIRE HANGING THE  
WORDS "PUSH & HANG" FROM THE PICTURE  
HANGER.

SER. NO. 77-361,754, FILED 12-31-2007.

ELLEN PERKINS, EXAMINING ATTORNEY

**Int. Cl.: 9**

**Prior U.S. Cls.: 21, 23, 26, 36 and 38**

**Reg. No. 3,498,368**

**United States Patent and Trademark Office**

**Registered Sep. 9, 2008**

**TRADEMARK  
PRINCIPAL REGISTER**



COLOR DREAMS, INC. (CALIFORNIA CORPORATION), DBA STARDOT TECHNOLOGIES  
6820 ORANGETHORPE AVE., SUITE G  
BUENA PARK, CA 90620

NO CLAIM IS MADE TO THE EXCLUSIVE RIGHT TO USE "TECHNOLOGIES", APART FROM THE MARK AS SHOWN.

FOR: VIDEO NETWORK CAMERAS, VIDEO SERVERS AND VIDEO RECORDING SOFTWARE, IN CLASS 9 (U.S. CLS. 21, 23, 26, 36 AND 38).

SER. NO. 77-361,921, FILED 12-31-2007.

FIRST USE 9-26-1995; IN COMMERCE 9-26-1995.

ANDREA HACK, EXAMINING ATTORNEY

Int. Cl.: 35

Prior U.S. Cls.: 100, 101 and 102

United States Patent and Trademark Office

Reg. No. 3,498,369

Registered Sep. 9, 2008

SERVICE MARK  
PRINCIPAL REGISTER

boomereware

BOOMER EYEWARE (CALIFORNIA LIMITED  
LIABILITY COMPANY)  
12121 WILSHIRE BLVD. #208  
LOS ANGELES, CA 90025

FOR: RETAIL AND ONLINE RETAIL STORE  
FEATURING SUNGLASSES, READING SUNGLAS-  
SES, BIFOCAL READING SUNGLASSES, SUN  
READERS, EYEGASSES, READING GLASSES,  
READING EYEGASSES, BIFOCAL EYEGASSES,  
FOLDING READING GLASSES, MAGNIFYING  
EYEGASSES, EYEGASS CASES, EYEGASS  
CHAINS AND CREDIT CARD SIZED MAGNIFY-

ING PIECE OF PLASTIC USED TO ASSIST WITH  
READING, IN CLASS 35 (U.S. CLS. 100, 101 AND 102).

FIRST USE 9-30-2005; IN COMMERCE 6-1-2006.

THE MARK CONSISTS OF THE STYLIZED  
WORDS "BOOMEREYEWARE". THE "O'S" ARE  
AN IMAGE OF GLASSES.

SER. NO. 77-362,070, FILED 12-31-2007.

MARIA-VICTORIA SUAREZ, EXAMINING ATTOR-  
NEY



**Int. Cl.: 41**

**Prior U.S. Cls.: 100, 101 and 107**

**United States Patent and Trademark Office**

**Reg. No. 3,498,370**

**Registered Sep. 9, 2008**

**SERVICE MARK  
PRINCIPAL REGISTER**

**MAGIS GROUP**

THE MAGIS GROUP, LLC (COLORADO LIMITED LIABILITY COMPANY)  
P.O. BOX 7456  
BOULDER, CO 80306

FOR: CONDUCTING PRE-, MID- AND POST-DEPLOYMENT EDUCATION AND TRAINING PROGRAMS, NAMELY, PROGRAMS, WORKSHOPS, SEMINARS, CLASSROOM INSTRUCTION, TESTING FOR MILITARY SERVICE PERSONNEL, THEIR FAMILIES AND CARE PROVIDERS IN THE AREAS OF PERFORMANCE OPTIMIZATION, STRESS MANAGEMENT, TRAUMA EDUCATION AND TRAUMA RECOVERY, AND SUCCESSFUL REINTEGRATION INTO FAMILY AND SOCIETY, IN CLASS 41 (U.S. CLS. 100, 101 AND 107).

FIRST USE 11-1-2002; IN COMMERCE 10-1-2003.

THE MARK CONSISTS OF STANDARD CHARACTERS WITHOUT CLAIM TO ANY PARTICULAR FONT, STYLE, SIZE, OR COLOR.

NO CLAIM IS MADE TO THE EXCLUSIVE RIGHT TO USE "GROUP", APART FROM THE MARK AS SHOWN.

SER. NO. 77-362,112, FILED 12-31-2007.

PAM WILLIS, EXAMINING ATTORNEY

**Int. Cl.: 3**

**Prior U.S. Cls.: 1, 4, 6, 50, 51 and 52**

**United States Patent and Trademark Office**

**Reg. No. 3,498,371**

**Registered Sep. 9, 2008**

**TRADEMARK  
PRINCIPAL REGISTER**

**POSICHEM**

ACOUSTI-CLEAN, INC. (FLORIDA CORPORATION)  
825 GATEPARK DRIVE #3  
DAYTONA BEACH, FL 32114

FOR: ALL-PURPOSE CLEANERS, AND STAIN REMOVERS, IN CLASS 3 (U.S. CLS. 1, 4, 6, 50, 51 AND 52).

FIRST USE 3-0-2007; IN COMMERCE 3-0-2007.

THE MARK CONSISTS OF STANDARD CHARACTERS WITHOUT CLAIM TO ANY PARTICULAR FONT, STYLE, SIZE, OR COLOR.

OWNER OF U.S. REG. NO. 2,076,480.

SER. NO. 77-362,797, FILED 1-2-2008.

AISHA CLARKE, EXAMINING ATTORNEY

**Int. Cl.: 41**

**Prior U.S. Cls.: 100, 101 and 107**

**United States Patent and Trademark Office**

**Reg. No. 3,498,372**

**Registered Sep. 9, 2008**

**SERVICE MARK  
PRINCIPAL REGISTER**



CANADIAN INITIATIVE FOR ELDER PLAN-  
NING STUDIES (CANADA CORPORATION)  
SUITE 203, 4438 ONTARIO STREET  
BEAMSVILLE, CANADA L0R1B5

THE COLOR(S) WHITE, BLACK, AND GREEN IS/  
ARE CLAIMED AS A FEATURE OF THE MARK.

FOR: EDUCATION IN THE FIELDS OF ELDER  
STUDIES RENDERED THROUGH CORRESPON-  
DENCE COURSES; EDUCATION INFORMATION;  
EDUCATION SERVICES, NAMELY, ONE-ON-ONE  
MENTORING IN THE FIELD OF ELDER STUDIES;  
EDUCATION SERVICES, NAMELY, PROVIDING  
TUTORIAL SESSIONS IN THE FIELD(S) OF ELDER  
STUDIES, IN CLASS 41 (U.S. CLS. 100, 101 AND 107).

THE MARK CONSISTS OF AN OBLONG CIRCLE  
WITH THE WORDS "CANADIAN INITIATIVE FOR  
ELDER PLANNING STUDIES" IN WHITE CIR-  
CLING THE OUTSIDE IN A GREEN BACK-  
GROUND. THE BACKGROUND OF THE CENTER  
CIRCLE IS WHITE AND INSIDE THE CIRCLE IS  
THE WORDING "EPC ELDER PLANNING COUN-  
SELOR" IN BLACK. THE LEAVE DESIGN CIR-  
CLING THE WORDING "EPC" IS GREEN AND  
WHITE.

FIRST USE 4-30-2003; IN COMMERCE 4-30-2003.

NO CLAIM IS MADE TO THE EXCLUSIVE  
RIGHT TO USE "ELDER PLANNING COUNSELOR"  
AND "CANADIAN INITIATIVES FOR ELDER  
PLANNING STUDIES", APART FROM THE MARK  
AS SHOWN.

SER. NO. 77-363,035, FILED 1-3-2008.

JENNY PARK, EXAMINING ATTORNEY

**Int. Cl.: 12**

**Prior U.S. Cls.: 19, 21, 23, 31, 35 and 44**

**United States Patent and Trademark Office**

**Reg. No. 3,498,373**

**Registered Sep. 9, 2008**

**TRADEMARK  
PRINCIPAL REGISTER**

**PIVOTAL EDGE**

JAY BEYER (UNITED STATES INDIVIDUAL)  
2024 N. GRANDVIEW LANE  
BISMARCK, ND 58503

FOR: STRUCTURAL PARTS FOR DRY BULK  
TANKERS, NAMELY, HATCH COVERS, IN CLASS  
12 (U.S. CLS. 19, 21, 23, 31, 35 AND 44).

FIRST USE 8-1-2005; IN COMMERCE 8-1-2005.

THE MARK CONSISTS OF STANDARD CHAR-  
ACTERS WITHOUT CLAIM TO ANY PARTICULAR  
FONT, STYLE, SIZE, OR COLOR.

OWNER OF U.S. REG. NO. 3,340,620.

SER. NO. 77-363,086, FILED 1-3-2008.

SETH A. RAPPAPORT, EXAMINING ATTORNEY

**Int. Cl.: 41**

**Prior U.S. Cls.: 100, 101 and 107**

**United States Patent and Trademark Office**

**Reg. No. 3,498,374**

**Registered Sep. 9, 2008**

**SERVICE MARK  
PRINCIPAL REGISTER**

**EcoCAR: The NeXt Challenge**

UNITED STATES DEPARTMENT OF ENERGY  
(UNITED STATES FEDERAL AGENCY)  
GC-62, MS 6F-067  
1000 INDEPENDENCE AVENUE, SW  
WASHINGTON, DC 20585

FOR: ARRANGING AND CONDUCTING ADVANCED VEHICLE TECHNOLOGY COMPETITIONS FOR UNIVERSITY AND COLLEGE ENGINEERING STUDENTS AIMED AT DEMONSTRATING TECHNOLOGIES THAT ADDRESS THE CRITICAL NEED FOR SUSTAINABLE PERSONAL TRANSPORTATION, IN CLASS 41 (U.S. CLS. 100, 101 AND 107).

FIRST USE 12-0-2007; IN COMMERCE 12-0-2007.

THE MARK CONSISTS OF STANDARD CHARACTERS WITHOUT CLAIM TO ANY PARTICULAR FONT, STYLE, SIZE, OR COLOR.

NO CLAIM IS MADE TO THE EXCLUSIVE RIGHT TO USE "CHALLENGE", APART FROM THE MARK AS SHOWN.

SER. NO. 77-363,122, FILED 1-3-2008.

HEATHER BIDDULPH, EXAMINING ATTORNEY

**Int. Cl.: 24**

**Prior U.S. Cls.: 42 and 50**

**United States Patent and Trademark Office**

**Reg. No. 3,498,375**

**Registered Sep. 9, 2008**

**TRADEMARK  
PRINCIPAL REGISTER**

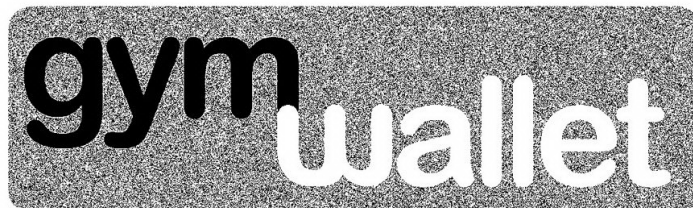

**"Never lose valuables in the gym again"**

BENNETT, REBEKAH (UNITED STATES INDIVIDUAL)

#136-470

18352 DALLAS PKWY.

DALLAS, TX 75287

FOR: TOWELS MADE OF TEXTILE HAVING A HOOK AND LOOP FASTENER POCKET SECURELY SEWN ON TO HOLD VALUABLES, IN CLASS 24 (U.S. CLS. 42 AND 50).

FIRST USE 2-11-2005; IN COMMERCE 2-11-2005.

NO CLAIM IS MADE TO THE EXCLUSIVE RIGHT TO USE "GYM WALLET", APART FROM THE MARK AS SHOWN.

THE MARK CONSISTS OF A RECTANGLE WITH THE STYLIZED WORDS "GYM WALLET". BELOW THE RECTANGLE ARE THE STYLIZED WORDS "NEVER LOSE VALUABLES IN THE GYM AGAIN".

SER. NO. 77-363,222, FILED 1-3-2008.

JAY BESCH, EXAMINING ATTORNEY

**Int. Cl.: 16**

**Prior U.S. Cls.: 2, 5, 22, 23, 29, 37, 38 and 50**

**United States Patent and Trademark Office**

**Reg. No. 3,498,376**

**Registered Sep. 9, 2008**

**TRADEMARK  
PRINCIPAL REGISTER**

**Where People Go for Pet  
Info**

PAPP, ELIZABETH (UNITED STATES INDIVIDUAL)  
PO BOX 4035  
CAMP CONNELL, CA 95223

THE MARK CONSISTS OF STANDARD CHARACTERS WITHOUT CLAIM TO ANY PARTICULAR FONT, STYLE, SIZE, OR COLOR.

FOR: DIRECTORIES OF PET INFORMATION AND RESOURCES, IN CLASS 16 (U.S. CLS. 2, 5, 22, 23, 29, 37, 38 AND 50).

SER. NO. 77-363,372, FILED S.R. 1-3-2008 AM. P.R. 5-17-2008.

FIRST USE 10-1-2007; IN COMMERCE 10-1-2007.

MICHAEL SOUDERS, EXAMINING ATTORNEY

**Int. Cl.: 16**

**Prior U.S. Cls.: 2, 5, 22, 23, 29, 37, 38 and 50**

**United States Patent and Trademark Office**

**Reg. No. 3,498,377**

**Registered Sep. 9, 2008**

**TRADEMARK  
PRINCIPAL REGISTER**

[www.BarleysList.org](http://www.BarleysList.org)

PAPP, ELIZABETH (UNITED STATES INDIVIDUAL)  
PO BOX 4035  
CAMP CONNELL, CA 95223

THE MARK CONSISTS OF STANDARD CHARACTERS WITHOUT CLAIM TO ANY PARTICULAR FONT, STYLE, SIZE, OR COLOR.

FOR: DIRECTORIES OF PET INFORMATION AND RESOURCES, IN CLASS 16 (U.S. CLS. 2, 5, 22, 23, 29, 37, 38 AND 50).

SER. NO. 77-363,406, FILED S.R. 1-3-2008 AM. P.R. 5-17-2008.

FIRST USE 10-1-2007; IN COMMERCE 10-1-2007.

MICHAEL SOUDERS, EXAMINING ATTORNEY



**Int. Cl.: 42**

**Prior U.S. Cls.: 100 and 101**

**United States Patent and Trademark Office**

**Reg. No. 3,498,378**

**Registered Sep. 9, 2008**

**SERVICE MARK  
PRINCIPAL REGISTER**

# Lunarline

LUNARLINE, INC. (MARYLAND CORPORATION)  
1875 I ST, NW  
SUITE 500  
WASHINGTON, DC 20006

THE MARK CONSISTS OF STANDARD CHARACTERS WITHOUT CLAIM TO ANY PARTICULAR FONT, STYLE, SIZE, OR COLOR.

FOR: COMPUTER CONSULTATION IN THE FIELD OF COMPUTER SECURITY, IN CLASS 42 (U.S. CLS. 100 AND 101).

SER. NO. 77-363,778, FILED 1-3-2008.

FIRST USE 3-3-2004; IN COMMERCE 3-3-2004.

WILLIAM VERHOSEK, EXAMINING ATTORNEY

**Int. Cl.: 42**

**Prior U.S. Cls.: 100 and 101**

**United States Patent and Trademark Office**

**Reg. No. 3,498,379**

**Registered Sep. 9, 2008**

**SERVICE MARK  
PRINCIPAL REGISTER**

**Solutions Built on Security**

LUNARLINE, INC. (MARYLAND CORPORATION)  
1875 I ST, NW  
SUITE 500  
WASHINGTON, DC 20006

FOR: COMPUTER CONSULTATION IN THE  
FIELD OF COMPUTER SECURITY, IN CLASS 42  
(U.S. CLS. 100 AND 101).

FIRST USE 3-20-2004; IN COMMERCE 3-20-2004.

THE MARK CONSISTS OF STANDARD CHARACTERS WITHOUT CLAIM TO ANY PARTICULAR FONT, STYLE, SIZE, OR COLOR.

NO CLAIM IS MADE TO THE EXCLUSIVE RIGHT TO USE "SOLUTIONS" AND "SECURITY", APART FROM THE MARK AS SHOWN.

SER. NO. 77-363,793, FILED 1-3-2008.

WILLIAM VERHOSEK, EXAMINING ATTORNEY

**Int. Cl.: 41**

**Prior U.S. Cls.: 100, 101 and 107**

**United States Patent and Trademark Office**

**Reg. No. 3,498,380**

**Registered Sep. 9, 2008**

**SERVICE MARK  
PRINCIPAL REGISTER**

# Boot Camp Training

HAMM, CINDY (UNITED STATES INDIVIDUAL)  
11072 MARTIN DR.  
FORNEY, TX 75126

FOR: ARRANGING PROFESSIONAL WORKSHOP AND TRAINING COURSES; BUSINESS TRAINING; PROVIDING ON-LINE TRAINING COURSES FOR CONSTRUCTION PROFESSIONALS IN THE FIELD OF CONSTRUCTION; TEACHING AND TRAINING IN BUSINESS, INDUSTRY AND INFORMATION TECHNOLOGY, IN CLASS 41 (U.S. CLS. 100, 101 AND 107).

FIRST USE 1-1-2003; IN COMMERCE 1-1-2003.

THE MARK CONSISTS OF STANDARD CHARACTERS WITHOUT CLAIM TO ANY PARTICULAR FONT, STYLE, SIZE, OR COLOR.

NO CLAIM IS MADE TO THE EXCLUSIVE RIGHT TO USE "TRAINING", APART FROM THE MARK AS SHOWN.

SER. NO. 77-364,061, FILED 1-4-2008.

BENJAMIN OKEKE, EXAMINING ATTORNEY

Int. Cl.: 41

Prior U.S. Cls.: 100, 101 and 107

Reg. No. 3,498,381

United States Patent and Trademark Office

Registered Sep. 9, 2008

SERVICE MARK  
PRINCIPAL REGISTER



NIAGARA UNIVERSITY (NEW YORK NON-  
PROFIT CORPORATION)  
P.O. BOX 2036  
NIAGARA UNIVERSITY, NY 14109

FOR: EDUCATION SERVICES IN THE NATURE  
OF COURSES AT THE UNIVERSITY LEVEL; PRO-  
VIDING A WEB SITE FEATURING INFORMATION  
REGARDING UNIVERSITY ADMINISTRATIVE  
SERVICES AND UNIVERSITY ALUMNI ACTIV-  
ITIES AND ORGANIZATIONS, IN CLASS 41 (U.S.  
CLS. 100, 101 AND 107).

FIRST USE 0-0-2006; IN COMMERCE 0-0-2006.

NO CLAIM IS MADE TO THE EXCLUSIVE  
RIGHT TO USE "1856", APART FROM THE MARK  
AS SHOWN.

THE MARK CONSISTS OF THE WORDS "NIA-  
GARA UNIVERSITY" AND, TO THE RIGHT OF  
"NIAGARA" AND ABOVE "UNIVERSITY" A  
SHIELD DESIGN WITH AN EAGLE ON TOP AND  
THE WORDS "UT OMNES TE 1856 COGNOSCAN'T"  
WRITTEN IN THE LOWER PORTION OF THE  
DESIGN.

THE FOREIGN WORDING IN THE MARK  
TRANSLATES INTO ENGLISH AS THAT ALL  
MAY KNOW YOU.

SEC. 2(F) AS TO "NIAGARA UNIVERSITY".

SER. NO. 77-364,098, FILED 1-4-2008.

ANNE E. GUSTASON, EXAMINING ATTORNEY

**Int. Cl.: 5**

**Prior U.S. Cls.: 6, 18, 44, 46, 51 and 52**

**United States Patent and Trademark Office**

**Reg. No. 3,498,382**

**Registered Sep. 9, 2008**

**TRADEMARK  
PRINCIPAL REGISTER**



ALFA VITAMINS LABORATORIES, INC. (FLORIDA CORPORATION)  
1472 NW 78TH AVE.  
DORAL, FL 33126

FOR: MENSTRUAL SYMPTOM TREATMENT PREPARATIONS; ORAL ANALGESICS, IN CLASS 5 (U.S. CLS. 6, 18, 44, 46, 51 AND 52).

FIRST USE 2-2-2006; IN COMMERCE 2-2-2006.

NO CLAIM IS MADE TO THE EXCLUSIVE RIGHT TO USE "MENSTRUAL", APART FROM THE MARK AS SHOWN.

THE COLOR(S) PINK AND WHITE IS/ARE CLAIMED AS A FEATURE OF THE MARK.

THE MARK CONSISTS OF THE WORD "MENSTRUAL" IN SOLID PINK LETTERS, WITH THE "M" CAPITALIZED, FOLLOWED BY A CAPITAL "W" OUTLINED IN PINK WITH A WHITE INTERIOR. THE "W" IS APPROXIMATELY 4/3 THE SIZE OF THE "M".

SER. NO. 77-364,175, FILED 1-4-2008.

LINDA ESTRADA, EXAMINING ATTORNEY

**Int. Cl.: 25**

**Prior U.S. Cls.: 22 and 39**

**United States Patent and Trademark Office**

**Reg. No. 3,498,383**

**Registered Sep. 9, 2008**

**TRADEMARK  
PRINCIPAL REGISTER**

**CRE8TIV R'MOR**

O'ROURKE, MICHAEL (UNITED STATES INDIVIDUAL)  
1135 N. TOPANGA CANYON BLVD.  
TOPANGA, CA 90290

FOR: CLOTHING FOR MEN, WOMEN AND CHILDREN, NAMELY, DRESSES, SHIRTS, PANTS, JEANS, JACKETS, COATS, VESTS, SWEATERS, KNIT TOPS, SKIRTS, BLOUSES, SOCKS, STOCKINGS, T-SHIRTS, SWEAT SHIRTS, LINGERIE, SHORTS, BATHING SUITS, BEACH AND SWIMMING COVER-UPS, PONCHOS, TANK TOPS, WARM-UP SUITS, JOGGING SUITS AND SWEAT

SUITS, BLAZERS, WALKING SHORTS, HATS AND CAPS, IN CLASS 25 (U.S. CLS. 22 AND 39).

FIRST USE 2-1-2005; IN COMMERCE 2-1-2005.

THE MARK CONSISTS OF STANDARD CHARACTERS WITHOUT CLAIM TO ANY PARTICULAR FONT, STYLE, SIZE, OR COLOR.

SER. NO. 77-364,262, FILED 1-4-2008.

ALEX KEAM, EXAMINING ATTORNEY

**Int. Cls.: 41 and 44**

**Prior U.S. Cls.: 100, 101 and 107**

**United States Patent and Trademark Office**

**Reg. No. 3,498,384**

**Registered Sep. 9, 2008**

**SERVICE MARK  
PRINCIPAL REGISTER**

**NATURAL NAIL TRANSPLANT**

JESSICA COSMETICS INTERNATIONAL, INC.  
(CALIFORNIA CORPORATION)  
12747 SATICOY STREET  
NORTH HOLLYWOOD, CA 91605

FOR: INSTRUCTION IN THE FIELD OF FINGER  
AND TOENAIL REPAIR, IN CLASS 41 (U.S. CLS. 100,  
101 AND 107).

FIRST USE 10-0-1986; IN COMMERCE 10-0-1986.

FOR: MANICURE SERVICES; DAY SPA SERVI-  
CES, NAMELY, NAIL CARE, MANICURES, PEDI-  
CURES AND NAIL ENHANCEMENTS, IN CLASS 44  
(U.S. CLS. 100 AND 101).

FIRST USE 10-0-1986; IN COMMERCE 10-0-1986.

THE MARK CONSISTS OF STANDARD CHAR-  
ACTERS WITHOUT CLAIM TO ANY PARTICULAR  
FONT, STYLE, SIZE, OR COLOR.

NO CLAIM IS MADE TO THE EXCLUSIVE  
RIGHT TO USE "NAIL", APART FROM THE MARK  
AS SHOWN.

SEC. 2(F).

SER. NO. 77-364,302, FILED 1-4-2008.

JESSICA A. POWERS, EXAMINING ATTORNEY

**Int. Cl.: 35**

**Prior U.S. Cls.: 100, 101 and 102**

**United States Patent and Trademark Office**

**Reg. No. 3,498,385**

**Registered Sep. 9, 2008**

**SERVICE MARK  
PRINCIPAL REGISTER**



DEUTSCHE TELEKOM (FED REP GERMANY  
AG CORPORATION)  
FRIEDRICH-EBERT-ALLEE 140  
BONN, FED REP GERMANY 53113

FOR: ADVERTISING SERVICES, NAMELY, PREPARING AND PLACING ADVERTISEMENTS FOR OTHERS, PROMOTING THE GOODS AND SERVICES OF OTHERS THROUGH PRINTED ADVERTISING, PRINTED DIRECTORIES, ENCODED MEDIA, DISSEMINATION OF PROMOTIONAL MATERIALS, DIRECT MAIL ADVERTISING, ELECTRONIC BILLBOARD ADVERTISING AND PREPARING AUDIO-VISUAL PRESENTATIONS FOR USE IN ADVERTISING; BUSINESS INFORMATION SERVICES IN THE FIELD OF TELECOMMUNICATIONS, ADVERTISING, INFORMATION TECHNOLOGY, IN CLASS 35 (U.S. CLS. 100, 101 AND 102).

PRIORITY CLAIMED UNDER SEC. 44(D) ON FED REP GERMANY APPLICATION NO. 30743564.4, FILED 7-4-2007, REG. NO. 30743564.4, DATED 12-19-2007, EXPIRES 12-19-2017.

OWNER OF U.S. REG. NOS. 3,153,493, 3,264,353 AND OTHERS.

THE COLOR(S) MAGENTA IS/ARE CLAIMED AS A FEATURE OF THE MARK.

THE MARK CONSISTS OF THE COLOR MAGENTA APPEARING IN THE LETTER "T" AND IN THE SQUARE DESIGNS.

SER. NO. 77-364,660, FILED 1-4-2008.

CAROLINE WOOD, EXAMINING ATTORNEY



**Int. Cl.: 45**

**Prior U.S. Cls.: 100 and 101**

**United States Patent and Trademark Office**

**Reg. No. 3,498,386**

**Registered Sep. 9, 2008**

**SERVICE MARK  
PRINCIPAL REGISTER**

**Securing Communities from  
the Inside and Out.**

ARGYLE SECURITY USA (TEXAS CORPORATION)  
12903 DELIVERY  
SAN ANTONIO, TX 78247

THE MARK CONSISTS OF STANDARD CHARACTERS WITHOUT CLAIM TO ANY PARTICULAR FONT, STYLE, SIZE, OR COLOR.

FOR: SECURITY SERVICES, NAMELY, PROVIDING EXECUTIVE PROTECTION, IN CLASS 45 (U.S. CLS. 100 AND 101).

SER. NO. 77-365,268, FILED 1-7-2008.

FIRST USE 1-3-2008; IN COMMERCE 1-3-2008.

TARA PATE, EXAMINING ATTORNEY

**Int. Cl.: 1**

**Prior U.S. Cls.: 1, 5, 6, 10, 26 and 46**

**Reg. No. 3,498,387**

**United States Patent and Trademark Office**

**Registered Sep. 9, 2008**

**TRADEMARK  
PRINCIPAL REGISTER**

**CHLOROPURE**

BECKMAN COULTER, INC. (DELAWARE CORPORATION)  
4300 N. HARBOR BOULEVARD  
FULLERTON, CA 92834

FOR: NUCLEIC ACID ISOLATION AND PURIFICATION KIT CONSISTING PRIMARILY OF CHEMICAL REAGENTS AND MAGNETIC BEADS FOR THE PURIFICATION AND ISOLATION OF DNA AND RNA FROM PLANT MATERIAL FOR SCIENTIFIC AND MEDICAL RESEARCH PURPOSES, IN CLASS 1 (U.S. CLS. 1, 5, 6, 10, 26 AND 46).

FIRST USE 12-0-2006; IN COMMERCE 12-0-2006.

THE MARK CONSISTS OF STANDARD CHARACTERS WITHOUT CLAIM TO ANY PARTICULAR FONT, STYLE, SIZE, OR COLOR.

SER. NO. 77-365,840, FILED 1-7-2008.

TRACY WHITTAKER-BROWN, EXAMINING ATTORNEY

**Int. Cl.: 5**

**Prior U.S. Cls.: 6, 18, 44, 46, 51 and 52**

**Reg. No. 3,498,388**

**United States Patent and Trademark Office**

**Registered Sep. 9, 2008**

**TRADEMARK  
PRINCIPAL REGISTER**

**MUSHROOM MATRIX**

GOLDEN GOURMET MUSHROOMS, INC. (NE-  
VADA CORPORATION)  
2033 MARILYN LANE  
SAN MARCOS, CA 92069

FOR: DIETARY AND NUTRITIONAL SUPPLE-  
MENTS FOR HUMAN CONSUMPTION; DIETARY  
AND NUTRITIONAL SUPPLEMENTS FOR ANI-  
MALS, IN CLASS 5 (U.S. CLS. 6, 18, 44, 46, 51 AND 52).

FIRST USE 4-1-2006; IN COMMERCE 4-1-2006.

THE MARK CONSISTS OF STANDARD CHAR-  
ACTERS WITHOUT CLAIM TO ANY PARTICULAR  
FONT, STYLE, SIZE, OR COLOR.

NO CLAIM IS MADE TO THE EXCLUSIVE  
RIGHT TO USE "MUSHROOM", APART FROM  
THE MARK AS SHOWN.

SER. NO. 77-366,001, FILED 1-7-2008.

SETH A. RAPPAPORT, EXAMINING ATTORNEY

Int. Cl.: 45

Prior U.S. Cls.: 100 and 101

United States Patent and Trademark Office

Reg. No. 3,498,389

Registered Sep. 9, 2008

SERVICE MARK  
PRINCIPAL REGISTER



DANIEL, ONICKA J. (UNITED STATES INDIVIDUAL)

433 S. WITCHDUCK RD  
433 S. WITCHDUCK RD  
VIRGINIA BEACH, VA 23462

FOR: ERRAND AND CONCIERGE SERVICE, NAMELY, RUNNING ERRANDS FOR OTHERS, PERSONAL SHOPPING FOR OTHERS, PERSONAL GIFT SHOPPING FOR OTHERS, SOCIAL SERVICES, NAMELY, COMPANIONSHIP SERVICES FOR ELDERLY, PERSONAL CHEF SERVICES, ALL OF THE AFOREMENTIONED SERVICES PERFORMED IN BUSINESS ESTABLISHMENTS OFFICE BUILDINGS AND RESIDENTIAL COMPLEXES, IN CLASS 45 (U.S. CLS. 100 AND 101).

FIRST USE 5-17-2007; IN COMMERCE 5-17-2007.

NO CLAIM IS MADE TO THE EXCLUSIVE RIGHT TO USE "LIFESTYLE MANAGEMENT" AND "CONCIERGE SERVICE", APART FROM THE MARK AS SHOWN.

THE MARK CONSISTS OF THE WORDS "LIFESTYLE MANAGEMENT LIFE OUTSOURCING & CONCIERGE SERVICE" OVERTOP A DESIGN OF A SUNDIAL.

SER. NO. 77-366,014, FILED 1-7-2008.

MICHAEL LITZAU, EXAMINING ATTORNEY

Int. Cl.: 44

Prior U.S. Cls.: 100 and 101

United States Patent and Trademark Office

Reg. No. 3,498,390

Registered Sep. 9, 2008

SERVICE MARK  
PRINCIPAL REGISTER



BALKE WORKS, LLC (TEXAS LIMITED LIABILITY COMPANY), DBA EARTHWORKS  
11465 MAJESTIC DR.  
MONTGOMERY, TX 77316

FOR: LAWN CARE, IN CLASS 44 (U.S. CLS. 100 AND 101).

FIRST USE 1-1-2006; IN COMMERCE 1-1-2006.

THE COLOR(S) BLUE, YELLOW, BLACK, GREEN, RED, BROWN, AND GRAY IS/ARE CLAIMED AS A FEATURE OF THE MARK.

THE MARK CONSISTS OF A DISSECTED PIECE OF GRASS SHOWING THE SIDE VIEW OF GRASS WITH THE SOIL UNDERNEATH. THE WORDS "EARTH WORKS" ARE PLANTED JUST BENEATH

THE GRASS AND COME UP OUT OF THE GROUND ABOVE THE GRASS. THE GRASS IS GREEN AND THE DIRT IS BROWN, AND THE WORDS "EARTH WORKS" ARE BROWN, GRAY, GREEN AND BLUE. THERE IS A RED FLOWER GROWING AT THE BOTTOM OF THE "E". THERE IS A SPRINKLER LINE IN THE DIRT UNDERNEATH THE WORD "WORKS". A SPRINKLER HEAD COMES UP BETWEEN THE WORDS "EARTH" AND "WORKS". THE SPRINKLER LINE AND HEAD ARE GRAY. THE SPRINKLER HEAD HAS BLUE WATER COMING FROM IT AND A BLACK AND YELLOW BUMBLE BEE IS FLYING ABOVE THE WATER.

SER. NO. 77-366,183, FILED 1-8-2008.

SAIMA MAKHDOOM, EXAMINING ATTORNEY

**Int. Cl.: 7**

**Prior U.S. Cls.: 13, 19, 21, 23, 31, 34 and 35**

**Reg. No. 3,498,391**

**United States Patent and Trademark Office**

**Registered Sep. 9, 2008**

**TRADEMARK  
PRINCIPAL REGISTER**

**LIMBHOG**

C & C ADVENTURES, INC. (OKLAHOMA CORPORATION)  
ROUTE 1 BOX 138  
STRATFORD, OK 74872

FIRST USE 8-20-2007; IN COMMERCE 8-20-2007.

FOR: TRACTOR AND FRONT LOADER MOUNTED, HYDRAULICALLY OPERATED, TREE CUTTING AND TRIMMING SAWS, EQUIPMENT, AND ACCESSORIES, NAMELY, HYDRAULIC SAWS, SAW MASTS, MAST RECEIVERS, SAW MOTOR GUARDS, AND SAW CHAINS AND CHAIN GUARDS, IN CLASS 7 (U.S. CLS. 13, 19, 21, 23, 31, 34 AND 35).

THE MARK CONSISTS OF STANDARD CHARACTERS WITHOUT CLAIM TO ANY PARTICULAR FONT, STYLE, SIZE, OR COLOR.

SER. NO. 77-366,318, FILED 1-8-2008.

SANI KHOURI, EXAMINING ATTORNEY

**Int. Cl.: 41**

**Prior U.S. Cls.: 100, 101 and 107**

**United States Patent and Trademark Office**

**Reg. No. 3,498,392**

**Registered Sep. 9, 2008**

**SERVICE MARK  
PRINCIPAL REGISTER**

**THE ROAD TO SAVING**

ING DIRECT BANCORP (DELAWARE COR-  
PORATION)  
802 DELAWARE AVENUE  
WILMINGTON, DE 19805

FOR: EDUCATION AND ENTERTAINMENT  
SERVICES, NAMELY, CONDUCTING A LIVE, IN-  
TERACTIVE BOARD GAME EVENT, IN CLASS 41  
(U.S. CLS. 100, 101 AND 107).

FIRST USE 12-7-2007; IN COMMERCE 12-7-2007.

THE MARK CONSISTS OF STANDARD CHAR-  
ACTERS WITHOUT CLAIM TO ANY PARTICULAR  
FONT, STYLE, SIZE, OR COLOR.

SER. NO. 77-366,669, FILED 1-8-2008.

MARK PILARO, EXAMINING ATTORNEY

**Int. Cls.: 9 and 42**

**Prior U.S. Cls.: 21, 23, 26, 36, 38, 100 and 101**

**United States Patent and Trademark Office**

**Reg. No. 3,498,393**

**Registered Sep. 9, 2008**

**TRADEMARK  
SERVICE MARK  
PRINCIPAL REGISTER**

**EMS**

SYMPHONY SERVICE CORP. (NEVADA CORPORATION)  
2ND FLOOR  
4015 MIRANDA AVENUE  
PALO ALTO, CA 94304

FOR: COMPUTER SOFTWARE FOR TELECOM EXPENSE AND ADMINISTRATION MANAGEMENT, IN CLASS 9 (U.S. CLS. 21, 23, 26, 36 AND 38).

FIRST USE 3-12-2007; IN COMMERCE 3-12-2007.

FOR: PROVIDING TEMPORARY USE OF ON-LINE NON-DOWNLOADABLE SOFTWARE FOR

TELECOM EXPENSE AND ADMINISTRATION MANAGEMENT, IN CLASS 42 (U.S. CLS. 100 AND 101).

FIRST USE 3-12-2007; IN COMMERCE 3-12-2007.

THE MARK CONSISTS OF STANDARD CHARACTERS WITHOUT CLAIM TO ANY PARTICULAR FONT, STYLE, SIZE, OR COLOR.

SER. NO. 77-366,808, FILED 1-8-2008.

MELVIN AXILBUND, EXAMINING ATTORNEY



**Int. Cls.: 9, 16, 35, 36 and 41**

**Prior U.S. Cls.: 2, 5, 21, 22, 23, 26, 29, 36, 37, 38, 50,  
100, 101, 102 and 107**

**Reg. No. 3,498,394**

**United States Patent and Trademark Office**

**Registered Sep. 9, 2008**

**TRADEMARK  
SERVICE MARK  
PRINCIPAL REGISTER**



GENERAL CONFERENCE CORPORATION OF  
SEVENTH-DAY ADVENTISTS (D.C. COR-  
PORATION)

OFFICE OF GENERAL COUNSEL  
12501 OLD COLUMBIA PIKE  
SILVER SPRING, MD 20904

FOR: COMPUTER SOFTWARE FOR AN AC-  
COUNTING PROGRAM; ELECTRONIC PUBLICA-  
TIONS, NAMELY, MANUALS FEATURING  
ACCOUNTING SOFTWARE RECORDED ON COM-  
PUTER MEDIA; COMPUTER SOFTWARE FOR AC-  
COUNTING THAT MAY BE DOWNLOADED FROM  
A GLOBAL COMPUTER NETWORK, IN CLASS 9  
(U.S. CLS. 21, 23, 26, 36 AND 38).

FIRST USE 2-26-2003; IN COMMERCE 2-26-2003.

FOR: PRINTED VISUALS IN THE NATURE OF  
PROMOTIONAL MATERIALS, PAPER BANNERS,  
EDUCATIONAL PUBLICATIONS, NAMELY,  
TRAINING MANUALS IN THE FIELD OF AC-  
COUNTING SOFTWARE, IN CLASS 16 (U.S. CLS. 2,  
5, 22, 23, 29, 37, 38 AND 50).

FIRST USE 2-26-2003; IN COMMERCE 2-26-2003.

FOR: CUSTOMER SERVICE IN THE FIELD OF  
ACCOUNTING; ACCOUNTING SERVICES; PRO-  
VIDING ONLINE COMPUTER WEBSITE THAT  
PROVIDES BUSINESS UNIT SETUP DATA AND  
MANAGEMENT, FINANCIAL REPORTING, AC-  
COUNTS PAYABLE, ACCOUNT MANAGEMENT,  
ACCOUNTING FEATURES AND RELATED RE-  
FERENCE INFORMATION ALL FOR CHURCH

ORGANIZATIONS, IN CLASS 35 (U.S. CLS. 100, 101  
AND 102).

FIRST USE 2-26-2003; IN COMMERCE 2-26-2003.

FOR: PROVIDING ONLINE A COMPUTER WEB-  
SITE THAT PROVIDES FINANCIAL TRANSA-  
CTION AND RELATED FINANCIAL DATA ABOUT  
CHURCH ASSETS, FUNDS, INVESTMENTS,  
TITHES AND DONORS, IN CLASS 36 (U.S. CLS.  
100, 101 AND 102).

FIRST USE 2-26-2003; IN COMMERCE 2-26-2003.

FOR: PROVIDING ONLINE INTERACTIVE COM-  
PUTER BASED TRAINING SESSIONS IN THE  
FIELD OF ACCOUNTING SOFTWARE, IN CLASS  
41 (U.S. CLS. 100, 101 AND 107).

FIRST USE 2-26-2003; IN COMMERCE 2-26-2003.

THE COLOR(S) WHITE, BLUE AND GOLD IS/  
ARE CLAIMED AS A FEATURE OF THE MARK.

THE MARK CONSISTS OF FOUR GOLD AND  
WHITE COLORED FLAMES ARRANGED IN A  
PINWHEEL FORMATION; THE WORD "SUN" IS  
DARK BLUE AND THE WORD "PLUS" IS LIGHT  
BLUE; THE BACKGROUND IS WHITE.

SER. NO. 77-366,809, FILED 1-8-2008.

G. MAYERSCHOFF, EXAMINING ATTORNEY

**Int. Cl.: 9**

**Prior U.S. Cls.: 21, 23, 26, 36 and 38**

**Reg. No. 3,498,395**

**United States Patent and Trademark Office**

**Registered Sep. 9, 2008**

---

**TRADEMARK  
PRINCIPAL REGISTER**

**VBOX3**

MAINTENANCE TECHNOLOGY SYSTEMS  
(UTAH LIMITED LIABILITY COMPANY)  
1466 NORTH 2050 EAST  
NORTH LOGAN, UT 84321

THE MARK CONSISTS OF STANDARD CHAR-  
ACTERS WITHOUT CLAIM TO ANY PARTICULAR  
FONT, STYLE, SIZE, OR COLOR.

FOR: VIBRATION METERS, IN CLASS 9 (U.S.  
CLS. 21, 23, 26, 36 AND 38).

SER. NO. 77-367,075, FILED 1-8-2008.

FIRST USE 9-16-2006; IN COMMERCE 9-16-2006.

H. M. FISHER, EXAMINING ATTORNEY

**Int. Cl.: 30**

**Prior U.S. Cl.: 46**

**United States Patent and Trademark Office**

**Reg. No. 3,498,396**

**Registered Sep. 9, 2008**

**TRADEMARK  
PRINCIPAL REGISTER**

**ENCOURAGEMENTS**

TESTAMINTS HOLDING, LLC (NEW JERSEY  
LIMITED LIABILITY COMPANY)  
41 LAKESIDE BOULEVARD  
HOPATCONG, NJ 07843

OWNER OF CANADA REG. NO. TMA586557,  
DATED 8-5-2003, EXPIRES 8-5-2018.

FOR: CANDY AND CANDY MINTS, IN CLASS 30  
(U.S. CL. 46).

SER. NO. 77-367,081, FILED 1-8-2008.

THE MARK CONSISTS OF STANDARD CHAR-  
ACTERS WITHOUT CLAIM TO ANY PARTICULAR  
FONT, STYLE, SIZE, OR COLOR.

SUNG IN, EXAMINING ATTORNEY

**Int. Cl.: 25**

**Prior U.S. Cls.: 22 and 39**

**United States Patent and Trademark Office**

**Reg. No. 3,498,397**

**Registered Sep. 9, 2008**

**TRADEMARK  
PRINCIPAL REGISTER**

**41N74W**

LYNNE LARSON, INC. (DELAWARE CORPORATION)  
PO BOX 6650  
NEW YORK, NY 101506650 AND  
HILLSON LIMITED (HONG KONG CORPORATION)  
41 HUNG TO ROAD  
4/F WAH HUNG CENTRE  
KWUN TONG, KOWLOON, HONG KONG

FOR: CLOTHING, NAMELY, TOPS, PANTS, SHORTS, JEANS, T-SHIRTS, DRESSES, SKIRTS, SUITS, VESTS, SHIRTS, POLO SHIRTS, BLOUSES, SWEATERS, CARDIGANS, PULLOVERS, JACKETS, OVERCOATS, RAINCOATS, SWIMWEAR, UNDERWEAR, SLEEPWEAR, ROBES, GLOVES, SHAWLS,

SCARVES, SOCKS, STOCKINGS, FOOTWEAR AND BELTS; HEADGEAR, NAMELY, HATS, BANDANAS AND CAPS; FOOTWEAR, NAMELY, BOOTS, SANDALS, SNEAKERS, SHOES, ATHLETIC SHOES, AND HEELS, IN CLASS 25 (U.S. CLS. 22 AND 39).

FIRST USE 12-27-2007; IN COMMERCE 12-27-2007.

THE MARK CONSISTS OF STANDARD CHARACTERS WITHOUT CLAIM TO ANY PARTICULAR FONT, STYLE, SIZE, OR COLOR.

SER. NO. 77-367,369, FILED 1-9-2008.

KELLY MCCOY, EXAMINING ATTORNEY

Int. Cl.: 35

Prior U.S. Cls.: 100, 101 and 102

United States Patent and Trademark Office

Reg. No. 3,498,398

Registered Sep. 9, 2008

SERVICE MARK  
PRINCIPAL REGISTER



CELESTIAN WATER LLC (MICHIGAN LIMITED  
LIABILITY COMPANY)  
13257 U.S. 223  
MANITOU BEACH, MI 49253

FOR: RETAIL SERVICES BY DIRECT SOLICITA-  
TION BY SALES AGENTS IN THE FIELD OF SALT  
FREE WATER CONDITIONING SYSTEMS, IN  
CLASS 35 (U.S. CLS. 100, 101 AND 102).

FIRST USE 6-1-2007; IN COMMERCE 6-1-2007.

NO CLAIM IS MADE TO THE EXCLUSIVE  
RIGHT TO USE "WATER" AND "SALT FREE WA-

TER SYSTEM", APART FROM THE MARK AS  
SHOWN.

THE MARK CONSISTS OF THE STYLIZED  
WORDS "CELESTIAN WATER A SPLASH OF HEA-  
VEN SALT FREE WATER SYSTEMS". ON TOP OF  
THE LETTER "N" IS A DESIGN OF A STAR.

SER. NO. 77-367,706, FILED 1-9-2008.

LIEF MARTIN, EXAMINING ATTORNEY

**Int. Cls.: 39 and 41**

**Prior U.S. Cls.: 100, 101, 105 and 107**

**United States Patent and Trademark Office**

**Reg. No. 3,498,399**

**Registered Sep. 9, 2008**

**SERVICE MARK  
PRINCIPAL REGISTER**



NATIONAL EVENTS, INC. (UTAH CORPORATION)  
SUITE 200  
9672 SOUTH 700 EAST  
SANDY, UT 84070

FOR: ARRANGING AND CONDUCTING TOURS FOR SCHOOL AND CIVIC MUSICAL GROUPS TO SPECIAL EVENTS, FESTIVALS AND CONCERTS, IN CLASS 39 (U.S. CLS. 100 AND 105).

FIRST USE 4-1-1987; IN COMMERCE 4-1-1987.

FOR: PRODUCING, ARRANGING AND CONDUCTING MUSICAL WORKSHOPS, FESTIVALS AND COMPETITIONS FOR SCHOOL AND CIVIC MUSICAL GROUPS, IN CLASS 41 (U.S. CLS. 100, 101 AND 107).

FIRST USE 4-1-1987; IN COMMERCE 4-1-1987.

NO CLAIM IS MADE TO THE EXCLUSIVE RIGHT TO USE "NATIONAL EVENTS", APART FROM THE MARK AS SHOWN.

THE COLOR(S) RED, WHITE, AND BLUE IS/ARE CLAIMED AS A FEATURE OF THE MARK.

THE MARK CONSISTS OF A MUSIC STAFF IN THE CENTER OF THE LETTER "N" IN "NE" WHICH APPEARS IN THE COLORS RED, WHITE, AND BLUE ALONG WITH THE WORDS "NATIONAL EVENTS" IN THE COLOR WHITE, ALL IN A BLUE BOX.

SER. NO. 77-367,777, FILED 1-9-2008.

ELISSA GARBER KON, EXAMINING ATTORNEY

Int. Cl.: 35

Prior U.S. Cls.: 100, 101 and 102

Reg. No. 3,498,400

United States Patent and Trademark Office

Registered Sep. 9, 2008

**SERVICE MARK  
PRINCIPAL REGISTER**



MIDWEST LABOR SERVICES, INC. (WISCONSIN CORPORATION)  
4102 VIETH AVENUE  
MADISON, WI 53704

FOR: EMPLOYMENT AGENCY SERVICES, IN CLASS 35 (U.S. CLS. 100, 101 AND 102).

FIRST USE 1-15-1999; IN COMMERCE 1-15-1999.

NO CLAIM IS MADE TO THE EXCLUSIVE RIGHT TO USE "LABOR", APART FROM THE MARK AS SHOWN.

THE MARK CONSISTS OF A STYLIZED HUMAN FIGURE SWINGING A HAMMER, POSITIONED WITHIN A TRIANGLE. THE LITERAL ELEMENT IS POSITIONED BELOW THE TRIANGLE.

SEC. 2(F) AS TO "MIDWEST LABOR".

SER. NO. 77-367,850, FILED 1-9-2008.

BARBARA RUTLAND, EXAMINING ATTORNEY

**Int. Cl.: 14**

**Prior U.S. Cls.: 2, 27, 28 and 50**

**United States Patent and Trademark Office**

**Reg. No. 3,498,401**

**Registered Sep. 9, 2008**

**TRADEMARK  
PRINCIPAL REGISTER**

**Denise Strength and  
Courage Jewelry**

VINCI, DENISE (UNITED STATES INDIVIDUAL)  
84 DOVECOTE LANE  
COMMACK, NY 11725

FOR: BRACELETS; ANKLE BRACELETS; JEWELRY; NECKLACES, IN CLASS 14 (U.S. CLS. 2, 27, 28 AND 50).

FIRST USE 10-0-2007; IN COMMERCE 10-0-2007.

THE MARK CONSISTS OF STANDARD CHARACTERS WITHOUT CLAIM TO ANY PARTICULAR FONT, STYLE, SIZE, OR COLOR.

NO CLAIM IS MADE TO THE EXCLUSIVE RIGHT TO USE "JEWELRY", APART FROM THE MARK AS SHOWN.

SER. NO. 77-368,061, FILED 1-9-2008.

KATHERINE CHANG, EXAMINING ATTORNEY



Int. Cl.: 35

Prior U.S. Cls.: 100, 101 and 102

United States Patent and Trademark Office

Reg. No. 3,498,402

Registered Sep. 9, 2008

SERVICE MARK  
PRINCIPAL REGISTER

FOTOS  
4ads

REPTHENET INTERNATIONAL, INC. (VIRGINIA CORPORATION)  
12005 RIDGE KNOLLE DR. #9  
FAIRFAX, VA 22033

NO CLAIM IS MADE TO THE EXCLUSIVE RIGHT TO USE "PHOTOS", APART FROM THE MARK AS SHOWN.

FOR: PLACEMENT OF ADVERTISEMENTS FOR OTHERS, IN CLASS 35 (U.S. CLS. 100, 101 AND 102).

SER. NO. 77-368,077, FILED 1-9-2008.

FIRST USE 11-14-2002; IN COMMERCE 11-14-2002.

KIMBERLY PERRY, EXAMINING ATTORNEY

**Int. Cl.: 43**

**Prior U.S. Cls.: 100 and 101**

**United States Patent and Trademark Office**

**Reg. No. 3,498,403**

**Registered Sep. 9, 2008**

**SERVICE MARK  
PRINCIPAL REGISTER**

**DENNY'S FRESH EXPRESS**

DFO, LLC (DELAWARE LIMITED LIABILITY  
COMPANY)  
203 EAST MAIN STREET  
SPARTANBURG, SC 29319

OWNER OF U.S. REG. NOS. 740,359, 1,903,868 AND  
OTHERS.

FOR: CARRY-OUT RESTAURANTS; RESTAU-  
RANT SERVICES, IN CLASS 43 (U.S. CLS. 100 AND  
101).

NO CLAIM IS MADE TO THE EXCLUSIVE  
RIGHT TO USE "FRESH EXPRESS", APART FROM  
THE MARK AS SHOWN.

FIRST USE 10-29-2007; IN COMMERCE 10-29-2007.

SER. NO. 77-368,328, FILED 1-10-2008.

THE MARK CONSISTS OF STANDARD CHAR-  
ACTERS WITHOUT CLAIM TO ANY PARTICULAR  
FONT, STYLE, SIZE, OR COLOR.

ELLEN PERKINS, EXAMINING ATTORNEY

**Int. Cl.: 35**

**Prior U.S. Cls.: 100, 101 and 102**

**United States Patent and Trademark Office**

**Reg. No. 3,498,404**

**Registered Sep. 9, 2008**

**SERVICE MARK  
PRINCIPAL REGISTER**

# DSC Frameworx

NET RESULTS, INC. (KENTUCKY CORPORATION)  
PO BOX 5208  
LOUISVILLE, KY 40255

FOR: ASSISTANCE, ADVISORY SERVICES AND CONSULTANCY WITH REGARD TO BUSINESS PLANNING, BUSINESS ANALYSIS, BUSINESS MANAGEMENT, AND BUSINESS ORGANIZATION; BUSINESS CONSULTATION , IN CLASS 35 (U.S. CLS. 100, 101 AND 102).

FIRST USE 1-7-2008; IN COMMERCE 1-8-2008.

THE MARK CONSISTS OF STANDARD CHARACTERS WITHOUT CLAIM TO ANY PARTICULAR FONT, STYLE, SIZE, OR COLOR.

SER. NO. 77-368,657, FILED 1-10-2008.

JAMES LOVELACE, EXAMINING ATTORNEY

**Int. Cl.: 35**

**Prior U.S. Cls.: 100, 101 and 102**

**United States Patent and Trademark Office**

**Reg. No. 3,498,405**

**Registered Sep. 9, 2008**

**SERVICE MARK  
PRINCIPAL REGISTER**

**DSC Analytix**

NET RESULTS, INC. (KENTUCKY CORPORATION)  
PO BOX 5208  
LOUISVILLE, KY 40255

FOR: ASSISTANCE, ADVISORY SERVICES AND CONSULTANCY WITH REGARD TO BUSINESS PLANNING, BUSINESS ANALYSIS, BUSINESS MANAGEMENT, AND BUSINESS ORGANIZATION; BUSINESS CONSULTATION , IN CLASS 35 (U.S. CLS. 100, 101 AND 102).

FIRST USE 1-7-2008; IN COMMERCE 1-8-2008.

THE MARK CONSISTS OF STANDARD CHARACTERS WITHOUT CLAIM TO ANY PARTICULAR FONT, STYLE, SIZE, OR COLOR.

NO CLAIM IS MADE TO THE EXCLUSIVE RIGHT TO USE "ANALYTICS", APART FROM THE MARK AS SHOWN.

SER. NO. 77-368,689, FILED 1-10-2008.

JAMES LOVELACE, EXAMINING ATTORNEY

**Int. Cl.: 44**

**Prior U.S. Cls.: 100 and 101**

**United States Patent and Trademark Office**

**Reg. No. 3,498,406**

**Registered Sep. 9, 2008**

**SERVICE MARK  
PRINCIPAL REGISTER**

**MARIA FARERI CHILDREN'S  
HOSPITAL**

CHILDREN'S HOSPITAL FOUNDATION AT  
WESTCHESTER MEDICAL CENTER, INC.  
(NEW YORK CORPORATION)  
BUILDING #9  
1 KID'S CORNER  
VALHALLA, NY 10595

FOR: HOSPITAL, HEALTHCARE AND MEDICAL  
SERVICES, IN CLASS 44 (U.S. CLS. 100 AND 101).

FIRST USE 9-0-2004; IN COMMERCE 9-0-2004.

THE MARK CONSISTS OF STANDARD CHAR-  
ACTERS WITHOUT CLAIM TO ANY PARTICULAR  
FONT, STYLE, SIZE, OR COLOR.

NO CLAIM IS MADE TO THE EXCLUSIVE  
RIGHT TO USE "CHILDREN'S HOSPITAL", APART  
FROM THE MARK AS SHOWN.

THE NAME(S), PORTRAIT(S), AND/OR SIGNA-  
TURE(S) SHOWN IN THE MARK DOES NOT IDEN-  
TIFY A PARTICULAR LIVING INDIVIDUAL.

SER. NO. 77-368,727, FILED 1-10-2008.

ADA HAN, EXAMINING ATTORNEY

**Int. Cl.: 35**

**Prior U.S. Cls.: 100, 101 and 102**

**United States Patent and Trademark Office**

**Reg. No. 3,498,407**

**Registered Sep. 9, 2008**

**SERVICE MARK  
PRINCIPAL REGISTER**

**DSC Optix**

NET RESULTS, INC. (KENTUCKY CORPORATION)  
PO BOX 5208  
LOUISVILLE, KY 40255

FOR: ASSISTANCE, ADVISORY SERVICES AND CONSULTANCY WITH REGARD TO BUSINESS PLANNING, BUSINESS ANALYSIS, BUSINESS MANAGEMENT, AND BUSINESS ORGANIZATION; BUSINESS CONSULTATION , IN CLASS 35 (U.S. CLS. 100, 101 AND 102).

FIRST USE 1-7-2008; IN COMMERCE 1-8-2008.

THE MARK CONSISTS OF STANDARD CHARACTERS WITHOUT CLAIM TO ANY PARTICULAR FONT, STYLE, SIZE, OR COLOR.

SER. NO. 77-368,751, FILED 1-10-2008.

JAMES LOVELACE, EXAMINING ATTORNEY

Int. Cl.: 40

Prior U.S. Cls.: 100, 103 and 106

United States Patent and Trademark Office

Reg. No. 3,498,408

Registered Sep. 9, 2008

SERVICE MARK  
PRINCIPAL REGISTER



GWIN'S STATIONERY & ENGRAVING CO., INC.  
(ALABAMA CORPORATION)  
957 SPRINGHILL AVENUE  
MOBILE, AL 36604

FOR: PRINTING SERVICES, NAMELY, OFFSET LITHOGRAPHIC, LETTERPRESS AND DIGITAL PRINTING SERVICES; BINDERY/FINISHING SERVICES FOR OTHERS, NAMELY, FOIL STAMPING, EMBOSSING, ENGRAVING, COLLATING, FOLDING, STAPLING, PERFORATING, CUTTING AND BINDING OF PRINTED, PHOTOCOPIED AND TYPEWRITTEN OR PRINTED MATERIALS; CONVERTING PAPER INTO MAILING ENVELOPES AND OTHER MAILERS; CUSTOMIZED PRINTING OF COMPANY NAMES, LOGOS, AND ART FOR COMMUNICATION, PROMOTIONAL AND AD-

VERTISING PURPOSES ON PAPER AND ON GOODS OF OTHERS, IN CLASS 40 (U.S. CLS. 100, 103 AND 106).

FIRST USE 11-1-2002; IN COMMERCE 11-1-2002.

THE COLOR(S) GREEN AND RED IS/ARE CLAIMED AS A FEATURE OF THE MARK.

THE MARK CONSISTS OF STYLIZED WORDING IN GREEN WITH A RED FROG.

SER. NO. 77-368,979, FILED 1-10-2008.

THEODORE MCBRIDE, EXAMINING ATTORNEY

Int. Cl.: 25

Prior U.S. Cls.: 22 and 39

**United States Patent and Trademark Office**

**Reg. No. 3,498,409**

Registered Sep. 9, 2008

**TRADEMARK  
PRINCIPAL REGISTER**



NELSON, MICHAEL R. (UNITED STATES INDIVIDUAL)  
4319 NORTHGATE DRIVE  
CARPENTERSVILLE, IL 60110

THE MARK CONSISTS OF A HUMAN FIGURE WITH THE WORDS "STEP CLOSER".

FOR: WRISTBANDS, IN CLASS 25 (U.S. CLS. 22 AND 39).

SER. NO. 77-369,491, FILED 1-11-2008.

FIRST USE 8-1-2007; IN COMMERCE 9-20-2007.

REBECCA GILBERT, EXAMINING ATTORNEY



**Int. Cl.: 28**

**Prior U.S. Cls.: 22, 23, 38 and 50**

**Reg. No. 3,498,410**

**United States Patent and Trademark Office**

**Registered Sep. 9, 2008**

**TRADEMARK  
PRINCIPAL REGISTER**

**BARKING DOG DESIGNS**

SCHROEDER, SUSAN M. (TEXAS SOLE PROPRIETORSHIP), DBA BARKING DOG GRAPHICS  
1441 BERING DR  
HOUSTON, TX 77057

FOR: STUFFED AND PLUSH TOYS; STUFFED DOLLS AND ANIMALS; STUFFED TOY ANIMALS; STUFFED TOY BEARS; STUFFED TOYS; TOY ANIMALS; TOY ANIMALS AND ACCESSORIES THEREFOR, IN CLASS 28 (U.S. CLS. 22, 23, 38 AND 50).

FIRST USE 10-0-2006; IN COMMERCE 6-6-2007.

THE MARK CONSISTS OF STANDARD CHARACTERS WITHOUT CLAIM TO ANY PARTICULAR FONT, STYLE, SIZE, OR COLOR.

NO CLAIM IS MADE TO THE EXCLUSIVE RIGHT TO USE "DOG DESIGNS", APART FROM THE MARK AS SHOWN.

SER. NO. 77-370,364, FILED 1-13-2008.

EMILY CARLSEN, EXAMINING ATTORNEY

**Int. Cl.: 9**

**Prior U.S. Cls.: 21, 23, 26, 36 and 38**

**United States Patent and Trademark Office**

**Reg. No. 3,498,411**

**Registered Sep. 9, 2008**

**TRADEMARK  
PRINCIPAL REGISTER**

# Pet-2-Ring

PET DOORBELL PRODUCTS, INC. (NEW JERSEY CORPORATION)  
39 MITCHELL COURT  
MARLTON, NJ 08053

FOR: ELECTRIC DOOR BELLS; ELECTRIC DOOR CHIMES, IN CLASS 9 (U.S. CLS. 21, 23, 26, 36 AND 38).

FIRST USE 8-1-2002; IN COMMERCE 8-1-2002.

THE MARK CONSISTS OF STANDARD CHARACTERS WITHOUT CLAIM TO ANY PARTICULAR FONT, STYLE, SIZE, OR COLOR.

SER. NO. 77-370,432, FILED 1-13-2008.

BRENDAN REGAN, EXAMINING ATTORNEY

**Int. Cls.: 24 and 25**

**Prior U.S. Cls.: 22, 39, 42 and 50**

**United States Patent and Trademark Office**

**Reg. No. 3,498,412**

**Registered Sep. 9, 2008**

**TRADEMARK  
PRINCIPAL REGISTER**

# Special Lady

LANGE, JUDITH (UNITED STATES INDIVIDUAL)  
210017  
MILWAUKEE, WI 53221

FOR: TOWELS, BEDCOVERS, BLANKET THROWS, THROWS, FACE TOWELS OF TEXTILES, LARGE BATH TOWELS, GOLF TOWELS, IN CLASS 24 (U.S. CLS. 42 AND 50).

FIRST USE 4-5-2008; IN COMMERCE 4-5-2008.

FOR: WOMEN'S CLOTHING, NAMELY, SHIRTS, PANTS, UNDERWEAR, PANTIES, SWEAT PANTS, SWEAT SHIRTS, SWEATERS, SLEEP WEAR, NIGHTGOWNS, NIGHT SHIRTS, BLOUSES, HOSIERY, FOOT WEAR, DRESSES, EVENING GOWNS, WRAPS, SHAWLS, BEACH COVER-UPS, SWIM WEAR, SHORTS, SKIRTS, LONG SLEEVE SHIRTS, SHORT SLEEVE SHIRTS, STRAPLESS SHIRTS,

SLEEVELESS SHIRTS, TANK TOPS, CAMISOLES, JACKETS, VESTS, SOCKS, SANDALS, DRESS SHOES, CASUAL SHOES, ATHLETIC SHOES, SLACKS, JEANS, APRONS, SCARVES, SKORTS, LEGGINGS, COATS, LINGERIE, HATS, CAPS, CROPPED PANTS, T-SHIRTS, HOODED SWEATSHIRTS, HEADWEAR, ROBES, GLOVES, MITTENS, SLIPPERS, SHOES, IN CLASS 25 (U.S. CLS. 22 AND 39).

FIRST USE 4-5-2008; IN COMMERCE 4-5-2008.

THE MARK CONSISTS OF STANDARD CHARACTERS WITHOUT CLAIM TO ANY PARTICULAR FONT, STYLE, SIZE, OR COLOR.

SER. NO. 77-370,703, FILED 1-14-2008.

DANIEL CAPSHAW, EXAMINING ATTORNEY

**Int. Cl.: 42**

**Prior U.S. Cls.: 100 and 101**

**United States Patent and Trademark Office**

**Reg. No. 3,498,413**

**Registered Sep. 9, 2008**

**SERVICE MARK  
PRINCIPAL REGISTER**

**GSP BIO**

COURT SQUARE GROUP, INC. (MASSACHU-  
SETTS CORPORATION)  
1441 MAIN STREET  
SUITE 223  
SPRINGFIELD, MA 01103

FOR: TECHNICAL CONSULTATION SERVICES  
IN THE FIELD OF INFORMATION TECHNOLOGY,  
IN CLASS 42 (U.S. CLS. 100 AND 101).

FIRST USE 10-16-2007; IN COMMERCE 10-16-2007.

THE MARK CONSISTS OF STANDARD CHAR-  
ACTERS WITHOUT CLAIM TO ANY PARTICULAR  
FONT, STYLE, SIZE, OR COLOR.

OWNER OF U.S. REG. NO. 3,082,167.

SER. NO. 77-370,717, FILED 1-14-2008.

LESLIE RICHARDS, EXAMINING ATTORNEY

**Int. Cl.: 36**

**Prior U.S. Cls.: 100, 101 and 102**

**United States Patent and Trademark Office**

**Reg. No. 3,498,414**

**Registered Sep. 9, 2008**

**SERVICE MARK  
PRINCIPAL REGISTER**

CHRISTMAS WISHES CHOOSE A  
CHILD. FILL A NEED. BRING  
THEM JOY.

UTAH CENTRAL CREDIT UNION (UTAH COR-  
PORATION)  
25 EAST 1700 SOUTH  
SALT LAKE CITY, UT 84115

FOR: CHARITABLE FUND RAISING SERVICES  
FOR UNDERPRIVILEGED ELEMENTARY  
SCHOOL CHILDREN, IN CLASS 36 (U.S. CLS. 100,  
101 AND 102).

FIRST USE 11-0-2007; IN COMMERCE 11-0-2007.

THE MARK CONSISTS OF STANDARD CHAR-  
ACTERS WITHOUT CLAIM TO ANY PARTICULAR  
FONT, STYLE, SIZE, OR COLOR.

SER. NO. 77-371,177, FILED 1-14-2008.

FRED MANDIR, EXAMINING ATTORNEY

**Int. Cl.: 35**

**Prior U.S. Cls.: 100, 101 and 102**

**United States Patent and Trademark Office**

**Reg. No. 3,498,415**

**Registered Sep. 9, 2008**

**SERVICE MARK  
PRINCIPAL REGISTER**

**HALLOGREEN**

COLWELL-LIPSON, COREY (UNITED STATES  
INDIVIDUAL)  
381 NW DOGWOOD STREET  
ISSAQUAH, WA 98027

FOR: PROMOTING PUBLIC AWARENESS IN  
COMMUNITIES OF THE NEED FOR INCORPOR-  
ATING HEALTHY AND EARTH-FRIENDLY PRAC-  
TICES INTO HALLOWEEN TRADITIONS, AND  
FOR PROVIDING HEALTHY AND EARTH-  
FRIENDLY HALLOWEEN TREATS, IN CLASS 35  
(U.S. CLS. 100, 101 AND 102).

FIRST USE 9-6-2007; IN COMMERCE 9-6-2007.

THE MARK CONSISTS OF STANDARD CHAR-  
ACTERS WITHOUT CLAIM TO ANY PARTICULAR  
FONT, STYLE, SIZE, OR COLOR.

SER. NO. 77-371,475, FILED 1-14-2008.

ZHALEH DELANEY, EXAMINING ATTORNEY

**Int. Cl.: 35**

**Prior U.S. Cls.: 100, 101 and 102**

**United States Patent and Trademark Office**

**Reg. No. 3,498,416**

**Registered Sep. 9, 2008**

**SERVICE MARK  
PRINCIPAL REGISTER**



LONE STAR MSO, INC. (TEXAS CORPORATION)  
SUITE 400  
8440 WALNUT HILL LANE  
DALLAS, TX 75231

FOR: BUSINESS MANAGEMENT SERVICES FOR  
THE MEDICAL PROFESSION, IN CLASS 35 (U.S.  
CLS. 100, 101 AND 102).

FIRST USE 4-6-2006; IN COMMERCE 4-6-2006.

NO CLAIM IS MADE TO THE EXCLUSIVE  
RIGHT TO USE "LONE STAR MSO PRACTICE  
MANAGEMENT SERVICES", APART FROM THE  
MARK AS SHOWN.

THE COLOR(S) WHITE, BLUE, AND RED IS/ARE  
CLAIMED AS A FEATURE OF THE MARK.

THE MARK CONSISTS OF A DESIGN OF A  
SINGLE STAR ON A SQUARE BACKGROUND  
AND THE WORDS "LONE STAR MSO" ABOVE  
THE LETTERS "PRACTICE MANAGEMENT SER-  
VICES". COLOR IS A FEATURE OF THE MARK.  
THE STAR IS WHITE. THE UPPER HALF OF THE  
SQUARE BACKGROUND IS RED AND THE LOW-  
ER HALF OF THE SQUARE BACKGROUND IS  
BLUE. THE WORDS "LONE STAR" ARE BLUE. THE  
LETTERS "MSO" ARE RED. THE LETTERS "PRAC-  
TICE MANAGEMENT SERVICES" ARE BLUE.

SER. NO. 77-371,490, FILED 1-14-2008.

KRISTIN DAHLING, EXAMINING ATTORNEY

**Int. Cl.: 28**

**Prior U.S. Cls.: 22, 23, 38 and 50**

**United States Patent and Trademark Office**

**Reg. No. 3,498,417**

**Registered Sep. 9, 2008**

**TRADEMARK  
PRINCIPAL REGISTER**

**DEATH**

ORECCHIO, NICHOLAS (UNITED KINGDOM  
INDIVIDUAL)  
14 ARKLEY ROAD  
HEMEL HEMPSTEAD, UNITED KINGDOM  
HA26NP

FOR: SKATEBOARDS; SKATEBOARD DECKS;  
SKATEBOARD WHEELS SOLD SEPARATELY OR  
SOLD AS A UNIT WITH SKATEBOARDS; SKATE-  
BOARD TRUCKS; BALL BEARINGS FOR SKATE-  
BOARDS; NUTS AND BOLTS FOR SKATEBOARDS;  
SKATEBOARD WAX FOR CURBS; SNOWBOARDS;  
SNOWBOARD BINDINGS; SNOWBOARD WAX;  
SNOWBOARD CARRYING CASES; SURFBOARDS;  
SURFBOARD DECK GRIP TAPES; WAX FOR SURF-

BOARDS; FITTED COVERS AND BAGS ESPECIAL-  
LY DESIGNED FOR SURFBOARDS; SURFBOARD  
LEASHES, IN CLASS 28 (U.S. CLS. 22, 23, 38 AND 50).

FIRST USE 10-1-1998; IN COMMERCE 10-1-1998.

THE MARK CONSISTS OF STANDARD CHAR-  
ACTERS WITHOUT CLAIM TO ANY PARTICULAR  
FONT, STYLE, SIZE, OR COLOR.

SER. NO. 77-371,590, FILED 1-14-2008.

ZHALEH DELANEY, EXAMINING ATTORNEY



**Int. Cl.: 14**

**Prior U.S. Cls.: 2, 27, 28 and 50**

**Reg. No. 3,498,418**

**United States Patent and Trademark Office**

**Registered Sep. 9, 2008**

**TRADEMARK  
PRINCIPAL REGISTER**



WHIMSICAL WATCHES INC. (GEORGIA CORPORATION), FORMERLY "WHAT'S YOUR LINE WATCHES"

3091 HOLCOMB BRIDGE RD; SUITE A-1  
NORCROSS, GA 30071

FOR: WATCHES, CLOCKS, JEWELLERY AND IMITATION JEWELLERY; CLOCKS AND WATCHES; JEWELLERY AND WATCHES; JEWELLERY, CLOCKS AND WATCHES; JEWELRY WATCHES; WATCH BANDS; WATCH BANDS AND STRAPS; WATCH BOXES; WATCH STRAPS; WATCH STRAPS MADE OF METAL OR LEATHER OR PLASTIC; WATCHES; WATCHES AND CLOCKS; WATCHES AND JEWELLERY; WATCHES AND JEWELRY; WATCHES AND STRAPS FOR WATCHES; WATCHES, CLOCKS; WATCHES, CLOCKS, JEWELRY AND IMITATION JEWELRY, IN CLASS 14 (U.S. CLS. 2, 27, 28 AND 50).

FIRST USE 7-1-2007; IN COMMERCE 7-1-2007.

NO CLAIM IS MADE TO THE EXCLUSIVE RIGHT TO USE "WATCHES" AND "SPECIALTY

WATCH FOR EVERY OCCASION" , APART FROM THE MARK AS SHOWN.

THE COLOR(S) NAVY BLUE ROYAL BLUE SKY BLUE BLACK SILVER IS/ARE CLAIMED AS A FEATURE OF THE MARK.

THE MARK CONSISTS OF THREE DIFFERENT SIZED, OVERLAPPING BLUE CIRCLES, ONE IN DARK BLUE, ONE IN SKY BLUE, AND ONE IN ROYAL BLUE, WITH A TIME PIECE SYMBOL AND LETTER "W" IN SILVER. TO THE RIGHT OF THE LOGO ARE THE WORDS "WHIMSICAL WATCHES" IN TWO SHADES OF BLUE, A SILVER UNDERLINE UNDER "WATCHES", ABOVE THE FOLLOWING WORDING, IN BLACK: "SPECIALTY WATCH FOR EVERY OCCASION".

SER. NO. 77-371,854, FILED 1-15-2008.

ELISSA GARBER KON, EXAMINING ATTORNEY

**Int. Cl.: 42**

**Prior U.S. Cls.: 100 and 101**

**United States Patent and Trademark Office**

**Reg. No. 3,498,419**

**Registered Sep. 9, 2008**

**SERVICE MARK  
PRINCIPAL REGISTER**

**HORIZON ENGINEERING  
ASSOCIATES**

HORIZON ENGINEERING ASSOCIATES (NEW  
YORK LIMITED LIABILITY COMPANY)  
30 BROAD STREET  
NEW YORK, NY 10004

FOR: ENGINEERING SERVICES USED IN THE  
FIELDS OF BUILDING AND PROPERTY CONDI-  
TION ASSESSMENT, FACILITY MANAGEMENT,  
REPAIR AND RESTORATION, BUILDING INSTRU-  
MENTATION AND MONITORING, AND ENVIR-  
ONMENTAL CONSULTING, IN CLASS 42 (U.S. CLS.  
100 AND 101).

FIRST USE 1-1-2008; IN COMMERCE 1-1-2008.

THE MARK CONSISTS OF STANDARD CHAR-  
ACTERS WITHOUT CLAIM TO ANY PARTICULAR  
FONT, STYLE, SIZE, OR COLOR.

NO CLAIM IS MADE TO THE EXCLUSIVE  
RIGHT TO USE "ENGINEERING ASSOCIATES",  
APART FROM THE MARK AS SHOWN.

SER. NO. 77-372,041, FILED 1-15-2008.

DAVID H. STINE, EXAMINING ATTORNEY

**Int. Cls.: 35, 38, 39, 42 and 45**

**Prior U.S. Cls.: 100, 101, 102, 104 and 105**

**United States Patent and Trademark Office**

**Reg. No. 3,498,420**

**Registered Sep. 9, 2008**

**SERVICE MARK  
PRINCIPAL REGISTER**

**TITLEPOINT XPRESS**

FNF INTELLECTUAL PROPERTY HOLDINGS,  
INC. (DELAWARE CORPORATION)  
601 RIVERSIDE AVENUE  
JACKSONVILLE, FL 32204

FOR: RECORDS MANAGEMENT, NAMELY,  
DOCUMENT INDEXING FOR OTHERS IN THE  
FIELD OF REAL ESTATE RECORDS, JUDGMENTS,  
ENCUMBRANCES AND TITLES, IN CLASS 35 (U.S.  
CLS. 100, 101 AND 102).

FIRST USE 11-22-2004; IN COMMERCE 2-28-2005.

FOR: ELECTRONIC TRANSMISSION OF DOCU-  
MENTS AND DATA VIA COMPUTER TERMINALS  
IN THE FIELD OF REAL ESTATE TITLE SEARCH-  
ING, IN CLASS 38 (U.S. CLS. 100, 101 AND 104).

FIRST USE 11-22-2004; IN COMMERCE 2-28-2005.

FOR: DOCUMENT DELIVERY SERVICES IN THE  
FIELD OF REAL ESTATE TITLE SEARCHING, IN  
CLASS 39 (U.S. CLS. 100 AND 105).

FIRST USE 11-28-2004; IN COMMERCE 2-28-2005.

FOR: PROVIDING TEMPORARY USE OF NON-  
DOWNLOADABLE SOFTWARE IN THE FIELD OF  
REAL ESTATE FOR THE RETRIEVAL, ORGANIZA-  
TION, DELIVERY AND INDEXING OF REAL ES-  
TATE RECORDS AND TAX RECORDS RELATED

TO REAL ESTATE, IN CLASS 42 (U.S. CLS. 100 AND  
101).

FIRST USE 11-22-2004; IN COMMERCE 2-28-2005.

FOR: PROVIDING REAL ESTATE TITLE INFOR-  
MATION AT THE SPECIFIC REQUEST OF END-  
USERS BY MEANS OF TELEPHONE OR GLOBAL  
COMPUTER NETWORKS FEATURING THE RE-  
TRIEVAL OF REAL ESTATE RECORDS, JUDG-  
MENTS, ENCUMBRANCES AND TITLES  
THROUGH ONLINE SYSTEMS AND MANUAL  
PROCESSES IN DATA AND IMAGE FORM, IN  
CLASS 45 (U.S. CLS. 100 AND 101).

FIRST USE 11-22-2004; IN COMMERCE 2-28-2005.

THE MARK CONSISTS OF STANDARD CHAR-  
ACTERS WITHOUT CLAIM TO ANY PARTICULAR  
FONT, STYLE, SIZE, OR COLOR.

OWNER OF U.S. REG. NO. 3,248,961.

NO CLAIM IS MADE TO THE EXCLUSIVE  
RIGHT TO USE "EXPRESS", APART FROM THE  
MARK AS SHOWN.

SER. NO. 77-372,283, FILED 1-15-2008.

JAY BESCH, EXAMINING ATTORNEY

**Int. Cls.: 35, 38, 39, 42 and 45**

**Prior U.S. Cls.: 100, 101, 102, 104 and 105**

**United States Patent and Trademark Office**

**Reg. No. 3,498,421**

**Registered Sep. 9, 2008**

**SERVICE MARK  
PRINCIPAL REGISTER**



FNF INTELLECTUAL PROPERTY HOLDINGS,  
INC. (DELAWARE CORPORATION)  
601 RIVERSIDE AVENUE  
JACKSONVILLE, FL 32204

FOR: RECORDS MANAGEMENT, NAMELY,  
DOCUMENT INDEXING FOR OTHERS IN THE  
FIELD OF REAL ESTATE RECORDS, JUDGMENTS,  
ENCUMBRANCES AND TITLES, IN CLASS 35 (U.S.  
CLS. 100, 101 AND 102).

FIRST USE 11-22-2004; IN COMMERCE 2-28-2005.

FOR: ELECTRONIC TRANSMISSION OF DOCU-  
MENTS AND DATA VIA COMPUTER TERMINALS  
IN THE FIELD OF REAL ESTATE TITLE SEARCH-  
ING, IN CLASS 38 (U.S. CLS. 100, 101 AND 104).

FIRST USE 11-22-2004; IN COMMERCE 2-28-2005.

FOR: DOCUMENT DELIVERY SERVICES IN THE  
FIELD OF REAL ESTATE TITLE SEARCHING, IN  
CLASS 39 (U.S. CLS. 100 AND 105).

FIRST USE 11-28-2004; IN COMMERCE 2-28-2005.

FOR: PROVIDING TEMPORARY USE OF NON-  
DOWNLOADABLE SOFTWARE IN THE FIELD OF  
REAL ESTATE FOR THE RETRIEVAL, ORGANIZA-  
TION, DELIVERY AND INDEXING OF REAL ES-  
TATE RECORDS AND TAX RECORDS RELATED  
TO REAL ESTATE, IN CLASS 42 (U.S. CLS. 100 AND  
101).

FIRST USE 11-22-2004; IN COMMERCE 2-28-2005.

FOR: PROVIDING REAL ESTATE TITLE INFOR-  
MATION AT THE SPECIFIC REQUEST OF END-  
USERS BY MEANS OF TELEPHONE OR GLOBAL  
COMPUTER NETWORKS FEATURING THE RE-  
TRIEVAL OF REAL ESTATE RECORDS, JUDG-  
MENTS, ENCUMBRANCES AND TITLES  
THROUGH ONLINE SYSTEMS AND MANUAL  
PROCESSES IN DATA AND IMAGE FORM, IN  
CLASS 45 (U.S. CLS. 100 AND 101).

FIRST USE 11-22-2004; IN COMMERCE 2-28-2005.

OWNER OF U.S. REG. NO. 3,248,961.

NO CLAIM IS MADE TO THE EXCLUSIVE  
RIGHT TO USE "EXPRESS", APART FROM THE  
MARK AS SHOWN.

THE MARK CONSISTS OF THE STYLIZED  
WORDING "TITLEPOINT XPRESS" AND THE DE-  
SIGN OF A CURVED BAND ABOVE THE TERM  
"TITLEPOINT", THE LETTER "O" IN THE TERM  
"TITLEPOINT" FORMED BY A SHADED CIRCLE,  
AND THE TERM "XPRESS" INSIDE A SHADED,  
RECTANGULAR SHAPE BELOW THE WORDING  
"TITLEPOINT".

SER. NO. 77-372,291, FILED 1-15-2008.

JAY BESCH, EXAMINING ATTORNEY

**Int. Cls.: 35, 38, 39, 42 and 45**

**Prior U.S. Cls.: 100, 101, 102, 104 and 105**

**United States Patent and Trademark Office**

**Reg. No. 3,498,422**

**Registered Sep. 9, 2008**

**SERVICE MARK  
PRINCIPAL REGISTER**

# TITLEPOINT

FNF INTELLECTUAL PROPERTY HOLDINGS,  
INC. (DELAWARE CORPORATION)  
601 RIVERSIDE AVENUE  
JACKSONVILLE, FL 32204

FOR: RECORDS MANAGEMENT, NAMELY,  
DOCUMENT INDEXING FOR OTHERS IN THE  
FIELD OF REAL ESTATE RECORDS, JUDGMENTS,  
ENCUMBRANCES AND TITLES, IN CLASS 35 (U.S.  
CLS. 100, 101 AND 102).

FIRST USE 11-22-2004; IN COMMERCE 2-28-2005.

FOR: ELECTRONIC TRANSMISSION OF DOCU-  
MENTS AND DATA VIA COMPUTER TERMINALS  
IN THE FIELD OF REAL ESTATE TITLE SEARCH-  
ING, IN CLASS 38 (U.S. CLS. 100, 101 AND 104).

FIRST USE 11-22-2004; IN COMMERCE 2-28-2005.

FOR: DOCUMENT DELIVERY SERVICES IN THE  
FIELD OF REAL ESTATE TITLE SEARCHING, IN  
CLASS 39 (U.S. CLS. 100 AND 105).

FIRST USE 11-28-2004; IN COMMERCE 2-28-2005.

FOR: PROVIDING TEMPORARY USE OF NON-  
DOWNLOADABLE SOFTWARE IN THE FIELD OF  
REAL ESTATE FOR THE RETRIEVAL, ORGANIZA-

TION, DELIVERY AND INDEXING OF REAL ES-  
TATE RECORDS AND TAX RECORDS RELATED  
TO REAL ESTATE, IN CLASS 42 (U.S. CLS. 100 AND  
101).

FIRST USE 11-22-2004; IN COMMERCE 2-28-2005.

FOR: PROVIDING REAL ESTATE TITLE INFOR-  
MATION AT THE SPECIFIC REQUEST OF END-  
USERS BY MEANS OF TELEPHONE OR GLOBAL  
COMPUTER NETWORKS FEATURING THE RE-  
TRIEVAL OF REAL ESTATE RECORDS, JUDG-  
MENTS, ENCUMBRANCES AND TITLES  
THROUGH ONLINE SYSTEMS AND MANUAL  
PROCESSES IN DATA AND IMAGE FORM, IN  
CLASS 45 (U.S. CLS. 100 AND 101).

FIRST USE 11-22-2004; IN COMMERCE 2-28-2005.

THE MARK CONSISTS OF STANDARD CHAR-  
ACTERS WITHOUT CLAIM TO ANY PARTICULAR  
FONT, STYLE, SIZE, OR COLOR.

OWNER OF U.S. REG. NO. 3,248,961.

SER. NO. 77-372,294, FILED 1-15-2008.

JAY BESCH, EXAMINING ATTORNEY

Int. Cl.: 30

Prior U.S. Cl.: 46

United States Patent and Trademark Office

Reg. No. 3,498,423

Registered Sep. 9, 2008

TRADEMARK  
PRINCIPAL REGISTER

**Mack Flavor**  
*Ingredients*

MACK FLAVOR INGREDIENTS, INC. (CALI-  
FORNIA CORPORATION)  
3502 BROKEN TWIG DRIVE  
NORCO, CA 92860

FOR: FOOD FLAVORINGS NOT IN THE NAT-  
URE OF ESSENTIAL OILS; FLAVOR ENHANCERS  
USED IN FOOD AND BEVERAGE PRODUCTS, IN  
CLASS 30 (U.S. CL. 46).

FIRST USE 3-1-2001; IN COMMERCE 3-1-2001.

NO CLAIM IS MADE TO THE EXCLUSIVE  
RIGHT TO USE "FLAVOR INGREDIENTS", APART  
FROM THE MARK AS SHOWN.

THE MARK CONSISTS OF THE STYLIZED  
WORDS "MACK FLAVOR INGREDIENTS".

SER. NO. 77-372,467, FILED 1-15-2008.

CHRIS WELLS, EXAMINING ATTORNEY

**Int. Cl.: 42**

**Prior U.S. Cls.: 100 and 101**

**United States Patent and Trademark Office**

**Reg. No. 3,498,424**

**Registered Sep. 9, 2008**

**SERVICE MARK  
PRINCIPAL REGISTER**



HORIZON ENGINEERING ASSOCIATES (NEW  
YORK LIMITED LIABILITY COMPANY)  
30 BROAD STREET  
NEW YORK, NY 10004

FOR: ENGINEERING SERVICES USED IN THE  
FIELDS OF BUILDING AND PROPERTY CONDI-  
TION ASSESSMENT, FACILITY MANAGEMENT,  
REPAIR AND RESTORATION, BUILDING INSTRU-  
MENTATION AND MONITORING, AND ENVIR-  
ONMENTAL CONSULTING, IN CLASS 42 (U.S. CLS.  
100 AND 101).

FIRST USE 1-1-2008; IN COMMERCE 1-1-2008.

THE MARK CONSISTS OF THE LETTERS "HEA"  
IN AN OVERLAPPED FORMAT ON A SQUARE  
BACKGROUND SURROUNDED BY A NARROW  
LINE AND A WIDER FRAME.

SER. NO. 77-372,566, FILED 1-15-2008.

DAVID H. STINE, EXAMINING ATTORNEY

**Int. Cl.: 9**

**Prior U.S. Cls.: 21, 23, 26, 36 and 38**

**Reg. No. 3,498,425**

**United States Patent and Trademark Office**

**Registered Sep. 9, 2008**

---

**TRADEMARK  
PRINCIPAL REGISTER**

**Mainstream Killed the  
Indie Star**

APEDO, SHEKINAH K (UNITED STATES INDIVIDUAL)  
908 EAST LAKE AVENUE  
TAMPA, FL 33605

FOR: DOWNLOADABLE TELEVISION SHOWS AND VIDEO RECORDINGS FEATURING MUSIC BY UNSIGNED AND INDEPENDENT MUSIC SOLO ARTISTS AND MUSIC GROUPS, IN CLASS 9 (U.S. CLS. 21, 23, 26, 36 AND 38).

FIRST USE 1-3-2008; IN COMMERCE 1-3-2008.

THE MARK CONSISTS OF STANDARD CHARACTERS WITHOUT CLAIM TO ANY PARTICULAR FONT, STYLE, SIZE, OR COLOR.

SER. NO. 77-372,713, FILED 1-16-2008.

SAIMA MAKHDOOM, EXAMINING ATTORNEY



**Int. Cls.: 35 and 42**

**Prior U.S. Cls.: 100, 101 and 102**

**United States Patent and Trademark Office**

**Reg. No. 3,498,426**

**Registered Sep. 9, 2008**

**SERVICE MARK  
PRINCIPAL REGISTER**

**SO MANY ROADS**

SO MANY ROADS, LLC (ILLINOIS LIMITED  
LIABILITY COMPANY)  
740 WAUKEGAN ROAD, SUITE 204  
DEERFIELD, IL 60015

FOR: RETAIL STORE SERVICES FEATURING  
JEWELRY, IN CLASS 35 (U.S. CLS. 100, 101 AND 102).

FIRST USE 2-0-2006; IN COMMERCE 2-0-2006.

FOR: CUSTOM DESIGN OF JEWELRY BASED  
ON PERSONAL SELECTIONS MADE BY THE CUS-  
TOMER, IN CLASS 42 (U.S. CLS. 100 AND 101).

FIRST USE 2-0-2006; IN COMMERCE 2-0-2006.

THE MARK CONSISTS OF STANDARD CHAR-  
ACTERS WITHOUT CLAIM TO ANY PARTICULAR  
FONT, STYLE, SIZE, OR COLOR.

SER. NO. 77-372,761, FILED 1-16-2008.

ARETHA SOMERVILLE, EXAMINING ATTORNEY

**Int. Cl.: 36**

**Prior U.S. Cls.: 100, 101 and 102**

**United States Patent and Trademark Office**

**Reg. No. 3,498,427**

**Registered Sep. 9, 2008**

**SERVICE MARK  
PRINCIPAL REGISTER**

# Goose Investments

SMITH, RICHARD A (UNITED STATES INDIVIDUAL)  
1045 LAKEVIEW TERRACE  
AZUSA, CA 917022453

FOR: FINANCIAL PLANNING AND INVESTMENT ADVISORY SERVICES, IN CLASS 36 (U.S. CLS. 100, 101 AND 102).

FIRST USE 9-12-2005; IN COMMERCE 9-12-2005.

THE MARK CONSISTS OF STANDARD CHARACTERS WITHOUT CLAIM TO ANY PARTICULAR FONT, STYLE, SIZE, OR COLOR.

NO CLAIM IS MADE TO THE EXCLUSIVE RIGHT TO USE "INVESTMENTS", APART FROM THE MARK AS SHOWN.

SER. NO. 77-373,168, FILED 1-16-2008.

GENE MACIOL, EXAMINING ATTORNEY

**Int. Cls.: 30, 35 and 43**

**Prior U.S. Cls.: 46, 100, 101 and 102**

**United States Patent and Trademark Office**

**Reg. No. 3,498,428**

**Registered Sep. 9, 2008**

**TRADEMARK  
SERVICE MARK  
PRINCIPAL REGISTER**

**ARGO**

ARGO TEA, INC. (DELAWARE CORPORATION)  
16 W. RANDOLPH  
CHICAGO, IL 60601

FOR: SPECIALTY TEAS, LOOSE TEAS, TEA  
BASED BEVERAGES AND PASTRIES, IN CLASS 30  
(U.S. CL. 46).

FIRST USE 6-1-2003; IN COMMERCE 6-1-2003.

FOR: RETAIL STORE SERVICES AND MAIL  
ORDER SERVICES FEATURING TEA, COFFEE,  
LOOSE TEAS, TEA BASED BEVERAGES, PASTRIES,  
TEAPOTS, KETTLES, CUPS, MUGS, CANISTERS,  
PITCHERS, TEA INFUSERS, TEA BALLS, IN CLASS  
35 (U.S. CLS. 100, 101 AND 102).

FIRST USE 6-1-2003; IN COMMERCE 6-1-2003.

FOR: RESTAURANTS, CAFE AND TEA HOUSE  
SERVICES, IN CLASS 43 (U.S. CLS. 100 AND 101).

FIRST USE 6-1-2003; IN COMMERCE 6-1-2003.

THE MARK CONSISTS OF STANDARD CHAR-  
ACTERS WITHOUT CLAIM TO ANY PARTICULAR  
FONT, STYLE, SIZE, OR COLOR.

SER. NO. 77-373,439, FILED 1-16-2008.

CURTIS FRENCH, EXAMINING ATTORNEY

**Int. Cl.: 9**

**Prior U.S. Cls.: 21, 23, 26, 36 and 38**

**Reg. No. 3,498,429**

**United States Patent and Trademark Office**

**Registered Sep. 9, 2008**

**TRADEMARK  
PRINCIPAL REGISTER**

qpod

QUANTUM NORTHWEST, INC. (WASHINGTON  
CORPORATION)  
22910 E APPLEWAY AVENUE  
SUITE 4  
LIBERTY LAKE, WA 99019

THE MARK CONSISTS OF STANDARD CHAR-  
ACTERS WITHOUT CLAIM TO ANY PARTICULAR  
FONT, STYLE, SIZE, OR COLOR.

FOR: SCIENTIFIC APPARATUS, NAMELY, SPEC-  
TROMETERS AND PARTS AND FITTINGS THERE-  
FOR, IN CLASS 9 (U.S. CLS. 21, 23, 26, 36 AND 38).

SER. NO. 77-373,497, FILED 1-16-2008.

FIRST USE 12-18-2007; IN COMMERCE 12-18-2007.

KIMBERLY FRYE, EXAMINING ATTORNEY

**Int. Cls.: 30, 35 and 43**

**Prior U.S. Cls.: 46, 100, 101 and 102**

**United States Patent and Trademark Office**

**Reg. No. 3,498,430**

**Registered Sep. 9, 2008**

**TRADEMARK  
SERVICE MARK  
PRINCIPAL REGISTER**

# ARGO TEA

ARGO TEA, INC. (DELAWARE CORPORATION)  
16 W. RANDOLPH  
CHICAGO, IL 60601

FOR: SPECIALTY TEAS, LOOSE TEAS, TEA  
BASED BEVERAGES AND PASTRIES, IN CLASS 30  
(U.S. CL. 46).

FIRST USE 6-1-2003; IN COMMERCE 6-1-2003.

FOR: RETAIL STORE SERVICES AND MAIL  
ORDER SERVICES FEATURING TEA, COFFEE,  
LOOSE TEAS, TEA BASED BEVERAGES, PASTRIES,  
TEAPOTS, KETTLES, CUPS, MUGS, CANISTERS,  
PITCHERS, TEA INFUSERS, TEA BALLS, IN CLASS  
35 (U.S. CLS. 100, 101 AND 102).

FIRST USE 6-1-2003; IN COMMERCE 6-1-2003.

FOR: RESTAURANT, CAFE AND TEA HOUSE  
SERVICES, IN CLASS 43 (U.S. CLS. 100 AND 101).

FIRST USE 6-1-2003; IN COMMERCE 6-1-2003.

THE MARK CONSISTS OF STANDARD CHAR-  
ACTERS WITHOUT CLAIM TO ANY PARTICULAR  
FONT, STYLE, SIZE, OR COLOR.

NO CLAIM IS MADE TO THE EXCLUSIVE  
RIGHT TO USE "TEA", APART FROM THE MARK  
AS SHOWN.

SER. NO. 77-373,558, FILED 1-16-2008.

CURTIS FRENCH, EXAMINING ATTORNEY

**Int. Cl.: 30**

**Prior U.S. Cl.: 46**

**United States Patent and Trademark Office**

**Reg. No. 3,498,431**

**Registered Sep. 9, 2008**

**TRADEMARK  
PRINCIPAL REGISTER**

**SLU BREW**

SAINT LOUIS UNIVERSITY (MISSOURI NON-  
PROFIT CORPORATION)  
221 NORTH GRAND BOULEVARD  
ST. LOUIS, MO 63103

NO CLAIM IS MADE TO THE EXCLUSIVE  
RIGHT TO USE "BREW", APART FROM THE  
MARK AS SHOWN.

FOR: COFFEE, IN CLASS 30 (U.S. CL. 46).

FIRST USE 12-0-2007; IN COMMERCE 12-0-2007.

SER. NO. 77-373,954, FILED 1-17-2008.

THE MARK CONSISTS OF STANDARD CHAR-  
ACTERS WITHOUT CLAIM TO ANY PARTICULAR  
FONT, STYLE, SIZE, OR COLOR.

SETH A. RAPPAPORT, EXAMINING ATTORNEY

**Int. Cl.: 30**

**Prior U.S. Cl.: 46**

**United States Patent and Trademark Office**

**Reg. No. 3,498,432**

**Registered Sep. 9, 2008**

**TRADEMARK  
PRINCIPAL REGISTER**

**JEBBY JAVA**

SAINT LOUIS UNIVERSITY (MISSOURI NON-  
PROFIT CORPORATION)  
221 NORTH GRAND BOULEVARD  
ST. LOUIS, MO 63103

NO CLAIM IS MADE TO THE EXCLUSIVE  
RIGHT TO USE JAVA, APART FROM THE MARK  
AS SHOWN.

FOR: COFFEE, IN CLASS 30 (U.S. CL. 46).

FIRST USE 12-0-2007; IN COMMERCE 12-0-2007.

SER. NO. 77-373,962, FILED 1-17-2008.

THE MARK CONSISTS OF STANDARD CHAR-  
ACTERS WITHOUT CLAIM TO ANY PARTICULAR  
FONT, STYLE, SIZE, OR COLOR.

SETH A. RAPPAPORT, EXAMINING ATTORNEY

**Int. Cl.: 14**

**Prior U.S. Cls.: 2, 27, 28 and 50**

**Reg. No. 3,498,433**

**United States Patent and Trademark Office**

**Registered Sep. 9, 2008**

**TRADEMARK  
PRINCIPAL REGISTER**

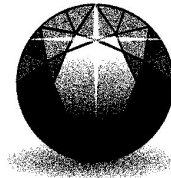

**G E M T E X**

PINNACLE BUSINESS MANAGEMENT, INC.  
(NEVADA CORPORATION), DBA GEMTEX  
SUITE 104B  
1310 HIGHWAY 96 E.  
WHITE BEAR LAKE, MN 55110

THE MARK CONSISTS OF A TECHNICAL  
DRAWING OF A ROUND DIAMOND. THE STONE  
FACES OUT AND HAS THE ADDED EFFECT OF  
SHADOWING UNDERNEATH THE STONE. THE  
STONE ITSELF HANGS IN MID AIR IN THE FORE-  
GROUND.

FOR: JEWELRY, IN CLASS 14 (U.S. CLS. 2, 27, 28  
AND 50).

SER. NO. 77-374,082, FILED 1-17-2008.

FIRST USE 12-1-2007; IN COMMERCE 12-1-2007.

THE STIPPLING IS FOR SHADING PURPOSES  
ONLY.

DEZMONA MIZELLE, EXAMINING ATTORNEY



**Int. Cl.: 35**

**Prior U.S. Cls.: 100, 101 and 102**

**United States Patent and Trademark Office**

**Reg. No. 3,498,434**

**Registered Sep. 9, 2008**

**SERVICE MARK  
PRINCIPAL REGISTER**

**YOU DILIGENCE**

NEWS IMAGING INC. (DELAWARE CORPORATION)  
3401 DENT PLACE  
WASHINGTON, DC 20007

FOR: BUSINESS RESEARCH AND ANALYSIS SERVICES FOR OTHERS, NAMELY, ANALYZING DATA FROM NEWS MEDIA AND SOCIAL NETWORKING RESOURCES CONCERNING THE NAMES OF INDIVIDUALS AND THEIR REPUTATIONS, IN CLASS 35 (U.S. CLS. 100, 101 AND 102).

FIRST USE 11-15-2007; IN COMMERCE 11-15-2007.

THE MARK CONSISTS OF STANDARD CHARACTERS WITHOUT CLAIM TO ANY PARTICULAR FONT, STYLE, SIZE, OR COLOR.

SER. NO. 77-374,161, FILED 1-17-2008.

CYNTHIA TRIPI, EXAMINING ATTORNEY

**Int. Cl.: 5**

**Prior U.S. Cls.: 6, 18, 44, 46, 51 and 52**

**United States Patent and Trademark Office**

**Reg. No. 3,498,435**

**Registered Sep. 9, 2008**

**TRADEMARK  
PRINCIPAL REGISTER**

**TOTAL JOINT SUPPORT**

NUTRITION CENTER, INC. (WYOMING CORPORATION)  
2132 EAST RICHARDS STREET  
DOUGLAS, WY 82633

FOR: DIETARY AND NUTRITIONAL SUPPLEMENTS, IN CLASS 5 (U.S. CLS. 6, 18, 44, 46, 51 AND 52).

FIRST USE 11-0-2006; IN COMMERCE 11-0-2006.

THE MARK CONSISTS OF STANDARD CHARACTERS WITHOUT CLAIM TO ANY PARTICULAR FONT, STYLE, SIZE, OR COLOR.

NO CLAIM IS MADE TO THE EXCLUSIVE RIGHT TO USE "JOINT SUPPORT", APART FROM THE MARK AS SHOWN.

SER. NO. 77-374,298, FILED 1-17-2008.

TEJBIR SINGH, EXAMINING ATTORNEY

**Int. Cl.: 39**

**Prior U.S. Cls.: 100 and 105**

**United States Patent and Trademark Office**

**Reg. No. 3,498,436**

**Registered Sep. 9, 2008**

**SERVICE MARK  
PRINCIPAL REGISTER**



CR CAR RENTAL (ILLINOIS CORPORATION),  
DBA COLLISION REVISION CAR RENTAL  
INC.  
901 SOUTH LARKIN AVENUE  
JOLIET, IL 60436

FOR: CAR RENTAL; RENTAL OF CARS; REN-  
TAL OF ELECTRIC CARS; RENTAL OF MOVING  
VANS; RENTAL OF TRUCKS, IN CLASS 39 (U.S.  
CLS. 100 AND 105).

FIRST USE 8-1-2007; IN COMMERCE 8-1-2007.

NO CLAIM IS MADE TO THE EXCLUSIVE  
RIGHT TO USE "CAR RENTAL COMPANY",  
APART FROM THE MARK AS SHOWN.

THE COLOR(S) DARK BLUE, LIGHT BLUE IS/  
ARE CLAIMED AS A FEATURE OF THE MARK.

THE MARK CONSISTS OF THE "CR" IS IN THE  
DARK BLUE. THE "CAR IN CAR RENTAL" IS ALSO  
IN THE DARK BLUE SHADE. THE "RENTAL" IN  
"CAR RENTAL" IS IN THE LIGHT BLUE SHADE.  
"COMPANY" IS ALSO IN THE LIGHT BLUE  
SHADE.

SER. NO. 77-374,482, FILED 1-17-2008.

GISELLE AGOSTO, EXAMINING ATTORNEY

**Int. Cl.: 25**

**Prior U.S. Cls.: 22 and 39**

**United States Patent and Trademark Office**

**Reg. No. 3,498,437**

**Registered Sep. 9, 2008**

**TRADEMARK  
PRINCIPAL REGISTER**

# Shoes Expert

SHENG, ANDY WEICHU (UNITED STATES INDIVIDUAL)  
P. O. BOX 4268  
CERRITOS, CA 90703

NO CLAIM IS MADE TO THE EXCLUSIVE RIGHT TO USE "SHOES", APART FROM THE MARK AS SHOWN.

FOR: SHOES, IN CLASS 25 (U.S. CLS. 22 AND 39).

FIRST USE 10-21-2003; IN COMMERCE 10-21-2003.

SER. NO. 77-374,588, FILED 1-17-2008.

THE MARK CONSISTS OF STANDARD CHARACTERS WITHOUT CLAIM TO ANY PARTICULAR FONT, STYLE, SIZE, OR COLOR.

RONALD DELGIZZI, EXAMINING ATTORNEY

**Int. Cl.: 29**

**Prior U.S. Cl.: 46**

**United States Patent and Trademark Office**

**Reg. No. 3,498,438**

**Registered Sep. 9, 2008**

**TRADEMARK  
PRINCIPAL REGISTER**



CFS HOLDINGS, INC. (DELAWARE CORPORATION)  
2000 WEST BROAD STREET  
RICHMOND, VA 23220

FOR: BUTTER SUBSTITUTES; MARGARINE, IN  
CLASS 29 (U.S. CL. 46).

FIRST USE 10-1-2007; IN COMMERCE 10-1-2007.

NO CLAIM IS MADE TO THE EXCLUSIVE  
RIGHT TO USE "NO TRANS FAT" , APART FROM  
THE MARK AS SHOWN.

THE MARK CONSISTS OF THE WORDS "NO  
TRANS FAT" WITHIN A CIRCLE WHICH IS PAR-  
TIALY FILLED IN WITH A WAVY BACK-  
GROUND.

SER. NO. 77-374,773, FILED 1-17-2008.

JENNY PARK, EXAMINING ATTORNEY

**Int. Cl.: 9**

**Prior U.S. Cls.: 21, 23, 26, 36 and 38**

**United States Patent and Trademark Office**

**Reg. No. 3,498,439**

**Registered Sep. 9, 2008**

**TRADEMARK  
PRINCIPAL REGISTER**

# Clean Space

SAPRYKIN, YURI (RUSSIAN FED. INDIVIDUAL)  
PROSPEKT REVOLUCII 25  
VORONEZ, RUSSIAN FED. 394000

THE MARK CONSISTS OF STANDARD CHARACTERS WITHOUT CLAIM TO ANY PARTICULAR FONT, STYLE, SIZE, OR COLOR.

FOR: DOWNLOADABLE COMPUTER SOFTWARE FOR DATA REMOVAL, IN CLASS 9 (U.S. CLS. 21, 23, 26, 36 AND 38).

SER. NO. 77-374,870, FILED 1-18-2008.

FIRST USE 8-20-2002; IN COMMERCE 8-20-2002.

ZHALEH DELANEY, EXAMINING ATTORNEY

**Int. Cl.: 42**

**Prior U.S. Cls.: 100 and 101**

**United States Patent and Trademark Office**

**Reg. No. 3,498,440**

**Registered Sep. 9, 2008**

**SERVICE MARK  
PRINCIPAL REGISTER**

**BRECKENRIDGE DESIGN GROUP**

BRECKENRIDGE DESIGNS, INC. (D.C. CORPORATION)  
5225 WISCONSIN AVENUE, N.W., SUITE 625  
WASHINGTON, DC 20015

FOR: VISUAL DESIGN SERVICES IN THE NATURE OF DESIGNING VISUAL ELEMENTS FOR ONLINE, BROADCAST, PRINT, OUTDOOR AND OTHER COMMUNICATION MEDIA , IN CLASS 42 (U.S. CLS. 100 AND 101).

FIRST USE 10-1-1990; IN COMMERCE 10-1-1990.

THE MARK CONSISTS OF STANDARD CHARACTERS WITHOUT CLAIM TO ANY PARTICULAR FONT, STYLE, SIZE, OR COLOR.

NO CLAIM IS MADE TO THE EXCLUSIVE RIGHT TO USE "DESIGN GROUP", APART FROM THE MARK AS SHOWN.

SER. NO. 77-374,951, FILED 1-18-2008.

JENNIFER VASQUEZ, EXAMINING ATTORNEY

**Int. Cl.: 35**

**Prior U.S. Cls.: 100, 101 and 102**

**United States Patent and Trademark Office**

**Reg. No. 3,498,441**

**Registered Sep. 9, 2008**

**SERVICE MARK  
PRINCIPAL REGISTER**



CONSOLIDATED INVENTORY SUPPLY, INC.  
(TENNESSEE CORPORATION), DBA CIS, INC.  
3485 NORTHBEND CIRCLE  
ALCOA, TN 37701

FOR: WHOLESALE DISTRIBUTORSHIPS FEATURING PARTS FOR EARTH MOVING EQUIPMENT, IN CLASS 35 (U.S. CLS. 100, 101 AND 102).

FIRST USE 4-5-2001; IN COMMERCE 4-5-2001.

NO CLAIM IS MADE TO THE EXCLUSIVE RIGHT TO USE "INC." & "QUALITY PARTS", APART FROM THE MARK AS SHOWN.

THE COLOR(S) GOLD AND BLUE IS/ARE CLAIMED AS A FEATURE OF THE MARK.

THE MARK CONSISTS OF THE WORDS "CIS INC." IN BLUE LETTERS ABOVE A GOLD RECTANGLE WITH THE LOWER RIGHT CORNER OF THE RECTANGLE CUT OUT WITH THE OUTLINE OF A BLUE GEAR APPEARING AROUND THE CUT OUT AND THE WORDS "QUALITY PARTS" APPEARING IN BLUE LETTERS ON THE GOLD RECTANGLE.

SER. NO. 77-375,406, FILED 1-18-2008.

KRISTIN CARLSON, EXAMINING ATTORNEY



**Int. Cl.: 9**

**Prior U.S. Cls.: 21, 23, 26, 36 and 38**

**Reg. No. 3,498,442**

**United States Patent and Trademark Office**

**Registered Sep. 9, 2008**

**TRADEMARK  
PRINCIPAL REGISTER**

**BINOC-LOC**

SHELTERED WINGS, INC. (WISCONSIN CORPORATION)  
SUITE FOUR  
2120 WEST GREENVIEW DRIVE  
MIDDLETOWN, WI 53562

FOR: ACCESSORIES FOR BINOCULARS, NAME-  
LY, BINOCULAR INTERPUPILLARY DISTANCE  
SETTING APPARATUS, IN CLASS 9 (U.S. CLS. 21,  
23, 26, 36 AND 38).

FIRST USE 5-0-2007; IN COMMERCE 5-0-2007.

THE MARK CONSISTS OF STANDARD CHAR-  
ACTERS WITHOUT CLAIM TO ANY PARTICULAR  
FONT, STYLE, SIZE, OR COLOR.

SER. NO. 77-375,446, FILED 1-18-2008.

SUNG IN, EXAMINING ATTORNEY

**Int. Cl.: 16**

**Prior U.S. Cls.: 2, 5, 22, 23, 29, 37, 38 and 50**

**United States Patent and Trademark Office**

**Reg. No. 3,498,443**

**Registered Sep. 9, 2008**

**TRADEMARK  
PRINCIPAL REGISTER**

**MORE CLING MORE STRETCH  
MORE STRENGTH**

POLYVINYL FILMS, INC. (MASSACHUSETTS  
CORPORATION)  
19 DEPOT ST.  
SUTTON, MA 01590

FOR: FOOD WRAPPING PLASTIC FILM FOR  
HOUSEHOLD USE; PLASTIC WRAP, IN CLASS 16  
(U.S. CLS. 2, 5, 22, 23, 29, 37, 38 AND 50).

FIRST USE 1-1-1980; IN COMMERCE 1-1-1980.

THE MARK CONSISTS OF STANDARD CHAR-  
ACTERS WITHOUT CLAIM TO ANY PARTICULAR  
FONT, STYLE, SIZE, OR COLOR.

SEC. 2(F).

SER. NO. 77-375,514, FILED 1-18-2008.

CAROLINE WOOD, EXAMINING ATTORNEY

**Int. Cl.: 7**

**Prior U.S. Cls.: 13, 19, 21, 23, 31, 34 and 35**

**United States Patent and Trademark Office**

**Reg. No. 3,498,444**

**Registered Sep. 9, 2008**

**TRADEMARK  
PRINCIPAL REGISTER**

**PIPEPRO**

ILLINOIS TOOL WORKS INC. (DELAWARE  
CORPORATION)  
3600 WEST LAKE AVENUE  
GLENVIEW, IL 600261215

FOR: ELECTRIC ARC-WELDING MACHINES,  
WIRE FEEDERS AND ENGINE-DRIVEN COMBI-  
NATION ELECTRIC GENERATOR AND ELECTRIC  
WELDING MACHINE , IN CLASS 7 (U.S. CLS. 13, 19,  
21, 23, 31, 34 AND 35).

FIRST USE 3-23-1999; IN COMMERCE 3-23-1999.

THE MARK CONSISTS OF STANDARD CHAR-  
ACTERS WITHOUT CLAIM TO ANY PARTICULAR  
FONT, STYLE, SIZE, OR COLOR.

OWNER OF U.S. REG. NO. 2,535,413.

SER. NO. 77-375,541, FILED 1-18-2008.

MICHELLE DUBOIS, EXAMINING ATTORNEY

**Int. Cl.: 41**

**Prior U.S. Cls.: 100, 101 and 107**

**United States Patent and Trademark Office**

**Reg. No. 3,498,445**

**Registered Sep. 9, 2008**

**SERVICE MARK  
PRINCIPAL REGISTER**

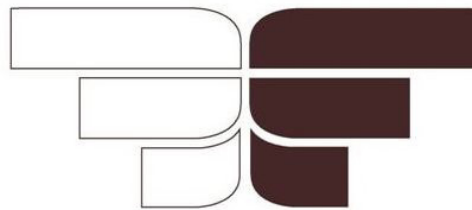

**FULCRUMSURF**

MORI, DANIEL (UNITED STATES INDIVIDUAL)  
UNIT 2101  
875 STEVENS AVE  
SOLANA BEACH, CA 92075

FOR: SURFING INSTRUCTION AND LESSONS;  
RENTAL OF SURFBOARDS, IN CLASS 41 (U.S. CLS.  
100, 101 AND 107).

FIRST USE 5-0-2004; IN COMMERCE 5-0-2004.

THE COLOR(S) WHITE, MAROON, YELLOW  
AND GREEN IS/ARE CLAIMED AS A FEATURE  
OF THE MARK.

THE MARK CONSISTS OF THREE CONSECUTIVE HORIZONTAL WHITE BARS, SHORTENING IN LENGTH FROM TOP TO BOTTOM AND LEFT TO RIGHT, SYMMETRICALLY ALIGNED WITH THREE HORIZONTAL MAROON BARS, SHORTENING IN LENGTH FROM TOP TO BOTTOM AND RIGHT TO LEFT WITH THE WORDS "FULCRUM" IN MAROON LETTERING AND "SURF" IN GREEN AND YELLOW LETTERING CENTERED BELOW THE DESIGN.

SER. NO. 77-375,770, FILED 1-18-2008.

SETH A. RAPPAPORT, EXAMINING ATTORNEY

**Int. Cl.: 40**

**Prior U.S. Cls.: 100, 103 and 106**

**United States Patent and Trademark Office**

**Reg. No. 3,498,446**

**Registered Sep. 9, 2008**

**SERVICE MARK  
PRINCIPAL REGISTER**

**Red Rock  
Hospitality**

RED ROCK HOSPITALITY, INC. (UTAH CORPORATION)  
3884 S. RIVER ROAD  
E-1  
ST. GEORGE, UT 84790

FOR: MANUFACTURE OF FURNITURE TO ORDER AND/OR SPECIFICATION OF OTHERS, IN CLASS 40 (U.S. CLS. 100, 103 AND 106).

FIRST USE 1-17-2008; IN COMMERCE 1-17-2008.

THE MARK CONSISTS OF STANDARD CHARACTERS WITHOUT CLAIM TO ANY PARTICULAR FONT, STYLE, SIZE, OR COLOR.

NO CLAIM IS MADE TO THE EXCLUSIVE RIGHT TO USE "HOSPITALITY", APART FROM THE MARK AS SHOWN.

SER. NO. 77-375,777, FILED 1-18-2008.

KHANH LE, EXAMINING ATTORNEY

**Int. Cl.: 35**

**Prior U.S. Cls.: 100, 101 and 102**

**United States Patent and Trademark Office**

**Reg. No. 3,498,447**

**Registered Sep. 9, 2008**

**SERVICE MARK  
PRINCIPAL REGISTER**

# Create-A-Frame

CHURCH HILL CLASSICS, LTD (CONNECTICUT CORPORATION)  
594 PEPPER STREET  
MONROE, CT 06468

FOR: ONLINE RETAIL STORE SERVICES, WHOLESALE DISTRIBUTORSHIPS AND MAIL ORDER CATALOG SERVICES, ALL FEATURING PICTURE FRAMES, PHOTO FRAMES, DIPLOMA FRAMES AND CERTIFICATE FRAMES, IN CLASS 35 (U.S. CLS. 100, 101 AND 102).

FIRST USE 8-6-2004; IN COMMERCE 8-6-2004.

THE MARK CONSISTS OF STANDARD CHARACTERS WITHOUT CLAIM TO ANY PARTICULAR FONT, STYLE, SIZE, OR COLOR.

OWNER OF U.S. REG. NO. 3,031,915.

SER. NO. 77-375,820, FILED 1-18-2008.

WON TEAK OH, EXAMINING ATTORNEY

Int. Cl.: 42

Prior U.S. Cls.: 100 and 101

United States Patent and Trademark Office

Reg. No. 3,498,448

Registered Sep. 9, 2008

SERVICE MARK  
PRINCIPAL REGISTER



PIATT, JAMES JOSEPH (UNITED STATES INDIVIDUAL)

2425 COLLINS DR  
SIDNEY, OH 45365

FOR: COMPUTER SERVICES, NAMELY, CREATING AN ONLINE COMMUNITY FOR REGISTERED USERS TO PARTICIPATE IN COMPETITIONS, SHOWCASE THEIR SKILLS, GET FEEDBACK FROM THEIR PEERS, FORM VIRTUAL COMMUNITIES, ENGAGE IN SOCIAL NETWORKING AND IMPROVE THEIR TALENT, IN CLASS 42 (U.S. CLS. 100 AND 101).

FIRST USE 3-1-2007; IN COMMERCE 3-18-2007.

NO CLAIM IS MADE TO THE EXCLUSIVE RIGHT TO USE "FANTASY FOOTBALL.COM", APART FROM THE MARK AS SHOWN.

THE COLOR(S) RED, WHITE, BLACK AND METALLIC GRAY IS/ARE CLAIMED AS A FEATURE OF THE MARK.

THE MARK CONSISTS OF A RED FOOTBALL IMAGE SURROUNDED WITH METALLIC GRAY AROUND THE EDGES THE WORD "FANATIC" IN STYLIZED WHITE LETTERING SURROUNDED WITH METALLIC GRAY AND LOCATED IN CENTER OF THE FOOTBALL IMAGE THE WORDS "FANTASYFOOTBALL" IN RED LETTERING WITH WHITE EDGES ALL SURROUNDED WITH METALLIC GRAY AND LOCATED IN THE CENTER OF THE FOOTBALL BELOW THE WORD "FANATIC" ".COM" IN WHITE LETTERING SURROUNDED BY METALLIC GRAY AND LOCATED IN CENTER OF FOOTBALL UNDER THE WORD "FOOTBALL" "LACE UP THOSE CLEATS! PULL THAT CHIN-STRAP TIGHT! GET IN THERE!" IN SOLID BLACK LETTERING AND ARCHED ALONG THE BOTTOM OF FOOTBALL IMAGE. THE COLOR WHITE IN THE CENTER OF THE FOOTBALL REPRESENTS A TRANSPARENT AREA AND IS NOT A FEATURE OF THE MARK.

SER. NO. 77-375,924, FILED 1-18-2008.

KATHRYN COWARD, EXAMINING ATTORNEY

**Int. Cl.: 25**

**Prior U.S. Cls.: 22 and 39**

**United States Patent and Trademark Office**

**Reg. No. 3,498,449**

**Registered Sep. 9, 2008**

**TRADEMARK  
PRINCIPAL REGISTER**

# Benny Stacks

KEFOVER, ALEX (UNITED STATES INDIVIDUAL)  
P.O. BOX 17094  
SAN DIEGO, CA 92177 AND  
KEFOVER, ARTHUR (UNITED STATES INDIVIDUAL)  
P.O. BOX 17094  
SAN DIEGO, CA 92177

FOR: MEN'S, WOMEN'S AND CHILDREN'S CLOTHING AND FASHION ACCESSORIES, NAMELY, DRESSES, COATS, SHORTS, SHIRTS, DRESS SHIRTS, PANTS, DRESS PANTS, JEANS, SWEATERS, JACKETS, SUITS, TUXEDOS, DINNER JACKETS, T-SHIRTS, BLOUSES, KNIT TOPS, HALTER TOPS, SMOCK TOPS, VESTS, WIND RESISTANT JACKETS, JOGGING SUITS, SWEATSHIRTS, SWEATPANTS, SKI JACKETS, SKI PANTS, MUFFLERS, HEAD BANDS, BELTS, GLOVES, SHAWLS, SCARVES, PONCHOS, SHOULDER WRAPS, NECKERCHIEFS, STOCKINGS, HOSIERY, SOCKS,

TIGHTS, LEGGINGS, LEOTARDS, PAJAMAS, ROBES, NIGHTGOWNS, PANTIES, BRAS, UNDERWEAR, UNDERSHIRTS, RAINWEAR, RAINCOATS, SWIMWEAR, BATHING SUITS, COVER-UPS, AND WOMEN'S LINGERIE; FOOTWEAR, HEADWEAR, TIES, CAPS, AND HATS, IN CLASS 25 (U.S. CLS. 22 AND 39).

FIRST USE 9-20-2007; IN COMMERCE 1-1-2008.

THE MARK CONSISTS OF STANDARD CHARACTERS WITHOUT CLAIM TO ANY PARTICULAR FONT, STYLE, SIZE, OR COLOR.

THE NAME SHOWN IN THE MARK DOES NOT IDENTIFY A PARTICULAR LIVING INDIVIDUAL.

SER. NO. 77-375,936, FILED 1-18-2008.

JAY BESCH, EXAMINING ATTORNEY



**Int. Cl.: 35**

**Prior U.S. Cls.: 100, 101 and 102**

**United States Patent and Trademark Office**

**Reg. No. 3,498,450**

**Registered Sep. 9, 2008**

**SERVICE MARK  
PRINCIPAL REGISTER**

# CompBuster

DELL'S INSURANCE AGENCY, INC. (COLOR-  
ADO CORPORATION)  
510 BELL AVENUE  
ALAMOSA, CO 81101

FOR: BUSINESS CONSULTATION AND ADVISORY SERVICES IN THE FIELD OF HELPING EMPLOYERS PROACTIVELY MANAGE THEIR WORKERS COMPENSATION INSURANCE IN ORDER TO REDUCE THEIR PREMIUM COSTS, IN CLASS 35 (U.S. CLS. 100, 101 AND 102).

FIRST USE 3-8-2007; IN COMMERCE 3-8-2007.

THE MARK CONSISTS OF STANDARD CHARACTERS WITHOUT CLAIM TO ANY PARTICULAR FONT, STYLE, SIZE, OR COLOR.

SER. NO. 77-376,574, FILED 1-21-2008.

LYDIA BELZER, EXAMINING ATTORNEY

**Int. Cl.: 29**

**Prior U.S. Cl.: 46**

**United States Patent and Trademark Office**

**Reg. No. 3,498,451**

**Registered Sep. 9, 2008**

**TRADEMARK  
PRINCIPAL REGISTER**

**CAN-ILLA VANILLA**

LUSTER CREATIONS (CALIFORNIA CORPORATION)

179 HOMESTEAD BOULEVARD

MILL VALLEY, CA 94941

FOR: PROTEIN BASED, NUTRIENT DENSE  
SNACK FOOD, IN CLASS 29 (U.S. CL. 46).

FIRST USE 9-24-2007; IN COMMERCE 10-8-2007.

THE MARK CONSISTS OF STANDARD CHARACTERS WITHOUT CLAIM TO ANY PARTICULAR FONT, STYLE, SIZE, OR COLOR.

NO CLAIM IS MADE TO THE EXCLUSIVE RIGHT TO USE "VANILLA", APART FROM THE MARK AS SHOWN.

SER. NO. 77-377,719, FILED 1-22-2008.

JILL PRATER, EXAMINING ATTORNEY

**Int. Cl.: 33**

**Prior U.S. Cls.: 47 and 49**

**United States Patent and Trademark Office**

**Reg. No. 3,498,452**

**Registered Sep. 9, 2008**

**TRADEMARK  
PRINCIPAL REGISTER**

**BELLA ROSA**

CEJA VINEYARDS, INC. (CALIFORNIA CORPORATION)  
1012 LAS AMIGAS ROAD  
NAPA, CA 94559

THE FOREIGN WORDING IN THE MARK  
TRANSLATES INTO ENGLISH AS BEAUTIFUL  
ROSE.

FOR: WINE, IN CLASS 33 (U.S. CLS. 47 AND 49).

FIRST USE 4-19-2008; IN COMMERCE 4-19-2008.

SER. NO. 77-377,757, FILED 1-22-2008.

THE MARK CONSISTS OF STANDARD CHARACTERS WITHOUT CLAIM TO ANY PARTICULAR FONT, STYLE, SIZE, OR COLOR.

MICHAEL ENGEL, EXAMINING ATTORNEY

Int. Cl.: 45

Prior U.S. Cls.: 100 and 101

United States Patent and Trademark Office

Reg. No. 3,498,453

Registered Sep. 9, 2008

SERVICE MARK  
PRINCIPAL REGISTER

M A C I A S  
C O U N S E L  
I N C .



MACIAS COUNSEL, INC. (CALIFORNIA CORPORATION)  
425 E. COLORADO ST., SUITE 710  
GLENDALE, CA 91205

FOR: LEGAL SERVICES, IN CLASS 45 (U.S. CLS. 100 AND 101).

FIRST USE 11-1-2006; IN COMMERCE 11-1-2006.

NO CLAIM IS MADE TO THE EXCLUSIVE RIGHT TO USE "COUNSEL INC." , APART FROM THE MARK AS SHOWN.

THE COLOR(S) BLACK AND GRAY IS/ARE CLAIMED AS A FEATURE OF THE MARK.

THE MARK CONSISTS OF THE WORDS "MACIAS COUNSEL, INC." AND THE LARGE "C" APPEAR IN GRAY WITH THE LARGE "M" IN BLACK.

SER. NO. 77-377,778, FILED 1-22-2008.

HEATHER SAPP, EXAMINING ATTORNEY

Int. Cl.: 33

Prior U.S. Cls.: 47 and 49

United States Patent and Trademark Office

Reg. No. 3,498,454

Registered Sep. 9, 2008

TRADEMARK  
PRINCIPAL REGISTER

BELVEDERE

POLMOS ZYRARDOW SPOLKA Z OGRANICZONA  
ODPOWIEDZIALNOSCIA (POLAND LIMITED  
LIABILITY COMPANY)  
UL. MICKIEWICZA 1-3, 96-300  
ZYRARDOW, POLAND

FOR: DISTILLED SPIRITS, IN CLASS 33 (U.S. CLS.  
47 AND 49).

FIRST USE 12-0-2005; IN COMMERCE 12-0-2005.

OWNER OF U.S. REG. NOS. 1,563,665, 2,670,702,  
AND 3,401,263.

THE MARK CONSISTS OF THE WORD "BELVE-  
DERE" IN STYLIZED SCRIPT.

SER. NO. 77-377,838, FILED 1-22-2008.

REBECCA EISINGER, EXAMINING ATTORNEY

Int. Cls.: 30 and 35

Prior U.S. Cls.: 46, 100, 101 and 102

United States Patent and Trademark Office

Reg. No. 3,498,455

Registered Sep. 9, 2008

TRADEMARK  
SERVICE MARK  
PRINCIPAL REGISTER



TROPHY CUPCAKES, LLC (WASHINGTON LIMITED LIABILITY COMPANY)  
SUITE 209  
1815 NORTH 45TH STREET  
SEATTLE, WA 98103

FOR: BAKERY GOODS, IN CLASS 30 (U.S. CL. 46).

FIRST USE 2-7-2007; IN COMMERCE 2-7-2007.

FOR: RETAIL BAKERY SHOPS AND RETAIL STORE SERVICES, FEATURING GIFTS, CARDS, DECORATIONS AND PARTY SUPPLIES, IN CLASS 35 (U.S. CLS. 100, 101 AND 102).

FIRST USE 2-7-2007; IN COMMERCE 2-7-2007.

NO CLAIM IS MADE TO THE EXCLUSIVE RIGHT TO USE "CUPCAKES AND PARTY", APART FROM THE MARK AS SHOWN.

THE MARK CONSISTS OF A GENERALLY CIRCULAR DESIGN IN A CIRCLE WITH FOUR SMALLER CIRCLES AND WORDING "TROPHY CUPCAKES AND PARTY".

SER. NO. 77-377,907, FILED 1-22-2008.

DAVID C. REIHNER, EXAMINING ATTORNEY

**Int. Cl.: 43**

**Prior U.S. Cls.: 100 and 101**

**United States Patent and Trademark Office**

**Reg. No. 3,498,456**

**Registered Sep. 9, 2008**

**SERVICE MARK  
PRINCIPAL REGISTER**



HALAL HARRY'S, LLC (PENNSYLVANIA LIMITED LIABILITY COMPANY), DBA HALAL HARRY'S  
248 N 5TH DTREET  
ALLENTOWN, PA 18102

FOR: RESTAURANT SERVICES FEATURING BUT NOT LIMITED TO POULTRY, PIZZA, MEAT PRODUCT SANDWICHES, BEVERAGES AND FAST FOOD, IN CLASS 43 (U.S. CLS. 100 AND 101).

FIRST USE 1-14-2008; IN COMMERCE 1-14-2008.

NO CLAIM IS MADE TO THE EXCLUSIVE RIGHT TO USE "HALAL", APART FROM THE MARK AS SHOWN.

THE COLOR(S) WHITE, RED AND YELLOW IS/ ARE CLAIMED AS A FEATURE OF THE MARK.

THE MARK CONSISTS OF WHITE BACKGROUND WITH RED RECTANGLE. STYLIZED "H" WITH A RED BORDER AND YELLOW FILLING. THE FOLLOWING LETTERS "ALAL" AND "ARRY'S" FILLED IN WHITE, ON THE RED RECTANGLE.

SER. NO. 77-377,963, FILED 1-22-2008.

CHRISTINE COOPER, EXAMINING ATTORNEY

**Int. Cl.: 38**

**Prior U.S. Cls.: 100, 101 and 104**

**United States Patent and Trademark Office**

**Reg. No. 3,498,457**

**Registered Sep. 9, 2008**

**SERVICE MARK  
PRINCIPAL REGISTER**

SIP ADVANTAGE OFFICEFONE

ADAPTION TECHNOLOGIES VENTURES, LTD.  
(TEXAS PARTNERSHIP)  
1009 PRUITT ROAD  
THE WOODLANDS, TX 77380

FOR: VOICE OVER INTERNET PROTOCOL SERVICE THAT PROVIDES VIRTUAL PRIVATE BRANCH EXCHANGE CAPABILITIES, IN CLASS 38 (U.S. CLS. 100, 101 AND 104).

FIRST USE 1-3-2008; IN COMMERCE 1-3-2008.

THE MARK CONSISTS OF STANDARD CHARACTERS WITHOUT CLAIM TO ANY PARTICULAR FONT, STYLE, SIZE, OR COLOR.

NO CLAIM IS MADE TO THE EXCLUSIVE RIGHT TO USE "SIP" AND "OFFICEFONE", APART FROM THE MARK AS SHOWN.

SER. NO. 77-378,184, FILED 1-23-2008.

JENNY PARK, EXAMINING ATTORNEY



**Int. Cl.: 42**

**Prior U.S. Cls.: 100 and 101**

**United States Patent and Trademark Office**

**Reg. No. 3,498,458**

**Registered Sep. 9, 2008**

**SERVICE MARK  
PRINCIPAL REGISTER**



TENANTWIZ SOFTWARE CORPORATION (NEVADA CORPORATION)  
650 SOUTH HILL STREET #J-4  
LOS ANGELES, CA 90014

THE COLOR(S) BLUE, AND GREY IS/ARE CLAIMED AS A FEATURE OF THE MARK.

FOR: ONLINE, NON-DOWNLOADABLE COMPUTER SOFTWARE FOR MANAGING VACATION RENTAL PROPERTIES THROUGH AN ONLINE INTERFACE AND WEBSITE, CREATING AVAILABILITY CALENDARS, ACCEPTING RESERVATIONS ONLINE, MANAGING RENTERS, MANAGING OWNERS, AND FILING ELECTRONIC RENTAL CONTRACTS, IN CLASS 42 (U.S. CLS. 100 AND 101).

THE MARK CONSISTS OF THE WORD "TENANT" AND ITS REFLECTION APPEARING IN BLUE AND THE WORD "WIZ" AND ITS REFLECTION APPEARING IN GREY. THE COLORS BLUE AND GREY ALSO APPEAR IN THE DESIGN OF A THREE-DIMENSIONAL HOUSE AND ITS REFLECTION.

FIRST USE 4-5-2005; IN COMMERCE 4-5-2005.

SER. NO. 77-378,670, FILED 1-23-2008.

NO CLAIM IS MADE TO THE EXCLUSIVE RIGHT TO USE "TENANT", APART FROM THE MARK AS SHOWN.

NATALIE POLZER, EXAMINING ATTORNEY

**Int. Cls.: 35 and 44**

**Prior U.S. Cls.: 100, 101 and 102**

**United States Patent and Trademark Office**

**Reg. No. 3,498,459**

**Registered Sep. 9, 2008**

**SERVICE MARK  
PRINCIPAL REGISTER**

**MYMONTEFIORE**

MONTEFIORE MEDICAL CENTER INC. (NEW  
YORK CORPORATION)  
111 EAST 210TH STREET  
BRONX, NY 104672490

FOR: PATIENT HEALTH SERVICES, NAMELY,  
DOCTOR REFERRALS, MEDICAL APPOINTMENT  
SCHEDULING, RETAIL PHARMACY SERVICES,  
AND PHYSICIAN REFERRALS PROVIDED VIA A  
COMPUTER PORTAL AND WEBSITE, IN CLASS 35  
(U.S. CLS. 100, 101 AND 102).

FIRST USE 5-1-2007; IN COMMERCE 6-1-2007.

FOR: MAINTAINING FILES AND RECORDS  
CONCERNING THE MEDICAL CONDITION OF  
INDIVIDUAL PATIENTS; MAINTAINING PERSO-

NAL MEDICAL HISTORY RECORDS AND FILES  
OF PATIENTS, IN CLASS 44 (U.S. CLS. 100 AND 101).

FIRST USE 5-1-2007; IN COMMERCE 6-6-2007.

THE MARK CONSISTS OF STANDARD CHAR-  
ACTERS WITHOUT CLAIM TO ANY PARTICULAR  
FONT, STYLE, SIZE, OR COLOR.

OWNER OF U.S. REG. NOS. 1,722,716, 3,255,293  
AND OTHERS.

SER. NO. 77-379,679, FILED 1-24-2008.

THOMAS MANOR, EXAMINING ATTORNEY

**Int. Cls.: 35 and 44**

**Prior U.S. Cls.: 100, 101 and 102**

**United States Patent and Trademark Office**

**Reg. No. 3,498,460**

**Registered Sep. 9, 2008**

**SERVICE MARK  
PRINCIPAL REGISTER**

[www.mymontefiore.org](http://www.mymontefiore.org)

MONTEFIORE MEDICAL CENTER INC. (NEW  
YORK CORPORATION)  
111 EAST 210TH STREET  
BRONX, NY 104672490

FOR: PATIENT HEALTH SERVICES, NAMELY,  
DOCTOR REFERRALS, MEDICAL APPOINTMENT  
SCHEDULING, RETAIL PHARMACY SERVICES,  
AND PHYSICIAN REFERRALS PROVIDED VIA A  
COMPUTER PORTAL AND WEBSITE, IN CLASS 35  
(U.S. CLS. 100, 101 AND 102).

FIRST USE 5-1-2007; IN COMMERCE 6-6-2007.

FOR: MAINTAINING FILES AND RECORDS  
CONCERNING THE MEDICAL CONDITION OF  
INDIVIDUAL PATIENTS; MAINTAINING PERSO-

NAL MEDICAL HISTORY RECORDS AND FILES  
OF PATIENTS, IN CLASS 44 (U.S. CLS. 100 AND 101).

FIRST USE 5-1-2007; IN COMMERCE 6-6-2007.

THE MARK CONSISTS OF STANDARD CHAR-  
ACTERS WITHOUT CLAIM TO ANY PARTICULAR  
FONT, STYLE, SIZE, OR COLOR.

OWNER OF U.S. REG. NOS. 1,722,716, 3,255,293  
AND OTHERS.

SER. NO. 77-379,730, FILED 1-24-2008.

THOMAS MANOR, EXAMINING ATTORNEY

Int. Cl.: 3

Prior U.S. Cls.: 1, 4, 6, 50, 51 and 52

United States Patent and Trademark Office

Reg. No. 3,498,461

Registered Sep. 9, 2008

TRADEMARK  
PRINCIPAL REGISTER



IDEASONE, INC. (CALIFORNIA CORPORATION)  
59-1526 KOHALA RANCH ROAD  
KAMUELA, HI 96743

FOR: SKIN AND BODY PREPARATIONS NAME-  
LY, LOTIONS, CREAMS, OILS AND GELS, IN  
CLASS 3 (U.S. CLS. 1, 4, 6, 50, 51 AND 52).

FIRST USE 1-18-2008; IN COMMERCE 1-18-2008.

NO CLAIM IS MADE TO THE EXCLUSIVE  
RIGHT TO USE "SKIN", APART FROM THE MARK  
AS SHOWN.

THE MARK CONSISTS OF A REPRESENTATION  
OF INSECT WINGS SPREAD OUT FROM THE  
BODY OF A SCARAB.

SER. NO. 77-379,768, FILED 1-24-2008.

MATTHEW PAPPAS, EXAMINING ATTORNEY

**Int. Cl.: 36**

**Prior U.S. Cls.: 100, 101 and 102**

**United States Patent and Trademark Office**

**Reg. No. 3,498,462**

**Registered Sep. 9, 2008**

**SERVICE MARK  
PRINCIPAL REGISTER**

**PRICEWATCH ALERTS**

VHS, LLC (VIRGINIA LIMITED LIABILITY  
COMPANY)  
3005 WAVERLY DRIVE  
CHARLOTTESVILLE, VA 22901

FOR: FINANCIAL INFORMATION PROVIDED  
BY ELECTRONIC MEANS, IN CLASS 36 (U.S. CLS.  
100, 101 AND 102).

FIRST USE 12-0-2002; IN COMMERCE 12-0-2002.

THE MARK CONSISTS OF STANDARD CHAR-  
ACTERS WITHOUT CLAIM TO ANY PARTICULAR  
FONT, STYLE, SIZE, OR COLOR.

SEC. 2(F).

SER. NO. 77-379,899, FILED 1-24-2008.

MELISSA VALLILLO, EXAMINING ATTORNEY

**Int. Cl.: 41**

**Prior U.S. Cls.: 100, 101 and 107**

**United States Patent and Trademark Office**

**Reg. No. 3,498,463**

**Registered Sep. 9, 2008**

**SERVICE MARK  
PRINCIPAL REGISTER**



CHAMPIONSHIP MARTIAL ARTS, INC. (FLORIDA CORPORATION)

#408

1969 S. ALAFAYA TRAIL  
ORLANDO, FL 32828

FOR: PROVIDING PHYSICAL FITNESS, EXERCISE AND STRENGTH AND CONDITIONING TRAINING CONSULTATION, INSTRUCTION AND FACILITIES, IN CLASS 41 (U.S. CLS. 100, 101 AND 107).

FIRST USE 12-1-2007; IN COMMERCE 12-1-2007.

NO CLAIM IS MADE TO THE EXCLUSIVE RIGHT TO USE "MARTIAL ARTS", APART FROM THE MARK AS SHOWN.

SER. NO. 77-379,936, FILED 1-24-2008.

KATHERINE CHANG, EXAMINING ATTORNEY

**Int. Cl.: 42**

**Prior U.S. Cls.: 100 and 101**

**United States Patent and Trademark Office**

**Reg. No. 3,498,464**

**Registered Sep. 9, 2008**

**SERVICE MARK  
PRINCIPAL REGISTER**

**RuRo**

RURO INCORPORATED (DELAWARE CORPORATION)  
3932 BRAVEHEART CIR  
FREDERICK, MD 21704

FOR: COMPUTER PROGRAMMING AND SOFTWARE DESIGN, IN CLASS 42 (U.S. CLS. 100 AND 101).

FIRST USE 1-23-2007; IN COMMERCE 1-31-2007.

THE MARK CONSISTS OF STANDARD CHARACTERS WITHOUT CLAIM TO ANY PARTICULAR FONT, STYLE, SIZE, OR COLOR.

THE WORD "RURO" HAS NO MEANING IN A FOREIGN LANGUAGE.

SER. NO. 77-380,305, FILED 1-25-2008.

ANDREW RHIM, EXAMINING ATTORNEY

Int. Cl.: 35

Prior U.S. Cls.: 100, 101 and 102

United States Patent and Trademark Office

Reg. No. 3,498,465

Registered Sep. 9, 2008

SERVICE MARK  
PRINCIPAL REGISTER



AIKEN INVESTMENTS AND ADVERTISING,  
INC. (SOUTH CAROLINA CORPORATION)  
2 OAKMONT LANE  
AIKEN, SC 29803

FOR: MAIL ORDER CATALOG SERVICES FEATURING FLOWER, VEGETABLE, HERB, FARM, AND FIELD SEEDS, SEEDLINGS, TRAYS, POTS, PROPAGATING MATS, PEAT PRODUCTS, PH METERS, RAIN GAUGES, AND THERMOMETERS, IN CLASS 35 (U.S. CLS. 100, 101 AND 102).

FIRST USE 6-30-2003; IN COMMERCE 6-30-2003.

NO CLAIM IS MADE TO THE EXCLUSIVE RIGHT TO USE "TOMATO" AND "SEEDS", APART FROM THE MARK AS SHOWN.

THE COLOR(S) RED, GREEN, BROWN AND WHITE IS/ARE CLAIMED AS A FEATURE OF THE MARK.

THE MARK CONSISTS OF THE IMAGE OF A RED TOMATO HAVING A GREEN STEM AND WHITE HIGHLIGHTS; THE TERM "TOMATO" APPEARING IN WHITE AND WITHIN A GREEN BANNER WITH WHITE AND GREEN BORDER EXTENDING ACROSS THE TOMATO; THE TERMS "SEEDS N SUCH" APPEARING IN BROWN WITH WHITE AND GREEN OUTLINES; AND A SPROUTING SEEDLING APPEARING IN GREEN WITH WHITE AND GREEN OUTLINES AND FORMING AN APOSTROPHE.

SER. NO. 77-380,393, FILED 1-25-2008.

JENNIFER VASQUEZ, EXAMINING ATTORNEY



**Int. Cls.: 35 and 42**

**Prior U.S. Cls.: 100, 101 and 102**

**United States Patent and Trademark Office**

**Reg. No. 3,498,466**

**Registered Sep. 9, 2008**

**SERVICE MARK  
PRINCIPAL REGISTER**



SO MANY ROADS, LLC (ILLINOIS LIMITED  
LIABILITY COMPANY)  
740 WAUKEGAN ROAD, SUITE 204  
DEERFIELD, IL 60015

FOR: RETAIL STORE SERVICES FEATURING  
JEWELRY, IN CLASS 35 (U.S. CLS. 100, 101 AND 102).

FIRST USE 2-0-2006; IN COMMERCE 2-0-2006.

FOR: CUSTOM DESIGN OF JEWELRY BASED  
ON PERSONAL SELECTIONS MADE BY THE CUS-  
TOMER, IN CLASS 42 (U.S. CLS. 100 AND 101).

FIRST USE 2-0-2006; IN COMMERCE 2-0-2006.

THE MARK CONSISTS OF THE LETTERS "SMR"  
INSIDE OF AN OVAL BORDERED WITH A FANCI-  
FUL SCROLL DESIGN.

SER. NO. 77-380,469, FILED 1-25-2008.

ARETHA SOMERVILLE, EXAMINING ATTORNEY

**Int. Cls.: 40 and 42**

**Prior U.S. Cls.: 100, 101, 103 and 106**

**United States Patent and Trademark Office**

**Reg. No. 3,498,467**

**Registered Sep. 9, 2008**

**SERVICE MARK  
PRINCIPAL REGISTER**

# ARRADIANCE

ARRADIANCE, INC. (DELAWARE CORPORATION)  
SUITE F-150  
142 NORTH ROAD  
SUDBURY, MA 01776

FOR: THIN FILM DEPOSITION CHEMICAL PROCESSING SERVICES IN THE FIELDS OF ENGINEERED MATERIALS, MICRO-STRUCTURES AND PROCESS EQUIPMENT AND TECHNOLOGY, IN CLASS 40 (U.S. CLS. 100, 103 AND 106).

FIRST USE 12-5-2007; IN COMMERCE 12-5-2007.

FOR: SCIENTIFIC AND TECHNOLOGICAL RESEARCH AND DESIGN SERVICES IN THE FIELDS

OF ENGINEERED MATERIALS, MICRO-STRUCTURES AND PROCESS EQUIPMENT AND TECHNOLOGY, IN CLASS 42 (U.S. CLS. 100 AND 101).

FIRST USE 12-5-2007; IN COMMERCE 12-5-2007.

THE MARK CONSISTS OF STANDARD CHARACTERS WITHOUT CLAIM TO ANY PARTICULAR FONT, STYLE, SIZE, OR COLOR.

SER. NO. 77-380,552, FILED 1-25-2008.

MICHAEL LITZAU, EXAMINING ATTORNEY

**Int. Cl.: 1**

**Prior U.S. Cls.: 1, 5, 6, 10, 26 and 46**

**United States Patent and Trademark Office**

**Reg. No. 3,498,468**

**Registered Sep. 9, 2008**

**TRADEMARK  
PRINCIPAL REGISTER**

# Glueit Green

AMERICAN CHEMICAL, INC. (MINNESOTA  
CORPORATION)  
2201 NORTH 2ND STREET  
MINNEAPOLIS, MN 55411

THE MARK CONSISTS OF STANDARD CHAR-  
ACTERS WITHOUT CLAIM TO ANY PARTICULAR  
FONT, STYLE, SIZE, OR COLOR.

FOR: ADHESIVES FOR INDUSTRIAL PURPOSES,  
IN CLASS 1 (U.S. CLS. 1, 5, 6, 10, 26 AND 46).

SER. NO. 77-380,607, FILED 1-25-2008.

FIRST USE 11-8-2007; IN COMMERCE 11-8-2007.

MATTHEW EINSTEIN, EXAMINING ATTORNEY

**Int. Cl.: 9**

**Prior U.S. Cls.: 21, 23, 26, 36 and 38**

**Reg. No. 3,498,469**

**United States Patent and Trademark Office**

**Registered Sep. 9, 2008**

**TRADEMARK  
PRINCIPAL REGISTER**

# VersaPanel

BOSTON RETAIL PRODUCTS, INC. (MASSACHUSETTS CORPORATION)  
400 RIVERSIDE AVENUE  
MEDFORD, MA 02155

FOR: ELECTRICAL POWER DISTRIBUTION BLOCKS AND MOUNTING DEVICES THEREFOR, IN CLASS 9 (U.S. CLS. 21, 23, 26, 36 AND 38).

FIRST USE 4-5-2008; IN COMMERCE 4-5-2008.

THE MARK CONSISTS OF STANDARD CHARACTERS WITHOUT CLAIM TO ANY PARTICULAR FONT, STYLE, SIZE, OR COLOR.

SER. NO. 77-380,633, FILED 1-25-2008.

MARIA-VICTORIA SUAREZ, EXAMINING ATTORNEY

**Int. Cl.: 1**

**Prior U.S. Cls.: 1, 5, 6, 10, 26 and 46**

**Reg. No. 3,498,470**

**United States Patent and Trademark Office**

**Registered Sep. 9, 2008**

**TRADEMARK  
PRINCIPAL REGISTER**



AJAY NORTH AMERICA, L.L.C. (GEORGIA  
LIMITED LIABILITY COMPANY)  
P.O. BOX 127, 1400 INDUSTRY RD.  
POWDER SPRINGS, GA 301270127

NO CLAIM IS MADE TO THE EXCLUSIVE  
RIGHT TO USE "BRANDS", APART FROM THE  
MARK AS SHOWN.

FOR: CATALYSTS FOR CHEMICAL AND BIO-  
CHEMICAL PROCESSES; CATALYSTS FOR USE IN  
THE MANUFACTURE OF INDUSTRIAL CHEMI-  
CALS; CHEMICAL PREPARATIONS FOR SCIENTI-  
FIC PURPOSES; CHEMICALS FOR USE IN  
INDUSTRY AND SCIENCE, IN CLASS 1 (U.S. CLS.  
1, 5, 6, 10, 26 AND 46).

THE MARK CONSISTS OF THE WORDS "IO-  
DEAL" AND "BRANDS" ACCOMPANIED BY A  
MOLECULAR STRUCTURE DECORATING THE  
WORD "IODEAL".

SER. NO. 77-380,701, FILED 1-25-2008.

FIRST USE 10-19-2007; IN COMMERCE 1-18-2008.

KIMBERLY PERRY, EXAMINING ATTORNEY

**Int. Cl.: 29**

**Prior U.S. Cl.: 46**

**United States Patent and Trademark Office**

**Reg. No. 3,498,471**

**Registered Sep. 9, 2008**

**TRADEMARK  
PRINCIPAL REGISTER**

**NEW COUNTRY FARMS**

NEW COUNTRY FARMS LLC (IOWA LIMITED  
LIABILITY JOINT STOCK COMPANY)

528 BILLY SUNDAY ROAD

AMES, IA 50010

FOR: PORK AND PORK PRODUCTS, NAMELY,  
SAUSAGE LINKS, SAUSAGE PATTIES, BACON,  
HAM, PORK LOIN, AND PORK CHOPS, IN CLASS  
29 (U.S. CL. 46).

FIRST USE 5-31-2003; IN COMMERCE 5-31-2003.

THE MARK CONSISTS OF STANDARD CHAR-  
ACTERS WITHOUT CLAIM TO ANY PARTICULAR  
FONT, STYLE, SIZE, OR COLOR.

OWNER OF U.S. REG. NO. 3,093,815.

NO CLAIM IS MADE TO THE EXCLUSIVE  
RIGHT TO USE "FARMS", APART FROM THE  
MARK AS SHOWN.

SER. NO. 77-380,720, FILED 1-25-2008.

MATTHEW EINSTEIN, EXAMINING ATTORNEY

**Int. Cl.: 36**

**Prior U.S. Cls.: 100, 101 and 102**

**United States Patent and Trademark Office**

**Reg. No. 3,498,472**

**Registered Sep. 9, 2008**

**SERVICE MARK  
PRINCIPAL REGISTER**

**PHOENIX SURVIVORSHIP UL  
WITH GUARANTEE**

PHOENIX LIFE INSURANCE COMPANY (NEW  
YORK CORPORATION)  
ONE AMERICAN ROW  
HARTFORD, CT 061025056

OWNER OF U.S. REG. NOS. 1,487,792, 3,323,744  
AND OTHERS.

FOR: INSURANCE SERVICES, NAMELY, UN-  
DERWRITING, ISSUING AND ADMINISTRATION  
OF LIFE INSURANCE, IN CLASS 36 (U.S. CLS. 100,  
101 AND 102).

NO CLAIM IS MADE TO THE EXCLUSIVE  
RIGHT TO USE "SURVIVORSHIP UL WITH GUAR-  
ANTEE", APART FROM THE MARK AS SHOWN.

FIRST USE 7-23-2007; IN COMMERCE 7-23-2007.

SER. NO. 77-380,736, FILED 1-25-2008.

THE MARK CONSISTS OF STANDARD CHAR-  
ACTERS WITHOUT CLAIM TO ANY PARTICULAR  
FONT, STYLE, SIZE, OR COLOR.

MONIQUE MILLER, EXAMINING ATTORNEY

**Int. Cl.: 36**

**Prior U.S. Cls.: 100, 101 and 102**

**United States Patent and Trademark Office**

**Reg. No. 3,498,473**

**Registered Sep. 9, 2008**

**SERVICE MARK  
PRINCIPAL REGISTER**

**BECAUSE THE CLAIM BEGINS  
BEFORE THE SMOKE CLEARS**

INSURANCE ADJUSTMENT BUREAU, INC.  
(PENNSYLVANIA CORPORATION)  
5 N. HIGHLAND AVENUE - P.O. BOX 145  
BALA CYNWYD, PA 190040145

THE MARK CONSISTS OF STANDARD CHAR-  
ACTERS WITHOUT CLAIM TO ANY PARTICULAR  
FONT, STYLE, SIZE, OR COLOR.

FOR: CLAIMS ADJUSTMENT IN THE FIELD OF  
INSURANCE, IN CLASS 36 (U.S. CLS. 100, 101 AND  
102).

SER. NO. 77-380,854, FILED 1-25-2008.

FIRST USE 10-31-2006; IN COMMERCE 10-31-2006.

KAREN SEVERSON, EXAMINING ATTORNEY



**Int. Cl.: 36**

**Prior U.S. Cls.: 100, 101 and 102**

**United States Patent and Trademark Office**

**Reg. No. 3,498,474**

**Registered Sep. 9, 2008**

**SERVICE MARK  
PRINCIPAL REGISTER**

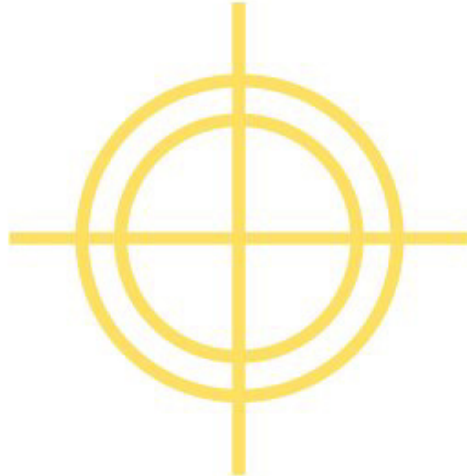

ROOF ADVISORY GROUP, INC. (PENNSYLVANIA CORPORATION)  
507 N. FRONT STREET  
HARRISBURG, PA 17101

FOR: FINANCIAL PLANNING AND INVESTMENT ADVISORY SERVICES, IN CLASS 36 (U.S. CLS. 100, 101 AND 102).

FIRST USE 1-20-1998; IN COMMERCE 1-20-1998.

THE COLOR(S) GOLD IS/ARE CLAIMED AS A FEATURE OF THE MARK.

THE MARK CONSISTS OF TWO CONCENTRIC CIRCLES WITH A CROSS GOING THROUGH.

SER. NO. 77-380,919, FILED 1-25-2008.

JOHN SCHUYLER YARD, EXAMINING ATTORNEY

Int. Cl.: 30

Prior U.S. Cl.: 46

United States Patent and Trademark Office

Reg. No. 3,498,475

Registered Sep. 9, 2008

TRADEMARK  
PRINCIPAL REGISTER



LUTKEWICH, IRIS GAIL (MISSOURI CORPORATION), DBA DOMATA LIVING FLOUR INC.  
23950 E 2160TH ROAD  
FAIR PLAY, MO 65649

FOR: CORN FLOUR; CORN STARCH FLOUR; EDIBLE FLOUR; RICE FLOUR; TAPIOCA FLOUR; FLOUR; FLOUR FOR FOOD; PROTEIN REDUCED AND GLUTEN FREE FLOUR AND BREAD, IN CLASS 30 (U.S. CL. 46).

FIRST USE 11-1-2007; IN COMMERCE 11-1-2007.

NO CLAIM IS MADE TO THE EXCLUSIVE RIGHT TO USE "FLOUR" AND "FOOD", APART FROM THE MARK AS SHOWN.

THE COLOR(S) RED, GREEN, YELLOW, BLACK AND TAN IS/ARE CLAIMED AS A FEATURE OF THE MARK.

THE COLOR RED APPEARS IN THE WORDING "DOMATA LIVING FLOUR"; THE COLOR GREEN APPEARS IN THE WORDING "A LIFE-GIVING FOOD" AND IN THE IMAGE OF THE HORIZONTAL BLADE OF GRASS; THE COLOR YELLOW APPEARS IN THE IMAGE OF THE SUN; THE COLOR BLACK APPEARS IN THE WHEAT STALK AND OUTLINES THE RED LETTERS "DOMATA"; THE COLOR TAN APPEARS IN THE BORDER OF THE SUN.

SER. NO. 77-381,003, FILED 1-25-2008.

SUZANNE BLANE, EXAMINING ATTORNEY

**Int. Cl.: 37**

**Prior U.S. Cls.: 100, 103 and 106**

**United States Patent and Trademark Office**

**Reg. No. 3,498,476**

**Registered Sep. 9, 2008**

**SERVICE MARK  
PRINCIPAL REGISTER**

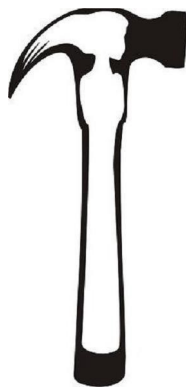

MS. FIX-IT, INC. (FLORIDA CORPORATION)  
800 WOODSTREAM LANE  
CASSELBERRY, FL 32707

FOR: BUILDING CONSTRUCTION AND REPAIR; BUILDING MAINTENANCE AND REPAIR; BUILDING SEALING AND CAULKING SERVICES; CABINET REPAIR; CARPET AND RUG CLEANING; CONSTRUCTION AND RENOVATION OF BUILDINGS; CONSTRUCTION AND REPAIR OF BUILDINGS; CONSTRUCTION, MAINTENANCE AND RENOVATION OF PROPERTY; CONSULTATION IN THE FIELD OF REPAIRING AND MAINTAINING HOME APPLIANCES; CONSULTING IN THE FIELD OF BUILDING CONSTRUCTION; CUSTOM CONSTRUCTION AND BUILDING RENOVATION; ELECTRICAL REPAIRS AND INSTALLATION OF LIGHT AND CEILING FAN FIXTURES, SWITCHES, OUTLETS, AND SMOKE DETECTORS; FIRE ALARM INSTALLATION AND REPAIR; FIRE AND/OR BURGLAR ALARM INSTALLATION AND/OR REPAIR; FURNITURE RESTORATION, REPAIR AND MAINTENANCE; HOUSE BUILDING AND REPAIR; HOUSING SERVICES, NAMELY, DEVELOPMENT OF REAL PROPERTY, NAMELY, REPAIR, IMPROVEMENT, AND NEW CONSTRUCTION; HOUSING SERVICES, NAMELY, REPAIR, IMPROVEMENT, AND CONSTRUCTION OF RESIDENTIAL REAL PROPERTY; INSTALLATION AND MAINTENANCE OF BURGLAR AND/OR FIRE ALARMS; INSTALLATION AND MAINTENANCE OF FIRE ALARM, DETECTION AND SUPPRESSION SYSTEMS; INSTALLATION AND MAINTENANCE OF IRRIGATION SYSTEMS; INSTALLATION AND REPAIR OF AIR CONDITIONING APPARATUS; INSTALLATION

AND REPAIR OF BLINDS; INSTALLATION OF DOORS AND WINDOWS; INSTALLATION OF HOME THEATRES AND RELATED STRUCTURED WIRING; INSTALLATION, MAINTENANCE, AND REMOVAL OF INTERIOR AND EXTERIOR CUSTOM SEASONAL DECORATIONS FOR OTHERS; INTERIOR SEALING AND CAULKING SERVICES; MAINTENANCE AND REPAIR OF BUILDINGS; PAINTING AND VARNISHING; RENOVATION AND RESTORATION OF BUILDINGS; REPAIR OF ALARMS; REPAIR OF BUILDINGS; REPAIR WORK ON BUILDINGS; RESIDENTIAL AND BUILDING CONSTRUCTION CONSULTING; RESIDENTIAL AND COMMERCIAL BUILDING CONSTRUCTION; SETUP OR REPAIR OF LOCKS; VENETIAN BLIND INSTALLATION AND REPAIR; WINDOW BLIND INSTALLATION AND REPAIR; BUILDING CAULKING SERVICES; BUILDING DAMP-PROOFING; BUILDING DEMOLITION; BUILDING RESTORATION; CLEANING OF EXTERNAL SURFACES OF BUILDINGS; CONSULTATION RELATING TO PAINTING OF BUILDINGS; INSTALLATION OF BUILDING INSULATION; RECAULKING SERVICES FOR BUILDINGS; REFURBISHMENT OF BUILDINGS; FURNITURE RESTORATION CONSULTATION; FURNITURE VARNISHING; PLUMBING; PLUMBING SERVICES; DRYWALL CONTRACTOR SERVICES; INSTALLING DRYWALL PANELS; HOUSE PAINTING; PAINTING; PAINTING CONTRACTOR SERVICES; INSTALLING FLOOR TILE; TILE LAYING, BRICK-LAYING OR BLOCK LAYING; INSTALLING CARPET; CARPENTRY; CARPENTRY CONTRACTOR SERVICES; PRESSURE WASHING SERVICES; REPAIR OR MAINTENANCE OF ELECTRIC LIGHT-

ING APPARATUS, IN CLASS 37 (U.S. CLS. 100, 103  
AND 106).

THE MARK CONSISTS OF HAMMER CONTAIN-  
ING SILHOUETTE OF WOMAN IN PROFILE.

SER. NO. 77-381,041, FILED 1-25-2008.

FIRST USE 6-13-2006; IN COMMERCE 6-30-2006.

ELLEN PERKINS, EXAMINING ATTORNEY

**Int. Cl.: 42**

**Prior U.S. Cls.: 100 and 101**

**United States Patent and Trademark Office**

**Reg. No. 3,498,477**

**Registered Sep. 9, 2008**

**SERVICE MARK  
PRINCIPAL REGISTER**

**DQCASES**

DECISIONQUEST, INC. (CALIFORNIA CORPORATION)  
2050 WEST 190TH STREET, SUITE 205  
TORRANCE, CA 90504

FOR: PROVIDING TEMPORARY USE OF ON-LINE NON-DOWNLOADABLE COMPUTER SOFTWARE FOR CASE DATA MANAGEMENT IN THE LEGAL FIELD OVER COMPUTER NETWORKS, INTRANETS, AND THE INTERNET , IN CLASS 42 (U.S. CLS. 100 AND 101).

FIRST USE 12-1-2006; IN COMMERCE 12-1-2006.

THE MARK CONSISTS OF STANDARD CHARACTERS WITHOUT CLAIM TO ANY PARTICULAR FONT, STYLE, SIZE, OR COLOR.

SER. NO. 77-381,130, FILED 1-25-2008.

TASHIA BUNCH, EXAMINING ATTORNEY

**Int. Cl.: 42**

**Prior U.S. Cls.: 100 and 101**

**United States Patent and Trademark Office**

**Reg. No. 3,498,478**

**Registered Sep. 9, 2008**

**SERVICE MARK  
PRINCIPAL REGISTER**

**DQPROJECTS**

DECISIONQUEST, INC. (CALIFORNIA CORPORATION)  
2050 WEST 190TH STREET, SUITE 205  
TORRANCE, CA 90504

FOR: PROVIDING ONLINE GRAPHICS DESIGN; PROVIDING TEMPORARY USE OF ONLINE NON-DOWNLOADABLE COMPUTER SOFTWARE FOR PREPARING PRESENTATION MATERIALS IN THE LEGAL FIELD FOR ACCESS AND REVIEW BY MULTIPLE USERS OVER COMPUTER NETWORKS, INTRANETS, AND THE INTERNET, IN CLASS 42 (U.S. CLS. 100 AND 101).

FIRST USE 9-21-1999; IN COMMERCE 9-21-1999.

THE MARK CONSISTS OF STANDARD CHARACTERS WITHOUT CLAIM TO ANY PARTICULAR FONT, STYLE, SIZE, OR COLOR.

SER. NO. 77-381,188, FILED 1-25-2008.

TASHIA BUNCH, EXAMINING ATTORNEY

**Int. Cl.: 41**

**Prior U.S. Cls.: 100, 101 and 107**

**United States Patent and Trademark Office**

**Reg. No. 3,498,479**

**Registered Sep. 9, 2008**

**SERVICE MARK  
PRINCIPAL REGISTER**

**DJS THAT PLEASE WITHOUT  
THE CHEESE**

DYSON, LEE H. (UNITED STATES INDIVIDUAL)  
# 103  
145 SOUTH GLENOAKS BOULEVARD  
BURBANK, CA 91502

FOR: DISC JOCKEYS FOR PARTIES AND SPECIAL EVENTS; ARRANGING AND CONDUCTING NIGHTCLUB PARTIES; CONSULTATION AND ADVICE REGARDING MUSICAL SELECTIONS AND ARRANGEMENTS FOR SOUND RECORDINGS AND LIVE PERFORMANCES; DANCE EVENTS; ENTERTAINMENT IN THE NATURE OF DANCE INSTRUCTION, COMEDY, DISK JOCKEY SERVICES AND MASTER OF CEREMONY SERVICES FOR PARTIES AND SPECIAL EVENTS; ENTERTAINMENT, NAMELY, LIGHTING PRODUCTION; ENTERTAINMENT SERVICES, NAMELY, CONDUCTING PARTIES; EDITING OR RECORDING OF SOUNDS AND IMAGES; ORGANIZATION OF DANCING EVENTS; PRODUCTION OF SOUND RECORDINGS; PRODUCTION OF SOUND AND MUSIC VIDEO RECORDINGS; PRODUCTION OF VIDEO AND CREATION OF VISUAL EFFECTS FOR

OTHERS FOR USE IN DVDS, TELEVISION PROGRAMS AND ON WEB SITES; PRODUCTION OF VIDEO DISCS FOR OTHERS; PRODUCTION OF VISUAL EFFECTS FOR VIDEOS, DVDS, TELEVISION AND FOR INTERNET WEB SITES; RENTAL OF PHONOGRAPHIC AND MUSIC RECORDINGS; RENTAL OF SOUND RECORDINGS; RENTAL SERVICES FOR AUDIO AND VIDEO EQUIPMENT; SPECIAL EVENT PLANNING; SPECIAL EVENT PLANNING CONSULTATION; MASTER OF CEREMONY SERVICES FOR PARTIES AND SPECIAL EVENTS, IN CLASS 41 (U.S. CLS. 100, 101 AND 107).

FIRST USE 8-15-2007; IN COMMERCE 8-15-2007.

THE MARK CONSISTS OF STANDARD CHARACTERS WITHOUT CLAIM TO ANY PARTICULAR FONT, STYLE, SIZE, OR COLOR.

SER. NO. 77-381,238, FILED 1-25-2008.

DAYNA BROWNE, EXAMINING ATTORNEY

**Int. Cl.: 25**

**Prior U.S. Cls.: 22 and 39**

**United States Patent and Trademark Office**

**Reg. No. 3,498,480**

**Registered Sep. 9, 2008**

**TRADEMARK  
PRINCIPAL REGISTER**

**boatschool**

BOAT SCHOOL CLOTHING, LLC (FLORIDA  
LIMITED LIABILITY COMPANY)  
7353 PETERSON LN  
PENSACOLA, FL 32506

FOR: ANKLE SOCKS; ANTI-PERSPIRANT SOCKS; BELTS; BELTS MADE OF LEATHER; BELTS OF TEXTILE; BERMUDA SHORTS; BOARD SHORTS; BOXER SHORTS; BUTTON-FRONT ALOHA SHIRTS; CAP VISORS; CAPRI PANTS; CAPS WITH VISORS; CARGO PANTS; DOWN JACKETS; DRESS SHIRTS; FABRIC BELTS; FISHERMEN'S JACKETS; GOLF SHIRTS; GYM SHORTS; HATS; HEAVY JACKETS; JACKET LINERS; JACKETS; LIGHT-REFLECTING JACKETS; LONG JACKETS; LONG-SLEEVED SHIRTS; OPEN-NECKED SHIRTS; PANTS; PIQUE SHIRTS; POLO SHIRTS; RAIN-PROOF JACKETS; RUGBY SHIRTS; RUGBY SHORTS; SHELL JACKETS; SHIRTS; SHORT-SLEEVED OR LONG-SLEEVED T-SHIRTS; SHORTS;

SLEEVED OR SLEEVELESS JACKETS; SNOW PANTS; SPORT SHIRTS; SPORTS JACKETS; SPORTS SHIRTS; SPORTS SHIRTS WITH SHORT SLEEVES; SWEAT SHIRTS; SWIMSUITS; THERMAL SOCKS; VISORS; WATER SOCKS; WATERPROOF JACKETS AND PANTS; WIND PANTS; WIND RESISTANT JACKETS; WIND SHIRTS, IN CLASS 25 (U.S. CLS. 22 AND 39).

FIRST USE 1-1-2008; IN COMMERCE 1-21-2008.

THE MARK CONSISTS OF STANDARD CHARACTERS WITHOUT CLAIM TO ANY PARTICULAR FONT, STYLE, SIZE, OR COLOR.

SER. NO. 77-381,319, FILED 1-25-2008.

SUSAN STIGLITZ, EXAMINING ATTORNEY



**Int. Cl.: 35**

**Prior U.S. Cls.: 100, 101 and 102**

**United States Patent and Trademark Office**

**Reg. No. 3,498,481**

**Registered Sep. 9, 2008**

**SERVICE MARK  
PRINCIPAL REGISTER**

**HOWARD ELLIOTT**

THE HOWARD ELLIOTT COLLECTION, INC.  
(ILLINOIS CORPORATION)  
489 MISSION STREET  
CAROL STREAM, IL 60188

FOR: WHOLESALE DISTRIBUTORSHIPS FEATURING FURNITURE, MIRRORS AND VASES, IN CLASS 35 (U.S. CLS. 100, 101 AND 102).

FIRST USE 1-31-2002; IN COMMERCE 1-31-2002.

THE MARK CONSISTS OF STANDARD CHARACTERS WITHOUT CLAIM TO ANY PARTICULAR FONT, STYLE, SIZE, OR COLOR.

THE NAME "HOWARD ELLIOTT" DOES NOT IDENTIFY A LIVING INDIVIDUAL.

SER. NO. 77-381,353, FILED 1-26-2008.

JAMES A. RAUEN, EXAMINING ATTORNEY

Int. Cl.: 35

Prior U.S. Cls.: 100, 101 and 102

**United States Patent and Trademark Office**

**Reg. No. 3,498,482**

Registered Sep. 9, 2008

**SERVICE MARK  
PRINCIPAL REGISTER**

A handwritten signature in black ink that reads "Howard Elliott". The signature is written in a cursive, flowing style with a large initial 'H' and 'E'.

THE HOWARD ELLIOTT COLLECTION, INC.  
(ILLINOIS CORPORATION)  
489 MISSION STREET  
CAROL STREAM, IL 60188

FOR: WHOLESALE DISTRIBUTORSHIPS FEATURING FURNITURE, MIRRORS AND VASES, IN CLASS 35 (U.S. CLS. 100, 101 AND 102).

FIRST USE 1-31-2002; IN COMMERCE 1-31-2002.

THE NAME "HOWARD ELLIOTT" DOES NOT IDENTIFY A LIVING INDIVIDUAL.

THE MARK CONSISTS OF THE WORDING "HOWARD ELLIOTT" IN SCRIPT FORM.

SER. NO. 77-381,354, FILED 1-26-2008.

JAMES A. RAUEN, EXAMINING ATTORNEY

**Int. Cl.: 35**

**Prior U.S. Cls.: 100, 101 and 102**

**United States Patent and Trademark Office**

**Reg. No. 3,498,483**

**Registered Sep. 9, 2008**

**SERVICE MARK  
PRINCIPAL REGISTER**

**GAIN INSIGHT. GET  
CUSTOMERS.**

USADATA, INC. (NEW YORK CORPORATION)  
292 MADISON AVENUE, 3RD FLOOR  
NEW YORK, NY 10017

THE MARK CONSISTS OF STANDARD CHAR-  
ACTERS WITHOUT CLAIM TO ANY PARTICULAR  
FONT, STYLE, SIZE, OR COLOR.

FOR: ADVERTISING, MARKETING AND PRO-  
MOTION SERVICES, IN CLASS 35 (U.S. CLS. 100, 101  
AND 102).

SER. NO. 77-381,391, FILED 1-26-2008.

FIRST USE 5-18-2000; IN COMMERCE 5-18-2000.

KIMBERLY PERRY, EXAMINING ATTORNEY

Int. Cl.: 25

Prior U.S. Cls.: 22 and 39

United States Patent and Trademark Office

Reg. No. 3,498,484

Registered Sep. 9, 2008

TRADEMARK  
PRINCIPAL REGISTER

# Yogatini

DEARING, JENNIFER (UNITED STATES INDIVIDUAL), DBA YOGATINI  
8214 INDIGO RIDGE TERRACE  
BRADENTON, FL 34201

FOR: GOLF SHIRTS; KNIT SHIRTS; OPEN-NECKED SHIRTS; PIQUE SHIRTS; POLO SHIRTS; SHIRTS; SHORT-SLEEVED OR LONG-SLEEVED T-SHIRTS; SHORT-SLEEVED SHIRTS; SPORT SHIRTS; SPORTS SHIRTS; SPORTS SHIRTS WITH SHORT SLEEVES; SWEAT SHIRTS; T-SHIRTS; TEE SHIRTS; YOGA PANTS; YOGA SHIRTS, IN CLASS 25 (U.S. CLS. 22 AND 39).

FIRST USE 12-13-2007; IN COMMERCE 1-25-2008.

THE MARK CONSISTS OF STANDARD CHARACTERS WITHOUT CLAIM TO ANY PARTICULAR FONT, STYLE, SIZE, OR COLOR.

SER. NO. 77-381,427, FILED 1-26-2008.

TOBY BULLOFF, EXAMINING ATTORNEY

**Int. Cl.: 45**

**Prior U.S. Cls.: 100 and 101**

**United States Patent and Trademark Office**

**Reg. No. 3,498,485**

**Registered Sep. 9, 2008**

**SERVICE MARK  
PRINCIPAL REGISTER**



**QALETAQA  
CORPS**

QALETAQA CORPS LLC (DELAWARE LIMITED  
LIABILITY COMPANY)  
SUITE 120 PMB 6400  
2711 CENTERVILLE RD.  
WILMINGTON, DE 19808

FOR: SECURITY CONSULTANCY, IN CLASS 45  
(U.S. CLS. 100 AND 101).

FIRST USE 1-21-2008; IN COMMERCE 1-21-2008.

THE MARK CONSISTS OF AN EAGLE FLYING  
ABOVE A TREE WHICH HAS A SCORPION COILED

AROUND ITS TRUNK AND ROOTS, AND THE  
WORDING "QALETAQA CORPS" BELOW THE DE-  
SIGN.

THE FOREIGN WORDING IN THE MARK  
TRANSLATES INTO ENGLISH AS GUARDIAN OF  
THE PEOPLE.

SER. NO. 77-381,479, FILED 1-27-2008.

AMEETA JORDAN, EXAMINING ATTORNEY

**Int. Cl.: 9**

**Prior U.S. Cls.: 21, 23, 26, 36 and 38**

**United States Patent and Trademark Office**

**Reg. No. 3,498,486**

**Registered Sep. 9, 2008**

**TRADEMARK  
PRINCIPAL REGISTER**

**SPEC MPI**

STANDARD PERFORMANCE EVALUATION  
CORPORATION (CALIFORNIA CORPORATION)

6585 MERCHANT PLACE, SUITE 100  
WARRENTON, VA 20187

FOR: COMPUTER PROGRAMS FOR USE IN  
MEASURING PERFORMANCE OF COMPUTERS  
AND COMPUTER OPERATING SYSTEMS, IN  
CLASS 9 (U.S. CLS. 21, 23, 26, 36 AND 38).

FIRST USE 7-11-2007; IN COMMERCE 7-11-2007.

THE MARK CONSISTS OF STANDARD CHAR-  
ACTERS WITHOUT CLAIM TO ANY PARTICULAR  
FONT, STYLE, SIZE, OR COLOR.

OWNER OF U.S. REG. NOS. 1,845,459, 3,302,382  
AND OTHERS.

NO CLAIM IS MADE TO THE EXCLUSIVE  
RIGHT TO USE "MPI", APART FROM THE MARK  
AS SHOWN.

SER. NO. 77-381,492, FILED 1-27-2008.

BRIAN CALLAGHAN, EXAMINING ATTORNEY

**Int. Cl.: 31**

**Prior U.S. Cls.: 1 and 46**

**United States Patent and Trademark Office**

**Reg. No. 3,498,487**

**Registered Sep. 9, 2008**

**TRADEMARK  
PRINCIPAL REGISTER**



STOKES & LOMBARDI FARMS LLC (CALIFORNIA LIMITED LIABILITY COMPANY)  
7581 W. KILE ROAD  
LODI, CA 95242

FIRST USE 6-0-2006; IN COMMERCE 6-0-2006.

SER. NO. 77-381,524, FILED 1-27-2008.

FOR: FRESH FRUITS, IN CLASS 31 (U.S. CLS. 1 AND 46).

APRIL HESIK, EXAMINING ATTORNEY

**Int. Cl.: 2**

**Prior U.S. Cls.: 6, 11 and 16**

**United States Patent and Trademark Office**

**Reg. No. 3,498,488**

**Registered Sep. 9, 2008**

**TRADEMARK  
PRINCIPAL REGISTER**

**STORMPLATE 30**

HALEY PAINT COMPANY (PENNSYLVANIA  
CORPORATION)  
901 WASHINGTON STREET  
CONSHOHOCKEN, PA 194282390

THE MARK CONSISTS OF STANDARD CHAR-  
ACTERS WITHOUT CLAIM TO ANY PARTICULAR  
FONT, STYLE, SIZE, OR COLOR.

FOR: EXTERIOR PAINT, IN CLASS 2 (U.S. CLS. 6,  
11 AND 16).

SER. NO. 77-381,547, FILED 1-27-2008.

FIRST USE 5-3-1972; IN COMMERCE 5-3-1972.

TASHIA BUNCH, EXAMINING ATTORNEY



**Int. Cl.: 41**

**Prior U.S. Cls.: 100, 101 and 107**

**United States Patent and Trademark Office**

**Reg. No. 3,498,489**

**Registered Sep. 9, 2008**

**SERVICE MARK  
PRINCIPAL REGISTER**

**SHORT ORDER DAD**

ROSENTHAL, ROBERT STEVEN (UNITED STATES INDIVIDUAL)  
444 CENTRAL PARK WEST  
NEW YORK CITY, NY 10025

FOR: ENTERTAINMENT IN THE NATURE OF VISUAL AND AUDIO PERFORMANCES, AND MUSICAL, VARIETY, NEWS AND COMEDY SHOWS; ENTERTAINMENT, NAMELY, A CONTINUING FOOD AND COOKING SHOW BROADCAST OVER TELEVISION, SATELLITE, AUDIO, AND VIDEO MEDIA; ENTERTAINMENT, NAMELY, PRODUCTION OF TV AND VIDEO FOOD AND COOKING SHOWS; PRODUCTION AND DISTRIBUTION OF TELEVISION SHOWS AND MOVIES; PRESENTATION OF LIVE SHOW PERFORMANCES; FILM AND VIDEO PRODUCTION; PRODUCTION OF CABLE TELEVISION PROGRAMS; PRODUCTION

OF RADIO OR TELEVISION PROGRAMS; TELEVISION SHOW PRODUCTION, IN CLASS 41 (U.S. CLS. 100, 101 AND 107).

FIRST USE 3-3-2007; IN COMMERCE 3-3-2007.

THE MARK CONSISTS OF STANDARD CHARACTERS WITHOUT CLAIM TO ANY PARTICULAR FONT, STYLE, SIZE, OR COLOR.

THE NAME IN THE MARK IDENTIFIES A LIVING INDIVIDUAL WHOSE CONSENT TO REGISTER IS OF RECORD.

SER. NO. 77-381,605, FILED 1-27-2008.

BRIDGETT SMITH, EXAMINING ATTORNEY

**Int. Cl.: 35**

**Prior U.S. Cls.: 100, 101 and 102**

**United States Patent and Trademark Office**

**Reg. No. 3,498,490**

**Registered Sep. 9, 2008**

**SERVICE MARK  
PRINCIPAL REGISTER**



ACTION AGAINST CRIME AND VIOLENCE  
EDUCATION FUND (D.C. NON-PROFIT COR-  
PORATION)  
SUITE 300  
1212 NEW YORK AVENUE, N.W.  
WASHINGTON, DC 20005

FOR: LEGISLATIVE LOBBYING SERVICES IN  
RELATION TO YOUTH CRIME AND VIOLENCE  
PREVENTION; PROMOTING PUBLIC AWARENESS  
OF THE NEED FOR THE PREVENTION OF YOUTH  
CRIME AND VIOLENCE, IN CLASS 35 (U.S. CLS. 100,  
101 AND 102).

FIRST USE 6-1-1996; IN COMMERCE 6-1-1996.

OWNER OF U.S. REG. NO. 2,773,643.

THE COLOR(S) BLUE AND RED IS/ARE  
CLAIMED AS A FEATURE OF THE MARK.

THE MARK CONSISTS OF A FIVE-POINTED  
STAR AND THE WORDS "FIGHT CRIME:" IN BLUE  
AND THREE STRIPES AND THE WORDS "INVEST  
IN KIDS" IN RED.

SER. NO. 77-381,792, FILED 1-28-2008.

KIMBERLY PERRY, EXAMINING ATTORNEY

**Int. Cl.: 20**

**Prior U.S. Cls.: 2, 13, 22, 25, 32 and 50**

**United States Patent and Trademark Office**

**Reg. No. 3,498,491**

**Registered Sep. 9, 2008**

**TRADEMARK  
PRINCIPAL REGISTER**

**for your lifetime and  
theirs**

HOMESTEAD FURNITURE, LTD. (OHIO LIMITED LIABILITY COMPANY)  
8233 ST. RT. 241  
MT. HOPE, OH 44660

THE MARK CONSISTS OF STANDARD CHARACTERS WITHOUT CLAIM TO ANY PARTICULAR FONT, STYLE, SIZE, OR COLOR.

FOR: FURNITURE, IN CLASS 20 (U.S. CLS. 2, 13, 22, 25, 32 AND 50).

SER. NO. 77-381,829, FILED 1-28-2008.

FIRST USE 6-30-2004; IN COMMERCE 6-30-2004.

CORY BOONE, EXAMINING ATTORNEY

**Int. Cl.: 35**

**Prior U.S. Cls.: 100, 101 and 102**

**United States Patent and Trademark Office**

**Reg. No. 3,498,492**

**Registered Sep. 9, 2008**

**SERVICE MARK  
PRINCIPAL REGISTER**

**GIFT GIRL**

GIFT GIRL, LLC (NEW YORK LIMITED LIABILITY COMPANY)  
16 JOHNSON PLACE  
RYE, NY 10580

FOR: BUSINESS SERVICES, NAMELY, ON-LINE INFORMATION SERVICES RELATING TO GIFT PURCHASING; PROVIDING A WEBSITE FEATURING RETAIL, HOLIDAY AND OCCASION SHOPPING INFORMATION; PROMOTING THE GOODS AND SERVICES OF OTHERS BY PROVIDING A SEARCHABLE WEB SITE AT WHICH USERS CAN LINK TO RETAIL WEB SITES OF OTHERS, IN CLASS 35 (U.S. CLS. 100, 101 AND 102).

FIRST USE 10-0-2007; IN COMMERCE 10-0-2007.

THE MARK CONSISTS OF STANDARD CHARACTERS WITHOUT CLAIM TO ANY PARTICULAR FONT, STYLE, SIZE, OR COLOR.

NO CLAIM IS MADE TO THE EXCLUSIVE RIGHT TO USE "GIFT", APART FROM THE MARK AS SHOWN.

SER. NO. 77-382,052, FILED 1-28-2008.

AMY GEARIN, EXAMINING ATTORNEY

**Int. Cl.: 44**

**Prior U.S. Cls.: 100 and 101**

**United States Patent and Trademark Office**

**Reg. No. 3,498,493**

**Registered Sep. 9, 2008**

**SERVICE MARK  
PRINCIPAL REGISTER**

**THERE ARE SOME CURVES A  
WOMAN SHOULDN'T HAVE**

BAYLOR HEALTH CARE SYSTEM (TEXAS COR-  
PORATION)  
SUITE 2800  
2001 BRYAN STREET  
DALLAS, TX 75201

FOR: MEDICAL SERVICES, IN CLASS 44 (U.S.  
CLS. 100 AND 101).

FIRST USE 12-17-2004; IN COMMERCE 12-17-2004.

THE MARK CONSISTS OF STANDARD CHAR-  
ACTERS WITHOUT CLAIM TO ANY PARTICULAR  
FONT, STYLE, SIZE, OR COLOR.

SER. NO. 77-382,124, FILED 1-28-2008.

SUE LAWRENCE, EXAMINING ATTORNEY

**Int. Cl.: 10**

**Prior U.S. Cls.: 26, 39 and 44**

**United States Patent and Trademark Office**

**Reg. No. 3,498,494**

**Registered Sep. 9, 2008**

**TRADEMARK  
PRINCIPAL REGISTER**

**SINUCLEANSE SQUEEZE**

MED-SYSTEMS, INC. (WISCONSIN CORPORATION)  
P.O. BOX 45634  
MADISON, WI 53774

FOR: MEDICAL DEVICE USED TO OPEN AND IRRIGATE NASAL PASSAGES, IN CLASS 10 (U.S. CLS. 26, 39 AND 44).

FIRST USE 8-0-2006; IN COMMERCE 8-0-2006.

THE MARK CONSISTS OF STANDARD CHARACTERS WITHOUT CLAIM TO ANY PARTICULAR FONT, STYLE, SIZE, OR COLOR.

OWNER OF U.S. REG. NOS. 2,205,705 AND 3,422,026.

SER. NO. 77-382,188, FILED 1-28-2008.

MICHAEL WIENER, EXAMINING ATTORNEY

**Int. Cl.: 36**

**Prior U.S. Cls.: 100, 101 and 102**

**United States Patent and Trademark Office**

**Reg. No. 3,498,495**

**Registered Sep. 9, 2008**

**SERVICE MARK  
PRINCIPAL REGISTER**

**BUSHWOOD**

MCLALLEN ENTERPRISES, INC. (DELAWARE  
CORPORATION)  
2170 POINT BOULEVARD, SUITE 600  
ELGIN, IL 60123

FOR: INSURANCE AGENCIES IN THE FIELD OF  
PRIVATE, PUBLIC AND MUNICIPAL CLUBS AND  
ASSOCIATIONS, IN CLASS 36 (U.S. CLS. 100, 101  
AND 102).

FIRST USE 11-0-2006; IN COMMERCE 11-0-2006.

THE MARK CONSISTS OF STANDARD CHAR-  
ACTERS WITHOUT CLAIM TO ANY PARTICULAR  
FONT, STYLE, SIZE, OR COLOR.

SER. NO. 77-382,386, FILED 1-28-2008.

KATHLEEN M. VANSTON, EXAMINING ATTOR-  
NEY

**Int. Cls.: 30 and 43**

**Prior U.S. Cls.: 46, 100 and 101**

**United States Patent and Trademark Office**

**Reg. No. 3,498,496**

**Registered Sep. 9, 2008**

**TRADEMARK  
SERVICE MARK  
PRINCIPAL REGISTER**

**Joe's Gourmet Coffee**

A SLICE OF HEAVEN, LLC (WYOMING LIMITED LIABILITY COMPANY)  
P.O. BOX 370  
545 WEST BROADWAY  
JACKSON, WY 83002

FOR: COFFEE-BASED BEVERAGES, IN CLASS 30 (U.S. CL. 46).

FIRST USE 5-1-2008; IN COMMERCE 5-1-2008.

FOR: COFFEE SHOPS; COFFEE-HOUSE AND SNACK-BAR SERVICES, IN CLASS 43 (U.S. CLS. 100 AND 101).

FIRST USE 5-1-2008; IN COMMERCE 5-1-2008.

THE MARK CONSISTS OF STANDARD CHARACTERS WITHOUT CLAIM TO ANY PARTICULAR FONT, STYLE, SIZE, OR COLOR.

NO CLAIM IS MADE TO THE EXCLUSIVE RIGHT TO USE "GOURMET COFFEE", APART FROM THE MARK AS SHOWN.

SER. NO. 77-382,388, FILED S.R. 1-28-2008 AM. P.R. 5-21-2008.

DOMINICK J. SALEMI, EXAMINING ATTORNEY



**Int. Cl.: 35**

**Prior U.S. Cls.: 100, 101 and 102**

**United States Patent and Trademark Office**

**Reg. No. 3,498,497**

**Registered Sep. 9, 2008**

**SERVICE MARK  
PRINCIPAL REGISTER**



**Cutting OEM Production Costs**

MCL INDUSTRIES, INC. (WISCONSIN CORPORATION)  
660 CORPORATE WAY  
PULASKI, WI 54162

FOR: BUSINESS CONSULTING SERVICES RELATING TO PRODUCT DISTRIBUTION, OPERATIONS MANAGEMENT SERVICES, LOGISTICS, REVERSE LOGISTICS, SUPPLY CHAIN, AND PRODUCTION SYSTEMS AND DISTRIBUTION SOLUTIONS; BUSINESS MANAGEMENT SERVICES, NAMELY, MANAGING LOGISTICS, REVERSE LOGISTICS, SUPPLY CHAIN SERVICES, SUPPLY CHAIN VISIBILITY AND SYNCHRONIZATION, SUPPLY AND DEMAND FORECASTING AND PRODUCT DISTRIBUTION PROCESSES FOR OTHERS; SUPPLY CHAIN MANAGEMENT SERVICES; INVENTORY CONTROL, IN CLASS 35 (U.S. CLS. 100, 101 AND 102).

FIRST USE 1-17-2008; IN COMMERCE 1-17-2008.

NO CLAIM IS MADE TO THE EXCLUSIVE RIGHT TO USE "LEAN SOURCING PROGRAM" AND "CUTTING OEM PRODUCTION COSTS" , APART FROM THE MARK AS SHOWN.

THE COLOR(S) BLACK, GREEN AND WHITE IS/ ARE CLAIMED AS A FEATURE OF THE MARK.

THE MARK CONSISTS OF A BLACK AND GREEN BLOCK, THE BLACK AND GREEN WITHIN THE BLOCK BEING SEPARATED BY A CURVED WHITE LINE; BLACK LETTERING; AND A GREEN HORIZONTAL LINE.

SER. NO. 77-382,408, FILED 1-28-2008.

KHANH LE, EXAMINING ATTORNEY

Int. Cl.: 35

Prior U.S. Cls.: 100, 101 and 102

United States Patent and Trademark Office

Reg. No. 3,498,498

Registered Sep. 9, 2008

SERVICE MARK  
PRINCIPAL REGISTER



UTAH CENTRAL CREDIT UNION (UTAH CORPORATION)  
25 EAST 1700 SOUTH  
SALT LAKE CITY, UT 84115

FOR: SERVICES WHICH PROMOTE CREDIT UNION ACCOUNTS FOR CHILDREN THROUGH REWARD INCENTIVES, FINANCIAL EDUCATION, AND INTERACTIVE PROGRAMS, IN CLASS 35 (U.S. CLS. 100, 101 AND 102).

FIRST USE 12-0-2006; IN COMMERCE 12-0-2006.

NO CLAIM IS MADE TO THE EXCLUSIVE RIGHT TO USE "UTAH" OR "YOUNG SAVERS", APART FROM THE MARK AS SHOWN.

THE COLOR(S) BLUE, GREEN, AND WHITE IS/ ARE CLAIMED AS A FEATURE OF THE MARK.

THE MARK CONSISTS OF A GREEN CIRCLE WITH BLUE DRAWINGS OF ANIMAL FOOTPRINTS AND SEA CREATURES ALONG THE OUTER EDGES OF THE CIRCLE. INSIDE THE CIRCLE, AGAINST A WHITE BACKGROUND, ARE THE WORDS "UTAH CENTRAL" IN BLUE, "CRITTER CREW" IN GREEN, AND "YOUNG SAVERS," IN A LIGHTER SHADE OF GREEN. THE "Y-O-U" AND THE "A" AND "E" ARE UNDERLINED IN THE WORDS "YOUNG SAVERS." ON BOTH THE LEFT AND RIGHT SIDE OF THE WORD "CREW," ARE A HUMAN HANDPRINT AND FOOTPRINT, IN BLUE

SER. NO. 77-382,498, FILED 1-28-2008.

FRED MANDIR, EXAMINING ATTORNEY

**Int. Cl.: 35**

**Prior U.S. Cls.: 100, 101 and 102**

**United States Patent and Trademark Office**

**Reg. No. 3,498,499**

**Registered Sep. 9, 2008**

**SERVICE MARK  
PRINCIPAL REGISTER**

**UTAH CENTRAL CRITTER CREW  
YOUNG SAVERS**

UTAH CENTRAL CREDIT UNION (UTAH CORPORATION)  
25 EAST 1700 SOUTH  
SALT LAKE CITY, UT 84115

FOR: PROMOTING THE SALE OF CREDIT UNION ACCOUNTS FOR CHILDREN THROUGH REWARD INCENTIVES, FINANCIAL EDUCATION, AND INTERACTIVE PROGRAMS, IN CLASS 35 (U.S. CLS. 100, 101 AND 102).

FIRST USE 12-0-2006; IN COMMERCE 12-0-2006.

THE MARK CONSISTS OF STANDARD CHARACTERS WITHOUT CLAIM TO ANY PARTICULAR FONT, STYLE, SIZE, OR COLOR.

NO CLAIM IS MADE TO THE EXCLUSIVE RIGHT TO USE "UTAH" OR "YOUNG SAVERS", APART FROM THE MARK AS SHOWN.

SER. NO. 77-382,545, FILED 1-28-2008.

FRED MANDIR, EXAMINING ATTORNEY

**Int. Cl.: 6**

**Prior U.S. Cls.: 2, 12, 13, 14, 23, 25 and 50**

**Reg. No. 3,498,500**

**United States Patent and Trademark Office**

**Registered Sep. 9, 2008**

**TRADEMARK  
PRINCIPAL REGISTER**

**accudraft**

SAIMA OF NORTH AMERICA, INC. (NEW JERSEY CORPORATION)  
SUITE #2K  
961 ROUTE #10 EAST  
RANDOLPH, NJ 07869

FOR: PREP STATIONS, MIXING ROOMS AND PAINT BOOTHS MADE OF METAL PAINT SPRAY BOOTHS, PAINT SPRAYING BOOTHS, PREPARATION STATIONS AND MIXING ROOMS OF METAL, IN CLASS 6 (U.S. CLS. 2, 12, 13, 14, 23, 25 AND 50).

FIRST USE 5-1-1987; IN COMMERCE 5-1-1987.

THE MARK CONSISTS OF STANDARD CHARACTERS WITHOUT CLAIM TO ANY PARTICULAR FONT, STYLE, SIZE, OR COLOR.

SER. NO. 77-382,554, FILED 1-28-2008.

FLORENTINA BLANDU, EXAMINING ATTORNEY

**Int. Cl.: 43**

**Prior U.S. Cls.: 100 and 101**

**United States Patent and Trademark Office**

**Reg. No. 3,498,501**

**Registered Sep. 9, 2008**

**SERVICE MARK  
PRINCIPAL REGISTER**

**BEL'GUSTOS**

GUSTOS, INC. (WISCONSIN CORPORATION),  
DBA BEL'GUSTOS

259 SOUTH STREET

WAUKESHA, WI 53186

FOR: BAR AND RESTAURANT SERVICES, IN  
CLASS 43 (U.S. CLS. 100 AND 101).

FIRST USE 9-1-2006; IN COMMERCE 9-1-2006.

THE MARK CONSISTS OF STANDARD CHAR-  
ACTERS WITHOUT CLAIM TO ANY PARTICULAR  
FONT, STYLE, SIZE, OR COLOR.

THE FOREIGN WORDING IN THE MARK  
TRANSLATES INTO ENGLISH AS BEAUTIFUL  
TASTES.

SER. NO. 77-382,765, FILED 1-29-2008.

LIEF MARTIN, EXAMINING ATTORNEY

**Int. Cl.: 16**

**Prior U.S. Cls.: 2, 5, 22, 23, 29, 37, 38 and 50**

**Reg. No. 3,498,502**

**United States Patent and Trademark Office**

**Registered Sep. 9, 2008**

**TRADEMARK  
PRINCIPAL REGISTER**

**STRATEGIES THE JOURNAL OF  
LEGAL MARKETING**

LEGAL MARKETING ASSOCIATION (ILLINOIS  
NON-PROFIT CORPORATION)  
1926 WAUKEGAN RD., SUITE 1  
GLENVIEW, IL 60025

FOR: PRINTED PUBLICATIONS, NAMELY, MA-  
GAZINES FEATURING ARTICLES AND COLUMNS  
THAT PROMOTE THE INTERESTS OF MARKET-  
ING AND MANAGEMENT PROFESSIONALS IN  
THE LEGAL FIELD, IN CLASS 16 (U.S. CLS. 2, 5,  
22, 23, 29, 37, 38 AND 50).

FIRST USE 4-0-1998; IN COMMERCE 4-0-1998.

THE MARK CONSISTS OF STANDARD CHAR-  
ACTERS WITHOUT CLAIM TO ANY PARTICULAR  
FONT, STYLE, SIZE, OR COLOR.

NO CLAIM IS MADE TO THE EXCLUSIVE  
RIGHT TO USE "THE JOURNAL OF LEGAL MAR-  
KETING", APART FROM THE MARK AS SHOWN.

SER. NO. 77-382,791, FILED 1-29-2008.

JESSICA FATHY, EXAMINING ATTORNEY

Int. Cl.: 41

Prior U.S. Cls.: 100, 101 and 107

United States Patent and Trademark Office

Reg. No. 3,498,503

Registered Sep. 9, 2008

**SERVICE MARK  
PRINCIPAL REGISTER**



OAKLAND COUNTY (MICHIGAN MUNICIPAL CORPORATION)  
1200 N. TELEGRAPH  
PONTIAC, MI 48341

FOR: ENTERTAINMENT IN THE NATURE OF HOCKEY GAMES, IN CLASS 41 (U.S. CLS. 100, 101 AND 107).

FIRST USE 10-1-2007; IN COMMERCE 10-1-2007.

NO CLAIM IS MADE TO THE EXCLUSIVE RIGHT TO USE "OAKLAND" AND "HOCKEY TOURNAMENT", APART FROM THE MARK AS SHOWN.

THE COLOR(S) BLACK, LIGHT GREY AND DARK GREY IS/ARE CLAIMED AS A FEATURE OF THE MARK.

THE MARK CONSISTS OF THE WORDS "OAKLAND EDGE" APPEARING IN THE COLOR BLACK WITH A LIGHT GREY BORDER ABOVE A DESIGN OF A SKATE BLADE, BEGINNING INSIDE THE CURVE OF THE BLADE. THE LETTERS ARE CAPITALIZED WITH ONE SIDE OF EACH LETTER MORE THICKLY SHADED IN COLOR BLACK. THE SKATE BLADE APPEARS IN THE COLOR LIGHT GREY WITH A DARK GREY BORDER. THE WORDS "HOCKEY TOURNAMENT" ARE FEATURED BELOW THE SKATE BLADE AND APPEAR IN THE COLOR BLACK WITH A LIGHT GREY BORDER

SER. NO. 77-382,833, FILED 1-29-2008.

CHARISMA HAMPTON, EXAMINING ATTORNEY

**Int. Cl.: 35**

**Prior U.S. Cls.: 100, 101 and 102**

**United States Patent and Trademark Office**

**Reg. No. 3,498,504**

**Registered Sep. 9, 2008**

**SERVICE MARK  
PRINCIPAL REGISTER**

**SAY YES TO ORLANDO**

ORLANDO/ORANGE COUNTY CONVENTION &  
VISITORS BUREAU, INC. (FLORIDA COR-  
PORATION)  
SUITE 100  
6700 FORUM DRIVE  
ORLANDO, FL 328218017

FOR: PROMOTIONAL SERVICES, NAMELY, THE  
PROMOTION OF TOURISM AND CONVENTIONS  
IN THE ORLANDO AREA, IN CLASS 35 (U.S. CLS.  
100, 101 AND 102).

FIRST USE 1-14-2008; IN COMMERCE 1-14-2008.

THE MARK CONSISTS OF STANDARD CHAR-  
ACTERS WITHOUT CLAIM TO ANY PARTICULAR  
FONT, STYLE, SIZE, OR COLOR.

NO CLAIM IS MADE TO THE EXCLUSIVE  
RIGHT TO USE "ORLANDO", APART FROM THE  
MARK AS SHOWN.

SER. NO. 77-382,839, FILED 1-29-2008.

TASHIA BUNCH, EXAMINING ATTORNEY



**Int. Cl.: 7**

**Prior U.S. Cls.: 13, 19, 21, 23, 31, 34 and 35**

**United States Patent and Trademark Office**

**Reg. No. 3,498,505**

**Registered Sep. 9, 2008**

**TRADEMARK  
PRINCIPAL REGISTER**

**PULLEY-MAN**

PULLEY-MAN U.S.A., INC. (FLORIDA CORPORATION)  
4700 NORTH PEARL ST.  
JACKSONVILLE, FL 32206

THE MARK CONSISTS OF STANDARD CHARACTERS WITHOUT CLAIM TO ANY PARTICULAR FONT, STYLE, SIZE, OR COLOR.

FOR: WINCHES, IN CLASS 7 (U.S. CLS. 13, 19, 21, 23, 31, 34 AND 35).

SER. NO. 77-383,084, FILED 1-29-2008.

FIRST USE 0-0-2000; IN COMMERCE 0-0-2000.

MICHAEL WIENER, EXAMINING ATTORNEY

**Int. Cl.: 44**

**Prior U.S. Cls.: 100 and 101**

**United States Patent and Trademark Office**

**Reg. No. 3,498,506**

**Registered Sep. 9, 2008**

**SERVICE MARK  
PRINCIPAL REGISTER**

**SCOI**

SOUTHERN CALIFORNIA ORTHOPEDIC INSTI-  
TUTE, L.P. (CALIFORNIA LIMITED PART-  
NERSHIP), DBA SCOI  
6815 NOBLE AVENUE  
VAN NUYS, CA 91405

THE MARK CONSISTS OF STANDARD CHAR-  
ACTERS WITHOUT CLAIM TO ANY PARTICULAR  
FONT, STYLE, SIZE, OR COLOR.

FOR: MEDICAL SERVICES, IN CLASS 44 (U.S.  
CLS. 100 AND 101).

SER. NO. 77-383,103, FILED 1-29-2008.

FIRST USE 12-14-1985; IN COMMERCE 12-14-1985.

JULIE WATSON, EXAMINING ATTORNEY

**Int. Cl.: 42**

**Prior U.S. Cls.: 100 and 101**

**United States Patent and Trademark Office**

**Reg. No. 3,498,507**

**Registered Sep. 9, 2008**

**SERVICE MARK  
PRINCIPAL REGISTER**

**Qrimp**

QRIMP, INC (OKLAHOMA CORPORATION)  
228 N. K ST.  
MUSKOGEE, OK 74403

THE MARK CONSISTS OF STANDARD CHAR-  
ACTERS WITHOUT CLAIM TO ANY PARTICULAR  
FONT, STYLE, SIZE, OR COLOR.

FOR: PROVIDING ON-LINE NON-DOWNLOAD-  
ABLE SOFTWARE FOR THE PURPOSE OF CREAT-  
ING DYNAMIC DATABASE DRIVEN  
APPLICATIONS, IN CLASS 42 (U.S. CLS. 100 AND  
101).

SER. NO. 77-383,164, FILED 1-29-2008.

FIRST USE 6-1-2006; IN COMMERCE 6-1-2006.

KATHLEEN M. VANSTON, EXAMINING ATTOR-  
NEY

**Int. Cl.: 7**

**Prior U.S. Cls.: 13, 19, 21, 23, 31, 34 and 35**

**Reg. No. 3,498,508**

**United States Patent and Trademark Office**

**Registered Sep. 9, 2008**

**TRADEMARK  
PRINCIPAL REGISTER**



US VALVE, LLC (NEW JERSEY LIMITED LIABILITY COMPANY)  
168 SOUTH VAN BRUNT STREET  
ENGLEWOOD, NJ 07631

NO CLAIM IS MADE TO THE EXCLUSIVE RIGHT TO USE "VALVE", APART FROM THE MARK AS SHOWN.

FOR: VALVES BEING PARTS OF MACHINES FOR USE IN THE CHEMICAL INDUSTRY, FOOD INDUSTRY AND INDUSTRIAL PROCESSES, IN CLASS 7 (U.S. CLS. 13, 19, 21, 23, 31, 34 AND 35).

SEC. 2(F).

SER. NO. 77-383,248, FILED 1-29-2008.

FIRST USE 7-16-1999; IN COMMERCE 7-16-1999.

HEATHER SAPP, EXAMINING ATTORNEY

**Int. Cl.: 41**

**Prior U.S. Cls.: 100, 101 and 107**

**United States Patent and Trademark Office**

**Reg. No. 3,498,509**

**Registered Sep. 9, 2008**

**SERVICE MARK  
PRINCIPAL REGISTER**

# Share the Experience

ARTREACH, INC. (PENNSYLVANIA CORPORATION), DBA ART-REACH  
1819 JFK BLVD., SUITE 200  
PHILADELPHIA, PA 19103

FOR: TICKET RESERVATION AND BOOKING SERVICES FOR ENTERTAINMENT, SPORTING AND CULTURAL EVENTS, IN CLASS 41 (U.S. CLS. 100, 101 AND 107).

FIRST USE 5-5-2007; IN COMMERCE 5-5-2007.

THE MARK CONSISTS OF STANDARD CHARACTERS WITHOUT CLAIM TO ANY PARTICULAR FONT, STYLE, SIZE, OR COLOR.

SER. NO. 77-383,468, FILED 1-29-2008.

MARIA-VICTORIA SUAREZ, EXAMINING ATTORNEY

**Int. Cl.: 38**

**Prior U.S. Cls.: 100, 101 and 104**

**United States Patent and Trademark Office**

**Reg. No. 3,498,510**

**Registered Sep. 9, 2008**

**SERVICE MARK  
PRINCIPAL REGISTER**

**K-Star Country**

NEW WAVO COMMUNICATION GROUP, INC.  
(TEXAS CORPORATION)

1212 S. FRAZIER

CONROE, TX 77301

FOR: RADIO BROADCASTING; INTERNET  
BROADCASTING SERVICES, IN CLASS 38 (U.S.  
CLS. 100, 101 AND 104).

FIRST USE 3-1-1992; IN COMMERCE 3-1-1992.

THE MARK CONSISTS OF STANDARD CHAR-  
ACTERS WITHOUT CLAIM TO ANY PARTICULAR  
FONT, STYLE, SIZE, OR COLOR.

NO CLAIM IS MADE TO THE EXCLUSIVE  
RIGHT TO USE "COUNTRY", APART FROM THE  
MARK AS SHOWN.

SER. NO. 77-383,469, FILED 1-29-2008.

MARIA-VICTORIA SUAREZ, EXAMINING ATTOR-  
NEY

Int. Cl.: 3

Prior U.S. Cls.: 1, 4, 6, 50, 51 and 52

Reg. No. 3,498,511

United States Patent and Trademark Office

Registered Sep. 9, 2008

TRADEMARK  
PRINCIPAL REGISTER



HIGGINS, SHERRI HOULÉ (UNITED STATES INDIVIDUAL)

5421 BRAEMAR DRIVE  
LAS VEGAS, NV 89130

FOR: CONDITIONERS; EXFOLIANTS FOR SKIN; GEL FOR HAIR, SCULPTING; HAIR BALSAM; HAIR CARE CREAMS; HAIR CARE KITS COMPRISING NON-MEDICATED HAIR CARE PREPARATIONS, NAMELY, SHAMPOO, CONDITIONER, GEL; HAIR CARE LOTIONS; HAIR CARE PREPARATIONS; HAIR CLEANING PREPARATIONS; HAIR CONDITIONER; HAIR CONDITIONERS; HAIR CREAMS; HAIR GEL; HAIR GEL AND HAIR MOUSSE; HAIR GELS; HAIR LOTION; HAIR MOUSSE; HAIR MOUSSES; HAIR NOURISHERS; HAIR OILS; HAIR RINSES; HAIR SHAMPOO; HAIR SHAMPOOS AND CONDITIONERS; HAIR SPRAY; HAIR SPRAYS; HAIR SPRAYS AND HAIR GELS; HAIR STYLING GEL; HAIR STYLING PREPARATIONS; HAIR STYLING SPRAY; LOTIONS FOR HAIR, FACE, BODY; MOUSSE FOR HAIR; NON-MEDICATED PREPARATIONS ALL FOR THE CARE OF SKIN, HAIR AND SCALP; OIL BATHS FOR HAIR CARE; OILS FOR HAIR CONDITIONING; BATH OILS FOR COSMETIC PURPOSES; BODY AND BEAUTY CARE COSMETICS; CLEANSING CREAMS; COCOA BUTTER FOR COSMETIC PURPOSES; COLOGNES, PERFUMES AND COSMETICS; COSMETIC CREAMS; COSMETIC CREAMS FOR SKIN CARE; COSMETIC MILKS; COSMETIC OILS; COSMETIC OILS FOR THE EPIDERMIS; COSMETIC PREPARATIONS FOR BODY CARE; COSMETIC PREPARATIONS FOR SKIN RE-NEWAL; COSMETIC SOAPS; COSMETICS; COSMETICS AND COSMETIC PREPARATIONS;

COSMETICS AND MAKE-UP; COSMETICS IN GENERAL, INCLUDING PERFUMES; FACE CREAMS FOR COSMETIC USE; HENNA FOR COSMETIC PURPOSES; LOTIONS FOR COSMETIC PURPOSES; NUTRITIONAL OILS FOR COSMETIC PURPOSES; OILS FOR COSMETIC PURPOSES; PERFUME OILS FOR THE MANUFACTURE OF COSMETIC PREPARATIONS; SKIN AND BODY TOPICAL LOTIONS, CREAMS AND OILS FOR COSMETIC USE; SOAPS; TOPICAL SKIN SPRAYS FOR COSMETIC PURPOSES; BATH AND SHOWER GELS AND SALTS NOT FOR MEDICAL PURPOSES; BATH BEADS; BATH CRYSTALS; BATH GEL; BATH GELS; BATH LOTION; BATH MILKS; BATH OIL; BATH OILS; BATH OILS AND BATH SALTS; BATH SALTS; BATH SOAPS; BATH SOAPS IN LIQUID, SOLID OR GEL FORM; BATHING LOTIONS; LIQUID BATH SOAPS; MINERAL SALT IN THE NATURE OF BATH SALTS NOT FOR MEDICAL PURPOSES; NON-MEDICATED BATH SALTS; SHOWER AND BATH GEL; SCULPTING GEL; SHAVING GEL; SHAVING GELS; SHOWER GEL; SHOWER GELS; TOOTH GEL; TOOTH WHITENING GELS; BEAUTY CREAMS; BEAUTY CREAMS FOR BODY CARE; BEAUTY GELS; BEAUTY LOTIONS; BEAUTY MILKS; FACE AND BODY BEAUTY CREAMS; BODY CREAM; BODY CREAM SOAP; BODY CREAMS; BODY DEODORANTS; BODY LOTION; BODY LOTIONS; BODY MILK; BODY MILKS; BODY OIL; BODY OILS; BODY SCRUB; BODY SPRAY USED AS A PERSONAL DEODORANT AND AS FRAGRANCE; BODY SPRAYS; BODY WASHES; FACE AND BODY CREAMS; FACE AND BODY LOTIONS; FACE AND BODY MILK; LIQUID SOAPS FOR HANDS, FACE AND BODY; LOTIONS FOR FACE AND BODY CARE; SCENTED BODY LOTIONS AND

CREAMS; SOAPS FOR BODY CARE; ANTI-AGING CREAM; ANTI-AGING CREAMS; ANTI-WRINKLE CREAM; ANTI-WRINKLE CREAMS; CREAM SOAPS; EXFOLIANT CREAMS; EYE CREAM; FACE CREAMS; FACIAL CLEANSING MILK; FACIAL CREAM; FACIAL CREAMS; HAND CREAM; HAND CREAMS; NON-MEDICATED SKIN CARE PREPARATIONS, NAMELY, CREAMS, LOTIONS, GELS, TONERS, CLEANERS AND PEELS; NON-MEDICATED SKIN CREAMS; PERFUMED CREAMS; SHAVING CREAM; SHAVING CREAMS; SKIN CLEANSING CREAM; SKIN CLEANSING LOTION; SKIN CREAM; SKIN CREAMS; SKIN CREAMS IN LIQUID AND IN SOLID FORM; SKIN CREAMS IN LIQUID AND SOLID; SKIN CREAMS IN LIQUID AND SOLID FORM; WRINKLE RESISTANT CREAM; EAU DE COLOGNE; EAU DE COLOGNES; EAU DE PARFUM; EAU DE PERFUME; EAU DE TOILETTE; EAU DE TOILETTE AND EAU DE COLOGNE; EAU-DE-COLOGNE; EAU-DE-TOILETTE; EAUX DE COLOGNE; EAUX DE TOILETTE; PERFUMES, EAU DE COLOGNES AND AFTERSHAVES; PERFUMES, EAUX DE COLOGNE AND AFTERSHAVES; NON-MEDICATED SKIN CARE PREPARATIONS; SKIN CLEANSERS; SKIN CONDITIONERS; SKIN LOTION; SKIN LOTIONS; SKIN MOISTURIZER; SKIN SOAP; ESSENTIAL OILS; ESSENTIAL OILS FOR PERSONAL USE; ESSENTIAL OILS FOR USE IN THE MANUFACTURE OF SCENTED PRODUCTS; NATURAL ESSENTIAL OILS; EYE LOTIONS; FACE MILK AND LOTIONS; LIQUID SOAPS FOR HANDS AND FACE; FACIAL CLEANSERS; FACIAL LOTION; FACIAL SCRUBS; FACIAL WASHES; FRAGRANCES; FRAGRANCES AND PERFUMERY; FRAGRANCES FOR PERSONAL USE; HAIR LOTIONS; HAND LOTIONS; SHAVING LOTION; SHAVING LOTIONS; STYLING LOTIONS; STYLING MOUSSE; LIQUID PERFUMES;

OILS FOR PERFUMES AND SCENTS; PERFUME; PERFUMED SOAP; PERFUMED SOAPS; PERFUMES; PERFUMES AND COLOGNES; PERFUMES, AFTERSHAVES AND COLOGNES; STYLING GELS; SHAMPOO-CONDITIONERS; SHAMPOOS; ALMOND SOAPS; BAR SOAP; HAND SOAPS; LIQUID SOAP; LIQUID SOAPS; SHAVING SOAP; SHAVING SOAPS; SOAPS FOR PERSONAL USE, IN CLASS 3 (U.S. CLS. 1, 4, 6, 50, 51 AND 52).

FIRST USE 12-0-2005; IN COMMERCE 5-0-2007.

NO CLAIM IS MADE TO THE EXCLUSIVE RIGHT TO USE "NATURALS", APART FROM THE MARK AS SHOWN.

"THE COLOR(S) RED, YELLOW, GREY, TAN, BLACK, AND WHITE IS/ARE CLAIMED AS A FEATURE OF THE MARK."

THE MARK CONSISTS OF RED FLOWERS WITH YELLOW CENTERS, AND STEMS IN VARIOUS SHADES OF GREY. THE EDGES OF, AND DEFINING LINES WITHIN, FLOWERS AND STEMS ARE BLACK OR GREY, AS IS ALL WRITING. THE BACKGROUND OF THE CENTRAL FLORAL IMAGE IS TAN, AS IS THE SEPARATED BORDER OF THAT IMAGE. THE BACKGROUND OF THE ENTIRE IMAGE IS WHITE.

"THE FOREIGN WORDING IN THE MARK TRANSLATES INTO ENGLISH AS 'BEAUTIFUL'."

SER. NO. 77-383,484, FILED 1-29-2008.

ANDREA BUTLER, EXAMINING ATTORNEY



**Int. Cl.: 41**

**Prior U.S. Cls.: 100, 101 and 107**

**United States Patent and Trademark Office**

**Reg. No. 3,498,512**

**Registered Sep. 9, 2008**

**SERVICE MARK  
PRINCIPAL REGISTER**



NATIONAL ASSOCIATION OF SCHOOL PSY-  
CHOLOGISTS, INC. (OHIO CORPORATION)  
SUITE 402  
4340 EAST WEST HIGHWAY  
BETHESDA, MD 20814

FOR: EDUCATIONAL SERVICES, NAMELY, DE-  
VELOPING CURRICULUM FOR OTHERS IN THE  
FIELD OF SCHOOL CRISIS PREVENTION, INTER-  
VENTION AND RECOVERY , IN CLASS 41 (U.S.  
CLS. 100, 101 AND 107).

FIRST USE 10-31-2007; IN COMMERCE 10-31-2007.

THE MARK CONSISTS OF A ROW OF SQUARES,  
CONTAINING THE WORD "PREPARE" WITHIN IT,  
ALONG WITH THE WORDS PREPARE PREVENT  
REAFFIRM EVALUATE PROVIDE AND RESPOND  
AND EXAMINE AT THE BOTTOM OF EACH  
SQUARE.

SER. NO. 77-383,489, FILED 1-29-2008.

MARCIE MILONE, EXAMINING ATTORNEY

Int. Cl.: 36

Prior U.S. Cls.: 100, 101 and 102

United States Patent and Trademark Office

Reg. No. 3,498,513

Registered Sep. 9, 2008

SERVICE MARK  
PRINCIPAL REGISTER

*Old South*



WALNUT ADVISORY CORPORATION (NEW  
JERSEY CORPORATION)  
95 MT. BETHEL ROAD  
WARREN, NJ 07059

FOR: INSURANCE ADMINISTRATION, INSURANCE AGENCIES, INSURANCE CLAIMS ADJUSTMENT, ADMINISTRATION AND PROCESSING, ELECTRONIC PROCESSING OF INSURANCE CLAIMS AND PAYMENT DATA, INSURANCE CONSULTATION, INSURANCE SUBROGATION AND SALVAGE, INSURANCE UNDERWRITING, INSURANCE ACTUARIAL SERVICES, ALL THE AFOREMENTIONED SERVICES IN THE FIELDS OF LIFE, HEALTH, HOME, ACCIDENT, FIRE, AUTO, DENTAL AND MEDICAL INSURANCE, APPRAISAL FOR INSURANCE CLAIMS OF PERSONAL PROPERTY AND OF REAL ESTATE, INSURANCE UNDERWRITING FOR PRE-PAID HEALTH CARE AND PRE-PAID LEGAL SERVICES, INSUR-

ANCE BROKERAGE IN THE FIELDS OF ART, STOCKS, COMMODITIES, LIFE, HEALTH, HOME, ACCIDENT, FIRE, AUTO, DENTAL AND MEDICAL, IN CLASS 36 (U.S. CLS. 100, 101 AND 102).

FIRST USE 2-1-2005; IN COMMERCE 2-1-2005.

THE COLOR(S) BLACK, BLUE AND WHITE IS/ARE CLAIMED AS A FEATURE OF THE MARK.

THE MARK CONSISTS OF THE TERM "OLD SOUTH" IN BLACK PLUS AN ILLUSTRATION OF A BUILDING IN BLACK AND WHITE AND BLACK TREES WITH BLUE AS A BACKGROUND.

SER. NO. 77-383,517, FILED 1-29-2008.

STEVEN JACKSON, EXAMINING ATTORNEY

**Int. Cl.: 12**

**Prior U.S. Cls.: 19, 21, 23, 31, 35 and 44**

**Reg. No. 3,498,514**

**United States Patent and Trademark Office**

**Registered Sep. 9, 2008**

**TRADEMARK  
PRINCIPAL REGISTER**

# Cattleman

EARL OWEN CO. INC. (TEXAS CORPORATION)  
334 N. HALL ST.  
DALLAS, TX 75226

FIRST USE 9-13-2007; IN COMMERCE 9-13-2007.

FOR: AFTERMARKET PARTS FOR TRUCKS, NAMELY, FRONT END REPLACEMENTS, BULL NOSE FRONT ENDS, GRILLE GUARDS, REAR BUMPERS, HEADACHE RACKS, ROOF RACKS, SIDE STEPS, RUNNING BOARDS, TOW BARS AND LUGGAGE CARRIERS, IN CLASS 12 (U.S. CLS. 19, 21, 23, 31, 35 AND 44).

THE MARK CONSISTS OF STANDARD CHARACTERS WITHOUT CLAIM TO ANY PARTICULAR FONT, STYLE, SIZE, OR COLOR.

SER. NO. 77-383,521, FILED 1-29-2008.

JACQUELINE A. LAVINE, EXAMINING ATTORNEY

**Int. Cl.: 9**

**Prior U.S. Cls.: 21, 23, 26, 36 and 38**

**Reg. No. 3,498,515**

**United States Patent and Trademark Office**

**Registered Sep. 9, 2008**

---

**TRADEMARK  
PRINCIPAL REGISTER**

**GoldKey**

ROGER BILLINGS (UNITED STATES INDIVIDUAL), DBA BILLINGS INTELLECTUAL PROPERTIES  
26900 E. PINK HILL RD.  
INDEPENDENCE, MO 64057

FOR: COMPUTER SOFTWARE THAT SECURES DATA ON A COMPUTER USING ENCRYPTION, IN CLASS 9 (U.S. CLS. 21, 23, 26, 36 AND 38).

FIRST USE 11-23-1993; IN COMMERCE 11-23-1993.

THE MARK CONSISTS OF STANDARD CHARACTERS WITHOUT CLAIM TO ANY PARTICULAR FONT, STYLE, SIZE, OR COLOR.

OWNER OF U.S. REG. NO. 3,156,136.

SER. NO. 77-383,841, FILED 1-30-2008.

MARGERY A. TIERNEY, EXAMINING ATTORNEY

**Int. Cl.: 11**

**Prior U.S. Cls.: 13, 21, 23, 31 and 34**

**United States Patent and Trademark Office**

**Reg. No. 3,498,516**

**Registered Sep. 9, 2008**

**TRADEMARK  
PRINCIPAL REGISTER**



NINGBO SELF ELECTRONICS CO., LTD. (CHI-  
NA LIMITED LIABILITY COMPANY)  
NO. 389, DONGQING ROAD, HI-TECH PARK  
NINGBO, ZHEJIANG, CHINA

FOR: LAMP BASES; LAMP BULBS; LAMP  
SHADES; LAMPS; CEILING LIGHTS; ELECTRIC  
HOLIDAY LIGHTS; LIGHT BULBS; LAMPSHADES;  
ELECTRIC LUMINARIES; LUMINARIES, IN CLASS  
11 (U.S. CLS. 13, 21, 23, 31 AND 34).

OWNER OF CHINA REG. NO. 1491200, DATED 12-  
14-2000, EXPIRES 12-13-2010.

THE MARK CONSISTS OF FOUR STYLIZED  
ENGLISH LETTERS "SELF".

SER. NO. 77-383,844, FILED 1-30-2008.

MARGERY A. TIERNEY, EXAMINING ATTORNEY

**Int. Cl.: 19**

**Prior U.S. Cls.: 1, 12, 33 and 50**

**United States Patent and Trademark Office**

**Reg. No. 3,498,517**

**Registered Sep. 9, 2008**

**TRADEMARK  
PRINCIPAL REGISTER**

# Flemington Granite

CRETER, MATTHEW T. (NEW JERSEY LIMITED  
LIABILITY COMPANY)  
417 US HIGHWAY 202  
FLEMINGTON, NJ 08822

FOR: NONSTRUCTURAL BUILDING MATERIALS, NAMELY, GRANITE USED IN DECORATIVE SURFACE APPLICATIONS FOR COUNTERTOPS AND VANITY TOPS; ROCK MATERIALS USED IN THE MANUFACTURE OF FLOORING, ROOFING, COUNTERTOPS, WALLS, CLADDING AND FIREPLACES; GRAVE MARKERS OF STONE, CONCRETE OR MARBLE; MANTELS FOR FIREPLACES OF STONE; MONUMENT STONE; MONUMENTS OF STONE; SCULPTURES OF STONE; TOMBSTONES OF STONE, CONCRETE

OR MARBLE, IN CLASS 19 (U.S. CLS. 1, 12, 33 AND 50).

FIRST USE 2-1-2004; IN COMMERCE 2-1-2004.

THE MARK CONSISTS OF STANDARD CHARACTERS WITHOUT CLAIM TO ANY PARTICULAR FONT, STYLE, SIZE, OR COLOR.

NO CLAIM IS MADE TO THE EXCLUSIVE RIGHT TO USE "GRANITE" , APART FROM THE MARK AS SHOWN.

SER. NO. 77-383,846, FILED 1-30-2008.

MARGERY A. TIERNEY, EXAMINING ATTORNEY

**Int. Cls.: 35, 36 and 41**

**Prior U.S. Cls.: 100, 101, 102 and 107**

**United States Patent and Trademark Office**

**Reg. No. 3,498,518**

**Registered Sep. 9, 2008**

**SERVICE MARK  
PRINCIPAL REGISTER**



PREVENT CANCER FOUNDATION (VIRGINIA CORPORATION)  
SUITE 500  
1600 DUKE STREET  
ALEXANDRIA, VA 22314

FOR: PROMOTING THE PUBLIC AWARENESS OF PREVENTION AND EARLY DETECTION OF CANCER THROUGH SCIENTIFIC RESEARCH AND EDUCATION; PROMOTING THE PUBLIC AWARENESS IN THE FIELD OF HEALTH, DIET, NUTRITION, CANCER, CANCER PREVENTION, DIAGNOSIS AND TREATMENT AND DISTRIBUTION OF INFORMATIONAL MATERIALS IN CONNECTION THEREWITH, IN CLASS 35 (U.S. CLS. 100, 101 AND 102).

FIRST USE 10-1-2007; IN COMMERCE 10-1-2007.

FOR: PROVIDING FUNDING AND GRANTS FOR RESEARCH AND DEVELOPMENT ACTIVITIES IN THE FIELD OF HEALTH, DIET, NUTRITION, CANCER, CANCER PREVENTION, DIAGNOSIS AND TREATMENT, IN CLASS 36 (U.S. CLS. 100, 101 AND 102).

FIRST USE 10-1-2007; IN COMMERCE 10-1-2007.

FOR: EDUCATIONAL SERVICES, NAMELY, CONDUCTING SEMINARS, WORKSHOPS, SYMPO-

SIA AND EDUCATIONAL CONFERENCES IN THE FIELD OF HEALTH, DIET, NUTRITION, CANCER, CANCER PREVENTION, DIAGNOSIS AND TREATMENT, AND DISTRIBUTION OF EDUCATIONAL MATERIALS IN CONNECTION THEREWITH, IN CLASS 41 (U.S. CLS. 100, 101 AND 107).

FIRST USE 10-1-2007; IN COMMERCE 10-1-2007.

NO CLAIM IS MADE TO THE EXCLUSIVE RIGHT TO USE "PREVENT CANCER FOUNDATION", APART FROM THE MARK AS SHOWN.

THE COLOR(S) LIGHT GREEN AND GRAY IS/ARE CLAIMED AS A FEATURE OF THE MARK.

THE MARK CONSISTS OF THE COLORS LIGHT GREEN AND GRAY, WITH THE COLOR GRAY APPEARING IN THE LITERAL ELEMENT "PREVENT CANCER FOUNDATION" AND THE COLOR LIGHT GREEN APPEARING IN THE DESIGN OF TWO WAVY LINES APPEARING BETWEEN THE WORDS "PREVENT" AND "CANCER".

SER. NO. 77-384,013, FILED 1-30-2008.

BARBARA BROWN, EXAMINING ATTORNEY

**Int. Cl.: 36**

**Prior U.S. Cls.: 100, 101 and 102**

**United States Patent and Trademark Office**

**Reg. No. 3,498,519**

**Registered Sep. 9, 2008**

**SERVICE MARK  
PRINCIPAL REGISTER**

**MONEY MANAGER CARD**

DIRECT BENEFITS, LLC (DELAWARE LIMITED  
LIABILITY COMPANY)

210 EAST CHURCHILL STREET

BALTIMORE, MD 21230

FOR: ISSUING STORED VALUE CARDS, IN  
CLASS 36 (U.S. CLS. 100, 101 AND 102).

FIRST USE 8-10-2005; IN COMMERCE 8-10-2005.

THE MARK CONSISTS OF STANDARD CHAR-  
ACTERS WITHOUT CLAIM TO ANY PARTICULAR  
FONT, STYLE, SIZE, OR COLOR.

NO CLAIM IS MADE TO THE EXCLUSIVE  
RIGHT TO USE "CARD", APART FROM THE  
MARK AS SHOWN.

SER. NO. 77-384,020, FILED 1-30-2008.

GRETTA YAO, EXAMINING ATTORNEY



**Int. Cl.: 9**

**Prior U.S. Cls.: 21, 23, 26, 36 and 38**

**Reg. No. 3,498,520**

**United States Patent and Trademark Office**

**Registered Sep. 9, 2008**

**TRADEMARK  
PRINCIPAL REGISTER**

**TEAM Online**   
**TOTAL ELECTRONIC ASSET MANAGEMENT**

THE LONGBOW GROUP, LLC (TENNESSEE  
LIMITED LIABILITY COMPANY)  
986 SURREY OAKS DR  
COLLIERVILLE, TN 38017

FIRST USE 8-7-2007; IN COMMERCE 10-1-2007.

FOR: AUTOMATED SYSTEMS, NAMELY, SOFTWARE, HARDWARE AND COMMUNICATIONS DEVICES FOR PLANNING, SCHEDULING, CONTROLLING, MONITORING AND PROVIDING INFORMATION ON TRANSPORTATION ASSETS AND PARTS THEREOF, IN CLASS 9 (U.S. CLS. 21, 23, 26, 36 AND 38).

NO CLAIM IS MADE TO THE EXCLUSIVE RIGHT TO USE "ONLINE" AND "ELECTRONIC ASSET MANAGEMENT", APART FROM THE MARK AS SHOWN.

SER. NO. 77-384,045, FILED 1-30-2008.

RENEE MCCRAY, EXAMINING ATTORNEY

Int. Cl.: 37

Prior U.S. Cls.: 100, 103 and 106

United States Patent and Trademark Office

Reg. No. 3,498,521

Registered Sep. 9, 2008

SERVICE MARK  
PRINCIPAL REGISTER



GOMEZ, ALAN (UNITED STATES INDIVIDUAL)  
13613 STANBRIDGE AVE.  
BELLFLOWER, CA 90706

FOR: CONSTRUCTION AND REPAIR OF BUILDINGS, IN CLASS 37 (U.S. CLS. 100, 103 AND 106).

FIRST USE 2-15-2007; IN COMMERCE 2-15-2007.

NO CLAIM IS MADE TO THE EXCLUSIVE RIGHT TO USE "SEAL BEACH CONSTRUCTION", APART FROM THE MARK AS SHOWN.

THE MARK CONSISTS OF THE WORDS "SEAL BEACH CONSTRUCTION" AND TWO STARS APPEARING BETWEEN TWO ROPES DRAWN TO FORM CONCENTRIC CIRCLES; IN THE CENTER OF THE CIRCLES IS A DEPICTION OF A SEAL WEARING PANTS, SHOES, SUNGLASSES, CONSTRUCTION BELT AND TOOLS.

SER. NO. 77-384,088, FILED 1-30-2008.

CYNTHIA TRIPI, EXAMINING ATTORNEY

**Int. Cl.: 2**

**Prior U.S. Cls.: 6, 11 and 16**

**United States Patent and Trademark Office**

**Reg. No. 3,498,522**

**Registered Sep. 9, 2008**

**TRADEMARK  
PRINCIPAL REGISTER**

**FUEL FOR YOUR BUSINESS**

LASERCYCLE, INC. (KANSAS CORPORATION)  
11100 WEST 82ND STREET  
SUITE 105  
LENEXA, KS 66214

THE MARK CONSISTS OF STANDARD CHAR-  
ACTERS WITHOUT CLAIM TO ANY PARTICULAR  
FONT, STYLE, SIZE, OR COLOR.

FOR: INK JET PRINTER INK CARTRIDGES FOR  
PRINTERS, FAX MACHINES AND COPIERS, IN  
CLASS 2 (U.S. CLS. 6, 11 AND 16).

SER. NO. 77-384,099, FILED 1-30-2008.

FIRST USE 5-9-2007; IN COMMERCE 5-9-2007.

TRACY CROSS, EXAMINING ATTORNEY

**Int. Cl.: 9**

**Prior U.S. Cls.: 21, 23, 26, 36 and 38**

**United States Patent and Trademark Office**

**Reg. No. 3,498,523**

**Registered Sep. 9, 2008**

**TRADEMARK  
PRINCIPAL REGISTER**

**VALCOBOND**

VALCO INSTRUMENTS CO., INC. (TEXAS CORPORATION)  
POST OFFICE 55603  
HOUSTON, TX 77255

FOR: CHROMATOGRAPHY COLUMNS, IN CLASS 9 (U.S. CLS. 21, 23, 26, 36 AND 38).

FIRST USE 10-4-2000; IN COMMERCE 10-4-2000.

THE MARK CONSISTS OF STANDARD CHARACTERS WITHOUT CLAIM TO ANY PARTICULAR FONT, STYLE, SIZE, OR COLOR.

OWNER OF U.S. REG. NO. 2,657,021.

SER. NO. 77-384,272, FILED 1-30-2008.

THEODORE MCBRIDE, EXAMINING ATTORNEY

**Int. Cls.: 3 and 4**

**Prior U.S. Cls.: 1, 4, 6, 15, 50, 51 and 52**

**United States Patent and Trademark Office**

**Reg. No. 3,498,524**

**Registered Sep. 9, 2008**

**TRADEMARK  
PRINCIPAL REGISTER**



OF THE SOUTH, LLC (SOUTH CAROLINA LIMITED LIABILITY COMPANY)  
1432 COLUMBIA ROAD  
JOHNSTON, SC 29832

FOR: AROMATHERAPY BODY CARE PRODUCTS, NAMELY, BODY LOTION, SHOWER GEL, CUTICLE CREAM, SHAMPOO, CONDITIONER, NON-MEDICATED LIP BALM, SOAP, BODY POLISH, BODY AND FOOT SCRUB AND NON-MEDICATED FOOT CREAM; BATH SOAPS; PERFUMED SOAPS; SKIN SOAP; SOAPS FOR PERSONAL USE, IN CLASS 3 (U.S. CLS. 1, 4, 6, 50, 51 AND 52).

FIRST USE 9-18-2007; IN COMMERCE 9-18-2007.

FOR: CANDLES; PERFUMED CANDLES; SCENTED CANDLES, IN CLASS 4 (U.S. CLS. 1, 6 AND 15).

FIRST USE 9-18-2007; IN COMMERCE 9-18-2007.

THE MARK CONSISTS OF A RECTANGLE DIVIDED INTO THREE SECTIONS. THE TOP SECTION INCLUDES THE WORDS "OF THE". THE MIDDLE SECTION INCLUDES A CURLY "S". THE BOTTOM SECTION INCLUDES THE WORD "SOUTH".

SER. NO. 77-384,422, FILED 1-30-2008.

TEJBIR SINGH, EXAMINING ATTORNEY

**Int. Cl.: 28**

**Prior U.S. Cls.: 22, 23, 38 and 50**

**United States Patent and Trademark Office**

**Reg. No. 3,498,525**

**Registered Sep. 9, 2008**

**TRADEMARK  
PRINCIPAL REGISTER**

DA FIN SURFING PRODUCTS, LLC (HAWAII  
LIMITED LIABILITY COMPANY)  
1149 BETHEL STREET, SUITE 501  
HONOLULU, HI 96813

FOR: SURF FINS; SURFBOARD FINS; SWIM  
FINS; SWIMMING FLIPPERS, IN CLASS 28 (U.S.  
CLS. 22, 23, 38 AND 50).

FIRST USE 6-15-2000; IN COMMERCE 6-15-2000.

THE MARK CONSISTS OF THE WORD "DAFIN"  
IN STYLIZED FONT DESIGN.

SEC. 2(F).

SER. NO. 77-384,461, FILED 1-30-2008.

THEODORE MCBRIDE, EXAMINING ATTORNEY

**Int. Cl.: 17**

**Prior U.S. Cls.: 1, 5, 12, 13, 35 and 50**

**United States Patent and Trademark Office**

**Reg. No. 3,498,526**

**Registered Sep. 9, 2008**

**TRADEMARK  
PRINCIPAL REGISTER**

**PENTALAN**

KLOCKNER PENTAPLAST GMBH & CO. KG  
(FED REP GERMANY GMBH & CO. KG)  
INDUSTRIESTRASSE 3-5  
HEILIGENROTH, FED REP GERMANY 56412

FOR: PLASTIC MATERIALS IN THE FORM OF  
SHEETS, FILMS, RODS AND TUBES; PLASTIC  
SHEETS FOR CONSTRUCTIONS AND GENERAL  
USE, IN CLASS 17 (U.S. CLS. 1, 5, 12, 13, 35 AND 50).

THE MARK CONSISTS OF STANDARD CHAR-  
ACTERS WITHOUT CLAIM TO ANY PARTICULAR  
FONT, STYLE, SIZE, OR COLOR.

OWNER OF FED REP GERMANY REG. NO.  
30750751, DATED 8-2-2007, EXPIRES 8-2-2017.

SER. NO. 77-384,466, FILED 1-30-2008.

JOHN WILKE, EXAMINING ATTORNEY

**Int. Cl.: 20**

**Prior U.S. Cls.: 2, 13, 22, 25, 32 and 50**

**Reg. No. 3,498,527**

**United States Patent and Trademark Office**

**Registered Sep. 9, 2008**

**TRADEMARK  
PRINCIPAL REGISTER**

**Grow and Show**

MRSE, LLC (NEBRASKA LIMITED LIABILITY  
COMPANY)  
623 NORTH 67TH STREET  
LINCOLN, NE 68505

THE MARK CONSISTS OF STANDARD CHAR-  
ACTERS WITHOUT CLAIM TO ANY PARTICULAR  
FONT, STYLE, SIZE, OR COLOR.

FOR: PLANT STANDS, IN CLASS 20 (U.S. CLS. 2,  
13, 22, 25, 32 AND 50).

SER. NO. 77-384,485, FILED 1-30-2008.

FIRST USE 12-10-2007; IN COMMERCE 12-10-2007.

HELENE LIWINSKI, EXAMINING ATTORNEY



**Int. Cl.: 25**

**Prior U.S. Cls.: 22 and 39**

**United States Patent and Trademark Office**

**Reg. No. 3,498,528**

**Registered Sep. 9, 2008**

**TRADEMARK  
PRINCIPAL REGISTER**

**Holaja**

HONGQINGTING GROUP CO., LTD. (CHINA  
LIMITED COMPANY (LTD.))  
YANGGUANG ROAD  
OUBEI YONGJIA  
ZHEJIANG PROVINCE, CHINA

FOR: CLOTHING, NAMELY, COATS, DRESSES,  
JACKETS, OVERALLS, OVERCOATS, SHIRTS,  
SLEEPWEAR, SUITS, SWEATERS, TROUSERS, T-  
SHIRTS, UNDERPANTS, UNDERWEAR, UNI-  
FORMS, WAISTCOATS; LAYETTES; INFANTS'  
SHOES AND BOOTS; RAIN BOOTS; RAINWEAR;  
SWIMSUITS; SWIMMING TRUNKS; CLOTHING,  
NAMELY, FOLK COSTUMES, MASQUERADE COS-  
TUMES, PLAY SUITS; ATHLETIC SHOES; BOOTS;  
CLIMBING BOOTS AND MOUNTAINEERING  
BOOTS; FOOTBALL SHOES; GYMNAS TIC SHOES;  
INSOLES; LEATHER SHOES; OVERSHOES; RUB-  
BER SHOES; SANDALS; SHOES; SKI BOOTS; SLIP-

PERS; SOCCER SHOES; TENNIS SHOES; TRACK  
AND FIELD SHOES; TRAINING SHOES; WORK  
SHOES AND BOOTS; HATS; HOSIERY; SOCKS AND  
STOCKINGS; GLOVES; NECKTIES; CRAVATS;  
SCARVES; BELTS; LEATHER BELTS; WEDDING  
DRESSES; WEDDING GOWNS, IN CLASS 25 (U.S.  
CLS. 22 AND 39).

FIRST USE 8-31-2007; IN COMMERCE 8-31-2007.

OWNER OF U.S. REG. NO. 2,695,286.

THE MARK CONSISTS OF THE STYLIZED  
WORDING "HOLAJA".

SER. NO. 77-384,553, FILED 1-30-2008.

KHANH LE, EXAMINING ATTORNEY

**Int. Cl.: 6**

**Prior U.S. Cls.: 2, 12, 13, 14, 23, 25 and 50**

**Reg. No. 3,498,529**

**United States Patent and Trademark Office**

**Registered Sep. 9, 2008**

**TRADEMARK  
PRINCIPAL REGISTER**

**BASE-X**

BASE-X, INC. (DELAWARE CORPORATION)  
6051 N. LEE HIGHWAY  
FAIRFIELD, VA 24435

FIRST USE 1-1-1999; IN COMMERCE 1-1-1999.

FOR: THE FOLLOWING GOODS FOR TENTS, AWNINGS, CANOPIES, SHELTERS AND TRANSPORTABLE BUILDINGS—METAL FRAMES, STAKES AND PEGS, POLES, CABLES AND BRACES; METAL COMPONENTS AND ACCESSORIES FOR THE FOREGOING GOODS, NAMELY, CLIPS, PINS AND BOLTS; AND CASES FOR STORAGE AND TRANSPORT OF SUCH GOODS, IN CLASS 6 (U.S. CLS. 2, 12, 13, 14, 23, 25 AND 50).

THE MARK CONSISTS OF STANDARD CHARACTERS WITHOUT CLAIM TO ANY PARTICULAR FONT, STYLE, SIZE, OR COLOR.

OWNER OF U.S. REG. NO. 2,534,311.

SER. NO. 77-384,667, FILED 1-30-2008.

SANI KHOURI, EXAMINING ATTORNEY

**Int. Cl.: 37**

**Prior U.S. Cls.: 100, 103 and 106**

**United States Patent and Trademark Office**

**Reg. No. 3,498,530**

**Registered Sep. 9, 2008**

**SERVICE MARK  
PRINCIPAL REGISTER**

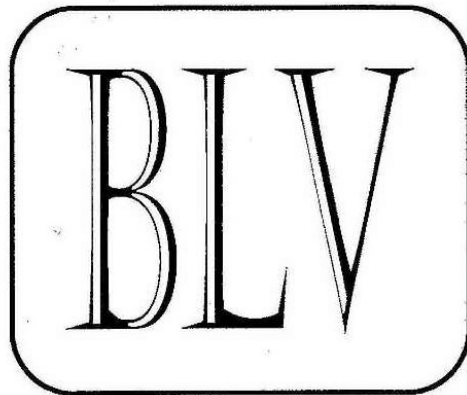

BELLE LA VIE DEVELOPMENT, L.L.C. (MISSISSIPPI LIMITED LIABILITY COMPANY)  
15039 LORRAINE ROAD  
BILOXI, MS 39532

THE MARK CONSISTS OF THE LETTERS "B" "L" AND "V" ENCLOSED BY A RECTANGULAR BOX WITH ROUNDED CORNERS.

FOR: REAL ESTATE DEVELOPMENT, IN CLASS 37 (U.S. CLS. 100, 103 AND 106).

SER. NO. 77-384,794, FILED 1-30-2008.

FIRST USE 5-4-2006; IN COMMERCE 5-4-2006.

ARETHA SOMERVILLE, EXAMINING ATTORNEY

**Int. Cl.: 35**

**Prior U.S. Cls.: 100, 101 and 102**

**United States Patent and Trademark Office**

**Reg. No. 3,498,531**

**Registered Sep. 9, 2008**

**SERVICE MARK  
PRINCIPAL REGISTER**

**Turca Education Group**

TURCA EDUCATION GROUP LTD. (OHIO LIMITED LIABILITY COMPANY)  
12114 HEATHERTREE CT  
CINCINNATI, OH 45249

FOR: RECRUITMENT OF STUDENTS FOR HIGHER EDUCATION INSTITUTIONS, IN CLASS 35 (U.S. CLS. 100, 101 AND 102).

FIRST USE 10-1-2007; IN COMMERCE 10-1-2007.

THE MARK CONSISTS OF STANDARD CHARACTERS WITHOUT CLAIM TO ANY PARTICULAR FONT, STYLE, SIZE, OR COLOR.

NO CLAIM IS MADE TO THE EXCLUSIVE RIGHT TO USE "EDUCATION GROUP", APART FROM THE MARK AS SHOWN.

SER. NO. 77-384,951, FILED 1-31-2008.

ALICIA COLLINS, EXAMINING ATTORNEY

**Int. Cl.: 41**

**Prior U.S. Cls.: 100, 101 and 107**

**United States Patent and Trademark Office**

**Reg. No. 3,498,532**

**Registered Sep. 9, 2008**

**SERVICE MARK  
PRINCIPAL REGISTER**

**Turca Education Group**

TURCA EDUCATION GROUP LTD. (OHIO LIMITED LIABILITY COMPANY)

12114 HEATHERTREE CT

CINCINNATI, OH 45249

FOR: EDUCATION INFORMATION, IN CLASS 41 (U.S. CLS. 100, 101 AND 107).

FIRST USE 10-1-2007; IN COMMERCE 10-1-2007.

THE MARK CONSISTS OF STANDARD CHARACTERS WITHOUT CLAIM TO ANY PARTICULAR FONT, STYLE, SIZE, OR COLOR.

NO CLAIM IS MADE TO THE EXCLUSIVE RIGHT TO USE "EDUCATION GROUP", APART FROM THE MARK AS SHOWN.

SER. NO. 77-384,953, FILED 1-31-2008.

ALICIA COLLINS, EXAMINING ATTORNEY

**Int. Cl.: 36**

**Prior U.S. Cls.: 100, 101 and 102**

**United States Patent and Trademark Office**

**Reg. No. 3,498,533**

**Registered Sep. 9, 2008**

**SERVICE MARK  
PRINCIPAL REGISTER**

**PNC INVESTMENTS**

THE PNC FINANCIAL SERVICES GROUP, INC.  
(PENNSYLVANIA CORPORATION)  
249 FIFTH AVENUE  
PITTSBURGH, PA 15222

FOR: BANKING SERVICES; INVESTMENT MANAGEMENT; STOCK BROKERAGE, FIDUCIARY REPRESENTATIVE SERVICES, NAMELY, ACTING AS PERSONAL REPRESENTATIVES OF DECEDENT'S ESTATES AND AS TRUSTEES OF TRUSTS; CUSTODIAN SERVICES, NAMELY, HOLDING STOCKS, BONDS, SECURITIES AND OTHER FINANCIAL AND INVESTMENT INSTRUMENTS FOR OTHERS; FINANCIAL AND ESTATE PLANNING; FINANCIAL PLANNING SERVICES IN THE NATURE OF RETIREMENT, GIFT, AND DISTRIBUTION PLANNING; ANNUITIES AND LIFE INSURANCE UNDERWRITING; FINANCIAL MANAGEMENT OF ENDOWMENTS AND CHARITABLE AND PRIVATE FOUNDATIONS; ADMINISTRATION OF EMPLOYEE BENEFIT PLANS; FINANCIAL INVESTMENT SERVICES, NAMELY,

OFFERING CERTIFICATES OF DEPOSIT, DEMAND DEPOSIT, AND TIME DEPOSIT PRODUCTS, IN CLASS 36 (U.S. CLS. 100, 101 AND 102).

FIRST USE 7-1-2002; IN COMMERCE 7-1-2002.

THE MARK CONSISTS OF STANDARD CHARACTERS WITHOUT CLAIM TO ANY PARTICULAR FONT, STYLE, SIZE, OR COLOR.

OWNER OF U.S. REG. NOS. 1,416,898, 2,032,406 AND OTHERS.

NO CLAIM IS MADE TO THE EXCLUSIVE RIGHT TO USE "INVESTMENTS", APART FROM THE MARK AS SHOWN.

SER. NO. 77-384,976, FILED 1-31-2008.

JEFF DEFORD, EXAMINING ATTORNEY

**Int. Cl.: 35**

**Prior U.S. Cls.: 100, 101 and 102**

**United States Patent and Trademark Office**

**Reg. No. 3,498,534**

**Registered Sep. 9, 2008**

**SERVICE MARK  
PRINCIPAL REGISTER**

**NAMB/SOUTHEAST**

NATIONAL ASSOCIATION OF MORTGAGE  
BROKERS (FLORIDA CORPORATION)  
SUITE T-309  
7900 WESTPARK DRIVE  
MCLEAN, VA 22102

FOR: ASSOCIATION SERVICES, NAMELY, PRO-  
MOTING THE INTERESTS OF MORTGAGE BRO-  
KERS, IN CLASS 35 (U.S. CLS. 100, 101 AND 102).

FIRST USE 12-1-2007; IN COMMERCE 12-1-2007.

THE MARK CONSISTS OF STANDARD CHAR-  
ACTERS WITHOUT CLAIM TO ANY PARTICULAR  
FONT, STYLE, SIZE, OR COLOR.

OWNER OF U.S. REG. NOS. 1,740,417, 1,820,229,  
AND 2,886,418.

SER. NO. 77-384,990, FILED 1-31-2008.

ARETHA SOMERVILLE, EXAMINING ATTORNEY

**Int. Cl.: 39**

**Prior U.S. Cls.: 100 and 105**

**United States Patent and Trademark Office**

**Reg. No. 3,498,535**

**Registered Sep. 9, 2008**

**SERVICE MARK  
PRINCIPAL REGISTER**

**The Fun Way to Get Around!**

INTERNATIONAL DRIVE TRANSIT & IMPROVEMENT DISTRICT (FLORIDA GOVERNMENTAL TAXING DISTRICT)  
SUITE 104  
7081 GRAND NATIONAL DRIVE  
ORLANDO, FL 32819

FOR: TRANSPORTATION SERVICES, NAMELY, PROVIDING A TROLLEY SERVICE FOR OTHERS, IN CLASS 39 (U.S. CLS. 100 AND 105).

FIRST USE 3-2-2003; IN COMMERCE 3-2-2003.

THE MARK CONSISTS OF STANDARD CHARACTERS WITHOUT CLAIM TO ANY PARTICULAR FONT, STYLE, SIZE, OR COLOR.

SER. NO. 77-385,098, FILED 1-31-2008.

ELLEN BURNS, EXAMINING ATTORNEY



**Int. Cl.: 39**

**Prior U.S. Cls.: 100 and 105**

**United States Patent and Trademark Office**

**Reg. No. 3,498,536**

**Registered Sep. 9, 2008**

**SERVICE MARK  
PRINCIPAL REGISTER**



INTERNATIONAL DRIVE TRANSIT & IMPROVEMENT DISTRICT (FLORIDA GOVERNMENTAL TAXING DISTRICT)  
7081 GRAND NATIONAL DRIVE  
SUITE 104  
ORLANDO, FL 32819

FOR: TRANSPORTATION SERVICES, NAMELY, PROVIDING A TROLLEY SERVICE FOR OTHERS, IN CLASS 39 (U.S. CLS. 100 AND 105).

FIRST USE 3-1-2006; IN COMMERCE 3-1-2006.

THE MARK CONSISTS OF A CARTOON TROLLEY WITH A FACE AND, ON THE NOSE, THE WORDS "I RIDE" INSIDE A STYLIZED TROLLEY CAR OVER THE WORD TROLLEY.

SER. NO. 77-385,104, FILED 1-31-2008.

ELLEN BURNS, EXAMINING ATTORNEY

**Int. Cl.: 11**

**Prior U.S. Cls.: 13, 21, 23, 31 and 34**

**United States Patent and Trademark Office**

**Reg. No. 3,498,537**

**Registered Sep. 9, 2008**

**TRADEMARK  
PRINCIPAL REGISTER**

**PREMIUM LEISURE**

PREMIUM LEISURE, LLC (FLORIDA LIMITED  
LIABILITY COMPANY)

6101 45TH STREET NORTH

ST. PETERSBURG, FL 33714

FOR: SPAS IN THE NATURE OF HEATED POOLS,  
IN CLASS 11 (U.S. CLS. 13, 21, 23, 31 AND 34).

FIRST USE 11-26-2007; IN COMMERCE 11-26-2007.

THE MARK CONSISTS OF STANDARD CHAR-  
ACTERS WITHOUT CLAIM TO ANY PARTICULAR  
FONT, STYLE, SIZE, OR COLOR.

NO CLAIM IS MADE TO THE EXCLUSIVE  
RIGHT TO USE "PREMIUM", APART FROM THE  
MARK AS SHOWN.

SER. NO. 77-385,163, FILED 1-31-2008.

MICHELE SWAIN, EXAMINING ATTORNEY

**Int. Cl.: 41**

**Prior U.S. Cls.: 100, 101 and 107**

**United States Patent and Trademark Office**

**Reg. No. 3,498,538**

**Registered Sep. 9, 2008**

**SERVICE MARK  
PRINCIPAL REGISTER**

# Priceless Parenting

PRICELESS PARENTING, LLC (WASHINGTON LIMITED LIABILITY COMPANY), DBA PRICELESS PARENTING  
15926 82ND PLACE NE  
KENMORE, WA 98028

FOR: EDUCATION SERVICES, NAMELY, PROVIDING LIVE AND ON-LINE CLASSES IN THE FIELD OF PARENTING, IN CLASS 41 (U.S. CLS. 100, 101 AND 107).

FIRST USE 1-31-2008; IN COMMERCE 1-31-2008.

THE MARK CONSISTS OF STANDARD CHARACTERS WITHOUT CLAIM TO ANY PARTICULAR FONT, STYLE, SIZE, OR COLOR.

NO CLAIM IS MADE TO THE EXCLUSIVE RIGHT TO USE "PARENTING", APART FROM THE MARK AS SHOWN.

SER. NO. 77-385,182, FILED 1-31-2008.

RON FAIRBANKS, EXAMINING ATTORNEY

**Int. Cl.: 35**

**Prior U.S. Cls.: 100, 101 and 102**

**United States Patent and Trademark Office**

**Reg. No. 3,498,539**

**Registered Sep. 9, 2008**

**SERVICE MARK  
PRINCIPAL REGISTER**

**Cloud Weavers at Alpaca  
Junction**

ALPACA JUNCTION, INC. (FLORIDA CORPORATION)  
14124 NIGHTHAWK TERRACE  
LAKEWOOD RANCH, FL 342026348

FOR: ON-LINE RETAIL STORE SERVICES FEATURING CLOTHING AND CLOTHING RELATED ITEMS, NAMELY SOCKS, SHAWLS, SCARVES, JACKETS, SWEATERS, YARNS, FLEECE, SPINNING WHEELS AND RELATED ITEMS, IN CLASS 35 (U.S. CLS. 100, 101 AND 102).

FIRST USE 11-23-2007; IN COMMERCE 11-23-2007.

THE MARK CONSISTS OF STANDARD CHARACTERS WITHOUT CLAIM TO ANY PARTICULAR FONT, STYLE, SIZE, OR COLOR.

SER. NO. 77-385,184, FILED 1-31-2008.

LESLIE RICHARDS, EXAMINING ATTORNEY

**Int. Cl.: 35**

**Prior U.S. Cls.: 100, 101 and 102**

**United States Patent and Trademark Office**

**Reg. No. 3,498,540**

**Registered Sep. 9, 2008**

**SERVICE MARK  
PRINCIPAL REGISTER**



REGIONS ASSET COMPANY (DELAWARE CORPORATION)  
SUITE 209  
3501 SILVERSIDE ROAD  
WILMINGTON, DE 19810

FOR: CHARITABLE SERVICES, NAMELY, ORGANIZING AND CONDUCTING A VOLUNTEER PROGRAM, IN CLASS 35 (U.S. CLS. 100, 101 AND 102).

FIRST USE 1-24-2008; IN COMMERCE 1-24-2008.

THE COLOR(S) GREEN, BLACK AND WHITE IS/ ARE CLAIMED AS A FEATURE OF THE MARK.

THE COLOR GREEN APPEARS IN THE STICK FIGURE CIRCULAR DESIGN, THE WORDING IS ALL IN BLACK AND THE BACKGROUND OF THE MARK IS IN WHITE.

SER. NO. 77-385,312, FILED 1-31-2008.

SUE LAWRENCE, EXAMINING ATTORNEY

**Int. Cl.: 41**

**Prior U.S. Cls.: 100, 101 and 107**

**United States Patent and Trademark Office**

**Reg. No. 3,498,541**

**Registered Sep. 9, 2008**

**SERVICE MARK  
PRINCIPAL REGISTER**



CENTER FOR GLOBAL DEVELOPMENT (D.C.  
CORPORATION)  
3RD FLOOR  
1776 MASSACHUSETTS AVE., NW  
WASHINGTON, DC 20036

FOR: EDUCATIONAL SERVICES, NAMELY,  
PROVIDING CLASSES, SEMINARS, CONFEREN-  
CES, WORKSHOPS, AND EDUCATIONAL RE-  
SEARCH IN THE FIELDS OF GLOBAL POVERTY  
AND INEQUALITY BY ENCOURAGING POLICY  
CHANGE THROUGHOUT THE WORLD, IN CLASS  
41 (U.S. CLS. 100, 101 AND 107).

FIRST USE 1-31-2002; IN COMMERCE 1-31-2002.

NO CLAIM IS MADE TO THE EXCLUSIVE  
RIGHT TO USE "CENTER FOR GLOBAL DEVEL-  
OPMENT", APART FROM THE MARK AS SHOWN.

THE MARK CONSISTS OF STANDARD CHAR-  
ACTERS AND DESIGN, WITHOUT CLAIM TO ANY  
PARTICULAR FONT, STYLE, SIZE, OR COLOR.

SER. NO. 77-385,333, FILED 1-31-2008.

LOURDES AYALA, EXAMINING ATTORNEY

**Int. Cls.: 35 and 36**

**Prior U.S. Cls.: 100, 101 and 102**

**United States Patent and Trademark Office**

**Reg. No. 3,498,542**

**Registered Sep. 9, 2008**

**SERVICE MARK  
PRINCIPAL REGISTER**

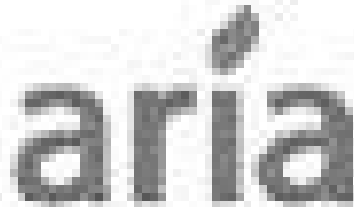

ARIA SYSTEMS, INC. (DELAWARE CORPORATION)  
1400 NORTH PROVIDENCE ROAD  
MEDIA, PA 19063

FOR: BILLING AND CUSTOMER RELATIONSHIP MANAGEMENT, IN CLASS 35 (U.S. CLS. 100, 101 AND 102).

FIRST USE 3-1-2002; IN COMMERCE 3-1-2002.

FOR: ELECTRONIC PAYMENT, NAMELY, ELECTRONIC PROCESSING AND TRANSMISSION OF BILL PAYMENT DATA, IN CLASS 36 (U.S. CLS. 100, 101 AND 102).

FIRST USE 3-1-2002; IN COMMERCE 3-1-2002.

THE MARK CONSISTS OF "ARIA" WITH DOTTED "I".

THE WORDING "ARIA" HAS NO MEANING IN A FOREIGN LANGUAGE.

SER. NO. 77-385,337, FILED 1-31-2008.

JOHN DALIER, EXAMINING ATTORNEY

**Int. Cl.: 11**

**Prior U.S. Cls.: 13, 21, 23, 31 and 34**

**United States Patent and Trademark Office**

**Reg. No. 3,498,543**

**Registered Sep. 9, 2008**

**TRADEMARK  
PRINCIPAL REGISTER**

**DRYMAX**

S.D. MYERS, INC. (OHIO CORPORATION)  
180 SOUTH AVENUE  
TALLMADGE, OH 44278

THE MARK CONSISTS OF STANDARD CHAR-  
ACTERS WITHOUT CLAIM TO ANY PARTICULAR  
FONT, STYLE, SIZE, OR COLOR.

FOR: ELECTRIC DEHYDRATOR FOR DEHY-  
DRATING OIL IN ELECTRICAL TRANSFORMERS,  
IN CLASS 11 (U.S. CLS. 13, 21, 23, 31 AND 34).

SER. NO. 77-385,350, FILED 1-31-2008.

FIRST USE 12-4-2007; IN COMMERCE 12-4-2007.

EVELYN BRADLEY, EXAMINING ATTORNEY



**Int. Cl.: 40**

**Prior U.S. Cls.: 100, 103 and 106**

**United States Patent and Trademark Office**

**Reg. No. 3,498,544**

**Registered Sep. 9, 2008**

**SERVICE MARK  
PRINCIPAL REGISTER**



INTERNATIONAL PAPER PRODUCTS COR-  
PORATION (MASSACHUSETTS CORPORA-  
TION)  
98 SGT. TM DION WAY  
WESTFIELD, MA 01085

FOR: CONVERSION OF RECYCLABLE RAW  
MATERIALS INTO BIOMASS OR ENVIRONMEN-  
TALLY FRIENDLY CUBES, IN CLASS 40 (U.S. CLS.  
100, 103 AND 106).

FIRST USE 7-1-2000; IN COMMERCE 7-1-2000.

OWNER OF U.S. REG. NOS. 3,229,149 AND  
3,274,896.

NO CLAIM IS MADE TO THE EXCLUSIVE  
RIGHT TO USE THE RECYCLING SYMBOL,  
APART FROM THE MARK AS SHOWN.

SER. NO. 77-385,373, FILED 1-31-2008.

AMEETA JORDAN, EXAMINING ATTORNEY

**Int. Cl.: 8**

**Prior U.S. Cls.: 23, 28 and 44**

**United States Patent and Trademark Office**

**Reg. No. 3,498,545**

**Registered Sep. 9, 2008**

**TRADEMARK  
PRINCIPAL REGISTER**

**DOUBLE-X**

EASCO HAND TOOLS, INC. (DELAWARE COR-  
PORATION)  
125 POWDER FOREST DRIVE  
SIMSBURY, CT 06070

THE MARK CONSISTS OF STANDARD CHAR-  
ACTERS WITHOUT CLAIM TO ANY PARTICULAR  
FONT, STYLE, SIZE, OR COLOR.

FOR: HAND TOOLS, NAMELY, PLIERS, IN  
CLASS 8 (U.S. CLS. 23, 28 AND 44).

SER. NO. 77-385,416, FILED 1-31-2008.

FIRST USE 10-2-2006; IN COMMERCE 10-2-2006.

KEVIN CORWIN, EXAMINING ATTORNEY

**Int. Cl.: 9**

**Prior U.S. Cls.: 21, 23, 26, 36 and 38**

**Reg. No. 3,498,546**

**United States Patent and Trademark Office**

**Registered Sep. 9, 2008**

**TRADEMARK  
PRINCIPAL REGISTER**

**INFOGIX ASSURE**

INFOGIX, INC. (DELAWARE CORPORATION)  
3RD FLOOR  
1240 EAST DIEHL ROAD  
NAPERVILLE, IL 605631439

FOR: ENTERPRISE COMPUTER SOFTWARE THAT MONITORS INFORMATION WITHIN VARIED PROCESSING STEPS OF OTHER COMPUTER SOFTWARE AND COMPUTER SYSTEMS TO DETECT INACCURATE, INCONSISTENT, OR INCOMPLETE INFORMATION AND MONITORS PROCESSING DELAYS, ERRONEOUS DUPLICATION, AND PROCESSING SEQUENCE ERRORS; COMPUTER SOFTWARE THAT ISSUES ALERTS, AUDIT TRAILS, AND REPORTS CONCERNING

THE FOREGOING; AND MANUALS DISTRIBUTED THEREWITH AS A UNIT, IN CLASS 9 (U.S. CLS. 21, 23, 26, 36 AND 38).

FIRST USE 8-24-2006; IN COMMERCE 8-24-2006.

THE MARK CONSISTS OF STANDARD CHARACTERS WITHOUT CLAIM TO ANY PARTICULAR FONT, STYLE, SIZE, OR COLOR.

OWNER OF U.S. REG. NO. 3,152,257.

SER. NO. 77-385,447, FILED 1-31-2008.

PRISCILLA MILTON, EXAMINING ATTORNEY

**Int. Cl.: 9**

**Prior U.S. Cls.: 21, 23, 26, 36 and 38**

**United States Patent and Trademark Office**

**Reg. No. 3,498,547**

**Registered Sep. 9, 2008**

**TRADEMARK  
PRINCIPAL REGISTER**

**INFOGIX INSIGHT**

INFOGIX, INC. (DELAWARE CORPORATION)  
3RD FLOOR  
1240 EAST DIEHL ROAD  
NAPERVILLE, IL 605631439

FOR: ENTERPRISE COMPUTER SOFTWARE THAT COLLECTS DATA FROM AUTOMATED AUDIT AND OTHER CONTROLS FROM ACROSS AN ORGANIZATION, DOCUMENTS THESE CONTROL DEPLOYMENTS, AND CONTINUOUSLY MONITORS CONTROLS ACROSS THE ENTERPRISE WHILE PROVIDING CENTRALIZED AUDITING, CONTROL TESTING AND REPORTING; AND

MANUALS DISTRIBUTED THEREWITH AS A UNIT, IN CLASS 9 (U.S. CLS. 21, 23, 26, 36 AND 38).

FIRST USE 8-24-2006; IN COMMERCE 8-24-2006.

THE MARK CONSISTS OF STANDARD CHARACTERS WITHOUT CLAIM TO ANY PARTICULAR FONT, STYLE, SIZE, OR COLOR.

OWNER OF U.S. REG. NO. 3,152,257.

SER. NO. 77-385,598, FILED 1-31-2008.

PRISCILLA MILTON, EXAMINING ATTORNEY

**Int. Cl.: 41**

**Prior U.S. Cls.: 100, 101 and 107**

**United States Patent and Trademark Office**

**Reg. No. 3,498,548**

**Registered Sep. 9, 2008**

**SERVICE MARK  
PRINCIPAL REGISTER**

**DIGGNATION**

DIGG INC. (DELAWARE CORPORATION)  
135 MISSISSIPPI STREET, 3RD FLOOR  
SAN FRANCISCO, CA 94107

FOR: ENTERTAINMENT IN THE NATURE OF  
ON-GOING AUDIOVISUAL PROGRAMS IN THE  
NATURE OF A NEWS AND VARIETY SHOW, IN  
CLASS 41 (U.S. CLS. 100, 101 AND 107).

FIRST USE 7-1-2005; IN COMMERCE 7-1-2005.

THE MARK CONSISTS OF STANDARD CHAR-  
ACTERS WITHOUT CLAIM TO ANY PARTICULAR  
FONT, STYLE, SIZE, OR COLOR.

OWNER OF U.S. REG. NOS. 3,317,123 AND  
3,422,895.

SER. NO. 77-385,645, FILED 1-31-2008.

JEFF DEFORD, EXAMINING ATTORNEY

**Int. Cl.: 9**

**Prior U.S. Cls.: 21, 23, 26, 36 and 38**

**Reg. No. 3,498,549**

**United States Patent and Trademark Office**

**Registered Sep. 9, 2008**

**TRADEMARK  
PRINCIPAL REGISTER**



TOOLWORXX, INC. (KANSAS CORPORATION)  
3945 NORTH LAKE RIDGE COURT  
WICHITA, KS 67205

FOR: TAPE MEASURERS INCORPORATING  
UTILITY KNIVES AND SCRIBER HOLDERS, IN  
CLASS 9 (U.S. CLS. 21, 23, 26, 36 AND 38).

FIRST USE 2-28-2000; IN COMMERCE 2-28-2000.

OWNER OF U.S. REG. NO. 3,111,838.

THE COLOR(S) YELLOW AND BLACK IS/ARE  
CLAIMED AS A FEATURE OF THE MARK.

THE MARK CONSISTS OF A SIDE PROFILE OF A  
SABER-TOOTH TIGER DESIGN FACING LEFT IN  
THE COLOR YELLOW AND THE WORD "SABRR".  
"S" IS A CAPITAL LETTER AND REMAINING  
LETTERS, "ABRR", IN LOWER CASE ALL IN THE  
COLOR BLACK.

SER. NO. 77-385,741, FILED 1-31-2008.

JENNY PARK, EXAMINING ATTORNEY

**Int. Cl.: 12**

**Prior U.S. Cls.: 19, 21, 23, 31, 35 and 44**

**Reg. No. 3,498,550**

**United States Patent and Trademark Office**

**Registered Sep. 9, 2008**

---

**TRADEMARK  
PRINCIPAL REGISTER**

**BALLISTIC OFF ROAD**

PRESTIGE AUTOTECH CORPORATION (NEVADA CORPORATION)

14035 PIPELINE AVENUE

CHINO, CA 91710

FOR: VEHICLE WHEELS, IN CLASS 12 (U.S. CLS. 19, 21, 23, 31, 35 AND 44).

FIRST USE 1-28-2008; IN COMMERCE 1-28-2008.

THE MARK CONSISTS OF STANDARD CHARACTERS WITHOUT CLAIM TO ANY PARTICULAR FONT, STYLE, SIZE, OR COLOR.

NO CLAIM IS MADE TO THE EXCLUSIVE RIGHT TO USE "OFF ROAD", APART FROM THE MARK AS SHOWN.

SER. NO. 77-385,790, FILED 1-31-2008.

TINA L. SNAPP, EXAMINING ATTORNEY

**Int. Cl.: 36**

**Prior U.S. Cls.: 100, 101 and 102**

**United States Patent and Trademark Office**

**Reg. No. 3,498,551**

**Registered Sep. 9, 2008**

**SERVICE MARK  
PRINCIPAL REGISTER**

**PACIFIC CAPITAL HOME LOANS**

PACIFIC TRUST HOME LOANS, INC. (CALIFORNIA CORPORATION)

57 CALLE VISTA DEL SOL

SAN CLEMENTE, CA 92673

FOR: MORTGAGE BROKERAGE, IN CLASS 36 (U.S. CLS. 100, 101 AND 102).

FIRST USE 11-7-2005; IN COMMERCE 11-7-2005.

THE MARK CONSISTS OF STANDARD CHARACTERS WITHOUT CLAIM TO ANY PARTICULAR FONT, STYLE, SIZE, OR COLOR.

NO CLAIM IS MADE TO THE EXCLUSIVE RIGHT TO USE "CAPITAL HOME LOANS", APART FROM THE MARK AS SHOWN.

SER. NO. 77-385,879, FILED 1-31-2008.

MARY CRAWFORD, EXAMINING ATTORNEY



**Int. Cl.: 42**

**Prior U.S. Cls.: 100 and 101**

**United States Patent and Trademark Office**

**Reg. No. 3,498,552**

**Registered Sep. 9, 2008**

**SERVICE MARK  
PRINCIPAL REGISTER**

**Mission Microsystems Inc.**

MISSION MICROSYSTEMS INC. (NEVADA CORPORATION)  
SUITE #113  
5942 EDINGER AVE.  
HUNTINGTON BEACH, CA 92649

FOR: ELECTRONIC ENGINEERING CONSULTING SERVICES, IN CLASS 42 (U.S. CLS. 100 AND 101).

FIRST USE 1-10-1991; IN COMMERCE 1-10-1991.

THE MARK CONSISTS OF STANDARD CHARACTERS WITHOUT CLAIM TO ANY PARTICULAR FONT, STYLE, SIZE, OR COLOR.

NO CLAIM IS MADE TO THE EXCLUSIVE RIGHT TO USE "MICROSYSTEMS INC.", APART FROM THE MARK AS SHOWN.

SER. NO. 77-385,899, FILED 1-31-2008.

MICHAEL KAZAZIAN, EXAMINING ATTORNEY

Int. Cl.: 41

Prior U.S. Cls.: 100, 101 and 107

**United States Patent and Trademark Office**

**Reg. No. 3,498,553**

Registered Sep. 9, 2008

**SERVICE MARK  
PRINCIPAL REGISTER**



CHILDREN'S SCHOOL OF EXCELLENCE (WA-  
SHINGTON CORPORATION)  
13411 CEDAR GROVE LANE SOUTHEAST  
RAINIER, WA 98576

FIRST USE 1-2-2008; IN COMMERCE 1-2-2008.

FOR: EDUCATION SERVICES, NAMELY, PRO-  
VIDING COURSES OF INSTRUCTION AT THE  
KINDERGARTEN THROUGH 8TH GRADE LEVEL,  
IN CLASS 41 (U.S. CLS. 100, 101 AND 107).

SER. NO. 77-385,926, FILED 1-31-2008.

JENNY PARK, EXAMINING ATTORNEY

**Int. Cl.: 33**

**Prior U.S. Cls.: 47 and 49**

**United States Patent and Trademark Office**

**Reg. No. 3,498,554**

**Registered Sep. 9, 2008**

**TRADEMARK  
PRINCIPAL REGISTER**

**BRICK HOUSE**

BRICK HOUSE WINE COMPANY (OREGON  
CORPORATION)  
18200 LEWIS ROGERS LANE  
NEWBERG, OR 97132

FOR: WINES, IN CLASS 33 (U.S. CLS. 47 AND 49).

FIRST USE 8-0-1992; IN COMMERCE 8-0-1992.

THE MARK CONSISTS OF STANDARD CHAR-  
ACTERS WITHOUT CLAIM TO ANY PARTICULAR  
FONT, STYLE, SIZE, OR COLOR.

OWNER OF U.S. REG. NO. 1,986,325.

SER. NO. 77-385,948, FILED 1-31-2008.

WON TEAK OH, EXAMINING ATTORNEY

**Int. Cls.: 16 and 41**

**Prior U.S. Cls.: 2, 5, 22, 23, 29, 37, 38, 50, 100, 101 and 107**

**Reg. No. 3,498,555**

**United States Patent and Trademark Office**

**Registered Sep. 9, 2008**

**TRADEMARK  
SERVICE MARK  
PRINCIPAL REGISTER**

**S.T.O.P.**

BROOKS, ROBERT (UNITED STATES INDIVIDUAL)  
8611 NORTH 17TH PLACE  
PHOENIX, AZ 85020

FOR: EDUCATIONAL BOOKS, GUIDE BOOKS, REFERENCE BOOKS, NEWSLETTERS, MAGAZINES, FLYERS, PRINTED COURSE MATERIALS, AND PRAYER BOOKS, ALL IN THE FIELD OF RELIGION; COMPOSITION BOOKS, COMIC STRIPS AND COMIC BOOKS; CHILDREN'S BOOKS; COLORING BOOKS; DATE BOOKS; PICTURE BOOKS; CHILDREN'S ACTIVITY BOOKS; STATIONERY; WRITING PAPER; NOTE PAPER; ENVELOPES; NOTEBOOKS; DIARIES; JOURNALS FEATURING THEMES ON RELIGION; NOTE CARDS; GIFT CARDS; GREETING CARDS; TRADING CARDS; POSTER BOARD AND STICKERS; LITHOGRAPHS; PENS, PENCILS, AND CASES THEREFOR; DECALS, PAPER HEAT TRANSFERS; POSTERS, PHOTOGRAPHIC, LITHOGRAPHIC, ART AND CARTOON PRINTS; MOUNTED AND UNMOUNTED PHOTOGRAPHS; BOOK COVERS; BOOK MARKS; CALENDARS; PAPER NAPKINS; PAPER DOILIES; PAPER PLACE MATS; CREPE PAPER; PRINTED INVITATIONS; PRINTED TRANSFERS FOR EMBROIDERY; PRINTED TRANSFERS FOR SILK-SCREENING; PRINTED PATTERNS FOR MAKING

COSTUMES, PAJAMAS, SWEATSHIRTS, PANTS, SHORTS, JACKETS, AND T-SHIRTS, IN CLASS 16 (U.S. CLS. 2, 5, 22, 23, 29, 37, 38 AND 50).

FIRST USE 2-0-2006; IN COMMERCE 2-0-2006.

FOR: PUBLICATION OF TEXT BOOKS, TEACHER'S MANUALS, AND WORKBOOKS; EDUCATIONAL SERVICES, NAMELY, CONDUCTING CLASSES, SEMINARS, CONFERENCES, WORKSHOPS, AND INDIVIDUAL INSTRUCTION, IN THE FIELD OF RELIGION, AND DISTRIBUTING COURSE MATERIALS IN CONNECTION THEREWITH, IN CLASS 41 (U.S. CLS. 100, 101 AND 107).

FIRST USE 2-0-2006; IN COMMERCE 2-0-2006.

THE MARK CONSISTS OF STANDARD CHARACTERS WITHOUT CLAIM TO ANY PARTICULAR FONT, STYLE, SIZE, OR COLOR.

OWNER OF U.S. REG. NOS. 2,999,696 AND 3,005,414.

SER. NO. 77-385,954, FILED 1-31-2008.

JACLYN KIDWELL, EXAMINING ATTORNEY

**Int. Cls.: 16 and 41**

**Prior U.S. Cls.: 2, 5, 22, 23, 29, 37, 38, 50, 100, 101 and 107**

**Reg. No. 3,498,556**

**United States Patent and Trademark Office**

**Registered Sep. 9, 2008**

**TRADEMARK  
SERVICE MARK  
PRINCIPAL REGISTER**

**P.A.C.T.**

BROOKS, ROBERT (UNITED STATES INDIVIDUAL)  
8611 NORTH 17TH PLACE  
PHOENIX, AZ 85020

FOR: EDUCATIONAL BOOKS, GUIDE BOOKS, REFERENCE BOOKS, NEWSLETTERS, MAGAZINES, FLYERS, PRINTED COURSE MATERIALS, AND PRAYER BOOKS, ALL IN THE FIELD OF RELIGION; COMPOSITION BOOKS, COMIC STRIPS AND COMIC BOOKS; CHILDREN'S BOOKS; COLORING BOOKS; DATE BOOKS; PICTURE BOOKS; CHILDREN'S ACTIVITY BOOKS; STATIONERY; WRITING PAPER; NOTE PAPER; ENVELOPES; NOTEBOOKS; DIARIES; JOURNALS FEATURING THEMES ON RELIGION; NOTE CARDS; GIFT CARDS; GREETING CARDS; TRADING CARDS; POSTER BOARD AND STICKERS; LITHOGRAPHS; PENS, PENCILS, AND CASES THEREFOR; DECALS, PAPER HEAT TRANSFERS; POSTERS, PHOTOGRAPHIC, LITHOGRAPHIC, ART AND CARTOON PRINTS; MOUNTED AND UNMOUNTED PHOTOGRAPHS; BOOK COVERS; BOOK MARKS; CALENDARS; PAPER NAPKINS; PAPER DOILIES; PAPER PLACE MATS; CREPE PAPER; PRINTED INVITATIONS; PRINTED TRANSFERS FOR EMBROIDERY; PRINTED TRANSFERS FOR SILK-

SCREENING; PRINTED PATTERNS FOR MAKING COSTUMES, PAJAMAS, SWEATSHIRTS, PANTS, SHORTS, JACKETS, AND T-SHIRTS, IN CLASS 16 (U.S. CLS. 2, 5, 22, 23, 29, 37, 38 AND 50).

FIRST USE 2-0-2006; IN COMMERCE 2-0-2006.

FOR: PUBLICATION OF TEXT BOOKS, TEACHER'S MANUALS, AND WORKBOOKS; EDUCATIONAL SERVICES, NAMELY, CONDUCTING CLASSES, SEMINARS, CONFERENCES, WORKSHOPS, AND INDIVIDUAL INSTRUCTION, IN THE FIELD OF RELIGION, AND DISTRIBUTING COURSE MATERIALS IN CONNECTION THEREWITH, IN CLASS 41 (U.S. CLS. 100, 101 AND 107).

FIRST USE 2-0-2006; IN COMMERCE 2-0-2006.

THE MARK CONSISTS OF STANDARD CHARACTERS WITHOUT CLAIM TO ANY PARTICULAR FONT, STYLE, SIZE, OR COLOR.

SER. NO. 77-386,019, FILED 1-31-2008.

JACLYN KIDWELL, EXAMINING ATTORNEY

**Int. Cl.: 35**

**Prior U.S. Cls.: 100, 101 and 102**

**United States Patent and Trademark Office**

**Reg. No. 3,498,557**

**Registered Sep. 9, 2008**

**SERVICE MARK  
PRINCIPAL REGISTER**

**RETRO▶TAX**

ASSOCIATED CONSULTANTS, INC. (INDIANA CORPORATION)  
3730 WASHINGTON BOULEVARD  
INDIANAPOLIS, IN 46205

FIRST USE 10-8-2007; IN COMMERCE 10-8-2007.

SER. NO. 77-386,033, FILED 1-31-2008.

FOR: CONSULTING SERVICES REGARDING THE MANAGEMENT AND COLLECTION OF TAX INCENTIVES AND TAX CREDITS, IN CLASS 35 (U.S. CLS. 100, 101 AND 102).

MICHAEL ENGEL, EXAMINING ATTORNEY

**Int. Cls.: 16 and 41**

**Prior U.S. Cls.: 2, 5, 22, 23, 29, 37, 38, 50, 100, 101 and 107**

**Reg. No. 3,498,558**

**United States Patent and Trademark Office**

**Registered Sep. 9, 2008**

**TRADEMARK  
SERVICE MARK  
PRINCIPAL REGISTER**

**C.L.O.U.T.**

BROOKS, ROBERT (UNITED STATES INDIVIDUAL)  
8611 NORTH 17TH PLACE  
PHOENIX, AZ 85020

FOR: EDUCATIONAL BOOKS, GUIDE BOOKS, REFERENCE BOOKS, NEWSLETTERS, MAGAZINES, FLYERS, PRINTED COURSE MATERIALS, AND PRAYER BOOKS, ALL IN THE FIELD OF RELIGION; COMPOSITION BOOKS, COMIC STRIPS AND COMIC BOOKS; CHILDREN'S BOOKS; COLORING BOOKS; DATE BOOKS; PICTURE BOOKS; CHILDREN'S ACTIVITY BOOKS; STATIONERY; WRITING PAPER; NOTE PAPER; ENVELOPES; NOTEBOOKS; DIARIES; JOURNALS FEATURING THEMES ON RELIGION; NOTE CARDS; GIFT CARDS; GREETING CARDS; TRADING CARDS; POSTER BOARD AND STICKERS; LITHOGRAPHS; PENS, PENCILS, AND CASES THEREFOR; DECALS, PAPER HEAT TRANSFERS; POSTERS, PHOTOGRAPHIC, LITHOGRAPHIC, ART AND CARTOON PRINTS; MOUNTED AND UNMOUNTED PHOTOGRAPHS; BOOK COVERS; BOOK MARKS; CALENDARS; PAPER NAPKINS; PAPER DOILIES; PAPER PLACE MATS; CREPE PAPER; PRINTED INVITATIONS; PRINTED TRANSFERS FOR EMBROIDERY; PRINTED TRANSFERS FOR SILK-

SCREENING; PRINTED PATTERNS FOR MAKING COSTUMES, PAJAMAS, SWEATSHIRTS, PANTS, SHORTS, JACKETS, AND T-SHIRTS, IN CLASS 16 (U.S. CLS. 2, 5, 22, 23, 29, 37, 38 AND 50).

FIRST USE 2-0-2006; IN COMMERCE 2-0-2006.

FOR: PUBLICATION OF TEXT BOOKS, TEACHER'S MANUALS, AND WORKBOOKS, EDUCATIONAL SERVICES, NAMELY, CONDUCTING CLASSES, SEMINARS, CONFERENCES, WORKSHOPS, AND INDIVIDUAL INSTRUCTION, IN THE FIELD OF RELIGION, AND DISTRIBUTING COURSE MATERIALS IN CONNECTION THEREWITH, IN CLASS 41 (U.S. CLS. 100, 101 AND 107).

FIRST USE 2-0-2006; IN COMMERCE 2-0-2006.

THE MARK CONSISTS OF STANDARD CHARACTERS WITHOUT CLAIM TO ANY PARTICULAR FONT, STYLE, SIZE, OR COLOR.

SER. NO. 77-386,045, FILED 1-31-2008.

JACLYN KIDWELL, EXAMINING ATTORNEY

**Int. Cls.: 16 and 41**

**Prior U.S. Cls.: 2, 5, 22, 23, 29, 37, 38, 50, 100, 101 and 107**

**Reg. No. 3,498,559**

**United States Patent and Trademark Office**

**Registered Sep. 9, 2008**

**TRADEMARK  
SERVICE MARK  
PRINCIPAL REGISTER**

**C.L.I.C.K.**

BROOKS, ROBERT (UNITED STATES INDIVIDUAL)  
8611 NORTH 17TH PLACE  
PHOENIX, AZ 85020

FOR: EDUCATIONAL BOOKS, GUIDE BOOKS, REFERENCE BOOKS, NEWSLETTERS, MAGAZINES, FLYERS, PRINTED COURSE MATERIALS, AND PRAYER BOOKS, ALL IN THE FIELD OF RELIGION; COMPOSITION BOOKS, COMIC STRIPS AND COMIC BOOKS; CHILDREN'S BOOKS; COLORING BOOKS; DATE BOOKS; PICTURE BOOKS; CHILDREN'S ACTIVITY BOOKS; STATIONERY; WRITING PAPER; NOTE PAPER; ENVELOPES; NOTEBOOKS; DIARIES; JOURNALS FEATURING THEMES ON RELIGION; NOTE CARDS; GIFT CARDS; GREETING CARDS; TRADING CARDS; POSTER BOARD AND STICKERS; LITHOGRAPHS; PENS, PENCILS, AND CASES THEREFOR; DECALS, PAPER HEAT TRANSFERS; POSTERS, PHOTOGRAPHIC, LITHOGRAPHIC, ART AND CARTOON PRINTS; MOUNTED AND UNMOUNTED PHOTOGRAPHS; BOOK COVERS; BOOK MARKS; CALENDARS; PAPER NAPKINS; PAPER DOILIES; PAPER PLACE MATS; CREPE PAPER; PRINTED INVITATIONS; PRINTED TRANSFERS FOR EMBROIDERY; PRINTED TRANSFERS FOR SILK-

SCREENING; PRINTED PATTERNS FOR MAKING COSTUMES, PAJAMAS, SWEATSHIRTS, PANTS, SHORTS, JACKETS, AND T-SHIRTS, IN CLASS 16 (U.S. CLS. 2, 5, 22, 23, 29, 37, 38 AND 50).

FIRST USE 2-0-2006; IN COMMERCE 2-0-2006.

FOR: PUBLICATION OF TEXT BOOKS, TEACHER'S MANUALS, AND WORKBOOKS; EDUCATIONAL SERVICES, NAMELY, CONDUCTING CLASSES, SEMINARS, CONFERENCES, WORKSHOPS, AND INDIVIDUAL INSTRUCTION, IN THE FIELD OF RELIGION, AND DISTRIBUTING COURSE MATERIALS IN CONNECTION THEREWITH, IN CLASS 41 (U.S. CLS. 100, 101 AND 107).

FIRST USE 2-0-2006; IN COMMERCE 2-0-2006.

THE MARK CONSISTS OF STANDARD CHARACTERS WITHOUT CLAIM TO ANY PARTICULAR FONT, STYLE, SIZE, OR COLOR.

SER. NO. 77-386,055, FILED 1-31-2008.

JACLYN KIDWELL, EXAMINING ATTORNEY



**Int. Cl.: 44**

**Prior U.S. Cls.: 100 and 101**

**United States Patent and Trademark Office**

**Reg. No. 3,498,560**

**Registered Sep. 9, 2008**

**SERVICE MARK  
PRINCIPAL REGISTER**

**CHEAP-SCAPES**

KEVIN F. BOBREK (UNITED STATES INDIVIDUAL), DBA CHEAP-SCAPES, PROFESSIONAL TREE & LANDSCAPING SERVICE  
134 MARLBOROUGH ROAD  
SALEM, MA 01970

FOR: LANDSCAPE GARDENING; TREE REMOVAL SERVICES, IN CLASS 44 (U.S. CLS. 100 AND 101).

FIRST USE 5-30-1987; IN COMMERCE 5-30-1987.

THE MARK CONSISTS OF STANDARD CHARACTERS WITHOUT CLAIM TO ANY PARTICULAR FONT, STYLE, SIZE, OR COLOR.

SER. NO. 77-386,156, FILED 2-1-2008.

MICHELLE DUBOIS, EXAMINING ATTORNEY

**Int. Cl.: 41**

**Prior U.S. Cls.: 100, 101 and 107**

**United States Patent and Trademark Office**

**Reg. No. 3,498,561**

**Registered Sep. 9, 2008**

**SERVICE MARK  
PRINCIPAL REGISTER**

**CHAISE LOUNGE**

O'LEARY, MARILYN (UNITED STATES INDIVIDUAL), DBA MARILYN OLDER  
7926 JACKSON ROAD  
ALEXANDRIA, VA 22308

THE MARK CONSISTS OF STANDARD CHARACTERS WITHOUT CLAIM TO ANY PARTICULAR FONT, STYLE, SIZE, OR COLOR.

FOR: ENTERTAINMENT, NAMELY, LIVE MUSIC CONCERTS, IN CLASS 41 (U.S. CLS. 100, 101 AND 107).

SER. NO. 77-386,162, FILED 2-1-2008.

FIRST USE 1-1-1998; IN COMMERCE 1-1-1998.

GENE MACIOL, EXAMINING ATTORNEY

**Int. Cls.: 9 and 16**

**Prior U.S. Cls.: 2, 5, 21, 22, 23, 26, 29, 36, 37, 38 and 50**

**United States Patent and Trademark Office**

**Reg. No. 3,498,562**

**Registered Sep. 9, 2008**

**TRADEMARK  
PRINCIPAL REGISTER**

**TREASURY AUTOMATED AUCTION  
PROCESSING SYSTEM (TAAPS)**

BUREAU OF THE PUBLIC DEBT (D.C. FEDERAL AGENCY)  
RM. 301  
200 THIRD STREET  
PARKERSBURG, WV 26106

FOR: COMPUTER SOFTWARE FOR RECEIVING AND PROCESSING THE SUBMISSION OF BIDS FOR TREASURY SECURITIES, IN CLASS 9 (U.S. CLS. 21, 23, 26, 36 AND 38).

FIRST USE 4-1-1991; IN COMMERCE 4-1-1991.

FOR: PRINTED MATERIALS, NAMELY, COMPUTER USER'S MANUALS AND GUIDES, BROCHURES, PAMPHLETS AND BULLETINS ON THE SUBJECT OF THE AUTOMATED SUBMISSION OF BIDS FOR TREASURY SECURITIES, IN CLASS 16 (U.S. CLS. 2, 5, 22, 23, 29, 37, 38 AND 50).

FIRST USE 4-1-1991; IN COMMERCE 4-1-1991.

THE MARK CONSISTS OF STANDARD CHARACTERS WITHOUT CLAIM TO ANY PARTICULAR FONT, STYLE, SIZE, OR COLOR.

OWNER OF U.S. REG. NO. 2,484,532.

NO CLAIM IS MADE TO THE EXCLUSIVE RIGHT TO USE "TREASURY AUTOMATED AUCTION PROCESSING SYSTEM", APART FROM THE MARK AS SHOWN.

SER. NO. 77-386,208, FILED 2-1-2008.

MARIAM MAHMOUDI, EXAMINING ATTORNEY

**Int. Cl.: 9**

**Prior U.S. Cls.: 21, 23, 26, 36 and 38**

**United States Patent and Trademark Office**

**Reg. No. 3,498,563**

**Registered Sep. 9, 2008**

**TRADEMARK  
PRINCIPAL REGISTER**

**JITI VERIFY**

HISoftware INC. (DELAWARE CORPORATION)  
SUITE 110  
9 TRAFALGAR SQUARE  
NASHUA, NH 03063

FOR: COMPUTER SOFTWARE, NAMELY, DOWNLOADABLE SOFTWARE TO FACILITATE AND ENABLE INDEXING, CATALOGING, MANAGEMENT AND PUBLISHING OF DOCUMENTS AND TO VERIFY DATA COLLECTIONS AND METADATA AND POLICY COMPLIANCE IN DOCUMENTS, IN CLASS 9 (U.S. CLS. 21, 23, 26, 36 AND 38).

FIRST USE 8-1-1999; IN COMMERCE 8-1-1999.

THE MARK CONSISTS OF STANDARD CHARACTERS WITHOUT CLAIM TO ANY PARTICULAR FONT, STYLE, SIZE, OR COLOR.

OWNER OF U.S. REG. NO. 2,529,204.

NO CLAIM IS MADE TO THE EXCLUSIVE RIGHT TO USE "VERIFY", APART FROM THE MARK AS SHOWN.

SER. NO. 77-386,228, FILED 2-1-2008.

TAMARA FRAZIER, EXAMINING ATTORNEY

**Int. Cl.: 5**

**Prior U.S. Cls.: 6, 18, 44, 46, 51 and 52**

**Reg. No. 3,498,564**

**United States Patent and Trademark Office**

**Registered Sep. 9, 2008**

**TRADEMARK  
PRINCIPAL REGISTER**

**Nature's Healing Rays**

KABALISTIC POWERS LLC (NEW YORK LIMITED LIABILITY COMPANY)  
1997 EAST 22ND STREET  
BROOKLYN, NY 11229

THE MARK CONSISTS OF STANDARD CHARACTERS WITHOUT CLAIM TO ANY PARTICULAR FONT, STYLE, SIZE, OR COLOR.

FOR: DIETARY AND NUTRITIONAL SUPPLEMENTS, VITAMINS, NUTRACEUTICALS FOR USE AS A DIETARY SUPPLEMENT, IN CLASS 5 (U.S. CLS. 6, 18, 44, 46, 51 AND 52).

SER. NO. 77-386,245, FILED 2-1-2008.

FIRST USE 11-4-2007; IN COMMERCE 11-4-2007.

TAMARA FRAZIER, EXAMINING ATTORNEY

**Int. Cl.: 9**

**Prior U.S. Cls.: 21, 23, 26, 36 and 38**

**Reg. No. 3,498,565**

**United States Patent and Trademark Office**

**Registered Sep. 9, 2008**

**TRADEMARK  
PRINCIPAL REGISTER**

**JITI BUILDER**

HISoftware INC. (DELAWARE CORPORATION)  
SUITE 110  
9 TRAFALGAR SQUARE  
NASHUA, NH 03063

FOR: COMPUTER SOFTWARE, NAMELY, DOWNLOADABLE SOFTWARE FOR MANAGING DOCUMENTS AND EMBEDDED METADATA, AND TO FACILITATE AND ENABLE INDEXING, CATALOGING AND MANAGEMENT OF DOCUMENTS, IN CLASS 9 (U.S. CLS. 21, 23, 26, 36 AND 38).

FIRST USE 8-1-1999; IN COMMERCE 8-1-1999.

THE MARK CONSISTS OF STANDARD CHARACTERS WITHOUT CLAIM TO ANY PARTICULAR FONT, STYLE, SIZE, OR COLOR.

OWNER OF U.S. REG. NO. 2,546,052.

SER. NO. 77-386,249, FILED 2-1-2008.

TAMARA FRAZIER, EXAMINING ATTORNEY

**Int. Cl.: 36**

**Prior U.S. Cls.: 100, 101 and 102**

**United States Patent and Trademark Office**

**Reg. No. 3,498,566**

**Registered Sep. 9, 2008**

**SERVICE MARK  
PRINCIPAL REGISTER**



AJP GROUP, LLC (DELAWARE LIMITED LIABILITY COMPANY)  
105 BROOKS AVENUE  
RALEIGH, NC 27607

FOR: VENTURE CAPITAL SERVICES, NAMELY, PROVIDING FINANCING TO EMERGING AND START-UP COMPANIES; FINANCIAL CONSULTING, IN CLASS 36 (U.S. CLS. 100, 101 AND 102).

FIRST USE 6-30-2003; IN COMMERCE 6-30-2003.

NO CLAIM IS MADE TO THE EXCLUSIVE RIGHT TO USE "GROUP LLC", APART FROM THE MARK AS SHOWN.

THE COLOR(S) BLUE AND BLACK IS/ARE CLAIMED AS A FEATURE OF THE MARK.

THE MARK CONSISTS OF VARIOUS SIZED-CIRCLES IN THE COLOR BLUE TO FORM A SHAPE OF AN ARROW HEAD. NEXT TO THE SHAPE ARE THE WORDS "AJP GROUP LLC" IN THE COLOR BLACK.

SER. NO. 77-386,251, FILED 2-1-2008.

TAMARA FRAZIER, EXAMINING ATTORNEY

**Int. Cl.: 41**

**Prior U.S. Cls.: 100, 101 and 107**

**United States Patent and Trademark Office**

**Reg. No. 3,498,567**

**Registered Sep. 9, 2008**

**SERVICE MARK  
PRINCIPAL REGISTER**

# Great Play

GREAT PLAY HOLDINGS LLC (CONNECTICUT  
LIMITED LIABILITY COMPANY)  
51 KNOBLOCH LANE  
STAMFORD, CT 06902

FOR: HEALTH CLUB SERVICES, NAMELY, PRO-  
VIDING INSTRUCTION AND EQUIPMENT IN THE  
FIELD OF PHYSICAL EXERCISE; PROVIDING A  
WEB SITE FEATURING INFORMATION ON EX-  
ERCISE AND FITNESS, IN CLASS 41 (U.S. CLS. 100,  
101 AND 107).

FIRST USE 7-27-2005; IN COMMERCE 7-29-2005.

THE MARK CONSISTS OF STANDARD CHAR-  
ACTERS WITHOUT CLAIM TO ANY PARTICULAR  
FONT, STYLE, SIZE, OR COLOR.

NO CLAIM IS MADE TO THE EXCLUSIVE  
RIGHT TO USE "PLAY", APART FROM THE MARK  
AS SHOWN.

SER. NO. 77-386,252, FILED 2-1-2008.

TAMARA FRAZIER, EXAMINING ATTORNEY



**Int. Cl.: 14**

**Prior U.S. Cls.: 2, 27, 28 and 50**

**United States Patent and Trademark Office**

**Reg. No. 3,498,568**

**Registered Sep. 9, 2008**

**TRADEMARK  
PRINCIPAL REGISTER**

**ELEGANZA D' ARGENTO**

KEN CRAFT INC (NEW YORK CORPORATION)  
ROOM 2006  
303 FIFTH AVENUE  
NEW YORK, NY 10016

FOR: BEADS FOR USE IN THE MANUFACTURE OF JEWELRY; BRACELETS; BROOCHES; CHARMS; DIAMOND JEWELRY; GEMSTONE JEWELRY; IDENTIFICATION BRACELETS; JEWELRY; JEWELRY BOXES; JEWELRY CASES; JEWELRY CASKETS OF PRECIOUS METAL; JEWELRY CHAINS; JEWELRY FINDINGS; JEWELRY FOR THE HEAD; JEWELRY ORGANIZERS; JEWELRY PINS FOR USE ON HATS; JEWELRY RING HOLDERS; JEWELRY TO BE AFFIXED TO BIKINIS; JEWELRY WATCHES; JEWELRY, NAMELY, AMULETS; JEWELRY, NAMELY, CROSSES; JEWELRY, NAMELY, PRECIOUS METAL PLATED REAL LEAVES AND FLOWERS; LAPEL PINS; LEATHER JEWELRY AND ACCESSORY BOXES; METAL WIRE FOR USE IN THE MAKING OF JEWELRY, NAMELY, JEWELRY CABLE; PET JEWELRY; PINS

BEING JEWELRY; RINGS; ALL OF THE AFORESAID GOODS MADE IN WHOLE OR IN SUBSTANTIAL PART OF SILVER, IN CLASS 14 (U.S. CLS. 2, 27, 28 AND 50).

FIRST USE 2-1-2006; IN COMMERCE 2-1-2006.

THE MARK CONSISTS OF STANDARD CHARACTERS WITHOUT CLAIM TO ANY PARTICULAR FONT, STYLE, SIZE, OR COLOR.

NO CLAIM IS MADE TO THE EXCLUSIVE RIGHT TO USE "ARGENTO", APART FROM THE MARK AS SHOWN.

"THE FOREIGN WORDING IN THE MARK TRANSLATES INTO ENGLISH AS ELEGANCE OF SILVER."

SER. NO. 77-386,335, FILED 2-1-2008.

CARRIE GENOVESE, EXAMINING ATTORNEY

**Int. Cl.: 24**

**Prior U.S. Cls.: 42 and 50**

**United States Patent and Trademark Office**

**Reg. No. 3,498,569**

**Registered Sep. 9, 2008**

**TRADEMARK  
PRINCIPAL REGISTER**

**SPINLACE**

POLYMER GROUP, INC. (DELAWARE CORPORATION)  
SUITE 300  
9335 HARRIS CORNERS PARKWAY  
CHARLOTTE, NC 28269

FOR: NON-WOVEN FABRIC CONTAINING SYNTHETIC FIBERS SOLD IN BULK AND ROLL FORM FOR USE IN THE MANUFACTURE OF PRODUCTS FOR A WIDE VARIETY OF INDUSTRIAL, MEDICAL AND HYGIENIC, AND COMMERCIAL APPLICATIONS, IN CLASS 24 (U.S. CLS. 42 AND 50).

FIRST USE 10-13-2006; IN COMMERCE 1-17-2008.

THE MARK CONSISTS OF STANDARD CHARACTERS WITHOUT CLAIM TO ANY PARTICULAR FONT, STYLE, SIZE, OR COLOR.

SER. NO. 77-386,404, FILED 2-1-2008.

WENDY GOODMAN, EXAMINING ATTORNEY

**Int. Cl.: 44**

**Prior U.S. Cls.: 100 and 101**

**United States Patent and Trademark Office**

**Reg. No. 3,498,570**

**Registered Sep. 9, 2008**

**SERVICE MARK  
PRINCIPAL REGISTER**

**NUTREVAL**

GENOVA DIAGNOSTICS, INC. (DELAWARE  
CORPORATION)  
63 ZILICOA STREET  
ASHEVILLE, NC 28801

FOR: MEDICAL TESTING SERVICES, NAMELY,  
METABOLIC ANALYSES, AMINO ACID ANALY-  
SES, ELEMENTAL ANALYSES, OXIDATIVE  
STRESS ANALYSES, ESSENTIAL AND METABOLIC  
FATTY ACID ASSESSMENTS , IN CLASS 44 (U.S.  
CLS. 100 AND 101).

FIRST USE 6-15-2005; IN COMMERCE 6-15-2005.

THE MARK CONSISTS OF STANDARD CHAR-  
ACTERS WITHOUT CLAIM TO ANY PARTICULAR  
FONT, STYLE, SIZE, OR COLOR.

SER. NO. 77-386,432, FILED 2-1-2008.

STEVEN R. FINE, EXAMINING ATTORNEY

Int. Cl.: 37

Prior U.S. Cls.: 100, 103 and 106

United States Patent and Trademark Office

Reg. No. 3,498,571

Registered Sep. 9, 2008

SERVICE MARK  
PRINCIPAL REGISTER



SHUMAKER ROOFING COMPANY, INC.  
(MARYLAND CORPORATION)  
26 WATER STREET  
FREDERICK, MD 21702

FOR: ROOFING CONTRACTING; ROOFING INSTALLATION; ROOFING REPAIR; ROOFING SERVICES, IN CLASS 37 (U.S. CLS. 100, 103 AND 106).

FIRST USE 1-2-2000; IN COMMERCE 1-2-2001.

NO CLAIM IS MADE TO THE EXCLUSIVE RIGHT TO USE "ROOFING CO. INC." AND "FREDERICK COUNTY'S ROOFING PRO SINCE 1946", APART FROM THE MARK AS SHOWN.

THE COLOR(S) BLUE AND ORANGE IS/ARE CLAIMED AS A FEATURE OF THE MARK.

THE MARK CONSISTS OF THE WORD "SHUMAKER" IN ORANGE IN WHICH THE LETTER A IS REPRESENTED BY A STYLIZED ORANGE TRIANGLE INSIDE OF WHICH THE COLORS FADE FROM BLUE TO ORANGE. THIS APPEARS ABOVE A LINE THAT FADES FROM LEFT TO RIGHT BEGINNING IN BLUE AND ENDING IN ORANGE, AND THE WORDS "ROOFING CO. INC." IN BLUE BELOW THE LINE AND THE WORDS "FREDERICK COUNTY'S ROOFING PRO SINCE 1946" IN ORANGE.

SER. NO. 77-386,446, FILED 2-1-2008.

WENDY GOODMAN, EXAMINING ATTORNEY

Int. Cl.: 43

Prior U.S. Cls.: 100 and 101

United States Patent and Trademark Office

Reg. No. 3,498,572

Registered Sep. 9, 2008

**SERVICE MARK  
PRINCIPAL REGISTER**



BARBERITOS FRANCHISING, INC. (GEORGIA CORPORATION)

P.O. BOX 888

ATHENS, GA 30603

FOR: RESTAURANT SERVICES, IN CLASS 43 (U.S. CLS. 100 AND 101).

FIRST USE 8-1-2007; IN COMMERCE 8-1-2007.

OWNER OF U.S. REG. NOS. 2,719,278 AND 2,930,374.

NO CLAIM IS MADE TO THE EXCLUSIVE RIGHT TO USE "A SOUTHWESTERN GRILLE & CANTINA", APART FROM THE MARK AS SHOWN.

THE COLOR(S) RED (PANTONE 185), GREEN (PANTON 376), YELLOW (PANTONE PROCESS YELLOW), BROWN (PANTON 464), BLACK (PANTONE PROCESS BLACK), WHITE IS/ARE CLAIMED AS A FEATURE OF THE MARK.

THE MARK CONSISTS OF A SMILING RED PEPPER CHARACTER WITH FACIAL FEATURES IN BLACK, TEETH IN BLACK AND WHITE, PEPPER CHARACTER SHAPE OUTLINED IN BLACK, BROWN BOOTS, GREEN LEGS, A YELLOW BELT OUTLINED IN BLACK WITH A BROWN BELT BUCKLE THAT INCLUDES A YELLOW SUN AND THE WORD "BARBERITOS" IN YELLOW LETTERS ARCHED OVER THE YELLOW SUN, GREEN ARMS, BROWN GLOVES, A BROWN HAT OUTLINED IN BLACK THAT INCLUDES A YELLOW SUN AND THE WORD "BARBERITOS" IN YELLOW

LETTERS ARCHED OVER THE YELLOW SUN, A GREEN STEM OUTLINED IN BLACK EXTENDING FROM THE TOP OF THE BROWN HAT, AND BLACK SUNGLASSES WITH WHITE HIGHLIGHTS; THE SMILING RED PEPPER CHARACTER IS HOLDING A ROLLED UP WHITE TORTILLA OUTLINED IN BLACK IN A RAISED HAND AND IS GIVING A "THUMBS UP" SIGN WITH AN EXTENDED HAND; THE SMILING RED PEPPER CHARACTER IS STANDING IN FRONT OF A BACKGROUND THAT INCLUDES A PORTION OF A YELLOW SUN AND A SILHOUETTED BLACK MOUNTAIN RANGE; THE SMILING RED PEPPER CHARACTER IS STANDING BEHIND THE WORD "BARBERITOS", THE WORD "BARBERITOS" CONSISTS OF YELLOW LETTERS WITH RED BORDERS AND IS SHADOWED IN BLACK; THE WORD "BARBERITOS" APPEARS POSITIONED OVER THE PHRASE "A SOUTHWESTERN GRILLE & CANTINA" IN BLACK AND A HORIZONTAL SEPARATOR IS POSITIONED BETWEEN THEM WHICH CONSISTS OF A HORIZONTAL LINE IN BLACK ON THE LEFT SIDE, FOLLOWED TO THE RIGHT BY FIVE STICK FIGURES OF TUMBLING MEN IN BLACK, FOLLOWED TO THE RIGHT BY A YELLOW SUN OUTLINED IN BLACK, FOLLOWED TO THE RIGHT BY FIVE STICK FIGURES OF TUMBLING MEN IN BLACK, FOLLOWED TO THE RIGHT BY A HORIZONTAL LINE IN BLACK. THE WHITE BACKGROUND OF THE MARK INDICATES A TRANSPARENT AREA AND IS NOT A PART OF THE MARK.

THE WORDING "BARBERITOS" IN THE MARK HAS NO MEANING IN A FOREIGN LANGUAGE.

SER. NO. 77-386,499, FILED 2-1-2008.

KAELIE KUNG, EXAMINING ATTORNEY

**Int. Cl.: 39**

**Prior U.S. Cls.: 100 and 105**

**United States Patent and Trademark Office**

**Reg. No. 3,498,573**

**Registered Sep. 9, 2008**

**SERVICE MARK  
PRINCIPAL REGISTER**



SPIRIT AIRLINES, INC. (DELAWARE CORPORATION)  
2800 EXECUTIVE WAY  
MIRAMAR, FL 33025

FOR: AIR TRANSPORTATION OF PASSENGERS AND FREIGHT, IN CLASS 39 (U.S. CLS. 100 AND 105).

FIRST USE 9-25-2007; IN COMMERCE 9-25-2007.

THE COLOR(S) RED, LIGHT GREEN, YELLOW, AND LIGHT BLUE IS/ARE CLAIMED AS A FEATURE OF THE MARK.

THE MARK CONSISTS OF THE MARK IS A STYLIZED "S" COMPRISED OF FOUR CRESCENT SHAPES, TWO FACING DOWNWARD AND TO THE RIGHT AND TWO BELOW FACING UP AND TO THE LEFT. THE TOPMOST IS RED, THE SECOND IS LIGHT GREEN, THE THIRD IS YELLOW, AND THE FOURTH IS LIGHT BLUE.

SER. NO. 77-386,541, FILED 2-1-2008.

MARLENE BELL, EXAMINING ATTORNEY

**Int. Cl.: 41**

**Prior U.S. Cls.: 100, 101 and 107**

**United States Patent and Trademark Office**

**Reg. No. 3,498,574**

**Registered Sep. 9, 2008**

**SERVICE MARK  
PRINCIPAL REGISTER**

**Many Minds. One Purpose.**

STONEHILL COLLEGE, INC. (MASSACHUSETTS  
CORPORATION)  
320 WASHINGTON ST.  
EASTON, MA 02357

THE MARK CONSISTS OF STANDARD CHAR-  
ACTERS WITHOUT CLAIM TO ANY PARTICULAR  
FONT, STYLE, SIZE, OR COLOR.

FOR: EDUCATING AT UNIVERSITY OR COLLE-  
GES, IN CLASS 41 (U.S. CLS. 100, 101 AND 107).

SER. NO. 77-386,604, FILED 2-1-2008.

FIRST USE 2-10-2007; IN COMMERCE 2-10-2007.

NELSON SNYDER, EXAMINING ATTORNEY



**Int. Cl.: 41**

**Prior U.S. Cls.: 100, 101 and 107**

**United States Patent and Trademark Office**

**Reg. No. 3,498,575**

**Registered Sep. 9, 2008**

**SERVICE MARK  
PRINCIPAL REGISTER**

# Merrillwood

DAVIS, MERRILL (UNITED STATES INDIVIDUAL)  
1422 NORTH KINGSLEY DRIVE, #108  
LOS ANGELES, CA 90027

FOR: ENTERTAINMENT IN THE NATURE OF AN ON-GOING SPECIAL VARIETY, NEWS, MUSIC OR COMEDY SHOW FEATURING INTERVIEWS WITH SPECIAL GUESTS INCLUDING CELEBRITIES BROADCAST OVER TELEVISION, INTERNET, SATELLITE, AUDIO, AND VIDEO MEDIA, IN CLASS 41 (U.S. CLS. 100, 101 AND 107).

FIRST USE 5-14-2007; IN COMMERCE 5-14-2007.

THE MARK CONSISTS OF STANDARD CHARACTERS WITHOUT CLAIM TO ANY PARTICULAR FONT, STYLE, SIZE, OR COLOR.

SER. NO. 77-386,637, FILED 2-1-2008.

CHRISTINE BLOMQUIST, EXAMINING ATTORNEY

**Int. Cl.: 16**

**Prior U.S. Cls.: 2, 5, 22, 23, 29, 37, 38 and 50**

**Reg. No. 3,498,576**

**United States Patent and Trademark Office**

**Registered Sep. 9, 2008**

**TRADEMARK  
PRINCIPAL REGISTER**

# Coal Age

MINING MEDIA, INC. (COLORADO CORPORATION), DBA MINING MEDIA INTERNATIONAL

8751 E. HAMDEN AVE.  
SUITE B1  
DENVER, CO 80231

FOR: PRINTED PERIODICALS IN THE FIELD OF COAL MINING, IN CLASS 16 (U.S. CLS. 2, 5, 22, 23, 29, 37, 38 AND 50).

FIRST USE 6-1-2003; IN COMMERCE 6-1-2003.

THE MARK CONSISTS OF STANDARD CHARACTERS WITHOUT CLAIM TO ANY PARTICULAR FONT, STYLE, SIZE, OR COLOR.

OWNER OF U.S. REG. NO. 2,161,406.

NO CLAIM IS MADE TO THE EXCLUSIVE RIGHT TO USE "COAL", APART FROM THE MARK AS SHOWN.

SER. NO. 77-386,813, FILED 2-1-2008.

JOHN E. MICHOS, EXAMINING ATTORNEY

**Int. Cl.: 25**

**Prior U.S. Cls.: 22 and 39**

**United States Patent and Trademark Office**

**Reg. No. 3,498,577**

**Registered Sep. 9, 2008**

**TRADEMARK  
PRINCIPAL REGISTER**

**SHIELD**

MUSSO, CARLOS (UNITED STATES INDIVIDUAL)  
480 CASUARINA CON  
CORAL GABLES, FL 33143

THE MARK CONSISTS OF STANDARD CHARACTERS WITHOUT CLAIM TO ANY PARTICULAR FONT, STYLE, SIZE, OR COLOR.

FOR: SHOES, IN CLASS 25 (U.S. CLS. 22 AND 39).

SER. NO. 77-386,839, FILED 2-1-2008.

FIRST USE 8-14-2004; IN COMMERCE 8-14-2004.

BRENDAN REGAN, EXAMINING ATTORNEY

**Int. Cl.: 41**

**Prior U.S. Cls.: 100, 101 and 107**

**United States Patent and Trademark Office**

**Reg. No. 3,498,578**

**Registered Sep. 9, 2008**

**SERVICE MARK  
PRINCIPAL REGISTER**

**LASSO THE MOON, A LIFE  
COACH COMPANY**

CASTALDI, JANIS (UNITED STATES INDIVIDUAL)  
25 BIRCH COURT  
OSSINING, NY 10562

FOR: LIFE COACHING SERVICES IN THE FIELD OF EXECUTIVE AND PROFESSIONAL RECRUITMENT, EMPLOYMENT CAREERS, AND BUSINESS MANAGEMENT, IN CLASS 41 (U.S. CLS. 100, 101 AND 107).

FIRST USE 1-16-2008; IN COMMERCE 1-16-2008.

THE MARK CONSISTS OF STANDARD CHARACTERS WITHOUT CLAIM TO ANY PARTICULAR FONT, STYLE, SIZE, OR COLOR.

NO CLAIM IS MADE TO THE EXCLUSIVE RIGHT TO USE "A LIFE COACH COMPANY", APART FROM THE MARK AS SHOWN.

SER. NO. 77-386,878, FILED 2-1-2008.

JEAN IM, EXAMINING ATTORNEY

**Int. Cl.: 35**

**Prior U.S. Cls.: 100, 101 and 102**

**United States Patent and Trademark Office**

**Reg. No. 3,498,579**

**Registered Sep. 9, 2008**

**SERVICE MARK  
PRINCIPAL REGISTER**

**PCIA**

PERSONAL COMMUNICATIONS INDUSTRY AS-  
SOCIATION, LTD. (VIRGINIA NON-STOCK  
CORPORATION)  
SUITE 700  
500 MONTGOMERY STREET  
ALEXANDRIA, VA 22314

FOR: ASSOCIATION SERVICES, NAMELY, PRO-  
MOTING THE INTERESTS OF THE WIRELESS,  
BROADCASTING AND TELECOMMUNICATIONS  
SERVICE INDUSTRIES, IN CLASS 35 (U.S. CLS. 100,  
101 AND 102).

FIRST USE 1-27-1994; IN COMMERCE 1-27-1994.

THE MARK CONSISTS OF STANDARD CHAR-  
ACTERS WITHOUT CLAIM TO ANY PARTICULAR  
FONT, STYLE, SIZE, OR COLOR.

OWNER OF U.S. REG. NOS. 2,539,393, 2,843,982  
AND OTHERS.

SER. NO. 77-386,940, FILED 2-1-2008.

ESTHER BELENKER, EXAMINING ATTORNEY

**Int. Cl.: 30**

**Prior U.S. Cl.: 46**

**United States Patent and Trademark Office**

**Reg. No. 3,498,580**

**Registered Sep. 9, 2008**

**TRADEMARK  
PRINCIPAL REGISTER**

**VINACAFE**

VINACAFE BIEN HOA, J.S.C. (VIETNAM JOINT  
STOCK COMPANY)  
BIEN HOA INDUSTRIAL ZONE  
DONG NAI, VIETNAM

FOR: ROASTED COFFEE; GROUND COFFEE;  
INSTANT COFFEE; INSTANT COFFEE MIX CON-  
TAINING MILK; BREAKFAST CEREALS IN POW-  
DERED FORM; INSTANT COFFEE MIX  
CONTAINING NON-DAIRY CREAMER , IN CLASS  
30 (U.S. CL. 46).

FIRST USE 3-31-1993; IN COMMERCE 11-30-1999.

THE MARK CONSISTS OF STANDARD CHAR-  
ACTERS WITHOUT CLAIM TO ANY PARTICULAR  
FONT, STYLE, SIZE, OR COLOR.

OWNER OF U.S. REG. NOS. 2,751,673, 2,794,951,  
AND 3,214,792.

SER. NO. 77-386,942, FILED 2-1-2008.

JASON BLAIR, EXAMINING ATTORNEY

**Int. Cl.: 41**

**Prior U.S. Cls.: 100, 101 and 107**

**United States Patent and Trademark Office**

**Reg. No. 3,498,581**

**Registered Sep. 9, 2008**

**SERVICE MARK  
PRINCIPAL REGISTER**

# Trendsetters

BROOKS, ROBERT (UNITED STATES INDIVIDUAL)  
8611 NORTH 17TH PLACE  
PHOENIX, AZ 85020

FOR: PUBLICATION OF TEXT BOOKS, TEACHER'S MANUALS, AND WORKBOOKS; EDUCATIONAL SERVICES, NAMELY, CONDUCTING CLASSES, SEMINARS, CONFERENCES, WORKSHOPS, AND INDIVIDUAL INSTRUCTION, IN THE FIELDS OF RELIGION, SPIRITUALITY, SELF-HELP, AND PERSONAL EMPOWERMENT, AND DISTRIBUTING COURSE MATERIALS IN

CONNECTION THEREWITH, IN CLASS 41 (U.S. CLS. 100, 101 AND 107).

FIRST USE 1-0-2006; IN COMMERCE 1-0-2006.

THE MARK CONSISTS OF STANDARD CHARACTERS WITHOUT CLAIM TO ANY PARTICULAR FONT, STYLE, SIZE, OR COLOR.

SER. NO. 77-386,974, FILED 2-1-2008.

JACLYN KIDWELL, EXAMINING ATTORNEY

**Int. Cl.: 41**

**Prior U.S. Cls.: 100, 101 and 107**

**United States Patent and Trademark Office**

**Reg. No. 3,498,582**

**Registered Sep. 9, 2008**

**SERVICE MARK  
PRINCIPAL REGISTER**

**T.O.G.A.**

BROOKS, ROBERT (UNITED STATES INDIVIDUAL)  
8611 NORTH 17TH PLACE  
PHOENIX, AZ 85020

FOR: PUBLICATION OF TEXT BOOKS, TEACHER'S MANUALS, AND WORKBOOKS; EDUCATIONAL SERVICES, NAMELY, CONDUCTING CLASSES, SEMINARS, CONFERENCES, WORKSHOPS, AND INDIVIDUAL INSTRUCTION, IN THE FIELDS OF RELIGION, SPIRITUALITY, SELF-HELP, AND PERSONAL EMPOWERMENT, AND DISTRIBUTING COURSE MATERIALS IN

CONNECTION THEREWITH, IN CLASS 41 (U.S. CLS. 100, 101 AND 107).

FIRST USE 5-4-2007; IN COMMERCE 5-4-2007.

THE MARK CONSISTS OF STANDARD CHARACTERS WITHOUT CLAIM TO ANY PARTICULAR FONT, STYLE, SIZE, OR COLOR.

SER. NO. 77-386,989, FILED 2-1-2008.

JACLYN KIDWELL, EXAMINING ATTORNEY



**Int. Cl.: 45**

**Prior U.S. Cls.: 100 and 101**

**United States Patent and Trademark Office**

**Reg. No. 3,498,583**

**Registered Sep. 9, 2008**

**SERVICE MARK  
PRINCIPAL REGISTER**

**MOSAIC**

MOSAIC, L.A. (CALIFORNIA CORPORATION)  
1539 E. HOWARD ST., MCGAVRAN BLDG., U6  
PASEDNA, CA 91104

FOR: RELIGIOUS AND SPIRITUAL SERVICES,  
NAMELY, PROVIDING GATHERINGS AND RE-  
TREATS TO DEVELOP AND ENHANCE THE SPIRI-  
TUAL LIVES OF INDIVIDUALS, IN CLASS 45 (U.S.  
CLS. 100 AND 101).

FIRST USE 0-0-1998; IN COMMERCE 0-0-1998.

THE MARK CONSISTS OF STANDARD CHAR-  
ACTERS WITHOUT CLAIM TO ANY PARTICULAR  
FONT, STYLE, SIZE, OR COLOR.

SER. NO. 77-387,051, FILED 2-1-2008.

NORA BUCHANAN WILL, EXAMINING ATTOR-  
NEY

**Int. Cls.: 16, 36 and 41**

**Prior U.S. Cls.: 2, 5, 22, 23, 29, 37, 38, 50, 100, 101, 102  
and 107**

**Reg. No. 3,498,584**

**United States Patent and Trademark Office**

**Registered Sep. 9, 2008**

**TRADEMARK  
SERVICE MARK  
PRINCIPAL REGISTER**

**COMMUNITY FORWARD**

STEWART TITLE GUARANTY COMPANY  
(TEXAS CORPORATION)  
SUITE 770  
1980 POST OAK BOULEVARD  
HOUSTON, TX 77056

FOR: BOOKS IN THE FIELD OF THE HOME  
ACQUISITION PROCESS, IN CLASS 16 (U.S. CLS. 2,  
5, 22, 23, 29, 37, 38 AND 50).

FIRST USE 4-19-2005; IN COMMERCE 4-19-2005.

FOR: PROVIDING INFORMATION IN THE  
FIELD OF THE HOME ACQUISITION PROCESS,  
IN CLASS 36 (U.S. CLS. 100, 101 AND 102).

FIRST USE 4-19-2005; IN COMMERCE 4-19-2005.

FOR: EDUCATIONAL SERVICES, NAMELY,  
CONDUCTING PROGRAMS AND SEMINARS IN  
THE FIELD OF THE HOME ACQUISITION PRO-  
CESS AND DISTRIBUTION OF COURSE MATERI-  
AL IN CONNECTION THEREWITH, IN CLASS 41  
(U.S. CLS. 100, 101 AND 107).

FIRST USE 4-19-2005; IN COMMERCE 4-19-2005.

THE MARK CONSISTS OF STANDARD CHAR-  
ACTERS WITHOUT CLAIM TO ANY PARTICULAR  
FONT, STYLE, SIZE, OR COLOR.

SER. NO. 77-387,134, FILED 2-2-2008.

EDWARD NELSON, EXAMINING ATTORNEY

Int. Cl.: 35

Prior U.S. Cls.: 100, 101 and 102

United States Patent and Trademark Office

Reg. No. 3,498,585

Registered Sep. 9, 2008

**SERVICE MARK  
PRINCIPAL REGISTER**

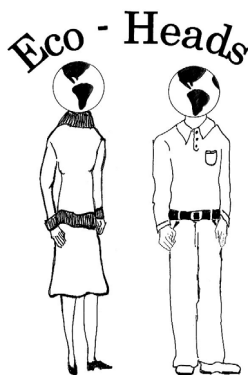

SILVA, THOMAS (UNITED STATES INDIVIDUAL)

6 LAURA LANE

MATTAPOISETT, MA 02739

FOR: ADVERTISING AGENCIES; ADVERTISING AGENCIES, NAMELY, PROMOTING THE GOODS AND SERVICES OF OTHERS; ADVERTISING AND ADVERTISEMENT SERVICES; ADVERTISING AND BUSINESS MANAGEMENT CONSULTANCY; ADVERTISING AND BUSINESS SERVICES, NAMELY, SECURING AIRTIME ON ALL FORMS OF MEDIA COMMUNICATIONS STATIONS, SYSTEMS, NETWORKS, AND SERVICES FOR THE PURPOSE OF PROMOTING THE GOODS AND SERVICES OF OTHERS; ADVERTISING AND COMMERCIAL INFORMATION SERVICES, VIA THE INTERNET; ADVERTISING AND MARKETING; ADVERTISING AND PROMOTION SERVICES AND RELATED CONSULTING; ADVERTISING AND PROMOTIONAL SERVICES; ADVERTISING AND PUBLICITY SERVICES; ADVERTISING AND PUBLICITY SERVICES, NAMELY, PROMOTING THE GOODS, SERVICES, BRAND IDENTITY AND COMMERCIAL INFORMATION AND NEWS OF THIRD PARTIES THROUGH PRINT, AUDIO, VIDEO, DIGITAL AND ON-LINE MEDIUM; ADVERTISING BY TRANSMISSION OF ON-LINE PUBLICITY FOR THIRD PARTIES THROUGH ELECTRONIC COMMUNICATIONS NETWORKS; ADVERTISING CONSULTATION; ADVERTISING FLYER DISTRIBUTION; ADVERTISING PARTICULARLY SERVICES FOR THE PROMOTION OF GOODS; ADVERTISING SERVICES; ADVERTISING SERVICES OF A RADIO AND TELEVISION ADVERTISING AGENCY; ADVERTISING SERVICES,

NAMELY, CREATING CORPORATE AND BRAND IDENTITY FOR OTHERS; ADVERTISING SERVICES, NAMELY, CREATING CORPORATE LOGOS FOR OTHERS; ADVERTISING SERVICES, NAMELY, PROMOTING AND MARKETING THE GOODS AND SERVICES OF OTHERS THROUGH ALL PUBLIC COMMUNICATION MEANS; ADVERTISING SERVICES, NAMELY, PROMOTING THE GIFT CARDS OF OTHERS; ADVERTISING SERVICES, PUBLIC RELATIONS AND MARKETING SERVICES, NAMELY, PROMOTING AND MARKETING THE GOODS AND SERVICES OF OTHERS THROUGH ALL PUBLIC COMMUNICATION MEANS; ADVERTISING THROUGH ALL PUBLIC COMMUNICATION MEANS; ADVERTISING VIA ELECTRONIC MEDIA AND SPECIFICALLY THE INTERNET; ADVERTISING, INCLUDING PROMOTION RELATING TO THE SALE OF ARTICLES AND SERVICES FOR THIRD PARTIES BY THE TRANSMISSION OF ADVERTISING MATERIAL AND THE DISSEMINATION OF ADVERTISING MESSAGES ON COMPUTER NETWORKS; ADVERTISING, MARKETING AND PROMOTION SERVICES; ADVERTISING, MARKETING AND PROMOTIONAL SERVICES FOR AUTOMOTIVE DEALERSHIPS; ADVICE AND INFORMATION ABOUT CUSTOMER SERVICES AND PRODUCT MANAGEMENT AND PRICES ON INTERNET SITES IN CONNECTION WITH PURCHASES MADE OVER THE INTERNET; ADVICE IN THE FIELD OF BUSINESS MANAGEMENT AND MARKETING; ADVICE RELATING TO THE ORGANISATION AND MANAGEMENT OF BUSINESS; ADVISORY SERVICE FOR ORGANIZATIONAL ISSUES AND BUSINESS ADMINISTRATION, WITH AND WITHOUT THE HELP OF ELECTRONIC DATA BASES;

ADVISORY SERVICES RELATING TO BUSINESS MANAGEMENT AND BUSINESS OPERATIONS; AGENCIES FOR ADVERTISING TIME AND SPACE; ARRANGING AND CONDUCTING BUSINESS CONFERENCES; ARRANGING AND CONDUCTING OF FAIRS AND EXHIBITIONS FOR BUSINESS AND ADVERTISING PURPOSES; ASSISTANCE IN MANAGEMENT OF BUSINESS ACTIVITIES; ASSISTANCE TO INDUSTRIAL OR COMMERCIAL ENTERPRISES IN THE RUNNING OF THEIR BUSINESS; ASSISTANCE WITH BUSINESS MANAGEMENT AND PLANNING; ASSISTANCE, ADVISORY SERVICES AND CONSULTANCY WITH REGARD TO BUSINESS PLANNING, BUSINESS ANALYSIS, BUSINESS MANAGEMENT, AND BUSINESS ORGANIZATION; ASSOCIATION SERVICES, NAMELY, PROMOTING DIVERSITY IN THE RESTAURANT AND HOTEL INDUSTRIES ON BEHALF OF EMPLOYEES, VENDORS, MANAGEMENT, AND OWNERS; AUCTION MANAGEMENT SERVICES PROVIDED TO OTHERS OVER AN ON-LINE WEB SITE ACCESSED THROUGH A GLOBAL COMPUTER NETWORK; BUSINESS ADMINISTRATION AND MANAGEMENT; BUSINESS ADMINISTRATION AND OFFICE WORK; BUSINESS ADMINISTRATION CONSULTANCY; BUSINESS ADVICE AND ANALYSIS OF MARKETS; BUSINESS ADVICE AND COMMERCIAL INFORMATION; BUSINESS ADVICE AND INFORMATION; BUSINESS ADVICE, INQUIRIES OR INFORMATION; BUSINESS ADVISORY SERVICES, CONSULTANCY AND INFORMATION; BUSINESS CONSULTATION; BUSINESS CONSULTATION AND MANAGEMENT REGARDING MARKETING ACTIVITIES AND LAUNCHING OF NEW PRODUCTS; BUSINESS CONSULTATION SERVICES; BUSINESS CONSULTATION SERVICES TO ASSIST NON-PROFIT ORGANIZATIONS IN PLANNING, MANAGING, AND CONDUCTING FUND RAISING ACTIVITIES VIA A GLOBAL COMPUTER NETWORK; BUSINESS CONSULTING AND BUSINESS INFORMATION FOR ENTERPRISES; BUSINESS CONSULTING AND INFORMATION SERVICES; BUSINESS CONSULTING, MANAGEMENT, PLANNING AND SUPERVISION; BUSINESS INFORMATION MANAGEMENT; BUSINESS INFORMATION SERVICES IN THE NATURE OF PROVIDING INFORMATION ON BUSINESS OPPORTUNITIES; BUSINESS INTERMEDIARY AND ADVISORY SERVICES IN THE FIELD OF SELLING PRODUCTS AND RENDERING SERVICES; BUSINESS MANAGEMENT AND CONSULTATION; BUSINESS MANAGEMENT ASSISTANCE TO INDUSTRIAL OR COMMERCIAL COMPANIES; BUSINESS MANAGEMENT CONSULTANCY AND ADVISORY SERVICES; BUSINESS MANAGEMENT OF THE NONPROFIT CORPORATIONS AND TRADE ASSOCIATIONS OF OTHERS; BUSINESS MANAGEMENT PLANNING; DATA MANAGEMENT SERVICES FOR USE IN DEBT COLLECTION, NAMELY, ELECTRONIC DATA COLLECTION AND ONLINE CLAIMS MANAGEMENT; BUSINESS MARKETING SERVICES; BUSINESS MERCHANDISING DISPLAY SERVICES; BUSINESS ORGANIZATION AND MANAGEMENT CONSULTING SERVICES; BUSINESS SERVICES FOR FUND RAISING PROGRAMS, NAMELY, DEVELOPING FUND RAISING PROGRAM CATALOGS, BROCHURES,

PRICE SHEETS, ORDER FORMS, AND OTHER DOCUMENTS FOR NOT-FOR-PROFIT ORGANIZATIONS; BUSINESS SERVICES, NAMELY, ASSISTING OTHERS IN THE ESTABLISHMENT OF CHARITABLE ORGANIZATIONS; COMMERCIAL BUSINESS MANAGEMENT; CONCEPT AND BRAND DEVELOPMENT IN THE FIELD OF ALTERNATE ENERGY BUSINESSES MANAGEMENT, ENVIRONMENTALLY-FRIENDLY BUSINESSES MARKETING, ENVIRONMENTALLY-FRIENDLY PRODUCT MERCHANDISING, ENERGY USE MANAGEMENT CONSERVATION AND ENVIRONMENTALLY-FRIENDLY REAL ESTATE ADVERTISING; CONDUCTING BUSINESS AND MARKET RESEARCH SURVEYS; CONDUCTING BUSINESS RESEARCH AND SURVEYS; CONDUCTING ONLINE BUSINESS MANAGEMENT RESEARCH SURVEYS; CONSUMER LOYALTY SERVICES FOR COMMERCIAL, PROMOTIONAL, AND/OR ADVERTISING PURPOSES, NAMELY, ADMINISTRATION OF FREQUENT FLYER PROGRAM THAT ALLOWS MEMBERS TO REDEEM MILES FOR POINTS OR AWARDS OFFERED BY OTHER LOYALTY PROGRAMS; COOPERATIVE ADVERTISING AND MARKETING SERVICES BY WAY OF SOLICITATION, CUSTOMER SERVICE AND PROVIDING MARKETING INFORMATION VIA WEB SITES ON A GLOBAL COMPUTER NETWORK; CREATING AND UPDATING ADVERTISING MATERIAL; CREATION OF MARKETING TOOLS DESIGNED TO INCREASE A CLIENT COMPANY'S KNOWLEDGE OF CUSTOMER NEEDS, AND ITS COMPETITORS' PRODUCTS AND SERVICES, PRICING, ADVERTISING STRATEGY AND SALES STRATEGY; CUSTOMER LOYALTY SERVICES AND CUSTOMER CLUB SERVICES, FOR COMMERCIAL, PROMOTIONAL AND/OR ADVERTISING PURPOSES; DESIGN OF ADVERTISING MATERIALS FOR OTHERS; DESIGN OF INTERNET ADVERTISING; DEVELOPING PROMOTIONAL CAMPAIGNS FOR BUSINESS; DISSEMINATION OF ADVERTISEMENTS AND OF ADVERTISING MATERIAL; DISSEMINATION OF ADVERTISING FOR OTHERS VIA AN ON-LINE COMMUNICATIONS NETWORK ON THE INTERNET; DISSEMINATION OF ADVERTISING FOR OTHERS VIA THE INTERNET; DISSEMINATION OF ADVERTISING MATERIAL; DISSEMINATION OF ADVERTISING MATTER; DISSEMINATION OF ADVERTISING, SCHEDULING AND MANAGING OF TRAINING COURSES AND PROGRAMS FOR OTHERS VIA A GLOBAL COMPUTER NETWORK; DISTRIBUTION AND DISSEMINATION OF ADVERTISING MATERIALS; DISTRIBUTION OF ADVERTISEMENTS AND COMMERCIAL ANNOUNCEMENTS; DISTRIBUTION OF ADVERTISING MAIL AND OF ADVERTISING SUPPLEMENTS ATTACHED TO REGULAR EDITIONS; DISTRIBUTION OF PRODUCTS FOR ADVERTISING PURPOSES; ENERGY USAGE MANAGEMENT; ENERGY USAGE MANAGEMENT INFORMATION SERVICES; ENTERTAINMENT MARKETING SERVICES, NAMELY, MARKETING, PROMOTION AND ADVERTISING FOR INDEPENDENT RECORDING ARTISTS; GENERAL BUSINESS MERCHANDISING SERVICES, NAMELY, MARKETING; GENERAL BUSINESS NETWORKING REFERRAL SERVICES, NAMELY, PROMOT-

ING THE GOODS AND SERVICES OF OTHERS BY PASSING BUSINESS LEADS AND REFERRALS AMONG GROUP MEMBERS; HELP IN THE MANAGEMENT OF BUSINESS AFFAIRS OR COMMERCIAL FUNCTIONS OF AN INDUSTRIAL OR COMMERCIAL ENTERPRISE; INTERNET ADVERTISING SERVICES; MARKETING AND ADVERTISING SERVICES FOR AUTOMOBILE DEALERSHIPS; PREPARING ADVERTISEMENTS FOR OTHERS; PREPARING AND PLACING ADVERTISEMENTS FOR OTHERS; PREPARING AND PLACING OF ADVERTISEMENTS; PREPARING AND PLACING OUTDOOR ADVERTISEMENTS FOR OTHERS; PREPARING AUDIO-VISUAL PRESENTATIONS FOR USE IN ADVERTISING; PREPARING BUSINESS REPORTS; PREPARING COMPUTER SLIDE TRANSPARENCIES FOR USE BY BUSINESS; PREPARING SPEECHES AND ORAL PRESENTATIONS FOR OTHERS FOR USE IN ADVERTISING; PROCESSING TELEPHONE INQUIRIES REGARDING ADVERTISED GOODS AND SERVICES; PROMOTING, ADVERTISING AND MARKETING OF THE ON-LINE WEB SITES OF OTHERS; PROMOTION OF BUSINESS OPPORTUNITIES; PROMOTION, ADVERTISING AND MARKETING OF ON-LINE WEB SITES; PROVIDING A LIVE FORUM FOR COMPANIES TO SHOWCASE, DISPLAY, DEMONSTRATE AND PROMOTE NEW AND INNOVATIVE IDEAS, PRODUCTS AND SERVICES IN THE CONVENTION/MEETING MANAGEMENT ARENA; PROVIDING A SEARCHABLE ONLINE ADVERTISING GUIDE FEATURING THE GOODS AND SERVICES OF OTHER ON-LINE VENDORS ON THE INTER-

NET; PROVIDING A WEB SITE WHICH FEATURES ADVERTISEMENTS FOR THE GOODS AND SERVICES OF OTHERS ON A GLOBAL COMPUTER NETWORK; PROVIDING A WEB-BASED SERVICE THAT ENABLES INDIVIDUALS TO MANAGE THE PRODUCTION AND PUBLICATION OF ELECTRONIC BOOKS (E-BOOKS) AND RELATED DIGITAL CONTENT AND OFFER THEM FOR SALE TO THE GENERAL PUBLIC; PROVIDING ADVERTISING SERVICES USING 3D AND ANIMATION DESIGNS; PROVIDING TELEVISION ADVERTISING FOR OTHERS; PROVISION OF ADVERTISING SPACE BY ELECTRONIC MEANS AND GLOBAL INFORMATION NETWORKS; PUBLISHING OF ADVERTISING TEXTS; REAL ESTATE ADVERTISING SERVICES; RENTAL OF ADVERTISEMENT SPACE AND ADVERTISING MATERIAL, IN CLASS 35 (U.S. CLS. 100, 101 AND 102).

FIRST USE 1-26-2008; IN COMMERCE 1-26-2008.

NO CLAIM IS MADE TO THE EXCLUSIVE RIGHT TO USE "ECO", APART FROM THE MARK AS SHOWN.

THE MARK CONSISTS OF THE WORDS "ECO - HEADS" AND TWO PEOPLE WITH GLOBES REPRESENTING HEADS.

SER. NO. 77-387,140, FILED 2-2-2008.

DAVID YONTEF, EXAMINING ATTORNEY

**Int. Cls.: 41, 43 and 45**

**Prior U.S. Cls.: 100, 101 and 107**

**United States Patent and Trademark Office**

**Reg. No. 3,498,586**

**Registered Sep. 9, 2008**

**SERVICE MARK  
PRINCIPAL REGISTER**

**ELDERHOOD & LIVING**

ELDERHEALTH & LIVING CORPORATION  
(OREGON CORPORATION)  
382-B SOUTH 58TH STREET  
SPRINGFIELD, OR 97478

FOR: EDUCATIONAL SERVICES, NAMELY,  
CONDUCTING SEMINARS CONFERENCES AND/  
OR WORKSHOPS FEATURING TOPICS RELATED  
TO ALZHEIMER'S DISEASE AND OTHER TYPES  
OF DEMENTIA, IN CLASS 41 (U.S. CLS. 100, 101 AND  
107).

FIRST USE 1-23-2008; IN COMMERCE 1-23-2008.

FOR: PROVIDING ASSISTED LIVING FACIL-  
ITIES, IN CLASS 43 (U.S. CLS. 100 AND 101).

FIRST USE 1-23-2008; IN COMMERCE 1-23-2008.

FOR: PERSONAL CARE ASSISTANCE OF ACTIV-  
ITIES OF DAILY LIVING, SUCH AS BATHING,  
GROOMING AND PERSONAL MOBILITY FOR  
MENTALLY OR PHYSICALLY CHALLENGED  
PEOPLE, IN CLASS 45 (U.S. CLS. 100 AND 101).

FIRST USE 1-23-2008; IN COMMERCE 1-23-2008.

THE MARK CONSISTS OF STANDARD CHAR-  
ACTERS WITHOUT CLAIM TO ANY PARTICULAR  
FONT, STYLE, SIZE, OR COLOR.

SER. NO. 77-387,160, FILED 2-2-2008.

DAVID ELTON, EXAMINING ATTORNEY

**Int. Cls.: 35 and 41**

**Prior U.S. Cls.: 100, 101, 102 and 107**

**United States Patent and Trademark Office**

**Reg. No. 3,498,587**

**Registered Sep. 9, 2008**

**SERVICE MARK  
PRINCIPAL REGISTER**

# True Classical Pilates

TRUE CLASSICAL PILATES, INC. (VIRGINIA CORPORATION)

# 725

2308 MT. VERNON AVENUE  
ALEXANDRIA, VA 22301

FOR: ADVERTISING AND PUBLICITY SERVICES, NAMELY, PROMOTING THE GOODS, SERVICES, BRAND IDENTITY AND COMMERCIAL INFORMATION AND NEWS OF THIRD PARTIES THROUGH PRINT, AUDIO, VIDEO, DIGITAL AND ON-LINE MEDIUM; ASSOCIATION SERVICES, NAMELY, PROMOTING THE INTERESTS OF TRADITIONAL PILATES INSTRUCTORS, IN CLASS 35 (U.S. CLS. 100, 101 AND 102).

FIRST USE 1-10-2008; IN COMMERCE 1-10-2008.

FOR: PRODUCTION OF DVDS, VIDEOTAPES AND TELEVISION PROGRAMS FEATURING SELECTION AND ORDERING OF PILATES BODY CONDITIONING EXERCISES; PHYSICAL FITNESS CONSULTATION; PHYSICAL FITNESS INSTRUC-

TION; ARRANGEMENT OF TRAINING COURSES IN TEACHING INSTITUTES; CONDUCTING WORKSHOPS AND SEMINARS IN THE PILATES METHOD OF BODY CONDITIONING; PERSONAL TRAINING SERVICES, NAMELY, STRENGTH AND CONDITIONING TRAINING, IN CLASS 41 (U.S. CLS. 100, 101 AND 107).

FIRST USE 1-10-2008; IN COMMERCE 1-10-2008.

THE MARK CONSISTS OF STANDARD CHARACTERS WITHOUT CLAIM TO ANY PARTICULAR FONT, STYLE, SIZE, OR COLOR.

NO CLAIM IS MADE TO THE EXCLUSIVE RIGHT TO USE "CLASSICAL PILATES", APART FROM THE MARK AS SHOWN.

SER. NO. 77-387,161, FILED 2-2-2008.

DAVID ELTON, EXAMINING ATTORNEY

**Int. Cl.: 41**

**Prior U.S. Cls.: 100, 101 and 107**

**United States Patent and Trademark Office**

**Reg. No. 3,498,588**

**Registered Sep. 9, 2008**

**SERVICE MARK  
PRINCIPAL REGISTER**

**RESILIENCY PLUS**

SERVICE INSTITUTE, INC (FLORIDA CORPORATION)  
310 MOREY AVENUE  
BELLINGHAM, WA 98225

FOR: EDUCATION SERVICES, NAMELY, PROVIDING LIVE AND ON-LINE CLASSES WORKSHOPS AND SEMINARS IN THE FIELD OF RESILIENCY SKILL DEVELOPMENT AND PROMOTION FOR EMPLOYEES IN TRAVEL INCLUDING AVIATION AND HOSPITALITY AND RETAIL, IN CLASS 41 (U.S. CLS. 100, 101 AND 107).

FIRST USE 1-25-2008; IN COMMERCE 1-25-2008.

THE MARK CONSISTS OF STANDARD CHARACTERS WITHOUT CLAIM TO ANY PARTICULAR FONT, STYLE, SIZE, OR COLOR.

NO CLAIM IS MADE TO THE EXCLUSIVE RIGHT TO USE "RESILIENCY", APART FROM THE MARK AS SHOWN.

SER. NO. 77-387,162, FILED 2-2-2008.

BRIDGETT SMITH, EXAMINING ATTORNEY



**Int. Cl.: 35**

**Prior U.S. Cls.: 100, 101 and 102**

**United States Patent and Trademark Office**

**Reg. No. 3,498,589**

**Registered Sep. 9, 2008**

**SERVICE MARK  
PRINCIPAL REGISTER**

# BLOCKTAX

MICHAEL BLOCK (UNITED STATES INDIVIDUAL)  
14 E OAKLAND PARK BLVD  
FORT LAUDERDALE, FL 33334

FOR: ACCOUNTANCY SERVICES; ACCOUNTING CONSULTATION; ACCOUNTING SERVICES; BUSINESS INFORMATION AND ACCOUNTING ADVISORY SERVICES; COMPUTERIZED ACCOUNTING SERVICES; BOOKKEEPING; INCOME TAX PREPARATION; TAX PREPARATION, IN CLASS 35 (U.S. CLS. 100, 101 AND 102).

FIRST USE 7-15-1982; IN COMMERCE 7-15-1982.

THE MARK CONSISTS OF STANDARD CHARACTERS WITHOUT CLAIM TO ANY PARTICULAR FONT, STYLE, SIZE, OR COLOR.

SER. NO. 77-387,170, FILED 2-2-2008.

LESLEY LAMOTHE, EXAMINING ATTORNEY

**Int. Cl.: 16**

**Prior U.S. Cls.: 2, 5, 22, 23, 29, 37, 38 and 50**

**United States Patent and Trademark Office**

**Reg. No. 3,498,590**

**Registered Sep. 9, 2008**

**TRADEMARK  
PRINCIPAL REGISTER**



THE SPORTING TIMES LLC (KENTUCKY LIMITED LIABILITY COMPANY)  
413 WEST CEDAR STREET  
FRANKLIN, KY 42134

FOR: NEWSPAPERS; NEWSPAPERS FOR GENERAL CIRCULATION, IN CLASS 16 (U.S. CLS. 2, 5, 22, 23, 29, 37, 38 AND 50).

FIRST USE 2-1-2005; IN COMMERCE 2-1-2005.

NO CLAIM IS MADE TO THE EXCLUSIVE RIGHT TO USE "SPORTING", APART FROM THE MARK AS SHOWN.

THE COLOR(S) RED AND BLACK IS/ARE CLAIMED AS A FEATURE OF THE MARK.

THE MARK CONSISTS OF THE WORDS "THE SPORTING TIMES" IN RED LETTERS OUTLINED IN BLACK, IN OLD ENGLISH FONT.

SER. NO. 77-387,223, FILED 2-2-2008.

JERI J. FICKES, EXAMINING ATTORNEY

**Int. Cl.: 35**

**Prior U.S. Cls.: 100, 101 and 102**

**United States Patent and Trademark Office**

**Reg. No. 3,498,591**

**Registered Sep. 9, 2008**

**SERVICE MARK  
PRINCIPAL REGISTER**



LOWE, JERRY JAMES (UNITED STATES INDIVIDUAL)  
1228 GROVE STREET APT. 3  
SAN FRANCISCO, CA 94117

FOR: ADVERTISING AGENCIES; ADVERTISING AGENCIES, NAMELY, PROMOTING THE GOODS AND SERVICES OF OTHERS; ADVERTISING AND MARKETING, IN CLASS 35 (U.S. CLS. 100, 101 AND 102).

FIRST USE 10-10-2006; IN COMMERCE 10-10-2006.

THE COLOR(S) REDDISH-BROWN IS/ARE CLAIMED AS A FEATURE OF THE MARK.

THE MARK CONSISTS OF THE COLOR REDDISH-BROWN APPEARING IN THE DESIGN OF A TOE WITH JET WINGS AND THE WORDING "JET TOE".

SER. NO. 77-387,255, FILED 2-3-2008.

DANIEL BRODY, EXAMINING ATTORNEY

**Int. Cl.: 12**

**Prior U.S. Cls.: 19, 21, 23, 31, 35 and 44**

**United States Patent and Trademark Office**

**Reg. No. 3,498,592**

**Registered Sep. 9, 2008**

**TRADEMARK  
PRINCIPAL REGISTER**

**SIGNATURE SERIES**

ADVANTAGE ASIA (NEW YORK SOLE PROPRIETORSHIP)

# 14L

400 E. 85TH ST.

NEW YORK, NY 10028

FOR: WINDSHIELD WIPER BLADES, IN CLASS 12 (U.S. CLS. 19, 21, 23, 31, 35 AND 44).

FIRST USE 0-0-1997; IN COMMERCE 0-0-1997.

THE MARK CONSISTS OF STANDARD CHARACTERS WITHOUT CLAIM TO ANY PARTICULAR FONT, STYLE, SIZE, OR COLOR.

NO CLAIM IS MADE TO THE EXCLUSIVE RIGHT TO USE "SERIES", APART FROM THE MARK AS SHOWN.

SER. NO. 77-387,280, FILED 2-3-2008.

CHARLES L. JENKINS, EXAMINING ATTORNEY

**Int. Cl.: 14**

**Prior U.S. Cls.: 2, 27, 28 and 50**

**United States Patent and Trademark Office**

**Reg. No. 3,498,593**

**Registered Sep. 9, 2008**

**TRADEMARK  
PRINCIPAL REGISTER**

**nipple**

JONES, LORRAINE, C (UNITED STATES INDIVIDUAL)  
9421 JAMAICA BEACH  
GALVESTON, TX 77554

THE MARK CONSISTS OF STANDARD CHARACTERS WITHOUT CLAIM TO ANY PARTICULAR FONT, STYLE, SIZE, OR COLOR.

FOR: JEWELRY, IN CLASS 14 (U.S. CLS. 2, 27, 28 AND 50).

SER. NO. 77-387,336, FILED 2-3-2008.

FIRST USE 1-1-2003; IN COMMERCE 1-1-2003.

REBECCA EISINGER, EXAMINING ATTORNEY

**Int. Cl.: 32**

**Prior U.S. Cls.: 45, 46 and 48**

**Reg. No. 3,498,594**

**United States Patent and Trademark Office**

**Registered Sep. 9, 2008**

---

**TRADEMARK  
PRINCIPAL REGISTER**

**JULIE**

ADVANCED FOODS & NUTRITION LLC (NEW  
JERSEY LIMITED LIABILITY COMPANY)  
1716 EAST ELIZABETH AVE  
LINDEN, NJ 07036

THE MARK CONSISTS OF STANDARD CHAR-  
ACTERS WITHOUT CLAIM TO ANY PARTICULAR  
FONT, STYLE, SIZE, OR COLOR.

FOR: FRUIT JUICES, NON-ALCOHOLIC FRUIT  
JUICE BEVERAGES, CARBONATED BEVERAGES,  
FRUIT JUICE CONCENTRATES, IN CLASS 32 (U.S.  
CLS. 45, 46 AND 48).

SER. NO. 77-387,339, FILED 2-3-2008.

FIRST USE 12-1-1971; IN COMMERCE 12-5-1971.

HOWARD FRIEDMAN, EXAMINING ATTORNEY

**Int. Cl.: 43**

**Prior U.S. Cls.: 100 and 101**

**United States Patent and Trademark Office**

**Reg. No. 3,498,595**

**Registered Sep. 9, 2008**

**SERVICE MARK  
PRINCIPAL REGISTER**

**ACHOTELEXPERTS.COM**

THE HOTEL EXPERTS, LLC (NEW JERSEY LIMITED LIABILITY COMPANY)  
34 N MISSISSIPPI AVE  
ATLANTIC CITY, NJ 08401

FOR: RESERVATION OF HOTEL ROOMS FOR TRAVELERS; RESERVATION OF ROOMS FOR TRAVELLERS; TRAVEL AGENCY SERVICES, NAMELY, MAKING RESERVATIONS AND BOOKING FOR TEMPORARY LODGING; MAKING HOTEL RESERVATIONS FOR OTHERS; RESERVATION OF HOTEL ROOMS FOR TRAVELERS; SERVICES FOR THE RESERVATION OF ROOMS; TRAVEL AGENCY SERVICES, NAMELY,

MAKING RESERVATIONS AND BOOKINGS FOR RESTAURANTS AND MEALS, IN CLASS 43 (U.S. CLS. 100 AND 101).

FIRST USE 10-8-2005; IN COMMERCE 10-8-2005.

THE MARK CONSISTS OF STANDARD CHARACTERS WITHOUT CLAIM TO ANY PARTICULAR FONT, STYLE, SIZE, OR COLOR.

SER. NO. 77-387,344, FILED 2-3-2008.

BRENDAN REGAN, EXAMINING ATTORNEY

**Int. Cl.: 25**

**Prior U.S. Cls.: 22 and 39**

**United States Patent and Trademark Office**

**Reg. No. 3,498,596**

**Registered Sep. 9, 2008**

**TRADEMARK  
PRINCIPAL REGISTER**

**JEWETINA**

LOPEZ, ADRIANA (UNITED STATES INDIVIDUAL)  
324 S. DIAMOND BAR BLVD. #144  
DIAMOND BAR, CA 91765

THE MARK CONSISTS OF STANDARD CHARACTERS WITHOUT CLAIM TO ANY PARTICULAR FONT, STYLE, SIZE, OR COLOR.

FOR: SHIRTS; T-SHIRTS; HATS; BELTS; SWEAT SHIRTS; PAJAMAS, IN CLASS 25 (U.S. CLS. 22 AND 39).

SER. NO. 77-387,352, FILED 2-3-2008.

FIRST USE 1-0-2008; IN COMMERCE 1-0-2008.

BRENDAN REGAN, EXAMINING ATTORNEY



**Int. Cl.: 5**

**Prior U.S. Cls.: 6, 18, 44, 46, 51 and 52**

**Reg. No. 3,498,597**

**United States Patent and Trademark Office**

**Registered Sep. 9, 2008**

---

**TRADEMARK  
PRINCIPAL REGISTER**

**Nick Stick**

PACIFIC SHAVING COMPANY, LLC (CALIFORNIA LIMITED LIABILITY COMPANY)  
PO BOX 590022  
SAN FRANCISCO, CA 94159

THE MARK CONSISTS OF STANDARD CHARACTERS WITHOUT CLAIM TO ANY PARTICULAR FONT, STYLE, SIZE, OR COLOR.

FOR: STYPTIC PENCILS, IN CLASS 5 (U.S. CLS. 6, 18, 44, 46, 51 AND 52).

SER. NO. 77-387,403, FILED 2-4-2008.

FIRST USE 7-1-2007; IN COMMERCE 2-3-2008.

LINDA MICKLEBURGH, EXAMINING ATTORNEY

**Int. Cl.: 42**

**Prior U.S. Cls.: 100 and 101**

**United States Patent and Trademark Office**

**Reg. No. 3,498,598**

**Registered Sep. 9, 2008**

**SERVICE MARK  
PRINCIPAL REGISTER**

**AMR5**

ERNEST ROZLOZNIK (SLOVAKIA INDIVIDUAL)  
98B WABENO AVE  
SPRINGFIELD, NJ 07081

FOR: PROVIDING TEMPORARY USE OF NON-DOWNLOADABLE COMPUTER SOFTWARE FOR USE IN CUSTOMER RELATIONSHIP MANAGEMENT (CRM); PROVIDING TEMPORARY USE OF NON-DOWNLOADABLE COMPUTER SOFTWARE THAT PROVIDES REAL-TIME, INTEGRATED BUSINESS MANAGEMENT INTELLIGENCE BY COMBINING INFORMATION FROM VARIOUS

DATABASES AND PRESENTING IT IN AN EASY-TO-UNDERSTAND USER INTERFACE, IN CLASS 42 (U.S. CLS. 100 AND 101).

FIRST USE 1-1-2007; IN COMMERCE 1-1-2007.

THE MARK CONSISTS OF STYLIZED LETTERS "AMRS".

SER. NO. 77-387,425, FILED 2-4-2008.

BRENDAN REGAN, EXAMINING ATTORNEY

**Int. Cl.: 42**

**Prior U.S. Cls.: 100 and 101**

**United States Patent and Trademark Office**

**Reg. No. 3,498,599**

**Registered Sep. 9, 2008**

**SERVICE MARK  
PRINCIPAL REGISTER**

**TRACLABS**

METRICA, INC. (TEXAS CORPORATION)  
SUITE 603  
8620 NORTH NEW BRAUNFELS  
SAN ANTONIO, TX 78217

THE MARK CONSISTS OF STANDARD CHAR-  
ACTERS WITHOUT CLAIM TO ANY PARTICULAR  
FONT, STYLE, SIZE, OR COLOR.

FOR: DESIGN ,DEVELOPMENT AND ENGI-  
NEERING IN THE FIELD OF ROBOTICS TECH-  
NOLOGY, IN CLASS 42 (U.S. CLS. 100 AND 101).

SER. NO. 77-387,473, FILED 2-4-2008.

FIRST USE 7-24-1997; IN COMMERCE 7-24-1997.

ANTHONY RINKER, EXAMINING ATTORNEY

**Int. Cl.: 41**

**Prior U.S. Cls.: 100, 101 and 107**

**United States Patent and Trademark Office**

**Reg. No. 3,498,600**

**Registered Sep. 9, 2008**

**SERVICE MARK  
PRINCIPAL REGISTER**

**THE BEAUTY OF MOTION**

KELLY HEGARTY CUSTOM DANCE CLINICS,  
LLC (MINNESOTA LIMITED LIABILITY  
COMPANY)  
4083 DRUMCLIFFE CIRC  
ROSEMOUNT, MN 55068

FOR: EDUCATIONAL SERVICES, NAMELY,  
CONDUCTING CONFERENCES, SEMINARS,  
WORKSHOPS AND CLASSES IN THE FIELD OF  
WOMEN'S WELLNESS AND WOMEN'S ISSUES  
AND DISTRIBUTING COURSE MATERIALS IN  
CONNECTION THEREWITH, IN CLASS 41 (U.S.  
CLS. 100, 101 AND 107).

FIRST USE 2-1-2008; IN COMMERCE 2-1-2008.

THE MARK CONSISTS OF STANDARD CHAR-  
ACTERS WITHOUT CLAIM TO ANY PARTICULAR  
FONT, STYLE, SIZE, OR COLOR.

SER. NO. 77-387,522, FILED 2-4-2008.

ELLEN BURNS, EXAMINING ATTORNEY

**Int. Cl.: 41**

**Prior U.S. Cls.: 100, 101 and 107**

**United States Patent and Trademark Office**

**Reg. No. 3,498,601**

**Registered Sep. 9, 2008**

**SERVICE MARK  
PRINCIPAL REGISTER**

**ADDICTIVE FISHING**

WIGGINS, BLAIR (UNITED STATES INDIVIDUAL)  
1811 4TH ST. W  
PALMETTO, FL 34221

FOR: ENTERTAINMENT SERVICES, NAMELY, AN ON-GOING SERIES FEATURING FISHING AND RELATED ACTIVITIES PROVIDED THROUGH TELEVISION AND WEBCASTS, IN CLASS 41 (U.S. CLS. 100, 101 AND 107).

FIRST USE 2-4-2008; IN COMMERCE 2-4-2008.

THE MARK CONSISTS OF STANDARD CHARACTERS WITHOUT CLAIM TO ANY PARTICULAR FONT, STYLE, SIZE, OR COLOR.

NO CLAIM IS MADE TO THE EXCLUSIVE RIGHT TO USE "FISHING", APART FROM THE MARK AS SHOWN.

SER. NO. 77-387,558, FILED 2-4-2008.

LESLIE RICHARDS, EXAMINING ATTORNEY

**Int. Cl.: 41**

**Prior U.S. Cls.: 100, 101 and 107**

**United States Patent and Trademark Office**

**Reg. No. 3,498,602**

**Registered Sep. 9, 2008**

**SERVICE MARK  
PRINCIPAL REGISTER**



TEVA PHARMACEUTICALS USA, INC. (DELA-  
WARE CORPORATION)  
1090 HORSHAM ROAD  
NORTH WALES, PA 19454

THE MARK CONSISTS OF THE LETTERS "TACT"  
AND A FANCIFUL DEPICTION OF A PERSON.

FOR: EDUCATIONAL SEMINARS IN THE FIELD  
OF PEDIATRIC ENDOCRINOLOGY, IN CLASS 41  
(U.S. CLS. 100, 101 AND 107).

SER. NO. 77-387,560, FILED 2-4-2008.

FIRST USE 11-30-2007; IN COMMERCE 1-26-2008.

KYLE PEETE, EXAMINING ATTORNEY

Int. Cl.: 25

Prior U.S. Cls.: 22 and 39

United States Patent and Trademark Office

Reg. No. 3,498,603

Registered Sep. 9, 2008

TRADEMARK  
PRINCIPAL REGISTER



AROYAN, BRANDEN M. (UNITED STATES  
SOLE PROPRIETORSHIP), DBA LOW TIDE  
RISING  
SUITE #376  
1187 COAST VILLAGE RD.  
SANTA BARBARA, CA 93108

THE MARK CONSISTS OF A DOLPHIN JUMP-  
ING OUT OF A WAVE IN FRONT OF THE SUN.

SER. NO. 77-387,657, FILED 2-4-2008.

FOR: SHIRTS, IN CLASS 25 (U.S. CLS. 22 AND 39).

FIRST USE 6-2-1997; IN COMMERCE 6-2-2007.

INGRID C. EULIN, EXAMINING ATTORNEY

**Int. Cl.: 35**

**Prior U.S. Cls.: 100, 101 and 102**

**United States Patent and Trademark Office**

**Reg. No. 3,498,604**

**Registered Sep. 9, 2008**

**SERVICE MARK  
PRINCIPAL REGISTER**

**PRINT ASSURANCE**

DISCOUNT SUPPLY, INC. (LOUISIANA CORPORATION)  
206 TEXAS AVENUE  
MONROE, LA 71201

FOR: INFORMATION AND DATA COMPILING AND ANALYZING RELATING TO BUSINESS MANAGEMENT, IN CLASS 35 (U.S. CLS. 100, 101 AND 102).

FIRST USE 12-1-2007; IN COMMERCE 12-1-2007.

THE MARK CONSISTS OF STANDARD CHARACTERS WITHOUT CLAIM TO ANY PARTICULAR FONT, STYLE, SIZE, OR COLOR.

NO CLAIM IS MADE TO THE EXCLUSIVE RIGHT TO USE "PRINT", APART FROM THE MARK AS SHOWN.

SER. NO. 77-387,737, FILED 2-4-2008.

SAMUEL E. SHARPER JR., EXAMINING ATTORNEY



**Int. Cl.: 41**

**Prior U.S. Cls.: 100, 101 and 107**

**United States Patent and Trademark Office**

**Reg. No. 3,498,605**

**Registered Sep. 9, 2008**

**SERVICE MARK  
PRINCIPAL REGISTER**

**The Adventures of Cubegirl**

KIM WALDAUER (UNITED STATES INDIVIDUAL)  
1508 MICHELTORENA ST #12  
LOS ANGELES, CA 90026 AND  
ROBERT CHRISTOPHE (UNITED STATES INDIVIDUAL)  
1508 MICHELTORENA ST #12  
LOS ANGELES, CA 90026

FOR: ENTERTAINMENT, NAMELY, AN ONGOING COMEDY SERIES FEATURING STORIES THAT FOLLOW KIM, A CUBICLE WORKER WHO BECOMES THE SUPERHERO CUBEGIRL IN ORDER TO STOP VARIOUS FORMS OF EVIL-DOERS, PROVIDED THROUGH WEBCASTS, PODCASTS,

MOBILE DEVICES, MOTION PICTURES, TELEVISION AND SATELLITE BROADCASTS, IN CLASS 41 (U.S. CLS. 100, 101 AND 107).

FIRST USE 7-26-2007; IN COMMERCE 7-26-2007.

THE MARK CONSISTS OF STANDARD CHARACTERS WITHOUT CLAIM TO ANY PARTICULAR FONT, STYLE, SIZE, OR COLOR.

SER. NO. 77-387,740, FILED 2-4-2008.

WILLIAM VERHOSEK, EXAMINING ATTORNEY

**Int. Cl.: 41**

**Prior U.S. Cls.: 100, 101 and 107**

**United States Patent and Trademark Office**

**Reg. No. 3,498,606**

**Registered Sep. 9, 2008**

**SERVICE MARK  
PRINCIPAL REGISTER**

**Why Didn't I Learn This in  
College?**

JUST ASK PUBLICATIONS & PROFESSIONAL  
DEVELOPMENT, INC. (VIRGINIA CORPORATION),  
DBA FORMERLY: ATTITUDES,  
SKILLS, & KNOWLEDGE, INC.  
2214 KING STREET  
ALEXANDRIA, VA 22301

FOR: EDUCATION SERVICES, NAMELY, PROVIDING  
WORKSHOPS IN THE FIELD OF TEACHER AND  
ADMINISTRATOR PROFESSIONAL DEVELOPMENT,  
IN CLASS 41 (U.S. CLS. 100, 101 AND 107).

FIRST USE 10-1-2006; IN COMMERCE 10-1-2006.

THE MARK CONSISTS OF STANDARD CHARACTERS  
WITHOUT CLAIM TO ANY PARTICULAR FONT,  
STYLE, SIZE, OR COLOR.

SER. NO. 77-387,748, FILED 2-4-2008.

EVELYN BRADLEY, EXAMINING ATTORNEY

**Int. Cl.: 11**

**Prior U.S. Cls.: 13, 21, 23, 31 and 34**

**United States Patent and Trademark Office**

**Reg. No. 3,498,607**

**Registered Sep. 9, 2008**

**TRADEMARK  
PRINCIPAL REGISTER**

**TWIN POOL**

FRANZ KALDEWEI GMBH & CO. KG (FED REP  
GERMANY KOMMANDITGESELLSCHAFT  
(KG))  
BECKUMER STRASSE 33-35  
AHLEN, FED REP GERMANY 59229

FOR: BATHTUBS, SHOWERS AND SHOWER  
TRAYS, IN CLASS 11 (U.S. CLS. 13, 21, 23, 31 AND 34).

FIRST USE 4-30-2002; IN COMMERCE 4-30-2002.

THE MARK CONSISTS OF STANDARD CHAR-  
ACTERS WITHOUT CLAIM TO ANY PARTICULAR  
FONT, STYLE, SIZE, OR COLOR.

SER. NO. 77-387,767, FILED 2-4-2008.

HAI-LY LAM, EXAMINING ATTORNEY

**Int. Cls.: 5, 40 and 42**

**Prior U.S. Cls.: 6, 18, 44, 46, 51, 52, 100, 101, 103 and 106**

**Reg. No. 3,498,608**

**United States Patent and Trademark Office**

**Registered Sep. 9, 2008**

**TRADEMARK  
SERVICE MARK  
PRINCIPAL REGISTER**

**AVEVA**

AVEVA DRUG DELIVERY SYSTEMS, INC.  
(FLORIDA CORPORATION)  
3250 COMMERCE PARKWAY  
MIRAMAR, FL 33025

FOR: TRANSDERMAL DRUG DELIVERY PATCHES FOR USE IN THE TREATMENT OF SMOKING CESSATION, BIOLOGICS, DERMATOLOGY, DIABETES, ASTHMA, INFLAMMATION, HORMONE REPLACEMENT THERAPY, IRRITABLE BOWEL SYNDROME, ONCOLOGY, NUTRACEUTICALS, PARKINSON'S DISEASE, PAIN MANAGEMENT, HYPERTENSION, WEIGHT LOSS AND CARDIOVASCULAR DISEASE, IN CLASS 5 (U.S. CLS. 6, 18, 44, 46, 51 AND 52).

FIRST USE 7-31-2004; IN COMMERCE 7-31-2004.

FOR: CUSTOM MANUFACTURE OF TRANSDERMAL DRUG DELIVERY PATCHES, IN CLASS 40 (U.S. CLS. 100, 103 AND 106).

FIRST USE 7-31-2004; IN COMMERCE 7-31-2004.

FOR: PRODUCT DEVELOPMENT FOR OTHERS REGARDING TRANSDERMAL DRUG DELIVERY PATCHES, IN CLASS 42 (U.S. CLS. 100 AND 101).

FIRST USE 3-31-2004; IN COMMERCE 3-31-2004.

THE MARK CONSISTS OF STANDARD CHARACTERS WITHOUT CLAIM TO ANY PARTICULAR FONT, STYLE, SIZE, OR COLOR.

OWNER OF U.S. REG. NO. 3,093,878.

SER. NO. 77-387,798, FILED 2-4-2008.

CARRIE GENOVESE, EXAMINING ATTORNEY

**Int. Cl.: 33**

**Prior U.S. Cls.: 47 and 49**

**United States Patent and Trademark Office**

**Reg. No. 3,498,609**

**Registered Sep. 9, 2008**

**TRADEMARK  
PRINCIPAL REGISTER**

**BRYAN WOODS**

GEERLINGS & WADE, INC. (MASSACHUSETTS  
CORPORATION)  
960 TURNPIKE STREET  
CANTON, MA 02021

FOR: WINES, IN CLASS 33 (U.S. CLS. 47 AND 49).

FIRST USE 5-26-2003; IN COMMERCE 11-14-2003.

THE MARK CONSISTS OF STANDARD CHAR-  
ACTERS WITHOUT CLAIM TO ANY PARTICULAR  
FONT, STYLE, SIZE, OR COLOR.

THE NAME(S), PORTRAIT(S), AND/OR SIGNA-  
TURE(S) SHOWN IN THE MARK DOES NOT IDEN-  
TIFY A PARTICULAR LIVING INDIVIDUAL.

THE WORDING "BRYAN WOODS" HAS NO  
MEANING IN A FOREIGN LANGUAGE.

SER. NO. 77-387,812, FILED 2-4-2008.

ELI HELLMAN, EXAMINING ATTORNEY

Int. Cl.: 25

Prior U.S. Cls.: 22 and 39

United States Patent and Trademark Office

Reg. No. 3,498,610

Registered Sep. 9, 2008

TRADEMARK  
PRINCIPAL REGISTER

*Bejeweled*

LTM INTERNATIONAL, INC. (FLORIDA CORPORATION)  
15851 SW 41ST STREET, SUITE 800  
DAVIE, FL 33331

FOR: CLOTHING, NAMELY, SHIRTS, T-SHIRTS, TANK TOPS, PANTS, GYM PANTS, SWEAT PANTS, SWEAT SUITS, JACKETS, HOODED JACKETS, ZIP-FRONT JACKETS, SHORTS, GYM SHORTS, JERSEY SHORTS, CLOTH BELTS, JEANS, DRESSES, SKIRTS, AND CAPS, IN CLASS 25 (U.S. CLS. 22 AND 39).

FIRST USE 3-31-2001; IN COMMERCE 3-31-2001.

OWNER OF U.S. REG. NO. 2,994,181.

THE MARK CONSISTS OF THE STYLIZED WORD "BEJEWELED".

SEC. 2(F).

SER. NO. 77-387,830, FILED 2-4-2008.

ALLISON SCHRODY, EXAMINING ATTORNEY

**Int. Cl.: 25**

**Prior U.S. Cls.: 22 and 39**

**United States Patent and Trademark Office**

**Reg. No. 3,498,611**

**Registered Sep. 9, 2008**

**TRADEMARK  
PRINCIPAL REGISTER**

**'TOON COUTURE**

LTM INTERNATIONAL, INC. (FLORIDA CORPORATION)  
15861 SW 41ST STREET, SUITE 800  
DAVIE, FL 33331

FOR: CLOTHING, NAMELY, SHIRTS, T-SHIRTS, TANK TOPS, PANTS, GYM PANTS, SWEAT PANTS, SWEAT SUITS, JACKETS, HOODED JACKETS, ZIP-FRONT JACKETS, SHORTS, GYM SHORTS, JERSEY SHORTS, CLOTH BELTS, JEANS, DRESSES, SKIRTS, AND CAPS, IN CLASS 25 (U.S. CLS. 22 AND 39).

FIRST USE 7-31-2005; IN COMMERCE 10-30-2005.

THE MARK CONSISTS OF STANDARD CHARACTERS WITHOUT CLAIM TO ANY PARTICULAR FONT, STYLE, SIZE, OR COLOR.

NO CLAIM IS MADE TO THE EXCLUSIVE RIGHT TO USE "COUTURE", APART FROM THE MARK AS SHOWN.

SER. NO. 77-387,854, FILED 2-4-2008.

BARBARA GAYNOR, EXAMINING ATTORNEY

**Int. Cl.: 33**

**Prior U.S. Cls.: 47 and 49**

**United States Patent and Trademark Office**

**Reg. No. 3,498,612**

**Registered Sep. 9, 2008**

**TRADEMARK  
PRINCIPAL REGISTER**

**CROSSBARN**

PAUL HOBBS WINERY, L.P. (CALIFORNIA LIMITED PARTNERSHIP)  
3355 GRAVENSTEIN HIGHWAY NORTH  
SEBASTOPOL, CA 95472

THE MARK CONSISTS OF STANDARD CHARACTERS WITHOUT CLAIM TO ANY PARTICULAR FONT, STYLE, SIZE, OR COLOR.

FOR: WINES, IN CLASS 33 (U.S. CLS. 47 AND 49).

SER. NO. 77-387,856, FILED 2-4-2008.

FIRST USE 1-1-2000; IN COMMERCE 1-1-2000.

BARBARA GAYNOR, EXAMINING ATTORNEY



Int. Cl.: 43

Prior U.S. Cls.: 100 and 101

United States Patent and Trademark Office

Reg. No. 3,498,613

Registered Sep. 9, 2008

SERVICE MARK  
PRINCIPAL REGISTER



E-BRANDS RESTAURANTS LLC (FLORIDA  
LIMITED LIABILITY COMPANY)  
7680 UNIVERSAL BLVD.  
ORLANDO, FL 32819

FOR: RESTAURANT, BAR, AND CATERING  
SERVICES, IN CLASS 43 (U.S. CLS. 100 AND 101).

FIRST USE 12-0-2006; IN COMMERCE 12-0-2006.

OWNER OF U.S. REG. NOS. 2,661,940 AND  
2,839,950.

NO CLAIM IS MADE TO THE EXCLUSIVE  
RIGHT TO USE "MARTINI BAR" AND "CHOP-  
HOUSE", APART FROM THE MARK AS SHOWN.

THE COLOR(S) BLACK, WHITE, YELLOW AND  
RED IS/ARE CLAIMED AS A FEATURE OF THE  
MARK.

THE MARK CONSISTS OF A BLACK RECTAN-  
GLE CONTAINING THE WORDS "MARTINI BAR"  
IN YELLOW LETTERING IN AN ARC FORMA-  
TION, BENEATH WHICH IS A STYLIZED LEAF  
DESIGN IN YELLOW, BOTH ON A BLACK BACK-  
GROUND, BENEATH WHICH IS THE STYLIZED  
WORD "TIMPANO" IN BLACK LETTERING ON A  
WHITE BACKGROUND BETWEEN TWO HORI-  
ZONTAL RED BARS, BENEATH WHICH IS A  
STYLIZED LEAF DESIGN IN RED, BENEATH  
WHICH IS THE WORD "CHOPHOUSE" IN BLACK  
LETTERING IN AN ARC FORMATION, BOTH ON A  
YELLOW BACKGROUND.

THE ENGLISH TRANSLATION OF "TIMPANO"  
IN THE MARK IS "KETTLEDRUM".

SER. NO. 77-387,861, FILED 2-4-2008.

CYNTHIA SLOAN, EXAMINING ATTORNEY

**Int. Cl.: 35**

**Prior U.S. Cls.: 100, 101 and 102**

**United States Patent and Trademark Office**

**Reg. No. 3,498,614**

**Registered Sep. 9, 2008**

**SERVICE MARK  
PRINCIPAL REGISTER**

**RUG & HOME**

RUG & HOME, INC. (SOUTH CAROLINA CORPORATION)  
4 FACTORY SHOPS BOULEVARD  
GAFFNEY, SC 29341

FOR: RETAIL HOME FURNISHING STORE SERVICES, IN CLASS 35 (U.S. CLS. 100, 101 AND 102).

FIRST USE 7-1-1998; IN COMMERCE 7-1-1998.

THE MARK CONSISTS OF STANDARD CHARACTERS WITHOUT CLAIM TO ANY PARTICULAR FONT, STYLE, SIZE, OR COLOR.

OWNER OF U.S. REG. NO. 2,346,214.

NO CLAIM IS MADE TO THE EXCLUSIVE RIGHT TO USE "RUG", APART FROM THE MARK AS SHOWN.

SEC. 2(F).

SER. NO. 77-387,933, FILED 2-4-2008.

CARRIE GENOVESE, EXAMINING ATTORNEY

Int. Cl.: 5

Prior U.S. Cls.: 6, 18, 44, 46, 51 and 52

United States Patent and Trademark Office

Reg. No. 3,498,615

Registered Sep. 9, 2008

TRADEMARK  
PRINCIPAL REGISTER



ACTIVE AND FREE LLC (ALABAMA LIMITED  
LIABILITY COMPANY)  
1957 HOOVER COURT SUITE 100  
BIRMINGHAM, AL 35226

THE MARK CONSISTS OF STYLIZED WORD  
"ACTIVE" IN GREEN; STYLIZED WORDS "AND  
FREE" IN BLUE; SILHOUETTES OF A MAN AND A  
WOMAN IN BLUE.

FOR: DIETARY AND NUTRITIONAL SUPPLE-  
MENTS, IN CLASS 5 (U.S. CLS. 6, 18, 44, 46, 51 AND  
52).

SER. NO. 77-387,938, FILED 2-4-2008.

FIRST USE 11-29-2007; IN COMMERCE 1-0-2008.

THE COLOR(S) GREEN AND BLUE IS/ARE  
CLAIMED AS A FEATURE OF THE MARK.

SARA THOMAS, EXAMINING ATTORNEY

**Int. Cl.: 37**

**Prior U.S. Cls.: 100, 103 and 106**

**United States Patent and Trademark Office**

**Reg. No. 3,498,616**

**Registered Sep. 9, 2008**

**SERVICE MARK  
PRINCIPAL REGISTER**

**CLOGMAN**

CLOGMAN, LLC (NEW JERSEY LIMITED LIABILITY COMPANY)  
115 BERGENLINE AVENUE  
WESTWOOD, NJ 07675

THE MARK CONSISTS OF STANDARD CHARACTERS WITHOUT CLAIM TO ANY PARTICULAR FONT, STYLE, SIZE, OR COLOR.

FOR: PLUMBING SERVICES, NAMELY, SEWER AND DRAIN CLEANING, IN CLASS 37 (U.S. CLS. 100, 103 AND 106).

SER. NO. 77-387,968, FILED 2-4-2008.

FIRST USE 5-1-2007; IN COMMERCE 5-1-2007.

ANGELA M. MICHELI, EXAMINING ATTORNEY

**Int. Cl.: 5**

**Prior U.S. Cls.: 6, 18, 44, 46, 51 and 52**

**Reg. No. 3,498,617**

**United States Patent and Trademark Office**

**Registered Sep. 9, 2008**

**TRADEMARK  
PRINCIPAL REGISTER**



MEDNUTRIENT PANACEUTICALS (CALIFORNIA PARTNERSHIP), DBA MEDNUTRIENT PANACEUTICALS  
12821 CORAL TREE PLACE  
LOS ANGELES, CA 90066

FOR: NUTRACEUTICALS FOR USE AS A DIETARY SUPPLEMENT, IN CLASS 5 (U.S. CLS. 6, 18, 44, 46, 51 AND 52).

FIRST USE 10-15-2006; IN COMMERCE 12-10-2006.

THE COLOR(S) PURPLE, GREEN AND WHITE IS/ARE CLAIMED AS A FEATURE OF THE MARK.

THE MARK CONSISTS OF PURPLE CAPSULE WITH GREEN LEAF INSIDE FOLLOWED BY "MEDNUTRIENT PANACEUTICALS MED" AND "PANACEUTICALS" ARE IN PURPLE, "NUTRIENT" IS IN GREEN. THE GREEN LIFE HAS A WHITE LINE INSIDE AND A WHITE OUTLINE.

SER. NO. 77-387,975, FILED 2-4-2008.

ANGELA M. MICHELI, EXAMINING ATTORNEY

**Int. Cl.: 35**

**Prior U.S. Cls.: 100, 101 and 102**

**United States Patent and Trademark Office**

**Reg. No. 3,498,618**

**Registered Sep. 9, 2008**

**SERVICE MARK  
PRINCIPAL REGISTER**

**WE MAKE IT FRESH. YOU MAKE  
IT PERSONAL.**

WORLD'S FINEST CHOCOLATE, INC. (DELA-  
WARE CORPORATION)  
4801 SOUTH LAWDALE  
CHICAGO, IL 60632

FOR: PROMOTING THE FUND RAISING EF-  
FORTS OF OTHERS BY PROVIDING CANDY PRO-  
DUCTS CUSTOMIZED TO THE SPECIFICATIONS  
OF FUND RAISERS, IN CLASS 35 (U.S. CLS. 100, 101  
AND 102).

FIRST USE 1-14-2008; IN COMMERCE 1-14-2008.

THE MARK CONSISTS OF STANDARD CHAR-  
ACTERS WITHOUT CLAIM TO ANY PARTICULAR  
FONT, STYLE, SIZE, OR COLOR.

SER. NO. 77-388,077, FILED 2-4-2008.

WENDY GOODMAN, EXAMINING ATTORNEY

**Int. Cl.: 35**

**Prior U.S. Cls.: 100, 101 and 102**

**United States Patent and Trademark Office**

**Reg. No. 3,498,619**

**Registered Sep. 9, 2008**

**SERVICE MARK  
PRINCIPAL REGISTER**

**RED ZONE LEADERSHIP**

KUZMESKI, MARIBETH (UNITED STATES IN-  
DIVIDUAL)  
1509 N. MILWAUKEE AVENUE  
LIBERTYVILLE, IL 60048

FOR: MARKETING CONSULTING; MANAGE-  
MENT AND BUSINESS CONSULTING SERVICES  
IN THE FIELD OF LEADERSHIP; BUSINESS MAN-  
AGEMENT CONSULTING SERVICES IN THE  
FIELD OF LEADERSHIP DEVELOPMENT, IN  
CLASS 35 (U.S. CLS. 100, 101 AND 102).

FIRST USE 11-6-2007; IN COMMERCE 11-6-2007.

THE MARK CONSISTS OF STANDARD CHAR-  
ACTERS WITHOUT CLAIM TO ANY PARTICULAR  
FONT, STYLE, SIZE, OR COLOR.

OWNER OF U.S. REG. NO. 2,575,977.

NO CLAIM IS MADE TO THE EXCLUSIVE  
RIGHT TO USE "LEADERSHIP", APART FROM  
THE MARK AS SHOWN.

SER. NO. 77-388,119, FILED 2-4-2008.

MARK SPARACINO, EXAMINING ATTORNEY

**Int. Cl.: 36**

**Prior U.S. Cls.: 100, 101 and 102**

**United States Patent and Trademark Office**

**Reg. No. 3,498,620**

**Registered Sep. 9, 2008**

**SERVICE MARK  
PRINCIPAL REGISTER**



PROPERTY DAMAGE APPRAISERS, INC.  
(TEXAS CORPORATION)  
6100 SOUTHWEST BOULEVARD  
FORT WORTH, TX 76109

FOR: RENDERING APPRAISALS FOR PROPERTY DAMAGE TO AUTOMOBILES, BUILDINGS, AND DWELLINGS FOR INSURANCE CLAIMS, IN CLASS 36 (U.S. CLS. 100, 101 AND 102).

FIRST USE 1-30-2008; IN COMMERCE 1-30-2008.

OWNER OF U.S. REG. NOS. 1,671,343 AND 1,674,517.

THE COLOR(S) GREEN AND YELLOW IS/ARE CLAIMED AS A FEATURE OF THE MARK.

THE MARK CONSISTS OF THREE THICK WAVY HORIZONTAL LINES, WITH THE TOP AND BOTTOM LINES IN GREEN AND THE MIDDLE LINE IN YELLOW. UNDER THE LINES ON THE RIGHT SIDE, THE WORDS "WE'RE WITH YOU" APPEAR IN GREEN. ON THE FAR RIGHT SIDE OF THE DESIGN, THE LETTERS "PDA" APPEAR IN GREEN IN LARGE PRINT.

SER. NO. 77-388,176, FILED 2-4-2008.

REBECCA SMITH, EXAMINING ATTORNEY



Int. Cl.: 16

Prior U.S. Cls.: 2, 5, 22, 23, 29, 37, 38 and 50

Reg. No. 3,498,621

United States Patent and Trademark Office

Registered Sep. 9, 2008

TRADEMARK  
PRINCIPAL REGISTER

DEⓈPHAERA

NIERMAN, DANIEL (MEXICO INDIVIDUAL)  
233 W NORTH AVE  
CHICAGO, IL 60610

FOR: BLANK PAPER NOTEBOOKS; NOTEBOOK DIVIDERS; NOTEBOOK PAPER; NOTEBOOKS; PAPER NOTEBOOKS; REPORTERS' NOTEBOOKS; SCHOOL SUPPLY KITS CONTAINING VARIOUS COMBINATIONS OF SELECTED SCHOOL SUPPLIES, NAMELY, WRITING INSTRUMENTS, PENS, PENCILS, MECHANICAL PENCILS, ERASERS, MARKERS, CRAYONS, HIGHLIGHTERS, FOLDERS, NOTEBOOKS, PAPER, GRADUATED RULERS, PROTRACTORS, PAPER CLIPS, PENCIL SHARPENERS, WRITING GRIPS, GLUE AND BOOK MARKS; STENOGRAPHERS' NOTEBOOKS; WIRE-BOUND NOTEBOOKS; ADHESIVE-BACKED LETTERS AND NUMBERS FOR USE IN MAKING NOTEBOOKS; EDUCATIONAL PUBLICATIONS, NAMELY, EDUCATIONAL LEARNING CARDS, FLASH CARDS, ACTIVITY CARDS, WORKBOOKS, TEXTBOOKS, ACTIVITY BOOKS, STORY BOOKS, PUZZLE BOOKS, PUZZLES, TEACHER GUIDES, MANUALS, POSTERS, EDUCATIONAL CARD GAMES AND EDUCATIONAL BOOKLETS IN THE FIELD OF DESIGN; MOUNTED POSTERS; PAPER LETTERS AND NUMBER FOR USE IN MAKING NOTEBOOKS; POSTER BOARD; POSTERS; POSTERS MADE OF PAPER; UNMOUNTED POSTERS; VINYL LETTERS AND NUMBER FOR USE IN MAKING NOTEBOOKS; ADVERTISING BOARDS OF PAPER OR CARDBOARD; ADVERTISING SIGNS OF PAPER OR CARDBOARD; BOTTLE WRAPPERS OF CARDBOARD OR PAPER; BOXES OF CARDBOARD OR PAPER; BOXES OF PAPER OR CARDBOARD; CARDBOARD; CARDBOARD BACKING FOR BINDING BOOKS; CARDBOARD BOXES; CARDBOARD CARRIERS FOR FOOD AND BEVERAGES; CARDBOARD CARTONS; CARDBOARD CONTAINERS; CARDBOARD FLOOR DISPLAY UNITS FOR MERCHANDISING PRODUCTS; CARDBOARD HANG TAGS; CARDBOARD MADE

FROM PAPER MULBERRY (SENKASI); CARDBOARD MAILING TUBES; CARDBOARD PACKAGING; CARDBOARD TUBES; COLLAPSIBLE CARDBOARD BOXES; CONTAINERS FOR ICE MADE OF PAPER OR CARDBOARD; CORRUGATED CARDBOARD; CORRUGATED CARDBOARD BOXES; FREE-STANDING AND WALL-MOUNTED PAPER AND CARDBOARD BOXES FOR DEPOSITING A WRITTEN MESSAGE OR PRAYER WISHING A LOVED ONE WELL, FOR USE IN HOSPITALS, ELDER CARE RESIDENCES, SCHOOLS, AND INSTITUTIONS FOR CHILDREN WITH SPECIAL NEEDS; HAT BOXES OF CARDBOARD; LINERBOARD FOR CORRUGATED CARDBOARD; PACKING CARDBOARD; PACKING CARDBOARD CONTAINERS; PAPER AND CARDBOARD; PAPERBOARD; PICTURE MOUNTS OF CARDBOARD; PLACARDS OF PAPER OR CARDBOARD; TRADING CARD DISCS OF PAPER OR CARDBOARD; ALUMINUM FOIL LAMINATED PAPER FOR PRINTING PURPOSES; ART PAPER; AUTOMATIC PAPER CLIP DISPENSING MACHINES FOR OFFICE OR STATIONERY USE; BABIES' DIAPERS OF PAPER; BANNERS OF PAPER; BIBS OF PAPER; BINDING MATERIALS FOR BOOKS AND PAPERS; BIODEGRADABLE PAPER PULP-BASED TO-GO CONTAINERS FOR FOOD; BLANK OR PARTIALLY PRINTED PAPER LABELS; BLANK PAPER COMPUTER TAPES; BLANK PAPER COMPUTER TAPES FOR RECORDING PROGRAMS; BLANK PAPER TAPES AND CARDS FOR THE RECORDING OF COMPUTER PROGRAMS; BLOTTING PAPER; BOND PAPER; BOOK-COVER PAPER; BOXES OF PAPER; BURP PADS OF PAPER; BUSINESS CARD PAPER; CALENDAR-FINISHED PAPER; CALLIGRAPHY PAPER; CARBON PAPER; CARBONLESS PAPER; CARRYING CASES MADE OF PAPER; CELLOPHANE PAPER; COASTERS MADE OF PAPER; COASTERS OF PAPER; COLLAPSIBLE BOXES OF PAPER; COMPOSITE PANELS CONSISTING OF A SPECIALLY-FORMULATED PAPERBOARD CORE WITH DENSE PAPER FACES FOR USE IN

FURTHER MANUFACTURING; COMPUTER PAPER; CONSTRUCTION PAPER; COPIER PAPER; COPY PAPER; CORRUGATED BOARD AND PAPER CONTAINERS; CORRUGATED PAPER; COSMETIC REMOVING PAPER; COVERS OF PAPER FOR FLOWER POTS; CRAFT PAPER; CREPE PAPER; CREPE PAPER FOR MEDICAL, SANITARY OR DOMESTIC USE; CUSHIONING OR PADDING MADE OF PAPER FOR PACKING PURPOSES; DECORATIVE PAPER CENTERPIECES; DIGITAL PRINTING PAPER; DIRECTORY PAPER; DISPOSABLE PAPER SHEETS FOR PERSONAL HYGIENIC USE IN THE NATURE OF DISPOSABLE HEADREST COVERS NOT FOR MEDICAL USE; DRAWING PAPER; DUPLICATING PAPER; DYE-SUBLIMATION PRINT PAPER; EKG PAPER; ELECTROCARDIOGRAPH PAPER; ELECTROSTATIC PAPER; EMBROIDERY DESIGN PATTERNS; ENVELOPE PAPER; ENVELOPE PAPERS; FACE TOWELS OF PAPER; FACSIMILE TRANSMISSION PAPER; FIBER PAPER; FILING FOLDERS, PAPER LABELS AND PRINTED INSTRUCTIONAL MATERIALS FOR ORGANIZING PERSONAL FILES; FILLER PAPER; FILTER PAPER; FLAGS AND PENNANTS OF PAPER; FLAGS OF PAPER; FLUORESCENT PAPER; FLUTING PAPER; GARBAGE BAGS OF PAPER; GIFT WRAP PAPER; GIFT WRAPPING PAPER; GIFT-WRAPPING PAPER; GLASSINE PAPER; GRAPH PAPER; GROCERY PAPER; GUMMED PAPER; GUNPOWDER WRAPPING PAPER; HALLOWEEN GOODIE BAGS OF PAPER OR PLASTIC; HAND TOWELS OF PAPER; HANDKERCHIEFS OF PAPER; HAT BOXES OF PAPER; HEAT SENSITIVE PAPER; HEAT TRANSFER PAPER; HONEYCOMB PAPER; HYGIENIC PAPER; ILLUSTRATION PAPER; IMITATION LEATHER PAPER; INDIA PAPER; INDUSTRIAL PACKAGING CONTAINERS OF PAPER; JAPANESE CEREMONIAL PAPER STRINGS (MIZUHIKI); JAPANESE HANDICRAFT PAPER; JAPANESE PAPER; JAPANESE PAPER (TORINOKO-GAMI); KRAFT PAPER; LABEL PAPER; LAMINATED PAPER; LASER PRINT PAPER; LASER PRINTING PAPER; LETTER PAPER; LETTERHEAD PAPER; LINING PAPER; LOOSE LEAF PAPER; LUMINOUS PAPER; MAGAZINE PAPER; MAGNETIC PAPER; MANIFOLD PAPER; MASKING PAPER; METALLIC GIFT WRAPPING PAPER; METALLIC PAPER PARTY DECORATIONS; MILDEWPROOF PAPER; MIMEOGRAPH PAPER; MODELING MATERIALS FOR USE IN MAKING CAST PAPER SCULPTURED FLOWERS; MOISTUREPROOF CELLOPHANE PAPER; MULCH PAPER; NAPKIN PAPER; NAPKINS OF PAPER FOR REMOVING MAKE-UP; NEWSPRINT PAPER; NOTE PAPER; NOTE PAPERS; OFFICE PAPER DRILL MACHINES; OFFICE PAPER STATIONERY; OFFSET PAPER; OFFSET PRINTING PAPER FOR PAMPHLETS; OILED PAPER FOR PAPER UMBRELLAS (KASA-GAMI); OILPROOF PAPER; ONION SKIN PAPER; OPAQUE PAPER; PACKAGING AND CONTAINERS COMPRISED OF STARCH-BASED MATERIALS IN THE NATURE OF A PAPER SUBSTITUTE FOR FOOD, BEVERAGES AND CONSUMER PRODUCTS; PACKAGING CONTAINERS OF PAPER; PACKING PAPER; PAPER; PAPER BABY BIBS; PAPER BADGES; PAPER BAGS; PAPER BAGS AND SACKS; PAPER BAGS FOR PACKAGING;

PAPER BANNERS; PAPER BOARD; PAPER BOARDS; PAPER BOWS FOR GIFT WRAP; PAPER BOXES; PAPER BOXES FOR STORING GREETING CARDS; PAPER BUNTING; PAPER CAKE DECORATIONS; PAPER CARTON SEALING TAPE; PAPER CARTONS FOR DELIVERING GOODS; PAPER CLIP HOLDERS; PAPER CLIPS; PAPER CLOSURES FOR CONTAINERS; PAPER CLOSURES FOR SEALING CONTAINERS; PAPER CONTAINERS; PAPER CONTAINING MICA; PAPER COVERS FOR TELEPHONE RECEIVERS; PAPER CUTTERS; PAPER DIAPERS; PAPER DIE CUT SHAPES; PAPER DISPLAY BOXES; PAPER DOILIES; PAPER DROP CLOTHS; PAPER EGG CARTONS; PAPER EMBLEMS; PAPER EMBOSSERS; PAPER ENVELOPES FOR PACKAGING; PAPER EXPANDING FILES; PAPER FASTENERS; PAPER FILE JACKETS; PAPER FILTERS FOR COFFEE MAKERS; PAPER FLAGS; PAPER FLOOR MATS; PAPER FLOWER POT COVERS; PAPER FOLDERS; PAPER FOLDING MACHINES AS OFFICE REQUISITES; PAPER FOLDING MACHINES FOR OFFICE USE; PAPER FOR JAPANESE INDOOR SLIDING PARTITIONS (FUSUMA-GAMI); PAPER FOR JAPANESE SLIDING SCREENS (SHOJI-GAMI); PAPER FOR BAGS AND SACKS; PAPER FOR PHOTOCOPIES; PAPER FOR PHOTOCOPYING; PAPER FOR RECORDING MACHINES; PAPER FOR USE AS MATERIAL OF STOCK CERTIFICATES (SHOKENSHI); PAPER FOR USE IN THE GRAPHIC ARTS INDUSTRY; PAPER FOR USE IN THE MANUFACTURE OF WALLPAPER; PAPER FOR USE IN THE MANUFACTURE OF NOTEBOOKS; PAPER FOR WRAPPING AND PACKAGING; PAPER FUTON COVERS; PAPER GARBAGE BAGS; PAPER GIFT BAGS; PAPER GIFT BAGS FOR WINE; PAPER GIFT TAGS; PAPER GIFT WRAP; PAPER GIFT WRAP BOWS; PAPER GIFT WRAPPING RIBBONS; PAPER HAND-TOWELS; PAPER HANDKERCHIEFS; PAPER HANDTOWELS; PAPER HANG TAGS; PAPER HOLE PUNCHES; PAPER IDENTIFICATION TAGS; PAPER ILLUSTRATION BOARDS; PAPER KNIVES; PAPER LABELS; PAPER LACE; PAPER LINERS FOR DIAPERS; PAPER MACHE; PAPER MACHE FIGURINES; PAPER MADE FROM PAPER MULBERRY (KOHZO-GAMI); PAPER MADE FROM PAPER MULBERRY (TENGUJOSI); PAPER MAIL POUCHES; PAPER MATS; PAPER NAME BADGES; PAPER NAPKINS; PAPER NOTE TABLETS; PAPER PACKAGING AND CONTAINERS FOR FOOD AND BEVERAGES COMPRISED OF MATERIALS DESIGNED TO LESSEN ADVERSE EFFECTS ON THE ENVIRONMENT; PAPER PADDING; PAPER PADS FOR CHANGING DIAPERS; PAPER PARTY BAGS; PAPER PARTY DECORATIONS; PAPER PARTY FAVORS; PAPER PATCHES FOR CLOTHING; PAPER PENNANTS; PAPER PET CRATE MATS; PAPER PICTURE MOUNTS; PAPER PILLOWCASES; PAPER PLACE MATS; PAPER POUCHES FOR PACKAGING; PAPER PRODUCTS, NAMELY, PAPER TUBES; PAPER PRODUCTS, NAMELY, PAPER TUBES AND PAPER CORES; PAPER RACKS; PAPER REFUSE BAGS; PAPER REPORT COVERS; PAPER RIBBONS; PAPER ROLLS FOR CALCULATING MACHINES; PAPER SHEETS FOR NOTE TAKING; PAPER SHOPPING BAGS; PAPER SHREDDERS; PAPER SIGN HOLDERS; PAPER STAPLERS; PAPER STAPLES; PAPER

STATIONERY; PAPER STOCK; PAPER TABLE CLOTHS; PAPER TABLE LINENS; PAPER TAGS; PAPER TAKE-OUT CARTONS FOR FOOD; PAPER TAPE; PAPER TAPES; PAPER TAPES FOR CALCULATING MACHINES; PAPER TAPES FOR CALCULATORS; PAPER TEACHING MATERIALS IN THE FIELD OF DESIGN; PAPER TOWELS; PAPER TRANSPARENCIES; PAPER TRAY COVERS; PAPER WASHCLOTHS; PAPER WEIGHTS; PAPER WINE GIFT BAGS; PAPER-FEEDING MACHINES FOR OFFICE USE; PAPERS FOR HOUSEHOLD AND INDUSTRIAL USE; PAPERS FOR USE IN THE GRAPHIC ARTS INDUSTRY; PARAFFINED PAPER; PARCHMENT PAPER; PARTY GOODIE BAGS OF PAPER OR PLASTIC; PARTY ORNAMENTS OF PAPER; PENNANTS OF PAPER; PHOTOCOPY PAPERS; PICTURE MOUNTS OF PAPER; PLACE MATS OF PAPER; PLASTIC COATED COPYING PAPER; PLASTIC OR PAPER BAGS FOR HOUSEHOLD USE; PLASTIC OR PAPER BAGS FOR MERCHANDISE PACKAGING; PLASTIC-COATED COPYING PAPER; PLOTTING PAPERS; POLYESTER FILM FOR USE AS A PAPER SUBSTITUTE FOR DRY TONER XEROGRAPHIC IMAGING, NAMELY, LASER PRINTING, COLOR COPIER PRINTING, DRY TONER PRINTING, SCREEN PRINTING, AND OFFSET PRINTING; POSTCARD PAPER; PRINTED PAPER LABELS; PRINTED PAPER SIGNS; PRINTED PAPER SIGNS, NAMELY, TABLE TENTS; PRINTING PAPER; PRINTING PAPERS; PROOFING PAPER; PROTECTIVE COVERS FOR SHEETS OR PAPER AND PAGES OF BOOKS AND THE LIKE; PUBLICATION PAPER; RECYCLED BOND PAPER; RECYCLED PAPER; REEL PAPER FOR PRINTERS; REPRODUCTION PAPER; RICE PAPER; RUBBISH BAGS MADE OF PAPER OR PLASTIC MATERIALS; RULED PAPER; SAFETY PAPER; SCENTED PAPER DRAWER LINERS; SEMI-PROCESSED PAPER; SHELF PAPER; SPECIALTY PAPERS, NAMELY, VEGETABLE PARCHMENT, FOR USE IN FOOD WRAPPING, PREPARATION, PROCESSING AND

PACKAGING APPLICATIONS; STATIONERY WRITING PAPER AND ENVELOPES; STENCIL PAPER; STENCILS AND PATTERNS, BEING OF PAPER AND PLASTIC, FOR THE TRANSFERRING OF GRAPHIC DESIGNS TO PUMPKINS, MINI-PUMPKINS, GOURDS, AND OTHER FRUITS AND VEGETABLES; STORAGE CONTAINERS MADE OF PAPER; STRIPS OF FANCY PAPER (TANZAKU); SUPERCALANDERED PRINTING PAPER; SYNTHETIC BOND PAPER; SYNTHETIC PAPER; TABLE CLOTHS OF PAPER; TABLE LINENS OF PAPER; TABLE MATS OF PAPER; TABLE NAPKINS OF PAPER; THERMOSENSITIVE PAPER; THICK JAPANESE PAPER; TISSUE PAPER; TISSUE PAPER FOR USE AS MATERIAL OF STENCIL PAPER (GANPISHI); TISSUES OF PAPER FOR REMOVING MAKE-UP; TOILET PAPER; TOILET SEAT COVER PAPER; TOILET TRAINING TARGETS MADE OF PAPER; TRACING PAPER; TREATED PAPER FOR WRAPPING FLOWERS AND FLORAL DISPLAYS; TYPEWRITER PAPER; UNFITTED FURNITURE COVERS OF PAPER; UNPRINTED PAPER; UNSENSITIZED PHOTO PAPER; WATERPROOF PAPER; WAX BOND PAPER; WAX PAPER; WOOD PULP PAPER; WORKS OF ART MADE FROM CUSTOM MANUFACTURED PAPER; WRAPPING PAPER; WRITING PAPER; WRITING PAPER HOLDERS; WRITING PAPER PADS; XEROGRAPHIC PAPER, IN CLASS 16 (U.S. CLS. 2, 5, 22, 23, 29, 37, 38 AND 50).

OWNER OF MEXICO REG. NO. 978560, DATED 3-26-2007, EXPIRES 12-20-2016.

THE MARK CONSISTS OF THE WORD "DE-SPHAERA" WITH A DOUBLE CIRCLE AROUND THE LETTER "S".

SER. NO. 77-388,227, FILED 2-4-2008.

MARK T. MULLEN, EXAMINING ATTORNEY

Int. Cls.: 37, 42 and 45

Prior U.S. Cls.: 100, 101, 103 and 106

Reg. No. 3,498,622

United States Patent and Trademark Office

Registered Sep. 9, 2008

SERVICE MARK  
PRINCIPAL REGISTER

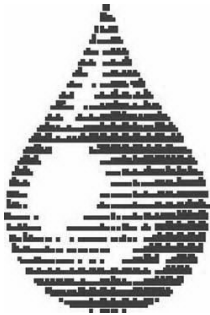

Balance  
Hydrologics, Inc.

BALANCE HYDROLOGICS, INC. (CALIFORNIA CORPORATION)

800 BANCROFT WAY  
SUITE 101  
BERKELEY, CA 94710

FOR: WATER WELL DRILLING, IN CLASS 37 (U.S. CLS. 100, 103 AND 106).

FIRST USE 9-5-1988; IN COMMERCE 9-5-1988.

FOR: ENVIRONMENTAL SERVICES, NAMELY, TECHNICAL CONSULTATION IN THE FIELD OF ENVIRONMENTAL SCIENCE, ENGINEERING SERVICES, DESIGN FOR OTHERS IN THE FIELD OF ENVIRONMENTAL ENGINEERING, DESIGNING AND TESTING OF NEW ENVIRONMENTALLY FRIENDLY PRODUCTS FOR OTHERS; CONSULTATION SERVICES IN THE FIELD OF HYDROLOGICAL RESEARCH; TECHNICAL MONITORING SERVICES FOR CONDITIONS OF WATER; WELL LOGGING; CIVIL ENGINEERING FOR THE DESIGN OF CONTROLS AND MONITORING DEVICES USED IN WATER RIGHTS DEVELOPMENT AND WATER DISTRIBUTION; LANDSCAPE ARCHITECTURAL DESIGN; ENVIRONMENTAL TESTING AND INSPECTION SERVICES; CONSULTING SERVICES IN THE FIELD OF ENVIRONMENTAL ASSESSMENT, COMPLIANCE AND PLANNING; ENGINEERING AND HYDROLOGICAL DESIGN OF RESTORATION OF STREAM CHANNELS, MARSHES, ESTUARIES, AND WETLANDS; HYDROLOGIC AND ENGINEERING MODELING AND DESIGN OF MEASURES TO PROTECT AREAS LIKELY TO BE INUNDATED BY STORM-WATER AND FLOOD-WATERS; HYDROLOGIC AND HYDRAULIC MODELING AND DESIGN OF STORM DRAINAGE INFRASTRUCTURE; HYDROLOGIC STUDY OF SURFACE AND

GROUND WATER; HYDROLOGICAL CALCULATIONS AND SIMULATIONS OF FLOOD FLOWS IN STREAMS, MARSHES, AND WETLANDS; HYDROLOGICAL RESEARCH; CALCULATING AND SIMULATING FLOOD FLOWS, MODELING OF AREAS LIKELY TO BE INUNDATED, AND PREPARING RELATED REPORTS AND TECHNICAL DOCUMENTATION; ANALYSIS OF STREAM WATER QUALITY; MONITORING OF STREAM WATER QUALITY; MONITORING OF EROSION AND SEDIMENTATION; RESEARCH IN THE FIELD OF HYDROGEOLOGY; HYDRAULIC ENGINEERING AND DESIGN, IN CLASS 42 (U.S. CLS. 100 AND 101).

FIRST USE 9-5-1988; IN COMMERCE 9-5-1988.

FOR: PERMITTING, NAMELY, OBTAINING ENVIRONMENTAL, DESIGN, ZONING AND OTHER GOVERNMENTAL PERMITS FOR DEVELOPMENT PROJECTS; REVIEWING STANDARDS AND PRACTICES TO ASSURE COMPLIANCE WITH ENVIRONMENTAL, WATER-RIGHTS, CADASTRAL, FORESTRY AND BUILDING CODE LAWS AND REGULATIONS, IN CLASS 45 (U.S. CLS. 100 AND 101).

FIRST USE 9-5-1988; IN COMMERCE 9-5-1988.

NO CLAIM IS MADE TO THE EXCLUSIVE RIGHT TO USE "HYDROLOGICS, INC.", APART FROM THE MARK AS SHOWN.

THE STIPPLING IS A FEATURE OF THE MARK.

THE MARK CONSISTS OF THE WORDING "BALANCE HYDROLOGICS, INC." ALONG WITH A STYLIZED DEPICTION OF A DROP OF WATER.

SER. NO. 77-388,254, FILED 2-4-2008.

MICHAEL GAAFAR, EXAMINING ATTORNEY

Int. Cl.: 36

Prior U.S. Cls.: 100, 101 and 102

United States Patent and Trademark Office

Reg. No. 3,498,623

Registered Sep. 9, 2008

**SERVICE MARK  
PRINCIPAL REGISTER**

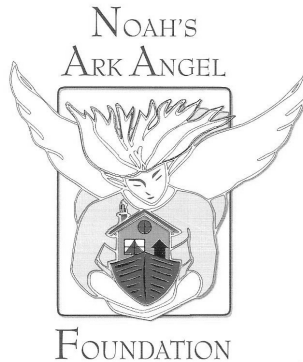

NOAH'S ARK ANGEL FOUNDATION (CALIFORNIA CORPORATION)  
SUITE 2000  
225 BROADWAY  
SAN DIEGO, CA 92101

FOR: CHARITABLE FUNDRAISING SERVICES,  
IN CLASS 36 (U.S. CLS. 100, 101 AND 102).

FIRST USE 9-27-2007; IN COMMERCE 9-27-2007.

NO CLAIM IS MADE TO THE EXCLUSIVE  
RIGHT TO USE "FOUNDATION", APART FROM  
THE MARK AS SHOWN.

THE MARK CONSISTS OF THE LITERAL ELEMENT "NOAH'S ARK ANGEL FOUNDATION" SURROUNDING AN ANGEL EMERGING THROUGH A RECTANGLE AND HOLDING NOAH'S ARK.

SER. NO. 77-388,276, FILED 2-4-2008.

PATRICIA EVANKO, EXAMINING ATTORNEY

Int. Cl.: 35

Prior U.S. Cls.: 100, 101 and 102

United States Patent and Trademark Office

Reg. No. 3,498,624

Registered Sep. 9, 2008

SERVICE MARK  
PRINCIPAL REGISTER



YOGIBERRY INC. (MARYLAND CORPORATION)  
3909 FOX VALLEY DR.  
ROCKVILLE, MD 20853

THE MARK CONSISTS OF THE TEXT "YOGIBERRY" WITH THE "I" REPLACED WITH A SPOON.

FOR: RETAIL FROZEN YOGURT STORE, IN CLASS 35 (U.S. CLS. 100, 101 AND 102).

SER. NO. 77-388,305, FILED 2-4-2008.

FIRST USE 2-15-2008; IN COMMERCE 2-15-2008.

ALEX KEAM, EXAMINING ATTORNEY

**Int. Cl.: 10**

**Prior U.S. Cls.: 26, 39 and 44**

**Reg. No. 3,498,625**

**United States Patent and Trademark Office**

**Registered Sep. 9, 2008**

---

**TRADEMARK  
PRINCIPAL REGISTER**

**AcuZone**

K.S. CHOI CORP. (CALIFORNIA CORPORATION)  
179 W. 39TH STREET  
LOS ANGELES, CA 90037

THE MARK CONSISTS OF STANDARD CHARACTERS WITHOUT CLAIM TO ANY PARTICULAR FONT, STYLE, SIZE, OR COLOR.

FOR: ACUPUNCTURE NEEDLES, IN CLASS 10 (U.S. CLS. 26, 39 AND 44).

SER. NO. 77-388,315, FILED 2-4-2008.

FIRST USE 1-1-2003; IN COMMERCE 1-1-2003.

LANA PHAM, EXAMINING ATTORNEY



**Int. Cl.: 41**

**Prior U.S. Cls.: 100, 101 and 107**

**United States Patent and Trademark Office**

**Reg. No. 3,498,626**

**Registered Sep. 9, 2008**

**SERVICE MARK  
PRINCIPAL REGISTER**

**EONSTERS**

WANG, EMERALD H. F. (UNITED STATES IN-  
DIVIDUAL)  
2438 LAUREL LAKES BLVD  
CARMEL, IN 46032

THE MARK CONSISTS OF STANDARD CHAR-  
ACTERS WITHOUT CLAIM TO ANY PARTICULAR  
FONT, STYLE, SIZE, OR COLOR.

FOR: PROVIDING A WEB SITE THAT FEATURES  
INFORMAL INSTRUCTION ON BEAUTY AND  
HEALTH, IN CLASS 41 (U.S. CLS. 100, 101 AND 107).

SER. NO. 77-388,357, FILED 2-4-2008.

FIRST USE 11-18-2007; IN COMMERCE 11-18-2007.

MEGHAN REINHART, EXAMINING ATTORNEY

**Int. Cl.: 35**

**Prior U.S. Cls.: 100, 101 and 102**

**United States Patent and Trademark Office**

**Reg. No. 3,498,627**

**Registered Sep. 9, 2008**

**SERVICE MARK  
PRINCIPAL REGISTER**

# Optimum Business Decisions

GOLDBERG, MELVIN (UNITED STATES INDIVIDUAL)  
4748 MERRIFIELD PLACE  
COLUMBUS, OH 43220

FOR: BUSINESS ADVISORY SERVICES, CONSULTANCY AND INFORMATION; BUSINESS CONSULTATION; BUSINESS CONSULTING AND BUSINESS INFORMATION FOR ENTERPRISES; CONSULTATION IN THE FIELD OF BUSINESS ACQUISITIONS, IN CLASS 35 (U.S. CLS. 100, 101 AND 102).

FIRST USE 7-23-2006; IN COMMERCE 7-23-2006.

THE MARK CONSISTS OF STANDARD CHARACTERS WITHOUT CLAIM TO ANY PARTICULAR FONT, STYLE, SIZE, OR COLOR.

NO CLAIM IS MADE TO THE EXCLUSIVE RIGHT TO USE "BUSINESS", APART FROM THE MARK AS SHOWN.

SER. NO. 77-388,375, FILED 2-4-2008.

MARY MUNSON, EXAMINING ATTORNEY

**Int. Cl.: 36**

**Prior U.S. Cls.: 100, 101 and 102**

**United States Patent and Trademark Office**

**Reg. No. 3,498,628**

**Registered Sep. 9, 2008**

**SERVICE MARK  
PRINCIPAL REGISTER**



CHANDLER (U.S.A.), INC. (OKLAHOMA CORPORATION)  
1006 MANVEL  
CHANDLER, OK 74834

FOR: INSURANCE CARRIER SERVICES; INSURANCE AGENCIES; INSURANCE CLAIMS ADMINISTRATION; INSURANCE SERVICES, NAMELY, WRITING PROPERTY AND CASUALTY INSURANCE, IN CLASS 36 (U.S. CLS. 100, 101 AND 102).

FIRST USE 1-1-1991; IN COMMERCE 1-1-1991.

THE COLOR(S) BLUE IS/ARE CLAIMED AS A FEATURE OF THE MARK.

THE MARK CONSISTS OF A STYLIZED LETTER "C" IN BLUE WITH STRIPS OF MISSING COLOR IN THE BASE OF THE LETTER AND CAPPED WITH A TRIANGLE AT THE OPPOSITE END.

SER. NO. 77-388,402, FILED 2-5-2008.

AMY GEARIN, EXAMINING ATTORNEY

**Int. Cl.: 30**

**Prior U.S. Cl.: 46**

**United States Patent and Trademark Office**

**Reg. No. 3,498,629**

**Registered Sep. 9, 2008**

**TRADEMARK  
PRINCIPAL REGISTER**

**LOCOPOPS**

SLB ENTERPRISES OF NC (NORTH CAROLINA  
LIMITED LIABILITY COMPANY)  
117 MARKET STREET  
DURHAM, NC 27701

FOR: FROZEN CONFECTIONS, IN CLASS 30 (U.S.  
CL. 46).

FIRST USE 5-28-2005; IN COMMERCE 6-3-2005.

THE MARK CONSISTS OF STANDARD CHAR-  
ACTERS WITHOUT CLAIM TO ANY PARTICULAR  
FONT, STYLE, SIZE, OR COLOR.

OWNER OF U.S. REG. NOS. 3,229,494 AND  
3,415,124.

SER. NO. 77-388,436, FILED 2-5-2008.

CYNTHIA TRIPI, EXAMINING ATTORNEY

**Int. Cl.: 25**

**Prior U.S. Cls.: 22 and 39**

**United States Patent and Trademark Office**

**Reg. No. 3,498,630**

**Registered Sep. 9, 2008**

**TRADEMARK  
PRINCIPAL REGISTER**



VITAL, LLC (MISSOURI LIMITED LIABILITY  
COMPANY)  
12763 NEW HALLS FERRY ROAD  
FLORISSANT, MO 63033

THE MARK CONSISTS OF A STAR WITH THE  
LETTER "V" IN THE MIDDLE.

FOR: T-SHIRTS; TANK TOPS; HATS; BASEBALL  
CAPS; BEANIES; HOSIERY; JACKETS; SWEAT  
SHIRTS, IN CLASS 25 (U.S. CLS. 22 AND 39).

SER. NO. 77-388,445, FILED 2-5-2008.

FIRST USE 12-13-2007; IN COMMERCE 12-13-2007.

MICHELE SWAIN, EXAMINING ATTORNEY

**Int. Cl.: 35**

**Prior U.S. Cls.: 100, 101 and 102**

**United States Patent and Trademark Office**

**Reg. No. 3,498,631**

**Registered Sep. 9, 2008**

**SERVICE MARK  
PRINCIPAL REGISTER**

**HYHEALTH**

HYHEALTH LLC (OHIO LIMITED LIABILITY  
COMPANY)  
811 MADISON AVENUE  
TOLEDO, OH 43624

THE MARK CONSISTS OF STANDARD CHAR-  
ACTERS WITHOUT CLAIM TO ANY PARTICULAR  
FONT, STYLE, SIZE, OR COLOR.

FOR: COST MANAGEMENT FOR THE HEALTH  
CARE BENEFIT PLANS OF OTHERS, IN CLASS 35  
(U.S. CLS. 100, 101 AND 102).

SER. NO. 77-388,453, FILED 2-5-2008.

FIRST USE 3-1-2004; IN COMMERCE 3-1-2004.

MICHELE SWAIN, EXAMINING ATTORNEY

**Int. Cl.: 43**

**Prior U.S. Cls.: 100 and 101**

**United States Patent and Trademark Office**

**Reg. No. 3,498,632**

**Registered Sep. 9, 2008**

**SERVICE MARK  
PRINCIPAL REGISTER**

**CAFE NOSTALGIA**

H.O.R. CORPORATION (FLORIDA CORPORATION)

3411 INDIAN CREEK DR., #1103

MIAMI BEACH, FL 33140

FOR: COCKTAIL LOUNGES AND CAFES, IN CLASS 43 (U.S. CLS. 100 AND 101).

FIRST USE 5-21-1995; IN COMMERCE 5-21-1995.

THE MARK CONSISTS OF STANDARD CHARACTERS WITHOUT CLAIM TO ANY PARTICULAR FONT, STYLE, SIZE, OR COLOR.

NO CLAIM IS MADE TO THE EXCLUSIVE RIGHT TO USE "CAFE", APART FROM THE MARK AS SHOWN.

SER. NO. 77-388,456, FILED 2-5-2008.

RICHARD WHITE, EXAMINING ATTORNEY

**Int. Cl.: 35**

**Prior U.S. Cls.: 100, 101 and 102**

**United States Patent and Trademark Office**

**Reg. No. 3,498,633**

**Registered Sep. 9, 2008**

**SERVICE MARK  
PRINCIPAL REGISTER**

**LOCKWOOD LEADERSHIP  
ASSESSMENT**

PPS INTERNATIONAL LIMITED (NEW YORK  
CORPORATION)  
163 SOUTH FIRST STREET  
FULTON, NY 13069

FOR: PROVIDING PROFESSIONAL BUSINESS  
CONSULTATIONS IN THE AREA OF MANAGE-  
MENT LEADERSHIP ASSESSMENT THAT IN-  
CLUDE BUSINESS EVALUATIONS AND  
REPORTS, IN CLASS 35 (U.S. CLS. 100, 101 AND 102).

FIRST USE 1-1-1999; IN COMMERCE 1-1-1999.

THE MARK CONSISTS OF STANDARD CHAR-  
ACTERS WITHOUT CLAIM TO ANY PARTICULAR  
FONT, STYLE, SIZE, OR COLOR.

OWNER OF U.S. REG. NO. 2,541,966.

NO CLAIM IS MADE TO THE EXCLUSIVE  
RIGHT TO USE "LEADERSHIP ASSESSMENT",  
APART FROM THE MARK AS SHOWN.

SEC. 2(F) AS TO "LOCKWOOD".

SER. NO. 77-388,468, FILED 2-5-2008.

DAWN FELDMAN, EXAMINING ATTORNEY



**Int. Cl.: 31**

**Prior U.S. Cls.: 1 and 46**

**United States Patent and Trademark Office**

**Reg. No. 3,498,634**

**Registered Sep. 9, 2008**

**TRADEMARK  
PRINCIPAL REGISTER**

**PIXIE SWEET**

IMAGINATION FARMS, LLC. (INDIANA LIMITED LIABILITY COMPANY)  
3120 N. POST ROAD  
INDIANAPOLIS, IN 46226

FOR: FRESH PRODUCE, NAMELY, SWEET CORN AND SWEET CHERRIES, IN CLASS 31 (U.S. CLS. 1 AND 46).

FIRST USE 5-31-2007; IN COMMERCE 5-31-2007.

THE MARK CONSISTS OF STANDARD CHARACTERS WITHOUT CLAIM TO ANY PARTICULAR FONT, STYLE, SIZE, OR COLOR.

NO CLAIM IS MADE TO THE EXCLUSIVE RIGHT TO USE "SWEET", APART FROM THE MARK AS SHOWN.

SER. NO. 77-388,473, FILED 2-5-2008.

DAWN FELDMAN, EXAMINING ATTORNEY

**Int. Cl.: 36**

**Prior U.S. Cls.: 100, 101 and 102**

**United States Patent and Trademark Office**

**Reg. No. 3,498,635**

**Registered Sep. 9, 2008**

**SERVICE MARK  
PRINCIPAL REGISTER**

**Solutions for Gift Annuity  
Programs**

UNITED OF OMAHA LIFE INSURANCE COM-  
PANY (NEBRASKA CORPORATION)

3 - LAW

MUTUAL OF OMAHA PLAZA

OMAHA, NE 68175

FOR: UNDERWRITING CHARITABLE GIFT AN-  
NUITY OBLIGATIONS, IN CLASS 36 (U.S. CLS. 100,  
101 AND 102).

FIRST USE 8-28-2002; IN COMMERCE 8-28-2002.

THE MARK CONSISTS OF STANDARD CHAR-  
ACTERS WITHOUT CLAIM TO ANY PARTICULAR  
FONT, STYLE, SIZE, OR COLOR.

NO CLAIM IS MADE TO THE EXCLUSIVE  
RIGHT TO USE "GIFT ANNUITY PROGRAMS",  
APART FROM THE MARK AS SHOWN.

SEC. 2(F).

SER. NO. 77-388,483, FILED 2-5-2008.

REBECCA GILBERT, EXAMINING ATTORNEY

**Int. Cl.: 14**

**Prior U.S. Cls.: 2, 27, 28 and 50**

**United States Patent and Trademark Office**

**Reg. No. 3,498,636**

**Registered Sep. 9, 2008**

**TRADEMARK  
PRINCIPAL REGISTER**

**FDI**

FACETED DESIGNS INC. (NEW YORK CORPORATION)  
SUITE 808  
62 WEST 47TH STREET  
NEW YORK, NY 10036

THE MARK CONSISTS OF STANDARD CHARACTERS WITHOUT CLAIM TO ANY PARTICULAR FONT, STYLE, SIZE, OR COLOR.

FOR: JEWELRY, IN CLASS 14 (U.S. CLS. 2, 27, 28 AND 50).

SER. NO. 77-388,545, FILED 2-5-2008.

FIRST USE 10-1-2002; IN COMMERCE 10-1-2002.

BRENDAN MCCAULEY, EXAMINING ATTORNEY

**Int. Cl.: 20**

**Prior U.S. Cls.: 2, 13, 22, 25, 32 and 50**

**United States Patent and Trademark Office**

**Reg. No. 3,498,637**

**Registered Sep. 9, 2008**

**TRADEMARK  
PRINCIPAL REGISTER**

**SEA SCREEN**

WINDOW COVERINGS ASSOCIATES (VIRGINIA  
LIMITED LIABILITY COMPANY)  
P.O. BOX 13  
CORBIN, VA 22445

FOR: ROMAN, VERTICAL, PANEL AND CLOTH  
FABRIC WINDOW SHADES, AND ROLLERS  
THEREFOR, IN CLASS 20 (U.S. CLS. 2, 13, 22, 25, 32  
AND 50).

FIRST USE 9-15-2007; IN COMMERCE 10-15-2007.

THE MARK CONSISTS OF STANDARD CHAR-  
ACTERS WITHOUT CLAIM TO ANY PARTICULAR  
FONT, STYLE, SIZE, OR COLOR.

NO CLAIM IS MADE TO THE EXCLUSIVE  
RIGHT TO USE "SCREEN", APART FROM THE  
MARK AS SHOWN.

SER. NO. 77-388,569, FILED 2-5-2008.

REBECCA GILBERT, EXAMINING ATTORNEY

**Int. Cl.: 27**

**Prior U.S. Cls.: 19, 20, 37, 42 and 50**

**United States Patent and Trademark Office**

**Reg. No. 3,498,638**

**Registered Sep. 9, 2008**

**TRADEMARK  
PRINCIPAL REGISTER**

**GRIP-TOP**

BOARDMAN MOLDED PRODUCTS, INC. (OHIO  
CORPORATION)  
1110 THALIA AVE.  
YOUNGSTOWN, OH 44512

FOR: INTERLOCKABLE PLASTIC FLOOR MATS  
HAVING AN ABRASIVE SURFACE, IN CLASS 27  
(U.S. CLS. 19, 20, 37, 42 AND 50).

FIRST USE 5-0-1973; IN COMMERCE 6-0-1973.

THE MARK CONSISTS OF STANDARD CHAR-  
ACTERS WITHOUT CLAIM TO ANY PARTICULAR  
FONT, STYLE, SIZE, OR COLOR.

OWNER OF U.S. REG. NO. 2,706,244.

SER. NO. 77-388,571, FILED 2-5-2008.

BRIAN CALLAGHAN, EXAMINING ATTORNEY

Int. Cl.: 42

Prior U.S. Cls.: 100 and 101

United States Patent and Trademark Office

Reg. No. 3,498,639

Registered Sep. 9, 2008

SERVICE MARK  
PRINCIPAL REGISTER

*Simply*  
Divine  
Development



KIRKSEY, TERRENCE (UNITED STATES INDIVIDUAL)

153 BROCKTON DRIVE

MADISON, AL 35756

FOR: DESIGN, CREATION, HOSTING, MAINTENANCE OF WEB SITES FOR OTHERS, IN CLASS 42 (U.S. CLS. 100 AND 101).

FIRST USE 11-1-2007; IN COMMERCE 12-14-2007.

NO CLAIM IS MADE TO THE EXCLUSIVE RIGHT TO USE "DEVELOPMENT", APART FROM THE MARK AS SHOWN.

THE MARK CONSISTS OF THE STYLIZED WORDS "SIMPLY DIVINE DEVELOPMENT". THERE ARE RAYS OF SUNLIGHT COMING FROM THE RIGHT SIDE OF THE WORD "DIVINE".

SER. NO. 77-388,600, FILED 2-5-2008.

KATINA MISTER, EXAMINING ATTORNEY

**Int. Cl.: 35**

**Prior U.S. Cls.: 100, 101 and 102**

**United States Patent and Trademark Office**

**Reg. No. 3,498,640**

**Registered Sep. 9, 2008**

**SERVICE MARK  
PRINCIPAL REGISTER**

**PROACTIVE CI NAVIGATOR**

PROACTIVE ENTERPRISE, INC. (ILLINOIS CORPORATION), DBA PROACTIVE WORLDWIDE, INC.

SUITE 400

3701 ALGONQUIN ROAD

ROLLING MEADOWS, IL 60008

FOR: BUSINESS CONSULTING AND INFORMATION SERVICES, NAMELY, PROVIDING NEEDS ASSESSMENT IN THE FIELD OF BUSINESS INFORMATION RESEARCH SERVICES FOR ENTERPRISES, IN CLASS 35 (U.S. CLS. 100, 101 AND 102).

FIRST USE 2-28-2008; IN COMMERCE 2-28-2008.

THE MARK CONSISTS OF STANDARD CHARACTERS WITHOUT CLAIM TO ANY PARTICULAR FONT, STYLE, SIZE, OR COLOR.

OWNER OF U.S. REG. NO. 3,116,992.

NO CLAIM IS MADE TO THE EXCLUSIVE RIGHT TO USE "CI", APART FROM THE MARK AS SHOWN.

SER. NO. 77-388,601, FILED 2-5-2008.

LINDSEY RUBIN, EXAMINING ATTORNEY

**Int. Cl.: 28**

**Prior U.S. Cls.: 22, 23, 38 and 50**

**United States Patent and Trademark Office**

**Reg. No. 3,498,641**

**Registered Sep. 9, 2008**

**TRADEMARK  
PRINCIPAL REGISTER**

**QUALITY IN EVERY PIECE**

RAVENSBURGER FX SCHMID USA INC. (DE-  
LAWARE CORPORATION)  
ONE PUZZLE LANE  
NEWTON, NH 03858

THE MARK CONSISTS OF STANDARD CHAR-  
ACTERS WITHOUT CLAIM TO ANY PARTICULAR  
FONT, STYLE, SIZE, OR COLOR.

FOR: PUZZLES, IN CLASS 28 (U.S. CLS. 22, 23, 38  
AND 50).

SER. NO. 77-388,660, FILED 2-5-2008.

FIRST USE 1-31-2008; IN COMMERCE 1-31-2008.

DANNEAN HETZEL, EXAMINING ATTORNEY



**Int. Cl.: 35**

**Prior U.S. Cls.: 100, 101 and 102**

**United States Patent and Trademark Office**

**Reg. No. 3,498,642**

**Registered Sep. 9, 2008**

**SERVICE MARK  
PRINCIPAL REGISTER**

**Impairment Rating  
Integrated Solution - IRIS**

BRIGHAM & ASSOCIATES, INC. (MAINE CORPORATION)

59 BAXTER BOULEVARD

PORTLAND, ME 04101

FOR: BUSINESS EVALUATION OF PERMANENT IMPAIRMENT, IN CLASS 35 (U.S. CLS. 100, 101 AND 102).

FIRST USE 7-1-2007; IN COMMERCE 7-1-2007.

THE MARK CONSISTS OF STANDARD CHARACTERS WITHOUT CLAIM TO ANY PARTICULAR FONT, STYLE, SIZE, OR COLOR.

NO CLAIM IS MADE TO THE EXCLUSIVE RIGHT TO USE "IMPAIRMENT RATING INTEGRATED SOLUTION", APART FROM THE MARK AS SHOWN.

SER. NO. 77-388,682, FILED 2-5-2008.

KATINA MISTER, EXAMINING ATTORNEY

**Int. Cl.: 37**

**Prior U.S. Cls.: 100, 103 and 106**

**United States Patent and Trademark Office**

**Reg. No. 3,498,643**

**Registered Sep. 9, 2008**

**SERVICE MARK  
PRINCIPAL REGISTER**

Why pay those geeks more?

UPTIME CONSULTING INC. (FLORIDA COR-  
PORATION)

#239

12472 LAKE UNDERHILL ROAD

ORLANDO, FL 32828

FOR: REPAIR OF COMPUTER HARDWARE, IN  
CLASS 37 (U.S. CLS. 100, 103 AND 106).

FIRST USE 10-1-2006; IN COMMERCE 10-1-2006.

THE MARK CONSISTS OF STANDARD CHAR-  
ACTERS WITHOUT CLAIM TO ANY PARTICULAR  
FONT, STYLE, SIZE, OR COLOR.

SER. NO. 77-388,741, FILED 2-5-2008.

LINDSEY RUBIN, EXAMINING ATTORNEY

**Int. Cl.: 44**

**Prior U.S. Cls.: 100 and 101**

**United States Patent and Trademark Office**

**Reg. No. 3,498,644**

**Registered Sep. 9, 2008**

**SERVICE MARK  
PRINCIPAL REGISTER**

**EXECUTIVE OUTHOUSES LLC**

EXECUTIVE OUTHOUSES, LLC (CALIFORNIA  
LIMITED LIABILITY COMPANY)

1055 E. GRINNELL DR.

BURBANK, CA 91501

FOR: RENTAL OF PORTABLE RESTROOMS, IN  
CLASS 44 (U.S. CLS. 100 AND 101).

FIRST USE 7-1-2006; IN COMMERCE 7-1-2006.

THE MARK CONSISTS OF STANDARD CHAR-  
ACTERS WITHOUT CLAIM TO ANY PARTICULAR  
FONT, STYLE, SIZE, OR COLOR.

NO CLAIM IS MADE TO THE EXCLUSIVE  
RIGHT TO USE "OUTHOUSES LLC", APART FROM  
THE MARK AS SHOWN.

SER. NO. 77-388,774, FILED 2-5-2008.

DOMINIC FATHY, EXAMINING ATTORNEY

**Int. Cl.: 35**

**Prior U.S. Cls.: 100, 101 and 102**

**United States Patent and Trademark Office**

**Reg. No. 3,498,645**

**Registered Sep. 9, 2008**

**SERVICE MARK  
PRINCIPAL REGISTER**

**BEHAVIOR NETWORK**

EXPONENTIAL EDGE, INC. (CALIFORNIA CORPORATION)  
228 HAMILTON AVENUE, SUITE 300  
PALO ALTO, CA 94301

FOR: ADVERTISING AND MARKETING; BUSINESS CONSULTING AND BUSINESS INFORMATION FOR ENTERPRISES; BUSINESS ORGANISATION AND MANAGEMENT CONSULTING SERVICES, IN CLASS 35 (U.S. CLS. 100, 101 AND 102).

FIRST USE 2-1-2008; IN COMMERCE 2-1-2008.

THE MARK CONSISTS OF STANDARD CHARACTERS WITHOUT CLAIM TO ANY PARTICULAR FONT, STYLE, SIZE, OR COLOR.

NO CLAIM IS MADE TO THE EXCLUSIVE RIGHT TO USE "NETWORK", APART FROM THE MARK AS SHOWN.

SER. NO. 77-388,783, FILED 2-5-2008.

GEOFFREY FOSDICK, EXAMINING ATTORNEY

**Int. Cl.: 35**

**Prior U.S. Cls.: 100, 101 and 102**

**United States Patent and Trademark Office**

**Reg. No. 3,498,646**

**Registered Sep. 9, 2008**

**SERVICE MARK  
PRINCIPAL REGISTER**

**PHARMASSURE**

MCKESSON MEDICATION MANAGEMENT LLC  
(DELAWARE LIMITED LIABILITY COMPAN-  
NY)  
SUITE 500  
7115 NORTHLAND TERRACE  
BROOKLYN PARK, MN 55428

FOR: MANAGING IN-PATIENT AND OUT-PA-  
TIENT PHARMACIES FOR HOSPITALS AND  
HEALTHCARE INSTITUTIONS, IN CLASS 35 (U.S.  
CLS. 100, 101 AND 102).

FIRST USE 12-31-2005; IN COMMERCE 12-31-2005.

THE MARK CONSISTS OF STANDARD CHAR-  
ACTERS WITHOUT CLAIM TO ANY PARTICULAR  
FONT, STYLE, SIZE, OR COLOR.

OWNER OF U.S. REG. NO. 3,176,639.

SER. NO. 77-388,792, FILED 2-5-2008.

ANNE E. GUSTASON, EXAMINING ATTORNEY

**Int. Cl.: 36**

**Prior U.S. Cls.: 100, 101 and 102**

**United States Patent and Trademark Office**

**Reg. No. 3,498,647**

**Registered Sep. 9, 2008**

**SERVICE MARK  
PRINCIPAL REGISTER**

**AFRICA RISING**

AFRICA RISING (NORTH CAROLINA NON-  
PROFIT CORPORATION)  
PO BOX 16964  
CHAPEL HILL, NC 27516

FOR: ACCEPTING AND ADMINISTERING  
MONETARY CHARITABLE CONTRIBUTIONS, IN  
CLASS 36 (U.S. CLS. 100, 101 AND 102).

FIRST USE 10-7-2007; IN COMMERCE 10-7-2007.

THE MARK CONSISTS OF STANDARD CHAR-  
ACTERS WITHOUT CLAIM TO ANY PARTICULAR  
FONT, STYLE, SIZE, OR COLOR.

NO CLAIM IS MADE TO THE EXCLUSIVE  
RIGHT TO USE "AFRICA", APART FROM THE  
MARK AS SHOWN.

SER. NO. 77-388,831, FILED 2-5-2008.

BRENDAN MCCAULEY, EXAMINING ATTORNEY

Int. Cl.: 35

Prior U.S. Cls.: 100, 101 and 102

Reg. No. 3,498,648

United States Patent and Trademark Office

Registered Sep. 9, 2008

**SERVICE MARK  
PRINCIPAL REGISTER**

think Smart, make Money, leave Duck Tracks



1 SMART DUCK MANAGEMENT GROUP, LLC  
(DELAWARE LIMITED LIABILITY COMPAN-  
NY)

60 CHELSEA CORNERS

#201

CHELSEA, AL 35043

FOR: ADVERTISING AGENCY SPECIALIZING IN THE DESIGN AND EXECUTION OF WORD OF MOUTH, VIRAL, BUZZ AND EXPERIENTIAL MARKETING PROGRAMS; ADVERTISING AND MARKETING; ADVERTISING SERVICES, NAMELY, PROMOTING AND MARKETING THE GOODS AND SERVICES OF OTHERS THROUGH ALL PUBLIC COMMUNICATION MEANS; ADVERTISING SERVICES, PUBLIC RELATIONS AND MARKETING SERVICES, NAMELY, PROMOTING AND MARKETING THE GOODS AND SERVICES OF OTHERS THROUGH ALL PUBLIC COMMUNICATION MEANS; ADVERTISING, MARKETING AND PROMOTION SERVICES; ADVERTISING, MARKETING AND PROMOTIONAL SERVICES FOR AUTOMOTIVE DEALERSHIPS; ADVERTISING, MARKETING AND PROMOTIONAL SERVICES FOR THE DONATION OF HUMAN BLOOD THAT EXACTLY MATCHES THE BLOOD TYPE OF INDIVIDUALS NEEDING TRANSFUSIONS; ADVERTISING, PROMOTION AND MARKETING SERVICES IN THE NATURE OF E-MAIL BLAST CAMPAIGNS FOR OTHERS; ADVICE CONCERNING CHEMICAL PRODUCT MARKETING; ADVICE IN THE FIELD OF BUSINESS MANAGEMENT AND MARKETING; ARRANGING AND CONDUCTING MARKETING PROMOTIONAL EVENTS FOR OTHERS; BUSINESS ADVICE AND ANALYSIS OF MARKETS; BUSINESS CONSULTATION AND MANAGEMENT REGARDING MARKETING ACTIVITIES AND LAUNCHING OF NEW PRODUCTS; BUSINESS MANAGEMENT AND CONSULTING SERVICES FOR THE HEALTH CARE INDUSTRY, NAMELY, CUSTOMER SERVICE, ACCOUNTING SERVICES, AND WEB-BASED ADVERTISING AND MARKETING SERVICES; BUSINESS MANAGEMENT CONSULTING WITH

RELATION TO STRATEGY, FINANCING, MARKETING, PRODUCTION, PERSONNEL AND SALE MATTERS FOR COMPANIES INVOLVED WITH THIN FILM AND NANO TECHNOLOGIES AND PLASMA PROCESSES; BUSINESS MANAGEMENT CONSULTING WITH RELATION TO STRATEGY, MARKETING, PRODUCTION, PERSONNEL AND RETAIL SALE MATTERS; BUSINESS MARKETING AND DIRECT MAIL CONSULTING SERVICES; BUSINESS MARKETING CONSULTING SERVICES; BUSINESS MARKETING CONSULTING SERVICES TO CHILDCARE ORGANIZATIONS; BUSINESS MARKETING SERVICES; COMMERCIAL INFORMATION AGENCIES; CONDUCTING BUSINESS AND MARKET RESEARCH SURVEYS; CONDUCTING MARKETING STUDIES; COOPERATIVE ADVERTISING AND MARKETING; COOPERATIVE ADVERTISING AND MARKETING SERVICES BY WAY OF SOLICITATION, CUSTOMER SERVICE AND PROVIDING MARKETING INFORMATION VIA WEB SITES ON A GLOBAL COMPUTER NETWORK; CREATION OF MARKETING TOOLS DESIGNED TO INCREASE A CLIENT COMPANY'S KNOWLEDGE OF CUSTOMER NEEDS, AND ITS COMPETITORS' PRODUCTS AND SERVICES, PRICING, ADVERTISING STRATEGY AND SALES STRATEGY; CREATIVE MARKETING DESIGN SERVICES; CUSTOM WRITING SERVICES COMPRISING PUBLIC RELATIONS AND MARKETING MATERIALS FOR THE AUDIO, VIDEO AND TECHNOLOGY INDUSTRIES; DEVELOPMENT OF MARKETING STRATEGIES AND CONCEPTS; DIRECT MARKETING ADVERTISING FOR OTHERS; DIRECT MARKETING CONSULTING SERVICES; DIRECT MARKETING SERVICES; ENTERTAINMENT MARKETING SERVICES, NAMELY, MARKETING, PROMOTION AND ADVERTISING FOR INDEPENDENT RECORDING ARTISTS; GENERAL BUSINESS MERCHANDISING SERVICES, NAMELY, MARKETING; IMPLEMENTATION AND FOLLOW-UP OF ADVICE IN THE FIELDS OF MARKETING; INFORMATION OR ENQUIRIES ON BUSINESS AND MARKETING; MARKET ANALY-

SIS; MARKET MANIPULATION, RESEARCH AND ANALYSIS, WHETHER OR NOT VIA THE INTERNET; MARKET OPINION POLLING STUDIES; MARKET REPORTS AND STUDIES; MARKET RESEARCH; MARKET RESEARCH CONSULTATION; MARKET RESEARCH SERVICES; MARKET RESEARCH STUDIES; MARKET SEGMENTATION CONSULTATION; MARKET STUDY AND ANALYSIS OF MARKET STUDIES; MARKETING AND ADVERTISING SERVICES FOR AUTOMOBILE DEALERSHIPS; MARKETING CONSULTING; MARKETING PLAN DEVELOPMENT; MARKETING SERVICES IN THE FIELD OF PLANNED-GIVING FOR NON-PROFIT AND CHARITABLE ORGANIZATIONS; MARKETING SERVICES, NAMELY, PROVIDING INFORMATIONAL WEB PAGES DESIGNED TO GENERATE SALES TRAFFIC VIA HYPERLINKS TO OTHER WEB SITES; MARKETING, PROMOTIONAL AND ADVERTISING SERVICES PROVIDED BY MOBILE TELEPHONE CONNECTIONS; MEDIA PLANNING, NAMELY, ADVISING THE CLIENT ON THE CORRECT TIMES AND STATIONS TO ADVERTISE BASED ON MEDIA ANALYSIS OF THE MARKET FOR THAT MEDIA; ON-LINE ADVERTISING AND MARKETING SERVICES; OUTSOURCING IN THE FIELD OF SALES AND MARKETING OF COMPUTER SOFTWARE; PROMOTING, ADVERTISING AND MARKETING OF THE ON-LINE WEB SITES OF OTHERS; PROMOTION AND MARKETING SERVICES AND RELATED CONSULTING; PROMOTION, ADVERTISING AND MARKETING OF ON-LINE WEB SITES; PROVIDING A WEB SITE THAT FEATURES AN ONLINE MARKET FOR USERS TO LIST OFFERED OR WANTED PERSONAL AND BUSINESS ASSETS AND SKILLS FOR HIRE, RENT, SALE OR AUCTION TRANSACTED ON THE BASIS

OF PREDEFINED PERFORMANCE AND CLOSING TERMS AND CONDITIONS; PROVIDING ADVERTISING, MARKETING AND PROMOTIONAL SERVICES FOR THE PHARMACEUTICAL AND MEDICAL INDUSTRY; PROVIDING ADVERTISING, MARKETING AND PROMOTIONAL SERVICES FOR THE PHARMACEUTICAL AND MEDICAL PRODUCTS OF OTHERS; PROVIDING ADVERTISING, MARKETING AND PROMOTIONAL SERVICES, NAMELY, DEVELOPMENT OF ADVERTISING CAMPAIGNS FOR BUSINESS DEVELOPMENT; PROVIDING BUSINESS MARKETING INFORMATION; PROVIDING INFORMATION IN THE FIELD OF MARKETING AND ON-LINE MARKETING MEDIA VIA THE INTERNET; PROVIDING MARKETING AND PROMOTION OF SPECIAL EVENTS; PROVIDING PROMOTIONAL MARKETING SERVICES TO BUSINESSES IN THE BROADBAND AND MEDIA INDUSTRIES, IN CLASS 35 (U.S. CLS. 100, 101 AND 102).

FIRST USE 11-1-2007; IN COMMERCE 11-1-2007.

THE COLOR(S) BLACK AND AQUA IS/ARE CLAIMED AS A FEATURE OF THE MARK.

THE MARK CONSISTS OF BLACK LETTERS SPELLING THE WORDS THINK "SMART, MAKE MONEY, LEAVE DUCK TRACKS" AND AQUA DUCK FOOT PRINTS WITH A PARTIAL BLACK BACKGROUND.

SER. NO. 77-388,848, FILED 2-5-2008.

CHRIS WELLS, EXAMINING ATTORNEY



**Int. Cl.: 17**

**Prior U.S. Cls.: 1, 5, 12, 13, 35 and 50**

**United States Patent and Trademark Office**

**Reg. No. 3,498,649**

**Registered Sep. 9, 2008**

**TRADEMARK  
PRINCIPAL REGISTER**

**WAFERTAPE**

NEPTCO INCORPORATED (RHODE ISLAND  
CORPORATION)  
30 HAMLET ST.  
PAWTUCKET, RI 02861

FOR: TAPE FOR USE IN MOUNTING POLISHED  
SILICON WAFERS, CERAMICS, GLASS, SAPHIRE  
AND FR4 ON FRAMES IN PREPARATION FOR  
DICING, IN CLASS 17 (U.S. CLS. 1, 5, 12, 13, 35 AND  
50).

FIRST USE 7-29-1999; IN COMMERCE 7-29-1999.

THE MARK CONSISTS OF STANDARD CHAR-  
ACTERS WITHOUT CLAIM TO ANY PARTICULAR  
FONT, STYLE, SIZE, OR COLOR.

OWNER OF U.S. REG. NO. 2,548,554.

SEC. 2(F).

SER. NO. 77-388,855, FILED 2-5-2008.

TARAH HARDY, EXAMINING ATTORNEY

**Int. Cl.: 41**

**Prior U.S. Cls.: 100, 101 and 107**

**United States Patent and Trademark Office**

**Reg. No. 3,498,650**

**Registered Sep. 9, 2008**

**SERVICE MARK  
PRINCIPAL REGISTER**

**VOODOO**

SIX FLAGS THEME PARKS, INC. (DELAWARE  
CORPORATION)  
924 AVENUE J. EAST  
GRAND PRAIRIE, TX 75050

THE MARK CONSISTS OF STANDARD CHAR-  
ACTERS WITHOUT CLAIM TO ANY PARTICULAR  
FONT, STYLE, SIZE, OR COLOR.

FOR: ENTERTAINMENT SERVICES, NAMELY,  
AMUSEMENT AND THEME PARK RIDES, AT-  
TRACTIONS AND SERVICES, IN CLASS 41 (U.S.  
CLS. 100, 101 AND 107).

SER. NO. 77-388,856, FILED 2-5-2008.

FIRST USE 5-1-1998; IN COMMERCE 5-1-1998.

DAVID H. STINE, EXAMINING ATTORNEY

**Int. Cl.: 36**

**Prior U.S. Cls.: 100, 101 and 102**

**United States Patent and Trademark Office**

**Reg. No. 3,498,651**

**Registered Sep. 9, 2008**

**SERVICE MARK  
PRINCIPAL REGISTER**

**INSURANCE THAT STARTS WITH  
YOU**

UTICA MUTUAL INSURANCE COMPANY (NEW  
YORK CORPORATION), DBA UTICA NA-  
TIONAL INSURANCE GROUP  
180 GENESEE STREET  
NEW HARTFORD, NY 13413

FOR: INSURANCE SERVICES, NAMELY, INSUR-  
ANCE UNDERWRITING SERVICES FOR CASUAL-  
TY INSURANCE, FIDELITY INSURANCE, SURETY  
INSURANCE, FIRE INSURANCE, PROPERTY IN-  
SURANCE, INLAND MARINE INSURANCE AND  
OCEAN MARINE INSURANCE, IN CLASS 36 (U.S.  
CLS. 100, 101 AND 102).

FIRST USE 9-0-1965; IN COMMERCE 9-0-1965.

THE MARK CONSISTS OF STANDARD CHAR-  
ACTERS WITHOUT CLAIM TO ANY PARTICULAR  
FONT, STYLE, SIZE, OR COLOR.

OWNER OF U.S. REG. NO. 1,846,967.

NO CLAIM IS MADE TO THE EXCLUSIVE  
RIGHT TO USE "INSURANCE", APART FROM  
THE MARK AS SHOWN.

SER. NO. 77-388,874, FILED 2-5-2008.

JEAN IM, EXAMINING ATTORNEY

**Int. Cl.: 33**

**Prior U.S. Cls.: 47 and 49**

**United States Patent and Trademark Office**

**Reg. No. 3,498,652**

**Registered Sep. 9, 2008**

**TRADEMARK  
PRINCIPAL REGISTER**

**PAUL HOBBS**

PAUL HOBBS WINERY, L.P. (CALIFORNIA LIMITED PARTNERSHIP)  
3355 GRAVENSTEIN HIGHWAY NORTH  
SEBASTOPOL, CA 95472

THE NAME(S), PORTRAIT(S), AND/OR SIGNATURE(S) SHOWN IN THE MARK IDENTIFIES "PAUL HOBBS", WHOSE CONSENT(S) TO REGISTER IS MADE OF RECORD.

FOR: WINES, IN CLASS 33 (U.S. CLS. 47 AND 49).

FIRST USE 1-1-1991; IN COMMERCE 1-1-1991.

SER. NO. 77-388,893, FILED 2-5-2008.

THE MARK CONSISTS OF STANDARD CHARACTERS WITHOUT CLAIM TO ANY PARTICULAR FONT, STYLE, SIZE, OR COLOR.

ELLEN B. AWRICH, EXAMINING ATTORNEY

**Int. Cl.: 41**

**Prior U.S. Cls.: 100, 101 and 107**

**United States Patent and Trademark Office**

**Reg. No. 3,498,653**

**Registered Sep. 9, 2008**

**SERVICE MARK  
PRINCIPAL REGISTER**

**SMARTER TODDLER**

ROBERT MING AND KETTIA MING (NEW  
YORK PARTNERSHIP)  
100A WEST 89TH ST  
NEW YORK, NY 10024

FOR: EDUCATIONAL SERVICES, NAMELY,  
CONDUCTING ART-BASED AND MUSIC-BASED  
INSTRUCTIONAL PROGRAMS FOR CHILDREN  
WHOSE METHODS AND STRATEGIES IMPROVE  
HOW THE BRAIN THINKS, LEARNS AND COM-  
MUNICATES, IN CLASS 41 (U.S. CLS. 100, 101 AND  
107).

FIRST USE 3-1-2003; IN COMMERCE 3-1-2003.

THE MARK CONSISTS OF STANDARD CHAR-  
ACTERS WITHOUT CLAIM TO ANY PARTICULAR  
FONT, STYLE, SIZE, OR COLOR.

NO CLAIM IS MADE TO THE EXCLUSIVE  
RIGHT TO USE "TODDLER", APART FROM THE  
MARK AS SHOWN.

SER. NO. 77-388,907, FILED 2-5-2008.

REBECCA GILBERT, EXAMINING ATTORNEY

**Int. Cl.: 41**

**Prior U.S. Cls.: 100, 101 and 107**

**United States Patent and Trademark Office**

**Reg. No. 3,498,654**

**Registered Sep. 9, 2008**

**SERVICE MARK  
PRINCIPAL REGISTER**

# SHOCKWAVES

PRINCESS CRUISE LINES, LTD. (BERMUDA CORPORATION)  
24305 TOWN CENTER DRIVE  
LEGAL DEPT/BLDG 5/5  
SANTA CLARITA, CA 91355

FOR: ARRANGING AND PROVIDING RECREATIONAL, ENTERTAINMENT AND EDUCATIONAL SERVICES AND ACTIVITIES FOR CHILDREN ON BOARD CRUISE VESSELS, NAMELY, ORGANIZING AND CONDUCTING SPORTS COMPETITIONS, TALENT SHOWS, CARD GAMES, BOARD GAMES, SCAVENGER HUNTS, DANCE CONTESTS, AND VIDEO GAME COMPETITIONS; CONDUCTING ARTS AND CRAFTS CLASSES, DANCE PARTIES, MOVIE PARTIES, BIRTHDAY PARTIES, PIZZA

PARTIES, AND ICE CREAM PARTIES; CONDUCTING EDUCATIONAL ACTIVITIES IN THE NATURE OF COOKING CLASSES, CHEMISTRY EXPERIMENTS AND "SCIENCE ON THE SEAS" PROGRAMS, IN CLASS 41 (U.S. CLS. 100, 101 AND 107).

FIRST USE 6-1-2006; IN COMMERCE 6-1-2006.

THE MARK CONSISTS OF STANDARD CHARACTERS WITHOUT CLAIM TO ANY PARTICULAR FONT, STYLE, SIZE, OR COLOR.

SER. NO. 77-388,931, FILED 2-5-2008.

JENNIFER MARTIN, EXAMINING ATTORNEY

**Int. Cl.: 45**

**Prior U.S. Cls.: 100 and 101**

**United States Patent and Trademark Office**

**Reg. No. 3,498,655**

**Registered Sep. 9, 2008**

**SERVICE MARK  
PRINCIPAL REGISTER**

**A Taste of the Jersey Shore**

ATLANTIC CREATIONS, LLC (NEW JERSEY  
LIMITED LIABILITY COMPANY)  
1321 VARDON ROAD  
BRIGANTINE, NJ 08203

FOR: PREPARATION OF CUSTOMIZED GIFT  
BASKETS WITH SELECTED ITEMS REGARDING  
A PARTICULAR OCCASION OR THEME, IN CLASS  
45 (U.S. CLS. 100 AND 101).

FIRST USE 8-1-2007; IN COMMERCE 11-11-2007.

THE MARK CONSISTS OF STANDARD CHAR-  
ACTERS WITHOUT CLAIM TO ANY PARTICULAR  
FONT, STYLE, SIZE, OR COLOR.

NO CLAIM IS MADE TO THE EXCLUSIVE  
RIGHT TO USE "JERSEY SHORE", APART FROM  
THE MARK AS SHOWN.

SER. NO. 77-388,996, FILED 2-5-2008.

SUSAN STIGLITZ, EXAMINING ATTORNEY

**Int. Cl.: 43**

**Prior U.S. Cls.: 100 and 101**

**United States Patent and Trademark Office**

**Reg. No. 3,498,656**

**Registered Sep. 9, 2008**

**SERVICE MARK  
PRINCIPAL REGISTER**

**FUBAR**

HASSAL, INC. (CALIFORNIA CORPORATION),  
DBA FUBAR  
7994 SANTA MONICA BLVD.  
WEST HOLLYWOOD, CA 90046

THE MARK CONSISTS OF STANDARD CHAR-  
ACTERS WITHOUT CLAIM TO ANY PARTICULAR  
FONT, STYLE, SIZE, OR COLOR.

FOR: BAR SERVICES, IN CLASS 43 (U.S. CLS. 100  
AND 101).

SER. NO. 77-389,011, FILED 2-5-2008.

FIRST USE 8-31-1999; IN COMMERCE 8-31-1999.

KRISTIN CARLSON, EXAMINING ATTORNEY



**Int. Cls.: 3 and 5**

**Prior U.S. Cls.: 1, 4, 6, 18, 44, 46, 50, 51 and 52**

**United States Patent and Trademark Office**

**Reg. No. 3,498,657**

**Registered Sep. 9, 2008**

**TRADEMARK  
PRINCIPAL REGISTER**

**FEEL BETTER NOW ENDAU**

NEWAYS, INC. (UTAH CORPORATION)  
LEGAL DEPARTMENT  
2089 NEWAYS DRIVE  
SPRINGVILLE, UT 84663

FOR: PERSONAL CARE PRODUCTS, NAMELY,  
SKIN LOTION AND SKIN CREAM, IN CLASS 3 (U.S.  
CLS. 1, 4, 6, 50, 51 AND 52).

FIRST USE 1-21-2007; IN COMMERCE 1-21-2007.

FOR: NUTRITIONAL SUPPLEMENT, IN CLASS 5  
(U.S. CLS. 6, 18, 44, 46, 51 AND 52).

FIRST USE 1-21-2007; IN COMMERCE 1-21-2007.

THE MARK CONSISTS OF STANDARD CHAR-  
ACTERS WITHOUT CLAIM TO ANY PARTICULAR  
FONT, STYLE, SIZE, OR COLOR.

OWNER OF U.S. REG. NOS. 2,219,040 AND  
2,925,232.

SER. NO. 77-389,025, FILED 2-5-2008.

ANNE MADDEN, EXAMINING ATTORNEY

**Int. Cl.: 16**

**Prior U.S. Cls.: 2, 5, 22, 23, 29, 37, 38 and 50**

**Reg. No. 3,498,658**

**United States Patent and Trademark Office**

**Registered Sep. 9, 2008**

**TRADEMARK  
PRINCIPAL REGISTER**

**LANDMARK SERIES**

PREMIER PAINT ROLLER COMPANY LLC  
(NEW YORK LIMITED LIABILITY COMPAN-  
NY)

131-11 ATLANTIC AVE.  
RICHMOND HILL, NY 11418

FOR: PAINT BRUSHES, IN CLASS 16 (U.S. CLS. 2,  
5, 22, 23, 29, 37, 38 AND 50).

FIRST USE 1-25-2008; IN COMMERCE 1-25-2008.

THE MARK CONSISTS OF STANDARD CHAR-  
ACTERS WITHOUT CLAIM TO ANY PARTICULAR  
FONT, STYLE, SIZE, OR COLOR.

NO CLAIM IS MADE TO THE EXCLUSIVE  
RIGHT TO USE "SERIES", APART FROM THE  
MARK AS SHOWN.

SER. NO. 77-389,042, FILED 2-5-2008.

KEVIN DINALLO, EXAMINING ATTORNEY

**Int. Cl.: 41**

**Prior U.S. Cls.: 100, 101 and 107**

**United States Patent and Trademark Office**

**Reg. No. 3,498,659**

**Registered Sep. 9, 2008**

**SERVICE MARK  
PRINCIPAL REGISTER**

**REMIX**

PRINCESS CRUISE LINES, LTD. (BERMUDA CORPORATION)  
LEGAL DEPARTMENT, BLDG 5/5  
24305 TOWN CENTER DRIVE  
SANTA CLARITA, CA 91355

FOR: ARRANGING AND PROVIDING RECREATIONAL, ENTERTAINMENT AND EDUCATIONAL SERVICES AND ACTIVITIES FOR TEENAGERS ON BOARD CRUISE VESSELS, NAMELY, ORGANIZING AND CONDUCTING SPORTS COMPETITIONS, TALENT SHOWS, CARD GAMES, BOARD GAMES, DANCE CONTESTS, AND VIDEO GAME COMPETITIONS; CONDUCTING DANCE PARTIES, MOVIE PARTIES, PIZZA PARTIES; CONDUCTING EDUCATIONAL ACTIVITIES IN THE NATURE OF COOK-

ING CLASSES, MAKE-UP AND SKIN-CARE TECHNIQUES, DANCE CLASSES AND DISC JOCKEY WORKSHOPS, IN CLASS 41 (U.S. CLS. 100, 101 AND 107).

FIRST USE 6-1-2006; IN COMMERCE 6-1-2006.

THE MARK CONSISTS OF STANDARD CHARACTERS WITHOUT CLAIM TO ANY PARTICULAR FONT, STYLE, SIZE, OR COLOR.

SER. NO. 77-389,044, FILED 2-5-2008.

JENNIFER MARTIN, EXAMINING ATTORNEY

**Int. Cl.: 42**

**Prior U.S. Cls.: 100 and 101**

**United States Patent and Trademark Office**

**Reg. No. 3,498,660**

**Registered Sep. 9, 2008**

**SERVICE MARK  
PRINCIPAL REGISTER**

**WHERE BEING FIRST IS  
EXPECTED**

CURTISS-WRIGHT FLOW CONTROL CORPORATION (NEW YORK CORPORATION)  
SUITE 850  
2941 FAIRVIEW PARK DRIVE  
FALLS CHURCH, VA 22042

FOR: ENGINEERING SERVICES IN THE FIELD OF COMMERCIAL POWER, GAS PROCESSING, OIL PROCESSING, PETROLEUM PROCESSING AND DEFENSE INDUSTRIES , IN CLASS 42 (U.S. CLS. 100 AND 101).

FIRST USE 11-5-2005; IN COMMERCE 4-30-2006.

THE MARK CONSISTS OF STANDARD CHARACTERS WITHOUT CLAIM TO ANY PARTICULAR FONT, STYLE, SIZE, OR COLOR.

SER. NO. 77-389,112, FILED 2-5-2008.

JORDAN BAKER, EXAMINING ATTORNEY

**Int. Cl.: 35**

**Prior U.S. Cls.: 100, 101 and 102**

**United States Patent and Trademark Office**

**Reg. No. 3,498,661**

**Registered Sep. 9, 2008**

**SERVICE MARK  
PRINCIPAL REGISTER**

**Enjoy the energy !**

FUELIFY, LLC (PENNSYLVANIA LIMITED LIABILITY COMPANY)  
6 REDTAIL COURT  
WEST CHESTER, PA 19382

THE MARK CONSISTS OF STANDARD CHARACTERS WITHOUT CLAIM TO ANY PARTICULAR FONT, STYLE, SIZE, OR COLOR.

FOR: ONLINE RETAIL STORE SERVICES FEATURING FOOD, IN CLASS 35 (U.S. CLS. 100, 101 AND 102).

SER. NO. 77-389,147, FILED 2-5-2008.

FIRST USE 1-19-2008; IN COMMERCE 1-19-2008.

LINDA ORNDORFF, EXAMINING ATTORNEY

**Int. Cls.: 3 and 30**

**Prior U.S. Cls.: 1, 4, 6, 46, 50, 51 and 52**

**United States Patent and Trademark Office**

**Reg. No. 3,498,662**

**Registered Sep. 9, 2008**

**TRADEMARK  
PRINCIPAL REGISTER**

**SUPER COOL**

INTELLIGENT NUTRIENTS, LLC (DELAWARE  
LIMITED LIABILITY COMPANY)  
983 E HENNEPIN AVENUE  
MINNEAPOLIS, MN 55414

FOR: BREATH FRESHENER; BREATH FRESH-  
ENING CONFECTIONARY, NAMELY, DISSOLVA-  
BLE BREATH STRIPS, BREATH MINTS, CANDY  
AND GUM, IN CLASS 3 (U.S. CLS. 1, 4, 6, 50, 51 AND  
52).

FIRST USE 10-1-2005; IN COMMERCE 10-1-2005.

FOR: CANDY; CANDY MINTS, IN CLASS 30 (U.S.  
CL. 46).

FIRST USE 10-1-2005; IN COMMERCE 10-1-2005.

THE MARK CONSISTS OF STANDARD CHAR-  
ACTERS WITHOUT CLAIM TO ANY PARTICULAR  
FONT, STYLE, SIZE, OR COLOR.

SER. NO. 77-389,215, FILED 2-5-2008.

NICHOLAS COLEMAN, EXAMINING ATTORNEY

**Int. Cl.: 37**

**Prior U.S. Cls.: 100, 103 and 106**

**United States Patent and Trademark Office**

**Reg. No. 3,498,663**

**Registered Sep. 9, 2008**

**SERVICE MARK  
PRINCIPAL REGISTER**

**WE'RE EAGER TO PLEASE**

WASH DEPOT HOLDINGS, INC. (DELAWARE  
CORPORATION)  
STE. 302  
14 SUMMER STREET  
MALDEN, MA 02148

FOR: AUTOMOBILE CLEANING AND CAR  
WASHING, IN CLASS 37 (U.S. CLS. 100, 103 AND 106).

FIRST USE 2-28-1977; IN COMMERCE 2-28-1977.

THE MARK CONSISTS OF STANDARD CHAR-  
ACTERS WITHOUT CLAIM TO ANY PARTICULAR  
FONT, STYLE, SIZE, OR COLOR.

SER. NO. 77-389,218, FILED 2-5-2008.

COURTNEY MCCORMICK, EXAMINING ATTOR-  
NEY

Int. Cl.: 41

Prior U.S. Cls.: 100, 101 and 107

United States Patent and Trademark Office

Reg. No. 3,498,664

Registered Sep. 9, 2008

**SERVICE MARK  
PRINCIPAL REGISTER**



MAGDALEN SARANTIS RODRIGUEZ (UNITED STATES INDIVIDUAL)  
953 AMELITH RD.  
FREELAND, MI 48623

FOR: EDUCATIONAL SERVICES, NAMELY, CONDUCTING WORKSHOPS AND SEMINARS IN THE FIELD OF DANCING, IN CLASS 41 (U.S. CLS. 100, 101 AND 107).

FIRST USE 11-1-2006; IN COMMERCE 11-1-2006.

NO CLAIM IS MADE TO THE EXCLUSIVE RIGHT TO USE "GREAT LAKES BELLYDANCE

CONVENTION", APART FROM THE MARK AS SHOWN.

THE MARK CONSISTS OF THE IMAGE OF A "BELLYDANCER" DISPOSED IN FRONT OF A CIRCLE, WITH THE TERMS "GREAT LAKES BELLYDANCE CONVENTION" DISPOSED ABOVE THE DANCER AND ABOVE AND AROUND THE CIRCLE.

SER. NO. 77-389,249, FILED 2-5-2008.

JENNY PARK, EXAMINING ATTORNEY



**Int. Cl.: 33**

**Prior U.S. Cls.: 47 and 49**

**United States Patent and Trademark Office**

**Reg. No. 3,498,665**

**Registered Sep. 9, 2008**

**TRADEMARK  
PRINCIPAL REGISTER**



GREG-MICHAEL CELLARS, LLC (WASHINGTON LIMITED LIABILITY COMPANY)  
1213 W. RAILROAD AVE.  
SPOKANE, WA 99201

THE MARK CONSISTS OF A SCALES WITH BUNCHES OF GRAPES HANGING FROM THE SCALES.

FOR: WINES, IN CLASS 33 (U.S. CLS. 47 AND 49).

SER. NO. 77-389,304, FILED 2-5-2008.

FIRST USE 3-1-2003; IN COMMERCE 3-1-2003.

OWNER OF U.S. REG. NO. 3,168,492.

AHSEN KHAN, EXAMINING ATTORNEY

**Int. Cl.: 41**

**Prior U.S. Cls.: 100, 101 and 107**

**United States Patent and Trademark Office**

**Reg. No. 3,498,666**

**Registered Sep. 9, 2008**

**SERVICE MARK  
PRINCIPAL REGISTER**



COUNTRYWIDE FINANCIAL CORPORATION  
(DELAWARE CORPORATION)  
4500 PARK GRANADA  
CALABASAS, CA 91302

FOR: EDUCATIONAL SERVICES, NAMELY, CONDUCTING SEMINARS IN THE FIELD OF PERSONAL FINANCE; EDUCATIONAL SERVICES, NAMELY, CONDUCTING INFORMAL PROGRAMS IN THE FIELD OF PERSONAL FINANCE USING INTERACTIVE ON-LINE ACTIVITIES AND EXHIBITS AND PRINTABLE MATERIALS DISTRIBUTED THEREWITH, IN CLASS 41 (U.S. CLS. 100, 101 AND 107).

FIRST USE 3-28-2007; IN COMMERCE 3-28-2007.

NO CLAIM IS MADE TO THE EXCLUSIVE RIGHT TO USE "HOME OWNERSHIP MORTGAGE

EDUCATION", APART FROM THE MARK AS SHOWN.

THE MARK CONSISTS OF THE WORD "HOME" WITH THE LETTERS "H" AND "E" IN WHITE AND THE LETTERS "O" AND "M" IN BLACK SUPERIMPOSED ON A HOUSE DESIGN. THE WALLS AND CHIMNEY OF THE HOUSE ARE WHITE AND THE ROOF OF THE HOUSE IS BLACK. THE LETTERS "H" AND "E" IN "HOME" AND A PORTION OF THE HOUSE DESIGN ARE UNDERLINED IN WHITE, AND APPEAR ABOVE THE WORDING "HOME OWNERSHIP MORTGAGE EDUCATION" WHICH IS WHITE ABOVE A WHITE LINE WITH A BLACK BACKGROUND.

SER. NO. 77-389,367, FILED 2-5-2008.

LINDA ORNDORFF, EXAMINING ATTORNEY

**Int. Cl.: 41**

**Prior U.S. Cls.: 100, 101 and 107**

**Reg. No. 3,498,667**

**United States Patent and Trademark Office**

**Registered Sep. 9, 2008**

**SERVICE MARK  
PRINCIPAL REGISTER**



COUNTRYWIDE FINANCIAL CORPORATION  
(DELAWARE CORPORATION)  
4500 PARK GRANADA  
CALABASAS, CA 91302

FOR: EDUCATIONAL SERVICES, NAMELY, CONDUCTING SEMINARS IN THE FIELD OF PERSONAL FINANCE; EDUCATIONAL SERVICES, NAMELY, CONDUCTING INFORMAL PROGRAMS IN THE FIELD OF PERSONAL FINANCE USING INTERACTIVE ON-LINE ACTIVITIES AND EXHIBITS AND PRINTABLE MATERIALS DISTRIBUTED THEREWITH, IN CLASS 41 (U.S. CLS. 100, 101 AND 107).

FIRST USE 10-11-2007; IN COMMERCE 10-11-2007.

NO CLAIM IS MADE TO THE EXCLUSIVE RIGHT TO USE "EDUCACION HIPOTECARIA PARA TENER CASA", APART FROM THE MARK AS SHOWN.

THE MARK CONSISTS OF THE WORDS "MI HOGAR" WITH THE LETTERS "MI" AND "GAR" IN BLACK AND THE LETTERS "H" AND "O" IN WHITE SUPERIMPOSED ON A HOUSE DESIGN. THE WALLS AND CHIMNEY OF THE HOUSE ARE BLACK AND THE ROOF OF THE HOUSE IS WHITE. THE LETTERS "MI" AND "GAR" IN "MI HOGAR" AND A PORTION OF THE HOUSE DESIGN ARE UNDERLINED IN BLACK AND APPEAR ABOVE THE WORDING "EDUCACION HIPOTECARIA PARA TENER CASA" WHICH IS BLACK ABOVE A BLACK LINE WITH A WHITE BACKGROUND.

THE FOREIGN WORDING IN THE MARK TRANSLATES INTO ENGLISH AS MY HOME MORTGAGE EDUCATION TO BECOME A HOMEOWNER.

SER. NO. 77-389,377, FILED 2-5-2008.

LINDA ORNDORFF, EXAMINING ATTORNEY

**Int. Cl.: 41**

**Prior U.S. Cls.: 100, 101 and 107**

**United States Patent and Trademark Office**

**Reg. No. 3,498,668**

**Registered Sep. 9, 2008**

**SERVICE MARK  
PRINCIPAL REGISTER**



COUNTRYWIDE FINANCIAL CORPORATION  
(DELAWARE CORPORATION)  
4500 PARK GRANADA  
CALABASAS, CA 91302

FOR: EDUCATIONAL SERVICES, NAMELY, CONDUCTING SEMINARS IN THE FIELD OF PERSONAL FINANCE; EDUCATIONAL SERVICES, NAMELY, CONDUCTING INFORMAL PROGRAMS IN THE FIELD OF PERSONAL FINANCE USING INTERACTIVE ON-LINE ACTIVITIES AND EXHIBITS AND PRINTABLE MATERIALS DISTRIBUTED THEREWITH, IN CLASS 41 (U.S. CLS. 100, 101 AND 107).

FIRST USE 7-10-2007; IN COMMERCE 7-10-2007.

NO CLAIM IS MADE TO THE EXCLUSIVE RIGHT TO USE "EDUCACION HIPOTECARIA PARA TENER CASA", APART FROM THE MARK AS SHOWN.

THE MARK CONSISTS OF THE WORDS MI HOGAR WITH THE LETTERS "MI" AND "GAR" IN WHITE AND THE LETTERS "H" AND "O" IN BLACK SUPERIMPOSED ON A HOUSE DESIGN. THE WALLS AND CHIMNEY OF THE HOUSE ARE WHITE AND THE ROOF OF THE HOUSE IS BLACK. THE LETTERS "MI" AND "GAR" IN "MI HOGAR" AND A PORTION OF THE HOUSE DESIGN ARE UNDERLINED IN WHITE, AND APPEAR ABOVE THE WORDING "EDUCACION HIPOTECARIA PARA TENER CASA" WHICH IS WHITE ABOVE A WHITE LINE WITH A BLACK BACKGROUND.

THE FOREIGN WORDING IN THE MARK TRANSLATES INTO ENGLISH AS MY HOME MORTGAGE EDUCATION TO BECOME A HOMEOWNER.

SER. NO. 77-389,384, FILED 2-5-2008.

LINDA ORNDORFF, EXAMINING ATTORNEY

**Int. Cl.: 41**

**Prior U.S. Cls.: 100, 101 and 107**

**United States Patent and Trademark Office**

**Reg. No. 3,498,669**

**Registered Sep. 9, 2008**

**SERVICE MARK  
PRINCIPAL REGISTER**



VOCAB LLC (NEW JERSEY LIMITED LIABILITY COMPANY)

# 358

765 MOUNTAIN AVENUE  
SPRINGFIELD, NJ 07081

FOR: PUBLICATION AND EDITING OF PRINTED MATTER; PUBLICATION OF LITERARY AND CREATIVE SUBJECT MATTER OF OTHERS, NAMELY, SHORT STORIES, BOOKS, AND POEMS , IN CLASS 41 (U.S. CLS. 100, 101 AND 107).

FIRST USE 10-12-2007; IN COMMERCE 12-7-2007.

NO CLAIM IS MADE TO THE EXCLUSIVE RIGHT TO USE "VOCAB LLC", APART FROM THE MARK AS SHOWN.

THE MARK CONSISTS OF THE LITERAL ELEMENT "VOCAB LLC" SUPERIMPOSED ON AN OVAL-SHAPED FIGURE.

SER. NO. 77-389,393, FILED 2-5-2008.

EMILY CHUO, EXAMINING ATTORNEY

**Int. Cl.: 43**

**Prior U.S. Cls.: 100 and 101**

**United States Patent and Trademark Office**

**Reg. No. 3,498,670**

**Registered Sep. 9, 2008**

**SERVICE MARK  
PRINCIPAL REGISTER**

**WOLFGANG PUCK GRILLE**

PUCK, WOLFGANG (UNITED STATES INDIVIDUAL)  
11400 WEST OLYMPIC BLVD., SUITE 330  
LOS ANGELES, CA 90064

FOR: RESTAURANT AND BAR SERVICES, IN CLASS 43 (U.S. CLS. 100 AND 101).

FIRST USE 10-3-2007; IN COMMERCE 10-3-2007.

THE MARK CONSISTS OF STANDARD CHARACTERS WITHOUT CLAIM TO ANY PARTICULAR FONT, STYLE, SIZE, OR COLOR.

OWNER OF U.S. REG. NOS. 1,901,065, 3,093,736, AND 3,213,815.

NO CLAIM IS MADE TO THE EXCLUSIVE RIGHT TO USE "GRILLE", APART FROM THE MARK AS SHOWN.

SER. NO. 77-389,457, FILED 2-5-2008.

CHRISTINA SOBRAL, EXAMINING ATTORNEY

**Int. Cl.: 36**

**Prior U.S. Cls.: 100, 101 and 102**

**United States Patent and Trademark Office**

**Reg. No. 3,498,671**

**Registered Sep. 9, 2008**

**SERVICE MARK  
PRINCIPAL REGISTER**

**Friends of Friends Network**

CHRISTOPHER DICRISTO, SR. (UNITED STATES INDIVIDUAL)  
SUITE 240  
3 EAST STOW ROAD  
MARLTON, NJ 08053

FOR: MORTGAGE BROKERAGE; MORTGAGE PROCUREMENT FOR OTHERS, IN CLASS 36 (U.S. CLS. 100, 101 AND 102).

FIRST USE 1-1-2007; IN COMMERCE 1-1-2007.

THE MARK CONSISTS OF STANDARD CHARACTERS WITHOUT CLAIM TO ANY PARTICULAR FONT, STYLE, SIZE, OR COLOR.

NO CLAIM IS MADE TO THE EXCLUSIVE RIGHT TO USE "NETWORK", APART FROM THE MARK AS SHOWN.

SER. NO. 77-389,467, FILED 2-5-2008.

CHRISTINA SOBRAL, EXAMINING ATTORNEY

**Int. Cl.: 3**

**Prior U.S. Cls.: 1, 4, 6, 50, 51 and 52**

**United States Patent and Trademark Office**

**Reg. No. 3,498,672**

**Registered Sep. 9, 2008**

**TRADEMARK  
PRINCIPAL REGISTER**

**SILVER SHIELD GEL**

AMERICAN SILVER, LLC (UTAH LIMITED LIABILITY COMPANY)  
80 WEST CANYON CREST ROAD  
ALPINE, UT 84004

OWNER OF U.S. REG. NO. 3,330,694.

FOR: HAND CLEANING PREPARATIONS; SKIN CLEANSERS, IN CLASS 3 (U.S. CLS. 1, 4, 6, 50, 51 AND 52).

NO CLAIM IS MADE TO THE EXCLUSIVE RIGHT TO USE "GEL", APART FROM THE MARK AS SHOWN.

FIRST USE 11-3-2005; IN COMMERCE 11-3-2005.

SER. NO. 77-389,548, FILED 2-5-2008.

THE MARK CONSISTS OF STANDARD CHARACTERS WITHOUT CLAIM TO ANY PARTICULAR FONT, STYLE, SIZE, OR COLOR.

BRIDGETT SMITH, EXAMINING ATTORNEY



**Int. Cl.: 5**

**Prior U.S. Cls.: 6, 18, 44, 46, 51 and 52**

**United States Patent and Trademark Office**

**Reg. No. 3,498,673**

**Registered Sep. 9, 2008**

**TRADEMARK  
PRINCIPAL REGISTER**

**SILVER SHIELD GEL**

AMERICAN SILVER, LLC (UTAH LIMITED LIABILITY COMPANY)  
80 WEST CANYON CREST ROAD  
ALPINE, UT 84004

FOR: HAND-SANITIZING PREPARATIONS, IN CLASS 5 (U.S. CLS. 6, 18, 44, 46, 51 AND 52).

FIRST USE 11-3-2005; IN COMMERCE 11-3-2005.

THE MARK CONSISTS OF STANDARD CHARACTERS WITHOUT CLAIM TO ANY PARTICULAR FONT, STYLE, SIZE, OR COLOR.

OWNER OF U.S. REG. NO. 3,330,694.

NO CLAIM IS MADE TO THE EXCLUSIVE RIGHT TO USE "GEL", APART FROM THE MARK AS SHOWN.

SER. NO. 77-389,558, FILED 2-5-2008.

BRIDGETT SMITH, EXAMINING ATTORNEY

**Int. Cl.: 35**

**Prior U.S. Cls.: 100, 101 and 102**

**United States Patent and Trademark Office**

**Reg. No. 3,498,674**

**Registered Sep. 9, 2008**

**SERVICE MARK  
PRINCIPAL REGISTER**

**Click.Bid.Rent.Save**

JEREMY EARLE (UNITED STATES INDIVIDUAL)  
1782 RIPLEY RUN  
WELLINGTON, FL 33414

THE MARK CONSISTS OF STANDARD CHARACTERS WITHOUT CLAIM TO ANY PARTICULAR FONT, STYLE, SIZE, OR COLOR.

FOR: REAL ESTATE ADVERTISING SERVICES,  
IN CLASS 35 (U.S. CLS. 100, 101 AND 102).

SER. NO. 77-389,570, FILED 2-5-2008.

FIRST USE 12-1-2007; IN COMMERCE 12-1-2007.

RONALD DELGIZZI, EXAMINING ATTORNEY

**Int. Cl.: 43**

**Prior U.S. Cls.: 100 and 101**

**United States Patent and Trademark Office**

**Reg. No. 3,498,675**

**Registered Sep. 9, 2008**

**SERVICE MARK  
PRINCIPAL REGISTER**



**VICTORIA COURT**

PANORAMA ENTERPRISES, INC. (PHILIPPINES  
CORPORATION)  
VICTORIA COURT  
# CANLEY ROAD  
PASIG, PHILIPPINES

THE MARK CONSISTS OF AN IMAGE OF A  
WOMAN WITH THE RIGHT FOREFINGER DIS-  
PLAYING A SILENT SIGN.

FOR: HOTEL, MOTEL, RESTAURANT, BAR AND  
CATERING SERVICES, IN CLASS 43 (U.S. CLS. 100  
AND 101).

SER. NO. 77-389,611, FILED 2-6-2008.

FIRST USE 1-1-1987; IN COMMERCE 1-1-1987.

CHERYL CLAYTON, EXAMINING ATTORNEY

**Int. Cl.: 29**

**Prior U.S. Cl.: 46**

**United States Patent and Trademark Office**

**Reg. No. 3,498,676**

**Registered Sep. 9, 2008**

**TRADEMARK  
PRINCIPAL REGISTER**

**MIA ROSE**

CAPCO ENTERPRISES INC. (NEW JERSEY CORPORATION)  
299 RIDGEDALE AVENUE  
EAST HANOVER, NJ 07936

THE MARK CONSISTS OF STANDARD CHARACTERS WITHOUT CLAIM TO ANY PARTICULAR FONT, STYLE, SIZE, OR COLOR.

FOR: PROCESSED NUTS, IN CLASS 29 (U.S. CL. 46).

SER. NO. 77-389,634, FILED 2-6-2008.

FIRST USE 2-27-2007; IN COMMERCE 2-27-2007.

CHERYL CLAYTON, EXAMINING ATTORNEY

**Int. Cl.: 41**

**Prior U.S. Cls.: 100, 101 and 107**

**United States Patent and Trademark Office**

**Reg. No. 3,498,677**

**Registered Sep. 9, 2008**

**SERVICE MARK  
PRINCIPAL REGISTER**



ROAR ON THE SHORE, INC. (PENNSYLVANIA CORPORATION)  
2171 WEST 38TH STREET  
ERIE, PA 16508

FOR: ENTERTAINMENT IN THE NATURE OF ORGANIZING, ARRANGING, AND CONDUCTING MOTORCYCLE RIDING EXCURSIONS AND MOTORCYCLE RALLIES; ENTERTAINMENT SERVICES, NAMELY, LIVE PERFORMANCES BY MUSICAL BANDS, IN CLASS 41 (U.S. CLS. 100, 101 AND 107).

FIRST USE 12-6-2007; IN COMMERCE 1-3-2008.

THE MARK CONSISTS OF A MOTORCYCLE WITH WATER RIPPLES ON EITHER SIDE, WITH THE WORDS "ROAR ON THE SHORE" UNDERNEATH. THE FRONT WHEEL OF THE MOTORCYCLE IS INCORPORATED INTO THE WORD "SHORE".

SER. NO. 77-389,666, FILED 2-6-2008.

WENDY JUN, EXAMINING ATTORNEY

**Int. Cl.: 35**

**Prior U.S. Cls.: 100, 101 and 102**

**United States Patent and Trademark Office**

**Reg. No. 3,498,678**

**Registered Sep. 9, 2008**

**SERVICE MARK  
PRINCIPAL REGISTER**

The logo consists of the letters "OTG" in a bold, orange, sans-serif font. The letters are stylized with thick strokes and a slight shadow effect, giving them a three-dimensional appearance. The "O" is a solid circle, the "T" has a vertical stem and a horizontal top bar, and the "G" has a curved bottom and a vertical stem.

OTG MANAGEMENT, INC. (PENNSYLVANIA CORPORATION)  
ONE INTERNATIONAL PLAZA  
SUITE 130  
PHILADELPHIA, PA 19113

FOR: OPERATION AND MANAGEMENT OF RESTAURANTS, BARS, MARKETS, BAKERIES, CAFES, CAFETERIAS, FOOD COURTS, LOUNGES, SNACK BARS, KIOSKS AND OTHER RETAIL FOOD AND BEVERAGE CONCEPTS FOR OTHERS; OPERATION AND MANAGEMENT OF FOOD AND BEVERAGE AND OTHER RETAIL STORES FOR OTHERS FEATURING TOUCH SCREEN ORDERING, COMPUTERS, INTERNET AND INFORMATION TECHNOLOGY EQUIPMENT, IN CLASS 35 (U.S. CLS. 100, 101 AND 102).

FIRST USE 1-18-2007; IN COMMERCE 1-18-2007.

OWNER OF U.S. REG. NO. 2,908,809.

THE COLOR(S) ORANGE IS/ARE CLAIMED AS A FEATURE OF THE MARK.

THE MARK CONSISTS OF THE LETTERS "OTG" IN THE COLOR ORANGE AND IN A STYLIZED FONT.

SER. NO. 77-389,716, FILED 2-6-2008.

DARRYL SPRUILL, EXAMINING ATTORNEY

**Int. Cl.: 33**

**Prior U.S. Cls.: 47 and 49**

**United States Patent and Trademark Office**

**Reg. No. 3,498,679**

**Registered Sep. 9, 2008**

**TRADEMARK  
PRINCIPAL REGISTER**

**Blue Sky Vineyard**

BLUE SKY VINEYARD, LLC (ILLINOIS LIMITED LIABILITY COMPANY)  
31 HOMEWOOD DR., PO BOX 3074  
CARBONDALE, IL 62902

NO CLAIM IS MADE TO THE EXCLUSIVE RIGHT TO USE "VINEYARD", APART FROM THE MARK AS SHOWN.

FOR: WINE, IN CLASS 33 (U.S. CLS. 47 AND 49).

FIRST USE 5-15-2002; IN COMMERCE 5-15-2002.

SER. NO. 77-389,718, FILED 2-6-2008.

THE MARK CONSISTS OF STANDARD CHARACTERS WITHOUT CLAIM TO ANY PARTICULAR FONT, STYLE, SIZE, OR COLOR.

DARRYL SPRUILL, EXAMINING ATTORNEY

**Int. Cl.: 41**

**Prior U.S. Cls.: 100, 101 and 107**

**United States Patent and Trademark Office**

**Reg. No. 3,498,680**

**Registered Sep. 9, 2008**

**SERVICE MARK  
PRINCIPAL REGISTER**

**LYMPHAQUATICS**

AMES, LISA (UNITED STATES INDIVIDUAL)  
34 INDEPENDENCE CT.  
JACKSON, NJ 08527

THE MARK CONSISTS OF STANDARD CHAR-  
ACTERS WITHOUT CLAIM TO ANY PARTICULAR  
FONT, STYLE, SIZE, OR COLOR.

FOR: PHYSICAL FITNESS CONDITIONING  
CLASSES, IN CLASS 41 (U.S. CLS. 100, 101 AND 107).

SER. NO. 77-389,721, FILED 2-6-2008.

FIRST USE 1-8-2008; IN COMMERCE 1-8-2008.

DOMINICK J. SALEMI, EXAMINING ATTORNEY



**Int. Cl.: 20**

**Prior U.S. Cls.: 2, 13, 22, 25, 32 and 50**

**United States Patent and Trademark Office**

**Reg. No. 3,498,681**

**Registered Sep. 9, 2008**

**TRADEMARK  
PRINCIPAL REGISTER**

# Tinkle Tally

ROSE ISLAND LIGHTHOUSE FOUNDATION  
(RHODE ISLAND CORPORATION)  
PO BOX 1419  
NEWPORT, RI 02840

FOR: WALL HANGING MADE PRIMARILY OF  
WOOD AND SEASHELLS FOR THE PURPOSE OF  
KEEPING TRACK OF TOILET FLUSHING FOR  
WATER CONSERVATION PURPOSES, IN CLASS  
20 (U.S. CLS. 2, 13, 22, 25, 32 AND 50).

FIRST USE 6-1-2005; IN COMMERCE 6-1-2005.

THE MARK CONSISTS OF STANDARD CHAR-  
ACTERS WITHOUT CLAIM TO ANY PARTICULAR  
FONT, STYLE, SIZE, OR COLOR.

SER. NO. 77-389,724, FILED 2-6-2008.

SANDRA MANIOS, EXAMINING ATTORNEY

**Int. Cl.: 35**

**Prior U.S. Cls.: 100, 101 and 102**

**United States Patent and Trademark Office**

**Reg. No. 3,498,682**

**Registered Sep. 9, 2008**

**SERVICE MARK  
PRINCIPAL REGISTER**

**NEXIDIOM**

NEXIDIOM, INC. (PENNSYLVANIA CORPORATION)  
3567 MOUNTAIN VIEW DRIVE  
BOX 301  
WEST MIFFLIN, PA 151222447

THE MARK CONSISTS OF STANDARD CHARACTERS WITHOUT CLAIM TO ANY PARTICULAR FONT, STYLE, SIZE, OR COLOR.

FOR: ADVERTISING VIA ELECTRONIC MEDIA AND SPECIFICALLY THE INTERNET, IN CLASS 35 (U.S. CLS. 100, 101 AND 102).

SER. NO. 77-389,761, FILED 2-6-2008.

FIRST USE 1-1-2004; IN COMMERCE 1-1-2004.

GEORGIA CARTY, EXAMINING ATTORNEY

**Int. Cl.: 25**

**Prior U.S. Cls.: 22 and 39**

**United States Patent and Trademark Office**

**Reg. No. 3,498,683**

**Registered Sep. 9, 2008**

**TRADEMARK  
PRINCIPAL REGISTER**

AMERICA'S HARDEST WORKING  
BOOT

ROCKY BRANDS WHOLESALE LLC (DELA-  
WARE LIMITED LIABILITY COMPANY)  
39 EAST CANAL STREET  
NELSONVILLE, OH 45764

THE MARK CONSISTS OF STANDARD CHAR-  
ACTERS WITHOUT CLAIM TO ANY PARTICULAR  
FONT, STYLE, SIZE, OR COLOR.

FOR: FOOTWEAR, IN CLASS 25 (U.S. CLS. 22 AND  
39).

SER. NO. 77-389,800, FILED 2-6-2008.

FIRST USE 6-1-2007; IN COMMERCE 6-1-2007.

ROBERT STRUCK, EXAMINING ATTORNEY

**Int. Cls.: 35 and 42**

**Prior U.S. Cls.: 100, 101 and 102**

**United States Patent and Trademark Office**

**Reg. No. 3,498,684**

**Registered Sep. 9, 2008**

**SERVICE MARK  
PRINCIPAL REGISTER**



ARES SYSTEMS GROUP, LLC (MISSISSIPPI LIMITED LIABILITY COMPANY)

P.O. BOX 387

GREAT FALLS, VA 22066

FOR: COMMERCIAL ASSISTANCE RELATING TO SYSTEM IMPLEMENTATION AND SYSTEM INTEGRATION, IN CLASS 35 (U.S. CLS. 100, 101 AND 102).

FIRST USE 3-23-2007; IN COMMERCE 3-23-2007.

FOR: INTEGRATION OF COMPUTER SYSTEMS AND NETWORKS; ACCREDITATION SERVICES, NAMELY, DEVELOPING, EVALUATING, AND TESTING STANDARDS FOR INTELLIGENCE, SURVEILLANCE, AND RECONNAISSANCE SYSTEMS FOR THE PURPOSE OF ACCREDITATION; DESIGN

AND TESTING FOR NEW PRODUCT DEVELOPMENT; DESIGN AND TESTING OF NEW PRODUCTS FOR OTHERS; MATERIALS TESTING AND ANALYZING; MATERIALS TESTING AND EVALUATION; TESTING OR RESEARCH ON MACHINES, APPARATUS AND INSTRUMENTS; TESTING, ANALYSIS AND EVALUATION OF THE GOODS AND SERVICES OF OTHERS FOR THE PURPOSE OF CERTIFICATION, IN CLASS 42 (U.S. CLS. 100 AND 101).

FIRST USE 3-23-2007; IN COMMERCE 3-23-2007.

SER. NO. 77-389,826, FILED 2-6-2008.

WILLIAM ROSSMAN, EXAMINING ATTORNEY

**Int. Cl.: 33**

**Prior U.S. Cls.: 47 and 49**

**United States Patent and Trademark Office**

**Reg. No. 3,498,685**

**Registered Sep. 9, 2008**

**TRADEMARK  
PRINCIPAL REGISTER**

**CONDADO DE ALMARA**

MACAYA S.XXI S.L (SPAIN LIMITED LIABILITY  
COMPANY)  
CARRETERA DE ESTELLA 28  
LARRAGA, NAVARRA, SPAIN 31251

THE FOREIGN WORDING IN THE MARK  
TRANSLATES INTO ENGLISH AS COUNTY OF  
ALMARA.

FOR: WINE AND ALCOHOLIC BEVERAGES EX-  
CEPT BEER, IN CLASS 33 (U.S. CLS. 47 AND 49).

SER. NO. 77-389,842, FILED 2-6-2008.

OWNER OF ERPN CMNTY TM OFC REG. NO.  
003175098, DATED 3-31-2006, EXPIRES 3-31-2016.

SANDRA MANIOS, EXAMINING ATTORNEY

**Int. Cl.: 42**

**Prior U.S. Cls.: 100 and 101**

**United States Patent and Trademark Office**

**Reg. No. 3,498,686**

**Registered Sep. 9, 2008**

**SERVICE MARK  
PRINCIPAL REGISTER**

**MY T.L. DESIGNS**

YOKLEY, TAMMY (UNITED STATES INDIVIDUAL)  
P.O. BOX 105  
UNION, MO 63084

FOR: INTERIOR DESIGN AND DECORATING SERVICES; INTERIOR DESIGN AND DECORATING CONSULTATION SERVICES, IN CLASS 42 (U.S. CLS. 100 AND 101).

FIRST USE 10-0-2006; IN COMMERCE 10-0-2006.

THE MARK CONSISTS OF STANDARD CHARACTERS WITHOUT CLAIM TO ANY PARTICULAR FONT, STYLE, SIZE, OR COLOR.

NO CLAIM IS MADE TO THE EXCLUSIVE RIGHT TO USE "DESIGNS", APART FROM THE MARK AS SHOWN.

SER. NO. 77-389,845, FILED 2-6-2008.

CYNTHIA TRIPI, EXAMINING ATTORNEY

**Int. Cl.: 30**

**Prior U.S. Cl.: 46**

**United States Patent and Trademark Office**

**Reg. No. 3,498,687**

**Registered Sep. 9, 2008**

**TRADEMARK  
PRINCIPAL REGISTER**

**MONU-MINTS**

QUIRING MONUMENTS, INC. (WASHINGTON  
CORPORATION)  
9608 AURORA AVENUE NORTH  
SEATTLE, WA 981033296

THE MARK CONSISTS OF STANDARD CHAR-  
ACTERS WITHOUT CLAIM TO ANY PARTICULAR  
FONT, STYLE, SIZE, OR COLOR.

FOR: CANDY, IN CLASS 30 (U.S. CL. 46).

SER. NO. 77-389,865, FILED 2-6-2008.

FIRST USE 1-31-2000; IN COMMERCE 1-31-2000.

SANDRA MANIOS, EXAMINING ATTORNEY

**Int. Cl.: 35**

**Prior U.S. Cls.: 100, 101 and 102**

**United States Patent and Trademark Office**

**Reg. No. 3,498,688**

**Registered Sep. 9, 2008**

**SERVICE MARK  
PRINCIPAL REGISTER**

**TIA ROSA**

GRUPO BIMBO, S.A. B. DE C.V. (MEXICO CORPORATION)  
NO. 1000, COL PENA BLANCA SANTA FE  
PROLONGACION PASEO DE LA REFORMA  
MEXICO CITY DF, MEXICO 01210

FOR: RETAIL STORE SERVICES FEATURING  
BREAD, BUNS, ROLLS, MUFFINS, SWEET BAKERY  
GOODS, TORTILLAS, TORTILLA CHIPS,  
SNACKS, COOKIES, CANDY AND CONFECTIONERY,  
IN CLASS 35 (U.S. CLS. 100, 101 AND 102).

FIRST USE 6-30-1998; IN COMMERCE 3-31-2002.

THE MARK CONSISTS OF STANDARD CHARACTERS  
WITHOUT CLAIM TO ANY PARTICULAR FONT,  
STYLE, SIZE, OR COLOR.

OWNER OF U.S. REG. NOS. 2,513,917, 2,762,390  
AND OTHERS.

THE FOREIGN WORDING IN THE MARK  
TRANSLATES INTO ENGLISH AS AUNT ROSA.

SER. NO. 77-389,876, FILED 2-6-2008.

ALLISON HOLTZ, EXAMINING ATTORNEY



**Int. Cl.: 35**

**Prior U.S. Cls.: 100, 101 and 102**

**United States Patent and Trademark Office**

**Reg. No. 3,498,689**

**Registered Sep. 9, 2008**

**SERVICE MARK  
PRINCIPAL REGISTER**

**SPORTS4LESS**

SPORTS 4 LESS, LLC (CALIFORNIA LIMITED  
LIABILITY COMPANY)  
22330 SHERMAN WAY #C6  
CANOGA PARK, CA 91303

FOR: RETAIL SPORTING GOODS STORES; RE-  
TAIL SHOPS FEATURING SPORTS EQUIPMENT,  
CLOTHING, AND SPORTING GOODS; COMPU-  
TERIZED ON-LINE RETAIL STORE SERVICES IN  
THE FIELD OF SPORTS EQUIPMENT, CLOTHING,  
AND SPORTING GOODS; ON-LINE RETAIL STORE  
SERVICES FEATURING SPORTS EQUIPMENT,  
CLOTHING, AND SPORTING GOODS, IN CLASS  
35 (U.S. CLS. 100, 101 AND 102).

FIRST USE 12-20-2001; IN COMMERCE 1-20-2002.

THE MARK CONSISTS OF STANDARD CHAR-  
ACTERS WITHOUT CLAIM TO ANY PARTICULAR  
FONT, STYLE, SIZE, OR COLOR.

OWNER OF U.S. REG. NO. 2,733,560.

NO CLAIM IS MADE TO THE EXCLUSIVE  
RIGHT TO USE "SPORTS", APART FROM THE  
MARK AS SHOWN.

SEC. 2(F).

SER. NO. 77-389,894, FILED 2-6-2008.

MARGERY A. TIERNEY, EXAMINING ATTORNEY

**Int. Cl.: 41**

**Prior U.S. Cls.: 100, 101 and 107**

**United States Patent and Trademark Office**

**Reg. No. 3,498,690**

**Registered Sep. 9, 2008**

**SERVICE MARK  
PRINCIPAL REGISTER**

# Swing Like Moe

TODD GRAVES GOLF SCHOOL (OKLAHOMA  
LIMITED LIABILITY COMPANY)  
1923 FAIR MEADOW  
EDMOND, OK 73003

THE MARK CONSISTS OF STANDARD CHAR-  
ACTERS WITHOUT CLAIM TO ANY PARTICULAR  
FONT, STYLE, SIZE, OR COLOR.

FOR: GOLF INSTRUCTION; TEACHING IN THE  
FIELD OF GOLF PHILOSOPHY, IN CLASS 41 (U.S.  
CLS. 100, 101 AND 107).

SER. NO. 77-389,897, FILED 2-6-2008.

FIRST USE 5-1-2000; IN COMMERCE 5-1-2000.

MARGERY A. TIERNEY, EXAMINING ATTORNEY

**Int. Cl.: 30**

**Prior U.S. Cl.: 46**

**United States Patent and Trademark Office**

**Reg. No. 3,498,691**

**Registered Sep. 9, 2008**

**TRADEMARK  
PRINCIPAL REGISTER**

**Got Salsa?**

TIM WILLHITE FOODS, LLC (ARIZONA LIMITED LIABILITY COMPANY)  
SUITE 300-202  
20118 N. 67TH AVE.  
GLENDALE, AZ 85308

THE MARK CONSISTS OF STANDARD CHARACTERS WITHOUT CLAIM TO ANY PARTICULAR FONT, STYLE, SIZE, OR COLOR.

FOR: SALSA, IN CLASS 30 (U.S. CL. 46).

SER. NO. 77-389,920, FILED 2-6-2008.

FIRST USE 4-25-1996; IN COMMERCE 4-25-1997.

JENNIFER HETU, EXAMINING ATTORNEY

**Int. Cl.: 35**

**Prior U.S. Cls.: 100, 101 and 102**

**United States Patent and Trademark Office**

**Reg. No. 3,498,692**

**Registered Sep. 9, 2008**

**SERVICE MARK  
PRINCIPAL REGISTER**

# Windows Made Easy

WINDOWS MADE EASY LLC (ALABAMA LIMITED LIABILITY COMPANY)  
P.O. BOX 130815  
BIRMINGHAM, AL 35213

FOR: ON-LINE RETAIL STORE SERVICES FEATURING WINDOWS AND DOORS; RETAIL STORE SERVICES FEATURING WINDOWS AND DOORS, IN CLASS 35 (U.S. CLS. 100, 101 AND 102).

FIRST USE 1-22-2008; IN COMMERCE 1-22-2008.

THE MARK CONSISTS OF STANDARD CHARACTERS WITHOUT CLAIM TO ANY PARTICULAR FONT, STYLE, SIZE, OR COLOR.

NO CLAIM IS MADE TO THE EXCLUSIVE RIGHT TO USE "WINDOWS", APART FROM THE MARK AS SHOWN.

SER. NO. 77-389,929, FILED 2-6-2008.

LINDSEY RUBIN, EXAMINING ATTORNEY

**Int. Cl.: 41**

**Prior U.S. Cls.: 100, 101 and 107**

**United States Patent and Trademark Office**

**Reg. No. 3,498,693**

**Registered Sep. 9, 2008**

**SERVICE MARK  
PRINCIPAL REGISTER**

**Love, Limits, & Lessons**

CORBETT, WILLIAM (UNITED STATES INDIVIDUAL)  
197 BRAINARD ROAD  
ENFIELD, CT 06082

FOR: EDUCATIONAL SERVICES, NAMELY, CONDUCTING CLASSES, SEMINARS, CONFERENCES, WORKSHOPS IN THE FIELD OF PARENT EDUCATION AND DISCIPLINE AND DISTRIBUTION OF COURSE MATERIAL IN CONNECTION THEREWITH, IN CLASS 41 (U.S. CLS. 100, 101 AND 107).

FIRST USE 10-1-2004; IN COMMERCE 10-1-2004.

THE MARK CONSISTS OF STANDARD CHARACTERS WITHOUT CLAIM TO ANY PARTICULAR FONT, STYLE, SIZE, OR COLOR.

SER. NO. 77-389,934, FILED 2-6-2008.

AMEETA JORDAN, EXAMINING ATTORNEY

**Int. Cl.: 44**

**Prior U.S. Cls.: 100 and 101**

**United States Patent and Trademark Office**

**Reg. No. 3,498,694**

**Registered Sep. 9, 2008**

**SERVICE MARK  
PRINCIPAL REGISTER**

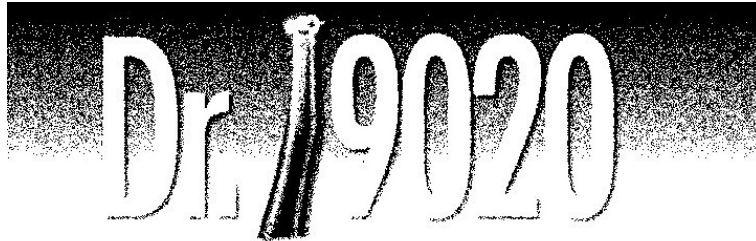

THE DENTAL COMFORT ZONE, PC (PENNSYLVANIA CORPORATION)  
2734 STREET ROAD  
BENSALEM, PA 19020

FOR: DENTISTRY, IN CLASS 44 (U.S. CLS. 100 AND 101).

FIRST USE 8-1-2007; IN COMMERCE 8-1-2007.

THE STIPPLING IS FOR SHADING PURPOSES ONLY.

THE MARK CONSISTS OF THE LETTERS "DR" AND THE NUMBERS "9020". THE FORM OF A DENTAL HIGH SPEED HAND PIECE REPRESENTS THE NUMBER "1".

SER. NO. 77-389,937, FILED 2-6-2008.

GISELLE AGOSTO, EXAMINING ATTORNEY

**Int. Cl.: 35**

**Prior U.S. Cls.: 100, 101 and 102**

**United States Patent and Trademark Office**

**Reg. No. 3,498,695**

**Registered Sep. 9, 2008**

**SERVICE MARK  
PRINCIPAL REGISTER**

**RIMFANS**

HARRIS, STEVEN (UNITED STATES INDIVIDUAL)

APT. 15

23018 ARLINGTON AVE.

TORRANCE, CA 90501 AND

HARRIS, AI (JAPAN INDIVIDUAL)

APT. 15

23018 ARLINGTON AVE.

TORRANCE, CA 90501

FOR: RETAIL STORES FEATURING DISPLAY  
MODELS FOR AUTOMOBILE RIMS , IN CLASS 35  
(U.S. CLS. 100, 101 AND 102).

FIRST USE 6-6-2007; IN COMMERCE 6-6-2007.

THE MARK CONSISTS OF STANDARD CHARACTERS WITHOUT CLAIM TO ANY PARTICULAR FONT, STYLE, SIZE, OR COLOR.

SER. NO. 77-389,944, FILED 2-6-2008.

GISELLE AGOSTO, EXAMINING ATTORNEY

**Int. Cl.: 9**

**Prior U.S. Cls.: 21, 23, 26, 36 and 38**

**Reg. No. 3,498,696**

**United States Patent and Trademark Office**

**Registered Sep. 9, 2008**

---

**TRADEMARK  
PRINCIPAL REGISTER**

**Boobtone**

LEVEY, STEVEN (UNITED STATES INDIVIDUAL)  
4032 SEQUOIA DRIVE  
EDWARDSVILLE, IL 62025

THE MARK CONSISTS OF STANDARD CHARACTERS WITHOUT CLAIM TO ANY PARTICULAR FONT, STYLE, SIZE, OR COLOR.

FOR: GUITAR AMPLIFIERS, IN CLASS 9 (U.S. CLS. 21, 23, 26, 36 AND 38).

SER. NO. 77-389,961, FILED 2-6-2008.

FIRST USE 1-20-2008; IN COMMERCE 1-20-2008.

ESTHER BELENKER, EXAMINING ATTORNEY



**Int. Cl.: 36**

**Prior U.S. Cls.: 100, 101 and 102**

**United States Patent and Trademark Office**

**Reg. No. 3,498,697**

**Registered Sep. 9, 2008**

**SERVICE MARK  
PRINCIPAL REGISTER**

**Montero Credit Management**

MONTERO CREDIT CONSULTING, LLC (MAS-  
SACHUSETTS LIMITED LIABILITY COMPA-  
NY)

202B

120 WASHINGTON ST

SALEM, MA 01970

FOR: CREDIT INQUIRY AND CONSULTATION;  
CREDIT RISK MANAGEMENT; BILL CONSOLIDA-  
TION SERVICES; DEBT COUNSELING SERVICES;  
DEBT MANAGEMENT CONSULTATION; CREDIT  
CONSULTATION; FINANCIAL SERVICES, NAME-  
LY, CREDIT REPAIR AND RESTORATION; CON-  
SUMER CREDIT CONSULTATION, IN CLASS 36  
(U.S. CLS. 100, 101 AND 102).

FIRST USE 1-14-2008; IN COMMERCE 1-14-2008.

THE MARK CONSISTS OF STANDARD CHAR-  
ACTERS WITHOUT CLAIM TO ANY PARTICULAR  
FONT, STYLE, SIZE, OR COLOR.

NO CLAIM IS MADE TO THE EXCLUSIVE  
RIGHT TO USE "CREDIT MANAGEMENT", APART  
FROM THE MARK AS SHOWN.

THE ENGLISH TRANSLATION OF "MONTERO"  
IS HUNTER.

SER. NO. 77-389,965, FILED 2-6-2008.

ESTHER BELENKER, EXAMINING ATTORNEY

**Int. Cl.: 35**

**Prior U.S. Cls.: 100, 101 and 102**

**United States Patent and Trademark Office**

**Reg. No. 3,498,698**

**Registered Sep. 9, 2008**

**SERVICE MARK  
PRINCIPAL REGISTER**

**THE GOTO NETWORK**

THE GOTO NETWORK, LLC (FLORIDA LIMITED LIABILITY COMPANY)

21844 MASTERS CIRCLE

ESTERO, FL 33928

FOR: BUSINESS NETWORKING, IN CLASS 35 (U.S. CLS. 100, 101 AND 102).

FIRST USE 2-1-2008; IN COMMERCE 2-1-2008.

THE MARK CONSISTS OF STANDARD CHARACTERS WITHOUT CLAIM TO ANY PARTICULAR FONT, STYLE, SIZE, OR COLOR.

NO CLAIM IS MADE TO THE EXCLUSIVE RIGHT TO USE "NETWORK", APART FROM THE MARK AS SHOWN.

SER. NO. 77-389,970, FILED 2-6-2008.

ESTHER BELENKER, EXAMINING ATTORNEY

**Int. Cl.: 25**

**Prior U.S. Cls.: 22 and 39**

**United States Patent and Trademark Office**

**Reg. No. 3,498,699**

**Registered Sep. 9, 2008**

**TRADEMARK  
PRINCIPAL REGISTER**

**Y & F**

LIU, YING (CHINA INDIVIDUAL)  
19058 TRANBARGER STREET  
ROWLAND HEIGHTS, CA 91748

PANTS, SWEAT SUITS, TIES, T-SHIRTS, UNDERWEAR AND WAIST BELTS, IN CLASS 25 (U.S. CLS. 22 AND 39).

FOR: BATHING SUITS, BATHROBES, BLOUSES, BODY SUITS, BRA, DRESSES, DRESSING GOWNS, EVENING GOWNS, FOOTWEAR, FUR COATS AND JACKETS, GLOVES, GYM SUITS, HAND-KNITTED SWEATERS, HEAD BAND, HEAD WEAR, JACKETS, JEANS, JOGGING SUITS, LINGERIE, NIGHT GOWNS, NIGHT SHIRTS, PAJAMAS, PANTS, RAIN COATS, SCARVES, SHIRTS, SHORTS, SKIRTS, SLACKS, SOCKS, SUITS, SPORTSWEAR, NAMELY, TOPS, SHORTS, AND PANTS; SWEATERS, SWEAT

FIRST USE 7-1-2003; IN COMMERCE 7-1-2003.

THE MARK CONSISTS OF STANDARD CHARACTERS WITHOUT CLAIM TO ANY PARTICULAR FONT, STYLE, SIZE, OR COLOR.

SER. NO. 77-389,980, FILED 2-6-2008.

JAMES LOVELACE, EXAMINING ATTORNEY

**Int. Cl.: 14**

**Prior U.S. Cls.: 2, 27, 28 and 50**

**United States Patent and Trademark Office**

**Reg. No. 3,498,700**

**Registered Sep. 9, 2008**

**TRADEMARK  
PRINCIPAL REGISTER**

**KALISTA**

NARRAGANSETT JEWELRY CO., INC. (DELA-  
WARE CORPORATION)  
100 DUPONT DRIVE  
PROVIDENCE, RI 02907

THE MARK CONSISTS OF STANDARD CHAR-  
ACTERS WITHOUT CLAIM TO ANY PARTICULAR  
FONT, STYLE, SIZE, OR COLOR.

FOR: JEWELRY, IN CLASS 14 (U.S. CLS. 2, 27, 28  
AND 50).

SER. NO. 77-389,999, FILED 2-6-2008.

FIRST USE 2-12-2008; IN COMMERCE 2-12-2008.

PAM WILLIS, EXAMINING ATTORNEY

Int. Cl.: 28

Prior U.S. Cls.: 22, 23, 38 and 50

Reg. No. 3,498,701

United States Patent and Trademark Office

Registered Sep. 9, 2008

TRADEMARK  
PRINCIPAL REGISTER

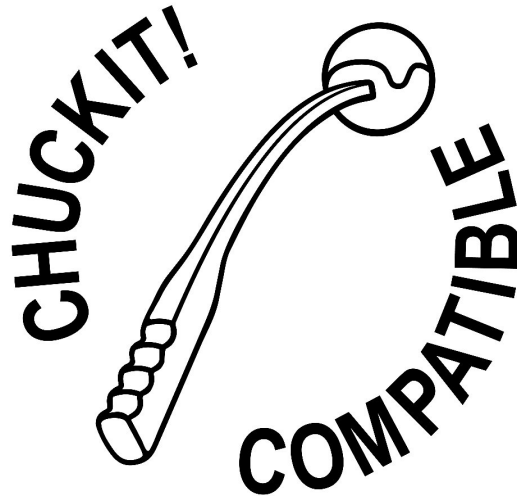

CANINE HARDWARE INC (WASHINGTON CORPORATION)  
18630 - 80TH CT. S.  
KENT, WA 980322513

NO CLAIM IS MADE TO THE EXCLUSIVE RIGHT TO USE "COMPATIBLE" , APART FROM THE MARK AS SHOWN.

FOR: PET TOYS, IN CLASS 28 (U.S. CLS. 22, 23, 38 AND 50).

SER. NO. 77-390,005, FILED 2-6-2008.

FIRST USE 5-0-2006; IN COMMERCE 5-0-2006.

LINDSEY RUBIN, EXAMINING ATTORNEY

**Int. Cl.: 35**

**Prior U.S. Cls.: 100, 101 and 102**

**United States Patent and Trademark Office**

**Reg. No. 3,498,702**

**Registered Sep. 9, 2008**

**SERVICE MARK  
PRINCIPAL REGISTER**

**AOTMP**

EVOTEM, LLC (INDIANA LIMITED LIABILITY  
COMPANY)  
SUITE 490  
6325 DIGITAL WAY  
INDIANAPOLIS, IN 46278

FOR: MANAGEMENT AND BUSINESS CON-  
SULTING SERVICES IN THE FIELD OF TELECOM-  
MUNICATIONS ENVIRONMENT MANAGEMENT,  
IN CLASS 35 (U.S. CLS. 100, 101 AND 102).

FIRST USE 7-0-2003; IN COMMERCE 7-0-2003.

THE MARK CONSISTS OF STANDARD CHAR-  
ACTERS WITHOUT CLAIM TO ANY PARTICULAR  
FONT, STYLE, SIZE, OR COLOR.

SER. NO. 77-390,008, FILED 2-6-2008.

MIDGE BUTLER, EXAMINING ATTORNEY

**Int. Cl.: 18**

**Prior U.S. Cls.: 1, 2, 3, 22 and 41**

**United States Patent and Trademark Office**

**Reg. No. 3,498,703**

**Registered Sep. 9, 2008**

**TRADEMARK  
PRINCIPAL REGISTER**



OKEKE, NKEMDILIM (UNITED STATES INDIVIDUAL)  
P.O. BOX 130216  
HOUSTON, TX 77219

FOR: DIAPER BAGS, IN CLASS 18 (U.S. CLS. 1, 2, 3, 22 AND 41).

FIRST USE 1-3-2008; IN COMMERCE 1-3-2008.

THE MARK CONSISTS OF THE LETTER "I" ABOVE THE LETTER "J" MERGED TOGETHER VERTICALLY AND THE LETTER "M" ON TOP OF THE MERGED LETTERS "I" AND "J".

SER. NO. 77-390,012, FILED 2-6-2008.

MICHAEL TANNER, EXAMINING ATTORNEY

**Int. Cl.: 35**

**Prior U.S. Cls.: 100, 101 and 102**

**United States Patent and Trademark Office**

**Reg. No. 3,498,704**

**Registered Sep. 9, 2008**

**SERVICE MARK  
PRINCIPAL REGISTER**

**EVOTEM**

EVOTEM, LLC (INDIANA LIMITED LIABILITY  
COMPANY)  
SUITE 490  
6325 DIGITAL WAY  
INDIANAPOLIS, IN 46278

FOR: MANAGEMENT AND BUSINESS CON-  
SULTING SERVICES IN THE FIELD OF TELECOM-  
MUNICATIONS ENVIRONMENT MANAGEMENT,  
IN CLASS 35 (U.S. CLS. 100, 101 AND 102).

FIRST USE 3-0-2007; IN COMMERCE 3-0-2007.

THE MARK CONSISTS OF STANDARD CHAR-  
ACTERS WITHOUT CLAIM TO ANY PARTICULAR  
FONT, STYLE, SIZE, OR COLOR.

SER. NO. 77-390,013, FILED 2-6-2008.

MIDGE BUTLER, EXAMINING ATTORNEY



Int. Cl.: 11

Prior U.S. Cls.: 13, 21, 23, 31 and 34

United States Patent and Trademark Office

Reg. No. 3,498,705

Registered Sep. 9, 2008

TRADEMARK  
PRINCIPAL REGISTER

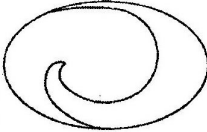
KING  AIR

SAINTYU GROUP CO., LTD (TAIWAN CORPORATION)  
4F, NO. 1, JHONGCING RD., BEITUN DIST.  
TAICHUNG, TAIWAN

FOR: DRYERS FOR THE REMOVAL OF WATER VAPOR FROM COMPRESSED AIR AND GASES; DRYERS USED FOR THE REMOVAL OF SOLID, LIQUID AND VAPOR CONTAMINANTS FROM COMPRESSED AIR AND GASES; GAS RECYCLING SYSTEM COMPRISED PRIMARILY OF PRESSURE SWING ADSORPTION EQUIPMENT FOR THE RECOVERY, PURIFICATION AND RETURN OF GASES IN INDUSTRIAL APPLICATIONS; WATER FILTERS; WATER TREATMENT EQUIPMENT, NAMELY, CARTRIDGE FILTRATION UNITS; WATER TREATMENT EQUIPMENT, NAMELY, REVERSE OSMOSIS FILTRATION UNITS;

FILTERING UNITS FOR PURIFYING WATER; DRINKING FOUNTAINS, IN CLASS 11 (U.S. CLS. 13, 21, 23, 31 AND 34).

FIRST USE 3-14-2006; IN COMMERCE 3-14-2006.

NO CLAIM IS MADE TO THE EXCLUSIVE RIGHT TO USE "AIR", APART FROM THE MARK AS SHOWN.

THE MARK CONSISTS OF WORDING "KING AIR" AND AN OVAL.

SER. NO. 77-390,041, FILED 2-6-2008.

MARK T. MULLEN, EXAMINING ATTORNEY

**Int. Cl.: 21**

**Prior U.S. Cls.: 2, 13, 23, 29, 30, 33, 40 and 50**

**United States Patent and Trademark Office**

**Reg. No. 3,498,706**

**Registered Sep. 9, 2008**

**TRADEMARK  
PRINCIPAL REGISTER**

**INFERNO PIZZA PAK**

RECRUITOPIA CORPORATION (CALIFORNIA CORPORATION)  
630 NAVAJO WAY  
FREMONT, CA 94539

FOR: THERMAL INSULATED BAGS FOR FOOD OR BEVERAGES; THERMAL INSULATED CONTAINERS FOR FOOD OR BEVERAGE; THERMAL INSULATED WRAP FOR CANS TO KEEP THE CONTENTS COLD OR HOT , IN CLASS 21 (U.S. CLS. 2, 13, 23, 29, 30, 33, 40 AND 50).

FIRST USE 2-17-1998; IN COMMERCE 11-9-1998.

THE MARK CONSISTS OF STANDARD CHARACTERS WITHOUT CLAIM TO ANY PARTICULAR FONT, STYLE, SIZE, OR COLOR.

NO CLAIM IS MADE TO THE EXCLUSIVE RIGHT TO USE "PIZZA PACK", APART FROM THE MARK AS SHOWN.

SER. NO. 77-390,043, FILED 2-6-2008.

JOHN HWANG, EXAMINING ATTORNEY

**Int. Cl.: 35**

**Prior U.S. Cls.: 100, 101 and 102**

**United States Patent and Trademark Office**

**Reg. No. 3,498,707**

**Registered Sep. 9, 2008**

**SERVICE MARK  
PRINCIPAL REGISTER**

**SOWINERGY**

GOOLSBY, TERRY (UNITED STATES INDIVIDUAL)  
2806 MATAPEAKE DRIVE  
UPPER MARLBORO, MD 20774

FOR: NEW BUSINESS VENTURE DEVELOPMENT AND FORMATION CONSULTING SERVICES; ENERGY USAGE MANAGEMENT INFORMATION SERVICES, IN CLASS 35 (U.S. CLS. 100, 101 AND 102).

FIRST USE 11-29-2007; IN COMMERCE 11-29-2007.

THE MARK CONSISTS OF STANDARD CHARACTERS WITHOUT CLAIM TO ANY PARTICULAR FONT, STYLE, SIZE, OR COLOR.

SER. NO. 77-390,051, FILED 2-6-2008.

JOHN WILKE, EXAMINING ATTORNEY

**Int. Cls.: 35 and 36**

**Prior U.S. Cls.: 100, 101 and 102**

**United States Patent and Trademark Office**

**Reg. No. 3,498,708**

**Registered Sep. 9, 2008**

**SERVICE MARK  
PRINCIPAL REGISTER**

# The Tax Surgeon

THE TAX SURGEON, LLC (GEORGIA LIMITED LIABILITY COMPANY)  
1675 CUMBERLAND PKWY, SUITE 101  
SMYRNA, GA 30080

FOR: TAX PREPARATION, TAX CONSULTATION, TAX AUDIT REPRESENTATION, AND BUSINESS CONSULTATION SERVICES, IN CLASS 35 (U.S. CLS. 100, 101 AND 102).

FIRST USE 1-25-2008; IN COMMERCE 1-25-2008.

FOR: FINANCIAL PLANNING, IN CLASS 36 (U.S. CLS. 100, 101 AND 102).

FIRST USE 1-25-2008; IN COMMERCE 1-25-2008.

THE MARK CONSISTS OF STANDARD CHARACTERS WITHOUT CLAIM TO ANY PARTICULAR FONT, STYLE, SIZE, OR COLOR.

NO CLAIM IS MADE TO THE EXCLUSIVE RIGHT TO USE "TAX", APART FROM THE MARK AS SHOWN.

SER. NO. 77-390,064, FILED 2-6-2008.

DOMINIC FATHY, EXAMINING ATTORNEY

**Int. Cl.: 35**

**Prior U.S. Cls.: 100, 101 and 102**

**United States Patent and Trademark Office**

**Reg. No. 3,498,709**

**Registered Sep. 9, 2008**

**SERVICE MARK  
PRINCIPAL REGISTER**

THE RIGHT COIN @ THE RIGHT  
PRICE.

GAINESVILLE COINS, INC. (FLORIDA COR-  
PORATION)  
P. O. BOX 2721  
LUTZ, FL 33548

FOR: ONLINE RETAIL SERVICES IN THE FIELD  
OF NUMISMATICS, IN CLASS 35 (U.S. CLS. 100, 101  
AND 102).

FIRST USE 7-0-2007; IN COMMERCE 7-0-2007.

THE MARK CONSISTS OF STANDARD CHAR-  
ACTERS WITHOUT CLAIM TO ANY PARTICULAR  
FONT, STYLE, SIZE, OR COLOR.

NO CLAIM IS MADE TO THE EXCLUSIVE  
RIGHT TO USE "COIN", APART FROM THE MARK  
AS SHOWN.

SER. NO. 77-390,068, FILED 2-6-2008.

JOHN HWANG, EXAMINING ATTORNEY

**Int. Cls.: 9 and 42**

**Prior U.S. Cls.: 21, 23, 26, 36, 38, 100 and 101**

**United States Patent and Trademark Office**

**Reg. No. 3,498,710**

**Registered Sep. 9, 2008**

**TRADEMARK  
SERVICE MARK  
PRINCIPAL REGISTER**



AMERICAN ROENTGEN RAY SOCIETY (VIRGINIA NON-PROFIT ASSOCIATION)  
44211 SLATESTONE COURT  
LEESBURG, VA 20176

FOR: COMPUTER SOFTWARE FOR IMAGE SEARCHING, VISUAL SEARCH, VIDEO AND IMAGE MONITORING AND CLASSIFICATION, COMPUTER SEARCH ENGINE SOFTWARE; COMPUTER SOFTWARE FOR USE IN THE FIELD OF IMAGE AND VIDEO MANAGEMENT; AND COMPUTER SOFTWARE FOR ORGANIZING AND VIEWING DIGITAL IMAGES, IN CLASS 9 (U.S. CLS. 21, 23, 26, 36 AND 38).

FIRST USE 3-1-2006; IN COMMERCE 3-1-2006.

FOR: COMPUTER SERVICE, NAMELY, PROVIDING SEARCH ENGINES FOR OBTAINING DATA ON A GLOBAL COMPUTER NETWORK, IN CLASS 42 (U.S. CLS. 100 AND 101).

FIRST USE 3-1-2006; IN COMMERCE 3-1-2006.

THE COLOR(S) YELLOW, BLACK, YELLOWISH ORANGE, WHITE, AND GRAYISH BLUE IS/ARE CLAIMED AS A FEATURE OF THE MARK.

THE MARK CONSISTS OF THE "GOLDMINER" PARTIALLY SET IN A BANDED YELLOW BACKGROUND, WITH THE "G" AND "M" IN UPPER-CASE LETTERS, THE "ARRS" IN UPPER-CASE LETTERS POSITIONED ABOVE THE "INER" AND A YELLOWISH ORANGE MINER'S HAT POSITIONED ABOVE THE "G" AND THE "O", A WHITE LIGHT SOURCE ATTACHED TO THE FRONT OF THE MINER'S HAT WITH A BLACK BELT, THE MINER'S HAT TILTED TOWARDS THE "LDM" WITH A GRAYISH BLUE RAY OF LIGHT EMANATING FROM THE LIGHT SOURCE AND COVERING ENTIRELY OR PARTIALLY THE "LDMINE".

SER. NO. 77-390,090, FILED 2-6-2008.

RICHARD A. STRASER, EXAMINING ATTORNEY

**Int. Cl.: 9**

**Prior U.S. Cls.: 21, 23, 26, 36 and 38**

**Reg. No. 3,498,711**

**United States Patent and Trademark Office**

**Registered Sep. 9, 2008**

---

**TRADEMARK  
PRINCIPAL REGISTER**

**MAXGUARD**

ABATIX CORP. (DELAWARE CORPORATION)  
SUITE 400  
2400 SKYLINE DRIVE  
MESQUITE, TX 751491972

THE MARK CONSISTS OF STANDARD CHAR-  
ACTERS WITHOUT CLAIM TO ANY PARTICULAR  
FONT, STYLE, SIZE, OR COLOR.

FOR: PROTECTIVE CLOTHING, IN CLASS 9 (U.S.  
CLS. 21, 23, 26, 36 AND 38).

SER. NO. 77-390,147, FILED 2-6-2008.

FIRST USE 6-11-2007; IN COMMERCE 8-29-2007.

ROBIN CHOSID, EXAMINING ATTORNEY

**Int. Cl.: 43**

**Prior U.S. Cls.: 100 and 101**

**United States Patent and Trademark Office**

**Reg. No. 3,498,712**

**Registered Sep. 9, 2008**

**SERVICE MARK  
PRINCIPAL REGISTER**

# Ketzal Mexican Grill

RENOR LLC (ARIZONA LIMITED LIABILITY  
COMPANY)

2390 E CAMELBACK RD SUITE 410

PHOENIX, AZ 85016

FOR: BAR AND RESTAURANT SERVICES, IN  
CLASS 43 (U.S. CLS. 100 AND 101).

FIRST USE 2-5-2008; IN COMMERCE 2-5-2008.

THE MARK CONSISTS OF STANDARD CHAR-  
ACTERS WITHOUT CLAIM TO ANY PARTICULAR  
FONT, STYLE, SIZE, OR COLOR.

NO CLAIM IS MADE TO THE EXCLUSIVE  
RIGHT TO USE "MEXICAN GRILL", APART FROM  
THE MARK AS SHOWN.

SER. NO. 77-390,156, FILED 2-6-2008.

DAVID MURRAY, EXAMINING ATTORNEY



**Int. Cls.: 9, 38 and 41**

**Prior U.S. Cls.: 21, 23, 26, 36, 38, 100, 101, 104 and 107**

**United States Patent and Trademark Office**

**Reg. No. 3,498,713**

**Registered Sep. 9, 2008**

**TRADEMARK  
SERVICE MARK  
PRINCIPAL REGISTER**

**BRAD**

BRAD, LLC (WASHINGTON LIMITED LIABILITY COMPANY)  
348 NW 54TH STREET  
SEATTLE, WA 98107

FOR: A SERIES OF MUSICAL SOUND RECORDINGS AND DOWNLOADABLE MUSICAL SOUND RECORDINGS, IN CLASS 9 (U.S. CLS. 21, 23, 26, 36 AND 38).

FIRST USE 0-0-1992; IN COMMERCE 0-0-1992.

FOR: STREAMING OF AUDIO AND VIDEO MATERIAL ON THE INTERNET, IN CLASS 38 (U.S. CLS. 100, 101 AND 104).

FIRST USE 0-0-1995; IN COMMERCE 0-0-1995.

FOR: ENTERTAINMENT SERVICES, NAMELY, LIVE PERFORMANCES BY A MUSICAL BAND; PROVIDING A WEBSITE FEATURING ENTERTAINMENT INFORMATION ON A MUSICAL BAND AND ITS TOURS, RECORDINGS, APPEARANCES, PHOTOGRAPHS AND OTHER ENTERTAINMENT INFORMATION, IN CLASS 41 (U.S. CLS. 100, 101 AND 107).

FIRST USE 0-0-1992; IN COMMERCE 0-0-1992.

THE MARK CONSISTS OF STANDARD CHARACTERS WITHOUT CLAIM TO ANY PARTICULAR FONT, STYLE, SIZE, OR COLOR.

SER. NO. 77-390,157, FILED 2-6-2008.

ROBIN CHOSID, EXAMINING ATTORNEY

**Int. Cl.: 41**

**Prior U.S. Cls.: 100, 101 and 107**

**United States Patent and Trademark Office**

**Reg. No. 3,498,714**

**Registered Sep. 9, 2008**

**SERVICE MARK  
PRINCIPAL REGISTER**

**SALUTE 2 AMERICA**

COX HOLDINGS, INC. (DELAWARE CORPORATION)  
6205 PEACHTREE DUNWOODY ROAD  
ATLANTA, GA 30328

FOR: ENTERTAINMENT SERVICES, NAMELY, ORGANIZING AND PRODUCING AN ANNUAL TELEVISION SHOW FEATURING LIVE PERFORMANCES BY MUSICIANS AND PERFORMANCES OF LIVE DRAMA, COMEDY AND MUSICAL SHOWS BY SINGERS, ACTORS AND CELEBRITIES, IN CLASS 41 (U.S. CLS. 100, 101 AND 107).

FIRST USE 7-4-1986; IN COMMERCE 7-4-1986.

THE MARK CONSISTS OF STANDARD CHARACTERS WITHOUT CLAIM TO ANY PARTICULAR FONT, STYLE, SIZE, OR COLOR.

OWNER OF U.S. REG. NO. 1,650,378.

SER. NO. 77-390,209, FILED 2-6-2008.

KATHY DE JONGE, EXAMINING ATTORNEY

**Int. Cl.: 42**

**Prior U.S. Cls.: 100 and 101**

**United States Patent and Trademark Office**

**Reg. No. 3,498,715**

**Registered Sep. 9, 2008**

**SERVICE MARK  
PRINCIPAL REGISTER**

**NEASC**

NEW ENGLAND ASSOCIATION OF SCHOOLS &  
COLLEGES, INC. (MASSACHUSETTS COR-  
PORATION)

209 BURLINGTON RD., SUITE 201  
BEDFORD, MA 017301433

FOR: ACCREDITATION SERVICES, NAMELY,  
ESTABLISHING AND MAINTAINING STAND-  
ARDS FOR EDUCATIONAL INSTITUTIONS FOR  
THE PURPOSE OF ACCREDITATION AND EVAL-  
UATING EDUCATIONAL INSTITUTIONS TO DE-  
TERMINE WHETHER THE EDUCATIONAL

INSTITUTIONS CONFORM TO THE ESTABLISHED  
STANDARDS, IN CLASS 42 (U.S. CLS. 100 AND 101).

FIRST USE 1-31-1972; IN COMMERCE 1-31-1972.

THE MARK CONSISTS OF STANDARD CHAR-  
ACTERS WITHOUT CLAIM TO ANY PARTICULAR  
FONT, STYLE, SIZE, OR COLOR.

SER. NO. 77-390,211, FILED 2-6-2008.

EMILY CARLSEN, EXAMINING ATTORNEY

**Int. Cl.: 42**

**Prior U.S. Cls.: 100 and 101**

**United States Patent and Trademark Office**

**Reg. No. 3,498,716**

**Registered Sep. 9, 2008**

**SERVICE MARK  
PRINCIPAL REGISTER**

**CAISA**

NEW ENGLAND ASSOCIATION OF SCHOOLS &  
COLLEGES, INC. (MASSACHUSETTS COR-  
PORATION)

209 BURLINGTON RD., SUITE 201  
BEDFORD, MA 017301433

FOR: ACCREDITATION SERVICES, NAMELY,  
ESTABLISHING AND MAINTAINING STAND-  
ARDS FOR EDUCATIONAL INSTITUTIONS FOR  
THE PURPOSE OF ACCREDITATION AND EVAL-  
UATING EDUCATIONAL INSTITUTIONS TO DE-  
TERMINE WHETHER THE EDUCATIONAL

INSTITUTIONS CONFORM TO THE ESTABLISHED  
STANDARDS, IN CLASS 42 (U.S. CLS. 100 AND 101).

FIRST USE 1-31-1991; IN COMMERCE 1-31-1991.

THE MARK CONSISTS OF STANDARD CHAR-  
ACTERS WITHOUT CLAIM TO ANY PARTICULAR  
FONT, STYLE, SIZE, OR COLOR.

SER. NO. 77-390,220, FILED 2-6-2008.

EMILY CARLSEN, EXAMINING ATTORNEY

**Int. Cl.: 42**

**Prior U.S. Cls.: 100 and 101**

**United States Patent and Trademark Office**

**Reg. No. 3,498,717**

**Registered Sep. 9, 2008**

**SERVICE MARK  
PRINCIPAL REGISTER**

**CPEMS**

NEW ENGLAND ASSOCIATION OF SCHOOLS &  
COLLEGES, INC. (MASSACHUSETTS COR-  
PORATION)

209 BURLINGTON RD., SUITE 201  
BEDFORD, MA 017301433

FOR: ACCREDITATION SERVICES, NAMELY,  
ESTABLISHING AND MAINTAINING STAND-  
ARDS FOR EDUCATIONAL INSTITUTIONS FOR  
THE PURPOSE OF ACCREDITATION AND EVAL-  
UATING EDUCATIONAL INSTITUTIONS TO DE-  
TERMINE WHETHER THE EDUCATIONAL

INSTITUTIONS CONFORM TO THE ESTABLISHED  
STANDARDS, IN CLASS 42 (U.S. CLS. 100 AND 101).

FIRST USE 1-31-1972; IN COMMERCE 1-31-1972.

THE MARK CONSISTS OF STANDARD CHAR-  
ACTERS WITHOUT CLAIM TO ANY PARTICULAR  
FONT, STYLE, SIZE, OR COLOR.

SER. NO. 77-390,231, FILED 2-6-2008.

EMILY CARLSEN, EXAMINING ATTORNEY

**Int. Cl.: 25**

**Prior U.S. Cls.: 22 and 39**

**United States Patent and Trademark Office**

**Reg. No. 3,498,718**

**Registered Sep. 9, 2008**

**TRADEMARK  
PRINCIPAL REGISTER**

**VOLCOM CREEDLERS**

VOLCOM, INC. (DELAWARE CORPORATION)  
1740 MONROVIA AVENUE  
COSTA MESA, CA 92627

FOR: FOOTWEAR FOR MEN AND WOMEN;  
SHOES; SLIPPERS; SANDALS; FLIP FLOPS; T-  
SHIRTS; BOARDSHORTS; SWEAT SHIRTS; SOCKS;  
HATS; CAPS; BEANIES, IN CLASS 25 (U.S. CLS. 22  
AND 39).

FIRST USE 11-8-2006; IN COMMERCE 11-8-2006.

THE MARK CONSISTS OF STANDARD CHAR-  
ACTERS WITHOUT CLAIM TO ANY PARTICULAR  
FONT, STYLE, SIZE, OR COLOR.

OWNER OF U.S. REG. NOS. 1,725,875, 2,534,210  
AND OTHERS.

SER. NO. 77-390,235, FILED 2-6-2008.

BENJAMIN ALLEN, EXAMINING ATTORNEY

**Int. Cl.: 42**

**Prior U.S. Cls.: 100 and 101**

**United States Patent and Trademark Office**

**Reg. No. 3,498,719**

**Registered Sep. 9, 2008**

**SERVICE MARK  
PRINCIPAL REGISTER**

**CIHE**

NEW ENGLAND ASSOCIATION OF SCHOOLS &  
COLLEGES, INC. (MASSACHUSETTS COR-  
PORATION)

209 BURLINGTON RD., SUITE 201  
BEDFORD, MA 017301433

FOR: ACCREDITATION SERVICES, NAMELY,  
ESTABLISHING AND MAINTAINING STAND-  
ARDS FOR EDUCATIONAL INSTITUTIONS FOR  
THE PURPOSE OF ACCREDITATION AND EVAL-  
UATING EDUCATIONAL INSTITUTIONS TO DE-  
TERMINE WHETHER THE EDUCATIONAL

INSTITUTIONS CONFORM TO THE ESTABLISHED  
STANDARDS, IN CLASS 42 (U.S. CLS. 100 AND 101).

FIRST USE 1-31-1929; IN COMMERCE 1-31-1929.

THE MARK CONSISTS OF STANDARD CHAR-  
ACTERS WITHOUT CLAIM TO ANY PARTICULAR  
FONT, STYLE, SIZE, OR COLOR.

SER. NO. 77-390,236, FILED 2-6-2008.

EMILY CARLSEN, EXAMINING ATTORNEY

**Int. Cl.: 42**

**Prior U.S. Cls.: 100 and 101**

**United States Patent and Trademark Office**

**Reg. No. 3,498,720**

**Registered Sep. 9, 2008**

**SERVICE MARK  
PRINCIPAL REGISTER**

**CPSS**

NEW ENGLAND ASSOCIATION OF SCHOOLS &  
COLLEGES, INC. (MASSACHUSETTS COR-  
PORATION)

209 BURLINGTON RD., SUITE 201  
BEDFORD, MA 017301433

FOR: ACCREDITATION SERVICES, NAMELY,  
ESTABLISHING AND MAINTAINING STAND-  
ARDS FOR EDUCATIONAL INSTITUTIONS FOR  
THE PURPOSE OF ACCREDITATION AND EVAL-  
UATING EDUCATIONAL INSTITUTIONS TO DE-  
TERMINE WHETHER THE EDUCATIONAL

INSTITUTIONS CONFORM TO THE ESTABLISHED  
STANDARDS, IN CLASS 42 (U.S. CLS. 100 AND 101).

FIRST USE 1-31-1964; IN COMMERCE 1-31-1964.

THE MARK CONSISTS OF STANDARD CHAR-  
ACTERS WITHOUT CLAIM TO ANY PARTICULAR  
FONT, STYLE, SIZE, OR COLOR.

SER. NO. 77-390,247, FILED 2-6-2008.

EMILY CARLSEN, EXAMINING ATTORNEY



**Int. Cl.: 41**

**Prior U.S. Cls.: 100, 101 and 107**

**United States Patent and Trademark Office**

**Reg. No. 3,498,721**

**Registered Sep. 9, 2008**

**SERVICE MARK  
PRINCIPAL REGISTER**

# Midlife Gals

KELLY JACKSON (UNITED STATES INDIVIDUAL)  
2301 BOWMAN AVE.  
AUSTIN, TX 78703 AND  
SALLY JACKSON (UNITED STATES INDIVIDUAL)  
2301 BOWMAN AVE.  
AUSTIN, TX 78703

FOR: ON-LINE JOURNALS, NAMELY, BLOGS  
FEATURING HUMOROUS OBSERVATIONS ON  
LIFE, IN CLASS 41 (U.S. CLS. 100, 101 AND 107).

FIRST USE 8-8-2007; IN COMMERCE 8-8-2007.

THE MARK CONSISTS OF STANDARD CHARACTERS WITHOUT CLAIM TO ANY PARTICULAR FONT, STYLE, SIZE, OR COLOR.

SER. NO. 77-390,251, FILED 2-6-2008.

AMEETA JORDAN, EXAMINING ATTORNEY

**Int. Cl.: 42**

**Prior U.S. Cls.: 100 and 101**

**United States Patent and Trademark Office**

**Reg. No. 3,498,722**

**Registered Sep. 9, 2008**

**SERVICE MARK  
PRINCIPAL REGISTER**

**CTCI**

NEW ENGLAND ASSOCIATION OF SCHOOLS &  
COLLEGES, INC. (MASSACHUSETTS COR-  
PORATION)

209 BURLINGTON RD., SUITE 201  
BEDFORD, MA 017301433

FOR: ACCREDITATION SERVICES, NAMELY,  
ESTABLISHING AND MAINTAINING STAND-  
ARDS FOR EDUCATIONAL INSTITUTIONS FOR  
THE PURPOSE OF ACCREDITATION AND EVAL-  
UATING EDUCATIONAL INSTITUTIONS TO DE-  
TERMINE WHETHER THE EDUCATIONAL

INSTITUTIONS CONFORM TO THE ESTABLISHED  
STANDARDS, IN CLASS 42 (U.S. CLS. 100 AND 101).

FIRST USE 1-31-1993; IN COMMERCE 1-31-1993.

THE MARK CONSISTS OF STANDARD CHAR-  
ACTERS WITHOUT CLAIM TO ANY PARTICULAR  
FONT, STYLE, SIZE, OR COLOR.

SER. NO. 77-390,258, FILED 2-6-2008.

EMILY CARLSEN, EXAMINING ATTORNEY

**Int. Cl.: 42**

**Prior U.S. Cls.: 100 and 101**

**United States Patent and Trademark Office**

**Reg. No. 3,498,723**

**Registered Sep. 9, 2008**

**SERVICE MARK  
PRINCIPAL REGISTER**

**CIS**

NEW ENGLAND ASSOCIATION OF SCHOOLS &  
COLLEGES, INC. (MASSACHUSETTS COR-  
PORATION)

209 BURLINGTON RD., SUITE 201  
BEDFORD, MA 017301433

FOR: ACCREDITATION SERVICES, NAMELY,  
ESTABLISHING AND MAINTAINING STAND-  
ARDS FOR EDUCATIONAL INSTITUTIONS FOR  
THE PURPOSE OF ACCREDITATION AND EVAL-  
UATING EDUCATIONAL INSTITUTIONS TO DE-  
TERMINE WHETHER THE EDUCATIONAL

INSTITUTIONS CONFORM TO THE ESTABLISHED  
STANDARDS, IN CLASS 42 (U.S. CLS. 100 AND 101).

FIRST USE 1-31-1929; IN COMMERCE 1-31-1929.

THE MARK CONSISTS OF STANDARD CHAR-  
ACTERS WITHOUT CLAIM TO ANY PARTICULAR  
FONT, STYLE, SIZE, OR COLOR.

SER. NO. 77-390,264, FILED 2-6-2008.

EMILY CARLSEN, EXAMINING ATTORNEY

**Int. Cl.: 41**

**Prior U.S. Cls.: 100, 101 and 107**

**United States Patent and Trademark Office**

**Reg. No. 3,498,724**

**Registered Sep. 9, 2008**

**SERVICE MARK  
PRINCIPAL REGISTER**

**STAT OF THE WEEK**

DEWAN, JOHN (UNITED STATES INDIVIDUAL)  
C/O ACTA SPORTS  
5559 WEST HOWARD STREET  
SKOKIE, IL 60077

FOR: ENTERTAINMENT SERVICES, NAMELY,  
AN ON-GOING SERIES FEATURING SPORTS PRO-  
VIDED THROUGH WEBCASTS AND RADIO  
BROADCASTS, IN CLASS 41 (U.S. CLS. 100, 101  
AND 107).

FIRST USE 11-20-1992; IN COMMERCE 11-20-1992.

THE MARK CONSISTS OF STANDARD CHAR-  
ACTERS WITHOUT CLAIM TO ANY PARTICULAR  
FONT, STYLE, SIZE, OR COLOR.

SER. NO. 77-390,267, FILED 2-6-2008.

JOHN WILKE, EXAMINING ATTORNEY

**Int. Cl.: 37**

**Prior U.S. Cls.: 100, 103 and 106**

**United States Patent and Trademark Office**

**Reg. No. 3,498,725**

**Registered Sep. 9, 2008**

**SERVICE MARK  
PRINCIPAL REGISTER**

**STARCLEAN**

ARAMARK UNIFORM & CAREER APPAREL  
GROUP, INC. (DELAWARE CORPORATION)  
115 NORTH FIRST STREET  
BURBANK, CA 91502

THE MARK CONSISTS OF STANDARD CHAR-  
ACTERS WITHOUT CLAIM TO ANY PARTICULAR  
FONT, STYLE, SIZE, OR COLOR.

FOR: CLEANING OF CLOTHING; LAUNDERING  
OF INDUSTRIAL CLOTHING, IN CLASS 37 (U.S.  
CLS. 100, 103 AND 106).

SER. NO. 77-390,287, FILED 2-6-2008.

FIRST USE 6-0-2007; IN COMMERCE 6-0-2007.

TARA PATE, EXAMINING ATTORNEY

**Int. Cl.: 35**

**Prior U.S. Cls.: 100, 101 and 102**

**United States Patent and Trademark Office**

**Reg. No. 3,498,726**

**Registered Sep. 9, 2008**

**SERVICE MARK  
PRINCIPAL REGISTER**

**VERRADO LEADERSHIP**

DMB WHITE TANK, LLC (ARIZONA LIMITED LIABILITY COMPANY)  
7600 E. DOUBLETREE RANCH ROAD, SUITE 300  
SCOTTSDALE, AZ 85258

FOR: COMMUNITY ASSOCIATIONS SERVICES, NAMELY, PROVIDING COMMUNITY LEADERSHIP SERVICES IN THE NATURE OF NEIGHBORHOOD TEAMS TO ORGANIZE, COORDINATE, MANAGE, AND OVERSEE COMMUNITY INVOLVEMENT AND RELATED EVENTS, NAMELY, WELCOMING COMMITTEES, NEIGHBORHOOD BLOCK PARTIES AND RECREATIONAL SPORTS, NAMELY, SOFTBALL; ORGANIZING AND PROMOTING COMMUNITY ADHESION AND PHILANTHROPIC ENDEAVORS, NAMELY, VOLUNTEER OPPORTUNITIES AND CHARITABLE ENDEAVORS, IN CLASS 35 (U.S. CLS. 100, 101 AND 102).

FIRST USE 3-31-2007; IN COMMERCE 3-31-2007.

THE MARK CONSISTS OF STANDARD CHARACTERS WITHOUT CLAIM TO ANY PARTICULAR FONT, STYLE, SIZE, OR COLOR.

OWNER OF U.S. REG. NOS. 2,849,391, 3,181,460 AND OTHERS.

NO CLAIM IS MADE TO THE EXCLUSIVE RIGHT TO USE "LEADERSHIP", APART FROM THE MARK AS SHOWN.

THE WORD "VERRADO" HAS NO MEANING IN A FOREIGN LANGUAGE.

SER. NO. 77-390,297, FILED 2-6-2008.

KATHY DE JONGE, EXAMINING ATTORNEY

Int. Cl.: 35

Prior U.S. Cls.: 100, 101 and 102

United States Patent and Trademark Office

Reg. No. 3,498,727

Registered Sep. 9, 2008

SERVICE MARK  
PRINCIPAL REGISTER



DMB WHITE TANK, LLC (ARIZONA LIMITED LIABILITY COMPANY)  
7600 E. DOUBLETREE RANCH ROAD, SUITE 300  
SCOTTSDALE, AZ 85258

FOR: COMMUNITY ASSOCIATIONS SERVICES, NAMELY, PROVIDING COMMUNITY LEADERSHIP SERVICES IN THE NATURE OF NEIGHBORHOOD TEAMS TO ORGANIZE, COORDINATE, MANAGE, AND OVERSEE COMMUNITY INVOLVEMENT AND RELATED EVENTS, NAMELY, WELCOMING COMMITTEES, NEIGHBORHOOD BLOCK PARTIES AND RECREATIONAL SPORTS, NAMELY, SOFTBALL; ORGANIZING AND PROMOTING COMMUNITY ADHESION AND PHILANTHROPIC ENDEAVORS, NAMELY, VOLUNTEER OPPORTUNITIES AND CHARITABLE ENDEAVORS, IN CLASS 35 (U.S. CLS. 100, 101 AND 102).

FIRST USE 3-31-2007; IN COMMERCE 3-31-2007.

OWNER OF U.S. REG. NOS. 2,849,391, 3,181,460 AND OTHERS.

NO CLAIM IS MADE TO THE EXCLUSIVE RIGHT TO USE "LEADERSHIP", APART FROM THE MARK AS SHOWN.

THE WORD "VERRADO" HAS NO MEANING IN A FOREIGN LANGUAGE.

SER. NO. 77-390,299, FILED 2-6-2008.

KATHY DE JONGE, EXAMINING ATTORNEY

**Int. Cl.: 30**

**Prior U.S. Cl.: 46**

**United States Patent and Trademark Office**

**Reg. No. 3,498,728**

**Registered Sep. 9, 2008**

**TRADEMARK  
PRINCIPAL REGISTER**

**SOUR RUDE DUDES**

WORLD CONFECTIONS, INC. (NEW YORK  
CORPORATION)  
185 30TH STREET  
BROOKLYN, NY 11232

FOR: CANDY, IN CLASS 30 (U.S. CL. 46).

FIRST USE 9-1-2000; IN COMMERCE 9-1-2000.

THE MARK CONSISTS OF STANDARD CHAR-  
ACTERS WITHOUT CLAIM TO ANY PARTICULAR  
FONT, STYLE, SIZE, OR COLOR.

OWNER OF U.S. REG. NO. 2,450,995.

NO CLAIM IS MADE TO THE EXCLUSIVE  
RIGHT TO USE "SOUR", APART FROM THE MARK  
AS SHOWN.

SER. NO. 77-390,300, FILED 2-6-2008.

LINDA MICKLEBURGH, EXAMINING ATTORNEY



**Int. Cl.: 3**

**Prior U.S. Cls.: 1, 4, 6, 50, 51 and 52**

**United States Patent and Trademark Office**

**Reg. No. 3,498,729**

**Registered Sep. 9, 2008**

**TRADEMARK  
PRINCIPAL REGISTER**

**JASON MARKK**

ANGSUVERN, JASON M. (UNITED STATES IN-  
DIVIDUAL)

#710

2390 CRENSHAW BLVD.

TORRANCE, CA 90501

FOR: SHOE CLEANING KITS, NAMELY, CLEAN-  
ING SOLUTION AND BRUSHES, IN CLASS 3 (U.S.  
CLS. 1, 4, 6, 50, 51 AND 52).

FIRST USE 2-7-2007; IN COMMERCE 2-7-2007.

THE MARK CONSISTS OF STANDARD CHAR-  
ACTERS WITHOUT CLAIM TO ANY PARTICULAR  
FONT, STYLE, SIZE, OR COLOR.

OWNER OF U.S. REG. NO. 3,402,469.

"JASON MARKK" DOES NOT IDENTIFY A LIV-  
ING INDIVIDUAL.

SER. NO. 77-390,319, FILED 2-6-2008.

WILLIAM VERHOSEK, EXAMINING ATTORNEY

**Int. Cl.: 35**

**Prior U.S. Cls.: 100, 101 and 102**

**United States Patent and Trademark Office**

**Reg. No. 3,498,730**

**Registered Sep. 9, 2008**

**SERVICE MARK  
PRINCIPAL REGISTER**

**DONATION XPRESS**

GOODWILL INDUSTRIES OF SACRAMENTO  
VALLEY & NORTHERN NEVADA, INC. (CALIFORNIA CORPORATION)  
6648 FRANKLIN BLVD.  
SACRAMENTO, CA 95823

FOR: CHARITABLE SERVICES BY MEANS OF PROVIDING A DONATION CENTER FOR THE COLLECTION OF DONATED GOODS AND MERCHANDISE FROM THE PUBLIC, IN CLASS 35 (U.S. CLS. 100, 101 AND 102).

FIRST USE 1-15-2007; IN COMMERCE 1-15-2007.

THE MARK CONSISTS OF STANDARD CHARACTERS WITHOUT CLAIM TO ANY PARTICULAR FONT, STYLE, SIZE, OR COLOR.

NO CLAIM IS MADE TO THE EXCLUSIVE RIGHT TO USE "DONATION", APART FROM THE MARK AS SHOWN.

SER. NO. 77-390,322, FILED 2-6-2008.

JOHN HWANG, EXAMINING ATTORNEY

**Int. Cl.: 35**

**Prior U.S. Cls.: 100, 101 and 102**

**United States Patent and Trademark Office**

**Reg. No. 3,498,731**

**Registered Sep. 9, 2008**

**SERVICE MARK  
PRINCIPAL REGISTER**



ZEUS JONES, LTD. (MINNESOTA CORPORATION)  
SUITE 203  
1221 W LAKE STREET  
MINNEAPOLIS, MN 55408

FOR: ADVERTISING AGENCIES, NAMELY, PROMOTING THE GOODS AND SERVICES OF OTHERS; ADVERTISING AND PUBLICITY SERVICES, NAMELY, PROMOTING THE GOODS, SERVICES, BRAND IDENTITY AND COMMERCIAL INFORMATION AND NEWS OF THIRD PARTIES THROUGH PRINT, AUDIO, VIDEO, DIGITAL AND ON-LINE MEDIUM; ADVERTISING SERVICES, NAMELY, CREATING CORPORATE AND BRAND IDENTITY FOR OTHERS; ADVERTISING, MARKETING AND PROMOTION SERVICES; DESIGN OF ADVERTISING MATERIALS FOR OTHERS; DESIGN OF INTERNET ADVERTISING; LAYOUT SERVICES FOR ADVERTISING PURPOSES; MUSIC SELECTION SERVICES FOR USE IN ADVERTISING; PREPARATION AND REALIZATION OF

MEDIA AND ADVERTISING PLANS AND CONCEPTS; PREPARATION OF CUSTOM ADVERTISEMENTS FOR OTHERS, IN CLASS 35 (U.S. CLS. 100, 101 AND 102).

FIRST USE 3-1-2007; IN COMMERCE 3-1-2007.

OWNER OF U.S. REG. NOS. 3,406,193 AND 3,406,194.

THE NAME(S), PORTRAIT(S), AND/OR SIGNATURE(S) SHOWN IN THE MARK DOES NOT IDENTIFY A PARTICULAR LIVING INDIVIDUAL.

THE MARK CONSISTS OF AN ABSTRACTED BIRD WITH SPREAD WINGS FOLLOWED BY THE WORDS "ZEUS JONES".

SER. NO. 77-390,329, FILED 2-6-2008.

CYNTHIA SLOAN, EXAMINING ATTORNEY

**Int. Cl.: 30**

**Prior U.S. Cl.: 46**

**United States Patent and Trademark Office**

**Reg. No. 3,498,732**

**Registered Sep. 9, 2008**

**TRADEMARK  
PRINCIPAL REGISTER**

**WEIRDS**

WORLD CONFECTIONS, INC. (NEW YORK  
CORPORATION)  
185 30TH STREET  
BROOKLYN, NY 11232

THE MARK CONSISTS OF STANDARD CHAR-  
ACTERS WITHOUT CLAIM TO ANY PARTICULAR  
FONT, STYLE, SIZE, OR COLOR.

FOR: CANDY, NAMELY, PANNED SUGAR NUG-  
GETS, IN CLASS 30 (U.S. CL. 46).

SER. NO. 77-390,335, FILED 2-6-2008.

FIRST USE 10-8-2002; IN COMMERCE 10-8-2002.

LINDA MICKLEBURGH, EXAMINING ATTORNEY

**Int. Cl.: 28**

**Prior U.S. Cls.: 22, 23, 38 and 50**

**United States Patent and Trademark Office**

**Reg. No. 3,498,733**

**Registered Sep. 9, 2008**

**TRADEMARK  
PRINCIPAL REGISTER**

**djubi**

PONDERING ARMORED VEHICLE LLC (NEW YORK LIMITED LIABILITY COMPANY), DBA MOONRACER  
8 KING EIDER WAY  
TAYLORS, SC 29687

FOR: BALLS FOR GAMES; NET BALLS; NETS FOR BALL GAMES; PADDLE BALL GAMES; RUBBER ACTION BALLS; SPORT BALLS, IN CLASS 28 (U.S. CLS. 22, 23, 38 AND 50).

FIRST USE 1-15-2008; IN COMMERCE 2-6-2008.

THE MARK CONSISTS OF STANDARD CHARACTERS WITHOUT CLAIM TO ANY PARTICULAR FONT, STYLE, SIZE, OR COLOR.

SER. NO. 77-390,350, FILED 2-6-2008.

ALICE BENMAMAN, EXAMINING ATTORNEY

**Int. Cl.: 37**

**Prior U.S. Cls.: 100, 103 and 106**

**United States Patent and Trademark Office**

**Reg. No. 3,498,734**

**Registered Sep. 9, 2008**

**SERVICE MARK  
PRINCIPAL REGISTER**

# UrbanMaids

URBAN MAIDS, INC. (OREGON CORPORATION)  
SUITE 509  
1221 SW 10TH AVENUE  
PORTLAND, OR 97205

THE MARK CONSISTS OF STANDARD CHARACTERS WITHOUT CLAIM TO ANY PARTICULAR FONT, STYLE, SIZE, OR COLOR.

FOR: COMMERCIAL AND RESIDENTIAL CLEANING SERVICES, IN CLASS 37 (U.S. CLS. 100, 103 AND 106).

SER. NO. 77-390,353, FILED 2-6-2008.

FIRST USE 1-9-2007; IN COMMERCE 1-9-2007.

KIM MONINGHOFF, EXAMINING ATTORNEY

Int. Cl.: 41

Prior U.S. Cls.: 100, 101 and 107

United States Patent and Trademark Office

Reg. No. 3,498,735

Registered Sep. 9, 2008

SERVICE MARK  
PRINCIPAL REGISTER



ZEUS JONES, LTD. (MINNESOTA CORPORATION)  
1221 W LAKE STREET  
MINNEAPOLIS, MN 55408

FOR: ENTERTAINMENT SERVICES, NAMELY, PROVIDING A WEB SITE FEATURING MUSICAL PERFORMANCES, MUSICAL VIDEOS, RELATED FILM CLIPS, PHOTOGRAPHS, AND OTHER MULTIMEDIA MATERIALS; PRODUCTION OF VIDEO AND CREATION OF VISUAL EFFECTS FOR OTHERS FOR USE IN DVDS, TELEVISION PROGRAMS AND ON WEB SITES; PRODUCTION OF VISUAL EFFECTS FOR VIDEOS, DVDS, TELEVISION AND FOR INTERNET WEB SITES; MUSIC COMPOSITION FOR OTHERS; MUSIC PRODUCTION SERVICES; MUSIC SELECTION SERVICES FOR USE IN TV, FILM, RADIO AND VIDEO GAMES; POST-PRODUCTION EDITING SERVICES IN THE FIELD OF MUSIC, VIDEOS AND FILMS; PRODUCTION OF SOUND AND MUSIC VIDEO RECORDINGS; CONSULTATION AND ADVICE REGARDING MUSICAL SELECTIONS AND ARRANGEMENTS FOR SOUND RECORDINGS AND LIVE PERFORMANCES; MOTION PICTURE FILM PRODUCTION; MULTIMEDIA ENTERTAINMENT SERVICES IN

THE NATURE OF RECORDING, PRODUCTION AND POST-PRODUCTION SERVICES IN THE FIELDS OF MUSIC, VIDEO, AND FILMS; MULTIMEDIA ENTERTAINMENT SOFTWARE PRODUCTION SERVICES; MULTIMEDIA PUBLISHING OF BOOKS, MAGAZINES, JOURNALS, SOFTWARE, GAMES, MUSIC, AND ELECTRONIC PUBLICATIONS, IN CLASS 41 (U.S. CLS. 100, 101 AND 107).

FIRST USE 3-1-2007; IN COMMERCE 3-1-2007.

OWNER OF U.S. REG. NOS. 3,406,193 AND 3,406,194.

THE NAME(S), PORTRAIT(S), AND/OR SIGNATURE(S) SHOWN IN THE MARK DOES NOT IDENTIFY A PARTICULAR LIVING INDIVIDUAL.

THE MARK CONSISTS OF AN ABSTRACTED BIRD WITH SPREAD WINGS FOLLOWED BY THE WORDS "ZEUS JONES".

SER. NO. 77-390,356, FILED 2-6-2008.

CYNTHIA SLOAN, EXAMINING ATTORNEY

**Int. Cl.: 41**

**Prior U.S. Cls.: 100, 101 and 107**

**United States Patent and Trademark Office**

**Reg. No. 3,498,736**

**Registered Sep. 9, 2008**

**SERVICE MARK  
PRINCIPAL REGISTER**

**SNOOP DOGG'S**

CALVIN BROADUS (UNITED STATES INDIVIDUAL)  
2000 AVENUE OF THE STARS  
C/OBARNES, MORRIS, KLEIN, MARK, YORN,  
BARNES & LEVINE, LLP  
LOS ANGELES, CA 90067

FOR: SERIES OF TELEVISION PROGRAMS FEATURING REALITY BASED ENTERTAINMENT; PROVIDING A WEBSITE THAT FEATURES INFORMATION ON A TELEVISION PROGRAM AND THE PEOPLE FEATURED THERE ON, IN CLASS 41 (U.S. CLS. 100, 101 AND 107).

FIRST USE 12-9-2007; IN COMMERCE 12-9-2007.

THE MARK CONSISTS OF STANDARD CHARACTERS WITHOUT CLAIM TO ANY PARTICULAR FONT, STYLE, SIZE, OR COLOR.

OWNER OF U.S. REG. NOS. 2,278,013 AND 2,697,128.

THE WORDING "SNOOP DOGG" IS A PERFORMING NAME THAT IDENTIFIES A LIVING INDIVIDUAL WHOSE CONSENT IS OF RECORD.

SER. NO. 77-390,378, FILED 2-6-2008.

BRIAN CALLAGHAN, EXAMINING ATTORNEY



**Int. Cl.: 41**

**Prior U.S. Cls.: 100, 101 and 107**

**United States Patent and Trademark Office**

**Reg. No. 3,498,737**

**Registered Sep. 9, 2008**

**SERVICE MARK  
PRINCIPAL REGISTER**

**CLIMATE.BNA.COM**

THE BUREAU OF NATIONAL AFFAIRS, INC.  
(DELAWARE CORPORATION)  
SUITE 11211  
1801 S. BELL STREET  
ARLINGTON, VA 22202

FOR: PROVIDING ONLINE PUBLICATIONS IN  
THE NATURE OF REPORTS, DIRECTORIES, AND  
REFERENCE MATERIALS FEATURING NEWS,  
INFORMATION, AND ANALYSIS IN THE FIELD  
OF CLIMATE CHANGE LEGISLATION, REGULA-  
TION, POLICY, LEGAL DEVELOPMENTS AND  
TRENDS, SCIENTIFIC RESEARCH, CONFERENCE  
LISTINGS, AND GREENHOUSE GAS/CARBON

EMISSIONS TRADING MARKETS, IN CLASS 41  
(U.S. CLS. 100, 101 AND 107).

FIRST USE 1-8-2008; IN COMMERCE 1-8-2008.

THE MARK CONSISTS OF STANDARD CHAR-  
ACTERS WITHOUT CLAIM TO ANY PARTICULAR  
FONT, STYLE, SIZE, OR COLOR.

SER. NO. 77-390,380, FILED 2-6-2008.

IRA J. GOODSaid, EXAMINING ATTORNEY

Int. Cl.: 42

Prior U.S. Cls.: 100 and 101

United States Patent and Trademark Office

Reg. No. 3,498,738

Registered Sep. 9, 2008

SERVICE MARK  
PRINCIPAL REGISTER



ZEUS JONES, LTD. (MINNESOTA CORPORATION)  
SUITE 203  
1221 W LAKE STREET  
MINNEAPOLIS, MN 55408

FOR: CREATING, DESIGNING AND MAINTAINING WEB SITES; RESEARCH AND DEVELOPMENT OF COMPUTER SOFTWARE; SOFTWARE AUTHORING; SOFTWARE DESIGN AND DEVELOPMENT; DESIGN AND DEVELOPMENT OF ONLINE COMPUTER SOFTWARE SYSTEMS; DESIGN OF HOME PAGES, COMPUTER SOFTWARE AND WEB SITES; DESIGN, DEVELOPMENT AND IMPLEMENTATION OF SOFTWARE; COMPUTER SOFTWARE CONSULTATION; DESIGN AND DEVELOPMENT OF MULTIMEDIA PRODUCTS; PROGRAMMING OF MULTIMEDIA APPLICATIONS; VISUAL DESIGN SERVICES IN THE NATURE OF DESIGNING VISUAL ELEMENTS FOR ONLINE, BROADCAST, PRINT, OUTDOOR AND OTHER COMMUNICATION MEDIA; PACKAGING DESIGN; DESIGNING OF PACKAGING AND WRAPPING MATERIALS; DEVELOPMENT AND DESIGN OF DIGITAL SOUND AND IMAGE CARRIERS; GRAPHIC ART DESIGN; GRAPHIC DESIGN; DE-

SIGN AND TESTING FOR NEW PRODUCT DEVELOPMENT; DESIGN AND TESTING OF NEW PRODUCTS FOR OTHERS; DESIGN FOR OTHERS IN THE FIELD OF ADVERTISING, PUBLICITY AND PROMOTIONS; CONSULTANCY IN THE FIELD OF SOFTWARE DESIGN; ANIMATION AND SPECIAL-EFFECTS DESIGN FOR OTHERS, IN CLASS 42 (U.S. CLS. 100 AND 101).

FIRST USE 3-1-2007; IN COMMERCE 3-1-2007.

OWNER OF U.S. REG. NOS. 3,406,193 AND 3,406,194.

THE NAME(S), PORTRAIT(S), AND/OR SIGNATURE(S) SHOWN IN THE MARK DOES NOT IDENTIFY A PARTICULAR LIVING INDIVIDUAL.

THE MARK CONSISTS OF AN ABSTRACTED BIRD WITH SPREAD WINGS FOLLOWED BY THE WORDS "ZEUS JONES".

SER. NO. 77-390,387, FILED 2-6-2008.

CYNTHIA SLOAN, EXAMINING ATTORNEY

**Int. Cl.: 41**

**Prior U.S. Cls.: 100, 101 and 107**

**United States Patent and Trademark Office**

**Reg. No. 3,498,739**

**Registered Sep. 9, 2008**

**SERVICE MARK  
PRINCIPAL REGISTER**

**BODYCAST**

ED LIBBY & COMPANY INC (NEW JERSEY  
CORPORATION)  
609 BROADWAY  
WESTWOOD, NJ 07675

FOR: ENTERTAINMENT SERVICES IN THE  
NATURE OF CHOREOGRAPHIED PERFORMERS  
WEARING COSTUMES AND/OR BODY PAINT SET  
IN ELABORATE SETTINGS, IN CLASS 41 (U.S. CLS.  
100, 101 AND 107).

FIRST USE 1-31-2000; IN COMMERCE 1-31-2000.

THE MARK CONSISTS OF STANDARD CHAR-  
ACTERS WITHOUT CLAIM TO ANY PARTICULAR  
FONT, STYLE, SIZE, OR COLOR.

SER. NO. 77-390,390, FILED 2-6-2008.

ODESSA BIBBINS, EXAMINING ATTORNEY

Int. Cls.: 5 and 44

Prior U.S. Cls.: 6, 18, 44, 46, 51, 52, 100 and 101

United States Patent and Trademark Office

Reg. No. 3,498,740

Registered Sep. 9, 2008

TRADEMARK  
SERVICE MARK  
PRINCIPAL REGISTER



HEALTH & BEAUTY INSTITUTE, INC. (TEXAS CORPORATION)  
6430 CALLAGHAN ROAD  
SAN ANTONIO, TX 78229

FOR: HERBAL SUPPLEMENTS, IN CLASS 5 (U.S. CLS. 6, 18, 44, 46, 51 AND 52).

FIRST USE 3-1-1998; IN COMMERCE 3-1-1998.

FOR: ACUPUNCTURE AND CHIROPRACTIC SERVICES, IN CLASS 44 (U.S. CLS. 100 AND 101).

FIRST USE 3-1-1998; IN COMMERCE 3-1-1998.

THE MARK CONSISTS OF CIRCLE CONTAINING A DESIGN OF A HEAD AND A HAND HOLDING AN ACUPUNCTURE NEEDLE WITH TWO CHINESE CHARACTERS DIRECTLY ABOVE THE HAND.

THE NON-LATIN CHARACTER(S) IN THE MARK TRANSLITERATE INTO "JEN", AND THIS MEANS NEEDLE IN ENGLISH.

SER. NO. 77-390,395, FILED 2-6-2008.

MATTHEW PAPPAS, EXAMINING ATTORNEY

**Int. Cl.: 5**

**Prior U.S. Cls.: 6, 18, 44, 46, 51 and 52**

**Reg. No. 3,498,741**

**United States Patent and Trademark Office**

**Registered Sep. 9, 2008**

**TRADEMARK  
PRINCIPAL REGISTER**

**DIESEL**

VIRGINIA BIONUTRIENTS, LLC (VIRGINIA  
LIMITED LIABILITY COMPANY)  
SUITE 101  
4200 INNSLAKE DRIVE  
GLEN ALLEN, VA 23060

FIRST USE 1-31-2008; IN COMMERCE 1-31-2008.

FOR: NUTRITIONAL SUPPLEMENTS, HERBAL  
SUPPLEMENTS, VITAMIN SUPPLEMENTS, MI-  
NERAL SUPPLEMENTS, VITAMIN AND MINERAL  
SUPPLEMENTS, DIETARY SUPPLEMENTS, DIET-  
ARY FOOD SUPPLEMENTS, AND FOOD SUPPLE-  
MENTS, ALL IN BAR FORM, IN CLASS 5 (U.S. CLS.  
6, 18, 44, 46, 51 AND 52).

THE MARK CONSISTS OF STANDARD CHAR-  
ACTERS WITHOUT CLAIM TO ANY PARTICULAR  
FONT, STYLE, SIZE, OR COLOR.

SER. NO. 77-390,419, FILED 2-6-2008.

MORGAN WYNNE, EXAMINING ATTORNEY

**Int. Cl.: 9**

**Prior U.S. Cls.: 21, 23, 26, 36 and 38**

**Reg. No. 3,498,742**

**United States Patent and Trademark Office**

**Registered Sep. 9, 2008**

**TRADEMARK  
PRINCIPAL REGISTER**

**Epicoutfit**

SKIERSBOARD LLC (COLORADO LIMITED LIABILITY COMPANY)  
460 MESA DRIVE  
LOVELAND, CO 80537

THE MARK CONSISTS OF STANDARD CHARACTERS WITHOUT CLAIM TO ANY PARTICULAR FONT, STYLE, SIZE, OR COLOR.

FOR: SUNGLASSES, IN CLASS 9 (U.S. CLS. 21, 23, 26, 36 AND 38).

SER. NO. 77-390,437, FILED 2-6-2008.

FIRST USE 1-1-2006; IN COMMERCE 1-1-2006.

ODESSA BIBBINS, EXAMINING ATTORNEY

Int. Cl.: 37

Prior U.S. Cls.: 100, 103 and 106

United States Patent and Trademark Office

Reg. No. 3,498,743

Registered Sep. 9, 2008

SERVICE MARK  
PRINCIPAL REGISTER



***We put the power in your hands.***

NORTHERN ELECTRIC, INC. (WISCONSIN CORPORATION)  
314 N. DANZ AVENUE  
GREEN BAY, WI 54302

FOR: ELECTRICAL CONTRACTOR SERVICES,  
IN CLASS 37 (U.S. CLS. 100, 103 AND 106).

FIRST USE 11-26-2007; IN COMMERCE 11-26-2007.

NO CLAIM IS MADE TO THE EXCLUSIVE  
RIGHT TO USE "ELECTRIC, INC.", APART FROM  
THE MARK AS SHOWN.

THE MARK CONSISTS OF THE LETTERS "NEI"  
INSIDE AN OVAL WITH A LIGHTNING BOLT  
GOING THROUGH THE "E". THE WORDS  
"NORTHERN ELECTRIC, INC." ARE WRAPPED  
AROUND THE BOTTOM OF THE OVAL. ALONG  
THE BOTTOM ARE THE WORDS "WE PUT THE  
POWER IN YOUR HANDS."

SER. NO. 77-390,447, FILED 2-6-2008.

STEVEN JACKSON, EXAMINING ATTORNEY

**Int. Cl.: 5**

**Prior U.S. Cls.: 6, 18, 44, 46, 51 and 52**

**Reg. No. 3,498,744**

**United States Patent and Trademark Office**

**Registered Sep. 9, 2008**

**TRADEMARK  
PRINCIPAL REGISTER**

**BURN IT OUT**

VIRGINIA BIONUTRIENTS, LLC (VIRGINIA  
LIMITED LIABILITY COMPANY)  
SUITE 101  
4200 INNSLAKE DRIVE  
GLEN ALLEN, VA 23060

FIRST USE 1-31-2008; IN COMMERCE 1-31-2008.

FOR: NUTRITIONAL SUPPLEMENTS, HERBAL  
SUPPLEMENTS, VITAMIN SUPPLEMENTS, MI-  
NERAL SUPPLEMENTS, VITAMIN AND MINERAL  
SUPPLEMENTS, DIETARY SUPPLEMENTS, DIET-  
ARY FOOD SUPPLEMENTS, AND FOOD SUPPLE-  
MENTS, ALL IN BAR FORM, IN CLASS 5 (U.S. CLS.  
6, 18, 44, 46, 51 AND 52).

THE MARK CONSISTS OF STANDARD CHAR-  
ACTERS WITHOUT CLAIM TO ANY PARTICULAR  
FONT, STYLE, SIZE, OR COLOR.

SER. NO. 77-390,448, FILED 2-6-2008.

MORGAN WYNNE, EXAMINING ATTORNEY



**Int. Cl.: 44**

**Prior U.S. Cls.: 100 and 101**

**United States Patent and Trademark Office**

**Reg. No. 3,498,745**

**Registered Sep. 9, 2008**

**SERVICE MARK  
PRINCIPAL REGISTER**



**little sprout imaging**

MARYLAND 3D ULTRASOUND SERVICES, INC.  
(MARYLAND CORPORATION)

P.O. BOX 992

OWINGS MILLS, MD 21117

FOR: MEDICAL IMAGING SERVICES, NAMELY,  
3/4D PRENATAL ULTRASOUND SERVICES, IN  
CLASS 44 (U.S. CLS. 100 AND 101).

FIRST USE 6-1-2003; IN COMMERCE 10-1-2004.

NO CLAIM IS MADE TO THE EXCLUSIVE  
RIGHT TO USE "IMAGING", APART FROM THE  
MARK AS SHOWN.

THE MARK CONSISTS OF A STICK FIGURE  
INSIDE WHAT IS INTENDED TO RESEMBLE A TV  
SCREEN. BELOW THE TV IS THE STYLIZED  
WORDS "LITTLE SPROUT IMAGING".

SER. NO. 77-390,451, FILED 2-6-2008.

MELVIN AXILBUND, EXAMINING ATTORNEY

**Int. Cl.: 9**

**Prior U.S. Cls.: 21, 23, 26, 36 and 38**

**Reg. No. 3,498,746**

**United States Patent and Trademark Office**

**Registered Sep. 9, 2008**

**TRADEMARK  
PRINCIPAL REGISTER**

**Alive**

ANIMUSOFT CORPORATION (FLORIDA CORPORATION)  
730 S.W. #20 ROAD  
MIAMI, FL 33129

THE MARK CONSISTS OF STANDARD CHARACTERS WITHOUT CLAIM TO ANY PARTICULAR FONT, STYLE, SIZE, OR COLOR.

FOR: COMPUTER OPERATING PROGRAMS; COMPUTER OPERATING SYSTEMS, IN CLASS 9 (U.S. CLS. 21, 23, 26, 36 AND 38).

SER. NO. 77-390,457, FILED 2-6-2008.

FIRST USE 2-1-2004; IN COMMERCE 2-1-2004.

RENEE MCCRAY, EXAMINING ATTORNEY

**Int. Cl.: 41**

**Prior U.S. Cls.: 100, 101 and 107**

**United States Patent and Trademark Office**

**Reg. No. 3,498,747**

**Registered Sep. 9, 2008**

**SERVICE MARK  
PRINCIPAL REGISTER**

**COHEALTH**

CONCEPT HEALTHCARE LLC (CALIFORNIA  
LIMITED LIABILITY COMPANY)  
4901 MORENA BOULEVARD, SUITE 109  
SAN DIEGO, CA 92117

FOR: EDUCATIONAL SERVICES, NAMELY,  
PROVIDING CLASSES AND SEMINARS IN THE  
FIELD OF MENTAL HEALTH CARE SERVICES,  
AND DISTRIBUTING EDUCATIONAL MATERI-  
ALS IN CONNECTION THEREWITH; PROVIDING  
SEMINARS AND CLASSES IN THE FIELD OF  
MENTAL HEALTH CARE VIA TELEPHONE AND  
WEBSITES ON THE INTERNET; EDUCATIONAL  
TRAINING COURSES CONCERNING COLLA-  
BORATION BETWEEN BEHAVIORAL HEALTH  
AND OTHER HEALTH CARE DISCIPLINES, AND  
DISTRIBUTING EDUCATIONAL MATERIALS IN  
CONNECTION THEREWITH; PROVIDING ONLINE

COURSES OF INSTRUCTION AND TRAINING  
CONCERNING MENTAL HEALTH AND AGING  
OFFERED TO PSYCHOLOGISTS, NURSES, DOC-  
TORS, AND OTHER CAREGIVERS, AND DISTRI-  
BUTING COURSE MATERIALS IN CONNECTION  
THEREWITH, IN CLASS 41 (U.S. CLS. 100, 101 AND  
107).

FIRST USE 1-22-2008; IN COMMERCE 1-22-2008.

THE MARK CONSISTS OF STANDARD CHAR-  
ACTERS WITHOUT CLAIM TO ANY PARTICULAR  
FONT, STYLE, SIZE, OR COLOR.

SER. NO. 77-390,465, FILED 2-6-2008.

BARBARA A. GOLD, EXAMINING ATTORNEY

**Int. Cl.: 41**

**Prior U.S. Cls.: 100, 101 and 107**

**United States Patent and Trademark Office**

**Reg. No. 3,498,748**

**Registered Sep. 9, 2008**

**SERVICE MARK  
PRINCIPAL REGISTER**

**WE DO CARE**

CONCEPT HEALTHCARE LLC (CALIFORNIA  
LIMITED LIABILITY COMPANY)  
4901 MORENA BOULEVARD, SUITE 109  
SAN DIEGO, CA 92117

FOR: EDUCATIONAL SERVICES, NAMELY,  
PROVIDING CLASSES AND SEMINARS IN THE  
FIELD OF MENTAL HEALTH CARE SERVICES,  
AND DISTRIBUTING EDUCATIONAL MATERI-  
ALS IN CONNECTION THEREWITH; PROVIDING  
SEMINARS AND CLASSES IN THE FIELD OF  
MENTAL HEALTH CARE VIA TELEPHONE AND  
WEBSITES ON THE INTERNET; EDUCATIONAL  
TRAINING COURSES CONCERNING COLLA-  
BORATION BETWEEN BEHAVIORAL HEALTH  
AND OTHER HEALTH CARE DISCIPLINES, AND  
DISTRIBUTING EDUCATIONAL MATERIALS IN  
CONNECTION THEREWITH; PROVIDING ONLINE  
COURSES OF INSTRUCTION AND TRAINING  
CONCERNING MENTAL HEALTH AND AGING

OFFERED TO PSYCHOLOGISTS, NURSES, DOC-  
TORS, AND OTHER CAREGIVERS, AND DISTRI-  
BUTING COURSE MATERIALS IN CONNECTION  
THEREWITH, IN CLASS 41 (U.S. CLS. 100, 101 AND  
107).

FIRST USE 1-22-2008; IN COMMERCE 1-22-2008.

THE MARK CONSISTS OF STANDARD CHAR-  
ACTERS WITHOUT CLAIM TO ANY PARTICULAR  
FONT, STYLE, SIZE, OR COLOR.

NO CLAIM IS MADE TO THE EXCLUSIVE  
RIGHT TO USE "CARE", APART FROM THE MARK  
AS SHOWN.

SER. NO. 77-390,476, FILED 2-6-2008.

BARBARA A. GOLD, EXAMINING ATTORNEY

**Int. Cl.: 5**

**Prior U.S. Cls.: 6, 18, 44, 46, 51 and 52**

**Reg. No. 3,498,749**

**United States Patent and Trademark Office**

**Registered Sep. 9, 2008**

**TRADEMARK  
PRINCIPAL REGISTER**

**ProVit Xcell +**

SOMALIFE INTERNATIONAL, INC. (WASHINGTON CORPORATION)  
300-3275 LAKESHORE ROAD  
300-3275 LAKESHORE ROAD  
KELOWNA, BC V1W3S9, CANADA

THE MARK CONSISTS OF STANDARD CHARACTERS WITHOUT CLAIM TO ANY PARTICULAR FONT, STYLE, SIZE, OR COLOR.

FOR: DIETARY FOOD SUPPLEMENTS, IN CLASS 5 (U.S. CLS. 6, 18, 44, 46, 51 AND 52).

SER. NO. 77-390,481, FILED 2-6-2008.

FIRST USE 1-1-2008; IN COMMERCE 1-1-2008.

BRIAN NEVILLE, EXAMINING ATTORNEY

**Int. Cl.: 35**

**Prior U.S. Cls.: 100, 101 and 102**

**United States Patent and Trademark Office**

**Reg. No. 3,498,750**

**Registered Sep. 9, 2008**

**SERVICE MARK  
PRINCIPAL REGISTER**

# The Sea Hagg

THE SEA HAGG OF LAKELAND,LLC (FLORIDA  
LIMITED LIABILITY COMPANY)  
1470 TOWN CENTER DR.  
LAKELAND, FL 33803

THE MARK CONSISTS OF STANDARD CHAR-  
ACTERS WITHOUT CLAIM TO ANY PARTICULAR  
FONT, STYLE, SIZE, OR COLOR.

FOR: RETAIL STORES FEATURING NAUTICAL  
ANTIQUES, IN CLASS 35 (U.S. CLS. 100, 101 AND  
102).

SER. NO. 77-390,483, FILED 2-6-2008.

FIRST USE 1-1-1998; IN COMMERCE 1-1-1998.

BRIAN NEVILLE, EXAMINING ATTORNEY

**Int. Cl.: 36**

**Prior U.S. Cls.: 100, 101 and 102**

**United States Patent and Trademark Office**

**Reg. No. 3,498,751**

**Registered Sep. 9, 2008**

**SERVICE MARK  
PRINCIPAL REGISTER**

**A STEADY HORIZON**

ALLIANZ GLOBAL RISKS US INSURANCE  
COMPANY (CALIFORNIA CORPORATION)  
2350 EMPIRE AVENUE  
BURBANK, CA 91504

THE MARK CONSISTS OF STANDARD CHAR-  
ACTERS WITHOUT CLAIM TO ANY PARTICULAR  
FONT, STYLE, SIZE, OR COLOR.

FOR: INSURANCE UNDERWRITING IN THE  
FIELD OF AVIATION; INSURANCE CARRIER SER-  
VICES, IN CLASS 36 (U.S. CLS. 100, 101 AND 102).

SER. NO. 77-390,524, FILED 2-6-2008.

FIRST USE 11-30-2007; IN COMMERCE 11-30-2007.

SUSAN LESLIE DUBOIS, EXAMINING ATTORNEY

Int. Cl.: 25

Prior U.S. Cls.: 22 and 39

United States Patent and Trademark Office

Reg. No. 3,498,752

Registered Sep. 9, 2008

TRADEMARK  
PRINCIPAL REGISTER



FIELD COLORS L.L.C. (CALIFORNIA LIMITED  
LIABILITY COMPANY)

#304

500 MOLINO STREET  
LOS ANGELES, CA 90013

FOR: MEN'S CLOTHING, NAMELY, SHIRTS,  
JACKETS, VESTS, PANTS, AND SHORTS, IN CLASS  
25 (U.S. CLS. 22 AND 39).

FIRST USE 7-1-2007; IN COMMERCE 9-1-2007.

THE MARK CONSISTS OF A PICTURE OF A  
BLACK EGYPTIAN JACKAL (DOG) WITH A COL-  
LAR BAND AROUND ITS NECK. BELOW THE  
JACKAL IS THE STYLIZED WORDS "COMMON  
JACKAL".

SER. NO. 77-390,533, FILED 2-6-2008.

FLORENTINA BLANDU, EXAMINING ATTORNEY



**Int. Cl.: 9**

**Prior U.S. Cls.: 21, 23, 26, 36 and 38**

**Reg. No. 3,498,753**

**United States Patent and Trademark Office**

**Registered Sep. 9, 2008**

**TRADEMARK  
PRINCIPAL REGISTER**

**POWERUP**

EARHUGGER, INC. (UTAH CORPORATION)  
875 WEST 325 NORTH  
LINDON, UT 84042

THE MARK CONSISTS OF STANDARD CHAR-  
ACTERS WITHOUT CLAIM TO ANY PARTICULAR  
FONT, STYLE, SIZE, OR COLOR.

FOR: ELECTRICAL ADAPTORS, NAMELY,  
ELECTRICAL ADAPTORS FOR CHARGING POR-  
TABLE ELECTRONIC DEVICES, IN CLASS 9 (U.S.  
CLS. 21, 23, 26, 36 AND 38).

SER. NO. 77-390,547, FILED 2-6-2008.

FIRST USE 11-0-2006; IN COMMERCE 11-0-2006.

RONALD MCMORROW, EXAMINING ATTORNEY

**Int. Cl.: 9**

**Prior U.S. Cls.: 21, 23, 26, 36 and 38**

**United States Patent and Trademark Office**

**Reg. No. 3,498,754**

**Registered Sep. 9, 2008**

**TRADEMARK  
PRINCIPAL REGISTER**

**STEREOPHILE**

SOURCE INTERLINK MAGAZINES, LLC (DELA-  
WARE CORPORATION), DBA PRIMEDIA SPE-  
CIALTY GROUP, INC.  
6TH FLOOR  
261 MADISON AVENUE  
NEW YORK, NY 10016

FOR: COMPACT DISCS FEATURING MUSIC, IN  
CLASS 9 (U.S. CLS. 21, 23, 26, 36 AND 38).

FIRST USE 9-0-1989; IN COMMERCE 9-0-1989.

THE MARK CONSISTS OF STANDARD CHAR-  
ACTERS WITHOUT CLAIM TO ANY PARTICULAR  
FONT, STYLE, SIZE, OR COLOR.

OWNER OF U.S. REG. NO. 1,725,547.

SER. NO. 77-390,549, FILED 2-6-2008.

RONALD MCMORROW, EXAMINING ATTORNEY

**Int. Cl.: 38**

**Prior U.S. Cls.: 100, 101 and 104**

**United States Patent and Trademark Office**

**Reg. No. 3,498,755**

**Registered Sep. 9, 2008**

**SERVICE MARK  
PRINCIPAL REGISTER**

**ANVEO**

ANVEO INC. (PENNSYLVANIA CORPORATION),  
DBA ANVEO.COM  
SUITE 107  
148 EAST STREET ROAD  
FEASTERVILLE, PA 19053

FOR: TELECOMMUNICATION SERVICES,  
NAMELY, PROVIDING AUDIO AND VIDEO TELE-  
CONFERRING, INTERNET TELEPHONY, CALL  
PROCESSING AND ROUTING, TRANSMISSION OF  
VOICE, DATA, IMAGES AND TEXT MESSAGES BY  
MEANS OF BROADBAND, COPPER AND OPTICAL

OR WIRELESS NETWORKS, IN CLASS 38 (U.S. CLS.  
100, 101 AND 104).

FIRST USE 12-1-2007; IN COMMERCE 12-1-2007.

THE MARK CONSISTS OF STANDARD CHAR-  
ACTERS WITHOUT CLAIM TO ANY PARTICULAR  
FONT, STYLE, SIZE, OR COLOR.

SER. NO. 77-390,558, FILED 2-6-2008.

DARRYL SPRUILL, EXAMINING ATTORNEY

**Int. Cl.: 41**

**Prior U.S. Cls.: 100, 101 and 107**

**United States Patent and Trademark Office**

**Reg. No. 3,498,756**

**Registered Sep. 9, 2008**

**SERVICE MARK  
PRINCIPAL REGISTER**

**THE BIGGER LIGHTS**

THE BIGGER LIGHTS, LLC (VIRGINIA LIMITED  
LIABILITY COMPANY)  
89 PARTRIDGE LANE  
STAFFORD, VA 22556

THE MARK CONSISTS OF STANDARD CHAR-  
ACTERS WITHOUT CLAIM TO ANY PARTICULAR  
FONT, STYLE, SIZE, OR COLOR.

FOR: ENTERTAINMENT IN THE NATURE OF A  
MUSICAL GROUP, IN CLASS 41 (U.S. CLS. 100, 101  
AND 107).

SER. NO. 77-390,563, FILED 2-6-2008.

FIRST USE 7-29-2007; IN COMMERCE 7-29-2007.

DARRYL SPRUILL, EXAMINING ATTORNEY

**Int. Cl.: 37**

**Prior U.S. Cls.: 100, 103 and 106**

**United States Patent and Trademark Office**

**Reg. No. 3,498,757**

**Registered Sep. 9, 2008**

**SERVICE MARK  
PRINCIPAL REGISTER**

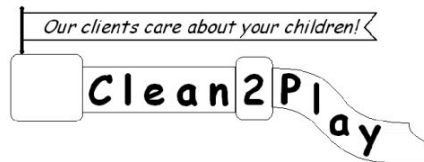

CLEAN2PLAY, LLC (ALABAMA LIMITED LIABILITY COMPANY)  
1803 4TH AVENUE NORTH  
PELL CITY, AL 35125

FIRST USE 10-30-2006; IN COMMERCE 10-30-2006.

SER. NO. 77-390,585, FILED 2-6-2008.

FOR: CLEANING AND MAINTAINING PLAY-  
GROUNDS AND PLAYGROUND FACILITIES, IN  
CLASS 37 (U.S. CLS. 100, 103 AND 106).

LESLEY LAMOTHE, EXAMINING ATTORNEY

**Int. Cl.: 37**

**Prior U.S. Cls.: 100, 103 and 106**

**United States Patent and Trademark Office**

**Reg. No. 3,498,758**

**Registered Sep. 9, 2008**

**SERVICE MARK  
PRINCIPAL REGISTER**

**CLEAN2PLAY**

CLEAN2PLAY, LLC (ALABAMA LIMITED LIABILITY COMPANY)  
1803 4TH AVENUE NORTH  
PELL CITY, AL 35125

THE MARK CONSISTS OF STANDARD CHARACTERS WITHOUT CLAIM TO ANY PARTICULAR FONT, STYLE, SIZE, OR COLOR.

FOR: CLEANING AND MAINTAINING PLAY-  
GROUNDS AND PLAYGROUND FACILITIES, IN  
CLASS 37 (U.S. CLS. 100, 103 AND 106).

SER. NO. 77-390,586, FILED 2-6-2008.

FIRST USE 10-30-2006; IN COMMERCE 10-30-2006.

LESLEY LAMOTHE, EXAMINING ATTORNEY

**Int. Cl.: 29**

**Prior U.S. Cl.: 46**

**United States Patent and Trademark Office**

**Reg. No. 3,498,759**

**Registered Sep. 9, 2008**

**TRADEMARK  
PRINCIPAL REGISTER**

**DAINTY-PAK**

VERONICA FOODS COMPANY (CALIFORNIA  
CORPORATION)  
1991 DENNISON STREET  
OAKLAND, CA 94606

THE MARK CONSISTS OF STANDARD CHAR-  
ACTERS WITHOUT CLAIM TO ANY PARTICULAR  
FONT, STYLE, SIZE, OR COLOR.

FOR: CANNED FRUITS AND VEGETABLES, IN  
CLASS 29 (U.S. CL. 46).

SER. NO. 77-390,601, FILED 2-6-2008.

FIRST USE 0-0-1974; IN COMMERCE 0-0-1974.

LESLEY LAMOTHE, EXAMINING ATTORNEY

**Int. Cl.: 16**

**Prior U.S. Cls.: 2, 5, 22, 23, 29, 37, 38 and 50**

**United States Patent and Trademark Office**

**Reg. No. 3,498,760**

**Registered Sep. 9, 2008**

**TRADEMARK  
PRINCIPAL REGISTER**

# Sandlady

THOMAS, HELEN (UNITED STATES INDIVIDUAL)  
10295 N 700 W  
TANGIER, IN 47952

THE MARK CONSISTS OF STANDARD CHARACTERS WITHOUT CLAIM TO ANY PARTICULAR FONT, STYLE, SIZE, OR COLOR.

FOR: PAINTINGS, IN CLASS 16 (U.S. CLS. 2, 5, 22, 23, 29, 37, 38 AND 50).

SER. NO. 77-390,641, FILED 2-6-2008.

FIRST USE 12-1-1988; IN COMMERCE 12-1-1988.

MICHAEL GAAFAR, EXAMINING ATTORNEY



**Int. Cl.: 36**

**Prior U.S. Cls.: 100, 101 and 102**

**United States Patent and Trademark Office**

**Reg. No. 3,498,761**

**Registered Sep. 9, 2008**

**SERVICE MARK  
PRINCIPAL REGISTER**



LINDSAY, CHANNING (UNITED STATES INDIVIDUAL)  
3 COTTONWOOD DRIVE  
ALISO VIEJO, CA 92656

FOR: MORTGAGE BROKERAGE FOR REAL ESTATE TRANSACTIONS IN RESIDENTIAL AND COMMERCIAL ARENAS, IN CLASS 36 (U.S. CLS. 100, 101 AND 102).

FIRST USE 11-1-2007; IN COMMERCE 11-1-2007.

NO CLAIM IS MADE TO THE EXCLUSIVE RIGHT TO USE "FINANCE", APART FROM THE MARK AS SHOWN.

THE MARK CONSISTS OF THE STYLIZED TEXT "CAPITOL PACIFIC FINANCE" INSIDE A RECTANGLE.

SER. NO. 77-390,656, FILED 2-6-2008.

JOHN WILKE, EXAMINING ATTORNEY

**Int. Cl.: 28**

**Prior U.S. Cls.: 22, 23, 38 and 50**

**Reg. No. 3,498,762**

**United States Patent and Trademark Office**

**Registered Sep. 9, 2008**

---

**TRADEMARK  
PRINCIPAL REGISTER**

**TURNIGY**

HAND, ANTHONY (AUSTRALIA INDIVIDUAL)  
1616 GOLDFIELD IND. CTR  
1 SUI WO RD  
FOTAN, HONG KONG

FOR: RADIO CONTROL TOY PARTS, NAMELY,  
RADIO CONTROL PLANE MOTORS AND ELEC-  
TRONIC SPEED CONTROLLERS, IN CLASS 28 (U.S.  
CLS. 22, 23, 38 AND 50).

FIRST USE 10-1-2007; IN COMMERCE 10-1-2007.

THE MARK CONSISTS OF STANDARD CHAR-  
ACTERS WITHOUT CLAIM TO ANY PARTICULAR  
FONT, STYLE, SIZE, OR COLOR.

SER. NO. 77-390,662, FILED 2-6-2008.

RICHARD A. STRASER, EXAMINING ATTORNEY

**Int. Cl.: 35**

**Prior U.S. Cls.: 100, 101 and 102**

**United States Patent and Trademark Office**

**Reg. No. 3,498,763**

**Registered Sep. 9, 2008**

**SERVICE MARK  
PRINCIPAL REGISTER**

# FoodieView

FOODIEVIEW, INC. (CALIFORNIA CORPORATION)  
1536 DALE STREET  
SAN DIEGO, CA 92102

THE MARK CONSISTS OF STANDARD CHARACTERS WITHOUT CLAIM TO ANY PARTICULAR FONT, STYLE, SIZE, OR COLOR.

FOR: PROVIDING A WEB SITE WHERE USERS CAN POST RATINGS, REVIEWS AND RECOMMENDATIONS ON PRODUCTS AND SERVICES, IN CLASS 35 (U.S. CLS. 100, 101 AND 102).

SER. NO. 77-390,691, FILED 2-6-2008.

FIRST USE 8-29-2005; IN COMMERCE 8-29-2005.

CYNTHIA TRIPI, EXAMINING ATTORNEY

**Int. Cl.: 19**

**Prior U.S. Cls.: 1, 12, 33 and 50**

**United States Patent and Trademark Office**

**Reg. No. 3,498,764**

**Registered Sep. 9, 2008**

**TRADEMARK  
PRINCIPAL REGISTER**

**ROMAN ROCK**

STEVEN RUSSELL (UNITED STATES INDIVIDUAL)  
15324 BRIAR RIDGE CIRCLE  
FORT MYERS, FL 33912

FOR: BUILDING MATERIALS, NAMELY, ARTIFICIAL STONE MATERIALS FOR USE ON INTERIOR AND EXTERIOR SURFACES, IN CLASS 19 (U.S. CLS. 1, 12, 33 AND 50).

FIRST USE 1-0-2002; IN COMMERCE 1-0-2002.

THE MARK CONSISTS OF STANDARD CHARACTERS WITHOUT CLAIM TO ANY PARTICULAR FONT, STYLE, SIZE, OR COLOR.

NO CLAIM IS MADE TO THE EXCLUSIVE RIGHT TO USE "ROCK", APART FROM THE MARK AS SHOWN.

SER. NO. 77-390,718, FILED 2-6-2008.

DAVID COLLIER, EXAMINING ATTORNEY

**Int. Cl.: 35**

**Prior U.S. Cls.: 100, 101 and 102**

**United States Patent and Trademark Office**

**Reg. No. 3,498,765**

**Registered Sep. 9, 2008**

**SERVICE MARK  
PRINCIPAL REGISTER**



FOODIEVIEW, INC. (CALIFORNIA CORPORATION)  
1536 DALE STREET  
SAN DIEGO, CA 92102

THE MARK CONSISTS OF THE WORD, "FOODIEVIEW" WHERE THE SECOND "O" IS REPLACED BY AN ORANGE.

FOR: PROVIDING A WEB SITE WHERE USERS CAN POST RATINGS, REVIEWS AND RECOMMENDATIONS ON PRODUCTS AND SERVICES, IN CLASS 35 (U.S. CLS. 100, 101 AND 102).

SER. NO. 77-390,724, FILED 2-6-2008.

FIRST USE 8-29-2005; IN COMMERCE 8-29-2005.

CYNTHIA TRIPI, EXAMINING ATTORNEY

**Int. Cl.: 9**

**Prior U.S. Cls.: 21, 23, 26, 36 and 38**

**United States Patent and Trademark Office**

**Reg. No. 3,498,766**

**Registered Sep. 9, 2008**

**TRADEMARK  
PRINCIPAL REGISTER**

# Bookventory

BOOKVENTORY, LLC (WISCONSIN LIMITED  
LIABILITY COMPANY)  
904 JAMES CT  
HARTFORD, WI 53027

FOR: COMPUTER SOFTWARE FOR LOOKING  
UP BOOK INFORMATION ONLINE, MANAGE-  
MENT AND DISPLAY OF BOOK INVENTORY,  
DETERMINING USED BOOK RESALE VALUES,  
PRINTING BOOK INFORMATION ONTO LABELS,  
SIGNING UP FOR AND SENDING EMAIL ALERTS  
REGARDING BOOKS, IN CLASS 9 (U.S. CLS. 21, 23,  
26, 36 AND 38).

FIRST USE 3-2-2007; IN COMMERCE 3-2-2007.

THE MARK CONSISTS OF STANDARD CHAR-  
ACTERS WITHOUT CLAIM TO ANY PARTICULAR  
FONT, STYLE, SIZE, OR COLOR.

SER. NO. 77-390,737, FILED 2-6-2008.

GEOFFREY FOSDICK, EXAMINING ATTORNEY

**Int. Cls.: 35 and 37**

**Prior U.S. Cls.: 100, 101, 102, 103 and 106**

**United States Patent and Trademark Office**

**Reg. No. 3,498,767**

**Registered Sep. 9, 2008**

**SERVICE MARK  
PRINCIPAL REGISTER**

# ENVISION

COALITION FOR UTAH'S FUTURE (UTAH  
NON-PROFIT CORPORATION)  
254 SOUTH 600 EAST, SUITE 201  
SALT LAKE CITY, UT 84102

FOR: PROMOTING PUBLIC AWARENESS OF  
THE NEED FOR CITIZEN INVOLVEMENT AND  
COMMUNITY PLANNING AND DEVELOPMENT,  
IN CLASS 35 (U.S. CLS. 100, 101 AND 102).

FIRST USE 11-18-1997; IN COMMERCE 11-18-1997.

FOR: CONSULTATION IN THE FIELD OF DE-  
VELOPING AND IMPLEMENTING STRATEGIES

IN RESIDENTIAL AND/OR COMMERCIAL COM-  
MUNITY PLANNING AND DEVELOPMENT, IN  
CLASS 37 (U.S. CLS. 100, 103 AND 106).

FIRST USE 11-18-1997; IN COMMERCE 11-18-1997.

THE MARK CONSISTS OF STANDARD CHAR-  
ACTERS WITHOUT CLAIM TO ANY PARTICULAR  
FONT, STYLE, SIZE, OR COLOR.

SER. NO. 77-390,738, FILED 2-6-2008.

GEOFFREY FOSDICK, EXAMINING ATTORNEY

**Int. Cls.: 37 and 42**

**Prior U.S. Cls.: 100, 101, 103 and 106**

**United States Patent and Trademark Office**

**Reg. No. 3,498,768**

**Registered Sep. 9, 2008**

**SERVICE MARK  
PRINCIPAL REGISTER**

**ALLIANCE**

ALLIANCE LAND AND WATER SCAPES, INC.  
(NEVADA CORPORATION)

2173 SAN MIGUEL CANYON ROAD

PRUNEDALE, CA 93907

FOR: CONSTRUCTION, INSTALLATION, MAINTENANCE, AND REPAIR OF WATER GARDENS, WATERSCAPES, PONDS, STREAMS, AND WATERFALLS, IN CLASS 37 (U.S. CLS. 100, 103 AND 106).

FIRST USE 4-24-1998; IN COMMERCE 5-24-1998.

FOR: DESIGN OF WATER GARDENS, WATERSCAPES, PONDS, STREAMS, AND WATERFALLS, IN CLASS 42 (U.S. CLS. 100 AND 101).

FIRST USE 4-24-1998; IN COMMERCE 5-24-1998.

THE MARK CONSISTS OF STANDARD CHARACTERS WITHOUT CLAIM TO ANY PARTICULAR FONT, STYLE, SIZE, OR COLOR.

SER. NO. 77-390,750, FILED 2-7-2008.

CHERYL CLAYTON, EXAMINING ATTORNEY



**Int. Cl.: 41**

**Prior U.S. Cls.: 100, 101 and 107**

**United States Patent and Trademark Office**

**Reg. No. 3,498,769**

**Registered Sep. 9, 2008**

**SERVICE MARK  
PRINCIPAL REGISTER**



GREAT PLAY HOLDINGS LLC (CONNECTICUT  
LIMITED LIABILITY COMPANY)  
51 KNOBLOCH LANE  
STAMFORD, CT 06902

FOR: PROVISION OF PLAY FACILITIES FOR  
CHILDREN; PROVIDING FITNESS AND EXERCISE  
FACILITIES, IN CLASS 41 (U.S. CLS. 100, 101 AND  
107).

FIRST USE 2-1-2006; IN COMMERCE 2-1-2006.

NO CLAIM IS MADE TO THE EXCLUSIVE  
RIGHT TO USE "PLAY", APART FROM THE MARK  
AS SHOWN.

THE COLOR(S) BLUE, YELLOW, ORANGE AND  
GRAY IS/ARE CLAIMED AS A FEATURE OF THE  
MARK.

THE MARK CONSISTS OF THE STYLIZED LET-  
TERS "GP" IN DARK BLUE APPEARING DIAGON-  
ALLY IN FRONT OF A YELLOW OVAL OUTLINED  
IN ORANGE TO THE LEFT OF THE STYLIZED  
WORDS "GREAT PLAY" IN DARK BLUE, ALL ON  
A GRAY SHADED BACKGROUND.

SER. NO. 77-390,817, FILED 2-7-2008.

TAMARA FRAZIER, EXAMINING ATTORNEY

**Int. Cl.: 41**

**Prior U.S. Cls.: 100, 101 and 107**

**United States Patent and Trademark Office**

**Reg. No. 3,498,770**

**Registered Sep. 9, 2008**

**SERVICE MARK  
PRINCIPAL REGISTER**



GREAT PLAY HOLDINGS LLC (CONNECTICUT  
LIMITED LIABILITY COMPANY)  
51 KNOBLOCH LANE  
STAMFORD, CT 06902

FOR: PROVISION OF PLAY FACILITIES FOR  
CHILDREN; PROVIDING FITNESS AND EXERCISE  
FACILITIES, IN CLASS 41 (U.S. CLS. 100, 101 AND  
107).

FIRST USE 10-15-2006; IN COMMERCE 10-31-2006.

NO CLAIM IS MADE TO THE EXCLUSIVE  
RIGHT TO USE "PLAY" AND "NEW GYM FOR  
KIDS", APART FROM THE MARK AS SHOWN.

THE COLOR(S) BLUE, YELLOW, ORANGE AND  
GRAY IS/ARE CLAIMED AS A FEATURE OF THE  
MARK.

THE MARK CONSISTS OF THE STYLIZED LET-  
TERS "GP" IN DARK BLUE APPEARING DIAGON-  
ALLY IN FRONT OF A YELLOW OVAL OUTLINED  
IN ORANGE TO THE LEFT OF THE STYLIZED  
WORDS "GREAT PLAY" IN DARK BLUE, ABOVE  
THE STYLIZED WORDS "A UNIQUE NEW GYM  
FOR KIDS" IN BLUE LETTERING, ALL ON A  
GRAY SHADED BACKGROUND.

SER. NO. 77-390,822, FILED 2-7-2008.

TAMARA FRAZIER, EXAMINING ATTORNEY

**Int. Cl.: 41**

**Prior U.S. Cls.: 100, 101 and 107**

**United States Patent and Trademark Office**

**Reg. No. 3,498,771**

**Registered Sep. 9, 2008**

**SERVICE MARK  
PRINCIPAL REGISTER**

**Seminary Beyond Walls**

BIBLICAL SEMINARY (PENNSYLVANIA NON-  
PROFIT CORPORATION)  
200 N. MAIN STREET  
HATFIELD, PA 19440

FOR: EDUCATIONAL SERVICES, NAMELY,  
CONDUCTING WEB BASED TRAINING COURSES,  
SEMINARS AND WORKSHOPS IN THE FIELD OF  
BIBLICAL STUDIES, THEOLOGY, LANGUAGES,  
HISTORY, CHRISTIAN EDUCATION AND COUN-  
SELING AND DISTRIBUTION OF COURSE MATE-  
RIAL IN CONNECTION THEREWITH;  
EDUCATIONAL SERVICES, NAMELY, CONDUCT-

ING PROGRAMS IN THE FIELD OF RELIGION, IN  
CLASS 41 (U.S. CLS. 100, 101 AND 107).

FIRST USE 6-28-2007; IN COMMERCE 6-28-2007.

THE MARK CONSISTS OF STANDARD CHAR-  
ACTERS WITHOUT CLAIM TO ANY PARTICULAR  
FONT, STYLE, SIZE, OR COLOR.

SER. NO. 77-390,832, FILED 2-7-2008.

FRED MANDIR, EXAMINING ATTORNEY

**Int. Cl.: 3**

**Prior U.S. Cls.: 1, 4, 6, 50, 51 and 52**

**United States Patent and Trademark Office**

**Reg. No. 3,498,772**

**Registered Sep. 9, 2008**

**TRADEMARK  
PRINCIPAL REGISTER**

**BIO-STYLE**

GARCOA, INC. (OHIO CORPORATION)  
24007 VENTURA BOULEVARD, SUITE 135  
CALABASAS, CA 91302

FOR: HAIR CARE PREPARATIONS; NON-MEDI-  
CATED SKIN CARE PREPARATIONS; ANTI-  
AGING CREAMS, IN CLASS 3 (U.S. CLS. 1, 4, 6, 50,  
51 AND 52).

FIRST USE 12-3-2007; IN COMMERCE 12-3-2007.

THE MARK CONSISTS OF STANDARD CHAR-  
ACTERS WITHOUT CLAIM TO ANY PARTICULAR  
FONT, STYLE, SIZE, OR COLOR.

OWNER OF U.S. REG. NOS. 3,179,083, 3,267,107,  
AND 3,267,108.

SER. NO. 77-390,860, FILED 2-7-2008.

ELLEN PERKINS, EXAMINING ATTORNEY

**Int. Cl.: 28**

**Prior U.S. Cls.: 22, 23, 38 and 50**

**United States Patent and Trademark Office**

**Reg. No. 3,498,773**

**Registered Sep. 9, 2008**

**TRADEMARK  
PRINCIPAL REGISTER**

**CARBOTEX**

BALÁZS FILAMENT TECHNOLOGIES LTD.  
(HUNGARY LIMITED LIABILITY COMPANY)  
2, HONVED ST  
TISZAUJVAROS, HUNGARY H-3580

THE MARK CONSISTS OF STANDARD CHAR-  
ACTERS WITHOUT CLAIM TO ANY PARTICULAR  
FONT, STYLE, SIZE, OR COLOR.

FOR: FISHING LINES, IN CLASS 28 (U.S. CLS. 22,  
23, 38 AND 50).

SER. NO. 77-390,889, FILED 2-7-2008.

FIRST USE 7-21-2006; IN COMMERCE 7-21-2006.

GEORGE LORENZO, EXAMINING ATTORNEY

**Int. Cl.: 33**

**Prior U.S. Cls.: 47 and 49**

**United States Patent and Trademark Office**

**Reg. No. 3,498,774**

**Registered Sep. 9, 2008**

**TRADEMARK  
PRINCIPAL REGISTER**

**STELTZNER VINEYARDS**

RICHARD STELTZNER (UNITED STATES INDIVIDUAL)  
5998 SILVERADO TRAIL  
NAPA, CA 94558

NO CLAIM IS MADE TO THE EXCLUSIVE RIGHT TO USE "VINEYARDS", APART FROM THE MARK AS SHOWN.

FOR: WINE, IN CLASS 33 (U.S. CLS. 47 AND 49).

SEC. 2(F).

FIRST USE 9-30-1979; IN COMMERCE 9-30-1979.

SER. NO. 77-390,903, FILED 2-7-2008.

THE MARK CONSISTS OF STANDARD CHARACTERS WITHOUT CLAIM TO ANY PARTICULAR FONT, STYLE, SIZE, OR COLOR.

GEORGE LORENZO, EXAMINING ATTORNEY

**Int. Cl.: 28**

**Prior U.S. Cls.: 22, 23, 38 and 50**

**United States Patent and Trademark Office**

**Reg. No. 3,498,775**

**Registered Sep. 9, 2008**

**TRADEMARK  
PRINCIPAL REGISTER**

# Fribbols

BOSWORTH, WENDY K (UNITED STATES IN-  
DIVIDUAL)

#8T

151 TREMONT ST  
BOSTON, MA 02111

THE MARK CONSISTS OF STANDARD CHAR-  
ACTERS WITHOUT CLAIM TO ANY PARTICULAR  
FONT, STYLE, SIZE, OR COLOR.

FOR: STUFFED AND PLUSH TOYS, IN CLASS 28  
(U.S. CLS. 22, 23, 38 AND 50).

SER. NO. 77-390,940, FILED 2-7-2008.

FIRST USE 2-6-2008; IN COMMERCE 2-6-2008.

KHANH LE, EXAMINING ATTORNEY

**Int. Cls.: 42 and 45**

**Prior U.S. Cls.: 100 and 101**

**United States Patent and Trademark Office**

**Reg. No. 3,498,776**

**Registered Sep. 9, 2008**

**SERVICE MARK  
PRINCIPAL REGISTER**

# JumpIn

RED PLANET MEDIA, INC. (FLORIDA CORPORATION)  
5127 LATROBE DRIVE  
WINDERMERE, FL 34786

FOR: COMPUTER SERVICES, NAMELY, HOSTING ON-LINE WEB FACILITIES FOR OTHERS FOR ORGANIZING AND CONDUCTING ONLINE MEETINGS, GATHERINGS, AND INTERACTIVE DISCUSSIONS; COMPUTER SERVICES, NAMELY, INTERACTIVE HOSTING SERVICES WHICH ALLOW THE USER TO PUBLISH AND SHARE THEIR OWN CONTENT AND IMAGES ONLINE, IN CLASS 42 (U.S. CLS. 100 AND 101).

FIRST USE 9-26-2006; IN COMMERCE 9-14-2007.

FOR: ONLINE SOCIAL NETWORKING SERVICES, IN CLASS 45 (U.S. CLS. 100 AND 101).

FIRST USE 9-26-2006; IN COMMERCE 9-14-2007.

THE MARK CONSISTS OF STANDARD CHARACTERS WITHOUT CLAIM TO ANY PARTICULAR FONT, STYLE, SIZE, OR COLOR.

SER. NO. 77-390,947, FILED 2-7-2008.

HEATHER THOMPSON, EXAMINING ATTORNEY



**Int. Cl.: 40**

**Prior U.S. Cls.: 100, 103 and 106**

**United States Patent and Trademark Office**

**Reg. No. 3,498,777**

**Registered Sep. 9, 2008**

**SERVICE MARK  
PRINCIPAL REGISTER**

**SUGAR HILL BAKING**

SUGAR HILL BAKING, LLC (MAINE LIMITED  
LIABILITY COMPANY)  
20 WILLARD HAVEN ROAD  
SOUTH PORTLAND, ME 04106

FOR: BAKERY SERVICES, NAMELY, BAKING  
COOKIES, SCONES, CAKES, PIES, AND MUFFINS  
TO THE ORDER AND SPECIFICATION OF OTHERS,  
IN CLASS 40 (U.S. CLS. 100, 103 AND 106).

FIRST USE 9-8-2006; IN COMMERCE 7-7-2007.

THE MARK CONSISTS OF STANDARD CHARACTERS  
WITHOUT CLAIM TO ANY PARTICULAR FONT,  
STYLE, SIZE, OR COLOR.

NO CLAIM IS MADE TO THE EXCLUSIVE  
RIGHT TO USE "BAKING", APART FROM THE  
MARK AS SHOWN.

SER. NO. 77-390,950, FILED 2-7-2008.

MICHAEL TANNER, EXAMINING ATTORNEY

**Int. Cl.: 9**

**Prior U.S. Cls.: 21, 23, 26, 36 and 38**

**Reg. No. 3,498,778**

**United States Patent and Trademark Office**

**Registered Sep. 9, 2008**

**TRADEMARK  
PRINCIPAL REGISTER**

**Alice's Magical Mahjong**

POBROS, INC. (FLORIDA CORPORATION)  
3279 RANGERS GATE  
MARIETTA, GA 30062

THE MARK CONSISTS OF STANDARD CHARACTERS WITHOUT CLAIM TO ANY PARTICULAR FONT, STYLE, SIZE, OR COLOR.

FOR: VIDEO GAME SOFTWARE; COMPUTER GAME PROGRAMS; COMPUTER GAME SOFTWARE; COMPUTER GAME DISCS; VIDEO AND COMPUTER GAME PROGRAMS; VIDEO GAME DISCS; INTERACTIVE MULTIMEDIA COMPUTER GAME PROGRAM; INTERACTIVE VIDEO GAME PROGRAMS, IN CLASS 9 (U.S. CLS. 21, 23, 26, 36 AND 38).

NO CLAIM IS MADE TO THE EXCLUSIVE RIGHT TO USE "MAHJONG", APART FROM THE MARK AS SHOWN.

SER. NO. 77-390,977, FILED 2-7-2008.

FIRST USE 1-5-2008; IN COMMERCE 2-5-2008.

RONALD DELGIZZI, EXAMINING ATTORNEY

**Int. Cl.: 42**

**Prior U.S. Cls.: 100 and 101**

**United States Patent and Trademark Office**

**Reg. No. 3,498,779**

**Registered Sep. 9, 2008**

**SERVICE MARK  
PRINCIPAL REGISTER**

**KZO**

KZO INNOVATIONS, INC. (DELAWARE COR-  
PORATION)  
STUDIO 020  
2214 ROCK HILL ROAD  
HERNDON, VA 20170

THE MARK CONSISTS OF STANDARD CHAR-  
ACTERS WITHOUT CLAIM TO ANY PARTICULAR  
FONT, STYLE, SIZE, OR COLOR.

FOR: RESEARCH AND DEVELOPMENT OF  
COMPUTER SOFTWARE, IN CLASS 42 (U.S. CLS.  
100 AND 101).

SER. NO. 77-391,006, FILED 2-7-2008.

FIRST USE 5-30-2007; IN COMMERCE 5-30-2007.

DAVID C. REIHNER, EXAMINING ATTORNEY

**Int. Cl.: 35**

**Prior U.S. Cls.: 100, 101 and 102**

**United States Patent and Trademark Office**

**Reg. No. 3,498,780**

**Registered Sep. 9, 2008**

**SERVICE MARK  
PRINCIPAL REGISTER**

**SERVING THOSE WHO'VE  
SERVED THIS COUNTRY**

WORKS, DR. RAPHAEL K. (UNITED STATES  
INDIVIDUAL)  
522 W 158TH STREET APT 34  
NEW YORK, NY 10032

FOR: ASSOCIATION SERVICES, NAMELY, PROMOTING THE INTERESTS OF VETERANS; CHARITABLE SERVICES, NAMELY, ORGANIZING AND CONDUCTING VOLUNTEER PROGRAMS AND COMMUNITY SERVICE PROJECTS AIMED AT INCREASING SUPPORT AND MORALE OF VETERANS OF THE US MILITARY, IN CLASS 35 (U.S. CLS. 100, 101 AND 102).

FIRST USE 1-0-2004; IN COMMERCE 1-0-2004.

THE MARK CONSISTS OF STANDARD CHARACTERS WITHOUT CLAIM TO ANY PARTICULAR FONT, STYLE, SIZE, OR COLOR.

SER. NO. 77-391,019, FILED 2-7-2008.

DAVID HOFFMAN, EXAMINING ATTORNEY

**Int. Cl.: 41**

**Prior U.S. Cls.: 100, 101 and 107**

**United States Patent and Trademark Office**

**Reg. No. 3,498,781**

**Registered Sep. 9, 2008**

**SERVICE MARK  
PRINCIPAL REGISTER**

## Brides Survival Guide

REVERIE UNLIMITED, LLC (TEXAS LIMITED  
LIABILITY COMPANY)  
P.O. BOX 92225  
AUSTIN, TX 78709

FOR: PROVIDING INFORMATION IN THE  
FIELD OF WEDDING PARTY PLANNING, IN  
CLASS 41 (U.S. CLS. 100, 101 AND 107).

FIRST USE 1-1-2002; IN COMMERCE 1-1-2002.

THE MARK CONSISTS OF STANDARD CHAR-  
ACTERS WITHOUT CLAIM TO ANY PARTICULAR  
FONT, STYLE, SIZE, OR COLOR.

NO CLAIM IS MADE TO THE EXCLUSIVE  
RIGHT TO USE "BRIDES" AND "GUIDE", APART  
FROM THE MARK AS SHOWN.

SER. NO. 77-391,030, FILED 2-7-2008.

KEVIN DINALLO, EXAMINING ATTORNEY

**Int. Cl.: 9**

**Prior U.S. Cls.: 21, 23, 26, 36 and 38**

**Reg. No. 3,498,782**

**United States Patent and Trademark Office**

**Registered Sep. 9, 2008**

---

**TRADEMARK  
PRINCIPAL REGISTER**

**SkySwitch**

SATPATH SYSTEMS, INC. (CALIFORNIA CORPORATION)  
47971 FREMONT BLVD.  
FREMONT, CA 94538

THE MARK CONSISTS OF STANDARD CHARACTERS WITHOUT CLAIM TO ANY PARTICULAR FONT, STYLE, SIZE, OR COLOR.

FOR: SATELLITE TRANSMITTERS AND RECEIVERS, IN CLASS 9 (U.S. CLS. 21, 23, 26, 36 AND 38).

SER. NO. 77-391,047, FILED 2-7-2008.

FIRST USE 6-1-2003; IN COMMERCE 6-1-2003.

LINDA LAVACHE, EXAMINING ATTORNEY

**Int. Cls.: 37 and 42**

**Prior U.S. Cls.: 100, 101, 103 and 106**

**United States Patent and Trademark Office**

**Reg. No. 3,498,783**

**Registered Sep. 9, 2008**

**SERVICE MARK  
PRINCIPAL REGISTER**



BH CONSTRUCTION, INC. (CALIFORNIA CORPORATION)  
2359 TOPSAIL CIRCLE  
WESTLAKE VILLAGE, CA 91361

FOR: CONSTRUCTION CONSULTATION; CONSTRUCTION MANAGEMENT; GENERAL CONSTRUCTION CONTRACTING; REMODELING OF RESIDENTIAL HOMES, COMMERCIAL BUILDINGS AND MULTI-UNIT RESIDENTIAL COMPLEXES, IN CLASS 37 (U.S. CLS. 100, 103 AND 106).

FIRST USE 1-1-1991; IN COMMERCE 1-1-1991.

FOR: ARCHITECTURAL DESIGN, IN CLASS 42 (U.S. CLS. 100 AND 101).

FIRST USE 1-1-1991; IN COMMERCE 1-1-1991.

NO CLAIM IS MADE TO THE EXCLUSIVE RIGHT TO USE "CONSTRUCTION INC.", APART FROM THE MARK AS SHOWN.

THE MARK CONSISTS OF A STYLIZED TRIANGLE WITH THE STYLIZED TEXT "BH" IN THE CENTER. BELOW THE TRIANGLE IS THE STYLIZED TEXT "B. H. CONSTRUCTION INC." THE TEXT "INC." IS WRITTEN VERTICALLY TO THE RIGHT OF THE LETTER "N" IN THE WORD "CONSTRUCTION".

SER. NO. 77-391,048, FILED 2-7-2008.

DOMINICK J. SALEMI, EXAMINING ATTORNEY

**Int. Cl.: 41**

**Prior U.S. Cls.: 100, 101 and 107**

**Reg. No. 3,498,784**

**United States Patent and Trademark Office**

**Registered Sep. 9, 2008**

**SERVICE MARK  
PRINCIPAL REGISTER**

**RAD**

ROYAL ACADEMY OF DANCE (UNITED KINGDOM CORPORATION)  
36 BATTERSEA SQUARE  
LONDON, UNITED KINGDOM

FOR: EDUCATION SERVICES, NAMELY, PROVIDING CLASSES, SEMINARS, AND WORKSHOPS IN THE FIELDS OF DANCE AND MUSIC; PROVIDING TRAINING IN THE FIELDS OF DANCE AND MUSIC; ENTERTAINMENT IN THE NATURE OF DANCE AND MUSICAL PERFORMANCES; PERFORMANCES, NAMELY, PRESENTATION OF BALLET AND DANCE PERFORMANCES; EDUCATIONAL AND TEACHING SERVICES, NAMELY, INSTRUCTION IN THE NATURE OF CLASSES AND COURSES IN THE FIELDS OF DANCE AND MUSIC; COACHING SERVICES IN THE FIELDS OF DANCE AND MUSIC; SCHOOL SERVICES, NAMELY, CONDUCTING OF BALLET AND DANCE CLASSES; INSTRUCTION IN BALLET; ENTERTAINMENT IN THE NATURE OF BALLET SHOWS; PRESENTATION OF LIVE PERFORMANCES IN THE NATURE OF BALLETS; PROVISION OF DANCE CLASSES; DANCE INSTRUCTION; DANCE HALL SERVICES, NAMELY, PROVIDING DANCE HALLS; PRODUCTION OF ENTERTAINMENT SHOWS FEATURING DANCERS; TRAINING OF TEACHERS IN THE MUSIC AND DANCE INDUSTRY; EDUCATIONAL SERVICES, NAMELY, CLASSES, SEMINARS AND WORKSHOPS PROVIDED FOR TEACHERS OF CHILDREN IN THE FIELD OF DANCE AND MUSIC; EDUCATIONAL EXAMINATION SERVICES, NAMELY, PROVISION OF EDUCATIONAL EXAMINATIONS IN THE FIELD OF DANCE; ORGANIZATION OF EXAMINATIONS TO GRADE LEVEL OF ACHIEVEMENT; RENTAL OF MUSICAL AND DANCE STUDIOS; PRODUCTION OF VIDEO, AUDIO, SOUND AND MUSICAL RECORDINGS; PUBLISHING OF

ELECTRONIC PUBLICATIONS, NAMELY, PROVIDING ELECTRONIC MAGAZINES AND BROCHURES IN THE FIELDS OF MUSIC AND DANCE; PUBLICATION OF ELECTRONIC BOOKS AND JOURNALS ON-LINE IN THE FIELD OF MUSIC AND DANCE; PUBLICATION OF ELECTRONIC MAGAZINES ACCESSIBLE VIA A GLOBAL COMPUTER NETWORK WHICH MAY BE BROWSED; PROVIDING INFORMATION RELATING TO EDUCATION AND ENTERTAINMENT BY MEANS OF A GLOBAL COMPUTER NETWORK; ORGANIZING AND CONDUCTING OF CONFERENCES, SEMINARS, EXHIBITIONS AND SYMPOSIUMS, TRAINING COURSES, LECTURES, WORKSHOPS, PRESENTATIONS IN THE FIELDS OF DANCE AND MUSIC; ARRANGING OF FESTIVALS IN THE FIELDS OF DANCE AND MUSIC FOR CULTURAL, EDUCATIONAL AND ENTERTAINMENT PURPOSES; ARRANGING OF COMPETITIONS IN THE FIELDS OF DANCE AND MUSIC FOR CULTURAL, EDUCATIONAL AND ENTERTAINMENT SERVICES; ARRANGING OF COMPETITIONS FOR TRAINING PURPOSES; AND ORGANIZING OF DANCING COMPETITIONS, IN CLASS 41 (U.S. CLS. 100, 101 AND 107).

THE MARK CONSISTS OF STANDARD CHARACTERS WITHOUT CLAIM TO ANY PARTICULAR FONT, STYLE, SIZE, OR COLOR.

OWNER OF ERPN CMNTY TM OFC REG. NO. 004256905, DATED 4-19-2006, EXPIRES 1-25-2015.

OWNER OF U.S. REG. NO. 3,421,642.

SER. NO. 77-391,072, FILED 2-7-2008.

DOMINIC FATHY, EXAMINING ATTORNEY



**Int. Cl.: 35**

**Prior U.S. Cls.: 100, 101 and 102**

**United States Patent and Trademark Office**

**Reg. No. 3,498,785**

**Registered Sep. 9, 2008**

**SERVICE MARK  
PRINCIPAL REGISTER**

**HISTORY LOVES COMPANY**

VALLEY FORGE CONVENTION AND VISITORS  
BUREAU (PENNSYLVANIA NON-PROFIT  
CORPORATION)

SUITE 130

600 WEST GERMANTOWN PIKE  
PLYMOUTH MEETING, PA 19462

FOR: CONVENTION AND VISITORS BUREAU  
SERVICES, NAMELY, PROVIDING INFORMATION  
TO MEETING PLANNERS PROMOTING BUSINESS  
AND TOURISM IN THE VALLEY FORGE, PENN-  
SYLVANIA AREA, IN CLASS 35 (U.S. CLS. 100, 101  
AND 102).

FIRST USE 11-0-2006; IN COMMERCE 11-0-2006.

THE MARK CONSISTS OF STANDARD CHAR-  
ACTERS WITHOUT CLAIM TO ANY PARTICULAR  
FONT, STYLE, SIZE, OR COLOR.

SER. NO. 77-391,115, FILED 2-7-2008.

HANNO RITTNER, EXAMINING ATTORNEY

**Int. Cl.: 44**

**Prior U.S. Cls.: 100 and 101**

**United States Patent and Trademark Office**

**Reg. No. 3,498,786**

**Registered Sep. 9, 2008**

**SERVICE MARK  
PRINCIPAL REGISTER**

**HI-STEP**

HI STEP, LLC (NEW JERSEY LIMITED LIABILITY COMPANY)  
SUITE 101  
35 CLYDE ROAD  
SOMERSET, NJ 08873

FOR: PSYCHOTHERAPY AND PSYCHOTHERAPY COUNSELING FOR CHILDREN; BEHAVIORAL THERAPY SERVICES, IN CLASS 44 (U.S. CLS. 100 AND 101).

FIRST USE 1-18-2008; IN COMMERCE 1-18-2008.

THE MARK CONSISTS OF STANDARD CHARACTERS WITHOUT CLAIM TO ANY PARTICULAR FONT, STYLE, SIZE, OR COLOR.

SER. NO. 77-391,154, FILED 2-7-2008.

TRACY CROSS, EXAMINING ATTORNEY

**Int. Cl.: 41**

**Prior U.S. Cls.: 100, 101 and 107**

**United States Patent and Trademark Office**

**Reg. No. 3,498,787**

**Registered Sep. 9, 2008**

**SERVICE MARK  
PRINCIPAL REGISTER**

**CREEK CONNECTIONS**

ALLEGHENY COLLEGE (PENNSYLVANIA NON-  
PROFIT CORPORATION)  
520 NORTH MAIN STREET  
MEADVILLE, PA 16335

FOR: EDUCATIONAL SERVICES, NAMELY, DE-  
VELOPING, ARRANGING AND CONDUCTING  
EDUCATIONAL PROGRAMS, CLASSES, LEC-  
TURES, CAMPS, SEMINARS, CONFERENCES,  
HANDS-ON FIELD AND LABORATORY CLASSES  
AND WORKSHOPS, WORKSHOPS AND SYMPO-  
SIUMS AND PROVIDING COURSES OF INSTRUC-  
TION, ALL IN THE FIELDS OF ENVIRONMENTAL  
SCIENCE AND NATURAL RESOURCES, AND DIS-

TRIBUTING SCIENTIFIC AND EDUCATIONAL  
COURSE MATERIALS IN CONNECTION THERE-  
WITH, IN CLASS 41 (U.S. CLS. 100, 101 AND 107).

FIRST USE 8-0-1999; IN COMMERCE 8-0-1999.

THE MARK CONSISTS OF STANDARD CHAR-  
ACTERS WITHOUT CLAIM TO ANY PARTICULAR  
FONT, STYLE, SIZE, OR COLOR.

SER. NO. 77-391,203, FILED 2-7-2008.

SUE LAWRENCE, EXAMINING ATTORNEY

**Int. Cl.: 10**

**Prior U.S. Cls.: 26, 39 and 44**

**United States Patent and Trademark Office**

**Reg. No. 3,498,788**

**Registered Sep. 9, 2008**

**TRADEMARK  
PRINCIPAL REGISTER**

**ALCOSCAN**

AK SOLUTIONS USA, LLC (NEW JERSEY LIMITED LIABILITY COMPANY), DBA BREATH-ALCOLYZER.COM / PERSONALALCOHOLTESTER.COM  
21 GRAND AVE. SUITE 102  
PALISADES PARK, NJ 07650

THE MARK CONSISTS OF STANDARD CHARACTERS WITHOUT CLAIM TO ANY PARTICULAR FONT, STYLE, SIZE, OR COLOR.

FOR: ALCOHOL BREATH TESTING UNITS, IN CLASS 10 (U.S. CLS. 26, 39 AND 44).

SER. NO. 77-391,268, FILED 2-7-2008.

FIRST USE 8-1-2003; IN COMMERCE 8-1-2003.

DAVID C. REIHNER, EXAMINING ATTORNEY

**Int. Cl.: 14**

**Prior U.S. Cls.: 2, 27, 28 and 50**

**United States Patent and Trademark Office**

**Reg. No. 3,498,789**

**Registered Sep. 9, 2008**

**TRADEMARK  
PRINCIPAL REGISTER**

**WAXING POETIC**

PATTI PAGLIEI (UNITED STATES INDIVIDUAL)  
2590 JANIN WAY  
SOLVANG, CA 93463

THE MARK CONSISTS OF STANDARD CHAR-  
ACTERS WITHOUT CLAIM TO ANY PARTICULAR  
FONT, STYLE, SIZE, OR COLOR.

FOR: JEWELRY, IN CLASS 14 (U.S. CLS. 2, 27, 28  
AND 50).

SER. NO. 77-391,271, FILED 2-7-2008.

FIRST USE 1-1-2008; IN COMMERCE 1-1-2008.

AMY ALFIERI, EXAMINING ATTORNEY

**Int. Cl.: 45**

**Prior U.S. Cls.: 100 and 101**

**United States Patent and Trademark Office**

**Reg. No. 3,498,790**

**Registered Sep. 9, 2008**

**SERVICE MARK  
PRINCIPAL REGISTER**



BARCELO & HARRISON, LLP (CALIFORNIA  
LIMITED LIABILITY PARTNERSHIP)  
SUITE 200  
2901 WEST COAST HWY.  
NEWPORT BEACH, CA 92663

FOR: LEGAL SERVICES, IN CLASS 45 (U.S. CLS.  
100 AND 101).

FIRST USE 1-15-2007; IN COMMERCE 1-15-2007.

THE COLOR(S) BLUE IS/ARE CLAIMED AS A  
FEATURE OF THE MARK.

THE MARK CONSISTS OF A BLUE ENGINEER-  
ING SYMBOL FOR A BAND-PASS FILTER, I.E.,  
THREE SINUSOIDAL WAVE IMAGES ARRANGED  
VERTICALLY, WITH HASH MARKS THROUGH  
THE TOP AND BOTTOM WAVES BUT NOT  
THROUGH THE MIDDLE WAVE.

SER. NO. 77-391,292, FILED 2-7-2008.

DOMINIC FATHY, EXAMINING ATTORNEY

**Int. Cl.: 9**

**Prior U.S. Cls.: 21, 23, 26, 36 and 38**

**Reg. No. 3,498,791**

**United States Patent and Trademark Office**

**Registered Sep. 9, 2008**

**TRADEMARK  
PRINCIPAL REGISTER**

# DENTVISOR

CREATING DENTAL SOFTWARE, INC. (WISCONSIN CORPORATION)  
2600 NORTH MAYFAIR ROAD, SUITE 700  
MILWAUKEE, WI 53226

FOR: A SOFTWARE PROGRAM DOWNLOADABLE FROM AN INTERNET WEBSITE FOR PROCESSING PHOTOGRAPHIC AND X-RAY DATA CONCERNING A PATIENT'S DENTAL SITUATION TO PROVIDE RISK ASSESSMENT, PROGNOSIS AND TREATMENT OPTIONS, WHICH ARE PRESENTED TO THE PATIENT IN A REPORT, IN CLASS 9 (U.S. CLS. 21, 23, 26, 36 AND 38).

FIRST USE 1-2-2007; IN COMMERCE 1-2-2007.

THE MARK CONSISTS OF STANDARD CHARACTERS WITHOUT CLAIM TO ANY PARTICULAR FONT, STYLE, SIZE, OR COLOR.

SER. NO. 77-391,295, FILED 2-7-2008.

WENDY JUN, EXAMINING ATTORNEY

**Int. Cl.: 28**

**Prior U.S. Cls.: 22, 23, 38 and 50**

**United States Patent and Trademark Office**

**Reg. No. 3,498,792**

**Registered Sep. 9, 2008**

**TRADEMARK  
PRINCIPAL REGISTER**

# Babel Blocks

BOYM PARTNERS (NEW YORK CORPORATION)  
131 VARICK STREET, SUITE 915 #915  
NEW YORK, NY 10013

THE MARK CONSISTS OF STANDARD CHARACTERS WITHOUT CLAIM TO ANY PARTICULAR FONT, STYLE, SIZE, OR COLOR.

FOR: COLLECTABLE TOY FIGURES; TOY FIGURES; ACTION FIGURES, IN CLASS 28 (U.S. CLS. 22, 23, 38 AND 50).

SER. NO. 77-391,334, FILED 2-7-2008.

FIRST USE 5-1-2007; IN COMMERCE 11-15-2007.

ODESSA BIBBINS, EXAMINING ATTORNEY



**Int. Cl.: 43**

**Prior U.S. Cls.: 100 and 101**

**United States Patent and Trademark Office**

**Reg. No. 3,498,793**

**Registered Sep. 9, 2008**

**SERVICE MARK  
PRINCIPAL REGISTER**

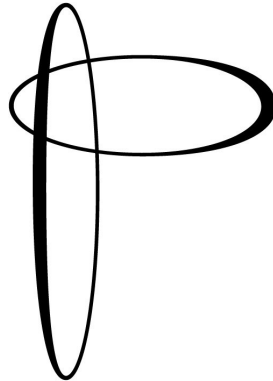

THE MARCUS CORPORATION (WISCONSIN CORPORATION)  
100 EAST WISCONSIN AVENUE, SUITE 1900  
MILWAUKEE, WI 53202

FOR: HOTEL, BAR AND RESTAURANT SERVICES, IN CLASS 43 (U.S. CLS. 100 AND 101).

FIRST USE 2-1-2006; IN COMMERCE 2-1-2006.

THE MARK CONSISTS OF TWO OVALS, ONE PLACED VERTICALLY AND THE OTHER HORIZONTALLY TO FORM THE LETTER "P".

SER. NO. 77-391,346, FILED 2-7-2008.

KATHERINE CONNOLLY, EXAMINING ATTORNEY

**Int. Cl.: 36**

**Prior U.S. Cls.: 100, 101 and 102**

**United States Patent and Trademark Office**

**Reg. No. 3,498,794**

**Registered Sep. 9, 2008**

**SERVICE MARK  
PRINCIPAL REGISTER**



YESKE BUIE INC. (CALIFORNIA CORPORATION)  
220 MONTGOMERY STREET, SUITE 994  
SAN FRANCISCO, CA 94104

THE MARK CONSISTS OF STYLIZED DEPICTION OF THE LETTERS "YB".

FOR: FINANCIAL PLANNING AND INVESTMENT MANAGEMENT SERVICES, IN CLASS 36 (U.S. CLS. 100, 101 AND 102).

SER. NO. 77-391,354, FILED 2-7-2008.

FIRST USE 9-7-2007; IN COMMERCE 9-7-2007.

LINDA E. BLOHM, EXAMINING ATTORNEY

**Int. Cl.: 36**

**Prior U.S. Cls.: 100, 101 and 102**

**United States Patent and Trademark Office**

**Reg. No. 3,498,795**

**Registered Sep. 9, 2008**

**SERVICE MARK  
PRINCIPAL REGISTER**

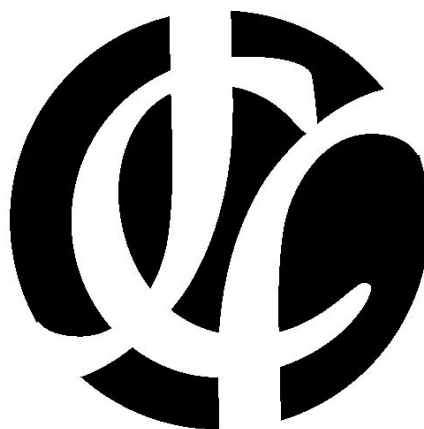

JEWISH COMMUNAL FUND (NEW YORK NON-PROFIT CORPORATION)  
575 MADISON AVENUE  
NEW YORK, NY 10022

FOR: CHARITABLE FUND RAISING, AND DISTRIBUTION OF COLLECTED FUNDS TO CHARITABLE ORGANIZATIONS; MANAGEMENT OF CHARITABLE ASSETS; ACCEPTING AND ADMINISTERING MONETARY CHARITABLE CONTRIBUTIONS; CHARITABLE FUND RAISING SERVICES, NAMELY, BY PROVIDING INDIVIDUALS WITH THE INFORMATION AND OPPORTUNITY TO MAKE MONETARY DONATIONS TO THEIR FA-

VORITE CHARITY; PROVIDING ONLINE INFORMATION IN THE FIELD OF CHARITABLE MONETARY GIVING THROUGH FINANCIAL PLANNING, IN CLASS 36 (U.S. CLS. 100, 101 AND 102).

FIRST USE 8-0-2007; IN COMMERCE 10-0-2007.

THE MARK CONSISTS OF STYLIZED VERSION OF THE LETTERS "J", "C" AND "F".

SER. NO. 77-391,371, FILED 2-7-2008.

TEJBIR SINGH, EXAMINING ATTORNEY

**Int. Cl.: 36**

**Prior U.S. Cls.: 100, 101 and 102**

**United States Patent and Trademark Office**

**Reg. No. 3,498,796**

**Registered Sep. 9, 2008**

**SERVICE MARK  
PRINCIPAL REGISTER**

**YOUR PERSONAL CONNECTION  
TO CHARITABLE GIVING**

JEWISH COMMUNAL FUND (NEW YORK NON-  
PROFIT CORPORATION)  
575 MADISON AVENUE  
NEW YORK, NY 10022

FOR: CHARITABLE FUND RAISING, AND DIS-  
TRIBUTION OF COLLECTED FUNDS TO CHARI-  
TABLE ORGANIZATIONS; MANAGEMENT OF  
CHARITABLE ASSETS; ACCEPTING AND ADMIN-  
ISTERING MONETARY CHARITABLE CONTRIBU-  
TIONS; CHARITABLE FUND RAISING SERVICES,  
NAMELY, BY PROVIDING INDIVIDUALS WITH  
THE INFORMATION AND OPPORTUNITY TO  
MAKE MONETARY DONATIONS TO THEIR FA-  
VORITE CHARITY; PROVIDING ONLINE INFOR-

MATION IN THE FIELD OF CHARITABLE  
MONETARY GIVING THROUGH FINANCIAL  
PLANNING, IN CLASS 36 (U.S. CLS. 100, 101 AND  
102).

FIRST USE 8-0-2007; IN COMMERCE 10-0-2007.

THE MARK CONSISTS OF STANDARD CHAR-  
ACTERS WITHOUT CLAIM TO ANY PARTICULAR  
FONT, STYLE, SIZE, OR COLOR.

SER. NO. 77-391,391, FILED 2-7-2008.

TEJBIR SINGH, EXAMINING ATTORNEY

**Int. Cl.: 9**

**Prior U.S. Cls.: 21, 23, 26, 36 and 38**

**Reg. No. 3,498,797**

**United States Patent and Trademark Office**

**Registered Sep. 9, 2008**

**TRADEMARK  
PRINCIPAL REGISTER**

**ANYTOOL**

DS ENGINEERING, LLC (DELAWARE LIMITED  
LIABILITY COMPANY)  
ENGINEERING  
3901 PROGRESS STREET  
NORTH LITTLE ROCK, AR 72114

THE MARK CONSISTS OF STANDARD CHAR-  
ACTERS WITHOUT CLAIM TO ANY PARTICULAR  
FONT, STYLE, SIZE, OR COLOR.

FOR: CABLE CONNECTORS, IN CLASS 9 (U.S.  
CLS. 21, 23, 26, 36 AND 38).

SER. NO. 77-391,406, FILED 2-7-2008.

FIRST USE 1-10-2008; IN COMMERCE 1-10-2008.

MICHAEL KAZAZIAN, EXAMINING ATTORNEY

**Int. Cl.: 35**

**Prior U.S. Cls.: 100, 101 and 102**

**United States Patent and Trademark Office**

**Reg. No. 3,498,798**

**Registered Sep. 9, 2008**

**SERVICE MARK  
PRINCIPAL REGISTER**

**ACCELERATE**

RECELLULAR, INC. (MICHIGAN CORPORATION)  
2555 BISHOP CIRCLE WEST  
DEXTER, MI 48130

THE MARK CONSISTS OF STANDARD CHARACTERS WITHOUT CLAIM TO ANY PARTICULAR FONT, STYLE, SIZE, OR COLOR.

FOR: ARRANGING AND CONDUCTION OF AUCTION SALES, IN CLASS 35 (U.S. CLS. 100, 101 AND 102).

SER. NO. 77-391,407, FILED 2-7-2008.

FIRST USE 10-18-2007; IN COMMERCE 10-18-2007.

BILL DAWE, EXAMINING ATTORNEY

**Int. Cl.: 42**

**Prior U.S. Cls.: 100 and 101**

**United States Patent and Trademark Office**

**Reg. No. 3,498,799**

**Registered Sep. 9, 2008**

**SERVICE MARK  
PRINCIPAL REGISTER**



**Shellinfotech**

SHELLINFOTECH INC. (ILLINOIS CORPORATION)  
1903 CONTINENTAL AVENUE, #207  
NAPERVILLE, IL 60563

FOR: COMPUTER SOFTWARE DESIGN, COMPUTER PROGRAMMING, OR MAINTENANCE OF COMPUTER SOFTWARE, IN CLASS 42 (U.S. CLS. 100 AND 101).

FIRST USE 7-9-2007; IN COMMERCE 7-9-2007.

THE COLOR(S) BLACK, BLUE, SILVER AND WHITE IS/ARE CLAIMED AS A FEATURE OF THE MARK.

THE MARK CONSISTS OF A CIRCLE WITH BLUE SHADING THAT INCLUDES A STYLIZED "S" IN THE MIDDLE OF THE CIRCLE. THE BLUE SHADING IS DARKER TOWARD THE EDGES OF THE CIRCLE AND LIGHTER TOWARD THE MIDDLE. THE "S" IS WHITE AND CONTAINS A SILVER LINE THAT TRAVELS IN THE MIDDLE OF THE "S" AND ALONG ITS LENGTH. TO THE RIGHT OF THE CIRCLE IS "SHELLINFOTECH", WHICH APPEARS IN BLACK TEXT. A LIGHT BLUE UNDERLINE APPEARS UNDER "SHELLINFOTECH".

SER. NO. 77-391,428, FILED 2-7-2008.

TARAH HARDY, EXAMINING ATTORNEY

**Int. Cls.: 16 and 28**

**Prior U.S. Cls.: 2, 5, 22, 23, 29, 37, 38 and 50**

**United States Patent and Trademark Office**

**Reg. No. 3,498,800**

**Registered Sep. 9, 2008**

**TRADEMARK  
PRINCIPAL REGISTER**

**WEIRD-OHS**

J. LLOYD INTERNATIONAL, INC. (IOWA CORPORATION)  
4520 20TH AVENUE SW  
CEDAR RAPIDS, IA 52404

FOR: TRADING CARDS, IN CLASS 16 (U.S. CLS. 2, 5, 22, 23, 29, 37, 38 AND 50).

FIRST USE 12-0-2007; IN COMMERCE 12-0-2007.

FOR: TOY ACTION FIGURES, IN CLASS 28 (U.S. CLS. 22, 23, 38 AND 50).

FIRST USE 12-0-2007; IN COMMERCE 12-0-2007.

THE MARK CONSISTS OF STANDARD CHARACTERS WITHOUT CLAIM TO ANY PARTICULAR FONT, STYLE, SIZE, OR COLOR.

OWNER OF U.S. REG. NO. 1,826,474.

SER. NO. 77-391,505, FILED 2-7-2008.

TEJBIR SINGH, EXAMINING ATTORNEY



**Int. Cl.: 36**

**Prior U.S. Cls.: 100, 101 and 102**

**United States Patent and Trademark Office**

**Reg. No. 3,498,801**

**Registered Sep. 9, 2008**

**SERVICE MARK  
PRINCIPAL REGISTER**

**GBT**

GBT REALTY CORPORATION (TENNESSEE  
CORPORATION)  
SUITE 110  
201 SUMMIT VIEW DRIVE  
BRENTWOOD, TN 37027

FOR: REAL ESTATE ACQUISITION SERVICES;  
LEASING OF REAL ESTATE; REAL ESTATE MAN-  
AGEMENT CONSULTATION; REAL ESTATE MAN-  
AGEMENT, IN CLASS 36 (U.S. CLS. 100, 101 AND  
102).

FIRST USE 8-0-1988; IN COMMERCE 8-0-1988.

THE MARK CONSISTS OF STANDARD CHAR-  
ACTERS WITHOUT CLAIM TO ANY PARTICULAR  
FONT, STYLE, SIZE, OR COLOR.

SER. NO. 77-391,538, FILED 2-7-2008.

ALLISON SCHRODY, EXAMINING ATTORNEY

**Int. Cl.: 25**

**Prior U.S. Cls.: 22 and 39**

**United States Patent and Trademark Office**

**Reg. No. 3,498,802**

**Registered Sep. 9, 2008**

**TRADEMARK  
PRINCIPAL REGISTER**

**FLEX WEST**

SHOE SHOW, INC. (NORTH CAROLINA COR-  
PORATION)  
2201 TRINITY CHURCH ROAD  
CONCORD, NC 28027

THE MARK CONSISTS OF STANDARD CHAR-  
ACTERS WITHOUT CLAIM TO ANY PARTICULAR  
FONT, STYLE, SIZE, OR COLOR.

FOR: BOOTS, IN CLASS 25 (U.S. CLS. 22 AND 39).

SER. NO. 77-391,540, FILED 2-7-2008.

FIRST USE 12-31-1999; IN COMMERCE 12-31-1999.

LINDA ORNDORFF, EXAMINING ATTORNEY

**Int. Cl.: 37**

**Prior U.S. Cls.: 100, 103 and 106**

**United States Patent and Trademark Office**

**Reg. No. 3,498,803**

**Registered Sep. 9, 2008**

**SERVICE MARK  
PRINCIPAL REGISTER**

**GBT**

GBT REALTY CORPORATION (TENNESSEE  
CORPORATION)  
SUITE 110  
201 SUMMIT VIEW DRIVE  
BRENTWOOD, TN 37027

FOR: REAL ESTATE SITE SELECTION; REAL  
ESTATE DEVELOPMENT; BUILDING CONSTRUCTION  
SERVICES; BUILDING CONSTRUCTION SUPERVISION;  
CONSTRUCTION CONSULTANCY;  
CONSTRUCTION MANAGEMENT; CONSTRUCTION  
OF RETAIL SHOPPING CENTERS, IN CLASS  
37 (U.S. CLS. 100, 103 AND 106).

FIRST USE 8-0-1988; IN COMMERCE 8-0-1988.

THE MARK CONSISTS OF STANDARD CHARACTERS  
WITHOUT CLAIM TO ANY PARTICULAR  
FONT, STYLE, SIZE, OR COLOR.

SER. NO. 77-391,545, FILED 2-7-2008.

ALLISON SCHRODY, EXAMINING ATTORNEY

**Int. Cl.: 35**

**Prior U.S. Cls.: 100, 101 and 102**

**United States Patent and Trademark Office**

**Reg. No. 3,498,804**

**Registered Sep. 9, 2008**

**SERVICE MARK  
PRINCIPAL REGISTER**

**BRANDEDTV**

REPLOGLE, INC. (VIRGINIA CORPORATION)  
43604 TUCKAWAY PLACE  
LEESBURG, VA 20176

THE MARK CONSISTS OF STANDARD CHAR-  
ACTERS WITHOUT CLAIM TO ANY PARTICULAR  
FONT, STYLE, SIZE, OR COLOR.

FOR: ADVERTISING, MARKETING AND PRO-  
MOTION SERVICES, IN CLASS 35 (U.S. CLS. 100, 101  
AND 102).

SER. NO. 77-391,546, FILED 2-7-2008.

FIRST USE 1-0-2005; IN COMMERCE 1-0-2005.

ALICE BENMAMAN, EXAMINING ATTORNEY

**Int. Cl.: 36**

**Prior U.S. Cls.: 100, 101 and 102**

**United States Patent and Trademark Office**

**Reg. No. 3,498,805**

**Registered Sep. 9, 2008**

**SERVICE MARK  
PRINCIPAL REGISTER**



GBT REALTY CORPORATION (TENNESSEE  
CORPORATION)  
SUITE 110  
201 SUMMIT VIEW DRIVE  
BRENTWOOD, TN 37027

FOR: REAL ESTATE ACQUISITION SERVICES;  
REAL ESTATE MANAGEMENT; LEASING OF  
REAL ESTATE; REAL ESTATE MANAGEMENT

CONSULTATION, IN CLASS 36 (U.S. CLS. 100, 101  
AND 102).

FIRST USE 8-0-1988; IN COMMERCE 8-0-1988.

SER. NO. 77-391,552, FILED 2-7-2008.

ALLISON SCHRODY, EXAMINING ATTORNEY

**Int. Cl.: 35**

**Prior U.S. Cls.: 100, 101 and 102**

**United States Patent and Trademark Office**

**Reg. No. 3,498,806**

**Registered Sep. 9, 2008**

**SERVICE MARK  
PRINCIPAL REGISTER**



MULLINS, WAYNE L (UNITED STATES INDIVIDUAL)  
2937 E. NISBET CT.  
PHOENIX, AZ 85032

FOR: ADVERTISING AND PUBLICITY SERVICES, NAMELY, PROMOTING THE GOODS, SERVICES, BRAND IDENTITY AND COMMERCIAL INFORMATION AND NEWS OF THIRD PARTIES THROUGH PRINT, AUDIO, VIDEO, DIGITAL AND ON-LINE MEDIUM, IN CLASS 35 (U.S. CLS. 100, 101 AND 102).

FIRST USE 11-1-2006; IN COMMERCE 12-1-2006.

NO CLAIM IS MADE TO THE EXCLUSIVE RIGHT TO USE "EBID", APART FROM THE MARK AS SHOWN.

THE COLOR(S) BLUE, RED, LIGHT ORANGE AND DARK YELLOW IS/ARE CLAIMED AS A FEATURE OF THE MARK.

THE MARK CONSISTS OF BEGINNING WITH A LOWER CAPITAL LETTER E IN THE COLOR BLUE, FOLLOWED BY THE WORD "BID" IN THE COLOR RED, FOLLOWED BY A CAPITAL LETTER "N" IN THE COLOR LIGHT ORANGE, FOLLOWED BY THE WORD "SAVE" IN THE COLOR DARK YELLOW.

SER. NO. 77-391,555, FILED 2-7-2008.

TEJBIR SINGH, EXAMINING ATTORNEY

**Int. Cl.: 37**

**Prior U.S. Cls.: 100, 103 and 106**

**United States Patent and Trademark Office**

**Reg. No. 3,498,807**

**Registered Sep. 9, 2008**

**SERVICE MARK  
PRINCIPAL REGISTER**



GBT REALTY CORPORATION (TENNESSEE CORPORATION)  
SUITE 110  
201 SUMMIT VIEW DRIVE  
BRENTWOOD, TN 37027

FOR: REAL ESTATE SITE SELECTION; REAL ESTATE DEVELOPMENT; BUILDING CONSTRUCTION SERVICES; BUILDING CONSTRUCTION SUPERVISION; CONSTRUCTION CONSULTANCY;

CONSTRUCTION MANAGEMENT; CONSTRUCTION OF RETAIL SHOPPING CENTERS, IN CLASS 37 (U.S. CLS. 100, 103 AND 106).

FIRST USE 8-0-1988; IN COMMERCE 8-0-1988.

SER. NO. 77-391,556, FILED 2-7-2008.

ALLISON SCHRODY, EXAMINING ATTORNEY

**Int. Cl.: 35**

**Prior U.S. Cls.: 100, 101 and 102**

**United States Patent and Trademark Office**

**Reg. No. 3,498,808**

**Registered Sep. 9, 2008**

**SERVICE MARK  
PRINCIPAL REGISTER**

COMMUNITY IS OUR BUSINESS

HOUSEWARMERS II, LLC (DELAWARE LIMITED LIABILITY COMPANY)  
SUITE 690  
2970 CLAIRMONT ROAD  
ATLANTA, GA 30329

FOR: FRANCHISE SERVICES, NAMELY, OFFERING BUSINESS MANAGEMENT ASSISTANCE IN THE ESTABLISHMENT AND OPERATION OF DIRECT MARKETING EFFECTED THROUGH IN-PERSON DELIVERY OF GIFTS AND PROMOTIONAL MATERIALS TO LOCAL RESIDENTS; DIRECT MARKETING ADVERTISING FOR OTHERS, IN CLASS 35 (U.S. CLS. 100, 101 AND 102).

FIRST USE 1-0-2008; IN COMMERCE 1-0-2008.

THE MARK CONSISTS OF STANDARD CHARACTERS WITHOUT CLAIM TO ANY PARTICULAR FONT, STYLE, SIZE, OR COLOR.

SER. NO. 77-391,562, FILED 2-7-2008.

KATHERINE E. HALMEN, EXAMINING ATTORNEY



**Int. Cl.: 9**

**Prior U.S. Cls.: 21, 23, 26, 36 and 38**

**Reg. No. 3,498,809**

**United States Patent and Trademark Office**

**Registered Sep. 9, 2008**

**TRADEMARK  
PRINCIPAL REGISTER**



LOUD TECHNOLOGIES INC. (WASHINGTON CORPORATION)  
16221 WOOD-RED ROAD NE  
WOODINVILLE, WA 98072

FOR: AMPLIFIERS; AUDIO AMPLIFIERS; GUITAR AMPLIFIERS; LOUDSPEAKERS WITH BUILT IN AMPLIFIERS; MUSICAL INSTRUMENT AMPLIFIERS; SOUND AMPLIFIERS; AUDIO SPEAKERS; LOUD SPEAKERS, IN CLASS 9 (U.S. CLS. 21, 23, 26, 36 AND 38).

FIRST USE 11-30-2007; IN COMMERCE 11-30-2007.

THE MARK CONSISTS OF AN IMAGE OF A BANNER WITH THE WORD "BLACKHEART" IN STYLIZED LETTERING ACROSS AN IMAGE OF A BLACK HEART WITH IMAGES OF TWO ROSES IN THE UPPER LEFT SIDE OF THE HEART AND TWO ROSES IN THE LOWER RIGHT SIDE OF THE HEART. THE MARK IS BLACK AND WHITE AND DOES NOT CONTAIN COLOR.

SER. NO. 77-391,563, FILED 2-7-2008.

KATHERINE E. HALMEN, EXAMINING ATTORNEY

**Int. Cl.: 41**

**Prior U.S. Cls.: 100, 101 and 107**

**United States Patent and Trademark Office**

**Reg. No. 3,498,810**

**Registered Sep. 9, 2008**

**SERVICE MARK  
PRINCIPAL REGISTER**

**THE CELESTIAL HEART**

CELESTIAL COACHING, INC. (FLORIDA CORPORATION)  
940 NE 20TH AVENUE  
FORT LAUDERDALE, FL 33304

FOR: EDUCATIONAL SERVICES, NAMELY, CONDUCTING INDIVIDUAL AND GROUP INSTRUCTION IN THE FIELD OF PERSONAL IMPROVEMENT USING MEDITATION, YOGA, JOURNALING AND ASTROLOGY, IN CLASS 41 (U.S. CLS. 100, 101 AND 107).

FIRST USE 2-23-2007; IN COMMERCE 4-14-2007.

THE MARK CONSISTS OF STANDARD CHARACTERS WITHOUT CLAIM TO ANY PARTICULAR FONT, STYLE, SIZE, OR COLOR.

SER. NO. 77-391,572, FILED 2-7-2008.

REBECCA SMITH, EXAMINING ATTORNEY

**Int. Cl.: 44**

**Prior U.S. Cls.: 100 and 101**

**United States Patent and Trademark Office**

**Reg. No. 3,498,811**

**Registered Sep. 9, 2008**

**SERVICE MARK  
PRINCIPAL REGISTER**

**MODERNEYES**

CUTTING EDGE KIOSKS, INC. (PENNSYLVANIA CORPORATION)  
2827 MICHENER DRIVE  
LANCASTER, PA 17601

THE MARK CONSISTS OF STANDARD CHARACTERS WITHOUT CLAIM TO ANY PARTICULAR FONT, STYLE, SIZE, OR COLOR.

FOR: FITTING OF OPTICAL LENSES; OPTICIAN SERVICES; OPTOMETRY SERVICES; EYEGLOSS FITTING, IN CLASS 44 (U.S. CLS. 100 AND 101).

SER. NO. 77-391,577, FILED 2-7-2008.

FIRST USE 2-4-2008; IN COMMERCE 2-4-2008.

ESTHER A. BORSUK, EXAMINING ATTORNEY

**Int. Cl.: 36**

**Prior U.S. Cls.: 100, 101 and 102**

**United States Patent and Trademark Office**

**Reg. No. 3,498,812**

**Registered Sep. 9, 2008**

**SERVICE MARK  
PRINCIPAL REGISTER**



EQUIMARK CAPITAL, LLC (DELAWARE LIMITED LIABILITY COMPANY)  
SUITE 1350  
8000 TOWERS CRESCENT DRIVE  
VIENNA, VA 22182

FOR: FINANCIAL CONSULTING; FINANCIAL PLANNING; FINANCIAL PLANNING CONSULTATION; FINANCIAL PORTFOLIO ANALYSIS SERVICES; FINANCIAL PORTFOLIO MANAGEMENT; FINANCIAL RISK MANAGEMENT, IN CLASS 36 (U.S. CLS. 100, 101 AND 102).

FIRST USE 7-1-1999; IN COMMERCE 7-1-1999.

THE MARK CONSISTS OF THE STYLIZED TEXT "EQUIMARK" WITH A HALF CIRCLE AT THE END OF THE TEXT.

SER. NO. 77-391,584, FILED 2-7-2008.

RENEE MCCRAY, EXAMINING ATTORNEY

**Int. Cl.: 35**

**Prior U.S. Cls.: 100, 101 and 102**

**United States Patent and Trademark Office**

**Reg. No. 3,498,813**

**Registered Sep. 9, 2008**

**SERVICE MARK  
PRINCIPAL REGISTER**



SERVICESPIDER (DELAWARE LIMITED LIABILITY COMPANY)  
34 LEXINGTON RD.  
HARTFORD, CT 06119

FOR: ONLINE AUCTION SERVICES, IN CLASS 35  
(U.S. CLS. 100, 101 AND 102).

FIRST USE 10-23-2007; IN COMMERCE 1-7-2008.

NO CLAIM IS MADE TO THE EXCLUSIVE  
RIGHT TO USE "SERVICE", APART FROM THE  
MARK AS SHOWN.

THE STIPPLING IS FOR SHADING PURPOSES  
ONLY.

THE MARK CONSISTS OF THE STYLIZED  
WORDS "SERVICE SPIDER". IN BETWEEN THE  
WORDS "SERVICE SPIDER" IS A PICTURE OF A  
SPIDER WALKING AWAY FROM THE VIEWER.

SER. NO. 77-391,586, FILED 2-7-2008.

DAVID MURRAY, EXAMINING ATTORNEY

**Int. Cl.: 14**

**Prior U.S. Cls.: 2, 27, 28 and 50**

**United States Patent and Trademark Office**

**Reg. No. 3,498,814**

**Registered Sep. 9, 2008**

**TRADEMARK  
PRINCIPAL REGISTER**

**Rio Grande**

THE BELL GROUP (NEW MEXICO CORPORATION), DBA RIO GRANDE  
7500 BLUEWATER RD NW  
ALBUQUERQUE, NM 87121

THE MARK CONSISTS OF STANDARD CHARACTERS WITHOUT CLAIM TO ANY PARTICULAR FONT, STYLE, SIZE, OR COLOR.

FOR: JEWELRY, IN CLASS 14 (U.S. CLS. 2, 27, 28 AND 50).

SER. NO. 77-391,592, FILED 2-7-2008.

FIRST USE 2-1-1980; IN COMMERCE 2-1-1980.

DAVID COLLIER, EXAMINING ATTORNEY

Int. Cl.: 35

Prior U.S. Cls.: 100, 101 and 102

United States Patent and Trademark Office

Reg. No. 3,498,815

Registered Sep. 9, 2008

**SERVICE MARK  
PRINCIPAL REGISTER**



HAGAN, SEAN (UNITED STATES INDIVIDUAL)  
20118 CORTEZ BLVD.  
BROOKSVILLE, FL 34601

FOR: RETAIL JEWELRY STORES, IN CLASS 35  
(U.S. CLS. 100, 101 AND 102).

FIRST USE 6-15-1997; IN COMMERCE 6-15-1997.

THE LIKENESS (OR, "PORTRAIT") IN THE  
MARK IDENTIFIES A LIVING INDIVIDUAL  
WHOSE CONSENT IS OF RECORD.

THE MARK CONSISTS OF A DRAWING OF A  
FACE, SHOULDERS, AND HANDS, HOLDING A  
LARGE GEMSTONE IN RIGHT HAND, A OVER-  
SIZED JEWELERS LOUPE IN LEFT HAND, LEFT  
EYE ENLARGED, A SMALL SIDE VIEW OF A  
GEMSTONE ON SHIRT WITH THE STYLIZED  
WORDS "JEWELERMAN" BELOW IT .

SER. NO. 77-391,594, FILED 2-7-2008.

DAVID COLLIER, EXAMINING ATTORNEY

**Int. Cl.: 41**

**Prior U.S. Cls.: 100, 101 and 107**

**United States Patent and Trademark Office**

**Reg. No. 3,498,816**

**Registered Sep. 9, 2008**

**SERVICE MARK  
PRINCIPAL REGISTER**

**CELESTIAL COACHING, INC.**

CELESTIAL COACHING, INC. (FLORIDA CORPORATION)  
940 NE 20TH AVENUE  
FORT LAUDERDALE, FL 33304

FOR: EDUCATIONAL SERVICES, NAMELY, CONDUCTING INDIVIDUAL AND GROUP INSTRUCTION IN THE FIELD OF PERSONAL IMPROVEMENT USING MEDITATION, YOGA, JOURNALING AND ASTROLOGY, IN CLASS 41 (U.S. CLS. 100, 101 AND 107).

FIRST USE 1-23-2007; IN COMMERCE 1-23-2007.

THE MARK CONSISTS OF STANDARD CHARACTERS WITHOUT CLAIM TO ANY PARTICULAR FONT, STYLE, SIZE, OR COLOR.

NO CLAIM IS MADE TO THE EXCLUSIVE RIGHT TO USE "COACHING, INC.", APART FROM THE MARK AS SHOWN.

SER. NO. 77-391,617, FILED 2-7-2008.

REBECCA SMITH, EXAMINING ATTORNEY



**Int. Cl.: 36**

**Prior U.S. Cls.: 100, 101 and 102**

**United States Patent and Trademark Office**

**Reg. No. 3,498,817**

**Registered Sep. 9, 2008**

**SERVICE MARK  
PRINCIPAL REGISTER**

**EUROCASTLE**

FORTRESS INVESTMENT GROUP LLC (DELA-  
WARE LIMITED LIABILITY COMPANY)  
1345 AVENUE OF THE AMERICAS  
NEW YORK, NY 10105

FOR: FINANCIAL SERVICES AND INVESTMENT  
SERVICES, NAMELY, INVESTMENT MANAGE-  
MENT SERVICES AND ASSET MANAGEMENT  
SERVICES; FINANCIAL INVESTMENT SERVICES  
IN THE FIELD OF REAL ESTATE, NAMELY, REAL  
ESTATE ASSET ACQUISITION, DEVELOPMENT  
AND MANAGEMENT SERVICES, IN CLASS 36  
(U.S. CLS. 100, 101 AND 102).

FIRST USE 8-31-2003; IN COMMERCE 8-31-2003.

THE MARK CONSISTS OF STANDARD CHAR-  
ACTERS WITHOUT CLAIM TO ANY PARTICULAR  
FONT, STYLE, SIZE, OR COLOR.

SER. NO. 77-391,620, FILED 2-7-2008.

BRIDGETT SMITH, EXAMINING ATTORNEY

**Int. Cl.: 35**

**Prior U.S. Cls.: 100, 101 and 102**

**United States Patent and Trademark Office**

**Reg. No. 3,498,818**

**Registered Sep. 9, 2008**

**SERVICE MARK  
PRINCIPAL REGISTER**

**PIGEONS IN COMBAT**

CROSERIALESSANDRO (UNITED STATES IN-  
DIVIDUAL)  
301 EAST 21ST STREET  
NEW YORK, NY 10010

THE MARK CONSISTS OF ALL TEXT IN CAPI-  
TAL LETTERS, USING "STENCIL" FONT, TEXT IS  
ENCASED WITHIN A RECTANGULAR BOX. .

FOR: ON-LINE RETAIL STORE SERVICES FEA-  
TURING DVDS, POSTERS, POSTCARDS, TSHIRTS  
AND SWEATSHIRTS, IN CLASS 35 (U.S. CLS. 100, 101  
AND 102).

SER. NO. 77-391,621, FILED 2-7-2008.

FIRST USE 9-1-2006; IN COMMERCE 12-1-2006.

BRIDGETT SMITH, EXAMINING ATTORNEY

**Int. Cl.: 37**

**Prior U.S. Cls.: 100, 103 and 106**

**United States Patent and Trademark Office**

**Reg. No. 3,498,819**

**Registered Sep. 9, 2008**

**SERVICE MARK  
PRINCIPAL REGISTER**

**JANSERV**

LLERENA, GALO H (UNITED STATES INDIVIDUAL)  
17800 CASTLETON ST., SUITE 578  
CITY OF INDUSTRY, CA 91748

THE MARK CONSISTS OF STANDARD CHARACTERS WITHOUT CLAIM TO ANY PARTICULAR FONT, STYLE, SIZE, OR COLOR.

FOR: JANITORIAL SERVICES, IN CLASS 37 (U.S. CLS. 100, 103 AND 106).

SER. NO. 77-391,660, FILED 2-7-2008.

FIRST USE 1-1-2006; IN COMMERCE 1-1-2006.

REBECCA SMITH, EXAMINING ATTORNEY

**Int. Cl.: 5**

**Prior U.S. Cls.: 6, 18, 44, 46, 51 and 52**

**Reg. No. 3,498,820**

**United States Patent and Trademark Office**

**Registered Sep. 9, 2008**

**TRADEMARK  
PRINCIPAL REGISTER**

**SweetTooth SweetaCeutical**

MCPEAK, NANA PATRICIA (UNITED STATES  
INDIVIDUAL)  
100 ROCK LANE  
EL DORADO HILLS, CA 95762

THE MARK CONSISTS OF STANDARD CHAR-  
ACTERS WITHOUT CLAIM TO ANY PARTICULAR  
FONT, STYLE, SIZE, OR COLOR.

FOR: DIETARY AND NUTRITIONAL SUPPLE-  
MENTS, IN CLASS 5 (U.S. CLS. 6, 18, 44, 46, 51 AND  
52).

SER. NO. 77-391,666, FILED 2-7-2008.

FIRST USE 11-1-2007; IN COMMERCE 11-1-2007.

ALICE BENMAMAN, EXAMINING ATTORNEY

**Int. Cl.: 25**

**Prior U.S. Cls.: 22 and 39**

**United States Patent and Trademark Office**

**Reg. No. 3,498,821**

**Registered Sep. 9, 2008**

**TRADEMARK  
PRINCIPAL REGISTER**



KARMAN, INC. (COLORADO CORPORATION),  
DBA ROPER APPAREL AND FOOTWEAR  
14707 E. 2ND AVENUE SUITE 300  
AURORA, CO 80011

FOR: CLOTHING, NAMELY, SHIRTS, KNIT AND  
WOVEN SHIRTS, BLOUSES, JEANS, PANTS,  
SHORTS, SKIRTS, DRESSES, SWEATERS, SWEAT-  
SHIRTS, T-SHIRTS, JACKETS, COATS, HATS,  
BELTS, CAPS, SOCKS, FOOTWEAR AND HEAD-  
WEAR, IN CLASS 25 (U.S. CLS. 22 AND 39).

FIRST USE 8-16-1976; IN COMMERCE 8-16-1976.

THE MARK CONSISTS OF A DEPICTION OF A  
WHITE BUFFALO.

SER. NO. 77-391,689, FILED 2-7-2008.

ANGELA M. MICHELI, EXAMINING ATTORNEY

**Int. Cl.: 36**

**Prior U.S. Cls.: 100, 101 and 102**

**United States Patent and Trademark Office**

**Reg. No. 3,498,822**

**Registered Sep. 9, 2008**

**SERVICE MARK  
PRINCIPAL REGISTER**

**Helping You to Secure the  
Financial Road Ahead**

LEE, KEE SOU JOHN (UNITED STATES INDIVIDUAL)  
9121 HARVEST WAY  
SACRAMENTO, CA 95826

FOR: FINANCIAL ADVICE; INSURANCE AGENCIES; MUTUAL FUND INVESTMENT; MUTUAL FUNDS AND CAPITAL INVESTMENT, IN CLASS 36 (U.S. CLS. 100, 101 AND 102).

FIRST USE 1-1-2006; IN COMMERCE 1-1-2006.

THE MARK CONSISTS OF STANDARD CHARACTERS WITHOUT CLAIM TO ANY PARTICULAR FONT, STYLE, SIZE, OR COLOR.

SER. NO. 77-391,709, FILED 2-7-2008.

ANDREA SAUNDERS, EXAMINING ATTORNEY

**Int. Cl.: 37**

**Prior U.S. Cls.: 100, 103 and 106**

**United States Patent and Trademark Office**

**Reg. No. 3,498,823**

**Registered Sep. 9, 2008**

**SERVICE MARK  
PRINCIPAL REGISTER**

**Call the Redd Man**

REDD PEST CONTROL COMPANY OF GULF-  
PORT, MISSISSIPPI (MISSISSIPPI CORPORA-  
TION), DBA REDD PEST SOLUTIONS  
POST OFFICE BOX 2245  
GULFPORT, MS 39505

THE MARK CONSISTS OF STANDARD CHAR-  
ACTERS WITHOUT CLAIM TO ANY PARTICULAR  
FONT, STYLE, SIZE, OR COLOR.

FOR: TERMITE AND PEST CONTROL, IN CLASS  
37 (U.S. CLS. 100, 103 AND 106).

SER. NO. 77-391,733, FILED 2-7-2008.

FIRST USE 1-4-1961; IN COMMERCE 1-4-1961.

SALLY SHIH, EXAMINING ATTORNEY

**Int. Cl.: 37**

**Prior U.S. Cls.: 100, 103 and 106**

**United States Patent and Trademark Office**

**Reg. No. 3,498,824**

**Registered Sep. 9, 2008**

**SERVICE MARK  
PRINCIPAL REGISTER**

# Redd Man

REDD PEST CONTROL COMPANY OF GULF-  
PORT, MISSISSIPPI (MISSISSIPPI CORPORA-  
TION), DBA REDD PEST SOLUTIONS  
POST OFFICE BOX 2245  
GULFPORT, MS 39505

THE MARK CONSISTS OF STANDARD CHAR-  
ACTERS WITHOUT CLAIM TO ANY PARTICULAR  
FONT, STYLE, SIZE, OR COLOR.

FOR: TERMITE AND PEST CONTROL, IN CLASS  
37 (U.S. CLS. 100, 103 AND 106).

SER. NO. 77-391,749, FILED 2-7-2008.

FIRST USE 9-1-1958; IN COMMERCE 9-1-1958.

SALLY SHIH, EXAMINING ATTORNEY



**Int. Cl.: 30**

**Prior U.S. Cl.: 46**

**United States Patent and Trademark Office**

**Reg. No. 3,498,825**

**Registered Sep. 9, 2008**

**TRADEMARK  
PRINCIPAL REGISTER**

**St. Nickerdoodle**

NORTH POLE COFFEE ROASTING COMPANY  
(ALASKA CORPORATION)  
P.O. BOX 56960  
FAIRBANKS, AK 99705

THE MARK CONSISTS OF STANDARD CHAR-  
ACTERS WITHOUT CLAIM TO ANY PARTICULAR  
FONT, STYLE, SIZE, OR COLOR.

FOR: COFFEE; COFFEE; COFFEE BEANS;  
GROUND COFFEE BEANS; ROASTED COFFEE  
BEANS, IN CLASS 30 (U.S. CL. 46).

SER. NO. 77-391,759, FILED 2-7-2008.

FIRST USE 1-1-1992; IN COMMERCE 1-1-1992.

CARYN GLASSER, EXAMINING ATTORNEY

**Int. Cl.: 35**

**Prior U.S. Cls.: 100, 101 and 102**

**United States Patent and Trademark Office**

**Reg. No. 3,498,826**

**Registered Sep. 9, 2008**

**SERVICE MARK  
PRINCIPAL REGISTER**

**COSMO STORE SERVICES**

COSMO STORE SERVICES, LLC (CALIFORNIA  
LIMITED LIABILITY COMPANY)

741 MAIN STREET

ORANGE, CA 92868

FOR: PRODUCT MERCHANDISING SERVICES  
IN THE FIELD OF HARDWARE AND HOME  
IMPROVEMENT STORES, IN CLASS 35 (U.S. CLS.  
100, 101 AND 102).

FIRST USE 7-31-2006; IN COMMERCE 7-31-2006.

THE MARK CONSISTS OF STANDARD CHAR-  
ACTERS WITHOUT CLAIM TO ANY PARTICULAR  
FONT, STYLE, SIZE, OR COLOR.

OWNER OF U.S. REG. NO. 2,570,170.

NO CLAIM IS MADE TO THE EXCLUSIVE  
RIGHT TO USE "STORE SERVICES", APART FROM  
THE MARK AS SHOWN.

SER. NO. 77-391,789, FILED 2-7-2008.

RENEE MCCRAY, EXAMINING ATTORNEY

**Int. Cl.: 9**

**Prior U.S. Cls.: 21, 23, 26, 36 and 38**

**United States Patent and Trademark Office**

**Reg. No. 3,498,827**

**Registered Sep. 9, 2008**

**TRADEMARK  
PRINCIPAL REGISTER**

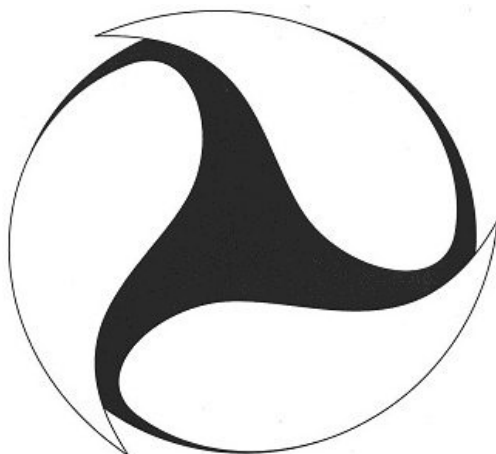

GARY FONG, INC. (WASHINGTON CORPORATION)  
1301 1ST AVENUE  
SUITE 2102  
SEATTLE, WA 98101

FOR: PHOTOGRAPHIC FLASH DIFFUSERS;  
COMPUTER SOFTWARE FOR INTEGRATING  
TEXT, AUDIO, GRAPHICS, AND STILL IMAGES  
INTO A MULTIMEDIA PRESENTATION; COMPU-  
TER SOFTWARE FOR CREATING PHOTOGRAPH  
ALBUMS; COMPUTER SOFTWARE FOR ORGA-  
NIZING AND VIEWING DIGITAL IMAGES AND

PHOTOGRAPHS; COMPUTER SOFTWARE FOR  
PROCESSING DIGITAL PHOTOGRAPHS; AND  
PRE-RECORDED DIGITAL VIDEO DISKS FEATUR-  
ING BUSINESS AND INVESTMENT INFORMA-  
TION, IN CLASS 9 (U.S. CLS. 21, 23, 26, 36 AND 38).

FIRST USE 10-31-2007; IN COMMERCE 10-31-2007.

SER. NO. 77-391,809, FILED 2-7-2008.

BARBARA A. GOLD, EXAMINING ATTORNEY

**Int. Cl.: 37**

**Prior U.S. Cls.: 100, 103 and 106**

**United States Patent and Trademark Office**

**Reg. No. 3,498,828**

**Registered Sep. 9, 2008**

**SERVICE MARK  
PRINCIPAL REGISTER**

**The Beautiful Life**

BELLE LA VIE DEVELOPMENT, L.L.C. (MISSISSIPPI LIMITED LIABILITY COMPANY)  
15039 LORRAINE ROAD  
BILOXI, MS 39532

THE MARK CONSISTS OF STANDARD CHARACTERS WITHOUT CLAIM TO ANY PARTICULAR FONT, STYLE, SIZE, OR COLOR.

FOR: REAL ESTATE DEVELOPMENT, IN CLASS 37 (U.S. CLS. 100, 103 AND 106).

SER. NO. 77-391,831, FILED 2-7-2008.

FIRST USE 5-4-2006; IN COMMERCE 5-4-2006.

ARETHA SOMERVILLE, EXAMINING ATTORNEY

**Int. Cl.: 35**

**Prior U.S. Cls.: 100, 101 and 102**

**United States Patent and Trademark Office**

**Reg. No. 3,498,829**

**Registered Sep. 9, 2008**

**SERVICE MARK  
PRINCIPAL REGISTER**

**THEQUIETMINDED**

THEQUIETMINDED INC. (RHODE ISLAND  
CORPORATION)  
70 STONY LN.  
NORTH KINGSTOWN, RI 02852

THE MARK CONSISTS OF STANDARD CHAR-  
ACTERS WITHOUT CLAIM TO ANY PARTICULAR  
FONT, STYLE, SIZE, OR COLOR.

FOR: MENTAL HEALTH PROFESSIONAL RE-  
FERRALS, IN CLASS 35 (U.S. CLS. 100, 101 AND 102).

SER. NO. 77-391,837, FILED 2-7-2008.

FIRST USE 1-1-2008; IN COMMERCE 1-1-2008.

BARBARA A. GOLD, EXAMINING ATTORNEY

**Int. Cl.: 41**

**Prior U.S. Cls.: 100, 101 and 107**

**United States Patent and Trademark Office**

**Reg. No. 3,498,830**

**Registered Sep. 9, 2008**

**SERVICE MARK  
PRINCIPAL REGISTER**

**TRANSPORTATIONU.COM**

ROBERT RAND & ASSOCIATES LLC (GEORGIA  
LIMITED LIABILITY COMPANY)  
2398 CANNON HILL ROAD  
LILBURN, GA 30047

FOR: EDUCATION SERVICES, NAMELY, PROVIDING LIVE AND ON-LINE CLASSES, SEMINARS, CONFERENCES, AND WORKSHOPS IN THE FIELD OF THE GENERAL TRANSPORTATION INDUSTRY, FEATURING FREIGHT TRANSPORTATION, PUBLIC TRANSIT, TRANSPORTATION BY RAIL, AND REGULATORY COMPLIANCE FOR THE GENERAL TRANSPORTATION INDUSTRY; EDUCATIONAL SERVICES, NAMELY, CONDUCTING COURSES, CLASSES, SEMINARS, CONFERENCES, AND WORKSHOPS IN THE FIELD OF THE GENERAL TRANSPORTATION INDUSTRY, FEATUR-

ING FREIGHT TRANSPORTATION, PUBLIC TRANSIT, TRANSPORTATION BY RAIL, AND REGULATORY COMPLIANCE FOR THE GENERAL TRANSPORTATION INDUSTRY, IN CLASS 41 (U.S. CLS. 100, 101 AND 107).

FIRST USE 6-30-2003; IN COMMERCE 1-1-2007.

THE MARK CONSISTS OF STANDARD CHARACTERS WITHOUT CLAIM TO ANY PARTICULAR FONT, STYLE, SIZE, OR COLOR.

SER. NO. 77-391,839, FILED 2-7-2008.

BARBARA A. GOLD, EXAMINING ATTORNEY

**Int. Cl.: 25**

**Prior U.S. Cls.: 22 and 39**

**United States Patent and Trademark Office**

**Reg. No. 3,498,831**

**Registered Sep. 9, 2008**

**TRADEMARK  
PRINCIPAL REGISTER**



GRD BIOTECH, INC (WASHINGTON CORPORATION), DBA POSTURE DYNAMICS  
325 WASHINGTON ST. NE #431  
OLYMPIA, WA 98501

THE MARK CONSISTS OF STYLIZED LETTER "P" AND LETTERS SPELLING "PROKINETICS".

FOR: INSOLES, IN CLASS 25 (U.S. CLS. 22 AND 39).

SER. NO. 77-391,846, FILED 2-7-2008.

FIRST USE 12-26-2007; IN COMMERCE 2-1-2008.

GIANCARLO CASTRO, EXAMINING ATTORNEY

Int. Cl.: 25

Prior U.S. Cls.: 22 and 39

United States Patent and Trademark Office

Reg. No. 3,498,832

Registered Sep. 9, 2008

TRADEMARK  
PRINCIPAL REGISTER

FIGJAM

FIGJAM APPAREL INC (CANADA CORPORATION)  
102-160 EAST 19TH STREET  
NORTH VANCOUVER, CANADA V7L2Y8

FOR: HEAD WEAR; SKI WEAR; SURF WEAR; SWIM WEAR; TENNIS WEAR; SHORT-SLEEVED OR LONG-SLEEVED T-SHIRTS; T-SHIRTS; DRESS SHIRTS; GOLF SHIRTS; LONG-SLEEVED SHIRTS; POLO SHIRTS; SHORT-SLEEVED SHIRTS; SPORT SHIRTS; SPORTS SHIRTS; SPORTS SHIRTS WITH SHORT SLEEVES; SWEAT SHIRTS; TEE SHIRTS; BERMUDA SHORTS; BOARD SHORTS; BOXER SHORTS; FLEECE SHORTS; GYM SHORTS; SHORTS; SWEAT SHORTS; UNDERWEAR, NAMELY, BOY SHORTS; WALKING SHORTS; CAPRI PANTS; CARGO PANTS; DENIMS, NAMELY, JEANS, JACKETS AND SHORTS; JOGGING PANTS; PANTS; SKI PANTS; SNOW PANTS; SNOWBOARD PANTS; SWEAT PANTS; TRACK PANTS; WATER-PROOF JACKETS AND PANTS; WIND PANTS; YOGA PANTS; HAT BANDS; HATS; SMALL HATS;

TUQUES; CAP VISORS; CAPS WITH VISORS; SUN VISORS; VISORS; SANDAL-CLOGS; SANDALS; BEACH SHOES; SHOES; TANK TOPS; TANK-TOPS; TOP COATS; TOPS; TUBE TOPS; APRES-SKI SHOES; SKI AND SNOWBOARD SHOES AND PARTS THEREOF; SKI BOOT BAGS; SKI GLOVES; SKI JACKETS; SKI SUITS; SKI SUITS FOR COMPETITION; SKIING SHOES; SKIWEAR; SNOWBOARD BOOTS; SNOWBOARD GLOVES; SNOWBOARD MITTENS, IN CLASS 25 (U.S. CLS. 22 AND 39).

FIRST USE 12-1-2006; IN COMMERCE 3-16-2007.

THE MARK CONSISTS OF STANDARD CHARACTERS WITHOUT CLAIM TO ANY PARTICULAR FONT, STYLE, SIZE, OR COLOR.

SER. NO. 77-391,855, FILED 2-7-2008.

JILL C. ALT, EXAMINING ATTORNEY



**Int. Cl.: 9**

**Prior U.S. Cls.: 21, 23, 26, 36 and 38**

**United States Patent and Trademark Office**

**Reg. No. 3,498,833**

**Registered Sep. 9, 2008**

**TRADEMARK  
PRINCIPAL REGISTER**

**AERO**

HARRINGTON, TIMOTHY LEWIS (UNITED STATES INDIVIDUAL)  
1300 OCEANSIDE LANE  
LEAGUE CITY, TX 77573

FOR: AMPLIFIERS; AUDIO AMPLIFIERS; ELECTRICAL CABLES FOR MUSICAL INSTRUMENTS; ELECTRONIC EFFECT PEDALS FOR USE WITH SOUND AMPLIFIERS; GUITAR AMPLIFIERS; LOUDSPEAKERS WITH BUILT IN AMPLIFIERS; MUSICAL INSTRUMENT AMPLIFIERS; POWER AMPLIFIERS; PRE-AMPLIFIERS; RACKS FOR AMPLIFIERS; SOUND MIXERS WITH INTEGRATED

AMPLIFIERS, IN CLASS 9 (U.S. CLS. 21, 23, 26, 36 AND 38).

FIRST USE 1-30-2008; IN COMMERCE 2-7-2008.

THE MARK CONSISTS OF STANDARD CHARACTERS WITHOUT CLAIM TO ANY PARTICULAR FONT, STYLE, SIZE, OR COLOR.

SER. NO. 77-391,883, FILED 2-7-2008.

EMILY CARLSEN, EXAMINING ATTORNEY

**Int. Cl.: 30**

**Prior U.S. Cl.: 46**

**United States Patent and Trademark Office**

**Reg. No. 3,498,834**

**Registered Sep. 9, 2008**

**TRADEMARK  
PRINCIPAL REGISTER**

**Matisse & Jack's**

MATISSE & JACK'S, LLC (CALIFORNIA LIMITED LIABILITY COMPANY)  
P.O. BOX 460217  
SAN FRANCISCO, CA 941460217

FOR: MIXES FOR BAKERY GOODS; COOKIE MIXES; CAKE MIXES; BROWNIE MIXES; MUFFIN MIXES; MIXES FOR MAKING GRANOLA SNACKS; MIXES FOR MAKING CEREAL-BASED ENERGY BARS, IN CLASS 30 (U.S. CL. 46).

FIRST USE 2-11-2005; IN COMMERCE 2-11-2005.

THE MARK CONSISTS OF STANDARD CHARACTERS WITHOUT CLAIM TO ANY PARTICULAR FONT, STYLE, SIZE, OR COLOR.

SER. NO. 77-391,890, FILED 2-8-2008.

KATHERINE E. HALMEN, EXAMINING ATTORNEY

**Int. Cl.: 3**

**Prior U.S. Cls.: 1, 4, 6, 50, 51 and 52**

**Reg. No. 3,498,835**

**United States Patent and Trademark Office**

**Registered Sep. 9, 2008**

**TRADEMARK  
PRINCIPAL REGISTER**

**Bayou Beauty**

KENNON, BELINDA G. (UNITED STATES INDIVIDUAL)  
305 CAMPBELL RD.  
HAUGHTON, LA 71037

FOR: HAIR LOTIONS; HAND LOTIONS; LOTIONS FOR CELLULITE REDUCTION; LOTIONS FOR COSMETIC PURPOSES; LOTIONS FOR FACE AND BODY CARE; LOTIONS FOR STRENGTHENING THE NAILS; SKIN AND BODY TOPICAL LOTIONS, CREAMS AND OILS FOR COSMETIC USE; BATH OILS FOR COSMETIC PURPOSES, IN CLASS 3 (U.S. CLS. 1, 4, 6, 50, 51 AND 52).

FIRST USE 2-1-2007; IN COMMERCE 1-1-2008.

THE MARK CONSISTS OF STANDARD CHARACTERS WITHOUT CLAIM TO ANY PARTICULAR FONT, STYLE, SIZE, OR COLOR.

NO CLAIM IS MADE TO THE EXCLUSIVE RIGHT TO USE "BEAUTY", APART FROM THE MARK AS SHOWN.

SER. NO. 77-391,895, FILED 2-8-2008.

JEFFERY COWARD, EXAMINING ATTORNEY

**Int. Cl.: 37**

**Prior U.S. Cls.: 100, 103 and 106**

**United States Patent and Trademark Office**

**Reg. No. 3,498,836**

**Registered Sep. 9, 2008**

**SERVICE MARK  
PRINCIPAL REGISTER**

**PRO ONE JANITORIAL**

PRO ONE JANITORIAL (WISCONSIN CORPORATION)

1101ASHWAUBENON STREET

GREEN BAY, WI 54304

FOR: JANITORIAL SERVICES, IN CLASS 37 (U.S. CLS. 100, 103 AND 106).

FIRST USE 6-1-1994; IN COMMERCE 6-1-1994.

THE MARK CONSISTS OF STANDARD CHARACTERS WITHOUT CLAIM TO ANY PARTICULAR FONT, STYLE, SIZE, OR COLOR.

NO CLAIM IS MADE TO THE EXCLUSIVE RIGHT TO USE "JANITORIAL", APART FROM THE MARK AS SHOWN.

SER. NO. 77-391,923, FILED 2-8-2008.

KATINA MISTER, EXAMINING ATTORNEY

**Int. Cl.: 22**

**Prior U.S. Cls.: 1, 2, 7, 19, 22, 42 and 50**

**United States Patent and Trademark Office**

**Reg. No. 3,498,837**

**Registered Sep. 9, 2008**

**TRADEMARK  
PRINCIPAL REGISTER**



EARTH SAVVY PRODUCTS, LLC (DELAWARE  
LIMITED LIABILITY COMPANY)  
SUITE 505  
1201 NORTH MARKET STREET  
WILMINGTON, DE 19801

FIRST USE 5-28-2007; IN COMMERCE 5-28-2007.

SER. NO. 77-391,946, FILED 2-8-2008.

FOR: MULTI-PURPOSE CLOTH BAGS, IN CLASS  
22 (U.S. CLS. 1, 2, 7, 19, 22, 42 AND 50).

DAVID MILLER, EXAMINING ATTORNEY

**Int. Cl.: 41**

**Prior U.S. Cls.: 100, 101 and 107**

**United States Patent and Trademark Office**

**Reg. No. 3,498,838**

**Registered Sep. 9, 2008**

**SERVICE MARK  
PRINCIPAL REGISTER**

**E · C · I**  

---

**ECONOMIC CRIME INSTITUTE**

UTICA COLLEGE (NEW YORK NON-PROFIT CORPORATION)  
1600 BURRSTONE ROAD  
UTICA, NY 13502

FOR: EDUCATIONAL SERVICES, NAMELY, PROVIDING COURSES OF INSTRUCTION AT THE UNIVERSITY LEVEL IN THE FIELDS OF ECONOMIC CRIME, INFORMATION SECURITY, FRAUD AND RISK MANAGEMENT; ARRANGING AND CONDUCTING EDUCATIONAL CONFERENCES IN THE FIELDS OF ECONOMIC CRIME, INFORMATION SECURITY, FRAUD AND RISK MANAGEMENT, IN CLASS 41 (U.S. CLS. 100, 101 AND 107).

FIRST USE 0-0-2003; IN COMMERCE 0-0-2003.

OWNER OF U.S. REG. NOS. 2,705,888 AND 3,113,488.

NO CLAIM IS MADE TO THE EXCLUSIVE RIGHT TO USE "INSTITUTE", APART FROM THE MARK AS SHOWN.

SEC. 2(F) AS TO "ECONOMIC CRIME INSTITUTE".

SER. NO. 77-391,959, FILED 2-8-2008.

ELIZABETH HUGHITT, EXAMINING ATTORNEY

**Int. Cls.: 2 and 19**

**Prior U.S. Cls.: 1, 6, 11, 12, 16, 33 and 50**

**United States Patent and Trademark Office**

**Reg. No. 3,498,839**

**Registered Sep. 9, 2008**

**TRADEMARK  
PRINCIPAL REGISTER**



R.M. LUCAS CO. (ILLINOIS CORPORATION)  
3211 S. WOOD  
CHICAGO, IL 60608

FOR: ELASTOMERIC-BASED COATINGS FOR USE ON ROOFS, WALLS AND BUILDING FOUNDATIONS; RESIN-BASED COATINGS FOR USE ON ROOFS, WALLS AND PAVEMENTS; WATER-BASED ROOF COATINGS, IN CLASS 2 (U.S. CLS. 6, 11 AND 16).

FIRST USE 1-1-1956; IN COMMERCE 1-1-1956.

FOR: ASPHALT ROOF COATINGS; ASPHALT ROOFING FELT; ASPHALT ROOFING PAPER; ASPHALT-BASED COATINGS AND SEALANTS FOR USE ON ROOFS, WALLS AND PAVEMENTS; ASPHALT-BASED ROOFING MASTICS; BITUMEN-BASED ROOFING SEALANTS; BITUMEN-BASED SEALANTS FOR ROOFING; BITUMINOUS COAT-

INGS FOR ROOFING; BITUMINOUS ROOF COATINGS; NON-METAL ROOF COVERINGS; ROOFING CEMENT; ROOFING FABRICS; ROOFING MEMBRANES; TAR-BASED ROOFING SEALANTS; TAR-BASED SEALANTS FOR ROOFING, IN CLASS 19 (U.S. CLS. 1, 12, 33 AND 50).

FIRST USE 1-1-1956; IN COMMERCE 1-1-1956.

THE COLOR(S) WHITE, PANTONE 287 BLUE IS/ARE CLAIMED AS A FEATURE OF THE MARK.

THE MARK CONSISTS OF "LUCAS", WHITE SOUVENIR FONT, ON PANTONE 287 BLUE BACKGROUND.

SER. NO. 77-391,978, FILED 2-8-2008.

JENNIFER MARTIN, EXAMINING ATTORNEY

**Int. Cl.: 35**

**Prior U.S. Cls.: 100, 101 and 102**

**United States Patent and Trademark Office**

**Reg. No. 3,498,840**

**Registered Sep. 9, 2008**

**SERVICE MARK  
PRINCIPAL REGISTER**

# Fairfield

LIFESPAN HEALTHCARE LLC (FLORIDA LIMITED LIABILITY COMPANY)  
270 SCIENTIFIC DR., SUITE 14  
NORCROSS, GA 30092

FOR: WHOLESALE DISTRIBUTORSHIPS FEATURING HOSPITAL EQUIPMENT MANAGEMENT PRODUCTS AND MEDICAL GAS AND POWER DISTRIBUTION PRODUCTS, USED IN HOSPITALS FOR DELIVERY OF MEDICAL GAS AND POWER TO PATIENT TREATMENT AREAS AND FOR THE ERGONOMIC STAGING OF MEDICAL SUPPLIES AND EQUIPMENT, NAMELY, HEADWALLS, FREE STANDING COLUMNS, GAS, POWER AND EQUIP-

MENT RAILS, MOBILE CARTS AND ACCESSORIES, IN CLASS 35 (U.S. CLS. 100, 101 AND 102).

FIRST USE 2-6-2008; IN COMMERCE 2-6-2008.

THE MARK CONSISTS OF STANDARD CHARACTERS WITHOUT CLAIM TO ANY PARTICULAR FONT, STYLE, SIZE, OR COLOR.

SER. NO. 77-391,995, FILED 2-8-2008.

JUSTINE D. PARKER, EXAMINING ATTORNEY



**Int. Cl.: 40**

**Prior U.S. Cls.: 100, 103 and 106**

**United States Patent and Trademark Office**

**Reg. No. 3,498,841**

**Registered Sep. 9, 2008**

**SERVICE MARK  
PRINCIPAL REGISTER**

**FLEXTRAN**

FLEXTRAN COMPANY LLC (CALIFORNIA LIMITED LIABILITY COMPANY)  
3846 S. SANTA FE AVE.  
LOS ANGELES, CA 90058

FOR: SCREEN PRINTING; CUSTOMIZED PRINTING OF COMPANY NAMES AND LOGOS FOR PROMOTIONAL AND ADVERTISING PURPOSES ON THE GOODS OF OTHERS; IMPRINTING MESSAGES ON T-SHIRTS, IN CLASS 40 (U.S. CLS. 100, 103 AND 106).

FIRST USE 7-26-1999; IN COMMERCE 8-9-1999.

THE MARK CONSISTS OF STANDARD CHARACTERS WITHOUT CLAIM TO ANY PARTICULAR FONT, STYLE, SIZE, OR COLOR.

SER. NO. 77-392,002, FILED 2-8-2008.

MARK T. MULLEN, EXAMINING ATTORNEY

**Int. Cl.: 35**

**Prior U.S. Cls.: 100, 101 and 102**

**United States Patent and Trademark Office**

**Reg. No. 3,498,842**

**Registered Sep. 9, 2008**

**SERVICE MARK  
PRINCIPAL REGISTER**



NOVANTAS LLC (DELAWARE LIMITED LIABILITY COMPANY)  
485 LEXINGTON AVENUE  
NEW YORK, NY 10017

THE COLOR(S) GOLD, BLUE IS/ARE CLAIMED AS A FEATURE OF THE MARK.

FOR: BUSINESS CONSULTING AND INFORMATION SERVICES; BUSINESS MANAGEMENT CONSULTING AND ADVISORY SERVICES; BUSINESS RESEARCH; CONSULTATION SERVICES IN THE FIELD OF COMPANY, BUSINESS SECTOR AND INDUSTRY DATA AND RESEARCH, IN CLASS 35 (U.S. CLS. 100, 101 AND 102).

THE MARK CONSISTS OF A STYLIZED GOLD RAMS HORN OR SWOOSH FOLLOWED BY THE WORD "NOVARICA" IN BLUE.

SER. NO. 77-392,013, FILED 2-8-2008.

FIRST USE 1-1-2008; IN COMMERCE 1-1-2008.

JUSTINE D. PARKER, EXAMINING ATTORNEY

**Int. Cl.: 43**

**Prior U.S. Cls.: 100 and 101**

**United States Patent and Trademark Office**

**Reg. No. 3,498,843**

**Registered Sep. 9, 2008**

**SERVICE MARK  
PRINCIPAL REGISTER**

**BE SUSHI & MARTINI**

6500 RETAIL GROUP, LLC (ARIZONA LIMITED  
LIABILITY COMPANY)  
610 E. BEL RD., STE 2-152  
PHOENIX, AZ 85022

FOR: BAR AND RESTAURANT SERVICES; PRO-  
VISION OF FOOD AND DRINK IN RESTAURANTS;  
RESTAURANT; RESTAURANT AND BAR SERVI-  
CES, IN CLASS 43 (U.S. CLS. 100 AND 101).

FIRST USE 11-15-2007; IN COMMERCE 11-15-2007.

THE MARK CONSISTS OF STANDARD CHAR-  
ACTERS WITHOUT CLAIM TO ANY PARTICULAR  
FONT, STYLE, SIZE, OR COLOR.

NO CLAIM IS MADE TO THE EXCLUSIVE  
RIGHT TO USE "SUSHI & MARTINI", APART  
FROM THE MARK AS SHOWN.

THE FOREIGN WORDING IN THE MARK  
TRANSLATES INTO ENGLISH AS RAIN.

SER. NO. 77-392,035, FILED 2-8-2008.

LINDA POWELL, EXAMINING ATTORNEY

**Int. Cl.: 43**

**Prior U.S. Cls.: 100 and 101**

**United States Patent and Trademark Office**

**Reg. No. 3,498,844**

**Registered Sep. 9, 2008**

**SERVICE MARK  
PRINCIPAL REGISTER**

**Pascoti**

6500 RETAIL GROUP, LLC (ARIZONA LIMITED  
LIABILITY COMPANY)  
610 E. BEL RD., STE 2-152  
PHOENIX, AZ 85022

FOR: BAR AND RESTAURANT SERVICES; PRO-  
VISION OF FOOD AND DRINK IN RESTAURANTS;  
RESTAURANT; RESTAURANT AND BAR SERVI-  
CES, IN CLASS 43 (U.S. CLS. 100 AND 101).

FIRST USE 11-15-2007; IN COMMERCE 11-15-2007.

THE MARK CONSISTS OF STANDARD CHAR-  
ACTERS WITHOUT CLAIM TO ANY PARTICULAR  
FONT, STYLE, SIZE, OR COLOR.

THE TERM "PASCOTI" HAS NO MEANING IN A  
FOREIGN LANGUAGE.

SER. NO. 77-392,066, FILED 2-8-2008.

LINDA POWELL, EXAMINING ATTORNEY

**Int. Cl.: 16**

**Prior U.S. Cls.: 2, 5, 22, 23, 29, 37, 38 and 50**

**Reg. No. 3,498,845**

**United States Patent and Trademark Office**

**Registered Sep. 9, 2008**

---

**TRADEMARK  
PRINCIPAL REGISTER**

**STRUCTURED SYNERGY**

SIDE BY SIDE, INC. (TEXAS CORPORATION),  
DBA PERFORMANCE RESOURCES, INC.  
9506 SAN DIEGO ROAD  
AUSTIN, TX 78737

THE MARK CONSISTS OF STANDARD CHAR-  
ACTERS WITHOUT CLAIM TO ANY PARTICULAR  
FONT, STYLE, SIZE, OR COLOR.

FOR: PRINTED TEACHING MATERIALS IN THE  
FIELD OF CORPORATE DEVELOPMENT AND  
ORGANIZATIONAL CONSULTING, IN CLASS 16  
(U.S. CLS. 2, 5, 22, 23, 29, 37, 38 AND 50).

SER. NO. 77-392,092, FILED 2-8-2008.

FIRST USE 8-15-2005; IN COMMERCE 10-15-2007.

AISHA CLARKE, EXAMINING ATTORNEY

**Int. Cl.: 35**

**Prior U.S. Cls.: 100, 101 and 102**

**United States Patent and Trademark Office**

**Reg. No. 3,498,846**

**Registered Sep. 9, 2008**

**SERVICE MARK  
PRINCIPAL REGISTER**

# Rough & Tumble

KAVANAGH, JOHN R. (UNITED STATES INDIVIDUAL)  
2308 SWARTHMORE DRIVE  
SACRAMENTO, CA 95825

FOR: SERVICES CONSISTING OF THE REGISTRATION, COLLECTION, TRANSCRIPTION, COMPILATION AND SYSTEMIZATION OF WRITTEN COMMUNICATIONS AND DATA; ADVERTISING AND PUBLICITY SERVICES, NAMELY, PROMOTING THE GOODS, SERVICES, BRAND IDENTITY AND COMMERCIAL INFORMATION AND NEWS OF THIRD PARTIES THROUGH PRINT, AUDIO, VIDEO, DIGITAL AND ON-LINE MEDIUM; SERVICES COMPRISING THE RECORDING, TRANSCRIPTION, COMPOSITION, COMPILATION AND

SYSTEMATIZATION OF WRITTEN COMMUNICATIONS AND RECORDINGS, AS WELL AS THE COMPILATION OF MATHEMATICAL OR STATISTICAL DATA, IN CLASS 35 (U.S. CLS. 100, 101 AND 102).

FIRST USE 1-1-1992; IN COMMERCE 1-1-1992.

THE MARK CONSISTS OF STANDARD CHARACTERS WITHOUT CLAIM TO ANY PARTICULAR FONT, STYLE, SIZE, OR COLOR.

SER. NO. 77-392,103, FILED 2-8-2008.

RICHARD A. STRASER, EXAMINING ATTORNEY

**Int. Cl.: 20**

**Prior U.S. Cls.: 2, 13, 22, 25, 32 and 50**

**Reg. No. 3,498,847**

**United States Patent and Trademark Office**

**Registered Sep. 9, 2008**

**TRADEMARK  
PRINCIPAL REGISTER**

# Run Run Studio

RUN RUN STUDIO INC. (MAINE CORPORATION)  
107 MAPLE STREET, PO 167  
CORNISH, ME 04020

FOR: FURNITURE; FURNITURE FOR HOUSE, OFFICE AND GARDEN; FURNITURE MADE FROM STEEL TUBING; FURNITURE OF METAL; LIVING ROOM FURNITURE; METAL FURNITURE; OUTDOOR FURNITURE; SEATING FURNITURE; SEATS; STONE FURNITURE; TABLES; UPHOLSTERED FURNITURE, IN CLASS 20 (U.S. CLS. 2, 13, 22, 25, 32 AND 50).

FIRST USE 8-1-1999; IN COMMERCE 8-1-1999.

THE MARK CONSISTS OF STANDARD CHARACTERS WITHOUT CLAIM TO ANY PARTICULAR FONT, STYLE, SIZE, OR COLOR.

NO CLAIM IS MADE TO THE EXCLUSIVE RIGHT TO USE "STUDIO", APART FROM THE MARK AS SHOWN.

SER. NO. 77-392,117, FILED 2-8-2008.

GRETTA YAO, EXAMINING ATTORNEY

**Int. Cl.: 9**

**Prior U.S. Cls.: 21, 23, 26, 36 and 38**

**Reg. No. 3,498,848**

**United States Patent and Trademark Office**

**Registered Sep. 9, 2008**

**TRADEMARK  
PRINCIPAL REGISTER**

**FIELDSYNC**

MOBILEDATAFORCE, INC. (IDAHO CORPORATION)  
SUITE 360  
3380 AMERICANA TERRACE  
BOISE, ID 83706

FIRST USE 1-29-2008; IN COMMERCE 1-29-2008.

THE MARK CONSISTS OF STANDARD CHARACTERS WITHOUT CLAIM TO ANY PARTICULAR FONT, STYLE, SIZE, OR COLOR.

FOR: COMPUTER SOFTWARE, NAMELY, FOR SYNCHRONIZING DATA BETWEEN A HANDHELD COMPUTER AND A DATABASE, IN CLASS 9 (U.S. CLS. 21, 23, 26, 36 AND 38).

SER. NO. 77-392,126, FILED 2-8-2008.

DAVID I, EXAMINING ATTORNEY



**Int. Cl.: 36**

**Prior U.S. Cls.: 100, 101 and 102**

**United States Patent and Trademark Office**

**Reg. No. 3,498,849**

**Registered Sep. 9, 2008**

**SERVICE MARK  
PRINCIPAL REGISTER**

**Sophisticated, Unbiased  
Solutions.**

CAPITAS FINANCIAL, LLC (DELAWARE LIMITED LIABILITY COMPANY), DBA CAPITAS RESOURCES, LLC  
600 SOUTH HIGHWAY 169, SUITE 710  
MINNEAPOLIS, MN 55426

FOR: LIFE INSURANCE BROKERAGE; PROVIDING INFORMATION IN INSURANCE MATTERS; INSURANCE INFORMATION AND CONSULTANCY, IN CLASS 36 (U.S. CLS. 100, 101 AND 102).

FIRST USE 1-4-2002; IN COMMERCE 1-4-2002.

THE MARK CONSISTS OF STANDARD CHARACTERS WITHOUT CLAIM TO ANY PARTICULAR FONT, STYLE, SIZE, OR COLOR.

SER. NO. 77-392,165, FILED 2-8-2008.

KATHY DE JONGE, EXAMINING ATTORNEY

**Int. Cl.: 22**

**Prior U.S. Cls.: 1, 2, 7, 19, 22, 42 and 50**

**Reg. No. 3,498,850**

**United States Patent and Trademark Office**

**Registered Sep. 9, 2008**

**TRADEMARK  
PRINCIPAL REGISTER**

**ENVIRO-TOTE**

ENVIRO-TOTE, INC. (NEW HAMPSHIRE COR-  
PORATION)  
4 COTE LANE  
BEDFORD, NH 03110

THE MARK CONSISTS OF STANDARD CHAR-  
ACTERS WITHOUT CLAIM TO ANY PARTICULAR  
FONT, STYLE, SIZE, OR COLOR.

FOR: COTTON BAGS FOR PACKAGING, IN  
CLASS 22 (U.S. CLS. 1, 2, 7, 19, 22, 42 AND 50).

SER. NO. 77-392,183, FILED 2-8-2008.

FIRST USE 3-1-1990; IN COMMERCE 3-1-1990.

MELISSA VALLILLO, EXAMINING ATTORNEY

**Int. Cl.: 19**

**Prior U.S. Cls.: 1, 12, 33 and 50**

**United States Patent and Trademark Office**

**Reg. No. 3,498,851**

**Registered Sep. 9, 2008**

**TRADEMARK  
PRINCIPAL REGISTER**

**WEATHERABLES**

USAVINYL, LLC (OHIO LIMITED LIABILITY  
COMPANY)  
3830 LACON ROAD  
HILLIARD, OH 43026

THE MARK CONSISTS OF STANDARD CHAR-  
ACTERS WITHOUT CLAIM TO ANY PARTICULAR  
FONT, STYLE, SIZE, OR COLOR.

FOR: VINYL FENCING, VINYL RAILING, VINYL  
GAZEBOS, AND VINYL ARBORS, IN CLASS 19 (U.S.  
CLS. 1, 12, 33 AND 50).

SER. NO. 77-392,187, FILED 2-8-2008.

FIRST USE 11-15-2007; IN COMMERCE 2-4-2008.

ERNEST SHOSHO, EXAMINING ATTORNEY

**Int. Cl.: 38**

**Prior U.S. Cls.: 100, 101 and 104**

**United States Patent and Trademark Office**

**Reg. No. 3,498,852**

**Registered Sep. 9, 2008**

**SERVICE MARK  
PRINCIPAL REGISTER**



TOMPKINS, TIM (UNITED STATES INDIVIDUAL)  
511 ROSS DR.  
ESCONDIDO, CA 92029

FOR: PROVIDING INTERNET CHATROOMS FOR TRANSMISSION OF MESSAGES AMONG COMPUTER USERS CONCERNING THEIR HOBBIES; STREAMING AUDIO AND VIDEO MATERIAL ON THE INTERNET, AND INTERNET BROADCASTING SERVICES, IN CLASS 38 (U.S. CLS. 100, 101 AND 104).

FIRST USE 3-1-2007; IN COMMERCE 5-18-2007.

THE MARK CONSISTS OF A STYLIZED IMAGE OF A FIREFLY WITHIN THE WORDING "BEETLE

LIGHT", AGAINST A SHADED RECTANGULAR BACKGROUND. THE FIREFLY IS COMPOSED OF A CIRCLE FOR THE HEAD AND A BIGGER CIRCLE FOR THE BODY. ATTACHED TO THIS BODY CIRCLE ARE TWO WINGS EXTENDING UP ON EACH SIDE OF THE HEAD. ALSO ATTACHED TO THE CIRCLE BODY ARE TWO ARMS AND TWO LEGS WITH FEET. THE FIREFLY IS POSED IN THE CENTER BETWEEN THE WORDS "BEETLE AND LIGHT".

SER. NO. 77-392,201, FILED 2-8-2008.

TOBY BULLOFF, EXAMINING ATTORNEY

**Int. Cl.: 9**

**Prior U.S. Cls.: 21, 23, 26, 36 and 38**

**Reg. No. 3,498,853**

**United States Patent and Trademark Office**

**Registered Sep. 9, 2008**

---

**TRADEMARK  
PRINCIPAL REGISTER**

**FLRT**

METHODS AND SOLUTIONS, INC. (ARIZONA CORPORATION), DBA MINDPLAY  
440 S. WILLIAM BLVD., #206  
TUCSON, AZ 85711

THE MARK CONSISTS OF STANDARD CHARACTERS WITHOUT CLAIM TO ANY PARTICULAR FONT, STYLE, SIZE, OR COLOR.

FOR: EDUCATIONAL SOFTWARE USED TO INCREASE READING ABILITIES, IN CLASS 9 (U.S. CLS. 21, 23, 26, 36 AND 38).

SER. NO. 77-392,232, FILED 2-8-2008.

FIRST USE 1-0-2007; IN COMMERCE 1-0-2007.

KATHERINE E. HALMEN, EXAMINING ATTORNEY

Int. Cl.: 25

Prior U.S. Cls.: 22 and 39

United States Patent and Trademark Office

Reg. No. 3,498,854

Registered Sep. 9, 2008

TRADEMARK  
PRINCIPAL REGISTER

The image shows the trademark 'haute monde' written in a black, cursive, handwritten-style font. The word 'haute' is on the left and 'monde' is on the right, with a small gap between them. The letters are fluid and connected, with a prominent loop at the top of the 'h'.

KIM, YOUNG JOON (REPUBLIC OF KOREA  
INDIVIDUAL)  
SUITE #R12  
1015 S. CROCKER ST.  
LOS ANGELES, CA 90021

FIRST USE 1-1-2008; IN COMMERCE 1-1-2008.

THE ENGLISH TRANSLATION OF THE MARK IS  
"FASHIONABLE SOCIETY".

FOR: WOMEN'S AND MEN'S CLOTHING,  
NAMELY, PANTS, JEANS, JACKETS, SHIRTS,  
BLOUSES, SKIRTS, SHORTS, COATS, OVERALLS,  
IN CLASS 25 (U.S. CLS. 22 AND 39).

SER. NO. 77-392,234, FILED 2-8-2008.

ALICE SUE CARRUTHERS, EXAMINING ATTOR-  
NEY

**Int. Cl.: 18**

**Prior U.S. Cls.: 1, 2, 3, 22 and 41**

**United States Patent and Trademark Office**

**Reg. No. 3,498,855**

**Registered Sep. 9, 2008**

**TRADEMARK  
PRINCIPAL REGISTER**

# E-Z Fit Saddle

BEILER, ELI L. (UNITED STATES INDIVIDUAL)  
1017 OREGON HOLLOW ROAD  
DRUMORE, PA 17518

FOR: RIDING SADDLES; SADDLES, IN CLASS 18  
(U.S. CLS. 1, 2, 3, 22 AND 41).

FIRST USE 1-15-2007; IN COMMERCE 1-30-2007.

THE MARK CONSISTS OF STANDARD CHARACTERS WITHOUT CLAIM TO ANY PARTICULAR FONT, STYLE, SIZE, OR COLOR.

NO CLAIM IS MADE TO THE EXCLUSIVE RIGHT TO USE "SADDLE", APART FROM THE MARK AS SHOWN.

SER. NO. 77-392,239, FILED 2-8-2008.

ELIZABETH HUGHITT, EXAMINING ATTORNEY

**Int. Cls.: 9 and 42**

**Prior U.S. Cls.: 21, 23, 26, 36, 38, 100 and 101**

**United States Patent and Trademark Office**

**Reg. No. 3,498,856**

**Registered Sep. 9, 2008**

**TRADEMARK  
SERVICE MARK  
PRINCIPAL REGISTER**

**PTP ONECLICK**

PTP ONECLICK, LLC (DELAWARE LIMITED  
LIABILITY COMPANY)  
1674 BARCLAY BOULEVARD  
BUFFALO GROVE, IL 60089

FOR: COMPUTER SOFTWARE AND ONLINE  
DOWNLOADABLE COMPUTER SOFTWARE FOR  
TAX MANAGEMENT AND FILING IN THE FIELD  
OF SALES AND USE TAX, IN CLASS 9 (U.S. CLS. 21,  
23, 26, 36 AND 38).

FIRST USE 12-26-2007; IN COMMERCE 12-26-2007.

FOR: COMPUTER SERVICES, NAMELY, PRO-  
VIDING TEMPORARY USE OF ONLINE DOWN-

LOADABLE SOFTWARE FOR SALES AND USE  
TAX PREPARATION AND ELECTRONIC FILING  
OF TAXES, AND FOR THE RETRIEVAL OF DATA  
LOSS, IN CLASS 42 (U.S. CLS. 100 AND 101).

FIRST USE 12-26-2007; IN COMMERCE 12-26-2007.

THE MARK CONSISTS OF STANDARD CHAR-  
ACTERS WITHOUT CLAIM TO ANY PARTICULAR  
FONT, STYLE, SIZE, OR COLOR.

SER. NO. 77-392,241, FILED 2-8-2008.

INGA ERVIN, EXAMINING ATTORNEY



**Int. Cl.: 36**

**Prior U.S. Cls.: 100, 101 and 102**

**United States Patent and Trademark Office**

**Reg. No. 3,498,857**

**Registered Sep. 9, 2008**

**SERVICE MARK  
PRINCIPAL REGISTER**

# ITRiskPro

HISCOX, INC. (DELAWARE CORPORATION)  
357 MAIN STREET  
ARMONK, NY 10504

FOR: INSURANCE UNDERWRITING SERVICES,  
NAMELY, PROVIDING PROFESSIONAL LIABILITY  
INSURANCE FOR INFORMATION TECHNOLOGY  
PROFESSIONALS, IN CLASS 36 (U.S. CLS. 100,  
101 AND 102).

FIRST USE 1-7-2008; IN COMMERCE 1-7-2008.

THE MARK CONSISTS OF STANDARD CHAR-  
ACTERS WITHOUT CLAIM TO ANY PARTICULAR  
FONT, STYLE, SIZE, OR COLOR.

SER. NO. 77-392,265, FILED 2-8-2008.

INGA ERVIN, EXAMINING ATTORNEY

**Int. Cl.: 21**

**Prior U.S. Cls.: 2, 13, 23, 29, 30, 33, 40 and 50**

**Reg. No. 3,498,858**

**United States Patent and Trademark Office**

**Registered Sep. 9, 2008**

**TRADEMARK  
PRINCIPAL REGISTER**



VAN NESS PLASTIC MOLDING CO., INC. (DE-  
LAWARE CORPORATION)

400 BRIGHTON ROAD

CLIFTON, NJ 07012

FOR: PLASTIC STORAGE CONTAINERS FOR  
DOMESTIC OR HOUSEHOLD USE FOR STORING  
PET FOOD SOLD EMPTY, IN CLASS 21 (U.S. CLS. 2,  
13, 23, 29, 30, 33, 40 AND 50).

FIRST USE 8-20-2007; IN COMMERCE 8-20-2007.

NO CLAIM IS MADE TO THE EXCLUSIVE  
RIGHT TO USE "PET FOOD CONTAINER", APART  
FROM THE MARK AS SHOWN.

THE MARK CONSISTS OF THE WORDS "PET  
FOOD CONTAINER" IN AN INVERTED TRIANGLE  
WITH A CIRCLE UNDER THE WORDS AND AN  
OVAL CUT OUT IN THE UPPER RIGHT CORNER  
OF THE TRIANGLE.

SER. NO. 77-392,302, FILED 2-8-2008.

MICHAEL TANNER, EXAMINING ATTORNEY

**Int. Cl.: 35**

**Prior U.S. Cls.: 100, 101 and 102**

**United States Patent and Trademark Office**

**Reg. No. 3,498,859**

**Registered Sep. 9, 2008**

**SERVICE MARK  
PRINCIPAL REGISTER**

**SMARTAGENT**

USI TECHNOLOGIES, INC. (CALIFORNIA CORPORATION), DBA UPSELLIT.COM  
811B CAMARILLO SPRINGS RD  
CAMARILLO, CA 90067

FOR: ONLINE SALES PROMOTION AND MARKETING SERVICES, NAMELY, PROMOTING THE SALE OF GOODS AND SERVICES OF OTHERS TO CUSTOMERS THROUGH INTERACTIVE ONLINE CHAT AND/OR INSTANT MESSAGING, IN CLASS 35 (U.S. CLS. 100, 101 AND 102).

FIRST USE 5-15-2006; IN COMMERCE 5-15-2006.

THE MARK CONSISTS OF STANDARD CHARACTERS WITHOUT CLAIM TO ANY PARTICULAR FONT, STYLE, SIZE, OR COLOR.

SER. NO. 77-392,355, FILED 2-8-2008.

DORITT L. CARROLL, EXAMINING ATTORNEY

**Int. Cl.: 35**

**Prior U.S. Cls.: 100, 101 and 102**

**United States Patent and Trademark Office**

**Reg. No. 3,498,860**

**Registered Sep. 9, 2008**

**SERVICE MARK  
PRINCIPAL REGISTER**

**UPSELLIT.COM**

USI TECHNOLOGIES, INC. (CALIFORNIA CORPORATION), DBA UPSSELLIT.COM  
811B CAMARILLO SPRINGS RD  
CAMARILLO, CA 93012

FOR: ONLINE SALES PROMOTION AND MARKETING SERVICES, NAMELY, PROMOTING THE SALE OF GOODS AND SERVICES OF OTHERS TO CUSTOMERS THROUGH INTERACTIVE ONLINE CHAT AND/OR INSTANT MESSAGING, IN CLASS 35 (U.S. CLS. 100, 101 AND 102).

FIRST USE 5-15-2006; IN COMMERCE 5-15-2006.

THE MARK CONSISTS OF STANDARD CHARACTERS WITHOUT CLAIM TO ANY PARTICULAR FONT, STYLE, SIZE, OR COLOR.

SER. NO. 77-392,384, FILED 2-8-2008.

DORITT L. CARROLL, EXAMINING ATTORNEY

**Int. Cls.: 36 and 37**

**Prior U.S. Cls.: 100, 101, 102, 103 and 106**

**United States Patent and Trademark Office**

**Reg. No. 3,498,861**

**Registered Sep. 9, 2008**

**SERVICE MARK  
PRINCIPAL REGISTER**

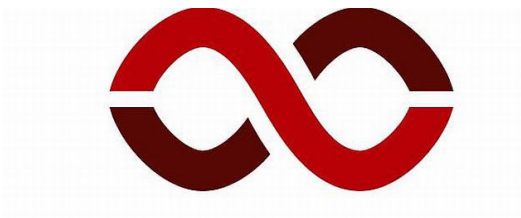

MCWHINNEY HOLDING COMPANY, LLLP  
(COLORADO LIMITED LIABILITY LIMITED  
PARTNERSHIP)  
RANGEVIEW ONE OFFICE BLDG. AT CENTERRA  
2725 ROCKY MOUNTAIN AVE., SUITE 200  
LOVELAND, CO 80538

FOR: REAL ESTATE MANAGEMENT; REAL  
ESTATE LISTING; REAL ESTATE BROKERAGE;  
REAL ESTATE AGENCIES; REAL ESTATE INVEST-  
MENT; LEASING OF REAL PROPERTY; LEASING  
OF RESIDENTIAL AND COMMERCIAL REAL ES-  
TATE; SHOPPING CENTER SERVICES, NAMELY,  
RENTAL OF SHOPPING CENTER SPACE; LEASING  
OF SHOPPING MALL SPACE, IN CLASS 36 (U.S.  
CLS. 100, 101 AND 102).

FIRST USE 10-31-2005; IN COMMERCE 10-31-2005.

FOR: REAL ESTATE DEVELOPMENT SERVICES;  
LAND DEVELOPMENT SERVICES, NAMELY,  
PLANNING AND LAYING OUT OF COMMERCIAL  
AND RESIDENTIAL COMMUNITIES; RESIDEN-

TIAL AND COMMERCIAL BUILDING CONSTRU-  
TION AND REPAIR; CUSTOM CONSTRUCTION  
AND BUILDING RENOVATION; RESIDENTIAL  
REAL ESTATE DEVELOPMENT, CONSTRUCTION  
AND REPAIR; COMMERCIAL REAL ESTATE DE-  
VELOPMENT, CONSTRUCTION AND REPAIR;  
SHOPPING CENTER REAL ESTATE DEVELOP-  
MENT, CONSTRUCTION AND REPAIR, IN CLASS  
37 (U.S. CLS. 100, 103 AND 106).

FIRST USE 10-31-2005; IN COMMERCE 10-31-2005.

THE COLOR(S) BLACK AND DARK RED IS/ARE  
CLAIMED AS A FEATURE OF THE MARK.

THE MARK CONSISTS OF A STYLIZED INFI-  
NITY SYMBOL IN BLACK AND DARK RED.

SER. NO. 77-392,396, FILED 2-8-2008.

LOURDES AYALA, EXAMINING ATTORNEY

**Int. Cls.: 37, 42 and 45**

**Prior U.S. Cls.: 100, 101, 103 and 106**

**United States Patent and Trademark Office**

**Reg. No. 3,498,862**

**Registered Sep. 9, 2008**

**SERVICE MARK  
PRINCIPAL REGISTER**

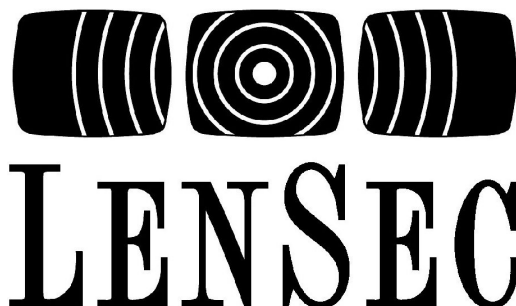

PROGRESSIVE SYSTEMS, LLC (ALABAMA CORPORATION), DBA LENSEC  
1800 BERING DRIVE, SUITE 751  
HOUSTON, TX 77057

FOR: INSTALLATION, SERVICE, REPAIR AND MAINTENANCE OF ELECTRONIC SECURITY, SURVEILLANCE AND MONITORING SYSTEMS FOR HOME, RETAIL, COMMERCIAL, INDUSTRIAL AND INSTITUTIONAL ENVIRONMENTS, IN CLASS 37 (U.S. CLS. 100, 103 AND 106).

FIRST USE 5-1-2005; IN COMMERCE 5-1-2005.

FOR: COMPUTER SOFTWARE DEVELOPMENT IN THE FIELD OF WEB BASED VIDEO SECURITY AND SURVEILLANCE SOFTWARE FOR MONITORING ACTIVITIES, EVENTS AND/OR BEHAVIORS RELATING TO THE SAFETY AND SECURITY OF STRUCTURES, AREAS, PEOPLE, AND THINGS; MAINTENANCE OF SOFTWARE FOR SECURITY, SURVEILLANCE AND MONITORING SYSTEMS, IN CLASS 42 (U.S. CLS. 100 AND 101).

FIRST USE 5-1-2005; IN COMMERCE 5-1-2005.

FOR: WEB BASED VIDEO SECURITY AND SURVEILLANCE SERVICES FOR THE PROTECTION OF PROPERTY AND INDIVIDUALS, NAMELY, ELECTRONIC MONITORING OF FACILITIES UTILIZING CUSTOMIZED, COMPUTER SOFTWARE APPLICATIONS VIEWABLE OVER THE INTERNET IN REAL-TIME AND RECORDED FOR LATER USE, AND STORAGE OF THE VIDEO RECORDS; MONITORING, REPORTING AND RESPONSE SERVICES FOR SECURITY PURPOSES IN THE FIELD OF INDIVIDUALS, FACILITIES AND ASSETS, IN CLASS 45 (U.S. CLS. 100 AND 101).

FIRST USE 5-1-2005; IN COMMERCE 5-1-2005.

SER. NO. 77-392,397, FILED 2-8-2008.

LINDA MICKLEBURGH, EXAMINING ATTORNEY

**Int. Cl.: 41**

**Prior U.S. Cls.: 100, 101 and 107**

**United States Patent and Trademark Office**

**Reg. No. 3,498,863**

**Registered Sep. 9, 2008**

**SERVICE MARK  
PRINCIPAL REGISTER**

**GONG BATH**

RUDIS, RICHARD (UNITED STATES INDIVIDUAL)  
380 EAST GLAUCUS ST.  
ENCINITAS, CA 92024

THE MARK CONSISTS OF STANDARD CHARACTERS WITHOUT CLAIM TO ANY PARTICULAR FONT, STYLE, SIZE, OR COLOR.

FOR: ENTERTAINMENT IN THE NATURE OF LIVE PERFORMANCES BY A MEDITATION LEADER, IN CLASS 41 (U.S. CLS. 100, 101 AND 107).

SER. NO. 77-392,425, FILED 2-8-2008.

FIRST USE 1-1-1997; IN COMMERCE 1-1-1997.

SHAUNIA CARLYLE, EXAMINING ATTORNEY

**Int. Cls.: 9 and 15**

**Prior U.S. Cls.: 2, 21, 23, 26, 36 and 38**

**United States Patent and Trademark Office**

**Reg. No. 3,498,864**

**Registered Sep. 9, 2008**

**TRADEMARK  
PRINCIPAL REGISTER**

**harpejji**

MARCODI MUSICAL PRODUCTS, LLC (MARY-  
LAND LIMITED LIABILITY COMPANY)  
411 GRANVILLE COURT  
HAVRE DE GRACE, MD 21078

FOR: COMPUTER SOFTWARE FOR PROCES-  
SING DIGITAL MUSIC FILES; ELECTRONIC EF-  
FECTS PEDALS FOR USE WITH MUSICAL  
INSTRUMENTS; MUSICAL INSTRUMENT AMPLI-  
FIERS, IN CLASS 9 (U.S. CLS. 21, 23, 26, 36 AND 38).

FIRST USE 12-26-2007; IN COMMERCE 1-4-2008.

FOR: SOUND EFFECT PEDALS FOR MUSICAL  
INSTRUMENTS; TUNERS FOR MUSICAL INSTRU-  
MENTS; TUNING APPARATUS FOR MUSICAL

INSTRUMENTS; WESTERN STYLE MUSICAL IN-  
STRUMENTS; MUSICAL INSTRUMENTS, NAME-  
LY, KEYBOARDS, STRINGED INSTRUMENTS  
AND ELECTRONIC MUSICAL KEYBOARDS, IN  
CLASS 15 (U.S. CLS. 2, 21 AND 36).

FIRST USE 12-26-2007; IN COMMERCE 1-4-2008.

THE MARK CONSISTS OF THE STYLIZED  
WORD "HARPEJJI" IN LOWER-CASE LETTERS.

SER. NO. 77-392,431, FILED 2-8-2008.

RICHARD WHITE, EXAMINING ATTORNEY



**Int. Cl.: 41**

**Prior U.S. Cls.: 100, 101 and 107**

**United States Patent and Trademark Office**

**Reg. No. 3,498,865**

**Registered Sep. 9, 2008**

**SERVICE MARK  
PRINCIPAL REGISTER**



MOUNTAIN LIGHT PHOTOGRAPHY, INC. (CALIFORNIA CORPORATION), DBA MOUNTAIN LIGHT  
106 S. MAIN ST.  
BISHOP, CA 93514

THE MARK CONSISTS OF THE WORDS "MOUNTAIN LIGHT" BENEATH A STYLIZED "M" MOUNTAIN LOGO.

FOR: PHOTOGRAPHY SERVICES; CONDUCTING WORKSHOPS AND SEMINARS IN PHOTOGRAPHY, IN CLASS 41 (U.S. CLS. 100, 101 AND 107).

SER. NO. 77-392,468, FILED 2-8-2008.

FIRST USE 12-31-1985; IN COMMERCE 12-31-1985.

TEJBIR SINGH, EXAMINING ATTORNEY

**Int. Cl.: 9**

**Prior U.S. Cls.: 21, 23, 26, 36 and 38**

**Reg. No. 3,498,866**

**United States Patent and Trademark Office**

**Registered Sep. 9, 2008**

---

**TRADEMARK  
PRINCIPAL REGISTER**

**HCUBE**

GLOBAL RAINMAKERS, INC. (PUERTO RICO CORPORATION)  
209 MUNOZ RIVERA AVENUE, SUITE 1822  
SAN JUAN, PUERTO RICO 00918

FOR: BIOMETRIC DEVICES, NAMELY, COMPUTER HARDWARE AND COMPUTER SOFTWARE DEVICES PROVIDING IDENTIFICATION VIA IRIS AND FACIAL RECOGNITION TO AUTOMATICALLY IDENTIFY PERSONS, DEPLOYED IN CONNECTION WITH SELF CONTAINED ELECTRONIC SURVEILLANCE DEVICES, DEPLOYED TO GATHER EVIDENCE OR INTELLIGENCE IN REMOTE

LOCATIONS, IN CLASS 9 (U.S. CLS. 21, 23, 26, 36 AND 38).

FIRST USE 2-6-2008; IN COMMERCE 2-6-2008.

THE MARK CONSISTS OF STANDARD CHARACTERS WITHOUT CLAIM TO ANY PARTICULAR FONT, STYLE, SIZE, OR COLOR.

SER. NO. 77-392,493, FILED 2-8-2008.

JACQUELINE A. LAVINE, EXAMINING ATTORNEY

**Int. Cl.: 44**

**Prior U.S. Cls.: 100 and 101**

**United States Patent and Trademark Office**

**Reg. No. 3,498,867**

**Registered Sep. 9, 2008**

**SERVICE MARK  
PRINCIPAL REGISTER**

**TARGETCARE**

TARGETCARE, INC. (NORTH CAROLINA CORPORATION)  
831 EAST MOREHEAD STREET  
CHARLOTTE, NC 28202

FOR: PROVIDING ASSISTANCE, FITNESS EVALUATION AND CONSULTATION TO CORPORATE CLIENTS TO HELP THEIR EMPLOYEES MAKE HEALTH, WELLNESS AND NUTRITIONAL CHANGES IN THEIR DAILY LIVING TO IMPROVE HEALTH, IN CLASS 44 (U.S. CLS. 100 AND 101).

FIRST USE 6-1-2004; IN COMMERCE 6-1-2004.

THE MARK CONSISTS OF STANDARD CHARACTERS WITHOUT CLAIM TO ANY PARTICULAR FONT, STYLE, SIZE, OR COLOR.

SER. NO. 77-392,499, FILED 2-8-2008.

JACQUELINE A. LAVINE, EXAMINING ATTORNEY

**Int. Cl.: 36**

**Prior U.S. Cls.: 100, 101 and 102**

**United States Patent and Trademark Office**

**Reg. No. 3,498,868**

**Registered Sep. 9, 2008**

**SERVICE MARK  
PRINCIPAL REGISTER**



HARBOURVEST PARTNERS II, LLC (DELA-  
WARE LIMITED LIABILITY COMPANY)  
44TH FLOOR  
ONE FINANCIAL CENTER  
BOSTON, MA 02111

FOR: FINANCIAL SERVICES, NAMELY, INVEST-  
MENT MANAGEMENT, INVESTMENT ADVICE,  
INVESTMENT CONSULTATION AND INVEST-  
MENT OF FUNDS FOR OTHERS , IN CLASS 36  
(U.S. CLS. 100, 101 AND 102).

FIRST USE 1-31-2004; IN COMMERCE 1-31-2004.

THE MARK CONSISTS OF "THREE GEOMETRIC  
SHAPES", TWO SQUARES AND A SCALENE  
RIGHT-ANGLED TRIANGLE, SEPARATED AND  
SPACED TO CREATE THE CAPITAL LETTERS H  
AND V.

SER. NO. 77-392,503, FILED 2-8-2008.

LINDA MICKLEBURGH, EXAMINING ATTORNEY

**Int. Cl.: 9**

**Prior U.S. Cls.: 21, 23, 26, 36 and 38**

**Reg. No. 3,498,869**

**United States Patent and Trademark Office**

**Registered Sep. 9, 2008**

---

**TRADEMARK  
PRINCIPAL REGISTER**

**PHILTEK**

PHILTEK ELECTRONICS LTD. (CANADA CORPORATION)  
11828 MACHRINA WAY  
RICHMOND, B.C., CANADA V7A4V1

THE MARK CONSISTS OF STANDARD CHARACTERS WITHOUT CLAIM TO ANY PARTICULAR FONT, STYLE, SIZE, OR COLOR.

FOR: UNINTERRUPTIBLE POWER SUPPLIES, RECTIFIERS, BATTERY CHARGERS, INVERTERS, DC POWER SUPPLIES AND DC-TO-DC CONVERTERS, IN CLASS 9 (U.S. CLS. 21, 23, 26, 36 AND 38).

SER. NO. 77-392,543, FILED 2-8-2008.

FIRST USE 6-0-1976; IN COMMERCE 12-0-1983.

ROBIN CHOSID, EXAMINING ATTORNEY

**Int. Cl.: 5**

**Prior U.S. Cls.: 6, 18, 44, 46, 51 and 52**

**Reg. No. 3,498,870**

**United States Patent and Trademark Office**

**Registered Sep. 9, 2008**

**TRADEMARK  
PRINCIPAL REGISTER**

**HAIRFINITY**

TYMEKA LAWRENCE (UNITED STATES INDIVIDUAL), DBA HAIRFINITY  
1703 WELLOCK COURT  
SAN ANTONIO, TX 78245

THE MARK CONSISTS OF STANDARD CHARACTERS WITHOUT CLAIM TO ANY PARTICULAR FONT, STYLE, SIZE, OR COLOR.

FOR: VITAMIN SUPPLEMENTS, IN CLASS 5 (U.S. CLS. 6, 18, 44, 46, 51 AND 52).

SER. NO. 77-392,553, FILED 2-8-2008.

FIRST USE 12-12-2004; IN COMMERCE 12-12-2004.

JEFFERY COWARD, EXAMINING ATTORNEY

**Int. Cl.: 18**

**Prior U.S. Cls.: 1, 2, 3, 22 and 41**

**Reg. No. 3,498,871**

**United States Patent and Trademark Office**

**Registered Sep. 9, 2008**

**TRADEMARK  
PRINCIPAL REGISTER**

**LOVE, LIFE AND THE  
UNEXPECTED**

J2 PRODUCTIONS, LLC (ILLINOIS LIMITED  
LIABILITY COMPANY)  
1837 N. HONORE ST.  
CHICAGO, IL 60622

THE MARK CONSISTS OF STANDARD CHAR-  
ACTERS WITHOUT CLAIM TO ANY PARTICULAR  
FONT, STYLE, SIZE, OR COLOR.

FOR: KIT BAGS, IN CLASS 18 (U.S. CLS. 1, 2, 3, 22  
AND 41).

SER. NO. 77-392,597, FILED 2-8-2008.

FIRST USE 1-18-2008; IN COMMERCE 1-18-2008.

JIM RINGLE, EXAMINING ATTORNEY

**Int. Cl.: 35**

**Prior U.S. Cls.: 100, 101 and 102**

**United States Patent and Trademark Office**

**Reg. No. 3,498,872**

**Registered Sep. 9, 2008**

**SERVICE MARK  
PRINCIPAL REGISTER**

**CHOOSE WISELY. IT'S A  
SMALL PLANET**

GREEN MOUNTAIN ENERGY COMPANY (DE-  
LAWARE CORPORATION)  
300 WEST SIXTH STREET, SUITE 900  
AUSTIN, TX 78701

FOR: PROMOTING PUBLIC AWARENESS OF  
THE NEED FOR THE MANAGEMENT OF THE  
USE OF CARBON RESOURCES BY PROVIDING  
RENEWABLE ENERGY CERTIFICATES AND PRO-  
VIDING INVESTMENT IN FOREST SEQUESTRA-  
TION, ENERGY EFFICIENCY AND CARBON  
OFFSET PRODUCTS AND SERVICES; ENERGY  
USAGE MANAGEMENT SERVICES THROUGH  
THE ESTABLISHMENT OF A SYSTEM OF ALLOW-  
ANCES, REDUCTIONS, CREDITS AND OFFSETS  
FOR CARBON DIOXIDE AND OTHER GREEN-

HOUSE GAS EMISSIONS, IN CLASS 35 (U.S. CLS.  
100, 101 AND 102).

FIRST USE 11-0-2007; IN COMMERCE 11-0-2007.

THE MARK CONSISTS OF STANDARD CHAR-  
ACTERS WITHOUT CLAIM TO ANY PARTICULAR  
FONT, STYLE, SIZE, OR COLOR.

OWNER OF U.S. REG. NO. 2,402,280.

SER. NO. 77-392,639, FILED 2-8-2008.

JAMES STEIN, EXAMINING ATTORNEY



**Int. Cl.: 35**

**Prior U.S. Cls.: 100, 101 and 102**

**United States Patent and Trademark Office**

**Reg. No. 3,498,873**

**Registered Sep. 9, 2008**

**SERVICE MARK  
PRINCIPAL REGISTER**

**ART OF POSSIBILITY**

ART OF POSSIBILITY, LLC (CALIFORNIA LIMITED LIABILITY COMPANY)  
732 VIADER COURT  
SANTA CLARA, CA 95050

FOR: COMMERCIAL ADMINISTRATION OF THE LICENSING OF FINE ART IMAGES OF OTHERS, IN CLASS 35 (U.S. CLS. 100, 101 AND 102).

FIRST USE 2-1-2008; IN COMMERCE 2-1-2008.

THE MARK CONSISTS OF STANDARD CHARACTERS WITHOUT CLAIM TO ANY PARTICULAR FONT, STYLE, SIZE, OR COLOR.

NO CLAIM IS MADE TO THE EXCLUSIVE RIGHT TO USE "ART", APART FROM THE MARK AS SHOWN.

SER. NO. 77-392,642, FILED 2-8-2008.

CHRIS WELLS, EXAMINING ATTORNEY

**Int. Cl.: 38**

**Prior U.S. Cls.: 100, 101 and 104**

**United States Patent and Trademark Office**

**Reg. No. 3,498,874**

**Registered Sep. 9, 2008**

**SERVICE MARK  
PRINCIPAL REGISTER**

**BREAK THE ICE**

TELIGENCE (CANADA) LTD. (CANADA CORPORATION)  
1045 HOWE STREET SUITE 700  
VANCOUVER, CANADA V6Z2A9

FOR: PROVIDING ON-LINE CHAT ROOMS FOR TRANSMISSION OF MESSAGES AMONG COMPUTER USERS CONCERNING DATING, RELATIONSHIPS AND TOPICS OF GENERAL INTEREST, AND ELECTRONIC VOICE MESSAGING, NAMELY, THE RECORDING AND SUBSEQUENT TRANSMISSION OF VOICE MESSAGES FOR SOCIAL PURPOSES BY

TELEPHONE; TELEPHONE COMMUNICATION SERVICES, IN CLASS 38 (U.S. CLS. 100, 101 AND 104).

FIRST USE 5-14-2007; IN COMMERCE 5-14-2007.

THE MARK CONSISTS OF STANDARD CHARACTERS WITHOUT CLAIM TO ANY PARTICULAR FONT, STYLE, SIZE, OR COLOR.

SER. NO. 77-392,643, FILED 2-8-2008.

KATHRYN COWARD, EXAMINING ATTORNEY

**Int. Cl.: 44**

**Prior U.S. Cls.: 100 and 101**

**United States Patent and Trademark Office**

**Reg. No. 3,498,875**

**Registered Sep. 9, 2008**

**SERVICE MARK  
PRINCIPAL REGISTER**

**DAVISPLUS**

F.A. DAVIS, INC. (DELAWARE CORPORATION)  
1915 ARCH STREET  
PHILADELPHIA, PA 19013

THE MARK CONSISTS OF STANDARD CHAR-  
ACTERS WITHOUT CLAIM TO ANY PARTICULAR  
FONT, STYLE, SIZE, OR COLOR.

FOR: PROVIDING ON-LINE MEDICAL INFOR-  
MATION CONCERNING PHARMACEUTICAL  
AND MEDICINAL PRODUCTS AND MEDICAL  
SERVICES, IN CLASS 44 (U.S. CLS. 100 AND 101).

SER. NO. 77-392,693, FILED 2-8-2008.

FIRST USE 3-31-2006; IN COMMERCE 3-31-2006.

AMY ALFIERI, EXAMINING ATTORNEY

**Int. Cl.: 33**

**Prior U.S. Cls.: 47 and 49**

**United States Patent and Trademark Office**

**Reg. No. 3,498,876**

**Registered Sep. 9, 2008**

**TRADEMARK  
PRINCIPAL REGISTER**

**Grove Street**

GROVE ACQUISITION, LLC (CALIFORNIA LIMITED LIABILITY COMPANY)  
9600 BELL ROAD  
WINDSOR, CA 95492

FOR: WINE, IN CLASS 33 (U.S. CLS. 47 AND 49).

FIRST USE 2-27-1992; IN COMMERCE 2-27-1992.

THE MARK CONSISTS OF STANDARD CHARACTERS WITHOUT CLAIM TO ANY PARTICULAR FONT, STYLE, SIZE, OR COLOR.

SEC. 2(F).

SER. NO. 77-392,718, FILED 2-8-2008.

DAVID MURRAY, EXAMINING ATTORNEY

**Int. Cl.: 43**

**Prior U.S. Cls.: 100 and 101**

**United States Patent and Trademark Office**

**Reg. No. 3,498,877**

**Registered Sep. 9, 2008**

**SERVICE MARK  
PRINCIPAL REGISTER**

INDEPENDENCE WHEN YOU WANT  
IT, ASSISTANCE WHEN YOU NEED  
IT

ALTERNATIVE CONTINUUM OF CARE OF  
IOWA, LLC (IOWA LIMITED LIABILITY  
COMPANY)  
7806 BETSY LANE  
VERONA, WI 535938679

FOR: PROVIDING ASSISTANCE TO SENIOR CI-  
TIZENS SEEKING TO DETERMINE ASSISTED LIV-  
ING FACILITIES APPROPRIATE FOR THEIR  
NEEDS, IN CLASS 43 (U.S. CLS. 100 AND 101).

FIRST USE 6-30-1999; IN COMMERCE 6-30-1999.

THE MARK CONSISTS OF STANDARD CHAR-  
ACTERS WITHOUT CLAIM TO ANY PARTICULAR  
FONT, STYLE, SIZE, OR COLOR.

SER. NO. 77-392,731, FILED 2-8-2008.

GEOFFREY FOSDICK, EXAMINING ATTORNEY

**Int. Cl.: 39**

**Prior U.S. Cls.: 100 and 105**

**United States Patent and Trademark Office**

**Reg. No. 3,498,878**

**Registered Sep. 9, 2008**

**SERVICE MARK  
PRINCIPAL REGISTER**

COMMITTED AND CONNECTED TO  
TANZANIA

WINELAND-THOMSON ADVENTURES, INC.  
(MASSACHUSETTS CORPORATION)

14 MOUNT AUBURN STREET

WATERTOWN, MA 02472

FOR: ARRANGING AND CONDUCTING TRAVEL TOURS, IN CLASS 39 (U.S. CLS. 100 AND 105).

FIRST USE 9-0-2001; IN COMMERCE 9-0-2001.

THE MARK CONSISTS OF STANDARD CHARACTERS WITHOUT CLAIM TO ANY PARTICULAR FONT, STYLE, SIZE, OR COLOR.

NO CLAIM IS MADE TO THE EXCLUSIVE RIGHT TO USE "TANZANIA", APART FROM THE MARK AS SHOWN.

SER. NO. 77-392,735, FILED 2-8-2008.

MARIAM MAHMOUDI, EXAMINING ATTORNEY

**Int. Cl.: 11**

**Prior U.S. Cls.: 13, 21, 23, 31 and 34**

**Reg. No. 3,498,879**

**United States Patent and Trademark Office**

**Registered Sep. 9, 2008**

**TRADEMARK  
PRINCIPAL REGISTER**

**DRYABOVE**

HEATLINK GROUP, INC. (CANADA CORPORATION)  
4603E - 13TH STREET NE  
CALGARY, CANADA T2EGM3

FOR: HYDRONIC RADIANT FLOOR HEATING SYSTEM SOLD AS A UNIT, CONSISTING OF HEAT TRANSFER PLATES, HEATING PIPE, PIPE SPACING AND LOCATING TRACK, PIPE SPACING AND LOCATING MATS, EXPANSON STRIPPING, PIPE COUPLINGS AND ADAPTERS, MIXING VALVES, MIXING VALVE MOTORS AND CONTROLLERS, DISTRIBUTION MANIFOLD, SUPPLY MODULES, BALANCE/RETURN MODULES, ZONE

DRIVE MODULES, THERMOSTATS AND SET-BACK THERMOSTATS, IN CLASS 11 (U.S. CLS. 13, 21, 23, 31 AND 34).

FIRST USE 4-15-2007; IN COMMERCE 4-15-2007.

THE MARK CONSISTS OF STANDARD CHARACTERS WITHOUT CLAIM TO ANY PARTICULAR FONT, STYLE, SIZE, OR COLOR.

SER. NO. 77-392,741, FILED 2-8-2008.

ELISSA GARBER KON, EXAMINING ATTORNEY

**Int. Cl.: 44**

**Prior U.S. Cls.: 100 and 101**

**United States Patent and Trademark Office**

**Reg. No. 3,498,880**

**Registered Sep. 9, 2008**

**SERVICE MARK  
PRINCIPAL REGISTER**



F.A. DAVIS, INC. (DELAWARE CORPORATION)  
1915 ARCH STREET  
PHILADELPHIA, PA 19013

FIRST USE 3-31-2006; IN COMMERCE 3-31-2006.

FOR: PROVIDING ON-LINE MEDICAL INFORMATION CONCERNING PHARMACEUTICAL AND MEDICINAL PRODUCTS AND MEDICAL SERVICES, IN CLASS 44 (U.S. CLS. 100 AND 101).

SER. NO. 77-392,746, FILED 2-8-2008.

AMY ALFIERI, EXAMINING ATTORNEY



**Int. Cl.: 11**

**Prior U.S. Cls.: 13, 21, 23, 31 and 34**

**Reg. No. 3,498,881**

**United States Patent and Trademark Office**

**Registered Sep. 9, 2008**

**TRADEMARK  
PRINCIPAL REGISTER**

**DRYBELOW**

HEATLINK GROUP, INC. (CANADA CORPORATION)  
4603E - 13TH STREET NE  
CALGARY, CANADA T2EGM3

FOR: HYDRONIC RADIANT FLOOR HEATING SYSTEM SOLD AS A UNIT, CONSISTING OF HEAT TRANSFER PLATES, HEATING PIPE, PIPE SPACING AND LOCATING TRACK, PIPE SPACING AND LOCATING MATS, EXPANSION STRIPPING, PIPE COUPLINGS AND ADAPTERS, MIXING VALVES, MIXING VALVE MOTORS AND CONTROLLERS, DISTRIBUTION MANIFOLDS, SUPPLY MODULES, BALANCE/RETURN MODULES, ZONE

DRIVE MODULES, THERMOSTATS AND SET-BACK THERMOSTATS, IN CLASS 11 (U.S. CLS. 13, 21, 23, 31 AND 34).

FIRST USE 4-15-2007; IN COMMERCE 4-15-2007.

THE MARK CONSISTS OF STANDARD CHARACTERS WITHOUT CLAIM TO ANY PARTICULAR FONT, STYLE, SIZE, OR COLOR.

SER. NO. 77-392,752, FILED 2-8-2008.

ELISSA GARBER KON, EXAMINING ATTORNEY

**Int. Cl.: 9**

**Prior U.S. Cls.: 21, 23, 26, 36 and 38**

**United States Patent and Trademark Office**

**Reg. No. 3,498,882**

**Registered Sep. 9, 2008**

**TRADEMARK  
PRINCIPAL REGISTER**

**WATER LESS**

HAWKER POWERSOURCE INC. (DELAWARE  
CORPORATION)

9404 OOLTEWAH INDUSTRIAL DRIVE

OOLTEWAH, TN 37363

FOR: INDUSTRIAL BATTERIES, IN CLASS 9 (U.S.  
CLS. 21, 23, 26, 36 AND 38).

FIRST USE 1-1-1991; IN COMMERCE 1-1-1991.

THE MARK CONSISTS OF STANDARD CHAR-  
ACTERS WITHOUT CLAIM TO ANY PARTICULAR  
FONT, STYLE, SIZE, OR COLOR.

OWNER OF U.S. REG. NO. 2,388,819.

SEC. 2(F).

SER. NO. 77-392,766, FILED 2-8-2008.

DAVID MURRAY, EXAMINING ATTORNEY

**Int. Cl.: 39**

**Prior U.S. Cls.: 100 and 105**

**United States Patent and Trademark Office**

**Reg. No. 3,498,883**

**Registered Sep. 9, 2008**

**SERVICE MARK  
PRINCIPAL REGISTER**

OUR HOME. YOUR ADVENTURE.

WINELAND-THOMSON ADVENTURES, INC.  
(MASSACHUSETTS CORPORATION)  
14 MOUNT AUBURN STREET  
WATERTOWN, MA 02472

THE MARK CONSISTS OF STANDARD CHAR-  
ACTERS WITHOUT CLAIM TO ANY PARTICULAR  
FONT, STYLE, SIZE, OR COLOR.

FOR: ARRANGING AND CONDUCTING TRA-  
VEL TOURS, IN CLASS 39 (U.S. CLS. 100 AND 105).

SER. NO. 77-392,770, FILED 2-8-2008.

FIRST USE 9-0-2006; IN COMMERCE 9-0-2006.

MARIAM MAHMOUDI, EXAMINING ATTORNEY

**Int. Cl.: 16**

**Prior U.S. Cls.: 2, 5, 22, 23, 29, 37, 38 and 50**

**Reg. No. 3,498,884**

**United States Patent and Trademark Office**

**Registered Sep. 9, 2008**

**TRADEMARK  
PRINCIPAL REGISTER**

**HOTLINE**

NEWPORT COMMUNICATIONS GROUP, INC.  
(CALIFORNIA CORPORATION), FORMERLY  
H.I.C. CORPORATION  
38 EXECUTIVE PARK, #300  
IRVINE, CA 92714

FIRST USE 6-1-1973; IN COMMERCE 6-1-1973.

THE MARK CONSISTS OF STANDARD CHAR-  
ACTERS WITHOUT CLAIM TO ANY PARTICULAR  
FONT, STYLE, SIZE, OR COLOR.

FOR: PERIODIC NEWSLETTERS PERTAINING  
TO HEAVY DUTY TRUCKS DIRECTED TO THE  
HEAVY DUTY TRUCKING INDUSTRY , IN CLASS  
16 (U.S. CLS. 2, 5, 22, 23, 29, 37, 38 AND 50).

SER. NO. 77-392,772, FILED 2-8-2008.

ELISSA GARBER KON, EXAMINING ATTORNEY

**Int. Cl.: 37**

**Prior U.S. Cls.: 100, 103 and 106**

**United States Patent and Trademark Office**

**Reg. No. 3,498,885**

**Registered Sep. 9, 2008**

**SERVICE MARK  
PRINCIPAL REGISTER**

**J FIELDS CLEANERS**

FIELDS, JACK (UNITED STATES INDIVIDUAL)  
#D-100  
30622 SANTA MARGARITA PKWY.  
RANCHO SANTA MARGARITA, CA 92688

FOR: DRY CLEANING; LAUNDRY SERVICES,  
IN CLASS 37 (U.S. CLS. 100, 103 AND 106).

FIRST USE 1-1-2003; IN COMMERCE 1-1-2003.

THE MARK CONSISTS OF STANDARD CHAR-  
ACTERS WITHOUT CLAIM TO ANY PARTICULAR  
FONT, STYLE, SIZE, OR COLOR.

NO CLAIM IS MADE TO THE EXCLUSIVE  
RIGHT TO USE "CLEANERS", APART FROM THE  
MARK AS SHOWN.

SER. NO. 77-392,819, FILED 2-8-2008.

JASON ROTH, EXAMINING ATTORNEY

Int. Cl.: 36

Prior U.S. Cls.: 100, 101 and 102

United States Patent and Trademark Office

Reg. No. 3,498,886

Registered Sep. 9, 2008

**SERVICE MARK  
PRINCIPAL REGISTER**



DREWRY, PHILIP (UNITED STATES INDIVIDUAL)  
103 N. EDINBURGH AVE.  
LOS ANGELES, CA 90048

FOR: REAL ESTATE AGENCIES; REAL ESTATE BROKERAGE; REAL ESTATE CONSULTATION; REAL ESTATE INVESTMENT, IN CLASS 36 (U.S. CLS. 100, 101 AND 102).

FIRST USE 1-22-2008; IN COMMERCE 1-22-2008.

NO CLAIM IS MADE TO THE EXCLUSIVE RIGHT TO USE "REAL ESTATE BROKER", APART FROM THE MARK AS SHOWN.

THE STIPPLING IS FOR SHADING PURPOSES ONLY.

THE MARK CONSISTS OF AN IMAGE OF A HOUSE WITH PALM TREES AND A LAWN WITH A PATHWAY. BELOW THE DESIGN IS THE STYLIZED TEXT "PHIL DREWRY REAL ESTATE BROKER".

SER. NO. 77-392,829, FILED 2-8-2008.

MORGAN WYNNE, EXAMINING ATTORNEY

**Int. Cl.: 41**

**Prior U.S. Cls.: 100, 101 and 107**

**United States Patent and Trademark Office**

**Reg. No. 3,498,887**

**Registered Sep. 9, 2008**

**SERVICE MARK  
PRINCIPAL REGISTER**

**WE PUT THE LAN IN ORLANDO**

GIGABITS LAN CENTER, INC. (FLORIDA CORPORATION), DBA GIGABITS LAN CENTER  
12243 UNIVERSITY BLVD.  
ORLANDO, FL 32817

FOR: RENTAL OF GAME MACHINES AND APPARATUS; PROVIDING A COMPUTER GAME THAT MAY BE ACCESSED NETWORK-WIDE BY NETWORK USERS; ENTERTAINMENT SERVICES, NAMELY, PROVIDING ON-LINE COMPUTER GAMES, IN CLASS 41 (U.S. CLS. 100, 101 AND 107).

FIRST USE 1-7-2005; IN COMMERCE 1-7-2005.

THE MARK CONSISTS OF STANDARD CHARACTERS WITHOUT CLAIM TO ANY PARTICULAR FONT, STYLE, SIZE, OR COLOR.

SER. NO. 77-392,852, FILED 2-8-2008.

KATHLEEN M. VANSTON, EXAMINING ATTORNEY

**Int. Cl.: 9**

**Prior U.S. Cls.: 21, 23, 26, 36 and 38**

**Reg. No. 3,498,888**

**United States Patent and Trademark Office**

**Registered Sep. 9, 2008**

**TRADEMARK  
PRINCIPAL REGISTER**

**MicroVi**

ASIA UNITED LIMITED, LLC (CALIFORNIA  
LIMITED LIABILITY COMPANY)  
5290 N. COLONIAL AVE. SUITE A  
FRESNO, CA 93704

THE MARK CONSISTS OF STANDARD CHAR-  
ACTERS WITHOUT CLAIM TO ANY PARTICULAR  
FONT, STYLE, SIZE, OR COLOR.

FOR: MINIATURE DIGITAL VIDEO CAMCOR-  
DER WITH BUILT-IN AUDIO RECORDING, IN  
CLASS 9 (U.S. CLS. 21, 23, 26, 36 AND 38).

SER. NO. 77-392,860, FILED 2-8-2008.

FIRST USE 7-0-2007; IN COMMERCE 7-0-2007.

TARAH HARDY, EXAMINING ATTORNEY



Int. Cl.: 43

Prior U.S. Cls.: 100 and 101

United States Patent and Trademark Office

Reg. No. 3,498,889

Registered Sep. 9, 2008

SERVICE MARK  
PRINCIPAL REGISTER

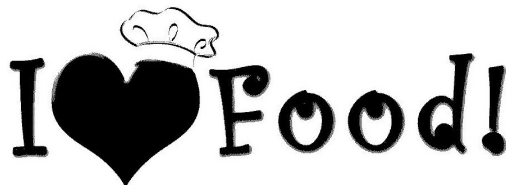

“Home-style meals made easy!”

TFM CO. (IOWA CORPORATION), DBA I LUV  
FOOD!  
1250 IOWA STREET, BOX 300  
DUBUQUE, IA 52001

FOR: MEAL PREPARATION SERVICE, IN CLASS  
43 (U.S. CLS. 100 AND 101).

FIRST USE 12-15-2007; IN COMMERCE 12-15-2007.

THE MARK CONSISTS OF THE CAPITAL LET-  
TER "I" IN A STYLIZED FONT, IMMEDIATELY TO  
THE RIGHT OF WHICH IS AN ILLUSTRATION OF  
A HEART SHAPE WITH A CHEF'S HAT SITUATED  
UPON THE UPPER-RIGHT-HAND ARC OF THE  
HEART SHAPE, IMMEDIATELY TO THE RIGHT

OF WHICH IS THE WORD "FOOD" IN A STYLIZED  
FONT, FOLLOWED BY AN EXCLAMATION POINT  
SYMBOL IN A STYLIZED FONT. UNDERNEATH  
THE AFORE-DESCRIBED "I [HEART WITH HAT]  
FOOD!" COMPONENT OF THE MARK ARE THE  
WORDS "HOME-STYLE MEALS MADE EASY" FOL-  
LOWED BY AN EXCLAMATION POINT SYMBOL.  
THE WORDS "HOME-STYLE MEALS MADE EASY"  
AND THE EXCLAMATION POINT SYMBOL  
THEREAFTER ARE ENCLOSED WITHIN QUOTA-  
TION MARKS.

SER. NO. 77-392,868, FILED 2-8-2008.

INGRID C. EULIN, EXAMINING ATTORNEY

**Int. Cl.: 36**

**Prior U.S. Cls.: 100, 101 and 102**

**United States Patent and Trademark Office**

**Reg. No. 3,498,890**

**Registered Sep. 9, 2008**

**SERVICE MARK  
PRINCIPAL REGISTER**



RESOURCE ONE REALTY GROUP, INC. (ILLINOIS CORPORATION), DBA STREETERVILLE PROPERTIES  
432 EAST GRAND AVENUE  
CHICAGO, IL 60611

FOR: REAL ESTATE BROKERAGE, IN CLASS 36 (U.S. CLS. 100, 101 AND 102).

FIRST USE 6-1-2006; IN COMMERCE 6-1-2006.

NO CLAIM IS MADE TO THE EXCLUSIVE RIGHT TO USE "STREETERVILLE PROPERTIES", APART FROM THE MARK AS SHOWN.

THE COLOR(S) BLACK AND BLUE IS/ARE CLAIMED AS A FEATURE OF THE MARK.

THE MARK CONSISTS OF A STYLIZED DESIGN OF HIGH-RISE BUILDINGS ABOVE THE WORDING "STREETERVILLE PROPERTIES", WHICH IS SHOWN IN BETWEEN TWO HORIZONTAL STRAIGHT LINES. THE COLOR BLACK APPEARS IN THE STYLIZED HIGH-RISE BUILDINGS DESIGN AND IN THE TWO HORIZONTAL STRAIGHT LINES SURROUNDING THE WORDING "STREETERVILLE PROPERTIES", AND THE COLOR BLUE APPEARS IN THE WORDING "STREETERVILLE PROPERTIES" OF THE MARK.

SER. NO. 77-392,875, FILED 2-8-2008.

ANDREW RHIM, EXAMINING ATTORNEY

Int. Cl.: 41

Prior U.S. Cls.: 100, 101 and 107

United States Patent and Trademark Office

Reg. No. 3,498,891

Registered Sep. 9, 2008

SERVICE MARK  
PRINCIPAL REGISTER

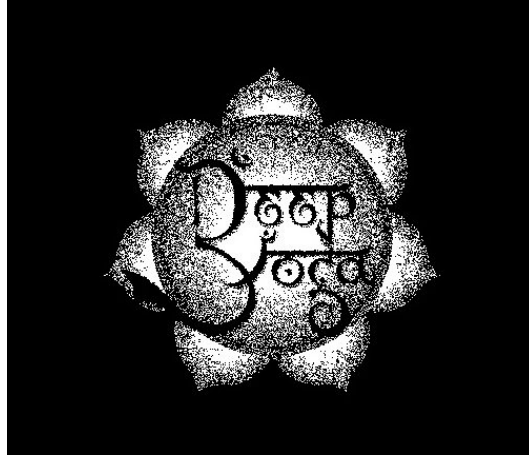

RAM, BHAVA (UNITED STATES INDIVIDUAL)  
757 C AVENUE  
CORONADO, CA 92118 AND  
PLUMB, LAURA (UNITED STATES INDIVIDUAL)  
757 C AVENUE  
CORONADO, CA 92118

FOR: INSTRUCTION IN THE FIELD OF YOGA,  
YOGA THERAPY, AYURVEDA, PRANAYAMA,  
MANTRA, ASANA, MEDITATION, SELF-HEAL-  
ING, PERSONAL TRANSFORMATION, IN CLASS  
41 (U.S. CLS. 100, 101 AND 107).

FIRST USE 1-1-2006; IN COMMERCE 1-1-2006.

NO CLAIM IS MADE TO THE EXCLUSIVE  
RIGHT TO USE "YOGA", APART FROM THE  
MARK AS SHOWN.

THE STIPLING IS FOR SHADING PURPOSES  
ONLY.

THE MARK CONSISTS OF A LOTUS WITH THE  
STYLIZED TEXT "DEEP YOGA" IN THE CENTER.

SER. NO. 77-392,884, FILED 2-8-2008.

REBECCA GILBERT, EXAMINING ATTORNEY

**Int. Cl.: 36**

**Prior U.S. Cls.: 100, 101 and 102**

**United States Patent and Trademark Office**

**Reg. No. 3,498,892**

**Registered Sep. 9, 2008**

**SERVICE MARK  
PRINCIPAL REGISTER**

**TSR**

CRITTENDEN, JADE (UNITED STATES INDIVIDUAL)  
2239 W. 190TH ST.  
TORRANCE, CA 90504

FOR: VACATION REAL ESTATE TIME SHARE EXCHANGE SERVICES, IN CLASS 36 (U.S. CLS. 100, 101 AND 102).

FIRST USE 2-1-2005; IN COMMERCE 2-1-2005.

THE MARK CONSISTS OF STANDARD CHARACTERS WITHOUT CLAIM TO ANY PARTICULAR FONT, STYLE, SIZE, OR COLOR.

SER. NO. 77-392,915, FILED 2-8-2008.

KATHLEEN M. VANSTON, EXAMINING ATTORNEY

**Int. Cl.: 25**

**Prior U.S. Cls.: 22 and 39**

**United States Patent and Trademark Office**

**Reg. No. 3,498,893**

**Registered Sep. 9, 2008**

**TRADEMARK  
PRINCIPAL REGISTER**

**D-LUX 57**

THIA B DESIGNS (CALIFORNIA LIMITED LIABILITY COMPANY)  
P.O. BOX 768  
PACIFIC PALISADES, CA 90272

THE MARK CONSISTS OF STANDARD CHARACTERS WITHOUT CLAIM TO ANY PARTICULAR FONT, STYLE, SIZE, OR COLOR.

FOR: APRONS, IN CLASS 25 (U.S. CLS. 22 AND 39).

SER. NO. 77-392,946, FILED 2-8-2008.

FIRST USE 5-22-2007; IN COMMERCE 7-18-2007.

REBECCA SMITH, EXAMINING ATTORNEY

**Int. Cl.: 38**

**Prior U.S. Cls.: 100, 101 and 104**

**United States Patent and Trademark Office**

**Reg. No. 3,498,894**

**Registered Sep. 9, 2008**

**SERVICE MARK  
PRINCIPAL REGISTER**

**TAGUARA**

DINAMA SERVICIOS, C.A. (VENEZUELA CORPORATION)  
AV. LIBERTADOR MULTICENTRO EMP. DEL ESTE  
TORRE MIRANDA, NÚCLEO A, OFIC. 131  
CHACAO, CARACAS, VENEZUELA

FOR: PROVIDING MULTIPLE-USER ACCESS TO A GLOBAL COMPUTER INFORMATION NETWORK; PROVIDING E-MAIL SERVICES; ELECTRONIC DELIVERY OF IMAGES AND PHOTOGRAPHS VIA A GLOBAL COMPUTER NETWORK; ELECTRONIC, ELECTRIC, AND DIGITAL TRANSMISSION OF VOICE, DATA, IMAGES, SIGNALS, AND MESSAGES; TRANSMISSION AND DISTRIBUTION OF DATA OR AUDIO VISUAL IMAGES VIA A GLOBAL COMPUTER NETWORK OR THE INTERNET; COMMUNICATION BY ELECTRONIC COMPUTER TERMINALS; ELECTRONIC TRANSMISSION OF DATA AND DOCUMENTS VIA COMPUTER TERMINALS; ELECTRONIC

MAIL AND MESSAGING SERVICES; TELEPHONE COMMUNICATION SERVICES; BROADCASTING OF RADIO AND TELEVISION PROGRAMMES; TELEPHONE CALL COMPLETION SERVICES FOR DIRECTORY ASSISTANCE CUSTOMERS; RADIO AND TELEVISION BROADCASTING SERVICES; RADIO AND TELEVISION PROGRAMME BROADCASTING, IN CLASS 38 (U.S. CLS. 100, 101 AND 104).

THE MARK CONSISTS OF STANDARD CHARACTERS WITHOUT CLAIM TO ANY PARTICULAR FONT, STYLE, SIZE, OR COLOR.

OWNER OF VENEZUELA REG. NO. S032166, DATED 6-19-2006, EXPIRES 6-19-2016.

SER. NO. 77-393,051, FILED 2-9-2008.

RONALD MCMORROW, EXAMINING ATTORNEY

**Int. Cl.: 41**

**Prior U.S. Cls.: 100, 101 and 107**

**United States Patent and Trademark Office**

**Reg. No. 3,498,895**

**Registered Sep. 9, 2008**

**SERVICE MARK  
PRINCIPAL REGISTER**

**Quicker! Better! Wiser!**

MARKS, GENE J (UNITED STATES INDIVIDUAL)  
330 CHERRY BEND  
MERION, PA 19066

FOR: WORKSHOPS AND SEMINARS IN THE  
FIELD OF SMALL BUSINESS MANAGEMENT, IN  
CLASS 41 (U.S. CLS. 100, 101 AND 107).

FIRST USE 1-15-2008; IN COMMERCE 1-15-2008.

THE MARK CONSISTS OF STANDARD CHARACTERS WITHOUT CLAIM TO ANY PARTICULAR FONT, STYLE, SIZE, OR COLOR.

SER. NO. 77-393,095, FILED 2-9-2008.

SCOTT BIBB, EXAMINING ATTORNEY

**Int. Cl.: 44**

**Prior U.S. Cls.: 100 and 101**

**United States Patent and Trademark Office**

**Reg. No. 3,498,896**

**Registered Sep. 9, 2008**

**SERVICE MARK  
PRINCIPAL REGISTER**

**MANGO TAN**

LAWRENCE VENTURES, LLC (KANSAS LIMITED LIABILITY COMPANY), DBA MANGO TAN

600 PRESCOTT DRIVE  
LAWRENCE, KS 660493783

FOR: TANNING SALONS, IN CLASS 44 (U.S. CLS. 100 AND 101).

FIRST USE 4-15-2003; IN COMMERCE 10-27-2003.

THE MARK CONSISTS OF STANDARD CHARACTERS WITHOUT CLAIM TO ANY PARTICULAR FONT, STYLE, SIZE, OR COLOR.

NO CLAIM IS MADE TO THE EXCLUSIVE RIGHT TO USE "TAN", APART FROM THE MARK AS SHOWN.

SER. NO. 77-393,101, FILED 2-9-2008.

MARGERY A. TIERNEY, EXAMINING ATTORNEY



Int. Cl.: 25

Prior U.S. Cls.: 22 and 39

United States Patent and Trademark Office

Reg. No. 3,498,897

Registered Sep. 9, 2008

TRADEMARK  
PRINCIPAL REGISTER

**Hell is bad.**

YONGE, LAURIE TYLER (UNITED STATES IN-  
DIVIDUAL)  
600 SE 48TH AVE  
OCALA, FL 34471

THE MARK CONSISTS OF THE WORDS "HELL IS  
BAD." WITH A SMALL IMAGE OF A FLAME THAT  
REPLACES THE DOT ABOVE THE LETTER "I".

FOR: SHORT-SLEEVED OR LONG-SLEEVED T-  
SHIRTS; SHORT-SLEEVED SHIRTS; T-SHIRTS; TEE  
SHIRTS, IN CLASS 25 (U.S. CLS. 22 AND 39).

SER. NO. 77-393,103, FILED 2-9-2008.

FIRST USE 1-23-2008; IN COMMERCE 1-23-2008.

MARGERY A. TIERNEY, EXAMINING ATTORNEY

**Int. Cl.: 36**

**Prior U.S. Cls.: 100, 101 and 102**

**United States Patent and Trademark Office**

**Reg. No. 3,498,898**

**Registered Sep. 9, 2008**

**SERVICE MARK  
PRINCIPAL REGISTER**

## A Note Of Thanks

FLYNN, KRISTY J. (UNITED STATES INDIVIDUAL)  
5949 SILVEYVILLE ROAD  
DIXON, CA 95620

FOR: CHARITABLE FUNDRAISING SERVICES,  
IN CLASS 36 (U.S. CLS. 100, 101 AND 102).

FIRST USE 12-12-2007; IN COMMERCE 2-5-2008.

THE MARK CONSISTS OF STANDARD CHARACTERS WITHOUT CLAIM TO ANY PARTICULAR FONT, STYLE, SIZE, OR COLOR.

SER. NO. 77-393,110, FILED 2-9-2008.

RUSS HERMAN, EXAMINING ATTORNEY

**Int. Cl.: 35**

**Prior U.S. Cls.: 100, 101 and 102**

**United States Patent and Trademark Office**

**Reg. No. 3,498,899**

**Registered Sep. 9, 2008**

**SERVICE MARK  
PRINCIPAL REGISTER**

**LOVE IS RICH**

SWAD, BERNADETTE (UNITED STATES INDIVIDUAL)  
10999 PETAL STREET, SUITE 200  
DALLAS, TX 75238

FOR: CHARITABLE SERVICES, NAMELY, ORGANIZING YOUTH GROUPS TO UNDERTAKE PROJECTS TO BENEFIT THE NEEDY AND THE COMMUNITY TO ENCOURAGE LEADERSHIP, CHARACTER, COMPASSION, AND GOOD CITIZENSHIP, IN CLASS 35 (U.S. CLS. 100, 101 AND 102).

FIRST USE 10-24-2007; IN COMMERCE 10-24-2007.

THE MARK CONSISTS OF STANDARD CHARACTERS WITHOUT CLAIM TO ANY PARTICULAR FONT, STYLE, SIZE, OR COLOR.

SER. NO. 77-393,137, FILED 2-9-2008.

SIMON TENG, EXAMINING ATTORNEY

**Int. Cl.: 35**

**Prior U.S. Cls.: 100, 101 and 102**

**United States Patent and Trademark Office**

**Reg. No. 3,498,900**

**Registered Sep. 9, 2008**

**SERVICE MARK  
PRINCIPAL REGISTER**

**adcamp**

ADCAMP (CALIFORNIA CORPORATION)  
5482 WILSHIRE BLVD STE 234  
LOS ANGELES, CA 90068

FOR: ADVERTISING AGENCIES, NAMELY, PROMOTING THE GOODS AND SERVICES OF OTHERS; ADVERTISING AND ADVERTISEMENT SERVICES; ADVERTISING AND BUSINESS MANAGEMENT CONSULTANCY; ADVERTISING AND MARKETING; ADVERTISING AND PROMOTION SERVICES AND RELATED CONSULTING; ADVERTISING AND PROMOTIONAL SERVICES; ADVERTISING AND PUBLICITY SERVICES; ADVERTISING CONSULTATION; ADVERTISING PARTICULARLY SERVICES FOR THE PROMOTION OF GOODS; ADVERTISING SERVICES; ADVERTISING SERVICES, NAMELY, CREATING CORPORATE AND BRAND IDENTITY FOR OTHERS; ADVERTISING SERVICES, NAMELY, CREATING CORPORATE LOGOS FOR OTHERS; ADVERTISING SERVICES, PUBLIC RELATIONS AND MARKETING SERVICES, NAMELY, PROMOTING AND MARKETING THE GOODS AND SERVICES OF OTHERS THROUGH ALL PUBLIC COMMUNICATION MEANS; ADVERTISING THROUGH ALL PUBLIC COMMUNICATION MEANS; ADVERTISING, MARKETING AND PROMOTION SERVICES; ADVERTISING, MARKETING AND PROMOTIONAL SERVICES FOR AUTOMOTIVE DEALERSHIPS; CREATING AND UPDATING ADVERTISING MATERIAL; DESIGN OF ADVERTISING MATERIALS FOR OTHERS; DIRECT MARKETING ADVERTISING FOR OTHERS; DISPLAYING ADVERTISEMENTS FOR OTHERS; DISSEMINATION OF ADVERTISING MATERIAL;

DISSEMINATION OF ADVERTISING MATTER; DISTRIBUTION OF ADVERTISEMENTS AND COMMERCIAL ANNOUNCEMENTS; DISTRIBUTION OF PRODUCTS FOR ADVERTISING PURPOSES; MARKETING AND ADVERTISING SERVICES FOR AUTOMOBILE DEALERSHIPS; PLACING ADVERTISEMENTS FOR OTHERS; PREPARATION OF CUSTOM ADVERTISEMENTS FOR OTHERS; PREPARING ADVERTISEMENTS FOR OTHERS; PREPARING AND PLACING ADVERTISEMENTS FOR OTHERS; PREPARING AND PLACING OF ADVERTISEMENTS; PREPARING AND PLACING OUTDOOR ADVERTISEMENTS FOR OTHERS; PROMOTING THE GOODS AND SERVICES OF OTHERS BY DISTRIBUTING ADVERTISING MATERIALS THROUGH A VARIETY OF METHODS; PROVIDING ADVERTISING, MARKETING AND PROMOTIONAL SERVICES, NAMELY, DEVELOPMENT OF ADVERTISING CAMPAIGNS FOR SCHOOLS AND PUBLIC CAMPUSES; PUBLISHING OF ADVERTISING TEXTS; RENTAL OF ADVERTISEMENT SPACE AND ADVERTISING MATERIAL; RENTAL OF ADVERTISING SPACE; RENTAL OF SIGNS FOR ADVERTISING PURPOSES, IN CLASS 35 (U.S. CLS. 100, 101 AND 102).

FIRST USE 9-10-1999; IN COMMERCE 9-10-1999.

THE MARK CONSISTS OF STANDARD CHARACTERS WITHOUT CLAIM TO ANY PARTICULAR FONT, STYLE, SIZE, OR COLOR.

SER. NO. 77-393,139, FILED 2-9-2008.

THOMAS MANOR, EXAMINING ATTORNEY

**Int. Cls.: 3 and 44**

**Prior U.S. Cls.: 1, 4, 6, 50, 51, 52, 100 and 101**

**United States Patent and Trademark Office**

**Reg. No. 3,498,901**

**Registered Sep. 9, 2008**

**TRADEMARK  
SERVICE MARK  
PRINCIPAL REGISTER**

# Spascriptions

BJD SOLUTIONS, INC. (NEW YORK CORPORATION)  
SUITE 5A  
219 17TH STREET  
BROOKLYN, NY 11215

FOR: AROMATHERAPY BODY CARE PRODUCTS, NAMELY, BODY LOTION, SHOWER GEL, CUTICLE CREAM, SHAMPOO, CONDITIONER, NON-MEDICATED LIP BALM, SOAP, BODY POLISH, BODY AND FOOT SCRUB AND NON-MEDICATED FOOT CREAM; BEAUTY CREAMS FOR BODY CARE; BODY AND BEAUTY CARE COSMETICS; COSMETIC CREAMS FOR SKIN CARE; LOTIONS FOR FACE AND BODY CARE; NAIL CARE PREPARATIONS; NON-MEDICATED SKIN CARE PREPARATIONS, NAMELY, CREAMS, LOTIONS, GELS, TONERS, CLEANSERS AND PEELS; NON-MEDICATED SUN CARE PREPARATIONS; SKIN AND BODY TOPICAL LOTIONS, CREAMS AND OILS FOR COSMETIC USE; SKIN BRONZER; SKIN CLARIFIERS; SKIN CLEANSERS; SKIN CLEANSING CREAM; SKIN CLEANSING LOTION; SKIN CONDITIONERS; SKIN CREAMS IN LIQUID AND IN SOLID FORM; SKIN EMOLLIENTS; SKIN LIGHTENERS; SKIN MASKS; SKIN MOISTURIZER; SKIN TONERS; SUN CARE LOTIONS; WRINKLE REMOVING SKIN CARE PREPARATIONS; FACIAL MAKE-UP; FACIAL SCRUBS; MASSAGE CREAMS; MASSAGE OILS; PARAFFIN WAX FOR COSMETIC PURPOSES, IN CLASS 3 (U.S. CLS. 1, 4, 6, 50, 51 AND 52).

FIRST USE 11-1-2007; IN COMMERCE 11-1-2007.

FOR: FACIAL TREATMENT SERVICES, NAMELY, COSMETIC PEELS; DAY SPA SERVICES, NAMELY, NAIL CARE, MANICURES, PEDICURES AND NAIL ENHANCEMENTS; MASSAGES; BODY WAXING SERVICES; HEALTH SPA SERVICES FOR HEALTH AND WELLNESS OF THE BODY AND SPIRIT OFFERED AT A HEALTH RESORT; HEALTH SPA SERVICES FOR HEALTH AND WELLNESS OF THE MIND, BODY AND SPIRIT OFFERED IN OR FROM A REMOTE, MOBILE OR TEMPORARY ON-SITE LOCATION; HEALTH SPA SERVICES, NAMELY, COSMETIC BODY CARE SERVICES; MAKING RESERVATIONS AND BOOKINGS FOR OTHERS FOR PHYSICAL AND BEAUTY TREATMENTS AT HEALTH SPAS; MICRODERMABRASION, NAMELY, A TOPICAL SKIN TREATMENT INVOLVING ABRASION OF THE SKIN WITH A HIGH-PRESSURE FLOW OF CRYSTALS; COSMETIC ELECTROLYSIS, IN CLASS 44 (U.S. CLS. 100 AND 101).

FIRST USE 11-1-2007; IN COMMERCE 11-1-2007.

THE MARK CONSISTS OF STANDARD CHARACTERS WITHOUT CLAIM TO ANY PARTICULAR FONT, STYLE, SIZE, OR COLOR.

SER. NO. 77-393,180, FILED 2-9-2008.

ROBERT STRUCK, EXAMINING ATTORNEY

**Int. Cl.: 9**

**Prior U.S. Cls.: 21, 23, 26, 36 and 38**

**Reg. No. 3,498,902**

**United States Patent and Trademark Office**

**Registered Sep. 9, 2008**

**TRADEMARK  
PRINCIPAL REGISTER**

**DYNACONE**

ALCO ELECTRONICS LIMITED (HONG KONG  
CORPORATION)  
11/F, ZUNG FU INDUSTRIAL BUILDING  
1067 KING'S ROAD, QUARRY BAY  
HONG KONG, HONG KONG

THE MARK CONSISTS OF STANDARD CHAR-  
ACTERS WITHOUT CLAIM TO ANY PARTICULAR  
FONT, STYLE, SIZE, OR COLOR.

FOR: AUDIO SPEAKERS, IN CLASS 9 (U.S. CLS.  
21, 23, 26, 36 AND 38).

SER. NO. 77-393,199, FILED 2-10-2008.

FIRST USE 10-15-2007; IN COMMERCE 10-15-2007.

SUSAN STIGLITZ, EXAMINING ATTORNEY

**Int. Cl.: 35**

**Prior U.S. Cls.: 100, 101 and 102**

**United States Patent and Trademark Office**

**Reg. No. 3,498,903**

**Registered Sep. 9, 2008**

**SERVICE MARK  
PRINCIPAL REGISTER**

# RESULTANCY

BAREKAT, MATTHEW MASOUD (UNITED KINGDOM INDIVIDUAL)  
HUGHENDEN HOUSE CHURCH LANE, FOUR ASHES  
BUCKS, ENGLAND HP156LD

FOR: PERSONNEL MANAGEMENT CONSULTANCY, BUSINESS MANAGEMENT CONSULTANCY AND BUSINESS PERFORMANCE ASSESSMENT AND ADVISORY SERVICES; BUSINESS OPERATIONS AND LOGISTICS ADVISORY SERVICES, IN CLASS 35 (U.S. CLS. 100, 101 AND 102).

THE MARK CONSISTS OF STANDARD CHARACTERS WITHOUT CLAIM TO ANY PARTICULAR FONT, STYLE, SIZE, OR COLOR.

OWNER OF UNITED KINGDOM REG. NO. 2140287, DATED 2-13-1998, EXPIRES 7-25-2017.

OWNER OF U.S. REG. NO. 2,657,493.

SER. NO. 77-393,202, FILED 2-10-2008.

JEFFERY COWARD, EXAMINING ATTORNEY

**Int. Cl.: 35**

**Prior U.S. Cls.: 100, 101 and 102**

**United States Patent and Trademark Office**

**Reg. No. 3,498,904**

**Registered Sep. 9, 2008**

**SERVICE MARK  
PRINCIPAL REGISTER**

**Carol Paterick**

PATERICK, CAROL A. (UNITED STATES INDIVIDUAL)  
12600 KAVANAUGH LN.  
BOWIE, MD 20715

FOR: BUSINESS MEETING PLANNING; BUSINESS MANAGEMENT CONSULTING AND ADVISORY SERVICES; BUSINESS MANAGEMENT OF THE NONPROFIT CORPORATIONS AND TRADE ASSOCIATIONS OF OTHERS; ASSISTANCE IN MANAGEMENT OF BUSINESS ACTIVITIES; ASSISTANCE WITH BUSINESS MANAGEMENT AND PLANNING; BUSINESS CONSULTATION SERVICES TO ASSIST NON-PROFIT ORGANIZATIONS IN PLANNING, MANAGING, AND CONDUCTING

FUND RAISING ACTIVITIES VIA A GLOBAL COMPUTER NETWORK; BUSINESS INFORMATION MANAGEMENT, IN CLASS 35 (U.S. CLS. 100, 101 AND 102).

FIRST USE 3-12-1972; IN COMMERCE 6-15-1998.

THE MARK CONSISTS OF STANDARD CHARACTERS WITHOUT CLAIM TO ANY PARTICULAR FONT, STYLE, SIZE, OR COLOR.

SER. NO. 77-393,209, FILED 2-10-2008.

TARAH HARDY, EXAMINING ATTORNEY



**Int. Cl.: 16**

**Prior U.S. Cls.: 2, 5, 22, 23, 29, 37, 38 and 50**

**United States Patent and Trademark Office**

**Reg. No. 3,498,905**

**Registered Sep. 9, 2008**

**TRADEMARK  
PRINCIPAL REGISTER**

**Mom is always write**

ORMA, STEPHANIE (CALIFORNIA SOLE PROPRIETORSHIP), DBA SHE'S SO CREATIVE  
2036 PARADISE DRIVE  
TIBURON, CA 94920

FOR: ANNOUNCEMENT CARDS; BLANK CARDS; BLANK NOTE CARDS; CARDS BEARING UNIVERSAL GREETINGS; CARDS NOT MAGNETICALLY CODED FOR USE IN BUSINESS TRANSACTIONS; CHRISTMAS CARDS; CORRESPONDENCE CARDS; GREETING CARDS; GREETINGS CARDS AND POSTCARDS; HOLIDAY CARDS; INVITATION CARDS; NOTE CARDS; OCCASION CARDS; PAPER BOXES FOR STORING GREETING CARDS; PLACE CARDS; POSTCARDS

AND GREETING CARDS; PRINTED GREETING CARDS WITH ELECTRONIC INFORMATION STORED THEREIN; SOCIAL NOTE CARDS, IN CLASS 16 (U.S. CLS. 2, 5, 22, 23, 29, 37, 38 AND 50).

FIRST USE 2-10-2008; IN COMMERCE 2-10-2008.

THE MARK CONSISTS OF STANDARD CHARACTERS WITHOUT CLAIM TO ANY PARTICULAR FONT, STYLE, SIZE, OR COLOR.

SER. NO. 77-393,224, FILED 2-10-2008.

REBECCA GILBERT, EXAMINING ATTORNEY

**Int. Cl.: 35**

**Prior U.S. Cls.: 100, 101 and 102**

**United States Patent and Trademark Office**

**Reg. No. 3,498,906**

**Registered Sep. 9, 2008**

**SERVICE MARK  
PRINCIPAL REGISTER**

**Sharp Minded Solutions.  
Executed.**

ARCHPOINT, LLC (TEXAS LIMITED LIABILITY COMPANY)  
14427 BROOK HOLLOW, #326  
SAN ANTONIO, TX 78232

FOR: BUSINESS CONSULTATION; BUSINESS CONSULTATION SERVICES; BUSINESS CONSULTING SERVICES RELATING TO PRODUCT DISTRIBUTION, OPERATIONS MANAGEMENT SERVICES, LOGISTICS, REVERSE LOGISTICS, SUPPLY CHAIN, AND PRODUCTION SYSTEMS AND DISTRIBUTION SOLUTIONS; BUSINESS CONSULTING SERVICES, NAMELY, PROVIDING ASSISTANCE IN DEVELOPMENT BUSINESS STRATEGIES AND CREATIVE IDEATION; BUSINESS CONSULTING, MANAGEMENT, PLANNING AND SUPERVISION; BUSINESS MANAGEMENT AND CONSULTATION; BUSINESS MANAGEMENT CONSULTANCY SERVICES; BUSINESS MANAGEMENT CONSULTATION; BUSINESS MANAGE-

MENT CONSULTING; BUSINESS ORGANISATION AND MANAGEMENT CONSULTING SERVICES; BUSINESS ORGANISATION CONSULTING; BUSINESS ORGANIZATION ADVICE; BUSINESS ORGANIZATION AND MANAGEMENT CONSULTING; BUSINESS ORGANIZATION AND OPERATION CONSULTANCY, IN CLASS 35 (U.S. CLS. 100, 101 AND 102).

FIRST USE 1-1-2008; IN COMMERCE 1-1-2008.

THE MARK CONSISTS OF STANDARD CHARACTERS WITHOUT CLAIM TO ANY PARTICULAR FONT, STYLE, SIZE, OR COLOR.

SER. NO. 77-393,236, FILED 2-10-2008.

JERI J. FICKES, EXAMINING ATTORNEY

**Int. Cl.: 35**

**Prior U.S. Cls.: 100, 101 and 102**

**United States Patent and Trademark Office**

**Reg. No. 3,498,907**

**Registered Sep. 9, 2008**

**SERVICE MARK  
PRINCIPAL REGISTER**

# Sportgenic

SPORTGENIC, INC. (DELAWARE CORPORATION), DBA ACTIVE ATHLETE, INC.  
ONE SANSOME, 15TH FLOOR  
SAN FRANCISCO, CA 94104

FOR: ADVERTISING AND ADVERTISEMENT SERVICES; ADVERTISING AND PUBLICITY SERVICES, NAMELY, PROMOTING THE GOODS, SERVICES, BRAND IDENTITY AND COMMERCIAL INFORMATION AND NEWS OF THIRD PARTIES THROUGH PRINT, AUDIO, VIDEO, DIGITAL AND ON-LINE MEDIUM, IN CLASS 35 (U.S. CLS. 100, 101 AND 102).

FIRST USE 9-1-2007; IN COMMERCE 9-1-2007.

THE MARK CONSISTS OF STANDARD CHARACTERS WITHOUT CLAIM TO ANY PARTICULAR FONT, STYLE, SIZE, OR COLOR.

SER. NO. 77-393,241, FILED 2-10-2008.

TARAH HARDY, EXAMINING ATTORNEY

Int. Cls.: 21, 30 and 35

Prior U.S. Cls.: 2, 13, 23, 29, 30, 33, 40, 46, 50, 100, 101  
and 102

Reg. No. 3,498,908

Registered Sep. 9, 2008

**United States Patent and Trademark Office**

---

**TRADEMARK  
SERVICE MARK  
PRINCIPAL REGISTER**



FOUR SWALLOWS, INC. (CALIFORNIA CORPORATION), DBA SILK ROAD TEAS  
203 GIBSON AVENUE  
MILL VALLEY, CA 94941

FOR: COFFEE CUPS, TEA CUPS AND MUGS, IN CLASS 21 (U.S. CLS. 2, 13, 23, 29, 30, 33, 40 AND 50).

FIRST USE 2-10-2002; IN COMMERCE 10-30-2004.

FOR: TEA, IN CLASS 30 (U.S. CL. 46).

FIRST USE 10-1-1997; IN COMMERCE 10-30-1997.

FOR: ON-LINE ORDERING SERVICES FEATURING TEAS, CUPS, DISHWARE AND TEAS MAKING AND SERVING ACCESSORIES, IN CLASS 35 (U.S. CLS. 100, 101 AND 102).

FIRST USE 5-1-2003; IN COMMERCE 10-30-2004.

THE MARK CONSISTS OF BACTRIAN CAMEL IN MOTION W/ RIDER AND SADDLE BAGS.

SER. NO. 77-393,256, FILED 2-10-2008.

REBECCA GILBERT, EXAMINING ATTORNEY

**Int. Cl.: 35**

**Prior U.S. Cls.: 100, 101 and 102**

**United States Patent and Trademark Office**

**Reg. No. 3,498,909**

**Registered Sep. 9, 2008**

**SERVICE MARK  
PRINCIPAL REGISTER**

**texas rollergirls**

TEXAS ROLLERGIRLS LLC (TEXAS LIMITED  
LIABILITY COMPANY)  
1111 MISSION RIDGE  
AUSTIN, TX 78704

FOR: ASSOCIATION SERVICES, NAMELY, PROMOTING THE INTERESTS OF INDIVIDUALS, TEAMS, AND LEAGUES THAT PARTICIPATE IN ORGANIZED COMPETITIONS; ADMINISTRATION OF COMMUNITY RECREATIONAL SPORTS LEAGUES; COORDINATION OF RECREATIONAL SPORTING OPPORTUNITIES FOR INDIVIDUALS WHO WISH TO PARTICIPATE IN TEAM LEAGUE SPORTS; BUSINESS MANAGEMENT SERVICES, NAMELY, ADMINISTRATION OF COMPETITIONS FOR INDIVIDUALS, TEAMS, AND LEAGUES; PROMOTING SPORTS COMPETITIONS AND/OR EVENTS OF OTHERS, IN CLASS 35 (U.S. CLS. 100, 101 AND 102).

FIRST USE 4-9-2003; IN COMMERCE 4-9-2003.

THE MARK CONSISTS OF STANDARD CHARACTERS WITHOUT CLAIM TO ANY PARTICULAR FONT, STYLE, SIZE, OR COLOR.

OWNER OF U.S. REG. NO. 3,028,923.

NO CLAIM IS MADE TO THE EXCLUSIVE RIGHT TO USE "TEXAS", APART FROM THE MARK AS SHOWN.

SER. NO. 77-393,263, FILED 2-10-2008.

GEOFFREY FOSDICK, EXAMINING ATTORNEY

**Int. Cl.: 41**

**Prior U.S. Cls.: 100, 101 and 107**

**United States Patent and Trademark Office**

**Reg. No. 3,498,910**

**Registered Sep. 9, 2008**

**SERVICE MARK  
PRINCIPAL REGISTER**

# Roboteknician

ROBOTEK AUDIO VIDEO SOLUTIONS, INC.  
(NEW YORK CORPORATION)  
69 SOUTH AVENUE  
WEBSTER, NY 145803529

FOR: OPERATION OF ROBOTIC CAMERAS, VIDEO EQUIPMENT AND/OR AUDIO EQUIPMENT FOR PRODUCTION OF INTERNET TELECONFERENCING, TELECONFERENCING OR TELEVISION PROGRAMS, IN CLASS 41 (U.S. CLS. 100, 101 AND 107).

FIRST USE 10-12-2005; IN COMMERCE 10-12-2005.

THE MARK CONSISTS OF STANDARD CHARACTERS WITHOUT CLAIM TO ANY PARTICULAR FONT, STYLE, SIZE, OR COLOR.

SER. NO. 77-393,265, FILED 2-10-2008.

GEOFFREY FOSDICK, EXAMINING ATTORNEY

**Int. Cl.: 25**

**Prior U.S. Cls.: 22 and 39**

**United States Patent and Trademark Office**

**Reg. No. 3,498,911**

**Registered Sep. 9, 2008**

**TRADEMARK  
PRINCIPAL REGISTER**

**CHEETAH CONSERVATION FUND**

CHEETAH CONSERVATION FUND, INC. (CALI-  
FORNIA CORPORATION)  
PO BOX 330-519  
BROOKLYN, NY 11233

FOR: CAPS; JACKETS; POLO SHIRTS; SHIRTS;  
SWEAT SHIRTS; T-SHIRTS; FLEECE VESTS, IN  
CLASS 25 (U.S. CLS. 22 AND 39).

FIRST USE 12-0-1990; IN COMMERCE 12-0-1990.

THE MARK CONSISTS OF STANDARD CHAR-  
ACTERS WITHOUT CLAIM TO ANY PARTICULAR  
FONT, STYLE, SIZE, OR COLOR.

OWNER OF U.S. REG. NO. 2,474,954.

SER. NO. 77-393,267, FILED 2-10-2008.

SANI KHOURI, EXAMINING ATTORNEY

**Int. Cl.: 30**

**Prior U.S. Cl.: 46**

**United States Patent and Trademark Office**

**Reg. No. 3,498,912**

**Registered Sep. 9, 2008**

**TRADEMARK  
PRINCIPAL REGISTER**

**DOUGH RAISE ME**

SALTSMAN, ERIN (UNITED STATES INDIVIDUAL)  
4 BELMONT STREET  
AMESBURY, MA 01913

THE MARK CONSISTS OF STANDARD CHARACTERS WITHOUT CLAIM TO ANY PARTICULAR FONT, STYLE, SIZE, OR COLOR.

FOR: BAKERY GOODS, IN CLASS 30 (U.S. CL. 46).

SER. NO. 77-393,298, FILED 2-10-2008.

FIRST USE 12-31-1998; IN COMMERCE 2-14-2004.

GINA HAYES, EXAMINING ATTORNEY



**Int. Cl.: 5**

**Prior U.S. Cls.: 6, 18, 44, 46, 51 and 52**

**Reg. No. 3,498,913**

**United States Patent and Trademark Office**

**Registered Sep. 9, 2008**

---

**TRADEMARK  
PRINCIPAL REGISTER**

**DAILYNEEDS**

BUCKMAN, KEVIN (UNITED STATES INDIVIDUAL)  
5937 CUMBERLAND PLACE  
STOCKTON, CA 95219

THE MARK CONSISTS OF STANDARD CHARACTERS WITHOUT CLAIM TO ANY PARTICULAR FONT, STYLE, SIZE, OR COLOR.

FOR: HERBAL SUPPLEMENTS, IN CLASS 5 (U.S. CLS. 6, 18, 44, 46, 51 AND 52).

SER. NO. 77-393,342, FILED 2-10-2008.

FIRST USE 1-1-2000; IN COMMERCE 1-1-2000.

ELISSA GARBER KON, EXAMINING ATTORNEY

**Int. Cl.: 25**

**Prior U.S. Cls.: 22 and 39**

**United States Patent and Trademark Office**

**Reg. No. 3,498,914**

**Registered Sep. 9, 2008**

**TRADEMARK  
PRINCIPAL REGISTER**

**THREAT TO HOMELAND SECURITY**

MIKOLAJCZYK, DAVID, JAY (UNITED STATES  
INDIVIDUAL)  
768 BRAYTON AVE.  
CLEVELAND, OH 44113

FOR: CLOTHING, NAMELY, T-SHIRTS, BOXERS,  
SWEATSHIRTS, SWEATPANTS, SCARVES, SWEAT-  
SHIRTS WITH HOODS, SOCKS, BANDANAS, HATS,  
CAPS, TANK-TOPS, PAJAMAS, LONG SLEEVE T  
SHIRTS, TIES, UNDERWEAR, DISPOSABLE UN-  
DERWEAR, THONGS, SWEAT SUITS, SWEAT  
SUITS WITH HOODS, SWEATBANDS, SWIM WEAR  
FOR GENTLEMEN AND LADIES, PANTIES,  
SHORTS, BRIEFS, BOXER BRIEFS, BRAS, FITTED  
SWIMMING COSTUMES WITH BRA CUPS, STRAP-

LESS BRA, SPORTS BRA, SHOES, FABRIC BELTS,  
LEATHER BELTS, SUSPENDER BELTS, AND MON-  
EY BELTS, IN CLASS 25 (U.S. CLS. 22 AND 39).

FIRST USE 6-4-2002; IN COMMERCE 6-6-2002.

THE MARK CONSISTS OF STANDARD CHAR-  
ACTERS WITHOUT CLAIM TO ANY PARTICULAR  
FONT, STYLE, SIZE, OR COLOR.

SER. NO. 77-393,347, FILED 2-10-2008.

LINDA ORNDORFF, EXAMINING ATTORNEY

**Int. Cl.: 18**

**Prior U.S. Cls.: 1, 2, 3, 22 and 41**

**United States Patent and Trademark Office**

**Reg. No. 3,498,915**

**Registered Sep. 9, 2008**

**TRADEMARK  
PRINCIPAL REGISTER**

**ROGUE WALLET**

LYONS, MICHAEL (UNITED STATES INDIVIDUAL)

588 SACO ROAD

STANDISH, ME 04084

FOR: WALLETS, IN CLASS 18 (U.S. CLS. 1, 2, 3, 22 AND 41).

FIRST USE 5-1-2006; IN COMMERCE 6-1-2006.

THE MARK CONSISTS OF STANDARD CHARACTERS WITHOUT CLAIM TO ANY PARTICULAR FONT, STYLE, SIZE, OR COLOR.

NO CLAIM IS MADE TO THE EXCLUSIVE RIGHT TO USE "WALLET", APART FROM THE MARK AS SHOWN.

SER. NO. 77-393,359, FILED 2-10-2008.

LINDA E. BLOHM, EXAMINING ATTORNEY

**Int. Cl.: 29**

**Prior U.S. Cl.: 46**

**United States Patent and Trademark Office**

**Reg. No. 3,498,916**

**Registered Sep. 9, 2008**

**TRADEMARK  
PRINCIPAL REGISTER**

**Piccoli Gusti**

VIAVANTI, LLC (NEW YORK LIMITED LIABILITY COMPANY)

226 S. GREELEY AVE.

CHAPPAQUA, NY 10514

FOR: VEGETABLE-BASED SNACK FOODS, IN CLASS 29 (U.S. CL. 46).

FIRST USE 6-1-2007; IN COMMERCE 12-1-2007.

THE MARK CONSISTS OF STANDARD CHARACTERS WITHOUT CLAIM TO ANY PARTICULAR FONT, STYLE, SIZE, OR COLOR.

THE FOREIGN WORDING IN THE MARK TRANSLATES INTO ENGLISH AS "LITTLE FLAVORS".

SER. NO. 77-393,368, FILED 2-11-2008.

LINDA MICKLEBURGH, EXAMINING ATTORNEY

Int. Cl.: 35

Prior U.S. Cls.: 100, 101 and 102

**United States Patent and Trademark Office**

**Reg. No. 3,498,917**

Registered Sep. 9, 2008

**SERVICE MARK  
PRINCIPAL REGISTER**

The image shows the word "Kelsey" written in a bold, black, cursive script. The letters are thick and connected, with a prominent 'K' and a long, sweeping tail on the 'y'.

KELSEY ADVERTISING & DESIGN, LLC (GEOR-  
GIA LIMITED LIABILITY COMPANY)  
133 MAIN ST., SUITE A  
LAGRANGE, GA 30240

THE MARK CONSISTS OF HANDWRITTEN SIG-  
NATURE OF THE FOUNDER'S NAME "KELSEY".

FOR: ADVERTISING AGENCIES, IN CLASS 35  
(U.S. CLS. 100, 101 AND 102).

SER. NO. 77-393,437, FILED 2-11-2008.

FIRST USE 11-15-2007; IN COMMERCE 11-15-2007.

CHERYL CLAYTON, EXAMINING ATTORNEY

**Int. Cls.: 35 and 39**

**Prior U.S. Cls.: 100, 101, 102 and 105**

**United States Patent and Trademark Office**

**Reg. No. 3,498,918**

**Registered Sep. 9, 2008**

**SERVICE MARK  
PRINCIPAL REGISTER**

**★AMERICRATE**

AMERICAN RELOCATION & LOGISTICS, INC.  
(CALIFORNIA CORPORATION)  
13565 LARWIN CIRCLE  
SANTA FE SPRINGS, CA 90670

FOR: MOVING AND RELOCATION SERVICES,  
NAMELY, PLANNING AND IMPLEMENTING  
MOVES OF HOMES AND OFFICES, IN CLASS 35  
(U.S. CLS. 100, 101 AND 102).

FIRST USE 4-1-2007; IN COMMERCE 4-1-2007.

FOR: WAREHOUSING SERVICES, NAMELY,  
STORAGE, DISTRIBUTION, PICK-UP, PACKING,

AND SHIPPING OF HOUSEHOLD AND COMMER-  
CIAL GOODS, IN CLASS 39 (U.S. CLS. 100 AND 105).

FIRST USE 4-1-2007; IN COMMERCE 4-1-2007.

THE MARK CONSISTS OF THE WORD "AMERI-  
CRATE" AND STAR DESIGN.

SER. NO. 77-393,456, FILED 2-11-2008.

KEVON CHISOLM, EXAMINING ATTORNEY

**Int. Cls.: 35 and 39**

**Prior U.S. Cls.: 100, 101, 102 and 105**

**United States Patent and Trademark Office**

**Reg. No. 3,498,919**

**Registered Sep. 9, 2008**

**SERVICE MARK  
PRINCIPAL REGISTER**

**A BETTER CONCEPT IN MOVING**

AMERICAN RELOCATION & LOGISTICS, INC.  
(CALIFORNIA CORPORATION)  
13565 LARWIN CIRCLE  
SANTE FE SPRINGS, CA 90670

FOR: MOVING AND RELOCATION SERVICES,  
NAMELY, PLANNING AND IMPLEMENTING  
MOVES OF HOMES AND OFFICES, IN CLASS 35  
(U.S. CLS. 100, 101 AND 102).

FIRST USE 4-1-2007; IN COMMERCE 4-1-2007.

FOR: WAREHOUSING SERVICES, NAMELY,  
STORAGE, DISTRIBUTION, PICK-UP, PACKING,

AND SHIPPING OF HOUSEHOLD AND COMME-  
RICAL GOODS, IN CLASS 39 (U.S. CLS. 100 AND  
105).

FIRST USE 4-1-2007; IN COMMERCE 4-1-2007.

THE MARK CONSISTS OF STANDARD CHAR-  
ACTERS WITHOUT CLAIM TO ANY PARTICULAR  
FONT, STYLE, SIZE, OR COLOR.

SER. NO. 77-393,466, FILED 2-11-2008.

KEVON CHISOLM, EXAMINING ATTORNEY

**Int. Cl.: 30**

**Prior U.S. Cl.: 46**

**United States Patent and Trademark Office**

**Reg. No. 3,498,920**

**Registered Sep. 9, 2008**

**TRADEMARK  
PRINCIPAL REGISTER**



GENERAL MILLS IP HOLDINGS I, LLC (DELA-  
WARE LIMITED LIABILITY COMPANY)  
NUMBER ONE GENERAL MILLS BOULEVARD  
MINNEAPOLIS, MN 55426

FOR: PROCESSED CEREAL-BASED FOOD TO BE  
USED AS A BREAKFAST FOOD, SNACK FOR OR  
INGREDIENT FOR MAKING OTHER FOODS, IN  
CLASS 30 (U.S. CL. 46).

FIRST USE 9-30-2003; IN COMMERCE 9-30-2003.

THE MARK CONSISTS OF A LEPRECHAUN  
SHOWN FROM THE CHEST TO THE HEAD.

SER. NO. 77-393,478, FILED 2-11-2008.

KEVON CHISOLM, EXAMINING ATTORNEY



**Int. Cl.: 45**

**Prior U.S. Cls.: 100 and 101**

**United States Patent and Trademark Office**

**Reg. No. 3,498,921**

**Registered Sep. 9, 2008**

**SERVICE MARK  
PRINCIPAL REGISTER**

**MYARTPLOT**

MYARTPLOT, LLC (DELAWARE LIMITED LIABILITY COMPANY)  
P.O. BOX 2483  
PROVIDENCE, RI 02906

THE MARK CONSISTS OF STANDARD CHARACTERS WITHOUT CLAIM TO ANY PARTICULAR FONT, STYLE, SIZE, OR COLOR.

FOR: ONLINE SOCIAL NETWORKING SERVICES, IN CLASS 45 (U.S. CLS. 100 AND 101).

SER. NO. 77-393,493, FILED 2-11-2008.

FIRST USE 8-14-2005; IN COMMERCE 9-28-2006.

ANDREA BUTLER, EXAMINING ATTORNEY

**Int. Cl.: 41**

**Prior U.S. Cls.: 100, 101 and 107**

**United States Patent and Trademark Office**

**Reg. No. 3,498,922**

**Registered Sep. 9, 2008**

**SERVICE MARK  
PRINCIPAL REGISTER**

**HOCKEY. THE WAY NATURE  
INTENDED.**

HABERMAN & ASSOCIATES, INC. (MINNESOTA  
CORPORATION)  
SUITE 301  
119 NORTH FOURTH STREET  
MINNEAPOLIS, MN 55401

FOR: ENTERTAINMENT SERVICES IN THE  
NATURE OF ARRANGING AND CONDUCTING  
ICE HOCKEY TOURNAMENTS, IN CLASS 41 (U.S.  
CLS. 100, 101 AND 107).

FIRST USE 11-0-2005; IN COMMERCE 11-0-2005.

THE MARK CONSISTS OF STANDARD CHAR-  
ACTERS WITHOUT CLAIM TO ANY PARTICULAR  
FONT, STYLE, SIZE, OR COLOR.

NO CLAIM IS MADE TO THE EXCLUSIVE  
RIGHT TO USE "HOCKEY", APART FROM THE  
MARK AS SHOWN.

SER. NO. 77-393,522, FILED 2-11-2008.

BRIAN CALLAGHAN, EXAMINING ATTORNEY

**Int. Cl.: 5**

**Prior U.S. Cls.: 6, 18, 44, 46, 51 and 52**

**Reg. No. 3,498,923**

**United States Patent and Trademark Office**

**Registered Sep. 9, 2008**

**TRADEMARK  
PRINCIPAL REGISTER**

**ALPINE FROST**

DIAL BRANDS INC. (ARIZONA CORPORATION)  
M.S. 2214  
15501 NORTH DIAL BOULEVARD  
SCOTTSDALE, AZ 852601619

FOR: AIR DEODORIZER; AIR FRESHENERS  
AND AIR FRESHENING PREPARATIONS, IN  
CLASS 5 (U.S. CLS. 6, 18, 44, 46, 51 AND 52).

FIRST USE 8-24-2006; IN COMMERCE 8-24-2006.

THE MARK CONSISTS OF STANDARD CHAR-  
ACTERS WITHOUT CLAIM TO ANY PARTICULAR  
FONT, STYLE, SIZE, OR COLOR.

OWNER OF U.S. REG. NO. 3,259,518.

SER. NO. 77-393,592, FILED 2-11-2008.

BRENDAN MCCAULEY, EXAMINING ATTORNEY

**Int. Cl.: 45**

**Prior U.S. Cls.: 100 and 101**

**United States Patent and Trademark Office**

**Reg. No. 3,498,924**

**Registered Sep. 9, 2008**

**SERVICE MARK  
PRINCIPAL REGISTER**



ISTALKING, LLC (ARIZONA LIMITED LIABILITY COMPANY)

#C200-177

10645 N. TATUM BLVD.

PHOENIX, AZ 85028

THE MARK CONSISTS OF AN ABSTRACT DESIGN AND THE STYLIZED TEXT "ISTALKING".

SER. NO. 77-393,603, FILED 2-11-2008.

FOR: ONLINE SOCIAL NETWORKING SERVICES, IN CLASS 45 (U.S. CLS. 100 AND 101).

FIRST USE 12-1-2007; IN COMMERCE 12-1-2007.

ATTIYA MALIK, EXAMINING ATTORNEY

**Int. Cl.: 44**

**Prior U.S. Cls.: 100 and 101**

**United States Patent and Trademark Office**

**Reg. No. 3,498,925**

**Registered Sep. 9, 2008**

**SERVICE MARK  
PRINCIPAL REGISTER**

**TIGHTLIPO**

MANGUBAT ENTERPRISES, INC. (WASHINGTON CORPORATION)  
16400 SOUTHCENTER PKWY, SUITE 101  
TUKWILA, WA 98188

FOR: COSMETIC AND PLASTIC SURGERY; COSMETIC SURGERY, NAMELY, A SURGICAL PROCEDURE IN THE NATURE OF LIPOSUCTION, IN CLASS 44 (U.S. CLS. 100 AND 101).

FIRST USE 1-17-2008; IN COMMERCE 2-8-2008.

THE MARK CONSISTS OF STANDARD CHARACTERS WITHOUT CLAIM TO ANY PARTICULAR FONT, STYLE, SIZE, OR COLOR.

SER. NO. 77-393,622, FILED 2-11-2008.

KATHY DE JONGE, EXAMINING ATTORNEY

**Int. Cl.: 41**

**Prior U.S. Cls.: 100, 101 and 107**

**United States Patent and Trademark Office**

**Reg. No. 3,498,926**

**Registered Sep. 9, 2008**

**SERVICE MARK  
PRINCIPAL REGISTER**

**PRESENCING INSTITUTE**

SCHARMER, OTTO (FED REP GERMANY INDIVIDUAL)  
19 LINCOLN ST  
ARLINGTON, MA 02476

FOR: EDUCATIONAL SERVICES, NAMELY, CLASSES, WORKSHOPS AND LECTURES AND SEMINARS IN THE FIELD OF SOCIAL TECHNOLOGY AND HUMAN PURPOSE, IN CLASS 41 (U.S. CLS. 100, 101 AND 107).

FIRST USE 12-0-2006; IN COMMERCE 12-0-2006.

THE MARK CONSISTS OF STANDARD CHARACTERS WITHOUT CLAIM TO ANY PARTICULAR FONT, STYLE, SIZE, OR COLOR.

NO CLAIM IS MADE TO THE EXCLUSIVE RIGHT TO USE "INSTITUTE", APART FROM THE MARK AS SHOWN.

SER. NO. 77-393,623, FILED 2-11-2008.

KAREN K. BUSH, EXAMINING ATTORNEY

**Int. Cls.: 9, 16, 38, 41 and 45**

**Prior U.S. Cls.: 2, 5, 21, 22, 23, 26, 29, 36, 37, 38, 50,  
100, 101, 104 and 107**

**Reg. No. 3,498,927**

**United States Patent and Trademark Office**

**Registered Sep. 9, 2008**

**TRADEMARK  
SERVICE MARK  
PRINCIPAL REGISTER**

# enlifement

ALAYA (OREGON CORPORATION)

PO BOX 6077

SANTA FE, NM 875026077

FOR: AUDIO AND VIDEO RECORDINGS FEATURING MEDITATIONS, AND SPIRITUAL AND RELIGIOUS MESSAGES AND INSTRUCTION; DIGITAL MEDIA, NAMELY, PRE-RECORDED VIDEO CASSETTES, DIGITAL VIDEO DISCS, DIGITAL VERSATILE DISCS, DOWNLOADABLE AUDIO AND VIDEO RECORDINGS, DVDS, AND HIGH DEFINITION DIGITAL DISKS FEATURING MEDITATIONS, AND SPIRITUAL AND RELIGIOUS MESSAGES AND INSTRUCTION; DOWNLOADABLE MP3 FILES, MP3 RECORDINGS, ONLINE DISCUSSION BOARDS, WEBCASTS AND PODCASTS FEATURING MUSIC, AUDIO BOOKS AND NEWS BROADCASTS; DOWNLOADABLE MUSICAL SOUND RECORDINGS; DOWNLOADABLE VIDEO RECORDINGS FEATURING MEDITATIONS, AND SPIRITUAL AND RELIGIOUS MESSAGES AND INSTRUCTION; ELECTRONIC PUBLICATIONS, NAMELY, ELECTRONIC BOOKS AND WRITTEN MATERIAL FEATURING SPIRITUAL AND RELIGIOUS MESSAGES AND INSTRUCTION RECORDED ON COMPUTER MEDIA; PRE-RECORDED CDS, VIDEO TAPES, LASER DISKS AND DVDS FEATURING SPIRITUAL AND RELIGIOUS MESSAGES AND INSTRUCTION; PRE-RECORDED DIGITAL MEDIA FEATURING SPIRITUAL AND RELIGIOUS MESSAGES AND INSTRUCTION; PRE-RECORDED ELECTRONIC MEDIA FEATURING SPIRITUAL AND RELIGIOUS MESSAGES AND INSTRUCTION, IN CLASS 9 (U.S. CLS. 21, 23, 26, 36 AND 38).

FIRST USE 5-19-2002; IN COMMERCE 5-19-2002.

FOR: PRINTED INSTRUCTIONAL, EDUCATIONAL, AND TEACHING MATERIALS IN THE FIELD OF SPIRITUALITY AND RELIGION; BOOKS IN THE FIELD OF SPIRITUALITY AND RELIGION, IN CLASS 16 (U.S. CLS. 2, 5, 22, 23, 29, 37, 38 AND 50).

FIRST USE 5-18-2002; IN COMMERCE 5-18-2002.

FOR: VIDEO BROADCASTING; STREAMING OF AUDIO MATERIAL ON THE INTERNET; STREAMING OF VIDEO MATERIAL ON THE INTERNET; AUDIO AND VIDEO BROADCASTING SERVICES OVER THE INTERNET, IN CLASS 38 (U.S. CLS. 100, 101 AND 104).

FIRST USE 2-9-2008; IN COMMERCE 2-9-2008.

FOR: EDUCATION SERVICES, NAMELY, PROVIDING LIVE AND ON-LINE TALKS AND INSTRUCTION IN THE FIELD OF SPIRITUALITY AND RELIGION; EDUCATION SERVICES, NAMELY, PROVIDING TALKS AND INSTRUCTION IN THE FIELDS OF SPIRITUALITY AND RELIGION, IN CLASS 41 (U.S. CLS. 100, 101 AND 107).

FIRST USE 5-18-2002; IN COMMERCE 2-9-2008.

FOR: RELIGIOUS AND SPIRITUAL SERVICES, NAMELY, PROVIDING GATHERINGS AND RETREATS TO DEVELOP AND ENHANCE THE SPIRITUAL LIVES OF INDIVIDUALS; MINISTERIAL SERVICES, IN CLASS 45 (U.S. CLS. 100 AND 101).

FIRST USE 2-9-2008; IN COMMERCE 2-9-2008.

THE MARK CONSISTS OF STANDARD CHARACTERS WITHOUT CLAIM TO ANY PARTICULAR FONT, STYLE, SIZE, OR COLOR.

SER. NO. 77-393,653, FILED 2-11-2008.

LINDA M. KING, EXAMINING ATTORNEY



**Int. Cl.: 34**

**Prior U.S. Cls.: 2, 8, 9 and 17**

**United States Patent and Trademark Office**

**Reg. No. 3,498,928**

**Registered Sep. 9, 2008**

**TRADEMARK  
PRINCIPAL REGISTER**

**KRISWILL**

NØRDING, ERIK (DENMARK INDIVIDUAL)  
9 BANEGRAVEN  
SLANGERUP, DENMARK DK-3550

FOR: SMOKERS' ARTICLES, NAMELY, SMOKING TOBACCO, SMOKING PIPES, CIGARS, HUMIDORS, TOBACCO TINS, TOBACCO POUCHES, TOBACCO PIPE CLEANERS, KEYSTONES FOR PIPES, IN CLASS 34 (U.S. CLS. 2, 8, 9 AND 17).

FIRST USE 7-1-2007; IN COMMERCE 7-1-2007.

THE MARK CONSISTS OF STANDARD CHARACTERS WITHOUT CLAIM TO ANY PARTICULAR FONT, STYLE, SIZE, OR COLOR.

SER. NO. 77-393,691, FILED 2-11-2008.

KAREN K. BUSH, EXAMINING ATTORNEY

**Int. Cl.: 35**

**Prior U.S. Cls.: 100, 101 and 102**

**United States Patent and Trademark Office**

**Reg. No. 3,498,929**

**Registered Sep. 9, 2008**

**SERVICE MARK  
PRINCIPAL REGISTER**

# TxtAHouse

DEMHA INC. (CALIFORNIA CORPORATION)  
878 WAVERLY COMMON  
LIVERMORE, CA 94551

FOR: PROVIDING AN ON-LINE COMPUTER DATABASE FEATURING TRADE INFORMATION IN THE FIELD OF REAL ESTATE; ADVERTISING SERVICES, NAMELY, PROVIDING INFORMATION AS TO THE AVAILABILITY OF HOMES FOR RENT OR PURCHASE; COMMERCIAL INFORMATION IN THE FIELD OF REAL ESTATE; PROVIDING CONSUMER INFORMATION IN THE FIELD OF REAL ESTATE; INFOMEDIARY SERVICES, NAMELY, FACILITATING TRANSACTIONS BETWEEN BUY-

ERS AND SELLERS THROUGH PROVIDING BUYERS WITH INFORMATION ABOUT SELLERS, GOODS, AND/OR SERVICES, IN CLASS 35 (U.S. CLS. 100, 101 AND 102).

FIRST USE 1-1-2008; IN COMMERCE 1-1-2008.

THE MARK CONSISTS OF STANDARD CHARACTERS WITHOUT CLAIM TO ANY PARTICULAR FONT, STYLE, SIZE, OR COLOR.

SER. NO. 77-393,752, FILED 2-11-2008.

MARK T. MULLEN, EXAMINING ATTORNEY

**Int. Cl.: 35**

**Prior U.S. Cls.: 100, 101 and 102**

**United States Patent and Trademark Office**

**Reg. No. 3,498,930**

**Registered Sep. 9, 2008**

**SERVICE MARK  
PRINCIPAL REGISTER**

**REALTY IN YOUR HANDS**

DEMHA INC. (CALIFORNIA CORPORATION)  
878 WAVERLY COMMON  
LIVERMORE, CA 94551

FOR: PROVIDING AN ON-LINE COMPUTER DATABASE FEATURING TRADE INFORMATION IN THE FIELD OF REAL ESTATE; ADVERTISING SERVICES, NAMELY, PROVIDING INFORMATION AS TO THE AVAILABILITY OF HOMES FOR RENT OR PURCHASE; COMMERCIAL INFORMATION IN THE FIELD OF REAL ESTATE; PROVIDING CONSUMER INFORMATION IN THE FIELD OF REAL ESTATE; INFOMEDIARY SERVICES, NAMELY, FACILITATING TRANSACTIONS BETWEEN BUYERS AND SELLERS THROUGH PROVIDING BUYERS WITH INFORMATION ABOUT SELLERS,

GOODS, AND/OR SERVICES, IN CLASS 35 (U.S. CLS. 100, 101 AND 102).

FIRST USE 1-1-2008; IN COMMERCE 1-1-2008.

THE MARK CONSISTS OF STANDARD CHARACTERS WITHOUT CLAIM TO ANY PARTICULAR FONT, STYLE, SIZE, OR COLOR.

NO CLAIM IS MADE TO THE EXCLUSIVE RIGHT TO USE "REALTY", APART FROM THE MARK AS SHOWN.

SER. NO. 77-393,757, FILED 2-11-2008.

MARK T. MULLEN, EXAMINING ATTORNEY

**Int. Cl.: 35**

**Prior U.S. Cls.: 100, 101 and 102**

**United States Patent and Trademark Office**

**Reg. No. 3,498,931**

**Registered Sep. 9, 2008**

**SERVICE MARK  
PRINCIPAL REGISTER**



DEMHA INC. (CALIFORNIA CORPORATION)  
878 WAVERLY COMMON  
LIVERMORE, CA 94551

FOR: PROVIDING AN ON-LINE COMPUTER DATABASE FEATURING TRADE INFORMATION IN THE FIELD OF REAL ESTATE; ADVERTISING SERVICES, NAMELY, PROVIDING INFORMATION AS TO THE AVAILABILITY OF HOMES FOR RENT OR PURCHASE; COMMERCIAL INFORMATION IN THE FIELD OF REAL ESTATE; PROVIDING CONSUMER INFORMATION IN THE FIELD OF REAL ESTATE; INFOMEDIARY SERVICES, NAMELY, FACILITATING TRANSACTIONS BETWEEN BUY-

ERS AND SELLERS THROUGH PROVIDING BUYERS WITH INFORMATION ABOUT SELLERS, GOODS, AND/OR SERVICES, IN CLASS 35 (U.S. CLS. 100, 101 AND 102).

FIRST USE 1-1-2008; IN COMMERCE 1-1-2008.

THE MARK CONSISTS OF A ROOF OVER A CELLPHONE WITH WAVES.

SER. NO. 77-393,766, FILED 2-11-2008.

MARK T. MULLEN, EXAMINING ATTORNEY

**Int. Cl.: 3**

**Prior U.S. Cls.: 1, 4, 6, 50, 51 and 52**

**United States Patent and Trademark Office**

**Reg. No. 3,498,932**

**Registered Sep. 9, 2008**

**TRADEMARK  
PRINCIPAL REGISTER**

**"FAMILY SECRET"**

GOLUB CAPITAL INCORPORATED (NEW YORK CORPORATION)  
551 MADISON AVENUE 6TH FLOOR  
NEW YORK, NY 10022

FOR: HAIR CARE AND HAIR TREATMENT PREPARATIONS, NAMELY, HAIR CONDITIONERS, HAIR OILS, HAIR RELAXERS AND HAIR MOISTURIZERS, IN CLASS 3 (U.S. CLS. 1, 4, 6, 50, 51 AND 52).

FIRST USE 8-18-2005; IN COMMERCE 8-18-2005.

THE MARK CONSISTS OF STANDARD CHARACTERS WITHOUT CLAIM TO ANY PARTICULAR FONT, STYLE, SIZE, OR COLOR.

SER. NO. 77-393,776, FILED 2-11-2008.

ATTIYA MALIK, EXAMINING ATTORNEY

**Int. Cls.: 9 and 16**

**Prior U.S. Cls.: 2, 5, 21, 22, 23, 26, 29, 36, 37, 38 and 50**

**Reg. No. 3,498,933**

**United States Patent and Trademark Office**

**Registered Sep. 9, 2008**

**TRADEMARK  
PRINCIPAL REGISTER**



CEV MULTIMEDIA, LTD. (TEXAS LIMITED LIABILITY COMPANY)  
1020 SE LOOP 289  
LUBBOCK, TX 79404

FOR: COMPUTER HARDWARE AND COMPUTER SOFTWARE PROGRAMS FOR THE INTEGRATION OF TEXT, AUDIO, GRAPHICS, STILL IMAGES AND MOVING PICTURES INTO AN INTERACTIVE DELIVERY FOR MULTIMEDIA APPLICATIONS; DOWNLOADABLE MULTIMEDIA FILE CONTAINING ARTWORK, TEXT, AUDIO, VIDEO, GAMES, AND INTERNET WEB LINKS RELATING TO EDUCATIONAL CURRICULUM; INTERACTIVE MULTIMEDIA COMPUTER PROGRAM FOR EDUCATIONAL CURRICULUM; MULTIMEDIA SOFTWARE RECORDED ON CD-ROM FEATURING EDUCATIONAL CURRICULUM, IN CLASS 9 (U.S. CLS. 21, 23, 26, 36 AND 38).

FIRST USE 10-12-2007; IN COMMERCE 12-10-2007.

FOR: ADVERTISING BOARDS OF PAPER OR CARDBOARD; ADVERTISING PAMPHLETS; ADVERTISING SIGNS OF PAPER OR CARDBOARD; BROCHURES ABOUT MULTIMEDIA CURRICULUM; INFORMATIONAL FLYERS FEATURING MULTIMEDIA CURRICULUM; INFORMATIONAL SHEETS ABOUT MULTIMEDIA CURRICULUM; LEAFLETS ABOUT MULTIMEDIA CURRICULUM; CARDBOARD PACKAGING; PAPER ENVELOPES

FOR PACKAGING; PLASTIC OR PAPER BAGS FOR MERCHANDISE PACKAGING, IN CLASS 16 (U.S. CLS. 2, 5, 22, 23, 29, 37, 38 AND 50).

FIRST USE 10-12-2007; IN COMMERCE 12-10-2007.

NO CLAIM IS MADE TO THE EXCLUSIVE RIGHT TO USE "MULTIMEDIA" AND "UNIT" , APART FROM THE MARK AS SHOWN.

THE COLOR(S) BLUES, ORANGES, YELLOWS, PURPLES, GRAYS, BLACK, WHITE, GREENS, PINKS AND REDS IS/ARE CLAIMED AS A FEATURE OF THE MARK.

THE MARK CONSISTS OF "CEV" STYLIZED IN BLUE; MULTIMEDIA STYLIZED IN ORANGE; PATHWAY UNIT STYLIZED IN YELLOW; THE REVERSE SIDE OF A CD-ROM WITH LIGHT REFLECTING OFF THE SURFACE IN BLUES, PURPLES, PINKS, REDS, ORANGES, YELLOWS AND GREENS CONTAINED WITHIN A STYLIZED METAL RIBBON IN GRAYS, WHITES AND BLACKS.

SER. NO. 77-393,827, FILED 2-11-2008.

SANDRA MANIOS, EXAMINING ATTORNEY

**Int. Cl.: 45**

**Prior U.S. Cls.: 100 and 101**

**United States Patent and Trademark Office**

**Reg. No. 3,498,934**

**Registered Sep. 9, 2008**

**SERVICE MARK  
PRINCIPAL REGISTER**

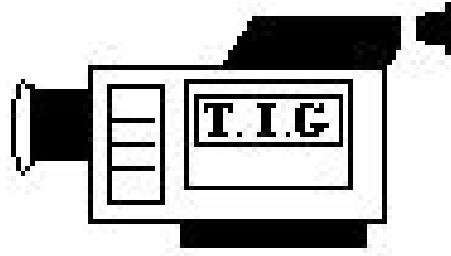

PI FRANCHISE GROUP LLC (MISSISSIPPI LIMITED LIABILITY COMPANY)  
P.O. BOX 1523  
TUPELO, MS 38802

FOR: PRIVATE INVESTIGATION AND SURVEILLANCE SERVICES, IN CLASS 45 (U.S. CLS. 100 AND 101).

FIRST USE 9-30-2006; IN COMMERCE 9-30-2006.

OWNER OF U.S. REG. NO. 2,795,770.

THE MARK CONSISTS OF A VIDEO CAMERA WITH THE LETTERS "TIG" ENGRAVED ON THE SIDE.

SER. NO. 77-393,836, FILED 2-11-2008.

DANIEL CAPSHAW, EXAMINING ATTORNEY

**Int. Cl.: 41**

**Prior U.S. Cls.: 100, 101 and 107**

**United States Patent and Trademark Office**

**Reg. No. 3,498,935**

**Registered Sep. 9, 2008**

**SERVICE MARK  
PRINCIPAL REGISTER**

**GROOBY**

SMY WEB IP, INC. (FLORIDA CORPORATION)  
770 KAPIOLANI BLVD. #514  
HONOLULU, HI 96813

FOR: ENTERTAINMENT SERVICES, NAMELY,  
PROVIDING A WEB SITE FEATURING PHOTO-  
GRAPHIC, AUDIO, VIDEO AND PROSE PRESEN-  
TATIONS FEATURING ADULT  
ENTERTAINMENT, IN CLASS 41 (U.S. CLS. 100,  
101 AND 107).

FIRST USE 5-12-1997; IN COMMERCE 11-30-1999.

THE MARK CONSISTS OF STANDARD CHAR-  
ACTERS WITHOUT CLAIM TO ANY PARTICULAR  
FONT, STYLE, SIZE, OR COLOR.

SER. NO. 77-393,899, FILED 2-11-2008.

GINA FINK, EXAMINING ATTORNEY



**Int. Cl.: 35**

**Prior U.S. Cls.: 100, 101 and 102**

**United States Patent and Trademark Office**

**Reg. No. 3,498,936**

**Registered Sep. 9, 2008**

**SERVICE MARK  
PRINCIPAL REGISTER**

**SERIOUS CHUTZPAH**

KIRSHENBAUM BOND & PARTNERS LLC (DE-  
LAWARE LIMITED LIABILITY COMPANY)  
160 VARICK STREET  
NEW YORK, NY 10013

FOR: ADVERTISING AGENCY SERVICES,  
NAMELY, PROVIDING BUSINESS MARKETING  
SERVICES, BRANDING SERVICES AND PROMO-  
TIONAL SERVICES FOR OTHERS , IN CLASS 35  
(U.S. CLS. 100, 101 AND 102).

FIRST USE 10-18-2007; IN COMMERCE 10-18-2007.

THE MARK CONSISTS OF STANDARD CHAR-  
ACTERS WITHOUT CLAIM TO ANY PARTICULAR  
FONT, STYLE, SIZE, OR COLOR.

SER. NO. 77-393,927, FILED 2-11-2008.

ROBIN CHOSID, EXAMINING ATTORNEY

**Int. Cls.: 20 and 24**

**Prior U.S. Cls.: 2, 13, 22, 25, 32, 42 and 50**

**United States Patent and Trademark Office**

**Reg. No. 3,498,937**

**Registered Sep. 9, 2008**

**TRADEMARK  
PRINCIPAL REGISTER**

**COLOR MY SLING**

HOMECREST OUTDOOR LIVING, LLC (MINNESOTA LIMITED LIABILITY COMPANY)  
1250 HOMECREST AVE.  
WADENA, MN 56482

FOR: CASUAL AND OUTDOOR FURNITURE, IN CLASS 20 (U.S. CLS. 2, 13, 22, 25, 32 AND 50).

FIRST USE 7-1-2007; IN COMMERCE 7-1-2007.

FOR: FABRICS FOR THE MANUFACTURE OF CASUAL AND OUTDOOR FURNITURE, IN CLASS 24 (U.S. CLS. 42 AND 50).

FIRST USE 7-1-2007; IN COMMERCE 7-1-2007.

THE MARK CONSISTS OF STANDARD CHARACTERS WITHOUT CLAIM TO ANY PARTICULAR FONT, STYLE, SIZE, OR COLOR.

SER. NO. 77-393,962, FILED 2-11-2008.

JACQUELINE A. LAVINE, EXAMINING ATTORNEY

**Int. Cl.: 30**

**Prior U.S. Cl.: 46**

**United States Patent and Trademark Office**

**Reg. No. 3,498,938**

**Registered Sep. 9, 2008**

**TRADEMARK  
PRINCIPAL REGISTER**

**SNOW VALLEY**

DESIGNPAC GIFTS LLC (ILLINOIS LIMITED  
LIABILITY COMPANY)  
2457 WEST NORTH AVENUE  
MELROSE PARK, IL 60160

THE MARK CONSISTS OF STANDARD CHAR-  
ACTERS WITHOUT CLAIM TO ANY PARTICULAR  
FONT, STYLE, SIZE, OR COLOR.

FOR: COCOA MIXES; MARSHMALLOWS; HOT  
CHOCOLATE, IN CLASS 30 (U.S. CL. 46).

SER. NO. 77-393,972, FILED 2-11-2008.

FIRST USE 10-1-2004; IN COMMERCE 10-1-2005.

LINDA LAVACHE, EXAMINING ATTORNEY

**Int. Cl.: 37**

**Prior U.S. Cls.: 100, 103 and 106**

**United States Patent and Trademark Office**

**Reg. No. 3,498,939**

**Registered Sep. 9, 2008**

**SERVICE MARK  
PRINCIPAL REGISTER**

**Rollins-PCI**

ROLLINS-PCI CONSTRUCTION (MARYLAND CORPORATION)  
1302 RISING RIDGE RD., #9  
MT. AIRY, MD 21771

THE MARK CONSISTS OF STANDARD CHARACTERS WITHOUT CLAIM TO ANY PARTICULAR FONT, STYLE, SIZE, OR COLOR.

FOR: COMMERCIAL BUILDING CONSTRUCTION, IN CLASS 37 (U.S. CLS. 100, 103 AND 106).

SER. NO. 77-393,994, FILED 2-11-2008.

FIRST USE 6-15-2004; IN COMMERCE 8-15-2004.

JACLYN KIDWELL, EXAMINING ATTORNEY

**Int. Cl.: 9**

**Prior U.S. Cls.: 21, 23, 26, 36 and 38**

**United States Patent and Trademark Office**

**Reg. No. 3,498,940**

**Registered Sep. 9, 2008**

**TRADEMARK  
PRINCIPAL REGISTER**

**logimax** 

INFORMATION & COMPUTING SERVICES, INC.  
(FLORIDA CORPORATION)  
SUITE 300  
1650 PRUDENTIAL DRIVE  
JACKSONVILLE, FL 32207

OWNER OF U.S. REG. NOS. 2,152,079 AND  
2,989,076.

FOR: COMPUTER SOFTWARE FOR FACILITATING PUBLIC WAREHOUSE OPERATIONS, NAME-  
LY, MANAGING THE DELIVERY, RECEIVING,  
INVENTORY, CUSTOMER COMMUNICATIONS,  
AND DISTRIBUTION OPERATIONS, IN CLASS 9  
(U.S. CLS. 21, 23, 26, 36 AND 38).

THE MARK CONSISTS OF THE WORD LOGI-  
MAX AND A WAVE EMITTING FROM THE LET-  
TER "X".

SER. NO. 77-394,002, FILED 2-11-2008.

FIRST USE 2-19-2004; IN COMMERCE 2-19-2004.

ROBIN CHOSID, EXAMINING ATTORNEY

**Int. Cl.: 43**

**Prior U.S. Cls.: 100 and 101**

**United States Patent and Trademark Office**

**Reg. No. 3,498,941**

**Registered Sep. 9, 2008**

**SERVICE MARK  
PRINCIPAL REGISTER**



BLUE SHELL RESTAURANT, INC. (TEXAS CORPORATION)  
141 PASEO DEL PRADO  
EDINBURG, TX 78539

OWNER OF U.S. REG. NO. 3,249,595.

FOR: RESTAURANT SERVICES, IN CLASS 43  
(U.S. CLS. 100 AND 101).

SER. NO. 77-394,025, FILED 2-11-2008.

FIRST USE 1-15-2007; IN COMMERCE 1-15-2007.

MELVIN AXILBUND, EXAMINING ATTORNEY

**Int. Cls.: 21, 30, 35 and 40**

**Prior U.S. Cls.: 2, 13, 23, 29, 30, 33, 40, 46, 50, 100,  
101, 102, 103 and 106**

**Reg. No. 3,498,942**

**United States Patent and Trademark Office**

**Registered Sep. 9, 2008**

**TRADEMARK  
SERVICE MARK  
PRINCIPAL REGISTER**

**GREAT NORTHERN**

GREAT NORTHERN COFFEE CO., INC. (WYOM-  
ING CORPORATION)  
P.O. BOX 1643  
JACKSON, WY 83001

FOR: CUPS AND MUGS, IN CLASS 21 (U.S. CLS. 2,  
13, 23, 29, 30, 33, 40 AND 50).

FIRST USE 6-0-2000; IN COMMERCE 6-0-2000.

FOR: COFFEE, IN CLASS 30 (U.S. CL. 46).

FIRST USE 12-0-1979; IN COMMERCE 12-0-1979.

FOR: RETAIL OUTLETS FEATURING COFFEE  
AND ESPRESSO BEVERAGES AND GROUND AND  
WHOLE BEAN COFFEE; MAIL ORDER SERVICES  
FEATURING GROUND AND WHOLE BEAN COF-  
FEE; WHOLESALE ORDERING SERVICES IN THE

FIELD OF COFFEE, IN CLASS 35 (U.S. CLS. 100, 101  
AND 102).

FIRST USE 12-0-1979; IN COMMERCE 12-0-1979.

FOR: COFFEE ROASTING AND PROCESSING,  
IN CLASS 40 (U.S. CLS. 100, 103 AND 106).

FIRST USE 12-0-1979; IN COMMERCE 12-0-1979.

THE MARK CONSISTS OF STANDARD CHAR-  
ACTERS WITHOUT CLAIM TO ANY PARTICULAR  
FONT, STYLE, SIZE, OR COLOR.

SER. NO. 77-394,034, FILED 2-11-2008.

PATRICIA EVANKO, EXAMINING ATTORNEY

**Int. Cl.: 25**

**Prior U.S. Cls.: 22 and 39**

**United States Patent and Trademark Office**

**Reg. No. 3,498,943**

**Registered Sep. 9, 2008**

**TRADEMARK  
PRINCIPAL REGISTER**

**DESPI**

FILIOS, DESPINA (BRAZIL INDIVIDUAL)  
PETROPOLIS  
VILA MANOEL CORREIA 82 ALTO DA SERRA  
RIO DE JANEIRO, BRAZIL 25625014

FOR: CLOTHING, NAMELY, BIKINIS, BATHING  
SUITS, SWIMWEAR, BEACHWEAR, HATS, SANDALS,  
DRESSES, AND BEACH COVER-UPS, IN  
CLASS 25 (U.S. CLS. 22 AND 39).

FIRST USE 0-0-1989; IN COMMERCE 9-0-2006.

THE MARK CONSISTS OF STANDARD CHARACTERS  
WITHOUT CLAIM TO ANY PARTICULAR  
FONT, STYLE, SIZE, OR COLOR.

THE WORDING "DESPI" HAS NO MEANING IN  
A FOREIGN LANGUAGE.

SER. NO. 77-394,062, FILED 2-11-2008.

DAVID I, EXAMINING ATTORNEY



**Int. Cl.: 35**

**Prior U.S. Cls.: 100, 101 and 102**

**United States Patent and Trademark Office**

**Reg. No. 3,498,944**

**Registered Sep. 9, 2008**

**SERVICE MARK  
PRINCIPAL REGISTER**



ON THE JOB CONCRETE, LLC (TEXAS LIMITED  
LIABILITY COMPANY)

4700 N. WARE RD.

MCALLEN, TX 78504

FOR: RETAIL STORE SERVICES FEATURING  
CONCRETE, IN CLASS 35 (U.S. CLS. 100, 101 AND  
102).

FIRST USE 4-12-2004; IN COMMERCE 4-12-2004.

NO CLAIM IS MADE TO THE EXCLUSIVE  
RIGHT TO USE "CONCRETE", APART FROM THE  
MARK AS SHOWN.

THE MARK CONSISTS OF THE STYLIZED  
WORDS "OTJ ON THE JOB CONCRETE" BENEATH  
THE STYLIZED WORDS "ON THE JOB" IS THE  
WORD "CONCRETE" .

SER. NO. 77-394,141, FILED 2-11-2008.

ATTIYA MALIK, EXAMINING ATTORNEY

**Int. Cl.: 30**

**Prior U.S. Cl.: 46**

**United States Patent and Trademark Office**

**Reg. No. 3,498,945**

**Registered Sep. 9, 2008**

**TRADEMARK  
PRINCIPAL REGISTER**

**DOCTOR DARK**

MOUNTAIN MAN NUT & FRUIT CO. (COLOR-  
ADO CORPORATION)  
10338 S. PROGRESS WAY  
PARKER, CO 80134

THE MARK CONSISTS OF STANDARD CHAR-  
ACTERS WITHOUT CLAIM TO ANY PARTICULAR  
FONT, STYLE, SIZE, OR COLOR.

FOR: CHOCOLATE-COATED NUTS AND BER-  
RIES, IN CLASS 30 (U.S. CL. 46).

SER. NO. 77-394,143, FILED 2-11-2008.

FIRST USE 7-0-2004; IN COMMERCE 7-0-2004.

REBECCA GILBERT, EXAMINING ATTORNEY

**Int. Cl.: 41**

**Prior U.S. Cls.: 100, 101 and 107**

**United States Patent and Trademark Office**

**Reg. No. 3,498,946**

**Registered Sep. 9, 2008**

**SERVICE MARK  
PRINCIPAL REGISTER**

# Children Unscripted

CZAJA, CHARISSE (UNITED STATES INDIVIDUAL)

28 AMBLER DRIVE

NORWALK, CT 06851

FOR: PHOTOGRAPHY SERVICES, IN CLASS 41  
(U.S. CLS. 100, 101 AND 107).

FIRST USE 1-1-2006; IN COMMERCE 1-1-2006.

THE MARK CONSISTS OF STANDARD CHARACTERS WITHOUT CLAIM TO ANY PARTICULAR FONT, STYLE, SIZE, OR COLOR.

NO CLAIM IS MADE TO THE EXCLUSIVE RIGHT TO USE "CHILDREN", APART FROM THE MARK AS SHOWN.

SER. NO. 77-394,157, FILED 2-11-2008.

GEOFFREY FOSDICK, EXAMINING ATTORNEY

**Int. Cl.: 31**

**Prior U.S. Cls.: 1 and 46**

**United States Patent and Trademark Office**

**Reg. No. 3,498,947**

**Registered Sep. 9, 2008**

**TRADEMARK  
PRINCIPAL REGISTER**

**GARDEN-GRO**

OMS INVESTMENTS, INC. (DELAWARE CORPORATION)  
10250 CONSTELLATION BLVD., SUITE 2800  
LOS ANGELES, CA 90067

THE MARK CONSISTS OF STANDARD CHARACTERS WITHOUT CLAIM TO ANY PARTICULAR FONT, STYLE, SIZE, OR COLOR.

FOR: MULCH, IN CLASS 31 (U.S. CLS. 1 AND 46).

SER. NO. 77-394,176, FILED 2-11-2008.

FIRST USE 2-9-2008; IN COMMERCE 2-9-2008.

STEVEN JACKSON, EXAMINING ATTORNEY

**Int. Cl.: 35**

**Prior U.S. Cls.: 100, 101 and 102**

**United States Patent and Trademark Office**

**Reg. No. 3,498,948**

**Registered Sep. 9, 2008**

**SERVICE MARK  
PRINCIPAL REGISTER**

**POLITEMPS**

POLITEMPS, INC. (VIRGINIA CORPORATION)  
2000 P ST., NW, STE. 400  
WASHINGTON, DC 20036

FOR: TEMPORARY AND PERMANENT EMPLOYMENT RECRUITING AND STAFFING, IN CLASS 35 (U.S. CLS. 100, 101 AND 102).

FIRST USE 10-31-1995; IN COMMERCE 10-31-1995.

THE MARK CONSISTS OF STANDARD CHARACTERS WITHOUT CLAIM TO ANY PARTICULAR FONT, STYLE, SIZE, OR COLOR.

OWNER OF U.S. REG. NO. 3,348,527.

SER. NO. 77-394,230, FILED 2-11-2008.

DOMINIC J. FERRAIUOLO, EXAMINING ATTORNEY

**Int. Cl.: 41**

**Prior U.S. Cls.: 100, 101 and 107**

**United States Patent and Trademark Office**

**Reg. No. 3,498,949**

**Registered Sep. 9, 2008**

**SERVICE MARK  
PRINCIPAL REGISTER**



MONMOUTH BEACH BATH AND TENNIS CLUB  
(NEW JERSEY CORPORATION)  
65 OCEAN AVENUE  
MONMOUTH BEACH, NJ 07750

FOR: SOCIAL CLUB SERVICES, NAMELY, ARRANGING, ORGANIZING, AND HOSTING SOCIAL EVENTS, GET-TOGETHERS, AND PARTIES FOR CLUB MEMBERS, IN CLASS 41 (U.S. CLS. 100, 101 AND 107).

FIRST USE 5-19-1924; IN COMMERCE 5-19-1924.

THE MARK CONSISTS OF A BURGEE FLAG WITH THE CAPITALIZED LETTER "M" IN THE MIDDLE.

SER. NO. 77-394,241, FILED 2-11-2008.

DOMINIC J. FERRAIUOLO, EXAMINING ATTORNEY

**Int. Cl.: 5**

**Prior U.S. Cls.: 6, 18, 44, 46, 51 and 52**

**United States Patent and Trademark Office**

**Reg. No. 3,498,950**

**Registered Sep. 9, 2008**

**TRADEMARK  
PRINCIPAL REGISTER**

# CarbMate

NEW SPIRIT NATURALS, INC. (CALIFORNIA  
CORPORATION)  
615 W ALLEN AVENUE  
SAN DIMAS, CA 91773

FOR: DIETARY SUPPLEMENTS; NUTRITIONAL  
SUPPLEMENTS, IN CLASS 5 (U.S. CLS. 6, 18, 44, 46, 51  
AND 52).

FIRST USE 10-0-2007; IN COMMERCE 1-0-2008.

THE MARK CONSISTS OF STANDARD CHAR-  
ACTERS WITHOUT CLAIM TO ANY PARTICULAR  
FONT, STYLE, SIZE, OR COLOR.

SER. NO. 77-394,255, FILED 2-11-2008.

DOMINIC J. FERRAIUOLO, EXAMINING ATTOR-  
NEY

**Int. Cl.: 34**

**Prior U.S. Cls.: 2, 8, 9 and 17**

**United States Patent and Trademark Office**

**Reg. No. 3,498,951**

**Registered Sep. 9, 2008**

**TRADEMARK  
PRINCIPAL REGISTER**

**BAHAMAS CIGARETTES**

UNIVERSAL TOBACCO S.A. (PARAGUAY COR-  
PORATION)  
BARRIO MCAL LOPEZ  
COLONIA FELIX DE AZARA-2DA FRACCION  
HERNAND. ALTO PARANA, PARAGUAY

FOR: FILTER-TIPPED CIGARETTES, IN CLASS  
34 (U.S. CLS. 2, 8, 9 AND 17).

FIRST USE 1-25-2000; IN COMMERCE 1-11-2002.

THE MARK CONSISTS OF STANDARD CHAR-  
ACTERS WITHOUT CLAIM TO ANY PARTICULAR  
FONT, STYLE, SIZE, OR COLOR.

NO CLAIM IS MADE TO THE EXCLUSIVE  
RIGHT TO USE "CIGARETTES", APART FROM  
THE MARK AS SHOWN.

SER. NO. 77-394,297, FILED 2-11-2008.

PATRICIA EVANKO, EXAMINING ATTORNEY



**Int. Cl.: 9**

**Prior U.S. Cls.: 21, 23, 26, 36 and 38**

**Reg. No. 3,498,952**

**United States Patent and Trademark Office**

**Registered Sep. 9, 2008**

**TRADEMARK  
PRINCIPAL REGISTER**

**OPTIVAULT**

TRANSOFT INTERNATIONAL, INC. (NORTH  
CAROLINA CORPORATION)  
115 CENTREWEST COURT  
CARY, NC 27513

THE MARK CONSISTS OF STANDARD CHAR-  
ACTERS WITHOUT CLAIM TO ANY PARTICULAR  
FONT, STYLE, SIZE, OR COLOR.

FOR: COMPUTER SOFTWARE FOR CURRENCY  
MANAGEMENT FOR BANKS, IN CLASS 9 (U.S.  
CLS. 21, 23, 26, 36 AND 38).

SER. NO. 77-394,376, FILED 2-12-2008.

FIRST USE 0-0-1999; IN COMMERCE 0-0-1999.

NANCY CLARKE, EXAMINING ATTORNEY

**Int. Cl.: 41**

**Prior U.S. Cls.: 100, 101 and 107**

**United States Patent and Trademark Office**

**Reg. No. 3,498,953**

**Registered Sep. 9, 2008**

**SERVICE MARK  
PRINCIPAL REGISTER**

**Evolve**

BEAUTY HOLDING LLC (DELAWARE LIMITED LIABILITY COMPANY), DBA BEAUTY HOLDING COMPANY, INC.

LEGAL DEPT.  
3001 COLORADO BLVD.  
DENTON, TX 76210

FOR: EDUCATIONAL SERVICES, NAMELY, CONDUCTING SEMINARS, CONFERENCES AND WORKSHOPS IN THE OPERATION AND MANAGEMENT OF BEAUTY SALON SERVICES AND DISTRIBUTION OF TRAINING MATERIALS IN

CONNECTION THEREWITH, IN CLASS 41 (U.S. CLS. 100, 101 AND 107).

FIRST USE 8-31-2007; IN COMMERCE 8-31-2007.

THE MARKS CONSIST OF THE STYLIZED WORD "EVOLVE".

SER. NO. 77-394,410, FILED 2-12-2008.

VIVIAN MICZNIK FIRST, EXAMINING ATTORNEY

**Int. Cl.: 41**

**Prior U.S. Cls.: 100, 101 and 107**

**United States Patent and Trademark Office**

**Reg. No. 3,498,954**

**Registered Sep. 9, 2008**

**SERVICE MARK  
PRINCIPAL REGISTER**

**EVOLVE**

BEAUTY HOLDING LLC (DELAWARE LIMITED LIABILITY COMPANY), DBA BEAUTY HOLDING COMPANY, INC.  
LEGAL DEPT.  
3001 COLORADO BLVD.  
DENTON, TX 76210

FOR: EDUCATIONAL SERVICES, NAMELY, CONDUCTING SEMINARS, CONFERENCES AND WORKSHOPS IN THE OPERATION AND MANAGEMENT OF BEAUTY SALON SERVICES AND DISTRIBUTION OF TRAINING MATERIALS IN CONNECTION THEREWITH, IN CLASS 41 (U.S. CLS. 100, 101 AND 107).

FIRST USE 8-31-2007; IN COMMERCE 8-31-2007.

THE MARK CONSISTS OF STANDARD CHARACTERS WITHOUT CLAIM TO ANY PARTICULAR FONT, STYLE, SIZE, OR COLOR.

SER. NO. 77-394,412, FILED 2-12-2008.

VIVIAN MICZNIK FIRST, EXAMINING ATTORNEY

**Int. Cl.: 35**

**Prior U.S. Cls.: 100, 101 and 102**

**United States Patent and Trademark Office**

**Reg. No. 3,498,955**

**Registered Sep. 9, 2008**

**SERVICE MARK  
PRINCIPAL REGISTER**

# RobeProbe

ROBEPROBE, LLC (NEW JERSEY LIMITED LIABILITY COMPANY)  
259 UNION STREET  
HACKENSACK, NJ 07601

THE MARK CONSISTS OF STANDARD CHARACTERS WITHOUT CLAIM TO ANY PARTICULAR FONT, STYLE, SIZE, OR COLOR.

FOR: PROVIDING A WEB SITE WHERE USERS CAN POST RATINGS, REVIEWS AND RECOMMENDATIONS ON PRODUCTS AND SERVICES, IN CLASS 35 (U.S. CLS. 100, 101 AND 102).

SER. NO. 77-394,476, FILED 2-12-2008.

FIRST USE 3-1-2006; IN COMMERCE 3-1-2006.

TARA PATE, EXAMINING ATTORNEY

**Int. Cls.: 9, 14 and 18**

**Prior U.S. Cls.: 1, 2, 3, 21, 22, 23, 26, 27, 28, 36, 38, 41  
and 50**

**Reg. No. 3,498,956**

**United States Patent and Trademark Office**

**Registered Sep. 9, 2008**

---

**TRADEMARK  
PRINCIPAL REGISTER**

# ABOUT COLOR

PINK HOUSE IMPORTS LLC (CALIFORNIA  
CORPORATION)  
16704 MARQUARDT AVENUE  
CERRITOS, CA 90703

FOR: EYEGLOSS HOLDERS, IN CLASS 9 (U.S.  
CLS. 21, 23, 26, 36 AND 38).

FIRST USE 6-0-2005; IN COMMERCE 6-0-2005.

FOR: JEWELRY, NAMELY, NECKLACES, BRA-  
CELETS, EARRINGS AND RINGS, IN CLASS 14  
(U.S. CLS. 2, 27, 28 AND 50).

FIRST USE 6-0-2005; IN COMMERCE 6-0-2005.

FOR: HANDBAGS AND PURSES, IN CLASS 18  
(U.S. CLS. 1, 2, 3, 22 AND 41).

FIRST USE 6-0-2005; IN COMMERCE 6-0-2005.

THE MARK CONSISTS OF STANDARD CHAR-  
ACTERS WITHOUT CLAIM TO ANY PARTICULAR  
FONT, STYLE, SIZE, OR COLOR.

SER. NO. 77-394,848, FILED 2-12-2008.

JOHN HWANG, EXAMINING ATTORNEY

**Int. Cl.: 44**

**Prior U.S. Cls.: 100 and 101**

**United States Patent and Trademark Office**

**Reg. No. 3,498,957**

**Registered Sep. 9, 2008**

**SERVICE MARK  
PRINCIPAL REGISTER**



AEGIS SCIENCES CORPORATION (TENNESSEE  
CORPORATION)  
345 HILL AVENUE  
NASHVILLE, TN 37210

THE MARK CONSISTS OF THE WORD "AEGIS",  
STYLIZED. THE HORIZONTAL LINE IN THE LET-  
TER "A" IN "AEGIS" MAKES AN ARC UP AND  
OVER LETTERS "E" AND "G".

FOR: DRUG TESTING FOR SUBSTANCE ABUSE,  
IN CLASS 44 (U.S. CLS. 100 AND 101).

SER. NO. 77-394,899, FILED 2-12-2008.

FIRST USE 1-0-2006; IN COMMERCE 1-0-2006.

KEVON CHISOLM, EXAMINING ATTORNEY

**Int. Cls.: 9 and 42**

**Prior U.S. Cls.: 21, 23, 26, 36, 38, 100 and 101**

**Reg. No. 3,498,958**

**United States Patent and Trademark Office**

**Registered Sep. 9, 2008**

**TRADEMARK  
SERVICE MARK  
PRINCIPAL REGISTER**

**PTP E-FILE.NET**

PTP ONECLICK, LLC (DELAWARE LIMITED  
LIABILITY COMPANY)  
1674 BARCLAY BOULEVARD  
BUFFALO GROVE, IL 60089

FOR: COMPUTER SOFTWARE APPLICATION  
FOR INTEGRATING ELECTRONIC FILING CAP-  
ABILITY IN THE FIELD OF SALES AND USE TAX,  
IN CLASS 9 (U.S. CLS. 21, 23, 26, 36 AND 38).

FIRST USE 12-26-2007; IN COMMERCE 12-26-2007.

FOR: ONLINE DOWNLOADABLE SOFTWARE  
APPLICATION FOR INTEGRATING ELECTRONIC

FILING CAPABILITY IN THE FIELD OF SALES  
AND USE TAX, IN CLASS 42 (U.S. CLS. 100 AND 101).

FIRST USE 12-26-2007; IN COMMERCE 12-26-2007.

THE MARK CONSISTS OF STANDARD CHAR-  
ACTERS WITHOUT CLAIM TO ANY PARTICULAR  
FONT, STYLE, SIZE, OR COLOR.

SER. NO. 77-395,088, FILED 2-12-2008.

INGA ERVIN, EXAMINING ATTORNEY

**Int. Cl.: 35**

**Prior U.S. Cls.: 100, 101 and 102**

**United States Patent and Trademark Office**

**Reg. No. 3,498,959**

**Registered Sep. 9, 2008**

**SERVICE MARK  
PRINCIPAL REGISTER**

**LIVE LAUGH LOVE**

D-GENERATION, INC. (FLORIDA CORPORATION)  
P. O. BOX 30  
DAYTONA BEACH, FL 321150030

FOR: COMPUTERIZED ON-LINE ORDERING  
FEATURING GENERAL MERCHANDISE AND  
GENERAL CONSUMER GOODS, IN CLASS 35 (U.S.  
CLS. 100, 101 AND 102).

FIRST USE 6-17-2004; IN COMMERCE 6-17-2004.

THE MARK CONSISTS OF STANDARD CHARACTERS WITHOUT CLAIM TO ANY PARTICULAR FONT, STYLE, SIZE, OR COLOR.

OWNER OF U.S. REG. NOS. 3,368,922 AND 3,385,179.

SER. NO. 77-395,336, FILED 2-12-2008.

MARY MUNSON, EXAMINING ATTORNEY



**Int. Cl.: 37**

**Prior U.S. Cls.: 100, 103 and 106**

**United States Patent and Trademark Office**

**Reg. No. 3,498,960**

**Registered Sep. 9, 2008**

**SERVICE MARK  
PRINCIPAL REGISTER**

**ASPYRATION**

ASPYRATION CAPITAL ADVISORS INC. (CALI-  
FORNIA CORPORATION)  
SUITE 1700  
655 N. CENTRAL AVENUE  
GLENDALE, CA 91203

THE MARK CONSISTS OF STANDARD CHAR-  
ACTERS WITHOUT CLAIM TO ANY PARTICULAR  
FONT, STYLE, SIZE, OR COLOR.

FOR: REAL ESTATE DEVELOPMENT, IN CLASS  
37 (U.S. CLS. 100, 103 AND 106).

SER. NO. 77-395,357, FILED 2-12-2008.

FIRST USE 1-1-2006; IN COMMERCE 1-1-2006.

RICHARD A. STRASER, EXAMINING ATTORNEY

**Int. Cl.: 42**

**Prior U.S. Cls.: 100 and 101**

**United States Patent and Trademark Office**

**Reg. No. 3,498,961**

**Registered Sep. 9, 2008**

**SERVICE MARK  
PRINCIPAL REGISTER**



**FREEPATH, INC. (DELAWARE CORPORATION)  
1036 MORNING GLORY COURT  
EL DORADO HILLS, CA 95762**

**FOR: PROVIDING ON-LINE DOWNLOADABLE  
SOFTWARE FOR DIGITAL ASSET MANAGEMENT,  
COLLABORATION, AND COMMUNICATION, IN  
CLASS 42 (U.S. CLS. 100 AND 101).**

**FIRST USE 2-7-2006; IN COMMERCE 2-7-2006.**

**THE MARK CONSISTS OF AN OUTLINE OF A  
PERSON JUGGLING BALLS IN THE AIR IN A  
SEMI-CIRCLE ABOVE THE HEAD. BELOW THE  
DESIGN IS THE STYLIZED TEXT "FREEPATH".**

**SER. NO. 77-395,402, FILED 2-12-2008.**

**INGRID C. EULIN, EXAMINING ATTORNEY**

**Int. Cl.: 9**

**Prior U.S. Cls.: 21, 23, 26, 36 and 38**

**Reg. No. 3,498,962**

**United States Patent and Trademark Office**

**Registered Sep. 9, 2008**

---

**TRADEMARK  
PRINCIPAL REGISTER**

planswift

TECH UNLIMITED, INC. (NEVADA CORPORATION)  
SUITE 212  
850 S. BOULDER HIGHWAY  
HENDERSON, NV 89009

THE MARK CONSISTS OF STANDARD CHARACTERS WITHOUT CLAIM TO ANY PARTICULAR FONT, STYLE, SIZE, OR COLOR.

FOR: SOFTWARE, NAMELY, CONSTRUCTION TAKEOFF AND ESTIMATING SOFTWARE, IN CLASS 9 (U.S. CLS. 21, 23, 26, 36 AND 38).

SER. NO. 77-395,418, FILED 2-12-2008.

FIRST USE 12-4-2006; IN COMMERCE 2-23-2007.

HOWARD SMIGA, EXAMINING ATTORNEY

**Int. Cl.: 35**

**Prior U.S. Cls.: 100, 101 and 102**

**United States Patent and Trademark Office**

**Reg. No. 3,498,963**

**Registered Sep. 9, 2008**

**SERVICE MARK  
PRINCIPAL REGISTER**

**LIVELAUGHLOVE.COM**

D-GENERATION, INC. (FLORIDA CORPORATION)  
P. O. BOX 30  
DAYTONA BEACH, FL 321150030

FOR: COMPUTERIZED ON-LINE ORDERING  
FEATURING GENERAL MERCHANDISE AND  
GENERAL CONSUMER GOODS, IN CLASS 35 (U.S.  
CLS. 100, 101 AND 102).

FIRST USE 6-17-2004; IN COMMERCE 6-17-2004.

THE MARK CONSISTS OF STANDARD CHARACTERS WITHOUT CLAIM TO ANY PARTICULAR FONT, STYLE, SIZE, OR COLOR.

OWNER OF U.S. REG. NOS. 3,368,922 AND 3,385,179.

SER. NO. 77-396,502, FILED 2-13-2008.

MARY MUNSON, EXAMINING ATTORNEY

**Int. Cl.: 35**

**Prior U.S. Cls.: 100, 101 and 102**

**United States Patent and Trademark Office**

**Reg. No. 3,498,964**

**Registered Sep. 9, 2008**

**SERVICE MARK  
PRINCIPAL REGISTER**

**dairyland dolls**

MAD ROLLIN' DOLLS LLC (WISCONSIN LIMITED LIABILITY COMPANY)  
201 N BREARLY ST APT 4  
MADISON, WI 53703

THE MARK CONSISTS OF STANDARD CHARACTERS WITHOUT CLAIM TO ANY PARTICULAR FONT, STYLE, SIZE, OR COLOR.

FOR: COORDINATION OF RECREATIONAL SPORTING OPPORTUNITIES FOR INDIVIDUALS WHO WISH TO PARTICIPATE IN TEAM LEAGUE SPORTS, IN CLASS 35 (U.S. CLS. 100, 101 AND 102).

SER. NO. 77-397,214, FILED 2-14-2008.

FIRST USE 6-1-2005; IN COMMERCE 6-1-2005.

REBECCA EISINGER, EXAMINING ATTORNEY

**Int. Cls.: 20 and 24**

**Prior U.S. Cls.: 2, 13, 22, 25, 32, 42 and 50**

**United States Patent and Trademark Office**

**Reg. No. 3,498,965**

**Registered Sep. 9, 2008**

**TRADEMARK  
PRINCIPAL REGISTER**

**VERONA**

DWI HOLDINGS, INC. (DELAWARE CORPORATION)  
SUITE 300  
2100 RIVEREDGE PARKWAY  
ATLANTA, GA 30328

FOR: DECORATIVE PILLOWS, IN CLASS 20 (U.S. CLS. 2, 13, 22, 25, 32 AND 50).

FIRST USE 10-31-2004; IN COMMERCE 10-31-2004.

FOR: DUVETS, PILLOW SHAMS, BEDSKIRTS, BED SHEETS, AND PILLOWCASES; COVERLETS, IN CLASS 24 (U.S. CLS. 42 AND 50).

FIRST USE 10-31-2004; IN COMMERCE 10-31-2004.

THE MARK CONSISTS OF STANDARD CHARACTERS WITHOUT CLAIM TO ANY PARTICULAR FONT, STYLE, SIZE, OR COLOR.

SER. NO. 77-397,376, FILED 2-14-2008.

PAUL CROWLEY, EXAMINING ATTORNEY

**Int. Cls.: 39 and 40**

**Prior U.S. Cls.: 100, 103, 105 and 106**

**United States Patent and Trademark Office**

**Reg. No. 3,498,966**

**Registered Sep. 9, 2008**

**SERVICE MARK  
PRINCIPAL REGISTER**

**THINK BLUE... IT'S EASY TO  
DO!**

RAINBOW DISPOSAL CO., INC. (CALIFORNIA  
CORPORATION)  
17121 NICHOLS ST.  
HUNTINGTON BEACH, CA 92647

FOR: GARBAGE COLLECTION, IN CLASS 39  
(U.S. CLS. 100 AND 105).

FIRST USE 2-1-2008; IN COMMERCE 2-1-2008.

FOR: RECYCLING OF WASTE AND TRASH , IN  
CLASS 40 (U.S. CLS. 100, 103 AND 106).

FIRST USE 2-1-2008; IN COMMERCE 2-1-2008.

THE MARK CONSISTS OF STANDARD CHAR-  
ACTERS WITHOUT CLAIM TO ANY PARTICULAR  
FONT, STYLE, SIZE, OR COLOR.

SER. NO. 77-397,463, FILED 2-14-2008.

RONALD MCMORROW, EXAMINING ATTORNEY

**Int. Cl.: 35**

**Prior U.S. Cls.: 100, 101 and 102**

**United States Patent and Trademark Office**

**Reg. No. 3,498,967**

**Registered Sep. 9, 2008**

**SERVICE MARK  
PRINCIPAL REGISTER**



YAHOO! INC. (DELAWARE CORPORATION)  
701 FIRST AVE.  
SUNNYVALE, CA 94089

FOR: ADVERTISING AND COMMERCIAL INFORMATION SERVICES, VIA THE INTERNET, IN CLASS 35 (U.S. CLS. 100, 101 AND 102).

FIRST USE 10-2-2006; IN COMMERCE 10-2-2006.

OWNER OF U.S. REG. NOS. 3,194,112, 3,194,124,  
AND 3,259,882.

THE MARK CONSISTS OF THE STYLIZED, LOWER-CASE LETTERS "R" AND "M".

SER. NO. 77-397,696, FILED 2-14-2008.

IRA J. GOODSaid, EXAMINING ATTORNEY



**Int. Cl.: 3**

**Prior U.S. Cls.: 1, 4, 6, 50, 51 and 52**

**Reg. No. 3,498,968**

**United States Patent and Trademark Office**

**Registered Sep. 9, 2008**

**TRADEMARK  
PRINCIPAL REGISTER**

**POWER 2**

MDSA, LLC (GEORGIA LIMITED LIABILITY  
COMPANY)  
650 ENGINEERING DRIVE  
NORCROSS, GA 30092

THE MARK CONSISTS OF STANDARD CHAR-  
ACTERS WITHOUT CLAIM TO ANY PARTICULAR  
FONT, STYLE, SIZE, OR COLOR.

FOR: AUTOMOTIVE CHEMICAL CLEANING  
PREPARATIONS FOR THE CLEANING OF GASO-  
LINE AND DIESEL COMBUSTION CHAMBERS,  
PISTONS, INTAKE VALVES, AND INTAKE PORTS  
AND MANIFOLDS, IN CLASS 3 (U.S. CLS. 1, 4, 6, 50,  
51 AND 52).

OWNER OF U.S. REG. NO. 2,450,196.

SER. NO. 77-397,699, FILED 2-14-2008.

FIRST USE 12-3-2002; IN COMMERCE 12-3-2002.

MICHAEL LITZAU, EXAMINING ATTORNEY

**Int. Cls.: 12 and 37**

**Prior U.S. Cls.: 19, 21, 23, 31, 35, 44, 100, 103 and 106**

**United States Patent and Trademark Office**

**Reg. No. 3,498,969**

**Registered Sep. 9, 2008**

**TRADEMARK  
SERVICE MARK  
PRINCIPAL REGISTER**

**THE FUSION OF ART &  
TECHNIQUE**

RAU CORPORATION (CALIFORNIA CORPORATION)  
2027 PONTIUS AVENUE  
WEST LOS ANGELES, CA 90025

FOR: VEHICLE PARTS AND ACCESSORIES, NAMELY, STEERING WHEELS, BRAKE HANDLES, GEAR SHIFT KNOBS, DASH BOARDS, DOOR PANELS, AND EXTERIOR AND INTERIOR TRIM PIECES, IN CLASS 12 (U.S. CLS. 19, 21, 23, 31, 35 AND 44).

FIRST USE 7-1-2002; IN COMMERCE 7-1-2002.

FOR: AUTOMOBILE CUSTOMIZATION SERVICES; CUSTOM REBUILDING OF PARTS AND AC-

CESSORIES FOR LAND VEHICLES, IN CLASS 37 (U.S. CLS. 100, 103 AND 106).

FIRST USE 7-1-2002; IN COMMERCE 7-1-2002.

THE MARK CONSISTS OF STANDARD CHARACTERS WITHOUT CLAIM TO ANY PARTICULAR FONT, STYLE, SIZE, OR COLOR.

SER. NO. 77-397,701, FILED 2-14-2008.

CHRISTINE BLOMQUIST, EXAMINING ATTORNEY

**Int. Cl.: 41**

**Prior U.S. Cls.: 100, 101 and 107**

**United States Patent and Trademark Office**

**Reg. No. 3,498,970**

**Registered Sep. 9, 2008**

**SERVICE MARK  
PRINCIPAL REGISTER**

**PYXTUNES**

PYXIX CORPORATION (DELAWARE CORPORATION)  
WARNER CENTER  
6303 OWENSMOUTH AVENUE, 10TH FLOOR  
WOODLAND HILLS, CA 913672263

FOR: ENTERTAINMENT SERVICES, NAMELY,  
PROVIDING PRERECORDED MUSIC, MUSIC VIDEOS,  
INFORMATION IN THE FIELD OF MUSIC,  
COMMENTARY AND ARTICLES ABOUT MUSIC,  
AND MUSIC NETWORKING, ALL ON-LINE VIA A  
GLOBAL COMPUTER NETWORK, IN CLASS 41  
(U.S. CLS. 100, 101 AND 107).

FIRST USE 1-7-2008; IN COMMERCE 2-27-2008.

THE MARK CONSISTS OF STANDARD CHARACTERS  
WITHOUT CLAIM TO ANY PARTICULAR FONT,  
STYLE, SIZE, OR COLOR.

SER. NO. 77-399,412, FILED 2-18-2008.

FRED MANDIR, EXAMINING ATTORNEY

**Int. Cl.: 9**

**Prior U.S. Cls.: 21, 23, 26, 36 and 38**

**Reg. No. 3,498,971**

**United States Patent and Trademark Office**

**Registered Sep. 9, 2008**

**TRADEMARK  
PRINCIPAL REGISTER**

**RAPS**

METHODS AND SOLUTIONS, INC. (ARIZONA CORPORATION), DBA MINDPLAY  
440 S. WILLIAM BLVD., #206  
TUCSON, AZ 85711

THE MARK CONSISTS OF STANDARD CHARACTERS WITHOUT CLAIM TO ANY PARTICULAR FONT, STYLE, SIZE, OR COLOR.

FOR: EDUCATIONAL SOFTWARE USED TO INCREASE READING ABILITIES BY ASSESSING READING SKILLS AND LEARNING DISABILITIES, IN CLASS 9 (U.S. CLS. 21, 23, 26, 36 AND 38).

SER. NO. 77-399,616, FILED 2-18-2008.

FIRST USE 1-0-2005; IN COMMERCE 1-0-2005.

KATHERINE E. HALMEN, EXAMINING ATTORNEY

**Int. Cl.: 32**

**Prior U.S. Cls.: 45, 46 and 48**

**Reg. No. 3,498,972**

**United States Patent and Trademark Office**

**Registered Sep. 9, 2008**

**TRADEMARK  
PRINCIPAL REGISTER**

**PASTRY**

DEVONE LAWSON, INC. (CALIFORNIA CORPORATION)

507

13428 MAXELLA AVENUE  
MARINA DEL REY, CA 90292

FOR: BOTTLED DRINKING WATER; BOTTLED WATER; DRINKING WATER; FLAVORED BOTTLED WATER; FLAVORED WATERS; FLAVOURED WATERS; MINERAL WATER, IN CLASS 32 (U.S. CLS. 45, 46 AND 48).

FIRST USE 2-4-2008; IN COMMERCE 2-4-2008.

THE MARK CONSISTS OF STANDARD CHARACTERS WITHOUT CLAIM TO ANY PARTICULAR FONT, STYLE, SIZE, OR COLOR.

SER. NO. 77-399,840, FILED 2-18-2008.

AMY GEARIN, EXAMINING ATTORNEY

Int. Cl.: 30

Prior U.S. Cl.: 46

United States Patent and Trademark Office

Reg. No. 3,498,973

Registered Sep. 9, 2008

TRADEMARK  
PRINCIPAL REGISTER



PROMARK BRANDS INC. (IDAHO CORPORATION)  
2541 NORTH STOKESBERRY PLACE, SUITE 100  
MERIDIAN, ID 83646

THE MARK CONSISTS OF "LEA & PERRINS" IN  
SIGNATURE FORM WITH A CURVED UNDER-  
LINE.

FOR: SAUCES, IN CLASS 30 (U.S. CL. 46).

SER. NO. 77-400,349, FILED 2-19-2008.

FIRST USE 1-1-1900; IN COMMERCE 1-1-1900.

OWNER OF U.S. REG. NOS. 68,150, 1,468,545 AND  
OTHERS.

CHRIS WELLS, EXAMINING ATTORNEY

**Int. Cls.: 35 and 36**

**Prior U.S. Cls.: 100, 101 and 102**

**United States Patent and Trademark Office**

**Reg. No. 3,498,974**

**Registered Sep. 9, 2008**

**SERVICE MARK  
PRINCIPAL REGISTER**

**SUSTAIN-A-BUILD**

AMERICAN INTERNATIONAL GROUP, INC.  
(DELAWARE CORPORATION)  
70 PINE STREET  
NEW YORK, NY 10270

FOR: PROVIDING INCENTIVES TO ENVIRONMENTAL INSURANCE CUSTOMERS ENABLING PARTICIPANTS WHO DEMONSTRATE EXCELLENCE IN THE FIELD OF ENVIRONMENTALLY FRIENDLY CONSTRUCTION AND BUILDING OPERATIONS TO OBTAIN DISCOUNTS ON SERVICES AND RECEIVE IMPROVED SERVICES, IN CLASS 35 (U.S. CLS. 100, 101 AND 102).

FIRST USE 1-1-2008; IN COMMERCE 1-1-2008.

FOR: INSURANCE UNDERWRITING IN THE FIELD OF ENVIRONMENTAL INSURANCE, IN CLASS 36 (U.S. CLS. 100, 101 AND 102).

FIRST USE 1-1-2008; IN COMMERCE 1-1-2008.

THE MARK CONSISTS OF STANDARD CHARACTERS WITHOUT CLAIM TO ANY PARTICULAR FONT, STYLE, SIZE, OR COLOR.

SER. NO. 77-400,619, FILED 2-19-2008.

TARA PATE, EXAMINING ATTORNEY

**Int. Cl.: 25**

**Prior U.S. Cls.: 22 and 39**

**United States Patent and Trademark Office**

**Reg. No. 3,498,975**

**Registered Sep. 9, 2008**

**TRADEMARK  
PRINCIPAL REGISTER**

**microwobbleboard**

FITFLOP LIMITED (UNITED KINGDOM LIMITED LIABILITY COMPANY)  
167-169 KENSINGTON HIGH STREET , ORCHARD HOUSE; FIRST FLOOR  
LONDON, UNITED KINGDOM W8 6SH

FOR: FOOTWEAR, SANDALS, FLIP FLOP SANDALS, ALL FEATURING BIOMECHANICALLY ENGINEERED WORKOUT ENHANCING ELEMENTS , IN CLASS 25 (U.S. CLS. 22 AND 39).

FIRST USE 5-20-2007; IN COMMERCE 5-20-2007.

THE MARK CONSISTS OF STANDARD CHARACTERS WITHOUT CLAIM TO ANY PARTICULAR FONT, STYLE, SIZE, OR COLOR.

SER. NO. 77-401,082, FILED 2-20-2008.

G. MAYERSCHOFF, EXAMINING ATTORNEY



**Int. Cl.: 3**

**Prior U.S. Cls.: 1, 4, 6, 50, 51 and 52**

**United States Patent and Trademark Office**

**Reg. No. 3,498,976**

**Registered Sep. 9, 2008**

**TRADEMARK  
PRINCIPAL REGISTER**

**HERSHEY'S HUGS**

HERSHEY CHOCOLATE & CONFECTIONERY  
CORPORATION (DELAWARE CORPORATION)

4860 ROBB STREET SUITE204  
WHEAT RIDGE, CO 80033

FOR: LIP GLOSS, IN CLASS 3 (U.S. CLS. 1, 4, 6, 50,  
51 AND 52).

FIRST USE 2-28-2007; IN COMMERCE 2-28-2007.

THE MARK CONSISTS OF STANDARD CHAR-  
ACTERS WITHOUT CLAIM TO ANY PARTICULAR  
FONT, STYLE, SIZE, OR COLOR.

OWNER OF U.S. REG. NOS. 54,041, 2,845,045 AND  
OTHERS.

SER. NO. 77-401,356, FILED 2-20-2008.

PAUL CROWLEY, EXAMINING ATTORNEY

**Int. Cl.: 41**

**Prior U.S. Cls.: 100, 101 and 107**

**United States Patent and Trademark Office**

**Reg. No. 3,498,977**

**Registered Sep. 9, 2008**

**SERVICE MARK  
PRINCIPAL REGISTER**

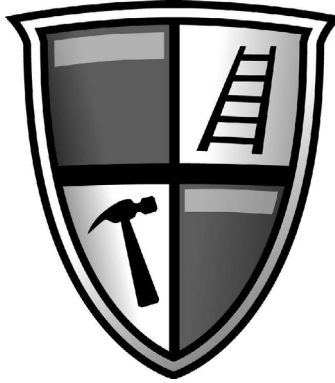

BUILDERS MUTUAL INSURANCE COMPANY  
(NORTH CAROLINA CORPORATION)  
6716 SIX FORKS ROAD  
RALEIGH, NC 27615

OWNER OF U.S. REG. NOS. 2,549,350, 2,962,860  
AND OTHERS.

FOR: EDUCATIONAL SERVICES, NAMELY,  
CONDUCTING CONTINUING EDUCATION PRO-  
GRAMS FOR THE INSURANCE INDUSTRY IN THE  
CONSTRUCTION AND HOMEBUILDING FIELDS,  
NAMELY, PROGRAMS FOR INSURANCE  
AGENTS, INDUSTRY EMPLOYEES, AND CONSU-  
MERS OF INSURANCE PRODUCTS RELATED TO  
CONSTRUCTION ISSUES, UNDERWRITING, RISK  
MANAGEMENT AND BUILDER TRAINING, IN  
CLASS 41 (U.S. CLS. 100, 101 AND 107).

THE MARK CONSISTS OF A FOUR PANEL COAT  
OF ARMS WITH EACH PANEL SEPARATED BY A  
LINE WITH THE UPPER RIGHT PANEL CONTAIN-  
ING A LADDER AND THE LOWER LEFT PANEL  
CONTAINING A HAMMER. THE LEFT UPPER  
PANEL AND RIGHT LOWER PANELS ARE BLANK.

SER. NO. 77-401,788, FILED 2-20-2008.

FIRST USE 1-31-2008; IN COMMERCE 2-15-2008.

REBECCA SMITH, EXAMINING ATTORNEY

**Int. Cls.: 9, 16 and 41**

**Prior U.S. Cls.: 2, 5, 21, 22, 23, 26, 29, 36, 37, 38, 50,  
100, 101 and 107**

**Reg. No. 3,498,978**

**United States Patent and Trademark Office**

**Registered Sep. 9, 2008**

**TRADEMARK  
SERVICE MARK  
PRINCIPAL REGISTER**

**JEFFREY GITOMER'S**

GITOMER, JEFFREY H. (UNITED STATES IN-  
DIVIDUAL)  
310 ARLINGTON LOFT, LOFT 329  
CHARLOTTE, NC 28203

FOR: PRE-RECORDED AUDIO AND VIDEO CAS-  
SETTE, CD AND DVD RECORDINGS IN THE  
FIELD OF SALES TRAINING, SELLING TECHNI-  
QUES, SELLING SKILLS, PEOPLE SKILLS, AND  
CUSTOMER SERVICE SKILLS AND TECHNIQUES,  
IN CLASS 9 (U.S. CLS. 21, 23, 26, 36 AND 38).

FIRST USE 0-0-1998; IN COMMERCE 0-0-1998.

FOR: A SERIES OF BOOKS IN THE FIELD OF  
SALES TRAINING, SELLING TECHNIQUES, SELL-  
ING SKILLS, PEOPLE SKILLS, AND CUSTOMER  
SERVICE SKILLS AND TECHNIQUES, IN CLASS 16  
(U.S. CLS. 2, 5, 22, 23, 29, 37, 38 AND 50).

FIRST USE 0-0-1998; IN COMMERCE 0-0-1998.

FOR: EDUCATIONAL SERVICES, NAMELY,  
PROVIDING LIVE AND ON-LINE SEMINARS,  
CLASSES AND WORKSHOPS IN THE FIELD OF  
SALES TRAINING, SELLING TECHNIQUES, SELL-  
ING SKILLS, PEOPLE SKILLS, AND CUSTOMER  
SERVICE SKILLS AND TECHNIQUES, AND PRINT-  
ED MATERIALS DISTRIBUTED THEREWITH, IN  
CLASS 41 (U.S. CLS. 100, 101 AND 107).

FIRST USE 0-0-1998; IN COMMERCE 0-0-1998.

THE MARK CONSISTS OF STANDARD CHAR-  
ACTERS WITHOUT CLAIM TO ANY PARTICULAR  
FONT, STYLE, SIZE, OR COLOR.

SER. NO. 77-402,248, FILED 2-21-2008.

JILL C. ALT, EXAMINING ATTORNEY

**Int. Cl.: 21**

**Prior U.S. Cls.: 2, 13, 23, 29, 30, 33, 40 and 50**

**Reg. No. 3,498,979**

**United States Patent and Trademark Office**

**Registered Sep. 9, 2008**

**TRADEMARK  
PRINCIPAL REGISTER**



MONROE HAIR CARE LLC (FLORIDA LIMITED  
LIABILITY COMPANY)  
1325 DIPLOMAT PARKWAY  
HOLLYWOOD, FL 33019

THE MARK CONSISTS OF THE TERM "ETI-  
QUETTE" WRITTEN IN ALL CAPITAL LETTERS  
AND IN A STYLIZED FONT.

FOR: HAIR BRUSHES; HAIR COMBS, IN CLASS  
21 (U.S. CLS. 2, 13, 23, 29, 30, 33, 40 AND 50).

SER. NO. 77-403,465, FILED 2-22-2008.

FIRST USE 9-21-2007; IN COMMERCE 10-25-2007.

RICHARD WHITE, EXAMINING ATTORNEY

**Int. Cl.: 21**

**Prior U.S. Cls.: 2, 13, 23, 29, 30, 33, 40 and 50**

**Reg. No. 3,498,980**

**United States Patent and Trademark Office**

**Registered Sep. 9, 2008**

**TRADEMARK  
PRINCIPAL REGISTER**

The logo features the words "Grand gala" in a bold, serif font. The word "Grand" is in all caps, and "gala" is in title case. A thick horizontal line underlines the entire phrase, with a small decorative flourish extending from the end of the line under the letter 'a'.

MONROE HAIR CARE LLC (FLORIDA LIMITED  
LIABILITY COMPANY)  
1325 DIPLOMAT PARKWAY  
HOLLYWOOD, FL 33019

THE MARK CONSISTS OF THE WORDING  
"GRAND GALA" WRITTEN IN A STYLIZED FONT  
AND UNDERLINED

FOR: HAIR BRUSHES; HAIR COMBS, IN CLASS  
21 (U.S. CLS. 2, 13, 23, 29, 30, 33, 40 AND 50).

SER. NO. 77-403,473, FILED 2-22-2008.

FIRST USE 9-21-2007; IN COMMERCE 10-25-2007.

RICHARD WHITE, EXAMINING ATTORNEY

**Int. Cl.: 21**

**Prior U.S. Cls.: 2, 13, 23, 29, 30, 33, 40 and 50**

**United States Patent and Trademark Office**

**Reg. No. 3,498,981**

**Registered Sep. 9, 2008**

**TRADEMARK  
PRINCIPAL REGISTER**



MONROE HAIR CARE LLC (FLORIDA LIMITED  
LIABILITY COMPANY)  
1325 DIPLOMAT PARKWAY  
HOLLYWOOD, FL 33019

THE MARK CONSISTS OF THE TERM "GLA-  
MOUR" IN A HIGHLY STYLIZED FONT.

FOR: HAIR BRUSHES; HAIR COMBS, IN CLASS  
21 (U.S. CLS. 2, 13, 23, 29, 30, 33, 40 AND 50).

SER. NO. 77-403,503, FILED 2-22-2008.

FIRST USE 9-21-2007; IN COMMERCE 10-25-2007.

RICHARD WHITE, EXAMINING ATTORNEY

**Int. Cl.: 21**

**Prior U.S. Cls.: 2, 13, 23, 29, 30, 33, 40 and 50**

**United States Patent and Trademark Office**

**Reg. No. 3,498,982**

**Registered Sep. 9, 2008**

**TRADEMARK  
PRINCIPAL REGISTER**

**RED CARPET**

MONROE HAIR CARE LLC (FLORIDA LIMITED  
LIABILITY COMPANY)  
1325 DIPLOMAT PARKWAY  
HOLLYWOOD, FL 33019

THE MARK CONSISTS OF THE WORDING "RED  
CARPET" WRITTEN IN A STYLIZED FONT AND  
UNDERLINED

FOR: HAIR BRUSHES; HAIR COMBS, IN CLASS  
21 (U.S. CLS. 2, 13, 23, 29, 30, 33, 40 AND 50).

SER. NO. 77-403,608, FILED 2-22-2008.

FIRST USE 9-21-2007; IN COMMERCE 10-25-2007.

RICHARD WHITE, EXAMINING ATTORNEY

**Int. Cl.: 21**

**Prior U.S. Cls.: 2, 13, 23, 29, 30, 33, 40 and 50**

**Reg. No. 3,498,983**

**United States Patent and Trademark Office**

**Registered Sep. 9, 2008**

**TRADEMARK  
PRINCIPAL REGISTER**

The trademark consists of the words "Lady in Red" written in a fluid, cursive script. A single horizontal line is drawn beneath the entire phrase, extending slightly beyond the left and right edges of the text.

MONROE HAIR CARE LLC (FLORIDA LIMITED  
LIABILITY COMPANY)  
1325 DIPLOMAT PARKWAY  
HOLLYWOOD, FL 33019

THE MARK CONSISTS OF THE WORDING  
"LADY IN RED" IN A STYLIZED FONT. FURTHER-  
MORE, THE LETTER "L" IN THE TERM "LADY" IS  
EXTENDED TO UNDERLINE THE ENTIRE MARK.

FOR: HAIR BRUSHES; HAIR COMBS, IN CLASS  
21 (U.S. CLS. 2, 13, 23, 29, 30, 33, 40 AND 50).

SER. NO. 77-403,942, FILED 2-22-2008.

FIRST USE 9-21-2007; IN COMMERCE 10-25-2007.

RICHARD WHITE, EXAMINING ATTORNEY



**Int. Cl.: 21**

**Prior U.S. Cls.: 2, 13, 23, 29, 30, 33, 40 and 50**

**Reg. No. 3,498,984**

**United States Patent and Trademark Office**

**Registered Sep. 9, 2008**

**TRADEMARK  
PRINCIPAL REGISTER**

The image shows the trademark logo for 'MYSTIQUE'. The word 'MYSTIQUE' is written in a bold, serif, all-caps font. A thick, dark swoosh underline starts from the left side of the letter 'M', curves under the word, and ends in a small loop on the right side.

MONROE HAIR CARE LLC (FLORIDA LIMITED  
LIABILITY COMPANY)  
1325 DIPLOMAT PARKWAY  
HOLLYWOOD, FL 33019

FOR: HAIR BRUSHES; HAIR COMBS, IN CLASS  
21 (U.S. CLS. 2, 13, 23, 29, 30, 33, 40 AND 50).

FIRST USE 9-21-2007; IN COMMERCE 10-25-2007.

THE MARK CONSISTS OF THE TERM "MYS-  
TIQUE" WRITTEN IN A STYLIZED FONT AND  
UNDERScoreD BY A SWOOSH DESIGN THAT  
EXTENDS FROM THE LEFT SIDE OF THE LETTER  
"M".

SER. NO. 77-404,001, FILED 2-22-2008.

RICHARD WHITE, EXAMINING ATTORNEY

**Int. Cl.: 21**

**Prior U.S. Cls.: 2, 13, 23, 29, 30, 33, 40 and 50**

**Reg. No. 3,498,985**

**United States Patent and Trademark Office**

**Registered Sep. 9, 2008**

**TRADEMARK  
PRINCIPAL REGISTER**

**LATINA ENVY**

MONROE HAIR CARE LLC (FLORIDA LIMITED  
LIABILITY COMPANY)  
1325 DIPLOMAT PARKWAY  
HOLLYWOOD, FL 33019

THE MARK CONSISTS OF THE WORDING "LA-  
TINA ENVY" WRITTEN IN A STYLIZED FONT.

FOR: HAIR BRUSHES; HAIR COMBS, IN CLASS  
21 (U.S. CLS. 2, 13, 23, 29, 30, 33, 40 AND 50).

SER. NO. 77-404,022, FILED 2-22-2008.

FIRST USE 9-21-2007; IN COMMERCE 10-25-2007.

RICHARD WHITE, EXAMINING ATTORNEY

**Int. Cl.: 35**

**Prior U.S. Cls.: 100, 101 and 102**

**United States Patent and Trademark Office**

**Reg. No. 3,498,986**

**Registered Sep. 9, 2008**

**SERVICE MARK  
PRINCIPAL REGISTER**

**DOCTOR LOVE'S**

DOCTOR LOVE'S, INC. (CALIFORNIA CORPORATION)  
1155 GARNET AVENUE  
SAN DIEGO, CA 92109

FOR: ON-LINE RETAIL STORE SERVICES FEATURING CONDOMS, GIFTS, NOVELTIES, LINGERIE, EROTIC GAMES, TOYS AND DVDS; RETAIL STORES FEATURING ADULT-ORIENTED PRODUCTS; MAIL ORDER SERVICES FEATURING ADULT-ORIENTED PRODUCTS, CONDOMS, GIFTS, NOVELTIES, LINGERIE, EROTIC GAMES, TOYS AND DVDS, IN CLASS 35 (U.S. CLS. 100, 101 AND 102).

FIRST USE 8-1-1996; IN COMMERCE 8-1-1996.

THE MARK CONSISTS OF STANDARD CHARACTERS WITHOUT CLAIM TO ANY PARTICULAR FONT, STYLE, SIZE, OR COLOR.

OWNER OF U.S. REG. NO. 2,338,085.

SER. NO. 77-404,405, FILED 2-22-2008.

WILLIAM VERHOSEK, EXAMINING ATTORNEY

**Int. Cl.: 25**

**Prior U.S. Cls.: 22 and 39**

**United States Patent and Trademark Office**

**Reg. No. 3,498,987**

**Registered Sep. 9, 2008**

**TRADEMARK  
PRINCIPAL REGISTER**

**FASTSKIN FSII**

SPEEDO INTERNATIONAL LIMITED (UNITED  
KINGDOM COMPANY)  
8 MANCHESTER SQUARE  
LONDON, UNITED KINGDOM W1U3PH

FOR: SWIMWEAR, IN CLASS 25 (U.S. CLS. 22  
AND 39).

FIRST USE 3-31-2004; IN COMMERCE 3-31-2004.

THE MARK CONSISTS OF STANDARD CHAR-  
ACTERS WITHOUT CLAIM TO ANY PARTICULAR  
FONT, STYLE, SIZE, OR COLOR.

OWNER OF U.S. REG. NOS. 2,701,688 AND  
3,306,353.

SER. NO. 77-404,889, FILED 2-25-2008.

MIDGE BUTLER, EXAMINING ATTORNEY

**Int. Cl.: 30**

**Prior U.S. Cl.: 46**

**United States Patent and Trademark Office**

**Reg. No. 3,498,988**

**Registered Sep. 9, 2008**

**TRADEMARK  
PRINCIPAL REGISTER**



GENERAL MILLS IP HOLDINGS I, LLC (DELA-  
WARE LIMITED LIABILITY COMPANY)  
NUMBER ONE GENERAL MILLS BOULEVARD  
MINNEAPOLIS, MN 55426

OWNER OF U.S. REG. NOS. 863,242, 1,666,000,  
AND 3,231,354.

FOR: BREAKFAST CEREAL, IN CLASS 30 (U.S.  
CL. 46).

SER. NO. 77-406,357, FILED 2-26-2008.

FIRST USE 12-31-1968; IN COMMERCE 12-31-1968.

KEVON CHISOLM, EXAMINING ATTORNEY

**Int. Cl.: 41**

**Prior U.S. Cls.: 100, 101 and 107**

**United States Patent and Trademark Office**

**Reg. No. 3,498,989**

**Registered Sep. 9, 2008**

**SERVICE MARK  
PRINCIPAL REGISTER**

# The Strut Zone

BONNIER ACTIVE MEDIA, INC. (NEW YORK CORPORATION)  
460 N. ORLANDO AVENUE, SUITE 200  
WINTER PARK, FL 32789

FOR: ON-LINE JOURNALS, NAMELY, BLOGS FEATURING ARTICLES, PHOTOS, IMAGES, AUDIO AND VIDEO ON THE TOPICS OF HUNTING, TURKEYS, FISHING, CAMPING, HIKING, SPORTS AND WILDLIFE BEHAVIOR; PROVIDING ONLINE INFORMATION IN THE FIELDS OF HUNTING, TURKEYS, FISHING, CAMPING, HIK-

ING, SPORTS AND WILDLIFE BEHAVIOR, IN CLASS 41 (U.S. CLS. 100, 101 AND 107).

FIRST USE 2-1-2006; IN COMMERCE 2-1-2006.

THE MARK CONSISTS OF STANDARD CHARACTERS WITHOUT CLAIM TO ANY PARTICULAR FONT, STYLE, SIZE, OR COLOR.

SER. NO. 77-406,414, FILED 2-26-2008.

ASMAT KHAN, EXAMINING ATTORNEY

**Int. Cl.: 10**

**Prior U.S. Cls.: 26, 39 and 44**

**United States Patent and Trademark Office**

**Reg. No. 3,498,990**

**Registered Sep. 9, 2008**

**TRADEMARK  
PRINCIPAL REGISTER**

# FlexioStill

CARL ZEISS AG (FED REP GERMANY CORPORATION)

CARL-ZEISS-STRASSE 22

73447 OBERKOCHEN, FED REP GERMANY

FOR: SURGICAL MICROSCOPES AND PARTS THEREOF, ESPECIALLY ADAPTERS, IN CLASS 10 (U.S. CLS. 26, 39 AND 44).

THE MARK CONSISTS OF STANDARD CHARACTERS WITHOUT CLAIM TO ANY PARTICULAR FONT, STYLE, SIZE, OR COLOR.

OWNER OF FED REP GERMANY REG. NO. 30734903, DATED 7-10-2007, EXPIRES 5-31-2017.

SER. NO. 77-406,469, FILED 2-26-2008.

JORDAN BAKER, EXAMINING ATTORNEY

**Int. Cl.: 10**

**Prior U.S. Cls.: 26, 39 and 44**

**United States Patent and Trademark Office**

**Reg. No. 3,498,991**

**Registered Sep. 9, 2008**

**TRADEMARK  
PRINCIPAL REGISTER**

# FlexioMotion

CARL ZEISS AG (FED REP GERMANY CORPORATION)

CARL-ZEISS-STRASSE 22

73447 OBERKOCHEN, FED REP GERMANY

FOR: SURGICAL MICROSCOPES AND PARTS THEREOF, ESPECIALLY ADAPTERS, IN CLASS 10 (U.S. CLS. 26, 39 AND 44).

THE MARK CONSISTS OF STANDARD CHARACTERS WITHOUT CLAIM TO ANY PARTICULAR FONT, STYLE, SIZE, OR COLOR.

OWNER OF FED REP GERMANY REG. NO. 30734904, DATED 7-9-2007, EXPIRES 5-31-2017.

SER. NO. 77-406,479, FILED 2-26-2008.

JORDAN BAKER, EXAMINING ATTORNEY



**Int. Cl.: 30**

**Prior U.S. Cl.: 46**

**United States Patent and Trademark Office**

**Reg. No. 3,498,992**

**Registered Sep. 9, 2008**

**TRADEMARK  
PRINCIPAL REGISTER**

**CINNAMON TOAST CRUNCH**

GENERAL MILLS IP HOLDINGS I, LLC (DELA-  
WARE LIMITED LIABILITY COMPANY)  
NUMBER ONE GENERAL MILLS BOULEVARD  
MINNEAPOLIS, MN 55426

FOR: PROCESSED CEREAL-BASED FOOD TO BE  
USED AS A BREAKFAST FOOD, SNACK FOR OR  
INGREDIENT FOR MAKING OTHER FOODS, IN  
CLASS 30 (U.S. CL. 46).

FIRST USE 6-15-1983; IN COMMERCE 6-15-1983.

THE MARK CONSISTS OF STANDARD CHAR-  
ACTERS WITHOUT CLAIM TO ANY PARTICULAR  
FONT, STYLE, SIZE, OR COLOR.

OWNER OF U.S. REG. NOS. 1,346,597, 1,681,353,  
AND 3,344,581.

SEC. 2(F) AS TO "CINNAMON TOAST".

SER. NO. 77-407,548, FILED 2-27-2008.

KEVON CHISOLM, EXAMINING ATTORNEY

**Int. Cl.: 9**

**Prior U.S. Cls.: 21, 23, 26, 36 and 38**

**Reg. No. 3,498,993**

**United States Patent and Trademark Office**

**Registered Sep. 9, 2008**

**TRADEMARK  
PRINCIPAL REGISTER**

**AU1250**

RMI CORPORATION (DELAWARE CORPORATION), DBA RAZA MICROELECTRONICS, INC.  
LEGAL DEPARTMENT  
18920 FORGE DRIVE  
CUPERTINO, CA 95014

FOR: SEMICONDUCTOR CHIPS; SEMICONDUCTOR DEVICES; SEMICONDUCTORS, IN CLASS 9 (U.S. CLS. 21, 23, 26, 36 AND 38).

FIRST USE 9-1-2002; IN COMMERCE 2-1-2003.

THE MARK CONSISTS OF STANDARD CHARACTERS WITHOUT CLAIM TO ANY PARTICULAR FONT, STYLE, SIZE, OR COLOR.

OWNER OF U.S. REG. NOS. 2,865,549, 2,897,576, AND 2,936,552.

SER. NO. 77-407,678, FILED 2-27-2008.

HANNO RITTNER, EXAMINING ATTORNEY

**Int. Cl.: 9**

**Prior U.S. Cls.: 21, 23, 26, 36 and 38**

**Reg. No. 3,498,994**

**United States Patent and Trademark Office**

**Registered Sep. 9, 2008**

**TRADEMARK  
PRINCIPAL REGISTER**

**AU1210**

RMI CORPORATION (DELAWARE CORPORATION), DBA RAZA MICROELECTRONICS, INC.  
LEGAL DEPARTMENT  
18920 FORGE DRIVE  
CUPERTINO, CA 95014

FOR: SEMICONDUCTOR CHIPS; SEMICONDUCTOR DEVICES; SEMICONDUCTORS, IN CLASS 9 (U.S. CLS. 21, 23, 26, 36 AND 38).

FIRST USE 2-8-2002; IN COMMERCE 12-20-2002.

THE MARK CONSISTS OF STANDARD CHARACTERS WITHOUT CLAIM TO ANY PARTICULAR FONT, STYLE, SIZE, OR COLOR.

OWNER OF U.S. REG. NOS. 2,865,549, 2,897,576, AND 2,936,552.

SER. NO. 77-407,701, FILED 2-27-2008.

HANNO RITTNER, EXAMINING ATTORNEY

**Int. Cl.: 5**

**Prior U.S. Cls.: 6, 18, 44, 46, 51 and 52**

**United States Patent and Trademark Office**

**Reg. No. 3,498,995**

**Registered Sep. 9, 2008**

**TRADEMARK  
PRINCIPAL REGISTER**

**XYLATHIN**

DENNY, SCOTT (UNITED STATES INDIVIDUAL)  
3602 DOVECOTE MEADOW LANE  
DAVIE, FL 33328

FOR: DIETARY SUPPLEMENTS; NUTRITIONAL SUPPLEMENTS, IN CLASS 5 (U.S. CLS. 6, 18, 44, 46, 51 AND 52).

FIRST USE 1-1-2008; IN COMMERCE 1-1-2008.

THE MARK CONSISTS OF STANDARD CHARACTERS WITHOUT CLAIM TO ANY PARTICULAR FONT, STYLE, SIZE, OR COLOR.

SER. NO. 77-407,783, FILED 2-27-2008.

KATHERINE E. HALMEN, EXAMINING ATTORNEY

**Int. Cl.: 25**

**Prior U.S. Cls.: 22 and 39**

**United States Patent and Trademark Office**

**Reg. No. 3,498,996**

**Registered Sep. 9, 2008**

**TRADEMARK  
PRINCIPAL REGISTER**

**Magic Group**

MAGIC HEADWEAR, INC. (CALIFORNIA CORPORATION)  
1100 W. WALNUT ST.  
COMPTON, CA 90220

THE MARK CONSISTS OF STANDARD CHARACTERS WITHOUT CLAIM TO ANY PARTICULAR FONT, STYLE, SIZE, OR COLOR.

FOR: TOPS, IN CLASS 25 (U.S. CLS. 22 AND 39).

SER. NO. 77-410,601, FILED 3-1-2008.

FIRST USE 11-1-2007; IN COMMERCE 11-1-2007.

JILL PRATER, EXAMINING ATTORNEY

**Int. Cl.: 25**

**Prior U.S. Cls.: 22 and 39**

**United States Patent and Trademark Office**

**Reg. No. 3,498,997**

**Registered Sep. 9, 2008**

**TRADEMARK  
PRINCIPAL REGISTER**

**Magic ECO**

MAGIC HEADWEAR, INC. (CALIFORNIA CORPORATION)  
1100 W. WALNUT ST.  
COMPTON, CA 90220

THE MARK CONSISTS OF STANDARD CHARACTERS WITHOUT CLAIM TO ANY PARTICULAR FONT, STYLE, SIZE, OR COLOR.

FOR: TOPS, IN CLASS 25 (U.S. CLS. 22 AND 39).

SER. NO. 77-410,608, FILED 3-1-2008.

FIRST USE 11-1-2007; IN COMMERCE 11-1-2007.

JILL PRATER, EXAMINING ATTORNEY

**Int. Cl.: 25**

**Prior U.S. Cls.: 22 and 39**

**United States Patent and Trademark Office**

**Reg. No. 3,498,998**

**Registered Sep. 9, 2008**

**TRADEMARK  
PRINCIPAL REGISTER**

# Wash Factory

MAGIC HEADWEAR, INC. (CALIFORNIA CORPORATION)  
1100 W. WALNUT ST.  
COMPTON, CA 90220

THE MARK CONSISTS OF STANDARD CHARACTERS WITHOUT CLAIM TO ANY PARTICULAR FONT, STYLE, SIZE, OR COLOR.

FOR: TOPS, IN CLASS 25 (U.S. CLS. 22 AND 39).

SER. NO. 77-410,609, FILED 3-1-2008.

FIRST USE 11-1-2007; IN COMMERCE 11-1-2007.

JILL PRATER, EXAMINING ATTORNEY

**Int. Cl.: 28**

**Prior U.S. Cls.: 22, 23, 38 and 50**

**Reg. No. 3,498,999**

**United States Patent and Trademark Office**

**Registered Sep. 9, 2008**

---

**TRADEMARK  
PRINCIPAL REGISTER**

**HOPEJAR**

AMERICAN LEBANESE SYRIAN ASSOCIATED  
CHARITIES, INC. (ILLINOIS CORPORATION)  
501 ST. JUDE PLACE  
MEMPHIS, TN 381051942

THE MARK CONSISTS OF STANDARD CHAR-  
ACTERS WITHOUT CLAIM TO ANY PARTICULAR  
FONT, STYLE, SIZE, OR COLOR.

FOR: TOY BANKS, IN CLASS 28 (U.S. CLS. 22, 23,  
38 AND 50).

SER. NO. 77-411,407, FILED 3-3-2008.

FIRST USE 5-29-2007; IN COMMERCE 5-29-2007.

TRICIA SONNEBORN, EXAMINING ATTORNEY



**Int. Cl.: 38**

**Prior U.S. Cls.: 100, 101 and 104**

**United States Patent and Trademark Office**

**Reg. No. 3,499,000**

**Registered Sep. 9, 2008**

**SERVICE MARK  
PRINCIPAL REGISTER**

**IN BUSINESS, IT'S SURVIVAL  
OF THE FASTEST.**

INSIGHT COMMUNICATIONS COMPANY, INC.  
(DELAWARE CORPORATION)  
810 SEVENTH AVENUE  
NEW YORK, NY 10019

FOR: TELECOMMUNICATION SERVICES, NAMELY, ELECTRONIC TRANSMISSION OF VOICE, DATA, VIDEO AND DIGITAL SIGNALS BY MEANS OF CABLE TELEVISION TRANSMISSIONS; TWO-WAY WIRELESS TRANSMISSION OF E-MAIL AND TEXT BETWEEN WIRELESS TELECOMMUNICATIONS TERMINALS AND COMPUTERS THROUGH CABLE TELEVISION; PROVIDING HIGH-SPEED ACCESS TO THE INTERNET AND PRIVATE AREA NETWORKS; PROVIDING ONLINE CHAT ROOMS AND NEWS GROUPS FOR TRANSMISSION OF MESSAGES AMONG COMPUTER USERS CONCERNING MATTERS OF GENERAL INTEREST; COMMUNICATIONS SER-

VICES, NAMELY, PROVIDING LOCAL AND LONG DISTANCE TELEPHONE SERVICES AND CALL MANAGEMENT SERVICES; AND TELEPHONE CALL MANAGEMENT SERVICES VIA THE INTERNET, NAMELY, WRITTEN AND VOICE MESSAGE NOTIFICATION, RECORDING, RETRIEVAL AND FORWARDING, IN CLASS 38 (U.S. CLS. 100, 101 AND 104).

FIRST USE 7-0-2007; IN COMMERCE 7-0-2007.

THE MARK CONSISTS OF STANDARD CHARACTERS WITHOUT CLAIM TO ANY PARTICULAR FONT, STYLE, SIZE, OR COLOR.

SER. NO. 77-412,721, FILED 3-4-2008.

ERIN FALK, EXAMINING ATTORNEY

**Int. Cl.: 1**

**Prior U.S. Cls.: 1, 5, 6, 10, 26 and 46**

**Reg. No. 3,499,001**

**United States Patent and Trademark Office**

**Registered Sep. 9, 2008**

**TRADEMARK  
PRINCIPAL REGISTER**

**PLUS-FIFTY**

ANSUL, INCORPORATED (DELAWARE CORPORATION)  
ONE STANTON STREET  
MARINETTE, WI 54143

FOR: DRY POWDERED CHEMICAL FIRE EXTINGUISHING COMPOSITIONS, IN CLASS 1 (U.S. CLS. 1, 5, 6, 10, 26 AND 46).

FIRST USE 9-23-1943; IN COMMERCE 9-23-1943.

THE MARK CONSISTS OF STANDARD CHARACTERS WITHOUT CLAIM TO ANY PARTICULAR FONT, STYLE, SIZE, OR COLOR.

OWNER OF U.S. REG. NOS. 409,942 AND 660,921.

SER. NO. 77-416,325, FILED 3-7-2008.

CHRISTOPHER BUONGIORNO, EXAMINING ATTORNEY

**Int. Cls.: 21, 25 and 28**

**Prior U.S. Cls.: 2, 13, 22, 23, 29, 30, 33, 38, 39, 40 and 50**

**United States Patent and Trademark Office**

**Reg. No. 3,499,002**

**Registered Sep. 9, 2008**

**TRADEMARK  
PRINCIPAL REGISTER**

**THE DEL**

HOTEL DEL PARTNERS, LP (DELAWARE LIMITED PARTNERSHIP)  
50-905 AVENIDA BERMUDAS  
LA QUINTA, CA 92253

FOR: MUGS, IN CLASS 21 (U.S. CLS. 2, 13, 23, 29, 30, 33, 40 AND 50).

FIRST USE 11-0-2002; IN COMMERCE 11-0-2002.

FOR: BATHROBES; HEADWEAR; SWEAT SHIRTS; T-SHIRTS, IN CLASS 25 (U.S. CLS. 22 AND 39).

FIRST USE 1-0-2001; IN COMMERCE 1-0-2001.

FOR: CHRISTMAS TREE ORNAMENTS, IN CLASS 28 (U.S. CLS. 22, 23, 38 AND 50).

FIRST USE 10-0-1995; IN COMMERCE 10-0-1995.

THE MARK CONSISTS OF STANDARD CHARACTERS WITHOUT CLAIM TO ANY PARTICULAR FONT, STYLE, SIZE, OR COLOR.

SER. NO. 77-416,693, FILED 3-7-2008.

STEVEN R. FINE, EXAMINING ATTORNEY

**Int. Cl.: 9**

**Prior U.S. Cls.: 21, 23, 26, 36 and 38**

**United States Patent and Trademark Office**

**Reg. No. 3,499,003**

**Registered Sep. 9, 2008**

**TRADEMARK  
PRINCIPAL REGISTER**

**SUPER SMASH BROS. BRAWL**

NINTENDO OF AMERICA INC. (WASHINGTON CORPORATION)  
4820 150TH AVENUE N.E.  
REDMOND, WA 98052

FOR: COMPACT DISCS AND OPTICAL DISCS FEATURING ENTERTAINMENT CONTENT, NAMELY, STORIES, MUSIC, AND GAMES; COMPUTER GAME DISCS; COMPUTER GAME PROGRAMS; COMPUTER GAME SOFTWARE; ELECTRONIC GAME DISCS; ELECTRONIC GAME PROGRAMS; ELECTRONIC GAME SOFTWARE; INTERACTIVE GAME DISCS; INTERACTIVE GAME PROGRAMS; INTERACTIVE GAME SOFTWARE; VIDEO GAME DISCS; VIDEO GAME PRO-

GRAMS; VIDEO GAME SOFTWARE, IN CLASS 9 (U.S. CLS. 21, 23, 26, 36 AND 38).

FIRST USE 3-9-2008; IN COMMERCE 3-9-2008.

THE MARK CONSISTS OF STANDARD CHARACTERS WITHOUT CLAIM TO ANY PARTICULAR FONT, STYLE, SIZE, OR COLOR.

OWNER OF U.S. REG. NOS. 2,578,692 AND 3,408,723.

SER. NO. 77-420,177, FILED 3-12-2008.

APRIL HESIK, EXAMINING ATTORNEY

**Int. Cl.: 30**

**Prior U.S. Cl.: 46**

**United States Patent and Trademark Office**

**Reg. No. 3,499,004**

**Registered Sep. 9, 2008**

**TRADEMARK  
PRINCIPAL REGISTER**

**REESTER BUNNIES**

HERSHEY CHOCOLATE & CONFECTIONERY  
CORPORATION (DELAWARE CORPORATION)

4860 ROBB STREET, SUITE 204  
WHEAT RIDGE, CO 80033

FOR: CANDY, IN CLASS 30 (U.S. CL. 46).

FIRST USE 11-14-2006; IN COMMERCE 11-14-2006.

THE MARK CONSISTS OF STANDARD CHARACTERS WITHOUT CLAIM TO ANY PARTICULAR FONT, STYLE, SIZE, OR COLOR.

OWNER OF U.S. REG. NO. 3,137,229.

SER. NO. 77-421,222, FILED 3-13-2008.

PAUL CROWLEY, EXAMINING ATTORNEY

**Int. Cl.: 35**

**Prior U.S. Cls.: 100, 101 and 102**

**United States Patent and Trademark Office**

**Reg. No. 3,499,005**

**Registered Sep. 9, 2008**

**SERVICE MARK  
PRINCIPAL REGISTER**

**KELLY-MOORE**

KELLY-MOORE PAINT COMPANY, INC. (CALIFORNIA CORPORATION)  
987 COMMERCIAL STREET  
SAN CARLOS, CA 94070

FOR: RETAIL PAINT STORE SERVICES; PROVIDING CONSUMER PRODUCT INFORMATION IN THE FIELDS OF PAINTS, COATINGS AND COLOR COORDINATION; PROMOTING PUBLIC AWARENESS OF GOVERNMENT REGULATIONS RELATING TO HEALTH, SAFETY AND THE ENVIRONMENT IN THE PAINT AND RELATED COATINGS INDUSTRY; RETAIL PAINT STORE SERVICES FEATURING PAINTS, COATINGS, PAINT SUPPLIES, PAINT-RELATED PRODUCTS, PAINT KITS, COLOR CARDS, PAINT BRUSHES, AND PRINTED MATERIALS TO AID ARTISTS, ARCHITECTS, AND CONSUMERS IN THE SELECTION AND COORDINATION OF COLORS; AND

PROVIDING ONLINE RETAIL STORE SERVICES FEATURING PAINTS, COATINGS, PAINT SUPPLIES AND PRINTED MATERIALS ABOUT PAINTS AND COLOR COORDINATION, IN CLASS 35 (U.S. CLS. 100, 101 AND 102).

FIRST USE 12-31-1946; IN COMMERCE 12-31-1946.

THE MARK CONSISTS OF STANDARD CHARACTERS WITHOUT CLAIM TO ANY PARTICULAR FONT, STYLE, SIZE, OR COLOR.

OWNER OF U.S. REG. NOS. 1,244,936, 3,213,486 AND OTHERS.

SER. NO. 77-421,257, FILED 3-13-2008.

HENRY S. ZAK, EXAMINING ATTORNEY

**Int. Cl.: 44**

**Prior U.S. Cls.: 100 and 101**

**United States Patent and Trademark Office**

**Reg. No. 3,499,006**

**Registered Sep. 9, 2008**

**SERVICE MARK  
PRINCIPAL REGISTER**

**WORLD-CLASS NURSING WITH A  
PERSONAL TOUCH**

ST. LUKE'S EPISCOPAL HEALTH SYSTEM  
(TEXAS NON-PROFIT CORPORATION)

6720 BERTNER

HOUSTON, TX 77030

FOR: NURSING CARE, IN CLASS 44 (U.S. CLS. 100  
AND 101).

FIRST USE 3-10-2008; IN COMMERCE 3-10-2008.

THE MARK CONSISTS OF STANDARD CHAR-  
ACTERS WITHOUT CLAIM TO ANY PARTICULAR  
FONT, STYLE, SIZE, OR COLOR.

NO CLAIM IS MADE TO THE EXCLUSIVE  
RIGHT TO USE "WORLD-CLASS NURSING",  
APART FROM THE MARK AS SHOWN.

SER. NO. 77-421,479, FILED 3-13-2008.

EMILY CHUO, EXAMINING ATTORNEY

**Int. Cl.: 14**

**Prior U.S. Cls.: 2, 27, 28 and 50**

**United States Patent and Trademark Office**

**Reg. No. 3,499,007**

**Registered Sep. 9, 2008**

**TRADEMARK  
PRINCIPAL REGISTER**

**THE USAA ADVANTAGE**

UNITED SERVICES AUTOMOBILE ASSOCIATION (TEXAS UNINCORPORATED RECIPROCAL INTERINSURANCE EXCHANGE)  
USAA BUILDING  
9800 FREDERICKSBURG ROAD  
SAN ANTONIO, TX 78288

FOR: JEWELRY, IN CLASS 14 (U.S. CLS. 2, 27, 28 AND 50).

FIRST USE 8-1-2006; IN COMMERCE 8-1-2006.

THE MARK CONSISTS OF STANDARD CHARACTERS WITHOUT CLAIM TO ANY PARTICULAR FONT, STYLE, SIZE, OR COLOR.

SER. NO. 77-422,694, FILED 3-14-2008.

JAMES A. RAUEN, EXAMINING ATTORNEY



**Int. Cl.: 7**

**Prior U.S. Cls.: 13, 19, 21, 23, 31, 34 and 35**

**Reg. No. 3,499,008**

**United States Patent and Trademark Office**

**Registered Sep. 9, 2008**

---

**TRADEMARK  
PRINCIPAL REGISTER**

**Neutec USA**

THE BELL GROUP (NEW MEXICO CORPORATION), DBA RIO GRANDE  
7500 BLUEWATER RD NW  
ALBUQUERQUE, NM 87121

FOR: CASTING MACHINES; LASER WELDING MACHINES, IN CLASS 7 (U.S. CLS. 13, 19, 21, 23, 31, 34 AND 35).

FIRST USE 1-19-1992; IN COMMERCE 1-19-1992.

THE MARK CONSISTS OF STANDARD CHARACTERS WITHOUT CLAIM TO ANY PARTICULAR FONT, STYLE, SIZE, OR COLOR.

NO CLAIM IS MADE TO THE EXCLUSIVE RIGHT TO USE "USA", APART FROM THE MARK AS SHOWN.

SER. NO. 77-424,163, FILED 3-17-2008.

DAVID COLLIER, EXAMINING ATTORNEY

**Int. Cl.: 9**

**Prior U.S. Cls.: 21, 23, 26, 36 and 38**

**Reg. No. 3,499,009**

**United States Patent and Trademark Office**

**Registered Sep. 9, 2008**

**TRADEMARK  
PRINCIPAL REGISTER**

**FASTLANE**

BOSTON RETAIL PRODUCTS, INC. (MASSACHUSETTS CORPORATION)  
400 RIVERSIDE AVENUE  
MEDFORD, MA 02155

FOR: WIRING SYSTEM COMPRISING DISTRIBUTION BOXES, DATA AND OUTLET BOXES AND MODULAR EXTENDER CABLES FOR POWER AND DATA DISTRIBUTION FOR USE IN RETAIL ESTABLISHMENTS, IN CLASS 9 (U.S. CLS. 21, 23, 26, 36 AND 38).

FIRST USE 0-0-1999; IN COMMERCE 0-0-1999.

THE MARK CONSISTS OF STANDARD CHARACTERS WITHOUT CLAIM TO ANY PARTICULAR FONT, STYLE, SIZE, OR COLOR.

OWNER OF U.S. REG. NO. 2,681,567.

SER. NO. 77-424,702, FILED 3-18-2008.

MARIA-VICTORIA SUAREZ, EXAMINING ATTORNEY

**Int. Cl.: 43**

**Prior U.S. Cls.: 100 and 101**

**United States Patent and Trademark Office**

**Reg. No. 3,499,010**

**Registered Sep. 9, 2008**

**SERVICE MARK  
PRINCIPAL REGISTER**

**KIL@WAT**

THE MARCUS CORPORATION (WISCONSIN  
CORPORATION)  
100 EAST WISCONSIN AVENUE, SUITE 1900  
MILWAUKEE, WI 53202

FOR: RESTAURANT SERVICES, IN CLASS 43  
(U.S. CLS. 100 AND 101).

FIRST USE 10-9-2006; IN COMMERCE 10-9-2006.

THE MARK CONSISTS OF STANDARD CHAR-  
ACTERS WITHOUT CLAIM TO ANY PARTICULAR  
FONT, STYLE, SIZE, OR COLOR.

SER. NO. 77-424,759, FILED 3-18-2008.

KATHERINE CONNOLLY, EXAMINING ATTOR-  
NEY

**Int. Cl.: 32**

**Prior U.S. Cls.: 45, 46 and 48**

**United States Patent and Trademark Office**

**Reg. No. 3,499,011**

**Registered Sep. 9, 2008**

**TRADEMARK  
PRINCIPAL REGISTER**



R.J. ROCKERS, INC. (SOUTH CAROLINA CORPORATION)  
113D BELTON DRIVE  
SPARTANBURG, SC 29301

THE MARK CONSISTS OF THE LETTERS "RJR" AND A CIRCLE.

FOR: BEER, IN CLASS 32 (U.S. CLS. 45, 46 AND 48).

SER. NO. 77-424,856, FILED 3-18-2008.

FIRST USE 3-4-2008; IN COMMERCE 3-4-2008.

BILL DAWE, EXAMINING ATTORNEY

**Int. Cl.: 9**

**Prior U.S. Cls.: 21, 23, 26, 36 and 38**

**Reg. No. 3,499,012**

**United States Patent and Trademark Office**

**Registered Sep. 9, 2008**

---

**TRADEMARK  
PRINCIPAL REGISTER**

**RIDGELOC**

DS ENGINEERING, LLC (DELAWARE LIMITED  
LIABILITY COMPANY)  
3901 PROGRESS STREET  
NORTH LITTLE ROCK, AR 72114

THE MARK CONSISTS OF STANDARD CHAR-  
ACTERS WITHOUT CLAIM TO ANY PARTICULAR  
FONT, STYLE, SIZE, OR COLOR.

FOR: CABLE CONNECTORS, IN CLASS 9 (U.S.  
CLS. 21, 23, 26, 36 AND 38).

SER. NO. 77-426,308, FILED 3-19-2008.

FIRST USE 1-10-2008; IN COMMERCE 1-10-2008.

MICHAEL KAZAZIAN, EXAMINING ATTORNEY

**Int. Cl.: 3**

**Prior U.S. Cls.: 1, 4, 6, 50, 51 and 52**

**Reg. No. 3,499,013**

**United States Patent and Trademark Office**

**Registered Sep. 9, 2008**

---

**TRADEMARK  
PRINCIPAL REGISTER**

**Lipify**

JPR&L ESSENTIALS, LLC (ARIZONA LIMITED  
LIABILITY COMPANY)  
SUITE 295  
14850 NORTH SCOTTSDALE RD  
SCOTTSDALE, AZ 85254

THE MARK CONSISTS OF STANDARD CHAR-  
ACTERS WITHOUT CLAIM TO ANY PARTICULAR  
FONT, STYLE, SIZE, OR COLOR.

FOR: LIP GLOSS, IN CLASS 3 (U.S. CLS. 1, 4, 6, 50,  
51 AND 52).

SER. NO. 77-429,251, FILED 3-24-2008.

FIRST USE 1-20-2008; IN COMMERCE 1-20-2008.

DARRYL SPRUILL, EXAMINING ATTORNEY

**Int. Cl.: 9**

**Prior U.S. Cls.: 21, 23, 26, 36 and 38**

**Reg. No. 3,499,014**

**United States Patent and Trademark Office**

**Registered Sep. 9, 2008**

**TRADEMARK  
PRINCIPAL REGISTER**

**miGATE**

ICONCONTROL, INC. (CALIFORNIA CORPORATION)  
PO BOX 3548  
SANTA CRUZ, CA 95063

FOR: AUTOMATED SYSTEMS, NAMELY, SOFTWARE, HARDWARE AND COMMUNICATIONS DEVICES FOR PLANNING, SCHEDULING, CONTROLLING, MONITORING AND PROVIDING INFORMATION ON TRANSPORTATION ASSETS AND PARTS THEREOF; COMPUTER HARDWARE AND SOFTWARE SYSTEM FOR TRACKING PEOPLE, OBJECTS AND PETS USING GPS DATA ON A DEVICE ON THE TRACKED PEOPLE, OBJECTS AND PETS; GLOBAL POSITIONING SYSTEM (GPS) CONSISTING OF COMPUTERS, COMPUTER SOFTWARE, TRANSMITTERS, RECEIVERS, AND NETWORK INTERFACE DEVICES; MOBILE

COMPUTING AND OPERATING PLATFORMS CONSISTING OF DATA TRANSCEIVERS, WIRELESS NETWORKS AND GATEWAYS FOR COLLECTION AND MANAGEMENT OF DATA, IN CLASS 9 (U.S. CLS. 21, 23, 26, 36 AND 38).

FIRST USE 8-31-2007; IN COMMERCE 8-31-2007.

THE MARK CONSISTS OF STANDARD CHARACTERS WITHOUT CLAIM TO ANY PARTICULAR FONT, STYLE, SIZE, OR COLOR.

SER. NO. 77-430,879, FILED 3-25-2008.

VIVIAN MICZNIK FIRST, EXAMINING ATTORNEY

**Int. Cl.: 28**

**Prior U.S. Cls.: 22, 23, 38 and 50**

**United States Patent and Trademark Office**

**Reg. No. 3,499,015**

**Registered Sep. 9, 2008**

**TRADEMARK  
PRINCIPAL REGISTER**

**MAGIC GRIP**

MUELLER SPORTS MEDICINE, INC. (WISCONSIN CORPORATION)  
ONE QUENCH DRIVE, P.O. BOX 99  
PRAIRIE DU SAC, WI 53578

FOR: SPRAY APPLIED TO HANDS OR GLOVES FOR IMPROVING GRIP IN SPORTS ACTIVITIES, IN CLASS 28 (U.S. CLS. 22, 23, 38 AND 50).

FIRST USE 1-1-1993; IN COMMERCE 1-1-1993.

THE MARK CONSISTS OF STANDARD CHARACTERS WITHOUT CLAIM TO ANY PARTICULAR FONT, STYLE, SIZE, OR COLOR.

NO CLAIM IS MADE TO THE EXCLUSIVE RIGHT TO USE "GRIP", APART FROM THE MARK AS SHOWN.

SER. NO. 77-430,984, FILED 3-25-2008.

JEFF DEFORD, EXAMINING ATTORNEY



**Int. Cl.: 41**

**Prior U.S. Cls.: 100, 101 and 107**

**United States Patent and Trademark Office**

**Reg. No. 3,499,016**

**Registered Sep. 9, 2008**

**SERVICE MARK  
PRINCIPAL REGISTER**

**The Little Lighthouse That  
Could**

ROSE ISLAND LIGHTHOUSE FOUNDATION  
(RHODE ISLAND CORPORATION)  
PO BOX 1419  
NEWPORT, RI 02840

FOR: EDUCATION SERVICES, NAMELY, PROVIDING LIVE HAND-ON DEMONSTRATIONS ACTIVITIES CLASSES IN THE FIELDS OF ENVIRONMENTAL CONCERNS AND CONSERVATION, IN CLASS 41 (U.S. CLS. 100, 101 AND 107).

FIRST USE 6-30-2004; IN COMMERCE 6-30-2004.

THE MARK CONSISTS OF STANDARD CHARACTERS WITHOUT CLAIM TO ANY PARTICULAR FONT, STYLE, SIZE, OR COLOR.

SER. NO. 77-431,126, FILED 3-25-2008.

SANDRA MANIOS, EXAMINING ATTORNEY

**Int. Cls.: 29 and 30**

**Prior U.S. Cl.: 46**

**United States Patent and Trademark Office**

**Reg. No. 3,499,017**

**Registered Sep. 9, 2008**

**TRADEMARK  
PRINCIPAL REGISTER**

**EXTRA EFFORT BOUQUET**

EDIBLE ARRANGEMENTS, LLC (CONNECTI-  
CUT LIMITED LIABILITY COMPANY)  
95 BARNES ROAD  
WALLINGFORD, CT 064921800

FOR: FRESH FRUIT CUT INTO FLOWER  
SHAPES AND ARRANGED IN CONTAINERS AS  
FLORAL DESIGNS; PROCESSED FRUITS; AR-  
RANGEMENTS MADE OF PROCESSED FRUITS,  
IN CLASS 29 (U.S. CL. 46).

FIRST USE 12-31-2007; IN COMMERCE 2-29-2008.

FOR: FRESH FRUIT CUT INTO FLOWER  
SHAPES AND COATED WITH CHOCOLATE;  
FRESH FRUIT CUT INTO FLOWER SHAPES AND  
COATED WITH CHOCOLATE AND ARRANGED IN  
CONTAINERS AS FLORAL DESIGNS; PROCESSED  
FRUITS COATED WITH CHOCOLATE; ARRANGE-

MENTS MADE OF FRESH PROCESSED FRUIT  
COATED WITH CHOCOLATE, IN CLASS 30 (U.S.  
CL. 46).

FIRST USE 12-31-2007; IN COMMERCE 2-29-2008.

THE MARK CONSISTS OF STANDARD CHAR-  
ACTERS WITHOUT CLAIM TO ANY PARTICULAR  
FONT, STYLE, SIZE, OR COLOR.

NO CLAIM IS MADE TO THE EXCLUSIVE  
RIGHT TO USE "BOUQUET", APART FROM THE  
MARK AS SHOWN.

SER. NO. 77-431,194, FILED 3-25-2008.

JEAN IM, EXAMINING ATTORNEY

**Int. Cl.: 10**

**Prior U.S. Cls.: 26, 39 and 44**

**United States Patent and Trademark Office**

**Reg. No. 3,499,018**

**Registered Sep. 9, 2008**

**TRADEMARK  
PRINCIPAL REGISTER**

**HOME C.A.R.E.**

ENCOMPASS GROUP, LLC (DELAWARE LIMITED LIABILITY COMPANY), DBA ALBA-HEALTH LLC  
615 MACON ROAD  
MCDONOUGH, GA 30253

FOR: MEDICAL COMPRESSION STOCKINGS AND TIGHTS, IN CLASS 10 (U.S. CLS. 26, 39 AND 44).

FIRST USE 2-25-2008; IN COMMERCE 2-25-2008.

THE MARK CONSISTS OF STANDARD CHARACTERS WITHOUT CLAIM TO ANY PARTICULAR FONT, STYLE, SIZE, OR COLOR.

OWNER OF U.S. REG. NO. 3,289,832.

SER. NO. 77-431,579, FILED 3-26-2008.

KEVIN CORWIN, EXAMINING ATTORNEY

**Int. Cl.: 29**

**Prior U.S. Cl.: 46**

**United States Patent and Trademark Office**

**Reg. No. 3,499,019**

**Registered Sep. 9, 2008**

**TRADEMARK  
PRINCIPAL REGISTER**

**THE BERRY IMPRESSIVE  
MEETING**

EDIBLE ARRANGEMENTS, LLC (CONNECTI-  
CUT LIMITED LIABILITY COMPANY)  
95 BARNES ROAD  
WALLINGFORD, CT 064921800

FOR: FRESH FRUIT CUT INTO FLOWER  
SHAPES AND ARRANGED IN CONTAINERS AS  
FLORAL DESIGNS; PROCESSED FRUITS; AR-  
RANGEMENTS MADE OF PROCESSED FRUITS,  
IN CLASS 29 (U.S. CL. 46).

FIRST USE 12-31-2007; IN COMMERCE 2-29-2008.

THE MARK CONSISTS OF STANDARD CHAR-  
ACTERS WITHOUT CLAIM TO ANY PARTICULAR  
FONT, STYLE, SIZE, OR COLOR.

SER. NO. 77-432,416, FILED 3-26-2008.

JEAN IM, EXAMINING ATTORNEY

**Int. Cl.: 4**

**Prior U.S. Cls.: 1, 6 and 15**

**United States Patent and Trademark Office**

**Reg. No. 3,499,020**

**Registered Sep. 9, 2008**

**TRADEMARK  
PRINCIPAL REGISTER**

**bur-life**

THE BELL GROUP (NEW MEXICO CORPORATION), DBA RIO GRANDE  
7500 BLUEWATER RD NW  
ALBUQUERQUE, NM 87121

THE MARK CONSISTS OF STANDARD CHARACTERS WITHOUT CLAIM TO ANY PARTICULAR FONT, STYLE, SIZE, OR COLOR.

FOR: LUBRICANTS FOR INDUSTRIAL MACHINERY, IN CLASS 4 (U.S. CLS. 1, 6 AND 15).

SER. NO. 77-432,440, FILED 3-26-2008.

FIRST USE 2-1-1983; IN COMMERCE 2-1-1983.

DAVID COLLIER, EXAMINING ATTORNEY

**Int. Cl.: 25**

**Prior U.S. Cls.: 22 and 39**

**United States Patent and Trademark Office**

**Reg. No. 3,499,021**

**Registered Sep. 9, 2008**

**TRADEMARK  
PRINCIPAL REGISTER**

**Big D**

MAGIC HEADWEAR, INC. (CALIFORNIA CORPORATION)  
1100 W. WALNUT ST.  
COMPTON, CA 90220

THE MARK CONSISTS OF STANDARD CHARACTERS WITHOUT CLAIM TO ANY PARTICULAR FONT, STYLE, SIZE, OR COLOR.

FOR: TOPS; SPORT SHIRTS; T-SHIRTS; PANTS,  
IN CLASS 25 (U.S. CLS. 22 AND 39).

SER. NO. 77-432,603, FILED 3-26-2008.

FIRST USE 1-1-2007; IN COMMERCE 1-1-2007.

JILL PRATER, EXAMINING ATTORNEY

**Int. Cl.: 36**

**Prior U.S. Cls.: 100, 101 and 102**

**United States Patent and Trademark Office**

**Reg. No. 3,499,022**

**Registered Sep. 9, 2008**

**SERVICE MARK  
PRINCIPAL REGISTER**



FORTRESS INVESTMENT GROUP LLC (DELA-  
WARE LIMITED LIABILITY COMPANY)  
1345 AVENUE OF THE AMERICAS  
NEW YORK, NY 10105

FOR: FINANCIAL SERVICES AND INVESTMENT  
SERVICES, NAMELY, INVESTMENT MANAGE-  
MENT SERVICES AND ASSET MANAGEMENT  
SERVICES; FINANCIAL INVESTMENT SERVICES  
IN THE FIELD OF REAL ESTATE, NAMELY, REAL  
ESTATE ASSET ACQUISITION, DEVELOPMENT  
AND MANAGEMENT SERVICES, IN CLASS 36  
(U.S. CLS. 100, 101 AND 102).

FIRST USE 8-31-2003; IN COMMERCE 8-31-2003.

THE MARK CONSISTS OF TWO CIRCLES EN-  
CLOSING A CASTLE TYPE DESIGN WITH THE  
LETTER "E" SUPERIMPOSED ON SAME.

SER. NO. 77-433,290, FILED 3-27-2008.

BRIDGETT SMITH, EXAMINING ATTORNEY

**Int. Cl.: 35**

**Prior U.S. Cls.: 100, 101 and 102**

**United States Patent and Trademark Office**

**Reg. No. 3,499,023**

**Registered Sep. 9, 2008**

**SERVICE MARK  
PRINCIPAL REGISTER**

**PYXWORLD**

PYXIX CORPORATION (DELAWARE CORPORATION)  
WARNER CENTER  
6303 OWENSMOUTH AVENUE, 10TH FLOOR  
WOODLAND HILLS, CA 913672263

FOR: ONLINE BUSINESS NETWORKING IN THE  
FIELD OF ENTERTAINMENT; BUSINESS NET-  
WORKING, IN CLASS 35 (U.S. CLS. 100, 101 AND  
102).

FIRST USE 1-27-2008; IN COMMERCE 3-5-2008.

THE MARK CONSISTS OF STANDARD CHAR-  
ACTERS WITHOUT CLAIM TO ANY PARTICULAR  
FONT, STYLE, SIZE, OR COLOR.

OWNER OF U.S. REG. NO. 3,376,543.

SER. NO. 77-433,681, FILED 3-27-2008.

FRED MANDIR, EXAMINING ATTORNEY



**Int. Cl.: 41**

**Prior U.S. Cls.: 100, 101 and 107**

**United States Patent and Trademark Office**

**Reg. No. 3,499,024**

**Registered Sep. 9, 2008**

**SERVICE MARK  
PRINCIPAL REGISTER**

**PYXWORLD**

PYXIX CORPORATION (DELAWARE CORPORATION)  
WARNER CENTER  
6303 OWENSMOUTH AVENUE, 10TH FLOOR  
WOODLAND HILLS, CA 913672263

FOR: ENTERTAINMENT SERVICES, NAMELY, CONDUCTING CONTESTS; EDUCATION SERVICES, NAMELY, PROVIDING ON-LINE SEMINARS, WORKSHOPS AND INSTRUCTION IN THE FIELD OF MUSIC AND ENTERTAINMENT; ENTERTAINMENT SERVICES, NAMELY, ARRANGING AND CONDUCTING OF COMPETITIONS IN THE FIELD OF MOTION PICTURE FILMS, COMEDY, MUSIC, DOCUMENTARY AND ANIMATED FILMS; PROVIDING RECOGNITION AND INCENTIVES BY THE WAY OF AWARDS AND CONTESTS TO DEMONSTRATE EXCELLENCE IN THE FIELD OF ENTERTAINMENT; EDUCATION AND ENTERTAINMENT SERVICES, NAMELY, PROVIDING INFORMATION IN THE FIELD OF MUSIC, COMEDY AND MOTION PICTURE FILM NETWORKING, ALL ON-LINE VIA A GLOBAL COMPUTER NET-

WORK; PROVIDING RECOGNITION AND INCENTIVES BY THE WAY OF AWARDS AND CONTESTS TO DEMONSTRATE EXCELLENCE IN THE FIELDS OF MOTION PICTURE FILMS, COMEDY, MUSIC, DOCUMENTARY AND ANIMATED FILMS; ENTERTAINMENT SERVICES, NAMELY, CONDUCTING SOCIAL EVENTS IN CONNECTION WITH THE MOTION PICTURE FILMS, COMEDY, MUSIC, DOCUMENTARY AND ANIMATED FILM INDUSTRIES, IN CLASS 41 (U.S. CLS. 100, 101 AND 107).

FIRST USE 1-27-2008; IN COMMERCE 3-5-2008.

THE MARK CONSISTS OF STANDARD CHARACTERS WITHOUT CLAIM TO ANY PARTICULAR FONT, STYLE, SIZE, OR COLOR.

OWNER OF U.S. REG. NO. 3,376,543.

SER. NO. 77-433,684, FILED 3-27-2008.

FRED MANDIR, EXAMINING ATTORNEY

**Int. Cl.: 25**

**Prior U.S. Cls.: 22 and 39**

**United States Patent and Trademark Office**

**Reg. No. 3,499,025**

**Registered Sep. 9, 2008**

**TRADEMARK  
PRINCIPAL REGISTER**



DAVIES, RICHARD D. (UNITED KINGDOM IN-  
DIVIDUAL)  
58111 MAIN ST.  
PLAQUEMINE, LA 70764

WEAR, GLOVES, SOCKS, HOSIERY, BELTS,  
SCARVES, HATS, TIES, SLIPPERS, IN CLASS 25  
(U.S. CLS. 22 AND 39).

FIRST USE 1-24-2008; IN COMMERCE 2-29-2008.

SER. NO. 77-433,796, FILED 3-27-2008.

FOR: CLOTHING, NAMELY, PANTS, SHORTS,  
SWEATPANTS, OVERALLS, SHIRTS, TEE-SHIRTS,  
SWEATSHIRTS, BLOUSES, SKIRTS, DRESSES,  
JACKETS, VESTS, COATS, RAINWEAR, SHOES,  
LINGERIE, SLEEPWEAR, LOUNGEWEAR, SWIM-

TARAH HARDY, EXAMINING ATTORNEY

**Int. Cl.: 9**

**Prior U.S. Cls.: 21, 23, 26, 36 and 38**

**Reg. No. 3,499,026**

**United States Patent and Trademark Office**

**Registered Sep. 9, 2008**

**TRADEMARK  
PRINCIPAL REGISTER**

**SPEC JMS**

STANDARD PERFORMANCE EVALUATION  
CORPORATION (CALIFORNIA MUTUAL  
BENEFIT NON-PROFIT CORPORATION),  
AKA SPEC

6585 MERCHANT PLACE, STE 100  
WARRENTON, VA 20187

FOR: COMPUTER PROGRAMS FOR USE IN  
MEASURING PERFORMANCE OF COMPUTERS  
AND COMPUTER OPERATING SYSTEMS , IN  
CLASS 9 (U.S. CLS. 21, 23, 26, 36 AND 38).

FIRST USE 11-28-2007; IN COMMERCE 11-28-2007.

THE MARK CONSISTS OF STANDARD CHAR-  
ACTERS WITHOUT CLAIM TO ANY PARTICULAR  
FONT, STYLE, SIZE, OR COLOR.

OWNER OF U.S. REG. NOS. 1,845,459, 3,302,382  
AND OTHERS.

NO CLAIM IS MADE TO THE EXCLUSIVE  
RIGHT TO USE "JMS", APART FROM THE MARK  
AS SHOWN.

SER. NO. 77-435,031, FILED 3-29-2008.

BRIAN CALLAGHAN, EXAMINING ATTORNEY

**Int. Cl.: 9**

**Prior U.S. Cls.: 21, 23, 26, 36 and 38**

**Reg. No. 3,499,027**

**United States Patent and Trademark Office**

**Registered Sep. 9, 2008**

**TRADEMARK  
PRINCIPAL REGISTER**

**SPEC POWER**

STANDARD PERFORMANCE EVALUATION  
CORPORATION (CALIFORNIA MUTUAL  
BENEFIT NON-PROFIT CORPORATION),  
AKA SPEC

6585 MERCHANT PLACE, STE 100  
WARRENTON, VA 20187

FOR: COMPUTER PROGRAMS FOR USE IN  
MEASURING PERFORMANCE OF COMPUTERS  
AND COMPUTER OPERATING SYSTEMS , IN  
CLASS 9 (U.S. CLS. 21, 23, 26, 36 AND 38).

FIRST USE 12-13-2007; IN COMMERCE 12-13-2007.

THE MARK CONSISTS OF STANDARD CHAR-  
ACTERS WITHOUT CLAIM TO ANY PARTICULAR  
FONT, STYLE, SIZE, OR COLOR.

OWNER OF U.S. REG. NOS. 1,845,459, 3,302,382  
AND OTHERS.

NO CLAIM IS MADE TO THE EXCLUSIVE  
RIGHT TO USE "POWER", APART FROM THE  
MARK AS SHOWN.

SER. NO. 77-435,048, FILED 3-29-2008.

BRIAN CALLAGHAN, EXAMINING ATTORNEY

**Int. Cl.: 35**

**Prior U.S. Cls.: 100, 101 and 102**

**United States Patent and Trademark Office**

**Reg. No. 3,499,028**

**Registered Sep. 9, 2008**

**SERVICE MARK  
PRINCIPAL REGISTER**

**ESCOSUPPLY**

ESCO CORPORATION (OREGON CORPORATION)  
2141 NW 25TH AVENUE, P.O. BOX 10123  
PORTLAND, OR 97210

FOR: RETAIL STORE SERVICES FEATURING  
MACHINERY, EQUIPMENT AND ACCESSORIES  
FOR THE MINING, CONSTRUCTION, AGGREGATE  
AND RECYCLING INDUSTRIES, IN CLASS  
35 (U.S. CLS. 100, 101 AND 102).

FIRST USE 2-6-2007; IN COMMERCE 2-6-2007.

THE MARK CONSISTS OF STANDARD CHARACTERS  
WITHOUT CLAIM TO ANY PARTICULAR  
FONT, STYLE, SIZE, OR COLOR.

OWNER OF U.S. REG. NOS. 530,350, 1,606,640 AND  
OTHERS.

SER. NO. 77-436,080, FILED 3-31-2008.

EMILY CHUO, EXAMINING ATTORNEY

**Int. Cl.: 10**

**Prior U.S. Cls.: 26, 39 and 44**

**United States Patent and Trademark Office**

**Reg. No. 3,499,029**

**Registered Sep. 9, 2008**

**TRADEMARK  
PRINCIPAL REGISTER**

**OPTIM**

PACESETTER, INC. (DELAWARE CORPORATION), DBA ST. JUDE MEDICAL CARDIAC RHYTHM MANAGEMENT DIVISION  
15900 VALLEY VIEW COURT  
SYLMAR, CA 91342

FOR: IMPLANTABLE CARDIAC STIMULATION LEAD, IN CLASS 10 (U.S. CLS. 26, 39 AND 44).

FIRST USE 8-1-2006; IN COMMERCE 8-1-2006.

THE MARK CONSISTS OF STANDARD CHARACTERS WITHOUT CLAIM TO ANY PARTICULAR FONT, STYLE, SIZE, OR COLOR.

OWNER OF U.S. REG. NO. 3,231,618.

SER. NO. 77-436,089, FILED 3-31-2008.

AMY GEARIN, EXAMINING ATTORNEY

**Int. Cl.: 9**

**Prior U.S. Cls.: 21, 23, 26, 36 and 38**

**Reg. No. 3,499,030**

**United States Patent and Trademark Office**

**Registered Sep. 9, 2008**

---

**TRADEMARK  
PRINCIPAL REGISTER**

**ULTRA CLEARCOAT**

NIKON CORPORATION (JAPAN CORPORATION)  
2-3, MARUNOUCHI 3-CHOME, CHIYODA-KU  
TOKYO, JAPAN 100

FOR: LENS COATING SOLD AS A COMPONENT  
OF RIFLE SCOPES, IN CLASS 9 (U.S. CLS. 21, 23, 26,  
36 AND 38).

FIRST USE 4-29-1996; IN COMMERCE 4-29-1996.

THE MARK CONSISTS OF STANDARD CHARACTERS WITHOUT CLAIM TO ANY PARTICULAR FONT, STYLE, SIZE, OR COLOR.

NO CLAIM IS MADE TO THE EXCLUSIVE RIGHT TO USE "CLEAR COAT", APART FROM THE MARK AS SHOWN.

SER. NO. 77-436,971, FILED 4-1-2008.

KRISTINA MORRIS, EXAMINING ATTORNEY

**Int. Cl.: 9**

**Prior U.S. Cls.: 21, 23, 26, 36 and 38**

**Reg. No. 3,499,031**

**United States Patent and Trademark Office**

**Registered Sep. 9, 2008**

**TRADEMARK  
PRINCIPAL REGISTER**

**TURBOTUNE**

DIRECTV, INC. (CALIFORNIA CORPORATION)  
2230 EAST IMPERIAL HIGHWAY  
EL SEGUNDO, CA 90245

FIRST USE 12-0-1997; IN COMMERCE 12-0-1997.

FOR: DIRECT-TO-HOME SATELLITE BROADCASTING AND RECEIVING EQUIPMENT, NAMELY, SET-TOP BOXES AND REMOTE CONTROLLERS FEATURING COMPUTER SOFTWARE WHICH ALLOWS THE CONSUMER TO ACCESS THEIR FAVORITE CHANNELS WHILE VIEWING ANOTHER PROGRAM AND INSTRUCTION MANUALS SOLD AS A UNIT, IN CLASS 9 (U.S. CLS. 21, 23, 26, 36 AND 38).

THE MARK CONSISTS OF STANDARD CHARACTERS WITHOUT CLAIM TO ANY PARTICULAR FONT, STYLE, SIZE, OR COLOR.

OWNER OF U.S. REG. NO. 2,436,804.

SER. NO. 77-439,588, FILED 4-3-2008.

RUSS HERMAN, EXAMINING ATTORNEY



**Int. Cl.: 41**

**Prior U.S. Cls.: 100, 101 and 107**

**United States Patent and Trademark Office**

**Reg. No. 3,499,032**

**Registered Sep. 9, 2008**

**SERVICE MARK  
PRINCIPAL REGISTER**

**OC**

MCCULLOUGH, PRESLEY L (UNITED STATES INDIVIDUAL)  
63 W. HUDSON AVE.  
ENGLEWOOD, NJ 07631

FOR: COUNSELING SERVICES IN THE FIELD PHYSICAL FITNESS; PHYSICAL FITNESS CONDITIONING CLASSES; PHYSICAL FITNESS CONSULTATION; PHYSICAL FITNESS INSTRUCTION; PHYSICAL FITNESS TRAINING SERVICES; PROVIDING A WEB SITE FEATURING INFORMATION ON EXERCISE AND FITNESS; PROVIDING ASSISTANCE, PERSONAL TRAINING AND PHYSICAL FITNESS CONSULTATION TO CORPORATE CLIENTS TO HELP THEIR EMPLOYEES MAKE PHYSICAL FITNESS, STRENGTH, CONDITIONING, AND EXERCISE ALTERATIONS IN THEIR DAILY LIVING; PROVIDING ASSISTANCE, PERSONAL TRAINING AND PHYSICAL FITNESS CONSULTATION TO INDIVIDUALS TO HELP THEM MAKE PHYSICAL FITNESS, STRENGTH, CONDITION-

ING, AND EXERCISE IMPROVEMENT IN THEIR DAILY LIVING; PROVIDING FITNESS AND EXERCISE FACILITIES; PERSONAL TRAINING SERVICES, NAMELY, STRENGTH AND CONDITIONING TRAINING; PROVIDING AN ON-LINE COMPUTER DATABASE FEATURING INFORMATION REGARDING EXERCISE AND FITNESS; PROVIDING INFORMATION IN THE FIELD OF EXERCISE TRAINING, IN CLASS 41 (U.S. CLS. 100, 101 AND 107).

FIRST USE 1-7-2008; IN COMMERCE 1-14-2008.

THE MARK CONSISTS OF STANDARD CHARACTERS WITHOUT CLAIM TO ANY PARTICULAR FONT, STYLE, SIZE, OR COLOR.

SER. NO. 77-441,162, FILED 4-7-2008.

TAMARA FRAZIER, EXAMINING ATTORNEY

**Int. Cl.: 21**

**Prior U.S. Cls.: 2, 13, 23, 29, 30, 33, 40 and 50**

**Reg. No. 3,499,033**

**United States Patent and Trademark Office**

**Registered Sep. 9, 2008**

**TRADEMARK  
PRINCIPAL REGISTER**

**SUNSHINE**

BELL GROUP, THE (NEW MEXICO CORPORATION), DBA RIO GRANDE  
7500 BLUEWATER RD NW  
ALBUQUERQUE, NM 87121

THE MARK CONSISTS OF STANDARD CHARACTERS WITHOUT CLAIM TO ANY PARTICULAR FONT, STYLE, SIZE, OR COLOR.

FOR: CLEANING AND POLISHING CLOTHS, IN CLASS 21 (U.S. CLS. 2, 13, 23, 29, 30, 33, 40 AND 50).

SER. NO. 77-443,787, FILED 4-9-2008.

FIRST USE 4-1-1983; IN COMMERCE 4-1-1983.

DAVID COLLIER, EXAMINING ATTORNEY

**Int. Cl.: 35**

**Prior U.S. Cls.: 100, 101 and 102**

**United States Patent and Trademark Office**

**Reg. No. 3,499,034**

**Registered Sep. 9, 2008**

**SERVICE MARK  
PRINCIPAL REGISTER**



VOLCOM, INC. (DELAWARE CORPORATION)  
1740 MONROVIA AVENUE  
COSTA MESA, CA 92627

OWNER OF U.S. REG. NOS. 1,725,875, 2,534,210,  
AND 2,797,305.

FOR: PROVIDING ONLINE AND RETAIL STORE  
SERVICES FEATURING CLOTHING, HEADWEAR,  
FOOTWEAR, SWIMWEAR AND RELATED ACCES-  
SORIES, SUNGLASSES, SPORTS BAGS, BACK-  
PACKS, PURSES, WALLETS, AND MUSIC , IN  
CLASS 35 (U.S. CLS. 100, 101 AND 102).

THE MARK CONSISTS OF THE WORD "VOL-  
COM" PLACED AGAINST A DARK IRREGULARLY  
SHAPED BACKGROUND.

SER. NO. 77-445,124, FILED 4-10-2008.

FIRST USE 11-15-2002; IN COMMERCE 11-15-2002.

BENJAMIN ALLEN, EXAMINING ATTORNEY

**Int. Cl.: 36**

**Prior U.S. Cls.: 100, 101 and 102**

**United States Patent and Trademark Office**

**Reg. No. 3,499,035**

**Registered Sep. 9, 2008**

**SERVICE MARK  
PRINCIPAL REGISTER**

**BIZ BASH**

COBIZ, INC. (COLORADO CORPORATION)  
821 17TH ST.  
DENVER, CO 80202

THE MARK CONSISTS OF STANDARD CHAR-  
ACTERS WITHOUT CLAIM TO ANY PARTICULAR  
FONT, STYLE, SIZE, OR COLOR.

FOR: CHARITABLE FUND RAISING SERVICES  
BY MEANS OF MUSICAL CONCERTS; CHARITA-  
BLE FUNDRAISING SERVICES, IN CLASS 36 (U.S.  
CLS. 100, 101 AND 102).

SER. NO. 77-445,749, FILED 4-11-2008.

FIRST USE 1-1-2001; IN COMMERCE 1-1-2001.

CHERYL CLAYTON, EXAMINING ATTORNEY

**Int. Cl.: 35**

**Prior U.S. Cls.: 100, 101 and 102**

**United States Patent and Trademark Office**

**Reg. No. 3,499,036**

**Registered Sep. 9, 2008**

**SERVICE MARK  
PRINCIPAL REGISTER**

# CustomCast

DVC, INCORPORATED (INDIANA CORPORATION)  
7301 EAST 46TH STREET  
INDIANAPOLIS, IN 46226

FOR: DESIGN OF INTERNET ADVERTISING PRODUCTS FOR OTHERS, DISSEMINATION OF ADVERTISING FOR OTHERS VIA THE INTERNET, ADVERTISING VIA ELECTRONIC MEDIA AND SPECIFICALLY THE INTERNET, ADVERTISING AND PUBLICITY SERVICES, NAMELY, PROMOTING THE GOODS, SERVICES, BRAND IDENTITY AND COMMERCIAL INFORMATION AND NEWS OF THIRD PARTIES THROUGH AUDIO, VIDEO,

DIGITAL AND ON-LINE MEDIUM, IN CLASS 35 (U.S. CLS. 100, 101 AND 102).

FIRST USE 9-1-2007; IN COMMERCE 1-1-2008.

THE MARK CONSISTS OF STANDARD CHARACTERS WITHOUT CLAIM TO ANY PARTICULAR FONT, STYLE, SIZE, OR COLOR.

SER. NO. 77-446,180, FILED 4-11-2008.

MAYUR VAGHANI, EXAMINING ATTORNEY

**Int. Cl.: 13**

**Prior U.S. Cls.: 2 and 9**

**United States Patent and Trademark Office**

**Reg. No. 3,499,037**

**Registered Sep. 9, 2008**

**TRADEMARK  
PRINCIPAL REGISTER**

**N6**

NOVESKE RIFLEWORKS, LLC (OREGON LIMITED LIABILITY COMPANY)  
594 NE E. ST. "REAR"  
GRANTS PASS, OR 97526

THE MARK CONSISTS OF STANDARD CHARACTERS WITHOUT CLAIM TO ANY PARTICULAR FONT, STYLE, SIZE, OR COLOR.

FOR: FIREARMS, IN CLASS 13 (U.S. CLS. 2 AND 9).

SER. NO. 77-447,228, FILED 4-14-2008.

FIRST USE 4-9-2008; IN COMMERCE 4-9-2008.

CURTIS FRENCH, EXAMINING ATTORNEY

**Int. Cl.: 25**

**Prior U.S. Cls.: 22 and 39**

**United States Patent and Trademark Office**

**Reg. No. 3,499,038**

**Registered Sep. 9, 2008**

**TRADEMARK  
PRINCIPAL REGISTER**

**TOPMAN**

ARCADIA GROUP BRANDS LIMITED (UNITED  
KINGDOM COMPANY)  
COLEGRAVE HOUSE  
70 BERNERS STREET  
LONDON, UNITED KINGDOM W1T3NL

FOR: CLOTHING FOR MEN, NAMELY, COATS,  
OVERCOATS, SPORTS COATS, RAINCOATS, SUITS,  
JACKETS, TROUSERS, PANTS, JEANS, SHORTS,  
SHIRTS, T-SHIRTS, POLO SHIRTS, TOPS, PULL-  
OVERS, SWEATERS, JERSEYS, CARDIGANS, JUM-  
PERS, FLEECE PULLOVERS, BELTS, SUSPENDERS,  
UNDERWEAR, VESTS, DINNER JACKETS,  
GLOVES, MITTENS, SOCKS, HATS, CAPS, BERETS,  
SWIMWEAR, PAJAMAS, BUT NOT TIES, SCARVES  
OR CRAVATS, IN CLASS 25 (U.S. CLS. 22 AND 39).

THE MARK CONSISTS OF STANDARD CHAR-  
ACTERS WITHOUT CLAIM TO ANY PARTICULAR  
FONT, STYLE, SIZE, OR COLOR.

OWNER OF UNITED KINGDOM REG. NO.  
B1091187, DATED 2-17-1978, EXPIRES 2-17-2009.

OWNER OF U.S. REG. NOS. 3,260,750 AND  
3,298,013.

SER. NO. 77-447,327, FILED 4-14-2008.

HEATHER THOMPSON, EXAMINING ATTORNEY

**Int. Cls.: 3, 16, 21, 29, 30 and 32**

**Prior U.S. Cls.: 1, 2, 4, 5, 6, 13, 22, 23, 29, 30, 33, 37, 38, 40, 45, 46, 48, 50, 51 and 52**

**Reg. No. 3,499,039**

**United States Patent and Trademark Office**

**Registered Sep. 9, 2008**

**TRADEMARK  
PRINCIPAL REGISTER**

# STOP & SHOP

S&S BRANDS, INC. (DELAWARE CORPORATION)

SUITE 1410  
1007 ORANGE STREET  
WILMINGTON, DE 19801

FOR: LAUNDRY BLEACH; ALL-PURPOSE CLEANING PREPARATIONS; ANTI-STATIC DRYER SHEETS; AMMONIA FOR CLEANING PURPOSES; WINDSHIELD CLEANING FLUID; AUTOMATIC DISHWASHING DETERGENTS; DISH DETERGENTS; LAUNDRY DETERGENTS; DRAIN OPENERS; FABRIC SOFTENERS; FURNITURE POLISH; GLASS CLEANING PREPARATIONS; LAUNDRY STARCH; CLEANING PREPARATIONS FOR HOUSEHOLD PURPOSES, IN CLASS 3 (U.S. CLS. 1, 4, 6, 50, 51 AND 52).

FIRST USE 0-0-1974; IN COMMERCE 0-0-1974.

FOR: PAPER NAPKINS; FACIAL TISSUE; BATHROOM TISSUE; PAPER TOWELS; PLASTIC FOOD STORAGE BAGS FOR HOUSEHOLD USE; PLASTIC TRASH BAGS; PAPER BAGS; PAPER COFFEE FILTERS; WAX PAPER; PLASTIC WRAP; DISPOSABLE DIAPERS; DISPOSABLE TRAINING PANTS; PAPER FREEZER WRAP, IN CLASS 16 (U.S. CLS. 2, 5, 22, 23, 29, 37, 38 AND 50).

FIRST USE 0-0-1977; IN COMMERCE 0-0-1977.

FOR: SCOURING SPONGES; SPONGES FOR HOUSEHOLD PURPOSES; PAPER CUPS; PLASTIC CUPS; FOAM CUPS; PAPER PLATES; PLASTIC PLATES; FOAM PLATES; PAPER BOWLS; PLASTIC BOWLS; FOAM BOWLS; DENTAL FLOSS; HAIR COMBS; NON-ELECTRIC TOOTHBRUSHES; PLASTIC DRINKING GLASSES; BEVERAGE GLASSWARE, NAMELY, TUMBLERS; MUGS, IN CLASS 21 (U.S. CLS. 2, 13, 23, 29, 30, 33, 40 AND 50).

FIRST USE 12-0-2006; IN COMMERCE 12-0-2006.

FOR: CHEESE; CHEESE SPREAD; CHEESE AND CRACKER COMBINATIONS; MILK; BUTTERMILK; CHOCOLATE MILK; SOY MILK; CREAM; HALF AND HALF; NON-DAIRY CREAMER; CREAM CHEESE; COTTAGE CHEESE; SOUR CREAM; YOGURT; WHIPPED TOPPING; BUTTER; BUTTER SUBSTITUTES; MARGARINE; EGG SUBSTITUTE; EGGNOG; EGGS; DAIRY-BASED DIPS; DIPS; SHELLED NUTS; ROASTED NUTS; CANNED FRUITS; DRIED FRUITS; FROZEN FRUITS; CANNED FRUIT SNACKS; CANNED VEGETABLES; FROZEN VEGETABLES; DRIED VEGETABLES; FROZEN BERRIES; PROCESSED POTATOES; POTATO CHIPS; VEGETABLE-BASED SNACK FOODS; FRESH FISH NOT LIVE; FROZEN FISH; CANNED FISH; PROCESSED CHICKEN; PICKLES; PROCESSED OLIVES; FROZEN ONION RINGS; PEANUT BUTTER; APPLE BUTTER; JAM; JELLY; FRUIT PRESERVES; FRUIT-BASED PIE FILLINGS; APPLE SAUCE; CRANBERRY SAUCE; FLAKED COCONUT; DRIED BEANS; CANNED SOUPS; DRIED SOUP MIXES; VEGETABLE OILS FOR COOKING; FRANKFURTERS; LUNCHEON MEATS; FRESH SHRIMP AND SEAFOOD, NOT LIVE; PROCESSED SHRIMP AND SEAFOOD, NOT LIVE; VEGETABLE SALADS; GARDEN SALADS; POTATO SALADS; FRESH MEATS; CANNED MEATS; PROCESSED MEATS; FROZEN MEATS; BACON; BACON-FLAVORED VEGETABLE PROTEIN BITS; FROZEN ENTREES CONSISTING PRIMARILY OF MEAT, FISH, POULTRY, AND VEGETABLES; PREPARED ENTREES CONSISTING PRIMARILY OF MEAT, FISH, POULTRY, AND VEGETABLES, IN CLASS 29 (U.S. CL. 46).

FIRST USE 9-0-1940; IN COMMERCE 9-0-1940.

FOR: BREAD; BAGELS; PITA; FROZEN WAFFLES; FROZEN PANCAKES; FROZEN STRUDEL;



ROLLS; FROZEN BREAD DOUGH; SOFT PRETZELS; FRESH PIZZA; FROZEN PIZZA; ICE CREAM; CONES FOR ICE CREAM; FROZEN CONFECTIONS; FROZEN YOGURT; ICE MILK; SHERBETS; PASTA; PREPARED PIE CRUST; REFRIGERATED DOUGH FOR BISCUITS, ROLLS, BREADSTICKS, AND PIZZA CRUST; TORTILLAS; TACO SHELLS; REFRIGERATED COOKIE DOUGH; COOKIES; CANDIES; CRACKERS; CAKES; CHEESECAKES; CAKE MIXES; PIES; MARSHMALLOWS; HONEY; BREADCRUMBS; SEASONED COATINGS FOR MEAT, FISH, AND POULTRY; CROUTONS; STUFFING MIXES CONTAINING BREAD; FLAVORED AND SWEETENED GELATINS; PUDDING; PREPARED CAKE FROSTING AND FROSTING MIXES; CHOCOLATE CHIPS FOR BAKING; FLOUR; BAKING SODA; BAKING POWDER; CORN STARCH; SUGAR; BROWN SUGAR; SALT; PANCAKE SYRUP; PANCAKE MIXES; MIXES FOR MAKING BAKERY GOODS; SPICES; EXTRACTS USED FOR FLAVORING NOT OF ESSENTIAL OILS; COFFEE; TEA; COCOA; CHOCOLATE SYRUP; PROCESSED UNPOPPED POPCORN; GRAVY; KETCHUP; MUSTARD; PICKLE RELISH; PICANTE SAUCE; SOY SAUCE; HOT SAUCE; PIZZA SAUCE; TERIYAKI SAUCE; BARBECUE SAUCE; WORCESTERSHIRE SAUCE; COCKTAIL SAUCE; TARTAR SAUCE; SPAGHETTI SAUCE; TOMATO SAUCE; PASTA SAUCE; SALSA; MAYONNAISE; SALAD DRESSINGS; VINEGAR; BREAKFAST CEREAL; CEREAL-BASED SNACK BARS; WHEAT-BASED SNACK BARS; PROCESSED OATS; OATMEAL; GRITS; BREAKFAST PASTRIES; RICE; RICE CAKES; PACKAGED MIXES CONSISTING PRI-

MARILY OF PASTA OR RICE; RICE SALADS; CANNED PREPARED FOODS CONSISTING PRIMARILY OF PASTA; BAGGED ICE; PASTA SALADS; DELI SANDWICHES; CORN-BASED SNACK FOODS; PRETZELS; FROZEN ENTREES CONSISTING PRIMARILY OF PASTA OR RICE; PREPARED ENTREES CONSISTING PRIMARILY OF PASTA OR RICE, IN CLASS 30 (U.S. CL. 46).

FIRST USE 0-0-1975; IN COMMERCE 0-0-1975.

FOR: CONCENTRATES, SYRUPS, OR POWDERS USED IN THE PREPARATION OF SOFT DRINKS; DRINKING WATER; FRUIT DRINKS; FRUIT FLAVORED SOFT DRINKS; FRUIT JUICES; FRUIT-FLAVORED BEVERAGES; MINERAL WATER; SELTZER WATER; SOFT DRINKS, NAMELY, CARBONATED SOFT DRINKS; SPRING WATER; SWEET CIDER; VEGETABLE JUICE, IN CLASS 32 (U.S. CLS. 45, 46 AND 48).

FIRST USE 0-0-1975; IN COMMERCE 0-0-1975.

THE MARK CONSISTS OF STANDARD CHARACTERS WITHOUT CLAIM TO ANY PARTICULAR FONT, STYLE, SIZE, OR COLOR.

OWNER OF U.S. REG. NOS. 1,529,879, 1,706,152 AND OTHERS.

SER. NO. 77-447,412, FILED 4-14-2008.

CORY BOONE, EXAMINING ATTORNEY

**Int. Cl.: 31**

**Prior U.S. Cls.: 1 and 46**

**United States Patent and Trademark Office**

**Reg. No. 3,499,040**

**Registered Sep. 9, 2008**

**TRADEMARK  
PRINCIPAL REGISTER**

**Life Line**

VETERINARY RESOURCE GROUP, INC. (WASHINGTON CORPORATION)  
5114 PT FOSDICK DR #E PMB32  
GIG HARBOR, WA 98335

FOR: PET FOOD, IN CLASS 31 (U.S. CLS. 1 AND 46).

FIRST USE 1-2-2008; IN COMMERCE 4-17-2008.

THE MARK CONSISTS OF STANDARD CHARACTERS WITHOUT CLAIM TO ANY PARTICULAR FONT, STYLE, SIZE, OR COLOR.

SER. NO. 77-451,169, FILED 4-17-2008.

DOMINIC J. FERRAIUOLO, EXAMINING ATTORNEY

**Int. Cl.: 1**

**Prior U.S. Cls.: 1, 5, 6, 10, 26 and 46**

**Reg. No. 3,499,041**

**United States Patent and Trademark Office**

**Registered Sep. 9, 2008**

**TRADEMARK  
PRINCIPAL REGISTER**

**ditto**

THE BELL GROUP (NEW MEXICO CORPORATION), DBA RIO GRANDE  
7500 BLUEWATER RD  
ALBUQUERQUE, NM 87121

THE MARK CONSISTS OF STANDARD CHARACTERS WITHOUT CLAIM TO ANY PARTICULAR FONT, STYLE, SIZE, OR COLOR.

FOR: PLASTIC INVESTMENT MATERIALS IN THE NATURE OF MOLDING COMPOUNDS FOR USE IN THE MANUFACTURE OF JEWELRY, IN CLASS 1 (U.S. CLS. 1, 5, 6, 10, 26 AND 46).

SER. NO. 77-456,050, FILED 4-23-2008.

FIRST USE 5-1-1986; IN COMMERCE 5-1-1986.

DAVID COLLIER, EXAMINING ATTORNEY

**Int. Cl.: 9**

**Prior U.S. Cls.: 21, 23, 26, 36 and 38**

**Reg. No. 3,499,042**

**United States Patent and Trademark Office**

**Registered Sep. 9, 2008**

---

**TRADEMARK  
PRINCIPAL REGISTER**

hot spot

THE BELL GROUP (NEW MEXICO CORPORATION), DBA RIO GRANDE  
7500 BLUEWATER RD NW  
ALBUQUERQUE, NM 87121

THE MARK CONSISTS OF STANDARD CHARACTERS WITHOUT CLAIM TO ANY PARTICULAR FONT, STYLE, SIZE, OR COLOR.

FOR: ELECTRIC SOLDERING APPARATUS, IN CLASS 9 (U.S. CLS. 21, 23, 26, 36 AND 38).

SER. NO. 77-457,492, FILED 4-24-2008.

FIRST USE 3-4-1996; IN COMMERCE 3-4-1996.

DAVID COLLIER, EXAMINING ATTORNEY

Int. Cl.: 35

Prior U.S. Cls.: 100, 101 and 102

Reg. No. 3,499,043

United States Patent and Trademark Office

Registered Sep. 9, 2008

SERVICE MARK  
PRINCIPAL REGISTER



HEB GROCERY COMPANY, L.P. (TEXAS LIMITED PARTNERSHIP)  
646 SOUTH MAIN  
SAN ANTONIO, TX 78204

THE MARK CONSISTS OF THE WORD "BLOOMS" WITH THE LETTER "L" REPRESENTED BY A FLOWER WITH THE LETTERS "H-E-B" ON ONE OF THE FLOWER PETALS.

FOR: RETAIL FLORIST SERVICES, IN CLASS 35 (U.S. CLS. 100, 101 AND 102).

SER. NO. 77-463,906, FILED 5-2-2008.

FIRST USE 2-11-2008; IN COMMERCE 2-11-2008.

OWNER OF U.S. REG. NOS. 1,519,398, 1,840,693 AND OTHERS.

JOHN WILKE, EXAMINING ATTORNEY

Int. Cl.: 35

Prior U.S. Cls.: 100, 101 and 102

United States Patent and Trademark Office

Reg. No. 3,499,044

Registered Sep. 9, 2008

SERVICE MARK  
PRINCIPAL REGISTER



ORLANDO/ORANGE COUNTY CONVENTION &  
VISITORS BUREAU, INC. (FLORIDA COR-  
PORATION)

SUITE 100

6700 FORUM DRIVE

ORLANDO, FL 328218017

FOR: PROMOTIONAL SERVICES, NAMELY, THE  
PROMOTION OF TOURISM AND CONVENTIONS  
IN THE ORLANDO AREA, IN CLASS 35 (U.S. CLS.  
100, 101 AND 102).

FIRST USE 1-14-2008; IN COMMERCE 1-14-2008.

NO CLAIM IS MADE TO THE EXCLUSIVE  
RIGHT TO USE "ORLANDO", APART FROM THE  
MARK AS SHOWN.

THE MARK CONSISTS OF AN OVAL FIGURE  
CONTAINING THE PHRASE "SAY YES TO ORLAN-  
DO" IN WHICH THE WORD "YES" IS THE MOST  
PROMINENT TEXT, EXTENDING THE LENGTH  
OF THE OVAL, AND IN WHICH A STAR IS  
LOCATED ABOVE THE "Y" CHARACTER IN THE  
WORD "YES".

SER. NO. 77-463,935, FILED 5-2-2008.

TASHIA BUNCH, EXAMINING ATTORNEY

**Int. Cl.: 35**

**Prior U.S. Cls.: 100, 101 and 102**

**United States Patent and Trademark Office**

**Reg. No. 3,499,045**

**Registered Sep. 9, 2008**

**SERVICE MARK  
PRINCIPAL REGISTER**

**DESIGN DEPOT**

DESIGN DEPOT FURNITURE, INC. (FLORIDA  
CORPORATION)  
8435 NW 74TH STREET  
MIAMI, FL 33166

FOR: RETAIL FURNITURE STORES, IN CLASS 35  
(U.S. CLS. 100, 101 AND 102).

FIRST USE 12-31-1989; IN COMMERCE 12-31-1989.

THE MARK CONSISTS OF STANDARD CHAR-  
ACTERS WITHOUT CLAIM TO ANY PARTICULAR  
FONT, STYLE, SIZE, OR COLOR.

SEC. 2(F).

SER. NO. 77-468,262, FILED 5-7-2008.

MAYUR VAGHANI, EXAMINING ATTORNEY

**Int. Cl.: 42**

**Prior U.S. Cls.: 100 and 101**

**United States Patent and Trademark Office**

**Reg. No. 3,499,046**

**Registered Sep. 9, 2008**

**SERVICE MARK  
PRINCIPAL REGISTER**

**DESIGN DEPOT**

DESIGN DEPOT FURNITURE, INC. (FLORIDA  
CORPORATION)  
8435 NW 74TH STREET  
MIAMI, FL 33166

FOR: INTERIOR DESIGN SERVICES INCLUD-  
ING SPACE PLANNING, FURNITURE SELECTION,  
MATERIAL AND SURFACE SELECTION, IN CLASS  
42 (U.S. CLS. 100 AND 101).

FIRST USE 12-31-1989; IN COMMERCE 12-31-1989.

THE MARK CONSISTS OF STANDARD CHAR-  
ACTERS WITHOUT CLAIM TO ANY PARTICULAR  
FONT, STYLE, SIZE, OR COLOR.

SEC. 2(F).

SER. NO. 77-468,282, FILED 5-7-2008.

MAYUR VAGHANI, EXAMINING ATTORNEY



Int. Cl.: 35

Prior U.S. Cls.: 100, 101 and 102

**United States Patent and Trademark Office**

**Reg. No. 3,499,047**

Registered Sep. 9, 2008

**SERVICE MARK  
PRINCIPAL REGISTER**



DESIGN DEPOT FURNITURE, INC. (FLORIDA CORPORATION)  
8435 NW 74TH STREET  
MIAMI, FL 33166

FOR: RETAIL FURNITURE STORES, IN CLASS 35  
(U.S. CLS. 100, 101 AND 102).

FIRST USE 12-31-1989; IN COMMERCE 12-31-1989.

THE MARK CONSISTS OF THE UNDERLINED WORD "DESIGN" IN SCRIPT ABOVE THE WORD "DEPOT".

SEC. 2(F).

SER. NO. 77-468,813, FILED 5-8-2008.

MAYUR VAGHANI, EXAMINING ATTORNEY

Int. Cl.: 42

Prior U.S. Cls.: 100 and 101

United States Patent and Trademark Office

Reg. No. 3,499,048

Registered Sep. 9, 2008

SERVICE MARK  
PRINCIPAL REGISTER



DESIGN DEPOT FURNITURE, INC. (FLORIDA CORPORATION)  
8435 NW 74TH STREET  
MIAMI, FL 33166

THE MARK CONSISTS OF THE UNDERLINED WORD "DESIGN" IN SCRIPT OVER THE WORD "DEPOT".

FOR: INTERIOR DESIGN SERVICES INCLUDING SPACE PLANNING, FURNITURE SELECTION, MATERIAL AND SURFACE SELECTION, IN CLASS 42 (U.S. CLS. 100 AND 101).

SEC. 2(F).

SER. NO. 77-468,815, FILED 5-8-2008.

FIRST USE 12-31-1989; IN COMMERCE 12-31-1989.

MAYUR VAGHANI, EXAMINING ATTORNEY

**Int. Cl.: 30**

**Prior U.S. Cl.: 46**

**United States Patent and Trademark Office**

**Reg. No. 3,499,049**

**Registered Sep. 9, 2008**

**TRADEMARK  
PRINCIPAL REGISTER**



HUHTAMAKI FINANCE B.V. (NETHERLANDS CORPORATION)  
JUPITERSTRAAAT 102  
2132 HE HOOFDDORP, NETHERLANDS

FOR: CANDY, IN CLASS 30 (U.S. CL. 46).

FIRST USE 2-28-2008; IN COMMERCE 2-28-2008.

OWNER OF U.S. REG. NOS. 243,197, 1,289,249,  
AND 2,293,885.

THE MARK CONSISTS OF THE WORDS "GOOD & FRUITY" SURROUNDED BY A CIRCLE.

SEC. 2(F).

SER. NO. 77-471,840, FILED 5-12-2008.

JOHN E. MICHOS, EXAMINING ATTORNEY

**Int. Cl.: 30**

**Prior U.S. Cl.: 46**

**United States Patent and Trademark Office**

**Reg. No. 3,499,050**

**Registered Sep. 9, 2008**

**TRADEMARK  
PRINCIPAL REGISTER**

**GOOD & FRUITY**

HUHTAMAKI FINANCE B.V. (NETHERLANDS  
CORPORATION)  
JUPITERSTRAAT 102  
2132 HE HOOFDDORP, NETHERLANDS

FOR: CANDY, IN CLASS 30 (U.S. CL. 46).

FIRST USE 2-28-2008; IN COMMERCE 2-29-2008.

THE MARK CONSISTS OF STANDARD CHAR-  
ACTERS WITHOUT CLAIM TO ANY PARTICULAR  
FONT, STYLE, SIZE, OR COLOR.

OWNER OF U.S. REG. NOS. 243,197, 1,289,249,  
AND 2,293,885.

NO CLAIM IS MADE TO THE EXCLUSIVE  
RIGHT TO USE "FRUITY", APART FROM THE  
MARK AS SHOWN.

SEC. 2(F).

SER. NO. 77-471,845, FILED 5-12-2008.

JOHN E. MICHOS, EXAMINING ATTORNEY

**Int. Cl.: 25**

**Prior U.S. Cls.: 22 and 39**

**United States Patent and Trademark Office**

**Reg. No. 3,499,051**

**Registered Sep. 9, 2008**

**TRADEMARK  
PRINCIPAL REGISTER**



ICECO LIMITED (HONG KONG CORPORATION)  
15TH FLOOR, UNIT 1504, EASTERN CENTER  
1065 KING'S ROAD  
QUARRY BAY, HONG KONG

FOR: FOOTWEAR, NAMELY, BOOTS; SHOES;  
HEELS, OUTER SOLES, SHOE JUMPERS AND TIPS  
FOR BOOTS AND SHOES; HOSIERY, LEGGINGS,  
SANDALS, WELTS FOR SHOES AND BOOTS, SLIP-  
PERS, ATHLETIC SHOES, IN CLASS 25 (U.S. CLS. 22  
AND 39).

FIRST USE 5-0-2005; IN COMMERCE 3-0-2006.

PRIORITY CLAIMED UNDER SEC. 44(D) ON  
HONG KONG APPLICATION NO. 300671887, FILED  
7-3-2006.

THE MARK CONSISTS OF CUPID WITH AN  
ARROW, TO THE LEFT OF THE WORD "DANCEA-  
MO", WITH THE WORDING, "CREAZIONE ARTIS-  
TICA DEL BALLO" BELOW. THE CUPID'S ARROW  
IS POINTING TO THE WORDING "CREAZIONE  
ARTISTICA DEL BALLO".

THE ENGLISH TRANSLATION OF THE WORD  
"CREAZIONE ARTISTICA DEL BALLO" IN THE  
MARK IS ARTISTIC CREATION THROUGH  
DANCE.

SER. NO. 77-975,081, FILED 10-6-2006.

ODESSA BIBBINS, EXAMINING ATTORNEY

**Int. Cl.: 9**

**Prior U.S. Cls.: 21, 23, 26, 36 and 38**

**Reg. No. 3,499,052**

**United States Patent and Trademark Office**

**Registered Sep. 9, 2008**

---

**TRADEMARK  
PRINCIPAL REGISTER**

# FestivaLive!

DAVID MARGULIES (UNITED STATES INDIVIDUAL)  
1131 GREEN MEADOWS WAY  
ASHLAND, OR 97520

FOR: DOWNLOADABLE MUSICAL SOUND RECORDINGS; MUSICAL SOUND RECORDINGS; DOWNLOADABLE MUSICAL SOUND RECORDINGS VIA THE INTERNET AND WIRELESS DEVICES, IN CLASS 9 (U.S. CLS. 21, 23, 26, 36 AND 38).

FIRST USE 7-10-2004; IN COMMERCE 7-10-2004.

THE MARK CONSISTS OF STANDARD CHARACTERS WITHOUT CLAIM TO ANY PARTICULAR FONT, STYLE, SIZE, OR COLOR.

SER. NO. 77-975,175, FILED 6-25-2007.

BILL DAWE, EXAMINING ATTORNEY

**Int. Cls.: 9, 35, 36 and 42**

**Prior U.S. Cls.: 21, 23, 26, 36, 38, 100, 101 and 102**

**United States Patent and Trademark Office**

**Reg. No. 3,499,053**

**Registered Sep. 9, 2008**

**TRADEMARK  
SERVICE MARK  
PRINCIPAL REGISTER**

**THE CENTER FOR THE  
FINANCIAL COMMUNITY**

RISKMETRICS SOLUTIONS, INC. (DELAWARE CORPORATION)  
ONE CHASE MANHATTAN PLAZA, 44TH FLOOR  
NEW YORK, NY 10005

FOR: COMPUTER PROGRAMS AND SOFTWARE FOR USE IN FINANCIAL AND INVESTMENT ANALYSIS AND DOWNLOADABLE COMPUTER PROGRAMS AND SOFTWARE FOR USE IN FINANCIAL AND INVESTMENT ANALYSIS AND PERFORMANCE SIMULATION, IN CLASS 9 (U.S. CLS. 21, 23, 26, 36 AND 38).

FIRST USE 9-17-2007; IN COMMERCE 9-17-2007.

FOR: BUSINESS CONSULTING AND INFORMATION SERVICES; BUSINESS RESEARCH; BUSINESS RESEARCH AND CONSULTATION IN THE FIELD OF CORPORATE GOVERNANCE AND PROXY VOTING; PROVIDING INFORMATION VIA A WEB SITE ON PROXY VOTING AND CORPORATE GOVERNANCE RESEARCH REPORTS, CORPORATE VOTING POLICIES, CORPORATE MEETING RESULTS, CORPORATE VOTING PATTERNS, AND CORPORATE GOVERNANCE; VOTING SERVICES, NAMELY, ALLOWING USERS TO CAST CORPO-

RATE PROXY VOTES VIA THE INTERNET, IN CLASS 35 (U.S. CLS. 100, 101 AND 102).

FIRST USE 9-17-2007; IN COMMERCE 9-17-2007.

FOR: FINANCIAL RISK MANAGEMENT, IN CLASS 36 (U.S. CLS. 100, 101 AND 102).

FIRST USE 9-17-2007; IN COMMERCE 9-17-2007.

FOR: APPLICATION SERVICE PROVIDER (ASP) FEATURING SOFTWARE FOR USE IN FINANCIAL AND INVESTMENT ANALYSIS AND PERFORMANCE SIMULATION, IN CLASS 42 (U.S. CLS. 100 AND 101).

FIRST USE 9-17-2007; IN COMMERCE 9-17-2007.

THE MARK CONSISTS OF STANDARD CHARACTERS WITHOUT CLAIM TO ANY PARTICULAR FONT, STYLE, SIZE, OR COLOR.

SER. NO. 77-975,431, FILED 6-26-2007.

PETER B. BROMAGHIM, EXAMINING ATTORNEY

**Int. Cl.: 3**

**Prior U.S. Cls.: 1, 4, 6, 50, 51 and 52**

**United States Patent and Trademark Office**

**Reg. No. 3,499,054**

**Registered Sep. 9, 2008**

**TRADEMARK  
PRINCIPAL REGISTER**

**HEATHERETTE**

LOT 6, LLC (NEW YORK LIMITED LIABILITY  
COMPANY)  
112 WINDSOR GATE  
LAKE SUCCESS, NY 11020

FOR: NON-MEDICATED FACE POWDER, LIP-  
STICKS AND EYE-LINER, IN CLASS 3 (U.S. CLS. 1, 4,  
6, 50, 51 AND 52).

FIRST USE 3-24-2008; IN COMMERCE 3-24-2008.

THE MARK CONSISTS OF STANDARD CHAR-  
ACTERS WITHOUT CLAIM TO ANY PARTICULAR  
FONT, STYLE, SIZE, OR COLOR.

OWNER OF U.S. REG. NOS. 2,932,600 AND  
3,164,534.

SER. NO. 77-975,497, FILED 2-7-2008.

LINDA MICKLEBURGH, EXAMINING ATTORNEY



**Int. Cls.: 37, 39 and 40**

**Prior U.S. Cls.: 100, 103, 105 and 106**

**United States Patent and Trademark Office**

**Reg. No. 3,499,055**

**Registered Sep. 9, 2008**

**SERVICE MARK  
PRINCIPAL REGISTER**

**ICON**

ICON CAPITAL CORP. (DELAWARE CORPORATION)  
100 FIFTH AVE, 4TH FLOOR  
NEW YORK, NY 10011

FOR: LEASING CONSTRUCTION EQUIPMENT,  
IN CLASS 37 (U.S. CLS. 100, 103 AND 106).

FIRST USE 12-15-1985; IN COMMERCE 12-15-1985.

FOR: LEASING AIRCRAFTS AND VESSELS, IN  
CLASS 39 (U.S. CLS. 100 AND 105).

FIRST USE 12-15-1985; IN COMMERCE 12-15-1985.

FOR: LEASING MANUFACTURING EQUIPMENT,  
IN CLASS 40 (U.S. CLS. 100, 103 AND 106).

FIRST USE 12-15-1985; IN COMMERCE 12-15-1985.

THE MARK CONSISTS OF STANDARD CHARACTERS  
WITHOUT CLAIM TO ANY PARTICULAR FONT,  
STYLE, SIZE, OR COLOR.

SER. NO. 77-975,559, FILED 9-28-2007.

CHARISMA HAMPTON, EXAMINING ATTORNEY

**Int. Cl.: 41**

**Prior U.S. Cls.: 100, 101 and 107**

**United States Patent and Trademark Office**

**Reg. No. 3,499,056**

**Registered Sep. 9, 2008**

**SERVICE MARK  
PRINCIPAL REGISTER**

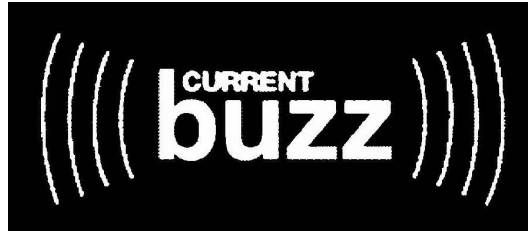

CURRENT MEDIA, LLC (DELAWARE LIMITED  
LIABILITY COMPANY)  
118 KING STREET  
SAN FRANCISCO, CA 94107

FIRST USE 5-23-2006; IN COMMERCE 9-19-2006.

SER. NO. 77-975,770, FILED 10-10-2006.

FOR: PRODUCTION OF VIDEO DISKS, PODS  
AND TAPES PERTAINING TO TOPICAL EVENTS,  
IN CLASS 41 (U.S. CLS. 100, 101 AND 107).

WILLIAM P. SHANAHAN, EXAMINING ATTOR-  
NEY

**Int. Cl.: 41**

**Prior U.S. Cls.: 100, 101 and 107**

**United States Patent and Trademark Office**

**Reg. No. 3,499,057**

**Registered Sep. 9, 2008**

**SERVICE MARK  
PRINCIPAL REGISTER**



MISSION: RENAISSANCE, INC. (CALIFORNIA CORPORATION)  
800 W. DORNAN STREET  
GLENDALE, CA 91203

FOR: EDUCATION IN THE FIELD OF ART RENDERED THROUGH CORRESPONDENCE COURSES; EDUCATIONAL SERVICES IN THE NATURE OF ART SCHOOLS; INSTRUCTION IN THE FIELD OF ART; WORKSHOPS AND SEMINARS IN THE FIELD OF ART; EDUCATION SERVICES, NAMELY, PROVIDING CLASSES, SEMINARS AND WORKSHOPS IN THE FIELD OF ART, IN CLASS 41 (U.S. CLS. 100, 101 AND 107).

FIRST USE 5-11-2007; IN COMMERCE 5-11-2007.

OWNER OF U.S. REG. NOS. 1,667,029, 2,697,872 AND OTHERS.

NO CLAIM IS MADE TO THE EXCLUSIVE RIGHT TO USE "FINE ART CLASSES", APART FROM THE MARK AS SHOWN.

THE STIPPLING IS FOR SHADING PURPOSES ONLY.

THE COLOR(S) BLUE, NAVY BLUE, LIGHT BLUE, YELLOW, BLACK AND WHITE IS/ARE CLAIMED AS A FEATURE OF THE MARK.

THE SQUARE AND EASEL ARE BLUE, THE BOY, BRUSH AND PALLET ARE NAVY BLUE ON A YELLOW BACKGROUND, THE SWIRLING LINE IS LIGHT BLUE, THE WORDS MISSION RENAISSANCE FINE ART CLASSES ARE BLACK ON A WHITE BACKGROUND, THE SEATED ARTIST IS WHITE ON A BLACK BACKGROUND.

SER. NO. 77-975,816, FILED 5-11-2007.

JOHN WILKE, EXAMINING ATTORNEY

**Int. Cl.: 10**

**Prior U.S. Cls.: 26, 39 and 44**

**United States Patent and Trademark Office**

**Reg. No. 3,499,058**

**Registered Sep. 9, 2008**

**TRADEMARK  
PRINCIPAL REGISTER**

**NEUROARM**

SUTHERLAND, GARNETTE (CANADA INDIVIDUAL)  
FOOTHILLS MEDICAL CENTRE/UNIVERSITY OF  
CALGARY, 1403 - 29TH STREET NW  
CALGARY, ALBERTA T2N 2T9

FOR: SURGICAL ROBOTS FOR NEUROSURGERY, IN CLASS 10 (U.S. CLS. 26, 39 AND 44).

PRIORITY CLAIMED UNDER SEC. 44(D) ON CANADA APPLICATION NO. 1136631, FILED 4-5-2002, REG. NO. TMA612979, DATED 6-17-2004, EXPIRES 6-17-2019.

SER. NO. 78-155,651, FILED 8-19-2002.

TRACY FLETCHER, EXAMINING ATTORNEY

**Int. Cls.: 36 and 38**

**Prior U.S. Cls.: 100, 101, 102 and 104**

**United States Patent and Trademark Office**

**Reg. No. 3,499,059**

**Registered Sep. 9, 2008**

**SERVICE MARK  
PRINCIPAL REGISTER**

**BOCHINCHE**

CODETEL, C. POR A. (DOMINICAN REP COR-  
PORATION)  
AVENIDA ABRAHAM LINCOLN 1101  
SANTO DOMINGO, DOMINICAN REP

FOR: PREPAID TELEPHONE CALLING CARD  
SERVICES, IN CLASS 36 (U.S. CLS. 100, 101 AND 102).

FIRST USE 6-30-2005; IN COMMERCE 6-30-2005.

FOR: TELECOMMUNICATIONS SERVICES,  
NAMELY, LONG DISTANCE TELEPHONE TELE-  
COMMUNICATIONS SERVICES PROVIDED VIA

PREPAID TELEPHONE CALLING CARDS, IN  
CLASS 38 (U.S. CLS. 100, 101 AND 104).

FIRST USE 6-30-2005; IN COMMERCE 6-30-2005.

THE FOREIGN WORDING IN THE MARK  
TRANSLATES INTO ENGLISH AS DISORDER.

SER. NO. 78-195,664, FILED 12-18-2002.

BENJAMIN OKEKE, EXAMINING ATTORNEY

**Int. Cl.: 9**

**Prior U.S. Cls.: 21, 23, 26, 36 and 38**

**Reg. No. 3,499,060**

**United States Patent and Trademark Office**

**Registered Sep. 9, 2008**

**TRADEMARK  
PRINCIPAL REGISTER**

**WORK**  
**SOFTWARE SYSTEMS**

WORKWIRELESS, LLC (NORTH CAROLINA  
LIMITED LIABILITY COMPANY)  
18145 WEST CATAWBA AVENUE  
CORNELIUS, NC 28031

FIRST USE 1-1-2003; IN COMMERCE 2-1-2003.

FOR: COMPUTER SOFTWARE FOR USE IN  
POINT-OF-SALE SYSTEMS IN RETAIL INDUS-  
TRIES; NAMELY, CUSTOMER DATA MANAGE-  
MENT, PAYROLL ADMINISTRATION, ACCOUNTS  
RECEIVABLE MANAGEMENT, INVENTORY  
MANAGEMENT AND REAL-TIME TRANSACTION  
PROCESSING, IN CLASS 9 (U.S. CLS. 21, 23, 26, 36  
AND 38).

NO CLAIM IS MADE TO THE EXCLUSIVE  
RIGHT TO USE "SOFTWARE SYSTEMS", APART  
FROM THE MARK AS SHOWN.

SER. NO. 78-295,195, FILED 9-2-2003.

NICHOLAS ALTREE, EXAMINING ATTORNEY

**Int. Cl.: 35**

**Prior U.S. Cls.: 100, 101 and 102**

**United States Patent and Trademark Office**

**Reg. No. 3,499,061**

**Registered Sep. 9, 2008**

**SERVICE MARK  
PRINCIPAL REGISTER**

**FROOGLES**

WOLFE, RICHARD (NEW YORK SOLE PROPRIETORSHIP), DBA FROOGLES.COM  
17 CASTLE LANE  
HOLTSVILLE, NY 11742

FOR: PROVIDING MARKETING INFORMATION AND ORDERING SERVICES IN THE FIELD OF ELECTRONIC COMMERCE VIA GLOBAL COMPUTER NETWORKS; DISSEMINATION OF ADVERTISING FOR OTHERS VIA ON-LINE ELECTRONIC COMMUNICATIONS NETWORK; PROVIDING INFORMATION ON GLOBAL COMPUTER NETWORKS IN THE FIELD OF ELECTRONIC COMMERCE IN THE NATURE OF PRICES, DISCOUNTS, SALES, AVAILABILITY, TERMS AND OTHER INFORMATION RELATING TO VARIOUS THIRD-PARTY MERCHANTS AND THE GOODS AND SERVICES OFFERED BY SUCH MERCHANTS; ENABLING CONSUMERS TO MAKE PURCHASES OF GOOD AND SERVICES FROM OTHERS ON GLOBAL COMPUTER NETWORKS;

INFOMEDIARY SERVICES, NAMELY, FACILITATING TRANSACTIONS BETWEEN BUYERS AND SELLERS THROUGH PROVIDING BUYERS WITH INFORMATION ABOUT SELLERS, GOODS, AND/OR SERVICES; PROMOTING THE SALE OF GOODS AND SERVICES OF OTHERS AND PROVIDING HYPERTEXT LINKS TO THE WEBSITES OF OTHERS; PROVIDING AN ONLINE COMPUTER DATABASE IN THE FIELD OF LOCATING PRODUCTS, DESCRIBING PRODUCTS, RATING PRODUCTS, PRICING PRODUCTS AND COMPARING PRICES OF PRODUCTS OF OTHERS, IN CLASS 35 (U.S. CLS. 100, 101 AND 102).

FIRST USE 12-31-2001; IN COMMERCE 12-31-2001.

SER. NO. 78-297,093, FILED 9-8-2003.

GEORGE LORENZO, EXAMINING ATTORNEY

**Int. Cl.: 35**

**Prior U.S. Cls.: 100, 101 and 102**

**United States Patent and Trademark Office**

**Reg. No. 3,499,062**

**Registered Sep. 9, 2008**

**SERVICE MARK  
PRINCIPAL REGISTER**

**VARSITY DRINKING**

MCKENZIE, BRANDON (UNITED STATES INDIVIDUAL)  
11628 MAYFIELD AVENUE APT. 11  
LOS ANGELES, CA 90049

FOR: RETAIL STORE SERVICES, NAMELY, ON-LINE RETAIL STORE SERVICES FEATURING SHIRTS, SWEATSHIRTS, UNDERGARMENTS, BAGS, HATS, BARWARE, CLOCKS, MOUSEPADS, AND STUFFED ANIMALS, GIFTS AND GENERAL CONSUMER MERCHANDISE, MANUFACTURED BY THIRD PARTIES, IN CLASS 35 (U.S. CLS. 100, 101 AND 102).

FIRST USE 10-7-2002; IN COMMERCE 7-14-2003.

NO CLAIM IS MADE TO THE EXCLUSIVE RIGHT TO USE VARSITY, APART FROM THE MARK AS SHOWN.

SER. NO. 78-304,528, FILED 9-24-2003.

EUGENIA MARTIN, EXAMINING ATTORNEY



**Int. Cl.: 28**

**Prior U.S. Cls.: 22, 23, 38 and 50**

**Reg. No. 3,499,063**

**United States Patent and Trademark Office**

**Registered Sep. 9, 2008**

**TRADEMARK  
PRINCIPAL REGISTER**

**SAMANTHA  
PARKINGTON**

AMERICAN GIRL, LLC (DELAWARE LIMITED  
LIABILITY COMPANY)  
333 CONTINENTAL BOULEVARD  
EL SEGUNDO, CA 90245

OWNER OF U.S. REG. NO. 2,572,652.

FOR: DOLLS, DOLL CLOTHING, AND DOLL  
ACCESSORIES, IN CLASS 28 (U.S. CLS. 22, 23, 38  
AND 50).

THE NAME(S), PORTRAIT(S), AND/OR SIGNA-  
TURE(S) SHOWN IN THE MARK DOES NOT IDENT-  
TIFY A PARTICULAR LIVING INDIVIDUAL.

FIRST USE 9-1-1986; IN COMMERCE 9-1-1986.

SER. NO. 78-325,943, FILED 11-11-2003.

THE MARK CONSISTS OF STANDARD CHAR-  
ACTERS WITHOUT CLAIM TO ANY PARTICULAR  
FONT, STYLE, SIZE, OR COLOR.

ALICIA COLLINS, EXAMINING ATTORNEY

**Int. Cl.: 36**

**Prior U.S. Cls.: 100, 101 and 102**

**United States Patent and Trademark Office**

**Reg. No. 3,499,064**

**Registered Sep. 9, 2008**

**SERVICE MARK  
PRINCIPAL REGISTER**

**DYNAMIC PROTECTED  
DIVIDEND VALUE  
FUND**

DUNDEE CORPORATION (CANADA CORPORATION)  
28TH FLOOR  
1 ADELAIDE STREET EAST  
TORONTO, ONTARIO, CANADA M5C 2V9

FOR: MUTUAL FUND SERVICES, NAMELY, FUND BROKERAGE, MUTUAL FUND DISTRIBUTION AND THE ADMINISTRATION AND MANAGEMENT OF MUTUAL FUNDS, IN CLASS 36 (U.S. CLS. 100, 101 AND 102).

THE MARK CONSISTS OF STANDARD CHARACTERS WITHOUT CLAIM TO ANY PARTICULAR FONT, STYLE, SIZE, OR COLOR.

PRIORITY CLAIMED UNDER SEC. 44(D) ON CANADA APPLICATION NO. 1201392, FILED 12-11-2003, REG. NO. TMA657020, DATED 1-20-2006, EXPIRES 1-20-2021.

NO CLAIM IS MADE TO THE EXCLUSIVE RIGHT TO USE "PROTECTED DIVIDEND VALUE FUND", APART FROM THE MARK AS SHOWN.

SER. NO. 78-343,376, FILED 12-19-2003.

CHRIS WELLS, EXAMINING ATTORNEY

Int. Cl.: 9

Prior U.S. Cls.: 21, 23, 26, 36 and 38

Reg. No. 3,499,065

United States Patent and Trademark Office

Registered Sep. 9, 2008

TRADEMARK  
PRINCIPAL REGISTER



HITACHI MAXELL, LTD. (JAPAN CORPORATION)  
1-88, USHITORA 1-CHOME, IBARAKI-SHI  
OSAKA, JAPAN

FOR: MAGNETIC RECORDINGS AND REPRODUCING MEDIA IN THE FORM OF TAPES, CARDS AND DISCS FOR RECORDING THEREIN SOUND, PICTURES, AND DATA; AND IN THE FORM OF PRERECORDED MAGNETIC RECORDING AND REPRODUCING MEDIA IN THE FORM OF TAPES, CARDS AND DISCS FEATURING MUSIC AND MOVIES, SOUND AND/OR PICTURES AND/OR DATA FOR REPRODUCING; OPTICAL RECORDING AND REPRODUCING MEDIA IN THE FORM OF CARDS AND DISCS FOR RECORDING THEREIN SOUND, PICTURES AND DATA; PRERECORDED OPTICAL RECORDING AND REPRODUCING MEDIA IN THE FORM OF CARDS AND DISCS FEATURING MUSIC AND MOVIES, SOUND AND/OR PICTURES AND/OR DATA FOR REPRODUCING; BATTERIES; DATA, SOUND, AND PICTURE MEDIA USING IC MEMORY FOR RECORDING AND REPRODUCING NAMELY, IC CARD AND

MEMORY CARD; COMPUTERS; BLANK AND FORMATTED MAGNETIC COMPUTER TAPE CARTRIDGES; MAGNETIC PARTICLE/POWDER MADE OF METAL FOR COMPUTER TAPE, IN CLASS 9 (U.S. CLS. 21, 23, 26, 36 AND 38).

OWNER OF JAPAN REG. NO. 4955292, DATED 5-26-2006, EXPIRES 5-26-2016.

THE COLOR(S) PINK AND WHITE IS/ARE CLAIMED AS A FEATURE OF THE MARK.

THE ENTIRE MARK IS DEEP PINK, EXCEPT A PORTION AT THE TOP OF THE "O", WHICH IS WHITE, AND ANOTHER PORTION, IN THE MIDDLE OF THE "O", WHERE THE PINK COLOR GRADUALLY BECOMES DARKER AND MORE SOLID.

SER. NO. 78-347,872, FILED 1-5-2004.

SHAUNIA CARLYLE, EXAMINING ATTORNEY

**Int. Cl.: 30**

**Prior U.S. Cl.: 46**

**United States Patent and Trademark Office**

**Reg. No. 3,499,066**

**Registered Sep. 9, 2008**

**TRADEMARK  
PRINCIPAL REGISTER**



GIVE AND GO PREPARED FOODS CORP. (CANADA CORPORATION)  
6650 FINCH AVENUE WEST  
TORONTO, ONTARIO, CANADA M9W 6C2

OWNER OF CANADA REG. NO. TMA702,076,  
DATED 11-30-2007, EXPIRES 11-30-2022.

FOR: BAKED GOODS, NAMELY, BROWNIES, MACAROONS, SCONES, BISCUITS, TARTS, COOKIES, CAKES, SQUARES, ROLLS, AND BUNS AND PARTY TRAYS CONSISTING OF COMBINATIONS OF THE FOREGOING, IN CLASS 30 (U.S. CL. 46).

SEC. 2(F) AS TO "HOMESTYLE".

SER. NO. 78-381,373, FILED 3-10-2004.

FIRST USE 0-0-1999; IN COMMERCE 0-0-1999.

TARAH HARDY, EXAMINING ATTORNEY

**Int. Cl.: 28**

**Prior U.S. Cls.: 22, 23, 38 and 50**

**United States Patent and Trademark Office**

**Reg. No. 3,499,067**

**Registered Sep. 9, 2008**

**TRADEMARK  
PRINCIPAL REGISTER**

**STREET MAYHEM**

NIKKO AMERICA, INC. (DELAWARE CORPORATION)  
2801 SUMMIT AVENUE  
PLANO, TX 75074

THE MARK CONSISTS OF STANDARD CHARACTERS WITHOUT CLAIM TO ANY PARTICULAR FONT, STYLE, SIZE, OR COLOR.

FOR: TOYS, NAMELY, RADIO-CONTROLLED VEHICLES, IN CLASS 28 (U.S. CLS. 22, 23, 38 AND 50).

SER. NO. 78-412,670, FILED 5-4-2004.

FIRST USE 1-4-2004; IN COMMERCE 1-4-2004.

DAWN HAN, EXAMINING ATTORNEY

Int. Cl.: 35

Prior U.S. Cls.: 100, 101 and 102

**United States Patent and Trademark Office**

**Reg. No. 3,499,068**

Registered Sep. 9, 2008

**SERVICE MARK  
PRINCIPAL REGISTER**



ENMARK STATIONS, INC. (GEORGIA CORPORATION)  
2112 RANKIN STREET POST OFFICE BOX 728  
SAVANNAH, GA 314020728

NO CLAIM IS MADE TO THE EXCLUSIVE RIGHT TO USE "COFFEE", APART FROM THE MARK AS SHOWN.

FOR: RETAIL STORE SERVICES FEATURING CARRY-OUT FOOD AND BEVERAGE ITEMS, IN CLASS 35 (U.S. CLS. 100, 101 AND 102).

SER. NO. 78-438,490, FILED 6-21-2004.

FIRST USE 5-6-1997; IN COMMERCE 5-6-1997.

RAUL CORDOVA, EXAMINING ATTORNEY

**Int. Cls.: 35, 39 and 43**

**Prior U.S. Cls.: 100, 101, 102 and 105**

**United States Patent and Trademark Office**

**Reg. No. 3,499,069**

**Registered Sep. 9, 2008**

**SERVICE MARK  
PRINCIPAL REGISTER**



AMERICAN AIRLINES, INC. (DELAWARE CORPORATION)  
4333 AMON CARTER BLVD.  
FORT WORTH, TX 76155

FOR: PROMOTING THE GOODS AND SERVICES OF OTHERS BY MEANS OF AN INCENTIVE AWARDS PROGRAM WHEREBY PURCHASE POINTS ARE AWARDED FOR PURCHASES MADE FROM VENDOR SUBSCRIBERS WHICH POINTS CAN THEN BE REDEEMED FOR MERCHANDISE, SERVICES AND TRAVEL; CUSTOMER LOYALTY PROGRAMS IN WHICH AWARDS ARE EARNED WITH AIRLINES, CRUISE COMPANIES, AND VEHICLE RENTAL COMPANIES; PROMOTING THE LODGING SERVICES OF OTHERS BY MEANS OF CUSTOMER LOYALTY PROGRAMS IN WHICH AWARDS ARE EARNED WITH HOTELS AND OTHER LODGING FACILITIES, IN CLASS 35 (U.S. CLS. 100, 101 AND 102).

FIRST USE 4-28-2004; IN COMMERCE 4-28-2004.

FOR: AIRLINE, CRUISE SHIP, AND VEHICLE TRANSPORTATION RESERVATION SERVICES FOR OTHERS, IN CLASS 39 (U.S. CLS. 100 AND 105).

FIRST USE 4-28-2004; IN COMMERCE 4-28-2004.

FOR: MAKING TEMPORARY ACCOMMODATION RESERVATIONS FOR OTHERS, IN CLASS 43 (U.S. CLS. 100 AND 101).

FIRST USE 4-28-2004; IN COMMERCE 4-28-2004.

OWNER OF U.S. REG. NOS. 893,040, 2,006,172 AND OTHERS.

NO CLAIM IS MADE TO THE EXCLUSIVE RIGHT TO USE "HOTEL", APART FROM THE MARK AS SHOWN.

SER. NO. 78-452,596, FILED 7-19-2004.

JANICE L. MCMORROW, EXAMINING ATTORNEY

**Int. Cl.: 25**

**Prior U.S. Cls.: 22 and 39**

**United States Patent and Trademark Office**

**Reg. No. 3,499,070**

**Registered Sep. 9, 2008**

**TRADEMARK  
PRINCIPAL REGISTER**

**PEE-PEE TEEPEE**

MALCIC, PETER (CANADA INDIVIDUAL)  
1234 BLUFF DRIVE  
COQUITLAM, BRITISH COLUMBIA, CANADA V3E  
1C1

FOR: CLOTH CONICAL COVERS FOR PLACE-  
MENT OVER THE PENIS OF AN UNCLOTHED  
INFANT TO PREVENT PERSONS IN PROXIMITY  
OF THE INFANT FROM BEING SPRAYED BY  
ACCIDENTAL URINATION , IN CLASS 25 (U.S.  
CLS. 22 AND 39).

FIRST USE 9-11-2003; IN COMMERCE 9-11-2003.

THE MARK CONSISTS OF STANDARD CHAR-  
ACTERS WITHOUT CLAIM TO ANY PARTICULAR  
FONT, STYLE, SIZE, OR COLOR.

PRIORITY CLAIMED UNDER SEC. 44(D) ON  
CANADA APPLICATION NO. 1203697, FILED 1-20-  
2004, REG. NO. TMA681106, DATED 2-5-2007, EX-  
PIRES 2-5-2022.

SER. NO. 78-453,311, FILED 7-20-2004.

HOWARD B. LEVINE, EXAMINING ATTORNEY



**Int. Cl.: 28**

**Prior U.S. Cls.: 22, 23, 38 and 50**

**Reg. No. 3,499,071**

**United States Patent and Trademark Office**

**Registered Sep. 9, 2008**

**TRADEMARK  
PRINCIPAL REGISTER**

**FRONT SEAT ANGEL**

GODU, INC. (GEORGIA CORPORATION)  
470 CAMBRIDGE WAY  
ATLANTA, GA 30328

FOR: DOLLS AND DOLL ACCESSORIES, IN  
CLASS 28 (U.S. CLS. 22, 23, 38 AND 50).

FIRST USE 6-1-2008; IN COMMERCE 6-1-2008.

THE MARK CONSISTS OF STANDARD CHAR-  
ACTERS WITHOUT CLAIM TO ANY PARTICULAR  
FONT, STYLE, SIZE, OR COLOR.

NO CLAIM IS MADE TO THE EXCLUSIVE  
RIGHT TO USE "ANGEL", APART FROM THE  
MARK AS SHOWN.

SER. NO. 78-456,760, FILED 7-26-2004.

DAWN FELDMAN, EXAMINING ATTORNEY

**Int. Cls.: 9, 35 and 41**

**Prior U.S. Cls.: 21, 23, 26, 36, 38, 100, 101, 102 and 107**

**United States Patent and Trademark Office**

**Reg. No. 3,499,072**

**Registered Sep. 9, 2008**

**TRADEMARK  
SERVICE MARK  
PRINCIPAL REGISTER**



L'ARENA DES CANADIENS INC. (CANADA CORPORATION)  
1260, DE LA GAUCHETIERE STREET WEST  
MONTREAL, QUEBEC, CANADA H3B5E8

FOR: PRE-RECORDED AUDIO AND VISUAL RECORDINGS, NAMELY, MOTION PICTURE FILMS AND FILM STRIPS, PRE-RECORDED AUDIO TAPES, COMPACT DISCS, VIDEO TAPES, VIDEO CASSETTES, DIGITAL AUDIO TAPES, COMPACT DISC VIDEO AND LASER DISCS AND DIGITAL VERSATILE DISCS ALL FEATURING MUSIC AND MUSIC ENTERTAINMENT, IN CLASS 9 (U.S. CLS. 21, 23, 26, 36 AND 38).

FOR: PROMOTION OF SPECIAL EVENTS OF OTHERS, NAMELY, LIVE THEATER, CONCERTS, MUSICALS, CIRCUS SHOWS, ICE SHOWS AND MAGIC SHOWS; PROMOTION OF MUSICAL ENTERTAINMENT EVENTS AND MUSICAL ACTS OF OTHERS THROUGH THE DISTRIBUTION OF PRINTED PROMOTIONAL MATERIALS; PROMOTION OF MUSICAL CONCERTS, MUSIC FESTIVALS, LIVE THEATER, CONCERTS, CIRCUS SHOWS, ICE SHOWS, AND MAGIC SHOWS BY SOLICITING AND ARRANGING FOR SPONSORS TO AFFILIATE THEIR GOODS AND SERVICES WITH SUCH ENTERTAINMENT EVENTS FOR A

FEE; MANAGEMENT SERVICES FOR THE REPRESENTATION OF ARTISTS, NAMELY, SINGERS, MUSICIANS AND COMEDIANS, IN CLASS 35 (U.S. CLS. 100, 101 AND 102).

FOR: ENTERTAINMENT SERVICES, NAMELY, PRODUCTION AND DISTRIBUTION OF RADIO AND TELEVISION PROGRAMS IN THE FIELD OF MUSIC; PRODUCTION OF TELEVISION PROGRAMS, RADIO PROGRAMS AND INTERNET ENTERTAINMENT PROGRAMS, IN CLASS 41 (U.S. CLS. 100, 101 AND 107).

PRIORITY CLAIMED UNDER SEC. 44(D) ON CANADA APPLICATION NO. 1207234, FILED 2-23-2004, REG. NO. TMA699,383, DATED 10-24-2007, EXPIRES 10-24-2022.

NO CLAIM IS MADE TO THE EXCLUSIVE RIGHT TO USE "ENTERTAINMENT GROUP", APART FROM THE MARK AS SHOWN.

THE STIPPLING IS A FEATURE OF THE MARK.

SER. NO. 78-471,671, FILED 8-23-2004.

KAPIL BHANOT, EXAMINING ATTORNEY

**Int. Cl.: 28**

**Prior U.S. Cls.: 22, 23, 38 and 50**

**Reg. No. 3,499,073**

**United States Patent and Trademark Office**

**Registered Sep. 9, 2008**

**TRADEMARK  
PRINCIPAL REGISTER**

**WSOP**

HARRAH'S LICENSE COMPANY, LLC (NEVADA  
LIMITED LIABILITY COMPANY)

TYLER - LAW

C/O HARRAH'S OPERATING COMPANY, INC. ONE  
HARRAH'S COURT

LAS VEGAS, NV 89119

FOR: EQUIPMENT SOLD AS A UNIT FOR PLAY-  
ING CARD GAMES; GAMING EQUIPMENT,  
NAMELY, POKER CHIPS, PLAYING CARDS, GAM-  
ING TABLE FELTS, AUTOMATIC CARD SHUF-  
FLERS; ELECTRONIC HAND-HELD GAMES FOR  
PLAYING VIDEO GAMES AND ELECTRONIC  
HAND-HELD GAMES WITH LIQUID CRYSTAL

DISPLAYS; GAME TABLES AND TABLE COVERS,  
IN CLASS 28 (U.S. CLS. 22, 23, 38 AND 50).

FIRST USE 12-1-2004; IN COMMERCE 12-1-2004.

THE MARK CONSISTS OF STANDARD CHAR-  
ACTERS WITHOUT CLAIM TO ANY PARTICULAR  
FONT, STYLE, SIZE, OR COLOR.

OWNER OF U.S. REG. NOS. 1,025,395 AND  
2,119,064.

SER. NO. 78-485,005, FILED 9-16-2004.

DOMINICK J. SALEMI, EXAMINING ATTORNEY

**Int. Cl.: 25**

**Prior U.S. Cls.: 22 and 39**

**United States Patent and Trademark Office**

**Reg. No. 3,499,074**

**Registered Sep. 9, 2008**

**TRADEMARK  
PRINCIPAL REGISTER**



VITAL APPAREL GROUP, INC. (NEW YORK CORPORATION)  
7 NORDEN LANE  
HUNTINGTON STATION, NY 11746

FOR: MEN'S, WOMEN'S AND CHILDREN'S ACTIVE SPORTS APPAREL, NAMELY, SHIRTS, T-SHIRTS AND SWEATSHIRTS, SHORTS, PANTS, AND JACKETS, IN CLASS 25 (U.S. CLS. 22 AND 39).

FIRST USE 5-1-1995; IN COMMERCE 5-1-1995.

OWNER OF U.S. REG. NO. 1,502,281.

THE MARK CONSISTS OF A STYLIZED WORD "VITAL".

SER. NO. 78-493,234, FILED 10-1-2004.

DAWN FELDMAN, EXAMINING ATTORNEY

**Int. Cls.: 41, 42 and 44**

**Prior U.S. Cls.: 100, 101 and 107**

**United States Patent and Trademark Office**

**Reg. No. 3,499,075**

**Registered Sep. 9, 2008**

**SERVICE MARK  
PRINCIPAL REGISTER**

**Cingulum  
Neurosciences  
Institute**

CINGULUM NEUROSCIENCES (NEW YORK  
NON-PROFIT CORPORATION)  
4435 STEPHANIE DRIVE  
MANLIUS, NY 13104

FOR: CONDUCTING CLASSES OF INSTRUCTION IN THE FIELD OF NEUROSCIENCE, PHYSIOLOGY AND PHARMACOLOGY, IN CLASS 41 (U.S. CLS. 100, 101 AND 107).

FIRST USE 6-1-2001; IN COMMERCE 6-1-2001.

FOR: SCIENTIFIC CONSULTING AND MEDICAL AND SCIENTIFIC RESEARCH, ALL IN THE FIELD OF NEUROTHERAPEUTICS, IN CLASS 42 (U.S. CLS. 100 AND 101).

FIRST USE 6-1-2001; IN COMMERCE 6-1-2001.

FOR: MEDICAL IMAGING SERVICES FOR OTHERS, NAMELY, MEDICAL IMAGING OF BRAIN STRUCTURES, IN CLASS 44 (U.S. CLS. 100 AND 101).

FIRST USE 6-1-2001; IN COMMERCE 6-1-2001.

THE MARK CONSISTS OF STANDARD CHARACTERS WITHOUT CLAIM TO ANY PARTICULAR FONT, STYLE, SIZE, OR COLOR.

NO CLAIM IS MADE TO THE EXCLUSIVE RIGHT TO USE "NEUROSCIENCES INSTITUTE", APART FROM THE MARK AS SHOWN.

SEC. 2(F).

SER. NO. 78-504,214, FILED 10-22-2004.

SONYA STEPHENS, EXAMINING ATTORNEY

**Int. Cl.: 3**

**Prior U.S. Cls.: 1, 4, 6, 50, 51 and 52**

**United States Patent and Trademark Office**

**Reg. No. 3,499,076**

**Registered Sep. 9, 2008**

**TRADEMARK  
PRINCIPAL REGISTER**

**Donnie's**

SOUTHWEST AMERICAN MFG., INC. (NEVADA CORPORATION)  
1623 EAST APACHE ST.  
TULSA, OK 74106

FOR: HAIR CONDITIONERS, HAIR PRESSING OIL, BERGAMOT HAIR DRESSING, HAIR SETTING LOTION, SHAMPOO AND HAIR RELAXER, IN CLASS 3 (U.S. CLS. 1, 4, 6, 50, 51 AND 52).

FIRST USE 6-15-1969; IN COMMERCE 7-22-1969.

THE MARK CONSISTS OF STANDARD CHARACTERS WITHOUT CLAIM TO ANY PARTICULAR FONT, STYLE, SIZE, OR COLOR.

SER. NO. 78-507,302, FILED 10-28-2004.

ESTHER BELENKER, EXAMINING ATTORNEY

**Int. Cl.: 25**

**Prior U.S. Cls.: 22 and 39**

**United States Patent and Trademark Office**

**Reg. No. 3,499,077**

**Registered Sep. 9, 2008**

**TRADEMARK  
PRINCIPAL REGISTER**

**VITAL GEAR**

VITAL APPAREL GROUP, INC. (NEW YORK CORPORATION)  
7 NORDEN LANE  
HUNTINGTON STATION, NY 11746

FOR: MEN'S, WOMEN'S AND CHILDREN'S ACTIVE SPORTS APPAREL, NAMELY, SHIRTS, NAMELY, T-SHIRTS AND SWEATSHIRTS, SHORTS, PANTS, AND JACKETS, IN CLASS 25 (U.S. CLS. 22 AND 39).

FIRST USE 7-1-2004; IN COMMERCE 7-1-2004.

THE MARK CONSISTS OF STANDARD CHARACTERS WITHOUT CLAIM TO ANY PARTICULAR FONT, STYLE, SIZE, OR COLOR.

OWNER OF U.S. REG. NO. 1,502,281.

NO CLAIM IS MADE TO THE EXCLUSIVE RIGHT TO USE "GEAR", APART FROM THE MARK AS SHOWN.

SER. NO. 78-517,179, FILED 11-15-2004.

ALEX KEAM, EXAMINING ATTORNEY

**Int. Cl.: 25**

**Prior U.S. Cls.: 22 and 39**

**United States Patent and Trademark Office**

**Reg. No. 3,499,078**

**Registered Sep. 9, 2008**

**TRADEMARK  
PRINCIPAL REGISTER**



2321 18TH STREET LLC (D.C. LIMITED LIABILITY COMPANY)  
2321 18TH ST., NW  
WASHINGTON, DC 20009

FIRST USE 1-0-2003; IN COMMERCE 1-0-2003.

SER. NO. 78-517,423, FILED 11-16-2004.

FOR: T-SHIRTS, CAPS, SWEATSHIRTS, ATHLETIC UNIFORMS, APRONS, AND GOLF SHIRTS, IN CLASS 25 (U.S. CLS. 22 AND 39).

EUGENIA MARTIN, EXAMINING ATTORNEY



**Int. Cl.: 36**

**Prior U.S. Cls.: 100, 101 and 102**

**United States Patent and Trademark Office**

**Reg. No. 3,499,079**

**Registered Sep. 9, 2008**

**SERVICE MARK  
PRINCIPAL REGISTER**

**THE PINNACLE GROUP**

PINNACLE MANAGING CO., LLC (NEW YORK  
LIMITED LIABILITY COMPANY)  
ONE PENN PLAZA  
NEW YORK, NY 10119

FOR: REAL ESTATE INVESTMENT; REAL ES-  
TATE EQUITY INVESTMENT, REAL ESTATE IN-  
VESTMENT MANAGEMENT; REAL ESTATE  
EQUITY SHARING, NAMELY, MANAGING AND  
ARRANGING FOR CO-OWNERSHIP OF REAL ES-  
TATE, IN CLASS 36 (U.S. CLS. 100, 101 AND 102).

FIRST USE 1-0-1997; IN COMMERCE 1-0-1997.

THE MARK CONSISTS OF STANDARD CHAR-  
ACTERS WITHOUT CLAIM TO ANY PARTICULAR  
FONT, STYLE, SIZE, OR COLOR.

NO CLAIM IS MADE TO THE EXCLUSIVE  
RIGHT TO USE "GROUP", APART FROM THE  
MARK AS SHOWN.

SER. NO. 78-534,761, FILED 12-17-2004.

PAULA MAHONEY, EXAMINING ATTORNEY

**Int. Cl.: 35**

**Prior U.S. Cls.: 100, 101 and 102**

**United States Patent and Trademark Office**

**Reg. No. 3,499,080**

**Registered Sep. 9, 2008**

**SERVICE MARK  
PRINCIPAL REGISTER**



**BILL GRAHAM ENTERPRISES, INC. (CALIFORNIA CORPORATION)  
200 EAST BASSE ROAD  
SAN ANTONIO, TX 78209**

**FOR: BUSINESS MANAGEMENT OF THE SPECIAL EVENTS OF OTHERS, ALL IN THE FIELD OF MUSICAL, THEATRICAL, EDUCATIONAL, CULTURAL, AND FAMILY/VARIETY TOURS AND PRESENTATIONS; RETAIL STORE SERVICES FEATURING ARTIST AND TOUR-RELATED MER-**

**CHANDISE AND COLLECTIBLES, IN CLASS 35 (U.S. CLS. 100, 101 AND 102).**

**FIRST USE 11-29-2004; IN COMMERCE 11-29-2004.**

**OWNER OF U.S. REG. NO. 1,960,048.**

**SER. NO. 78-541,306, FILED 1-3-2005.**

**ALEX KEAM, EXAMINING ATTORNEY**

**Int. Cl.: 35**

**Prior U.S. Cls.: 100, 101 and 102**

**United States Patent and Trademark Office**

**Reg. No. 3,499,081**

**Registered Sep. 9, 2008**

**SERVICE MARK  
PRINCIPAL REGISTER**

**WILD RUMPUS**

WILD RUMPUS, INC. (MINNESOTA CORPORATION)  
2720 WEST 43RD STREET  
MINNEAPOLIS, MN 55410

FOR: RETAIL STORE SERVICES FEATURING  
BOOKS, IN CLASS 35 (U.S. CLS. 100, 101 AND 102).

FIRST USE 9-30-1991; IN COMMERCE 9-30-1991.

THE MARK CONSISTS OF STANDARD CHARACTERS WITHOUT CLAIM TO ANY PARTICULAR FONT, STYLE, SIZE, OR COLOR.

SER. NO. 78-558,251, FILED 2-1-2005.

ROBERT C. CLARK JR., EXAMINING ATTORNEY

**Int. Cl.: 35**

**Prior U.S. Cls.: 100, 101 and 102**

**United States Patent and Trademark Office**

**Reg. No. 3,499,082**

**Registered Sep. 9, 2008**

**SERVICE MARK  
PRINCIPAL REGISTER**



AMERICAN IMAGING MANAGEMENT, INC.  
(ILLINOIS CORPORATION)  
SUITE 500  
40 SKOKIE BLVD  
NORTHBROOK, IL 60062

RELATES TO THESE SERVICES, SOME OF THE  
ABOVE SERVICES PROVIDED THROUGH THE  
INTERNET, IN CLASS 35 (U.S. CLS. 100, 101 AND  
102).

FOR: HEALTH CARE COST MANAGEMENT  
SERVICES IN THE FIELD OF MEDICAL DIAGNOS-  
TIC IMAGING, HEALTH CARE UTILIZATION AND  
REVIEW SERVICES IN THE FIELD OF MEDICAL  
DIAGNOSTIC IMAGING AND ELECTRONIC PRO-  
CESSING OF HEALTH CARE INFORMATION AS IT

FIRST USE 2-0-2003; IN COMMERCE 2-0-2003.

SER. NO. 78-559,811, FILED 2-3-2005.

INGRID C. EULIN, EXAMINING ATTORNEY

**Int. Cl.: 9**

**Prior U.S. Cls.: 21, 23, 26, 36 and 38**

**Reg. No. 3,499,083**

**United States Patent and Trademark Office**

**Registered Sep. 9, 2008**

**TRADEMARK  
PRINCIPAL REGISTER**



TANDEM TOWNE PUBLISHING LLC (OHIO LIMITED LIABILITY COMPANY)  
32 WILDWOOD DRIVE  
FAIRFIELD, OH 45014

FIRST USE 11-25-2001; IN COMMERCE 1-0-2005.

SER. NO. 78-577,026, FILED 2-28-2005.

FOR: AUDIO ENVIRONMENTS RECORDED ON COMPACT DISCS FOR USE IN CD-ROM'S, IN CLASS 9 (U.S. CLS. 21, 23, 26, 36 AND 38).

FLORENTINA BLANDU, EXAMINING ATTORNEY

Int. Cl.: 33

Prior U.S. Cls.: 47 and 49

United States Patent and Trademark Office

Reg. No. 3,499,084

Registered Sep. 9, 2008

TRADEMARK  
PRINCIPAL REGISTER



P C KELDERS (PTY) LTD (SOUTH AFRICA  
CORPORATION)  
DE RUST ESTATE  
GRABOUW, SOUTH AFRICA 7160

FOR: ALCOHOLIC BEVERAGES, NAMELY,  
WINE, IN CLASS 33 (U.S. CLS. 47 AND 49).

FIRST USE 1-1-2008; IN COMMERCE 1-1-2008.

NO CLAIM IS MADE TO THE EXCLUSIVE  
RIGHT TO USE "SLOW WINE", APART FROM  
THE MARK AS SHOWN.

SER. NO. 78-588,520, FILED 3-16-2005.

ALICE SUE CARRUTHERS, EXAMINING ATTOR-  
NEY

**Int. Cl.: 35**

**Prior U.S. Cls.: 100, 101 and 102**

**United States Patent and Trademark Office**

**Reg. No. 3,499,085**

**Registered Sep. 9, 2008**

**SERVICE MARK  
PRINCIPAL REGISTER**

**jeantherapy**

AMA PARTNERS LLC (LOUISIANA LIMITED  
LIABILITY COMPANY)  
5505 MAGAZINE ST.  
NEW ORLEANS, LA 70115

FOR: RETAIL STORE SERVICES AND ONLINE  
RETAIL STORE SERVICES FEATURING CLOTH-  
ING, INCLUDING JEANS, SHIRTS, PANTS,  
SHORTS, JACKETS, COATS, SWEATSHIRTS, SWEA-  
TERS, AND FOOTWEAR, IN CLASS 35 (U.S. CLS.  
100, 101 AND 102).

FIRST USE 7-1-2002; IN COMMERCE 11-1-2002.

THE MARK CONSISTS OF STANDARD CHAR-  
ACTERS WITHOUT CLAIM TO ANY PARTICULAR  
FONT, STYLE, SIZE, OR COLOR.

SER. NO. 78-600,177, FILED 4-1-2005.

MARIA-VICTORIA SUAREZ, EXAMINING ATTOR-  
NEY

Int. Cl.: 44

Prior U.S. Cls.: 100 and 101

United States Patent and Trademark Office

Reg. No. 3,499,086

Registered Sep. 9, 2008

SERVICE MARK  
PRINCIPAL REGISTER



FAMILY HOME HEALTH CARE

FAMILY HOME HEALTH CARE, INC. (KENTUCKY CORPORATION)  
4600 TURPEN COURT, SUITES A & B  
SOMERSET, KY 42501

FOR: HOME HEALTH CARE SERVICES; HEALTH CARE SERVICES, NAMELY, SKILLED NURSING, PRIVATE DUTY NURSING; REHABILITATIVE CARE SERVICES, NAMELY, PHYSICAL THERAPY, SPEECH LANGUAGE PATHOLOGY, AND OCCUPATIONAL THERAPY; VENTILATOR CARE SERVICES, NAMELY, EVALUATION OF PATIENT VITAL SIGNS, AND VENTILATOR MONITORING AND OPERATION; PROVIDING CARE OF THE TERMINALLY ILL, NAMELY, PERSONAL MEDICAL CARE; MEDICAL CASE MANAGEMENT, NAMELY, PSYCHOLOGICAL AND EMOTIONAL EVALUATIONS AND ASSESSMENTS; ADULT DAY HEALTH CARE SERVICES, NAMELY, ASSESSMENT AND TREATMENT OF MEDICAL NEEDS; EARLY PERIODIC MEDICAL SCREENING AND DEVELOPMENT TESTING (EPSDT); APNEA

MONITORING; PHOTO THERAPY; NUTRITIONAL COUNSELING; SPECIALIZED DISEASE MANAGEMENT PROGRAMS, IN CLASS 44 (U.S. CLS. 100 AND 101).

FIRST USE 12-16-2001; IN COMMERCE 12-16-2001.

OWNER OF U.S. REG. NO. 2,692,329.

NO CLAIM IS MADE TO THE EXCLUSIVE RIGHT TO USE "FAMILY HOME HEALTH CARE", APART FROM THE MARK AS SHOWN.

THE MARK CONSISTS OF THE TERM "FAMILY HOME HEALTH CARE" BELOW A STYLIZED DEPICTION OF FOUR STICK FIGURES.

SER. NO. 78-612,085, FILED 4-19-2005.

SARA THOMAS, EXAMINING ATTORNEY



**Int. Cl.: 41**

**Prior U.S. Cls.: 100, 101 and 107**

**United States Patent and Trademark Office**

**Reg. No. 3,499,087**

**Registered Sep. 9, 2008**

**SERVICE MARK  
PRINCIPAL REGISTER**

**WSOP**

HARRAH'S LICENSE COMPANY, LLC (NEVADA  
LIMITED LIABILITY COMPANY)

LAW

ONE HARRAH'S COURT  
LAS VEGAS, NV 89119

FOR: ENTERTAINMENT SERVICES, NAMELY,  
ORGANIZING, CONDUCTING, PRODUCING AND  
EXHIBITING POKER EVENTS RENDERED LIVE  
AND THROUGH THE MEDIA OF TELEVISION  
AND THE INTERNET, AND PROVIDING POKER  
NEWS AND INFORMATION VIA A GLOBAL COM-  
PUTER NETWORK, IN CLASS 41 (U.S. CLS. 100, 101  
AND 107).

FIRST USE 4-15-2003; IN COMMERCE 4-15-2003.

THE MARK CONSISTS OF STANDARD CHAR-  
ACTERS WITHOUT CLAIM TO ANY PARTICULAR  
FONT, STYLE, SIZE, OR COLOR.

OWNER OF U.S. REG. NOS. 1,025,395 AND  
2,119,064.

SER. NO. 78-615,434, FILED 4-23-2005.

TARAH HARDY, EXAMINING ATTORNEY

**Int. Cl.: 5**

**Prior U.S. Cls.: 6, 18, 44, 46, 51 and 52**

**United States Patent and Trademark Office**

**Reg. No. 3,499,088**

**Registered Sep. 9, 2008**

**TRADEMARK  
PRINCIPAL REGISTER**

**PROMACTA**

GLAXO GROUP LIMITED (UNITED KINGDOM  
CORPORATION)

GLAXO WELLCOME HOUSE, BERKELEY AVENUE  
GREENFORD, MIDDLESEX, ENGLAND UB6 0NN

FOR: PHARMACEUTICAL PREPARATIONS  
AND SUBSTANCES FOR THE TREATMENT OF  
VIRAL AND ONCOLOGICAL RELATED DISEASES  
AND DISORDERS, IN CLASS 5 (U.S. CLS. 6, 18, 44, 46,  
51 AND 52).

THE MARK CONSISTS OF STANDARD CHAR-  
ACTERS WITHOUT CLAIM TO ANY PARTICULAR  
FONT, STYLE, SIZE, OR COLOR.

OWNER OF ERPN CMNTY TM OFC REG. NO.  
000510875, DATED 5-7-1999, EXPIRES 5-7-2019.

OWNER OF U.S. REG. NO. 2,358,999.

SER. NO. 78-616,041, FILED 4-25-2005.

H. M. FISHER, EXAMINING ATTORNEY

Int. Cl.: 33

Prior U.S. Cls.: 47 and 49

United States Patent and Trademark Office

Reg. No. 3,499,089

Registered Sep. 9, 2008

TRADEMARK  
PRINCIPAL REGISTER

GRAYSON  
CELLARS



WOODMAR GROUP (CALIFORNIA CORPORATION)  
1247 DURANT CT  
WALNUT CREEK, CA 94596

FOR: WINE, IN CLASS 33 (U.S. CLS. 47 AND 49).

FIRST USE 4-25-2005; IN COMMERCE 4-25-2005.

NO CLAIM IS MADE TO THE EXCLUSIVE RIGHT TO USE "CELLARS", APART FROM THE MARK AS SHOWN.

THE MARK CONSISTS OF THE WORDS GRAYSON CELLARS AND A DRAWING OF A TOP HAT.

SER. NO. 78-616,559, FILED 4-25-2005.

BERYL GARDNER, EXAMINING ATTORNEY

Int. Cl.: 43

Prior U.S. Cls.: 100 and 101

United States Patent and Trademark Office

Reg. No. 3,499,090

Registered Sep. 9, 2008

SERVICE MARK  
PRINCIPAL REGISTER

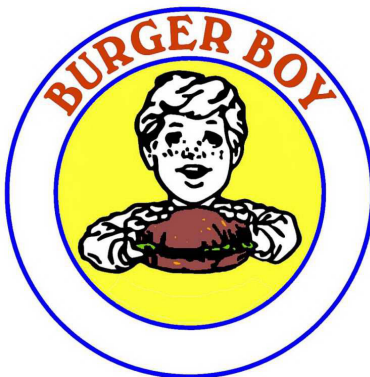

SOPASAKIS, GEORGE (UNITED STATES INDIVIDUAL)  
P.O. BOX 4679  
COLLEGE STATION, TX 77844

FOR: RESTAURANT SERVICES; RESTAURANTS FEATURING HOME DELIVERY, IN CLASS 43 (U.S. CLS. 100 AND 101).

FIRST USE 9-30-1979; IN COMMERCE 9-30-1979.

NO CLAIM IS MADE TO THE EXCLUSIVE RIGHT TO USE "BURGER", APART FROM THE MARK AS SHOWN.

THE COLOR(S) RED, BLUE, YELLOW, BROWN, ORANGE, GREEN, BLACK, AND WHITE IS/ARE CLAIMED AS A FEATURE OF THE MARK.

THE MARK CONSISTS OF THE COLOR RED APPEARS IN THE WORDING, BLUE APPEARS IN THE OUTLINE OF THE CIRCLES, YELLOW APPEARS IN THE BACKGROUND OF THE SMALLER CIRCLE, BROWN APPEARS IN THE BUN, ORANGE APPEARS IN THE SPOTS OF THE BUN, GREEN APPEARS IN THE SANDWICH, BLACK APPEARS IN THE SANDWICH AND THE OUTLINE OF THE BOY, AND WHITE APPEARS IN THE BOY AND THE OUTER BAND OF THE CIRCLE.

SER. NO. 78-638,682, FILED 5-27-2005.

KRISTINA MORRIS, EXAMINING ATTORNEY

**Int. Cls.: 35 and 42**

**Prior U.S. Cls.: 100, 101 and 102**

**United States Patent and Trademark Office**

**Reg. No. 3,499,091**

**Registered Sep. 9, 2008**

**SERVICE MARK  
PRINCIPAL REGISTER**

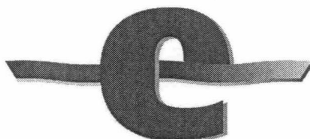

**Environmental Strategist**

ENVIRONMENTAL RISK MANAGERS, INC. (MI-  
CHIGAN CORPORATION)  
BOX 1127  
LELAND, MI 49654

FOR: CONSULTING SERVICES IN THE FIELDS  
OF ENVIRONMENTAL LIABILITY AND RISK AS-  
SESSMENT, IN CLASS 35 (U.S. CLS. 100, 101 AND  
102).

FIRST USE 12-31-1997; IN COMMERCE 12-31-1997.

FOR: CONSULTING SERVICES IN THE FIELDS  
OF ENVIRONMENTAL ASSESSMENT, COMPLI-  
ANCE AND PLANNING, IN CLASS 42 (U.S. CLS.  
100 AND 101).

FIRST USE 12-31-1997; IN COMMERCE 12-31-1997.

OWNER OF U.S. REG. NO. 2,014,893.

THE MARK CONSISTS OF A STYLIZED "E"  
WITH THE WORDS "ENVIRONMENTAL STRATE-  
GIST" BELOW SAID "E".

SEC. 2(F) AS TO "ENVIRONMENTAL STRATE-  
GIST".

SER. NO. 78-659,632, FILED 6-28-2005.

KELLY MCCOY, EXAMINING ATTORNEY

Int. Cl.: 29

Prior U.S. Cl.: 46

Reg. No. 3,499,092

United States Patent and Trademark Office

Registered Sep. 9, 2008

TRADEMARK  
PRINCIPAL REGISTER

PQP

PREMIUM QUALITY PRODUCT, INC. (CALIFORNIA CORPORATION)  
3435 WILSHIRE BOULEVARD, SUITE 2820  
LOS ANGELES, CA 90010

FOR: PHEASANT MEAT; CHICKEN; PORK; HORSE MEAT; BEEF; MUTTON; DUCK MEAT; ARTIFICIAL MEAT; TURKEY; HARE MEAT; DE-SICCATED EGGS; EGGS; FROZEN EGGS; QUAIL EGGS; POWDERED EGGS; DUCK EGGS; LIVER; LIVER PATE; LIVER PASTE; MEAT EXTRACTS; MEAT JELLIES; PORK CUTLETS; RENNET; BACON; BOUILLON; PREPARATIONS FOR MAKING BOUILLON; BROTH; BLACK PUDDING BLOOD SAUSAGE; BEEFSTEAK; CHARCUTERIE; SAUSAGES; TRIPE; ANIMAL MARROW FOR FOOD; UNSWEETENED GELATINE FOR FOOD; BEEF JERKY; SAUSAGES IN BATTER; CANNED MEAT; HAM; HAMBURGER MEAT; FERMENTED MILK; BUTTER; BUTTERCREAM; POWDERED MILK EXCEPT FOR INFANTS; SOUR CREAM; GOAT'S MILK; SHEEP MILK; YOGURT; MILK; LACTIC ACID BACTERIA DRINKS; LACTIC ACID DRINKS; WHEY; CHEESE; KEFIR MILK BEVERAGE; CONDENSED MILK; KOUMISS MILK BEVERAGES; CREAM; WHIPPED CREAM; PERILLA OIL FOR FOOD; PEANUT OIL FOR FOOD; COTTON SEED OIL FOR FOOD; WHEAT OIL FOR FOOD; LINSEED OIL FOR FOOD; CORN OIL FOR FOOD; OLIVE OIL FOR FOOD; SESAME OIL FOR FOOD; COCONUT PALM OIL FOR FOOD; SOYBEAN OIL FOR FOOD; PALM KERNEL OIL FOR FOOD; FRUIT PECTIN FOR FOOD; RAPESEED OIL FOR FOOD; SUNFLOWER OIL FOR FOOD; WHALE OIL AND FAT FOR FOOD; BONE OIL; LANOLINE FOR FOOD; LARD FOR FOOD; FISH OIL FOR FOOD; BEEF TALLOW FOR FOOD; MARGARINE; SHORTENING; HARDENED OIL HYDROGENATED OIL FOR FOOD; POWDERED OIL AND FAT FOR FOOD; SNAKEHEADS NOT LIVE; STINGRAY NOT LIVE; FLOUNDER NOT LIVE; CRAYFISH NOT LIVE; HAIRTAIL NOT LIVE; CRABS NOT LIVE; MACK-

ERELS NOT LIVE; WHALES NOT LIVE; FLATFISH NOT LIVE; OYSTERS NOT LIVE; SAURY NOT LIVE; SMALL OCTOPUSES NOT LIVE; FLATFISH NOT LIVE; BLUE MARLIN NOT LIVE; SEA BASSES NOT LIVE; CODS NOT LIVE; SALT-FERMENTED COD ROE NOT LIVE; DOLPHINS NOT LIVE; SEA BREAMS NOT LIVE; DRIED HERRING ROE NOT LIVE; ANCHOVY NOT LIVE; ALASKA POLLACK NOT LIVE; OCTOPUS NOT LIVE; LOACH NOT LIVE; SHORT-NECKED CLAMS NOT LIVE; YELLOW TAILS NOT LIVE; LARGE-EYED HERRING NOT LIVE; EELS NOT LIVE; POMFRET NOT LIVE; SAND SMELT NOT LIVE; SWELLFISH NOT LIVE; ROCKFISH NOT LIVE; CRUCIAN CARPS NOT LIVE; CONGERS NOT LIVE; SPANISH MACKEREL NOT LIVE; SHARKS NOT LIVE; SHRIMPS NOT LIVE; SEA URCHINS NOT LIVE; SALT-FERMENTED SEA URCHIN ROE NOT LIVE; SALTED SALMON ROE NOT LIVE; TURBAN SHELL NOT LIVE; GRAY MULLET NOT LIVE; FROGS FOR FOOD NOT LIVE; SALMON NOT LIVE; SQUID NOT LIVE; SEA SQUIRT NOT LIVE; SWEETFISH NOT LIVE; CARP NOT LIVE; SOFT-SHELLED TURTLES NOT LIVE; SAUREL NOT LIVE; ABOLONES NOT LIVE; GIZZARD SHAD NOT LIVE; SARDINES NOT LIVE; SHELLFISH NOT LIVE; YELLOW CORVENIA NOT LIVE; SLENDER SHAD NOT LIVE; FILEFISH NOT LIVE; TUNA FISH NOT LIVE; SPEARFISH NOT LIVE; HERRINGS NOT LIVE; CAVIAR; SEA-CUCUMBERS NOT LIVE; SKATE NOT LIVE; MUSSEL NOT LIVE; SWORDFISH NOT LIVE; SWEET LAVER; SEA TANGLE; GULF WEED; BROWN SEAWEED; SEA-WEED FUSIFORME; GREEN LAVER; AGAR-AGAR; LAVER; DRIED FISH AND SHELLFISH; STEAMED OR TOASTED CAKES OF FISH PASTE; FISH FILLETS; CANNED OR BOTTLED FISHES; ISINGLASS FOR FOOD; FISHMEAL FOR HUMAN CONSUMPTION; SMOKED FISHES, IN CLASS 29 (U.S. CL. 46).

THE MARK CONSISTS OF STANDARD CHAR-  
ACTERS WITHOUT CLAIM TO ANY PARTICULAR  
FONT, STYLE, SIZE, OR COLOR.

OWNER OF REPUBLIC OF KOREA REG. NO.  
0660244, DATED 4-27-2006, EXPIRES 4-27-2016.

SER. NO. 78-672,302, FILED 7-18-2005.

LESLEY LAMOTHE, EXAMINING ATTORNEY

**Int. Cl.: 30**

**Prior U.S. Cl.: 46**

**United States Patent and Trademark Office**

**Reg. No. 3,499,093**

**Registered Sep. 9, 2008**

**TRADEMARK  
PRINCIPAL REGISTER**

**MaggieMoo's Quick Escapes**

MAGGIEMOO'S INTERNATIONAL, LLC (DELA-  
WARE LIMITED LIABILITY COMPANY)  
SUITE 301  
10025 GOVERNOR WARFIELD PARKWAY  
COLUMBIA, MD 21044

FOR: ICE CREAM AND FROZEN YOGURT, IN  
CLASS 30 (U.S. CL. 46).

FIRST USE 6-17-2005; IN COMMERCE 6-17-2005.

THE MARK CONSISTS OF STANDARD CHAR-  
ACTERS WITHOUT CLAIM TO ANY PARTICULAR  
FONT, STYLE, SIZE, OR COLOR.

OWNER OF U.S. REG. NOS. 2,208,567 AND  
2,282,514.

SER. NO. 78-675,552, FILED 7-21-2005.

KIMBERLY FRYE, EXAMINING ATTORNEY



**Int. Cl.: 33**

**Prior U.S. Cls.: 47 and 49**

**United States Patent and Trademark Office**

**Reg. No. 3,499,094**

**Registered Sep. 9, 2008**

**TRADEMARK  
PRINCIPAL REGISTER**

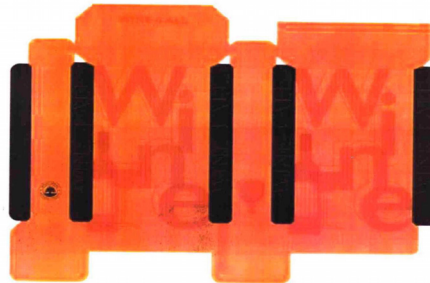

LA FIEE DES LOIS SA (FRANCE SOCIETE  
ANONYME)  
ZONE INDUSTRIELLE  
RUE MONTGOLFIER  
PRAHECQ, FRANCE 79230

FOR: ALCOHOLIC BEVERAGES, NAMELY  
WINES, IN CLASS 33 (U.S. CLS. 47 AND 49).

OWNER OF ERPN CMNTY TM OFC REG. NO.  
004218798, DATED 1-19-2006, EXPIRES 12-23-2014.

THE COLOR(S) ORANGE AND BLACK IS/ARE  
CLAIMED AS A FEATURE OF THE MARK.

THE COLOR ORANGE APPEARS IN THE BACK-  
GROUND, THE COLOR ORANGE APPEARS IN  
THE WORDING AND DESIGNS, AND THE BLACK  
COLOR APPEARS IN FOUR VERTICAL BLACK  
BANDS AT REGULAR INTERVALS.

SER. NO. 78-677,095, FILED 7-25-2005.

MARK SPARACINO, EXAMINING ATTORNEY

Int. Cl.: 28

Prior U.S. Cls.: 22, 23, 38 and 50

Reg. No. 3,499,095

United States Patent and Trademark Office

Registered Sep. 9, 2008

TRADEMARK  
PRINCIPAL REGISTER



AUGUST, ROBERT (UNITED STATES INDIVIDUAL)  
17621 SAMPSON LN  
HUNTINGTON BEACH, CA 926476750

FOR: SKATEBOARDS; SURFBOARDS, IN CLASS  
28 (U.S. CLS. 22, 23, 38 AND 50).

FIRST USE 12-15-1966; IN COMMERCE 9-1-2001.

OWNER OF U.S. REG. NOS. 2,869,829, 2,869,832,  
AND 3,135,456.

THE NAME "ROBERT AUGUST" IDENTIFIES A  
LIVING INDIVIDUAL WHOSE CONSENT IS OF  
RECORD.

THE MARK CONSISTS OF "ROBERT AUGUST"  
LOGO.

SEC. 2(F).

SER. NO. 78-680,798, FILED 7-28-2005.

CHRIS DONINGER, EXAMINING ATTORNEY

Int. Cl.: 36

Prior U.S. Cls.: 100, 101 and 102

United States Patent and Trademark Office

Reg. No. 3,499,096

Registered Sep. 9, 2008

SERVICE MARK  
PRINCIPAL REGISTER

The logo for Ground FORCE Building Systems. The word "Ground" is in a blue, italicized, sans-serif font. Below it, the word "FORCE" is in a large, bold, orange, italicized, sans-serif font. Underneath "FORCE", the words "Building Systems" are in a smaller, black, italicized, sans-serif font.

GROUND FORCE IP, LLC (TEXAS LIMITED LIABILITY COMPANY)  
9601 INDUSTRIAL DRIVE  
NAVASOTA, TX 77868

FOR: PROVIDING FINANCING FOR THE CONSTRUCTION OF RESIDENTIAL AND COMMERCIAL MODULAR BUILDINGS, IN CLASS 36 (U.S. CLS. 100, 101 AND 102).

FIRST USE 12-1-2003; IN COMMERCE 12-1-2003.

NO CLAIM IS MADE TO THE EXCLUSIVE RIGHT TO USE "BUILDING SYSTEMS", APART FROM THE MARK AS SHOWN.

THE COLOR(S) BLUE, ORANGE AND BLACK IS/ARE CLAIMED AS A FEATURE OF THE MARK.

THE MARK CONSISTS OF THE WORD GROUND IN BLUE, THE WORD FORCE IN ORANGE, AND THE WORDS BUILDING SYSTEMS IN BLACK.

THE MARK CONSISTS OF THE WORD "GROUND" IN BLUE, THE WORD "FORCE" IN ORANGE AND THE WORDS "BUILDING SYSTEMS" IN BLACK. THE WORD "FORCE" IS POSITIONED UNDERNEATH THE WORD "GROUND" AND IS INDENTED TO A POSITION BETWEEN THE "U" AND THE "N" IN "GROUND". THE WORDS "BUILDING SYSTEMS" ARE SMALLER AND POSITIONED DIRECTLY UNDERNEATH THE WORD "FORCE".

SER. NO. 78-685,967, FILED 8-4-2005.

JAMES GRIFFIN, EXAMINING ATTORNEY

**Int. Cls.: 17 and 35**

**Prior U.S. Cls.: 1, 5, 12, 13, 35, 50, 100, 101 and 102**

**United States Patent and Trademark Office**

**Reg. No. 3,499,097**

**Registered Sep. 9, 2008**

**TRADEMARK  
SERVICE MARK  
PRINCIPAL REGISTER**

ADVANCED CHEMISTRY & TECHNOLOGY, INC.

ADVANCED CHEMISTRY & TECHNOLOGY,  
INC. (DELAWARE CORPORATION)  
7341 ANACONDA AVENUE  
GARDEN GROVE, CA 92841

FOR: ADHESIVE SEALANTS AND GENERAL  
PURPOSE SILICONE RUBBER SEALANTS ALL  
FOR AEROSPACE APPLICATIONS , IN CLASS 17  
(U.S. CLS. 1, 5, 12, 13, 35 AND 50).

FIRST USE 8-0-1997; IN COMMERCE 8-0-1997.

FOR: PACKAGING ARTICLES TO THE ORDER  
AND SPECIFICATION OF OTHERS, IN CLASS 35  
(U.S. CLS. 100, 101 AND 102).

FIRST USE 8-0-1997; IN COMMERCE 8-0-1997.

THE MARK CONSISTS OF STANDARD CHAR-  
ACTERS WITHOUT CLAIM TO ANY PARTICULAR  
FONT, STYLE, SIZE, OR COLOR.

NO CLAIM IS MADE TO THE EXCLUSIVE  
RIGHT TO USE INC., APART FROM THE MARK  
AS SHOWN.

SER. NO. 78-686,940, FILED 8-5-2005.

CHERYL CLAYTON, EXAMINING ATTORNEY

**Int. Cl.: 9**

**Prior U.S. Cls.: 21, 23, 26, 36 and 38**

**Reg. No. 3,499,098**

**United States Patent and Trademark Office**

**Registered Sep. 9, 2008**

**TRADEMARK  
PRINCIPAL REGISTER**



US BIOMETRICS CORPORATION (ILLINOIS CORPORATION)

1560 WALL ST., UNIT 304

NAPERVILLE, IL 60563

FOR: COMPUTER HARDWARE AND SOFTWARE FOR AUTHENTICATION, IDENTIFICATION AND VERIFICATION PURPOSES BY USE OF BIOMETRICS, IN CLASS 9 (U.S. CLS. 21, 23, 26, 36 AND 38).

FIRST USE 8-30-2002; IN COMMERCE 8-30-2002.

NO CLAIM IS MADE TO THE EXCLUSIVE RIGHT TO USE "BIOMETRICS", APART FROM THE MARK AS SHOWN.

THE MARK CONSISTS OF A FINGER PRINT DESIGN WITH A VERTICAL LINE SEPARATING THE TERM "US" FROM THE TERM 'BIOMETRICS'.

SEC. 2(F).

SER. NO. 78-694,802, FILED S.R. 8-17-2005 AM. P.R. 4-12-2007.

DAVID HOFFMAN, EXAMINING ATTORNEY

**Int. Cl.: 16**

**Prior U.S. Cls.: 2, 5, 22, 23, 29, 37, 38 and 50**

**Reg. No. 3,499,099**

**United States Patent and Trademark Office**

**Registered Sep. 9, 2008**

**TRADEMARK  
PRINCIPAL REGISTER**

**CORRO-SEAL**

IVEX PACKAGING LLC (DELAWARE LIMITED  
LIABILITY COMPANY)  
ONE SOUND SHORE DRIVE  
SUITE 302  
GREENWICH, CT 06830

FIRST USE 10-15-1962; IN COMMERCE 10-15-1962.

THE MARK CONSISTS OF STANDARD CHAR-  
ACTERS WITHOUT CLAIM TO ANY PARTICULAR  
FONT, STYLE, SIZE, OR COLOR.

FOR: CELLULOSE-BASED PAPER FOR WRAP-  
PING AND PACKAGING, AND CELLULOSE-  
BASED CORRUGATED PAPER, CORRUGATED  
BOARD AND PAPER CONTAINERS , IN CLASS 16  
(U.S. CLS. 2, 5, 22, 23, 29, 37, 38 AND 50).

SER. NO. 78-696,303, FILED 8-19-2005.

AISHA CLARKE, EXAMINING ATTORNEY

Int. Cl.: 9

Prior U.S. Cls.: 21, 23, 26, 36 and 38

Reg. No. 3,499,100

United States Patent and Trademark Office

Registered Sep. 9, 2008

TRADEMARK  
PRINCIPAL REGISTER



*QuickSilver*

DYER, DAVID, T. (UNITED STATES INDIVIDUAL)  
SUITE 311-1  
1135 KILDAIRE FARM RD.  
CARY, NC 27511

FOR: COMPUTER SOFTWARE FOR CREATING SEARCHABLE DATABASES OF INFORMATION AND DATA; DOWNLOADABLE SOFTWARE FOR MORTGAGE LOAN PRICING AND SUITABILITY ANALYSIS, IN CLASS 9 (U.S. CLS. 21, 23, 26, 36 AND 38).

FIRST USE 3-1-2005; IN COMMERCE 4-11-2005.

THE COLORS BLACK, GRAY, AND BLUE ARE CLAIMED AS A FEATURE OF THE MARK

THE STYLIZED "Q" IS BLUE AND THE DOT APPEARS IN GRAY AND BLUE; THE WORDING "QUICKSILVER" APPEARS IN BLACK.

SER. NO. 78-698,428, FILED 8-23-2005.

JEAN IM, EXAMINING ATTORNEY

**Int. Cls.: 7 and 11**

**Prior U.S. Cls.: 13, 19, 21, 23, 31, 34 and 35**

**United States Patent and Trademark Office**

**Reg. No. 3,499,101**

**Registered Sep. 9, 2008**

**TRADEMARK  
PRINCIPAL REGISTER**

**REVOLUTION**

COINAMATIC CANADA INC. (CANADA CORPORATION)  
301 MATHESON BOULEVARD WEST  
MISSISSAUGA, ONTARIO, CANADA L5A 3G3

FOR: CLOTHES WASHING MACHINES AND PARTS THEREOF, IN CLASS 7 (U.S. CLS. 13, 19, 21, 23, 31, 34 AND 35).

FOR: CLOTHES DRYER MACHINES AND PARTS THEREOF, IN CLASS 11 (U.S. CLS. 13, 21, 23, 31 AND 34).

THE MARK CONSISTS OF STANDARD CHARACTERS WITHOUT CLAIM TO ANY PARTICULAR FONT, STYLE, SIZE, OR COLOR.

PRIORITY CLAIMED UNDER SEC. 44(D) ON CANADA APPLICATION NO. 1,269,373, FILED 8-22-2005, REG. NO. TMA712,191, DATED 4-17-2008, EXPIRES 4-17-2023.

SER. NO. 78-703,697, FILED 8-30-2005.

KATHLEEN M. VANSTON, EXAMINING ATTORNEY



**Int. Cls.: 35, 41 and 42**

**Prior U.S. Cls.: 100, 101, 102 and 107**

**United States Patent and Trademark Office**

**Reg. No. 3,499,102**

**Registered Sep. 9, 2008**

**SERVICE MARK  
PRINCIPAL REGISTER**



SUCCESSFACTORS, INC. (DELAWARE CORPORATION)  
1500 FASHION ISLAND BOULEVARD  
SUITE 300  
SAN MATEO, CA 94404

FOR: BUSINESS CONSULTATION TO ASSIST IN BUSINESS PERFORMANCE, NAMELY, ON THE SUBJECTS OF WORKFORCE DEVELOPMENT AND PLANNING, MANAGEMENT OF CHANGES IN THE WORKFORCE, CAREER DEVELOPMENT AND PLANNING, EMPLOYEE TRAINING AND EDUCATION, COMPENSATION PLANNING, HUMAN RESOURCES, WORKFORCE RECRUITING, WORKFORCE ATTRIBUTES, WORKFORCE PERFORMANCE, AND THE EVALUATION OF PERSONNEL, IN CLASS 35 (U.S. CLS. 100, 101 AND 102).

FIRST USE 5-31-2005; IN COMMERCE 5-31-2005.

FOR: OFFERING ONLINE EDUCATIONAL TRAINING SERVICES AND ONLINE SEMINARS TO ASSIST IN BUSINESS PERFORMANCE, NAMELY, EMPLOYMENT TRAINING AND TRAINING ON THE SUBJECTS OF WORKFORCE PLANNING AND DEVELOPMENT, MANAGEMENT OF CHANGES IN THE WORKFORCE, EMPLOYEE CAREER DEVELOPMENT AND PLANNING, COMPENSATION PLANNING, WORKFORCE RECRUITING, EVALUATION OF PERSONNEL, DATA ANALYSIS AND REPORTING IN THE FIELDS OF HUMAN RESOURCES, WORKFORCE ATTRIBUTES, AND WORKFORCE PERFORMANCE; PROVIDING ONLINE JOURNALS, NAMELY, BLOGS, ON THE SUBJECTS OF BUSINESS PERFORMANCE, NAMELY, WORKFORCE PLANNING AND DEVELOPMENT, CAREER DEVELOPMENT AND PLANNING, EM-

PLOYEE TRAINING AND EDUCATION, COMPENSATION PLANNING, WORKFORCE RECRUITING, DATA ANALYSIS AND REPORTING IN THE FIELDS OF HUMAN RESOURCES, WORKFORCE ATTRIBUTES, AND WORKFORCE PERFORMANCE, AND THE EVALUATION OF PERSONNEL, IN CLASS 41 (U.S. CLS. 100, 101 AND 107).

FIRST USE 5-31-2005; IN COMMERCE 5-31-2005.

FOR: PROVIDING TEMPORARY USE OF ONLINE NON-DOWNLOADABLE SOFTWARE TO ASSIST IN BUSINESS PERFORMANCE, NAMELY, FOR WORKFORCE PLANNING AND DEVELOPMENT, MANAGEMENT OF CHANGES IN THE WORKFORCE, EMPLOYEE CAREER DEVELOPMENT AND PLANNING, COMPENSATION PLANNING, WORKFORCE RECRUITING, DATA ANALYSIS AND REPORTING IN THE FIELDS OF HUMAN RESOURCES, WORKFORCE ATTRIBUTES, AND WORKFORCE PERFORMANCE, AND FOR EVALUATION OF PERSONNEL, IN CLASS 42 (U.S. CLS. 100 AND 101).

FIRST USE 5-31-2005; IN COMMERCE 5-31-2005.

THE MARK CONSISTS OF THE WORD "SUCCESSFACTORS" IN CAPITAL LETTERS, TO THE RIGHT OF AN "X" DESIGN WITH AN ARROWHEAD DESIGN ON THE FOUR COMPASS POINTS AND A DIAMOND DESIGN AT 12 O'CLOCK.

SER. NO. 78-706,535, FILED 9-2-2005.

RICHARD WHITE, EXAMINING ATTORNEY

**Int. Cls.: 9, 16, 28 and 38**

**Prior U.S. Cls.: 2, 5, 21, 22, 23, 26, 29, 36, 37, 38, 50,  
100, 101 and 104**

**Reg. No. 3,499,103**

**United States Patent and Trademark Office**

**Registered Sep. 9, 2008**

**TRADEMARK  
SERVICE MARK  
PRINCIPAL REGISTER**

# MEEGOS

3H GROUP PTY LIMITED (AUSTRALIA COMPANY)  
1 NEWLAND STREET SUITE 504  
BONDI JUNCTION NSW 2022, AUSTRALIA

FOR: SOFTWARE WHICH ALLOWS USERS TO CREATE AND CUSTOMIZE ANIMATED CHARACTERS ONTO COMPUTERS AND MOBILE PHONES; DOWNLOADABLE RING TONES, GRAPHICS AND IMAGES VIA A GLOBAL COMPUTER NETWORK AND WIRELESS DEVICES; COMPUTER GAME SOFTWARE; COMPUTER PROGRAMS FOR VIDEO AND COMPUTER GAMES, IN CLASS 9 (U.S. CLS. 21, 23, 26, 36 AND 38).

FOR: PUBLICATIONS, NAMELY, COMIC BOOKS, COMIC STRIPS, STICKER ACTIVITY BOOKS; INSTRUCTIONAL MANUALS ON THE TOPIC OF UPLOADING ANIMATED CHARACTERS TO MOBILES PHONES AND COMPUTERS; STICKERS, NAMELY, PLASTIC STICKERS, PAPER STICKERS, PRINTED STICKERS, WINDOW STICKERS, CAR STICKERS; PACKAGING, NAMELY, CARDBOARD PACKAGING; PAPER BAGS FOR PACKAGING; ADHESIVE PAPER AND CARDBOARD; COMPUTER STATIONERY, STATIONERY

FOLDERS, NOTE PADS, IN CLASS 16 (U.S. CLS. 2, 5, 22, 23, 29, 37, 38 AND 50).

FOR: TOYS, NAMELY, PLUSH TOYS BASED ON ANIMATED CHARACTERS, IN CLASS 28 (U.S. CLS. 22, 23, 38 AND 50).

FOR: WIRELESS COMMUNICATION SERVICES, NAMELY, TRANSMISSION OF GRAPHICS, SOUNDS AND MESSAGES TO MOBILE TELEPHONES, IN CLASS 38 (U.S. CLS. 100, 101 AND 104).

THE MARK CONSISTS OF STANDARD CHARACTERS WITHOUT CLAIM TO ANY PARTICULAR FONT, STYLE, SIZE, OR COLOR.

PRIORITY CLAIMED UNDER SEC. 44(D) ON AUSTRALIA APPLICATION NO. 1062338, FILED 6-28-2005, REG. NO. 1062338, DATED 6-28-2005, EXPIRES 6-28-2015.

SER. NO. 78-706,958, FILED 9-6-2005.

CHRISTOPHER BUONGIORNO, EXAMINING ATTORNEY

**Int. Cl.: 25**

**Prior U.S. Cls.: 22 and 39**

**United States Patent and Trademark Office**

**Reg. No. 3,499,104**

**Registered Sep. 9, 2008**

**TRADEMARK  
PRINCIPAL REGISTER**

**GET WET**

SR HOLDINGS, INC. (DELAWARE CORPORATION)  
191 SPRING STREET, P.O. BOX 9191  
WALTHAM, MA 024209191

THE MARK CONSISTS OF STANDARD CHARACTERS WITHOUT CLAIM TO ANY PARTICULAR FONT, STYLE, SIZE, OR COLOR.

FOR: FOOTWEAR, IN CLASS 25 (U.S. CLS. 22 AND 39).

SER. NO. 78-716,309, FILED 9-20-2005.

FIRST USE 6-30-2003; IN COMMERCE 6-30-2003.

MARY ROSSMAN, EXAMINING ATTORNEY

**Int. Cl.: 41**

**Prior U.S. Cls.: 100, 101 and 107**

**United States Patent and Trademark Office**

**Reg. No. 3,499,105**

**Registered Sep. 9, 2008**

**SERVICE MARK  
PRINCIPAL REGISTER**

**FLAWLESS CONSULTING**

DESIGNED LEARNING, INC. (NEW JERSEY CORPORATION)  
527 DOWNER STREET  
WESTFIELD, NJ 07090

FOR: WORKSHOPS AND SEMINARS IN THE FIELD OF BUILDING PARTNERSHIPS, NEGOTIATING CONTRACTS, TRAINING HOW TO PROVIDE FEEDBACK, AND ORGANIZATIONAL MANAGEMENT AND DISTRIBUTING WRITTEN COURSE MATERIALS IN CONNECTION THEREWITH, IN CLASS 41 (U.S. CLS. 100, 101 AND 107).

FIRST USE 6-30-1980; IN COMMERCE 1-1-1998.

THE MARK CONSISTS OF STANDARD CHARACTERS WITHOUT CLAIM TO ANY PARTICULAR FONT, STYLE, SIZE, OR COLOR.

NO CLAIM IS MADE TO THE EXCLUSIVE RIGHT TO USE "CONSULTING", APART FROM THE MARK AS SHOWN.

SER. NO. 78-717,292, FILED 9-21-2005.

CHARLES L. JENKINS, EXAMINING ATTORNEY

**Int. Cls.: 41 and 44**

**Prior U.S. Cls.: 100, 101 and 107**

**United States Patent and Trademark Office**

**Reg. No. 3,499,106**

**Registered Sep. 9, 2008**

**SERVICE MARK  
PRINCIPAL REGISTER**

**MIND BODY SPIRIT**

CREATIVE VIDEO MARKETING, INC. (OHIO CORPORATION)  
19345 FRAZIER DRIVE  
CLEVELAND, OH 44116

FOR: PROVIDING ON-LINE NEWSLETTERS IN THE FIELDS OF HEALTH AND WELLNESS, FOODS, HERBS, PSYCHOLOGY, HEALTH, WELLNESS, FITNESS, LEISURE, NUTRITION, DIETING, MEDICAL TOPICS, HEALTH CARE, AROMATHERAPY, HOMEOPATHY, AND NUTRITIONAL SUPPLEMENTS; ENTERTAINMENT IN THE NATURE OF ON-GOING TELEVISION AND RADIO PROGRAMS IN THE FIELDS OF HEALTH AND WELLNESS, FOODS, HERBS, PSYCHOLOGY, HEALTH, WELLNESS, FITNESS, LEISURE, NUTRITION, DIETING, MEDICAL TOPICS, HEALTH CARE, AROMATHERAPY, HOMEOPATHY, AND NUTRITIONAL SUPPLEMENTS; PROVIDING ON-LINE WEB SITES IN THE FIELDS OF FITNESS AND LEISURE ACTIVITIES, IN CLASS 41 (U.S. CLS. 100, 101 AND 107).

FIRST USE 9-24-2005; IN COMMERCE 9-24-2005.

FOR: PROVIDING ON-LINE WEB SITES IN THE FIELDS OF HEALTH AND WELLNESS, PSYCHOLOGY, HEALTH, WELLNESS, NUTRITION, DIETING, MEDICAL TOPICS, HEALTH CARE, AROMATHERAPY, HOMEOPATHY, AND NUTRITIONAL SUPPLEMENTS, IN CLASS 44 (U.S. CLS. 100 AND 101).

FIRST USE 9-24-2005; IN COMMERCE 9-24-2005.

THE MARK CONSISTS OF STANDARD CHARACTERS WITHOUT CLAIM TO ANY PARTICULAR FONT, STYLE, SIZE, OR COLOR.

SER. NO. 78-732,801, FILED 10-13-2005.

RICHARD WHITE, EXAMINING ATTORNEY

**Int. Cls.: 35, 37, 41 and 42**

**Prior U.S. Cls.: 100, 101, 102, 103, 106 and 107**

**United States Patent and Trademark Office**

**Reg. No. 3,499,107**

**Registered Sep. 9, 2008**

**SERVICE MARK  
PRINCIPAL REGISTER**

**COMPUTERXPERTS**

COMPUTERXPERTS, INC. (GEORGIA CORPORATION)  
2897 N. DRUID HILLS ROAD SUITE 108  
ATLANTA, GA 30329

FOR: RETAIL SERVICES BY DIRECT SOLICITATION BY SALES AGENTS IN THE FIELDS OF COMPUTER HARDWARE, COMPUTER SOFTWARE, AND COMPUTER PERIPHERALS, IN CLASS 35 (U.S. CLS. 100, 101 AND 102).

FIRST USE 9-17-1991; IN COMMERCE 9-17-1991.

FOR: INSTALLATION, MAINTENANCE AND REPAIR OF COMPUTER HARDWARE; INSTALLATION, MAINTENANCE AND REPAIR OF COMPUTER NETWORKS; UPGRADE OF COMPUTER HARDWARE, IN CLASS 37 (U.S. CLS. 100, 103 AND 106).

FIRST USE 9-17-1991; IN COMMERCE 9-17-1991.

FOR: EDUCATIONAL SERVICES, NAMELY, TRAINING SERVICES IN THE FIELDS OF COMPUTER HARDWARE AND SOFTWARE, COMPUTER AND NETWORK SECURITY, COMPUTER AND NETWORK TECHNOLOGY, COMPUTER AND NETWORK HARDWARE, AND COMPUTER AND NETWORK SOFTWARE; EDUCATIONAL SERVICES, NAMELY, TRAINING SERVICES IN THE USE AND MAINTENANCE OF COMPUTER SYSTEMS AND NETWORKS, IN CLASS 41 (U.S. CLS. 100, 101 AND 107).

FIRST USE 9-17-1991; IN COMMERCE 9-17-1991.

FOR: DESIGN OF COMPUTERS, COMPUTER SOFTWARE AND COMPUTER NETWORKS FOR OTHERS; CONSULTING SERVICES IN THE FIELD OF DESIGN, SELECTION, IMPLEMENTATION AND USE OF COMPUTER HARDWARE AND SOFTWARE SYSTEMS FOR OTHERS; COMPUTER SERVICES, NAMELY, VIRUS PROTECTION, DATA BACK-UP AND RECOVERY SERVICES; TECHNICAL SUPPORT SERVICES, NAMELY, TROUBLESHOOTING OF COMPUTER HARDWARE AND SOFTWARE PROBLEMS; INSTALLATION, MAINTENANCE AND REPAIR OF COMPUTER SOFTWARE; UPGRADE OF COMPUTER SOFTWARE FOR OTHERS, IN CLASS 42 (U.S. CLS. 100 AND 101).

FIRST USE 9-17-1991; IN COMMERCE 9-17-1991.

THE MARK CONSISTS OF STANDARD CHARACTERS WITHOUT CLAIM TO ANY PARTICULAR FONT, STYLE, SIZE, OR COLOR.

OWNER OF U.S. REG. NOS. 1,767,602, 1,801,764 AND OTHERS.

SEC. 2(F).

SER. NO. 78-733,339, FILED 10-14-2005.

JORDAN BAKER, EXAMINING ATTORNEY

**Int. Cl.: 25**

**Prior U.S. Cls.: 22 and 39**

**United States Patent and Trademark Office**

**Reg. No. 3,499,108**

**Registered Sep. 9, 2008**

**TRADEMARK  
PRINCIPAL REGISTER**

**CANDY CATCHERS**

DISGUISE, INC. (DELAWARE CORPORATION)  
11906 TECH CENTER COURT  
POWAY, CA 92064

THE MARK CONSISTS OF STANDARD CHAR-  
ACTERS WITHOUT CLAIM TO ANY PARTICULAR  
FONT, STYLE, SIZE, OR COLOR.

FOR: HALLOWEEN AND MASQUERADE COS-  
TUMES, AND MASKS SOLD IN CONNECTION  
THEREWITH, IN CLASS 25 (U.S. CLS. 22 AND 39).

SER. NO. 78-740,691, FILED 10-26-2005.

FIRST USE 2-0-2001; IN COMMERCE 5-22-2001.

DAVID TOOLEY, EXAMINING ATTORNEY

**Int. Cls.: 2, 16 and 40**

**Prior U.S. Cls.: 2, 5, 6, 11, 16, 22, 23, 29, 37, 38, 50,  
100, 103 and 106**

**Reg. No. 3,499,109**

**United States Patent and Trademark Office**

**Registered Sep. 9, 2008**

**TRADEMARK  
SERVICE MARK  
PRINCIPAL REGISTER**

**PICTAFLEX**

IMPERIAL CHEMICAL INDUSTRIES PLC (UNI-  
TED KINGDOM PUBLIC LIMITED COMPANY  
(PLC))

20 MANCHESTER SQUARE  
LONDON, UNITED KINGDOM W1U 3AN

FOR: THERMAL RETRANSFER INKS, INK RE-  
CEPTIVE COATINGS , IN CLASS 2 (U.S. CLS. 6, 11  
AND 16).

FOR: COATED RETRANSFER SUBSTRATES,  
NAMELY, DYE-SUBLIMATION PRINT PAPER  
AND PLASTIC FILMS FOR DYE-SUBLIMATION  
PRINTING, IN CLASS 16 (U.S. CLS. 2, 5, 22, 23, 29, 37,  
38 AND 50).

FOR: THERMAL RETRANSFER PRINTING, IN  
CLASS 40 (U.S. CLS. 100, 103 AND 106).

THE MARK CONSISTS OF STANDARD CHAR-  
ACTERS WITHOUT CLAIM TO ANY PARTICULAR  
FONT, STYLE, SIZE, OR COLOR.

OWNER OF ERPN CMNTY TM OFC REG. NO.  
004676938, DATED 4-8-2006, EXPIRES 10-26-2015.

SER. NO. 78-741,215, FILED 10-26-2005.

BRIAN PINO, EXAMINING ATTORNEY



**Int. Cl.: 25**

**Prior U.S. Cls.: 22 and 39**

**United States Patent and Trademark Office**

**Reg. No. 3,499,110**

**Registered Sep. 9, 2008**

**TRADEMARK  
PRINCIPAL REGISTER**

**ALFRED RYN**

RYTTON INTERNATIONAL DEVELOPMENT  
(H.K.) LIMITED (HONG KONG CORPORATION)  
RM 1602, 16/F HIP KWAN COMM. BLDG PIT  
STREET, YAUMATEI;  
KOWLOON, HONG KONG

FOR: CASUAL, FORMAL AND ATHLETIC  
CLOTHING FOR MEN, WOMEN AND CHILDREN,  
NAMELY, BLOUSES, DRESSES, DRESS SKIRTS,  
SWEATERS, SCARVES, UNDERWEAR, PANTS,  
SKIRTS, SOCKS, TIES, T-SHIRTS, SHIRTS, BUSI-  
NESS SUITS, TUXEDOS, NIGHTGOWNS, AND PA-  
JAMAS; HEADGEAR, NAMELY, HATS, CAPS AND  
BONNETS; FOOTWEAR, IN CLASS 25 (U.S. CLS. 22  
AND 39).

THE MARK CONSISTS OF STANDARD CHAR-  
ACTERS WITHOUT CLAIM TO ANY PARTICULAR  
FONT, STYLE, SIZE, OR COLOR.

PRIORITY CLAIMED UNDER SEC. 44(D) ON  
HONG KONG APPLICATION NO. 300462023, FILED  
7-21-2005, REG. NO. 300462023, DATED 7-21-2005,  
EXPIRES 7-20-2015.

THE NAME(S), PORTRAIT(S), AND/OR SIGNA-  
TURE(S) SHOWN IN THE MARK DOES NOT IDEN-  
TIFY A PARTICULAR LIVING INDIVIDUAL.

SER. NO. 78-745,288, FILED 11-2-2005.

CARRIE GENOVESE, EXAMINING ATTORNEY

**Int. Cl.: 25**

**Prior U.S. Cls.: 22 and 39**

**United States Patent and Trademark Office**

**Reg. No. 3,499,111**

**Registered Sep. 9, 2008**

**TRADEMARK  
PRINCIPAL REGISTER**

**FRANK MORRIS**

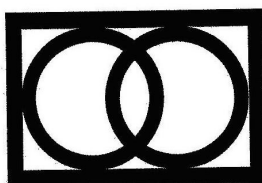

RYTTON INTERNATIONAL DEVELOPMENT  
(H.K.) LIMITED (HONG KONG CORPORATION)

RM 1602, 16/F HIP KWAN COMM. BLDG.  
PITT STREET, YAUMATEI  
KOWLOON, HONG KONG

FOR: CASUAL, FORMAL AND ATHLETIC  
CLOTHING FOR MEN, WOMEN AND CHILDREN,  
NAMELY, BLOUSES, DRESSES, DRESS SKIRTS,  
SWEATERS, SCARVES, UNDERWEAR, PANTS,  
SKIRTS, SOCKS, TIES, T-SHIRTS, SHIRTS, BUSI-  
NESS SUITS, TUXEDOS, NIGHTGOWNS, AND PA-  
JAMAS; HEADGEAR, NAMELY, HATS, CAPS AND

BONNETS; FOOTWEAR; BELTS, IN CLASS 25 (U.S.  
CLS. 22 AND 39).

PRIORITY CLAIMED UNDER SEC. 44(D) ON  
HONG KONG APPLICATION NO. 300462014, FILED  
7-21-2005, REG. NO. 300462014, DATED 7-21-2005,  
EXPIRES 7-20-2015.

THE NAME SHOWN IN THE MARK DOES NOT  
IDENTIFY A PARTICULAR LIVING INDIVIDUAL.

SER. NO. 78-745,328, FILED 11-2-2005.

CARRIE GENOVESE, EXAMINING ATTORNEY

Int. Cl.: 43

Prior U.S. Cls.: 100 and 101

United States Patent and Trademark Office

Reg. No. 3,499,112

Registered Sep. 9, 2008

**SERVICE MARK  
PRINCIPAL REGISTER**



PLANET HOLLYWOOD (REGION IV), INC.  
(MINNESOTA CORPORATION)  
7598 W. SAND LAKE ROAD  
ORLANDO, FL 32819

FOR: RESTAURANT SERVICES, IN CLASS 43  
(U.S. CLS. 100 AND 101).

FIRST USE 0-0-2005; IN COMMERCE 0-0-2005.

NO CLAIM IS MADE TO THE EXCLUSIVE  
RIGHT TO USE "KIDS", APART FROM THE MARK  
AS SHOWN.

THE COLOR(S) BLUE, ORANGE, GREEN, YEL-  
LOW, RED AND WHITE IS/ARE CLAIMED AS A  
FEATURE OF THE MARK.

THE MARK CONSISTS OF THE COLOR ORANGE  
IN THE ORBIT FORMED BY THE ROCKET'S  
EXHAUST AND THE LETTER "D" IN "KIDS". THE  
COLOR YELLOW APPEARS IN THE LIGHTNING  
BOLTS ABOVE THE LETTER "P", THE LETTER "K"  
IN "KIDS" AND THE DOTS ON THE STARS AND  
THE NOSE CONE OF THE ROCKET. THE COLOR  
GREEN APPEARS IN THE STARS AND THE LET-  
TER "I". THE COLOR RED APPEARS IN THE  
WORD "PLANET" AND THE NOSE CONE AND BASE OF  
THE ROCKET. THE COLOR BLUE APPEARS IN  
THE "PLANET". THE COLOR WHITE APPEARS IN  
THE BODY OF THE ROCKET.

SER. NO. 78-747,420, FILED 11-4-2005.

DORITT L. CARROLL, EXAMINING ATTORNEY

**Int. Cl.: 36**

**Prior U.S. Cls.: 100, 101 and 102**

**United States Patent and Trademark Office**

**Reg. No. 3,499,113**

**Registered Sep. 9, 2008**

**SERVICE MARK  
PRINCIPAL REGISTER**



SKYLINE PROPERTIES, INC. (WASHINGTON CORPORATION)  
SUITE D-204  
606 - 120TH AVE. NE  
BELLEVUE, WA 98005

FOR: REAL ESTATE BROKERAGE SERVICES, IN CLASS 36 (U.S. CLS. 100, 101 AND 102).

FIRST USE 8-1-1993; IN COMMERCE 8-1-1995.

THE MARK CONSISTS OF BUILDINGS WITHIN ARCH.

SER. NO. 78-750,118, FILED 11-9-2005.

ELISSA GARBER KON, EXAMINING ATTORNEY

**Int. Cl.: 35**

**Prior U.S. Cls.: 100, 101 and 102**

**United States Patent and Trademark Office**

**Reg. No. 3,499,114**

**Registered Sep. 9, 2008**

**SERVICE MARK  
PRINCIPAL REGISTER**

***e-EXECUTIVES***

REALTY EXECUTIVES INTERNATIONAL, INC.  
(ARIZONA CORPORATION)  
SUITE 900  
2398 E. CAMELBACK ROAD  
PHOENIX, AZ 85016

FOR: FRANCHISING, NAMELY, TECHNICAL  
ASSISTANCE IN THE ESTABLISHMENT OF REAL  
ESTATE AGENCIES; PERSONNEL RECRUITMENT

IN THE REAL ESTATE FIELD , IN CLASS 35 (U.S.  
CLS. 100, 101 AND 102).

FIRST USE 11-21-2005; IN COMMERCE 11-21-2005.

SER. NO. 78-759,705, FILED 11-22-2005.

SANDRA MANIOS, EXAMINING ATTORNEY

**Int. Cls.: 35 and 41**

**Prior U.S. Cls.: 100, 101, 102 and 107**

**United States Patent and Trademark Office**

**Reg. No. 3,499,115**

**Registered Sep. 9, 2008**

**SERVICE MARK  
PRINCIPAL REGISTER**

THE ALLIANCE FOR CORPORATE WEALTH,  
LLC (DELAWARE LIMITED LIABILITY COM-  
PANY)  
SUITE 2700  
150 NORTH MICHIGAN AVENUE  
CHICAGO, IL 60601

FOR: PROVIDING PRACTICE RESOURCES AND  
TOOLS TO PROFESSIONALS PROVIDING FINAN-  
CIAL ADVISORY SERVICES, NAMELY, CREATION  
OF MARKETING TOOLS DESIGNED TO IN-  
CREASE A CLIENT COMPANY'S KNOWLEDGE  
OF CUSTOMER NEEDS, AND ITS COMPETITORS'  
PRODUCTS AND SERVICES, PRICING, ADVERTIS-  
ING STRATEGY AND SALES STRATEGY; PROVID-  
ING MARKETING ASSISTANCE AND MARKET  
INFORMATION TO PROFESSIONALS PROVIDING  
FINANCIAL ADVISORY SERVICES, IN CLASS 35  
(U.S. CLS. 100, 101 AND 102).

FIRST USE 4-30-1999; IN COMMERCE 4-30-1999.

FOR: TRAINING IN THE FIELD OF MERGERS  
AND ACQUISITIONS FOR PROFESSIONALS PRO-  
VIDING LEGAL, TAX, ACCOUNTING, AND FI-  
NANCIAL ADVISORY SERVICES, IN CLASS 41 (U.S.  
CLS. 100, 101 AND 107).

FIRST USE 4-30-1999; IN COMMERCE 4-30-1999.

OWNER OF U.S. REG. NO. 2,562,677.

THE MARK CONSISTS OF THE LETTERS  
"AM&AA" SHADED FROM LIGHT TO DARK  
FROM THE ENDS TOWARDS THE CENTER.

SEC. 2(F).

SER. NO. 78-760,203, FILED 11-23-2005.

MELVIN AXILBUND, EXAMINING ATTORNEY

**Int. Cls.: 35 and 41**

**Prior U.S. Cls.: 100, 101, 102 and 107**

**United States Patent and Trademark Office**

**Reg. No. 3,499,116**

**Registered Sep. 9, 2008**

**SERVICE MARK  
PRINCIPAL REGISTER**

**AM&AA**

THE ALLIANCE FOR CORPORATE GROWTH,  
LLC (DELAWARE LIMITED LIABILITY COM-  
PANY)  
SUITE 2700  
150 NORTH MICHIGAN AVENUE  
CHICAGO, IL 60601

FOR: PROVIDING PRACTICE RESOURCES AND  
TOOLS TO PROFESSIONALS PROVIDING FINAN-  
CIAL ADVISORY SERVICES, NAMELY, CREATION  
OF MARKETING TOOLS DESIGNED TO IN-  
CREASE A CLIENT COMPANY'S KNOWLEDGE  
OF CUSTOMER NEEDS, AND ITS COMPETITORS'  
PRODUCTS AND SERVICES, PRICING, ADVERTIS-  
ING STRATEGY AND SALES STRATEGY; PROVID-  
ING MARKETING ASSISTANCE AND MARKET  
INFORMATION TO PROFESSIONALS PROVIDING  
FINANCIAL ADVISORY SERVICES, IN CLASS 35  
(U.S. CLS. 100, 101 AND 102).

FIRST USE 4-30-1999; IN COMMERCE 4-30-1999.

FOR: TRAINING IN THE FIELD OF MERGERS  
AND ACQUISITIONS FOR PROFESSIONALS PRO-  
VIDING LEGAL, TAX, ACCOUNTING, AND FI-  
NANCIAL ADVISORY SERVICES, IN CLASS 41 (U.S.  
CLS. 100, 101 AND 107).

FIRST USE 4-30-1999; IN COMMERCE 4-30-1999.

THE MARK CONSISTS OF STANDARD CHAR-  
ACTERS WITHOUT CLAIM TO ANY PARTICULAR  
FONT, STYLE, SIZE, OR COLOR.

OWNER OF U.S. REG. NO. 2,562,677.

SEC. 2(F).

SER. NO. 78-760,604, FILED 11-23-2005.

JENNIFER VASQUEZ, EXAMINING ATTORNEY

**Int. Cl.: 7**

**Prior U.S. Cls.: 13, 19, 21, 23, 31, 34 and 35**

**Reg. No. 3,499,117**

**United States Patent and Trademark Office**

**Registered Sep. 9, 2008**

**TRADEMARK  
PRINCIPAL REGISTER**

**X-TEC**

X-TEC OY LTD. (FINLAND JOINT STOCK COMPANY)  
SAMMONKATU 10  
VALKEAKOSKI, FINLAND FIN-37600

FOR: MACHINES AND EQUIPMENT USED IN THE PRODUCTION OF CONCRETE, PRECAST CONCRETE AND CONCRETE ELEMENTS, NAMELY, CONCRETE CASTING MACHINES, SLIDECASTING EXTRUDERS, CONCRETE VIBRATORS, ELECTRIC MOTORS AND NOZZLES FOR CONCRETE PRODUCING MACHINES, CONCRETE PRESTRESSING MACHINES, CONCRETE MOULDING MACHINES, MACHINES FOR CLEANING CASTING BEDS, MOULDS FOR PRECAST CONCRETE ELEMENTS FOR USE WITH CONCRETE MOULDING MACHINES, CONCRETE MIXERS, SAWING AND DRILLING MACHINES FOR CONCRETE AND PRECAST CONCRETE ELEMENTS, CONVEYORS, CRANES, LIFTING BEAMS, TRANS-

PORT RAILS AND BUCKETS FOR CONCRETE PRODUCING MACHINES OR FOR THE TRANSPORT OF CONCRETE AND PRECAST CONCRETE ELEMENTS, IN CLASS 7 (U.S. CLS. 13, 19, 21, 23, 31, 34 AND 35).

THE MARK CONSISTS OF STANDARD CHARACTERS WITHOUT CLAIM TO ANY PARTICULAR FONT, STYLE, SIZE, OR COLOR.

PRIORITY CLAIMED UNDER SEC. 44(D) ON ERPN CMNTY TM OFC APPLICATION NO. 004665659, FILED 10-4-2005, REG. NO. 004665659, DATED 10-4-2005, EXPIRES 10-4-2015.

SER. NO. 78-766,363, FILED 12-5-2005.

NAKIA HENRY, EXAMINING ATTORNEY



**Int. Cl.: 2**

**Prior U.S. Cls.: 6, 11 and 16**

**United States Patent and Trademark Office**

**Reg. No. 3,499,118**

**Registered Sep. 9, 2008**

**TRADEMARK  
PRINCIPAL REGISTER**

**DURA-POXY+**

KELLY-MOORE PAINT COMPANY, INC. (CALI-  
FORNIA CORPORATION)  
987 COMMERCIAL STREET  
SAN CARLOS, CA 94070

FOR: EXTERIOR AND INTERIOR PAINT FOR  
WOOD, CONCRETE AND METAL SURFACES; AND  
ARCHITECTURAL EXTERIOR AND INTERIOR  
ENAMEL PAINTS, IN CLASS 2 (U.S. CLS. 6, 11  
AND 16).

FIRST USE 12-15-2002; IN COMMERCE 2-15-2003.

THE MARK CONSISTS OF STANDARD CHAR-  
ACTERS WITHOUT CLAIM TO ANY PARTICULAR  
FONT, STYLE, SIZE, OR COLOR.

SER. NO. 78-771,720, FILED 12-12-2005.

DAWN HAN, EXAMINING ATTORNEY

**Int. Cls.: 19, 20 and 31**

**Prior U.S. Cls.: 1, 2, 12, 13, 22, 25, 32, 33, 46 and 50**

**United States Patent and Trademark Office**

**Reg. No. 3,499,119**

**Registered Sep. 9, 2008**

**TRADEMARK  
PRINCIPAL REGISTER**

**ACCOYA**

TITAN WOOD LIMITED (ENGLAND LIMITED  
LIABILITY COMPANY)  
46 BERKELEY SQUARE, MAYFAIR  
LONDON, UNITED KINGDOM W1J 5AT

FOR: NON-METALLIC BUILDING MATERIALS,  
NAMELY, LUMBER AND TREATED WOOD; NON-  
METALLIC RIGID PIPES FOR BUILDING; NON-  
METALLIC TRANSPORTABLE BUILDINGS; NON-  
METAL MONUMENTS MADE OF WOOD, IN  
CLASS 19 (U.S. CLS. 1, 12, 33 AND 50).

FOR: FURNITURE; PICTURE FRAMES NOT OF  
PRECIOUS METAL; GOODS MADE OF WOOD,  
CORK, REED CANE OR WICKER, NAMELY,  
BLINDS, CARVINGS, COMPOSITE PANELS, FUR-  
NITURE, HANDLES, STOPPERS, REEDS, AND  
SCULPTURES, IN CLASS 20 (U.S. CLS. 2, 13, 22, 25,  
32 AND 50).

FOR: AGRICULTURAL, HORTICULTURAL  
AND FORESTRY PRODUCTS, NAMELY, UNDRES-

SED LUMBER, UNSAWN LUMBER, TRUNKS OF  
TREES, LIVE TREES AND PLANTS, SEEDLINGS,  
DRIED PLANTS, UNPROCESSED GRAINS, SEEDS,  
SPORES AND BULBS; WOOD CHIPS FOR THE  
MANUFACTURE OF BUILDING MATERIALS, IN  
CLASS 31 (U.S. CLS. 1 AND 46).

THE MARK CONSISTS OF STANDARD CHAR-  
ACTERS WITHOUT CLAIM TO ANY PARTICULAR  
FONT, STYLE, SIZE, OR COLOR.

PRIORITY CLAIMED UNDER SEC. 44(D) ON  
ERPNTY TM OFC APPLICATION NO.  
4497335, FILED 6-20-2005, REG. NO. 4497335, DATED  
7-3-2006, EXPIRES 6-20-2015.

SER. NO. 78-774,841, FILED 12-16-2005.

ERNEST SHOSHO, EXAMINING ATTORNEY

**Int. Cl.: 42**

**Prior U.S. Cls.: 100 and 101**

**United States Patent and Trademark Office**

**Reg. No. 3,499,120**

**Registered Sep. 9, 2008**

**SERVICE MARK  
PRINCIPAL REGISTER**

**SURVEY ON CONNECTION**

SCHLUMBERGER TECHNOLOGY CORPORATION (TEXAS CORPORATION)  
300 SCHLUMBERGER DRIVE  
SUGAR LAND, TX 77478

FOR: GEOPHYSICAL EXPLORATION FOR THE OIL AND GAS INDUSTRIES, NAMELY, DIRECTIONAL SURVEYS FOR THE PURPOSES OF ACQUIRING DATA RELATED TO OIL AND GAS WELLS; OIL AND GAS WELL DRILLING SERVICES, NAMELY, PROVIDING MEASUREMENTS AND DOWNHOLE TELEMETRY WHILE DRILLING, IN CLASS 42 (U.S. CLS. 100 AND 101).

PRIORITY CLAIMED UNDER SEC. 44(D) ON CANADA APPLICATION NO. 1282391, FILED 12-8-2005, REG. NO. TMA686488, DATED 4-24-2007, EXPIRES 4-24-2022.

NO CLAIM IS MADE TO THE EXCLUSIVE RIGHT TO USE "SURVEY", APART FROM THE MARK AS SHOWN.

SER. NO. 78-777,146, FILED 12-20-2005.

BRENDAN MCCAULEY, EXAMINING ATTORNEY

**Int. Cl.: 9**

**Prior U.S. Cls.: 21, 23, 26, 36 and 38**

**United States Patent and Trademark Office**

**Reg. No. 3,499,121**

**Registered Sep. 9, 2008**

**TRADEMARK  
PRINCIPAL REGISTER**

**ACCELERATOR AUTOMATED  
PROCESSING SYSTEMS**

ABBOTT LABORATORIES (ILLINOIS CORPORATION)  
100 ABBOTT PARK ROAD  
ABBOTT PARK, IL 60064

FOR: DATA MANAGEMENT AND LABORATORY COMPUTER HARDWARE; LABORATORY EQUIPMENT FOR USE IN THE FIELD OF MEDICAL DIAGNOSTICS, NAMELY, A UNIT COMPRISING AN INPUT/OUTPUT MODULE FOR SORTING TUBES, CENTRIFUGE, DECAPPER, ALIQUOTTER, TRANSPORT OR TRACK SYSTEMS USED FOR THE TRANSPORTATION OF SPECIMEN VIALS AND TUBES, RESEALER/RECAPPER, TUBE STORAGE UNIT, AND DESEALER, IN CLASS 9 (U.S. CLS. 21, 23, 26, 36 AND 38).

FIRST USE 4-30-2006; IN COMMERCE 4-30-2006.

THE MARK CONSISTS OF STANDARD CHARACTERS WITHOUT CLAIM TO ANY PARTICULAR FONT, STYLE, SIZE, OR COLOR.

NO CLAIM IS MADE TO THE EXCLUSIVE RIGHT TO USE "AUTOMATED PROCESSING SYSTEMS", APART FROM THE MARK AS SHOWN.

SER. NO. 78-791,926, FILED 1-14-2006.

JERI J. FICKES, EXAMINING ATTORNEY

Int. Cl.: 43

Prior U.S. Cls.: 100 and 101

United States Patent and Trademark Office

Reg. No. 3,499,122

Registered Sep. 9, 2008

**SERVICE MARK  
PRINCIPAL REGISTER**



MIXT GREENS, INC. (CALIFORNIA CORPORATION)  
SUITE 120  
114 SANSOME STREET  
SAN FRANCISCO, CA 94104

FOR: CAFE-RESTAURANTS; CARRY-OUT RESTAURANTS; FAST-FOOD RESTAURANTS; RESTAURANTS, IN CLASS 43 (U.S. CLS. 100 AND 101).

FIRST USE 5-11-2005; IN COMMERCE 5-11-2005.

NO CLAIM IS MADE TO THE EXCLUSIVE RIGHT TO USE "MIXED GREENS", APART FROM THE MARK AS SHOWN.

THE COLOR(S) GRAY, GREEN AND IVORY IS/ARE CLAIMED AS A FEATURE OF THE MARK.

THE MARK CONSISTS OF A FORK SHAPED LIKE A STYLIZED LETTER "M" STICKING INTO THE LETTER "G" IN THE COLOR GRAY. SPACE INSIDE THE "G" IS THE COLOR IVORY. THE BACKGROUND IS GREEN. THE WORD "MIXT" IS WRITTEN BELOW THE "G" IN THE COLOR GRAY. THE WORD "GREENS" IS WRITTEN IN THE COLOR IVORY, WITH THE COLOR GRAY AS THE BACKGROUND. THE MARK IS CONTAINED IN A RECTANGLE WITH ROUNDED CORNERS IN THE COLOR GRAY.

SER. NO. 78-802,948, FILED 1-31-2006.

CAROLYN CATALDO, EXAMINING ATTORNEY

**Int. Cl.: 12**

**Prior U.S. Cls.: 19, 21, 23, 31, 35 and 44**

**Reg. No. 3,499,123**

**United States Patent and Trademark Office**

**Registered Sep. 9, 2008**

**TRADEMARK  
PRINCIPAL REGISTER**

**BASECAMP**

THOR TECH, INC. (NEVADA CORPORATION)  
653 SOUTH SAGINAW STREET, SUITE 310  
SAGINAW, MI 48502

FOR: RECREATIONAL VEHICLES, NAMELY,  
TRAVEL TRAILERS, IN CLASS 12 (U.S. CLS. 19, 21,  
23, 31, 35 AND 44).

FIRST USE 12-3-2003; IN COMMERCE 12-3-2003.

THE MARK CONSISTS OF STANDARD CHAR-  
ACTERS WITHOUT CLAIM TO ANY PARTICULAR  
FONT, STYLE, SIZE, OR COLOR.

OWNER OF U.S. REG. NO. 3,240,988.

SER. NO. 78-804,490, FILED 2-1-2006.

DAVID HOFFMAN, EXAMINING ATTORNEY

**Int. Cl.: 42**

**Prior U.S. Cls.: 100 and 101**

**United States Patent and Trademark Office**

**Reg. No. 3,499,124**

**Registered Sep. 9, 2008**

**SERVICE MARK  
PRINCIPAL REGISTER**

**KALEIDOSCOPE IMAGING**

KALEIDOSCOPE IMAGING, INC. (ILLINOIS CORPORATION)  
700 NORTH SACRAMENTO BLVD., 2ND FLOOR  
CHICAGO, IL 60612

FOR: GRAPHIC ART DESIGN FOR PACKAGING OF OTHER BUSINESSES, GRAPHIC DESIGN SERVICES FOR PACKAGING OF OTHER BUSINESSES, GRAPHIC ILLUSTRATION SERVICES FOR PACKAGING FOR OTHER BUSINESSES, PACKAGING DESIGN FOR OTHER BUSINESSES, PRODUCT DEVELOPMENT CONSULTATION, PRODUCT DEVELOPMENT FOR OTHER BUSINESSES, AND RESEARCH AND DEVELOPMENT FOR NEW PRODUCTS FOR OTHER BUSINESSES, IN CLASS 42 (U.S. CLS. 100 AND 101).

FIRST USE 2-1-2006; IN COMMERCE 2-1-2006.

THE MARK CONSISTS OF STANDARD CHARACTERS WITHOUT CLAIM TO ANY PARTICULAR FONT, STYLE, SIZE, OR COLOR.

OWNER OF U.S. REG. NO. 2,218,746.

NO CLAIM IS MADE TO THE EXCLUSIVE RIGHT TO USE "IMAGING" , APART FROM THE MARK AS SHOWN.

SER. NO. 78-804,816, FILED 2-1-2006.

TRACY WHITTAKER-BROWN, EXAMINING ATTORNEY

**Int. Cl.: 45**

**Prior U.S. Cls.: 100 and 101**

**United States Patent and Trademark Office**

**Reg. No. 3,499,125**

**Registered Sep. 9, 2008**

**SERVICE MARK  
PRINCIPAL REGISTER**

**QUORUM REVIEW**

QUORUM REVIEW, INC. (WASHINGTON CORPORATION)  
SUITE 1000  
1601 FIFTH AVENUE  
SEATTLE, WA 98101

FOR: PROVIDING INDEPENDENT REVIEW OF CLINICAL TRIALS INVOLVING HUMAN SUBJECTS, NAMELY, REVIEWING RESEARCH PROTOCOLS AND RELATED INFORMATION TO ENSURE PROTECTION OF THE RIGHTS AND WELFARE OF HUMAN SUBJECTS OF RESEARCH, IN CLASS 45 (U.S. CLS. 100 AND 101).

FIRST USE 7-1-1992; IN COMMERCE 7-1-1992.

THE MARK CONSISTS OF STANDARD CHARACTERS WITHOUT CLAIM TO ANY PARTICULAR FONT, STYLE, SIZE, OR COLOR.

NO CLAIM IS MADE TO THE EXCLUSIVE RIGHT TO USE "REVIEW", APART FROM THE MARK AS SHOWN.

SER. NO. 78-805,997, FILED 2-2-2006.

ROBERT C. CLARK JR., EXAMINING ATTORNEY



**Int. Cls.: 9, 35 and 42**

**Prior U.S. Cls.: 21, 23, 26, 36, 38, 100, 101 and 102**

**Reg. No. 3,499,126**

**United States Patent and Trademark Office**

**Registered Sep. 9, 2008**

**TRADEMARK  
SERVICE MARK  
PRINCIPAL REGISTER**

# TELECHIPS

TELECHIPS INC. (REPUBLIC OF KOREA CORPORATION)  
KORAD BUILDING, 1000-12 DAECHI-DONG, KANGNAM-GU;  
SEOUL, REPUBLIC OF KOREA 138-160

FOR: SEMI-CONDUCTORS, INTEGRATED CIRCUITS, PRINTED CIRCUIT BOARDS, RECORDED COMPUTER SOFTWARE FOR USE IN DIGITAL AUDIO/VIDEO DATA PROCESSING; COMPUTER PROGRAMS FOR USE IN DIGITAL AUDIO/VIDEO DATA PROCESSING; BLANK CD-ROMS FOR SOUND OR VIDEO RECORDING, CD-ROM DRIVES, CD-ROM WRITERS, MULTIMEDIA SOFTWARE RECORDED ON CD-ROM FEATURING RECORD AND PLAYBACK OF DIGITAL AUDIO/VIDEO DATA; INTEGRATED CIRCUITS FOR MP3 REPRODUCTION, INTEGRATED CIRCUITS FOR MP3 COMPRESSION, INTEGRATED CIRCUITS FOR MPEG4 REPRODUCTION, INTEGRATED CIRCUITS FOR MPEG4 COMPRESSION, INTEGRATED CIRCUITS FOR DIGITAL AUDIO REPRODUCTION, INTEGRATED CIRCUITS FOR DIGITAL AUDIO COMPRESSION, INTEGRATED CIRCUITS FOR DIGITAL VIDEO REPRODUCTION, INTEGRATED CIRCUITS FOR DIGITAL VIDEO COMPRESSION, INTEGRATED CIRCUITS FOR CALLER IDENTIFICATION, INTEGRATED CIRCUITS FOR DIGITAL MULTIMEDIA BROADCASTING REPRODUCTION, INTEGRATED CIRCUITS FOR DIGITAL AUDIO BROADCASTING REPRODUCTION, INTEGRATED CIRCUITS FOR CAR AUDIO, INTEGRATED CIRCUITS FOR HOME AUDIO, INTEGRATED CIRCUITS FOR CELL PHONES, INTEGRATED CIRCUITS FOR PERSONAL DIGITAL ASSISTANT, SOFTWARE FOR MP3 REPRODUCTION, SOFTWARE FOR MP3 COMPRESSION, SOFTWARE FOR MPEG4 REPRODUCTION, SOFTWARE FOR MPEG4 COMPRESSION, SOFTWARE FOR DIGITAL AUDIO REPRODUCTION, SOFTWARE FOR DIGITAL AUDIO DATA COMPRESSION, SOFTWARE

FOR DIGITAL VIDEO REPRODUCTION, SOFTWARE FOR DIGITAL VIDEO DATA COMPRESSION, SOFTWARE FOR USE IN THE IDENTIFICATION OF TELEPHONE CALLS, SOFTWARE FOR DIGITAL MULTIMEDIA BROADCASTING REPRODUCTION, SOFTWARE FOR DIGITAL AUDIO BROADCASTING REPRODUCTION, SOFTWARE FOR USE IN CONTROLLING CAR AUDIO EQUIPMENT AND AUDIO MEDIA, SOFTWARE FOR USE IN CONTROLLING HOME AUDIO EQUIPMENT AND AUDIO MEDIA, COMPUTER APPLICATION SOFTWARE FOR CELL PHONES, COMPUTER APPLICATION SOFTWARE FOR PERSONAL DIGITAL ASSISTANTS, DIGITAL AUDIO PLAYER, DIGITAL VIDEO PLAYER, CAR AUDIO PLAYER, NAMELY, MEDIA PLAYERS; HOME AUDIO PLAYER, NAMELY, MEDIA PLAYERS; MP3 PLAYER, DVD PLAYER, DIGITAL AUDIO-VIDEO RECEIVER, DIGITAL SATELLITE BROADCASTING RECEIVER, PERSONAL DIGITAL ASSISTANT, PERSONAL DIGITAL VIDEO RECORDER, DIGITAL TERRESTRIAL BROADCASTING RECEIVER, DIGITAL CABLE BROADCASTING RECEIVER, DIGITAL VIDEO RECORDER, MINIATURE COMPACT DISC PLAYER, VIDEO DISK PLAYER; VIDEO GAME PLAYER, NAMELY, VIDEO GAME MACHINES FOR USE WITH TELEVISIONS; ANALOG BROADCASTING RECEIVER, DIGITAL AUDIO BROADCASTING RECEIVER; GLOBAL POSITIONING SYSTEM CONSISTING OF COMPUTERS, COMPUTER SOFTWARE, TRANSMITTERS, RECEIVERS, AND NETWORK INTERFACE DEVICES; DIGITAL MULTIMEDIA BROADCASTING RECEIVER, MOBILE TELEPHONES, IN CLASS 9 (U.S. CLS. 21, 23, 26, 36 AND 38).

FOR: SALES PROMOTION SERVICES AND RETAIL SERVICES BY DIRECT SOLICITATION BY SALES AGENTS IN THE FIELD OF SEMI-CONDUCTOR PRODUCTS, PROCURING OF CONTRACTS FOR THE PURCHASE AND SALE OF GOODS,

NAMELY, SEMI-CONDUCTOR PRODUCTS, IN CLASS 35 (U.S. CLS. 100, 101 AND 102).

FOR: DRAFTING OF DESIGNS FOR SEMI-CONDUCTORS, DRAFTING OF DESIGNS FOR INTEGRATED CIRCUITS FOR MP3 REPRODUCTION, DRAFTING OF DESIGNS FOR INTEGRATED CIRCUITS FOR MP3 COMPRESSION, DRAFTING OF DESIGNS FOR INTEGRATED CIRCUITS FOR MPEG4 REPRODUCTION, DRAFTING OF DESIGNS FOR INTEGRATED CIRCUITS FOR MPEG4 COMPRESSION, DRAFTING OF DESIGNS FOR INTEGRATED CIRCUITS FOR DIGITAL AUDIO REPRODUCTION, DRAFTING OF DESIGNS FOR INTEGRATED CIRCUITS FOR DIGITAL AUDIO COMPRESSION, DRAFTING OF DESIGNS FOR INTEGRATED CIRCUITS FOR DIGITAL VIDEO REPRODUCTION, DRAFTING OF DESIGNS FOR INTEGRATED CIRCUITS FOR DIGITAL VIDEO COMPRESSION, DRAFTING OF DESIGNS FOR INTEGRATED CIRCUITS FOR CALLER IDENTIFICATION, DRAFTING OF DESIGNS FOR INTEGRATED CIRCUITS FOR DIGITAL MULTIMEDIA BROADCASTING REPRODUCTION, DRAFTING OF DESIGNS FOR INTEGRATED CIRCUITS FOR DIGITAL AUDIO BROADCASTING REPRODUCTION, DRAFTING OF DESIGNS FOR INTEGRATED CIRCUITS FOR CAR AUDIO EQUIPMENT, DRAFTING OF DESIGNS FOR INTEGRATED CIRCUITS FOR HOME AUDIO EQUIPMENT, DRAFTING OF DESIGNS FOR INTEGRATED CIRCUITS FOR CELL PHONES, DRAFTING OF DESIGNS FOR INTEGRATED CIRCUITS FOR PERSONAL DIGITAL ASSISTANTS; DESIGN AND DEVELOPMENT OF SOFTWARE FOR OTHERS FOR MP3 REPRODUCTION, DESIGN AND DEVELOPMENT OF SOFTWARE FOR OTHERS FOR MP3 COMPRESSION, DESIGN AND DEVELOPMENT OF SOFTWARE FOR OTHERS FOR MPEG4 REPRODUCTION, DESIGN AND DEVELOPMENT OF SOFTWARE FOR OTHERS FOR MPEG4 COMPRESSION, DESIGN AND DEVELOPMENT OF SOFTWARE FOR OTHERS FOR DIGITAL AUDIO REPRODUCTION, DESIGN AND DEVELOPMENT OF SOFTWARE FOR OTHERS FOR DIGITAL AUDIO COMPRESSION, DESIGN AND DEVELOPMENT OF SOFTWARE FOR OTHERS FOR DIGITAL VIDEO REPRODUCTION, DESIGN AND DEVELOPMENT OF SOFTWARE FOR OTHERS FOR DIGITAL VIDEO COMPRESSION, DESIGN AND DEVELOPMENT OF SOFTWARE FOR OTHERS FOR IDENTIFICATION OF TELEPHONE CALLERS, DESIGN AND DEVELOPMENT OF SOFTWARE FOR OTHERS FOR DIGITAL MULTIMEDIA BROADCASTING REPRODUCTION, DESIGN AND DEVELOPMENT OF SOFTWARE FOR OTHERS FOR DIGITAL AUDIO BROADCASTING REPRODUCTION, DESIGN AND DEVELOPMENT OF SOFTWARE FOR OTHERS FOR DIGITAL VIDEO REPRODUCTION, DESIGN AND DEVELOPMENT OF SOFTWARE FOR OTHERS FOR DIGITAL VIDEO COMPRESSION, DESIGN AND DEVELOPMENT OF SOFTWARE FOR OTHERS FOR IDENTIFICATION OF TELEPHONE CALLERS, DESIGN AND DEVELOPMENT OF SOFTWARE FOR OTHERS FOR DIGITAL MULTIMEDIA BROADCASTING REPRODUCTION, DESIGN AND DEVELOPMENT OF SOFTWARE FOR OTHERS FOR DIGITAL AUDIO BROADCASTING REPRODUCTION, DESIGN AND DEVELOPMENT OF SOFTWARE FOR OTHERS FOR HOME AUDIO EQUIPMENT, DESIGN AND DEVELOPMENT OF SOFTWARE FOR OTHERS FOR USE WITH CELL PHONES, DESIGN AND DEVELOPMENT

OF SOFTWARE FOR OTHERS FOR USE WITH PERSONAL DIGITAL ASSISTANTS, INSTALLATION OF SOFTWARE FOR MP3 REPRODUCTION, INSTALLATION OF SOFTWARE FOR MP3 COMPRESSION, INSTALLATION OF SOFTWARE FOR MPEG4 REPRODUCTION, INSTALLATION OF SOFTWARE FOR MPEG4 COMPRESSION, INSTALLATION OF SOFTWARE FOR DIGITAL AUDIO REPRODUCTION, INSTALLATION OF SOFTWARE FOR DIGITAL AUDIO COMPRESSION, INSTALLATION OF SOFTWARE FOR DIGITAL VIDEO REPRODUCTION, INSTALLATION OF SOFTWARE FOR DIGITAL VIDEO COMPRESSION, INSTALLATION OF SOFTWARE FOR IDENTIFICATION OF TELEPHONE CALLERS, INSTALLATION OF SOFTWARE FOR DIGITAL MULTIMEDIA BROADCASTING REPRODUCTION, INSTALLATION OF SOFTWARE FOR DIGITAL AUDIO BROADCASTING REPRODUCTION, INSTALLATION OF SOFTWARE FOR CAR AUDIO EQUIPMENT, INSTALLATION OF SOFTWARE FOR HOME AUDIO EQUIPMENT, INSTALLATION OF SOFTWARE FOR USE WITH CELL PHONES, INSTALLATION OF SOFTWARE FOR PERSONAL DIGITAL ASSISTANTS; DRAFTING OF DESIGNS FOR SYSTEMS FOR MP3 REPRODUCTION, DRAFTING OF DESIGNS FOR SYSTEMS FOR MP3 COMPRESSION, DRAFTING OF DESIGNS FOR SYSTEMS FOR MPEG4 REPRODUCTION, DRAFTING OF DESIGNS FOR SYSTEMS FOR MPEG4 COMPRESSION, DRAFTING OF DESIGNS FOR SYSTEMS FOR DIGITAL AUDIO REPRODUCTION, DRAFTING OF DESIGNS FOR SYSTEMS FOR DIGITAL AUDIO COMPRESSION, DRAFTING OF DESIGNS FOR SYSTEMS FOR DIGITAL VIDEO REPRODUCTION, DRAFTING OF DESIGNS FOR SYSTEMS FOR DIGITAL VIDEO COMPRESSION, DRAFTING OF DESIGNS FOR SYSTEMS FOR IDENTIFICATION OF TELEPHONE CALLERS, DRAFTING OF DESIGNS FOR SYSTEMS FOR DIGITAL MULTIMEDIA BROADCASTING REPRODUCTION, DRAFTING OF DESIGNS FOR SYSTEMS FOR DIGITAL AUDIO BROADCASTING REPRODUCTION, DRAFTING OF DESIGNS FOR SYSTEMS FOR CAR AUDIO EQUIPMENT, DRAFTING OF DESIGNS FOR SYSTEMS FOR HOME AUDIO EQUIPMENT, DRAFTING OF DESIGNS FOR SYSTEMS FOR CELL PHONES, DRAFTING OF DESIGNS FOR SYSTEMS FOR PERSONAL DIGITAL ASSISTANTS, IN CLASS 42 (U.S. CLS. 100 AND 101).

THE MARK CONSISTS OF STANDARD CHARACTERS WITHOUT CLAIM TO ANY PARTICULAR FONT, STYLE, SIZE, OR COLOR.

PRIORITY CLAIMED UNDER SEC. 44(D) ON REPUBLIC OF KOREA APPLICATION NO. 2005-0003391, FILED 8-11-2005, REG. NO. 45-0015770, DATED 4-11-2006, EXPIRES 4-11-2016.

SER. NO. 78-807,042, FILED 2-3-2006.

JAY BESCH, EXAMINING ATTORNEY

**Int. Cls.: 16, 35 and 41**

**Prior U.S. Cls.: 2, 5, 22, 23, 29, 37, 38, 50, 100, 101, 102  
and 107**

**Reg. No. 3,499,127**

**United States Patent and Trademark Office**

**Registered Sep. 9, 2008**

**TRADEMARK  
SERVICE MARK  
PRINCIPAL REGISTER**

**KIDSNET**

KIDSNET (D.C. NON-PROFIT CORPORATION)  
2506 CAMPBELL PLACE  
KENSINGTON, MD 20895

FOR: PRINTED PUBLICATIONS, NAMELY,  
NEWSLETTER COLUMNS AND STUDY GUIDES  
RELATING TO CHILDREN'S RADIO, TELEVISION,  
AUDIO, VIDEO, AND MULTI-MEDIA PROGRAM-  
MING, IN CLASS 16 (U.S. CLS. 2, 5, 22, 23, 29, 37, 38  
AND 50).

FIRST USE 0-0-1984; IN COMMERCE 0-0-1985.

FOR: PUBLIC RELATIONS CONSULTING; AND  
PROMOTING THE SPECIAL EDUCATIONAL  
EVENTS AND CONFERENCES OF OTHERS, IN  
CLASS 35 (U.S. CLS. 100, 101 AND 102).

FIRST USE 2-1-1989; IN COMMERCE 1-1-2005.

FOR: ONLINE PUBLICATIONS, NAMELY,  
NEWSLETTER COLUMNS AND STUDY GUIDES,  
RELATING TO CHILDREN'S RADIO, TELEVISION,  
AUDIO, VIDEO, AND MULTI-MEDIA PROGRAM-  
MING , IN CLASS 41 (U.S. CLS. 100, 101 AND 107).

FIRST USE 0-0-1986; IN COMMERCE 0-0-1986.

THE MARK CONSISTS OF STANDARD CHAR-  
ACTERS WITHOUT CLAIM TO ANY PARTICULAR  
FONT, STYLE, SIZE, OR COLOR.

OWNER OF U.S. REG. NO. 1,417,425.

SER. NO. 78-812,065, FILED 2-10-2006.

JOHN SCHUYLER YARD, EXAMINING ATTOR-  
NEY

**Int. Cls.: 21 and 30**

**Prior U.S. Cls.: 2, 13, 23, 29, 30, 33, 40, 46 and 50**

**United States Patent and Trademark Office**

**Reg. No. 3,499,128**

**Registered Sep. 9, 2008**

**TRADEMARK  
PRINCIPAL REGISTER**

# ZenMatcha

THOMAS, NAOMI (CANADA INDIVIDUAL)  
#105, WEST 3RD AVENUE  
VANCOUVER, BRITISH COLUMBIA, CANADA V5Y  
1E6

FOR: HOUSEHOLD UTENSILS, NAMELY BAM-  
BOO WHISKS, WHISK STAND; AND TEA BOWLS,  
IN CLASS 21 (U.S. CLS. 2, 13, 23, 29, 30, 33, 40 AND 50).

FOR: JAPANESE GREEN TEA POWDER; JAPA-  
NESE TEA SET CONSISTING OF JAPANESE GREEN  
TEA POWDER, TEA BOWL, BAMBOO WHISK,  
WHISK HOLDER, AND BAMBOO SPOON; PRE-  
MIXED, SWEETENED JAPANESE GREEN TEA

POWDER; CHOCOLATES; CARAMELS; COOKIES;  
HARD CANDY, IN CLASS 30 (U.S. CL. 46).

THE MARK CONSISTS OF STANDARD CHAR-  
ACTERS WITHOUT CLAIM TO ANY PARTICULAR  
FONT, STYLE, SIZE, OR COLOR.

PRIORITY CLAIMED UNDER SEC. 44(D) ON  
CANADA APPLICATION NO. 1,290,318, FILED 2-16-  
2006, REG. NO. TMA701,355, DATED 11-21-2007,  
EXPIRES 11-21-2022.

SER. NO. 78-816,893, FILED 2-16-2006.

DAYNA BROWNE, EXAMINING ATTORNEY

**Int. Cls.: 9 and 10**

**Prior U.S. Cls.: 21, 23, 26, 36, 38, 39 and 44**

**United States Patent and Trademark Office**

**Reg. No. 3,499,129**

**Registered Sep. 9, 2008**

**TRADEMARK  
PRINCIPAL REGISTER**

**PERSONAL PA**

WILLIAMS SOUND CORP. (MINNESOTA CORPORATION)  
10321 WEST 70TH STREET  
EDEN PRAIRIE, MN 553443459

FOR: RADIO FREQUENCY TRANSMITTER AND RECEIVER AND AMPLIFIER WITH AUDIO OUTPUT FOR USE WITH ASSISTIVE LISTENING SYSTEMS, IN CLASS 9 (U.S. CLS. 21, 23, 26, 36 AND 38).

FIRST USE 2-25-1976; IN COMMERCE 2-25-1976.

FOR: WIRELESS TRANSMITTERS AND RECEIVERS FOR USE WITH ASSISTIVE LISTENING

SYSTEMS FOR THE HEARING IMPAIRED, IN CLASS 10 (U.S. CLS. 26, 39 AND 44).

FIRST USE 2-25-1976; IN COMMERCE 2-25-1976.

THE MARK CONSISTS OF STANDARD CHARACTERS WITHOUT CLAIM TO ANY PARTICULAR FONT, STYLE, SIZE, OR COLOR.

SEC. 2(F).

SER. NO. 78-817,806, FILED 2-17-2006.

DORITT L. CARROLL, EXAMINING ATTORNEY

**Int. Cl.: 16**

**Prior U.S. Cls.: 2, 5, 22, 23, 29, 37, 38 and 50**

**United States Patent and Trademark Office**

**Reg. No. 3,499,130**

**Registered Sep. 9, 2008**

**TRADEMARK  
PRINCIPAL REGISTER**

**COLOR CODING KIDS**

VITAL SIGNS, INC. (NEW JERSEY CORPORATION)  
20 CAMPUS ROAD  
TOTOWA, NJ 07512

FOR: PRINTED MATERIALS, NAMELY, PEDIATRIC MEASURING AND MEDICATION DOSAGE INFORMATION CHARTS, IN CLASS 16 (U.S. CLS. 2, 5, 22, 23, 29, 37, 38 AND 50).

FIRST USE 8-5-2002; IN COMMERCE 8-5-2002.

THE MARK CONSISTS OF STANDARD CHARACTERS WITHOUT CLAIM TO ANY PARTICULAR FONT, STYLE, SIZE, OR COLOR.

SEC. 2(F).

SER. NO. 78-820,836, FILED 2-22-2006.

JASON BLAIR, EXAMINING ATTORNEY

Prior U.S. Cl.: A

United States Patent and Trademark Office

Reg. No. 3,499,131

Registered Sep. 9, 2008

**CERTIFICATION MARK  
PRINCIPAL REGISTER**



FLAG MANUFACTURERS ASSOCIATION OF AMERICA, INC. (NEW JERSEY NON-PROFIT CORPORATION)  
SUITE C  
15000 COMMERCE PARKWAY  
MT. LAUREL, NJ 08054

FOR: FLAGS, IN CLASS A (U.S. CL. A).

FIRST USE 3-0-2004; IN COMMERCE 8-0-2004.

NO CLAIM IS MADE TO THE EXCLUSIVE RIGHT TO USE "FLAG MANUFACTURERS ASSOCIATION OF AMERICA CERTIFIED MADE IN U.S.A.", APART FROM THE MARK AS SHOWN.

THE COLOR(S) RED, WHITE AND BLUE IS/ARE CLAIMED AS A FEATURE OF THE MARK.

THE MARK CONSISTS OF A SERIES OF CONCENTRIC OVALS: THE CENTER OVAL IS BLUE

WITH A STYLIZED DESIGN OF A U.S. FLAG IN RED, WHITE AND BLUE, ALONG WITH THE LETTERS "FMAA" IN WHITE; THE BLUE CENTER OVAL IS SURROUNDED BY A WHITE OVAL WITH THE WORDS "CERTIFIED MADE IN U.S.A." IN BLUE LETTERS; THE OUTERMOST OVAL IS RED WITH THE WORDS "FLAG MANUFACTURERS ASSOCIATION OF AMERICA" IN WHITE LETTERS.

THE CERTIFICATION MARK, AS USED BY AUTHORIZED PERSONS, CERTIFIES THAT THE FLAG HAS BEEN MADE IN THE USA OF MATERIALS THAT ARE DOMESTIC IN ORIGIN AND THAT ALL PROCESSES IN EVERY STEP OF THE U.S. FLAG'S MANUFACTURE WERE COMPLETED IN USA FACILITIES WITH USA LABOR.

SER. NO. 78-824,897, FILED 2-28-2006.

NAAKWAMA ANKRAH, EXAMINING ATTORNEY

**Int. Cl.: 9**

**Prior U.S. Cls.: 21, 23, 26, 36 and 38**

**Reg. No. 3,499,132**

**United States Patent and Trademark Office**

**Registered Sep. 9, 2008**

---

**TRADEMARK  
PRINCIPAL REGISTER**

**VESTA**

THE PARTNERSHIP CENTER, LTD. (OHIO LIMITED LIABILITY COMPANY)  
SUITE 402  
2260 PARK AVENUE  
CINCINNATI, OH 452062755

FOR: COMPUTER SOFTWARE, NAMELY, SOFTWARE FOR ELECTRONIC TRACKING OF CLIENTS AND FUNDS FOR NON-PROFIT AGENCIES, IN CLASS 9 (U.S. CLS. 21, 23, 26, 36 AND 38).

FIRST USE 0-0-1999; IN COMMERCE 0-0-1999.

THE MARK CONSISTS OF STANDARD CHARACTERS WITHOUT CLAIM TO ANY PARTICULAR FONT, STYLE, SIZE, OR COLOR.

SER. NO. 78-825,246, FILED 2-28-2006.

NAAKWAMA ANKRAH, EXAMINING ATTORNEY



**Int. Cl.: 29**

**Prior U.S. Cl.: 46**

**United States Patent and Trademark Office**

**Reg. No. 3,499,133**

**Registered Sep. 9, 2008**

**TRADEMARK  
PRINCIPAL REGISTER**

**DIET DELIGHT**

TROPICAL NUT & FRUIT, CO. (NORTH CAROLINA CORPORATION)  
1100 CONTINENTAL BLVD.  
CHARLOTTE, NC 28241

FOR: PROCESSED NUTS, CANDIED NUTS, DRIED FRUITS, SNACK MIXES CONSISTING PRIMARILY OF PROCESSED NUTS AND DRIED FRUITS, IN CLASS 29 (U.S. CL. 46).

FIRST USE 0-0-1977; IN COMMERCE 0-0-1977.

THE MARK CONSISTS OF STANDARD CHARACTERS WITHOUT CLAIM TO ANY PARTICULAR FONT, STYLE, SIZE, OR COLOR.

NO CLAIM IS MADE TO THE EXCLUSIVE RIGHT TO USE "DIET", APART FROM THE MARK AS SHOWN.

SER. NO. 78-825,634, FILED 2-28-2006.

RONALD MCMORROW, EXAMINING ATTORNEY

**Int. Cl.: 35**

**Prior U.S. Cls.: 100, 101 and 102**

**United States Patent and Trademark Office**

**Reg. No. 3,499,134**

**Registered Sep. 9, 2008**

**SERVICE MARK  
PRINCIPAL REGISTER**



DONGIL RUBBER BELT CO., LTD. (REPUBLIC  
OF KOREA CORPORATION)  
7, GEUMSA-DONG, GEUMJEONG-GU  
BUSAN, REPUBLIC OF KOREA

FOR: DISTRIBUTORSHIP SERVICES IN THE  
FIELDS OF POWER TRANSMISSION BELTS FOR  
SHIPS AND AIRCRAFT, BELTS FOR TRANSMIS-  
SIONS OTHER THAN LAND VEHICLES, AND  
TRANSMISSION BELTS FOR LAND VEHICLES;  
DISTRIBUTORSHIP SERVICES IN THE FIELD OF  
CONSTRUCTION AND CIVIL ENGINEERING PRO-  
DUCTS, NAMELY, UNDERCARRIAGE PARTS FOR  
CRAWLER TYPE VEHICLES, CONVEYORS, AND  
TRACKS FOR CRAWLER TYPE VEHICLES AND  
THEIR PARTS; RETAIL STORE SERVICES FEAT-  
URING POWER TRANSMISSION BELTS FOR  
SHIPS AND AIRCRAFT, BELTS FOR TRANSMIS-

SIONS OTHER THAN LAND VEHICLES, AND  
TRANSMISSION BELTS FOR LAND VEHICLES;  
AND RETAIL STORE SERVICES FEATURING CON-  
STRUCTION AND CIVIL ENGINEERING PRO-  
DUCTS, NAMELY, UNDERCARRIAGE PARTS  
FOR CRAWLER TYPE VEHICLES, CONVEYORS,  
AND TRACKS FOR CRAWLER TYPE VEHICLES  
AND THEIR PARTS, IN CLASS 35 (U.S. CLS. 100, 101  
AND 102).

OWNER OF REPUBLIC OF KOREA REG. NO.  
0014470, DATED 2-16-2007, EXPIRES 2-16-2017.

SER. NO. 78-827,547, FILED 3-2-2006.

JOHN KELLY, EXAMINING ATTORNEY

**Int. Cl.: 33**

**Prior U.S. Cls.: 47 and 49**

**United States Patent and Trademark Office**

**Reg. No. 3,499,135**

**Registered Sep. 9, 2008**

**TRADEMARK  
PRINCIPAL REGISTER**

# Porto Alegre

SOCIEDADE QUINTA DO PORTAL, SA (PORTUGAL CORPORATION)  
PRACA FRANCISCO SA CARNEIRO, NO. 293  
PORTO, PORTUGAL 4202-801

FOR: ALCOHOLIC BEVERAGES, NAMELY, PORT WINE, IN CLASS 33 (U.S. CLS. 47 AND 49).

FIRST USE 0-0-1998; IN COMMERCE 0-0-1999.

THE MARK CONSISTS OF STANDARD CHARACTERS WITHOUT CLAIM TO ANY PARTICULAR FONT, STYLE, SIZE, OR COLOR.

OWNER OF PORTUGAL REG. NO. 004009908, DATED 5-16-2006, EXPIRES 9-3-2014.

OWNER OF PORTUGAL REG. NO. 316181, DATED 11-6-1996, RENEWED AS REG. NO. 316181, DATED 11-6-2006, EXPIRES 11-6-2016.

THE FOREIGN WORDING IN THE MARK TRANSLATES INTO ENGLISH AS HAPPY PORT.

SER. NO. 78-829,390, FILED 3-4-2006.

SALLY SHIH, EXAMINING ATTORNEY

**Int. Cl.: 25**

**Prior U.S. Cls.: 22 and 39**

**United States Patent and Trademark Office**

**Reg. No. 3,499,136**

**Registered Sep. 9, 2008**

**TRADEMARK  
PRINCIPAL REGISTER**



SAWYERS, MICHAEL JR. (UNITED STATES IN-  
DIVIDUAL)  
3221 NICOL AVENUE  
OAKLAND, CA 94602

FOR: BELTS; BOOTS; CAPS; CHILDREN'S AND  
INFANTS' CLOTH BIBS; COATS; DRESSES; HATS;  
JACKETS; JEANS; JOGGING SUITS; OVERALLS;  
PAJAMAS; PANTS; RAIN COATS; ROBES; SAN-  
DALS; SCARVES; SHIRTS; SHOES; SHORTS;  
SKIRTS; SLEEPWEAR; SUN VISORS; SUSPENDERS;  
SWEAT SHIRTS; SWEATERS; SWIM WEAR; T-

SHIRTS; TANK TOPS; TIES; UNDERWEAR, IN  
CLASS 25 (U.S. CLS. 22 AND 39).

FIRST USE 5-0-1998; IN COMMERCE 2-0-1999.

THE MARK CONSISTS OF THE LETTER "O"  
INTERSECTED BY THE LETTER "E" AT THE  
BOTTOM OF THE "O".

SER. NO. 78-832,157, FILED 3-8-2006.

JOHN DALIER, EXAMINING ATTORNEY

**Int. Cls.: 11 and 22**

**Prior U.S. Cls.: 1, 2, 7, 13, 19, 21, 22, 23, 31, 34, 42 and 50**

**United States Patent and Trademark Office**

**Reg. No. 3,499,137**

**Registered Sep. 9, 2008**

**TRADEMARK  
PRINCIPAL REGISTER**

**POOLWERX**

POOLWERX INC. (CANADA CORPORATION)  
1650 ENTERPRISE ROAD  
MISSISSAUGA, CANADA L4W 4L4

FOR: SWIMMING POOL CHLORINATING UNITS; FILTERS, HEATERS AND PUMPS SOLD IN COMBINATION FOR USE IN SWIMMING POOLS; SWIMMING POOL WATER CLEANING AND FILTERING UNITS; SOLAR BLANKETS FOR SWIMMING POOLS, IN CLASS 11 (U.S. CLS. 13, 21, 23, 31 AND 34).

FIRST USE 3-9-2005; IN COMMERCE 3-16-2006.

FOR: PROTECTIVE LINERS FOR SWIMMING POOLS; UNFITTED SWIMMING POOL COVERS, IN CLASS 22 (U.S. CLS. 1, 2, 7, 19, 22, 42 AND 50).

FIRST USE 3-9-2005; IN COMMERCE 3-16-2006.

THE MARK CONSISTS OF STANDARD CHARACTERS WITHOUT CLAIM TO ANY PARTICULAR FONT, STYLE, SIZE, OR COLOR.

PRIORITY CLAIMED UNDER SEC. 44(D) ON CANADA APPLICATION NO. 1286596, FILED 1-19-2006, REG. NO. 694371, DATED 8-20-2007, EXPIRES 8-20-2022.

SER. NO. 78-837,452, FILED 3-15-2006.

STEVEN R. FINE, EXAMINING ATTORNEY

**Int. Cls.: 17 and 37**

**Prior U.S. Cls.: 1, 5, 12, 13, 35, 50, 100, 103 and 106**

**United States Patent and Trademark Office**

**Reg. No. 3,499,138**

**Registered Sep. 9, 2008**

**TRADEMARK  
SERVICE MARK  
PRINCIPAL REGISTER**

**CANTEGA**

GREAT CANADIAN SHIELD CORPORATION  
(CANADA CORPORATION)  
142 STREET  
PARK VIEW OFFICE CENTRE, 11420  
EDMONTON, CANADA AB T5M 1V

FOR: PREFABRICATED INSULATION AND RUST PREVENTION COATING AND FIRE RETARDANT COATING COVERS FOR USE IN OR ON ELECTRICAL DISTRIBUTION AND TRANSMISSION LINES, TRANSFORMERS, SUBSTATIONS AND OTHER COMMERCIAL ELECTRICAL EQUIPMENT AND STRUCTURES, IN CLASS 17 (U.S. CLS. 1, 5, 12, 13, 35 AND 50).

FOR: APPLICATION OF PROTECTIVE INSULATION, RUST PREVENTION AND FIRE RETARDANT COATINGS IN OR ON ELECTRICAL DISTRIBUTION AND TRANSMISSION LINES,

TRANSFORMERS, SUBSTATIONS AND OTHER COMMERCIAL ELECTRICAL EQUIPMENT AND STRUCTURES, IN CLASS 37 (U.S. CLS. 100, 103 AND 106).

THE MARK CONSISTS OF STANDARD CHARACTERS WITHOUT CLAIM TO ANY PARTICULAR FONT, STYLE, SIZE, OR COLOR.

PRIORITY CLAIMED UNDER SEC. 44(D) ON CANADA APPLICATION NO. 1294662, FILED 3-9-2006, REG. NO. TMA701737, DATED 11-27-2007, EXPIRES 11-27-2022.

SER. NO. 78-839,015, FILED 3-16-2006.

PETER B. BROMAGHIM, EXAMINING ATTORNEY

**Int. Cl.: 35**

**Prior U.S. Cls.: 100, 101 and 102**

**United States Patent and Trademark Office**

**Reg. No. 3,499,139**

**Registered Sep. 9, 2008**

**SERVICE MARK  
PRINCIPAL REGISTER**

# HMS Affiliations

HEALTH MARKET SCIENCE (PENNSYLVANIA  
CORPORATION)  
SUITE 200  
2700 HORIZON DRIVE  
KING OF PRUSSIA, PA 19428

FOR: PROVIDING AN ONLINE DATABASE IN  
THE FIELD OF PHYSICIAN AFFILIATION RELATIONSHIPS, NAMELY, HOSPITAL, GROUP PRACTICE AND LONG TERM CARE AFFILIATIONS, IN CLASS 35 (U.S. CLS. 100, 101 AND 102).

FIRST USE 5-16-2006; IN COMMERCE 5-16-2005.

THE MARK CONSISTS OF STANDARD CHARACTERS WITHOUT CLAIM TO ANY PARTICULAR FONT, STYLE, SIZE, OR COLOR.

NO CLAIM IS MADE TO THE EXCLUSIVE RIGHT TO USE "AFFILIATIONS", APART FROM THE MARK AS SHOWN.

SER. NO. 78-840,895, FILED 3-20-2006.

JAMES GRIFFIN, EXAMINING ATTORNEY

**Int. Cl.: 9**

**Prior U.S. Cls.: 21, 23, 26, 36 and 38**

**Reg. No. 3,499,140**

**United States Patent and Trademark Office**

**Registered Sep. 9, 2008**

**TRADEMARK  
PRINCIPAL REGISTER**

**RFCPU**

SEMICONDUCTOR ENERGY LABORATORY  
CO., LTD. (JAPAN CORPORATION)  
398 HASA, ATSUGI-SHI  
KANAGAWA-KEN, JAPAN 243-0036

FOR: ELECTRICAL MACHINES OR APPARATUS, NAMELY, TELECOMMUNICATIONS AND DATA NETWORKING HARDWARE, NAMELY, DEVICES FOR TRANSPORTING AND AGGREGATING VOICE, DATA, AND VIDEO COMMUNICATIONS ACROSS MULTIPLE NETWORK INFRASTRUCTURES AND COMMUNICATIONS PROTOCOLS AND COMMUNICATION HUBS; MOBILE TELEPHONES; MAGNETIC CARDS; OPTICAL CARDS, NAMELY, GRAPHICS CARDS; CARDS WITH INTEGRATED CIRCUITS IN THE FIELD OF CREDIT CARDS, BANK CARDS, CARDS FOR ELECTRONIC TOLL COLLECTION, PREPAID RAIL PASS CARDS, MEMBERSHIP CARDS AND ACCESS CARDS; CONTACTLESS CARDS WITH INTEGRATED CIRCUITS, NAMELY, BLANK CONTACTLESS INTEGRATED CIRCUIT CARDS; CARDS WITH INTEGRATED CIRCUITS FOR IDENTITY VERIFICATION, NAMELY, ENCODED INTEGRATED CIRCUIT CARDS CONTAINING PROGRAMMING USED FOR IDENTITY VERIFICATION; CARDS WITH INTEGRATED CIRCUITS FOR RECORDING INFORMATION IN THE FIELD OF CREDIT CARDS, BANK CARDS, CARDS FOR ELECTRONIC TOLL COLLECTION, PREPAID RAIL PASS CARDS, MEMBERSHIP CARDS AND ACCESS CARDS; ONCE-WRITABLE CARDS WITH INTEGRATED CIRCUITS IN THE FIELD OF CREDIT CARDS, BANK CARDS, CARDS FOR ELECTRONIC TOLL COLLECTION, PREPAID RAIL PASS CARDS, MEMBERSHIP CARDS AND ACCESS CARDS; OTHER RECORDING MEDIUMS IN WHICH A COMPUTER PROGRAM IS STORED, NAMELY, COMPUTER SOFTWARE FOR USE IN DATABASE MANAGEMENT, USE AS A SPREADSHEET, WORD PROCESSING; SEMICONDUCTOR ELEMENTS, NAMELY, SEMICONDUCTOR

SWITCHING ELEMENTS, SEMICONDUCTOR SENSORS, SEMICONDUCTOR ELEMENTS CONSTITUTING A CIRCUIT, INTEGRATED SEMICONDUCTOR ELEMENTS, NAMELY, MICRO ELECTRO MECHANICAL SYSTEMS, INTEGRATED SEMICONDUCTOR SENSORS, INTEGRATED SEMICONDUCTOR ELEMENTS CONSTITUTING A CIRCUIT; INTEGRATED SEMICONDUCTOR POWER ELEMENTS; ELECTRONIC APPLIED MACHINES OR APPARATUS WITH A SEMICONDUCTOR ELEMENT, NAMELY, SEMICONDUCTOR DEVICES, SEMICONDUCTORS; OTHER ELECTRONIC APPLIED MACHINES OR APPARATUSES AND PARTS THEREOF, NAMELY, ELECTRONIC CONTROL SYSTEMS FOR MACHINES AND PARTS THEREOF; IMAGING SENSORS, NAMELY, ELECTRONIC IMAGING APPARATUS IN THE FIELD OF CHARGE COUPLED DEVICE CAMERAS, LINE SENSORS, PHOTO SENSORS; RASTER IMAGE PROCESSORS; DISPLAY DEVICES, NAMELY, LCD LARGE-SCREEN DISPLAYS; LIQUID CRYSTAL DISPLAY DEVICES; DISPLAY DEVICES USING AN ELECTROLUMINESCENT ELEMENT, NAMELY, PERSONAL DIGITAL ASSISTANTS (PDAS), CELLULAR PHONES, TELEVISIONS, VIDEO CAMERAS, CAMERAS, OPTICAL SCANNERS OR PERSONAL COMPUTERS; APPARATUS FOR READING WITHOUT CONTACT IDENTIFICATION INFORMATION OF AN INTEGRATED CIRCUIT CHIP, WHICH IS ATTACHED TO A MOVABLE BODY SUCH AS HUMAN BEINGS AND OBJECTS, BY A READER CONNECTED TO A COMPUTER USING RADIO FREQUENCY, IDENTIFYING THE INFORMATION AUTOMATICALLY, AND WRITING THE IDENTIFICATION INFORMATION, INTEGRATED CIRCUITS OR A LARGE-SCALE INTEGRATED CIRCUIT, FOR THE OPERATIONS OF READING, IDENTIFYING AND WRITING, NAMELY, RADIO FREQUENCY IDENTIFICATION TAGS AND RFID READERS; ELECTRONIC TAGS, NAMELY, TAGS WITH INTEGRATED CIRCUIT CHIPS AND CONTACTLESS



RADIO FREQUENCY TAGS FOR USE IN PASSIVE LABELING, TRACING OR TRACKING OF PERSONS, ANIMALS, VEHICLES OR GOODS, IN CLASS 9 (U.S. CLS. 21, 23, 26, 36 AND 38).

THE MARK CONSISTS OF STANDARD CHARACTERS WITHOUT CLAIM TO ANY PARTICULAR FONT, STYLE, SIZE, OR COLOR.

OWNER OF JAPAN REG. NO. 4963906, DATED 6-23-2006, EXPIRES 6-23-2016.

SER. NO. 78-842,062, FILED 3-21-2006.

KATHERINE M. DUBRAY, EXAMINING ATTORNEY

**Int. Cl.: 2**

**Prior U.S. Cls.: 6, 11 and 16**

**United States Patent and Trademark Office**

**Reg. No. 3,499,141**

**Registered Sep. 9, 2008**

**TRADEMARK  
PRINCIPAL REGISTER**

**TONY BENNETT**

BENEDETTO ARTS GMBH (FED REP GERMA-  
NY GMBH)  
GRUENEWALDER STR. 30  
SOLINGEN, FED REP GERMANY 42657

FOR: PIGMENTS; DYES, NAMELY, NATURAL  
AND SYNTHETIC DYES FOR USE TO MAKE  
PAINTS AND PIGMENTS; PAINTS; METALS IN  
FOIL AND POWDER FORM FOR PAINTERS; DEC-  
ORATORS AND ARTISTS, PAINT PRIMERS AND  
PAINT SEALERS; PAINT FOR ARTISTS; AND WA-  
TERCOLOR PAINTS, IN CLASS 2 (U.S. CLS. 6, 11  
AND 16).

THE MARK CONSISTS OF STANDARD CHAR-  
ACTERS WITHOUT CLAIM TO ANY PARTICULAR  
FONT, STYLE, SIZE, OR COLOR.

PRIORITY CLAIMED UNDER SEC. 44(D) ON FED  
REP GERMANY APPLICATION NO. 305569139,  
FILED 9-27-2005, REG. NO. 30556913, DATED 12-1-  
2005, EXPIRES 9-30-2015.

THE NAME(S), PORTRAIT(S), AND/OR SIGNA-  
TURE(S) SHOWN IN THE MARK IDENTIFIES  
"TONY BENNETT", WHOSE CONSENT(S) TO REG-  
ISTER IS SUBMITTED.

SER. NO. 78-845,745, FILED 3-24-2006.

DAYNA BROWNE, EXAMINING ATTORNEY

**Int. Cls.: 24 and 25**

**Prior U.S. Cls.: 22, 39, 42 and 50**

**United States Patent and Trademark Office**

**Reg. No. 3,499,142**

**Registered Sep. 9, 2008**

**TRADEMARK  
PRINCIPAL REGISTER**



BENCOM S.R.L. (ITALY CORPORATION)  
31050 PONZANO VENETO VIA VILLA MINELLI  
TREVISO, ITALY 31050

FOR: BATH MITTS, BATH SHEETS, BATH TOWELS, BEACH TOWELS, BED LINEN, BED PADS, BED SHEETS, BED SPREADS, BLANKET THROWS, BLANKETS, PLAIDS, TEXTILE FABRICS, KITCHEN LINEN, KITCHEN TEXTILES, CLOTH COASTERS, CLOTH FLAGS, CLOTH DOILIES, CLOTH NAPKINS FOR REMOVING MAKEUP, CLOTH LABELS, COMFORTERS, MATTRESS COVERS, COVERLETS, COVERS FOR CUSHIONS, CURTAINS, DECORATIVE FABRIC FOR CURTAINS, DIAPER CHANGING MATS, DINING LINENS, DUVET COVERS, DUVETS, QUILTS, FABRIC WINDOW COVERINGS AND TREATMENTS, NAMELY, CURTAINS, DRAPERIES, SHEERS, SWAGS AND FABRIC VALANCES, FOULARD HANDKERCHIEFS, HOUSEHOLD LINEN, LAP ROBES, LINEN, PILLOW CASES, PILLOW COVERS, PILLOW SHAMS, PLACE MATS, PRINTED TEXTILE LABELS, TABLE LINENS, TAPESTRIES OF TEXTILE, TEXTILE WALL HANGINGS, IN CLASS 24 (U.S. CLS. 42 AND 50).

FOR: TROUSERS, JACKETS, TUNICS, BANDANAS, HATS, HEAD WRAPS, VISORS, BERETS, CAPES, JERKINS, CLOAKS, DRESSING GOWNS, BATHROBES, BATHING SUITS, BEACHWEAR,

BELTS, BERMUDA SHORTS, UNDERWEAR, NIGHTWEAR, CAMISOLES, CARDIGANS, CHILDREN'S AND INFANTS' CLOTH BIBS, INFANTWEAR, EAR BANDS, JOGGING PANTS, JOGGING SUITS, KNITTED WEAR, LEGGINGS, LEOTARDS, NECKERCHIEFS, OVERALLS, POLO SHIRTS, PULLOVERS, SUITS, SUSPENDERS, TANK TOPS, WAISTCOATS, WIND-JACKETS, IN CLASS 25 (U.S. CLS. 22 AND 39).

OWNER OF ITALY REG. NO. 686322, DATED 9-12-1996, EXPIRES 9-12-2016.

OWNER OF U.S. REG. NOS. 1,610,037, 1,809,273 AND OTHERS.

THE COLOR(S) GREEN AND WHITE IS/ARE CLAIMED AS A FEATURE OF THE MARK.

THE MARK CONSISTS OF THE WORDS AND PUNCTUATION "UNITED COLORS OF BENETTON." IN WHITE FONT IN THE UPPER LEFT-HAND SECTION OF A GREEN RECTANGLE.

SER. NO. 78-847,546, FILED 3-28-2006.

MARGERY A. TIERNEY, EXAMINING ATTORNEY

Int. Cl.: 28

Prior U.S. Cls.: 22, 23, 38 and 50

Reg. No. 3,499,143

United States Patent and Trademark Office

Registered Sep. 9, 2008

TRADEMARK  
PRINCIPAL REGISTER



Fishing Rods

RICK'S RODS CO. (COLORADO CORPORATION)  
2066 SOUTH HURON STREET  
DENVER, CO 80223

FOR: FISHING ROD BLANKS; FISHING ROD  
CASES; FISHING ROD HANDLES; FISHING RODS;  
SPORTSMAN'S FISHING BAGS, IN CLASS 28 (U.S.  
CLS. 22, 23, 38 AND 50).

FIRST USE 1-2-1997; IN COMMERCE 1-2-1997.

OWNER OF U.S. REG. NO. 3,290,683.

NO CLAIM IS MADE TO THE EXCLUSIVE  
RIGHT TO USE "WORLD'S FINEST FISHING RODS",  
APART FROM THE MARK AS SHOWN.

THE MARK CONSISTS OF THE NAME "PHIL-  
LIPSON" AND A GLOBE WITH "WORLD'S FINEST"  
INSIDE THE GLOBE. THE WORDS "FISHING  
RODS" IS BELOW THE GLOBE.

SER. NO. 78-849,280, FILED 3-29-2006.

ALLISON SCHRODY, EXAMINING ATTORNEY

**Int. Cl.: 35**

**Prior U.S. Cls.: 100, 101 and 102**

**United States Patent and Trademark Office**

**Reg. No. 3,499,144**

**Registered Sep. 9, 2008**

**SERVICE MARK  
PRINCIPAL REGISTER**

**IMPORT BRANDS ALLIANCE**

ANHEUSER-BUSCH, INCORPORATED (MISSOURI CORPORATION)

202-6

ONE BUSCH PLACE

ST. LOUIS, MO 63118

FOR: MARKETING CONSULTING AND DISTRIBUTORSHIP SERVICES IN THE FIELD OF BEER, IN CLASS 35 (U.S. CLS. 100, 101 AND 102).

FIRST USE 3-21-2006; IN COMMERCE 3-21-2006.

THE MARK CONSISTS OF STANDARD CHARACTERS WITHOUT CLAIM TO ANY PARTICULAR FONT, STYLE, SIZE, OR COLOR.

NO CLAIM IS MADE TO THE EXCLUSIVE RIGHT TO USE "ALLIANCE", APART FROM THE MARK AS SHOWN.

SEC. 2(F).

SER. NO. 78-859,026, FILED 4-11-2006.

JOHN E. MICHOS, EXAMINING ATTORNEY

**Int. Cls.: 7 and 12**

**Prior U.S. Cls.: 13, 19, 21, 23, 31, 34, 35 and 44**

**Reg. No. 3,499,145**

**United States Patent and Trademark Office**

**Registered Sep. 9, 2008**

**TRADEMARK  
PRINCIPAL REGISTER**



CRAWLER PARTS, INC. (MISSISSIPPI CORPORATION)  
P.O. BOX 54227  
PEARL, MS 39288

FOR: HEAVY EQUIPMENT, NAMELY, CONSTRUCTION EQUIPMENT AND EARTH MOVING EQUIPMENT IN THE NATURE OF BULLDOZERS, SCRAPERS, EXCAVATORS, MOTOR GRADERS, TRACTOR LOADER BACKHOES, DIRT COMPACTORS, TRASH COMPACTORS, SKIDSTEER LOADERS, ROCK AND ORE CRUSHERS, ROCK DRILLS AND ASPHALT PAVERS; MACHINERY PARTS, NAMELY, BUCKET TEETH FOR USE WITH EXCAVATION MACHINES, CUTTING EDGES, CONVEYOR CHAIN AND BAR ASSEMBLIES, TRACK ROLLERS, WEAR STRIPS, CAM SPROCKETS, PISTONS FOR DIESEL ENGINES, ENGINE BEARINGS, CRANKSHAFTS FOR DIESEL ENGINES, OIL PUMPS FOR LAND VEHICLES, OIL PUMPS FOR USE IN MOTORS AND ENGINES, WATER PUMPS FOR LAND VEHICLES, WATER PUMPS FOR USE IN MOTORS AND ENGINES,

PUMPS FOR COOLING ENGINES, RUBBER TRACKS FOR EXCAVATING MACHINES, SELF-PROPELLED SCREED MACHINE, TRANSMISSION GEARS FOR MACHINES, IN CLASS 7 (U.S. CLS. 13, 19, 21, 23, 31, 34 AND 35).

FIRST USE 0-0-1986; IN COMMERCE 0-0-1986.

FOR: TRACTORS; ARTICULATED TRUCKS; TRACTOR PARTS, NAMELY, UNDERCARRIAGE, TRACK CHAINS, IDLERS, TIRE LINERS, ROLLER AXLE BEARINGS, RUBBER TRACKS FOR LAND VEHICLES, FLOOR PLATES FOR LAND VEHICLES, GEARS FOR VEHICLES, CARGO CARRIERS FOR VEHICLES, IN CLASS 12 (U.S. CLS. 19, 21, 23, 31, 35 AND 44).

FIRST USE 0-0-1986; IN COMMERCE 0-0-1986.

SER. NO. 78-859,234, FILED 4-11-2006.

SHANNON TWOHIG, EXAMINING ATTORNEY

**Int. Cl.: 34**

**Prior U.S. Cls.: 2, 8, 9 and 17**

**United States Patent and Trademark Office**

**Reg. No. 3,499,146**

**Registered Sep. 9, 2008**

**TRADEMARK  
PRINCIPAL REGISTER**

**BONJOUR**



ROCK INTERNATIONAL (SINGAPORE) PTE  
LTD (SINGAPORE CORPORATION)  
#08-302 THE PLAZA  
7500 BEACH ROAD  
SINGAPORE, SINGAPORE 199591

FOR: TOBACCO AND TOBACCO PRODUCTS  
FOR SMOKING, NAMELY, CIGARETTES AND  
CIGARS, SMOKER ARTICLES, NAMELY, ASH-  
TRAYS, CIGARETTE LIGHTERS MADE OF NON-  
PRECIOUS METALS, CIGAR HUMIDORS, CIGAR  
CLIPPERS, CIGAR BANDS, CIGAR AND CIGAR-  
ETTE CASES, CIGARETTE PAPER, CIGARETTE  
FILTER, CIGAR CUTTERS, POCKET APPARATUS  
FOR ROLLING CIGARETTES, CIGARETTE FIL-  
TERS AND CIGARETTE HOLDERS, IN CLASS 34  
(U.S. CLS. 2, 8, 9 AND 17).

OWNER OF SINGAPORE REG. NO. T0118797D,  
DATED 12-7-2001, EXPIRES 12-7-2011.

THE MARK CONSISTS OF THE STYLIZED  
WORDING FOR "BONJOUR" OVER AN IMAGE  
OF THE EIFFEL TOWER FLANKED WITH WINGS.

THE FOREIGN WORDING IN THE MARK  
TRANSLATES INTO ENGLISH AS HELLO.

SER. NO. 78-859,429, FILED 4-11-2006.

JACQUELINE A. LAVINE, EXAMINING ATTOR-  
NEY

**Int. Cl.: 17**

**Prior U.S. Cls.: 1, 5, 12, 13, 35 and 50**

**Reg. No. 3,499,147**

**United States Patent and Trademark Office**

**Registered Sep. 9, 2008**

**TRADEMARK  
PRINCIPAL REGISTER**

**QUINTIUM**

QD PRODUCTS, LLC (ARIZONA LIMITED LIABILITY COMPANY)  
5005 LAKE COUNTRY ROAD  
FLAGSTAFF, AZ 86004

FOR: POLYMER MATERIALS, NAMELY, FINISHED URETHANES AND UREAS FOR USE IN THE MANUFACTURE OF COMMERCIAL AND INDUSTRIAL GOODS, NAMELY, STRUCTURAL AND IMPACT RESISTANCE BARRIERS, IN CLASS 17 (U.S. CLS. 1, 5, 12, 13, 35 AND 50).

FIRST USE 12-10-2004; IN COMMERCE 12-10-2004.

THE MARK CONSISTS OF STANDARD CHARACTERS WITHOUT CLAIM TO ANY PARTICULAR FONT, STYLE, SIZE, OR COLOR.

THE WORDING "QUINTIUM" HAS NO MEANING IN A FOREIGN LANGUAGE.

SER. NO. 78-859,719, FILED 4-12-2006.

DAVID MURRAY, EXAMINING ATTORNEY



**Int. Cl.: 10**

**Prior U.S. Cls.: 26, 39 and 44**

**United States Patent and Trademark Office**

**Reg. No. 3,499,148**

**Registered Sep. 9, 2008**

**TRADEMARK  
PRINCIPAL REGISTER**

**DURA-FIT**

BERNHARD FORESTER GMBH (FED REP GER-  
MANY CORPORATION)  
WESTLICHE KARL-FRIEDRICH-STRASSE 151  
75172 PFORZHEIM, FED REP GERMANY

FOR: SURGICAL, MEDICAL, DENTAL AND VE-  
TERINARY APPARATUS AND INSTRUMENTS,  
NAMELY, DENTAL IMPLANTS AND SURGICAL  
IMPLANTS COMPRISED OF ARTIFICIAL MATERI-  
ALS AND STENTS; ARTIFICIAL TEETH AND  
PROTHESES FOR TEETH AND SPARE PARTS  
FOR THE AFOREMENTIONED GOODS; ORTHO-  
PEDIC AND JAW ORTHOPEDIC ARTICLES, NAME-  
LY, BRACES, SUPPORTS AND SPLINTS;  
PRODUCTS FOR USE IN JAW-ORTHOPEDICS  
AND ORTHODONTIA IN FORM OF APPARATUS  
AND OF COMPONENTS MADE OF METAL, PLAS-  
TIC, FILLED PLASTIC AND OF CERAMIC, NAME-  
LY, EXPANSION SCREWS FOR TEETH, DENTAL  
SCREWS FOR INDIVIDUAL TOOTH MOVEMENTS,  
WIRES FOR TEETH, PREFORMED WIRES FOR  
TEETH, ARCH WIRES FOR TEETH, BRACKETS

FOR TEETH, BUCCAL TUBES, BANDS AND MO-  
LAR BANDS WITH AND WITHOUT PARTS WEL-  
DED THERETO, SPRINGS FOR TEETH, DENTAL  
SCREWS HAVING A SPRING-LOADED PISTON  
FOR TEETH AND PARTS FOR THE AFOREMEN-  
TIONED GOODS, IN CLASS 10 (U.S. CLS. 26, 39 AND  
44).

FIRST USE 7-11-2001; IN COMMERCE 7-11-2001.

THE MARK CONSISTS OF STANDARD CHAR-  
ACTERS WITHOUT CLAIM TO ANY PARTICULAR  
FONT, STYLE, SIZE, OR COLOR.

OWNER OF FED REP GERMANY REG. NO.  
768345, DATED 9-7-2001, EXPIRES 3-19-2011.

SER. NO. 78-860,266, FILED 4-12-2006.

AMY MCMENAMIN, EXAMINING ATTORNEY

**Int. Cls.: 9, 16, 25 and 41**

**Prior U.S. Cls.: 2, 5, 21, 22, 23, 26, 29, 36, 37, 38, 39,  
50, 100, 101 and 107**

**Reg. No. 3,499,149**

**United States Patent and Trademark Office**

**Registered Sep. 9, 2008**

**TRADEMARK  
SERVICE MARK  
PRINCIPAL REGISTER**

# WINTER HARP

PAPPAJOHN, LORI LYNN (CANADA INDIVIDUAL)  
209 E 8TH AVENUE  
NEW WESTMINSTER, CANADA V3L 4K1

FOR: PRE-RECORDED AUDIO TAPES, COMPACT DISKS, VIDEO TAPES AND DVD'S CONTAINING MUSIC, IN CLASS 9 (U.S. CLS. 21, 23, 26, 36 AND 38).

FIRST USE 0-0-1993; IN COMMERCE 0-0-1993.

FOR: PRINTED MATERIAL, NAMELY, POSTERS, STICKERS, BUMPER STICKERS, DECALS AND CONCERT SOUVENIR PROGRAMS, IN CLASS 16 (U.S. CLS. 2, 5, 22, 23, 29, 37, 38 AND 50).

FIRST USE 0-0-1993; IN COMMERCE 0-0-1993.

FOR: SOUVENIR MERCHANDISE, NAMELY, T-SHIRTS, JACKETS, SWEATSHIRTS, JERSEYS, HATS, CAPS, IN CLASS 25 (U.S. CLS. 22 AND 39).

FIRST USE 0-0-1993; IN COMMERCE 0-0-2002.

FOR: PROVIDING A WEBSITE FEATURING MUSIC; ENTERTAINMENT SERVICES, NAMELY, LIVE

MUSICAL PERFORMANCES BY A MUSICAL BAND, MUSIC PUBLISHING SERVICES, PRODUCTION OF MUSICAL AUDIO AND VIDEO RECORDINGS, MUSIC COMPOSITION AND TRANSCRIPTION FOR OTHERS, SONG WRITING SERVICES, IN CLASS 41 (U.S. CLS. 100, 101 AND 107).

FIRST USE 0-0-1993; IN COMMERCE 0-0-1993.

THE MARK CONSISTS OF STANDARD CHARACTERS WITHOUT CLAIM TO ANY PARTICULAR FONT, STYLE, SIZE, OR COLOR.

PRIORITY CLAIMED UNDER SEC. 44(D) ON CANADA APPLICATION NO. 1286684, FILED 1-19-2006, REG. NO. TMA692320, DATED 7-18-2007, EXPIRES 7-18-2022.

NO CLAIM IS MADE TO THE EXCLUSIVE RIGHT TO USE "HARP" AS TO CLASSES 9 AND 41, APART FROM THE MARK AS SHOWN.

SER. NO. 78-868,285, FILED 4-24-2006.

TRACY WHITTAKER-BROWN, EXAMINING ATTORNEY

**Int. Cls.: 9, 35, 38, 41 and 42**

**Prior U.S. Cls.: 21, 23, 26, 36, 38, 100, 101, 102, 104  
and 107**

**Reg. No. 3,499,150**

**United States Patent and Trademark Office**

**Registered Sep. 9, 2008**

**TRADEMARK  
SERVICE MARK  
PRINCIPAL REGISTER**

# TAGWORLD

SOCIAL PROJECT, INC. (DELAWARE CORPORATION), DBA TAGWORLD  
227 BROADWAY, SUITE 300  
SANTA MONICA, CA 904011809

FOR: SOFTWARE TO ENABLE UPLOADING, DISPLAYING, TAGGING, BLOGGING AND SHARING OF ELECTRONIC MEDIA OR INFORMATION, ALL FOR THE PURPOSE OF INTERNET BASED SOCIAL NETWORKING, IN CLASS 9 (U.S. CLS. 21, 23, 26, 36 AND 38).

FIRST USE 6-1-2005; IN COMMERCE 8-1-2005.

FOR: ADVERTISING AND ADVERTISEMENT, PROMOTION AND MARKETING SERVICES FOR PROVIDING ELECTRONIC MEDIA OR INFORMATION OVER THE INTERNET, ALL FOR THE PURPOSE OF INTERNET BASED SOCIAL NETWORKING, IN CLASS 35 (U.S. CLS. 100, 101 AND 102).

FIRST USE 6-1-2005; IN COMMERCE 8-1-2005.

FOR: PROVIDING ON-LINE CHAT ROOMS AND ELECTRONIC BULLETIN BOARDS FOR TRANSMISSION OF MESSAGES AMONG USERS AND E-MAIL AND INSTANT MESSAGING SERVICES, ALL FOR THE PURPOSE OF INTERNET BASED SOCIAL NETWORKING, IN CLASS 38 (U.S. CLS. 100, 101 AND 104).

FIRST USE 6-1-2005; IN COMMERCE 8-1-2005.

FOR: ENTERTAINMENT SERVICES, NAMELY, PROVIDING ON-LINE MUSIC AND VIDEO, ALL FOR THE PURPOSE OF INTERNET BASED SOCIAL NETWORKING, IN CLASS 41 (U.S. CLS. 100, 101 AND 107).

FIRST USE 6-1-2005; IN COMMERCE 8-1-2005.

FOR: COMPUTER SERVICES IN THE NATURE OF CUSTOMIZED WEB PAGES FEATURING USER-DEFINED INFORMATION AND PERSONAL PROFILES, NAMELY, BY UPLOADING, DISPLAYING, TAGGING, BLOGGING AND SHARING ELECTRONIC MEDIA OR INFORMATION, ALL FOR THE PURPOSE OF INTERNET BASED SOCIAL NETWORKING, IN CLASS 42 (U.S. CLS. 100 AND 101).

FIRST USE 6-1-2005; IN COMMERCE 8-1-2005.

THE MARK CONSISTS OF STANDARD CHARACTERS WITHOUT CLAIM TO ANY PARTICULAR FONT, STYLE, SIZE, OR COLOR.

SER. NO. 78-868,287, FILED 4-24-2006.

ZACHARY BELLO, EXAMINING ATTORNEY

**Int. Cl.: 9**

**Prior U.S. Cls.: 21, 23, 26, 36 and 38**

**United States Patent and Trademark Office**

**Reg. No. 3,499,151**

**Registered Sep. 9, 2008**

**TRADEMARK  
PRINCIPAL REGISTER**

**WAYPOINT**

NOVATEL INC. (CANADA CORPORATION)  
1120 68TH AVENUE N.E.  
CALGARY, CANADA T2E 8S5

FOR: SOFTWARE FOR PROCESSING AND DISPLAYING NAVIGATION AND POSITIONING DATA, IN CLASS 9 (U.S. CLS. 21, 23, 26, 36 AND 38).

FIRST USE 3-1-1997; IN COMMERCE 3-1-1997.

THE MARK CONSISTS OF STANDARD CHARACTERS WITHOUT CLAIM TO ANY PARTICULAR FONT, STYLE, SIZE, OR COLOR.

SEC. 2(F).

SER. NO. 78-869,190, FILED 4-25-2006.

LINDA LAVACHE, EXAMINING ATTORNEY

**Int. Cl.: 42**

**Prior U.S. Cls.: 100 and 101**

**United States Patent and Trademark Office**

**Reg. No. 3,499,152**

**Registered Sep. 9, 2008**

**SERVICE MARK  
PRINCIPAL REGISTER**

**STRAIGHT-THROUGH  
INTEGRATION**

HUBSPAN, INC. (WASHINGTON CORPORATION)  
505 FIFTH AVENUE SOUTH, SUITE 350  
SEATTLE, WA 98104

FOR: PROVIDING ELECTRONIC COMMERCE SERVICES, NAMELY, APPLICATION SERVICE PROVIDER FEATURING SOFTWARE THAT ALLOWS FOR AUTOMATING THE DELIVERY OF DATA RELATING TO PRODUCT INFORMATION AND COMMERCIAL TRANSACTIONS BETWEEN COMPANIES VIA A GLOBAL COMPUTER NETWORK, AND PROVIDING CONSULTATION SER-

VICES IN THE ABOVE AREA, IN CLASS 42 (U.S. CLS. 100 AND 101).

FIRST USE 8-0-2006; IN COMMERCE 8-0-2006.

THE MARK CONSISTS OF STANDARD CHARACTERS WITHOUT CLAIM TO ANY PARTICULAR FONT, STYLE, SIZE, OR COLOR.

SER. NO. 78-871,586, FILED 4-27-2006.

PAM WILLIS, EXAMINING ATTORNEY

**Int. Cl.: 39**

**Prior U.S. Cls.: 100 and 105**

**United States Patent and Trademark Office**

**Reg. No. 3,499,153**

**Registered Sep. 9, 2008**

**SERVICE MARK  
PRINCIPAL REGISTER**

**KOREAN AIR** Prestige class

KOREAN AIRLINES CO., LTD. (REPUBLIC OF KOREA CORPORATION)  
41-3, SEOSOMUN-DONG  
CHUNG-KU, SEOUL, REPUBLIC OF KOREA

FOR: TRANSPORTATION OF TRAVELERS BY AIR, BUS, SHIPS, RAIL AND CAR; INTERNATIONAL COMPLEX TRANSPORTATION, NAMELY, TRANSPORTATION OF PASSENGERS AND/OR GOODS BY AIR, BUS, SHIPS, TRUCK, RAIL AND CAR; BUS TRANSPORT; PASSENGER SHIP TRANSPORT; RENTAL OF SHIPS; TRANSPORTATION RESERVATION SERVICES; TRANSPORTATION INFORMATION SERVICES; TRANSPORT BROKERAGE; PLEASURE BOAT TRANSPORT; CAR TRANSPORT; AIRCRAFT RENTAL; AIR TRANSPORT AGENCY, NAMELY, MAKING RESERVATIONS AND BOOKING FOR TRANSPORTATION OF PASSENGERS AND GOODS BY AIR; AIR TRANSPORT; MARINE TRANSPORT; MARINE TRANSPORTATION AGENCY, NAMELY, MAKING RESERVATIONS AND BOOKING FOR TRANSPORTATION OF PASSENGERS AND GOODS BY WATER; TOUR ESCORTING, NAMELY, TRAVEL GUIDE SERVICES; ARRANGING OF TRAVEL; TRANSPORTATION RESERVATION SERVICES; TRAVEL AGENCY SERVICES, NAMELY, MAKING RESERVATIONS AND BOOKINGS FOR TRANSPORTATION, NOT INCLUDING HOTEL RESERVATION SERVICES; AND TOURIST OFFICES, NAMELY, TOUR GUIDE SERVICES, IN CLASS 39 (U.S. CLS. 100 AND 105).

OWNER OF REPUBLIC OF KOREA REG. NO. 127671, DATED 2-10-2006, EXPIRES 2-10-2016.

OWNER OF U.S. REG. NOS. 1,379,608, 2,177,744 AND OTHERS.

THE COLOR(S) BLACK, WHITE, BLUE, AND RED IS/ARE CLAIMED AS A FEATURE OF THE MARK.

THE MARK CONSISTS OF THE WORDS "KOREAN AIR" IN BLUE, WITH A "YIN-YANG" SYMBOL FOR THE LETTER "O" IN RED, WHITE AND BLUE, FOLLOWED BY THE WORDS "PRESTIGE CLASS" IN BLACK.

SEC. 2(F) AS TO "KOREAN AIR".

SER. NO. 78-873,621, FILED 5-1-2006.

LAURA HAMMEL, EXAMINING ATTORNEY

**Int. Cl.: 35**

**Prior U.S. Cls.: 100, 101 and 102**

**United States Patent and Trademark Office**

**Reg. No. 3,499,154**

**Registered Sep. 9, 2008**

**SERVICE MARK  
PRINCIPAL REGISTER**

**WORKING MOTHER BEST SMALL  
COMPANIES**

WORKING MOTHER MEDIA, INC. (DELAWARE  
CORPORATION)  
60 E. 42ND STREET  
NEW YORK, NY 10165

FOR: PREPARING BUSINESS REPORTS, IN  
CLASS 35 (U.S. CLS. 100, 101 AND 102).

FIRST USE 4-1-2006; IN COMMERCE 4-1-2006.

THE MARK CONSISTS OF STANDARD CHAR-  
ACTERS WITHOUT CLAIM TO ANY PARTICULAR  
FONT, STYLE, SIZE, OR COLOR.

OWNER OF U.S. REG. NOS. 1,243,573 AND  
2,437,700.

NO CLAIM IS MADE TO THE EXCLUSIVE  
RIGHT TO USE "BEST SMALL COMPANIES",  
APART FROM THE MARK AS SHOWN.

SEC. 2(F) AS TO "WORKING MOTHER".

SER. NO. 78-874,583, FILED 5-2-2006.

ELLEN PERKINS, EXAMINING ATTORNEY

**Int. Cls.: 16 and 35**

**Prior U.S. Cls.: 2, 5, 22, 23, 29, 37, 38, 50, 100, 101 and 102**

**United States Patent and Trademark Office**

**Reg. No. 3,499,155**

**Registered Sep. 9, 2008**

**TRADEMARK  
SERVICE MARK  
PRINCIPAL REGISTER**

**FOCUS**

THE FEDERATED GROUP, INC. (ILLINOIS CORPORATION)  
3025 WEST SALT CREEK LANE  
ARLINGTON HEIGHTS, IL 60005

FOR: MAGAZINES FEATURING BRANDED FOOD AND GROCERY STORE PRODUCTS, IN CLASS 16 (U.S. CLS. 2, 5, 22, 23, 29, 37, 38 AND 50).

FIRST USE 7-31-1992; IN COMMERCE 7-31-1992.

FOR: ADVERTISING AND MARKETING; ADVERTISING AND PROMOTION SERVICES AND

RELATED CONSULTING, IN CLASS 35 (U.S. CLS. 100, 101 AND 102).

FIRST USE 7-31-1992; IN COMMERCE 7-31-1992.

THE MARK CONSISTS OF STANDARD CHARACTERS WITHOUT CLAIM TO ANY PARTICULAR FONT, STYLE, SIZE, OR COLOR.

SER. NO. 78-875,396, FILED 5-3-2006.

DORITT L. CARROLL, EXAMINING ATTORNEY



**Int. Cls.: 16 and 21**

**Prior U.S. Cls.: 2, 5, 13, 22, 23, 29, 30, 33, 37, 38, 40  
and 50**

**Reg. No. 3,499,156**

**United States Patent and Trademark Office**

**Registered Sep. 9, 2008**

**TRADEMARK  
PRINCIPAL REGISTER**

**DOT·IT**

INOVAR PACKAGING GROUP, LLC (TEXAS  
LIMITED LIABILITY COMPANY)  
602 MAGIC MILE STREET  
ARLINGTON, TX 760115108

FOR: ADHESIVE LABELS; ADHESIVE LABEL  
DISPENSERS FOR USE IN THE FOOD SERVICE  
INDUSTRY; BAGS FOR MICROWAVE COOKING;  
PLASTIC FOOD STORAGE AND MICROWAVABLE  
BAGS FOR USE IN THE FOOD SERVICE INDUS-  
TRY, IN CLASS 16 (U.S. CLS. 2, 5, 22, 23, 29, 37, 38  
AND 50).

FIRST USE 1-0-1997; IN COMMERCE 1-0-1997.

FOR: PAN LINERS FOR KITCHEN AND COOK-  
ING USE, NAMELY, HIGH TEMPERATURE NY-  
LON AND HIGH DENSITY POLYETHYLENE PAN  
LINERS THAT HELP PREVENT FOOD FROM  
STICKING TO THE PAN WHILE STORING, WARM-  
ING AND COOKING FOOD; DISPOSABLE PLASTIC

KITCHEN GLOVES FOR CUTTING; DISPOSABLE  
VINYL GLOVES, DISPOSABLE LATEX GLOVES,  
DISPOSABLE POLYETHYLENE GLOVES, DISPOS-  
ABLE KNIT GLOVES, ALL FOR USE IN THE FOOD  
SERVICE INDUSTRY; NAIL BRUSHES; CUTTING  
BOARDS; CUTTING BOARD RACKS; THERMAL  
INSULATED BAGS FOR FOOD OR BEVERAGES;  
ICE SCOOPS; ICE SCOOP HOLDERS; PAILS, IN  
CLASS 21 (U.S. CLS. 2, 13, 23, 29, 30, 33, 40 AND 50).

FIRST USE 5-0-2004; IN COMMERCE 5-0-2004.

THE MARK CONSISTS OF STANDARD CHAR-  
ACTERS WITHOUT CLAIM TO ANY PARTICULAR  
FONT, STYLE, SIZE, OR COLOR.

SER. NO. 78-882,154, FILED 5-12-2006.

DAVID COLLIER, EXAMINING ATTORNEY

**Int. Cls.: 9, 12, 14, 16, 18, 25, 28 and 38**

**Prior U.S. Cls.: 1, 2, 3, 5, 19, 21, 22, 23, 26, 27, 28, 29,  
31, 35, 36, 37, 38, 39, 41, 44, 50, 100, 101 and 104**

**Reg. No. 3,499,157**

**United States Patent and Trademark Office**

**Registered Sep. 9, 2008**

**TRADEMARK  
SERVICE MARK  
PRINCIPAL REGISTER**

**VR|46**

ROSSI, VALENTINO (ITALY INDIVIDUAL)  
FLAT 4  
DOWN STREET 23  
LONDON, UNITED KINGDOM W1J7AR

FOR: (BASED ON 44(E)) PHOTOGRAPHIC APPARATUS AND INSTRUMENTS, NAMELY, CAMERA LENSES AND LENS HOODS; CINEMATOGRAPHIC APPARATUS AND INSTRUMENTS, NAMELY, CINEMATOGRAPHIC FILM; OPTICAL APPARATUS AND INSTRUMENTS, NAMELY, MAGNIFYING GLASSES, INSTRUMENTS CONTAINING EYEPIECES, NAMELY, MICROSCOPES, TELESCOPES, OPTICAL LENS SIGHTS, TELESCOPIC LENS SIGHTS, AND MAGNIFYING PEEPHOLES FOR DOORS; MEASURING APPARATUS AND INSTRUMENTS, NAMELY, MEASURING LABORATORY GLASSWARE, GRADUATED GLASSWARE; APPARATUS AND INSTRUMENTS FOR CONDUCTING, SWITCHING, TRANSFORMING, ACCUMULATING, REGULATING OR CONTROLLING ELECTRICITY, NAMELY, CAPACITORS; APPARATUS FOR RECORDING, TRANSMISSION OR REPRODUCTION OF DATA, SOUND AND IMAGES, NAMELY, VIDEO TELEPHONES, PORTABLE TELEPHONES, PERSONAL DIGITAL AUDIO PLAYERS, ELECTRONIC AGENDAS, JUKEBOXES, VIDEO GAME MACHINES FOR USE WITH TELEVISIONS, ELECTRONIC GAME CONSOLES FOR USE WITH TELEVISIONS, FACSIMILE MACHINES, RADIOS, VEHICLE RADIOS; BLANK MAGNETIC DATA CARRIERS, NAMELY, VIDEOCASSETTES, AUDIO CASSETTES, AND RECORDING DISCS, NAMELY, FLOPPY DISCS, CDS, CD-ROMS AND DVDS; PRERECORDED PHONOGRAPHIC RECORDS, AUDIO CASSETTES, VIDEO CASSETTES AND COMPACT DISCS FEATURING AUDIO CONTENT IN THE NATURE OF MUSIC AND INTERVIEWS, VIDEO CONTENT IN THE FIELD OF SPORTS AND MO-

TORCYCLE RACING, AND COMPUTER PROGRAMS FOR PRERECORDED GAMES; PRERECORDED VIDEO GAME MEMORY CARTRIDGES; AUTOMATIC VENDING MACHINES; CASH REGISTERS; CALCULATING MACHINES, NAMELY, ACCOUNTING MACHINES, ADDING MACHINES, POCKET CALCULATORS; DATA PROCESSING EQUIPMENT, NAMELY, NOTEBOOK COMPUTERS, LAPTOP COMPUTERS, COMPUTER HARDWARE; COMPUTER SOFTWARE, NAMELY, COMPUTER APPLICATION SOFTWARE FOR MOBILE PHONES AND FOR DIGITAL CAMERAS AND COMPUTER GAME SOFTWARE, COMPUTER OPERATING SYSTEMS, AND DOWNLOADABLE ELECTRONIC PUBLICATIONS IN THE NATURE OF MAGAZINES AND JOURNALS IN THE FIELD OF SPORTS, GAMES, RECREATION, MUSIC, CLOTHING FASHION, TRAVEL, THEATRE, FILMS, CARTOONS, EDUCATION, HEALTH AND ECOLOGY; VIDEO DISKS AND VIDEO TAPES WITH RECORDED ANIMATED CARTOONS; PROTECTIVE HELMETS; DIVING HELMETS; SCUBA DIVING MASKS; DIVING SUITS, IN CLASS 9 (U.S. CLS. 21, 23, 26, 36 AND 38).

FOR: (BASED ON 44(E)) LAND VEHICLES; AIR AND WATER VEHICLES, NAMELY, HELICOPTERS, BOATS, AND STRUCTURAL PARTS THEREFOR; APPARATUS FOR LOCOMOTION BY LAND, AIR OR WATER, NAMELY, AUTOMOBILES, TRICYCLES, BICYCLES, MOTORCYCLE SIDECARS; MOTORCYCLES; AUTOMOBILES; BOATS; PARTS AND ACCESSORIES FOR VEHICLES, NAMELY, WINDSHIELD WIPERS; SLEIGHS, IN CLASS 12 (U.S. CLS. 19, 21, 23, 31, 35 AND 44).

FOR: (BASED ON 44(E)) PRECIOUS METALS AND THEIR ALLOYS; GOODS IN PRECIOUS METALS OR COATED THEREWITH, NAMELY, AMU-

LETS, BADGES, JEWELRY BOXES, BUCKLES FOR WATCHSTRAPS, JEWELRY CASES, KEY CHAINS, JEWELRY CHAINS, CHARMS, COLLECTIBLE COINS, COMMEMORATIVE COINS, PILLBOXES MADE OF PRECIOUS METAL, MEDALS, ORNAMENTAL PINS, ORNAMENTS, STATUETTES, WATCH STRAPS, TIE CLIPS, TIE PINS, CUFF LINKS, AND TRINKETS BEING JEWELRY; JEWELRY; PRECIOUS STONES; NECKLACES; BRACELETS; RINGS BEING JEWELRY; EARRINGS; ANKLE BRACELETS; PENDANTS; BROOCHES; WRISTWATCHES; POCKET WATCHES; TABLE CLOCKS; PENDULUM CLOCKS; HOROLOGICAL AND CHRONOMETRIC INSTRUMENTS, IN CLASS 14 (U.S. CLS. 2, 27, 28 AND 50).

FOR: (BASED ON 44(E)) PAPER; CARDBOARD; ARTICLES MADE FROM PAPER OR CARDBOARD, NAMELY, BOXES, CARTONS, LABELS, ADHESIVES FOR STATIONERY PURPOSES; PRINTED MAGAZINES, EVENT PROGRAMS AND PERIODICALS IN THE FIELD OF MOTORCYCLE RACING, SPORTS, GAMES, RECREATION, MUSIC, CLOTHING, FASHION, TRAVEL, THEATRE, FILMS, CARTOONS, EDUCATION, HEALTH AND ECOLOGY; PHOTOGRAPHS; STATIONERY, IN CLASS 16 (U.S. CLS. 2, 5, 22, 23, 29, 37, 38 AND 50).

FOR: (BASED ON 44(E)) LEATHER; IMITATION LEATHER SOLD IN BULK; GOODS MADE OF LEATHER AND IMITATION LEATHER, NAMELY, HATBOXES FOR TRAVEL NOT OF PAPER OR CARDBOARD, ANIMAL LEASHES, SHOULDER BELTS, STRAPS, THONGS, RIDING SADDLES AND VANITY CASES SOLD EMPTY; ANIMAL SKINS; TRUNKS; SUITCASES; BAGS, NAMELY, BACKPACKS, BEACH BAGS, HANDBAGS, HAVERSACKS, NET MESH BAGS FOR SHOPPING, POUCHES OF LEATHER OR FELT, PURSES, RUCKSACKS, SACHELS, SCHOOL BAGS, SCHOOL SACHELS, LEATHER SHOPPING BAGS, SLING BAGS FOR CARRYING INFANTS, TOOL BAGS SOLD EMPTY, TRAVELING BAGS, VALISES, AND WHEELED SHOPPING BAGS; WALLETS; BRIEFCASES; UMBRELLAS, PARASOLS; WALKING STICKS; PURSES MADE OF PRECIOUS METAL, IN CLASS 18 (U.S. CLS. 1, 2, 3, 22 AND 41).

FOR: (BASED ON 44(E)) CLOTHING, NAMELY, APRONS, ASCOTS, BABIES' PANTS, BANDANAS AND NECKERCHIEFS, BATHROBES, BATHING DRAWERS; BATHING SUITS, BATHING TRUNKS, BEACHWEAR, BOAS, BODICES, BRASSIERES, BREECHES, CAMISOLES, CAP PEAKS, CAPS, CHEMISETTES, GYMNASTICS WEAR, NAMELY, LEOTARDS, TRACK SUITS, COATS, TOPCOATS, CYCLIST CLOTHING, NAMELY, JERSEYS, SHORTS, PANTS, HATS, GLOVES, DRAWERS, DRESS SHIELDS, DRESSING GOWNS, FOOTMUFFS, FROCKS, GARTER BELTS, GIRDLES, GLOVES, HOSIERY, JACKETS, JERSEYS, JUMPERS, KNITWEAR, NAMELY, SWEATERS, SCARVES, HATS, AND GLOVES, BODY LINEN, NAMELY, PANTIES AND UNDERWEAR, MITTENS, MONEY BELTS, MUFFS, NECKTIES, OUTERWEAR, NAMELY, COATS, RAINCOATS;

OVERALLS, OVERCOATS, PAJAMAS, PANTS, PELERINES, PELISSES, PULLOVERS, SASHES, SCARVES, SHAWLS, SHIRT YOKES, SHIRTS, SHOULDER WRAPS, STOCKINGS, SUITS, SUNVISORS, SWEATERS, SWIMSUITS, TEDDIES, T-SHIRTS, TIGHTS, TROUSERS, UNDERGARMENTS, UNDERPANTS, UNDERWEAR, UNIFORMS, VEILS, VESTS, VISORS, WATERPROOF PANTS, WATERPROOF SHIRTS, WATERPROOF JACKETS, WATERPROOF COATS, RAIN SLICKERS, WIMPLES, AND WRISTBANDS; FOOTWEAR; HEADGEAR, NAMELY, HATS, BERETS, HOODS, SKULL CAPS, TOP HATS, TURBANS, AND HEADBANDS; GOODS MADE OF LEATHER AND IMITATION LEATHER, NAMELY, HEADBANDS, ARMBANDS, WRISTBANDS, SASHES, AND BELTS, IN CLASS 25 (U.S. CLS. 22 AND 39).

FOR: (BASED ON 44(E)) PLAYTHINGS, NAMELY, SOCCER BALLS, BASEBALLS, BASKET BALLS, GOLF BALLS, FOOTBALLS, CRICKET BALLS, TENNIS BALLS, GYMNASTICS EXERCISE BALLS, AND PLAY BALLOONS; TOYS, NAMELY BATH TOYS, DOLLS, PUPPETS; TOY MODEL VEHICLES; GYMNASTIC APPARATUS; SPORTING ARTICLES, NAMELY, BATTING GLOVES, BOB-SLEIGHS, BODY BOARDS, BODY-BUILDING APPARATUS, NAMELY WEIGHT WORK-OUT BENCHES, BODY TRAINING APPARATUS, NAMELY, ELLIPTICAL EXERCISE MACHINES, EXERCISE EQUIPMENT, NAMELY, STATIONARY CYCLES, ELECTRONIC SPORTS TRAINING SIMULATORS, NAMELY, SKI SIMULATORS AND JOGGING SIMULATORS, CHEST EXPANDERS, COVERS FOR SKI BINDINGS, ELBOW GUARDS FOR ATHLETIC USE, CHEST EXPANDERS, FLIPPERS FOR SWIMMING, SPORTS GLOVES, NAMELY, SOFTBALL GLOVES, BASEBALL GLOVES, BOXING GLOVES, GOLF GLOVES, GOLF CLUBS, TOY GUNS; SCUBA EQUIPMENT, NAMELY, SPEAR FISHING HARPOON GUNS AND SPEAR FISHING HARPOONS THEREFOR, HARNESSES FOR SAILBOARDS, ICE SKATES, IN-LINE ROLLER SKATES, KNEE GUARDS FOR ATHLETIC USE, MACHINES FOR PHYSICAL EXERCISE, MASTS FOR SAILBOARDS, RACKETS, EXERCISE APPARATUS FOR THE BODY, NAMELY, TREADMILLS, ROWING MACHINES, ROLLER SKATES, SAILBOARDS FOR BOARD SAILING, SHINGUARDS FOR ATHLETIC USE, SKATEBOARDS, SKIS, PLAYGROUND EQUIPMENT, NAMELY, SLIDES, SNOWSHOES, STATIONARY EXERCISE BICYCLES, SURFBOARDS, SURF SKIS AND WATER SKIS; CHRISTMAS TREE DECORATIONS NOT INCLUDING CONFECTIONERY OR ILLUMINATION ARTICLES; PLAYING CARDS; HANG GLIDERS; GOLF CLUB BAGS, IN CLASS 28 (U.S. CLS. 22, 23, 38 AND 50).

FOR: (BASED ON 44(E)) TELECOMMUNICATIONS SERVICES, NAMELY PERSONAL COMMUNICATION SERVICES, PROVIDING MULTIPLE USER DIAL-UP AND DEDICATED ACCESS TO THE INTERNET, PROVIDING REMOTE INTERNET ACCESS, PROVIDING MULTIPLE USER DIAL-UP AND DEDICATED ACCESS TO THE INTERNET INCLUDING PORTALS ON THE INTERNET, PROVIDING INTERNET CHATROOMS, INTERNET

BASED VOICE CHAT SERVICES, ELECTRONIC MAIL SERVICES, WEB MESSAGING, COMPUTER-AIDED TRANSMISSION OF MESSAGES AND IMAGES; TELEPHONE COMMUNICATIONS SERVICES, IN CLASS 38 (U.S. CLS. 100, 101 AND 104).

OWNER OF ERPN CMNTY TM OFC REG. NO. 003519725, DATED 4-22-2005, EXPIRES 4-22-2015.

OWNER OF ERPN CMNTY TM OFC REG. NO. 004583084, DATED 8-2-2006, EXPIRES 8-2-2016.

SER. NO. 78-883,746, FILED 5-15-2006.

JAMES LOVELACE, EXAMINING ATTORNEY

**Int. Cls.: 5 and 10**

**Prior U.S. Cls.: 6, 18, 26, 39, 44, 46, 51 and 52**

**United States Patent and Trademark Office**

**Reg. No. 3,499,158**

**Registered Sep. 9, 2008**

**TRADEMARK  
PRINCIPAL REGISTER**

# GLUCOCARD

ARKRAY, INC. (JAPAN CORPORATION)  
57, NISHI AKETA-CHO HIGASHI-KUJO  
MINAMI-KU  
KYOTO-SHI, KYOTO, JAPAN

FOR: MEDICAL DIAGNOSTIC TEST STRIPS,  
CALIBRATION STRIPS AND ELECTRODE STRIPS  
USED IN THE FIELDS OF BLOOD GLUCOSE  
TESTING, MONITORING AND MEASUREMENT,  
IN CLASS 5 (U.S. CLS. 6, 18, 44, 46, 51 AND 52).

FOR: MEDICAL APPARATUS AND INSTRU-  
MENTS, NAMELY, DIAGNOSTIC DEVICES FOR  
MEASURING BLOOD GLUCOSE; AND PARTS AND

ACCESSORIES FOR THE AFORESAID GOODS,  
NAMELY, BLOOD COLLECTING DEVICES, IN  
CLASS 10 (U.S. CLS. 26, 39 AND 44).

THE MARK CONSISTS OF STANDARD CHAR-  
ACTERS WITHOUT CLAIM TO ANY PARTICULAR  
FONT, STYLE, SIZE, OR COLOR.

OWNER OF JAPAN REG. NO. 4716978, DATED 10-  
10-2003, EXPIRES 4-3-2013.

SER. NO. 78-885,670, FILED 5-17-2006.

MICHAEL WIENER, EXAMINING ATTORNEY

**Int. Cls.: 21, 24, 25 and 41**

**Prior U.S. Cls.: 2, 13, 22, 23, 29, 30, 33, 39, 40, 42, 50, 100, 101 and 107**

**Reg. No. 3,499,159**

**United States Patent and Trademark Office**

**Registered Sep. 9, 2008**

**TRADEMARK  
SERVICE MARK  
PRINCIPAL REGISTER**



LONGWOOD UNIVERSITY (VIRGINIA CORPORATION)  
201 HIGH STREET  
FARMVILLE, VA 23909

FOR: PLASTIC CUPS, DRINKING GLASSES, MUGS, SHOT GLASSES, PLASTIC WATER BOTTLES SOLD EMPTY, IN CLASS 21 (U.S. CLS. 2, 13, 23, 29, 30, 33, 40 AND 50).

FIRST USE 2-18-2006; IN COMMERCE 2-18-2006.

FOR: CLOTH AND FABRIC FLAGS, IN CLASS 24 (U.S. CLS. 42 AND 50).

FIRST USE 2-18-2006; IN COMMERCE 2-18-2006.

FOR: CLOTHING, NAMELY, MEN'S, WOMEN'S AND CHILDREN'S SHIRTS, SWEAT SHIRTS, SWEAT SUITS, HATS, CAPS, JERSEYS, JACKETS, FLEECE PULLOVERS, T-SHIRTS, SHORTS, GOLF SHIRTS, PANTS, TRACK PANTS, TIES, TANK TOPS, SWEATERS, SLEEPWEAR, BOXER SHORTS, SOCKS, WOMEN'S BLOUSES, SKIRTS AND DRESSES, BASEBALL CAPS, IN CLASS 25 (U.S. CLS. 22 AND 39).

FIRST USE 2-18-2006; IN COMMERCE 2-18-2006.

FOR: EDUCATIONAL SERVICES, NAMELY, PROVIDING COURSES, SEMINARS, CLASSES AND WORKSHOPS AT THE COLLEGE LEVEL; SPORTING ACTIVITIES IN THE NATURE OF CONDUCTING ATHLETIC COMPETITIONS AND EXHI-

BITIONS AND ENTERTAINMENT SERVICES, NAMELY, MUSICALS, THEATRICALS AND DANCE PERFORMANCES, IN CLASS 41 (U.S. CLS. 100, 101 AND 107).

FIRST USE 2-18-2006; IN COMMERCE 2-18-2006.

OWNER OF U.S. REG. NOS. 2,506,678, 2,815,114, AND 2,815,115.

NO CLAIM IS MADE TO THE EXCLUSIVE RIGHT TO USE "UNIVERSITY", APART FROM THE MARK AS SHOWN.

THE COLOR(S) GRAY, BLUE AND WHITE IS/ ARE CLAIMED AS A FEATURE OF THE MARK.

THE COLOR WHITE IS IN THE EYE OF THE HORSE DESIGN; THE COLOR GRAY IS IN THE CENTER PORTION OF THE HORSE HEAD DESIGN, ON THE EDGE AROUND THE HORSE HEAD DESIGN AND ON THE INSIDE OF THE RIBBON AS WELL AS THE WORDING "LONGWOOD UNIVERSITY;" THE COLOR BLUE IS AN OUTLINE OF THE EYE OF THE HORSE HEAD DESIGN, A PORTION OF THE HORSE HEAD DESIGN, THE OUTER EDGE OF THE RIBBON DESIGN, THE ARROW DESIGN, AND THE WORDING "LANCERS".

SER. NO. 78-887,130, FILED 5-18-2006.

MICHAEL SOUDERS, EXAMINING ATTORNEY

**Int. Cl.: 35**

**Prior U.S. Cls.: 100, 101 and 102**

**United States Patent and Trademark Office**

**Reg. No. 3,499,160**

**Registered Sep. 9, 2008**

**SERVICE MARK  
PRINCIPAL REGISTER**

# Customer Chemistry

DHSOFT, INC. (VIRGINIA CORPORATION)  
607 HERNDON PARKWAY, SUITE 301  
HERNDON, VA 20170

FOR: BUSINESS CONSULTING SERVICES RELATED TO IMPROVING SALES, MARKETING AND CUSTOMER DEVELOPMENT AND RELATIONSHIPS, IN CLASS 35 (U.S. CLS. 100, 101 AND 102).

FIRST USE 4-7-2006; IN COMMERCE 4-7-2006.

THE MARK CONSISTS OF STANDARD CHARACTERS WITHOUT CLAIM TO ANY PARTICULAR FONT, STYLE, SIZE, OR COLOR.

NO CLAIM IS MADE TO THE EXCLUSIVE RIGHT TO USE "CUSTOMER", APART FROM THE MARK AS SHOWN.

SER. NO. 78-897,195, FILED 5-31-2006.

MICHAEL WIENER, EXAMINING ATTORNEY

Int. Cl.: 31

Prior U.S. Cls.: 1 and 46

United States Patent and Trademark Office

Reg. No. 3,499,161

Registered Sep. 9, 2008

TRADEMARK  
PRINCIPAL REGISTER

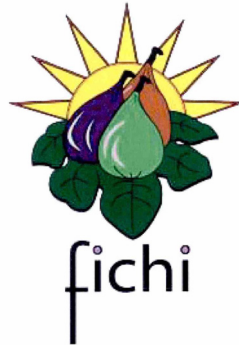

AJ TRUCCO, INC. (NEW YORK CORPORATION)  
343-344 NYC TERMINAL MARKET  
BRONX, NY 10474

FOR: FRUITS, NAMELY, UNPROCESSED FIGS,  
IN CLASS 31 (U.S. CLS. 1 AND 46).

FIRST USE 6-1-2005; IN COMMERCE 6-1-2005.

NO CLAIM IS MADE TO THE EXCLUSIVE  
RIGHT TO USE "FICHI" , APART FROM THE  
MARK AS SHOWN.

THE COLOR(S) BLACK, PURPLE, GREEN, YEL-  
LOW AND WHITE IS/ARE CLAIMED AS A FEAT-  
URE OF THE MARK.

THE MARK CONSISTS OF THE STYLIZED  
WORD "FICHI" IN BLACK UNDER AN ILLUSTRATION  
OF FRESH FIGS IN PURPLE, GREEN AND  
YELLOW, ON GREEN LEAVES, IN FRONT OF A  
YELLOW SUN, AGAINST A WHITE BACK-  
GROUND.

THE FOREIGN WORDING IN THE MARK  
TRANSLATES INTO ENGLISH AS FIG.

SER. NO. 78-900,877, FILED 6-5-2006.

VIVIAN MICZNIK FIRST, EXAMINING ATTOR-  
NEY



**Int. Cl.: 41**

**Prior U.S. Cls.: 100, 101 and 107**

**United States Patent and Trademark Office**

**Reg. No. 3,499,162**

**Registered Sep. 9, 2008**

**SERVICE MARK  
PRINCIPAL REGISTER**

**BLACKZILLA**

HUSH HUSH ENTERTAINMENT, INC. (CALIFORNIA CORPORATION)  
22287 MULHOLLAND HIGHWAY, #416  
CALABASAS, CA 91302

FOR: ENTERTAINMENT SERVICES, NAMELY, PROVIDING VISUAL IMAGES IN THE FIELD OF ADULT ENTERTAINMENT VIA GLOBAL COMPUTER NETWORK, IN CLASS 41 (U.S. CLS. 100, 101 AND 107).

FIRST USE 9-3-2007; IN COMMERCE 9-3-2007.

THE MARK CONSISTS OF STANDARD CHARACTERS WITHOUT CLAIM TO ANY PARTICULAR FONT, STYLE, SIZE, OR COLOR.

SER. NO. 78-902,386, FILED 6-7-2006.

ALEX KEAM, EXAMINING ATTORNEY

**Int. Cl.: 7**

**Prior U.S. Cls.: 13, 19, 21, 23, 31, 34 and 35**

**United States Patent and Trademark Office**

**Reg. No. 3,499,163**

**Registered Sep. 9, 2008**

**TRADEMARK  
PRINCIPAL REGISTER**

**360°**

ROTOVAC CORPORATION (WASHINGTON CORPORATION)  
17905 BOTHELL-EVERETT HIGHWAY  
MILL CREEK, WA 98012

FOR: CLEANING MACHINES USING PRESSURIZED WATER AND A HORIZONTALLY ROTATING CLEANING HEAD, FOR HARD AND SOFT FLOORING SURFACES; EXCLUDING HOUSEHOLD AIR CLEANERS, AND EXCLUDING VACUUM CLEANERS AND ATTACHMENTS, NAMELY, BAGS, HOSES AND BELTS, AND CLEANING TOOLS, IN CLASS 7 (U.S. CLS. 13, 19, 21, 23, 31, 34 AND 35).

FIRST USE 5-11-2006; IN COMMERCE 5-11-2006.

THE MARK CONSISTS OF THE LITERAL NUMBERS "360" FOLLOWED BY A STYLIZED DEGREE SYMBOL.

SER. NO. 78-902,867, FILED 6-7-2006.

MICHAEL WIENER, EXAMINING ATTORNEY

**Int. Cl.: 36**

**Prior U.S. Cls.: 100, 101 and 102**

**United States Patent and Trademark Office**

**Reg. No. 3,499,164**

**Registered Sep. 9, 2008**

**SERVICE MARK  
PRINCIPAL REGISTER**

**BECOME THE BEST**

SELLSTATE REALTY SYSTEMS NETWORK,  
INC. (FLORIDA CORPORATION)  
UNIT 575  
12800 UNIVERSITY DRIVE  
FT. MYERS, FL 33907

THE MARK CONSISTS OF STANDARD CHAR-  
ACTERS WITHOUT CLAIM TO ANY PARTICULAR  
FONT, STYLE, SIZE, OR COLOR.

FOR: REAL ESTATE BROKERAGE SERVICES, IN  
CLASS 36 (U.S. CLS. 100, 101 AND 102).

SER. NO. 78-902,895, FILED 6-7-2006.

FIRST USE 11-1-2005; IN COMMERCE 11-1-2005.

DAVID I, EXAMINING ATTORNEY

**Int. Cl.: 36**

**Prior U.S. Cls.: 100, 101 and 102**

**United States Patent and Trademark Office**

**Reg. No. 3,499,165**

**Registered Sep. 9, 2008**

**SERVICE MARK  
PRINCIPAL REGISTER**

**BE WITH THE BEST**

SELLSTATE REALTY SYSTEMS NETWORK,  
INC. (FLORIDA CORPORATION)  
UNIT 575  
12800 UNIVERSITY DRIVE  
FT. MYERS, FL 33907

THE MARK CONSISTS OF STANDARD CHAR-  
ACTERS WITHOUT CLAIM TO ANY PARTICULAR  
FONT, STYLE, SIZE, OR COLOR.

FOR: REAL ESTATE BROKERAGE SERVICES, IN  
CLASS 36 (U.S. CLS. 100, 101 AND 102).

SER. NO. 78-902,910, FILED 6-7-2006.

FIRST USE 11-1-2005; IN COMMERCE 11-1-2005.

DAVID I, EXAMINING ATTORNEY

**Int. Cls.: 35 and 42**

**Prior U.S. Cls.: 100, 101 and 102**

**United States Patent and Trademark Office**

**Reg. No. 3,499,166**

**Registered Sep. 9, 2008**

**SERVICE MARK  
PRINCIPAL REGISTER**

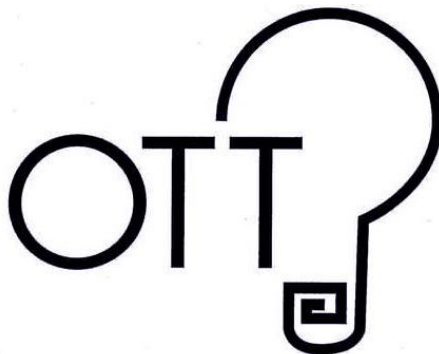

UNIVERSITY OF LOUISVILLE RESEARCH  
FOUNDATION, INC. (KENTUCKY CORPORATION)  
UNIVERSITY OF LOUISVILLE MEDCENTER  
THREE  
201 EAST JEFFERSON STREET, SUITE 215  
LOUISVILLE, KY 40202

FOR: BUSINESS MANAGEMENT SERVICES,  
NAMELY, ASSISTANCE WITH THE COMMERCIA-  
LIZATION OF TECHNOLOGY FOR NON-PROFIT  
ENTITIES AND EMERGING AND START-UP COM-  
PANIES; ACQUISITION OF INTELLECTUAL PROP-  
ERTY RIGHTS FOR OTHERS, IN CLASS 35 (U.S.  
CLS. 100, 101 AND 102).

FIRST USE 7-0-2005; IN COMMERCE 7-0-2005.

FOR: LICENSING OF INTELLECTUAL PROP-  
ERTY RIGHTS, IN CLASS 42 (U.S. CLS. 100 AND 101).

FIRST USE 7-0-2005; IN COMMERCE 7-0-2005.

THE MARK CONSISTS OF STYLIZED DRAWING  
OF A LIGHT BULB WITH "OTT" OVERLAYING  
THE LEFT PORTION OF THE DRAWING.

SER. NO. 78-902,925, FILED 6-7-2006.

JESSICA A. POWERS, EXAMINING ATTORNEY

**Int. Cl.: 36**

**Prior U.S. Cls.: 100, 101 and 102**

**United States Patent and Trademark Office**

**Reg. No. 3,499,167**

**Registered Sep. 9, 2008**

**SERVICE MARK  
PRINCIPAL REGISTER**

**IT DOESN'T COST ANY MORE  
TO BE THE BEST**

SELLSTATE REALTY SYSTEMS NETWORK,  
INC. (FLORIDA CORPORATION)  
UNIT 575  
12800 UNIVERSITY DRIVE  
FT. MYERS, FL 33907

THE MARK CONSISTS OF STANDARD CHAR-  
ACTERS WITHOUT CLAIM TO ANY PARTICULAR  
FONT, STYLE, SIZE, OR COLOR.

FOR: REAL ESTATE BROKERAGE SERVICES, IN  
CLASS 36 (U.S. CLS. 100, 101 AND 102).

SER. NO. 78-902,953, FILED 6-7-2006.

FIRST USE 11-1-2005; IN COMMERCE 11-1-2005.

DAVID I, EXAMINING ATTORNEY

**Int. Cl.: 36**

**Prior U.S. Cls.: 100, 101 and 102**

**United States Patent and Trademark Office**

**Reg. No. 3,499,168**

**Registered Sep. 9, 2008**

**SERVICE MARK  
PRINCIPAL REGISTER**

**IT DOESN'T COST ANY MORE  
TO BE WITH THE BEST**

SELLSTATE REALTY SYSTEMS NETWORK,  
INC. (FLORIDA CORPORATION)  
UNIT 575  
12800 UNIVERSITY DRIVE  
FT. MYERS, FL 33907

THE MARK CONSISTS OF STANDARD CHAR-  
ACTERS WITHOUT CLAIM TO ANY PARTICULAR  
FONT, STYLE, SIZE, OR COLOR.

FOR: REAL ESTATE BROKERAGE SERVICES, IN  
CLASS 36 (U.S. CLS. 100, 101 AND 102).

SER. NO. 78-902,969, FILED 6-7-2006.

FIRST USE 11-1-2005; IN COMMERCE 11-1-2005.

DAVID I, EXAMINING ATTORNEY

**Int. Cl.: 9**

**Prior U.S. Cls.: 21, 23, 26, 36 and 38**

**Reg. No. 3,499,169**

**United States Patent and Trademark Office**

**Registered Sep. 9, 2008**

**TRADEMARK  
PRINCIPAL REGISTER**

**VICE**

VICE MAGAZINE PUBLISHING INC. (CANADA CORPORATION)  
SUITE 500  
24, MONT-ROYAL STREET WEST  
MONTREAL, CANADA H2T 2S2

FOR: APPARATUS FOR RECORDING, TRANSMISSION OR REPRODUCTION OF SOUND OR IMAGES AND REPLACEMENT PARTS THEREFOR; BLANK MAGNETIC DATA CARRIERS; BLANK AUDIO AND VIDEO RECORDING DISCS, CASSETTES, CARTRIDGES AND TAPES; VIDEO RECORDING TAPES IN THE FIELD OF DRAMATIC, COMEDY, DOCUMENTARY, TRAVEL, MUSIC AND VARIETY MOTION PICTURE FILMS; MOTION PICTURE FILMS FEATURING DRAMATIC, COMEDY, DOCUMENTARY, TRAVEL, MUSIC AND VARIETY MOTION PICTURE FILMS; CD-ROMS AND DVDS FEATURING DRAMATIC, COMEDY, DOCUMENTARY, TRAVEL, MUSIC AND

VARIETY MOTION PICTURE FILMS; ELECTRONIC PUBLICATIONS, NAMELY, MAGAZINES AND WEBSITES FEATURING INTERACTIVE FILMS, GAMES, MUSIC AND ARTICLES RECORDED ON COMPUTER MEDIA, IN CLASS 9 (U.S. CLS. 21, 23, 26, 36 AND 38).

FIRST USE 10-22-2002; IN COMMERCE 10-22-2002.

THE MARK CONSISTS OF STANDARD CHARACTERS WITHOUT CLAIM TO ANY PARTICULAR FONT, STYLE, SIZE, OR COLOR.

OWNER OF U.S. REG. NO. 2,312,005.

SER. NO. 78-903,732, FILED 6-8-2006.

NAKIA HENRY, EXAMINING ATTORNEY



**Int. Cl.: 19**

**Prior U.S. Cls.: 1, 12, 33 and 50**

**United States Patent and Trademark Office**

**Reg. No. 3,499,170**

**Registered Sep. 9, 2008**

**TRADEMARK  
PRINCIPAL REGISTER**

**PIETRA ART**

FLORIDA TILE, INC. (DELAWARE CORPORATION)  
320 WEST MAIN STREET  
LAKELAND, FL 33815

FOR: WALL AND FLOOR TILE; MOSAIC TILE MADE OF STONE FOR BUILDING AND CONSTRUCTION PURPOSES; MOSAIC TILES MADE OF STONE FOR ORNAMENTAL USE AS A BUILDING MATERIAL FOR INCORPORATION INTO STRUCTURES, IN CLASS 19 (U.S. CLS. 1, 12, 33 AND 50).

FIRST USE 5-31-2003; IN COMMERCE 5-31-2003.

THE MARK CONSISTS OF STANDARD CHARACTERS WITHOUT CLAIM TO ANY PARTICULAR FONT, STYLE, SIZE, OR COLOR.

NO CLAIM IS MADE TO THE EXCLUSIVE RIGHT TO USE "PIETRA", APART FROM THE MARK AS SHOWN.

THE FOREIGN WORDING IN THE MARK TRANSLATES INTO ENGLISH AS STONE.

SER. NO. 78-904,731, FILED 6-9-2006.

HOWARD B. LEVINE, EXAMINING ATTORNEY

Int. Cl.: 39

Prior U.S. Cls.: 100 and 105

United States Patent and Trademark Office

Reg. No. 3,499,171

Registered Sep. 9, 2008

**SERVICE MARK  
PRINCIPAL REGISTER**



EUROPCAR INTERNATIONAL (FRANCE CORPORATION)  
3, AVENUE DE CENTRE  
78280 GUYANCOURT, FRANCE

FOR: TRANSPORT, NAMELY, TRANSPORT OF GOODS AND TRANSPORT OF PASSENGERS; PACKAGING ARTICLES FOR TRANSPORTATION; SHIPPING AND DELIVERY SERVICES, NAMELY, PICKUP, TRANSPORTATION, AND DELIVERY OF PACKAGES AND LETTERS BY VARIOUS MODES OF TRANSPORTATION; PACKAGING ARTICLES FOR TRANSPORTATION; DELIVERY OF GOODS BY AIR, LAND OR WATER; TRAVEL ARRANGEMENT; TRANSPORTATION OF PERSONS OR MERCHANDISE BY AIR, LAND OR WATER; ARRANGING FOR THE TRANSPORTATION OF PERSONS OR MERCHANDISE BY AIR, LAND OR WATER; RENTAL OF VEHICLES FOR LOCOMOTION BY AIR, LAND OR WATER; RENTAL OF CARS, BICYCLES, MOTORCYCLES, CAMPING CARS, TRUCKS, LORRIES, VANS, COACHES, BUSES, CARAVANS; VEHICLE LEASING SERVICES; ARRANGING FOR THE RENTAL OF VEHICLES FOR LOCOMOTION BY AIR, LAND OR WATER; RENTAL OF VEHICLE EQUIPMENT AND PARTS THEREFORE; VEHICLE TRANSPORT RESERVATION SERVICES NAMELY, RESERVATION OF CARS; CHAUFFEUR SERVICES; RENTAL OF CHAUFFEUR DRIVEN VEHICLES; FREIGHT SERVICES, NAMELY, FREIGHT TRANSPORTATION BY AIR, LAND OR WATER; VEHICLE HAULAGE SERVICES; COURIER SERVICES OF MESSAGES OR MERCHANDISE; VEHICLE TOWING SERVICES;

INFORMATION AND ADVICE RELATING TO RENTAL OF VEHICLES FOR LOCOMOTION BY AIR LAND OR WATER, IN CLASS 39 (U.S. CLS. 100 AND 105).

OWNER OF ERPN CMNTY TM OFC REG. NO. 003345899, DATED 3-18-2005, EXPIRES 4-9-2013.

OWNER OF U.S. REG. NO. 1,064,660.

NO CLAIM IS MADE TO THE EXCLUSIVE RIGHT TO USE ".COM", APART FROM THE MARK AS SHOWN.

THE COLOR(S) LIGHT BLUE, BLUE, AND WHITE IS/ARE CLAIMED AS A FEATURE OF THE MARK.

THE COLOR BLUE APPEARS AS THE BACKGROUND FOR THE MARK; THE COLOR WHITE APPEARS AS THE COLOR OF THE LETTERS I, N, T, R, R, N, T, C, O, AND M IN INTERRENT.COM, AND THE BASE OF THE LETTER I AND THE LETTER R IN IR; AND THE COLOR LIGHT BLUE APPEARS AS THE COLOR OF THE LETTERS E AND E IN INTERRENT.COM, AND AS THE PERIOD FOLLOWING THE WORD INTERRENT, AND AS THE DOT ABOVE THE I IN IR.

SER. NO. 78-904,938, FILED 6-9-2006.

LOURDES AYALA, EXAMINING ATTORNEY

Int. Cls.: 9, 38 and 41

Prior U.S. Cls.: 21, 23, 26, 36, 38, 100, 101, 104 and 107

Reg. No. 3,499,172

United States Patent and Trademark Office

Registered Sep. 9, 2008

**TRADEMARK  
SERVICE MARK  
PRINCIPAL REGISTER**



**THE  
WORLD  
SONG CONTEST**

WILLIAMS, PAUL (UNITED KINGDOM INDIVIDUAL)

MEDDOWES, HOLWOOD PARK AVENUE  
KESTON PARK, ORPINGTON  
KENT, UNITED KINGDOM BR6 8NG

FOR: BLANK OPTICAL DISCS, AUDIO CASSETTE TAPES, VIDEO CASSETTE TAPES, CINEMATOGRAFIC FILMS, FLASH MEMORY CARDS AND TRANSMISSION WIRES, ALL FOR THE RECORDING, STORAGE, TRANSMISSION AND REPRODUCTION OF AUDIO, VISUAL AND AUDIO VISUAL INFORMATION AND DATA; APPARATUS AND INSTRUMENTS FOR THE RECORDING, STORAGE, TRANSMISSION, RETRIEVAL AND REPRODUCTION OF AUDIO, VISUAL AND AUDIO-VISUAL INFORMATION AND DATA, NAMELY, GAMES CONSOLES, PERSONAL DIGITAL ASSISTANTS, CAMERA TELEPHONES AND POCKETS PCS; PRERECORDED AUDIO CASSETTE DISCS, VIDEO CASSETTE DISCS, COMPUTER TAPES, CINEMATOGRAFIC FILMS AND TRANSMISSION WIRES ALL CONTAINING AUDIO, VISUAL AND AUDIO-VISUAL INFORMATION AND DATA IN THE NATURE OF MUSIC; REPLACEMENT PARTS AND FITTINGS FOR ALL THE AFORESAID GOODS, IN CLASS 9 (U.S. CLS. 21, 23, 26, 36 AND 38).

FOR: COMMUNICATION SERVICES, NAMELY, BROADCASTING OF RADIO AND TELEVISION PROGRAMMES; TELEX SERVICES, NAMELY, TRANSMISSION OF MESSAGES VIA TELEX; TELEPHONE SERVICES, NAMELY, OPERATION OF A TELEPHONE NETWORK; RADIO SERVICES, NAMELY, TRANSMISSION OF MESSAGES; SOUND AND PICTURE TRANSMISSION VIA SATELLITE, IN CLASS 38 (U.S. CLS. 100, 101 AND 104).

FOR: ORGANIZATION OF COMPETITIONS FOR POP MUSICIANS, ROCK MUSICIANS AND COUNTRY AND WESTERN MUSICIANS, IN CLASS 41 (U.S. CLS. 100, 101 AND 107).

OWNER OF UNITED KINGDOM REG. NO. 2418189, DATED 9-15-2006, EXPIRES 3-30-2016.

OWNER OF ERPN CMNTY TM OFC REG. NO. 005123815, DATED 7-26-2007, EXPIRES 6-8-2016.

NO CLAIM IS MADE TO THE EXCLUSIVE RIGHT TO USE "THE WORLD SONG CONTEST", APART FROM THE MARK AS SHOWN.

SER. NO. 78-905,815, FILED 6-12-2006.

ELLEN BURNS, EXAMINING ATTORNEY

**Int. Cl.: 9**

**Prior U.S. Cls.: 21, 23, 26, 36 and 38**

**United States Patent and Trademark Office**

**Reg. No. 3,499,173**

**Registered Sep. 9, 2008**

**TRADEMARK  
PRINCIPAL REGISTER**

**GRIDSCALE**

XKOTO INC. (CANADA CORPORATION)  
SUITE 1902  
2300 YONGE STREET  
TORONTO, ONTARIO, CANADA M4P 1E4

FOR: COMPUTER SOFTWARE FOR DATABASE  
MANAGEMENT; COMPUTER DATABASE MAN-  
AGEMENT SYSTEMS COMPRISED OF DATABASE  
MANAGEMENT SOFTWARE. , IN CLASS 9 (U.S.  
CLS. 21, 23, 26, 36 AND 38).

THE MARK CONSISTS OF STANDARD CHAR-  
ACTERS WITHOUT CLAIM TO ANY PARTICULAR  
FONT, STYLE, SIZE, OR COLOR.

PRIORITY CLAIMED UNDER SEC. 44(D) ON  
CANADA APPLICATION NO. 1304161, FILED 6-5-  
2006, REG. NO. TMA687227, DATED 5-8-2007, EX-  
PIRES 5-8-2022.

SER. NO. 78-908,279, FILED 6-14-2006.

MICHAEL KEATING, EXAMINING ATTORNEY

**Int. Cl.: 17**

**Prior U.S. Cls.: 1, 5, 12, 13, 35 and 50**

**Reg. No. 3,499,174**

**United States Patent and Trademark Office**

**Registered Sep. 9, 2008**

---

**TRADEMARK  
PRINCIPAL REGISTER**

**SOLARGUARD**

GUARDIAN BUILDING PRODUCTS DISTRIBUTION, INC. (GEORGIA CORPORATION)  
979 BATESVILLE  
GREER, SC 29651

THE MARK CONSISTS OF STANDARD CHARACTERS WITHOUT CLAIM TO ANY PARTICULAR FONT, STYLE, SIZE, OR COLOR.

FOR: BUILDING INSULATION, IN CLASS 17 (U.S. CLS. 1, 5, 12, 13, 35 AND 50).

SER. NO. 78-909,326, FILED 6-15-2006.

FIRST USE 1-2-2001; IN COMMERCE 1-2-2001.

EMILY CARLSEN, EXAMINING ATTORNEY

**Int. Cls.: 7, 38 and 42**

**Prior U.S. Cls.: 13, 19, 21, 23, 31, 34, 35, 100, 101 and 104**

**Reg. No. 3,499,175**

**United States Patent and Trademark Office**

**Registered Sep. 9, 2008**

**TRADEMARK  
SERVICE MARK  
PRINCIPAL REGISTER**

**SMX**

SNECMA (FRANCE CORPORATION)  
2, BOULEVARD DU GÉNÉRAL MARTIAL VALIN  
PARIS CEDEX 15, FRANCE 75724

FOR: MACHINE TOOLS FOR PRODUCING PARTS TO BE USED IN AIRCRAFT ENGINES; MACHINES FOR WINDING ELECTRICAL WIRE FOR USE IN THE AIRCRAFT AND AEROSPACE INDUSTRIES; COUPLINGS FOR MACHINES, NOT FOR LAND VEHICLES; TRANSMISSION AND THRUST ORGANS, NOT FOR LAND VEHICLES, NAMELY, POWER TRANSMISSIONS AND GEARING FOR MACHINES; ENGINES OF ALL TYPES FOR FIXED OR MOBILE INSTALLATIONS, NOT FOR LAND VEHICLES, NAMELY, TURBOJETS, JET PROP ENGINES, GAS TURBINE ENGINES, HEAT ENGINES, ELECTRO-HEAT ENGINES, AND COMBINED JET TURBINE ENGINES; EJECTION ASSEMBLIES FOR AIRCRAFT ENGINES; THRUST REVERSERS AND PODS FOR AIRCRAFT ENGINES; REPLACEMENT PARTS FOR AIRCRAFT ENGINES, THRUSTERS, EJECTION ASSEMBLIES, REVERSERS AND PODS, IN CLASS 7 (U.S. CLS. 13, 19, 21, 23, 31, 34 AND 35).

FOR: ELECTRONIC TRANSMISSION OF DATA BY TELEVISION AND VIDEO BROADCASTING; INFORMATION TRANSMISSION VIA ELECTRONIC COMMUNICATIONS NETWORKS; SATELLITE COMMUNICATIONS; INFORMATION TRANSMISSION SERVICES VIA COMPUTERS CONNECTED

TO THE SAME TELEMATIC NETWORK; DATA TRANSMISSION VIA TELECOMMUNICATION MEANS; COMMUNICATION BY COMPUTER TERMINALS; ELECTRONIC DATA DISTRIBUTION VIA THE INTERNET AND INTRANETS, IN CLASS 38 (U.S. CLS. 100, 101 AND 104).

FOR: SCIENTIFIC AND INDUSTRIAL RESEARCH IN THE FIELD OF ENGINEERING; COUNSELING SERVICES AND PROFESSIONAL CONSULTATION RELATING TO ENGINEERING; EQUIPMENT TESTING; LABORATORY RESEARCH SERVICES IN THE FIELD OF ENGINEERING AND AERONAUTICAL SCIENCE; SOFTWARE AND COMPUTER PROGRAMMING DEVELOPMENT AND DESIGN IN THE FIELDS OF AERONAUTICS AND SPACE, IN CLASS 42 (U.S. CLS. 100 AND 101).

THE MARK CONSISTS OF STANDARD CHARACTERS WITHOUT CLAIM TO ANY PARTICULAR FONT, STYLE, SIZE, OR COLOR.

PRIORITY CLAIMED UNDER SEC. 44(D) ON FRANCE APPLICATION NO. 063405263, FILED 1-24-2006, REG. NO. 063405263, DATED 1-24-2006, EXPIRES 1-24-2016.

SER. NO. 78-911,964, FILED 6-20-2006.

MICHAEL ENGEL, EXAMINING ATTORNEY

**Int. Cls.: 7, 38 and 42**

**Prior U.S. Cls.: 13, 19, 21, 23, 31, 34, 35, 100, 101 and 104**

**Reg. No. 3,499,176**

**United States Patent and Trademark Office**

**Registered Sep. 9, 2008**

**TRADEMARK  
SERVICE MARK  
PRINCIPAL REGISTER**

**SMZ**

SNECMA (FRANCE CORPORATION)  
2, BOULEVARD DU GÉNÉRAL MARTIAL VALIN  
PARIS CEDEX 15, FRANCE 75724

FOR: MACHINES FOR PRODUCING PARTS TO BE USED IN AIRCRAFT ENGINES, PACKAGING AND WINDING MACHINES; HEAT EXCHANGERS BEING PART OF ENGINES OTHER THAN FOR LAND VEHICLES; COUPLINGS FOR MACHINES, NOT FOR LAND VEHICLES; TRANSMISSION AND THRUST ORGANS, NOT FOR LAND VEHICLES, NAMELY, POWER TRANSMISSIONS AND GEARING FOR MACHINES; ENGINES OF ALL TYPES FOR FIXED OR MOBILE INSTALLATIONS, NOT FOR LAND VEHICLES, NAMELY, FOR TURBO-JETS, JET PROP ENGINES, GAS TURBINE ENGINES, HEAT, ELECTRO-HEAT ENGINES, AND COMBINED JET TURBINE ENGINES; EJECTION ASSEMBLIES FOR AIRCRAFT ENGINES; THRUST REVERSERS AND PODS FOR AIRCRAFT ENGINES; AND REPLACEMENT PARTS THEREFOR, IN CLASS 7 (U.S. CLS. 13, 19, 21, 23, 31, 34 AND 35).

FOR: ELECTRONIC TRANSMISSION OF DATA BY TELEVISION AND VIDEO BROADCASTING; INFORMATION TRANSMISSION VIA ELECTRONIC COMMUNICATIONS NETWORKS; SATELLITE COMMUNICATIONS; INFORMATION TRANSMISSION SERVICES VIA COMPUTERS CONNECTED TO THE SAME TELEMATIC NETWORK; DATA TRANSMISSION VIA TELECOMMUNICATION

MEANS; COMMUNICATION BY COMPUTER TERMINALS; ELECTRONIC DATA DISTRIBUTION VIA THE INTERNET AND INTRANETS, NAMELY, ELECTRONIC TRANSMISSION OF DATA AMONG INTERNET COMPUTER USERS, IN CLASS 38 (U.S. CLS. 100, 101 AND 104).

FOR: SCIENTIFIC AND INDUSTRIAL RESEARCH IN THE FIELD OF ENGINEERING; COUNSELING SERVICES AND PROFESSIONAL CONSULTATION RELATING TO ENGINEERING; ENGINEERING EQUIPMENT TESTING; LABORATORY RESEARCH SERVICES IN THE FIELD OF ENGINEERING AND AERONAUTICAL SCIENCE; SOFTWARE AND COMPUTER PROGRAMMING DEVELOPMENT AND DESIGN IN THE FIELDS OF AERONAUTICS AND SPACE, IN CLASS 42 (U.S. CLS. 100 AND 101).

THE MARK CONSISTS OF STANDARD CHARACTERS WITHOUT CLAIM TO ANY PARTICULAR FONT, STYLE, SIZE, OR COLOR.

PRIORITY CLAIMED UNDER SEC. 44(D) ON FRANCE APPLICATION NO. 063405266, FILED 1-24-2006, REG. NO. 063405266, DATED 1-24-2006, EXPIRES 1-24-2016.

SER. NO. 78-912,120, FILED 6-20-2006.

ALYSSA PALADINO, EXAMINING ATTORNEY

**Int. Cl.: 42**

**Prior U.S. Cls.: 100 and 101**

**United States Patent and Trademark Office**

**Reg. No. 3,499,177**

**Registered Sep. 9, 2008**

**SERVICE MARK  
PRINCIPAL REGISTER**

**WELLNESS LAYERS**

WELLNESS LAYERS, INC. (DELAWARE CORPORATION)  
336 ATLANTIC AVE  
SUITE 301, ATTN: SALTZ  
EAST ROCKAWAY, NY 11518

FOR: PROVIDING ONLINE NON-DOWNLOADABLE SOFTWARE FOR USE IN PLANNING AND MANAGING DIET, FITNESS AND HEALTH PLANS AND REGIMENS, IN CLASS 42 (U.S. CLS. 100 AND 101).

FIRST USE 8-20-2005; IN COMMERCE 8-20-2005.

THE MARK CONSISTS OF STANDARD CHARACTERS WITHOUT CLAIM TO ANY PARTICULAR FONT, STYLE, SIZE, OR COLOR.

NO CLAIM IS MADE TO THE EXCLUSIVE RIGHT TO USE "WELLNESS", APART FROM THE MARK AS SHOWN.

SER. NO. 78-917,656, FILED 6-27-2006.

JEFF DEFORD, EXAMINING ATTORNEY



**Int. Cl.: 31**

**Prior U.S. Cls.: 1 and 46**

**United States Patent and Trademark Office**

**Reg. No. 3,499,178**

**Registered Sep. 9, 2008**

**TRADEMARK  
PRINCIPAL REGISTER**

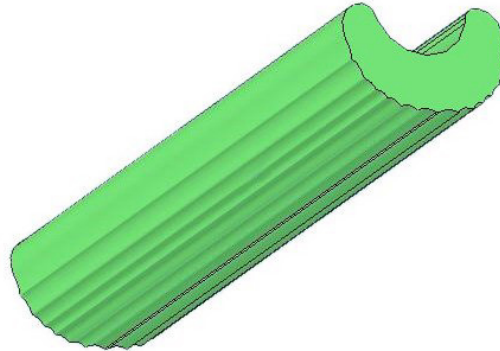

POWER PRODUCTS, INC. (MISSOURI CORPORATION)  
3325 WYOMING ST.  
KANSAS CITY, MO 64111

THE MARK CONSISTS OF A ANIMAL CHEW IN THE COLOR AND SHAPE OF A GREEN PIECE OF CELERY STALK.

FOR: EDIBLE CHEWS FOR ANIMALS, IN CLASS 31 (U.S. CLS. 1 AND 46).

SEC. 2(F).

FIRST USE 5-1-2006; IN COMMERCE 5-1-2006.

SER. NO. 78-922,405, FILED 7-5-2006.

THE COLOR(S) GREEN IS/ARE CLAIMED AS A FEATURE OF THE MARK.

KATHRYN COWARD, EXAMINING ATTORNEY

**Int. Cl.: 1**

**Prior U.S. Cls.: 1, 5, 6, 10, 26 and 46**

**United States Patent and Trademark Office**

**Reg. No. 3,499,179**

**Registered Sep. 9, 2008**

**TRADEMARK  
PRINCIPAL REGISTER**

**ROSES 'N BLOOM**

2077333 ONTARIO INC. (CANADA CORPORATION)  
122 EARL THOMPSON ROAD, UNIT 1  
AYR, CANADA N0B 1E0

FOR: FERTILIZERS, IN CLASS 1 (U.S. CLS. 1, 5, 6,  
10, 26 AND 46).

THE MARK CONSISTS OF STANDARD CHARACTERS  
WITHOUT CLAIM TO ANY PARTICULAR FONT,  
STYLE, SIZE, OR COLOR.

PRIORITY CLAIMED UNDER SEC. 44(D) ON  
CANADA APPLICATION NO. 1308639, FILED 7-11-  
2006, REG. NO. TMA713584, DATED 5-6-2008, EX-  
PIRES 5-6-2023.

SER. NO. 78-927,900, FILED 7-12-2006.

GEOFFREY FOSDICK, EXAMINING ATTORNEY

**Int. Cl.: 37**

**Prior U.S. Cls.: 100, 103 and 106**

**United States Patent and Trademark Office**

**Reg. No. 3,499,180**

**Registered Sep. 9, 2008**

**SERVICE MARK  
PRINCIPAL REGISTER**

**HARMONY**

HARMONY ACQUISITIONS, INC. (NORTH CAROLINA CORPORATION)  
645 ROBY GREENE ROAD  
BOONE, NC 28607

FOR: CUSTOM CONSTRUCTION OF FLOORS AND ROOFS FROM TIMBERS, FULL AND PARTIAL TIMBER FRAME STRUCTURES, HEAVY TIMBER TRUSSES, HEAVY TIMBER ROOF SYSTEMS, AND RELATED STRUCTURAL INSULATED PANELS AND DECKING, IN CLASS 37 (U.S. CLS. 100, 103 AND 106).

FIRST USE 1-0-1979; IN COMMERCE 1-0-1979.

THE MARK CONSISTS OF STANDARD CHARACTERS WITHOUT CLAIM TO ANY PARTICULAR FONT, STYLE, SIZE, OR COLOR.

OWNER OF U.S. REG. NOS. 2,582,094 AND 2,582,095.

SER. NO. 78-931,967, FILED 7-18-2006.

DAVID TOOLEY, EXAMINING ATTORNEY

**Int. Cl.: 32**

**Prior U.S. Cls.: 45, 46 and 48**

**United States Patent and Trademark Office**

**Reg. No. 3,499,181**

**Registered Sep. 9, 2008**

**TRADEMARK  
PRINCIPAL REGISTER**

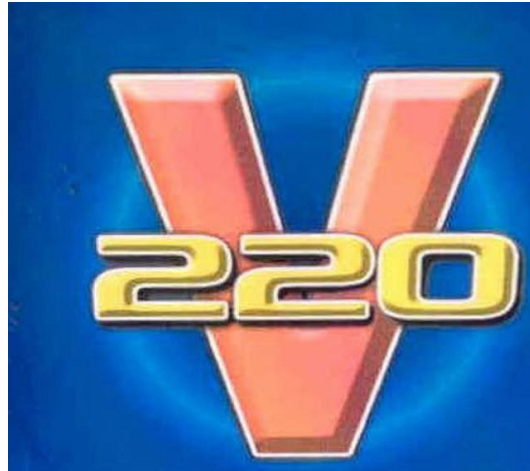

THE TESALIA SPRINGS HOLDING CORP. (PANAMA CORPORATION)  
19TH FLOOR  
50TH STREET PLAZA 2000 BUILDING  
PANAMA CITY, PANAMA

FOR: ENERGY DRINKS, IN CLASS 32 (U.S. CLS. 45, 46 AND 48).

FIRST USE 4-3-2006; IN COMMERCE 6-30-2006.

THE COLOR(S) BLUE, RED, YELLOW, WHITE IS/ARE CLAIMED AS A FEATURE OF THE MARK.

THE MARK CONSISTS OF THE LETTER "V" IN RED AND OUTLINED IN WHITE BEHIND THE NUMBER "220" SHOWN IN YELLOW AND OUTLINED IN WHITE, ALL IN FRONT OF A BLUE BACKGROUND WITH A FAINT WHITE CIRCLE BEHIND THE TEXT.

SER. NO. 78-937,670, FILED 7-26-2006.

DAVID YONTEF, EXAMINING ATTORNEY

**Int. Cl.: 29**

**Prior U.S. Cl.: 46**

**United States Patent and Trademark Office**

**Reg. No. 3,499,182**

**Registered Sep. 9, 2008**

**TRADEMARK  
PRINCIPAL REGISTER**

**OLYMPIA VALLEY**

WILCOX FARMS, INC. (WASHINGTON COR-  
PORATION)  
40400 HARTS LAKE VALLEY ROAD  
ROY, WA 98580

FOR: EGGS; MILK, IN CLASS 29 (U.S. CL. 46).

FIRST USE 4-0-1992; IN COMMERCE 4-0-1992.

THE MARK CONSISTS OF STANDARD CHAR-  
ACTERS WITHOUT CLAIM TO ANY PARTICULAR  
FONT, STYLE, SIZE, OR COLOR.

SEC. 2(F).

SER. NO. 78-938,876, FILED 7-27-2006.

BARNEY CHARLON, EXAMINING ATTORNEY

**Int. Cl.: 33**

**Prior U.S. Cls.: 47 and 49**

**United States Patent and Trademark Office**

**Reg. No. 3,499,183**

**Registered Sep. 9, 2008**

**TRADEMARK  
PRINCIPAL REGISTER**



BLUE COVE BRANDS LTD (UNITED KINGDOM  
COMPANY)  
5 JUPITER HOUSE, CALLEVA PARK  
ALDERMASTON, READING, UNITED KINGDOM  
RG7 8NN

FOR: ALCOHOLIC BEVERAGES, NAMELY,  
WINE, DISTILLED SPIRITS DERIVED FROM

GRAPES, LIQUEURS, IN CLASS 33 (U.S. CLS. 47  
AND 49).

FIRST USE 9-30-2006; IN COMMERCE 3-1-2007.

SER. NO. 78-940,882, FILED 7-31-2006.

MARK PILARO, EXAMINING ATTORNEY

**Int. Cls.: 35 and 41**

**Prior U.S. Cls.: 100, 101, 102 and 107**

**United States Patent and Trademark Office**

**Reg. No. 3,499,184**

**Registered Sep. 9, 2008**

**SERVICE MARK  
PRINCIPAL REGISTER**



HEALTH AND WELLNESS PARTNERS GROUP,  
LLC (NEW JERSEY LIMITED LIABILITY  
COMPANY)  
70 HILLTOP ROAD  
RAMSEY, NJ 07446

FOR: BUSINESS STRATEGIC CONSULTING FOR  
THE MEDICAL INDUSTRY AND HEALTHCARE  
PROFESSIONALS, IN CLASS 35 (U.S. CLS. 100, 101  
AND 102).

FIRST USE 9-0-2005; IN COMMERCE 9-0-2005.

FOR: MEDICAL EDUCATION SERVICES, NAME-  
LY, PROVIDING COURSES OF INSTRUCTION,  
SEMINARS, SYMPOSIUMS, ADVISORY BOARDS,  
AND TRAINING SESSIONS IN THE FIELD OF

HEALTH CARE TO PHYSICIANS, PHARMACEUTI-  
CAL COMPANIES, AND THE GENERAL PUBLIC,  
IN CLASS 41 (U.S. CLS. 100, 101 AND 107).

FIRST USE 9-0-2005; IN COMMERCE 9-0-2005.

OWNER OF U.S. REG. NO. 3,178,541.

NO CLAIM IS MADE TO THE EXCLUSIVE  
RIGHT TO USE "HEALTH & WELLNESS PART-  
NERS", APART FROM THE MARK AS SHOWN.

SER. NO. 78-941,224, FILED 7-31-2006.

LESLEY LAMOTHE, EXAMINING ATTORNEY

**Int. Cl.: 5**

**Prior U.S. Cls.: 6, 18, 44, 46, 51 and 52**

**Reg. No. 3,499,185**

**United States Patent and Trademark Office**

**Registered Sep. 9, 2008**

**TRADEMARK  
PRINCIPAL REGISTER**

**JointVictory**

BLUE SPRING WELLNESS, L.L.C. (OKLAHOMA  
LIMITED LIABILITY COMPANY)  
6301 WATERFORD BLVD., STE. 404  
OKLAHOMA CITY, OK 73118

THE MARK CONSISTS OF STANDARD CHAR-  
ACTERS WITHOUT CLAIM TO ANY PARTICULAR  
FONT, STYLE, SIZE, OR COLOR.

FOR: DIETARY SUPPLEMENTS, IN CLASS 5 (U.S.  
CLS. 6, 18, 44, 46, 51 AND 52).

SER. NO. 78-941,687, FILED 7-31-2006.

FIRST USE 7-27-2006; IN COMMERCE 7-27-2006.

STANLEY I. OSBORNE, EXAMINING ATTORNEY



**Int. Cl.: 25**

**Prior U.S. Cls.: 22 and 39**

**United States Patent and Trademark Office**

**Reg. No. 3,499,186**

**Registered Sep. 9, 2008**

**TRADEMARK  
PRINCIPAL REGISTER**

**UNITED COREA**

JUNG, TAEWON (REPUBLIC OF KOREA INDIVIDUAL)  
925-4, HWAGOK 1-DONG, GANGSEO-GU  
SEOUL, REPUBLIC OF KOREA

FOR: MASQUERADE COSTUMES, SCHOOL UNIFORMS, RAINCOATS, OVERCOATS, LIVERIES, MANTLES, BLOUSONS, SARIS, SUITS, SMOCKS, SKIRTS, SLACKS, MENS' SUITS, TROUSERS, WOMEN'S CEREMONIAL DRESSES, OVERALLS, OVERCOATS, DRESSES, INFANT AND TODDLER ONE PIECE CLOTHING, EVENING DRESSES, JACKETS, WORKING OVERALLS, JUMPERS, CHASUBLES, JEANS, CAPES, COMBINATIONS, TOPCOATS, TUXEDOS, TOGAS, TUNICS, PARKAS, PELISSES, FROCKS, GIRDLES, EVENING GOWNS, NEGLIGEES, DRESSING GOWNS, ROMPERS, LEOTARDS, MANTILLAS, BRASSIERES, BLOUSES, SHOWER CAPS, SHIRT YOKES, SHIRT FRONTS, UNDERWEAR, UNDERSHIRTS, UNDERPANTS, BATHING CAPS, SWIMSUITS, BATHING TRUNKS, CHERNISSETTES, CHEMISES, SWEATERS, SWEAT SHIRTS, SWEAT PANTS, SPORTS SHIRTS, SLIPS, ATHLETIC UNIFORMS, UNITARDS, COLLARS, NIGHTWEAR, JERSEYS, VESTS, CARDIGANS, COLLAR PROTECTORS, CUFFS, CAMISOLES, CORSETS, CORSELETS, TANK TOPS, TEDDIES, TRACKSUITS, PAJAMAS, PANTYHOSE, PETTICOATS, POLO SHIRTS, PULLOVERS, NECKTIES,

SWEAT-ABSORBENT STOCKINGS, LEGWARMERS, LEGGINGS, MUFFS, MUFFLERS, BANDANAS, EAR MUFFS, MITTENS, VEILS, BOAS, SHAWLS, SHOULDER WRAPS, SCARVES, STOCKINGS, STOLE, ASCOTS, POCKET SQUARES, APRONS, TIGHTS, PELERINES, NIGHTCAPS, CAPS, SUN VISORS, BERETS, HOODS, TURBANS, WATERPROOF JACKETS AND PANTS, GAITERS, SOCK SUSPENDERS, SUSPENDERS, LEATHER BELTS, IN CLASS 25 (U.S. CLS. 22 AND 39).

THE MARK CONSISTS OF STANDARD CHARACTERS WITHOUT CLAIM TO ANY PARTICULAR FONT, STYLE, SIZE, OR COLOR.

PRIORITY CLAIMED UNDER SEC. 44(D) ON REPUBLIC OF KOREA APPLICATION NO. 2006002687, FILED 5-19-2006, REG. NO. 0698528, DATED 2-15-2007, EXPIRES 2-15-2017.

NO CLAIM IS MADE TO THE EXCLUSIVE RIGHT TO USE "KOREA" , APART FROM THE MARK AS SHOWN.

SER. NO. 78-947,227, FILED 8-8-2006.

JAY FLOWERS, EXAMINING ATTORNEY

**Int. Cls.: 9 and 42**

**Prior U.S. Cls.: 21, 23, 26, 36, 38, 100 and 101**

**United States Patent and Trademark Office**

**Reg. No. 3,499,187**

**Registered Sep. 9, 2008**

**TRADEMARK  
SERVICE MARK  
PRINCIPAL REGISTER**

**CLIPPZ**

JOHN, PHILIP (UNITED KINGDOM INDIVIDUAL)  
NANT LLE, TRERHYNGYLL, COWBRIDGE  
VALE OF GLAMORGAN, UNITED KINGDOM CF71  
7TN

FOR: SOFTWARE TOOLS AND APPLICATIONS FOR THE PROVISION OVER GLOBAL COMMUNICATIONS NETWORKS OF MEDIA, MUSIC, MOVIES AND INFORMATION; MEMORY CARDS; DATA STORAGE MEDIA, NAMELY CD'S OR DVD'S; COMPUTER SOFTWARE AND COMPUTER PROGRAMS TO ALLOW DATA AND MEDIA TO BE USED BY DIFFERENT TYPES OF MOBILE PHONES; COMPUTER SOFTWARE FOR FORMATTING MEDIA FILES, IN CLASS 9 (U.S. CLS. 21, 23, 26, 36 AND 38).

FOR: SOFTWARE DEVELOPMENT, IN PARTICULAR IN THE FIELD OF COMMUNICATIONS EQUIPMENT AND COMMUNICATIONS SOFT-

WARE; UPDATING COMPUTER SOFTWARE FOR OTHERS; COMPUTER PROGRAM MAINTENANCE; RENTAL OF COMPUTER SOFTWARE; PROVIDING CONSULTANCY AND INFORMATION SERVICES IN RELATION TO THE AFORESAID, IN CLASS 42 (U.S. CLS. 100 AND 101).

THE MARK CONSISTS OF STANDARD CHARACTERS WITHOUT CLAIM TO ANY PARTICULAR FONT, STYLE, SIZE, OR COLOR.

PRIORITY CLAIMED UNDER SEC. 44(D) ON UNITED KINGDOM APPLICATION NO. 2413673, FILED 2-11-2006, REG. NO. 2413673, DATED 2-11-2006, EXPIRES 2-11-2016.

SER. NO. 78-948,813, FILED 8-9-2006.

MICHAEL WEBSTER, EXAMINING ATTORNEY

**Int. Cls.: 37, 41 and 42**

**Prior U.S. Cls.: 100, 101, 103, 106 and 107**

**Reg. No. 3,499,188**

**United States Patent and Trademark Office**

**Registered Sep. 9, 2008**

**SERVICE MARK  
PRINCIPAL REGISTER**

**JFK AUDIO-VISUAL FORENSICS**

FORENSIC SCIENCE SERVICE LTD (UNITED KINGDOM CORPORATION)  
BIRMINGHAM BUSINESS PARK, TRIDENT COURT  
2920 SOLIHULL PARKWAY  
SOLIHULL, UNITED KINGDOM B37 7YN

FOR: MAINTENANCE AND UPDATING OF COMPUTERS, COMPUTER HARDWARE, AND COMPUTER PERIPHERALS FOR POLICE FORCES, LAW ENFORCEMENT AGENCIES, INSURANCE AGENCIES, FORENSIC INVESTIGATORS, LABORATORIES, IN CLASS 37 (U.S. CLS. 100, 103 AND 106).

FOR: EDUCATION AND TRAINING SERVICES, NAMELY, CONDUCTING CLASSES, SEMINARS, CONFERENCES, WORKSHOPS RELATING TO SCIENTIFIC SERVICES RELATING TO VIDEO, AUDIO AND OTHER RECORDED DATA FORMAT CONVERSION, VIDEO, AUDIO AND OTHER RECORDED DATA FORMAT ENHANCEMENT AND RESTORATION, VIDEO, AUDIO AND OTHER RECORDED DATA FORMAT REPAIR; EDUCATION AND TRAINING SERVICES, NAMELY, CONDUCTING CLASSES, SEMINARS, CONFERENCES, WORKSHOPS RELATING TO TRANSCRIPTION SERVICES; EDUCATION AND TRAINING SERVICES, NAMELY, CONDUCTING CLASSES, SEMINARS, CONFERENCES, WORKSHOPS RELATING TO COLLECTION OF EVIDENCE FROM AND PROVISION OF REPORTS ON CRIME SCENES AND ACCIDENT SCENES; EDUCATION AND TRAINING SERVICES, NAMELY, CONDUCTING CLASSES, SEMINARS, CONFERENCES, WORKSHOPS RELATING TO PHOTOGRAPHY AND VIDEO PHOTOGRAPHY; EDUCATION AND TRAINING SERVICES, NAMELY, CONDUCTING CLASSES, SEMINARS, CONFERENCES, WORKSHOPS RELATING TO SCIENTIFIC SERVICES IN THE NATURE OF ANALYSING, INTERPRETING AND EXTRACTING INFORMATION FROM ELECTRONIC SIGNALS, RECORDINGS AND IMAGES; EDUCATION AND TRAINING SERVICES, NAMELY, CONDUCTING CLASSES, SEMINARS, CONFERENCES, WORKSHOPS RELATING TO SCIENTIFIC SEARCHING SERVICES; EDUCATION AND TRAINING SERVICES, NAMELY, CONDUCTING CLASSES, SEMINARS, CONFERENCES,

WORKSHOPS RELATING TO SEARCHING, ANALYSING, INTERPRETING AND EXTRACTING INFORMATION FROM ELECTRONIC SIGNALS, RECORDINGS AND IMAGES; EDUCATION AND TRAINING, NAMELY, CONDUCTING CLASSES, SEMINARS, CONFERENCES, WORKSHOPS SERVICES RELATING TO PRESENTATION OF EVIDENCE; EDUCATION AND TRAINING SERVICES, NAMELY, CONDUCTING CLASSES, SEMINARS, CONFERENCES, WORKSHOPS RELATING TO DETECTION OF FRAUD, ARSON, FIRES, MALICIOUS DAMAGE AND COUNTERFEITING; EDUCATION AND TRAINING SERVICES, NAMELY, CONDUCTING CLASSES, SEMINARS, CONFERENCES, WORKSHOPS RELATING TO CONFIRMATION AND EVALUATION OF IDENTITY, PATERNITY, MATERNITY; EDUCATION AND TRAINING SERVICES, NAMELY, CONDUCTING CLASSES, SEMINARS, CONFERENCES, WORKSHOPS RELATING TO COMPUTER DATABASE SERVICES; EDUCATION AND TRAINING SERVICES, NAMELY, CONDUCTING CLASSES, SEMINARS, CONFERENCES, WORKSHOPS RELATING TO FORENSIC SCIENCE SERVICES; EDUCATION AND TRAINING SERVICES, NAMELY, CONDUCTING CLASSES, SEMINARS, CONFERENCES, WORKSHOPS RELATING TO SCIENTIFIC INVESTIGATION SERVICES; EDUCATION AND TRAINING SERVICES, NAMELY, CONDUCTING CLASSES, SEMINARS, CONFERENCES, WORKSHOPS RELATING TO TOXICOLOGY SERVICES; EDUCATION AND TRAINING SERVICES, NAMELY, CONDUCTING CLASSES, SEMINARS, CONFERENCES, WORKSHOPS RELATING TO FORENSIC EXAMINATION OF COMPUTERS, COMPUTER SOFTWARE AND COMPUTER RECORDS; EDUCATION AND TRAINING SERVICES, NAMELY, CONDUCTING CLASSES, SEMINARS, CONFERENCES, WORKSHOPS RELATING TO FORENSIC INVESTIGATION OF COMPUTER CRIME, IN CLASS 41 (U.S. CLS. 100, 101 AND 107).

FOR: SCIENTIFIC SERVICES RELATING TO VIDEO, AUDIO AND OTHER RECORDED DATA FORMAT CONVERSION, VIDEO, AUDIO AND OTHER RECORDED DATA FORMAT ENHANCEMENT AND RESTORATION, VIDEO, AUDIO AND OTHER RECORDED DATA FORMAT REPAIR, ALL FOR THE PURPOSE OF FORENSIC INTELLI-

GENE AND/OR CORROBORATION; SCIENTIFIC SERVICES RELATING TO THE COLLECTION OF EVIDENCE FROM AND PROVISION OF REPORTS ON CRIME SCENES AND ACCIDENT SCENES, ALL FOR THE PURPOSE OF FORENSIC INTELLIGENCE AND/OR CORROBORATION; SCIENTIFIC SERVICES RELATING TO ANALYSING, INTERPRETING AND EXTRACTING INFORMATION FROM ELECTRONIC SIGNALS, RECORDINGS AND IMAGES, ALL FOR THE PURPOSE OF FORENSIC INTELLIGENCE AND/OR CORROBORATION; SEARCHING, ANALYSING, INTERPRETING AND EXTRACTING INFORMATION FROM ELECTRONIC SIGNALS, RECORDINGS AND IMAGES, ALL FOR THE PURPOSE OF FORENSIC INTELLIGENCE AND/OR CORROBORATION; LEGAL SERVICES, NAMELY, EXPERT WITNESS SERVICES AND PRESENTATION OF EVIDENCE IN LEGAL PROCEEDINGS IN THE FIELD OF FORENSIC SCIENCE; SCIENTIFIC INVESTIGATION SERVICES, NAMELY, INVESTIGATION, SAMPLING, EXAMINATION, ANALYSIS AND EVALUATION OF BODY FLUIDS, BLOOD, SEMEN, BUCCAL SWABS, CRIME STAINS, PAINT, EXPLOSIVES, DRUGS, DNA, DNA PROFILE RESULTS, FINGERPRINTS, HAIR, FIBRES, CLOTHING, FOOTWEAR, GRAPHS, TACHOGRAPHS, PARTICULATE DEBRIS, DOCUMENTS, LETTERS, STATISTICS, HANDWRITING, FOOTPRINTS, TOOL MARKS, WEAPONS, FIREARMS, AMMUNITION, DISCHARGE RESIDUES, FIRE SCENES, THEFT SCENES AND VIDEOS, AS WELL AS FOR PRODUCT COUNTERFEITING, PRODUCT ADULTERATION, PRODUCT CONTAMINATION, ALL FOR THE PURPOSE OF FORENSIC INTELLIGENCE AND/OR CORROBORATION; SCIENTIFIC INVESTIGATION SERVICES, NAMELY, DETECTION OF FRAUD, ARSON, FIRES, MALICIOUS DAMAGE AND COUNTERFEITING, ALL FOR THE PURPOSE OF FORENSIC INTELLIGENCE AND/OR CORROBORATION; FORENSIC SCIENCE SERVICES, NAMELY, CONFIRMATION AND EVALUATION OF IDENTITY, PATERNITY, MATERNITY; COMPUTER DATABASE SERVICES, NAMELY, COLLECTING, SEARCHING AND PRESENTING SCIENTIFIC INFORMATION, ALL FOR THE PURPOSE OF FORENSIC INTELLIGENCE AND/OR CORROBORATION; FORENSIC SCIENCE SERVICES, NAMELY, SCIENTIFIC INVESTIGA-

TION SERVICES FOR POLICE FORCES, LAW ENFORCEMENT AGENCIES, INSURANCE AGENCIES, FORENSIC INVESTIGATORS AND LABORATORIES; SCIENTIFIC INVESTIGATION SERVICES FOR FORENSIC PURPOSES; TOXICOLOGY SERVICES, NAMELY, FORENSIC TOXICOLOGY; FORENSIC TOXICOLOGY, NAMELY, SCREENING FOR DRUGS AND ALCOHOL; FORENSIC EXAMINATION OF COMPUTERS, COMPUTER SOFTWARE AND COMPUTER RECORDS; FORENSIC INVESTIGATION OF COMPUTER CRIME; DESIGN AND CREATION OF TELECOMMUNICATIONS SUPPORT FACILITIES, INTERNET SITES, WORLD WIDE WEB SITES, ELECTRONIC LINK FACILITIES, ON-LINE ACCESS FACILITIES, E-COMMERCE PORTALS, C-COMMERCE NETWORKS, WEB LINKS, PARTICULARLY FOR POLICE FORCES, LAW ENFORCEMENT AGENCIES, INSURANCE AGENCIES, FORENSIC INVESTIGATORS, LABORATORIES AND/OR RELATING TO FORENSIC SCIENCE SERVICES, LEGAL SERVICES AND ANALYTICAL SERVICES; COMPUTER PROGRAMMING SERVICES; MAINTENANCE AND UPDATING OF COMPUTER SOFTWARE; COMPUTER SYSTEMS DESIGN, NAMELY, DESIGN, MAINTENANCE AND UPDATING OF FIRM WARE, COMPUTERS LINKS AND DATABASES, PARTICULARLY FOR POLICE FORCES, LAW ENFORCEMENT AGENCIES, INSURANCE AGENCIES, FORENSIC INVESTIGATORS, LABORATORIES AND/OR RELATING TO FORENSIC SCIENCE SERVICES, IN CLASS 42 (U.S. CLS. 100 AND 101).

THE MARK CONSISTS OF STANDARD CHARACTERS WITHOUT CLAIM TO ANY PARTICULAR FONT, STYLE, SIZE, OR COLOR.

OWNER OF UNITED KINGDOM REG. NO. 2428562, DATED 7-29-2006, EXPIRES 7-29-2016.

NO CLAIM IS MADE TO THE EXCLUSIVE RIGHT TO USE "AUDIO-VISUAL FORENSICS" , APART FROM THE MARK AS SHOWN.

SER. NO. 78-949,119, FILED 8-10-2006.

AMEETA JORDAN, EXAMINING ATTORNEY

**Int. Cls.: 29, 30 and 33**

**Prior U.S. Cls.: 46, 47 and 49**

**United States Patent and Trademark Office**

**Reg. No. 3,499,189**

**Registered Sep. 9, 2008**

**TRADEMARK  
PRINCIPAL REGISTER**

**TERANA**

TERANA, S.A. (MEXICO CORPORATION)  
NO. 64-A, COLONIA PROGRESO  
CERRADA CANALITO  
MEXICO, D.F., MEXICO 01080

FOR: UNFLAVORED AND UNSWEETENED GELATIN; CANNED FOOD, NAMELY, JALAPENOS, VEGETABLES, MEAT, FISH, AND POULTRY; MEAT EXTRACT; CANNED, DRIED, AND COOKED FRUITS AND VEGETABLES; MARMALADES, COMPOTES, EGGS, MILK AND LACTIC ACID DRINKS, EDIBLE OILS AND FATS, IN CLASS 29 (U.S. CL. 46).

FOR: SPICES, PROCESSED CEREALS, COFFEE, TEA, COCOA, SUGAR, RICE, TAPIOCA, SAGE, COFFEE SUBSTITUTES, BREAD, BAKERY PRODUCTS, PASTRY, EDIBLE ICE CREAM, HONEY, MOLASSES SYRUP, YEAST, BAKING POWDERS, SALT, MUSTARD, VINEGAR, SEASONED SAUCES, SALSA, AND ICE; FLOUR AND PROCESSED CEREAL PREPARATIONS, NAMELY, BREAKFAST CEREALS, CEREAL BASED SNACK FOOD, READY-TO-EAT CEREALS AND FLOUR-BASED CHIPS, IN CLASS 30 (U.S. CL. 46).

FOR: ALCOHOLIC BEVERAGES, NAMELY, TEQUILA, RUM, VODKA AND WHISKEY EXCLUDING WINE, IN CLASS 33 (U.S. CLS. 47 AND 49).

THE MARK CONSISTS OF STANDARD CHARACTERS WITHOUT CLAIM TO ANY PARTICULAR FONT, STYLE, SIZE, OR COLOR.

PRIORITY CLAIMED UNDER SEC. 44(D) ON MEXICO APPLICATION NO. 792491, FILED 7-5-2006, REG. NO. 945698, DATED 7-5-2006, EXPIRES 7-5-2016.

OWNER OF MEXICO REG. NO. 505794, DATED 8-31-1995, RENEWED AS REG. NO. 74043/2005, DATED 8-31-2005, EXPIRES 8-31-2015.

OWNER OF MEXICO REG. NO. 505795, DATED 8-31-1995, RENEWED AS REG. NO. 75174/2005, DATED 8-31-2005, EXPIRES 8-31-2015.

SER. NO. 78-949,509, FILED 8-10-2006.

DAVID TOOLEY, EXAMINING ATTORNEY

**Int. Cl.: 45**

**Prior U.S. Cls.: 100 and 101**

**United States Patent and Trademark Office**

**Reg. No. 3,499,190**

**Registered Sep. 9, 2008**

**SERVICE MARK  
PRINCIPAL REGISTER**



CURCIONE, JEANINE (UNITED STATES INDIVIDUAL)

4310 WESTLAWN AVE.

LOS ANGELES, CA 90066

FOR: ANIMAL ADOPTION SERVICE, NAMELY, ARRANGING FOR DOGS AND CATS FROM SHELTERS TO BE PLACED IN HOMES, IN CLASS 45 (U.S. CLS. 100 AND 101).

FIRST USE 10-27-2004; IN COMMERCE 10-27-2004.

NO CLAIM IS MADE TO THE EXCLUSIVE RIGHT TO USE "BICHONS", APART FROM THE MARK AS SHOWN.

THE COLOR(S) BLUE, BLACK, WHITE, PINK AND YELLOW IS/ARE CLAIMED AS A FEATURE OF THE MARK.

THE COLOR YELLOW APPEARS IN THE WORDING. THE COLOR BLACK APPEARS AS THE OUTLINE AROUND THE YELLOW WORDING, AND IN DETAILS ON THE FACE OF THE DOG DESIGN. THE COLOR BLUE APPEARS IN THE BACKGROUND. THE COLOR WHITE APPEARS ON THE DOG DESIGN. THE COLOR PINK APPEARS ON THE TONGUE OF THE DOG DESIGN

SER. NO. 78-958,760, FILED 8-23-2006.

DORITT L. CARROLL, EXAMINING ATTORNEY

**Int. Cl.: 37**

**Prior U.S. Cls.: 100, 103 and 106**

**United States Patent and Trademark Office**

**Reg. No. 3,499,191**

**Registered Sep. 9, 2008**

**SERVICE MARK  
PRINCIPAL REGISTER**

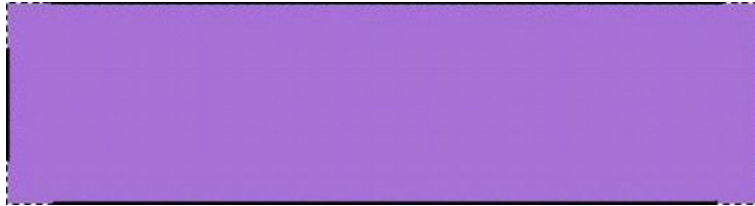

CORBOND CORPORATION (DELAWARE CORPORATION)  
32404 EAST FRONTAGE ROAD  
BOZEMAN, MT 59715

FOR: INSTALLATION OF SPRAY IN PLACE POLYURETHANE INSULATION FOR USE IN SEALING AND INSULATING, IN CLASS 37 (U.S. CLS. 100, 103 AND 106).

FIRST USE 10-8-1986; IN COMMERCE 10-8-1986.

OWNER OF U.S. REG. NO. 1,829,415.

THE COLOR(S) LAVENDER IS/ARE CLAIMED AS A FEATURE OF THE MARK.

THE MARK CONSISTS OF THE COLOR LAVENDER WITHIN A SHAPE OF A RECTANGLE OF VARYING LENGTHS AND WIDTHS. THE BROKEN LINES ARE INCLUDED ONLY TO VISUALLY DEMONSTRATE THE VARYING LENGTHS AND WIDTHS OF THE RECTANGLE.

SEC. 2(F).

SER. NO. 78-960,883, FILED 8-25-2006.

TERESA M. RUPP, EXAMINING ATTORNEY

**Int. Cl.: 35**

**Prior U.S. Cls.: 100, 101 and 102**

**United States Patent and Trademark Office**

**Reg. No. 3,499,192**

**Registered Sep. 9, 2008**

**SERVICE MARK  
PRINCIPAL REGISTER**

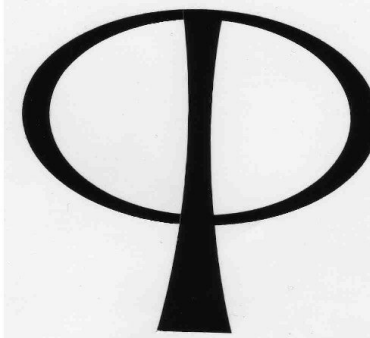

PAMPALLONA, CARMELO (UNITED STATES  
INDIVIDUAL)  
67 2ND STREET  
POTTSBORO, TX 75076

THE MARK CONSISTS OF AN OVAL INTERSEC-  
TED BY A VERTICAL LINE, IMPLYING THE  
LETTER "C" TOUCHING THE LETTER "P" .

FOR: ART GALLERIES, IN CLASS 35 (U.S. CLS.  
100, 101 AND 102).

SER. NO. 78-961,731, FILED 8-28-2006.

FIRST USE 1-31-2001; IN COMMERCE 12-31-2001.

PAUL E. FAHRENKOPF, EXAMINING ATTORNEY



**Int. Cls.: 3, 9, 14, 16, 18 and 25**

**Prior U.S. Cls.: 1, 2, 3, 4, 5, 6, 21, 22, 23, 26, 27, 28, 29, 36, 37, 38, 39, 41, 50, 51 and 52**

**Reg. No. 3,499,193**

**United States Patent and Trademark Office**

**Registered Sep. 9, 2008**

**TRADEMARK  
PRINCIPAL REGISTER**

**გომიაშვილი**  
**КАТЯ**

EKATERINA ARCHILOVNA GOMIASHVILI  
(RUSSIAN FED. INDIVIDUAL)  
ID NO. 261860  
MOSCOW, RUSSIAN FED. 103050

FOR: SOAPS; PERFUMERY; ESSENTIAL OILS; HAIR LOTIONS; DENTIFRICES; BODY SOAPS; PERFUMES; ESSENTIAL OILS FOR PERSONAL USE; COSMETICS; AFTERSHAVE LOTIONS; AFTERSHAVE BALM; CLEANSING MILK; TALCUM POWDER; SUNSCREENS; ASTRINGENTS FOR COSMETIC PURPOSES; SKIN AND FACIAL CLEANSERS; FOUNDATION CREAMS; SKIN TONERS; COMPACTS; EYE SHADOW; ROUGE; MASCARA; SKIN CREAMS; EYE LINER AND LIP LINER; LIPSTICKS; SKIN LOTIONS; POWDER MAKEUP; LIQUID MAKEUP; MAKEUP REMOVING CREAMS AND LOTIONS; BEAUTY MASKS; NAIL CARE PREPARATIONS; NAIL VARNISH REMOVER; NAIL TOP GLOSS HARDENERS; CUTICLE OIL; NAIL BUFFING PREPARATIONS, IN CLASS 3 (U.S. CLS. 1, 4, 6, 50, 51 AND 52).

FOR: ELECTRONIC TOYS, GAMES, PLAYTHINGS, AND AMUSEMENT APPARATUS, NAMELY, VIDEO GAME MACHINES ADAPTED FOR USE WITH TELEVISION RECEIVERS ONLY; ELECTRONIC GAMES, NAMELY, COMPUTER SOFTWARE FOR VIDEOGAMES; COMPUTER GAME SOFTWARE; CD-ROM GAMES; ELECTRONIC GAME CARDS; OPTICAL APPARATUS AND INSTRUMENTS, NAMELY, EYE GLASSES, SUNGLASSES, SPECTACLES, FRAMES, SPECTACLES IN THE NATURE OF GOGGLES AND PARTS THEREFOR; PHOTOGRAPHIC APPARATUS AND INSTRUMENTS, NAMELY, CAMERAS, CAMCORDERS; AUDIO AND VIDEO RECORDINGS FEATURING FASHION, ENTERTAINMENT, MUSIC, TRAVEL, ARTS; BLANK MAGNETIC AND OPTICAL DISCS; DVDS, CDS FEATURING FASHION, ENTERTAINMENT, MUSIC, TRAVEL, ARTS; BLANK VIDEO CASSETTES; CLOTHING AND FOOTWEAR FOR

PROTECTION AGAINST ACCIDENTS, IRRADIATION AND FIRE; PROTECTIVE CLOTHING, NAMELY, VESTS, JACKETS, TROUSERS, GLOVES, PROTECTIVE SHOES AND BOOTS; PROTECTIVE CAPS AND PROTECTIVE GLASSES; EYEGGLASS FRAMES OF PRECIOUS METAL, IN CLASS 9 (U.S. CLS. 21, 23, 26, 36 AND 38).

FOR: PRECIOUS METALS, NAMELY, GOLD, SILVER, AND PLATINUM; JEWELLERY; PRECIOUS STONES; COSTUME JEWELLERY AND TRINKETS; CUFF LINKS, TIE PINS; JEWELLERY BOXES OF PRECIOUS METAL; CUPS, MEDALS, AND BADGES, ALL OF PRECIOUS METAL; KEY RINGS OF PRECIOUS METAL; HOROLOGICAL AND CHRONOMETRIC INSTRUMENTS, NAMELY, CLOCKS, WATCHES, WRIST WATCHES, MASTER WATCHES AND PARTS THEREOF, NAMELY, WATCH BANDS AND LACES, IN CLASS 14 (U.S. CLS. 2, 27, 28 AND 50).

FOR: PRINTED MATTER, NAMELY, NEWSPAPERS, MAGAZINES FEATURING FASHION, ENTERTAINMENT, MUSIC, TRAVEL, ARTS, BOOKS IN THE FIELD OF FASHION, ENTERTAINMENT, MUSIC, TRAVEL, ARTS, BOOKLETS IN THE FIELD OF FASHION, ENTERTAINMENT, MUSIC, TRAVEL, ARTS, BROCHURES ABOUT FASHION, ENTERTAINMENT, MUSIC, TRAVEL, ARTS, TRAVEL GUIDES, LOG BOOKS, MAPS AND CHARTS IN THE FIELD OF FASHION, ENTERTAINMENT, MUSIC, TRAVEL, ARTS; PICTURES, PHOTOGRAPHS, POSTERS AND PRINTS; POSTCARDS AND GREETINGS CARDS; STATIONERY; PAPER LABELS, PAPER BADGES, STICKERS, PRINTED PAPER SIGNS AND BANNERS; BOOK BINDINGS; DIARIES, CALENDARS, TELEPHONE NUMBER BOOKS AND ADDRESS BOOKS; BOOKMARKS; DESKTOP ORGANIZERS; PAPER CARRIER BAGS; PLASTIC BAGS FOR MERCHANDISE PACKAGING, GIFT WRAP PAPER; PAPER PLACE MATS AND PAPER

COASTERS; PAPER FOR PACKAGING; CARDBOARD FOR PACKAGING; ARTIST'S MATERIAL, NAMELY, DRAWING PAPER, SKETCH PAPER, PAINTING PAPER, ARTIST BOOKS; PLASTIC MATERIALS FOR PACKAGING, NAMELY, PLASTIC BUBBLE PACKS FOR WRAPPING OR PACKAGING, IN CLASS 16 (U.S. CLS. 2, 5, 22, 23, 29, 37, 38 AND 50).

FOR: PURSES OF PRECIOUS METAL; GOODS MADE OF LEATHER AND IMITATIONS OF LEATHER, NAMELY, ALPENSTOCKS, CARD CASES, HANDBAG FRAMES, HAT BOXES OF LEATHER; LEATHER BOXES FOR STORING GREETING CARDS; HAT BOXES OF VULCANIZED FIBER FOR TRAVEL; VANITY CASES SOLD EMPTY; LEATHER THREAD; FURNITURE COVERINGS OF LEATHER; CLOTHING FOR PETS; COLLARS FOR ANIMALS; COVERINGS OF SKINS FURS; LEATHER SHOULDER BELTS; LEATHER STRAPS; TRAVELING BAGS; SLING BAGS FOR CARRYING INFANTS; WHEELED SHOPPING BAGS; HANDBAGS; KNAPSACKS; RUCKSACKS; SCHOOL BAGS; BEACH BAGS; TRAVELING TRUNKS; KEY CASES; SUITCASES; BRIEFCASES; ALL-PURPOSE SPORTS BAGS; PURSES; WALLETS; VALISES; HUNTING ACCESSORIES, NAMELY, LEATHER AND IMITATION LEATHER CASES FOR HOLDING HUNTING WEAPONS AND HUNTING SUPPLIES, HUNTING BAGS, HUNTING CROPS; UMBRELLAS; PARASOLS AND WALKING STICKS; WHIPS, HARNESSES AND SADDLERY, IN CLASS 18 (U.S. CLS. 1, 2, 3, 22 AND 41).

FOR: CLOTHING, NAMELY, OVERALLS, BOAS, BREECHES, CAPRIS, BRASSIERES, CLOTHING COLLARS, SHIRT YOKES, VEILS, NECKTIES, LEGGINGS, SINGLET, TEDDIES, HOODS, POCKETS FOR CLOTHING, COLLAR PROTECTORS, TIGHTS, COMBINATIONS, BODICES, BATHING SUITS, MASQUERADE COSTUMES, CUFFS, CAMISOLES, SHIRT FRONTS, MANTILLAS, MITTENS, MUFFS, FUR STOLE, EAR MUFFS, CYCLISTS' JERSEYS, CLOTHING FOR GYMNASTICS, NAMELY, PANTS, SHORTS, TANK TOPS, TOPS, T-SHIRTS, LONG-SLEEVE SHIRTS, BODY LEOTARDS, UNIFORMS, PELERINES, PAJAMAS, BATHING DRAWERS,

SCARVES, FROCKS, STOCKING SUSPENDERS, SUSPENDERS, BELTS, LEATHER BELTS, LAYETTES, SARIS, TOGAS, DRESSING GOWNS, SHAWLS, BATHING CAPS, SASHES, BABIES PANTS, PELISSES, PETTICOATS; SPORTSWEAR, NAMELY, SPORTS UNIFORMS AND JERSEYS, SWIMWEAR, UNDERWEAR, LEATHERWEAR, NAMELY, LEATHER TROUSERS, LEATHER SKIRTS, LEATHER JACKETS, LEATHER COATS, LEATHER VESTS, AND LOUNGEWEAR; PANTS, TROUSERS, JEANS, SHORTS, JACKETS, COATS, OVERCOATS, RAINCOATS, HOSIERY, SWEATERS, CARDIGANS, FLEECE AND POLAR FLEECE TOPS AND BOTTOMS, TRAINING AND TRACK SUITS, SHIRTS, WOVEN SHIRTS, SWEAT SHIRTS, POLO SHIRTS, T-SHIRTS, TANK TOPS, TOPS, CUT AND SEW TOPS, DRESSES, SKIRTS, GOWNS, SOCKS; ROBES; BANDS, NAMELY, SWEAT BANDS, WRIST BANDS; GLOVES; FOOTWEAR, NAMELY, SHOES, SANDALS, SLIPPERS, SABOTS, BOOTS, RUBBERS, FOOTBALL BOOTS, SOCCER BOOTS, BEACH SHOES, SPORT SHOES, HEELS, GAITERS; HEADGEAR, NAMELY, HATS, CAPS, HEAD BANDS, BONNETS, BERETS, IN CLASS 25 (U.S. CLS. 22 AND 39).

PRIORITY CLAIMED UNDER SEC. 44(D) ON ERPN CMNTY TM OFC APPLICATION NO. 005137443, FILED 6-14-2006, REG. NO. 005137443, DATED 12-3-2007, EXPIRES 6-14-2016.

THE MARK CONSISTS OF THE OWNER'S FAMILY NAME "GOMIASHVILI" IN GEORGIAN SCRIPT AND THE NAME "KATIA" - BEING THE ABBREVIATION OF THE OWNER'S NAME EKATERINA - IN CYRILLIC SCRIPT.

THE NON-LATIN CHARACTERS IN THE MARK TRANSLITERATE TO "KATIA GOMIASHVILI" AND THIS MEANS THE OWNER'S FAMILY NAME, AND THE ABBREVIATION OF THE OWNER'S NAME EKATERINA IN ENGLISH.

SER. NO. 78-962,122, FILED 8-28-2006.

SCOTT BIBB, EXAMINING ATTORNEY

Int. Cl.: 35

Prior U.S. Cls.: 100, 101 and 102

United States Patent and Trademark Office

Reg. No. 3,499,194

Registered Sep. 9, 2008

SERVICE MARK  
PRINCIPAL REGISTER



CPE HR, INC. (CALIFORNIA CORPORATION)  
9200 SUNSET BLVD. STE. 1100  
WEST HOLLYWOOD, CA 90069

FOR: HUMAN CAPITAL MANAGEMENT OUT-  
SOURCING SERVICE, IN CLASS 35 (U.S. CLS. 100,  
101 AND 102).

FIRST USE 10-8-2005; IN COMMERCE 10-8-2005.

OWNER OF U.S. REG. NO. 2,550,055.

NO CLAIM IS MADE TO THE EXCLUSIVE  
RIGHT TO USE "HUMAN RESOURCES", APART  
FROM THE MARK AS SHOWN.

THE COLOR(S) GRAY AND BLUE IS/ARE  
CLAIMED AS A FEATURE OF THE MARK.

THE COLOR BLUE APPEARS IN THE "CPE" AND  
THE COLOR GRAY APPEARS IN THE "HR" AND  
"YOUR HUMAN RESOURCES PARTNER".

SER. NO. 78-972,251, FILED 9-12-2006.

GRETTA YAO, EXAMINING ATTORNEY

**Int. Cls.: 25 and 41**

**Prior U.S. Cls.: 22, 39, 100, 101 and 107**

**United States Patent and Trademark Office**

**Reg. No. 3,499,195**

**Registered Sep. 9, 2008**

**TRADEMARK  
SERVICE MARK  
PRINCIPAL REGISTER**

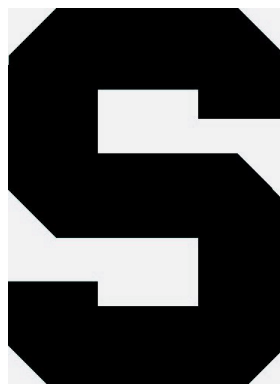

MICHIGAN STATE UNIVERSITY (MICHIGAN  
CONSTITUTIONAL CORPORATION)  
C/O OFFICE OF GENERAL COUNSEL  
494 ADMINISTRATION BUILDING  
EAST LANSING, MI 48824

FOR: CLOTHING, NAMELY; SHIRTS, T-SHIRTS,  
JERSEYS, TURTLENECKS, TANK TOPS, SWEAT-  
SHIRTS, PANTS, SWEATPANTS, WARM-UP SUITS,  
SHORTS, JACKETS, VESTS, SKIRTS, DRESSES,  
JUMPERS, OVERALLS, ROMPERS, BIBS, CAMI-  
SOLES, CHEMISES, PAJAMAS, SCRUBS, SOCKS,  
UNDERWEAR, ATHLETIC UNIFORMS, WIND-  
SUITS, PONCHOS, RAIN SUITS, WRISTBANDS,  
BELTS, NECKWEAR, BANDANAS, SCARVES,  
GLOVES, MITTENS; HEADWEAR; FOOTWEAR, IN  
CLASS 25 (U.S. CLS. 22 AND 39).

FIRST USE 1-1-1980; IN COMMERCE 1-1-1980.

FOR: EDUCATIONAL SERVICES, NAMELY,  
PROVIDING COURSES OF INSTRUCTION AND  
CONTINUING EDUCATION AT THE COLLEGE  
AND GRADUATE LEVEL AND CONDUCTING  
SUMMER CAMPS AND WORKSHOPS FOR YOUTH  
IN THE FIELDS OF ATHLETICS, MUSIC, AND FINE  
ARTS AND CRAFTS; ENTERTAINMENT SERVICES  
IN THE NATURE OF COLLEGIATE SPORTING  
EVENTS AND COMPETITIONS AND CONDUCT-  
ING MUSIC CONCERTS AND ARTS FESTIVALS, IN  
CLASS 41 (U.S. CLS. 100, 101 AND 107).

FIRST USE 1-1-1980; IN COMMERCE 1-1-1980.

SER. NO. 78-972,563, FILED 9-12-2006.

JAY BESCH, EXAMINING ATTORNEY

**Int. Cl.: 14**

**Prior U.S. Cls.: 2, 27, 28 and 50**

**United States Patent and Trademark Office**

**Reg. No. 3,499,196**

**Registered Sep. 9, 2008**

**TRADEMARK  
PRINCIPAL REGISTER**

**Waltham**

M. Z. BERGER & CO., INC. (NEW YORK CORPORATION)  
4TH FLOOR  
29-76 NORTHERN BLVD  
LONG ISLAND CITY, NY 11101

FOR: JEWELRY AND WATCHES, IN CLASS 14  
(U.S. CLS. 2, 27, 28 AND 50).

FIRST USE 12-1-1859; IN COMMERCE 12-1-1859.

THE MARK CONSISTS OF STANDARD CHARACTERS WITHOUT CLAIM TO ANY PARTICULAR FONT, STYLE, SIZE, OR COLOR.

OWNER OF U.S. REG. NOS. 82,124 AND 99,132.

THE NAME(S), PORTRAIT(S), AND/OR SIGNATURE(S) SHOWN IN THE MARK DOES NOT IDENTIFY A PARTICULAR LIVING INDIVIDUAL.

SEC. 2(F).

SER. NO. 78-972,646, FILED 9-12-2006.

SUNG IN, EXAMINING ATTORNEY

**Int. Cls.: 10, 25, 28 and 35**

**Prior U.S. Cls.: 22, 23, 26, 38, 39, 44, 50, 100, 101 and 102**

**Reg. No. 3,499,197**

**United States Patent and Trademark Office**

**Registered Sep. 9, 2008**

**TRADEMARK  
SERVICE MARK  
PRINCIPAL REGISTER**



SKINS CAPITAL PTY LIMITED (AUSTRALIA  
AUSTRALIAN PTY LIMITED COMPANY)

SUITE 407, 12 CENTURY CIRCUIT

BAULKHAM HILLS, NSW, AUSTRALIA 2153

FOR: SURGICAL AND MEDICAL GARMENTS FOR SUPPORTING SPECIFIC MUSCLES OR GROUPS OF MUSCLES, FOR PREVENTION OF MUSCLE INJURY; FOR THERAPEUTIC PURPOSES; FOR THE CONTROL OF VASCULAR AND/OR CIRCULATORY AILMENTS; FOR STABILIZING INJURED AREAS OF THE BODY AND FOR PREVENTION OF MUSCLE INJURY, NAMELY, COMPRESSION STOCKINGS, COMPRESSION LONG AND SHORT PANTS, COMPRESSION SHORTS INCLUDING SHORT, HALF, AND THREE-QUARTER LENGTH COMPRESSION SHORTS, COMPRESSION TIGHTS, COMPRESSION LONG AND SHORT LEGGINGS, COMPRESSION SOCKS, COMPRESSION SLEEVES, COMPRESSION VESTS, COMPRESSION JERSEYS, COMPRESSION LONG AND SHORT SLEEVED TOPS, COMPRESSION BIBS, COMPRESSION UNDERWEAR, THERAPEUTIC COMPRESSION GARMENTS FOR SUPPORTING SPECIFIC MUSCLES OR GROUPS OF MUSCLES, THERAPEUTIC COMPRESSION GARMENTS FOR PREVENTION OF MUSCLE INJURY; THERAPEUTIC COMPRESSION GARMENTS; ELASTIC STOCKINGS FOR MEDICAL OR THERAPEUTIC PURPOSES; ELASTIC SUPPORTS, NAMELY, ELASTIC SUPPORTS FOR STABILIZING INJURED AREAS OF THE BODY AND FOR PREVENTION OF MUSCLE INJURY, IN CLASS 10 (U.S. CLS. 26, 39 AND 44).

FOR: COMPRESSION GARMENTS IN THE NATURE OF APPAREL, NAMELY, COMPRESSION STOCKINGS, COMPRESSION LONG AND SHORT PANTS, COMPRESSION SHORTS INCLUDING SHORT, HALF, AND THREE-QUARTER LENGTH COMPRESSION SHORTS, COMPRESSION TIGHTS, COMPRESSION LONG AND SHORT LEGGINGS, COMPRESSION SOCKS, COMPRESSION SLEEVES, COMPRESSION VESTS, COMPRESSION JERSEYS, COMPRESSION LONG AND SHORT SLEEVED TOPS, COMPRESSION BIBS, AND COMPRESSION UNDERWEAR, IN CLASS 25 (U.S. CLS. 22 AND 39).

FOR: PADS FOR MEN, WOMEN, CHILDREN AND BABIES IN THE NATURE OF ELBOW PADS FOR ATHLETIC USE, SHIN PADS FOR ATHLETIC USE, KNEE PADS FOR ATHLETIC USE, SHOULDER PADS FOR ATHLETIC USE, HIP PADS FOR ATHLETIC USE, THIGH PADS FOR ATHLETIC USE, RIB PROTECTORS FOR ATHLETIC USE, PADDED HAND AND FINGER PROTECTORS FOR SPORT OR ATHLETIC ACTIVITY, PADDED JACKETS FOR ATHLETIC USE; SPORTS GUARDS, NAMELY, SHIN PADS, KNEE PADS, AND ELBOW PADS FOR ATHLETIC USE, AND CHEST PROTECTOR PADS FOR ATHLETIC USE, IN CLASS 28 (U.S. CLS. 22, 23, 38 AND 50).

FOR: RETAIL STORE SERVICES, WHOLESALE STORE SERVICES, MAIL ORDER SERVICES, ONLINE ORDERING SERVICES, AND DISTRIBUTORSHIPS, ALL FEATURING: SURGICAL AND MEDICAL GARMENTS FOR SUPPORTING SPECIFIC MUSCLES OR GROUPS OF MUSCLES, FOR PRE-

VENTION OF MUSCLE INJURY; FOR THERAPEUTIC PURPOSES; FOR THE CONTROL OF VASCULAR AND/OR CIRCULATORY AILMENTS; FOR STABILIZING INJURED AREAS OF THE BODY AND FOR PREVENTION OF MUSCLE INJURY, NAMELY, COMPRESSION STOCKINGS, COMPRESSION LONG AND SHORT PANTS, COMPRESSION SHORTS INCLUDING SHORT, HALF, AND THREE-QUARTER LENGTH COMPRESSION SHORTS, COMPRESSION TIGHTS, COMPRESSION LONG AND SHORT LEGGINGS, COMPRESSION SOCKS, COMPRESSION SLEEVES, COMPRESSION VESTS, COMPRESSION JERSEYS, COMPRESSION LONG AND SHORT SLEEVED TOPS, COMPRESSION BIBS, COMPRESSION UNDERWEAR, THERAPEUTIC COMPRESSION GARMENTS FOR SUPPORTING SPECIFIC MUSCLES OR GROUPS OF MUSCLES, THERAPEUTIC COMPRESSION GARMENTS FOR PREVENTION OF MUSCLE INJURY; THERAPEUTIC COMPRESSION GARMENTS; ELASTIC STOCKINGS FOR MEDICAL OR THERAPEUTIC PURPOSES; ELASTIC SUPPORTS, NAMELY, ELASTIC SUPPORTS FOR STABILIZING INJURED AREAS OF THE BODY AND FOR PREVENTION OF MUSCLE INJURY; COMPRESSION GARMENTS IN THE NATURE OF APPAREL, NAMELY, COMPRESSION STOCKINGS, COMPRESSION LONG AND SHORT PANTS, COMPRESSION SHORTS INCLUDING SHORT, HALF, AND THREE-QUARTER LENGTH COMPRESSION

SHORTS, COMPRESSION TIGHTS, COMPRESSION LONG AND SHORT LEGGINGS, COMPRESSION SOCKS, COMPRESSION SLEEVES, COMPRESSION VESTS, COMPRESSION JERSEYS, COMPRESSION LONG AND SHORT SLEEVED TOPS, COMPRESSION BIBS, AND COMPRESSION UNDERWEAR; PADS FOR MEN, WOMEN, CHILDREN AND BABIES IN THE NATURE OF ELBOW PADS FOR ATHLETIC USE, SHIN PADS FOR ATHLETIC USE, KNEE PADS FOR ATHLETIC USE, SHOULDER PADS FOR ATHLETIC USE, HIP PADS FOR ATHLETIC USE, THIGH PADS FOR ATHLETIC USE, RIB PROTECTORS FOR ATHLETIC USE, PADDED HAND AND FINGER PROTECTORS FOR SPORT OR ATHLETIC ACTIVITY, PADDED JACKETS FOR ATHLETIC USE; SPORTS GUARDS, NAMELY, SHIN PADS, KNEE PADS, AND ELBOW PADS FOR ATHLETIC USE, AND CHEST PROTECTOR PADS FOR ATHLETIC USE, IN CLASS 35 (U.S. CLS. 100, 101 AND 102).

PRIORITY CLAIMED UNDER SEC. 44(D) ON AUSTRALIA APPLICATION NO. 1106064, FILED 3-29-2006, REG. NO. 1106064, DATED 3-29-2006, EXPIRES 3-29-2016.

SER. NO. 78-972,753, FILED 9-12-2006.

SUNG IN, EXAMINING ATTORNEY

**Int. Cls.: 9, 16, 35, 41 and 42**

**Prior U.S. Cls.: 2, 5, 21, 22, 23, 26, 29, 36, 37, 38, 50,  
100, 101, 102 and 107**

**Reg. No. 3,499,198**

**United States Patent and Trademark Office**

**Registered Sep. 9, 2008**

**TRADEMARK  
SERVICE MARK  
PRINCIPAL REGISTER**

**PLAY BEYOND**

KABUSHIKI KAISHA SONY COMPUTER ENTERTAINMENT (A/T/A SONY COMPUTER ENTERTAINMENT INC.) (JAPAN CORPORATION)

2-6-21, MINAMI-AOYAMA, MINATO-KU  
TOKYO, JAPAN 107-0062

FOR: AUDIO-VISUAL COMMUNICATION CABLES; AMPLIFIERS; CD-ROMS FEATURING RECORDED AUTOMATIC PERFORMANCE PROGRAMS FOR ELECTRONIC MUSICAL INSTRUMENTS; BATTERY CHARGERS; BLANK OPTICAL DISCS; BLUEPRINTING APPARATUS, NAMELY, DIAZO COPYING MACHINES; ELECTRIC CABLES; CAR ADAPTERS; COMPUTERS; USER OPERATED ELECTRONIC CONTROLLERS ESPECIALLY DESIGNED FOR CD RECORDERS; USER OPERATED ELECTRONIC CONTROLLERS ESPECIALLY DESIGNED FOR DVD PLAYERS; USER OPERATED ELECTRONIC CONTROLLERS ESPECIALLY DESIGNED FOR DVD RECORDERS; CONSUMER VIDEO GAME MACHINES ADAPTED FOR USE WITH TELEVISION RECEIVERS ONLY; USER OPERATED ELECTRONIC CONTROLLERS ESPECIALLY DESIGNED FOR DVD VIDEO RECORDERS; USER OPERATED ELECTRONIC CONTROLLERS ESPECIALLY DESIGNED FOR DVD-ROM PLAYERS; DOWNLOADABLE ELECTRONIC PUBLICATIONS IN THE NATURE OF MAGAZINES, BOOKS AND MANUAL IN THE FIELDS OF GAMES, MUSIC AND CINEMAS; DIGITAL STILL CAMERAS; CATHODE RAY TUBES; PLASMA DISPLAY PANELS; ELECTROLUMINESCENCE DISPLAY PANELS ; ENCODED MICRO TAGS OF PLASTIC, METAL OR SILICATE FOR USE IN THE FIELD OF PASSIVE LABELING, TRACING OR TRACKING OF PERSONS, ANIMALS, VEHICLES OR GOODS OF ANY KIND; OPTICAL SCANNERS; FREQUENCY MOD-

ULATION(FM) RADIO TRANSMITTERS; SATELLITE NAVIGATIONAL SYSTEMS, NAMELY, A GLOBAL POSITIONING SYSTEM(GPS); COMPUTER HARD DISC RECORDERS; COMPUTER HARD DISK DRIVES ; KEYBOARDS; KEYBOARDS FOR USE WITH VIDEO GAME MACHINES WITH TELEVISION FOR PERSONAL USE ONLY; LIQUID CRYSTAL DISPLAY PANELS; LIQUID CRYSTAL DISPLAYS; LOUD SPEAKERS; MEMORY CARDS; MICROPHONES; MODEMS; MOUSE FOR COMPUTERS; OPTICAL DISC PLAYERS INCLUDING USER OPERATED ELECTRONIC CONTROLLERS; OPTICAL DISC RECORDERS INCLUDING USER OPERATED ELECTRONIC CONTROLLERS; OPTICAL FIBER CABLES; PORTABLE DIGITAL AUDIO PLAYERS; GAME PROGRAMS FOR HAND-HELD GAMES WITH LIQUID CRYSTAL DISPLAYS; RECEIVING TUNERS FOR SATELLITE TELEVISION BROADCASTING; RECEIVING TUNERS FOR TERRESTRIAL DIGITAL BROADCASTING; RECHARGEABLE BATTERIES; RECORDED OPTICAL DISCS FEATURING COMPUTER GAME PROGRAMS; REMOTE CONTROLLERS FOR USE WITH HAND-HELD GAMES WITH LIQUID CRYSTAL DISPLAYS ONLY; REMOTE CONTROLLERS ESPECIALLY DESIGNED FOR CD PLAYERS; REMOTE CONTROLLERS ESPECIALLY DESIGNED FOR DVD PLAYERS; REMOTE CONTROLLERS FOR USE WITH COMPUTERS; REMOTE CONTROLLERS FOR USE WITH PORTABLE AUDIO-VISUAL PLAYERS ONLY; REMOTE CONTROLLERS FOR USE WITH PORTABLE DIGITAL AUDIO PLAYERS ONLY; REMOTE CONTROLLERS FOR USE WITH VIDEO GAME MACHINES WITH TELEVISION FOR PERSONAL USE ONLY; COMPUTER NETWORK ROUTERS; SOUND RECORDED COMPACT DISCS FEATURING MUSIC AND EXPOSED



CINEMATOGRAPHIC FILMS; SOUND RECORDED MAGNETIC CARDS, SHEETS AND TAPES; TUNERS FOR TELEVISION RECEIVERS; VIDEO RECORDED OPTICAL DISCS FEATURING MUSIC AND EXPOSED CINEMATOGRAPHIC FILMS; VIDEO RECORDED OPTICAL MAGNETIC DISCS FEATURING MUSIC AND EXPOSED CINEMATOGRAPHIC FILMS; DOWNLOADABLE IMAGES AND SOUND FOR GAMES AND KARAOKE, IN CLASS 9 (U.S. CLS. 21, 23, 26, 36 AND 38).

FOR: ADDRESSING MACHINES; ADHESIVE TAPES FOR STATIONERY OR HOUSEHOLD PURPOSES; ALBUMS FOR PHOTOGRAPHS; AUTOMATIC STAMP PUTTING-ON MACHINES; BABIES' DIAPERS OF PAPER; PAPER IDENTIFICATION TAGS FOR BAGGAGE; BALL-POINT PENS; BANNERS OF PAPER; PAPER BOOKMARKERS; BOOKS, NAMELY, MAGAZINES FEATURING VIDEO GAMES, MUSIC AND CINEMAS; CALENDARS; INDEX CARDS, STATIONERY; CATALOGUES IN THE FIELD OF ADVERTISING; CRAYONS; DECORATORS' PAINTBRUSHES; DIARIES; PAINTERS' ARTICLE, NAMELY, DRAWING BOARDS; DRAWING INSTRUMENTS; ELECTRIC PENCIL SHARPENERS; ELECTRIC STAPLERS FOR OFFICES; ENVELOPE SEALING MACHINES FOR OFFICES; ENVELOPES; FELT WRITING PENS; FLAGS OF PAPER; FOOD WRAPPING PLASTIC FILM FOR HOUSEHOLD PURPOSES; FRANKING MACHINES; GARBAGE BAGS OF PAPER FOR HOUSEHOLD USE; GARBAGE BAGS OF PLASTICS FOR HOUSEHOLD USE; GEOGRAPHICAL MAPS; HAND TOWELS OF PAPER; HANDKERCHIEFS OF PAPER; HYGIENIC PAPER; INKING RIBBONS; INSTRUCTION MANUALS IN THE FIELD OF VIDEO GAME MACHINES AND SOFTWARE; MAGAZINES IN THE FIELD OF VIDEO GAME, MUSIC, AND CINEMAS; DRAWING TEMPLATES; MECHANICAL PENCILS; MEMO PADS CONTAINING ADHESIVE ON ONE SIDE OF THE SHEETS FOR ATTACHMENT TO SURFACES; MIMEOGRAPHS; NEWSLETTERS IN THE FIELD OF VIDEO GAME, MUSIC, AND CINEMAS; NEWSPAPERS; NOTE BOOKS; PAINTINGS AND THEIR REPRODUCTIONS; ENGRAVINGS; PAMPHLETS IN THE FIELD OF VIDEO GAME, MUSIC, AND CINEMAS; PAPER PRINTED PATTERNS; PAPER SHREDDERS FOR OFFICE USE; PAPERBOARD BOXES FOR INDUSTRIAL PACKAGING; PEN CASES; PENCILS; PHOTOGRAPH STANDS; PHOTOGRAPHS; PICTURE POSTCARDS; POCKET MEMORANDUM BOOKS; PRINTED LOTTERY TICKETS OTHER THAN TOYS; PRINTED TIMETABLES; PRINTERS' REGLETS; PRINTING PAPER; TOILET PAPER; FILTER PAPER; POSTCARD PAPER; PRINTING TYPE; NON-ELECTRIC RELIEF DUPLICATORS; NON-ELECTRIC ROTARY DUPLICATORS; RUBBER ERASERS; RULERS FOR STATIONERY AND OFFICE USE, NAMELY, DRAFTING RULERS; SEALING WAX; STATIONERY, NAMELY, SEALS; SHEET MUSIC; SKETCHBOOKS; SONG BOOKS; SPECIFICATION MANUALS FOR VIDEO GAME PROGRAMS; STAMP OBLITERATING MACHINES; STANDS FOR PENS AND PENCILS; STATIONERY NOTES AND NOTE PADS CONTAINING ADHESIVE ON ONE SIDE OF THE SHEETS FOR ATTACH-

MENT TO SURFACES; NON-ELECTRIC STAPLING PRESSES; STICKERS; STRATEGIC MANUALS FOR VIDEO GAME MACHINES; TABLE CLOTHS OF PAPER; TABLE NAPKINS OF PAPER; TAGS CONTAINING ADHESIVE ON ONE SIDE OF THE SHEETS FOR ATTACHMENT TO SURFACES; TAILORS' CHALK; TOWELS OF PAPER; TYPEWRITERS; SYNTHETIC RESIN TYPE UNDERLAY FOR WRITING PAPER; WRITING PADS; ADHESIVES FOR STATIONERY OR HOUSEHOLD PURPOSES, IN CLASS 16 (U.S. CLS. 2, 5, 22, 23, 29, 37, 38 AND 50).

FOR: ONLINE RETAIL STORE SERVICES FEATURING DOWNLOADABLE SOUND AND IMAGES, IN CLASS 35 (U.S. CLS. 100, 101 AND 102).

FOR: AGENCIES FOR OPERATING LOTTERIES; ANIMAL EXHIBITIONS; ANIMAL TRAINING; ART EXHIBITIONS; BOOK RENTAL; BOOKING OF SEATS FOR SHOWS; ENTERTAINMENT SERVICES, SHOWING CAVES TO THE PUBLIC; DIRECTING OR PRESENTATION OF PLAYS; DIRECTION OF MAKING RADIO OR TELEVISION PROGRAMS; EDUCATIONAL SERVICES, NAMELY, CONDUCTING SEMINARS AND WORKSHOPS IN THE FIELD OF VIDEO GAMES; PUBLISHING OF ELECTRONIC PUBLICATIONS; ENTERTAINMENT SERVICES, NAMELY, PROVIDING GAME SERVICES USING COMMUNICATION VIA COMPUTER NETWORKS OR THE INTERNET; PROVIDING ONLINE GAME SERVICES USING COMMUNICATION VIA VIDEO GAME MACHINES WITH TELEVISION FOR PERSONAL USE AND/OR PERSONAL COMPUTERS; ENTERTAINMENT SERVICES, NAMELY, PROVIDING GARDEN TOURS TO PUBLIC; LANGUAGE INTERPRETATION; ENTERTAINMENT SERVICES, NAMELY, MOVIE SHOWING, MOTION PICTURE FILM PRODUCTION; MOVIE FILM DISTRIBUTION; EDUCATIONAL SERVICES, NAMELY, CONDUCTING ON-LINE SEMINAR AND WORKSHOPS IN THE FIELD OF VIDEO GAME; OPERATION OF VIDEO MACHINES OR AUDIO MACHINES FOR PRODUCTION OF RADIO OR TELEVISION PROGRAMS; OPERATING LOTTERIES; ORGANIZATION, MANAGEMENT OR ARRANGEMENT OF SEMINARS; CONDUCTING SEMINAR IN THE FIELD OF VIDEO GAME, MUSIC AND CINEMAS; ORGANIZATION, CONDUCTION OR ARRANGEMENT OF SPORTS COMPETITIONS IN THE FIELD OF BASEBALL; ORGANIZATION, CONDUCTION OR ARRANGEMENT OF HORSE RACES; ORGANIZATION, CONDUCTION OR ARRANGEMENT OF MINI-CAR RACES; PHOTOGRAPHY; PLANNING ARRANGEMENT OF SHOWING MOVIES, SHOWS, PLAYS OR MUSICAL PERFORMANCES; PLANT EXHIBITIONS; PRESENTATION OF LIVE SHOW PERFORMANCE; PRESENTATION OF MUSICAL PERFORMANCE; PRODUCTION OF RADIO OR TELEVISION PROGRAMS; PRODUCTION OF VIDEO TAPE FILM IN THE FIELDS OF EDUCATION, CULTURE, ENTERTAINMENT OR SPORTS, NOT FOR MOVIES, ENTERTAINMENT SERVICES, NAMELY, PROVIDING RADIO OR TELEVISION PROGRAMS AND NOT FOR ADVERTISING OR PUBLICITY IN THE FIELD OF CHILDREN'S ENTERTAINMENT; PROVIDING AMUSEMENT PARKS; PROVIDING AUDIO OR VIDEO STUDIOS;

PROVIDING BILLIARD ROOMS; PROVIDING DANCE HALLS; PUBLISHING OF ELECTRONIC PUBLICATIONS; PROVIDING FACILITIES FOR MOVIES, SHOWS, PLAYS, MUSIC OR EDUCATIONAL TRAINING; PROVIDING GAME SERVICES VIA THE INTERNET OR COMPUTER NETWORKS; PROVIDING NON-DOWNLOADABLE IMAGES AND SOUNDS FOR KARAOKE USING COMMUNICATION VIA COMPUTER TERMINALS; PROVIDING NON-DOWNLOADABLE IMAGES AND SOUNDS FOR GAMES USING COMMUNICATION VIA COMPUTER TERMINALS; PROVIDING MAH-JONG PARLORS; PROVIDING MUSIC VIA THE INTERNET OF COMPUTER NETWORKS NOT FOR DOWNLOAD; PROVIDING MOVIES VIA THE INTERNET OF COMPUTER NETWORKS NOT FOR DOWNLOAD; ON-LINE LIBRARY SERVICES, NAMELY, PROVIDING ELECTRONIC LIBRARY SERVICES WHICH FEATURE NEWSPAPERS, MAGAZINES, PHOTOGRAPHS AND PICTURES VIA AN ON-LINE COMPUTER NETWORK; RENTAL OF COMPUTER GAME PROGRAMS FOR HANDHELD GAMES WITH LIQUID CRYSTAL DISPLAYS; PROVIDING SLOT MACHINE PARLORS; PUBLICATION OF BOOKS; REFERENCE LIBRARIES OF LITERATURE AND DOCUMENTARY RECORDS; RENTAL OF KARAOKE FACILITIES; RENTAL OF AMUSEMENT MACHINES AND APPARATUS; RENTAL OF CINEMA FILMS; RENTAL OF ELECTRONIC CIRCUITS, MAGNETIC DISCS, OPTICAL DISCS, OPTICAL MAGNETIC DISCS, CD-ROMS AND MAGNETIC TAPES FEATURING PROGRAMS FOR VIDEO GAME MACHINES WITH TELEVISION FOR PERSONAL USE; RENTAL OF GAME MA-

CHINES AND APPARATUS; RENTAL OF IMAGE-RECORDED MAGNETIC TAPES; RENTAL OF MOVIE PROJECTORS AND PARTS AND FITTINGS FOR MOVIE PROJECTORS; RENTAL OF MUSICAL INSTRUMENTS; RENTAL OF FILM NEGATIVES; RENTAL OF OPTICAL MACHINES AND APPARATUS, NAMELY, OPTICAL SCANNERS AND OPTICAL READERS FOR ENTERTAINMENT; RENTAL OF CINEMATOGRAPHIC MACHINES; RENTAL OF OVERHEAD PROJECTORS; RENTAL OF PHOTOGRAPHIC CAMERAS; RENTAL OF POSITIVE FILMS; RENTAL OF PROGRAMS FOR VIDEO GAME MACHINES WITH TELEVISION FOR PERSONAL USE; RENTAL OF RADIO SETS; RENTAL OF RECORDS OR SOUND-RECORDED MAGNETIC TAPES; RENTAL OF SPORTS EQUIPMENT; RENTAL OF SPORTS FACILITIES; RENTAL OF TELEVISION SETS; RENTAL OF TOYS; RENTAL OF VIDEO GAME MACHINES WITH TELEVISION FOR PERSONAL USE; TRANSLATION, IN CLASS 41 (U.S. CLS. 100, 101 AND 107).

FOR: DUPLICATION OF COMPUTER PROGRAMS, IN CLASS 42 (U.S. CLS. 100 AND 101).

OWNER OF ERPN CMNTY TM OFC REG. NO. 005346069, DATED 11-19-2007, EXPIRES 9-8-2016.

OWNER OF U.S. REG. NO. 1,903,261.

SER. NO. 78-973,603, FILED 9-13-2006.

DAYNA BROWNE, EXAMINING ATTORNEY

**Int. Cl.: 32**

**Prior U.S. Cls.: 45, 46 and 48**

**United States Patent and Trademark Office**

**Reg. No. 3,499,199**

**Registered Sep. 9, 2008**

**TRADEMARK  
PRINCIPAL REGISTER**

# ANTIPODES

ANTIPODES WATER COMPANY LIMITED (NEW  
ZEALAND LIMITED COMPANY)  
APARTMENT 501  
121 CUSTOM STREET WEST  
AUCKLAND, NEW ZEALAND

FOR: (BASED ON 44(E)) PREPARATIONS FOR  
MAKING SOFT DRINKS; FRUIT DRINKS AND  
FRUIT JUICES; MINERAL AND AERATED WA-  
TERS; SOFT DRINKS; NON-ALCOHOLIC FRUIT  
JUICE BEVERAGES, NON-ALCOHOLIC MALT  
BEVERAGES, NON-ALCOHOLIC BEVERAGES  
WITH TEA FLAVOR, NON-ALCOHOLIC BEVERA-  
GES CONTAINING FRUIT JUICES, NON-CARBO-

NATED, NON-ALCOHOLIC FROZEN FLAVORED  
BEVERAGES, IN CLASS 32 (U.S. CLS. 45, 46 AND 48).

THE MARK CONSISTS OF STANDARD CHAR-  
ACTERS WITHOUT CLAIM TO ANY PARTICULAR  
FONT, STYLE, SIZE, OR COLOR.

OWNER OF NEW ZEALAND REG. NO. 677945,  
DATED 10-30-2003, EXPIRES 4-28-2010.

SER. NO. 78-980,521, FILED 5-10-2005.

KRISTIN DAHLING, EXAMINING ATTORNEY

**Int. Cl.: 24**

**Prior U.S. Cls.: 42 and 50**

**United States Patent and Trademark Office**

**Reg. No. 3,499,200**

**Registered Sep. 9, 2008**

**TRADEMARK  
PRINCIPAL REGISTER**

**AURA**

AURA LIFESTYLE PTY LTD (AUSTRALIA PROPRIETARY COMPANY)  
60 CORPORATE DRIVE  
MOORABBIN, VICTORIA, 3189  
AUSTRALIA

FOR: TEXTILE GOODS SUCH AS NAPERY, NAMELY, TABLE LINENS, TABLE COVERS, SERVIETTES AND TEA TOWELS; BED LINENS, BED SHEETS, PILLOW CASES, QUILT COVERS, BED SPREADS AND VALANCES; AND WINDOW COVERS, NAMELY, CURTAINS AND DRAPES, IN CLASS 24 (U.S. CLS. 42 AND 50).

THE MARK CONSISTS OF STANDARD CHARACTERS WITHOUT CLAIM TO ANY PARTICULAR FONT, STYLE, SIZE, OR COLOR.

OWNER OF INTERNATIONAL REGISTRATION  
0816551 DATED 12-16-2003, EXPIRES 12-16-2013.

SER. NO. 79-000,421, FILED 12-16-2003.

ALLISON HOLTZ, EXAMINING ATTORNEY

**Int. Cls.: 7 and 8**

**Prior U.S. Cls.: 13, 19, 21, 23, 28, 31, 34, 35 and 44**

**United States Patent and Trademark Office**

**Reg. No. 3,499,201**

**Registered Sep. 9, 2008**

**TRADEMARK  
PRINCIPAL REGISTER**

**VECTOR**

WIKUS-SÄGENFABRIK WILHELM H. KULL-  
MANN GMBH & CO. KG (FED REP GERMA-  
NY KOMMANDITGESELLSCHAFT (KG))  
MELSUNGER STRAßE 30  
34286 SPANGENBERG, FED REP GERMANY

FOR: SAW BLADES, SAW BANDS, CIRCULAR  
SAW BLADES, BAND SAW BLADES, AS PARTS OF  
MACHINES, ALL OF THE FOREGOING EXCLUD-  
ING CUTTING MACHINES USED IN THE CLOTH-  
ING, SHOE AND UPHOLSTERY INDUSTRIES, IN  
CLASS 7 (U.S. CLS. 13, 19, 21, 23, 31, 34 AND 35).

FOR: HAND TOOLS; NAMELY HAND SAW  
BLADES; HAND BAND SAW BLADES, IN CLASS 8  
(U.S. CLS. 23, 28 AND 44).

THE MARK CONSISTS OF STANDARD CHAR-  
ACTERS WITHOUT CLAIM TO ANY PARTICULAR  
FONT, STYLE, SIZE, OR COLOR.

PRIORITY DATE OF 5-25-2004 IS CLAIMED.

OWNER OF INTERNATIONAL REGISTRATION  
0849783 DATED 11-24-2004, EXPIRES 11-24-2014.

SER. NO. 79-010,978, FILED 11-24-2004.

SANI KHOURI, EXAMINING ATTORNEY

**Int. Cl.: 5**

**Prior U.S. Cls.: 6, 18, 44, 46, 51 and 52**

**United States Patent and Trademark Office**

**Reg. No. 3,499,202**

**Registered Sep. 9, 2008**

**TRADEMARK  
PRINCIPAL REGISTER**

**RYMEGRA**

ASTRAZENECA AB (SWEDEN LIMITED LIABILITY CORPORATION)  
VÄSTRA MÄLAREHAMNEN 9  
SE-151 85 SÖDERTÄLJE, SWEDEN

FOR: PHARMACEUTICAL PREPARATIONS AND SUBSTANCES FOR THE PREVENTION AND TREATMENT OF DISEASES AND DISORDERS OF THE RESPIRATORY SYSTEM, CENTRAL NERVOUS SYSTEM, PERIPHERAL NERVOUS SYSTEM, CARDIOVASCULAR SYSTEM, GASTRO-INTESTINAL SYSTEM; PHARMACEUTICAL PREPARATIONS AND SUBSTANCES FOR USE IN PAIN CONTROL, ARTHRITIS, ANAESTHESIA, ONCOLOGY, INFECTION, INFLAMMATION, UROLOGY, GYNAECOL-

OGY; PHARMACEUTICAL PREPARATIONS AND SUBSTANCES FOR THE TREATMENT AND PREVENTION OF DIABETES, IN CLASS 5 (U.S. CLS. 6, 18, 44, 46, 51 AND 52).

OWNER OF INTERNATIONAL REGISTRATION  
0858888 DATED 7-1-2005, EXPIRES 7-1-2015.

SER. NO. 79-014,253, FILED 7-1-2005.

JOHN SCHUYLER YARD, EXAMINING ATTORNEY

**Int. Cls.: 1, 12 and 42**

**Prior U.S. Cls.: 1, 5, 6, 10, 19, 21, 23, 26, 31, 35, 44, 46,  
100 and 101**

**Reg. No. 3,499,203**

**United States Patent and Trademark Office**

**Registered Sep. 9, 2008**

**TRADEMARK  
SERVICE MARK  
PRINCIPAL REGISTER**

# NIDACELL

SOLVAY (SOCIÉTÉ ANONYME) (BELGIUM CORPORATION)  
RUE DU PRINCE ALBERT 33  
B-1050 BRUXELLES, BELGIUM

FOR: CHEMICALS FOR USE IN INDUSTRIAL USE, NAMELY, ALLYL CHLORIDE, BARIUM, CALCIUM CHLORIDE, CAPROLACTONE, CAUSTIC SODA, CHLORINE, DICHLORETHANE, EPICHIOR-OHYDRIN, FERIC CHLORIDE, FLUORINATED ORGANIC INTERMEDIATES, FLUORINE, GLYCEROL, HYDROCHLORIC ACID, HYDROCHLOROFLUOROCARBONS, HYDROGEN, HYDROGEN PEROXIDE, MAGNESIUM CARBONATE, INORGANIC FLUORIDES, PERACETIC ACID, PRECIPITATED CALCIUM CHLORIDE, SALT IN THE NATURE OF MAGNESIUM SALTS AND SALTS FROM RARE EARTH METALS, SODIUM BICARBONATE, SODIUM HYPOCHLORITE, SODIUM PERBORATE, SODIUM PERCARBONATE, STRONTIUM ALL FOR USE IN THE MANUFACTURE OF A WIDE VARIETY OF GOODS; UNPROCESSED ARTIFICIAL RESINS AS RAW MATERIALS IN THE FORM OF POWDERS, LIQUIDS OR PASTES; UNPROCESSED PLASTICS, IN CLASS 1 (U.S. CLS. 1, 5, 6, 10, 26 AND 46).

FOR: LAND VEHICLES; APPARATUS FOR LOCOMOTION BY AIR OR WATER, NAMELY, BOATS

AND AIRPLANES, IN CLASS 12 (U.S. CLS. 19, 21, 23, 31, 35 AND 44).

FOR: SCIENTIFIC RESEARCH AND DEVELOPMENT; INDUSTRIAL RESEARCH SERVICES IN THE FIELD OF CHEMICALS, PLASTICS AND RESINS; INTELLECTUAL PROPERTY CONSULTATION FOR THE ENHANCEMENT OF THE VALUE OF INTELLECTUAL ASSETS; TECHNOLOGY CONSULTATION AND RESEARCH IN THE FIELD OF CHEMICALS, PLASTICS AND RESINS, IN CLASS 42 (U.S. CLS. 100 AND 101).

THE MARK CONSISTS OF STANDARD CHARACTERS WITHOUT CLAIM TO ANY PARTICULAR FONT, STYLE, SIZE, OR COLOR.

PRIORITY DATE OF 10-12-2004 IS CLAIMED.

OWNER OF INTERNATIONAL REGISTRATION 0863449 DATED 4-7-2005, EXPIRES 4-7-2015.

SER. NO. 79-015,810, FILED 4-7-2005.

KRISTINA MORRIS, EXAMINING ATTORNEY

**Int. Cls.: 1, 5, 9, 10 and 42**

**Prior U.S. Cls.: 1, 5, 6, 10, 18, 21, 23, 26, 36, 38, 39, 44, 46, 51, 52, 100 and 101**

**Reg. No. 3,499,204**

**United States Patent and Trademark Office**

**Registered Sep. 9, 2008**

**TRADEMARK  
SERVICE MARK  
PRINCIPAL REGISTER**

# CapitalBio

CAPITALBIO CORPORATION (CHINA LIMITED LIABILITY COMPANY)

18 LIFE SCIENCE PARKWAY

CHANGPING DISTRICT 102206 BEIJING

CHINA

FOR: SURFACE ACTIVE CHEMICAL AGENTS FOR USE IN THE MANUFACTURE OF SLIDES, BEADS AND PARTICLES; ANTI-ANIMALCULE PREPARATIONS USED IN FOOD AND MEDICINE TO PREVENT MICRO-ORGANISMS; CHEMICAL PREPARATIONS FOR SCIENTIFIC APPLICATIONS; CHEMICAL REAGENTS FOR RESEARCH PURPOSES; CHEMICAL REAGENTS FOR USE IN SCIENTIFIC APPARATUS FOR CHEMICAL OR BIOLOGICAL ANALYSIS, NAMELY, PHOSPHATE BUFFER, POLYETHYLENE GLYCOL (PEG), DEXTRAN, AND SILANE REAGENTS FOR SURFACE TREATMENT; CHEMICAL PREPARATIONS USED FOR ANALYSIS IN LABORATORIES, NAMELY SOLVENTS FOR USE IN THE SEPARATION, ISOLATION AND PURIFICATION OF BIOLOGICALLY ACTIVE SUBSTANCES IN BACTERIOLOGICAL CULTURES, NAMELY DMSO, ETHANOL, AND GLYCEROL; CHEMICAL PREPARATIONS FOR SCIENTIFIC ANALYSES IN LABORATORIES; CRYOGENIC PREPARATIONS FOR PRESERVATION OF BIOLOGICAL PRODUCTS; DIAGNOSTIC PREPARATIONS OTHER THAN FOR MEDICAL OR VETERINARY APPLICATIONS; REAGENT PAPERS FOR SCIENTIFIC RESEARCH; CHEMICAL TEST PAPERS; BIOLOGICAL PREPARATIONS FOR SCIENTIFIC AND LABORATORY RESEARCH; BACTERIOLOGICAL PREPARATIONS FOR USE IN FOOD MANUFACTURE AND COSMETIC MANUFACTURE OTHER THAN FOR MEDICAL AND VETERINARY APPLICATIONS; MEDIA CULTURES OF MICROORGANISMS FOR USE IN SCIENTIFIC RESEARCH AND TESTING AND NOT FOR MEDICAL AND VETERINARY APPLICA-

TIONS; BACTERIOLOGICAL PREPARATIONS TO CREATE ACIDIFICATION IN LABORATORY RESEARCH, IN CLASS 1 (U.S. CLS. 1, 5, 6, 10, 26 AND 46).

FOR: SOLVENTS FOR DISSOLVING BACTERIOLOGICAL CULTURES FOR LABORATORY USE; BACTERIAL PREPARATIONS FOR MEDICAL AND VETERINARY APPLICATIONS; CHEMICAL-PHARMACEUTICAL PREPARATIONS FOR USE IN MEDICAL DIAGNOSIS AND MEDICAL DIAGNOSTIC TESTING; NUTRITIVE SUBSTANCES FOR MICROORGANISM CULTURES; CULTURE MEDIUM OF BACTERIOLOGICAL MICROORGANISMS FOR MEDICAL AND VETERINARY APPLICATIONS; BIOLOGICAL PREPARATIONS FOR MEDICAL APPLICATIONS; CHEMICAL PREPARATIONS FOR PHARMACEUTICAL APPLICATIONS; DIAGNOSTIC PREPARATIONS FOR MEDICAL APPLICATIONS; CHEMICAL PREPARATIONS FOR MEDICAL OR VETERINARY APPLICATIONS; PREPARATIONS FOR TRACE ELEMENTS FOR HUMAN AND ANIMAL USE AS DIETARY FOOD SUPPLEMENTS; SEMEN FOR ARTIFICIAL FERTILIZATION; SOIL DISINFECTANTS; CHEMICAL PREPARATIONS FOR MEDICAL APPLICATIONS, IN CLASS 5 (U.S. CLS. 6, 18, 44, 46, 51 AND 52).

FOR: LABORATORY INCUBATORS FOR BACTERIA CULTURE; CHROMATOGRAPHY APPARATUS FOR LABORATORIAL APPLICATIONS; DIAGNOSTIC APPARATUS FOR DETERMINING THE CONTENT OF VETERINARY DRUG RESIDUES IN FOOD SAMPLES; APPARATUS FOR PHYSICAL CHEMICAL TESTING, NAMELY, PLANT METABOLITE ANALYZER AND PROFILER APPARATUS; APPARATUS AND INSTRUMENTS FOR MEASURING, TESTING AND ANALYZING PHYSICAL AND CHEMICAL INGREDIENTS FOR LABORATORY USE; APPARATUS AND INSTRUMENTS FOR MEASURING PHYSICAL



PROPERTIES OF MATTER AND ENERGY; APPARATUS AND INSTRUMENTS FOR MEASURING AND TESTING CHEMICAL AND BIOCHEMICAL COMPOSITIONS, STRUCTURES, PROPERTIES AND REACTIONS FOR LABORATORY USE IN SCIENTIFIC RESEARCH; APPARATUS AND INSTRUMENTS FOR NON-MEDICAL DETECTION AND ANALYSIS OF MANUFACTURING TECHNIQUES IN THE COMPOSITION OF BIOCHIPS MADE FROM ORGANIC MOLECULES; NON-MEDICAL DIAGNOSTIC APPARATUS AND INSTRUMENTS FOR USE IN THE APPLICATION OF MEDICAL BIOCHIP MANUFACTURING TECHNIQUES, IN CLASS 9 (U.S. CLS. 21, 23, 26, 36 AND 38).

FOR: INCUBATORS FOR MEDICAL APPLICATIONS; MEDICAL INSTRUMENTS, NAMELY, MICRO ARRAY BIOCHIP SCANNERS FOR TESTING, ANALYZING, AND EVALUATING BIOLOGICAL SAMPLES FOR MEDICAL APPLICATIONS; ANALYSIS INSTRUMENTS FOR MEDICAL TREATMENT APPLICATIONS, NAMELY, AUTOMATED AND SEMI-AUTOMATED CHEMILUMINESCENT IMMUNOASSAY ANALYZER, AUTOMATED BIOCHEMICAL ANALYZER, AUTOMATED NUCLEIC ACID EXTRACTOR; DIAGNOSTIC APPARATUS FOR MEDICAL APPLICATIONS, NAMELY, REAL-TIME PCR MACHINE, LIQUID HANDLING MACHINE; APPARATUS FOR DIAGNOSING HUMAN GENETIC DISEASE, INFECTION DISEASE, CARDIAC DISEASE, TUMOR, DIABETES, BY THE APPLICATION OF BIOCHIP TECHNIQUES; MEDICAL APPARATUS AND INSTRUMENTS FOR DETECTION AND ANALYSIS OF HUMAN GENETIC DISEASE OR INFECTION DISEASE, CARDIAC DISEASE, TUMOR, DIABETES, BY THE APPLICATION OF BIOCHIP TECHNIQUE, IN CLASS 10 (U.S. CLS. 26, 39 AND 44).

FOR: RESEARCH AND DEVELOPMENT OF NEW PRODUCTS FOR OTHERS; TECHNICAL RESEARCH IN THE FIELDS OF MOLECULAR TYP-

ING, PROTOMICS, SYSTEM BIOLOGY, GENETICS, GENOMIC MEDICINE, MOLECULAR MEDICINE, HEALTH CARE, DIAGNOSTICS, BIOSAFETY, FORENSIC SCIENCE, CONDUCTING HIGH-THROUGHPUT TECHNIQUE SERVICES IN MULTI-FIELD INCLUDING NUCLEIC ACID, PROTEIN, CELL, TISSUE, WHILE EMPLOYING MICROARRAY PLATFORMS; CONDUCTING TECHNICAL PROJECT STUDIES IN THE FIELD OF MOLECULAR TYPING, PROTOMICS, GENETICS, GENOMIC MEDICINE, MOLECULAR MEDICINE, HEALTH CARE, DIAGNOSTICS, BIOSAFETY, FORENSIC SCIENCE, CONDUCTING HIGH-THROUGHPUT TECHNIQUE SERVICES IN THE MULTI-FIELD INCLUDING NUCLEIC ACID, PROTEIN, CELL, TISSUE, WHILE EMPLOYING MICROARRAY PLATFORMS; CHEMICAL ANALYSES; CHEMICAL LABORATORY SERVICES, NAMELY, SYNTHESIS, SURFACE CHEMISTRY, REAGENTS; CHEMICAL RESEARCH; BACTERIOLOGICAL RESEARCH; BIOLOGICAL RESEARCH; RENTAL OF SCIENTIFIC LABORATORY APPARATUS FOR USE IN BIOCHIP RESEARCH; RENTAL OF LABORATORY APPARATUS AND INSTRUMENTS FOR DETECTION AND ANALYSIS OF MEDICAL CONDITIONS AND DISEASES BY THE APPLICATION OF BIOCHIP TECHNIQUE; PROVIDING MEDICAL DIAGNOSTIC SERVICES BY THE APPLICATION OF BIOCHIP TECHNIQUE; QUALITY CONTROL FOR OTHERS; PROVIDING QUALITY ASSURANCE SERVICES BY EVALUATING RESEARCH CONTROLS AND DETECTING AREA FOR IMPROVEMENT, IN CLASS 42 (U.S. CLS. 100 AND 101).

OWNER OF INTERNATIONAL REGISTRATION 0867527 DATED 8-3-2005, EXPIRES 8-3-2015.

SER. NO. 79-017,322, FILED 8-3-2005.

KELLY BOULTON, EXAMINING ATTORNEY

**Int. Cls.: 6 and 20**

**Prior U.S. Cls.: 2, 12, 13, 14, 22, 23, 25, 32 and 50**

**United States Patent and Trademark Office**

**Reg. No. 3,499,205**

**Registered Sep. 9, 2008**

**TRADEMARK  
PRINCIPAL REGISTER**

# ixConnect

HÄFELE GMBH & CO KG (FED REP GERMANY  
GMBH & CO KG)  
ADOLF-HÄFELE-STRASSE 1  
72202 NAGOLD  
FED REP GERMANY

FOR: METAL FITTINGS FOR WINDOWS, DOORS  
AND FURNITURE, NAMELY, CONNECTING  
BOLTS, TRANSVERSE NUT BOLTS, EXPANDING  
SLEEVES, INSET SLEEVES, CORPUS CONNec-  
TORS, SHELF CONNECTORS, CORNER CONNec-  
TORS, CONNECTING ANGLES, HEADBOARD  
CONNECTORS, FOOTBOARD CONNECTORS,  
SNAP-IN LOCKS; METAL DOOR LOCKS, IN CLASS  
6 (U.S. CLS. 2, 12, 13, 14, 23, 25 AND 50).

FOR: NON-METALLIC FITTINGS FOR USE IN  
FURNITURE, NAMELY, CONNECTING BOLTS,  
TRANSVERSE NUT BOLTS, EXPANDING

SLEEVES, INSET SLEEVES, CORPUS CONNec-  
TORS, SHELF CONNECTORS, CORNER CONNec-  
TORS, CONNECTING ANGLES, HEADBOARD  
CONNECTORS, FOOTBOARD CONNECTORS,  
SNAP-IN LOCKS; DOOR LOCKS NOT OF METAL ,  
IN CLASS 20 (U.S. CLS. 2, 13, 22, 25, 32 AND 50).

PRIORITY DATE OF 4-28-2005 IS CLAIMED.

OWNER OF INTERNATIONAL REGISTRATION  
0870996 DATED 8-5-2005, EXPIRES 8-5-2015.

SER. NO. 79-018,620, FILED 8-5-2005.

RON FAIRBANKS, EXAMINING ATTORNEY

**Int. Cl.: 21**

**Prior U.S. Cls.: 2, 13, 23, 29, 30, 33, 40 and 50**

**Reg. No. 3,499,206**

**United States Patent and Trademark Office**

**Registered Sep. 9, 2008**

**TRADEMARK  
PRINCIPAL REGISTER**

**EXPRESS YOURSELF**

COFFEE NATION LIMITED (UNITED KING-  
DOM LIMITED LIABILITY COMPANY)  
3 KNAVES BEECH  
LOUDWATER, BUCKINGHAMSHIRE HP10 9QR  
UNITED KINGDOM

FOR: CUPS; CUPS FOR COFFEE; CUPS FOR  
DRINKING CHOCOLATES; LIDS FOR CUPS; COF-  
FEE BREWERS, NON-ELECTRIC; NON-PAPER  
COFFEE FILTERS BEING PART OF NON-ELEC-  
TRIC COFFEE MAKERS; COFFEE GRINDERS,  
HAND-OPERATED; COFFEE MAKERS, NON-  
ELECTRIC; COFFEE MAKING MACHINES, NON-  
ELECTRIC; COFFEE MILLS, HAND-OPERATED;  
COFFEE PERCOLATORS, NON-ELECTRIC; COF-  
FEE POTS, NON-ELECTRIC AND NOT OF PRE-

CIOUS METAL; COFFEE SERVICES NOT OF  
PRECIOUS METAL, IN CLASS 21 (U.S. CLS. 2, 13,  
23, 29, 30, 33, 40 AND 50).

THE MARK CONSISTS OF STANDARD CHAR-  
ACTERS WITHOUT CLAIM TO ANY PARTICULAR  
FONT, STYLE, SIZE, OR COLOR.

OWNER OF INTERNATIONAL REGISTRATION  
0871701 DATED 11-7-2005, EXPIRES 11-7-2015.

SER. NO. 79-019,025, FILED 11-7-2005.

JAMES A. RAUEN, EXAMINING ATTORNEY

**Int. Cls.: 18, 25 and 32**

**Prior U.S. Cls.: 1, 2, 3, 22, 39, 41, 45, 46 and 48**

**United States Patent and Trademark Office**

**Reg. No. 3,499,207**

**Registered Sep. 9, 2008**

**TRADEMARK  
PRINCIPAL REGISTER**



MONSIEUR XAVIER LAMADRID (FED REP  
GERMANY INDIVIDUAL)  
6 QUAI JEAN-CHARLES REY, LE RAPHAËL  
F-98000 MONACO, FRANCE

OWNER OF INTERNATIONAL REGISTRATION  
0875537 DATED 1-13-2006, EXPIRES 1-13-2016.

FOR: LEATHER AND IMITATION LEATHER  
GOODS, NAMELY, WALLETS AND HANDBAGS;  
LUGGAGE TRUNKS AND SUITCASES; CARRY-  
ALL BAGS; UMBRELLAS, PARASOLS; WALKING  
STICKS, IN CLASS 18 (U.S. CLS. 1, 2, 3, 22 AND 41).

THE COLOR(S) RED, BLACK AND WHITE IS/  
ARE CLAIMED AS A FEATURE OF THE MARK.

FOR: CLOTHING, NAMELY, T-SHIRTS, POLO  
SHIRTS, SHIRTS, BELTS, JACKETS, PULLOVERS,  
SHORTS, SOCKS, TROUSERS, GLOVES; FOOT-  
WEAR; AND HEADWEAR, IN CLASS 25 (U.S. CLS.  
22 AND 39).

THE COLOR RED APPEARS IN THE RECTAN-  
GULAR BACKGROUND FOR THE LITERAL ELE-  
MENTS, THE LITERAL ELEMENTS APPEAR IN  
THE COLOR WHITE, AND THE COLOR BLACK  
APPEARS IN THE RECTANGLE THAT IS BENEATH  
THE RED RECTANGLE.

FOR: NON-ALCOHOLIC DRINKS, NAMELY, EN-  
ERGY DRINKS; FRUIT DRINKS AND FRUIT JUI-  
CES, IN CLASS 32 (U.S. CLS. 45, 46 AND 48).

SER. NO. 79-020,418, FILED 1-13-2006.

PRIORITY DATE OF 12-16-2005 IS CLAIMED.

CHRISIE B. KING, EXAMINING ATTORNEY

**Int. Cl.: 20**

**Prior U.S. Cls.: 2, 13, 22, 25, 32 and 50**

**United States Patent and Trademark Office**

**Reg. No. 3,499,208**

**Registered Sep. 9, 2008**

**TRADEMARK  
PRINCIPAL REGISTER**

***INTERACT***

OKAMURA CORPORATION (JAPAN CORPORATION)  
7-18, KITASAIWAI 2-CHOME  
NISHI-KU, YOKOHAMA-SHI; KANAGAWA-KEN  
220-0004  
JAPAN

FOR: FURNITURE, NAMELY, OFFICE FURNITURE; SCHOOL FURNITURE; FURNITURE FOR HOUSE; CHAIRS; ARMCHAIRS; DESKS; TABLES; LOCKERS; INDEX CABINETS; FILING CABINETS; SHELVES FOR FILING-CABINETS; RACKS, NAMELY COAT RACKS, HAT RACKS, MAGAZINE RACKS, SHOE RACKS, STORAGE RACKS; DISPLAY RACKS; SCREENS; SHELVES FOR STORAGE;

STOOLS; SOFAS; SEATS; BENCHES; SIDEBOARDS; CHESTS OF DRAWERS; SHOWCASES, NAMELY DISPLAY CASES AND DISPLAY CASES FOR MERCHANDISE; SALES AND DISPLAY COUNTERS; FURNITURE PARTITIONS; FURNITURE OF METAL, IN CLASS 20 (U.S. CLS. 2, 13, 22, 25, 32 AND 50).

OWNER OF INTERNATIONAL REGISTRATION  
0882593 DATED 2-9-2006, EXPIRES 2-9-2016.

SER. NO. 79-022,902, FILED 2-9-2006.

SUE LAWRENCE, EXAMINING ATTORNEY

**Int. Cls.: 7 and 9**

**Prior U.S. Cls.: 13, 19, 21, 23, 26, 31, 34, 35, 36 and 38**

**Reg. No. 3,499,209**

**United States Patent and Trademark Office**

**Registered Sep. 9, 2008**

**TRADEMARK  
PRINCIPAL REGISTER**



EMUGE-WERK RICHARD GLIMPEL; GMBH & CO KG FABRIK FÜR; PRÄZISIONSWERKZEUGE (FED REP GERMANY GMBH & CO KG)

NÜRNBERGER STR. 96-100  
91207 LAUF AN DER PEGNITZ  
FED REP GERMANY

FOR: TOOLS FOR USE IN MACHINES, NAMELY, DIES, CUTTERS, DRILLS, DRILL BITS, POLISHERS, SANDERS, GRINDERS AND STRUCTURAL PARTS THEREFORE, NAMELY, DIES, CUTTERS, DRILLS, DRILL BITS, POLISHERS, SANDERS, GRINDERS; TOOLS FOR USE IN MACHINES FOR THE CUTTING AND FORMING OF MATERIALS, NAMELY, CUTTING TOOLS, MILLING TOOLS, DRILLING TOOLS, THREAD-GENERATING TOOLS, SCREW THREAD-TAPPING TOOLS, THREAD-MILLING TOOLS, THREAD-FORMING TOOLS; MACHINE TOOL HOLDERS; MACHINE TOOL COMPONENTS FOR MACHINES FOR THE TREATMENT OF MATERIALS, NAMELY, FOR CUTTING TOOLS, MILLING TOOLS, DRILLING TOOLS, THREAD-GENERATING TOOLS, SCREW THREAD-TAPPING TOOLS, THREAD-MILLING TOOLS, THREAD-FORMING TOOLS, IN CLASS 7 (U.S. CLS. 13, 19, 21, 23, 31, 34 AND 35).

FOR: TOOL MONITORING SYSTEMS FOR MACHINES AND MACHINE TOOLS, IN PARTICULAR FOR MACHINES AND MACHINE TOOLS FOR THE TREATMENT OF MATERIALS, NAMELY, COMPUTER HARDWARE; SURVEYING MACHINES AND

INSTRUMENTS FOR THE SURVEYING OF MACHINES AND MACHINE TOOLS FOR THE TREATMENT OF MATERIALS; GAUGES, NAMELY, THREAD GAUGES, THREAD RING GAUGES, THREAD PLUG GAUGES, IN CLASS 9 (U.S. CLS. 21, 23, 26, 36 AND 38).

PRIORITY DATE OF 8-22-2005 IS CLAIMED.

OWNER OF INTERNATIONAL REGISTRATION 0887800 DATED 2-10-2006, EXPIRES 2-10-2016.

OWNER OF U.S. REG. NOS. 872,072, 1,453,945, AND 1,923,300.

THE COLOR(S) WHITE, ORANGE IS/ARE CLAIMED AS A FEATURE OF THE MARK.

THE MARK CONSISTS OF "EMUGE" IN WHITE WITH AN ORANGE RECTANGLE AS A BACKGROUND. THE WORD "FRANKEN" APPEARS IN ORANGE WITH A WHITE RECTANGLE AND AN ORANGE OUTLINE AROUND THE WHITE RECTANGLE.

SER. NO. 79-024,943, FILED 2-10-2006.

KAPIL BHANOT, EXAMINING ATTORNEY

Int. Cls.: 3, 9, 14, 16, 18, 21, 24, 25, 28, 38, 41 and 42

Prior U.S. Cls.: 1, 2, 3, 4, 5, 6, 13, 21, 22, 23, 26, 27, 28, 29, 30, 33, 36, 37, 38, 39, 40, 41, 42, 50, 51, 52, 100, 101, 104 and 107

Reg. No. 3,499,210

United States Patent and Trademark Office

Registered Sep. 9, 2008

TRADEMARK  
SERVICE MARK  
PRINCIPAL REGISTER



VOOZ CO., LTD. (REPUBLIC OF KOREA CORPORATION)  
3F SUN BUILDING  
669-9 YEOKSAM-DONG, KANGNAM-KU  
SEOUL, REPUBLIC OF KOREA

FOR: NOURISHING SKIN CREAMS, COSMETIC SUN-TANNING PREPARATIONS, SUNSCREEN LOTIONS, EYE SHADOW, DEODORANTS FOR PERSONAL USE, COLD CREAMS, FOUNDATION CREAMS, PERFUMES, SKIN WHITENING CREAMS, HAIR MOUSSE, LIPSTICKS, HAIR LOTIONS, HAIR CREAMS, MAKE-UP POWDER, FALSE EYELASHES, LAUNDRY SOAPS, COSMETIC SOAPS, SHAMPOOS, HAIR RINSES, DENTIFRICES, MASCARA, NON-MEDICATED MOUTH WASHES, NAIL POLISH, BATH OIL, BABY OIL, SUNTAN OILS FOR COSMETIC PURPOSES, IN CLASS 3 (U.S. CLS. 1, 4, 6, 50, 51 AND 52).

FOR: COMPUTER HARDWARE, CAMERAS, CAMCORDERS, PROTECTIVE HELMETS, COMPUTER GAME SOFTWARE AND COMPUTER GAME SOFTWARE THAT MAY BE DOWNLOADED FROM A GLOBAL COMPUTER NETWORK, GAME SOFTWARE FOR VIDEO GAME PLAYERS, AND VIDEO OUTPUT GAME AMUSEMENT MACHINES FOR USE WITH TELEVISION, RECORDED VIDEO-

TAPES FEATURING ANIMATED CARTOONS, BLANK CD-ROMS FOR SOUND OR VIDEO RECORDING, PERSONAL DIGITAL ASSISTANTS, COMPUTER OPERATING PROGRAMS, COMPUTER MONITORS, NOTEBOOK COMPUTERS, COMPUTER MOUSE, MOUSE PADS, ELECTRONIC VENDING MACHINES, COMPUTER DISC DRIVES, WRIST RESTS FOR USE WITH COMPUTERS, BLANK MAGNETIC COMPUTER TAPES, JUKE BOXES FOR COMPUTERS, COMPUTER PRINTERS, COMPUTER GAME EQUIPMENT ADAPTED FOR USE WITH TELEVISION RECEIVERS ONLY CONTAINING MEMORY DEVICES, NAMELY, DISCS, VIDEO DISCS AND VIDEO TAPES WITH RECORDED ANIMATED CARTOONS, DRY CELLS, TELESCOPES, BINOCULARS, EYEGLASSES, SUNGLASSES, DVD PLAYERS, MP3 PLAYERS, DOWNLOADABLE DIGITAL MUSIC VIA A GLOBAL COMPUTER NETWORK, IN CLASS 9 (U.S. CLS. 21, 23, 26, 36 AND 38).

FOR: TEAPOTS OF PRECIOUS METAL, BOWLS OF PRECIOUS METAL, SOUP BOWLS OF PRECIOUS METAL, RICE BOWLS OF PRECIOUS METAL, DISHES OF PRECIOUS METAL, TEACUPS OF PRECIOUS METAL, COFFEE CUPS OF PRECIOUS METAL, CUPS OF PRECIOUS METAL, KEY RINGS AND KEY FOBs OF PRECIOUS METAL, STOPWAT-

CHES, AUTOMOBILE CLOCKS, ALARM CLOCKS, ELECTRONIC CLOCKS AND WATCHES, TABLE CLOCKS, WRISTWATCHES, POCKET WATCHES, EARRINGS, BADGES OF PRECIOUS METAL, BUCKLES OF PRECIOUS METAL, BELT ORNAMENTS OF PRECIOUS METALS, MEDALS, NECKLACES, RINGS BEING JEWELRY, IN CLASS 14 (U.S. CLS. 2, 27, 28 AND 50).

FOR: GARBAGE BAGS OF PAPER OR OF PLASTICS; STICKERS; SIGNBOARDS OF PAPER OR CARDBOARD; PLACARDS OF PAPER OR CARDBOARD; ADVERTISEMENT BOARDS OF PAPER OR CARDBOARD; PENNANTS OF PAPER; CORRUGATED CARDBOARDS; NAPKIN PAPER; LUMINOUS PAPER; WATERPROOF PAPER; FIREPROOF PAPER; WHITE PAPERBOARD; DUPLICATING PAPER; CARDBOARD MADE FROM PAPER MULBERRY; PRINTING PAPER; OIL PAPER FOR FLOOR; HANDKERCHIEFS OF PAPER; TOWELS OF PAPER; FACE TOWELS OF PAPER; CARBON PAPER; TYPEWRITING PAPER; CARDBOARD PAPERBOARD; FACSIMILE PAPER; POSTCARD PAPER; PACKING PAPER; MILLBOARD; WRITING AND DRAWING PAPER; TISSUES OF PAPER FOR REMOVING MAKE-UP; TAGS FOR INDEX CARDS; CALCULATING TABLES; NOTE BOOKS; MEMO PAPER; PLOTTING PAPERS; ENVELOPES; POCKET NOTEBOOKS; SKETCH BOOKS; SCRAPBOOKS; ALBUMS FOR PHOTOGRAPHS; FOUNTAIN PENS; BALL POINT PENS; CHALKS; WRITING BRUSHES; FELT PENS FOR WRITING; SHARP PENCILS; SLATE PENCILS; PENCILS; STEEL PENS; PENS FOR USE AS WRITING INSTRUMENTS; PEN-HOLDERS; PAINT BOXES FOR USE IN SCHOOLS; CHARCOAL PENCILS; ENGRAVING PLATES; CANVAS FOR PAINTING; CRAYONS; PASTELS; PAINTBRUSHES; PAINTERS' EASELS; PALETTES FOR PAINTERS; RUBBER ERASERS; SEALING STAMPS; LOOSE-LEAF BINDERS; DOCUMENT FILES; GUMMED TAPE FOR STATIONERY; ADHESIVE TAPES FOR STATIONERY; GLUE FOR STATIONERY; CHALK ERASERS; OFFICE REQUISITES, NAMELY, RUBBER BANDS, PUNCHES, CORRECTING FLUIDS FOR TYPE, PAPER KNIVES AND STAPLERS; PHOTOGRAPH STANDS; PAPER FOLDERS; STAMP STANDS; STAMP PADS; STAMP CASES; THUMBTRACKS; PENCIL SHARPENERS; DUPLICATING INK; INKWELLS; INK ERASERS; DRAWING SQUARES; COMPASSES FOR DRAWING; DRAWING T-SQUARES; DRAFTING PAPER; SQUARE RULERS FOR DRAFTING; PRINTED CHARTS; BLACKBOARDS; PAPER CLIPS; PEN AND PENCIL CASES AND BOXES; CORRUGATED CARDBOARD BOXES; PAPER BOXES; PAPER SACKS FOR WRAPPING; PLASTIC SACKS FOR WRAPPING; PICTURE POSTCARDS; SONG BOOKS; CALENDARS; COMIC BOOKS; MUSICAL GREETING CARDS; TELEPHONE CALLING CARDS NOT MAGNETICALLY ENCODED; CREDIT CARDS WITHOUT MAGNETIC CODING; MUSICAL NOTE SHEETS; GREETING CARDS; POSTCARDS; POSTAGE STAMPS; PRINTED TEACHING MATERIALS IN THE FIELD OF MUSIC; DIARIES; TELEPHONE DIRECTORIES; GEOGRAPHICAL MAPS; CATALOGUES IN THE FIELD OF COMPUTER ANIMATION; PRINTED TICKETS, PAMPHLETS IN THE FIELD

OF COMPUTER ANIMATION; POSTERS, PHOTOGRAPHS; MODELING CLAY; BABIES' DIAPERS OF PAPER; ENGRAVINGS, IN CLASS 16 (U.S. CLS. 2, 5, 22, 23, 29, 37, 38 AND 50).

FOR: CLOTHING FOR PETS; DOG COLLARS; ARTIFICIAL FUR; DIAPER BAGS; BACKPACKS IN THE NATURE OF RUCKSACKS; SCHOOL CHILDREN'S BACKPACKS; BUSINESS CARD CASES; BOSTON BAGS; PURSES NOT OF PRECIOUS METAL; BEACH BAGS; BRIEFCASES; SUITCASES; CASES FOR CREDIT CARDS; TRAVELING BAGS; TRAVELING TRUNKS; PASSPORT CASES; BAGS FOR PACKING IN THE NATURE OF CARRY-ON BAGS; SCHOOL BAGS; HANDBAGS; BEACH UMBRELLAS IN THE NATURE OF BEACH PARASOLS; PARASOLS IN THE NATURE OF SUN UMBRELLAS; UMBRELLAS, IN CLASS 18 (U.S. CLS. 1, 2, 3, 22 AND 41).

FOR: SOAP BOXES, COSMETIC BRUSHES, FITTED VANITY CASES, TOOTHBRUSHES, BROOMS, TRASH CANS, DUST BINS, DUST PANS, CLEANING RAGS, TEMPERED GLASS NOT FOR BUILDING, MOSAICS OF GLASS NOT FOR BUILDING, COMMON SHEET GLASS NOT FOR BUILDING, PANS, PITCHERS, NON-ELECTRIC KETTLES, NON-ELECTRIC FRYING PANS, NON-ELECTRIC COFFEEPOTS NOT OF PRECIOUS METAL, MUGS NOT OF PRECIOUS METAL, DRINKING CUPS NOT OF PRECIOUS METAL, DISHES NOT OF PRECIOUS METAL, TEACUPS NOT OF PRECIOUS METAL, PLASTIC CUPS, DRINKING HORNS, MESS-TINS, CHOPPING BOARDS FOR KITCHEN USE, SPICE RACKS, BUCKETS, INSULATING FLASKS, PORTABLE COOLER, PIGGY BANKS NOT OF METAL, BIRDCAGES, CAGES FOR HOUSEHOLD PETS, TOILET PAPER HOLDERS, HOLDERS FOR HOUSEHOLD IRONS, PORTABLE BABY BATH TUBS, PAPER CUPS, BOTTLES FOR BEVERAGES SOLD EMPTY, PLASTIC BOTTLES SOLD EMPTY, SHOE BRUSHES, FLOWER VASES NOT OF PRECIOUS METAL, POTTERY, NAMELY, DISHES, ELECTRIC HAIR COMBS, ELECTRIC TOOTHBRUSHES, SCULPTURES MADE OF GLASS, SCULPTURES MADE OF PORCELAIN, IN CLASS 21 (U.S. CLS. 2, 13, 23, 29, 30, 33, 40 AND 50).

FOR: SHOWER CURTAINS, FITTED TOILET LID COVERS MADE OF FABRIC, UNFITTED FURNITURE COVERINGS OF TEXTILE, TEXTILE TABLECLOTHS, PLACE MATS OF TEXTILE, FABRIC TABLE RUNNERS, TEXTILE PIANO COVERS, QUILTS, MATTRESS COVERS, PILLOWCASES, SLEEPING BAGS AS BED LINENS, PAPER BED COVERS, COVERS FOR CUSHIONS, HANDKERCHIEFS OF TEXTILE, TOWELS OF TEXTILE, SILK FABRICS, COTTON FABRICS, WOOL BASE MIXED FABRICS, COTTON BASE MIXED FABRICS, SEMI-SYNTHETIC FIBER FABRICS, IN CLASS 24 (U.S. CLS. 42 AND 50).

FOR: LEATHER SHOES, GOLF SHOES, BASKETBALL SHOES, SHOES, MOUNTAINEERING BOOTS, LACE BOOTS, BATH SANDALS, BATH SLIPPERS, HALF-BOOTS, WINTER BOOTS, BOOTS, VINYL SHOES, BEACH SHOES, SANDALS, SKI BOOTS,



SLIPPERS, NON-SLIPPING DEVICES FOR BOOTS AND SHOES IN THE NATURE OF SOLES, BASE-BALL SHOES, ESPARTO SHOES OR SANDALS, OVERSHOES, RAIN BOOTS, TRAINING SHOES, WORK SHOES AND BOOTS, LONG BOOTS, GYM-NASTIC SHOES, FOOTBALL SHOES, AEROBICS SUITS, ANORAKS FOR EXERCISES, MASQUERADE COSTUMES, SCHOOL UNIFORMS, RAIN-COATS, OVERCOATS, LIVERIES, KNEE TROUSERS, HALF-COATS, BLOUSONS, SARIS, SAFARIS SUITS, SUITS, SMOCKS, SKIRTS, SLACKS, ANORAKS NOT FOR EXERCISES, CHILDREN'S SHIRTS, CEREMONIAL DRESSES, OVERALLS, INFANTS' SLEEPERS, EVENING DRESSES, JACKETS, WORK UNIFORMS, JUMPERS, CHASUBLES, BLUE JEANS, CAPES, COMBINATIONS, TOPCOATS, TO-GAS, TUNICS, PARKAS, PELISSES, FROCKS, T-SHIRTS, GIRDLES, NIGHTGOWNS, BUTTON-FRONT ALOHA SHIRTS, NEGLIGEEES, DRESSING GOWNS, ROMPERS, LEOTARDS, MANTILLAS, BATH ROBES, BODICES, BODY SHIRTS, BRAS-SIERES, BLOUSES, SHOWER CAPS, SHIRT YOKES, SHIRT FRONTS, UNDERWEAR, UNDERSHIRTS, UNDERPANTS, BATHING CAPS, SWIMSUITS, BATHING TRUNKS, CHEMISETTES, CHEMISES, SWEATERS, SWEAT SHIRTS, SWEAT PANTS, SPORTS SHIRTS, SLIPS FOR USE AS UNDERGAR-MENTS, UNIFORMS FOR EXERCISES, COLLARS, NIGHTWEAR, JERSEYS, VESTS, CARDIGANS, COLLAR PROTECTORS, COLLAR CUFFS, CAMI-SOLES, TANK TOPS, TEDDIES IN THE NATURE OF UNDERGARMENTS, TRACKSUITS, PAJAMAS, PETTICOATS, POLO SHIRTS, PULLOVERS, NECK-TIES, SWEAT-ABSORBENT STOCKINGS, LEG WARMERS, LEGGINGS, MUFFS, MUFFLERS, BANDANAS, EAR MUFFS, WINTER GLOVES, MIT-TENS, VEILS, BOAS, FOOT MUFFS NOT ELECTRI-CALLY HEATED, SHAWLS, SHOULDER WRAPS, SCARVES, STOCKINGS, STOLEES, SOCKS, POCKET SQUARES, APRONS, STOCKINGS FOR EXERCISES, INFANT CLOTH DIAPERS, TIGHTS, NIGHTCAPS, CAPS, SUN VISORS, HOODS, WATERPROOF JACK-ETS, GAITERS, STOCKING SUSPENDERS, SOCK SUSPENDERS, BRACES FOR CLOTHING IN THE NATURE OF SUSPENDERS, AND LEATHER BELTS, IN CLASS 25 (U.S. CLS. 22 AND 39).

FOR: TOYS FOR DOMESTIC PETS; TOY MASKS; RUBBER CHARACTER TOYS; METAL CLOCK-  
WORK TOYS; MARIONETTES; BABY RATTLES;  
REMOTE CONTROLLED MOBILES TOYS EXCEPT  
AMUSEMENT APPARATUS ADAPTED FOR USE  
WITH TELEVISION RECEIVERS; MASCOT DOLLS;  
TOY MOBILES; WOODEN ACTION TOYS; TOY  
CONSTRUCTION SETS; PUPPETS; SCALE MODEL  
VEHICLES FOR CHILDREN; TOY TRICYCLES FOR  
INFANTS; ROCKING HORSES; MUSICAL TOYS;  
TOY BUILDING BLOCKS; TOY SCOOTERS; TOY  
FLYING DISCS; DOLLS' ROOMS; DOLLS' FEEDING  
BOTTLES; CLOTHES FOR DOLLS; DOLLS'  
HOUSES; DOLLS' BEDS; TOY PISTOLS; PAPER  
AIRPLANES; PLUSH TOYS; PLASTIC CHARACTER  
TOYS; DARTS; DOMINOES; BOARD GAMES; BIN-  
GO CARDS; CONFETTI; BACKGAMMON GAMES;  
KITES; TOY SLOT MACHINES; DICE; CHESS  
BOARDS; CHECKERS; PLAYING CARDS; SPIN-  
NING TOPS; JIGSAW PUZZLES; SWING SETS;

RACKETS; GLOVES FOR RACKETS; RUNNING  
MACHINES; ROWING MACHINES FOR PHYSICAL  
EXERCISE OTHER THAN FOR MEDICAL USE;  
ROLLER SKATES; ROCKING HORSES; KNEE  
GUARDS FOR SPORTS USE; PLAYGROUND  
EQUIPMENT IN THE NATURE OF SLIDES; BOWL-  
ING BAGS; BOWLING GLOVES; BOWLING BALLS;  
CYCLE GLOVES; PAINTBALL GUNS; SURF-  
BOARDS; SNOW GLOBES; SNOWSHOES; SKATE-  
BOARDS; SKIS; SKI BAGS; SKI GLOVES; TOY  
SLEIGHS; SPRING BOARDS FOR USE AS SPORT-  
ING ARTICLES; ICE SKATES; PREFABRICATED  
SWIMMING POOLS; SKIPPING ROPES; PUNCHING  
BALLS FOR BOXING PRACTICE; RODS FOR FISH-  
ING, IN CLASS 28 (U.S. CLS. 22, 23, 38 AND 50).

FOR: COMMUNICATIONS BY FIBER OPTIC  
NETWORKS, WIRELESS BROADBAND COMMU-  
NICATION SERVICES, ELECTRONIC MAIL SERVIC-  
ES, SATELLITE COMMUNICATION SERVICES,  
PROVIDING USER ACCESS TO A GLOBAL COM-  
PUTER NETWORK, RENTAL OF TELECOMMUNI-  
CATION EQUIPMENT, COMMUNICATIONS BY  
TELEGRAM, PROVIDING ELECTRONIC BULLE-  
TIN BOARD FOR THE TRANSMISSION OF MES-  
SAGES AMONG USERS IN THE FIELD OF  
GENERAL INTEREST, ELECTRONIC TRANSMIS-  
SION OF MESSAGES AND IMAGES, TELECOMMU-  
NICATIONS ROUTING AND JUNCTION  
SERVICES, CELLULAR TELEPHONE COMMUNI-  
CATION, RADIO BROADCASTING, CABLE TELE-  
VISION BROADCASTING, BROADCASTING  
SERVICES PROVIDED VIA THE INTERNET, TELE-  
VISION BROADCASTING, IN CLASS 38 (U.S. CLS.  
100, 101 AND 104).

FOR: RENTAL OF RADIO AND TELEVISION  
SETS, PRODUCTION OF RADIO AND TELEVISION  
PROGRAMS, PRODUCTION OF VIDEO FILMS,  
VIDEO TAPE EDITING, DISTRIBUTION OF FILMS,  
FILM PRODUCTION, PUBLICATION OF BOOKS,  
PROVIDING ONLINE NON-DOWNLOADABLE  
ELECTRONIC PUBLICATIONS IN THE NATURE  
OF MAGAZINES IN THE FIELD OF ANIMATION,  
PUBLICATION OF ELECTRONIC BOOKS AND  
JOURNALS ONLINE, ANIMATION PRODUCTION  
SERVICES, PROVIDING ONLINE COMPUTER  
GAMES, PROVIDING INFORMATION ABOUT ON-  
LINE GAMES, IN CLASS 41 (U.S. CLS. 100, 101 AND  
107).

FOR: CREATING AND MAINTAINING WEB  
SITES FOR OTHERS, CONVERSION OF DATA OR  
DOCUMENTS FROM PHYSICAL TO ELECTRONIC  
MEDIA, RENTAL OF COMPUTER SOFTWARE,  
COMPUTER SOFTWARE DESIGN FOR OTHERS,  
COMPUTER SYSTEMS DESIGN FOR OTHERS,  
COMPUTER PROGRAMMING, INDUSTRIAL DE-  
SIGN, CARTOON CHARACTER ANIMATION DE-  
SIGN FOR OTHERS, LICENSING OF  
INTELLECTUAL PROPERTY , IN CLASS 42 (U.S.  
CLS. 100 AND 101).

OWNER OF INTERNATIONAL REGISTRATION  
0890793 DATED 5-27-2005, EXPIRES 5-27-2015.

THE COLOR(S) BLACK, RED, BEIGE, PURPLE AND WHITE IS/ARE CLAIMED AS A FEATURE OF THE MARK.

THE MARK CONSISTS OF A DESIGN OF A GIRL'S FACE WITH BLACK HAIR. UNDERNEATH APPEAR THE WORD "PUCCA" IN RED AND OUTLINED IN BLACK, THE "AND" SYMBOL APPEARING IN WHITE OUTLINED IN BLACK, AND THE

WORD "GARU" APPEARING IN PURPLE OUTLINED IN BLACK. THE LETTER "P" OF "PUCCA" HAS A DESIGN OF TWO BLACK CIRCLES AND THE LETTER "A" OF "GARU" HAS A WHITE TEARDROP DESIGN.

SER. NO. 79-026,038, FILED 5-27-2005.

GISELLE AGOSTO, EXAMINING ATTORNEY

**Int. Cls.: 38, 41 and 42**

**Prior U.S. Cls.: 100, 101, 104 and 107**

**United States Patent and Trademark Office**

**Reg. No. 3,499,211**

**Registered Sep. 9, 2008**

**SERVICE MARK  
PRINCIPAL REGISTER**



TRANSMEDIA COMMUNICATIONS SA (SWITZERLAND SOCIÉTÉ ANONYME)  
RUE DE LYON 107  
CH-1203 GENÈVE  
SWITZERLAND

FOR: TELECOMMUNICATION SERVICES, NAMELY, SATELLITE TELEVISION, VIDEO BROADCASTING AND PROVISION OF TELECOMMUNICATION ACCESS TO VISUAL AND AUDIO PERFORMANCES, NAMELY, MUSICAL, VARIETY, AND COMEDY PERFORMANCES PROVIDED VIA A VIDEO-ON-DEMAND SERVICE; ELECTRONIC AND DIGITAL TRANSMISSION OF VOICE, DATA, IMAGES, SIGNALS AND MESSAGES; ELECTRONIC TRANSMISSION OF VOICE, DATA AND IMAGES BY SATELLITE TELEVISION AND VIDEO BROADCASTING AND VIA A VIDEO-ON-DEMAND TRANSMISSION SERVICE; TELECOMMUNICATIONS CONSULTATION SERVICES, NAMELY, CONSULTATION SERVICES TO CABLE NETWORKS, TELEPHONY, DSL AND FIBER-OPTIC NETWORKS, SATELLITE NETWORKS AND MEDIA NETWORKS RELATING TO THE PROVISION OF VIDEO ON DEMAND SERVICES, IN CLASS 38 (U.S. CLS. 100, 101 AND 104).

FOR: MULTIMEDIA ENTERTAINMENT SERVICES IN THE NATURE OF RECORDING, PRODUCTION AND POST-PRODUCTION SERVICES IN THE FIELDS OF MUSIC, VIDEO, TELEVISION, AND FILMS; MOBILE MEDIA AND ENTERTAINMENT SERVICES IN THE NATURE OF CONTENT PREPARATION; ENTERTAINMENT SERVICES, NAMELY, THE PRODUCTION AND DISTRIBUTION OF VISUAL AND AUDIO PERFORMANCES, NAMELY, MUSICAL, VARIETY, COMEDY AND DRAMATIC PERFORMANCES AND LIVE TELEVISION AND INTERNET SHOWS; ENTERTAINMENT SERVICES, NAMELY, THE PRODUCTION AND DISTRIBUTION OF VISUAL AND AUDIO PERFORMANCES,

NAMELY, MUSICAL, VARIETY, COMEDY AND DRAMATIC PERFORMANCES, SHORT FILMS, FEATURES, MOVIES, TELEVISION SERIES, MINI-SERIES, DOCUMENTARY FILMS, MOCK DOCUMENTARY FILMS, ANIMATED FILMS, CARTOONS, REALITY TELEVISION SHOWS; ENTERTAINMENT SERVICES, NAMELY, THE PRODUCTION AND DISTRIBUTION OF INTERACTIVE DIGITAL PROGRAMS IN THE NATURE OF LIVE MUSICAL, VARIETY, COMEDY AND DRAMATIC PERFORMANCES AND LIVE TELEVISION AND INTERNET SHOWS; ENTERTAINMENT SERVICES, NAMELY, THE PRODUCTION AND DISTRIBUTION OF INTERACTIVE DIGITAL PROGRAMS IN THE NATURE OF MUSICAL, VARIETY, COMEDY AND DRAMATIC PERFORMANCES, SHORT FILMS, FEATURES, MOVIES, TELEVISION SERIES, MINI-SERIES, DOCUMENTARY FILMS, MOCK DOCUMENTARY FILMS, ANIMATED FILMS, CARTOONS, REALITY TELEVISION SHOWS; ENTERTAINMENT SERVICES, NAMELY, THE PRODUCTION AND DISTRIBUTION OF SATELLITE TELEVISION PROGRAMS; PROVISION OF NON-DOWNLOADABLE LIVE OR RECORDED VISUAL AND AUDIO PERFORMANCES, NAMELY, MUSICAL, VARIETY, AND COMEDY PERFORMANCES VIA A VIDEO-ON-DEMAND SERVICE, IN CLASS 41 (U.S. CLS. 100, 101 AND 107).

FOR: SCIENTIFIC AND TECHNOLOGICAL RESEARCH IN THE FIELD OF TELECOMMUNICATIONS; INDUSTRIAL DESIGN SERVICES; CONSULTING SERVICES IN THE FIELD OF DESIGN, SELECTION, IMPLEMENTATION AND USE OF COMPUTER HARDWARE AND SOFTWARE SYSTEMS FOR OTHERS; RENTAL OF COMPUTER SOFTWARE; INSTALLATION, MAINTENANCE, AND REPAIR OF COMPUTER SOFTWARE; UPDATING OF COMPUTER SOFTWARE FOR OTHERS; LEGAL SERVICES; LEGAL SERVICES, NAMELY, LICENSING OF INTELLECTUAL PROP-

ERTY; CONVERSION OF DATA OR DOCUMENTS FROM PHYSICAL TO COMPUTER MEDIA; CONVERSION OF DATA AND COMPUTER PROGRAMS; COMPUTER PROGRAMMING; DATABASE DEVELOPMENT SERVICES, IN CLASS 42 (U.S. CLS. 100 AND 101).

PRIORITY DATE OF 1-3-2006 IS CLAIMED.

OWNER OF INTERNATIONAL REGISTRATION 0894433 DATED 6-27-2006, EXPIRES 6-27-2016.

NO CLAIM IS MADE TO THE EXCLUSIVE RIGHT TO USE "I-CINEMA", APART FROM THE MARK AS SHOWN.

THE ENGLISH TRANSLATION OF THE FOREIGN WORD(S) IN THE MARK IS: I CINEMA.

SER. NO. 79-027,287, FILED 6-27-2006.

SETH A. RAPPAPORT, EXAMINING ATTORNEY

**Int. Cls.: 3, 14 and 18**

**Prior U.S. Cls.: 1, 2, 3, 4, 6, 22, 27, 28, 41, 50, 51 and 52**

**United States Patent and Trademark Office**

**Reg. No. 3,499,212**

**Registered Sep. 9, 2008**

**TRADEMARK  
PRINCIPAL REGISTER**



BHL S.A. (LUXEMBOURG SOCIÉTÉ ANONYME)  
10, RUE NICOLAS ADAMES  
L-1114 LUXEMBOURG  
LUXEMBOURG

FOR: COSMETICS, NAMELY, DAY AND NIGHT CREAMS, NON-MEDICATED SKIN CLEANSING PREPARATIONS FOR FACE AND BODY CARE, BUBBLE BATH, SHAVING FOAM, AFTER-SHAVE, FOUNDATION, NAIL POLISH, PERSONAL DEODORANTS FOR MEN AND WOMEN, HAND AND BODY SOAPS, SHAMPOOS AND HAIR RINSES, DENTIFRICES AND PERFUMERY, NAMELY, PERFUME AND TOILET WATER, AND ESSENTIAL OILS FOR PERSONAL USE, IN CLASS 3 (U.S. CLS. 1, 4, 6, 50, 51 AND 52).

FOR: PRECIOUS METALS AND THEIR ALLOYS; GOODS FORMED OF PRECIOUS METALS AND THEIR ALLOYS OR COATED THEREWITH, NAMELY, SCULPTURES AND SERVIETTE RINGS; JEWELRY; PRECIOUS STONES; TIMEPIECES AND CHRONOMETRIC INSTRUMENTS, IN CLASS 14 (U.S. CLS. 2, 27, 28 AND 50).

FOR: LEATHER AND IMITATION LEATHER; SCHOOL BAGS, HANDBAGS, RUCKSACKS,

TRUNKS AND SUITCASES; SADDLEBAGS; TRAVELING BAGS AND TRUNKS; CARRY-ALL BAGS AND HOLDALLS; LEATHER AND IMITATION LEATHER HAT BOXES FOR TRAVEL; ATTACHE CASES; CASES SOLD EMPTY FOR MAKEUP; BUSINESS CASES; BRIEFCASES; KEY CASES OF LEATHER; UNFITTED TOILETRY AND MAKEUP BAGS SOLD EMPTY; WALLETS; PURSES NOT OF PRECIOUS METAL; DOCUMENT HOLDERS, NAMELY, CARRYING CASES FOR DOCUMENTS; CARD WALLETS; LEATHER STRAPS; UMBRELLAS; PARASOLS AND WALKING STICKS; WHIPS, HARNESSES AND SADDLERY, IN CLASS 18 (U.S. CLS. 1, 2, 3, 22 AND 41).

PRIORITY DATE OF 11-3-2005 IS CLAIMED.

OWNER OF INTERNATIONAL REGISTRATION  
0894634 DATED 4-21-2006, EXPIRES 4-21-2016.

SER. NO. 79-027,359, FILED 4-21-2006.

MICHAEL WIENER, EXAMINING ATTORNEY

**Int. Cls.: 3 and 11**

**Prior U.S. Cls.: 1, 4, 6, 13, 21, 23, 31, 34, 50, 51 and 52**

**United States Patent and Trademark Office**

**Reg. No. 3,499,213**

**Registered Sep. 9, 2008**

**TRADEMARK  
PRINCIPAL REGISTER**

# OPTIONS BY HIVE

HIVE OF BEAUTY LIMITED (UNITED KING-  
DOM LIMITED COMPANY)  
LOVELL, LICHFIELD ROAD  
INDUSTRIAL ESTATE, TAMWORTH  
STAFFORDSHIRE, UNITED KINGDOM B79 7TA

FOR: WAX FOR COSMETIC PURPOSES, NAME-  
LY, WAX STRIPS FOR REMOVING BODY HAIR;  
NON-MEDICATED SKIN CARE PREPARATIONS;  
DEPILATORY PREPARATIONS, NAMELY, DEPI-  
LATORIES AND DEPILATORY CREAMS; SUN  
PROTECTION PREPARATIONS, NAMELY, SUN  
SCREEN PREPARATIONS AND SUN BLOCK PRE-  
PARATIONS; COTTON WOOL FOR COSMETIC  
PURPOSES; EMERY BOARDS; GAUZE FOR COS-  
METIC PURPOSES; COTTON SWABS FOR COS-  
METIC PURPOSES; HAND CLEANING  
PREPARATIONS, IN CLASS 3 (U.S. CLS. 1, 4, 6, 50,  
51 AND 52).

FOR: WAX HEATING APPARATUS, PARTS AND  
FITTINGS FOR THE AFORESAID GOODS SOLD AS  
A UNIT, IN CLASS 11 (U.S. CLS. 13, 21, 23, 31 AND 34).

THE MARK CONSISTS OF STANDARD CHAR-  
ACTERS WITHOUT CLAIM TO ANY PARTICULAR  
FONT, STYLE, SIZE, OR COLOR.

PRIORITY DATE OF 12-16-2005 IS CLAIMED.

OWNER OF INTERNATIONAL REGISTRATION  
0895173 DATED 6-12-2006, EXPIRES 6-12-2016.

SER. NO. 79-027,614, FILED 6-12-2006.

STEPHEN AQUILA, EXAMINING ATTORNEY

**Int. Cls.: 7 and 11**

**Prior U.S. Cls.: 13, 19, 21, 23, 31, 34 and 35**

**Reg. No. 3,499,214**

**United States Patent and Trademark Office**

**Registered Sep. 9, 2008**

**TRADEMARK  
PRINCIPAL REGISTER**

**IFD**

NIRO A/S (DENMARK LIMITED LIABILITY  
COMPANY)  
GLADSAXEVEJ 305  
DK-2860 SØBORG  
DENMARK

FOR: DRYING MACHINES THAT USE PRES-  
SURE OR CENTRIFUGAL FORCE FOR DRYING  
GOODS FOR THE FOOD INDUSTRY THE DAIRY  
INDUSTRY, THE PHARMACEUTICAL INDUSTRY  
OR THE CHEMICAL INDUSTRY, NAMELY, SPRAY  
DRYERS, FLUID BED DRYERS AND FLUID BED  
AGGLOMERATOR DRYERS, IN CLASS 7 (U.S. CLS.  
13, 19, 21, 23, 31, 34 AND 35).

FOR: DRYERS THAT USE HEAT FOR DRYING  
GOODS FOR THE FOOD INDUSTRY, THE DAIRY  
INDUSTRY, THE PHARMACEUTICAL INDUSTRY  
OR THE CHEMICAL INDUSTRY, NAMELY, FLASH  
DRYERS, MICROWAVE DRYERS; COOLERS FOR  
THE FOOD INDUSTRY, THE DAIRY INDUSTRY,  
THE PHARMACEUTICAL INDUSTRY OR THE

CHEMICAL INDUSTRY, NAMELY, SPRAY COOL-  
ERS, FLUID BED COOLERS; INDUSTRIAL FILTER  
MACHINES FOR ALL THE AFOREMENTIONED  
APPARATUSES, NAMELY, BAG FILTERS OR ME-  
TAL FILTERS FOR USE IN INDUSTRIAL DRYING  
EQUIPMENT, INDUSTRIAL COOLING PROCESS  
EQUIPMENT, AGGLOMERATION EQUIPMENT  
OR COATING EQUIPMENT; ALL THE AFORE-  
MENTIONED GOODS FOR THE FOOD INDUSTRY,  
THE DAIRY INDUSTRY, THE PHARMACEUTICAL  
INDUSTRY OR THE CHEMICAL INDUSTRY, IN  
CLASS 11 (U.S. CLS. 13, 21, 23, 31 AND 34).

OWNER OF INTERNATIONAL REGISTRATION  
0896700 DATED 2-14-2006, EXPIRES 2-14-2016.

SER. NO. 79-028,165, FILED 2-14-2006.

EDWARD FENNESSY, EXAMINING ATTORNEY

Int. Cl.: 25

Prior U.S. Cls.: 22 and 39

United States Patent and Trademark Office

Reg. No. 3,499,215

Registered Sep. 9, 2008

TRADEMARK  
PRINCIPAL REGISTER

LITTLE MARCEL

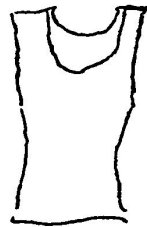

SCHIEVEN ERIC (FRANCE INDIVIDUAL)  
24, RUE DU PONENT  
F-30240 LE GRAU DU ROI, FRANCE AND  
LESEIGNEUR LYNDY (FRANCE INDIVIDUAL)  
24 RUE DU PONENT  
F-30240 LE GRAU DU ROI, FRANCE

FOR: TEE-SHIRTS, TANK TOPS, LONG-SLEEVE  
SHIRTS, DRESSES, SKIRTS, CAMISOLES, TUNICS,  
SHOES, BELTS, UNDERWEAR, AND G-STRING  
UNDERWEAR, IN CLASS 25 (U.S. CLS. 22 AND 39).

OWNER OF INTERNATIONAL REGISTRATION  
0899134 DATED 8-3-2006, EXPIRES 8-3-2016.

THE MARK CONSISTS OF THE WORDING "LIT-  
TLE MARCEL" AND A STYLIZED REPRESENTA-  
TION OF A CAMISOLE.

SER. NO. 79-029,149, FILED 8-3-2006.

AMY ALFIERI, EXAMINING ATTORNEY



**Int. Cls.: 18, 24, 25 and 28**

**Prior U.S. Cls.: 1, 2, 3, 22, 23, 38, 39, 41, 42 and 50**

**United States Patent and Trademark Office**

**Reg. No. 3,499,216**

**Registered Sep. 9, 2008**

**TRADEMARK  
PRINCIPAL REGISTER**

**İDSPORT**

ID GROUP (FRANCE SOCIÉTÉ ANONYME)  
162, BOULEVARD DE FOURMIÉS  
F-59100 ROUBAIX  
FRANCE

FOR: LEATHER AND IMITATION LEATHER; ANIMAL SKINS AND HIDES; TRUNKS, SUITCASES AND VALISES; UMBRELLAS, PARASOLS AND WALKING STICKS; WHIPS, HARNESSES AND SADDLERY; HARNESS ARTICLES, NAMELY, STRAPS AND TRACES; HANDBAGS; BEACH BAGS; TRAVEL BAGS; SHOPPING BAGS MADE OF LEATHER AND MESH; RUCKSACKS; SPORTS BAGS; ROLL BAGS; GARMENT BAGS FOR TRAVEL; SCHOOL BAGS; WALLETS; CREDIT CARD CASES; WALLETS, BRIEFCASES; ATTACHE CASES MADE OF LEATHER; KEY CASES OF LEATHER; PURSES NOT OF PRECIOUS METAL; TOILETRY CASES SOLD EMPTY; VANITY CASES SOLD EMPTY; LEATHER HATBOXES FOR TRAVEL; SLING BAGS FOR CARRYING INFANTS; COLLARS AND CLOTHING FOR ANIMALS, IN CLASS 18 (U.S. CLS. 1, 2, 3, 22 AND 41).

FOR: FIBERGLASS FABRICS FOR TEXTILE USE; FABRICS FOR DRESSMAKING AND FOR THE MANUFACTURE OF HOME FURNISHINGS; ADHESIVE FABRICS FOR APPLICATION BY HEAT; BED LINEN, BED BLANKETS, BED SHEETS, PILLOWCASES, BEDSPREADS; EIDERDOWNS; MATTRESS COVERS; TABLE LINEN NOT OF PAPER, TABLE CLOTHS NOT OF PAPER, TEXTILE TABLE NAPKINS; BATH LINEN; FACE TOWELS AND BATH GLOVES; TEXTILE NAPKINS FOR REMOVING MAKE-UP; FABRIC LABELS; TEXTILE HAND TOWELS; HANDKERCHIEFS OF TEXTILE; TEXTILE WALL HANGINGS; PLASTIC AND TEXTILE CURTAINS; MOSQUITO NETS, IN CLASS 24 (U.S. CLS. 42 AND 50).

FOR: CLOTHING, NAMELY, SHIRTS, PANTS AND JACKETS; KNITWEAR, NAMELY, SWEATERS; UNDERCLOTHES; UNDERWEAR; PAJAMA-

MAS; DRESSING GOWNS; SWEATERS; SKIRTS; DRESSES; TROUSERS; JACKETS; COATS; WATER-PROOF JACKETS AND PANTS; SHIRTS; NECKTIES; SCARVES; SASHES FOR WEAR; BELTS; GLOVES BEING CLOTHING; BRACES IN THE NATURE OF SUSPENDERS; HEADGEAR, NAMELY, HATS AND CAPS; FOOTWEAR; SOCKS, STOCKINGS, TIGHTS; SHOES, SLIPPERS, BOOTS; BEACH SHOES, SKI BOOTS; SPORTS SHOES; BATHING TRUNKS AND BATHING SUITS; SPORTSWEAR, NAMELY, JERSEYS; LAYETTES, TEXTILE BABY NAPPIES, IN CLASS 25 (U.S. CLS. 22 AND 39).

FOR: GAMES, NAMELY, BOARD GAMES; RIDE-ON TOYS; GYMNASTIC APPARATUS AND SPORTS ARTICLES, NAMELY, FOOTBALLS AND SOCCER BALLS; RACKETS AND BASEBALL BATS; PROTECTIVE PADDINGS AS PARTS OF SPORTS SUITS, NAMELY, FOOTBALL SHOULDER PADS; SPORTS ARTICLES IN THE NATURE OF SHIN GUARDS, SPORTS ARTICLES IN THE NATURE OF KNEE GUARDS; SPORTS ARTICLES IN THE NATURE OF NETS FOR BALL GAMES; ARCHERY IMPLEMENTS; CLAY PIGEON TRAPS; TARGETS, DARTS; DISCUSSES FOR SPORTS; SKIS; SURF BOARDS; SKATING BOOTS WITH SKATES ATTACHED; ICE SKATES; ROLLER-SKATES; SKATEBOARDS; KITES; CHRISTMAS TREE DECORATIONS; PARTY FAVORS IN THE NATURE OF SMALL TOYS, TOY MASKS; PLAYGROUND SWINGS; GAME BALLS OF DIFFERENT SIZES; TOY ROCKING HORSES; PLAY SWIMMING POOLS; MARBLES FOR GAMES; CUDDLY PLUSH TOYS; DOLLS AND DOLLS' HOUSES; PUPPETS; DOLLS' CLOTHING; MODELED PLASTIC TOY FIGURINES; PARLOR GAMES; TOY BUILDING BLOCK GAMES; TOY SPINNING TOPS; TOY MOBILES; TOY VEHICLES; TOY SCOOTERS; HAND HELD UNIT FOR PLAYING ELECTRONIC GAMES; BALLS FOR PLAYING GAMES; PLAYING CARDS, IN CLASS 28 (U.S. CLS. 22, 23, 38 AND 50).

THE MARK CONSISTS OF STANDARD CHARACTERS WITHOUT CLAIM TO ANY PARTICULAR FONT, STYLE, SIZE, OR COLOR.

OWNER OF INTERNATIONAL REGISTRATION 0899425 DATED 7-28-2006, EXPIRES 7-28-2016.

SER. NO. 79-029,279, FILED 7-28-2006.

PRIORITY DATE OF 2-9-2006 IS CLAIMED.

PAULA MAHONEY, EXAMINING ATTORNEY

**Int. Cls.: 9 and 42**

**Prior U.S. Cls.: 21, 23, 26, 36, 38, 100 and 101**

**Reg. No. 3,499,217**

**United States Patent and Trademark Office**

**Registered Sep. 9, 2008**

**TRADEMARK  
SERVICE MARK  
PRINCIPAL REGISTER**

# BLUEGEM

BLUE-GEM PTY LTD (AUSTRALIA COMPANY)  
SUITE 20  
18 STIRLING HIGHWAY; NEDLANDS WA 6009  
AUSTRALIA

FOR: COMPUTER SOFTWARE, NAMELY, BUSINESS MANAGEMENT SOFTWARE FOR USE IN COST ESTIMATION AND INVOICING; CUSTOMER RELATIONSHIP MANAGEMENT SOFTWARE; PROJECT MANAGEMENT SOFTWARE; INCIDENT MANAGEMENT SOFTWARE; COMPUTER SOFTWARE FOR CAPTURE, STORAGE AND DISPLAY OF INTERNAL BUSINESS KNOWLEDGE AND PROCESSES FOR EDUCATION AND TRAINING PURPOSES; COMPUTER SOFTWARE FOR MANAGING AND ADMINISTRATION OF TRAINING PROGRAMS CONDUCTED BY TRAINING ORGANIZATIONS; AND COMPACT DISCS AND DVD'S FEATURING SOFTWARE FOR ALL OF THE FOREGOING; BLANK MAGNETIC DATA CARRIERS; BLANK RECORDING DISCS; COMPUTERS; COMPUTER HARDWARE; THE FOREGOING GOODS SPECIFICALLY EXCLUDING COMPUTER SECURITY SOFTWARE, COMPUTER PRIVACY SOFTWARE, IDENTITY THEFT PROTECTION SOFTWARE TRANSACTION SECURITY SOFTWARE WEB THREAT PROTECTION SOFTWARE, WEBSITE RATING SOFTWARE SAFE/SECURED BROWSING SOFTWARE, E-MAIL SECURITY SOFTWARE, MESSAGING SECURITY SOFTWARE, PERSONAL FINANCIAL MANAGEMENT SECURITY SOFTWARE, COMPUTER SECURITY ASSESSMENT SOFTWARE AND COMPUTER PRIVACY ASSESSMENT SOFTWARE, IN CLASS 9 (U.S. CLS. 21, 23, 26, 36 AND 38).

FOR: DESIGN AND DEVELOPMENT OF COMPUTER SOFTWARE, NAMELY BUSINESS MANAGEMENT SOFTWARE; INSTALLATION,

MAINTENANCE AND UPDATING OF BUSINESS MANAGEMENT SOFTWARE; COMPUTER PROGRAMMING; CONSULTANCY, INFORMATION AND ADVISORY SERVICES IN RELATION TO BUSINESS MANAGEMENT SOFTWARE AND HARDWARE; CREATING AND MAINTAINING WEBSITES FOR OTHERS; HOSTING WEBSITES; ENGINEERING SERVICES INCLUDING IN RELATION TO BUSINESS MANAGEMENT AND COMPUTING APPLICATIONS; RENTAL OF COMPUTERS AND COMPUTER SOFTWARE; RECOVERY OF COMPUTER DATA; CONVERSION OF DATA OR DOCUMENTS FROM PHYSICAL TO ELECTRONIC MEDIA; DESIGN AND DEVELOPMENT OF COMPUTER HARDWARE; AND DATA CONVERSION OF COMPUTER PROGRAM DATA OR INFORMATION; THE FOREGOING SERVICES SPECIFICALLY EXCLUDING SERVICES IN RELATION TO COMPUTER SECURITY, COMPUTER PRIVACY, IDENTITY THEFT PROTECTION, TRANSACTION SECURITY, WEB THREAT PROTECTION, WEBSITE RATING, SAFE/SECURED BROWSING, E-MAIL SECURITY, MESSAGING SECURITY, PERSONAL FINANCIAL MANAGEMENT SECURITY, COMPUTER SECURITY, ASSESSMENT AND COMPUTER PRIVACY ASSESSMENT , IN CLASS 42 (U.S. CLS. 100 AND 101).

THE MARK CONSISTS OF STANDARD CHARACTERS WITHOUT CLAIM TO ANY PARTICULAR FONT, STYLE, SIZE, OR COLOR.

OWNER OF INTERNATIONAL REGISTRATION 0900647 DATED 9-4-2006, EXPIRES 9-4-2016.

SER. NO. 79-029,534, FILED 9-4-2006.

KIMBERLY PERRY, EXAMINING ATTORNEY

**Int. Cl.: 12**

**Prior U.S. Cls.: 19, 21, 23, 31, 35 and 44**

**Reg. No. 3,499,218**

**United States Patent and Trademark Office**

**Registered Sep. 9, 2008**

**TRADEMARK  
PRINCIPAL REGISTER**

**C E L E R I O**

SUZUKI MOTOR CORPORATION (JAPAN CORPORATION)  
300, TAKATSUKA-CHO  
HAMAMATSU-SHI; SHIZUOKA-KEN 432-8611  
JAPAN

FOR: BOATS AND PERSONAL WATERCRAFT, EXCLUDING AIR CUSHION VEHICLES; AUTOMOBILES AND STRUCTURAL PARTS THEREOF; AUTOMOBILE PARTS AND ACCESSORIES, NAMELY, TIRES, WHEELS, BUMPERS, SPOILERS, FENDERS, GRILLES, GRILLE GUARDS, BUSH GUARDS, LAMP STAYS, STEPS, REAR LADDERS, UNDER GUARDS, TANK GUARDS, MUD FLAPS, STABILIZERS, WHEEL RIM CAPS, WHEEL COVERS, ROOF CARRIERS, ROOF RACKS, ROOF BOXES, STEERING WHEELS, STEERING BOSSES, HORN BUTTONS, FOOT RESTS, SPARE TIRE COVERS, SAFETY BARS, STRUT BARS, LATERAL CONNECTING RODS OTHER THAN PARTS OF MOTOR ENGINES, SUN SHADES, MIRROR COWLINGS, CLUTCH COVERS, CLUTCH DISKS, SEAT AND SEAT BELTS; MOTORCYCLES AND STRUCTURAL PARTS THEREOF; MOTORCYCLE PARTS AND ACCESSORIES, NAMELY, TIRES, WHEELS, REAR VIEW MIRRORS, WINDSHIELDS, METER VISORS,

NUMBER PLATE HOLDERS, COWLINGS, GAS TANK COVERS, GAS TANK PADS, SEAT COVERS, HANDLE COVERS, KNUCKLE COVERS, FITTED BIKE COVERS, REAR CARRIERS, NAMELY, SADDLE BAGS AND TAIL BOXES, FRONT BASKETS, SIDE STANDS, CLUTCHES, TURN SIGNALS, FUEL TANKS, HANDLEBARS AND SWING ARMS; BICYCLES, ELECTRIC TRICYCLES, ADHESIVE RUBBER PATCHES FOR REPAIRING TIRES OR TUBES, IN CLASS 12 (U.S. CLS. 19, 21, 23, 31, 35 AND 44).

PRIORITY DATE OF 4-24-2006 IS CLAIMED.

OWNER OF INTERNATIONAL REGISTRATION  
0900548 DATED 7-31-2006, EXPIRES 7-31-2016.

THE FOREIGN WORDING IN THE MARK TRANSLATES INTO ENGLISH AS "CELERY" OR "SILVER-STRIPED HAWK MOTH".

SER. NO. 79-029,820, FILED 7-31-2006.

SUSAN RICHARDS, EXAMINING ATTORNEY

**Int. Cls.: 28, 35 and 39**

**Prior U.S. Cls.: 22, 23, 38, 50, 100, 101, 102 and 105**

**United States Patent and Trademark Office**

**Reg. No. 3,499,219**

**Registered Sep. 9, 2008**

**TRADEMARK  
SERVICE MARK  
PRINCIPAL REGISTER**



PUNTOSHOP S.R.L. (ITALY LIMITED LIABILITY COMPANY)  
VIA LUIGI NANNI, 18  
I-47100 FORLI (FC), ITALY

FOR: GYMNAS TIC AND SPORTING ARTICLES, NAMELY, EXERCISE BENCHES, STAIR-STEPPING EXERCISE MACHINES, ROTARY ABDOMINAL BOARDS, CHESTPULLS, STATIONARY EXERCISE BIKES, EXERCISE TREADMILLS, MANUALLY-OPERATED EXERCISE EQUIPMENT, EXERCISE MACHINES, IN CLASS 28 (U.S. CLS. 22, 23, 38 AND 50).

FOR: ADVERTISING, IN CLASS 35 (U.S. CLS. 100, 101 AND 102).

FOR: WAREHOUSING SERVICES, NAMELY, STORAGE, DISTRIBUTION, PICK-UP, PACKING AND SHIPPING OF CONSUMER PRODUCTS, PRO-

DUCTS FOR HOUSEHOLD PURPOSES, GYMNAS TIC APPARATUS, EXERCISE EQUIPMENT AND SPORTING GOODS, IN CLASS 39 (U.S. CLS. 100 AND 105).

PRIORITY DATE OF 7-5-2006 IS CLAIMED.

OWNER OF INTERNATIONAL REGISTRATION 0901390 DATED 10-4-2006, EXPIRES 10-4-2016.

THE ENGLISH TRANSLATION OF THE FOREIGN WORD(S) IN THE MARK IS "POINT SHOP".

SER. NO. 79-030,034, FILED 10-4-2006.

STEVEN PEREZ, EXAMINING ATTORNEY

**Int. Cl.: 9**

**Prior U.S. Cls.: 21, 23, 26, 36 and 38**

**Reg. No. 3,499,220**

**United States Patent and Trademark Office**

**Registered Sep. 9, 2008**

**TRADEMARK  
PRINCIPAL REGISTER**



SHENZHEN GAOXINQI; TECHNOLOGY CO.,  
LTD. (CHINA CORPORATION)  
2 BUILDING, AN HUA INDUSTRY AREA  
XIN AN DISTRICT 35, BAO AN  
SHENZHEN CITY; GUANGDONG PROVINCE, CHI-  
NA

FOR: RADIOTELEPHONY SETS; TELEPHONE  
APPARATUS; GALVANIC CELLS; BATTERY  
CHARGERS; PHOTOTELEGRAPHY APPARATUS;  
FACSIMILE MACHINES; ELECTRONIC NOTICE  
BOARDS, IN CLASS 9 (U.S. CLS. 21, 23, 26, 36 AND  
38).

OWNER OF INTERNATIONAL REGISTRATION  
0901606 DATED 8-15-2006, EXPIRES 8-15-2016.

THE MARK CONSISTS OF LATIN CHARACTERS  
"GAOXINQI" IN STYLIZED FORM.

SER. NO. 79-030,124, FILED 8-15-2006.

KAREN K. BUSH, EXAMINING ATTORNEY

**Int. Cls.: 5, 42 and 44**

**Prior U.S. Cls.: 6, 18, 44, 46, 51, 52, 100 and 101**

**Reg. No. 3,499,221**

**United States Patent and Trademark Office**

**Registered Sep. 9, 2008**

**TRADEMARK  
SERVICE MARK  
PRINCIPAL REGISTER**

# OSSOGEN

BDD BEROLINA DRUG; DEVELOPMENT GMBH  
(FED REP GERMANY GMBH)  
FONTANESTRAÙE 84-90  
15366 NEUENHAGEN  
FED REP GERMANY

FOR: PHARMACEUTICAL AND VETERINARY PREPARATIONS, PLASTERS, DIETETIC SUBSTANCES, AND FOOD FOR BABIES FOR USE IN THE TREATMENT AND PREVENTION OF CONDITIONS RELATED TO THE SKELETAL SYSTEM, TO PARATHYROID HORMONE FUNCTION, AND TO BOTH THE SKELETAL SYSTEM AND PARATHYROID HORMONE FUNCTION, NAMELY, OSTEOPOROSIS, OSTEOPOROSIS IMPERFECTA, BONE METASTASES, BONE FRACTURES, LOW BONE MINERAL DENSITY IN HEMODIALYSIS PATIENTS, HYPOPARATHYROIDISM, PSORIASIS, AS WELL AS PHARMACEUTICAL AND VETERINARY PREPARATIONS, PLASTERS, DIETETIC SUBSTANCES, AND FOOD FOR BABIES TO SUPPORT BONE HEALING AND OSTEOGENESIS IN GENERAL; MATERIAL FOR STOPPING TEETH, DENTAL WAX; FUNGICIDES, HERBICIDES, IN CLASS 5 (U.S. CLS. 6, 18, 44, 46, 51 AND 52).

FOR: SCIENTIFIC AND TECHNOLOGICAL SERVICES, RESEARCH, DESIGN, INDUSTRIAL ANALYSIS, RESEARCH SERVICES AND MEDICAL SERVICES RELATED TO THE DEVELOPMENT AND USE OF PHARMACEUTICAL AND VETERINARY PREPARATIONS FOR THE TREATMENT AND PREVENTION OF CONDITIONS RELATED

TO THE SKELETAL SYSTEM, TO PARATHYROID HORMONE FUNCTION, AND TO BOTH THE SKELETAL SYSTEM AND PARATHYROID HORMONE FUNCTION, NAMELY, OSTEOPOROSIS, OSTEOGENESIS IMPERFECTA, BONE METASTASES, BONE FRACTURES, LOW MINERAL DENSITY IN HEMODIALYSIS PATIENTS, HYPOPARATHYROIDISM, PSORIASIS, AS WELL AS PHARMACEUTICAL AND VETERINARY PREPARATIONS TO SUPPORT BONE HEALING AND OSTEOGENESIS IN GENERAL, IN CLASS 42 (U.S. CLS. 100 AND 101).

FOR: MEDICAL SERVICES; VETERINARY SERVICES; ANIMAL GROOMING; BEAUTY SALONS; AGRICULTURE ADVICE; HORTICULTURAL SERVICES, IN CLASS 44 (U.S. CLS. 100 AND 101).

THE MARK CONSISTS OF STANDARD CHARACTERS WITHOUT CLAIM TO ANY PARTICULAR FONT, STYLE, SIZE, OR COLOR.

PRIORITY DATE OF 3-31-2006 IS CLAIMED.

OWNER OF INTERNATIONAL REGISTRATION 0901874 DATED 9-29-2006, EXPIRES 9-29-2016.

SER. NO. 79-030,230, FILED 9-29-2006.

KELLY MCCOY, EXAMINING ATTORNEY

**Int. Cls.: 9, 16 and 41**

**Prior U.S. Cls.: 2, 5, 21, 22, 23, 26, 29, 36, 37, 38, 50,  
100, 101 and 107**

**Reg. No. 3,499,222**

**United States Patent and Trademark Office**

**Registered Sep. 9, 2008**

**TRADEMARK  
SERVICE MARK  
PRINCIPAL REGISTER**

**PAMBIANCO**

MATTEOTTI 11 S.R.L. (ITALY LIMITED PART-  
NERSHIP)  
CORSO GIACOMO MATTEOTTI, 11  
I-20121 MILANO  
ITALY

FOR: DOWNLOADABLE ELECTRONIC PUBLI-  
CATIONS IN THE NATURE OF MAGAZINES,  
NEWSLETTERS AND PERIODICALS IN THE FIELD  
OF MARKET ANALYSIS, ECONOMIC FORECAST-  
ING AND ANALYSIS, BUSINESS CONSULTATION  
AND INFORMATION RELATING TO LUXURY  
GOODS, NAMELY, CLOTHING, YARNS, FABRICS,  
FOOTWEAR, LEATHER GOODS, EYEWEAR, JEW-  
ELRY, WATCHES, PERFUMES AND COSMETICS,  
FURNITURE, IN CLASS 9 (U.S. CLS. 21, 23, 26, 36  
AND 38).

FOR: MAGAZINES, PERIODICALS, REVIEWS,  
NEWSPAPERS, BOOKS, CATALOGUES, HAND-  
BOOKS AND MANUAL, ALL IN THE FIELD OF  
MARKET ANALYSIS, ECONOMIC FORECASTING  
AND ANALYSIS, BUSINESS CONSULTATION AND  
INFORMATION RELATING TO LUXURY GOODS,  
NAMELY, CLOTHING, YARNS, FABRICS, FOOT-  
WEAR, LEATHER GOODS, EYEWEAR, JEWELRY,  
WATCHES, PERFUMES AND COSMETICS, FURNI-  
TURE, IN CLASS 16 (U.S. CLS. 2, 5, 22, 23, 29, 37, 38  
AND 50).

FOR: ARRANGING AND CONDUCTING OF  
CONFERENCES, CONGRESSES, SEMINARS AND  
SYMPOSIUMS, ALL IN THE FIELD OF MARKET  
ANALYSIS, ECONOMIC FORECASTING AND  
ANALYSIS, BUSINESS CONSULTATION AND IN-  
FORMATION RELATING TO LUXURY GOODS,  
NAMELY, CLOTHING, YARNS, FABRICS, FOOT-  
WEAR, LEATHER GOODS, EYEWEAR, JEWELRY,  
WATCHES, PERFUMES AND COSMETICS, FURNI-  
TURE; COMPUTER TRAINING; PUBLICATIONS  
OF BOOKS; PUBLISHING OF ELECTRONIC PUB-  
LICATIONS, IN CLASS 41 (U.S. CLS. 100, 101 AND  
107).

PRIORITY DATE OF 11-30-2005 IS CLAIMED.

OWNER OF INTERNATIONAL REGISTRATION  
0903000 DATED 12-30-2005, EXPIRES 12-30-2015.

THE MARK CONSISTS OF THE WORD "PAM-  
BIANCO" IN SPECIAL CHARACTERS.

SEC. 2(F).

SER. NO. 79-030,763, FILED 12-30-2005.

ANNE MADDEN, EXAMINING ATTORNEY



Int. Cls.: 25, 28 and 41

Prior U.S. Cls.: 22, 23, 38, 39, 50, 100, 101 and 107

United States Patent and Trademark Office

Reg. No. 3,499,223

Registered Sep. 9, 2008

TRADEMARK  
SERVICE MARK  
PRINCIPAL REGISTER



GANDINI MAURO PIETRO (ITALY INDIVIDUAL)  
VIA SAN CARLO, 16  
I-23846 GARBAGNATE MONASTERO (LC)  
ITALY AND  
SCICHLONE ELOISA ANGELA (ITALY INDIVIDUAL)  
VIA SAN CARLO, 16  
I-23846 GARBAGNATE MONASTERO (LC), ITALY

FOR: CLOTHING, NAMELY, BATH ROBES, BATHING TRUNKS, BELTS, COATS, DRESSING GOWNS, DRESSES, GLOVES, HOSIERY, JACKETS, NECKTIES, PYJAMAS, PANTS, PULLOVERS, SCARVES, SHAWLS, SHIRTS, SKIRTS, SLIPS, SOCKS, STOCKINGS, STUFF JACKETS, SUITS, SWEATERS, SWIMSUITS, TEE-SHIRTS, TROUSERS, UNDERWEAR, VESTS; FOOTWEAR, HEADGEAR, NAMELY, BERETS, CAPS, HATS, IN CLASS 25 (U.S. CLS. 22 AND 39).

FOR: GAMES AND PLAYTHINGS, NAMELY, SMALL BALLS FOR GAMES, BINGO CARDS, BUILDING BLOCKS, BUILDING GAMES, PLAYING CARDS, CHECKERS, CHESS GAMES, DARTS, DICE, DOLLS, DOLLS' CLOTHES, DOLL'S HOUSES, DOMINOES, DOLL'S FEEDING BOTTLES, FLYING DISCS, KALEIDOSCOPIES, KITES, MARIONETTES, TOY MASKS, PLUSH TOYS, PUPPETS, ROCKING HORSES, ROLLER SKATES; TOY SCOOTERS, SKATEBOARDS, SNOW GLOBES, TEDDY BEARS,

RADIO CONTROLLED TOY VEHICLES, IN CLASS 28 (U.S. CLS. 22, 23, 38 AND 50).

FOR: EDUCATION SERVICES, NAMELY, PROVIDING CLASSES, SEMINARS AND WORKSHOPS IN THE FIELD OF ILLUSTRATION, CARTOON, CHARACTER DESIGN, ANIMATION, COMICS, FASHION STYLE; TRAINING SERVICES IN THE FIELD OF ILLUSTRATION, CARTOON, CHARACTER DESIGN, COMICS, FASHION STYLE; ENTERTAINMENT IN THE FIELD OF ART EXHIBITION, IN CLASS 41 (U.S. CLS. 100, 101 AND 107).

PRIORITY DATE OF 3-16-2006 IS CLAIMED.

OWNER OF INTERNATIONAL REGISTRATION 0903743 DATED 9-14-2006, EXPIRES 9-14-2016.

THE MARK CONSISTS OF THE WORD "LILUDORI" IN STYLIZED CHARACTERS WITH SPIRAL SHAPES ON THE SECOND AND LAST LETTER AND A DOLL WITH TWO SHORT TAILS, DRESS TRIMMED WITH LACE AND BUTTON ON THE CHEST.

SER. NO. 79-031,003, FILED 9-14-2006.

DOMINIC FATHY, EXAMINING ATTORNEY

**Int. Cls.: 1, 5 and 42**

**Prior U.S. Cls.: 1, 5, 6, 10, 18, 26, 44, 46, 51, 52, 100  
and 101**

**Reg. No. 3,499,224**

**United States Patent and Trademark Office**

**Registered Sep. 9, 2008**

**TRADEMARK  
SERVICE MARK  
PRINCIPAL REGISTER**



GENE SIGNAL INTERNATIONAL SA (SWITZERLAND SOCIETE ANONYME)  
CHEMIN DES PLANCHAMPS 32  
CH-1066 EPALINGES  
SWITZERLAND

FOR: CHEMICALS FOR USE IN SCIENCE; CHEMICAL PREPARATIONS FOR SCIENTIFIC APPLICATIONS; BIOTECHNOLOGICAL PRODUCTS, NAMELY, SUBSTANCES FOR USE IN THE SCIENTIFIC RESEARCH AND DEVELOPMENT OF MEDICINES FOR THE TREATMENT OF EYE CONDITIONS, SKIN CONDITIONS, CANCER, AND FOR THE CONTROLLING AND AFFECTING ANGIOGENESIS, IN CLASS 1 (U.S. CLS. 1, 5, 6, 10, 26 AND 46).

FOR: CHEMICAL, PHARMACEUTICAL AND BIOTECHNOLOGICAL PREPARATIONS FOR MEDICAL AND PHARMACEUTICAL PURPOSES, NAMELY, PREPARATIONS FOR THE TREATMENT OF EYE CONDITIONS, SKIN CONDITIONS, CANCER, AND FOR CONTROLLING AND AFFECTING ANGIOGENESIS; PHARMACEUTICAL PREPARATIONS FOR THE TREATMENT OF PATHOLOGIES LINKED TO ANGIOGENESIS; THERAPEUTIC PREPARATIONS FOR THE TREATMENT OF PATHOLOGIES LINKED TO ANGIOGENESIS, IN CLASS 5 (U.S. CLS. 6, 18, 44, 46, 51 AND 52).

FOR: SCIENTIFIC RESEARCH FOR MEDICAL PURPOSES, RESEARCH AND ENGINEERING IN THE MEDICAL, PHARMACEUTICAL, CHEMICAL AND BIOTECHNOLOGICAL FIELDS, RESEARCH AND DEVELOPMENT OF THERAPEUTIC PRODUCTS AND PREPARATIONS INTENDED FOR PATHOLOGIES LINKED AMONG OTHER THINGS TO ANGIOGENESIS, IN CLASS 42 (U.S. CLS. 100 AND 101).

PRIORITY DATE OF 6-13-2006 IS CLAIMED.

OWNER OF INTERNATIONAL REGISTRATION 0906928 DATED 11-14-2006, EXPIRES 11-14-2016.

NO CLAIM IS MADE TO THE EXCLUSIVE RIGHT TO USE "GENE", APART FROM THE MARK AS SHOWN.

THE MARK CONSISTS OF THE WORDING "GENE SIGNAL". THE "S" IN "SIGNAL" IS CONTAINED WITHIN A RECTANGLE WITH THREE CURVED LINES ABOVE AND BELOW IT.

SER. NO. 79-032,284, FILED 11-14-2006.

TASHIA BUNCH, EXAMINING ATTORNEY

**Int. Cls.: 9 and 38**

**Prior U.S. Cls.: 21, 23, 26, 36, 38, 100, 101 and 104**

**United States Patent and Trademark Office**

**Reg. No. 3,499,225**

**Registered Sep. 9, 2008**

**TRADEMARK  
SERVICE MARK  
PRINCIPAL REGISTER**

**FOLIO**

TAGSYS (FRANCE SOCIÉTÉ ANONYME À CONSEIL D'ADMINISTRATION)  
180, CHEMIN DE SAINT LAMBERT  
F-13821 LA PENNE SUR HUVEAUNE  
FRANCE

FOR: RADIO FREQUENCY IDENTIFICATION TAGS, IN CLASS 9 (U.S. CLS. 21, 23, 26, 36 AND 38).

FOR: COMMUNICATIONS BY COMPUTER TERMINALS, COMMUNICATIONS BY TELEPHONE, ELECTRONIC MAIL, COMPUTER-ASSISTED TRANSMISSION OF MESSAGES, DATA AND IMAGES, RENTAL OF MESSAGE SENDING APPARATUS, MESSAGE AND DATA COMMUNICATION BY TELEPHONE ALL IN THE FIELD OF RADIO

FREQUENCY IDENTIFICATION TECHNOLOGY, IN CLASS 38 (U.S. CLS. 100, 101 AND 104).

THE MARK CONSISTS OF STANDARD CHARACTERS WITHOUT CLAIM TO ANY PARTICULAR FONT, STYLE, SIZE, OR COLOR.

OWNER OF INTERNATIONAL REGISTRATION 0907096 DATED 10-20-2006, EXPIRES 10-20-2016.

SER. NO. 79-032,356, FILED 10-20-2006.

DANIEL BRODY, EXAMINING ATTORNEY

**Int. Cl.: 2**

**Prior U.S. Cls.: 6, 11 and 16**

**United States Patent and Trademark Office**

**Reg. No. 3,499,226**

**Registered Sep. 9, 2008**

**TRADEMARK  
PRINCIPAL REGISTER**

**BITUSEAL**

PHOENIX INTERNATIONAL A/S (DENMARK  
LIMITED LIABILITY COMPANY)  
GRØNHØJGADE 45  
DK-6600 VEJEN, DENMARK

FOR: PRIMERS FOR PREPARING SURFACES  
FOR THE APPLICATION OF BITUMEN; PRESER-  
VATIVES AGAINST RUST IN THE NATURE OF A  
COATING; ANTI-CORROSIVE PAINT COM-  
POUNDS OF BITUMEN AND POLYMERS; CLEAR  
AND PIGMENTED COATINGS USED IN THE NAT-  
URE OF PAINT, NAMELY, BITUMINOUS AND  
ASPHALTIC MASTICS AND MEMBRANES FOR  
USE AS ANTI-CORROSIVE COATING AND CLAD-

DING PREPARATIONS, IN CLASS 2 (U.S. CLS. 6, 11  
AND 16).

THE MARK CONSISTS OF STANDARD CHAR-  
ACTERS WITHOUT CLAIM TO ANY PARTICULAR  
FONT, STYLE, SIZE, OR COLOR.

OWNER OF INTERNATIONAL REGISTRATION  
0902499 DATED 7-18-2006, EXPIRES 7-18-2016.

SER. NO. 79-032,378, FILED 11-29-2006.

JESSICA FATHY, EXAMINING ATTORNEY

**Int. Cls.: 9, 16 and 42**

**Prior U.S. Cls.: 2, 5, 21, 22, 23, 26, 29, 36, 37, 38, 50,  
100 and 101**

**Reg. No. 3,499,227**

**United States Patent and Trademark Office**

**Registered Sep. 9, 2008**

**TRADEMARK  
SERVICE MARK  
PRINCIPAL REGISTER**

# **E-Booster**

SMART PACKAGING SOLUTIONS (FRANCE  
S.A.S.)  
AVENUE OLIVIER PERROY -  
Z.I. DE ROUSSET; F-13106 ROUSSET  
FRANCE

FOR: MAGNETICALLY ENCODED CARDS AND DOCUMENTS, NAMELY, ELECTRONIC IDENTIFICATION MEDIA, ELECTRONIC PASSPORTS, ELECTRONIC VISAS, ELECTRONIC NATIONAL IDENTITY CARDS, ELECTRONIC DRIVING LICENSES, ELECTRONIC VEHICLE REGISTRATION CERTIFICATES, AND ELECTRONIC VOTING CARDS; COMPUTER MEMORY AND MICROPROCESSOR CARDS; CONTACTLESS CHIP CARDS; DUAL INTERFACE CONTACT AND CONTACTLESS CHIP CARDS; COMPUTER SOFTWARE FOR USE IN IDENTITY, ACCESS CONTROL AND SECURITY USED IN COMPUTER CHIPS, INTEGRATED CIRCUITS AND MICROCIRCUITS FOR MEMORY CARDS OR CHIP CARDS, IN CLASS 9 (U.S. CLS. 21, 23, 26, 36 AND 38).

FOR: PRINTED IDENTIFICATION DOCUMENTS, NAMELY, PASSPORTS, BIRTH CERTIFICATES, DRIVING LICENSES, AND NON-MAGNETICALLY ENCODED NATIONAL IDENTIFICATION CARDS FOR PERSONS, ANIMALS, OR

GOODS, IN CLASS 16 (U.S. CLS. 2, 5, 22, 23, 29, 37, 38 AND 50).

FOR: SOFTWARE PROGRAMMING FOR CHIP CARDS, MEMORY OR MICROPROCESSOR CARDS; CONVERSION OF DOCUMENTS FROM PHYSICAL TO AN ELECTRONIC MEDIUM; CUSTOM SOFTWARE PROGRAMMING AND IMPLEMENTATION OF SOFTWARE, CHIP CARDS, INTEGRATED CIRCUIT CARDS, CONTACTLESS CARDS, IN CLASS 42 (U.S. CLS. 100 AND 101).

THE MARK CONSISTS OF STANDARD CHARACTERS WITHOUT CLAIM TO ANY PARTICULAR FONT, STYLE, SIZE, OR COLOR.

PRIORITY DATE OF 1-31-2006 IS CLAIMED.

OWNER OF INTERNATIONAL REGISTRATION  
0907554 DATED 7-28-2006, EXPIRES 7-28-2016.

SER. NO. 79-032,516, FILED 7-28-2006.

SEAN CROWLEY, EXAMINING ATTORNEY

**Int. Cl.: 7**

**Prior U.S. Cls.: 13, 19, 21, 23, 31, 34 and 35**

**United States Patent and Trademark Office**

**Reg. No. 3,499,228**

**Registered Sep. 9, 2008**

**TRADEMARK  
PRINCIPAL REGISTER**

**brabender TECHNOLOGIE**

BRABENDER TECHNOLOGIE KG (FED REP  
GERMANY LIMITED PARTNERSHIP)  
55-73, KULTURSTRASSE  
47055 DUISBURG  
FED REP GERMANY

FOR: MACHINES FOR DISTRIBUTING AND  
DISPENSING OF BULK GOODS AS ACCESSORY  
PARTS TO MACHINES FOR THE CHEMICAL AND  
PHARMACEUTICAL INDUSTRY, FOR USE IN THE  
MANUFACTURE OF PLASTIC MATERIAL, FOR  
THE FOOD INDUSTRY, FOR HEAVY INDUSTRY,  
FOR THE DETERGENT INDUSTRY, NAMELY,  
WEIGHT-BELT-CONVEYORS, LOSS-IN-WEIGHT  
FEEDERS AND WEIGHT-SCREW-CONVEYORS,  
MOTOR-DRIVEN VIBRATORY FEEDING HOP-  
PERS TO DISCHARGE BIG BAGS AS PARTS OR  
ACCESSORY PARTS TO MACHINES FOR THE  
CHEMICAL AND PHARMACEUTICAL INDUSTRY,  
FOR USE IN THE MANUFACTURE OF PLASTIC  
MATERIAL, FOR THE FOOD INDUSTRY AND FOR  
HEAVY INDUSTRY, IN CLASS 7 (U.S. CLS. 13, 19, 21,  
23, 31, 34 AND 35).

THE MARK CONSISTS OF STANDARD CHAR-  
ACTERS WITHOUT CLAIM TO ANY PARTICULAR  
FONT, STYLE, SIZE, OR COLOR.

OWNER OF INTERNATIONAL REGISTRATION  
0907831 DATED 9-6-2006, EXPIRES 9-6-2016.

NO CLAIM IS MADE TO THE EXCLUSIVE  
RIGHT TO USE "TECHNOLOGIE", APART FROM  
THE MARK AS SHOWN.

THE ENGLISH TRANSLATION OF "TECHNOLO-  
GIE" IS TECHNOLOGY.

SEC. 2(F).

SER. NO. 79-032,618, FILED 9-6-2006.

TRICIA SONNEBORN, EXAMINING ATTORNEY

**Int. Cls.: 14, 16, 35, 41 and 42**

**Prior U.S. Cls.: 2, 5, 22, 23, 27, 28, 29, 37, 38, 50, 100, 101, 102 and 107**

**Reg. No. 3,499,229**

**United States Patent and Trademark Office**

**Registered Sep. 9, 2008**

**TRADEMARK  
SERVICE MARK  
PRINCIPAL REGISTER**



NOBELSTIFTELSEN (SWEDEN FOUNDATION)  
P.O.BOX 5232  
SE-S-102 45; SE-102 45 STOCKHOLM, SWEDEN

FOR: MEDALS; MEDALLIONS; COMMEMORATIVE COINS; BADGES OF PRECIOUS METAL; DISHES OF PRECIOUS METALS, NAMELY, POTPOURRI DISHES; CUFF LINKS; TIE CLIPS; BELT BUCKLES OF PRECIOUS METAL; PRECIOUS METALS AND THEIR ALLOYS IN GENERAL, IN CLASS 14 (U.S. CLS. 2, 27, 28 AND 50).

FOR: PRINTED PUBLICATIONS, NAMELY, MAGAZINES IN THE FIELDS OF SCIENCE, MEDICINE, HUMAN AND POLITICAL RELATIONS AND ECONOMICS; NEWSPAPERS FOR GENERAL CIRCULATION; PERIODICAL MAGAZINES AND NEWSLETTERS IN THE FIELDS OF SCIENCE, MEDICINE, HUMAN AND POLITICAL RELATIONS AND ECONOMICS; BOOKS IN THE FIELDS OF SCIENCE, MEDICINE, HUMAN AND POLITICAL RELATIONS AND ECONOMICS; NOTEBOOKS; PRINTED TICKETS; PRINTED FORMS; BOOKMARKS; COMMEMORATIVE STAMP SHEETS; GREETING CARDS; POSTCARDS; ENVELOPES; PENCILS; GRAPHIC ART REPRODUCTIONS; PRINTED MATTER, NAMELY, PRINTED REPORTS IN THE FIELDS OF SCIENCE, MEDICINE, HUMAN AND POLITICAL RELATIONS AND ECONOMICS; PHOTOGRAPHS; LITHOGRAPHS; POSTERS; OLEO-

GRAPHS; BOOKLETS; PAMPHLETS AND BROCHURES IN THE FIELDS OF SCIENCE, MEDICINE, HUMAN AND POLITICAL RELATIONS AND ECONOMICS, IN CLASS 16 (U.S. CLS. 2, 5, 22, 23, 29, 37, 38 AND 50).

FOR: ADVERTISING; ON-LINE ADVERTISING ON A COMPUTER NETWORK; COMPILATION OF INFORMATION INTO COMPUTER DATABASES; SYSTEMIZATION OF INFORMATION INTO COMPUTER DATABASES; COMPUTER DATABASE MANAGEMENT, IN CLASS 35 (U.S. CLS. 100, 101 AND 102).

FOR: EDUCATIONAL SERVICES, NAMELY, ARRANGING AND CONDUCTING SEMINARS, LECTURES, EXHIBITIONS, CONFERENCES, CONGRESSES, SEMINARS AND SYMPOSIUMS FOR CULTURAL AND EDUCATIONAL PURPOSES IN THE FIELD OF SCIENCE, HEALTH, HUMAN AND POLITICAL RELATIONS AND ECONOMICS; ELECTRONIC PUBLISHING, NAMELY, PUBLICATION OF TEXTS AND GRAPHIC WORKS OF OTHERS ON CD-ROMS, DVDS AND THE INTERNET FEATURING SCIENCE, HEALTH, HUMAN AND POLITICAL RELATIONS AND ECONOMICS; MOTION PICTURE FILM PRODUCTION; PRODUCTION OF RADIO AND TELEVISION PROGRAMS; PUBLICATION OF TEXTBOOKS, PUBLICATION OF

BOOKS AND TEXTBOOKS, IN CLASS 41 (U.S. CLS. 100, 101 AND 107).

FOR: SCIENTIFIC RESEARCH AND INFORMATION ON THE SUBJECT OF LEGAL AFFAIRS IN INTERNATIONAL LAW AND PUBLIC INTERNATIONAL LAW; LEGAL AFFAIRS AND INTERNATIONAL LAW INFORMATION AS IT RELATES TO THE NOBEL PEACE PRIZE AND ITS LAUREATES; PROVIDING INFORMATION IN THE FIELD OF SCIENCE, SCIENTIFIC RESEARCH, AND LEGAL AFFAIRS IN INTERNATIONAL LAW AND PUBLIC INTERNATIONAL LAW; SCIENTIFIC RESEARCH SERVICES; COPYRIGHT MANAGEMENT; LICENSING OF INTELLECTUAL PROPERTY, IN CLASS 42 (U.S. CLS. 100 AND 101).

OWNER OF INTERNATIONAL REGISTRATION 0908678 DATED 5-29-2006, EXPIRES 5-29-2016.

OWNER OF U.S. REG. NO. 2,924,605.

NO CLAIM IS MADE TO THE EXCLUSIVE RIGHT TO USE "NAT MDCCCXXXIII OB. MDCCCXCVI", APART FROM THE MARK AS SHOWN.

THE PORTRAIT IN THE MARK DOES NOT IDENTIFY A LIVING INDIVIDUAL.

THE MARK CONSIST OF A ROUND MEDALION WITH A STYLIZED PICTURE OF ALFRED NOBEL IN PROFILE AND THE TEXT "ALFR. NOBEL" AND "NAT MDCCCXXXIII OB MDCCCXCVI" AROUND THE PROFILE.

SER. NO. 79-032,955, FILED 5-29-2006.

SANJEEV VOHRA, EXAMINING ATTORNEY



**Int. Cls.: 5, 40 and 42**

**Prior U.S. Cls.: 6, 18, 44, 46, 51, 52, 100, 101, 103 and 106**

**Reg. No. 3,499,230**

**United States Patent and Trademark Office**

**Registered Sep. 9, 2008**

**TRADEMARK  
SERVICE MARK  
PRINCIPAL REGISTER**

**DIFFUSPHERES**

EURAND PHARMACEUTICALS LIMITED (IRELAND AN IRISH COMPANY)  
THE YARD HOUSE, KILRUDDERY ESTATE  
SOUTHERN CROSS ROAD  
BRAY, COUNTY WICKLOW, IRELAND

FOR: PHARMACEUTICAL PREPARATIONS AND SUBSTANCES FOR THE TREATMENT OF GASTROINTESTINAL DISORDERS, CENTRAL NERVOUS SYSTEM DISORDERS, CARDIOVASCULAR DISORDERS, DISEASES OF THE MUSCULAR SKELETAL SYSTEM AND INFECTIOUS DISEASES IN THE FORM OF CONTROLLED RELEASE TABLETS OR CAPSULES FOR PROLONGED OR DELAYED ACTION; DIETETIC SUBSTANCES IN THE NATURE OF DIETARY SUPPLEMENTS ADAPTED FOR MEDICAL USE, IN CLASS 5 (U.S. CLS. 6, 18, 44, 46, 51 AND 52).

FOR: MANUFACTURE AND FORMULATION OF PHARMACEUTICAL SUBSTANCES TO THE REQUIREMENTS OF OTHERS, NAMELY, TREATMENT OF PHARMACEUTICAL SUBSTANCES

INTO CONTROLLED RELEASE MICROTABLETS AND CAPSULES, IN CLASS 40 (U.S. CLS. 100, 103 AND 106).

FOR: RESEARCH AND DEVELOPMENT OF ORAL DRUG DELIVERY FORMULATIONS USED AS FACILITATING AGENTS FOR PHARMACEUTICALS COMPOUNDS, VITAMINS, FOODS SUPPLEMENTS, AND VETERINARY PREPARATIONS, IN CLASS 42 (U.S. CLS. 100 AND 101).

PRIORITY DATE OF 10-27-2006 IS CLAIMED.

OWNER OF INTERNATIONAL REGISTRATION 0908691 DATED 11-23-2006, EXPIRES 11-23-2016.

SER. NO. 79-032,958, FILED 11-23-2006.

CHRISIE B. KING, EXAMINING ATTORNEY

**Int. Cls.: 9, 11, 37 and 42**

**Prior U.S. Cls.: 13, 21, 23, 26, 31, 34, 36, 38, 100, 101,  
103 and 106**

**Reg. No. 3,499,231**

**United States Patent and Trademark Office**

**Registered Sep. 9, 2008**

**TRADEMARK  
SERVICE MARK  
PRINCIPAL REGISTER**

# **WÜRTH SOLAR**

WÜRTH ELEKTRONIK GMBH & CO. KG (FED  
REP GERMANY LIMITED LIABILITY COM-  
PANY)

SALZSTR. 21

74676 NIEDERNHALL, FED REP GERMANY

FOR: PHOTOVOLTAIC INSTALLATIONS FOR THE TRANSFORMATION OF SOLAR ENERGY INTO ELECTRICITY; APPARATUS FOR CONVERTING ELECTRONIC RADIATION TO ELECTRICAL ENERGY, NAMELY, PHOTOVOLTAIC SOLAR MODULES; CURRENT CONVERTERS, SOLAR CHARGE REGULATORS; SOLAR ENERGY DRIVEN LOADING UNITS FOR LOADING BATTERIES AND ACCUMULATORS; BATTERIES; ACCESSORIES FOR AFOREMENTIONED GOODS, NAMELY, ELECTRIC CABLES, ELECTRIC CABLE CARRIERS, INTERMEDIATE CURRENT METERS; SOLAR BATTERIES; PHOTOVOLTAIC MODULES FOR GENERATION OF ELECTRICITY; MONITORING EQUIPMENT FOR PHOTOVOLTAIC INSTALLATIONS, NAMELY, VOLTAGE AND CURRENT MONITOR MODULES; MONITORING EQUIPMENT FOR CURRENT CONVERTERS, NAMELY, VOLTAGE, CURRENT AND FREQUENCY MONITOR MODULES; PHOTOVOLTAIC INSTALLATIONS DATA LOGGER RECORDER FOR VOLTAGE, AMPERAGE AND POWER MEASUREMENTS; CURRENT CONVERTER DATA LOGGER FOR VOLTAGE, AMPERAGE AND POWER MEASUREMENTS, IN CLASS 9 (U.S. CLS. 21, 23, 26, 36 AND 38).

FOR: SOLAR POWERED FLUID HEATERS, WATER HEATERS, HEATERS FOR COMMERCIAL USE, RADIANT HEATERS; SOLAR THERMAL INSTALLATIONS FOR HEAT AND ENERGY PRODUCTION, NAMELY, SOLAR THERMAL MODULES, SOLAR THERMAL ENERGY STORAGE PLANTS AND SOLAR THERMAL ENERGY POWER PLANTS, IN CLASS 11 (U.S. CLS. 13, 21, 23, 31 AND 34).

FOR: INSTALLATION AND MAINTENANCE OF PHOTOVOLTAIC INSTALLATIONS, IN CLASS 37 (U.S. CLS. 100, 103 AND 106).

FOR: TECHNICAL PLANNING OF PHOTOVOLTAIC INSTALLATIONS, IN CLASS 42 (U.S. CLS. 100 AND 101).

PRIORITY DATE OF 8-30-2006 IS CLAIMED.

OWNER OF INTERNATIONAL REGISTRATION 0909417 DATED 10-11-2006, EXPIRES 10-11-2016.

NO CLAIM IS MADE TO THE EXCLUSIVE RIGHT TO USE "SOLAR", APART FROM THE MARK AS SHOWN.

SER. NO. 79-033,312, FILED 10-11-2006.

ELI HELLMAN, EXAMINING ATTORNEY

**Int. Cls.: 9, 11, 37 and 42**

**Prior U.S. Cls.: 13, 21, 23, 26, 31, 34, 36, 38, 100, 101,  
103 and 106**

**Reg. No. 3,499,232**

**United States Patent and Trademark Office**

**Registered Sep. 9, 2008**

**TRADEMARK  
SERVICE MARK  
PRINCIPAL REGISTER**

# **WÜRTH SOLERGY**

WÜRTH ELEKTRONIK GMBH & CO. KG (FED  
REP GERMANY LIMITED LIABILITY COM-  
PANY)  
SALZSTR. 21  
74676 NIEDERNHALL, FED REP GERMANY

FOR: PHOTOVOLTAIC INSTALLATIONS FOR THE TRANSFORMATION OF SOLAR ENERGY INTO ELECTRICITY; APPARATUS FOR CONVERTING ELECTRONIC RADIATION TO ELECTRICAL ENERGY, NAMELY, PHOTOVOLTAIC SOLAR MODULES; CURRENT CONVERTERS, SOLAR CHARGE REGULATORS; SOLAR ENERGY DRIVEN LOADING UNITS FOR LOADING BATTERIES AND ACCUMULATORS; BATTERIES; ACCESSORIES FOR AFOREMENTIONED GOODS, NAMELY, ELECTRIC CABLES, ELECTRIC CABLE CARRIERS, INTERMEDIATE CURRENT METERS; SOLAR BATTERIES; PHOTOVOLTAIC MODULES FOR GENERATION OF ELECTRICITY; MONITORING EQUIPMENT FOR PHOTOVOLTAIC INSTALLATIONS, NAMELY, VOLTAGE AND CURRENT MONITOR MODULES; MONITORING EQUIPMENT FOR CURRENT CONVERTERS, NAMELY, VOLTAGE, CURRENT AND FREQUENCY MONITOR MODULES; PHOTOVOLTAIC INSTALLATIONS DATA LOGGER RECORDER FOR VOLTAGE, AMPERAGE AND POWER MEASUREMENTS; CURRENT CONVERTER DATA LOGGER FOR VOLTAGE, AMPERAGE AND POWER MEASUREMENTS, IN CLASS 9 (U.S. CLS. 21, 23, 26, 36 AND 38).

FOR: SOLAR POWERED FLUID HEATERS, WATER HEATERS, HEATERS FOR COMMERCIAL USE, RADIANT HEATERS; SOLAR THERMAL INSTALLATIONS FOR HEAT AND ENERGY PRODUCTION, NAMELY, SOLAR THERMAL MODULES, SOLAR, THERMAL ENERGY STORAGE PLANTS AND SOLAR THERMAL ENERGY POWER PLANTS, IN CLASS 11 (U.S. CLS. 13, 21, 23, 31 AND 34).

FOR: INSTALLATION AND MAINTENANCE OF PHOTOVOLTAIC INSTALLATIONS, IN CLASS 37 (U.S. CLS. 100, 103 AND 106).

FOR: TECHNICAL PLANNING OF PHOTOVOLTAIC INSTALLATIONS, IN CLASS 42 (U.S. CLS. 100 AND 101).

PRIORITY DATE OF 8-30-2006 IS CLAIMED.

OWNER OF INTERNATIONAL REGISTRATION  
0909416 DATED 10-11-2006, EXPIRES 10-11-2016.

SER. NO. 79-033,316, FILED 10-11-2006.

ELI HELLMAN, EXAMINING ATTORNEY

Int. Cls.: 9, 16, 35, 38 and 41

Prior U.S. Cls.: 2, 5, 21, 22, 23, 26, 29, 36, 37, 38, 50,  
100, 101, 102, 104 and 107

Reg. No. 3,499,233

United States Patent and Trademark Office

Registered Sep. 9, 2008

TRADEMARK  
SERVICE MARK  
PRINCIPAL REGISTER

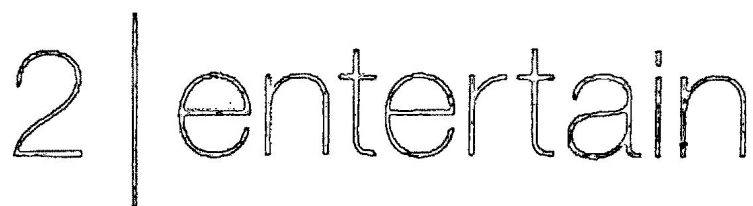

2 ENTERTAIN MANAGEMENT LIMITED (UNI-  
TED KINGDOM LIMITED COMPANY)  
33 FOLEY STREET  
LONDON W1W 7TL  
UNITED KINGDOM

FOR: BLANK VIDEO TAPES AND AUDIO TAPES, BLANK MAGNETIC TAPES FOR TAPE RECORDERS, BLANK DISCS, NAMELY, BLANK COMPACT DISCS, BLANK DIGITAL VERSATILE COMPUTER DISCS, BLANK DIGITAL VERSATILE MAGNETIC DISCS, BLANK DIGITAL VERSATILE OPTICAL DISCS, BLANK OPTICAL DISCS AND BLANK COMPUTER DISCS; PRERECORDED VIDEO TAPES, AUDIO TAPES, MAGNETIC TAPES, VIDEO DISCS AND AUDIO DISCS FEATURING CINEMATOGRAPHIC AND MOTION PICTURE FILMS AND VIDEO PROGRAMS IN THE FIELDS OF DRAMA, FICTION, WAR, CRIME, ROMANCE, COMEDY, SCIENCE FICTION, FANTASY, ANIMATION, MUSIC, BIOGRAPHY, BUSINESS, SPORTS, HORROR, HISTORY, SCIENCE, NATURAL HISTORY, HOBBIES, CHILDREN'S PROGRAMMING, TRAVEL, AUTOMOTIVE, COOKING, POLITICS, LITERATURE, HEALTH, FITNESS, RELIGION, SPIRITUALITY, ANIMATED CARTOONS, AND MUSICAL AND STAGE PERFORMANCES; INTERCOMMUNICATION APPARATUS, NAMELY, TELEPHONES, MOBILE TELEPHONES, PERSONAL DIGITAL ASSISTANTS, VIDEO GAME CONSOLES FOR USE WITH AN EXTERNAL DISPLAY SCREEN OR MONITOR, HAND-HELD UNITS FOR PLAYING VIDEO GAMES, COMPUTERS, TELEVISIONS, AND SET-TOP BOXES; SOUND RECORDING APPARATUS, NAMELY, PERSONAL STEREOs, VIDEO PLAYERS AND RECORDERS, DIGITAL VIDEO PLAYERS AND RECORDERS, DVD PLAYERS AND RECORDERS, MINI DISC PLAYERS AND RECORDERS, COMPACT DISC PLAYERS AND RECORDERS, MP3 PLAYERS AND RECORDERS,

AND CASSETTE PLAYERS AND RECORDERS; SOUND TRANSMISSION APPARATUS; DOWNLOADABLE AUDIO AND VIDEO DIGITAL FILES STORED IN ELECTRONIC FORM IN THE FIELDS OF MUSIC, DRAMA, FICTION, WAR, CRIME, ROMANCE, COMEDY, SCIENCE FICTION, FANTASY, ANIMATION, BIOGRAPHY, BUSINESS, SPORTS, HORROR, HISTORY, SCIENCE, NATURAL HISTORY, HOBBIES, CHILDREN'S PROGRAMS, TRAVEL, AUTOMOTIVE, COOKING, POLITICS, LITERATURE, HEALTH, FITNESS, RELIGION, SPIRITUALITY, ANIMATED CARTOONS, MUSICAL AND STAGE PERFORMANCES, AND MOVIES; ELECTRONIC DOWNLOADABLE PUBLICATIONS, NAMELY, INFORMATION SHEETS, NEWSLETTERS, MAGAZINES, REVIEWS AND JOURNALS ALL IN THE FIELD OF MUSICAL PERFORMANCES, TELEVISION PROGRAMS AND MOVIES; ELECTRONIC MEMORIES; ELECTRONIC STORAGE APPARATUS, NAMELY, COMPUTER MEMORY CARDS, DRIVES AND HARDWARE; DOWNLOADABLE MUSICAL SOUND RECORDINGS; DOWNLOADABLE VIDEO RECORDINGS PROVIDED FROM THE INTERNET FEATURING DRAMATIC OR COMEDIC MOTION PICTURE FILMS, DRAMATIC OR COMEDIC TELEVISION PROGRAMS, ANIMATED CARTOONS, AND DRAMATIC OR COMEDIC VIDEO AND MUSICAL ENTERTAINMENT; MOUSE PADS, IN CLASS 9 (U.S. CLS. 21, 23, 26, 36 AND 38).

FOR: PRINTED MATTER, NAMELY, BOOKS, MAGAZINES, PERIODICAL PUBLICATIONS IN THE FIELD OF MOTION PICTURE FILM, TELEVISION ENTERTAINMENT, ANIMATED CARTOONS, AND VIDEO AND MUSICAL ENTERTAINMENT; POSTERS; PHOTOGRAPHS; STATIONERY, GREETING CARDS, CALENDARS, HOLOGRAMS, NAMELY, PRINTED HOLOGRAMS; PENS, PENCILS; PAMPHLETS IN THE FIELD OF MOTION PICTURE

FILM, TELEVISION ENTERTAINMENT, ANIMATED CARTOONS, AND VIDEO AND MUSICAL ENTERTAINMENT; PHOTOGRAPH ALBUMS, PAINTBRUSHES, BLACKBOARDS, BOOKMARKS, PAPER BOWS FOR GIFT WRAPPING, BOXES FOR PENS AND PENCILS, STICKERS, DECALCOMANIAS, DRAWER LINERS OF PAPER, FLAGS OF PAPER, FLOWER POT COVERS OF PAPER, BEER MATS OF PAPER, PAPERWEIGHTS, SCRAPBOOKS, SONG BOOKS, TERRESTRIAL GLOBES, PAPER BAGS, GENERAL PURPOSE PLASTIC BAGS, PRINTED INSTRUCTIONAL AND TEACHING MATERIALS IN THE FIELD OF ENTERTAINMENT, MOTION PICTURE FILM, TELEVISION ENTERTAINMENT, ANIMATED CARTOONS, AND VIDEO AND MUSICAL ENTERTAINMENT, IN CLASS 16 (U.S. CLS. 2, 5, 22, 23, 29, 37, 38 AND 50).

FOR: PRODUCTION AND DIRECTION OF ADVERTISEMENTS, NAMELY, TELEVISION, RADIO, ON-LINE, AND PRINTED COMMERCIALS, AND COMMERCIALS FOR MOBILE PHONES, IN CLASS 35 (U.S. CLS. 100, 101 AND 102).

FOR: BROADCASTING SERVICES, NAMELY, AUDIO, RADIO, TELEVISION AND SATELLITE BROADCASTING; COMMUNICATIONS SERVICES, NAMELY, TELEVISION, RADIO AND SATELLITE COMMUNICATIONS SERVICES; VIDEO ON DEMAND TRANSMISSION SERVICES; AUDIO AND/OR VIDEO TRANSMISSION SERVICES, NAMELY, TRANSMISSION OF SOUND AND VIDEO; TRANSMISSION OF RECORDED MATERIAL IN ELECTRONIC FORM, NAMELY, ELECTRONIC DATA TRANSMISSION; PROVIDING ACCESS TO DATABASES ON THE INTERNET FEATURING DIGITAL MUSIC AND VIDEO WEBSITES, IN CLASS 38 (U.S. CLS. 100, 101 AND 104).

FOR: ENTERTAINMENT SERVICES, NAMELY, RADIO, TELEVISION, MOTION PICTURE FILM AND MUSICAL ENTERTAINMENT SERVICES, NAMELY, PRODUCTION AND DISTRIBUTION OF RADIO AND TELEVISION PROGRAMS; PRODUCTION AND DIRECTION OF MOTION PICTURE FILMS, TELEVISION, AND RADIO PROGRAMS; SCRIPT WRITING; FILMING SERVICES, NAMELY, FILM STUDIOS; RECORDING SERVICES, NAMELY, RECORDING STUDIOS; EDITING SERVICES, NAMELY, TELEVISION,

RADIO, MOTION PICTURE FILM AND MUSICAL EDITING SERVICES; POST PRODUCTION SERVICES NAMELY, AUDIO AND VIDEO EDITING, CREATION OF ON-SCREEN GRAPHICS, MENUS, TITLE SEQUENCE EDITING; SOUND RECORDING SERVICES, NAMELY, AUDIO RECORDING AND PRODUCTION; DUBBING SERVICES; ORGANIZING OF LOTTERIES, RADIO AND TELEVISION CALL-IN COMPETITIONS, COMPETITIONS OF MANUAL, PHYSICAL, OR MENTAL SKILL, REALITY TELEVISION COMPETITIONS, AND GAME SHOW COMPETITIONS; ORGANIZATION AND ARRANGEMENT OF CONCERTS, SHOWS, SPECIAL EVENTS AND OUTSIDE BROADCASTS OF MUSIC, MOVIES, CURRENT EVENTS, CONTINUING VARIETY SHOWS, CHARITABLE CONCERTS, AND SOCIAL, HISTORICAL, AND POLITICAL SOCIAL EVENTS; RENTAL OF MOTION PICTURE FILMS, SOUND RECORDINGS AND VIDEO TAPES; VIDEO TAPE EDITING SERVICES, NAMELY, VIDEO EDITING; PROVIDING ON-LINE ELECTRONIC PUBLICATIONS IN THE NATURE OF MAGAZINES, BOOKS, OR BOOKLETS IN THE FIELD OF RADIO, TELEVISION, MOTION PICTURE FILM AND MUSICAL ENTERTAINMENT; MUSIC COMPOSITION SERVICES FOR OTHERS; PUBLICATION SERVICES, NAMELY, PUBLISHING OF BOOKS, MAGAZINES, NEWSPAPERS, PARTWORKS, PREMIUMS, NEWSPAPER AND MAGAZINE COVER MOUNTS, ELECTRONIC PUBLICATIONS IN THE NATURE OF MAGAZINES, BOOKS, OR BOOKLETS IN THE FIELD OF DRAMATIC OR COMEDIC PRESENTATIONS, VIDEO RECORDINGS IN THE NATURE OF DRAMATIC, COMEDIC, OR MUSICAL PRESENTATIONS, AUDIO RECORDINGS AND MUSICAL RECORDINGS; ENTERTAINMENT SERVICES, NAMELY, PROVIDING DIGITAL MUSIC RECORDINGS AND VIDEO RECORDINGS IN THE NATURE OF DRAMATIC, COMEDIC, OR MUSICAL RECORDINGS VIA A GLOBAL COMPUTER NETWORK, IN CLASS 41 (U.S. CLS. 100, 101 AND 107).

OWNER OF INTERNATIONAL REGISTRATION 0909759 DATED 2-14-2006, EXPIRES 2-14-2016.

SER. NO. 79-033,437, FILED 2-14-2006.

RICHARD A. STRASER, EXAMINING ATTORNEY

**Int. Cls.: 1, 5 and 10**

**Prior U.S. Cls.: 1, 5, 6, 10, 18, 26, 39, 44, 46, 51 and 52**

**United States Patent and Trademark Office**

**Reg. No. 3,499,234**

**Registered Sep. 9, 2008**

**TRADEMARK  
PRINCIPAL REGISTER**

# **STALLERGENES**

STALLERGENES SA. (SOCIÉTÉ ANONYME)  
(FRANCE SOCIÉTÉ ANONYME)  
6, RUE ALEXIS DE TOCQUEVILLE  
F-92160 ANTONY  
FRANCE

FOR: DIAGNOSTIC PREPARATIONS, OTHER THAN FOR MEDICAL OR VETERINARY PURPOSES, IN CLASS 1 (U.S. CLS. 1, 5, 6, 10, 26 AND 46).

FOR: PHARMACEUTICAL PRODUCTS FOR THE TREATMENT OF ALLERGIES; MEDICINES USED IN ALLERGOLOGY; DIAGNOSTIC PREPARATIONS FOR MEDICAL USE; CHEMICAL REAGENTS FOR MEDICAL OR VETERINARY PURPOSES; CHEMICAL PREPARATIONS FOR MEDICAL PURPOSES; DIAGNOSTICS PREPARATIONS FOR ANTIBODY OR ANTIGEN SCREENING OR DETERMINATION IN IMMUNOLOGY OR ALLERGOLOGY; VETERINARY PRODUCTS FOR THE TREATMENT OF ALLERGIES; BABY FOOD; MATERIALS FOR FILLING TEETH AND MAKING DENTAL IMPRESSIONS, IN CLASS 5 (U.S. CLS. 6, 18, 44, 46, 51 AND 52).

FOR: DIAGNOSTIC APPARATUS FOR MEDICAL PURPOSES, NAMELY, NEEDLES, PRICK-TEST NEEDLES; MEDICAL DEVICE FOR USE IN ALLERGOLOGY, NAMELY, A DEVICE THAT TESTS FOR ALLERGIC REACTIONS USING THE SCRATCH METHOD; MEDICAL KITS COMPRISED PRIMARILY OF DIPSTICKS, VIALS AND TUBES FOR COLLECTING, STORING AND TRANSPORTING BIOLOGICAL SUBSTANCES AND LACRYMAL FLUIDS, IN CLASS 10 (U.S. CLS. 26, 39 AND 44).

THE MARK CONSISTS OF STANDARD CHARACTERS WITHOUT CLAIM TO ANY PARTICULAR FONT, STYLE, SIZE, OR COLOR.

OWNER OF INTERNATIONAL REGISTRATION 0749758 DATED 11-30-2000, EXPIRES 11-30-2010.

SER. NO. 79-033,468, FILED 12-8-2006.

DAVID MILLER, EXAMINING ATTORNEY

Int. Cls.: 3, 5, 7, 29 and 30

Prior U.S. Cls.: 1, 4, 6, 13, 18, 19, 21, 23, 31, 34, 35, 44, 46, 50, 51 and 52

Reg. No. 3,499,235

United States Patent and Trademark Office

Registered Sep. 9, 2008

TRADEMARK  
PRINCIPAL REGISTER



SAS SERVICE ALLERGIE SUISSE SA (SWITZERLAND SOCIÉTÉ ANONYME)  
GRYPHENHÜBELIWEG 40  
CH-3006 BERN  
SWITZERLAND

FOR: BLEACHING PREPARATIONS FOR HOUSEHOLD USE; LAUNDRY BLEACH; LAUNDRY BLUEING; LAUNDRY DETERGENT; LAUNDRY PRE-SOAK; LAUNDRY SOAP; LAUNDRY STARCH; FABRIC SOFTENERS FOR LAUNDRY USE; ESSENTIAL OILS AS PERFUME FOR LAUNDRY PURPOSES; ALL PURPOSE CLEANING PREPARATIONS; HOUSEHOLD CLEANING PREPARATIONS; TEETH CLEANING PREPARATIONS; GLASS CLEANING PREPARATIONS; HAIR CLEANING PREPARATIONS; HAND CLEANING PREPARATIONS; POLISHING PREPARATIONS; SCOURING LIQUIDS; SCOURING POWDERS; GENERAL PURPOSE CLEANING, POLISHING, AND ABRASIVE LIQUIDS AND POWDERS; BAR SOAPS; BATH SOAPS; DETERGENT SOAPS; INDUSTRIAL SOAPS; HAND SOAPS; LIQUID SOAPS; SOAPS FOR PERSONAL USE; SOAPS FOR HOUSEHOLD USE; PERFUMERY, ESSENTIAL OILS, COSMETICS, HAIR LOTIONS; DENTIFRICES, IN CLASS 3 (U.S. CLS. 1, 4, 6, 50, 51 AND 52).

FOR: PHARMACEUTICAL PREPARATIONS FOR THE TREATMENT OF ALLERGIES; ALLERGY MEDICATIONS; ALLERGY TABLETS; ALLERGY CAPSULES; SANITARY PREPARATIONS FOR MEDICAL PURPOSES; DIETETIC FOODS AND SUGARS ADAPTED FOR MEDICAL USE; BABY FOOD; MEDICAL PLASTERS, STICKING PLAS-

TERS FOR MEDICAL USE; BANDAGES FOR DRESSINGS; GAUZE FOR DRESSINGS; MATERIAL FOR STOPPING TEETH AND DENTAL WAX; ALL PURPOSE DISINFECTANTS; PREPARATIONS FOR DESTROYING VERMIN; FUNGICIDES, HERBICIDES, IN CLASS 5 (U.S. CLS. 6, 18, 44, 46, 51 AND 52).

FOR: VACUUM CLEANERS; CLOTHES WASHING MACHINES; DISH WASHING MACHINES; FLOOR WASHING MACHINES; FILTERS FOR CLOTHES WASHING, DISH WASHING, AND FLOOR WASHING MACHINES; OIL FILTERS FOR ENGINES; AIR FILTERS FOR ENGINES, IN CLASS 7 (U.S. CLS. 13, 19, 21, 23, 31, 34 AND 35).

FOR: MEAT, FISH, POULTRY AND GAME; MEAT EXTRACTS; EGGS, MILK, AND MILK PRODUCTS EXCLUDING ICE CREAM, ICE MILK AND FROZEN YOGURT; EDIBLE OILS AND FATS, IN CLASS 29 (U.S. CL. 46).

FOR: COFFEE, TEA, COCOA, SUGAR, RICE, TAPIOCA, SAGO, ARTIFICIAL COFFEE; FLOUR; CEREAL-BASED SNACK FOOD; BREAD; PASTRIES; CONFECTIONERY CHIPS FOR BAKING; CONFECTIONERY, NAMELY, PASTILLES; FLAVORED ICES; FRUIT ICES; HONEY, TREACLE SYRUP; YEAST, BAKING-POWDER; ICE FOR REFRESHMENT, IN CLASS 30 (U.S. CL. 46).

PRIORITY DATE OF 6-6-2006 IS CLAIMED.

OWNER OF INTERNATIONAL REGISTRATION 0910084 DATED 12-5-2006, EXPIRES 12-5-2016.

NO CLAIM IS MADE TO THE EXCLUSIVE RIGHT TO USE "RACCOMANDATO DA", "EMPFOHLEN DURCH", "RECOMMANDÉ PAR", AND "SERVICE ALLERGIE", APART FROM THE MARK AS SHOWN.

THE ENGLISH TRANSLATION OF "RACCOMANDATO DA" IS RECOMMENDED BY. THE ENGLISH TRANSLATION OF "EMPFOHLEN

DURCH" IS RECOMMENDED BY. THE ENGLISH TRANSLATION OF "RECOMMANDÉ PAR" IS RECOMMENDED BY. THE ENGLISH TRANSLATION OF "SERVICE ALLERGIE" IS SERVICE ALLERGY.

SER. NO. 79-033,501, FILED 12-5-2006.

GILBERT SWIFT, EXAMINING ATTORNEY



**Int. Cl.: 9**

**Prior U.S. Cls.: 21, 23, 26, 36 and 38**

**United States Patent and Trademark Office**

**Reg. No. 3,499,236**

**Registered Sep. 9, 2008**

**TRADEMARK  
PRINCIPAL REGISTER**

**SAMOS**

WIELAND ELECTRIC GMBH (FED REP GER-  
MANY CORPORATION)  
BRENNER STRASSE 10-14  
96052 BAMBERG  
FED REP GERMANY

FOR: ELECTRONIC DEVICES, NAMELY, AC-  
TUATORS, SAFETY RELAYS, ELECTRONIC MOD-  
ULES, NAMELY, RELAYS, SWITCHES,  
ACTUATORS AND MODULAR SYSTEMS CON-  
SISTING OF SWITCHES, ACTUATORS, SIGNAL  
TRANSMITTERS, SAFETY RELAYS FOR MONI-  
TORING SAFETY CIRCUITS, EMERGENCY-CUT-  
OUT CIRCUITS, ELECTRIC POSITION SWITCHES,  
TWO-HAND-PUSH BUTTONS, NAMELY, TWO-  
HAND-CONTROL BUTTONS, SOLENOID-OPER-  
ATED SWITCHES, LASER SCANNERS, ELECTRIC  
MUTING SENSORS, ELECTRIC PERMISSIVE  
SWITCHES, ELECTRIC KEY-OPERATED  
SWITCHES, ALL BEFORE-MENTIONED GOOD

FOR USE ON PRODUCTION MACHINES AND  
PRODUCTION INSTALLATIONS, IN CLASS 9 (U.S.  
CLS. 21, 23, 26, 36 AND 38).

THE MARK CONSISTS OF STANDARD CHAR-  
ACTERS WITHOUT CLAIM TO ANY PARTICULAR  
FONT, STYLE, SIZE, OR COLOR.

PRIORITY DATE OF 8-19-2005 IS CLAIMED.

OWNER OF INTERNATIONAL REGISTRATION  
0910406 DATED 2-8-2006, EXPIRES 2-8-2016.

SER. NO. 79-033,693, FILED 2-8-2006.

DOMINIC FATHY, EXAMINING ATTORNEY

**Int. Cls.: 3, 9, 10, 12, 14, 16, 21, 24, 26, 28 and 35**

**Prior U.S. Cls.: 1, 2, 4, 5, 6, 13, 19, 21, 22, 23, 26, 27, 28, 29, 30, 31, 33, 35, 36, 37, 38, 39, 40, 42, 44, 50, 51, 52, 100, 101 and 102**

**Reg. No. 3,499,237**

**United States Patent and Trademark Office**

**Registered Sep. 9, 2008**

**TRADEMARK  
SERVICE MARK  
PRINCIPAL REGISTER**

**SKHUABAN**

INDUSTRIA DE DISEÑO TEXTIL S.A.; (INDITEX S.A.) (SPAIN SOCIEDAD ANONIMA)  
AVDA. DE LA DIPUTACIÓN  
EDIFICIO INDITEX  
E-15142 ARTEIXO (A CORUÑA), SPAIN

FOR: CLEANING PREPARATIONS FOR HOUSEHOLD USE; POLISHING PREPARATIONS; SOAPS, NAMELY, BATH SOAPS AND LIQUID HAND SOAP; PERFUMERY, ESSENTIAL OILS, COSMETICS, HAIR LOTIONS; DENTIFRICES, SHAVING PREPARATIONS; TOILET WATERS; COTTON BUDS FOR COSMETIC PURPOSES; BEAUTY MASKS; COSMETIC SUN-TANNING PREPARATIONS; COSMETIC PREPARATIONS FOR SKIN CARE; HAIR COLORING AND DYES; POLISH AND CREAM FOR FOOTWEAR; WAX STRIPS FOR REMOVING BODY HAIR; SHAMPOOS; COSMETIC KITS COMPRISED OF MAKE-UP; DEPILATORIES; MAKE-UP REMOVING PRODUCTS, NAMELY, LOTIONS AND CREAMS; DEODORANTS FOR PERSONAL USE; LIPSTICK; COSMETIC PENCILS; HAIR SPRAYS; NAIL PREPARATIONS, NAMELY, NAIL SPRAYS; LACQUER-REMOVING PREPARATIONS; TISSUES IMPREGNATED WITH COSMETIC LOTIONS; PRE-MOISTENED OR IMPREGNATED CLEANING WIPES OR TOWELETTES FOR COSMETIC PURPOSES; AFTERSHAVE LOTIONS; LOTIONS FOR COSMETIC PURPOSES; MAKE-UP PREPARATIONS; POMADES FOR COSMETIC PURPOSES; SACHETS FOR PERFUMING LINEN; NAIL CARE PREPARATIONS; SHOE POLISH; BLEACHING PREPARATIONS FOR COSMETIC PURPOSES; INCENSE; SCENTED WOOD; DECORATIVE TRANSFERS FOR COSMETIC PURPOSES; FALSE NAILS AND EYELASHES; PUMICE STONE FOR PERSONAL USE; POTPOURRI; COSMETIC PREPARATIONS FOR SLIMMING PURPOSES, NAMELY, CREAMS AND LOTIONS FOR CELLULITE REDUCTION; NON-MEDICATED COSMETIC PREPARATIONS FOR BATHS; HAIR WAVING PREPARATIONS, NAMELY, LOTIONS; NON-MEDICATED TOILE-

TRIES; NON-MEDICATED MOUTH CARE PRODUCTS, NAMELY, MOUTH WASH; BATH SALTS, NOT FOR MEDICAL PURPOSES; OILS FOR TOILETRY PURPOSES; SUNSCREEN PRODUCTS, NAMELY, SUNSCREEN CREAMS; EAU DE COLOGNE; DEODORANT SOAPS; TALCUM POWDER, IN CLASS 3 (U.S. CLS. 1, 4, 6, 50, 51 AND 52).

FOR: EYEGLASSES; SUNGLASSES; CASES AND CHAINS FOR EYEWEAR; SPECTACLE FRAMES AND LENSES; PRE-RECORDED COMPACT DISCS FEATURING MUSIC; APPARATUS FOR RECORDING, TRANSMITTING AND REPRODUCING SOUND OR IMAGES; CALCULATING MACHINES; FLOTATION AND LIFESAVING JACKETS; SURVIVAL SUITS, NAMELY, INSULATED OVERALL WET SUITS; PROTECTIVE HELMETS; CHRONOGRAPHS FOR USE AS SPECIAL TIME RECORDING APPARATUS; MEASURING SPOONS; TEMPERATURE INDICATORS; ELECTRONIC GAMES PROGRAMS; COMPUTER SOFTWARE FOR GAMES, SCREEN SAVERS, WORD PROCESSING; NON-MEDICAL THERMOMETERS; INTERCOMMUNICATIONS APPARATUS, NAMELY, TELEPHONES; BABY INTERCOM MONITORS; PORTABLE TELEPHONES, WALKIE-TALKIES, IN CLASS 9 (U.S. CLS. 21, 23, 26, 36 AND 38).

FOR: TEETHING RINGS; BABY FEEDING BOTTLES; FEEDING BOTTLE VALVES IN THE NATURE OF NIPPLES; FEEDING BOTTLE TEATS; BABIES' PACIFIERS; BREAST PUMPS; COMMUNE CHAIRS FOR MEDICAL USE; ORTHOPAEDIC SHOES FOR MEDICAL USE, IN CLASS 10 (U.S. CLS. 26, 39 AND 44).

FOR: BABY CARRIAGES; VEHICLE SAFETY SEATS FOR CHILDREN; BICYCLES; PARTS AND ACCESSORIES FOR BICYCLES INCLUDED IN THIS CLASS, NAMELY, DRIVE CHAINS, BRAKE SHOES, BELLS, KICKSTANDS, BRAKES, CHAINS, HANDLE BARS, TUBES AND CONNECTORS FOR BI-

CYCLE FRAMES; VEHICLES, NAMELY, SLEIGHS, IN CLASS 12 (U.S. CLS. 19, 21, 23, 31, 35 AND 44).

FOR: PRECIOUS METALS AND THEIR ALLOYS AND GOODS IN PRECIOUS METALS OR COATED THEREWITH, NAMELY, JEWELRY BOXES, SERVING TRAYS, SERVING PLATTERS, AND NAPKIN RINGS; JEWELRY; WATCHES AND CLOCKS, ORNAMENTAL PINS; TIE PINS; FANCY KEY RINGS; CUFFLINKS, IN CLASS 14 (U.S. CLS. 2, 27, 28 AND 50).

FOR: STATIONERY; WRITING INSTRUMENTS, NAMELY, PENS AND PENCILS; PENCIL HOLDERS; NOTEBOOKS; PHOTO AND SOUVENIR ALBUMS; ADDRESS BOOKS; APPOINTMENT BOOKS; BLANK JOURNALS; DIARIES; CALENDARS; POSTERS AND LITHOGRAPHS; GIFT WRAPPING PAPER; GIFT CARDS; POSTCARDS; PAPER NAPKINS; PAPER TABLE LINENS; PASSPORT HOLDERS; CHECKBOOK HOLDERS; MAGAZINES FEATURING INFORMATION AND ENTERTAINMENT OF GENERAL INTEREST; PAPERWEIGHTS; BOOK MARKS; BOOKENDS; BABIES' DISPOSABLE DIAPERS OF PAPER AND CELLULOSE; PAPER HANDKERCHIEFS AND FACE TOWELS; BOXES OF CARDBOARD OR PAPER FOR HOLDING PENS; WRITING SETS COMPRISED OF PEN, PENCIL AND CARRYING CASE SOLD AS A UNIT; PICTURE POSTCARDS; PAPER BIBS; COMIC BOOKS; BOOKS, NAMELY, CHILDREN'S BOOKS AND FICTION BOOKS, IN CLASS 16 (U.S. CLS. 2, 5, 22, 23, 29, 37, 38 AND 50).

FOR: HOUSEHOLD OR KITCHEN UTENSILS AND CONTAINERS NOT OF PRECIOUS METALS OR COATED THEREWITH, NAMELY, PLATES, BOWLS, CUPS, BEVERAGE GLASSWARE, SERVING FORKS, SERVING SPOONS, SERVING LADDLES, AND SERVING TONGS; COMBS; BATH SPONGES; FACIAL SPONGES FOR APPLYING MAKEUP; SPONGES FOR HOUSEHOLD PURPOSES; HAIR BRUSHES; NAIL BRUSHES; CLOTHES BRUSHES; COSMETIC BRUSHES; SCRUBBING BRUSHES; DECORATIVE PORCELAIN AND EARTHENWARE IN THE NATURE OF STATUARY, FIGURINES, ORNAMENTS, PLATES, VASES AND BOWLS; BOTTLE OPENERS; OIL CRUETS; SHAVING BRUSHES; SHOE HORNS; WICKER, STRAW AND WOOD BASKETS; TROUSER STRETCHERS; SOAP DISHES; SHAVING BRUSH STANDS; PERFUME SPRAYERS AND VAPORIZERS SOLD EMPTY; PLASTIC COASTERS FOR BOTTLES; TABLEWARE IN THE NATURE OF SERVING TRAYS AND PLATTERS NOT OF PRECIOUS METAL; TOOTHBRUSHES; ELECTRIC TOOTHBRUSHES; NON-ELECTRIC HEATERS FOR FEEDING BOTTLES, NAMELY, HEAT-INSULATED VESSELS; JUGS; TOILET SETS COMPRISED OF TISSUE HOLDERS, TOILET PAPER DISPENSERS, TOILET BRUSHES, TOILET BRUSH HOLDERS; CUPS; TOILET UTENSILS IN THE NATURE OF TOILET BRUSHES AND TOILET BRUSH HOLDERS; THERMALLY INSULATED CONTAINERS FOR FOOD AND BEVERAGES, IN CLASS 21 (U.S. CLS. 2, 13, 23, 29, 30, 33, 40 AND 50).

FOR: TEXTILES AND TEXTILE GOODS, NAMELY, BED SHEETS, BED BLANKETS, PILLOW COVERS, PILLOW SHAMS, DUST RUFFLES, DUVET COVERS, QUILTS, COMFORTERS, AFGHANS, CRIB BUMPERS, BED SPREADS, PLACEMATS, NAPKINS, TABLE CLOTHS NOT MADE OF PAPER; BATH LINEN; TEXTILE TISSUES FOR REMOVING MAKE-UP; LABELS OF CLOTH; LINING CLOTH, NAMELY, TEXTILE USED AS LINING FOR CLOTHING; TOILET GLOVES, NAMELY, BATH GLOVES; WALL HANGINGS OF TEXTILE; HANDKERCHIEFS OF TEXTILE; CURTAINS OF TEXTILE, SHOWER CURTAINS; HOUSEHOLD LINEN; TOWELS OF TEXTILE; LAP RUGS; NET CURTAINS; CURTAIN TIE BACKS OF TEXTILE MATERIALS; FABRIC FLAGS; EIDERDOWNS IN THE NATURE OF DOWN COVERLETS; UNFITTED FABRIC FURNITURE COVERS; COVERS FOR CUSHIONS; MOSQUITO NETS; BILLIARD CLOTH; TRACED CLOTHS FOR EMBROIDERY; UPHOLSTERY FABRICS; FACE TOWELS OF TEXTILE, IN CLASS 24 (U.S. CLS. 42 AND 50).

FOR: HAIR ACCESSORIES, NAMELY, ELASTIC AND RIGID HAIR BANDS, HAIR GRIPS, BARRETTES, HAIR ORNAMENTS NOT MADE OF PRECIOUS METAL, AND HAIR PINS; BROOCHES NOT MADE OF PRECIOUS METAL AND NOT IMITATION JEWELRY; ARTIFICIAL FLOWERS; SHOE ORNAMENTS NOT MADE OF PRECIOUS METAL; HAT ORNAMENTS NOT MADE OF PRECIOUS METAL; SHOE LACES; ORNAMENTS FOR CLOTHING NOT MADE OF PRECIOUS METAL, NAMELY, ORNAMENTAL BADGES; SHOULDER PADS FOR CLOTHING; REINS FOR GUIDING CHILDREN, IN CLASS 26 (U.S. CLS. 37, 39, 40, 42 AND 50).

FOR: TOYS, NAMELY, TOY VEHICLES, TOY BUILDING BLOCKS, CONSTRUCTION TOYS, MECHANICAL ACTION TOYS, BATTERY-OPERATED ACTION TOYS, CHILDREN'S MULTIPLE ACTIVITY TOYS, BATH TOYS, SPORT BALLS, PLUSH AND STUFFED TOYS, DOLLS, ACTION FIGURES, AND PLAY FIGURES AND CLOTHING AND ACCESSORIES THEREOF, PUPPETS, PLAY BALLOONS, SOAP BUBBLES IN THE NATURE OF BUBBLE MAKING WAND AND SOLUTION SETS; GAMES, NAMELY, HAND-HELD ELECTRONIC GAMES, CARD GAMES, ACTION SKILL GAMES, BOARD GAMES, JIGSAW PUZZLES; NON-EDIBLE, NON-LUMINARY CHRISTMAS TREE DECORATIONS; DOLL HOUSES; PARTY FAVORS IN THE NATURE OF SMALL TOYS; KITES; BABY RATTLES; FLYING DISCS; SCALE MODELS OF VEHICLES; TOY MOBILES; CHRISTMAS TREES OF SYNTHETIC MATERIAL; SPORTS ARTICLES, NAMELY, SKATEBOARDS, ROLLER AND ICE SKATES, IN CLASS 28 (U.S. CLS. 22, 23, 38 AND 50).

FOR: RETAIL STORE AND COMPUTERIZED ONLINE RETAIL STORE SERVICES FEATURING CLOTHING, CLOTHING ACCESSORIES, FOOTWEAR, HEADWEAR, LEATHER GOODS, LUGGAGE AND BAGS, JEWELRY, PERSONAL CARE PRODUCTS, COSMETICS, FRAGRANCES, EYEWEAR, HOUSEWARES, TOYS, CONSUMER ELECTRONICS, BABY PRODUCTS, SPORTS ARTICLES;

PROMOTION SERVICES PROVIDED BY A COMMERCIAL COMPANY BY MEANS OF A PREFERRED CUSTOMER PROGRAM FEATURING A CUSTOMER LOYALTY CARD, IN CLASS 35 (U.S. CLS. 100, 101 AND 102).

THE MARK CONSISTS OF STANDARD CHARACTERS WITHOUT CLAIM TO ANY PARTICULAR FONT, STYLE, SIZE, OR COLOR.

PRIORITY DATE OF 1-16-2006 IS CLAIMED.

OWNER OF INTERNATIONAL REGISTRATION 0910414 DATED 6-27-2006, EXPIRES 6-27-2016.

OWNER OF U.S. REG. NO. 2,991,093.

SER. NO. 79-033,763, FILED 6-27-2006.

ATTIYA MALIK, EXAMINING ATTORNEY

**Int. Cls.: 7, 8, 12, 35 and 36**

**Prior U.S. Cls.: 13, 19, 21, 23, 28, 31, 34, 35, 44, 100,  
101 and 102**

**Reg. No. 3,499,238**

**United States Patent and Trademark Office**

**Registered Sep. 9, 2008**

**TRADEMARK  
SERVICE MARK  
PRINCIPAL REGISTER**

# Krone

BERNARD KRONE HOLDING GMBH & CO. KG  
(FED REP GERMANY KOMMANDITGESELL-  
SCHAFT)

HEINRICH-KRONE-STR. 10  
48480 SPELLE  
FED REP GERMANY

FOR: AGRICULTURAL IMPLEMENTS, IN PARTICULAR REAPERS AND THRESHERS, CHOPPERS, NAMELY, FORAGE HARVESTERS, BALING PRESSES, FARM TRACTORS, AGRICULTURAL TRANSPORT APPARATUS, NAMELY, PLOWS, MOWERS, CORN HUSKERS, FRONT END SELF-LOADERS, CRAWLER-TRACKED SELF-LOADERS, MOWERS, AGRICULTURAL MACHINERY, NAMELY, TURNERS AND SWATHERS, SOIL CULTIVATION MACHINES AND IMPLEMENTS, NAMELY, SOIL CULTIVATORS, POWER OPERATED SOIL CULTIVATORS, AGRICULTURAL MACHINES, NAMELY, SOWERS IMPLEMENTS FOR RELEASING FERTILIZERS AND PLANT PROTECTION SUBSTANCES, NAMELY, TRACTOR-TOWED FERTILIZER APPLICATORS, FERTILIZER DISTRIBUTORS, AND PARTS AND FITTINGS THEREFORE, INCLUDED IN THIS CLASS, IN CLASS 7 (U.S. CLS. 13, 19, 21, 23, 31, 34 AND 35).

FOR: HAND-OPERATED EQUIPMENT USED IN AGRICULTURE, HORTICULTURE AND FORESTRY, FOR THE CONSTRUCTION OF MACHINES, APPARATUS AND VEHICLES AND FOR STRUCTURAL ENGINEERING, NAMELY, HAND HELD CUTTING TOOLS; HAND TOOLS, NAMELY, PICKS; HAND TOOLS, NAMELY, REAMERS, IN CLASS 8 (U.S. CLS. 23, 28 AND 44).

FOR: LAND VEHICLES, APPARATUS FOR LOCOMOTION BY LAND, NAMELY, TRACTORS,

TRACTOR TRAILERS, LOADERS AND PARTS AND FITTINGS THEREFOR, TRAILER COUPLINGS, GEARS FOR VEHICLES, HYDRAULIC AND MECHANICAL APPARATUS FOR LAND VEHICLES, INCLUDED IN THIS CLASS, EXCEPT CARS, NAMELY, HYDRAULIC DISC BRAKES, HYDRAULIC CIRCUITS FOR MOTOR CARS, TRANSMISSION MECHANISMS FOR LAND VEHICLES; AUTOMOBILE BODIES, NAMELY, TIPPING BODIES FOR VEHICLES, SEMI-TRAILERS, VEHICLE SYSTEMS, NAMELY, MOTOR VEHICLE ALARM SYSTEMS, BRAKE SYSTEMS FOR VEHICLES, SUSPENSION SYSTEMS FOR VEHICLES, INTERCHANGEABLE CONTAINERS FOR VEHICLES, NAMELY, ROOF RACK STORAGE CONTAINERS FOR LAND VEHICLES, CONTAINER VEHICLES, NAMELY, EQUIPMENT TRAILERS, HORSE TRAILERS, CAMPING TRAILERS, IN CLASS 12 (U.S. CLS. 19, 21, 23, 31, 35 AND 44).

FOR: RETAIL STORE SERVICES, WHOLESALE STORE, ORDERING, DISTRIBUTORSHIP AND MAIL ORDER SERVICES RELATING TO MACHINES AND MACHINE TOOLS; RETAIL STORE SERVICES, WHOLESALE STORE, ORDERING, DISTRIBUTORSHIP AND MAIL ORDER SERVICES RELATING TO AGRICULTURAL IMPLEMENTS, IN PARTICULAR REAPERS AND THRESHERS, CHOPPERS, NAMELY, FORAGE HARVESTERS, BALING PRESSES, FARM TRACTORS, AGRICULTURAL TRANSPORT APPARATUS, SELF-LOADERS, MOWERS, TURNERS AND SWATHERS, SOIL CULTIVATION MACHINES AND IMPLEMENTS, AGRICULTURAL MACHINES, NAMELY, SOWERS, IMPLEMENTS FOR RELEASING FERTILIZERS AND PLANT PROTECTION SUBSTANCES, AND PARTS AND FITTINGS THEREFOR, INCLUDED IN CLASS 7, HAND-OPERATED APPARATUS

FOR USE IN AGRICULTURE, HORTICULTURE AND FORESTRY, FOR THE CONSTRUCTION OF MACHINES, APPARATUS AND VEHICLES, AND FOR STRUCTURAL ENGINEERING, VEHICLES, APPARATUS FOR LOCOMOTION BY LAND, AND PARTS AND FITTINGS THEREFOR, TRACTORS, LOADERS, TRACTORS, COUPLINGS, GEARS, HYDRAULIC AND MECHANICAL APPARATUS FOR LAND VEHICLES, INCLUDED IN CLASS 12, EXCEPT CARS, TIPPING BODIES FOR VEHICLES, SEMI-TRAILERS, VEHICLE SYSTEMS, INTERCHANGEABLE CONTAINERS FOR VEHICLES, CONTAINER VEHICLES; RETAIL STORE SERVICES, WHOLESALE STORE, ORDERING, DISTRIBUTORSHIP AND MAIL ORDER SERVICES RELATING TO CLOTHING, INCLUDING T-SHIRTS, SWEATSHIRTS, SHIRTS, TROUSERS, JACKETS, WAISTCOATS, CLOTHING COMBINATIONS, COATS, SUITS, NECKTIES, FOOTWEAR, HEADGEAR; RETAIL STORE SERVICES, WHOLESALE STORE, ORDERING, DISTRIBUTORSHIP AND MAIL ORDER SERVICES RELATING TO GAMES AND PLAYTHINGS, GYMNASTIC AND SPORTING ARTICLES, TOY MODELS OF MA-

CHINES AND VEHICLES, IN CLASS 35 (U.S. CLS. 100, 101 AND 102).

FOR: INSURANCE, NAMELY, INSURANCE AGENCIES, INSURANCE BROKERAGE, INSURANCE CONSULTATION, FINANCING SERVICES, LEASING OF MACHINES, NAMELY, RENTAL OF CASH DISPENSERS OR AUTOMATED TELLER MACHINES, LEASING OF VEHICLES AND PARTS THEREFOR, IN CLASS 36 (U.S. CLS. 100, 101 AND 102).

PRIORITY DATE OF 3-31-2006 IS CLAIMED.

OWNER OF INTERNATIONAL REGISTRATION 0911460 DATED 8-16-2006, EXPIRES 8-16-2016.

THE ENGLISH TRANSLATION OF THE WORD "KRONE" IN THE MARK IS "CROWN".

SER. NO. 79-033,924, FILED 8-16-2006.

TINA BROWN, EXAMINING ATTORNEY

**Int. Cls.: 7, 9, 17, 35, 37 and 42**

**Prior U.S. Cls.: 1, 5, 12, 13, 19, 21, 23, 26, 31, 34, 35,  
36, 38, 50, 100, 101, 102, 103 and 106**

**Reg. No. 3,499,239**

**United States Patent and Trademark Office**

**Registered Sep. 9, 2008**

**TRADEMARK  
SERVICE MARK  
PRINCIPAL REGISTER**

**BXPL**

BADGER EXPLORER ASA (NORWAY ASA)  
P.O. BOX 360 FORUS  
N-4067 STAVANGER  
NORWAY

FOR: MACHINES, NAMELY, DRILLING MACHINES AND THEIR STRUCTURAL PARTS, AND MACHINE TOOLS, NAMELY, METALWORKING MACHINE TOOLS AND THEIR STRUCTURAL PARTS; MOTORS NOT FOR LAND VEHICLES, NAMELY, ELECTRIC MOTORS AND THEIR STRUCTURAL PARTS, FOR DRILLING MACHINES; AND ENGINES, AND THEIR STRUCTURAL PARTS, NOT FOR LAND VEHICLES; MACHINE COUPLINGS AND TRANSMISSION COMPONENTS, NAMELY, TRANSMISSION BELTS; BITS FOR POWER DRILLS; DRILLING HEADS, NAMELY, DRILLING HEADS AND THEIR STRUCTURAL PARTS FOR UNDERGROUND DRILLING; POWER TRANSMISSIONS AND THEIR STRUCTURAL PARTS, NOT FOR LAND VEHICLES; COMPRESSORS, NAMELY, COMPRESSORS AND THEIR STRUCTURAL PARTS, FOR MACHINES; ROBOTS, NAMELY, INDUSTRIAL ROBOTS AND THEIR STRUCTURAL PARTS; CONTROL MECHANISMS, NAMELY, SPEED AND DIRECTION CONTROLS AND THEIR STRUCTURAL PARTS FOR MACHINES, FOR ENGINES AND FOR MOTORS; EXTRACTORS, NAMELY, HYDROCARBON EXTRACTORS AND THEIR STRUCTURAL PARTS, IN CLASS 7 (U.S. CLS. 13, 19, 21, 23, 31, 34 AND 35).

FOR: SCIENTIFIC APPARATUS AND INSTRUMENTS, NAMELY, SENSING AND SIGNALING DEVICES FOR MEASUREMENT OF MINERALS, FLUIDS AND HYDROCARBONS; NAUTICAL APPARATUS AND INSTRUMENTS, NAMELY, COMPASSES, MARINE DEPTH FINDERS,

WAVEMETERS, SONARS; WEIGHING APPARATUS AND INSTRUMENTS, NAMELY, SCALES; MEASURING APPARATUS AND INSTRUMENTS, NAMELY, LASER MEASURING SYSTEMS, PRESSURE GAUGES, THERMOMETERS, DENSIMETERS, DENSITOMETERS, HYDROMETERS, HYDROCARBON METERS, SLOPE INDICATORS; CHECKING AND SUPERVISING APPARATUS AND INSTRUMENTS, NAMELY, ALARM MONITORING SYSTEMS, VIDEO AND AUDIO MONITORS; SENSORS, NAMELY, ACCELERATION SENSORS, OIL LEVEL SENSORS; APPARATUS AND INSTRUMENTS FOR CONDUCTING ELECTRICITY, NAMELY, CONDUCTIVE FIBERS, NAMELY, FIBERS FOR CONDUCTING ELECTRICAL CHARGES AND STATIC ELECTRICAL CHARGES; APPARATUS AND INSTRUMENTS FOR SWITCHING ELECTRICITY, NAMELY, ELECTRIC SWITCHES; APPARATUS AND INSTRUMENTS FOR TRANSFORMING ELECTRICITY, NAMELY, ELECTRIC TRANSFORMERS; APPARATUS AND INSTRUMENTS FOR ACCUMULATING ELECTRICITY, NAMELY, ELECTRIC ACCUMULATORS; APPARATUS AND INSTRUMENTS FOR REGULATING ELECTRICITY, NAMELY, VOLTAGE REGULATORS FOR ELECTRIC POWER; APPARATUS AND INSTRUMENTS FOR CONTROLLING ELECTRICITY, NAMELY, ELECTRICAL CONTROLLERS; ELECTRIC CABLES AND CONDUCTORS; TESTING APPARATUS, NAMELY, CIRCUIT TESTERS, CARBON TESTERS; COMPUTER PROGRAMMES FOR THE MANAGEMENT OF UNDERGROUND DRILLING ACTIVITIES; DATA PROCESSING EQUIPMENT, NAMELY, DATA PROCESSORS; ELECTRONIC SIGNAL TRANSMITTERS, NAMELY, CABLES FOR ELECTRICAL OR OPTICAL SIGNAL TRANSMISSION, IN CLASS 9 (U.S. CLS. 21, 23, 26, 36 AND 38).

FOR: RUBBER, GUTTA-PERCHA, MICA, AND GOODS MADE FROM THESE MATERIALS, NAME- LY, CLUTCH LININGS, RUBBER SLEEVES AND PIPE JACKETS ALL FOR USE WITH PIPES FOR UNDERWATER EXPLORATION; PIPE JACKETS NOT OF METAL FOR USE WITH PIPES FOR UNDERWATER EXPLORATION; PACKING MATE- RIALS, NAMELY, JOINT PACKINGS FOR USE WITH PIPES FOR UNDERWATER EXPLORATION; CYLINDER JOINTINGS FOR USE WITH PIPES FOR UNDERWATER EXPLORATION; STOPPING MA- TERIALS, NAMELY, WASHERS OF RUBBER OR VULCANIZED FIBER, STAFFING RINGS OF PLAS- TIC OR RUBBER; INSULATION FOR ELECTRIC CABLES AND ELECTRICITY CONDUITS; WATER- PROOF PACKINGS FOR SUBSEA DRILLING; VALVES OF INDIA-RUBBER OR VULCANIZED FIBER; FLEXIBLE PIPES, NOT OF METAL, IN CLASS 17 (U.S. CLS. 1, 5, 12, 13, 35 AND 50).

FOR: SYSTEMATIZING AND COMPILATION OF INFORMATION INTO COMPUTER DATABASES; MANAGEMENT OF COMPUTERIZED FILES; PRO- VIDING STATISTICAL INFORMATION; SALES PROMOTION SERVICES AND RETAIL STORE SER- VICES FEATURING MACHINES AND MACHINE TOOLS, MOTORS, MACHINE COUPLING AND TRANSMISSION COMPONENTS, DRILLING MA- CHINES, DRILLING BITS AND DRILLING HEADS, TRANSMISSIONS, OTHER THAN FOR LAND VE- HICLES, COMPRESSORS, ROBOTS, CONTROL ME- CHANISMS FOR MACHINES, ENGINES OR MOTORS, EXTRACTORS, SCIENTIFIC, NAUTICAL, WEIGHING, MEASURING, CHECKING, SUPERVI- SION AND REGULATING APPARATUS AND IN- STRUMENTS, SENSORS, APPARATUS AND INSTRUMENTS FOR CONDUCTING, SWITCHING, TRANSFORMING, ACCUMULATING, REGULAT- ING OR CONTROLLING ELECTRICITY, ELECTRIC CABLES AND CONDUCTORS, TESTING APPARA- TUS, COMPUTER PROGRAMMES, DATA PROCES- SING EQUIPMENT, ELECTRONIC SIGNAL TRANSMITTERS, RUBBER, GUTTA-PERCHA, GUM, ASBESTOS, MICA AND GOODS MADE FROM THESE MATERIALS, PACKING, STOPPING AND INSULATING MATERIALS, INSULATION FOR ELECTRIC CABLES AND ELECTRICITY CON- DUITS, WATERPROOF PACKINGS, VALVES OF INDIA-RUBBER OR VULCANIZED FIBER, FLEX- IBLE PIPES, NOT OF METAL, PARTS AND FIT- TINGS FOR ALL THE AFOREMENTIONED GOODS, IN CLASS 35 (U.S. CLS. 100, 101 AND 102).

FOR: INSTALLATION, MAINTENANCE AND REPAIR OF MACHINES AND MACHINE TOOLS, MOTORS, MACHINE COUPLING AND TRANSMIS- SION COMPONENTS, DRILLING MACHINES, DRILLING BITS AND DRILLING HEADS, TRAN- SMISIONS, OTHER THAN FOR LAND VEHICLES, COMPRESSORS, ROBOTS, CONTROL MECHAN- ISMS FOR MACHINES, ENGINES OR MOTORS, EXTRACTORS, SCIENTIFIC, NAUTICAL, WEIGH- ING, MEASURING, CHECIDUG, AND SUPERVI- SION APPARATUS AND INSTRUMENTS, SENSORS, APPARATUS AND INSTRUMENTS FOR CONDUCTING, SWITCHING, TRANSFORMING, ACCUMULATING, REGULATING OR CONTROL-

LING ELECTRICITY, ELECTRIC CABLES AND CONDUCTORS, TESTING APPARATUS, PARTS AND FITTINGS FOR ALL THE AFOREMEN- TIONED GOODS; RENTAL OF DRILLING MA- CHINES AND MACHINE TOOLS, NAMELY, METALWORKING MACHINE TOOLS, MOTORS AND ENGINES EXCEPT FOR LAND VEHICLES, MACHINE COUPLING AND TRANSMISSION COM- PONENTS, DRILLING BITS, DRILLING HEADS, TRANSMISSIONS, OTHER THAN FOR LAND VE- HICLES, COMPRESSORS, ROBOTS, CONTROL ME- CHANISMS FOR MACHINES, ENGINES OR MOTORS, EXTRACTORS, PARTS AND FITTINGS FOR ALL THE AFOREMENTIONED GOODS; DRIL- LING OF WELLS, IN CLASS 37 (U.S. CLS. 100, 103 AND 106).

FOR: SCIENTIFIC AND TECHNOLOGICAL SER- VICES, NAMELY, GEOLOGICAL PROSPECTING, GEOLOGICAL SURVEYS, OIL-FIELD AND GAS- FIELD ENGINEERING SURVEYS, UNDERWATER EXPLORATION; SCIENTIFIC, TECHNOLOGICAL AND INDUSTRIAL RESEARCH, NAMELY, GEO- LOGICAL RESEARCH, TECHNICAL RESEARCH, NAMELY, TECHNICAL RESEARCH REGARDING UNDERWATER EXPLORATION, CHEMICAL RE- SEARCH, MECHANICAL RESEARCH, AND SCIE- NTFIC AND TECHNOLOGICAL DESIGN RELATING TO THE AFOREMENTIONED SERVIC- ES, NAMELY, DESIGN OF DRILLING MACHIN- ERY; INDUSTRIAL ANALYSIS SERVICES, NAMELY, CHEMICAL ANALYSIS, ANALYSIS FOR OIL-FIELD AND GAS-FIELD EXPLORATION AND EXPLOITATION, TECHNICAL ANALYSIS OF DRILLING SAMPLES FROM UNDERGROUND DRILLING FOR EXPLOITATION OF NATURAL RESOURCES, TECHNICAL CONSULTANCY SER- VICES CONCERNING GEOLOGICAL PROSPECT- ING, EXPLORATION AND SURVEYS; ENGINEERING; DESIGN AND DEVELOPMENT OF COMPUTER HARDWARE AND SOFTWARE; DESIGN, UPDATING AND MAINTENANCE OF COMPUTER SOFTWARE; RENTAL OF SCIENTI- FIC, NAUTICAL, WEIGHING, MEASURING, CHECKING SUPERVISION APPARATUS AND IN- STRUMENTS, NAMELY, COMPUTERS, COMPU- TER SYSTEMS, COMPUTER PROGRAMMES, DATA PROCESSORS, SENSING AND SIGNALING DEVICES FOR MEASUREMENT OF MINERALS, FLUIDS AND HYDROCARBONS, COMPASSES, MARINE DEPTH FINDERS, WAVEMETERS, SO- NARS, SOUNDING LINES, SCALES, LASER MEA- SURING SYSTEMS, PRESSURE GAUGES, THERMOMETERS, DENSIMETERS, DENSITOM- ETERS, HYDROMETERS, HYDROCARBON ME- TERS, SLOPE INDICATORS, ALARM MONITORING SYSTEMS, VIDEO AND AUDIO MONITORS, SENSORS, NAMELY, ACCELE- RATION SENSORS, OIL LEVEL SENSORS, TESTING APPARATUS, NAMELY, CARBON TESTERS, COM- PUTERS AND COMPUTER PROGRAMMES; QUAL- ITY CONTROL FOR OTHERS, IN CLASS 42 (U.S. CLS. 100 AND 101).

THE MARK CONSISTS OF STANDARD CHAR- ACTERS WITHOUT CLAIM TO ANY PARTICULAR FONT, STYLE, SIZE, OR COLOR.



PRIORITY DATE OF 3-6-2006 IS CLAIMED.

SER. NO. 79-033,943, FILED 9-5-2006.

OWNER OF INTERNATIONAL REGISTRATION  
0911568 DATED 9-5-2006, EXPIRES 9-5-2016.

ANDREA BUTLER, EXAMINING ATTORNEY

**Int. Cls.: 9, 16, 35, 38, 39, 41 and 42**

**Prior U.S. Cls.: 2, 5, 21, 22, 23, 26, 29, 36, 37, 38, 50,  
100, 101, 102, 104, 105 and 107**

**Reg. No. 3,499,240**

**United States Patent and Trademark Office**

**Registered Sep. 9, 2008**

**TRADEMARK  
SERVICE MARK  
PRINCIPAL REGISTER**

# DADANET

DADA S.P.A. (ITALY JOINT STOCK COMPANY)  
BORGO DEGLI ALBIZI, 12  
I-50122 FIRENZE  
ITALY

FOR: TRAVEL ARRANGEMENT, NAMELY, MAKING RESERVATIONS AND BOOKINGS FOR TRANSPORTATION, IN CLASS 39 (U.S. CLS. 100 AND 105).

FOR: PRODUCTS FOR COMPUTERS AND RELATED PROGRAMS, NAMELY, BLANK MAGNETIC DATA-CARRIERS AND RECORDING DISCS, COMPUTER GAME SOFTWARE, AND COMPUTER PROGRAMS FOR EDITING IMAGES, SOUND AND VIDEO; PROTECTIVE HELMETS; DOWNLOADABLE SOFTWARE FOR USE IN TELECOMMUNICATIONS, NAMELY, CONTENT SOFTWARE TO WIRELESS COMMUNICATION DEVICES CONCERNING RING TONES, GAMES, GRAPHICS, LOGOS AND SCREEN SAVERS, IN CLASS 9 (U.S. CLS. 21, 23, 26, 36 AND 38).

FOR: TRAINING AND EDUCATION SERVICES, NAMELY, PROVIDING CLASSES, SEMINARS, WORKSHOPS, ONLINE COURSES, IN THE FIELD OF COMPUTER PROGRAMMING, MULTIMEDIA CREATION AND WEBSITE DESIGN; ENTERTAINMENT SERVICES, NAMELY, PROVIDING A WEB SITE FEATURING MUSICAL PERFORMANCES, MUSICAL VIDEOS, RELATED FILM CLIPS, PHOTOGRAPHS AND OTHER MULTIMEDIA MATERIALS; PROVIDING NEWS HEADLINES IN THE NATURE OF CURRENT EVENT REPORTING; PRODUCTION OF MUSICAL VIDEOS AND MOTION PICTURE FILMS; TELEVISION PRODUCTIONS; ENTERTAINMENT SERVICES, NAMELY, PROVIDING NON-DOWNLOADABLE WIRELESS GAMES, RING TONES, SCREEN SAVERS, LOGOS AND IMAGES TO MOBILE PHONES AND OTHER WIRELESS DEVICES, IN CLASS 41 (U.S. CLS. 100, 101 AND 107).

FOR: STATIONERY, MAGAZINES IN THE FIELD OF COMPUTER PROGRAMMING, WIRELESS TELECOMMUNICATIONS AND ENTERTAINMENT; NEWSPAPERS, CATALOGUES IN THE FIELD OF WIRELESS TELECOMMUNICATIONS COMMUNICATIONS, IN CLASS 16 (U.S. CLS. 2, 5, 22, 23, 29, 37, 38 AND 50).

FOR: ADVERTISING SERVICES; INSERTION OF ADVERTISEMENTS, NAMELY, PLACEMENT OF ADVERTISING FOR OTHERS; SALES PROMOTION SERVICES THROUGH THE DISTRIBUTION OF E-CATALOGUES; RENTAL OF ADVERTISING SPACE; BUSINESS MANAGEMENT; BUSINESS ADMINISTRATION, IN CLASS 35 (U.S. CLS. 100, 101 AND 102).

FOR: COMPUTER PROGRAMMING; MULTIMEDIA CREATIONS, NAMELY, DESIGN AND DEVELOPMENT OF MULTIMEDIA PRODUCTS; HOSTING COMPUTER WEB SITES; PROVIDING MOBILE SERVICES FOR MOBILE SITES, NAMELY, HOSTING, MANAGING, DEVELOPING AND MAINTAINING APPLICATIONS, SOFTWARE AND WEBSITES IN THE FIELD OF WIRELESS COMMUNICATION, MOBILE INFORMATION ACCESS AND REMOTE DATA MANAGEMENT FOR WIRELESS DELIVERY OF CONTENT TO HANDHELD COMPUTERS, LAPTOPS AND MOBILE ELECTRONIC DEVICES; DESIGN AND DEVELOPMENT OF ELECTRONIC CATALOGUES ENABLING USERS TO VIEW AND PURCHASE GOODS VIA INTERNET SITES, IN CLASS 42 (U.S. CLS. 100 AND 101).

FOR: TELECOMMUNICATIONS GATEWAY SERVICES; COMMUNICATIONS SERVICES BY COMPUTER VIA DATA TRANSMISSION NETWORKS, NAMELY, ELECTRONIC TRANSMISSION OF IMAGES, PHOTOS AND USER GENERATED CONTENT; ELECTRONIC MAIL SERVICES, IN CLASS 38 (U.S. CLS. 100, 101 AND 104).

THE MARK CONSISTS OF STANDARD CHAR-  
ACTERS WITHOUT CLAIM TO ANY PARTICULAR  
FONT, STYLE, SIZE, OR COLOR.

OWNER OF INTERNATIONAL REGISTRATION  
0912204 DATED 10-24-2006, EXPIRES 10-24-2016.

SER. NO. 79-034,150, FILED 10-24-2006.

PRIORITY DATE OF 8-4-2006 IS CLAIMED.

RON FAIRBANKS, EXAMINING ATTORNEY

**Int. Cls.: 9, 16, 35, 38, 39, 41 and 42**

**Prior U.S. Cls.: 2, 5, 21, 22, 23, 26, 29, 36, 37, 38, 50,  
100, 101, 102, 104, 105 and 107**

**Reg. No. 3,499,241**

**United States Patent and Trademark Office**

**Registered Sep. 9, 2008**

**TRADEMARK  
SERVICE MARK  
PRINCIPAL REGISTER**

The logo for Dada.net is rendered in a bold, stylized, rounded font. The letters are white with a thick black outline, giving it a three-dimensional, bubbly appearance. The word "Dada" is followed by a period and then "net".

DADA S.P.A. (ITALY JOINT STOCK COMPANY)  
BORGO DEGLI ALBIZI, 12  
I-50122 FIRENZE  
ITALY

FOR: PRODUCTS FOR COMPUTERS AND RELATED PROGRAMS, NAMELY, BLANK MAGNETIC DATA-CARRIERS AND RECORDING DISCS, COMPUTER GAME SOFTWARE, AND COMPUTER PROGRAMS FOR EDITING IMAGES, SOUND AND VIDEO; PROTECTIVE HELMETS; DOWNLOADABLE SOFTWARE FOR USE IN TELECOMMUNICATIONS, NAMELY, CONTENT SOFTWARE TO WIRELESS COMMUNICATION DEVICES CONCERNING RING TONES, GAMES, GRAPHICS, LOGOS AND SCREEN SAVERS, IN CLASS 9 (U.S. CLS. 21, 23, 26, 36 AND 38).

FOR: STATIONERY, MAGAZINES IN THE FIELD OF COMPUTER PROGRAMMING, WIRELESS TELECOMMUNICATIONS AND ENTERTAINMENT; NEWSPAPERS, CATALOGUES IN THE FIELD OF WIRELESS TELECOMMUNICATIONS COMMUNICATIONS, IN CLASS 16 (U.S. CLS. 2, 5, 22, 23, 29, 37, 38 AND 50).

FOR: ADVERTISING SERVICES; INSERTION OF ADVERTISEMENTS, NAMELY, PLACEMENT OF ADVERTISING FOR OTHERS; SALES PROMOTION SERVICES THROUGH THE DISTRIBUTION OF E-CATALOGUES; RENTAL OF ADVERTISING SPACE; BUSINESS MANAGEMENT; BUSINESS ADMINISTRATION, IN CLASS 35 (U.S. CLS. 100, 101 AND 102).

FOR: TELECOMMUNICATIONS GATEWAY SERVICES; COMMUNICATIONS SERVICES BY COMPUTER VIA DATA TRANSMISSION NETWORKS, NAMELY, ELECTRONIC TRANSMISSION OF IMAGES, PHOTOS AND USER GENERATED CONTENT;

ELECTRONIC MAIL SERVICES, IN CLASS 38 (U.S. CLS. 100, 101 AND 104).

FOR: TRAVEL ARRANGEMENT, NAMELY, MAKING RESERVATIONS AND BOOKINGS FOR TRANSPORTATION, IN CLASS 39 (U.S. CLS. 100 AND 105).

FOR: TRAINING AND EDUCATION SERVICES, NAMELY, PROVIDING CLASSES, SEMINARS, WORKSHOPS, ONLINE COURSES, IN THE FIELD OF COMPUTER PROGRAMMING, MULTIMEDIA CREATION AND WEBSITE DESIGN; ENTERTAINMENT SERVICES, NAMELY, PROVIDING A WEB SITE FEATURING MUSICAL PERFORMANCES, MUSICAL VIDEOS, RELATED FILM CLIPS, PHOTOGRAPHS AND OTHER MULTIMEDIA MATERIALS; PROVIDING NEWS HEADLINES IN THE NATURE OF CURRENT EVENT REPORTING; PRODUCTION OF MUSICAL VIDEOS AND MOTION PICTURE FILMS; TELEVISION PRODUCTIONS; ENTERTAINMENT SERVICES, NAMELY, PROVIDING NON-DOWNLOADABLE WIRELESS GAMES, RING TONES, SCREEN SAVERS, LOGOS AND IMAGES TO MOBILE PHONES AND OTHER WIRELESS DEVICES, IN CLASS 41 (U.S. CLS. 100, 101 AND 107).

FOR: COMPUTER PROGRAMMING; MULTIMEDIA CREATIONS, NAMELY, DESIGN AND DEVELOPMENT OF MULTIMEDIA PRODUCTS; HOSTING COMPUTER WEB SITES PROVIDING MOBILE SERVICES FOR MOBILE SITES, NAMELY, HOSTING, MANAGING, DEVELOPING AND MAINTAINING APPLICATIONS, SOFTWARE AND WEBSITES IN THE FIELD OF WIRELESS COMMUNICATION, MOBILE INFORMATION ACCESS AND REMOTE DATA MANAGEMENT FOR WIRELESS DELIVERY OF CONTENT TO HANDHELD COMPUTERS, LAPTOPS AND MOBILE ELECTRONIC DEVICES; DESIGN AND DEVELOPMENT OF ELECTRONIC

CATALOGUES ENABLING USERS TO VIEW AND PURCHASE GOODS VIA INTERNET SITES, IN CLASS 42 (U.S. CLS. 100 AND 101).

PRIORITY DATE OF 8-4-2006 IS CLAIMED.

OWNER OF INTERNATIONAL REGISTRATION 0912205 DATED 10-24-2006, EXPIRES 10-24-2016.

THE MARK IS COMPOSED OF THE WORDING "DADA.NET" WHICH IS CHARACTERISED BY AN IRREGULAR FRAME BORDERING THE LETTERS; THE WORD "DADA" IS PRECEDED AND FOLLOWED BY A POINT AND THE FIRST LETTER "D" IS BIGGER THAN THE REMAINING LETTERS.

SER. NO. 79-034,151, FILED 10-24-2006.

RON FAIRBANKS, EXAMINING ATTORNEY

**Int. Cls.: 9, 16, 35, 38, 39, 41 and 42**

**Prior U.S. Cls.: 2, 5, 21, 22, 23, 26, 29, 36, 37, 38, 50,  
100, 101, 102, 104, 105 and 107**

**Reg. No. 3,499,242**

**United States Patent and Trademark Office**

**Registered Sep. 9, 2008**

**TRADEMARK  
SERVICE MARK  
PRINCIPAL REGISTER**

***Dada.***

DADA S.P.A. (ITALY JOINT STOCK COMPANY)  
BORGHI DEGLI ALBIZI, 12  
I-50122 FIRENZE  
ITALY

FOR: PRODUCTS FOR COMPUTERS AND RELATED PROGRAMS, NAMELY, BLANK MAGNETIC DATA-CARRIERS AND RECORDING DISCS, COMPUTER GAME SOFTWARE, AND COMPUTER PROGRAMS FOR EDITING IMAGES, SOUND AND VIDEO; PROTECTIVE HELMETS; DOWNLOADABLE SOFTWARE FOR USE IN TELECOMMUNICATIONS, NAMELY, CONTENT SOFTWARE TO WIRELESS COMMUNICATION DEVICES CONCERNING RING TONES, GAMES, GRAPHICS, LOGOS AND SCREEN SAVERS, IN CLASS 9 (U.S. CLS. 21, 23, 26, 36 AND 38).

FOR: STATIONERY, MAGAZINES IN THE FIELD OF COMPUTER PROGRAMMING, WIRELESS TELECOMMUNICATIONS AND ENTERTAINMENT; NEWSPAPERS, CATALOGUES IN THE FIELD OF WIRELESS TELECOMMUNICATIONS COMMUNICATIONS, IN CLASS 16 (U.S. CLS. 2, 5, 22, 23, 29, 37, 38 AND 50).

FOR: ADVERTISING SERVICES; INSERTION OF ADVERTISEMENTS, NAMELY, PLACEMENT OF ADVERTISING FOR OTHERS; SALES PROMOTION SERVICES THROUGH THE DISTRIBUTION OF E-CATALOGUES; RENTAL OF ADVERTISING SPACE; BUSINESS MANAGEMENT; BUSINESS ADMINISTRATION, IN CLASS 35 (U.S. CLS. 100, 101 AND 102).

FOR: TELECOMMUNICATIONS GATEWAY SERVICES; COMMUNICATIONS SERVICES BY COMPUTER VIA DATA TRANSMISSION NETWORKS, NAMELY, ELECTRONIC TRANSMISSION OF IMA-

GES, PHOTOS AND USER GENERATED CONTENT; ELECTRONIC MAIL, IN CLASS 38 (U.S. CLS. 100, 101 AND 104).

FOR: TRAVEL ARRANGEMENT, NAMELY, MAKING RESERVATIONS AND BOOKINGS FOR TRANSPORTATION, IN CLASS 39 (U.S. CLS. 100 AND 105).

FOR: TRAINING AND EDUCATION SERVICES, NAMELY, PROVIDING CLASSES, SEMINARS, WORKSHOPS, ONLINE COURSES, IN THE FIELD OF COMPUTER PROGRAMMING, MULTIMEDIA CREATION AND WEBSITE DESIGN; ENTERTAINMENT SERVICES, NAMELY, PROVIDING A WEB SITE FEATURING MUSICAL PERFORMANCES, MUSICAL VIDEOS, RELATED FILM CLIPS, PHOTOGRAPHS AND OTHER MULTIMEDIA MATERIALS; PROVIDING NEWS HEADLINES IN THE NATURE OF CURRENT EVENT REPORTING; PRODUCTION OF MUSICAL VIDEOS AND MOTION PICTURE FILMS; TELEVISION PRODUCTIONS; ENTERTAINMENT SERVICES, NAMELY, PROVIDING NON-DOWNLOADABLE WIRELESS GAMES, RING TONES, SCREEN SAVERS, LOGOS AND IMAGES TO MOBILE PHONES AND OTHER WIRELESS DEVICES, IN CLASS 41 (U.S. CLS. 100, 101 AND 107).

FOR: COMPUTER PROGRAMMING; MULTIMEDIA CREATIONS, NAMELY, DESIGN AND DEVELOPMENT OF MULTIMEDIA PRODUCTS; HOSTING COMPUTER WEB SITES; PROVIDING MOBILE SERVICES FOR MOBILE SITES, NAMELY, HOSTING, MANAGING, DEVELOPING AND MAINTAINING APPLICATIONS, SOFTWARE AND WEBSITES IN THE FIELD OF WIRELESS COMMUNICATION, MOBILE INFORMATION ACCESS AND REMOTE DATA MANAGEMENT FOR WIRELESS DELIVERY OF CONTENT TO HANDHELD COM-

PUTERS, LAPTOPS AND MOBILE ELECTRONIC DEVICES; DESIGN AND DEVELOPMENT OF ELECTRONIC CATALOGUES ENABLING USERS TO VIEW AND PURCHASE GOODS VIA INTERNET SITES, IN CLASS 42 (U.S. CLS. 100 AND 101).

PRIORITY DATE OF 8-4-2006 IS CLAIMED.

OWNER OF INTERNATIONAL REGISTRATION 0912206 DATED 10-24-2006, EXPIRES 10-24-2016.

THE MARK IS COMPOSED OF THE WORD "DADA" WHICH IS PRECEDED AND FOLLOWED BY A POINT AND THE FIRST LETTER "D" IS BIGGER THAN THE REMAINING LETTERS; THE MARK MAY BE REPRODUCED IN ANY COLOUR OR COMBINATION OF COLOURS.

SER. NO. 79-034,152, FILED 10-24-2006.

RON FAIRBANKS, EXAMINING ATTORNEY

**Int. Cls.: 9, 28, 35, 36, 37, 38, 39, 41, 42 and 45**

**Prior U.S. Cls.: 21, 22, 23, 26, 36, 38, 50, 100, 101, 102, 103, 104, 105, 106 and 107**

**Reg. No. 3,499,243**

**United States Patent and Trademark Office**

**Registered Sep. 9, 2008**

**TRADEMARK  
SERVICE MARK  
PRINCIPAL REGISTER**



INSPIRED GAMING (UK) LIMITED  
3 THE MALTINGS, WETMORE ROAD  
BURTON ON TRENT, STAFFORDSHIRE DE14 1SE  
UNITED KINGDOM

FOR: COMPUTER SOFTWARE FOR ENABLING THE OPERATION OF GAMING AND ENTERTAINMENT APPARATUS AND INSTRUMENTS; JUKE-BOXES; ELECTRONIC, ELECTRICAL AND DIGITAL ENTERTAINMENT APPARATUS AND INSTRUMENTS, NAMELY, GAMING MACHINES AND VIDEO GAME CONSOLES FOR USE WITH AN EXTERNAL DISPLAY SCREEN OR MONITOR; ELECTRONIC, ELECTRICAL AND DIGITAL APPARATUS AND INSTRUMENTS FOR THE PLAYING OF MUSIC AND VIDEOS, NAMELY, MP3 PLAYERS; TELEVISIONS; RADIOS; DOWNLOADABLE MOBILE TELEPHONE RING TONES VIA A GLOBAL COMPUTER NETWORK AND WIRELESS DEVICES; BLANK VIDEO TAPES, CDS, DVDS, CD-ROMS, AUDIO TAPES AND AUDIO CASSETTES; AUTOMATIC VENDING MACHINES; CABINETS AND CONSOLES FOR HOUSING ELECTRONIC ENTERTAINMENT AND GAMING APPARATUS AND INSTRUMENTS, NAMELY, MOUNTING RACKS FOR COMPUTER AND TELECOMMUNICATIONS HARDWARE; STRUCTURAL PARTS FOR ALL THE AFORESAID GOODS, IN CLASS 9 (U.S. CLS. 21, 23, 26, 36 AND 38).

FOR: ARCADE-TYPE ELECTRONIC VIDEO GAMES; GAMING APPARATUS AND INSTRUMENTS, NAMELY, CHIPS, GAME WHEELS, POKER CHIPS, CARD GAME TABLES AND GAMING TABLES; ELECTRONIC, ELECTRICAL AND DIGITAL GAMING APPARATUS AND INSTRUMENTS, NAMELY, STAND ALONE VIDEO GAME AND GAMBLING MACHINES, IN CLASS 28 (U.S. CLS. 22, 23, 38 AND 50).

FOR: MARKET RESEARCH AND ANALYSIS SERVICES; DATA PROCESSING, STORAGE, COMPILATION AND RETRIEVAL SERVICES, NAMELY, COMMERCIAL INFORMATION AGENCIES; BUSINESS INFORMATION AND CONSULTANCY SERVICES; BUSINESS MANAGEMENT SERVICES; ADVERTISING SERVICES; SALES PROMOTION AND PUBLICITY SERVICES; BUSINESS MARKETING SERVICES; RETAIL STORE SERVICES FEATURING ELECTRONIC, ELECTRICAL DIGITAL APPARATUS AND INSTRUMENTS, ENTERTAINMENT APPARATUS AND INSTRUMENTS, GAMING AND GAMBLING APPARATUS AND INSTRUMENTS, COMMUNICATIONS AND TELECOMMUNICATIONS APPARATUS AND INSTRUMENTS; PROVISION OF LOYALTY REDEMPTION AND BONUS POINTS SCHEMES, NAMELY, CUSTOMER LOYALTY SERVICES AND CUSTOMER CLUB SERVICES FOR COMMERCIAL, PROMOTIONAL AND ADVERTISING PURPOSES; PROVI-



SION OF DISCOUNT SERVICES, NAMELY, PROMOTING THE GOODS AND SERVICES OF OTHER THROUGH THE DISTRIBUTION OF DISCOUNT CARDS; ADVICE, INFORMATION AND CONSULTANCY SERVICES RELATING TO ALL OF THE AFORESAID SERVICES, IN CLASS 35 (U.S. CLS. 100, 101 AND 102).

FOR: INSURANCE SERVICES, NAMELY, BROKERAGE, PROVISION OF CREDIT FACILITIES, NAMELY, CREDIT AGENCIES; CREDIT CARD SERVICES; CREDIT CARD TRANSACTION PROCESSING SERVICES; COLLECTION AND REFILLING OF CASH, CARDS AND/OR TOKENS FOR ELECTRONIC, ELECTRICAL, DIGITAL AND TELECOMMUNICATIONS APPARATUS AND INSTRUMENTS, NAMELY, AUTOMATED TELLER MACHINE SERVICES; ADVICE, INFORMATION AND CONSULTANCY SERVICES RELATING TO ALL OF THE AFORESAID SERVICES, IN CLASS 36 (U.S. CLS. 100, 101 AND 102).

FOR: INSTALLATION, REPAIR AND MAINTENANCE SERVICES FOR GAMING MACHINES AND GAME CONSOLES, APPARATUS AND INSTRUMENTS FOR THE PLAYING OF MUSIC AND VIDEOS; TELEVISIONS; RADIOS; CABINETS AND CONSOLES AND FOR HOUSING ELECTRONIC ENTERTAINMENT AND GAMING APPARATUS AND INSTRUMENTS, NAMELY, STAND ALONE VIDEO GAME AND GAMBLING MACHINES; ADVICE, INFORMATION AND CONSULTANCY SERVICES RELATING TO ALL OF THE AFORESAID SERVICES, IN CLASS 37 (U.S. CLS. 100, 103 AND 106).

FOR: TELECOMMUNICATIONS, COMMUNICATIONS, SATELLITE AND DIGITAL COMMUNICATION SERVICES, NAMELY, COMMUNICATIONS BY MOBILE PHONES AND COMPUTER TERMINALS; TELECOMMUNICATION SERVICES FOR THE PROVISION AND DOWNLOADING OF MOBILE TELEPHONE RING TONES AND OF TELEVISION, RADIO, FILM, VIDEO AND AUDIO MATERIAL, NAMELY, DATA TRANSMISSION AND RECEPTION SERVICES VIA TELECOMMUNICATIONS MEANS; NETWORKING SERVICES, NAMELY, COMMUNICATION VIA MULTI NATIONAL TELECOMMUNICATION NETWORKS; INTERNET SERVICE PROVIDER SERVICES; PROVISION OF TELECOMMUNICATIONS SERVICES ENABLING COMMERCE TO BE CONDUCTED OVER NETWORKS AND OVER THE INTERNET, NAMELY, PROVISION OF ACCESS TO ELECTRONIC SITES; TELEVISION, SATELLITE, DIGITAL VIDEO AND RADIO BROADCASTING AND TRANSMISSION SERVICES; RENTAL OF TELECOMMUNICATIONS, COMMUNICATIONS, DIGITAL AND SATELLITE COMMUNICATIONS APPARATUS AND INSTRUMENTS; ADVICE, INFORMATION AND CONSULTANCY SERVICES RELATING TO ALL THE AFORESAID SERVICES, IN CLASS 38 (U.S. CLS. 100, 101 AND 104).

FOR: WAREHOUSING SERVICES; TRANSPORTATION AND DISTRIBUTION SERVICES, NAMELY, TRANSPORT OF GOODS; TRAVEL AGENCY SERVICES, NAMELY, MAKING RESERVATIONS

AND BOOKINGS FOR TRANSPORTATION; SERVICES FOR BOOKING HOLIDAYS AND TRAVEL ARRANGEMENTS, NAMELY, TRAVEL BOOKING AGENCIES; TRAVEL SERVICES, NAMELY, TRAVEL GUIDE SERVICES; ADVICE, INFORMATION AND CONSULTANCY SERVICES RELATING TO ALL OF THE AFORESAID SERVICES, IN CLASS 39 (U.S. CLS. 100 AND 105).

FOR: ENTERTAINMENT SERVICES, NAMELY, GAMBLING SERVICES; PROVISION OF LEISURE ACTIVITIES, NAMELY, PROVIDING FACILITIES FOR RECREATION ACTIVITIES; RENTAL OF ELECTRONIC, ELECTRICAL AND DIGITAL GAMING, GAMBLING AND ENTERTAINMENT MACHINES; GAMING SERVICES, NAMELY, CONDUCTING AND PROVIDING FACILITIES FOR SPECIAL EVENTS FEATURING E-MAIL AND GAMING CONTESTS AND TOURNAMENTS; GAMBLING AND LOTTERY SERVICES; PROVISION AND COMMISSION OF TELEVISION AND RADIO PROGRAMMERS AND VIDEOS, NAMELY, TELEVISION AND RADIO ENTERTAINMENT PRODUCTION; MAGAZINE PUBLISHING SERVICES; ADVICE, INFORMATION AND CONSULTANCY SERVICES RELATING TO ALL THE AFORESAID SERVICES, IN CLASS 41 (U.S. CLS. 100, 101 AND 107).

FOR: DESIGN SERVICES, NAMELY, DESIGN FOR OTHERS IN THE FIELD OF ELECTRONIC, ELECTRICAL DIGITAL APPARATUS AND INSTRUMENTS, ENTERTAINMENT APPARATUS AND INSTRUMENTS, GAMING AND GAMBLING APPARATUS AND INSTRUMENTS, COMMUNICATIONS AND TELECOMMUNICATIONS APPARATUS AND INSTRUMENTS; PRODUCT RESEARCH SERVICES; PROVISION OF TECHNICAL SERVICES OFFERED BY AN ENGINEER OR TECHNICAL ADVISER, NAMELY, PRODUCT DEVELOPMENT CONSULTATION; CONSULTANCY, PLANNING, MONITORING, TESTING, FAULT FINDING AND COLLATION OF DATA RELATING TO ELECTRONIC, ELECTRICAL AND DIGITAL ENTERTAINMENT, VIDEO, MUSIC, GAMING, GAMBLING, TELECOMMUNICATION, COMMUNICATION AND SATELLITE APPARATUS AND INSTRUMENTS, NAMELY, PRODUCT RESEARCH AND DEVELOPMENT, COMPUTER MONITORING AND SECURITY SERVICES, NAMELY, MONITORING AND REPORTING ON THE PERFORMANCE, AVAILABILITY, AND ERRORS OF WEB SITES OF OTHERS; COMPUTER PROGRAMMING SERVICES; RENTAL OF COMPUTERS, COMPUTER HARDWARE AND COMPUTER SOFTWARE; ADVICE, INFORMATION AND CONSULTANCY SERVICES RELATING TO ALL OF THE AFORESAID SERVICES, IN CLASS 42 (U.S. CLS. 100 AND 101).

FOR: SECURITY GUARD SERVICES; SECURITY SERVICES FOR MONITORING AND DETECTING TAMPERING WITH ELECTRONIC, ELECTRICAL AND DIGITAL ENTERTAINMENT, VIDEO, MUSIC, GAMING, GAMBLING, TELECOMMUNICATIONS AND SATELLITE APPARATUS AND INSTRUMENTS, NAMELY, SECURITY INSPECTION SERVICES FOR OTHERS, IN CLASS 45 (U.S. CLS. 100 AND 101).

PRIORITY DATE OF 8-29-2006 IS CLAIMED.

SER. NO. 79-034,254, FILED 9-11-2006.

OWNER OF INTERNATIONAL REGISTRATION  
0912527 DATED 9-11-2006, EXPIRES 9-11-2016.

ROBERT STRUCK, EXAMINING ATTORNEY

Int. Cls.: 7, 9, 16, 20, 35, 36, 37, 38, 39 and 42

Prior U.S. Cls.: 2, 5, 13, 19, 21, 22, 23, 25, 26, 29, 31, 32, 34, 35, 36, 37, 38, 50, 100, 101, 102, 103, 104, 105 and 106

Reg. No. 3,499,244

Registered Sep. 9, 2008

United States Patent and Trademark Office

**TRADEMARK  
SERVICE MARK  
PRINCIPAL REGISTER**



NEOPOST SA (FRANCE SOCIÉTÉ ANONYME)  
113 RUE JEAN MARIN NAUDIN  
F-92220 BAGNEUX  
FRANCE

FOR: MAIL PROCESSING MACHINES, NAMELY, FRANKING MACHINES, FEEDERS, CONVEYORS, FOLDERS, INSERTERS, DOCUMENT SHREDDERS, NAMELY, SHREDDING MACHINES, NOT INCLUDING PAPER SHREDDERS FOR OFFICES; STACKING MACHINES AND STRUCTURAL PARTS AND COMPONENTS OF THE AFORESAID MACHINES; LETTER SORTING MACHINES; BURSTERS, NAMELY, PAPER PROCESSING MACHINES FOR AUTOMATICALLY SEPARATING FROM ONE ANOTHER DOCUMENTS PRODUCED BY COMPUTERS IN A CONTINUOUS SHEET; EXTRACTORS, NAMELY, MACHINES FOR AUTOMATICALLY OPENING LETTERS AND EXTRACTING THEIR CONTENTS; ELECTRONIC DATA PROCESSING APPARATUS FOR PREPARING MAIL, NAMELY, LETTERS AND PARCELS, FOR DISPATCH, NAMELY, APPARATUS FOR FOLDING AND INSERTING LETTERS IN ENVELOPES; LETTER OPENERS; DATING MACHINES, NAMELY, DATE-STAMPING MACHINES; POSTAL MACHINES FOR POST OFFICES, NAMELY, DISTRIBUTION MACHINES FOR POSTAL APPLICATIONS, NAMELY, CONVEYORS; LETTER SORTING MACHINES; ADDRESSING AND BARCODING EQUIPMENT FOR MAILING APPLICATIONS, NAMELY, ADDRESSING AND CODING MACHINES, IN CLASS 7 (U.S. CLS. 13, 19, 21, 23, 31, 34 AND 35).

FOR: COMPUTER APPARATUS FOR MAIL PROCESSING, NAMELY, COMPUTER HARDWARE; COMPUTER APPARATUS FOR PROGRAMMING AND MONITORING THE FOLDING AND INSERTING OF MAIL, NAMELY, COMPUTER TERMINALS, ELECTRONIC COMPUTERS, COMPUTER SERVERS; POSTAL SCALES; RECORDED COMPUTER PROGRAMS USED FOR PROCESSING MAIL, PARCELS AND FOLLOW-UP OF THEIR ROUTING AND DELIVERY; RECORDED COMPUTER PROGRAMS FOR PROCESSING POSTAL ADDRESSES; RECORDED COMPUTER PROGRAMS FOR OPTIMIZING PARCEL AND MAIL SENDING RATES AND FOR EXPENSE MANAGEMENT; RECORDED COMPUTER PROGRAMS FOR UPDATING DISPATCH RATES AND DATA; RECORDED COMPUTER PROGRAMS FOR ENABLING REMOTE ACCESS TO POSTAL SERVICES; RECORDED COMPUTER PROGRAMS FOR CONVERTING DATA FROM A PHYSICAL MEDIUM TO AN ELECTRONIC MEDIUM; MACHINES FOR CONTACT AND CONTACTLESS PRINTING OF POSTAL MARKINGS; AND ELECTRONIC APPLIANCES FOR VERIFYING FRANKING PARTICULARLY DESIGNED FOR COUNTER-TOP USE, NAMELY, OPTICAL SCANNERS, BARCODE SCANNERS, LASER SCANNERS FOR INDUSTRIAL INSPECTION, DIGITAL INPUT AND OUTPUT SCANNERS; MAIL PROCESSING APPARATUS FOR USE IN CONJUNCTION WITH COMPUTERS, NAMELY, ELECTRONIC APPARATUS TO CHECK FRANKING AND APPARATUS TO CANCEL FRANKING AND FOR FOLDING AND INSERTING MAIL, NAMELY, OPTICAL SCANNERS, HAND SCANNERS, BARCODE SCANNERS; DATA PROCESSING EQUIPMENT, NAMELY, DATA PROCESSING UNITS; COMPUTER

PRINTERS; MACHINES AND APPARATUS FOR FRANKING CONTROL, NAMELY, COMPUTERS, HAND SCANNERS, LASER SCANNERS FOR INDUSTRIAL INSPECTIONS, BARCODE SCANNERS, OPTICAL SCANNERS, LETTER SCALES; BARCODE READERS; COMPUTER SOFTWARE FOR MANAGING CONSIGNMENTS OF MAIL, NAMELY, LETTERS, TELEGRAMS, NEWSPAPERS, PARCELS, FRANKING THEREOF AND PROCESSING OF MAIL, NAMELY, SENDING AND FRANKING DOCUMENTS; COMPUTER PROGRAMS PROVIDING ACCESS TO COMPUTER SERVICES VIA THE INTERNET OR OTHER COMPUTER TELECOMMUNICATION NETWORKS; COMPUTER APPARATUS FOR FRANKING PAYMENT AND REGISTRATION OF POSTAL AND CARRIAGE COSTS FOR LETTERS AND PARCELS, INCLUDING BY REMOTE CONTROL AND DOWNLOADING, VIA THE INTERNET AND INTRANET NETWORKS, INTERACTIVE COMPUTER KIOSKS COMPRISING COMPUTERS, COMPUTER HARDWARE, COMPUTER PERIPHERALS, AND COMPUTER OPERATING SOFTWARE, FOR USE IN ELECTRONIC PREPAYMENT FOR FRANKING OF LETTERS AND PARCELS DISPATCHED BY POSTAL SERVICES OR BY PRIVATE COURIER; COMPUTERS AND THEIR PERIPHERAL DEVICES, ESPECIALLY PRINTERS AND DIGITIZERS, IN CLASS 9 (U.S. CLS. 21, 23, 26, 36 AND 38).

FOR: NON-TEXTILE LABELS, NAMELY, PAPER LABELS, SHIPPING LABELS, ADHESIVE LABELS AND BARCODE LABELS; LABELS FOR LETTERS AND PARCELS, NAMELY, ADDRESS LABELS, SHIPPING LABELS, BAR CODE LABELS; USER MANUALS AND DOCUMENTS FOR MAIL PROCESSING; MAIL PROCESSING EQUIPMENT, APPARATUS AND DEVICES, NAMELY, FRANKING MACHINES, FRANKING BASES AND HEADS BEING STRUCTURAL PARTS OF FRANKING MACHINES AND STRUCTURAL PARTS AND SPARE STRUCTURAL PARTS OF FRANKING MACHINES; COUNTER EQUIPMENT FOR FRANKING APPLICATIONS, NAMELY, FRANKING MACHINES, IN CLASS 16 (U.S. CLS. 2, 5, 22, 23, 29, 37, 38 AND 50).

FOR: OFFICE FURNITURE SPECIFICALLY DESIGNED FOR MAIL PROCESSING EQUIPMENT, APPARATUS AND DEVICES, IN CLASS 20 (U.S. CLS. 2, 13, 22, 25, 32 AND 50).

FOR: COMPUTER-ASSISTED MAIL FRANKING SERVICES; MAIL FRANKING SERVICES VIA THE INTERNET; BUSINESS MARKETING AND DIRECT MAIL CONSULTING SERVICES, NAMELY, SERVICES OF SELECTION AND PROCESSING OF PRIVATE AND COMPANY ADDRESSES BY MEANS OF COMPUTER NETWORKS; ASSISTANCE AND CONSULTANCY SERVICES IN THE FIELD OF MAIL MANAGEMENT; BUSINESS MANAGEMENT AND CONSULTATION IN THE FIELDS OF LOGISTICS, TRANSPORT, ROUTING OF GOODS, PACKAGES AND MAIL; DOCUMENT REPRODUCTION SERVICES; PROVIDING ASSISTANCE TO COMPANIES IN THE OPTIMIZATION OF RATES FOR DISPATCHING PARCELS, MAIL AND IN THE MANAGEMENT OF THEIR EXPENDITURES, THESE SERVICES

MAY BE PROVIDED ON LINE; COMPUTER FILE MANAGEMENT; COMPILATION OF INFORMATION INTO COMPUTER DATABASES, THESE SERVICES MAY BE PROVIDED ON LINE; PROVISION, FOR THIRD PARTIES, OF PERSONNEL FOR CARRYING OUT MAIL PROCESSING OPERATIONS, IN CLASS 35 (U.S. CLS. 100, 101 AND 102).

FOR: FINANCIAL SERVICES, NAMELY, MANAGEMENT OF FINANCIAL ACCOUNTS FOR REMOTE FRANKING OF LETTERS AND PARCELS; POSTAL CREDIT RECHARGING SERVICES, NAMELY, PREPAID SERVICES IN THE NATURE OF MAKING PAYMENT FOR ADDING POSTAL CREDITS TO PREPAID OR PAY-AS-YOU-GO POSTAL SERVICES; PROCESSING OF ELECTRONIC FUNDS TRANSFERS AND ELECTRONIC DEDUCTIONS OF MONEY FOR FRANKING COSTS FOR LETTERS AND PARCELS; MANAGEMENT OF A PORTFOLIO OF SHARES AND SECURITIES AND OPERATIONS PERTAINING THERETO; MANAGEMENT OF ALL BUILDINGS, IN CLASS 36 (U.S. CLS. 100, 101 AND 102).

FOR: INSTALLATION, MAINTENANCE AND REPAIR SERVICES OF ALL MACHINES, ALL EQUIPMENT, APPARATUS AND DEVICES CONNECTED WITH PROCESSING, TRANSPORT AND DELIVERY OF MAIL, THESE SERVICES ALSO AVAILABLE ONLINE, NAMELY, FRANKING MACHINES, WEIGHTING APPARATUS AND INSTRUMENTS, COMPUTERS, HAND SCANNERS, BARCODE SCANNERS, LETTER SCALES, POSTAL SCALES, LASER SCANNERS FOR INDUSTRIAL INSPECTIONS, COMPUTER TERMINALS, IN CLASS 37 (U.S. CLS. 100, 103 AND 106).

FOR: PROVISION OF ACCESS TO COMPUTER TELECOMMUNICATION NETWORKS; PROVIDING MULTIPLE-USER ACCESS TO A GLOBAL COMPUTER INFORMATION NETWORK BY MEANS OF COMPUTERS GROUPED ON A GLOBAL COMMUNICATION NETWORK BEING THE INTERNET, OR A PRIVATE OR RESERVED ACCESS NETWORK BEING AN INTRANET, IN CLASS 38 (U.S. CLS. 100, 101 AND 104).

FOR: ASSISTANCE TO COMPANIES FOR THE MANAGEMENT OF THEIR LETTER OR PARCEL SENDING SERVICES, THESE SERVICES MAY BE PROVIDED ON LINE, NAMELY, CONSULTATION SERVICES IN THE FORM OF ASSISTANCE TO COMPANIES FOR THE MANAGEMENT OF THEIR LETTER OR PARCEL SENDING SERVICES, IN CLASS 39 (U.S. CLS. 100 AND 105).

FOR: SOFTWARE DESIGN AND DEVELOPMENT; COMPUTER SOFTWARE MAINTENANCE, TECHNICAL RESEARCH AND TECHNICAL CONSULTATION SERVICES IN THE FIELD OF MAIL AND PARCEL PROCESSING TECHNIQUES, NAMELY, TROUBLESHOOTING COMPUTER HARDWARE AND SOFTWARE PROBLEMS; CONVERSION OF COMPUTER DATA AND PROGRAMS, NAMELY, FROM PHYSICAL TO ELECTRONIC MEDIA; CONVERSION OF DATA AND DOCUMENTS FROM A PHYSICAL MEDIUM TO

AN ELECTRONIC MEDIUM; CONSULTANCY AND ASSISTANCE SERVICES IN THE FIELD OF THE INSTALLATION, MAINTENANCE AND UPDATING OF ELECTRONIC DATA PROCESSING SOFTWARE USED FOR TRACKING, FOLLOWING, LOCATING PARCELS, MAIL AND PALLETS IN THE COURSE OF THEIR PROCESSING, THEIR TRANSPORT AND THEIR DELIVERY; CONSULTANCY SERVICES FOR THE INSTALLATION OF ELECTRONIC DATA PROCESSING SOFTWARE FOR TRACKING AND LOCATING PARCELS, MAIL AND PALLETS IN THE COURSE OF THEIR TRANSPORT AND DELIVERY, IN CLASS 42 (U.S. CLS. 100 AND 101).

PRIORITY DATE OF 1-9-2006 IS CLAIMED.

OWNER OF INTERNATIONAL REGISTRATION 0912611 DATED 6-9-2006, EXPIRES 6-9-2016.

"THE MARK CONSISTS OF THE PHRASE WE VALUE YOUR MAIL ABOVE A RIBBON, THAT WRAPS AROUND LIKE A FIGURE EIGHT TO THE RIGHT OF THE WORDING AND REPRESENTS A STYLIZED N."

SER. NO. 79-034,280, FILED 6-9-2006.

MYRIAH HABEEB, EXAMINING ATTORNEY

**Int. Cls.: 37 and 42**

**Prior U.S. Cls.: 100, 101, 103 and 106**

**United States Patent and Trademark Office**

**Reg. No. 3,499,245**

**Registered Sep. 9, 2008**

**SERVICE MARK  
PRINCIPAL REGISTER**

**NLR**

STICHTING NATIONAAL LUCHT- EN; RUIMTE-  
VAARTLABORATORIUM (NETHERLANDS  
NONPROFIT FOUNDATION)  
ANTHONY FOKKERWEG 2  
NL-1059 CM AMSTERDAM  
NETHERLANDS

FOR: INSTALLATION, MAINTENANCE AND  
REPAIR OF ELECTRICAL, ELECTRONIC, CON-  
TROL, TESTING AND MEASURING APPARATUS  
AND INSTRUMENTS IN THE FIELD OF AVIA-  
TION, SPACE TRAVEL AND NAVIGATION; MAIN-  
TENANCE OF COMPUTER HARDWARE, IN  
PARTICULAR IN THE FIELD OF AVIATION AND  
SPACE TRAVEL, IN CLASS 37 (U.S. CLS. 100, 103  
AND 106).

FOR: RESEARCH, DESIGN AND DEVELOP-  
MENT IN SCIENTIFIC AND INDUSTRIAL SEC-  
TORS, IN PARTICULAR IN THE FIELD OF  
AVIATION AND SPACE TRAVEL, NAMELY,  
DRAWING UP EXPERT REPORTS WITH REGARD  
TO AFORESAID SERVICES IN THE FIELD OF  
AVIATION AND SPACE TRAVEL; SERVICES OF  
ENGINEERS, NAMELY, IN THE FIELD OF AVIA-  
TION AND SPACE TRAVEL; INDUSTRIAL DESIGN  
AND DRAWINGS; MATERIAL TESTING OF  
TOOLS, MACHINES AND AIRCRAFTS; RE-

SEARCH, MAINTENANCE AND DEVELOPMENT  
OF SOFTWARE AND COMMUNICATION TECH-  
NOLOGY, EXCEPT FOR MAINTENANCE OF  
HARDWARE, IN PARTICULAR IN THE FIELD OF  
AVIATION AND SPACE TRAVEL; RESEARCH AND  
DEVELOPMENT OF HARDWARE, IN PARTICU-  
LAR IN FIELD OF AVIATION AND SPACE TRA-  
VEL; CONSULTANCY IN THE FIELD OF  
COMPUTER HARDWARE AND COMMUNICA-  
TION TECHNOLOGY, IN PARTICULAR IN THE  
FIELD OF AVIATION AND SPACE TRAVEL, IN  
CLASS 42 (U.S. CLS. 100 AND 101).

THE MARK CONSISTS OF STANDARD CHAR-  
ACTERS WITHOUT CLAIM TO ANY PARTICULAR  
FONT, STYLE, SIZE, OR COLOR.

PRIORITY DATE OF 12-23-2005 IS CLAIMED.

OWNER OF INTERNATIONAL REGISTRATION  
0912628 DATED 6-22-2006, EXPIRES 6-22-2016.

SER. NO. 79-034,285, FILED 6-22-2006.

MYRIAH HABEEB, EXAMINING ATTORNEY

**Int. Cls.: 9, 28, 35, 36, 37, 38, 39, 41, 42 and 45**

**Prior U.S. Cls.: 21, 22, 23, 26, 36, 38, 50, 100, 101, 102, 103, 104, 105, 106 and 107**

**Reg. No. 3,499,246**

**United States Patent and Trademark Office**

**Registered Sep. 9, 2008**

**TRADEMARK  
SERVICE MARK  
PRINCIPAL REGISTER**

# INSPIRED GAMING

INSPIRED GAMING (UK) LIMITED  
3 THE MALTINGS, WETMORE ROAD  
BURTON ON TRENT, STAFFORDSHIRE DE14 1SE  
UNITED KINGDOM

FOR: COMPUTER SOFTWARE FOR ENABLING THE OPERATION OF GAMING AND ENTERTAINMENT APPARATUS AND INSTRUMENTS; JUKEBOXES; ELECTRONIC, ELECTRICAL AND DIGITAL ENTERTAINMENT APPARATUS AND INSTRUMENTS, NAMELY, GAMING MACHINES AND VIDEO GAME CONSOLES FOR USE WITH AN EXTERNAL DISPLAY SCREEN OR MONITOR; ELECTRONIC, ELECTRICAL AND DIGITAL APPARATUS AND INSTRUMENTS FOR THE PLAYING OF MUSIC AND VIDEOS, NAMELY, MP3 PLAYERS; TELEVISIONS; RADIOS; DOWNLOADABLE MOBILE TELEPHONE RING TONES VIA A GLOBAL COMPUTER NETWORK AND WIRELESS DEVICES; BLANK VIDEO TAPES, CDS, DVDS, CD-ROMS, AUDIO TAPES AND AUDIO CASSETTES; AUTOMATIC VENDING MACHINES; CABINETS AND CONSOLES FOR HOUSING ELECTRONIC ENTERTAINMENT AND GAMING APPARATUS AND INSTRUMENTS, NAMELY, MOUNTING RACKS FOR COMPUTER AND TELECOMMUNICATIONS HARDWARE; STRUCTURAL PARTS FOR ALL THE AFORESAID GOODS, IN CLASS 9 (U.S. CLS. 21, 23, 26, 36 AND 38).

FOR: ARCADE-TYPE ELECTRONIC VIDEO GAMES; GAMING APPARATUS AND INSTRUMENTS, NAMELY, CHIPS, GAME WHEELS, POKER CHIPS, CARD GAME TABLES AND GAMING TABLES; ELECTRONIC, ELECTRICAL AND DIGITAL GAMING APPARATUS AND INSTRUMENTS, NAMELY, STAND ALONE VIDEO GAME MACHINES, IN CLASS 28 (U.S. CLS. 22, 23, 38 AND 50).

FOR: MARKET RESEARCH AND ANALYSIS SERVICES; DATA PROCESSING, STORAGE, COMPILATION AND RETRIEVAL SERVICES, NAMELY, COMMERCIAL INFORMATION AGENCIES; BUSINESS INFORMATION AND CONSULTANCY SERVICES; BUSINESS MANAGEMENT SERVICES;

ADVERTISING SERVICES; SALES PROMOTION AND PUBLICITY SERVICES; BUSINESS MARKETING SERVICES; RETAIL STORE SERVICES FEATURING ELECTRONIC, ELECTRICAL DIGITAL APPARATUS AND INSTRUMENTS, ENTERTAINMENT APPARATUS AND INSTRUMENTS, GAMING AND GAMBLING APPARATUS AND INSTRUMENTS, COMMUNICATIONS AND TELECOMMUNICATIONS APPARATUS AND INSTRUMENTS; PROVISION OF LOYALTY REDEMPTION AND BONUS POINTS SCHEMES, NAMELY, CUSTOMER LOYALTY SERVICES AND CUSTOMER CLUB SERVICES FOR COMMERCIAL, PROMOTIONAL AND ADVERTISING PURPOSES; PROVISION OF DISCOUNT SERVICES, NAMELY, PROMOTING THE GOODS AND SERVICES OF OTHER THROUGH THE DISTRIBUTION OF DISCOUNT CARDS; ADVICE, INFORMATION AND CONSULTANCY SERVICES RELATING TO ALL OF THE AFORESAID SERVICES, IN CLASS 35 (U.S. CLS. 100, 101 AND 102).

FOR: INSURANCE SERVICES, NAMELY, BROKERAGE, PROVISION OF CREDIT FACILITIES, NAMELY, CREDIT AGENCIES; CREDIT CARD SERVICES; CREDIT CARD TRANSACTION PROCESSING SERVICES; COLLECTION AND REFILLING OF CASH, CARDS AND/OR TOKENS FOR ELECTRONIC, ELECTRICAL, DIGITAL AND TELECOMMUNICATIONS APPARATUS AND INSTRUMENTS, NAMELY, AUTOMATED TELLER MACHINE SERVICES; ADVICE, INFORMATION AND CONSULTANCY SERVICES RELATING TO ALL OF THE AFORESAID SERVICES, IN CLASS 36 (U.S. CLS. 100, 101 AND 102).

FOR: INSTALLATION, REPAIR AND MAINTENANCE SERVICES FOR GAMING MACHINES AND GAME CONSOLES, APPARATUS AND INSTRUMENTS FOR THE PLAYING OF MUSIC AND VIDEOS; TELEVISIONS; RADIOS; CABINETS AND CONSOLES AND FOR HOUSING ELECTRONIC ENTERTAINMENT AND GAMING APPARATUS AND INSTRUMENTS, NAMELY, STAND ALONE VIDEO GAME AND GAMBLING MACHINES; AD-

VICE, INFORMATION AND CONSULTANCY SERVICES RELATING TO ALL OF THE AFORESAID SERVICES, IN CLASS 37 (U.S. CLS. 100, 103 AND 106).

FOR: TELECOMMUNICATIONS, COMMUNICATIONS, SATELLITE AND DIGITAL COMMUNICATION SERVICES, NAMELY, COMMUNICATIONS BY MOBILE PHONES AND COMPUTER TERMINALS; TELECOMMUNICATION SERVICES FOR THE PROVISION AND DOWNLOADING OF MOBILE TELEPHONE RING TONES AND OF TELEVISION, RADIO, FILM, VIDEO AND AUDIO MATERIAL, NAMELY, DATA TRANSMISSION AND RECEPTION SERVICES VIA TELECOMMUNICATIONS MEANS; NETWORKING SERVICES, NAMELY, COMMUNICATION VIA MULTI NATIONAL TELECOMMUNICATION NETWORKS; INTERNET SERVICE PROVIDER SERVICES; PROVISION OF TELECOMMUNICATIONS SERVICES ENABLING COMMERCE TO BE CONDUCTED OVER NETWORKS AND OVER THE INTERNET, NAMELY, PROVISION OF ACCESS TO ELECTRONIC SITES; TELEVISION, SATELLITE, DIGITAL VIDEO AND RADIO BROADCASTING AND TRANSMISSION SERVICES; RENTAL OF TELECOMMUNICATIONS, COMMUNICATIONS, DIGITAL AND SATELLITE COMMUNICATIONS APPARATUS AND INSTRUMENTS; ADVICE, INFORMATION AND CONSULTANCY SERVICES RELATING TO ALL THE AFORESAID SERVICES, IN CLASS 38 (U.S. CLS. 100, 101 AND 104).

FOR: WAREHOUSING SERVICES; TRANSPORTATION AND DISTRIBUTION SERVICES, NAMELY, TRANSPORT OF GOODS; TRAVEL AGENCY SERVICES, NAMELY, MAKING RESERVATIONS AND BOOKINGS FOR TRANSPORTATION; SERVICES FOR BOOKING HOLIDAYS AND TRAVEL ARRANGEMENTS, NAMELY, TRAVEL BOOKING AGENCIES; TRAVEL SERVICES, NAMELY, TRAVEL GUIDE SERVICES; ADVICE, INFORMATION AND CONSULTANCY SERVICES RELATING TO ALL OF THE AFORESAID SERVICES, IN CLASS 39 (U.S. CLS. 100 AND 105).

FOR: ENTERTAINMENT SERVICES, NAMELY, GAMBLING SERVICES; PROVISION OF LEISURE ACTIVITIES, NAMELY, PROVIDING FACILITIES FOR RECREATION ACTIVITIES; RENTAL OF ELECTRONIC, ELECTRICAL AND DIGITAL GAMING, GAMBLING AND ENTERTAINMENT MACHINES; GAMING SERVICES, NAMELY, CONDUCTING AND PROVIDING FACILITIES FOR SPECIAL EVENTS FEATURING E-MAIL AND GAMING CONTESTS AND TOURNAMENTS; GAMBLING AND LOTTERY SERVICES; PROVISION AND COMMISSION OF TELEVISION AND RADIO PROGRAMMERS AND VIDEOS, NAMELY, TELEVISION AND RADIO ENTERTAINMENT PRODUCTION; MAGAZINE PUBLISHING SERVICES; ADVICE, INFORMATION AND CONSULTANCY

SERVICES RELATING TO ALL THE AFORESAID SERVICES, IN CLASS 41 (U.S. CLS. 100, 101 AND 107).

FOR: DESIGN SERVICES, NAMELY, DESIGN FOR OTHERS IN THE FIELD OF ELECTRONIC, ELECTRICAL DIGITAL APPARATUS AND INSTRUMENTS, ENTERTAINMENT APPARATUS AND INSTRUMENTS, GAMING AND GAMBLING APPARATUS AND INSTRUMENTS, COMMUNICATIONS AND TELECOMMUNICATIONS APPARATUS AND INSTRUMENTS; PRODUCT RESEARCH SERVICES; PROVISION OF TECHNICAL SERVICES OFFERED BY AN ENGINEER OR TECHNICAL ADVISER, NAMELY, PRODUCT DEVELOPMENT CONSULTATION; CONSULTANCY, PLANNING, MONITORING, TESTING, FAULT FINDING AND COLLATION OF DATA RELATING TO ELECTRONIC, ELECTRICAL AND DIGITAL ENTERTAINMENT, VIDEO, MUSIC, GAMING, GAMBLING, TELECOMMUNICATION, COMMUNICATION AND SATELLITE APPARATUS AND INSTRUMENTS, NAMELY, PRODUCT RESEARCH AND DEVELOPMENT, COMPUTER MONITORING AND SECURITY SERVICES, NAMELY, MONITORING AND REPORTING ON THE PERFORMANCE, AVAILABILITY, AND ERRORS OF WEB SITES OF OTHERS; COMPUTER PROGRAMMING SERVICES; RENTAL OF COMPUTERS, COMPUTER HARDWARE AND COMPUTER SOFTWARE; ADVICE, INFORMATION AND CONSULTANCY SERVICES RELATING TO ALL OF THE AFORESAID SERVICES, IN CLASS 42 (U.S. CLS. 100 AND 101).

FOR: SECURITY GUARD SERVICES; SECURITY SERVICES FOR MONITORING AND DETECTING TAMPERING WITH ELECTRONIC, ELECTRICAL AND DIGITAL ENTERTAINMENT, VIDEO, MUSIC, GAMING, GAMBLING, TELECOMMUNICATIONS AND SATELLITE APPARATUS AND INSTRUMENTS, NAMELY, SECURITY INSPECTION SERVICES FOR OTHERS, IN CLASS 45 (U.S. CLS. 100 AND 101).

THE MARK CONSISTS OF STANDARD CHARACTERS WITHOUT CLAIM TO ANY PARTICULAR FONT, STYLE, SIZE, OR COLOR.

PRIORITY DATE OF 8-31-2006 IS CLAIMED.

OWNER OF INTERNATIONAL REGISTRATION 0912838 DATED 9-11-2006, EXPIRES 9-11-2016.

NO CLAIM IS MADE TO THE EXCLUSIVE RIGHT TO USE "GAMING", APART FROM THE MARK AS SHOWN.

SER. NO. 79-034,374, FILED 9-11-2006.

ROBERT STRUCK, EXAMINING ATTORNEY



**Int. Cls.: 23 and 24**

**Prior U.S. Cls.: 42, 43 and 50**

**United States Patent and Trademark Office**

**Reg. No. 3,499,247**

**Registered Sep. 9, 2008**

**TRADEMARK  
PRINCIPAL REGISTER**

**DYNETEX**

FILTES INTERNATIONAL S.R.L. (ITALY LIMITED LIABILITY COMPANY)  
VIA FALETTI, 33/35  
I-25031 CAPRIOLO (BRESCIA)  
ITALY

FOR: YARNS AND THREADS FOR TEXTILE USE, IN CLASS 23 (U.S. CL. 43).

FOR: FABRICS, NAMELY, METALLIC FABRIC CONSISTING OF YARN THAT CONTAINS METAL FOR TEXTILE USE AND CERAMIC FABRIC CONSISTING OF YARN THAT CONTAINS CERAMIC FOR TEXTILE USE, IN CLASS 24 (U.S. CLS. 42 AND 50).

THE MARK CONSISTS OF STANDARD CHARACTERS WITHOUT CLAIM TO ANY PARTICULAR FONT, STYLE, SIZE, OR COLOR.

PRIORITY DATE OF 10-30-2006 IS CLAIMED.

OWNER OF INTERNATIONAL REGISTRATION 0912882 DATED 11-22-2006, EXPIRES 11-22-2016.

SER. NO. 79-034,387, FILED 11-22-2006.

STEVEN R. FINE, EXAMINING ATTORNEY

Int. Cl.: 25

Prior U.S. Cls.: 22 and 39

United States Patent and Trademark Office

Reg. No. 3,499,248

Registered Sep. 9, 2008

TRADEMARK  
PRINCIPAL REGISTER



MARCO FANTINI MUZZARELLI (ITALY INDIVIDUAL)  
VIALE DEI POGGIO IMPERIALE, 15/A  
I-50125 FIRENZE, ITALY

FOR: SCARVES, SHAWLS, NECKTIES, IN CLASS  
25 (U.S. CLS. 22 AND 39).

PRIORITY DATE OF 5-4-2006 IS CLAIMED.

OWNER OF INTERNATIONAL REGISTRATION  
0913879 DATED 9-13-2006, EXPIRES 9-13-2016.

THE MARK CONSISTS OF THE SCRIPT "FOU-  
LARD'ART" IN FANCIFUL CHARACTERS, WITH  
THE IMAGE OF TWO CRESTS DEPICTING A  
FLORENTINE IRIS SURROUNDED BY THREE  
JARS, PLACED AT BOTH EXTREMITIES OF THE  
SCRIPT.

SER. NO. 79-034,679, FILED 9-13-2006.

JAMES STEIN, EXAMINING ATTORNEY

**Int. Cls.: 1, 2, 5, 6, 7, 8, 9, 10, 11, 12, 14, 15, 16, 20, 21, 22, 27, 35, 37, 38, 40 and 41**

**Prior U.S. Cls.: 1, 2, 5, 6, 7, 10, 11, 12, 13, 14, 16, 18, 19, 20, 21, 22, 23, 25, 26, 27, 28, 29, 30, 31, 32, 33, 34, 35, 36, 37, 38, 39, 40, 42, 44, 46, 50, 51, 52, 100, 101, 102, 103, 104, 106 and 107**

**Reg. No. 3,499,249**

**Registered Sep. 9, 2008**

**United States Patent and Trademark Office**

**TRADEMARK  
SERVICE MARK  
PRINCIPAL REGISTER**

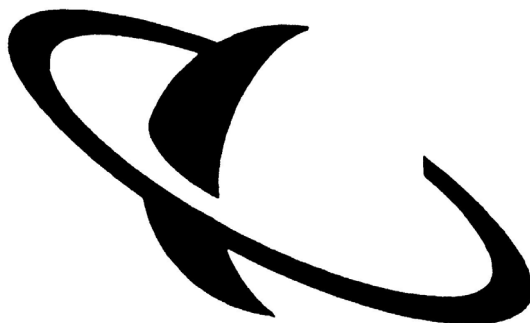

MEDIA-SATURN-HOLDING GMBH (FED REP  
GERMANY LIMITED LIABILITY COMPANY)  
WANKELSTRASSE 5  
85053 INGOLSTADT  
FED REP GERMANY

FOR: UNEXPOSED PHOTOGRAPHIC FILMS,  
BRAKE FLUID FOR MOTOR CARS, IN CLASS 1  
(U.S. CLS. 1, 5, 6, 10, 26 AND 46).

FOR: MOTOR CAR ACCESSORIES, NAMELY,  
CAR BODY LACQUERS, RUST PRESERVATIVES  
FOR LACQUERS IN THE NATURE OF A COATING,  
IN CLASS 2 (U.S. CLS. 6, 11 AND 16).

FOR: MOTOR CAR ACCESSORIES, NAMELY,  
FILLED FIRST AID BOXES, NAMELY, FIRST AID  
KITS, IN CLASS 5 (U.S. CLS. 6, 18, 44, 46, 51 AND 52).

FOR: MOTOR CAR ACCESSORIES, NAMELY,  
METAL KEY RINGS, SMALL ITEMS OF METAL  
HARDWARE, NAMELY, SCREWS, CLAMPS, PIPE  
COLLARS, NUTS; METAL SPARE CANS, METAL  
BOXES, NAMELY, EMPTY EMERGENCY TOOL  
KITS, IN CLASS 6 (U.S. CLS. 2, 12, 13, 14, 23, 25  
AND 50).

FOR: ELECTRICAL DOMESTIC MACHINES,  
NAMELY, CLOTHES WASHING MACHINES, DISH-  
WASHERS, IRONING MACHINES, FOOD PROCES-  
SORS, ELECTRIC MIXERS, ELECTRIC KNIVES,

JUICE EXTRACTORS, MEAT MINCERS, COFFEE  
MILLS; MOTOR CAR ACCESSORIES, NAMELY,  
SPARK PLUGS, COMPRESSORS, AIR FILTERS  
FOR VEHICLE MOTORS AND ENGINES, OIL FIL-  
TERS, IN CLASS 7 (U.S. CLS. 13, 19, 21, 23, 31, 34 AND  
35).

FOR: ELECTRIC SHAVERS, BEARD TRIMMERS,  
ELECTRIC HAIR CLIPPERS, ELECTRIC HAIR  
TWEEZERS AND OTHER HAIR-CUTTING EQUIP-  
MENT, NAMELY, HAND OPERATED HAIR CUT-  
TING SCISSORS; KNIFE SHARPENERS; MOTOR  
CAR ACCESSORIES, NAMELY, RESCUE HAM-  
MER, IN CLASS 8 (U.S. CLS. 23, 28 AND 44).

FOR: APPARATUS FOR RECORDING, TRANS-  
MITTING AND REPRODUCING SOUNDS AND  
IMAGES AND ELECTRONICALLY PROCESSED  
DATA, NAMELY, TELEVISION SETS, RADIO SETS,  
ANALOGUE AND DIGITAL TAPE RECORDERS  
AND CASSETTE RECORDERS, ANALOGUE AND  
DIGITAL RECORD PLAYERS, LOUDSPEAKERS,  
TELEPHONES, GSM-DEVICES, NAMELY, CELLU-  
LAR PHONES, TELEPHONE ANSWERING MA-  
CHINES, FACSIMILE MACHINES, AMPLIFIERS,  
ALARMS, NAMELY, BURGLAR ALARMS AND  
FIRE ALARMS, INTERCOMS, BABY-LISTENING  
PHONES, NAMELY, BABY MONITORS, AERIALS;  
AFORESAID EQUIPMENT ALSO FOR MOBILE USE  
AND INSTALLATION IN AUTOMOTIVE VEHI-  
CLES, NAMELY, TELEVISIONS, RADIOS, CAS-

SETTE RECORDERS, RECORD PLAYERS, LOUD-SPEAKERS, TELEPHONES, CELLULAR PHONES, AMPLIFIERS, AERIALS FOR MOBILE USE AND INSTALLATION IN AUTOMOTIVE VEHICLES; MICROPHONES, HEADPHONES, CONNECTION CABLES, MAGNETIC RECORDING CARRIERS, NAMELY, PRE-RECORDED AUDIO AND VIDEO TAPES, AND RECORDS ALL FEATURING MUSIC, MOVIES, AUDIO BOOKS, EDUCATION COURSES; BLANK AUDIO AND VIDEO TAPES; PRE-RECORDED COMPACT DISCS FEATURING MUSIC, MOVIES, AUDIO BOOKS, EDUCATION COURSES; BATTERIES; PHOTOGRAPHIC FILM AND OPTICAL EQUIPMENT AND INSTRUMENTS, NAMELY, CAMERA LENSES, TELESCOPES, VIDEO CAMERAS, FILM CAMERAS, DIGITAL VIDEO RECORDERS, VIDEO TAPE RECORDERS, VIDEO PRINTERS; MOVIE, SLIDE, DATA, COMPUTER, AND VIDEO PROJECTORS, PHOTOGRAPHIC EXPOSURE METERS, FLASH EQUIPMENT, NAMELY, FLASH GUNS; PROJECTION SCREENS, SLIDE FILM MOUNTS, TRIPODS, PHOTOGRAPHIC BAGS; CALCULATORS, DATA PROCESSORS, COMPUTERS, COMPUTER MONITORS, PRINTERS, PERIPHERAL COMPUTER EQUIPMENT AS WELL AS ACCESSORIES THEREOF NAMELY, PRERECORDED DISKETTES AND CD-ROMS FEATURING MUSIC, MOVIES, AUDIO BOOKS, EDUCATION COURSES AND BLANK DISKETTES AND CD-ROMS; KEYBOARDS, COMPUTER MICE, COMPUTER JOYSTICKS; PRERECORDED ELECTRONIC MEDIA FEATURING MUSIC, MOVIES, AUDIO BOOKS, EDUCATION COURSES; COMPUTER PROGRAMS, NAMELY, COMPUTER SOFTWARE FOR WORD PROCESSING, SPREADSHEET HANDLING, DATABASE MANAGEMENT, COMPUTER SECURITY, IMAGES, SOUND AND VIDEO EDITING, COMPUTER GAME PLAYING; SATELLITE RECEIVER, INCLUDING SATELLITE AERIALS; ELECTRIC IRONS, SCALES; MOTOR CAR ACCESSORIES, NAMELY, FIRE EXTINGUISHERS, WARNING TRIANGLES, ELECTRICAL INDICATOR INSTRUMENTS FOR MOTOR FUNCTIONS, NAMELY, OIL PRESSURE GAUGE, BATTERY VOLTAGE INDICATOR AND WATER TEMPERATURE INDICATOR; ELECTRONIC APPARATUS FOR CONTROLLING THE OPERATING CONDITION OF THE AUTOMOBILE MOTOR AT TRAFFIC LIGHT STOPS, NAMELY, UNITS FOR ELECTRICALLY SWITCHING ON AND SWITCHING OFF VEHICLE ENGINES; BATTERY CHARGER, ELECTRIC SWITCHES, ELECTRIC RELAYS, ELECTRICAL FUSES, SMALL INDICATOR INSTRUMENTS FOR MEASURING OUTSIDE CONDITIONS, NAMELY, FOR MEASURING ALTIMETER, OUTSIDE TEMPERATURE; MOTOR TEST APPARATUS, NAMELY, MOTOR TESTING INSTRUMENTS FOR CONTROLLING ENGINE SPEED, IGNITION TIMING AND COMPRESSION; ELECTRICAL SECURITY SYSTEM AGAINST THEFT, NAMELY, PERSONAL SECURITY ALARMS; CABLE JUMP LEADS; COMPUTER GAME SOFTWARE; VIDEO GAME SOFTWARE, IN CLASS 9 (U.S. CLS. 21, 23, 26, 36 AND 38).

FOR: MEDICAL EQUIPMENT AND APPLIANCES, NAMELY, SPHYGMOTENSIMETERS AND

HEART RATE MONITORS, CLINICAL THERMOMETERS, MASSAGING EQUIPMENT, NAMELY, MASSAGING APPARATUS FOR PERSONAL USE, IN CLASS 10 (U.S. CLS. 26, 39 AND 44).

FOR: ELECTRICALLY OPERATED EQUIPMENT FOR DOMESTIC AND KITCHEN PURPOSES, NAMELY, CLOTHES DRYERS, ELECTRIC HAIR DRYERS, HEATING EQUIPMENT, NAMELY, ELECTRIC HEATING FANS, HEATING PADS NOT FOR MEDICAL PURPOSES, ELECTRIC BLANKET; TANNING EQUIPMENT, AIR-CONDITIONING EQUIPMENT, HUMIDIFIERS, AIR PURIFIERS, DISINFECTING EQUIPMENT, NAMELY, DISINFECTANT DISPENSERS FOR TOILETS NOT FOR MEDICAL PURPOSES; HOT-WATER STORAGE MEANS, NAMELY, HOT WATER HEATERS, HOT WATER TANKS; FANS FOR AIR CONDITIONING, TUMBLE DRYERS FOR CLOTHES, ELECTRIC FOOT-WARMERS, ICE-MAKING MACHINES, SINKS, EXTRACTOR HOODS, NAMELY, RANGE HOODS, COOKING APPLIANCES, NAMELY, GAS COOKING OVENS, ELECTRIC COOKING OVENS, HOT PLATES, MICROWAVE OVENS FOR COOKING; ELECTRIC TOASTERS, ELECTRIC REFRIGERATORS, FREEZERS, HOT WATER HEATERS, GRILLS, NAMELY, GAS GRILLS, CHARCOAL GRILLS AND ELECTRIC GRILLS; DEEP FAT FRYERS, ELECTRIC EGG BOILERS, FONDUE EQUIPMENT, NAMELY, FONDUE POTS; LAMPS, LIGHT BULBS; MOTOR CAR ACCESSORIES, NAMELY, FLASHING WARNING LIGHTS, LIGHTING APPARATUS AND APPLIANCES FOR MOTOR CARS, NAMELY, FLASHING STROBE LIGHT APPARATUS; HIGH BEAM LIGHT REFLECTORS, FOG LAMPS FOR CARS, WORKING LAMPS, READING LAMPS, COCKPIT LAMPS, ELECTRIC TORCHES FOR LIGHTING, REPLACEMENT LAMPS, IN CLASS 11 (U.S. CLS. 13, 21, 23, 31 AND 34).

FOR: MOTOR CAR ACCESSORIES, NAMELY, BRAKE LININGS, ELECTRIC MOTORS FOR SUN BLINDS, SAFETY BELTS, CHILD'S SEATS, SPORTS SEATS, SIGNAL HORNS, MULTI-TONE HORNS, MECHANICAL ANTI-THEFT SAFETY DEVICE, FRONT-SPOILERS, REAR SPOILERS, WHEEL RIMS, TRIMS FOR WHEELS, AIR PUMPS, OUTSIDE AND INSIDE REAR-VIEW MIRRORS, STEERING WHEELS, HUBS, REAR DESIGN TRIMS, NAMELY, REAR DECORATIVE PANELS, EXHAUST TRIMS, FRONT GRILL INSERTS, GLASS SUNROOFS, SEAT COVERS, LAMBSKIN SEAT COVERS, LUGGAGE RACKS, ROOF LUGGAGE RACKS, PETROL TANK CAPS, WINDSCREEN WIPERS, DOOR SILL SCUFF PLATES FOR MOTOR CARS; EQUIPMENT FOR LOWERING THE CHASSIS OF MOTOR CARS, NAMELY, LOW-RIDER EQUIPMENT COMPRISING SUSPENSION STRUTS, SHOCK ABSORBERS; TOW-RODS, NAMELY, TOW BARS; CONTROL LEVERS, NAMELY, GEAR SHIFT LEVERS; CONTROL KNOBS, NAMELY, GEAR SHIFT LEVER KNOBS; BRAKE CALIPER LOCKS, SUNBLINDS, NAMELY, SUN SHIELDS, IN CLASS 12 (U.S. CLS. 19, 21, 23, 31, 35 AND 44).

FOR: ELECTRONIC CLOCKS, CLOCKS INCORPORATING RADIOS, IN CLASS 14 (U.S. CLS. 2, 27, 28 AND 50).

FOR: ELECTRIC MUSICAL INSTRUMENTS, NAMELY, HOME ORGANS, IN CLASS 15 (U.S. CLS. 2, 21 AND 36).

FOR: PAPER, CARDBOARD AND GOODS MADE OF THESE MATERIALS, NAMELY, CARDBOARD CARTONS, CARDBOARD BOXES, BANNERS OF PAPER; ALBUMS FOR COINS, PHOTOGRAPHS AND STAMPS, BLANK JOURNAL BOOKS; TYPEWRITERS, SELF-HELP MOTOR CAR MANUALS, IN CLASS 16 (U.S. CLS. 2, 5, 22, 23, 29, 37, 38 AND 50).

FOR: FURNITURE, NAMELY, KITCHEN FURNITURE; RADIO AND TELEVISION FURNITURE; MOTOR CAR ACCESSORIES, NAMELY, DECORATIVE NON-METAL SCREW COVERINGS; FUNNELS, EMPTY FIRST AID BOXES MADE OF PLASTIC, NAMELY, EMPTY PLASTIC BOXES, AND FIRST AID CUSHIONS, PLASTIC KEY RINGS; EMPTY EMERGENCY TOOL KITS MADE OF PLASTIC, NAMELY, EMPTY PLASTIC BOXES, IN CLASS 20 (U.S. CLS. 2, 13, 22, 25, 32 AND 50).

FOR: EQUIPMENT AND CONTAINERS FOR HOUSEHOLD AND KITCHEN USE NOT OF PRECIOUS METAL OR PLATED, NAMELY, CLOTHES DRYING RACKS, COOKING POTS, PANS, CARPET BEATERS, FONDUE SETS COMPOSED OF FONDUE POT STANDS AND FONDUE FORKS; ELECTRIC MOUTH CARE EQUIPMENT, NAMELY, TOOTHBRUSHES, INTERDENTAL CLEANERS, DENTAL WATERJETS, NAMELY, APPARATUS FOR CLEANING TEETH AND GUMS USING HIGH PRESSURE WATER; GLASS FIBER PLACEMATS, IN CLASS 21 (U.S. CLS. 2, 13, 23, 29, 30, 33, 40 AND 50).

FOR: MOTOR CAR ACCESSORIES, NAMELY, LUGGAGE COVERS, NAMELY, TARPAULINS, SAFETY HARNESS, TOWING-ROPES, PLASTIC TARPAULINS AS COVERS FOR CARS, IN CLASS 22 (U.S. CLS. 1, 2, 7, 19, 22, 42 AND 50).

FOR: MOTOR CAR ACCESSORIES, NAMELY, RUBBER MATS, ANTI-SLIP MATS, IN CLASS 27 (U.S. CLS. 19, 20, 37, 42 AND 50).

FOR: PROVIDING BUSINESS MANAGEMENT AND BUSINESS ADMINISTRATIVE SERVICES FOR COMPANIES WHICH OPERATE IN LARGE MARKETS FOR ALL TYPES OF ELECTRONIC MEDIA AND ELECTRICAL EQUIPMENT; PROVIDING OFFERS TO THIRD PERSONS FOR THE DISTRIBUTION OF GOODS AND SERVICES OF ANY KIND, NAMELY, PROMOTING THE GOODS AND

SERVICES OF OTHERS BY DISTRIBUTING ADVERTISING MATERIALS THROUGH A VARIETY OF METHODS; PURCHASING AND PROCUREMENT SERVICES, NAMELY, PROCURING OF CONTRACTS FOR OTHERS FOR THE PURCHASE OF GOODS AND LABOR CONTRACTING SERVICES; ALL FOREGOING SERVICES FOR THIRD PERSONS VIA ELECTRONIC DATA NETS, NAMELY, THE INTERNET, IN CLASS 35 (U.S. CLS. 100, 101 AND 102).

FOR: INSTALLATION AND REPAIR OF ELECTRIC AND ELECTRONIC EQUIPMENT, NAMELY, INSTALLATION OF CAR RADIOS AND MOBILE PHONES IN AUTOMOTIVE VEHICLES; REPAIR SERVICES FOR ELECTRICAL AND ELECTRONIC EQUIPMENT AND SYSTEMS, NAMELY, REPAIR SERVICES IN THE FIELD OF COMPUTER HARDWARE, HOME ELECTRONICS, AUDIO EQUIPMENT, VIDEO EQUIPMENT, TELEPHONE EQUIPMENT, ELECTRIC LIGHTING FIXTURES, ELECTRIC HOME APPLIANCES, IN CLASS 37 (U.S. CLS. 100, 103 AND 106).

FOR: TELECOMMUNICATION SERVICES, NAMELY, MOBILE TELEPHONE SERVICES, TELEPHONE SERVICES, TELEFACSIMILE SERVICES, NAMELY, FACSIMILE TRANSMISSION, TWO-WAY RADIO COMMUNICATION SERVICES, PAGING SERVICES, TELEGRAM TRANSMISSION SERVICES, DATA COMMUNICATION BY ELECTRONIC MAIL SERVICES, E-MAIL DATA SERVICES; TELEVISION AND RADIO TRANSMISSION; COMMUNICATION SERVICES VIA THE INTERNET, INTRANET, EXTRANET, NAMELY, INFORMATION TRANSMISSION VIA ELECTRONIC COMMUNICATIONS NETWORKS; PROVIDING ACCESS TO DATA BASES AND TO THE INTERNET VIA TELECOMMUNICATION, NAMELY, PROVIDING MULTIPLE-USER ACCESS TO A GLOBAL COMPUTER INFORMATION NETWORK, IN CLASS 38 (U.S. CLS. 100, 101 AND 104).

FOR: PHOTOGRAPHIC FILM DEVELOPMENT, IN CLASS 40 (U.S. CLS. 100, 103 AND 106).

FOR: RENTAL OF VIDEO FILMS AND EQUIPMENT FOR RECORDING, TRANSMITTING AND REPRODUCING OF SOUND AND IMAGES, IN CLASS 41 (U.S. CLS. 100, 101 AND 107).

OWNER OF INTERNATIONAL REGISTRATION 0755815 DATED 10-31-2000, EXPIRES 10-31-2010.

SER. NO. 79-034,778, FILED 7-11-2006.

JAMES STEIN, EXAMINING ATTORNEY

**Int. Cls.: 9, 35, 38 and 42**

**Prior U.S. Cls.: 21, 23, 26, 36, 38, 100, 101, 102 and 104**

**United States Patent and Trademark Office**

**Reg. No. 3,499,250**

**Registered Sep. 9, 2008**

**TRADEMARK  
SERVICE MARK  
PRINCIPAL REGISTER**

# LEOtrace

SIRVALUSE CONSULTING GMBH (FED REP  
GERMANY LIMITED LIABILITY COMPANY)  
SCHLOSSSTR. 8G  
22041 HAMBURG  
FED REP GERMANY

FOR: COMPUTER PROGRAMS FOR USE IN  
MARKETING RESEARCH, OPINION POLLING, US-  
ABILITY RESEARCH, USER EXPERIENCE RE-  
SEARCH; COMPUTER PROGRAMS TO MONITOR,  
SURVEY, TRACK, ANALYZE AND METER THE  
BEHAVIOR OF COMPUTER USERS, THE USAGE  
OF WEBSITES AND THE USAGE OF TECHNICAL  
DEVICES WITH A GRAPHICAL USER INTERFACE,  
IN CLASS 9 (U.S. CLS. 21, 23, 26, 36 AND 38).

FOR: MARKETING RESEARCH; OPINION POLL-  
ING, IN CLASS 35 (U.S. CLS. 100, 101 AND 102).

FOR: PROVIDING MULTIPLE USER ACCESS TO  
PROPRIETARY COLLECTIONS OF INFORMATION  
BY MEANS OF COMPUTER INFORMATION NET-  
WORKS, IN CLASS 38 (U.S. CLS. 100, 101 AND 104).

FOR: UPDATING OF COMPUTER SOFTWARE  
FOR OTHERS; COMPUTER SYSTEMS ANALYSIS;  
PROVIDING ON-LINE NON-DOWNLOADABLE  
SOFTWARE FOR USE IN DATA MANAGEMENT

ON SERVERS IN THE FIELD OF USABILITY RE-  
SEARCH AND USER EXPERIENCE RESEARCH;  
ELECTRONIC DATA STORAGE; COMPUTER PRO-  
GRAMMING FOR OTHERS, NAMELY, IMPLE-  
MENTATION OF COMPUTER PROGRAMS IN  
DATA NETWORKS; INSTALLATION, MAINTEN-  
ANCE AND REPAIR OF COMPUTER SOFTWARE;  
COMPUTER SERVICES, NAMELY, MONITORING,  
TESTING, ANALYZING AND REPORTING ON THE  
INTERNET TRAFFIC CONTROL AND ON THE  
USABILITY OF WEBSITES OF OTHERS, IN CLASS  
42 (U.S. CLS. 100 AND 101).

THE MARK CONSISTS OF STANDARD CHAR-  
ACTERS WITHOUT CLAIM TO ANY PARTICULAR  
FONT, STYLE, SIZE, OR COLOR.

PRIORITY DATE OF 10-6-2006 IS CLAIMED.

OWNER OF INTERNATIONAL REGISTRATION  
0914265 DATED 12-4-2006, EXPIRES 12-4-2016.

SER. NO. 79-034,805, FILED 12-4-2006.

LAURIE KAUFMAN, EXAMINING ATTORNEY

**Int. Cl.: 36**

**Prior U.S. Cls.: 100, 101 and 102**

**United States Patent and Trademark Office**

**Reg. No. 3,499,251**

**Registered Sep. 9, 2008**

**SERVICE MARK  
PRINCIPAL REGISTER**

**OLYMPIA GROUP OF COMPANIES**

OLYMPIA GROUP OF COMPANIES, (FRANCE  
SOCIÉTÉ PAR ACTIONS SIMPLIFIÉE)  
21-25 RUE BALZAC  
F-75008 PARIS, FRANCE

FOR: INSURANCE UNDERWRITING IN THE  
FIELD OF LIFE INSURANCE; FINANCIAL SERVI-  
CES IN THE FIELD OF INVESTMENT ADVISORY  
AND PATRIMONIAL ADVISORY; FINANCIAL  
PORTFOLIO AND FINANCIAL INSTRUMENT  
MANAGEMENT AND FINANCIAL ANALYSIS  
AND CONSULTATION; CURRENCY EXCHANGE  
OPERATIONS; FISCAL VALUATIONS AND AS-  
SESSMENTS; FINANCIAL MANAGEMENT OF IN-  
VESTMENT TRUSTS; FINANCIAL  
CONSULTATION AND ADVICE; FINANCIAL IN-  
VESTMENT ADVICE, IN CLASS 36 (U.S. CLS. 100, 101  
AND 102).

THE MARK CONSISTS OF STANDARD CHAR-  
ACTERS WITHOUT CLAIM TO ANY PARTICULAR  
FONT, STYLE, SIZE, OR COLOR.

PRIORITY DATE OF 9-7-2006 IS CLAIMED.

OWNER OF INTERNATIONAL REGISTRATION  
0915638 DATED 2-9-2007, EXPIRES 2-9-2017.

NO CLAIM IS MADE TO THE EXCLUSIVE  
RIGHT TO USE "GROUP OF COMPANIES", APART  
FROM THE MARK AS SHOWN.

SER. NO. 79-035,292, FILED 2-9-2007.

ANDREA BUTLER, EXAMINING ATTORNEY

**Int. Cls.: 9, 38 and 42**

**Prior U.S. Cls.: 21, 23, 26, 36, 38, 100, 101 and 104**

**United States Patent and Trademark Office**

**Reg. No. 3,499,252**

**Registered Sep. 9, 2008**

**TRADEMARK  
SERVICE MARK  
PRINCIPAL REGISTER**



ARTIMI LTD (UNITED KINGDOM LIMITED COMPANY)  
BETJEMAN HOUSE,  
104 HILLS ROAD; CAMBRIDGE, CAMBRIDGE-  
SHIRE CB2 1LQ  
UNITED KINGDOM

FOR: COMPUTER HARDWARE, COMPUTER SOFTWARE AND FIRMWARE FOR DELIVERING WIRELESS CONNECTIVELY FOR USE IN CONSUMER ELECTRONIC DEVICES; SEMICONDUCTORS; INTEGRATED CIRCUITS, IN CLASS 9 (U.S. CLS. 21, 23, 26, 36 AND 38).

FOR: TELECOMMUNICATIONS CONSULTING SERVICES IN THE FIELD OF TELECOMMUNICATIONS, WIRELESS, SATELLITE, AND COMMUNICATION SERVICES, IN CLASS 38 (U.S. CLS. 100, 101 AND 104).

FOR: COMPUTER CONSULTATION SERVICES; COMPUTER SOFTWARE AND HARDWARE DEVELOPMENT AND DESIGN FOR OTHERS; COMPUTER PROGRAMMING; TECHNICAL CONSULTANCY AND DESIGN SERVICES RELAT-

ING TO COMPUTER HARDWARE AND SOFTWARE AND INTEGRATED CIRCUITS; TECHNICAL DESIGN, TESTING, ENGINEERING, RESEARCH, INFORMATION, CONSULTATION AND ADVISORY SERVICES FOR OTHERS, ALL RELATING TO COMPUTERS, COMPUTER NETWORKS, COMPUTER SYSTEMS, COMPUTER SOFTWARE AND COMPUTER PROGRAMMING; MAINTENANCE AND UPGRADING OF COMPUTER SOFTWARE FOR OTHERS, IN CLASS 42 (U.S. CLS. 100 AND 101).

OWNER OF INTERNATIONAL REGISTRATION 0915841 DATED 12-15-2006, EXPIRES 12-15-2016.

THE MARK HAS NO MEANING IN A FOREIGN LANGUAGE.

SER. NO. 79-035,364, FILED 12-15-2006.

REBECCA POVARCHUK, EXAMINING ATTORNEY



**Int. Cls.: 9, 35, 38, 41 and 42**

**Prior U.S. Cls.: 21, 23, 26, 36, 38, 100, 101, 102, 104  
and 107**

**Reg. No. 3,499,253**

**United States Patent and Trademark Office**

**Registered Sep. 9, 2008**

**TRADEMARK  
SERVICE MARK  
PRINCIPAL REGISTER**



KONINKLIJKE KPN N.V. (NETHERLANDS LIMITED LIABILITY COMPANY)

MAANPLEIN 55

NL-2516 CK DEN HAAG

NETHERLANDS

FOR: COMPUTER HARDWARE AND SOFTWARE FOR TELECOMMUNICATION NETWORKS; APPARATUS FOR RECORDING, TRANSMITTING, AND REPRODUCTION OF SOUND AND IMAGE; MAGNETIC AND OPTIC DATA AND SOUND CARRIERS, NAMELY, MP3 PLAYERS; PHOTOGRAPHIC CAMERAS; COMPUTER CHIPS; BLANK ELECTRONIC CHIP CARDS; SIM CARDS, NAMELY, SUBSCRIBER IDENTITY MODULE CARDS; TELEPHONE APPARATUS; MOBILE TELEPHONES; TELEPHONE ANSWERING MACHINES, IN CLASS 9 (U.S. CLS. 21, 23, 26, 36 AND 38).

FOR: ADVERTISING SERVICES; BUSINESS MANAGEMENT; BUSINESS ADMINISTRATION; PROVIDING OFFICE FUNCTIONS; ORGANIZATION OF PROMOTIONAL ACTIVITIES, NAMELY, FAIRS AND EXHIBITIONS FOR TELECOMMUNICATION SERVICES; ARRANGING AND CONDUCTING FAIRS AND EXHIBITIONS FOR PUBLICITY AND COMMERCIAL PURPOSES, IN CLASS 35 (U.S. CLS. 100, 101 AND 102).

FOR: TELECOMMUNICATION SERVICES, NAMELY, PROVIDING CELLULAR TELEPHONE NETWORK SERVICES; PROVIDING MULTIPLE USER DIAL-UP AND DEDICATED ACCESS TO THE INTERNET; ELECTRONIC DATA TRANSFER BY TELECOMMUNICATIONS; CONSULTATION SERVICES IN THE FIELD OF TELECOMMUNICATION APPARATUS AND PERIPHERALS, IN CLASS 38 (U.S. CLS. 100, 101 AND 104).

FOR: EDUCATION AND ENTERTAINMENT SERVICES, NAMELY, PROVIDING COURSES, SEMINARS, AND ON-GOING SCHOOL TELEVISION PROGRAMS IN THE FIELD OF TELECOMMUNICATION AND INFORMATION COMMUNICATION TECHNOLOGY, IN CLASS 41 (U.S. CLS. 100, 101 AND 107).

FOR: TECHNICAL ADVICE IN RELATION TO THE INSTALLATION OF COMPUTER SOFTWARE; TECHNICAL ADVICE IN THE FIELD OF DESIGNING, DEVELOPING, AND APPLYING TELECOMMUNICATION AND COMPUTERIZATION NETWORK APPARATUS AND INTERFACES OFFERED IN PERSON, BY TELEPHONE AND OVER THE INTERNET; TECHNICAL ADVICE IN THE FIELD OF SOFTWARE AND HARDWARE, NAMELY, ADVICE RELATING TO THE INSTALLATION OF SOFTWARE IN PERSON, BY TELEPHONE AND OVER THE INTERNET; INSTALLATION OF COMPUTER SOFTWARE; INSTALLING, MAINTAINING AND UPDATING OF SOFTWARE, IN CLASS 42 (U.S. CLS. 100 AND 101).

PRIORITY DATE OF 3-22-2006 IS CLAIMED.

OWNER OF INTERNATIONAL REGISTRATION 0916031 DATED 9-11-2006, EXPIRES 9-11-2016.

OWNER OF U.S. REG. NOS. 2,455,603 AND 2,457,515.

"THE MARK CONSISTS OF THE LETTERS KPN NEAR A CROWN DESIGN THAT IS SUPERIMPOSED OVER THREE OVERLAPPING CELLS."

SER. NO. 79-035,417, FILED 9-11-2006.

BERNICE MIDDLETON, EXAMINING ATTORNEY

**Int. Cls.: 9 and 42**

**Prior U.S. Cls.: 21, 23, 26, 36, 38, 100 and 101**

**United States Patent and Trademark Office**

**Reg. No. 3,499,254**

**Registered Sep. 9, 2008**

**TRADEMARK  
SERVICE MARK  
PRINCIPAL REGISTER**



KONINKLIJKE PHILIPS ELECTRONICS N.V.  
(NETHERLANDS LLC)  
GROENEWOUDSEWEG 1  
NL-5621 BA EINDHOVEN, NETHERLANDS

FOR: COMPUTER HARDWARE, NAMELY, MICROPROCESSORS, DIGITAL SIGNAL PROCESSORS; MICRO CONTROLLERS, ACCELERATORS AND RECONFIGURABLE HARDWARE; SOFTWARE, NAMELY, DESIGN TOOLS, SPATIAL COMPILERS, ASSEMBLERS, TRANSFORMATION AND DEBUGGING SOFTWARE; COMPUTER HARDWARE, NAMELY, ELECTRONIC, ELECTROTECHNICAL AND ELECTROMECHANICAL MODULES AND PARTS AND COMPONENTS, NAMELY, INTEGRATED CIRCUITS COMPUTER CHIPS, DIODES, TRANSISTORS, SEMICONDUCTORS AND SEMICONDUCTOR ELEMENTS; ASYNCHRONOUS CIRCUITS, SMART CARDS, IN CLASS 9 (U.S. CLS. 21, 23, 26, 36 AND 38).

FOR: DESIGN, DEVELOPMENT AND UPDATING OF SOFTWARE; DESIGN AND DEVELOPMENT OF HARDWARE AND OF PARTS THEREFOR; DESIGN AND DEVELOPMENT OF INTEGRATED CIRCUITS, COMPUTER PROGRAMMING, DESIGN AND DEVELOPMENT OF SOFTWARE PROGRAMS, IN CLASS 42 (U.S. CLS. 100 AND 101).

PRIORITY DATE OF 7-13-2006 IS CLAIMED.

OWNER OF INTERNATIONAL REGISTRATION  
0916148 DATED 12-13-2006, EXPIRES 12-13-2016.

NO CLAIM IS MADE TO THE EXCLUSIVE RIGHT TO USE "SOLUTIONS", APART FROM THE MARK AS SHOWN.

THE COLOR(S) BLACK, WHITE, LILAC IS/ARE CLAIMED AS A FEATURE OF THE MARK.

THE COLOR BLUE APPEARS IN THE WORDING "HANDSHAKE SOLUTIONS". THE COLOR BLUE APPEARS IN THE DESIGN FORMING TWO BOXES FORMING THE LETTER "H"; WITH A LETTER "S" APPEARING IN WHITE. JOINING THE BOXES TOGETHER.

SER. NO. 79-035,454, FILED 12-13-2006.

CAROLYN CATALDO, EXAMINING ATTORNEY

**Int. Cls.: 3, 4, 9, 18, 20, 25 and 28**

**Prior U.S. Cls.: 1, 2, 3, 4, 6, 13, 15, 21, 22, 23, 25, 26, 32, 36, 38, 39, 41, 50, 51 and 52**

**Reg. No. 3,499,255**

**United States Patent and Trademark Office**

**Registered Sep. 9, 2008**

**TRADEMARK  
PRINCIPAL REGISTER**

The logo for ZETT features a stylized 'Z' composed of three parallel diagonal lines on the left, followed by the letters 'E', 'T', 'T' in a bold, blocky, sans-serif font.

ZETT KABUSHIKI KAISHA (JAPAN CORPORATION)  
1-2-16, KARASUGATSUJI  
TENNOJI-KU, OSAKA-SHI  
OSAKA-FU 543-8601, JAPAN

FOR: SHOE AND BOOT CREAM; SHOE BLACK, NAMELY, SHOE POLISH; POLISHING PREPARATIONS; POLISHING CREAMS FOR LEATHERS; POLISHING OIL FOR LEATHERS; LEATHER LOTIONS; SHOE CREAM; SHOE POLISH; CLEANING PREPARATIONS FOR SHOES; DEODORANT SPRAYS FOR PERSONAL USE; CLEANING PREPARATIONS FOR USE ON BASEBALL AND SOFTBALL GLOVES AND SHOES, IN CLASS 3 (U.S. CLS. 1, 4, 6, 50, 51 AND 52).

FOR: GREASE FOR SHOES AND BOOTS; LEATHER PRESERVING OIL AND GREASE; OIL FOR THE PRESERVATION OF LEATHER; GREASE FOR THE PRESERVATION OF LEATHER; GREASE FOR LUBRICATING AND PRESERVING LEATHER; GREASE FOR SHOES, IN CLASS 4 (U.S. CLS. 1, 6 AND 15).

FOR: SPORTS TRAINING SIMULATORS; SPECTACLES, EYEGLASSES AND SAFETY AND SWIMMING GOGGLES; PROTECTIVE HELMETS FOR SPORTS; HELMETS FOR PROTECTIVE USE; GLASSES FOR SPORTS USE; SUNGLASSES; CASES FOR EYE GLASSES SOLD EMPTY; SPEED GUNS, NAMELY, RADAR GUNS FOR SPORTING EVENTS; HELMET CASES FOR PROTECTIVE HELMETS SOLD EMPTY; ELECTRONIC SCOREBOARDS FOR GAMES, IN CLASS 9 (U.S. CLS. 21, 23, 26, 36 AND 38).

FOR: INDUSTRIAL PACKAGING CONTAINERS OF LEATHER; ALL PURPOSE SPORTS BAGS, ATHLETIC BAGS, SHOE BAGS FOR STORAGE, SHOULDER BAGS, TRAVELING BAGS, BOSTON BAGS, SPORTS BAGS SOLD EMPTY, NAMELY, BASEBALL AND SOFTBALL BAT BAGS, BASEBALL

BAGS, SOFTBALL BAGS, SHOE BAGS AND CATCHER MASK BAGS; POUCHES, NAMELY, LEATHER POUCHES, IMITATION LEATHER POUCHES, DRAWSTRING POUCHES, ALL SOLD EMPTY; VANITY CASES SOLD EMPTY; HAND BAGS SOLD EMPTY; PACK SACKS SOLD EMPTY, NAMELY, SPORTS PACKS; SHOE BAGS FOR TRAVEL; DRAWSTRING POUCHES SOLD EMPTY; LEATHER STRAPS, IN CLASS 18 (U.S. CLS. 1, 2, 3, 22 AND 41).

FOR: SCOREBOARDS FOR SPORTS, NAMELY, NON-ELECTRIC, PLASTIC OR WOODEN SPORTS SCORING USING MANUAL DIALS THAT ALLOW SPECTATORS TO KEEP TRACK OF SCORES AND OTHER DATA AT SPORTS EVENTS, IN CLASS 20 (U.S. CLS. 2, 13, 22, 25, 32 AND 50).

FOR: CLOTHING, NAMELY, WRIST BANDS, WIND-RESISTANT JACKETS, SPORT SHORTS, T-SHIRTS, COATS, UNDERSHIRTS, UNDERPANTS, SWEATSHIRTS, SWEAT PANTS, WARM-UP SHIRTS, WARM-UP PANTS, SPORTS UNIFORMS; GARTER BELTS; SOCK SUSPENDERS; WAISTBANDS; BELTS FOR CLOTHING; FOOTWEAR; MASQUERADE COSTUMES; CLOTHES FOR SPORTS, NAMELY, SPORTS BRAS, SHIRTS, COATS, JACKETS, T-SHIRTS, PANTS, UNDERWEAR AND UNIFORMS; BOOTS FOR SPORTS; SWEATERS; SPECIAL SPORTSWEAR FOR BALL SPORTS, NAMELY, SPORTS BRAS, BASEBALL UNIFORMS, SOFTBALL UNIFORMS, SLIDING PANTS, AND JACKETS MAINLY DESIGNED FOR BASEBALL OR SOFTBALL GAMES; SOCKS; SPORTS STOCKINGS; GARTERS FOR SPORTS STOCKINGS; BELTS; CAPS; SUN VISORS; HEADWEAR; SHOES; SPORTS SHOES AND SPIKE SHOES, NAMELY, BASEBALL SPIKE SHOES, SOFTBALL SPIKE SHOES, BASEBALL SHOES AND SOFTBALL SHOES; NON-ORTHOPEDIC SHOE INSOLES; PROTECTIVE METAL MEMBERS FOR SHOES; TOE COVERS FOR THE

PROTECTION OF SHOE TOES, NAMELY, TOE-CAPS, IN CLASS 25 (U.S. CLS. 22 AND 39).

FOR: SPORTS EQUIPMENT, NAMELY, HURDLES, SPORTS FIELD TRAINING GRIDS, BALANCE BALLS AND EXERCISE TRAMPOLINES; NETS FOR SPORTS USE, NAMELY, NETS FOR BASEBALL AND SOFTBALL GAMES AND PRACTICES; ROSIN FOR USE BY ATHLETES; GLOVES FOR SPORTS USE, NAMELY, BASEBALL GLOVES, BASEBALL GLOVE REPLACEMENT WEBBING AND REPLACEMENT FINGER FOR BASEBALL GLOVES THAT PROTECT THE WEARER'S FINGERS AGAINST IMPACT WHEN CATCHING A BALL; BASEBALL AND SOFTBALL BATS; GRIP TAPES FOR BASEBALL AND SOFTBALL BATS; EXERCISE WEIGHTS FOR ADDING WEIGHT TO BASEBALL AND SOFTBALL BATS; BASEBALL AND SOFTBALL BAT STANDS; BASEBALLS AND SOFTBALLS; BATTING GLOVES; BASEBALL AND FOOTBALL MASKS FOR PROTECTING THE FACE; SUN SHIELD AND RAIN SHIELD MASKS FOR PROTECTING THE FACE, NAMELY, CATCHERS' MASKS AND FENCING MASKS; LEG GUARDS FOR ATHLETIC USES; ARM GUARDS FOR SPORTS; FOOT GUARDS FOR SPORTS; THROAT PROTECTORS FOR SPORTS; CHEST PROTECTORS FOR SPORTS; ANKLE SUPPORTERS FOR SPORTS; KNEE SUPPORTERS FOR SPORTS; WAIST SUPPORTERS FOR SPORTS; BODY EXERCISING APPARATUS IN THE NATURE OF MANUALLY OPERATED MUSCLE STRETCHING EQUIPMENT, WEIGHT AND STRENGTH TRAINING EQUIP-

MENT, QUICKNESS AND LEGERITY TRAINING EQUIPMENT, NAMELY, ROPES, TRAMPOLINES, BALANCE BOARDS, BALANCE BALLS, SLIDE-BOARDS, STRETCHING BARS AND POLES, WEIGHTS, SPEED LADDERS; BASEBALL AND SOFTBALL BALL CASES SOLD EMPTY; BASEBALL AND SOFTBALL BAT CASES SOLD EMPTY; BASEBALL BASES; SOFTBALL BASES; PITCHER'S PLATES; LINE MARKERS FOR SPORTS FIELDS; UMPIRE BASEBALL AND SOFTBALL CASES SOLD EMPTY; BAGS ESPECIALLY DESIGNED FOR UMPIRE BASEBALLS AND SOFTBALLS; BALL PITCHING MACHINES AND REPLACEMENT PARTS AND REPLACEMENT FITTINGS; BALL TOSSING MACHINES AND REPLACEMENT PARTS AND REPLACEMENT FITTINGS; WRIST SUPPORT FOR USE IN PLAYING SPORTS, IN CLASS 28 (U.S. CLS. 22, 23, 38 AND 50).

PRIORITY DATE OF 7-13-2005 IS CLAIMED.

OWNER OF INTERNATIONAL REGISTRATION 0916270 DATED 1-10-2006, EXPIRES 1-10-2016.

OWNER OF U.S. REG. NOS. 1,201,186, 2,192,435 AND OTHERS.

SER. NO. 79-035,492, FILED 1-10-2006.

ELI HELLMAN, EXAMINING ATTORNEY

**Int. Cls.: 25 and 28**

**Prior U.S. Cls.: 22, 23, 38, 39 and 50**

**United States Patent and Trademark Office**

**Reg. No. 3,499,256**

**Registered Sep. 9, 2008**

**TRADEMARK  
PRINCIPAL REGISTER**



VIST S.R.L. (ITALY LIMITED LIABILITY COMPANY)  
VIA PALUDI DI CALDARO, 15  
I-39052 CALDARO S.S. DEL VINO (BZ)  
ITALY

FOR: CLOTHING, NAMELY, SWEATERS, WOOLLEN SWEATERS, FLEECE PULLOVERS, ANORAKS, WIND-RESISTANT JACKETS, EARMUFFS, SKI GLOVES, SKI SUITS AND SKI WEAR; FOOTWEAR, NAMELY, SKI AND SNOWBOARD SHOES AND BOOTS AND PARTS THEREOF; AND HEADGEAR, NAMELY, WOOLLEN HATS, SKI HATS, IN CLASS 25 (U.S. CLS. 22 AND 39).

FOR: GYMNASTIC AND SPORTING ARTICLES NOT INCLUDED IN OTHER CLASSES, NAMELY SKIS, CROSS-COUNTRY SKIS, SKI BINDINGS, PLATES FOR SKI BINDINGS, SKI POLES, SKI STICKS, SKI BAGS, ICE SKATES, SKATING BOOTS, AND SHIN GUARDS; DECORATIONS FOR

CHRISTMAS TREES, IN CLASS 28 (U.S. CLS. 22, 23, 38 AND 50).

PRIORITY DATE OF 11-10-2006 IS CLAIMED.

OWNER OF INTERNATIONAL REGISTRATION 0916462 DATED 1-30-2007, EXPIRES 1-30-2017.

THE LETTER "V", STYLIZED, WHOSE LEFT STROKE IS REGULAR WHILE ITS RIGHT STROKE IS THIN, LENGTHY AND CURVILINEAR.

THE WORDING "V" HAS NO MEANING IN A FOREIGN LANGUAGE.

SER. NO. 79-035,569, FILED 1-30-2007.

SEAN CROWLEY, EXAMINING ATTORNEY

**Int. Cls.: 9, 41 and 42**

**Prior U.S. Cls.: 21, 23, 26, 36, 38, 100, 101 and 107**

**United States Patent and Trademark Office**

**Reg. No. 3,499,257**

**Registered Sep. 9, 2008**

**TRADEMARK  
SERVICE MARK  
PRINCIPAL REGISTER**



ALMANID GROUP GMBH (SWITZERLAND LIMITED LIABILITY COMPANY)

HOCHSTRASSE 31

CH-4053 BASEL, SWITZERLAND

FOR: PHOTOGRAPHIC AND OPTICAL APPARATUS AND INSTRUMENTS USED TO CAPTURE HAND WRITING OR HAND DRAWN IMAGES, NAMELY, TABLET PCS, COMPUTERIZED ELECTRONIC PENS FOR USE IN CAPTURING WRITING STROKES AND DRAWING STROKES, DIGITAL CAMERAS FOR USE IN CAPTURING WRITING STROKES AND DRAWING STROKES, GRAPHICAL TABLETS FOR USE IN CAPTURING WRITING STROKES AND DRAWING STROKES; APPARATUS FOR RECORDING, TRANSMITTING AND REPRODUCING DIGITALIZED HAND WRITING OR HAND DRAWN IMAGES, NAMELY, TABLET PCS, PDAS, CELL PHONES, COMPUTERIZED ELECTRONIC PENS FOR USE IN CAPTURING WRITING STROKES AND DRAWING STROKES, DIGITAL CAMERAS FOR USE IN CAPTURING WRITING STROKES AND DRAWING STROKES, GRAPHICAL TABLETS FOR USE IN CAPTURING WRITING STROKES AND DRAWING STROKES; APPARATUS FOR RECORDING, TRANSMITTING AND REPRODUCING SOUND, NAMELY, MP3 PLAYERS, CD RECORDERS, MINI-CASSETTE RECORDERS, DIGITAL VOICE RECORDERS; BLANK MAGNETIC AND OPTICAL RECORDING MEDIA; MAGNETIC AND OPTICAL RECORDING MEDIA CONTAIN-

ING COMPUTER SOFTWARE FOR USE IN ELECTRONIC FORMS PROCESSING, DATA PROCESSING, DIRECTORY SERVICES, DATA TRANSFORMATION AND USER DOCUMENTATION; SOUND RECORDING DISKS CONTAINING TRAINING AND EDUCATION LESSONS; CALCULATING MACHINES, DATA PROCESSING AND COMPUTER EQUIPMENT, IN CLASS 9 (U.S. CLS. 21, 23, 26, 36 AND 38).

FOR: EDUCATIONAL SERVICES, NAMELY, SEMINARS, CLASSES, WORKSHOPS, WEBINARS AND TRAINING IN THE FIELDS OF COMPUTER SOFTWARE, ELECTRONIC FORMS PROCESSING, DATA PROCESSING, DIRECTORY SERVICES AND DATA TRANSFORMATION, IN CLASS 41 (U.S. CLS. 100, 101 AND 107).

FOR: SCIENTIFIC SERVICES, NAMELY, CUSTOM COMPUTER PROGRAMMING, FOR DIRECTORY SERVICES, DATA PROCESSING, ELECTRONIC FORMS PROCESSING AND DATA TRANSFORMATION; TECHNOLOGICAL SERVICES, NAMELY, CUSTOM COMPUTER PROGRAMMING, FOR DIRECTORY SERVICES, DATA PROCESSING, ELECTRONIC FORMS PROCESSING AND DATA TRANSFORMATION; RESEARCH AND DESIGN IN THE FIELDS OF DIRECTORY SERVICES, DATA PROCESSING, ELECTRONIC FORMS PROCESSING AND DATA TRANSFORMATION; INDUSTRIAL DESIGN ANALYSIS AND RE-

SEARCH SERVICES IN THE FIELDS OF DIRECTORY SERVICES, DATA PROCESSING, ELECTRONIC FORMS PROCESSING AND DATA TRANSFORMATION; DESIGN AND DEVELOPMENT OF COMPUTERS AND SOFTWARE FOR BACKUP AND RECOVERY OF DIRECTORY SERVICES, ELECTRONIC FORMS PROCESSING, IDENTITY MANAGEMENT, META-DIRECTORIES, DATA PROCESSING AND DATA TRANSFORMATION, IN CLASS 42 (U.S. CLS. 100 AND 101).

PRIORITY DATE OF 1-2-2007 IS CLAIMED.

OWNER OF INTERNATIONAL REGISTRATION 0917095 DATED 1-2-2007, EXPIRES 1-2-2017.

SER. NO. 79-035,823, FILED 1-2-2007.

RONALD AIKENS, EXAMINING ATTORNEY



**Int. Cls.: 3, 5, 29 and 30**

**Prior U.S. Cls.: 1, 4, 6, 18, 44, 46, 50, 51 and 52**

**United States Patent and Trademark Office**

**Reg. No. 3,499,258**

**Registered Sep. 9, 2008**

**TRADEMARK  
PRINCIPAL REGISTER**

**PES**

BIONORICA AG (FED REP GERMANY STOCK CORPORATION)  
KERSCHENSTEINERSTRASSE 11-15  
92318 NEUMARKT, FED REP GERMANY

FOR: ESSENTIAL OILS; PLANT EXTRACTS FOR USE AS COSMETICS, HAIR LOTIONS AND PERFUMERY; COSMETICS, IN CLASS 3 (U.S. CLS. 1, 4, 6, 50, 51 AND 52).

FOR: PHARMACEUTICAL, VETERINARY AND SANITARY PREPARATIONS FOR USE IN THE TREATMENT OF INFECTION OF RESPIRATORY TRACT, INFECTION OF URINARY TRACT, URINARY OBSTRUCTION, CHRONICAL VENOUS INSUFFICIENCY, PROSTATE HYPERPLASIA, MUSCLE PAINS, SOFT TISSUE RHEUMATISM, MUSCULOSKELETAL DISEASE, LIVER DISEASE, HEPATITIS, CIRRHOSIS OF THE LIVER; PHARMACEUTICAL PREPARATIONS FOR THE USE IN THE TREATMENT OF ANGINA, ATHEROSCLEROSIS, BRONCHIAL ASTHMA, CIRCULATORY DISORDERS, CONSTIPATION, DIARRHEA, HEART FAILURE, HEART RHYTHM DISORDERS, HIGH BLOOD PRESSURE, INDIGESTION, INSOMNIA, MIGRAINE, MOTION SICKNESS, NAUSEA, PEPTIC ULCERS, VOMITING AND ALLERGY; PHARMACEUTICAL PREPARATIONS, NAMELY, PLANT EXTRACTS FOR USE AS AN ANTIDEPRESSANT, DIURETIC, HYPNOTIC, SEDATIVE, STIMULANT AND TRANQUILIZER; HEMORRHOIDAL OINTMENT, LAXATIVE, NASAL DECONGESTANT CAPSULES, NASAL SPRAY PREPARATION, NON-NARCOTIC ANALGESIC, THROAT LOZENGES; MEDICAMENTS FOR THE TREATMENT OF GYNECOLOGICAL DISORDERS; MEDICINAL PREPARATIONS IN TABLET FORM, NAMELY, TABLETS FOR REGULATING MENSTRUATION CIRCULATION; DRUGS FOR TREATMENT OF CIRCULATORY ORGAN AILMENTS; HORMONE

PREPARATIONS FOR MEDICAL USE; MEDICINAL PREPARATIONS FOR TREATMENT OF AILMENTS OF THE URINARY, GENITAL AND ANAL ORGANS; MEDICINAL PREPARATIONS FOR TREATMENT OF BLOOD DISEASES AND DISORDERS; ORIENTAL MEDICINE FOR THE TREATMENT OF GYNECOLOGIC DISORDERS; PILLS FOR TREATING DIZZINESS; IMMUNE REGULATORS, NAMELY, MEDICINAL PREPARATIONS FOR THE STRENGTHENING OF THE IMMUNE SYSTEM; PHARMACEUTICAL PREPARATIONS AND MEDICINES FOR THE TREATMENT OF WOMEN'S DISEASES, NAMELY, MIGRAINE AND DEPRESSION; MEDICINES FOR THE TREATMENT OF BREAST PAIN; PHARMACEUTICAL PREPARATIONS AND MEDICINES FOR THE TREATMENT OF GYNECOLOGICAL DISORDERS AFFECTING MENSTRUATION, STERILITY, MENSTRUOUS SYNDROMES, MAMMAE, MASTOPATHY, MASTODYNIA, CLIMACTERIC COMPLAINTS, PREMENSTRUAL SYNDROME, DYSMENORRHEA; HEALTH FOOD, NAMELY, FOOD FOR DIABETICS; DIETETIC SUBSTANCES ADAPTED FOR MEDICAL USE, NAMELY, FOOD FOR MEDICALLY RESTRICTED DIETS, FOOD FOR DIABETICS, DIETARY FOOD SUPPLEMENTS, VITAMIN AND MINERAL SUPPLEMENTS, HERB TEAS FOR MEDICINAL PURPOSES AND MEDICINAL TEAS; PLANT EXTRACTS, TINCTURES AND AROMATIC SUBSTANCES IN LIQUID, SOLID OR GASEOUS FORM FOR PHARMACEUTICAL PREPARATIONS AND FOR DIETETIC SUBSTANCES FOR MEDICAL USE, NAMELY, MEDICINAL HERB EXTRACTS; NUTRITIONAL ADDITIVES FOR MEDICAL PURPOSES FOR USE IN FOODS AND DIETARY SUPPLEMENTS FOR HUMAN AND ANIMAL CONSUMPTION; DIETETIC SUPPLEMENTS IN THE FORM OF TABLETS, DROPS, CAPSULES, EXTRACT PREPARATIONS, BALMS AND/OR IN LIQUID FORM, CONTAINING PLANT EXTRACTS FOR THE TREATMENT OF

INFECTION OF RESPIRATORY TRACT, INFECTION OF URINARY TRACT, URINARY OBSTRUCTION, CHRONICAL VENOUS INSUFFICIENCY, PROSTATE HYPERPLASIA, MUSCLE PAINS, SOFT TISSUE RHEUMATISM, MUSCULOSKELETAL DISEASE, LIVER DISEASE, HEPATITIS, CIRRHOSIS OF THE LIVER, ANGINA, ATHEROSCLEROSIS, BRONCHIAL ASTHMA, CIRCULATORY DISORDERS, CONSTIPATION, DIARRHEA, HEART FAILURE, HEART RHYTHM DISORDERS, HIGH BLOOD PRESSURE, INDIGESTION, INSOMNIA, MIGRAINE, MOTION SICKNESS, NAUSEA, PEPTIC ULCERS, VOMITING AND ALLERGY, WOMEN'S DISEASES, NAMELY, MIGRAINE AND DEPRESSION, BREAST PAIN, GYNECOLOGICAL DISORDERS AFFECTING MENSTRUATION, STERILITY, MENSTRUOUS SYNDROMES, MAMMAE, MASTOPATHY, MASTODYNIA CLIMACTERIC COMPLAINTS, PREMENSTRUAL SYNDROME, DYSMENORRHEA; DIETETIC SUPPLEMENTS IN THE FORM OF TABLETS, DROPS, CAPSULES, EXTRACT PREPARATIONS, BALMS AND/OR IN LIQUID FORM, CONTAINING PLANT EXTRACTS FOR USE AS AN ANTIDEPRESSANT, DIURETIC, HYPNOTIC, SEDATIVE, STIMULANT AND TRANQUILIZER, HEMORRHOIDAL OINTMENT, LAXATIVE, NASAL DECONGESTANT CAPSULES, NASAL SPRAY PREPARATION, NON-NARCOTIC ANALGESIC, THROAT LOZENGES; DIETETIC SUPPLEMENTS IN THE FORM OF TABLETS, DROPS, CAPSULES, EXTRACT PREPARATIONS, BALMS AND/OR IN LIQUID FORM, CONTAINING PLANT EXTRACTS FOR THE TREATMENT OF GYNECO-

LOGICAL DISORDERS; DIETETIC FOOD SUPPLEMENTS; MINERAL FOOD SUPPLEMENTS, FOOD SUPPLEMENTS BASED ON AMINO ACIDS, MINERALS AND/OR TRACE ELEMENTS, IN CLASS 5 (U.S. CLS. 6, 18, 44, 46, 51 AND 52).

FOR: PLANT EXTRACTS, TINCTURES AND FLAVORINGS FOR FOODSTUFFS, FOOD SUPPLEMENTS AND FOOD, NAMELY, PROTEIN AND FAT BASED EXTRACTS FOR SOUPS, IN CLASS 29 (U.S. CL. 46).

FOR: PLANT EXTRACTS, TINCTURES AND FLAVORINGS FOR NON-MEDICAL FOOD PURPOSES, NAMELY, GRAIN BASED FOOD FLAVORINGS AND GRAIN BASED EXTRACTS USED AS A FLAVORING, IN CLASS 30 (U.S. CL. 46).

THE MARK CONSISTS OF STANDARD CHARACTERS WITHOUT CLAIM TO ANY PARTICULAR FONT, STYLE, SIZE, OR COLOR.

PRIORITY DATE OF 1-2-2006 IS CLAIMED.

OWNER OF INTERNATIONAL REGISTRATION 0917374 DATED 6-28-2006, EXPIRES 6-28-2016.

SER. NO. 79-035,934, FILED 6-28-2006.

STEVEN PEREZ, EXAMINING ATTORNEY

**Int. Cls.: 32 and 35**

**Prior U.S. Cls.: 45, 46, 48, 100, 101 and 102**

**United States Patent and Trademark Office**

**Reg. No. 3,499,259**

**Registered Sep. 9, 2008**

**TRADEMARK  
SERVICE MARK  
PRINCIPAL REGISTER**

# ABSOURCE

STADE VERMÖGENSVERWALTUNGS GMBH  
(AUSTRIA LIMITED LIABILITY CORPORATION)  
WINDMÜHLGASSE 7/22  
A-1060 WIEN  
AUSTRIA

FOR: MINERAL WATERS; CARBONATED WATERS; NON-ALCOHOLIC FRUIT JUICE BEVERAGES; FRUIT JUICES; ENERGY DRINKS, IN CLASS 32 (U.S. CLS. 45, 46 AND 48).

FOR: BUSINESS CONSULTANCY IN THE FIELD OF FRANCHISE DISTRIBUTION OF BEVERAGES; BUSINESS CONSULTANCY IN THE FIELD OF BEVERAGE DISTRIBUTION AND IN THE FIELD OF BEVERAGE MARKETING, IN CLASS 35 (U.S. CLS. 100, 101 AND 102).

THE MARK CONSISTS OF STANDARD CHARACTERS WITHOUT CLAIM TO ANY PARTICULAR FONT, STYLE, SIZE, OR COLOR.

PRIORITY DATE OF 6-8-2006 IS CLAIMED.

OWNER OF INTERNATIONAL REGISTRATION  
0917731 DATED 12-7-2006, EXPIRES 12-7-2016.

SER. NO. 79-036,115, FILED 12-7-2006.

DAVID HOFFMAN, EXAMINING ATTORNEY

**Int. Cls.: 9, 36 and 38**

**Prior U.S. Cls.: 21, 23, 26, 36, 38, 100, 101, 102 and 104**

**United States Patent and Trademark Office**

**Reg. No. 3,499,260**

**Registered Sep. 9, 2008**

**TRADEMARK  
SERVICE MARK  
PRINCIPAL REGISTER**

**COGNOTEC REALSTREAM**

COGNOTEC LIMITED (IRELAND LIMITED  
COMPANY (LTD.))  
2-4 ELY PLACE  
DUBLIN, IRELAND 2

FOR: COMPUTER TERMINALS; COMPUTER PROGRAMS AND COMPUTER SOFTWARE FOR FINANCIAL DEALING IN STOCKS, SHARES, FOREIGN CURRENCY EXCHANGE AND OTHER SUCH FINANCIAL INSTRUMENTS; DATA TRANSMITTING AND RECEIVING APPARATUS AND INSTRUMENTS, NAMELY, MODEMS, FOR THE USE IN THE TRANSFER AND RECEIPT OF DATA; COMPUTER TERMINALS USED FOR PROCESSING ELECTRONIC PAYMENTS; COMPUTER SOFTWARE FOR PROCESSING FINANCIAL TRANSACTIONS, PERFORMING FINANCIAL COMPUTATION AND DISPLAY AND MANAGEMENT OF FINANCIAL INFORMATION; ENCODED MAGNETIC CARDS BEARING RECORDED FINANCIAL DATA; AND REPLACEMENT PARTS FOR ALL THE AFORESAID GOODS, IN CLASS 9 (U.S. CLS. 21, 23, 26, 36 AND 38).

FOR: FINANCIAL SERVICES, NAMELY, STOCK AND COMMODITIES BROKERAGE, FOREIGN CURRENCY EXCHANGE AND FINANCIAL MANAGEMENT SERVICES; FINANCIAL ADVICE, CONSULTANCY, RESEARCH AND INFORMATION SERVICES, IN CLASS 36 (U.S. CLS. 100, 101 AND 102).

FOR: TELECOMMUNICATIONS SERVICES, NAMELY, PROVIDING ELECTRONIC TRANSMISSION OF DATA AND DOCUMENTS VIA COMPUTER TERMINALS, NAMELY, ELECTRONIC MAIL SERVICES, MESSAGE SENDING; AND ELECTRONIC TRANSMISSION OF DATA AND DOCUMENTS CONCERNING ELECTRONIC FINANCIAL TRANSACTIONS, IN CLASS 38 (U.S. CLS. 100, 101 AND 104).

THE MARK CONSISTS OF STANDARD CHARACTERS WITHOUT CLAIM TO ANY PARTICULAR FONT, STYLE, SIZE, OR COLOR.

PRIORITY DATE OF 11-3-2006 IS CLAIMED.

OWNER OF INTERNATIONAL REGISTRATION 0918113 DATED 11-29-2006, EXPIRES 11-29-2016.

OWNER OF U.S. REG. NOS. 2,956,388, 3,086,943, AND 3,091,792.

SER. NO. 79-036,246, FILED 11-29-2006.

VERNA BETH RIRIE, EXAMINING ATTORNEY

**Int. Cls.: 9, 21 and 25**

**Prior U.S. Cls.: 2, 13, 21, 22, 23, 26, 29, 30, 33, 36, 38,  
39, 40 and 50**

**Reg. No. 3,499,261**

**United States Patent and Trademark Office**

**Registered Sep. 9, 2008**

**TRADEMARK  
PRINCIPAL REGISTER**

**SHOWA GLOVE**

SHOWA GLOVE CO. (JAPAN CORPORATION)  
565, TOHORI,  
HIMEJI-SHI; HYOGO 670-0802  
JAPAN

FOR: GLOVES FOR PROTECTION AGAINST  
ACCIDENTS, IN CLASS 9 (U.S. CLS. 21, 23, 26, 36  
AND 38).

FOR: GLOVES FOR HOUSEHOLD PURPOSES;  
GARDENING GLOVES, IN CLASS 21 (U.S. CLS. 2, 13,  
23, 29, 30, 33, 40 AND 50).

FOR: GLOVES; MITTENS, IN CLASS 25 (U.S. CLS.  
22 AND 39).

THE MARK CONSISTS OF STANDARD CHAR-  
ACTERS WITHOUT CLAIM TO ANY PARTICULAR  
FONT, STYLE, SIZE, OR COLOR.

OWNER OF INTERNATIONAL REGISTRATION  
0918207 DATED 1-17-2007, EXPIRES 1-17-2017.

OWNER OF U.S. REG. NOS. 2,524,435 AND  
3,125,720.

NO CLAIM IS MADE TO THE EXCLUSIVE  
RIGHT TO USE "GLOVE", APART FROM THE  
MARK AS SHOWN.

SER. NO. 79-036,275, FILED 1-17-2007.

KEVIN CORWIN, EXAMINING ATTORNEY

**Int. Cls.: 9, 10 and 11**

**Prior U.S. Cls.: 13, 21, 23, 26, 31, 34, 36, 38, 39 and 44**

**Reg. No. 3,499,262**

**United States Patent and Trademark Office**

**Registered Sep. 9, 2008**

**TRADEMARK  
PRINCIPAL REGISTER**

# NANOSONICS

NANOSONICS LIMITED (AUSTRALIA CORPORATION)  
UNIT 24  
566 GARDENERS ROAD; ALEXANDRIA NSW 2015  
AUSTRALIA

FOR: SCIENTIFIC APPARATUS AND INSTRUMENTS FOR USE IN THE FIELD OF CHEMISTRY, NAMELY, MICROSCOPES AND PARTICLE ACCELERATORS; ELECTRONIC TESTERS USED TO TEST AEROSOL SPRAY CONTAINERS AND VALVES BY MEASURING THE SPRAY OUTPUT; PARTICLE ACCELERATORS USED TO CLASSIFY DIFFERENT PARTICLES, DETECT DIFFERENT PARTICLES, AND SEPARATE AND TRANSPORT PARTICLES; SCIENTIFIC RESEARCH APPARATUS, NAMELY, ULTRASOUND DIAGNOSTIC AND IMAGING APPARATUS FOR USE IN A RESEARCH LABORATORY ENVIRONMENT; SCIENTIFIC, OPTICAL, APPARATUS AND INSTRUMENTS INCORPORATING OR CONTAINING CERAMIC PARTICLES CONTAINING ACTIVE MOLECULES FOR CONTROLLED RELEASE, NAMELY, OPTICAL MIRRORS; BLANK MAGNETIC DATA CARRIERS; BLANK RECORDABLE OPTICAL DISCS; DATA PROCESSORS; AND COMPUTER HARDWARE AND SOFTWARE, FOR USE WITH MEDICAL PATIENT MONITORING EQUIPMENT, FOR RECEIVING, PROCESSING, TRANSMITTING AND DISPLAYING DATA, IN CLASS 9 (U.S. CLS. 21, 23, 26, 36 AND 38).

FOR: SURGICAL, MEDICAL, DENTAL AND VETERINARY APPARATUS AND INSTRUMENTS, NAMELY, CLINICAL CHEMISTRY ANALYZERS FOR MEDICAL OR VETERINARY USE TO ANA-

LYZE BLOOD AND OTHER BODILY FLUIDS; STERILIZATION AND DISINFECTION UNITS FOR MEDICAL PURPOSES; STERILIZATION AND DISINFECTION UNITS FOR MEDICAL INSTRUMENTS; MEDICAL ENDOSCOPIC EQUIPMENT; ENDOSCOPY CAMERAS; ENDOSCOPES FOR DIAGNOSTIC, MEDICAL, SURGICAL AND THERAPEUTIC USE; MEDICAL STERILIZATION UNITS FOR THE DECONTAMINATION AND DISINFECTION OF ENDOSCOPES; DIAGNOSTIC ULTRASOUND APPARATUS AND NUCLEAR MEDICINE MEDICAL DIAGNOSTIC IMAGING APPARATUS; AND VALVE-OPERATED AEROSOL DISPENSERS FOR MEDICAL USE, IN CLASS 10 (U.S. CLS. 26, 39 AND 44).

FOR: STERILIZERS NOT FOR MEDICAL PURPOSES; AND DISINFECTION APPARATUS FOR DISINFECTING INDUSTRIAL EQUIPMENT, IN CLASS 11 (U.S. CLS. 13, 21, 23, 31 AND 34).

THE MARK CONSISTS OF STANDARD CHARACTERS WITHOUT CLAIM TO ANY PARTICULAR FONT, STYLE, SIZE, OR COLOR.

PRIORITY DATE OF 8-21-2006 IS CLAIMED.

OWNER OF INTERNATIONAL REGISTRATION 0918381 DATED 11-29-2006, EXPIRES 11-29-2016.

SER. NO. 79-036,347, FILED 11-29-2006.

VERNA BETH RIRIE, EXAMINING ATTORNEY

**Int. Cl.: 28**

**Prior U.S. Cls.: 22, 23, 38 and 50**

**United States Patent and Trademark Office**

**Reg. No. 3,499,263**

**Registered Sep. 9, 2008**

**TRADEMARK  
PRINCIPAL REGISTER**

# SCHELDE SPORTS

SCHELDE INTERNATIONAL B.V. (NETHERLANDS LIMITED LIABILITY COMPANY)

OLYMPIASTRAAT 2

NL-4462 GG GOES, NETHERLANDS

FOR: GYMNAS TIC AND SPORTING ARTICLES NOT INCLUDED IN OTHER CLASSES, NAMELY, BASKETBALL HOOPS; LEISURE AND SPORT EQUIPMENT, NAMELY, FIXED AND PORTABLE BASKETBALL, SOCCER AND HOCKEY GOALS; GOALPOSTS, NAMELY, FOOTBALL, SOCCER OR HOCKEY GOALS; NETS AND THEIR FRAMES CONCERNING BASKETBALL, VOLLEYBALL, TENNIS AND OTHER BALL GAMES, NAMELY, BASKETBALL NETS, TENNIS NETS, VOLLEYBALL NETS, BADMINTON NETS AND UPRIGHTS, IN CLASS 28 (U.S. CLS. 22, 23, 38 AND 50).

THE MARK CONSISTS OF STANDARD CHARACTERS WITHOUT CLAIM TO ANY PARTICULAR FONT, STYLE, SIZE, OR COLOR.

PRIORITY DATE OF 12-11-2006 IS CLAIMED.

OWNER OF INTERNATIONAL REGISTRATION 0918758 DATED 12-21-2006, EXPIRES 12-21-2016.

NO CLAIM IS MADE TO THE EXCLUSIVE RIGHT TO USE "SPORTS", APART FROM THE MARK AS SHOWN.

SER. NO. 79-036,475, FILED 12-21-2006.

ROBERT STRUCK, EXAMINING ATTORNEY

**Int. Cls.: 35 and 41**

**Prior U.S. Cls.: 100, 101, 102 and 107**

**United States Patent and Trademark Office**

**Reg. No. 3,499,264**

**Registered Sep. 9, 2008**

**SERVICE MARK  
PRINCIPAL REGISTER**



I.E.M. INTERNATIONAL EXHIBITION MAN-  
AGEMENT S.R.L.  
VIA SAVAL, 21/C  
I-37124 VERONA  
ITALY

FOR: ORGANIZATION OF EXHIBITIONS OR  
TRADE FAIRS FOR COMMERCIAL OR ADVERTIS-  
ING PURPOSES; ADVERTISING SERVICES FOR  
PROMOTING EXHIBITIONS; BUSINESS MANAGE-  
MENT; BUSINESS ADMINISTRATION; PROVID-  
ING OFFICE FUNCTIONS, IN CLASS 35 (U.S. CLS.  
100, 101 AND 102).

FOR: ORGANIZATION OF EXHIBITIONS FOR  
CULTURAL OR EDUCATIONAL PURPOSES,  
NAMELY, EDUCATION REGARDING WINE, DIS-  
TILLED SPIRITS AND LIQUEUR; ARRANGING  
AND CONDUCTING OF CONFERENCES, CON-  
GRESSES, COLLOQUIUMS, SEMINARS AND SYM-  
POSIUMS IN THE FIELD OF EDUCATION  
REGARDING WINES, DISTILLED SPIRITS AND  
LIQUEUR; EDUCATION SERVICES, NAMELY,  
PROVIDING GUIDED WINE TASTINGS; TRAIN-  
ING AND EDUCATIONAL SERVICES, NAMELY,  
CONFERENCES, CONGRESSES, COLLOQUIUMS,  
SEMINARS AND SYMPOSIUMS IN WINE TYPOL-

OGIES AND VARIETALS AND THE MAKING OF  
WINE, DISTILLED SPIRITS AND LIQUEURS; EN-  
TERTAINMENT SERVICES, NAMELY, ORGANIZA-  
TION OF EVENTS INVOLVING TASTING OF  
WINES, DISTILLED SPIRITS AND LIQUEURS, IN  
CLASS 41 (U.S. CLS. 100, 101 AND 107).

PRIORITY DATE OF 8-11-2006 IS CLAIMED.

OWNER OF INTERNATIONAL REGISTRATION  
0919225 DATED 9-7-2006, EXPIRES 9-7-2016.

THE MARK CONSIST OF AND IS CONSTITUTED  
BY A GRAPHIC COMPOSITION INCLUDING A  
FIGURE OF HEAD OF A LION WITH MANE,  
PARTIALLY PLACED UPON A FIGURE OF A  
GLASS, IN THE FOREGROUND OF WHICH THERE  
IS THE WORDING "YOUNG LIONS" WRITTEN IN  
SMALL LETTERS.

SER. NO. 79-036,640, FILED 9-7-2006.

WILLIAM ROSSMAN, EXAMINING ATTORNEY



**Int. Cls.: 9, 37, 38 and 42**

**Prior U.S. Cls.: 21, 23, 26, 36, 38, 100, 101, 103, 104  
and 106**

**Reg. No. 3,499,265**

**United States Patent and Trademark Office**

**Registered Sep. 9, 2008**

**TRADEMARK  
SERVICE MARK  
PRINCIPAL REGISTER**

**CORINA**

SIEMENS AKTIENGESELLSCHAFT (FED REP  
GERMANY LIMITED PARTNERSHIP)  
WITTELSBACHERPLATZ 2  
80333 MÜNCHEN  
FED REP GERMANY

FOR: COMMUNICATION COMPUTERS; COM-  
PUTER SOFTWARE TO ALLOW REMOTE INTRA-  
NET ACCESS, IN CLASS 9 (U.S. CLS. 21, 23, 26, 36  
AND 38).

FOR: INSTALLATION WORK, IN PARTICULAR  
THE INSTALLATION OF TELEPHONE SYSTEMS,  
NAMELY, INSTALLATION OF TELEPHONE LINES  
AND TELEPHONE INSTALLATION, IN CLASS 37  
(U.S. CLS. 100, 103 AND 106).

FOR: INFORMATION AND TELECOMMUNICA-  
TION SERVICES, NAMELY, PROVIDING MULTI-  
PLE USER ACCESS TO A GLOBAL COMPUTER  
INFORMATION NETWORK AND PROVIDING  
CUSTOMER ACCESS TO INTRANET SYSTEMS;  
PROVIDING TECHNICAL SUPPORT AND TECH-  
NICAL CONSULTATION REGARDING OBTAIN-  
ING REMOTE ACCESS TO INTRANET SYSTEMS  
AND THE INTERNET, IN CLASS 38 (U.S. CLS. 100,  
101 AND 104).

FOR: COMPUTER AND SOFTWARE CONSUL-  
TANCY; ADMINISTRATION OF COMPUTER DA-  
TABASES, NAMELY, UPDATING OF DATABASES;

INSTALLATION WORK, IN PARTICULAR THE  
INSTALLATION OF COMMUNICATION COMPU-  
TER SOFTWARE; CONSULTING IN THE FIELD OF  
COMMUNICATION SOFTWARE AND COMPUTER  
SOFTWARE; CONSULTING SERVICES IN THE  
FIELD OF DESIGNING COMPUTER SOFTWARE  
THAT IS USED FOR REMOTE ACCESS TO INTRA-  
NET SYSTEMS AND THE INTERNET; DESIGNING,  
CREATING AND MAINTAINING COMMUNICA-  
TION SOFTWARE FOR OTHERS; REPAIR AND  
MAINTENANCE OF COMMUNICATION COMPU-  
TER SOFTWARE USED FOR INTERNET AND IN-  
TRANET SOLUTIONS; SERVICES OF AN  
INFORMATION AND SUPPORT HOTLINE FOR  
TECHNICAL PURPOSES, NAMELY, TROUBLE-  
SHOOTING OF COMPUTER HARDWARE AND  
SOFTWARE PROGRAMS, IN CLASS 42 (U.S. CLS.  
100 AND 101).

THE MARK CONSISTS OF STANDARD CHAR-  
ACTERS WITHOUT CLAIM TO ANY PARTICULAR  
FONT, STYLE, SIZE, OR COLOR.

OWNER OF INTERNATIONAL REGISTRATION  
0756353 DATED 11-7-2000, EXPIRES 11-7-2010.

SER. NO. 79-037,089, FILED 7-27-2006.

TANYA AMOS, EXAMINING ATTORNEY

**Int. Cls.: 9 and 45**

**Prior U.S. Cls.: 21, 23, 26, 36, 38, 100 and 101**

**United States Patent and Trademark Office**

**Reg. No. 3,499,266**

**Registered Sep. 9, 2008**

**TRADEMARK  
SERVICE MARK  
PRINCIPAL REGISTER**

# **FIND MY PAST**

FIND MY PAST LIMITED (UNITED KINGDOM  
PRIVATE LIMITED COMPANY)  
24 BRITTON STREET  
LONDON EC1M 5UA  
UNITED KINGDOM

FOR: SOFTWARE FOR BUILDING, STORING, REPORTING, SHARING AND MATCHING FAMILY TREES RELATING TO GENEALOGY, THE STUDY OF HISTORY, FAMILY HISTORY, MILITARY HISTORY, LOCAL HISTORY, HOUSE HISTORY AND SOCIAL HISTORY; SOFTWARE FOR CREATING FAMILY TREES PROVIDED BY PHYSICAL MEANS OF DISTRIBUTION SUCH AS CD AND DVD, IN CLASS 9 (U.S. CLS. 21, 23, 26, 36 AND 38).

FOR: GENEALOGICAL SERVICES; FAMILY HISTORY SERVICES; PROVISION OF GENEALOGICAL INFORMATION; PROVISION OF TESTAMENTARY INFORMATION; GENEALOGICAL RESEARCH, NAMELY, RESEARCH FOR TRACING PERSONAL FAMILY HISTORY; PRODUCTION OF GENEALOGICAL TABLES; CONSULTANCY SERVICES RELATING TO GENEALOGY; PROVISION OF DATA TO FACILITATE THE TRACING OF FAMILY MEMBERS, BOTH LIVING AND DECEASED; PROVISION OF HISTORICAL DATA; PROVISION OF INFORMATION FOR THE STUDY OF HISTORY, FAMILY

HISTORY, MILITARY HISTORY, LOCAL HISTORY, HOUSE HISTORY AND SOCIAL HISTORY; SERVICES ENABLING PERSONAL DATA TO BE MATCHED AGAINST FAMILY TREES; INTERACTIVE ONLINE SERVICES TO FACILITATE THE DISCUSSION, INSTRUCTION AND COLLABORATION OF HISTORICAL PROJECTS RELATED TO FAMILY HISTORY, MILITARY HISTORY, LOCAL HISTORY, HOUSE HISTORY, SOCIAL HISTORY AND OTHER FORMS OF HISTORICAL STUDY; THE PROVISION OF ELECTRONICALLY TAGGED HISTORICAL RECORDS AND GENEALOGICAL DATA; FACILITATING THE ELECTRONIC TAGGING OF HISTORICAL RECORDS AND GENEALOGICAL DATA BY OTHERS; ANY OF THE ABOVE SERVICES PROVIDED VIA THE INTERNET, IN CLASS 45 (U.S. CLS. 100 AND 101).

PRIORITY DATE OF 10-27-2006 IS CLAIMED.

OWNER OF INTERNATIONAL REGISTRATION  
0920656 DATED 12-4-2006, EXPIRES 12-4-2016.

SER. NO. 79-037,176, FILED 12-4-2006.

ROBERT STRUCK, EXAMINING ATTORNEY

**Int. Cls.: 9 and 45**

**Prior U.S. Cls.: 21, 23, 26, 36, 38, 100 and 101**

**United States Patent and Trademark Office**

**Reg. No. 3,499,267**

**Registered Sep. 9, 2008**

**TRADEMARK  
SERVICE MARK  
PRINCIPAL REGISTER**

**ANCESTORS ON BOARD**

FIND MY PAST LIMITED (UNITED KINGDOM  
PRIVATE LIMITED COMPANY)  
24 BRITTON STREET  
LONDON EC1M 5UA  
UNITED KINGDOM

FOR: SOFTWARE FOR BUILDING, STORING, REPORTING, SHARING AND MATCHING FAMILY TREES RELATING TO GENEALOGY, THE STUDY OF HISTORY, FAMILY HISTORY, MILITARY HISTORY, LOCAL HISTORY, HOUSE HISTORY AND SOCIAL HISTORY; SOFTWARE FOR CREATING FAMILY TREES PROVIDED BY PHYSICAL MEANS OF DISTRIBUTION SUCH AS CD AND DVD, IN CLASS 9 (U.S. CLS. 21, 23, 26, 36 AND 38).

FOR: GENEALOGICAL SERVICES; FAMILY HISTORY SERVICES; PROVISION OF GENEALOGICAL INFORMATION; PROVISION OF TESTAMENTARY INFORMATION; GENEALOGICAL RESEARCH, NAMELY, RESEARCH FOR TRACING PERSONAL FAMILY HISTORY; PRODUCTION OF GENEALOGICAL TABLES; CONSULTANCY SERVICES RELATING TO GENEALOGY; PROVISION OF DATA TO FACILITATE THE TRACING OF FAMILY MEMBERS, BOTH LIVING AND DECEASED; PROVISION OF HISTORICAL DATA; PROVISION OF INFORMATION FOR THE STUDY OF HISTORY, FAMILY HISTORY, MILITARY HISTORY, LOCAL HISTORY, HOUSE HISTORY AND SOCIAL HISTORY; SERVI-

CES ENABLING PERSONAL DATA TO BE MATCHED AGAINST FAMILY TREES; INTERACTIVE ONLINE SERVICES TO FACILITATE THE DISCUSSION, INSTRUCTION AND COLLABORATION OF HISTORICAL PROJECTS RELATED TO FAMILY HISTORY, MILITARY HISTORY, LOCAL HISTORY, HOUSE HISTORY, SOCIAL HISTORY AND OTHER FORMS OF HISTORICAL STUDY; THE PROVISION OF ELECTRONICALLY TAGGED HISTORICAL RECORDS AND GENEALOGICAL DATA; FACILITATING THE ELECTRONIC TAGGING OF HISTORICAL RECORDS AND GENEALOGICAL DATA BY OTHERS; ANY OF THE ABOVE SERVICES PROVIDED VIA THE INTERNET, IN CLASS 45 (U.S. CLS. 100 AND 101).

PRIORITY DATE OF 10-27-2006 IS CLAIMED.

OWNER OF INTERNATIONAL REGISTRATION  
0920658 DATED 12-4-2006, EXPIRES 12-4-2016.

NO CLAIM IS MADE TO THE EXCLUSIVE RIGHT TO USE "ANCESTORS", APART FROM THE MARK AS SHOWN.

SER. NO. 79-037,178, FILED 12-4-2006.

ROBERT STRUCK, EXAMINING ATTORNEY

**Int. Cl.: 11**

**Prior U.S. Cls.: 13, 21, 23, 31 and 34**

**United States Patent and Trademark Office**

**Reg. No. 3,499,268**

**Registered Sep. 9, 2008**

**TRADEMARK  
PRINCIPAL REGISTER**



WENZHOU HAIBA SANITARY CO., LTD (CHINA CORPORATION)  
NO. 1, SECOND STREET  
HAICHENG INDUSTRIAL CITY; LONGWAN DISTRICT, WENZHOU 325000  
CHINA

FOR: HYDRANTS NOT FIRE HYDRANTS; PLUMBING FITTINGS, NAMELY, COUPLERS, DRAINS, SPOUTS, COCKS AND VALVES BEING PARTS OF SANITARY FACILITIES; STRAINERS FOR WATER LINES; FAUCETS; SHOWERS; WATER FLUSHING INSTALLATIONS, NAMELY, FLUSH LEVERS, FLUSHMETERS; PIPES BEING PARTS OF SANITARY FACILITIES; TOILET BOWLS; ELECTRIC HOT AIR HAND DRYERS; SINKS; AIR CON-

DITIONING UNITS; WATER PURIFYING APPARATUS; WATER HEATERS FOR DOMESTIC USE, IN CLASS 11 (U.S. CLS. 13, 21, 23, 31 AND 34).

OWNER OF INTERNATIONAL REGISTRATION 0920859 DATED 11-28-2006, EXPIRES 11-28-2016.

THE WORDING "HAIBA" HAS NO MEANING IN ANY FOREIGN LANGUAGE.

SER. NO. 79-037,238, FILED 11-28-2006.

DAVID MILLER, EXAMINING ATTORNEY

**Int. Cls.: 6, 35 and 42**

**Prior U.S. Cls.: 2, 12, 13, 14, 23, 25, 50, 100, 101 and 102**

**Reg. No. 3,499,269**

**United States Patent and Trademark Office**

**Registered Sep. 9, 2008**

**TRADEMARK  
SERVICE MARK  
PRINCIPAL REGISTER**



ANCOFERWALDRAM STEELPLATES B.V.  
(NETHERLANDS CORPORATION)  
STATENDAMWEG 81  
NL-4905 AD OOSTERHOUT  
NETHERLANDS

OWNER OF INTERNATIONAL REGISTRATION  
0921276 DATED 2-7-2007, EXPIRES 2-7-2017.

FOR: STEEL SHEETS; PARTS OF STEEL SHEETS  
MADE BY SAWING, NAMELY, STEEL IN THE  
FORM OF PLATES, FOILS AND COILS, IN CLASS  
6 (U.S. CLS. 2, 12, 13, 14, 23, 25 AND 50).

NO CLAIM IS MADE TO THE EXCLUSIVE  
RIGHT TO USE "STEELPLATES", APART FROM  
THE MARK AS SHOWN.

FOR: WHOLESALE ORDERING SERVICES IN  
THE FIELD OF STEEL IN SHEET, PLATE, FOIL  
AND COIL FORM; INFORMATION ADVISORY  
AND CONSULTANCY SERVICES RELATING TO  
BUSINESS ADMINISTRATION, IN CLASS 35 (U.S.  
CLS. 100, 101 AND 102).

THE COLOR(S) ORANGE AND BLACK IS/ARE  
CLAIMED AS A FEATURE OF THE MARK.

FOR: QUALITY CONTROL FOR OTHERS TO  
DETERMINE THE QUALITY OF MATERIALS, IN  
CLASS 42 (U.S. CLS. 100 AND 101).

THE MARK CONSISTS OF FOUR ORANGE BARS  
OF VARYING HEIGHTS AND THE WORDING  
"ANCOFER WALDRAM STEELPLATES" IN  
BLACK.

PRIORITY DATE OF 11-9-2006 IS CLAIMED.

SER. NO. 79-037,424, FILED 2-7-2007.

BERNICE MIDDLETON, EXAMINING ATTORNEY

**Int. Cls.: 9 and 35**

**Prior U.S. Cls.: 21, 23, 26, 36, 38, 100, 101 and 102**

**Reg. No. 3,499,270**

**United States Patent and Trademark Office**

**Registered Sep. 9, 2008**

**TRADEMARK  
SERVICE MARK  
PRINCIPAL REGISTER**

**SUNIT**

SUNIT OY (FINLAND LIMITED LIABILITY COMPANY)  
KEHRÄÄMÖTIE 4  
FI-87400 KAJAANI  
FINLAND

FOR: TELEMATICS APPARATUS, NAMELY, WIRELESS INTERNET DEVICES WHICH PROVIDE TELEMATIC SERVICES AND HAVE A CELLULAR PHONE FUNCTION; VEHICLE LOCATOR AND RECOVERY DEVICE PROGRAMMED TO USE GLOBAL POSITIONING SYSTEMS (GPS) AND CELLULAR TELECOMMUNICATIONS; NAVIGATION APPARATUS FOR VEHICLES IN THE NATURE OF ON-BOARD COMPUTERS; SATELLITE NAVIGATION SYSTEM, NAMELY, A GLOBAL POSITIONING SYSTEM (GPS), IN CLASS 9 (U.S. CLS. 21, 23, 26, 36 AND 38).

FOR: TRACKING, LOCATING AND MONITORING OF VEHICLES, FREIGHT CARS, MARITIME VESSELS, POLICE CARS, AMBULANCES, FIRE RESCUE VEHICLES AND OTHER EMERGENCY VEHICLES, COACHES, BUSES AND OTHER PUBLIC TRANSPORTATION VEHICLES, CUSTOMS BOATS, PILOT BOATS, MILITARY BOATS, TRUCKS AND TIMBER HARVESTING MACHINES, EARTH MOVING MACHINES AND ROAD MAINTENANCE MACHINES SERVICES BY MEANS OF

COMPUTER AND SATELLITE FOR COMMERCIAL PURPOSES; PROVIDING ELECTRONIC TRACKING OF FREIGHT INFORMATION TO OTHERS; MONITORING AND TRACKING OF PACKAGE SHIPMENTS; COMPUTERIZED TRACKING AND TRACING OF PACKAGES IN TRANSIT; LOGISTICS MANAGEMENT AND ELECTRONIC TRACKING AND POSITIONING IN RESPECT OF TIMBER MEASURING AND HARVESTING EQUIPMENT FOR COMMERCIAL PURPOSES; LOGISTICS MANAGEMENT AND ELECTRONIC TRACKING AND POSITIONING OF ROAD MAINTENANCE MACHINES FOR COMMERCIAL PURPOSES; HARBOR LOGISTICS MANAGEMENT; LOGISTICS MANAGEMENT OF PUBLIC TRANSPORTATIONS AND EMERGENCY VEHICLES, IN CLASS 35 (U.S. CLS. 100, 101 AND 102).

PRIORITY DATE OF 11-30-2005 IS CLAIMED.

OWNER OF INTERNATIONAL REGISTRATION 0922276 DATED 5-26-2006, EXPIRES 5-26-2016.

SER. NO. 79-037,801, FILED 5-26-2006.

KELLEY WELLS, EXAMINING ATTORNEY

**Int. Cl.: 36**

**Prior U.S. Cls.: 100, 101 and 102**

**United States Patent and Trademark Office**

**Reg. No. 3,499,271**

**Registered Sep. 9, 2008**

**SERVICE MARK  
PRINCIPAL REGISTER**

**CATS TRUST**

PETER ALEXANDER DENEGA (UNITED KING-  
DOM INDIVIDUAL)  
33 MEAD ROAD  
TORQUAY TQ2 6TG, UNITED KINGDOM

OWNER OF INTERNATIONAL REGISTRATION  
0922559 DATED 3-5-2007, EXPIRES 3-5-2017.

FOR: INSURANCE UNDERWRITING IN THE  
FIELD OF PET HEALTH INSURANCE AND PET  
ACCIDENT INSURANCE; CHARITABLE FUND  
RAISING; CREDIT CARD SERVICES, IN CLASS 36  
(U.S. CLS. 100, 101 AND 102).

NO CLAIM IS MADE TO THE EXCLUSIVE  
RIGHT TO USE "CATS", APART FROM THE MARK  
AS SHOWN.

THE MARK CONSISTS OF STANDARD CHAR-  
ACTERS WITHOUT CLAIM TO ANY PARTICULAR  
FONT, STYLE, SIZE, OR COLOR.

SER. NO. 79-037,895, FILED 3-5-2007.

TANYA AMOS, EXAMINING ATTORNEY

Int. Cl.: 9

Prior U.S. Cls.: 21, 23, 26, 36 and 38

United States Patent and Trademark Office

Reg. No. 3,499,272

Registered Sep. 9, 2008

TRADEMARK  
PRINCIPAL REGISTER



AICHELE GROUP GMBH & CO. KG (FED REP  
GERMANY LIMITED PARTNERSHIP)  
GEWERBESTRAÙE 44  
75015 BRETTEEN  
FED REP GERMANY

FOR: ELECTROTECHNICAL AND ELECTRONIC  
EQUIPMENT, DEVICES AND INSTRUMENTS FOR  
AUTOMOBILES, AS FAR AS CONTAINED IN THIS  
CLASS, NAMELY, ELECTRICAL CONTACT SETS  
FOR AUTOMOTIVE IGNITION SYSTEMS, CAPACI-  
TORS, ELECTRICAL DISTRIBUTORS, ELECTRI-  
CAL CABLES, ELECTRICAL CABLE TERMINALS  
AND CABLE CONNECTORS, ELECTRICAL  
SWITCHES, ELECTRICAL MALE AND FEMALE  
CONNECTORS, ELECTRICAL FUSES AND FUSE  
CASES, IGNITION COILS, ELECTRICAL DEVICES  
FOR INTERFERENCE SUPPRESSION, NAMELY,  
ANTI-INTERFERENCE FILTERS FOR CAR  
RADIOS, ANTI-INTERFERENCE FILTERS FOR  
AMATEUR RADIO FREQUENCIES AND ANTI-  
INTERFERENCE FILTERS FOR IGNITION  
CABLES, ELECTRICAL PLUG CONNECTORS, IN  
CLASS 9 (U.S. CLS. 21, 23, 26, 36 AND 38).

PRIORITY DATE OF 10-18-2006 IS CLAIMED.

OWNER OF INTERNATIONAL REGISTRATION  
0923429 DATED 4-18-2007, EXPIRES 4-18-2017.

OWNER OF U.S. REG. NO. 3,211,624.

NO CLAIM IS MADE TO THE EXCLUSIVE  
RIGHT TO USE "PREMIUM CAR SYSTEMS" AND  
"GERMANY", APART FROM THE MARK AS  
SHOWN.

THE COLOR(S) RED AND WHITE IS/ARE  
CLAIMED AS A FEATURE OF THE MARK.

THE LETTER "A" APPEARS IN WHITE WITHIN A  
RED CIRCULAR BACKGROUND. THE CURVED  
LINE, AND WORDING "BREMI PREMIUM CAR  
SYSTEMS GERMANY" ALL APPEAR IN RED.

SER. NO. 79-038,221, FILED 4-18-2007.

AMY ALFIERI, EXAMINING ATTORNEY



**Int. Cls.: 9 and 41**

**Prior U.S. Cls.: 21, 23, 26, 36, 38, 100, 101 and 107**

**United States Patent and Trademark Office**

**Reg. No. 3,499,273**

**Registered Sep. 9, 2008**

**TRADEMARK  
SERVICE MARK  
PRINCIPAL REGISTER**



REX HUNT HOLDINGS PTY LTD (AUSTRALIA  
AUSTRALIAN COMPANY)  
1A KEYS STREET  
BEAUMARIS VIC 3193, AUSTRALIA

FOR: CINEMATOGRAPHIC FILMS, COMPACT  
DISCS, CD-ROMS, DVDS AND VIDEO CASSETTES  
FEATURING INFORMATION AND ACTIVITIES IN  
THE SUBJECTS OF FISHING, WATERCRAFT, EN-  
VIRONMENTAL ISSUES AND OUTDOOR RE-  
CREATION, IN CLASS 9 (U.S. CLS. 21, 23, 26, 36  
AND 38).

FOR: EDUCATIONAL SERVICES IN THE NAT-  
URE OF AN ON-GOING TELEVISION PROGRAM  
FEATURING INFORMATION AND SUBJECTS OF  
OUTDOOR RECREATION, FISHING, WATER-

CRAFT, ENVIRONMENTAL ISSUES AND SPORTS;  
ENTERTAINMENT SERVICES, NAMELY, A CON-  
TINUING EDUCATIONAL PROGRAM ABOUT  
FISHING, WATERCRAFT, ENVIRONMENTAL IS-  
SUES AND SPORTS ACCESSIBLE BY RADIO AND  
TELEVISION, IN CLASS 41 (U.S. CLS. 100, 101 AND  
107).

OWNER OF INTERNATIONAL REGISTRATION  
0923665 DATED 2-1-2007, EXPIRES 2-1-2017.

SER. NO. 79-038,309, FILED 2-1-2007.

CHRISTOPHER BUONGIORNO, EXAMINING AT-  
TORNEY

**Int. Cls.: 1, 2, 6, 17 and 40**

**Prior U.S. Cls.: 1, 2, 5, 6, 10, 11, 12, 13, 14, 16, 23, 25,  
26, 35, 46, 50, 100, 103 and 106**

**Reg. No. 3,499,274**

**United States Patent and Trademark Office**

**Registered Sep. 9, 2008**

**TRADEMARK  
SERVICE MARK  
PRINCIPAL REGISTER**

# Elantas

ALTANA CHEMIE AG (FED REP GERMANY  
AG)  
ABELSTRASSE 45  
46483 WESEL  
FED REP GERMANY

FOR: CHEMICAL PRODUCTS FOR COMMERCIAL AND SCIENTIFIC PURPOSES, NAMELY, ADHESIVES FOR INDUSTRIAL AND SCIENTIFIC PURPOSES; POLYMERS BASED ON POLYIMIDE, POLYAMIDEIMIDE, POLYESTER, POLYESTERIMIDE, POLYURETHANE, PHENOXY AND POLYAMIDE FOR COPPER AND ALUMINUM CONDUCTORS; POLYMERS FOR THE COATINGS OF ELECTRIC AND ELECTRONIC DEVICES; CHEMICAL ADDITIVES FOR OILS, PAINTS, VARNISHES, LACQUERS; WETTING AGENTS FOR USE IN THE MANUFACTURE OF PAINTS, VARNISHES, LACQUERS; POLYMERS FOR ELECTRONIC MATERIALS, CHEMICAL PRODUCTS FOR THE PREPARATION OF ENAMELS, INDUSTRIAL ADHESIVES FOR USE IN COATING AND SEALING, AND UNPROCESSED SYNTHETIC RESINS FOR THE MANUFACTURE OF IMPREGNATIONS, ENCAPSULATING AND POTTING COMPOUNDS; POLYMERS, NAMELY, COMPOSITIONS USED IN THE MANUFACTURE OF COMMERCIAL AND INDUSTRIAL GOODS FOR APPLICATIONS IN THE ELECTRICAL AND ELECTRONIC INDUSTRIES; UNPROCESSED PLASTICS FOR INDUSTRIAL USE; ADHESIVES FOR GENERAL INDUSTRIAL USE; EMULSION AGENTS, DISPERSING AGENTS, CHEMICAL AGENTS FOR INCREASING OR REDUCING THE SURFACE TENSION OF PAINTS AND LACQUERS; SILICONE RESINS, IN CLASS 1 (U.S. CLS. 1, 5, 6, 10, 26 AND 46).

FOR: PAINTS, VARNISHES, LACQUERS; PIGMENTS, NAMELY, IRON PIGMENTS, PEARL GLOSS PIGMENTS, METAL EFFECT PIGMENTS,

INTERFERENCE PIGMENTS; POWDER COATINGS FOR METAL, PLASTIC AND SYNTHETIC SURFACES; ANTI-CORROSIVE COATINGS, ANTI-RUST OILS AND SEALANTS, DYES FOR GENERAL INDUSTRIAL USE, UNPROCESSED NATURAL RESINS FOR USE IN THE MANUFACTURE OF IMPREGNATIONS, ENCAPSULATING AND POTTING COMPOUNDS, MOTORS COILS, POLYMERS FOR APPLICATIONS IN THE ELECTRICAL AND ELECTRONIC INDUSTRIES; METALS IN FOIL AND METALS IN POWDER FORM FOR PAINTERS, DECORATORS, PRINTERS AND ARTISTS; CUT UP FOILS MADE OF COMMON METAL IN REGULAR FORMS, NAMELY, IN LEAF SHAPE FOR PAINTERS, DECORATORS, PRINTERS, ARTISTS AND FOR GENERAL INDUSTRIAL USE; LACQUERS FOR USE IN THE ELECTRIC AND ELECTRONIC INDUSTRY; PROTECTIVE COATINGS THAT ARE ULTRAVIOLET RAYS-RESISTANT, HEAT-RESISTANT AND HIGH-VOLTAGE RESISTANT FOR METALS, IN CLASS 2 (U.S. CLS. 6, 11 AND 16).

FOR: UNWROUGHT AND SEMI-WORKED COMMON METALS FOR FURTHER MANUFACTURE; CASTINGS, FOILS, POWDER, AND ROLLED, DRAWN OR EXTRUDED SEMI-FINISHED ARTICLES OF LEAD, ALUMINUM, NICKEL, TIN OR THEIR ALLOYS; METAL CLOSURES FOR FOODS CONTAINERS AND BEVERAGE CASES, IN CLASS 6 (U.S. CLS. 2, 12, 13, 14, 23, 25 AND 50).

FOR: RAW RUBBER, GUTTA-PERCHA, RUBBER, MICA AND ELECTRICAL INSULATING MICA PRODUCTS, PLASTICS IN EXTRUDED FORM USED IN PRODUCTION, SEMI-PROCESSED PLASTICS IN THE FORM OF SHEETS, FILMS, BLOCKS, RODS AND TUBES; PLASTIC SEALS, SYNTHETIC FOIL FOR FLEXIBLE PACKAGES, PLASTIC FILM FOR INDUSTRIAL AND COMMERCIAL PACKING USE; INSULATING AND PROTEC-

TIVE INTERLAYER DIELECTRIC MATERIALS AND COATINGS FOR USE IN INTEGRATED CIRCUITS, SEMICONDUCTOR DEVICES, COMPUTER DISK DRIVES AND OTHER COMPUTER HARDWARE; INSULATORS FOR ELECTRICAL CABLES, INSULATING OIL FOR TRANSFORMERS; INSULATING PAINTS, INSULATING PLASTER, INSULATING SPLICE COVER FOR ELECTRICAL CABLE; LIQUID INSULATIONS, NAMELY, INSULATING OILS FOR ELECTRICAL AND ELECTRONIC CABLE AND COMPONENTS, INSULATING WIRE ENAMELS, FOR THE ELECTRIC AND ELECTRONIC INDUSTRY; PLASTIC SEALANTS FOR BOTTLE, GLASS AND CAN CAPS; NON-METAL HOSES FOR THE ELECTRIC AND ELECTRONIC INDUSTRY, IN CLASS 17 (U.S. CLS. 1, 5, 12, 13, 35 AND 50).

FOR: TREATMENT OF MATERIAL, NAMELY, TREATMENT OF METALS, COAT STEEL, ALUMINUM, PLASTIC, PAPER AND BOARD, PAINTS AND LACQUERS; METAL AND PLASTIC LAMINATING AND PLATING, TIN PLATING, APPLICATION OF

PROTECTIVE COATINGS, PAINT AND LACQUER ADDITIVES; GALVANIZATION, MAGNETIZATION, VULCANIZATION; PROCESSING OF PIGMENTS INTO RAW LACQUERS, NAMELY, BONDING OF POWDER LACQUERS, IN CLASS 40 (U.S. CLS. 100, 103 AND 106).

THE MARK CONSISTS OF STANDARD CHARACTERS WITHOUT CLAIM TO ANY PARTICULAR FONT, STYLE, SIZE, OR COLOR.

PRIORITY DATE OF 7-6-2006 IS CLAIMED.

OWNER OF INTERNATIONAL REGISTRATION 0923981 DATED 12-21-2006, EXPIRES 12-21-2016.

SER. NO. 79-038,422, FILED 12-21-2006.

CHRISTOPHER BUONGIORNO, EXAMINING ATTORNEY

**Int. Cl.: 9**

**Prior U.S. Cls.: 21, 23, 26, 36 and 38**

**Reg. No. 3,499,275**

**United States Patent and Trademark Office**

**Registered Sep. 9, 2008**

**TRADEMARK  
PRINCIPAL REGISTER**



**Imagery Library for Intelligent  
Detection Systems**

SECRETARY OF STATE FOR THE; HOME DEPARTMENT (UNITED KINGDOM UK GOVERNMENT)

HOME OFFICE SCIENTIFIC DEVELOPMENT BRANCH (HOSDB); LANGHURST HOUSE, LANGHURSTWOOD ROAD; HORSHAM; WEST SUSSEX RH12 4WX  
UNITED KINGDOM

FOR: VIDEO RECORDINGS FEATURING SURVEILLANCE SEQUENCES FOR THE DEVELOPMENT AND TESTING OF VISION-BASED SECURITY SYSTEMS, IN CLASS 9 (U.S. CLS. 21, 23, 26, 36 AND 38).

OWNER OF INTERNATIONAL REGISTRATION 0924681 DATED 3-1-2007, EXPIRES 3-1-2017.

THE COLOR(S) PURPLE (PANTONE 2592) IS/ARE CLAIMED AS A FEATURE OF THE MARK.

THE MARK CONSIST OF THE WORDING "ILIDS" IN BETWEEN TWO BANDS, AND THE WORDING "IMAGERY LIBRARY FOR INTELLIGENT DETECTION SYSTEMS " BELOW THE LOWER BAND, WITH THE ENTIRE MARK IN PURPLE.

SER. NO. 79-038,658, FILED 3-1-2007.

SANJEEV VOHRA, EXAMINING ATTORNEY

**Int. Cl.: 28**

**Prior U.S. Cls.: 22, 23, 38 and 50**

**Reg. No. 3,499,276**

**United States Patent and Trademark Office**

**Registered Sep. 9, 2008**

**TRADEMARK  
PRINCIPAL REGISTER**



**Puppenmanufaktur**

GÖTZ-PUPPENFABRIK GMBH (FED REP GER-  
MANY GMBH)  
EINBERGER STRASSE 113  
96472 RÖDENTAL  
FED REP GERMANY

FOR: ARTIST DOLLS AND PLAY DOLLS AND  
DOLL ACCESSORIES, NAMELY, CLOTHING,  
SHOES, HEADWEAR AND FURNITURE, IN CLASS  
28 (U.S. CLS. 22, 23, 38 AND 50).

OWNER OF INTERNATIONAL REGISTRATION  
0924769 DATED 2-15-2007, EXPIRES 2-15-2017.

OWNER OF U.S. REG. NO. 2,043,090.

NO CLAIM IS MADE TO THE EXCLUSIVE  
RIGHT TO USE "PUPPENMANUFAKTUR", APART  
FROM THE MARK AS SHOWN.

THE ENGLISH TRANSLATION OF "PUPPENMA-  
NUFAKTUR" IS DOLL MANUFACTORY.

SER. NO. 79-038,697, FILED 2-15-2007.

LESLEY LAMOTHE, EXAMINING ATTORNEY

**Int. Cls.: 9 and 38**

**Prior U.S. Cls.: 21, 23, 26, 36, 38, 100, 101 and 104**

**United States Patent and Trademark Office**

**Reg. No. 3,499,277**

**Registered Sep. 9, 2008**

**TRADEMARK  
SERVICE MARK  
PRINCIPAL REGISTER**

# SEEKER ZONE

SEEKER WIRELESS PTY LIMITED (AUSTRALIA  
COMPANY)  
SUITE 15  
924 PACIFIC HIGHWAY; GORDON NSW 2072  
AUSTRALIA

FOR: SOFTWARE FOR PROVIDING MOBILE  
LOCATION DATA FOR MOBILE DEVICES IN A  
MOBILE COMMUNICATIONS NETWORK , IN  
CLASS 9 (U.S. CLS. 21, 23, 26, 36 AND 38).

FOR: SERVICES RELATING TO LOCATION OF  
MOBILE COMMUNICATION DEVICES IN A MO-  
BILE COMMUNICATIONS NETWORK, NAMELY,  
ELECTRONIC TRANSMISSION OF MESSAGES  
AND DATA THAT ASSISTS IN LOCATING MOBILE  
DEVICES IN A MOBILE COMMUNICATIONS NET-  
WORK, AND TRANSMISSION OF MOBILE DEVICE  
LOCATION DATA FOR MOBILE DEVICES IN A  
MOBILE COMMUNICATIONS NETWORK TO AD-  
VERTISERS AND TELECOMMUNICATION SER-

VICE PROVIDERS, IN CLASS 38 (U.S. CLS. 100, 101  
AND 104).

THE MARK CONSISTS OF STANDARD CHAR-  
ACTERS WITHOUT CLAIM TO ANY PARTICULAR  
FONT, STYLE, SIZE, OR COLOR.

PRIORITY DATE OF 3-30-2007 IS CLAIMED.

OWNER OF INTERNATIONAL REGISTRATION  
0924885 DATED 4-5-2007, EXPIRES 4-5-2017.

NO CLAIM IS MADE TO THE EXCLUSIVE  
RIGHT TO USE "ZONE", APART FROM THE MARK  
AS SHOWN.

SER. NO. 79-038,753, FILED 4-5-2007.

ELI HELLMAN, EXAMINING ATTORNEY

**Int. Cls.: 3, 35 and 44**

**Prior U.S. Cls.: 1, 4, 6, 50, 51, 52, 100, 101 and 102**

**Reg. No. 3,499,278**

**United States Patent and Trademark Office**

**Registered Sep. 9, 2008**

**TRADEMARK  
SERVICE MARK  
PRINCIPAL REGISTER**

**INGU**

TERRY DE GUNZBURG (FRANCE INDIVIDUAL)  
1A NEVILLE TERRACE  
LONDON SW7 3AT  
UNITED KINGDOM

FOR: COSMETICS; PERFUMES; EAU DE TOILETTE; EAU-DE-COLOGNE; ESSENTIAL OILS; SOAPS; CLEANSING MILKS; DEODORANTS FOR PERSONAL USE; CREAMS, GELS, MILKS, LOTIONS, MASKS, POMADES, POWDERS, AND COSMETIC PREPARATIONS FOR SKIN CARE; COSMETIC SUN BLOCKS; COSMETIC SUNTAN PREPARATIONS; DEPILATORIES; HAIR SPRAYS AND LOTIONS; SHAMPOOS; COSMETIC PREPARATIONS FOR BATHS; MAKE-UP AND MAKE-UP REMOVING PRODUCTS; FALSE EYELASHES; COSMETIC SETS COMPRISED OF MAKE-UP, LIPSTICKS, FOUNDATIONS, CREAMS, GELS, MILKS, LOTIONS, MASKS, POMADES, POWDERS, HAIR SPRAYS, AND LOTIONS, IN CLASS 3 (U.S. CLS. 1, 4, 6, 50, 51 AND 52).

FOR: RETAIL STORES FEATURING COSMETICS, CLOTHING, FOOTWEAR, HEADWEAR, HOME FURNISHINGS, JEWELRY, AND LEATHER GOODS; ON-LINE RETAIL STORE SERVICES FEATURING COSMETICS, CLOTHING, FOOTWEAR, HEADWEAR, HOME FURNISHINGS, JEWELRY,

AND LEATHER GOODS; MAIL ORDER CATALOGUE SERVICES FEATURING COSMETICS, CLOTHING, FOOTWEAR, HEADWEAR, HOME FURNISHINGS, JEWELRY, AND LEATHER GOODS; ADVERTISING; CONSULTING, INFORMATION, AND ADVISORY SERVICES REGARDING ADVERTISING; BUSINESS MANAGEMENT AND ADMINISTRATION; CONSULTING, INFORMATION, AND ADVISORY SERVICES REGARDING BUSINESS; PROVIDING OFFICE FUNCTIONS; PROVISION OF COMMERCIAL INFORMATION AND ADVICE TO CONSUMERS; COMPARISON SHOPPING SERVICES PROVIDED TO CONSUMERS, IN CLASS 35 (U.S. CLS. 100, 101 AND 102).

FOR: CONSULTING AND ADVISORY SERVICES RELATING TO BEAUTY TREATMENT; BEAUTY SALON SERVICES; BEAUTY SALONS; BEAUTY THERAPY SERVICES; BEAUTY TREATMENTS, IN CLASS 44 (U.S. CLS. 100 AND 101).

OWNER OF INTERNATIONAL REGISTRATION  
0925053 DATED 4-27-2007, EXPIRES 4-27-2017.

SER. NO. 79-038,821, FILED 4-27-2007.

CORY BOONE, EXAMINING ATTORNEY

**Int. Cls.: 9, 16, 35, 41 and 42**

**Prior U.S. Cls.: 2, 5, 21, 22, 23, 26, 29, 36, 37, 38, 50,  
100, 101, 102 and 107**

**Reg. No. 3,499,279**

**United States Patent and Trademark Office**

**Registered Sep. 9, 2008**

**TRADEMARK  
SERVICE MARK  
PRINCIPAL REGISTER**

**IN CUBO VERITAS THE METHOD OF POWER**

VINCENT EURIEULT (FRANCE INDIVIDUAL)  
20 RUE LITTRÉ  
F-75006 PARIS  
FRANCE

FOR: APPARATUS FOR RECORDING, TRANSMITTING AND REPRODUCING SOUND OR IMAGES; PRE-RECORDED MAGNETIC DATA CARRIERS FEATURING SCIENCE, MUSIC, ART, INFORMATION AND ADVICE ON BUSINESS MANAGEMENT AND BUSINESS MEDIATION AND NEGOTIATION, INFORMATION AND ADVICE ON COMMUNICATIONS, AND INFORMATION AND ADVICE IN THE FIELD OF SOFTWARE; PRE-RECORDED RECORDING DISKS FEATURING SCIENCE, MUSIC, ART, INFORMATION AND ADVICE ON BUSINESS MANAGEMENT AND BUSINESS MEDIATION AND NEGOTIATION, INFORMATION AND ADVICE ON COMMUNICATIONS, AND INFORMATION AND ADVICE IN THE FIELD OF SOFTWARE; PRE-RECORDED COMPACT DISKS, DVDS, CD-ROMS FEATURING SCIENCE, MUSIC, ART, INFORMATION AND ADVICE ON BUSINESS MANAGEMENT AND BUSINESS MEDIATION AND NEGOTIATION, INFORMATION AND ADVICE ON COMMUNICATIONS, AND INFORMATION AND ADVICE IN THE FIELD OF SOFTWARE; DATA PROCESSING AND COMPUTER EQUIPMENT, NAMELY, CENTRAL PROCESSING UNITS (CPU), COMPUTER HARDWARE, COMMUNICATIONS COMPUTERS, COMPUTER KEYBOARDS, LAPTOP COMPUTERS, PERSONAL DIGITAL ASSISTANT (PDA); COMPUTER PROGRAMS AND SOFTWARE FOR USE IN TRAINING IN THE FIELDS OF BUSINESS MANAGEMENT, MEDIATION AND NEGOTIATION SKILLS, LEADERSHIP, CRITICAL THINKING SKILLS, INFLUENCE AND COMMUNICATION SKILLS, PRESENTATION SKILLS AND CUSTOMER RELATIONSHIP MANAGEMENT; COMPUTER SOFTWARE FOR USE IN CUSTOMER RELATIONSHIP MANAGEMENT; DOWNLOADABLE ELECTRONIC PUBLICATIONS IN THE FORM OF ONLINE MAGAZINES, ONLINE NEWSLETTERS IN THE FIELD OF SCIENCE, MUSIC, ART, BUSINESS MANAGEMENT, BUSINESS MEDIATION AND NEGOTIA-

TION, COMMUNICATIONS, AND SOFTWARE, IN CLASS 9 (U.S. CLS. 21, 23, 26, 36 AND 38).

FOR: PAPER, CARDBOARD; PRINTED MATTER, NAMELY, PRINTED GUIDES, PRINTED INSTRUCTIONAL MATERIAL, PRINTED INFORMATIONAL AND EDUCATIONAL CARDS, PRINTED LEAFLETS, PRINTED BROCHURES IN THE FIELD OF SCIENCE, MUSIC, ART, BUSINESS MANAGEMENT, BUSINESS MEDIATION AND NEGOTIATION, COMMUNICATIONS, AND SOFTWARE; NEWSPAPERS; PRINTED PERIODICALS IN THE FIELD OF SCIENCE, MUSIC, ART, BUSINESS MANAGEMENT, BUSINESS MEDIATION AND NEGOTIATION, COMMUNICATIONS, AND SOFTWARE; PRINTED BOOKS IN THE FIELD OF SCIENCE, MUSIC, ART, BUSINESS MANAGEMENT, BUSINESS MEDIATION AND NEGOTIATION, COMMUNICATIONS, AND SOFTWARE; BOOKBINDING MATERIAL, NAMELY, BOOKBINDING STRIPS, BOOKBINDING CLOTH, BOOKBINDING TAPE, BOOKBINDING WIRE, AND BOOKBINDING GLUE; PHOTOGRAPHS; STATIONERY; ADHESIVES FOR STATIONERY OR HOUSEHOLD PURPOSES; ARTISTS' SUPPLIES, NAMELY, ARTISTS' PENS, ARTISTS' PASTELS, AND ARTISTS' PENCILS; PAINTBRUSHES; TYPEWRITERS AND OFFICE REQUISITES, EXCEPT FURNITURE, NAMELY, BINDERS FOR OFFICE USE, ENVELOPE SEALING MACHINES FOR OFFICES, AND OFFICE HOLE PUNCHERS, IN CLASS 16 (U.S. CLS. 2, 5, 22, 23, 29, 37, 38 AND 50).

FOR: ADVERTISING, BUSINESS MANAGEMENT, BUSINESS ADMINISTRATION, BUSINESS ORGANISATION AND MANAGEMENT CONSULTING, ORGANISATION OF EXHIBITIONS FOR COMMERCIAL AND ADVERTISING PURPOSES, EFFICIENCY EXPERTS, PROFESSIONAL BUSINESS CONSULTING, MARKET STUDY, HUMAN RESOURCES CONSULTING, IN CLASS 35 (U.S. CLS. 100, 101 AND 102).

FOR: EDUCATIONAL SERVICES, NAMELY, TRAINING COURSES, ARRANGING AND CONDUCTING OF COLLOQUIUMS, SYMPOSIUMS,



CONFERENCES IN THE FIELD OF SCIENCE, MUSIC, ART, BUSINESS MANAGEMENT, BUSINESS MEDIATION AND NEGOTIATION, COMMUNICATIONS, AND SOFTWARE; PUBLISHING OF BOOKS, NEWSPAPERS, PAMPHLETS; ELECTRONIC PUBLISHING OF ONLINE BOOKS AND PERIODICALS, IN CLASS 41 (U.S. CLS. 100, 101 AND 107).

FOR: EVALUATIONS OF SCIENTIFIC DATA AND PSYCHOLOGICAL DATA, ESTIMATES OF SCIENTIFIC DATA AND PSYCHOLOGICAL DATA AND RESEARCH OF SCIENTIFIC DATA AND PSYCHOLOGICAL DATA ALL IN THE SCIENTIFIC AND TECHNOLOGICAL FIELDS, NAMELY, STUDYING THE BEHAVIOUR AND REACTION OF HUMAN BEINGS IN THE COURSE OF BUSINESS MANAGEMENT AND PARTICULARLY BUSINESS MEDIATION AND NEGOTIATION IN ORDER TO ESTABLISH AND APPLY A NEGOTIATION METHOD; SOFTWARE DESIGN AND DEVELOPMENT, IN CLASS 42 (U.S. CLS. 100 AND 101).

THE MARK CONSISTS OF STANDARD CHARACTERS WITHOUT CLAIM TO ANY PARTICULAR FONT, STYLE, SIZE, OR COLOR.

PRIORITY DATE OF 10-3-2006 IS CLAIMED.

OWNER OF INTERNATIONAL REGISTRATION 0926002 DATED 4-2-2007, EXPIRES 4-2-2017.

THE FOREIGN WORDING IN THE MARK TRANSLATES INTO ENGLISH AS THE TRUTH IS IN THE CUBE.

SER. NO. 79-039,243, FILED 4-2-2007.

RICHARD A. STRASER, EXAMINING ATTORNEY

**Int. Cls.: 19, 35 and 38**

**Prior U.S. Cls.: 1, 12, 33, 50, 100, 101, 102 and 104**

**United States Patent and Trademark Office**

**Reg. No. 3,499,280**

**Registered Sep. 9, 2008**

**TRADEMARK  
SERVICE MARK  
PRINCIPAL REGISTER**

# Standland

A PLUS 4 GMBH (FED REP GERMANY GMBH)  
NIENBURGER STRABE 2  
27755 DELMENHORST  
FED REP GERMANY

FOR: FRAMEWORKS, NOT OF METAL, FOR BUILDINGS, NAMELY, FOR STANDS AT A FAIR, BUILDINGS TRANSPORTABLE, NOT OF METAL, NAMELY, FOR STANDS AT A FAIR, IN CLASS 19 (U.S. CLS. 1, 12, 33 AND 50).

FOR: UPDATING OF ADVERTISING MATERIAL FOR PROMOTION OF STANDS AT A FAIR, SERVICES OF AN ADVERTISING AGENCY, NAMELY, FOR EXHIBITIONS AND FAIRS; FACILITY MANAGEMENT, NAMELY, MANAGEMENT OF EXHIBITION STANDS AND MANAGEMENT OF TECHNICAL OPERATION OF EXHIBITION STANDS; BUSINESS INVESTIGATIONS IN REGARD TO FAIRS AND EXHIBITIONS; COMMERCIAL ADMINISTRATION MANAGEMENT OF THE LICENSING OF GOODS AND SERVICES FOR THIRD PARTIES, NAMELY, FOR STANDS AT A FAIR AND THE SERVICES OF PROVIDING A FAIR UNDER A WELL-KNOWN BRAND; PRODUCT MERCHANDISING, NAMELY, OF EXHIBITION

STANDS; ON-LINE ADVERTISING ON A COMPUTER NETWORK FOR AFORESAID GOODS AND SERVICES; ORGANIZATION OF EXHIBITIONS FOR COMMERCIAL OR ADVERTISING PURPOSES, IN CLASS 35 (U.S. CLS. 100, 101 AND 102).

FOR: PROVIDING USER ACCESS TO A GLOBAL COMPUTER NETWORK TO COMPUTER PROGRAMS IN DATA NETWORKS, IN CLASS 38 (U.S. CLS. 100, 101 AND 104).

THE MARK CONSISTS OF STANDARD CHARACTERS WITHOUT CLAIM TO ANY PARTICULAR FONT, STYLE, SIZE, OR COLOR.

PRIORITY DATE OF 10-12-2006 IS CLAIMED.

OWNER OF INTERNATIONAL REGISTRATION 0926068 DATED 4-11-2007, EXPIRES 4-11-2017.

SER. NO. 79-039,268, FILED 4-11-2007.

CARYN GLASSER, EXAMINING ATTORNEY

**Int. Cls.: 9, 14, 16, 20, 21, 25, 28, 41 and 42**

**Prior U.S. Cls.: 2, 5, 13, 21, 22, 23, 25, 26, 27, 28, 29,  
30, 32, 33, 36, 37, 38, 39, 40, 50, 100, 101 and 107**

**Reg. No. 3,499,281**

**United States Patent and Trademark Office**

**Registered Sep. 9, 2008**

**TRADEMARK  
SERVICE MARK  
PRINCIPAL REGISTER**

# **PLASTINARIUM**

VON HAGENS, GUNTHER (FED REP GERMA-  
NY JOINT APPLICANTS)  
RATHAUSSTR. 18  
69126 HEIDELBERG, FED REP GERMANY AND  
WHALLEY, ANGELINA (FED REP GERMANY  
JOINT APPLICANTS)  
RATHAUSSTR. 18  
69126 HEIDELBERG, FED REP GERMANY

FOR: DATA-PROCESSING EQUIPMENT, NAME-  
LY, DATA PROCESSORS AND COMPUTER HARD-  
WARE; DATA CARRIERS, NAMELY, MAGNETIC  
AND OPTIC RECORDING CARRIERS IN THE  
NATURE OF BLANK MAGNETIC COMPUTER  
TAPES, BLANK AUDIO CASSETTES, BLANK VI-  
DEO CASSETTES, BLANK COMPUTER DISCS,  
BLANK OPTICAL DISCS, PRE-RECORDED DIGI-  
TAL AUDIO TAPES FEATURING ARTISTIC ANA-  
TOMICAL RENDERINGS, PRE-RECORDED  
AUDIO TAPES FEATURING ARTISTIC ANATOMI-  
CAL RENDERINGS, PRE-RECORDED VIDEO  
TAPES FEATURING ARTISTIC ANATOMICAL  
RENDERINGS, PRE-RECORDED AUDIO CAS-  
SETTES FEATURING ARTISTIC ANATOMICAL  
RENDERINGS, PRE-RECORDED VIDEO CAS-  
SETTES FEATURING ARTISTIC ANATOMICAL  
RENDERINGS, AUDIO DISCS FEATURING ARTIS-  
TIC ANATOMICAL RENDERINGS, COMPACT  
DISCS FEATURING ARTISTIC ANATOMICAL  
RENDERINGS, VIDEO DISCS FEATURING ARTIS-  
TIC ANATOMICAL RENDERINGS, AND PRE-RE-  
CORDED OPTICAL DISKS FEATURING ARTISTIC  
ANATOMICAL RENDERINGS, AND PHOTO-  
GRAPHIC SLIDE TRANSPARENCIES, IN CLASS 9  
(U.S. CLS. 21, 23, 26, 36 AND 38).

FOR: PRECIOUS METALS AND THEIR ALLOYS;  
GOODS OF PRECIOUS METALS OR COATED  
THEREWITH, NAMELY, SCULPTURES MADE OF  
PRECIOUS METALS, SMALL JEWELRY BOXES  
MADE OF PRECIOUS METALS, FIGURINES OF  
PRECIOUS METAL; JEWELRY; HOROLOGICAL  
AND CHRONOMETRIC INSTRUMENTS, IN CLASS  
14 (U.S. CLS. 2, 27, 28 AND 50).

FOR: PRINTED MATTER, NAMELY, BOOKS,  
JOURNALS, CATALOGS, PLASTIC TRANSPAREN-  
CIES, PAPER TRANSPARENCIES, AND INSTRUC-  
TIONAL AND TEACHING MATERIAL, ALL IN THE  
FIELD OF ANATOMICAL MODELS AND PRE-  
PARATIONS IN THE NATURE OF ARTISTIC ANA-  
TOMICAL PREPARATIONS, IN PARTICULAR  
PLASTINATES; POSTERS; POSTCARDS; MOUNTED  
PHOTOGRAPHS; AND UNMOUNTED PHOTO-  
GRAPHS, IN CLASS 16 (U.S. CLS. 2, 5, 22, 23, 29, 37,  
38 AND 50).

FOR: ANATOMICAL MODELS, INCLUDED IN  
THIS CLASS, OF WOOD, CORK, REED, CANE,  
WICKER, HORN, BONE, IVORY, WHALEBONE,  
SHELL, AMBER, MOTHER-OF-PEARL, MEER-  
SCHAUM AND SUBSTITUTES FOR ALL THESE  
MATERIALS, OR OF PLASTICS, IN CLASS 20 (U.S.  
CLS. 2, 13, 22, 25, 32 AND 50).

FOR: HOUSEHOLD UTENSILS, NAMELY, POT  
AND PAN SCRAPERS, ROLLING PINS, SPATULAS,  
TURNERS, WHISKS; ALL PURPOSE PORTABLE  
HOUSEHOLD CONTAINERS; CONTAINERS, NOT  
OF PRECIOUS METAL, FOR HOUSEHOLD OR  
KITCHEN USE; BEVERAGE GLASSWARE; ITEMS  
MADE OF PORCELAIN, NAMELY, SCULPTURES,  
STATUES, MUGS, CHINA ORNAMENTS, FIGUR-  
INES; ITEMS MADE OF EARTHENWARE, NAME-  
LY, SCULPTURES, STATUES, MUGS, ORNAMENTS  
OF PORCELAIN NOT INCLUDING CHRISTMAS  
TREE ORNAMENTS, AND FIGURINES, IN CLASS  
21 (U.S. CLS. 2, 13, 23, 29, 30, 33, 40 AND 50).

FOR: CLOTHING, NAMELY, SHIRTS, SHORTS,  
PANTS, SWEATSHIRTS, DRESSES, JACKETS,  
PULLOVERS; FOOTWEAR; HEADGEAR, NAMELY,  
CAPS AND HATS, IN CLASS 25 (U.S. CLS. 22 AND  
39).

FOR: GAMES AND PLAYTHINGS, NAMELY,  
DOLLS, TOY ACTION FIGURES, AND BOARD  
GAMES, IN CLASS 28 (U.S. CLS. 22, 23, 38 AND 50).

FOR: EDUCATIONAL SERVICES, NAMELY, CONDUCTING SEMINARS AND LECTURES IN THE FIELD OF ARTISTIC ANATOMICAL RENDERINGS; ENTERTAINMENT SERVICES, NAMELY, CONDUCTING EXHIBITS OF ARTISTIC ANATOMICAL RENDERINGS; CULTURAL ACTIVITIES, NAMELY, ORGANIZING EXHIBITIONS FOR ARTISTIC ANATOMICAL RENDERINGS, IN CLASS 41 (U.S. CLS. 100, 101 AND 107).

FOR: SCIENTIFIC RESEARCH; COMPUTER PROGRAMMING FOR OTHERS, IN CLASS 42 (U.S. CLS. 100 AND 101).

PRIORITY DATE OF 10-10-2006 IS CLAIMED.

OWNER OF INTERNATIONAL REGISTRATION 0926696 DATED 4-5-2007, EXPIRES 4-5-2017.

SER. NO. 79-039,504, FILED 4-5-2007.

ODESSA BIBBINS, EXAMINING ATTORNEY

**Int. Cls.: 16 and 41**

**Prior U.S. Cls.: 2, 5, 22, 23, 29, 37, 38, 50, 100, 101 and 107**

**Reg. No. 3,499,282**

**United States Patent and Trademark Office**

**Registered Sep. 9, 2008**

**TRADEMARK  
SERVICE MARK  
PRINCIPAL REGISTER**

# Pixelteacher

WOLFGANG PFAFFE (FED REP GERMANY  
INDIVIDUAL)  
KLEINER KIELORT 3-5  
20144 HAMBURG, FED REP GERMANY

THE MARK CONSISTS OF STANDARD CHARACTERS WITHOUT CLAIM TO ANY PARTICULAR FONT, STYLE, SIZE, OR COLOR.

FOR: PRINTED INSTRUCTIONAL, EDUCATIONAL, AND TEACHING MATERIALS IN THE FIELD OF DIGITAL IMAGING/PHOTOGRAPHY, IN CLASS 16 (U.S. CLS. 2, 5, 22, 23, 29, 37, 38 AND 50).

OWNER OF INTERNATIONAL REGISTRATION  
0926768 DATED 4-17-2007, EXPIRES 4-17-2017.

FOR: EDUCATION SERVICES, NAMELY, PROVIDING CLASSES AND SEMINARS IN THE FIELD OF DIGITAL IMAGING/PHOTOGRAPHY, IN CLASS 41 (U.S. CLS. 100, 101 AND 107).

SER. NO. 79-039,533, FILED 4-17-2007.

VERNA BETH RIRIE, EXAMINING ATTORNEY

**Int. Cl.: 7**

**Prior U.S. Cls.: 13, 19, 21, 23, 31, 34 and 35**

**Reg. No. 3,499,283**

**United States Patent and Trademark Office**

**Registered Sep. 9, 2008**

**TRADEMARK  
PRINCIPAL REGISTER**

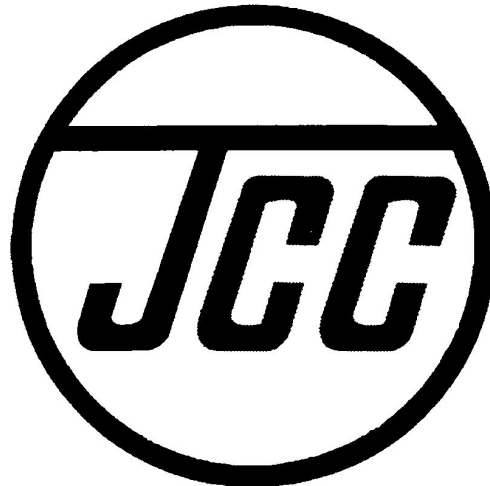

**FUZHOU JIEH CHUFENG; AUTOMOBILE FIT-  
TING CO., LTD. (CHINA CORPORATION)  
FUXING INVESTMENT AREA  
GUSHAN TOWN.; FUZHOU CITY; 350014 FUJIAN-  
PROVINCE  
CHINA**

**CRANK SHAFTS FOR VEHICLES, IN CLASS 7  
(U.S. CLS. 13, 19, 21, 23, 31, 34 AND 35).**

**OWNER OF INTERNATIONAL REGISTRATION  
0927083 DATED 5-11-2007, EXPIRES 5-11-2017.**

**FOR: PISTONS FOR VEHICLES; PISTON RINGS;  
CYLINDERS FOR VEHICLES, NAMELY, ENGINE  
CYLINDERS FOR OTHER THAN LAND VEHICLES;  
ENGINE CYLINDER FOR LAND VEHICLES;**

**SER. NO. 79-039,665, FILED 5-11-2007.**

**SUZANNE BLANE, EXAMINING ATTORNEY**

**Int. Cls.: 3, 18 and 25**

**Prior U.S. Cls.: 1, 2, 3, 4, 6, 22, 39, 41, 50, 51 and 52**

**United States Patent and Trademark Office**

**Reg. No. 3,499,284**

**Registered Sep. 9, 2008**

**TRADEMARK  
PRINCIPAL REGISTER**

# CINUCCI

GIACALONE CHRISTIAN (ITALY INDIVIDUAL)  
174 AV. GASTON DIDERICH  
L-1420 LUXEMBOURG  
LUXEMBOURG

FOR: SOAPS; PERFUMERY, ESSENTIAL OILS,  
COSMETICS, HAIR LOTIONS, IN CLASS 3 (U.S. CLS.  
1, 4, 6, 50, 51 AND 52).

FOR: LEATHER AND IMITATIONS OF LEA-  
THER, AND GOODS MADE OF THESE MATERI-  
ALS, NAMELY, BAGS, HANDBAGS, PURSES,  
POCKET WALLETS, TRAVELLING BAGS,  
TRUNKS, EMPTY MAKE-UP BAGS AND VANITY  
CASES, CARRYING CASES FOR DOCUMENTS,  
DOCUMENT CASES; SUITCASES, UMBRELLAS,  
PARASOLS AND WALKING STICKS; WHIPS, HAR-  
NESS AND SADDLERY, IN CLASS 18 (U.S. CLS. 1, 2,  
3, 22 AND 41).

FOR: CLOTHING NAMELY, COATS, SKIRTS,  
DRESSES, TROUSERS, SHIRTS, JACKETS, OVER-

COATS, SWEATERS AND PULLOVERS, HATS,  
SCARVES, GLOVES INCLUDING THOSE OF LEA-  
THER OR FUR, BELTS, TIES, SHOES, BOOTS,  
SANDALS, CLOGS, SLIPPERS, TENNIS SHOES,  
SOCKS, STOCKINGS, NECKTIES, UNDERWEAR,  
T-SHIRTS, SWEATSHIRTS ; FOOTWEAR; HEAD-  
WEAR, IN CLASS 25 (U.S. CLS. 22 AND 39).

THE MARK CONSISTS OF STANDARD CHAR-  
ACTERS WITHOUT CLAIM TO ANY PARTICULAR  
FONT, STYLE, SIZE, OR COLOR.

OWNER OF INTERNATIONAL REGISTRATION  
0927444 DATED 4-10-2007, EXPIRES 4-10-2017.

CINUCCI HAS NO MEANING IN A FOREIGN  
LANGUAGE.

SER. NO. 79-039,779, FILED 4-10-2007.

ELLEN B. AWRICH, EXAMINING ATTORNEY

**Int. Cls.: 25, 28 and 41**

**Prior U.S. Cls.: 22, 23, 38, 39, 50, 100, 101 and 107**

**United States Patent and Trademark Office**

**Reg. No. 3,499,285**

**Registered Sep. 9, 2008**

**TRADEMARK  
SERVICE MARK  
PRINCIPAL REGISTER**

# Zipflracer

2962 GMBH (FED REP GERMANY LIMITED  
LIABILITY COMPANY)  
WALTHERSTRASSE 19  
80337 MUNICH  
FED REP GERMANY

FOR: CLOTHING, NAMELY, SHIRTS, PANTS,  
SHORTS, JACKETS, SWEATERS, OUTERWEAR,  
NAMELY, PARKAS AND ANORAKS; FOOTWEAR,  
HEADGEAR, NAMELY, HATS AND CAPS, IN  
CLASS 25 (U.S. CLS. 22 AND 39).

FOR: SPORTING ARTICLES AND PIECES OF  
SPORTS EQUIPMENT, NAMELY, SNOW SLEDS  
FOR RECREATIONAL USE, BOB SLEDS, RACE  
BOB-SLEIGHS, IN CLASS 28 (U.S. CLS. 22, 23, 38  
AND 50).

FOR: PROVIDING OF TRAINING IN THE FORM  
OF COURSES, SEMINARS, AND WORKSHOPS IN  
THE FIELD OF PROVIDING CONSULTATIONS IN

SALES OF SPORTS EQUIPMENT; ENTERTAIN-  
MENT IN THE NATURE OF ORGANIZING WIN-  
TER SPORTS COMPETITIONS AND RACES;  
SPORTING AND CULTURAL ACTIVITIES, NAME-  
LY, ORGANIZING EXHIBITIONS FOR SPORTING  
AND CULTURAL PURPOSES, IN CLASS 41 (U.S.  
CLS. 100, 101 AND 107).

PRIORITY DATE OF 12-20-2006 IS CLAIMED.

OWNER OF INTERNATIONAL REGISTRATION  
0927474 DATED 6-19-2007, EXPIRES 6-19-2017.

SER. NO. 79-039,790, FILED 6-19-2007.

WARREN L. OLANDRIA, EXAMINING ATTOR-  
NEY



**Int. Cls.: 3, 35 and 44**

**Prior U.S. Cls.: 1, 4, 6, 50, 51, 52, 100, 101 and 102**

**Reg. No. 3,499,286**

**United States Patent and Trademark Office**

**Registered Sep. 9, 2008**

**TRADEMARK  
SERVICE MARK  
PRINCIPAL REGISTER**

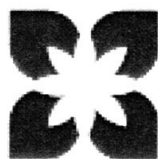

**edelbio**

KAEL COSMETIC SA (SWITZERLAND SOCIÉTÉ ANONYME)  
50A, CH. DES GOTETTES  
CH-1222 VÉSENAZ  
SWITZERLAND

FOR: COSMETICS; MAKE-UP PREPARATIONS; CREAMS AND LOTIONS FOR BODY, FACE, AND SKIN; HAIR CARE PREPARATIONS, IN CLASS 3 (U.S. CLS. 1, 4, 6, 50, 51 AND 52).

FOR: COMPUTERIZED ON-LINE RETAIL STORE SERVICES IN THE FIELD OF COSMETIC PREPARATIONS, MAKE UP PREPARATIONS, AND BODY, FACE, SKIN AND HAIR CARE PRODUCTS; RETAIL STORE SERVICES IN THE FIELD OF COSMETIC PREPARATIONS, MAKE UP PREPARATIONS, AND BODY, FACE, SKIN AND HAIR CARE PRODUCTS; ADVERTISING, IN CLASS 35 (U.S. CLS. 100, 101 AND 102).

FOR: HYGIENE AND BEAUTY CARE FOR HUMAN BEINGS, NAMELY HAIR STYLING AND MASSAGE SERVICES; HEALTH SPA SERVICES FOR HEALTH AND WELLNESS OF THE BODY

AND SPIRIT OFFERED AT A HEALTH RESORT; HEALTH SPA SERVICES OFFERED AT A BEAUTY SALON, NAMELY, COSMETIC BODY CARE SERVICES; SAUNA SERVICES; MASSAGE SERVICES; MANICURE SERVICES; PEDICURE SERVICES; SERVICES OF A MAKE-UP ARTIST; BEAUTY SALONS; HAIRDRESSING SALONS; CONSULTING IN HYGIENE AND BEAUTY CARE; PROVIDING INFORMATION ON THE INTERNET WITH RESPECT TO BEAUTY AND BEAUTY CARE PRODUCTS; ADVICE IN THE FIELD OF DIET AND FOOD NUTRITION, IN CLASS 44 (U.S. CLS. 100 AND 101).

PRIORITY DATE OF 3-2-2007 IS CLAIMED.

OWNER OF INTERNATIONAL REGISTRATION 0927548 DATED 5-3-2007, EXPIRES 5-3-2017.

SER. NO. 79-039,818, FILED 5-3-2007.

CIMMERIAN COLEMAN, EXAMINING ATTORNEY

**Int. Cl.: 3**

**Prior U.S. Cls.: 1, 4, 6, 50, 51 and 52**

**United States Patent and Trademark Office**

**Reg. No. 3,499,287**

**Registered Sep. 9, 2008**

**TRADEMARK  
PRINCIPAL REGISTER**

**BREATH GUARD**

KADANA HOLDINGS PTY LTD (AUSTRALIA  
CORPORATION)  
PO BOX 29  
ROSE BAY NSW 2029, AUSTRALIA

FOR: TOOTHPASTES AND TOOTH GELS FOR  
WHITENING TEETH AND FRESHENING BREATH;  
NON-MEDICATED MOUTH RINSES AND CON-  
CENTRATED MOUTH RINSES FOR FRESHENING  
BREATH AND WHITENING TEETH , IN CLASS 3  
(U.S. CLS. 1, 4, 6, 50, 51 AND 52).

OWNER OF INTERNATIONAL REGISTRATION  
0928139 DATED 6-12-2007, EXPIRES 6-12-2017.

NO CLAIM IS MADE TO THE EXCLUSIVE  
RIGHT TO USE "BREATH", APART FROM THE  
MARK AS SHOWN.

SER. NO. 79-039,994, FILED 6-12-2007.

KRISTINA MORRIS, EXAMINING ATTORNEY

**Int. Cl.: 2**

**Prior U.S. Cls.: 6, 11 and 16**

**United States Patent and Trademark Office**

**Reg. No. 3,499,288**

**Registered Sep. 9, 2008**

**TRADEMARK  
PRINCIPAL REGISTER**

**HEMPEL**

HEMPEL A/S (DENMARK CORPORATION)  
LUNDTOFTEVEJ 150  
DK-2800 KONGENS LYNGBY  
DENMARK

FOR: PAINTS, INCLUDING PRIMERS AND SEALERS, PAINTS WITH ANTI-FOULING PROPERTIES, EMULSION PAINTS, TEXTURED PAINTS, PAINTS WITH SPECIAL EFFECTS, FILLERS, NAMELY, PAINT SEALERS AND PAINT FOR FILLING AND REPAIR FOR PAINTING PURPOSES, VARNISHES, LACQUERS, ENAMEL PAINTS, PRESERVATIVES AGAINST RUST AND AGAINST DETERIORATION OF WOOD, THINNERS FOR LACQUERS AND PAINTS, DYES FOR USE IN THE MANUFACTURE OF PAINTS, MORDANT DYES, RAW NATURAL RESINS FOR USE IN THE MANUFACTURE OF RESINS AND FOR GENERAL INDUSTRIAL USE, METALS IN FOIL AND POWDER

FORM FOR PAINTERS, DECORATORS, PRINTERS AND ARTIST, IN CLASS 2 (U.S. CLS. 6, 11 AND 16).

THE MARK CONSISTS OF STANDARD CHARACTERS WITHOUT CLAIM TO ANY PARTICULAR FONT, STYLE, SIZE, OR COLOR.

OWNER OF INTERNATIONAL REGISTRATION 0768712 DATED 10-22-2001, EXPIRES 10-22-2011.

OWNER OF U.S. REG. NOS. 582,760, 1,732,311, AND 2,539,543.

SEC. 2(F).

SER. NO. 79-040,075, FILED 6-8-2007.

JOHN SCHUYLER YARD, EXAMINING ATTORNEY

**Int. Cls.: 16, 35 and 41**

**Prior U.S. Cls.: 2, 5, 22, 23, 29, 37, 38, 50, 100, 101, 102  
and 107**

**Reg. No. 3,499,289**

**United States Patent and Trademark Office**

**Registered Sep. 9, 2008**

**TRADEMARK  
SERVICE MARK  
PRINCIPAL REGISTER**

# RogenSi

ROGENSI WORLDWIDE PTY LTD (AUSTRALIA  
AUSTRALIAN COMPANY WITH ACN 060 015  
938)

LEVEL 7

35 CLARENCE STREET; SYDNEY NSW 2000

AUSTRALIA

FOR: PRINTED MATTER, NAMELY, PRINTED INSTRUCTIONAL, EDUCATION, TEACHING AND PAPER AND CARDBOARD MARKETING MATERIALS IN RELATION TO BUSINESS CONSULTANCY, MANAGEMENT CONSULTANCY, ORGANISATION CONSULTANCY, LEADERSHIP CONSULTANCY IN A BUSINESS AND OTHER ORGANISATIONAL CONTEXTS, MANAGEMENT OF CHANGE CONSULTING, BUSINESS ASSISTANCE, MANAGEMENT ASSISTANCE, BUSINESS APPRAISALS, COMMUNICATION CONSULTANCY, BUSINESS INVESTIGATIONS, EFFICIENCY ADVICE, PERSONNEL MANAGEMENT CONSULTANCY, MARKETING RESEARCH AND STUDIES, PUBLIC RELATIONS, TELECOMMUNICATIONS INFORMATION AND CONSULTANCY, EDUCATIONAL AND TRAINING INFORMATION AND PROGRAMMES, CORRESPONDENCE COURSES, TEACHING AND COACHING IN THE FIELDS OF PERSONAL AND BUSINESS COMMUNICATION SKILLS, INCLUDING FACE TO FACE AND OTHER COMMUNICATION METHODS, PRESENTING, SELLING, SALES MANAGEMENT, NEGOTIATING, INFLUENCING, COACHING, PLANNING, TRAINING, LEARNING TECHNIQUES, REHEARSING, BUSINESS PITCHING, NEW BUSINESS DEVELOPMENT, DEALING WITH THE MEDIA, PUBLIC SPEAKING, LEADERSHIP, BUSINESS MANAGEMENT, CHANGE MANAGEMENT, MINDSET CHANGE, IN CLASS 16 (U.S. CLS. 2, 5, 22, 23, 29, 37, 38 AND 50).

FOR: BUSINESS CONSULTANCY, BUSINESS MANAGEMENT CONSULTANCY, BUSINESS MANAGEMENT ORGANISATION CONSULTANCY; LEADERSHIP MANAGEMENT CONSULTANCY IN BUSINESS AND OTHER ORGANISATIONAL CONTEXTS; MANAGEMENT OF CHANGE CONSULTING; SALES MANAGEMENT CONSULTANCY; ASSISTANCE IN MANAGEMENT OF BUSINESS ACTIVITIES; CORPORATE MANAGEMENT ASSISTANCE; BUSINESS APPRAISALS; BUSINESS COMMUNICATION CONSULTANCY; BUSINESS INVESTIGATIONS; BUSINESS EFFICIENCY ADVICE; PERSONNEL MANAGEMENT CONSULTANCY; MARKETING RESEARCH AND STUDIES; PUBLIC RELATIONS SERVICES; PUBLICATION OF PUBLICITY TEXTS; PUBLICITY AGENCY SERVICES; PUBLICITY COLUMNS PREPARATION, IN CLASS 35 (U.S. CLS. 100, 101 AND 102).

FOR: ARRANGING AND CONDUCTING EDUCATIONAL CONFERENCES, SEMINARS, SYMPOSIUMS AND EDUCATIONAL AND TRAINING PROGRAMMES; CORRESPONDENCE COURSES; EDUCATION AND TRAINING INFORMATION; EDUCATION AND TRAINING SERVICES; INSTRUCTION SERVICES; PRACTICAL TRAINING AND PRACTICAL TRAINING DEMONSTRATION; TEACHING; COACHING; ALL IN THE FIELDS OF ORGANISATIONAL MANAGEMENT AND PERSONAL AND BUSINESS COMMUNICATION SKILLS, INCLUDING FACE TO FACE AND OTHER COMMUNICATION METHODS, PRESENTING, SELLING, NEGOTIATING, INFLUENCING, COACHING, PLANNING, TRAINING, MOTIVATING, MINDSET CHANGE, LEARNING TECHNIQUES, REHEARSING, FACILITATING PITCHING AND NEW BUSINESS DEVELOPMENT, DEALING WITH THE MEDIA, PUBLIC SPEAKING, LEADER-

SHIP, BUSINESS MANAGEMENT, CHANGE MANAGEMENT; PROFESSIONAL NON-BUSINESS CONSULTANCY SERVICES IN RELATION TO EDUCATION ON PERSONAL COMMUNICATION SKILLS INCLUDING FACE-TO-FACE AND OTHER COMMUNICATION METHODS, PRESENTING, NEGOTIATING, INFLUENCING, COACHING, PLANNING, REHEARSING, FACILITATING, DEALING WITH THE MEDIA, PUBLIC SPEAKING AND LEADERSHIP, MOTIVATION AND MINDSET CHANGE, IN CLASS 41 (U.S. CLS. 100, 101 AND 107).

THE MARK CONSISTS OF STANDARD CHARACTERS WITHOUT CLAIM TO ANY PARTICULAR FONT, STYLE, SIZE, OR COLOR.

PRIORITY DATE OF 2-23-2007 IS CLAIMED.

OWNER OF INTERNATIONAL REGISTRATION 0928606 DATED 3-16-2007, EXPIRES 3-16-2017.

SER. NO. 79-040,177, FILED 3-16-2007.

KAREN K. BUSH, EXAMINING ATTORNEY

**Int. Cl.: 1**

**Prior U.S. Cls.: 1, 5, 6, 10, 26 and 46**

**Reg. No. 3,499,290**

**United States Patent and Trademark Office**

**Registered Sep. 9, 2008**

**TRADEMARK  
PRINCIPAL REGISTER**

**DELTAZYM**

ADD FOOD SERVICE GMBH (FED REP GER-  
MANY LIMITED LIABILITY COMPANY)

AN DER HANSALINIE 48-50

59387 ASCHEBERG

FED REP GERMANY

THE MARK CONSISTS OF STANDARD CHAR-  
ACTERS WITHOUT CLAIM TO ANY PARTICULAR  
FONT, STYLE, SIZE, OR COLOR.

OWNER OF INTERNATIONAL REGISTRATION  
0929383 DATED 5-30-2007, EXPIRES 5-30-2017.

FOR: ENZYMES FOR INDUSTRIAL PURPOSES,  
IN PARTICULAR FOR FOODSTUFF INDUSTRIES,  
IN CLASS 1 (U.S. CLS. 1, 5, 6, 10, 26 AND 46).

SER. NO. 79-040,491, FILED 5-30-2007.

STEVEN PEREZ, EXAMINING ATTORNEY

**Int. Cls.: 15, 28 and 35**

**Prior U.S. Cls.: 2, 21, 22, 23, 36, 38, 50, 100, 101 and 102**

**Reg. No. 3,499,291**

**United States Patent and Trademark Office**

**Registered Sep. 9, 2008**

**TRADEMARK  
SERVICE MARK  
PRINCIPAL REGISTER**

**Copa rocar**

DR. MATTHIAS WEILER (FED REP GERMANY  
INDIVIDUAL)  
HEFNERSPLATZ 10/III  
90402 NÜRNBERG  
FED REP GERMANY

FOR: MUSICAL INSTRUMENTS; TAMBOUR-  
INES; MUSICAL INSTRUMENTS FOR PRODUC-  
TION OF NOISE, NAMELY, ARTICLES IN DIF-  
FERENT FORMS WITH BELLS OR DISCS  
BEING NOISEMAKERS FOR MAKING NOISE TO  
CHEER SOMEBODY ON, ESPECIALLY FOR USE  
BY SPECTATORS, IN CLASS 15 (U.S. CLS. 2, 21 AND  
36).

FOR: TOYS FOR THE PRODUCTION OF NOISE,  
NAMELY, BELLS ON RINGS; ARTICLES IN DIF-  
FERENT FORMS WITH BELLS OR DISCS FOR THE  
PRODUCTION OF NOISE, NAMELY, TOY NOISE-  
MAKERS, IN CLASS 28 (U.S. CLS. 22, 23, 38 AND 50).

FOR: ADVERTISING, IN CLASS 35 (U.S. CLS. 100,  
101 AND 102).

THE MARK CONSISTS OF STANDARD CHAR-  
ACTERS WITHOUT CLAIM TO ANY PARTICULAR  
FONT, STYLE, SIZE, OR COLOR.

PRIORITY DATE OF 9-7-2006 IS CLAIMED.

OWNER OF INTERNATIONAL REGISTRATION  
0929397 DATED 3-1-2007, EXPIRES 3-1-2017.

THE MARK HAS NO ENGLISH TRANSLATION.

SER. NO. 79-040,493, FILED 3-1-2007.

EVELYN BRADLEY, EXAMINING ATTORNEY

**Int. Cls.: 35 and 36**

**Prior U.S. Cls.: 100, 101 and 102**

**United States Patent and Trademark Office**

**Reg. No. 3,499,292**

**Registered Sep. 9, 2008**

**SERVICE MARK  
PRINCIPAL REGISTER**

# DealSafe

DELOITTE FINANCE (FRANCE SOCIÉTÉ PAR  
ACTIONS SIMPLIFIÉE)  
185 AVENUE CHARLES DE GAULLE  
F-92200 NEUILLY SUR SEINE  
FRANCE

FOR: ECONOMIC FORECASTING AND CON-  
SULTING SERVICES IN THE BUSINESS FIELD,  
BUSINESS CONSULTING, IN CLASS 35 (U.S. CLS.  
100, 101 AND 102).

FOR: FINANCIAL RISK MANAGEMENT CON-  
SULTATION FEATURING COMPUTER DATABASE  
DEFINING RISK CRITERIA; PROVIDING INFOR-  
MATION IN THE FIELD OF FINANCIAL FORE-  
CASTING AND CONSULTING, IN CLASS 36 (U.S.  
CLS. 100, 101 AND 102).

PRIORITY DATE OF 12-22-2006 IS CLAIMED.

OWNER OF INTERNATIONAL REGISTRATION  
0929413 DATED 5-25-2007, EXPIRES 5-25-2017.

THE COLOR(S) BLUE IS/ARE CLAIMED AS A  
FEATURE OF THE MARK.

THE COLOR BLUE APPEARS IN THE WORDING  
"DEALSAFE".

THE WORDING "DEALSAFE" HAS NO MEAN-  
ING IN A FOREIGN LANGUAGE.

SER. NO. 79-040,502, FILED 5-25-2007.

WARREN L. OLANDRIA, EXAMINING ATTOR-  
NEY



**Int. Cl.: 7**

**Prior U.S. Cls.: 13, 19, 21, 23, 31, 34 and 35**

**United States Patent and Trademark Office**

**Reg. No. 3,499,293**

**Registered Sep. 9, 2008**

**TRADEMARK  
PRINCIPAL REGISTER**

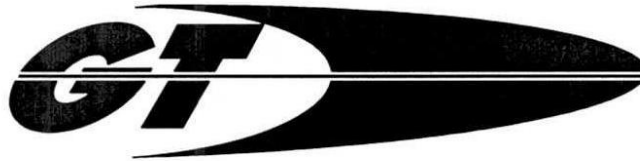

IMG KLETT HOLDING GMBH (FED REP GER-  
MANY LIMITED LIABILITY COMPANY)  
KÖLNERSTR. 5  
51429 BERGISCH GLADBACH  
FED REP GERMANY

FOR: MACHINES FOR PROCESSING WORK  
PIECES OF CARDBOARD AND CORRUGATED  
CARDBOARD INTO CARTONS AND CARTON  
SECTIONS, IN CLASS 7 (U.S. CLS. 13, 19, 21, 23, 31,  
34 AND 35).

OWNER OF INTERNATIONAL REGISTRATION  
0929810 DATED 6-13-2007, EXPIRES 6-13-2017.

THE MARK CONSISTS OF THE LETTERS "GT"  
WITH A CHEVRON DISPOSED ESSENTIALLY TO  
THE RIGHT THEREOF.

SER. NO. 79-040,682, FILED 6-13-2007.

STEVEN JACKSON, EXAMINING ATTORNEY

**Int. Cls.: 3, 9 and 36**

**Prior U.S. Cls.: 1, 4, 6, 21, 23, 26, 36, 38, 50, 51, 52,  
100, 101 and 102**

**Reg. No. 3,499,294**

**United States Patent and Trademark Office**

**Registered Sep. 9, 2008**

**TRADEMARK  
SERVICE MARK  
PRINCIPAL REGISTER**

**SONA**

SONOVA HOLDING AG (SWITZERLAND COR-  
PORATION)  
LAUBISRÜTISTRASSE 28  
CH-8712 STÄFA  
SWITZERLAND

FOR: WASH AND CARE PREPARATIONS,  
NAMELY, CLEANERS FOR HEARING AIDS FOR  
ACOUSTIC APPARATUS, AND PARTS THEREOF  
FOR THE HEARING IMPAIRED, IN CLASS 3 (U.S.  
CLS. 1, 4, 6, 50, 51 AND 52).

FOR: CORDLESS TRANSMITTERS AND RECEI-  
VERS FOR USE WITH ACOUSTIC SYSTEMS AS  
WELL AS ELECTRIC BATTERIES AND ACCUMU-  
LATORS FOR HEARING DEVICES FOR THE  
HEARING-IMPAIRED, IN CLASS 9 (U.S. CLS. 21,  
23, 26, 36 AND 38).

FOR: INSURANCE SERVICES IN CONNECTION  
WITH THE REPLACEMENT AND REPAIR OF

ACOUSTIC APPARATUS FOR THE HEARING IM-  
PAIRED AND FINANCING SERVICES IN CONNEC-  
TION WITH THE SALE OF ACOUSTIC APPARATUS  
FOR THE HEARING IMPAIRED, IN CLASS 36 (U.S.  
CLS. 100, 101 AND 102).

THE MARK CONSISTS OF STANDARD CHAR-  
ACTERS WITHOUT CLAIM TO ANY PARTICULAR  
FONT, STYLE, SIZE, OR COLOR.

PRIORITY DATE OF 1-24-2007 IS CLAIMED.

OWNER OF INTERNATIONAL REGISTRATION  
0929865 DATED 5-18-2007, EXPIRES 5-18-2017.

SER. NO. 79-040,707, FILED 5-18-2007.

EUGENIA MARTIN, EXAMINING ATTORNEY

**Int. Cl.: 25**

**Prior U.S. Cls.: 22 and 39**

**United States Patent and Trademark Office**

**Reg. No. 3,499,295**

**Registered Sep. 9, 2008**

**TRADEMARK  
PRINCIPAL REGISTER**

**OMNIGOD**

DOMINGO CO., LTD. (JAPAN CORPORATION)  
1-13-4, KOJIMA-AKASAKI  
KURASHIKI-SHI; OKAYAMA 711-0931  
JAPAN

FOR: CLOTHING, NAMELY, TOPS, SHIRTS, T-SHIRTS, JEANS, PAINTER'S PANTS, PANTS, SKIRTS, TROUSERS, OVERALLS, PARKAS, BLOUSES, COATS, OVERCOATS, TOPCOATS, DRESS SHIRTS, OPEN-NECKED SHIRTS, SPORTS SHIRTS, POLO SHIRTS, SWEAT SHIRTS, SWEAT PANTS, SWEATERS, PULLOVERS, SOCKS, JACKETS, JUMPERS, SHORTS, VESTS AND WIND RESISTANT JACKETS, ATHLETIC UNIFORMS; ATHLETIC

FOOTWEAR; ATHLETIC SHOES; SHOES; BOOTS; HATS; CAPS; AND BERETS, IN CLASS 25 (U.S. CLS. 22 AND 39).

OWNER OF INTERNATIONAL REGISTRATION  
0930258 DATED 5-23-2007, EXPIRES 5-23-2017.

THE WORDING "OMNIGOD" HAS NO MEANING IN A FOREIGN LANGUAGE.

SER. NO. 79-040,840, FILED 5-23-2007.

DANIEL BRODY, EXAMINING ATTORNEY

**Int. Cl.: 29**

**Prior U.S. Cl.: 46**

**United States Patent and Trademark Office**

**Reg. No. 3,499,296**

**Registered Sep. 9, 2008**

**TRADEMARK  
PRINCIPAL REGISTER**

**VILLANI**

VILLANI S.P.A. (ITALY CORPORATION)  
VIA ZANASI, 24  
I-41051 CASTELNUOVO RANGONE (MODENA),  
ITALY

FOR: MEAT AND MEAT PRODUCTS, NAMELY,  
COOKED, CURED AND SMOKED SAUSAGE AND  
HAM; SALAMI AND MORTADELLA, WHOLE LEG  
HAMS, BONED OR PACKAGED HAMS, WHOLE  
NATURAL SPECK SMOKED HAMS, HAMS AND  
PRESERVED MEATS, SALAD DRESSINGS, PRE-  
SERVES, SALTED MEATS, SAUSAGES, SPECIAL-  
ITY HAM, NAMELY, CULATELLO, SPECIALTY  
SALAMI, NAMELY, COPPA, BACON, IN CLASS 29  
(U.S. CL. 46).

THE MARK CONSISTS OF STANDARD CHAR-  
ACTERS WITHOUT CLAIM TO ANY PARTICULAR  
FONT, STYLE, SIZE, OR COLOR.

PRIORITY DATE OF 4-3-2007 IS CLAIMED.

OWNER OF INTERNATIONAL REGISTRATION  
0930376 DATED 6-6-2007, EXPIRES 6-6-2017.

THE FOREIGN WORDING IN THE MARK  
TRANSLATES INTO ENGLISH AS "RUDE",  
"LOUT", "VILLAINOUS", "COUNTRYMAN", AND  
"PEASANT".

SEC. 2(F).

SER. NO. 79-040,882, FILED 6-6-2007.

ALLISON HOLTZ, EXAMINING ATTORNEY

Int. Cl.: 25

Prior U.S. Cls.: 22 and 39

United States Patent and Trademark Office

Reg. No. 3,499,297

Registered Sep. 9, 2008

TRADEMARK  
PRINCIPAL REGISTER



NAFNAAF

NAF NAF; SOCIÉTÉ PAR ACTIONS SIMPLIFIÉE  
(FRANCE SOCIÉTÉ PAR ACTIONS SIMPLIFIÉE)

6/10, BOULEVARD FOCH  
F-93800 EPINAY-SUR-SEINE, FRANCE

FOR: CLOTHING, NAMELY, JEANS, DRESSES, SKIRTS, SUITS, TROUSERS, SHORTS, BERMUDA SHORTS, DUNGAREES, OVERALLS, COMBINATIONS, SHIRTS, BLOUSES, T-SHIRTS, SWEAT SHIRTS, TANK TOPS, PULLOVERS; KNITWEAR, NAMELY, KNITTED GLOVES, KNITTED MITTENS, KNITTED SCARVES, KNITTED SWEATERS, KNITTED SKIRTS, KNITTED JUMPERS, KNITTED TANK TOPS, KNITTED DRESSES, KNITTED SLEEPWEAR; VESTS, TRACKSUITS, COATS, PARKAS, RAINCOATS, PETTICOATS, OVERCOATS, WIND-RESISTANT JACKETS, CAPES, PONCHOS, SWIMMING SUITS, UNDERWEAR, STOCKINGS, TIGHTS, SOCKS, BOXER SHORTS, LEGGINGS, CAMISOLES, NIGHT DRESSES, NIGHT SHIRTS, DRESSING GOWNS, BATH ROBES, LINGERIE, LAYETTES, PAJAMAS, LEOTARDS, BELTS, TIES,

GLOVES, STOLEES, SCARVES, SHAWLS, SASHES FOR WEAR; HEADGEAR, NAMELY HATS, BONNETS, CAPS, BERETS, SUN HATS, VISORS, BOWLER HATS, BOATERS, STRAW HATS, TOP HATS, PANAMA HATS, FUR HATS, BALACLAVA; FOOTWEAR, NAMELY SHOES, THONGS, COURT SHOES, ESPADRILLES, SANDALS, MULES, SLIPPERS, ANKLE BOOTS, BOOTS, THIGH BOOTS, MOCCASINS, TENNIS SHOES, PUMPS, IN CLASS 25 (U.S. CLS. 22 AND 39).

OWNER OF INTERNATIONAL REGISTRATION  
0710174 DATED 3-19-1999, EXPIRES 3-19-2009.

OWNER OF U.S. REG. NOS. 2,715,031 AND  
3,249,791.

SER. NO. 79-040,914, FILED 9-18-2006.

MARY CRAWFORD, EXAMINING ATTORNEY

**Int. Cl.: 29**

**Prior U.S. Cl.: 46**

**United States Patent and Trademark Office**

**Reg. No. 3,499,298**

**Registered Sep. 9, 2008**

**CERTIFICATION MARK  
PRINCIPAL REGISTER**



CONSORZIO PER LA TUTELA DEL FORMAGGIO GRANA PADANO (ITALY INCORPORATED ASSOCIATION)  
VIA XXIV GIUGNO 8  
FRAZIONE S. MARTINO DELLA BATTAGLIA; I-25015 DESENZANO DEL GARDA (BRESCIA)  
ITALY

FOR: CHEESE, IN CLASS 29 (U.S. CL. 46).

PRIORITY DATE OF 3-29-2007 IS CLAIMED.

OWNER OF INTERNATIONAL REGISTRATION 0931289 DATED 6-6-2007, EXPIRES 6-6-2017.

NO CLAIM IS MADE TO THE EXCLUSIVE RIGHT TO USE "RISERVA" AND "OLTRE 20 MESI", APART FROM THE MARK AS SHOWN.

THE WORDING "RISERVA" TRANSLATED INTO ENGLISH IS "RESERVE", THE WORDING "OLTRE" TRANSLATES INTO ENGLISH AS "BEYOND" AND THE WORDING "MESI" TRANSLATES INTO ENGLISH AS "MONTHS".

THE CERTIFICATION MARK, AS USED BY PERSONS AUTHORIZED BY THE CERTIFIER, CERTIFIES THAT THE GOODS HAVE MET THE CONSORTIUM'S REGULATIONS CONCERNING RAW MATERIALS, PROCESSING, PRODUCTION HYGIENE, SANITARY CONDITIONS AND THAT THE CHEESE HAS BEEN AGED A CERTAIN AMOUNT OF TIME.

SER. NO. 79-041,240, FILED 6-6-2007.

MELISSA VALLILLO, EXAMINING ATTORNEY

**Int. Cls.: 15, 28, 35 and 41**

**Prior U.S. Cls.: 2, 21, 22, 23, 36, 38, 50, 100, 101, 102  
and 107**

**Reg. No. 3,499,299**

**United States Patent and Trademark Office**

**Registered Sep. 9, 2008**

**TRADEMARK  
SERVICE MARK  
PRINCIPAL REGISTER**

# Herbert von Karajan

ELIETTE VON KARAJAN (AUSTRIA INDIVIDUAL)  
VILLA ELISARA,  
VIA SUVRETTA 55; CH-7500 ST. MORITZ  
SWITZERLAND

FOR: MUSICAL INSTRUMENTS AND ACCESSORIES FOR SUCH PRODUCTS, NAMELY, SHEET MUSIC STANDS, CONDUCTOR'S SHEET MUSIC DESKS, MUSIC CASES, CARRYING CASES FOR MUSICAL INSTRUMENTS, CONDUCTOR'S BATONS, CHIN RESTS, BOWS, MOUTHPIECES, REEDS FOR USE IN WOODWIND MOUTHPIECES, STRINGS, VALVES, CATGUTS, DRUMSTICKS, DRUMHEADS, SOUND EFFECT PEDALS; MUSICAL BOXES, IN CLASS 15 (U.S. CLS. 2, 21 AND 36).

FOR: GAMES, NAMELY, BOARD GAMES, CARD GAMES, BALL GAMES, ARCADE GAMES, ARCADE-TYPE ELECTRONIC VIDEO GAMES, BATTERY-POWERED COMPUTER GAME WITH LCD SCREEN WHICH FEATURES ANIMATION AND SOUND EFFECTS, PARLOR GAMES; TOYS, NAMELY, DOLLS, TOY FIGURES, SOFT SCULPTURE TOYS, RUBBER CHARACTER TOYS, TOY TRAINS AND VEHICLES, MULTIPLE ACTIVITY TOYS, ELECTRIC AND ELECTRONIC ACTION TOYS, ELECTRIC LEARNING TOYS, MUSICAL TOYS, MECHANICAL TOYS; DECORATIONS FOR CHRISTMAS TREES, IN CLASS 28 (U.S. CLS. 22, 23, 38 AND 50).

FOR: ADVERTISING; BUSINESS MANAGEMENT, IN CLASS 35 (U.S. CLS. 100, 101 AND 102).

FOR: EDUCATION, NAMELY, PROVIDING MUSIC CLASSES, TRAINING IN THE FIELD OF MUSIC AND TEACHING IN THE FIELD OF MUSIC; ARRANGING AND CONDUCTING CONCERTS AND OTHER COMMENTED MUSICAL PERFORMANCES; ARRANGING AND CONDUCTING OF SEMINARS, CLASSES AND EDUCATIONAL CONVENTIONS IN THE FIELD OF MUSIC; ENTERTAINMENT, NAMELY, LIVE MUSICAL PERFORMANCES AND CONCERTS, IN CLASS 41 (U.S. CLS. 100, 101 AND 107).

THE MARK CONSISTS OF STANDARD CHARACTERS WITHOUT CLAIM TO ANY PARTICULAR FONT, STYLE, SIZE, OR COLOR.

PRIORITY DATE OF 1-22-2007 IS CLAIMED.

OWNER OF INTERNATIONAL REGISTRATION 0931533 DATED 5-22-2007, EXPIRES 5-22-2017.

OWNER OF U.S. REG. NO. 3,127,030.

"THE NAME(S), PORTRAIT(S), AND/OR SIGNATURE(S) SHOWN IN THE MARK DOES NOT IDENTIFY A PARTICULAR LIVING INDIVIDUAL."

SER. NO. 79-041,345, FILED 5-22-2007.

KRISTINA MORRIS, EXAMINING ATTORNEY

**Int. Cls.: 1, 3, 5, 41 and 42**

**Prior U.S. Cls.: 1, 4, 5, 6, 10, 18, 26, 44, 46, 50, 51, 52,  
100, 101 and 107**

**Reg. No. 3,499,300**

**United States Patent and Trademark Office**

**Registered Sep. 9, 2008**

**TRADEMARK  
SERVICE MARK  
PRINCIPAL REGISTER**

# SupplementMix

PROMOCELL BIOSCIENCE ALIVE GMBH (FED  
REP GERMANY GMBH)  
SICKINGENSTR. 63/65  
69126 HEIDELBERG  
FED REP GERMANY

FOR: CHEMICALS USED IN SCIENCE AND INDUSTRY, IN PARTICULAR RAW, AUXILIARY AND ACTIVE SUBSTANCES FOR MANUFACTURING CHEMICAL, BIOCHEMICAL, BIOLOGICAL AND CELLBIOLOGICAL PREPARATIONS; CHEMICAL, BIOCHEMICAL, BIOLOGICAL, CELLBIOLOGICAL PREPARATIONS FOR INDUSTRIAL USE, IN CLASS 1 (U.S. CLS. 1, 5, 6, 10, 26 AND 46).

FOR: COSMETICS; PERFUMERY; ESSENTIAL OILS; SOAPS FOR PERSONAL USE; DENTIFRICES, IN CLASS 3 (U.S. CLS. 1, 4, 6, 50, 51 AND 52).

FOR: SANITARY PREPARATIONS FOR MEDICAL USE; DIETETIC FOODSTUFFS ADAPTED FOR MEDICAL USE; MEDICAL PLASTERS; MEDICAL DRESSINGS; CHEMICAL, BIOCHEMICAL, BIOLOGICAL, CELLBIOLOGICAL PREPARATIONS FOR MEDICAL AND BIOMEDICAL PURPOSES; CELL CULTURES AND CELL CULTURE SYSTEMS FOR MEDICAL OR CLINICAL USE, CONSISTING OF CELLS, MEDIA FOR CELLS, MEDIA REAGENTS AND BIOCHEMICALS; CHEMICALS FOR MANUFACTURING BIOMEDICAL AND MEDICAL PREPARATIONS, NAMELY, CHEMICAL REAGENTS FOR MEDICAL PURPOSES, IN CLASS 5 (U.S. CLS. 6, 18, 44, 46, 51 AND 52).

FOR: PROVIDING OF TRAINING AND FURTHER TRAINING IN THE FIELDS OF CHEMISTRY, BIOLOGY AND BIOCHEMISTRY; ARRANGING AND CONDUCTING OF CONGRESSES, COLLOQUIUMS, SYMPOSIUMS, SEMINARS AND WORKSHOPS IN THE FIELDS OF CHEMISTRY, BIOLOGY AND BIOCHEMISTRY, IN CLASS 41 (U.S. CLS. 100, 101 AND 107).

FOR: SCIENTIFIC AND INDUSTRIAL RESEARCH, IN THE FIELDS OF CHEMISTRY, BIOLOGY AND BIOCHEMISTRY; CHEMICAL, BIOLOGICAL AND BIOCHEMICAL LABORATORY SERVICES, NAMELY, THE PREPARATION AND TESTING OF CELL CULTURES AND CELL CULTURE SYSTEMS; PROVIDING OF EXPERTISE, NAMELY, CONSULTANCY AND ADVISORY SERVICES IN THE FIELD OF CHEMISTRY, BIOLOGY AND BIOCHEMISTRY, IN CLASS 42 (U.S. CLS. 100 AND 101).

PRIORITY DATE OF 11-2-2006 IS CLAIMED.

OWNER OF INTERNATIONAL REGISTRATION  
0931578 DATED 4-30-2007, EXPIRES 4-30-2017.

SER. NO. 79-041,372, FILED 4-30-2007.

MARK PILARO, EXAMINING ATTORNEY



Int. Cls.: 8, 20 and 21

Prior U.S. Cls.: 2, 13, 22, 23, 25, 28, 29, 30, 32, 33, 40,  
44 and 50

Reg. No. 3,499,301

United States Patent and Trademark Office

Registered Sep. 9, 2008

TRADEMARK  
PRINCIPAL REGISTER



Tognana

TOGNANA PORCELLANE S.P.A. (ITALY JOINT  
STOCK COMPANY)  
VIA CAPITELLO, 22  
I-31030 CASIER (TREVISO), ITALY

FOR: CUTLERY, NAMELY, FORKS, SPOONS  
AND KNIVES; NON-ELECTRIC CAN OPENERS;  
CHEESE SLICERS, HAND-OPERATED PASTA  
AND PIZZA CUTTERS, NON-ELECTRIC EGG SLI-  
CERS, NON-ELECTRIC FRUIT AND VEGETABLE  
PEELERS; HAND TOOLS FOR KITCHEN PURPO-  
SES, NAMELY, ICE PICKS AND TONGS; KNIFE  
SHARPENERS; HAND-OPERATED VEGETABLE  
SHREDDERS, NUT CRACKERS, SCISSORS, PAR-  
ING KNIVES, APPLE AND VEGETABLE CORERS,  
IN CLASS 8 (U.S. CLS. 23, 28 AND 44).

FOR: KNIFE HANDLES, NOT OF METAL; TOOL  
HANDLES, NOT OF METAL; MIRROR AND PIC-  
TURE FRAMES, NON-METALLIC CONTAINERS  
FOR COMMERCIAL USE, UMBRELLA STANDS,  
MIRROR STANDS, MIRRORS, HAND FANS, FIXED  
TOWEL DISPENSERS NOT OF METAL, NON-ME-  
TAL DOOR HANDLES, NON-METAL WINDOW  
HANDLES, IN CLASS 20 (U.S. CLS. 2, 13, 22, 25, 32  
AND 50).

FOR: TEA SERVICES; COFFEE SERVICES;  
WORKS OF ART, OF PORCELAIN, TERRA-COTTA  
OR GLASS; BOTTLES, SOLD EMPTY; NON ELEC-  
TRIC TEA POTS; DISHES; DRINKING GLASSES;  
BOWLS; CUPS; SALAD BOWLS; DESSERT CUPS;  
NON-ELECTRIC COFFEE POTS AND COFFEE PER-  
COLATORS; SUGAR BOWLS; TUREENS; HORS  
D'OEUVRES DISHES; SAUCE BOATS; SERVING  
TRAYS; MILK JUGS; SALT SHAKERS; FRUIT

CUPS; DISH AND JAR COVERS; SAUCEPANS; POTS  
AND VASES; OPAL GLASS; ENAMELLED GLASS;  
FLOWER POTS; GLASS BOWLS; GLASS BOXES;  
GLASS CARAFES; GLASS MUGS; MUGS; JUGS;  
COLOURED GLASS, NOT FOR BUILDING; GLASS,  
UNWORKED OR SEMI-WORKED, EXCEPT BUILD-  
ING GLASS; DECORATIVE GLASS, NOT FOR  
BUILDING; DECORATIVE PLATES; DECORATIVE  
CRYSTAL PRISMS; ORNAMENTS OF CHINA,  
GLASS, PORCELAIN, NOT INCLUDING CHRIST-  
MAS TREE ORNAMENTS, IN CLASS 21 (U.S. CLS. 2,  
13, 23, 29, 30, 33, 40 AND 50).

PRIORITY DATE OF 4-24-2007 IS CLAIMED.

OWNER OF INTERNATIONAL REGISTRATION  
0931613 DATED 6-18-2007, EXPIRES 6-18-2017.

OWNER OF U.S. REG. NO. 1,733,099.

THE MARK CONSISTS OF A SIGN DEPICTING  
THE WORDING "TOGNANA" IN FANCY CHAR-  
ACTERS ABOVE WHICH THERE ARE THREE  
CURVED SIGNS OF EQUAL SIZE PLACED VERTI-  
CALLY ONE ABOVE THE OTHER.

THE WORDING "TOGNANA" HAS NO MEAN-  
ING IN ENGLISH.

SER. NO. 79-041,384, FILED 6-18-2007.

MARK PILARO, EXAMINING ATTORNEY

**Int. Cls.: 1, 3, 5, 41 and 42**

**Prior U.S. Cls.: 1, 4, 5, 6, 10, 18, 26, 44, 46, 50, 51, 52,  
100, 101 and 107**

**Reg. No. 3,499,302**

**United States Patent and Trademark Office**

**Registered Sep. 9, 2008**

**TRADEMARK  
SERVICE MARK  
PRINCIPAL REGISTER**

# SupplementPack

PROMOCELL BIOSCIENCE ALIVE GMBH (FED  
REP GERMANY GMBH)  
SICKINGENSTR. 63/65  
69126 HEIDELBERG  
FED REP GERMANY

FOR: CHEMICALS USED IN SCIENCE AND INDUSTRY, IN PARTICULAR RAW, AUXILIARY AND ACTIVE SUBSTANCES FOR MANUFACTURING CHEMICAL, BIOCHEMICAL, BIOLOGICAL AND CELLBIOLOGICAL PREPARATIONS; CHEMICAL, BIOCHEMICAL, BIOLOGICAL, CELLBIOLOGICAL PREPARATIONS FOR INDUSTRIAL USE, IN CLASS 1 (U.S. CLS. 1, 5, 6, 10, 26 AND 46).

FOR: COSMETICS; PERFUMERY; ESSENTIAL OILS; SOAPS FOR PERSONAL USE; DENTIFRICES, IN CLASS 3 (U.S. CLS. 1, 4, 6, 50, 51 AND 52).

FOR: SANITARY PREPARATIONS FOR MEDICAL USE; DIETETIC FOODSTUFFS ADAPTED FOR MEDICAL USE; MEDICAL PLASTERS; MEDICAL DRESSINGS; CHEMICAL, BIOCHEMICAL, BIOLOGICAL, CELLBIOLOGICAL PREPARATIONS FOR MEDICAL AND BIOMEDICAL PURPOSES; CELL CULTURES AND CELL CULTURE SYSTEMS FOR MEDICAL OR CLINICAL USE, CONSISTING OF CELLS, MEDIA FOR CELLS, MEDIA REAGENTS AND BIOCHEMICALS; CHEMICALS FOR MANUFACTURING BIOMEDICAL AND MEDICAL PREPARATIONS, NAMELY, CHEMICAL REAGENTS FOR MEDICAL PURPOSES, IN CLASS 5 (U.S. CLS. 6, 18, 44, 46, 51 AND 52).

FOR: PROVIDING OF TRAINING AND FURTHER TRAINING IN THE FIELDS OF CHEMISTRY, BIOLOGY AND BIOCHEMISTRY; ARRANGING AND CONDUCTING OF CONGRESSES, COLLOQUIUMS, SYMPOSIUMS, SEMINARS AND WORKSHOPS IN THE FIELDS OF CHEMISTRY, BIOLOGY AND BIOCHEMISTRY, IN CLASS 41 (U.S. CLS. 100, 101 AND 107).

FOR: SCIENTIFIC AND INDUSTRIAL RESEARCH, IN THE FIELDS OF CHEMISTRY, BIOLOGY AND BIOCHEMISTRY; CHEMICAL, BIOLOGICAL AND BIOCHEMICAL LABORATORY SERVICES, NAMELY, THE PREPARATION AND TESTING OF CELL CULTURES AND CELL CULTURE SYSTEMS; PROVIDING OF EXPERTISE, NAMELY, CONSULTANCY AND ADVISORY SERVICES IN THE FIELD OF CHEMISTRY, BIOLOGY AND BIOCHEMISTRY, IN CLASS 42 (U.S. CLS. 100 AND 101).

PRIORITY DATE OF 11-2-2006 IS CLAIMED.

OWNER OF INTERNATIONAL REGISTRATION  
0931853 DATED 4-30-2007, EXPIRES 4-30-2017.

SER. NO. 79-041,493, FILED 4-30-2007.

MARK PILARO, EXAMINING ATTORNEY

**Int. Cls.: 1 and 25**

**Prior U.S. Cls.: 1, 5, 6, 10, 22, 26, 39 and 46**

**United States Patent and Trademark Office**

**Reg. No. 3,499,303**

**Registered Sep. 9, 2008**

**TRADEMARK  
PRINCIPAL REGISTER**



ALERT DISASTER CONTROL; (ASIA) PTE LTD  
(SINGAPORE CORPORATION)  
BOX NO. 5008, BLOCK B  
LOYANG CRESCENT, #01-00LOYANG OFFSHORE  
SUPPLY BASE  
SINGAPORE 508988, SINGAPORE

FOR: FIRE EXTINGUISHING COMPOSITIONS,  
IN CLASS 1 (U.S. CLS. 1, 5, 6, 10, 26 AND 46).

FOR: UNIFORMS; CLOTHING, NAMELY, POLO-  
SHIRTS, T-SHIRTS, JACKETS, COVERALLS; HEAD-  
GEAR, NAMELY, CAPS; FOOTWEAR, IN CLASS 25  
(U.S. CLS. 22 AND 39).

PRIORITY DATE OF 4-11-2007 IS CLAIMED.

OWNER OF INTERNATIONAL REGISTRATION  
0931913 DATED 4-26-2007, EXPIRES 4-26-2017.

THE COLOR(S) YELLOW AND BLUE IS/ARE  
CLAIMED AS A FEATURE OF THE MARK.

THE MARK CONSISTS OF THE WORDS  
"STORM" AND "ALERT" WITH A LIGHTNING  
BETWEEN THE WORDS. THE COLOR YELLOW  
APPEARS IN THE WORDING "STORM" AND THE  
TOP HALF OF THE LIGHTNING DESIGN. THE  
COLOR BLUE APPEARS IN THE WORDING  
"ALERT" AND THE BOTTOM HALF OF THE  
LIGHTNING DESIGN.

SER. NO. 79-041,519, FILED 4-26-2007.

MARK PILARO, EXAMINING ATTORNEY

Int. Cls.: 25, 29, 30, 32, 33, 35 and 41

Prior U.S. Cls.: 22, 39, 45, 46, 47, 48, 49, 100, 101, 102 and 107

Reg. No. 3,499,304

United States Patent and Trademark Office

Registered Sep. 9, 2008

TRADEMARK  
SERVICE MARK  
PRINCIPAL REGISTER



CONSORZIO EUROQUALITA' SOC. COOP. (ITALY COOPERATIVE SOCIETY)  
VIA DELLA CITTADILLA, 10/E  
I-10122 TORINO  
ITALY

FOR: ARTICLES OF CLOTHING MADE FROM LEATHER, NAMELY, LEATHER COATS, LEATHER JACKETS, LEATHER SKIRTS, LEATHER TROUSERS, CLOTHING ACCESSORIES MADE FROM LEATHER, NAMELY, LEATHER BELTS, LEATHER GLOVES, LEATHER SHOES, LEATHER HATS AND LEATHER CAPS; SHOES, ATHLETIC SHOES, BOOTS, SLIPPERS, OVERSHOES, SUITS, JACKETS, TROUSERS, JEANS, SKIRTS, DRESSES, COATS, OVERCOATS, CLOAKS, RAINCOATS, PARKAS, PADDING JACKETS, PULLOVERS, SHIRTS, T-SHIRTS, BLOUSES, SWEATERS, UNDERWEAR, NEGLIGEE, DRESSING GOWNS, BATHROBES, SWIMMING SUITS, SHAWLS, GLOVES, HATS AND CAPS, VISORS, SCARVES, TIES, IN CLASS 25 (U.S. CLS. 22 AND 39).

FOR: MEAT, FISH, POULTRY AND GAME; MEAT EXTRACTS; PRESERVED, DRIED, COOKED AND FROZEN FRUITS AND VEGETABLES; JELLIES, JAMS; COMPOTES; EGGS, MILK AND DAIRY PRODUCTS EXCLUDING ICE CREAM, ICE MILK AND FROZEN YOGURT; EDIBLE OILS AND FATS, IN CLASS 29 (U.S. CL. 46).

FOR: COFFEE, TEA, COCOA, SUGAR, RICE, TAPIOCA, SAGO, ARTIFICIAL COFFEE; FLOURS AND PREPARATIONS MADE FROM CEREALS, NAMELY, CEREAL BASED SNACK FOODS, READY-TO-EAT CEREALS, PROCESSED CEREAL-BASED FOOD TO BE USED AS A BREAKFAST

FOOD, SNACK FOR OR INGREDIENT FOR MAKING OTHER FOODS, BREAD, PASTRY AND CONFECTIONERY, NAMELY, PASTRIES, CRYSTAL SUGAR PIECES, FONDANTS, FROZEN CONFECTIONERY, FRUIT JELLY; ICES, NAMELY, EDIBLE ICES, FRUIT ICES, ICE CANDIES, ICE CREAMS, ICE CREAM DRINKS, ICE MILK-BARS, SOY-BASED ICE CREAM SUBSTITUTES; HONEY, TREATLE; YEAST, BAKING POWDER; SALT, MUSTARD; VINEGAR, SAUCES; SPICES; ICE CUBES, IN CLASS 30 (U.S. CL. 46).

FOR: BEERS; MINERAL AND NON-ALCOHOLIC BEVERAGES, NAMELY, CARBONATED WATER BEVERAGES; FRUIT DRINKS AND FRUIT JUICES; SYRUPS AND OTHER PREPARATIONS FOR MAKING BEVERAGES, IN CLASS 32 (U.S. CLS. 45, 46 AND 48).

FOR: ALCOHOLIC BEVERAGES EXCEPT BEERS, IN CLASS 33 (U.S. CLS. 47 AND 49).

FOR: ADVERTISING AND MARKETING; BUSINESS MANAGEMENT; BUSINESS ADMINISTRATION; PROVIDING OFFICE FUNCTIONS, IN CLASS 35 (U.S. CLS. 100, 101 AND 102).

FOR: EDUCATIONAL AND TRAINING SERVICES, NAMELY, ARRANGING AND ORGANIZING EXHIBITIONS, SEMINARS, WORKSHOPS, CONFERENCES AND CAREER EVENTS IN THE FIELDS OF BUSINESS EDUCATION, BUSINESS MANAGEMENT, HUMAN RESOURCES MANAGEMENT, PERSONAL DEVELOPMENT, JOB RECRUITMENT, PERSONNEL EMPLOYMENT CAREERS, CAREER COUNSELING, EMPLOYMENT HIRING, PERSONNEL PLACEMENT, PERSONNEL RECRUITMENT,

STAFFING AND CAREER PLACEMENT; PROVIDING ONLINE ELECTRONIC PUBLICATIONS IN THE NATURE OF BOOKS, GUIDES, MAGAZINES, BROCHURES, DIRECTORIES, NEWSLETTERS, MANUALS, CATALOGS, COURSE CATALOGUES AND PERIODICALS IN THE FIELDS OF BUSINESS EDUCATION, BUSINESS MANAGEMENT, HUMAN RESOURCES MANAGEMENT, PERSONAL DEVELOPMENT, JOB RECRUITMENT, PERSONNEL EMPLOYMENT CAREERS, CAREER COUNSELING, EMPLOYMENT HIRING, PERSONNEL PLACEMENT, PERSONNEL RECRUITMENT, STAFFING AND CAREER PLACEMENT; PROVIDING INFORMATION AND ADVICE ON EDUCATIONAL COURSES, EDUCATION AND CAREERS; PROVIDING INFORMATION AND ADVICE ON CRITERIA FOR THE SELECTION AND ACCEPTANCE OF EDUCATIONAL COURSES; NEWS REPORTING SERVICES; PUBLICATION OF BOOKS, JOURNALS, NEWSPAPERS, MAGAZINES, DIRECTORIES AND GUIDES; EDUCATIONAL SERVICES IN THE FIELD OF BUSINESS MANAGEMENT, NAMELY, PROVIDING INFORMATION, MENTORING AND TUTORING FOR ACCEPTANCE INTO EDUCATIONAL COURSES IN BUSINESS MANAGEMENT; RESEARCHING, INVESTIGATING, COMPILING, ANALYZING AND PROVIDING INFORMATION

ABOUT EDUCATIONAL INSTITUTIONS AND EDUCATIONAL COURSES; ALL OF THE AFORESAID SERVICES RELATING TO EDUCATIONAL INSTITUTIONS; ENTERTAINMENT IN THE NATURE OF LIVE PERFORMANCE SHOWS, LIVE PLAYS AND MUSIC CONCERTS; AMUSEMENT CENTERS; ORGANIZING COMMUNITY SPORTING AND CULTURAL ACTIVITIES, IN CLASS 41 (U.S. CLS. 100, 101 AND 107).

PRIORITY DATE OF 4-16-2007 IS CLAIMED.

OWNER OF INTERNATIONAL REGISTRATION 0932041 DATED 5-30-2007, EXPIRES 5-30-2017.

THE MARK CONSISTS OF A DESIGN IN THE SHAPE OF A RACETRACK.

THE FOREIGN WORDING IN THE MARK TRANSLATES INTO ENGLISH AS ITALY RUNS.

SER. NO. 79-041,582, FILED 5-30-2007.

EDWARD NELSON, EXAMINING ATTORNEY

**Int. Cl.: 9**

**Prior U.S. Cls.: 21, 23, 26, 36 and 38**

**United States Patent and Trademark Office**

**Reg. No. 3,499,305**

**Registered Sep. 9, 2008**

**TRADEMARK  
PRINCIPAL REGISTER**

# SPECTROQUANT

MERCK KGAA (FED REP GERMANY PART-  
NERSHIP LIMITED BY SHARES)  
FRANKFURTER STRASSE 250  
64293 DARMSTADT  
FED REP GERMANY

FOR: SCIENTIFIC APPARATUSES AND INSTRUMENTS, NAMELY, OPTICAL MEASURING, OPTICAL CONTROL AND OPTICAL ANALYSIS APPARATUSES AND INSTRUMENTS FOR SCIENTIFIC PURPOSES, NAMELY, FOR MEASUREMENT OF TRANSMISSION OF LIGHT AND MEASUREMENT OF COLOR AND TURBIDITY; SCIENTIFIC APPARATUSES AND INSTRUMENTS, NAMELY, OPTICAL MEASURING, OPTICAL CONTROL AND OPTICAL ANALYSIS APPARATUSES AND INSTRUMENTS FOR SCIENTIFIC PURPOSES, NAMELY, FOR MEASUREMENT OF ABSORBANCE OF LIGHT AND MEASUREMENT OF COLOR AND TURBIDITY; COLORIMETERS; PHOTOMETERS, IN PARTICULAR SPECTROPHOTOMETERS; APPARATUSES AND INSTRUMENTS FOR SAMPLE PREPARATION AND SAMPLE DIGESTION, NAMELY, PHOTOMETERS, SPECTROPHOTOMETERS AND COLORIMETERS MEASURING IN THE VISUAL AND ULTRAVIOLET WAVELENGTH RANGE, THERMOREACTORS FOR DECOMPOSITION AND SAMPLE PREPARATION, MICROWAVE OVENS FOR DECOMPOSITION AND SAMPLE PREPARA-

TION; OPERATING SOFTWARE FOR THE AFOREMENTIONED GOODS; SOFTWARE FOR DATA TRANSMISSION AND DATA EVALUATION IN THE FIELD OF OPTICAL MEASURING, OPTICAL CONTROL AND OPTICAL ANALYSIS; DATA PROCESSORS; COMPUTERS FOR DATA RECORDING, EVALUATION AND OUTPUT, IN THE FIELD OF OPTICAL MEASURING, OPTICAL CONTROL AND OPTICAL ANALYSIS, IN CLASS 9 (U.S. CLS. 21, 23, 26, 36 AND 38).

THE MARK CONSISTS OF STANDARD CHARACTERS WITHOUT CLAIM TO ANY PARTICULAR FONT, STYLE, SIZE, OR COLOR.

PRIORITY DATE OF 12-20-2006 IS CLAIMED.

OWNER OF INTERNATIONAL REGISTRATION  
0932163 DATED 6-13-2007, EXPIRES 6-13-2017.

OWNER OF U.S. REG. NO. 1,031,117.

SER. NO. 79-041,635, FILED 6-13-2007.

SUSAN STIGLITZ, EXAMINING ATTORNEY

Int. Cls.: 29 and 30

Prior U.S. Cl.: 46

United States Patent and Trademark Office

Reg. No. 3,499,306

Registered Sep. 9, 2008

TRADEMARK  
PRINCIPAL REGISTER



GARMO AG (FED REP GERMANY CORPORATION)

ULMER STRASSE 187

70188 STUTTGART

FED REP GERMANY

FOR: MILK AND MILK PRODUCTS, NAMELY, CHEESE, YOGURT BUTTER, SOFT CHOOSE, AND CREAM; DESSERTS MADE OF YOGURT EXCLUDING FROZEN YOGURT, IN CLASS 29 (U.S. CL. 46).

FOR: CUSTARD DESSERTS, IN CLASS 30 (U.S. CL. 46).

OWNER OF INTERNATIONAL REGISTRATION 0736075 DATED 5-15-2000, EXPIRES 5-15-2010.

THE MARK CONSISTS OF A MOSQUE DESIGN, WHICH INCLUDES FOUR MINARETS. THE DESIGN APPEARS ABOVE THE WORDING "GAZI".

THE TURKISH LANGUAGE "GAZI" MEANS "HERO" OR "VETERAN".

SER. NO. 79-041,680, FILED 2-23-2007.

ELI HELLMAN, EXAMINING ATTORNEY

**Int. Cl.: 42**

**Prior U.S. Cls.: 100 and 101**

**United States Patent and Trademark Office**

**Reg. No. 3,499,307**

**Registered Sep. 9, 2008**

**SERVICE MARK  
PRINCIPAL REGISTER**

**SHOW**

DESMOND CORNELIUS ADRIAAN SPRUIJT;  
H.O.D.N. MAPPING WORLDS (NETHER-  
LANDS INDIVIDUAL)  
BERTUS VAN GROUWSTRAAT 39  
NL-1063 AS AMSTERDAM  
NETHERLANDS

FOR: GRAPHIC ILLUSTRATION SERVICES FOR OTHERS WHETHER OR NOT IN COMBINATION WITH PROPORTIONAL SCALING OF ELEMENTS; SCIENTIFIC RESEARCH AND TECHNOLOGY CONSULTATION IN THE FIELD OF GRAPHIC ILLUSTRATION; GRAPHIC DESIGN SERVICES RELATING TO GRAPHIC ILLUSTRATION; INDUSTRIAL DESIGN; INDUSTRIAL RESEARCHING THE FIELD OF GRAPHIC DESIGN; DESIGN AND DEVELOPMENT OF SOFTWARE IN THE FIELD OF GRAPHIC ILLUSTRATION INCLUDING BUT NOT LIMITED TO SCALING ON THE BASIS OF VALUES; VISUAL DESIGN SERVICES IN THE NATURE OF DESIGNING VISUAL ELEMENTS FOR ONLINE, BROADCAST, PRINT, OUTDOOR AND OTHER COMMUNICATION MEDIA; MAPPING SERVICES, WHETHER OR NOT VIA THE INTERNET; DESIGN

OF DATA BASES IN THE FIELD OF GRAPHIC ILLUSTRATION; DESIGN FOR OTHERS IN THE FIELD OF GEOGRAPHIC MAPS, ILLUSTRATED MAPS, POSTERS, INSTRUCTIONAL AND TEACHING MATERIALS; DESIGN OF INTERACTIVE GAMES AND PUZZLES; DESIGN OF GAMES AND PUZZLES; RECORDING DATA FOR OTHERS, IN THE FORM OF GRAPHIC ILLUSTRATIONS ON OPTICAL, DIGITAL AND MAGNETIC MEDIA FOR ELECTRONIC STORAGE, IN CLASS 42 (U.S. CLS. 100 AND 101).

PRIORITY DATE OF 1-2-2007 IS CLAIMED.

OWNER OF INTERNATIONAL REGISTRATION  
0932251 DATED 6-29-2007, EXPIRES 6-29-2017.

SER. NO. 79-041,703, FILED 6-29-2007.

MONIQUE MILLER, EXAMINING ATTORNEY



**Int. Cls.: 9, 11, 20 and 42**

**Prior U.S. Cls.: 2, 13, 21, 22, 23, 25, 26, 31, 32, 34, 36,  
38, 50, 100 and 101**

**Reg. No. 3,499,308**

**United States Patent and Trademark Office**

**Registered Sep. 9, 2008**

**TRADEMARK  
SERVICE MARK  
PRINCIPAL REGISTER**

**ZYKEN**

ZYKEN (FRANCE SOCIETE PAR ACTIONS SIM-  
PLIFIEE)  
14 AVENUE DE L'OPERA  
F-75001 PARIS, FRANCE

FOR: ELECTRONIC EQUIPMENT, NAMELY,  
SOUND AND LIGHT UNIT PRODUCING SOUND  
AND LIGHT TO AID IN SLEEP AND RELAXATION,  
IN CLASS 9 (U.S. CLS. 21, 23, 26, 36 AND 38).

FOR: ELECTRIC LIGHTING, NAMELY, LUMI-  
NOUS TUBES AND LIGHT BULBS FOR GENERAT-  
ING LIGHT AND PROVIDING THERAPEUTIC  
BENEFITS IN SLEEP AND RELAXATION, IN CLASS  
11 (U.S. CLS. 13, 21, 23, 31 AND 34).

FOR: FURNITURE, NAMELY, BEDS, MATTRES-  
SES, BOX SPRINGS, BED FRAMES, HEADBOARDS,  
FOOTBOARDS, SOFA BEDS, PILLOWS, AND BOL-

STERS, IN CLASS 20 (U.S. CLS. 2, 13, 22, 25, 32 AND  
50).

FOR: RESEARCH AND DEVELOPMENT OF PRO-  
DUCTS IN THE FIELDS OF HEALTH, WELLNESS  
AND SLEEP QUALITY, IN CLASS 42 (U.S. CLS. 100  
AND 101).

PRIORITY DATE OF 11-24-2006 IS CLAIMED.

OWNER OF INTERNATIONAL REGISTRATION  
0932294 DATED 5-9-2007, EXPIRES 5-9-2017.

SER. NO. 79-041,720, FILED 5-9-2007.

AMY MCMENAMIN, EXAMINING ATTORNEY

**Int. Cls.: 9, 16, 40, 41 and 45**

**Prior U.S. Cls.: 2, 5, 21, 22, 23, 26, 29, 36, 37, 38, 50,  
100, 101, 103, 106 and 107**

**Reg. No. 3,499,309**

**United States Patent and Trademark Office**

**Registered Sep. 9, 2008**

**TRADEMARK  
SERVICE MARK  
PRINCIPAL REGISTER**

# BIRKHÄUSER

BIRKHÄUSER VERLAG AG (SWITZERLAND  
SOCIÉTÉ ANONYME (SA), TRANSLATED AS  
"JOINT-STOCK COMPANY")  
VIADUKTSTRASSE 42  
CH-4051 BASEL  
SWITZERLAND

FOR: AUDIO AND VIDEO RECORDINGS FEATURING MATHEMATICS, PHYSICS, BIO-SCIENCE, COMPUTER-SCIENCE, APPLIED PROBABILITY AND STATISTICS, ENGINEERING, GEOSCIENCES, HISTORY OF SCIENCE, ARCHITECTURE AND DESIGN SAVED IN ELECTRONIC, OPTICAL AND MAGNETIC DATABASES; AUDIO-VIDEO COMPACT DISCS FEATURING MATHEMATICS, PHYSICS, BIO-SCIENCE, COMPUTER-SCIENCE, APPLIED PROBABILITY AND STATISTICS, ENGINEERING, GEOSCIENCES, HISTORY OF SCIENCE, ARCHITECTURE AND DESIGN; CD-ROMS FEATURING MATHEMATICS, PHYSICS, BIO-SCIENCE, COMPUTER-SCIENCE, APPLIED PROBABILITY AND STATISTICS, ENGINEERING, GEOSCIENCES, HISTORY OF SCIENCE, ARCHITECTURE AND DESIGN; CD-I, NAMELY, COMPACT DISC INTERACTIVE FEATURING MATHEMATICS, PHYSICS, BIO-SCIENCE, COMPUTER-SCIENCE, APPLIED PROBABILITY AND STATISTICS, ENGINEERING, GEOSCIENCES, HISTORY OF SCIENCE, ARCHITECTURE AND DESIGN; DOWNLOADABLE ELECTRONIC PUBLICATIONS FEATURING MATHEMATICS, PHYSICS, BIO-SCIENCE, COMPUTER-SCIENCE, APPLIED PROBABILITY AND STATISTICS, ENGINEERING, GEOSCIENCES, HISTORY OF SCIENCE, ARCHITECTURE AND DESIGN, IN CLASS 9 (U.S. CLS. 21, 23, 26, 36 AND 38).

FOR: PRINTED MATTER, NAMELY, BOOKS, JOURNALS, PERIODICALS, CATALOGUES, AND BROCHURES ON MATHEMATICS, PHYSICS, BIO-SCIENCE, COMPUTER-SCIENCE, APPLIED PROBABILITY AND STATISTICS, ENGINEERING, GEOSCIENCES, HISTORY OF SCIENCE, ARCHITECTURE AND DESIGN, AND NEWSPAPERS, DIARIES, AND ADDRESS-BOOKS; PRINTED

PUBLICATIONS, NAMELY, SCIENTIFIC PUBLICATIONS, NAMELY, JOURNALS AND BOOKS OF MATHEMATICS, PHYSICS, BIO-SCIENCE, COMPUTER-SCIENCE, APPLIED PROBABILITY AND STATISTICS, ENGINEERING, GEOSCIENCES, HISTORY OF SCIENCE, ARCHITECTURE AND DESIGN, IN CLASS 16 (U.S. CLS. 2, 5, 22, 23, 29, 37, 38 AND 50).

FOR: PRINTING, IN CLASS 40 (U.S. CLS. 100, 103 AND 106).

FOR: PUBLICATION OF BOOKS, OF JOURNALS, AND OF MAGAZINES; SERVICES OF A PUBLISHING COMPANY, NAMELY, PUBLISHING OF JOURNALS, BOOKS, MAGAZINES, EBOOKS, EJOURNALS; SERVICES OF AN EDITOR, NAMELY, WRITTEN TEXT EDITING; PUBLICATION OF ELECTRONIC BOOKS AND JOURNALS ONLINE; PUBLISHING ONLINE ELECTRONIC PUBLICATIONS THAT ARE NOT DOWNLOADABLE, IN CLASS 41 (U.S. CLS. 100, 101 AND 107).

FOR: COPYRIGHT MANAGEMENT, IN CLASS 45 (U.S. CLS. 100 AND 101).

THE MARK CONSISTS OF STANDARD CHARACTERS WITHOUT CLAIM TO ANY PARTICULAR FONT, STYLE, SIZE, OR COLOR.

PRIORITY DATE OF 5-15-2007 IS CLAIMED.

OWNER OF INTERNATIONAL REGISTRATION  
0932609 DATED 6-27-2007, EXPIRES 6-27-2017.

THE ENGLISH TRANSLATION OF THE WORD BIRKHAUSER IN THE MARK IS "BIRCH HOUSES".

SER. NO. 79-041,854, FILED 6-27-2007.

LEIGH CAROLINE CASE, EXAMINING ATTOR-  
NEY

Int. Cls.: 20 and 21

Prior U.S. Cls.: 2, 13, 22, 23, 25, 29, 30, 32, 33, 40 and 50

Reg. No. 3,499,310

United States Patent and Trademark Office

Registered Sep. 9, 2008

TRADEMARK  
PRINCIPAL REGISTER

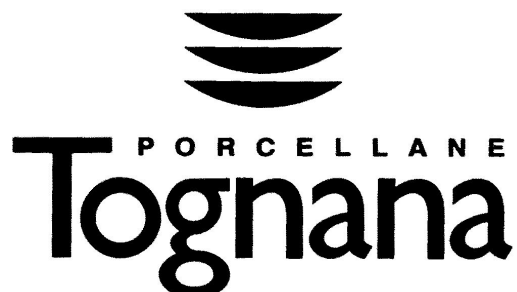

TOGNANA PORCELLANE S.P.A. (ITALY JOINT STOCK COMPANY)  
VIA CAPITELLO, 22  
I-31030 CASIER (TREVISO), ITALY

FOR: KNIFE HANDLES OF PORCELAIN; TOOL HANDLES OF PORCELAIN, IN CLASS 20 (U.S. CLS. 2, 13, 22, 25, 32 AND 50).

FOR: TEA SERVICES OF PORCELAIN; COFFEE SERVICES OF PORCELAIN; TEAPOTS OF PORCELAIN; DISHES OF PORCELAIN; DRINKING GLASSES OF PORCELAIN; BOWLS OF PORCELAIN; CUPS OF PORCELAIN; SALAD BOWLS OF PORCELAIN; DESSERT CUPS OF PORCELAIN; NON-ELECTRIC COFFEE POTS AND COFFEE PERCOLATORS OF PORCELAIN; SUGAR BASINS OF PORCELAIN; TUREENS OF PORCELAIN; HORS D'OEUVRES DISHES OF PORCELAIN; SAUCE BOATS OF PORCELAIN; SERVING TRAYS OF PORCELAIN; MILK JUGS OF PORCELAIN; SALT SHAKERS OF PORCELAIN; FRUIT CUPS OF PORCELAIN; DISH AND JAR COVERS OF PORCELAIN; SAUCEPANS OF PORCELAIN; POTS AND VASES OF PORCELAIN; PLATES, DINNER PLATES, SOUP PLATES, SIDE PLATES, DESSERT PLATES, BREAD AND BUTTER PLATES, PASTA PLATES, OVAL PLATES, CHARGER PLATES, STEAK PLATES, BARBECUE PLATES, FONDUE PLATES, BUFFET PLATES, ALL OF PORCELAIN; SERVING PLATES AND PLATTERS, OVAL PLATTERS, ROUND PLATTERS, CAKE PLATTERS, FISH PLATTERS, CEREAL BOWLS, FRUIT BOWLS, PASTA BOWLS, SOUP BOWLS, VEGETABLE BOWLS, COVERED VEGETABLE BOWLS, SUGAR BOWLS WITH OR WITHOUT LIDS, CHIP AND DIP BOWLS, SOUFFLE BOWLS, ALL OF PORCELAIN; SOUP TUREENS OF PORCELAIN; SAUCERS, ESPRESSO CUPS AND SAUCERS,

CAPPUCCINO CUPS AND SAUCERS, BREAKFAST CUPS AND SAUCERS, ALL OF PORCELAIN; JUGS, CREAM JUGS, EGG CUPS, TOOTHPICK HOLDERS, PEPPER SHAKERS, FLOWER VASES, MUGS, COFFEE MUGS, TEA MUGS, ALL OF PORCELAIN; FOOD PRESERVING JARS, COFFEE JARS, SUGAR JARS, ALL OF PORCELAIN; BAKING DISHES, RECTANGULAR BAKING DISHES, OVAL BAKING DISHES, SQUARE BAKING DISHES, QUICHE DISHES, GRATIN DISHES, ALL OF PORCELAIN; SUSHI TRAYS, CHIP AND DIP TRAYS, VINEGAR AND OIL BOTTLES SOLD EMPTY, OLIVE BOATS, ALL OF PORCELAIN, IN CLASS 21 (U.S. CLS. 2, 13, 23, 29, 30, 33, 40 AND 50).

PRIORITY DATE OF 3-23-2007 IS CLAIMED.

OWNER OF INTERNATIONAL REGISTRATION 0932747 DATED 6-18-2007, EXPIRES 6-18-2017.

OWNER OF U.S. REG. NO. 1,733,099.

NO CLAIM IS MADE TO THE EXCLUSIVE RIGHT TO USE "PORCELLANE", APART FROM THE MARK AS SHOWN.

THE MARK CONSISTS OF A DESIGN DEPICTING THE WORDING "TOGNANA PORCELLANE", IN FANCY CHARACTERS, IN WHICH THE WORDING "PORCELLANE" IS OF A SMALLER SIZE AND PLACED ABOVE THE WORDING "TOGNANA" AND ABOVE THE SAME THERE ARE THREE CURVED DESIGNS OF EQUAL SIZE PLACED VERTICALLY ONE ABOVE THE OTHER.

THE ENGLISH TRANSLATION OF "PORCEL-  
LANE" IN THE MARK IS PORCELAIN. THE WORD-  
ING "TOGNANA" HAS NO MEANING IN ENGLISH.

SER. NO. 79-041,898, FILED 6-18-2007.  
MARK PILARO, EXAMINING ATTORNEY

**Int. Cls.: 41 and 43**

**Prior U.S. Cls.: 100, 101 and 107**

**United States Patent and Trademark Office**

**Reg. No. 3,499,311**

**Registered Sep. 9, 2008**

**SERVICE MARK  
PRINCIPAL REGISTER**



KENMARK BRAND B.V. (NETHERLANDS CORPORATION)  
VONDELLAAN 35  
NL-3818 WN AMERSFOORT  
NETHERLANDS

FOR: ARRANGING OF EXHIBITIONS, SEMINARS AND CONFERENCES; MEETING AND SEMINAR ARRANGING; ENTERTAINMENT SERVICES, NAMELY, LIVE MUSIC CONCERT SERVICES; ENTERTAINMENT SERVICES FEATURING MUSIC, NAMELY, LIVE PERFORMANCES BY INDIVIDUALS AND GROUPS PLAYING JAZZ AND LOUNGE MUSIC, IN CLASS 41 (U.S. CLS. 100, 101 AND 107).

FOR: CAFÉ, RESTAURANT, BAR AND CATERING SERVICES; PRIVATE DINING SERVICES, NAMELY, PROVIDING OF FOOD AND DRINK, IN CLASS 43 (U.S. CLS. 100 AND 101).

OWNER OF INTERNATIONAL REGISTRATION  
0932856 DATED 6-7-2007, EXPIRES 6-7-2017.

NO CLAIM IS MADE TO THE EXCLUSIVE RIGHT TO USE "RESTAURANT, BAR & LOUNGE", APART FROM THE MARK AS SHOWN.

"THE COLOR(S) WHITE, LIGHT GREEN AND GREEN IS/ARE CLAIMED AS A FEATURE OF THE MARK."

THE MARK CONSISTS OF A RECTANGLE IN WHICH THE WORDS BRANCHE RESTAURANT, BAR & LOUNGE ARE WRITTEN. THE COLOR GREEN APPEARS IN THE RECTANGLE BACKGROUND. THE COLOR WHITE APPEARS IN THE WORD BRANCHE. THE WORDING RESTAURANT, BAR & LOUNGE IS WRITTEN IN A LIGHT GREEN. THE LINE BETWEEN THE WORDING BRANCHE AND RESTAURANT, BAR & LOUNGE IS ALSO WRITTEN IN A LIGHT GREEN.

SER. NO. 79-041,932, FILED 6-7-2007.

RAMONA ORTIGA, EXAMINING ATTORNEY

**Int. Cls.: 16, 38 and 41**

**Prior U.S. Cls.: 2, 5, 22, 23, 29, 37, 38, 50, 100, 101, 104  
and 107**

**Reg. No. 3,499,312**

**United States Patent and Trademark Office**

**Registered Sep. 9, 2008**

**TRADEMARK  
SERVICE MARK  
PRINCIPAL REGISTER**

# Russian Times

PRINZ MEDIEN, INHABER DETLEF PRINZ  
(FED REP GERMANY INDIVIDUAL)

TEMPELHOFER UFER 23/24

10963 BERLIN

FED REP GERMANY

FOR: PRINTED MATTER, NAMELY, NEWSPAPERS AND JOURNALS, MAGAZINES, AND BOOKS AND PERIODICALS IN THE FIELDS OF POLITICAL AND ECONOMIC MATTERS; AND PHOTOGRAPHS, IN CLASS 16 (U.S. CLS. 2, 5, 22, 23, 29, 37, 38 AND 50).

FOR: NEWS AGENCIES, NAMELY, THE TRANSMISSION OF NEWS ITEMS TO NEWS REPORTING ORGANIZATIONS AND TO INDIVIDUALS, IN CLASS 38 (U.S. CLS. 100, 101 AND 104).

FOR: RENTAL OF MAGAZINES; PUBLICATION OF BOOKS, NEWSPAPERS AND MAGAZINES, IN CLASS 41 (U.S. CLS. 100, 101 AND 107).

THE MARK CONSISTS OF STANDARD CHARACTERS WITHOUT CLAIM TO ANY PARTICULAR FONT, STYLE, SIZE, OR COLOR.

OWNER OF INTERNATIONAL REGISTRATION 0923081 DATED 4-17-2007, EXPIRES 4-17-2017.

NO CLAIM IS MADE TO THE EXCLUSIVE RIGHT TO USE "RUSSIAN", APART FROM THE MARK AS SHOWN.

SER. NO. 79-041,947, FILED 7-5-2007.

AMY HELLA, EXAMINING ATTORNEY

Int. Cl.: 3

Prior U.S. Cls.: 1, 4, 6, 50, 51 and 52

United States Patent and Trademark Office

Reg. No. 3,499,313

Registered Sep. 9, 2008

TRADEMARK  
PRINCIPAL REGISTER



MARIELLA BURANI FASHION GROUP S.P.A.  
(ITALY JOINT STOCK COMPANY)  
VIA DELLA REPUBBLICA, 86  
I-42025 CAVRIAGO (REGGIO EMILIA)  
ITALY

FOR: LAUNDRY BLEACHING PREPARATIONS;  
GENERAL PURPOSE CLEANING, POLISHING  
AND ABRASIVE LIQUIDS AND POWDERS; SOAPS;  
PERFUMERY; ESSENTIAL OILS; COSMETICS;  
HAIR LOTIONS; DENTIFRICES, IN CLASS 3 (U.S.  
CLS. 1, 4, 6, 50, 51 AND 52).

PRIORITY DATE OF 4-18-2007 IS CLAIMED.

OWNER OF INTERNATIONAL REGISTRATION  
0933183 DATED 6-26-2007, EXPIRES 6-26-2017.

OWNER OF U.S. REG. NOS. 2,714,800 AND  
3,216,016.

THE ENGLISH TRANSLATION OF THE FOR-  
EIGN WORD(S) IN THE MARK IS AMULETS J.

SER. NO. 79-042,055, FILED 6-26-2007.

STEVEN R. FINE, EXAMINING ATTORNEY



**Int. Cl.: 16**

**Prior U.S. Cls.: 2, 5, 22, 23, 29, 37, 38 and 50**

**Reg. No. 3,499,314**

**United States Patent and Trademark Office**

**Registered Sep. 9, 2008**

**TRADEMARK  
PRINCIPAL REGISTER**

**NAUTILUX**

AZIMUT-BENETTI S.P.A. (ITALY JOINT STOCK  
COMPANY)  
VIA MICHELE COPPINO, 104  
I-55049 VIAREGGIO (LU)  
ITALY

PRIORITY DATE OF 6-1-2007 IS CLAIMED.

OWNER OF INTERNATIONAL REGISTRATION  
0933184 DATED 6-29-2007, EXPIRES 6-29-2017.

FOR: PAPER; CARDBOARD; PRINTED MATTER,  
NAMELY, MAGAZINES IN THE NAUTICAL FIELD;  
PHOTOGRAPHS; STATIONERY; ADHESIVES FOR  
STATIONERY OR HOUSEHOLD PURPOSES, IN  
CLASS 16 (U.S. CLS. 2, 5, 22, 23, 29, 37, 38 AND 50).

SER. NO. 79-042,056, FILED 6-29-2007.

MONIQUE MILLER, EXAMINING ATTORNEY

**Int. Cl.: 25**

**Prior U.S. Cls.: 22 and 39**

**United States Patent and Trademark Office**

**Reg. No. 3,499,315**

**Registered Sep. 9, 2008**

**TRADEMARK  
PRINCIPAL REGISTER**



KANEDA, MAKI (JAPAN INDIVIDUAL)  
1-35-7-906, YOYOGI  
SHIBUYA-KU; TOKYO 151-0053  
JAPAN

FOR: NON-JAPANESE STYLE OUTERWEAR IN THE NATURE OF ANORAKS, COATS IN THE NATURE OF JACKETS, UNDERWEAR, T-SHIRTS, OTHER CLOTHING IN THE NATURE OF PANTS, IN CLASS 25 (U.S. CLS. 22 AND 39).

OWNER OF INTERNATIONAL REGISTRATION  
0933524 DATED 7-17-2007, EXPIRES 7-17-2017.

NO CLAIM IS MADE TO THE EXCLUSIVE RIGHT TO USE "COMPANY", APART FROM THE MARK AS SHOWN.

SER. NO. 79-042,215, FILED 7-17-2007.

LAURA HAMMEL, EXAMINING ATTORNEY

**Int. Cls.: 12, 35 and 37**

**Prior U.S. Cls.: 19, 21, 23, 31, 35, 44, 100, 101, 102,  
103 and 106**

**Reg. No. 3,499,316**

**United States Patent and Trademark Office**

**Registered Sep. 9, 2008**

**TRADEMARK  
SERVICE MARK  
PRINCIPAL REGISTER**

**H. R. OWEN**

H R OWEN PLC (UNITED KINGDOM PUBLIC  
LIMITED COMPANY)  
75 KINNERTON STREET  
LONDON SW1X 8ED  
UNITED KINGDOM

FOR: MOTOR LAND VEHICLES, CARS AND VEHICLES FOR TRANSPORTING LIGHT GOODS, NAMELY, AUTOMOBILES, TRUCKS, SPORT-UTILITY VEHICLES, MOTORCYCLES; PARTS AND FITTINGS FOR MOTOR LAND VEHICLES, CARS AND LIGHT GOODS VEHICLES, NAMELY, STRUCTURAL PARTS, AUTOMOBILE ENGINES, EXTERIOR INSIGNIA BADGES FOR MOTOR VEHICLES, LUGGAGE CARRIERS FOR MOTOR VEHICLES, SPARE TIRE COVERS FOR MOTOR VEHICLES, FITTED COVERS FOR MOTOR VEHICLES, MUD FLAPS FOR MOTOR VEHICLES, ANTI-SKID CHAINS FOR MOTOR VEHICLES, AUTOMOBILE TIRES, BRAKES FOR MOTOR VEHICLES, MOTOR VEHICLE BUMPERS, SEAT COVERS FOR MOTOR VEHICLES, DIRECTION SIGNALS FOR MOTOR VEHICLES, ENGINES FOR MOTOR VEHICLES, GEAR BOXES FOR MOTOR VEHICLES, HUBS FOR MOTOR VEHICLES, REAR VIEW MIRRORS FOR MOTOR VEHICLES, SAFETY SEATS FOR CHILDREN FOR MOTOR VEHICLES, SHOCK ABSORBERS FOR MOTOR VEHICLES, STEERING WHEELS FOR MOTOR VEHICLES, UPHOLSTERY FOR MOTOR VEHICLES, MOTOR VEHICLE GAS TANKS, MOTOR VEHICLE SEATS, MOTOR VEHICLE WHEELS, WINDOWS FOR MOTOR VEHICLES WINDSCREEN WIPERS, IN CLASS 12 (U.S. CLS. 19, 21, 23, 31, 35 AND 44).

FOR: RETAIL STORE SERVICES FEATURING MOTOR VEHICLES AND PARTS FOR MOTOR VEHICLES; ONLINE RETAIL STORE SERVICES

FEATURING MOTOR VEHICLES AND PARTS FOR MOTOR VEHICLES; RETAIL STORE SERVICES FEATURING MOTOR VEHICLES AND PARTS FOR MOTOR VEHICLES FEATURING PHONE-IN ORDERS; BUSINESS ACQUISITION CONSULTATION, NAMELY, CONSULTANCY SERVICES RELATING TO THE ACQUISITION OF MOTOR VEHICLES AND PARTS OF MOTOR VEHICLES AND SERVICES RELATING THERETO, IN CLASS 35 (U.S. CLS. 100, 101 AND 102).

FOR: MAINTENANCE AND REPAIR OF MOTOR VEHICLES, CARS AND LIGHT GOODS VEHICLES; MAINTENANCE AND REPAIR OF ENGINES AND BODIES OF MOTOR VEHICLES, CARS AND LIGHT GOODS VEHICLES; PAINTING OF MOTOR LAND VEHICLES, CARS AND LIGHT GOODS VEHICLES, IN CLASS 37 (U.S. CLS. 100, 103 AND 106).

THE MARK CONSISTS OF STANDARD CHARACTERS WITHOUT CLAIM TO ANY PARTICULAR FONT, STYLE, SIZE, OR COLOR.

PRIORITY DATE OF 5-2-2007 IS CLAIMED.

OWNER OF INTERNATIONAL REGISTRATION 0933605 DATED 7-24-2007, EXPIRES 7-24-2017.

THE NAME "H. R. OWEN" DOES NOT IDENTIFY A LIVING INDIVIDUAL.

SER. NO. 79-042,248, FILED 7-24-2007.

SETH A. RAPPAPORT, EXAMINING ATTORNEY

**Int. Cls.: 3, 5, 30 and 32**

**Prior U.S. Cls.: 1, 4, 6, 18, 44, 45, 46, 48, 50, 51 and 52**

**United States Patent and Trademark Office**

**Reg. No. 3,499,317**

**Registered Sep. 9, 2008**

**TRADEMARK  
PRINCIPAL REGISTER**

**YES FOR LOV**

PALIX SAS (FRANCE SOCIÉTÉ PAR ACTIONS  
SIMPLIFIÉE)  
129 AVENUE DE GENÈVE  
F-74000 ANNECY  
FRANCE

FOR: COSMETICS; COSMETIC OILS, COSMETIC OILS FOR MASSAGES, AFTER-SHAVE BALMS, BEAUTY CREAMS AND BODY POWDERS; MASSAGE OILS AND CREAMS; ESSENTIAL OILS, PERFUMES; COSMETIC SOAPS; SHOWER GELS; AIR FRESHENING PREPARATIONS; ALL OF THE ABOVE INTENDED TO INTENSIFY AND/OR ENHANCE PLEASURE, IN CLASS 3 (U.S. CLS. 1, 4, 6, 50, 51 AND 52).

FOR: SANITARY PREPARATIONS FOR PERSONAL HYGIENE, OTHER THAN TOILETRIES, NAMELY, WATER-BASED AND SILICONE-BASED PERSONAL LUBRICANTS; NUTRITIONAL SUPPLEMENTS FOR MEDICAL USE IN THE FORM OF PILLS, GELATINE CAPSULES AND BEVERAGES; ALL OF THE ABOVE INTENDED TO INTENSIFY AND/OR ENHANCE PLEASURE, IN CLASS 5 (U.S. CLS. 6, 18, 44, 46, 51 AND 52).

FOR: NUTRITIONAL SUPPLEMENTS IN THE FORM OF PILLS AND/OR GELATINE CAPSULES MADE FROM PLANTS, NOT FOR MEDICAL USE; ALL OF THE ABOVE INTENDED TO INTENSIFY AND/OR ENHANCE PLEASURE, IN CLASS 30 (U.S. CL. 46).

FOR: NUTRITIONAL BEVERAGES, NAMELY, ENERGY DRINKS; NON-ALCOHOLIC ENERGY AND STIMULATION BEVERAGES; ALL OF THE ABOVE INTENDED TO INTENSIFY AND/OR ENHANCE PLEASURE, IN CLASS 32 (U.S. CLS. 45, 46 AND 48).

THE MARK CONSISTS OF STANDARD CHARACTERS WITHOUT CLAIM TO ANY PARTICULAR FONT, STYLE, SIZE, OR COLOR.

OWNER OF INTERNATIONAL REGISTRATION  
0933629 DATED 4-26-2007, EXPIRES 4-26-2017.

SER. NO. 79-042,259, FILED 4-26-2007.

SUNG IN, EXAMINING ATTORNEY

**Int. Cls.: 1, 7, 8 and 9**

**Prior U.S. Cls.: 1, 5, 6, 10, 13, 19, 21, 23, 26, 28, 31, 34,  
35, 36, 38, 44 and 46**

**Reg. No. 3,499,318**

**United States Patent and Trademark Office**

**Registered Sep. 9, 2008**

**TRADEMARK  
PRINCIPAL REGISTER**

**POOL ONE**

KONG'S (AUST) PTY LIMITED (AUSTRALIA  
COMPANY)  
48 WILLIAMSON ROAD  
INGLEBURN NSW 2565  
AUSTRALIA

FOR: CHEMICALS AND CHEMICAL PRODUCTS  
USED IN THE TESTING OF SWIMMING POOLS  
AND SPAS; CHEMICALS AND CHEMICAL PRO-  
DUCTS USED IN THE TREATMENT AND MAIN-  
TENANCE OF SWIMMING POOLS AND SPAS,  
NAMELY, CHLORINE, IN CLASS 1 (U.S. CLS. 1, 5,  
6, 10, 26 AND 46).

FOR: ELECTRIC OPERATED WATER PUMPS  
FOR USE IN OR WITH SWIMMING POOLS AND  
SPAS; ACCESSORIES AND COMPONENT PARTS  
THEREFOR FOR USE IN OR WITH SWIMMING  
POOLS AND SPAS, NAMELY, PUMP CONTROL  
VALVES, VALVES FOR PUMPS, PUMP IMPELLERS;  
CLEANING APPARATUS, ACCESSORIES AND  
COMPONENT PARTS FOR USE IN OR WITH  
SWIMMING POOLS AND SPAS, NAMELY, AUTO-  
MATIC SWIMMING POOL CLEANERS AND PARTS  
THEREFOR, IN CLASS 7 (U.S. CLS. 13, 19, 21, 23, 31,  
34 AND 35).

FOR: ACCESSORIES BEING HAND TOOLS FOR  
USE IN OR WITH SWIMMING POOLS AND SPAS,  
NAMELY, SKIMMERS AND RAKES, IN CLASS 8  
(U.S. CLS. 23, 28 AND 44).

FOR: THERMOMETERS NOT FOR MEDICAL  
PURPOSES; TESTING APPARATUS, NAMELY, WA-  
TER TESTING INSTRUMENTATION FOR MONI-  
TORING AND DETECTING CONTAMINATION;  
TESTING KITS COMPRISED OF WATER TESTING  
INSTRUMENTATION FOR MONITORING AND  
DETECTING CONTAMINATION; TESTING PENS  
AS WATER TESTING INSTRUMENTATION FOR  
MONITORING AND DETECTING CONTAMINA-  
TION, ALL THE AFORESAID FOR USE IN OR WITH  
SWIMMING POOLS AND SPAS, IN CLASS 9 (U.S.  
CLS. 21, 23, 26, 36 AND 38).

THE MARK CONSISTS OF STANDARD CHAR-  
ACTERS WITHOUT CLAIM TO ANY PARTICULAR  
FONT, STYLE, SIZE, OR COLOR.

OWNER OF INTERNATIONAL REGISTRATION  
0933846 DATED 3-29-2007, EXPIRES 3-29-2017.

NO CLAIM IS MADE TO THE EXCLUSIVE  
RIGHT TO USE "POOL", APART FROM THE MARK  
AS SHOWN.

SER. NO. 79-042,361, FILED 3-29-2007.

REBECCA POVARCHUK, EXAMINING ATTOR-  
NEY

**Int. Cl.: 44**

**Prior U.S. Cls.: 100 and 101**

**United States Patent and Trademark Office**

**Reg. No. 3,499,319**

**Registered Sep. 9, 2008**

**SERVICE MARK  
PRINCIPAL REGISTER**

# KINOMINO

MICROLIFE INTELLECTUAL PROPERTY  
GMBH (SWITZERLAND SOCIÉTÉ À RE-  
SPONSABILITÉ LIMITÉE)  
ESPENSTRASSE 139  
CH-9443 WIDNAU  
SWITZERLAND

FOR: AROMATHERAPY; HOSPITALS; HEALTH  
CARE SERVICES IN THE NATURE OF HYGIENIC  
CARE FOR HUMAN BEINGS; HEALTH CARE;  
SERVICES OF A PHARMACIST TO MAKE UP  
PRESCRIPTIONS; PHARMACEUTICAL ADVICE;  
PHYSICAL THERAPY; PHYSIOTHERAPY; SERVI-  
CES OF A PSYCHOLOGIST, NAMELY, PSYCHOLO-  
GICAL CONSULTATION; MEDICAL SERVICES;  
MEDICAL SERVICES, NAMELY, THE SERVICES  
OF A PHARMACIST OR NURSE FOR MONITOR-

ING THE STATE OF HEALTH OF PATIENTS AND  
PROVIDING HEALTH CARE AND HEALTH CON-  
SULTING SERVICES TO THESE PERSONS VIA THE  
INTERNET, IN CLASS 44 (U.S. CLS. 100 AND 101).

THE MARK CONSISTS OF STANDARD CHAR-  
ACTERS WITHOUT CLAIM TO ANY PARTICULAR  
FONT, STYLE, SIZE, OR COLOR.

OWNER OF INTERNATIONAL REGISTRATION  
0933862 DATED 5-29-2007, EXPIRES 5-29-2017.

SER. NO. 79-042,366, FILED 5-29-2007.

MARILYN IZZI, EXAMINING ATTORNEY

**Int. Cl.: 10**

**Prior U.S. Cls.: 26, 39 and 44**

**United States Patent and Trademark Office**

**Reg. No. 3,499,320**

**Registered Sep. 9, 2008**

**TRADEMARK  
PRINCIPAL REGISTER**

**TimCT**

SIEMENS AKTIENGESELLSCHAFT (FED REP  
GERMANY JOINT STOCK COMPANY)  
WITTELSBACHERPLATZ 2  
80333 MÜNCHEN  
FED REP GERMANY

FOR: MEDICAL DIAGNOSTIC DEVICES, NAME-  
LY, MRI DIAGNOSTIC APPARATUS; MEDICAL  
APPARATUS AND DEVICES FOR MAGNETIC RE-  
SONANCE TOMOGRAPHY; MEDICAL DEVICES  
FOR PROTON IMAGING; REPLACEMENT PARTS  
OF THESE MEDICAL APPARATUS AND DEVICES,  
IN CLASS 10 (U.S. CLS. 26, 39 AND 44).

THE MARK CONSISTS OF STANDARD CHAR-  
ACTERS WITHOUT CLAIM TO ANY PARTICULAR  
FONT, STYLE, SIZE, OR COLOR.

PRIORITY DATE OF 2-21-2007 IS CLAIMED.

OWNER OF INTERNATIONAL REGISTRATION  
0934237 DATED 7-24-2007, EXPIRES 7-24-2017.

OWNER OF U.S. REG. NO. 2,906,556.

SER. NO. 79-042,497, FILED 7-24-2007.

SUZANNE BLANE, EXAMINING ATTORNEY

**Int. Cls.: 9, 16, 37, 38, 41 and 42**

**Prior U.S. Cls.: 2, 5, 21, 22, 23, 26, 29, 36, 37, 38, 50,  
100, 101, 103, 104, 106 and 107**

**Reg. No. 3,499,321**

**United States Patent and Trademark Office**

**Registered Sep. 9, 2008**

**TRADEMARK  
SERVICE MARK  
PRINCIPAL REGISTER**

**VPI**

ALSTOM (FRANCE SOCIÉTÉ ANONYME)  
3, AVENUE ANDRÉ MALRAUX  
F-92300 LEVALLOIS-PERRET, FRANCE

FOR: BLANK CARDS FOR INTEGRATED CIRCUITS OR MICROPROCESSORS; CENTRAL PROCESSING UNITS; CENTRAL PROCESSING UNITS; SOFTWARE-PROGRAMMABLE MICROPROCESSORS; COMPUTER HARDWARE AND PERIPHERALS; COMPUTER NETWORKING HARDWARE; APPLICATION SOFTWARE, NAMELY, FOR APPLICATION AND DATABASE INTEGRATION; COMPUTER SOFTWARE, NAMELY, FOR CONTROLLING AND MANAGING ACCESS SERVER APPLICATIONS; COMPUTER SOFTWARE DEVELOPMENT TOOLS; COMPUTER SOFTWARE FOR COMPUTER-ASSISTED SOFTWARE ENGINEERING, NAMELY, FOR SETTING UP AND CONFIGURING SIDE AREA NETWORKS; MICROPROCESSOR-CONTROLLED SWITCHING UNITS, ALL OF THE FOREGOING IN THE FIELD OF RAIL SYSTEMS, IN CLASS 9 (U.S. CLS. 21, 23, 26, 36 AND 38).

FOR: USER AND INSTRUCTION MANUALS FOR COMPUTER HARDWARE AND SOFTWARE IN THE FIELD OF RAIL SYSTEMS, IN CLASS 16 (U.S. CLS. 2, 5, 22, 23, 29, 37, 38 AND 50).

FOR: INSTALLATION, MAINTENANCE AND REPAIR OF COMPUTER HARDWARE IN THE FIELD OF RAIL SYSTEMS, IN CLASS 37 (U.S. CLS. 100, 103 AND 106).

FOR: PROVIDING COMMUNICATION PROTOCOLS FOR FACILITATING THE EXCHANGE OF DATA OR THE TRANSMISSION OF DATA BE-

TWEEN TWO OR MORE COMMUNICATION PARTNERS, NAMELY, PROVIDING ONLINE LIST SERVERS FOR TRANSMISSION OF MESSAGES AMONG COMPUTER USERS IN THE FIELD OF RAIL SYSTEMS, IN CLASS 38 (U.S. CLS. 100, 101 AND 104).

FOR: TRAINING SERVICES FOR THE USE OF COMPUTER SOFTWARE IN THE FIELD OF RAIL SYSTEMS, IN CLASS 41 (U.S. CLS. 100, 101 AND 107).

FOR: DESIGN OF COMPUTER EQUIPMENT, PROGRAMS AND SOFTWARE FOR OTHERS; COMPUTER PROGRAMMING; INSTALLATION, DESIGN, WRITING, MAINTENANCE, DEVELOPMENT AND UPDATING OF COMPUTER SOFTWARE; RESEARCH, DEVELOPMENT AND UPGRADING FOR COMPUTER SOFTWARE AND HARDWARE; INSTALLATION, MAINTENANCE AND REPAIR OF FIRMWARE; DESIGN OF COMMUNICATION PROTOCOLS FOR FACILITATING THE EXCHANGE OF DATA OR THE TRANSMISSION OF DATA BETWEEN TWO OR MORE COMMUNICATION PARTNERS; DIAGNOSTIC SERVICES WITH REGARD TO MICROPROCESSORS, CENTRAL PROCESSING UNITS, COMPUTER HARDWARE AND SOFTWARE; CONSULTATION AND ADVISORY SERVICES REGARDING INSTALLING AND INTEGRATING A COMPUTER NETWORK, SOFTWARE, PERIPHERAL EQUIPMENT IN THE FIELD OF COMPUTER HARDWARE AND SOFTWARE, ALL OF THE FOREGOING IN THE FIELD OF RAIL SYSTEMS, IN CLASS 42 (U.S. CLS. 100 AND 101).



THE MARK CONSISTS OF STANDARD CHAR-  
ACTERS WITHOUT CLAIM TO ANY PARTICULAR  
FONT, STYLE, SIZE, OR COLOR.

OWNER OF INTERNATIONAL REGISTRATION  
0934647 DATED 4-20-2007, EXPIRES 4-20-2017.

SER. NO. 79-042,655, FILED 4-20-2007.

PRIORITY DATE OF 11-13-2006 IS CLAIMED.

SUZANNE BLANE, EXAMINING ATTORNEY

**Int. Cl.: 35**

**Prior U.S. Cls.: 100, 101 and 102**

**United States Patent and Trademark Office**

**Reg. No. 3,499,322**

**Registered Sep. 9, 2008**

**SERVICE MARK  
PRINCIPAL REGISTER**



BUHLMANN ROHR-FITTINGS-STAHLHANDEL;  
GMBH + CO. KG (FED REP GERMANY  
LIMITED PARTNERSHIP)

ARBERGER HAFENDAMM 1  
BREMEN, FED REP GERMANY 28309

FOR: WHOLESALING STORES AND DISTRIBUTORSHIPS FEATURING METAL PIPES, METAL SHEETS, METAL PIPELINES, METAL PIPE CONNECTORS, METAL MANIFOLDS, METAL PIPE BENDS, STEEL PIPES, STAINLESS STEEL PIPES, METAL DISCHARGE PIPES, METAL BRANCH PIPES, METAL FAUCET PIPES, PIPE ACCESSORIES IN THE NATURE OF METAL CONNECTING SLEEVES, METAL PIPE CLAMPS, METAL PIPE BENDERS, METAL VALVES, METAL SLIDERS, METAL SUPPORTS, METAL SEALING FLAPS, METAL FIXING MATERIAL, METAL CLIPS, METAL FLANGES, METAL CAPS, AND METAL FILINGS, METAL FRAMES, METAL RINGS; BUSINESS MANAGEMENT IN THE NATURE OF ORGANIZATIONAL PRODUCT MANAGEMENT FOR THE INSTALLATION OF PIPELINE SYSTEMS, IN CLASS 35 (U.S. CLS. 100, 101 AND 102).

PRIORITY DATE OF 10-31-2006 IS CLAIMED.

OWNER OF INTERNATIONAL REGISTRATION  
0934721 DATED 4-27-2007, EXPIRES 4-27-2017.

NO CLAIM IS MADE TO THE EXCLUSIVE RIGHT TO USE "TUBE-SOLUTIONS", APART FROM THE MARK AS SHOWN.

THE COLOR(S) BLACK, GRAY, RED, BLUE, GREEN, AND YELLOW IS/ARE CLAIMED AS A FEATURE OF THE MARK.

THE COLOR BLACK APPEARS IN THE TEXT OF THE WORDING "BUHLMANN TUBE-SOLUTIONS". A HORIZONTAL LINE APPEARS BELOW THE TEXT. THE HORIZONTAL LINE IS MADE UP OF 5 RECTANGLES APPEARING SIDE BY SIDE. FROM LEFT TO RIGHT, THE FIRST RECTANGLE IS GRAY, THE SECOND RECTANGLE IS RED, THE THIRD RECTANGLE IS BLUE, THE FOURTH RECTANGLE IS GREEN, AND THE FIFTH RECTANGLE IS YELLOW.

SER. NO. 79-042,676, FILED 4-27-2007.

ELI HELLMAN, EXAMINING ATTORNEY

**Int. Cls.: 9, 18, 25 and 28**

**Prior U.S. Cls.: 1, 2, 3, 21, 22, 23, 26, 36, 38, 39, 41 and 50**

**Reg. No. 3,499,323**

**United States Patent and Trademark Office**

**Registered Sep. 9, 2008**

**TRADEMARK  
PRINCIPAL REGISTER**

**KJUS**

LASSE KJUS (NORWAY INDIVIDUAL)  
DIAKONVEIEN 7  
N-0370 OSLO, NORWAY

FOR: PROTECTIVE HELMETS FOR SPORTS, NAMELY, SKIING; CORRECTIVE GLASSES, SPORT'S GLASSES, SKI GLASSES, CASES FOR EYE GLASSES, CASES FOR SPORT'S GLASSES, CASES FOR SUN GLASSES, CASES FOR CORRECTIVE GLASSES, SUNGLASSES, SKI GOGGLES, PROTECTIVE FACE MASKS FOR SKIING, IN CLASS 9 (U.S. CLS. 21, 23, 26, 36 AND 38).

FOR: TRUNKS; TRAVELING BAGS; BAGS, NAMELY, ATHLETIC BAGS, BAGS FOR SPORTS CLOTHING, BAGS FOR SPORTS, BEACH BAGS, SPORTS BAGS, CARRY-ALL BAGS, DUFFEL BAGS, GARMENT BAGS FOR TRAVEL, GYM BAGS, TOTE BAGS, WAIST BAGS, SHOULDER BAGS, WRISTLET BAGS; RUCKSACKS; HANDBAGS; BAGS TO BE WORN ON THE BELT; SHOPPING BAGS MADE OF CANVAS, TEXTILE, LEATHER, MESH; SHOE BAGS FOR TRAVEL; ALPINE BAGS FOR CARRYING SPORTS EQUIPMENT; SCHOOL BAGS; ROLLING BAGS, NAMELY, WHEELED BAGS, WHEELED TOTE BAGS, WHEELED MESSENGER BAGS, WHEELED DUFFEL BAGS, SHOPPING BAGS WITH WHEELS ATTACHED, LUGGAGE WITH WHEELS ATTACHED; TOOL BAGS SOLD EMPTY; SUIT BAGS; ALL PURPOSE SPORTS BAGS, IN CLASS 18 (U.S. CLS. 1, 2, 3, 22 AND 41).

FOR: CLOTHING, NAMELY, SPORTS CLOTHING IN THE FORM OF SKI JACKETS, SKI PANTS, SKI MASKS, SKI WEAR, SKI SUITS, BIBS, GLOVES; SPORTS CLOTHING FOR MOUNTAIN SPORTS IN THE FORM OF JACKETS, TROUSERS, PARKAS, SHORTS, GLOVES, CLIMBING BOOTS; INSULATED CLOTHING, NAMELY, JACKETS, PANTS, GLOVES; GAITERS; OVER CLOTHES, NAMELY,

OVERCOATS, OVERALLS, OVER-TROUSERS, OVERSHOES; RAINCOATS, RAINWEAR, NAMELY, RAIN RESISTANT JACKETS, TROUSERS AND PONCHOS; GLOVES; MITTENS; MITTENS COVERS, NAMELY, MITTENS WORN OVER MITTENS; BEANIES, HEADBANDS; BELTS; SKI CLOTHES, NAMELY, PARKAS, ANORAKS; SHIRTS; POLO SHIRTS; T-SHIRTS; SHORTS; SKIRTS; SWEATSHIRTS; BERMUDA SHORTS; VESTS; WIND-RESISTANT JACKETS AND TROUSERS; SOCKS, FOOTWEAR, NAMELY, BOOTS, HIKING SHOES, WALKING SHOES, MOUNTAIN SHOES, LEISURE SHOES, SKI BOOTS, AFTER-SKI SHOES; SKI GLOVES; HEADGEAR, NAMELY, HATS AND CAPS, VISORS FOR CAPS, BEANIES, IN CLASS 25 (U.S. CLS. 22 AND 39).

FOR: GYMNASTIC AND SPORTS ARTICLES, NAMELY, SNOW SKIS, CROSS-COUNTRY SKIS, SNOW BOARDS, SNOW SAUCERS, PORTABLE SKI CARRIERS, SKI STICKS, SKI ROPES, ALPINE SKIS, SKI BINDINGS, SKI POLES, DISCS FOR SKI POLES, GRIPS AND LOOPS FOR SKI POLES, SKI EDGES, BINDINGS FOR SKIS, SKI BRAKES, FRICTION DISCS FOR SKIS, SKI COVERINGS, BINDING COVERINGS, SCRAPERS AND SCRAPER PROTECTORS FOR SKIS, SLALOM PLUGS AND GATES, SKI WAX, KNEE PROTECTORS FOR ATHLETIC USE, TIBIA PROTECTORS FOR ATHLETIC USE, ELBOW PROTECTORS, NAMELY, ELBOW GUARDS AND PADS FOR ATHLETIC USE; SKI SCRAPERS; PROTECTION PADDING FOR SPORTS, NAMELY, FOR ELBOWS, KNEES AND WRISTS, FOR USE IN SKIING, HOCKEY, FOOTBALL, BASEBALL; SPORTS BAGS ESPECIALLY ADAPTED FOR SPORTS ARTICLES, NAMELY, SKIS, SKI POLES, BINDING FOR SKIS, SKI BRAKES, BINDING COVERS, IN CLASS 28 (U.S. CLS. 22, 23, 38 AND 50).

THE MARK CONSISTS OF STANDARD CHARACTERS WITHOUT CLAIM TO ANY PARTICULAR FONT, STYLE, SIZE, OR COLOR.

OWNER OF INTERNATIONAL REGISTRATION 0934730 DATED 4-20-2007, EXPIRES 4-20-2017.

OWNER OF U.S. REG. NOS. 2,572,723 AND 2,711,706.

THE NAME(S), PORTRAIT(S), AND/OR SIGNATURE(S) SHOWN IN THE MARK IDENTIFIES A LIVING INDIVIDUAL, WHOSE CONSENT(S) TO REGISTER IS SUBMITTED.

SER. NO. 79-042,678, FILED 4-20-2007.

SUZANNE BLANE, EXAMINING ATTORNEY

**Int. Cls.: 3 and 25**

**Prior U.S. Cls.: 1, 4, 6, 22, 39, 50, 51 and 52**

**United States Patent and Trademark Office**

**Reg. No. 3,499,324**

**Registered Sep. 9, 2008**

**TRADEMARK  
PRINCIPAL REGISTER**

# **SPEEDSTER**

DR. ING. H.C. F. PORSCHE AKTIENGESELL-  
SCHAFT  
PORSCHEPLATZ, 1  
70435 STUTTGART  
FED REP GERMANY

FOR: PERFUMERY, COSMETICS, IN CLASS 3  
(U.S. CLS. 1, 4, 6, 50, 51 AND 52).

FOR: CLOTHING, NAMELY, BELTS, GLOVES,  
SCARVES, TIES, JACKETS, SHIRTS, TOPS, BERMU-  
DAS SHORTS, LEATHER BIKE JACKETS, BLOU-  
SONS, COATS, DOWN JACKETS, POLOS, BLAZERS,  
LONG-SLEEVED PULLOVERS, PANTS, TROUSERS,  
T-SHIRTS, SWEATERS, SWEATSHIRTS, RAIN  
JACKETS, RAIN PANTS, WIND PANTS, WIND  
SHIRTS, WIND SWEATERS, SOCKS, GOLF SWEA-

TERS, GOLF RAIN JACKETS, GOLF RAIN PANTS,  
GOLF WIND SWEATERS, RUNNING TIGHTS,  
TRAINING SHORTS, AND TENNIS PANTS, IN  
CLASS 25 (U.S. CLS. 22 AND 39).

OWNER OF INTERNATIONAL REGISTRATION  
0635851 DATED 4-19-1995, EXPIRES 4-19-2015.

OWNER OF U.S. REG. NOS. 2,100,600 AND  
2,143,812.

SER. NO. 79-042,823, FILED 7-17-2007.

MARILYN IZZI, EXAMINING ATTORNEY

**Int. Cl.: 36**

**Prior U.S. Cls.: 100, 101 and 102**

**United States Patent and Trademark Office**

**Reg. No. 3,499,325**

**Registered Sep. 9, 2008**

**SERVICE MARK  
PRINCIPAL REGISTER**

**SBC**

UBS AG (SWITZERLAND SOCIÉTÉ ANONYME  
(SA) (JOINT STOCK COMPANY))  
BAHNHOFSTRASSE 45  
CH-8001 ZÜRICH, SWITZERLAND

FOR: INSURANCE UNDERWRITING FOR ALL TYPES OF INSURANCE AND BANKING SERVICES IN CONNECTION WITH BANKING AND BANKING-RELATED ESTABLISHMENTS, NAMELY, MONEY EXCHANGING OFFICES, LENDING INSTITUTIONS, INVESTMENT TRUSTS, TRUST COMPANIES AND REAL ESTATE COMPANIES IN THE FIELD OF INSURANCE, UNDERWRITING AND FINANCIAL AFFAIRS, PAPER SECURITIES, CURRENCIES AND PRECIOUS METALS AS WELL AS ADMINISTRATION OF ASSETS, AND BROKERAGE IN CONNECTION WITH THE AFOREMEN-

TIONED AFFAIRS, IN CLASS 36 (U.S. CLS. 100, 101 AND 102).

THE MARK CONSISTS OF STANDARD CHARACTERS WITHOUT CLAIM TO ANY PARTICULAR FONT, STYLE, SIZE, OR COLOR.

OWNER OF INTERNATIONAL REGISTRATION 0671220 DATED 3-20-1997, EXPIRES 3-20-2017.

OWNER OF U.S. REG. NO. 2,996,435.

SER. NO. 79-042,829, FILED 3-22-2007.

ELLEN PERKINS, EXAMINING ATTORNEY

**Int. Cls.: 6, 12 and 42**

**Prior U.S. Cls.: 2, 12, 13, 14, 19, 21, 23, 25, 31, 35, 44,  
50, 100 and 101**

**Reg. No. 3,499,326**

**Registered Sep. 9, 2008**

**United States Patent and Trademark Office**

---

**TRADEMARK  
SERVICE MARK  
PRINCIPAL REGISTER**



L & S LUDDENEIT UND SCHERF GMBH (FED  
REP GERMANY LIMITED LIABILITY COM-  
PANY)

WIMMLERSTRABE 25  
07806 NEUSTADT/ORLA  
FED REP GERMANY

FOR: RAILS OF METAL, IN CLASS 6 (U.S. CLS. 2,  
12, 13, 14, 23, 25 AND 50).

FOR: MOTOR CARS; RAILWAY ROLLING  
STOCK, IN CLASS 12 (U.S. CLS. 19, 21, 23, 31, 35  
AND 44).

FOR: RESEARCH AND DEVELOPMENT FOR  
NEW PRODUCTS FOR OTHERS; TECHNICAL RE-

SEARCH, NAMELY, MECHANICAL RESEARCH,  
IN CLASS 42 (U.S. CLS. 100 AND 101).

OWNER OF INTERNATIONAL REGISTRATION  
0935249 DATED 7-19-2007, EXPIRES 7-19-2017.

NO CLAIM IS MADE TO THE EXCLUSIVE  
RIGHT TO USE "GMBH", APART FROM THE  
MARK AS SHOWN.

THE FOREIGN WORDING IN THE MARK  
TRANSLATES INTO ENGLISH AS "AND".

SER. NO. 79-042,918, FILED 7-19-2007.

DAVID I, EXAMINING ATTORNEY

**Int. Cls.: 1 and 4**

**Prior U.S. Cls.: 1, 5, 6, 10, 15, 26 and 46**

**Reg. No. 3,499,327**

**United States Patent and Trademark Office**

**Registered Sep. 9, 2008**

**TRADEMARK  
PRINCIPAL REGISTER**

# MoCOOL

MOTUL (FRANCE SOCIÉTÉ ANONYME)  
119, BOULEVARD FÉLIX-FAURE  
F-93300 AUBERVILLIERS  
FRANCE

FOR: CHEMICAL ADDITIVES FOR LIQUID COOLANTS, ALL THESE GOODS NOT INTENDED FOR USE IN THE METALLURGY INDUSTRY, IN CLASS 1 (U.S. CLS. 1, 5, 6, 10, 26 AND 46).

FOR: INDUSTRIAL OILS AND GREASES; ALL PURPOSE LUBRICANTS; DUST ABSORBING, WETTING AND BINDING PRODUCTS FOR USE IN THE MAINTENANCE OF MOTOR VEHICLES AND RECREATIONAL MOTORIZED VEHICLES; FUELS INCLUDING MOTOR FUELS, NAMELY, GASO-

LINE AND DIESEL FUELS FOR MOTOR VEHICLES, ALL THESE GOODS NOT INTENDED FOR USE IN THE METALLURGY INDUSTRY, IN CLASS 4 (U.S. CLS. 1, 6 AND 15).

PRIORITY DATE OF 12-14-2006 IS CLAIMED.

OWNER OF INTERNATIONAL REGISTRATION 0935884 DATED 5-31-2007, EXPIRES 5-31-2017.

SER. NO. 79-043,148, FILED 5-31-2007.

DEBRA LEE, EXAMINING ATTORNEY



**Int. Cls.: 7, 9 and 11**

**Prior U.S. Cls.: 13, 19, 21, 23, 26, 31, 34, 35, 36 and 38**

**Reg. No. 3,499,328**

**United States Patent and Trademark Office**

**Registered Sep. 9, 2008**

**TRADEMARK  
PRINCIPAL REGISTER**

The logo for Everel, featuring the word "Everel" in a bold, italicized, sans-serif font. The letter "E" is significantly larger and more prominent than the other letters, which are smaller and more closely spaced.

VEMER-SIBER GROUP S.P.A. (ITALY JOINT STOCK COMPANY)  
VIA CAVOUR, 9  
I-37067 VALEGGIO SUL MINCIO (VERONA), ITALY

FOR: PARTS FOR MACHINES, NAMELY, FANS FOR MOTOR AND ENGINES; PARTS FOR MACHINES, NAMELY, FAN BELTS FOR MOTORS AND ENGINES; AXIAL FAN CONDENSERS; CENTRIFUGAL FAN CONDENSERS; HYDRAULIC MOTORS AND ENGINES FOR MACHINES; ELECTRIC MOTORS, OTHER THAN FOR LAND VEHICLES; INDUCTION MOTORS, OTHER THAN FOR LAND VEHICLES; AXIAL MOTORS, OTHER THAN FOR LAND VEHICLES; COOLING RADIATORS FOR MOTORS AND ENGINES, IN CLASS 7 (U.S. CLS. 13, 19, 21, 23, 31, 34 AND 35).

FOR: STARTER CABLES FOR MOTORS; ELECTRIC RESISTANCES; ELECTRIC COILS; QUARTZ TUBE RESISTANCES WITH CERAMIC INSULATING SUPPORT FOR APPLICATIONS IN OVENS AND RADIATORS; ELECTRICAL SWITCHES FOR ELECTRICAL APPLIANCES; ELECTRIC SWITCHES, NAMELY, ROCKER SWITCHES; SLIDE SWITCHES; ROTARY SWITCHES; PUSH-BUTTON SWITCHES; SINGLE-POLE SWITCHES; DOUBLE-POLE SWITCHES; SINGLE-POLE MOMENTARY SWITCHES; DOUBLE-POLE MOMENTARY SWITCHES; CHANGE-OVER SWITCHES FOR TELECOMMUNICATION APPARATUS; CUT-OUT SWITCHES; DIFFERENTIAL SWITCHES; ELECTRIC CURRENT SWITCHES; ELECTRIC LIGHT SWITCHES; ELECTRIC SWITCHES; ELECTRONIC TOUCH SENSITIVE SWITCHES; HIGH FREQUENCY SWITCHES; LIGHT SWITCHES; POWER SWITCHES; SWITCH BOXES; TELECOMMUNICATION SWITCHES; ELECTRIC SOCKETS; ELECTRICAL SOCKETS; MOVEABLE SOCKETS; MULTI-OUTLET SOCKET BLOCKS; INDICATOR LIGHTS; FLASHING SAFETY LIGHTS; SOCKETS FOR ELEC-

TRIC RELAYS, IN CLASS 9 (U.S. CLS. 21, 23, 26, 36 AND 38).

FOR: AIR CONDITIONING FANS FOR COMMERCIAL USE; FANS FOR AIR-CONDITIONING INSTALLATIONS; COOLING FAN SYSTEMS FOR WALL OVENS; ELECTRIC FANS; ELECTRIC HEATING FANS; VENTILATING FANS FOR COMMERCIAL AND INDUSTRIAL USE; AIR-CONDITIONING VENTILATION APPARATUS FOR INDUSTRIAL PURPOSES; COILS SOLD AS A COMPONENT OF DISTILLING, HEATING AND COOLING UNITS; HEATING ELEMENTS, NAMELY, HEATING PADS NOT FOR MEDICAL PURPOSES; HEATING APPARATUS, NAMELY ELECTRIC SPACE HEATERS; HEATING RADIATORS; THERMOSTATIC VALVES, BEING PARTS OF HEATING INSTALLATIONS; VENTILATORS FOR OVENS EXTERNAL VENTILATION AND NO-FROST VENTILATION APPLICATIONS; HEATING ELEMENTS, NAMELY, AXIAL FAN HEATERS, RADIAL FAN HEATERS AND CENTRIFUGAL FAN HEATERS; SOCKETS FOR ELECTRIC LIGHTS, IN CLASS 11 (U.S. CLS. 13, 21, 23, 31 AND 34).

PRIORITY DATE OF 11-24-2006 IS CLAIMED.

OWNER OF INTERNATIONAL REGISTRATION 0935899 DATED 4-6-2007, EXPIRES 4-6-2017.

THE MARK CONSISTS OF A SIGN DEPICTING THE WORDING "EVEREL" IN FANCY CHARACTERS AND IN WHICH THE INITIAL LETTER "E" IS OF A LARGER SIZE.

SER. NO. 79-043,156, FILED 4-6-2007.

SUSAN RICHARDS, EXAMINING ATTORNEY

**Int. Cl.: 30**

**Prior U.S. Cl.: 46**

**United States Patent and Trademark Office**

**Reg. No. 3,499,329**

**Registered Sep. 9, 2008**

**TRADEMARK  
PRINCIPAL REGISTER**

**Conditorei Coppenrath & Wiese**

CONDITOREI COPPENRATH & WIESE; GMBH &  
CO. KG (FED REP GERMANY GMBH & CO.  
KB (LIMITED PARTNERSHIP; LIMITED LIA-  
BILITY COMPANY AS GENERAL PARTNER))  
ZUM ATTERSEE 2  
49076 OSNABRÜCK  
FED REP GERMANY

FOR: FINE PASTRIES AND CONFECTIONERY  
GOODS, NAMELY, CREAM CAKES AND CREAM  
CAKE SLICES, BAKED CAKES AND BAKED CAKE  
SLICES, STRUDELS, AND PASTRIES; EACH OF  
THE GOODS ALSO FROZEN, IN CLASS 30 (U.S.  
CL. 46).

OWNER OF INTERNATIONAL REGISTRATION  
0636501 DATED 4-12-1995, EXPIRES 4-12-2015.

OWNER OF U.S. REG. NOS. 2,092,766, 3,246,416  
AND OTHERS.

NO CLAIM IS MADE TO THE EXCLUSIVE  
RIGHT TO USE "CONDITOREI", APART FROM  
THE MARK AS SHOWN.

THE ENGLISH TRANSLATION OF THE WORD  
"CONDITOREI" IN THE MARK IS "CONFECTION-  
ERY".

SER. NO. 79-043,218, FILED 7-24-2007.

CHRISTOPHER BUONGIORNO, EXAMINING AT-  
TORNEY

**Int. Cls.: 3, 7 and 8**

**Prior U.S. Cls.: 1, 4, 6, 13, 19, 21, 23, 28, 31, 34, 35, 44,  
50, 51 and 52**

**Reg. No. 3,499,330**

**United States Patent and Trademark Office**

**Registered Sep. 9, 2008**

**TRADEMARK  
PRINCIPAL REGISTER**

**DRONCO**

DRONCO AG (FED REP GERMANY JOINT  
STOCK COMPANY)  
WIESENMÜHLE 1  
95632 WUNSIEDEL  
FED REP GERMANY

FOR: CLEANING, POLISHING, SCOURING AND  
ABRASIVE PREPARATIONS, IN CLASS 3 (U.S. CLS.  
1, 4, 6, 50, 51 AND 52).

FOR: MACHINES FOR MATERIAL WORKING  
AND PROCESSING, NAMELY, GRINDING MA-  
CHINES, CUTTING MACHINES, POLISHING MA-  
CHINES; MACHINE TOOLS, NAMELY, WHEELS,  
DISCS AND DRILLS, GRINDING POINTS, ROUTER  
BITS AND PARTS THEREOF INCLUDED IN THIS  
CLASS, NAMELY, STRIPS, ROLLS AND BELTS, IN  
CLASS 7 (U.S. CLS. 13, 19, 21, 23, 31, 34 AND 35).

FOR: HAND TOOLS AND IMPLEMENTS FOR  
MATERIAL WORKING AND PROCESSING, NAME-  
LY, GRINDERS, SANDERS, POLISHERS, DRILLS  
AND DRILL BITS, IN CLASS 8 (U.S. CLS. 23, 28 AND  
44).

THE MARK CONSISTS OF STANDARD CHAR-  
ACTERS WITHOUT CLAIM TO ANY PARTICULAR  
FONT, STYLE, SIZE, OR COLOR.

OWNER OF INTERNATIONAL REGISTRATION  
0797728 DATED 2-21-2003, EXPIRES 2-21-2013.

SER. NO. 79-043,231, FILED 8-10-2007.

JAMES STEIN, EXAMINING ATTORNEY

**Int. Cl.: 33**

**Prior U.S. Cls.: 47 and 49**

**United States Patent and Trademark Office**

**Reg. No. 3,499,331**

**Registered Sep. 9, 2008**

**TRADEMARK  
PRINCIPAL REGISTER**

**TOUR DE MANDELOTTE**

MAISON GINESTET, SOCIÉTÉ ANONYME  
(FRANCE SOCIÉTÉ ANONYME)  
19, AVENUE DE FONTENILLE  
F-33360 CARRIGNAN DE BORDEAUX  
FRANCE

FOR: PROTECTED LABEL OF ORIGIN WINES,  
PROTECTED LABEL OF ORIGIN BRANDIES, IN  
CLASS 33 (U.S. CLS. 47 AND 49).

THE MARK CONSISTS OF STANDARD CHAR-  
ACTERS WITHOUT CLAIM TO ANY PARTICULAR  
FONT, STYLE, SIZE, OR COLOR.

OWNER OF INTERNATIONAL REGISTRATION  
0847849 DATED 3-31-2005, EXPIRES 3-31-2015.

THE FOREIGN WORDING IN THE MARK  
TRANSLATES INTO ENGLISH AS TOWER OF  
MANDELOTTE.

SER. NO. 79-043,241, FILED 1-24-2007.

SUSAN RICHARDS, EXAMINING ATTORNEY

**Int. Cl.: 3**

**Prior U.S. Cls.: 1, 4, 6, 50, 51 and 52**

**United States Patent and Trademark Office**

**Reg. No. 3,499,332**

**Registered Sep. 9, 2008**

**TRADEMARK  
PRINCIPAL REGISTER**

**MYRREA**

PIERRE FABRE DERMOCOSMETIQUE  
(FRANCE SOCIÉTÉ ANONYME)  
45, PLACE ABEL GANCE,  
F-92100 BOULOGNE  
FRANCE

FOR: HAIR BEAUTY AND HAIR CARE  
SMOOTHING PREPARATIONS, IN CLASS 3 (U.S.  
CLS. 1, 4, 6, 50, 51 AND 52).

THE MARK CONSISTS OF STANDARD CHAR-  
ACTERS WITHOUT CLAIM TO ANY PARTICULAR  
FONT, STYLE, SIZE, OR COLOR.

PRIORITY DATE OF 3-12-2007 IS CLAIMED.

OWNER OF INTERNATIONAL REGISTRATION  
0936012 DATED 8-17-2007, EXPIRES 8-17-2017.

SER. NO. 79-043,249, FILED 8-17-2007.

DAVID C. REIHNER, EXAMINING ATTORNEY

**Int. Cl.: 11**

**Prior U.S. Cls.: 13, 21, 23, 31 and 34**

**United States Patent and Trademark Office**

**Reg. No. 3,499,333**

**Registered Sep. 9, 2008**

**TRADEMARK  
PRINCIPAL REGISTER**

# FireBird

PICWAL AUSTRALIA PTY LTD; ACN 057 415 997  
(AUSTRALIA PROPRIETARY LIMITED COMPANY)  
114-118 CAPEL STREET  
NORTH MELBOURNE VIC 3051  
AUSTRALIA

FOR: BARBECUES, BARBECUE GRILLS, BARBECUE HOT PLATES, OUTDOOR COOKERS FOR CURING FOOD, IN CLASS 11 (U.S. CLS. 13, 21, 23, 31 AND 34).

THE MARK CONSISTS OF STANDARD CHARACTERS WITHOUT CLAIM TO ANY PARTICULAR FONT, STYLE, SIZE, OR COLOR.

OWNER OF INTERNATIONAL REGISTRATION  
0936083 DATED 8-27-2007, EXPIRES 8-27-2017.

SER. NO. 79-043,270, FILED 8-27-2007.

CYNTHIA SLOAN, EXAMINING ATTORNEY

**Int. Cl.: 20**

**Prior U.S. Cls.: 2, 13, 22, 25, 32 and 50**

**United States Patent and Trademark Office**

**Reg. No. 3,499,334**

**Registered Sep. 9, 2008**

**TRADEMARK  
PRINCIPAL REGISTER**

**ebag**

PICWAL AUSTRALIA PTY LTD; ACN 057 415 997  
(AUSTRALIA PROPRIETARY LIMITED COM-  
PANY)

114-118 CAPEL STREET  
NORTH MELBOURNE VIC 3051  
AUSTRALIA

FOR: SLEEPING BAGS, SLEEPING BAGS FOR  
CAMPING, SLEEPING BAGS INCORPORATING A  
CUSHION, SLEEPING BAGS FOR INCORPORAT-  
ING A PILLOW, CAMPING FURNITURE, IN CLASS  
20 (U.S. CLS. 2, 13, 22, 25, 32 AND 50).

THE MARK CONSISTS OF STANDARD CHAR-  
ACTERS WITHOUT CLAIM TO ANY PARTICULAR  
FONT, STYLE, SIZE, OR COLOR.

PRIORITY DATE OF 8-8-2007 IS CLAIMED.

OWNER OF INTERNATIONAL REGISTRATION  
0936089 DATED 8-27-2007, EXPIRES 8-27-2017.

SER. NO. 79-043,272, FILED 8-27-2007.

CYNTHIA SLOAN, EXAMINING ATTORNEY

**Int. Cl.: 3**

**Prior U.S. Cls.: 1, 4, 6, 50, 51 and 52**

**United States Patent and Trademark Office**

**Reg. No. 3,499,335**

**Registered Sep. 9, 2008**

**TRADEMARK  
PRINCIPAL REGISTER**

**AMOUR D'ANGE**

MONSIEUR LESMAN STEVE (FRANCE JOINT  
APPLICANT)

31 RUE GREFFULHE

F-92300 LEVALLOIS PERRET

FRANCE AND

MADAME MEYER PATRICIA (FRANCE JOINT  
APPLICANT)

31 RUE GREFFULHE

F-92300 LEVALLOIS PERRET

FRANCE

FOR: PERFUMES, NAMELY, PERFUMES FOR  
PERSONAL USE, SCENTED WATER, COLOGNE  
WATER, TOILET WATER, PERFUME EXTRACTS;  
COSMETICS, IN CLASS 3 (U.S. CLS. 1, 4, 6, 50, 51 AND  
52).

THE MARK CONSISTS OF STANDARD CHAR-  
ACTERS WITHOUT CLAIM TO ANY PARTICULAR  
FONT, STYLE, SIZE, OR COLOR.

PRIORITY DATE OF 2-20-2007 IS CLAIMED.

OWNER OF INTERNATIONAL REGISTRATION  
0936146 DATED 8-20-2007, EXPIRES 8-20-2017.

THE FOREIGN WORDING IN THE MARK  
TRANSLATES INTO ENGLISH AS "ANGEL LOVE".

SER. NO. 79-043,291, FILED 8-20-2007.

DAVID C. REIHNER, EXAMINING ATTORNEY



Int. Cl.: 33

Prior U.S. Cls.: 47 and 49

United States Patent and Trademark Office

Reg. No. 3,499,336

Registered Sep. 9, 2008

TRADEMARK  
PRINCIPAL REGISTER

DOMINGOS

José Maria da Fonseca

JOSÉ MARIA DA FONSECA, VINHOS, S.A. (PORTUGAL SOCIÉTÉ ANONYME)  
R. JOSÉ AUGUSTO COELHO 11-13  
VILA NOGUEIRA DE AZEITÃO  
P-2925-542 AZEITÃO, PORTUGAL

THE NAME(S), PORTRAIT(S), AND/OR SIGNATURE(S) SHOWN IN THE MARK DOES NOT IDENTIFY A PARTICULAR LIVING INDIVIDUAL.

FOR: ALCOHOLIC BEVERAGES EXCEPT BEERS, IN CLASS 33 (U.S. CLS. 47 AND 49).

THE WORD "DOMINGOS" APPEARING IN THE MARK IS PORTUGUESE FOR SUNDAYS.

PRIORITY DATE OF 3-29-2007 IS CLAIMED.

SER. NO. 79-043,327, FILED 8-14-2007.

OWNER OF INTERNATIONAL REGISTRATION 0936240 DATED 8-14-2007, EXPIRES 8-14-2017.

SHANNON TWOHIG, EXAMINING ATTORNEY

**Int. Cl.: 21**

**Prior U.S. Cls.: 2, 13, 23, 29, 30, 33, 40 and 50**

**United States Patent and Trademark Office**

**Reg. No. 3,499,337**

**Registered Sep. 9, 2008**

**TRADEMARK  
PRINCIPAL REGISTER**

**TEA ROAD 5000**

KABUSHIKI KAISHA MINO AGE (JAPAN CORPORATION)  
72, OTOWA-CHO 3-CHOME  
TAJIMI-SHI; GIFU-KEN 507-0037  
JAPAN

OWNER OF INTERNATIONAL REGISTRATION  
0936576 DATED 8-9-2007, EXPIRES 8-9-2017.

FOR: HOUSEHOLD ITEMS NOT MADE OF PRECIOUS METAL, NAMELY, DISHES, PLATES, TEAPOTS, POTS, PANS, SOUP BOWLS, BOWLS, FRUIT CUPS, EGG CUPS, TEA CUPS, CUPS, SAUCERS, KETTLES, JUGS, TRAY, TOOTHPICK HOLDERS, BASINS, VASES, URNS, IN CLASS 21 (U.S. CLS. 2, 13, 23, 29, 30, 33, 40 AND 50).

NO CLAIM IS MADE TO THE EXCLUSIVE RIGHT TO USE "TEA", APART FROM THE MARK AS SHOWN.

SER. NO. 79-043,469, FILED 8-9-2007.

WENDY GOODMAN, EXAMINING ATTORNEY

**Int. Cls.: 9 and 38**

**Prior U.S. Cls.: 21, 23, 26, 36, 38, 100, 101 and 104**

**United States Patent and Trademark Office**

**Reg. No. 3,499,338**

**Registered Sep. 9, 2008**

**TRADEMARK  
SERVICE MARK  
PRINCIPAL REGISTER**



**BlueAnt**

BLUEANT WIRELESS PTY LTD (AUSTRALIA  
REGISTERED AUSTRALIAN COMPANY)  
245 ST KILDA ROAD  
ST KILDA VIC 3182  
AUSTRALIA

FOR: TELECOMMUNICATIONS EQUIPMENT, NAMELY, APPARATUS FOR RECORDING, TRANSMISSION OR REPRODUCTION OF SOUND OR IMAGES; INSTRUMENTS FOR DATA COMMUNICATION AND TELECOMMUNICATION, NAMELY, DEVICES FOR TRANSPORTING AND AGGREGATING VOICE COMMUNICATIONS ACROSS MULTIPLE NETWORK INFRASTRUCTURES AND COMMUNICATIONS PROTOCOLS; TELEPHONE APPARATUS; TELEPHONE RECEIVERS; TELEPHONE TRANSMITTERS; HEADSETS FOR TELEPHONES, LOUDSPEAKERS FOR TELEPHONES, EAR PIECES FOR TELEPHONES, MICROPHONES FOR TELECOMMUNICATIONS APPARATUS, AND PARTS AND ACCESSORIES FOR THE FOREGOING GOODS SOLD AS A UNIT WITH THE GOODS; COMPUTER PERIPHERALS, IN CLASS 9 (U.S. CLS. 21, 23, 26, 36 AND 38).

FOR: TELECOMMUNICATIONS SERVICES, NAMELY, CELLULAR TELEPHONE COMMUNICATION, COMMUNICATION BY COMPUTER TERMINALS, COMPUTER AIDED TRANSMISSION

OF MESSAGES AND IMAGES; PROVIDING INFORMATION IN THE FIELD OF TELECOMMUNICATIONS VIA THE INTERNET, IN CLASS 38 (U.S. CLS. 100, 101 AND 104).

PRIORITY DATE OF 1-22-2007 IS CLAIMED.

OWNER OF INTERNATIONAL REGISTRATION 0936693 DATED 6-15-2007, EXPIRES 6-15-2017.

OWNER OF U.S. REG. NOS. 3,258,855 AND 3,258,856.

THE COLOR(S) BLACK AND BLUE IS/ARE CLAIMED AS A FEATURE OF THE MARK.

THE MARK CONSISTS OF THE COLOR BLACK APPEARS IN THE WORDING, "BLUE ANT"; THE COLOR BLUE APPEARS IN THE DESIGN OF AN ANT AND IN THE SQUARE SURROUNDING THE ANT.

SER. NO. 79-043,535, FILED 6-15-2007.

GILBERT SWIFT, EXAMINING ATTORNEY

**Int. Cls.: 9, 28 and 41**

**Prior U.S. Cls.: 21, 22, 23, 26, 36, 38, 50, 100, 101 and 107**

**Reg. No. 3,499,339**

**United States Patent and Trademark Office**

**Registered Sep. 9, 2008**

**TRADEMARK  
SERVICE MARK  
PRINCIPAL REGISTER**

# WorldShift

BLACK SEA STUDIOS LTD. (BULGARIA LIMITED LIABILITY COMPANY)  
B.I.C. IZOT, 7TH.FLOOR, OFFICE 730  
7TH KM, TZARIGRADSKO SHOSSE, BLVD.  
SOFIA, BULGARIA BG1784

FOR: COMPUTER PROGRAMS FOR USE IN INTERACTIVE VIDEO GAMES; DOWNLOADABLE COMPUTER PROGRAMS FOR USE IN INTERACTIVE VIDEO GAMES; COMPUTER SOFTWARE FOR USE IN INTERACTIVE VIDEO GAMES; DOWNLOADABLE ELECTRONIC PUBLICATIONS IN THE NATURE OF INSTRUCTIONS IN THE FIELD OF INTERACTIVE VIDEO GAMES; COMPUTER GAME SOFTWARE; AMUSEMENT APPARATUS ADAPTED FOR USE WITH TELEVISION RECEIVERS ONLY; VIDEO GAME MACHINES ADAPTED FOR USE WITH TELEVISION RECEIVERS ONLY; VIDEO GAME CASSETTES; VIDEO DISKS AND VIDEO TAPES WITH RECORDED ANIMATED CARTOONS, IN CLASS 9 (U.S. CLS. 21, 23, 26, 36 AND 38).

FOR: BOARD GAMES; APPARATUS FOR ELECTRONIC GAMES, INCLUDING VIDEO GAMES, OTHER THAN THOSE ADAPTED FOR USE WITH TELEVISION RECEIVERS ONLY; SLOT MACHINES, AUTOMATIC; PARLOUR GAMES; PLAY-

ING CARDS, IN CLASS 28 (U.S. CLS. 22, 23, 38 AND 50).

FOR: PUBLISHING OF ELECTRONIC PUBLICATIONS; DESKTOP PUBLISHING FOR OTHERS; ENTERTAINMENT SERVICES, NAMELY, PROVIDING ON-LINE COMPUTER GAMES; MOTION PICTURE FILM PRODUCTION; FILM STUDIOS; PUBLICATION OF TEXTS; ONLINE ELECTRONIC PUBLISHING OF NEWSPAPERS AND BOOKS; COMPOSITION OF MUSIC FOR OTHERS; PROVIDING A COMPUTER GAME THAT MAY BE ACCESSED NETWORK-WIDE BY NETWORK USERS; ONLINE PUBLICATION OF ELECTRONIC BOOKS AND MAGAZINES; SCREENPLAY WRITING SERVICES; WRITING OF TEXTS OTHER THAN PUBLICITY TEXTS; PUBLICATION OF BOOKS; VIDEO TAPE PRODUCTION, ALL RELATED TO INTERACTIVE VIDEO GAMES, IN CLASS 41 (U.S. CLS. 100, 101 AND 107).

OWNER OF INTERNATIONAL REGISTRATION 0936718 DATED 7-23-2007, EXPIRES 7-23-2017.

SER. NO. 79-043,544, FILED 7-23-2007.

SCOTT BIBB, EXAMINING ATTORNEY

**Int. Cls.: 3, 9, 14, 16, 18 and 25**

**Prior U.S. Cls.: 1, 2, 3, 4, 5, 6, 21, 22, 23, 26, 27, 28, 29, 36, 37, 38, 39, 41, 50, 51 and 52**

**Reg. No. 3,499,340**

**United States Patent and Trademark Office**

**Registered Sep. 9, 2008**

**TRADEMARK  
PRINCIPAL REGISTER**

# DANIEL PONI

MOHAMMED S. DABAAN (SYRIAN ARAB REP  
INDIVIDUAL)  
BAHSAH, ASIA HOTEL BUILDING  
1ST FLOOR, ROOM 10 & 22; DAMAS  
SYRIAN ARAB REP

FOR: PERFUMES, ESSENTIAL OILS FOR PERSONAL USE, NON-MEDICATED PREPARATIONS FOR LIP AND SKIN CARE, AFTER-SHAVE LOTIONS, HAIR LOTIONS, BATH AND SHOWER FOAMS AND GELS, COSMETICS FOR BEAUTY CARE, TOILET SOAPS, IN CLASS 3 (U.S. CLS. 1, 4, 6, 50, 51 AND 52).

FOR: SPECTACLES, EYEGLASSES, SWIMMING GOGGLES, DIVING GOGGLES, SUNGLASSES, SPORTS EYEWEAR, SPECTACLE GLASSES, SPECTACLE FRAMES, SPECTACLE CASES, IN CLASS 9 (U.S. CLS. 21, 23, 26, 36 AND 38).

FOR: FANCY KEY RINGS OF PRECIOUS METAL, ALLOYED OR PLATED WITH PRECIOUS METAL; CUFF LINKS, TIE PINS, TIE TACKS; JEWELLERY; CUT DIAMONDS; HOROLOGICAL AND CHRONOMETRIC INSTRUMENTS AND PARTS THEREOF, IN CLASS 14 (U.S. CLS. 2, 27, 28 AND 50).

FOR: WRITING INSTRUMENTS, PENCIL STANDS, PENS, FOUNTAIN PENS; CASES AND BOXES FOR FOUNTAIN PENS AND PENCILS; INK WELLS FOR DESKS; AGENDAS; BROCHURES AND CATALOGUES IN THE FIELDS OF PERFUMERY, EYEWEAR, JEWELLERY AND CLOCKS AND WATCHES, OFFICE REQUISITES, LEATHER GOODS AND FASHION CLOTHING, IN CLASS 16 (U.S. CLS. 2, 5, 22, 23, 29, 37, 38 AND 50).

FOR: RUCKSACKS, HANDBAGS, TRAVELLING BAGS, TRUNKS IN THE NATURE OF LUGGAGE, SUITCASES, CHANGE PURSES, UNFITTED VANITY CASES, BRIEFCASES, WALLETS, ATTACHÉ CASES, WALLETS, NAMELY, CARD CASES AND HOLDERS; UMBRELLAS, PARASOLS AND WALKING STICKS; ARTICLES MADE OF LEATHER OR OF IMITATION LEATHER, NAMELY, BAGS AND POUCHES FOR PACKAGING PURPOSES, HAT BOXES, BOXES FOR STORING GREETING CARDS, BOXES FOR STORING CREDIT CARDS, TRAVELLING SETS, BUSINESS CASES, KEY CASES, IN CLASS 18 (U.S. CLS. 1, 2, 3, 22 AND 41).

FOR: CLOTHING, NAMELY, FOOTWEAR, BELTS, JERSEYS, PULLOVERS, T-SHIRTS, JACKETS, TROUSERS, TIES, TOPS; HEADGEAR, NAMELY, HATS, CAPS, IN CLASS 25 (U.S. CLS. 22 AND 39).

THE MARK CONSISTS OF STANDARD CHARACTERS WITHOUT CLAIM TO ANY PARTICULAR FONT, STYLE, SIZE, OR COLOR.

OWNER OF INTERNATIONAL REGISTRATION 0936809 DATED 8-6-2007, EXPIRES 8-6-2017.

THE NAME(S), PORTRAIT(S), AND/OR SIGNATURE(S) SHOWN IN THE MARK IDENTIFIES "DANIEL PONI", WHOSE CONSENT(S) TO REGISTER IS SUBMITTED.

SER. NO. 79-043,590, FILED 8-6-2007.

KRISTIN DAHLING, EXAMINING ATTORNEY

Int. Cl.: 16

Prior U.S. Cls.: 2, 5, 22, 23, 29, 37, 38 and 50

Reg. No. 3,499,341

United States Patent and Trademark Office

Registered Sep. 9, 2008

TRADEMARK  
PRINCIPAL REGISTER

SumoGrip

SAKURA COLOR PRODUCTS CORPORATION  
(JAPAN CORPORATION)  
10-17, NAKAMICHI 1-CHOME  
HIGASHINARI-KU.; OSAKA-SHI; OSAKA-FU 537-  
0025  
JAPAN

FOR: STATIONERY; CARBON PAPER; ALBUMS FOR COINS, PHOTOGRAPHS, AND STAMPS; LOOSE-LEAF BINDERS; DOCUMENT FILES; FOLDERS; FOLDERS FOR PAPERS; ENVELOPES; WRITING PADS; NOTE BOOKS; STATIONERY, NAMELY, PAPER SHEETS; SCRAPBOOKS; STENCILS; POCKET MEMORANDUM BOOKS; DRAWING PADS; DOCUMENT FILES; BOOKS IN THE FIELD OF WRITING OR DRAWING; COPY PAPER; WRITING INSTRUMENTS; FELT WRITING PENS; BALL-POINT PENS; ROLLER PENS; GEL INK ROLLER BALL PENS; MECHANICAL PENCILS; BRUSH PENS; MARKING PENS; PENCILS; PENCIL LEAD HOLDERS; COLORED PENCILS; PENS; WRITING BRUSHES; FELT TIP MARKERS; WHITEBOARD MARKERS; HIGHLIGHTING MARKERS; PAINT STICK MARKERS; PLASTIC NIB PENS; WRITING INK; ADHESIVE TAPES FOR STATIONERY OR HOUSEHOLD PURPOSES; SEALING STAMPS; INKING PADS; PAPER CLIPS FOR OFFICES; BALLS FOR BALL-POINT PENS; ERASERS; MECHANICAL ERASERS WITH STICK ERASERS THAT MAY BE ADVANCED AS NEEDED; ERASERS FOR WHITEBOARDS; INDIA INK; MARKING

CHALK; STICK FORM MARKERS FOR MARKING OR WRITING; PEN NIBS; PAPER KNIVES; PEN CLIPS; PENCIL LEADS; CORRECTION FLUIDS FOR DOCUMENTS; CORRECTION PENS; WHITEBOARDS, NAMELY, DRY ERASE WRITING BOARDS AND WRITING SURFACES; PEN CASES; PENCIL POINT PROTECTORS; DRAWING RULERS; PENCIL SHARPENERS; NON-ELECTRIC STAPLING PRESSES; STAPLES FOR OFFICES; ARTISTS' MATERIALS, NAMELY, WATER COLORS FINISHED PAINTING, WATER-COLORS PAINTS SOLD AS PART OF AN ARTS AND CRAFT PAINT KIT; CRAYONS; PLASTIC CRAYONS; PASTELS; OIL PASTELS; CHARCOAL PENCILS; SCHOOL PAINT BOXES COMPRISING ARTS AND CRAFT PAINT KITS; PALETTES FOR PAINTERS; ARTISTS' WATERCOLOR SAUCERS, NAMELY, PALETTES FOR PAINTING; PAINTERS' EASELS; PAINT BRUSHES, IN CLASS 16 (U.S. CLS. 2, 5, 22, 23, 29, 37, 38 AND 50).

OWNER OF INTERNATIONAL REGISTRATION  
0936875 DATED 4-19-2007, EXPIRES 4-19-2017.

OWNER OF U.S. REG. NO. 2,319,749.

SER. NO. 79-043,613, FILED 4-19-2007.

FRED MANDIR, EXAMINING ATTORNEY

**Int. Cl.: 9**

**Prior U.S. Cls.: 21, 23, 26, 36 and 38**

**United States Patent and Trademark Office**

**Reg. No. 3,499,342**

**Registered Sep. 9, 2008**

**TRADEMARK  
PRINCIPAL REGISTER**

**the sensor people**

LEUZE ELECTRONIC GMBH + CO KG (FED  
REP GERMANY KOMMANDITGESELL-  
SCHAFT)

IN DER BRAIKE 1  
73277 OWEN/TECK  
FED REP GERMANY

FOR: OPTOELECTRONIC SENSORS, NAMELY,  
LIGHT BARRIERS, REFLECTIVE LIGHT SCAN-  
NERS, LIGHT CURTAINS, OPTICAL DISTANCE  
SENSORS, OPTICAL DATA TRANSMISSION SEN-  
SORS, BARCODE READERS, CAMERAS, PARTS  
AND COMPONENTS OF THE FOREGOING OPTOE-  
LECTRONIC SENSORS; VISION SYSTEMS COM-  
PRISED OF DATA PROCESSORS, CAMERAS,  
SENSORS, COMPUTERS, AND COMPUTER SOFT-  
WARE FOR OPERATING AND MONITORING THE  
FOREGOING; INDUCTIVE SENSORS, CAPACITIVE  
SENSORS, ULTRA SONIC SENSORS; CONTROL  
UNITS AND BUS SYSTEMS COMPRISING FIELD  
BUSSES AND LOCAL BUSSES FOR OPERATION OF

SENSORS, IN CLASS 9 (U.S. CLS. 21, 23, 26, 36 AND  
38).

THE MARK CONSISTS OF STANDARD CHAR-  
ACTERS WITHOUT CLAIM TO ANY PARTICULAR  
FONT, STYLE, SIZE, OR COLOR.

PRIORITY DATE OF 2-2-2007 IS CLAIMED.

OWNER OF INTERNATIONAL REGISTRATION  
0937001 DATED 7-12-2007, EXPIRES 7-12-2017.

NO CLAIM IS MADE TO THE EXCLUSIVE  
RIGHT TO USE "SENSOR", APART FROM THE  
MARK AS SHOWN.

SER. NO. 79-043,666, FILED 7-12-2007.

ALICE BENMAMAN, EXAMINING ATTORNEY

**Int. Cls.: 10, 11 and 21**

**Prior U.S. Cls.: 2, 13, 21, 23, 26, 29, 30, 31, 33, 34, 39, 40, 44 and 50**

**Reg. No. 3,499,343**

**United States Patent and Trademark Office**

**Registered Sep. 9, 2008**

**TRADEMARK  
PRINCIPAL REGISTER**



MAPA GMBH GUMMI- UND PLASTIKWERKE  
(FED REP GERMANY LIMITED LIABILITY  
COMPANY)  
INDUSTRIESTRASSE 21-25  
27404 ZEVEN, FED REP GERMANY

FOR: PACIFIERS FOR BABIES, NAMELY, TRAN-  
QUILIZING AND SLEEPING PACIFIERS MADE  
FROM LATEX OR OTHER THERMOPLASTIC  
ELASTOMERS; BABY BOTTLE NIPPLES FOR BABY  
BOTTLES MADE FROM LATEX OR OTHER THER-  
MOPLASTIC ELASTOMERS, IN CLASS 10 (U.S. CLS.  
26, 39 AND 44).

FOR: ELECTRIC DISINFECTING VAPORIZERS  
FOR DISINFECTION OF BABY BOTTLES, IN CLASS  
11 (U.S. CLS. 13, 21, 23, 31 AND 34).

FOR: GLASS AND PLASTIC BABY BOTTLES, IN  
CLASS 21 (U.S. CLS. 2, 13, 23, 29, 30, 33, 40 AND 50).

OWNER OF INTERNATIONAL REGISTRATION  
0721304 DATED 9-11-1999, EXPIRES 9-11-2009.

OWNER OF U.S. REG. NOS. 2,860,094 AND  
3,249,816.

NO CLAIM IS MADE TO THE EXCLUSIVE  
RIGHT TO USE "AIR SYSTEM", APART FROM  
THE MARK AS SHOWN.

THE COLOR(S) BLUE, RED AND WHITE IS/ARE  
CLAIMED AS A FEATURE OF THE MARK.

THE MARK CONSISTS OF A FAN-SHAPED DE-  
SIGN MADE OF QUADRILATERALS IN THE COL-  
ORS BLUE AND WHITE PLACED OVER TOP THE  
WORD "NUK", IN THE COLOR RED WHICH IS  
PLACED OVER THE WORD "AIR SYSTEM", IN THE  
COLOR BLUE.

SER. NO. 79-043,791, FILED 8-15-2007.

SANJEEV VOHRA, EXAMINING ATTORNEY



**Int. Cls.: 1, 5, 10 and 42**

**Prior U.S. Cls.: 1, 5, 6, 10, 18, 26, 39, 44, 46, 51, 52, 100  
and 101**

**Reg. No. 3,499,344**

**United States Patent and Trademark Office**

**Registered Sep. 9, 2008**

**TRADEMARK  
SERVICE MARK  
PRINCIPAL REGISTER**

**ELBION**

ELBION AG (FED REP GERMANY JOINT  
STOCK COMPANY)  
MEISSNER STRASSE 191  
01445 RADEBEUL  
FED REP GERMANY

FOR: CHEMICAL FOR USE IN INDUSTRY AND  
FOR SCIENTIFIC USE, IN CLASS 1 (U.S. CLS. 1, 5, 6,  
10, 26 AND 46).

FOR: PHARMACEUTICAL PREPARATIONS FOR  
THE TREATMENT OF NEUROLOGICAL DISEASES  
AND IMMUNOLOGICAL DISORDERS; SANITARY  
STERILIZING PREPARATIONS, IN CLASS 5 (U.S.  
CLS. 6, 18, 44, 46, 51 AND 52).

FOR: SURGICAL INSTRUMENTS AND APPARA-  
TUS, IN CLASS 10 (U.S. CLS. 26, 39 AND 44).

FOR: SCIENTIFIC RESEARCH AND INDUS-  
TRIAL RESEARCH IN THE FIELD OF PHARMA-  
CEUTICALS, IN CLASS 42 (U.S. CLS. 100 AND 101).

THE MARK CONSISTS OF STANDARD CHAR-  
ACTERS WITHOUT CLAIM TO ANY PARTICULAR  
FONT, STYLE, SIZE, OR COLOR.

OWNER OF INTERNATIONAL REGISTRATION  
0759458 DATED 5-3-2001, EXPIRES 5-3-2011.

SER. NO. 79-043,795, FILED 3-19-2007.

MARILYN IZZI, EXAMINING ATTORNEY

Int. Cl.: 3

Prior U.S. Cls.: 1, 4, 6, 50, 51 and 52

United States Patent and Trademark Office

Reg. No. 3,499,345

Registered Sep. 9, 2008

TRADEMARK  
PRINCIPAL REGISTER

*Miss Magic*

DROUJESTVO S OGRANITCHENA OTGOVOR-  
NOST; "SOLVEKS- COZMETITCHNI PRO-  
DOUCTI" (BULGARIA LIMITED LIABILITY  
COMPANY)  
2, DARWIN STR.  
BG-4002 PLOVDIV  
BULGARIA

OWNER OF INTERNATIONAL REGISTRATION  
0777348 DATED 3-4-2002, EXPIRES 3-4-2012.

SER. NO. 79-043,796, FILED 6-5-2007.

FOR: PERFUMERY, COSMETICS, TOILET WA-  
TER FOR HAIR, ESSENTIAL OILS, DENTIFRICES,  
IN CLASS 3 (U.S. CLS. 1, 4, 6, 50, 51 AND 52).

KRISTINA MORRIS, EXAMINING ATTORNEY

**Int. Cls.: 1 and 31**

**Prior U.S. Cls.: 1, 5, 6, 10, 26 and 46**

**United States Patent and Trademark Office**

**Reg. No. 3,499,346**

**Registered Sep. 9, 2008**

**TRADEMARK  
PRINCIPAL REGISTER**

**SEACTIV**

COMPAGNIE FINANCIERE ET DE PARTICIPATIONS ROULLIER (FRANCE JOINT STOCK COMPANY)  
27, AVENUE FRANKLIN ROOSEVELT  
F-35400 SAINT MALO  
FRANCE

FOR: FERTILIZERS, IN CLASS 1 (U.S. CLS. 1, 5, 6, 10, 26 AND 46).

FOR: FRESH FRUITS AND VEGETABLES; FOOD-STUFFS FOR ANIMALS; LIVE ANIMALS; LIVE PLANTS AND FLOWERS, IN CLASS 31 (U.S. CLS. 1 AND 46).

THE MARK CONSISTS OF STANDARD CHARACTERS WITHOUT CLAIM TO ANY PARTICULAR FONT, STYLE, SIZE, OR COLOR.

OWNER OF INTERNATIONAL REGISTRATION  
0888588 DATED 4-24-2006, EXPIRES 4-24-2016.

SER. NO. 79-043,814, FILED 7-24-2007.

CHRISTOPHER BUONGIORNO, EXAMINING ATTORNEY

**Int. Cl.: 7**

**Prior U.S. Cls.: 13, 19, 21, 23, 31, 34 and 35**

**United States Patent and Trademark Office**

**Reg. No. 3,499,347**

**Registered Sep. 9, 2008**

**TRADEMARK  
PRINCIPAL REGISTER**

**WAFIOS** 

WAFIOS AKTIENGESELLSCHAFT (FED REP  
GERMANY SOCIÉTÉ ANONYME)  
SILBERBURGSTRABE 5  
72764 REUTLINGEN  
FED REP GERMANY

FOR: MACHINES FOR MANUFACTURING  
MESH, MESH MADE OF CRIMPED WIRE, BARBED  
WIRE, STAPLES, RINGS, SPIKES, TACKS, WIRE  
SPIRALS, WELDED WIRE MESH, ARCHED WIRE  
PARTS, FLEXIBLE METAL TUBES AND PIPES,  
WIRE SPRINGS, CHAINS, CLIPS; MACHINES FOR  
CONTROLLING WIRE SPRINGS AND CHAINS;  
WIRE STRAIGHTENING AND CUTTING MA-  
CHINES AS WELL AS MACHINES FOR PACKING  
POINTS AND MACHINES FOR FORMING TUBES;  
POWER OPERATED MACHINES FOR REELING

WIRES; MACHINES FOR FORMING WIRE LINKS,  
IN CLASS 7 (U.S. CLS. 13, 19, 21, 23, 31, 34 AND 35).

PRIORITY DATE OF 12-30-2006 IS CLAIMED.

OWNER OF INTERNATIONAL REGISTRATION  
0937573 DATED 6-29-2007, EXPIRES 6-29-2017.

OWNER OF U.S. REG. NO. 907,927.

SER. NO. 79-043,875, FILED 6-29-2007.

DAWN HAN, EXAMINING ATTORNEY

**Int. Cls.: 9, 41 and 42**

**Prior U.S. Cls.: 21, 23, 26, 36, 38, 100, 101 and 107**

**Reg. No. 3,499,348**

**United States Patent and Trademark Office**

**Registered Sep. 9, 2008**

**TRADEMARK  
SERVICE MARK  
PRINCIPAL REGISTER**

**icanetix**

ICANETIX SOFTWARE SYSTEMS AND; CONSULTING GMBH (FED REP GERMANY GESELLSCHAFT MIT BESCHRÄNKTER HAFTUNG)

STUHLSATZENHAUSWEG 71,  
SCIENCE PARK 2; 66123 SAARBRÜCKEN  
FED REP GERMANY

FOR: COMPUTERS; COMPUTER HARDWARE; COMPUTER PROGRAMS AND SOFTWARE, NAMELY, EDUCATIONAL SOFTWARE FEATURING INSTRUCTION IN COMPUTERS, COMPUTER SOFTWARE AND COMPUTER DATABASES; CHILDREN'S EDUCATIONAL SOFTWARE; COMPILER SOFTWARE; COMPUTER APPLICATION SOFTWARE FOR MOBILE PHONES; COMPUTER DATABASE MANAGEMENT SOFTWARE FOR USE IN PERSONALIZING THE CONTENT OF E-MAIL COMMUNICATIONS; COMPUTER GRAPHICS SOFTWARE; COMPUTER HARDWARE AND COMPUTER SOFTWARE PROGRAMS FOR THE INTEGRATION OF TEXT, AUDIO, GRAPHICS, STILL IMAGES AND MOVING PICTURES INTO AN INTERACTIVE DELIVERY FOR MULTIMEDIA APPLICATIONS; COMPUTER SEARCH ENGINE SOFTWARE; COMPUTER SOFTWARE DEVELOPMENT TOOLS; COMPUTER SOFTWARE FEATURING MUSICAL SOUND RECORDINGS AND MUSICAL VIDEO RECORDINGS; COMPUTER SOFTWARE FOR ACCESSING INFORMATION DIRECTORIES THAT MAY BE DOWNLOADED FROM THE GLOBAL COMPUTER NETWORK; COMPUTER SOFTWARE FOR APPLICATION AND DATABASE INTEGRATION; COMPUTER SOFTWARE FOR CREATING SEARCHABLE DATABASES OF INFORMATION AND DATA; COMPUTER SOFTWARE FOR THE COLLECTION, EDITING, ORGANIZING, MODIFYING, BOOK MARKING, TRANSMISSION, STORAGE AND SHARING OF DATA AND INFORMATION; COMPUTER SOFTWARE FOR ORGANIZING AND VIEWING DIGITAL IMAGES AND PHOTO-

GRAPHS; COMPUTER SOFTWARE FOR USE IN RELATION TO DIGITAL ANIMATION AND SPECIAL EFFECTS OF IMAGES; COMPUTER SOFTWARE FOR USE IN CUSTOMER RELATIONSHIP MANAGEMENT; COMPUTER SOFTWARE FOR MANIPULATING DIGITAL AUDIO INFORMATION FOR USE IN AUDIO MEDIA APPLICATIONS; COMPUTER SOFTWARE FOR PROVIDING AN ONLINE DATABASE IN THE FIELD OF TRANSACTION PROCESSING TO UPLOAD TRANSACTIONAL DATA, PROVIDE STATISTICAL ANALYSIS, AND PRODUCE NOTIFICATIONS AND REPORTS; COMPUTER SOFTWARE FOR USE IN THE SAFEGUARDING OF DIGITAL FILES, INCLUDING AUDIO, VIDEO, TEXT, BINARY, STILL IMAGES, GRAPHICS AND MULTIMEDIA FILES; COMPUTER SOFTWARE FOR USE IN THE ENCRYPTION AND DECRYPTION OF DIGITAL FILES, INCLUDING AUDIO, VIDEO, TEXT, BINARY, STILL IMAGES, GRAPHICS AND MULTIMEDIA FILES; COMPUTER SOFTWARE FOR COMPUTER SYSTEM AND APPLICATION DEVELOPMENT, DEPLOYMENT AND MANAGEMENT; COMPUTER SOFTWARE THAT PROVIDES REAL-TIME, INTEGRATED BUSINESS MANAGEMENT INTELLIGENCE BY COMBINING INFORMATION FROM VARIOUS DATABASES AND PRESENTING IT IN A EASY-TO-UNDERSTAND USER INTERFACE; COMPUTER SOFTWARE TO ENHANCE THE AUDIO-VISUAL CAPABILITIES OF MULTIMEDIA APPLICATIONS, NAMELY, FOR THE INTEGRATION OF TEXT, AUDIO, GRAPHICS, STILL IMAGES AND MOVING PICTURES; COMPUTER SOFTWARE, NAMELY, SOFTWARE DEVELOPMENT TOOLS FOR THE CREATION OF MOBILE INTERNET APPLICATIONS AND CLIENT INTERFACES; DATA COMPRESSION SOFTWARE; DESKTOP PUBLISHING SOFTWARE; GRAPHICAL USER INTERFACE SOFTWARE; OPERATING AND USER INSTRUCTIONS STORED IN DIGITAL FORM FOR COMPUTERS AND COMPUTER SOFTWARE, IN

PARTICULAR ON FLOPPY DISKS, CD-ROM OR DVDS; SOFTWARE FOR PROCESSING IMAGES, GRAPHICS AND TEXT; USB (UNIVERSAL SERIAL BUS) OPERATING SOFTWARE; WEB SITE DEVELOPMENT SOFTWARE; COMPUTER OPERATING SYSTEM PROGRAMS; COMPUTER SOFTWARE FOR AUTHORING, MANAGEMENT AND TRANSFORMATION OF STRUCTURED INFORMATION; COMPUTER SOFTWARE FOR GENERATING USER INTERFACES AND PRESENTATION OF INFORMATION IN STATIC AND INTERACTIVE FORMS; COMPUTER SOFTWARE FOR CREATING, MANAGING, DEPLOYING, MIGRATING AND TRANSFORMING USER INFORMATION IN THE FORM OF DIRECTORY SERVICES; AUTHENTICATION AND AUTHORIZATION SOFTWARE FOR USE ON NETWORKED AND NON-NETWORKED COMPUTERS; COMPUTER SOFTWARE FOR USING AND MANAGING LOCAL AND NETWORKED PRINTERS AND PRINT SERVERS; SOFTWARE FOR USING AND MANAGING HIERARCHICAL AND RELATIONAL DATABASE AND OTHER STRUCTURED INFORMATION SOURCES ON NETWORKED AND NON-NETWORKED COMPUTERS AND MOBILE DEVICES, IN CLASS 9 (U.S. CLS. 21, 23, 26, 36 AND 38).

FOR: EDUCATIONAL SERVICES, NAMELY, CONDUCTING TRAINING COURSES AND SEMINARS IN THE FIELDS OF COMPUTERS, COMPUTER SOFTWARE AND COMPUTER DATABASES;

EDUCATIONAL SERVICES, NAMELY, PROVIDING ONLINE TRAINING COURSES AND SEMINARS IN THE FIELDS OF COMPUTERS, COMPUTER SOFTWARE AND COMPUTER DATABASES, IN CLASS 41 (U.S. CLS. 100, 101 AND 107).

FOR: DESIGN AND DEVELOPMENT OF COMPUTER HARDWARE AND SOFTWARE; COMPUTER SOFTWARE DEVELOPMENT, NAMELY, DATABASE SOFTWARE DEVELOPMENT; QUALITY CONTROL OF SOFTWARE FOR OTHERS; TECHNICAL CONSULTATION RELATING TO THE DESIGN AND USE OF SOFTWARE, COMPUTERS, COMPUTER HARDWARE AND COMPUTER SYSTEMS; LICENSING OF COMPUTER SOFTWARE, IN CLASS 42 (U.S. CLS. 100 AND 101).

THE MARK CONSISTS OF STANDARD CHARACTERS WITHOUT CLAIM TO ANY PARTICULAR FONT, STYLE, SIZE, OR COLOR.

OWNER OF INTERNATIONAL REGISTRATION 0937818 DATED 8-8-2007, EXPIRES 8-8-2017.

THE WORD "ICANETIX" HAS NO MEANING IN ANY FOREIGN LANGUAGE.

SER. NO. 79-043,937, FILED 8-8-2007.

LINDA E. BLOHM, EXAMINING ATTORNEY

**Int. Cls.: 12, 17 and 28**

**Prior U.S. Cls.: 1, 5, 12, 13, 19, 21, 22, 23, 31, 35, 38, 44  
and 50**

**Reg. No. 3,499,349**

**United States Patent and Trademark Office**

**Registered Sep. 9, 2008**

**TRADEMARK  
PRINCIPAL REGISTER**



GRP GANDINI RACING PRODUCTION SRL  
(ITALY LIMITED LIABILITY COMPANY)  
VIA MICHELANGELO, 3  
I-46040 GUIDIZZOLO (MN)  
ITALY

MADE OF RUBBER, NAMELY, TIRES FOR MODEL  
CARS, MODEL MOTORCYCLES, MODEL AIR-  
PLANES AND MODEL BOATS, IN CLASS 28 (U.S.  
CLS. 22, 23, 38 AND 50).

FOR: VEHICLES, NAMELY ,LAND VEHICLES,  
APPARATUS FOR LOCOMOTION BY LAND, AIR  
OR WATER, NAMELY, CARS, MOTORCYCLES,  
AIRPLANES AND BOATS, MICRO COMBUSTION  
ENGINES FOR LAND VEHICLES, IN CLASS 12 (U.S.  
CLS. 19, 21, 23, 31, 35 AND 44).

PRIORITY DATE OF 10-30-2006 IS CLAIMED.

FOR: GUM, NAMELY, RUBBER COMPOUNDS  
FOR USE IN THE MANUFACTURE OF TIRES, IN  
CLASS 17 (U.S. CLS. 1, 5, 12, 13, 35 AND 50).

OWNER OF INTERNATIONAL REGISTRATION  
0937921 DATED 4-2-2007, EXPIRES 4-2-2017.

FOR: GAMES AND PLAYTHINGS, NAMELY,  
BOARD GAMES, MODEL CARS, ARTICLES AND  
COMPONENTS FOR MODEL-MAKING, NAMELY,  
TOY MODEL HOBBYCRAFT KITS, ARTICLES

NO CLAIM IS MADE TO THE EXCLUSIVE  
RIGHT TO USE "RACING PRODUCTION", APART  
FROM THE MARK AS SHOWN.

SER. NO. 79-043,972, FILED 4-2-2007.

MARY BOAGNI, EXAMINING ATTORNEY

**Int. Cls.: 9, 35 and 41**

**Prior U.S. Cls.: 21, 23, 26, 36, 38, 100, 101, 102 and 107**

**Reg. No. 3,499,350**

**United States Patent and Trademark Office**

**Registered Sep. 9, 2008**

**TRADEMARK  
SERVICE MARK  
PRINCIPAL REGISTER**

# **INFOSTRADA**

INFOSTRADA B.V. (NETHERLANDS BESLOTEN  
VENNOOTSCHAP)  
2, BINNENWAL  
NL-3432 GH NIEUWEGEIN  
NETHERLANDS

FOR: APPARATUS FOR RECORDING, TRANSMITTING AND REPRODUCING SOUND OR IMAGES; COMPUTERS; PRERECORDED MAGNETIC DATA CARRIERS IN THE FIELD OF SPORTS; MULTIMEDIA SOFTWARE FOR MULTIMEDIA PURPOSES IN THE FIELD OF SPORTS, IN CLASS 9 (U.S. CLS. 21, 23, 26, 36 AND 38).

FOR: ADVERTISING; COMMERCIAL MANAGEMENT; BUSINESS MANAGEMENT; MANAGEMENT SERVICES IN THE FIELD OF SPORTS MANAGEMENT; BUSINESS AGENCY FOR BUYING AND SELLING OF SOFTWARE PRODUCTS FOR MULTIMEDIA PURPOSES, SUCH AS CD-ROMS; COMPILING STATISTICS; DATA PROCESSING SERVICES, NAMELY, COLLECTING, CLAS-

SIFYING, ORGANIZING, BRINGING UP TO DATE OF DATA FOR DATABASES; DATABASE MANAGEMENT AND REPLICATION, IN CLASS 35 (U.S. CLS. 100, 101 AND 102).

FOR: PUBLISHING SOFTWARE PRODUCTS FOR MULTIMEDIA PURPOSES; SUPPLYING INFORMATION IN THE FIELD OF SPORTS, EDUCATION AND AMUSEMENT THROUGH ELECTRONIC DATA TRANSMISSION, INCLUDING WORLD-WIDE INFORMATION NETWORKS; PUBLISHING BOOKS, NEWSPAPERS AND MAGAZINES, IN CLASS 41 (U.S. CLS. 100, 101 AND 107).

OWNER OF INTERNATIONAL REGISTRATION  
0705749 DATED 11-13-1998, EXPIRES 11-13-2008.

SER. NO. 79-044,097, FILED 4-20-2007.

Laurie Kaufman, Examining Attorney



**Int. Cl.: 5**

**Prior U.S. Cls.: 6, 18, 44, 46, 51 and 52**

**United States Patent and Trademark Office**

**Reg. No. 3,499,351**

**Registered Sep. 9, 2008**

**TRADEMARK  
PRINCIPAL REGISTER**

**VENDICID**

PHARMA MAR, S.A. (SPAIN SOCIEDAD ANÓNIMA)  
POLÍGONO INDUSTRIAL LA MINA NORTE  
AVENIDA DE LOS REYES ICOLMENAR VIEJO, E-28770 MADRID  
SPAIN

OWNER OF INTERNATIONAL REGISTRATION  
0938285 DATED 7-2-2007, EXPIRES 7-2-2017.

FOR: PHARMACEUTICAL AND VETERINARY  
PREPARATIONS FOR USE IN ONCOLOGY, IN  
CLASS 5 (U.S. CLS. 6, 18, 44, 46, 51 AND 52).

SER. NO. 79-044,124, FILED 7-2-2007.

PRIORITY DATE OF 1-18-2007 IS CLAIMED.

DAYNA BROWNE, EXAMINING ATTORNEY

Int. Cl.: 11

Prior U.S. Cls.: 13, 21, 23, 31 and 34

United States Patent and Trademark Office

Reg. No. 3,499,352

Registered Sep. 9, 2008

TRADEMARK  
PRINCIPAL REGISTER



CIXI ZHONGFA LAMPS CO., LTD (CHINA CORPORATION)  
NO.48, XINGYUAN ROAD  
ZONGHAN DEVELOPMENT AREA., CIXI CITY;  
315301 ZHEJIANG PROVINCE  
CHINA

FOR: LAMPS; ELECTRIC WATER HEATERS; FAUCETS FOR PIPES; WATER PURIFICATION INSTALLATIONS; DRINKING WATER FOUNTAINS; NON-ELECTRIC POCKET WARMERS, NAMELY, CHEMICALLY-ACTIVATED HEATING PACKETS FOR WARMING HANDS NOT FOR MEDICAL PURPOSES; BATH FITTINGS, NAMELY, BATHS, BATHTUBS, WHIRLPOOL BATHS AND BATH INSTALLATIONS; LIGHTING APPARATUS AND INSTALLATIONS, NAMELY, LIGHTING FIXTURES; LIGHTS FOR VEHICLES; POCKET SEARCH LIGHTS; ELECTRIC HOTPLATES; ELECTRIC COFFEE MACHINES; ELECTRIC GRIDDLES; ELECTRIC PRESSURE COOKERS; FANS, NAMELY, ELECTRIC FANS; HAND-HELD ELECTRIC HAIR DRYERS; EXTRACTOR RANGE HOODS FOR KITCHENS , IN CLASS 11 (U.S. CLS. 13, 21, 23, 31 AND 34).

OWNER OF INTERNATIONAL REGISTRATION  
0938448 DATED 8-7-2007, EXPIRES 8-7-2017.

THE ENGLISH TRANSLATION OF THE FOREIGN WORD(S) IN THE MARK IS: THE FIRST CHINESE CHARACTER WHOSE TRANSLITERATION IS "ZHONG" MEANS "CENTRAL"; THE SECOND CHINESE CHARACTER WHOSE TRANSLITERATION IS "FA" MEANS "DEVELOP"; THE COMBINATION OF THE TWO CHINESE CHARACTERS HAS NO SIGNIFICANCE IN THE RELEVANT TRADE OR INDUSTRY, AND HAS NO GEOGRAPHICAL SIGNIFICANCE, AND HAS NO MEANING IN A FOREIGN LANGUAGE, AND HAS NO SIGNIFICANCE AS APPLIED TO THE GOODS.

THE TRANSLITERATION OF THE NON-LATIN CHARACTERS IN THE MARK IS: "ZHONG FA"

SER. NO. 79-044,202, FILED 8-7-2007.

CARYN GLASSER, EXAMINING ATTORNEY

**Int. Cl.: 17**

**Prior U.S. Cls.: 1, 5, 12, 13, 35 and 50**

**United States Patent and Trademark Office**

**Reg. No. 3,499,353**

**Registered Sep. 9, 2008**

**TRADEMARK  
PRINCIPAL REGISTER**

# ALFATECH

SETIO B.V. (NETHERLANDS B.V.)  
L.J. COSTERSTRAAT 52  
NL-5916 PS VENLO  
NETHERLANDS

FOR: FLEXIBLE TUBES NOT OF METAL FOR USE IN MANUFACTURING, FLEXIBLE PIPES NOT OF METAL, RUBBER HOSES AND TUBES, RUBBER SHEETS AND RUBBER PANELS; RUBBER PRODUCTS AND SYNTHETIC RUBBER PRODUCTS, NAMELY, CONNECTORS, INSERTS, ADAPTERS, CASES, MATS, PRESSES AND VALVES, ALL FOR USE IN HYDRAULIC SYSTEMS IN MACHINES; NON-METALLIC HOSES FOR TRANSFERRING HYDRAULIC POWER IN MACHINES; NON-METALLIC HOSES FOR USE IN HYDRAULIC SYS-

TEMS IN MACHINES, IN CLASS 17 (U.S. CLS. 1, 5, 12, 13, 35 AND 50).

THE MARK CONSISTS OF STANDARD CHARACTERS WITHOUT CLAIM TO ANY PARTICULAR FONT, STYLE, SIZE, OR COLOR.

PRIORITY DATE OF 4-13-2007 IS CLAIMED.

OWNER OF INTERNATIONAL REGISTRATION 0938967 DATED 7-19-2007, EXPIRES 7-19-2017.

SER. NO. 79-044,391, FILED 7-19-2007.

WENDY JUN, EXAMINING ATTORNEY

**Int. Cl.: 5**

**Prior U.S. Cls.: 6, 18, 44, 46, 51 and 52**

**United States Patent and Trademark Office**

**Reg. No. 3,499,354**

**Registered Sep. 9, 2008**

**TRADEMARK  
PRINCIPAL REGISTER**

**ProntoVet**

**B. BRAUN VETCARE GMBH (FED REP GERMA-  
NY CORPORATION)**

**AM AESCULAP-PLATZ**

**78532 TUTTLINGEN**

**FED REP GERMANY**

**THE MARK CONSISTS OF STANDARD CHAR-  
ACTERS WITHOUT CLAIM TO ANY PARTICULAR  
FONT, STYLE, SIZE, OR COLOR.**

**OWNER OF INTERNATIONAL REGISTRATION  
0939146 DATED 9-5-2007, EXPIRES 9-5-2017.**

**FOR: WOUND DRESSINGS, NAMELY, WOUND  
IRRIGATION WASHES AND WOUND CLEANSING  
GEL, IN CLASS 5 (U.S. CLS. 6, 18, 44, 46, 51 AND 52).**

**SER. NO. 79-044,495, FILED 9-5-2007.**

**MICHAEL KEATING, EXAMINING ATTORNEY**

**Int. Cl.: 7**

**Prior U.S. Cls.: 13, 19, 21, 23, 31, 34 and 35**

**Reg. No. 3,499,355**

**United States Patent and Trademark Office**

**Registered Sep. 9, 2008**

**TRADEMARK  
PRINCIPAL REGISTER**

**BOYSEN**

FRIEDRICH BOYSEN GMBH & CO. KG (FED  
REP GERMANY LIMITED PARTNERSHIP  
WITH LIMITED LIABILITY COMPANY AS  
GENERAL PARTNER)  
FRIEDRICH-BOYSEN-STRASSE 14-17  
72213 ALTENSTEIG  
FED REP GERMANY

FOR: EXHAUST SYSTEMS FOR INTERNAL  
COMBUSTION ENGINES COMPRISED OF EX-  
HAUST MANIFOLDS, EXHAUST PIPES, CATALY-  
TIC CONVERTERS FOR EXHAUST GAS  
SILENCERS, CARBON FILTERS, INDUCTION  
NOISE SILENCERS AND EXHAUST SILENCERS;  
CONSTRUCTIONAL PARTS OF INTERNAL COM-  
BUSTION ENGINE EXHAUST SYSTEMS, NAMELY,  
EXHAUST MANIFOLDS, EXHAUST PIPES, CATA-  
LYTIC CONVERTERS FOR EXHAUST SYSTEMS,  
EXHAUST GAS SILENCERS, CARBON FILTERS,  
INDUCTION NOISE SILENCERS AND EXHAUST  
SILENCERS; EXHAUST GAS SYSTEMS FOR MO-  
TOR VEHICLES, COMPRISED OF EXHAUST MANI-  
FOLDS, EXHAUST PIPES, CATALYTIC  
CONVERTERS, EXHAUST GAS SILENCERS, CAR-  
BON FILTERS, INDUCTION NOISE SILENCERS

AND EXHAUST SILENCERS; CONSTRUCTIONAL  
PARTS OF EXHAUST GAS SYSTEMS FOR MOTOR  
VEHICLES, NAMELY, EXHAUST MANIFOLDS, EX-  
HAUST PIPES, CATALYTIC CONVERTERS FOR  
EXHAUST SYSTEMS, EXHAUST GAS SILENCERS,  
CARBON FILTERS, INDUCTION NOISE SILEN-  
CERS AND EXHAUST SILENCERS, IN EACH CASE  
ALONE OR HELD IN THE ASSOCIATED HOUSING,  
IN CLASS 7 (U.S. CLS. 13, 19, 21, 23, 31, 34 AND 35).

THE MARK CONSISTS OF STANDARD CHAR-  
ACTERS WITHOUT CLAIM TO ANY PARTICULAR  
FONT, STYLE, SIZE, OR COLOR.

OWNER OF INTERNATIONAL REGISTRATION  
0939697 DATED 4-26-2007, EXPIRES 4-26-2017.

SEC. 2(F).

SER. NO. 79-044,634, FILED 4-26-2007.

EVELYN BRADLEY, EXAMINING ATTORNEY

**Int. Cls.: 7 and 35**

**Prior U.S. Cls.: 13, 19, 21, 23, 31, 34, 35, 100, 101 and 102**

**Reg. No. 3,499,356**

**United States Patent and Trademark Office**

**Registered Sep. 9, 2008**

**TRADEMARK  
SERVICE MARK  
PRINCIPAL REGISTER**

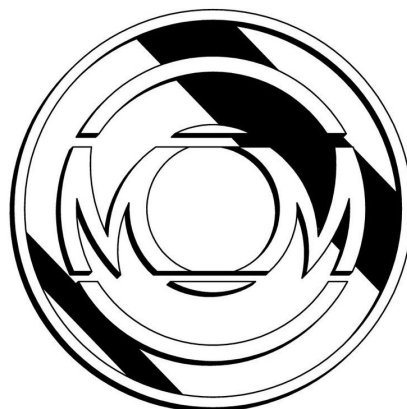

**MEC-MOR**

SANTONI S.P.A. (ITALY JOINT STOCK COMPANY)  
VIA CARLO FENZI, 14  
I-25135 BRESCIA, ITALY

FOR: DYEING MACHINES; HOT AIR DRYING MACHINES FOR TEXTILES; KNITTING MACHINES; PORTABLE ROTARY STEAM PRESSES FOR FABRICS; CHEMICAL FIBER SPINNING MACHINES; YARN WARPING MACHINES; PRINTING MACHINES FOR TEXTILES; EMBROIDERY MACHINES; HOSIERY LOOMS; LACE MAKING MACHINES AND IMPLEMENTS, NAMELY, STITCH MARKERS; HOSIERY KNITTING MACHINES AND IMPLEMENTS, NAMELY, STITCH GAUGES; SPINNING WHEELS AND FRAMES, NAMELY, CHEMICAL FIBER SPINNING MACHINES, SPINNING BOXES FOR OPEN-END ROTOR SPINNING MACHINES; AUTOMATIC POWER WEAVING LOOMS; SIZING MACHINES FOR USE IN THE MANUFACTURE OF TEXTILES; ELECTRIC CLOTHING PRESSING MACHINES IN THE NATURE OF PRESSING MACHINES TO MAKE FABRIC APPEAR SATIN-LIKE; CARDING MACHINES; WIRE DRAWING MACHINES; POWER-OPERATED REELS FOR WEAVING LOOMS; BOBBINS FOR WEAVING LOOMS; SLIDES FOR KNITTING MACHINES; CARRIAGES FOR KNITTING MACHINES; THREAD TWISTING MACHINES; THREADING MACHINES; LOOM SHAFTS; LOOMS BEING MACHINES; TAM-

BOURS FOR EMBROIDERY MACHINES; INDUSTRIAL SEWING MACHINES, IN CLASS 7 (U.S. CLS. 13, 19, 21, 23, 31, 34 AND 35).

FOR: PREPARING AND PLACING ADVERTISEMENTS FOR OTHERS; SAMPLE DISTRIBUTION; ORGANIZATION OF TRADE EXHIBITIONS FOR COMMERCIAL OR ADVERTISING PURPOSES; PUBLICATION OF PUBLICITY TEXTS; BUSINESS MANAGEMENT AND ORGANIZATION CONSULTANCY; MARKETING RESEARCH, IN CLASS 35 (U.S. CLS. 100, 101 AND 102).

PRIORITY DATE OF 3-13-2007 IS CLAIMED.

OWNER OF INTERNATIONAL REGISTRATION 0939843 DATED 5-22-2007, EXPIRES 5-22-2017.

THE MARK CONSISTS OF A SIGN DEPICTING THE WORDING "MEC-MOR" IN FANCY CHARACTERS, UNDER AN OUTLINED CIRCULAR SHAPE CONTAINING TWO OBLIQUE SUBSTANTIALLY TRAPEZOIDAL BANDS, PARTIALLY OVERLAPPING WHICH ARE TWO PROFILED CONCENTRIC CIRCLES, TWO SPECULAR OUTLINED BANDS OF CURVED EXTENSION STARTING FROM TWO POINTS OF THE CIRCUMFERENCE OF THE LARGER, JOINING THE CIRCUMFERENCE OF THE

SMALLER AT TWO POINTS, EVOCATIVE OF TWO STRONGLY STYLIZED LETTER MS, THE RESPECTIVE VERTICAL STROKES OF WHICH BEING REPRESENTED BY THE PORTIONS OF THE TWO CONCENTRIC CIRCLES, INTERRUPTED BY THE

REMAINING RESPECTIVE PORTIONS OF THE CIRCUMFERENCE.

SER. NO. 79-044,735, FILED 5-22-2007.

GILBERT SWIFT, EXAMINING ATTORNEY

**Int. Cls.: 9, 38, 41, 44 and 45**

**Prior U.S. Cls.: 21, 23, 26, 36, 38, 100, 101, 104 and 107**

**Reg. No. 3,499,357**

**United States Patent and Trademark Office**

**Registered Sep. 9, 2008**

**TRADEMARK  
SERVICE MARK  
PRINCIPAL REGISTER**



**CaringTV**

LAUREA-AMMATTIKORKEAKOULU OY (FINLAND OSAKEYHTIÖ (OY))  
RATATIE 22  
FI-01300 VANTAA  
FINLAND

FOR: TWO-WAY, INTERACTIVE TELEVISIONS WITH TOUCH-SCREEN CAPABILITY FOR USE IN SOCIAL WELFARE PROGRAMS, HAND-HELD UNITS FOR PLAYING ELECTRONIC GAMES FOR USE WITH EXTERNAL DISPLAY SCREEN OR MONITOR; TOUCH-SENSITIVE FLAT PANEL DISPLAY TELEVISION SCREENS, IN CLASS 9 (U.S. CLS. 21, 23, 26, 36 AND 38).

FOR: TELEVISION BROADCASTING; TELECOMMUNICATION SERVICES, NAMELY, PROVIDING ACCESS TO TELECOMMUNICATIONS NETWORKS FOR SOCIAL WELFARE AND SOCIAL WELFARE COMMUNICATION CENTERS, IN CLASS 38 (U.S. CLS. 100, 101 AND 104).

FOR: PRODUCTION OF TELEVISION PROGRAMS; INTERACTIVE TV PROGRAMS, NAMELY, ENTERTAINMENT IN THE NATURE OF AN ONGOING TELEVISION PROGRAM FEATURING SOCIAL WELFARE AND HEALTH CARE ISSUES, PHYSICAL FITNESS INSTRUCTION AND EDUCATION, MEDICATION AND NUTRITION FOR THE

ELDERLY, AND COOKING, IN CLASS 41 (U.S. CLS. 100, 101 AND 107).

FOR: MEDICAL CARE AND HEALTH CARE INFORMATION SERVICES IN COOPERATION WITH THE PUBLIC, PRIVATE AND THIRD SECTOR HEALTH CARE PROVIDERS DISTRIBUTED OVER TELEVISION PICTURE LINKS, IN CLASS 44 (U.S. CLS. 100 AND 101).

FOR: SOCIAL WELFARE SERVICES, AND PERSONAL AND SOCIAL SERVICES, NAMELY, SOCIAL NETWORKING SERVICES TO MEET THE NEEDS OF INDIVIDUALS UTILIZING TV PICTURE LINKS IN WHICH THE USER CAN INTERACT WITH PERSONS ON THE TELEVISION SCREEN, IN CLASS 45 (U.S. CLS. 100 AND 101).

PRIORITY DATE OF 10-19-2006 IS CLAIMED.

OWNER OF INTERNATIONAL REGISTRATION 0939947 DATED 4-19-2007, EXPIRES 4-19-2017.

SER. NO. 79-044,761, FILED 4-19-2007.

WILLIAM ROSSMAN, EXAMINING ATTORNEY



**Int. Cl.: 9**

**Prior U.S. Cls.: 21, 23, 26, 36 and 38**

**United States Patent and Trademark Office**

**Reg. No. 3,499,358**

**Registered Sep. 9, 2008**

**TRADEMARK  
PRINCIPAL REGISTER**

# InnovaStar

DIASYS DIAGNOSTIC SYSTEMS GMBH (FED  
REP GERMANY GMBH)  
ALTE STR. 9  
65558 HOLZHEIM  
FED REP GERMANY

FOR: APPARATUS AND INSTRUMENTS FOR  
CHEMICAL, CLINICAL CHEMICAL, IMMUNOLO-  
GICAL, SEROLOGICAL AND SCIENTIFIC ANALY-  
SIS AND DIAGNOSIS, NAMELY, FOR  
MEASURING, TESTING, AND ANALYZING  
BLOOD AND OTHER BODILY FLUIDS; ANALY-  
ZERS FOR CHEMICAL, CLINICAL CHEMICAL  
AND SCIENTIFIC LABORATORIES, NAMELY,  
CLINICAL LABORATORY ANALYZERS FOR MEASURING,

SURING, TESTING, AND ANALYZING BLOOD  
AND OTHER BODILY FLUIDS, IN CLASS 9 (U.S.  
CLS. 21, 23, 26, 36 AND 38).

PRIORITY DATE OF 4-3-2007 IS CLAIMED.

OWNER OF INTERNATIONAL REGISTRATION  
0940098 DATED 9-25-2007, EXPIRES 9-25-2017.

SER. NO. 79-044,802, FILED 9-25-2007.

EUGENIA MARTIN, EXAMINING ATTORNEY

**Int. Cl.: 7**

**Prior U.S. Cls.: 13, 19, 21, 23, 31, 34 and 35**

**United States Patent and Trademark Office**

**Reg. No. 3,499,359**

**Registered Sep. 9, 2008**

**TRADEMARK  
PRINCIPAL REGISTER**

**TURBOSTREAM**

OERLIKON LEYBOLD VACUUM GMBH (FED  
REP GERMANY LIMITED LIABILITY COM-  
PANY)

BONNER STR. 498  
50968 KÖLN, FED REP GERMANY

FOR: VACUUM GENERATING DEVICES, NAME-  
LY, BLOWERS FOR THE LASER INDUSTRY; VA-  
CUUM PUMPS, IN CLASS 7 (U.S. CLS. 13, 19, 21, 23,  
31, 34 AND 35).

OWNER OF INTERNATIONAL REGISTRATION  
0940117 DATED 10-1-2007, EXPIRES 10-1-2017.

SER. NO. 79-044,810, FILED 10-1-2007.

AISHA SALEM, EXAMINING ATTORNEY

**Int. Cl.: 11**

**Prior U.S. Cls.: 13, 21, 23, 31 and 34**

**United States Patent and Trademark Office**

**Reg. No. 3,499,360**

**Registered Sep. 9, 2008**

**TRADEMARK  
PRINCIPAL REGISTER**

**OPALINE**

OTV SA (FRANCE SOCIÉTÉ ANONYME)

IMMEUBLE L'AQUARÈNE -

1, PLACE MONTGOLFIER; F-94410 SAINT MAUR-  
ICE

FRANCE

FOR: APPARATUS, DEVICES AND INSTALLA-  
TIONS FOR TREATING WATER AND FOR REN-  
DERING WATER DRINKABLE, NAMELY, WATER  
FILTERING UNITS, IN CLASS 11 (U.S. CLS. 13, 21, 23,  
31 AND 34).

THE MARK CONSISTS OF STANDARD CHAR-  
ACTERS WITHOUT CLAIM TO ANY PARTICULAR  
FONT, STYLE, SIZE, OR COLOR.

PRIORITY DATE OF 12-21-2006 IS CLAIMED.

OWNER OF INTERNATIONAL REGISTRATION  
0940121 DATED 6-18-2007, EXPIRES 6-18-2017.

SER. NO. 79-044,813, FILED 6-18-2007.

ADA HAN, EXAMINING ATTORNEY

**Int. Cl.: 7**

**Prior U.S. Cls.: 13, 19, 21, 23, 31, 34 and 35**

**United States Patent and Trademark Office**

**Reg. No. 3,499,361**

**Registered Sep. 9, 2008**

**TRADEMARK  
PRINCIPAL REGISTER**

# Pre Turbo Metalit

EMITEC GESELLSCHAFT; FÜR EMISSION-  
TECHNOLOGIE MBH (FED REP GERMANY  
LIMITED LIABILITY COMPANY)

HAUPTSTRASSE 128  
53797 LOHMAR  
FED REP GERMANY

FOR: CATALYTIC CONVERTERS FOR INTERNAL COMBUSTION ENGINES; CATALYTIC CONVERTERS CONTAINING CATALYST SUBSTRATES FOR CLEANING EXHAUST GASES FOR USE IN INTERNAL COMBUSTION ENGINES; CATALYTIC CONVERTERS FOR THE TRACTION OR PROPULSION SYSTEMS OF LAND, AIR AND WATER VEHICLES; CATALYTIC CONVERTERS CONTAINING CATALYST SUBSTRATES FOR USE IN CLEANING EXHAUST GASES FOR USE IN TRACTION OR PROPULSION SYSTEMS OF LAND, AIR

AND WATER VEHICLES, IN CLASS 7 (U.S. CLS. 13, 19, 21, 23, 31, 34 AND 35).

THE MARK CONSISTS OF STANDARD CHARACTERS WITHOUT CLAIM TO ANY PARTICULAR FONT, STYLE, SIZE, OR COLOR.

OWNER OF INTERNATIONAL REGISTRATION 0940222 DATED 5-23-2007, EXPIRES 5-23-2017.

OWNER OF U.S. REG. NO. 1,374,563.

SER. NO. 79-044,856, FILED 5-23-2007.

WILLIAM ROSSMAN, EXAMINING ATTORNEY

**Int. Cls.: 35 and 43**

**Prior U.S. Cls.: 100, 101 and 102**

**United States Patent and Trademark Office**

**Reg. No. 3,499,362**

**Registered Sep. 9, 2008**

**SERVICE MARK  
PRINCIPAL REGISTER**

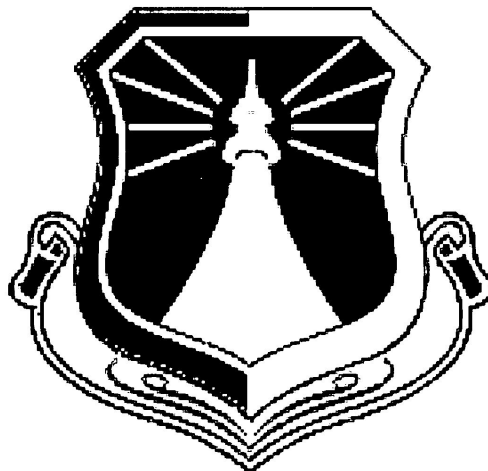

SUNYEE INDUSTRY (WUHAN) CO., LTD. (CHI-  
NA CORPORATION)  
NO. 438, ZHONGSHAN ROAD  
WUCHANG DISTRICT  
WUHAN; HUBEI, CHINA 430000

FOR: HOTEL MANAGEMENT FOR OTHERS;  
BUSINESS MANAGEMENT OF HOTELS FOR OTH-  
ERS; ARRANGING AND CONDUCTING OF FAIRS  
FOR BUSINESS OR ADVERTISING PURPOSES;  
BUSINESS ORGANIZATION AND MANAGEMENT  
CONSULTING; PERSONNEL MANAGEMENT  
CONSULTING; DISSEMINATION OF ADVERTIS-  
ING MATTER; ACCOUNTING SERVICES; PROVID-  
ING TELEVISION ADVERTISING FOR OTHERS;  
ADVERTISING AGENCIES; BUSINESS CONSULT-  
ING AND INFORMATION SERVICES, IN CLASS 35  
(U.S. CLS. 100, 101 AND 102).

FOR: HOTELS; BOARDING HOUSES; CAFES;  
SELF SERVICE RESTAURANTS; BOOKING OF  
CAMPGROUND ACCOMMODATION; MOTELS;  
BAR SERVICES; TEA ROOMS; PROVIDING CON-  
FERENCE ROOMS; PROVIDING CAMPGROUND  
FACILITIES, IN CLASS 43 (U.S. CLS. 100 AND 101).

PRIORITY DATE OF 11-29-2006 IS CLAIMED.

OWNER OF INTERNATIONAL REGISTRATION  
0940225 DATED 5-29-2007, EXPIRES 5-29-2017.

SER. NO. 79-044,858, FILED 5-29-2007.

KELLY MCCOY, EXAMINING ATTORNEY

**Int. Cl.: 9**

**Prior U.S. Cls.: 21, 23, 26, 36 and 38**

**Reg. No. 3,499,363**

**United States Patent and Trademark Office**

**Registered Sep. 9, 2008**

**TRADEMARK  
PRINCIPAL REGISTER**



TIBOR BALOGH (HUNGARY INDIVIDUAL)  
ADY ENDRE U. 3/A  
H-1192 BUDAPEST  
HUNGARY

FOR: THREE DIMENSIONAL VISUAL DISPLAY  
UNITS, MONITORS FOR COMPUTERS, TELEVI-  
SIONS, VIDEO AND DIGITAL CAMERAS, VIDEO  
AND DATA PROJECTORS FOR PRESENTATIONS,  
COMPUTER AIDED DESIGN, VIRTUAL REALITY

AND TELEPRESENCE, IN CLASS 9 (U.S. CLS. 21, 23,  
26, 36 AND 38).

OWNER OF INTERNATIONAL REGISTRATION  
0834853 DATED 4-23-2004, EXPIRES 4-23-2014.

SER. NO. 79-044,905, FILED 8-13-2007.

CAROLYN CATALDO, EXAMINING ATTORNEY

**Int. Cls.: 9, 35, 36, 38, 39 and 41**

**Prior U.S. Cls.: 21, 23, 26, 36, 38, 100, 101, 102, 104, 105 and 107**

**Reg. No. 3,499,364**

**United States Patent and Trademark Office**

**Registered Sep. 9, 2008**

**TRADEMARK  
SERVICE MARK  
PRINCIPAL REGISTER**

**Nàsuba**  
**CORPORATE GOLD**

LC2 MEDIAS SA (FRANCE SOCIÉTÉ ANONYME)  
76 AVENUE DES CHAMPS ELYSÉES  
F-75008 PARIS  
FRANCE

FOR: BLANK MAGNETIC DISKS AND CARDS; PRE-RECORDED MAGNETIC DISKS AND CARDS FEATURING FINANCIAL DATA, MUSIC, AND VIDEOS IN THE FIELDS OF NEWS, SPORTS, ENTERTAINMENT, MUSIC AND MOTION PICTURES; BLANK ACOUSTIC AND OPTICAL DISKS; ACOUSTIC DISKS FEATURING MUSIC; PRE-RECORDED OPTICAL DISKS FEATURING FINANCIAL DATA, MUSIC AND VIDEOS IN THE FIELDS OF NEWS, SPORTS, ENTERTAINMENT, MUSIC AND MOTION PICTURES; AUTOMATIC VENDING MACHINES AND MECHANISMS FOR COIN-OPERATED APPARATUS; CASH REGISTERS; DATA PROCESSING AND COMPUTER EQUIPMENT, NAMELY, MICRO-PROCESSORS, COMPUTER SERVERS, COMPUTER TERMINALS, LAPTOPS, PERSONAL DIGITAL ASSISTANTS, TELEPHONE TERMINALS; DIGITAL AUDIO AND VIDEO PLAYERS AND RECORDERS; COMPUTER-GAMING SOFTWARE; COMPUTER SOFTWARE FOR USE IN THE FIELD OF FINANCIAL SERVICES FOR PROCESSING INFORMATION, FOR CREATING, MANAGING, AND OPERATING DATABASES, AND FOR PROVIDING ACCESS TO A WORLD-WIDE COMMUNICATION NETWORK AND TO PRIVATE OR RESERVED ACCESS NETWORKS; MEMORY AND MICROPROCESSOR CARDS, IN CLASS 9 (U.S. CLS. 21, 23, 26, 36 AND 38).

FOR: ADVERTISING; BUSINESS MANAGEMENT; BUSINESS ADMINISTRATION; DISSEMINATION OF ADVERTISING MATERIAL; BUSINESS ORGANIZATION AND MANAGEMENT ADVICE; EMPLOYMENT AGENCIES; COMPUTER FILE MANAGEMENT; ON-LINE ADVERTISING

ON A COMPUTER NETWORK; RENTAL OF ACCESS TIME TO COMMUNICATION MEANS OF ALL KINDS FOR ADVERTISING, NAMELY, RENTAL OF ADVERTISING SPACE ON WEBSITES, IN NEWSPAPERS, IN MAGAZINES, AND RENTAL OF ADVERTISING ACCESS TIME ON RADIO, TELEVISION AND CINEMA; PUBLISHING OF ADVERTISING TEXTS; RENTAL OF ADVERTISING SPACE; DISSEMINATION OF ADVERTISEMENTS; PUBLIC RELATIONS, IN CLASS 35 (U.S. CLS. 100, 101 AND 102).

FOR: INSURANCE UNDERWRITING IN THE FIELDS OF ACCIDENT, HEALTH, LIFE, AND TRAVEL INSURANCE; FINANCIAL AFFAIRS, NAMELY, FINANCIAL ADVISORY AND CONSULTANCY SERVICES, FINANCIAL ANALYSIS AND RESEARCH SERVICES, FINANCIAL SERVICES IN THE FIELD OF MONEY LENDING, INVESTMENT FUND TRANSFER AND TRANSACTION SERVICES, CREDIT REPAIR AND RESTORATION; PROVIDING FINANCIAL RISK MANAGEMENT SERVICES FOR ELECTRONIC FUNDS TRANSFER, CREDIT AND DEBIT CARD AND ELECTRONIC CHECK TRANSACTIONS VIA A GLOBAL COMPUTER NETWORK; MONETARY AFFAIRS, NAMELY, FINANCIAL PLANNING; HOME BANKING, NAMELY, ON-LINE BANKING SERVICES; ISSUANCE OF TRAVELERS' CHECKS AND CREDIT CARDS; FINANCING SERVICES; FINANCIAL ANALYSIS; MUTUAL FUNDS BROKERAGE, DISTRIBUTION AND INVESTMENT; CAPITAL INVESTMENT; FINANCIAL CONSULTING; FINANCIAL EVALUATIONS FOR INSURANCE PURPOSES; FINANCIAL EVALUATION OF REAL ESTATE; FUNDS INVESTMENT, IN CLASS 36 (U.S. CLS. 100, 101 AND 102).

FOR: TELECOMMUNICATIONS, NAMELY, PROVIDING TRANSMISSION OF DATA, VOICE, AND

IMAGES BY CABLE, SATELLITE, ELECTRONIC, DIGITAL, HERTZIAN NETWORK, TELEPHONIC, TELEMATIC AND RADIOPHONIC MEANS; PROVIDING INFORMATION IN THE FIELD OF TELECOMMUNICATIONS; COMMUNICATIONS VIA COMPUTER TERMINALS AND VIA FIBER-OPTIC NETWORKS; RADIO AND TELEPHONE COMMUNICATION SERVICES; MOBILE RADIOTELEPHONY SERVICES; PROVISION OF ACCESS TO A GLOBAL COMPUTER NETWORK; CONNECTION BY TELECOMMUNICATIONS TO A GLOBAL COMPUTER NETWORK; RENTAL OF TELECOMMUNICATION APPARATUS; BROADCASTING RADIO AND TELEVISION PROGRAMS; AUDIO AND VIDEO TELECONFERENCING SERVICES; ELECTRONIC MESSAGING SERVICES, IN CLASS 38 (U.S. CLS. 100, 101 AND 104).

FOR: TRAVEL ARRANGEMENT; TRANSPORT INFORMATION, NAMELY, PROVIDING BOAT, FLIGHT, AND TRAIN ARRIVAL AND DEPARTURE INFORMATION AND PROVIDING INFORMATION ON TRANSPORT FACILITIES AND TRANSPORTATION COSTS; RENTAL OF GARAGES AND PARKING SPACES; RENTAL OF VEHICLES, BOATS AND HORSES; TAXI TRANSPORT; TRAVEL RESERVATION; TOURIST OFFICES, NAMELY, MAKING RESERVATIONS AND BOOKINGS FOR TRANSPORTATION; STORAGE OF DATA MEDIA AND DOCUMENTS STORED IN ELECTRONIC FORMAT, IN CLASS 39 (U.S. CLS. 100 AND 105).

FOR: PROVIDING INFORMATION ABOUT EDUCATIONAL AND ENTERTAINMENT EVENTS, NAMELY, PROVIDING INFORMATION ABOUT

LIVE MUSICAL PERFORMANCES, LIVE THEATRICAL PERFORMANCES, MUSEUM LOCATIONS AND OPERATING HOURS, CULTURAL ACTIVITIES AND EXPOSITIONS, MOVIES, AND SPORT COMPETITIONS; BOOKING OF SEATS FOR SHOWS; PROVIDING ON-LINE COMPUTER GAMES VIA A GLOBAL COMPUTER NETWORK; GAMBLING SERVICES, IN CLASS 41 (U.S. CLS. 100, 101 AND 107).

PRIORITY DATE OF 11-23-2006 IS CLAIMED.

OWNER OF INTERNATIONAL REGISTRATION 0940318 DATED 5-22-2007, EXPIRES 5-22-2017.

NO CLAIM IS MADE TO THE EXCLUSIVE RIGHT TO USE "CORPORATE", APART FROM THE MARK AS SHOWN.

THE COLOR(S) BLACK, YELLOW AND GREY IS/ ARE CLAIMED AS A FEATURE OF THE MARK.

THE MARK CONSISTS OF THE WORD "NÀSU-BA" IN BLACK AND THE WORDS "CORPORATE GOLD" IN YELLOW AND GREY SHADING.

THE FOREIGN WORDING IN THE MARK TRANSLATES INTO ENGLISH AS HELLO.

SER. NO. 79-044,977, FILED 5-22-2007.

LINDA LAVACHE, EXAMINING ATTORNEY



**Int. Cls.: 35 and 41**

**Prior U.S. Cls.: 100, 101, 102 and 107**

**United States Patent and Trademark Office**

**Reg. No. 3,499,365**

**Registered Sep. 9, 2008**

**SERVICE MARK  
PRINCIPAL REGISTER**

**eFIDIC**

FÉDÉRATION INTERNATIONALE; DES INGÉ-  
NIEURS-CONSEILS; (FIDIC) (SWITZERLAND  
INCORPORATED ASSOCIATION)  
2 WORLD TRADE CENTRE  
AÉROPORT DE GENÈVE; CASE POSTALE 311  
CH-1215 GENÈVE 15, SWITZERLAND

FOR: BUSINESS ORGANIZATION AND MAN-  
AGEMENT CONSULTING SERVICES, BUSINESS  
ORGANIZATION AND MANAGEMENT CONSULT-  
ING SERVICES IN THE FIELD OF BUSINESS ETH-  
ICS; BUSINESS CONSULTING AND LOBBYING  
SERVICES, NAMELY, PROMOTING THE INTER-  
ESTS OF CONSULTING ENGINEERS IN THE  
FIELDS OF LEGISLATION AND REGULATION,  
IN CLASS 35 (U.S. CLS. 100, 101 AND 102).

FOR: ORGANIZATION OF MEETINGS FOR CUL-  
TURAL AND EDUCATIONAL PURPOSES; ONLINE  
TRAINING IN THE FORM OF COURSES, SEMI-  
NARS, WORKSHOPS IN THE FIELD OF FOREIGN

LANGUAGE, HISTORY, ART, SCIENCE, TECH-  
NOLOGY FOR CULTURAL AND EDUCATIONAL  
PURPOSES, IN CLASS 41 (U.S. CLS. 100, 101 AND  
107).

THE MARK CONSISTS OF STANDARD CHAR-  
ACTERS WITHOUT CLAIM TO ANY PARTICULAR  
FONT, STYLE, SIZE, OR COLOR.

PRIORITY DATE OF 2-22-2007 IS CLAIMED.

OWNER OF INTERNATIONAL REGISTRATION  
0940432 DATED 8-22-2007, EXPIRES 8-22-2017.

SER. NO. 79-045,006, FILED 8-22-2007.

KEVIN CORWIN, EXAMINING ATTORNEY

**Int. Cls.: 6, 20 and 35**

**Prior U.S. Cls.: 2, 12, 13, 14, 22, 23, 25, 32, 50, 100, 101 and 102**

**Reg. No. 3,499,366**

**Registered Sep. 9, 2008**

**United States Patent and Trademark Office**

**TRADEMARK  
SERVICE MARK  
PRINCIPAL REGISTER**

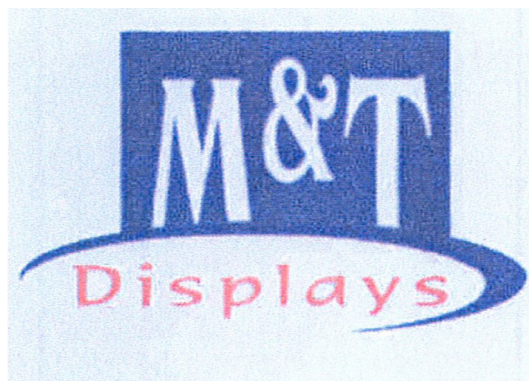

M.T. REKLAM VE PAZARLAMA; SANAYI TICARET LIMITED SIRKETI (TURKEY LIMITED COMPANY)  
ORGANIZE DERI  
SANAYI BÖLGESİ YA 11  
TUZLA ISTANBUL, TURKEY

FIELD OF METAL SIGNBOARD PLATES AND BOARDS, FRAMES FOR PAINTINGS NOT OF PRECIOUS METAL, MIRROR FRAMES, PICTURE FRAMES, WALL FRAME FOR THE DISPLAY OF MEDIA STORAGE CONTAINERS, IN CLASS 35 (U.S. CLS. 100, 101 AND 102).

FOR: NON-MECHANICAL, NON-LUMINOUS METAL SIGNBOARD PLATES AND BOARDS, IN CLASS 6 (U.S. CLS. 2, 12, 13, 14, 23, 25 AND 50).

OWNER OF INTERNATIONAL REGISTRATION 0940452 DATED 8-29-2007, EXPIRES 8-29-2017.

FOR: FRAMES FOR PAINTINGS NOT OF PRECIOUS METAL, MIRROR FRAMES, PICTURE FRAMES, WALL FRAME FOR THE DISPLAY OF MEDIA STORAGE CONTAINERS, IN CLASS 20 (U.S. CLS. 2, 13, 22, 25, 32 AND 50).

NO CLAIM IS MADE TO THE EXCLUSIVE RIGHT TO USE "DISPLAYS", APART FROM THE MARK AS SHOWN.

FOR: ADVERTISING SERVICES; ADVERTISING AGENCIES; PRODUCTION OF RADIO AND TELEVISION COMMERCIALS; DISSEMINATION OF ADVERTISING MATTER; ORGANIZATION OF EXHIBITIONS FOR COMMERCIAL OR ADVERTISING PURPOSES; MODELING FOR ADVERTISING OR SALES PROMOTION; MARKETING STUDIES; SALES PROMOTION; SHOP WINDOW DRESSING; QUESTIONNAIRE SERVICES, NAMELY, MARKET AND PUBLIC OPINION POLLING; PUBLIC RELATIONS; THE BRINGING TOGETHER OF A WIDE VARIETY OF GOODS ENABLING CUSTOMERS TO VIEW AND PURCHASE THOSE GOODS IN THE

THE COLOR(S) RED, BLUE AND LIGHT BLUE IS/ ARE CLAIMED AS A FEATURE OF THE MARK.

THE MARK CONSISTS OF THE WORD "DISPLAYS" IN RED, THE RECTANGLE AND CURVED LINE UNDER THE RECTANGLE ARE BLUE, AND THE LETTERS "M&T" AND THE BACKGROUND OF THE ENTIRE DESIGN ARE LIGHT BLUE.

SER. NO. 79-045,014, FILED 8-29-2007.

AMY MCMENAMIN, EXAMINING ATTORNEY

Int. Cl.: 29

Prior U.S. Cl.: 46

United States Patent and Trademark Office

Reg. No. 3,499,367

Registered Sep. 9, 2008

TRADEMARK  
PRINCIPAL REGISTER

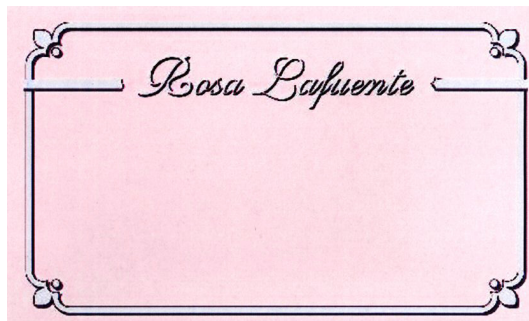

CONSERVERA GALLEGA, S.A. (SPAIN SOCIEDAD ANONIMA)

EL CASTRO, S/N

E-36620 VILLANUEVA DE AROSA (PONTEVEDRA), SPAIN

FOR: MEAT, FISH, POULTRY AND GAME; MEAT EXTRACTS; PRESERVED, DRIED AND COOKED FRUITS AND VEGETABLES; JELLIES, JAMS, COMPOTES; EGGS; EDIBLE OILS AND FATS, IN CLASS 29 (U.S. CL. 46).

PRIORITY DATE OF 10-6-2006 IS CLAIMED.

OWNER OF INTERNATIONAL REGISTRATION 0940632 DATED 4-4-2007, EXPIRES 4-4-2017.

THE NAME "ROSA LAFUENTE" IDENTIFIES A LIVING INDIVIDUAL WHOSE CONSENT IS OF RECORD.

THE COLOR(S) PINK, SILVER AND BLACK IS/ ARE CLAIMED AS A FEATURE OF THE MARK.

THE MARK CONSISTS OF THE COLOR PINK WHICH APPEARS IN THE BACKGROUND OF THE RECTANGLE; THE COLOR SILVER WHICH APPEARS IN THE WORDING "ROSA LAFUENTE" AND IN THE DESIGN ELEMENTS, AND THE COLOR BLACK WHICH APPEARS AS AN OUTLINE AROUND THE SILVER WORDING AND THE SILVER DESIGN ELEMENTS.

SER. NO. 79-045,098, FILED 4-4-2007.

SUZANNE BLANE, EXAMINING ATTORNEY

**Int. Cl.: 14**

**Prior U.S. Cls.: 2, 27, 28 and 50**

**United States Patent and Trademark Office**

**Reg. No. 3,499,368**

**Registered Sep. 9, 2008**

**TRADEMARK  
PRINCIPAL REGISTER**

POMELLATO S.P.A. (ITALY CORPORATION)  
VIA NEERA, 37  
I-20141 MILANO, ITALY

FOR: GOLD; SILVER; PLATINUM; PRECIOUS METALS AND THEIR ALLOYS; OBJECTS MADE OF PRECIOUS METALS AND THEIR ALLOYS, NAMELY, BOXES OF PRECIOUS METAL, BRACELETS OF PRECIOUS METAL, HAT ORNAMENTS OF PRECIOUS METAL, FIGURINES OF PRECIOUS METAL, RINGS, NECKLACES, BRACELETS, BROOCHES, EARRINGS, TIE CLASPS, TRINKETS, NAMELY, CHARMS, AND KEY CHAINS OF PRECIOUS METAL; DIAMONDS; PRECIOUS STONES; JEWELRY; CUFF LINKS ARID TIE PINS; WRISTWATCHES; CLOCKS; WATCH BANDS; CHRONOMETRIC INSTRUMENTS; JEWELRY PLATED WITH PRECIOUS METALS; CASES AND BOXES

FOR CLOCKS AND JEWELRY, IN CLASS 14 (U.S. CLS. 2, 27, 28 AND 50).

PRIORITY DATE OF 6-13-2007 IS CLAIMED.

OWNER OF INTERNATIONAL REGISTRATION  
0940712 DATED 8-27-2007, EXPIRES 8-27-2017.

THE MARK COMPRISES THE TEXT "POM POM"  
WRITTEN IN SPECIAL LETTERS.

SER. NO. 79-045,133, FILED 8-27-2007.

KATHERINE E. HALMEN, EXAMINING ATTORNEY

**Int. Cls.: 16, 37 and 39**

**Prior U.S. Cls.: 2, 5, 22, 23, 29, 37, 38, 50, 100, 103, 105  
and 106**

**Reg. No. 3,499,369**

**United States Patent and Trademark Office**

**Registered Sep. 9, 2008**

**TRADEMARK  
SERVICE MARK  
PRINCIPAL REGISTER**

# **Bake-Well**

PILLOPAK B.V. (NETHERLANDS GMBH)  
COLDENHOVENSEWEG 89  
NL-6961 EC EERBEEK  
NETHERLANDS

FOR: PAPER, CARDBOARD, CORRUGATED PAPER, CORRUGATED CARDBOARD, GOODS OF PAPER AND CARDBOARD, NAMELY, OVENABLE TRAYS; BISCUITS PACKAGING CONTAINERS OF PAPER, PASTRY PACKAGING CONTAINERS OF PAPER, SNACK PACKAGING CONTAINERS OF PAPER, PACKAGING CONTAINERS OF PAPER FOR FRUIT AND/OR VEGETABLES, BAKING TRAYS BEING PACKAGING CONTAINERS OF PAPER, TRANSPORT PACKAGING CONTAINERS OF PAPER AND POS (POINT OF SALE) PACKAGING CONTAINERS OF PAPER, CARDBOARD FLOOR DISPLAY UNITS FOR MERCHANDISING PRODUCTS; PACKING CARDBOARD, PACKING PAPER, BOXES OF PAPER, BOXES OF CARDBOARD, AND BOXES COMPOSED PRIMARILY OF CARDBOARD AND INCORPORATING PLASTIC MATERIALS IN THE NATURE OF PLASTIC CARRYING HANDLES, PLASTIC CONTAINER CLOSURES SOLD AS A UNIT THEREWITH; CARDBOARD; CORRUGATED BOARD AND PAPER CONTAINERS, BOXES OF PAPER, CARDBOARD AND CORRUGATED BOARD; REINFORCED AND PADDED ENVELOPES; COLLAPSIBLE BOXES OF PAPER, CARDBOARD, CORRUGATED CARDBOARD AND COLLAPSIBLE BOXES COMPOSED PRIMARILY OF PAPER, CARDBOARD OR CORRUGATED CARDBOARD AND INCORPORATING PLASTIC MATERIALS IN THE NATURE OF PLASTIC CARRYING HANDLES, PLASTIC CONTAINER CLOSURES SOLD AS A UNIT THEREWITH; COLLAPSIBLE BOXES COMPOSED PRIMARILY OF CARDBOARD, CORRUGATED CARDBOARD AND INCORPORATING A PROTECTIVE INTER-

NAL PACKAGING OF PLASTIC IN THE FORM OF PLASTIC FILM, PLASTIC BUBBLE PACKS OR PLASTIC FOAM PELLETS FOR PACKAGING PURPOSES, SOLD AS A UNIT THEREWITH, IN CLASS 16 (U.S. CLS. 2, 5, 22, 23, 29, 37, 38 AND 50).

FOR: INSTALLATION, REPAIR AND MAINTENANCE OF MACHINES AND EQUIPMENT FOR MAKING SECTIONS OF PAPER, CARDBOARD, CORRUGATED CARDBOARD AND CARD LENGTHS AND FOR MAKING CONTAINERS AND TRAYS FOR USE WITH THE AFORESAID PRODUCTS; INSTALLATION, REPAIR AND MAINTENANCE OF MACHINES AND EQUIPMENT FOR FILLING CONTAINERS AND TRAYS WITH FILLING MATERIALS; INSTALLATION; REPAIR AND MAINTENANCE OF MACHINES AND EQUIPMENT FOR PACKAGING AND ASSEMBLY OF PACKAGING MATERIALS, IN CLASS 37 (U.S. CLS. 100, 103 AND 106).

FOR: PACKAGING ARTICLES AND PACKAGING ARTICLES FOR TRANSPORTATION TO THE ORDER AND SPECIFICATION OF OTHERS AND FREIGHT FORWARDING; SERVICES RELATING TO THE PROTECTIVE PACKAGING OF GOODS, NAMELY, PACKAGING ARTICLES FOR TRANSPORTATION AND PACKAGING ARTICLES TO THE ORDER AND SPECIFICATION OF OTHERS, IN CLASS 39 (U.S. CLS. 100 AND 105).

OWNER OF INTERNATIONAL REGISTRATION  
0940764 DATED 8-3-2007, EXPIRES 8-3-2017.

SER. NO. 79-045,158, FILED 8-3-2007.

KAELIE KUNG, EXAMINING ATTORNEY

**Int. Cls.: 7, 9 and 42**

**Prior U.S. Cls.: 13, 19, 21, 23, 26, 31, 34, 35, 36, 38, 100  
and 101**

**Reg. No. 3,499,370**

**United States Patent and Trademark Office**

**Registered Sep. 9, 2008**

**TRADEMARK  
SERVICE MARK  
PRINCIPAL REGISTER**

# attocube

ATTOCUBE SYSTEMS AG (FED REP GERMANY  
AG (= AKTIENGESELLSCHAFT): GERMAN  
PUBLIC COMPANY)  
KOENIGINSTR. 11A RGB  
80539 MÜNCHEN  
FED REP GERMANY

FOR: MOTORS FOR MICROSCOPIC POSITIONING AND SCANNING INSTRUMENTS, PIEZO MOTORS AND ELECTRIC MOTORS FOR INSTRUMENTS; ELECTROMOTIVE AND PIEZO-ELECTRIC DRIVES FOR ONE AND MULTIPLE AXIAL POSITIONING SYSTEMS, IN CLASS 7 (U.S. CLS. 13, 19, 21, 23, 31, 34 AND 35).

FOR: ELECTRIC AND ELECTRONIC MEASURING AND CONTROL UNITS FOR MICROANALYSIS AND NANOANALYSIS; SCIENTIFIC APPARATUSES, EQUIPMENT AND INSTRUMENTS, NAMELY, PRECISION POSITIONING SYSTEMS COMPRISED OF LINEAR POSITIONERS, ROTATORS, GONIOMETERS AND SCANNERS, ADJUSTMENT AND POSITIONING SYSTEMS COMPRISED OF LINEAR POSITIONERS, ROTATORS, GONIOMETERS AND SCANNERS WITH PIEZO DRIVES, ELECTRONICALLY CONTROLLABLE MECHANICAL ADJUSTING UNITS AS WELL AS OPEN LOOP CONTROL UNITS AND CLOSED LOOP CONTROL UNITS FOR THE AFOREMENTIONED ADJUSTING UNITS; MICRO POSITIONERS FOR FIBER OPTIC CABLES AND FIBER OPTICS; INTEGRATED POSITION SENSORS FOR MECHANICAL POSITIONING SYSTEMS; MICROSCOPES, ESPECIALLY PRECISION MICROSCOPES, SCANNING PROBE MICROSCOPES AND CONFOCAL MICROSCOPES; EQUIPMENT FOR ELECTRONIC OPTICAL MEASUREMENTS, NAMELY, EQUIPMENT FOR MOVING MIRRORS IN THE APPLICATION OF MICROSCOPICS AND LASERS,

NAMELY, PIEZO-ELECTRIC CONTROLLERS; OPTICAL APPARATUSES AND INSTRUMENTS, NAMELY, MICROSCOPES AND THEIR PARTS; OPTOELECTRONIC AND NON-CONTACT OPERATIONAL SURFACE MEASUREMENT EQUIPMENT, NAMELY, CONFOCAL MICROSCOPES, ATOMIC FORCE MICROSCOPES, SCANNING NEAR-FIELD OPTICAL MICROSCOPES AND SCANNING TUNNELING MICROSCOPES; DATA PROCESSING EQUIPMENT, NAMELY, LOW TEMPERATURE PHYSICS MEASUREMENT ELECTRONIC SYSTEMS; COMPUTERS AND COMPUTER SOFTWARE FOR THE OPERATION OF ADJUSTMENT AND POSITIONING SYSTEMS, IN CLASS 9 (U.S. CLS. 21, 23, 26, 36 AND 38).

FOR: DEVELOPMENT OF COMPUTER SOFTWARE; SERVICES OF ENGINEERS IN THE FIELD OF MICROSCOPICS AND NANOTECHNOLOGY; PHYSICAL RESEARCH IN THE FIELD OF MICROSCOPICS AND NANOTECHNOLOGY; RESEARCH IN THE AREA OF TECHNOLOGY, ESPECIALLY SCIENTIFIC AND INDUSTRIAL RESEARCH; EXECUTION OF TECHNICAL MEASUREMENTS; SEARCH AND DEVELOPMENT SERVICES REGARDING NEW PRODUCTS FOR THIRD PARTIES , IN CLASS 42 (U.S. CLS. 100 AND 101).

THE MARK CONSISTS OF STANDARD CHARACTERS WITHOUT CLAIM TO ANY PARTICULAR FONT, STYLE, SIZE, OR COLOR.

PRIORITY DATE OF 5-11-2007 IS CLAIMED.

OWNER OF INTERNATIONAL REGISTRATION  
0940788 DATED 8-13-2007, EXPIRES 8-13-2017.

SER. NO. 79-045,169, FILED 8-13-2007.

CAROLYN CATALDO, EXAMINING ATTORNEY

Int. Cls.: 3, 14 and 25

Prior U.S. Cls.: 1, 2, 4, 6, 22, 27, 28, 39, 50, 51 and 52

Reg. No. 3,499,371

United States Patent and Trademark Office

Registered Sep. 9, 2008

TRADEMARK  
PRINCIPAL REGISTER



CARLO SPITALER  
HÖTTINGER AU 23A  
A-6020 INNSBRUCK  
AUSTRIA

FOR: HAND SOAPS, PERFUMERY, ESSENTIAL OILS, COSMETICS, HAIR LOTIONS, TOILETRIES INHIBITING PERSPIRATION, NAMELY, DEODORANTS FOR PERSONAL USE AND DEODORANT SOAPS; COSMETIC CREAMS, NAIL VARNISH, NAIL VARNISH REMOVER, SELF-TANNING CREAMS, COSMETIC PENCILS, PERFUME, EAU DE PERFUME, EAU DE TOILETTE, SHAVING FOAM, NON-MEDICATED LIP CARE PREPARATIONS, LIP STICKS, ANTI-AGING COSMETICS, IN CLASS 3 (U.S. CLS. 1, 4, 6, 50, 51 AND 52).

FOR: PRECIOUS METALS AND ALLOYS THEREOF AS WELL AS JEWELLERY PLATED WITH PRECIOUS METALS AND THEIR ALLOYS; JEWELLERY, PRECIOUS AND SEMI-PRECIOUS STONES, WATCHES AND CLOCKS AND TIMING INSTRUMENTS, NAMELY, STOP WATCHES, WRIST WATCHES, AND TIMEPIECES, IN CLASS 14 (U.S. CLS. 2, 27, 28 AND 50).

FOR: ALL KINDS OF CLOTHING FOR LADIES AND GENTLEMEN, ADOLESCENTS AND CHILDREN, NAMELY, PANTS, TROUSERS, SWEATERS, SWEAT SHIRTS, TOPS, T-SHIRTS, BLOUSES, JACKETS, COATS, JERSEYS, BELTS, SOCKS; FOOTWEAR; CLOTHING FOR LEISURE TIME AND SPORTS, NAMELY, BEACHWEAR, BIKINIS, BATHING SUITS, SPORTS SHIRTS WITH SHORT SLEEVES, SPORTS SHIRTS, SPORTS OVERUNIFORMS, SPORTS JERSEYS AND BREECHES FOR SPORTS, SPORTS JACKETS, SPORTS BRAS; FOOTWEAR FOR LEISURE TIME AND SPORTS, IN CLASS 25 (U.S. CLS. 22 AND 39).

PRIORITY DATE OF 1-12-2007 IS CLAIMED.

OWNER OF INTERNATIONAL REGISTRATION  
0940866 DATED 6-13-2007, EXPIRES 6-13-2017.

SER. NO. 79-045,209, FILED 6-13-2007.

CHARISMA HAMPTON, EXAMINING ATTORNEY



Int. Cl.: 9

Prior U.S. Cls.: 21, 23, 26, 36 and 38

United States Patent and Trademark Office

Reg. No. 3,499,372

Registered Sep. 9, 2008

TRADEMARK  
PRINCIPAL REGISTER



LIWO PRODUCTION (FRANCE SOCIÉTÉ À RE-  
SPONSABILITÉ LIMITÉE)  
38 RUE PROFESSEUR FLORENCE  
F-69003 LYON  
FRANCE

FOR: APPARATUS FOR RECORDING, TRANS-  
MITTING, REPRODUCING OR PROCESSING  
SOUND OR IMAGES ; MAGNETIC RECORDING  
MEDIA, NAMELY, OPTICAL DISKS ; GAME WARE,  
NAMELY, INTERACTIVE DVD'S ; COMPUTER  
SOFTWARE, NAMELY, VIDEO GAMES, IN CLASS  
9 (U.S. CLS. 21, 23, 26, 36 AND 38).

PRIORITY DATE OF 4-3-2007 IS CLAIMED.

OWNER OF INTERNATIONAL REGISTRATION  
0941187 DATED 9-28-2007, EXPIRES 9-28-2017.

NO CLAIM IS MADE TO THE EXCLUSIVE  
RIGHT TO USE "DVD PETS COLLECTION", APART  
FROM THE MARK AS SHOWN.

THE COLOR(S) BROWN, BEIGE, ORANGE, RED-  
DISH-BROWN, WHITE, YELLOW AND PURPLE-  
BLUE IS/ARE CLAIMED AS A FEATURE OF THE  
MARK.

DOG: BROWN AND BEIGE; FISH: ORANGE;  
HAMSTER: REDDISH-BROWN AND WHITE; LET-  
TERS: YELLOW; BACKGROUND: PURPLE-BLUE.

SER. NO. 79-045,296, FILED 9-28-2007.

INGA ERVIN, EXAMINING ATTORNEY

**Int. Cl.: 19**

**Prior U.S. Cls.: 1, 12, 33 and 50**

**United States Patent and Trademark Office**

**Reg. No. 3,499,373**

**Registered Sep. 9, 2008**

**TRADEMARK  
PRINCIPAL REGISTER**

**PANEFRI**

PANEFRI INDUSTRIAL CO., LTD. (JAPAN CORPORATION)  
BABA 2-6-7,  
NAGAOKAKYO CITY; KYOTO PREF. 617-0828  
JAPAN

FOR: BUILDING MATERIALS NOT OF METAL, NAMELY, PLASTIC EDGE BANDING AND RUBBER EDGE BANDING IN THE NATURE OF NON-METAL DECORATIVE MOLDINGS AND DECORATIVE TRIM FOR USE IN BUILDING CONSTRUCTION; NON-METAL WINDOW FRAMES; NON-METAL DECORATIVE DOOR MOLDINGS; PLASTIC STAYS, NAMELY, STAY-IN-PLACE PLASTIC PANELS USED TO SUPPORT THE INNER-GLASS PORTION OF DOORS; NON-METAL DOOR FRAMES; SKIRTING BOARDS IN THE NATURE OF NON-METAL DECORATIVE MOLDINGS AND DECORATIVE TRIM FOR USE IN BUILDING CONSTRUCTION; NON-METAL NON-SLIP MATERIALS FOR STAIRS IN THE NATURE OF RUBBER AND PLASTIC STAIRWAY WARNING TILES AND STAIR TREADS; NON-METAL HANDRAILS, NON-METAL SILLS FOR SLIDING SCREEN OR DOOR; NON-METAL HEAD JAMBS FOR SLIDING SCREEN OR DOORS; NON-METAL HAND RAILINGS FOR STAIRCASES; DECORATIVE PLASTIC MOLDINGS; PLASTIC WALL PANELING; DEC-

ORATIVE RUBBER MOLDINGS; PLASTIC DECKING BOARDS AND PLANKS; PLASTIC COPINGS USED FOR STAIR RAILS; PLASTIC PARTITIONS IN THE NATURE OF GLASS-LIKE BRICKS; PLASTIC SHOCK ABSORBERS AND RUBBER SHOCK ABSORBERS FOR DOORS, NAMELY, SLAMMING STILES ATTACHED TO A DOORFRAME FOR ABSORBING SHOCK WHEN CLOSING A DOOR; PLASTIC FENCING PANELS; NON-METAL JOINERY FITTINGS, IN CLASS 19 (U.S. CLS. 1, 12, 33 AND 50).

THE MARK CONSISTS OF STANDARD CHARACTERS WITHOUT CLAIM TO ANY PARTICULAR FONT, STYLE, SIZE, OR COLOR.

PRIORITY DATE OF 7-12-2007 IS CLAIMED.

OWNER OF INTERNATIONAL REGISTRATION  
0941227 DATED 8-22-2007, EXPIRES 8-22-2017.

SER. NO. 79-045,310, FILED 8-22-2007.

TOBY BULLOFF, EXAMINING ATTORNEY

**Int. Cl.: 8**

**Prior U.S. Cls.: 23, 28 and 44**

**Reg. No. 3,499,374**

**United States Patent and Trademark Office**

**Registered Sep. 9, 2008**

**TRADEMARK  
PRINCIPAL REGISTER**



HTP BETEILIGUNGS AG (FED REP GERMANY  
AKTIENGESELLSCHAFT)  
SEEBERSTRASSE 1  
CH-4132 MUTTENZ  
SWITZERLAND

THE MARK CONSISTS OF THE LITERAL ELEM-  
ENT "TB", STYLIZED, WITH A CIRCLE DESIGN  
ELEMENT APPEARING BETWEEN THE "T AND B".

FOR: SOLDERING BLOW PIPES AND THEIR  
SPARE PARTS, IN CLASS 8 (U.S. CLS. 23, 28 AND 44).

SER. NO. 79-045,325, FILED 10-10-2007.

OWNER OF INTERNATIONAL REGISTRATION  
0637080 DATED 10-19-1994, EXPIRES 10-19-2014.

LAURIE KAUFMAN, EXAMINING ATTORNEY

**Int. Cls.: 5 and 31**

**Prior U.S. Cls.: 1, 6, 18, 44, 46, 51 and 52**

**United States Patent and Trademark Office**

**Reg. No. 3,499,375**

**Registered Sep. 9, 2008**

**TRADEMARK  
PRINCIPAL REGISTER**

**TYLOVET**

AKTIONERNO DROUJESTVO; "HUVEPHAR-  
MA" (BULGARIA PUBLIC LIMITED COMPA-  
NY)

"JAMES BOUCHER" BLVD. 33  
BG-1407 SOFIA, BULGARIA

FOR: VETERINARY PREPARATIONS FOR  
FARM ANIMALS AND PETS FOR PREVENTION  
AND TREATMENT OF RESPIRATORY AND GAS-  
TRO-INTESTINAL DISEASES CAUSED BY TYLO-  
SIN-SENSITIVE MICROORGANISMS; ADDITIVES  
TO FODDER FOR MEDICAL PURPOSES, IN CLASS  
5 (U.S. CLS. 6, 18, 44, 46, 51 AND 52).

FOR: ADDITIVES TO ANIMAL FODDER, NOT  
FOR MEDICAL PURPOSES, NAMELY, NON-MEDI-  
CATED ADDITIVES FOR ANIMAL FODDER, IN  
CLASS 31 (U.S. CLS. 1 AND 46).

THE MARK CONSISTS OF STANDARD CHAR-  
ACTERS WITHOUT CLAIM TO ANY PARTICULAR  
FONT, STYLE, SIZE, OR COLOR.

PRIORITY DATE OF 4-24-2007 IS CLAIMED.

OWNER OF INTERNATIONAL REGISTRATION  
0941543 DATED 10-3-2007, EXPIRES 10-3-2017.

THE WORDING "TYLOVET" HAS NO MEANING  
IN A FOREIGN LANGUAGE.

SER. NO. 79-045,414, FILED 10-3-2007.

MYRIAH HABEEB, EXAMINING ATTORNEY

**Int. Cls.: 12, 28 and 37**

**Prior U.S. Cls.: 19, 21, 22, 23, 31, 35, 38, 44, 50, 100,  
103 and 106**

**Reg. No. 3,499,376**

**United States Patent and Trademark Office**

**Registered Sep. 9, 2008**

**TRADEMARK  
SERVICE MARK  
PRINCIPAL REGISTER**

# Amalfitana

HEINZ-E. GRAFFMANN (FED REP GERMANY  
INDIVIDUAL)  
AN DER SCHINNENBURG 4  
RATINGEN, FED REP GERMANY 40883

FOR: AUTOMOBILES AND STRUCTURAL  
PARTS THEREFOR, IN CLASS 12 (U.S. CLS. 19, 21,  
23, 31, 35 AND 44).

FOR: MODEL CARS, IN CLASS 28 (U.S. CLS. 22, 23,  
38 AND 50).

FOR: REPARATION AND MAINTENANCE OF  
VEHICLES, IN CLASS 37 (U.S. CLS. 100, 103 AND 106).

THE MARK CONSISTS OF STANDARD CHAR-  
ACTERS WITHOUT CLAIM TO ANY PARTICULAR  
FONT, STYLE, SIZE, OR COLOR.

PRIORITY DATE OF 3-26-2007 IS CLAIMED.

OWNER OF INTERNATIONAL REGISTRATION  
0941713 DATED 9-21-2007, EXPIRES 9-21-2017.

SER. NO. 79-045,465, FILED 9-21-2007.

PATRICIA EVANKO, EXAMINING ATTORNEY

**Int. Cls.: 7, 10, 12 and 40**

**Prior U.S. Cls.: 13, 19, 21, 23, 26, 31, 34, 35, 39, 44,  
100, 103 and 106**

**Reg. No. 3,499,377**

**United States Patent and Trademark Office**

**Registered Sep. 9, 2008**

**TRADEMARK  
SERVICE MARK  
PRINCIPAL REGISTER**

***POGGIPOLINI***

POGGIPOLINI S.R.L. (ITALY LIMITED LIABILITY COMPANY)  
VIA EMILIA, 262  
I-40068 S. LAZZARO DI SAVENA (BOLOGNA)  
ITALY

FOR: FAUCETS, BEING PARTS OF MACHINES, ENGINES OR MOTORS, IN CLASS 7 (U.S. CLS. 13, 19, 21, 23, 31, 34 AND 35).

FOR: SURGICAL PROSTHESES, BEING DENTAL, BREAST, HAND, ARM, LEG, VASCULAR AND GASTROINTESTINAL PROSTHESES, IN CLASS 10 (U.S. CLS. 26, 39 AND 44).

FOR: MOTORS FOR AUTOMOBILES; MOTORS FOR BICYCLES; ENGINES FOR LAND VEHICLES; MACHINE COUPLINGS AND TRANSMISSION COMPONENTS FOR LAND VEHICLES; TRANSMISSION BELTS FOR LAND VEHICLES; TRANSMISSION CASES FOR LAND VEHICLES; TRANSMISSION MECHANISMS FOR LAND VEHICLES; UNIVERSAL JOINTS FOR LAND VEHICLES; DRIVE SHAFTS FOR LAND VEHICLES; DRIVE

SHAFT JOINTS FOR LAND VEHICLES; TORSION SHAFTS FOR LAND VEHICLES; GEARS FOR LAND VEHICLES; CHASSIS FOR LAND VEHICLES; LAND VEHICLE SUSPENSION PARTS, NAMELY, WISH-BONES; STEERING ARMS FOR LAND VEHICLES; AXLES FOR LAND VEHICLES; RIMS FOR VEHICLE WHEELS; VEHICLE BRAKES; COIL, LEAF AND SHOCK ABSORBING SPRINGS FOR LAND VEHICLES; SHOCK ABSORBERS FOR LAND VEHICLES; TIRES FOR LAND VEHICLES, IN CLASS 12 (U.S. CLS. 19, 21, 23, 31, 35 AND 44).

FOR: METAL CASTING; MILLWORKING; BLACKSMITHING, IN CLASS 40 (U.S. CLS. 100, 103 AND 106).

OWNER OF INTERNATIONAL REGISTRATION  
0941804 DATED 5-25-2007, EXPIRES 5-25-2017.

SER. NO. 79-045,502, FILED 5-25-2007.

ERNEST SHOSHO, EXAMINING ATTORNEY

**Int. Cl.: 21**

**Prior U.S. Cls.: 2, 13, 23, 29, 30, 33, 40 and 50**

**United States Patent and Trademark Office**

**Reg. No. 3,499,378**

**Registered Sep. 9, 2008**

**TRADEMARK  
PRINCIPAL REGISTER**

**GREENSPEED**

MAINTENANCE GENERAL SUPPLY; INTERNATIONAL B.V. (NETHERLANDS BESLOTEN VENNOOTSCHAP (B.V.))  
COBBENHAGENSTRAAT 26  
NL-2288 CG RIJSWIJK  
NETHERLANDS

BING BRUSHES, DUSTERS, IN CLASS 21 (U.S. CLS. 2, 13, 23, 29, 30, 33, 40 AND 50).

OWNER OF INTERNATIONAL REGISTRATION  
0667719 DATED 12-20-1996, EXPIRES 12-20-2016.

FOR: CLEANING EQUIPMENT, NAMELY, MOPS, CLEANING CLOTHS, CLEANING PADS, FLOOR BRUSHES, DUSTING BRUSHES, SCRUB-

SER. NO. 79-045,591, FILED 6-5-2007.

ERNEST SHOSHO, EXAMINING ATTORNEY

**Int. Cls.: 9, 25 and 35**

**Prior U.S. Cls.: 21, 22, 23, 26, 36, 38, 39, 100, 101 and 102**

**Reg. No. 3,499,379**

**United States Patent and Trademark Office**

**Registered Sep. 9, 2008**

**TRADEMARK  
SERVICE MARK  
PRINCIPAL REGISTER**

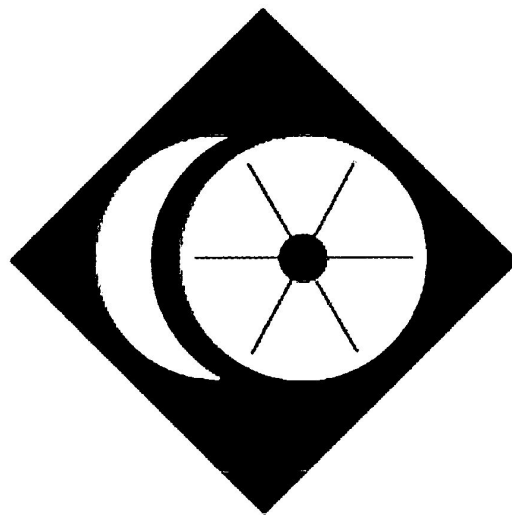

CHARLES OWEN; AND COMPANY (BOW) LIMITED (UNITED KINGDOM LIMITED COMPANY)

ROYAL WORKS  
CROESFOEL INDUSTRIAL PARK  
RHOSTYLLEN, WREXHAM LL14 4BJ, UNITED KINGDOM

FOR: SAFETY CLOTHING, APPARATUS AND EQUIPMENT FOR SPORT OR RIDING, NAMELY, PROTECTIVE HELMETS, PROTECTIVE FOOTWEAR, PROTECTIVE GLOVES; SAFETY BODY PROTECTORS FOR SPORT OR RIDING, IN CLASS 9 (U.S. CLS. 21, 23, 26, 36 AND 38).

FOR: CLOTHING, NAMELY, COATS, JACKETS, SHORTS, T-SHIRTS, TOPS, SHIRTS, SCARVES, JUMPERS, GLOVES, RIDING GLOVES, BELTS; HEADGEAR, NAMELY, BASEBALL CAPS AND SUNVISORS; FOOTWEAR; RIDING BOOTS, IN CLASS 25 (U.S. CLS. 22 AND 39).

FOR: ADVERTISING AND PROMOTIONAL SERVICES; RETAIL SERVICES, NAMELY, STORES FEATURING CLOTHING, FOOTWEAR, HEADGEAR, SPORTSWEAR, SPORTS EQUIPMENT, EQUESTRIAN EQUIPMENT AND APPAREL, SADDLERY, STABLE EQUIPMENT, PROTECTIVE CLOTHING AND HEADWEAR, PROTECTIVE EQUESTRIAN CLOTHING AND HEADWEAR, PROTECTIVE

EQUESTRIAN HEADGEAR, BODY PROTECTORS, BAGS, CLOTHES CARRIERS, HAT BOXES, CLEANING PREPARATIONS AND PRODUCTS, SHOE AND BOOT CLEANING PREPARATIONS AND PRODUCTS, GLOVES, RIDING BOOTS, DEODORIZERS, SUNVISORS, BASEBALL CAPS, PROTECTIVE COVERS FOR HATS, HUMAN POSTURE AIDS, RIDER POSTURE AIDS; ON-LINE RETAIL STORE SERVICES AND MAIL ORDER CATALOG SERVICES FEATURING CLOTHING, FOOTWEAR, HEADGEAR, SPORTSWEAR, SPORTS EQUIPMENT, EQUESTRIAN EQUIPMENT AND APPAREL, SADDLERY, STABLE EQUIPMENT, PROTECTIVE CLOTHING AND HEADWEAR, PROTECTIVE EQUESTRIAN CLOTHING AND HEADWEAR, PROTECTIVE EQUESTRIAN HEADGEAR, BODY PROTECTORS, BAGS, CLOTHES CARRIERS, HAT BOXES, CLEANING PREPARATIONS AND PRODUCTS, SHOE AND BOOT CLEANING PREPARATIONS AND PRODUCTS, GLOVES, RIDING BOOTS, DEODORIZERS, SUNVISORS, BASEBALL CAPS, PROTECTIVE COVERS FOR HATS, HUMAN POSTURE AIDS, RIDER POSTURE AIDS; INFORMATION, ADVISORY AND CONSULTANCY SERVICES IN RELATION TO ALL OF THE AFOREMENTIONED SERVICES, IN CLASS 35 (U.S. CLS. 100, 101 AND 102).

PRIORITY DATE OF 7-19-2007 IS CLAIMED.



OWNER OF INTERNATIONAL REGISTRATION  
0942267 DATED 9-28-2007, EXPIRES 9-28-2017.

SER. NO. 79-045,705, FILED 9-28-2007.

ESTHER A. BORSUK, EXAMINING ATTORNEY

Int. Cl.: 30

Prior U.S. Cl.: 46

United States Patent and Trademark Office

Reg. No. 3,499,380

Registered Sep. 9, 2008

TRADEMARK  
PRINCIPAL REGISTER

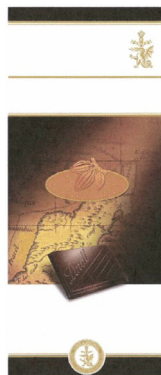

CHOCOLAFABRIKEN LINDT & SPRÜNGLI  
AG (SWITZERLAND CORPORATION)  
SEESTRASSE 204  
CH-8802 KILCHBERG ZH  
SWITZERLAND

FOR: CHOCOLATE, IN CLASS 30 (U.S. CL. 46).

PRIORITY DATE OF 4-12-2007 IS CLAIMED.

OWNER OF INTERNATIONAL REGISTRATION  
0942396 DATED 8-30-2007, EXPIRES 8-30-2017.

OWNER OF U.S. REG. NOS. 2,031,928, 3,127,059  
AND OTHERS.

THE COLOR(S) BLACK, DARK BROWN, LIGHT  
BROWN, BEIGE, WHITE, YELLOW, ORANGE,  
OCHRE AND GOLD IS/ARE CLAIMED AS A FEAT-  
URE OF THE MARK.

THE MARK CONSISTS OF THE LITERAL ELE-  
MENT LINDT, WHICH APPEARS ON A SQUARE  
PIECE OF CHOCOLATE, AND A DESIGN ELE-

MENT COMPRISING A MAP FRAMED IN A  
SQUARE BOX WITH AN ORANGE OVAL OUT-  
LINED IN BEIGE AND AN ORANGE PLANT DE-  
SIGN APPEARING OVER THE MIDDLE OF THE  
MAP AND A PIECE OF CHOCOLATE AT THE  
BOTTOM CENTER OF THE MAP. THE COLORS  
BLACK, LIGHT BROWN, ORANGE, OCHRE AND  
YELLOW APPEAR IN THE MAP. THE COLOR  
DARK BROWN APPEARS IN THE CHOCOLATE  
DESIGN. THE COLOR GOLD APPEARS AT THE  
TOP OF THE SQUARE BOX FRAMING THE MAP.  
TWO RECTANGULAR BARS APPEAR AT THE TOP  
AND BOTTOM OF THE MARK. THE COLORS  
GOLD AND DARK BROWN APPEAR IN THE  
RECTANGLES. A GOLD DRAGON APPEARS UN-  
DERNEATH THE TOP RECTANGLE. A GOLD BAR  
SEPARATES THE TOP DRAGON AND THE MAP  
DESIGN. A SECOND GOLD DRAGON APPEARS IN  
A CIRCLE OVER THE CENTER OF THE BOTTOM  
RECTANGLE. THE BACKGROUND OF THE MARK  
APPEARS IN THE COLOR WHITE.

SER. NO. 79-045,752, FILED 8-30-2007.

LAURIE KAUFMAN, EXAMINING ATTORNEY

Int. Cl.: 30

Prior U.S. Cl.: 46

United States Patent and Trademark Office

Reg. No. 3,499,381

Registered Sep. 9, 2008

TRADEMARK  
PRINCIPAL REGISTER

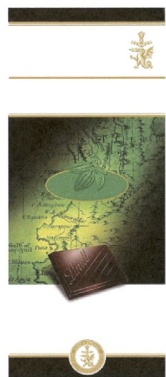

CHOCOLADEFABRIKEN LINDT & SPRÜNGLI  
AG (SWITZERLAND CORPORATION)  
SEESTRASSE 204  
CH-8802 KILCHBERG ZH  
SWITZERLAND

FOR: CHOCOLATE, IN CLASS 30 (U.S. CL. 46).

PRIORITY DATE OF 4-12-2007 IS CLAIMED.

OWNER OF INTERNATIONAL REGISTRATION  
0942397 DATED 8-30-2007, EXPIRES 8-30-2017.

OWNER OF U.S. REG. NOS. 2,031,928, 3,127,059  
AND OTHERS.

THE COLOR(S) BLACK, DARK BROWN, LIGHT  
BROWN, BEIGE, WHITE, YELLOW, LIGHT GREEN,  
DARK GREEN AND GOLD IS/ARE CLAIMED AS A  
FEATURE OF THE MARK.

THE MARK CONSISTS OF THE LITERAL ELE-  
MENT LINDT, WHICH APPEARS ON A SQUARE  
PIECE OF CHOCOLATE, AND A DESIGN ELE-

MENT COMPRISING A MAP FRAMED IN A  
SQUARE BOX WITH A GREEN OVAL OUTLINED  
IN BEIGE AND A GREEN PLANT DESIGN AP-  
PEARING OVER THE MIDDLE OF THE MAP AND  
A PIECE OF CHOCOLATE AT THE BOTTOM CER-  
TER OF THE MAP. THE COLORS BLACK, LIGHT  
BROWN, DARK GREEN, LIGHT GREEN AND  
YELLOW APPEAR IN THE MAP. THE COLOR  
DARK BROWN APPEARS IN THE CHOCOLATE  
DESIGN. THE COLOR GOLD APPEARS AT THE  
TOP OF THE SQUARE BOX FRAMING THE MAP.  
TWO RECTANGULAR BARS APPEAR AT THE TOP  
AND BOTTOM OF THE MARK. THE COLORS  
GOLD AND DARK BROWN APPEAR IN THE  
RECTANGLES. A GOLD DRAGON APPEARS UN-  
DERNEATH THE TOP RECTANGLE. A GOLD BAR  
SEPARATES THE TOP DRAGON AND THE MAP  
DESIGN. A SECOND GOLD DRAGON APPEARS IN  
A CIRCLE OVER THE CENTER OF THE BOTTOM  
RECTANGLE. THE BACKGROUND OF THE MARK  
APPEARS IN THE COLOR WHITE.

SER. NO. 79-045,753, FILED 8-30-2007.

LAURIE KAUFMAN, EXAMINING ATTORNEY

Int. Cl.: 14

Prior U.S. Cls.: 2, 27, 28 and 50

United States Patent and Trademark Office

Reg. No. 3,499,382

Registered Sep. 9, 2008

TRADEMARK  
PRINCIPAL REGISTER

**HIERSUN**  
**恒 信**

BEIJING HIERSUN ZHENGLONG; COMMERCIAL & TRADE CO., LTD (CHINA CORPORATION)

B2004

NO.2, FUQIAN WEST STREETPINGGU TOWN  
PINGGU DISTRICT, 101200 BEIJING, CHINA

FOR: IMITATIONS OF GOLD; AGATES; SILVER ORNAMENTS; JEWELLERY CHAINS; JEWELLERY ORNAMENTS, NAMELY, ORNAMENTAL PINS, ORNAMENTS OF PRECIOUS METAL; JEWELLERY, NAMELY, PEARLS; DIAMONDS; PRECIOUS STONES; CLOCKS, IN CLASS 14 (U.S. CLS. 2, 27, 28 AND 50).

OWNER OF INTERNATIONAL REGISTRATION  
0942555 DATED 5-15-2007, EXPIRES 5-15-2017.

THE STIPPLING IS A FEATURE OF THE MARK.

THE CHINESE CHARACTERS IN THE MARK  
TRANSLITERATE TO HENG AND XIN AND THIS  
MEANS CONSTANT FAITH IN ENGLISH.

SER. NO. 79-045,817, FILED 5-15-2007.

TINA BROWN, EXAMINING ATTORNEY

**Int. Cls.: 16, 35 and 41**

**Prior U.S. Cls.: 2, 5, 22, 23, 29, 37, 38, 50, 100, 101, 102  
and 107**

**Reg. No. 3,499,383**

**United States Patent and Trademark Office**

**Registered Sep. 9, 2008**

**TRADEMARK  
SERVICE MARK  
PRINCIPAL REGISTER**

# **BIOTECHNICA**

DEUTSCHE MESSE AKTIENGESELLSCHAFT  
(FED REP GERMANY JOINT STOCK COMPAN-  
NY)  
5, RUE DE STOCKHOLM  
F-75008 PARIS  
FRANCE

FOR: MAGAZINES, CATALOGUES, POSTCARDS  
IN THE FIELD OF TRADE FAIRS AND EXHIBI-  
TIONS, IN CLASS 16 (U.S. CLS. 2, 5, 22, 23, 29, 37, 38  
AND 50).

FOR: CONSULTATION IN THE ORGANIZATION  
OF TRADE FAIRS, ORGANIZATION OF PARTICI-  
PATION IN TRADE FAIRS, MARKETING STUDIES  
AND MARKETING ANALYSIS, MARKET RE-  
SEARCH; ORGANIZATION OF TRADE FAIRS  
AND EXHIBITIONS, IN PARTICULAR CONCERN-

ING PROCESSES, INSTRUMENTS, PRODUCTS  
AND SERVICES RELEVANT TO THE FIELD OF  
BIOTECHNOLOGY, IN CLASS 35 (U.S. CLS. 100, 101  
AND 102).

FOR: PUBLICATION OF BOOKS, JOURNALS,  
MAGAZINES AND CATALOGUES IN THE FIELD  
OF TRADE FAIRS AND EXHIBITIONS, IN CLASS 41  
(U.S. CLS. 100, 101 AND 107).

OWNER OF INTERNATIONAL REGISTRATION  
0559916 DATED 9-21-1990, EXPIRES 9-21-2010.

SER. NO. 79-045,913, FILED 4-16-2007.

HEATHER THOMPSON, EXAMINING ATTORNEY

**Int. Cl.: 3**

**Prior U.S. Cls.: 1, 4, 6, 50, 51 and 52**

**United States Patent and Trademark Office**

**Reg. No. 3,499,384**

**Registered Sep. 9, 2008**

**TRADEMARK  
PRINCIPAL REGISTER**

**HAPPY TIME**

BEIERSDORF AG (FED REP GERMANY JOINT  
STOCK COMPANY)  
UNNASTRASSE 48  
20253 HAMBURG  
FED REP GERMANY

OWNER OF INTERNATIONAL REGISTRATION  
0911019 DATED 12-16-2006, EXPIRES 12-16-2016.

FOR: SOAPS, COSMETICS, IN CLASS 3 (U.S. CLS.  
1, 4, 6, 50, 51 AND 52).

SER. NO. 79-045,947, FILED 10-20-2007.

THE MARK CONSISTS OF STANDARD CHAR-  
ACTERS WITHOUT CLAIM TO ANY PARTICULAR  
FONT, STYLE, SIZE, OR COLOR.

PAUL E. FAHRENKOPF, EXAMINING ATTORNEY

**Int. Cl.: 6**

**Prior U.S. Cls.: 2, 12, 13, 14, 23, 25 and 50**

**Reg. No. 3,499,385**

**United States Patent and Trademark Office**

**Registered Sep. 9, 2008**

**TRADEMARK  
PRINCIPAL REGISTER**

# Manganin

ISABELLENHÜTTE HEUSLER GMBH & CO. KG  
(FED REP GERMANY LIMITED PARTNER-  
SHIP)

EIBACHER WEG 3-5  
35683 DILLENBURG, FED REP GERMANY

FOR: NICKEL-MANGANESE-COPPER ALLOY IN  
THE FORM OF INGOTS, PLATES, BARS, SHEET  
METAL, STRIPS, PIPES, TUBES AND STRANDED  
OR FLAT WIRES; METAL WIRE LAYERS OR  
LAMINATES, NAMELY, FOILS, BOLTS PROFILES,

RODS, STRIPS WITH SHARP EDGES, IN CLASS 6  
(U.S. CLS. 2, 12, 13, 14, 23, 25 AND 50).

OWNER OF INTERNATIONAL REGISTRATION  
0199740 DATED 4-12-1957, EXPIRES 4-12-2017.

SER. NO. 79-046,179, FILED 4-13-2007.

JILL C. ALT, EXAMINING ATTORNEY

**Int. Cl.: 10**

**Prior U.S. Cls.: 26, 39 and 44**

**United States Patent and Trademark Office**

**Reg. No. 3,499,386**

**Registered Sep. 9, 2008**

**TRADEMARK  
PRINCIPAL REGISTER**

**INFUSOMAT**

**B. BRAUN MELSUNGEN AKTIENGESELL-  
SCHAFT  
CARL-BRAUN-STRASSE 1  
34212 MELSUNGEN  
FED REP GERMANY**

**OWNER OF INTERNATIONAL REGISTRATION  
0357490 DATED 5-23-1969, EXPIRES 5-23-2009.**

**FOR: MEDICAL INSTRUMENTS, NAMELY, A  
PUMP FOR INFUSING PRECISE QUANTITIES OF  
LIQUID AT A CONSTANT FLOW RATE, IN CLASS  
10 (U.S. CLS. 26, 39 AND 44).**

**SER. NO. 79-046,180, FILED 10-19-2007.**

**MICHAEL KEATING, EXAMINING ATTORNEY**



Int. Cl.: 25

Prior U.S. Cls.: 22 and 39

United States Patent and Trademark Office

Reg. No. 3,499,387

Registered Sep. 9, 2008

TRADEMARK  
PRINCIPAL REGISTER



MAIER SPORTS GMBH & CO. KG (FED REP  
GERMANY IS A LIMITED LIABILITY COM-  
PANY & BUSINESS ON JOINT ACCOUNT  
LIMITED PARTNERSHIP (GMBH & CO. KG))

NÜRTINGER STRASSE 27

73257 KÖNGEN

FED REP GERMANY

FOR: CLOTHING, NAMELY, SOCKS, STOCKINGS AND SWEAT-ABSORBENT STOCKINGS, SUITS, BODYSUITS, TEDDIES, BRASSIERES, UNDERWEAR AND SWEAT-ABSORBENT UNDERWEAR, UNDERPANTS, PYJAMAS, UNDERCLOTHES, HOSIERY, CORSETS, CORSELETS, FROCKS, BELTS, BLOUSES, BREECHES, CAMISOLES, DRESSING GOWNS, DRESSES, PETTICOATS, COATS, WAISTCOATS, OVERCOATS, JACKETS, STUFF JACKETS, SPORT JACKETS, PULLOVERS, JERSEYS, JUMPERS, SHIRTS, POLO SHIRTS, T-SHIRTS, SHIRT YOKES, COLLARS, SWEATERS, VESTS, TROUSERS, SUSPENDERS, OVERALLS, PANTS, STRAP PANTS, SKIRTS, JEANS, SHORTS, TIGHTS, SINGLET, LEGGINGS, UNIFORMS, PELISSES; NECK TIES AND BOW TIES, BANDANNAS, SCARVES, IN PARTICULAR HEAD SCARVES, NECK SCARVES, SQUARE SCARVES AND POCKET SCARVES, LEISURE CLOTHING, NAMELY, SWEAT SHIRTS, SWEAT SUITS; READY MADE CLOTHING, NAMELY, SOCKS, STOCKINGS AND SWEAT -ABSORBENT STOCKINGS, SUITS, BODYSUITS, TEDDIES, BRASSIERES, UNDERWEAR AND SWEAT-ABSORBENT UNDERWEAR, UNDERPANTS, PYJAMAS, UNDERCLOTHES, HOSIERY, CORSETS, CORSELETS, FROCKS, BELTS, BLOUSES, BREECHES, CAMISOLES, DRESSING GOWNS, DRESSES, PETTICOATS, COATS, WAIST COATS, OVERCOATS, JACKETS, STUFF JACKETS, SPORT JACKETS, PULLOVERS, JERSEYS, JUMPERS, SHIRTS, POLO SHIRTS, T-SHIRTS, SHIRT YOKES, COLLARS, SWEATERS, VESTS, TROUSERS, SUSPENDERS, OVERALLS, PANTS,

STRAP PANTS, SKIRTS, JEANS, SHORTS, TIGHTS, SINGLET, LEGGINGS, UNIFORMS, PELISSES, NECK TIES AND BOW TIES; BATH CLOTHING, NAMELY, BATHROBES, BATHING SUITS, SWIMMING TRUNKS; BEACH CLOTHING; LEISURE CLOTHING, NAMELY, SWEAT SHIRTS, SWEAT SUITS; OUTDOOR CLOTHING, NAMELY, ANORAKS, MITTENS, SWEATERS, COVERALLS, UNDERWEAR, GLOVES, PARKAS, OVERCOATS, COATS, PANTS, JACKETS, VESTS, FLEECE, SHIRTS, SHORTS, BRIEFS, LONG JOHNS, PULLOVERS, TROUSERS, OVERALLS; CYCLIST'S CLOTHING, NAMELY, RIDING PANTS, RIDING SHIRTS; WATERPROOF CLOTHING, NAMELY, RAIN JACKETS, RAIN SUITS, RAIN COATS, KNIT WEAR, NAMELY, KNIT SHIRTS, KNIT SKIRTS, KNIT BLOUSES, KNIT SWEATERS, KNIT VESTS; OUTDOOR CLOTHING, NAMELY, ANORAKS, MITTENS, SWEATERS, COVERALLS, UNDERWEAR, GLOVES, PARKAS, OVERCOATS, COATS, PANTS, JACKETS, VESTS, FLEECE, SHIRTS, SHORTS, BRIEFS, LONG JOHNS, PULLOVERS, TROUSERS, OVERALLS; CYCLIST'S CLOTHING, NAMELY, CYCLIST'S SHOES, RIDING PANTS, RIDING SHIRTS; CLOTHING FOR GYMNASTICS; PREPARED POCKETS FOR CLOTHING; COSTUMES, NAMELY, HALLOWEEN COSTUMES, MASQUERADE COSTUMES, COSTUMES FOR USE IN ROLE-PLAYING GAMES. FOOTWEAR, NAMELY, SANDALS, SLIPPERS, SPORT AND LEISURE SHOES, PUMPS IN THE NATURE OF SHOES, SKI BOOTS, ESPARTO SHOES, BOOTS FOR SPORTS, LACE BOOTS, AND HALF-BOOTS, NAMELY, ANKLE BOOTS, LOW SHOES AND OXFORDS; BATHING SANDALS, BATHING SLIPPERS; CYCLIST'S FOOTWEAR, NAMELY, CYCLIST'S SHOES; GYMNASTIC SHOES. HEADGEAR, NAMELY, BEANIES, CAPS, CAP PEAKS, HATS, HEADBANDS, HOODS, MITTENS, TOP HATS, CYCLIST'S CAPS, SKULL CAPS, BATHING CAPS, IN CLASS 25 (U.S. CLS. 22 AND 39).

OWNER OF INTERNATIONAL REGISTRATION  
0752290 DATED 1-29-2001, EXPIRES 1-29-2011.

SER. NO. 79-046,196, FILED 7-19-2007.  
STEPHANIE ALI, EXAMINING ATTORNEY

Int. Cls.: 3, 5 and 44

Prior U.S. Cls.: 1, 4, 6, 18, 44, 46, 50, 51, 52, 100 and 101

Reg. No. 3,499,388

United States Patent and Trademark Office

Registered Sep. 9, 2008

TRADEMARK  
SERVICE MARK  
PRINCIPAL REGISTER

*sweat*  
**STOP**

FUNCTIONAL COSMETICS COMPANY AG  
(SWITZERLAND SOCIÉTÉ ANONYME)  
NAUENSTRASSE 67  
CH-4052 BASEL  
SWITZERLAND

FOR: BLEACHING PREPARATIONS FOR LAUNDRY USE, NAMELY, DETERGENT, SOAP AND STARCH; CLEANING, POLISHING, SCOURING AND ABRASIVE PREPARATIONS; SOAPS, NAMELY, BATH SOAPS, BATH SOAPS IN LIQUID, SOLID OR GEL FORM, COSMETIC SOAPS, LAUNDRY SOAPS, ANTIBACTERIAL SKIN SOAPS, ANTIBACTERIAL SOAP, BODY CREAM SOAP, HAND SOAPS, SOAPS FOR BODY CARE, AND SOAPS FOR PERSONAL USE; PERFUMERY; ESSENTIAL OILS; COSMETICS; HAIR LOTIONS; DENTIFRICES; COSMETICS, NAMELY, BEAUTY CREAMS, BEAUTY GELS, BEAUTY LOTIONS, BEAUTY MASKS, BEAUTY MILKS, BEAUTY SERUMS, BODY AND BEAUTY CARE COSMETICS, BODY CREAMS, BODY LOTIONS, BODY MASK CREAMS, BODY MASK LOTIONS, BODY MASK POWDER, BODY MILKS, BODY OILS, BODY POWDER, BODY SCRUB, AFTER-SUN GELS, AFTER-SUN LOTIONS, AFTER-SUN MILKS, AFTER-SUN OILS, AGE RETARDANT GEL, AGE RETARDANT LOTION, AGE SPOT REDUCING CREAMS, ALOE VERA GEL FOR COSMETIC PURPOSES, ANTI-AGING CREAMS, ANTI-FRECKLE CREAMS, COSMETIC PREPARATIONS FOR BODY CARE, COSMETIC SUN-PROTECTING PREPARATIONS, COSMETICS IN GENERAL, INCLUDING PERFUMES, FACE AND BODY BEAUTY CREAMS, FACE CREAMS FOR COSMETIC USE, HAND CREAMS, HAND LOTIONS, HAND SCRUBS, MAKE-UP FOR THE FACE AND BODY, NIGHT CREAM, SKIN AND BODY TOPICAL LOTIONS, CREAMS AND OILS FOR COSMETIC USE, SKIN CREAMS IN LIQUID AND

IN SOLID FORM; PERFUMERY, NAMELY, BODY DEODORANT IN PILL FORM, BODY DEODORANTS, BODY SPRAY USED AS A PERSONAL DEODORANT AND AS FRAGRANCE, ANTIPERSPIRANTS, ANTIPERSPIRANTS AND DEODORANTS FOR PERSONAL USE, ANTI-PERSPIRANTS, DEODORANTS FOR BODY CARE, DEODORANTS FOR PERSONAL USE, FRAGRANCES FOR PERSONAL USE, IN CLASS 3 (U.S. CLS. 1, 4, 6, 50, 51 AND 52).

FOR: PHARMACEUTICAL PREPARATIONS FOR TREATING PERSPIRATION, SWEATING, AND HYPERHIDROSIS; SANITARY PREPARATIONS FOR MEDICAL PURPOSES; DIETETIC FOODS ADAPTED FOR MEDICAL USE; FOOD FOR BABIES; MEDICAL PLASTERS; MEDICAL DRESSINGS; MATERIAL FOR STOPPING TEETH; DENTAL WAX; ALL PURPOSE DISINFECTANTS; PREPARATIONS FOR DESTROYING VERMIN; FUNGICIDES; HERBICIDES; ALL PURPOSE DISINFECTING AND DEODORIZING PREPARATIONS; ALOE VERA GEL FOR THERAPEUTIC PURPOSES; ANTIBACTERIAL ALCOHOL SKIN SANITIZER GEL; ANTIBACTERIAL CLEANERS; ANTIBACTERIAL HAND LOTIONS; ANTIBACTERIAL PHARMACEUTICALS; ANTIBACTERIAL SPRAY; ANTIBACTERIAL SUBSTANCES FOR MEDICAL PURPOSES; ANTI-ITCH CREAM; ANTI-ITCH OINTMENT; BACTERIAL POISONS; DISINFECTING HANDWASH; MEDICATED HAND WASH; MEDICATED SKIN CARE PREPARATIONS, NAMELY, CREAMS, LOTIONS, GELS, TONERS, CLEANERS AND PEELS; MEDICATED SUN CARE PREPARATIONS; MEDICINAL CREAMS FOR SKIN CARE; PRODUCTS AND PREPARATIONS FOR CLEANSING THE SKIN FOR MEDICAL USE, IN CLASS 5 (U.S. CLS. 6, 18, 44, 46, 51 AND 52).

FOR: MEDICAL SERVICES; VETERINARY SERVICES; HYGIENIC AND BEAUTY CARE FOR HUMAN BEINGS OR ANIMALS; AGRICULTURE ADVICE; HORTICULTURAL SERVICES; PEST CONTROL AND VERMIN EXTERMINATING FOR FORESTRY; COUNSELING SERVICES IN THE FIELDS OF HEALTH, NUTRITION AND LIFESTYLE WELLNESS; HEALTH CARE SERVICES, NAMELY, WELLNESS PROGRAMS; HEALTH SPA SERVICES, NAMELY, COSMETIC BODY CARE SERVICES; PROVIDING MEDICAL INFORMATION; MEDICAL, HYGIENIC AND BEAUTY CARE; SKIN CARE

SALONS; SPEECH AND HEARING THERAPY, IN CLASS 44 (U.S. CLS. 100 AND 101).

PRIORITY DATE OF 6-29-2007 IS CLAIMED.

OWNER OF INTERNATIONAL REGISTRATION 0943507 DATED 10-23-2007, EXPIRES 10-23-2017.

SER. NO. 79-046,251, FILED 10-23-2007.

JENNIFER HETU, EXAMINING ATTORNEY

**Int. Cls.: 18 and 25**

**Prior U.S. Cls.: 1, 2, 3, 22, 39 and 41**

**Reg. No. 3,499,389**

**United States Patent and Trademark Office**

**Registered Sep. 9, 2008**

**TRADEMARK  
PRINCIPAL REGISTER**



SALVATORE FERRAGAMO ITALIA S.P.A. (ITALY JOINT STOCK COMPANY)  
VIA DEI TORNABUONI, 2  
I-50123 FIRENZE (FI)  
ITALY

FOR: BAGS, NAMELY, HANDBAGS, SHOULDER BAGS, BRIEFCASES, WAIST PACKS, LEATHER AND CANVAS SHOPPING BAGS, DUFFLE BAGS, TOTE BAGS, CLUTCH BAGS, ATTACHE-CASES, SUITCASES, GARMENT BAGS FOR TRAVEL, RUCKSACKS, TRUNKS, TRAVELING BAGS, WALLET, PURSES, KEY CASES, VANITY CASES SOLD EMPTY, UMBRELLAS, IN CLASS 18 (U.S. CLS. 1, 2, 3, 22 AND 41).

FOR: ARTICLES OF CLOTHING FOR MEN, WOMEN AND CHILDREN, NAMELY, PULL-OVERS, CARDIGANS, SWEATERS, JERSEYS, JUMPERS, JACKETS, SWEATSHIRTS, PARKAS, BATHING SUITS, BLOUSES, SHIRTS, TROUSERS, JEANS, WAISTCOATS, SKIRTS, SHORTS, T-SHIRTS, DRESSES, MEN'S SUITS, COATS, RAINCOATS, OVERCOATS, OVERALLS, UNDERWEAR, VESTS, HOSIERY AND PANTY-HOSES, BATHROBES,

SHAWLS, SCARVES, NECKTIES, GLOVES FOR CLOTHING, BELTS FOR CLOTHING, SHOES, BOOTS, SANDALS, SLIPPERS, CLOGS, HATS AND CAPS, IN CLASS 25 (U.S. CLS. 22 AND 39).

OWNER OF INTERNATIONAL REGISTRATION 0943551 DATED 10-8-2007, EXPIRES 10-8-2017.

OWNER OF U.S. REG. NOS. 1,016,032, 1,505,915 AND OTHERS.

NO CLAIM IS MADE TO THE EXCLUSIVE RIGHT TO USE "FLORENCE" AND "MADE IN ITALY", APART FROM THE MARK AS SHOWN.

THE NAME(S), PORTRAIT(S), AND/OR SIGNATURE(S) SHOWN IN THE MARK DOES NOT IDENTIFY A PARTICULAR LIVING INDIVIDUAL.

SER. NO. 79-046,265, FILED 10-8-2007.

CHARISMA HAMPTON, EXAMINING ATTORNEY

**Int. Cls.: 9, 35, 42 and 45**

**Prior U.S. Cls.: 21, 23, 26, 36, 38, 100, 101 and 102**

**Reg. No. 3,499,390**

**United States Patent and Trademark Office**

**Registered Sep. 9, 2008**

**TRADEMARK  
SERVICE MARK  
PRINCIPAL REGISTER**



POLARION SOFTWARE AG (SWITZERLAND CORPORATION)  
WIESHOLZ 452  
CH-8262 RAMSEN, SWITZERLAND

FOR: RECORDED COMPUTER PROGRAMS AND COMPUTER SOFTWARE FOR SOFTWARE DEVELOPMENT AND DEVELOPMENT OF COMPUTER OPERATING SYSTEMS; NONE OF THE COMPUTER PROGRAMS AND SOFTWARE FOR DIGITAL IMAGE MANIPULATION, CAMERAS, PRINTERS, DVDS OR TELEVISIONS, IN CLASS 9 (U.S. CLS. 21, 23, 26, 36 AND 38).

FOR: MANAGEMENT OF COMPUTERIZED FILES AND BUSINESS ORGANIZATIONAL CONSULTING IN THE FIELD OF EDP (ELECTRONIC DATA PROCESSING) PROJECT MANAGEMENT, SPECIFICALLY EXCLUDING SERVICES REGARDING SOFTWARE FOR DIGITAL IMAGE MANIPULATION, CAMERAS, PRINTERS, DVDS AND TELEVISIONS, IN CLASS 35 (U.S. CLS. 100, 101 AND 102).

FOR: UPDATING OF COMPUTER SOFTWARE; COMPUTER SOFTWARE CONSULTANCY; SERVICES OF A COMPUTER PROGRAMMER; COMPUTER CONSULTANCY IN THE FIELD OF EDP (ELECTRONIC DATA PROCESSING); COMPUTER SOFTWARE DEVELOPMENT IN THE FIELD OF COMPUTER ANIMATION; COMPUTER HARDWARE AND SOFTWARE CONSULTING; SOFTWARE IMPLEMENTATION IN NETWORKS; INSTALLATION OF COMPUTER SOFTWARE;

CONFIGURATION OF COMPUTER NETWORKS BY MEANS OF SOFTWARE; DATA CONVERSION OF COMPUTER PROGRAMS AND DATA NOT BEING PHYSICAL CONVERSION; INSTALLATION AND MANAGEMENT OF COMPUTER SOFTWARE; COMPUTER PROJECT MANAGEMENT IN THE FIELD OF EDP (ELECTRONIC DATA PROCESSING); RENTAL OF COMPUTER SOFTWARE; MAINTENANCE OF COMPUTER SOFTWARE; ALL AFOREMENTIONED SERVICES SPECIFICALLY EXCLUDING SERVICES REGARDING SOFTWARE FOR DIGITAL IMAGE MANIPULATION, CAMERAS, PRINTERS, DVDS AND TELEVISIONS, IN CLASS 42 (U.S. CLS. 100 AND 101).

FOR: LICENSING OF COMPUTER SOFTWARE, SPECIFICALLY EXCLUDING SERVICES REGARDING SOFTWARE FOR DIGITAL IMAGE MANIPULATION, CAMERAS, PRINTERS, DVDS AND TELEVISIONS, IN CLASS 45 (U.S. CLS. 100 AND 101).

PRIORITY DATE OF 1-29-2007 IS CLAIMED.

OWNER OF INTERNATIONAL REGISTRATION 0944413 DATED 7-26-2007, EXPIRES 7-26-2017.

OWNER OF U.S. REG. NO. 3,256,570.

SER. NO. 79-046,591, FILED 7-26-2007.

KRISTINA MORRIS, EXAMINING ATTORNEY

**Int. Cls.: 35, 42 and 44**

**Prior U.S. Cls.: 100, 101 and 102**

**United States Patent and Trademark Office**

**Reg. No. 3,499,391**

**Registered Sep. 9, 2008**

**SERVICE MARK  
PRINCIPAL REGISTER**

**K M L**

GUANGZHOU XINSHENG; INVESTMENT &  
CONSULTATION CO., LTD. (CHINA COR-  
PORATION)  
ROOM 403/404  
HAIZHU SCIENCE AND TECHNOLOGY BUILD-  
ING; 2429 XINGANG DONG ROAD; GUANGZ-  
HOU; GUANGDONG  
CHINA

FOR: IMPORT-EXPORT AGENCIES; PROCURE-  
MENT SERVICES FOR OTHERS, NAMELY, PUR-  
CHASING CLOTHING, FURNITURE, FOOD FOR  
OTHER BUSINESSES; PUBLICITY SERVICES;  
SALES PROMOTION FOR OTHERS; MARKETING  
RESEARCH; BUSINESS MANAGEMENT CONSUL-  
TANCY; PERSONNEL MANAGEMENT CONSUL-  
TANCY; RELOCATION SERVICES FOR  
BUSINESSES; SYSTEMIZATION OF INFORMA-  
TION INTO COMPUTER DATABASES, IN CLASS  
35 (U.S. CLS. 100, 101 AND 102).

FOR: TECHNICAL PROJECT STUDIES, NAME-  
LY, TECHNICAL RESEARCH IN THE FIELD OF

MEDICINES AND VACCINES; CHEMICAL ANALY-  
SIS; BACTERIOLOGICAL RESEARCH; SCIENTIFIC  
RESEARCH AND DEVELOPMENT, FOR OTHERS;  
CALIBRATION FOR MEASURING; CHEMISTRY  
SERVICES, NAMELY, CHEMISTRY CONSULTA-  
TION; BIOLOGICAL RESEARCH, IN CLASS 42  
(U.S. CLS. 100 AND 101).

FOR: HOSPITALS; HEALTH CARE; MEDICAL  
ASSISTANCE; SERVICES OF A PSYCHOLOGIST;  
CONVALESCENT HOMES; BEAUTY SALONS;  
CHIROPRACTICS; MEDICAL NURSING; PLASTIC  
SURGERY; PHARMACEUTICAL ADVICE, IN  
CLASS 44 (U.S. CLS. 100 AND 101).

OWNER OF INTERNATIONAL REGISTRATION  
0944473 DATED 10-22-2007, EXPIRES 10-22-2017.

SER. NO. 79-046,609, FILED 10-22-2007.

DOMINIC FATHY, EXAMINING ATTORNEY

**Int. Cl.: 9**

**Prior U.S. Cls.: 21, 23, 26, 36 and 38**

**Reg. No. 3,499,392**

**United States Patent and Trademark Office**

**Registered Sep. 9, 2008**

**TRADEMARK  
PRINCIPAL REGISTER**

**IR LAB**

VIEWLINK TECHNOLOGY LTD (CHINA LIMITED COMPANY)  
NO. 30, THE 8TH FLOOR, DIGANGHAIWAN  
HAOYUAN CITY 3.6 METER APARTMENT, VELVET FLOWERS ROAD, FUTIAN BONDED AREA  
SHENZHEN CITY, GUANGDONG, CHINA

FOR: COMPUTER HARDWARE, NAMELY, MONITORS; ELECTRONIC TAGS FOR GOODS; CAMCORDERS; CAMERAS; OPTICAL LENSES; LIGHTNING ARRESTERS; ELECTRIC THEFT PREVENTION INSTALLATIONS, NAMELY, BURGLAR ALARMS; SOLAR BATTERIES, IN CLASS 9 (U.S. CLS. 21, 23, 26, 36 AND 38).

THE MARK CONSISTS OF STANDARD CHARACTERS WITHOUT CLAIM TO ANY PARTICULAR FONT, STYLE, SIZE, OR COLOR.

OWNER OF INTERNATIONAL REGISTRATION 0944621 DATED 11-15-2007, EXPIRES 11-15-2017.

THE WORDING "IR" HAS NO MEANING IN A FOREIGN LANGUAGE.

SER. NO. 79-046,649, FILED 11-15-2007.

CHERYL CLAYTON, EXAMINING ATTORNEY



**Int. Cl.: 14**

**Prior U.S. Cls.: 2, 27, 28 and 50**

**United States Patent and Trademark Office**

**Reg. No. 3,499,393**

**Registered Sep. 9, 2008**

**TRADEMARK  
PRINCIPAL REGISTER**

**TRIFLEX**

CHOPARD INTERNATIONAL SA (SWITZER-  
LAND SOCIÉTÉ ANONYME)  
ROUTE DE PROMENTHOUX  
CH-1197 PRANGINS  
SWITZERLAND

FOR: HOROLOGICAL AND CHRONOMETRIC  
INSTRUMENTS, NAMELY CHRONOGRAPHS,  
CHRONOMETERS FOR USE AS WATCHES,  
WATCHES, WRISTWATCHES, WATCH AND  
CLOCK MOVEMENTS, AND CHRONOGRAPH  
HAMMERS, IN CLASS 14 (U.S. CLS. 2, 27, 28 AND 50).

THE MARK CONSISTS OF STANDARD CHAR-  
ACTERS WITHOUT CLAIM TO ANY PARTICULAR  
FONT, STYLE, SIZE, OR COLOR.

PRIORITY DATE OF 5-8-2007 IS CLAIMED.

OWNER OF INTERNATIONAL REGISTRATION  
0944756 DATED 11-7-2007, EXPIRES 11-7-2017.

THE WORDING "TRIFLEX" HAS NO TRANSLA-  
TION FROM A FOREIGN LANGUAGE.

SER. NO. 79-046,733, FILED 11-7-2007.

MARK PILARO, EXAMINING ATTORNEY

**Int. Cl.: 9**

**Prior U.S. Cls.: 21, 23, 26, 36 and 38**

**Reg. No. 3,499,394**

**United States Patent and Trademark Office**

**Registered Sep. 9, 2008**

**TRADEMARK  
PRINCIPAL REGISTER**

**orkio**

HANS DEPRETTERE (BELGIUM INDIVIDUAL)  
NO. 3, ALLEY 6, LANE 137,  
MIN-SHENG EAST ROAD,; SECTION 5; 105 TAIPEI  
CHINA

FOR: CASES ESPECIALLY ADAPTED FOR  
HANDHELD OR MOBILE APPARATUS AND IN-  
STRUMENTS; CASES ESPECIALLY MADE FOR  
PHOTOGRAPHIC APPARATUS AND INSTRU-  
MENTS, NAMELY, CAMERA CASES; CASES SPE-  
CIALLY ADAPTED FOR HOLDING OR CARRYING  
PORTABLE TELEPHONES, LAPTOPS, AND EQUIP-  
MENT, AND FOR INSTRUMENTS FOR RECORD-  
ING, TRANSMISSION OR REPRODUCTION OF

SOUNDS AND IMAGES, IN CLASS 9 (U.S. CLS. 21,  
23, 26, 36 AND 38).

THE MARK CONSISTS OF STANDARD CHAR-  
ACTERS WITHOUT CLAIM TO ANY PARTICULAR  
FONT, STYLE, SIZE, OR COLOR.

OWNER OF INTERNATIONAL REGISTRATION  
0944978 DATED 10-19-2007, EXPIRES 10-19-2017.

SER. NO. 79-046,814, FILED 10-19-2007.

ARETHA SOMERVILLE, EXAMINING ATTORNEY

Int. Cls.: 30 and 32

Prior U.S. Cls.: 45, 46 and 48

United States Patent and Trademark Office

Reg. No. 3,499,395

Registered Sep. 9, 2008

TRADEMARK  
PRINCIPAL REGISTER



TIBET GLACIER MINERAL; WATER CO. LTD.  
(CHINA CORPORATION)  
CHONGGA VILLAGE  
GONGTANG COUNTRY,; DANGXIONG COUNTY;  
LHASA, TIBET  
CHINA

FOR: COFFEE-BASED BEVERAGES; TEA-BASED  
BEVERAGES; HONEY; FARINACEOUS FOOD  
PASTES FOR HUMAN CONSUMPTION; EDIBLE  
ICES; SAFFRON FOR USE AS A FOOD SEASONING;  
FLAVORINGS, OTHER THAN ESSENTIAL OILS,  
FOR BEVERAGES, IN CLASS 30 (U.S. CL. 46).

FOR: MINERAL WATER; TABLE WATERS; AER-  
ATED WATER; SWEET CIDER; DISTILLED DRINK-  
ING WATER; PURE DRINKING WATER; FRUIT

AND VEGETABLE JUICE BEVERAGES; BEER; GIN-  
GER ALE; MALT WORT; PREPARATIONS FOR  
MAKING BEVERAGES, NAMELY, FRUIT DRINKS,  
IN CLASS 32 (U.S. CLS. 45, 46 AND 48).

PRIORITY DATE OF 3-27-2007 IS CLAIMED.

OWNER OF INTERNATIONAL REGISTRATION  
0945236 DATED 9-13-2007, EXPIRES 9-13-2017.

SER. NO. 79-046,897, FILED 9-13-2007.

DAVID HOFFMAN, EXAMINING ATTORNEY

**Int. Cl.: 3**

**Prior U.S. Cls.: 1, 4, 6, 50, 51 and 52**

**United States Patent and Trademark Office**

**Reg. No. 3,499,396**

**Registered Sep. 9, 2008**

**TRADEMARK  
PRINCIPAL REGISTER**

**康齿灵**

DANDONG KANGCHILING; TOOTHPASTE CO.,  
LTD. (CHINA CORPORATION)  
NO. 148, ZHONGHE VILLAGE  
LANGTOU TOWN.; ZHENXING DISTRICT.; DAN-  
DONG CITY; LIAONING  
CHINA

FOR: ANTIMICROBIAL HAND LOTIONS, CAKES  
OF TOILET SOAP, LAUNDRY DETERGENT, DEN-  
TIFRICES, IN CLASS 3 (U.S. CLS. 1, 4, 6, 50, 51 AND  
52).

OWNER OF INTERNATIONAL REGISTRATION  
0945412 DATED 11-21-2007, EXPIRES 11-21-2017.

THE TRANSLITERATION OF THE NON-LATIN  
CHARACTERS IN THE MARK IS "KANGCHILING"  
AND THIS MEANS "HEALTHY", "GEAR", AND  
"FLEXIBLE" IN ENGLISH.

SER. NO. 79-046,954, FILED 11-21-2007.

DANIEL CAPSHAW, EXAMINING ATTORNEY

**Int. Cl.: 7**

**Prior U.S. Cls.: 13, 19, 21, 23, 31, 34 and 35**

**Reg. No. 3,499,397**

**United States Patent and Trademark Office**

**Registered Sep. 9, 2008**

**TRADEMARK  
PRINCIPAL REGISTER**



INTERPULS S.P.A. (ITALY SOCIÉTÉ PAR AC-  
TIONS)  
VIA F. MARITANO, 11  
I-42020 ALBINEA (RE)  
ITALY

THE COLOR(S) BLUE AND WHITE IS/ARE  
CLAIMED AS A FEATURE OF THE MARK.

FOR: PARTS OF MILKING MACHINES, NAME-  
LY, PNEUMATIC PULSATORS, INDIVIDUAL  
ELECTRONIC PULSATORS, SOLENOID VALVES,  
GRIPPERS, CLUSTERS, TRANSPARENT COVERS  
MADE OF STAINLESS STEEL, MUGS MADE OF  
STAINLESS STEEL, SUPPORTS MADE OF STAIN-  
LESS STEEL FOR MILK FILTERS, SANITARY  
TRAPS, VACUUM REGULATORS, AUTOMATIC  
DISCONNECTION SYSTEMS COMPRISED OF A  
VACUUM CYLINDER, CONTROL VALVES, FLOW  
SENSORS, AN ELECTRONIC CONTROL PANEL, A  
MICROPROCESSOR AND A POWER UNIT, IN  
CLASS 7 (U.S. CLS. 13, 19, 21, 23, 31, 34 AND 35).

THE MARK CONSISTS OF A VAGUELY REC-  
TANGULAR SHAPE WITH SLIGHTLY CURVED  
UPPER AND LOWER SIDES; WITHIN THE ABOVE,  
THERE IS THE WORD "INTERPULS" IN FANCY  
FONT WITH THE LETTERS "I" AND "P" IN UPPER-  
CASE AND THE OTHERS IN LOWERCASE FONT.  
THE WORD "INTERPULS" IS THE COLOR WHITE  
AND THE VAGUELY RECTANGULAR SHAPE IS  
COLOR BLUE.

SER. NO. 79-046,975, FILED 9-14-2007.

OWNER OF INTERNATIONAL REGISTRATION  
0830144 DATED 12-19-2003, EXPIRES 12-19-2013.

CHARLOTTE CORWIN, EXAMINING ATTORNEY

**Int. Cls.: 7, 12 and 35**

**Prior U.S. Cls.: 13, 19, 21, 23, 31, 34, 35, 44, 100, 101  
and 102**

**Reg. No. 3,499,398**

**United States Patent and Trademark Office**

**Registered Sep. 9, 2008**

**TRADEMARK  
SERVICE MARK  
PRINCIPAL REGISTER**



EISENHART LAEPPCHÉ GMBH (FED REP GER-  
MANY LIMITED LIABILITY COMPANY)  
AN DER JUNKEREI 27  
26389 WILHELMSHAVEN  
FED REP GERMANY

FOR: MACHINES FOR METAL WORKING AND METALWORKING MACHINE TOOLS; MOTORS AND ENGINES NOT FOR LAND VEHICLES; MACHINE COUPLINGS AND DEVICES IN THE NATURE OF BEARINGS FOR TRANSMISSION COMPONENTS FOR MACHINES; MACHINE PARTS, NAMELY, BALL AND ROLLER BEARINGS; BALL JOINTS AS PARTS OF MACHINES; MACHINE PARTS, NAMELY, JOURNAL BOXES; WHEEL BEARINGS FOR VEHICLE WHEELS; MACHINE PARTS, NAMELY, NEEDLE BEARINGS; MACHINE PARTS, NAMELY, BALL BEARINGS; BEARINGS FOR TRANSMISSION SHAFTS BEING PARTS OF MACHINES SHAFT SUPPORTS IN THE NATURE OF COUPLINGS AS PARTS OF MACHINES; HYDROSTATIC BEARINGS AS PARTS OF MACHINES; PARTS AND FITTINGS THEREFOR FOR THE ABOVE MENTIONED MACHINES; MACHINE PARTS, NAMELY, SEALS FOR ATTACHMENT FOR ROLLER BEARINGS; MACHINE PARTS, NAMELY, BEARING HOUSINGS FOR ROLLER BEARINGS; MACHINE PARTS, TRANSMISSIONS, SHAFTS, COUPLINGS, AND BEARINGS NOT FOR LAND VEHICLES; MACHINE PARTS, NAMELY, FOLLOWERS, BALL BUSHINGS, BALL SCREW AND ROLLER SPINDLES, AND JOINT HEADS FOR PARTS OR ATTACHMENTS BY MACHINES; METALWORKING MACHINE TOOLS; POWER TOOLS AND PARTS AND FITTINGS THEREFOR IN THE NATURE OF SCREW DRIVERS AND OTHER TOOLS FOR LOOSENING OR FIXING PARTS OF MACHINES; POWER TOOLS FOR MACHINE PARTS FOR ASSEMBLY OF BEARINGS AND COUPLINGS; DRIVE CHAINS NOT FOR LAND VEHICLES IN THE NATURE OF COU-

PLINGS; TRANSMISSION COMPONENTS AND TRANSMISSIONS, RESPECTIVELY FOR MACHINES; PARTS FOR MACHINES, NAMELY, STOP BLOCKS, DRIVES, AS WELL AS PARTS FOR TRANSMISSION COMPONENTS; LINEAR GUIDES IN THE NATURE OF COUPLINGS AND BEARINGS FOR MACHINES; SHAFT GUIDES IN THE NATURE OF COUPLINGS AND BEARINGS FOR MACHINES; BALL RECIRCULATING GUIDES IN THE NATURE OF COUPLINGS AND BEARINGS FOR MACHINES; ROLLER RECIRCULATING GUIDES IN THE NATURE OF COUPLINGS AND BEARINGS FOR MACHINES; MACHINE PARTS, NAMELY, CASTOR GUIDES FOR PART ATTACHMENTS FOR MACHINES; MACHINE PARTS, NAMELY, BALL SCREWS FOR MACHINES; MACHINE PARTS, NAMELY, BEARINGS AND THEIR PARTS AND ATTACHMENTS FOR VEHICLES; MACHINE PARTS, NAMELY, BEARINGS, PARTS AND ACCESSORIES FOR VEHICLE BEARINGS, IN CLASS 7 (U.S. CLS. 13, 19, 21, 23, 31, 34 AND 35).

FOR: VEHICLES IN THE NATURE OF AUTOMOBILES, AIRPLANES AND BOATS AND PARTS THEREFOR INCLUDED IN THIS CLASS; APPARATUS FOR TRANSPORTATION ON LAND, IN THE AIR OR ON WATER IN THE NATURE OF AUTOMOBILES, AIRPLANES AND BOATS, IN CLASS 12 (U.S. CLS. 19, 21, 23, 31, 35 AND 44).

FOR: ADVERTISING; BUSINESS MANAGEMENT SERVICES; BUSINESS ADMINISTRATION; OFFICE FUNCTIONS; ARRANGING OF CONTRACTS, FOR OTHERS, FOR THE PURCHASE AND SALE OF GOODS, IN PARTICULAR BEARINGS, ROLLER BEARINGS AND LINEAR SYSTEM COMPONENTS; PROCUREMENT, NAMELY, PURCHASING OF GOODS FOR OTHERS FROM VARIOUS MANUFACTURERS, NAMELY, BEARINGS, ROLLER BEARINGS AND LINEAR SYSTEM COMPONENTS, IN CLASS 35 (U.S. CLS. 100, 101 AND 102).

PRIORITY DATE OF 1-22-2007 IS CLAIMED.

SER. NO. 79-047,156, FILED 7-12-2007.

OWNER OF INTERNATIONAL REGISTRATION  
0945917 DATED 7-12-2007, EXPIRES 7-12-2017.

ANN E. SAPPENFIELD, EXAMINING ATTORNEY

**Int. Cls.: 7, 9, 37 and 42**

**Prior U.S. Cls.: 13, 19, 21, 23, 26, 31, 34, 35, 36, 38,  
100, 101, 103 and 106**

**Reg. No. 3,499,399**

**United States Patent and Trademark Office**

**Registered Sep. 9, 2008**

**TRADEMARK  
SERVICE MARK  
PRINCIPAL REGISTER**

# Cardline

ATLANTIC ZEISER GMBH (FED REP GERMA-  
NY GMBH)  
BOGENSTRASSE 6-8  
78576 EMMINGEN-LIPTINGEN  
FED REP GERMANY

FOR: MACHINES FOR MANUFACTURING, PERSONALISING, PROGRAMMING, ENCODING, NUMBERING, EDITING, INSCRIBING AND PACKAGING OF DATA CARRIERS; PRINTING MACHINES FOR INDUSTRIAL AND COMMERCIAL USE; AUTOMATIC STAMPING MACHINES, PRESSING MACHINES, IN THE NATURE OF STAMPING PRESSES; MACHINES FOR EDITING DATA CARRIERS; ELECTRONIC, HYDRAULIC AND PNEUMATIC CONTROLS AND MONITORING SYSTEMS FOR MACHINES FOR MANUFACTURING, PERSONALISING, PROGRAMMING, ENCODING, NUMBERING, EDITING, INSCRIBING AND PACKAGING OF DATA CARRIERS, AND FOR PRINTING MACHINES, STAMPING MACHINES AND PRESSING MACHINES, IN CLASS 7 (U.S. CLS. 13, 19, 21, 23, 31, 34 AND 35).

FOR: COMPUTER HARDWARE AND SOFTWARE FOR THE OPERATION OF PERSONALISATION SYSTEMS; SOUND, IMAGE AND DATA CARRIERS OF ALL KINDS, NAMELY, BLANK OPTICAL AND MAGNETIC DATA CARRIERS; APPARATUS FOR RECORDING, TRANSMISSION OR REPRODUCTION OF SOUND OR IMAGES; PHOTOGRAPHIC, CINEMATOGRAPHIC AND OPTICAL APPARATUS AND INSTRUMENTS, NAMELY, CAMERA SYSTEMS; MAGNETIC AND/OR OPTICAL ENCODED SERVICE AND IDENTIFICATION DATA CARRIERS; BLANK MAGNETIC DATA CARRIERS, BLANK DATA CARRIERS WITH INTEGRATED CIRCUITS, NAMELY, SMART CARDS; ELECTRONIC CARD READERS AND OPTICAL CHARACTER READERS FOR DATA CARRIERS, IN CLASS 9 (U.S. CLS. 21, 23, 26, 36 AND 38).

FOR: INSTALLATION, REPAIR AND MAINTENANCE OF COMPUTER HARDWARE AND SOFTWARE, AND OF MACHINES FOR THE MANUFACTURING, PERSONALISING, PROGRAMMING, ENCODING, NUMBERING, EDITING, INSCRIBING AND PACKAGING OF DATA CARRIERS, IN CLASS 37 (U.S. CLS. 100, 103 AND 106).

FOR: DEVELOPMENT, CREATION, IMPROVEMENT AND UPDATING OF PROGRAMS FOR WORD PROCESSING AND DATA PROCESSING, IN PARTICULAR FOR MACHINES FOR THE MANUFACTURING, PERSONALISING, PROGRAMMING, ENCODING, NUMBERING, EDITING, INSCRIBING AND PACKAGING OF DATA CARRIERS; DESIGNING OF WEBSITES, COMPUTER PROGRAMMING FOR SOLVING SECTORAL PROBLEMS ON THE INTERNET, COMPUTER PROGRAMMING, ELECTRONIC DATA PROCESSING CONSULTANCY, TECHNICAL PROJECT MANAGEMENT IN CONNECTION WITH MACHINES FOR THE MANUFACTURING, PERSONALISING, PROGRAMMING, ENCODING, NUMBERING, EDITING, INSCRIBING AND PACKAGING OF DATA CARRIERS; SERVICES OF A TECHNICAL MEASURING AND TESTING LABORATORY, NAMELY, CONDUCTING TECHNICAL TESTS AND CHECKS, TECHNICAL MEASURING, TECHNICAL SURVEYS, ALL IN THE FIELD OF DATA CARRIER PERSONALISATION SYSTEMS; CALIBRATION AND FUNCTION TESTING OF MEASURING APPARATUS, AND OF MACHINES FOR THE MANUFACTURING, PERSONALISING, PROGRAMMING, ENCODING, NUMBERING, EDITING, INSCRIBING AND PACKAGING OF DATA CARRIERS; INSTALLATION, REPAIR AND MAINTENANCE OF COMPUTER SOFTWARE, IN CLASS 42 (U.S. CLS. 100 AND 101).



PRIORITY DATE OF 4-19-2007 IS CLAIMED.

THE WORD "CARDLINE" DOES NOT HAVE ANY  
MEANING IN ENGLISH.

OWNER OF INTERNATIONAL REGISTRATION  
0945940 DATED 10-8-2007, EXPIRES 10-8-2017.

SER. NO. 79-047,164, FILED 10-8-2007.

MARK PILARO, EXAMINING ATTORNEY

**Int. Cl.: 18**

**Prior U.S. Cls.: 1, 2, 3, 22 and 41**

**United States Patent and Trademark Office**

**Reg. No. 3,499,400**

**Registered Sep. 9, 2008**

**TRADEMARK  
PRINCIPAL REGISTER**

**NEVERFULL**

LOUIS VUITTON MALLETIER (FRANCE SOCI-  
ÉTÉ ANONYME)  
2 RUE DU PONT-NEUF  
F-75001 PARIS, FRANCE

FOR: LEATHER AND IMITATION LEATHER PRODUCTS, NAMELY, BOXES OF LEATHER OR IMITATION LEATHER FOR PACKAGING AND CARRYING GOODS, TRUNKS, SUITCASES, TRAVELING SETS COMPRISED OF TRAVELING CASES OR LUGGAGE, TRAVELING BAGS, LUGGAGE, GARMENT BAGS FOR TRAVEL, HATBOXES, UNFITTED VANITY CASES SOLD EMPTY, TOILETRY BAGS SOLD EMPTY, RUCKSACKS, SATCHELS, HANDBAGS, BEACH BAGS, SHOPPING BAGS, SHOULDER BAGS, CARRY-ALL BAGS, BELT BAGS, PURSES, ATTACHÉ CASES, BRIEFCASES, SCHOOL BAGS, DOCUMENT CASES, POUCHES, ALL OF THE FOREGOING MADE OF LEATHER

OR IMITATION LEATHER; SMALL GOODS MADE OF LEATHER, NAMELY, WALLETS, CHANGE PURSES, KEY CASES, BUSINESS CARD CASES, CALLING CARD CASES, CREDIT CARD CASES, TELEPHONE CARD CASES; UMBRELLAS, PARASOLS, IN CLASS 18 (U.S. CLS. 1, 2, 3, 22 AND 41).

PRIORITY DATE OF 5-31-2007 IS CLAIMED.

OWNER OF INTERNATIONAL REGISTRATION  
0947362 DATED 11-22-2007, EXPIRES 11-22-2017.

SER. NO. 79-047,673, FILED 11-22-2007.

MICHAEL TANNER, EXAMINING ATTORNEY

**Int. Cls.: 14, 18, 25 and 34**

**Prior U.S. Cls.: 1, 2, 3, 8, 9, 17, 22, 27, 28, 39, 41 and 50**

**United States Patent and Trademark Office**

**Reg. No. 3,499,401**

**Registered Sep. 9, 2008**

**TRADEMARK  
PRINCIPAL REGISTER**

# CHEVIREX

JÜRGEN RABERG (FED REP GERMANY INDIVIDUAL)  
8, HAHNSTRASSE  
49835 WIETMARSCHEN-LOHNE  
FED REP GERMANY

FOR: FASHION JEWELRY, CUFF LINKS, TIE PINS OF PRECIOUS METAL, CASES FOR CLOCK AND WATCH-MAKING; AND CHRONOMETRIC INSTRUMENTS, IN CLASS 14 (U.S. CLS. 2, 27, 28 AND 50).

FOR: GOODS MADE OF LEATHER AND IMITATIONS OF LEATHER, NAMELY BAGS, HANDBAGS, BELT BAGS; SMALL LEATHER GOODS, IN PARTICULAR PURSES, WALLETS, KEY CASES; RUCKSACKS, ALL-PURPOSE CARRYING BAGS FOR USE IN CAMPING, LEATHER STRAPS IN THE NATURE OF SHOULDER BELTS, SETS OF TRAVEL BAGS; TRUNKS AND SUITCASES, IN CLASS 18 (U.S. CLS. 1, 2, 3, 22 AND 41).

FOR: CLOTHING, NAMELY, LEATHER JACKETS, LONG JACKETS, AND LEATHER COATS; FOOTWEAR; HEADWEAR; BELTS AND GLOVES, IN CLASS 25 (U.S. CLS. 22 AND 39).

FOR: CIGARETTE CASES NOT OF PRECIOUS METAL; LIGHTERS FOR SMOKERS; AND MATCHES, IN CLASS 34 (U.S. CLS. 2, 8, 9 AND 17).

OWNER OF INTERNATIONAL REGISTRATION  
0568477 DATED 3-4-1991, EXPIRES 3-4-2011.

THE TERM "CHEVIREX" HAS NO MEANING IN A FOREIGN LANGUAGE.

SER. NO. 79-047,692, FILED 11-3-2007.

ELLEN BURNS, EXAMINING ATTORNEY

**Int. Cl.: 12**

**Prior U.S. Cls.: 19, 21, 23, 31, 35 and 44**

**Reg. No. 3,499,402**

**United States Patent and Trademark Office**

**Registered Sep. 9, 2008**

**TRADEMARK  
PRINCIPAL REGISTER**

**MAMMUT**

RUD KETTEN RIEGER; & DIETZ GMBH U. CO.  
KG (FED REP GERMANY LIMITED PART-  
NERSHIP)  
FRIEDENSINSEL  
73432 AALEN-UNTERKOCHEN, FED REP GERMA-  
NY

FOR: LAND VEHICLE PARTS, NAMELY, ANTI-  
SKID CHAINS AND TIRE PROTECTION CHAINS,  
IN CLASS 12 (U.S. CLS. 19, 21, 23, 31, 35 AND 44).

OWNER OF INTERNATIONAL REGISTRATION  
0433634 DATED 11-3-1977, EXPIRES 11-3-2017.

THE ENGLISH TRANSLATION OF "MAMMUT"  
IS MAMMOTH.

SER. NO. 79-048,040, FILED 11-21-2007.

MARGERY A. TIERNEY, EXAMINING ATTORNEY

**Int. Cl.: 39**

**Prior U.S. Cls.: 100 and 105**

**United States Patent and Trademark Office**

**Reg. No. 3,499,403**

**Registered Sep. 9, 2008**

**SERVICE MARK  
PRINCIPAL REGISTER**



EAST JAPAN RAILWAY COMPANY (JAPAN  
JOINT STOCK COMPANY)

2-2, YOYOGI 2-CHOME  
SHIBUYA-KU.; TOKYO 151-8578

JAPAN AND

HOKKAIDO RAILWAY COMPANY (JAPAN JOINT  
STOCK COMPANY)

1-1, KITA 11-JO NISHI 15-CHOME  
CHUO-KU.; SAPPORO-SHI; HOKKAIDO 060-8644

JAPAN AND

CENTRAL JAPAN RAILWAY COMPANY (JAPAN  
JOINT STOCK COMPANY)

1-4, MEIEKI 1-CHOME  
NAKAMURA-KU.; NAGOYA-SHI; AICHI 450-6101

JAPAN AND

WEST JAPAN RAILWAY COMPANY (JAPAN JOINT  
STOCK COMPANY)

4-24, SHIBATA 2-CHOME  
KITA-KU.; OSAKA-SHI; OSAKA 530-8341

JAPAN AND

SHIKOKU RAILWAY COMPANY (JAPAN JOINT  
STOCK COMPANY)

8-33, HAMANOCHO  
TAKAMASTSU-SHI; KAGAWA 760-8580

JAPAN AND

KYUSHU RAILWAY COMPANY (JAPAN JOINT  
STOCK COMPANY)

25-21, HAKATAEKIMAE 3-CHOME

HAKATA-KU.; FUKUOKA-SHI; FUKUOKA 812-  
8566

JAPAN AND

JAPAN FREIGHT RAILWAY COMPANY (JAPAN  
JOINT STOCK COMPANY)

13-1, IIDABASHI 3-CHOME  
CHIYODA-KU; TOKYO 102-0072

JAPAN

FOR: PASSENGER TRAIN TRANSPORT;  
FREIGHT TRAIN TRANSPORT; ARRANGING OF  
TRAVEL; AGENCIES FOR TRAVEL CONTRACTS,  
EXCEPT FOR LODGING CONTRACTS, NAMELY,  
CONTRACTS FOR RESERVING AND BOOKING  
TRANSPORTATION; ONLINE TICKET RESERVA-  
TION FOR RAILWAY TRANSPORT; AGENCIES  
FOR ONLINE TICKET RESERVATION FOR RAIL-  
WAY TRANSPORT; WAREHOUSING, IN CLASS 39  
(U.S. CLS. 100 AND 105).

OWNER OF INTERNATIONAL REGISTRATION  
0871292 DATED 10-12-2005, EXPIRES 10-12-2015.

SER. NO. 79-048,065, FILED 11-30-2007.

KATINA MISTER, EXAMINING ATTORNEY

**Int. Cl.: 45**

**Prior U.S. Cls.: 100 and 101**

**United States Patent and Trademark Office**

**Reg. No. 3,499,404**

**Registered Sep. 9, 2008**

**SERVICE MARK  
PRINCIPAL REGISTER**



THE HALO TRUST (GREAT BRITAIN COMPANY LIMITED BY GUARANTEE)  
CARRONFOOT  
THORNHILL, DUMFRIES DG3 5AY  
UNITED KINGDOM

FOR: BOMB DETECTION AND DISPOSAL SERVICES; ORDNANCE DETECTION AND DISPOSAL SERVICES; SECURITY SERVICES, NAMELY, INSPECTION FOR LANDMINES, BOMB, AND UNEXPLODED ORDNANCES; SAFETY SERVICES, NAMELY, PROVIDING INFORMATION REGARDING LOCATIONS OF LANDMINES, BOMB, AND

UNEXPLODED ORDNANCES AND RISKS ASSOCIATED WITH TRAVELLING IN AREAS CONTAINING LANDMINES, BOMB, AND UNEXPLODED ORDNANCES, IN CLASS 45 (U.S. CLS. 100 AND 101).

OWNER OF INTERNATIONAL REGISTRATION  
0948453 DATED 12-6-2007, EXPIRES 12-6-2017.

SER. NO. 79-048,122, FILED 12-6-2007.

TOBY BULLOFF, EXAMINING ATTORNEY

**Int. Cl.: 39**

**Prior U.S. Cls.: 100 and 105**

**United States Patent and Trademark Office**

**Reg. No. 3,499,405**

**Registered Sep. 9, 2008**

**SERVICE MARK  
PRINCIPAL REGISTER**

**BEAM**

ALL NIPPON AIRWAYS CO., LTD. (JAPAN CORPORATION)  
1-5-2, HIGASHI-SHIMBASHI,  
MINATO-KU; TOKYO 105-7133  
JAPAN AND  
OVERSEAS COURIER SERVICE CO., LTD. (JAPAN CORPORATION)  
2-9-13, SHIBAURA  
MINATO-KU.; TOKYO 108-0023  
JAPAN

FOR: AIR TRANSPORTATION SERVICES;  
TRANSPORTATION BROKERAGE; FREIGHT  
BROKERAGE; FREIGHT FORWARDING; COURIER  
SERVICES, NAMELY, DELIVERY OF MESSAGES  
AND MERCHANDISE BY NON-ELECTRONIC

MEANS; DELIVERY OF GOODS; FREIGHTING  
SERVICES, NAMELY, FREIGHT TRANSPORTATION  
BY TRUCK, TRAIN, SHIP AND AIR, IN CLASS  
39 (U.S. CLS. 100 AND 105).

PRIORITY DATE OF 6-6-2007 IS CLAIMED.

OWNER OF INTERNATIONAL REGISTRATION  
0948557 DATED 12-5-2007, EXPIRES 12-5-2017.

SER. NO. 79-048,146, FILED 12-5-2007.

DAVID ELTON, EXAMINING ATTORNEY

**Int. Cls.: 35 and 41**

**Prior U.S. Cls.: 100, 101, 102 and 107**

**United States Patent and Trademark Office**

**Reg. No. 3,499,406**

**Registered Sep. 9, 2008**

**SERVICE MARK  
PRINCIPAL REGISTER**

**THE STORYTELLERS**

THE STORYTELLERS LIMITED (UNITED KING-  
DOM CORPORATION)  
SPRATTON LODGE  
HOLDENBY ROADSPRATTON, NORTHAMPTON  
NN6 8LD  
UNITED KINGDOM

FOR: BUSINESS MANAGEMENT CONSULTAN-  
CY AND ADVISORY SERVICES; ADVISORY SER-  
VICES PROVIDED TO BUSINESSES IN THE FIELDS  
OF HUMAN RESOURCES AND THE DEVELOP-  
MENT OF MANAGERIAL PROCEDURES, IN  
CLASS 35 (U.S. CLS. 100, 101 AND 102).

FOR: EDUCATIONAL ADVISORY SERVICES  
PROVIDED TO BUSINESSES, NAMELY, BUSINESS  
TRAINING; EDUCATIONAL ADVISORY SERVI-

CES, NAMELY, PROVIDING CLASSES, SEMINARS  
AND WORKSHOPS TO BUSINESSES IN THE FIELD  
OF DEVELOPING MANAGEMENT SKILLS, IN  
CLASS 41 (U.S. CLS. 100, 101 AND 107).

THE MARK CONSISTS OF STANDARD CHAR-  
ACTERS WITHOUT CLAIM TO ANY PARTICULAR  
FONT, STYLE, SIZE, OR COLOR.

OWNER OF INTERNATIONAL REGISTRATION  
0948755 DATED 5-30-2007, EXPIRES 5-30-2017.

SER. NO. 79-048,206, FILED 5-30-2007.

DAVID HOFFMAN, EXAMINING ATTORNEY



**Int. Cls.: 16 and 34**

**Prior U.S. Cls.: 2, 5, 8, 9, 17, 22, 23, 29, 37, 38 and 50**

**United States Patent and Trademark Office**

**Reg. No. 3,499,407**

**Registered Sep. 9, 2008**

**TRADEMARK  
PRINCIPAL REGISTER**

# **GIANFRANCO FERRÈ**

GIANFRANCO FERRE' S.P.A. (ITALY JOINT  
STOCK COMPANY)  
VIA PONTACCIO 21  
I-20121 MILANO  
ITALY

FOR: GENERAL PURPOSE, PLASTIC BAGS, DECALCOMANIAS, NON-TEXTILE LABELS, NAMELY, PAPER LABELS, OFFICE REQUISITES, NAMELY, PUNCHES, DOCUMENT HOLDERS; STATIONERY-TYPE PORTFOLIOS, GIFT CARDS, OCCASION CARDS, POSTCARDS, BLANK CARDS, NOTE PADS, SCRATCH PADS; BOND PAPER, ILLUSTRATION PAPER, GIFT WRAPPING PAPER, WRITING PAPER, ENVELOPES, PAPER BOXES, WRITING PAPER PADS, PAPER BOARDS, POSTERS, GREETING CARDS, CARD BOXES, PICTURES, ANNIVERSARY BOOKS, RECIPE BOOKS, GUEST BOOKS, DRAWING BOOKS, NAMELY, SKETCH BOOKS, TELEPHONE NUMBER BOOKS, UNMOUNTED PHOTOGRAPHS, PHOTOGRAPH MOUNTS, ERASERS, MAGNETIC BOARDS, PENCIL SHARPENERS, PENS, PENCILS, PENCIL CASES, PEN CASES, GLUE FOR STATIONERY USE, ARTISTS' PASTELS, PAINT BRUSHES, PAPER CUTTERS, PAPERWEIGHTS, PAPER FASTENERS, FILE FOLDERS, DESK SETS, DESK TOP ORGANIZERS; TABLE LINEN OF PAPER, TABLE CLOTH ALL OF PAPER, PAPER BAGS, PAPER BATHMATS, PAPER BLINDS, PAPER RIBBONS AND PAPER BOWS FOR GIFT WRAP, PAPER CAKE DECORATION, DECORATIVE PAPER CENTERPIECES, PAPER DOILIES, PAPER HANDKERCHIEFS, PAPER NAPKINS, PAPER MATS, PAPER TOWELS, PAPER TRAY COVERS, FOOD WRAPPERS, PAPER FILTERS FOR COFFEE MAKERS, CALENDARS, PHOTOGRAPH

ALBUMS, EXERCISE BOOKS, PERSONAL ORGANIZERS, IN CLASS 16 (U.S. CLS. 2, 5, 22, 23, 29, 37, 38 AND 50).

FOR: TOBACCO; CIGARS; CIGARETTES; MATCHES; ASHTRAYS, NOT OF PRECIOUS METAL, FOR SMOKERS; CIGAR CASES, NOT OF PRECIOUS METAL; CIGARETTE CASES, NOT OF PRECIOUS METAL; CIGAR CUTTERS; CIGAR HOLDERS, NOT OF PRECIOUS METAL; CIGARETTE HOLDERS, NOT OF PRECIOUS METAL; CIGARETTE FILTER TIPS; LIGHTERS FOR SMOKERS; MATCH BOXES, NOT OF PRECIOUS METAL; MATCH HOLDERS, NOT OF PRECIOUS METAL; TOBACCO PIPES; TOBACCO POUCHES; BOOKS OF CIGARETTE PAPERS; CHEWING TOBACCO; CIGARETTE FILTERS; CIGARETTE PAPER; POCKET MACHINES FOR ROLLING CIGARETTES; CIGARILLOS; MOUTHPIECES FOR CIGARETTE HOLDERS; PIPE CLEANERS; TOBACCO JARS, NOT OF PRECIOUS METAL; SNUFF; SNUFF BOXES, NOT OF PRECIOUS METAL, IN CLASS 34 (U.S. CLS. 2, 8, 9 AND 17).

OWNER OF INTERNATIONAL REGISTRATION  
0631101 DATED 1-24-1995, EXPIRES 1-24-2015.

THE NAME(S), PORTRAIT(S), AND/OR SIGNATURE(S) SHOWN IN THE MARK DOES NOT IDENTIFY A PARTICULAR LIVING INDIVIDUAL.

SER. NO. 79-048,337, FILED 8-12-2005.

JESSICA FATHY, EXAMINING ATTORNEY

**Int. Cl.: 10**

**Prior U.S. Cls.: 26, 39 and 44**

**United States Patent and Trademark Office**

**Reg. No. 3,499,408**

**Registered Sep. 9, 2008**

**TRADEMARK  
PRINCIPAL REGISTER**

**CLOSE UP**

CELLO EUROPE LTD (UNITED KINGDOM LIMITED COMPANY (LTD.))  
UNIT A108 FAIRCHARM TRADING ESTATE,  
8-12 CREEKSIDE,; LONDON SE8 3DX  
UNITED KINGDOM

OWNER OF INTERNATIONAL REGISTRATION  
0949197 DATED 12-26-2007, EXPIRES 12-26-2017.

SER. NO. 79-048,376, FILED 12-26-2007.

FOR: CONDOMS, IN CLASS 10 (U.S. CLS. 26, 39 AND 44).

CHRISTOPHER BUONGIORNO, EXAMINING ATTORNEY

**Int. Cl.: 16**

**Prior U.S. Cls.: 2, 5, 22, 23, 29, 37, 38 and 50**

**Reg. No. 3,499,409**

**United States Patent and Trademark Office**

**Registered Sep. 9, 2008**

**TRADEMARK  
PRINCIPAL REGISTER**

**Cello**

CELLO EUROPE LTD (UNITED KINGDOM LIMITED COMPANY (LTD.))  
UNIT A108 FAIRCHARM TRADING ESTATE,  
8-12 CREEKSIDE., LONDON SE8 3DX  
UNITED KINGDOM

FOR: PENS, MARKERS, HIGHLIGHTING MARKERS, HIGHLIGHTING PENS, IN CLASS 16 (U.S. CLS. 2, 5, 22, 23, 29, 37, 38 AND 50).

OWNER OF INTERNATIONAL REGISTRATION  
0949672 DATED 12-26-2007, EXPIRES 12-26-2017.

SER. NO. 79-048,543, FILED 12-26-2007.

CHRISTOPHER BUONGIORNO, EXAMINING ATTORNEY

**Int. Cl.: 7**

**Prior U.S. Cls.: 13, 19, 21, 23, 31, 34 and 35**

**Reg. No. 3,499,410**

**United States Patent and Trademark Office**

**Registered Sep. 9, 2008**

**TRADEMARK  
PRINCIPAL REGISTER**

***Kralle***

ZHEJIANG KRALLE TOOLS CO., LTD (CHINA CORPORATION)  
NO. 2, INDUSTRY ZONE  
DANXI TOWN; YUEQING CITY, ZHEJIANG  
CHINA

FOR: TOOL BITS FOR MACHINES; BITS FOR POWER DRILLS; POWER DRILL BITS; DRILL BITS FOR ROCK DRILLING; DRILLING MACHINES AND PARTS THEREFOR; BLADES FOR POWER SAWS; CIRCULAR SAWS, IN CLASS 7 (U.S. CLS. 13, 19, 21, 23, 31, 34 AND 35).

OWNER OF INTERNATIONAL REGISTRATION  
0949991 DATED 1-7-2008, EXPIRES 1-7-2018.

THE WORD "KRALLE" HAS NO GEOGRAPHIC PLACE AND MEANINGLESS IN A FOREIGN LANGUAGE.

SER. NO. 79-048,675, FILED 1-7-2008.

AMOS T. MATTHEWS, JR., EXAMINING ATTORNEY

**Int. Cls.: 9 and 42**

**Prior U.S. Cls.: 21, 23, 26, 36, 38, 100 and 101**

**Reg. No. 3,499,411**

**United States Patent and Trademark Office**

**Registered Sep. 9, 2008**

**TRADEMARK  
SERVICE MARK  
PRINCIPAL REGISTER**



LMS INTERNATIONAL N.V.; A PUBLIC LIMITED COMPANY (BELGIUM NAAMLOZE VENNOOTSCHAP (NV))  
INTERLEUVENLAAN 68  
B-3001 LEUVEN, BELGIUM

FOR: COMPUTERS; COMPUTER PERIPHERALS; COMPUTER TERMINALS; COMPUTER PROGRAMS TO TEST AND SIMULATE THE BEHAVIOR OF PRODUCT DESIGNS AND TO MANAGE ALL DATA, MODELS AND RESULTS RELATED TO THESE TESTING AND SIMULATION OPERATIONS, IN CLASS 9 (U.S. CLS. 21, 23, 26, 36 AND 38).

FOR: COMPUTER PROGRAMMING, COMPUTER SOFTWARE AND HARDWARE DEVELOPING AND ENGINEERING; DESIGNING AND DEVELOPING COMPUTER SYSTEMS AND SOFTWARE; COMPUTER SYSTEM HARDWARE AND SOFTWARE DEVELOPMENT; ADVISING SERVICES ON THE CHOICE OF COMPUTER HARDWARE AND SOFTWARE; TECHNICAL RESEARCH IN THE FIELD OF TESTING AND SIMULATING THE BEHAVIOR OF PRODUCT DESIGNS; DRAWING UP TECHNICAL AND SCIENTIFIC REPORTS FOR TESTING AND SIMULATING THE BEHAVIOR OF PRODUCT DESIGNS; COMPUTER SYSTEM ANALYSES; RENTAL OF COMPUTER SOFTWARE; ADVICE AND INFORMATION ON WORKPLACE AUTOMATION HARDWARE AND SOFTWARE; SCIENTIFIC AND TECHNOLOGICAL CONSULTING, RESEARCH, AND DESIGN SERVICES FOR MECHANICAL PRODUCT DEVELOPMENT RELATED TO SOUND, VIBRATION, HARSHNESS, FATIGUE AND DURABILITY, STRENGTH, STRUCTURAL INTEGRITY, SAFETY, CRASH AND SHOCK RESISTANCE, MOTION, VEHICLE

RIDE AND HANDLING; SCIENTIFIC AND TECHNOLOGICAL CONSULTING, RESEARCH, AND DESIGN SERVICES FOR THE DEVELOPMENT OF MECHATRONICS SYSTEMS, CONTROL SYSTEMS AND MECHANICAL SYSTEMS AND PRODUCTS, IN CLASS 42 (U.S. CLS. 100 AND 101).

PRIORITY DATE OF 12-22-2006 IS CLAIMED.

OWNER OF INTERNATIONAL REGISTRATION 0950950 DATED 6-18-2007, EXPIRES 6-18-2017.

OWNER OF U.S. REG. NO. 1,744,305.

NO CLAIM IS MADE TO THE EXCLUSIVE RIGHT TO USE "ENGINEERING INNOVATION", APART FROM THE MARK AS SHOWN.

THE COLOR(S) BLUE, LIGHT BLUE, AND WHITE IS/ARE CLAIMED AS A FEATURE OF THE MARK.

THE COLOR LIGHT BLUE APPEARS IN THE WORDING "ENGINEERING INNOVATION" AND THE DESIGN OF A TRIANGLE ON THE RIGHT. THE COLOR BLUE APPEARS IN THE WORDING "LMS" AND THE REMAINING TRIANGLES. THE COLOR WHITE APPEARS IN THE BACKGROUND.

SER. NO. 79-049,027, FILED 6-18-2007.

DANNAN HETZEL, EXAMINING ATTORNEY

**Int. Cl.: 9**

**Prior U.S. Cls.: 21, 23, 26, 36 and 38**

**Reg. No. 3,499,412**

**United States Patent and Trademark Office**

**Registered Sep. 9, 2008**

**TRADEMARK  
PRINCIPAL REGISTER**



ZHEJIANG HUACHAO ELECTRICAL; EQUIP-  
MENT CO., LTD. (CHINA CORPORATION)  
QIANJIAYANG INDUSTRY ZONE  
HONGQIAO; YUEQING  
CHINA

FOR: ELECTRONIC BATHROOM SCALES FOR  
PERSONAL USE; SPRING BALANCES FOR WEIGH-  
ING; BEAM SCALES; WEIGHING EQUIPMENT;  
PLATFORM BALANCES FOR WEIGHING; WEIGH-  
ING APPARATUS, NAMELY, AUTOMATIC  
WEIGHT GAUGES; STEELYARDS; BALANCES  
FOR WEIGHING; MEASURING WEIGHTS, NAME-  
LY, STEELYARD WEIGHTS, BALANCE WEIGHTS;  
WEIGHING APPARATUS AND INSTRUMENT, IN  
CLASS 9 (U.S. CLS. 21, 23, 26, 36 AND 38).

OWNER OF INTERNATIONAL REGISTRATION  
0951230 DATED 10-24-2007, EXPIRES 10-24-2017.

THE MARK CONSISTS OF THE WORDING  
"HUACHAO" AND CHINESE CHARACTERS.

THE NON-LATIN CHARACTERS IN THE MARK  
TRANSLITERATE TO "HUA" AND "CHAO" AND  
THIS MEANS "PROSPEROUS" AND "TIDE" IN  
ENGLISH.

SER. NO. 79-049,100, FILED 10-24-2007.

LAURA HAMMEL, EXAMINING ATTORNEY

**Int. Cls.: 18 and 25**

**Prior U.S. Cls.: 1, 2, 3, 22, 39 and 41**

**Reg. No. 3,499,413**

**United States Patent and Trademark Office**

**Registered Sep. 9, 2008**

**TRADEMARK  
PRINCIPAL REGISTER**



SALVATORE FERRAGAMO ITALIA S.P.A. (ITALY JOINT STOCK COMPANY)  
VIA DEI TORNABUONI, 2  
I-50123 FIRENZE (FI)  
ITALY

FOR: BAGS, NAMELY, HANDBAGS, SHOULDER BAGS, BRIEFCASES, WAIST PACKS, LEATHER AND CANVAS SHOPPING BAGS, DUFFLE BAGS, TOTE BAGS, CLUTCH BAGS, ATTACHÉ-CASES, SUITCASES, GARMENT BAGS FOR TRAVEL, RUCKSACKS, TRUNKS, TRAVELING BAGS, WALLETS, PURSES, KEY CASES, VANITY CASES SOLD EMPTY, UMBRELLAS, IN CLASS 18 (U.S. CLS. 1, 2, 3, 22 AND 41).

FOR: ARTICLES OF CLOTHING FOR MEN, WOMEN AND CHILDREN, NAMELY, PULL-OVERS, CARDIGANS, SWEATERS, JERSEYS, JUMPERS, JACKETS, SWEATSHIRTS, PARKAS, BATHING SUITS, BLOUSES, SHIRTS, TROUSERS, JEANS, WAISTCOATS, SKIRTS, SHORTS, T-SHIRTS, DRESSES, MEN'S SUITS, COATS, RAINCOATS, OVERCOATS, OVERALLS, UNDERWEAR, VESTS, HOSIERY AND PANTY-HOSES, BATHROBES,

SHAWLS, SCARVES, NECKTIES, GLOVES FOR CLOTHING, BELTS FOR CLOTHING, SHOES, BOOTS, SANDALS, SLIPPERS, CLOGS, HATS AND CAPS, IN CLASS 25 (U.S. CLS. 22 AND 39).

OWNER OF INTERNATIONAL REGISTRATION 0951747 DATED 11-21-2007, EXPIRES 11-21-2017.

OWNER OF U.S. REG. NOS. 1,016,032, 1,505,915 AND OTHERS.

NO CLAIM IS MADE TO THE EXCLUSIVE RIGHT TO USE "CREATIONS" "FLORENCE" AND "ITALY", APART FROM THE MARK AS SHOWN.

THE NAME(S), PORTRAIT(S), AND/OR SIGNATURE(S) SHOWN IN THE MARK DOES NOT IDENTIFY A PARTICULAR LIVING INDIVIDUAL.

SER. NO. 79-049,297, FILED 11-21-2007.

MARGERY A. TIERNEY, EXAMINING ATTORNEY

**Int. Cls.: 7, 9 and 37**

**Prior U.S. Cls.: 13, 19, 21, 23, 26, 31, 34, 35, 36, 38,  
100, 103 and 106**

**Reg. No. 3,499,414**

**United States Patent and Trademark Office**

**Registered Sep. 9, 2008**

**TRADEMARK  
SERVICE MARK  
PRINCIPAL REGISTER**

# DYNASTOP

SEW-EURODRIVE GMBH & CO. KG (FED REP  
GERMANY LIMITED PARTNERSHIP)  
ERNST-BLICKLE-STRASSE 42  
76646 BRUCHSAL  
FED REP GERMANY

FOR: ELECTRIC MOTORS, OTHER THAN FOR AUTOMOTIVE VEHICLES, FOR MACHINES, MATERIALS HANDLING EQUIPMENT AND INDUSTRIAL MACHINERY; ELECTRIC MOTORS WITH INTEGRATED ELECTRO-DYNAMIC BRAKING FUNCTION, OTHER THAN FOR AUTOMOTIVE VEHICLES, FOR MACHINES, MATERIALS HANDLING EQUIPMENT AND INDUSTRIAL MACHINERY; GEAR BOXES, OTHER THAN FOR LAND VEHICLES AND OTHER THAN FOR AUTOMOTIVE VEHICLES; HELICAL GEAR MOTORS OTHER THAN FOR AUTOMOTIVE VEHICLES; BEVEL GEARED MOTORS OTHER THAN FOR AUTOMOTIVE VEHICLES; PLANETARY GEARED MOTORS OTHER THAN FOR AUTOMOTIVE VEHICLES; BRAKES AS MACHINE PARTS, OTHER THAN FOR AUTOMOTIVE VEHICLES, IN CLASS 7 (U.S. CLS. 13, 19, 21, 23, 31, 34 AND 35).

FOR: FREQUENCY CONVERTERS, OTHER THAN FOR AUTOMOTIVE VEHICLES; ELECTRONIC CONTROLS FOR ELECTRIC MOTORS, OTHER THAN FOR AUTOMOTIVE VEHICLES; ELECTRONIC CONTROLS WITH INTEGRATED ELECTRO-DYNAMIC BRAKING FUNCTION, OTHER THAN

FOR AUTOMOTIVE VEHICLES, FOR ELECTRIC MOTORS, IN CLASS 9 (U.S. CLS. 21, 23, 26, 36 AND 38).

FOR: INSTALLATION AND REPAIR SERVICES, OTHER THAN FOR AUTOMOTIVE VEHICLES, FOR ELECTRONIC, ELECTRIC AND/OR MECHANICAL DRIVES, NAMELY, ELECTRIC MOTORS, GEARBOXES AND ELECTRONIC CONTROL EQUIPMENT FOR MOTORS, IN CLASS 37 (U.S. CLS. 100, 103 AND 106).

THE MARK CONSISTS OF STANDARD CHARACTERS WITHOUT CLAIM TO ANY PARTICULAR FONT, STYLE, SIZE, OR COLOR.

PRIORITY DATE OF 6-19-2007 IS CLAIMED.

OWNER OF INTERNATIONAL REGISTRATION  
0951807 DATED 12-11-2007, EXPIRES 12-11-2017.

"DYNASTOP" HAS NO SIGNIFICANCE OR GEOGRAPHICAL SIGNIFICANCE MEANING IN A FOREIGN LANGUAGE.

SER. NO. 79-049,314, FILED 12-11-2007.

SANDRA MANIOS, EXAMINING ATTORNEY



**Int. Cls.: 16, 35, 36, 39, 42 and 43**

**Prior U.S. Cls.: 2, 5, 22, 23, 29, 37, 38, 50, 100, 101, 102  
and 105**

**Reg. No. 3,499,415**

**United States Patent and Trademark Office**

**Registered Sep. 9, 2008**

**TRADEMARK  
SERVICE MARK  
PRINCIPAL REGISTER**

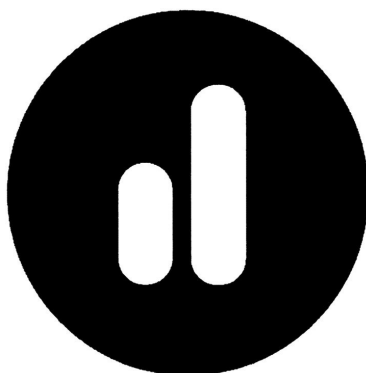

DESIGN HOTELS AG (FED REP GERMANY AG)  
STRALAUER ALLEE 2C  
10245 BERLIN  
FED REP GERMANY

FOR: PRINTED MATTER, NAMELY, HOTEL DIRECTORIES; PHOTOGRAPHS; STATIONERY, IN CLASS 16 (U.S. CLS. 2, 5, 22, 23, 29, 37, 38 AND 50).

FOR: ADVERTISING; BUSINESS MANAGEMENT CONSULTANCY; BUSINESS MANAGEMENT OF HOTELS FOR OTHERS; BUSINESS MANAGEMENT, NAMELY, ORGANIZATIONAL PREPARATION FOR BUILDING PROJECTS; BUSINESS MANAGEMENT SERVICES, NAMELY, DEVELOPMENT OF UTILIZATION PLANS FOR REAL ESTATE AND HOTELS; PROMOTING THE SERVICES OF OTHERS BY PRESENTATION OF ENTERPRISES THROUGH THE INTERNET, PRINT, VIDEO AND DIGITAL MEDIA; COMPILATION AND ADMINISTRATION OF DATA IN COMPUTER DATA BANKS; PROMOTING THE GOODS AND SERVICES OF OTHERS VIA PRESENTATION OF THE GOODS AND SERVICES THROUGH THE INTERNET, IN CLASS 35 (U.S. CLS. 100, 101 AND 102).

FOR: FINANCIAL AFFAIRS IN THE NATURE OF FINANCIAL ANALYSES; REAL ESTATE AFFAIRS IN THE NATURE OF REAL ESTATE APPRAISAL, REAL ESTATE INVESTMENT, REAL ESTATE BROKERAGE, REAL ESTATE CONSULTING AND REAL ESTATE MANAGEMENT; FINANCIAL MANAGEMENT FOR THE PREPARATION OF BUILDING PROJECTS; FINANCIAL MANAGEMENT

SERVICES, NAMELY, DEVELOPMENT OF FINANCIAL UTILIZATION PLANS FOR REAL ESTATE AND HOTELS, IN CLASS 36 (U.S. CLS. 100, 101 AND 102).

FOR: TRAVEL AGENCY SERVICES, NAMELY, MAKING RESERVATIONS AND BOOKINGS FOR TRANSPORTATION, TRAVEL BOOKING AGENCIES, IN CLASS 39 (U.S. CLS. 100 AND 105).

FOR: ARCHITECTURAL AND CONSTRUCTION CONSULTANCY; ARCHITECTURE; DESIGN OF INTERIOR DECOR AS WELL AS OF ARTICLES OF INTERIOR DECOR AND FURNITURE; ENGINEERING SERVICES FOR THE CONSTRUCTION OF HOTELS; PLANNING OF BUILDINGS AND INFRASTRUCTURE SYSTEMS FOR BUILDINGS FOR THE TECHNICAL PREPARATION OF BUILDING PROJECTS; COMMERCIAL BUILDING DESIGN AND ENGINEERING SERVICES FOR THE DEVELOPMENT OF UTILIZATION PLANS FOR REAL ESTATE AND HOTELS, IN CLASS 42 (U.S. CLS. 100 AND 101).

FOR: TEMPORARY ACCOMMODATION; SERVICES FOR PROVIDING FOOD AND DRINK; TEMPORARY ACCOMMODATION RESERVATIONS; ARRANGING TEMPORARY ACCOMMODATIONS; CATERING SERVICES, IN CLASS 43 (U.S. CLS. 100 AND 101).

PRIORITY DATE OF 5-23-2007 IS CLAIMED.

OWNER OF INTERNATIONAL REGISTRATION  
0952423 DATED 11-7-2007, EXPIRES 11-7-2017.

SER. NO. 79-049,527, FILED 11-7-2007.

THE MARK CONSISTS OF THE STYLIZED LOW-  
ER CASE LETTER "D" SURROUNDED BY A CIR-  
CLE.

CHARLOTTE CORWIN, EXAMINING ATTORNEY

**Int. Cls.: 3 and 5**

**Prior U.S. Cls.: 1, 4, 6, 18, 44, 46, 50, 51 and 52**

**United States Patent and Trademark Office**

**Reg. No. 3,499,416**

**Registered Sep. 9, 2008**

**TRADEMARK  
PRINCIPAL REGISTER**

**ETAT PUR**

INSTITUT ESTHEDERM (FRANCE SOCIÉTÉ  
PAR ACTIONS SIMPLIFIÉE (SAS))  
3, RUE PALATINE  
F-75006 PARIS  
FRANCE

FOR: COSMETICS, IN CLASS 3 (U.S. CLS. 1, 4, 6, 50,  
51 AND 52).

FOR: BIO-ECOLOGICAL PREPARATIONS FOR  
THE DEVELOPMENT OF SKIN CELLS IN THE  
NATURE OF MEDICINAL SKIN CARE PREPARA-  
TIONS AS PERSONAL HYGIENE PRODUCTS, IN  
CLASS 5 (U.S. CLS. 6, 18, 44, 46, 51 AND 52).

OWNER OF INTERNATIONAL REGISTRATION  
0675476 DATED 6-23-1997, EXPIRES 6-23-2017.

THE FOREIGN WORDING IN THE MARK  
TRANSLATES INTO ENGLISH AS PURE STATE.

SER. NO. 79-049,738, FILED 10-9-2007.

KRISTINA MORRIS, EXAMINING ATTORNEY

**Int. Cls.: 6 and 9**

**Prior U.S. Cls.: 2, 12, 13, 14, 21, 23, 25, 26, 36, 38 and 50**

**Reg. No. 3,499,417**

**United States Patent and Trademark Office**

**Registered Sep. 9, 2008**

**TRADEMARK  
PRINCIPAL REGISTER**

OJMAR, S.A. (SPAIN SOCIEDAD ANONIMA)  
POLÍGONO INDUSTRIAL DE LERUN  
E-20870 ELGOIBAR (GUIPÚZCOA)  
SPAIN

FOR: IRONMONGERY, NAMELY, CAST IRON;  
SMALL ITEMS OF METAL HARDWARE, NAMELY  
SPRINGS, NUTS AND WASHERS; METAL FIT-  
TINGS FOR FURNITURE, NAMELY, HINGES, IN  
CLASS 6 (U.S. CLS. 2, 12, 13, 14, 23, 25 AND 50).

FOR: ELECTRIC OR ELECTRONIC LOCKS,  
ELECTRICAL APPARATUS FOR OPENING

DOORS, MONITORING AND TESTING APPARA-  
TUS, NAMELY, TESTING INSTRUMENTATION  
FOR ELECTRIC AND ELECTRONIC LOCKS, DATA  
PROCESSING EQUIPMENT, IN CLASS 9 (U.S. CLS.  
21, 23, 26, 36 AND 38).

OWNER OF INTERNATIONAL REGISTRATION  
0714096 DATED 4-29-1999, EXPIRES 4-29-2009.

SER. NO. 79-049,743, FILED 1-3-2008.

ANTHONY RINKER, EXAMINING ATTORNEY

**Int. Cl.: 32**

**Prior U.S. Cls.: 45, 46 and 48**

**Reg. No. 3,499,418**

**United States Patent and Trademark Office**

**Registered Sep. 9, 2008**

**TRADEMARK  
PRINCIPAL REGISTER**

**HEIDILAND**

KUR- UND VERKEHRSVEREIN; ST. MORITZ  
(SWITZERLAND VEREIN)  
GEMEINDEHAUS  
CH-7500 ST. MORITZ, SWITZERLAND

THE MARK CONSISTS OF STANDARD CHARACTERS WITHOUT CLAIM TO ANY PARTICULAR FONT, STYLE, SIZE, OR COLOR.

FOR: BEERS; MINERAL AND SPARKLING WATER FROM THE GRISONS AREA; NON-ALCOHOLIC BEVERAGES, NAMELY, LEMONADE, VEGETABLE JUICES, NON-ALCOHOLIC BEER, SWEET CIDER, NON-ALCOHOLIC COCKTAIL MIXES, SODA WATER, ROOT BEER; FRUIT DRINKS AND FRUIT JUICES; SYRUPS FOR MAKING BEVERAGES; PREPARATIONS FOR MAKING BEVERAGES, NAMELY, POWDERS AND CONCENTRATES, ALL FOR MAKING FRUIT DRINKS, SOFT DRINKS AND MALT BEVERAGES, IN CLASS 32 (U.S. CLS. 45, 46 AND 48).

OWNER OF INTERNATIONAL REGISTRATION 0716693 DATED 6-17-1999, EXPIRES 6-17-2009.

OWNER OF U.S. REG. NO. 2,560,923.

SER. NO. 79-049,744, FILED 12-10-2007.

ALLISON HOLTZ, EXAMINING ATTORNEY

**Int. Cl.: 14**

**Prior U.S. Cls.: 2, 27, 28 and 50**

**United States Patent and Trademark Office**

**Reg. No. 3,499,419**

**Registered Sep. 9, 2008**

**TRADEMARK  
PRINCIPAL REGISTER**

# **kirchhofer**

KIRCHHOFFER AG (SWITZERLAND AKTIENGESELLSCHAFT)  
GENERAL-GUISAN-STRASSE 27B  
CH-3800 INTERLAKEN, SWITZERLAND

FOR: PRECIOUS METALS AND THEIR ALLOYS AND GOODS MADE OF THESE MATERIALS OR PLATED THEREWITH, NAMELY, JEWELLERY, BOXES, STATUES, PINS, PENDANTS, SHOE AND HAT ORNAMENTS; JEWELLERY, PRECIOUS STONES; HOROLOGICAL AND CHRONOMETRIC INSTRUMENTS, THEIR PARTS AND ACCESSORIES INCLUDED IN THIS CLASS; WRIST-WATCHES, CHRONOMETERS, CHRONOGRAPHS FOR USES AS WATCHES AND TIMEPIECES, CHARMS, WATCH BANDS, WATCH CHAINS, CLOCK CASES, CLOCK AND WATCH MOVEMENTS, DIALS FOR CLOCKS AND WATCH-MAKING, AND CASES FOR CLOCK AND WATCH-MAKING, IN CLASS 14 (U.S. CLS. 2, 27, 28 AND 50).

THE MARK CONSISTS OF STANDARD CHARACTERS WITHOUT CLAIM TO ANY PARTICULAR FONT, STYLE, SIZE, OR COLOR.

PRIORITY DATE OF 6-13-2007 IS CLAIMED.

OWNER OF INTERNATIONAL REGISTRATION 0952950 DATED 12-13-2007, EXPIRES 12-13-2017.

THE FOREIGN WORDING IN THE MARK TRANSLATES INTO ENGLISH AS THE ONE FROM THE CHURCH YARD.

SER. NO. 79-049,778, FILED 12-13-2007.

AMEETA JORDAN, EXAMINING ATTORNEY

**Int. Cl.: 25**

**Prior U.S. Cls.: 22 and 39**

**United States Patent and Trademark Office**

**Reg. No. 3,499,420**

**Registered Sep. 9, 2008**

**TRADEMARK  
PRINCIPAL REGISTER**

**JIERDA**

WENZHOU JIERDA SHOES CO., LTD. (CHINA CORPORATION)  
NO. 10, DISTRICT, WENZHOU ECONOMIC & TECHNOLOGY DEVELOPMENT ZONE,; WENZHOU; 325000 ZHEJIANG CHINA

FOR: BEACH SHOES; FOOTBALL SHOES; BOOTS; FOOTWEAR FOR MEN AND WOMEN; SLIPPERS; SHOES; GLOVES; SOCKS; NECKTIES; SKIRTS; SHIRTS; SANDALS; HATS; LEATHER SHOES; LEA-

OTHER BELTS FOR CLOTHING, IN CLASS 25 (U.S. CLS. 22 AND 39).

OWNER OF INTERNATIONAL REGISTRATION 0953720 DATED 1-10-2008, EXPIRES 1-10-2018.

SER. NO. 79-050,055, FILED 1-10-2008.

SAIMA MAKHDOOM, EXAMINING ATTORNEY

**Int. Cls.: 20 and 35**

**Prior U.S. Cls.: 2, 13, 22, 25, 32, 50, 100, 101 and 102**

**United States Patent and Trademark Office**

**Reg. No. 3,499,421**

**Registered Sep. 9, 2008**

**TRADEMARK  
SERVICE MARK  
PRINCIPAL REGISTER**

**REPUBLIC OF FRITZ HANSEN**

FRITZ HANSEN A/S (DENMARK CORPORATION)  
ALLERØDVEJ 8,  
DK-3450 ALLERØD  
DENMARK

FOR: FURNITURE, IN CLASS 20 (U.S. CLS. 2, 13, 22, 25, 32 AND 50).

FOR: RETAIL STORE SERVICES FEATURING FURNITURE , IN CLASS 35 (U.S. CLS. 100, 101 AND 102).

THE MARK CONSISTS OF STANDARD CHARACTERS WITHOUT CLAIM TO ANY PARTICULAR FONT, STYLE, SIZE, OR COLOR.

PRIORITY DATE OF 9-11-2007 IS CLAIMED.

OWNER OF INTERNATIONAL REGISTRATION  
0953722 DATED 1-22-2008, EXPIRES 1-22-2018.

OWNER OF U.S. REG. NO. 2,227,939.

THE NAME(S), PORTRAIT(S), AND/OR SIGNATURE(S) SHOWN IN THE MARK DOES NOT IDENTIFY A PARTICULAR LIVING INDIVIDUAL.

SER. NO. 79-050,056, FILED 1-22-2008.

MICHAEL SOUDERS, EXAMINING ATTORNEY



**Int. Cl.: 5**

**Prior U.S. Cls.: 6, 18, 44, 46, 51 and 52**

**United States Patent and Trademark Office**

**Reg. No. 3,499,422**

**Registered Sep. 9, 2008**

**TRADEMARK  
PRINCIPAL REGISTER**

**CAPILIA**

KABUSHIKI KAISHA BL (JAPAN CORPORATION)  
6-26, KANDA-CHO, NUMAZU-SHI  
SHIZUOKA-KEN; TOKYO, JAPAN 4100042

FOR: PHARMACEUTICAL PREPARATIONS, NAMELY, DIAGNOSTIC AGENTS, PREPARATIONS AND REAGENTS FOR MEDICAL PURPOSES, DIAGNOSTIC KITS CONSISTING PRIMARILY OF MONOCLONAL ANTIBODIES, BUFFERS AND REAGENTS FOR USE IN DISEASE TESTING, PREGNANCY TESTING, HORMONE TESTING AND BLOOD TESTING; AND VETERINARY AND SANITARY PREPARATIONS, NAMELY, DIAGNOSTIC AGENTS, PREPARATIONS AND REAGENTS FOR VETERINARY PURPOSES, AND SANITARY STERILIZING PREPARATIONS, IN CLASS 5 (U.S. CLS. 6, 18, 44, 46, 51 AND 52).

THE MARK CONSISTS OF STANDARD CHARACTERS WITHOUT CLAIM TO ANY PARTICULAR FONT, STYLE, SIZE, OR COLOR.

OWNER OF INTERNATIONAL REGISTRATION  
0954343 DATED 11-27-2007, EXPIRES 11-27-2017.

THE WORDING "CAPILIA" HAS NO MEANING IN A FOREIGN LANGUAGE.

SER. NO. 79-050,289, FILED 11-27-2007.

ROBERT STRUCK, EXAMINING ATTORNEY

**Int. Cl.: 3**

**Prior U.S. Cls.: 1, 4, 6, 50, 51 and 52**

**United States Patent and Trademark Office**

**Reg. No. 3,499,423**

**Registered Sep. 9, 2008**

**TRADEMARK  
PRINCIPAL REGISTER**

**MOUNTAIN WATER**

VICTORINOX SWISS ARMY FRAGRANCE AG  
(SWITZERLAND SOCIÉTÉ ANONYME)  
SCHMIEDGASSE 57  
CH-6438 IBACH, SWITZERLAND

FOR: PERFUMERY, IN CLASS 3 (U.S. CLS. 1, 4, 6,  
50, 51 AND 52).

THE MARK CONSISTS OF STANDARD CHAR-  
ACTERS WITHOUT CLAIM TO ANY PARTICULAR  
FONT, STYLE, SIZE, OR COLOR.

PRIORITY DATE OF 9-27-2007 IS CLAIMED.

OWNER OF INTERNATIONAL REGISTRATION  
0954895 DATED 2-1-2008, EXPIRES 2-1-2018.

SER. NO. 79-050,462, FILED 2-1-2008.

DAVID TOOLEY, EXAMINING ATTORNEY

Int. Cl.: 14

Prior U.S. Cls.: 2, 27, 28 and 50

United States Patent and Trademark Office

Reg. No. 3,499,424

Registered Sep. 9, 2008

TRADEMARK  
PRINCIPAL REGISTER



BAYMONTE KUYUMCULUK; SANAYI YI VE  
TICARET LIMITED SIRKETI (TURKEY LIM-  
ITED COMPANY)  
NURUOSMANIYE CADDESI NO: 79 A-6  
VE GAZISINAN PASA SOKAK NO: 12 B-5 B-4  
EMINÖNÜ - ISTANBUL, TURKEY

FOR: PRECIOUS METALS AND THEIR ALLOYS,  
NAMELY, GOLD, SILVER, PLATINUM; PRECIOUS  
STONES, JEWELRY MADE OF PRECIOUS METAL  
OR COATED THEREWITH, NAMELY BRACELETS,  
RINGS, NECKLACES, EAR CLIPS, CUFF-LINKS,  
EARRINGS, ORNAMENTAL PINS, TIE PINS, PEN-  
DANTS, BROOCHES, ORNAMENTS OF PRECIOUS  
METAL, STATUES OF PRECIOUS METAL, BUSTS  
OF PRECIOUS METAL, HOROLOGICAL AND  
CHRONOMETRIC INSTRUMENTS AND PARTS

AND ACCESSORIES THEREOF, NAMELY, CHRON-  
OMETERS, WRIST WATCHES, POCKET WATCHES,  
JEWELRY WATCHES, WALL CLOCKS, TABLE  
CLOCKS, WATCH BANDS, WATCH STRAPS,  
WATCH BRACELETS, CASES FOR WATCHES  
AND CLOCKS, PARTS FOR WATCHES AND  
CLOCKS, IN CLASS 14 (U.S. CLS. 2, 27, 28 AND 50).

OWNER OF INTERNATIONAL REGISTRATION  
0955062 DATED 1-30-2008, EXPIRES 1-30-2018.

SER. NO. 79-050,521, FILED 1-30-2008.

MICHAEL WIENER, EXAMINING ATTORNEY

**Int. Cls.: 35, 38, 42 and 45**

**Prior U.S. Cls.: 100, 101, 102 and 104**

**United States Patent and Trademark Office**

**Reg. No. 3,499,425**

**Registered Sep. 9, 2008**

**SERVICE MARK  
PRINCIPAL REGISTER**

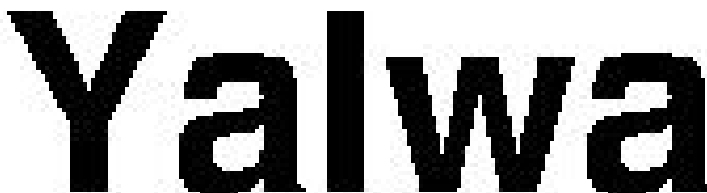

YALWA GMBH (FED REP GERMANY GMBH)  
NICOLAISTR 3  
65193 WIESBADEN  
FED REP GERMANY

FOR: BUSINESS CONSULTANCY; EMPLOYMENT AGENCIES; EMPLOYMENT AGENCIES FEATURING AN ONLINE VIRTUAL JOB MARKET ON THE INTERNET; BUSINESS MARKETING SERVICES; MARKETING CONSULTING; ADVERTISING, EMPLOYMENT AGENCIES, INCLUDING ON THE INTERNET; ELECTRONIC DATA PROCESSING FOR OTHERS; ADVERTISING AND PUBLICITY SERVICES, NAMELY, DISSEMINATING PRIVATE AND COMMERCIAL ADVERTISING MATERIAL INCLUDING CLASSIFIED ADVERTISEMENTS AND JOB ADVERTISEMENTS IN PRINTED OR ELECTRONIC MEDIA; SALES PROMOTION FOR THE GOODS AND SERVICES OF OTHERS, INCLUDING ON THE INTERNET; COMPUTER-AIDED DATABASE MANAGEMENT, IN CLASS 35 (U.S. CLS. 100, 101 AND 102).

FOR: OPERATING AND PRESENTATION OF CHATLINES, NAMELY, PROVIDING VOICE CHAT SERVICES; PROVIDING INTERNET CHATROOMS; PROVIDING ON-LINE FORUMS FOR TRANSMISSION OF MESSAGES AMONG COMPUTER USERS CONCERNING NEWS, SPORTING-EVENTS, EDUCATIONAL COURSES, EDUCATIONAL ACTIVITIES, HOTEL ACCOMMODATION, REAL ESTATE, APARTMENT TIME SHARING, RENTAL OF REAL ESTATE, REAL ESTATE SALES NOTICES, JOB-SEARCH NOTICES, JOB-OFFER NOTICES, JOB HIRING SERVICES, JOB-HIRING CONFERENCES, EMPLOYMENT, CURRICULUM VITAE, VOLUNTEER WORK PROJECTS FOR CHARITABLE ORGANIZATIONS, JOB HIRING SERVICES, COMMUNITY ART FESTIVALS, MISCELLANEOUS SPORTING EVENTS, FAMILY, MOVIE ENTERTAINMENT, LEISURE TIME, ROMANCE, WORK,

HEALTH, POLITICS AND ART; NEWS AGENCY AND PRESS REPORT SERVICES, NAMELY, THE TRANSMISSION OF NEWS ITEMS TO NEWS REPORTING ORGANIZATIONS; ELECTRONIC DATA TRANSMISSION OF PRIVATE AND COMMERCIAL ADVERTISEMENTS OF ALL KINDS INCLUDING CLASSIFIED ADVERTISEMENTS AND JOB ADVERTISEMENTS; WEB-MESSAGING; PROVIDING REMOTE INTERNET ACCESS; PROVIDING INTERACTIVE ONLINE ELECTRONIC BULLETIN BOARDS FOR TRANSMISSION OF MESSAGES AMONG COMPUTER USERS CONCERNING LISTS OF JOBS, JOB HIRING, EVENT DIRECTORIES, BUSINESS NEWS, AND COLLECTIONS OF CURRICULUM VITAE; PROVIDING INTERACTIVE ONLINE ELECTRONIC BULLETIN BOARDS FOR TRANSMISSION OF MESSAGES AMONG COMPUTER USERS CONCERNING CLASSIFIED ADVERTISEMENTS, NEWS DIRECTORIES, JOB HIRING EVENTS, EDUCATIONAL COURSES, JOB HIRING CONFERENCES, EDUCATIONAL ACTIVITIES, HOTEL ACCOMMODATION, REAL ESTATE, APARTMENT TIME SHARING, RENTAL OF REAL ESTATE, REAL ESTATE SALES NOTICES, JOB SEARCH NOTICES, EMPLOYMENT, CURRICULUM VITAE, VOLUNTEER WORK PROJECTS FOR CHARITABLE ORGANIZATIONS, JOB HIRING SERVICES, COMMUNITY ART FESTIVALS, MISCELLANEOUS SPORTING EVENTS, POLITICS, FAMILY MOVIE ENTERTAINMENT AND ART; PROVIDING ELECTRONIC BULLETIN BOARDS FOR TRANSMISSION OF MESSAGES AMONG USERS IN THE FIELD OF GENERAL INTEREST TO THE PUBLIC; PROVIDING ON-LINE FORUMS FOR TRANSMISSION OF MESSAGES AMONG COMPUTER USERS CONCERNING THE TRANSMISSION OF NEWS IN RELATION TO HEALTH, FAMILY, ART, POLITICS, LEISURE TIME, ROMANCE AND WORK; ELECTRONIC MAIL SERVICES; ELECTRONIC MAIL SERVICES FOR SUBSCRIBERS; ELECTRONIC TRANSMISSION OF

MESSAGES, DATA AND IMAGES; ONLINE TELEPHONE DIRECTORY SERVICES, NAMELY, TELEPHONE CALL COMPLETION SERVICES FOR DIRECTORY ASSISTANCE CUSTOMERS; PROVIDING ACCESS TO AN ONLINE COMPUTER DATABASE AND SEARCHABLE ONLINE COMPUTER DATABASES CONTAINING CLASSIFIED ADVERTISEMENTS AND DIRECTORIES WITH NEWS, SPORTING EVENTS, EDUCATIONAL COURSES, JOB HIRING CONFERENCES, EDUCATIONAL ACTIVITIES, HOTEL ACCOMMODATION, REAL ESTATE, APARTMENT TIME SHARING, RENTAL OF REAL ESTATE, REAL ESTATE SALES NOTICES, JOB SEARCH NOTICES, EMPLOYMENT, CURRICULUM VITAE, VOLUNTEER WORK PROJECT FOR CHARITABLE ORGANIZATIONS, JOB HIRING SERVICES, COMMUNITY ART FESTIVALS, MISCELLANEOUS SPORTING EVENTS, POLITICS, FAMILY MOVIE ENTERTAINMENT AND ART; PROVIDING ACCESS TO AN ONLINE COMPUTER DATABASE AND A SEARCHABLE ONLINE DATABASE CONTAINING INFORMATION ON HEALTH, ART, FAMILY, POLITICS, LEISURE TIME, ROMANCE AND WORK, IN CLASS 38 (U.S. CLS. 100, 101 AND 104).

FOR: DESIGN, DEVELOPMENT AND IMPLEMENTATION OF COMPUTER SOFTWARE, COMPUTER HARDWARE AND SOFTWARE SYSTEMS FOR OTHERS, AND PROVIDING INFORMATION ABOUT THE SAME VIA THE INTERNET; DESIGN, DEVELOPMENT AND IMPLEMENTATION OF COMPUTER SOFTWARE, AND COMPUTER HARDWARE AND SOFTWARE SYSTEMS FOR OTHERS VIA THE INTERNET AND OTHER DATA NETWORKS, AND PROVIDING INFORMATION ABOUT THE SAME VIA THE INTERNET; DESIGN, DEVELOPMENT AND IMPLEMENTATION OF INTERNET WEBSITES FOR OTHERS, AND PROVIDING INFORMATION ABOUT THE SAME VIA THE INTERNET; CREATION AND MAINTENANCE OF INTERNET WEBSITES FOR OTHERS, AND PROVIDING INFORMATION ABOUT THE SAME VIA THE INTERNET; INSTALLATION OF COMPUTER SOFTWARE FOR OTHERS, AND PROVIDING INFORMATION ABOUT THE SAME VIA THE INTERNET; INSTALLATION OF COMPUTER SOFTWARE FOR OTHERS VIA THE INTERNET AND OTHER DATA NETWORKS, AND PROVIDING INFORMATION ABOUT THE SAME VIA THE INTERNET; MAINTENANCE OF COMPUTER SOFTWARE, AND PROVIDING INFORMATION ABOUT THE SAME VIA THE INTERNET, MAINTENANCE OF COMPUTER SOFTWARE VIA THE INTERNET AND OTHER DATA NETWORKS, AND PROVIDING INFORMATION ABOUT THE SAME VIA THE INTERNET; PROVIDING TEMPORARY USE OF ON-LINE NON-DOWNLOADABLE SOFTWARE FOR USE IN DATABASE MANAGEMENT, AND PROVIDING INFORMATION ABOUT THE SAME VIA THE INTERNET; RENTAL OF COMPUTERS AND COMPUTER SOFTWARE, AND PROVIDING INFORMATION ABOUT THE SAME VIA THE INTERNET; DESIGN, DEVELOPMENT, UPDATING AND MAINTENANCE OF DATABASES, AND PROVIDING INFORMATION ABOUT THE SAME VIA THE INTERNET; DESIGN, DEVELOPMENT, UP-

DATING AND MAINTENANCE OF DATABASES VIA THE INTERNET AND OTHER DATA NETWORKS, AND PROVIDING INFORMATION ABOUT THE SAME VIA THE INTERNET; COMPUTER PROGRAMMING, AND PROVIDING INFORMATION ABOUT THE SAME VIA THE INTERNET; SCIENTIFIC RESEARCH, AND PROVIDING INFORMATION ABOUT THE SAME VIA THE INTERNET; TECHNOLOGY CONSULTATION AND RESEARCH IN THE FIELD OF COMPUTER SCIENCE AND INTERNET SEARCH MACHINES AND INTERNET SEARCH STRATEGIES, AND PROVIDING INFORMATION ABOUT THE SAME VIA THE INTERNET; COMPUTER CODE CONVERSION FOR OTHERS, AND PROVIDING INFORMATION ABOUT THE SAME VIA THE INTERNET; DATA CONVERSION OF COMPUTER PROGRAM DATA, AND PROVIDING INFORMATION ABOUT THE SAME VIA THE INTERNET; CONSULTATION IN THE FIELD OF DEVELOPMENT OF ELECTRONIC DATA PROCESSING PROGRAMS BY ORDER OF THIRD PARTIES, AND PROVIDING INFORMATION ABOUT THE SAME VIA THE INTERNET; COMPUTER SOFTWARE CONSULTATION, AND PROVIDING INFORMATION ABOUT THE SAME VIA THE INTERNET; INFORMATION TECHNOLOGY CONSULTATION IN THE FIELD OF ELECTRONIC DATA PROCESSING, AND PROVIDING INFORMATION ABOUT THE SAME VIA INTERNET; TECHNICAL COMPUTER PROJECT MANAGEMENT SERVICES IN THE FIELD OF ELECTRONIC DATA PROCESSING, AND PROVIDING INFORMATION ABOUT THE SAME VIA THE INTERNET; DATABASE SERVICES, NAMELY, COMPUTER PROGRAMMING AND DEVELOPMENT OF SOFTWARE FOR DATABASES, AND PROVIDING INFORMATION ABOUT THE SAME VIA THE INTERNET; DEVELOPMENT OF AN ONLINE COMPUTER DATABASE AND SEARCHABLE ONLINE COMPUTER DATABASES FOR CLASSIFIED ADVERTISEMENTS, NEWS DIRECTORIES, JOB HIRING EVENTS, EDUCATIONAL COURSES, JOB HIRING CONFERENCES, EDUCATIONAL ACTIVITIES, HOTEL ACCOMMODATION, REAL ESTATE, APARTMENT TIME SHARING, RENTAL OF REAL ESTATE, REAL ESTATE SALES NOTICES, JOB SEARCH NOTICES, EMPLOYMENT, CURRICULUM VITAE, VOLUNTEER WORK PROJECTS FOR CHARITABLE ORGANIZATIONS, JOB HIRING SERVICES, COMMUNITY ART FESTIVALS, MISCELLANEOUS SPORTING EVENTS, POLITICS, FAMILY MOVIE ENTERTAINMENT AND ART; DEVELOPMENT AND UPDATING OF AN ONLINE COMPUTER DATABASE AND A SEARCHABLE ONLINE COMPUTER DATABASE CONTAINING INFORMATION ON HEALTH, ART, FAMILY, POLITICS, LEISURE TIME, ROMANCE AND WORK; COMPUTER SERVICES, NAMELY, HOSTING ONLINE WEB FACILITIES FOR OTHERS FOR ORGANIZING AND CONDUCTING ONLINE MEETINGS, GATHERINGS AND INTERACTIVE ONLINE DISCUSSIONS; COMPUTER SERVICES IN THE FORM OF CUSTOMIZED WEBSITES WITH USER DEFINED INFORMATION, PERSONAL PROFILES AND INFORMATION, IN CLASS 42 (U.S. CLS. 100 AND 101).

FOR: LICENSING OF COMPUTER PROGRAMS  
AND DATABASES FOR USE BY OTHERS AND  
ALSO FOR USE ON THE INTERNET AND OTHER  
DATA NETWORKS, IN CLASS 45 (U.S. CLS. 100 AND  
101).

PRIORITY DATE OF 7-4-2007 IS CLAIMED.

OWNER OF INTERNATIONAL REGISTRATION  
0955223 DATED 11-14-2007, EXPIRES 11-14-2017.

SER. NO. 79-050,567, FILED 11-14-2007.

PETER B. BROMAGHIM, EXAMINING ATTORNEY

**Int. Cl.: 28**

**Prior U.S. Cls.: 22, 23, 38 and 50**

**United States Patent and Trademark Office**

**Reg. No. 3,499,426**

**Registered Sep. 9, 2008**

**TRADEMARK  
PRINCIPAL REGISTER**

**SWINDLE**

NITRO AG (SWITZERLAND SOCIÉTÉ ANON-  
YME)  
IM BÖSCH 104  
CH-6331 HÜNENBERG, SWITZERLAND

FOR: SNOWBOARDS; BINDINGS FOR SNOW-  
BOARDS, IN CLASS 28 (U.S. CLS. 22, 23, 38 AND 50).

THE MARK CONSISTS OF STANDARD CHAR-  
ACTERS WITHOUT CLAIM TO ANY PARTICULAR  
FONT, STYLE, SIZE, OR COLOR.

PRIORITY DATE OF 10-12-2007 IS CLAIMED.

OWNER OF INTERNATIONAL REGISTRATION  
0955806 DATED 2-7-2008, EXPIRES 2-7-2018.

SER. NO. 79-050,780, FILED 2-7-2008.

SUE LAWRENCE, EXAMINING ATTORNEY

**Int. Cl.: 5**

**Prior U.S. Cls.: 6, 18, 44, 46, 51 and 52**

**Reg. No. 3,499,427**

**United States Patent and Trademark Office**

**Registered Sep. 9, 2008**

**TRADEMARK  
PRINCIPAL REGISTER**

**KIDAPRIL**

SPECIAL PRODUCTS LIMITED (UNITED KING-  
DOM LIMITED COMPANY)  
8-10 NEW FETTER LANE  
LONDON EC4A 1RS  
UNITED KINGDOM

FOR: PHARMACEUTICAL PREPARATIONS  
AND SUBSTANCES FOR TREATING HYPERTEN-  
SION; PHARMACEUTICAL PREPARATIONS AND  
SUBSTANCES FOR PREVENTING AND TREATING  
HEART FAILURE; ALL THE AFORESAID BEING  
GOODS SUPPLIED ONLY UNDER MEDICAL PRE-  
SCRIPTION, IN CLASS 5 (U.S. CLS. 6, 18, 44, 46, 51  
AND 52).

THE MARK CONSISTS OF STANDARD CHAR-  
ACTERS WITHOUT CLAIM TO ANY PARTICULAR  
FONT, STYLE, SIZE, OR COLOR.

PRIORITY DATE OF 8-28-2007 IS CLAIMED.

OWNER OF INTERNATIONAL REGISTRATION  
0956318 DATED 2-25-2008, EXPIRES 2-25-2018.

SER. NO. 79-050,955, FILED 2-25-2008.

KELLY MCCOY, EXAMINING ATTORNEY



**Int. Cls.: 37, 42 and 45**

**Prior U.S. Cls.: 100, 101, 103 and 106**

**United States Patent and Trademark Office**

**Reg. No. 3,499,428**

**Registered Sep. 9, 2008**

**SERVICE MARK  
PRINCIPAL REGISTER**

# Proximan

POMAGALSKI SA (FRANCE SA)

11 RUE RENÉ CAMPHIN

F-38600 FONTAINE

FRANCE AND

SOCIÉTÉ ELECTROMÉCANIQUE ET; ELECTRONI-  
QUE ROGER SEMER-SEMER; SOCIÉTÉ ANON-  
YME (FRANCE SOCIÉTÉ ANONYME)

PAE DU PAYS DU MONT BLANC

F-74190 LE FAYET

FRANCE

FOR: ADVISORY SERVICES FOR INSTALLA-  
TION, MAINTENANCE, REPAIR AND SERVICING  
OF MECHANICAL LIFTS, IN CLASS 37 (U.S. CLS.  
100, 103 AND 106).

FOR: TECHNICAL APPRAISALS AND ANALY-  
SES CONCERNING MECHANICAL LIFTS, IN  
CLASS 42 (U.S. CLS. 100 AND 101).

FOR: CONSULTANCY RELATING TO THE  
SAFETY OF MECHANICAL LIFTS, IN CLASS 45  
(U.S. CLS. 100 AND 101).

PRIORITY DATE OF 8-10-2007 IS CLAIMED.

OWNER OF INTERNATIONAL REGISTRATION  
0956994 DATED 2-7-2008, EXPIRES 2-7-2018.

SER. NO. 79-051,239, FILED 2-7-2008.

WENDY JUN, EXAMINING ATTORNEY

**Int. Cl.: 1**

**Prior U.S. Cls.: 1, 5, 6, 10, 26 and 46**

**Reg. No. 3,499,429**

**United States Patent and Trademark Office**

**Registered Sep. 9, 2008**

**TRADEMARK  
PRINCIPAL REGISTER**

**DAPRASLIP**

ITALMATCH CHEMICALS S.P.A. (ITALY JOINT  
STOCK COMPANY)  
VIA PIETRO CHIESA, 7/13  
I-16149 GENOVA  
ITALY

FOR: CHEMICAL ADDITIVES USED IN INDUS-  
TRY AND SCIENCE, IN PARTICULAR CHEMICAL  
ADDITIVES USED IN THE MANUFACTURE OF  
PLASTICS, COATINGS, VARNISHES AND INKS;  
CHEMICAL ADDITIVES USED IN THE MANUFAC-  
TURE OF LUBRICATING OILS, GREASES AND  
ADHESIVES, IN CLASS 1 (U.S. CLS. 1, 5, 6, 10, 26 AND  
46).

THE MARK CONSISTS OF STANDARD CHAR-  
ACTERS WITHOUT CLAIM TO ANY PARTICULAR  
FONT, STYLE, SIZE, OR COLOR.

PRIORITY DATE OF 8-13-2007 IS CLAIMED.

OWNER OF INTERNATIONAL REGISTRATION  
0957053 DATED 2-7-2008, EXPIRES 2-7-2018.

SER. NO. 79-051,270, FILED 2-7-2008.

CHERYL CLAYTON, EXAMINING ATTORNEY

**Int. Cl.: 1**

**Prior U.S. Cls.: 1, 5, 6, 10, 26 and 46**

**Reg. No. 3,499,430**

**United States Patent and Trademark Office**

**Registered Sep. 9, 2008**

**TRADEMARK  
PRINCIPAL REGISTER**

**DAPRAMID**

ITALMATCH CHEMICALS S.P.A. (ITALY JOINT  
STOCK COMPANY)

VIA PIETRO CHIESA, 7/13

I-16149 GENOVA, ITALY

FOR: CHEMICAL ADDITIVES USED IN INDUS-  
TRY AND SCIENCE, IN PARTICULAR CHEMICAL  
ADDITIVES USED IN THE MANUFACTURE OF  
PLASTICS, COATINGS, VARNISHES AND INKS;  
CHEMICAL ADDITIVES USED IN THE MANUFAC-  
TURE OF LUBRICATING OILS, GREASES AND  
ADHESIVES, IN CLASS 1 (U.S. CLS. 1, 5, 6, 10, 26 AND  
46).

THE MARK CONSISTS OF STANDARD CHAR-  
ACTERS WITHOUT CLAIM TO ANY PARTICULAR  
FONT, STYLE, SIZE, OR COLOR.

PRIORITY DATE OF 8-13-2007 IS CLAIMED.

OWNER OF INTERNATIONAL REGISTRATION  
0957054 DATED 2-7-2008, EXPIRES 2-7-2018.

SER. NO. 79-051,271, FILED 2-7-2008.

CHERYL CLAYTON, EXAMINING ATTORNEY

**Int. Cls.: 14, 18 and 25**

**Prior U.S. Cls.: 1, 2, 3, 22, 27, 28, 39, 41 and 50**

**United States Patent and Trademark Office**

**Reg. No. 3,499,431**

**Registered Sep. 9, 2008**

**TRADEMARK  
PRINCIPAL REGISTER**

**PZEROROSSO**

PIRELLI & C. S.P.A. (ITALY JOINT STOCK  
COMPANY)

VIA GAETANO NEGRI, 10  
I-20123 MILANO (MI)  
ITALY

FOR: JEWELRY, BELT BUCKLES OF PRECIOUS METAL, BRACELETS OF PRECIOUS METALS, BROOCHES, CUFF LINKS, DIAMONDS, NECKLACES, PRECIOUS METALS AND THEIR ALLOYS, RINGS, BRACELETS, CHARMS, EARRINGS IN PRECIOUS METAL OR COATED THEREWITH, PRECIOUS STONES, HOROLOGICAL AND CHRONOMETRIC INSTRUMENTS, NAMELY, WRISTWATCHES, WATCHES, CLOCKS AND PARTS THEREOF, IN CLASS 14 (U.S. CLS. 2, 27, 28 AND 50).

FOR: HANDBAGS, SUITCASES, WALLETS, BRIEFCASES, SCHOOL BAGS, HANDBAGS FOR MEN, TRUNKS FOR TRAVEL, LEATHER AND IMITATION LEATHER, IN CLASS 18 (U.S. CLS. 1, 2, 3, 22 AND 41).

FOR: CLOTHING ARTICLES FOR MEN, WOMEN AND CHILDREN, NAMELY, SHIRTS, BLOUSES,

SKIRTS, COATS, TROUSERS, PANTS, VESTS, JERSEYS, PAJAMAS, SOCKS AND STOCKINGS, SINGLETTS, CORSETS, GARTERS, UNDERPANTS, PETTICOATS, HATS, HEADSCARVES, NECKTIES, RAINCOATS, OVERCOATS, BATHING SUITS, SPORTS OVERALLS, JACKETTS, BELTS, FUR COATS, SCARVES, GLOVES, DRESSING GOWNS; FOOTWEAR, NAMELY, SHOES, SLIPPERS AND BOOTS, IN CLASS 25 (U.S. CLS. 22 AND 39).

THE MARK CONSISTS OF STANDARD CHARACTERS WITHOUT CLAIM TO ANY PARTICULAR FONT, STYLE, SIZE, OR COLOR.

OWNER OF INTERNATIONAL REGISTRATION  
0957204 DATED 2-6-2008, EXPIRES 2-6-2018.

THE ENGLISH TRANSLATION OF THE FOREIGN WORD IN THE MARK IS PZERORED.

SER. NO. 79-051,330, FILED 2-6-2008.

ALLISON HOLTZ, EXAMINING ATTORNEY

**Int. Cl.: 1**

**Prior U.S. Cls.: 1, 5, 6, 10, 26 and 46**

**United States Patent and Trademark Office**

**Reg. No. 3,499,432**

**Registered Sep. 9, 2008**

**TRADEMARK  
PRINCIPAL REGISTER**

**POLINACEA**

INDENA S.P.A. (ITALY CORPORATION)

VIALE ORTLES, 12

I-20139 MILANO

ITALY

FOR: BOTANICAL EXTRACTS FOR USE IN MAKING PHARMACEUTICALS FOR THE TREATMENT OF CARDIOVASCULAR, GASTROINTESTINAL, RESPIRATORY, IMMUNE AND ENDOCRINE SYSTEM AND FOR THE TREATMENT OF VIRAL DISEASES; BOTANICAL EXTRACTS FOR USE IN MAKING COSMETICS AND FOOD, IN CLASS 1 (U.S. CLS. 1, 5, 6, 10, 26 AND 46).

THE MARK CONSISTS OF STANDARD CHARACTERS WITHOUT CLAIM TO ANY PARTICULAR FONT, STYLE, SIZE, OR COLOR.

PRIORITY DATE OF 11-15-2007 IS CLAIMED.

OWNER OF INTERNATIONAL REGISTRATION 0957361 DATED 1-25-2008, EXPIRES 1-25-2018.

OWNER OF U.S. REG. NO. 2,796,918.

SER. NO. 79-051,377, FILED 1-25-2008.

MONIQUE MILLER, EXAMINING ATTORNEY

**Int. Cls.: 9, 41, 42 and 45**

**Prior U.S. Cls.: 21, 23, 26, 36, 38, 100, 101 and 107**

**Reg. No. 3,499,433**

**United States Patent and Trademark Office**

**Registered Sep. 9, 2008**

**TRADEMARK  
SERVICE MARK  
PRINCIPAL REGISTER**

# Picodome

DALLMEIER ELECTRONIC GMBH & CO. KG  
(FED REP GERMANY GMBH & CO. KG)  
CRANACHWEG 1  
93051 REGENSBURG  
FED REP GERMANY

FOR: ELECTRIC AND ELECTRONIC APPARATUS FOR THE TRANSMISSION OF INFORMATION, DATA AND IMAGES; ELECTRIC AND ELECTRONIC APPARATUS FOR COMPUTER AND/OR CONTROL ENGINEERING, NAMELY, A VIDEO MONITORING SYSTEM CONSISTING OF APPARATUS FOR SIGNAL PICKUP, SIGNAL RECORDING AND SIGNAL PROCESSING, AS WELL AS A CENTRAL CONTROL STATION; APPARATUS FOR RECORDING AND REPRODUCING DATA, SOUND AND/OR IMAGES, NAMELY, VIDEO APPARATUS, MONITORS, VIDEO RECORDERS; CAMERAS FOR BOTH MOVING IMAGES AND STILL IMAGES, NAMELY, VIDEO CAMERAS, ELECTRONIC CAMERAS, DIGITAL CAMERAS, MOVIE CAMERAS, AND PHOTOGRAPHIC CAMERAS; THEFT, ROBBERY, VANDALISM, FIRE AND CHEMICAL DISASTER ALARM DEVICES AND INSTALLATIONS FOR OBJECT PROTECTION, IN PARTICULAR FOR BUILDINGS AND VEHICLES, EXCLUDING VEHICLE ANTI-THEFT ALARMS; ELECTRIC SURVEILLANCE DEVICES FOR OBJECT PROTECTION, NAMELY, VIDEO RECORDING APPARATUS, APPARATUS FOR IMAGE PROCESSING AND/OR IMAGE RECOGNITION AND/OR IMAGE EVALUATION, VIDEO CAMERAS AS WELL AS INSTALLATIONS COMPRISED OF SUCH APPARATUS AND PARTS OF THE ABOVE NAMED APPARATUS; ELECTRIC AND ELECTRONIC LOCKS FOR BUILDINGS; COMPUTERS, PERSONAL COMPUTERS, PRINTERS, SCANNERS, VIDEO SCREENS, COMPUTER HARD DISKS, DRIVES FOR DATA CARRIERS, NAMELY, CD DRIVES FOR COMPUTERS, CD PRINTERS, COMPUTER DISK DRIVES, KEYBOARDS, COMPUTER MOUSE, COMPUTER CARDS, NAMELY, GRAPHICS CARDS, INTERFACE CARDS FOR DATA

PROCESSING EQUIPMENT IN THE FORM OF PRINTED CIRCUITS, MEMORY CARDS, MODEMS; COMPUTER SOFTWARE, NAMELY, COMPUTER PROGRAMS STORED ON DATA CARRIERS FOR CONTROLLING AND MONITORING ALARM AND SURVEILLANCE APPARATUS AND INSTALLATIONS; COMPUTER SOFTWARE DEVELOPMENT TOOLS; DATA COMMUNICATIONS SOFTWARE FOR ELECTRONIC EXCHANGE OF DATA BETWEEN COMPUTERS, COMPUTER SYSTEMS AND INTERNET OR INTRANET NETWORK INTERFACES, IN CLASS 9 (U.S. CLS. 21, 23, 26, 36 AND 38).

FOR: TRAINING IN THE FIELD OF SURVEILLANCE AND SECURITY TECHNOLOGY; EDUCATIONAL SERVICES RENDERED THROUGH CORRESPONDENCE COURSES IN THE FIELD OF SURVEILLANCE AND SECURITY TECHNOLOGY; ORGANIZATION OF WORKSHOPS IN THE FIELD OF SURVEILLANCE AND SECURITY TECHNOLOGY; TRAINING SERVICES IN THE FIELD OF SURVEILLANCE AND SECURITY TECHNOLOGY FOR PURPOSES OF PERSONNEL DEVELOPMENT, IN CLASS 41 (U.S. CLS. 100, 101 AND 107).

FOR: SERVICES OF AN ELECTRONIC DATA PROCESSING PROGRAMMER, NAMELY, CREATION, MAINTENANCE, SERVICING AND UPDATING OF DATA PROCESSING COMPUTER PROGRAMS FOR ALARM, LOCKING AND SURVEILLANCE SYSTEMS FOR BUILDINGS AND VEHICLES; COMPUTER HARDWARE AND SOFTWARE CONSULTATION IN THE FIELD OF ELECTRONIC DATA PROCESSING; INSTALLATION OF COMPUTER PROGRAMS; CONFIGURATION OF COMPUTER NETWORKS BY MEANS OF SOFTWARE, NAMELY, COMPUTER MANAGEMENT SOFTWARE FOR CONVERGING VARIOUS DATA ON ONE COMPUTER; IMPLEMENTATION OF ELECTRONIC DATA PROCESSING PROGRAMS IN NETWORKS, DESIGN OF COMPUTER ANIMATION FOR OTHERS; DATA CONVERSION OF

COMPUTER PROGRAMS AND DATA, IN CLASS 42  
(U.S. CLS. 100 AND 101).

FOR: SOFTWARE LICENSING, IN CLASS 45 (U.S.  
CLS. 100 AND 101).

THE MARK CONSISTS OF STANDARD CHAR-  
ACTERS WITHOUT CLAIM TO ANY PARTICULAR  
FONT, STYLE, SIZE, OR COLOR.

PRIORITY DATE OF 3-23-2007 IS CLAIMED.

OWNER OF INTERNATIONAL REGISTRATION  
0957754 DATED 8-22-2007, EXPIRES 8-22-2017.

SER. NO. 79-051,532, FILED 8-22-2007.

STEVEN PEREZ, EXAMINING ATTORNEY

**Int. Cl.: 9**

**Prior U.S. Cls.: 21, 23, 26, 36 and 38**

**Reg. No. 3,499,434**

**United States Patent and Trademark Office**

**Registered Sep. 9, 2008**

**TRADEMARK  
PRINCIPAL REGISTER**

# DeviceCon

HARTING ELECTRIC GMBH & CO. KG (FED  
REP GERMANY GMBH & CO. KG)  
WILHELM-HARTING-STRASSE 1  
32339 ESPELKAMP  
FED REP GERMANY

FOR: ELECTRICAL PLUG CONNECTORS, PLUG  
CONNECTOR INSERTS AND PARTS THEREOF,  
INCLUDED IN THIS CLASS, IN PARTICULAR LINE  
CONNECTORS AND LINE CONNECTOR TERMIN-  
ALS, AND PLUG CONNECTORS FOR CONTACT-  
ING CIRCUIT BOARDS, FOR USE IN THE FIELDS  
OF TELECOMMUNICATIONS, ELECTRICS, ELEC-  
TRONICS AND IN OTHER INDUSTRIAL ENVIR-  
ONMENTS, IN CLASS 9 (U.S. CLS. 21, 23, 26, 36 AND  
38).

THE MARK CONSISTS OF STANDARD CHAR-  
ACTERS WITHOUT CLAIM TO ANY PARTICULAR  
FONT, STYLE, SIZE, OR COLOR.

PRIORITY DATE OF 8-31-2007 IS CLAIMED.

OWNER OF INTERNATIONAL REGISTRATION  
0958246 DATED 2-1-2008, EXPIRES 2-1-2018.

SER. NO. 79-051,694, FILED 2-1-2008.

LAURIE KAUFMAN, EXAMINING ATTORNEY



**Int. Cl.: 9**

**Prior U.S. Cls.: 21, 23, 26, 36 and 38**

**United States Patent and Trademark Office**

**Reg. No. 3,499,435**

**Registered Sep. 9, 2008**

**TRADEMARK  
PRINCIPAL REGISTER**

**WINDBLAST**

BODYCOTE MATERIALS TESTING AB (SWE-  
DEN JOINT STOCK COMPANY)  
P.O. BOX 1340  
SE-581 13 LINKÖPING  
SWEDEN

FOR: SCANNER TO CONTROL BLADES FOR  
WIND TURBINES BY MEANS OF ULTRASOUND,  
IN CLASS 9 (U.S. CLS. 21, 23, 26, 36 AND 38).

THE MARK CONSISTS OF STANDARD CHAR-  
ACTERS WITHOUT CLAIM TO ANY PARTICULAR  
FONT, STYLE, SIZE, OR COLOR.

PRIORITY DATE OF 8-23-2007 IS CLAIMED.

OWNER OF INTERNATIONAL REGISTRATION  
0958837 DATED 2-6-2008, EXPIRES 2-6-2018.

SER. NO. 79-051,923, FILED 2-6-2008.

WILLIAM ROSSMAN, EXAMINING ATTORNEY

**Int. Cls.: 18 and 25**

**Prior U.S. Cls.: 1, 2, 3, 22, 39 and 41**

**United States Patent and Trademark Office**

**Reg. No. 3,499,436**

**Registered Sep. 9, 2008**

**TRADEMARK  
PRINCIPAL REGISTER**



DELBONO LUCIANO (ITALY INDIVIDUAL)  
VIA GUARESCHI ICILIO, 15  
I-43100 PARMA  
ITALY

FOR: HANDBAGS; LUGGAGE; SHOULDER BAGS; BEACH BAGS; CLUTCH BAGS; ALL PURPOSE SPORTS BAGS; ATTACHÉ CASES; SCHOOL BAGS; TOTE BAGS; TRAVELLING BAGS; CASES, BEING NOTECASES, OF LEATHER OR LEATHERBOARD; COSMETIC CASES SOLD EMPTY; KEY CASES; KNAPSACKS; RUCKSACKS; BRIEFCASES; PURSES; WALLETS; TRAVELLING TRUNKS; SUITCASES; UMBRELLAS; PARASOLS; WALKING STICKS, IN CLASS 18 (U.S. CLS. 1, 2, 3, 22 AND 41).

FOR: PULLOVERS; GLOVES; CARDIGANS; JERSEYS; NECKWEAR; SWEATERS; SOCKS; STOCKINGS; TIGHTS; TROUSERS; LEGGINGS; SKIRTS; JACKETS; JERKINS; SHIRTS; VESTS; WAISTCOATS; JUMPERS; TRACK SUITS; BLOUSES; BLOUSONS; JEANS; SWEAT PANTS; GYM SUITS; KNICKERS; PANTS; SHORTS; T-SHIRTS; SWEATSHIRTS; SUITS AND DRESSES; OVERCOATS;

COATS; ANORAKS; RAINCOATS; BELTS; SUSPENDERS; LOUNGEWEAR; UNDERWEAR; BEACHWEAR; SLEEPWEAR; FOOTWEAR; HEADWEAR, HOSIERY, IN CLASS 25 (U.S. CLS. 22 AND 39).

PRIORITY DATE OF 9-12-2007 IS CLAIMED.

OWNER OF INTERNATIONAL REGISTRATION  
0959552 DATED 1-25-2008, EXPIRES 1-25-2018.

THE MARK CONSISTS OF A SIGN DEPICTING THE WORDING "KE" IN FANCY CHARACTERS, THE LETTERS "K" AND "E" BEING STRONGLY STYLIZED AND WITH THE LETTER "E" HAVING THE OUTER PORTION IN COMMON WITH THE "K" AND THE INNER STROKE DETACHED AND COMPOSED OF A SLIGHTLY CURVED BAND WITH THE LEFT-HAND END POINTED.

SER. NO. 79-052,196, FILED 1-25-2008.

CHARLOTTE CORWIN, EXAMINING ATTORNEY

**Int. Cl.: 9**

**Prior U.S. Cls.: 21, 23, 26, 36 and 38**

**United States Patent and Trademark Office**

**Reg. No. 3,499,437**

**Registered Sep. 9, 2008**

**TRADEMARK  
PRINCIPAL REGISTER**

**POSIWIRE**

ASM; AUTOMATION SENSORIK MESSTECHNIK  
GMBH (FED REP GERMANY GMBH)  
AM BLEICHBACH 18-22  
85452 MOOSINNING  
FED REP GERMANY

FOR: ELECTRIC MEASURING APPARATUS  
AND INSTRUMENTS, NAMELY, ELECTRIC OR  
ELECTRONIC SENSORS FOR PATH-MEASURING,  
ELECTRIC OR ELECTRONIC POSITION SENSORS,  
ELECTRIC OR ELECTRONIC SPEED DETECTORS,  
ALL FOR USE IN DETECTING AND MEASURING  
LINEAR, ROTATIVE OR MULTI-DIMENSIONAL  
MOVEMENTS WITH MAGNETIC OR ELECTRIC  
EFFECTS, IN CLASS 9 (U.S. CLS. 21, 23, 26, 36 AND  
38).

THE MARK CONSISTS OF STANDARD CHAR-  
ACTERS WITHOUT CLAIM TO ANY PARTICULAR  
FONT, STYLE, SIZE, OR COLOR.

PRIORITY DATE OF 7-11-2007 IS CLAIMED.

OWNER OF INTERNATIONAL REGISTRATION  
0959909 DATED 1-11-2008, EXPIRES 1-11-2018.

SER. NO. 79-052,303, FILED 1-11-2008.

MICHAEL GAAFAR, EXAMINING ATTORNEY

**Int. Cl.: 9**

**Prior U.S. Cls.: 21, 23, 26, 36 and 38**

**United States Patent and Trademark Office**

**Reg. No. 3,499,438**

**Registered Sep. 9, 2008**

**TRADEMARK  
PRINCIPAL REGISTER**

**POSITAPE**

ASM; AUTOMATION SENSORIK MESSTECHNIK  
GMBH (FED REP GERMANY GMBH)  
AM BLEICHBACH 18-22  
85452 MOOSINNING  
FED REP GERMANY

FOR: ELECTRIC MEASURING APPARATUS  
AND INSTRUMENTS, NAMELY, ELECTRIC OR  
ELECTRONIC SENSORS FOR PATH-MEASURING,  
ELECTRIC OR ELECTRONIC POSITION SENSORS,  
ELECTRIC OR ELECTRONIC SPEED DETECTORS  
ALL FOR USE IN DETECTING AND MEASURING  
LINEAR, ROTATIVE OR MULTI-DIMENSIONAL  
MOVEMENTS WITH MAGNETIC OR ELECTRIC  
EFFECTS, IN CLASS 9 (U.S. CLS. 21, 23, 26, 36 AND  
38).

THE MARK CONSISTS OF STANDARD CHAR-  
ACTERS WITHOUT CLAIM TO ANY PARTICULAR  
FONT, STYLE, SIZE, OR COLOR.

PRIORITY DATE OF 7-11-2007 IS CLAIMED.

OWNER OF INTERNATIONAL REGISTRATION  
0959910 DATED 1-11-2008, EXPIRES 1-11-2018.

SER. NO. 79-052,304, FILED 1-11-2008.

LINDSEY RUBIN, EXAMINING ATTORNEY

**Int. Cl.: 3**

**Prior U.S. Cls.: 1, 4, 6, 50, 51 and 52**

**United States Patent and Trademark Office**

**Reg. No. 3,499,439**

**Registered Sep. 9, 2008**

**TRADEMARK  
PRINCIPAL REGISTER**

# **BIOTA59ELEMENTS**

BIOTA BITKISEL KOZMETIK; LABORATUAR-  
LARI; TICARET LIMITED SIRKETI (TURKEY  
LIMITED COMPANY)

MEHMET AKIF MAHALLSI BARIS CADDESI,  
YÜCEDAG SOKAK NO. 15; ÜMRANIYE ISTANBUL  
TURKEY

FOR: HAIR CARE CREAMS, HAIR CARE LO-  
TIONS, HAIR CARE PREPARATIONS, HAIR  
CLEANING PREPARATIONS, HAIR CONDITION-  
ER, HAIR CREAMS, HAIR GELS, HAIR LOTIONS,  
HAIR OILS, DEPILATORIES, DEPILATORY  
CREAMS, SKIN CREAMS IN LIQUID AND IN  
SOLID FORM, SKIN LOTIONS, BATH CRYSTALS,  
BATH GELS, BATH LOTION, BATH MILKS, BATH  
OILS FOR COSMETIC PURPOSES, NON-MEDICA-  
TED BATH SALTS, BATH SOAPS IN LIQUID, SOLID  
OR GEL FORM, BATHING LOTIONS, BATH  
FOAMS, HAIR TONICS, AFTER-SHAVE CREAMS,  
SHAMPOOS, SHAMPOOS FOR BABIES, WRINKLE  
REMOVING SKIN CARE PREPARATIONS, WRIN-

KLE RESISTANT CREAM, SPOT REMOVER, SKIN  
MOISTURIZER, SKIN MOISTURIZER MASKS,  
SELF TANNING GEL, SELF TANNING CREAMS,  
SELF TANNING LOTIONS, SUN TANNING PRE-  
PARATIONS, COSMETIC CLEANSING CREAMS,  
CLEANSING MILK, PERFUMES, ESSENTIAL OILS  
FOR PERSONAL USE, DEODORANTS FOR PERSO-  
NAL USE, SOAPS FOR BODY CARE, SOAPS FOR  
PERSONAL USE, SOAPS FOR TOILET PURPOSES,  
TOOTH PASTE, IN CLASS 3 (U.S. CLS. 1, 4, 6, 50, 51  
AND 52).

OWNER OF INTERNATIONAL REGISTRATION  
0960219 DATED 1-24-2008, EXPIRES 1-24-2018.

SER. NO. 79-052,399, FILED 1-24-2008.

SEAN CROWLEY, EXAMINING ATTORNEY

**Int. Cl.: 35**

**Prior U.S. Cls.: 100, 101 and 102**

**United States Patent and Trademark Office**

**Reg. No. 3,499,440**

**Registered Sep. 9, 2008**

**SERVICE MARK  
PRINCIPAL REGISTER**

**KUHN FINANCE**

KUHN S.A. (FRANCE SOCIÉTÉ ANONYME)  
4, IMPASSE DES FABRIQUES  
F-67700 SAVERNE  
FRANCE

PRIORITY DATE OF 8-25-2004 IS CLAIMED.

FOR: ADVERTISING AND SALES PROMOTION  
SERVICES; AND BUSINESS MANAGEMENT FOR  
OTHERS IN THE FIELD OF AGRICULTURAL  
EQUIPMENT, IN CLASS 35 (U.S. CLS. 100, 101 AND  
102).

OWNER OF INTERNATIONAL REGISTRATION  
0846583A DATED 2-18-2005, EXPIRES 2-18-2015.

SER. NO. 79-975,046, FILED 2-18-2005.

THE MARK CONSISTS OF STANDARD CHAR-  
ACTERS WITHOUT CLAIM TO ANY PARTICULAR  
FONT, STYLE, SIZE, OR COLOR.

JERI J. FICKES, EXAMINING ATTORNEY

**Int. Cls.: 35 and 36**

**Prior U.S. Cls.: 100, 101, and 102**

**United States Patent and Trademark Office**

**Reg. No. 3,499,441**

**Registered Sep. 9, 2008**

**SERVICE MARK  
PRINCIPAL REGISTER**

**E4E**

E4E, INC. (DELAWARE CORPORATION)  
3979 FREEDOM CIRCLE, 6TH FLOOR  
SANTA CLARA, CA 95054

FOR: BUSINESS CONSULTING SERVICES, NAMELY, CUSTOMER RELATIONSHIP MANAGEMENT SERVICES; BUSINESS ACQUISITION OF TECHNOLOGY COMPANIES, ELECTRONIC COMMERCE COMPANIES, GLOBAL COMPUTER NETWORK-BASED COMPANIES AND EXCHANGES AND INFRASTRUCTURE SERVICE PROVIDERS, IN CLASS 35 (U.S. CLS. 100, 101 AND 102).

FIRST USE 11-0-2000; IN COMMERCE 11-0-2000.

FOR: FINANCIAL INVESTMENT IN THE FIELD OF TECHNOLOGY COMPANIES, ELECTRONIC

COMMERCE COMPANIES, GLOBAL COMPUTER NETWORK-BASED COMPANIES AND EXCHANGES AND INFRASTRUCTURE SERVICE PROVIDERS; FINANCIAL CONSULTATION SERVICES FOR TECHNOLOGY COMPANIES, ELECTRONIC COMMERCE COMPANIES, GLOBAL COMPUTER NETWORK-BASED COMPANIES AND EXCHANGES AND INFRASTRUCTURE SERVICE PROVIDERS, IN CLASS 36 (U.S. CLS. 100, 101 AND 102).

FIRST USE 11-0-2000; IN COMMERCE 11-0-2000.

SN 76-065,423, FILED 6-6-2000.

ALICE BENMAMAN, EXAMINING ATTORNEY

**Int. Cl.: 28**

**Prior U.S. Cls.: 22, 23, 38, and 50**

**United States Patent and Trademark Office**

**Reg. No. 3,499,442**

**Registered Sep. 9, 2008**

**TRADEMARK  
PRINCIPAL REGISTER**

**SLAMSYSTEM**

CONNOR SPORT COURT INTERNATIONAL,  
INC. (DELAWARE CORPORATION)  
939 SOUTH 700 WEST  
SALT LAKE CITY, UT 84104

FOR: SPORTS EQUIPMENT, NAMELY, BASKET-  
BALL STANDARDS AND BACKBOARDS, RIMS,  
NETS AND POLES FOR USE WITH BASKETBALL

STANDARDS, IN CLASS 28 (U.S. CLS. 22, 23, 38 AND  
50).

FIRST USE 1-15-1996; IN COMMERCE 1-15-1996.

SN 76-288,435, FILED 7-18-2001.

MONIQUE MILLER, EXAMINING ATTORNEY



**Int. Cl.: 3**

**Prior U.S. Cls.: 1, 4, 6, 50, 51, and 52**

**United States Patent and Trademark Office**

**Reg. No. 3,499,443**

**Registered Sep. 9, 2008**

**TRADEMARK  
PRINCIPAL REGISTER**

**CLOUT**

HUIH DETERGENTS, INC. (UTAH CORPORATION)  
15 WEST SOUTH TEMPLE, SUITE 1400  
SALT LAKE CITY, UT 84101

FOR: CLEANERS AND CLEANSERS FOR USE ON HARD SURFACES; FLOOR CLEANING PREPARATIONS; LAUNDRY PRE-SOAK; LAUNDRY BLUEING; FABRIC SOFTENERS; ANTI-STATIC DRYER SHEETS; LIQUID, POWDER, AND GEL DISHWASHING DETERGENTS; AUTOMATIC DISHWASHING DETERGENTS; LIQUID DISHWASHING SOAPS; LIQUID ANTIBACTERIAL

SOAPS; LIQUID HAND SOAPS, IN CLASS 3 (U.S. CLS. 1, 4, 6, 50, 51 AND 52).

FIRST USE 3-24-1992; IN COMMERCE 3-24-1992.

OWNER OF U.S. REG. NOS. 1,640,169 AND 2,019,393.

SN 76-370,351, FILED 2-12-2002.

G. MAYERSCHOFF, EXAMINING ATTORNEY

**Int. Cl.: 25**

**Prior U.S. Cls.: 22 and 39**

**United States Patent and Trademark Office**

**Reg. No. 3,499,444**

**Registered Sep. 9, 2008**

**TRADEMARK  
PRINCIPAL REGISTER**

**TEKFIT BY TALON**

TALON INTERNATIONAL, INC. (DELAWARE  
CORPORATION)  
21900 BURBANK BLVD.  
SUITE 270  
WOODLAND HILLS, CA 91367

FOR: MEN'S, WOMEN'S AND CHILDREN'S  
PANTS, SHORTS AND JEANS, IN CLASS 25 (U.S.  
CLS. 22 AND 39).

FIRST USE 7-31-2002; IN COMMERCE 7-31-2002.

OWNER OF U.S. REG. NOS. 243,746, 856,635, AND  
OTHERS.

SN 76-436,520, FILED 8-1-2002.

KIM SAITO, EXAMINING ATTORNEY

**Int. Cls.: 41 and 42**

**Prior U.S. Cls.: 100, 101, and 107**

**United States Patent and Trademark Office**

**Reg. No. 3,499,445**

**Registered Sep. 9, 2008**

**SERVICE MARK  
PRINCIPAL REGISTER**

***FUTURE***

ANDERSON, KENT G (UNITED STATES INDIVIDUAL)  
FUTURE BRANDS GLOBAL LICENCING  
925 N GRIFFIN  
BISMARCK, ND 58501

FOR: SPORT REFEREEING; MENTORING IN THE FIELD OF PERSONAL ACHIEVEMENT AND ACTS OF HUMAN KINDNESS; CAREER COUNSELING, IN CLASS 41 (U.S. CLS. 100, 101 AND 107).

FIRST USE 9-21-2002; IN COMMERCE 9-21-2002.

FOR: PROVIDING RESEARCH FACILITIES FOR OTHERS FOR THE DEVELOPMENT OF NEW PRODUCTS AND SERVICES, NAMELY, AUTOMO-

BILES, VEHICLES, AIRCRAFT, LAND CRAFT, SPACECRAFT, ELECTRONICS, TECHNOLOGY, INVENTIONS OF NEW PRODUCTS", IN CLASS 42 (U.S. CLS. 100 AND 101).

FIRST USE 9-21-2002; IN COMMERCE 9-21-2002.

THE MARK CONSISTS OF STANDARD CHARACTERS WITHOUT CLAIM TO ANY PARTICULAR FONT, STYLE, SIZE, OR COLOR.

SN 76-453,276, FILED 9-20-2002.

CAROLYN CATALDO, EXAMINING ATTORNEY

**Int. Cls.: 32 and 43**

**Prior U.S. Cls.: 45, 46, 48, 100, and 101**

**Reg. No. 3,499,446**

**Registered Sep. 9, 2008**

**United States Patent and Trademark Office**

---

**TRADEMARK  
SERVICE MARK  
PRINCIPAL REGISTER**



SAGUARO RANCH DEVELOPMENT CORPORATION (ARIZONA CORPORATION)  
3800 WEST MOORE ROAD  
TUCSON, AZ 85742

FOR: BOTTLED DRINKING WATER, IN CLASS 32 (U.S. CLS. 45, 46 AND 48).

FIRST USE 6-1-2006; IN COMMERCE 6-1-2006.

FOR: HEALTH RESORT SERVICES, NAMELY, PROVIDING FOOD AND LODGING THAT PRO-

MOTE PATRON'S GENERAL HEALTH AND WELL BEING, RESTAURANT SERVICES, IN CLASS 43 (U.S. CLS. 100 AND 101).

FIRST USE 5-7-2007; IN COMMERCE 5-7-2007.

SN 76-531,858, FILED 7-24-2003.

WILLIAM P. SHANAHAN, EXAMINING ATTORNEY

**Int. Cl.: 25**

**Prior U.S. Cls.: 22 and 39**

**United States Patent and Trademark Office**

**Reg. No. 3,499,447**

**Registered Sep. 9, 2008**

**TRADEMARK  
PRINCIPAL REGISTER**

**AS ONE**

GALIGA, MICHAEL L. (UNITED STATES INDIVIDUAL)  
6432 COFFEE CREEK ROAD  
EDMOND, OK 73034

FIRST USE 6-23-2008; IN COMMERCE 6-23-2008.

SN 76-552,299, FILED 10-17-2003.

FOR: CLOTHING, NAMELY, HEADWEAR AND SWEATSHIRTS, IN CLASS 25 (U.S. CLS. 22 AND 39).

NICHOLAS ALTREE, EXAMINING ATTORNEY

**Int. Cl.: 9**

**Prior U.S. Cls.: 21, 23, 26, 36, and 38**

**Reg. No. 3,499,448**

**United States Patent and Trademark Office**

**Registered Sep. 9, 2008**

**TRADEMARK  
PRINCIPAL REGISTER**

**DIGITAL-T**

BRAINSHIELD TECHNOLOGIES, INC. (DELA-  
WARE CORPORATION)  
352 7TH AVENUE, SUITE 703  
NEW YORK, NY 10001

THE MARK CONSISTS OF STANDARD CHAR-  
ACTERS WITHOUT CLAIM TO ANY PARTICULAR  
FONT, STYLE, SIZE, OR COLOR.

FOR: HARDWARE AND SOFTWARE FOR DE-  
LIVERY OF DIGITAL CONTENT, IN CLASS 9 (U.S.  
CLS. 21, 23, 26, 36 AND 38).

SN 76-561,407, FILED 11-24-2003.

FIRST USE 7-31-2005; IN COMMERCE 7-31-2005.

JAMES GRIFFIN, EXAMINING ATTORNEY

**Int. Cl.: 5**

**Prior U.S. Cls.: 6, 18, 44, 46, 51, and 52**

**Reg. No. 3,499,449**

**United States Patent and Trademark Office**

**Registered Sep. 9, 2008**

**TRADEMARK  
PRINCIPAL REGISTER**

**LIBRACOL**

DNP CANADA INC. (CANADA CORPORATION)  
2000 MANSFIELD STREET, SUITE 700  
MONTREAL (QUEBEC), CANADA H3A 2Z4

FOR: NUTRITIONAL SUPPLEMENTS IN THE NATURE OF TABLETS, CAPSULES, ELIXIR, AND ADDITIVES FOR FOOD, ALL COMPRISING EXTRACT OF SHELLFISH SCALE USED TO HELP REDUCE CHOLESTEROL LEVEL IN THE HUMAN BODY, IN CLASS 5 (U.S. CLS. 6, 18, 44, 46, 51 AND 52).

FIRST USE 5-1-2008; IN COMMERCE 5-1-2008.

THE MARK CONSISTS OF STANDARD CHARACTERS WITHOUT CLAIM TO ANY PARTICULAR FONT, STYLE, SIZE, OR COLOR.

SN 76-565,745, FILED 12-17-2003.

MARTHA SANTOMARTINO, EXAMINING ATTORNEY

**Int. Cl.: 33**

**Prior U.S. Cls.: 47 and 49**

**United States Patent and Trademark Office**

**Reg. No. 3,499,450**

**Registered Sep. 9, 2008**

**TRADEMARK  
PRINCIPAL REGISTER**

**BULLDOG**

CK3 LLC (DELAWARE LIMITED LIABILITY  
COMPANY)  
225 VARICK, SUITE 303  
NEW YORK, NY 10014

FIRST USE 11-0-2006; IN COMMERCE 11-0-2006.

SN 76-567,470, FILED 12-22-2003.

FOR: DISTILLED SPIRITS, NAMELY, GIN, IN  
CLASS 33 (U.S. CLS. 47 AND 49).

JOHN WILKE, EXAMINING ATTORNEY



**Int. Cl.: 32**

**Prior U.S. Cls.: 45, 46, and 48**

**United States Patent and Trademark Office**

**Reg. No. 3,499,451**

**Registered Sep. 9, 2008**

**TRADEMARK  
PRINCIPAL REGISTER**

**NEPTUNE BEVERAGE CO.**

HENNIGH, STEVEN (UNITED STATES INDIVIDUAL)  
136 OCEAN STREET  
CAYUCOS, CA 93430

NO CLAIM IS MADE TO THE EXCLUSIVE RIGHT TO USE "BEVERAGE CO"., APART FROM THE MARK AS SHOWN.

FOR: BEVERAGES, NAMELY, BEER, IN CLASS 32 (U.S. CLS. 45, 46 AND 48).

SN 76-580,150, FILED 3-10-2004.

FIRST USE 5-31-2008; IN COMMERCE 5-31-2008.

THE MARK CONSISTS OF STANDARD CHARACTERS WITHOUT CLAIM TO ANY PARTICULAR FONT, STYLE, SIZE, OR COLOR.

WILLIAM P. SHANAHAN, EXAMINING ATTORNEY

**Int. Cl.: 42**

**Prior U.S. Cls.: 100 and 101**

**United States Patent and Trademark Office**

**Reg. No. 3,499,452**

**Registered Sep. 9, 2008**

**SERVICE MARK  
PRINCIPAL REGISTER**

**DELOS & LAUREL**

DELOS & LAUREL, LLC (DELAWARE LIMITED  
LIABILITY CORPORATION)  
101 UNIVERSITY DRIVE  
SUITE B-6  
AMHERST, MA 01002

FOR: INTERIOR DECORATING AND DESIGN  
SERVICES; PROVIDING INFORMATION REGARD-  
ING INTERIOR DECORATING AND DESIGN VIA A  
GLOBAL COMPUTER NETWORK , IN CLASS 42  
(U.S. CLS. 100 AND 101).

FIRST USE 6-1-2008; IN COMMERCE 6-1-2008.

THE MARK CONSISTS OF STANDARD CHAR-  
ACTERS WITHOUT CLAIM TO ANY PARTICULAR  
FONT, STYLE, SIZE, OR COLOR.

SN 76-588,358, FILED 4-22-2004.

BARBARA RUTLAND, EXAMINING ATTORNEY

**Int. Cl.: 35**

**Prior U.S. Cls.: 100, 101, and 102**

**United States Patent and Trademark Office**

**Reg. No. 3,499,453**

**Registered Sep. 9, 2008**

**SERVICE MARK  
PRINCIPAL REGISTER**

# **Culinary Care Center**

FORTIN, DENISE (UNITED STATES INDIVIDUAL)  
40 LEEWARD ROAD  
FALL RIVER, MA 02720

FOR: WHOLESALE AND RETAIL DISTRIBUTORSHIP FEATURING HEALTH FOOD AND NUTRITIONAL PRODUCTS TO MEET THE NEEDS OF INDIVIDUALS WITH SPECIFIC HEALTH PROBLEMS AND DIETARY REQUIREMENTS , IN CLASS 35 (U.S. CLS. 100, 101 AND 102).

FIRST USE 9-1-2007; IN COMMERCE 9-1-2007.

THE MARK CONSISTS OF STANDARD CHARACTERS WITHOUT CLAIM TO ANY PARTICULAR FONT, STYLE, SIZE, OR COLOR.

NO CLAIM IS MADE TO THE EXCLUSIVE RIGHT TO USE "CULINARY", APART FROM THE MARK AS SHOWN.

SN 76-600,310, FILED 7-1-2004.

RUDY R. SINGLETON, EXAMINING ATTORNEY

**Int. Cl.: 44**

**Prior U.S. Cls.: 100 and 101**

**United States Patent and Trademark Office**

**Reg. No. 3,499,454**

**Registered Sep. 9, 2008**

**SERVICE MARK  
PRINCIPAL REGISTER**

**ENGAGEMENT THERAPY TREATMENT  
MIRRORING THE PAST, FULFILLING THE FUTURE**

HCR HEALTHCARE, LLC (DELAWARE LIMITED LIABILITY COMPANY)

333 NORTH SUMMIT STREET

TOLEDO, OH 436042617

FOR: HEALTH CARE; TRANSITIONAL HEALTH CARE; NURSING HOME CARE, IN CLASS 44 (U.S. CLS. 100 AND 101).

FIRST USE 4-29-2008; IN COMMERCE 4-29-2008.

THE MARK CONSISTS OF STANDARD CHARACTERS WITHOUT CLAIM TO ANY PARTICULAR FONT, STYLE, SIZE, OR COLOR.

NO CLAIM IS MADE TO THE EXCLUSIVE RIGHT TO USE "ENGAGEMENT THERAPY TREATMENT", APART FROM THE MARK AS SHOWN.

SN 76-616,992, FILED 10-21-2004.

MICHAEL WEBSTER, EXAMINING ATTORNEY

Int. Cl.: 3

Prior U.S. Cls.: 1, 4, 6, 50, 51, and 52

Reg. No. 3,499,455

United States Patent and Trademark Office

Registered Sep. 9, 2008

TRADEMARK  
PRINCIPAL REGISTER

VILLASPORT

SYUFY ENTERPRISES (CALIFORNIA LIMITED  
PARTNERSHIP)  
150 PELICAN WAY  
SAN RAFAEL, CA 94901

FOR: FRAGRANCE PRODUCTS FOR PERSONAL USE, NAMELY, PERFUME, ESSENTIAL OILS, COLOGNE, EAU DE PERFUME, EAU DE TOILETTE, SCENTED BODY LOTIONS AND CREAMS, MOISTURIZING LOTIONS AND CREAMS, BODY OIL, BODY POWDER, SCENTED SOAP, BODY WASH, BODY SCRUB AND AFTER SHOWER SPLASH, DEODORANT, ANTIPERSPIRANT, POTPOURRI, AND SACHETS; NON-MEDICATED SKIN CARE PREPARATIONS, NAMELY, FACIAL MASKS, EYE TREATMENTS AND MOISTURIZERS, LIP TREATMENTS AND MOISTURIZERS, SKIN TREATMENTS, CLEANSERS, MOISTURIZERS, TONERS, PRE-SHAVE LOTIONS, AFTER SHAVE LOTIONS AND CLARIFIERS, SOAPS, BATH AND SHOWER GELS, SUN TANNING PREPARATIONS, SUNSCREEN AND SUN BLOCK PREPARATIONS, AND AFTER-SUN LOTIONS; COSMETICS, NAMELY, FACE, LIP, EYE AND CHEEK MAKEUP, FOUNDATION MAKE-UP, FACE POWDER, CONCEALER, BLUSHER, LIP PENCILS, LIPSTICK, LIP GLOSS, NON-MEDICATED LIP BALM, MASCARA, EYELI-

NERS, EYE SHADOW, EYEBROW MAKEUP AND HIGHLIGHTER; AND NAIL CARE PREPARATIONS, NAMELY, CUTICLE CONDITIONERS, CUTICLE CREAMS, CUTICLE REMOVING PREPARATIONS; NAIL POLISHES, NAIL LACQUERS NAIL TOPCOATS, NAIL HARDENERS, NAIL BASE COATS, NAIL STRENGTHENERS, NAIL POLISH REMOVERS, NAIL GLUES, NAIL ENAMELS, NAIL TREATMENTS, NAMELY, ARTIFICIAL AND ACRYLIC NAILS, NAIL TIPS, NAIL BUFFERING PREPARATIONS, NAIL SHAPERS, NAIL SMOOTHERS AND EMERY BOARDS; AND HAIR CARE PRODUCTS, NAMELY, SHAMPOOS, CONDITIONERS, GELS, MOUSSE, IN CLASS 3 (U.S. CLS. 1, 4, 6, 50, 51 AND 52).

FIRST USE 6-10-2007; IN COMMERCE 12-6-2007.

THE MARK CONSISTS OF STANDARD CHARACTERS WITHOUT CLAIM TO ANY PARTICULAR FONT, STYLE, SIZE, OR COLOR.

SN 76-618,092, FILED 10-28-2004.

GRETTA YAO, EXAMINING ATTORNEY

**Int. Cl.: 41**

**Prior U.S. Cls.: 100, 101, and 107**

**United States Patent and Trademark Office**

**Reg. No. 3,499,456**

**Registered Sep. 9, 2008**

**SERVICE MARK  
PRINCIPAL REGISTER**

**GLOBAL LOVE**

FLAX & FLAX ENTERTAINMENT (CALIFORNIA PARTNERSHIP)  
957 JOAQUIN AVE. #A  
SAN LEANDRO, CA 94577

THE MARK CONSISTS OF STANDARD CHARACTERS WITHOUT CLAIM TO ANY PARTICULAR FONT, STYLE, SIZE, OR COLOR.

FOR: ENTERTAINMENT SERVICES IN THE NATURE OF LIVE VOCAL AND MUSICAL PERFORMANCES BY A MUSICAL BAND, IN CLASS 41 (U.S. CLS. 100, 101 AND 107).

SN 76-618,865, FILED 11-1-2004.

FIRST USE 1-1-2004; IN COMMERCE 6-1-2007.

STEVEN JACKSON, EXAMINING ATTORNEY

**Int. Cls.: 29 and 30**

**Prior U.S. Cl.: 46**

**United States Patent and Trademark Office**

**Reg. No. 3,499,457**

**Registered Sep. 9, 2008**

**TRADEMARK  
PRINCIPAL REGISTER**

**THE VALUE OF A GOOD MEAL**

JONMOR INVESTMENTS, INC. (DELAWARE CORPORATION)  
3411 SILVERSIDE ROAD  
103 BAYNARD BUILDING  
WILMINGTON, DE 19810

FOR: BEEF, PORK AND POULTRY; GROUND BEEF, PORK AND POULTRY; PRE-COOKED BEEF, PORK AND POULTRY; PROCESSED BEEF, PORK AND POULTRY; POWDERED EGGS; SAUSAGE; SUMMER SAUSAGE; PEPPERONI; SMOKED SAUSAGE; SAUSAGE LINKS; HOT DOGS; FRANKFURTERS; COLD CUTS; LUNCH MEATS; DELI MEATS; MEATBALLS, IN CLASS 29 (U.S. CL. 46).

FIRST USE 9-19-2005; IN COMMERCE 9-19-2005.

FOR: SANDWICHES; BREAKFAST SANDWICHES; BISCUIT SANDWICHES, IN CLASS 30 (U.S. CL. 46).

FIRST USE 9-19-2005; IN COMMERCE 9-19-2005.

THE MARK CONSISTS OF STANDARD CHARACTERS WITHOUT CLAIM TO ANY PARTICULAR FONT, STYLE, SIZE, OR COLOR.

SN 76-620,738, FILED 11-15-2004.

EDWARD NELSON, EXAMINING ATTORNEY

**Int. Cl.: 43**

**Prior U.S. Cls.: 100 and 101**

**United States Patent and Trademark Office**

**Reg. No. 3,499,458**

**Registered Sep. 9, 2008**

**SERVICE MARK  
PRINCIPAL REGISTER**

**YARD HOUSE BAR · GRILL**

YARD HOUSE USA, INC. (DELAWARE CORPORATION)  
SUITE 1170, 8001 IRVINE CENTER DRIVE  
IRVINE, CA 92618

OWNER OF U.S. REG. NOS. 2,441,608 AND  
2,620,238.

FOR: RESTAURANT SERVICES, IN CLASS 43  
(U.S. CLS. 100 AND 101).

NO CLAIM IS MADE TO THE EXCLUSIVE  
RIGHT TO USE "HOUSE BAR & GRILL", APART  
FROM THE MARK AS SHOWN.

FIRST USE 6-15-2008; IN COMMERCE 6-15-2008.

SN 76-621,017, FILED 11-18-2004.

THE MARK CONSISTS OF STANDARD CHARACTERS  
WITHOUT CLAIM TO ANY PARTICULAR  
FONT, STYLE, SIZE, OR COLOR.

DAWN FELDMAN, EXAMINING ATTORNEY



Int. Cl.: 9

Prior U.S. Cls.: 21, 23, 26, 36, and 38

Reg. No. 3,499,459

United States Patent and Trademark Office

Registered Sep. 9, 2008

TRADEMARK  
PRINCIPAL REGISTER

**BATTLE SIGHT**

RELYANT TECHNOLOGY INC. (VIRGINIA  
CORPORATION)  
8002 REVENNA LANE  
SPRINGFIELD, VA 22153

FOR: COMPUTERS, COMPUTER HARDWARE,  
COMPUTER PERIPHERALS AND COMPUTER  
SOFTWARE FOR COMMAND AND CONTROL OF  
TASK FORCE OPERATIONS FOR PROVIDING  
REAL TIME SITUATIONAL AWARENESS OF A  
BATTLEFIELD, IN CLASS 9 (U.S. CLS. 21, 23, 26, 36  
AND 38).

FIRST USE 7-30-2005; IN COMMERCE 7-30-2005.

THE MARK CONSISTS OF STANDARD CHAR-  
ACTERS WITHOUT CLAIM TO ANY PARTICULAR  
FONT, STYLE, SIZE, OR COLOR.

NO CLAIM IS MADE TO THE EXCLUSIVE  
RIGHT TO USE "BATTLE", APART FROM THE  
MARK AS SHOWN.

SN 76-622,460, FILED 11-29-2004.

CAROLYN GRAY, EXAMINING ATTORNEY

**Int. Cl.: 35**

**Prior U.S. Cls.: 100, 101, and 102**

**United States Patent and Trademark Office**

**Reg. No. 3,499,460**

**Registered Sep. 9, 2008**

**SERVICE MARK  
PRINCIPAL REGISTER**



GLOBAL AGRI LLC (DELAWARE LIMITED LIABILITY COMPANY)  
511 BARRY STREET  
BRONX, NY 10474

NO CLAIM IS MADE TO THE EXCLUSIVE RIGHT TO USE "AGRI", APART FROM THE MARK AS SHOWN.

FOR: WHOLESALE DISTRIBUTORSHIP FEATURING UNPROCESSED AND PROCESSED FRUITS, VEGETABLES, HERBS, AND SPECIALTY FOODS, IN CLASS 35 (U.S. CLS. 100, 101 AND 102).

SN 76-630,386, FILED 2-7-2005.

FIRST USE 1-1-2005; IN COMMERCE 1-1-2005.

ROSELLE HERRERA, EXAMINING ATTORNEY

Int. Cl.: 29

Prior U.S. Cl.: 46

United States Patent and Trademark Office

Reg. No. 3,499,461

Registered Sep. 9, 2008

TRADEMARK  
PRINCIPAL REGISTER



JAG INTERNATIONAL, INC. (NEW YORK CORPORATION)  
524 CHAUNCY LANE  
LAWRENCE, NY 11559

FOR: PREPARED ORGANIC GOURMET FOOD PRODUCTS AVAILABLE IN FROZEN, NONFROZEN, REFRIGERATED AND SHELF-STABLE FORMATS, NAMELY, VEGETARIAN CHILI, ASIAN CHILI AND MUSHROOM CHILI COMPRISING ORGANIC BEANS AND ASIAN, MEXICAN, INDIAN, ITALIAN AND AMERICAN FOODS IN THE NATURE OF PACKAGED MEALS CONSISTING

PRIMARILY OF MEAT AND VEGETABLES, IN CLASS 29 (U.S. CL. 46).

FIRST USE 10-5-2005; IN COMMERCE 10-5-2005.

NO CLAIM IS MADE TO THE EXCLUSIVE RIGHT TO USE "GOURMET", APART FROM THE MARK AS SHOWN.

SN 76-633,849, FILED 3-21-2005.

KIMBERLY FRYE, EXAMINING ATTORNEY

Prior U.S. Cl.: A

United States Patent and Trademark Office

Reg. No. 3,499,462

Registered Sep. 9, 2008

CERTIFICATION MARK  
GOODS  
PRINCIPAL REGISTER



COMPOSITE PANEL ASSOCIATION (ILLINOIS  
NON-PROFIT CORPORATION)  
18922 PREMIERE COURT  
GAITHERSBURG, MD 208791574

FOR: PARTICLEBOARD, MEDIUM DENSITY FI-  
BERBOARD, PLYWOOD AND HARDBOARD, IN  
CLASS A (U.S. CL. A).

FIRST USE 7-1-2006; IN COMMERCE 7-1-2006.

NO CLAIM IS MADE TO THE EXCLUSIVE  
RIGHT TO USE "EPP" AND "CERTIFIED", APART  
FROM THE MARK AS SHOWN.

"THE CERTIFICATION MARK, AS USED BY  
PERSONS AUTHORIZED BY THE CERTIFIER,  
CERTIFIES THAT THE FORMALDEHYDE EMIS-  
SION AND WOOD FIBER CONTENT STANDARDS  
FROM THE CERTIFIER HAVE BEEN MET FOR  
THE CERTIFIED GOODS."

SN 76-653,145, FILED 1-9-2006.

DAWN FELDMAN, EXAMINING ATTORNEY

**Int. Cls.: 35, 36, and 39**

**Prior U.S. Cls.: 100, 101, 102, and 105**

**United States Patent and Trademark Office**

**Reg. No. 3,499,463**

**Registered Sep. 9, 2008**

**SERVICE MARK  
PRINCIPAL REGISTER**



PEOPLES ENERGY CORPORATION (ILLINOIS CORPORATION)  
130 EAST RANDOLPH DRIVE  
CHICAGO, IL 60601

FOR: NATURAL GAS MANAGEMENT SERVICES, IN CLASS 35 (U.S. CLS. 100, 101 AND 102).

FIRST USE 6-7-2006; IN COMMERCE 6-7-2006.

FOR: NATURAL GAS BROKERAGE, IN CLASS 36 (U.S. CLS. 100, 101 AND 102).

FIRST USE 6-7-2006; IN COMMERCE 6-7-2006.

FOR: PUBLIC NATURAL GAS UTILITY SERVICE; STORAGE, DISTRIBUTION AND TRANSPORTATION OF NATURAL GAS, IN CLASS 39 (U.S. CLS. 100 AND 105).

FIRST USE 8-31-1999; IN COMMERCE 8-31-1999.

THE MARK CONSISTS OF THREE DECORATIVE BANDS THAT FORM A CIRCULAR-LIKE ELEMENT AND CONNECT TO ONE END.

SN 76-653,496, FILED 1-18-2006.

DAWN FELDMAN, EXAMINING ATTORNEY

**Int. Cls.: 25 and 41**

**Prior U.S. Cls.: 22, 39, 100, 101, and 107**

**Reg. No. 3,499,464**

**United States Patent and Trademark Office**

**Registered Sep. 9, 2008**

**TRADEMARK  
SERVICE MARK  
PRINCIPAL REGISTER**

# **ROLE MOMMY**

FELDMAN, BETH (UNITED STATES INDIVIDUAL)  
36 RUTLEDGE ROAD  
SCARSDALE, NY 10583 AND  
CORPORON, YVETTE MANESSIS (UNITED STATES INDIVIDUAL)  
85 ROCKLEDGE ROAD  
BRONXVILLE, NY 10708

FOR: CLOTHING, NAMELY, T-SHIRTS, SWEAT-SHIRTS, JACKETS, COATS, SHIRTS, PULLOVERS, NECKTIES, GLOVES, MITTENS, HEAD SCARVES, NECK SCARVES, HATS, STOCKINGS, SOCKS, UNDERWEAR, PANTS, SWEAT PANTS, SHORTS AND SWIMWEAR, IN CLASS 25 (U.S. CLS. 22 AND 39).

FIRST USE 1-31-2006; IN COMMERCE 1-31-2006.

FOR: ENTERTAINMENT SERVICES, NAMELY, PROVIDING A WEB SITE FEATURING VIDEOS AND/OR TELEVISION SPECIALS, PHOTOGRAPHS, AND OTHER MULTIMEDIA MATERIALS, IN CLASS 41 (U.S. CLS. 100, 101 AND 107).

FIRST USE 9-21-2005; IN COMMERCE 9-21-2005.

SN 76-653,837, FILED 1-23-2006.

MARGERY A. TIERNEY, EXAMINING ATTORNEY

**Int. Cl.: 9**

**Prior U.S. Cls.: 21, 23, 26, 36, and 38**

**Reg. No. 3,499,465**

**United States Patent and Trademark Office**

**Registered Sep. 9, 2008**

**TRADEMARK  
PRINCIPAL REGISTER**

**OPENGEAR**

ROSS VIDEO LIMITED (CANADA CORPORATION)  
P.O. BOX 220  
8 JOHN STREET  
IROQUOIS, ONTARIO, CANADA K0E 1K0

FIRST USE 1-16-2006; IN COMMERCE 1-16-2006.

THE MARK CONSISTS OF STANDARD CHARACTERS WITHOUT CLAIM TO ANY PARTICULAR FONT, STYLE, SIZE, OR COLOR.

FOR: AUDIO AND VIDEO EQUIPMENT, NAME-  
LY, CARDS WITH INTEGRATED CIRCUITS FOR  
USE IN TERMINAL EQUIPMENT FOR DIGITAL  
AND ANALOG AUDIO, VIDEO, AND DATA DIS-  
TRIBUTION AND MONITORING, PROCESSING,  
CONVERSION, AND MIXING, IN CLASS 9 (U.S.  
CLS. 21, 23, 26, 36 AND 38).

SN 76-654,511, FILED 2-2-2006.

AMY HELLA, EXAMINING ATTORNEY

**Int. Cl.: 34**

**Prior U.S. Cls.: 2, 8, 9, and 17**

**United States Patent and Trademark Office**

**Reg. No. 3,499,466**

**Registered Sep. 9, 2008**

**TRADEMARK  
PRINCIPAL REGISTER**

**PT TIPS**

PRIME TIME INTERNATIONAL COMPANY (ARIZONA CORPORATION)

2019 W. LONE CACTUS DRIVE

PHOENIX, AZ 85027

FOR: CIGARS, IN CLASS 34 (U.S. CLS. 2, 8, 9 AND 17).

FIRST USE 11-30-2007; IN COMMERCE 12-12-2007.

THE MARK CONSISTS OF STANDARD CHARACTERS WITHOUT CLAIM TO ANY PARTICULAR FONT, STYLE, SIZE, OR COLOR.

NO CLAIM IS MADE TO THE EXCLUSIVE RIGHT TO USE "TIPS", APART FROM THE MARK AS SHOWN.

SN 76-656,940, FILED 3-20-2006.

MARTHA FROMM, EXAMINING ATTORNEY



**Int. Cl.: 35**

**Prior U.S. Cls.: 100, 101, and 102**

**United States Patent and Trademark Office**

**Reg. No. 3,499,467**

**Registered Sep. 9, 2008**

**SERVICE MARK  
PRINCIPAL REGISTER**



SMART TECHNOLOGY EXPORT CORP. (FLORIDA CORPORATION)  
8321 NW 74TH ST.  
MIAMI, FL 33166

FOR: ONLINE AND WHOLESALE STORE SERVICES FEATURING COMPUTER AND ELECTRONIC EQUIPMENT, IN CLASS 35 (U.S. CLS. 100, 101 AND 102).

FIRST USE 4-23-2008; IN COMMERCE 4-23-2008.

NO CLAIM IS MADE TO THE EXCLUSIVE RIGHT TO USE "SMART" AND "TECH", APART FROM THE MARK AS SHOWN.

THE COLOR(S) BLUE AND ORANGE IS/ARE CLAIMED AS A FEATURE OF THE MARK.

THE COLOR ORANGE APPEARS ON THE CIRCLES AND THE WORD "TECH". THE COLOR BLUE APPEARS ON THE WORD "SMART" AND ON THE REFLECTION OF THE WORD "SMART".

THE MARK CONSISTS OF THE WORDS "SMART TECH". THE COLOR ORANGE APPEARS ON THE CIRCLES AND THE WORD "TECH". THE COLOR BLUE APPEARS ON THE WORD "SMART" AND ON THE REFLECTION OF THE WORD "SMART".

SN 76-662,107, FILED 6-26-2006.

KATHRYN COWARD, EXAMINING ATTORNEY

**Int. Cl.: 9**

**Prior U.S. Cls.: 21, 23, 26, 36, and 38**

**Reg. No. 3,499,468**

**United States Patent and Trademark Office**

**Registered Sep. 9, 2008**

**TRADEMARK  
PRINCIPAL REGISTER**

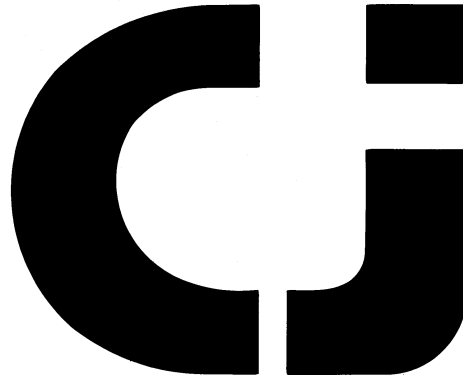

**C J CROOKED JAW FASHIONS**

FRENCH, CRAIG J. (UNITED STATES INDIVIDUAL)  
36 SYMPHONY DRIVE  
LAKE GROVE, NY 11755

NO CLAIM IS MADE TO THE EXCLUSIVE RIGHT TO USE "FASHIONS", APART FROM THE MARK AS SHOWN.

FOR: SUNGLASSES, IN CLASS 9 (U.S. CLS. 21, 23, 26, 36 AND 38).

SN 76-664,947, FILED 8-22-2006.

FIRST USE 1-1-2007; IN COMMERCE 1-1-2007.

SKYE YOUNG, EXAMINING ATTORNEY

**Int. Cls.: 9, 35, 41, and 42**

**Prior U.S. Cls.: 21, 23, 26, 36, 38, 100, 101, 102, and 107**

**Reg. No. 3,499,469**

**United States Patent and Trademark Office**

**Registered Sep. 9, 2008**

**TRADEMARK  
SERVICE MARK  
PRINCIPAL REGISTER**



**MCMANIS & MONSALVE ASSOCIATES (VIRGINIA CORPORATION)**

7518-20 DIPLOMAT DRIVE, SUITE 201  
MANASSAS, VA 20109

FOR: PRE-RECORDED DIGITAL STORAGE MEDIA, NAMELY, CD-ROMS AND FLASH DRIVES, CONTAINING SOFTWARE AND DOWNLOADABLE SOFTWARE, IN THE FIELDS OF STRATEGIC PLANNING, ORGANIZATIONAL ASSESSMENT AND DEVELOPMENT, PROGRAM EVALUATION AND DEVELOPMENT, RISK ASSESSMENT, RISK MITIGATION, FORMULATION AND IMPLEMENTATION, PROGRAM MANAGEMENT, WORKFORCE LEARNING, ORGANIZATIONAL TRANSFORMATION, SUPPLY CHAIN LOGISTICS, AND DECISION SUPPORT SYSTEMS, IN CLASS 9 (U.S. CLS. 21, 23, 26, 36 AND 38).

FIRST USE 8-1-2001; IN COMMERCE 8-1-2001.

FOR: BUSINESS CONSULTANCY SERVICES IN THE FIELDS OF STRATEGIC PLANNING, ORGANIZATIONAL ASSESSMENT AND DEVELOPMENT, PROGRAM EVALUATION AND DEVELOPMENT, RISK ASSESSMENT, RISK MITIGATION, FORMULATION AND IMPLEMENTATION, PROGRAM MANAGEMENT, WORKFORCE LEARNING, ORGANIZATIONAL TRANSFORMATION, SUPPLY

CHAIN LOGISTICS, AND DECISION SUPPORT SYSTEMS, IN CLASS 35 (U.S. CLS. 100, 101 AND 102).

FIRST USE 8-1-2001; IN COMMERCE 8-1-2001.

FOR: TRAINING SERVICES IN THE FIELDS OF STRATEGIC PLANNING, ORGANIZATIONAL ASSESSMENT AND DEVELOPMENT, PROGRAM EVALUATION AND DEVELOPMENT, RISK ASSESSMENT, RISK MITIGATION, FORMULATION AND IMPLEMENTATION, PROGRAM MANAGEMENT, WORKFORCE LEARNING, ORGANIZATIONAL TRANSFORMATION, SUPPLY CHAIN LOGISTICS, AND DECISION SUPPORT SYSTEMS, IN CLASS 41 (U.S. CLS. 100, 101 AND 107).

FIRST USE 8-1-2001; IN COMMERCE 8-1-2001.

FOR: DESIGN AND DEVELOPMENT OF COMPUTER SOFTWARE IN THE FIELDS OF STRATEGIC PLANNING, ORGANIZATIONAL ASSESSMENT AND DEVELOPMENT, PROGRAM EVALUATION AND DEVELOPMENT, RISK ASSESSMENT, RISK MITIGATION, FORMULATION AND IMPLEMENTATION, PROGRAM MANAGEMENT, WORKFORCE LEARNING, ORGANIZATIONAL TRANSFORMATION, SUPPLY CHAIN LOGISTICS, AND DECISION SUPPORT SYSTEMS; WEBSITE DESIGN SERVICE, IN CLASS 42 (U.S. CLS. 100 AND 101).

FIRST USE 8-1-2001; IN COMMERCE 8-1-2001.

SN 76-665,501, FILED 9-1-2006.

DEIRDRE ROBERTSON, EXAMINING ATTORNEY

Int. Cl.: 37

Prior U.S. Cls.: 100, 103, and 106

United States Patent and Trademark Office

Reg. No. 3,499,470

Registered Sep. 9, 2008

**SERVICE MARK  
PRINCIPAL REGISTER**

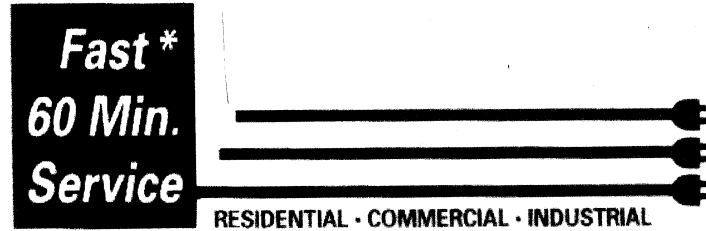

DIRECT ELECTRIC (CALIFORNIA CORPORATION)  
2865 SOQUEL AVE.  
SANTA CRUZ, CA 95062

FOR: INSTALLATION AND REPAIR OF RESIDENTIAL, COMMERCIAL AND INDUSTRIAL ELECTRICAL WIRING AND SYSTEMS; ELECTRICAL CONTRACTOR SERVICES, IN CLASS 37 (U.S. CLS. 100, 103 AND 106).

FIRST USE 5-14-2003; IN COMMERCE 5-14-2003.

NO CLAIM IS MADE TO THE EXCLUSIVE RIGHT TO USE "FAST 60 MIN. SERVICE RESIDENTIAL COMMERCIAL INDUSTRIAL", APART FROM THE MARK AS SHOWN.

SN 76-666,334, FILED 9-20-2006.

ANNE MADDEN, EXAMINING ATTORNEY

Int. Cl.: 20

Prior U.S. Cls.: 2, 13, 22, 25, 32, and 50

United States Patent and Trademark Office

Reg. No. 3,499,471

Registered Sep. 9, 2008

TRADEMARK  
PRINCIPAL REGISTER



AMERICAN EAGLE FURNITURE CORP. (NEW  
JERSEY CORPORATION)  
107 TRUMBULL ST. #S13  
ELIZABETH, NJ 07206

FOR: FURNITURE SOLD TO WHOLESALERS, IN  
CLASS 20 (U.S. CLS. 2, 13, 22, 25, 32 AND 50).

FIRST USE 7-1-2004; IN COMMERCE 8-1-2004.

NO CLAIM IS MADE TO THE EXCLUSIVE  
RIGHT TO USE "USA" AND "FURNITURE", APART  
FROM THE MARK AS SHOWN.

THE MARK CONSISTS OF A EAGLE HOLDING A  
RIBBON IT ITS TALONS, WITH THE WORDS "AEF"  
AND THE WORDS "USA" IN A CIRCLE, ALL OF  
THIS INSIDE OF A CIRCLE WITH THE WORDS  
"AMERICAN EAGLE FURNITURE" AND FIVE  
STARS, THE CIRCLE IS OUTLINED BY TWO  
OTHER CIRCLES.

SN 76-670,176, FILED 12-11-2006.

TANYA AMOS, EXAMINING ATTORNEY

**Int. Cls.: 35 and 36**

**Prior U.S. Cls.: 100, 101, and 102**

**United States Patent and Trademark Office**

**Reg. No. 3,499,472**

**Registered Sep. 9, 2008**

**SERVICE MARK  
PRINCIPAL REGISTER**



HSBC FINANCE CORPORATION (DELAWARE CORPORATION)  
26525 N. RIVERWOODS BOULEVARD  
METTAWA, IL 60045

OWNER OF U.S. REG. NOS. 2,863,257 AND 3,017,823.

FOR: PROMOTING PUBLIC AWARENESS OF CONSUMER CREDIT ISSUES, IN CLASS 35 (U.S. CLS. 100, 101 AND 102).

NO CLAIM IS MADE TO THE EXCLUSIVE RIGHT TO USE "CREDIT", APART FROM THE MARK AS SHOWN.

FIRST USE 11-30-2006; IN COMMERCE 11-30-2006.

THE ENGLISH TRANSLATION OF THE WORD "VUE" IN THE MARK IS VIEW.

FOR: PROVIDING INFORMATION IN THE AREA OF CONSUMER CREDIT, SPECIFICALLY, FREE CREDIT SCORES, IN CLASS 36 (U.S. CLS. 100, 101 AND 102).

SN 76-670,756, FILED 12-26-2006.

FIRST USE 11-30-2006; IN COMMERCE 11-30-2006.

MARTHA FROMM, EXAMINING ATTORNEY

**Int. Cl.: 16**

**Prior U.S. Cls.: 2, 5, 22, 23, 29, 37, 38, and 50**

**Reg. No. 3,499,473**

**United States Patent and Trademark Office**

**Registered Sep. 9, 2008**

**TRADEMARK  
PRINCIPAL REGISTER**

**ART ON BOARD**

EXECUTIVE TRADING COMPANY, LTD. (NEW  
YORK CORPORATION), DBA DIONI,  
49-29 30TH PLACE  
LONG ISLAND CITY, NY 11101

FOR: BULLETIN BOARDS CONTAINING ART  
WORK THEREON, IN CLASS 16 (U.S. CLS. 2, 5, 22, 23,  
29, 37, 38 AND 50).

FIRST USE 7-31-2007; IN COMMERCE 7-31-2007.

THE MARK CONSISTS OF STANDARD CHAR-  
ACTERS WITHOUT CLAIM TO ANY PARTICULAR  
FONT, STYLE, SIZE, OR COLOR.

NO CLAIM IS MADE TO THE EXCLUSIVE  
RIGHT TO USE "ART", APART FROM THE MARK  
AS SHOWN.

SN 76-671,367, FILED 1-16-2007.

ROBIN CHOSID, EXAMINING ATTORNEY



Int. Cl.: 25

Prior U.S. Cls.: 22 and 39

**United States Patent and Trademark Office**

**Reg. No. 3,499,474**

Registered Sep. 9, 2008

**TRADEMARK  
PRINCIPAL REGISTER**

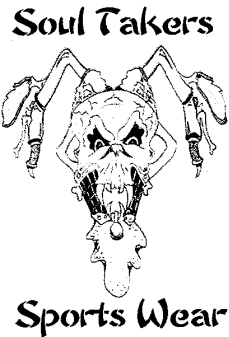

MORGAN, ADAM CARL (UNITED STATES IN-  
DIVIDUAL)

9058 S. UNION AVE

CHICAGO, IL 60620

FOR: SHIRTS, JACKETS, PANTS, SHOES, HATS,  
GLOVES, IN CLASS 25 (U.S. CLS. 22 AND 39).

FIRST USE 5-7-2007; IN COMMERCE 5-7-2007.

NO CLAIM IS MADE TO THE EXCLUSIVE  
RIGHT TO USE "SPORTS WEAR", APART FROM  
THE MARK AS SHOWN.

DRAWING OF A SKELETON PARTS MADE IN  
THE SHAPE OF MOTORCYCLE PARTS, WITH THE  
NAME "SOUL TAKERS SPORTSWEAR".

SN 76-672,399, FILED 2-6-2007.

BRIAN NEVILLE, EXAMINING ATTORNEY

**Int. Cl.: 38**

**Prior U.S. Cls.: 100, 101, and 104**

**United States Patent and Trademark Office**

**Reg. No. 3,499,475**

**Registered Sep. 9, 2008**

**SERVICE MARK  
PRINCIPAL REGISTER**

**LA MEGA SE PEGA**

MEGA MEDIA HOLDINGS, INC (DELAWARE  
CORPORATION)  
2601 SOUTH BAYSHORE DRIVE, PH 2  
COCONUT GROVE, FL 33133

FOR: TELEVISION BROADCASTING SERVICES,  
IN CLASS 38 (U.S. CLS. 100, 101 AND 104).

FIRST USE 3-30-2007; IN COMMERCE 3-30-2007.

THE MARK CONSISTS OF STANDARD CHAR-  
ACTERS WITHOUT CLAIM TO ANY PARTICULAR  
FONT, STYLE, SIZE, OR COLOR.

OWNER OF U.S. REG. NO. 3,189,970.

THE ENGLISH TRANSLATION OF "LA MEGA SE  
PEGA" IS THE MEGA STICKS / STAYS WITH YOU.

SN 76-672,643, FILED 2-8-2007.

LINDA E. BLOHM, EXAMINING ATTORNEY

**Int. Cl.: 10**

**Prior U.S. Cls.: 26, 39, and 44**

**United States Patent and Trademark Office**

**Reg. No. 3,499,476**

**Registered Sep. 9, 2008**

**TRADEMARK  
PRINCIPAL REGISTER**

**BIAXIAL POWERMAG**

NIKKEN, INC. (CALIFORNIA CORPORATION)  
52 DISCOVERY  
IRVINE, CA 92618

FOR: ELECTRIC HAND-HELD MASSAGE APPARATUS FOR HOUSEHOLD USE, IN CLASS 10 (U.S. CLS. 26, 39 AND 44).

FIRST USE 10-4-2007; IN COMMERCE 10-4-2007.

THE MARK CONSISTS OF STANDARD CHARACTERS WITHOUT CLAIM TO ANY PARTICULAR FONT, STYLE, SIZE, OR COLOR.

NO CLAIM IS MADE TO THE EXCLUSIVE RIGHT TO USE "BIAXIAL", APART FROM THE MARK AS SHOWN.

SN 76-673,498, FILED 3-2-2007.

HOWARD SMIGA, EXAMINING ATTORNEY

**Int. Cl.: 41**

**Prior U.S. Cls.: 100, 101, and 107**

**United States Patent and Trademark Office**

**Reg. No. 3,499,477**

**Registered Sep. 9, 2008**

**SERVICE MARK  
PRINCIPAL REGISTER**

**ACE COMBAT**

NAMCO BANDAI GAMES INC. (JAPAN CORPORATION)  
4-5-15 HIGASHI SHINAGAWA, SHINAGAWA-KU  
TOKYO, JAPAN 1408590

FOR: ENTERTAINMENT, NAMELY, PROVIDING A COMPUTER GAME THAT MAY BE ACCESSED NETWORK-WIDE BY NETWORK USERS VIA MOBILE PHONES AND COMPUTERS; PROVIDING COMPUTER GAMES VIA NETWORK BETWEEN COMMUNICATIONS NETWORKS AND COMPUTERS, IN CLASS 41 (U.S. CLS. 100, 101 AND 107).

FIRST USE 10-18-2007; IN COMMERCE 10-18-2007.

THE MARK CONSISTS OF STANDARD CHARACTERS WITHOUT CLAIM TO ANY PARTICULAR FONT, STYLE, SIZE, OR COLOR.

OWNER OF U.S. REG. NOS. 2,234,771 AND 3,003,501.

SN 76-674,138, FILED 3-15-2007.

KAPIL BHANOT, EXAMINING ATTORNEY

**Int. Cl.: 41**

**Prior U.S. Cls.: 100, 101, and 107**

**United States Patent and Trademark Office**

**Reg. No. 3,499,478**

**Registered Sep. 9, 2008**

**SERVICE MARK  
PRINCIPAL REGISTER**

**BEDSIDE MANOR**

NATURAL WELLNESS USA, INC. (DELAWARE  
CORPORATION)  
2301 E. LAMAR, SUITE 140  
ARLINGTON, TX 76006

THE MARK CONSISTS OF STANDARD CHAR-  
ACTERS WITHOUT CLAIM TO ANY PARTICULAR  
FONT, STYLE, SIZE, OR COLOR.

FOR: ENTERTAINMENT IN THE NATURE OF A  
TELEVISION SERIES ON THE BEST APPROACHES  
TO COMMON MEDICAL ISSUES, IN CLASS 41 (U.S.  
CLS. 100, 101 AND 107).

SN 76-674,524, FILED 3-26-2007.

FIRST USE 7-1-2007; IN COMMERCE 8-7-2007.

KIMBERLY PERRY, EXAMINING ATTORNEY

**Int. Cl.: 41**

**Prior U.S. Cls.: 100, 101, and 107**

**United States Patent and Trademark Office**

**Reg. No. 3,499,479**

**Registered Sep. 9, 2008**

---

**SERVICE MARK  
PRINCIPAL REGISTER**

**WHAT'S THE ALTERNATIVE?**

NATURAL WELLNESS USA, INC. (DELAWARE CORPORATION)  
2301 E. LAMAR, SUITE 140  
ARLINGTON, TX 76006

FOR: ENTERTAINMENT IN THE NATURE OF A TELEVISION SERIES FEATURING INTERVIEWS AND INFORMATIVE DEMONSTRATIONS WITH MEDICAL EXPERTS, PSYCHOLOGISTS AND HEALING ART PRACTITIONERS ON HOW TO DEVELOP A HEALTHIER BODY, SHARPER MIND, BETTER RELATIONS AND A FULLER LIFE, IN CLASS 41 (U.S. CLS. 100, 101 AND 107).

FIRST USE 7-1-2007; IN COMMERCE 8-7-2007.

THE MARK CONSISTS OF STANDARD CHARACTERS WITHOUT CLAIM TO ANY PARTICULAR FONT, STYLE, SIZE, OR COLOR.

SN 76-674,526, FILED 3-26-2007.

KIMBERLY PERRY, EXAMINING ATTORNEY

**Int. Cl.: 41**

**Prior U.S. Cls.: 100, 101, and 107**

**United States Patent and Trademark Office**

**Reg. No. 3,499,480**

**Registered Sep. 9, 2008**

**SERVICE MARK  
PRINCIPAL REGISTER**

**THE INCURABLES**

NATURAL WELLNESS USA, INC. (DELAWARE CORPORATION)  
2301 E. LAMAR, SUITE 140  
ARLINGTON, TX 76006

THE MARK CONSISTS OF STANDARD CHARACTERS WITHOUT CLAIM TO ANY PARTICULAR FONT, STYLE, SIZE, OR COLOR.

FOR: ENTERTAINMENT IN THE NATURE OF A TELEVISION SERIES ABOUT MEDICAL CONDITIONS THAT PERPLEX CONVENTIONAL DOCTORS, IN CLASS 41 (U.S. CLS. 100, 101 AND 107).

SN 76-674,531, FILED 3-26-2007.

FIRST USE 7-1-2007; IN COMMERCE 8-7-2007.

KIMBERLY PERRY, EXAMINING ATTORNEY

**Int. Cl.: 41**

**Prior U.S. Cls.: 100, 101, and 107**

**United States Patent and Trademark Office**

**Reg. No. 3,499,481**

**Registered Sep. 9, 2008**

**SERVICE MARK  
PRINCIPAL REGISTER**

**UNDER THE SUN**

NATURAL WELLNESS USA, INC. (DELAWARE CORPORATION)  
2301 E. LAMAR, SUITE 140  
ARLINGTON, TX 76006

FOR: ENTERTAINMENT IN THE NATURE OF A TELEVISION SERIES ABOUT AN INTERNATIONAL SEARCH FOR THE BEST ORGANIC FARMS, ORCHARDS AND PROCESSING FACILITIES, IN CLASS 41 (U.S. CLS. 100, 101 AND 107).

FIRST USE 7-1-2007; IN COMMERCE 8-7-2007.

THE MARK CONSISTS OF STANDARD CHARACTERS WITHOUT CLAIM TO ANY PARTICULAR FONT, STYLE, SIZE, OR COLOR.

SN 76-674,533, FILED 3-26-2007.

KIMBERLY PERRY, EXAMINING ATTORNEY



**Int. Cl.: 41**

**Prior U.S. Cls.: 100, 101, and 107**

**United States Patent and Trademark Office**

**Reg. No. 3,499,482**

**Registered Sep. 9, 2008**

**SERVICE MARK  
PRINCIPAL REGISTER**

**SIMPLY BEAUTIFUL**

NATURAL WELLNESS USA, INC. (DELAWARE  
CORPORATION)  
2301 E. LAMAR, SUITE 140  
ARLINGTON, TX 76006

THE MARK CONSISTS OF STANDARD CHAR-  
ACTERS WITHOUT CLAIM TO ANY PARTICULAR  
FONT, STYLE, SIZE, OR COLOR.

FOR: ENTERTAINMENT IN THE NATURE OF A  
TELEVISION SERIES ABOUT NATURAL BEAUTY  
AND FASHION, IN CLASS 41 (U.S. CLS. 100, 101 AND  
107).

SN 76-674,534, FILED 3-26-2007.

FIRST USE 7-1-2007; IN COMMERCE 8-7-2007.

KIMBERLY PERRY, EXAMINING ATTORNEY

**Int. Cl.: 41**

**Prior U.S. Cls.: 100, 101, and 107**

**United States Patent and Trademark Office**

**Reg. No. 3,499,483**

**Registered Sep. 9, 2008**

**SERVICE MARK  
PRINCIPAL REGISTER**

**WHAT HAPPENS NEXT**

NATURAL WELLNESS USA, INC. (DELAWARE CORPORATION)

2301 E. LAMAR, SUITE 140  
ARLINGTON, TX 76006

FOR: ENTERTAINMENT IN THE NATURE OF A TELEVISION SERIES ABOUT EXPLORING THE DYNAMIC RELATIONSHIP BETWEEN THE HUMAN BODY AND EVERYDAY STIMULI, IN CLASS 41 (U.S. CLS. 100, 101 AND 107).

FIRST USE 7-1-2007; IN COMMERCE 8-7-2007.

THE MARK CONSISTS OF STANDARD CHARACTERS WITHOUT CLAIM TO ANY PARTICULAR FONT, STYLE, SIZE, OR COLOR.

SN 76-674,535, FILED 3-26-2007.

KIMBERLY PERRY, EXAMINING ATTORNEY

**Int. Cl.: 41**

**Prior U.S. Cls.: 100, 101, and 107**

**United States Patent and Trademark Office**

**Reg. No. 3,499,484**

**Registered Sep. 9, 2008**

**SERVICE MARK  
PRINCIPAL REGISTER**

**THE GENESIS OF HEALING**

NATURAL WELLNESS USA, INC. (DELAWARE  
CORPORATION)  
2301 E. LAMAR, SUITE 140  
ARLINGTON, TX 76006

THE MARK CONSISTS OF STANDARD CHAR-  
ACTERS WITHOUT CLAIM TO ANY PARTICULAR  
FONT, STYLE, SIZE, OR COLOR.

FOR: ENTERTAINMENT IN THE NATURE OF A  
TELEVISION SERIES ABOUT NATURAL HEALTH  
REMEDIES, THERAPIES AND CURES, IN CLASS 41  
(U.S. CLS. 100, 101 AND 107).

SN 76-674,536, FILED 3-26-2007.

FIRST USE 7-1-2007; IN COMMERCE 8-7-2007.

KIMBERLY PERRY, EXAMINING ATTORNEY

**Int. Cl.: 41**

**Prior U.S. Cls.: 100, 101, and 107**

**United States Patent and Trademark Office**

**Reg. No. 3,499,485**

**Registered Sep. 9, 2008**

**SERVICE MARK  
PRINCIPAL REGISTER**

**FENG SHUI LIVING**

NATURAL WELLNESS USA, INC. (DELAWARE CORPORATION)  
2301 E. LAMAR, SUITE 140  
ARLINGTON, TX 76006

FOR: ENTERTAINMENT IN THE NATURE OF A TELEVISION SERIES ABOUT THE ANCIENT CHINESE ART, SCIENCE AND PHILOSOPHY OF FENG SHUI, IN CLASS 41 (U.S. CLS. 100, 101 AND 107).

FIRST USE 7-1-2007; IN COMMERCE 8-7-2007.

THE MARK CONSISTS OF STANDARD CHARACTERS WITHOUT CLAIM TO ANY PARTICULAR FONT, STYLE, SIZE, OR COLOR.

NO CLAIM IS MADE TO THE EXCLUSIVE RIGHT TO USE "FENG SHUI", APART FROM THE MARK AS SHOWN.

THE ENGLISH TRANSLATION FOR THE FOREIGN WORDING "FENG SHUI" IS THE WAY OF WIND AND WATER.

SN 76-674,539, FILED 3-26-2007.

KIMBERLY PERRY, EXAMINING ATTORNEY

**Int. Cl.: 41**

**Prior U.S. Cls.: 100, 101, and 107**

**United States Patent and Trademark Office**

**Reg. No. 3,499,486**

**Registered Sep. 9, 2008**

**SERVICE MARK  
PRINCIPAL REGISTER**

**EVERYBODY NOSE**

NATURAL WELLNESS USA, INC. (DELAWARE  
CORPORATION)  
2301 E. LAMAR, SUITE 140  
ARLINGTON, TX 76006

FOR: ENTERTAINMENT IN THE NATURE OF A  
TELEVISION SERIES ABOUT EXPLORING ESSEN-  
TIAL OILS AND AROMATHERAPY AND FEATUR-  
ING INFORMATION ON THE PHYSICAL AND  
EMOTIONAL EFFECTS OF ESSENTIALS OILS  
AND AROMATHERAPY, IN CLASS 41 (U.S. CLS.  
100, 101 AND 107).

FIRST USE 7-1-2007; IN COMMERCE 8-7-2007.

THE MARK CONSISTS OF STANDARD CHAR-  
ACTERS WITHOUT CLAIM TO ANY PARTICULAR  
FONT, STYLE, SIZE, OR COLOR.

SN 76-674,540, FILED 3-26-2007.

KIMBERLY PERRY, EXAMINING ATTORNEY

**Int. Cl.: 41**

**Prior U.S. Cls.: 100, 101, and 107**

**United States Patent and Trademark Office**

**Reg. No. 3,499,487**

**Registered Sep. 9, 2008**

**SERVICE MARK  
PRINCIPAL REGISTER**

**YOGA FOR LIFE**

NATURAL WELLNESS USA, INC. (DELAWARE CORPORATION)  
2301 E. LAMAR, SUITE 140  
ARLINGTON, TX 76006

FOR: ENTERTAINMENT IN THE NATURE OF A TELEVISION SERIES FEATURING INFORMATION ABOUT YOGA, IN CLASS 41 (U.S. CLS. 100, 101 AND 107).

FIRST USE 7-1-2007; IN COMMERCE 8-7-2007.

THE MARK CONSISTS OF STANDARD CHARACTERS WITHOUT CLAIM TO ANY PARTICULAR FONT, STYLE, SIZE, OR COLOR.

NO CLAIM IS MADE TO THE EXCLUSIVE RIGHT TO USE "YOGA", APART FROM THE MARK AS SHOWN.

SN 76-674,541, FILED 3-26-2007.

KIMBERLY PERRY, EXAMINING ATTORNEY

**Int. Cl.: 41**

**Prior U.S. Cls.: 100, 101, and 107**

**United States Patent and Trademark Office**

**Reg. No. 3,499,488**

**Registered Sep. 9, 2008**

**SERVICE MARK  
PRINCIPAL REGISTER**

**PILATES: FROM THE INSIDE OUT**

NATURAL WELLNESS USA, INC. (DELAWARE CORPORATION)  
2301 E. LAMAR, SUITE 140  
ARLINGTON, TX 76006

FOR: ENTERTAINMENT IN THE NATURE OF A TELEVISION SERIES ABOUT PILATES, IN CLASS 41 (U.S. CLS. 100, 101 AND 107).

FIRST USE 7-1-2007; IN COMMERCE 8-7-2007.

THE MARK CONSISTS OF STANDARD CHARACTERS WITHOUT CLAIM TO ANY PARTICULAR FONT, STYLE, SIZE, OR COLOR.

NO CLAIM IS MADE TO THE EXCLUSIVE RIGHT TO USE "PILATES", APART FROM THE MARK AS SHOWN.

SN 76-674,542, FILED 3-26-2007.

KIMBERLY PERRY, EXAMINING ATTORNEY

**Int. Cl.: 35**

**Prior U.S. Cls.: 100, 101, and 102**

**United States Patent and Trademark Office**

**Reg. No. 3,499,489**

**Registered Sep. 9, 2008**

**SERVICE MARK  
PRINCIPAL REGISTER**

**FILL A BASKET**

BABASKET INC. (NEW JERSEY CORPORATION)  
519 ROUTE 46 EAST  
CLIFTON, NJ 07011

FOR: RETAIL STORE SERVICES FEATURING  
GIFTS AND ACCESSORIES IN THE NATURE OF  
GIFT WRAPPING AND GIFT PACKAGING AND  
GIFT BASKETS, IN CLASS 35 (U.S. CLS. 100, 101 AND  
102).

FIRST USE 6-13-2008; IN COMMERCE 6-13-2008.

THE MARK CONSISTS OF STANDARD CHAR-  
ACTERS WITHOUT CLAIM TO ANY PARTICULAR  
FONT, STYLE, SIZE, OR COLOR.

NO CLAIM IS MADE TO THE EXCLUSIVE  
RIGHT TO USE "BASKET", APART FROM THE  
MARK AS SHOWN.

SN 76-675,016, FILED 4-4-2007.

ANDREW RHIM, EXAMINING ATTORNEY



Int. Cl.: 40

Prior U.S. Cls.: 100, 103, and 106

United States Patent and Trademark Office

Reg. No. 3,499,490

Registered Sep. 9, 2008

SERVICE MARK  
PRINCIPAL REGISTER

***SAFESHRED***

SAFESHRED CO., INC. (CALIFORNIA CORPORATION)  
5928 SOUTH MALT AVENUE  
LOS ANGELES, CA 90040

FOR: DESTRUCTION OF DOCUMENTS, DATA STORAGE MEDIA, TRASH AND WASTE, WHETHER CONTAINING PERSONAL, BUSINESS, LEGAL, TECHNICAL, MEDICAL, FINANCIAL, CONFIDENTIAL, OR SECURITY INFORMATION; SHREDDING OF DOCUMENTS, DATA STORAGE MEDIA, AND RELATED TRASH AND WASTE; RECYCLING OF WASTE PAPER FOR PULPING; PAPER COLLECTION FOR RECYCLING, NAMELY,

THE COLLECTION OF WASTE PAPER FOR PULPING, IN CLASS 40 (U.S. CLS. 100, 103 AND 106).

FIRST USE 12-24-2006; IN COMMERCE 1-21-2008.

OWNER OF U.S. REG. NO. 3,248,014.

THE MARK CONSISTS OF THE LETTERS "SAFE" AND ITALICIZED "SHRED".

SN 76-675,634, FILED 4-16-2007.

COLLEEN DOMBROW, EXAMINING ATTORNEY

**Int. Cl.: 10**

**Prior U.S. Cls.: 26, 39, and 44**

**United States Patent and Trademark Office**

**Reg. No. 3,499,491**

**Registered Sep. 9, 2008**

**TRADEMARK  
PRINCIPAL REGISTER**

**SOUNDSTAR**

CORDIS CORPORATION (FLORIDA CORPORATION)  
14201 N.W. 60TH AVENUE  
MIAMI LAKES, FL 33014

THE MARK CONSISTS OF STANDARD CHARACTERS WITHOUT CLAIM TO ANY PARTICULAR FONT, STYLE, SIZE, OR COLOR.

FOR: ULTRASOUND CATHETERS, IN CLASS 10  
(U.S. CLS. 26, 39 AND 44).

SN 76-676,528, FILED 5-7-2007.

FIRST USE 10-16-2007; IN COMMERCE 10-16-2007.

JORDAN BAKER, EXAMINING ATTORNEY

**Int. Cl.: 36**

**Prior U.S. Cls.: 100, 101, and 102**

**United States Patent and Trademark Office**

**Reg. No. 3,499,492**

**Registered Sep. 9, 2008**

**SERVICE MARK  
PRINCIPAL REGISTER**

**GEORGIA'S OWN CREDIT UNION**

GEORGIA TELCO CREDIT UNION (GEORGIA CORPORATION)

1155 PEACHTREE STREET

ATLANTA, GA 30348

FOR: CREDIT UNION SERVICES, IN CLASS 36 (U.S. CLS. 100, 101 AND 102).

FIRST USE 9-10-2007; IN COMMERCE 9-10-2007.

THE MARK CONSISTS OF STANDARD CHARACTERS WITHOUT CLAIM TO ANY PARTICULAR FONT, STYLE, SIZE, OR COLOR.

NO CLAIM IS MADE TO THE EXCLUSIVE RIGHT TO USE "GEORGIA'S" AND "CREDIT UNION", APART FROM THE MARK AS SHOWN.

SN 76-676,698, FILED 5-11-2007.

GILBERT SWIFT, EXAMINING ATTORNEY

**Int. Cl.: 29**

**Prior U.S. Cl.: 46**

**United States Patent and Trademark Office**

**Reg. No. 3,499,493**

**Registered Sep. 9, 2008**

**TRADEMARK  
PRINCIPAL REGISTER**

**PREMIER CREATIONS**

NORTH STAR FOODS, INC. (MINNESOTA CORPORATION)  
1279 ST. CHARLES AVENUE  
P.O. BOX 587  
ST. CHARLES, MN 55972

FOR: FRESH, FROZEN, REFRIGERATED AND PROCESSED MEAT PRODUCTS, NAMELY, POULTRY, BEEF AND PORK, IN CLASS 29 (U.S. CL. 46).

FIRST USE 5-0-2007; IN COMMERCE 5-0-2007.

THE MARK CONSISTS OF STANDARD CHARACTERS WITHOUT CLAIM TO ANY PARTICULAR FONT, STYLE, SIZE, OR COLOR.

NO CLAIM IS MADE TO THE EXCLUSIVE RIGHT TO USE "PREMIER", APART FROM THE MARK AS SHOWN.

SN 76-677,763, FILED 6-4-2007.

AMY HELLA, EXAMINING ATTORNEY

**Int. Cl.: 20**

**Prior U.S. Cls.: 2, 13, 22, 25, 32, and 50**

**United States Patent and Trademark Office**

**Reg. No. 3,499,494**

**Registered Sep. 9, 2008**

**TRADEMARK  
PRINCIPAL REGISTER**



AWI LICENSING COMPANY (DELAWARE COR-  
PORATION)  
802 WEST STREET  
WILMINGTON, DE 19801

FIRST USE 11-0-2007; IN COMMERCE 11-0-2007.

SN 76-678,616, FILED 6-22-2007.

FOR: KITCHEN CABINETS, IN CLASS 20 (U.S.  
CLS. 2, 13, 22, 25, 32 AND 50).

IRA J. GOODSaid, EXAMINING ATTORNEY

**Int. Cl.: 20**

**Prior U.S. Cls.: 2, 13, 22, 25, 32, and 50**

**Reg. No. 3,499,495**

**United States Patent and Trademark Office**

**Registered Sep. 9, 2008**

---

**TRADEMARK  
PRINCIPAL REGISTER**

**KIDZONE**

AWI LICENSING COMPANY (DELAWARE COR-  
PORATION)  
802 WEST STREET  
WILMINGTON, DE 19801

THE MARK CONSISTS OF STANDARD CHAR-  
ACTERS WITHOUT CLAIM TO ANY PARTICULAR  
FONT, STYLE, SIZE, OR COLOR.

FOR: KITCHEN CABINETS, IN CLASS 20 (U.S.  
CLS. 2, 13, 22, 25, 32 AND 50).

SN 76-678,619, FILED 6-22-2007.

FIRST USE 11-0-2007; IN COMMERCE 11-0-2007.

IRA J. GOODSID, EXAMINING ATTORNEY

**Int. Cl.: 20**

**Prior U.S. Cls.: 2, 13, 22, 25, 32, and 50**

**United States Patent and Trademark Office**

**Reg. No. 3,499,496**

**Registered Sep. 9, 2008**

**TRADEMARK  
PRINCIPAL REGISTER**



AWI LICENSING COMPANY (DELAWARE COR-  
PORATION)  
802 WEST STREET  
WILMINGTON, DE 19801

FIRST USE 8-0-2007; IN COMMERCE 8-0-2007.

SN 76-678,621, FILED 6-22-2007.

FOR: KITCHEN CABINETS, IN CLASS 20 (U.S.  
CLS. 2, 13, 22, 25, 32 AND 50).

IRA J. GOODSaid, EXAMINING ATTORNEY

**Int. Cl.: 28**

**Prior U.S. Cls.: 22, 23, 38, and 50**

**United States Patent and Trademark Office**

**Reg. No. 3,499,497**

**Registered Sep. 9, 2008**

**TRADEMARK  
PRINCIPAL REGISTER**

**BOTTLE SHOT**

HASBRO, INC. (RHODE ISLAND CORPORATION)

1027 NEWPORT AVENUE

PAWTUCKET, RI 02862

FOR: WATER SQUIRTING TOYS, IN CLASS 28  
(U.S. CLS. 22, 23, 38 AND 50).

FIRST USE 4-4-2008; IN COMMERCE 4-4-2008.

THE MARK CONSISTS OF STANDARD CHARACTERS WITHOUT CLAIM TO ANY PARTICULAR FONT, STYLE, SIZE, OR COLOR.

NO CLAIM IS MADE TO THE EXCLUSIVE RIGHT TO USE "BOTTLE", APART FROM THE MARK AS SHOWN.

SN 76-679,932, FILED 7-25-2007.

JULIE GUTTADAURO, EXAMINING ATTORNEY



**Int. Cl.: 25**

**Prior U.S. Cls.: 22 and 39**

**United States Patent and Trademark Office**

**Reg. No. 3,499,498**

**Registered Sep. 9, 2008**

**TRADEMARK  
PRINCIPAL REGISTER**

**TREASURE ROCK**

CHAZOOT, URIEL (UNITED STATES INDIVIDUAL)  
1300 SOUTH SAN PEDRO STREET, UNIT 101  
LOS ANGELES, CA 90015

FOR: MEN'S AND BOY'S WEARING APPAREL, NAMELY, T-SHIRTS, SWEATSHIRTS, TANK TOPS, WOVEN SHIRTS, SWEATERS, CARDIGANS, VESTS, JACKETS, PANTS, SWEATPANTS, JEANS, SHORTS, HATS, CAPS, COATS, SCARVES, NECKERCHIEFS, NECK BANDS, WRIST BANDS, HEAD BANDS, GLOVES, BELTS WORN WITH CLOTHING, PAJAMAS, SHOES, SOCKS, UNDERWEAR, SWIM WEAR, AND TRUNKS; AND WOMEN'S AND GIRL'S WEARING APPAREL, NAMELY, T-SHIRTS, SWEATSHIRTS, TANK TOPS, WOVEN SHIRTS, SWEATERS, CARDIGANS, VESTS, JACKETS, PANTS, SWEATPANTS, JEANS, SHORTS, HATS,

CAPS, COATS, BELTS WORN WITH CLOTHING, SCARVES, NECKERCHIEFS, NECK BANDS, WRIST BANDS, HEAD BANDS, GLOVES, PAJAMAS, SHOES, SOCKS, UNDERWEAR, FOUNDATION GARMENTS, PANTYHOSE, TEDDIES, BRAS, SKIRTS, DRESSES, BLOUSES, SWIM WEAR, AND BIKINIS, IN CLASS 25 (U.S. CLS. 22 AND 39).

FIRST USE 1-8-2008; IN COMMERCE 1-8-2008.

THE MARK CONSISTS OF STANDARD CHARACTERS WITHOUT CLAIM TO ANY PARTICULAR FONT, STYLE, SIZE, OR COLOR.

SN 76-680,140, FILED 8-1-2007.

EDWARD NELSON, EXAMINING ATTORNEY

**Int. Cl.: 33**

**Prior U.S. Cls.: 47 and 49**

**United States Patent and Trademark Office**

**Reg. No. 3,499,499**

**Registered Sep. 9, 2008**

**TRADEMARK  
PRINCIPAL REGISTER**

**STONY LONESOME WINE CELLARS**

THREE BROTHERS WINERY & ESTATES LLC  
(NEW YORK LIMITED LIABILITY COMPAN-  
NY)

45 BOUGHTON HILL ROAD

HONEOYE FALLS, NY 14472

FOR: WINES, IN CLASS 33 (U.S. CLS. 47 AND 49).

FIRST USE 8-31-2007; IN COMMERCE 3-10-2008.

THE MARK CONSISTS OF STANDARD CHAR-  
ACTERS WITHOUT CLAIM TO ANY PARTICULAR  
FONT, STYLE, SIZE, OR COLOR.

NO CLAIM IS MADE TO THE EXCLUSIVE  
RIGHT TO USE "WINE CELLARS", APART FROM  
THE MARK AS SHOWN.

SN 76-681,083, FILED 8-24-2007.

CARYN GLASSER, EXAMINING ATTORNEY

**Int. Cl.: 9**

**Prior U.S. Cls.: 21, 23, 26, 36, and 38**

**Reg. No. 3,499,500**

**United States Patent and Trademark Office**

**Registered Sep. 9, 2008**

**TRADEMARK  
PRINCIPAL REGISTER**

**SIMUCAN**

EEPOD LLC (MICHIGAN LIMITED LIABILITY  
COMPANY)  
8609 PARSHALLVILLE ROAD  
FENTON, MI 48430

THE MARK CONSISTS OF STANDARD CHAR-  
ACTERS WITHOUT CLAIM TO ANY PARTICULAR  
FONT, STYLE, SIZE, OR COLOR.

FOR: COMPUTER SOFTWARE THAT SIMU-  
LATES THE NETWORK MESSAGES ON A CON-  
TROLLER AREA NETWORK (CAN), IN CLASS 9  
(U.S. CLS. 21, 23, 26, 36 AND 38).

SN 76-683,395, FILED 10-29-2007.

FIRST USE 11-15-2007; IN COMMERCE 12-16-2007.

MARGARET POWER, EXAMINING ATTORNEY

**Int. Cl.: 29**

**Prior U.S. Cl.: 46**

**United States Patent and Trademark Office**

**Reg. No. 3,499,501**

**Registered Sep. 9, 2008**

**TRADEMARK  
PRINCIPAL REGISTER**

**MAKING TIME FLY**

ARLINGTON SERVICES, INC. (DELAWARE  
CORPORATION)  
300 DELAWARE AVENUE  
WILMINGTON, DE 19801

THE MARK CONSISTS OF STANDARD CHAR-  
ACTERS WITHOUT CLAIM TO ANY PARTICULAR  
FONT, STYLE, SIZE, OR COLOR.

FOR: READY PREPARED PREPACKAGED  
MEALS CONSISTING PRIMARILY OF MEAT, FISH,  
POULTRY OR VEGETABLES, IN CLASS 29 (U.S. CL.  
46).

SN 76-978,853, FILED 12-5-2005.

FIRST USE 10-30-2007; IN COMMERCE 10-30-2007.

ANGELA M. MICHELI, EXAMINING ATTORNEY

**Int. Cls.: 35 and 41**

**Prior U.S. Cls.: 100, 101, 102, and 107**

**United States Patent and Trademark Office**

**Reg. No. 3,499,502**

**Registered Sep. 9, 2008**

**SERVICE MARK  
PRINCIPAL REGISTER**

**Marty Wilson, Jr. Art &  
Music Foundation**

WILSON, KATHRYN (UNITED STATES INDIVIDUAL)

514 N. DORSET AVENUE  
VENTNOR, NJ 08401 AND

GRANIERI, MEREDITH (UNITED STATES INDIVIDUAL)

514 N. DORSET AVENUE  
VENTNOR, NJ 08401 AND

WILSON, MARTIN L. (UNITED STATES INDIVIDUAL)

7 LEWIS DRIVE

MAPLEWOOD, NJ 07040 AND

FRIEDRICH, KATHRYN (UNITED STATES INDIVIDUAL)

209 ASHLAND ROAD

SUMMIT, NJ 07901

FOR: ADVERTISING THROUGH ALL PUBLIC COMMUNICATION MEANS, IN CLASS 35 (U.S. CLS. 100, 101 AND 102).

FIRST USE 9-1-2007; IN COMMERCE 9-1-2007.

FOR: EDUCATIONAL SERVICES, NAMELY, PROVIDING CLASSES, SEMINARS, AND WORKSHOPS IN THE FIELDS OF ART AND MUSIC AT PUBLIC AND PRIVATE SCHOOLS, IN CLASS 41 (U.S. CLS. 100, 101 AND 107).

FIRST USE 9-16-2007; IN COMMERCE 9-16-2007.

THE MARK CONSISTS OF STANDARD CHARACTERS WITHOUT CLAIM TO ANY PARTICULAR FONT, STYLE, SIZE, OR COLOR.

NO CLAIM IS MADE TO THE EXCLUSIVE RIGHT TO USE "ART & MUSIC FOUNDATION", APART FROM THE MARK AS SHOWN.

THE NAME "MARTY WILSON, JR." IN THE MARK DOES NOT IDENTIFY A LIVING INDIVIDUAL.

SN 77-000,161, FILED 9-15-2006.

RICHARD A. STRASER, EXAMINING ATTORNEY

**Int. Cl.: 41**

**Prior U.S. Cls.: 100, 101, and 107**

**United States Patent and Trademark Office**

**Reg. No. 3,499,503**

**Registered Sep. 9, 2008**

**SERVICE MARK  
PRINCIPAL REGISTER**

**ARS NOVA**

ARS NOVA PGM, LLC (NEW YORK LIMITED  
LIABILITY COMPANY)  
511 WEST 54TH STREET  
NEW YORK, NY 10019

OWNER OF U.S. REG. NO. 3,125,824.

FOR: NIGHT CLUB SERVICES, IN CLASS 41 (U.S.  
CLS. 100, 101 AND 107).

THE FOREIGN WORDING IN THE MARK  
TRANSLATES INTO ENGLISH AS NEW ART.

FIRST USE 6-1-2007; IN COMMERCE 6-1-2007.

SN 77-000,610, FILED 9-15-2006.

THE MARK CONSISTS OF STANDARD CHAR-  
ACTERS WITHOUT CLAIM TO ANY PARTICULAR  
FONT, STYLE, SIZE, OR COLOR.

MIDGE BUTLER, EXAMINING ATTORNEY

**Int. Cl.: 38**

**Prior U.S. Cls.: 100, 101, and 104**

**United States Patent and Trademark Office**

**Reg. No. 3,499,504**

**Registered Sep. 9, 2008**

**SERVICE MARK  
PRINCIPAL REGISTER**

**1CAST**

EAGLE RIVER HOLDINGS, LLC (WASHINGTON  
LIMITED LIABILITY COMPANY)  
2300 CARILLON POINT  
KIRKLAND, WA 98033

THE MARK CONSISTS OF STANDARD CHAR-  
ACTERS WITHOUT CLAIM TO ANY PARTICULAR  
FONT, STYLE, SIZE, OR COLOR.

FOR: ELECTRONIC TRANSMISSION OF VIDEO  
MESSAGES AND IMAGES OVER THE INTERNET,  
IN CLASS 38 (U.S. CLS. 100, 101 AND 104).

SN 77-001,675, FILED 9-18-2006.

FIRST USE 4-15-2008; IN COMMERCE 5-26-2008.

CHARISMA HAMPTON, EXAMINING ATTORNEY

**Int. Cl.: 42**

**Prior U.S. Cls.: 100 and 101**

**United States Patent and Trademark Office**

**Reg. No. 3,499,505**

**Registered Sep. 9, 2008**

**SERVICE MARK  
PRINCIPAL REGISTER**



SECOND LICENSE APPLICATION CORPORA-  
TION (DELAWARE CORPORATION)  
2200 W. AIRFIELD DRIVE  
D/FW AIRPORT, TX 75261

FOR: WEBSITE DESIGN; WEBSITE DESIGN,  
NAMELY, DEVELOPING ONLINE STORES FOR  
OTHERS; WEB HOSTING SERVICES; REGISTRA-  
TION OF DOMAIN NAMES; AND PROVIDING  
SEARCH ENGINES FOR OBTAINING DATA ON

THE INTERNET, IN CLASS 42 (U.S. CLS. 100 AND  
101).

FIRST USE 11-0-2006; IN COMMERCE 11-0-2006.

SN 77-002,188, FILED 9-19-2006.

SAIMA MAKHDOOM, EXAMINING ATTORNEY



**Int. Cl.: 28**

**Prior U.S. Cls.: 22, 23, 38, and 50**

**United States Patent and Trademark Office**

**Reg. No. 3,499,506**

**Registered Sep. 9, 2008**

**TRADEMARK  
PRINCIPAL REGISTER**

**CORE DRIVE**

TRUE FITNESS TECHNOLOGY, INC. (MISSOURI  
CORPORATION)  
865 HOFF ROAD  
O'FALLON, MO 63366

THE MARK CONSISTS OF STANDARD CHAR-  
ACTERS WITHOUT CLAIM TO ANY PARTICULAR  
FONT, STYLE, SIZE, OR COLOR.

FOR: EXERCISE EQUIPMENT COMPONENT  
SOLD AS PART OF THE FINAL PRODUCT IN THE  
NATURE OF A CRANK, IN CLASS 28 (U.S. CLS. 22,  
23, 38 AND 50).

SN 77-003,015, FILED 9-20-2006.

FIRST USE 11-0-2006; IN COMMERCE 11-0-2006.

SUE LAWRENCE, EXAMINING ATTORNEY

**Int. Cl.: 25**

**Prior U.S. Cls.: 22 and 39**

**United States Patent and Trademark Office**

**Reg. No. 3,499,507**

**Registered Sep. 9, 2008**

**TRADEMARK  
PRINCIPAL REGISTER**

SHH... TELL ALL YOUR FRIENDS!

SAVVY ENTERPRISE, LLC (COLORADO LIMITED LIABILITY COMPANY)  
SUITE J301  
3121 S. TAMARAC  
DENVER, CO 80231

FOR: INTIMATE APPAREL AND FIGURE ENHANCING GARMENTS, NAMELY, LINGERIE, BRAS, UNDERWEAR, UNDERGARMENTS, AND UNDERCLOTHING, IN CLASS 25 (U.S. CLS. 22 AND 39).

FIRST USE 7-23-2008; IN COMMERCE 7-23-2008.

THE MARK CONSISTS OF STANDARD CHARACTERS WITHOUT CLAIM TO ANY PARTICULAR FONT, STYLE, SIZE, OR COLOR.

SN 77-003,361, FILED 9-20-2006.

IRA J. GOODSaid, EXAMINING ATTORNEY

**Int. Cl.: 36**

**Prior U.S. Cls.: 100, 101, and 102**

**United States Patent and Trademark Office**

**Reg. No. 3,499,508**

**Registered Sep. 9, 2008**

**SERVICE MARK  
PRINCIPAL REGISTER**

**COMMUNITY DIVIDENDS**

MONTECITO BANK & TRUST (CALIFORNIA  
CORPORATION)  
P.O. BOX 2460  
SANTA BARBARA, CA 93120

FOR: BANKING SERVICES, NAMELY, PROVID-  
ING CHECKING AND SAVINGS ACCOUNT SER-  
VICES; PHILANTHROPIC SERVICES  
CONCERNING MONETARY DONATIONS, IN  
CLASS 36 (U.S. CLS. 100, 101 AND 102).

FIRST USE 11-22-2007; IN COMMERCE 11-22-2007.

THE MARK CONSISTS OF STANDARD CHAR-  
ACTERS WITHOUT CLAIM TO ANY PARTICULAR  
FONT, STYLE, SIZE, OR COLOR.

SN 77-004,347, FILED 9-21-2006.

WILLIAM P. SHANAHAN, EXAMINING ATTOR-  
NEY

**Int. Cl.: 28**

**Prior U.S. Cls.: 22, 23, 38, and 50**

**United States Patent and Trademark Office**

**Reg. No. 3,499,509**

**Registered Sep. 9, 2008**

**TRADEMARK  
PRINCIPAL REGISTER**

**FRESH CUT**

ATP LEISURE, LLC (DELAWARE LIMITED LIABILITY COMPANY)  
1120 WEST 130TH  
BRUNSWICK, OH 44212

THE MARK CONSISTS OF STANDARD CHARACTERS WITHOUT CLAIM TO ANY PARTICULAR FONT, STYLE, SIZE, OR COLOR.

FOR: ARTIFICIAL CHRISTMAS TREES, IN CLASS 28 (U.S. CLS. 22, 23, 38 AND 50).

SN 77-004,452, FILED 9-21-2006.

FIRST USE 5-31-2008; IN COMMERCE 5-31-2008.

BENJAMIN OKEKE, EXAMINING ATTORNEY

**Int. Cls.: 35 and 42**

**Prior U.S. Cls.: 100, 101, and 102**

**United States Patent and Trademark Office**

**Reg. No. 3,499,510**

**Registered Sep. 9, 2008**

**SERVICE MARK  
PRINCIPAL REGISTER**

**BE&P**

BARKLEY EVERGREEN & PARTNERS, INC.  
(MISSOURI CORPORATION)  
1740 MAIN  
KANSAS CITY, MO 64108

FOR: ADVERTISING AGENCY SERVICES; ADVERTISING AND MARKETING SERVICES; PROMOTING THE GOODS AND SERVICES OF OTHERS THROUGH ALL PUBLIC COMMUNICATION MEANS; PUBLIC RELATIONS SERVICES; BUSINESS PLANNING AND ADVERTISING SERVICES FOR DEVELOPING BRAND IDENTIFIERS, COMPANY LITERATURE, SALES PROMOTION MATERIALS, POINT OF PURCHASE DISPLAYS, PRODUCT PACKAGING, SIGNAGE, CATALOGS, RETAIL AND CORPORATE ENVIRONMENTAL MATERIALS AND MOTION GRAPHICS FOR OTHERS; BUSINESS MARKETING SERVICES THROUGH PRINT, AUDIO, VIDEO, DIGITAL AND ON-LINE MEDIUM; BUSINESS MARKETING CONSULTING SERVICES; AND CONDUCTING MARKETING PROMOTIONAL EVENTS FOR OTHERS, MARKETING SERVICES FOR OTHERS, NAMELY, PROVIDING INFORMATIONAL WEB

PAGES DESIGNED TO GENERATE SALES TRAFFIC VIA HYPERLINKS TO OTHER WEBSITE, IN CLASS 35 (U.S. CLS. 100, 101 AND 102).

FIRST USE 8-21-2002; IN COMMERCE 8-21-2002.

FOR: DESIGNING BRAND IDENTIFIERS, COMPANY LITERATURE, SALES PROMOTION MATERIALS, POINT OF PURCHASE DISPLAYS, PRODUCT PACKAGING, SIGNAGE, CATALOGS, RETAIL AND CORPORATE ENVIRONMENTAL MATERIALS AND MOTION GRAPHICS FOR OTHERS, IN CLASS 42 (U.S. CLS. 100 AND 101).

FIRST USE 8-21-2002; IN COMMERCE 8-21-2002.

THE MARK CONSISTS OF STANDARD CHARACTERS WITHOUT CLAIM TO ANY PARTICULAR FONT, STYLE, SIZE, OR COLOR.

SN 77-005,495, FILED 9-22-2006.

DAVID MURRAY, EXAMINING ATTORNEY

**Int. Cl.: 35**

**Prior U.S. Cls.: 100, 101, and 102**

**United States Patent and Trademark Office**

**Reg. No. 3,499,511**

**Registered Sep. 9, 2008**

**SERVICE MARK  
PRINCIPAL REGISTER**

**APRÈS PEAU**

ALSTER, TINA S. (UNITED STATES INDIVIDUAL)

2311 M STREET, NW, SUITE 200

WASHINGTON, DC 20037

FOR: RETAIL BOUTIQUE FEATURING HIGH-END FASHION CLOTHING AND ACCESSORIES, GIFT AND NOVELTY ITEMS, DISHWARE AND SKIN CARE PRODUCTS, IN CLASS 35 (U.S. CLS. 100, 101 AND 102).

FIRST USE 2-0-2007; IN COMMERCE 2-0-2007.

THE MARK CONSISTS OF STANDARD CHARACTERS WITHOUT CLAIM TO ANY PARTICULAR FONT, STYLE, SIZE, OR COLOR.

NO CLAIM IS MADE TO THE EXCLUSIVE RIGHT TO USE "PEAU", APART FROM THE MARK AS SHOWN.

THE FOREIGN WORDING IN THE MARK TRANSLATES INTO ENGLISH AS AFTER SKIN.

SN 77-006,831, FILED 9-25-2006.

MICHAEL WEBSTER, EXAMINING ATTORNEY

**Int. Cl.: 36**

**Prior U.S. Cls.: 100, 101, and 102**

**United States Patent and Trademark Office**

**Reg. No. 3,499,512**

**Registered Sep. 9, 2008**

**SERVICE MARK  
PRINCIPAL REGISTER**

**THE COMMERCIAL PROTECTOR  
SERIES**

LIBERTY MUTUAL INSURANCE COMPANY  
(MASSACHUSETTS CORPORATION)  
175 BERKELEY STREET  
BOSTON, MA 02117

FOR: INSURANCE SERVICES, NAMELY, INSURANCE UNDERWRITING AND ADMINISTRATION OF INSURANCE IN THE FIELDS OF ACCIDENT, LIABILITY, PROPERTY AND CASUALTY, FIRE AND OTHER PROPERTY, GENERAL LIABILITY, WORKMEN'S COMPENSATION, AUTOMOBILE, AIRCRAFT, DISABILITY, FIDELITY, SURETY, BURGLARY, FORGERY, WATER DAMAGE, MARINE AND OCEAN MARINE; PROPERTY AND CASUALTY LOSS MANAGEMENT SERVICES; INSURANCE INFORMATION, MANAGEMENT, AND CONSULTANCY SERVICES; AND PROVISION OF THE ABOVE-LISTED INSURANCE SERVICES ON-LINE FROM A COMPUTER DATABASE OR VIA

THE INTERNET, IN CLASS 36 (U.S. CLS. 100, 101 AND 102).

FIRST USE 2-27-2007; IN COMMERCE 2-27-2007.

THE MARK CONSISTS OF STANDARD CHARACTERS WITHOUT CLAIM TO ANY PARTICULAR FONT, STYLE, SIZE, OR COLOR.

OWNER OF U.S. REG. NO. 1,506,319.

NO CLAIM IS MADE TO THE EXCLUSIVE RIGHT TO USE "COMMERCIAL" AND "SERIES", APART FROM THE MARK AS SHOWN.

SN 77-007,763, FILED 9-26-2006.

ALICE SUE CARRUTHERS, EXAMINING ATTORNEY

**Int. Cl.: 20**

**Prior U.S. Cls.: 2, 13, 22, 25, 32, and 50**

**United States Patent and Trademark Office**

**Reg. No. 3,499,513**

**Registered Sep. 9, 2008**

**TRADEMARK  
PRINCIPAL REGISTER**

**FRĀME-OLGYXPRES**

THE ENCORE GROUP, INC. (CALIFORNIA COR-  
PORATION)  
P.O. BOX 500780  
SAN DIEGO, CA 921500780

THE MARK CONSISTS OF STANDARD CHAR-  
ACTERS WITHOUT CLAIM TO ANY PARTICULAR  
FONT, STYLE, SIZE, OR COLOR.

FOR: PICTURE FRAMES, IN CLASS 20 (U.S. CLS.  
2, 13, 22, 25, 32 AND 50).

SN 77-007,983, FILED 9-26-2006.

FIRST USE 1-1-2007; IN COMMERCE 1-1-2007.

RENEE MCCRAY, EXAMINING ATTORNEY



**Int. Cl.: 9**

**Prior U.S. Cls.: 21, 23, 26, 36, and 38**

**Reg. No. 3,499,514**

**United States Patent and Trademark Office**

**Registered Sep. 9, 2008**

**TRADEMARK  
PRINCIPAL REGISTER**

**TRANS-GUARD**

THOMAS & BETTS INTERNATIONAL, INC. (DE-  
LAWARE CORPORATION)  
501 SILVERSIDE ROAD, SUITE 67  
WILMINGTON, DE 19809

THE MARK CONSISTS OF STANDARD CHAR-  
ACTERS WITHOUT CLAIM TO ANY PARTICULAR  
FONT, STYLE, SIZE, OR COLOR.

FOR: HI-VOLTAGE ELECTRICAL FUSES FOR  
DISTRIBUTION AND TRANSMISSION ELECTRI-  
CAL NETWORKS, IN CLASS 9 (U.S. CLS. 21, 23, 26, 36  
AND 38).

SN 77-008,514, FILED 9-27-2006.

FIRST USE 12-31-1984; IN COMMERCE 12-31-1984.

GINA HAYES, EXAMINING ATTORNEY

Int. Cl.: 38

Prior U.S. Cls.: 100, 101, and 104

United States Patent and Trademark Office

Reg. No. 3,499,515

Registered Sep. 9, 2008

SERVICE MARK  
PRINCIPAL REGISTER



SHANGHAI TIANYU MEDIA CO., LTD. (CHINA CORPORATION)  
ROOM 605, NO. 128 WEIHAI ROAD  
HUANGPU DISTRICT  
SHANGHAI, CHINA

FOR: CABLE TELEVISION BROADCASTING; TELEVISION BROADCASTING; ELECTRONIC MESSAGE SENDING; PROVIDING ON-LINE CHAT ROOMS AND ELECTRONIC BULLETIN BOARDS FOR TRANSMISSION OF MESSAGES AMONG USERS IN THE FIELD OF GENERAL INTEREST; PROVIDING TELECOMMUNICATIONS CONNECTIONS TO A GLOBAL COMPUTER NETWORK; RADIO BROADCASTING INFORMATION; TELEVISION BROADCASTING INFORMATION; COMMUNICATIONS VIA FIBRE-OPTIC NETWORKS;

SATELLITE TRANSMISSION SERVICES; VIDEO TELECONFERENCING; AUDIO TELECONFERENCING, IN CLASS 38 (U.S. CLS. 100, 101 AND 104).

FIRST USE 4-1-2004; IN COMMERCE 4-28-2005.

THE ENGLISH TRANSLATION OF CHAO; JI; NU; SHENG IS SUPERIOR; RANK; WOMEN; REPUTATION.

THE NON-LATIN CHARACTERS IN THE MARK TRANSLITERATE TO CHAO; JI; NU; SHENG.

SN 77-009,128, FILED 9-27-2006.

JENNIFER MARTIN, EXAMINING ATTORNEY

**Int. Cl.: 18**

**Prior U.S. Cls.: 1, 2, 3, 22, and 41**

**United States Patent and Trademark Office**

**Reg. No. 3,499,516**

**Registered Sep. 9, 2008**

**TRADEMARK  
PRINCIPAL REGISTER**

**TOSCANI**

SAMSONITE CORPORATION (DELAWARE CORPORATION)  
575 WEST STREET, SUITE 110  
MANSFIELD, MA 02048

FOR: LUGGAGE, IN CLASS 18 (U.S. CLS. 1, 2, 3, 22 AND 41).

FIRST USE 11-1-2006; IN COMMERCE 11-1-2006.

THE MARK CONSISTS OF STANDARD CHARACTERS WITHOUT CLAIM TO ANY PARTICULAR FONT, STYLE, SIZE, OR COLOR.

OWNER OF U.S. REG. NO. 2,681,916.

THE ENGLISH TRANSLATION OF "TOSCANI" IS "TUSCANY."

SN 77-010,424, FILED 9-29-2006.

ELLEN PERKINS, EXAMINING ATTORNEY

**Int. Cl.: 1**

**Prior U.S. Cls.: 1, 5, 6, 10, 26, and 46**

**Reg. No. 3,499,517**

**United States Patent and Trademark Office**

**Registered Sep. 9, 2008**

**TRADEMARK  
PRINCIPAL REGISTER**



BIOLIFE SOLUTIONS, INC. (DELAWARE CORPORATION)  
3303 MONTE VILLA PARKWAY, SUITE 310  
BOTHELL, WA 98021

FOR: CHEMICAL PREPARATIONS FOR SCIENTIFIC PURPOSES, NAMELY, HYPOTHERMIC STORAGE AND CRYOPRESERVATION SOLUTIONS FOR USE WITH CELLS AND TISSUE IN LOW TEMPERATURE ENVIRONMENTS IN ACADEMIC AND CLINICAL RESEARCH, IN CLASS 1 (U.S. CLS. 1, 5, 6, 10, 26 AND 46).

FIRST USE 3-10-2008; IN COMMERCE 3-10-2008.

THE MARK CONSISTS OF THREE CIRCLES LINKED IN THE VERTICAL DIRECTION, WHERE THE CENTER CIRCLE IS A COMPLETE CIRCLE, AND THE OUTER CIRCLES ARE INCOMPLETE CIRCLES.

SN 77-011,434, FILED 10-2-2006.

DAVID HOFFMAN, EXAMINING ATTORNEY

Int. Cl.: 41

Prior U.S. Cls.: 100, 101, and 107

United States Patent and Trademark Office

Reg. No. 3,499,518

Registered Sep. 9, 2008

SERVICE MARK  
PRINCIPAL REGISTER



THE UNIVERSITY OF AKRON (OHIO STATE  
UNIVERSITY)  
302 E. BUCHEL COMMON  
AKRON, OH 44325

FOR: EDUCATIONAL SERVICES, NAMELY,  
CONDUCTING COLLEGE AND GRADUATE LE-  
VEL COURSES; AND ENTERTAINMENT SERVI-  
CES, NAMELY, THE PRESENTATION OF LIVE  
ATHLETIC EVENTS AND SPORTS CONTESTS AT  
THE COLLEGE LEVEL AND CULTURAL EVENTS,  
IN CLASS 41 (U.S. CLS. 100, 101 AND 107).

FIRST USE 8-1-2002; IN COMMERCE 8-1-2002.

OWNER OF U.S. REG. NOS. 2,768,792, 2,821,597,  
AND OTHERS.

NO CLAIM IS MADE TO THE EXCLUSIVE  
RIGHT TO USE "UNIVERSITY", APART FROM  
THE MARK AS SHOWN.

THE MARK CONSISTS OF THE WORDS "THE  
UNIVERSITY OF AKRON" IN STYLIZED LETTER-  
ING WITH A DESIGN BELOW THESE WORDS.

SEC. 2(F).

SN 77-011,559, FILED 10-2-2006.

RONALD DELGIZZI, EXAMINING ATTORNEY

**Int. Cls.: 9 and 37**

**Prior U.S. Cls.: 21, 23, 26, 36, 38, 100, 103, and 106**

**United States Patent and Trademark Office**

**Reg. No. 3,499,519**

**Registered Sep. 9, 2008**

**TRADEMARK  
SERVICE MARK  
PRINCIPAL REGISTER**

**THE PURSUIT ENDS HERE**

STAR CHASE, LLC (VIRGINIA LIMITED LIABILITY COMPANY)

1900 WOODSIDE LANE

VIRGINIA BEACH, VA 23454

FOR: ELECTRONIC TAGGING AND TRACKING DEVICE, NAMELY, A DEVICE FOR ADHERING TO A VEHICLE WHICH DETERMINES AND TRANSMITS THE VEHICLE'S LOCATION VIA SATELLITE, IN CLASS 9 (U.S. CLS. 21, 23, 26, 36 AND 38).

FIRST USE 12-2-2005; IN COMMERCE 6-30-2007.

FOR: INSTALLATION AND MAINTENANCE OF AN ELECTRONIC TAGGING AND TRACKING DEVICE, IN CLASS 37 (U.S. CLS. 100, 103 AND 106).

FIRST USE 12-2-2005; IN COMMERCE 6-30-2007.

THE MARK CONSISTS OF STANDARD CHARACTERS WITHOUT CLAIM TO ANY PARTICULAR FONT, STYLE, SIZE, OR COLOR.

SN 77-012,117, FILED 10-2-2006.

JANICE L. MCMORROW, EXAMINING ATTORNEY

**Int. Cl.: 6**

**Prior U.S. Cls.: 2, 12, 13, 14, 23, 25, and 50**

**Reg. No. 3,499,520**

**United States Patent and Trademark Office**

**Registered Sep. 9, 2008**

**TRADEMARK  
PRINCIPAL REGISTER**

**SURE-GUARD**

DAYTON SUPERIOR CORPORATION (DELA-  
WARE CORPORATION)  
7777 WASHINGTON VILLAGE DRIVE  
SUITE 130  
DAYTON, OH 45459

FOR: METAL POSTS; METAL GUARD RAILS;  
AND METAL SAFETY POST SYSTEMS COMPRIS-  
ING METAL POSTS, METAL GUARD RAILS AND  
BRACKETS, IN CLASS 6 (U.S. CLS. 2, 12, 13, 14, 23, 25  
AND 50).

FIRST USE 12-0-2005; IN COMMERCE 12-0-2005.

THE MARK CONSISTS OF STANDARD CHAR-  
ACTERS WITHOUT CLAIM TO ANY PARTICULAR  
FONT, STYLE, SIZE, OR COLOR.

NO CLAIM IS MADE TO THE EXCLUSIVE  
RIGHT TO USE "GUARD", APART FROM THE  
MARK AS SHOWN.

SN 77-012,699, FILED 10-3-2006.

CAROL SPILS, EXAMINING ATTORNEY

**Int. Cl.: 1**

**Prior U.S. Cls.: 1, 5, 6, 10, 26, and 46**

**Reg. No. 3,499,521**

**United States Patent and Trademark Office**

**Registered Sep. 9, 2008**

**TRADEMARK  
PRINCIPAL REGISTER**

**FULTONTEC**

SICHUAN FULTONTEC CO., LTD. (CHINA CORPORATION)  
SUITE 401, JIUYUAN OFFICE BLD.  
97 EAST MIANXING ST., HIGH-TECH PARK  
MIANYANG 621000, CHINA

FOR: CHEMICAL ADDITIVES FOR USE IN THE  
MANUFACTURE OF CERAMIC FRACTURING  
PROPPANT USED FOR DOWN HOLE DRILLING ,  
IN CLASS 1 (U.S. CLS. 1, 5, 6, 10, 26 AND 46).

FIRST USE 8-10-2004; IN COMMERCE 3-21-2006.

THE MARK CONSISTS OF STANDARD CHARACTERS WITHOUT CLAIM TO ANY PARTICULAR FONT, STYLE, SIZE, OR COLOR.

SN 77-012,779, FILED 10-3-2006.

TEJBIR SINGH, EXAMINING ATTORNEY



**Int. Cl.: 7**

**Prior U.S. Cls.: 13, 19, 21, 23, 31, 34, and 35**

**Reg. No. 3,499,522**

**United States Patent and Trademark Office**

**Registered Sep. 9, 2008**

**TRADEMARK  
PRINCIPAL REGISTER**

**SWINGING-DRAGON**

ELLICOTT DREDGES, LLC (MARYLAND LIMITED LIABILITY COMPANY)  
1425 WICOMICO STREET  
BALTIMORE, MD 21230

FOR: DREDGES, DREDGING MACHINES AND STRUCTURAL PARTS THEREOF, IN CLASS 7 (U.S. CLS. 13, 19, 21, 23, 31, 34 AND 35).

FIRST USE 10-0-2007; IN COMMERCE 10-0-2007.

THE MARK CONSISTS OF STANDARD CHARACTERS WITHOUT CLAIM TO ANY PARTICULAR FONT, STYLE, SIZE, OR COLOR.

OWNER OF U.S. REG. NOS. 586,574 AND 687,887.

SN 77-013,342, FILED 10-4-2006.

SOPHIA S. KIM, EXAMINING ATTORNEY

**Int. Cl.: 36**

**Prior U.S. Cls.: 100, 101, and 102**

**United States Patent and Trademark Office**

**Reg. No. 3,499,523**

**Registered Sep. 9, 2008**

**SERVICE MARK  
PRINCIPAL REGISTER**

**CAPITAL SYNERGY PARTNERS**

CPS CAPITAL, INC. (CALIFORNIA CORPORATION)  
18551 VON KARMEN AVE.  
SUITE 160  
IRVINE, CA 92612

FOR: BROKERAGE IN THE FIELD OF STOCKS, BONDS, MUTUAL FUNDS, LIFE INSURANCE, ANNUITIES AND FEE-BASED ASSET MANAGEMENT, IN CLASS 36 (U.S. CLS. 100, 101 AND 102).

FIRST USE 4-18-2008; IN COMMERCE 4-18-2008.

THE MARK CONSISTS OF STANDARD CHARACTERS WITHOUT CLAIM TO ANY PARTICULAR FONT, STYLE, SIZE, OR COLOR.

NO CLAIM IS MADE TO THE EXCLUSIVE RIGHT TO USE "CAPITAL" AND "PARTNERS", APART FROM THE MARK AS SHOWN.

SN 77-014,672, FILED 10-5-2006.

GINA HAYES, EXAMINING ATTORNEY

**Int. Cl.: 41**

**Prior U.S. Cls.: 100, 101, and 107**

**Reg. No. 3,499,524**

**United States Patent and Trademark Office**

**Registered Sep. 9, 2008**

**SERVICE MARK  
PRINCIPAL REGISTER**

The logo consists of the word "PHAIXX" in a bold, black, stylized font. The letters are thick and blocky, with sharp, pointed edges. The 'H' and 'A' are particularly prominent, with the 'A' having a very sharp, downward-pointing tail. The 'I' is a simple vertical bar. The 'X' is composed of two thick, diagonal strokes that meet at a sharp point. The overall appearance is that of a heavy, industrial or rock-style typeface.

ROSAS, CESAR IVAN (UNITED STATES INDIVIDUAL)  
1261 E. 90TH ST  
LOS ANGELES, CA 90002

FOR: ENTERTAINMENT IN THE NATURE OF MUSICAL PERFORMANCE; ENTERTAINMENT, NAMELY, LIVE PERFORMANCES BY A MUSICAL BAND; ENTERTAINMENT SERVICES, NAMELY, PROVIDING A WEB SITE FEATURING MUSICAL PERFORMANCES, MUSICAL VIDEOS, RELATED FILM CLIPS, PHOTOGRAPHS, AND OTHER MULTIMEDIA MATERIALS; ENTERTAINMENT,

NAMELY, LIVE MUSIC CONCERTS; PRESENTATION OF MUSICAL PERFORMANCE; PRODUCTION OF SOUND AND MUSIC VIDEO RECORDINGS, IN CLASS 41 (U.S. CLS. 100, 101 AND 107).

FIRST USE 2-1-2006; IN COMMERCE 8-10-2006.

SN 77-016,438, FILED 10-8-2006.

SUZANNE BLANE, EXAMINING ATTORNEY

**Int. Cl.: 22**

**Prior U.S. Cls.: 1, 2, 7, 19, 22, 42, and 50**

**Reg. No. 3,499,525**

**United States Patent and Trademark Office**

**Registered Sep. 9, 2008**

**TRADEMARK  
PRINCIPAL REGISTER**

**AXXEL**

FIBER INNOVATION TECHNOLOGY, INC.  
(TENNESSEE CORPORATION)  
398 INNOVATION DRIVE  
JOHNSON CITY, TN 37604

FIRST USE 10-15-1999; IN COMMERCE 10-15-1999.

FOR: SYNTHETIC FIBERS FOR USE IN APPAREL, HOME FASHIONS, INDUSTRIAL, MEDICAL, COSMETIC, AEROSPACE AND UPHOLSTERY INDUSTRIES, AND FOR USE IN FILTRATION PRODUCTS, IN CLASS 22 (U.S. CLS. 1, 2, 7, 19, 22, 42 AND 50).

THE MARK CONSISTS OF STANDARD CHARACTERS WITHOUT CLAIM TO ANY PARTICULAR FONT, STYLE, SIZE, OR COLOR.

SN 77-018,311, FILED 10-11-2006.

CARYN GLASSER, EXAMINING ATTORNEY

**Int. Cl.: 20**

**Prior U.S. Cls.: 2, 13, 22, 25, 32, and 50**

**Reg. No. 3,499,526**

**United States Patent and Trademark Office**

**Registered Sep. 9, 2008**

**TRADEMARK  
PRINCIPAL REGISTER**



**NELLA VETRINA**

VETRINA LTD. (NEW YORK CORPORATION)  
979 THIRD AVENUE, SUITE 814  
NEW YORK, NY 10022

THE ENGLISH TRANSLATION OF THE WORDS  
"NELLA VETRINA" IN THE MARK IS "INSIDE THE  
WINDOW."

FOR: FURNITURE, IN CLASS 20 (U.S. CLS. 2, 13,  
22, 25, 32 AND 50).

SN 77-018,428, FILED 10-11-2006.

FIRST USE 11-16-2006; IN COMMERCE 11-16-2006.

AMOS T. MATTHEWS, JR., EXAMINING ATTOR-  
NEY

**Int. Cl.: 9**

**Prior U.S. Cls.: 21, 23, 26, 36, and 38**

**United States Patent and Trademark Office**

**Reg. No. 3,499,527**

**Registered Sep. 9, 2008**

**TRADEMARK  
PRINCIPAL REGISTER**

**RIPCODE**

RIPCODE, INC. (DELAWARE CORPORATION)  
1130 E. ARAPAHO ROAD  
SUITE 435  
RICHARDSON, TX 75081

FOR: COMPUTER HARDWARE AND COMPUTER SOFTWARE FOR ACCELERATING AND AUTOMATING VIDEO FORMAT TRANSCODING, IN CLASS 9 (U.S. CLS. 21, 23, 26, 36 AND 38).

FIRST USE 7-27-2007; IN COMMERCE 7-27-2007.

THE MARK CONSISTS OF STANDARD CHARACTERS WITHOUT CLAIM TO ANY PARTICULAR FONT, STYLE, SIZE, OR COLOR.

SN 77-020,133, FILED 10-12-2006.

DANIEL CAPSHAW, EXAMINING ATTORNEY

**Int. Cl.: 9**

**Prior U.S. Cls.: 21, 23, 26, 36, and 38**

**United States Patent and Trademark Office**

**Reg. No. 3,499,528**

**Registered Sep. 9, 2008**

**TRADEMARK  
PRINCIPAL REGISTER**



RIPCODE, INC. (DELAWARE CORPORATION)  
SUITE 435  
1130 E. ARAPAHO ROAD  
RICHARDSON, TX 75081

FOR: COMPUTER HARDWARE AND COMPU-  
TER SOFTWARE FOR ACCELERATING AND AU-

TOMATING VIDEO FORMAT TRANSCODING, IN  
CLASS 9 (U.S. CLS. 21, 23, 26, 36 AND 38).

FIRST USE 8-15-2007; IN COMMERCE 8-15-2007.

SN 77-020,168, FILED 10-12-2006.

DANIEL CAPSHAW, EXAMINING ATTORNEY

**Int. Cl.: 40**

**Prior U.S. Cls.: 100, 103, and 106**

**United States Patent and Trademark Office**

**Reg. No. 3,499,529**

**Registered Sep. 9, 2008**

**SERVICE MARK  
PRINCIPAL REGISTER**

**TURBOFOIL**

INTEGRATED POWER TECHNOLOGY COR-  
PORATION (CALIFORNIA CORPORATION)  
24471 CORTA CRESTA DRIVE  
LAKE FOREST, CA 926303914

THE MARK CONSISTS OF STANDARD CHAR-  
ACTERS WITHOUT CLAIM TO ANY PARTICULAR  
FONT, STYLE, SIZE, OR COLOR.

FOR: PRODUCTION OF ENERGY, IN CLASS 40  
(U.S. CLS. 100, 103 AND 106).

SN 77-021,487, FILED 10-15-2006.

FIRST USE 11-8-2006; IN COMMERCE 11-27-2006.

HOWARD SMIGA, EXAMINING ATTORNEY



**Int. Cl.: 5**

**Prior U.S. Cls.: 6, 18, 44, 46, 51, and 52**

**United States Patent and Trademark Office**

**Reg. No. 3,499,530**

**Registered Sep. 9, 2008**

**TRADEMARK  
PRINCIPAL REGISTER**

**RICEBEAUX**

RICECO LLC (DELAWARE LIMITED LIABILITY  
COMPANY)  
5100 POPLAR AVENUE, SUITE 2428  
MEMPHIS, TN 38137

FOR: HERBICIDES FOR AGRICULTURAL USE,  
IN CLASS 5 (U.S. CLS. 6, 18, 44, 46, 51 AND 52).

FIRST USE 4-10-2008; IN COMMERCE 4-10-2008.

THE MARK CONSISTS OF STANDARD CHAR-  
ACTERS WITHOUT CLAIM TO ANY PARTICULAR  
FONT, STYLE, SIZE, OR COLOR.

OWNER OF U.S. REG. NOS. 2,691,280, 3,047,832,  
AND OTHERS.

SN 77-021,821, FILED 10-16-2006.

JENNIFER MARTIN, EXAMINING ATTORNEY

**Int. Cl.: 20**

**Prior U.S. Cls.: 2, 13, 22, 25, 32, and 50**

**United States Patent and Trademark Office**

**Reg. No. 3,499,531**

**Registered Sep. 9, 2008**

**TRADEMARK  
PRINCIPAL REGISTER**



VETRINA, LTD. (NEW YORK CORPORATION)  
979 THIRD AVENUE, SUITE 814  
NEW YORK, NY 10022

FIRST USE 11-16-2006; IN COMMERCE 11-16-2006.

SN 77-022,103, FILED 10-16-2006.

FOR: FURNITURE, IN CLASS 20 (U.S. CLS. 2, 13,  
22, 25, 32 AND 50).

AMOS T. MATTHEWS, JR., EXAMINING ATTOR-  
NEY

Int. Cl.: 20

Prior U.S. Cls.: 2, 13, 22, 25, 32, and 50

United States Patent and Trademark Office

Reg. No. 3,499,532

Registered Sep. 9, 2008

TRADEMARK  
PRINCIPAL REGISTER



THER-A-PEDIC ASSOCIATES, INC. (NEW JERSEY CORPORATION)  
2ND FLOOR  
103 COLLEGE ROAD EAST  
PRINCETON, NJ 08540

THE MARK CONSISTS OF THE WORDS "COMFORT TOUCH" WITH A LEAPING STICK FIGURE PERSON TO THE RIGHT OF THE WORDS.

FOR: MATTRESSES AND BOXSPRINGS, IN CLASS 20 (U.S. CLS. 2, 13, 22, 25, 32 AND 50).

SN 77-022,394, FILED 10-17-2006.

FIRST USE 12-1-2006; IN COMMERCE 12-1-2006.

ALICIA COLLINS, EXAMINING ATTORNEY

**Int. Cl.: 44**

**Prior U.S. Cls.: 100 and 101**

**United States Patent and Trademark Office**

**Reg. No. 3,499,533**

**Registered Sep. 9, 2008**

**SERVICE MARK  
PRINCIPAL REGISTER**

**ANTI-AGING TIME RESPONSE  
EYE TREATMENT**

AMOREPACIFIC CORPORATION (REPUBLIC OF KOREA CORPORATION)  
181, 2-KA, HANGANG-RO, YONGSAN-KU  
SEOUL, REPUBLIC OF KOREA 140-777

FOR: MASSAGE; CONSULTATION SERVICES IN THE FIELD OF COSMETICS, MASSAGE, BEAUTY CARE, MAKE-UP, BODY SLIMMING, FACIAL CARE, SKIN CARE, HAIR CARE, SCALP CARE, AND FOOT CARE; BEAUTY SALONS; NAIL CARE SERVICES, NAMELY, NAIL MANICURE, NAIL MASSAGE, NAIL BUFFING, NAIL POLISH AND NAIL MAINTENANCE; HEALTH SPA SERVICES FOR HEALTH AND WELLNESS OF THE BODY AND SPIRIT OFFERED AT A HEALTH RESORT; HEALTH SPA SERVICES, NAMELY, COSMETIC BODY CARE SERVICES; PROVIDING INFORMATION ABOUT COSMETIC MASSAGE, BEAUTY CARE, MAKE-UP ANALYSIS, BODY SLIMMING, FACIAL CARE, SKIN CARE, HAIR CARE, SCALP CARE, AND FOOT CARE; AROMATHERAPY SERVICES; SPA SERVICES FOR BEAUTY AND HEALTH CARE FOR HUMANS, NAMELY, AROMATHERAPY, BALNEOTHERAPY AND THALASSOTHER-

APY SERVICES; SLIMMING AND WEIGHT REDUCTION TREATMENT, NAMELY, WEIGHT REDUCTION DIET PLANNING AND SUPERVISION; COSMETIC ADVICE, NAMELY, OFFERING ADVICE REGARDING THE METHODS OF MAKE-UP; ARTIFICIAL SUN TANNING SERVICES; MAKE-UP SERVICES; OPERATION OF SAUNA FACILITIES; HEALTH CARE, IN CLASS 44 (U.S. CLS. 100 AND 101).

FIRST USE 9-0-2003; IN COMMERCE 9-0-2003.

THE MARK CONSISTS OF STANDARD CHARACTERS WITHOUT CLAIM TO ANY PARTICULAR FONT, STYLE, SIZE, OR COLOR.

NO CLAIM IS MADE TO THE EXCLUSIVE RIGHT TO USE "EYE", APART FROM THE MARK AS SHOWN.

SN 77-022,811, FILED 10-17-2006.

SHAILA SETTLES, EXAMINING ATTORNEY

**Int. Cls.: 29 and 30**

**Prior U.S. Cl.: 46**

**United States Patent and Trademark Office**

**Reg. No. 3,499,534**

**Registered Sep. 9, 2008**

**TRADEMARK  
PRINCIPAL REGISTER**

**CHEF INSPIRATIONS**

SMALL PLANET FOODS, INC. (WASHINGTON CORPORATION)

719 METCALF STREET

SEDRO-WOOLLEY, WA 98284

FOR: CANNED SOUP; CANNED TOMATOES; FROZEN ENTREES CONSISTING PRIMARILY OF MEAT, FISH, POULTRY, OR VEGETABLES, IN CLASS 29 (U.S. CL. 46).

FIRST USE 7-23-2007; IN COMMERCE 7-23-2007.

FOR: SAUCE FOR PASTA; FROZEN ENTREES CONSISTING PRIMARILY OF PASTA OR RICE, IN CLASS 30 (U.S. CL. 46).

FIRST USE 6-16-2008; IN COMMERCE 6-16-2008.

THE MARK CONSISTS OF STANDARD CHARACTERS WITHOUT CLAIM TO ANY PARTICULAR FONT, STYLE, SIZE, OR COLOR.

SN 77-023,646, FILED 10-18-2006.

SUNG IN, EXAMINING ATTORNEY

**Int. Cl.: 33**

**Prior U.S. Cls.: 47 and 49**

**United States Patent and Trademark Office**

**Reg. No. 3,499,535**

**Registered Sep. 9, 2008**

**TRADEMARK  
PRINCIPAL REGISTER**

**WAIKI**

VITIVINICOLA PEREZ CRUZ LIMITADA (CHILE  
CORPORATION)  
FUNDO LIGUAI DE HUELQUEN S/N  
PAINE, CHILE

THE MARK CONSISTS OF STANDARD CHAR-  
ACTERS WITHOUT CLAIM TO ANY PARTICULAR  
FONT, STYLE, SIZE, OR COLOR.

FOR: WINES, IN CLASS 33 (U.S. CLS. 47 AND 49).

SN 77-023,928, FILED 10-18-2006.

FIRST USE 2-0-2007; IN COMMERCE 4-0-2008.

WENDY GOODMAN, EXAMINING ATTORNEY

**Int. Cl.: 8**

**Prior U.S. Cls.: 23, 28, and 44**

**Reg. No. 3,499,536**

**United States Patent and Trademark Office**

**Registered Sep. 9, 2008**

**TRADEMARK  
PRINCIPAL REGISTER**



GUSTAV PFOHL GMBH (FED REP GERMANY  
CORPORATION)  
AM SONNENRING 31  
LANDSHUT-ALTDORF, FED REP GERMANY D-  
84032

FOR: MANUALLY OPERATED HAND TOOLS,  
NAMELY, APPLICATORS AND ROLLERS FOR  
APPLYING ADHESIVES, GLUE, MORTAR, AND  
PASTE; AND MANUALLY OPERATED TOOLS,  
NAMELY, TOOLS WHICH ARE OPERATED BY

HAND BUT THAT ARE NOT NECESSARILY HAND  
HELD, NAMELY, APPLICATORS AND ROLLERS  
FOR APPLYING ADHESIVES, GLUE, MORTAR,  
AND PASTE, IN CLASS 8 (U.S. CLS. 23, 28 AND 44).

FIRST USE 12-0-1959; IN COMMERCE 12-0-1959.

SN 77-024,315, FILED 10-18-2006.

LAURIE MAYES, EXAMINING ATTORNEY

Int. Cl.: 16

Prior U.S. Cls.: 2, 5, 22, 23, 29, 37, 38, and 50

United States Patent and Trademark Office

Reg. No. 3,499,537

Registered Sep. 9, 2008

TRADEMARK  
PRINCIPAL REGISTER

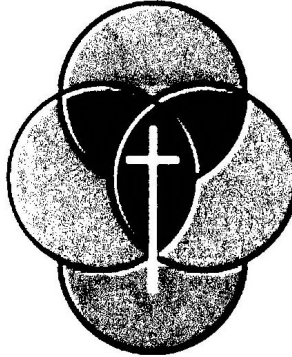

SHIELD AND BUCKLER SOCIETY (MAINE  
CORPORATION)  
9 OTTER TRACE  
BRUNSWICK, ME 040117378

FOR: PUBLICATIONS, NAMELY, BROCHURES,  
BOOKLETS, AND TEACHING MATERIALS IN THE  
FIELD OF RELIGIOUS TEACHINGS, IN CLASS 16  
(U.S. CLS. 2, 5, 22, 23, 29, 37, 38 AND 50).

FIRST USE 10-19-2006; IN COMMERCE 12-13-2006.

NO CLAIM IS MADE TO THE EXCLUSIVE  
RIGHT TO USE "THE IMAGE OF THE LATIN  
CROSS", APART FROM THE MARK AS SHOWN.

THE STIPPLING IS FOR SHADING PURPOSES  
ONLY.

THE MARK CONSISTS OF A SYMBOL REPRESENTATIVE OF RESTORATION OF A PERSON TO UNITY WITH THE CHRISTIAN TRIUNE GOD-HEAD, FATHER, SON, AND HOLY SPIRIT.

SN 77-024,354, FILED 10-18-2006.

TIMOTHY FINNEGAN, EXAMINING ATTORNEY



**Int. Cl.: 8**

**Prior U.S. Cls.: 23, 28, and 44**

**Reg. No. 3,499,538**

**United States Patent and Trademark Office**

**Registered Sep. 9, 2008**

**TRADEMARK  
PRINCIPAL REGISTER**

**DOCTOR PRELOAD**

TEMPER CORPORATION (NEW YORK COR-  
PORATION)  
P.O. BOX 1127  
PERSEE ROAD  
FONDA, NY 12068

THE MARK CONSISTS OF STANDARD CHAR-  
ACTERS WITHOUT CLAIM TO ANY PARTICULAR  
FONT, STYLE, SIZE, OR COLOR.

FOR: HAND-OPERATED WHEEL BEARING AD-  
JUSTMENT TOOLS, IN CLASS 8 (U.S. CLS. 23, 28  
AND 44).

SN 77-025,125, FILED 10-19-2006.

FIRST USE 4-10-2008; IN COMMERCE 4-10-2008.

JOHN KELLY, EXAMINING ATTORNEY

**Int. Cls.: 9 and 20**

**Prior U.S. Cls.: 2, 13, 21, 22, 23, 25, 26, 32, 36, 38, and 50**

**United States Patent and Trademark Office**

**Reg. No. 3,499,539**

**Registered Sep. 9, 2008**

**TRADEMARK  
PRINCIPAL REGISTER**

**SLEEP MACHINE**

KINGSDOWN, INC. (NORTH CAROLINA CORPORATION)  
P.O. BOX 388  
MEBANE, NC 27302

FOR: BEDDING DIAGNOSTIC SYSTEM COMPRISING A COMPUTER AND COMPUTER SOFTWARE, A MATTRESS AND BOX SPRING, AND A PRESSURE SENSITIVE PAD, SOLD AS A UNIT FOR USE IN ANALYZING AND EVALUATING INDIVIDUALS AND PRESCRIBING PREFERRED MATTRESS COMPONENTS THEREOF, IN CLASS 9 (U.S. CLS. 21, 23, 26, 36 AND 38).

FIRST USE 7-16-2008; IN COMMERCE 7-16-2008.

FOR: MATTRESSES AND BOX SPRINGS, IN CLASS 20 (U.S. CLS. 2, 13, 22, 25, 32 AND 50).

FIRST USE 7-16-2008; IN COMMERCE 7-16-2008.

THE MARK CONSISTS OF STANDARD CHARACTERS WITHOUT CLAIM TO ANY PARTICULAR FONT, STYLE, SIZE, OR COLOR.

SN 77-028,423, FILED 10-24-2006.

DAWN FELDMAN, EXAMINING ATTORNEY

**Int. Cl.: 20**

**Prior U.S. Cls.: 2, 13, 22, 25, 32, and 50**

**United States Patent and Trademark Office**

**Reg. No. 3,499,540**

**Registered Sep. 9, 2008**

**TRADEMARK  
PRINCIPAL REGISTER**

**PHOTO PIC**

THE ENCORE GROUP, INC. (CALIFORNIA CORPORATION)  
P.O. BOX 500780  
SAN DIEGO, CA 921500780

FOR: PICTURE FRAMES WITH DETACHABLE NON-METAL STAKES, IN CLASS 20 (U.S. CLS. 2, 13, 22, 25, 32 AND 50).

FIRST USE 6-1-2007; IN COMMERCE 6-1-2007.

THE MARK CONSISTS OF STANDARD CHARACTERS WITHOUT CLAIM TO ANY PARTICULAR FONT, STYLE, SIZE, OR COLOR.

NO CLAIM IS MADE TO THE EXCLUSIVE RIGHT TO USE "PHOTO", APART FROM THE MARK AS SHOWN.

SN 77-029,117, FILED 10-25-2006.

RENEE MCCRAY, EXAMINING ATTORNEY

**Int. Cl.: 45**

**Prior U.S. Cls.: 100 and 101**

**United States Patent and Trademark Office**

**Reg. No. 3,499,541**

**Registered Sep. 9, 2008**

**SERVICE MARK  
PRINCIPAL REGISTER**

**MOGREET**

MOGREET, INC. (CALIFORNIA CORPORATION)  
SUITE G  
555 ROSE AVENUE  
LOS ANGELES, CA 90291

FOR: PROVIDING A SELECTION OF ELECTRO-  
NIC GREETING CARDS VIA ONLINE, THE INTER-  
NET, AND CELL PHONES, IN CLASS 45 (U.S. CLS.  
100 AND 101).

FIRST USE 1-0-2008; IN COMMERCE 1-0-2008.

THE MARK CONSISTS OF STANDARD CHAR-  
ACTERS WITHOUT CLAIM TO ANY PARTICULAR  
FONT, STYLE, SIZE, OR COLOR.

SN 77-030,074, FILED 10-26-2006.

DAVID YONTEF, EXAMINING ATTORNEY

**Int. Cl.: 41**

**Prior U.S. Cls.: 100, 101, and 107**

**United States Patent and Trademark Office**

**Reg. No. 3,499,542**

**Registered Sep. 9, 2008**

**SERVICE MARK  
PRINCIPAL REGISTER**

**one mississippi**

BYRD, CHARLES RONALD (UNITED STATES  
INDIVIDUAL)  
10206 CARLOTTA COVE  
AUSTIN, TX 78733

THE MARK CONSISTS OF STANDARD CHAR-  
ACTERS WITHOUT CLAIM TO ANY PARTICULAR  
FONT, STYLE, SIZE, OR COLOR.

FOR: PRESENTATION OF MUSICAL PERFOR-  
MANCE, IN CLASS 41 (U.S. CLS. 100, 101 AND 107).

SN 77-030,424, FILED 10-26-2006.

FIRST USE 8-31-2005; IN COMMERCE 9-14-2007.

ESTHER A. BORSUK, EXAMINING ATTORNEY

Int. Cl.: 25

Prior U.S. Cls.: 22 and 39

United States Patent and Trademark Office

Reg. No. 3,499,543

Registered Sep. 9, 2008

TRADEMARK  
PRINCIPAL REGISTER



**Juicy Couture**

JUICY COUTURE, INC. (CALIFORNIA CORPORATION)  
12720 WENTWORTH STREET  
PACOIMA, CA 91331

FOR: MEN'S APPAREL, NAMELY, SHIRTS, PANTS, JEANS, SWEATERS, AND JACKETS, IN CLASS 25 (U.S. CLS. 22 AND 39).

FIRST USE 1-30-2007; IN COMMERCE 1-30-2007.

OWNER OF U.S. REG. NOS. 2,978,046, 3,194,741, AND OTHERS.

NO CLAIM IS MADE TO THE EXCLUSIVE RIGHT TO USE "COUTURE", APART FROM THE MARK AS SHOWN.

THE MARK CONSISTS OF TWO HERALDIC LIONS HOLDING A SHIELD WITH "JM" AND A BAR DESIGN. ABOVE THE SHIELD IS A CROWN. BELOW THE SHIELD IS A BANNER AND PLANT DESIGN.

SN 77-032,126, FILED 10-30-2006.

LESLEY LAMOTHE, EXAMINING ATTORNEY

**Int. Cl.: 28**

**Prior U.S. Cls.: 22, 23, 38, and 50**

**United States Patent and Trademark Office**

**Reg. No. 3,499,544**

**Registered Sep. 9, 2008**

**TRADEMARK  
PRINCIPAL REGISTER**

**EasyOUT**

JOHN ITAMURA (CALIFORNIA SOLE PROPRIETORSHIP)  
3359 ZENOBIA WAY  
ZENOBIA59@SBCGLOBAL.NET  
SACRAMENTO, CA 95834

THE MARK CONSISTS OF STANDARD CHARACTERS WITHOUT CLAIM TO ANY PARTICULAR FONT, STYLE, SIZE, OR COLOR.

FOR: FISH HOOK REMOVERS, IN CLASS 28 (U.S. CLS. 22, 23, 38 AND 50).

SN 77-032,234, FILED 10-30-2006.

FIRST USE 4-1-2008; IN COMMERCE 4-1-2008.

ALICIA COLLINS, EXAMINING ATTORNEY

**Int. Cl.: 39**

**Prior U.S. Cls.: 100 and 105**

**United States Patent and Trademark Office**

**Reg. No. 3,499,545**

**Registered Sep. 9, 2008**

**SERVICE MARK  
PRINCIPAL REGISTER**

**Selection and Performance  
.... That's Priceless**

PRICELESS RENT-A-CAR LLC (MARYLAND  
LIMITED LIABILITY COMPANY)  
105 MAIN STREET  
LAUREL, MD 20707

THE MARK CONSISTS OF STANDARD CHAR-  
ACTERS WITHOUT CLAIM TO ANY PARTICULAR  
FONT, STYLE, SIZE, OR COLOR.

FOR: VEHICLE RENTAL AND LEASE SERVICES,  
IN CLASS 39 (U.S. CLS. 100 AND 105).

SN 77-033,146, FILED 10-31-2006.

FIRST USE 12-31-2007; IN COMMERCE 12-31-2007.

KAREN K. BUSH, EXAMINING ATTORNEY



**Int. Cl.: 25**

**Prior U.S. Cls.: 22 and 39**

**United States Patent and Trademark Office**

**Reg. No. 3,499,546**

**Registered Sep. 9, 2008**

**TRADEMARK  
PRINCIPAL REGISTER**

**STEADFAST BRAND**

COLLINS, CHRIS (UNITED STATES INDIVIDUAL)  
14 S. MAGNOLIA AVENUE  
OCALA, FL 34474

FOR: CLOTHING, NAMELY, T-SHIRTS, LONG SLEEVE T-SHIRTS, GIRL'S TEES, SWEATSHIRTS, HOODED SWEATSHIRTS, ZIPPER HOODED SWEATSHIRTS, BELTS AND BASEBALL CAPS, IN CLASS 25 (U.S. CLS. 22 AND 39).

FIRST USE 1-19-2007; IN COMMERCE 1-19-2007.

THE MARK CONSISTS OF STANDARD CHARACTERS WITHOUT CLAIM TO ANY PARTICULAR FONT, STYLE, SIZE, OR COLOR.

NO CLAIM IS MADE TO THE EXCLUSIVE RIGHT TO USE "BRAND", APART FROM THE MARK AS SHOWN.

SN 77-033,930, FILED 11-1-2006.

JAMES A. RAUEN, EXAMINING ATTORNEY

**Int. Cl.: 5**

**Prior U.S. Cls.: 6, 18, 44, 46, 51, and 52**

**Reg. No. 3,499,547**

**United States Patent and Trademark Office**

**Registered Sep. 9, 2008**

**TRADEMARK  
PRINCIPAL REGISTER**

**Feiron**

E. EXCEL INTERNATIONAL, INC. (UTAH CORPORATION)  
9957 SOUTH JORDAN GATEWAY  
SANDY, UT 84070

THE MARK CONSISTS OF STANDARD CHARACTERS WITHOUT CLAIM TO ANY PARTICULAR FONT, STYLE, SIZE, OR COLOR.

FOR: NUTRITIONAL SUPPLEMENTS IN PASTE FORM THAT CAN BE MIXED WITH HOT WATER TO FORM A DRINK OR SOUP BASE, IN CLASS 5 (U.S. CLS. 6, 18, 44, 46, 51 AND 52).

SN 77-035,886, FILED 11-3-2006.

FIRST USE 6-18-2007; IN COMMERCE 6-18-2007.

NELSON SNYDER, EXAMINING ATTORNEY

**Int. Cl.: 30**

**Prior U.S. Cl.: 46**

**Reg. No. 3,499,548**

**United States Patent and Trademark Office**

**Registered Sep. 9, 2008**

**TRADEMARK  
PRINCIPAL REGISTER**

**MISS DIXIE'S ORGANICS**

DIXIE DEW PRODUCTS, INC. (KENTUCKY CORPORATION)  
1360 JAMIKE AVE  
ERLANGER, KY 41018

THE MARK CONSISTS OF STANDARD CHARACTERS WITHOUT CLAIM TO ANY PARTICULAR FONT, STYLE, SIZE, OR COLOR.

FOR: ORGANIC FOOD ITEMS, NAMELY, BREADS, BREAD MIXES, MUFFINS, MUFFIN MIXES, BARBECUE SAUCE, CAKE MIXES, PANCAKE MIXES, BROWNIE MIXES, GRAVY MIXES, PASTA, CEREAL BASED SNACK FOOD, CEREAL DERIVED FOOD BARS, BREAKFAST CEREALS, GRANOLA BASED SNACK BARS, OATMEAL, PANCAKE SYRUP, TOMATO SAUCE, SLOPPY JOE SEASONING MIX, SPICES, SEASONINGS, SALAD DRESSING AND DESSERT SAUCES, IN CLASS 30 (U.S. CL. 46).

NO CLAIM IS MADE TO THE EXCLUSIVE RIGHT TO USE "ORGANICS", APART FROM THE MARK AS SHOWN.

THE NAME "MISS DIXIE'S" DOES NOT IDENTIFY A LIVING INDIVIDUAL.

SN 77-036,331, FILED 11-3-2006.

FIRST USE 8-22-2007; IN COMMERCE 11-7-2007.

RAMONA ORTIGA, EXAMINING ATTORNEY

**Int. Cl.: 11**

**Prior U.S. Cls.: 13, 21, 23, 31, and 34**

**United States Patent and Trademark Office**

**Reg. No. 3,499,549**

**Registered Sep. 9, 2008**

**TRADEMARK  
PRINCIPAL REGISTER**

**TRANSCAPE**

EMERSON ELECTRIC CO. (MISSOURI CORPORATION)  
8000 WEST FLORISSANT AVENUE  
ST. LOUIS, MO 63136

FOR: WATER DISPENSING UNITS FOR DOMESTIC USE COMPRISED PRIMARILY OF FAUCET, WATER TANK, HOT WATER HEATER UNITS, AND COMPONENT PARTS THEREFOR, SOLD AS A UNIT; WATER DISPENSING UNITS FOR DOMESTIC USE COMPRISED PRIMARILY OF FAUCET, WATER TANK, HOT WATER HEATER UNITS,

AND COMPONENT PARTS THEREFOR, SOLD AS A UNIT, IN CLASS 11 (U.S. CLS. 13, 21, 23, 31 AND 34).

FIRST USE 2-0-2008; IN COMMERCE 2-0-2008.

THE MARK CONSISTS OF STANDARD CHARACTERS WITHOUT CLAIM TO ANY PARTICULAR FONT, STYLE, SIZE, OR COLOR.

SN 77-036,588, FILED 11-3-2006.

HANNO RITTNER, EXAMINING ATTORNEY

**Int. Cl.: 10**

**Prior U.S. Cls.: 26, 39, and 44**

**United States Patent and Trademark Office**

**Reg. No. 3,499,550**

**Registered Sep. 9, 2008**

**TRADEMARK  
PRINCIPAL REGISTER**

**SPECTRUM SUPER CUT**

SPECTRUM SURGICAL INSTRUMENTS CORP.  
(OHIO CORPORATION)

4575 HUDSON DRIVE

STOW, OH 44224

FOR: SURGICAL SCISSORS, IN CLASS 10 (U.S.  
CLS. 26, 39 AND 44).

FIRST USE 10-0-2006; IN COMMERCE 10-0-2006.

THE MARK CONSISTS OF STANDARD CHAR-  
ACTERS WITHOUT CLAIM TO ANY PARTICULAR  
FONT, STYLE, SIZE, OR COLOR.

NO CLAIM IS MADE TO THE EXCLUSIVE  
RIGHT TO USE "CUT", APART FROM THE MARK  
AS SHOWN.

SN 77-037,709, FILED 11-6-2006.

RUSS HERMAN, EXAMINING ATTORNEY

**Int. Cl.: 11**

**Prior U.S. Cls.: 13, 21, 23, 31, and 34**

**United States Patent and Trademark Office**

**Reg. No. 3,499,551**

**Registered Sep. 9, 2008**

**TRADEMARK  
PRINCIPAL REGISTER**

**H-WAVE**

EMERSON ELECTRIC CO. (MISSOURI CORPORATION)  
8000 WEST FLORISSANT AVENUE  
ST. LOUIS, MO 63136

FOR: WATER DISPENSING UNITS FOR DOMESTIC USE COMPRISED PRIMARILY OF FAUCET, WATER TANK, HOT WATER HEATER UNITS, AND COMPONENT PARTS THEREFOR, SOLD AS A UNIT; WATER DISPENSING UNITS FOR DOMESTIC USE COMPRISED PRIMARILY OF FAUCET, WATER TANK, HOT WATER HEATER UNITS,

AND COMPONENT PARTS THEREFOR, SOLD AS A UNIT, IN CLASS 11 (U.S. CLS. 13, 21, 23, 31 AND 34).

FIRST USE 10-15-2006; IN COMMERCE 10-15-2006.

THE MARK CONSISTS OF STANDARD CHARACTERS WITHOUT CLAIM TO ANY PARTICULAR FONT, STYLE, SIZE, OR COLOR.

SN 77-039,346, FILED 11-8-2006.

HANNO RITTNER, EXAMINING ATTORNEY

**Int. Cl.: 11**

**Prior U.S. Cls.: 13, 21, 23, 31, and 34**

**Reg. No. 3,499,552**

**United States Patent and Trademark Office**

**Registered Sep. 9, 2008**

**TRADEMARK  
PRINCIPAL REGISTER**

**HC-WAVE**

EMERSON ELECTRIC CO. (MISSOURI CORPORATION)  
8000 WEST FLORISSANT AVENUE  
ST. LOUIS, MO 63136

FOR: WATER DISPENSING UNITS FOR DOMESTIC USE COMPRISED PRIMARILY OF FAUCET, WATER TANK, HOT WATER HEATER UNITS, AND COMPONENT PARTS THEREFOR, SOLD AS A UNIT; WATER DISPENSING UNITS FOR DOMESTIC USE COMPRISED PRIMARILY OF FAUCET, WATER TANK, HOT WATER HEATER UNITS,

AND COMPONENT PARTS THEREFOR, SOLD AS A UNIT, IN CLASS 11 (U.S. CLS. 13, 21, 23, 31 AND 34).

FIRST USE 7-2-2007; IN COMMERCE 7-2-2007.

THE MARK CONSISTS OF STANDARD CHARACTERS WITHOUT CLAIM TO ANY PARTICULAR FONT, STYLE, SIZE, OR COLOR.

SN 77-039,352, FILED 11-8-2006.

HANNO RITTNER, EXAMINING ATTORNEY

**Int. Cl.: 11**

**Prior U.S. Cls.: 13, 21, 23, 31, and 34**

**United States Patent and Trademark Office**

**Reg. No. 3,499,553**

**Registered Sep. 9, 2008**

**TRADEMARK  
PRINCIPAL REGISTER**

**H-VIEW**

EMERSON ELECTRIC CO. (MISSOURI CORPORATION)  
8000 WEST FLORISSANT AVENUE  
ST. LOUIS, MO 63136

FOR: WATER DISPENSING UNITS FOR DOMESTIC USE COMPRISED PRIMARILY OF FAUCET, WATER TANK, HOT WATER HEATER UNITS, AND COMPONENT PARTS THEREFOR, SOLD AS A UNIT; WATER DISPENSING UNITS FOR DOMESTIC USE COMPRISED PRIMARILY OF FAUCET, WATER TANK, HOT WATER HEATER UNITS,

AND COMPONENT PARTS THEREFOR, SOLD AS A UNIT, IN CLASS 11 (U.S. CLS. 13, 21, 23, 31 AND 34).

FIRST USE 3-15-2007; IN COMMERCE 3-15-2007.

THE MARK CONSISTS OF STANDARD CHARACTERS WITHOUT CLAIM TO ANY PARTICULAR FONT, STYLE, SIZE, OR COLOR.

SN 77-039,357, FILED 11-8-2006.

HANNO RITTNER, EXAMINING ATTORNEY



**Int. Cl.: 11**

**Prior U.S. Cls.: 13, 21, 23, 31, and 34**

**Reg. No. 3,499,554**

**United States Patent and Trademark Office**

**Registered Sep. 9, 2008**

**TRADEMARK  
PRINCIPAL REGISTER**

**HC-VIEW**

EMERSON ELECTRIC CO. (MISSOURI CORPORATION)  
8000 WEST FLORISSANT AVENUE  
ST. LOUIS, MO 63136

FOR: WATER DISPENSING UNITS FOR DOMESTIC USE COMPRISED PRIMARILY OF FAUCET, WATER TANK, HOT WATER HEATER UNITS, AND COMPONENT PARTS THEREFOR, SOLD AS A UNIT; WATER DISPENSING UNITS FOR DOMESTIC USE COMPRISED PRIMARILY OF FAUCET, WATER TANK, HOT WATER HEATER UNITS,

AND COMPONENT PARTS THEREFOR, SOLD AS A UNIT, IN CLASS 11 (U.S. CLS. 13, 21, 23, 31 AND 34).

FIRST USE 7-2-2007; IN COMMERCE 7-2-2007.

THE MARK CONSISTS OF STANDARD CHARACTERS WITHOUT CLAIM TO ANY PARTICULAR FONT, STYLE, SIZE, OR COLOR.

SN 77-039,364, FILED 11-8-2006.

HANNO RITTNER, EXAMINING ATTORNEY

**Int. Cl.: 25**

**Prior U.S. Cls.: 22 and 39**

**United States Patent and Trademark Office**

**Reg. No. 3,499,555**

**Registered Sep. 9, 2008**

**TRADEMARK  
PRINCIPAL REGISTER**



STANCHFIELD, ERIK M. (UNITED STATES INDIVIDUAL)  
5875 EL DORA DR.  
COLORADO SPRINGS, CO 80918

FOR: SHIRTS, IN CLASS 25 (U.S. CLS. 22 AND 39).

FIRST USE 9-11-2007; IN COMMERCE 11-1-2007.

THE MARK CONSISTS OF A SOLID CROSS SHAPE CONSISTING OF TWO INTERSECTING PIECES SIMILAR IN OVERALL SHAPE TO A SIMPLE TWO BRANCHED SAGUARO CACTUS WITH THE VERTICAL PIECE BEING SPIKE SHAPED AND

POINTING DOWNWARD WHILE CROSSING THE SPIKE AT THE TOP IS A NARROW PIECE THAT CURVES UPWARD AND WIDENS ON EITHER SIDE OF THE SPIKE AND FLATTENS WITH A NOTCH IN THE SPIKE WHERE THE RIGHT SIDE CROSS PIECE INTERCEPTS AND THE TOP OF THE SPIKE IS PULLED TO A POINT ON THE LEFT TOP SIDE OF THE SPIKE AND ALL PARTS OF THE MARK ARE SOLID AND BLACK.

SN 77-040,180, FILED 11-9-2006.

DAVID I, EXAMINING ATTORNEY

**Int. Cl.: 25**

**Prior U.S. Cls.: 22 and 39**

**United States Patent and Trademark Office**

**Reg. No. 3,499,556**

**Registered Sep. 9, 2008**

**TRADEMARK  
PRINCIPAL REGISTER**

**COLD-SNAP**

VEXILAR, INC. (MINNESOTA CORPORATION)  
6667 W. OLD SHAKOPEE ROAD  
MINNEAPOLIS, MN 55438

THE MARK CONSISTS OF STANDARD CHAR-  
ACTERS WITHOUT CLAIM TO ANY PARTICULAR  
FONT, STYLE, SIZE, OR COLOR.

FOR: CLOTHING, NAMELY, PARKAS, BIB  
OVERALLS; FOOTWEAR; HEADWEAR; GLOVES  
AND MITTENS, IN CLASS 25 (U.S. CLS. 22 AND 39).

SN 77-040,222, FILED 11-9-2006.

FIRST USE 5-1-2006; IN COMMERCE 10-1-2006.

SARA THOMAS, EXAMINING ATTORNEY

**Int. Cl.: 1**

**Prior U.S. Cls.: 1, 5, 6, 10, 26, and 46**

**United States Patent and Trademark Office**

**Reg. No. 3,499,557**

**Registered Sep. 9, 2008**

**TRADEMARK  
PRINCIPAL REGISTER**

**THIOCURE**

EVANS CHEMETICS LP (DELAWARE LIMITED  
PARTNERSHIP)  
33 WOOD AVENUE SOUTH, SUITE 600  
ISELIN, NJ 08830

THE MARK CONSISTS OF STANDARD CHAR-  
ACTERS WITHOUT CLAIM TO ANY PARTICULAR  
FONT, STYLE, SIZE, OR COLOR.

FOR: SULFUR-BASED CHEMICALS FOR USE IN  
THE MANUFACTURE OF POLYMERS, IN CLASS 1  
(U.S. CLS. 1, 5, 6, 10, 26 AND 46).

SN 77-042,522, FILED 11-13-2006.

FIRST USE 1-8-2007; IN COMMERCE 1-8-2007.

PAUL E. FAHRENKOPF, EXAMINING ATTORNEY

**Int. Cl.: 9**

**Prior U.S. Cls.: 21, 23, 26, 36, and 38**

**United States Patent and Trademark Office**

**Reg. No. 3,499,558**

**Registered Sep. 9, 2008**

**TRADEMARK  
PRINCIPAL REGISTER**

**COSI CARD**

COSI, INC. (DELAWARE CORPORATION)  
6TH FLOOR  
1751 LAKE COOK RD.  
DEERFIELD, IL 60015

FOR: MAGNETICALLY AND ELECTRONICAL-  
LY CODED STORED VALUE CARDS FOR PUR-  
CHASING GOODS AND SERVICES AND FOR  
TRACKING CUSTOMER REWARDS, IN CLASS 9  
(U.S. CLS. 21, 23, 26, 36 AND 38).

FIRST USE 11-20-2006; IN COMMERCE 11-20-2006.

THE MARK CONSISTS OF STANDARD CHAR-  
ACTERS WITHOUT CLAIM TO ANY PARTICULAR  
FONT, STYLE, SIZE, OR COLOR.

NO CLAIM IS MADE TO THE EXCLUSIVE  
RIGHT TO USE "CARD", APART FROM THE  
MARK AS SHOWN.

SN 77-043,807, FILED 11-14-2006.

WANDA KAY PRICE, EXAMINING ATTORNEY

**Int. Cl.: 11**

**Prior U.S. Cls.: 13, 21, 23, 31, and 34**

**Reg. No. 3,499,559**

**United States Patent and Trademark Office**

**Registered Sep. 9, 2008**

**TRADEMARK  
PRINCIPAL REGISTER**

**LUCE GIUDECCA**

RIAD & FAMILY LLC (NEW YORK LIMITED  
LIABILITY COMPANY)  
SUITE 2000  
200 PARK AVENUE  
NEW YORK, NY 10166

NO CLAIM IS MADE TO THE EXCLUSIVE  
RIGHT TO USE "LUCE", APART FROM THE MARK  
AS SHOWN.

FOR: LAMPS; LIGHTING FIXTURES, IN CLASS  
11 (U.S. CLS. 13, 21, 23, 31 AND 34).

THE ENGLISH TRANSLATION OF THE WORD  
"LUCE" IN THE MARK IS LIGHT.

FIRST USE 4-1-2007; IN COMMERCE 4-1-2007.

SN 77-043,979, FILED 11-14-2006.

THE MARK CONSISTS OF STANDARD CHAR-  
ACTERS WITHOUT CLAIM TO ANY PARTICULAR  
FONT, STYLE, SIZE, OR COLOR.

SALLY SHIH, EXAMINING ATTORNEY

**Int. Cl.: 30**

**Prior U.S. Cl.: 46**

**United States Patent and Trademark Office**

**Reg. No. 3,499,560**

**Registered Sep. 9, 2008**

**TRADEMARK  
PRINCIPAL REGISTER**

**BOLD BEGINNINGS**

MARRIOTT INTERNATIONAL, INC. (DELA-  
WARE CORPORATION)  
10400 FERNWOOD ROAD  
BETHESDA, MD 20817

THE MARK CONSISTS OF STANDARD CHAR-  
ACTERS WITHOUT CLAIM TO ANY PARTICULAR  
FONT, STYLE, SIZE, OR COLOR.

FOR: COFFEE, IN CLASS 30 (U.S. CL. 46).

SN 77-044,712, FILED 11-15-2006.

FIRST USE 4-17-2007; IN COMMERCE 4-17-2007.

AMY ALFIERI, EXAMINING ATTORNEY

Int. Cl.: 42

Prior U.S. Cls.: 100 and 101

United States Patent and Trademark Office

Reg. No. 3,499,561

Registered Sep. 9, 2008

SERVICE MARK  
PRINCIPAL REGISTER



ACARTE TECHNOLOGY SERVICES, INC.  
(FLORIDA CORPORATION)  
2271 MCGREGOR BLVD  
FORT MYERS, FL 33901

FIRST USE 10-24-2006; IN COMMERCE 10-24-2006.

NO CLAIM IS MADE TO THE EXCLUSIVE RIGHT TO USE "TECHNOLOGY SERVICES", APART FROM THE MARK AS SHOWN.

THE APPLICANT CLAIMS COLOR AS A FEATURE OF THE MARK, NAMELY, BLACK AND BLUE.

THE MARK CONSISTS OF BLUE SWOOSH CROSSING OVER A BLACK SWOOSH TO FORM THE LETTER "A"; APPEARING TO THE RIGHT OF THE LETTER "A" IS THE WORD "ACARTE" IN BLACK WITH BLUE SWOOSHES FORMING THE CROSS-BAR IN THE "A" AND THE ACCENT OVER THE "E"; APPEARING BELOW THE WORD "ACARTE" ARE THE WORDS "TECHNOLOGY SERVICES" IN BLUE.

SN 77-046,188, FILED 11-16-2006.

FOR: COMPUTER CONSULTATION; COMPUTER CONSULTATION IN THE FIELD OF COMPUTER SECURITY; COMPUTER DIAGNOSTIC SERVICES; COMPUTER DISASTER RECOVERY PLANNING; COMPUTER NETWORK DESIGN FOR OTHERS; COMPUTER PROGRAMMING; COMPUTER SECURITY SERVICE, NAMELY, HARD DRIVE ERASURE; COMPUTER SERVICES, NAMELY, PROVIDING SEARCH ENGINES FOR OBTAINING DATA ON A GLOBAL COMPUTER NETWORK; CONSULTATION SERVICES IN THE FIELDS OF SELECTION, IMPLEMENTATION AND USE OF COMPUTER HARDWARE AND SOFTWARE SYSTEMS FOR OTHERS; CONSULTING SERVICES IN THE FIELD OF DESIGN, SELECTION, IMPLEMENTATION AND USE OF COMPUTER HARDWARE AND SOFTWARE SYSTEMS FOR OTHERS; CUSTOMIZATION OF COMPUTER HARDWARE AND SOFTWARE; DESIGN OF HOME PAGES, COMPUTER SOFTWARE AND WEB SITES, IN CLASS 42 (U.S. CLS. 100 AND 101).

KATHERINE CHANG, EXAMINING ATTORNEY



**Int. Cl.: 10**

**Prior U.S. Cls.: 26, 39, and 44**

**United States Patent and Trademark Office**

**Reg. No. 3,499,562**

**Registered Sep. 9, 2008**

**TRADEMARK  
PRINCIPAL REGISTER**

**PLUME-AWAY 4.0**

JLJ MEDICAL DEVICES INTERNATIONAL, LLC  
(MINNESOTA LIMITED LIABILITY COMPAN-  
NY)  
6585 EDENVALE BLVD.  
SUITE 150  
EDEN PRAIRIE, MN 55346

FOR: MEDICAL APPARATUS PROVIDING FIL-  
TRATION FOR REMOVING EMISSIONS OF  
SMOKE, AIRBORNE PARTICLES, GASEOUS OR  
LIKE BY-PRODUCTS FROM THE SITE OF MEDI-  
CAL PROCEDURES, IN CLASS 10 (U.S. CLS. 26, 39  
AND 44).

FIRST USE 1-15-2007; IN COMMERCE 1-15-2007.

THE MARK CONSISTS OF STANDARD CHAR-  
ACTERS WITHOUT CLAIM TO ANY PARTICULAR  
FONT, STYLE, SIZE, OR COLOR.

OWNER OF U.S. REG. NO. 2,421,811.

SN 77-046,872, FILED 11-17-2006.

MONIQUE MILLER, EXAMINING ATTORNEY

**Int. Cl.: 10**

**Prior U.S. Cls.: 26, 39, and 44**

**United States Patent and Trademark Office**

**Reg. No. 3,499,563**

**Registered Sep. 9, 2008**

**TRADEMARK  
PRINCIPAL REGISTER**

**ULTRA PLUME-AWAY 6.0**

JLJ MEDICAL DEVICES INTERNATIONAL, LLC  
(MINNESOTA LIMITED LIABILITY COMPAN-  
NY)  
6585 EDENVALE BLVD.  
SUITE 150  
EDEN PRAIRIE, MN 55346

FOR: MEDICAL APPARATUS PROVIDING FIL-  
TRATION FOR REMOVING EMISSIONS OF  
SMOKE, AIRBORNE PARTICLES, GASEOUS OR  
LIKE BY-PRODUCTS FROM THE SITE OF MEDI-  
CAL PROCEDURES, IN CLASS 10 (U.S. CLS. 26, 39  
AND 44).

FIRST USE 1-15-2007; IN COMMERCE 1-15-2007.

THE MARK CONSISTS OF STANDARD CHAR-  
ACTERS WITHOUT CLAIM TO ANY PARTICULAR  
FONT, STYLE, SIZE, OR COLOR.

OWNER OF U.S. REG. NO. 2,421,811.

SN 77-046,876, FILED 11-17-2006.

MONIQUE MILLER, EXAMINING ATTORNEY

**Int. Cl.: 9**

**Prior U.S. Cls.: 21, 23, 26, 36, and 38**

**Reg. No. 3,499,564**

**United States Patent and Trademark Office**

**Registered Sep. 9, 2008**

**TRADEMARK  
PRINCIPAL REGISTER**

**SCREENFX**

GESTURETEK, INC. (DELAWARE CORPORATION)  
455 GOLDEN OAK DRIVE  
PORTOLA VALLEY, CA 94028

FOR: A SYSTEM FOR USE IN ADVERTISING AND MARKETING AND FOR VIDEOGAME-LIKE PLAY COMPRISING A COMPUTER FOR PLAYING INTERACTIVE CONTENT DETERMINED BY THE OWNER/ADVERTISER OR USER, A FLAT PANEL OR PROJECTOR-DRIVEN DISPLAY SCREEN SHOWING THIS CONTENT, AND ONE OR MORE SENSORS TO ALLOW INTERACTIVITY WITH THE CONTENT BY USERS, DRIVEN BY CUSTOM SOFTWARE FOR TRACKING THE USER AND FOR

PLAYING THE CONTENT, IN CLASS 9 (U.S. CLS. 21, 23, 26, 36 AND 38).

FIRST USE 6-4-2007; IN COMMERCE 6-4-2007.

THE MARK CONSISTS OF STANDARD CHARACTERS WITHOUT CLAIM TO ANY PARTICULAR FONT, STYLE, SIZE, OR COLOR.

OWNER OF U.S. REG. NO. 3,135,350.

SN 77-053,099, FILED 11-29-2006.

MICHAEL WEBSTER, EXAMINING ATTORNEY

**Int. Cl.: 6**

**Prior U.S. Cls.: 2, 12, 13, 14, 23, 25, and 50**

**Reg. No. 3,499,565**

**United States Patent and Trademark Office**

**Registered Sep. 9, 2008**

**TRADEMARK  
PRINCIPAL REGISTER**

**STEELDIRECT**

BUTLER MANUFACTURING COMPANY (DE-  
LAWARE CORPORATION)  
1540 GENESSEE  
KANSAS CITY, MO 64102

THE MARK CONSISTS OF STANDARD CHAR-  
ACTERS WITHOUT CLAIM TO ANY PARTICULAR  
FONT, STYLE, SIZE, OR COLOR.

FOR: PRE-ENGINEERED METAL BUILDINGS,  
IN CLASS 6 (U.S. CLS. 2, 12, 13, 14, 23, 25 AND 50).

SN 77-053,893, FILED 11-30-2006.

FIRST USE 8-9-2007; IN COMMERCE 8-9-2007.

JESSICA A. POWERS, EXAMINING ATTORNEY

**Int. Cls.: 16 and 41**

**Prior U.S. Cls.: 2, 5, 22, 23, 29, 37, 38, 50, 100, 101, and 107**

**Reg. No. 3,499,566**

**United States Patent and Trademark Office**

**Registered Sep. 9, 2008**

**TRADEMARK  
SERVICE MARK  
PRINCIPAL REGISTER**

**ACSM AMERICAN FITNESS INDEX**

AMERICAN COLLEGE OF SPORTS MEDICINE,  
INC. (WISCONSIN NON-PROFIT CORPORATION)

401 WEST MICHIGAN STREET  
INDIANAPOLIS, IN 46202

FOR: PRINTED MATERIALS, NAMELY, REPORTS, SURVEYS, CHARTS, PAMPHLETS AND INFORMATIONAL FLYERS RELATED TO PHYSICAL FITNESS, IN CLASS 16 (U.S. CLS. 2, 5, 22, 23, 29, 37, 38 AND 50).

FIRST USE 5-0-2008; IN COMMERCE 5-0-2008.

FOR: PROVIDING INFORMATION IN THE FIELD OF PHYSICAL FITNESS, NAMELY, A MULTI-COMPONENT INDEX TO MEASURE PHYSICAL FITNESS AND CHANGES IN PHYSICAL FITNESS, AND EVALUATE PHYSICAL FITNESS PROGRAMS

AND INITIATIVES, IN CLASS 41 (U.S. CLS. 100, 101 AND 107).

FIRST USE 5-0-2008; IN COMMERCE 5-0-2008.

THE MARK CONSISTS OF STANDARD CHARACTERS WITHOUT CLAIM TO ANY PARTICULAR FONT, STYLE, SIZE, OR COLOR.

OWNER OF U.S. REG. NOS. 1,707,304, 1,805,609, AND OTHERS.

NO CLAIM IS MADE TO THE EXCLUSIVE RIGHT TO USE "AMERICAN FITNESS INDEX", APART FROM THE MARK AS SHOWN.

SN 77-056,005, FILED 12-3-2006.

PAUL E. FAHRENKOPF, EXAMINING ATTORNEY

**Int. Cl.: 35**

**Prior U.S. Cls.: 100, 101, and 102**

**United States Patent and Trademark Office**

**Reg. No. 3,499,567**

**Registered Sep. 9, 2008**

**SERVICE MARK  
PRINCIPAL REGISTER**

# HUE STUDIO

KAYSER-ROTH CORPORATION (DELAWARE CORPORATION)  
102 CORPORATE CENTER BOULEVARD  
GREENSBORO, NC 27408

FOR: RETAIL STORE AND ON-LINE RETAIL STORE SERVICES FEATURING CLOTHING, FOOTWEAR, PURSES, HAND BAGS AND RELATED ACCESSORIES, IN CLASS 35 (U.S. CLS. 100, 101 AND 102).

FIRST USE 5-17-2007; IN COMMERCE 5-17-2007.

THE MARK CONSISTS OF STANDARD CHARACTERS WITHOUT CLAIM TO ANY PARTICULAR FONT, STYLE, SIZE, OR COLOR.

OWNER OF U.S. REG. NOS. 1,250,432, 2,944,689, AND OTHERS.

SN 77-056,195, FILED 12-4-2006.

RONALD MCMORROW, EXAMINING ATTORNEY

**Int. Cl.: 14**

**Prior U.S. Cls.: 2, 27, 28, and 50**

**United States Patent and Trademark Office**

**Reg. No. 3,499,568**

**Registered Sep. 9, 2008**

**TRADEMARK  
PRINCIPAL REGISTER**

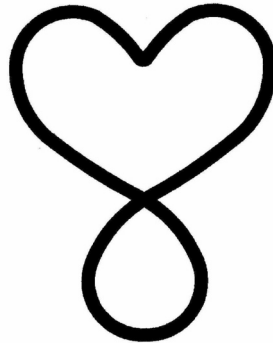

CHRISTIE, JACKIE (UNITED STATES INDIVIDUAL)  
PMB 381, 14150 N.E. 20TH STREET, F-1  
BELLEVIEW, WA 98007 AND  
CHRISTIE, DOUG (UNITED STATES INDIVIDUAL)  
PMB 381, 14150 N.E. 20TH STREET, F-1  
BELLEVIEW, WA 98007

FIRST USE 1-0-2006; IN COMMERCE 1-0-2006.

OWNER OF U.S. REG. NO. 3,197,184.

SN 77-057,122, FILED 12-5-2006.

FOR: JEWELRY, IN CLASS 14 (U.S. CLS. 2, 27, 28 AND 50).

KAPIL BHANOT, EXAMINING ATTORNEY

**Int. Cl.: 16**

**Prior U.S. Cls.: 2, 5, 22, 23, 29, 37, 38, and 50**

**United States Patent and Trademark Office**

**Reg. No. 3,499,569**

**Registered Sep. 9, 2008**

**TRADEMARK  
PRINCIPAL REGISTER**

**K.I.S.S.E.D.**

DRUMM, KEITH A. (UNITED STATES INDIVIDUAL)  
2612 PAMELA DRIVE SE  
WINTER HAVEN, FL 33884

FOR: NON-METAL TRAVEL DOCUMENT HOLDER FOR HANDS-FREE AIRLINE SECURITY IDENTIFICATION, IN CLASS 16 (U.S. CLS. 2, 5, 22, 23, 29, 37, 38 AND 50).

FIRST USE 3-1-2008; IN COMMERCE 3-1-2008.

THE MARK CONSISTS OF STANDARD CHARACTERS WITHOUT CLAIM TO ANY PARTICULAR FONT, STYLE, SIZE, OR COLOR.

SN 77-057,254, FILED 12-5-2006.

DOMINIC J. FERRAIUOLO, EXAMINING ATTORNEY



**Int. Cl.: 36**

**Prior U.S. Cls.: 100, 101, and 102**

**United States Patent and Trademark Office**

**Reg. No. 3,499,570**

**Registered Sep. 9, 2008**

**SERVICE MARK  
PRINCIPAL REGISTER**

**TRADEBRIDGE**

EAST WEST BANK (CALIFORNIA CORPORATION)  
135 N. LOS ROBLES AVE.  
PASADENA, CA 91101

FOR: FINANCIAL SERVICES, NAMELY, ISSUANCE OF LETTERS OF CREDIT AND BANKER'S ACCEPTANCE FINANCING, IN CLASS 36 (U.S. CLS. 100, 101 AND 102).

FIRST USE 12-1-2006; IN COMMERCE 12-1-2006.

THE MARK CONSISTS OF STANDARD CHARACTERS WITHOUT CLAIM TO ANY PARTICULAR FONT, STYLE, SIZE, OR COLOR.

SN 77-058,115, FILED 12-6-2006.

COLLEEN DOMBROW, EXAMINING ATTORNEY

**Int. Cl.: 9**

**Prior U.S. Cls.: 21, 23, 26, 36, and 38**

**Reg. No. 3,499,571**

**United States Patent and Trademark Office**

**Registered Sep. 9, 2008**

**TRADEMARK  
PRINCIPAL REGISTER**

**SOUNDMASTER**

EXCALIBUR ELECTRONICS, INC. (FLORIDA CORPORATION)  
13755 SW 119TH AVENUE  
MIAMI, FL 33186

FOR: ACCESSORIES FOR PORTABLE AND HANDHELD DIGITAL ELECTRONIC DEVICES FOR RECORDING, ORGANIZING, TRANSMITTING, MANIPULATING, AND REVIEWING AUDIO FILES AND MP3 PLAYERS, NAMELY, PROTECTIVE CARRYING CASES, AMPLIFIED DOCKING STATIONS FOR PORTABLE AUDIO DEVICES, AUDIO SPEAKERS, EAR PHONES, RADIOS INCORPORATING CLOCKS, ELECTRICAL CABLES, WIR-

ING AND CONNECTORS, IN CLASS 9 (U.S. CLS. 21, 23, 26, 36 AND 38).

FIRST USE 4-30-2006; IN COMMERCE 4-30-2006.

THE MARK CONSISTS OF STANDARD CHARACTERS WITHOUT CLAIM TO ANY PARTICULAR FONT, STYLE, SIZE, OR COLOR.

SN 77-060,116, FILED 12-8-2006.

DAVID YONTEF, EXAMINING ATTORNEY

**Int. Cl.: 24**

**Prior U.S. Cls.: 42 and 50**

**United States Patent and Trademark Office**

**Reg. No. 3,499,572**

**Registered Sep. 9, 2008**

**TRADEMARK  
PRINCIPAL REGISTER**

**LAND OF WHIMZIE**

FABRIC EDITIONS LLC (SOUTH CAROLINA  
CORPORATION)  
1 INDEPENDENCE POINTE, STUDIO 202  
GREENVILLE, SC 29615

FOR: KITS COMPRISED OF FABRICS FOR MAK-  
ING QUILTS, DECORATIVE PILLOWS, AND CAR-  
RYING BAGS, IN CLASS 24 (U.S. CLS. 42 AND 50).

FIRST USE 2-27-2007; IN COMMERCE 2-27-2007.

THE MARK CONSISTS OF STANDARD CHAR-  
ACTERS WITHOUT CLAIM TO ANY PARTICULAR  
FONT, STYLE, SIZE, OR COLOR.

SN 77-060,236, FILED 12-8-2006.

JOHN WILKE, EXAMINING ATTORNEY

**Int. Cl.: 16**

**Prior U.S. Cls.: 2, 5, 22, 23, 29, 37, 38, and 50**

**Reg. No. 3,499,573**

**United States Patent and Trademark Office**

**Registered Sep. 9, 2008**

**TRADEMARK  
PRINCIPAL REGISTER**

**LA MIREYA**

TELMEX USA, L.L.C. (DELAWARE LIMITED  
LIABILITY COMPANY)  
3350 S.W. 148TH AVENUE  
MIRAMAR, FL 33027

THE MARK CONSISTS OF STANDARD CHAR-  
ACTERS WITHOUT CLAIM TO ANY PARTICULAR  
FONT, STYLE, SIZE, OR COLOR.

FOR: PRE-PAID TELEPHONE CALLING CARDS  
NOT MAGNETICALLY ENCODED, IN CLASS 16  
(U.S. CLS. 2, 5, 22, 23, 29, 37, 38 AND 50).

SN 77-064,497, FILED 12-14-2006.

FIRST USE 8-13-2007; IN COMMERCE 8-13-2007.

CHERYL CLAYTON, EXAMINING ATTORNEY

**Int. Cl.: 41**

**Prior U.S. Cls.: 100, 101, and 107**

**United States Patent and Trademark Office**

**Reg. No. 3,499,574**

**Registered Sep. 9, 2008**

**SERVICE MARK  
PRINCIPAL REGISTER**

**TREND-O-LICIOUS**

TISHERMAN, WILLIAM R. (UNITED STATES  
INDIVIDUAL)  
24 MCQUEEN STREET  
KATONAH, NY 10536

FOR: CONSULTING SERVICES IN THE FIELD  
OF WINE AND FOOD, NAMELY, WINE AND FOOD  
TASTING EVENTS; PROVIDING A WEBSITE FEAT-  
URING INFORMATION IN THE FIELD OF WINE  
AND FOOD, NAMELY, WINE AND FOOD TAST-  
ING, IN CLASS 41 (U.S. CLS. 100, 101 AND 107).

FIRST USE 9-19-2007; IN COMMERCE 9-19-2007.

THE MARK CONSISTS OF STANDARD CHAR-  
ACTERS WITHOUT CLAIM TO ANY PARTICULAR  
FONT, STYLE, SIZE, OR COLOR.

SN 77-065,241, FILED 12-15-2006.

MARGARET POWER, EXAMINING ATTORNEY

**Int. Cl.: 35**

**Prior U.S. Cls.: 100, 101, and 102**

**United States Patent and Trademark Office**

**Reg. No. 3,499,575**

**Registered Sep. 9, 2008**

**SERVICE MARK  
PRINCIPAL REGISTER**

**SMARTOFFICE**

SMARTTALENT LLC (WASHINGTON LIMITED  
LIABILITY COMPANY)  
1321 FOURTH AVENUE  
SEATTLE, WA 98101

FOR: BUSINESS SERVICES, NAMELY, BUSINESS  
CONSULTING IN THE FIELDS OF HUMAN RE-  
SOURCE, MANAGEMENT CONSULTING, AND  
SCREENING, EVALUATION AND TRAINING JOB  
RECRUITS; TEMPORARY EMPLOYMENT STAFF-  
ING SERVICES; EMPLOYMENT RECRUITING  
AND PLACEMENT SERVICES IN THE FIELDS/  
POSITIONS INCLUDING GENERAL OFFICE, RE-  
CEPTIONIST, OFFICE ASSISTANT, MAIL ROOM,  
CUSTOMER SERVICE, CALL CENTER, DATA EN-

TRY, ADMINISTRATIVE, SALES AND MARKET-  
ING, ESCROW ASSISTANT, LOAN PROCESSORS,  
AND TITLE ASSISTANTS, IN CLASS 35 (U.S. CLS.  
100, 101 AND 102).

FIRST USE 10-0-2001; IN COMMERCE 7-0-2007.

THE MARK CONSISTS OF STANDARD CHAR-  
ACTERS WITHOUT CLAIM TO ANY PARTICULAR  
FONT, STYLE, SIZE, OR COLOR.

SN 77-065,723, FILED 12-15-2006.

ALEX KEAM, EXAMINING ATTORNEY

**Int. Cl.: 35**

**Prior U.S. Cls.: 100, 101, and 102**

**United States Patent and Trademark Office**

**Reg. No. 3,499,576**

**Registered Sep. 9, 2008**

**SERVICE MARK  
PRINCIPAL REGISTER**

**SMARTACCOUNTING**

SMARTTALENT LLC (WASHINGTON LIMITED  
LIABILITY COMPANY)  
1321 FOURTH AVENUE  
SEATTLE, WA 98101

FOR: BUSINESS SERVICES, NAMELY, BUSINESS  
CONSULTING IN THE FIELDS OF HUMAN RE-  
SOURCE, MANAGEMENT CONSULTING, AND  
SCREENING, EVALUATION AND TRAINING JOB  
RECRUITS; TEMPORARY EMPLOYMENT STAFF-  
ING SERVICES; EMPLOYMENT RECRUITING  
AND PLACEMENT SERVICES IN THE FIELDS/  
POSITIONS/ROLES INCLUDING ACCOUNTING  
CLERKS, ACCOUNTS PAYABLE, ACCOUNTS RE-  
CEIVABLE, DATA ENTRY SPECIALIST, PAYROLL

CLERKS, BILLING, CREDIT AND COLLECTIONS,  
BOOKKEEPERS AND FINANCE, IN CLASS 35 (U.S.  
CLS. 100, 101 AND 102).

FIRST USE 10-0-2001; IN COMMERCE 7-0-2007.

THE MARK CONSISTS OF STANDARD CHAR-  
ACTERS WITHOUT CLAIM TO ANY PARTICULAR  
FONT, STYLE, SIZE, OR COLOR.

SN 77-065,724, FILED 12-15-2006.

ALEX KEAM, EXAMINING ATTORNEY

**Int. Cl.: 16**

**Prior U.S. Cls.: 2, 5, 22, 23, 29, 37, 38, and 50**

**Reg. No. 3,499,577**

**United States Patent and Trademark Office**

**Registered Sep. 9, 2008**

**TRADEMARK  
PRINCIPAL REGISTER**

# Creative Brain

SEEBER, ECKART (CANADA INDIVIDUAL)  
15790 PRAIRIE WAY  
RIVERSIDE, CA 92508

ART AND SCIENCE, IN CLASS 16 (U.S. CLS. 2, 5, 22,  
23, 29, 37, 38 AND 50).

FIRST USE 11-1-2007; IN COMMERCE 11-1-2007.

FOR: CHILDREN'S INTERACTIVE EDUCATION-  
AL BOOKS; EDUCATIONAL BOOKS FEATURING  
MUSIC, ART AND SCIENCE; EDUCATIONAL PUB-  
LICATIONS, NAMELY, TRAINING MANUALS IN  
THE FIELD OF MUSIC, ART AND SCIENCE; PRIN-  
TED INSTRUCTIONAL, EDUCATIONAL, AND  
TEACHING MATERIALS IN THE FIELD OF MUSIC,

THE MARK CONSISTS OF STANDARD CHAR-  
ACTERS WITHOUT CLAIM TO ANY PARTICULAR  
FONT, STYLE, SIZE, OR COLOR.

SN 77-065,816, FILED 12-16-2006.

SANI KHOURI, EXAMINING ATTORNEY



**Int. Cl.: 41**

**Prior U.S. Cls.: 100, 101, and 107**

**Reg. No. 3,499,578**

**United States Patent and Trademark Office**

**Registered Sep. 9, 2008**

**SERVICE MARK  
PRINCIPAL REGISTER**

**SYNCLIVE**

SYNCHRONICITY LIVE, LLC (FLORIDA LIMITED LIABILITY COMPANY)  
637 1ST AVE. NORTH  
SUITE C  
JACKSONVILLE BEACH, FL 32250

FOR: ENTERTAINMENT SERVICES, NAMELY, PROVIDING A WEBSITE FEATURING MUSICAL PERFORMANCES, MUSIC CONCERTS, MUSICAL VIDEOS, AND COMMENTARY ABOUT MUSIC AND RELATED FILM CLIPS, PHOTOGRAPHS, AND OTHER MULTI-MEDIA MATERIALS, ALL ON-LINE VIA THE INTERNET OR OTHER COM-

MUNICATIONS NETWORKS, IN CLASS 41 (U.S. CLS. 100, 101 AND 107).

FIRST USE 12-1-2007; IN COMMERCE 12-1-2007.

THE MARK CONSISTS OF STANDARD CHARACTERS WITHOUT CLAIM TO ANY PARTICULAR FONT, STYLE, SIZE, OR COLOR.

SN 77-065,885, FILED 12-16-2006.

MICHAEL GAAFAR, EXAMINING ATTORNEY

**Int. Cl.: 12**

**Prior U.S. Cls.: 19, 21, 23, 31, 35, and 44**

**United States Patent and Trademark Office**

**Reg. No. 3,499,579**

**Registered Sep. 9, 2008**

**TRADEMARK  
PRINCIPAL REGISTER**

**coasting**

SHIMANO INC. (JAPAN CORPORATION)  
3-77 OIMATSU-CHO, SAKAI-KU  
SAKAI CITY, JAPAN 590-8577

FIRST USE 1-1-2007; IN COMMERCE 1-1-2007.

FOR: BICYCLE PARTS, NAMELY, FENDERS,  
HANDLEBAR, BICYCLE PEDALS; REAR WHEEL  
RACKS FOR BICYCLES, IN CLASS 12 (U.S. CLS. 19,  
21, 23, 31, 35 AND 44).

SN 77-066,028, FILED 12-17-2006.

SUNG IN, EXAMINING ATTORNEY

**Int. Cl.: 41**

**Prior U.S. Cls.: 100, 101, and 107**

**United States Patent and Trademark Office**

**Reg. No. 3,499,580**

**Registered Sep. 9, 2008**

**SERVICE MARK  
PRINCIPAL REGISTER**

**EC&C GROUP**

BR CONSULTING, INC. (NEW JERSEY CORPORATION)  
340 JORDAN ROAD  
SEDONA, AZ 86336

FOR: EDUCATIONAL SERVICES, NAMELY, CONDUCTING CORPORATE TRAINING AND EDUCATION PROGRAMS IN THE FIELD OF PERSONAL AND PROFESSIONAL DEVELOPMENT, IN CLASS 41 (U.S. CLS. 100, 101 AND 107).

FIRST USE 2-0-2007; IN COMMERCE 2-0-2007.

THE MARK CONSISTS OF STANDARD CHARACTERS WITHOUT CLAIM TO ANY PARTICULAR FONT, STYLE, SIZE, OR COLOR.

NO CLAIM IS MADE TO THE EXCLUSIVE RIGHT TO USE "GROUP", APART FROM THE MARK AS SHOWN.

SN 77-066,596, FILED 12-18-2006.

JENNIFER MARTIN, EXAMINING ATTORNEY

**Int. Cl.: 5**

**Prior U.S. Cls.: 6, 18, 44, 46, 51, and 52**

**Reg. No. 3,499,581**

**United States Patent and Trademark Office**

**Registered Sep. 9, 2008**

**TRADEMARK  
PRINCIPAL REGISTER**

**COCOON**

ADVAN LLC (GEORGIA LIMITED LIABILITY  
COMPANY)  
SUITE 230  
300 COLONIAL PARKWAY  
ROSWELL, GA 30076

FOR: PLANT HEALTH PRODUCTS, NAMELY,  
INSECTICIDES, INSECT REPELLENTS, PLANT  
SUNBURN PREVENTATIVES, AND REFLECTIVE  
PARTICULATE MATERIALS FOR APPLICATION  
TO THE SURFACE OF PLANTS, NAMELY, KAO-  
LIN, IN CLASS 5 (U.S. CLS. 6, 18, 44, 46, 51 AND 52).

FIRST USE 6-14-2007; IN COMMERCE 6-14-2007.

THE MARK CONSISTS OF STANDARD CHAR-  
ACTERS WITHOUT CLAIM TO ANY PARTICULAR  
FONT, STYLE, SIZE, OR COLOR.

SN 77-066,752, FILED 12-18-2006.

CAROLYN GRAY, EXAMINING ATTORNEY

**Int. Cl.: 36**

**Prior U.S. Cls.: 100, 101, and 102**

**United States Patent and Trademark Office**

**Reg. No. 3,499,582**

**Registered Sep. 9, 2008**

**SERVICE MARK  
PRINCIPAL REGISTER**

**POST PAST DUE**

LAURA L. JENIFER (UNITED STATES INDIVIDUAL)  
11230 GLEN ARM ROAD  
GLEN ARM, MD 21029

FOR: PROVIDING AN ON-LINE SEARCHABLE DATABASE THAT ALLOWS THIRD PARTIES TO SEARCH A DATABASE OF PEOPLE AND/OR BUSINESSES THAT HAVE FAILED TO PAY INVOICES, IN CLASS 36 (U.S. CLS. 100, 101 AND 102).

FIRST USE 1-14-2008; IN COMMERCE 3-1-2008.

THE MARK CONSISTS OF STANDARD CHARACTERS WITHOUT CLAIM TO ANY PARTICULAR FONT, STYLE, SIZE, OR COLOR.

SN 77-067,351, FILED 12-19-2006.

KIMBERLY PERRY, EXAMINING ATTORNEY

**Int. Cl.: 24**

**Prior U.S. Cls.: 42 and 50**

**United States Patent and Trademark Office**

**Reg. No. 3,499,583**

**Registered Sep. 9, 2008**

**TRADEMARK  
PRINCIPAL REGISTER**

**SANELIN**

BVBA SANELIN (BELGIUM CORPORATION)  
NIEPKERKESTAAT 72  
NIEUWKERKE, BELGIUM B.8950

FOR: TEXTILE FABRICS, NAMELY, LINEN FAB-  
RIC, IN CLASS 24 (U.S. CLS. 42 AND 50).

FIRST USE 4-25-2008; IN COMMERCE 4-25-2008.

THE MARK CONSISTS OF STANDARD CHAR-  
ACTERS WITHOUT CLAIM TO ANY PARTICULAR  
FONT, STYLE, SIZE, OR COLOR.

OWNER OF U.S. REG. NO. 1,377,250.

SN 77-068,703, FILED 12-20-2006.

LINDA POWELL, EXAMINING ATTORNEY

**Int. Cl.: 36**

**Prior U.S. Cls.: 100, 101, and 102**

**United States Patent and Trademark Office**

**Reg. No. 3,499,584**

**Registered Sep. 9, 2008**

**SERVICE MARK  
PRINCIPAL REGISTER**

**PPD**

LAURA L. JENIFER (UNITED STATES INDIVIDUAL)  
11230 GLEN ARM ROAD  
GLEN ARM, MD 21057

FOR: PROVIDING AN ON-LINE SEARCHABLE DATABASE THAT ALLOWS THIRD PARTIES TO POST TO AND SEARCH A DATABASE OF PEOPLE AND/OR BUSINESSES THAT HAVE FAILED TO PAY INVOICES, IN CLASS 36 (U.S. CLS. 100, 101 AND 102).

FIRST USE 1-14-2008; IN COMMERCE 3-1-2008.

THE MARK CONSISTS OF STANDARD CHARACTERS WITHOUT CLAIM TO ANY PARTICULAR FONT, STYLE, SIZE, OR COLOR.

SN 77-068,872, FILED 12-20-2006.

KIMBERLY PERRY, EXAMINING ATTORNEY

**Int. Cl.: 20**

**Prior U.S. Cls.: 2, 13, 22, 25, 32, and 50**

**Reg. No. 3,499,585**

**United States Patent and Trademark Office**

**Registered Sep. 9, 2008**

**TRADEMARK  
PRINCIPAL REGISTER**

**LOVE HOW YOU WORK**

STEELCASE INC. (MICHIGAN CORPORATION)  
PO BOX 1967  
901 44TH STREET SE  
GRAND RAPIDS, MI 49501

THE MARK CONSISTS OF STANDARD CHAR-  
ACTERS WITHOUT CLAIM TO ANY PARTICULAR  
FONT, STYLE, SIZE, OR COLOR.

FOR: FURNITURE, IN CLASS 20 (U.S. CLS. 2, 13,  
22, 25, 32 AND 50).

SN 77-069,817, FILED 12-21-2006.

FIRST USE 6-9-2007; IN COMMERCE 8-22-2007.

CHRISTINA SOBRAL, EXAMINING ATTORNEY



Int. Cl.: 13

Prior U.S. Cls.: 2 and 9

United States Patent and Trademark Office

Reg. No. 3,499,586

Registered Sep. 9, 2008

TRADEMARK  
PRINCIPAL REGISTER



ALLIANT TECHSYSTEMS INC. (DELAWARE CORPORATION)  
5050 LINCOLN DRIVE  
EDINA, MN 55436

FOR: AMMUNITION, IN CLASS 13 (U.S. CLS. 2 AND 9).

FIRST USE 11-0-2006; IN COMMERCE 4-0-2007.

THE COLOR(S) BLACK, ORANGE, YELLOW, AND RED IS/ARE CLAIMED AS A FEATURE OF THE MARK.

THE MARK CONSISTS OF THE COLOR BLACK APPEARING AS THE BORDER OF THE MARK, THE GRASS DESIGN ELEMENT, AND THE DESIGN ELEMENTS OF THE WATERFOWL. IN ORDER FROM TOP TO BOTTOM, THE COLORS RED, ORANGE, AND YELLOW APPEAR AS THE COLORS REPRESENTING A SUNRISE.

SN 77-070,612, FILED 12-22-2006.

LYDIA BELZER, EXAMINING ATTORNEY

**Int. Cl.: 36**

**Prior U.S. Cls.: 100, 101, and 102**

**United States Patent and Trademark Office**

**Reg. No. 3,499,587**

**Registered Sep. 9, 2008**

**SERVICE MARK  
PRINCIPAL REGISTER**



NEW YORK MERCANTILE EXCHANGE, INC.  
(DELAWARE CORPORATION)  
WORLD FINANCIAL CENTER  
ONE NORTH END AVENUE  
NEW YORK, NY 10282

FOR: PROVIDING FINANCIAL AND INVESTMENT INFORMATION SERVICES; PROVIDING FINANCIAL SERVICES, NAMELY, PROVIDING AN ELECTRONIC EXCHANGE MARKET FOR TRADING, CLEARING, CONFIRMING TRANSACTIONS, AND OTHER SERVICES IN THE FIELD OF COMMODITY FUTURES, OPTIONS AND OTHER DERIVATIVES; PROVIDING INFORMATION ON SETTLEMENT PRICES, TRADING PRICES, BID AND ASK PRICES, PRICE RANGES, VOLUME

DATA, AND OTHER MARKET DATA ON COMMODITY FUTURES CONTRACTS, OPTIONS AND OTHER DERIVATIVES, IN CLASS 36 (U.S. CLS. 100, 101 AND 102).

FIRST USE 12-20-2006; IN COMMERCE 12-20-2006.

NO CLAIM IS MADE TO THE EXCLUSIVE RIGHT TO USE "COFFEE SUGAR COCOA COTTON FCOJ", APART FROM THE MARK AS SHOWN.

SN 77-070,795, FILED 12-22-2006.

BARBARA BROWN, EXAMINING ATTORNEY

**Int. Cls.: 3 and 7**

**Prior U.S. Cls.: 1, 4, 6, 13, 19, 21, 23, 31, 34, 35, 50, 51,  
and 52**

**Reg. No. 3,499,588**

**United States Patent and Trademark Office**

**Registered Sep. 9, 2008**

**TRADEMARK  
PRINCIPAL REGISTER**

**DURAGON**

PARK, SANG WON (UNITED STATES INDIVIDUAL)  
11931 LOS NIENTOS ROAD  
SANTA FE SPRINGS, CA 92833

FOR: ABRASIVE CLOTH; ABRASIVE PAPER; ABRASIVE PASTE; ABRASIVE ROLLS; ABRASIVE SAND; ABRASIVE SHEETS; ABRASIVE STRIPS; COATED ABRASIVES AND SANDPAPER IN THE FORM OF BELTS, SHEETS, ROLLS AND DISCS; FLEXIBLE ABRASIVES; GENERAL PURPOSE CLEANING, POLISHING, AND ABRASIVE LIQUIDS AND POWDERS; SAND FOR USE AS ABRASIVE IN SANDBLASTING; SKIN ABRASIVE PREPARATIONS, IN CLASS 3 (U.S. CLS. 1, 4, 6, 50, 51 AND 52).

FIRST USE 1-1-2008; IN COMMERCE 1-1-2008.

FOR: ABRASIVE BELTS FOR POWER-OPERATED SANDERS; ABRASIVE DISKS FOR POWER-OPERATED GRINDERS; ABRASIVE DISKS FOR POWER-OPERATED SANDERS; ABRASIVE WHEELS FOR POWER-OPERATED GRINDERS; POWER-OPERATED ABRASIVE WHEELS, IN CLASS 7 (U.S. CLS. 13, 19, 21, 23, 31, 34 AND 35).

FIRST USE 1-1-2008; IN COMMERCE 1-1-2008.

THE MARK CONSISTS OF STANDARD CHARACTERS WITHOUT CLAIM TO ANY PARTICULAR FONT, STYLE, SIZE, OR COLOR.

SN 77-071,294, FILED 12-26-2006.

STEVEN JACKSON, EXAMINING ATTORNEY

**Int. Cl.: 41**

**Prior U.S. Cls.: 100, 101, and 107**

**United States Patent and Trademark Office**

**Reg. No. 3,499,589**

**Registered Sep. 9, 2008**

**SERVICE MARK  
PRINCIPAL REGISTER**

**HEARTSTREAMS**

THE HEARTS CENTER, INC. (ILLINOIS COR-  
PORATION)  
P.O. BOX 277  
LIVINGSTON, MT 59047

FOR: PROVIDING ONLINE PUBLICATIONS,  
NAMELY, TEACHING MATERIALS, IN THE FIELD  
OF SPIRITUALITY, IN CLASS 41 (U.S. CLS. 100, 101  
AND 107).

FIRST USE 10-28-2007; IN COMMERCE 10-28-2007.

THE MARK CONSISTS OF STANDARD CHAR-  
ACTERS WITHOUT CLAIM TO ANY PARTICULAR  
FONT, STYLE, SIZE, OR COLOR.

SN 77-072,943, FILED 12-28-2006.

CAROLYN GRAY, EXAMINING ATTORNEY

**Int. Cls.: 2, 6, 8, 16, and 18**

**Prior U.S. Cls.: 1, 2, 3, 5, 6, 11, 12, 13, 14, 16, 22, 23, 25, 28, 29, 37, 38, 41, 44, and 50**

**Reg. No. 3,499,590**

**United States Patent and Trademark Office**

**Registered Sep. 9, 2008**

**TRADEMARK  
PRINCIPAL REGISTER**

# Tim Holtz

TIM HOLTZ, LLC (ARIZONA LIMITED LIABILITY COMPANY)  
1778 JADE CIRCLE  
PRESCOTT, AZ 86301

FOR: METALS IN LEAF AND POWDER FORM FOR PAINTERS, DECORATORS, PRINTERS AND ARTISTS; NONFERROUS METALS IN FOIL OR POWDER FORM FOR PAINTERS, DECORATORS, PRINTERS AND ARTISTS; PAINTS FOR ARTS AND CRAFTS, IN CLASS 2 (U.S. CLS. 6, 11 AND 16).

FIRST USE 5-1-2007; IN COMMERCE 7-17-2007.

FOR: GENERAL PURPOSE METAL STORAGE BINS; GENERAL PURPOSE METAL STORAGE CONTAINERS; METAL BOXES; METAL CHAINS; METAL CLASPS FOR PAPER CRAFTS; METAL CLIP FOR PAPER CRAFTS; METAL CLOSURES FOR PAPER CRAFTS; METAL KEY BLANKS; METAL TOOL BOXES, IN CLASS 6 (U.S. CLS. 2, 12, 13, 14, 23, 25 AND 50).

FIRST USE 1-1-2007; IN COMMERCE 5-31-2007.

FOR: HAND TOOLS NAMELY, HAMMERS; HAND TOOLS NAMELY, NEEDLE TOOL FOR MANIPULATING FIBROUS MATERIALS INCLUDING PAPER AND FABRIC, THREAD CUTTER/DISTRESSER FOR MANIPULATING FIBROUS MATERIALS INCLUDING PAPER AND FABRIC, CRAFT KNIFE, AND SCRATCHER FOR MANIPULATING FIBROUS MATERIALS INCLUDING PAPER AND FABRIC; ROLL-UP FABRIC CONTAINER FOR HAND TOOLS; SANDING BLOCKS; SCISSORS, IN CLASS 8 (U.S. CLS. 23, 28 AND 44).

FIRST USE 1-1-2006; IN COMMERCE 7-21-2006.

FOR: ACID-RESISTANT PAPER; ADHESIVE CORNERS FOR PHOTOGRAPHS; ADHESIVE LA-

BELS; ADHESIVE MATERIALS FOR OFFICE USE; ADHESIVE-BACKED LETTERS AND NUMBERS FOR USE IN MAKING PAPER CRAFTS, ALTERED ART, AND HOME DECOR;; ADHESIVES FOR STATIONERY OR HOUSEHOLD PURPOSES; ALBUMS FOR ALTERED ART, PAPER CRAFT, AND HOME DECOR;; ART PAPER; ARTISTS' BRUSHES; ARTISTS' PENS; ARTS AND CRAFT PAINT KITS; BLANK JOURNAL BOOKS; BOOKS IN THE FIELD OF ALTERED ARTS, HOME DECOR, AND PAPER CRAFT;; CARDBOARD BOXES; COFFEE TABLE BOOKS FEATURING ALTERED ART;; CRAFT PAPER; EDUCATIONAL BOOKS FEATURING PAPER CRAFT; HOME DECOR, AND ALTERED ART; EMBOSING POWDERS; FIBERBOARD BOXES; GIFT WRAP PAPER; GUIDE BOOKS FEATURING HOW-TO ALTERED ART, PAPER CRAFT, AND HOME DECOR;; ILLUSTRATION PAPER; IMPRESSION STAMPS; INK FOR WRITING INSTRUMENTS; INK PENS; INK STAMPS; INKING PADS; LABEL PRINTING MACHINES; LIQUID PAINT FELT TIP MARKING AND COLORING APPLICATORS; MARKING STAMPS; NUMBERING STAMPS; PAINT BRUSHES; PAINTING SETS; PAINTING SETS FOR ARTISTS; PAPER; PAPER AND CARDBOARD; PAPER BOARDS; PAPER BOXES; PAPER BOXES FOR STORING GREETING CARDS; PAPER CLIPS; PAPER CONTAINERS; PAPER CUTTERS; PAPER DIE CUT SHAPES; PAPER EMBLEMS; PAPER EMBOSSERS; PAPER FASTENERS; PAPER FILE JACKETS; PAPER FOLDERS; PAPER FOR USE IN THE MANUFACTURE OF ALTERED ART, PAPER CRAFT, AND HOME DECOR;; PAPER HANG TAGS; PAPER HOLE PUNCHES; PAPER LABELS; PAPER LETTERS AND NUMBER FOR USE IN MAKING ALTERED ART, PAPER CRAFT AND HOME DECOR;; PAPER RACKS; PAPER STAPLERS; PAPER STAPLES; PAPER STATIONERY; PAPER STOCK; PAPER TAGS; PAPER TRANSPARENCIES; PASTES AND OTHER ADHESIVES FOR STATIONERY OR HOUSEHOLD PURPOSES; PEN

INK REFILLS; PHOTO STORAGE BOXES; PRINT LETTERS AND BLOCKS; PRINTED INSTRUCTIONAL, EDUCATIONAL, AND TEACHING MATERIALS IN THE FIELD OF PAPER CRAFTS, ALTERED ART, AND HOME DECOR.; PROTECTIVE COVERS FOR SHEETS OR PAPER AND PAGES OF BOOKS AND THE LIKE; RUBBER STAMPS; SERIES OF NON-FICTION BOOKS IN THE FIELD OF ALTERED ART, HOME DECOR, AND PAPER CRAFTS.; SKETCH BOOKS; STAMP INKS; STAMP PAD INKS; STAMP PADS; STAMPING INKS; STATIONERY BOXES; STORAGE CONTAINERS MADE OF PAPER; VINYL LETTERS AND NUMBER FOR USE IN MAKING ALTERED ART; WIREBOUND BOOKS; WRITING INK, IN CLASS 16 (U.S. CLS. 2, 5, 22, 23, 29, 37, 38 AND 50).

FIRST USE 4-1-2003; IN COMMERCE 2-5-2004.

FOR: ALL-PURPOSE CARRYING BAGS; BARREL BAGS; BOOK BAGS; CARRY-ALL BAGS; COSMET-

IC BAGS SOLD EMPTY; KIT BAGS; LUGGAGE; ROLL BAGS; TOOL BAGS SOLD EMPTY; TOTE BAGS; TRAVEL BAGS , IN CLASS 18 (U.S. CLS. 1, 2, 3, 22 AND 41).

FIRST USE 1-1-2006; IN COMMERCE 7-21-2006.

THE MARK CONSISTS OF STANDARD CHARACTERS WITHOUT CLAIM TO ANY PARTICULAR FONT, STYLE, SIZE, OR COLOR.

THE NAME(S), PORTRAIT(S), AND/OR SIGNATURE(S) SHOWN IN THE MARK IDENTIFIES "TIM HOLTZ", WHOSE CONSENT(S) TO REGISTER IS MADE OF RECORD.

SN 77-073,475, FILED 12-29-2006.

ESTHER A. BORSUK, EXAMINING ATTORNEY

**Int. Cl.: 42**

**Prior U.S. Cls.: 100 and 101**

**United States Patent and Trademark Office**

**Reg. No. 3,499,591**

**Registered Sep. 9, 2008**

**SERVICE MARK  
PRINCIPAL REGISTER**

**8w8**

8W8 VENTURES INC. (NEW YORK CORPORATION)  
SUITE 4F  
1 UNIVERSITY PLACE  
NEW YORK, NY 10003

FOR: APPLICATION SERVICE PROVIDER (ASP) FEATURING SOFTWARE IN THE FIELD OF DATA-BASED MODELING; COMPUTER GRAPHICS SERVICES; COMPUTER SERVICE, NAMELY, ACTING AS AN APPLICATION SERVICE PROVIDER IN THE FIELD OF KNOWLEDGE MANAGEMENT TO HOST COMPUTER APPLICATION SOFTWARE FOR CREATING SEARCHABLE DATABASES OF INFORMATION AND DATA; COMPUTER SERVICE, NAMELY, ACTING AS AN APPLICATION SERVICE PROVIDER IN THE FIELD OF KNOWLEDGE MANAGEMENT TO HOST COMPUTER APPLICATION SOFTWARE FOR THE COLLECTION, EDITING, ORGANIZING, MODIFYING, BOOK MARKING, TRANSMISSION, STORAGE AND SHARING OF DATA AND INFORMATION; COMPUTER SERVICES, NAMELY, PROVIDING SEARCH ENGINES FOR OBTAINING DATA ON A GLOBAL COMPUTER NETWORK; COMPUTER SOFTWARE DESIGN, COMPUTER PROGRAMMING, OR MAINTENANCE OF COMPUTER SOFTWARE; COMPUTER SOFTWARE DEVELOPMENT; COMPUTER SYSTEMS ANALYSIS; DATABASE DEVELOPMENT SERVICES; DESIGN AND DEVELOPMENT OF ON-LINE COMPUTER SOFTWARE SYSTEMS; DEVELOPMENT OF COMPUTER PROGRAMS RECORDED ON DATA MEDIA (SOFTWARE) DESIGNED FOR USE IN CONSTRUCTION

AND AUTOMATED MANUFACTURING (CAD/CAM); DEVELOPMENT, UPDATING AND MAINTENANCE OF SOFTWARE AND DATA BASES; INTEGRATION OF COMPUTER SYSTEMS AND NETWORKS; PROVIDING A WEBSITE THAT FEATURES INFORMATION ON COMPUTER TECHNOLOGY AND PROGRAMMING; PROVIDING INFORMATION AT THE SPECIFIC REQUEST OF END-USERS BY MEANS OF TELEPHONE OR GLOBAL COMPUTER NETWORKS; PROVIDING ON-LINE NON-DOWNLOADABLE SOFTWARE FOR ACCESS TO AND MANIPULATION OF DATA FOR A DATA-BASED WORLD MODELING ENGINE; PROVIDING SPECIFIC INFORMATION AS REQUESTED BY CUSTOMERS VIA THE INTERNET; PROVIDING TEMPORARY USE OF ON-LINE NON-DOWNLOADABLE SOFTWARE FOR ACCESS TO AND MANIPULATION OF DATA FOR A DATA-BASED WORLD MODELING ENGINE; TECHNOLOGICAL CONSULTATION IN THE TECHNOLOGY FIELD OF MANIPULATION OF DATA FOR A DATA-BASED WORLD MODELING ENGINE, IN CLASS 42 (U.S. CLS. 100 AND 101).

FIRST USE 6-15-2008; IN COMMERCE 6-15-2008.

THE MARK CONSISTS OF STANDARD CHARACTERS WITHOUT CLAIM TO ANY PARTICULAR FONT, STYLE, SIZE, OR COLOR.

SN 77-073,636, FILED 12-29-2006.

ROBIN CHOSID, EXAMINING ATTORNEY

Int. Cl.: 42

Prior U.S. Cls.: 100 and 101

Reg. No. 3,499,592

United States Patent and Trademark Office

Registered Sep. 9, 2008

**SERVICE MARK  
PRINCIPAL REGISTER**



8W8 VENTURES INC. (NEW YORK CORPORATION)  
SUITE 4F  
1 UNIVERSITY PLACE  
NEW YORK, NY 10003

FOR: APPLICATION SERVICE PROVIDER (ASP) FEATURING SOFTWARE IN THE FIELD OF DATA-BASED MODELING; APPLICATION SERVICE PROVIDER (ASP), NAMELY, HOSTING COMPUTER SOFTWARE APPLICATIONS OF OTHERS; APPLICATION SERVICE PROVIDER FEATURING SOFTWARE FOR PROVIDING AN ON-LINE DATABASE IN THE FIELD OF TRANSACTION PROCESSING TO UPLOAD TRANSACTIONAL DATA, PROVIDE STATISTICAL ANALYSIS, AND PRODUCE NOTIFICATIONS AND REPORTS; COMPUTER SERVICE, NAMELY, ACTING AS AN APPLICATION SERVICE PROVIDER IN THE FIELD OF KNOWLEDGE MANAGEMENT TO HOST COMPUTER APPLICATION SOFTWARE FOR CREATING SEARCHABLE DATABASES OF INFORMATION AND DATA; COMPUTER SERVICE, NAMELY, ACTING AS AN APPLICATION SERVICE PROVIDER IN THE FIELD OF KNOWLEDGE MANAGEMENT TO HOST COMPUTER APPLICATION SOFTWARE FOR SEARCHING AND RETRIEVING INFORMATION FROM DATABASES AND COMPUTER NETWORKS; COMPUTER SERVICE, NAMELY, ACTING AS AN APPLICATION SERVICE PROVIDER IN THE FIELD OF KNOWLEDGE MANAGEMENT TO HOST COMPUTER APPLICATION SOFTWARE FOR THE COLLECTION, EDITING, ORGANIZING, MODIFYING, BOOK MARKING, TRANSMISSION, STORAGE AND SHARING OF DATA AND INFORMATION; COMPUTER SOFTWARE CONSULTATION; CUSTOMIZATION OF COMPUTER HARDWARE AND SOFTWARE; DESIGN FOR OTHERS IN THE FIELD

OF COMPUTER NETWORKS, SOFTWARE, AND ENGINEERING FOR THE ACCESS TO AND MANIPULATION OF DATA FOR A DATA-BASED WORLD MODELING ENGINE; DESIGN, DEVELOPMENT AND IMPLEMENTATION OF SOFTWARE; DEVELOPMENT OF COMPUTER PROGRAMS RECORDED ON DATA MEDIA (SOFTWARE) DESIGNED FOR USE IN CONSTRUCTION AND AUTOMATED MANUFACTURING (CAD/CAM); DEVELOPMENT, UPDATING AND MAINTENANCE OF SOFTWARE AND DATA BASES; PROVIDING INFORMATION AT THE SPECIFIC REQUEST OF END-USERS BY MEANS OF TELEPHONE OR GLOBAL COMPUTER NETWORKS; PROVIDING ON-LINE NON-DOWNLOADABLE SOFTWARE FOR ACCESS TO AND MANIPULATION OF DATA FOR A DATA-BASED WORLD MODELING ENGINE; PROVIDING TECHNICAL INFORMATION UPDATES OF INDUSTRIAL PROCESS CONTROL COMPUTER SOFTWARE VIA THE GLOBAL COMPUTER NETWORK; PROVIDING TEMPORARY USE OF ON-LINE NON-DOWNLOADABLE SOFTWARE FOR ACCESS TO AND MANIPULATION OF DATA FOR A DATA-BASED WORLD MODELING ENGINE; TECHNOLOGICAL CONSULTATION IN THE TECHNOLOGY FIELD OF DATA-BASED MODELING, IN CLASS 42 (U.S. CLS. 100 AND 101).

FIRST USE 6-15-2008; IN COMMERCE 6-15-2008.

THE MARK CONSISTS OF TWO EIGHTS WITH A "W" IN THE MIDDLE.

SN 77-073,663, FILED 12-29-2006.

ROBIN CHOSID, EXAMINING ATTORNEY



**Int. Cl.: 20**

**Prior U.S. Cls.: 2, 13, 22, 25, 32, and 50**

**Reg. No. 3,499,593**

**United States Patent and Trademark Office**

**Registered Sep. 9, 2008**

**TRADEMARK  
PRINCIPAL REGISTER**

**FENWICK**

MASCO RETAIL CABINET GROUP, LLC (OHIO  
LIMITED LIABILITY COMPANY)  
15535 SOUTH STATE  
MIDDLEFIELD, OH 44062

THE MARK CONSISTS OF STANDARD CHAR-  
ACTERS WITHOUT CLAIM TO ANY PARTICULAR  
FONT, STYLE, SIZE, OR COLOR.

FOR: CABINETS, NAMELY, KITCHEN AND  
BATHROOM CABINETS, IN CLASS 20 (U.S. CLS. 2,  
13, 22, 25, 32 AND 50).

SN 77-074,297, FILED 1-2-2007.

FIRST USE 9-19-2007; IN COMMERCE 9-19-2007.

YAT SYE, LEE, EXAMINING ATTORNEY

**Int. Cl.: 20**

**Prior U.S. Cls.: 2, 13, 22, 25, 32, and 50**

**Reg. No. 3,499,594**

**United States Patent and Trademark Office**

**Registered Sep. 9, 2008**

**TRADEMARK  
PRINCIPAL REGISTER**

**TUBE ULTRA**

SKYLINE DISPLAYS, INC. (MINNESOTA CORPORATION)  
3355 DISCOVERY ROAD  
EAGAN, MN 55121

FOR: PORTABLE DISPLAY AND EXHIBITION STANDS FOR BUSINESSES TO USE AT COMMERCIAL TRADE SHOWS AND EXHIBITIONS FOR THE PROMOTION OF THEIR PRODUCTS AND SERVICES, IN CLASS 20 (U.S. CLS. 2, 13, 22, 25, 32 AND 50).

FIRST USE 1-15-2007; IN COMMERCE 1-15-2007.

THE MARK CONSISTS OF STANDARD CHARACTERS WITHOUT CLAIM TO ANY PARTICULAR FONT, STYLE, SIZE, OR COLOR.

NO CLAIM IS MADE TO THE EXCLUSIVE RIGHT TO USE "TUBE", APART FROM THE MARK AS SHOWN.

SN 77-074,340, FILED 1-2-2007.

YAT SYE, LEE, EXAMINING ATTORNEY

**Int. Cl.: 43**

**Prior U.S. Cls.: 100 and 101**

**United States Patent and Trademark Office**

**Reg. No. 3,499,595**

**Registered Sep. 9, 2008**

**SERVICE MARK  
PRINCIPAL REGISTER**

**JAMESON SUITES**

ARGILA JAMESON BRAND, LLC (DELAWARE  
LIMITED LIABILITY COMPANY)  
4770 S. ATLANTA ROAD, SUITE 200  
SMYRNA, GA 30080

FOR: HOTEL AND MOTEL SERVICES, IN CLASS  
43 (U.S. CLS. 100 AND 101).

FIRST USE 11-16-2006; IN COMMERCE 11-16-2006.

THE MARK CONSISTS OF STANDARD CHAR-  
ACTERS WITHOUT CLAIM TO ANY PARTICULAR  
FONT, STYLE, SIZE, OR COLOR.

OWNER OF U.S. REG. NOS. 1,547,818 AND  
1,719,701.

NO CLAIM IS MADE TO THE EXCLUSIVE  
RIGHT TO USE "SUITES", APART FROM THE  
MARK AS SHOWN.

SEC. 2(F) AS TO "JAMESON".

SN 77-075,648, FILED 1-4-2007.

APRIL ROACH, EXAMINING ATTORNEY

**Int. Cl.: 12**

**Prior U.S. Cls.: 19, 21, 23, 31, 35, and 44**

**Reg. No. 3,499,596**

**United States Patent and Trademark Office**

**Registered Sep. 9, 2008**

**TRADEMARK  
PRINCIPAL REGISTER**

**SAFEGUARD TRANSPORT**

INDIANA MILLS & MANUFACTURING, INC.  
(INDIANA CORPORATION)  
18881 U.S. 31 NORTH, P.O. BOX 408  
WESTFIELD, IN 460740408

OWNER OF U.S. REG. NOS. 2,711,608, 2,808,722,  
AND 2,990,622.

FOR: VEHICLE CHILD RESTRAINTS FOR AM-  
BULANCE COTS, IN CLASS 12 (U.S. CLS. 19, 21, 23,  
31, 35 AND 44).

NO CLAIM IS MADE TO THE EXCLUSIVE  
RIGHT TO USE "TRANSPORT", APART FROM  
THE MARK AS SHOWN.

FIRST USE 12-13-2007; IN COMMERCE 12-13-2007.

SN 77-077,131, FILED 1-5-2007.

THE MARK CONSISTS OF STANDARD CHAR-  
ACTERS WITHOUT CLAIM TO ANY PARTICULAR  
FONT, STYLE, SIZE, OR COLOR.

CHRISTOPHER BUONGIORNO, EXAMINING AT-  
TORNEY

Int. Cl.: 16

Prior U.S. Cls.: 2, 5, 22, 23, 29, 37, 38, and 50

Reg. No. 3,499,597

United States Patent and Trademark Office

Registered Sep. 9, 2008

TRADEMARK  
PRINCIPAL REGISTER



A.F. GILMORE COMPANY (CALIFORNIA CORPORATION)  
6301 WEST THIRD STREET  
LOS ANGELES, CA 90036

FOR: PAPER PRODUCTS, NAMELY, DECALS, STICKERS, AND PRODUCT PACKAGING, IN CLASS 16 (U.S. CLS. 2, 5, 22, 23, 29, 37, 38 AND 50).

FIRST USE 2-0-2008; IN COMMERCE 6-0-2008.

NO CLAIM IS MADE TO THE EXCLUSIVE RIGHT TO USE "OIL CO.", APART FROM THE MARK AS SHOWN.

THE MARK CONSISTS OF A LION LEAPING WITHIN THE UPPER PART OF A CIRCLE.

SN 77-079,509, FILED 1-10-2007.

JILL C. ALT, EXAMINING ATTORNEY

Int. Cl.: 16

Prior U.S. Cls.: 2, 5, 22, 23, 29, 37, 38, and 50

Reg. No. 3,499,598

United States Patent and Trademark Office

Registered Sep. 9, 2008

TRADEMARK  
PRINCIPAL REGISTER

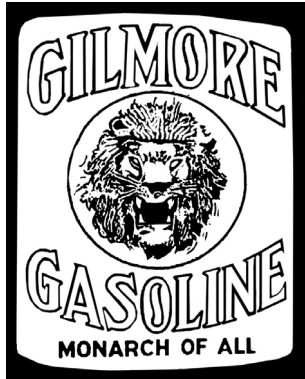

A.F. GILMORE COMPANY (CALIFORNIA CORPORATION)  
6301 WEST THIRD STREET  
LOS ANGELES, CA 90036

FOR: PAPER PRODUCTS, NAMELY, DECALS, STICKERS, AND PRODUCT PACKAGING, IN CLASS 16 (U.S. CLS. 2, 5, 22, 23, 29, 37, 38 AND 50).

FIRST USE 2-0-2008; IN COMMERCE 6-0-2008.

NO CLAIM IS MADE TO THE EXCLUSIVE RIGHT TO USE "GASOLINE", APART FROM THE MARK AS SHOWN.

THE MARK CONSISTS OF A ROARING LION'S HEAD WITHIN A CIRCLE.

SN 77-079,510, FILED 1-10-2007.

JILL C. ALT, EXAMINING ATTORNEY

**Int. Cls.: 17 and 20**

**Prior U.S. Cls.: 1, 2, 5, 12, 13, 22, 25, 32, 35, and 50**

**United States Patent and Trademark Office**

**Reg. No. 3,499,599**

**Registered Sep. 9, 2008**

**TRADEMARK  
PRINCIPAL REGISTER**

# SignaStone

SIGNATURE SOLID SURFACES, INC. (ARIZONA CORPORATION)  
6502 WEST SOFT WIND DRIVE  
6502 WEST SOFT WIND DRIVE  
GLENDALE, AZ 85310

FOR: PLASTIC LAMINATED SHEETS AND PANELS FOR USE IN THE MANUFACTURE OF COUNTERTOPS AND TABLETOPS , IN CLASS 17 (U.S. CLS. 1, 5, 12, 13, 35 AND 50).

FIRST USE 5-9-2007; IN COMMERCE 5-9-2007.

FOR: BATHROOM VANITIES; FURNITURE PARTS, NAMELY, COUNTERTOPS; SHOWER

SEATS, IN CLASS 20 (U.S. CLS. 2, 13, 22, 25, 32 AND 50).

FIRST USE 5-9-2007; IN COMMERCE 5-9-2007.

THE MARK CONSISTS OF STANDARD CHARACTERS WITHOUT CLAIM TO ANY PARTICULAR FONT, STYLE, SIZE, OR COLOR.

SN 77-082,694, FILED 1-14-2007.

AMY HELLA, EXAMINING ATTORNEY

**Int. Cl.: 36**

**Prior U.S. Cls.: 100, 101, and 102**

**United States Patent and Trademark Office**

**Reg. No. 3,499,600**

**Registered Sep. 9, 2008**

**SERVICE MARK  
PRINCIPAL REGISTER**



P2 CAPITAL PARTNERS LLC (DELAWARE LIMITED LIABILITY COMPANY)  
9TH FLOOR  
445 PARK AVENUE  
NEW YORK, NY 10022

FOR: FINANCIAL SERVICES, NAMELY, INVESTMENT MANAGEMENT SERVICES, INVESTMENT ADVISORY SERVICES AND ASSET MANAGEMENT SERVICES, NAMELY, ASSET ACQUISITION, IN CLASS 36 (U.S. CLS. 100, 101 AND 102).

FIRST USE 5-1-2008; IN COMMERCE 5-1-2008.

THE MARK CONSISTS OF THE LITERAL ELEMENT P2, IN THE CENTER OF TWO CONCENTRIC SQUARES WITH THE INTERIOR SQUARE DEFINED BY A LINED BORDER.

SN 77-084,409, FILED 1-17-2007.

SALLY SHIH, EXAMINING ATTORNEY



**Int. Cls.: 41 and 42**

**Prior U.S. Cls.: 100, 101, and 107**

**United States Patent and Trademark Office**

**Reg. No. 3,499,601**

**Registered Sep. 9, 2008**

**SERVICE MARK  
PRINCIPAL REGISTER**

**GEORGIA CORE**

GEORGIA CENTER FOR ONCOLOGY RE-  
SEARCH AND EDUCATION, INC. (GEORGIA  
CORPORATION)

50 HURT PLAZA  
SUITE 704  
ATLANTA, GA 30303

FOR: ARRANGING AND CONDUCTING EDU-  
CATIONAL SEMINARS IN THE FIELD OF ONCOL-  
OGY; PUBLICATION OF INSTRUCTIONAL,  
EDUCATIONAL AND TEACHING MATERIALS  
FOR OTHERS, NAMELY, NEWSLETTERS, POSI-  
TION PAPERS, WORKBOOKS, REFERENCE DOCU-  
MENTS AND ARTICLES IN THE FIELD OF  
ONCOLOGY, IN CLASS 41 (U.S. CLS. 100, 101 AND  
107).

FIRST USE 11-0-2006; IN COMMERCE 11-0-2006.

FOR: MEDICAL RESEARCH, NAMELY, PROVID-  
ING MEDICAL RESEARCH ASSISTANCE FOR  
OTHERS IN THE FIELD OF ONCOLOGY IN THE  
NATURE OF CONDUCTING AND COORDINAT-

ING CLINICAL TRIALS; PROVIDING RESEARCH  
AND CONSULTATION SERVICES TO OTHERS IN  
THE FIELD OF CLINICAL TRIALS; PROVIDING  
AN INTERACTIVE DATABASE FEATURING A  
WIDE VARIETY OF ONCOLOGICAL RESEARCH  
AND DATA FOR USE BY OTHERS, IN CLASS 42  
(U.S. CLS. 100 AND 101).

FIRST USE 3-0-2007; IN COMMERCE 3-0-2007.

THE MARK CONSISTS OF STANDARD CHAR-  
ACTERS WITHOUT CLAIM TO ANY PARTICULAR  
FONT, STYLE, SIZE, OR COLOR.

NO CLAIM IS MADE TO THE EXCLUSIVE  
RIGHT TO USE "GEORGIA", APART FROM THE  
MARK AS SHOWN.

SN 77-084,959, FILED 1-17-2007.

PAUL MORENO, EXAMINING ATTORNEY

**Int. Cl.: 32**

**Prior U.S. Cls.: 45, 46, and 48**

**United States Patent and Trademark Office**

**Reg. No. 3,499,602**

**Registered Sep. 9, 2008**

**TRADEMARK  
PRINCIPAL REGISTER**

**FREAK OUT!**

THE TRUSTEES OF THE ZAPPA FAMILY  
TRUST, A CALIFORNIA TRUST COMPRIS-  
ING ADELAIDE GAIL ZAPPA, A U.S. CITI-  
ZEN (CALIFORNIA TRUST)  
SUITE 802  
11684 VENTURA BLVD.  
STUDIO CITY, CA 91604

FOR: BEER AND ALE, IN CLASS 32 (U.S. CLS. 45,  
46 AND 48).

FIRST USE 8-8-2006; IN COMMERCE 8-8-2006.

THE MARK CONSISTS OF STANDARD CHAR-  
ACTERS WITHOUT CLAIM TO ANY PARTICULAR  
FONT, STYLE, SIZE, OR COLOR.

SN 77-085,159, FILED 1-17-2007.

ROBIN MITTLER, EXAMINING ATTORNEY

**Int. Cl.: 7**

**Prior U.S. Cls.: 13, 19, 21, 23, 31, 34, and 35**

**Reg. No. 3,499,603**

**United States Patent and Trademark Office**

**Registered Sep. 9, 2008**

---

**TRADEMARK  
PRINCIPAL REGISTER**

**RESIDUE RAZOR**

NORTH AMERICAN TILLAGE TOOLS COMP-  
NY (CANADA CORPORATION)  
460 SHERMAN AVENUE NORTH  
HAMILTON, CANADA L6L 8J6

FOR: AGRICULTURAL MACHINES, NAMELY,  
DISC HARROWS; TRACTOR TOWED AGRICUL-  
TURAL IMPLEMENTS, NAMELY, DISC HAR-  
ROWS, IN CLASS 7 (U.S. CLS. 13, 19, 21, 23, 31, 34  
AND 35).

FIRST USE 6-22-2007; IN COMMERCE 6-22-2007.

THE MARK CONSISTS OF STANDARD CHAR-  
ACTERS WITHOUT CLAIM TO ANY PARTICULAR  
FONT, STYLE, SIZE, OR COLOR.

SN 77-085,236, FILED 1-17-2007.

MARK SPARACINO, EXAMINING ATTORNEY

**Int. Cl.: 3**

**Prior U.S. Cls.: 1, 4, 6, 50, 51, and 52**

**Reg. No. 3,499,604**

**United States Patent and Trademark Office**

**Registered Sep. 9, 2008**

**TRADEMARK  
PRINCIPAL REGISTER**

# Great Shakes

SOAP & GLORY LIMITED (UNITED KINGDOM  
LIMITED LIABILITY COMPANY)  
167-169 KENSINGTON HIGH STREET  
FIRST FLOOR  
LONDON, UNITED KINGDOM W8 6SH

THE MARK CONSISTS OF STANDARD CHAR-  
ACTERS WITHOUT CLAIM TO ANY PARTICULAR  
FONT, STYLE, SIZE, OR COLOR.

FOR: COSMETICS HAND PRODUCTS, NAMELY,  
HAND CARE CREAMS, HAND CARE LOTIONS, IN  
CLASS 3 (U.S. CLS. 1, 4, 6, 50, 51 AND 52).

SN 77-088,607, FILED 1-23-2007.

FIRST USE 2-2-2008; IN COMMERCE 2-2-2008.

CORY BOONE, EXAMINING ATTORNEY

**Int. Cl.: 29**

**Prior U.S. Cl.: 46**

**United States Patent and Trademark Office**

**Reg. No. 3,499,605**

**Registered Sep. 9, 2008**

**TRADEMARK  
PRINCIPAL REGISTER**

# Intoxi-tators

INFUSED-SUN PRODUCTS, INC. (FLORIDA  
CORPORATION)  
234 OCEAN TERRACE  
PALM BEACH, FL 33480

THE MARK CONSISTS OF STANDARD CHAR-  
ACTERS WITHOUT CLAIM TO ANY PARTICULAR  
FONT, STYLE, SIZE, OR COLOR.

FOR: POTATO CHIPS; SNACK FOOD DIPS, IN  
CLASS 29 (U.S. CL. 46).

SN 77-088,849, FILED 1-23-2007.

FIRST USE 5-31-2008; IN COMMERCE 5-31-2008.

JOHN DWYER, EXAMINING ATTORNEY

Int. Cls.: 9, 16, 41, 44, and 45

Prior U.S. Cls.: 2, 5, 21, 22, 23, 26, 29, 36, 37, 38, 50,  
100, 101, and 107

Reg. No. 3,499,606

United States Patent and Trademark Office

Registered Sep. 9, 2008

TRADEMARK  
SERVICE MARK  
PRINCIPAL REGISTER



Living Your Light

Promoting Creative Conscious Living

KUMAR, SANJAY (UNITED STATES INDIVIDUAL)  
4279 22ND STREET  
SAN FRANCISCO, CA 94114

FOR: COMPACT DISCS FEATURING MUSIC AND SOUNDS FOR USE IN TEACHING YOGA, IN CLASS 9 (U.S. CLS. 21, 23, 26, 36 AND 38).

FIRST USE 5-1-2005; IN COMMERCE 5-1-2005.

FOR: PRINTED NEWSLETTER, RELATING TO HEALTH CARE, NUTRITIONAL INFORMATION, AND HOLISTIC HEALTH, BOTH FOR HUMANS AND ANIMALS, IN CLASS 16 (U.S. CLS. 2, 5, 22, 23, 29, 37, 38 AND 50).

FIRST USE 5-1-2005; IN COMMERCE 5-1-2005.

FOR: TEACHING OF YOGA CLASSES, YOGA WORKSHOPS, YOGA TEACHER TRAININGS, EDUCATIONAL YOGA RETREATS, AND YOGA LECTURES; EDUCATIONAL SERVICES, NAMELY, TRAINING CLASSES AND WORKSHOPS FEATURING INSTRUCTION IN THE FIELD OF YOGA, HEALTH, EXERCISE, AND COUNSELING AND EDUCATIONAL MATERIALS DISTRIBUTED IN CONNECTION THEREWITH; EDUCATIONAL SERVICES, NAMELY, TEACHER TRAINING CERTIFICATION PROGRAM FOR YOGA INSTRUCTORS; AND HEALTH CLUB SERVICES, NAMELY, PRO-

VIDING INSTRUCTION AND EQUIPMENT IN THE FIELD OF PHYSICAL EXERCISE, IN CLASS 41 (U.S. CLS. 100, 101 AND 107).

FIRST USE 5-1-2005; IN COMMERCE 5-1-2005.

FOR: HEALTH AND NUTRITION COUNSELING, NAMELY, COUNSELING IN QUITTING SMOKING, DRUG ABUSE, EATING DISORDERS, UNHEALTHFUL SEXUAL ACTIVITIES; COUNSELING IN HEALTHY NUTRITION AND LIFESTYLE; PROVIDING MEDICAL INFORMATION ON PHARMACEUTICALS, NATURAL PRODUCT BASED PHARMACEUTICALS, COSMETICS AND MEDICINAL TRADITIONS OF THE WORLD; AND MASSAGE SERVICES, IN CLASS 44 (U.S. CLS. 100 AND 101).

FIRST USE 5-1-2005; IN COMMERCE 5-1-2005.

FOR: ASTROLOGICAL AND HOROSCOPE FORECASTING AND CONSULTATION ON-LINE, IN CLASS 45 (U.S. CLS. 100 AND 101).

FIRST USE 5-1-2005; IN COMMERCE 5-1-2005.

SN 77-088,923, FILED 1-23-2007.

BRENDAN MCCAULEY, EXAMINING ATTORNEY

**Int. Cl.: 3**

**Prior U.S. Cls.: 1, 4, 6, 50, 51, and 52**

**United States Patent and Trademark Office**

**Reg. No. 3,499,607**

**Registered Sep. 9, 2008**

**TRADEMARK  
PRINCIPAL REGISTER**

# LIP TEASERS

JOHNSON PUBLISHING COMPANY, INC (ILLINOIS CORPORATION)

820 SOUTH MICHIGAN AVENUE

CHICAGO, IL 60601

FOR: LIP GLOSS, IN CLASS 3 (U.S. CLS. 1, 4, 6, 50, 51 AND 52).

FIRST USE 2-26-2008; IN COMMERCE 2-26-2008.

THE MARK CONSISTS OF STANDARD CHARACTERS WITHOUT CLAIM TO ANY PARTICULAR FONT, STYLE, SIZE, OR COLOR.

NO CLAIM IS MADE TO THE EXCLUSIVE RIGHT TO USE "LIP", APART FROM THE MARK AS SHOWN.

SN 77-089,745, FILED 1-24-2007.

BARBARA GAYNOR, EXAMINING ATTORNEY

**Int. Cl.: 19**

**Prior U.S. Cls.: 1, 12, 33, and 50**

**United States Patent and Trademark Office**

**Reg. No. 3,499,608**

**Registered Sep. 9, 2008**

**TRADEMARK  
PRINCIPAL REGISTER**

WHITE MOUNTAIN FLOORING

HOSKING HARDWOOD FLOORING, INC. (MAS-  
SACHUSETTS CORPORATION)

456 LINCOLN ROAD

WALPOLE, MA 02081

FOR: WOODEN FLOORING, IN CLASS 19 (U.S.  
CLS. 1, 12, 33 AND 50).

FIRST USE 2-1-2004; IN COMMERCE 2-1-2004.

THE MARK CONSISTS OF STANDARD CHAR-  
ACTERS WITHOUT CLAIM TO ANY PARTICULAR  
FONT, STYLE, SIZE, OR COLOR.

NO CLAIM IS MADE TO THE EXCLUSIVE  
RIGHT TO USE "FLOORING", APART FROM THE  
MARK AS SHOWN.

SN 77-089,787, FILED 1-24-2007.

KIMBERLY FRYE, EXAMINING ATTORNEY



**Int. Cl.: 16**

**Prior U.S. Cls.: 2, 5, 22, 23, 29, 37, 38, and 50**

**United States Patent and Trademark Office**

**Reg. No. 3,499,609**

**Registered Sep. 9, 2008**

**TRADEMARK  
PRINCIPAL REGISTER**

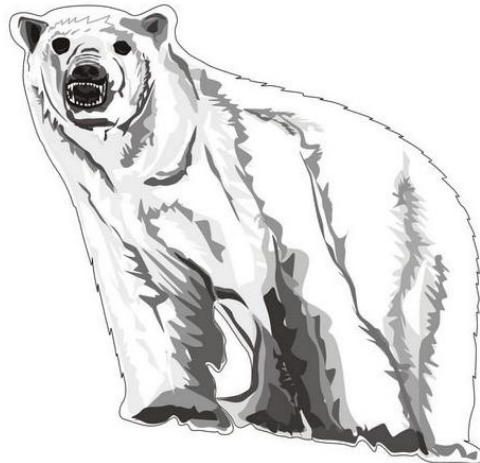

WIN VISION INVESTMENTS LTD. (TAIWAN  
LIMITED LIABILITY COMPANY)  
3F, NO. 47, LANE 139, HUAN TEH STREET  
PANCHIAO CITY, TAIWAN

FOR: CD SHREDDERS FOR HOME OR OFFICE  
USE; PAPER SHREDDERS, IN CLASS 16 (U.S. CLS. 2,  
5, 22, 23, 29, 37, 38 AND 50).

FIRST USE 2-1-2008; IN COMMERCE 2-1-2008.

THE COLOR(S) BLACK, WHITE, AND GRAY IS/  
ARE CLAIMED AS A FEATURE OF THE MARK.

THE MARK CONSISTS OF A POLAR BEAR. THE  
COLOR WHITE APPEARS IN THE BEAR'S FUR.  
THE COLOR BLACK APPEARS IN THE BEAR'S  
EYES, NOSE, EARS, AND PAWS. THE COLOR  
GRAY APPEARS IN THE SHADING ON THE  
BEAR'S FUR.

SN 77-091,630, FILED 1-25-2007.

DORITT L. CARROLL, EXAMINING ATTORNEY

**Int. Cl.: 16**

**Prior U.S. Cls.: 2, 5, 22, 23, 29, 37, 38, and 50**

**Reg. No. 3,499,610**

**United States Patent and Trademark Office**

**Registered Sep. 9, 2008**

**TRADEMARK  
PRINCIPAL REGISTER**

**WRAPITFAST**

SWM, LLC (IOWA LIMITED LIABILITY COMPANY)  
3809 ELMWOOD DR NE  
CEDAR RAPIDS, IA 52402

THE MARK CONSISTS OF STANDARD CHARACTERS WITHOUT CLAIM TO ANY PARTICULAR FONT, STYLE, SIZE, OR COLOR.

FOR: PAPER DISPENSER BOX FOR PAPER PRODUCTS; PAPER STORAGE BOX FOR PAPER PRODUCTS, IN CLASS 16 (U.S. CLS. 2, 5, 22, 23, 29, 37, 38 AND 50).

SN 77-092,208, FILED 1-26-2007.

FIRST USE 6-23-2008; IN COMMERCE 6-23-2008.

JANICE L. MCMORROW, EXAMINING ATTORNEY

**Int. Cls.: 35 and 41**

**Prior U.S. Cls.: 100, 101, 102, and 107**

**United States Patent and Trademark Office**

**Reg. No. 3,499,611**

**Registered Sep. 9, 2008**

**SERVICE MARK  
PRINCIPAL REGISTER**

**SMART PARTNERSHIP**

SMARTTALENT LLC (WASHINGTON LIMITED  
LIABILITY COMPANY)  
1321 4TH AVENUE  
SEATTLE, WA 98101

FOR: BUSINESS SERVICES, NAMELY, BUSINESS CONSULTING SERVICES IN THE FIELD OF HUMAN RESOURCES; STAFFING SERVICES IN THE NATURE OF PROVIDING A CLIENT WITH ON-SITE HUMAN RESOURCES MANAGEMENT, PERSONNEL MANAGEMENT, BUSINESS OVERSIGHT, BUSINESS SUPERVISION, AND REPORTING SERVICES IN THE NATURE OF PREPARING REPORTS RELATED TO BUSINESS MATTERS AND EMPLOYMENT HIRING, RECRUITING, PLACEMENT AND STAFFING MATTERS AND PREPARING FINANCIAL REPORTS FOR OTHERS, IN CLASS 35 (U.S. CLS. 100, 101 AND 102).

FIRST USE 0-0-2001; IN COMMERCE 0-0-2007.

FOR: TRAINING SERVICES IN THE FIELD OF HUMAN RESOURCES, IN CLASS 41 (U.S. CLS. 100, 101 AND 107).

FIRST USE 0-0-2001; IN COMMERCE 0-0-2007.

THE MARK CONSISTS OF STANDARD CHARACTERS WITHOUT CLAIM TO ANY PARTICULAR FONT, STYLE, SIZE, OR COLOR.

SN 77-092,604, FILED 1-26-2007.

BARBARA RUTLAND, EXAMINING ATTORNEY

**Int. Cl.: 30**

**Prior U.S. Cl.: 46**

**United States Patent and Trademark Office**

**Reg. No. 3,499,612**

**Registered Sep. 9, 2008**

**TRADEMARK  
PRINCIPAL REGISTER**

**MORNING CAFE**

THE FOLGER COFFEE COMPANY (OHIO COR-  
PORATION)

C2 / BOX 11

ONE PROCTER & GAMBLE PLAZA

CINCINNATI, OH 45202

FOR: COFFEE, IN CLASS 30 (U.S. CL. 46).

FIRST USE 8-30-2006; IN COMMERCE 8-30-2006.

THE MARK CONSISTS OF STANDARD CHAR-  
ACTERS WITHOUT CLAIM TO ANY PARTICULAR  
FONT, STYLE, SIZE, OR COLOR.

NO CLAIM IS MADE TO THE EXCLUSIVE  
RIGHT TO USE "CAFE", APART FROM THE MARK  
AS SHOWN.

SN 77-093,154, FILED 1-29-2007.

JOSETTE BEVERLY, EXAMINING ATTORNEY

**Int. Cl.: 25**

**Prior U.S. Cls.: 22 and 39**

**United States Patent and Trademark Office**

**Reg. No. 3,499,613**

**Registered Sep. 9, 2008**

**TRADEMARK  
PRINCIPAL REGISTER**

**MAXAVI**

KAPLAN, MAX AVI (UNITED STATES INDIVIDUAL)  
800 HARDING STREET  
WESTFIELD, NJ 07090

FOR: MEN'S, WOMEN'S AND CHILDREN'S CLOTHING, NAMELY, SWEATERS, CARDIGANS, HATS, GLOVES, SHOES, VESTS, PANTS, COATS, BOOTS, TIES, BOWTIES, SWEATSHIRTS, BELTS, DRESSES, SCARVES, SWEATPANTS, SKIRTS, SHORTS, SHIRTS, TOPS, SWIMWEAR, SOCKS, HOSIERY, FOOTWEAR, SLEEPWEAR AND JOGGING SUITS, IN CLASS 25 (U.S. CLS. 22 AND 39).

FIRST USE 1-31-2008; IN COMMERCE 1-31-2008.

THE MARK CONSISTS OF STANDARD CHARACTERS WITHOUT CLAIM TO ANY PARTICULAR FONT, STYLE, SIZE, OR COLOR.

SN 77-096,012, FILED 1-31-2007.

FRED MANDIR, EXAMINING ATTORNEY

**Int. Cl.: 38**

**Prior U.S. Cls.: 100, 101, and 104**

**United States Patent and Trademark Office**

**Reg. No. 3,499,614**

**Registered Sep. 9, 2008**

**SERVICE MARK  
PRINCIPAL REGISTER**

**GYM TV**

GYM-MARK, INC. (CALIFORNIA CORPORATION)  
500 HOWARD STREET  
SAN FRANCISCO, CA 94105

FOR: TRANSMISSION OF INFORMATION THROUGH VIDEO COMMUNICATION SYSTEMS; TRANSMISSION OF SOUND, VIDEO AND INFORMATION; VIDEO BROADCASTING SERVICES; VIDEO BROADCASTING SERVICES, IN CLASS 38 (U.S. CLS. 100, 101 AND 104).

FIRST USE 5-1-2007; IN COMMERCE 5-1-2007.

THE MARK CONSISTS OF STANDARD CHARACTERS WITHOUT CLAIM TO ANY PARTICULAR FONT, STYLE, SIZE, OR COLOR.

NO CLAIM IS MADE TO THE EXCLUSIVE RIGHT TO USE "TV", APART FROM THE MARK AS SHOWN.

SN 77-097,165, FILED 2-1-2007.

JULIE WATSON, EXAMINING ATTORNEY

Int. Cl.: 30

Prior U.S. Cl.: 46

United States Patent and Trademark Office

Reg. No. 3,499,615

Registered Sep. 9, 2008

**TRADEMARK  
PRINCIPAL REGISTER**



*Juan Valdez y Conchita*

FEDERACION NACIONAL DE CAFETEROS DE COLOMBIA, (COLOMBIA NON-PROFIT ASSOCIATION ORGANIZED AND EXISTING UNDER THE LAWS OF THE REPUBLIC OF COLOMBIA AND ACTING IN ITS CAPACITY AS ADMINISTRATOR OF THE NATIONAL COFFEE FUND), DBA NATIONAL FEDERATION OF COFFEE GROWERS OF COLOMBIA,

CALLE 73 NO. 8-13

BOGOTA, D.C., COLOMBIA 0

FOR: COFFEE, IN CLASS 30 (U.S. CL. 46).

FIRST USE 1-30-2008; IN COMMERCE 1-30-2008.

THE NAME "JUAN VALDEZ" DOES NOT IDENTIFY A LIVING INDIVIDUAL.

THE MARK CONSISTS OF A MULE DESIGN BESIDE A MAN DESIGN OVER THE WORDS "JUAN VALDEZ Y CONCHITA".

THE ENGLISH TRANSLATION OF "JUAN VALDEZ Y CONCHITA" IS "JUAN VALDEZ AND CONCHITA".

SN 77-100,032, FILED 2-6-2007.

RUSS HERMAN, EXAMINING ATTORNEY

**Int. Cl.: 43**

**Prior U.S. Cls.: 100 and 101**

**United States Patent and Trademark Office**

**Reg. No. 3,499,616**

**Registered Sep. 9, 2008**

**SERVICE MARK  
PRINCIPAL REGISTER**

**SEGA**

KABUSHIKI KAISHA SEGA (JAPAN CORPORATION), DBA SEGA CORPORATION,  
2-12, HANEDA 1-CHOME  
OHTA-KU, TOKYO, JAPAN

FOR: RESTAURANTS; CAFES, IN CLASS 43 (U.S. CLS. 100 AND 101).

FIRST USE 5-0-2005; IN COMMERCE 5-0-2005.

THE MARK CONSISTS OF STANDARD CHARACTERS WITHOUT CLAIM TO ANY PARTICULAR FONT, STYLE, SIZE, OR COLOR.

OWNER OF U.S. REG. NOS. 1,050,573, 2,315,166, AND OTHERS.

SN 77-100,684, FILED 2-6-2007.

MARIAM MAHMOUDI, EXAMINING ATTORNEY



**Int. Cl.: 3**

**Prior U.S. Cls.: 1, 4, 6, 50, 51, and 52**

**Reg. No. 3,499,617**

**United States Patent and Trademark Office**

**Registered Sep. 9, 2008**

**TRADEMARK  
PRINCIPAL REGISTER**



FANG, KUO CHUNG (TAIWAN INDIVIDUAL)  
NO. 230, YUCHENG ROAD  
TAINAN CITY, TAIWAN

FOR: PERSONAL CARE PRODUCTS, NAMELY,  
COSMETICS, SMOOTHING REPAIR LOTION FOR  
FACE AND BODY, SMOOTHING SUPPLE DEW  
LOTION FOR FACE AND BODY, REPAIR NIGHT  
CREAM, MOIST BALANCING DEW LOTION FOR  
FACE AND BODY, SILK TENDERNESS ESSENCE

LOTION FOR FACE AND BODY, SKIN CREAM,  
BEAUTY MASKS, HAIR SHAMPOO, PERFUME,  
HAIR CARE LOTIONS, HAIR CARE PREPARA-  
TIONS, IN CLASS 3 (U.S. CLS. 1, 4, 6, 50, 51 AND 52).

FIRST USE 1-1-2004; IN COMMERCE 7-1-2008.

SN 77-101,527, FILED 2-7-2007.

JERI J. FICKES, EXAMINING ATTORNEY

**Int. Cl.: 21**

**Prior U.S. Cls.: 2, 13, 23, 29, 30, 33, 40, and 50**

**United States Patent and Trademark Office**

**Reg. No. 3,499,618**

**Registered Sep. 9, 2008**

**TRADEMARK  
PRINCIPAL REGISTER**

**WASTE 'N WIPE**

DCI MARKETING, INC. (WISCONSIN CORPORATION)  
2727 WEST GOOD HOPE ROAD  
MILWAUKEE, WI 53209

FOR: DISPENSER FOR PAPER TOWELS WITH INTEGRATED TRASH CAN AND PLASTIC BUCKET FOR HOLDING A SQUEEGEE AND WINDSHIELD CLEANER FLUID , IN CLASS 21 (U.S. CLS. 2, 13, 23, 29, 30, 33, 40 AND 50).

FIRST USE 7-21-2008; IN COMMERCE 7-21-2008.

THE MARK CONSISTS OF STANDARD CHARACTERS WITHOUT CLAIM TO ANY PARTICULAR FONT, STYLE, SIZE, OR COLOR.

SN 77-101,755, FILED 2-7-2007.

NELSON SNYDER, EXAMINING ATTORNEY

Int. Cl.: 38

Prior U.S. Cls.: 100, 101, and 104

United States Patent and Trademark Office

Reg. No. 3,499,619

Registered Sep. 9, 2008

SERVICE MARK  
PRINCIPAL REGISTER



WEN, TAI-CHUN (TAIWAN INDIVIDUAL)  
ROOM 413, 4F., NO.333  
SEC. 1, KEELUNG RD., XINYI DISTRICT  
TAIPEI CITY, TAIWAN

FOR: COMMUNICATION SERVICES, NAMELY, ELECTRONIC TRANSMISSION OF DATA AND DOCUMENTS AMONG USERS OF COMPUTERS; ELECTRONIC DATA INTERCHANGE SERVICES; ELECTRONIC DATA INTERCHANGE; ELECTRONIC DATA TRANSMISSION; ELECTRONIC DELIVERY OF IMAGES AND PHOTOGRAPHS VIA A GLOBAL COMPUTER NETWORK; ELECTRONIC EXCHANGE OF DATA STORED IN DATABASES ACCESSIBLE VIA TELECOMMUNICATION NETWORKS; ELECTRONIC MAIL SERVICES; ELECTRONIC MESSAGE SENDING; ELECTRONIC MESSAGE TRANSMISSION; ELECTRONIC MESSAGING SYSTEM, NAMELY, ELECTRONIC QUEUING SERVICES; PROVIDING A HIGH SPEED ACCESS TO AREA NETWORKS AND A GLOBAL COMPUTER INFORMATION NETWORK; PROVIDING ACCESS TO TELECOMMUNICATION NETWORKS; PROVIDING ACCESS TO DATABASES; PROVIDING CO-LOCATION SERVICES FOR

VOICE, VIDEO AND DATA COMMUNICATIONS APPLICATIONS; PROVIDING ELECTRONIC TELECOMMUNICATION CONNECTIONS; PROVIDING ELECTRONIC TRANSMISSION OF CREDIT CARD TRANSACTION DATA AND ELECTRONIC PAYMENT DATA VIA A GLOBAL COMPUTER NETWORK, IN CLASS 38 (U.S. CLS. 100, 101 AND 104).

FIRST USE 4-1-2006; IN COMMERCE 4-1-2006.

THE MARK CONSISTS OF AN OBLONG SHAPE CONTAINING THE LETTERS "USTSU" IN STYLIZED LETTERS ON THE RIGHT SIDE AND THE LETTERS "USTSU" TO THE LEFT SIDE OF THE OBLONG DESIGN FORM INTO A SHAPE OF A DRAGON. THE FIRST "U" APPEARS ON THE TOP OF THE DESIGN. TWO THIN WAVY LINES REPRESENTED AS "S" ARE DISPLAYED ON EACH SIDE OF THE "T". ANOTHER "U" APPEARS ON THE BOTTOM OF THE DESIGN WITH A WAVY LINE UNDERNEATH.

SN 77-101,885, FILED 2-7-2007.

RENEE SERVANCE, EXAMINING ATTORNEY

**Int. Cl.: 33**

**Prior U.S. Cls.: 47 and 49**

**United States Patent and Trademark Office**

**Reg. No. 3,499,620**

**Registered Sep. 9, 2008**

**TRADEMARK  
PRINCIPAL REGISTER**

**MADRONE KNOLL**

PATERNO IMPORTS, LTD., D/B/A PATERNO  
WINES INTERNATIONAL (ILLINOIS COR-  
PORATION)  
900 ARMOUR DRIVE  
LAKE BLUFF, IL 60044

THE MARK CONSISTS OF STANDARD CHAR-  
ACTERS WITHOUT CLAIM TO ANY PARTICULAR  
FONT, STYLE, SIZE, OR COLOR.

FOR: WINE, IN CLASS 33 (U.S. CLS. 47 AND 49).

SN 77-104,932, FILED 2-12-2007.

FIRST USE 8-27-2007; IN COMMERCE 8-27-2007.

SAIMA MAKHDOOM, EXAMINING ATTORNEY

**Int. Cl.: 45**

**Prior U.S. Cls.: 100 and 101**

**United States Patent and Trademark Office**

**Reg. No. 3,499,621**

**Registered Sep. 9, 2008**

**SERVICE MARK  
PRINCIPAL REGISTER**

**EFC A CONNECT**

THE EVANGELICAL FREE CHURCH OF AMERICA (MINNESOTA NON-PROFIT CORPORATION)

901 EAST 78TH STREET  
MINNEAPOLIS, MN 554201300

FOR: EVANGELICAL MISSIONARY AND MINISTERIAL SERVICES; CHARITABLE SERVICES, NAMELY, ORGANIZING GROUPS TO UNDERTAKE PROJECTS TO BENEFIT THE NEEDY AND THE COMMUNITY TO ENCOURAGE LEADERSHIP, CHARACTER, COMPASSION, AND GOOD CITIZENSHIP; COUNSELING SERVICES IN THE FIELD OF CHRISTIAN CONDUCT IN PERSONAL RELATIONSHIPS; PROVIDING ON-LINE INFORMATION IN THE FIELD OF RELIGION, SPIRITUALITY, SELF-HELP, AND PERSONAL

EMPOWERMENT SUBJECT MATTERS, IN CLASS 45 (U.S. CLS. 100 AND 101).

FIRST USE 6-27-2007; IN COMMERCE 6-27-2007.

THE MARK CONSISTS OF STANDARD CHARACTERS WITHOUT CLAIM TO ANY PARTICULAR FONT, STYLE, SIZE, OR COLOR.

OWNER OF U.S. REG. NOS. 2,777,789, 2,818,951, AND OTHERS.

SN 77-107,701, FILED 2-14-2007.

SALLY SHIH, EXAMINING ATTORNEY

**Int. Cl.: 41**

**Prior U.S. Cls.: 100, 101, and 107**

**United States Patent and Trademark Office**

**Reg. No. 3,499,622**

**Registered Sep. 9, 2008**

**SERVICE MARK  
PRINCIPAL REGISTER**

**EFCA EQUIP**

THE EVANGELICAL FREE CHURCH OF AMERICA (MINNESOTA NON-PROFIT CORPORATION)

901 EAST 78TH STREET  
MINNEAPOLIS, MN 554201300

FOR: EDUCATIONAL AND TRAINING SERVICES, NAMELY, CONDUCTING LIVE CONFERENCES, SEMINARS, RETREATS, CLASSES, COURSES AND WORKSHOPS IN THE FIELD OF EVANGELICAL CHRISTIAN MINISTRY, MISSIONARY TRAINING, RELIGION, RELIGIOUS WORSHIP, THEOLOGY, AND THE EVANGELICAL CHRISTIAN FAITH AND DISTRIBUTING INSTRUCTIONAL MATERIALS IN CONNECTION THEREWITH; RELIGIOUS INSTRUCTION SERVICES; PROVIDING INFORMATION IN THE FIELD OF RELIGIOUS EDUCATION AND RELIGIOUS INSTRUCTION MATERIALS; PROVIDING ONGO-

ING EVANGELICAL CHRISTIAN PROGRAMS BROADCAST OVER TELEVISION, RADIO, SATELLITE AUDIO AND VIDEO MEDIA, CABLE, AND THE INTERNET, IN CLASS 41 (U.S. CLS. 100, 101 AND 107).

FIRST USE 2-1-2007; IN COMMERCE 2-1-2007.

THE MARK CONSISTS OF STANDARD CHARACTERS WITHOUT CLAIM TO ANY PARTICULAR FONT, STYLE, SIZE, OR COLOR.

OWNER OF U.S. REG. NOS. 2,777,789, 2,818,951, AND OTHERS.

SN 77-107,706, FILED 2-14-2007.

SALLY SHIH, EXAMINING ATTORNEY

**Int. Cl.: 25**

**Prior U.S. Cls.: 22 and 39**

**United States Patent and Trademark Office**

**Reg. No. 3,499,623**

**Registered Sep. 9, 2008**

**TRADEMARK  
PRINCIPAL REGISTER**

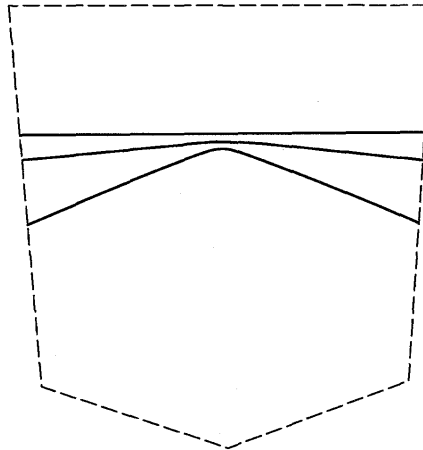

EXPRESS, LLC (DELAWARE LIMITED LIABILITY COMPANY)  
ONE LIMITED PARKWAY  
ATTN: KATHY HAMILTON  
COLUMBUS, OH 43230

FOR: CLOTHING, NAMELY, JEANS, IN CLASS 25  
(U.S. CLS. 22 AND 39).

FIRST USE 1-31-2007; IN COMMERCE 1-31-2007.

THE MARK CONSISTS OF A STYLIZED PEAK DESIGN. THE MATTER SHOWN BY THE DOTTED LINES IS NOT A PART OF THE MARK AND SERVES ONLY TO SHOW THE POSITION OF THE MARK ON THE GOODS.

SN 77-108,983, FILED 2-16-2007.

WILLIAM P. SHANAHAN, EXAMINING ATTORNEY

**Int. Cl.: 30**

**Prior U.S. Cl.: 46**

**United States Patent and Trademark Office**

**Reg. No. 3,499,624**

**Registered Sep. 9, 2008**

**TRADEMARK  
PRINCIPAL REGISTER**

**FORGET LOVE I'D RATHER  
FALL IN CHOCOLATE**

CERRETA CANDY COMPANY, INC. (ARIZONA  
CORPORATION)  
5345 W. GLENDALE AVENUE  
GLENDALE, AZ 85301

THE MARK CONSISTS OF STANDARD CHAR-  
ACTERS WITHOUT CLAIM TO ANY PARTICULAR  
FONT, STYLE, SIZE, OR COLOR.

FOR: CANDY, IN CLASS 30 (U.S. CL. 46).

SN 77-109,166, FILED 2-16-2007.

FIRST USE 11-0-2007; IN COMMERCE 11-0-2007.

JENNIFER VASQUEZ, EXAMINING ATTORNEY



Int. Cl.: 9

Prior U.S. Cls.: 21, 23, 26, 36, and 38

Reg. No. 3,499,625

United States Patent and Trademark Office

Registered Sep. 9, 2008

TRADEMARK  
PRINCIPAL REGISTER

# Super Blu

LG ELECTRONICS INC. (REPUBLIC OF KOREA CORPORATION)  
20, YOIDO-DONG, YONGDUNGPO-GU  
SEOUL, REPUBLIC OF KOREA

FOR: COMPACT DISC PLAYERS (CDP) ; DIGITAL VERSATILE DISC (DVD) PLAYERS; PRE-RECORDED COMPACT DISCS READ-ONLY MEMORY (CD-ROM) FEATURING MUSICAL SOUND AND/OR VIDEO RECORDING; PRE-RECORDED DIGITAL VIDEO DISC-READ ONLY MEMORY (DVD-ROM) FEATURING MUSICAL SOUND AND/OR VIDEO RECORDING; COMPUTERS; COMPUTER MONITORS; TELEVISION RECEIVERS; RECORDED COMPUTER PROGRAMS FOR USE IN DATABASE MANAGEMENT, USE AS A SPREADSHEET, AND WORD PROCESSING; BLANK CD FOR SOUND AND/OR VIDEO RECORDING; AUDIO COMPONENT AND SOUND RECORDING AND REPRODUCING APPARATUS

COMPRISING COMPACT DISC (CD) PLAYERS, DIGITAL VERSATILE DISC (DVD) PLAYERS, MPEG AUDIO LAYER-3(MP3) PLAYERS, VIDEO PLAYERS, DIGITAL AUDIO PLAYERS; VIDEO CASSETTE RECORDER (VCR) PLAYER; HOME THEATER EQUIPMENT, NAMELY, PROJECTORS, STEREOS, SPEAKERS, MODULATORS; SPEAKERS, IN CLASS 9 (U.S. CLS. 21, 23, 26, 36 AND 38).

FIRST USE 2-0-2007; IN COMMERCE 2-0-2007.

THE MARK CONSISTS OF STANDARD CHARACTERS WITHOUT CLAIM TO ANY PARTICULAR FONT, STYLE, SIZE, OR COLOR.

SN 77-109,291, FILED 2-16-2007.

JENNY PARK, EXAMINING ATTORNEY

**Int. Cl.: 5**

**Prior U.S. Cls.: 6, 18, 44, 46, 51, and 52**

**Reg. No. 3,499,626**

**United States Patent and Trademark Office**

**Registered Sep. 9, 2008**

**TRADEMARK  
PRINCIPAL REGISTER**

The logo for "CommitQuitTracker" features the word "Commit" in blue, "Quit" in red, and "Tracker" in blue. A red circle with a diagonal slash is superimposed over the letter "Q" in "Quit", and a white cigarette is positioned inside the circle.

SMITHKLINE BEECHAM CORPORATION  
(PENNSYLVANIA CORPORATION)  
ONE FRANKLIN PLAZA  
PHILADELPHIA, PA 19102

FOR: SMOKING CESSATION PREPARATIONS,  
IN CLASS 5 (U.S. CLS. 6, 18, 44, 46, 51 AND 52).

FIRST USE 12-31-2006; IN COMMERCE 12-31-2006.

OWNER OF U.S. REG. NOS. 2,243,110, 2,718,146,  
AND OTHERS.

THE COLOR(S) BLUE AND RED IS/ARE  
CLAIMED AS A FEATURE OF THE MARK.

THE MARK CONSISTS OF THE STYLIZED  
WORD "COMMIT" IN THE COLOR BLUE, THE  
STYLIZED WORD "QUIT" IN THE COLOR RED  
WITH A CIGARETTE IN THE MIDDLE OF THE  
LETTER "Q" AND THE STYLIZED WORD "TRACK-  
ER" IN THE COLOR BLUE WITH A BLUE LINE  
BELOW ALL THE WORDS.

SN 77-109,350, FILED 2-16-2007.

CARRIE GENOVESE, EXAMINING ATTORNEY

**Int. Cls.: 9 and 35**

**Prior U.S. Cls.: 21, 23, 26, 36, 38, 100, 101, and 102**

**United States Patent and Trademark Office**

**Reg. No. 3,499,627**

**Registered Sep. 9, 2008**

**TRADEMARK  
SERVICE MARK  
PRINCIPAL REGISTER**

**up to speed, asap!**

ECOMMERCE ACTIVITIES, LLC (MISSOURI  
LIMITED LIABILITY COMPANY)  
13025 TWIN MEADOWS COURT  
SAINT LOUIS, MO 63146

FOR: ELECTRONIC PUBLICATIONS, NAMELY,  
BOOKS FEATURING PROJECT MANAGEMENT  
RECORDED ON COMPUTER MEDIA , IN CLASS 9  
(U.S. CLS. 21, 23, 26, 36 AND 38).

FIRST USE 3-13-2007; IN COMMERCE 4-26-2008.

FOR: BUSINESS CONSULTATION SERVICES;  
BUSINESS CONSULTING AND BUSINESS INFOR-  
MATION FOR ENTERPRISES; BUSINESS CON-

SULTING AND INFORMATION SERVICES;  
BUSINESS INFORMATION IN THE FIELD OF  
PROJECT MANAGEMENT, IN CLASS 35 (U.S. CLS.  
100, 101 AND 102).

FIRST USE 3-13-2007; IN COMMERCE 3-13-2007.

THE MARK CONSISTS OF STANDARD CHAR-  
ACTERS WITHOUT CLAIM TO ANY PARTICULAR  
FONT, STYLE, SIZE, OR COLOR.

SN 77-110,204, FILED 2-17-2007.

JENNY PARK, EXAMINING ATTORNEY

**Int. Cl.: 11**

**Prior U.S. Cls.: 13, 21, 23, 31, and 34**

**United States Patent and Trademark Office**

**Reg. No. 3,499,628**

**Registered Sep. 9, 2008**

**TRADEMARK  
PRINCIPAL REGISTER**

**MINI-PREDATOR**

ABATEMENT TECHNOLOGIES, INC. (GEORGIA CORPORATION)  
SUITE 300  
605 SATELLITE BOULEVARD  
SUWANEE, GA 30024

FOR: PORTABLE AIR SCRUBBERS FOR COMMERCIAL, DOMESTIC AND INDUSTRIAL USE; AIR PURIFYING UNITS FOR COMMERCIAL, DOMESTIC AND INDUSTRIAL USE; AND AIR FILTRATION UNITS FOR COMMERCIAL, DOMESTIC AND INDUSTRIAL USE, IN CLASS 11 (U.S. CLS. 13, 21, 23, 31 AND 34).

FIRST USE 4-0-2008; IN COMMERCE 4-0-2008.

THE MARK CONSISTS OF STANDARD CHARACTERS WITHOUT CLAIM TO ANY PARTICULAR FONT, STYLE, SIZE, OR COLOR.

SN 77-111,058, FILED 2-20-2007.

SHAILA SETTLES, EXAMINING ATTORNEY

**Int. Cl.: 29**

**Prior U.S. Cl.: 46**

**United States Patent and Trademark Office**

**Reg. No. 3,499,629**

**Registered Sep. 9, 2008**

**TRADEMARK  
PRINCIPAL REGISTER**

**OMAGGIO**

AXIOM ENTERPRISES, L.L.C. (DELAWARE LIMITED LIABILITY COMPANY)

4142 OGLETOWN-STANTON RD., PMB #710

NEWARK, DE 19713

FOR: GRAPSEED OIL, IN CLASS 29 (U.S. CL. 46).

FIRST USE 9-20-2007; IN COMMERCE 9-20-2007.

THE MARK CONSISTS OF STANDARD CHARACTERS WITHOUT CLAIM TO ANY PARTICULAR FONT, STYLE, SIZE, OR COLOR.

OWNER OF U.S. REG. NOS. 2,110,250 AND 2,425,309.

SN 77-113,728, FILED 2-22-2007.

WILLIAM ROSSMAN, EXAMINING ATTORNEY

Int. Cl.: 30

Prior U.S. Cl.: 46

United States Patent and Trademark Office

Reg. No. 3,499,630

Registered Sep. 9, 2008

TRADEMARK  
PRINCIPAL REGISTER

REPUBLICA DEL CACAO<sup>o</sup>

WESTERN INTERTRADE LTD. (BR.VIRGIN ISLANDS CORPORATION)  
ROAD TOWN TORTOLA  
TORTOLA, BR.VIRGIN ISLANDS

FOR: CANDIES; CANDY; CANDY BARS; CANDY CAKE DECORATIONS; CANDY COATED APPLES; CANDY COATED POPCORN; CANDY CONTAINING ALCOHOLIC BEVERAGE CONTENT AND FLAVOR; CANDY DECORATIONS FOR CAKES; CANDY MINTS; CANDY WITH CARAMEL; CANDY WITH COCOA; CHOCOLATE; CHOCOLATE BARS; CHOCOLATE CANDIES; CHOCOLATE CHIPS; CHOCOLATE COVERED NUTS; CHOCOLATE COVERED RAISINS; CHOCOLATE FONDUE; CHOCOLATE FOOD BEVERAGES NOT BEING DAIRY-BASED OR VEGETABLE BASED; CHOCOLATE MOUSSE; CHOCOLATE PASTES; CHOCOLATE POWDER; CHOCOLATE SYRUP; CHOCOLATE TOPPING; CHOCOLATE TRUFFLES; CHOCOLATE-BASED FILLINGS FOR CAKES AND PIES; CHOCOLATE-BASED READY-TO-EAT FOOD BARS; CHOCOLATE-COVERED POTATO CHIPS; COCOA; COCOA-BASED INGREDIENT IN CONFECTIONERY PRODUCTS; CONFECTIONERY CHIPS FOR BAKING; CONFECTIONERY, NAME-

LY, PASTILLES; FILLED CHOCOLATE; GIFT BASKETS CONTAINING CANDY; GUMMY CANDIES; HOT CHOCOLATE; ICE CANDIES; MILK CHOCOLATE; PEPPERMINT CANDY; SPREAD CONTAINING CHOCOLATE AND NUTS; STARCH-BASED CANDIES (AME); SUGARLESS CANDIES, IN CLASS 30 (U.S. CL. 46).

FIRST USE 11-20-2007; IN COMMERCE 11-20-2007.

THE MARK CONSISTS OF STANDARD CHARACTERS WITHOUT CLAIM TO ANY PARTICULAR FONT, STYLE, SIZE, OR COLOR.

NO CLAIM IS MADE TO THE EXCLUSIVE RIGHT TO USE "CACAO", APART FROM THE MARK AS SHOWN.

THE FOREIGN WORDING IN THE MARK TRANSLATES INTO ENGLISH AS "REPUBLIC OF THE COCOA".

SN 77-114,187, FILED 2-23-2007.

JAY BESCH, EXAMINING ATTORNEY

**Int. Cls.: 16, 35, and 41**

**Prior U.S. Cls.: 2, 5, 22, 23, 29, 37, 38, 50, 100, 101, 102, and 107**

**Reg. No. 3,499,631**

**United States Patent and Trademark Office**

**Registered Sep. 9, 2008**

**TRADEMARK  
SERVICE MARK  
PRINCIPAL REGISTER**

**ABMS MAINTENANCE OF  
CERTIFICATION**

AMERICAN BOARD OF MEDICAL SPECIALTIES  
(ILLINOIS CORPORATION)  
1007 CHURCH STREET, SUITE 404  
EVANSTON, IL 602015913

FOR: PRINTED PUBLICATIONS, NAMELY, BOOKLETS AND NEWSLETTERS RELATING TO TEST PREPARATION FOR MAINTENANCE OF CERTIFICATION FOR MEDICAL PROFESSIONALS IN SPECIALTY FIELDS, IN CLASS 16 (U.S. CLS. 2, 5, 22, 23, 29, 37, 38 AND 50).

FIRST USE 7-15-2007; IN COMMERCE 7-15-2007.

FOR: TESTING AND EVALUATING THE COMPETENCE OF MEDICAL PROFESSIONALS FOR THE PURPOSE OF MAINTAINING CERTIFICATION IN SPECIALTY FIELDS, IN CLASS 35 (U.S. CLS. 100, 101 AND 102).

FIRST USE 7-15-2007; IN COMMERCE 7-15-2007.

FOR: EDUCATIONAL SERVICES, NAMELY, PROVIDING EDUCATIONAL PROGRAMS RELAT-

ING TO MAINTENANCE OF CERTIFICATION FOR MEDICAL PROFESSIONALS IN SPECIALTY FIELDS, IN CLASS 41 (U.S. CLS. 100, 101 AND 107).

FIRST USE 7-15-2007; IN COMMERCE 7-15-2007.

THE MARK CONSISTS OF STANDARD CHARACTERS WITHOUT CLAIM TO ANY PARTICULAR FONT, STYLE, SIZE, OR COLOR.

OWNER OF U.S. REG. NOS. 3,067,687, 3,241,858, AND OTHERS.

NO CLAIM IS MADE TO THE EXCLUSIVE RIGHT TO USE "MAINTENANCE OF CERTIFICATION", APART FROM THE MARK AS SHOWN.

SN 77-114,627, FILED 2-23-2007.

CHRISTOPHER BUONGIORNO, EXAMINING ATTORNEY

**Int. Cl.: 41**

**Prior U.S. Cls.: 100, 101, and 107**

**United States Patent and Trademark Office**

**Reg. No. 3,499,632**

**Registered Sep. 9, 2008**

**SERVICE MARK  
PRINCIPAL REGISTER**

CITY UNIVERSITY OF SEATTLE

CITY UNIVERSITY OF SEATTLE (WASHINGTON NONPROFIT CORPORATION)  
150 - 120TH AVENUE NE  
BELLEVUE, WA 98005

FOR: EDUCATIONAL SERVICES, NAMELY, PROVIDING COURSES AT THE COLLEGE LEVEL AND DISTRIBUTING COURSE MATERIALS IN CONNECTION THEREWITH, IN CLASS 41 (U.S. CLS. 100, 101 AND 107).

FIRST USE 4-9-2007; IN COMMERCE 4-9-2007.

THE MARK CONSISTS OF STANDARD CHARACTERS WITHOUT CLAIM TO ANY PARTICULAR FONT, STYLE, SIZE, OR COLOR.

OWNER OF U.S. REG. NOS. 1,918,423 AND 2,923,886.

NO CLAIM IS MADE TO THE EXCLUSIVE RIGHT TO USE "UNIVERSITY OF SEATTLE", APART FROM THE MARK AS SHOWN.

SEC. 2(F) AS TO "CITY".

SN 77-115,206, FILED 2-23-2007.

RUDY R. SINGLETON, EXAMINING ATTORNEY



**Int. Cl.: 7**

**Prior U.S. Cls.: 13, 19, 21, 23, 31, 34, and 35**

**Reg. No. 3,499,633**

**United States Patent and Trademark Office**

**Registered Sep. 9, 2008**

**TRADEMARK  
PRINCIPAL REGISTER**

# Pool Mite

WATER TECH, LLC (DELAWARE LIMITED LIABILITY COMPANY)

44 W. FERRIS STREET, SUITE A

EAST BRUNSWICK, NJ 088162159

FOR: WATER VACUUM CLEANERS; WET VACUUM CLEANERS, IN CLASS 7 (U.S. CLS. 13, 19, 21, 23, 31, 34 AND 35).

FIRST USE 6-1-2008; IN COMMERCE 6-1-2008.

THE MARK CONSISTS OF STANDARD CHARACTERS WITHOUT CLAIM TO ANY PARTICULAR FONT, STYLE, SIZE, OR COLOR.

NO CLAIM IS MADE TO THE EXCLUSIVE RIGHT TO USE "POOL", APART FROM THE MARK AS SHOWN.

SN 77-115,907, FILED 2-26-2007.

DOMINIC J. FERRAIUOLO, EXAMINING ATTORNEY

**Int. Cls.: 3, 8, and 21**

**Prior U.S. Cls.: 1, 2, 4, 6, 13, 23, 28, 29, 30, 33, 40, 44,  
50, 51, and 52**

**Reg. No. 3,499,634**

**United States Patent and Trademark Office**

**Registered Sep. 9, 2008**

**TRADEMARK  
PRINCIPAL REGISTER**

**CREATE BEAUTY**

KKMC, LLC (CALIFORNIA LIMITED LIABILITY  
COMPANY)  
7011 KOLL CENTER PARKWAY, SUITE 230  
PLEASANTON, CA 94566

FOR: COSMETICS, NAMELY, LIPSTICKS, LIP GLOSS, LIP LINERS, LIP BALMS, EYE SHADOWS, EYE LINING PENCILS, LIQUID EYE LINERS, EYE MAKEUP, MASCARA, EYEBROW PENCILS, ARTIFICIAL EYELASHES, BLUSHERS, SKIN BRONZER, COTTON STICKS FOR COSMETIC PURPOSES, FOUNDATION MAKEUP, PRESSED FACE POWDER, LOOSE FACE POWDER, MAKEUP REMOVER, CONCEALERS, COMPACTS CONTAINING MAKEUP, NAMELY, EYE PALLETS AND LIP PALLETTES, MAKE-UP KITS COMPRISED OF THE GOODS SET FORTH IN THIS DESCRIPTION, MULTI-USE COLORED CREAMS, POWDERS AND GELS FOR USE ON FACE; NAIL POLISH, NAIL ENAMEL, NAIL POLISH REMOVER; NON-MEDICATED SKIN CARE PRODUCTS, NAMELY, CLEANSERS, EXFOLIATORS, TONERS, ASTRINGENTS, EYE CREAMS, DISPOSABLE WIPES IMPREGNATED WITH CLEANSING COMPOUNDS FOR USE ON FACE AND SKIN, MOISTURIZING SPRITZERS, NAMELY, BODY SPRAYS AND TINTED SKIN MOISTURIZERS; FRAGRANCES FOR PERSONAL USE, IN CLASS 3 (U.S. CLS. 1, 4, 6, 50, 51 AND 52).

FIRST USE 3-20-2008; IN COMMERCE 3-20-2008.

FOR: COSMETIC TOOLS AND INSTRUMENTS, NAMELY, TWEEZERS, EYELASH CURLERS,

FOAM APPLICATOR STICKS FOR APPLYING COSMETICS TO EYELASHES, MANICURE AND PEDICURE IMPLEMENTS, NAMELY, NAIL FILES, NAIL CLIPPERS AND SCISSORS, CUTICLE PUSHERS, TWEEZERS, NAIL AND CUTICLE SCISSORS, IN CLASS 8 (U.S. CLS. 23, 28 AND 44).

FIRST USE 3-20-2008; IN COMMERCE 3-20-2008.

FOR: COSMETIC TOOLS, APPLICATORS AND INSTRUMENTS USED IN THE APPLICATION OF COSMETICS, NAMELY, BRUSHES FOR USE IN THE APPLICATION OF COSMETICS, COMBS, APPLICATOR STICKS FOR APPLYING MAKEUP, HAIR BRUSHES AND COMBS, FACIAL SPONGES FOR APPLYING MAKE-UP, FOAM APPLICATOR STICKS FOR APPLYING COSMETICS, BODY SCRUBBING PUFFS, NYLON MESH BODY CLEANSING PUFFS, POWDER PUFFS, COSMETIC FACIAL BLOTTING PAPERS, COSMETIC BRUSHES, EYEBROW BRUSHES, IN CLASS 21 (U.S. CLS. 2, 13, 23, 29, 30, 33, 40 AND 50).

FIRST USE 3-20-2008; IN COMMERCE 3-20-2008.

THE MARK CONSISTS OF STANDARD CHARACTERS WITHOUT CLAIM TO ANY PARTICULAR FONT, STYLE, SIZE, OR COLOR.

SN 77-116,336, FILED 2-26-2007.

ROBERT C. CLARK JR., EXAMINING ATTORNEY

**Int. Cls.: 3, 8, and 21**

**Prior U.S. Cls.: 1, 2, 4, 6, 13, 23, 28, 29, 30, 33, 40, 44,  
50, 51, and 52**

**Reg. No. 3,499,635**

**United States Patent and Trademark Office**

**Registered Sep. 9, 2008**

**TRADEMARK  
PRINCIPAL REGISTER**

**JAPONESQUE CREATE BEAUTY**

KKMC, LLC (CALIFORNIA LIMITED LIABILITY  
COMPANY)  
7011 KOLL CENTER PARKWAY, SUITE 230  
PLEASANTON, CA 94566

FOR: COSMETICS, NAMELY, LIPSTICKS, LIP GLOSS, LIP LINERS, LIP BALMS, EYE SHADOWS, EYE LINING PENCILS, LIQUID EYE LINERS, EYE MAKEUP, MASCARA, EYEBROW PENCILS, ARTIFICIAL EYELASHES, BLUSHERS, SKIN BRONZER, COTTON STICKS FOR COSMETIC PURPOSES, FOUNDATION MAKEUP, PRESSED FACE POWDER, LOOSE FACE POWDER, MAKEUP REMOVER, CONCEALERS, COMPACTS CONTAINING MAKEUP, NAMELY, EYE PALLETS AND LIP PALLETTES, MAKE-UP KITS COMPRISED OF THE GOODS SET FORTH IN THIS DESCRIPTION, MULTI-USE COLORED CREAMS, POWDERS AND GELS FOR USE ON FACE; NAIL POLISH, NAIL ENAMEL, NAIL POLISH REMOVER; NON-MEDICATED SKIN CARE PRODUCTS, NAMELY, CLEANSERS, EXFOLIATORS, TONERS, ASTRINGENTS, EYE CREAMS, DISPOSABLE WIPES IMPREGNATED WITH CLEANSING COMPOUNDS FOR USE ON FACE AND SKIN, MOISTURIZING SPRITZERS, NAMELY, BODY SPRAYS AND TINTED SKIN MOISTURIZERS; FRAGRANCES FOR PERSONAL USE, IN CLASS 3 (U.S. CLS. 1, 4, 6, 50, 51 AND 52).

FIRST USE 3-31-2008; IN COMMERCE 3-31-2008.

FOR: COSMETIC TOOLS AND INSTRUMENTS, NAMELY, TWEEZERS, EYELASH CURLERS,

FOAM APPLICATOR STICKS FOR APPLYING COSMETICS TO EYELASHES, MANICURE AND PEDICURE IMPLEMENTS, NAMELY, NAIL FILES, NAIL CLIPPERS AND SCISSORS, CUTICLE PUSHERS, TWEEZERS, NAIL AND CUTICLE SCISSORS, IN CLASS 8 (U.S. CLS. 23, 28 AND 44).

FIRST USE 3-31-2008; IN COMMERCE 3-31-2008.

FOR: COSMETIC TOOLS, APPLICATORS AND INSTRUMENTS USED IN THE APPLICATION OF COSMETICS, NAMELY, BRUSHES FOR USE IN THE APPLICATION OF COSMETICS, COMBS, APPLICATOR STICKS FOR APPLYING MAKEUP, HAIR BRUSHES AND COMBS, FACIAL SPONGES FOR APPLYING MAKE-UP, FOAM APPLICATOR STICKS FOR APPLYING COSMETICS, BODY SCRUBBING PUFFS, NYLON MESH BODY CLEANSING PUFFS, POWDER PUFFS, COSMETIC FACIAL BLOTTING PAPERS, COSMETIC BRUSHES, EYEBROW BRUSHES, IN CLASS 21 (U.S. CLS. 2, 13, 23, 29, 30, 33, 40 AND 50).

FIRST USE 3-31-2008; IN COMMERCE 3-31-2008.

THE MARK CONSISTS OF STANDARD CHARACTERS WITHOUT CLAIM TO ANY PARTICULAR FONT, STYLE, SIZE, OR COLOR.

SN 77-116,384, FILED 2-26-2007.

ROBERT C. CLARK JR., EXAMINING ATTORNEY

Int. Cl.: 35

Prior U.S. Cls.: 100, 101, and 102

United States Patent and Trademark Office

Reg. No. 3,499,636

Registered Sep. 9, 2008

SERVICE MARK  
PRINCIPAL REGISTER

The logo features a stylized orange and black symbol resembling two interlocking crescents to the left of the text. The text "DowLohnes" is in black, "GovernmentStrategies" is in orange, and "LLC" is in black.

DOW LOHNES PLLC (D.C. PROFESSIONAL LIMITED LIABILITY COMPANY)  
SUITE 800  
1200 NEW HAMPSHIRE AVENUE, N.W.  
WASHINGTON, DC 20036

FOR: LOBBYING SERVICES, NAMELY, PROMOTING THE INTERESTS OF DOMESTIC AND INTERNATIONAL COMPANIES, NON-PROFIT COMPANIES, EDUCATIONAL INSTITUTIONS, TRADE ASSOCIATIONS AND INDIVIDUALS IN THE FIELDS OF POLITICS, LEGISLATION AND REGULATION, IN CLASS 35 (U.S. CLS. 100, 101 AND 102).

FIRST USE 3-6-2008; IN COMMERCE 3-6-2008.

OWNER OF U.S. REG. NO. 2,917,416.

NO CLAIM IS MADE TO THE EXCLUSIVE RIGHT TO USE "GOVERNMENTSTRATEGIES LLC", APART FROM THE MARK AS SHOWN.

THE COLOR(S) BLACK AND ORANGE IS/ARE CLAIMED AS A FEATURE OF THE MARK.

THE MARK CONSISTS OF TWO INTERLOCKING CRESCENTS, ONE ORANGE AND ONE BLACK, FOLLOWED BY THE WORDS "DOW LOHNES GOVERNMENT STRATEGIES LLC". THE WORDS "DOW", "LOHNES", "STRATEGIES" AND "LLC" ARE IN THE COLOR BLACK. THE WORD "GOVERNMENT" IS IN THE COLOR ORANGE.

SN 77-117,399, FILED 2-27-2007.

YAT SYE, LEE, EXAMINING ATTORNEY

**Int. Cl.: 11**

**Prior U.S. Cls.: 13, 21, 23, 31, and 34**

**United States Patent and Trademark Office**

**Reg. No. 3,499,637**

**Registered Sep. 9, 2008**

**TRADEMARK  
PRINCIPAL REGISTER**

**DAEDALUS**

IVALO LIGHTING INC. (PENNSYLVANIA CORPORATION)  
7136 SUTER ROAD  
COOPERSBURG, PA 18036

THE MARK CONSISTS OF STANDARD CHARACTERS WITHOUT CLAIM TO ANY PARTICULAR FONT, STYLE, SIZE, OR COLOR.

FOR: LIGHTING FIXTURES AND PARTS THEREOF, IN CLASS 11 (U.S. CLS. 13, 21, 23, 31 AND 34).

SN 77-117,425, FILED 2-27-2007.

FIRST USE 11-15-2007; IN COMMERCE 5-28-2008.

GEORGE LORENZO, EXAMINING ATTORNEY

**Int. Cls.: 38 and 41**

**Prior U.S. Cls.: 100, 101, 104, and 107**

**United States Patent and Trademark Office**

**Reg. No. 3,499,638**

**Registered Sep. 9, 2008**

**SERVICE MARK  
PRINCIPAL REGISTER**

**BLACK BELT POKER**

IAMPLIFY LLC (DELAWARE LIMITED LIABILITY COMPANY)  
11TH FLOOR  
45 WEST 25 STREET  
NEW YORK, NY 10010

FOR: TRANSMISSION OF POKER INSTRUCTIONAL MATERIALS VIA WIRELESS COMMUNICATIONS NETWORKS, IN CLASS 38 (U.S. CLS. 100, 101 AND 104).

FIRST USE 7-2-2008; IN COMMERCE 7-2-2008.

FOR: PROVIDING A WEBSITE FEATURING INFORMAL INSTRUCTION ON POKER, IN CLASS 41 (U.S. CLS. 100, 101 AND 107).

FIRST USE 7-2-2008; IN COMMERCE 7-2-2008.

THE MARK CONSISTS OF STANDARD CHARACTERS WITHOUT CLAIM TO ANY PARTICULAR FONT, STYLE, SIZE, OR COLOR.

NO CLAIM IS MADE TO THE EXCLUSIVE RIGHT TO USE "POKER", APART FROM THE MARK AS SHOWN.

SN 77-119,688, FILED 3-1-2007.

PAUL E. FAHRENKOPF, EXAMINING ATTORNEY

**Int. Cl.: 36**

**Prior U.S. Cls.: 100, 101, and 102**

**United States Patent and Trademark Office**

**Reg. No. 3,499,639**

**Registered Sep. 9, 2008**

**SERVICE MARK  
PRINCIPAL REGISTER**

**ESSENTIAL PLANNING SERVICES**

ESSENTIAL PLANNING SERVICES, LLC (CALIFORNIA LIMITED LIABILITY COMPANY)  
6540 LUSK BOULEVARD, SUITE C225  
SAN DIEGO, CA 92121

FOR: FINANCIAL PLANNING SERVICES AND INVESTMENT ADVISORY SERVICES, IN CLASS 36 (U.S. CLS. 100, 101 AND 102).

FIRST USE 1-31-2007; IN COMMERCE 1-31-2007.

THE MARK CONSISTS OF STANDARD CHARACTERS WITHOUT CLAIM TO ANY PARTICULAR FONT, STYLE, SIZE, OR COLOR.

NO CLAIM IS MADE TO THE EXCLUSIVE RIGHT TO USE "PLANNING SERVICES", APART FROM THE MARK AS SHOWN.

SN 77-120,263, FILED 3-1-2007.

SETH A. RAPPAPORT, EXAMINING ATTORNEY

**Int. Cls.: 41, 42, and 45**

**Prior U.S. Cls.: 100, 101, and 107**

**United States Patent and Trademark Office**

**Reg. No. 3,499,640**

**Registered Sep. 9, 2008**

**SERVICE MARK  
PRINCIPAL REGISTER**

**VOTIGO**

VOTIGO, INC. (DELAWARE CORPORATION)  
5515 DOYLE STREET, SUITE 12  
EMERYVILLE, CA 94608

FOR: ARRANGING OF ON-LINE CONTESTS, IN  
CLASS 41 (U.S. CLS. 100, 101 AND 107).

FIRST USE 2-15-2007; IN COMMERCE 2-15-2007.

FOR: COMPUTER SERVICES, NAMELY, CREAT-  
ING AN ONLINE COMMUNITY FOR REGISTERED  
USERS TO CREATE AND PARTICIPATE IN CON-  
TESTS, COMPETITIONS, SHOWCASE THEIR  
SKILLS, SHARE DIGITAL MEDIA, GET FEEDBACK  
FROM THEIR PEERS, FORM VIRTUAL COMMU-  
NITIES, AND ENGAGE IN SOCIAL NETWORKING  
AND HOSTING OF DIGITAL CONTENT ON THE  
INTERNET, IN CLASS 42 (U.S. CLS. 100 AND 101).

FIRST USE 2-15-2007; IN COMMERCE 2-15-2007.

FOR: INTERNET BASED SOCIAL NETWORKING  
AND ONLINE SOCIAL NETWORKING SERVICES,  
IN CLASS 45 (U.S. CLS. 100 AND 101).

FIRST USE 2-15-2007; IN COMMERCE 2-15-2007.

THE MARK CONSISTS OF STANDARD CHAR-  
ACTERS WITHOUT CLAIM TO ANY PARTICULAR  
FONT, STYLE, SIZE, OR COLOR.

SN 77-120,508, FILED 3-2-2007.

JEFFERY COWARD, EXAMINING ATTORNEY



**Int. Cl.: 41**

**Prior U.S. Cls.: 100, 101, and 107**

**United States Patent and Trademark Office**

**Reg. No. 3,499,641**

**Registered Sep. 9, 2008**

**SERVICE MARK  
PRINCIPAL REGISTER**



DREAMWORKS ANIMATION L.L.C. (DELA-  
WARE LIMITED LIABILITY COMPANY)  
1000 FLOWER STREET  
GLENDALE, CA 91201

FOR: ENTERTAINMENT SERVICES, NAMELY,  
THE PRODUCTION AND DISTRIBUTION OF ANI-  
MATED MOTION PICTURES AND ANIMATED  
TELEVISION PROGRAMS , IN CLASS 41 (U.S. CLS.  
100, 101 AND 107).

FIRST USE 3-31-2007; IN COMMERCE 3-31-2007.

OWNER OF U.S. REG. NOS. 2,596,916, 2,644,242,  
AND 2,665,088.

NO CLAIM IS MADE TO THE EXCLUSIVE  
RIGHT TO USE "ANIMATION", APART FROM  
THE MARK AS SHOWN.

THE COLOR(S) RED, BLUE, ORANGE, PINK  
AND GREEN IS/ARE CLAIMED AS A FEATURE  
OF THE MARK.

THE MARK CONSISTS OF RED ON THE LET-  
TERS "D" AND "W"; BLUE ON THE LETTERS "R"  
AND "O"; ORANGE ON THE LETTERS "E" AND  
THE SECOND "R"; PINK ON THE LETTERS "A"  
AND "K"; AND GREEN ON THE LETTERS "M"  
AND "S". THE WORDS "ANIMATION SKG" AND  
THE LINE ARE IN BLUE. THE DESIGN IS IN BLUE.

SN 77-122,557, FILED 3-5-2007.

SAIMA MAKHDOOM, EXAMINING ATTORNEY

Int. Cl.: 25

Prior U.S. Cls.: 22 and 39

United States Patent and Trademark Office

Reg. No. 3,499,642

Registered Sep. 9, 2008

TRADEMARK  
PRINCIPAL REGISTER

TRIPLE L SOCIETY

NURSE, LAWRENCE EMMANUEL (TRINIDAD/  
TOBAGO INDIVIDUAL)  
129 E 35 ST  
BROOKLYN, NY 11203

FOR: BUTTON-FRONT ALOHA SHIRTS; CAMP SHIRTS; DRESS SHIRTS; GOLF SHIRTS; KNIT SHIRTS; NIGHT SHIRTS; OPEN-NECKED SHIRTS; PIQUE SHIRTS; POLO SHIRTS; SHIRT FRONTS; SHIRT YOKES; SHIRTS; SHIRTS FOR SUITS; SHORT-SLEEVED OR LONG-SLEEVED T-SHIRTS; SHORT-SLEEVED SHIRTS; SLEEP SHIRTS; SPORT SHIRTS; SPORTS SHIRTS; SPORTS SHIRTS WITH SHORT SLEEVES; SWEAT SHIRTS; T-SHIRTS; WIND SHIRTS; BALLOON PANTS; CAPRI PANTS; CARGO PANTS; DENIMS; JOGGING PANTS; LEATHER PANTS; NON-DISPOSABLE CLOTH TRAINING PANTS; NURSE PANTS; PANTS; PETTI-PANTS; SKI PANTS; SNOW PANTS; SNOWBOARD PANTS; SWEAT PANTS; TAP PANTS; TOBOGGAN HATS, PANTS AND CAPS; TRACK PANTS; WATERPROOF JACKETS AND PANTS; COATS; COATS FOR MEN AND WOMEN; COATS MADE OF COTTON; COATS OF DENIM; DUST COATS; FUR COATS; FUR COATS AND JACKETS; LAB COATS; LEATHER COATS; LIGHT-REFLECTING COATS; MEN AND WOMEN JACKETS, COATS, TROUSERS, VESTS; MORNING COATS; OVER COATS; RAIN COATS; RIDING COATS; SPORT COATS; SUIT COATS; TOP COATS; TRENCH COATS; WIND COATS; BRIEFS; DISPOSABLE UNDERWEAR; KNITTED UNDERWEAR; LADIES' UNDERWEAR; PARTS OF CLOTHING, NAMELY, GUSSETS FOR TIGHTS, GUSSETS FOR STOCKINGS, GUSSETS FOR BATHING SUITS, GUSSETS FOR UNDERWEAR, GUSSETS FOR LEOTARDS AND GUSSETS FOR FOOTLETS; PERSPIRATION ABSORBENT UNDERWEAR CLOTHING; THERMAL UNDERWEAR; THONGS; UNDERWEAR; WOMEN'S UNDERWEAR; WOVEN OR KNITTED UNDERWEAR; NIGHTWEAR; BASKETBALL SNEAKERS; SNEAKERS; BATHING SUITS; BATHING SUITS FOR MEN; BODY SUITS;

DRESS SUITS; DRY SUITS; FLIGHT SUITS; GYM SUITS; JOGGING SUITS; JUDO SUITS; KARATE SUITS; LADIES' SUITS; MEN'S SUITS; MEN'S SUITS, WOMEN'S SUITS; PLAY SUITS; RAIN SUITS; SKI SUITS; SKI SUITS FOR COMPETITION; SKIRT SUITS; SNOW BOARDING SUITS; SNOW SUITS; SUITS; SUITS OF LEATHER; SWEAT SUITS; TRACK SUITS; TRAINING SUITS; VESTED SUITS; WARM UP SUITS; WET SUIT GLOVES; WET SUITS; WET SUITS FOR WATER-SKIING AND SUB-AQUA; ZOOT SUITS; JEANS; PLEATED SKIRTS FOR FORMAL KIMONOS (HAKAMA); SKIRTS; SKIRTS AND DRESSES; CHEF'S HATS; FUR HATS; HAT BANDS; HATS; HEADGEAR, NAMELY, FITTED CAPS, SNAP BACK CAPS, WINTER CAPS; PAPER HATS FOR USE AS CLOTHING ITEMS; SEDGE HATS (SUGE-GASA); SMALL HATS; WOOLLY HATS; BUSTLE HOLDER BANDS FOR OBI (OBIAGE); NECK BANDS; SASH BANDS FOR KIMONO (OBI); SWEAT BANDS; WRIST BANDS; WRISTBANDS; WRISTBANDS CONTAINING A COOLING SUBSTANCE TO COOL THE WEARER; BLAZERS; HUNTING BOOT BAGS; SKI BOOT BAGS; MOCK TURTLE-NECK SWEATERS; SWEATERS; TURTLENECK SWEATERS; V-NECK SWEATERS; BLOUSES; HEADBANDS AGAINST SWEATING; STOCKINGS; SWEAT SHORTS; TROUSERS FOR SWEATING; HOODS; HOODS; FISHING VESTS; HUNTING VESTS; LONG SLEEVED VESTS; QUILTED VESTS; VEST EXTENDERS; VESTS; WIND VESTS; BED JACKETS; DENIM JACKETS; DOWN JACKETS; FISHERMEN'S JACKETS; FUR JACKETS; HEAVY JACKETS; JACKET LINERS; JACKETS; LEATHER JACKETS; LIGHT-REFLECTING JACKETS; LONG JACKETS; RAIN JACKETS; RAINPROOF JACKETS; SKI JACKETS; SLEEVED OR SLEEVELESS JACKETS; SMOKING JACKETS; SPORTS JACKETS; STUFF JACKETS; SUEDE JACKETS; WIND RESISTANT JACKETS; WIND-JACKETS; ANGLERS' SHOES; APRES-SKI SHOES; ATHLETIC SHOES; BALLET SHOES; BASEBALL SHOES; BEACH SHOES; BOWLING SHOES; BOXING SHOES; CANVAS SHOES; CLEATS FOR

ATTACHMENT TO SPORTS SHOES; CYCLING SHOES; DECK-SHOES; DRIVERS; FOOTBALL SHOES; GOLF SHOES; GYMNAS TIC SHOES; HANDBALL SHOES; HEEL PIECES FOR SHOES; HOCKEY SHOES; INFANTS' SHOES AND BOOTS; INSOLES; LEATHER SHOES; PROTECTIVE METAL MEMBERS FOR SHOES AND BOOTS; RUBBER SHOES; RUGBY SHOES; RUNNING SHOES; SHOE DOWELS; SHOE INSERTS FOR PRIMARILY NON-ORTHOPEDIC PURPOSES; SHOE PEGS; SHOE SOLES; SHOES; SHOES SOLES FOR REPAIR; SKI AND SNOWBOARD SHOES AND PARTS THEREOF; SKIING SHOES; SOCCER SHOES; TAP SHOES; TENNIS SHOES; TONGUE OR PULLSTRAP FOR SHOES AND BOOTS; TRACK AND FIELD SHOES; TRAINING SHOES; VOLLEYBALL SHOES; WOMEN'S SHOES; WORK SHOES AND BOOTS; JAPANESE STYLE CLOGS AND SANDALS; JAPANESE STYLE SANDALS (ZORI); JAPANESE STYLE SANDALS OF FELT; JAPANESE STYLE SANDALS OF LEATHER; JAPANESE TOE-STRAP SANDALS (ASAURAZORI); PEDICURE SANDALS; SANDAL-CLOGS; SANDALS; SOLES FOR JAPANESE STYLE SANDALS; UPPERS FOR JAPANESE STYLE SANDALS; UPPERS OF WOVEN RATTAN FOR JAPANESE STYLE SANDALS; BANDANAS; WINTER BOOTS; CAP VISORS; CAPS WITH VISORS; SUN VISORS; VISORS; CHOIR ROBES; JAPANESE SLEEPING ROBES (NEMAKI); ROBES; BELTS; BELTS MADE OF LEATHER; BELTS OF TEXTILE; FABRIC BELTS; GARTER BELTS; LEATHER BELTS; MONEY BELTS; SUSPENDER BELTS FOR MEN; SUSPENDER BELTS FOR WOMEN; TUXEDO BELTS; WAIST BELTS; WRAP BELTS FOR KIMONOS (DATEMAKI); ANKLE SOCKS; ANKLETS; ANTI-PERSPIRANT SOCKS; JAPANESE STYLE SOCKS (TABI COVERS); JAPANESE STYLE SOCKS (TABI); MEN'S SOCKS; SOCK SUSPENDERS; SOCKS; SOCKS AND STOCKINGS; THERMAL SOCKS; WATER SOCKS; WOOLLEN SOCKS; BOXER BRIEFS; BRIEFS; PANTIES, SHORTS AND BRIEFS; BOXER SHORTS; BERMUDA SHORTS; BOARD SHORTS; FLEECE SHORTS; GYM SHORTS; RUGBY SHORTS; SHORT OVERCOAT FOR KIMONO (HAORI); SHORT PETTI-

COATS; SHORT SETS; SHORT TROUSERS; SHORTS; SLIDING SHORTS; WALKING SHORTS; CLOTHING FOR WEAR IN JUDO PRACTICES; CLOTHING FOR WEAR IN WRESTLING GAMES; HEAD WEAR; NIGHT GOWNS; SKI WEAR; SURF WEAR; SWIM WEAR; SWIM WEAR FOR GENTLEMEN AND LADIES; TENNIS WEAR; BATH SLIPPERS; BATHING CAPS; BATHING COSTUMES; BATHING COSTUMES FOR WOMEN; BATHING TRUNKS; BATHROBES; SWIMMING CAPS; FLEECE PULLOVERS; PULLOVERS; WAISTCOATS; OVERCOATS; LIVERIES; BOLO TIES; BOW TIES; TIES; PAJAMAS; BICYCLE GLOVES; BICYCLING GLOVES; GLOVES; GLOVES FOR PERSONAL HAND CONDITIONING USE; GLOVES INCLUDING THOSE MADE OF SKIN, HIDE OR FUR; MOTORCYCLE GLOVES; RIDING GLOVES; SKI GLOVES; SNOWBOARD GLOVES; PANTIES; BALLET SLIPPERS; DISPOSABLE SLIPPERS; FOAM PEDICURE SLIPPERS; LEATHER SLIPPERS; PEDICURE SLIPPERS; SLIPPER SOLES; SLIPPERS; AFTER SKI BOOTS; ANKLE BOOTS; BOOTS; CLIMBING BOOTS; FOOTBALL BOOTS AND STUDS THEREFOR; HIKING BOOTS; HORSE-RIDING BOOTS; LACE BOOTS; LADIES' BOOTS; MOTORCYCLIST BOOTS; MOUNTAINEERING BOOTS; RAIN BOOTS; RIDING BOOTS; SKI BOOTS; SNOWBOARD BOOTS; SOCCER BOOTS; ADHESIVE BRAS; BRAS; FITTED SWIMMING COSTUMES WITH BRA CUPS; SHAPEWEAR, NAMELY, GIRDLES, BRAS; SPORTS BRA; STRAPLESS BRAS; STRAPS FOR BRAS; NECKERCHIEFS, IN CLASS 25 (U.S. CLS. 22 AND 39).

FIRST USE 5-1-2003; IN COMMERCE 5-1-2003.

THE MARK CONSISTS OF STANDARD CHARACTERS WITHOUT CLAIM TO ANY PARTICULAR FONT, STYLE, SIZE, OR COLOR.

SN 77-122,842, FILED 3-6-2007.

ALICIA COLLINS, EXAMINING ATTORNEY

**Int. Cls.: 6, 9, and 20**

**Prior U.S. Cls.: 2, 12, 13, 14, 21, 22, 23, 25, 26, 32, 36,  
38, and 50**

**Reg. No. 3,499,643**

**United States Patent and Trademark Office**

**Registered Sep. 9, 2008**

**TRADEMARK  
PRINCIPAL REGISTER**

**RMI**

RATERMANN MANUFACTURING, INC. (CALI-  
FORNIA CORPORATION)  
601 PINNACLE PLACE  
LIVERMORE, CA 94550

FOR: METAL PARTS, NAMELY, BRASS JOIN-  
ERY FITTINGS AND RELIEFS AND HIGH PRES-  
SURE METAL HOSES FOR GAS SUPPLY TANKS  
AND DEWAR VESSELS SOLD IN THE INDUSTRIAL  
COMPRESSED GAS MARKET, THE SPECIALTY  
GAS MARKET, THE CRYOGENIC FLUID MAR-  
KET, AND THE MEDICAL GAS MARKET, IN  
CLASS 6 (U.S. CLS. 2, 12, 13, 14, 23, 25 AND 50).

FIRST USE 12-31-2000; IN COMMERCE 12-31-2000.

FOR: GAS PRESSURE REGULATORS AND GAS  
GAUGES FOR GAS SUPPLY TANKS AND DEWAR  
VESSELS SOLD IN THE INDUSTRIAL COMPRES-  
SED GAS MARKET, THE SPECIALTY GAS MAR-  
KET, THE CRYOGENIC FLUID MARKET, AND  
THE MEDICAL GAS MARKET, IN CLASS 9 (U.S.  
CLS. 21, 23, 26, 36 AND 38).

FIRST USE 12-31-2000; IN COMMERCE 12-31-2000.

FOR: PLASTIC COLLARS AND TAGS FOR GAS  
CYLINDER IDENTIFICATION FOR GAS SUPPLY  
TANKS AND DEWAR VESSELS SOLD IN THE  
INDUSTRIAL COMPRESSED GAS MARKET, THE  
SPECIALTY GAS MARKET, THE CRYOGENIC  
FLUID MARKET, AND THE MEDICAL GAS MAR-  
KET, IN CLASS 20 (U.S. CLS. 2, 13, 22, 25, 32 AND 50).

FIRST USE 12-31-2000; IN COMMERCE 12-31-2000.

THE MARK CONSISTS OF STANDARD CHAR-  
ACTERS WITHOUT CLAIM TO ANY PARTICULAR  
FONT, STYLE, SIZE, OR COLOR.

SN 77-123,073, FILED 3-6-2007.

JEAN IM, EXAMINING ATTORNEY

**Int. Cl.: 1**

**Prior U.S. Cls.: 1, 5, 6, 10, 26, and 46**

**Reg. No. 3,499,644**

**United States Patent and Trademark Office**

**Registered Sep. 9, 2008**

**TRADEMARK  
PRINCIPAL REGISTER**

**LUNASIN XP**

SOY LABS, LLC (MISSOURI CORPORATION)  
333 EMERALD LANE  
JEFFERSON CITY, CA 65110

FOR: SOYBEAN PEPTIDE BLEND USED AS AN  
INGREDIENT FOR FUNCTIONAL FOODS, DIET-  
ARY SUPPLEMENTS, FOOD AND BEVERAGE  
POWDERS, FOOD BARS, BEVERAGES, AND FOOD  
FOR HUMAN AND ANIMAL CONSUMPTION, IN  
CLASS 1 (U.S. CLS. 1, 5, 6, 10, 26 AND 46).

FIRST USE 3-0-2007; IN COMMERCE 3-0-2007.

THE MARK CONSISTS OF STANDARD CHAR-  
ACTERS WITHOUT CLAIM TO ANY PARTICULAR  
FONT, STYLE, SIZE, OR COLOR.

NO CLAIM IS MADE TO THE EXCLUSIVE  
RIGHT TO USE "LUNASIN", APART FROM THE  
MARK AS SHOWN.

SN 77-124,258, FILED 3-7-2007.

CAROLYN GRAY, EXAMINING ATTORNEY

**Int. Cl.: 33**

**Prior U.S. Cls.: 47 and 49**

**United States Patent and Trademark Office**

**Reg. No. 3,499,645**

**Registered Sep. 9, 2008**

**TRADEMARK  
PRINCIPAL REGISTER**

**ANCIENT PEAKS**

MARGARITA VINEYARDS LLC (CALIFORNIA  
LIMITED LIABILITY COMPANY)  
5875 STOCKDALE ROAD  
PASO ROBLES, CA 93446

THE MARK CONSISTS OF STANDARD CHAR-  
ACTERS WITHOUT CLAIM TO ANY PARTICULAR  
FONT, STYLE, SIZE, OR COLOR.

FOR: WINES, IN CLASS 33 (U.S. CLS. 47 AND 49).

SN 77-124,520, FILED 3-7-2007.

FIRST USE 7-1-2008; IN COMMERCE 7-1-2008.

KHANH LE, EXAMINING ATTORNEY

**Int. Cls.: 35 and 36**

**Prior U.S. Cls.: 100, 101, and 102**

**United States Patent and Trademark Office**

**Reg. No. 3,499,646**

**Registered Sep. 9, 2008**

**SERVICE MARK  
PRINCIPAL REGISTER**

# Fidancia

FIDANCIA, S.L. (SPAIN SOCIEDAD LIMITADA)  
C. DE CASP, 118, PRAL. 4A.  
08013 BARCELONA, SPAIN

FOR: BUSINESS ADVICE, PARTICULARLY, BUSINESS ASSESSMENT ABOUT THE SOLVENCY OF THE SALES POINT, ARRANGEMENT OF TRADE FAIR SPACE FOR BUSINESS PURPOSES IN THE FIELDS OF FINANCE, CONSULTANCY AND FASHION; ADVERTISING SERVICES, NAME- LY, CREATING CORPORATE AND BRAND IDEN- TITY FOR OTHERS; ADVERTISING AGENCIES, ORGANIZATION OF PROMOTIONAL EVENTS; MARKET RESEARCH, IN CLASS 35 (U.S. CLS. 100, 101 AND 102).

FIRST USE 1-1-1995; IN COMMERCE 1-7-2007.

FOR: PROVIDING ONLINE INFORMATION AND CONSULTATION IN THE FIELD OF FI- NANCE; HANDLING DEBT COLLECTION ON OR- DERS AT A WORLDWIDE LEVEL, IN CLASS 36 (U.S. CLS. 100, 101 AND 102).

FIRST USE 1-1-1995; IN COMMERCE 1-7-2007.

SN 77-124,744, FILED 3-7-2007.

JANICE L. MCMORROW, EXAMINING ATTOR- NEY

**Int. Cls.: 9 and 36**

**Prior U.S. Cls.: 21, 23, 26, 36, 38, 100, 101, and 102**

**United States Patent and Trademark Office**

**Reg. No. 3,499,647**

**Registered Sep. 9, 2008**

**TRADEMARK  
SERVICE MARK  
PRINCIPAL REGISTER**

**PROPERTY GENIE**

MONCLA, GAIL A., MS. (UNITED STATES INDIVIDUAL)

659 MAITLAND AVENUE

ALTAMONTE SPRINGS, FL 32701 AND

BENNETT, GENE D., MR. (UNITED STATES INDIVIDUAL)

659 MAITLAND AVENUE

ALTAMONTE SPRINGS, FL 32701 AND

PITTMAN, BEN, MR. (UNITED STATES INDIVIDUAL)

659 MAITLAND AVENUE

ALTAMONTE SPRINGS, FL 32701

FOR: COMPUTER SOFTWARE FOR USE IN REAL ESTATE PROPERTY MANAGEMENT, IN CLASS 9 (U.S. CLS. 21, 23, 26, 36 AND 38).

FIRST USE 9-26-2007; IN COMMERCE 2-28-2008.

FOR: REAL ESTATE PROPERTY MANAGEMENT, IN CLASS 36 (U.S. CLS. 100, 101 AND 102).

FIRST USE 9-26-2007; IN COMMERCE 2-28-2008.

THE MARK CONSISTS OF STANDARD CHARACTERS WITHOUT CLAIM TO ANY PARTICULAR FONT, STYLE, SIZE, OR COLOR.

NO CLAIM IS MADE TO THE EXCLUSIVE RIGHT TO USE "PROPERTY", APART FROM THE MARK AS SHOWN.

SN 77-124,745, FILED 3-7-2007.

JANICE L. MCMORROW, EXAMINING ATTORNEY



**Int. Cl.: 9**

**Prior U.S. Cls.: 21, 23, 26, 36, and 38**

**Reg. No. 3,499,648**

**United States Patent and Trademark Office**

**Registered Sep. 9, 2008**

**TRADEMARK  
PRINCIPAL REGISTER**

**EDS-PAK**

MILLIPORE CORPORATION (ARIZONA COR-  
PORATION)  
290 CONCORD ROAD  
BILLERICA, MA 01821

THE MARK CONSISTS OF STANDARD CHAR-  
ACTERS WITHOUT CLAIM TO ANY PARTICULAR  
FONT, STYLE, SIZE, OR COLOR.

FOR: LABORATORY FILTERS, NAMELY, FIL-  
TER USED TO REMOVE ENDOCRINE DISRUPTER  
MOLECULES FROM WATER, IN CLASS 9 (U.S. CLS.  
21, 23, 26, 36 AND 38).

SN 77-125,925, FILED 3-8-2007.

FIRST USE 3-7-2007; IN COMMERCE 3-7-2007.

LINDA ORNDORFF, EXAMINING ATTORNEY

Int. Cls.: 29 and 30

Prior U.S. Cl.: 46

United States Patent and Trademark Office

Reg. No. 3,499,649

Registered Sep. 9, 2008

**TRADEMARK  
PRINCIPAL REGISTER**

**JTM MORE OF WHAT YOU'RE  
HUNGRY FOR**

JTM PROVISIONS COMPANY, INC. (OHIO CORPORATION)  
200 SALES DRIVE  
HARRISON, OH 45030

FOR: MEAT PRODUCTS, NAMELY, BEEF PATTIES, BEEF STEAKS, BEEF HOAGIE PATTIES, PORK PATTIES, PORK RIBS, TACO MEAT, BARBECUED BEEF, BARBECUED PORK, BARBECUED CHICKEN, RAW BEEF STEAK; CHILI WITH AND WITHOUT MEAT, CHILI WITH AND WITHOUT BEANS; BEEF; PORK; BEEF STEW; FULLY-COOKED PRE-PORTIONED MEAT PRODUCTS, NAMELY, SAUSAGE LINKS, BEEF AND PORK RIB PATTIES, COOKED HAMBURGER PATTIES, BEEF PATTIES, SALISBURY BEEF STEAK, MEATLOAF, MEATBALLS, PORK BREAKFAST PATTIES, PORK RIBS, ITALIAN SAUSAGE; SOUPS, NAMELY, TOMATO BISQUE AND TOMATO SOUP; BEEF AND PORK RIBS; PACKAGED MEAL KITS CONSISTING PRIMARILY OF MEAT IN THE NATURE OF BEEF, CHICKEN, SAUSAGE, WITH CHEESE, ONIONS, AND BUNS; FROZEN, PREPARED AND PACKAGED BEEF BARBECUE MEAL CONSISTING PRIMARILY OF MEAT; FROZEN, PREPARED AND PACKAGED PORK BARBECUE MEAL CONSISTING PRIMARILY OF MEAT; AND FROZEN, PREPARED AND PACKAGED CHICKEN BARBECUE MEAL CONSISTING PRIMARILY OF MEAT, IN CLASS 29 (U.S. CL. 46).

FIRST USE 11-0-2006; IN COMMERCE 11-0-2006.

FOR: CHICKEN FAJITAS; MEAT GRAVIES, BISCUIT GRAVY WITH MEAT, SPAGHETTI SAUCE WITH MEAT; MACARONI AND CHEESE; BEEF

TACOS; TURKEY TACOS; FRENCH BREAD PIZZA SAUCE; BREADSTICKS WITH AND WITHOUT CHEESE; SAUCES, NAMELY, CHEESE SAUCES, BARBECUE SAUCE, PIZZA SAUCE, SPAGHETTI SAUCE, ALFREDO SAUCE, MARINARA SAUCE, CHILI SAUCE, MEXICAN SAUCE, QUESO SAUCE, MUSHROOM SAUCE AND SPANISH RICE; BAKERY PRODUCTS, NAMELY, ROLLS, HOAGIE BUNS, SLICED BREADS, BAGUETTE ROLLS, WHEAT BUNS, WHEAT BAGUETTES, MINI BAGUETTE BUNS, BAGUETTES, BREAD CRUSTS, SUB BUNS, SLICED BUNS, UNSLICED BUNS, ITALIAN ROLLS, PANINO BREAD, BUNS, KAISER ROLLS, BREADSTICKS, BREAD IN THE NATURE OF BREAD BOWLS, PANINO BUNS, SLICED FOCACCIA BREAD, CHEESE STEAK BUNS, SLICED PANINO BREAD, AND SLICED HOAGIE BUNS; SANDWICHES, NAMELY, MEAT SANDWICHES, MEATBALL SANDWICHES, BREAKFAST SANDWICHES WITH MEAT, FRENCH TOAST SANDWICHES WITH MEAT; HOAGIES, IN CLASS 30 (U.S. CL. 46).

FIRST USE 11-0-2006; IN COMMERCE 11-0-2006.

THE MARK CONSISTS OF STANDARD CHARACTERS WITHOUT CLAIM TO ANY PARTICULAR FONT, STYLE, SIZE, OR COLOR.

OWNER OF U.S. REG. NOS. 1,481,747, 1,570,010, AND OTHERS.

SN 77-129,3 28, FILED 3-13-2007.

SOPHIA S. KIM, EXAMINING ATTORNEY

**Int. Cl.: 25**

**Prior U.S. Cls.: 22 and 39**

**United States Patent and Trademark Office**

**Reg. No. 3,499,650**

**Registered Sep. 9, 2008**

**TRADEMARK  
PRINCIPAL REGISTER**

**CALIO**

GREGORY G. JOHNSON (UNITED STATES IN-  
DIVIDUAL)  
7310 132ND STREET  
HUGO, MN 55035

THE MARK CONSISTS OF STANDARD CHAR-  
ACTERS WITHOUT CLAIM TO ANY PARTICULAR  
FONT, STYLE, SIZE, OR COLOR.

FOR: SHOES, IN CLASS 25 (U.S. CLS. 22 AND 39).

SN 77-130,687, FILED 3-14-2007.

FIRST USE 8-1-2007; IN COMMERCE 8-1-2007.

CAROLYN CATALDO, EXAMINING ATTORNEY

**Int. Cl.: 43**

**Prior U.S. Cls.: 100 and 101**

**United States Patent and Trademark Office**

**Reg. No. 3,499,651**

**Registered Sep. 9, 2008**

**SERVICE MARK  
PRINCIPAL REGISTER**

**THE JOULE**

DUNHILL 1530 MAIN, L.P. (TEXAS LIMITED  
PARTNERSHIP)  
7557 RAMBLER ROAD, SUITE 1100  
DALLAS, TX 75231

THE MARK CONSISTS OF STANDARD CHAR-  
ACTERS WITHOUT CLAIM TO ANY PARTICULAR  
FONT, STYLE, SIZE, OR COLOR.

FOR: HOTEL, RESTAURANT, BAR, AND CATER-  
ING SERVICES, IN CLASS 43 (U.S. CLS. 100 AND  
101).

SN 77-130,784, FILED 3-14-2007.

FIRST USE 5-30-2008; IN COMMERCE 5-30-2008.

MARLENE BELL, EXAMINING ATTORNEY

**Int. Cl.: 25**

**Prior U.S. Cls.: 22 and 39**

**United States Patent and Trademark Office**

**Reg. No. 3,499,652**

**Registered Sep. 9, 2008**

**TRADEMARK  
PRINCIPAL REGISTER**



FIRST CLOTHING LLC (CALIFORNIA LIMITED  
LIABILITY COMPANY)  
2973 HARBOR BLVD., #150  
COSTA MESA, CA 92626

FOR: JACKETS; T-SHIRTS; SWEAT SHIRTS;  
SWEATERS, IN CLASS 25 (U.S. CLS. 22 AND 39).

FIRST USE 1-0-2006; IN COMMERCE 1-0-2006.

THE MARK CONSISTS OF A STYLIZED REPRESENTATION OF A CLOSED RIGHT HAND, WITH THE THUMB RESTING Laterally OR HORIZONTALLY AGAINST THE MIDDLE FINGER AND THE INDEX OR FIRST FINGER FULLY EXTENDED.

SN 77-130,987, FILED 3-14-2007.

STEVEN PEREZ, EXAMINING ATTORNEY

**Int. Cl.: 35**

**Prior U.S. Cls.: 100, 101, and 102**

**United States Patent and Trademark Office**

**Reg. No. 3,499,653**

**Registered Sep. 9, 2008**

**SERVICE MARK  
PRINCIPAL REGISTER**



NATURAL HABITAT, INC. (COLORADO CORPORATION)  
2945 CENTER GREEN CT., STE. C  
BOULDER, CO 80301

FOR: COMMERCIAL INFORMATION SERVICES, NAMELY, PROVIDING COMMERCIAL INFORMATION RELATED TO CARBON EMISSION GENERATED BY TRAVEL AND CARBON CREDITS REQUIRED TO OFFSET THE GENERATED CARBON EMISSION, IN CLASS 35 (U.S. CLS. 100, 101 AND 102).

FIRST USE 6-30-2007; IN COMMERCE 7-14-2008.

THE MARK CONSISTS OF THE WORDS "KICK GLOBAL WARMING", WITH THE "O" PORTION IN

GLOBAL HAVING A SOCCER BALL DESIGN WITH THE PICTURE OF A PORTION OF THE EARTH ON THE SURFACE. A SERIES OF CONCENTRIC CIRCLES, CENTERED ON THE CENTER OF THE "O" PORTION, EXTEND OUT TO THE LEFT EDGE OF THE LOGO. THE WORDING PORTION IS ARRANGED IN THREE LINES, WITH THE TOP AND BOTTOM LINE CORRESPONDING TO "KICK" AND "WARMING" RESPECTIVELY, HAVING OUTLINE LETTERING, AND THE NON-"O" PORTION OF GLOBAL HAVING FILLED LETTERING.

SN 77-131,035, FILED 3-14-2007.

JAMES LOVELACE, EXAMINING ATTORNEY

**Int. Cls.: 41 and 42**

**Prior U.S. Cls.: 100, 101, and 107**

**United States Patent and Trademark Office**

**Reg. No. 3,499,654**

**Registered Sep. 9, 2008**

**SERVICE MARK  
PRINCIPAL REGISTER**

**INTERNET SOLUTIONS  
LIFECYCLE**

1175856 ONTARIO LTD. (CANADA CORPORATION)  
SUITE 600  
5580 EXPLORER DRIVE  
MISSISSAUGA, CANADA L4W4Y1

FOR: TECHNICAL TRAINING OF CONSULTANTS IN THE FIELD OF INTERNET AND WEBSITE USE, IN CLASS 41 (U.S. CLS. 100, 101 AND 107).

FIRST USE 5-29-2005; IN COMMERCE 5-29-2005.

FOR: TECHNICAL CONSULTING SERVICES TO BUSINESSES IN THE FIELD OF INTERNET AND WEBSITE USE, IN CLASS 42 (U.S. CLS. 100 AND 101).

FIRST USE 5-29-2005; IN COMMERCE 5-29-2005.

THE MARK CONSISTS OF STANDARD CHARACTERS WITHOUT CLAIM TO ANY PARTICULAR FONT, STYLE, SIZE, OR COLOR.

NO CLAIM IS MADE TO THE EXCLUSIVE RIGHT TO USE "INTERNET SOLUTIONS", APART FROM THE MARK AS SHOWN.

SN 77-132,922, FILED 3-16-2007.

WILLIAM ROSSMAN, EXAMINING ATTORNEY

**Int. Cl.: 14**

**Prior U.S. Cls.: 2, 27, 28, and 50**

**United States Patent and Trademark Office**

**Reg. No. 3,499,655**

**Registered Sep. 9, 2008**

**TRADEMARK  
PRINCIPAL REGISTER**

**life-links.us**

MOORE, LINDA M. (UNITED STATES INDIVIDUAL)  
2026 W. SUMMIT AVE.  
SAN ANTONIO, TX 78201

THE MARK CONSISTS OF STANDARD CHARACTERS WITHOUT CLAIM TO ANY PARTICULAR FONT, STYLE, SIZE, OR COLOR.

FOR: CHARMS; JEWELRY, IN CLASS 14 (U.S. CLS. 2, 27, 28 AND 50).

SN 77-133,198, FILED 3-16-2007.

FIRST USE 2-17-2007; IN COMMERCE 8-23-2007.

MARLENE BELL, EXAMINING ATTORNEY



**Int. Cl.: 41**

**Prior U.S. Cls.: 100, 101, and 107**

**United States Patent and Trademark Office**

**Reg. No. 3,499,656**

**Registered Sep. 9, 2008**

**SERVICE MARK  
PRINCIPAL REGISTER**

**LOLA. ÉRASE UNA VEZ**

TELEVISA, S.A. DE C.V. (MEXICO CORPORATION)  
EDIFICIO A, PISO 4  
AVENIDA VASCO DE QUIROGA 2000  
COLONIA ZEDEC SANTA FE, MEXICO 01210

FOR: ENTERTAINMENT SERVICES, NAMELY,  
AN ONGOING DRAMATIC TELEVISION PROGRAM,  
IN CLASS 41 (U.S. CLS. 100, 101 AND 107).

FIRST USE 2-26-2007; IN COMMERCE 3-3-2008.

THE MARK CONSISTS OF STANDARD CHARACTERS  
WITHOUT CLAIM TO ANY PARTICULAR FONT,  
STYLE, SIZE, OR COLOR.

THE NAME(S), PORTRAIT(S), AND/OR SIGNATURE(S)  
SHOWN IN THE MARK DOES NOT IDENTIFY A  
PARTICULAR LIVING INDIVIDUAL.

THE ENGLISH TRANSLATION OF ÉRASE UNA VEZ  
IS ONCE UPON A TIME.

SN 77-133,233, FILED 3-16-2007.

LAURIE MAYES, EXAMINING ATTORNEY

**Int. Cls.: 16 and 42**

**Prior U.S. Cls.: 2, 5, 22, 23, 29, 37, 38, 50, 100, and 101**

**United States Patent and Trademark Office**

**Reg. No. 3,499,657**

**Registered Sep. 9, 2008**

**TRADEMARK  
SERVICE MARK  
PRINCIPAL REGISTER**

The logo for "Allergy Alert" features a stylized graphic on the left consisting of three curved lines that resemble a box with three white line designs. To the right of this graphic, the words "Allergy Alert" are written in a large, bold, sans-serif font.

SDI HEALTH LLC (DELAWARE LIMITED LIABILITY COMPANY)  
220 W. GERMANTOWN PIKE  
PLYMOUTH MEETING, PA 19462

FOR: PRINTED RESEARCH REPORTS FEATURING RESEARCH IN THE FIELD OF DISEASES, IN CLASS 16 (U.S. CLS. 2, 5, 22, 23, 29, 37, 38 AND 50).

FIRST USE 10-0-2006; IN COMMERCE 10-0-2006.

FOR: RESEARCH IN THE FIELD OF DISEASES, IN CLASS 42 (U.S. CLS. 100 AND 101).

FIRST USE 10-0-2006; IN COMMERCE 10-0-2006.

OWNER OF U.S. REG. NOS. 2,610,786 AND 3,274,276.

THE MARK CONSISTS OF THE WORDS "ALLERGY ALERT" NEXT TO A BOX WITH THREE WHITE LINE DESIGNS.

SEC. 2(F) AS TO ALLERGY.

SN 77-133,978, FILED 3-19-2007.

MARK T. MULLEN, EXAMINING ATTORNEY

**Int. Cl.: 41**

**Prior U.S. Cls.: 100, 101, and 107**

**United States Patent and Trademark Office**

**Reg. No. 3,499,658**

**Registered Sep. 9, 2008**

**SERVICE MARK  
PRINCIPAL REGISTER**

**EVERYTHING LOOKS BETTER  
WHEN YOU START IN 4K**

DALSA INC. (CANADA CORPORATION)  
605 MCMURRAY ROAD  
WATERLOO, CANADA N2V2E9

FOR: RENTAL OF DIGITAL CINEMATOGRAPHY CAMERAS, FILM SCANNERS AND RELATED EQUIPMENT, IN CLASS 41 (U.S. CLS. 100, 101 AND 107).

FIRST USE 4-10-2007; IN COMMERCE 4-10-2007.

THE MARK CONSISTS OF STANDARD CHARACTERS WITHOUT CLAIM TO ANY PARTICULAR FONT, STYLE, SIZE, OR COLOR.

PRIORITY CLAIMED UNDER SEC. 44(D) ON CANADA APPLICATION NO. 1,335,712, FILED 2-15-2007.

SN 77-134,394, FILED 3-19-2007.

MARTHA SANTOMARTINO, EXAMINING ATTORNEY

**Int. Cl.: 32**

**Prior U.S. Cls.: 45, 46, and 48**

**Reg. No. 3,499,659**

**United States Patent and Trademark Office**

**Registered Sep. 9, 2008**

**TRADEMARK  
PRINCIPAL REGISTER**

**MORNING BOOST**

THE KROGER CO. OF MICHIGAN (MICHIGAN  
CORPORATION)  
18334 LAUREL PARK DRIVE NORTH  
LIVONIA, MI 481522686

THE MARK CONSISTS OF STANDARD CHAR-  
ACTERS WITHOUT CLAIM TO ANY PARTICULAR  
FONT, STYLE, SIZE, OR COLOR.

FOR: CAFFEINATED DRINK POWDER FOR  
MAKING ENERGY DRINKS, IN CLASS 32 (U.S.  
CLS. 45, 46 AND 48).

SN 77-134,883, FILED 3-19-2007.

FIRST USE 1-1-2008; IN COMMERCE 1-1-2008.

YAT SYE, LEE, EXAMINING ATTORNEY

**Int. Cls.: 20 and 21**

**Prior U.S. Cls.: 2, 13, 22, 23, 25, 29, 30, 32, 33, 40, and 50**

**United States Patent and Trademark Office**

**Reg. No. 3,499,660**

**Registered Sep. 9, 2008**

**TRADEMARK  
PRINCIPAL REGISTER**

**GREEN WITH ENVY**

THE TJX COMPANIES, INC. (DELAWARE CORPORATION)  
770 COCHITUATE ROAD  
FRAMINGHAM, MA 01701

FOR: PLANT STANDS FOR OUTDOOR USE, IN CLASS 20 (U.S. CLS. 2, 13, 22, 25, 32 AND 50).

FIRST USE 2-13-2008; IN COMMERCE 2-13-2008.

FOR: BIRD FEEDERS, IN CLASS 21 (U.S. CLS. 2, 13, 23, 29, 30, 33, 40 AND 50).

FIRST USE 2-13-2008; IN COMMERCE 2-13-2008.

THE MARK CONSISTS OF STANDARD CHARACTERS WITHOUT CLAIM TO ANY PARTICULAR FONT, STYLE, SIZE, OR COLOR.

SN 77-135,022, FILED 3-20-2007.

B. PARADEWELAI, EXAMINING ATTORNEY

**Int. Cls.: 16 and 41**

**Prior U.S. Cls.: 2, 5, 22, 23, 29, 37, 38, 50, 100, 101, and 107**

**Reg. No. 3,499,661**

**United States Patent and Trademark Office**

**Registered Sep. 9, 2008**

**TRADEMARK  
SERVICE MARK  
PRINCIPAL REGISTER**

**HIGHLY QUALIFIED PARENT**

RANDALL, CATHERINE J. (UNITED STATES INDIVIDUAL)  
1001 WELLESLEY GREEN  
TUSCALOOSA, AL 35406

FOR: BROCHURES AND SYNDICATED COLUMNS IN THE FIELD OF PARENTING, IN CLASS 16 (U.S. CLS. 2, 5, 22, 23, 29, 37, 38 AND 50).

FIRST USE 6-0-2007; IN COMMERCE 6-0-2007.

FOR: EDUCATIONAL SERVICES, NAMELY, PROVIDING LECTURES, SEMINARS AND WORKSHOPS IN THE FIELD OF PARENTING, AND DISTRIBUTING COURSE MATERIALS IN CONNECTION THEREWITH, IN CLASS 41 (U.S. CLS. 100, 101 AND 107).

FIRST USE 9-19-2007; IN COMMERCE 9-19-2007.

THE MARK CONSISTS OF STANDARD CHARACTERS WITHOUT CLAIM TO ANY PARTICULAR FONT, STYLE, SIZE, OR COLOR.

NO CLAIM IS MADE TO THE EXCLUSIVE RIGHT TO USE "PARENT" , APART FROM THE MARK AS SHOWN.

SN 77-136,218, FILED 3-21-2007.

ARETHA SOMERVILLE, EXAMINING ATTORNEY

**Int. Cl.: 41**

**Prior U.S. Cls.: 100, 101, and 107**

**United States Patent and Trademark Office**

**Reg. No. 3,499,662**

**Registered Sep. 9, 2008**

**SERVICE MARK  
PRINCIPAL REGISTER**

**VALUE REFERENCE MODEL**

VALUE CHAIN GROUP, INC. (OHIO CORPORATION)  
109 VIP DRIVE SUITE 210  
WEXFORD, PA 15090

FOR: EDUCATIONAL SERVICES, NAMELY, PROVIDING CLASSES, SEMINARS AND WORKSHOPS FOR ENTERPRISES AND INDIVIDUALS IN THE FIELD OF BUSINESS IMPROVEMENT VIA AN ANALYTICAL FRAMEWORK THROUGH CUSTOMIZED ENTERPRISE MODELS THAT ESTABLISH A CLASSIFICATION SCHEME FOR BUSINESS PROCESSES USING A HIERARCHY OF LEVELS AND RELATIONSHIPS THROUGH INPUTS AND OUTPUTS BY ESTABLISHING A CONTEXTUAL RELATIONSHIP WITH BEST PRACTICES AND METRICS TO HELP CLASSIFY THE PROCESSES WHICH ARE

MOST CRITICAL TO AN ENTERPRISE, IN CLASS 41 (U.S. CLS. 100, 101 AND 107).

FIRST USE 4-27-2007; IN COMMERCE 4-27-2007.

THE MARK CONSISTS OF STANDARD CHARACTERS WITHOUT CLAIM TO ANY PARTICULAR FONT, STYLE, SIZE, OR COLOR.

NO CLAIM IS MADE TO THE EXCLUSIVE RIGHT TO USE "MODEL", APART FROM THE MARK AS SHOWN.

SN 77-136,276, FILED 3-21-2007.

PAUL MORENO, EXAMINING ATTORNEY

**Int. Cl.: 3**

**Prior U.S. Cls.: 1, 4, 6, 50, 51, and 52**

**Reg. No. 3,499,663**

**United States Patent and Trademark Office**

**Registered Sep. 9, 2008**

**TRADEMARK  
PRINCIPAL REGISTER**

**FRESH RELEASE ESSENTIALS**

UNILEVER SUPPLY CHAIN, INC. (DELAWARE  
CORPORATION)  
1 JOHN STREET  
CLINTON, CT 06413

THE MARK CONSISTS OF STANDARD CHAR-  
ACTERS WITHOUT CLAIM TO ANY PARTICULAR  
FONT, STYLE, SIZE, OR COLOR.

FOR: LAUNDRY DETERGENT, IN CLASS 3 (U.S.  
CLS. 1, 4, 6, 50, 51 AND 52).

SN 77-137,438, FILED 3-22-2007.

FIRST USE 1-31-2008; IN COMMERCE 1-31-2008.

EMILY CARLSEN, EXAMINING ATTORNEY



**Int. Cl.: 3**

**Prior U.S. Cls.: 1, 4, 6, 50, 51, and 52**

**United States Patent and Trademark Office**

**Reg. No. 3,499,664**

**Registered Sep. 9, 2008**

**TRADEMARK  
PRINCIPAL REGISTER**

**WAVES OF ENVY**

UNILEVER SUPPLY CHAIN, INC. (DELAWARE  
CORPORATION)  
1 JOHN STREET  
CLINTON, CT 06413

THE MARK CONSISTS OF STANDARD CHAR-  
ACTERS WITHOUT CLAIM TO ANY PARTICULAR  
FONT, STYLE, SIZE, OR COLOR.

FOR: SHAMPOO-CONDITIONERS; HAIR STY-  
LING GEL; HAIR CREAMS, IN CLASS 3 (U.S. CLS.  
1, 4, 6, 50, 51 AND 52).

SN 77-137,706, FILED 3-22-2007.

FIRST USE 1-31-2008; IN COMMERCE 1-31-2008.

EMILY CARLSEN, EXAMINING ATTORNEY

**Int. Cl.: 9**

**Prior U.S. Cls.: 21, 23, 26, 36, and 38**

**Reg. No. 3,499,665**

**United States Patent and Trademark Office**

**Registered Sep. 9, 2008**

**TRADEMARK  
PRINCIPAL REGISTER**

**AccuTrac**

SEARS BRANDS, LLC (ILLINOIS LIMITED LIABILITY COMPANY)  
3333 BEVERLY ROAD  
HOFFMAN ESTATES, IL 60179

THE MARK CONSISTS OF STANDARD CHARACTERS WITHOUT CLAIM TO ANY PARTICULAR FONT, STYLE, SIZE, OR COLOR.

FOR: LASER LEVELS IN THE NATURE OF CARPENTER'S LEVELS, IN CLASS 9 (U.S. CLS. 21, 23, 26, 36 AND 38).

SN 77-143,104, FILED 3-28-2007.

FIRST USE 6-0-2007; IN COMMERCE 6-0-2007.

JEFFERY COWARD, EXAMINING ATTORNEY

**Int. Cl.: 25**

**Prior U.S. Cls.: 22 and 39**

**United States Patent and Trademark Office**

**Reg. No. 3,499,666**

**Registered Sep. 9, 2008**

**TRADEMARK  
PRINCIPAL REGISTER**



SAM PHANKONSY (UNITED STATES INDIVIDUAL)  
800 N RAINBOW BLVD STE 215  
LAS VEGAS, NV 89107

FOR: SHIRTS; PANTS; SHORTS; BEANIES;  
SWEAT SHIRTS; HATS; JACKETS; SHOES; JEANS;  
TANK-TOPS; SWIM WEAR; HEADBANDS, IN  
CLASS 25 (U.S. CLS. 22 AND 39).

FIRST USE 0-0-2007; IN COMMERCE 0-0-2007.

THE MARK CONSISTS OF THE HEAD OF A  
MONKEY.

SN 77-143,242, FILED 3-28-2007.

MICHELE SWAIN, EXAMINING ATTORNEY

**Int. Cl.: 28**

**Prior U.S. Cls.: 22, 23, 38, and 50**

**United States Patent and Trademark Office**

**Reg. No. 3,499,667**

**Registered Sep. 9, 2008**

**TRADEMARK  
PRINCIPAL REGISTER**

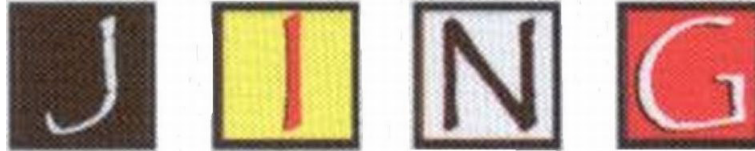

BRET W. TALBERT (UNITED STATES INDIVIDUAL)  
531 W. 3RD STREET, APT. 2C  
BETHLEHEM, PA 18015

FOR: BOARD GAMES, IN CLASS 28 (U.S. CLS. 22, 23, 38 AND 50).

FIRST USE 9-15-2006; IN COMMERCE 3-18-2007.

THE COLOR(S) BLACK, WHITE, YELLOW AND RED IS/ARE CLAIMED AS A FEATURE OF THE MARK.

THE MARK CONSISTS OF "J" IN WHITE ON A SQUARE BLACK BACKGROUND, "I" IN RED ON A SQUARE YELLOW BACKGROUND WHICH HAS A BLACK BORDER, "N" IN BLACK ON A SQUARE WHITE BACKGROUND WHICH HAS A BLACK BORDER, AND "G" IN WHITE ON A SQUARE RED BACKGROUND WHICH HAS A BLACK BORDER.

SN 77-143,473, FILED 3-29-2007.

JEAN IM, EXAMINING ATTORNEY

**Int. Cl.: 28**

**Prior U.S. Cls.: 22, 23, 38, and 50**

**United States Patent and Trademark Office**

**Reg. No. 3,499,668**

**Registered Sep. 9, 2008**

**TRADEMARK  
PRINCIPAL REGISTER**

**BALLCLUB.COM**

BASEBALL OF THE MONTH CLUB, INC. (MAS-  
SACHUSETTS CORPORATION)  
10-BB ROESSLER ROAD  
WOBURN, MA 01801

FOR: BASEBALLS, BASEBALL BATS, BASEBALL  
GLOVES; PINBALL-LIKE BASEBALL GAMES; TOY  
BUILDING AND ACCESSORIES THEREFOR,  
NAMELY, TOY BASEBALL STADIUM REPLICAS ,  
IN CLASS 28 (U.S. CLS. 22, 23, 38 AND 50).

FIRST USE 3-8-2008; IN COMMERCE 3-8-2008.

OWNER OF U.S. REG. NO. 3,162,273.

NO CLAIM IS MADE TO THE EXCLUSIVE  
RIGHT TO USE "THE TWO INSTANCES OF A  
DESIGN OF A BASEBALL", APART FROM THE  
MARK AS SHOWN.

THE COLOR(S) RED, BLACK, WHITE AND GREY  
IS/ARE CLAIMED AS A FEATURE OF THE MARK.

THE MARK CONSISTS OF THE WORD "BALL-  
CLUB .COM" WITH A BASEBALL IMPOSED OVER  
THE LETTER "A" AND ANOTHER BASEBALL  
BETWEEN "BALLCLUB" AND "COM". THE WORD-  
ING "BALLCLUB.COM" IS IN RED, OUTLINED IN  
BLACK AND THE BASEBALLS ARE WHITE WITH  
SHADING INTO GRAY, AND WITH RED STITCH-  
ING.

SN 77-144,098, FILED 3-29-2007.

RICHARD A. STRASER, EXAMINING ATTORNEY

**Int. Cl.: 43**

**Prior U.S. Cls.: 100 and 101**

**United States Patent and Trademark Office**

**Reg. No. 3,499,669**

**Registered Sep. 9, 2008**

**SERVICE MARK  
PRINCIPAL REGISTER**

**CUPPA SPOTTA**

COMPASS GROUP USA, INC. (DELAWARE CORPORATION)  
2400 YORKMONT ROAD  
CHARLOTTE, NC 28217

THE MARK CONSISTS OF STANDARD CHARACTERS WITHOUT CLAIM TO ANY PARTICULAR FONT, STYLE, SIZE, OR COLOR.

FOR: RESTAURANT SERVICES; COFFEE SHOPS,  
IN CLASS 43 (U.S. CLS. 100 AND 101).

SN 77-144,859, FILED 3-30-2007.

FIRST USE 8-28-2006; IN COMMERCE 8-28-2006.

STEVEN JACKSON, EXAMINING ATTORNEY

**Int. Cl.: 41**

**Prior U.S. Cls.: 100, 101, and 107**

**United States Patent and Trademark Office**

**Reg. No. 3,499,670**

**Registered Sep. 9, 2008**

**SERVICE MARK  
PRINCIPAL REGISTER**

**X-TREME WARRIOR**

X-TREME WARRIORS, LLC (MICHIGAN LIMITED LIABILITY COMPANY)  
38839 COUNTRY CIRCLE  
FARMINGTON HILLS, MI 48331

THE MARK CONSISTS OF STANDARD CHARACTERS WITHOUT CLAIM TO ANY PARTICULAR FONT, STYLE, SIZE, OR COLOR.

FOR: ENTERTAINMENT SERVICES IN THE NATURE OF AN ONGOING REALITY BASED TELEVISION SERIES, IN CLASS 41 (U.S. CLS. 100, 101 AND 107).

SN 77-144,863, FILED 3-30-2007.

FIRST USE 5-31-2006; IN COMMERCE 5-31-2006.

ROBERT LAVACHE, EXAMINING ATTORNEY

Int. Cl.: 8

Prior U.S. Cls.: 23, 28, and 44

United States Patent and Trademark Office

Reg. No. 3,499,671

Registered Sep. 9, 2008

TRADEMARK  
PRINCIPAL REGISTER

▶**Click**◀ **n Cut**

KURT REINER WITTE GMBH & CO. KG (FED  
REP GERMANY KOMMANDITGESELL-  
SCHAFT (KG))

FELDER STRASSE 41

SOLINGEN, FED REP GERMANY D-42651

FOR: CUTLERY, HAND-HELD CUTTING TOOLS  
FOR CUTTING HAIR, CUTTING BLADE HAND  
TOOLS, SCISSORS, HAIR CLIPPERS, HAIR CUT-  
TING BLADES, RAZORS , IN CLASS 8 (U.S. CLS. 23,  
28 AND 44).

FIRST USE 2-26-2007; IN COMMERCE 8-17-2007.

NO CLAIM IS MADE TO THE EXCLUSIVE  
RIGHT TO USE "CUT", APART FROM THE MARK  
AS SHOWN.

THE MARK CONSISTS OF A SOLID TRIANGLE  
POINTED TOWARD "CLICK" ON THE RIGHT SIDE  
OF "CLICK" AND A SOLID TRIANGLE POINTED  
TOWARD "CLICK" ON THE LEFT SIDE OF  
"CLICK" WITH THE WORDS "CLICK N CUT"  
AND THE TWO TRIANGLES COMPRISING THE  
MARK.

SN 77-146,599, FILED 4-2-2007.

TEJBIR SINGH, EXAMINING ATTORNEY



**Int. Cls.: 9 and 12**

**Prior U.S. Cls.: 19, 21, 23, 26, 31, 35, 36, 38, and 44**

**United States Patent and Trademark Office**

**Reg. No. 3,499,672**

**Registered Sep. 9, 2008**

**TRADEMARK  
PRINCIPAL REGISTER**

**DYNAMIC**

DYNAMIC CONTROLS LIMITED (NEW ZEALAND CORPORATION)  
RICCARTON 17 PRINT PLACE  
CHRISTCHURCH, NEW ZEALAND

FOR: ELECTRONIC EQUIPMENT FOR ELECTRIC WHEELCHAIRS, NAMELY, CONTROLLERS, AND JOYSTICKS; COMPUTER SOFTWARE FOR USE IN CONTROLLING ELECTRIC WHEELCHAIRS, IN CLASS 9 (U.S. CLS. 21, 23, 26, 36 AND 38).

FIRST USE 0-0-1982; IN COMMERCE 0-0-1982.

FOR: EQUIPMENT FOR ELECTRIC WHEELCHAIRS, NAMELY, MOTORS, GEAR BOXES AND

CLUTCHES, IN CLASS 12 (U.S. CLS. 19, 21, 23, 31, 35 AND 44).

FIRST USE 0-0-1995; IN COMMERCE 0-0-1995.

THE MARK CONSISTS OF STANDARD CHARACTERS WITHOUT CLAIM TO ANY PARTICULAR FONT, STYLE, SIZE, OR COLOR.

OWNER OF U.S. REG. NO. 1,975,149.

SN 77-147,225, FILED 4-3-2007.

ROBERT LAVACHE, EXAMINING ATTORNEY

**Int. Cl.: 16**

**Prior U.S. Cls.: 2, 5, 22, 23, 29, 37, 38, and 50**

**United States Patent and Trademark Office**

**Reg. No. 3,499,673**

**Registered Sep. 9, 2008**

**TRADEMARK  
PRINCIPAL REGISTER**

**BLUE SHADOW PUBLISHING**

GRAPHIQUE DE FRANCE, LTD. (MASSACHU-  
SETTS CORPORATION)

9 STATE STREET

WOBURN, MA 01801

FOR: CALENDARS, IN CLASS 16 (U.S. CLS. 2, 5,  
22, 23, 29, 37, 38 AND 50).

FIRST USE 6-25-2007; IN COMMERCE 6-25-2007.

THE MARK CONSISTS OF STANDARD CHAR-  
ACTERS WITHOUT CLAIM TO ANY PARTICULAR  
FONT, STYLE, SIZE, OR COLOR.

NO CLAIM IS MADE TO THE EXCLUSIVE  
RIGHT TO USE "PUBLISHING", APART FROM  
THE MARK AS SHOWN.

SN 77-147,644, FILED 4-3-2007.

KAPIL BHANOT, EXAMINING ATTORNEY

**Int. Cl.: 9**

**Prior U.S. Cls.: 21, 23, 26, 36, and 38**

**Reg. No. 3,499,674**

**United States Patent and Trademark Office**

**Registered Sep. 9, 2008**

**TRADEMARK  
PRINCIPAL REGISTER**

**MAXIMUM**

AXIUM TECHNOLOGIES, INC. (NEVADA CORPORATION)  
SUITE 110  
465 N. HALSTEAD STREET  
PASADENA, CA 91107

FOR: COMPUTER SURVEILLANCE SOFTWARE, NAMELY, SOFTWARE FOR A CENTRAL SECURITY SURVEILLANCE SYSTEM FOR REAL-TIME MONITORING OF MULTIPLE LOCATIONS WITH VIDEO, AUDIO AND ALARM SIGNALS OVER COMPUTER NETWORKS, IN CLASS 9 (U.S. CLS. 21, 23, 26, 36 AND 38).

FIRST USE 9-26-2005; IN COMMERCE 7-26-2006.

THE MARK CONSISTS OF STANDARD CHARACTERS WITHOUT CLAIM TO ANY PARTICULAR FONT, STYLE, SIZE, OR COLOR.

SN 77-147,866, FILED 4-3-2007.

PAUL E. FAHRENKOPF, EXAMINING ATTORNEY

**Int. Cl.: 24**

**Prior U.S. Cls.: 42 and 50**

**United States Patent and Trademark Office**

**Reg. No. 3,499,675**

**Registered Sep. 9, 2008**

**TRADEMARK  
PRINCIPAL REGISTER**

**SARANONI**

THE WHITNEY CONNECTION, LLC (UTAH  
LIMITED LIABILITY COMPANY)  
862 STONE CREEK DRIVE  
RIVER HEIGHTS, UT 84321

THE MARK CONSISTS OF STANDARD CHAR-  
ACTERS WITHOUT CLAIM TO ANY PARTICULAR  
FONT, STYLE, SIZE, OR COLOR.

FOR: BLANKETS; BURP CLOTHS, IN CLASS 24  
(U.S. CLS. 42 AND 50).

SN 77-148,725, FILED 4-4-2007.

FIRST USE 11-21-2007; IN COMMERCE 11-21-2007.

PAUL E. FAHRENKOPF, EXAMINING ATTORNEY

**Int. Cl.: 35**

**Prior U.S. Cls.: 100, 101, and 102**

**United States Patent and Trademark Office**

**Reg. No. 3,499,676**

**Registered Sep. 9, 2008**

**SERVICE MARK  
PRINCIPAL REGISTER**

**SARANONI**

THE WHITNEY CONNECTION, LLC (UTAH  
LIMITED LIABILITY COMPANY)  
862 STONE CREEK DRIVE  
RIVER HEIGHTS, UT 84321

FOR: RETAIL, WHOLESALE, AND ONLINE  
STORE SERVICES AND MAIL ORDER SERVICES,  
ALL FEATURING GIFT BASKETS, CLOTHING,  
BLANKETS, JEWELRY, RATTLES, TOYS, SHOES,  
BOOKS, TRAVEL ACCESSORIES, BIBS, BURP  
CLOTHS, AND PORTABLE MEDIA FEATURING  
MUSIC, IN CLASS 35 (U.S. CLS. 100, 101 AND 102).

FIRST USE 11-21-2007; IN COMMERCE 11-21-2007.

THE MARK CONSISTS OF STANDARD CHAR-  
ACTERS WITHOUT CLAIM TO ANY PARTICULAR  
FONT, STYLE, SIZE, OR COLOR.

SN 77-148,776, FILED 4-4-2007.

PAUL E. FAHRENKOPF, EXAMINING ATTORNEY

**Int. Cl.: 25**

**Prior U.S. Cls.: 22 and 39**

**United States Patent and Trademark Office**

**Reg. No. 3,499,677**

**Registered Sep. 9, 2008**

**TRADEMARK  
PRINCIPAL REGISTER**

**SARANONI**

THE WHITNEY CONNECTION, LLC (UTAH  
LIMITED LIABILITY COMPANY)  
862 STONE CREEK DRIVE  
RIVER HEIGHTS, UT 84321

FOR: SHOES; CHILDREN'S CLOTHING, NAME-  
LY, SHIRTS, PANTS, ROMPERS, DRESSES, HATS,  
LOUNGEWEAR, SWEATERS, JACKETS, SOCKS,  
SHORTS, BOOTIES, SKIRTS, T-SHIRTS, AND  
GLOVES; CLOTH BIBS, IN CLASS 25 (U.S. CLS. 22  
AND 39).

FIRST USE 11-21-2007; IN COMMERCE 11-21-2007.

THE MARK CONSISTS OF STANDARD CHAR-  
ACTERS WITHOUT CLAIM TO ANY PARTICULAR  
FONT, STYLE, SIZE, OR COLOR.

SN 77-148,794, FILED 4-4-2007.

PAUL E. FAHRENKOPF, EXAMINING ATTORNEY

Int. Cl.: 35

Prior U.S. Cls.: 100, 101, and 102

United States Patent and Trademark Office

Reg. No. 3,499,678

Registered Sep. 9, 2008

SERVICE MARK  
PRINCIPAL REGISTER

# SpaDelicious

EDGARDO VEGA (UNITED STATES INDIVIDUAL)  
1179 BRASADO WAY  
RIVERSIDE, CA 92508

FOR: WHOLESALE AND RETAIL STORE SERVICES AND ON-LINE WHOLESALE AND RETAIL STORE SERVICES- IN THE AREA OF SKIN CARE PRODUCTS, NAMELY, FACE CREAMS, FACE CLEANSING MILKS, FACE LOTIONS, FACE MASKS, FACE OILS, LIP CARE PRODUCTS, BODY CARE PRODUCTS, IN THE AREA OF COSMETICS, NAMELY, PERSONAL CARE PRODUCTS, TOILETRIES, FRAGRANCES, SKIN CARE PRODUCTS AND HAIR CARE PRODUCTS, IN THE AREA OF SPA PRODUCTS FOR SPA SERVICES, NAMELY, FACIALS, BODY TREATMENTS, MANICURES AND PEDICURES, IN THE AREA OF BEAUTY AND MEDICAL SUPPLIES FOR BEAUTY PROFESSION, NAMELY, SHEARS, NIPPERS, TWEEZERS, COME DO EXTRACTORS, COMPLEXION SPONGES, BRUSHES, COTTON GLOVES, HEATED MITTS AND BOOTIES FOR LOTION ABSORPTION, WAXING TREATMENTS, HAIR DIES, BATH ACCESSORIES AND SUPPLIES, AND AROMA THERAPY PRODUCTS, AND IN THE AREA OF PROVIDING A FULL LINE OF SALON AND SPA EQUIPMENT, NAMELY, MULTI-PURPOSE FACIAL/MASSAGE CHAIRS, MULTI-FUNCTION MASSAGE TABLES, STOOLS AND SKIN CARE EQUIPMENT, HIGH FREQUENCY, GALVANIC MACHINES, VACUUM SPRAYER, BRUSHING MACHINES, WORKSTATIONS, STEAMERS, MAGNI-

FYING LAMPS, HOT TOWEL CABBIES AND RELATED PRODUCTS; MAIL ORDER CATALOG SERVICES IN THE AREA OF SKIN CARE, LIP CARE, BODY CARE PRODUCTS, COSMETICS, SPA PRODUCTS, BEAUTY AND MEDICAL SUPPLIES FOR BEAUTY PROFESSIONALS, AND A FULL LINE OF SALON AND SPA EQUIPMENT; WHOLESALE AND RETAIL STORE SERVICES FEATURING PHONE IN ORDERS IN THE AREA OF SKIN CARE, LIP CARE, BODY CARE PRODUCTS, COSMETICS, SPA PRODUCTS, BEAUTY AND MEDICAL SUPPLIES FOR BEAUTY PROFESSIONALS, AND A FULL LINE OF SALON AND SPA EQUIPMENT; AND WHOLESALE AND RETAIL STORE SERVICES FEATURING FACSIMILE ORDERS IN THE AREA OF SKIN CARE, LIP CARE, BODY CARE PRODUCTS, COSMETICS, SPA PRODUCTS, BEAUTY AND MEDICAL SUPPLIES FOR BEAUTY PROFESSIONALS, AND A FULL LINE OF SALON AND SPA EQUIPMENT, IN CLASS 35 (U.S. CLS. 100, 101 AND 102).

FIRST USE 5-1-2008; IN COMMERCE 5-1-2008.

THE MARK CONSISTS OF STANDARD CHARACTERS WITHOUT CLAIM TO ANY PARTICULAR FONT, STYLE, SIZE, OR COLOR.

SN 77-148,812, FILED 4-4-2007.

LOURDES AYALA, EXAMINING ATTORNEY

**Int. Cl.: 14**

**Prior U.S. Cls.: 2, 27, 28, and 50**

**Reg. No. 3,499,679**

**United States Patent and Trademark Office**

**Registered Sep. 9, 2008**

**TRADEMARK  
PRINCIPAL REGISTER**

**SARANONI**

THE WHITNEY CONNECTION, LLC (UTAH  
LIMITED LIABILITY COMPANY)  
862 STONE CREEK DRIVE  
RIVER HEIGHTS, UT 84321

THE MARK CONSISTS OF STANDARD CHAR-  
ACTERS WITHOUT CLAIM TO ANY PARTICULAR  
FONT, STYLE, SIZE, OR COLOR.

FOR: JEWELRY, IN CLASS 14 (U.S. CLS. 2, 27, 28  
AND 50).

SN 77-148,824, FILED 4-4-2007.

FIRST USE 11-21-2007; IN COMMERCE 11-21-2007.

PAUL E. FAHRENKOPF, EXAMINING ATTORNEY



**Int. Cl.: 35**

**Prior U.S. Cls.: 100, 101, and 102**

**United States Patent and Trademark Office**

**Reg. No. 3,499,680**

**Registered Sep. 9, 2008**

**SERVICE MARK  
PRINCIPAL REGISTER**

CREATIVE PITCH.ORG DON'T  
THROW AWAY YOUR CHANCE TO  
HELP

BFRIEND, INC. (ILLINOIS CORPORATION)  
SUITE 301  
2211 N. ELSTON AVENUE  
CHICAGO, IL 60614

FOR: CHARITABLE SERVICES, NAMELY, CO-  
ORDINATION OF THE COLLECTION AND DIS-  
TRIBUTION OF ART MATERIAL DONATIONS TO  
ART TEACHERS FOR UNDERSERVED CHIL-  
DREN, IN CLASS 35 (U.S. CLS. 100, 101 AND 102).

FIRST USE 12-1-2006; IN COMMERCE 5-18-2007.

THE MARK CONSISTS OF STANDARD CHAR-  
ACTERS WITHOUT CLAIM TO ANY PARTICULAR  
FONT, STYLE, SIZE, OR COLOR.

SN 77-149,154, FILED 4-5-2007.

ROBIN MITTLER, EXAMINING ATTORNEY

**Int. Cl.: 35**

**Prior U.S. Cls.: 100, 101, and 102**

**United States Patent and Trademark Office**

**Reg. No. 3,499,681**

**Registered Sep. 9, 2008**

**SERVICE MARK  
PRINCIPAL REGISTER**



BFRIEND, INC. (ILLINOIS CORPORATION)  
SUITE 301  
2211 N. ELSTON AVENUE  
CHICAGO, IL 60614

FOR: CHARITABLE SERVICES, NAMELY, CO-ORDINATION OF THE COLLECTION AND DISTRIBUTION OF ART MATERIAL DONATIONS TO ART TEACHERS FOR UNDERSERVED CHILDREN, IN CLASS 35 (U.S. CLS. 100, 101 AND 102).

FIRST USE 12-1-2003; IN COMMERCE 5-18-2007.

THE MARK CONSISTS OF A GARBAGE CAN WITH THE LID PARTIALLY OPEN TO THE LEFT

OF THE WORDS "CREATIVE PITCH.ORG DON'T THROW AWAY YOUR CHANCE TO HELP". THE LID OF THE GARBAGE CAN CONTAINS AN ARROW. THE WORD "CREATIVE" IS TO THE RIGHT OF THE GARBAGE CAN LID. UNDERNEATH "CREATIVE" IS A LINE, AND UNDER THAT IS THE WORDING PITCH.ORG, WITH THE ORG SITUATED SIDWAYS. UNDERNEATH "PITCH.ORG" IS THE WORDING "DON'T THROW AWAY YOUR" "CHANCE TO HELP". ENCLOSED IN A RECTANGULAR BORDER.

SN 77-149,157, FILED 4-5-2007.

ROBIN MITTLER, EXAMINING ATTORNEY

**Int. Cl.: 36**

**Prior U.S. Cls.: 100, 101, and 102**

**United States Patent and Trademark Office**

**Reg. No. 3,499,682**

**Registered Sep. 9, 2008**

**SERVICE MARK  
PRINCIPAL REGISTER**

MORE SERVICE. LESS SYSTEM.

CARDSMITH, LLC (DELAWARE LIMITED LIABILITY COMPANY)  
P.O. BOX 5145  
BASKING RIDGE, NJ 07920

FOR: CREDIT CARD TRANSACTION PROCESSING SERVICES; DEBIT CARD TRANSACTION PROCESSING SERVICES; ELECTRONIC CASH TRANSACTIONS; ELECTRONIC PAYMENT PROCESSING SERVICES, IN CLASS 36 (U.S. CLS. 100, 101 AND 102).

FIRST USE 6-30-2008; IN COMMERCE 6-30-2008.

THE MARK CONSISTS OF STANDARD CHARACTERS WITHOUT CLAIM TO ANY PARTICULAR FONT, STYLE, SIZE, OR COLOR.

SN 77-149,588, FILED 4-5-2007.

ANGELA GAW, EXAMINING ATTORNEY

Int. Cl.: 45

Prior U.S. Cls.: 100 and 101

United States Patent and Trademark Office

Reg. No. 3,499,683

Registered Sep. 9, 2008

SERVICE MARK  
PRINCIPAL REGISTER



JAMES CELESTE (UNITED STATES INDIVIDUAL)  
265 LAFAYETTE ST. #A21  
NEW YORK, NY 10012

FOR: ADOPTION AGENCIES FOR DOMESTIC ANIMALS; ADOPTION COUNSELING IN THE FIELD OF DOMESTIC ANIMAL ADOPTION; ADOPTION PLACEMENT FOR DOMESTIC ANIMALS; ADOPTION SERVICES FOR DOMESTIC ANIMALS; ANIMAL ADOPTION SERVICE, NAMELY, ARRANGING FOR DOGS AND CATS FROM SHELTERS TO BE PLACED IN HOMES; ANIMAL CRUELTY INVESTIGATION, IN CLASS 45 (U.S. CLS. 100 AND 101).

FIRST USE 6-3-2007; IN COMMERCE 6-3-2007.

THE COLOR(S) BLACK, WHITE, BROWN, RED, YELLOW AND GREY IS/ARE CLAIMED AS A FEATURE OF THE MARK.

THE MARK CONSISTS OF THE LITERAL ELEMENT "SIT, STAY AND" ABOVE THE LITERAL ELEMENT "STAND-UP!" THE LITERAL ELEMENT IS TO THE LEFT OF A PERSONIFIED BROWN DOG STANDING ON ITS HIND LEGS AND HOLDING A BLACK AND GREY MICROPHONE. THE DOG HAS WHITE TEETH AND BLACK SPOTS, WHITE EYES WITH BLACK PUPILS, A RED COLLAR WITH WHITE DOTS AND A YELLOW DOG-TAG. THE LITERAL ELEMENT AND THE DOG ALL APPEAR ABOVE A GREY OVAL.

SN 77-150,141, FILED 4-5-2007.

THOMAS MANOR, EXAMINING ATTORNEY

**Int. Cl.: 2**

**Prior U.S. Cls.: 6, 11, and 16**

**United States Patent and Trademark Office**

**Reg. No. 3,499,684**

**Registered Sep. 9, 2008**

**TRADEMARK  
PRINCIPAL REGISTER**

**UNITED POLYMERS**

CORNERSTONE INDUSTRIES CORP. (KEN-  
TUCKY CORPORATION)  
BUILDING A  
750 PATRICK PLACE  
BROWNSBURG, IN 46112

FOR: SEALER COATINGS FOR USE ON FLOORS,  
WALLS, AND CEILINGS, IN CLASS 2 (U.S. CLS. 6, 11  
AND 16).

FIRST USE 3-26-2002; IN COMMERCE 3-26-2002.

THE MARK CONSISTS OF STANDARD CHAR-  
ACTERS WITHOUT CLAIM TO ANY PARTICULAR  
FONT, STYLE, SIZE, OR COLOR.

NO CLAIM IS MADE TO THE EXCLUSIVE  
RIGHT TO USE "POLYMERS", APART FROM THE  
MARK AS SHOWN.

SN 77-150,567, FILED 4-6-2007.

C. DIONNE CLYBURN, EXAMINING ATTORNEY

**Int. Cls.: 29 and 30**

**Prior U.S. Cl.: 46**

**United States Patent and Trademark Office**

**Reg. No. 3,499,685**

**Registered Sep. 9, 2008**

**TRADEMARK  
PRINCIPAL REGISTER**

**TASTE THE CULTURE**

SB PHILLIPS LLC (MARYLAND LIMITED LIABILITY COMPANY)  
1215 E. FORT AVENUE  
BALTIMORE, MD 21230

FOR: FROZEN PREPARED ENTREES CONSISTING PRIMARILY OF MEAT, FISH, SEAFOOD, POULTRY OR VEGETABLES; FROZEN PREPARED DISHES CONSISTING PRIMARILY OF MEAT, FISH, SEAFOOD, POULTRY OR VEGETABLES; FROZEN PREPARED APPETIZERS CONSISTING PRIMARILY OF MEAT, FISH, SEAFOOD, POULTRY OR VEGETABLES; SOUPS, IN CLASS 29 (U.S. CL. 46).

FIRST USE 10-0-2006; IN COMMERCE 10-0-2006.

FOR: FROZEN PREPARED DISHES CONSISTING PRIMARILY OF RICE OR PASTA, IN CLASS 30 (U.S. CL. 46).

FIRST USE 10-0-2006; IN COMMERCE 10-0-2006.

THE MARK CONSISTS OF STANDARD CHARACTERS WITHOUT CLAIM TO ANY PARTICULAR FONT, STYLE, SIZE, OR COLOR.

SN 77-150,778, FILED 4-6-2007.

DORITT L. CARROLL, EXAMINING ATTORNEY

**Int. Cl.: 29**

**Prior U.S. Cl.: 46**

**United States Patent and Trademark Office**

**Reg. No. 3,499,686**

**Registered Sep. 9, 2008**

**TRADEMARK  
PRINCIPAL REGISTER**

**Merit-Fry**

SLE COMPANY (TEXAS CORPORATION)  
1110 AVE H EAST SUITE 100  
ARLINGTON, TX 76011

THE MARK CONSISTS OF STANDARD CHAR-  
ACTERS WITHOUT CLAIM TO ANY PARTICULAR  
FONT, STYLE, SIZE, OR COLOR.

FOR: SHORTENING, IN CLASS 29 (U.S. CL. 46).

SN 77-151,288, FILED 4-7-2007.

FIRST USE 1-2-2008; IN COMMERCE 1-2-2008.

AMY ALFIERI, EXAMINING ATTORNEY

**Int. Cl.: 16**

**Prior U.S. Cls.: 2, 5, 22, 23, 29, 37, 38, and 50**

**Reg. No. 3,499,687**

**United States Patent and Trademark Office**

**Registered Sep. 9, 2008**

**TRADEMARK  
PRINCIPAL REGISTER**



VITAL COMMUNICATIONS, INC. (ARKANSAS CORPORATION)  
P. O. BOX 2042  
LITTLE ROCK, AR 72203

THE COLOR(S) DARK GOLD, MEDIUM GOLD, LIGHT GOLD, WHITE, AND BLUE IS/ARE CLAIMED AS A FEATURE OF THE MARK.

FOR: BINDERS; BROCHURES ABOUT CUSTOMER SERVICE, HEROISM, PRESENTATION SKILLS, HEROES AND CHARACTER DEVELOPMENT; EDUCATIONAL PUBLICATIONS, NAMELY, EDUCATIONAL LEARNING CARDS, FLASHCARDS, ACTIVITY CARDS, WORKBOOKS, TEXTBOOKS, ACTIVITY BOOKS, STORY BOOKS, PUZZLE BOOKS, PUZZLES, TEACHER GUIDES, MANUALS, POSTERS EDUCATIONAL CARD GAMES AND EDUCATIONAL BOOKLETS IN THE FIELD OF CUSTOMER SERVICE, HEROISM, PRESENTATION SKILLS AND CHARACTER DEVELOPMENT; SERIES OF BOOKS, WRITTEN ARTICLES, HANDOUTS AND WORKSHEETS IN THE FIELD OF CUSTOMER SERVICE, HEROISM, PRESENTATION SKILLS AND CHARACTER DEVELOPMENT; ADHESIVE LABELS; BOOKMARKS; CARDS, NAMELY, GREETING CARDS, NOTE CARDS AND BUSINESS CARDS; DAILY PLANNERS; DESK SETS; JOURNALS CONCERNING CUSTOMER SERVICE, HEROISM, PRESENTATION SKILLS AND CHARACTER DEVELOPMENT; STATIONERY; WRITING PAPER AND ENVELOPES; PAPER WEIGHTS, PRINTED CERTIFICATES AND WRITING INSTRUMENTS, IN CLASS 16 (U.S. CLS. 2, 5, 22, 23, 29, 37, 38 AND 50).

THE MARK CONSISTS OF THE COLOR LIGHT GOLD APPEARS IN THE LETTERS HW OVERLAYING AND SURROUNDED BY A CIRCLE OF BLUE SURROUNDED BY A RING OF LIGHT GOLD, SURROUNDED BY A CIRCLE OF BLUE OVERLAYING A TWO-TONE STAR CONSISTING OF DARK GOLD AND LIGHT GOLD OVER A FIELD OF WHITE, ENCLOSED BY A WREATH OF LEAVES CONSISTING OF DARK GOLD AND LIGHT GOLD, OVER A FIELD OF WHITE WHICH IS OVERLAID WITH THE WORDS "A HERO WITHIN" IN COLOR DARK GOLD AND TWO BRANCHES EACH CONSISTING OF SIX TWO TONE LEAVES EACH CONSISTING OF THE COLORS DARK GOLD AND LIGHT GOLD, SURROUNDED BY A RING OF MEDIUM GOLD SURROUNDED BY A RING OF DARK GOLD, SURROUNDED BY A RING OF LIGHT GOLD, SURROUNDED BY A RING OF DARK GOLD, SURROUNDED BY A RING OF LIGHT GOLD, SURROUNDED BY A RING OF DARK GOLD, SURROUNDED BY A RING OF LIGHT GOLD, SURROUNDED BY A RING OF DARK GOLD, SURROUNDED BY TWO-TONE POINTS CONSISTING OF THE COLORS DARK GOLD AND LIGHT GOLD.

FIRST USE 3-19-2007; IN COMMERCE 4-2-2007.



SN 77-151,422, FILED 4-8-2007.

MARLENE BELL, EXAMINING ATTORNEY

**Int. Cl.: 25**

**Prior U.S. Cls.: 22 and 39**

**United States Patent and Trademark Office**

**Reg. No. 3,499,688**

**Registered Sep. 9, 2008**

**TRADEMARK  
PRINCIPAL REGISTER**

**VILLANCICO**

KIM, DONG SOON (REPUBLIC OF KOREA IN-  
DIVIDUAL)  
212-1804 , BUYOUNG APT. 2-1  
DONONGDONG, NAMYANGJUSI  
KYOUNGGIDO, REPUBLIC OF KOREA

FOR: CLOTHING, NAMELY, COATS, DRAWERS,  
FROCKS, HOODS, JACKETS, JERSEYS, JUMPERS,  
LEGGINGS, OVERALLS, OVERCOATS, PANTS,  
SKIRTS, SUITS, SWEATERS, TEE-SHIRTS, TIGHTS,  
TOGAS, TROUSERS, IN CLASS 25 (U.S. CLS. 22 AND  
39).

FIRST USE 10-9-2007; IN COMMERCE 10-9-2007.

THE MARK CONSISTS OF STANDARD CHAR-  
ACTERS WITHOUT CLAIM TO ANY PARTICULAR  
FONT, STYLE, SIZE, OR COLOR.

THE FOREIGN WORDING IN THE MARK  
TRANSLATES INTO ENGLISH AS CHRISTMAS  
SONG.

SN 77-151,491, FILED 4-9-2007.

KAREN BRACEY, EXAMINING ATTORNEY

**Int. Cl.: 44**

**Prior U.S. Cls.: 100 and 101**

**United States Patent and Trademark Office**

**Reg. No. 3,499,689**

**Registered Sep. 9, 2008**

**SERVICE MARK  
PRINCIPAL REGISTER**

**ALLEGIANCE**

FOOTE HEALTH SYSTEM (MICHIGAN NON-  
PROFIT ORGANIZATION)  
205 N EAST AVENUE  
JACKSON, MI 49201

THE MARK CONSISTS OF STANDARD CHAR-  
ACTERS WITHOUT CLAIM TO ANY PARTICULAR  
FONT, STYLE, SIZE, OR COLOR.

FOR: HEALTH CARE SERVICES, IN CLASS 44  
(U.S. CLS. 100 AND 101).

SN 77-151,972, FILED 4-9-2007.

FIRST USE 7-3-2008; IN COMMERCE 7-3-2008.

MIDGE BUTLER, EXAMINING ATTORNEY

**Int. Cls.: 35 and 42**

**Prior U.S. Cls.: 100, 101, and 102**

**United States Patent and Trademark Office**

**Reg. No. 3,499,690**

**Registered Sep. 9, 2008**

**SERVICE MARK  
PRINCIPAL REGISTER**

**RESOLVIT**

CONSULTING INVESTMENT GROUP, LLC (DE-  
LAWARE CORPORATION)  
1950 OLD GALLOWS ROAD, SUITE 450  
VIENNA, VA 22182

FOR: INFORMATION TECHNOLOGY CON-  
SULTING SERVICES, NAMELY, PERSONNEL PLA-  
CEMENT AND PERSONNEL SUPPLEMENTATION,  
NAMELY, PROVIDING PERSONNEL ON A TEM-  
PORARY BASIS FOR INFORMATION TECHNOL-  
OGY SUPPORT, IN CLASS 35 (U.S. CLS. 100, 101 AND  
102).

FIRST USE 8-0-2007; IN COMMERCE 8-0-2007.

FOR: INFORMATION TECHNOLOGY CON-  
SULTING SERVICES, NAMELY, COMPUTER SYS-  
TEMS INTEGRATION, IN CLASS 42 (U.S. CLS. 100  
AND 101).

FIRST USE 8-0-2007; IN COMMERCE 8-0-2007.

THE MARK CONSISTS OF STANDARD CHAR-  
ACTERS WITHOUT CLAIM TO ANY PARTICULAR  
FONT, STYLE, SIZE, OR COLOR.

SN 77-152,258, FILED 4-9-2007.

SUSAN STIGLITZ, EXAMINING ATTORNEY

Int. Cls.: 16 and 28

Prior U.S. Cls.: 2, 5, 22, 23, 29, 37, 38, and 50

United States Patent and Trademark Office

Reg. No. 3,499,691

Registered Sep. 9, 2008

TRADEMARK  
PRINCIPAL REGISTER



EXERCISE RHYMES, LLC (ARIZONA LIMITED  
LIABILITY COMPANY)  
20701 N. SCOTTSDALE RD., STE. 107-435  
SCOTTSDALE, AZ 852556499

FOR: EDUCATIONAL PUBLICATIONS, NAME-  
LY, EDUCATIONAL LEARNING CARDS, EDUCA-  
TIONAL CARD GAMES AND INSTRUCTION  
SHEETS THAT FEATURE RHYMING EXERCISES  
TO PROMOTE PHYSICAL FITNESS AND FAMILY  
FUN, IN CLASS 16 (U.S. CLS. 2, 5, 22, 23, 29, 37, 38  
AND 50).

FIRST USE 4-1-2007; IN COMMERCE 12-1-2007.

FOR: CARD GAMES AND BOARD GAMES THAT  
FEATURE RHYMING EXERCISES TO PROMOTE

PHYSICAL FITNESS AND FAMILY FUN, IN CLASS  
28 (U.S. CLS. 22, 23, 38 AND 50).

FIRST USE 4-1-2007; IN COMMERCE 12-1-2007.

NO CLAIM IS MADE TO THE EXCLUSIVE  
RIGHT TO USE "EXERCISE RHYMES", APART  
FROM THE MARK AS SHOWN.

THE MARK CONSISTS OF AN ADULT AND  
CHILD FIGURE HOLDING HANDS.

SN 77-153,074, FILED 4-10-2007.

RUSS HERMAN, EXAMINING ATTORNEY

**Int. Cl.: 9**

**Prior U.S. Cls.: 21, 23, 26, 36, and 38**

**United States Patent and Trademark Office**

**Reg. No. 3,499,692**

**Registered Sep. 9, 2008**

**TRADEMARK  
PRINCIPAL REGISTER**

**LOGIQ PDF**

SKILLEN, WILLIAM ANDREW (UNITED STATES INDIVIDUAL)  
1101 JUNIPER ST. NE, #1420  
ATLANTA, GA 30309

FOR: COMPUTER SOFTWARE FOR APPLICATION AND DATABASE INTEGRATION, IN CLASS 9 (U.S. CLS. 21, 23, 26, 36 AND 38).

FIRST USE 10-11-2007; IN COMMERCE 10-11-2007.

THE MARK CONSISTS OF STANDARD CHARACTERS WITHOUT CLAIM TO ANY PARTICULAR FONT, STYLE, SIZE, OR COLOR.

NO CLAIM IS MADE TO THE EXCLUSIVE RIGHT TO USE "PDF", APART FROM THE MARK AS SHOWN.

SN 77-153,958, FILED 4-11-2007.

CARYN GLASSER, EXAMINING ATTORNEY

**Int. Cl.: 25**

**Prior U.S. Cls.: 22 and 39**

**United States Patent and Trademark Office**

**Reg. No. 3,499,693**

**Registered Sep. 9, 2008**

**TRADEMARK  
PRINCIPAL REGISTER**

**SCRAPYARD**

RICHARD CHOU (UNITED STATES INDIVIDUAL)  
3157 CHARLES ST.  
HONOLULU, HI 96816

FOR: T-SHIRTS; BOARD SHORTS; GYM SHORTS; SHORTS; JACKETS; SWEATERS; HATS; HEADGEAR, NAMELY, HATS; SOCKS; TRACK SUITS; THONGS; BELTS; PANTS; BEANIES, IN CLASS 25 (U.S. CLS. 22 AND 39).

FIRST USE 10-10-2007; IN COMMERCE 10-10-2007.

THE MARK CONSISTS OF STANDARD CHARACTERS WITHOUT CLAIM TO ANY PARTICULAR FONT, STYLE, SIZE, OR COLOR.

SN 77-154,687, FILED 4-12-2007.

ERIN FALK, EXAMINING ATTORNEY

Int. Cls.: 3, 5, and 8

Prior U.S. Cls.: 1, 4, 6, 18, 23, 28, 44, 46, 50, 51, and 52

United States Patent and Trademark Office

Reg. No. 3,499,694

Registered Sep. 9, 2008

TRADEMARK  
PRINCIPAL REGISTER

*Best Choice*



ASSOCIATED WHOLESALE GROCERS, INC.  
(KANSAS CORPORATION)  
5000 KANSAS AVE  
KANSAS CITY, KS 66106

FOR: HAIR SHAMPOO; HAIR CONDITIONERS;  
HAIR STYLING PREPARATIONS; SKIN LOTIONS;  
FACE CREAMS; BATH SOAPS IN LIQUID, SOLID  
OR GEL FORM; AND BODY WASHES, IN CLASS 3  
(U.S. CLS. 1, 4, 6, 50, 51 AND 52).

FIRST USE 6-25-2008; IN COMMERCE 6-25-2008.

FOR: PREGNANCY TEST KITS FOR HOME USE;  
FEMININE HYGIENE PADS, IN CLASS 5 (U.S. CLS.  
6, 18, 44, 46, 51 AND 52).

FIRST USE 6-25-2008; IN COMMERCE 6-25-2008.

FOR: RAZORS, IN CLASS 8 (U.S. CLS. 23, 28 AND  
44).

FIRST USE 6-25-2008; IN COMMERCE 6-25-2008.

OWNER OF U.S. REG. NOS. 1,997,604, 2,550,300,  
AND OTHERS.

SN 77-154,903, FILED 4-12-2007.

ALICE SUE CARRUTHERS, EXAMINING ATTOR-  
NEY



**Int. Cls.: 16 and 25**

**Prior U.S. Cls.: 2, 5, 22, 23, 29, 37, 38, 39, and 50**

**United States Patent and Trademark Office**

**Reg. No. 3,499,695**

**Registered Sep. 9, 2008**

**TRADEMARK  
PRINCIPAL REGISTER**



**DO THE MATH 247**

GONTANG, PETER (UNITED STATES INDIVIDUAL)  
50 RADIANCE LN  
RANCHO SANTA MARGARITA, CA 92688 AND  
LUCAS, MICHAEL (UNITED STATES INDIVIDUAL)  
50 RADIANCE LN  
RANCHO SANTA MARGARITA, CA 92688 AND  
LILLY, TABARAS (UNITED STATES INDIVIDUAL)  
50 RADIANCE LN  
RANCHO SANTA MARGARITA, CA 92688 AND  
CAMARATA, ANTHONY (UNITED STATES INDIVIDUAL)  
50 RADIANCE LN  
RANCHO SANTA MARGARITA, CA 92688

FOR: STICKERS, IN CLASS 16 (U.S. CLS. 2, 5, 22, 23, 29, 37, 38 AND 50).

FIRST USE 3-6-2007; IN COMMERCE 3-6-2007.

FOR: HATS; PANTS; SHIRTS; SHORTS; SOCKS, IN CLASS 25 (U.S. CLS. 22 AND 39).

FIRST USE 6-15-2007; IN COMMERCE 10-5-2007.

THE MARK CONSISTS OF 4 EQUIDISTANT LINES WHICH SHARE AN OVERLAPPING MIDPOINT. THE FOUR LINES ARE SEPARATED BY ROTATING THEM AT THEIR MIDPOINTS FROM ONE ANOTHER AT 45 DEGREE ANGLES. PARALLEL TO THE HORIZONTAL AXIS LINE ARE TWO EQUIDISTANT LINES, ONE ABOVE AND ONE BELOW THE HORIZONTAL AXIS. JUST ABOVE AND BELOW THE ENDPOINTS OF THE VERTICAL AXIS LINE ARE TWO CIRCLES, EACH OF WHICH SHARE THE SAME DIAMETER AS THE WIDTH OF THE VERTICAL AXIS LINE. INTERSECTING THESE CIRCLES, BUT VISUALLY PLACED BEHIND THEM, IS A FINAL ENCOMPASSING CIRCLE WHICH ALSO SHARES THE WIDTH OF ALL OF THE AXIS LINES, VERTICAL, HORIZONTAL, AND AT 45 DEGREE ANGLES. BY SEPARATING SPECIFIC PIECES OF THE TRADEMARK, ONE COULD DERIVE THE FOLLOWING MATHEMATICAL SYMBOLS: A PLUS SIGN (+), AND MINUS SIGN (-), AND MULTIPLICATION SIGN (X), AND DIVISION SIGN (\*) AND AN EQUAL SIGN (=).

SN 77-155,639, FILED 4-12-2007.

GIANCARLO CASTRO, EXAMINING ATTORNEY

**Int. Cl.: 8**

**Prior U.S. Cls.: 23, 28, and 44**

**United States Patent and Trademark Office**

**Reg. No. 3,499,696**

**Registered Sep. 9, 2008**

**TRADEMARK  
PRINCIPAL REGISTER**

**DUAL 80**

SNAP-ON INCORPORATED (DELAWARE COR-  
PORATION)  
2801 80TH STREET  
KENOSHA, WI 53143

THE MARK CONSISTS OF STANDARD CHAR-  
ACTERS WITHOUT CLAIM TO ANY PARTICULAR  
FONT, STYLE, SIZE, OR COLOR.

FOR: HAND TOOLS, NAMELY, RATCHETS, IN  
CLASS 8 (U.S. CLS. 23, 28 AND 44).

SN 77-155,796, FILED 4-13-2007.

FIRST USE 6-22-2007; IN COMMERCE 6-22-2007.

KIMBERLY PERRY, EXAMINING ATTORNEY

**Int. Cls.: 9 and 38**

**Prior U.S. Cls.: 21, 23, 26, 36, 38, 100, 101, and 104**

**United States Patent and Trademark Office**

**Reg. No. 3,499,697**

**Registered Sep. 9, 2008**

**TRADEMARK  
SERVICE MARK  
PRINCIPAL REGISTER**

# L-3 GUARDIAN

L-3 COMMUNICATIONS CORPORATION (DELA-  
WARE CORPORATION)  
600 THIRD AVENUE  
NEW YORK, NY 10016

FOR: ELECTRONIC HANDHELD DEVICE THAT  
ENABLES THE WIRELESS RECEIPT AND TRANS-  
MISSION OF ENCRYPTED ELECTRONIC COMMU-  
NICATIONS AND THAT ENABLES TWO-WAY  
VOICE COMMUNICATIONS, IN CLASS 9 (U.S.  
CLS. 21, 23, 26, 36 AND 38).

FIRST USE 5-22-2007; IN COMMERCE 5-22-2007.

FOR: ELECTRONIC MAIL SERVICES AND WIRE-  
LESS DIGITAL MESSAGING SERVICES THAT EN-

ABLE A USER TO SEND OR RECEIVE MESSAGES  
THROUGH A WIRELESS DATA NETWORK, IN  
CLASS 38 (U.S. CLS. 100, 101 AND 104).

FIRST USE 5-22-2007; IN COMMERCE 5-22-2007.

THE MARK CONSISTS OF STANDARD CHAR-  
ACTERS WITHOUT CLAIM TO ANY PARTICULAR  
FONT, STYLE, SIZE, OR COLOR.

SN 77-156,184, FILED 4-13-2007.

RENEE MCCRAY, EXAMINING ATTORNEY

**Int. Cl.: 5**

**Prior U.S. Cls.: 6, 18, 44, 46, 51, and 52**

**United States Patent and Trademark Office**

**Reg. No. 3,499,698**

**Registered Sep. 9, 2008**

**TRADEMARK  
PRINCIPAL REGISTER**

**BRONCOSEDIN**

C.J.LABS,INC. (FLORIDA CORPORATION)  
12302 SW 128 CT #106  
MIAMI, FL 33186

FOR: COLD SORE TREATMENT PREPARATIONS; PHARMACEUTICAL ANTITUSSIVE-COLD PREPARATIONS; PREPARATIONS FOR TREATING COLDS, IN CLASS 5 (U.S. CLS. 6, 18, 44, 46, 51 AND 52).

FIRST USE 1-5-2006; IN COMMERCE 7-15-2006.

THE MARK CONSISTS OF STANDARD CHARACTERS WITHOUT CLAIM TO ANY PARTICULAR FONT, STYLE, SIZE, OR COLOR.

SN 77-156,833, FILED 4-14-2007.

SOPHIA S. KIM, EXAMINING ATTORNEY

**Int. Cl.: 43**

**Prior U.S. Cls.: 100 and 101**

**United States Patent and Trademark Office**

**Reg. No. 3,499,699**

**Registered Sep. 9, 2008**

**SERVICE MARK  
PRINCIPAL REGISTER**

**FOOD YOU LUV TO LOVE**

C R K MANAGEMENT, LLC (PENNSYLVANIA  
LIMITED LIABILITY COMPANY)  
1583 TIFFANY DRIVE  
PITTSBURGH, PA 15241

THE MARK CONSISTS OF STANDARD CHAR-  
ACTERS WITHOUT CLAIM TO ANY PARTICULAR  
FONT, STYLE, SIZE, OR COLOR.

FOR: RESTAURANT AND BAR SERVICES, IN  
CLASS 43 (U.S. CLS. 100 AND 101).

SN 77-156,937, FILED 4-14-2007.

FIRST USE 11-1-2006; IN COMMERCE 5-9-2008.

ANGELA M. MICHELI, EXAMINING ATTORNEY

**Int. Cl.: 35**

**Prior U.S. Cls.: 100, 101, and 102**

**United States Patent and Trademark Office**

**Reg. No. 3,499,700**

**Registered Sep. 9, 2008**

**SERVICE MARK  
PRINCIPAL REGISTER**

**BLD SAFETY**

BLD INTERNATIONAL (FLORIDA CORPORATION)  
301 SOUTH RICHEY ROAD, SUITE 1001  
LEESBURG, FL 34748

FOR: RETAIL STORE AND ONLINE RETAIL STORE SERVICES, ALL IN THE FIELD OF SAFETY EQUIPMENT AND ACCESSORIES FOR USE IN LABORATORY SETTINGS, IN CLASS 35 (U.S. CLS. 100, 101 AND 102).

FIRST USE 4-1-2008; IN COMMERCE 4-1-2008.

THE MARK CONSISTS OF STANDARD CHARACTERS WITHOUT CLAIM TO ANY PARTICULAR FONT, STYLE, SIZE, OR COLOR.

NO CLAIM IS MADE TO THE EXCLUSIVE RIGHT TO USE "SAFETY", APART FROM THE MARK AS SHOWN.

SN 77-157,297, FILED 4-16-2007.

JASON BLAIR, EXAMINING ATTORNEY

Int. Cl.: 9

Prior U.S. Cls.: 21, 23, 26, 36, and 38

Reg. No. 3,499,701

United States Patent and Trademark Office

Registered Sep. 9, 2008

TRADEMARK  
PRINCIPAL REGISTER



ISSPRO, INC. (OREGON CORPORATION)  
2515 NE RIVERSIDE WAY  
PORTLAND, OR 97211

FOR: DATA ACQUISITION AND COMMUNICATION DEVICES, NAMELY, PRESSURE AND TEMPERATURE GAUGES, VOLTMETERS, FUEL LEVEL GAUGES, HOURMETERS, SPEEDOMETERS, TACHOMETERS, PYROMETERS, AMMETERS AND THE ASSOCIATED SENSORS AND SWITCHES USED TO OPERATE THE GAUGES; WIRE HARNESSES AND SUPPORTING BRACKETS FOR ATTACHMENT TO GAUGES; INSTRUMENT CLUSTERS AND ELECTRONIC CONTROLLERS FOR MOBILE OR STATIONARY EQUIPMENT AND VEHICLES INCORPORATING INTERNAL COMBUSTION OR ELECTRIC MOTORS; ELECTRICAL AND ELECTROMECHANICAL GAUGES AND

CONTROLS, NAMELY, PYROMETERS, TACHOMETERS, AND LIQUID LEVEL ALARMS, IN CLASS 9 (U.S. CLS. 21, 23, 26, 36 AND 38).

FIRST USE 9-0-2007; IN COMMERCE 9-0-2007.

OWNER OF U.S. REG. NOS. 747,593, 2,374,834, AND 2,399,380.

THE MARK CONSISTS OF THE WORD "ISSPRO" INSIDE A BORDER WITH THE WORD "PERFORMAX" UNDERNEATH, OUTSIDE THE BORDER.

SN 77-158,053, FILED 4-16-2007.

JANICE L. MCMORROW, EXAMINING ATTORNEY

**Int. Cl.: 9**

**Prior U.S. Cls.: 21, 23, 26, 36, and 38**

**Reg. No. 3,499,702**

**United States Patent and Trademark Office**

**Registered Sep. 9, 2008**

---

**TRADEMARK  
PRINCIPAL REGISTER**

**ECONO-FLARE**

ROADSIDE SAFETY SUPPLY INC. (CALIFORNIA CORPORATION)  
SUITE A & B  
1170 CENTRE DRIVE  
CITY OF INDUSTRY, CA 91789

THE MARK CONSISTS OF STANDARD CHARACTERS WITHOUT CLAIM TO ANY PARTICULAR FONT, STYLE, SIZE, OR COLOR.

FOR: HIGHWAY FLARES, IN CLASS 9 (U.S. CLS. 21, 23, 26, 36 AND 38).

SN 77-158,173, FILED 4-17-2007.

FIRST USE 5-0-2007; IN COMMERCE 5-0-2007.

CHERYL CLAYTON, EXAMINING ATTORNEY



**Int. Cl.: 9**

**Prior U.S. Cls.: 21, 23, 26, 36, and 38**

**United States Patent and Trademark Office**

**Reg. No. 3,499,703**

**Registered Sep. 9, 2008**

**TRADEMARK  
PRINCIPAL REGISTER**

**DURO-FLASH**

ROADSIDE SAFETY SUPPLY INC. (CALIFORNIA CORPORATION)  
SUITE A & B  
1170 CENTRE DRIVE  
CITY OF INDUSTRY, CA 91789

THE MARK CONSISTS OF STANDARD CHARACTERS WITHOUT CLAIM TO ANY PARTICULAR FONT, STYLE, SIZE, OR COLOR.

FOR: HIGHWAY FLARES, IN CLASS 9 (U.S. CLS. 21, 23, 26, 36 AND 38).

SN 77-158,176, FILED 4-17-2007.

FIRST USE 7-0-2007; IN COMMERCE 7-0-2007.

CHERYL CLAYTON, EXAMINING ATTORNEY

**Int. Cl.: 16**

**Prior U.S. Cls.: 2, 5, 22, 23, 29, 37, 38, and 50**

**United States Patent and Trademark Office**

**Reg. No. 3,499,704**

**Registered Sep. 9, 2008**

**TRADEMARK  
PRINCIPAL REGISTER**

**NATURAL CHOICE**

ROCKLINE INDUSTRIES, INC. (WISCONSIN  
CORPORATION)  
1113 MARYLAND AVENUE  
SHEBOYGAN, WI 53081

FOR: DISPOSABLE DIAPERS AND TRAINING  
PANTS, IN CLASS 16 (U.S. CLS. 2, 5, 22, 23, 29, 37, 38  
AND 50).

FIRST USE 9-30-2007; IN COMMERCE 9-30-2007.

THE MARK CONSISTS OF STANDARD CHAR-  
ACTERS WITHOUT CLAIM TO ANY PARTICULAR  
FONT, STYLE, SIZE, OR COLOR.

OWNER OF U.S. REG. NO. 2,458,214.

SN 77-158,508, FILED 4-17-2007.

KEVIN DINALLO, EXAMINING ATTORNEY

Int. Cls.: 18 and 25

Prior U.S. Cls.: 1, 2, 3, 22, 39, and 41

United States Patent and Trademark Office

Reg. No. 3,499,705

Registered Sep. 9, 2008

TRADEMARK  
PRINCIPAL REGISTER



FLIPPIN' OUT ENTERPRISES (MASSACHUSETTS SOLE PROPRIETORSHIP)  
109 HIGH RD  
NEWBURY, MA 01951

FOR: BAGS AND HOLDALLS FOR SPORTS CLOTHING; BEACH BAGS; BOOK BAGS; CARRY-ALL BAGS; CLUTCH BAGS; SHOULDER BAGS; TOTE BAGS; ALL-PURPOSE CARRYING BAGS; DIAPER BAGS; EVENING HANDBAGS; HANDBAGS, IN CLASS 18 (U.S. CLS. 1, 2, 3, 22 AND 41).

FIRST USE 6-1-2006; IN COMMERCE 6-1-2006.

FOR: BERMUDA SHORTS; BOARD SHORTS; BOXER SHORTS; CAMP SHIRTS; DRESS SHIRTS; FLEECE SHORTS; GOLF SHIRTS; KNIT SHIRTS; PIQUE SHIRTS; POLO SHIRTS; SHIRTS; SHORT-SLEEVED OR LONG-SLEEVED T-SHIRTS; SHORT-SLEEVED SHIRTS; SPORT SHIRTS; SWEAT SHIRTS;

T-SHIRTS; WALKING SHORTS; FLIP FLOPS, IN CLASS 25 (U.S. CLS. 22 AND 39).

FIRST USE 6-1-2006; IN COMMERCE 6-1-2006.

NO CLAIM IS MADE TO THE EXCLUSIVE RIGHT TO USE "NEWBURYPORT", APART FROM THE MARK AS SHOWN.

THE MARK CONSISTS OF A PAIR OF FLIP FLOPS WITH THE STYLIZED WORDS "FLIPPIN' OUT" TO THE RIGHT OF THE FLIP FLOPS, WITH THE STYLIZED WORD "NEWBURYPORT" UNDERNEATH THE WORDS "FLIPPIN' OUT".

SN 77-158,557, FILED 4-17-2007.

HEATHER THOMPSON, EXAMINING ATTORNEY

**Int. Cls.: 37 and 42**

**Prior U.S. Cls.: 100, 101, 103, and 106**

**United States Patent and Trademark Office**

**Reg. No. 3,499,706**

**Registered Sep. 9, 2008**

**SERVICE MARK  
PRINCIPAL REGISTER**

# RAMPACT

GEOPIER FOUNDATION COMPANY, INC.  
(GEORGIA CORPORATION)  
SUITE 300  
5871 GLENRIDGE DRIVE  
ATLANTA, GA 30328

FOR: CONSTRUCTION OF CIVIL ENGINEERING STRUCTURES, NAMELY, FOUNDATIONS FOR BUILDINGS AND OTHER COMMERCIAL, INDUSTRIAL, RESIDENTIAL, AND TRANSPORTATION-RELATED STRUCTURES, IN CLASS 37 (U.S. CLS. 100, 103 AND 106).

FIRST USE 6-30-2008; IN COMMERCE 6-30-2008.

FOR: ENGINEERING AND DESIGN SERVICES FOR CONSTRUCTION OF CIVIL ENGINEERING STRUCTURES, NAMELY, STRUCTURAL FOUNDATIONS, IN CLASS 42 (U.S. CLS. 100 AND 101).

FIRST USE 6-30-2008; IN COMMERCE 6-30-2008.

THE MARK CONSISTS OF STANDARD CHARACTERS WITHOUT CLAIM TO ANY PARTICULAR FONT, STYLE, SIZE, OR COLOR.

SN 77-159,535, FILED 4-18-2007.

JENNIFER HETU, EXAMINING ATTORNEY

Int. Cl.: 8

Prior U.S. Cls.: 23, 28, and 44

Reg. No. 3,499,707

United States Patent and Trademark Office

Registered Sep. 9, 2008

TRADEMARK  
PRINCIPAL REGISTER



KEENCO INDUSTRIAL CO., LTD (TAIWAN CORPORATION)  
NO.37, GONGYE 9TH RD., DALI CITY  
TAICHUNG COUNTY, TAIWAN 412

NAMELY, RASPS; HAND TOOLS, NAMELY, MANUALLY-OPERATED GRINDING WHEELS; HAND TOOLS, NAMELY, RATCHET WRENCHES, IN CLASS 8 (U.S. CLS. 23, 28 AND 44).

FOR: SCREWDRIVERS; SCISSORS; PLIERS; WRENCHES; HAMMERS; HAND TOOLS, NAMELY, TAPS; HAND-POWERED STAPLE GUNS; HAND TOOLS, NAMELY, HAMMERS; SAWS; HAND-OPERATED CHOPPERS; HAND-OPERATED SHEARS; TOOL BELTS; DRILL BITS FOR HAND DRILLS; HAND TOOLS, NAMELY, DRILLS; HAND TOOLS,

FIRST USE 4-17-2007; IN COMMERCE 4-17-2007.

SN 77-160,204, FILED 4-18-2007.

LINDSEY RUBIN, EXAMINING ATTORNEY

Int. Cl.: 25

Prior U.S. Cls.: 22 and 39

United States Patent and Trademark Office

Reg. No. 3,499,708

Registered Sep. 9, 2008

TRADEMARK  
PRINCIPAL REGISTER



ADVANCED GRAPHICS, INC. (FLORIDA CORPORATION)  
342 WILLIAM POINT BLVD.  
COCOA, FL 32927

FOR: CLOTHING, FOR WOMEN AND CHILDREN, NAMELY, T-SHIRTS AND TANK TOPS, IN CLASS 25 (U.S. CLS. 22 AND 39).

FIRST USE 6-0-2007; IN COMMERCE 6-0-2007.

THE MARK CONSISTS OF THE WORD "MY" IN CAPS AND THE WORD "CHICK" IN CURSIVE LETTERS WITH A BABY CHICK BETWEEN THE TWO WORDS.

SN 77-160,471, FILED 4-19-2007.

CARYN GLASSER, EXAMINING ATTORNEY

**Int. Cl.: 44**

**Prior U.S. Cls.: 100 and 101**

**United States Patent and Trademark Office**

**Reg. No. 3,499,709**

**Registered Sep. 9, 2008**

**SERVICE MARK  
PRINCIPAL REGISTER**

# LIFE FOCUS

SECURITY HEALTH PLAN OF WISCONSIN,  
INC. (WISCONSIN CORPORATION)  
1515 SAINT JOSEPH AVENUE  
MARSHFIELD, WI 544498000

FOR: PROVIDING PERSONAL ASSESSMENTS  
VIA ONLINE QUESTIONNAIRES IN THE FIELDS  
OF WELLNESS, HEALTH PROMOTION, PREVEN-  
TATIVE HEALTH CARE, DISEASE MANAGE-  
MENT, AND HEALTH RISK; AND PROVIDING  
TAILORED FOLLOW-UP MATERIALS, NAMELY,  
PERSONALLY TAILORED HEALTH INFORMA-  
TION IN THE FIELDS OF WELLNESS, HEALTH  
PROMOTION, PREVENTATIVE HEALTH CARE,

DISEASE MANAGEMENT, AND HEALTH RISK,  
IN CLASS 44 (U.S. CLS. 100 AND 101).

FIRST USE 0-0-2007; IN COMMERCE 0-0-2007.

THE MARK CONSISTS OF STANDARD CHAR-  
ACTERS WITHOUT CLAIM TO ANY PARTICULAR  
FONT, STYLE, SIZE, OR COLOR.

SN 77-160,702, FILED 4-19-2007.

JAMES LOVELACE, EXAMINING ATTORNEY

**Int. Cls.: 10 and 28**

**Prior U.S. Cls.: 22, 23, 26, 38, 39, 44, and 50**

**United States Patent and Trademark Office**

**Reg. No. 3,499,710**

**Registered Sep. 9, 2008**

**TRADEMARK  
PRINCIPAL REGISTER**

# FITFORM

STL INTERNATIONAL, INCORPORATED (WASHINGTON CORPORATION)  
9902 - 162ND STREET CT. E  
PUYALLUP, WA 98375

FOR: MEDICAL TREATMENT APPARATUS, NAMELY, INVERSION TABLES, INVERSION RACKS, NAMELY, RACKS USED TO HOLD A PERSON IN AN INVERTED POSITION AND INVERSION CHAIRS, IN CLASS 10 (U.S. CLS. 26, 39 AND 44).

FIRST USE 4-17-2007; IN COMMERCE 9-10-2007.

FOR: EXERCISE EQUIPMENT, NAMELY, INVERSION TABLES, INVERSION RACKS, NAMELY,

RACKS USED TO HOLD A PERSON IN AN INVERTED POSITION AND INVERSION CHAIRS, IN CLASS 28 (U.S. CLS. 22, 23, 38 AND 50).

FIRST USE 4-17-2007; IN COMMERCE 9-10-2007.

THE MARK CONSISTS OF STANDARD CHARACTERS WITHOUT CLAIM TO ANY PARTICULAR FONT, STYLE, SIZE, OR COLOR.

SN 77-160,790, FILED 4-19-2007.

JENNIFER VASQUEZ, EXAMINING ATTORNEY



**Int. Cl.: 25**

**Prior U.S. Cls.: 22 and 39**

**United States Patent and Trademark Office**

**Reg. No. 3,499,711**

**Registered Sep. 9, 2008**

**TRADEMARK  
PRINCIPAL REGISTER**

**PRETTYPOWER**

SUSAN DELL, INC. (TEXAS CORPORATION)  
76 NINTH AVENUE, 16TH FLOOR  
NEW YORK, NY 10011

NAMELY, PANTS, JEANS AND PAJAMAS, IN  
CLASS 25 (U.S. CLS. 22 AND 39).

FIRST USE 6-20-2008; IN COMMERCE 6-20-2008.

FOR: CLOTHING, NAMELY, ATHLETIC UNI-  
FORMS, BASEBALL CAPS, BATHING SUITS, BATH-  
ROBES, BEACH SHOES, BEACHWEAR, BELTS,  
BLAZERS, BLOUSES, CAPS, CARDIGANS, COATS,  
DRESSES, FOOTWEAR, HATS, JACKETS, JERSEYS,  
NECKWEAR, SANDALS, SHIRTS, SHOES, SHORTS,  
SLACKS, SOCKS, SUN VISORS, SWIMSUITS, TANK  
TOPS, T-SHIRTS, AND WOMEN'S APPAREL,

THE MARK CONSISTS OF STANDARD CHAR-  
ACTERS WITHOUT CLAIM TO ANY PARTICULAR  
FONT, STYLE, SIZE, OR COLOR.

SN 77-161,091, FILED 4-19-2007.

TINA BROWN, EXAMINING ATTORNEY

**Int. Cl.: 33**

**Prior U.S. Cls.: 47 and 49**

**United States Patent and Trademark Office**

**Reg. No. 3,499,712**

**Registered Sep. 9, 2008**

**TRADEMARK  
PRINCIPAL REGISTER**

**THE EVENING COAST**

ELV HOLDINGS, INC. (DELAWARE CORPORATION)  
PO BOX 10217  
NAPA, CA 94581

THE MARK CONSISTS OF STANDARD CHARACTERS WITHOUT CLAIM TO ANY PARTICULAR FONT, STYLE, SIZE, OR COLOR.

FOR: WINE, IN CLASS 33 (U.S. CLS. 47 AND 49).

SN 77-162,046, FILED 4-20-2007.

FIRST USE 4-24-2008; IN COMMERCE 4-24-2008.

KHANH LE, EXAMINING ATTORNEY

**Int. Cl.: 14**

**Prior U.S. Cls.: 2, 27, 28, and 50**

**United States Patent and Trademark Office**

**Reg. No. 3,499,713**

**Registered Sep. 9, 2008**

**TRADEMARK  
PRINCIPAL REGISTER**

**HOLESHOT**

OAKLEY, INC. (WASHINGTON CORPORATION)  
ONE ICON  
FOOTHILL RANCH, CA 92610

FOR: TIME PIECES, NAMELY, CLOCKS,  
WATCHES AND COMPONENTS THEREOF, IN  
CLASS 14 (U.S. CLS. 2, 27, 28 AND 50).

FIRST USE 7-1-2007; IN COMMERCE 7-1-2007.

THE MARK CONSISTS OF STANDARD CHAR-  
ACTERS WITHOUT CLAIM TO ANY PARTICULAR  
FONT, STYLE, SIZE, OR COLOR.

SN 77-163,168, FILED 4-23-2007.

CHARLES L. JENKINS, EXAMINING ATTORNEY

**Int. Cl.: 36**

**Prior U.S. Cls.: 100, 101, and 102**

**United States Patent and Trademark Office**

**Reg. No. 3,499,714**

**Registered Sep. 9, 2008**

**SERVICE MARK  
PRINCIPAL REGISTER**

FRANKLIN FINANCIAL NETWORK

FRANKLIN FINANCIAL NETWORK, INC. (TEN-  
NESSEE CORPORATION)  
SUITE 130-120  
2000 MALLORY LANE  
FRANKLIN, TN 370679231

FOR: FINANCIAL SERVICES, NAMELY, BANK-  
ING SERVICES, MORTGAGE LENDING SERVICES,  
CONSUMER AND COMMERCIAL LENDING SER-  
VICES, INSURANCE AGENCY SERVICES AND  
FINANCING LEASES, IN CLASS 36 (U.S. CLS. 100,  
101 AND 102).

FIRST USE 11-5-2007; IN COMMERCE 11-5-2007.

THE MARK CONSISTS OF STANDARD CHAR-  
ACTERS WITHOUT CLAIM TO ANY PARTICULAR  
FONT, STYLE, SIZE, OR COLOR.

NO CLAIM IS MADE TO THE EXCLUSIVE  
RIGHT TO USE "FINANCIAL NETWORK", APART  
FROM THE MARK AS SHOWN.

SN 77-163,169, FILED 4-23-2007.

JESSICA A. POWERS, EXAMINING ATTORNEY

**Int. Cls.: 35 and 42**

**Prior U.S. Cls.: 100, 101, and 102**

**United States Patent and Trademark Office**

**Reg. No. 3,499,715**

**Registered Sep. 9, 2008**

**SERVICE MARK  
PRINCIPAL REGISTER**

# Adisn

ADISN, INC. (DELAWARE CORPORATION)  
500 NEWPORT CENTER DRIVE  
SUITE 800  
NEWPORT BEACH, CA 92660

FOR: PROVIDING ONLINE ADVERTISING SERVICES FOR OTHERS VIA THE INTERNET, ADVERTISING SERVICES FOR OTHERS, NAMELY, A SERVICE FOR DELIVERING ADVERTISING TO A SPECIFIC USER BASED ON THEIR PERSONAL DATA AND RELATIONSHIPS TO OTHER USERS AND SUGGESTING ITEMS, CONTENT, PRODUCTS OR SERVICES OF INTEREST TO SPECIFIC USERS BASED ON THEIR BEHAVIOR OR THE BEHAVIOR OF OTHER USERS, IN CLASS 35 (U.S. CLS. 100, 101 AND 102).

FIRST USE 3-28-2007; IN COMMERCE 10-29-2007.

FOR: COMPUTER SERVICES, NAMELY, EXTRACTION AND RETRIEVAL OF USER INFOR-

MATION AND DATA MINING BY MEANS OF GLOBAL COMPUTER NETWORKS; ORGANIZING USER INFORMATION AND OTHER RESOURCES AVAILABLE ON COMPUTER NETWORKS, BASED ON RELATIONSHIPS IN ORDER TO CREATE ADVERTISING SERVICES; CREATING INDEXES OF USER INFORMATION AND RELATIONSHIPS IN CONNECTION WITH GLOBAL COMPUTER NETWORKS, IN CLASS 42 (U.S. CLS. 100 AND 101).

FIRST USE 3-28-2007; IN COMMERCE 10-29-2007.

THE MARK CONSISTS OF STANDARD CHARACTERS WITHOUT CLAIM TO ANY PARTICULAR FONT, STYLE, SIZE, OR COLOR.

SN 77-163,228, FILED 4-23-2007.

CAROLYN CATALDO, EXAMINING ATTORNEY

**Int. Cl.: 38**

**Prior U.S. Cls.: 100, 101, and 104**

**United States Patent and Trademark Office**

**Reg. No. 3,499,716**

**Registered Sep. 9, 2008**

**SERVICE MARK  
PRINCIPAL REGISTER**

**RUNAWAYBOX**

HOME BOX OFFICE, INC. (DELAWARE CORPORATION)  
1100 AVENUE OF THE AMERICAS  
NEW YORK, NY 10036

FOR: AUDIO AND VIDEO BROADCASTING SERVICES OVER THE INTERNET OR OTHER COMMUNICATIONS NETWORK, NAMELY, UPLOADING, POSTING, SHOWING, DISPLAYING, TAGGING AND ELECTRONICALLY TRANSMITTING INFORMATION, AUDIO, AND VIDEO CLIPS; PROVIDING MULTIPLE USE ACCESS TO GLOBAL COMPUTER INFORMATION NETWORKS, NAMELY, WEBSITES, ON-LINE FORUMS, CHAT ROOMS, LISTSERVICES AND BLOGS, FOR THE TRANSFER AND DISSEMINATION OF A WIDE RANGE OF

INFORMATION; PROVIDING ON-LINE CHAT ROOMS AND ELECTRONIC BULLETIN BOARDS FOR TRANSMISSION OF MESSAGES AMONG USERS IN THE FIELD OF GENERAL INTEREST, IN CLASS 38 (U.S. CLS. 100, 101 AND 104).

FIRST USE 4-23-2007; IN COMMERCE 4-23-2007.

THE MARK CONSISTS OF STANDARD CHARACTERS WITHOUT CLAIM TO ANY PARTICULAR FONT, STYLE, SIZE, OR COLOR.

SN 77-163,391, FILED 4-23-2007.

LINDA E. BLOHM, EXAMINING ATTORNEY

**Int. Cl.: 28**

**Prior U.S. Cls.: 22, 23, 38, and 50**

**United States Patent and Trademark Office**

**Reg. No. 3,499,717**

**Registered Sep. 9, 2008**

**TRADEMARK  
PRINCIPAL REGISTER**

**THE DYNAMITE GIRLS**

INTEGRITY TOYS, INC. (NEW JERSEY COR-  
PORATION)  
100 CHESTNUT SPRINGS ROAD  
CHESAPEAKE CITY, MD 21915

THE MARK CONSISTS OF STANDARD CHAR-  
ACTERS WITHOUT CLAIM TO ANY PARTICULAR  
FONT, STYLE, SIZE, OR COLOR.

FOR: DOLLS, IN CLASS 28 (U.S. CLS. 22, 23, 38  
AND 50).

SN 77-163,961, FILED 4-24-2007.

FIRST USE 10-0-2007; IN COMMERCE 10-0-2007.

CHRISTINE COOPER, EXAMINING ATTORNEY

**Int. Cl.: 9**

**Prior U.S. Cls.: 21, 23, 26, 36, and 38**

**Reg. No. 3,499,718**

**United States Patent and Trademark Office**

**Registered Sep. 9, 2008**

---

**TRADEMARK  
PRINCIPAL REGISTER**

**WE LIGHT IT UP**

OPNEXT, INC. (DELAWARE CORPORATION)  
1 CHRISTOPHER WAY  
EATONTOWN, NJ 07724

FIRST USE 8-1-2006; IN COMMERCE 3-1-2007.

FOR: FIBER OPTIC COMPONENTS AND DEVICES, NAMELY, LASER DIODE MODULES AND PHOTO DIODE MODULES; FIBER OPTIC TRANSMITTERS AND RECEIVERS; ALL FOR USE IN TELECOMMUNICATIONS, DATA COMMUNICATIONS AND INDUSTRIAL APPLICATIONS, IN CLASS 9 (U.S. CLS. 21, 23, 26, 36 AND 38).

THE MARK CONSISTS OF STANDARD CHARACTERS WITHOUT CLAIM TO ANY PARTICULAR FONT, STYLE, SIZE, OR COLOR.

SN 77-164,343, FILED 4-24-2007.

SALLY SHIH, EXAMINING ATTORNEY



**Int. Cl.: 36**

**Prior U.S. Cls.: 100, 101, and 102**

**United States Patent and Trademark Office**

**Reg. No. 3,499,719**

**Registered Sep. 9, 2008**

**SERVICE MARK  
PRINCIPAL REGISTER**

**HOMEBUCKS REALTY**

NICK SCHIAFFINO (UNITED STATES INDIVIDUAL)  
8830 ORCHARD TREE LANE  
TOWSON, MD 21286

FOR: REAL ESTATE BROKERAGE SERVICES; REAL ESTATE MANAGEMENT AND LEASING SERVICES; REAL ESTATE INSURANCE BROKERAGE SERVICES; APPRAISALS FOR INSURANCE CLAIMS ON REAL ESTATE , IN CLASS 36 (U.S. CLS. 100, 101 AND 102).

FIRST USE 4-20-2006; IN COMMERCE 1-1-2008.

THE MARK CONSISTS OF STANDARD CHARACTERS WITHOUT CLAIM TO ANY PARTICULAR FONT, STYLE, SIZE, OR COLOR.

NO CLAIM IS MADE TO THE EXCLUSIVE RIGHT TO USE "REALTY", APART FROM THE MARK AS SHOWN.

SN 77-165,000, FILED 4-25-2007.

GISELLE AGOSTO, EXAMINING ATTORNEY

**Int. Cl.: 24**

**Prior U.S. Cls.: 42 and 50**

**United States Patent and Trademark Office**

**Reg. No. 3,499,720**

**Registered Sep. 9, 2008**

**TRADEMARK  
PRINCIPAL REGISTER**



MONOSOL LLC (DELAWARE LIMITED LIABILITY COMPANY)  
SUITE 301  
707 EAST 80TH PLACE  
MERRILLVILLE, IN 46410

FOR: WATER SOLUBLE FILM USED AS A SUPPORT FOR EMBROIDERY OR SEWING ON TEXTILES AND APPAREL AND AS A BACKING FOR

EMBROIDERY OR SEWING ON TEXTILES AND APPAREL, IN CLASS 24 (U.S. CLS. 42 AND 50).

FIRST USE 5-0-2006; IN COMMERCE 5-0-2006.

SN 77-165,341, FILED 4-25-2007.

MICHAEL GAAFAR, EXAMINING ATTORNEY

**Int. Cl.: 9**

**Prior U.S. Cls.: 21, 23, 26, 36, and 38**

**Reg. No. 3,499,721**

**United States Patent and Trademark Office**

**Registered Sep. 9, 2008**

**TRADEMARK  
PRINCIPAL REGISTER**

**MYTEMP**

HOME COMFORT ZONES, INC. (OREGON CORPORATION)  
8239 SW CIRRUS DR.  
BEAVERTON, OR 97008

FOR: TEMPERATURE CONTROL SYSTEMS COMPRISED OF DISPLAY DEVICES, CONTROL STATIONS, DAMPERS, SENSORS, AND SOFTWARE AND HARDWARE FOR COLLECTING, SCHEDULING, CONTROLLING, AND DISPLAYING DATA FOR RETROFITTING HVAC SYSTEMS; ENERGY MANAGEMENT SYSTEMS COMPRISED OF DISPLAY DEVICES, CONTROL STATIONS, DAMPERS, SENSORS, AND SOFTWARE AND HARDWARE FOR COLLECTING, SCHEDULING,

CONTROLLING, AND DISPLAYING DATA FOR RETROFITTING HVAC SYSTEMS, IN CLASS 9 (U.S. CLS. 21, 23, 26, 36 AND 38).

FIRST USE 8-1-2007; IN COMMERCE 8-1-2007.

THE MARK CONSISTS OF STANDARD CHARACTERS WITHOUT CLAIM TO ANY PARTICULAR FONT, STYLE, SIZE, OR COLOR.

SN 77-165,609, FILED 4-25-2007.

WENDY GOODMAN, EXAMINING ATTORNEY

**Int. Cl.: 9**

**Prior U.S. Cls.: 21, 23, 26, 36, and 38**

**Reg. No. 3,499,722**

**United States Patent and Trademark Office**

**Registered Sep. 9, 2008**

**TRADEMARK  
PRINCIPAL REGISTER**

**COGNIMAX**

CADARET, PAUL (UNITED STATES INDIVIDUAL)  
SUITE A-275  
31441 SANTA MARGARITA PARKWAY  
RANCHO SANTA MARGARITA, CA 92688

THE MARK CONSISTS OF STANDARD CHARACTERS WITHOUT CLAIM TO ANY PARTICULAR FONT, STYLE, SIZE, OR COLOR.

FOR: PATTERN RECOGNITION SYSTEMS COMPOSED OF COMPUTER CHIPS, COMPUTER HARDWARE AND SOFTWARE, IN CLASS 9 (U.S. CLS. 21, 23, 26, 36 AND 38).

SN 77-166,261, FILED 4-26-2007.

FIRST USE 1-1-2008; IN COMMERCE 1-1-2008.

JACQUELINE A. LAVINE, EXAMINING ATTORNEY

**Int. Cl.: 16**

**Prior U.S. Cls.: 2, 5, 22, 23, 29, 37, 38, and 50**

**United States Patent and Trademark Office**

**Reg. No. 3,499,723**

**Registered Sep. 9, 2008**

**TRADEMARK  
PRINCIPAL REGISTER**

# Hot Stepz

JEANNETTE LYNDA BLAKE (UNITED STATES  
INDIVIDUAL)  
42 EDSON ST. #2  
DORCHESTER, MA 02124

THE MARK CONSISTS OF STANDARD CHAR-  
ACTERS WITHOUT CLAIM TO ANY PARTICULAR  
FONT, STYLE, SIZE, OR COLOR.

FOR: MAGAZINES FEATURING DANCE, DAN-  
CING, IN CLASS 16 (U.S. CLS. 2, 5, 22, 23, 29, 37, 38  
AND 50).

SN 77-166,414, FILED 4-26-2007.

FIRST USE 10-3-2007; IN COMMERCE 10-3-2007.

BRIAN PINO, EXAMINING ATTORNEY

**Int. Cl.: 25**

**Prior U.S. Cls.: 22 and 39**

**United States Patent and Trademark Office**

**Reg. No. 3,499,724**

**Registered Sep. 9, 2008**

**TRADEMARK  
PRINCIPAL REGISTER**

**LIPGLOSS**

STONY APPAREL CORP. (CALIFORNIA CORPORATION)  
1500 S. EVERGREEN  
LOS ANGELES, CA 90023

THE MARK CONSISTS OF STANDARD CHARACTERS WITHOUT CLAIM TO ANY PARTICULAR FONT, STYLE, SIZE, OR COLOR.

FOR: WOMEN'S AND CHILDREN'S CLOTHING, NAMELY, TOPS, SHIRTS, BLOUSES, IN CLASS 25 (U.S. CLS. 22 AND 39).

SN 77-166,930, FILED 4-26-2007.

FIRST USE 6-1-2007; IN COMMERCE 8-3-2007.

SHARON MEIER, EXAMINING ATTORNEY

**Int. Cl.: 25**

**Prior U.S. Cls.: 22 and 39**

**United States Patent and Trademark Office**

**Reg. No. 3,499,725**

**Registered Sep. 9, 2008**

**TRADEMARK  
PRINCIPAL REGISTER**

**STIR THE SOUL**

UNITED STATES OLYMPIC COMMITTEE (UNI-  
TED STATES CONGRESSIONALLY CHAR-  
TERED NONPROFIT ORGANIZATION)  
OFFICE OF THE GENERAL COUNSEL  
1 OLYMPIC PLAZA  
COLORADO SPRINGS, CO 80909

FOR: CLOTHING, NAMELY, T-SHIRTS, HATS,  
AND JACKETS, IN CLASS 25 (U.S. CLS. 22 AND 39).

FIRST USE 1-1-2007; IN COMMERCE 1-1-2007.

THE MARK CONSISTS OF STANDARD CHAR-  
ACTERS WITHOUT CLAIM TO ANY PARTICULAR  
FONT, STYLE, SIZE, OR COLOR.

OWNER OF U.S. REG. NOS. 3,355,939 AND  
3,355,956.

SN 77-166,967, FILED 4-26-2007.

JEFFERY COWARD, EXAMINING ATTORNEY

**Int. Cl.: 36**

**Prior U.S. Cls.: 100, 101, and 102**

**United States Patent and Trademark Office**

**Reg. No. 3,499,726**

**Registered Sep. 9, 2008**

**SERVICE MARK  
PRINCIPAL REGISTER**



SOCIETE DES PRODUITS NESTLE S.A. (SWITZERLAND SOCIETE ANONYME)  
INTELLECTUAL PROPERTY DEPARTMENT  
CASE POSTALE 353  
VEVEY, SWITZERLAND 1800

FOR: INSURANCE UNDERWRITING IN THE FIELD OF HEALTH INSURANCE FOR ANIMALS AND PETS, IN CLASS 36 (U.S. CLS. 100, 101 AND 102).

FIRST USE 6-6-2008; IN COMMERCE 6-6-2008.

OWNER OF U.S. REG. NOS. 523,420, 2,249,732, AND OTHERS.

THE MARK CONSISTS OF A 9 SQUARE CHECKERBOARD DESIGN INSIDE A SQUARE FRAME ON LEFT SIDE, A SOLID BLACK RECTANGLE CONTAINING THE WORD "PURINA" ON RIGHT SIDE.

SN 77-167,219, FILED 4-27-2007.

PAUL CROWLEY, EXAMINING ATTORNEY



**Int. Cl.: 16**

**Prior U.S. Cls.: 2, 5, 22, 23, 29, 37, 38, and 50**

**United States Patent and Trademark Office**

**Reg. No. 3,499,727**

**Registered Sep. 9, 2008**

**TRADEMARK  
PRINCIPAL REGISTER**

**ACCIDENTS HAPPEN...TO BE  
PREVENTABLE!**

SAFETY SOLUTION CONSULTANTS, INC.  
(MASSACHUSETTS CORPORATION)  
99H RAINBOW ROAD  
EAST GRANBY, CT 06026

FOR: BULLETINS CONCERNING SAFETY IN THE HOME, AND MORE PARTICULARLY CONCERNING SAFEGUARDING THE HOME FROM COMMON HOUSEHOLD HAZARDS; PRINTED INSTRUCTIONAL, EDUCATIONAL, AND TEACHING MATERIALS IN THE FIELD OF SAFETY; AND PRINTED GUIDES IN THE FIELD OF SAFETY, NAMELY, HOW TO IMPROVE THE SAFETY OF ONE'S HOME, IN CLASS 16 (U.S. CLS. 2, 5, 22, 23, 29, 37, 38 AND 50).

FIRST USE 9-17-2007; IN COMMERCE 9-17-2007.

THE MARK CONSISTS OF STANDARD CHARACTERS WITHOUT CLAIM TO ANY PARTICULAR FONT, STYLE, SIZE, OR COLOR.

OWNER OF U.S. REG. NO. 2,917,058.

SN 77-167,335, FILED 4-27-2007.

SUSAN STIGLITZ, EXAMINING ATTORNEY

**Int. Cl.: 1**

**Prior U.S. Cls.: 1, 5, 6, 10, 26, and 46**

**Reg. No. 3,499,728**

**United States Patent and Trademark Office**

**Registered Sep. 9, 2008**

**TRADEMARK  
PRINCIPAL REGISTER**

**GROUT BOOST**

SPECIALTY CONSTRUCTION BRANDS, INC.  
(MINNESOTA CORPORATION)  
WLB-LAW-TRADEMARKS  
1200 WILLOW LAKE BOULEVARD  
SAINT PAUL, MN 551105101

FOR: CHEMICAL ADDITIVES FOR USE IN THE  
MANUFACTURE OF STAIN RESISTANT GROUT,  
IN CLASS 1 (U.S. CLS. 1, 5, 6, 10, 26 AND 46).

FIRST USE 4-29-2008; IN COMMERCE 6-16-2008.

THE MARK CONSISTS OF STANDARD CHAR-  
ACTERS WITHOUT CLAIM TO ANY PARTICULAR  
FONT, STYLE, SIZE, OR COLOR.

NO CLAIM IS MADE TO THE EXCLUSIVE  
RIGHT TO USE "GROUT", APART FROM THE  
MARK AS SHOWN.

SN 77-169,113, FILED 4-30-2007.

LAURA HAMMEL, EXAMINING ATTORNEY

**Int. Cl.: 45**

**Prior U.S. Cls.: 100 and 101**

**United States Patent and Trademark Office**

**Reg. No. 3,499,729**

**Registered Sep. 9, 2008**

**SERVICE MARK  
PRINCIPAL REGISTER**

**THINK GLOBALLY.  
SCREEN LOCALLY.**

SCREENING INTERNATIONAL LLC (DELA-  
WARE LIMITED LIABILITY COMPANY)  
629 CEDAR CREEK GRADE  
WINCHESTER, VA 22601

THE MARK CONSISTS OF STANDARD CHAR-  
ACTERS WITHOUT CLAIM TO ANY PARTICULAR  
FONT, STYLE, SIZE, OR COLOR.

FOR: BACKGROUND INVESTIGATION SERVI-  
CES, IN CLASS 45 (U.S. CLS. 100 AND 101).

SN 77-169,681, FILED 5-1-2007.

FIRST USE 6-0-2005; IN COMMERCE 6-0-2005.

RICHARD A. STRASER, EXAMINING ATTORNEY

**Int. Cl.: 16**

**Prior U.S. Cls.: 2, 5, 22, 23, 29, 37, 38, and 50**

**Reg. No. 3,499,730**

**United States Patent and Trademark Office**

**Registered Sep. 9, 2008**

**TRADEMARK  
PRINCIPAL REGISTER**

**DOUBLE SMART**

CARSON-DELLOSA PUBLISHING COMPANY,  
INC. (NORTH CAROLINA CORPORATION)  
7027 ALBERT PICK RD.  
GREENSBORO, NC 27409

FOR: ELEMENTARY SCHOOL LEVEL EDUCATIONAL KITS COMPRISED OF LEARNING CARDS, ACTIVITY CARDS, EDUCATIONAL CARD GAMES, PLASTIC COUNTING STRAWS AND PRINTED CHARTS WITH POCKETS MADE OF NYLON FABRIC AND VINYL, IN CLASS 16 (U.S. CLS. 2, 5, 22, 23, 29, 37, 38 AND 50).

FIRST USE 6-1-2007; IN COMMERCE 6-1-2007.

THE MARK CONSISTS OF STANDARD CHARACTERS WITHOUT CLAIM TO ANY PARTICULAR FONT, STYLE, SIZE, OR COLOR.

SN 77-169,702, FILED 5-1-2007.

IRA J. GOODSaid, EXAMINING ATTORNEY

**Int. Cl.: 41**

**Prior U.S. Cls.: 100, 101, and 107**

**United States Patent and Trademark Office**

**Reg. No. 3,499,731**

**Registered Sep. 9, 2008**

**SERVICE MARK  
PRINCIPAL REGISTER**

**BABYROO**

SASSE, MARGARET K AND HARRY A (AUSTRALIA JOINT VENTURE)  
4 SELBOURNE ROAD, KEW  
MELBOURNE, AUSTRALIA 3101

FOR: EDUCATION SERVICES, NAMELY, PROVIDING CLASSES AND WORKSHOPS IN THE FIELDS OF CHILDREN'S NEURO ACTIVITIES, PROVIDING GYMNASTIC FACILITIES, EDUCATIONAL SERVICES, NAMELY, CONDUCTING PROGRAMS IN THE FIELD OF PHYSICAL AND NEURO DEVELOPMENT OF CHILDREN; RECREATIONAL SERVICES IN THE NATURE OF CHIL-

DREN'S PLAY AREAS, IN CLASS 41 (U.S. CLS. 100, 101 AND 107).

FIRST USE 5-1-2008; IN COMMERCE 5-1-2008.

THE MARK CONSISTS OF STANDARD CHARACTERS WITHOUT CLAIM TO ANY PARTICULAR FONT, STYLE, SIZE, OR COLOR.

SN 77-170,472, FILED 5-1-2007.

LOURDES AYALA, EXAMINING ATTORNEY

**Int. Cl.: 36**

**Prior U.S. Cls.: 100, 101, and 102**

**United States Patent and Trademark Office**

**Reg. No. 3,499,732**

**Registered Sep. 9, 2008**

**SERVICE MARK  
PRINCIPAL REGISTER**

**SERVING THOSE WHO SERVE  
RURAL AMERICA**

AGRIBANK, FCB (UNITED STATES CHAR-  
TERED BANK)  
375 JACKSON STREET  
SAINT PAUL, MN 55101

THE MARK CONSISTS OF STANDARD CHAR-  
ACTERS WITHOUT CLAIM TO ANY PARTICULAR  
FONT, STYLE, SIZE, OR COLOR.

FOR: BANKING SERVICES, IN CLASS 36 (U.S.  
CLS. 100, 101 AND 102).

SN 77-170,636, FILED 5-2-2007.

FIRST USE 11-1-2007; IN COMMERCE 11-1-2007.

KEVIN CORWIN, EXAMINING ATTORNEY

**Int. Cl.: 1**

**Prior U.S. Cls.: 1, 5, 6, 10, 26, and 46**

**United States Patent and Trademark Office**

**Reg. No. 3,499,733**

**Registered Sep. 9, 2008**

**TRADEMARK  
PRINCIPAL REGISTER**

**BUXOM**

INTERNATIONAL AG LABS, INC. (MINNESOTA  
CORPORATION)  
800 W. LAKE AVE., P.O. BOX 788  
FAIRMONT, MN 56031

THE MARK CONSISTS OF STANDARD CHAR-  
ACTERS WITHOUT CLAIM TO ANY PARTICULAR  
FONT, STYLE, SIZE, OR COLOR.

FOR: GRASS AND TURF FERTILIZERS, IN  
CLASS 1 (U.S. CLS. 1, 5, 6, 10, 26 AND 46).

SN 77-170,810, FILED 5-2-2007.

FIRST USE 6-13-2007; IN COMMERCE 6-13-2007.

JENNIFER VASQUEZ, EXAMINING ATTORNEY

**Int. Cl.: 16**

**Prior U.S. Cls.: 2, 5, 22, 23, 29, 37, 38, and 50**

**Reg. No. 3,499,734**

**United States Patent and Trademark Office**

**Registered Sep. 9, 2008**

**TRADEMARK  
PRINCIPAL REGISTER**



CL & CO. DISTINCTIVE LGBT GREETING  
CARDS, LLC (WISCONSIN LIMITED LIABILITY  
COMPANY)  
P.O. BOX 24  
BERLIN, WI 54923

THE MARK CONSISTS OF DESIGN OF DIA-  
MOND-SHAPED MULTI-FACETED CRYSTAL  
ABOVE THE LETTERS "CL."

FOR: GREETING CARDS, IN CLASS 16 (U.S. CLS.  
2, 5, 22, 23, 29, 37, 38 AND 50).

SN 77-171,272, FILED 5-2-2007.

FIRST USE 10-15-2007; IN COMMERCE 10-15-2007.

ERIN FALK, EXAMINING ATTORNEY



**Int. Cl.: 7**

**Prior U.S. Cls.: 13, 19, 21, 23, 31, 34, and 35**

**United States Patent and Trademark Office**

**Reg. No. 3,499,735**

**Registered Sep. 9, 2008**

**TRADEMARK  
PRINCIPAL REGISTER**

**FLEXTEND**

ARIENS COMPANY (WISCONSIN CORPORATION)  
655 WEST RYAN STREET  
BRILLION, WI 54110

THE MARK CONSISTS OF STANDARD CHARACTERS WITHOUT CLAIM TO ANY PARTICULAR FONT, STYLE, SIZE, OR COLOR.

FOR: ARMRESTS FOR LAWN MOWERS, IN CLASS 7 (U.S. CLS. 13, 19, 21, 23, 31, 34 AND 35).

SN 77-171,366, FILED 5-2-2007.

FIRST USE 7-0-2007; IN COMMERCE 7-0-2007.

KHANH LE, EXAMINING ATTORNEY

**Int. Cl.: 35**

**Prior U.S. Cls.: 100, 101, and 102**

**United States Patent and Trademark Office**

**Reg. No. 3,499,736**

**Registered Sep. 9, 2008**

**SERVICE MARK  
PRINCIPAL REGISTER**

**SHOPWISE**

MARKETING ANALYSTS INC. (NEW YORK CORPORATION)  
ALBERMARLE POINTE CENTER, SUITE 100  
176 CROGHAN SPUR ROAD  
CHARLESTON, SC 29407

FOR: MARKET RESEARCH AND BUSINESS CONSULTING AND INFORMATION SERVICES, NAMELY, PROVIDING TOOLS TO MEASURE CONSUMER SHOPPING BEHAVIOR IN A VIRTUAL SHOPPING ENVIRONMENT FOR THE PURPOSE OF MERCHANDISING, IN CLASS 35 (U.S. CLS. 100, 101 AND 102).

FIRST USE 9-28-2006; IN COMMERCE 9-28-2006.

THE MARK CONSISTS OF STANDARD CHARACTERS WITHOUT CLAIM TO ANY PARTICULAR FONT, STYLE, SIZE, OR COLOR.

SN 77-171,756, FILED 5-3-2007.

VIVIAN MICZNIK FIRST, EXAMINING ATTORNEY

**Int. Cl.: 16**

**Prior U.S. Cls.: 2, 5, 22, 23, 29, 37, 38, and 50**

**United States Patent and Trademark Office**

**Reg. No. 3,499,737**

**Registered Sep. 9, 2008**

**TRADEMARK  
PRINCIPAL REGISTER**

**PERFORMANCE 7**

THE HOLLISTION MILLS, INC. (DELAWARE  
CORPORATION)  
P. O. BOX 478  
KINGSPORT, TN 37662

THE MARK CONSISTS OF STANDARD CHAR-  
ACTERS WITHOUT CLAIM TO ANY PARTICULAR  
FONT, STYLE, SIZE, OR COLOR.

FOR: LATEX SATURATED PAPER USED FOR  
COVERING BOOKS, BOXES, AND CARTONS, IN  
CLASS 16 (U.S. CLS. 2, 5, 22, 23, 29, 37, 38 AND 50).

SN 77-171,913, FILED 5-3-2007.

FIRST USE 2-0-2008; IN COMMERCE 4-18-2008.

CAROL SPILS, EXAMINING ATTORNEY

**Int. Cl.: 28**

**Prior U.S. Cls.: 22, 23, 38, and 50**

**United States Patent and Trademark Office**

**Reg. No. 3,499,738**

**Registered Sep. 9, 2008**

**TRADEMARK  
PRINCIPAL REGISTER**

**BATTLE WHEELS**

LEARNING CURVE BRANDS, INC. (DELAWARE  
CORPORATION)  
2021 9TH STREET SE  
DYERSVILLE, IA 52040

FOR: ACTION FIGURES; TOY ROBOTS; TOY  
VEHICLES; RADIO CONTROLLED TOY VEHICLES,  
IN CLASS 28 (U.S. CLS. 22, 23, 38 AND 50).

FIRST USE 6-4-2007; IN COMMERCE 6-4-2007.

THE MARK CONSISTS OF STANDARD CHAR-  
ACTERS WITHOUT CLAIM TO ANY PARTICULAR  
FONT, STYLE, SIZE, OR COLOR.

NO CLAIM IS MADE TO THE EXCLUSIVE  
RIGHT TO USE "WHEELS", APART FROM THE  
MARK AS SHOWN.

SN 77-172,002, FILED 5-3-2007.

JAMES LOVELACE, EXAMINING ATTORNEY

**Int. Cl.: 3**

**Prior U.S. Cls.: 1, 4, 6, 50, 51, and 52**

**Reg. No. 3,499,739**

**United States Patent and Trademark Office**

**Registered Sep. 9, 2008**

**TRADEMARK  
PRINCIPAL REGISTER**

**SVELTYNES**

FIORINI COSMETICI, S.A. DE C.V. (MEXICO CORPORATION)  
FRACC. INDUSTRIAL MONTE DE LOS OLIVOS  
MONTE DE LOS OLIVOS NO. 112-B  
S. CATERINA NUEVO LEON, MEXICO C.P.66143

FOR: COSMETIC PATCHES FOR USE IN THE REDUCTION OF FAT IN THE EPIDERMIS FOR THE PURPOSE OF LOSING WEIGHT, REDUCING CELLULITE AND REDUCING ORANGE SKIN, IN CLASS 3 (U.S. CLS. 1, 4, 6, 50, 51 AND 52).

FIRST USE 7-31-2006; IN COMMERCE 7-9-2008.

THE MARK CONSISTS OF STANDARD CHARACTERS WITHOUT CLAIM TO ANY PARTICULAR FONT, STYLE, SIZE, OR COLOR.

SN 77-172,166, FILED 5-3-2007.

DEIRDRE ROBERTSON, EXAMINING ATTORNEY

**Int. Cl.: 9**

**Prior U.S. Cls.: 21, 23, 26, 36, and 38**

**Reg. No. 3,499,740**

**United States Patent and Trademark Office**

**Registered Sep. 9, 2008**

---

**TRADEMARK  
PRINCIPAL REGISTER**

**HIQUBE**

ALTAIR ENGINEERING, INC. (MICHIGAN CORPORATION)  
1820 E. BIG BEAVER ROAD  
TROY, MI 480832031

THE MARK CONSISTS OF STANDARD CHARACTERS WITHOUT CLAIM TO ANY PARTICULAR FONT, STYLE, SIZE, OR COLOR.

FOR: BUSINESS INTELLIGENCE SOFTWARE, IN CLASS 9 (U.S. CLS. 21, 23, 26, 36 AND 38).

SN 77-172,214, FILED 5-3-2007.

FIRST USE 10-0-2007; IN COMMERCE 10-0-2007.

SUSAN LESLIE DUBOIS, EXAMINING ATTORNEY

**Int. Cl.: 3**

**Prior U.S. Cls.: 1, 4, 6, 50, 51, and 52**

**Reg. No. 3,499,741**

**United States Patent and Trademark Office**

**Registered Sep. 9, 2008**

**TRADEMARK  
PRINCIPAL REGISTER**

**IN TOUCH**

IREDALE MINERAL COSMETICS, LTD. (DELA-  
WARE CORPORATION)  
28 CHURCH STREET  
GREAT BARRINGTON, MA 01230

THE MARK CONSISTS OF STANDARD CHAR-  
ACTERS WITHOUT CLAIM TO ANY PARTICULAR  
FONT, STYLE, SIZE, OR COLOR.

FOR: COSMETICS, NAMELY, CREAM COLOR  
FOR LIPS AND CHEEKS, IN CLASS 3 (U.S. CLS. 1, 4,  
6, 50, 51 AND 52).

SN 77-173,969, FILED 5-7-2007.

FIRST USE 8-8-2007; IN COMMERCE 8-8-2007.

ERIN FALK, EXAMINING ATTORNEY

**Int. Cls.: 35, 41, and 44**

**Prior U.S. Cls.: 100, 101, 102, and 107**

**Reg. No. 3,499,742**

**Registered Sep. 9, 2008**

**United States Patent and Trademark Office**

**SERVICE MARK  
PRINCIPAL REGISTER**



POPULATION COMMUNICATIONS INTERNATIONAL, INC. (NEW YORK NON-PROFIT CORPORATION)  
777 UNITED NATIONS PLAZA  
NEW YORK, NY 10017

FOR: PROVIDING INFORMATION VIA A WEB SITE IN THE FIELD OF POLITICAL AFFAIRS, GOVERNMENT AND QUASI-GOVERNMENTAL AFFAIRS, IN CLASS 35 (U.S. CLS. 100, 101 AND 102).

FIRST USE 6-30-2007; IN COMMERCE 6-30-2007.

FOR: EDUCATIONAL AND ENTERTAINMENT SERVICES, NAMELY, CONDUCTING LECTURES, CLASSES, SEMINARS, EDUCATIONAL CONFERENCES, AND DISTRIBUTING COURSE MATERIAL IN CONNECTION THEREWITH, AND PRODUCING AND DISTRIBUTING TELEVISION, RADIO AND ON-LINE AUDIO/VISUAL PROGRAMS ON THE ROLE, CAPACITY AND POTENTIAL OF THE ENTERTAINMENT MEDIA, NEWS MEDIA, GOVERNMENT AND QUASI-GOVERNMENTAL ORGANIZATIONS IN ADDRESSING REPRODUCTIVE BEHAVIOR, POPULATION, HEALTH AND SOCIAL ISSUES, PROVIDING INFORMATION VIA A WEB SITE ABOUT TELEVISION, RADIO AND ON-LINE AUDIO/VISUAL MEDIA PROGRAMS

THAT FEATURE THE ROLE, CAPACITY AND POTENTIAL OF THE ENTERTAINMENT MEDIA, NEWS MEDIA, GOVERNMENT AND QUASI-GOVERNMENTAL ORGANIZATION IN ADDRESSING REPRODUCTIVE BEHAVIOR, POPULATION, HEALTH AND SOCIAL ISSUES, IN CLASS 41 (U.S. CLS. 100, 101 AND 107).

FIRST USE 6-30-2007; IN COMMERCE 6-30-2007.

FOR: PROVIDING INFORMATION VIA A WEB SITE CONCERNING HEALTH AND RELATED REPRODUCTIVE BEHAVIOR, IN CLASS 44 (U.S. CLS. 100 AND 101).

FIRST USE 6-30-2007; IN COMMERCE 6-30-2007.

THE COLOR(S) ORANGE IS/ARE CLAIMED AS A FEATURE OF THE MARK.

THE COLOR ORANGE APPEARS IN THE DESIGN OF A SOUND OR RADIO WAVE.

SN 77-174,374, FILED 5-7-2007.

SOPHIA S. KIM, EXAMINING ATTORNEY



**Int. Cl.: 5**

**Prior U.S. Cls.: 6, 18, 44, 46, 51, and 52**

**Reg. No. 3,499,743**

**United States Patent and Trademark Office**

**Registered Sep. 9, 2008**

**TRADEMARK  
PRINCIPAL REGISTER**

# Algisol

SWEETWATER NATURAL PRODUCTS, LLC  
(NEW HAMPSHIRE LIMITED LIABILITY  
COMPANY)  
116 PETERBOROUGH ROAD  
HANCOCK, NH 03449

THE MARK CONSISTS OF STANDARD CHAR-  
ACTERS WITHOUT CLAIM TO ANY PARTICULAR  
FONT, STYLE, SIZE, OR COLOR.

FOR: INGREDIENT SOLD AS AN INTEGRAL  
COMPONENT OF DIETARY SUPPLEMENTS, IN  
CLASS 5 (U.S. CLS. 6, 18, 44, 46, 51 AND 52).

SN 77-174,743, FILED 5-7-2007.

FIRST USE 7-26-2002; IN COMMERCE 7-26-2002.

STEPHANIE ALI, EXAMINING ATTORNEY

**Int. Cl.: 3**

**Prior U.S. Cls.: 1, 4, 6, 50, 51, and 52**

**Reg. No. 3,499,744**

**United States Patent and Trademark Office**

**Registered Sep. 9, 2008**

**TRADEMARK  
PRINCIPAL REGISTER**



HONG, HOA (UNITED STATES INDIVIDUAL)  
2452 ELLIOT STREET  
SANTA CLARA, CA 95051

THE STIPPLING IS FOR SHADING PURPOSES ONLY.

FOR: NON-MEDICATED SKIN CARE PRODUCTS, NAMELY, CLEANSER, SERUM, TONER, MASK, EYE CREAM, THROAT CREAM, EXFOLIATES, MOISTURIZER, POWDER SUNSCREEN, PEEL, FOUNDATION, COSMETICS , IN CLASS 3 (U.S. CLS. 1, 4, 6, 50, 51 AND 52).

THE MARK CONSISTS OF THE WORD "LIFT" WITH A PEELING LIFT EFFECT ON THE DOT OF THE LETTER "I", AND THERE IS A SWIRL-LIKE DESIGN ABOVE THE WORD "GLOW", WITH "PERFORMANCE SKINCARE" UNDERNEATH, SEPARATED BY A LINE.

FIRST USE 3-0-2007; IN COMMERCE 3-0-2007.

SN 77-174,934, FILED 5-7-2007.

NO CLAIM IS MADE TO THE EXCLUSIVE RIGHT TO USE "SKINCARE", APART FROM THE MARK AS SHOWN.

SUSAN LESLIE DUBOIS, EXAMINING ATTORNEY

**Int. Cl.: 42**

**Prior U.S. Cls.: 100 and 101**

**United States Patent and Trademark Office**

**Reg. No. 3,499,745**

**Registered Sep. 9, 2008**

**SERVICE MARK  
PRINCIPAL REGISTER**

# SATISFACTION

SATISFACTION UNLIMITED, INC. (DELAWARE CORPORATION)  
164 SOUTH PARK STREET  
SAN FRANCISCO, CA 94107

FOR: COMPUTER SERVICES, NAMELY, ACTING AS AN APPLICATION SERVICE PROVIDER IN THE FIELD OF KNOWLEDGE MANAGEMENT TO HOST COMPUTER APPLICATION SOFTWARE FOR THE COLLECTION, EDITING, ORGANIZING, MODIFYING, BOOK MARKING, TRANSMISSION, STORAGE AND SHARING OF DATA AND INFORMATION; COMPUTER SERVICES, NAMELY, ACTING AS AN APPLICATION SERVICE PROVIDER IN THE FIELD OF KNOWLEDGE MANAGEMENT TO HOST COMPUTER APPLICATION SOFTWARE FOR CREATING SEARCHABLE DATABASES OF INFORMATION AND DATA TO ALLOW USERS TO PERFORM, ON-LINE, THE COLLECTING AND ANALYZING OF DIFFERENT TYPES OF OPINION SURVEYS; DATA AUTOMATION AND COLLECTION SERVICE USING PROPRIETARY SOFTWARE

TO EVALUATE, ANALYZE AND COLLECT SERVICE DATA; COMPUTER SERVICES, NAMELY, CREATING AN ONLINE COMMUNITY FOR REGISTERED USERS TO GET FEEDBACK FROM THEIR PEERS, FORM VIRTUAL COMMUNITIES, AND ENGAGE IN SOCIAL NETWORKING; PROVIDING CUSTOMIZED ON-LINE WEB PAGES FEATURING USER-DEFINED INFORMATION, WHICH INCLUDES SEARCH ENGINES AND ON-LINE WEB LINKS TO OTHER WEB SITES, IN CLASS 42 (U.S. CLS. 100 AND 101).

FIRST USE 6-15-2006; IN COMMERCE 3-15-2007.

THE MARK CONSISTS OF STANDARD CHARACTERS WITHOUT CLAIM TO ANY PARTICULAR FONT, STYLE, SIZE, OR COLOR.

SN 77-175,365, FILED 5-8-2007.

SUSAN LESLIE DUBOIS, EXAMINING ATTORNEY

**Int. Cl.: 9**

**Prior U.S. Cls.: 21, 23, 26, 36, and 38**

**Reg. No. 3,499,746**

**United States Patent and Trademark Office**

**Registered Sep. 9, 2008**

**TRADEMARK  
PRINCIPAL REGISTER**

**CyFi**

GLOBAL ICONS (CALIFORNIA LIMITED LIABILITY COMPANY)

#1400

12400 WILSHIRE BLVD

LOS ANGELES, CA 90025

THE MARK CONSISTS OF STANDARD CHARACTERS WITHOUT CLAIM TO ANY PARTICULAR FONT, STYLE, SIZE, OR COLOR.

FOR: WIRELESS OUTDOOR AUDIO SPEAKERS FOR BIKING, CAMPING, HIKING AND BOATING, IN CLASS 9 (U.S. CLS. 21, 23, 26, 36 AND 38).

SN 77-175,539, FILED 5-8-2007.

FIRST USE 7-3-2007; IN COMMERCE 9-26-2007.

FRANK LATTUCA, EXAMINING ATTORNEY

**Int. Cls.: 16 and 21**

**Prior U.S. Cls.: 2, 5, 13, 22, 23, 29, 30, 33, 37, 38, 40,  
and 50**

**Reg. No. 3,499,747**

**United States Patent and Trademark Office**

**Registered Sep. 9, 2008**

**TRADEMARK  
PRINCIPAL REGISTER**

**INSTANT ATTITUDE**

BATH & BODY WORKS BRAND MANAGE-  
MENT, INC. (DELAWARE CORPORATION)  
7 LIMITED PARKWAY EAST  
REYNOLDSBURG, OH 43068

FOR: TEMPORARY TATTOOS, IN CLASS 16 (U.S.  
CLS. 2, 5, 22, 23, 29, 37, 38 AND 50).

FIRST USE 11-30-2007; IN COMMERCE 11-30-2007.

FOR: STENCILS FOR APPLYING TEMPORARY  
TATTOOS, IN CLASS 21 (U.S. CLS. 2, 13, 23, 29, 30, 33,  
40 AND 50).

FIRST USE 11-30-2007; IN COMMERCE 11-30-2007.

THE MARK CONSISTS OF STANDARD CHAR-  
ACTERS WITHOUT CLAIM TO ANY PARTICULAR  
FONT, STYLE, SIZE, OR COLOR.

SN 77-175,735, FILED 5-8-2007.

KATHY DE JONGE, EXAMINING ATTORNEY

**Int. Cl.: 25**

**Prior U.S. Cls.: 22 and 39**

**United States Patent and Trademark Office**

**Reg. No. 3,499,748**

**Registered Sep. 9, 2008**

**TRADEMARK  
PRINCIPAL REGISTER**

**SUDDENLY SAUNA**

BATH & BODY WORKS BRAND MANAGEMENT, INC. (DELAWARE CORPORATION)  
7 LIMITED PARKWAY EAST  
REYNOLDSBURG, OH 43068

FOR: NON-ELECTRIC GLOVES AND SOCKS, NAMELY, CHEMICALLY-ACTIVATED HEATING PACKETS IMPREGNATED INTO GLOVES AND SOCKS FOR WARMING HANDS AND FEET FOR COSMETIC TREATMENT PURPOSES, IN CLASS 25 (U.S. CLS. 22 AND 39).

FIRST USE 10-15-2007; IN COMMERCE 10-15-2007.

THE MARK CONSISTS OF STANDARD CHARACTERS WITHOUT CLAIM TO ANY PARTICULAR FONT, STYLE, SIZE, OR COLOR.

SN 77-175,766, FILED 5-8-2007.

KATHY DE JONGE, EXAMINING ATTORNEY

Int. Cl.: 9

Prior U.S. Cls.: 21, 23, 26, 36, and 38

United States Patent and Trademark Office

Reg. No. 3,499,749

Registered Sep. 9, 2008

TRADEMARK  
PRINCIPAL REGISTER

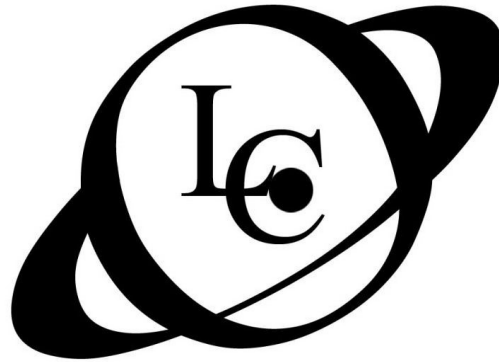

LoSt-CaUzE

BRYANT, RAFIK (UNITED STATES INDIVIDUAL)  
918 WESTMINSTER LANE  
DUNCANVILLE, TX 75137

FOR: HEADPHONES, IN CLASS 9 (U.S. CLS. 21, 23, 26, 36 AND 38).

FIRST USE 11-0-2007; IN COMMERCE 11-0-2007.

THE MARK CONSISTS OF THE WORDS LOST-CAUZE BENEATH A STYLIZED MONOGRAM LC FORMED WITH A DOT INSIDE TWO CLOSED CURVES.

SN 77-175,768, FILED 5-8-2007.

LINDA M. KING, EXAMINING ATTORNEY

**Int. Cl.: 29**

**Prior U.S. Cl.: 46**

**United States Patent and Trademark Office**

**Reg. No. 3,499,750**

**Registered Sep. 9, 2008**

**TRADEMARK  
PRINCIPAL REGISTER**

**TANQUERAY**

DIAGEO BRANDS B.V. (NETHERLANDS PRIVATE LIMITED COMPANY)  
MOLENWERF 10-12  
1014 BG AMSTERDAM, NETHERLANDS

FOR: PRESERVED OLIVES AND COCKTAIL ONIONS, IN CLASS 29 (U.S. CL. 46).

FIRST USE 2-29-2008; IN COMMERCE 2-29-2008.

THE MARK CONSISTS OF STANDARD CHARACTERS WITHOUT CLAIM TO ANY PARTICULAR FONT, STYLE, SIZE, OR COLOR.

OWNER OF U.S. REG. NOS. 120,024, 2,874,913, AND OTHERS.

SN 77-175,856, FILED 5-8-2007.

DAWN FELDMAN, EXAMINING ATTORNEY



**Int. Cl.: 20**

**Prior U.S. Cls.: 2, 13, 22, 25, 32, and 50**

**Reg. No. 3,499,751**

**United States Patent and Trademark Office**

**Registered Sep. 9, 2008**

**TRADEMARK  
PRINCIPAL REGISTER**

**THERMO COOL**

RESTONIC CORPORATION (DELAWARE COR-  
PORATION)  
SUITE 102  
1540 EAST DUNDEE ROAD  
PALATINE, IL 60074

THE MARK CONSISTS OF STANDARD CHAR-  
ACTERS WITHOUT CLAIM TO ANY PARTICULAR  
FONT, STYLE, SIZE, OR COLOR.

FOR: MEMORY FOAM SOLD AS AN INTEGRAL  
COMPONENT OF MATTRESSES, IN CLASS 20 (U.S.  
CLS. 2, 13, 22, 25, 32 AND 50).

SN 77-176,581, FILED 5-9-2007.

FIRST USE 5-10-2007; IN COMMERCE 5-10-2007.

BARBARA GAYNOR, EXAMINING ATTORNEY

**Int. Cl.: 41**

**Prior U.S. Cls.: 100, 101, and 107**

**United States Patent and Trademark Office**

**Reg. No. 3,499,752**

**Registered Sep. 9, 2008**

**SERVICE MARK  
PRINCIPAL REGISTER**

**GALAXY RIOS**

MAJOR LEAGUE SOCCER, LLC (DELAWARE  
LIMITED LIABILITY COMPANY)  
420 FIFTH AVENUE  
NEW YORK, NY 10018

FOR: YOUTH SOCCER TEAM- ENTERTAIN-  
MENT SERVICES, NAMELY, SOCCER EXHIBI-  
TIONS RENDERED LIVE IN A STADIUM, AND  
THROUGH THE MEDIA OF TELEVISION AND  
RADIO AND VIA THE INTERNET; PROVISION OF  
ENTERTAINMENT IN THE NATURE OF CLIPS  
FROM SOCCER GAMES VIA MOBILE DEVICES;  
PROVISION OF INFORMATION IN THE FIELD OF

SOCCER VIA THE INTERNET AND MOBILE DE-  
VICES, IN CLASS 41 (U.S. CLS. 100, 101 AND 107).

FIRST USE 3-31-2007; IN COMMERCE 3-31-2007.

THE MARK CONSISTS OF STANDARD CHAR-  
ACTERS WITHOUT CLAIM TO ANY PARTICULAR  
FONT, STYLE, SIZE, OR COLOR.

SN 77-176,608, FILED 5-9-2007.

JOHN WILKE, EXAMINING ATTORNEY

**Int. Cl.: 35**

**Prior U.S. Cls.: 100, 101, and 102**

**United States Patent and Trademark Office**

**Reg. No. 3,499,753**

**Registered Sep. 9, 2008**

**SERVICE MARK  
PRINCIPAL REGISTER**

**SCRIPTPOINT**

LEVERAGEPOINT MEDIA INC. (WISCONSIN  
CORPORATION)  
SUITE 250  
2895 GREENSPOINT PARKWAY  
HOFFMAN ESTATES, IL 60195

FOR: ADVERTISING SERVICES, NAMELY, PROMOTING THE GOODS, SERVICES AND INFORMATIONAL MESSAGES OF OTHERS IN A WIDE VARIETY OF FIELDS THROUGH THE CREATION AND DISTRIBUTION OF PRINTED PROMOTIONAL AND INFORMATION MATERIALS; PLACING ADVERTISEMENTS FOR OTHERS; AND, BUSI-

NESS MARKETING CONSULTING SERVICES, IN CLASS 35 (U.S. CLS. 100, 101 AND 102).

FIRST USE 6-30-2007; IN COMMERCE 6-30-2007.

THE MARK CONSISTS OF STANDARD CHARACTERS WITHOUT CLAIM TO ANY PARTICULAR FONT, STYLE, SIZE, OR COLOR.

SN 77-176,619, FILED 5-9-2007.

JAY BESCH, EXAMINING ATTORNEY

**Int. Cl.: 25**

**Prior U.S. Cls.: 22 and 39**

**United States Patent and Trademark Office**

**Reg. No. 3,499,754**

**Registered Sep. 9, 2008**

**TRADEMARK  
PRINCIPAL REGISTER**

**FROZEN IN THE FIFTIES**

HUGGIN' MOLLY'S, INC. (ALABAMA COR-  
PORATION)  
1100 HIGHWAY 431 NORTH  
ABBEVILLE, AL 36310

THE MARK CONSISTS OF STANDARD CHAR-  
ACTERS WITHOUT CLAIM TO ANY PARTICULAR  
FONT, STYLE, SIZE, OR COLOR.

FOR: CAPS; SHIRTS; T-SHIRTS, IN CLASS 25 (U.S.  
CLS. 22 AND 39).

SN 77-177,317, FILED 5-10-2007.

FIRST USE 6-17-2008; IN COMMERCE 6-17-2008.

HEATHER BIDDULPH, EXAMINING ATTORNEY

**Int. Cls.: 35 and 41**

**Prior U.S. Cls.: 100, 101, 102, and 107**

**United States Patent and Trademark Office**

**Reg. No. 3,499,755**

**Registered Sep. 9, 2008**

**SERVICE MARK  
PRINCIPAL REGISTER**

**EXPECT SUCCESS**

FITNESS RENAISSANCE, LLC (NEW JERSEY  
LIMITED LIABILITY COMPANY)  
600 HUDSON STREET #6A  
HOBOKEN, NJ 07030

FOR: PROVIDING ON-LINE DIRECTORY INFORMATION SERVICES ALSO FEATURING HYPERLINKS TO OTHER WEB SITES FEATURING TEXT AND GRAPHIC WORKS OF OTHERS IN THE FIELD SELF HELP, PERSONAL SUCCESS, MOTIVATION AND PERSONAL DEVELOPMENT, IN CLASS 35 (U.S. CLS. 100, 101 AND 102).

FIRST USE 7-10-2008; IN COMMERCE 7-10-2008.

FOR: ELECTRONIC PUBLISHING SERVICES, NAMELY, PUBLICATION OF TEXT AND GRAPHIC

WORKS OF OTHERS ON LINE FEATURING INFORMATION IN THE FIELD SELF HELP, PERSONAL SUCCESS, MOTIVATION AND PERSONAL DEVELOPMENT; PUBLISHING OF ELECTRONIC PUBLICATIONS; PUBLISHING OF REVIEWS, IN CLASS 41 (U.S. CLS. 100, 101 AND 107).

FIRST USE 7-10-2008; IN COMMERCE 7-10-2008.

THE MARK CONSISTS OF STANDARD CHARACTERS WITHOUT CLAIM TO ANY PARTICULAR FONT, STYLE, SIZE, OR COLOR.

SN 77-177,434, FILED 5-10-2007.

KIMBERLY PERRY, EXAMINING ATTORNEY

**Int. Cl.: 12**

**Prior U.S. Cls.: 19, 21, 23, 31, 35, and 44**

**United States Patent and Trademark Office**

**Reg. No. 3,499,756**

**Registered Sep. 9, 2008**

**TRADEMARK  
PRINCIPAL REGISTER**

**Real Truck Bed Protection  
System**

DUALLINER, LLC (WISCONSIN LIMITED LIABILITY COMPANY)  
PO BOX 423  
114 MAIN STREET  
KEWASKUM, WI 53040

FOR: FITTED LINERS FOR THE CARGO AREA OF VEHICLES; FITTED TRUCK BED LINERS, IN CLASS 12 (U.S. CLS. 19, 21, 23, 31, 35 AND 44).

FIRST USE 1-0-2007; IN COMMERCE 1-0-2007.

THE MARK CONSISTS OF STANDARD CHARACTERS WITHOUT CLAIM TO ANY PARTICULAR FONT, STYLE, SIZE, OR COLOR.

NO CLAIM IS MADE TO THE EXCLUSIVE RIGHT TO USE "TRUCK BED PROTECTION SYSTEM", APART FROM THE MARK AS SHOWN.

SN 77-177,943, FILED 5-10-2007.

KATHERINE CHANG, EXAMINING ATTORNEY

**Int. Cls.: 9 and 28**

**Prior U.S. Cls.: 21, 22, 23, 26, 36, 38, and 50**

**United States Patent and Trademark Office**

**Reg. No. 3,499,757**

**Registered Sep. 9, 2008**

**TRADEMARK  
PRINCIPAL REGISTER**

**HEXBUG**

INNOVATION FIRST, INC. (TEXAS CORPORATION)  
1519 INTERSTATE 30 WEST  
GREENVILLE, TX 75402

FOR: ROBOTS, NAMELY, ROBOTS WITH SENSORS FOR DETECTION AND NAVIGATION OF THE SURROUNDING ENVIRONMENT, FOR EDUCATIONAL, HOBBY OR PERSONAL USE; ROBOTS RESEMBLING INSECTS, NAMELY, ROBOTS WITH SENSORS FOR DETECTION AND NAVIGATION OF THE SURROUNDING ENVIRONMENT, FOR EDUCATIONAL, HOBBY OR PERSONAL USE, IN CLASS 9 (U.S. CLS. 21, 23, 26, 36 AND 38).

FIRST USE 4-0-2007; IN COMMERCE 4-0-2007.

FOR: TOY ROBOTS, IN CLASS 28 (U.S. CLS. 22, 23, 38 AND 50).

FIRST USE 4-0-2007; IN COMMERCE 4-0-2007.

THE MARK CONSISTS OF STANDARD CHARACTERS WITHOUT CLAIM TO ANY PARTICULAR FONT, STYLE, SIZE, OR COLOR.

SN 77-178,113, FILED 5-10-2007.

SALLY SHIH, EXAMINING ATTORNEY

**Int. Cl.: 35**

**Prior U.S. Cls.: 100, 101, and 102**

**United States Patent and Trademark Office**

**Reg. No. 3,499,758**

**Registered Sep. 9, 2008**

**SERVICE MARK  
PRINCIPAL REGISTER**

**PETK**

SEARS BRANDS, LLC (ILLINOIS LIMITED LIABILITY COMPANY)  
3333 BEVERLY ROAD  
HOFFMAN ESTATES, IL 60179

THE MARK CONSISTS OF STANDARD CHARACTERS WITHOUT CLAIM TO ANY PARTICULAR FONT, STYLE, SIZE, OR COLOR.

FOR: RETAIL PHARMACY SERVICES, IN CLASS 35 (U.S. CLS. 100, 101 AND 102).

SN 77-178,268, FILED 5-10-2007.

FIRST USE 5-0-2007; IN COMMERCE 5-0-2007.

KIMBERLY PERRY, EXAMINING ATTORNEY



**Int. Cl.: 30**

**Prior U.S. Cl.: 46**

**United States Patent and Trademark Office**

**Reg. No. 3,499,759**

**Registered Sep. 9, 2008**

**TRADEMARK  
PRINCIPAL REGISTER**

**COUNTRY PRIDE**

QUALITY FOOD BRANDS, INC. (NEVADA COR-  
PORATION)  
317 W. FRONT STREET  
MONROE, MI 48161

FOR: CAKE MIXES, IN CLASS 30 (U.S. CL. 46).

FIRST USE 6-0-2007; IN COMMERCE 6-0-2007.

THE MARK CONSISTS OF STANDARD CHAR-  
ACTERS WITHOUT CLAIM TO ANY PARTICULAR  
FONT, STYLE, SIZE, OR COLOR.

SN 77-178,461, FILED 5-11-2007.

ALICE SUE CARRUTHERS, EXAMINING ATTOR-  
NEY

**Int. Cls.: 35 and 41**

**Prior U.S. Cls.: 100, 101, 102, and 107**

**United States Patent and Trademark Office**

**Reg. No. 3,499,760**

**Registered Sep. 9, 2008**

**SERVICE MARK  
PRINCIPAL REGISTER**

**RECOGNIZE THE MOMENT**

V&S VIN & SPRIT AKTIEBOLAG (PUBL) (SWEDEN CORPORATION)  
SE-117 97  
STOCKHOLM, SWEDEN

FOR: PROMOTING PUBLIC AWARENESS OF THE NEED FOR ALCOHOL BEVERAGE AWARENESS, ALCOHOL BEVERAGE MODERATION, RESPONSIBLE CONSUMPTION OF ALCOHOLIC BEVERAGES; AND PROVIDING CONSUMER INFORMATION IN THE FIELDS OF BEVERAGES, ALCOHOLIC BEVERAGES, ALCOHOL BEVERAGE AWARENESS, ALCOHOL BEVERAGE MODERATION AND RESPONSIBLE CONSUMPTION OF ALCOHOLIC BEVERAGES, IN CLASS 35 (U.S. CLS. 100, 101 AND 102).

FIRST USE 5-0-2007; IN COMMERCE 5-0-2007.

FOR: ARRANGING AND CONDUCTING CLASSES, SEMINARS AND WORKSHOPS IN THE FIELDS OF BEVERAGES, ALCOHOLIC BEVERAGES, ALCOHOL BEVERAGE AWARENESS, ALCO-

HOL BEVERAGE MODERATION AND RESPONSIBLE CONSUMPTION OF ALCOHOLIC BEVERAGES, AND DISTRIBUTION OF COURSE MATERIALS IN CONNECTION THEREWITH; PROVIDING RECOGNITION AND INCENTIVES BY THE WAY OF AWARDS TO DEMONSTRATE EXCELLENCE IN THE FIELDS OF BEVERAGES, ALCOHOLIC BEVERAGES, ALCOHOL BEVERAGE AWARENESS, ALCOHOL BEVERAGE MODERATION AND RESPONSIBLE CONSUMPTION OF ALCOHOLIC BEVERAGES, IN CLASS 41 (U.S. CLS. 100, 101 AND 107).

FIRST USE 5-0-2007; IN COMMERCE 5-0-2007.

THE MARK CONSISTS OF STANDARD CHARACTERS WITHOUT CLAIM TO ANY PARTICULAR FONT, STYLE, SIZE, OR COLOR.

SN 77-179,759, FILED 5-14-2007.

MARY CRAWFORD, EXAMINING ATTORNEY

**Int. Cl.: 35**

**Prior U.S. Cls.: 100, 101, and 102**

**United States Patent and Trademark Office**

**Reg. No. 3,499,761**

**Registered Sep. 9, 2008**

**SERVICE MARK  
PRINCIPAL REGISTER**

**WIRELESS ETC.**

CELLULAR DEPOT, INC. (GEORGIA CORPORATION)  
SUITE F  
240 CORPORATE CENTER DRIVE  
STOCKBRIDGE, GA 302814170

FOR: RETAIL STORE SERVICES FEATURING WIRELESS COMMUNICATION PRODUCTS AND RELATED ACCESSORIES AND WIRELESS PERSONAL TELECOMMUNICATIONS SERVICES , IN CLASS 35 (U.S. CLS. 100, 101 AND 102).

FIRST USE 9-27-2007; IN COMMERCE 9-27-2007.

THE MARK CONSISTS OF STANDARD CHARACTERS WITHOUT CLAIM TO ANY PARTICULAR FONT, STYLE, SIZE, OR COLOR.

NO CLAIM IS MADE TO THE EXCLUSIVE RIGHT TO USE "WIRELESS", APART FROM THE MARK AS SHOWN.

SN 77-179,773, FILED 5-14-2007.

KATHERINE CONNOLLY, EXAMINING ATTORNEY

**Int. Cl.: 38**

**Prior U.S. Cls.: 100, 101, and 104**

**United States Patent and Trademark Office**

**Reg. No. 3,499,762**

**Registered Sep. 9, 2008**

**SERVICE MARK  
PRINCIPAL REGISTER**

**WE THINK LIKE YOU THINK**

TIME WARNER CABLE INC. (DELAWARE CORPORATION)  
290 HARBOR DRIVE  
STAMFORD, CT 06902

FOR: CABLE TELEVISION BROADCASTING; CABLE TELEVISION TRANSMISSION; TELECOMMUNICATION SERVICES, NAMELY, LOCAL AND LONG DISTANCE TRANSMISSION OF VOICE, DATA, GRAPHICS BY MEANS OF TELEPHONE, TELEGRAPHIC, CABLE AND SATELLITE TRANSMISSIONS; LOCAL AND LONG DISTANCE TELEPHONE SERVICES; TELEPHONE COMMUNICATION SERVICES; ELECTRONIC, ELECTRIC AND DIGITAL TRANSMISSION OF VOICE, DATA, IMAGES, SIGNALS AND MESSAGES; INTERNET TELEPHONE SERVICES; ELECTRONIC AND VOICE MESSAGING, NAMELY, THE RECORDING AND SUBSEQUENT TRANSMISSION OF VOICE MESSAGES BY TELEPHONE; TELEPHONE VOICE MESSAGING SERVICES; WEB MESSAGING; PROVIDING HIGH SPEED ACCESS TO AREA NETWORKS AND A GLOBAL COMPUTER INFORMATION NETWORK; INTERACTIVE TELEVISION TRANSMISSION SERVICES AND TELEVISION ON DEMAND TRANSMISSION SERVICES

AND WIRELESS COMMUNICATION SERVICES, NAMELY, TEXT AND NUMERIC WIRELESS DIGITAL MESSAGING SERVICES, WIRELESS BROADBAND COMMUNICATION SERVICES, TRANSMISSION OF GRAPHICS TO MOBILE TELEPHONES, WIRELESS DIGITAL MESSAGING SERVICES, WIRELESS ELECTRONIC TRANSMISSION OF VOICE SIGNALS, DATA, FACSIMILES, IMAGES AND INFORMATION, WIRELESS FACSIMILE MAIL SERVICES, WIRELESS PBX SERVICES, WIRELESS TELEPHONE TELECOMMUNICATIONS SERVICES, NAMELY, WIRELESS MOBILE TELEPHONE SERVICES AND WIRELESS VOICE MAIL SERVICES, IN CLASS 38 (U.S. CLS. 100, 101 AND 104).

FIRST USE 6-13-2007; IN COMMERCE 6-13-2007.

THE MARK CONSISTS OF STANDARD CHARACTERS WITHOUT CLAIM TO ANY PARTICULAR FONT, STYLE, SIZE, OR COLOR.

SN 77-179,806, FILED 5-14-2007.

MELVIN AXILBUND, EXAMINING ATTORNEY

**Int. Cl.: 25**

**Prior U.S. Cls.: 22 and 39**

**United States Patent and Trademark Office**

**Reg. No. 3,499,763**

**Registered Sep. 9, 2008**

**TRADEMARK  
PRINCIPAL REGISTER**

**2 A.M. ARTISANS**

KOONTZ, MARK W. (UNITED STATES INDIVIDUAL)  
907 S. LOOMIS STREET  
CHICAGO, IL 60607

THE MARK CONSISTS OF STANDARD CHARACTERS WITHOUT CLAIM TO ANY PARTICULAR FONT, STYLE, SIZE, OR COLOR.

FOR: CLOTHING FOR MEN AND CHILDREN, NAMELY, T-SHIRTS, IN CLASS 25 (U.S. CLS. 22 AND 39).

SN 77-179,860, FILED 5-14-2007.

FIRST USE 9-1-2007; IN COMMERCE 9-1-2007.

KAREN K. BUSH, EXAMINING ATTORNEY

**Int. Cl.: 25**

**Prior U.S. Cls.: 22 and 39**

**United States Patent and Trademark Office**

**Reg. No. 3,499,764**

**Registered Sep. 9, 2008**

**TRADEMARK  
PRINCIPAL REGISTER**

**TLH**

HARKHAM INDUSTRIES, INC. (CALIFORNIA  
CORPORATION)  
857 SAN PEDRO STREET  
LOS ANGELES, CA 90014

THE MARK CONSISTS OF STANDARD CHAR-  
ACTERS WITHOUT CLAIM TO ANY PARTICULAR  
FONT, STYLE, SIZE, OR COLOR.

FOR: DRESSES; WOMEN'S BLOUSES AND T-  
SHIRTS; SKIRTS, IN CLASS 25 (U.S. CLS. 22 AND 39).

SN 77-180,314, FILED 5-14-2007.

FIRST USE 1-30-2008; IN COMMERCE 1-30-2008.

JAY BESCH, EXAMINING ATTORNEY

**Int. Cls.: 35 and 44**

**Prior U.S. Cls.: 100, 101, and 102**

**United States Patent and Trademark Office**

**Reg. No. 3,499,765**

**Registered Sep. 9, 2008**

**SERVICE MARK  
PRINCIPAL REGISTER**

**MUSIC2**

P&M HOLDING GROUP, LLP (DELAWARE LIMITED PARTNERSHIP)  
27400 NORTHWESTERN HIGHWAY  
SOUTHFIELD, MI 48034

FOR: BUSINESS OPERATIONS CONSULTING SERVICES FOR LONG-TERM AND CONTINUING CARE PROVIDERS AND INSTITUTIONS, IN CLASS 35 (U.S. CLS. 100, 101 AND 102).

FIRST USE 12-10-2007; IN COMMERCE 12-10-2007.

FOR: MEDICAL AND CLINICAL OPERATIONS CONSULTANCY SERVICES RELATED TO PA-

TIENT CARE AND MEDICAL OPERATIONS AND PROCEDURES, IN CLASS 44 (U.S. CLS. 100 AND 101).

FIRST USE 12-10-2007; IN COMMERCE 12-10-2007.

THE MARK CONSISTS OF STANDARD CHARACTERS WITHOUT CLAIM TO ANY PARTICULAR FONT, STYLE, SIZE, OR COLOR.

SN 77-180,611, FILED 5-14-2007.

RENEE MCCRAY, EXAMINING ATTORNEY

**Int. Cl.: 43**

**Prior U.S. Cls.: 100 and 101**

**United States Patent and Trademark Office**

**Reg. No. 3,499,766**

**Registered Sep. 9, 2008**

**SERVICE MARK  
PRINCIPAL REGISTER**

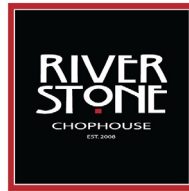

RIVERSTONE CHOP HOUSE LLC (VIRGINIA  
LIMITED LIABILITY COMPANY)  
SUITE B, 1885 GOVERNOR'S POINTE DRIVE  
SUFFOLK, VA 23436

FOR: BAR SERVICES; RESTAURANT SERVICES,  
INCLUDING FOOD CARRYOUT, IN CLASS 43 (U.S.  
CLS. 100 AND 101).

FIRST USE 3-6-2008; IN COMMERCE 3-6-2008.

NO CLAIM IS MADE TO THE EXCLUSIVE  
RIGHT TO USE "CHOPHOUSE" AND "EST. 2008",  
APART FROM THE MARK AS SHOWN.

THE COLOR(S) WHITE, BLACK AND RED IS/  
ARE CLAIMED AS A FEATURE OF THE MARK.

THE COLOR WHITE APPEARS IN THE WORD-  
ING "RIVER STONE CHOPHOUSE EST. 2008" AND  
IN THE INSIDE SQUARE BORDER, THE COLOR  
BLACK APPEARS IN THE SQUARE BACK-  
GROUND, AND THE COLOR RED APPEARS IN  
THE SMALL RED SQUARE DESIGN BENEATH  
THE LETTER O AND IN THE OUTSIDE SQUARE  
BORDER.

SN 77-181,573, FILED 5-15-2007.

JOHN GARTNER, EXAMINING ATTORNEY



Int. Cl.: 11

Prior U.S. Cls.: 13, 21, 23, 31, and 34

**United States Patent and Trademark Office**

**Reg. No. 3,499,767**

Registered Sep. 9, 2008

**TRADEMARK  
PRINCIPAL REGISTER**

**GFS WAVE**

GLOBAL FINISHING SOLUTIONS L.L.C. (DELA-  
WARE LIMITED LIABILITY COMPANY)  
P.O. BOX 250  
12731 NORWAY ROAD  
OSSEO, WI 54758

FOR: FILTER MEDIA, NAMELY, POLYESTER  
FILTERS FOR USE IN THE REMOVAL OF IMPU-  
RITIES IN THE NATURE OF EXCESS PAINT FROM  
PAINT SPRAYING OPERATIONS, IN CLASS 11 (U.S.  
CLS. 13, 21, 23, 31 AND 34).

FIRST USE 6-29-2007; IN COMMERCE 7-23-2007.

THE MARK CONSISTS OF STANDARD CHAR-  
ACTERS WITHOUT CLAIM TO ANY PARTICULAR  
FONT, STYLE, SIZE, OR COLOR.

OWNER OF U.S. REG. NO. 3,280,757.

SN 77-181,612, FILED 5-15-2007.

BRIAN CALLAGHAN, EXAMINING ATTORNEY

**Int. Cl.: 3**

**Prior U.S. Cls.: 1, 4, 6, 50, 51, and 52**

**United States Patent and Trademark Office**

**Reg. No. 3,499,768**

**Registered Sep. 9, 2008**

**TRADEMARK  
PRINCIPAL REGISTER**

**442-S**

TUPPERWARE PRODUCTS S.A. (SWITZERLAND  
CORPORATION)  
ROUTE DU JURA 37  
FRIBOURG, SWITZERLAND CH-1700

FOR: PERFUMES; EAU DE COLOGNE; FRA-  
GRANCES FOR PERSONAL USE; DEODORANTS  
AND ANTIPERSPIRANTS FOR PERSONAL USE;  
TALCUM POWDER, IN CLASS 3 (U.S. CLS. 1, 4, 6, 50,  
51 AND 52).

FIRST USE 6-14-2008; IN COMMERCE 6-14-2008.

THE MARK CONSISTS OF STANDARD CHAR-  
ACTERS WITHOUT CLAIM TO ANY PARTICULAR  
FONT, STYLE, SIZE, OR COLOR.

SN 77-181,767, FILED 5-15-2007.

SETH A. RAPPAPORT, EXAMINING ATTORNEY

**Int. Cl.: 18**

**Prior U.S. Cls.: 1, 2, 3, 22, and 41**

**United States Patent and Trademark Office**

**Reg. No. 3,499,769**

**Registered Sep. 9, 2008**

**TRADEMARK  
PRINCIPAL REGISTER**

**ZOTIES**

FINCH, DEBORAH (UNITED STATES INDIVIDUAL)  
247 HIDDEN DEN CIRCLE  
DOYLESTOWN, PA 18901

FOR: TEXTILE SHOPPING BAGS FOR WINE, IN CLASS 18 (U.S. CLS. 1, 2, 3, 22 AND 41).

FIRST USE 9-18-2007; IN COMMERCE 11-19-2007.

THE MARK CONSISTS OF STANDARD CHARACTERS WITHOUT CLAIM TO ANY PARTICULAR FONT, STYLE, SIZE, OR COLOR.

SN 77-182,425, FILED 5-16-2007.

MARTHA SANTOMARTINO, EXAMINING ATTORNEY

**Int. Cl.: 3**

**Prior U.S. Cls.: 1, 4, 6, 50, 51, and 52**

**United States Patent and Trademark Office**

**Reg. No. 3,499,770**

**Registered Sep. 9, 2008**

**TRADEMARK  
PRINCIPAL REGISTER**

**MISS MANHATTAN**

LERNER NEW YORK, INC. (DELAWARE CORPORATION)  
450 WEST 33RD STREET  
NEW YORK, NY 10001

FOR: PERSONAL CARE PRODUCTS, NAMELY, BODY MIST, BODY SCRUB, CREAM FOR THE BODY, CREAM FOR THE HANDS LOTION FOR THE BODY AND SHOWER GEL, IN CLASS 3 (U.S. CLS. 1, 4, 6, 50, 51 AND 52).

FIRST USE 1-8-2008; IN COMMERCE 1-8-2008.

THE MARK CONSISTS OF STANDARD CHARACTERS WITHOUT CLAIM TO ANY PARTICULAR FONT, STYLE, SIZE, OR COLOR.

NO CLAIM IS MADE TO THE EXCLUSIVE RIGHT TO USE "MANHATTAN", APART FROM THE MARK AS SHOWN.

SN 77-182,833, FILED 5-16-2007.

KATHERINE CONNOLLY, EXAMINING ATTORNEY

**Int. Cl.: 30**

**Prior U.S. Cl.: 46**

**United States Patent and Trademark Office**

**Reg. No. 3,499,771**

**Registered Sep. 9, 2008**

**TRADEMARK  
PRINCIPAL REGISTER**

**ALL-IN-ONE SUPER SYRUP**

SMART & FINAL STORES CORPORATION (CALIFORNIA CORPORATION)

600 CITADEL DRIVE

COMMERCE, CA 90040

FOR: FLAVORING SYRUP, IN CLASS 30 (U.S. CL. 46).

FIRST USE 2-4-2008; IN COMMERCE 2-4-2008.

THE MARK CONSISTS OF STANDARD CHARACTERS WITHOUT CLAIM TO ANY PARTICULAR FONT, STYLE, SIZE, OR COLOR.

NO CLAIM IS MADE TO THE EXCLUSIVE RIGHT TO USE "SUPER SYRUP", APART FROM THE MARK AS SHOWN.

SN 77-182,997, FILED 5-16-2007.

ELLEN PERKINS, EXAMINING ATTORNEY

Int. Cl.: 11

Prior U.S. Cls.: 13, 21, 23, 31, and 34

United States Patent and Trademark Office

Reg. No. 3,499,772

Registered Sep. 9, 2008

TRADEMARK  
PRINCIPAL REGISTER

**COLUMBIA**  
V O R T E X

PARTITION SYSTEMS INCORPORATED OF  
SOUTH CAROLINA (SOUTH CAROLINA  
CORPORATION)

825 GARLAND STREET  
COLUMBIA, SC 29201

FOR: ELECTRIC HOT AIR HAND DRYERS, IN  
CLASS 11 (U.S. CLS. 13, 21, 23, 31 AND 34).

FIRST USE 5-31-2007; IN COMMERCE 5-31-2007.

NO CLAIM IS MADE TO THE EXCLUSIVE  
RIGHT TO USE "COLUMBIA", APART FROM THE  
MARK AS SHOWN.

THE MARK CONSISTS OF THE WORD "COLUM-  
BIA" IN BOLD OVER THE WORD "VORTEX" NOT  
BOLDED WITH A HORIZONTAL HOLLOW BAR  
BETWEEN THEM.

SN 77-183,241, FILED 5-17-2007.

ELLEN PERKINS, EXAMINING ATTORNEY

**Int. Cl.: 35**

**Prior U.S. Cls.: 100, 101, and 102**

**United States Patent and Trademark Office**

**Reg. No. 3,499,773**

**Registered Sep. 9, 2008**

**SERVICE MARK  
PRINCIPAL REGISTER**

YOUR GLOBAL MARKETPLACE

CASTELLA IMPORTS, INC. (NEW YORK CORPORATION)  
60 DAVIDS DRIVE  
HAUPPAUGE, NY 11788

FOR: WHOLESALE ORDERING SERVICES IN THE FIELD OF MEDITERRANEAN FOOD PRODUCTS, SPECIALTY FOODS AND SPICES, IN CLASS 35 (U.S. CLS. 100, 101 AND 102).

FIRST USE 4-7-2007; IN COMMERCE 4-7-2007.

THE MARK CONSISTS OF STANDARD CHARACTERS WITHOUT CLAIM TO ANY PARTICULAR FONT, STYLE, SIZE, OR COLOR.

SN 77-183,252, FILED 5-17-2007.

PATRICIA EVANKO, EXAMINING ATTORNEY

**Int. Cl.: 9**

**Prior U.S. Cls.: 21, 23, 26, 36, and 38**

**United States Patent and Trademark Office**

**Reg. No. 3,499,774**

**Registered Sep. 9, 2008**

**TRADEMARK  
PRINCIPAL REGISTER**

**GEM LOVERS' COLLECTION**

AMERICA'S COLLECTIBLES NETWORK, INC.  
(TENNESSEE CORPORATION)  
10001 KINGSTON PIKE, SUITE 57  
KNOXVILLE, TN 37922

FOR: SERIES OF DVD'S ON THE SUBJECT OF  
PRECIOUS AND SEMIPRECIOUS STONES, IN  
CLASS 9 (U.S. CLS. 21, 23, 26, 36 AND 38).

FIRST USE 10-27-2007; IN COMMERCE 10-27-2007.

THE MARK CONSISTS OF STANDARD CHAR-  
ACTERS WITHOUT CLAIM TO ANY PARTICULAR  
FONT, STYLE, SIZE, OR COLOR.

NO CLAIM IS MADE TO THE EXCLUSIVE  
RIGHT TO USE "GEM" AND "COLLECTION",  
APART FROM THE MARK AS SHOWN.

SN 77-183,510, FILED 5-17-2007.

RONALD MCMORROW, EXAMINING ATTORNEY



**Int. Cl.: 3**

**Prior U.S. Cls.: 1, 4, 6, 50, 51, and 52**

**Reg. No. 3,499,775**

**United States Patent and Trademark Office**

**Registered Sep. 9, 2008**

**TRADEMARK  
PRINCIPAL REGISTER**

**FABULOUS ON FIFTH**

LERNER NEW YORK, INC. (DELAWARE CORPORATION)  
450 WEST 33RD STREET  
NEW YORK, NY 10001

FIRST USE 10-25-2007; IN COMMERCE 10-25-2007.

THE MARK CONSISTS OF STANDARD CHARACTERS WITHOUT CLAIM TO ANY PARTICULAR FONT, STYLE, SIZE, OR COLOR.

FOR: PERSONAL CARE PRODUCTS, NAMELY, BODY MIST, BODY SCRUB, CREAM FOR THE BODY, CREAM FOR THE HANDS, LOTION FOR THE BODY AND SHOWER GEL, IN CLASS 3 (U.S. CLS. 1, 4, 6, 50, 51 AND 52).

SN 77-183,988, FILED 5-17-2007.

PAUL E. FAHRENKOPF, EXAMINING ATTORNEY

**Int. Cls.: 11 and 35**

**Prior U.S. Cls.: 13, 21, 23, 31, 34, 100, 101, and 102**

**United States Patent and Trademark Office**

**Reg. No. 3,499,776**

**Registered Sep. 9, 2008**

**TRADEMARK  
SERVICE MARK  
PRINCIPAL REGISTER**

**JAPIN**

JAPIN INTERNATIONAL, INC. (TAIWAN CORPORATION)  
57, SEC. 2, JIAO-TAN RD.  
FONG YUAN, TAICHUNG, TAIWAN

FOR: WATER PURIFYING APPARATUS; WATER PURIFYING MACHINES; WATER FILTERING APPARATUS, NAMELY, WATER FILTERS AND WATER FILTERING UNITS FOR DOMESTIC AND COMMERCIAL USE; DRINKING FOUNTAINS; WATER FILTER REPLACEMENTS FOR DRINKING FOUNTAINS; WATER FILTER REPLACEMENTS FOR WATER FILTERING UNITS; PLASTIC WATER BOTTLE SOLD EMPTY WITH A PURIFYING FILTER IN THE CAP; WATER FILTRATION PITCHERS SOLD EMPTY; HAND HELD SHOWER HEADS; SHOWER HEAD UNITS, NAMELY, COMBINED WATER FILTERS AND WATER FLOW REGULATORS; HAND-HELD SHOWERS; PLUMBING FIXTURES, NAMELY, SHOWER SPRAYERS; SHOWER HEAD SPRAYERS; WATER STERILIZERS, IN CLASS 11 (U.S. CLS. 13, 21, 23, 31 AND 34).

FIRST USE 8-7-2006; IN COMMERCE 8-7-2006.

FOR: MULTILEVEL MARKETING BUSINESS SERVICES IN THE FIELDS OF HEALTH, BEAUTY AND NUTRITIONAL CARE; PHONE AND MAIL ORDER RETAIL SERVICES, CATALOG RETAIL SERVICES, AND E-COMMERCE RETAIL SERVI-

CES, ALL IN THE FIELD OF GENERAL MERCHANDISE, NAMELY, COSMETICS AND TOILETRIES, DOMESTIC WATER TREATMENT SYSTEMS; ONLINE ORDERING SERVICE VIA COMPUTER NETWORKS AND GLOBAL COMMUNICATION NETWORKS IN THE FIELDS OF GENERAL MERCHANDISE, NAMELY, COSMETICS AND TOILETRIES, DOMESTIC WATER TREATMENT SYSTEMS, HEALTH, BEAUTY AND NUTRITIONAL CARE ITEMS; ASSISTING OTHERS IN PLACING AND RUNNING ADVERTISEMENTS ON COMPUTER NETWORKS AND GLOBAL COMMUNICATION NETWORKS; AND BUSINESS INFORMATION SERVICES IN THE NATURE OF PROVIDING INFORMATION ON SMALL BUSINESSES AND SMALL BUSINESS OPPORTUNITIES VIA ONLINE ELECTRONIC COMPUTER NETWORKS, IN CLASS 35 (U.S. CLS. 100, 101 AND 102).

FIRST USE 8-7-2006; IN COMMERCE 8-7-2006.

THE MARK CONSISTS OF STANDARD CHARACTERS WITHOUT CLAIM TO ANY PARTICULAR FONT, STYLE, SIZE, OR COLOR.

SN 77-184,126, FILED 5-17-2007.

MIDGE BUTLER, EXAMINING ATTORNEY

**Int. Cl.: 25**

**Prior U.S. Cls.: 22 and 39**

**United States Patent and Trademark Office**

**Reg. No. 3,499,777**

**Registered Sep. 9, 2008**

**TRADEMARK  
PRINCIPAL REGISTER**

**TOUR sand, rough, water**

BLACKBURN, LEEANN (UNITED STATES INDIVIDUAL)  
505 E. WASHINGTON ST.  
MORRIS, IL 60450 AND  
BLACKBURN, MICHAEL J. (UNITED STATES INDIVIDUAL)  
505 E. WASHINGTON ST.  
MORRIS, IL 60450

FOR: BOTTOMS; CAPS; HATS; HEADWEAR;  
JACKETS; PANTS; SHIRTS; SHORTS; SKIRTS;  
SWEAT SHIRTS; T-SHIRTS; VESTS; VISORS, IN  
CLASS 25 (U.S. CLS. 22 AND 39).

FIRST USE 5-7-2008; IN COMMERCE 7-16-2008.

THE MARK CONSISTS OF STANDARD CHARACTERS WITHOUT CLAIM TO ANY PARTICULAR FONT, STYLE, SIZE, OR COLOR.

SN 77-184,164, FILED 5-17-2007.

ANDREA K. NADELMAN, EXAMINING ATTORNEY

**Int. Cl.: 29**

**Prior U.S. Cl.: 46**

**United States Patent and Trademark Office**

**Reg. No. 3,499,778**

**Registered Sep. 9, 2008**

**TRADEMARK  
PRINCIPAL REGISTER**

**YogLife**

NISHIMOTO TRADING CO., LTD. (CALIFORNIA  
CORPORATION)  
13409 ORDEN DRIVE  
SANTA FE SPRINGS, CA 90670

THE MARK CONSISTS OF STANDARD CHAR-  
ACTERS WITHOUT CLAIM TO ANY PARTICULAR  
FONT, STYLE, SIZE, OR COLOR.

FOR: YOGURT BASED BEVERAGE, IN CLASS 29  
(U.S. CL. 46).

SN 77-184,220, FILED 5-17-2007.

FIRST USE 5-8-2008; IN COMMERCE 5-8-2008.

RUDY R. SINGLETON, EXAMINING ATTORNEY

**Int. Cl.: 39**

**Prior U.S. Cls.: 100 and 105**

**United States Patent and Trademark Office**

**Reg. No. 3,499,779**

**Registered Sep. 9, 2008**

**SERVICE MARK  
PRINCIPAL REGISTER**

**WYNDHAM REWARDS**

WYNDHAM TM CORP. (DELAWARE CORPORATION)  
10750 WEST CHARLESTON BLVD., SUITE 130  
LAS VEGAS, NV 89135

FOR: TRAVEL AGENCY SERVICES, NAMELY, MAKING RESERVATIONS AND BOOKINGS FOR TRANSPORTATION, IN CLASS 39 (U.S. CLS. 100 AND 105).

FIRST USE 5-1-2008; IN COMMERCE 5-1-2008.

THE MARK CONSISTS OF STANDARD CHARACTERS WITHOUT CLAIM TO ANY PARTICULAR FONT, STYLE, SIZE, OR COLOR.

NO CLAIM IS MADE TO THE EXCLUSIVE RIGHT TO USE "REWARDS", APART FROM THE MARK AS SHOWN.

SN 77-184,839, FILED 5-18-2007.

JILL C. ALT, EXAMINING ATTORNEY

**Int. Cl.: 25**

**Prior U.S. Cls.: 22 and 39**

**United States Patent and Trademark Office**

**Reg. No. 3,499,780**

**Registered Sep. 9, 2008**

**TRADEMARK  
PRINCIPAL REGISTER**

**WOOT!**

WOOT, INC. (TEXAS CORPORATION)  
4121 INTERNATIONAL PARKWAY  
CARROLLTON, TX 75007

FOR: T-SHIRTS, IN CLASS 25 (U.S. CLS. 22 AND  
39).

FIRST USE 6-1-2007; IN COMMERCE 6-1-2007.

THE MARK CONSISTS OF STANDARD CHAR-  
ACTERS WITHOUT CLAIM TO ANY PARTICULAR  
FONT, STYLE, SIZE, OR COLOR.

OWNER OF U.S. REG. NO. 3,012,788.

SN 77-184,866, FILED 5-18-2007.

ANDREA K. NADELMAN, EXAMINING ATTOR-  
NEY

**Int. Cl.: 9**

**Prior U.S. Cls.: 21, 23, 26, 36, and 38**

**Reg. No. 3,499,781**

**United States Patent and Trademark Office**

**Registered Sep. 9, 2008**

**TRADEMARK  
PRINCIPAL REGISTER**

**G-RFID**

NUMEREX CORP. (PENNSYLVANIA CORPORATION)  
1600 PARKWOOD CIRCLE, 5TH FLOOR  
ATLANTA, GA 30339

FOR: SATELLITE TRACKING DEVICE, NAME-  
LY, COMPUTER HARDWARE AND SOFTWARE  
THAT ENABLES USERS TO LOCATE AND TRACK  
FIXED AND MOBILE ITEMS THROUGH THE USE  
OF SATELLITE COMMUNICATION SYSTEMS, IN  
CLASS 9 (U.S. CLS. 21, 23, 26, 36 AND 38).

FIRST USE 1-29-2008; IN COMMERCE 1-29-2008.

THE MARK CONSISTS OF STANDARD CHAR-  
ACTERS WITHOUT CLAIM TO ANY PARTICULAR  
FONT, STYLE, SIZE, OR COLOR.

SN 77-184,940, FILED 5-18-2007.

FRED MANDIR, EXAMINING ATTORNEY

**Int. Cl.: 20**

**Prior U.S. Cls.: 2, 13, 22, 25, 32, and 50**

**United States Patent and Trademark Office**

**Reg. No. 3,499,782**

**Registered Sep. 9, 2008**

**TRADEMARK  
PRINCIPAL REGISTER**

# Garborone

HOMER TLC, INC. (DELAWARE CORPORATION)  
1404 SOCIETY DRIVE  
CLAYMONT, DE 19703

THE MARK CONSISTS OF STANDARD CHARACTERS WITHOUT CLAIM TO ANY PARTICULAR FONT, STYLE, SIZE, OR COLOR.

FOR: LAWN FURNITURE; OUTDOOR FURNITURE, IN CLASS 20 (U.S. CLS. 2, 13, 22, 25, 32 AND 50).

SN 77-185,105, FILED 5-18-2007.

FIRST USE 7-30-2007; IN COMMERCE 7-30-2007.

VERNA BETH RIRIE, EXAMINING ATTORNEY



**Int. Cl.: 25**

**Prior U.S. Cls.: 22 and 39**

**United States Patent and Trademark Office**

**Reg. No. 3,499,783**

**Registered Sep. 9, 2008**

**TRADEMARK  
PRINCIPAL REGISTER**

**Color Me Balanced**

PUTTIN' ON THE BLISS LLC (ARIZONA LIMITED LIABILITY COMPANY)  
2842 N RALPH AVE  
TUCSON, AZ 85712

THE MARK CONSISTS OF STANDARD CHARACTERS WITHOUT CLAIM TO ANY PARTICULAR FONT, STYLE, SIZE, OR COLOR.

FOR: UNDERWEAR AND LINGERIE, IN CLASS 25 (U.S. CLS. 22 AND 39).

SN 77-185,188, FILED 5-18-2007.

FIRST USE 5-10-2008; IN COMMERCE 5-10-2008.

CHRISTINA SOBRAL, EXAMINING ATTORNEY

**Int. Cl.: 32**

**Prior U.S. Cls.: 45, 46, and 48**

**United States Patent and Trademark Office**

**Reg. No. 3,499,784**

**Registered Sep. 9, 2008**

**TRADEMARK  
PRINCIPAL REGISTER**

# Holy Mackerel

GORDASH BREWING COMPANY (FLORIDA  
CORPORATION)  
3804 SW 30 AVENUE  
FT. LAUDERDALE, FL 33312

THE MARK CONSISTS OF STANDARD CHAR-  
ACTERS WITHOUT CLAIM TO ANY PARTICULAR  
FONT, STYLE, SIZE, OR COLOR.

FOR: BEVERAGES, NAMELY BEERS AND ALES,  
IN CLASS 32 (U.S. CLS. 45, 46 AND 48).

SN 77-185,344, FILED 5-19-2007.

FIRST USE 7-24-2007; IN COMMERCE 7-24-2007.

ELIZABETH KAJUBI, EXAMINING ATTORNEY

**Int. Cl.: 25**

**Prior U.S. Cls.: 22 and 39**

**United States Patent and Trademark Office**

**Reg. No. 3,499,785**

**Registered Sep. 9, 2008**

**TRADEMARK  
PRINCIPAL REGISTER**

**ActiVHeat**

RICHMOND, SIMON N (AUSTRALIA INDIVIDUAL)  
47 GRASMERE WAY  
PRINCETON, NJ 08540

THE MARK CONSISTS OF STANDARD CHARACTERS WITHOUT CLAIM TO ANY PARTICULAR FONT, STYLE, SIZE, OR COLOR.

FOR: SLEEVED OR SLEEVELESS JACKETS;  
GLOVES, IN CLASS 25 (U.S. CLS. 22 AND 39).

SN 77-185,494, FILED 5-20-2007.

FIRST USE 8-1-2007; IN COMMERCE 8-1-2007.

SOPHIA S. KIM, EXAMINING ATTORNEY

**Int. Cl.: 3**

**Prior U.S. Cls.: 1, 4, 6, 50, 51, and 52**

**United States Patent and Trademark Office**

**Reg. No. 3,499,786**

**Registered Sep. 9, 2008**

**TRADEMARK  
PRINCIPAL REGISTER**

**AZZIS**

TUPPERWARE PRODUCTS S.A. (SWITZERLAND  
CORPORATION)  
ROUTE DU JURA 37  
FRIBOURG, SWITZERLAND CH-1700

FOR: PERFUMES; EAU DE COLOGNE; FRA-  
GRANCES FOR PERSONAL USE; DEODORANTS  
AND ANTIPERSPIRANTS FOR PERSONAL USE;  
TALCUM POWDER, IN CLASS 3 (U.S. CLS. 1, 4, 6, 50,  
51 AND 52).

FIRST USE 6-28-2008; IN COMMERCE 6-28-2008.

THE MARK CONSISTS OF STANDARD CHAR-  
ACTERS WITHOUT CLAIM TO ANY PARTICULAR  
FONT, STYLE, SIZE, OR COLOR.

SN 77-187,201, FILED 5-22-2007.

SETH A. RAPPAPORT, EXAMINING ATTORNEY

**Int. Cls.: 5, 29, and 30**

**Prior U.S. Cls.: 6, 18, 44, 46, 51, and 52**

**United States Patent and Trademark Office**

**Reg. No. 3,499,787**

**Registered Sep. 9, 2008**

**TRADEMARK  
PRINCIPAL REGISTER**



FORWARD FOODS LLC (DELAWARE LIMITED  
LIABILITY COMPANY)  
2542 BUSINESS PARKWAY, #2  
MINDEN, NV 89423

FOR: NUTRITIONAL ENERGY BARS FOR USE  
AS A MEAL SUBSTITUTE; VITAMIN AND MINER-  
AL FORMED AND PACKAGED AS BARS; AND  
MEAL REPLACEMENT BARS , IN CLASS 5 (U.S.  
CLS. 6, 18, 44, 46, 51 AND 52).

FIRST USE 6-21-2007; IN COMMERCE 6-21-2007.

FOR: PROTEIN BASED, NUTRIENT-DENSE  
SNACK BARS, IN CLASS 29 (U.S. CL. 46).

FIRST USE 6-21-2007; IN COMMERCE 6-21-2007.

FOR: CEREAL AND GRAIN BASED FOOD BARS,  
IN CLASS 30 (U.S. CL. 46).

FIRST USE 6-21-2007; IN COMMERCE 6-21-2007.

SN 77-187,701, FILED 5-22-2007.

APRIL ROACH, EXAMINING ATTORNEY

**Int. Cls.: 5, 29, and 30**

**Prior U.S. Cls.: 6, 18, 44, 46, 51, and 52**

**United States Patent and Trademark Office**

**Reg. No. 3,499,788**

**Registered Sep. 9, 2008**

**TRADEMARK  
PRINCIPAL REGISTER**



FORWARD FOODS LLC (DELAWARE LIMITED  
LIABILITY COMPANY)  
2542 BUSINESS PARKWAY, #2  
MINDEN, NV 89423

FOR: NUTRITIONAL ENERGY BARS FOR USE  
AS A MEAL SUBSTITUTE; VITAMIN AND MINER-  
AL FORMED AND PACKAGED AS BARS; AND  
MEAL REPLACEMENT BARS , IN CLASS 5 (U.S.  
CLS. 6, 18, 44, 46, 51 AND 52).

FIRST USE 6-21-2007; IN COMMERCE 6-21-2007.

FOR: PROTEIN BASED, NUTRIENT-DENSE  
SNACK BARS, IN CLASS 29 (U.S. CL. 46).

FIRST USE 6-21-2007; IN COMMERCE 6-21-2007.

FOR: CEREAL AND GRAIN BASED FOOD BARS,  
IN CLASS 30 (U.S. CL. 46).

FIRST USE 6-21-2007; IN COMMERCE 6-21-2007.

SN 77-187,705, FILED 5-22-2007.

APRIL ROACH, EXAMINING ATTORNEY

**Int. Cls.: 5 and 29**

**Prior U.S. Cls.: 6, 18, 44, 46, 51, and 52**

**Reg. No. 3,499,789**

**Registered Sep. 9, 2008**

**United States Patent and Trademark Office**

---

**TRADEMARK  
PRINCIPAL REGISTER**



FORWARD FOODS LLC (DELAWARE LIMITED  
LIABILITY COMPANY)  
2542 BUSINESS PARKWAY, #2  
MINDEN, NV 89423

FOR: PROTEIN BASED, NUTRIENT-DENSE  
SNACK BARS, IN CLASS 29 (U.S. CL. 46).

FOR: NUTRITIONAL ENERGY BARS FOR USE  
AS A MEAL SUBSTITUTE; VITAMIN AND MINER-  
AL FORMED AND PACKAGED AS BARS; AND  
MEAL REPLACEMENT BARS , IN CLASS 5 (U.S.  
CLS. 6, 18, 44, 46, 51 AND 52).

FIRST USE 6-21-2007; IN COMMERCE 6-21-2007.

SN 77-187,709, FILED 5-22-2007.

FIRST USE 6-21-2007; IN COMMERCE 6-21-2007.

APRIL ROACH, EXAMINING ATTORNEY

**Int. Cl.: 8**

**Prior U.S. Cls.: 23, 28, and 44**

**Reg. No. 3,499,790**

**United States Patent and Trademark Office**

**Registered Sep. 9, 2008**

**TRADEMARK  
PRINCIPAL REGISTER**

**IN-LINE**

CASWELL KNIVES (CALIFORNIA PARTNER-  
SHIP)  
173 S. VENTU PARK RD.  
NEWBURY PARK, CA 91320

THE MARK CONSISTS OF STANDARD CHAR-  
ACTERS WITHOUT CLAIM TO ANY PARTICULAR  
FONT, STYLE, SIZE, OR COLOR.

FOR: POCKET CLIPS SOLD AS AN INTEGRAL  
COMPONENT OF FOLDING POCKET KNIVES, IN  
CLASS 8 (U.S. CLS. 23, 28 AND 44).

SN 77-191,444, FILED 5-28-2007.

FIRST USE 6-7-2007; IN COMMERCE 6-7-2007.

DAVID YONTEF, EXAMINING ATTORNEY



**Int. Cl.: 35**

**Prior U.S. Cls.: 100, 101, and 102**

**United States Patent and Trademark Office**

**Reg. No. 3,499,791**

**Registered Sep. 9, 2008**

**SERVICE MARK  
PRINCIPAL REGISTER**

**WHERE TALENT LIVES**

INKTEL DIRECT CORPORATION (FLORIDA  
CORPORATION)  
13975 NW 58TH COURT  
MIAMI, FL 33014

THE MARK CONSISTS OF STANDARD CHAR-  
ACTERS WITHOUT CLAIM TO ANY PARTICULAR  
FONT, STYLE, SIZE, OR COLOR.

FOR: BUSINESS MARKETING SERVICES, IN  
CLASS 35 (U.S. CLS. 100, 101 AND 102).

SN 77-192,098, FILED 5-29-2007.

FIRST USE 8-1-2007; IN COMMERCE 8-1-2007.

JENNIFER HETU, EXAMINING ATTORNEY

**Int. Cl.: 9**

**Prior U.S. Cls.: 21, 23, 26, 36, and 38**

**Reg. No. 3,499,792**

**United States Patent and Trademark Office**

**Registered Sep. 9, 2008**

**TRADEMARK  
PRINCIPAL REGISTER**



BYRNE ELECTRICAL SPECIALISTS, INC. (MI-  
CHIGAN CORPORATION)  
320 BYRNE INDUSTRIAL DRIVE  
ROCKFORD, MI 49341

FOR: WIRING AND ELECTRICAL STRUCTUR-  
AL COMPONENTS, NAMELY, ELECTRICAL CON-  
NECTORS, CONDUCTIVE WIRING,  
RECEPTACLES, NAMELY, ELECTRICAL RESEP-  
TACLES, RACEWAYS, TERMINALS, NAMELY,  
ELECTRICAL TERMINALS, ELECTRICAL JUNC-  
TION APPARATUS, NAMELY, POWER AND DATA  
ASSEMBLIES AND ELECTRICAL RACEWAY AS-

SEMBLIES AND PLUGS ASSEMBLIES AND PLUGS,  
IN CLASS 9 (U.S. CLS. 21, 23, 26, 36 AND 38).

FIRST USE 6-0-2001; IN COMMERCE 6-0-2001.

OWNER OF U.S. REG. NO. 3,156,759.

THE MARK CONSISTS OF AN ELECTRICAL  
CORD.

SN 77-193,278, FILED 5-30-2007.

LANA PHAM, EXAMINING ATTORNEY

**Int. Cl.: 16**

**Prior U.S. Cls.: 2, 5, 22, 23, 29, 37, 38, and 50**

**Reg. No. 3,499,793**

**United States Patent and Trademark Office**

**Registered Sep. 9, 2008**

**TRADEMARK  
PRINCIPAL REGISTER**

**FIRST 30 DAYS**

THE FIRST 30 DAYS, INC. (DELAWARE CORPORATION)  
29 KING STREET APT 2H  
NEW YORK, NY 10014

FIRST USE 4-30-2008; IN COMMERCE 4-30-2008.

FOR: BOOKS IN THE FIELD OF DECISION MAKING METHODS AND TECHNIQUES FOR LIFE CHANGES AND TRANSITIONS; PUBLICATIONS, NAMELY, BROCHURES, BOOKLETS, AND TEACHING MATERIALS IN THE FIELD OF DECISION MAKING METHODS AND TECHNIQUES FOR LIFE CHANGES AND TRANSITIONS, IN CLASS 16 (U.S. CLS. 2, 5, 22, 23, 29, 37, 38 AND 50).

THE MARK CONSISTS OF STANDARD CHARACTERS WITHOUT CLAIM TO ANY PARTICULAR FONT, STYLE, SIZE, OR COLOR.

SN 77-193,990, FILED 5-31-2007.

ALICIA COLLINS, EXAMINING ATTORNEY

**Int. Cls.: 16 and 28**

**Prior U.S. Cls.: 2, 5, 22, 23, 29, 37, 38, and 50**

**United States Patent and Trademark Office**

**Reg. No. 3,499,794**

**Registered Sep. 9, 2008**

**TRADEMARK  
PRINCIPAL REGISTER**

**MAFATHER**

FLETCHER, MAYNARD J. (UNITED STATES  
INDIVIDUAL)  
217 WEST ABBOTTSFORD AVENUE  
PHILADELPHIA, PA 19144

FOR: GREETING CARDS, IN CLASS 16 (U.S. CLS.  
2, 5, 22, 23, 29, 37, 38 AND 50).

FIRST USE 6-0-2008; IN COMMERCE 6-0-2008.

FOR: BALLOONS , IN CLASS 28 (U.S. CLS. 22, 23,  
38 AND 50).

FIRST USE 6-0-2008; IN COMMERCE 6-0-2008.

THE MARK CONSISTS OF STANDARD CHAR-  
ACTERS WITHOUT CLAIM TO ANY PARTICULAR  
FONT, STYLE, SIZE, OR COLOR.

SN 77-194,403, FILED 5-31-2007.

JENNIFER HETU, EXAMINING ATTORNEY

**Int. Cls.: 16 and 28**

**Prior U.S. Cls.: 2, 5, 22, 23, 29, 37, 38, and 50**

**United States Patent and Trademark Office**

**Reg. No. 3,499,795**

**Registered Sep. 9, 2008**

**TRADEMARK  
PRINCIPAL REGISTER**

**MOFATHER**

FLETCHER, MAYNARD J. (UNITED STATES  
INDIVIDUAL)  
217 WEST ABBOTTSFORD AVENUE  
PHILADELPHIA, PA 19144

FOR: GREETING CARDS, IN CLASS 16 (U.S. CLS.  
2, 5, 22, 23, 29, 37, 38 AND 50).

FIRST USE 6-0-2008; IN COMMERCE 6-0-2008.

FOR: BALLOONS , IN CLASS 28 (U.S. CLS. 22, 23,  
38 AND 50).

FIRST USE 6-0-2008; IN COMMERCE 6-0-2008.

THE MARK CONSISTS OF STANDARD CHAR-  
ACTERS WITHOUT CLAIM TO ANY PARTICULAR  
FONT, STYLE, SIZE, OR COLOR.

SN 77-194,439, FILED 5-31-2007.

JENNIFER HETU, EXAMINING ATTORNEY

**Int. Cl.: 25**

**Prior U.S. Cls.: 22 and 39**

**United States Patent and Trademark Office**

**Reg. No. 3,499,796**

**Registered Sep. 9, 2008**

**TRADEMARK  
PRINCIPAL REGISTER**

**C9 BY CHAMPION**

HBI BRANDED APPAREL ENTERPRISES, LLC  
(DELAWARE LIMITED LIABILITY COMPA-  
NY)  
1000 EAST HANES MILL ROAD  
WINSTON-SALEM, NC 27105

FOR: HEADBANDS; WRISTBANDS, IN CLASS 25  
(U.S. CLS. 22 AND 39).

FIRST USE 5-11-2008; IN COMMERCE 5-11-2008.

THE MARK CONSISTS OF STANDARD CHAR-  
ACTERS WITHOUT CLAIM TO ANY PARTICULAR  
FONT, STYLE, SIZE, OR COLOR.

OWNER OF U.S. REG. NO. 3,174,791.

SN 77-195,208, FILED 6-1-2007.

JASON TURNER, EXAMINING ATTORNEY

**Int. Cl.: 36**

**Prior U.S. Cls.: 100, 101, and 102**

**United States Patent and Trademark Office**

**Reg. No. 3,499,797**

**Registered Sep. 9, 2008**

**SERVICE MARK  
PRINCIPAL REGISTER**

**WELDING DISTRIBUTORPRO**

AMWINS GROUP, INC. (DELAWARE CORPORATION)  
SUITE 600  
4725 PIEDMONT ROW DRIVE  
CHARLOTTE, NC 28210

FOR: INSURANCE SERVICES, NAMELY, THE BROKERAGE, UNDERWRITING, ISSUANCE AND ADMINISTRATION OF PROPERTY, CASUALTY, PROFESSIONAL LIABILITY AND GENERAL LIABILITY INSURANCE FOR WELDING SUPPLY DISTRIBUTORS, IN CLASS 36 (U.S. CLS. 100, 101 AND 102).

FIRST USE 4-24-2007; IN COMMERCE 4-24-2007.

THE MARK CONSISTS OF STANDARD CHARACTERS WITHOUT CLAIM TO ANY PARTICULAR FONT, STYLE, SIZE, OR COLOR.

NO CLAIM IS MADE TO THE EXCLUSIVE RIGHT TO USE "WELDING", APART FROM THE MARK AS SHOWN.

SN 77-195,381, FILED 6-1-2007.

DAVID TOOLEY, EXAMINING ATTORNEY

**Int. Cl.: 45**

**Prior U.S. Cls.: 100 and 101**

**United States Patent and Trademark Office**

**Reg. No. 3,499,798**

**Registered Sep. 9, 2008**

**SERVICE MARK  
PRINCIPAL REGISTER**

**HIS LOVE IS HERE FOR YOU**

THE LUTHERAN CHURCH-MISSOURI SYNOD  
(MISSOURI NON-PROFIT CORPORATION)  
1333 S. KIRKWOOD ROAD  
ST. LOUIS, MO 63122

FOR: RELIGIOUS SERVICES, NAMELY, MIS-  
SIONARY, EVANGELISTIC AND MINISTERIAL  
SERVICES, IN CLASS 45 (U.S. CLS. 100 AND 101).

FIRST USE 3-27-2007; IN COMMERCE 3-27-2007.

THE MARK CONSISTS OF STANDARD CHAR-  
ACTERS WITHOUT CLAIM TO ANY PARTICULAR  
FONT, STYLE, SIZE, OR COLOR.

SN 77-195,499, FILED 6-1-2007.

LYDIA BELZER, EXAMINING ATTORNEY



**Int. Cl.: 3**

**Prior U.S. Cls.: 1, 4, 6, 50, 51, and 52**

**Reg. No. 3,499,799**

**United States Patent and Trademark Office**

**Registered Sep. 9, 2008**

**TRADEMARK  
PRINCIPAL REGISTER**

**AWAKE POLYPHECTION**

KOSE CORPORATION (JAPAN CORPORATION)  
6-2, NIHONBASHI 3-CHOME, CHUO-KU  
TOKYO, JAPAN

THE MARK CONSISTS OF STANDARD CHAR-  
ACTERS WITHOUT CLAIM TO ANY PARTICULAR  
FONT, STYLE, SIZE, OR COLOR.

FOR: COSMETICS, PERFUMES, COSMETIC  
SOAPS, COTTON FOR COSMETIC USE AND HAIR  
CARE PREPARATIONS, IN CLASS 3 (U.S. CLS. 1, 4, 6,  
50, 51 AND 52).

SN 77-195,930, FILED 6-1-2007.

FIRST USE 10-30-2007; IN COMMERCE 10-30-2007.

REBECCA GILBERT, EXAMINING ATTORNEY

**Int. Cl.: 30**

**Prior U.S. Cl.: 46**

**United States Patent and Trademark Office**

**Reg. No. 3,499,800**

**Registered Sep. 9, 2008**

**TRADEMARK  
PRINCIPAL REGISTER**

**DESPERATELY SEEKING  
CHOCOLATE**

D.S. CHOCOLATE, INC. (CALIFORNIA CORPORATION)  
BOX 426  
11600 CLEAR CREEK RD.  
BROOKDALE, CA 95007

FOR: SAUCES, NAMELY, SAUCES FOR USE AS  
DESSERT CONDIMENTS, IN CLASS 30 (U.S. CL. 46).

FIRST USE 7-6-2006; IN COMMERCE 10-15-2006.

THE MARK CONSISTS OF STANDARD CHARACTERS WITHOUT CLAIM TO ANY PARTICULAR FONT, STYLE, SIZE, OR COLOR.

NO CLAIM IS MADE TO THE EXCLUSIVE RIGHT TO USE "CHOCOLATE", APART FROM THE MARK AS SHOWN.

SN 77-196,041, FILED 6-1-2007.

ALEX KEAM, EXAMINING ATTORNEY

**Int. Cls.: 9 and 41**

**Prior U.S. Cls.: 21, 23, 26, 36, 38, 100, 101, and 107**

**United States Patent and Trademark Office**

**Reg. No. 3,499,801**

**Registered Sep. 9, 2008**

**TRADEMARK  
SERVICE MARK  
PRINCIPAL REGISTER**

## Wetsand Publications

WETSAND PUBLICATIONS, LLC (NEW HAMPSHIRE LIMITED LIABILITY COMPANY)  
21A MONT VERNON ROAD  
NEW BOSTON, NH 03070

FOR: SOUND RECORDINGS FEATURING MUSIC; VIDEO RECORDINGS FEATURING MUSIC; VISUAL RECORDINGS AND AUDIO VISUAL RECORDINGS FEATURING MUSIC AND ANIMATION, IN CLASS 9 (U.S. CLS. 21, 23, 26, 36 AND 38).

FIRST USE 8-9-2007; IN COMMERCE 8-9-2007.

FOR: ENTERTAINMENT IN THE NATURE OF VISUAL AND AUDIO PERFORMANCES, AND MUSICAL, VARIETY, NEWS AND COMEDY SHOWS; ENTERTAINMENT IN THE NATURE OF VISUAL AND AUDIO PERFORMANCES, NAMELY, MUSICAL BAND, ROCK GROUP, GYMNASTIC, DANCE, AND BALLET PERFORMANCES; ENTERTAINMENT, NAMELY, LIVE PERFORMANCES BY A MUSICAL BAND; ENTERTAINMENT SERVICES, NAMELY, NON-DOWNLOADABLE RINGTONES, PRE-RECORDED MUSIC, VIDEO AND GRAPHICS PRESENTED TO MOBILE COMMUNICATIONS DEVICES VIA A GLOBAL COMPUTER NETWORK AND WIRELESS NETWORKS; ENTERTAINMENT SERVICES, NAMELY, PROVIDING A WEB SITE FEATURING MUSICAL PERFORMANCES, MUSI-

CAL VIDEOS, RELATED FILM CLIPS, PHOTOGRAPHS, AND OTHER MULTIMEDIA MATERIALS; ENTERTAINMENT SERVICES, NAMELY, PROVIDING PRERECORDED MUSIC, INFORMATION IN THE FIELD OF MUSIC, AND COMMENTARY AND ARTICLES ABOUT MUSIC, ALL ON-LINE VIA A GLOBAL COMPUTER NETWORK; ENTERTAINMENT, NAMELY, LIVE MUSIC CONCERTS; ENTERTAINMENT, NAMELY, LIVE PERFORMANCES BY MUSICAL BANDS; MUSIC PRODUCTION SERVICES; MUSIC PUBLISHING SERVICES; MUSIC SELECTION SERVICES FOR USE IN TV, FILM, RADIO AND VIDEO GAMES, IN CLASS 41 (U.S. CLS. 100, 101 AND 107).

FIRST USE 8-9-2007; IN COMMERCE 8-9-2007.

THE MARK CONSISTS OF STANDARD CHARACTERS WITHOUT CLAIM TO ANY PARTICULAR FONT, STYLE, SIZE, OR COLOR.

NO CLAIM IS MADE TO THE EXCLUSIVE RIGHT TO USE "PUBLICATIONS", APART FROM THE MARK AS SHOWN.

SN 77-196,821, FILED 6-4-2007.

JIM RINGLE, EXAMINING ATTORNEY

**Int. Cl.: 39**

**Prior U.S. Cls.: 100 and 105**

**United States Patent and Trademark Office**

**Reg. No. 3,499,802**

**Registered Sep. 9, 2008**

**SERVICE MARK  
PRINCIPAL REGISTER**

**LOCAL FOR A DAY**

NAGASAKO ENTERPRISES LLC (HAWAII LIMITED LIABILITY COMPANY)  
1360 HIAHIA STREET  
WAILUKU, HI 96793

THE MARK CONSISTS OF STANDARD CHARACTERS WITHOUT CLAIM TO ANY PARTICULAR FONT, STYLE, SIZE, OR COLOR.

FOR: ORGANIZATION, BOOKING AND ARRANGEMENT OF EXCURSIONS, DAY TRIPS AND SIGHTSEEING TOURS, IN CLASS 39 (U.S. CLS. 100 AND 105).

SN 77-196,949, FILED 6-4-2007.

FIRST USE 11-4-2004; IN COMMERCE 8-16-2006.

CHRISTINE COOPER, EXAMINING ATTORNEY

**Int. Cl.: 41**

**Prior U.S. Cls.: 100, 101, and 107**

**United States Patent and Trademark Office**

**Reg. No. 3,499,803**

**Registered Sep. 9, 2008**

**SERVICE MARK  
PRINCIPAL REGISTER**

**ART IN HAND**

ART IN HAND (VIRGINIA SOLE PROPRIETORSHIP)  
2655 CONQUEST PLACE  
HERNDON, VA 20171

FOR: EDUCATIONAL SERVICES, NAMELY, PROVIDING PROGRAMS IN THE FIELD OF ART; EDUCATIONAL SERVICES, NAMELY, PROVIDING CLASSES IN THE FIELD OF ART; EDUCATIONAL SERVICES, NAMELY, PROVIDING SEMINARS IN THE FIELD OF ART EDUCATION; EDUCATIONAL SERVICES, NAMELY, PROVIDING WORKSHOPS IN THE FIELD OF ART EDUCATION, IN CLASS 41 (U.S. CLS. 100, 101 AND 107).

FIRST USE 3-3-2007; IN COMMERCE 1-25-2008.

THE MARK CONSISTS OF STANDARD CHARACTERS WITHOUT CLAIM TO ANY PARTICULAR FONT, STYLE, SIZE, OR COLOR.

NO CLAIM IS MADE TO THE EXCLUSIVE RIGHT TO USE "ART", APART FROM THE MARK AS SHOWN.

SN 77-197,381, FILED 6-4-2007.

SANI KHOURI, EXAMINING ATTORNEY

**Int. Cl.: 9**

**Prior U.S. Cls.: 21, 23, 26, 36, and 38**

**Reg. No. 3,499,804**

**United States Patent and Trademark Office**

**Registered Sep. 9, 2008**

**TRADEMARK  
PRINCIPAL REGISTER**

**TARGET100**

DOUGLAS, JOEL STERLING (UNITED STATES  
INDIVIDUAL)  
66 NEPTUNE DRIVE  
GROTON, CT 06340

THE MARK CONSISTS OF STANDARD CHAR-  
ACTERS WITHOUT CLAIM TO ANY PARTICULAR  
FONT, STYLE, SIZE, OR COLOR.

FOR: COMPUTER SOFTWARE FOR USE IN THE  
HEALTHCARE INDUSTRY FOR USE TO CALCU-  
LATE DRUG DOSAGE FOR PATIENTS, IN CLASS 9  
(U.S. CLS. 21, 23, 26, 36 AND 38).

SN 77-197,396, FILED 6-4-2007.

FIRST USE 7-3-2007; IN COMMERCE 7-3-2007.

JEAN IM, EXAMINING ATTORNEY

**Int. Cl.: 18**

**Prior U.S. Cls.: 1, 2, 3, 22, and 41**

**Reg. No. 3,499,805**

**United States Patent and Trademark Office**

**Registered Sep. 9, 2008**

---

**TRADEMARK  
PRINCIPAL REGISTER**

**FITS YOU. FITS BABY. FITS  
LIFE.**

INFANTINO, LLC (CALIFORNIA LIMITED LIABILITY COMPANY)  
SUITE 200  
4920 CARROLL CANYON ROAD  
SAN DIEGO, CA 92121

THE MARK CONSISTS OF STANDARD CHARACTERS WITHOUT CLAIM TO ANY PARTICULAR FONT, STYLE, SIZE, OR COLOR.

FOR: INFANT CARRIERS WORN ON THE BODY,  
IN CLASS 18 (U.S. CLS. 1, 2, 3, 22 AND 41).

SN 77-198,382, FILED 6-5-2007.

FIRST USE 4-30-2007; IN COMMERCE 1-31-2008.

DAVID YONTEF, EXAMINING ATTORNEY

Int. Cl.: 18

Prior U.S. Cls.: 1, 2, 3, 22, and 41

United States Patent and Trademark Office

Reg. No. 3,499,806

Registered Sep. 9, 2008

TRADEMARK  
PRINCIPAL REGISTER

densimilan

登喜米兰

U.S.A DENSIMILAN INTERNATIONAL GROUP  
LEATHER LIMITED (HONG KONG LIMITED  
LIABILITY COMPANY)  
RM 1302, 13 FLOOR, CRE BUILDING  
303 HENNESSY ROAD  
WANCHAI, HONG KONG

FOR: LEATHER AND IMITATION LEATHER;  
LEATHER PURSES; LEATHER CASES; LEATHER  
STRAPS; FUR; TRAVELLING CASES OF LEATHER;  
TRAVEL BAGS; UMBRELLAS; WHIPS; ANIMAL  
SKINS, IN CLASS 18 (U.S. CLS. 1, 2, 3, 22 AND 41).

FIRST USE 11-4-2004; IN COMMERCE 3-10-2008.

THE NON-LATIN CHARACTERS IN THE MARK  
TRANSLITERATE TO "DENG; XI; MI"; "LAN" AND  
THIS MEANS "MOUNT"; "HAPPY"; "RICE"; "ORCH-  
ID" IN ENGLISH.

SN 77-198,619, FILED 6-5-2007.

ALICIA COLLINS, EXAMINING ATTORNEY



**Int. Cl.: 19**

**Prior U.S. Cls.: 1, 12, 33, and 50**

**United States Patent and Trademark Office**

**Reg. No. 3,499,807**

**Registered Sep. 9, 2008**

**TRADEMARK  
PRINCIPAL REGISTER**

**GARDEN GLITTER**

BIRD BRAIN, INC. (MICHIGAN CORPORATION)  
52 EAST CROSS STREET  
YPSILANTI, MI 48195

FOR: GLOW-IN-THE-DARK ROCKS FOR LAND-  
SCAPING, IN CLASS 19 (U.S. CLS. 1, 12, 33 AND 50).

FIRST USE 7-31-2007; IN COMMERCE 7-31-2007.

THE MARK CONSISTS OF STANDARD CHAR-  
ACTERS WITHOUT CLAIM TO ANY PARTICULAR  
FONT, STYLE, SIZE, OR COLOR.

NO CLAIM IS MADE TO THE EXCLUSIVE  
RIGHT TO USE "GARDEN", APART FROM THE  
MARK AS SHOWN.

SN 77-198,851, FILED 6-6-2007.

PATRICIA EVANKO, EXAMINING ATTORNEY

**Int. Cls.: 16 and 35**

**Prior U.S. Cls.: 2, 5, 22, 23, 29, 37, 38, 50, 100, 101, and 102**

**United States Patent and Trademark Office**

**Reg. No. 3,499,808**

**Registered Sep. 9, 2008**

**TRADEMARK  
SERVICE MARK  
PRINCIPAL REGISTER**

**GET TO IT.**

IDEARC MEDIA CORP. (DELAWARE CORPORATION)  
2200 W. AIRFIELD DRIVE  
DFW AIRPORT, TX 752619810

FOR: PRINTED PUBLICATIONS, NAMELY, TELEPHONE DIRECTORIES, IN CLASS 16 (U.S. CLS. 2, 5, 22, 23, 29, 37, 38 AND 50).

FIRST USE 6-23-2008; IN COMMERCE 6-23-2008.

FOR: ELECTRONIC TELEPHONE DIRECTORY SERVICES, NAMELY, ONLINE TELEPHONE DIRECTORY INFORMATION; ADVERTISING SERVICES, NAMELY, PROMOTING THE GOODS AND

SERVICES OF OTHERS BY MEANS OF TELEPHONE DIRECTORIES; DISSEMINATION OF ADVERTISING FOR OTHERS VIA THE INTERNET, IN CLASS 35 (U.S. CLS. 100, 101 AND 102).

FIRST USE 12-0-2006; IN COMMERCE 12-0-2006.

THE MARK CONSISTS OF STANDARD CHARACTERS WITHOUT CLAIM TO ANY PARTICULAR FONT, STYLE, SIZE, OR COLOR.

SN 77-198,858, FILED 6-6-2007.

DAYNA BROWNE, EXAMINING ATTORNEY

**Int. Cl.: 35**

**Prior U.S. Cls.: 100, 101, and 102**

**United States Patent and Trademark Office**

**Reg. No. 3,499,809**

**Registered Sep. 9, 2008**

**SERVICE MARK  
PRINCIPAL REGISTER**

**CLEARPOINTT**

CLEARPOINTT LOGISTICS, LLC (WASHINGTON  
LIMITED LIABILITY COMPANY)  
808 134TH STREET, SW, SUITE 209  
EVERETT, WA 98204

THE MARK CONSISTS OF STANDARD CHAR-  
ACTERS WITHOUT CLAIM TO ANY PARTICULAR  
FONT, STYLE, SIZE, OR COLOR.

FOR: TRANSPORTATION LOGISTICS SERVICES,  
NAMELY, ARRANGING THE TRANSPORTATION  
OF GOODS FOR OTHERS, IN CLASS 35 (U.S. CLS.  
100, 101 AND 102).

SN 77-199,019, FILED 6-6-2007.

FIRST USE 10-15-2007; IN COMMERCE 10-22-2007.

WANDA KAY PRICE, EXAMINING ATTORNEY

**Int. Cl.: 4**

**Prior U.S. Cls.: 1, 6, and 15**

**United States Patent and Trademark Office**

**Reg. No. 3,499,810**

**Registered Sep. 9, 2008**

**TRADEMARK  
PRINCIPAL REGISTER**

**CLOUDBURST**

THE KROGER CO. OF MICHIGAN (MICHIGAN  
CORPORATION)  
18334 LAUREL PARK DRIVE NORTH  
LIVONIA, MI 481522686

THE MARK CONSISTS OF STANDARD CHAR-  
ACTERS WITHOUT CLAIM TO ANY PARTICULAR  
FONT, STYLE, SIZE, OR COLOR.

FOR: SCENTED CANDLES, IN CLASS 4 (U.S. CLS.  
1, 6 AND 15).

SN 77-199,147, FILED 6-6-2007.

FIRST USE 9-14-2007; IN COMMERCE 9-14-2007.

CHERYL CLAYTON, EXAMINING ATTORNEY

**Int. Cl.: 12**

**Prior U.S. Cls.: 19, 21, 23, 31, 35, and 44**

**Reg. No. 3,499,811**

**United States Patent and Trademark Office**

**Registered Sep. 9, 2008**

**TRADEMARK  
PRINCIPAL REGISTER**

**RADAR**

OMNI UNITED (S) PTE LTD. (SINGAPORE CORPORATION)  
5 SHENTON WAY, #28-03 UIC BUILDING  
SINGAPORE, SINGAPORE 068808

THE MARK CONSISTS OF STANDARD CHARACTERS WITHOUT CLAIM TO ANY PARTICULAR FONT, STYLE, SIZE, OR COLOR.

FOR: TRUCK AND BUS RADIAL TIRES AND INNER TUBES; LIGHT TRUCK RADIAL TIRES AND INNER TUBES; PASSENGER CAR RADIAL TIRES AND INNER TUBES; OFF-ROAD RADIAL TIRES AND INNER TUBES, IN CLASS 12 (U.S. CLS. 19, 21, 23, 31, 35 AND 44).

OWNER OF U.S. REG. NO. 3,055,006.

SN 77-199,559, FILED 6-6-2007.

FIRST USE 7-17-2008; IN COMMERCE 7-17-2008.

WILLIAM VERHOSEK, EXAMINING ATTORNEY

**Int. Cl.: 7**

**Prior U.S. Cls.: 13, 19, 21, 23, 31, 34, and 35**

**United States Patent and Trademark Office**

**Reg. No. 3,499,812**

**Registered Sep. 9, 2008**

**TRADEMARK  
PRINCIPAL REGISTER**

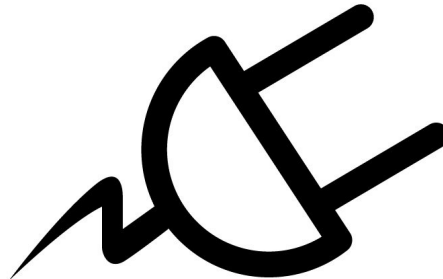

THE BLACK & DECKER CORPORATION  
(MARYLAND CORPORATION)  
TW199  
701 E. JOPPA ROAD  
TOWSON, MD 21286

FIRST USE 9-30-2007; IN COMMERCE 9-30-2007.

THE MARK CONSISTS OF ELECTRICAL PLUG  
WITH NO CLAIM TO COLOR.

FOR: DIRECT PLUG IN RECHARGEABLE POW-  
ER TOOLS, NAMELY, SCREWDRIVERS, IN CLASS  
7 (U.S. CLS. 13, 19, 21, 23, 31, 34 AND 35).

SN 77-199,961, FILED 6-7-2007.

ASMAT KHAN, EXAMINING ATTORNEY

**Int. Cl.: 25**

**Prior U.S. Cls.: 22 and 39**

**United States Patent and Trademark Office**

**Reg. No. 3,499,813**

**Registered Sep. 9, 2008**

**TRADEMARK  
PRINCIPAL REGISTER**



**HATS**

PARIS ACCESSORIES, INC. (NEW YORK CORPORATION)  
350 FIFTH AVENUE, 70TH FLOOR  
NEW YORK, NY 10018

FOR: ACCESSORIES, NAMELY, HATS, IN CLASS  
25 (U.S. CLS. 22 AND 39).

FIRST USE 7-9-2008; IN COMMERCE 7-9-2008.

NO CLAIM IS MADE TO THE EXCLUSIVE  
RIGHT TO USE "HATS", APART FROM THE MARK  
AS SHOWN.

SN 77-200,055, FILED 6-7-2007.

KATHERINE M. DUBRAY, EXAMINING ATTORNEY

**Int. Cl.: 25**

**Prior U.S. Cls.: 22 and 39**

**United States Patent and Trademark Office**

**Reg. No. 3,499,814**

**Registered Sep. 9, 2008**

**TRADEMARK  
PRINCIPAL REGISTER**



**GLOVES**

PARIS ACCESSORIES, INC. (NEW YORK CORPORATION)  
350 FIFTH AVENUE, 70TH FLOOR  
NEW YORK, NY 10018

FOR: WOMEN, MEN AND CHILDREN'S  
GLOVES, IN CLASS 25 (U.S. CLS. 22 AND 39).

FIRST USE 7-9-2008; IN COMMERCE 7-9-2008.

NO CLAIM IS MADE TO THE EXCLUSIVE  
RIGHT TO USE "GLOVES", APART FROM THE  
MARK AS SHOWN.

SN 77-200,319, FILED 6-7-2007.

KATHERINE M. DUBRAY, EXAMINING ATTORNEY



**Int. Cl.: 28**

**Prior U.S. Cls.: 22, 23, 38, and 50**

**United States Patent and Trademark Office**

**Reg. No. 3,499,815**

**Registered Sep. 9, 2008**

**TRADEMARK  
PRINCIPAL REGISTER**



JAKKS PACIFIC, INC. (DELAWARE CORPORATION)  
22619 PACIFIC COAST HIGHWAY  
MALIBU, CA 90265

FOR: TOYS GAMES AND PLAYTHINGS, NAME-  
LY, TOY VEHICLES AND PLAY SETS AND ACCES-  
SORIES THEREFOR, IN CLASS 28 (U.S. CLS. 22, 23,  
38 AND 50).

FIRST USE 6-29-2007; IN COMMERCE 6-29-2007.

OWNER OF U.S. REG. NO. 2,544,678.

NO CLAIM IS MADE TO THE EXCLUSIVE  
RIGHT TO USE "RACERS", APART FROM THE  
MARK AS SHOWN.

THE COLOR(S) RED, WHITE, BLACK, GRAY  
AND YELLOW IS/ARE CLAIMED AS A FEATURE  
OF THE MARK.

THE MARK CONSISTS OF THE WORDS "SHOCK  
RACERS" SUPERIMPOSED ON A ROUND OBJECT  
THAT IS PARTIALLY SURROUNDED BY A COIL.  
THE WORD "SHOCK" IS A COMBINATION OF  
SHADED WHITE AND GRAY OUTLINED WITH  
THE COLORS BLACK, GRAY AND YELLOW. THE  
TERM "RACERS" APPEARS IN THE COLOR WHITE  
WITH BLACK OUTLINING. THE COIL IS RED. THE  
ROUND OBJECT IS BLACK, GRAY, AND WHITE.

SN 77-200,941, FILED 6-7-2007.

KAREN BRACEY, EXAMINING ATTORNEY

**Int. Cls.: 11 and 32**

**Prior U.S. Cls.: 13, 21, 23, 31, 34, 45, 46, and 48**

**United States Patent and Trademark Office**

**Reg. No. 3,499,816**

**Registered Sep. 9, 2008**

**TRADEMARK  
PRINCIPAL REGISTER**

**CHRYSALIS**

SCHMIDT, JOSEPH (UNITED STATES INDIVIDUAL)  
715 W. EDNA PLACE  
COVINA, CA 91722

FOR: WATER PURIFICATION UNITS AND COMPONENTS THEREFOR, IN CLASS 11 (U.S. CLS. 13, 21, 23, 31 AND 34).

FIRST USE 6-30-2008; IN COMMERCE 7-15-2008.

FOR: BOTTLED WATER, DRINKING WATER, PURIFIED WATER, SPRING WATER, MINERAL

WATER, DISTILLED DRINKING WATER, IN CLASS 32 (U.S. CLS. 45, 46 AND 48).

FIRST USE 6-21-2007; IN COMMERCE 11-9-2007.

THE MARK CONSISTS OF STANDARD CHARACTERS WITHOUT CLAIM TO ANY PARTICULAR FONT, STYLE, SIZE, OR COLOR.

SN 77-203,375, FILED 6-11-2007.

ANN E. SAPPENFIELD, EXAMINING ATTORNEY

**Int. Cls.: 11 and 32**

**Prior U.S. Cls.: 13, 21, 23, 31, 34, 45, 46, and 48**

**United States Patent and Trademark Office**

**Reg. No. 3,499,817**

**Registered Sep. 9, 2008**

**TRADEMARK  
PRINCIPAL REGISTER**



JOSEPH SCHMIDT (UNITED STATES INDIVIDUAL)  
715 W. EDNA PLACE  
COVINA, CA 91722

FOR: WATER PURIFICATION UNITS AND COMPONENTS THEREFOR, IN CLASS 11 (U.S. CLS. 13, 21, 23, 31 AND 34).

FIRST USE 6-30-2008; IN COMMERCE 7-15-2008.

FOR: BOTTLED WATER, DRINKING WATER, PURIFIED WATER, SPRING WATER, MINERAL

WATER, DISTILLED DRINKING WATER, IN CLASS 32 (U.S. CLS. 45, 46 AND 48).

FIRST USE 6-21-2007; IN COMMERCE 11-9-2007.

THE MARK CONSISTS OF THE WORD "CHRY-SALIS" WITH A BUTTERFLY RESTING ON THE LETTER "C".

SN 77-203,376, FILED 6-11-2007.

ANN E. SAPPENFIELD, EXAMINING ATTORNEY

**Int. Cl.: 30**

**Prior U.S. Cl.: 46**

**United States Patent and Trademark Office**

**Reg. No. 3,499,818**

**Registered Sep. 9, 2008**

**TRADEMARK  
PRINCIPAL REGISTER**

**PINTACORAZONES**

PRODUCTOS MILKEN DE MEXICO S.A. DE C.V.  
(MEXICO CORPORATION)  
KM 1 CARRETERA A BUENAVISTA S/N  
TLAJOMULCO DE ZUÑIGA, MEXICO

FOR: CANDY, COCOA, TAPIOCA, CARMELLS,  
FROZEN CONFECTIONS, SUGAR, HONEY, PRE-  
PARATIONS MADE OF CEREALS AND FLOUR,  
NAMELY, COOKIES, CAKES, BREAD AND ROLLS,  
AND CHOCOLATE, IN CLASS 30 (U.S. CL. 46).

FIRST USE 4-4-2008; IN COMMERCE 4-4-2008.

THE MARK CONSISTS OF STANDARD CHAR-  
ACTERS WITHOUT CLAIM TO ANY PARTICULAR  
FONT, STYLE, SIZE, OR COLOR.

THE FOREIGN WORDING IN THE MARK  
TRANSLATES INTO ENGLISH AS HEART PAIN-  
TER.

SN 77-203,457, FILED 6-11-2007.

PAUL F. GAST, EXAMINING ATTORNEY

Int. Cl.: 25

Prior U.S. Cls.: 22 and 39

United States Patent and Trademark Office

Reg. No. 3,499,819

Registered Sep. 9, 2008

TRADEMARK  
PRINCIPAL REGISTER



WALKER, DOUGLAS K (UNITED STATES INDIVIDUAL)  
3940 LAUREL CANYON BLVD. SUITE 1193  
STUDIO CITY, CA 91604

FOR: WEARING APPAREL, NAMELY, T-SHIRTS, SHIRTS, SHORTS, PANTS, SWEATSHIRTS, SWEAT-PANTS, SWEATERS, JACKETS, PAJAMAS, HATS,

BEANIES, VISORS, SOCKS, SHOES, SANDALS AND BELTS, IN CLASS 25 (U.S. CLS. 22 AND 39).

FIRST USE 3-1-2008; IN COMMERCE 3-1-2008.

SN 77-203,800, FILED 6-12-2007.

WANDA KAY PRICE, EXAMINING ATTORNEY

**Int. Cl.: 25**

**Prior U.S. Cls.: 22 and 39**

**United States Patent and Trademark Office**

**Reg. No. 3,499,820**

**Registered Sep. 9, 2008**

**TRADEMARK  
PRINCIPAL REGISTER**

**MARCH FOR BABIES**

MARCH OF DIMES FOUNDATION (NEW YORK  
NOT-FOR-PROFIT CORPORATION)  
1275 MAMARONECK AVENUE  
WHITE PLAINS, NY 10605

THE MARK CONSISTS OF STANDARD CHAR-  
ACTERS WITHOUT CLAIM TO ANY PARTICULAR  
FONT, STYLE, SIZE, OR COLOR.

FOR: SHIRTS; SWEAT SHIRTS; T-SHIRTS; HATS,  
IN CLASS 25 (U.S. CLS. 22 AND 39).

SN 77-204,837, FILED 6-13-2007.

FIRST USE 1-16-2008; IN COMMERCE 1-16-2008.

BONNIE LUKEN, EXAMINING ATTORNEY

**Int. Cls.: 21 and 25**

**Prior U.S. Cls.: 2, 13, 22, 23, 29, 30, 33, 39, 40, and 50**

**United States Patent and Trademark Office**

**Reg. No. 3,499,821**

**Registered Sep. 9, 2008**

**TRADEMARK  
PRINCIPAL REGISTER**

**OHMYGOV!**

KILIMEDIA LLC (DELAWARE LIMITED LIABILITY COMPANY)  
6327 FRANCONIA COMMONS DRIVE  
ALEXANDRIA, VA 22310

FOR: INSULATED COFFEE AND BEVERAGE CUPS, COFFEE CUPS, TEA CUPS AND MUGS, IN CLASS 21 (U.S. CLS. 2, 13, 23, 29, 30, 33, 40 AND 50).

FIRST USE 10-15-2007; IN COMMERCE 10-15-2007.

FOR: CLOTHING, NAMELY, SHIRTS, TEE-SHIRTS, SWEATSHIRTS, SWEATPANTS, SHORTS AND HATS, IN CLASS 25 (U.S. CLS. 22 AND 39).

FIRST USE 10-15-2007; IN COMMERCE 10-15-2007.

THE MARK CONSISTS OF STANDARD CHARACTERS WITHOUT CLAIM TO ANY PARTICULAR FONT, STYLE, SIZE, OR COLOR.

SN 77-205,223, FILED 6-13-2007.

MARTHA SANTOMARTINO, EXAMINING ATTORNEY

**Int. Cl.: 9**

**Prior U.S. Cls.: 21, 23, 26, 36, and 38**

**Reg. No. 3,499,822**

**United States Patent and Trademark Office**

**Registered Sep. 9, 2008**

---

**TRADEMARK  
PRINCIPAL REGISTER**

**GAM PLUS+**

GREAT AMERICAN MARKETING, INC. (CALI-  
FORNIA CORPORATION)  
29145 THE OLD ROAD  
VALENCIA, CA 91355

FOR: INDUSTRIAL DISPOSABLE PRODUCTS,  
NAMELY, PROTECTIVE LATEX, VINYL, NITRILE  
AND POLYETHYLENE GLOVES AND DUST  
MASKS FOR INDUSTRIAL USE, IN CLASS 9 (U.S.  
CLS. 21, 23, 26, 36 AND 38).

FIRST USE 10-31-2007; IN COMMERCE 10-31-2007.

THE MARK CONSISTS OF STANDARD CHAR-  
ACTERS WITHOUT CLAIM TO ANY PARTICULAR  
FONT, STYLE, SIZE, OR COLOR.

SN 77-206,112, FILED 6-14-2007.

TINA BROWN, EXAMINING ATTORNEY



**Int. Cls.: 30 and 43**

**Prior U.S. Cls.: 46, 100, and 101**

**United States Patent and Trademark Office**

**Reg. No. 3,499,823**

**Registered Sep. 9, 2008**

**TRADEMARK  
SERVICE MARK  
PRINCIPAL REGISTER**

**WE TAKE FRESH SERIOUSLY**

CHICAGO FRANCHISE SYSTEMS, INC. (ILLI-  
NOIS CORPORATION)  
SUITE J  
8200 WEST 185TH STREET  
TINLEY PARK, IL 60487

FOR: PIZZA; PASTA; SANDWICHES, IN CLASS 30  
(U.S. CL. 46).

FIRST USE 7-3-2007; IN COMMERCE 7-3-2007.

FOR: RESTAURANTS; RESTAURANT SERVICES;  
TAKE-OUT RESTAURANT SERVICES, IN CLASS 43  
(U.S. CLS. 100 AND 101).

FIRST USE 7-3-2007; IN COMMERCE 7-3-2007.

THE MARK CONSISTS OF STANDARD CHAR-  
ACTERS WITHOUT CLAIM TO ANY PARTICULAR  
FONT, STYLE, SIZE, OR COLOR.

SN 77-206,853, FILED 6-15-2007.

SUNG IN, EXAMINING ATTORNEY

**Int. Cls.: 35, 36, 37, 39, and 42**

**Prior U.S. Cls.: 100, 101, 102, 103, 105, and 106**

**United States Patent and Trademark Office**

**Reg. No. 3,499,824**

**Registered Sep. 9, 2008**

**SERVICE MARK  
PRINCIPAL REGISTER**



***San Antonio***



MANHEIM AUCTIONS, INC. (DELAWARE CORPORATION)  
6205 PEACHTREE DUNWOODY ROAD  
ATLANTA, GA 30328

FOR: AUTOMOBILE AUCTION SERVICES; AUTOMOBILE AUCTION SERVICES PROVIDED VIA THE INTERNET, IN CLASS 35 (U.S. CLS. 100, 101 AND 102).

FIRST USE 6-20-2008; IN COMMERCE 6-20-2008.

FOR: AUTOMOBILE FINANCING SERVICES, IN CLASS 36 (U.S. CLS. 100, 101 AND 102).

FIRST USE 6-20-2008; IN COMMERCE 6-20-2008.

FOR: AUTOMOTIVE DETAILING, RECONDITIONING, REPAIR, CONVERSION, AND CUSTOMIZATION SERVICES, IN CLASS 37 (U.S. CLS. 100, 103 AND 106).

FIRST USE 6-20-2008; IN COMMERCE 6-20-2008.

FOR: BUSINESS-TO-BUSINESS AUTOMOTIVE TRANSPORTATION AND STORAGE SERVICES, IN CLASS 39 (U.S. CLS. 100 AND 105).

FIRST USE 6-20-2008; IN COMMERCE 6-20-2008.

FOR: AUTOMOTIVE INSPECTION SERVICES, IN CLASS 42 (U.S. CLS. 100 AND 101).

FIRST USE 6-20-2008; IN COMMERCE 6-20-2008.

OWNER OF U.S. REG. NOS. 1,699,332, 3,329,428, AND OTHERS.

NO CLAIM IS MADE TO THE EXCLUSIVE RIGHT TO USE "SAN ANTONIO", APART FROM THE MARK AS SHOWN.

THE COLOR(S) GOLD, BLUE, BROWN, RED, YELLOW, GREEN, GREY, BLACK AND WHITE IS/ARE CLAIMED AS A FEATURE OF THE MARK.

THE MARK CONSISTS OF A GOLD "M" OVER A BLUE CIRCULAR BACKGROUND AND WITHIN TWO GOLD OUTER RINGS. THE COLOR BROWN OUTLINES THE MARK. TO THE RIGHT OF THE M IS THE WORD "MANHEIM" IN THE COLOR BLACK. A BLACK LINE SEPARATES THE ABOVE DESIGN AND THE WORD "MANHEIM" AND THE WORDS "SAN ANTONIO" IN THE COLOR BLACK AND DESIGN OF A TRAFFIC LIGHT IN THE COLOR WHITE WITH RED, YELLOW AND GREEN CIRCLES ON A YELLOW BACKGROUND, INSIDE CONCENTRIC WHITE AND GREY SQUARES TO THE RIGHT OF THE WORDS "SAN ANTONIO".

SN 77-207,148, FILED 6-15-2007.

GRETTA YAO, EXAMINING ATTORNEY

Int. Cls.: 35, 36, 37, 39, and 42

Prior U.S. Cls.: 100, 101, 102, 103, 105, and 106

United States Patent and Trademark Office

Reg. No. 3,499,825

Registered Sep. 9, 2008

SERVICE MARK  
PRINCIPAL REGISTER



*Philadelphia*



MANHEIM AUCTIONS, INC. (DELAWARE CORPORATION)  
6205 PEACHTREE DUNWOODY ROAD  
ATLANTA, GA 30328

FOR: AUTOMOBILE AUCTION SERVICES; AUTOMOBILE AUCTION SERVICES PROVIDED VIA THE INTERNET, IN CLASS 35 (U.S. CLS. 100, 101 AND 102).

FIRST USE 6-20-2008; IN COMMERCE 6-20-2008.

FOR: AUTOMOBILE FINANCING SERVICES, IN CLASS 36 (U.S. CLS. 100, 101 AND 102).

FIRST USE 6-20-2008; IN COMMERCE 6-20-2008.

FOR: AUTOMOTIVE DETAILING, RECONDITIONING, REPAIR, CONVERSION, AND CUSTOMIZATION SERVICES, IN CLASS 37 (U.S. CLS. 100, 103 AND 106).

FIRST USE 6-20-2008; IN COMMERCE 6-20-2008.

FOR: BUSINESS-TO-BUSINESS AUTOMOTIVE TRANSPORTATION AND STORAGE SERVICES, IN CLASS 39 (U.S. CLS. 100 AND 105).

FIRST USE 6-20-2008; IN COMMERCE 6-20-2008.

FOR: AUTOMOTIVE INSPECTION SERVICES, IN CLASS 42 (U.S. CLS. 100 AND 101).

FIRST USE 6-20-2008; IN COMMERCE 6-20-2008.

OWNER OF U.S. REG. NOS. 1,699,332, 3,229,428, AND OTHERS.

NO CLAIM IS MADE TO THE EXCLUSIVE RIGHT TO USE "PHILADELPHIA", APART FROM THE MARK AS SHOWN.

THE COLOR(S) GOLD, BLUE, BROWN, GREY, BLACK AND WHITE IS/ARE CLAIMED AS A FEATURE OF THE MARK.

THE MARK CONSISTS OF A GOLD "M" OVER A BLUE CIRCULAR BACKGROUND AND WITHIN TWO GOLD OUTER RINGS. THE COLOR BROWN OUTLINES THE MARK. TO THE RIGHT OF THE M IS THE WORD "MANHEIM" IN THE COLOR BLACK. A BLACK LINE SEPARATES THE ABOVE DESIGN AND THE WORD "MANHEIM" AND THE WORDS "PHILADELPHIA" IN THE COLOR BLACK AND DESIGN OF THE LIBERTY BELL IN THE COLOR WHITE ON A BLUE BACKGROUND, INSIDE CONCENTRIC WHITE AND GREY SQUARES TO THE RIGHT OF THE WORDS "PHILADELPHIA".

SN 77-207,376, FILED 6-15-2007.

GRETТА YAO, EXAMINING ATTORNEY

**Int. Cls.: 35, 36, 37, 39, and 42**

**Prior U.S. Cls.: 100, 101, 102, 103, 105, and 106**

**United States Patent and Trademark Office**

**Reg. No. 3,499,826**

**Registered Sep. 9, 2008**

**SERVICE MARK  
PRINCIPAL REGISTER**



***Tucson***



MANHEIM AUCTIONS, INC. (DELAWARE CORPORATION)  
6205 PEACHTREE DUNWOODY ROAD  
ATLANTA, GA 30328

FOR: AUTOMOBILE AUCTION SERVICES; AUTOMOBILE AUCTION SERVICES PROVIDED VIA THE INTERNET, IN CLASS 35 (U.S. CLS. 100, 101 AND 102).

FIRST USE 6-20-2008; IN COMMERCE 6-20-2008.

FOR: AUTOMOBILE FINANCING SERVICES, IN CLASS 36 (U.S. CLS. 100, 101 AND 102).

FIRST USE 6-20-2008; IN COMMERCE 6-20-2008.

FOR: AUTOMOTIVE DETAILING, RECONDITIONING, REPAIR, CONVERSION, AND CUSTOMIZATION SERVICES, IN CLASS 37 (U.S. CLS. 100, 103 AND 106).

FIRST USE 6-20-2008; IN COMMERCE 6-20-2008.

FOR: BUSINESS-TO-BUSINESS AUTOMOTIVE TRANSPORTATION AND STORAGE SERVICES, IN CLASS 39 (U.S. CLS. 100 AND 105).

FIRST USE 6-20-2008; IN COMMERCE 6-20-2008.

FOR: AUTOMOTIVE INSPECTION SERVICES, IN CLASS 42 (U.S. CLS. 100 AND 101).

FIRST USE 6-20-2008; IN COMMERCE 6-20-2008.

OWNER OF U.S. REG. NOS. 1,699,332, 3,329,428, AND OTHERS.

NO CLAIM IS MADE TO THE EXCLUSIVE RIGHT TO USE "TUCSON", APART FROM THE MARK AS SHOWN.

THE COLOR(S) GOLD, BLUE, GREEN, BROWN, GREY, BLACK AND WHITE IS/ARE CLAIMED AS A FEATURE OF THE MARK.

THE MARK CONSISTS OF A GOLD "M" OVER A BLUE CIRCULAR BACKGROUND AND WITHIN TWO GOLD OUTER RINGS. THE COLOR BROWN OUTLINES THE MARK. TO THE RIGHT OF THE M IS THE WORD "MANHEIM" IN THE COLOR BLACK. A BLACK LINE SEPARATES THE ABOVE DESIGN AND THE WORD "MANHEIM" AND THE WORD "TUCSON" IN THE COLOR BLACK AND DESIGN OF WHITE CACTI ON A GREEN BACKGROUND, INSIDE CONCENTRIC WHITE AND GREY SQUARES TO THE RIGHT OF THE WORD "TUCSON".

SN 77-207,477, FILED 6-15-2007.

GRETТА YAO, EXAMINING ATTORNEY

**Int. Cls.: 35, 36, 37, 39, and 42**

**Prior U.S. Cls.: 100, 101, 102, 103, 105, and 106**

**United States Patent and Trademark Office**

**Reg. No. 3,499,827**

**Registered Sep. 9, 2008**

**SERVICE MARK  
PRINCIPAL REGISTER**



**Lakeland**



MANHEIM AUCTIONS, INC. (DELAWARE CORPORATION)  
6205 PEACHTREE DUNWOODY ROAD  
ATLANTA, GA 30328

FOR: AUTOMOBILE AUCTION SERVICES; AUTOMOBILE AUCTION SERVICES PROVIDED VIA THE INTERNET, IN CLASS 35 (U.S. CLS. 100, 101 AND 102).

FIRST USE 6-20-2008; IN COMMERCE 6-20-2008.

FOR: AUTOMOBILE FINANCING SERVICES, IN CLASS 36 (U.S. CLS. 100, 101 AND 102).

FIRST USE 6-20-2008; IN COMMERCE 6-20-2008.

FOR: AUTOMOTIVE DETAILING, RECONDITIONING, REPAIR, CONVERSION, AND CUSTOMIZATION SERVICES, IN CLASS 37 (U.S. CLS. 100, 103 AND 106).

FIRST USE 6-20-2008; IN COMMERCE 6-20-2008.

FOR: BUSINESS-TO-BUSINESS AUTOMOTIVE TRANSPORTATION AND STORAGE SERVICES, IN CLASS 39 (U.S. CLS. 100 AND 105).

FIRST USE 6-20-2008; IN COMMERCE 6-20-2008.

FOR: AUTOMOTIVE INSPECTION SERVICES, IN CLASS 42 (U.S. CLS. 100 AND 101).

FIRST USE 6-20-2008; IN COMMERCE 6-20-2008.

OWNER OF U.S. REG. NOS. 1,699,332, 3,229,428, AND OTHERS.

NO CLAIM IS MADE TO THE EXCLUSIVE RIGHT TO USE "LAKELAND", APART FROM THE MARK AS SHOWN.

THE COLOR(S) GOLD, BLUE, BROWN, GREY, BLACK AND WHITE IS/ARE CLAIMED AS A FEATURE OF THE MARK.

THE MARK CONSISTS OF A GOLD "M" OVER A BLUE CIRCULAR BACKGROUND AND WITHIN TWO GOLD OUTER RINGS. THE COLOR BROWN OUTLINES THE MARK. TO THE RIGHT OF THE M IS THE WORD "MANHEIM" IN THE COLOR BLACK. A BLACK LINE SEPARATES THE ABOVE DESIGN AND THE WORD "MANHEIM" AND THE WORD "LAKELAND" IN THE COLOR BLACK AND DESIGN OF A PALM TREE AND THREE BIRDS IN THE COLOR WHITE ON A BLUE BACKGROUND, INSIDE CONCENTRIC WHITE AND GREY SQUARES TO THE RIGHT OF THE WORD "LAKE-LAND".

SN 77-207,501, FILED 6-15-2007.

GRETТА YAO, EXAMINING ATTORNEY

**Int. Cls.: 35, 36, 37, 39, and 42**

**Prior U.S. Cls.: 100, 101, 102, 103, 105, and 106**

**United States Patent and Trademark Office**

**Reg. No. 3,499,828**

**Registered Sep. 9, 2008**

**SERVICE MARK  
PRINCIPAL REGISTER**



MANHEIM AUCTIONS, INC. (DELAWARE CORPORATION)  
6205 PEACHTREE DUNWOODY ROAD  
ATLANTA, GA 30328

FOR: AUTOMOBILE AUCTION SERVICES; AUTOMOBILE AUCTION SERVICES PROVIDED VIA THE INTERNET, IN CLASS 35 (U.S. CLS. 100, 101 AND 102).

FIRST USE 6-20-2008; IN COMMERCE 6-20-2008.

FOR: AUTOMOBILE FINANCING SERVICES, IN CLASS 36 (U.S. CLS. 100, 101 AND 102).

FIRST USE 6-20-2008; IN COMMERCE 6-20-2008.

FOR: AUTOMOTIVE DETAILING, RECONDITIONING, REPAIR, CONVERSION, AND CUSTOMIZATION SERVICES, IN CLASS 37 (U.S. CLS. 100, 103 AND 106).

FIRST USE 6-20-2008; IN COMMERCE 6-20-2008.

FOR: BUSINESS-TO-BUSINESS AUTOMOTIVE TRANSPORTATION AND STORAGE SERVICES, IN CLASS 39 (U.S. CLS. 100 AND 105).

FIRST USE 6-20-2008; IN COMMERCE 6-20-2008.

FOR: AUTOMOTIVE INSPECTION SERVICES, IN CLASS 42 (U.S. CLS. 100 AND 101).

FIRST USE 6-20-2008; IN COMMERCE 6-20-2008.

OWNER OF U.S. REG. NOS. 1,699,332, 3,229,428, AND OTHERS.

NO CLAIM IS MADE TO THE EXCLUSIVE RIGHT TO USE "DALLAS", APART FROM THE MARK AS SHOWN.

THE COLOR(S) GOLD, BLUE, MAROON, BROWN, GREY, BLACK AND WHITE IS/ARE CLAIMED AS A FEATURE OF THE MARK.

THE MARK CONSISTS OF A GOLD "M" OVER A BLUE CIRCULAR BACKGROUND AND WITHIN TWO GOLD OUTER RINGS. THE COLOR BROWN OUTLINES THE MARK. TO THE RIGHT OF THE M IS THE WORD "MANHEIM" IN THE COLOR BLACK. A BLACK LINE SEPARATES THE ABOVE DESIGN AND THE WORD "MANHEIM" AND THE WORD "DALLAS" IN THE COLOR BLACK AND DESIGN WITH A STYLIZED LETTER "D" IN THE COLOR WHITE ON A MAROON BACKGROUND, INSIDE CONCENTRIC WHITE AND GREY SQUARES TO THE RIGHT OF THE WORD "DALLAS".

SN 77-207,519, FILED 6-15-2007.

GRETТА YAO, EXAMINING ATTORNEY

**Int. Cl.: 42**

**Prior U.S. Cls.: 100 and 101**

**United States Patent and Trademark Office**

**Reg. No. 3,499,829**

**Registered Sep. 9, 2008**

**SERVICE MARK  
PRINCIPAL REGISTER**

**PHYSICIANCLAIM INSIGHT**

URIX, INC. (MASSACHUSETTS CORPORATION)  
99 SUMMER STREET  
SUITE 520  
BOSTON, MA 02110

FOR: PROVIDING TEMPORARY USE OF NON-DOWNLOADABLE WEB-BASED SOFTWARE FOR REDUCING PROFESSIONAL CLAIMS COSTS BY IDENTIFYING FRAUD, ABUSE, AND OVERPAYMENTS IN ORDER TO MAXIMIZE CLAIM PAYMENT ACCURACY, IDENTIFY FRAUDULENT PROVIDERS, AND CLINICALLY VALIDATE CLAIM SUBMISSIONS, IN CLASS 42 (U.S. CLS. 100 AND 101).

FIRST USE 9-0-2007; IN COMMERCE 9-0-2007.

THE MARK CONSISTS OF STANDARD CHARACTERS WITHOUT CLAIM TO ANY PARTICULAR FONT, STYLE, SIZE, OR COLOR.

OWNER OF U.S. REG. NO. 3,185,661.

NO CLAIM IS MADE TO THE EXCLUSIVE RIGHT TO USE "PHYSICIAN CLAIM", APART FROM THE MARK AS SHOWN.

SN 77-207,697, FILED 6-15-2007.

ALYSSA PALADINO, EXAMINING ATTORNEY

**Int. Cl.: 42**

**Prior U.S. Cls.: 100 and 101**

**United States Patent and Trademark Office**

**Reg. No. 3,499,830**

**Registered Sep. 9, 2008**

**SERVICE MARK  
PRINCIPAL REGISTER**

**DENTALCLAIM INSIGHT**

URIX, INC. (MASSACHUSETTS CORPORATION)  
99 SUMMER STREET  
SUITE 520  
BOSTON, MA 02110

FOR: PROVIDING TEMPORARY USE OF NON-DOWNLOADABLE WEB-BASED SOFTWARE FOR REDUCING DENTAL BENEFIT CLAIM COSTS BY IDENTIFYING FRAUD, ABUSE, AND OVERPAYMENT TO MAXIMIZE DENTAL CLAIMS PAYMENT ACCURACY, IDENTIFY FRAUDULENT PROVIDERS, AND CLINICALLY VALIDATE CLAIM SUBMISSIONS, IN CLASS 42 (U.S. CLS. 100 AND 101).

FIRST USE 9-0-2007; IN COMMERCE 9-0-2007.

THE MARK CONSISTS OF STANDARD CHARACTERS WITHOUT CLAIM TO ANY PARTICULAR FONT, STYLE, SIZE, OR COLOR.

OWNER OF U.S. REG. NO. 3,185,661.

NO CLAIM IS MADE TO THE EXCLUSIVE RIGHT TO USE "DENTAL CLAIM", APART FROM THE MARK AS SHOWN.

SN 77-207,710, FILED 6-15-2007.

ALYSSA PALADINO, EXAMINING ATTORNEY



**Int. Cl.: 42**

**Prior U.S. Cls.: 100 and 101**

**United States Patent and Trademark Office**

**Reg. No. 3,499,831**

**Registered Sep. 9, 2008**

**SERVICE MARK  
PRINCIPAL REGISTER**

**FACILITYCLAIM INSIGHT**

URIX, INC. (MASSACHUSETTS CORPORATION)  
99 SUMMER STREET  
SUITE 520  
BOSTON, MA 02110

FOR: PROVIDING TEMPORARY USE OF NON-DOWNLOADABLE WEB-BASED SOFTWARE FOR REDUCING HEALTHCARE FACILITY CLAIM COSTS, DIAGNOSTIC RELATED GROUPINGS AND AMBULATORY PAYMENT CLASSIFICATION EXPENDITURES BY IDENTIFYING FRAUD, ABUSE, AND OVERPAYMENTS TO MAXIMIZE CLAIMS PAYMENT ACCURACY, IDENTIFY FRAUDULENT FACILITIES, AND CLINICALLY VALIDATE CLAIM SUBMISSIONS, IN CLASS 42 (U.S. CLS. 100 AND 101).

FIRST USE 9-0-2007; IN COMMERCE 9-0-2007.

THE MARK CONSISTS OF STANDARD CHARACTERS WITHOUT CLAIM TO ANY PARTICULAR FONT, STYLE, SIZE, OR COLOR.

OWNER OF U.S. REG. NO. 3,185,661.

NO CLAIM IS MADE TO THE EXCLUSIVE RIGHT TO USE "FACILITY CLAIM", APART FROM THE MARK AS SHOWN.

SN 77-207,723, FILED 6-15-2007.

ALYSSA PALADINO, EXAMINING ATTORNEY

**Int. Cl.: 9**

**Prior U.S. Cls.: 21, 23, 26, 36, and 38**

**Reg. No. 3,499,832**

**United States Patent and Trademark Office**

**Registered Sep. 9, 2008**

**TRADEMARK  
PRINCIPAL REGISTER**

**STEPWISE**

TECH SAFETY LINES, INC. (TEXAS CORPORATION)  
3409 COLGATE  
DALLAS, TX 75225

FOR: FALL PROTECTION EQUIPMENT FOR FALL RESTRAINT AND FALL ARREST, NAMELY, BARS, ANCHORS, HARNESES, LINES, LANYARDS, CARABINERS AND ANCHORAGE CONNECTORS, IN CLASS 9 (U.S. CLS. 21, 23, 26, 36 AND 38).

FIRST USE 12-31-2005; IN COMMERCE 12-31-2005.

THE MARK CONSISTS OF STANDARD CHARACTERS WITHOUT CLAIM TO ANY PARTICULAR FONT, STYLE, SIZE, OR COLOR.

SN 77-209,716, FILED 6-19-2007.

TASHIA BUNCH, EXAMINING ATTORNEY

**Int. Cl.: 25**

**Prior U.S. Cls.: 22 and 39**

**United States Patent and Trademark Office**

**Reg. No. 3,499,833**

**Registered Sep. 9, 2008**

**TRADEMARK  
PRINCIPAL REGISTER**



LINCOLN HOCKEY LLC (DELAWARE LIMITED  
LIABILITY COMPANY)  
SUITE 850  
627 GLEBE ROAD  
ARLINGTON, VA 22203

FOR: CLOTHING, NAMELY, BANDANNAS,  
BEACH COVER-UPS, BOXER SHORTS, CAPS,  
CLOTH BIBS, FOOTWEAR, EAR MUFFS, GLOVES,  
HATS, HEADBANDS, JACKETS, JERSEYS, MIT-  
TENS, NIGHTSHIRTS, PAJAMAS, PANTS, RAIN  
COATS, RAIN WEAR, ROBES, SCARVES, SHIRTS,  
SHORTS, SOCKS, SUN VISORS, SWEATERS,  
SWEATPANTS, SWEATSHIRTS, SWIMSUITS, T-  
SHIRTS, TIES, TOQUES, UNDERWEAR, WARM-  
UP SUITS, WRISTBANDS, IN CLASS 25 (U.S. CLS.  
22 AND 39).

FIRST USE 6-0-2007; IN COMMERCE 6-0-2007.

OWNER OF U.S. REG. NOS. 1,019,629, 1,768,704,  
AND 2,240,908.

NO CLAIM IS MADE TO THE EXCLUSIVE  
RIGHT TO USE "WASHINGTON", APART FROM  
THE MARK AS SHOWN.

THE MARK CONSISTS OF STARS AND THE  
LETTER "T" IN THE FORM OF A HOCKEY STICK  
AND PUCK.

SN 77-210,364, FILED 6-20-2007.

MARTHA SANTOMARTINO, EXAMINING ATTOR-  
NEY

**Int. Cl.: 41**

**Prior U.S. Cls.: 100, 101, and 107**

**United States Patent and Trademark Office**

**Reg. No. 3,499,834**

**Registered Sep. 9, 2008**

**SERVICE MARK  
PRINCIPAL REGISTER**

**THE TURN ON**

LIBRA BABY BURLEY PRODUCTIONS, LLC  
(D.C. LIMITED LIABILITY COMPANY)  
C/O WYZ GIRL ENT  
1229 15TH STREET, NW  
WASHINGTON NW, DC 20005

FOR: ENTERTAINMENT SERVICES IN THE  
NATURE OF AN ONGOING TELEVISION PRO-  
GRAM ON LOVE, SEX AND RELATIONSHIPS, IN  
CLASS 41 (U.S. CLS. 100, 101 AND 107).

FIRST USE 10-13-2006; IN COMMERCE 10-13-2006.

THE MARK CONSISTS OF STANDARD CHAR-  
ACTERS WITHOUT CLAIM TO ANY PARTICULAR  
FONT, STYLE, SIZE, OR COLOR.

SN 77-211,324, FILED 6-20-2007.

CAROLYN CATALDO, EXAMINING ATTORNEY

Int. Cl.: 41

Prior U.S. Cls.: 100, 101, and 107

United States Patent and Trademark Office

Reg. No. 3,499,835

Registered Sep. 9, 2008

**SERVICE MARK  
PRINCIPAL REGISTER**

**SALSA CON SALSA**

GOYA FOODS, INC. (DELAWARE CORPORATION)  
100 SEAVIEW DRIVE  
SECAUCUS, NJ 07096

FOR: ARRANGING AND CONDUCTING EDUCATIONAL CONFERENCES; EDUCATION SERVICES, NAMELY, PROVIDING LIVE AND ON-LINE CLASSES, SEMINARS AND WORKSHOPS IN THE FIELD OF CULTURAL EVENTS, HISTORY, ETHIC STUDIES, FOODS, BEVERAGES AND MUSIC; EDUCATIONAL DEMONSTRATIONS; EDUCATIONAL SERVICES, NAMELY, CONDUCTING PROGRAMS IN THE FIELD OF CULTURAL EVENTS, HISTORY, ETHIC STUDIES, FOODS, BEVERAGES AND MUSIC; ORGANIZING EXHIBITIONS FOR EDUCATIONAL, CULTURAL, SPORTING AND/OR ENTERTAINMENT PURPOSE; CONDUCTING ENTERTAINMENT EXHIBITIONS IN THE NATURE OF EDUCATIONAL, CULTURAL, SPORTING AND/OR ENTERTAINMENT PURPOSE; ENTERTAINMENT IN THE NATURE OF THEATER PRODUCTIONS; ENTERTAINMENT IN THE NATURE OF PARADES, FESTIVALS, FAIRS, SPORTING EVENTS, CONCERTS AND CONCERTS; ENTERTAINMENT, NAMELY, PRODUCTION OF PARADES, FESTIVALS, FAIRS, SPORTING EVENTS, CONTESTS AND CONCERTS; ENTERTAINMENT

SERVICES, NAMELY, WINE AND FOOD TASTING; ENTERTAINMENT SERVICES, NAMELY, CONDUCTING CONTESTS; ENTERTAINMENT SERVICES, NAMELY, CONDUCTING FAIRS; ENTERTAINMENT SERVICES, NAMELY, PARTICIPATION IN PARADES, FESTIVALS, FAIRS, SPORTING EVENTS, CONTESTS AND CONCERTS; ENTERTAINMENT, NAMELY, LIVE MUSIC CONCERTS, IN CLASS 41 (U.S. CLS. 100, 101 AND 107).

FIRST USE 6-27-2007; IN COMMERCE 6-27-2007.

THE MARK CONSISTS OF STANDARD CHARACTERS WITHOUT CLAIM TO ANY PARTICULAR FONT, STYLE, SIZE, OR COLOR.

NO CLAIM IS MADE TO THE EXCLUSIVE RIGHT TO USE "SALSA", APART FROM THE MARK AS SHOWN.

THE FOREIGN WORDING IN THE MARK TRANSLATES INTO ENGLISH AS WITH.

SN 77-212,510, FILED 6-21-2007.

LINDA ORNDORFF, EXAMINING ATTORNEY

Int. Cls.: 35 and 36

Prior U.S. Cls.: 100, 101, and 102

United States Patent and Trademark Office

Reg. No. 3,499,836

Registered Sep. 9, 2008

SERVICE MARK  
PRINCIPAL REGISTER

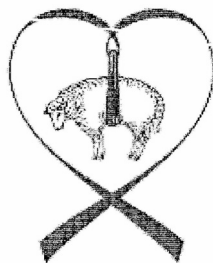

GOLDEN FLEECE  
FOUNDATION

RETAIL BRAND ALLIANCE, INC. (DELAWARE CORPORATION)  
100 PHOENIX AVENUE  
ENFIELD, CT 06082

FOR: ORGANIZING, ARRANGING AND CONDUCTING CHARITABLE FUNDRAISING EVENTS, IN CLASS 35 (U.S. CLS. 100, 101 AND 102).

FIRST USE 11-29-2007; IN COMMERCE 11-29-2007.

FOR: CHARITABLE FUNDRAISING SERVICES, IN CLASS 36 (U.S. CLS. 100, 101 AND 102).

FIRST USE 11-29-2007; IN COMMERCE 11-29-2007.

OWNER OF U.S. REG. NOS. 640,370, 1,908,540, AND 1,949,836.

NO CLAIM IS MADE TO THE EXCLUSIVE RIGHT TO USE "FOUNDATION", APART FROM THE MARK AS SHOWN.

THE MARK CONSISTS OF A HANGING LAMB DESIGN KNOWN AS THE "GOLDEN FLEECE."

SN 77-212,950, FILED 6-22-2007.

JESSICA A. POWERS, EXAMINING ATTORNEY

**Int. Cls.: 35 and 36**

**Prior U.S. Cls.: 100, 101, and 102**

**United States Patent and Trademark Office**

**Reg. No. 3,499,837**

**Registered Sep. 9, 2008**

**SERVICE MARK  
PRINCIPAL REGISTER**

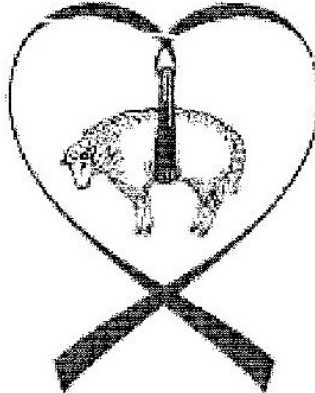

RETAIL BRAND ALLIANCE, INC. (DELAWARE CORPORATION)  
100 PHOENIX AVENUE  
ENFIELD, CT 06082

FOR: ORGANIZING, ARRANGING AND CONDUCTING CHARITABLE FUNDRAISING EVENTS, IN CLASS 35 (U.S. CLS. 100, 101 AND 102).

FIRST USE 11-29-2007; IN COMMERCE 11-29-2007.

FOR: CHARITABLE FUNDRAISING SERVICES, IN CLASS 36 (U.S. CLS. 100, 101 AND 102).

FIRST USE 11-29-2007; IN COMMERCE 11-29-2007.

OWNER OF U.S. REG. NOS. 640,370, 1,908,540, AND 1,949,836.

THE MARK CONSISTS OF A HANGING LAMB DESIGN KNOWN AS THE "GOLDEN FLEECE."

SN 77-212,956, FILED 6-22-2007.

JESSICA A. POWERS, EXAMINING ATTORNEY

**Int. Cl.: 41**

**Prior U.S. Cls.: 100, 101, and 107**

**United States Patent and Trademark Office**

**Reg. No. 3,499,838**

**Registered Sep. 9, 2008**

**SERVICE MARK  
PRINCIPAL REGISTER**

# LEADHERSHIP1

LEADHERSHIP1 LLC (MINNESOTA LIMITED  
LIABILITY COMPANY)  
656 SUMMIT AVENUE  
SAINT PAUL, MN 55105

FOR: PERSONAL COACHING SERVICES IN THE  
FIELDS OF CAREERS, LIFE, BUSINESS; EDUCA-  
TION SERVICES, NAMELY, PROVIDING LIVE AND  
ON-LINE CLASSES, SEMINARS, AND WORKSHOPS  
IN THE FIELD OF CAREERS, LIFE, BUSINESS AND  
DISTRIBUTING COURSE MATERIALS IN CON-  
NECTION THEREWITH; CONDUCTING ONLINE  
PERSONAL LIFESTYLE PERFORMANCE ASSES-  
MENTS AND SKILL ENHANCEMENT PROGRAMS  
BASED ON PRINCIPLES OF EMOTIONAL INTEL-

LIGENCE, BY MEANS OF PERFORMANCE  
TRACKING, REWARD AND INCENTIVE PRO-  
GRAMS, IN CLASS 41 (U.S. CLS. 100, 101 AND 107).

FIRST USE 11-19-2007; IN COMMERCE 2-28-2008.

THE MARK CONSISTS OF STANDARD CHAR-  
ACTERS WITHOUT CLAIM TO ANY PARTICULAR  
FONT, STYLE, SIZE, OR COLOR.

SN 77-213,085, FILED 6-22-2007.

CURTIS FRENCH, EXAMINING ATTORNEY



**Int. Cl.: 25**

**Prior U.S. Cls.: 22 and 39**

**United States Patent and Trademark Office**

**Reg. No. 3,499,839**

**Registered Sep. 9, 2008**

**TRADEMARK  
PRINCIPAL REGISTER**



WATSON, THOMAS A. (UNITED STATES INDIVIDUAL)  
PO BOX 840 PMB 367  
HELENDALE, CA 92342

FOR: SHIRTS; SHOES; SHORTS; HATS, IN CLASS 25 (U.S. CLS. 22 AND 39).

FIRST USE 7-3-2007; IN COMMERCE 7-10-2008.

THE COLOR(S) BLUE, GRAY AND BLACK IS/ARE CLAIMED AS A FEATURE OF THE MARK.

THE MARK CONSISTS OF A GRAY FOOT WITH BLUE FLAMES COMING OFF OF THE BACK OF THE FOOT, WITHIN THE FLAMES IS THE LETTERS "LFG" WHICH ARE IN GRAY. THE FLAMES ARE IN TWO TONES OF BLUE. THE ENTIRE MARK IS OUTLINED IN BLACK.

SN 77-213,129, FILED 6-22-2007.

DAWN FELDMAN, EXAMINING ATTORNEY

**Int. Cl.: 28**

**Prior U.S. Cls.: 22, 23, 38, and 50**

**United States Patent and Trademark Office**

**Reg. No. 3,499,840**

**Registered Sep. 9, 2008**

**TRADEMARK  
PRINCIPAL REGISTER**

**POPPLES**

THOSE CHARACTERS FROM CLEVELAND,  
INC. (OHIO CORPORATION)  
ONE AMERICAN ROAD  
CLEVELAND, OH 44144

FOR: TOY FIGURES; PLUSH TOYS; TOY ACTION  
FIGURES; TOY ACTION FIGURES AND ACCES-  
SORIES THEREFOR; ACTION FIGURES; ACTION  
FIGURES AND ACCESSORIES THEREFOR, IN  
CLASS 28 (U.S. CLS. 22, 23, 38 AND 50).

FIRST USE 7-31-2007; IN COMMERCE 7-31-2007.

THE MARK CONSISTS OF STANDARD CHAR-  
ACTERS WITHOUT CLAIM TO ANY PARTICULAR  
FONT, STYLE, SIZE, OR COLOR.

OWNER OF U.S. REG. NOS. 1,430,199, 1,440,047,  
AND 2,714,111.

SN 77-213,985, FILED 6-24-2007.

KAPIL BHANOT, EXAMINING ATTORNEY

**Int. Cl.: 35**

**Prior U.S. Cls.: 100, 101, and 102**

**United States Patent and Trademark Office**

**Reg. No. 3,499,841**

**Registered Sep. 9, 2008**

**SERVICE MARK  
PRINCIPAL REGISTER**

**SAKER EXECUTIVE RESOURCES**

SAKER EXECUTIVE RESOURCES, INC. (CALI-  
FORNIA CORPORATION)  
SUITE 200  
299 W. HILLCREST DRIVE  
THOUSAND OAKS, CA 91360

FOR: PERSONNEL SEARCH, RECRUITING,  
STAFFING, AND PLACEMENT SERVICES, IN  
CLASS 35 (U.S. CLS. 100, 101 AND 102).

FIRST USE 11-0-2007; IN COMMERCE 11-0-2007.

THE MARK CONSISTS OF STANDARD CHAR-  
ACTERS WITHOUT CLAIM TO ANY PARTICULAR  
FONT, STYLE, SIZE, OR COLOR.

NO CLAIM IS MADE TO THE EXCLUSIVE  
RIGHT TO USE "EXECUTIVE RESOURCES",  
APART FROM THE MARK AS SHOWN.

SN 77-215,055, FILED 6-25-2007.

MATTHEW EINSTEIN, EXAMINING ATTORNEY

**Int. Cl.: 9**

**Prior U.S. Cls.: 21, 23, 26, 36, and 38**

**Reg. No. 3,499,842**

**United States Patent and Trademark Office**

**Registered Sep. 9, 2008**

---

**TRADEMARK  
PRINCIPAL REGISTER**

**WHEN IN ROME**

ATLANTIC CITY COIN & SLOT SERVICE COM-  
PANY, INC. (NEW JERSEY CORPORATION)  
201 WEST DECATUR AVE.  
PLEASANTVILLE, NJ 08232

THE MARK CONSISTS OF STANDARD CHAR-  
ACTERS WITHOUT CLAIM TO ANY PARTICULAR  
FONT, STYLE, SIZE, OR COLOR.

FOR: GAMING MACHINES, IN CLASS 9 (U.S.  
CLS. 21, 23, 26, 36 AND 38).

SN 77-215,876, FILED 6-26-2007.

FIRST USE 5-20-2008; IN COMMERCE 5-20-2008.

MARIAM MAHMOUDI, EXAMINING ATTORNEY

**Int. Cl.: 38**

**Prior U.S. Cls.: 100, 101, and 104**

**United States Patent and Trademark Office**

**Reg. No. 3,499,843**

**Registered Sep. 9, 2008**

**SERVICE MARK  
PRINCIPAL REGISTER**

**GOGO**

AIRCELL LLC (DELAWARE LIMITED LIABILITY COMPANY)  
303 SOUTH TECHNOLOGY COURT, BUILDING A  
BROOMFIELD, CO 80021

FOR: BROADBAND AND NARROWBAND COMMUNICATION SERVICES ONBOARD AIRCRAFTS TO ENABLE USERS TO TRANSMIT AND RECEIVE VOICE, VIDEO, AND DATA WITHIN THE AIRCRAFTS, BETWEEN THE AIRCRAFTS, BETWEEN THE AIRCRAFTS AND THE GROUND, AND BETWEEN THE GROUND AND THE AIRCRAFTS. BROADBAND AND NARROWBAND COMMUNICATION SERVICES TO INTERCONNECT USERS, LOCATED ONBOARD AN AIRCRAFT, WITH USERS LOCATED ONBOARD ANOTHER AIRCRAFT, TO INTERCONNECT USERS LOCATED ONBOARD AN AIRCRAFT WITH USERS AND

DESTINATIONS ON THE GROUND, TO INTERCONNECT USERS AND DESTINATIONS ON THE GROUND WITH USERS ONBOARD THE AIRCRAFTS, AND TO INTERCONNECT USERS LOCATED ONBOARD AN AIRCRAFT, IN CLASS 38 (U.S. CLS. 100, 101 AND 104).

FIRST USE 6-28-2008; IN COMMERCE 6-28-2008.

THE MARK CONSISTS OF STANDARD CHARACTERS WITHOUT CLAIM TO ANY PARTICULAR FONT, STYLE, SIZE, OR COLOR.

SN 77-216,180, FILED 6-26-2007.

DAVID H. STINE, EXAMINING ATTORNEY

**Int. Cl.: 25**

**Prior U.S. Cls.: 22 and 39**

**United States Patent and Trademark Office**

**Reg. No. 3,499,844**

**Registered Sep. 9, 2008**

**TRADEMARK  
PRINCIPAL REGISTER**

**TEA AND HONEY**

PAN GLOBAL BRANDS, INC. (FLORIDA CORPORATION)  
2853 E. PICO BLVD.  
LOS ANGELES, CA 90023

THE MARK CONSISTS OF STANDARD CHARACTERS WITHOUT CLAIM TO ANY PARTICULAR FONT, STYLE, SIZE, OR COLOR.

FOR: CLOTHING, NAMELY, WRAP AROUNDS, JERSEYS; TOPS; WRAPS; BOTTOMS; SHIRTS, IN CLASS 25 (U.S. CLS. 22 AND 39).

SN 77-217,438, FILED 6-27-2007.

FIRST USE 5-31-2008; IN COMMERCE 5-31-2008.

NICHOLAS ALTREE, EXAMINING ATTORNEY

**Int. Cl.: 42**

**Prior U.S. Cls.: 100 and 101**

**United States Patent and Trademark Office**

**Reg. No. 3,499,845**

**Registered Sep. 9, 2008**

**SERVICE MARK  
PRINCIPAL REGISTER**

**CFARI**

SOMERSET TECHNOLOGY PARTNERS LLC  
(PENNSYLVANIA LIMITED LIABILITY COM-  
PANY)  
PO BOX 427  
NEW HOPE, PA 18938

FOR: PROVIDING TEMPORARY USE OF ON-  
LINE NON-DOWNLOADABLE COMPUTER PRO-  
GRAMS FOR MANAGEMENT OF CORPORATE  
ACCOUNTS RECEIVABLE, NAMELY, ACCOUNTS  
RECEIVABLE BOOKKEEPING, CASH APPLICA-  
TION, CREDIT, COLLECTIONS AND DEDUC-  
TIONS, IN CLASS 42 (U.S. CLS. 100 AND 101).

FIRST USE 1-25-2008; IN COMMERCE 1-25-2008.

THE MARK CONSISTS OF STANDARD CHAR-  
ACTERS WITHOUT CLAIM TO ANY PARTICULAR  
FONT, STYLE, SIZE, OR COLOR.

SN 77-217,629, FILED 6-28-2007.

SHAILA SETTLES, EXAMINING ATTORNEY

**Int. Cl.: 43**

**Prior U.S. Cls.: 100 and 101**

**United States Patent and Trademark Office**

**Reg. No. 3,499,846**

**Registered Sep. 9, 2008**

**SERVICE MARK  
PRINCIPAL REGISTER**

**BE WELL**

WYNDHAM TM CORP. (DELAWARE CORPORATION)  
10750 WEST CHARLESTON BLVD., SUITE 130  
LAS VEGAS, NV 89135

THE MARK CONSISTS OF STANDARD CHARACTERS WITHOUT CLAIM TO ANY PARTICULAR FONT, STYLE, SIZE, OR COLOR.

FOR: HOTEL AND MOTEL SERVICES, IN CLASS 43 (U.S. CLS. 100 AND 101).

SN 77-218,958, FILED 6-29-2007.

FIRST USE 12-16-2007; IN COMMERCE 12-16-2007.

JILL C. ALT, EXAMINING ATTORNEY



**Int. Cl.: 41**

**Prior U.S. Cls.: 100, 101, and 107**

**United States Patent and Trademark Office**

**Reg. No. 3,499,847**

**Registered Sep. 9, 2008**

**SERVICE MARK  
PRINCIPAL REGISTER**

**WE HAVE THE ATHLETE DOWN  
TO A SCIENCE**

ACCELERATION PRODUCTS, INC. (NORTH DA-  
KOTA CORPORATION)  
SUITE E  
2301 - 25TH STREET SOUTH  
FARGO, ND 58103

FOR: EDUCATIONAL SERVICES, NAMELY,  
CONDUCTING SEMINARS IN THE FIELD OF EX-  
ERCISE AND SPORT TRAINING; SPORT SKILLS  
TRAINING INSTRUCTION; PHYSICAL FITNESS  
INSTRUCTION, IN CLASS 41 (U.S. CLS. 100, 101  
AND 107).

FIRST USE 4-5-2007; IN COMMERCE 4-5-2007.

THE MARK CONSISTS OF STANDARD CHAR-  
ACTERS WITHOUT CLAIM TO ANY PARTICULAR  
FONT, STYLE, SIZE, OR COLOR.

SN 77-219,145, FILED 6-29-2007.

DOMINIC J. FERRAIUOLO, EXAMINING ATTOR-  
NEY

**Int. Cl.: 41**

**Prior U.S. Cls.: 100, 101, and 107**

**United States Patent and Trademark Office**

**Reg. No. 3,499,848**

**Registered Sep. 9, 2008**

**SERVICE MARK  
PRINCIPAL REGISTER**

UNLEVEL THE PLAYING FIELD

ACCELERATION PRODUCTS, INC. (NORTH DA-  
KOTA CORPORATION)  
SUITE E  
2301 - 25TH STREET SOUTH  
FARGO, ND 58103

FOR: EDUCATIONAL SERVICES, NAMELY,  
CONDUCTING SEMINARS IN THE FIELD OF EX-  
ERCISE AND SPORT TRAINING; SPORT SKILLS  
TRAINING INSTRUCTION; PHYSICAL FITNESS  
INSTRUCTION, IN CLASS 41 (U.S. CLS. 100, 101  
AND 107).

FIRST USE 7-18-2007; IN COMMERCE 7-18-2007.

THE MARK CONSISTS OF STANDARD CHAR-  
ACTERS WITHOUT CLAIM TO ANY PARTICULAR  
FONT, STYLE, SIZE, OR COLOR.

SN 77-219,152, FILED 6-29-2007.

DOMINIC J. FERRAIUOLO, EXAMINING ATTOR-  
NEY

**Int. Cl.: 25**

**Prior U.S. Cls.: 22 and 39**

**United States Patent and Trademark Office**

**Reg. No. 3,499,849**

**Registered Sep. 9, 2008**

**TRADEMARK  
PRINCIPAL REGISTER**

**ALSTYLE**

A AND G, INC. (ILLINOIS CORPORATION)  
2441 PRESIDENTIAL PKWY  
MIDLOTHIAN, TX 76065

FOR: CLOTHING, NAMELY, SWEAT SHIRTS,  
SWEAT PANTS, SHORTS, TANK TOPS, BASEBALL  
JERSEYS, PULLOVERS, JACKETS, AND GOLF  
SHIRTS, IN CLASS 25 (U.S. CLS. 22 AND 39).

FIRST USE 1-31-2008; IN COMMERCE 1-31-2008.

THE MARK CONSISTS OF STANDARD CHAR-  
ACTERS WITHOUT CLAIM TO ANY PARTICULAR  
FONT, STYLE, SIZE, OR COLOR.

OWNER OF U.S. REG. NOS. 2,017,574, 2,951,680,  
AND OTHERS.

SN 77-220,681, FILED 7-2-2007.

BONNIE LUKEN, EXAMINING ATTORNEY

**Int. Cl.: 25**

**Prior U.S. Cls.: 22 and 39**

**United States Patent and Trademark Office**

**Reg. No. 3,499,850**

**Registered Sep. 9, 2008**

**TRADEMARK  
PRINCIPAL REGISTER**

**ALSTYLE APPAREL &  
ACTIVEWEAR**

A AND G, INC. (ILLINOIS CORPORATION)  
2441 PRESIDENTIAL PKWY  
MIDLOTHIAN, TX 76065

OWNER OF U.S. REG. NOS. 2,017,574, 2,951,680,  
AND OTHERS.

FOR: CLOTHING, NAMELY, SWEAT SHIRTS,  
SWEAT PANTS, SHORTS, TANK TOPS, BASEBALL  
JERSEYS, PULLOVERS, JACKETS, GOLF SHIRTS,  
IN CLASS 25 (U.S. CLS. 22 AND 39).

NO CLAIM IS MADE TO THE EXCLUSIVE  
RIGHT TO USE "APPAREL & ACTIVEWEAR",  
APART FROM THE MARK AS SHOWN.

FIRST USE 1-31-2008; IN COMMERCE 1-31-2008.

SN 77-220,716, FILED 7-2-2007.

THE MARK CONSISTS OF STANDARD CHAR-  
ACTERS WITHOUT CLAIM TO ANY PARTICULAR  
FONT, STYLE, SIZE, OR COLOR.

BONNIE LUKEN, EXAMINING ATTORNEY

**Int. Cl.: 5**

**Prior U.S. Cls.: 6, 18, 44, 46, 51, and 52**

**United States Patent and Trademark Office**

**Reg. No. 3,499,851**

**Registered Sep. 9, 2008**

**TRADEMARK  
PRINCIPAL REGISTER**

**TRISLIDE**

SBR SPORTS, INC. (CALIFORNIA CORPORATION)  
4790 IRVINE BLVD.  
IRVINE, CA 92620

THE MARK CONSISTS OF STANDARD CHARACTERS WITHOUT CLAIM TO ANY PARTICULAR FONT, STYLE, SIZE, OR COLOR.

FOR: SILICONE-BASED PERSONAL LUBRICANTS, IN CLASS 5 (U.S. CLS. 6, 18, 44, 46, 51 AND 52).

SN 77-221,930, FILED 7-3-2007.

FIRST USE 6-1-2007; IN COMMERCE 6-1-2007.

GEORGE LORENZO, EXAMINING ATTORNEY

**Int. Cls.: 43 and 44**

**Prior U.S. Cls.: 100 and 101**

**United States Patent and Trademark Office**

**Reg. No. 3,499,852**

**Registered Sep. 9, 2008**

**SERVICE MARK  
PRINCIPAL REGISTER**

**THE JEWISH HOME FAMILY**

THE JEWISH HOME FAMILY, INC. (NEW JERSEY CORPORATION)  
10 LINK DRIVE  
ROCKLEIGH, NJ 07647

FOR: PROVIDING ASSISTED LIVING FACILITIES; RETIREMENT HOMES, IN CLASS 43 (U.S. CLS. 100 AND 101).

FIRST USE 9-20-2007; IN COMMERCE 9-20-2007.

FOR: NURSING HOMES, CONVALESCENT HOMES, AND NURSING AND HEALTH CARE SERVICES, IN CLASS 44 (U.S. CLS. 100 AND 101).

FIRST USE 9-20-2007; IN COMMERCE 9-20-2007.

THE MARK CONSISTS OF STANDARD CHARACTERS WITHOUT CLAIM TO ANY PARTICULAR FONT, STYLE, SIZE, OR COLOR.

NO CLAIM IS MADE TO THE EXCLUSIVE RIGHT TO USE "JEWISH HOME", APART FROM THE MARK AS SHOWN.

SN 77-222,785, FILED 7-5-2007.

DEIRDRE ROBERTSON, EXAMINING ATTORNEY

**Int. Cls.: 9 and 42**

**Prior U.S. Cls.: 21, 23, 26, 36, 38, 100, and 101**

**United States Patent and Trademark Office**

**Reg. No. 3,499,853**

**Registered Sep. 9, 2008**

**TRADEMARK  
SERVICE MARK  
PRINCIPAL REGISTER**

**Revenue Intelligence**

TELESCIENCES, INC. (DELAWARE CORPORATION)  
SUITE 410  
2000 MIDLANTIC DRIVE  
MOUNT LAUREL, NJ 08054

FOR: COMPUTERS AND SOFTWARE USED TO COLLECT, MEDIATE AND ANALYZE USAGE AND NON-USAGE DATA FOR COMMUNICATIONS PROVIDERS AND COMMUNICATIONS EQUIPMENT MANUFACTURERS, IN CLASS 9 (U.S. CLS. 21, 23, 26, 36 AND 38).

FIRST USE 12-3-2007; IN COMMERCE 12-3-2007.

FOR: COMPUTER SOFTWARE DESIGN AND CUSTOMIZATION, COMPUTER PROGRAMMING AND MAINTENANCE OF COMPUTER SOFTWARE, IN CLASS 42 (U.S. CLS. 100 AND 101).

FIRST USE 12-3-2007; IN COMMERCE 12-3-2007.

THE APPLICANT CLAIMS COLOR AS A FEATURE OF THE MARK, NAMELY, GREEN AND BLACK.

THE MARK CONSISTS OF THE STYLIZED WORDS "REVENUE" AND "INTELLIGENCE" WITH THE FIRST IN GREEN AND THE LAST IN BLACK.

SN 77-223,747, FILED 7-6-2007.

ZACHARY BELLO, EXAMINING ATTORNEY

**Int. Cl.: 3**

**Prior U.S. Cls.: 1, 4, 6, 50, 51, and 52**

**Reg. No. 3,499,854**

**United States Patent and Trademark Office**

**Registered Sep. 9, 2008**

**TRADEMARK  
PRINCIPAL REGISTER**

**BE CONDITIONED**

ELEMENTAGE, LLC (NEW YORK LIMITED  
LIABILITY COMPANY)  
754 FIFTH AVENUE  
NEW YORK, NY 10019

THE MARK CONSISTS OF STANDARD CHAR-  
ACTERS WITHOUT CLAIM TO ANY PARTICULAR  
FONT, STYLE, SIZE, OR COLOR.

FOR: HAIR CARE PREPARATIONS, IN CLASS 3  
(U.S. CLS. 1, 4, 6, 50, 51 AND 52).

SN 77-224,553, FILED 7-9-2007.

FIRST USE 11-2-2007; IN COMMERCE 11-2-2007.

BRIAN CALLAGHAN, EXAMINING ATTORNEY



**Int. Cl.: 3**

**Prior U.S. Cls.: 1, 4, 6, 50, 51, and 52**

**Reg. No. 3,499,855**

**United States Patent and Trademark Office**

**Registered Sep. 9, 2008**

**TRADEMARK  
PRINCIPAL REGISTER**

**BE CLEANSED**

ELEMENTAGE, LLC (NEW YORK LIMITED  
LIABILITY COMPANY)  
754 FIFTH AVENUE  
NEW YORK, NY 10019

THE MARK CONSISTS OF STANDARD CHAR-  
ACTERS WITHOUT CLAIM TO ANY PARTICULAR  
FONT, STYLE, SIZE, OR COLOR.

FOR: HAIR CARE PREPARATIONS, IN CLASS 3  
(U.S. CLS. 1, 4, 6, 50, 51 AND 52).

SN 77-224,601, FILED 7-9-2007.

FIRST USE 11-2-2007; IN COMMERCE 11-2-2007.

BRIAN CALLAGHAN, EXAMINING ATTORNEY

**Int. Cl.: 2**

**Prior U.S. Cls.: 6, 11, and 16**

**United States Patent and Trademark Office**

**Reg. No. 3,499,856**

**Registered Sep. 9, 2008**

**TRADEMARK  
PRINCIPAL REGISTER**

**ALKATEX**

ACE HARDWARE CORPORATION (DELAWARE  
CORPORATION)  
2200 KENSINGTON COURT  
OAK BROOK, IL 60523

THE MARK CONSISTS OF STANDARD CHAR-  
ACTERS WITHOUT CLAIM TO ANY PARTICULAR  
FONT, STYLE, SIZE, OR COLOR.

FOR: INDOOR AND OUTDOOR HOUSE AND  
HOME FURNISHINGS PAINT, PAINT PRIMERS,  
LACQUERS IN THE NATURE OF COATINGS, AND  
VARNISHES, IN CLASS 2 (U.S. CLS. 6, 11 AND 16).

SN 77-225,878, FILED 7-10-2007.

FIRST USE 9-1-2007; IN COMMERCE 9-1-2007.

JENNIFER HETU, EXAMINING ATTORNEY

**Int. Cl.: 25**

**Prior U.S. Cls.: 22 and 39**

**United States Patent and Trademark Office**

**Reg. No. 3,499,857**

**Registered Sep. 9, 2008**

**TRADEMARK  
PRINCIPAL REGISTER**



RICCOMINI, TONY B. (UNITED STATES INDIVIDUAL)  
776 ARLEEN WAY  
PACIFICA, CA 94044

FOR: HATS; SHIRTS; POLO SHIRTS; SHORT-SLEEVED OR LONG-SLEEVED T-SHIRTS; SHORT-SLEEVED SHIRTS; SPORT SHIRTS; SPORTS SHIRTS; SPORTS SHIRTS WITH SHORT SLEEVES;

SWEAT SHIRTS; T-SHIRTS , IN CLASS 25 (U.S. CLS. 22 AND 39).

FIRST USE 10-1-2007; IN COMMERCE 12-1-2007.

SN 77-227,594, FILED 7-12-2007.

BRIAN PINO, EXAMINING ATTORNEY

Int. Cl.: 41

Prior U.S. Cls.: 100, 101, and 107

United States Patent and Trademark Office

Reg. No. 3,499,858

Registered Sep. 9, 2008

**SERVICE MARK  
PRINCIPAL REGISTER**



NEW JERSEY COMEDY FESTIVAL, INC. (DELAWARE CORPORATION)  
195 HIGHWAY 36  
WEST LONG BRANCH, NJ 07764

FOR: ENTERTAINMENT SERVICES IN THE NATURE OF LIVE COMEDIC PERFORMANCES, ARRANGING OF COMEDIC CONTESTS, IN CLASS 41 (U.S. CLS. 100, 101 AND 107).

FIRST USE 12-8-2007; IN COMMERCE 12-8-2007.

NO CLAIM IS MADE TO THE EXCLUSIVE RIGHT TO USE "NEW JERSEY COMEDY FESTIVAL" AND "THE REPRESENTATION OF THE STATE OF NEW JERSEY", APART FROM THE MARK AS SHOWN.

THE COLOR(S) GREEN AND BLACK IS/ARE CLAIMED AS A FEATURE OF THE MARK.

THE MARK CONSIST OF THE WORDS "NEW JERSEY COMEDY FESTIVAL," THE WORD "HA" REPEATED MANY TIMES, AND THE DESIGN OF A MICROPHONE STAND WITH MICROPHONE IN BLACK, ALL WITHIN AN OUTLINE OF THE STATE OF NEW JERSEY. THE BACKGROUND OF THE OUTLINED SHAPE OF THE STATE OF NEW JERSEY IS GREEN WITH THE OUTLINE IN BLACK.

SN 77-228,025, FILED 7-12-2007.

CARYN GLASSER, EXAMINING ATTORNEY

**Int. Cl.: 41**

**Prior U.S. Cls.: 100, 101, and 107**

**United States Patent and Trademark Office**

**Reg. No. 3,499,859**

**Registered Sep. 9, 2008**

**SERVICE MARK  
PRINCIPAL REGISTER**

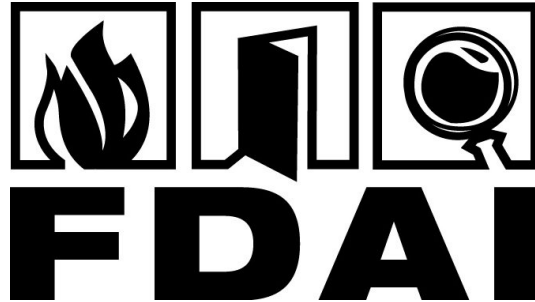

DOOR AND HARDWARE INSTITUTE (D.C.  
CORPORATION)  
14150 NEWBROOK DR.  
SUITE 200  
CHANTILLY, VA 20151

FOR: EDUCATIONAL SERVICES, NAMELY, ARRANGING AND CONDUCTING CLASSES, SEMINARS, WORKSHOPS, SYMPOSIA AND EDUCATIONAL CONFERENCES IN THE FIELD OF INSPECTION OF FIRE-RATED DOOR ASSEMBLIES AND DISTRIBUTION OF INSTRUCTIONAL COURSE MATERIALS IN CONNECTION THEREWITH; PREPARING, ADMINISTERING AND SCORING EXAMS IN THE FIELD OF INSPECTION OF

FIRE-RATED DOOR ASSEMBLIES, IN CLASS 41 (U.S. CLS. 100, 101 AND 107).

FIRST USE 10-13-2007; IN COMMERCE 10-13-2007.

THE MARK CONSISTS OF A REPRESENTATION OF A FLAME, AN OPEN DOOR AND A MAGNIFYING GLASS STACKED HORIZONTALLY ON TOP OF THE LITERAL ELEMENT "FDAI".

SN 77-228,157, FILED 7-12-2007.

DANIEL CAPSHAW, EXAMINING ATTORNEY

**Int. Cl.: 39**

**Prior U.S. Cls.: 100 and 105**

**Reg. No. 3,499,860**

**United States Patent and Trademark Office**

**Registered Sep. 9, 2008**

**SERVICE MARK  
PRINCIPAL REGISTER**



SECURCARE SELF STORAGE, INC (COLORADO CORPORATION)  
ROOSEVELT BUILDING  
9226 TEDDY BEAR LANE  
LONE TREE, CO 80124

THE MARK CONSISTS OF AN OUTLINE OF A TOWER HAVING THREE CREPELLATIONS ON THE TOP AND HAVING A LARGE PROMINENT KEYHOLE IN THE CENTER OF THE TOWER.

FOR: PROVIDING SELF-STORAGE FACILITIES FOR OTHERS, IN CLASS 39 (U.S. CLS. 100 AND 105).

SN 77-228,420, FILED 7-12-2007.

FIRST USE 12-20-2007; IN COMMERCE 12-20-2007.

LINDA M. KING, EXAMINING ATTORNEY

Int. Cl.: 25

Prior U.S. Cls.: 22 and 39

United States Patent and Trademark Office

Reg. No. 3,499,861

Registered Sep. 9, 2008

TRADEMARK  
PRINCIPAL REGISTER

BILLI ROSS

RODRIGUEZ, GUIDO (UNITED STATES INDIVIDUAL)  
88 MANSFIELD AVENUE  
DARIEN, CT 06820

FOR: CARGO PANTS; DENIMS; PANTS; SWEAT PANTS; BERMUDA SHORTS; BOARD SHORTS; BOXER SHORTS; GYM SHORTS; PANTIES, SHORTS AND BRIEFS; SHORTS; SOCKS; FOOTWEAR FOR MEN AND WOMEN; SANDALS; POLO SHIRTS; SHIRTS; SPORT SHIRTS; SWEAT SHIRTS; T-SHIRTS; BASEBALL CAPS; HATS; JACKETS, IN CLASS 25 (U.S. CLS. 22 AND 39).

FIRST USE 6-11-2008; IN COMMERCE 6-11-2008.

THE MARK CONSISTS OF STANDARD CHARACTERS WITHOUT CLAIM TO ANY PARTICULAR FONT, STYLE, SIZE, OR COLOR.

THE NAME "BILLI ROSS" DOES NOT IDENTIFY A LIVING INDIVIDUAL.

SN 77-229,121, FILED 7-13-2007.

JESSICA A. POWERS, EXAMINING ATTORNEY

**Int. Cl.: 25**

**Prior U.S. Cls.: 22 and 39**

**United States Patent and Trademark Office**

**Reg. No. 3,499,862**

**Registered Sep. 9, 2008**

**TRADEMARK  
PRINCIPAL REGISTER**



BROWN JR., CLIMMEL (UNITED STATES INDIVIDUAL)  
100 BRIGHTON HILL CIRCLE APT 12H  
COLUMBIA, SC 29223

THE MARK CONSISTS OF INTERLOCKING  
DOUBLE BARRED DOLLAR SIGN AND LETTER  
"C".

FOR: CAPS; SHIRTS; HATS, IN CLASS 25 (U.S.  
CLS. 22 AND 39).

SN 77-230,173, FILED 7-16-2007.

FIRST USE 7-16-2007; IN COMMERCE 4-12-2008.

MARTHA FROMM, EXAMINING ATTORNEY



**Int. Cl.: 14**

**Prior U.S. Cls.: 2, 27, 28, and 50**

**United States Patent and Trademark Office**

**Reg. No. 3,499,863**

**Registered Sep. 9, 2008**

**TRADEMARK  
PRINCIPAL REGISTER**

**ADORELLE**

ADORELLE, L.L.C. (CALIFORNIA LIMITED LIABILITY COMPANY)  
1009 E. CAPITOL EXPRESSWAY #538  
SAN JOSE, CA 951212415

THE MARK CONSISTS OF STANDARD CHARACTERS WITHOUT CLAIM TO ANY PARTICULAR FONT, STYLE, SIZE, OR COLOR.

FOR: JEWELRY, IN CLASS 14 (U.S. CLS. 2, 27, 28 AND 50).

SN 77-230,264, FILED 7-16-2007.

FIRST USE 8-2-2007; IN COMMERCE 9-18-2007.

JESSICA A. POWERS, EXAMINING ATTORNEY

**Int. Cl.: 16**

**Prior U.S. Cls.: 2, 5, 22, 23, 29, 37, 38, and 50**

**Reg. No. 3,499,864**

**United States Patent and Trademark Office**

**Registered Sep. 9, 2008**

**TRADEMARK  
PRINCIPAL REGISTER**

**SALTY BONES**

ADVANCED GRAPHICS, INC. (FLORIDA CORPORATION)  
342 WILLIAMS POINT BLVD.  
COCOA, FL 32927

THE MARK CONSISTS OF STANDARD CHARACTERS WITHOUT CLAIM TO ANY PARTICULAR FONT, STYLE, SIZE, OR COLOR.

FOR: PAPER GOODS, NAMELY, DECALS AND BUMPER STICKERS, IN CLASS 16 (U.S. CLS. 2, 5, 22, 23, 29, 37, 38 AND 50).

SN 77-230,345, FILED 7-16-2007.

FIRST USE 6-0-2007; IN COMMERCE 6-0-2007.

CARYN GLASSER, EXAMINING ATTORNEY

**Int. Cl.: 6**

**Prior U.S. Cls.: 2, 12, 13, 14, 23, 25, and 50**

**United States Patent and Trademark Office**

**Reg. No. 3,499,865**

**Registered Sep. 9, 2008**

**TRADEMARK  
PRINCIPAL REGISTER**

# CopperXT

SOUTHEASTERN METALS MANUFACTURING  
COMPANY, INC. (FLORIDA CORPORATION)  
3556 LAKESHORE ROAD  
BUFFALO, NY 14219

FOR: METAL AND METALLIC COMPOSITE  
PRODUCTS, IN PARTICULAR COPPER BONDED  
TO STAINLESS STEEL, USED IN BUILDING AND  
CONSTRUCTION MATERIALS, NAMELY, ROOF-  
ING MATERIALS, ROOF COVERINGS, ROOFING  
PANELS, ROOFING TRIMS, EAVE DRIPS, TRIMS,  
FLASHING AND VENTILATION PRODUCTS FOR  
USE IN RESIDENTIAL AND COMMERCIAL

BUILDINGS, IN CLASS 6 (U.S. CLS. 2, 12, 13, 14, 23,  
25 AND 50).

FIRST USE 7-18-2007; IN COMMERCE 8-30-2007.

THE MARK CONSISTS OF STANDARD CHAR-  
ACTERS WITHOUT CLAIM TO ANY PARTICULAR  
FONT, STYLE, SIZE, OR COLOR.

SN 77-230,573, FILED 7-16-2007.

FRED CARL, EXAMINING ATTORNEY

**Int. Cl.: 16**

**Prior U.S. Cls.: 2, 5, 22, 23, 29, 37, 38, and 50**

**Reg. No. 3,499,866**

**United States Patent and Trademark Office**

**Registered Sep. 9, 2008**

**TRADEMARK  
PRINCIPAL REGISTER**



KUZNAR, KEVIN J. (UNITED STATES INDIVIDUAL)  
2129 EAGLE BLUFF CIRCLE  
BURNSVILLE, MN 55337

FOR: DECALS; PRESSURE SENSITIVE GRAPHICS FOR APPLICATION TO AUTOMOBILES; MURALS; PAINTINGS; PHOTO MATS, IN CLASS 16 (U.S. CLS. 2, 5, 22, 23, 29, 37, 38 AND 50).

FIRST USE 7-8-2008; IN COMMERCE 7-8-2008.

THE COLOR(S) COPPER AND BLACK IS/ARE CLAIMED AS A FEATURE OF THE MARK.

THE MARK CONSISTS OF A DOG STRETCHING ABOVE THE WORDS "QUANTUM DOG" IN ALL UPPER CASE BOLDFACE LETTERING IN THE COLOR COPPER WITH HIGHLIGHTS AND SHADING TO MAKE THE LETTERS AND DOG APPEAR METALLIC ON A BLACK BACKGROUND.

SN 77-232,909, FILED 7-18-2007.

KAREN K. BUSH, EXAMINING ATTORNEY

**Int. Cl.: 35**

**Prior U.S. Cls.: 100, 101, and 102**

**United States Patent and Trademark Office**

**Reg. No. 3,499,867**

**Registered Sep. 9, 2008**

**SERVICE MARK  
PRINCIPAL REGISTER**

# Response Coach

SMA RESOURCE, INC. (NEVADA CORPORATION)  
2300 W. SAHARA AVE, SUITE 800  
LAS VEGAS, NV 89102

FOR: PROVIDING INFORMATION IN THE FIELD OF MARKETING AND ON-LINE MARKETING MEDIA VIA THE INTERNET, IN CLASS 35 (U.S. CLS. 100, 101 AND 102).

FIRST USE 4-15-2008; IN COMMERCE 4-15-2008.

THE MARK CONSISTS OF STANDARD CHARACTERS WITHOUT CLAIM TO ANY PARTICULAR FONT, STYLE, SIZE, OR COLOR.

NO CLAIM IS MADE TO THE EXCLUSIVE RIGHT TO USE "RESPONSE", APART FROM THE MARK AS SHOWN.

SN 77-233,130, FILED 7-18-2007.

KAPIL BHANOT, EXAMINING ATTORNEY

**Int. Cl.: 36**

**Prior U.S. Cls.: 100, 101, and 102**

**United States Patent and Trademark Office**

**Reg. No. 3,499,868**

**Registered Sep. 9, 2008**

**SERVICE MARK  
PRINCIPAL REGISTER**

**PAS INCOME OPPORTUNITIES  
FUND OF FUNDS**

FMR LLC (DELAWARE LIMITED LIABILITY  
COMPANY)  
F7D  
82 DEVONSHIRE STREET  
BOSTON, MA 02109

FOR: MUTUAL FUND INVESTMENT AND  
BROKERAGE SERVICES, IN CLASS 36 (U.S. CLS.  
100, 101 AND 102).

FIRST USE 10-2-2007; IN COMMERCE 10-2-2007.

THE MARK CONSISTS OF STANDARD CHAR-  
ACTERS WITHOUT CLAIM TO ANY PARTICULAR  
FONT, STYLE, SIZE, OR COLOR.

OWNER OF U.S. REG. NOS. 1,266,587, 3,101,812,  
AND OTHERS.

NO CLAIM IS MADE TO THE EXCLUSIVE  
RIGHT TO USE "INCOME" AND "FUND OF  
FUNDS", APART FROM THE MARK AS SHOWN.

SN 77-233,227, FILED 7-19-2007.

ANDREW RHIM, EXAMINING ATTORNEY

**Int. Cl.: 45**

**Prior U.S. Cls.: 100 and 101**

**United States Patent and Trademark Office**

**Reg. No. 3,499,869**

**Registered Sep. 9, 2008**

**SERVICE MARK  
PRINCIPAL REGISTER**



SPIES, POWERS & ROBINSON, P.C. (COLORADO CORPORATION)  
SUITE 2220  
1660 LINCOLN STREET  
DENVER, CO 80264

THE MARK CONSISTS OF A FILLED IN CIRCLE WITH A JAGGED LINE REPRESENTING MOUNTAINS RUNNING ACROSS THE CIRCLE HORIZONTALLY.

FOR: ATTORNEY SERVICES; LITIGATION SERVICES, IN CLASS 45 (U.S. CLS. 100 AND 101).

SN 77-233,300, FILED 7-19-2007.

FIRST USE 10-13-2007; IN COMMERCE 10-13-2007.

ELIZABETH HUGHITT, EXAMINING ATTORNEY

**Int. Cl.: 41**

**Prior U.S. Cls.: 100, 101, and 107**

**United States Patent and Trademark Office**

**Reg. No. 3,499,870**

**Registered Sep. 9, 2008**

**SERVICE MARK  
PRINCIPAL REGISTER**

# Animal All-Stars

GOLDENBAUM, JOYCE (UNITED STATES INDIVIDUAL), DBA ALL STAR ANIMALS, 187 LAKEVIEW DRIVE HEWLETT, NY 11557

FOR: ANIMAL EXHIBITIONS; ANIMAL TRAINING; RENTAL OF TRAINED ANIMALS FOR USE IN MOTION PICTURES AND THE ENTERTAINMENT INDUSTRY; TRAINING ANIMALS FOR OTHERS , IN CLASS 41 (U.S. CLS. 100, 101 AND 107).

FIRST USE 5-10-2007; IN COMMERCE 5-10-2007.

THE MARK CONSISTS OF STANDARD CHARACTERS WITHOUT CLAIM TO ANY PARTICULAR FONT, STYLE, SIZE, OR COLOR.

NO CLAIM IS MADE TO THE EXCLUSIVE RIGHT TO USE "ANIMAL", APART FROM THE MARK AS SHOWN.

SN 77-233,566, FILED 7-19-2007.

RUSS HERMAN, EXAMINING ATTORNEY



**Int. Cl.: 3**

**Prior U.S. Cls.: 1, 4, 6, 50, 51, and 52**

**Reg. No. 3,499,871**

**United States Patent and Trademark Office**

**Registered Sep. 9, 2008**

**TRADEMARK  
PRINCIPAL REGISTER**

**BUG BLITZER**

STEARNS PACKAGING CORPORATION (WIS-  
CONSIN CORPORATION)

4200 SYCAMORE AVENUE

MADISON, WI 53714

FOR: WINDSHIELD CLEANER FLUIDS, IN  
CLASS 3 (U.S. CLS. 1, 4, 6, 50, 51 AND 52).

FIRST USE 7-19-2007; IN COMMERCE 10-3-2007.

THE MARK CONSISTS OF STANDARD CHAR-  
ACTERS WITHOUT CLAIM TO ANY PARTICULAR  
FONT, STYLE, SIZE, OR COLOR.

NO CLAIM IS MADE TO THE EXCLUSIVE  
RIGHT TO USE "BUG", APART FROM THE MARK  
AS SHOWN.

SN 77-233,660, FILED 7-19-2007.

LINDA ORNDORFF, EXAMINING ATTORNEY

**Int. Cl.: 45**

**Prior U.S. Cls.: 100 and 101**

**United States Patent and Trademark Office**

**Reg. No. 3,499,872**

**Registered Sep. 9, 2008**

**SERVICE MARK  
PRINCIPAL REGISTER**

**UNDERSTANDING THE BIG  
PICTURE**

HARNESS, DICKEY & PIERCE, P.L.C. (MICHIGAN LIMITED LIABILITY COMPANY)  
SUITE 200  
5445 CORPORATE DRIVE  
TROY, MI 48098

THE MARK CONSISTS OF STANDARD CHARACTERS WITHOUT CLAIM TO ANY PARTICULAR FONT, STYLE, SIZE, OR COLOR.

FOR: LEGAL SERVICES, IN CLASS 45 (U.S. CLS. 100 AND 101).

SN 77-233,841, FILED 7-19-2007.

FIRST USE 6-0-2008; IN COMMERCE 6-0-2008.

TEJBIR SINGH, EXAMINING ATTORNEY

**Int. Cl.: 35**

**Prior U.S. Cls.: 100, 101, and 102**

**United States Patent and Trademark Office**

**Reg. No. 3,499,873**

**Registered Sep. 9, 2008**

**SERVICE MARK  
PRINCIPAL REGISTER**

**MOKU MAN ISLAND WEAR**

HACK, DAVID D. (UNITED STATES INDIVIDUAL)

7486 WETHERBURN WAY

HUDSON, OH 442361285

FOR: ON-LINE RETAIL STORE SERVICES FEATURING BEACH CLOTHING APPAREL AND ACCESSORIES, NAMELY, PANTS, SHIRTS, SHORTS, T-SHIRTS, HATS, BELTS, AND SUNGLASSES, IN CLASS 35 (U.S. CLS. 100, 101 AND 102).

FIRST USE 6-27-2007; IN COMMERCE 3-14-2008.

THE MARK CONSISTS OF STANDARD CHARACTERS WITHOUT CLAIM TO ANY PARTICULAR FONT, STYLE, SIZE, OR COLOR.

NO CLAIM IS MADE TO THE EXCLUSIVE RIGHT TO USE "ISLAND WEAR", APART FROM THE MARK AS SHOWN.

THE ENGLISH TRANSLATION OF THE WORD "MOKU" IN THE MARK IS ISLAND.

SN 77-233,883, FILED 7-19-2007.

LINDA M. KING, EXAMINING ATTORNEY

**Int. Cl.: 9**

**Prior U.S. Cls.: 21, 23, 26, 36, and 38**

**Reg. No. 3,499,874**

**United States Patent and Trademark Office**

**Registered Sep. 9, 2008**

**TRADEMARK  
PRINCIPAL REGISTER**

**AUTOGENESIS**

D4D TECHNOLOGIES, LLC (TEXAS LIMITED  
LIABILITY COMPANY)  
640 INTERNATIONAL PARKWAY  
RICHARDSON, TX 75081

THE MARK CONSISTS OF STANDARD CHAR-  
ACTERS WITHOUT CLAIM TO ANY PARTICULAR  
FONT, STYLE, SIZE, OR COLOR.

FOR: COMPUTER SOFTWARE FOR DESIGNING  
A DENTAL RESTORATION, IN CLASS 9 (U.S. CLS.  
21, 23, 26, 36 AND 38).

SN 77-234,399, FILED 7-20-2007.

FIRST USE 12-17-2007; IN COMMERCE 12-17-2007.

NICHOLAS ALTREE, EXAMINING ATTORNEY

**Int. Cl.: 5**

**Prior U.S. Cls.: 6, 18, 44, 46, 51, and 52**

**Reg. No. 3,499,875**

**United States Patent and Trademark Office**

**Registered Sep. 9, 2008**

**TRADEMARK  
PRINCIPAL REGISTER**

**SKIPPY-FLEA**

SERGEANT'S PET CARE PRODUCTS, INC. (NE-  
VADA CORPORATION)  
2625 S 158TH PLAZA  
OMAHA, NE 681301770

THE MARK CONSISTS OF STANDARD CHAR-  
ACTERS WITHOUT CLAIM TO ANY PARTICULAR  
FONT, STYLE, SIZE, OR COLOR.

FOR: FLEA AND TICK CONTROL PRODUCTS,  
NAMELY, MEDICATED SHAMPOOS FOR PUPPIES,  
TOPICAL OINTMENTS FOR PETS, COLLARS,  
SPRAYS, AND POWDERS , IN CLASS 5 (U.S. CLS.  
6, 18, 44, 46, 51 AND 52).

OWNER OF U.S. REG. NO. 218,757.

SN 77-234,962, FILED 7-20-2007.

FIRST USE 6-0-2008; IN COMMERCE 6-0-2008.

NELSON SNYDER, EXAMINING ATTORNEY

**Int. Cl.: 41**

**Prior U.S. Cls.: 100, 101, and 107**

**United States Patent and Trademark Office**

**Reg. No. 3,499,876**

**Registered Sep. 9, 2008**

**SERVICE MARK  
PRINCIPAL REGISTER**

**HOOKED ON DRIVING**

PERFORMANCE DRIVING PROGRAMS, INC.  
(CALIFORNIA CORPORATION)  
2347 SADDLEBACK DRIVE  
DANVILLE, CA 94506

FOR: DRIVER SAFETY TRAINING; PERFORMANCE DRIVING TRAINING; TRAINING OF PEOPLE TO IMPROVE THEIR SKILLS AS DRIVERS IN CONTROLLED ENVIRONMENTS, SUCH AS ROAD COURSES, PRIVATE PARKING AREAS, AND OTHER SUPERVISED LOCATION; PREPARATION OF DRIVERS FOR COMPETITION DRIVING LICENSES; PROFESSIONAL RACING SCHOOLS OFFERING CAR CONTROL AND PERFORMANCE DRIVING PROGRAMS; HIGH PERFORMANCE DRIVING TRAINING; INSTRUCTION IN CAR CONTROL FEATURING BRAKING TECHNIQUES, SKID CONTROL, AND SIMILAR "ADVANCED" TECHNIQUES; PLANNING "BEHIND THE WHEEL" SPECIAL EVENTS FOR THOSE WHO WISH TO IMPROVE THEIR SKILLS AS DRIVERS; ORGANIZING SPECIAL EVENTS FOR DRIVING ENTHUSIASTS FEATURING BANQUETS WITH

KEYNOTE SPEAKERS; ORGANIZING GROUP OUTINGS TO PROFESSIONAL AUTOMOBILE RACES; SOCIAL CLUB SERVICES FOR CAR ENTHUSIASTS, NAMELY, ARRANGING, ORGANIZING, AND HOSTING SOCIAL EVENTS, GET-TOGETHERS, AND PARTIES FOR CLUB MEMBERS; CAR CLINICS FOR TEENS AND ADULTS, NAMELY, PROVIDING EDUCATIONAL CLASSES AND WORKSHOPS PROVIDED OUTSIDE EDUCATIONAL INSTITUTIONS IN THE FIELD OF CARS AND DRIVING, IN CLASS 41 (U.S. CLS. 100, 101 AND 107).

FIRST USE 6-1-2004; IN COMMERCE 6-1-2004.

THE MARK CONSISTS OF STANDARD CHARACTERS WITHOUT CLAIM TO ANY PARTICULAR FONT, STYLE, SIZE, OR COLOR.

SN 77-235,328, FILED 7-20-2007.

KELLEY WELLS, EXAMINING ATTORNEY

**Int. Cls.: 7, 35, 40, and 42**

**Prior U.S. Cls.: 13, 19, 21, 23, 31, 34, 35, 100, 101, 102, 103, and 106**

**Reg. No. 3,499,877**

**United States Patent and Trademark Office**

**Registered Sep. 9, 2008**

**TRADEMARK  
SERVICE MARK  
PRINCIPAL REGISTER**

***EAR*technology**

EQUIPMENT ACQUISITION RESOURCES, INC.  
(ILLINOIS CORPORATION)  
555 SOUTH VERMONT STREET  
PALATINE, IL 60067

FOR: MACHINES FOR SLICING, DICING, LAPPING, GRINDING, POLISHING, LACQUERING AND COATING SUBSTRATES AND DISKS, MACHINES FOR THE HARDENING OF COATINGS AND LACQUERS; MACHINES FOR THE CLEANING OF SUBSTRATES, DISKS, AND MASKS; MACHINES FOR THE INSPECTION OF SUBSTRATES AND DISK, MACHINES FOR THE ETCHING OF LAYERS ON SUBSTRATE, AND MACHINES FOR THE MANUFACTURING, LACQUERING, AND COATING OF OPTICAL INFORMATION STORAGE MEDIA, ALL ABOVE LISTED MACHINES IN THE FIELDS OF SEMICONDUCTOR MANUFACTURING, NANOTECHNOLOGY, NANOSCIENCES AND ADVANCED MATERIALS, IN CLASS 7 (U.S. CLS. 13, 19, 21, 23, 31, 34 AND 35).

FIRST USE 11-26-2007; IN COMMERCE 11-26-2007.

FOR: ONLINE STORE SERVICES FEATURING NEW AND REFURBISHED EQUIPMENT AND MATERIALS IN THE FIELDS OF SEMICONDUCTOR MANUFACTURING, NANOTECHNOLOGY, NANOSCIENCES AND ADVANCED MATERIALS, IN CLASS 35 (U.S. CLS. 100, 101 AND 102).

FIRST USE 6-1-2007; IN COMMERCE 6-1-2007.

FOR: PROTOTYPE FABRICATION OF NEW PRODUCTS FOR OTHERS; PILOT MANUFACTURING, NAMELY, MANUFACTURING NEW PRODUCTS TO THE ORDER AND SPECIFICATION OF OTHERS, ALL IN THE FIELDS OF SEMICONDUCTOR MANUFACTURING, NANOTECHNOLOGY, NA-

NOSCIENCES AND ADVANCED MATERIALS, IN CLASS 40 (U.S. CLS. 100, 103 AND 106).

FIRST USE 6-1-2007; IN COMMERCE 6-1-2007.

FOR: SCIENTIFIC RESEARCH AND DEVELOPMENT; NEW TECHNOLOGY DEVELOPMENT FOR OTHERS IN THE FIELDS OF SEMICONDUCTOR MANUFACTURING, NANOTECHNOLOGY, NANOSCIENCES AND ADVANCED MATERIALS; PRODUCT AND PROCESS DEVELOPMENT FOR OTHERS; NEW MATERIALS DEVELOPMENT FOR OTHERS, CHARACTERIZATION AND TESTING OF PRODUCTS AND MATERIALS FOR OTHERS; TECHNOLOGY COMMERCIALIZATION SERVICES, NAMELY, ASSISTING BUSINESSES IN TRANSFORMING IDEAS INTO COMMERCIAL PRODUCTS IN THE NATURE OF PRODUCT DEVELOPMENT FOR OTHERS; ENGINEERING AND TECHNOLOGICAL CONSULTING SERVICES FOR OTHERS; DESIGN AND TESTING OF MANUFACTURING APPLICATIONS AND PROCESSES, ALL IN THE FIELDS OF SEMICONDUCTOR MANUFACTURING, NANOTECHNOLOGY, NANOSCIENCES AND ADVANCED MATERIALS, IN CLASS 42 (U.S. CLS. 100 AND 101).

FIRST USE 6-1-2007; IN COMMERCE 6-1-2007.

NO CLAIM IS MADE TO THE EXCLUSIVE RIGHT TO USE "TECHNOLOGY", APART FROM THE MARK AS SHOWN.

THE MARK CONSISTS OF THE WORDS "EAR TECHNOLOGY" IN STYLIZED FORMAT.

SN 77-235,629, FILED 7-22-2007.

RAUL CORDOVA, EXAMINING ATTORNEY

**Int. Cl.: 9**

**Prior U.S. Cls.: 21, 23, 26, 36, and 38**

**Reg. No. 3,499,878**

**United States Patent and Trademark Office**

**Registered Sep. 9, 2008**

**TRADEMARK  
PRINCIPAL REGISTER**

**GX**

LEUPOLD & STEVENS, INC. (OREGON CORPORATION)  
PO BOX 688  
BEAVERTON, OR 97075

THE MARK CONSISTS OF STANDARD CHARACTERS WITHOUT CLAIM TO ANY PARTICULAR FONT, STYLE, SIZE, OR COLOR.

FOR: LASER RANGE FINDERS USED IN GOLF,  
IN CLASS 9 (U.S. CLS. 21, 23, 26, 36 AND 38).

SN 77-236,504, FILED 7-23-2007.

FIRST USE 3-17-2008; IN COMMERCE 3-17-2008.

CHRISTINA SOBRAL, EXAMINING ATTORNEY



**Int. Cl.: 41**

**Prior U.S. Cls.: 100, 101, and 107**

**United States Patent and Trademark Office**

**Reg. No. 3,499,879**

**Registered Sep. 9, 2008**

**SERVICE MARK  
PRINCIPAL REGISTER**

**LOCKDOWN**

MICHAEL BLAND (UNITED STATES INDIVIDUAL)  
9524 MOON VISTA AVENUE  
LAS VEGAS, NV 89148

THE MARK CONSISTS OF STANDARD CHARACTERS WITHOUT CLAIM TO ANY PARTICULAR FONT, STYLE, SIZE, OR COLOR.

FOR: EDUCATION SERVICES, NAMELY, PROVIDING CLASSES, SEMINARS, WORKSHOPS IN THE FIELD OF HAND-TO-HAND DEFENSIVE TACTICS, IN CLASS 41 (U.S. CLS. 100, 101 AND 107).

SN 77-236,548, FILED 7-23-2007.

FIRST USE 1-20-2008; IN COMMERCE 1-20-2008.

KATHRYN COWARD, EXAMINING ATTORNEY

**Int. Cl.: 18**

**Prior U.S. Cls.: 1, 2, 3, 22, and 41**

**United States Patent and Trademark Office**

**Reg. No. 3,499,880**

**Registered Sep. 9, 2008**

**TRADEMARK  
PRINCIPAL REGISTER**

**BROOKSIDE**

SAMSONITE CORPORATION (DELAWARE CORPORATION)  
575 WEST STREET, SUITE 110  
MANSFIELD, MA 02048

THE MARK CONSISTS OF STANDARD CHARACTERS WITHOUT CLAIM TO ANY PARTICULAR FONT, STYLE, SIZE, OR COLOR.

FOR: LUGGAGE, IN CLASS 18 (U.S. CLS. 1, 2, 3, 22 AND 41).

SN 77-237,287, FILED 7-24-2007.

FIRST USE 7-1-2007; IN COMMERCE 7-1-2007.

PAUL E. FAHRENKOPF, EXAMINING ATTORNEY

**Int. Cls.: 1, 5, and 9**

**Prior U.S. Cls.: 1, 5, 6, 10, 18, 21, 23, 26, 36, 38, 44, 46, 51, and 52**

**Reg. No. 3,499,881**

**United States Patent and Trademark Office**

**Registered Sep. 9, 2008**

**TRADEMARK  
PRINCIPAL REGISTER**

**X TAG**

LUMINEX CORPORATION (DELAWARE CORPORATION)  
12212 TECHNOLOGY BOULEVARD  
AUSTIN, TX 78727

FOR: DIAGNOSTIC PREPARATIONS FOR SCIENTIFIC OR RESEARCH USE, NAMELY, MICROSPHERES AND NUCLEIC ACID DETECTION KITS, IN CLASS 1 (U.S. CLS. 1, 5, 6, 10, 26 AND 46).

FIRST USE 7-0-2007; IN COMMERCE 7-0-2007.

FOR: DIAGNOSTIC PREPARATIONS FOR MEDICAL OR CLINICAL USE, NAMELY, MICROSPHERES AND NUCLEIC ACID DETECTION KITS, IN CLASS 5 (U.S. CLS. 6, 18, 44, 46, 51 AND 52).

FIRST USE 7-0-2007; IN COMMERCE 7-0-2007.

FOR: COMPUTER SOFTWARE FOR APPLICATIONS IN THE FIELD OF BIOTECHNOLOGY, NAMELY, SOFTWARE FOR GENETIC ANALYSIS, TESTING AND/OR INVESTIGATION, IN CLASS 9 (U.S. CLS. 21, 23, 26, 36 AND 38).

FIRST USE 7-0-2007; IN COMMERCE 7-0-2007.

THE MARK CONSISTS OF STANDARD CHARACTERS WITHOUT CLAIM TO ANY PARTICULAR FONT, STYLE, SIZE, OR COLOR.

SN 77-237,474, FILED 7-24-2007.

DAVID TOOLEY, EXAMINING ATTORNEY

**Int. Cl.: 9**

**Prior U.S. Cls.: 21, 23, 26, 36, and 38**

**United States Patent and Trademark Office**

**Reg. No. 3,499,882**

**Registered Sep. 9, 2008**

**TRADEMARK  
PRINCIPAL REGISTER**

**TRUECORE**

ON2 TECHNOLOGIES, INC. (DELAWARE CORPORATION)  
580 WHITE PLAINS ROAD  
TARRYTOWN, NY 10591

FOR: COMPUTER SOFTWARE FOR VIDEO COMPRESSION AND DECOMPRESSION, IN CLASS 9 (U.S. CLS. 21, 23, 26, 36 AND 38).

FIRST USE 7-23-2008; IN COMMERCE 7-23-2008.

THE MARK CONSISTS OF STANDARD CHARACTERS WITHOUT CLAIM TO ANY PARTICULAR FONT, STYLE, SIZE, OR COLOR.

OWNER OF U.S. REG. NOS. 1,845,078 AND 2,047,131.

SN 77-238,103, FILED 7-25-2007.

ESTHER BELENKER, EXAMINING ATTORNEY

**Int. Cl.: 21**

**Prior U.S. Cls.: 2, 13, 23, 29, 30, 33, 40, and 50**

**United States Patent and Trademark Office**

**Reg. No. 3,499,883**

**Registered Sep. 9, 2008**

**TRADEMARK  
PRINCIPAL REGISTER**

**HOT MIX 90**

HOLLANDER GLASS EAST, INC. (NEW YORK CORPORATION)  
50 CLEARVIEW ROAD  
EDISON, NJ 08837

FOR: GLASS IN THE FORM OF SHEETS, RODS, POWDERS, AND FRITS FOR USE IN THE CREATION OF ART AND CRAFT PRODUCTS, IN CLASS 21 (U.S. CLS. 2, 13, 23, 29, 30, 33, 40 AND 50).

FIRST USE 2-19-2008; IN COMMERCE 2-19-2008.

THE MARK CONSISTS OF STANDARD CHARACTERS WITHOUT CLAIM TO ANY PARTICULAR FONT, STYLE, SIZE, OR COLOR.

NO CLAIM IS MADE TO THE EXCLUSIVE RIGHT TO USE "90", APART FROM THE MARK AS SHOWN.

SN 77-238,416, FILED 7-25-2007.

KATHLEEN M. VANSTON, EXAMINING ATTORNEY

**Int. Cls.: 35, 36, 37, 39, and 42**

**Prior U.S. Cls.: 100, 101, 102, 103, 105, and 106**

**United States Patent and Trademark Office**

**Reg. No. 3,499,884**

**Registered Sep. 9, 2008**

**SERVICE MARK  
PRINCIPAL REGISTER**



**Orlando**



MANHEIM AUCTIONS, INC. (DELAWARE CORPORATION)  
6205 PEACHTREE DUNWOODY ROAD  
ATLANTA, GA 30328

FOR: AUTOMOBILE AUCTION SERVICES; AUTOMOBILE AUCTION SERVICES PROVIDED VIA THE INTERNET, IN CLASS 35 (U.S. CLS. 100, 101 AND 102).

FIRST USE 6-20-2008; IN COMMERCE 6-20-2008.

FOR: AUTOMOBILE FINANCING SERVICES, IN CLASS 36 (U.S. CLS. 100, 101 AND 102).

FIRST USE 6-20-2008; IN COMMERCE 6-20-2008.

FOR: AUTOMOTIVE DETAILING, RECONDITIONING, REPAIR, CONVERSION AND CUSTOMIZATION SERVICES, IN CLASS 37 (U.S. CLS. 100, 103 AND 106).

FIRST USE 6-20-2008; IN COMMERCE 6-20-2008.

FOR: BUSINESS-TO-BUSINESS AUTOMOTIVE TRANSPORTATION AND STORAGE SERVICES, IN CLASS 39 (U.S. CLS. 100 AND 105).

FIRST USE 6-20-2008; IN COMMERCE 6-20-2008.

FOR: AUTOMOBILE INSPECTION SERVICES, IN CLASS 42 (U.S. CLS. 100 AND 101).

FIRST USE 6-20-2008; IN COMMERCE 6-20-2008.

OWNER OF U.S. REG. NOS. 1,699,332, 3,075,304, AND 3,229,428.

NO CLAIM IS MADE TO THE EXCLUSIVE RIGHT TO USE "ORLANDO", APART FROM THE MARK AS SHOWN.

THE COLOR(S) GOLD, BLUE, YELLOW, ORANGE, BROWN, GREY, BLACK AND WHITE IS/ARE CLAIMED AS A FEATURE OF THE MARK.

THE MARK CONSISTS OF GOLD "M" OVER A BLUE CIRCULAR BACKGROUND AND WITHIN TWO GOLD OUTER RINGS. THE COLOR BROWN OUTLINES THE MARK. TO THE RIGHT OF THE "M" IS THE WORD "MANHEIM" IN THE COLOR BLACK. A BLACK LINE SEPARATES THE ABOVE DESIGN AND WORD "MANHEIM" AND THE WORD "ORLANDO" IN THE COLOR BLACK AND DESIGN OF A YELLOW AND ORANGE SUN, BLUE AND WHITE WAVES ON A WHITE BACKGROUND, INSIDE CONCENTRIC WHITE AND GREY SQUARES TO THE RIGHT OF THE WORD "ORLANDO".

SN 77-238,641, FILED 7-25-2007.

GRETTA YAO, EXAMINING ATTORNEY

**Int. Cls.: 35, 36, 37, 39, and 42**

**Prior U.S. Cls.: 100, 101, 102, 103, 105, and 106**

**United States Patent and Trademark Office**

**Reg. No. 3,499,885**

**Registered Sep. 9, 2008**

**SERVICE MARK  
PRINCIPAL REGISTER**



MANHEIM AUCTIONS, INC. (DELAWARE CORPORATION)  
6205 PEACHTREE DUNWOODY ROAD  
ATLANTA, GA 30328

FOR: AUTOMOBILE AUCTION SERVICES; AUTOMOBILE AUCTION SERVICES PROVIDED VIA THE INTERNET, IN CLASS 35 (U.S. CLS. 100, 101 AND 102).

FIRST USE 6-20-2008; IN COMMERCE 6-20-2008.

FOR: AUTOMOBILE FINANCING SERVICES, IN CLASS 36 (U.S. CLS. 100, 101 AND 102).

FIRST USE 6-20-2008; IN COMMERCE 6-20-2008.

FOR: AUTOMOTIVE DETAILING, RECONDITIONING, REPAIR, CONVERSION AND CUSTOMIZATION SERVICES, IN CLASS 37 (U.S. CLS. 100, 103 AND 106).

FIRST USE 6-20-2008; IN COMMERCE 6-20-2008.

FOR: BUSINESS-TO-BUSINESS AUTOMOTIVE TRANSPORTATION AND STORAGE SERVICES, IN CLASS 39 (U.S. CLS. 100 AND 105).

FIRST USE 6-20-2008; IN COMMERCE 6-20-2008.

FOR: AUTOMOBILE INSPECTION SERVICES, IN CLASS 42 (U.S. CLS. 100 AND 101).

FIRST USE 6-20-2008; IN COMMERCE 6-20-2008.

OWNER OF U.S. REG. NOS. 1,699,332, 3,075,304, AND 3,229,428.

NO CLAIM IS MADE TO THE EXCLUSIVE RIGHT TO USE "PORTLAND", APART FROM THE MARK AS SHOWN.

THE COLOR(S) GOLD, BLUE, BROWN, GREY, BLACK AND WHITE IS/ARE CLAIMED AS A FEATURE OF THE MARK.

THE MARK CONSISTS OF GOLD "M" OVER A BLUE CIRCULAR BACKGROUND AND WITHIN TWO GOLD OUTER RINGS. THE COLOR BROWN OUTLINES THE MARK. TO THE RIGHT OF THE "M" IS THE WORD "MANHEIM" IN THE COLOR BLACK. A BLACK LINE SEPARATES THE ABOVE DESIGN AND WORD "MANHEIM" AND THE WORD "PORTLAND" IN THE COLOR BLACK AND DESIGN OF WHITE AND BLUE MOUNTAINS ON A BLUE BACKGROUND, INSIDE CONCENTRIC WHITE AND GREY SQUARES TO THE RIGHT OF THE WORD "PORTLAND".

SN 77-238,647, FILED 7-25-2007.

GRETTA YAO, EXAMINING ATTORNEY

Int. Cls.: 35, 36, 37, 39, and 42

Prior U.S. Cls.: 100, 101, 102, 103, 105, and 106

United States Patent and Trademark Office

Reg. No. 3,499,886

Registered Sep. 9, 2008

SERVICE MARK  
PRINCIPAL REGISTER



MANHEIM AUCTIONS, INC. (DELAWARE CORPORATION)  
6205 PEACHTREE DUNWOODY ROAD  
ATLANTA, GA 30328

FOR: AUTOMOBILE AUCTION SERVICES; AUTOMOBILE AUCTION SERVICES PROVIDED VIA THE INTERNET, IN CLASS 35 (U.S. CLS. 100, 101 AND 102).

FIRST USE 6-20-2008; IN COMMERCE 6-20-2008.

FOR: AUTOMOBILE FINANCING SERVICES, IN CLASS 36 (U.S. CLS. 100, 101 AND 102).

FIRST USE 6-20-2008; IN COMMERCE 6-20-2008.

FOR: AUTOMOTIVE DETAILING, RECONDITIONING, REPAIR, CONVERSION AND CUSTOMIZATION SERVICES, IN CLASS 37 (U.S. CLS. 100, 103 AND 106).

FIRST USE 6-20-2008; IN COMMERCE 6-20-2008.

FOR: BUSINESS-TO-BUSINESS AUTOMOTIVE TRANSPORTATION AND STORAGE SERVICES, IN CLASS 39 (U.S. CLS. 100 AND 105).

FIRST USE 6-20-2008; IN COMMERCE 6-20-2008.

FOR: AUTOMOBILE INSPECTION SERVICES, IN CLASS 42 (U.S. CLS. 100 AND 101).

FIRST USE 6-20-2008; IN COMMERCE 6-20-2008.

OWNER OF U.S. REG. NOS. 1,699,332, 3,075,304, AND 3,229,428.

NO CLAIM IS MADE TO THE EXCLUSIVE RIGHT TO USE "HARRISONBURG", APART FROM THE MARK AS SHOWN.

THE COLOR(S) GOLD, BLUE, BROWN, GREY, BLACK AND WHITE IS/ARE CLAIMED AS A FEATURE OF THE MARK.

THE MARK CONSISTS OF GOLD "M" OVER A BLUE CIRCULAR BACKGROUND AND WITHIN TWO GOLD OUTER RINGS. THE COLOR BROWN OUTLINES THE MARK. TO THE RIGHT OF THE "M" IS THE WORD "MANHEIM" IN THE COLOR BLACK. A BLACK LINE SEPARATES THE ABOVE DESIGN AND WORD "MANHEIM" AND THE WORD "HARRISONBURG" IN THE COLOR BLACK AND A STYLIZED CAPITAL LETTER "H" IN THE COLOR WHITE ON A BLUE BACKGROUND, INSIDE CONCENTRIC WHITE AND GREY SQUARES TO THE RIGHT OF THE WORD "HARRISONBURG".

SN 77-238,651, FILED 7-25-2007.

GRETTA YAO, EXAMINING ATTORNEY



Int. Cl.: 5

Prior U.S. Cls.: 6, 18, 44, 46, 51, and 52

United States Patent and Trademark Office

Reg. No. 3,499,887

Registered Sep. 9, 2008

TRADEMARK  
PRINCIPAL REGISTER

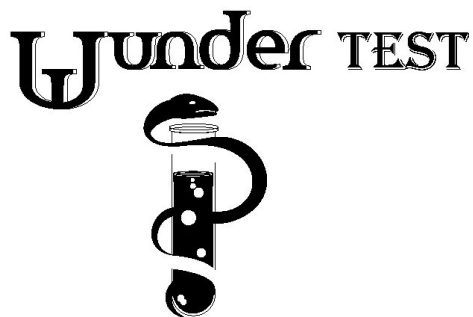

NGUYEN, HIEN HELEN (UNITED STATES IN-  
DIVIDUAL)  
P.O.BOX 611954  
SAN JOSE, CA 95161

FOR: PHARMACOLOGICAL TESTING KITS  
COMPRISED PRIMARILY OF CLINICAL DIAG-  
NOSTIC REAGENTS FOR THE PURPOSE OF DE-  
TECTION OF DRUG METABOLITES AND  
HORMONAL LEVELS PRESENT IN THE BODILY  
FLUIDS OF HUMAN SUBJECTS, NAMELY, DRUG  
TESTING KITS AND PREGNANCY TEST KITS FOR  
HOME USE, IN CLASS 5 (U.S. CLS. 6, 18, 44, 46, 51  
AND 52).

FIRST USE 7-18-2008; IN COMMERCE 7-18-2008.

NO CLAIM IS MADE TO THE EXCLUSIVE  
RIGHT TO USE "TEST", APART FROM THE MARK  
AS SHOWN.

THE MARK CONSISTS OF TUBE TUBE WITH A  
SNAKE AROUND THE TUBE, ABOVE THAT IS THE  
WORDS "WUNDER TEST" IN STYLIZED TEXT.

THE ENGLISH TRANSLATION OF THE WORD  
"WUNDER" IN THE MARK IS MIRACLE.

SN 77-241,257, FILED 7-27-2007.

TOBY BULLOFF, EXAMINING ATTORNEY

**Int. Cl.: 25**

**Prior U.S. Cls.: 22 and 39**

**United States Patent and Trademark Office**

**Reg. No. 3,499,888**

**Registered Sep. 9, 2008**

**TRADEMARK  
PRINCIPAL REGISTER**

**LIL EVIL**

DONAVAN J. WELCH (UNITED STATES INDIVIDUAL), DBA YA WANNIT COMPANY,  
401 E. NORDIN  
SPOKANE, WA 99218

THE MARK CONSISTS OF STANDARD CHARACTERS WITHOUT CLAIM TO ANY PARTICULAR FONT, STYLE, SIZE, OR COLOR.

FOR: T-SHIRTS, UNDERWEAR, PANTS, YOGA PANTS, SHORT SLEEVED OR LONG SLEEVED T-SHIRT, HOODS, JERSEYS, BELTS, TOPS, IN CLASS 25 (U.S. CLS. 22 AND 39).

SN 77-241,540, FILED 7-29-2007.

FIRST USE 12-21-2007; IN COMMERCE 1-7-2008.

MICHAEL GAAFAR, EXAMINING ATTORNEY

**Int. Cl.: 7**

**Prior U.S. Cls.: 13, 19, 21, 23, 31, 34, and 35**

**Reg. No. 3,499,889**

**United States Patent and Trademark Office**

**Registered Sep. 9, 2008**

**TRADEMARK  
PRINCIPAL REGISTER**

# TURBO-BUBBLE

AQUAVAN TECHNOLOGY INC. (CANADA CORPORATION)

BC

6969 HALLIGAN ST.

BURNABY, CANADA V5E1R4

FOR: AQUARIUM PUMPS; ELECTRIC PUMPS FOR AQUARIUM; POND AND WATER GARDEN AERATION SYSTEMS COMPRISING WATER PUMPS, AIR COMPRESSORS, AIR BLOWERS AND A FINNED WHEEL FOR PRESURIZING AND AERATING POND AND AQUARIUMS; AND BUBBLE GENERATING DEVICES CONSISTING OF MOTORS, PUMPS, WATER AND AIR MIXING DEVICES, CONTROL SWITCHES AND OVERCURRENT

PROTECTION SWITCHES FOR USE IN INCREASING OXYGEN IN CULTURED PONDS, IN CLASS 7 (U.S. CLS. 13, 19, 21, 23, 31, 34 AND 35).

FIRST USE 6-27-2008; IN COMMERCE 6-27-2008.

THE MARK CONSISTS OF STANDARD CHARACTERS WITHOUT CLAIM TO ANY PARTICULAR FONT, STYLE, SIZE, OR COLOR.

SN 77-241,788, FILED 7-30-2007.

COLLEEN KEARNEY, EXAMINING ATTORNEY

**Int. Cl.: 25**

**Prior U.S. Cls.: 22 and 39**

**United States Patent and Trademark Office**

**Reg. No. 3,499,890**

**Registered Sep. 9, 2008**

**TRADEMARK  
PRINCIPAL REGISTER**



**NorthWolf**

XU, XIANGYANG (CHINA INDIVIDUAL)  
38 CABLE LANE  
HICKSVILLE, NY 11801

FIRST USE 5-15-2008; IN COMMERCE 5-15-2008.

FOR: GOLF SHIRTS; POLO SHIRTS; SHIRTS;  
SPORT SHIRTS; T-SHIRTS; SWEATERS; RUNNING  
SHOES; TENNIS SHOES; ATHLETIC SHOES; CAN-  
VAS SHOES; SHOES; JOGGING PANTS; LOUNGE  
PANTS; PANTS; SWEAT PANTS; JEANS; DENIMS;  
JACKETS; SPORTS JACKETS, IN CLASS 25 (U.S.  
CLS. 22 AND 39).

THE MARK CONSISTS OF THE FIGURE OF A  
WOLF ABOVE THE WORD "NORTHWOLF".

SN 77-242,054, FILED 7-30-2007.

PAUL E. FAHRENKOPF, EXAMINING ATTORNEY

**Int. Cl.: 40**

**Prior U.S. Cls.: 100, 103, and 106**

**United States Patent and Trademark Office**

**Reg. No. 3,499,891**

**Registered Sep. 9, 2008**

**SERVICE MARK  
PRINCIPAL REGISTER**

**HYPERVELOCITY**

TECT HYPERVELOCITY, INC. (DELAWARE  
CORPORATION)  
1 WEST PACK SQUARE, BB&T BUILDING  
SUITE 305  
ASHEVILLE, NC 288013419

THE MARK CONSISTS OF STANDARD CHAR-  
ACTERS WITHOUT CLAIM TO ANY PARTICULAR  
FONT, STYLE, SIZE, OR COLOR.

FOR: MANUFACTURING SERVICES FOR OTH-  
ERS IN THE FIELD OF AERONAUTICS, IN CLASS  
40 (U.S. CLS. 100, 103 AND 106).

SN 77-242,071, FILED 7-30-2007.

FIRST USE 7-9-2008; IN COMMERCE 7-9-2008.

PAUL E. FAHRENKOPF, EXAMINING ATTORNEY

**Int. Cl.: 25**

**Prior U.S. Cls.: 22 and 39**

**United States Patent and Trademark Office**

**Reg. No. 3,499,892**

**Registered Sep. 9, 2008**

**TRADEMARK  
PRINCIPAL REGISTER**

**DREAMTOP**

R. G. BARRY CORPORATION (OHIO CORPORATION)  
13405 YARMOUTH ROAD NW  
PICKERINGTON, OH 43147

THE MARK CONSISTS OF STANDARD CHARACTERS WITHOUT CLAIM TO ANY PARTICULAR FONT, STYLE, SIZE, OR COLOR.

FOR: FOOTWEAR; SLIPPERS, IN CLASS 25 (U.S. CLS. 22 AND 39).

SN 77-242,287, FILED 7-30-2007.

FIRST USE 1-24-2008; IN COMMERCE 1-24-2008.

TINA BROWN, EXAMINING ATTORNEY

**Int. Cl.: 9**

**Prior U.S. Cls.: 21, 23, 26, 36, and 38**

**Reg. No. 3,499,893**

**United States Patent and Trademark Office**

**Registered Sep. 9, 2008**

**TRADEMARK  
PRINCIPAL REGISTER**

**CREOSO**

CREOSO CORPORATION (DELAWARE CORPORATION)  
2810 S. 24TH STREET, STE. 102  
PHOENIX, AZ 85034

FOR: COMPUTER HARDWARE AND SOFTWARE FOR USE IN DATA COLLECTION AND MARKET RESEARCH; INTERACTIVE TOUCH SCREEN COMPUTER KIOSKS COMPRISING COMPUTERS, COMPUTER HARDWARE, COMPUTER PERIPHERALS, AND SOFTWARE, FOR USE IN DATA COLLECTION AND MARKET RESEARCH; INTERACTIVE INFORMATION DISPLAYS IN THE NATURE OF ELECTRONIC APPARATUS, NAMELY, PLASMA DISPLAY PANELS AND LIQUID CRYSTAL DISPLAYS; MOBILE TOUCH SCREEN

COMPUTERS COMPRISING COMPUTER HARDWARE, COMPUTER PERIPHERALS, AND SOFTWARE, FOR USE IN DATA COLLECTION AND MARKET RESEARCH, IN CLASS 9 (U.S. CLS. 21, 23, 26, 36 AND 38).

FIRST USE 8-20-2007; IN COMMERCE 8-20-2007.

THE MARK CONSISTS OF STANDARD CHARACTERS WITHOUT CLAIM TO ANY PARTICULAR FONT, STYLE, SIZE, OR COLOR.

SN 77-244,115, FILED 8-1-2007.

MARGERY A. TIERNEY, EXAMINING ATTORNEY

**Int. Cl.: 35**

**Prior U.S. Cls.: 100, 101, and 102**

**United States Patent and Trademark Office**

**Reg. No. 3,499,894**

**Registered Sep. 9, 2008**

**SERVICE MARK  
PRINCIPAL REGISTER**

**CREOSO**

CREOSO CORPORATION (DELAWARE CORPORATION)  
STE. 102  
2810 S. 24TH STREET  
PHOENIX, AZ 85034

FOR: COLLECTION, PREPARATION, COMPOSITION, STORAGE, PROCESSING, ACQUISITION, DISPLAY AND PROVISION OF BUSINESS INFORMATION, DATA, STATISTICS AND INDICES, IN CLASS 35 (U.S. CLS. 100, 101 AND 102).

FIRST USE 8-20-2007; IN COMMERCE 8-20-2007.

THE MARK CONSISTS OF STANDARD CHARACTERS WITHOUT CLAIM TO ANY PARTICULAR FONT, STYLE, SIZE, OR COLOR.

SN 77-244,116, FILED 8-1-2007.

MARGERY A. TIERNEY, EXAMINING ATTORNEY



**Int. Cl.: 25**

**Prior U.S. Cls.: 22 and 39**

**United States Patent and Trademark Office**

**Reg. No. 3,499,895**

**Registered Sep. 9, 2008**

**TRADEMARK  
PRINCIPAL REGISTER**

# Burtago

BURTAGO (FLORIDA CORPORATION), DBA  
LUCA BUTTAZZONI,  
# 41  
6538 COLLINS AVENUE  
MIAMI BEACH, FL 33141

FOR: BLAZERS; COATS FOR MEN AND WOMEN; CREWNECKS; DRESS SHIRTS; JACKETS; MEN AND WOMEN JACKETS, COATS, TROUSERS, VESTS; PIQUE SHIRTS; POLO SHIRTS; PULL-OVERS; SHIRTS; SLEEVED OR SLEEVELESS JACKETS; SPORT COATS; SPORTS SHIRTS; SPORTS SHIRTS WITH SHORT SLEEVES; T-SHIRTS; TANK-TOPS, IN CLASS 25 (U.S. CLS. 22 AND 39).

FIRST USE 6-11-2008; IN COMMERCE 6-11-2008.

THE MARK CONSISTS OF STANDARD CHARACTERS WITHOUT CLAIM TO ANY PARTICULAR FONT, STYLE, SIZE, OR COLOR.

THE WORDING "BURTAGO" HAS NO MEANING OTHER THAN TRADEMARK SIGNIFICANCE.

SN 77-245,483, FILED 8-2-2007.

WENDY GOODMAN, EXAMINING ATTORNEY

**Int. Cl.: 3**

**Prior U.S. Cls.: 1, 4, 6, 50, 51, and 52**

**United States Patent and Trademark Office**

**Reg. No. 3,499,896**

**Registered Sep. 9, 2008**

**TRADEMARK  
PRINCIPAL REGISTER**

# Mythique

PARFUMS DELRAE (CALIFORNIA CORPORATION)  
2149 LYON STREET, SUITE 4  
SAN FRANCISCO, CA 94115

FOR: BEAUTY CREAMS FOR BODY CARE; BODY CREAM; BODY CREAMS; BODY LOTIONS; BODY MILKS; BODY OILS; EAU DE PARFUM; EAU DE PERFUME; EAU DE TOILETTE; PERFUME; PERFUME OILS; PERFUMED SOAPS; PERFUMES; SOAPS FOR BODY CARE, IN CLASS 3 (U.S. CLS. 1, 4, 6, 50, 51 AND 52).

FIRST USE 10-1-2007; IN COMMERCE 5-1-2008.

THE MARK CONSISTS OF STANDARD CHARACTERS WITHOUT CLAIM TO ANY PARTICULAR FONT, STYLE, SIZE, OR COLOR.

THE ENGLISH TRANSLATION OF THE FRENCH WORD MYTHIQUE IN THE MARK IS MYTHICAL.

SN 77-245,888, FILED 8-2-2007.

CHARISMA HAMPTON, EXAMINING ATTORNEY

**Int. Cl.: 28**

**Prior U.S. Cls.: 22, 23, 38, and 50**

**United States Patent and Trademark Office**

**Reg. No. 3,499,897**

**Registered Sep. 9, 2008**

**TRADEMARK  
PRINCIPAL REGISTER**

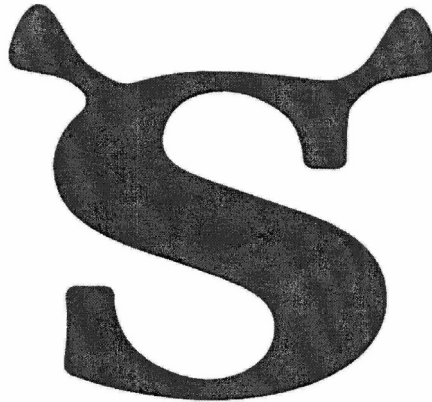

DREAMWORKS ANIMATION L.L.C. (DELA-  
WARE LIMITED LIABILITY COMPANY)  
1000 FLOWER STREET  
GLENDALE, CA 91201

FOR: DOLLS, BENDABLE PLAY FIGURES, IN  
CLASS 28 (U.S. CLS. 22, 23, 38 AND 50).

FIRST USE 5-1-2008; IN COMMERCE 5-1-2008.

OWNER OF U.S. REG. NOS. 2,594,275, 2,865,459,  
AND OTHERS.

THE MARK CONSISTS OF THE LETTER "S"  
WITH AN EAR DESIGN AT THE TOP.

SN 77-250,421, FILED 8-8-2007.

YAT SYE, LEE, EXAMINING ATTORNEY

**Int. Cl.: 42**

**Prior U.S. Cls.: 100 and 101**

**United States Patent and Trademark Office**

**Reg. No. 3,499,898**

**Registered Sep. 9, 2008**

**SERVICE MARK  
PRINCIPAL REGISTER**

CORSOURCE TECHNOLOGY GROUP

CORSOURCE TECHNOLOGY GROUP, INC.  
(OREGON CORPORATION)  
SUITE 201  
14795 SW MURRAY SCHOLLS DRIVE  
BEAVERTON, OR 97007

FOR: SOFTWARE DEVELOPMENT, CONSULTING SERVICES IN THE FIELD OF DESIGN, SELECTION, IMPLEMENTATION AND USE OF COMPUTER HARDWARE AND SOFTWARE SYSTEMS FOR OTHERS AND COMPUTER PROGRAMMING FOR OTHERS, IN CLASS 42 (U.S. CLS. 100 AND 101).

FIRST USE 9-17-2007; IN COMMERCE 9-17-2007.

THE MARK CONSISTS OF STANDARD CHARACTERS WITHOUT CLAIM TO ANY PARTICULAR FONT, STYLE, SIZE, OR COLOR.

NO CLAIM IS MADE TO THE EXCLUSIVE RIGHT TO USE "TECHNOLOGY GROUP", APART FROM THE MARK AS SHOWN.

SN 77-252,713, FILED 8-10-2007.

GINA HAYES, EXAMINING ATTORNEY

**Int. Cl.: 42**

**Prior U.S. Cls.: 100 and 101**

**United States Patent and Trademark Office**

**Reg. No. 3,499,899**

**Registered Sep. 9, 2008**

**SERVICE MARK  
PRINCIPAL REGISTER**

# POINTBOUND

FISHER, JOHN ROBERT (UNITED STATES INDIVIDUAL)  
202 MOUNTAIN VIEW DRIVE  
PHOENIXVILLE, PA 19460

FOR: PROVIDING TEMPORARY USE OF ON-LINE NON-DOWNLOADABLE SOFTWARE FOR TRACKING INFORMATION AND DATA RELATED TO BUSINESS FUNCTIONS THAT INCLUDE SALES, MARKETING, CUSTOMER SUPPORT, EMPLOYEE MANAGEMENT, PARTNER MANAGEMENT, PROJECT MANAGEMENT, ENGINEERING AND MANUFACTURING MANAGEMENT, AND FOR CUSTOMIZATION COMPUTER APPLICATION USER INTERFACE, COMPUTER SERVICES FOR DESIGNING, DEVELOPING AND MAINTAINING COMPUTER SOFTWARE APPLICATION FOR OTHERS AND CONSULTING SERVICES RELATED THERETO, IN CLASS 42 (U.S. CLS. 100 AND 101).

OPING AND MAINTAINING COMPUTER SOFTWARE APPLICATION FOR OTHERS AND CONSULTING SERVICES RELATED THERETO, IN CLASS 42 (U.S. CLS. 100 AND 101).

FIRST USE 2-1-2008; IN COMMERCE 6-1-2008.

THE MARK CONSISTS OF STANDARD CHARACTERS WITHOUT CLAIM TO ANY PARTICULAR FONT, STYLE, SIZE, OR COLOR.

SN 77-253,175, FILED 8-12-2007.

DAWN FELDMAN, EXAMINING ATTORNEY

Int. Cl.: 31

Prior U.S. Cls.: 1 and 46

United States Patent and Trademark Office

Reg. No. 3,499,900

Registered Sep. 9, 2008

TRADEMARK  
PRINCIPAL REGISTER



CRANE AND CRANE, INC. (WASHINGTON CORPORATION)  
100 CRANE ORCHARD ROAD  
BREWSTER, WA 98812

FOR: FRESH APPLES; FRESH FRUITS; RAW FRUITS; UNPROCESSED FRUITS, IN CLASS 31 (U.S. CLS. 1 AND 46).

FIRST USE 5-1-2008; IN COMMERCE 5-1-2008.

NO CLAIM IS MADE TO THE EXCLUSIVE RIGHT TO USE "ORCHARDS", APART FROM THE MARK AS SHOWN.

THE MARK CONSISTS OF A FLYING CRANE AGAINST THE BACKGROUND OF AN SINGLE HILL RISING IN THE DISTANCE, AND THE WORDS "CRANE FAMILY ORCHARDS" DIRECTLY BENEATH THE FLYING CRANE.

SN 77-254,076, FILED 8-13-2007.

TEJBIR SINGH, EXAMINING ATTORNEY

**Int. Cl.: 20**

**Prior U.S. Cls.: 2, 13, 22, 25, 32, and 50**

**Reg. No. 3,499,901**

**United States Patent and Trademark Office**

**Registered Sep. 9, 2008**

**TRADEMARK  
PRINCIPAL REGISTER**



JONTI-CRAFT, INC. (MINNESOTA CORPORATION)  
HIGHWAY 68  
WABASSO, MN 56293

THE MARK CONSISTS OF A BERRY WITH DOTS IN FRONT SHOWING MOVEMENT OVER THE WORDS "BERRIES CHAIRS FOR FRUITFUL LEARNING".

FOR: MOLDED PLASTIC CHAIRS, IN CLASS 20 (U.S. CLS. 2, 13, 22, 25, 32 AND 50).

FIRST USE 8-17-2007; IN COMMERCE 8-17-2007.

SN 77-254,787, FILED 8-14-2007.

NO CLAIM IS MADE TO THE EXCLUSIVE RIGHT TO USE "CHAIRS", APART FROM THE MARK AS SHOWN.

JUSTINE D. PARKER, EXAMINING ATTORNEY

**Int. Cl.: 16**

**Prior U.S. Cls.: 2, 5, 22, 23, 29, 37, 38, and 50**

**Reg. No. 3,499,902**

**United States Patent and Trademark Office**

**Registered Sep. 9, 2008**

**TRADEMARK  
PRINCIPAL REGISTER**

**ACCUFIT**

HERITAGE BAG COMPANY (TEXAS CORPORATION)  
1648 DIPLOMAT DRIVE  
CARROLLTON, TX 75006

THE MARK CONSISTS OF STANDARD CHARACTERS WITHOUT CLAIM TO ANY PARTICULAR FONT, STYLE, SIZE, OR COLOR.

FOR: PLASTIC TRASH CAN LINERS AND TRASH BAGS, IN CLASS 16 (U.S. CLS. 2, 5, 22, 23, 29, 37, 38 AND 50).

SN 77-255,543, FILED 8-15-2007.

FIRST USE 8-1-2007; IN COMMERCE 9-1-2007.

SHAUNIA CARLYLE, EXAMINING ATTORNEY



**Int. Cl.: 16**

**Prior U.S. Cls.: 2, 5, 22, 23, 29, 37, 38, and 50**

**Reg. No. 3,499,903**

**United States Patent and Trademark Office**

**Registered Sep. 9, 2008**

**TRADEMARK  
PRINCIPAL REGISTER**



VIVID ENTERTAINMENT LLC (CALIFORNIA  
LIMITED LIABILITY COMPANY)  
4TH FLOOR  
3599 CAHUENGA BLVD.  
WEST LOS ANGELES, CA 90068

FOR: CARDS, NAMELY, NON-MAGNETIC IN-  
TERNET ACCESS CARDS, IN CLASS 16 (U.S. CLS. 2,  
5, 22, 23, 29, 37, 38 AND 50).

FIRST USE 9-1-2007; IN COMMERCE 9-1-2007.

THE COLOR(S) DARK BLUE, WHITE, AND  
LIGHT BLUE IS/ARE CLAIMED AS A FEATURE  
OF THE MARK.

THE MARK CONSISTS OF AN ELONGATED  
BLUE AND WHITE FIVE POINTED STAR. THE  
OUTER EDGES OF THE STAR ARE DARK BLUE;  
THE INTERIOR IS LIGHT BLUE, AND, TO ADD  
DIMENSION, THERE IS A WHITE "CHECK MARK"  
IN THE MIDDLE OF THE STAR.

SN 77-256,230, FILED 8-15-2007.

TRACY CROSS, EXAMINING ATTORNEY

**Int. Cl.: 25**

**Prior U.S. Cls.: 22 and 39**

**United States Patent and Trademark Office**

**Reg. No. 3,499,904**

**Registered Sep. 9, 2008**

**TRADEMARK  
PRINCIPAL REGISTER**



UNDER ARMOUR, INC. (MARYLAND CORPORATION)  
1020 HULL STREET  
BALTIMORE, MD 21230

FOR: ATHLETIC FOOTWEAR, IN CLASS 25 (U.S. CLS. 22 AND 39).

FIRST USE 4-3-2008; IN COMMERCE 4-3-2008.

OWNER OF U.S. REG. NOS. 2,727,031, 2,991,123, AND 2,991,125.

THE MARK CONSISTS OF A STYLIZED LETTER "U" AND A STYLIZED LETTER "A" VERTICALLY OVERLAPPED AND POSITIONED ADJACENT TO THE WORDS "PROTO EVADE".

THE WORDING "PROTO" HAS NO MEANING OTHER THAN TRADEMARK SIGNIFICANCE.

SN 77-256,394, FILED 8-15-2007.

TAMARA FRAZIER, EXAMINING ATTORNEY

**Int. Cl.: 25**

**Prior U.S. Cls.: 22 and 39**

**United States Patent and Trademark Office**

**Reg. No. 3,499,905**

**Registered Sep. 9, 2008**

**TRADEMARK  
PRINCIPAL REGISTER**



UNDER ARMOUR, INC. (MARYLAND CORPORATION)  
1020 HULL STREET  
BALTIMORE, MD 21230

FOR: ATHLETIC FOOTWEAR, IN CLASS 25 (U.S. CLS. 22 AND 39).

FIRST USE 4-4-2008; IN COMMERCE 4-4-2008.

OWNER OF U.S. REG. NOS. 2,727,031, 2,991,125, AND OTHERS.

THE MARK CONSISTS OF A STYLIZED LETTER "U" AND A STYLIZED LETTER "A" VERTICALLY OVERLAPPED AND POSITIONED ADJACENT TO THE WORDS "PROTO POWER".

SN 77-256,403, FILED 8-15-2007.

TAMARA FRAZIER, EXAMINING ATTORNEY

**Int. Cl.: 25**

**Prior U.S. Cls.: 22 and 39**

**United States Patent and Trademark Office**

**Reg. No. 3,499,906**

**Registered Sep. 9, 2008**

**TRADEMARK  
PRINCIPAL REGISTER**



UNDER ARMOUR, INC. (MARYLAND CORPORATION)  
1020 HULL STREET  
BALTIMORE, MD 21230

FOR: ATHLETIC FOOTWEAR, IN CLASS 25 (U.S. CLS. 22 AND 39).

FIRST USE 4-4-2008; IN COMMERCE 4-4-2008.

OWNER OF U.S. REG. NOS. 2,727,031, 2,991,125, AND OTHERS.

THE MARK CONSISTS OF A STYLIZED LETTER "U" AND A STYLIZED LETTER "A" VERTICALLY OVERLAPPED AND POSITIONED ADJACENT TO THE WORDS "PROTO SPEED".

SN 77-256,406, FILED 8-15-2007.

TAMARA FRAZIER, EXAMINING ATTORNEY

**Int. Cl.: 9**

**Prior U.S. Cls.: 21, 23, 26, 36, and 38**

**United States Patent and Trademark Office**

**Reg. No. 3,499,907**

**Registered Sep. 9, 2008**

**TRADEMARK  
PRINCIPAL REGISTER**

**REDI-PAK**

RED-RAY MANUFACTURING CO., INC. (DELA-  
WARE CORPORATION)  
10-22 COUNTY LINE ROAD  
BRANCBURG, NJ 08876

THE MARK CONSISTS OF STANDARD CHAR-  
ACTERS WITHOUT CLAIM TO ANY PARTICULAR  
FONT, STYLE, SIZE, OR COLOR.

FOR: MODULAR PREMIX BURNER CONTROLS  
FOR OVENS AND HEATERS, IN CLASS 9 (U.S. CLS.  
21, 23, 26, 36 AND 38).

SN 77-256,714, FILED 8-16-2007.

FIRST USE 5-29-2008; IN COMMERCE 5-29-2008.

ALICE BENMAMAN, EXAMINING ATTORNEY

**Int. Cl.: 19**

**Prior U.S. Cls.: 1, 12, 33, and 50**

**United States Patent and Trademark Office**

**Reg. No. 3,499,908**

**Registered Sep. 9, 2008**

**TRADEMARK  
PRINCIPAL REGISTER**

**STANDING UP FOR THE  
ENVIRONMENT**

SILTSHIELD, LLC (MICHIGAN LIMITED LIABILITY COMPANY)  
6220 18-1/2 MILE ROAD  
STERLING HEIGHTS, MI 48314

THE MARK CONSISTS OF STANDARD CHARACTERS WITHOUT CLAIM TO ANY PARTICULAR FONT, STYLE, SIZE, OR COLOR.

FOR: NONMETALLIC ENVIRONMENTAL BARRIERS FOR PREVENTING SOIL EROSION, IN CLASS 19 (U.S. CLS. 1, 12, 33 AND 50).

SN 77-256,877, FILED 8-16-2007.

FIRST USE 11-30-2006; IN COMMERCE 1-31-2007.

LINDSEY RUBIN, EXAMINING ATTORNEY

**Int. Cl.: 25**

**Prior U.S. Cls.: 22 and 39**

**United States Patent and Trademark Office**

**Reg. No. 3,499,909**

**Registered Sep. 9, 2008**

**TRADEMARK  
PRINCIPAL REGISTER**

**DCE**

UNDER ARMOUR, INC. (MARYLAND COR-  
PORATION)  
1020 HULL STREET  
BALTIMORE, MD 21230

THE MARK CONSISTS OF STANDARD CHAR-  
ACTERS WITHOUT CLAIM TO ANY PARTICULAR  
FONT, STYLE, SIZE, OR COLOR.

FOR: ATHLETIC FOOTWEAR, IN CLASS 25 (U.S.  
CLS. 22 AND 39).

SN 77-257,737, FILED 8-17-2007.

FIRST USE 4-3-2008; IN COMMERCE 4-3-2008.

TAMARA FRAZIER, EXAMINING ATTORNEY

**Int. Cl.: 36**

**Prior U.S. Cls.: 100, 101, and 102**

**United States Patent and Trademark Office**

**Reg. No. 3,499,910**

**Registered Sep. 9, 2008**

**SERVICE MARK  
PRINCIPAL REGISTER**

**ADDING BALANCE TO WEALTH**

EQUIUS PARTNERS (CALIFORNIA PARTNER-  
SHIP), DBA HALCYON PARTNERS,  
4 HAMILTON LANDING, SUITE 205  
NOVATO, CA 94949

THE MARK CONSISTS OF STANDARD CHAR-  
ACTERS WITHOUT CLAIM TO ANY PARTICULAR  
FONT, STYLE, SIZE, OR COLOR.

FOR: INVESTMENT ADVISORY SERVICES, IN  
CLASS 36 (U.S. CLS. 100, 101 AND 102).

SN 77-258,668, FILED 8-18-2007.

FIRST USE 1-1-2008; IN COMMERCE 1-1-2008.

ROSELLE HERRERA, EXAMINING ATTORNEY



**Int. Cl.: 7**

**Prior U.S. Cls.: 13, 19, 21, 23, 31, 34, and 35**

**Reg. No. 3,499,911**

**United States Patent and Trademark Office**

**Registered Sep. 9, 2008**

**TRADEMARK  
PRINCIPAL REGISTER**

**PHANTOM****M**  
**TURBO**

HAYWARD INDUSTRIES, INC. (NEW JERSEY  
CORPORATION)  
620 DIVISION STREET  
ELIZABETH, NJ 07207

FIRST USE 10-0-2007; IN COMMERCE 10-0-2007.

OWNER OF U.S. REG. NO. 2,996,052.

FOR: UNDERWATER SWIMMING POOL  
CLEANING MACHINES FOR CLEANING THE  
SURFACE OF A SWIMMING POOL, IN CLASS 7  
(U.S. CLS. 13, 19, 21, 23, 31, 34 AND 35).

SN 77-260,867, FILED 8-21-2007.

DEBRA LEE, EXAMINING ATTORNEY

**Int. Cl.: 35**

**Prior U.S. Cls.: 100, 101, and 102**

**United States Patent and Trademark Office**

**Reg. No. 3,499,912**

**Registered Sep. 9, 2008**

**SERVICE MARK  
PRINCIPAL REGISTER**



IAB SOLUTIONS LLC (DELAWARE LIMITED  
LIABILITY COMPANY)  
233 NORTHERN BOULEVARD  
CLARKS SUMMIT, PA 18411

FOR: ACCOUNTS RECEIVABLE SERVICES, IN  
CLASS 35 (U.S. CLS. 100, 101 AND 102).

FIRST USE 8-31-2007; IN COMMERCE 8-31-2007.

OWNER OF U.S. REG. NOS. 2,307,213 AND  
3,203,966.

NO CLAIM IS MADE TO THE EXCLUSIVE  
RIGHT TO USE "SOLUTIONS LLC", APART FROM  
THE MARK AS SHOWN.

THE MARK CONSISTS OF THE WORDS "IAB  
SOLUTIONS LLC" OVER A PICTURE OF A MAG-  
NIFYING GLASS WITH THE LETTERS "IAB" UN-  
DERNEATH IT.

SN 77-261,568, FILED 8-22-2007.

ZHALEH DELANEY, EXAMINING ATTORNEY

**Int. Cl.: 9**

**Prior U.S. Cls.: 21, 23, 26, 36, and 38**

**Reg. No. 3,499,913**

**United States Patent and Trademark Office**

**Registered Sep. 9, 2008**

**TRADEMARK  
PRINCIPAL REGISTER**

# INFOPACER

CREOSO CORPORATION (DELAWARE CORPORATION)  
2810 S. 24TH STREET, STE. 102  
PHOENIX, AZ 85034

FOR: COMPUTER AUTHORING SOFTWARE FOR USE ON STANDALONE COMPUTERS OR COMPUTER COMMUNICATION NETWORKS, NAMELY, SOFTWARE FOR CREATING, EDITING AND DELIVERING TEXTUAL AND GRAPHIC INFORMATION ON INTERACTIVE INFORMATION KIOSKS, IN CLASS 9 (U.S. CLS. 21, 23, 26, 36 AND 38).

FIRST USE 8-20-2007; IN COMMERCE 8-20-2007.

THE MARK CONSISTS OF STANDARD CHARACTERS WITHOUT CLAIM TO ANY PARTICULAR FONT, STYLE, SIZE, OR COLOR.

SN 77-262,120, FILED 8-22-2007.

MARGERY A. TIERNEY, EXAMINING ATTORNEY

**Int. Cl.: 36**

**Prior U.S. Cls.: 100, 101, and 102**

**United States Patent and Trademark Office**

**Reg. No. 3,499,914**

**Registered Sep. 9, 2008**

**SERVICE MARK  
PRINCIPAL REGISTER**

**SPRING MOUNTAIN CAPITAL**

SPRING MOUNTAIN CAPITAL, LP (DELAWARE  
LIMITED PARTNERSHIP)  
65 EAST 55TH STREET, 33RD FLOOR  
NEW YORK, NY 10022

FOR: FINANCIAL SERVICES, NAMELY, INVEST-  
MENT ADVISORY SERVICES, INVESTMENT MAN-  
AGEMENT SERVICES AND ASSET  
MANAGEMENT SERVICES, IN CLASS 36 (U.S.  
CLS. 100, 101 AND 102).

FIRST USE 7-27-2001; IN COMMERCE 7-27-2001.

THE MARK CONSISTS OF STANDARD CHAR-  
ACTERS WITHOUT CLAIM TO ANY PARTICULAR  
FONT, STYLE, SIZE, OR COLOR.

NO CLAIM IS MADE TO THE EXCLUSIVE  
RIGHT TO USE "CAPITAL", APART FROM THE  
MARK AS SHOWN.

SN 77-262,128, FILED 8-22-2007.

DAVID ELTON, EXAMINING ATTORNEY

**Int. Cl.: 43**

**Prior U.S. Cls.: 100 and 101**

**United States Patent and Trademark Office**

**Reg. No. 3,499,915**

**Registered Sep. 9, 2008**

**SERVICE MARK  
PRINCIPAL REGISTER**

**BURGERS ON THE EDGE**

LAUGHING GRAVY PARTNERS INC. (HAWAII  
CORPORATION)  
604 LAUNA ALOHA PLACE  
KAILUA, HI 96734

FOR: CAFE-RESTAURANTS; CARRY-OUT RESTAURANTS; FAST-FOOD RESTAURANTS; FAST-FOOD RESTAURANTS AND SNACKBARS; RESTAURANT AND BAR SERVICES; RESTAURANT SERVICES; RESTAURANTS; TAKE-OUT RESTAURANT SERVICES, IN CLASS 43 (U.S. CLS. 100 AND 101).

FIRST USE 7-4-2008; IN COMMERCE 7-4-2008.

THE MARK CONSISTS OF STANDARD CHARACTERS WITHOUT CLAIM TO ANY PARTICULAR FONT, STYLE, SIZE, OR COLOR.

NO CLAIM IS MADE TO THE EXCLUSIVE RIGHT TO USE "BURGERS", APART FROM THE MARK AS SHOWN.

SN 77-263,302, FILED 8-24-2007.

JANET LEE, EXAMINING ATTORNEY

**Int. Cls.: 2 and 17**

**Prior U.S. Cls.: 1, 5, 6, 11, 12, 13, 16, 35, and 50**

**United States Patent and Trademark Office**

**Reg. No. 3,499,916**

**Registered Sep. 9, 2008**

**TRADEMARK  
PRINCIPAL REGISTER**

# SILTANIUM

SILTANIUM CORPORATION (GEORGIA CORPORATION), DBA MG DISTRIBUTION INC.,  
6 BROOKLAND DRIVE  
CARTERSVILLE, GA 30120

FOR: COATINGS, NAMELY, STAINS AND CLEAR FINISHES FOR EXTERIOR AND INTERIOR USE ON A VARIETY OF SUBSTRATES, NAMELY, CONCRETE, TILE, BRICK, STONE, MORTAR AND PAINTED SURFACES; COATINGS FOR CONCRETE, NAMELY, CONCRETE MOISTURE BARRIER COATINGS; COATINGS FOR STONE, NAMELY, PRESERVATIVE COATINGS FOR MASONRY; CORROSION INHIBITANTS IN THE NATURE OF COATINGS; PAINT PROTECTANTS AND SEALANTS, IN CLASS 2 (U.S. CLS. 6, 11 AND 16).

FIRST USE 11-1-2007; IN COMMERCE 1-5-2008.

FOR: WATERPROOF SILICA-BASED SEALANTS FOR EXTERIOR AND INTERIOR USE ON A VARIETY OF SURFACES, NAMELY, GROUT, MORTAR, CONCRETE, STONE, TILE AND BRICK; WATERPROOF SEALANTS, IN CLASS 17 (U.S. CLS. 1, 5, 12, 13, 35 AND 50).

FIRST USE 11-1-2007; IN COMMERCE 1-5-2008.

THE MARK CONSISTS OF STANDARD CHARACTERS WITHOUT CLAIM TO ANY PARTICULAR FONT, STYLE, SIZE, OR COLOR.

SN 77-264,697, FILED 8-27-2007.

JESSICA A. POWERS, EXAMINING ATTORNEY

**Int. Cl.: 35**

**Prior U.S. Cls.: 100, 101, and 102**

**United States Patent and Trademark Office**

**Reg. No. 3,499,917**

**Registered Sep. 9, 2008**

**SERVICE MARK  
PRINCIPAL REGISTER**

**IMEA**

NATIONAL MARINE ELECTRONICS ASSOCIATION, INC. (MARYLAND CORPORATION)  
7 RIGGS AVE.  
SEVERNA PARK, MD 21146

THE MARK CONSISTS OF STANDARD CHARACTERS WITHOUT CLAIM TO ANY PARTICULAR FONT, STYLE, SIZE, OR COLOR.

FOR: ASSOCIATION SERVICES, NAMELY, PROMOTING THE INTERESTS OF THE MARINE ELECTRONICS INDUSTRY, IN CLASS 35 (U.S. CLS. 100, 101 AND 102).

SN 77-264,809, FILED 8-27-2007.

FIRST USE 6-6-2008; IN COMMERCE 6-6-2008.

ZHALEH DELANEY, EXAMINING ATTORNEY

**Int. Cl.: 42**

**Prior U.S. Cls.: 100 and 101**

**United States Patent and Trademark Office**

**Reg. No. 3,499,918**

**Registered Sep. 9, 2008**

**SERVICE MARK  
PRINCIPAL REGISTER**

# DCConsult

FOUNDATION FOR CHIROPRACTIC EDUCATION AND RESEARCH (DELAWARE CORPORATION)  
380 WRIGHT ROAD  
NORWALK, IA 50211

FOR: COMPILING DATA FOR RESEARCH PURPOSES IN THE FIELD OF MEDICAL SCIENCE AND MEDICAL CONSULTANCY; COMPUTER SERVICE, NAMELY, ACTING AS AN APPLICATION SERVICE PROVIDER IN THE FIELD OF KNOWLEDGE MANAGEMENT TO HOST COMPUTER APPLICATION SOFTWARE FOR SEARCHING AND RETRIEVING INFORMATION FROM DATABASES AND COMPUTER NETWORKS; MEDICAL AND SCIENTIFIC

RESEARCH INFORMATION IN THE FIELD OF CHIROPRACTIC AND ALTERNATIVE MEDICINE, IN CLASS 42 (U.S. CLS. 100 AND 101).

FIRST USE 11-7-2007; IN COMMERCE 11-7-2007.

THE MARK CONSISTS OF STANDARD CHARACTERS WITHOUT CLAIM TO ANY PARTICULAR FONT, STYLE, SIZE, OR COLOR.

SN 77-265,879, FILED 8-28-2007.

BILL DAWE, EXAMINING ATTORNEY



Int. Cl.: 33

Prior U.S. Cls.: 47 and 49

United States Patent and Trademark Office

Reg. No. 3,499,919

Registered Sep. 9, 2008

TRADEMARK  
PRINCIPAL REGISTER



CRAMELE RECAS SA (ROMANIA CORPORATION)  
COMPLEX VINIFICATIE, CP 1, 307340  
RECAS, JUD. TIMIS, ROMANIA

FOR: WINE, IN CLASS 33 (U.S. CLS. 47 AND 49).

FIRST USE 4-30-2007; IN COMMERCE 4-30-2007.

NO CLAIM IS MADE TO THE EXCLUSIVE RIGHT TO USE "RECAS" , APART FROM THE MARK AS SHOWN.

THE MARK CONSISTS OF A WINE LABEL WITH A BEAR'S HEAD AT THE TOP, THE WORDING "LA

PUTERE" FOLLOWED BY "LA" AND "P" (WITH THE "P" PARTIALLY OFF THE LABEL) FOLLOWED BY "PUTERE" FOLLOWED BY A CROWN DESIGN FOLLOWED BY THE WORD "RECAS".

THE FOREIGN WORDING "LA PUTERE" IN THE MARK TRANSLATES INTO ENGLISH AS "IN POWER".

SN 77-268,065, FILED 8-30-2007.

C. DIONNE CLYBURN, EXAMINING ATTORNEY

**Int. Cl.: 11**

**Prior U.S. Cls.: 13, 21, 23, 31, and 34**

**United States Patent and Trademark Office**

**Reg. No. 3,499,920**

**Registered Sep. 9, 2008**

**TRADEMARK  
PRINCIPAL REGISTER**



CAMZ ENTERPRISES CORP. (FLORIDA CORPORATION)  
SUITE #10  
8346 NW 10TH ST  
MIAMI, FL 33126

FOR: WINDOW-MOUNTING AIR-CONDITIONERS; EVAPORATIVE AIR COOLING UNITS FOR DOMESTIC USE; EVAPORATORS FOR AIR CONDITIONERS; AIR CONDITIONERS; AIR CONDITIONING UNITS; AIR-CONDITIONING APPARATUS; CENTRAL AIR-CONDITIONING INSTALLATIONS; LOCALLY INDUCED AIR-CONDITIONERS, IN CLASS 11 (U.S. CLS. 13, 21, 23, 31 AND 34).

FIRST USE 1-7-2008; IN COMMERCE 1-18-2008.

THE MARK CONSISTS OF AN OVAL WITH A SERIES OF SNOWFLAKES INSIDE AND THE WORD "NEVE" WRITTEN ON TOP IN STYLIZED CAPITAL LETTERS.

THE FOREIGN WORDING IN THE MARK TRANSLATES INTO ENGLISH AS SNOW.

SN 77-268,975, FILED 8-31-2007.

DOMINIC J. FERRAIUOLO, EXAMINING ATTORNEY

**Int. Cl.: 43**

**Prior U.S. Cls.: 100 and 101**

**United States Patent and Trademark Office**

**Reg. No. 3,499,921**

**Registered Sep. 9, 2008**

**SERVICE MARK  
PRINCIPAL REGISTER**

**STRATFORD CATERING**

SAMOU, LLC (ILLINOIS LIMITED LIABILITY  
COMPANY)

442 W. ARMY TRAIL ROAD

BLOOMINGDALE, IL 60108

FOR: CATERING, IN CLASS 43 (U.S. CLS. 100  
AND 101).

FIRST USE 11-30-2007; IN COMMERCE 11-30-2007.

THE MARK CONSISTS OF STANDARD CHAR-  
ACTERS WITHOUT CLAIM TO ANY PARTICULAR  
FONT, STYLE, SIZE, OR COLOR.

NO CLAIM IS MADE TO THE EXCLUSIVE  
RIGHT TO USE "CATERING", APART FROM THE  
MARK AS SHOWN.

SN 77-269,666, FILED 8-31-2007.

ERIN FALK, EXAMINING ATTORNEY

**Int. Cl.: 7**

**Prior U.S. Cls.: 13, 19, 21, 23, 31, 34, and 35**

**Reg. No. 3,499,922**

**United States Patent and Trademark Office**

**Registered Sep. 9, 2008**

**TRADEMARK  
PRINCIPAL REGISTER**

**COBRA**

LIN, PO-HSIU (TAIWAN INDIVIDUAL)  
SEC. 4, JHONGSIAO E. RD.  
6 F., NO. 30, LANE 101  
TAIPEI CITY 106, TAIWAN

THE MARK CONSISTS OF STANDARD CHAR-  
ACTERS WITHOUT CLAIM TO ANY PARTICULAR  
FONT, STYLE, SIZE, OR COLOR.

FOR: RACKET STRINGING MACHINES, IN  
CLASS 7 (U.S. CLS. 13, 19, 21, 23, 31, 34 AND 35).

SN 77-271,363, FILED 9-4-2007.

FIRST USE 4-16-2008; IN COMMERCE 4-16-2008.

HOWARD SMIGA, EXAMINING ATTORNEY

**Int. Cl.: 9**

**Prior U.S. Cls.: 21, 23, 26, 36, and 38**

**Reg. No. 3,499,923**

**United States Patent and Trademark Office**

**Registered Sep. 9, 2008**

**TRADEMARK  
PRINCIPAL REGISTER**



HM ELECTRONICS, INC (CALIFORNIA CORPORATION)  
14110 STOWE DRIVE  
POWAY, CA 92064

FOR: ELECTRONIC TIMERS, IN CLASS 9 (U.S. CLS. 21, 23, 26, 36 AND 38).

FIRST USE 7-1-2007; IN COMMERCE 11-1-2007.

THE MARK CONSISTS OF A STYLIZED LETTER "Z", TWO STYLIZED LETTER "OS", AND A STYLIZED LETTER "M".

SN 77-273,514, FILED 9-6-2007.

CHRISTOPHER BUONGIORNO, EXAMINING ATTORNEY

**Int. Cl.: 9**

**Prior U.S. Cls.: 21, 23, 26, 36, and 38**

**Reg. No. 3,499,924**

**United States Patent and Trademark Office**

**Registered Sep. 9, 2008**

**TRADEMARK  
PRINCIPAL REGISTER**

**DIAMOND SPINNER**

KONAMI GAMING, INC. (NEVADA CORPORATION)  
585 TRADE CENTER DRIVE  
LAS VEGAS, NV 89119

FOR: ELECTRONIC GAME PROGRAMS; GAMING EQUIPMENT, NAMELY, SLOT MACHINES WITH OR WITHOUT VIDEO OUTPUT; GAMING MACHINES; MACHINES FOR PLAYING GAMES OF CHANCE; SLOT MACHINES, IN CLASS 9 (U.S. CLS. 21, 23, 26, 36 AND 38).

FIRST USE 8-31-2007; IN COMMERCE 8-31-2007.

THE MARK CONSISTS OF STANDARD CHARACTERS WITHOUT CLAIM TO ANY PARTICULAR FONT, STYLE, SIZE, OR COLOR.

OWNER OF U.S. REG. NOS. 2,968,515, 3,151,915, AND 3,160,532.

NO CLAIM IS MADE TO THE EXCLUSIVE RIGHT TO USE "SPINNER", APART FROM THE MARK AS SHOWN.

SN 77-273,719, FILED 9-7-2007.

JENNIFER MARTIN, EXAMINING ATTORNEY

**Int. Cl.: 41**

**Prior U.S. Cls.: 100, 101, and 107**

**Reg. No. 3,499,925**

**United States Patent and Trademark Office**

**Registered Sep. 9, 2008**

---

**SERVICE MARK  
PRINCIPAL REGISTER**

**1600**

XM SATELLITE RADIO INC. (DELAWARE CORPORATION)  
1500 ECKINGTON PLACE, N.E.  
WASHINGTON, DC 20002

THE MARK CONSISTS OF STANDARD CHARACTERS WITHOUT CLAIM TO ANY PARTICULAR FONT, STYLE, SIZE, OR COLOR.

FOR: ENTERTAINMENT SERVICES, NAMELY, AN ONGOING RADIO PROGRAM IN THE FIELD OF POLITICS, IN CLASS 41 (U.S. CLS. 100, 101 AND 107).

SN 77-274,252, FILED 9-7-2007.

FIRST USE 9-24-2007; IN COMMERCE 9-24-2007.

BRENDAN MCCAULEY, EXAMINING ATTORNEY

**Int. Cl.: 35**

**Prior U.S. Cls.: 100, 101, and 102**

**United States Patent and Trademark Office**

**Reg. No. 3,499,926**

**Registered Sep. 9, 2008**

**SERVICE MARK  
PRINCIPAL REGISTER**

# Stone Soup

STONE SOUP, LLC (OREGON LIMITED LIABILITY COMPANY)  
1740 NW PENCE LANE SUITE 4  
BEND, OR 97701

FOR: RETAIL STORES FEATURING NEW AND USED CHILDREN'S CLOTHING AND ACCESSORIES, AND MATERNITY CLOTHING AND ACCESSORIES; RETAIL CONSIGNMENT STORES FEATURING NEW AND USED CHILDREN'S CLOTHING AND ACCESSORIES, AND MATERNITY CLOTHING AND ACCESSORIES, IN CLASS 35 (U.S. CLS. 100, 101 AND 102).

FIRST USE 10-12-2007; IN COMMERCE 10-12-2007.

THE MARK CONSISTS OF STANDARD CHARACTERS WITHOUT CLAIM TO ANY PARTICULAR FONT, STYLE, SIZE, OR COLOR.

SN 77-275,030, FILED 9-9-2007.

SHAILA SETTLES, EXAMINING ATTORNEY



**Int. Cl.: 29**

**Prior U.S. Cl.: 46**

**United States Patent and Trademark Office**

**Reg. No. 3,499,927**

**Registered Sep. 9, 2008**

**TRADEMARK  
PRINCIPAL REGISTER**

**STEAMSUPREME**

ALLENS, INC. (ARKANSAS CORPORATION)  
305 EAST MAIN STREET  
P.O. BOX 250  
SILOAM SPRINGS, AR 72761

THE MARK CONSISTS OF STANDARD CHAR-  
ACTERS WITHOUT CLAIM TO ANY PARTICULAR  
FONT, STYLE, SIZE, OR COLOR.

FOR: FROZEN VEGETABLES, IN CLASS 29 (U.S.  
CL. 46).

SN 77-275,171, FILED 9-10-2007.

FIRST USE 1-0-2008; IN COMMERCE 1-0-2008.

AMY GEARIN, EXAMINING ATTORNEY

**Int. Cl.: 41**

**Prior U.S. Cls.: 100, 101, and 107**

**United States Patent and Trademark Office**

**Reg. No. 3,499,928**

**Registered Sep. 9, 2008**

**SERVICE MARK  
PRINCIPAL REGISTER**

**THE DECISION HOUSE**

MYNETWORKTV, INC. (DELAWARE CORPORATION)  
10201 WEST PICO BOULEVARD  
LOS ANGELES, CA 90035

THE MARK CONSISTS OF STANDARD CHARACTERS WITHOUT CLAIM TO ANY PARTICULAR FONT, STYLE, SIZE, OR COLOR.

FOR: ENTERTAINMENT SERVICES IN THE NATURE OF A TELEVISION SERIES IN THE REALITY GENRE, IN CLASS 41 (U.S. CLS. 100, 101 AND 107).

SN 77-275,595, FILED 9-10-2007.

FIRST USE 9-12-2007; IN COMMERCE 9-12-2007.

JOHN GARTNER, EXAMINING ATTORNEY

**Int. Cl.: 35**

**Prior U.S. Cls.: 100, 101, and 102**

**United States Patent and Trademark Office**

**Reg. No. 3,499,929**

**Registered Sep. 9, 2008**

**SERVICE MARK  
PRINCIPAL REGISTER**

**BIGY2GO**

BIG Y FOODS, INC. (MASSACHUSETTS CORPORATION)  
2145 ROOSEVELT AVENUE  
SPRINGFIELD, MA 01102

FOR: PROVIDING ON-LINE ORDERING SERVICES OF SUPERMARKET GOODS, IN CLASS 35 (U.S. CLS. 100, 101 AND 102).

FIRST USE 11-0-2007; IN COMMERCE 11-0-2007.

THE MARK CONSISTS OF STANDARD CHARACTERS WITHOUT CLAIM TO ANY PARTICULAR FONT, STYLE, SIZE, OR COLOR.

OWNER OF U.S. REG. NOS. 1,643,113, 2,833,715, AND OTHERS.

SN 77-277,622, FILED 9-12-2007.

CHARLES L. JENKINS, EXAMINING ATTORNEY

**Int. Cl.: 36**

**Prior U.S. Cls.: 100, 101, and 102**

**United States Patent and Trademark Office**

**Reg. No. 3,499,930**

**Registered Sep. 9, 2008**

**SERVICE MARK  
PRINCIPAL REGISTER**

**EXPERIENCE LIFE**

NATIONAL LIFE INSURANCE COMPANY (VER-  
MONT CORPORATION)  
NATIONAL LIFE DRIVE  
MONTPELIER, VT 05604

FOR: LIFE INSURANCE UNDERWRITING; ISSU-  
ANCE AND ADMINISTRATION OF ANNUITIES;  
FUNDS INVESTMENT; INVESTMENT ADVISORY  
SERVICES; INVESTMENT MANAGEMENT; FI-  
NANCIAL PLANNING, IN CLASS 36 (U.S. CLS. 100,  
101 AND 102).

FIRST USE 11-0-2007; IN COMMERCE 11-0-2007.

THE MARK CONSISTS OF STANDARD CHAR-  
ACTERS WITHOUT CLAIM TO ANY PARTICULAR  
FONT, STYLE, SIZE, OR COLOR.

NO CLAIM IS MADE TO THE EXCLUSIVE  
RIGHT TO USE "LIFE", APART FROM THE MARK  
AS SHOWN.

SN 77-277,691, FILED 9-12-2007.

MARGARET POWER, EXAMINING ATTORNEY

**Int. Cl.: 3**

**Prior U.S. Cls.: 1, 4, 6, 50, 51, and 52**

**Reg. No. 3,499,931**

**United States Patent and Trademark Office**

**Registered Sep. 9, 2008**

**TRADEMARK  
PRINCIPAL REGISTER**

**DRYTEK**

THE DIAL CORPORATION (DELAWARE COR-  
PORATION)  
SUITE 2214  
15501 NORTH DIAL BOULEVARD  
SCOTTSDALE, AZ 852601619

THE MARK CONSISTS OF STANDARD CHAR-  
ACTERS WITHOUT CLAIM TO ANY PARTICULAR  
FONT, STYLE, SIZE, OR COLOR.

FOR: DEODORANTS AND ANTIPERSPIRANTS,  
IN CLASS 3 (U.S. CLS. 1, 4, 6, 50, 51 AND 52).

SN 77-278,265, FILED 9-12-2007.

FIRST USE 1-15-2008; IN COMMERCE 1-15-2008.

KELLEY WELLS, EXAMINING ATTORNEY

**Int. Cl.: 28**

**Prior U.S. Cls.: 22, 23, 38, and 50**

**United States Patent and Trademark Office**

**Reg. No. 3,499,932**

**Registered Sep. 9, 2008**

**TRADEMARK  
PRINCIPAL REGISTER**

**POKARA**

RILEY, ROBERT E. (UNITED STATES INDIVIDUAL), DBA N/A,  
1522 DELVALE STREET  
WEST COVINA, CA 91790

THE MARK CONSISTS OF STANDARD CHARACTERS WITHOUT CLAIM TO ANY PARTICULAR FONT, STYLE, SIZE, OR COLOR.

FOR: CARD GAMES, IN CLASS 28 (U.S. CLS. 22, 23, 38 AND 50).

SN 77-278,323, FILED 9-12-2007.

FIRST USE 4-10-2008; IN COMMERCE 4-10-2008.

STEPHANIE ALI, EXAMINING ATTORNEY

**Int. Cl.: 9**

**Prior U.S. Cls.: 21, 23, 26, 36, and 38**

**Reg. No. 3,499,933**

**United States Patent and Trademark Office**

**Registered Sep. 9, 2008**

**TRADEMARK  
PRINCIPAL REGISTER**

The logo for Labthink, featuring the word "Labthink" in a bold, black, sans-serif font. The letters are closely spaced, and the overall style is clean and modern.

JINAN LANGUANG M & E TECHNOLOGY CO.,  
LIMITED (CHINA CORPORATION)  
JINAN CITY, NO.144 WUYINGSHAN ROAD  
SHANGDONG PROVINCE, CHINA 00000

DETECTORS FOR DETECTING THE PRESENCE OF  
GAS, PRESSURE SENSORS, GAS CHROMATOGRAPHY  
APPARATUS, IN CLASS 9 (U.S. CLS. 21, 23, 26,  
36 AND 38).

FOR: GAS PERMEABILITY TESTERS, OXYGEN  
TRANSMISSION RATE TESTERS, WATER VAPOR  
PERMEABILITY TESTERS, TESTERS FOR PACKA-  
GING MATERIALS, TEXTILE TESTING MA-  
CHINES, TOOL MEASURING INSTRUMENTS,  
HEAT SEALING MACHINES FOR HEAT SEAL  
PROPERTIES OF PACKAGING MATERIALS, GAS

FIRST USE 8-24-2007; IN COMMERCE 8-24-2007.

SN 77-279,341, FILED 9-14-2007.

DOMINIC J. FERRAIUOLO, EXAMINING ATTOR-  
NEY

**Int. Cl.: 32**

**Prior U.S. Cls.: 45, 46, and 48**

**Reg. No. 3,499,934**

**United States Patent and Trademark Office**

**Registered Sep. 9, 2008**

**TRADEMARK  
PRINCIPAL REGISTER**

**KERN'S**

KERNS BEVERAGES, LLC (DELAWARE LIMITED LIABILITY COMPANY)  
4002 W. WESTMINSTER AVENUE  
SANTA ANA, CA 92703

FOR: TOMATO AND CLAM JUICE COCKTAIL,  
IN CLASS 32 (U.S. CLS. 45, 46 AND 48).

FIRST USE 4-17-2008; IN COMMERCE 4-17-2008.

THE MARK CONSISTS OF STANDARD CHARACTERS WITHOUT CLAIM TO ANY PARTICULAR FONT, STYLE, SIZE, OR COLOR.

OWNER OF U.S. REG. NO. 892,137.

SN 77-280,261, FILED 9-14-2007.

DEIRDRE ROBERTSON, EXAMINING ATTORNEY



**Int. Cl.: 41**

**Prior U.S. Cls.: 100, 101, and 107**

**United States Patent and Trademark Office**

**Reg. No. 3,499,935**

**Registered Sep. 9, 2008**

**SERVICE MARK  
PRINCIPAL REGISTER**

**SPIRAL UP!**

NVLC, INC. (CALIFORNIA CORPORATION)  
C/O GOLDRING, HERTZ & LICHTENSTEIN, LLP  
450 N. ROXBURY DR., 8TH FLOOR  
BEVERLY HILLS, CA 90210

FOR: EDUCATION SERVICES, NAMELY, DEVELOPING A COMPREHENSIVE MODEL CURRICULUM FOR OTHERS IN THE FIELDS OF COMPUTERS, MUSIC, ART, DANCE, HISTORY, PHILOSOPHY, LANGUAGE STUDY, PHYSICAL EDUCATION, SCIENCE, MATHEMATICS; PROVIDING COURSES OF INSTRUCTION AT THE PRE-K

THROUGH 12TH GRADE LEVELS, IN CLASS 41 (U.S. CLS. 100, 101 AND 107).

FIRST USE 9-30-2007; IN COMMERCE 9-30-2007.

THE MARK CONSISTS OF STANDARD CHARACTERS WITHOUT CLAIM TO ANY PARTICULAR FONT, STYLE, SIZE, OR COLOR.

SN 77-280,294, FILED 9-14-2007.

MARY BOAGNI, EXAMINING ATTORNEY

Int. Cl.: 45

Prior U.S. Cls.: 100 and 101

United States Patent and Trademark Office

Reg. No. 3,499,936

Registered Sep. 9, 2008

SERVICE MARK  
PRINCIPAL REGISTER



THE UNIVERSITY OF SOUTHERN MISSISSIPPI  
(MISSISSIPPI STATE UNIVERSITY)  
118 COLLEGE DRIVE #5116  
HATTIESBURG, MS 39406

FOR: SECURITY INSPECTION SERVICES FOR  
OTHERS, IN CLASS 45 (U.S. CLS. 100 AND 101).

FIRST USE 1-1-2008; IN COMMERCE 1-1-2008.

NO CLAIM IS MADE TO THE EXCLUSIVE  
RIGHT TO USE "SPORTS EVENT SECURITY",  
APART FROM THE MARK AS SHOWN.

THE COLOR(S) BLUE, RED, WHITE IS/ARE  
CLAIMED AS A FEATURE OF THE MARK.

THE MARK CONSISTS OF BLUE AND RED NON-  
CONCENTRIC CIRCLES WITH "SPORTS EVENT  
SECURITY AWARE" WRITTEN IN WHITE IN THAT  
SECTION. THE CENTER WHITE SECTION CON-  
TAINS THE INITIALS "SESA" IN BLUE. TWO  
WHITE STARS APPEAR TO THE LEFT AND RIGHT  
OF THE INITIALS.

SN 77-280,940, FILED 9-17-2007.

MARIA-VICTORIA SUAREZ, EXAMINING ATTOR-  
NEY

**Int. Cl.: 28**

**Prior U.S. Cls.: 22, 23, 38, and 50**

**Reg. No. 3,499,937**

**United States Patent and Trademark Office**

**Registered Sep. 9, 2008**

**TRADEMARK  
PRINCIPAL REGISTER**

**JUNIOR HELPER**

SCHYLLING ASSOCIATES, INC. (MASSACHU-  
SETTS CORPORATION)  
306 NEWBURYPORT TURNPIKE  
ROWLEY, MA 01969

FOR: CHILDREN'S TOY HOUSEHOLD IMPLE-  
MENTS, NAMELY, TOY BROOMS, TOY DUST-  
PANS, TOY DUSTPAN BRUSHES, TOY MOPS, TOY  
MOP BUCKETS, TOY FEATHER DUSTERS, TOY  
IRONING BOARDS AND TOY IRONS, IN CLASS 28  
(U.S. CLS. 22, 23, 38 AND 50).

FIRST USE 3-24-2004; IN COMMERCE 3-24-2004.

THE MARK CONSISTS OF STANDARD CHAR-  
ACTERS WITHOUT CLAIM TO ANY PARTICULAR  
FONT, STYLE, SIZE, OR COLOR.

SN 77-281,729, FILED 9-18-2007.

TASHIA BUNCH, EXAMINING ATTORNEY

**Int. Cl.: 27**

**Prior U.S. Cls.: 19, 20, 37, 42, and 50**

**United States Patent and Trademark Office**

**Reg. No. 3,499,938**

**Registered Sep. 9, 2008**

**TRADEMARK  
PRINCIPAL REGISTER**

**REVOLVE**

MANNINGTON MILLS, INC. (NEW JERSEY  
CORPORATION)  
P.O. BOX 30  
SALEM, NJ 08079

THE MARK CONSISTS OF STANDARD CHAR-  
ACTERS WITHOUT CLAIM TO ANY PARTICULAR  
FONT, STYLE, SIZE, OR COLOR.

FOR: CARPET BACKING; CARPET TILES; CAR-  
PETING, IN CLASS 27 (U.S. CLS. 19, 20, 37, 42 AND  
50).

SN 77-282,301, FILED 9-18-2007.

FIRST USE 10-31-2007; IN COMMERCE 10-31-2007.

GEORGE LORENZO, EXAMINING ATTORNEY

**Int. Cl.: 9**

**Prior U.S. Cls.: 21, 23, 26, 36, and 38**

**Reg. No. 3,499,939**

**United States Patent and Trademark Office**

**Registered Sep. 9, 2008**

**TRADEMARK  
PRINCIPAL REGISTER**

The logo for FASTTRACK is rendered in a bold, italicized, sans-serif font. The letters 'F', 'A', 'S', and 'T' are connected to each other, and the 'R', 'A', 'C', and 'K' are also connected. The 'T' has a distinctive shape with a horizontal bar that extends to the right. The entire logo is in a dark gray color.

KES SYSTEMS, INC. (DELAWARE CORPORATION)  
1407 WEST DRIVERS WAY  
TEMPE, AZ 85284

FOR: APPARATUS FOR LOADING AND UNLOADING INTEGRATED CIRCUITS ONTO PRINTED CIRCUIT BOARDS AND FOR MONITORING, PROCESSING AND TESTING IN PARALLELISM OF

DEVICES ON PRINTED CIRCUIT BOARDS, IN CLASS 9 (U.S. CLS. 21, 23, 26, 36 AND 38).

FIRST USE 12-6-2007; IN COMMERCE 12-6-2007.

SN 77-283,619, FILED 9-19-2007.

PAUL E. FAHRENKOPF, EXAMINING ATTORNEY

**Int. Cl.: 9**

**Prior U.S. Cls.: 21, 23, 26, 36, and 38**

**United States Patent and Trademark Office**

**Reg. No. 3,499,940**

**Registered Sep. 9, 2008**

**TRADEMARK  
PRINCIPAL REGISTER**

**FASTRACK**

KES SYSTEMS, INC. (DELAWARE CORPORATION)  
1407 WEST DRIVERS WAY  
TEMPE, AZ 85284

FOR: APPARATUS FOR LOADING AND UNLOADING INTEGRATED CIRCUITS ONTO PRINTED CIRCUIT BOARDS AND FOR MONITORING, PROCESSING AND TESTING IN PARALLELISM OF DEVICES LOCATED ON PRINTED CIRCUIT BOARDS, IN CLASS 9 (U.S. CLS. 21, 23, 26, 36 AND 38).

FIRST USE 12-6-2007; IN COMMERCE 12-6-2007.

THE MARK CONSISTS OF STANDARD CHARACTERS WITHOUT CLAIM TO ANY PARTICULAR FONT, STYLE, SIZE, OR COLOR.

SN 77-283,624, FILED 9-19-2007.

PAUL E. FAHRENKOPF, EXAMINING ATTORNEY

**Int. Cl.: 43**

**Prior U.S. Cls.: 100 and 101**

**United States Patent and Trademark Office**

**Reg. No. 3,499,941**

**Registered Sep. 9, 2008**

**SERVICE MARK  
PRINCIPAL REGISTER**

**YOGURTAGOGO**

B.E.K. GROUP, LLC (CALIFORNIA LIMITED  
LIABILITY COMPANY)  
4580 BEECHWOOD DR.  
EL DORADO HILLS, CA 95762

THE MARK CONSISTS OF STANDARD CHAR-  
ACTERS WITHOUT CLAIM TO ANY PARTICULAR  
FONT, STYLE, SIZE, OR COLOR.

FOR: RESTAURANTS, IN CLASS 43 (U.S. CLS. 100  
AND 101).

SN 77-283,822, FILED 9-19-2007.

FIRST USE 9-29-2007; IN COMMERCE 9-29-2007.

MARY ROSSMAN, EXAMINING ATTORNEY

**Int. Cl.: 10**

**Prior U.S. Cls.: 26, 39, and 44**

**United States Patent and Trademark Office**

**Reg. No. 3,499,942**

**Registered Sep. 9, 2008**

**TRADEMARK  
PRINCIPAL REGISTER**

**Odyssey Blood Glucose  
Monitoring System**

LIFESYSTEMS, INC. (GEORGIA CORPORATION)  
7320 CENTRAL AVE.  
SAVANNAH, GA 31406

FOR: BLOOD GLUCOSE METER; BLOOD TEST-  
ING APPARATUS, IN CLASS 10 (U.S. CLS. 26, 39  
AND 44).

FIRST USE 4-15-2008; IN COMMERCE 5-1-2008.

THE MARK CONSISTS OF STANDARD CHAR-  
ACTERS WITHOUT CLAIM TO ANY PARTICULAR  
FONT, STYLE, SIZE, OR COLOR.

NO CLAIM IS MADE TO THE EXCLUSIVE  
RIGHT TO USE "BLOOD GLUCOSE MONITORING  
SYSTEM", APART FROM THE MARK AS SHOWN.

SN 77-285,649, FILED 9-21-2007.

ARETHA SOMERVILLE, EXAMINING ATTORNEY



Int. Cl.: 9

Prior U.S. Cls.: 21, 23, 26, 36, and 38

United States Patent and Trademark Office

Reg. No. 3,499,943

Registered Sep. 9, 2008

TRADEMARK  
PRINCIPAL REGISTER



**POWERADVANTAGE**

SYMARK INTERNATIONAL, INC. (CALIFORNIA CORPORATION)  
30401 AGOURA ROAD, SUITE 200  
AGOURA HILLS, CA 91301

FIRST USE 9-1-2007; IN COMMERCE 1-9-2008.

SN 77-286,036, FILED 9-21-2007.

FOR: COMPUTER SOFTWARE THAT FACILITATES THE INTEGRATION OF COMPUTER SERVERS TO OTHER OPERATING SYSTEMS, IN CLASS 9 (U.S. CLS. 21, 23, 26, 36 AND 38).

MARK T. MULLEN, EXAMINING ATTORNEY

**Int. Cl.: 1**

**Prior U.S. Cls.: 1, 5, 6, 10, 26, and 46**

**Reg. No. 3,499,944**

**United States Patent and Trademark Office**

**Registered Sep. 9, 2008**

**TRADEMARK  
PRINCIPAL REGISTER**

**FLEXFILL**

AMERITYRE (NEVADA CORPORATION)  
1501 INDUSTRIAL ROAD  
BOULDER CITY, NV 89005

THE MARK CONSISTS OF STANDARD CHAR-  
ACTERS WITHOUT CLAIM TO ANY PARTICULAR  
FONT, STYLE, SIZE, OR COLOR.

FOR: CHEMICAL COMPOUNDS FOR USE AS A  
TIRE FILL TO FILL THE VOID IN A PNEUMATIC  
TIRE, IN CLASS 1 (U.S. CLS. 1, 5, 6, 10, 26 AND 46).

SN 77-286,105, FILED 9-21-2007.

FIRST USE 7-1-2008; IN COMMERCE 7-1-2008.

ALEX KEAM, EXAMINING ATTORNEY

Int. Cl.: 35

Prior U.S. Cls.: 100, 101, and 102

United States Patent and Trademark Office

Reg. No. 3,499,945

Registered Sep. 9, 2008

**SERVICE MARK  
PRINCIPAL REGISTER**

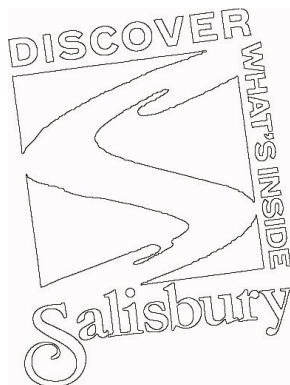

THE CITY OF SALISBURY, NORTH CAROLINA  
(NORTH CAROLINA CORPORATION), DBA A  
MUNICIPAL CORPORATION ORGANIZED  
UNDER THE LAWS OF THE STATE OF  
NORTH CAROLINA,

P.O. BOX 479  
SALISBURY, NC 281450479

FOR: PROMOTING THE BUSINESS, TOURISM,  
MUNICIPAL AND CIVIC INTERESTS OF THE CITY  
OF SALISBURY, NORTH CAROLINA, IN CLASS 35  
(U.S. CLS. 100, 101 AND 102).

FIRST USE 7-1-2008; IN COMMERCE 7-1-2008.

NO CLAIM IS MADE TO THE EXCLUSIVE  
RIGHT TO USE "SALISBURY", APART FROM THE  
MARK AS SHOWN.

THE MARK CONSISTS OF AN ANGLED REC-  
TANGLE WITH A STYLIZED LETTER "S" BOR-  
DERED ON THREE SIDES BY THE STYLIZED  
TEXT "DISCOVER WHAT'S INSIDE SALISBURY".

SN 77-286,602, FILED 9-23-2007.

LINDA M. KING, EXAMINING ATTORNEY

Int. Cl.: 3

Prior U.S. Cls.: 1, 4, 6, 50, 51, and 52

Reg. No. 3,499,946

United States Patent and Trademark Office

Registered Sep. 9, 2008

**TRADEMARK  
PRINCIPAL REGISTER**

**GUYS GONE STYLED**

METRO MEN'S GROOMING PRODUCTS, INC.  
(GEORGIA CORPORATION)  
250 10TH STREET NE #1212  
ATLANTA, GA 30309

FOR: HAIR CARE CREAMS; HAIR CARE LOTIONS; HAIR CARE PREPARATIONS; HAIR CONDITIONER; HAIR CONDITIONERS; HAIR CREAMS; HAIR DRESSINGS FOR MEN; HAIR FIXERS; HAIR GEL; HAIR GELS; HAIR LACQUERS; HAIR LOTIONS; HAIR MOUSSES; HAIR POMADES; HAIR RINSES; HAIR RINSES; HAIR SHAMPOO; HAIR SPRAY; HAIR STRAIGHTENING PREPARATIONS; HAIR STYLING FIXATIVE IN THE NATURE OF HAIR WAX; HAIR STYLING GEL; HAIR STYLING PREPARATIONS; HAIR STYLING SPRAY; HAIR TONIC; HAIR TONICS; AFTER-SHAVE; AFTER-SHAVE BALMS; AFTER-SHAVE CREAMS; AFTER-SHAVE EMULSIONS; AFTER-SHAVE GEL; AFTER-SHAVE LOTIONS; PRE-SHAVE CREAMS; SHAVING BALM; SHAVING CREAM; SHAVING CREAMS; SHAVING FOAM; SHAVING GEL; SHAVING GELS; SHAVING LOTION; SHAVING LOTIONS; SHAVING MOUSSE; SHAVING PREPARATIONS; SHAVING SOAP; SHAVING SPRITZ IN THE NATURE OF A MOISTURIZING SOLUTION FOR SHAVING; COSMETIC CREAMS FOR SKIN CARE; COSMETIC PREPARATIONS FOR BODY CARE; COSMETIC PREPARATIONS FOR SKIN RENEWAL; COSMETIC PREPARATIONS FOR THE CARE OF MOUTH AND TEETH; COSMETIC PRODUCTS IN THE FORM OF AEROSOLS FOR SKIN CARE; DEODORANTS FOR BODY CARE; LOTIONS FOR FACE AND BODY CARE; NON-MEDICATED LIP CARE PREPARATIONS; NON-MEDICATED SKIN CARE PREPARATIONS; NON-MEDICATED SKIN CARE PREPARATIONS, NAMELY, CREAMS, LOTIONS, GELS, TONERS, CLEANERS AND PEELS; NON-

MEDICATED SKIN CREAMS; NON-MEDICATED STIMULATING LOTIONS FOR THE SKIN; NON-MEDICATED SUN CARE PREPARATIONS; SKIN ABRASIVE PREPARATIONS; SKIN AND BODY TOPICAL LOTIONS, CREAMS AND OILS FOR COSMETIC USE; SKIN BRONZER; SKIN BRONZING CREAMS; SKIN CARE PREPARATION, NAMELY, BODY POLISH; SKIN CLARIFIERS; SKIN CLEANSERS; SKIN CLEANSING CREAM; SKIN CLEANSING LOTION; SKIN CONDITIONERS; SKIN CREAM; SKIN CREAMS; SKIN CREAMS IN LIQUID AND IN SOLID FORM; SKIN CREAMS IN LIQUID AND SOLID; SKIN CREAMS IN LIQUID AND SOLID FORM; SKIN EMOLLIENTS; SKIN GELS FOR ACCELERATING, ENHANCING OR EXTENDING TANS; SKIN LIGHTENERS; SKIN LIGHTENING CREAMS; SKIN LOTION; SKIN LOTIONS; SKIN MASKS; SKIN MOISTURIZER; SKIN MOISTURIZER MASKS; SKIN POLISHING RICE BRAN (ARAI-NUKA); SKIN SOAP; SKIN TEXTURIZERS; SKIN TONERS; SKIN WHITENING CREAMS; SKIN WHITENING PREPARATIONS; SOAPS FOR BODY CARE; SUN CARE LOTIONS; TOPICAL SKIN SPRAYS FOR COSMETIC PURPOSES; WRINKLE REMOVING SKIN CARE PREPARATIONS, IN CLASS 3 (U.S. CLS. 1, 4, 6, 50, 51 AND 52).

FIRST USE 7-31-2007; IN COMMERCE 7-31-2007.

THE MARK CONSISTS OF STANDARD CHARACTERS WITHOUT CLAIM TO ANY PARTICULAR FONT, STYLE, SIZE, OR COLOR.

SN 77-286,624, FILED 9-23-2007.

HOWARD B. LEVINE, EXAMINING ATTORNEY

**Int. Cl.: 5**

**Prior U.S. Cls.: 6, 18, 44, 46, 51, and 52**

**Reg. No. 3,499,947**

**United States Patent and Trademark Office**

**Registered Sep. 9, 2008**

**TRADEMARK  
PRINCIPAL REGISTER**

**STATTEST**

MICRO DISTRIBUTING II, LTD. (TEXAS CORPORATION)  
620 KENNEDY COURT  
BELTON, TX 76513

THE MARK CONSISTS OF STANDARD CHARACTERS WITHOUT CLAIM TO ANY PARTICULAR FONT, STYLE, SIZE, OR COLOR.

FOR: DRUG TESTING KITS COMPRISED OF MEDICAL DIAGNOSTIC REAGENTS AND ASSAYS FOR TESTING BODY FLUIDS, IN CLASS 5 (U.S. CLS. 6, 18, 44, 46, 51 AND 52).

SN 77-287,059, FILED 9-24-2007.

FIRST USE 4-15-2007; IN COMMERCE 12-1-2007.

RONALD MCMORROW, EXAMINING ATTORNEY

**Int. Cl.: 11**

**Prior U.S. Cls.: 13, 21, 23, 31, and 34**

**Reg. No. 3,499,948**

**United States Patent and Trademark Office**

**Registered Sep. 9, 2008**

**TRADEMARK  
PRINCIPAL REGISTER**

**TOILET PAK**

GLOBE UNION (BERMUDA) TRADING LTD.  
(BERMUDA COMPANY)  
C/O HOLLIS & CO.  
REID HALL, 3 REID STREET  
HAMILTON, BERMUDA

FOR: TOILETS, IN CLASS 11 (U.S. CLS. 13, 21, 23, 31  
AND 34).

FIRST USE 2-15-2008; IN COMMERCE 2-15-2008.

THE MARK CONSISTS OF STANDARD CHAR-  
ACTERS WITHOUT CLAIM TO ANY PARTICULAR  
FONT, STYLE, SIZE, OR COLOR.

NO CLAIM IS MADE TO THE EXCLUSIVE  
RIGHT TO USE "TOILET", APART FROM THE  
MARK AS SHOWN.

SN 77-287,221, FILED 9-24-2007.

KEVIN DINALLO, EXAMINING ATTORNEY

**Int. Cl.: 9**

**Prior U.S. Cls.: 21, 23, 26, 36, and 38**

**Reg. No. 3,499,949**

**United States Patent and Trademark Office**

**Registered Sep. 9, 2008**

---

**TRADEMARK  
PRINCIPAL REGISTER**

**RAZER**

BANOM, INC. (PENNSYLVANIA CORPORATION)  
BOX 687  
WAYNE, PA 19087

THE MARK CONSISTS OF STANDARD CHARACTERS WITHOUT CLAIM TO ANY PARTICULAR FONT, STYLE, SIZE, OR COLOR.

FOR: CUT-RESISTANT GLOVES FOR INDUSTRIAL USE, IN CLASS 9 (U.S. CLS. 21, 23, 26, 36 AND 38).

SN 77-287,354, FILED 9-24-2007.

FIRST USE 5-6-2008; IN COMMERCE 5-6-2008.

ROBIN CHOSID, EXAMINING ATTORNEY

**Int. Cls.: 5 and 11**

**Prior U.S. Cls.: 6, 13, 18, 21, 23, 31, 34, 44, 46, 51, and 52**

**United States Patent and Trademark Office**

**Reg. No. 3,499,950**

**Registered Sep. 9, 2008**

**TRADEMARK  
PRINCIPAL REGISTER**

**Closet<sup>®</sup>**

SARAMAR LLC (DELAWARE LIMITED LIABILITY COMPANY)  
70 WEST MADISON  
THREE FIRST NATIONAL PLAZA  
CHICAGO, IL 60602

FOR: AIR FRESHENING PREPARATIONS, IN CLASS 5 (U.S. CLS. 6, 18, 44, 46, 51 AND 52).

FIRST USE 2-21-2008; IN COMMERCE 2-21-2008.

FOR: DISPENSING UNITS FOR AIR FRESHENERS, IN CLASS 11 (U.S. CLS. 13, 21, 23, 31 AND 34).

FIRST USE 2-21-2008; IN COMMERCE 2-21-2008.

NO CLAIM IS MADE TO THE EXCLUSIVE RIGHT TO USE "CLOSET", APART FROM THE MARK AS SHOWN.

THE MARK CONSISTS OF THE WORD CLOSET WITH A TEARDROP CONTAINING THE LETTER "p."

SN 77-287,931, FILED 9-25-2007.

CAROL SPILS, EXAMINING ATTORNEY



**Int. Cl.: 42**

**Prior U.S. Cls.: 100 and 101**

**United States Patent and Trademark Office**

**Reg. No. 3,499,951**

**Registered Sep. 9, 2008**

**SERVICE MARK  
PRINCIPAL REGISTER**

**FIO FIGURE IT OUT**

FIO CONSULTING, INC. (WISCONSIN CORPORATION)  
571 E. GENEVA STREET, P.O. BOX 698  
WILLIAMS BAY, WI 53191

THE MARK CONSISTS OF STANDARD CHARACTERS WITHOUT CLAIM TO ANY PARTICULAR FONT, STYLE, SIZE, OR COLOR.

FOR: INFORMATION TECHNOLOGY CONSULTATION, IN CLASS 42 (U.S. CLS. 100 AND 101).

SN 77-287,949, FILED 9-25-2007.

FIRST USE 1-31-2008; IN COMMERCE 1-31-2008.

ESTHER BELENKER, EXAMINING ATTORNEY

**Int. Cl.: 42**

**Prior U.S. Cls.: 100 and 101**

**United States Patent and Trademark Office**

**Reg. No. 3,499,952**

**Registered Sep. 9, 2008**

**SERVICE MARK  
PRINCIPAL REGISTER**

**HOMETRACKERONE**

HOMETRACKER, L.P. (TEXAS LIMITED PART-  
NERSHIP)  
14651 DALLAS PARKWAY, SUITE 414  
DALLAS, TX 75254

FOR: PROVIDING TEMPORARY USE OF ON-  
LINE NONDOWNLOADABLE SOFTWARE FOR  
MANAGING AND MARKETING REAL ESTATE  
ASSETS, FOR USE BY REAL ESTATE BROKERS  
AND REAL ESTATE AGENTS, IN CLASS 42 (U.S.  
CLS. 100 AND 101).

FIRST USE 9-10-2007; IN COMMERCE 10-1-2007.

THE MARK CONSISTS OF STANDARD CHAR-  
ACTERS WITHOUT CLAIM TO ANY PARTICULAR  
FONT, STYLE, SIZE, OR COLOR.

OWNER OF U.S. REG. NOS. 2,871,548 AND  
2,908,180.

SN 77-288,493, FILED 9-25-2007.

PAUL E. FAHRENKOPF, EXAMINING ATTORNEY

Int. Cl.: 35

Prior U.S. Cls.: 100, 101, and 102

United States Patent and Trademark Office

Reg. No. 3,499,953

Registered Sep. 9, 2008

**SERVICE MARK  
PRINCIPAL REGISTER**



HOLOVISIONS LLC (MINNESOTA LIMITED LIABILITY COMPANY)  
100 THIRD AVENUE SOUTH, #304  
MINNEAPOLIS, MN 55401

FOR: ADVERTISING SERVICES, NAMELY, CREATING CORPORATE LOGOS FOR OTHERS, IN CLASS 35 (U.S. CLS. 100, 101 AND 102).

FIRST USE 7-7-2008; IN COMMERCE 7-7-2008.

THE COLOR(S) RED, YELLOW, GREEN, BLUE, PURPLE, LIGHT BLUE AND GRAY IS/ARE CLAIMED AS A FEATURE OF THE MARK.

THE MARK CONSISTS OF THE STYLIZED WORD "VIRTUAL", IN AN UPWARD-BENT ARCH, WITH LETTERS IN A RAINBOW OF COLORS, FROM LEFT TO RIGHT – RED TO YELLOW TO GREEN TO BLUE TO PURPLE – WITH A GRAY DROP-SHADOW BEHIND THE COLORED LETTERS; ON TOP OF A GRADIATED LIGHT BLUE RECTANGULAR BACKGROUND.

SN 77-289,936, FILED 9-26-2007.

SHAUNIA CARLYLE, EXAMINING ATTORNEY

**Int. Cl.: 29**

**Prior U.S. Cl.: 46**

**United States Patent and Trademark Office**

**Reg. No. 3,499,954**

**Registered Sep. 9, 2008**

**TRADEMARK  
PRINCIPAL REGISTER**

**LES ARACHIDES DU VILLAGE**

ACR GROUP, INC. (VIRGINIA CORPORATION)  
P.O. BOX 1246  
ASHBURN, VA 20146

FOR: PROCESSED PEANUTS, IN CLASS 29 (U.S.  
CL. 46).

FIRST USE 1-16-2008; IN COMMERCE 1-16-2008.

THE MARK CONSISTS OF STANDARD CHAR-  
ACTERS WITHOUT CLAIM TO ANY PARTICULAR  
FONT, STYLE, SIZE, OR COLOR.

NO CLAIM IS MADE TO THE EXCLUSIVE  
RIGHT TO USE "LES ARACHIDES", APART FROM  
THE MARK AS SHOWN.

THE ENGLISH TRANSLATION OF THE MARK IS  
THE PEANUTS FROM THE VILLAGE.

SN 77-290,049, FILED 9-27-2007.

PAUL E. FAHRENKOPF, EXAMINING ATTORNEY

**Int. Cl.: 35**

**Prior U.S. Cls.: 100, 101, and 102**

**United States Patent and Trademark Office**

**Reg. No. 3,499,955**

**Registered Sep. 9, 2008**

**SERVICE MARK  
PRINCIPAL REGISTER**

**Distinguish Your People**

REXI MEDIA (CALIFORNIA LIMITED LIABILITY COMPANY)  
1706 FOUNTAIN SPRING ROAD  
DANVILLE, CA 94526

FOR: BUSINESS ADVISORY SERVICES, CONSULTANCY AND INFORMATION, IN CLASS 35 (U.S. CLS. 100, 101 AND 102).

FIRST USE 10-1-2007; IN COMMERCE 10-1-2007.

THE MARK CONSISTS OF STANDARD CHARACTERS WITHOUT CLAIM TO ANY PARTICULAR FONT, STYLE, SIZE, OR COLOR.

SN 77-291,659, FILED 9-28-2007.

CURTIS FRENCH, EXAMINING ATTORNEY

**Int. Cl.: 44**

**Prior U.S. Cls.: 100 and 101**

**United States Patent and Trademark Office**

**Reg. No. 3,499,956**

**Registered Sep. 9, 2008**

**SERVICE MARK  
PRINCIPAL REGISTER**

MAPLE LAWN ORTHODONTICS

PATEL, KAMLESH G (UNITED STATES INDIVIDUAL)  
9 HONEYSTONE COURT  
BROOKEVILLE, MD 20833

FOR: DENTISTRY; ORTHODONTIC SERVICES; PROVIDING NEWS AND INFORMATION IN THE FIELD OF DENTISTRY; COSMETIC DENTISTRY, IN CLASS 44 (U.S. CLS. 100 AND 101).

FIRST USE 3-5-2008; IN COMMERCE 3-5-2008.

THE MARK CONSISTS OF STANDARD CHARACTERS WITHOUT CLAIM TO ANY PARTICULAR FONT, STYLE, SIZE, OR COLOR.

NO CLAIM IS MADE TO THE EXCLUSIVE RIGHT TO USE "ORTHODONTICS", APART FROM THE MARK AS SHOWN.

SN 77-292,360, FILED 9-30-2007.

JESSICA A. POWERS, EXAMINING ATTORNEY

**Int. Cl.: 35**

**Prior U.S. Cls.: 100, 101, and 102**

**United States Patent and Trademark Office**

**Reg. No. 3,499,957**

**Registered Sep. 9, 2008**

**SERVICE MARK  
PRINCIPAL REGISTER**

**ISC SURFACES**

INTERSTATE FLOORING, L.L.C. (MISSOURI  
LIMITED LIABILITY COMPANY)  
4445 GUSTINE AVENUE  
SAINT LOUIS, MO 63116

FOR: WHOLESALE DISTRIBUTORSHIP, RETAIL  
STORE, AND ONLINE RETAIL STORE SERVICES  
IN THE FIELDS OF WOOD, CERAMIC, STONE AND  
VINYL FLOORING AND TILES, CARPETING,  
FLOOR VENTS, FLOOR SANDING, FLOOR STAIN-  
ING AND FLOOR MAINTENANCE PRODUCTS,  
WOOD ADHESIVES AND WOOD FLOOR INSTAL-  
LERS, WOOD FLOOR FASTENERS AND WOOD  
FLOOR INSTALLATION TOOLS, COUNTERTOPS,  
CABINETS, DECORATIVE CABINET HARDWARE,  
CABINET TOOLING AND RELATED CABINET

PRODUCTS, IN CLASS 35 (U.S. CLS. 100, 101 AND  
102).

FIRST USE 12-1-2007; IN COMMERCE 12-1-2007.

THE MARK CONSISTS OF STANDARD CHAR-  
ACTERS WITHOUT CLAIM TO ANY PARTICULAR  
FONT, STYLE, SIZE, OR COLOR.

NO CLAIM IS MADE TO THE EXCLUSIVE  
RIGHT TO USE "SURFACES", APART FROM THE  
MARK AS SHOWN.

SN 77-292,885, FILED 10-1-2007.

SARA THOMAS, EXAMINING ATTORNEY

**Int. Cl.: 5**

**Prior U.S. Cls.: 6, 18, 44, 46, 51, and 52**

**Reg. No. 3,499,958**

**United States Patent and Trademark Office**

**Registered Sep. 9, 2008**

**TRADEMARK  
PRINCIPAL REGISTER**

**Omega Greens**

HEARTLAND PRODUCTS, INC. (NORTH DAKOTA CORPORATION)  
849 14TH ST SW  
VALLEY CITY, ND 58072

THE MARK CONSISTS OF STANDARD CHARACTERS WITHOUT CLAIM TO ANY PARTICULAR FONT, STYLE, SIZE, OR COLOR.

FOR: DIETARY FOOD SUPPLEMENTS, IN CLASS 5 (U.S. CLS. 6, 18, 44, 46, 51 AND 52).

SN 77-293,686, FILED 10-2-2007.

FIRST USE 10-7-2007; IN COMMERCE 11-15-2007.

RICHARD WHITE, EXAMINING ATTORNEY



**Int. Cls.: 18 and 25**

**Prior U.S. Cls.: 1, 2, 3, 22, 39, and 41**

**United States Patent and Trademark Office**

**Reg. No. 3,499,959**

**Registered Sep. 9, 2008**

**TRADEMARK  
PRINCIPAL REGISTER**

# DECREE

J. C. PENNEY PRIVATE BRANDS, INC. (DELA-  
WARE CORPORATION)  
6501 LEGACY DRIVE  
PLANO, TX 750243698

FOR: HANDBAGS, BACKPACKS, AND LUG-  
GAGE, IN CLASS 18 (U.S. CLS. 1, 2, 3, 22 AND 41).

FIRST USE 7-1-2008; IN COMMERCE 7-1-2008.

FOR: SHIRTS, PANTS, JACKETS, COATS, SWIM-  
WEAR, SHOES, SLIPPERS, HEADWEAR, BELTS, IN  
CLASS 25 (U.S. CLS. 22 AND 39).

FIRST USE 7-1-2008; IN COMMERCE 7-1-2008.

THE MARK CONSISTS OF STANDARD CHAR-  
ACTERS WITHOUT CLAIM TO ANY PARTICULAR  
FONT, STYLE, SIZE, OR COLOR.

SN 77-294,001, FILED 10-2-2007.

JIM RINGLE, EXAMINING ATTORNEY

**Int. Cl.: 30**

**Prior U.S. Cl.: 46**

**United States Patent and Trademark Office**

**Reg. No. 3,499,960**

**Registered Sep. 9, 2008**

**TRADEMARK  
PRINCIPAL REGISTER**

**KRYSTAL ROKS**

GRAVYMASTER, INC. (CONNECTICUT CORPORATION), DBA DRYDEN & PALMER CO.,  
16 BUSINESS PARK DRIVE  
BRANFORD, CT 06405

FOR: FLAVORED SUGAR CANDY, IN CLASS 30  
(U.S. CL. 46).

FIRST USE 12-31-2007; IN COMMERCE 12-31-2007.

THE MARK CONSISTS OF STANDARD CHARACTERS WITHOUT CLAIM TO ANY PARTICULAR FONT, STYLE, SIZE, OR COLOR.

NO CLAIM IS MADE TO THE EXCLUSIVE RIGHT TO USE "ROCKS", APART FROM THE MARK AS SHOWN.

SN 77-294,890, FILED 10-3-2007.

DAVID MURRAY, EXAMINING ATTORNEY

**Int. Cl.: 36**

**Prior U.S. Cls.: 100, 101, and 102**

**United States Patent and Trademark Office**

**Reg. No. 3,499,961**

**Registered Sep. 9, 2008**

**SERVICE MARK  
PRINCIPAL REGISTER**



HUGHES FEDERAL CREDIT UNION (ARIZONA  
CREDIT UNION)  
P.O. BOX 11900  
TUCSON, AZ 85734

FOR: CREDIT UNION SERVICES FOR CREDIT UNION MEMBERS; SAVINGS ACCOUNT SERVICES, NAMELY, PROVIDING CERTIFICATES OF DEPOSIT AND MONEY MARKET SAVINGS ACCOUNTS; CHECKING ACCOUNT SERVICES; INDIVIDUAL RETIREMENT ACCOUNT SERVICES; PERSONAL PROPERTY AND REAL ESTATE FINANCING SERVICES; UNSECURED LOAN SERVICES; CREDIT CARD SERVICES; AND ON-LINE BANKING SERVICES; ELECTRONIC BILL PAYMENT SERVICES; SAFE DEPOSIT BOX SERVICES, IN CLASS 36 (U.S. CLS. 100, 101 AND 102).

FIRST USE 5-27-2008; IN COMMERCE 5-27-2008.

NO CLAIM IS MADE TO THE EXCLUSIVE RIGHT TO USE "FEDERAL CREDIT UNION", APART FROM THE MARK AS SHOWN.

THE MARK CONSISTS OF THE WORD "HUGHES" ABOVE THE WORDS "FEDERAL CREDIT UNION" BOTH TO THE RIGHT OF A STYLIZED "H" AND A STAR INSIDE A SHADED SQUARE.

SN 77-295,275, FILED 10-3-2007.

DAVID TOOLEY, EXAMINING ATTORNEY

**Int. Cl.: 43**

**Prior U.S. Cls.: 100 and 101**

**United States Patent and Trademark Office**

**Reg. No. 3,499,962**

**Registered Sep. 9, 2008**

**SERVICE MARK  
PRINCIPAL REGISTER**



CAPITOL BURGER LLC (MARYLAND LIMITED  
LIABILITY COMPANY)  
7820 STRATFORD ROAD  
BETHESDA, MD 20814

NO CLAIM IS MADE TO THE EXCLUSIVE  
RIGHT TO USE "THE BURGER JOINT DC", APART  
FROM THE MARK AS SHOWN.

FOR: RESTAURANT SERVICES, IN CLASS 43  
(U.S. CLS. 100 AND 101).

SN 77-296,143, FILED 10-4-2007.

FIRST USE 1-0-2008; IN COMMERCE 5-1-2008.

ELLEN BURNS, EXAMINING ATTORNEY

**Int. Cl.: 36**

**Prior U.S. Cls.: 100, 101, and 102**

**United States Patent and Trademark Office**

**Reg. No. 3,499,963**

**Registered Sep. 9, 2008**

**SERVICE MARK  
PRINCIPAL REGISTER**

**CASH IN A BLINK**

CLOVERLEAF HOLDINGS, LLC (MISSOURI  
LIMITED LIABILITY COMPANY)  
8304 WORNALL ROAD  
KANSAS CITY, MO 64114

FOR: FINANCIAL SERVICES, NAMELY, PRO-  
VIDING TEMPORARY LOANS IN THE NATURE  
OF INSTALLMENT AND PAYCHECK LOANS AND  
CONSUMER LOANS, IN CLASS 36 (U.S. CLS. 100, 101  
AND 102).

FIRST USE 11-7-2007; IN COMMERCE 11-7-2007.

THE MARK CONSISTS OF STANDARD CHAR-  
ACTERS WITHOUT CLAIM TO ANY PARTICULAR  
FONT, STYLE, SIZE, OR COLOR.

NO CLAIM IS MADE TO THE EXCLUSIVE  
RIGHT TO USE "CASH", APART FROM THE MARK  
AS SHOWN.

SN 77-296,923, FILED 10-5-2007.

MARIA-VICTORIA SUAREZ, EXAMINING ATTOR-  
NEY

**Int. Cl.: 9**

**Prior U.S. Cls.: 21, 23, 26, 36, and 38**

**United States Patent and Trademark Office**

**Reg. No. 3,499,964**

**Registered Sep. 9, 2008**

**TRADEMARK  
PRINCIPAL REGISTER**

**FLEXsearch**

NACHI ROBOTIC SYSTEMS INC. (DELAWARE  
CORPORATION)  
22285 ROETHEL DR.  
NOVI, MI 48375

THE MARK CONSISTS OF STANDARD CHAR-  
ACTERS WITHOUT CLAIM TO ANY PARTICULAR  
FONT, STYLE, SIZE, OR COLOR.

FOR: PROGRAMMING INTERFACE SOFTWARE  
FOR OPERATING INDUSTRIAL, VISION GUIDED  
ROBOTS, IN CLASS 9 (U.S. CLS. 21, 23, 26, 36 AND 38).

SN 77-297,015, FILED 10-5-2007.

FIRST USE 11-1-2007; IN COMMERCE 3-1-2008.

IRA J. GOODSaid, EXAMINING ATTORNEY

**Int. Cl.: 5**

**Prior U.S. Cls.: 6, 18, 44, 46, 51, and 52**

**United States Patent and Trademark Office**

**Reg. No. 3,499,965**

**Registered Sep. 9, 2008**

**TRADEMARK  
PRINCIPAL REGISTER**



CRAMER, GARY (UNITED STATES INDIVIDUAL)  
455 FOLSOM RD.  
LOXAHATCHEE, FL 33470

FOR: VAGINAL LIP BALM MOISTURIZER STICK IN THE NATURE OF A PERSONAL LUBRICANT WITH A HUMOROUS LABEL AND DIRECTIONS FOR USE, IN CLASS 5 (U.S. CLS. 6, 18, 44, 46, 51 AND 52).

FIRST USE 1-10-2008; IN COMMERCE 2-11-2008.

THE MARK CONSISTS OF THE STYLIZED TEXT "HARD-ON".

SN 77-297,066, FILED 10-5-2007.

ALEXANDER L. POWERS, EXAMINING ATTORNEY

**Int. Cl.: 40**

**Prior U.S. Cls.: 100, 103, and 106**

**United States Patent and Trademark Office**

**Reg. No. 3,499,966**

**Registered Sep. 9, 2008**

**SERVICE MARK  
PRINCIPAL REGISTER**



STAR COMMUNICATIONS, INC. (NEW JERSEY CORPORATION)

11 MAIDEN LANE

BOUND BROOK, NJ 08805

FOR: PRINTING, IN CLASS 40 (U.S. CLS. 100, 103 AND 106).

FIRST USE 11-1-2007; IN COMMERCE 11-1-2007.

NO CLAIM IS MADE TO THE EXCLUSIVE RIGHT TO USE "PRINT" , APART FROM THE MARK AS SHOWN.

THE MARK CONSISTS OF THE WORD "ENVIRO" FOLLOWED BY A LEAF, FOLLOWED BY THE WORD "PRINT"; ALL ON ONE LINE.

SN 77-297,387, FILED 10-5-2007.

KAPIL BHANOT, EXAMINING ATTORNEY



Int. Cl.: 43

Prior U.S. Cls.: 100 and 101

United States Patent and Trademark Office

Reg. No. 3,499,967

Registered Sep. 9, 2008

SERVICE MARK  
PRINCIPAL REGISTER

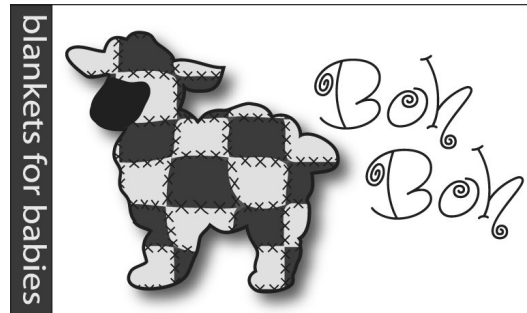

BLANKETS FOR BABIES (ARIZONA CORPORATION)

#124

8880 E. PARAISO DRIVE  
SCOTTSDALE, AZ 85255

NO CLAIM IS MADE TO THE EXCLUSIVE RIGHT TO USE "BLANKETS FOR BABIES", APART FROM THE MARK AS SHOWN.

FOR: CHARITABLE SERVICES, NAMELY, PROVIDING BLANKETS TO THOSE IN NEED, IN CLASS 43 (U.S. CLS. 100 AND 101).

SN 77-297,725, FILED 10-5-2007.

FIRST USE 10-14-2007; IN COMMERCE 10-14-2007.

SIMON TENG, EXAMINING ATTORNEY

**Int. Cl.: 21**

**Prior U.S. Cls.: 2, 13, 23, 29, 30, 33, 40, and 50**

**Reg. No. 3,499,968**

**United States Patent and Trademark Office**

**Registered Sep. 9, 2008**

---

**TRADEMARK  
PRINCIPAL REGISTER**

**Peace Love Chow**

JOHNSON, BARBARA (UNITED STATES INDIVIDUAL)  
1565 HOOT OWL COURT  
TRACY, CA 95376

THE MARK CONSISTS OF STANDARD CHARACTERS WITHOUT CLAIM TO ANY PARTICULAR FONT, STYLE, SIZE, OR COLOR.

FOR: CERAMIC SCULPTURES, VASES, VESSELS, BOWLS, PLATES AND POTS, IN CLASS 21 (U.S. CLS. 2, 13, 23, 29, 30, 33, 40 AND 50).

SN 77-297,977, FILED 10-6-2007.

FIRST USE 9-21-2004; IN COMMERCE 9-21-2004.

ROBERT C. CLARK JR., EXAMINING ATTORNEY

**Int. Cl.: 25**

**Prior U.S. Cls.: 22 and 39**

**United States Patent and Trademark Office**

**Reg. No. 3,499,969**

**Registered Sep. 9, 2008**

**TRADEMARK  
PRINCIPAL REGISTER**



ZOOMERS, INC. (NEW YORK CORPORATION)  
32 33RD STREET  
BROOKLYN, NY 10028

FOR: BATHING SUITS; BLOUSES; BRAS; COATS;  
DRESSES; HATS; JACKETS; JEANS; JOGGING  
PANTS; JOGGING SUITS; JUMPERS; LINGERIE;  
OVERALLS; PAJAMAS; PANTIES; PANTS; SHIRTS;  
SHOES; SHORTS; SKIRTS; SLEEPWEAR; SLIPPERS;  
SNEAKERS; SOCKS; SUITS; SWEAT PANTS; SWEAT  
SHIRTS; SWEATERS; T-SHIRTS; BOXER SHORTS;  
BRIEFS, IN CLASS 25 (U.S. CLS. 22 AND 39).

FIRST USE 3-15-2008; IN COMMERCE 5-8-2008.

THE MARK CONSISTS OF A SET OF SIX LINES  
CURVING UP TO THE RIGHT, THEN LEFT TO A  
POINT WHERE ALL LINES ARE CONJOINED. AT  
THE BOTTOM WHERE THE LINES ARE SEPA-  
RATE, THE NUMERALS "00:00.01" APPEAR, THE  
LINES STARTING AT THE TOP OF EACH NUMER-  
AL.

SN 77-299,230, FILED 10-9-2007.

JILL C. ALT, EXAMINING ATTORNEY

**Int. Cl.: 28**

**Prior U.S. Cls.: 22, 23, 38, and 50**

**United States Patent and Trademark Office**

**Reg. No. 3,499,970**

**Registered Sep. 9, 2008**

**TRADEMARK  
PRINCIPAL REGISTER**



CHIEN-MING WANG (TAIWAN INDIVIDUAL)  
C/O CSMG SPORTS, LTD., 20 WEST KINZIE  
SUITE 1000  
CHICAGO, IL 60610

THE MARK CONSISTS OF PROFILE OF BASE-  
BALL PLAYER AND THE LETTERS "CMW" WITH  
A BASEBALL DIAMOND BACKGROUND.

FOR: BOBBLEHEAD DOLLS, IN CLASS 28 (U.S.  
CLS. 22, 23, 38 AND 50).

SN 77-300,428, FILED 10-10-2007.

FIRST USE 1-28-2008; IN COMMERCE 1-28-2008.

JUDITH HELFMAN, EXAMINING ATTORNEY

**Int. Cl.: 33**

**Prior U.S. Cls.: 47 and 49**

**United States Patent and Trademark Office**

**Reg. No. 3,499,971**

**Registered Sep. 9, 2008**

**TRADEMARK  
PRINCIPAL REGISTER**

**STAVE 28**

STAVE 28, LTD. (CALIFORNIA CORPORATION)  
2175 WEST PARK, #B  
NAPA, CA 94558

THE MARK CONSISTS OF STANDARD CHAR-  
ACTERS WITHOUT CLAIM TO ANY PARTICULAR  
FONT, STYLE, SIZE, OR COLOR.

FOR: WINE, IN CLASS 33 (U.S. CLS. 47 AND 49).

SN 77-300,702, FILED 10-10-2007.

FIRST USE 5-31-2005; IN COMMERCE 5-31-2005.

CAROLYN CATALDO, EXAMINING ATTORNEY

**Int. Cl.: 9**

**Prior U.S. Cls.: 21, 23, 26, 36, and 38**

**United States Patent and Trademark Office**

**Reg. No. 3,499,972**

**Registered Sep. 9, 2008**

**TRADEMARK  
PRINCIPAL REGISTER**

**FRIDGE-IT**

BIRDS EYE FOODS, INC. (DELAWARE COR-  
PORATION)  
90 LINDEN OAKS  
ROCHESTER, NY 14625

THE MARK CONSISTS OF STANDARD CHAR-  
ACTERS WITHOUT CLAIM TO ANY PARTICULAR  
FONT, STYLE, SIZE, OR COLOR.

FOR: DOWNLOADABLE COMPUTER SOFT-  
WARE FOR PROVIDING RECIPES TO USERS, IN  
CLASS 9 (U.S. CLS. 21, 23, 26, 36 AND 38).

SN 77-301,294, FILED 10-11-2007.

FIRST USE 3-3-2008; IN COMMERCE 3-3-2008.

MAUREEN DALL, EXAMINING ATTORNEY

Int. Cl.: 35

Prior U.S. Cls.: 100, 101, and 102

United States Patent and Trademark Office

Reg. No. 3,499,973

Registered Sep. 9, 2008

**SERVICE MARK  
PRINCIPAL REGISTER**



CIK ENTERPRISES, LLC (INDIANA LIMITED LIABILITY COMPANY), DBA TRI-AUTO ENTERPRISES, LLC,  
7225 GEORGETOWN ROAD  
INDIANAPOLIS, IN 46268

FOR: ADVERTISING AND ADVERTISEMENT SERVICES, IN CLASS 35 (U.S. CLS. 100, 101 AND 102).

FIRST USE 10-11-2007; IN COMMERCE 10-11-2007.

THE COLOR(S) MEDIUM BLUE, LIGHT BLUE, ORANGE, GREEN, GRAY, BLACK AND WHITE IS/ ARE CLAIMED AS A FEATURE OF THE MARK.

THE MARK CONSISTS OF A MEDIUM BLUE SQUARE WITH A JAGGED OUTLINE. INSIDE THE SQUARE IS A LIGHT BLUE AND WHITE ENVELOPE WITH A MEDIUM BLUE OUTLINE AND ORANGE FLAMES FLOWING FROM LEFT SIDE, APPEARING ON A LIGHT BLUE SKY. BELOW THE ENVELOPE IS A WHITE CLOUD, OUTLINED IN GRAY, AND A GREEN HALF-CIRCLE WITH THE WORDING "MAILPLUS" IN WHITE AND "DELIVERING YOUR MESSAGE ON TIME." IN BLACK.

SN 77-301,300, FILED 10-11-2007.

KATHERINE CHANG, EXAMINING ATTORNEY

**Int. Cl.: 5**

**Prior U.S. Cls.: 6, 18, 44, 46, 51, and 52**

**Reg. No. 3,499,974**

**United States Patent and Trademark Office**

**Registered Sep. 9, 2008**

**TRADEMARK  
PRINCIPAL REGISTER**

**Primavie**

NATREON, INC. (NEW JERSEY CORPORATION)  
2D JANINE PLACE  
NEW BRUNSWICK, NJ 08901

THE MARK CONSISTS OF STANDARD CHAR-  
ACTERS WITHOUT CLAIM TO ANY PARTICULAR  
FONT, STYLE, SIZE, OR COLOR.

FOR: DIETARY AND NUTRITIONAL SUPPLE-  
MENTS, IN CLASS 5 (U.S. CLS. 6, 18, 44, 46, 51 AND  
52).

SN 77-301,346, FILED 10-11-2007.

FIRST USE 11-6-2007; IN COMMERCE 11-29-2007.

WILLIAM VERHOSEK, EXAMINING ATTORNEY



**Int. Cl.: 35**

**Prior U.S. Cls.: 100, 101, and 102**

**United States Patent and Trademark Office**

**Reg. No. 3,499,975**

**Registered Sep. 9, 2008**

**SERVICE MARK  
PRINCIPAL REGISTER**

**IVITA**

ONYX M.D. (COLORADO CORPORATION)  
1660 PEARL STREET  
DENVER, CO 80203

THE MARK CONSISTS OF STANDARD CHAR-  
ACTERS WITHOUT CLAIM TO ANY PARTICULAR  
FONT, STYLE, SIZE, OR COLOR.

FOR: BUSINESS MANAGEMENT AND CONSUL-  
TATION IN THE FIELD OF HEALTHCARE, IN  
CLASS 35 (U.S. CLS. 100, 101 AND 102).

SN 77-301,861, FILED 10-11-2007.

FIRST USE 8-4-2007; IN COMMERCE 8-4-2007.

JILL C. ALT, EXAMINING ATTORNEY

**Int. Cl.: 5**

**Prior U.S. Cls.: 6, 18, 44, 46, 51, and 52**

**Reg. No. 3,499,976**

**United States Patent and Trademark Office**

**Registered Sep. 9, 2008**

---

**TRADEMARK  
PRINCIPAL REGISTER**

**VOOTS**

LAUNCH PAD LLC (COLORADO LIMITED LIABILITY COMPANY)  
7315 E. ORCHARD ROAD  
SUITE 100  
GREENWOOD VILLAGE, CO 80111

THE MARK CONSISTS OF STANDARD CHARACTERS WITHOUT CLAIM TO ANY PARTICULAR FONT, STYLE, SIZE, OR COLOR.

FOR: DIETARY SUPPLEMENTS, IN CLASS 5 (U.S. CLS. 6, 18, 44, 46, 51 AND 52).

SN 77-301,923, FILED 10-11-2007.

FIRST USE 2-2-2008; IN COMMERCE 2-2-2008.

DAVID ELTON, EXAMINING ATTORNEY

**Int. Cl.: 8**

**Prior U.S. Cls.: 23, 28, and 44**

**United States Patent and Trademark Office**

**Reg. No. 3,499,977**

**Registered Sep. 9, 2008**

**TRADEMARK  
PRINCIPAL REGISTER**

**CANDLEWICK COMPANION**

KUDYBA, ROBERT (UNITED STATES INDIVIDUAL)  
104 PEARSALL DR. #H-GLA  
104 PEARSALL DR.  
MOUNT VERNON, NY 10552

FOR: SCOOPS FOR RESTORATION OF CANDLEWICKS AND FOR REMOVING WAX, IN CLASS 8 (U.S. CLS. 23, 28 AND 44).

FIRST USE 3-1-2008; IN COMMERCE 7-1-2008.

THE MARK CONSISTS OF STANDARD CHARACTERS WITHOUT CLAIM TO ANY PARTICULAR FONT, STYLE, SIZE, OR COLOR.

NO CLAIM IS MADE TO THE EXCLUSIVE RIGHT TO USE "CANDLEWICK", APART FROM THE MARK AS SHOWN.

SN 77-302,139, FILED 10-11-2007.

MICHAEL WIENER, EXAMINING ATTORNEY

**Int. Cl.: 37**

**Prior U.S. Cls.: 100, 103, and 106**

**United States Patent and Trademark Office**

**Reg. No. 3,499,978**

**Registered Sep. 9, 2008**

**SERVICE MARK  
PRINCIPAL REGISTER**

# Leafland Homes

FITZGERALD, CINDI (UNITED STATES INDIVIDUAL)  
1500 BELLA VISTA DR.  
DALLAS, TX 75218

FOR: CUSTOM CONSTRUCTION OF HOMES;  
REMODELING OF HOMES, IN CLASS 37 (U.S.  
CLS. 100, 103 AND 106).

FIRST USE 10-4-2007; IN COMMERCE 11-20-2007.

THE MARK CONSISTS OF STANDARD CHARACTERS WITHOUT CLAIM TO ANY PARTICULAR FONT, STYLE, SIZE, OR COLOR.

NO CLAIM IS MADE TO THE EXCLUSIVE RIGHT TO USE "HOMES", APART FROM THE MARK AS SHOWN.

SN 77-302,210, FILED 10-11-2007.

ALLISON SCHRODY, EXAMINING ATTORNEY

**Int. Cl.: 43**

**Prior U.S. Cls.: 100 and 101**

**United States Patent and Trademark Office**

**Reg. No. 3,499,979**

**Registered Sep. 9, 2008**

**SERVICE MARK  
PRINCIPAL REGISTER**

**CHICKEN FEAST**

EVANS, SCOTT (UNITED STATES INDIVIDUAL)  
BOX 354  
HIGLEY, AZ 85236

FOR: CAFE-RESTAURANTS; CARRY-OUT RESTAURANTS; FAST-FOOD RESTAURANTS; FAST-FOOD RESTAURANTS AND SNACKBARS; RESTAURANT AND BAR SERVICES; RESTAURANT SERVICES; RESTAURANT SERVICES FEATURING SANDWICHES; RESTAURANTS; RESTAURANTS FEATURING HOME DELIVERY; TAKE-OUT RESTAURANT SERVICES, IN CLASS 43 (U.S. CLS. 100 AND 101).

FIRST USE 5-1-2008; IN COMMERCE 5-1-2008.

THE MARK CONSISTS OF STANDARD CHARACTERS WITHOUT CLAIM TO ANY PARTICULAR FONT, STYLE, SIZE, OR COLOR.

NO CLAIM IS MADE TO THE EXCLUSIVE RIGHT TO USE "CHICKEN", APART FROM THE MARK AS SHOWN.

SN 77-302,389, FILED 10-12-2007.

SHAILA SETTLES, EXAMINING ATTORNEY

**Int. Cl.: 8**

**Prior U.S. Cls.: 23, 28, and 44**

**Reg. No. 3,499,980**

**United States Patent and Trademark Office**

**Registered Sep. 9, 2008**

---

**TRADEMARK  
PRINCIPAL REGISTER**

**SHOCK-ZERO**

AMES TRUE TEMPER PROPERTIES, INC. (MI-  
CHIGAN CORPORATION)  
300 DELAWARE AVENUE, SUITE 1704  
WILMINGTON, DE 19801

THE MARK CONSISTS OF STANDARD CHAR-  
ACTERS WITHOUT CLAIM TO ANY PARTICULAR  
FONT, STYLE, SIZE, OR COLOR.

FOR: MANUALLY OPERATED HAND TOOLS,  
NAMELY, STRIKING TOOLS, IN CLASS 8 (U.S. CLS.  
23, 28 AND 44).

SN 77-305,727, FILED 10-17-2007.

FIRST USE 1-0-2008; IN COMMERCE 1-0-2008.

NICHOLAS ALTREE, EXAMINING ATTORNEY

**Int. Cls.: 41 and 44**

**Prior U.S. Cls.: 100, 101, and 107**

**United States Patent and Trademark Office**

**Reg. No. 3,499,981**

**Registered Sep. 9, 2008**

**SERVICE MARK  
PRINCIPAL REGISTER**

**EMM**

SPECIAL EDUCATION SERVICES (ILLINOIS CORPORATION)  
1720 N. RANDALL ROAD  
AURORA, IL 60506

FOR: EDUCATION SERVICES, NAMELY, THERAPEUTIC DAY SCHOOLS PROVIDING MENTAL HEALTH AND ACADEMIC SUPPORT FOR AT-RISK STUDENTS, IN CLASS 41 (U.S. CLS. 100, 101 AND 107).

FIRST USE 11-29-2007; IN COMMERCE 11-29-2007.

FOR: MENTAL HEALTH SERVICES, IN CLASS 44 (U.S. CLS. 100 AND 101).

FIRST USE 11-29-2007; IN COMMERCE 11-29-2007.

THE MARK CONSISTS OF STANDARD CHARACTERS WITHOUT CLAIM TO ANY PARTICULAR FONT, STYLE, SIZE, OR COLOR.

SN 77-306,023, FILED 10-17-2007.

CARYN GLASSER, EXAMINING ATTORNEY

**Int. Cl.: 16**

**Prior U.S. Cls.: 2, 5, 22, 23, 29, 37, 38, and 50**

**United States Patent and Trademark Office**

**Reg. No. 3,499,982**

**Registered Sep. 9, 2008**

**TRADEMARK  
PRINCIPAL REGISTER**

# Pulp Dreams

HAMTRAMCK IDEA MEN (MICHIGAN PART-  
NERSHIP)

11661 MITCHELL ST

HAMTRAMCK, MI 48212

FOR: COMIC BOOKS, IN CLASS 16 (U.S. CLS. 2, 5,  
22, 23, 29, 37, 38 AND 50).

FIRST USE 9-22-2007; IN COMMERCE 10-19-2007.

THE MARK CONSISTS OF STANDARD CHAR-  
ACTERS WITHOUT CLAIM TO ANY PARTICULAR  
FONT, STYLE, SIZE, OR COLOR.

NO CLAIM IS MADE TO THE EXCLUSIVE  
RIGHT TO USE "PULP", APART FROM THE MARK  
AS SHOWN.

SN 77-309,697, FILED 10-22-2007.

LYDIA BELZER, EXAMINING ATTORNEY



**Int. Cl.: 9**

**Prior U.S. Cls.: 21, 23, 26, 36, and 38**

**United States Patent and Trademark Office**

**Reg. No. 3,499,983**

**Registered Sep. 9, 2008**

**TRADEMARK  
PRINCIPAL REGISTER**

**INFINITY**

YADA SYSTEMS, INC. (MINNESOTA CORPORATION)  
2717 LINCOLN DRIVE  
ST. PAUL, MN 55113

THE MARK CONSISTS OF STANDARD CHARACTERS WITHOUT CLAIM TO ANY PARTICULAR FONT, STYLE, SIZE, OR COLOR.

FOR: COMPUTER SOFTWARE USED FOR AUTOMOTIVE PAINT FORMULA RETRIEVAL AND MANAGEMENT, IN CLASS 9 (U.S. CLS. 21, 23, 26, 36 AND 38).

SN 77-310,232, FILED 10-22-2007.

FIRST USE 2-1-2008; IN COMMERCE 2-1-2008.

AMY HELLA, EXAMINING ATTORNEY

**Int. Cl.: 31**

**Prior U.S. Cls.: 1 and 46**

**United States Patent and Trademark Office**

**Reg. No. 3,499,984**

**Registered Sep. 9, 2008**

**TRADEMARK  
PRINCIPAL REGISTER**

**MONKEY JUMBLE**

PMI NUTRITION INTERNATIONAL LLC. (DE-  
LAWARE LIMITED LIABILITY COMPANY)

1080 COUNTY ROAD F WEST

SHOREVIEW, MN 55126

FOR: ANIMAL FEED, IN CLASS 31 (U.S. CLS. 1  
AND 46).

FIRST USE 10-31-2007; IN COMMERCE 10-31-2007.

THE MARK CONSISTS OF STANDARD CHAR-  
ACTERS WITHOUT CLAIM TO ANY PARTICULAR  
FONT, STYLE, SIZE, OR COLOR.

NO CLAIM IS MADE TO THE EXCLUSIVE  
RIGHT TO USE "MONKEY", APART FROM THE  
MARK AS SHOWN.

SN 77-310,654, FILED 10-23-2007.

KATHRYN COWARD, EXAMINING ATTORNEY

**Int. Cl.: 36**

**Prior U.S. Cls.: 100, 101, and 102**

**United States Patent and Trademark Office**

**Reg. No. 3,499,985**

**Registered Sep. 9, 2008**

**SERVICE MARK  
PRINCIPAL REGISTER**

**MLGPE**

MERRILL LYNCH & CO., INC. (DELAWARE  
CORPORATION)  
4 WORLD FINANCIAL CENTER  
NEW YORK, NY 10080

THE MARK CONSISTS OF STANDARD CHAR-  
ACTERS WITHOUT CLAIM TO ANY PARTICULAR  
FONT, STYLE, SIZE, OR COLOR.

FOR: FINANCIAL SERVICES, NAMELY, INVEST-  
MENT BANKING AND ASSET MANAGEMENT  
SERVICES, IN CLASS 36 (U.S. CLS. 100, 101 AND 102).

SN 77-311,301, FILED 10-23-2007.

FIRST USE 1-8-2008; IN COMMERCE 1-8-2008.

GEOFFREY FOSDICK, EXAMINING ATTORNEY

**Int. Cl.: 35**

**Prior U.S. Cls.: 100, 101, and 102**

**United States Patent and Trademark Office**

**Reg. No. 3,499,986**

**Registered Sep. 9, 2008**

**SERVICE MARK  
PRINCIPAL REGISTER**

**BBI Bear Berry Imports, LLC**

BEAR BERRY IMPORTS, LLC (CALIFORNIA  
LIMITED LIABILITY COMPANY)  
4275 EXECUTIVE SQUARE, SUITE 290  
LA JOLLA, CA 92037

FOR: WHOLESALE DISTRIBUTORSHIPS FEATURING FOOD; IMPORT AND EXPORT AGENCIES IN THE FIELD OF FOOD; AND DISTRIBUTORSHIP SERVICES IN THE FIELD OF FOOD, IN CLASS 35 (U.S. CLS. 100, 101 AND 102).

FIRST USE 5-29-2007; IN COMMERCE 5-29-2007.

THE MARK CONSISTS OF STANDARD CHARACTERS WITHOUT CLAIM TO ANY PARTICULAR FONT, STYLE, SIZE, OR COLOR.

NO CLAIM IS MADE TO THE EXCLUSIVE RIGHT TO USE "BERRY IMPORTS, LLC", APART FROM THE MARK AS SHOWN.

SN 77-312,028, FILED 10-24-2007.

KATHERINE CHANG, EXAMINING ATTORNEY

**Int. Cl.: 35**

**Prior U.S. Cls.: 100, 101, and 102**

**United States Patent and Trademark Office**

**Reg. No. 3,499,987**

**Registered Sep. 9, 2008**

**SERVICE MARK  
PRINCIPAL REGISTER**



BEAR BERRY IMPORTS, LLC (CALIFORNIA  
LIMITED LIABILITY COMPANY)  
4275 EXECUTIVE SQUARE, SUITE 290  
LA JOLLA, CA 92037

FOR: WHOLESALE DISTRIBUTORSHIPS FEATURING FOOD; IMPORT AND EXPORT AGENCIES IN THE FIELD OF FOOD; AND DISTRIBUTORSHIP SERVICES IN THE FIELD OF FOOD, IN CLASS 35 (U.S. CLS. 100, 101 AND 102).

FIRST USE 2-0-2008; IN COMMERCE 2-0-2008.

NO CLAIM IS MADE TO THE EXCLUSIVE RIGHT TO USE "BERRY IMPORTS", APART FROM THE MARK AS SHOWN.

SN 77-312,032, FILED 10-24-2007.

KATHERINE CHANG, EXAMINING ATTORNEY

**Int. Cl.: 9**

**Prior U.S. Cls.: 21, 23, 26, 36, and 38**

**Reg. No. 3,499,988**

**United States Patent and Trademark Office**

**Registered Sep. 9, 2008**

**TRADEMARK  
PRINCIPAL REGISTER**

# Miccus

STEELHEAD INTERNATIONAL (MICHIGAN  
LIMITED LIABILITY COMPANY)  
1543 STILLWATER DR  
HOLLAND, MI 49424

FOR: AUDIO ELECTRONIC COMPONENTS, NAMELY, SURROUND SOUND SYSTEMS; ELECTRONIC AND OPTICAL COMMUNICATIONS INSTRUMENTS AND COMPONENTS, NAMELY, OPTICAL TRANSCEIVERS; APPARATUS FOR WIRELESS TRANSMISSION OF ACOUSTIC INFORMATION; COMPUTER HARDWARE, NAMELY, WIRELESS ACCESS POINT (WAP) DEVICES; HOME AND OFFICE AUTOMATION SYSTEMS COMPRISING WIRELESS AND WIRED CONTROLLERS, CONTROLLED DEVICES, AND SOFTWARE FOR LIGHTING, HVAC, SECURITY, SAFETY AND OTHER HOME AND OFFICE MONITORING AND CONTROL APPLICATIONS; INTEGRATED CIRCUITS AND INTEGRATED CIRCUIT CORES FOR USE IN WIRELESS COMMUNICATIONS AND WIRELESS COMMUNICATION EQUIPMENT AND APPARATI AND DIGITAL SIGNAL PROCESSORS (DSP); WIRELESS POS (POINT OF SERVICE) DEVICES; WIRELESS COMPUTER PERIPHERALS; WIRELESS TELEVISION SET FOR PROVIDING VIDEO CONFERENCING AND TELEPHONE SERVICE OVER THE INTERNET; AUDIO AMPLIFIERS; AUDIO MIXERS; AUDIO PROCESSING EQUIPMENT, NAMELY LIMITERS AND COMPRESSORS; AUDIO SPEAKER ENCLOSURES; AUDIO SPEAKERS; AUDIO TAPE RECORDERS; AUDIO-VIDEO RECEIVERS; COMPUTER HARDWARE AND COMPUTER SOFTWARE PROGRAMS FOR THE INTEGRATION OF TEXT, AUDIO, GRAPHICS, STILL IMAGES AND MOVING PICTURES INTO AN INTERACTIVE DELIVERY FOR MULTIMEDIA APPLICATIONS; COMPUTER SOFTWARE FOR MANIPULATING DIGITAL AUDIO INFORMATION FOR USE IN AUDIO MEDIA APPLICATIONS; COMPUTER SOFTWARE TO CONTROL AND IMPROVE COMPUTER AND AUDIO EQUIPMENT

SOUND QUALITY; COMPUTER SOFTWARE TO ENHANCE THE AUDIO-VISUAL CAPABILITIES OF MULTIMEDIA APPLICATIONS, NAMELY, FOR THE INTEGRATION OF TEXT, AUDIO, GRAPHICS, STILL IMAGES AND MOVING PICTURES; DIGITAL AUDIO PLAYERS; DIGITAL AUDIO TAPE PLAYERS; DIGITAL AUDIO TAPE RECORDERS; DISTRIBUTION AMPLIFIERS FOR AUDIO AND VIDEO SIGNALS; ELECTRIC AUDIO PLAYBACK UNITS; ELECTRIC AUDIO PLAYBACK UNITS WITH LIGHTS AND SPEAKERS; ELECTRONIC INTERCONNECTERS FOR AUDIO AND VIDEO SIGNALS; ELECTRONIC PRODUCTS FOR THE MANIPULATION OF THE FREQUENCY, TIME, AND AMPLITUDE CHARACTERISTICS OF AUDIO SIGNALS, NAMELY, AUDIO PROCESSORS; ELECTRONIC SCALERS FOR AUDIO AND VIDEO SIGNALS; ELECTRONIC SWITCHERS FOR AUDIO AND VIDEO SIGNALS; MATRIX SWITCHERS FOR AUDIO AND VIDEO SIGNALS; SOFTWARE TO CONTROL AND IMPROVE AUDIO EQUIPMENT SOUND QUALITY; TRANSMITTERS AND RECEIVERS FOR AUDIO AND VIDEO SIGNALS FOR TRANSMISSION OVER TWISTED PAIR CABLES; COMBINATION VIDEO PLAYERS AND RECORDERS; COMPUTER PROGRAMS FOR EDITING IMAGES, SOUND AND VIDEO; DIGITAL PHOTO FRAMES FOR DISPLAYING DIGITAL PICTURES, VIDEO CLIPS AND MUSIC; DIGITAL VIDEO DISC DRIVES; DIGITAL VIDEO RECORDERS; HEAD-MOUNTED VIDEO DISPLAYS; PORTABLE VIDEO CAMERAS WITH BUILT-IN VIDEOCASSETTE RECORDERS; SOUND AND VIDEO RECORDING AND PLAYBACK MACHINES; TV AND VIDEO CONVERTERS; TELECOMMUNICATIONS AND DATA NETWORKING HARDWARE, NAMELY, DEVICES FOR TRANSPORTING AND AGGREGATING VOICE, DATA, AND VIDEO COMMUNICATIONS ACROSS MULTIPLE NETWORK INFRASTRUCTURES AND COMMUNICATIONS PROTOCOLS; VIDEO CAMERAS; VIDEO DISKS AND VIDEO TAPES WITH RECORDED

ANIMATED CARTOONS; VIDEO DISPLAYS MOUNTED IN EYEGLASSES; VIDEO GAME INTERACTIVE HAND HELD REMOTE CONTROLS FOR PLAYING ELECTRONIC GAMES; VIDEO GAME JOYSTICKS; VIDEO GAME MACHINES FOR USE WITH EXTERNAL DISPLAY SCREEN OR MONITOR; VIDEO GAME MACHINES FOR USE WITH TELEVISIONS; VIDEO GAME SOFTWARE; VIDEO CAPTURE CARDS; VIDEO CASSETTE RECORDERS; VIDEO CIRCUIT BOARDS; VIDEO DISK PLAYERS; VIDEO DISPLAY CARDS; VIDEO DISPLAYS THAT MAY BE WORN ON THE BODY; VIDEO GRAPHICS ACCELERATOR; VIDEO GRAPHICS CONTROLLER; VIDEO MONITORS; VIDEO MULTIPLEXERS; VIDEO PHONES; VIDEO PROJECTORS; VIDEO SCREENS; VIDEO TAPE RECORDERS; VIDEO TRANSMISSION APPARATUS; VIDEO-TELEPHONES; COMPUTER HARDWARE AND SOFTWARE FOR SETTING UP AND CONFIGURING LOCAL AREA NETWORKS; COMPUTER HARDWARE AND SOFTWARE FOR SETTING UP AND CONFIGURING WIDE AREA NETWORKS; COMPUTER NETWORK ADAPTERS; COMPUTER NETWORK HUBS, SWITCHES AND ROUTERS; COMPUTER NETWORKING HARDWARE; COMPUTER SOFTWARE FOR ADMINISTRATION OF COMPUTER LOCAL AREA NETWORKS; COMPUTER SOFTWARE FOR ADMINISTRATION OF COMPUTER NETWORKS; GLOBAL POSITIONING SYSTEM (GPS) CONSISTING OF COMPUTERS, COMPUTER SOFTWARE, TRANSMITTERS, RECEIVERS, AND NETWORK INTERFACE DEVICES; LAN (LOCAL AREA NETWORK) ACCESS POINTS FOR CONNECTING NETWORK COMPUTER USERS; LAN (LOCAL AREA NETWORK) COMPUTER CARDS FOR CONNECTING PORTABLE COMPUTER DEVICES TO COMPUTER NETWORKS; LAN (LOCAL AREA NETWORK) HARDWARE; LAN (LOCAL AREA NETWORK) OPERATING SOFTWARE; MOBILE COMPUTING AND OPERATING PLATFORMS CONSISTING OF DATA TRANSCIEVERS, WIRELESS NETWORKS AND GATEWAYS FOR COLLECTION AND MANAGEMENT OF DATA; NETWORK ACCESS SERVER HARDWARE; NETWORK ACCESS SERVER OPERATING SOFTWARE; RECONFIGURABLE PROCESSORS FOR USE IN WIRELESS COMMUNICATION HANDSETS AND NETWORK EQUIPMENT IN THE FIELD OF WIDEBAND COMMUNICATIONS; VPN (VIRTUAL PRIVATE NETWORK) HARDWARE; VPN (VIRTUAL PRIVATE NETWORK) OPERATING SOFTWARE; WAN (WIDE AREA NETWORK) HARDWARE; WAN (WIDE AREA NETWORK) OPERATING SOFTWARE; BACKUP DRIVES FOR COMPUTERS; CD DRIVES FOR COMPUTERS; CAR NAVIGATION COMPUTERS; COMPUTER ACCELERATOR BOARD; COMPUTER APPLICATION SOFTWARE FOR MOBILE PHONES; COMPUTER BACKUP AND STORAGE SYSTEMS WITH MULTIPLE REMOVABLE RAID CARTRIDGES; COMPUTER CABLES; COMPUTER CAMERAS; COMPUTER CARD ADAPTER; COMPUTER CARRYING CASES; COMPUTER CHASSIS; COMPUTER CHIPS; COMPUTER CURSOR CONTROL DEVICES, NAMELY, COMPUTER MOUSE; COMPUTER CURSOR CONTROL DEVICES, NAMELY, DIGITIZER TABLETS; COMPUTER CURSOR CONTROL DEVICES, NAME-

LY, LIGHT PENS; COMPUTER CURSOR CONTROL DEVICES, NAMELY, TOUCH PADS; COMPUTER CURSOR CONTROL DEVICES, NAMELY, TRACKBALLS; COMPUTER EXPANSION BOARDS; COMPUTER GRAPHICS BOARDS; COMPUTER GRAPHICS SOFTWARE; COMPUTER HARD DRIVE ENCLOSURES; COMPUTER HARDWARE; COMPUTER HARDWARE AND SOFTWARE SYSTEM FOR REMOTELY MONITORING ENVIRONMENTAL CONDITIONS AND CONTROLLING DEVICES WITHIN A BUILDING, FACILITY, GROUNDS, OR DESIGNATED SPATIAL AREA; COMPUTER HARDWARE AND SOFTWARE USED FOR THE CONTROL OF VOICE CONTROLLED INFORMATION AND COMMUNICATION DEVICES; COMPUTER HARDWARE FOR TELECOMMUNICATIONS; COMPUTER INTERFACE BOARDS; COMPUTER KEYBOARDS; COMPUTER KEYPADS; COMPUTER MEMORIES; COMPUTER MEMORY HARDWARE; COMPUTER MONITORS; COMPUTER MOUSE; COMPUTER MOUSE, NAMELY, TOUCHPADS; COMPUTER MOUSE, NAMELY, TRACKBALLS; COMPUTER PERIPHERALS; COMPUTER SOFTWARE FOR ORGANIZING AND VIEWING DIGITAL IMAGES AND PHOTOGRAPHS; COMPUTER SOFTWARE FOR PROCESSING DIGITAL MUSIC FILES; COMPUTER SOFTWARE FOR WIRELESS CONTENT DELIVERY; COMPUTER STANDS SPECIALLY DESIGNED FOR HOLDING A COMPUTER, PRINTER AND ACCESSORIES; COMPUTER STORAGE DEVICES, NAMELY, FLASH DRIVES; COMPUTER STORAGE DEVICES, NAMELY, THUMB DRIVES; COMPUTER SWITCHES; COMPUTER TELEPHONY SOFTWARE; COMPUTER TERMINALS; COMPUTER TOUCH SCREENS; ELECTRONIC COMPONENTS FOR COMPUTERS; ELECTRONIC COMPUTERS; ENTERTAINMENT SYSTEM COMPRISING A COMPUTER, MULTIPLE DISPLAY SCREEN, MULTIPLE INPUT DEVICES AND A PRINTER; GATEWAY ROUTERS IN THE NATURE OF COMPUTER CONTROL HARDWARE; HANDHELD COMPUTERS; HANDHELD PERSONAL COMPUTERS; HEADSETS FOR USE WITH COMPUTERS; MEMORY CARDS; MOBILE COMPUTERS; MOUSE PADS; PERSONAL DIGITAL ASSISTANT COMPUTERS; POCKET COMPUTERS FOR NOTE-TAKING; BATTERIES; BATTERY CABLES; BATTERY CASES; BATTERY CHARGE DEVICES; BATTERY CHARGERS; BATTERY PACKS; CELL PHONE BATTERY CHARGERS; CELL PHONE BATTERY CHARGERS FOR USE IN VEHICLES; ELECTRICAL CELLS AND BATTERIES; ELECTRICAL STORAGE BATTERIES; INTEGRATED BATTERY BACKUP SYSTEMS COMPRISING A BATTERY, AN ELECTRONIC MEASUREMENT APPARATUS FOR USE IN THE MEASUREMENT OF BATTERY HEALTH AND PERFORMANCE, AND A REMOTE COMPUTER SOFTWARE PROGRAM THAT USES THE FOREGOING DATA TO TREND, PREDICT, AND STORE DATA RELATED TO THE HEALTH OF THE BATTERY; MOBILE TELEPHONE BATTERIES; NICKEL-CADMIUM STORAGE BATTERIES; RECHARGEABLE ELECTRIC BATTERIES; CELLULAR PHONE ACCESSORY CHARMS; DIGITAL CAMERA ACCESSORY IN THE NATURE OF A DIGITAL PHOTO VIEWER; MP3 PLAYERS; PORTA-

BLE LISTENING DEVICES, NAMELY, MP3 PLAYERS; PROTECTIVE CARRYING CASES FOR PORTABLE MUSIC PLAYERS, NAMELY, MP3 PLAYERS; DVD BURNERS; DVD CASES; DVD DRIVES; DVD MACHINES; DVD PLAYERS; DVD RECORDING APPARATUS; DVD SLEEVES; PORTABLE DVD PLAYERS; CASES FOR MOBILE PHONES; MOBILE PHONE STRAPS; MOBILE PHONES; BEEPER CARRYING CASES; CAMERA CASES; CARRYING CASES FOR CELL PHONES; CARRYING CASES FOR RADIO PAGERS; CARRYING CASES SPECIALLY ADAPTED FOR POCKET CALCULATORS AND CELLPHONES; CASES FOR PHOTOGRAPHIC APPARATUS; CASES FOR POCKET CALCULATORS; CASES FOR TELEPHONES; PROTECTIVE CARRYING CASES SPECIALLY ADAPTED FOR GLOBAL POSITIONING SYSTEM (GPS) APPARATUS; PROTECTIVE CARRYING CASES SPECIALLY ADAPTED FOR PERSONAL DIGITAL ASSISTANTS (PDA); LOUD SPEAKER SYSTEMS; SPEAKER ENCLOSURES; INTEGRATED CIRCUITS INCORPORATING ALGORITHMS FOR USE IN PROCESSING TV SIGNALS; TV MONITORS;

TELEVISION RECEIVERS; APPARATUS FOR RECORDING, TRANSMISSION OR REPRODUCTION OF SOUND AND IMAGES; APPARATUS FOR SPEECH RECORDING AND REPLAYING; AUDIO CASSETTE RECORDERS; SOUND RECORDING APPARATUS; TAPE RECORDERS; TELEPHONE RECORDERS; TIME CLOCKS; COMPACT DISC PLAYERS; MUSICAL INSTRUMENT ADAPTORS; MUSICAL INSTRUMENT AMPLIFIERS; MUSICAL INSTRUMENT CONNECTORS, IN CLASS 9 (U.S. CLS. 21, 23, 26, 36 AND 38).

FIRST USE 12-15-2007; IN COMMERCE 6-5-2008.

THE MARK CONSISTS OF STANDARD CHARACTERS WITHOUT CLAIM TO ANY PARTICULAR FONT, STYLE, SIZE, OR COLOR.

SN 77-312,767, FILED 10-24-2007.

LEIGH CAROLINE CASE, EXAMINING ATTORNEY



**Int. Cl.: 9**

**Prior U.S. Cls.: 21, 23, 26, 36, and 38**

**Reg. No. 3,499,989**

**United States Patent and Trademark Office**

**Registered Sep. 9, 2008**

**TRADEMARK  
PRINCIPAL REGISTER**

**Lospro**

LOSPRO, LLC (FLORIDA LIMITED LIABILITY  
COMPANY)  
2610 TAMARIND DRIVE  
EDGEWATER, FL 32141

THE MARK CONSISTS OF STANDARD CHAR-  
ACTERS WITHOUT CLAIM TO ANY PARTICULAR  
FONT, STYLE, SIZE, OR COLOR.

FOR: COMPUTER SOFTWARE FOR USE IN THE  
MEDICAL FIELD TO ASSIST WITH DISCHARGE  
PLANNING, IN CLASS 9 (U.S. CLS. 21, 23, 26, 36 AND  
38).

SN 77-314,085, FILED 10-26-2007.

FIRST USE 7-5-2008; IN COMMERCE 7-5-2008.

ZACHARY BELLO, EXAMINING ATTORNEY

**Int. Cl.: 36**

**Prior U.S. Cls.: 100, 101, and 102**

**United States Patent and Trademark Office**

**Reg. No. 3,499,990**

**Registered Sep. 9, 2008**

**SERVICE MARK  
PRINCIPAL REGISTER**

**FARMERS. FOR YOU.**

FARMERS GROUP, INC. (NEVADA CORPORATION)  
4680 WILSHIRE BOULEVARD  
LOS ANGELES, CA 90010

FOR: INSURANCE SERVICES, NAMELY, UNDERWRITING, INSURANCE ADMINISTRATION, CLAIMS ADMINISTRATION, AND AGENCY SERVICES; AND PROVIDING INFORMATION ABOUT INSURANCE AND UNDERWRITING SERVICES VIA THE INTERNET, IN CLASS 36 (U.S. CLS. 100, 101 AND 102).

FIRST USE 2-0-2007; IN COMMERCE 2-0-2007.

THE MARK CONSISTS OF STANDARD CHARACTERS WITHOUT CLAIM TO ANY PARTICULAR FONT, STYLE, SIZE, OR COLOR.

OWNER OF U.S. REG. NOS. 953,862, 1,821,672, AND OTHERS.

SN 77-314,567, FILED 10-26-2007.

SUNG IN, EXAMINING ATTORNEY

Int. Cls.: 30 and 43

Prior U.S. Cls.: 46, 100, and 101

United States Patent and Trademark Office

Reg. No. 3,499,991

Registered Sep. 9, 2008

TRADEMARK  
SERVICE MARK  
PRINCIPAL REGISTER

**SHRIMP  
BASKET**

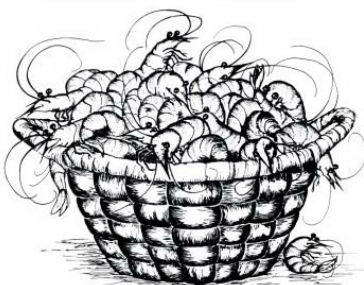

SPENCE, EDWIN JOSEPH (UNITED STATES INDIVIDUAL)

P.O. BOX 904

GULF SHORES, AL 36547 AND

CAHOON, DAVID PATRICK (UNITED STATES INDIVIDUAL)

4521 CORAL CIR.

GULF SHORES, AL 36542

FOR: DIPPING SAUCES; READY-MADE SAUCES; TARTAR SAUCE; SAUCES, IN CLASS 30 (U.S. CL. 46).

FIRST USE 6-20-2008; IN COMMERCE 6-20-2008.

FOR: CARRY-OUT RESTAURANTS; RESTAURANTS, IN CLASS 43 (U.S. CLS. 100 AND 101).

FIRST USE 3-1-2008; IN COMMERCE 3-1-2008.

NO CLAIM IS MADE TO THE EXCLUSIVE RIGHT TO USE "SHRIMP", APART FROM THE MARK AS SHOWN.

THE MARK CONSISTS OF THE TEXT "SHRIMP BASKET" ABOVE A BASKET OF SHRIMP.

SN 77-315,945, FILED 10-29-2007.

DANIEL CAPSHAW, EXAMINING ATTORNEY

**Int. Cl.: 3**

**Prior U.S. Cls.: 1, 4, 6, 50, 51, and 52**

**United States Patent and Trademark Office**

**Reg. No. 3,499,992**

**Registered Sep. 9, 2008**

**TRADEMARK  
PRINCIPAL REGISTER**

**BEGIN AGAIN**

PHILOSOPHY, INC. (ARIZONA CORPORATION)  
3809 EAST WATKINS STREET  
PHOENIX, AZ 85034

THE MARK CONSISTS OF STANDARD CHAR-  
ACTERS WITHOUT CLAIM TO ANY PARTICULAR  
FONT, STYLE, SIZE, OR COLOR.

FOR: COSMETICS; SHOWER AND BATH GEL, IN  
CLASS 3 (U.S. CLS. 1, 4, 6, 50, 51 AND 52).

SN 77-316,680, FILED 10-30-2007.

FIRST USE 11-27-2007; IN COMMERCE 11-27-2007.

KATHERINE STOIDES, EXAMINING ATTORNEY

Int. Cl.: 9

Prior U.S. Cls.: 21, 23, 26, 36, and 38

United States Patent and Trademark Office

Reg. No. 3,499,993

Registered Sep. 9, 2008

TRADEMARK  
PRINCIPAL REGISTER



HARRIS CORPORATION (DELAWARE CORPORATION)  
1025 WEST NASA BOULEVARD  
MELBOURNE, FL 32919

FOR: MULTI-CHANNEL, SOFTWARE-DEFINED, TWO-WAY ELECTRONIC SURVEILLANCE RADIOS FOR AUTHORIZED LAW ENFORCEMENT AND GOVERNMENT AGENCIES FOR INTERROGATING, LOCATING, TRACKING AND GATHERING INFORMATION FROM CELLULAR PHONES, IN CLASS 9 (U.S. CLS. 21, 23, 26, 36 AND 38).

FIRST USE 7-17-2008; IN COMMERCE 7-17-2008.

OWNER OF U.S. REG. NO. 2,762,468.

THE MARK CONSISTS OF THE WORD "STINGRAY" FOLLOWED BY THE ROMAN NUMERAL "II" AND A DESIGN OF A "STINGRAY".

SN 77-316,689, FILED 10-30-2007.

ANDREA K. NADELMAN, EXAMINING ATTORNEY

**Int. Cl.: 3**

**Prior U.S. Cls.: 1, 4, 6, 50, 51, and 52**

**Reg. No. 3,499,994**

**United States Patent and Trademark Office**

**Registered Sep. 9, 2008**

---

**TRADEMARK  
PRINCIPAL REGISTER**

**YOU ARE MY SUNSHINE**

PHILOSOPHY, INC. (ARIZONA CORPORATION)  
3809 EAST WATKINS STREET  
PHOENIX, AZ 85034

FOR: COSMETICS; SHOWER AND BATH GEL, IN  
CLASS 3 (U.S. CLS. 1, 4, 6, 50, 51 AND 52).

FIRST USE 11-27-2007; IN COMMERCE 11-27-2007.

THE MARK CONSISTS OF STANDARD CHAR-  
ACTERS WITHOUT CLAIM TO ANY PARTICULAR  
FONT, STYLE, SIZE, OR COLOR.

OWNER OF U.S. REG. NO. 3,171,973.

SN 77-316,769, FILED 10-30-2007.

KATHERINE STOIDES, EXAMINING ATTORNEY

**Int. Cl.: 31**

**Prior U.S. Cls.: 1 and 46**

**United States Patent and Trademark Office**

**Reg. No. 3,499,995**

**Registered Sep. 9, 2008**

**TRADEMARK  
PRINCIPAL REGISTER**

**SUNRISE COAST**

SALYER AMERICAN FRESH FOODS (CALIFORNIA CORPORATION)  
21 LOWER RAGSDALE DRIVE  
MONTEREY, CA 93940

THE MARK CONSISTS OF STANDARD CHARACTERS WITHOUT CLAIM TO ANY PARTICULAR FONT, STYLE, SIZE, OR COLOR.

FOR: FRESH FRUITS; FRESH VEGETABLES, IN CLASS 31 (U.S. CLS. 1 AND 46).

SN 77-317,076, FILED 10-30-2007.

FIRST USE 11-19-2007; IN COMMERCE 11-19-2007.

KELLEY WELLS, EXAMINING ATTORNEY

**Int. Cl.: 35**

**Prior U.S. Cls.: 100, 101, and 102**

**United States Patent and Trademark Office**

**Reg. No. 3,499,996**

**Registered Sep. 9, 2008**

**SERVICE MARK  
PRINCIPAL REGISTER**

# Concord Staffing

CHANDLER, DAVID M (UNITED STATES INDIVIDUAL)  
276 BERKELEY AVENUE  
BLOOMFIELD, NJ 07003

FOR: EMPLOYMENT HIRING, RECRUITING, PLACEMENT, STAFFING AND CAREER NETWORKING SERVICES, IN CLASS 35 (U.S. CLS. 100, 101 AND 102).

FIRST USE 3-1-2007; IN COMMERCE 1-1-2008.

THE MARK CONSISTS OF STANDARD CHARACTERS WITHOUT CLAIM TO ANY PARTICULAR FONT, STYLE, SIZE, OR COLOR.

NO CLAIM IS MADE TO THE EXCLUSIVE RIGHT TO USE "STAFFING", APART FROM THE MARK AS SHOWN.

SN 77-317,764, FILED 10-31-2007.

HOWARD SMIGA, EXAMINING ATTORNEY



**Int. Cl.: 36**

**Prior U.S. Cls.: 100, 101, and 102**

**United States Patent and Trademark Office**

**Reg. No. 3,499,997**

**Registered Sep. 9, 2008**

**SERVICE MARK  
PRINCIPAL REGISTER**

# IronOak Advisors

SUNTRUST BANKS, INC. (GEORGIA CORPORATION)  
MC: FL/ORL 1093  
200 SOUTH ORANGE AVENUE  
ORLANDO, FL 32801

FOR: INVESTMENT SERVICES, NAMELY, INSTITUTIONAL ASSET MANAGEMENT SERVICES WITH A SPECIALIZATION IN EQUITY INVESTMENT, IN CLASS 36 (U.S. CLS. 100, 101 AND 102).

FIRST USE 3-31-2008; IN COMMERCE 3-31-2008.

THE MARK CONSISTS OF STANDARD CHARACTERS WITHOUT CLAIM TO ANY PARTICULAR FONT, STYLE, SIZE, OR COLOR.

NO CLAIM IS MADE TO THE EXCLUSIVE RIGHT TO USE "ADVISORS", APART FROM THE MARK AS SHOWN.

SN 77-318,970, FILED 11-1-2007.

SAIMA MAKHDOOM, EXAMINING ATTORNEY

**Int. Cl.: 41**

**Prior U.S. Cls.: 100, 101, and 107**

**United States Patent and Trademark Office**

**Reg. No. 3,499,998**

**Registered Sep. 9, 2008**

**SERVICE MARK  
PRINCIPAL REGISTER**

**BUILT FROM SKRATCH**

ABS-CBN INTERNATIONAL (CALIFORNIA CORPORATION)  
150 SHORELINE DRIVE  
REDWOOD CITY, CA 94065

FOR: ENTERTAINMENT IN THE NATURE OF ON-GOING PROGRAMS IN THE FIELDS OF MUSIC, MUSIC VIDEOS, LIFESTYLE, URBAN LIFESTYLE, DANCE, ENTERTAINMENT, POP CULTURE, ASIAN CULTURE, NEWS AND ENTERTAINMENT NEWS, AND LIVE PERFORMANCES BY MUSICAL ARTISTS DISTRIBUTED OVER TELEVISION, SATELLITE, AND VIA A GLOBAL COMPUTER NETWORK; PROVIDING ONLINE INFORMATION IN THE FIELDS OF MUSIC, MUSIC VIDEOS, LIFESTYLE, URBAN LIFESTYLE, DANCE,

ENTERTAINMENT, POP CULTURE, ASIAN CULTURE AND CURRENT EVENT NEWS AND ENTERTAINMENT NEWS VIA A GLOBAL COMPUTER NETWORK, IN CLASS 41 (U.S. CLS. 100, 101 AND 107).

FIRST USE 12-12-2007; IN COMMERCE 12-12-2007.

THE MARK CONSISTS OF STANDARD CHARACTERS WITHOUT CLAIM TO ANY PARTICULAR FONT, STYLE, SIZE, OR COLOR.

SN 77-319,062, FILED 11-1-2007.

ROBERT C. CLARK JR., EXAMINING ATTORNEY

**Int. Cl.: 41**

**Prior U.S. Cls.: 100, 101, and 107**

**United States Patent and Trademark Office**

**Reg. No. 3,499,999**

**Registered Sep. 9, 2008**

**SERVICE MARK  
PRINCIPAL REGISTER**

**MYXTURE**

ABS-CBN INTERNATIONAL (CALIFORNIA CORPORATION)  
150 SHORELINE DRIVE  
REDWOOD CITY, CA 94065

FOR: ENTERTAINMENT IN THE NATURE OF ON-GOING PROGRAMS IN THE FIELDS OF MUSIC, MUSIC VIDEOS, ENTERTAINMENT, LIFESTYLE, POP CULTURE, ASIAN CULTURE, NEWS AND ENTERTAINMENT NEWS DISTRIBUTED OVER TELEVISION, SATELLITE, AND VIA A GLOBAL COMPUTER NETWORK; PROVIDING ON-LINE INFORMATION IN THE FIELDS OF MUSIC, MUSIC VIDEOS, LIFESTYLE, ENTERTAINMENT, POP CULTURE, ASIAN CULTURE AND CURRENT

EVENT NEWS AND ENTERTAINMENT NEWS VIA A GLOBAL COMPUTER NETWORK, IN CLASS 41 (U.S. CLS. 100, 101 AND 107).

FIRST USE 11-26-2007; IN COMMERCE 11-26-2007.

THE MARK CONSISTS OF STANDARD CHARACTERS WITHOUT CLAIM TO ANY PARTICULAR FONT, STYLE, SIZE, OR COLOR.

SN 77-319,083, FILED 11-1-2007.

ROBERT C. CLARK JR., EXAMINING ATTORNEY

Int. Cl.: 40

Prior U.S. Cls.: 100, 103, and 106

United States Patent and Trademark Office

Reg. No. 3,500,000

Registered Sep. 9, 2008

SERVICE MARK  
PRINCIPAL REGISTER



CORRESPONDENCE MANAGEMENT SOLUTIONS INC. (MINNESOTA CORPORATION)  
SUITE 300-311  
8160 COUNTY RD 42 W  
SAVAGE, MN 55378

FOR: ELECTRONIC IMAGING, SCANNING, DIGITIZING, ALTERATION AND/OR RETOUCHING OF LETTERS AND MAIL CORRESPONDENCE; PRINTING, IN CLASS 40 (U.S. CLS. 100, 103 AND 106).

FIRST USE 11-13-2007; IN COMMERCE 11-13-2007.

THE COLOR(S) BLUE, LIGHT BLUE, GRAY, AND WHITE IS/ARE CLAIMED AS A FEATURE OF THE MARK.

THE MARK CONSISTS OF A GEOMETRIC IMAGE OF AN ENVELOPE COMPOSED OF 5 TRIANGLES. THE LEFT AND RIGHT TRIANGLES ARE GRAY AND SMALLER. THE TOP AND BOTTOM TRIANGLES ARE BLUE, AND THE INTERIOR TRIANGLE IS A LIGHT BLUE. THE WORD "SMART" APPEARS IN BLUE ITALICS TO THE RIGHT OF THE IMAGE, AND ADJACENT TO THAT THE WORD "LETTER" APPEARS IN NORMAL GRAY TYPE.

SN 77-320,004, FILED 11-2-2007.

RUSS HERMAN, EXAMINING ATTORNEY

**Int. Cl.: 41**

**Prior U.S. Cls.: 100, 101, and 107**

**United States Patent and Trademark Office**

**Reg. No. 3,500,001**

**Registered Sep. 9, 2008**

**SERVICE MARK  
PRINCIPAL REGISTER**



KRAMER, SIG (FED REP GERMANY INDIVIDUAL)  
5776D LINDERO CANYON SUITE 404  
WESTLAKE VILLAGE, CA 91362

FOR: PROVIDING FITNESS AND EXERCISE FACILITIES, IN CLASS 41 (U.S. CLS. 100, 101 AND 107).

FIRST USE 2-10-2008; IN COMMERCE 2-10-2008.

THE STIPPLING IS FOR SHADING PURPOSES.

SN 77-320,400, FILED 11-2-2007.

STEPHEN AQUILA, EXAMINING ATTORNEY

**Int. Cl.: 32**

**Prior U.S. Cls.: 45, 46, and 48**

**United States Patent and Trademark Office**

**Reg. No. 3,500,002**

**Registered Sep. 9, 2008**

**TRADEMARK  
PRINCIPAL REGISTER**

**MOUNTAIN DEW VOLTAGE**

PEPSICO, INC. (NORTH CAROLINA CORPORATION)  
700 ANDERSON HILL ROAD  
PURCHASE, NY 10577

FOR: SOFT DRINKS, AND SYRUPS AND CONCENTRATES FOR MAKING THE SAME, IN CLASS 32 (U.S. CLS. 45, 46 AND 48).

FIRST USE 6-2-2008; IN COMMERCE 6-2-2008.

THE MARK CONSISTS OF STANDARD CHARACTERS WITHOUT CLAIM TO ANY PARTICULAR FONT, STYLE, SIZE, OR COLOR.

OWNER OF U.S. REG. NOS. 820,362, 3,134,243, AND OTHERS.

SN 77-321,528, FILED 11-5-2007.

GEOFFREY FOSDICK, EXAMINING ATTORNEY

**Int. Cl.: 42**

**Prior U.S. Cls.: 100 and 101**

**United States Patent and Trademark Office**

**Reg. No. 3,500,003**

**Registered Sep. 9, 2008**

**SERVICE MARK  
PRINCIPAL REGISTER**



MOTIVEARTH, LLC (CALIFORNIA LIMITED LIABILITY COMPANY)  
16308 PINTO RIDGE COURT  
SAN DIEGO, CA 92127

FOR: CONSULTING SERVICES IN THE FIELD OF ENVIRONMENTAL ASSESSMENT, COMPLIANCE AND PLANNING; ENVIRONMENTAL SERVICES, NAMELY, TECHNICAL CONSULTATION IN THE FIELD OF ENVIRONMENTAL SCIENCE, ENGINEERING SERVICES, DESIGN FOR OTHERS IN THE FIELD OF ENVIRONMENTAL ENGINEERING, DESIGNING AND TESTING OF NEW ENVIRONMENTALLY FRIENDLY PRODUCTS FOR OTHERS, IN CLASS 42 (U.S. CLS. 100 AND 101).

FIRST USE 5-1-2007; IN COMMERCE 5-1-2007.

THE COLOR(S) GREEN AND BLUE IS/ARE CLAIMED AS A FEATURE OF THE MARK.

THE MARK CONSISTS OF A BLUE CAPITAL LETTER "E" WITH TWO ARROWS CIRCLING

COUNTER CLOCKWISE AROUND THE "E" IN SUCH A WAY THAT THEY MAKE A SHAPE THAT LOOKS LIKE AN OVAL THAT SLANTS APPROXIMATELY 40 DEGREES TO THE RIGHT. THE TOP/LEFT ARROW IS BLUE AND THE BOTTOM/RIGHT ARROW IS GREEN. THE ARROWS ARE MADE IN SUCH A WAY THAT THE LENGTH OF EACH ARROW NARROWS AND TAPERS TO A POINT WHICH GRADUALLY FADES IN COLOR. THE TOP/LEFT BLUE ARROW CURVES FROM THE TOP RIGHT CORNER OF THE "E" DOWN TO THE LEFT BOTTOM CORNER OF THE "E". THE BOTTOM/RIGHT GREEN ARROW CURVES FROM THE BOTTOM LEFT CORNER OF THE "E" TO THE TOP RIGHT CORNER OF THE "E". THE ARROWS DO NOT TOUCH EACH OTHER NOR DO THEY TOUCH THE "E". THE SPACE BETWEEN THE ARROWS IS APPROXIMATELY ONE QUARTER OF EACH ARROW'S LENGTH.

SN 77-321,589, FILED 11-5-2007.

ZACHARY BELLO, EXAMINING ATTORNEY

**Int. Cl.: 3**

**Prior U.S. Cls.: 1, 4, 6, 50, 51, and 52**

**Reg. No. 3,500,004**

**United States Patent and Trademark Office**

**Registered Sep. 9, 2008**

**TRADEMARK  
PRINCIPAL REGISTER**

**COLOURFIX3 COMPLEX**

SUDZZ FX, INC. (CALIFORNIA CORPORATION)  
321 HEARST DRIVE  
OXNARD, CA 93030

FOR: SHAMPOOS, CONDITIONERS, STYLING  
LOTIONS AND GELS, HAIR COLOR AND HAIR  
CARE PREPARATIONS, IN CLASS 3 (U.S. CLS. 1, 4, 6,  
50, 51 AND 52).

FIRST USE 5-21-2008; IN COMMERCE 5-27-2008.

THE MARK CONSISTS OF STANDARD CHAR-  
ACTERS WITHOUT CLAIM TO ANY PARTICULAR  
FONT, STYLE, SIZE, OR COLOR.

NO CLAIM IS MADE TO THE EXCLUSIVE  
RIGHT TO USE "COMPLEX", APART FROM THE  
MARK AS SHOWN.

SN 77-321,705, FILED 11-5-2007.

CHRISTINE COOPER, EXAMINING ATTORNEY



**Int. Cl.: 32**

**Prior U.S. Cls.: 45, 46, and 48**

**United States Patent and Trademark Office**

**Reg. No. 3,500,005**

**Registered Sep. 9, 2008**

**TRADEMARK  
PRINCIPAL REGISTER**

**PUNCH! KNOCK YOURSELF OUT**

WORKMAN, ZACHARY A. (UNITED STATES  
INDIVIDUAL)

6 TIMBER RIDGE LANE

MARSHALL, IL 62441

FOR: ENERGY DRINKS, IN CLASS 32 (U.S. CLS.  
45, 46 AND 48).

FIRST USE 7-21-2008; IN COMMERCE 7-21-2008.

THE MARK CONSISTS OF STANDARD CHAR-  
ACTERS WITHOUT CLAIM TO ANY PARTICULAR  
FONT, STYLE, SIZE, OR COLOR.

NO CLAIM IS MADE TO THE EXCLUSIVE  
RIGHT TO USE "PUNCH", APART FROM THE  
MARK AS SHOWN.

SN 77-321,902, FILED 11-5-2007.

GILBERT SWIFT, EXAMINING ATTORNEY

**Int. Cl.: 35**

**Prior U.S. Cls.: 100, 101, and 102**

**United States Patent and Trademark Office**

**Reg. No. 3,500,006**

**Registered Sep. 9, 2008**

**SERVICE MARK  
PRINCIPAL REGISTER**

**DECOVAN**

DALE, STEVEN (UNITED STATES INDIVIDUAL)  
H202  
23052 ALICIA PARKWAY  
MISSION VIEJO, CA 92692

FOR: RETAIL SHOP AT HOME SERVICES IN THE  
FIELD OF WINDOW FASHIONS, BLINDS, SHADES,  
SHUTTERS, TINT, BEDDING, FURNITURE AND  
FLOORING, IN CLASS 35 (U.S. CLS. 100, 101 AND  
102).

FIRST USE 1-2-2008; IN COMMERCE 1-2-2008.

THE MARK CONSISTS OF STANDARD CHAR-  
ACTERS WITHOUT CLAIM TO ANY PARTICULAR  
FONT, STYLE, SIZE, OR COLOR.

SN 77-322,186, FILED 11-6-2007.

KAREN K. BUSH, EXAMINING ATTORNEY

**Int. Cl.: 43**

**Prior U.S. Cls.: 100 and 101**

**United States Patent and Trademark Office**

**Reg. No. 3,500,007**

**Registered Sep. 9, 2008**

**SERVICE MARK  
PRINCIPAL REGISTER**

THE WARMEST OF WELCOMES

CBOCS PROPERTIES, INC. (MICHIGAN CORPORATION)  
45525 N. I-94 SERVICE ROAD  
BELLEVILLE, MI 48111

THE MARK CONSISTS OF STANDARD CHARACTERS WITHOUT CLAIM TO ANY PARTICULAR FONT, STYLE, SIZE, OR COLOR.

FOR: RESTAURANT SERVICES, IN CLASS 43 (U.S. CLS. 100 AND 101).

SN 77-322,477, FILED 11-6-2007.

FIRST USE 1-21-2008; IN COMMERCE 1-21-2008.

JASON TURNER, EXAMINING ATTORNEY

**Int. Cl.: 35**

**Prior U.S. Cls.: 100, 101, and 102**

**United States Patent and Trademark Office**

**Reg. No. 3,500,008**

**Registered Sep. 9, 2008**

**SERVICE MARK  
PRINCIPAL REGISTER**

THE WARMEST OF WELCOMES

CBOCS PROPERTIES, INC. (MICHIGAN CORPORATION)  
45525 N. I-94 SERVICE ROAD  
BELLEVILLE, MI 48111

THE MARK CONSISTS OF STANDARD CHARACTERS WITHOUT CLAIM TO ANY PARTICULAR FONT, STYLE, SIZE, OR COLOR.

FOR: RETAIL GIFT SHOPS, IN CLASS 35 (U.S. CLS. 100, 101 AND 102).

SN 77-322,481, FILED 11-6-2007.

FIRST USE 1-21-2008; IN COMMERCE 1-21-2008.

JASON TURNER, EXAMINING ATTORNEY

**Int. Cl.: 11**

**Prior U.S. Cls.: 13, 21, 23, 31, and 34**

**United States Patent and Trademark Office**

**Reg. No. 3,500,009**

**Registered Sep. 9, 2008**

**TRADEMARK  
PRINCIPAL REGISTER**

**BIOGASKET**

GENERAL FILTERS, INC. (MICHIGAN CORPORATION)  
43800 GRAND RIVER  
NOVI, MI 483751115

FOR: FUEL OIL FILTERS AND REPLACEMENT CARTRIDGES THEREFOR USED FOR HEATING APPLIANCES NOT OTHERWISE BEING PARTS OF MACHINES, ENGINES OR LAND VEHICLES, IN CLASS 11 (U.S. CLS. 13, 21, 23, 31 AND 34).

FIRST USE 1-26-2008; IN COMMERCE 1-26-2008.

THE MARK CONSISTS OF STANDARD CHARACTERS WITHOUT CLAIM TO ANY PARTICULAR FONT, STYLE, SIZE, OR COLOR.

SN 77-322,658, FILED 11-6-2007.

MARY ROSSMAN, EXAMINING ATTORNEY

**Int. Cl.: 36**

**Prior U.S. Cls.: 100, 101, and 102**

**United States Patent and Trademark Office**

**Reg. No. 3,500,010**

**Registered Sep. 9, 2008**

**SERVICE MARK  
PRINCIPAL REGISTER**



VIST FINANCIAL CORP. (PENNSYLVANIA CORPORATION)  
1240 BROADCAST ROAD,  
WYOMISSING, PA 19533

FOR: FINANCIAL SERVICES, NAMELY, BANKING; CREDIT CARD SERVICES; ELECTRONIC CREDIT CARD TRANSACTIONS; COMMERCIAL AND CONSUMER LENDING AND FINANCING; REAL ESTATE AND MORTGAGE BROKERAGE; TRUST, ESTATE, AND FIDUCIARY MANAGEMENT, PLANNING AND CONSULTING; SECURITIES AND MUTUAL FUND INVESTMENT, BROKERAGE AND TRADING SERVICES; INVESTMENT ADVISORY AND CONSULTING SERVICES; SECURITIES BROKERAGE AND TRADING SERVICES; PROVIDING SECURE FINANCIAL TRANSACTIONS IN THE NATURE OF ELECTRONIC CASH TRANSACTIONS, ELECTRONIC CREDIT CARD TRANSACTIONS, ELECTRONIC DEBIT TRANSACTIONS, ELECTRONIC CHECK PROCESSING TRANSACTIONS AND ELECTRONIC TRANSMISSION OF BILL PAYMENT DATA VIA A GLOBAL COMPUTER NETWORK; INSURANCE SERVICES, NAMELY, BROKERAGE OF PROPERTY, CASUALTY AND LIFE INSURANCE POLICIES AND ANNU-

ITY CONTRACTS; PROVIDING FINANCIAL NEWS AND INFORMATION VIA WEBSITES ON A GLOBAL COMPUTER NETWORK, IN CLASS 36 (U.S. CLS. 100, 101 AND 102).

FIRST USE 3-15-2008; IN COMMERCE 3-15-2008.

NO CLAIM IS MADE TO THE EXCLUSIVE RIGHT TO USE "FINANCIAL", APART FROM THE MARK AS SHOWN.

THE COLOR(S) YELLOW, ORANGE AND GRAY IS/ARE CLAIMED AS A FEATURE OF THE MARK.

THE MARK CONSISTS OF CURVED LINES IN YELLOW ON THE LEFT AND ORANGE ON THE RIGHT FORMING A V-SHAPE, WITH THE WORDS "VIST FINANCIAL" IN GRAY ALONGSIDE THE GRAPHIC.

SN 77-322,701, FILED 11-6-2007.

BRIAN PINO, EXAMINING ATTORNEY

**Int. Cl.: 36**

**Prior U.S. Cls.: 100, 101, and 102**

**United States Patent and Trademark Office**

**Reg. No. 3,500,011**

**Registered Sep. 9, 2008**

**SERVICE MARK  
PRINCIPAL REGISTER**

**VIST FINANCIAL**

VIST FINANCIAL CORP. (PENNSYLVANIA CORPORATION)  
1240 BROADCAST ROAD  
WYOMISSING, PA 19533

FOR: FINANCIAL SERVICES, NAMELY, BANKING; CREDIT CARD SERVICES; ELECTRONIC CREDIT CARD TRANSACTIONS; COMMERCIAL AND CONSUMER LENDING AND FINANCING; REAL ESTATE AND MORTGAGE BROKERAGE; TRUST, ESTATE, AND FIDUCIARY MANAGEMENT, PLANNING AND CONSULTING; SECURITIES AND MUTUAL FUND INVESTMENT, BROKERAGE AND TRADING SERVICES; INVESTMENT ADVISORY AND CONSULTING SERVICES; SECURITIES BROKERAGE AND TRADING SERVICES; PROVIDING SECURE FINANCIAL TRANSACTIONS IN THE NATURE OF ELECTRONIC CASH TRANSACTIONS, ELECTRONIC CREDIT CARD TRANSACTIONS, ELECTRONIC DEBIT TRANSACTIONS, ELECTRONIC CHECK PROCESSING TRANSACTIONS AND ELECTRONIC TRANSMISSION OF BILL PAYMENT DATA VIA A GLOBAL

COMPUTER NETWORK; INSURANCE SERVICES, NAMELY, BROKERAGE OF PROPERTY, CASUALTY AND LIFE INSURANCE POLICIES AND ANNUITY CONTRACTS; PROVIDING FINANCIAL NEWS AND INFORMATION VIA WEBSITES ON A GLOBAL COMPUTER NETWORK, IN CLASS 36 (U.S. CLS. 100, 101 AND 102).

FIRST USE 3-15-2008; IN COMMERCE 3-15-2008.

THE MARK CONSISTS OF STANDARD CHARACTERS WITHOUT CLAIM TO ANY PARTICULAR FONT, STYLE, SIZE, OR COLOR.

NO CLAIM IS MADE TO THE EXCLUSIVE RIGHT TO USE "FINANCIAL", APART FROM THE MARK AS SHOWN.

SN 77-322,787, FILED 11-6-2007.

BRIAN PINO, EXAMINING ATTORNEY

**Int. Cl.: 9**

**Prior U.S. Cls.: 21, 23, 26, 36, and 38**

**United States Patent and Trademark Office**

**Reg. No. 3,500,012**

**Registered Sep. 9, 2008**

**TRADEMARK  
PRINCIPAL REGISTER**

**DROP POINT**

DESTINEER, INC. (DELAWARE CORPORATION)  
SUITE 500  
13755 FIRST AVENUE NORTH  
PLYMOUTH, MN 55441

FOR: COMPUTER GAME SOFTWARE FOR USE WITH PERSONAL COMPUTERS AND VIDEO GAME CONSOLES; DOWNLOADABLE COMPUTER GAME SOFTWARE FOR USE WITH CABLE AND SATELLITE ACCESSIBLE VIDEO CONTROLLERS AND PORTABLE VIDEO DISPLAYS, IN CLASS 9 (U.S. CLS. 21, 23, 26, 36 AND 38).

FIRST USE 1-18-2008; IN COMMERCE 1-18-2008.

THE MARK CONSISTS OF STANDARD CHARACTERS WITHOUT CLAIM TO ANY PARTICULAR FONT, STYLE, SIZE, OR COLOR.

SN 77-323,672, FILED 11-7-2007.

BRIAN PINO, EXAMINING ATTORNEY



**Int. Cl.: 32**

**Prior U.S. Cls.: 45, 46, and 48**

**United States Patent and Trademark Office**

**Reg. No. 3,500,013**

**Registered Sep. 9, 2008**

**TRADEMARK  
PRINCIPAL REGISTER**

**MOUNTAIN DEW SUPERNOVA**

PEPSICO, INC. (NORTH CAROLINA CORPORATION)  
700 ANDERSON HILL ROAD  
PURCHASE, NY 10577

FOR: SOFT DRINKS, AND SYRUPS AND CONCENTRATES FOR MAKING THE SAME, IN CLASS 32 (U.S. CLS. 45, 46 AND 48).

FIRST USE 6-2-2008; IN COMMERCE 6-2-2008.

THE MARK CONSISTS OF STANDARD CHARACTERS WITHOUT CLAIM TO ANY PARTICULAR FONT, STYLE, SIZE, OR COLOR.

OWNER OF U.S. REG. NOS. 820,362, 3,134,243, AND OTHERS.

SN 77-324,696, FILED 11-8-2007.

GEOFFREY FOSDICK, EXAMINING ATTORNEY

Int. Cl.: 14

Prior U.S. Cls.: 2, 27, 28, and 50

United States Patent and Trademark Office

Reg. No. 3,500,014

Registered Sep. 9, 2008

TRADEMARK  
PRINCIPAL REGISTER



SANDERS, MARK R (UNITED STATES INDIVIDUAL)  
5728 TUSCANY TERRACE  
TAMARAC, FL 33321 AND  
MICHELLE NOVATO (BRAZIL INDIVIDUAL)  
5728 TUSCANY TERRACE  
TAMARAC, FL 33321

FOR: JEWELRY, IN CLASS 14 (U.S. CLS. 2, 27, 28 AND 50).

FIRST USE 11-1-2007; IN COMMERCE 11-1-2007.

THE COLOR(S) RED, BLACK AND GRAY IS/ARE CLAIMED AS A FEATURE OF THE MARK.

THE MARK CONSISTS OF THE WORDING "LEVITA, ELEVATE YOUR STYLE". THE WORDING "LEVITA" APPEARS IN A LARGER SIZE AND A STYLIZED FONT ABOVE THE OTHER WORDING, AND IT APPEARS IN BLACK AND RED COLOR, WITH A LIGHT GRAY SHADOW. THE REMAINING WORDING APPEARS IN BLACK COLOR.

SN 77-326,645, FILED 11-11-2007.

LINDA E. BLOHM, EXAMINING ATTORNEY

Int. Cl.: 3

Prior U.S. Cls.: 1, 4, 6, 50, 51, and 52

Reg. No. 3,500,015

United States Patent and Trademark Office

Registered Sep. 9, 2008

TRADEMARK  
PRINCIPAL REGISTER

# FaceMD

LANGSDON, PHILLIP, R. (UNITED STATES INDIVIDUAL)  
7499 POPLAR PIKE  
GERMANTOWN, TN 38138

FOR: AFTER SUN CREAMS; AFTER-SHAVE CREAMS; AGE SPOT REDUCING CREAMS; ANTI-AGING CREAM; ANTI-AGING CREAMS; ANTI-FRECKLE CREAMS; ANTI-WRINKLE CREAM; ANTI-WRINKLE CREAMS; AROMATHERAPY BODY CARE PRODUCTS, NAMELY, BODY LOTION, SHOWER GEL, CUTICLE CREAM, SHAMPOO, CONDITIONER, NON-MEDICATED LIP BALM, SOAP, BODY POLISH, BODY AND FOOT SCRUB AND NON-MEDICATED FOOT CREAM; BEAUTY CREAMS; BEAUTY CREAMS FOR BODY CARE; BODY AND BEAUTY CARE COSMETICS; BODY CREAM; BODY CREAM SOAP; BODY CREAMS; BODY DEODORANTS; BODY LOTION; BODY LOTIONS; BODY MASK CREAM; BODY MASK LOTION; BODY MASK POWDER; BODY MASKS; BODY MILK; BODY MILKS; BODY OIL; BODY OILS; BODY POWDER; BODY SCRUB; BODY SPRAY USED AS A PERSONAL DEODORANT AND AS FRAGRANCE; BODY SPRAYS; BODY WASHES; CLEANSING CREAMS; COLD CREAM; COLD CREAMS; CONCEALERS FOR FACE, SKIN, BODY; COSMETIC CREAMS; COSMETIC CREAMS FOR SKIN CARE; COSMETIC PREPARATIONS FOR BODY CARE; CREAM SOAPS; CREAMY FACE POWDER; DEODORANTS FOR BODY CARE; EX-FOLIANT CREAMS; EYE CREAM; FACE AND BODY BEAUTY CREAMS; FACE AND BODY CREAMS; FACE AND BODY LOTIONS; FACE AND BODY MILK; FACE CREAMS; FACE CREAMS FOR COSMETIC USE; FACE MILK AND LOTIONS; FACE POWDER; FACE POWDER PASTE; FACIAL CREAM; FACIAL CREAMS; FAIR COMPLEXION CREAM; HAIR CARE CREAMS; HAIR CREAMS; HAND CREAM; HAND CREAMS; LIP CREAM; LIQUID SOAPS FOR HANDS AND FACE; LIQUID

SOAPS FOR HANDS, FACE AND BODY; LOOSE FACE POWDER; LOTIONS FOR FACE AND BODY CARE; LOTIONS FOR FACE, SKIN, BODY, HAIR; MAKE-UP FOR THE FACE AND BODY; MAKE-UP REMOVING MILK, GEL, LOTIONS AND CREAMS; MOISTURIZING CREAMS; NIGHT CREAM; NON-MEDICATED BODY SOAKS; NON-MEDICATED SCALP TREATMENT CREAM; NON-MEDICATED SKIN CARE PREPARATIONS, NAMELY, CREAMS, LOTIONS, GELS, TONERS, CLEANERS AND PEELS; NON-MEDICATED SKIN CREAMS; PERFUMED CREAMS; PRE-SHAVE CREAMS; PRESSED FACE POWDER; RETINOL CREAM FOR COSMETIC PURPOSES; SCENTED BODY LOTIONS AND CREAMS; SCENTED BODY SPRAY; SHAVING CREAM; SHAVING CREAMS; SHOWER CREAMS; SKIN AND BODY TOPICAL LOTIONS, CREAMS AND OILS FOR COSMETIC USE; SKIN BRONZING CREAMS; SKIN CARE PREPARATION, NAMELY, BODY POLISH; SKIN CARE PREPARATIONS, NAMELY, BODY BALM; SKIN CLEANSING CREAM; SKIN CREAM; SKIN CREAMS; SKIN CREAMS IN LIQUID AND IN SOLID FORM; SKIN CREAMS IN LIQUID AND SOLID; SKIN CREAMS IN LIQUID AND SOLID FORM; SKIN LIGHTENING CREAMS; SKIN WHITENING CREAMS; SOAPS FOR BODY CARE; TONING LOTION, FOR THE FACE, BODY AND HANDS; WRINKLE RESISTANT CREAM, IN CLASS 3 (U.S. CLS. 1, 4, 6, 50, 51 AND 52).

FIRST USE 12-21-2007; IN COMMERCE 3-3-2008.

THE MARK CONSISTS OF STANDARD CHARACTERS WITHOUT CLAIM TO ANY PARTICULAR FONT, STYLE, SIZE, OR COLOR.

SN 77-326,972, FILED 11-12-2007.

SHANNON TWOHIG, EXAMINING ATTORNEY

**Int. Cl.: 35**

**Prior U.S. Cls.: 100, 101, and 102**

**United States Patent and Trademark Office**

**Reg. No. 3,500,016**

**Registered Sep. 9, 2008**

**SERVICE MARK  
PRINCIPAL REGISTER**



SULLIVAN, PETER R (UNITED STATES INDIVIDUAL)  
33RD FLOOR  
475 PARK AVE SOUTH  
NEW YORK CITY, NY 10016

FOR: BUSINESS CONSULTING AND INFORMATION SERVICES, IN CLASS 35 (U.S. CLS. 100, 101 AND 102).

FIRST USE 1-1-2008; IN COMMERCE 1-1-2008.

THE COLOR(S) BLUE AND GREEN IS/ARE CLAIMED AS A FEATURE OF THE MARK.

THE MARK CONSISTS OF A BLUE ARROW RISING FROM A GREEN ARCH.

SN 77-329,074, FILED 11-14-2007.

WILLIAM P. SHANAHAN, EXAMINING ATTORNEY

**Int. Cls.: 42 and 43**

**Prior U.S. Cls.: 100 and 101**

**United States Patent and Trademark Office**

**Reg. No. 3,500,017**

**Registered Sep. 9, 2008**

**SERVICE MARK  
PRINCIPAL REGISTER**

**TIERRA SAGRADO**

FAIN, RICKEY M. (UNITED STATES INDIVIDUAL)  
1755 C.R. 2013  
WALNUT SPRINGS, TX 76690

FOR: AGRICULTURAL RESEARCH, IN CLASS 42 (U.S. CLS. 100 AND 101).

FIRST USE 7-6-2008; IN COMMERCE 7-6-2008.

FOR: HEALTH RESORT SERVICES, NAMELY, PROVIDING FOOD AND LODGING THAT SPECIALIZE IN PROMOTING PATRONS' GENERAL HEALTH AND WELL-BEING, IN CLASS 43 (U.S. CLS. 100 AND 101).

FIRST USE 7-6-2008; IN COMMERCE 7-6-2008.

THE MARK CONSISTS OF STANDARD CHARACTERS WITHOUT CLAIM TO ANY PARTICULAR FONT, STYLE, SIZE, OR COLOR.

THE ENGLISH TRANSLATION OF "TIERRA SAGRADO" IS SACRED LAND.

SN 77-330,626, FILED 11-15-2007.

JOHN WILKE, EXAMINING ATTORNEY

**Int. Cl.: 35**

**Prior U.S. Cls.: 100, 101, and 102**

**United States Patent and Trademark Office**

**Reg. No. 3,500,018**

**Registered Sep. 9, 2008**

**SERVICE MARK  
PRINCIPAL REGISTER**

**WIDGNET**

PLATFORM-A INC. (MARYLAND CORPORATION)  
IVORY BUILDING, SUITE 200  
1020 HULL STREET  
BALTIMORE, MD 21230

FOR: ADVERTISING, MARKETING, AND PROMOTIONAL SERVICES; PLACEMENT AND DISSEMINATION OF ADVERTISING FOR OTHERS VIA THE INTERNET; PROVIDING ADVERTISING SPACE ON INTERNET WEBSITES, IN CLASS 35 (U.S. CLS. 100, 101 AND 102).

FIRST USE 10-20-2007; IN COMMERCE 10-20-2007.

THE MARK CONSISTS OF STANDARD CHARACTERS WITHOUT CLAIM TO ANY PARTICULAR FONT, STYLE, SIZE, OR COLOR.

SN 77-331,994, FILED 11-16-2007.

NATALIE POLZER, EXAMINING ATTORNEY

**Int. Cl.: 16**

**Prior U.S. Cls.: 2, 5, 22, 23, 29, 37, 38, and 50**

**Reg. No. 3,500,019**

**United States Patent and Trademark Office**

**Registered Sep. 9, 2008**

**TRADEMARK  
PRINCIPAL REGISTER**

**THE TWELVE**

MARVEL CHARACTERS, INC. (DELAWARE  
CORPORATION)  
9242 BEVERLY BLVD.  
BEVERLY HILLS, CA 90210

FOR: COMIC BOOKS; MAGAZINES FEATURING  
PRINTED STORIES IN ILLUSTRATED FORM AND  
COMIC BOOK STORIES AND ARTWORK; PRIN-  
TED PERIODICALS IN THE FIELD OF COMIC  
BOOK STORIES AND ARTWORK, IN CLASS 16  
(U.S. CLS. 2, 5, 22, 23, 29, 37, 38 AND 50).

FIRST USE 12-5-2007; IN COMMERCE 12-5-2007.

THE MARK CONSISTS OF STANDARD CHAR-  
ACTERS WITHOUT CLAIM TO ANY PARTICULAR  
FONT, STYLE, SIZE, OR COLOR.

SN 77-338,870, FILED 11-28-2007.

JENNY PARK, EXAMINING ATTORNEY

**Int. Cl.: 35**

**Prior U.S. Cls.: 100, 101, and 102**

**United States Patent and Trademark Office**

**Reg. No. 3,500,020**

**Registered Sep. 9, 2008**

**SERVICE MARK  
PRINCIPAL REGISTER**

**MYMENU REWARDS**

MYMENU CANADA INC. (CANADA CORPORATION)  
640 TRILLIUM DRIVE  
PO BOX 2488  
KITCHENER, ONTARIO, CANADA N2H 6M3

FOR: ADMINISTRATION OF A DISCOUNT PROGRAM FOR ENABLING PARTICIPANTS TO OBTAIN DISCOUNTS ON GOODS AND SERVICES THROUGH USE OF A DISCOUNT MEMBERSHIP CARD , IN CLASS 35 (U.S. CLS. 100, 101 AND 102).

FIRST USE 6-0-2008; IN COMMERCE 6-0-2008.

THE MARK CONSISTS OF STANDARD CHARACTERS WITHOUT CLAIM TO ANY PARTICULAR FONT, STYLE, SIZE, OR COLOR.

NO CLAIM IS MADE TO THE EXCLUSIVE RIGHT TO USE "REWARDS", APART FROM THE MARK AS SHOWN.

SN 77-339,161, FILED 11-28-2007.

MARK T. MULLEN, EXAMINING ATTORNEY



Int. Cl.: 43

Prior U.S. Cls.: 100 and 101

United States Patent and Trademark Office

Reg. No. 3,500,021

Registered Sep. 9, 2008

SERVICE MARK  
PRINCIPAL REGISTER



ALTOMARE, ANTHONY J. (UNITED STATES  
INDIVIDUAL)  
1301 SKIPPACK PIKE  
BLUE BELL, PA 19422

FOR: RESTAURANT SERVICES, IN CLASS 43  
(U.S. CLS. 100 AND 101).

FIRST USE 5-1-2007; IN COMMERCE 5-1-2007.

THE NAME(S), PORTRAIT(S), AND/OR SIGNA-  
TURE(S) SHOWN IN THE MARK DOES NOT IDEN-  
TIFY A PARTICULAR LIVING INDIVIDUAL.

THE MARK CONSISTS OF THE WORDS "TONY  
RONI'S" WITH THE DESIGN OF A PIZZA SLICE  
BETWEEN THE WORDS "TONY" AND "RONI'S",  
WITH THE WORDS IN SCRIPT FONT.

SN 77-340,034, FILED 11-29-2007.

MICHAEL KEATING, EXAMINING ATTORNEY

Int. Cl.: 7

Prior U.S. Cls.: 13, 19, 21, 23, 31, 34, and 35

Reg. No. 3,500,022

United States Patent and Trademark Office

Registered Sep. 9, 2008

TRADEMARK  
PRINCIPAL REGISTER



THANE INTERNATIONAL, INC. (DELAWARE CORPORATION)  
78-140 CALLE TAMPICO  
LA QUINTA, CA 92253

FOR: MULTI-PURPOSE STEAM CLEANERS AND STEAM CLEANING MACHINES, IN CLASS 7 (U.S. CLS. 13, 19, 21, 23, 31, 34 AND 35).

FIRST USE 3-18-2008; IN COMMERCE 3-18-2008.

NO CLAIM IS MADE TO THE EXCLUSIVE RIGHT TO USE "MOP" AND "STEAM CLEANER", APART FROM THE MARK AS SHOWN.

THE MARK CONSISTS OF THE LETTERS "H2O" WITHIN A RECTANGULAR BOX IN THE MIDDLE, THE LETTERS "M" AND "O" IN THE BACKGROUND AND THE LETTERS "MOP" AND "STEAM CLEANER" ON 2 SEPARATE LINES PLACED DIAGONALLY, FROM BOTTOM LEFT TO RIGHT, IN THE FOREGROUND.

SN 77-340,337, FILED 11-29-2007.

DANNAN HETZEL, EXAMINING ATTORNEY

Int. Cl.: 32

Prior U.S. Cls.: 45, 46, and 48

Reg. No. 3,500,023

United States Patent and Trademark Office

Registered Sep. 9, 2008

TRADEMARK  
PRINCIPAL REGISTER



PEPSICO, INC. (NORTH CAROLINA CORPORATION)  
700 ANDERSON HILL ROAD  
PURCHASE, NY 10577

FOR: SOFT DRINKS, IN CLASS 32 (U.S. CLS. 45, 46 AND 48).

FIRST USE 4-0-2008; IN COMMERCE 4-0-2008.

OWNER OF U.S. REG. NOS. 2,495,127, 3,183,872, AND OTHERS.

NO CLAIM IS MADE TO THE EXCLUSIVE RIGHT TO USE "ORANGE", APART FROM THE MARK AS SHOWN.

THE COLOR(S) BLUE, WHITE, ORANGE, YELLOW AND GREEN IS/ARE CLAIMED AS A FEATURE OF THE MARK.

THE MARK CONSISTS OF THE WORDS "SIERRA MIST UNDERCOVER ORANGE" ON A BLUE

BACKGROUND. THE WORDS "SIERRA MIST" ARE IN WHITE LETTERING. THE WORD "MIST" IS OUTLINED WITH ORANGE AND BLUE. THE WORDS "UNDERCOVER ORANGE" ARE IN YELLOW LETTERING. THE UPPER PORTION OF THE BLUE BACKGROUND DEPICTS A MOUNTAIN DESIGN WITH A BLUE AND WHITE OUTLINE AND A YELLOW PARTIAL SUN DESIGN. THE BOTTOM PORTION OF THE MARK DEPICTS A YELLOW LEMON WEDGE DESIGN WITH A YELLOW AND WHITE RIND AND A BLUE AND YELLOW OUTLINE, AN ORANGE WEDGE DESIGN WITH AN ORANGE AND WHITE RIND AND A BLUE AND YELLOW OUTLINE, AND A GREEN LIME WEDGE DESIGN WITH A GREEN AND WHITE RIND AND A BLUE AND GREEN OUTLINE.

SN 77-343,594, FILED 12-4-2007.

AMEETA JORDAN, EXAMINING ATTORNEY

Int. Cl.: 32

Prior U.S. Cls.: 45, 46, and 48

Reg. No. 3,500,024

United States Patent and Trademark Office

Registered Sep. 9, 2008

TRADEMARK  
PRINCIPAL REGISTER



PEPSICO, INC. (NORTH CAROLINA CORPORATION)  
700 ANDERSON HILL ROAD  
PURCHASE, NY 10577

FOR: SOFT DRINKS, IN CLASS 32 (U.S. CLS. 45, 46 AND 48).

FIRST USE 4-0-2008; IN COMMERCE 4-0-2008.

OWNER OF U.S. REG. NOS. 2,495,127, 3,183,872, AND OTHERS.

NO CLAIM IS MADE TO THE EXCLUSIVE RIGHT TO USE "FREE" OR "ORANGE", APART FROM THE MARK AS SHOWN.

THE COLOR(S) BLUE, WHITE, ORANGE, YELLOW AND GREEN IS/ARE CLAIMED AS A FEATURE OF THE MARK.

THE MARK CONSISTS OF THE WORDS "SIERRA MIST UNDERCOVER ORANGE" ON A BLUE

BACKGROUND. THE WORDS "SIERRA MIST" ARE IN WHITE LETTERING. THE WORD "MIST" IS OUTLINED WITH ORANGE AND BLUE. THE WORDS "UNDERCOVER ORANGE" ARE IN YELLOW LETTERING. THE UPPER PORTION OF THE BLUE BACKGROUND DEPICTS A MOUNTAIN DESIGN WITH A BLUE AND WHITE OUTLINE AND A YELLOW PARTIAL SUN DESIGN. THE BOTTOM PORTION OF THE MARK DEPICTS A YELLOW LEMON WEDGE DESIGN WITH A YELLOW AND WHITE RIND AND A BLUE AND YELLOW OUTLINE, AN ORANGE WEDGE DESIGN WITH AN ORANGE AND WHITE RIND AND A BLUE AND YELLOW OUTLINE, AND A GREEN LIME WEDGE DESIGN WITH A GREEN AND WHITE RIND AND A BLUE AND GREEN OUTLINE.

SN 77-343,610, FILED 12-4-2007.

AMEETA JORDAN, EXAMINING ATTORNEY

**Int. Cl.: 32**

**Prior U.S. Cls.: 45, 46, and 48**

**United States Patent and Trademark Office**

**Reg. No. 3,500,025**

**Registered Sep. 9, 2008**

**TRADEMARK  
PRINCIPAL REGISTER**

**SIERRA MIST UNDERCOVER  
ORANGE**

PEPSICO, INC. (NORTH CAROLINA CORPORATION)  
700 ANDERSON HILL ROAD  
PURCHASE, NY 10577

OWNER OF U.S. REG. NOS. 2,495,127, 2,988,284,  
AND OTHERS.

FOR: SOFT DRINKS, AND SYRUPS AND CONCENTRATES FOR MAKING THE SAME, IN CLASS 32 (U.S. CLS. 45, 46 AND 48).

NO CLAIM IS MADE TO THE EXCLUSIVE RIGHT TO USE "ORANGE", APART FROM THE MARK AS SHOWN.

FIRST USE 4-0-2008; IN COMMERCE 4-0-2008.

SN 77-343,711, FILED 12-4-2007.

THE MARK CONSISTS OF STANDARD CHARACTERS WITHOUT CLAIM TO ANY PARTICULAR FONT, STYLE, SIZE, OR COLOR.

AMEETA JORDAN, EXAMINING ATTORNEY

**Int. Cl.: 32**

**Prior U.S. Cls.: 45, 46, and 48**

**United States Patent and Trademark Office**

**Reg. No. 3,500,026**

**Registered Sep. 9, 2008**

**TRADEMARK  
PRINCIPAL REGISTER**

**SIERRA MIST FREE  
UNDERCOVER ORANGE**

PEPSICO, INC. (NORTH CAROLINA CORPORATION)  
700 ANDERSON HILL ROAD  
PURCHASE, NY 10577

OWNER OF U.S. REG. NOS. 2,495,127, 2,988,284,  
AND OTHERS.

FOR: SOFT DRINKS, AND SYRUPS AND CONCENTRATES FOR MAKING THE SAME, IN CLASS 32 (U.S. CLS. 45, 46 AND 48).

NO CLAIM IS MADE TO THE EXCLUSIVE RIGHT TO USE "FREE" OR "ORANGE", APART FROM THE MARK AS SHOWN.

FIRST USE 4-0-2008; IN COMMERCE 4-0-2008.

SN 77-344,313, FILED 12-5-2007.

THE MARK CONSISTS OF STANDARD CHARACTERS WITHOUT CLAIM TO ANY PARTICULAR FONT, STYLE, SIZE, OR COLOR.

AMEETA JORDAN, EXAMINING ATTORNEY

**Int. Cl.: 8**

**Prior U.S. Cls.: 23, 28, and 44**

**Reg. No. 3,500,027**

**United States Patent and Trademark Office**

**Registered Sep. 9, 2008**

**TRADEMARK  
PRINCIPAL REGISTER**

**RIFT**

BENCHMADE KNIFE CO., INC. (OREGON CORPORATION)  
300 BEAVERCREEK RD.  
OREGON CITY, OR 97045

FOR: KNIVES, NAMELY, POCKET KNIVES, COLLECTOR KNIVES, FOLDING KNIVES, SPORT KNIVES, RESCUE KNIVES, UTILITY KNIVES, TACTICAL KNIVES, FISHING KNIVES, HUNTING KNIVES, CAMPING KNIVES, AND SURVIVAL KNIVES, IN CLASS 8 (U.S. CLS. 23, 28 AND 44).

FIRST USE 2-26-2008; IN COMMERCE 2-26-2008.

THE MARK CONSISTS OF STANDARD CHARACTERS WITHOUT CLAIM TO ANY PARTICULAR FONT, STYLE, SIZE, OR COLOR.

SN 77-348,300, FILED 12-10-2007.

TOBY BULLOFF, EXAMINING ATTORNEY

**Int. Cl.: 36**

**Prior U.S. Cls.: 100, 101, and 102**

**United States Patent and Trademark Office**

**Reg. No. 3,500,028**

**Registered Sep. 9, 2008**

**SERVICE MARK  
PRINCIPAL REGISTER**

**GLOBAL 8 INDEX**

AMERICAN INTERNATIONAL GROUP, INC.  
(DELAWARE CORPORATION)  
70 PINE STREET  
NEW YORK, NY 10270

FOR: ANNUITY UNDERWRITING; ISSUANCE  
AND ADMINISTRATION OF ANNUITIES, IN  
CLASS 36 (U.S. CLS. 100, 101 AND 102).

FIRST USE 3-5-2008; IN COMMERCE 3-5-2008.

THE MARK CONSISTS OF STANDARD CHAR-  
ACTERS WITHOUT CLAIM TO ANY PARTICULAR  
FONT, STYLE, SIZE, OR COLOR.

NO CLAIM IS MADE TO THE EXCLUSIVE  
RIGHT TO USE "GLOBAL" AND "INDEX", APART  
FROM THE MARK AS SHOWN.

SN 77-350,377, FILED 12-12-2007.

KEVIN DINALLO, EXAMINING ATTORNEY



**Int. Cl.: 36**

**Prior U.S. Cls.: 100, 101, and 102**

**United States Patent and Trademark Office**

**Reg. No. 3,500,029**

**Registered Sep. 9, 2008**

**SERVICE MARK  
PRINCIPAL REGISTER**

**GLOBAL 6 INDEX**

AMERICAN INTERNATIONAL GROUP, INC.  
(DELAWARE CORPORATION)  
70 PINE STREET  
NEW YORK, NY 10270

FOR: ANNUITY UNDERWRITING; ISSUANCE  
AND ADMINISTRATION OF ANNUITIES, IN  
CLASS 36 (U.S. CLS. 100, 101 AND 102).

FIRST USE 3-5-2008; IN COMMERCE 3-5-2008.

THE MARK CONSISTS OF STANDARD CHAR-  
ACTERS WITHOUT CLAIM TO ANY PARTICULAR  
FONT, STYLE, SIZE, OR COLOR.

NO CLAIM IS MADE TO THE EXCLUSIVE  
RIGHT TO USE "GLOBAL" AND "INDEX", APART  
FROM THE MARK AS SHOWN.

SN 77-350,385, FILED 12-12-2007.

KEVIN DINALLO, EXAMINING ATTORNEY

**Int. Cl.: 41**

**Prior U.S. Cls.: 100, 101, and 107**

**United States Patent and Trademark Office**

**Reg. No. 3,500,030**

**Registered Sep. 9, 2008**

**SERVICE MARK  
PRINCIPAL REGISTER**

# DC WorldFest

BARBECUE BATTLE, INC. (MARYLAND CORPORATION)  
4335 NORTHVIEW DRIVE  
BOWIE, MD 20716

FOR: ORGANIZATION OF EXHIBITIONS FOR CULTURAL OR EDUCATIONAL PURPOSES; ORGANIZING COMMUNITY CULTURAL EVENTS; ENTERTAINMENT IN THE NATURE OF FOOD AND WINE TASTING; ENTERTAINMENT IN THE NATURE OF CONDUCTING FAIRS AND ETHNIC FESTIVALS; ENTERTAINMENT IN THE NATURE OF LIVE MUSICAL, DANCE AND CULTURAL PERFORMANCES; PROVIDING A WEBSITE FEATURING INFORMATION REGARDING CULTURAL, EDUCATIONAL, ENTERTAINMENT AND CULINARY EVENTS, IN CLASS 41 (U.S. CLS. 100, 101 AND 107).

FIRST USE 1-31-2007; IN COMMERCE 1-31-2007.

THE MARK CONSISTS OF STANDARD CHARACTERS WITHOUT CLAIM TO ANY PARTICULAR FONT, STYLE, SIZE, OR COLOR.

NO CLAIM IS MADE TO THE EXCLUSIVE RIGHT TO USE "DC" , APART FROM THE MARK AS SHOWN.

SN 77-355,622, FILED 12-19-2007.

ANDREA K. NADELMAN, EXAMINING ATTORNEY

**Int. Cl.: 25**

**Prior U.S. Cls.: 22 and 39**

**United States Patent and Trademark Office**

**Reg. No. 3,500,031**

**Registered Sep. 9, 2008**

**TRADEMARK  
PRINCIPAL REGISTER**



BEBE AU LAIT (CALIFORNIA LIMITED LIABILITY COMPANY)  
400 BLOSSOM HILL ROAD  
LOS GATOS, CA 95032

FOR: NURSING APPAREL, NAMELY, NURSING COVERS, IN CLASS 25 (U.S. CLS. 22 AND 39).

FIRST USE 10-31-2007; IN COMMERCE 1-21-2008.

OWNER OF U.S. REG. NO. 3,027,101.

NO CLAIM IS MADE TO THE EXCLUSIVE RIGHT TO USE "COVER", APART FROM THE MARK AS SHOWN.

THE MARK CONSISTS OF THE LITERAL WORDS "COVER IN STYLE BY HOOTER HIDERS" SURROUNDED BY STYLISTIC SWIRLS SHAPED IN AN UPWARD ARCH ABOVE THE LITERAL WORDS AND STYLISTIC SWIRLS SHAPED IN A DOWNWARD ARCH BELOW THE LITERAL WORDS.

SN 77-359,054, FILED 12-24-2007.

LINDA M. KING, EXAMINING ATTORNEY

**Int. Cls.: 16, 36, and 41**

**Prior U.S. Cls.: 2, 5, 22, 23, 29, 37, 38, 50, 100, 101, 102, and 107**

**Reg. No. 3,500,032**

**United States Patent and Trademark Office**

**Registered Sep. 9, 2008**

**TRADEMARK  
SERVICE MARK  
PRINCIPAL REGISTER**

**REAL LIFE. REAL ANSWERS.**

NAPLES AREA BOARD OF REALTORS, INC.  
(FLORIDA CORPORATION)  
1455 PINE RIDGE ROAD  
NAPLES, FL 341092187

FOR: PRINTED MATTER, NAMELY, ASSOCIATION MEMBERSHIP ROSTERS, MAGAZINES FEATURING INFORMATION IN THE AREA OF REAL ESTATE, AND REAL ESTATE TRANSACTION DOCUMENTS, IN CLASS 16 (U.S. CLS. 2, 5, 22, 23, 29, 37, 38 AND 50).

FIRST USE 1-1-2008; IN COMMERCE 1-1-2008.

FOR: REAL ESTATE MULTIPLE LISTING SERVICES ACCESSIBLE VIA THE INTERNET; PROVIDING AN ON-LINE COMPUTER DATABASE OF REAL ESTATE TRANSACTION AND TAX INFORMATION; PROVIDING INFORMATION ON CURRENT LEGISLATION RELATING TO REAL ESTATE AND LOCAL REAL ESTATE NEWS VIA

THE INTERNET, IN CLASS 36 (U.S. CLS. 100, 101 AND 102).

FIRST USE 1-1-2008; IN COMMERCE 1-1-2008.

FOR: EDUCATIONAL SERVICES, NAMELY, CONDUCTING SEMINARS AND TRAINING RELATING TO THE PROFESSION OF REAL ESTATE BROKERAGE, IN CLASS 41 (U.S. CLS. 100, 101 AND 107).

FIRST USE 7-1-2008; IN COMMERCE 7-1-2008.

THE MARK CONSISTS OF STANDARD CHARACTERS WITHOUT CLAIM TO ANY PARTICULAR FONT, STYLE, SIZE, OR COLOR.

SN 77-359,129, FILED 12-24-2007.

BARBARA RUTLAND, EXAMINING ATTORNEY

**Int. Cl.: 38**

**Prior U.S. Cls.: 100, 101, and 104**

**United States Patent and Trademark Office**

**Reg. No. 3,500,033**

**Registered Sep. 9, 2008**

**SERVICE MARK  
PRINCIPAL REGISTER**

**ZOO TOO**

ZOO TOO LLC (DELAWARE LIMITED LIABILITY COMPANY)  
400 PLAZA DRIVE, 1ST FLOOR  
SECAUCUS, NJ 07094

FOR: VIDEO BROADCASTING SERVICES OVER THE INTERNET OR OTHER COMMUNICATIONS NETWORK, NAMELY, UPLOADING, POSTING, SHOWING, DISPLAYING, TAGGING AND ELECTRONICALLY TRANSMITTING VIDEO CLIPS; PROVIDING ON-LINE FORUMS, CHAT ROOMS, AND BULLETIN BOARDS FOR TRANSMISSION OF MESSAGES AMONG COMPUTER USERS IN THE

FIELD OF PET OWNERSHIP, CARE AND MAINTENANCE, IN CLASS 38 (U.S. CLS. 100, 101 AND 104).

FIRST USE 1-1-2007; IN COMMERCE 1-1-2007.

THE MARK CONSISTS OF STANDARD CHARACTERS WITHOUT CLAIM TO ANY PARTICULAR FONT, STYLE, SIZE, OR COLOR.

SN 77-975,772, FILED 11-20-2006.

RUSS HERMAN, EXAMINING ATTORNEY

**Int. Cls.: 1, 20, and 24**

**Prior U.S. Cls.: 1, 2, 5, 6, 10, 13, 22, 25, 26, 32, 42, 46,  
and 50**

**Reg. No. 3,500,034**

**United States Patent and Trademark Office**

**Registered Sep. 9, 2008**

**TRADEMARK  
PRINCIPAL REGISTER**

# Ecopreme

INTERDESIGN, INC. (OHIO CORPORATION)  
30725 SOLON INDUSTRIAL PARKWAY  
SOLON, OH 44139

FOR: POLYMER BASE COMPOSITIONS FOR USE  
IN THE MANUFACTURE OF HOUSEHOLD  
GOODS, NAMELY, SINK MATS, SHOWER CUR-  
TAINS, SHOE BAGS FOR STORAGE, HAMPERS,  
NON-METAL SHOWER ORGANIZERS AND SHOW-  
ER CADDIES, CLOTH BAGS FOR STORAGE, BATH  
MATS, PLASTIC STORAGE CONTAINERS FOR  
DOMESTIC USE, IN CLASS 1 (U.S. CLS. 1, 5, 6, 10,  
26 AND 46).

FIRST USE 12-1-2007; IN COMMERCE 12-1-2007.

FOR: SINK MATS AND HAMPERS, IN CLASS 20  
(U.S. CLS. 2, 13, 22, 25, 32 AND 50).

FIRST USE 12-1-2007; IN COMMERCE 12-1-2007.

FOR: SHOWER CURTAINS, IN CLASS 24 (U.S.  
CLS. 42 AND 50).

FIRST USE 5-19-2008; IN COMMERCE 5-19-2008.

THE MARK CONSISTS OF STANDARD CHAR-  
ACTERS WITHOUT CLAIM TO ANY PARTICULAR  
FONT, STYLE, SIZE, OR COLOR.

SN 77-975,787, FILED 6-7-2007.

LINDA MICKLEBURGH, EXAMINING ATTORNEY

**Int. Cls.: 9 and 44**

**Prior U.S. Cls.: 21, 23, 26, 36, 38, 100, and 101**

**United States Patent and Trademark Office**

**Reg. No. 3,500,035**

**Registered Sep. 9, 2008**

**TRADEMARK  
SERVICE MARK  
PRINCIPAL REGISTER**

**BEAUTY METRIX**

CCT NEWCO INC. (DELAWARE CORPORATION)

4200 NORTHSIDE PARKWAY, BUILDING 5, 1ST

FLOOR

ATLANTA, GA 30327

FOR: COMPUTER HARDWARE AND SOFTWARE FOR USE IN PROVIDING A DETAILED ANALYSIS OF AN INDIVIDUAL'S HAIR AND SKIN TYPES AND PROVIDING A DETAILED PRODUCT RECOMMENDATION BASED ON THE INDIVIDUAL'S HAIR AND SKIN TYPE, IN CLASS 9 (U.S. CLS. 21, 23, 26, 36 AND 38).

FIRST USE 11-28-2006; IN COMMERCE 11-28-2006.

FOR: BEAUTY SALON SERVICES; COSMETIC ANALYSIS, NAMELY, SKIN AND HAIR ANALYSIS SERVICES, IN CLASS 44 (U.S. CLS. 100 AND 101).

FIRST USE 11-28-2006; IN COMMERCE 11-28-2006.

THE MARK CONSISTS OF STANDARD CHARACTERS WITHOUT CLAIM TO ANY PARTICULAR FONT, STYLE, SIZE, OR COLOR.

NO CLAIM IS MADE TO THE EXCLUSIVE RIGHT TO USE "BEAUTY", APART FROM THE MARK AS SHOWN.

SN 77-975,812, FILED 11-21-2006.

TOBY BULLOFF, EXAMINING ATTORNEY

**Int. Cls.: 36 and 42**

**Prior U.S. Cls.: 100, 101, and 102**

**United States Patent and Trademark Office**

**Reg. No. 3,500,036**

**Registered Sep. 9, 2008**

**SERVICE MARK  
PRINCIPAL REGISTER**



EVOLUTION BENEFITS, INC. (DELAWARE CORPORATION)  
22 WATERVILLE ROAD  
AVON, CT 06001

FOR: FINANCIAL SERVICES, NAMELY, AUTOMATICALLY VERIFYING ELIGIBILITY, ADJUDICATING CLAIMS, PROCESSING PAYMENT, TRANSFERRING FUNDS, AND UPDATING RECORDS OF EMPLOYEE EXPENDITURES, ALL VIA COMMUNICATIONS NETWORKS, USING ENCODED SMART CARDS OPERATING IN CONJUNCTION WITH ELECTRONICALLY-STORED, VOLUNTARY EMPLOYEE SAVINGS AND DEFINED CONTRIBUTION PLAN ACCOUNTS; EMPLOYEE BENEFITS SERVICES, NAMELY, PROVIDING EMPLOYEE BENEFITS AND BENEFIT MANAGEMENT SERVICES TO THIRD PARTY ADMINISTRATORS AND EMPLOYERS, NAMELY, PROVIDING PROGRAM DEVELOPMENT AND AIDING ADMINISTRATION OF VOLUNTARY EMPLOYEE SAVINGS AND DEFINED CONTRIBUTION PLANS FOR OTHERS; AND PROVIDING EDUCATIONAL INFORMATION IN THE FIELD OF EMPLOYEE BENEFITS, SPECIFICALLY TO PATIENTS, EMPLOYEES, AND EMPLOYERS IN THE AREA OF EMPLOYEE BENEFITS INVOLVING VOLUNTARY EMPLOYEE SAVINGS AND DEFINED CONTRIBUTION PLANS AND SERVICES, IN CLASS 36 (U.S. CLS. 100, 101 AND 102).

FIRST USE 10-7-2004; IN COMMERCE 10-7-2004.

FOR: COMPUTER SERVICES, NAMELY, PROVIDING TEMPORARY USE OF ONLINE, NON-DOWNLOADABLE SOFTWARE THAT PERMITS EMPLOYERS AND THIRD PARTY ADMINISTRATORS TO SUBSTANTIATE AND ADMINISTER EMPLOYEE BENEFITS PROGRAM TRANSACTIONS INVOLVING ELECTRONICALLY ENCODED SMART CARDS OPERATING IN CONJUNCTION WITH VOLUNTARY EMPLOYEE SAVINGS AND DEFINED CONTRIBUTION PLAN ACCOUNTS, AND ALLOWS EMPLOYEES, EMPLOYERS AND THIRD PARTY ADMINISTRATORS TO ACCESS EMPLOYEE BENEFITS PROGRAM SERVICES INVOLVING VOLUNTARY EMPLOYEE SAVING AND DEFINED CONTRIBUTION PLANS, IN CLASS 42 (U.S. CLS. 100 AND 101).

FIRST USE 4-30-2002; IN COMMERCE 4-30-2002.

NO CLAIM IS MADE TO THE EXCLUSIVE RIGHT TO USE "BENEFITS" , APART FROM THE MARK AS SHOWN.

SN 78-019,803, FILED 8-4-2000.

MARTHA SANTOMARTINO, EXAMINING ATTORNEY



**Int. Cl.: 7**

**Prior U.S. Cls.: 13, 19, 21, 23, 31, 34, and 35**

**United States Patent and Trademark Office**

**Reg. No. 3,500,037**

**Registered Sep. 9, 2008**

**TRADEMARK  
PRINCIPAL REGISTER**

**IF IT'S NOT METAL, IT'S NOT COMMERCIAL**

ROYAL APPLIANCE MFG. CO. (OHIO COR-  
PORATION)  
7005 COCHRAN ROAD  
GLENWILLOW, OH 44139

FIRST USE 10-16-2001; IN COMMERCE 10-16-2001.

SN 78-118,706, FILED 4-1-2002.

FOR: ELECTRICAL VACUUM CLEANERS FOR  
DOMESTIC AND COMMERCIAL USE, IN CLASS 7  
(U.S. CLS. 13, 19, 21, 23, 31, 34 AND 35).

RAUL CORDOVA, EXAMINING ATTORNEY

**Int. Cl.: 36**

**Prior U.S. Cls.: 100, 101, and 102**

**United States Patent and Trademark Office**

**Reg. No. 3,500,038**

**Registered Sep. 9, 2008**

**SERVICE MARK  
PRINCIPAL REGISTER**

**HOMELAND COMMUNITY BANK**

HOMELAND COMMUNITY BANK (TENNESSEE  
CHARTERED BANK)  
900 N. CHANCERY STREET  
MCMINNVILLE, TN 37111

NO CLAIM IS MADE TO THE EXCLUSIVE  
RIGHT TO USE "COMMUNITY BANK", APART  
FROM THE MARK AS SHOWN.

FOR: BANKING SERVICES, IN CLASS 36 (U.S.  
CLS. 100, 101 AND 102).

SN 78-156,096, FILED 8-20-2002.

FIRST USE 11-10-2003; IN COMMERCE 11-10-2003.

LESLIE RICHARDS, EXAMINING ATTORNEY

**Int. Cls.: 35, 39, 41, and 43**

**Prior U.S. Cls.: 100, 101, 102, 105, and 107**

**United States Patent and Trademark Office**

**Reg. No. 3,500,039**

**Registered Sep. 9, 2008**

**SERVICE MARK  
PRINCIPAL REGISTER**

**Coast Hotels & Resorts ©**

COAST HOTELS LIMITED (CANADA CORPORATION)  
900-1090 WEST GEORGIA STREET  
VANCOUVER, BC, CANADA V6E 3V7

FOR: PROVIDING FACILITIES FOR BUSINESS MEETINGS, IN CLASS 35 (U.S. CLS. 100, 101 AND 102).

FIRST USE 0-0-1972; IN COMMERCE 0-0-1993.

FOR: (BASED ON 44(E) MARINA SERVICES, IN CLASS 39 (U.S. CLS. 100 AND 105).

FOR: PROVIDING FITNESS AND EXERCISE FACILITIES, IN CLASS 41 (U.S. CLS. 100, 101 AND 107).

FIRST USE 0-0-1972; IN COMMERCE 0-0-1993.

FOR: HOTEL AND MOTEL SERVICES; RESTAURANT SERVICES; BAR SERVICES; PROVIDING

CONVENTION FACILITIES; PROVIDING BANQUET AND SOCIAL FUNCTION FACILITIES FOR SPECIAL OCCASIONS; CATERING SERVICES, IN CLASS 43 (U.S. CLS. 100 AND 101).

FIRST USE 0-0-1972; IN COMMERCE 0-0-1993.

OWNER OF CANADA REG. NO. TMA336475, DATED 1-29-1988, EXPIRES 1-29-2018.

OWNER OF U.S. REG. NOS. 1,514,046 AND 2,575,187.

NO CLAIM IS MADE TO THE EXCLUSIVE RIGHT TO USE "HOTELS & RESORTS", APART FROM THE MARK AS SHOWN.

SN 78-176,191, FILED 10-18-2002.

JOHN GARTNER, EXAMINING ATTORNEY

**Int. Cl.: 35**

**Prior U.S. Cls.: 100, 101, and 102**

**United States Patent and Trademark Office**

**Reg. No. 3,500,040**

**Registered Sep. 9, 2008**

**SERVICE MARK  
PRINCIPAL REGISTER**



JORDAN, GARY L. (UNITED STATES INDIVIDUAL)

P. O. BOX 2456

PALM BEACH, FL 334802456

FOR: PROVIDING ON-LINE DIRECTORY INFORMATION FEATURING PET OWNERS' IDENTIFICATION AND CORRESPONDING OWNED PET IDENTIFICATION AND DESCRIPTION, IN CLASS 35 (U.S. CLS. 100, 101 AND 102).

FIRST USE 7-18-2008; IN COMMERCE 7-18-2008.

THE HEART SHOWN IN THE DRAWING IS LINED FOR THE COLOR RED.

SN 78-243,464, FILED 4-29-2003.

MICHAEL SOUDERS, EXAMINING ATTORNEY

**Int. Cl.: 42**

**Prior U.S. Cls.: 100 and 101**

**United States Patent and Trademark Office**

**Reg. No. 3,500,041**

**Registered Sep. 9, 2008**

**SERVICE MARK  
PRINCIPAL REGISTER**

**EPROPERTY**

LARIVIERE, GRUBMAN & PAYNE, LLP (CALI-  
FORNIA LIMITED PARTNERSHIP)  
P.O. BOX 3140  
19 UPPER RAGSDALE DRIVE, SUITE 200  
MONTEREY, CA 93942

FIRST USE 5-0-2007; IN COMMERCE 5-0-2007.

SN 78-252,598, FILED 5-21-2003.

FOR: LEGAL SERVICES, IN CLASS 42 (U.S. CLS.  
100 AND 101).

SKYE YOUNG, EXAMINING ATTORNEY

**Int. Cl.: 16**

**Prior U.S. Cls.: 2, 5, 22, 23, 29, 37, 38, and 50**

**Reg. No. 3,500,042**

**United States Patent and Trademark Office**

**Registered Sep. 9, 2008**

---

**TRADEMARK  
PRINCIPAL REGISTER**

**TRUE COLORS**

NEW VIEW GIFTS AND ACCESSORIES, LTD.  
(PENNSYLVANIA CORPORATION)  
311 E. BALTIMORE AVE  
MEDIA, PA 19063

MEMORY BOOKS, IN CLASS 16 (U.S. CLS. 2, 5, 22, 23,  
29, 37, 38 AND 50).

FIRST USE 4-27-2004; IN COMMERCE 4-27-2004.

FOR: DISPLAY BOARDS FOR PICTURES, PHOTOGRAPHS, MEMOS, NOTE CARDS AND OTHER PAPERS; WALL DÉCOR, NAMELY, ART PICTURES; PHOTO ALBUMS AND PHOTO BOXES AS

SN 78-256,804, FILED 6-2-2003.

RICHARD A. STRASER, EXAMINING ATTORNEY

**Int. Cl.: 37**

**Prior U.S. Cls.: 100, 103, and 106**

**United States Patent and Trademark Office**

**Reg. No. 3,500,043**

**Registered Sep. 9, 2008**

**SERVICE MARK  
PRINCIPAL REGISTER**

**CAP D'ANTIBES**

GB 500, INC. (FLORIDA CORPORATION)  
8156 FIDDLER'S CREEK PARKWAY  
NAPLES, FL 34114

FOR: REAL ESTATE DEVELOPMENT; LAND  
DEVELOPMENT SERVICES, NAMELY, PLANNING  
AND LAYING OUT OF RESIDENTIAL AND/OR

COMMERCIAL COMMUNITIES, IN CLASS 37 (U.S.  
CLS. 100, 103 AND 106).

FIRST USE 11-7-2004; IN COMMERCE 11-7-2004.

SN 78-269,989, FILED 7-2-2003.

RUSS HERMAN, EXAMINING ATTORNEY

**Int. Cl.: 35**

**Prior U.S. Cls.: 100, 101, and 102**

**United States Patent and Trademark Office**

**Reg. No. 3,500,044**

**Registered Sep. 9, 2008**

**SERVICE MARK  
PRINCIPAL REGISTER**

**INTELLI**

INTELLIDYN CORP. (DELAWARE CORPORATION)  
175 DERBY STREET, SUITE 40  
HINGHAM, MA 02043

FOR: HOUSE MARK FOR MARKETING SERVICES, NAMELY, ANALYZING DEMOGRAPHICS, MARKETING AND SALES DATA FOR OTHERS; PROVIDING TARGETED MARKETING LISTS AND PROSPECTIVE CLIENT LISTS FOR THE MARKET-

ING CAMPAIGNS, IN CLASS 35 (U.S. CLS. 100, 101 AND 102).

FIRST USE 10-15-2006; IN COMMERCE 10-15-2006.

OWNER OF U.S. REG. NO. 2,539,525.

SN 78-294,010, FILED 8-29-2003.

JENNIFER VASQUEZ, EXAMINING ATTORNEY



**Int. Cl.: 40**

**Prior U.S. Cls.: 100, 103, and 106**

**United States Patent and Trademark Office**

**Reg. No. 3,500,045**

**Registered Sep. 9, 2008**

---

**SERVICE MARK  
PRINCIPAL REGISTER**

**MOLDSHIELD**

KOP-COAT, INC. (OHIO CORPORATION)  
3020 WILLIAM PITT WAY  
PITTSBURGH, PA 15238

THE MARK CONSISTS OF STANDARD CHARACTERS WITHOUT CLAIM TO ANY PARTICULAR FONT, STYLE, SIZE, OR COLOR.

FOR: CONSULTING SERVICES IN THE FIELD OF PROTECTIVE CHEMICAL TREATMENT PROCESSES FOR WOOD AND WOOD-BASED COMPOSITES, IN CLASS 40 (U.S. CLS. 100, 103 AND 106).

SN 78-328,913, FILED 11-17-2003.

FIRST USE 6-27-2008; IN COMMERCE 6-27-2008.

DAVID HOFFMAN, EXAMINING ATTORNEY

Int. Cl.: 25

Prior U.S. Cls.: 22 and 39

United States Patent and Trademark Office

Reg. No. 3,500,046

Registered Sep. 9, 2008

**TRADEMARK  
PRINCIPAL REGISTER**

**FIERCELY AMERICAN**

FIERCE WORLD CLOTHING INC. (CANADA CORPORATION)  
BOX 315, 16 MIDLAKE BLVD. SE  
CALGARY, CANADA T2X 2X7

FOR: CLOTHING, NAMELY, T-SHIRTS, ANORAKS, APRONS, CLOTH BABY BIBS, BANDANNAS, JERSEYS, SOCKS, SHORTS, PANTS, COATS, BLOUSES, BODY SUITS, BOOTIES, BOOTS, BOXING TRUNKS, CAPS, HATS, BERETS, SPORT CAPS, GOLF CAPS, GOLF HATS, STRAW HATS, VISORS, TOQUES, EAR-MUFFS, FUR HATS, CAPES, JACKETS, BLAZERS, TOPCOATS, WAISTCOATS, PARKAS, PONCHOS, COVERALLS, GLOVES, MITTENS, LINGERIE, UNDERWEAR, SLEEPWEAR, NAMELY, NIGHT SHIRTS, NIGHTGOWNS, PAJAMAS, BATH WRAPS, BATHROBES, DRESSING GOWNS, HOUSECOATS, KIMONOS, ROBES, WRAP-AROUNDS AND WRAPS, THERMAL UNDERWEAR, NECKTIES, NECK WARMERS, OVERALLS, RAIN PONCHOS, RAINCOATS, SANDALS, SCARVES, TANK TOPS, SKIRTS, SLACKS, SNOW SUITS, SNOWMOBILE SUITS, LEG WAR-

MERS, LEGGINGS, LEOTARDS, SUSPENDERS, SWEAT SHIRTS, SWEATBAND WRISTLETS, SWEATERS, SWEATPANTS, TRACK SUITS, SWIM PANTS, BIKINIS, SWIM TRUNKS, HALTERS, WRESTLING SINGLET, SHOES, BOOTS, ATHLETIC SHOES, JOGGING SHOES, OVERSHOES, SLIP-ONS, SLIPPERS, THONGS, AND TOE RUBBERS, AND WRIST BANDS, IN CLASS 25 (U.S. CLS. 22 AND 39).

FIRST USE 6-1-2008; IN COMMERCE 6-1-2008.

THE MARK CONSISTS OF STANDARD CHARACTERS WITHOUT CLAIM TO ANY PARTICULAR FONT, STYLE, SIZE, OR COLOR.

NO CLAIM IS MADE TO THE EXCLUSIVE RIGHT TO USE "AMERICAN", APART FROM THE MARK AS SHOWN.

SN 78-333,466, FILED 11-26-2003.

WON TEAK OH, EXAMINING ATTORNEY

Int. Cl.: 21

Prior U.S. Cls.: 2, 13, 23, 29, 30, 33, 40, and 50

United States Patent and Trademark Office

Reg. No. 3,500,047

Registered Sep. 9, 2008

TRADEMARK  
PRINCIPAL REGISTER



FOREHAND, JAMES DANIEL (UNITED STATES INDIVIDUAL)  
42 PARKSTONE COURT  
STONE MOUNTAIN, GA 30087

FOR: INSECT TRAPS, IN CLASS 21 (U.S. CLS. 2, 13, 23, 29, 30, 33, 40 AND 50).

FIRST USE 4-0-2008; IN COMMERCE 4-0-2008.

NO CLAIM IS MADE TO THE EXCLUSIVE RIGHT TO USE THE REPRESENTATION OF THE UNIVERSAL PROHIBITION SYMBOL, APART FROM THE MARK AS SHOWN.

THE COLOR(S) BLACK, WHITE, GREY, RED IS/ ARE CLAIMED AS A FEATURE OF THE MARK.

THE MARK CONSISTS OF A CARICATURE OF A MOSQUITO WITH AN OVERSIZED HEAD AND

PROBOSCIS TRAPPED IN THE UNIVERSAL PROHIBITION SYMBOL FOLLOWED BY THE WORDING "BITE BACK!" THE WORD "BITE" IS LOCATED DIRECTLY ABOVE THE WORD "BACK." THE COLOR BLACK APPEARS IN THE WORDING AND IN THE BODY, LEGS, EYEBROWS AND OUTLINE OF THE WINGS, EYES, HEAD AND PROBOSCIS OF THE MOSQUITO. THE COLOR WHITE APPEARS IN THE WINGS AND EYES OF THE MOSQUITO AND THE SPACE BETWEEN THE MOSQUITO AND UNIVERSAL PROHIBITION SYMBOL. THE COLOR GRAY APPEARS IN THE HEAD AND PROBOSCIS OF THE MOSQUITO. THE COLOR RED APPEARS IN THE UNIVERSAL PROHIBITION SYMBOL.

SN 78-340,615, FILED 12-14-2003.

ALEX KEAM, EXAMINING ATTORNEY

**Int. Cl.: 10**

**Prior U.S. Cls.: 26, 39, and 44**

**United States Patent and Trademark Office**

**Reg. No. 3,500,048**

**Registered Sep. 9, 2008**

**TRADEMARK  
PRINCIPAL REGISTER**

**SnörEx**

TIELEMANS NV (TNV) (BELGIUM CORPORATION)  
HEIRWEG 38  
MAASEIK, BELGIUM B-3860

FIRST USE 10-7-2007; IN COMMERCE 10-7-2007.

SN 78-363,634, FILED 2-6-2004.

FOR: ORAL ORTHESIS FOR REDUCTION OF  
SNORING AND SLEEP APNEA SYMPTOMS, IN  
CLASS 10 (U.S. CLS. 26, 39 AND 44).

ANN E. SAPPENFIELD, EXAMINING ATTORNEY

**Int. Cls.: 7 and 9**

**Prior U.S. Cls.: 13, 19, 21, 23, 26, 31, 34, 35, 36, and 38**

**Reg. No. 3,500,049**

**United States Patent and Trademark Office**

**Registered Sep. 9, 2008**

**TRADEMARK  
PRINCIPAL REGISTER**

**TMEIC**

TOSHIBA MITSUBISHI-ELECTRIC INDUSTRIAL  
SYSTEMS CORPORATION (JAPAN COR-  
PORATION)  
13-16 MITA 3-CHOME, MINATO-KU  
TOKYO, JAPAN

FOR: ELECTRIC MOTORS FOR INDUSTRIAL  
MACHINES; ELECTRIC GENERATORS, IN CLASS  
7 (U.S. CLS. 13, 19, 21, 23, 31, 34 AND 35).

FIRST USE 10-1-2003; IN COMMERCE 2-29-2004.

FOR: OZONE GENERATORS FOR INDUSTRIAL  
USE, UNINTERRUPTIBLE POWER SUPPLY, ELEC-

TRIC CONVERTERS; ELECTRIC INVERTERS;  
ELECTRIC RECTIFIERS, IN CLASS 9 (U.S. CLS. 21,  
23, 26, 36 AND 38).

FIRST USE 10-1-2003; IN COMMERCE 2-29-2004.

THE MARK CONSISTS OF STANDARD CHAR-  
ACTERS WITHOUT CLAIM TO ANY PARTICULAR  
FONT, STYLE, SIZE, OR COLOR.

SN 78-377,071, FILED 3-2-2004.

ZACHARY BELLO, EXAMINING ATTORNEY

**Int. Cl.: 3**

**Prior U.S. Cls.: 1, 4, 6, 50, 51, and 52**

**Reg. No. 3,500,050**

**United States Patent and Trademark Office**

**Registered Sep. 9, 2008**

---

**TRADEMARK  
PRINCIPAL REGISTER**

**ANTAR**

TUPPERWARE PRODUCTS S.A. (SWITZERLAND  
CORPORATION)  
ROUTE DU JURA 37  
FRIBOURG, SWITZERLAND CH-1700

THE MARK CONSISTS OF STANDARD CHAR-  
ACTERS WITHOUT CLAIM TO ANY PARTICULAR  
FONT, STYLE, SIZE, OR COLOR.

FOR: EAU DE COLOGNE; DEODORANTS AND  
ANTI-PERSPIRANTS FOR PERSONAL USE, IN  
CLASS 3 (U.S. CLS. 1, 4, 6, 50, 51 AND 52).

SN 78-378,260, FILED 3-4-2004.

FIRST USE 6-28-2008; IN COMMERCE 6-28-2008.

ELLEN B. AWRICH, EXAMINING ATTORNEY

**Int. Cl.: 3**

**Prior U.S. Cls.: 1, 4, 6, 50, 51, and 52**

**Reg. No. 3,500,051**

**United States Patent and Trademark Office**

**Registered Sep. 9, 2008**

**TRADEMARK  
PRINCIPAL REGISTER**

**TENDER BLUE**

TUPPERWARE PRODUCTS S.A. (SWITZERLAND  
CORPORATION)  
ROUTE DU JURA 37  
FRIBOURG, SWITZERLAND CH-1700

FOR: PERFUMES; EAU DE COLOGNE; DEODOR-  
ANTS AND ANTI-PERSPIRANTS FOR PERSONAL  
USE, IN CLASS 3 (U.S. CLS. 1, 4, 6, 50, 51 AND 52).

FIRST USE 6-14-2008; IN COMMERCE 6-14-2008.

THE MARK CONSISTS OF STANDARD CHAR-  
ACTERS WITHOUT CLAIM TO ANY PARTICULAR  
FONT, STYLE, SIZE, OR COLOR.

NO CLAIM IS MADE TO THE EXCLUSIVE  
RIGHT TO USE "BLUE", APART FROM THE MARK  
AS SHOWN.

SN 78-378,325, FILED 3-4-2004.

RONALD MCMORROW, EXAMINING ATTORNEY

**Int. Cl.: 5**

**Prior U.S. Cls.: 6, 18, 44, 46, 51, and 52**

**United States Patent and Trademark Office**

**Reg. No. 3,500,052**

**Registered Sep. 9, 2008**

**TRADEMARK  
PRINCIPAL REGISTER**

**CERENEW**

SOFT GEL TECHNOLOGIES, INC. (CALIFORNIA  
CORPORATION)  
6982 BANDINI BLVD.  
LOS ANGELES, CA 90040

THE MARK CONSISTS OF STANDARD CHAR-  
ACTERS WITHOUT CLAIM TO ANY PARTICULAR  
FONT, STYLE, SIZE, OR COLOR.

FOR: DIETARY AND NUTRITIONAL SUPPLE-  
MENTS, IN CLASS 5 (U.S. CLS. 6, 18, 44, 46, 51 AND  
52).

SN 78-382,317, FILED 3-11-2004.

FIRST USE 4-11-2008; IN COMMERCE 4-11-2008.

B. PARADEWELAI, EXAMINING ATTORNEY



**Int. Cls.: 9, 37, and 42**

**Prior U.S. Cls.: 21, 23, 26, 36, 38, 100, 101, 103, and 106**

**Reg. No. 3,500,053**

**United States Patent and Trademark Office**

**Registered Sep. 9, 2008**

**TRADEMARK  
SERVICE MARK  
PRINCIPAL REGISTER**

**POWER**

INTERNATIONAL BUSINESS MACHINES CORPORATION (NEW YORK CORPORATION)  
NEW ORCHARD ROAD  
ARMONK, NY 10504

FOR: COMPUTER SOFTWARE FOR DESIGNING AND DEVELOPING SOFTWARE APPLICATIONS; COMPUTER SOFTWARE DEVELOPMENT TOOLS; COMPUTER OPERATING SYSTEM PROGRAMS; COMPUTER SOFTWARE APPLICATION PROGRAMS WHICH IMPLEMENT A SUBSET OF THE SPECIFICATION FOR A SET OF SOFTWARE INTERFACES FOR DESIGNING AND DEVELOPING SOFTWARE APPLICATIONS IN A SPECIFIC ENVIRONMENT; AND INSTRUCTION MANUALS SOLD THEREWITH, IN CLASS 9 (U.S. CLS. 21, 23, 26, 36 AND 38).

FIRST USE 2-0-2002; IN COMMERCE 5-12-2008.

FOR: CUSTOM INSTALLATION, REPAIR AND MAINTENANCE OF COMPUTER HARDWARE, IN CLASS 37 (U.S. CLS. 100, 103 AND 106).

FIRST USE 5-12-2008; IN COMMERCE 5-12-2008.

FOR: COMPUTER PROJECT MANAGEMENT SERVICES; CONSULTING SERVICES CONCERNING DESIGN AND DEVELOPMENT OF COMPUTER SOFTWARE PROGRAMS AND

ARCHITECTURE AND COMPUTER HARDWARE ARCHITECTURE; CONSULTING SERVICES IN THE FIELD OF DESIGNING, DEVELOPING AND USING COMPUTER HARDWARE AND COMPUTER SOFTWARE; TECHNICAL SUPPORT SERVICES, NAMELY, TROUBLESHOOTING OF COMPUTER HARDWARE AND COMPUTER SOFTWARE PROBLEMS; INTEGRATION OF COMPUTER HARDWARE AND SOFTWARE; COMPUTER SOFTWARE AND HARDWARE TESTING SERVICES; INSTALLATION, UPDATING AND MAINTENANCE OF COMPUTER SOFTWARE; COMPUTER PROGRAMMING FOR OTHERS; COMPUTER CONSULTING SERVICES IN THE FIELD OF COMPUTER HARDWARE AND COMPUTER SOFTWARE FOR MANAGING HARDWARE AND SOFTWARE AND PROCESSES THAT EXIST WITHIN AN INFORMATION TECHNOLOGY ENVIRONMENT; AND COMPUTER SYSTEMS ANALYSIS, IN CLASS 42 (U.S. CLS. 100 AND 101).

FIRST USE 5-12-2008; IN COMMERCE 5-12-2008.

THE MARK CONSISTS OF STANDARD CHARACTERS WITHOUT CLAIM TO ANY PARTICULAR FONT, STYLE, SIZE, OR COLOR.

SN 78-383,224, FILED 3-12-2004.

JIM RINGLE, EXAMINING ATTORNEY

**Int. Cl.: 9**

**Prior U.S. Cls.: 21, 23, 26, 36, and 38**

**Reg. No. 3,500,054**

**United States Patent and Trademark Office**

**Registered Sep. 9, 2008**

**TRADEMARK  
PRINCIPAL REGISTER**

**SMS**

VANDERPLAATS RESEARCH & DEVELOPMENT, INC. (COLORADO CORPORATION)

1767 SOUTH 8TH STREET

COLORADO SPRINGS, CO 80906

FOR: COMPUTER SOFTWARE FOR CALCULATING FASTER EIGENVALUE SOLUTIONS, NAMELY, FREQUENCIES AND VIBRATION MODES, TO BE UTILIZED WITH STRUCTURAL ANALYSIS ENGINEERING SOFTWARE IN A VARIETY OF INDUSTRIES INCLUDING VEHICLE, AEROSPACE,

AND MECHANICAL DESIGN, IN CLASS 9 (U.S. CLS. 21, 23, 26, 36 AND 38).

FIRST USE 6-1-2001; IN COMMERCE 7-17-2001.

THE MARK CONSISTS OF STANDARD CHARACTERS WITHOUT CLAIM TO ANY PARTICULAR FONT, STYLE, SIZE, OR COLOR.

SN 78-385,067, FILED 3-16-2004.

MARY ROSSMAN, EXAMINING ATTORNEY

**Int. Cls.: 9 and 38**

**Prior U.S. Cls.: 21, 23, 26, 36, 38, 100, 101, and 104**

**United States Patent and Trademark Office**

**Reg. No. 3,500,055**

**Registered Sep. 9, 2008**

**TRADEMARK  
SERVICE MARK  
PRINCIPAL REGISTER**



CREATECNA XXI S.L. (SPAIN CORPORATION)  
GRAN VIA 31 9/10  
MADRID, SPAIN 28013

FIRST USE 1-7-2003; IN COMMERCE 4-24-2006.

FOR: COMPUTER PROGRAMS FOR USE IN  
DATABASE MANAGEMENT, USE AS A SPREAD-  
SHEET, AND WORD PROCESSING, IN CLASS 9  
(U.S. CLS. 21, 23, 26, 36 AND 38).

NO CLAIM IS MADE TO THE EXCLUSIVE  
RIGHT TO USE "DIGITAL", APART FROM THE  
MARK AS SHOWN.

FIRST USE 1-7-2003; IN COMMERCE 4-24-2006.

SN 78-391,021, FILED 3-25-2004.

FOR: TELECOMMUNICATION SERVICES,  
NAMELY, PERSONAL COMMUNICATION SERVI-  
CES, IN CLASS 38 (U.S. CLS. 100, 101 AND 104).

REBECCA POVARCHUK, EXAMINING ATTOR-  
NEY

**Int. Cls.: 9, 28, 38, and 41**

**Prior U.S. Cls.: 21, 22, 23, 26, 36, 38, 50, 100, 101, 104,  
and 107**

**Reg. No. 3,500,056**

**United States Patent and Trademark Office**

**Registered Sep. 9, 2008**

**TRADEMARK  
SERVICE MARK  
PRINCIPAL REGISTER**

# LINEAGE

NCSOFT CORPORATION (REPUBLIC OF KOREA CORPORATION)  
157-33 OKSAN BUILDING  
SAMSUNG-DONG GANGNAM-GU  
SEOUL, REPUBLIC OF KOREA 135090

FOR: COMPUTER GAME SOFTWARE; INTERACTIVE MULTIMEDIA COMPUTER GAME PROGRAMS; DOWNLOADABLE ELECTRONIC PUBLICATIONS IN THE NATURE OF NEWSLETTERS AND MAGAZINES FEATURING ROLE-PLAYING, IN CLASS 9 (U.S. CLS. 21, 23, 26, 36 AND 38).

FIRST USE 12-0-2000; IN COMMERCE 12-0-2000.

FOR: GAMES, NAMELY, ROLE PLAYING AND ACTION SKILL GAMES, IN CLASS 28 (U.S. CLS. 22, 23, 38 AND 50).

FIRST USE 12-0-2000; IN COMMERCE 12-0-2000.

FOR: PROVIDING ONLINE CHAT ROOMS AND ELECTRONIC BULLETIN BOARDS FOR TRANSMISSION, RECEPTION AND SHARING OF MESSAGES BY MEANS OF ELECTRONIC OR OPTICAL COMMUNICATIONS NETWORKS, ALL IN THE FIELDS OF ENTERTAINMENT OR AMUSEMENT TYPE ACTIVITY, MULTI-PLAYER GAME COMPE-

TITIONS AND ELECTRONIC ENTERTAINMENT, IN CLASS 38 (U.S. CLS. 100, 101 AND 104).

FIRST USE 12-0-2000; IN COMMERCE 12-0-2000.

FOR: PROVIDING ENTERTAINMENT IN THE NATURE OF ELECTRONIC GAMES, AND MULTI-PLAYER ELECTRONIC GAMING, AND MULTI-PLAYER GAME COMPETITIONS, ALL BY MEANS OF ELECTRONIC OR OPTICAL COMMUNICATIONS NETWORKS; PROVIDING INFORMATION, PUBLISHING OF ELECTRONIC PUBLICATIONS, AND PROVIDING ADVICE, ALL BY MEANS OF ELECTRONIC OR OPTICAL NETWORKS, IN THE FIELDS OF ELECTRONIC GAMING, COMPUTER GAMES, AMUSEMENT TYPE ACTIVITY GAMES AND MULTIPLAYER GAME COMPETITIONS; PROVIDING ONLINE COMMUNICATIONS LINKS WHICH TRANSFER WEB SITE USERS TO OTHER LOCAL AND GLOBAL WEB SITES IN THE FIELDS OF ELECTRONIC ENTERTAINMENT, GAMES, AMUSEMENT TYPE ACTIVITY GAMES AND MULTIPLAYER GAME COMPETITIONS; PROVIDING A WEBSITE FEATURING ONLINE COMPUTER GAMES, MUSICAL PERFORMANCES, MUSICAL VIDEOS, RELATED FILM CLIPS, PHOTOGRAPHS AND OTHER MULTIMEDIA MATERIALS, IN CLASS 41 (U.S. CLS. 100, 101 AND 107).

FIRST USE 12-0-2000; IN COMMERCE 12-0-2000.

THE MARK CONSISTS OF STANDARD CHARACTERS WITHOUT CLAIM TO ANY PARTICULAR FONT, STYLE, SIZE, OR COLOR.

OWNER OF U.S. REG. NO. 2,645,603.

SN 78-394,896, FILED 4-1-2004.

WARREN L. OLANDRIA, EXAMINING ATTORNEY

**Int. Cl.: 28**

**Prior U.S. Cls.: 22, 23, 38, and 50**

**United States Patent and Trademark Office**

**Reg. No. 3,500,057**

**Registered Sep. 9, 2008**

**TRADEMARK  
PRINCIPAL REGISTER**

**BACKSEAT ANGEL**

GODU, INC. (GEORGIA CORPORATION)  
470 CAMBRIDGE WAY  
ATLANTA, GA 30328

FOR: DOLLS, IN CLASS 28 (U.S. CLS. 22, 23, 38  
AND 50).

FIRST USE 7-1-2008; IN COMMERCE 7-1-2008.

THE MARK CONSISTS OF STANDARD CHAR-  
ACTERS WITHOUT CLAIM TO ANY PARTICULAR  
FONT, STYLE, SIZE, OR COLOR.

NO CLAIM IS MADE TO THE EXCLUSIVE  
RIGHT TO USE "ANGEL", APART FROM THE  
MARK AS SHOWN.

SN 78-398,378, FILED 4-8-2004.

AMY HELLA, EXAMINING ATTORNEY

**Int. Cl.: 9**

**Prior U.S. Cls.: 21, 23, 26, 36, and 38**

**United States Patent and Trademark Office**

**Reg. No. 3,500,058**

**Registered Sep. 9, 2008**

**TRADEMARK  
PRINCIPAL REGISTER**

**OFF-ROAD**

TCL GOVIDEO (CAYMAN ISLANDS CORPORATION)  
7835 EAST MCCLAIN DRIVE  
SCOTTSDALE, AZ 85260

FOR: CONSUMER ELECTRONIC DEVICES, NAMELY, DVD PLAYERS AND RECORDERS; DIGITAL VIDEO RECORDERS; PORTABLE MEDIA PLAYERS, NAMELY, AUDIO AND VIDEO PLAYERS, IN CLASS 9 (U.S. CLS. 21, 23, 26, 36 AND 38).

FIRST USE 6-0-2004; IN COMMERCE 6-0-2004.

THE MARK CONSISTS OF STANDARD CHARACTERS WITHOUT CLAIM TO ANY PARTICULAR FONT, STYLE, SIZE, OR COLOR.

SN 78-401,867, FILED 4-14-2004.

TIMOTHY FINNEGAN, EXAMINING ATTORNEY

**Int. Cls.: 5, 31, and 42**

**Prior U.S. Cls.: 1, 6, 18, 44, 46, 51, 52, 100, and 101**

**United States Patent and Trademark Office**

**Reg. No. 3,500,059**

**Registered Sep. 9, 2008**

**TRADEMARK  
SERVICE MARK  
PRINCIPAL REGISTER**

**OPTIMIZOR  
PALATABILITY**

APPLIED FOOD BIOTECHNOLOGY, INC. (MISSOURI CORPORATION)  
3 RESEARCH PARK DRIVE  
ST. CHARLES, MO 63304

FOR: VITAMINS, MINERALS, AND NUTRITIONAL SUPPLEMENTS FOR FOOD, SNACKS AND EDIBLE TREATS FOR ANIMALS, IN CLASS 5 (U.S. CLS. 6, 18, 44, 46, 51 AND 52).

FIRST USE 10-0-2005; IN COMMERCE 10-0-2005.

FOR: SPOILAGE RETARDANTS, AROMA ENHANCERS AND FEED ATTRACTANTS, NAMELY, FLAVORINGS, COATINGS AND SEASONINGS FOR NON-NUTRITIONAL PURPOSES FOR PETS AND COMPANION ANIMALS, AND TO INCREASE THE UPTAKE OF FOOD, BY FISH, SHRIMP AND OTHER FARM-RAISED MARINE LIFE, IN CLASS 31 (U.S. CLS. 1 AND 46).

FIRST USE 10-0-2005; IN COMMERCE 10-0-2005.

FOR: TECHNICAL CONSULTATION IN THE FIELDS OF MANUFACTURING, DISTRIBUTION,

REGULATORY COMPLIANCE, QUALITY ASSURANCE, QUALITY CONTROL, RESEARCH AND DEVELOPMENT, WITH RESPECT TO FOOD, SNACKS AND EDIBLE TREATS FOR ANIMALS, AND IN THE FIELD OF FEEDING AND RAISING FISH, SHRIMP AND OTHER FARM-RAISED MARINE LIFE, IN CLASS 42 (U.S. CLS. 100 AND 101).

FIRST USE 10-0-2005; IN COMMERCE 10-0-2005.

THE MARK CONSISTS OF STANDARD CHARACTERS WITHOUT CLAIM TO ANY PARTICULAR FONT, STYLE, SIZE, OR COLOR.

OWNER OF U.S. REG. NOS. 1,662,676 AND 1,937,054.

NO CLAIM IS MADE TO THE EXCLUSIVE RIGHT TO USE "PALATABILITY", APART FROM THE MARK AS SHOWN.

SN 78-403,246, FILED 4-16-2004.

JAMES STEIN, EXAMINING ATTORNEY



**Int. Cl.: 25**

**Prior U.S. Cls.: 22 and 39**

**United States Patent and Trademark Office**

**Reg. No. 3,500,060**

**Registered Sep. 9, 2008**

**TRADEMARK  
PRINCIPAL REGISTER**

**SILPADA DESIGNS**

SILPADA DESIGNS, INC. (KANSAS CORPORATION)

11550 RENNER BOULEVARD

LENEXA, KS 66219

FOR: WOMEN'S WEARING APPAREL, NAMELY, SHIRTS, PANTS, T-SHIRTS, SWEATSHIRTS, SWEATPANTS, WOMEN'S FOOTWEAR, NAMELY, FLIP FLOPS; HEADWEAR, NAMELY, CAPS AND HATS, IN CLASS 25 (U.S. CLS. 22 AND 39).

FIRST USE 1-1-2004; IN COMMERCE 1-1-2006.

THE MARK CONSISTS OF STANDARD CHARACTERS WITHOUT CLAIM TO ANY PARTICULAR FONT, STYLE, SIZE, OR COLOR.

OWNER OF U.S. REG. NOS. 2,308,977 AND 2,881,357.

NO CLAIM IS MADE TO THE EXCLUSIVE RIGHT TO USE "DESIGNS", APART FROM THE MARK AS SHOWN.

SN 78-421,669, FILED 5-19-2004.

JOHN WILKE, EXAMINING ATTORNEY

**Int. Cl.: 9**

**Prior U.S. Cls.: 21, 23, 26, 36, and 38**

**Reg. No. 3,500,061**

**United States Patent and Trademark Office**

**Registered Sep. 9, 2008**

**TRADEMARK  
PRINCIPAL REGISTER**

**XOE**

TWIN COMMUNICATIONS OF AMERICA, INC.  
(CALIFORNIA CORPORATION)  
2674 NORTH FIRST STREET, SUITE 104  
SAN JOSE, CA 95134

FOR: COMPUTER SOFTWARE FOR MANAGING COMMUNICATION BETWEEN AND OPERATION OF COMPUTERS; COMPUTER SOFTWARE FOR USE IN THE MANAGEMENT AND DISPLAY OF BUSINESS INFORMATION AND FOR THE OPERATION OF ELECTRONIC CONTROLLING DEVICES, COMPUTERS, APPLIANCES, AND REMOTE CONTROL EQUIPMENT; COMPUTER SOFTWARE FOR USE IN DATABASE MANAGEMENT, ELECTRONIC ORGANIZERS, AND USED TO FACILITATE INTERNET ACCESS; COMPUTER SOFTWARE FOR

REMOTE AND WIRELESS CONTROL OF ELECTRONIC, COMMUNICATIONS, AND ENTERTAINMENT EQUIPMENT, IN CLASS 9 (U.S. CLS. 21, 23, 26, 36 AND 38).

FIRST USE 1-7-2008; IN COMMERCE 1-7-2008.

THE MARK CONSISTS OF STANDARD CHARACTERS WITHOUT CLAIM TO ANY PARTICULAR FONT, STYLE, SIZE, OR COLOR.

SN 78-425,783, FILED 5-26-2004.

ODESSA BIBBINS, EXAMINING ATTORNEY

**Int. Cl.: 5**

**Prior U.S. Cls.: 6, 18, 44, 46, 51, and 52**

**Reg. No. 3,500,062**

**United States Patent and Trademark Office**

**Registered Sep. 9, 2008**

**TRADEMARK  
PRINCIPAL REGISTER**

**CyPath**

BIOMODA, INC. (NEW MEXICO CORPORATION)  
12017 DONNA COURT NE  
ALBUQUERQUE, NM 871124506

FOR: CHEMICAL AGENTS AND PREPARATIONS FOR MEDICAL AND CLINICAL LABORATORY DIAGNOSTIC USE; ASSAY KITS CONTAINING CHEMICAL AGENTS AND PREPARATIONS FOR MEDICAL AND CLINICAL LABORATORY DIAGNOSTIC USE, IN CLASS 5 (U.S. CLS. 6, 18, 44, 46, 51 AND 52).

FIRST USE 6-26-2008; IN COMMERCE 6-26-2008.

THE MARK CONSISTS OF STANDARD CHARACTERS WITHOUT CLAIM TO ANY PARTICULAR FONT, STYLE, SIZE, OR COLOR.

SN 78-431,048, FILED 6-7-2004.

NICHOLAS ALTREE, EXAMINING ATTORNEY

**Int. Cl.: 14**

**Prior U.S. Cls.: 2, 27, 28, and 50**

**Reg. No. 3,500,063**

**United States Patent and Trademark Office**

**Registered Sep. 9, 2008**

---

**TRADEMARK  
PRINCIPAL REGISTER**

**TOO HOT TO BE  
ROUND. TOO COOL TO  
BE SQUARE**

K.P. SANGHVI, INC. (NEW YORK CORPORATION)  
SUITE 1008  
589 FIFTH AVEUNE  
NEW YORK, NY 10017

THE MARK CONSISTS OF STANDARD CHARACTERS WITHOUT CLAIM TO ANY PARTICULAR FONT, STYLE, SIZE, OR COLOR.

FOR: JEWELRY AND DIAMONDS, IN CLASS 14  
(U.S. CLS. 2, 27, 28 AND 50).

SN 78-431,063, FILED 6-7-2004.

FIRST USE 7-2-2008; IN COMMERCE 7-2-2008.

JASON TURNER, EXAMINING ATTORNEY

**Int. Cl.: 14**

**Prior U.S. Cls.: 2, 27, 28, and 50**

**United States Patent and Trademark Office**

**Reg. No. 3,500,064**

**Registered Sep. 9, 2008**

**TRADEMARK  
PRINCIPAL REGISTER**

**DESIRE TO BE  
DIFFERENT**

K.P. SANGHVI, INC. (NEW YORK CORPORATION)  
SUITE 1008  
589 FIFTH AVENUE  
NEW YORK, NY 10017

THE MARK CONSISTS OF STANDARD CHARACTERS WITHOUT CLAIM TO ANY PARTICULAR FONT, STYLE, SIZE, OR COLOR.

FOR: JEWELRY AND DIAMONDS, IN CLASS 14  
(U.S. CLS. 2, 27, 28 AND 50).

SN 78-431,072, FILED 6-7-2004.

FIRST USE 7-2-2008; IN COMMERCE 7-2-2008.

JASON TURNER, EXAMINING ATTORNEY

**Int. Cls.: 16 and 41**

**Prior U.S. Cls.: 2, 5, 22, 23, 29, 37, 38, 50, 100, 101, and 107**

**Reg. No. 3,500,065**

**United States Patent and Trademark Office**

**Registered Sep. 9, 2008**

**TRADEMARK  
SERVICE MARK  
PRINCIPAL REGISTER**

**3 X 3**

ACCLIVUS CORPORATION (TEXAS CORPORATION)  
14500 MIDWAY ROAD  
DALLAS, TX 75244

FOR: PRINTED MATERIALS, NAMELY, WORKBOOKS, WALL CHARTS, AND SKILL GUIDES FOR USE IN WORKSHOPS, LECTURES, COURSE SYMPOSIA AND CONFERENCES IN THE FIELD OF BUSINESS MANAGEMENT, SALES COMMUNICATION AND BUILDING RELATIONSHIPS WITH CUSTOMERS, IN CLASS 16 (U.S. CLS. 2, 5, 22, 23, 29, 37, 38 AND 50).

FIRST USE 9-30-2003; IN COMMERCE 9-30-2003.

FOR: EDUCATIONAL SERVICES, NAMELY CONDUCTING WORKSHOPS, LECTURES,

COURSE SYMPOSIA, AND CONFERENCES IN THE FIELD OF BUSINESS MANAGEMENT, SALES COMMUNICATION AND BUILDING RELATIONSHIPS WITH CUSTOMERS, AND DISTRIBUTING COURSE MATERIALS IN CONNECTION THEREWITH, IN CLASS 41 (U.S. CLS. 100, 101 AND 107).

FIRST USE 6-13-2008; IN COMMERCE 6-13-2008.

THE MARK CONSISTS OF STANDARD CHARACTERS WITHOUT CLAIM TO ANY PARTICULAR FONT, STYLE, SIZE, OR COLOR.

SN 78-432,538, FILED 6-9-2004.

JEFFERY COWARD, EXAMINING ATTORNEY

**Int. Cl.: 9**

**Prior U.S. Cls.: 21, 23, 26, 36, and 38**

**Reg. No. 3,500,066**

**United States Patent and Trademark Office**

**Registered Sep. 9, 2008**

**TRADEMARK  
PRINCIPAL REGISTER**

**ARMOR**

LOCAL TV ALABAMA, LLC (DELAWARE LIMITED LIABILITY COMPANY)  
1717 DIXIE HIGHWAY, SUITE 650  
FT WRIGHT, KY 41011

THE MARK CONSISTS OF STANDARD CHARACTERS WITHOUT CLAIM TO ANY PARTICULAR FONT, STYLE, SIZE, OR COLOR.

FOR: WEATHER MONITORING EQUIPMENT, NAMELY, RADAR, IN CLASS 9 (U.S. CLS. 21, 23, 26, 36 AND 38).

SN 78-444,689, FILED 7-1-2004.

FIRST USE 11-0-2004; IN COMMERCE 11-0-2004.

JOHN DWYER, EXAMINING ATTORNEY

**Int. Cl.: 36**

**Prior U.S. Cls.: 100, 101, and 102**

**United States Patent and Trademark Office**

**Reg. No. 3,500,067**

**Registered Sep. 9, 2008**

---

**SERVICE MARK  
PRINCIPAL REGISTER**

**FINISH LOW**

AMERICAN STOCK EXCHANGE LLC (NEW  
YORK LIMITED LIABILITY COMPANY)  
86 TRINITY PLACE  
NEW YORK, NY 10006

FOR: FINANCIAL SERVICES, NAMELY, THE  
LISTING AND TRADING OF OPTIONS WITH A  
KNOWN CASH AMOUNT PAYABLE IF THE UN-  
DERLYING ASSET IS BELOW THE SET STRIKE  
PRICE ON EXPIRATION, IN CLASS 36 (U.S. CLS. 100,  
101 AND 102).

FIRST USE 5-8-2008; IN COMMERCE 5-8-2008.

THE MARK CONSISTS OF STANDARD CHAR-  
ACTERS WITHOUT CLAIM TO ANY PARTICULAR  
FONT, STYLE, SIZE, OR COLOR.

SN 78-454,254, FILED 7-21-2004.

AMY HELLA, EXAMINING ATTORNEY



**Int. Cl.: 28**

**Prior U.S. Cls.: 22, 23, 38, and 50**

**United States Patent and Trademark Office**

**Reg. No. 3,500,068**

**Registered Sep. 9, 2008**

**TRADEMARK  
PRINCIPAL REGISTER**

**Gaydar Gun**

LAFOND, LARRY M. (UNITED STATES INDIVIDUAL)

839 PARKMAN AVE. #109

LOS ANGELES, CA 90026 AND

RAY, TERRY (UNITED STATES INDIVIDUAL)

906 HYPERION AVE. #3

LOS ANGELES, CA 90029 AND

RAY, BRET A. (UNITED STATES INDIVIDUAL)

12712 39TH AVE. N.E.

SEATTLE, WA 98125

FOR: NOVELTY ITEM, NAMELY, A TOY GUN THAT "DETECTS" IF A LIVING BEING IS HETEROSEXUAL, BISEXUAL, HOMOSEXUAL OR ANY VARIATION IN BETWEEN, IN CLASS 28 (U.S. CLS. 22, 23, 38 AND 50).

FIRST USE 3-2-2008; IN COMMERCE 3-2-2008.

THE MARK CONSISTS OF STANDARD CHARACTERS WITHOUT CLAIM TO ANY PARTICULAR FONT, STYLE, SIZE, OR COLOR.

NO CLAIM IS MADE TO THE EXCLUSIVE RIGHT TO USE "GUN", APART FROM THE MARK AS SHOWN.

SN 78-459,222, FILED 7-29-2004.

MARTHA SANTOMARTINO, EXAMINING ATTORNEY

**Int. Cl.: 44**

**Prior U.S. Cls.: 100 and 101**

**United States Patent and Trademark Office**

**Reg. No. 3,500,069**

**Registered Sep. 9, 2008**

**SERVICE MARK  
PRINCIPAL REGISTER**

**21ST CENTURY  
HOUSECALL**

AMERIGROUP CORPORATION (DELAWARE  
CORPORATION)  
4425 CORPORATION LANE SUITE 100  
VIRGINIA BEACH, VA 23462

FOR: HEALTH AND MEDICAL SERVICES,  
NAMELY, PROVIDING HEALTH AND MEDICAL  
INFORMATION VIA TELEPHONE, HOME VISITS, A  
GLOBAL COMPUTER NETWORK, ELECTRONIC  
MAIL AND ELECTRONIC VIDEO COMMUNICA-  
TION, IN CLASS 44 (U.S. CLS. 100 AND 101).

FIRST USE 12-31-2006; IN COMMERCE 12-31-2006.

THE MARK CONSISTS OF STANDARD CHAR-  
ACTERS WITHOUT CLAIM TO ANY PARTICULAR  
FONT, STYLE, SIZE, OR COLOR.

NO CLAIM IS MADE TO THE EXCLUSIVE  
RIGHT TO USE "HOUSECALL", APART FROM  
THE MARK AS SHOWN.

SN 78-490,461, FILED 9-28-2004.

ELLEN BURNS, EXAMINING ATTORNEY

**Int. Cl.: 19**

**Prior U.S. Cls.: 1, 12, 33, and 50**

**United States Patent and Trademark Office**

**Reg. No. 3,500,070**

**Registered Sep. 9, 2008**

**TRADEMARK  
PRINCIPAL REGISTER**

**SYNCHRO-PILE**

SYNCHRO PATENTS, INC. (TEXAS CORPORATION)  
4643 GREEN WILLOW WOODS  
SAN ANTONIO, TX 78249

FOR: STRUCTURAL FOUNDATION COMPONENTS, NAMELY, CEMENT PIERS, RUBBER BLADDERS, CONDUITS, PILING, ANCHORS, SUPPORTS, AND METAL RODS, PIPES AND PLATES ALL SOLD TOGETHER AS A UNIT , IN CLASS 19 (U.S. CLS. 1, 12, 33 AND 50).

FIRST USE 9-27-2004; IN COMMERCE 9-27-2004.

THE MARK CONSISTS OF STANDARD CHARACTERS WITHOUT CLAIM TO ANY PARTICULAR FONT, STYLE, SIZE, OR COLOR.

SN 78-491,673, FILED 9-29-2004.

ANN E. SAPPENFIELD, EXAMINING ATTORNEY

**Int. Cl.: 3**

**Prior U.S. Cls.: 1, 4, 6, 50, 51, and 52**

**Reg. No. 3,500,071**

**United States Patent and Trademark Office**

**Registered Sep. 9, 2008**

**TRADEMARK  
PRINCIPAL REGISTER**

**REAL LOVE**

TUPPERWARE PRODUCTS S.A. (SWITZERLAND  
CORPORATION)  
ROUTE DU JURA 37  
FRIBOURG, SWITZERLAND CH-1700

THE MARK CONSISTS OF STANDARD CHAR-  
ACTERS WITHOUT CLAIM TO ANY PARTICULAR  
FONT, STYLE, SIZE, OR COLOR.

FOR: EAU DE COLOGNE AND PERFUMES, IN  
CLASS 3 (U.S. CLS. 1, 4, 6, 50, 51 AND 52).

SN 78-496,017, FILED 10-7-2004.

FIRST USE 7-12-2008; IN COMMERCE 7-12-2008.

MARIAM MAHMOUDI, EXAMINING ATTORNEY

**Int. Cl.: 16**

**Prior U.S. Cls.: 2, 5, 22, 23, 29, 37, 38, and 50**

**Reg. No. 3,500,072**

**United States Patent and Trademark Office**

**Registered Sep. 9, 2008**

**TRADEMARK  
PRINCIPAL REGISTER**

**COURT APPOINTED SPECIAL  
ADVOCATES**

NATIONAL CASA ASSOCIATION (WASHINGTON PUBLIC BENEFIT CORPORATION)

100 WEST HARRISON  
NORTH TOWER SUITE 500  
SEATTLE, WA 98119

FOR: PRINTED MATERIALS, NAMELY, BOOKS, BROCHURES, HANDBOOKS, MAGAZINES, MANUALS AND NEWSLETTERS RELATING TO CHILD WELFARE, CHILDREN INVOLVED IN LEGAL ACTIONS AND VOLUNTEERS ACTING ON BEHALF OF CHILDREN; EDUCATIONAL PUBLICATIONS, NAMELY, TRAINING MANUALS IN THE FIELD OF CHILD WELFARE, CHILDREN INVOLVED IN LEGAL ACTIONS AND VOLUNTEERS ACTING ON BEHALF OF CHILDREN; POSTERS; PENS; NOTE CARDS; NOTE PADS; STATIONERY; STICKERS;

PAPER SHOPPING BAGS, IN CLASS 16 (U.S. CLS. 2, 5, 22, 23, 29, 37, 38 AND 50).

FIRST USE 0-0-2004; IN COMMERCE 0-0-2004.

THE MARK CONSISTS OF STANDARD CHARACTERS WITHOUT CLAIM TO ANY PARTICULAR FONT, STYLE, SIZE, OR COLOR.

OWNER OF U.S. REG. NO. 2,936,016.

SEC. 2(F).

SN 78-498,482, FILED 10-12-2004.

ELIZABETH BEYER, EXAMINING ATTORNEY

**Int. Cls.: 35, 36, and 41**

**Prior U.S. Cls.: 100, 101, 102, and 107**

**United States Patent and Trademark Office**

**Reg. No. 3,500,073**

**Registered Sep. 9, 2008**

**SERVICE MARK  
PRINCIPAL REGISTER**

**CAPITAL FOR  
COMMUNITIES -  
OPPORTUNITIES FOR  
PEOPLE**

COMMUNITY REINVESTMENT FUND, INC.  
(MINNESOTA NON-PROFIT CORPORATION)  
SUITE 1700 WEST  
801 NICOLLET MALL  
MINNEAPOLIS, MN 55402

FOR: BUSINESS CONSULTING SERVICES TO  
LENDERS IN THE FIELDS OF COMMUNITY AND  
ECONOMIC DEVELOPMENT LENDING AND  
SPONSORING OF NEW MARKET TAX CREDIT  
INCENTIVES, IN CLASS 35 (U.S. CLS. 100, 101 AND  
102).

FIRST USE 12-31-2005; IN COMMERCE 12-31-2005.

FOR: FINANCIAL SERVICES, NAMELY, PRO-  
VIDING CAPITAL THROUGH THE OPERATION  
OF A SECONDARY MARKET FOR LOANS, IN-  
CLUDING COMMUNITY AND ECONOMIC DE-  
VELOPMENT LOANS; FINANCIAL SERVICES,  
NAMELY, PROVIDING INVESTORS WITH ASSET-

BACKED SECURITIES, IN CLASS 36 (U.S. CLS. 100,  
101 AND 102).

FIRST USE 12-31-2005; IN COMMERCE 12-31-2005.

FOR: PROVIDING TRAINING TO LENDERS IN  
THE FIELDS OF COMMUNITY AND ECONOMIC  
DEVELOPMENT LENDING AND SPONSORING OF  
NEW MARKET TAX CREDIT INCENTIVES, IN  
CLASS 41 (U.S. CLS. 100, 101 AND 107).

FIRST USE 12-31-2005; IN COMMERCE 12-31-2005.

THE MARK CONSISTS OF STANDARD CHAR-  
ACTERS WITHOUT CLAIM TO ANY PARTICULAR  
FONT, STYLE, SIZE, OR COLOR.

SN 78-499,947, FILED 10-14-2004.

SANI KHOURI, EXAMINING ATTORNEY

**Int. Cl.: 9**

**Prior U.S. Cls.: 21, 23, 26, 36, and 38**

**Reg. No. 3,500,074**

**United States Patent and Trademark Office**

**Registered Sep. 9, 2008**

**TRADEMARK  
PRINCIPAL REGISTER**

**GIGACOLOR**

PIXELWORKS, INC. (OREGON CORPORATION)  
8100 SW NYBERG ROAD  
TUALATIN, OR 97062

FOR: INTEGRATED CIRCUITS; INTEGRATED CIRCUIT MODULES; COMPUTER SOFTWARE FOR THE PROCESSING, PERFORMANCE ENHANCEMENT, AND OPTIMIZATION OF VIDEO, COMPUTER GRAPHICS, AND WEB INFORMATION ON A WIDE VARIETY OF DISPLAY MEDIA; COMPUTER SOFTWARE TO AID IN THE DESIGN OF GRAPHICAL USER INTERFACES FOR USE WITH FLAT-PANEL MONITORS, PROJECTORS, DIGITAL TELEVISIONS, AND OTHER ADVANCED DISPLAY PRODUCTS; COMPUTER SOFTWARE PROGRAMS AND COMPUTER SOFTWARE OBJECT LIBRARIES TO ASSIST ENGINEERS TO DESIGN AND DEVELOP PROTOTYPES FOR ADVANCED DISPLAY APPLICATIONS, AND TO DEBUG AND CONFIGURE ADVANCED DISPLAY APPLICATIONS; COMPUTER SOFTWARE TO ASSIST ENGINEERS IN THE DESIGN OF PRODUC-

TION DISPLAY PRODUCTS THAT USE LIQUID CRYSTAL DISPLAY (LCD), LIQUID CRYSTAL ON SILICON (LCOS), POLYSILICON, PLASMA, CATHODE RAY TUBE (CRT), AND DIGITAL LIGHT PROCESSING TECHNOLOGIES; COMPUTER SOFTWARE FOR USE AS DEVICE DRIVERS IN THE FORMATS OF HIGH DEFINITION TELEVISION (HDTV), STANDARD DEFINITION TELEVISION (SDTV), DIGITAL RED-GREEN-BLUE (RGB), ANALOG RED-GREEN-BLUE (RGB), AND VIDEO TV, IN CLASS 9 (U.S. CLS. 21, 23, 26, 36 AND 38).

FIRST USE 6-30-2008; IN COMMERCE 6-30-2008.

THE MARK CONSISTS OF STANDARD CHARACTERS WITHOUT CLAIM TO ANY PARTICULAR FONT, STYLE, SIZE, OR COLOR.

SN 78-501,756, FILED 10-18-2004.

RENEE MCCRAY, EXAMINING ATTORNEY

**Int. Cl.: 9**

**Prior U.S. Cls.: 21, 23, 26, 36, and 38**

**United States Patent and Trademark Office**

**Reg. No. 3,500,075**

**Registered Sep. 9, 2008**

**TRADEMARK  
PRINCIPAL REGISTER**

**DATACOLOR PAINT**

DATACOLOR HOLDING AG. (SWITZERLAND  
JOINT STOCK COMPANY)  
OBERGRUNDSTRASSE 110  
CH-6002 LUCERN, SWITZERLAND

FOR: COMPUTER SOFTWARE FOR USE IN RE-  
TAIL PAINT INDUSTRY FOR LOOKING UP PAINT  
RECIPES FOR STANDARD PAINT COLORS AND  
GENERATING RECIPES FOR CUSTOM PAINT  
COLORS, IN CLASS 9 (U.S. CLS. 21, 23, 26, 36 AND 38).

FIRST USE 12-1-2005; IN COMMERCE 12-1-2005.

THE MARK CONSISTS OF STANDARD CHAR-  
ACTERS WITHOUT CLAIM TO ANY PARTICULAR  
FONT, STYLE, SIZE, OR COLOR.

OWNER OF U.S. REG. NO. 1,423,732.

NO CLAIM IS MADE TO THE EXCLUSIVE  
RIGHT TO USE "PAINT", APART FROM THE  
MARK AS SHOWN.

SN 78-521,594, FILED 11-23-2004.

RUDY R. SINGLETON, EXAMINING ATTORNEY



**Int. Cls.: 29 and 32**

**Prior U.S. Cls.: 45, 46, and 48**

**United States Patent and Trademark Office**

**Reg. No. 3,500,076**

**Registered Sep. 9, 2008**

**TRADEMARK  
PRINCIPAL REGISTER**

**OVALTINE**

SOCIETE DES PRODUITS NESTLE, S.A. (SWITZERLAND CORPORATION)  
CASE POSTALE 353  
1800 VEVEY, SWITZERLAND

FOR: DAIRY-BASED CHOCOLATE BEVERAGE MIX, IN CLASS 29 (U.S. CL. 46).

FIRST USE 6-30-1985; IN COMMERCE 6-30-1985.

FOR: NON-ALCOHOLIC DAIRY-BASED MALT BEVERAGE MIX, IN CLASS 32 (U.S. CLS. 45, 46 AND 48).

FIRST USE 12-30-1909; IN COMMERCE 12-30-1909.

THE MARK CONSISTS OF STANDARD CHARACTERS WITHOUT CLAIM TO ANY PARTICULAR FONT, STYLE, SIZE, OR COLOR.

OWNER OF U.S. REG. NOS. 93,650, 1,335,768, AND OTHERS.

SN 78-525,016, FILED 12-1-2004.

LANA PHAM, EXAMINING ATTORNEY

**Int. Cl.: 8**

**Prior U.S. Cls.: 23, 28, and 44**

**Reg. No. 3,500,077**

**United States Patent and Trademark Office**

**Registered Sep. 9, 2008**

**TRADEMARK  
PRINCIPAL REGISTER**



UTICA CUTLERY COMPANY (NEW YORK CORPORATION)  
820 NOYES STREET  
P.O. BOX 10527  
UTICA, NY 135031527

FOR: KNIVES, NAMELY, POCKET KNIVES, JACK KNIVES, FIXED BLADE CUTLERY, FIXED BLADE KNIVES, KNIFE SHEATHS, SPORT KNIVES, TABLE KNIVES, AND MULTI-FUNCTION HAND TOOLS COMPRISED OF KNIFE BLADES, SCISSORS, SCREW DRIVERS, FILES, CAN OPENERS AND TWEEZERS, IN CLASS 8 (U.S. CLS. 23, 28 AND 44).

FIRST USE 5-0-2008; IN COMMERCE 5-0-2008.

NO CLAIM IS MADE TO THE EXCLUSIVE RIGHT TO USE "WARRANTED", APART FROM THE MARK AS SHOWN.

THE MARK CONSISTS OF STYLIZED "UTK" AS SHOWN WITH THE DESIGN AND THE WORD "WARRANTED" INSIDE A BANNER STRETCHING ACROSS THE STYLIZED "UTK", ALL INSIDE A DOUBLE OVAL.

SN 78-525,731, FILED 12-2-2004.

ALICIA COLLINS, EXAMINING ATTORNEY

**Int. Cl.: 11**

**Prior U.S. Cls.: 13, 21, 23, 31, and 34**

**United States Patent and Trademark Office**

**Reg. No. 3,500,078**

**Registered Sep. 9, 2008**

**TRADEMARK  
PRINCIPAL REGISTER**

**ILLUMINATED BY IO**

COOPER LIGHTING, LLC (DELAWARE LIMITED LIABILITY COMPANY)  
600 TRAVIS  
SUITE 5800  
HOUSTON, TX 77002

FOR: LOW VOLTAGE LINEAR FLOODLIGHTS,  
IN CLASS 11 (U.S. CLS. 13, 21, 23, 31 AND 34).

FIRST USE 3-1-2006; IN COMMERCE 3-1-2006.

THE MARK CONSISTS OF STANDARD CHARACTERS WITHOUT CLAIM TO ANY PARTICULAR FONT, STYLE, SIZE, OR COLOR.

NO CLAIM IS MADE TO THE EXCLUSIVE RIGHT TO USE "ILLUMINATED BY", APART FROM THE MARK AS SHOWN.

SN 78-526,067, FILED 12-2-2004.

ZHALEH DELANEY, EXAMINING ATTORNEY

**Int. Cl.: 24**

**Prior U.S. Cls.: 42 and 50**

**United States Patent and Trademark Office**

**Reg. No. 3,500,079**

**Registered Sep. 9, 2008**

**TRADEMARK  
PRINCIPAL REGISTER**



SMITHEY, MAUREEN WURST (CALIFORNIA  
SOLE PROPRIETORSHIP)  
1653 MYRTLE AVE.  
EUREKA, CA 95501

FOR: SEWN TEXTILE GOODS FOR HOME INTERIORS, NAMELY, TABLE LINENS, FABRIC TABLE RUNNERS, TEXTILE NAPKINS, TEXTILE PLACE MATS; BEDDING, NAMELY, BED SHEETS, PILLOW CASES, DUVET COVERS, BLANKET THROWS, RECEIVING BLANKETS, IN CLASS 24 (U.S. CLS. 42 AND 50).

FIRST USE 6-1-2005; IN COMMERCE 6-1-2005.

THE COLOR(S) LAVENDER, NAVY BLUE, BROWN AND WHITE IS/ARE CLAIMED AS A FEATURE OF THE MARK.

THE COLORS LAVENDER AND WHITE COMPOSE THE BACKGROUND OF THE MARK. THE WORD "CASTLEWARE" IS NAVY. THE DECORATIVE MOTIF LOCATED BELOW "CASTLEWARE" IS BROWN AS IS THE BORDER OF THE MARK.

SN 78-526,818, FILED 12-3-2004.

MARIAM MAHMOUDI, EXAMINING ATTORNEY

**Int. Cl.: 33**

**Prior U.S. Cls.: 47 and 49**

**United States Patent and Trademark Office**

**Reg. No. 3,500,080**

**Registered Sep. 9, 2008**

**TRADEMARK  
PRINCIPAL REGISTER**

**KAYA**

ALTIUS TRADING 53 (PTY) LTD (SOUTH AFRICA CORPORATION)  
37 STRAND STREET  
CAPE TOWN, 8000, SOUTH AFRICA

FOR: WINE, IN CLASS 33 (U.S. CLS. 47 AND 49).

FIRST USE 5-0-2007; IN COMMERCE 6-17-2008.

THE MARK CONSISTS OF STANDARD CHARACTERS WITHOUT CLAIM TO ANY PARTICULAR FONT, STYLE, SIZE, OR COLOR.

SN 78-530,961, FILED 12-11-2004.

TEJBIR SINGH, EXAMINING ATTORNEY

**Int. Cl.: 28**

**Prior U.S. Cls.: 22, 23, 38, and 50**

**Reg. No. 3,500,081**

**United States Patent and Trademark Office**

**Registered Sep. 9, 2008**

---

**TRADEMARK  
PRINCIPAL REGISTER**

**UBE**

NORTHLAND INDUSTRIES, INC. (WISCONSIN CORPORATION), DBA MAGNUM FITNESS SYSTEMS,  
2201 - 12TH AVENUE  
SOUTH MILWAUKEE, WI 53172

THE MARK CONSISTS OF STANDARD CHARACTERS WITHOUT CLAIM TO ANY PARTICULAR FONT, STYLE, SIZE, OR COLOR.

FOR: WEIGHT LIFTING MACHINES, IN CLASS 28 (U.S. CLS. 22, 23, 38 AND 50).

SN 78-537,176, FILED 12-22-2004.

FIRST USE 6-30-2008; IN COMMERCE 6-30-2008.

DAVID MURRAY, EXAMINING ATTORNEY

**Int. Cls.: 18 and 20**

**Prior U.S. Cls.: 1, 2, 3, 13, 22, 25, 32, 41, and 50**

**United States Patent and Trademark Office**

**Reg. No. 3,500,082**

**Registered Sep. 9, 2008**

**TRADEMARK  
PRINCIPAL REGISTER**

SABBAI, LLC (FLORIDA LIMITED LIABILITY  
COMPANY)  
150 SOUTHEAST 25 ROAD  
MIAMI, FL 33129

FOR: ACCESSORIES, NAMELY, LEATHER KEY  
CASES, LEATHER KEY CHAINS, LEATHER TRA-  
VELING CASES, IN CLASS 18 (U.S. CLS. 1, 2, 3, 22  
AND 41).

FIRST USE 12-7-2004; IN COMMERCE 12-7-2004.

FOR: NON METAL KEY HOLDERS, IN CLASS 20  
(U.S. CLS. 2, 13, 22, 25, 32 AND 50).

FIRST USE 12-7-2004; IN COMMERCE 12-7-2004.

SN 78-539,738, FILED 12-29-2004.

SIMON TENG, EXAMINING ATTORNEY

**Int. Cl.: 3**

**Prior U.S. Cls.: 1, 4, 6, 50, 51, and 52**

**United States Patent and Trademark Office**

**Reg. No. 3,500,083**

**Registered Sep. 9, 2008**

**TRADEMARK  
PRINCIPAL REGISTER**

**GET PURE**

L'AVANT GARDE, INC. (CALIFORNIA CORPORATION)  
4109 GUARDIAN STREET  
SIMI VALLEY, CA 93063

THE MARK CONSISTS OF STANDARD CHARACTERS WITHOUT CLAIM TO ANY PARTICULAR FONT, STYLE, SIZE, OR COLOR.

FOR: HAIR CARE PRODUCTS, NAMELY, HAIR CARE PREPARATIONS AND HAIR CLEANING PREPARATIONS, IN CLASS 3 (U.S. CLS. 1, 4, 6, 50, 51 AND 52).

SN 78-551,187, FILED 1-20-2005.

FIRST USE 2-27-2008; IN COMMERCE 2-27-2008.

ELLEN BURNS, EXAMINING ATTORNEY



**Int. Cl.: 35**

**Prior U.S. Cls.: 100, 101, and 102**

**United States Patent and Trademark Office**

**Reg. No. 3,500,084**

**Registered Sep. 9, 2008**

**SERVICE MARK  
PRINCIPAL REGISTER**

**Resource4**

COMPLETE ONLINE MARKETING SOLUTIONS,  
LLC (CALIFORNIA LIMITED LIABILITY  
CORPORATION)  
SUITE 208  
1133 COLUMBIA STREET  
SAN DIEGO, CA 92101

FOR: ADVERTISING AND MARKETING SERVI-  
CES, NAMELY, PROMOTION, ADVERTISING AND  
MARKETING OF ON-LINE MARKETING FEATUR-  
ING ON-LINE WEBSITES, HOSTING, SEARCH EN-  
GINE OPTIMIZATION, AND PAY PER CLICK, IN  
CLASS 35 (U.S. CLS. 100, 101 AND 102).

FIRST USE 2-1-2005; IN COMMERCE 2-1-2005.

THE MARK CONSISTS OF STANDARD CHAR-  
ACTERS WITHOUT CLAIM TO ANY PARTICULAR  
FONT, STYLE, SIZE, OR COLOR.

SN 78-559,641, FILED 2-3-2005.

JACQUELINE A. LAVINE, EXAMINING ATTOR-  
NEY

**Int. Cl.: 20**

**Prior U.S. Cls.: 2, 13, 22, 25, 32, and 50**

**United States Patent and Trademark Office**

**Reg. No. 3,500,085**

**Registered Sep. 9, 2008**

**TRADEMARK  
PRINCIPAL REGISTER**

**STOR-POD**

JOKARI/US, INC. (TEXAS CORPORATION)  
1815 MONETARY LANE  
SUITE 100  
CARROLLTON, TX 750067029

FOR: COLLAPSIBLE-SIDED MULTI-PURPOSE  
PLASTIC STORAGE CONTAINERS FOR HOME  
AND OFFICE USE, IN CLASS 20 (U.S. CLS. 2, 13, 22,  
25, 32 AND 50).

FIRST USE 3-31-2005; IN COMMERCE 8-9-2005.

THE MARK CONSISTS OF STANDARD CHAR-  
ACTERS WITHOUT CLAIM TO ANY PARTICULAR  
FONT, STYLE, SIZE, OR COLOR.

SN 78-562,840, FILED 2-8-2005.

H. M. FISHER, EXAMINING ATTORNEY

**Int. Cl.: 10**

**Prior U.S. Cls.: 26, 39, and 44**

**United States Patent and Trademark Office**

**Reg. No. 3,500,086**

**Registered Sep. 9, 2008**

**TRADEMARK  
PRINCIPAL REGISTER**

**HYDROPEEL**

EDGE SYSTEMS CORPORATION (CALIFORNIA  
CORPORATION)  
2277 REDONDO AVE  
SIGNAL HILL, CA 90755

FOR: MEDICAL APPARATUS AND INSTRU-  
MENTS FOR RESURFACING AND NOURISHING  
TISSUE, IN CLASS 10 (U.S. CLS. 26, 39 AND 44).

FIRST USE 5-17-2005; IN COMMERCE 5-17-2005.

THE MARK CONSISTS OF STANDARD CHAR-  
ACTERS WITHOUT CLAIM TO ANY PARTICULAR  
FONT, STYLE, SIZE, OR COLOR.

SN 78-563,556, FILED 2-9-2005.

ANDREA BUTLER, EXAMINING ATTORNEY

**Int. Cls.: 16, 41, and 44**

**Prior U.S. Cls.: 2, 5, 22, 23, 29, 37, 38, 50, 100, 101, and 107**

**Reg. No. 3,500,087**

**United States Patent and Trademark Office**

**Registered Sep. 9, 2008**

**TRADEMARK  
SERVICE MARK  
PRINCIPAL REGISTER**



POMWONDERFUL LLC (DELAWARE LIMITED LIABILITY COMPANY)  
11444 W. OLYMPIC BLVD., 10TH FLOOR  
LOS ANGELES, CA 90064

OWNER OF U.S. REG. NOS. 2,637,053, 2,644,365, AND OTHERS.

FOR: PRINTED MATERIALS, NAMELY, BROCHURES, MAGAZINES, NEWSLETTERS, INFORMATIONAL PAMPHLETS IN THE FIELD OF HEALTHCARE; PENS, PENCILS, AND NOTE PADS, IN CLASS 16 (U.S. CLS. 2, 5, 22, 23, 29, 37, 38 AND 50).

NO CLAIM IS MADE TO THE EXCLUSIVE RIGHT TO USE THE REPRESENTATION OF THE DESIGN OF A CADUCEUS, APART FROM THE MARK AS SHOWN.

FIRST USE 5-31-2005; IN COMMERCE 5-31-2005.

THE COLORS BLACK, RED AND WHITE ARE CLAIMED AS A FEATURE OF THE MARK.

FOR: PROVIDING ON-LINE NEWSLETTERS TO THE HEALTHCARE INDUSTRY, IN CLASS 41 (U.S. CLS. 100, 101 AND 107).

FIRST USE 5-31-2005; IN COMMERCE 5-31-2005.

THE MARK CONSISTS OF THE WORD "POM" IN BLACK; THE WORD "POMWONDERFUL" AND THE INTERIOR OF THE HEART ARE IN RED, AND THE CADUCEUS IS IN WHITE.

FOR: PROVIDING MEDICAL INFORMATION IN THE FIELD OF HEALTH VIA A WEBSITE DIRECTED TO THE HEALTHCARE PRACTITIONER INDUSTRY, IN CLASS 44 (U.S. CLS. 100 AND 101).

FIRST USE 5-31-2005; IN COMMERCE 5-31-2005.

SN 78-569,682, FILED 2-17-2005.

PAUL E. FAHRENKOPF, EXAMINING ATTORNEY

**Int. Cl.: 7**

**Prior U.S. Cls.: 13, 19, 21, 23, 31, 34, and 35**

**Reg. No. 3,500,088**

**United States Patent and Trademark Office**

**Registered Sep. 9, 2008**

**TRADEMARK  
PRINCIPAL REGISTER**

**CORIOLIS**

THUT, BRUNO H. (SWITZERLAND INDIVIDUAL)

16755 PARK CIRCLE DR.  
CHAGRIN FALLS, OH 44023

FOR: MACHINERY AND COMPONENTS THEREOF USED FOR MELTING SCRAP IN MOLTEN METAL, NAMELY, SCRAP CHARGING VESSELS, PUMPS FOR PUMPING MOLTEN METAL, SHAFTS, IMPELLERS AND BASES USED IN THE PUMPS, AND CARTRIDGES COMPRISED OF

BASES, SUPPORT POSTS AND RISERS, IN CLASS 7 (U.S. CLS. 13, 19, 21, 23, 31, 34 AND 35).

FIRST USE 12-9-2004; IN COMMERCE 12-9-2004.

THE MARK CONSISTS OF STANDARD CHARACTERS WITHOUT CLAIM TO ANY PARTICULAR FONT, STYLE, SIZE, OR COLOR.

SN 78-575,263, FILED 2-25-2005.

RENEE SERVANCE, EXAMINING ATTORNEY

**Int. Cl.: 22**

**Prior U.S. Cls.: 1, 2, 7, 19, 22, 42, and 50**

**Reg. No. 3,500,089**

**United States Patent and Trademark Office**

**Registered Sep. 9, 2008**

**TRADEMARK  
PRINCIPAL REGISTER**

**VERSAPRO**

HAGEMeyer NORTH AMERICA, INC. (DELA-  
WARE CORPORATION)  
1460 TOBIAS GADSON BLVD.  
CHARLESTON, SC 29407

THE MARK CONSISTS OF STANDARD CHAR-  
ACTERS WITHOUT CLAIM TO ANY PARTICULAR  
FONT, STYLE, SIZE, OR COLOR.

FOR: TARPAULINS FOR GENERAL USE, IN  
CLASS 22 (U.S. CLS. 1, 2, 7, 19, 22, 42 AND 50).

SN 78-582,403, FILED 3-8-2005.

FIRST USE 3-29-2005; IN COMMERCE 3-29-2005.

CAROLYN CATALDO, EXAMINING ATTORNEY

Int. Cls.: 37 and 41

Prior U.S. Cls.: 100, 101, 103, 106, and 107

United States Patent and Trademark Office

Reg. No. 3,500,090

Registered Sep. 9, 2008

SERVICE MARK  
PRINCIPAL REGISTER



BOBST S.A. (SWITZERLAND CORPORATION)  
CASE POSTALE  
LAUSANNE, SWITZERLAND CH-1001

FOR: INSTALLATION, MAINTENANCE AND REPAIR OF EQUIPMENT AND MACHINES FOR PRINTING AND PROCESSING PAPER, CARDBOARD AND CORRUGATED CARDBOARD FOR THE PACKAGING INDUSTRY, IN CLASS 37 (U.S. CLS. 100, 103 AND 106).

FIRST USE 3-31-1978; IN COMMERCE 3-31-1978.

FOR: THEORETICAL AND PRACTICAL TRAINING COURSES CONDUCTED IN WORKSHOPS FOR INSTALLATION, USE MAINTENANCE AND REPAIR OF CONDUCTING MACHINES USED IN THE PACKAGING INDUSTRY, NAMELY, MACHINES TO PRINT, CUT AND FOLD CARDBOARD, CORRUGATED CARDBOARD OR PAPER TO PRODUCE FOLDING BOXES; EDITING OF TRAINING MATERIALS AND PUBLICATION OF TRAINING BOOKS FOR OTHERS IN THE FIELD OF MACHINES FOR

PRINTING AND PROCESSING PAPER, CARDBOARD AND CORRUGATED CARDBOARD FOR THE PACKAGING INDUSTRY; EDUCATIONAL SERVICES, NAMELY, TRAINING IN INSTALLATION, OPERATION, USE MAINTENANCE, SERVICING AND REPAIR, RELATED TO EQUIPMENT AND MACHINES FOR PRINTING AND PROCESSING PAPER, CARDBOARD AND CORRUGATED CARDBOARD FOR THE PACKAGING INDUSTRY, PERFORMED IN SEMINARS, CLASSES AND INDIVIDUAL INSTRUCTION, IN CLASS 41 (U.S. CLS. 100, 101 AND 107).

FIRST USE 3-31-1978; IN COMMERCE 3-31-1978.

OWNER OF U.S. REG. NOS. 560,685, 953,587, AND OTHERS.

SN 78-584,237, FILED 3-10-2005.

TRACY WHITTAKER-BROWN, EXAMINING ATTORNEY

**Int. Cl.: 36**

**Prior U.S. Cls.: 100, 101, and 102**

**United States Patent and Trademark Office**

**Reg. No. 3,500,091**

**Registered Sep. 9, 2008**

**SERVICE MARK  
PRINCIPAL REGISTER**

**ITITHE**

ITITHE CONSULTING (NEW JERSEY CORPORATION)  
30 MOUNTAINSIDE DRIVE  
COLTS NECK, NJ 07722

FOR: PROVIDING ON-LINE AND VIA THE INTERNET, FINANCIAL PLANNING AND ADVISORY SERVICES, MANAGEMENT AND REVIEW OF FINANCIAL BUDGETS, AND FINANCIAL COUNSELING INFORMATION FROM VARIOUS SOURCES, IN CLASS 36 (U.S. CLS. 100, 101 AND 102).

FIRST USE 4-5-2005; IN COMMERCE 4-5-2005.

THE MARK CONSISTS OF STANDARD CHARACTERS WITHOUT CLAIM TO ANY PARTICULAR FONT, STYLE, SIZE, OR COLOR.

SN 78-588,584, FILED 3-16-2005.

JEAN IM, EXAMINING ATTORNEY



Int. Cl.: 5

Prior U.S. Cls.: 6, 18, 44, 46, 51, and 52

United States Patent and Trademark Office

Reg. No. 3,500,092

Registered Sep. 9, 2008

TRADEMARK  
PRINCIPAL REGISTER



WHERE'S THE ODOR? INC. (FLORIDA CORPORATION)  
PO BOX 170153  
HIALEAH, FL 33017

FOR: ALL NATURAL ODOR NEUTRALIZING PREPARATION FOR USE ON CARPET, TILE, WOOD, FOAM, FOR THE PURPOSE OF ELIMINATING FOOD ODORS, MILDEW ODORS, BLEACH ODORS, AND SHOE ODORS, IN CLASS 5 (U.S. CLS. 6, 18, 44, 46, 51 AND 52).

FIRST USE 5-18-2006; IN COMMERCE 5-31-2008.

NO CLAIM IS MADE TO THE EXCLUSIVE RIGHT TO USE "EXPERTS IN ODOR REMOVAL", APART FROM THE MARK AS SHOWN.

THE COLOR(S) RED, BLACK, LIGHT BLUE, BLUE, PURPLE, WHITE, GRAY, BEIGE, LIGHT YELLOW, AND TAN IS/ARE CLAIMED AS A FEATURE OF THE MARK.

THE COLOR RED APPEARS IN THE RECTANGLE CONTAINING THE LITERAL ELEMENT OF THE MARK, AS WELL AS IN THE STYLIZED GIRL'S LIPS AND JACKET. THE COLOR BLACK APPEARS IN THE WORDING "EXPERTS IN ODOR

REMOVAL," IN THE SHADOWING OF THE WORDING "WHERE'S THE ODOR?," IN THE STYLIZED GIRL'S HAIR, FACIAL FEATURES, SHOES, JACKET LAPELS AND BUTTONS, AND IN THE OUTLINES OF THE GIRL, HER CLOTHING, AND THE MAGNIFYING GLASS. THE COLOR LIGHT BLUE APPEARS IN THE MAGNIFYING GLASS, ABOVE THE STYLIZED GIRL'S EYELASHES, AND AS HIGHLIGHTS IN THE STYLIZED GIRL'S SKIRT. THE COLORS BLUE AND PURPLE APPEAR AS HIGHLIGHTS IN THE STYLIZED GIRL'S HAIR. THE COLOR WHITE APPEARS IN THE WORDING "WHERE'S THE ODOR?," IN THE MAGNIFYING GLASS, IN THE STYLIZED GIRL'S SKIRT AND SHIRT, AND ABOVE THE STYLIZED GIRL'S EYES. THE COLOR GRAY APPEARS IN THE FRAME OF THE MAGNIFYING GLASS, IN THE SHADOW THAT APPEARS BELOW THE STYLIZED GIRL, IN THE STYLIZED GIRL'S SKIRT AND SHIRT, AND ABOVE THE STYLIZED GIRL'S EYES. THE COLORS BEIGE, LIGHT YELLOW, AND TAN APPEAR IN THE STYLIZED GIRL'S LEGS, HANDS, AND FACE.

SN 78-597,314, FILED 3-29-2005.

ROBERT LAVACHE, EXAMINING ATTORNEY

**Int. Cls.: 35, 38, 41, and 42**

**Prior U.S. Cls.: 100, 101, 102, 104, and 107**

**Reg. No. 3,500,093**

**United States Patent and Trademark Office**

**Registered Sep. 9, 2008**

**SERVICE MARK  
PRINCIPAL REGISTER**

**EMBARK**

E-MYTH WORLDWIDE, INC. (DELAWARE CORPORATION)  
2235 MERCURY WAY, SUITE 200  
SANTA ROSA, CA 95407

FOR: PROVIDING BUSINESS CONSULTATION SERVICES VIA ELECTRONIC NETWORKS; WEB SITES IN THE FIELDS OF BUSINESS CONSULTATION, EXCEPT WEB SITES PROVIDING INFORMATION ABOUT EDUCATIONAL OPPORTUNITIES AT OR FINANCIAL AID FROM INSTITUTIONS OF HIGHER LEARNING, IN CLASS 35 (U.S. CLS. 100, 101 AND 102).

FIRST USE 11-30-2006; IN COMMERCE 11-30-2006.

FOR: PROVIDING ELECTRONIC BULLETIN BOARDS AND LIVE INTERACTIVE CHAT SERVICES FOR THE TRANSMISSION OF MESSAGES, POSTING OF ARTICLES AND COMMENTS, AND SHARING OF INFORMATION AMONG SERVICE USERS, ALL IN THE FIELDS OF BUSINESS AND MANAGEMENT, EXCEPT MESSAGES, ARTICLES AND INFORMATION ABOUT EDUCATIONAL OPPORTUNITIES AT OR FINANCIAL AID FROM INSTITUTIONS OF HIGHER LEARNING, IN CLASS 38 (U.S. CLS. 100, 101 AND 104).

FIRST USE 11-6-2006; IN COMMERCE 11-6-2006.

FOR: EDUCATION SERVICES, NAMELY, PROVIDING CLASSES, SEMINARS, CONFERENCES, WORKSHOPS, AND ONE-ON-ONE TELEPHONIC INSTRUCTION IN THE FIELDS OF BUSINESS, MANAGEMENT, ENTREPRENEURSHIP, AND LEADERSHIP; TRAINING SERVICES IN THE FIELDS OF BUSINESS, MANAGEMENT, ENTRE-

PRENEURSHIP, AND LEADERSHIP; COMPUTER-BASED AND ONLINE COURSES IN THE FIELDS OF BUSINESS AND MANAGEMENT; DISTANCE LEARNING SERVICES IN THE FIELDS OF BUSINESS AND MANAGEMENT; COACHING OF BUSINESS OWNERS VIA ELECTRONIC NETWORKS; WEB SITES IN THE FIELDS OF BUSINESS EDUCATION AND COACHING, EXCEPT WEB SITES PROVIDING INFORMATION ABOUT EDUCATIONAL OPPORTUNITIES AT OR FINANCIAL AID FROM INSTITUTIONS OF HIGHER LEARNING; ON-LINE JOURNALS, NAMELY, BLOGS IN THE FIELDS OF BUSINESS AND MANAGEMENT, IN CLASS 41 (U.S. CLS. 100, 101 AND 107).

FIRST USE 11-30-2006; IN COMMERCE 11-30-2006.

FOR: PROVIDING TEMPORARY USE OF NON-DOWNLOADABLE SOFTWARE, NAMELY, BUSINESS COURSEWARE; PROVIDING TEMPORARY USE OF NON-DOWNLOADABLE SOFTWARE FOR ALLOWING USERS TO CREATE, MAINTAIN, AND UPDATE ONLINE JOURNALS, NAMELY, BLOGS IN THE FIELDS OF BUSINESS AND MANAGEMENT, IN CLASS 42 (U.S. CLS. 100 AND 101).

FIRST USE 11-30-2006; IN COMMERCE 11-30-2006.

THE MARK CONSISTS OF STANDARD CHARACTERS WITHOUT CLAIM TO ANY PARTICULAR FONT, STYLE, SIZE, OR COLOR.

SN 78-597,652, FILED 3-29-2005.

LYDIA BELZER, EXAMINING ATTORNEY

**Int. Cl.: 41**

**Prior U.S. Cls.: 100, 101, and 107**

**United States Patent and Trademark Office**

**Reg. No. 3,500,094**

**Registered Sep. 9, 2008**

**SERVICE MARK  
PRINCIPAL REGISTER**

**LIVING ESSENTIALS**

CR LICENSE, LLC (ARIZONA LIMITED LIABILITY COMPANY)  
8600 EAST ROCKCLIFF ROAD  
TUCSON, AZ 85750

FOR: HEALTH CLUB SERVICES, NAMELY, PROVIDING INSTRUCTION AND EQUIPMENT IN THE FIELD OF PHYSICAL EXERCISE AND EXERCISE CLASSES TO OTHERS AND CONDUCTING CLASSES IN EXERCISE AND PHYSICAL CONDITIONING; EDUCATIONAL SERVICES, NAMELY, CONDUCTING CLASSES, SEMINARS, CONFERENCES, AND WORKSHOPS IN THE FIELDS OF NUTRITION, EXERCISE, PHYSICAL CONDITIONING, CONFLICT MANAGEMENT, FAMILY HEALTH, WELLNESS, PREVENTION OF DISEASE, BEAUTY, SKIN CARE, PHYSICAL FITNESS, PHYSICAL TRAINING, STRESS MANAGEMENT AND BEHAVIOR MODIFICATION; COUNSELING AND CON-

SULTATION SERVICES IN THE FIELDS OF EXERCISE AND PHYSICAL CONDITIONING, PHYSICAL FITNESS AND PHYSICAL TRAINING, IN CLASS 41 (U.S. CLS. 100, 101 AND 107).

FIRST USE 2-12-2008; IN COMMERCE 2-12-2008.

THE MARK CONSISTS OF STANDARD CHARACTERS WITHOUT CLAIM TO ANY PARTICULAR FONT, STYLE, SIZE, OR COLOR.

OWNER OF U.S. REG. NOS. 2,384,229, 2,702,882, AND OTHERS.

SN 78-602,529, FILED 4-5-2005.

PAUL CROWLEY, EXAMINING ATTORNEY

**Int. Cl.: 41**

**Prior U.S. Cls.: 100, 101, and 107**

**United States Patent and Trademark Office**

**Reg. No. 3,500,095**

**Registered Sep. 9, 2008**

**SERVICE MARK  
PRINCIPAL REGISTER**

**AFTERLIFE PICTURES**

WOODS, RAYDER (UNITED STATES INDIVIDUAL)

936 N. SAN VICENTE, SUITE 15

W. HOLLYWOOD, CA 90069

FOR: MOTION PICTURE FILM PRODUCTION,  
IN CLASS 41 (U.S. CLS. 100, 101 AND 107).

FIRST USE 3-21-2008; IN COMMERCE 3-21-2008.

THE MARK CONSISTS OF STANDARD CHARACTERS WITHOUT CLAIM TO ANY PARTICULAR FONT, STYLE, SIZE, OR COLOR.

NO CLAIM IS MADE TO THE EXCLUSIVE RIGHT TO USE "PICTURES", APART FROM THE MARK AS SHOWN.

SN 78-604,014, FILED 4-7-2005.

H. M. FISHER, EXAMINING ATTORNEY

Int. Cl.: 41

Prior U.S. Cls.: 100, 101, and 107

United States Patent and Trademark Office

Reg. No. 3,500,096

Registered Sep. 9, 2008

SERVICE MARK  
PRINCIPAL REGISTER

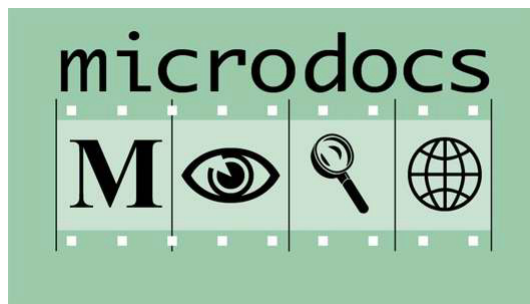

GARTHWAIT & GRIFFIN FILMS, INC. (CALIFORNIA CORPORATION)  
815 15TH AVE.  
MENLO PARK, CA 94025

FOR: ENTERTAINMENT SERVICES, NAMELY, PRODUCTION AND DISTRIBUTION OF DOCUMENTARIES FOR TELEVISION AND OVER THE INTERNET, AND PRIVATE NETWORKS, IN CLASS 41 (U.S. CLS. 100, 101 AND 107).

FIRST USE 2-17-2005; IN COMMERCE 3-3-2005.

NO CLAIM IS MADE TO THE EXCLUSIVE RIGHT TO USE "MICRODOCS", APART FROM THE MARK AS SHOWN.

THE COLOR(S) LIGHT GREEN, DARK GREEN, BLACK AND WHITE IS/ARE CLAIMED AS A FEATURE OF THE MARK.

THE MARK CONSISTS OF THE WORDING "MICRODOCS" IN BLACK, PLACED ON TOP OF A STYLIZED STRIP OF MOVIE FILM. THE MOVIE FILMSTRIP CONSISTS OF 4 FRAMES, AND EACH FRAME IS IN LIGHT GREEN COLOR. THE 4 FRAMES EACH CONTAIN A SINGLE DESIGN ELEMENT. THE FIRST IS THE LETTER "M", THE SECOND AN EYE ICON, THE THIRD AN ICON OF A MAGNIFYING GLASS, AND THE FORTH AN ICON OF THE GLOBE, AND EACH DESIGN ELEMENT IS IN BLACK COLOR. EIGHTEEN SMALL WHITE COLOR BOXES APPEAR AROUND THE FILMSTRIP. THE BACKGROUND OF THE DRAWING IS IN DARK GREEN.

SN 78-604,794, FILED 4-8-2005.

TEJBIR SINGH, EXAMINING ATTORNEY

**Int. Cl.: 38**

**Prior U.S. Cls.: 100, 101, and 104**

**United States Patent and Trademark Office**

**Reg. No. 3,500,097**

**Registered Sep. 9, 2008**

**SERVICE MARK  
PRINCIPAL REGISTER**

**COLLIDER.COM**

COLLIDER HOLDINGS LLC (CALIFORNIA CORPORATION)  
SUITE 700  
1999 AVENUE OF THE STARS  
LOS ANGELES, CA 900676035

FOR: PROVIDING ON-LINE CHAT ROOMS AND ELECTRONIC BULLETIN BOARDS FOR TRANSMISSION OF MESSAGES AMONG USERS IN THE FIELD OF ENTERTAINMENT, SPORTS, TELECOMMUNICATIONS, AND ELECTRONICS; AND PROVIDING ONLINE INFORMATION IN THE FIELD OF TELECOMMUNICATIONS, IN CLASS 38 (U.S. CLS. 100, 101 AND 104).

FIRST USE 1-1-2008; IN COMMERCE 1-1-2008.

THE MARK CONSISTS OF STANDARD CHARACTERS WITHOUT CLAIM TO ANY PARTICULAR FONT, STYLE, SIZE, OR COLOR.

SN 78-606,049, FILED 4-11-2005.

JANICE L. MCMORROW, EXAMINING ATTORNEY

**Int. Cl.: 30**

**Prior U.S. Cl.: 46**

**United States Patent and Trademark Office**

**Reg. No. 3,500,098**

**Registered Sep. 9, 2008**

**TRADEMARK  
PRINCIPAL REGISTER**

**MAGICTIME**

MAGIC TIME INT'L, LLC (FLORIDA LIMITED  
LIABILITY COMPANY)  
2101 N.W. 84TH AVENUE  
MIAMI, FL 33122

THE MARK CONSISTS OF STANDARD CHAR-  
ACTERS WITHOUT CLAIM TO ANY PARTICULAR  
FONT, STYLE, SIZE, OR COLOR.

FOR: UNPOPPED POPCORN AND MICROWAVE  
POPCORN, IN CLASS 30 (U.S. CL. 46).

SN 78-613,964, FILED 4-21-2005.

FIRST USE 9-1-2005; IN COMMERCE 9-1-2005.

LAURIE MAYES, EXAMINING ATTORNEY

**Int. Cl.: 36**

**Prior U.S. Cls.: 100, 101, and 102**

**United States Patent and Trademark Office**

**Reg. No. 3,500,099**

**Registered Sep. 9, 2008**

**SERVICE MARK  
PRINCIPAL REGISTER**

**SIMPLY EFFECTIVE**

ALLIANCEBERNSTEIN L.P. (DELAWARE LIMITED PARTNERSHIP)  
1345 AVENUE OF THE AMERICAS  
NEW YORK, NY 10105

FOR: FINANCIAL SERVICES, NAMELY, INVESTMENT MANAGEMENT AND INVESTMENT CONSULTING SERVICES FOR OTHERS; MUTUAL FUNDS INVESTMENT; STOCK BROKERAGE, INVESTMENT MANAGEMENT AND FINANCIAL RESEARCH IN THE AREA OF PORTFOLIO STRATEGY AND FUNDAMENTAL FINANCIAL RESEARCH ON INDUSTRY SECTORS AND US

AND FOREIGN PUBLIC COMPANIES, IN CLASS 36 (U.S. CLS. 100, 101 AND 102).

FIRST USE 9-0-2005; IN COMMERCE 9-0-2005.

THE MARK CONSISTS OF STANDARD CHARACTERS WITHOUT CLAIM TO ANY PARTICULAR FONT, STYLE, SIZE, OR COLOR.

SN 78-614,560, FILED 4-22-2005.

TEJBIR SINGH, EXAMINING ATTORNEY



**Int. Cl.: 12**

**Prior U.S. Cls.: 19, 21, 23, 31, 35, and 44**

**Reg. No. 3,500,100**

**United States Patent and Trademark Office**

**Registered Sep. 9, 2008**

---

**TRADEMARK  
PRINCIPAL REGISTER**

**SimilAir**

ARVINMERITOR TECHNOLOGY LLC (DELA-  
WARE LIMITED LIABILITY CORPORATION)  
2135 W. MAPLE ROAD  
TROY, MI 48084

THE MARK CONSISTS OF STANDARD CHAR-  
ACTERS WITHOUT CLAIM TO ANY PARTICULAR  
FONT, STYLE, SIZE, OR COLOR.

FOR: SUSPENSION SYSTEMS FOR LAND VEHI-  
CLES, IN CLASS 12 (U.S. CLS. 19, 21, 23, 31, 35 AND  
44).

SN 78-621,037, FILED 5-2-2005.

FIRST USE 4-1-2007; IN COMMERCE 4-1-2007.

LYDIA BELZER, EXAMINING ATTORNEY

**Int. Cl.: 9**

**Prior U.S. Cls.: 21, 23, 26, 36, and 38**

**United States Patent and Trademark Office**

**Reg. No. 3,500,101**

**Registered Sep. 9, 2008**

**TRADEMARK  
PRINCIPAL REGISTER**

# Magmacore

ARMORDYNAMICS, INC (NEW YORK CORPORATION)  
37 STILLWATER ROAD  
STONE RIDGE, NY 12484

FOR: ARMOR PANELS CAPABLE OF PROTECTING AGAINST BALLISTIC PROJECTILES AND EXPLOSIVE FRAGMENTS, PARTICULARLY ARMOR PANELS USED AS PROTECTIVE OR CONTAINMENT STRUCTURES, INSTALLED IN OR ATTACHED TO VEHICLES, BUILDINGS OR OTHER STRUCTURES, SHAPED AND USED AS BUILDING BLOCKS OR OTHER BUILDING PARTS, OR USED AS PERSONAL BALLISTIC SHIELDS BUT NOT

COMPRISING PERSONAL BODY ARMOR, IN CLASS 9 (U.S. CLS. 21, 23, 26, 36 AND 38).

FIRST USE 6-29-2005; IN COMMERCE 6-29-2005.

THE MARK CONSISTS OF STANDARD CHARACTERS WITHOUT CLAIM TO ANY PARTICULAR FONT, STYLE, SIZE, OR COLOR.

SN 78-621,269, FILED 5-2-2005.

KIMBERLY PERRY, EXAMINING ATTORNEY

**Int. Cl.: 31**

**Prior U.S. Cls.: 1 and 46**

**United States Patent and Trademark Office**

**Reg. No. 3,500,102**

**Registered Sep. 9, 2008**

**TRADEMARK  
PRINCIPAL REGISTER**

**PET COUNTRY**

BERGER, KEITH (UNITED STATES INDIVIDUAL)

22485 EL TORO RD, #A

LAKE FOREST, CA 92630

FOR: PET LITTER, IN CLASS 31 (U.S. CLS. 1 AND 46).

FIRST USE 1-24-2008; IN COMMERCE 1-24-2008.

THE MARK CONSISTS OF STANDARD CHARACTERS WITHOUT CLAIM TO ANY PARTICULAR FONT, STYLE, SIZE, OR COLOR.

NO CLAIM IS MADE TO THE EXCLUSIVE RIGHT TO USE "PET", APART FROM THE MARK AS SHOWN.

SN 78-627,576, FILED 5-11-2005.

NICHOLAS ALTREE, EXAMINING ATTORNEY

**Int. Cl.: 32**

**Prior U.S. Cls.: 45, 46, and 48**

**United States Patent and Trademark Office**

**Reg. No. 3,500,103**

**Registered Sep. 9, 2008**

**TRADEMARK  
PRINCIPAL REGISTER**

**VIBE ENERGY**

ALLIED TOBACCO CONSULTING AND DISTRIBUTION, INC. (ILLINOIS CORPORATION)

2541 TECHNOLOGY DR., SUITE 410

ELGIN, IL 60123

FOR: ENERGY DRINK, IN CLASS 32 (U.S. CLS. 45, 46 AND 48).

FIRST USE 6-15-2007; IN COMMERCE 6-15-2007.

THE MARK CONSISTS OF STANDARD CHARACTERS WITHOUT CLAIM TO ANY PARTICULAR FONT, STYLE, SIZE, OR COLOR.

NO CLAIM IS MADE TO THE EXCLUSIVE RIGHT TO USE "ENERGY", APART FROM THE MARK AS SHOWN.

SN 78-628,120, FILED 5-11-2005.

GEORGIA CARTY, EXAMINING ATTORNEY

**Int. Cl.: 25**

**Prior U.S. Cls.: 22 and 39**

**United States Patent and Trademark Office**

**Reg. No. 3,500,104**

**Registered Sep. 9, 2008**

**TRADEMARK  
PRINCIPAL REGISTER**

**RHYTHM & BLUES**

L.C. LICENSING, INC. (DELAWARE CORPORATION)  
1441 BROADWAY  
NEW YORK, NY 10018

THE MARK CONSISTS OF STANDARD CHARACTERS WITHOUT CLAIM TO ANY PARTICULAR FONT, STYLE, SIZE, OR COLOR.

FOR: CLOTHING, NAMELY, SHIRTS, PANTS, IN CLASS 25 (U.S. CLS. 22 AND 39).

SN 78-630,389, FILED 5-16-2005.

FIRST USE 9-0-2005; IN COMMERCE 9-0-2005.

YONG KIM, EXAMINING ATTORNEY

**Int. Cl.: 35**

**Prior U.S. Cls.: 100, 101, and 102**

**United States Patent and Trademark Office**

**Reg. No. 3,500,105**

**Registered Sep. 9, 2008**

**SERVICE MARK  
PRINCIPAL REGISTER**

**CUSTOMER CONNECT**

UNITED STATES POSTAL SERVICE (UNITED STATES INDEPENDENT ESTABLISHMENT OF THE EXECUTIVE BRANCH OF THE GOVERNMENT)

475 L'ENFANT PLAZA, SW  
WASHINGTON, DC 202601136

FOR: BUSINESS CONSULTING SERVICES RELATING TO THE SHIPMENT AND DELIVERY OF PRODUCTS AND PACKAGES , IN CLASS 35 (U.S. CLS. 100, 101 AND 102).

FIRST USE 0-0-2003; IN COMMERCE 0-0-2003.

THE MARK CONSISTS OF STANDARD CHARACTERS WITHOUT CLAIM TO ANY PARTICULAR FONT, STYLE, SIZE, OR COLOR.

SN 78-633,747, FILED 5-20-2005.

JEFFERY COWARD, EXAMINING ATTORNEY

**Int. Cl.: 4**

**Prior U.S. Cls.: 1, 6, and 15**

**United States Patent and Trademark Office**

**Reg. No. 3,500,106**

**Registered Sep. 9, 2008**

**TRADEMARK  
PRINCIPAL REGISTER**

**READY 2FUEL**

CONSUMER READY PRODUCTS, LLC (DELA-  
WARE LIMITED LIABILITY COMPANY)  
CORPORATION TRUST CENTER  
1209 ORANGE STREET  
WILMINGTON, DE 19801

FOR: FUELS; NON-CHEMICAL FUEL ADDI-  
TIVES; A MIXTURE OF FUEL AND FUEL ADDI-  
TIVES FOR FUEL TREATMENT AND ENHANCING  
THE PERFORMANCE OF LUBRICATING OILS,  
GREASES, ENGINE OILS, GASOLINE AND DIESEL  
FUELS, TRANSMISSION FLUIDS, COOLING SYS-  
TEMS AND INTERNAL COMBUSTION ENGINE  
FUELS; A MIXTURE OF FUEL AND NON-CHEMI-

CAL FUEL ADDITIVES, IN CLASS 4 (U.S. CLS. 1, 6  
AND 15).

FIRST USE 1-0-2005; IN COMMERCE 1-0-2005.

THE MARK CONSISTS OF STANDARD CHAR-  
ACTERS WITHOUT CLAIM TO ANY PARTICULAR  
FONT, STYLE, SIZE, OR COLOR.

SN 78-638,851, FILED 5-27-2005.

MICHELLE DUBOIS, EXAMINING ATTORNEY

**Int. Cls.: 9 and 42**

**Prior U.S. Cls.: 21, 23, 26, 36, 38, 100, and 101**

**United States Patent and Trademark Office**

**Reg. No. 3,500,107**

**Registered Sep. 9, 2008**

**TRADEMARK  
SERVICE MARK  
PRINCIPAL REGISTER**

**NJINI**

NJINI, INC. (UNITED KINGDOM CORPORATION)  
1ST FLOOR OFFICE SUITE  
THE DOME BUILDING THE SQUARE RICHMOND  
SURREY, ENGLAND TW9 1DT

FOR: COMPUTER SOFTWARE FOR DATA STORAGE MANAGEMENT ON A COMPUTER NETWORK, IN CLASS 9 (U.S. CLS. 21, 23, 26, 36 AND 38).

FIRST USE 5-0-2006; IN COMMERCE 5-0-2006.

FOR: TECHNICAL SUPPORT SERVICES VIA TELEPHONE, ON-LINE AND E-MAIL, NAMELY, TROUBLESHOOTING OF COMPUTER SOFTWARE

PROBLEMS ASSOCIATED WITH DATA STORAGE MANAGEMENT ON A COMPUTER NETWORK, IN CLASS 42 (U.S. CLS. 100 AND 101).

FIRST USE 5-0-2006; IN COMMERCE 5-0-2006.

THE MARK CONSISTS OF STANDARD CHARACTERS WITHOUT CLAIM TO ANY PARTICULAR FONT, STYLE, SIZE, OR COLOR.

SN 78-641,405, FILED 6-1-2005.

MARIAM MAHMOUDI, EXAMINING ATTORNEY



Int. Cl.: 9

Prior U.S. Cls.: 21, 23, 26, 36, and 38

Reg. No. 3,500,108

United States Patent and Trademark Office

Registered Sep. 9, 2008

TRADEMARK  
PRINCIPAL REGISTER

The logo consists of the letters 'EMP' in a bold, blocky, sans-serif font. The letter 'E' has a diamond shape cut out of its center. The letter 'P' has a diamond shape cut out of its upper right portion. The letters are black and set against a white background.

ELITE MICROPOWER INC. (TAIWAN CORPORATION)  
HSIN PU  
1F, 12, ALLEY 10, SHEN DU LANE, WEN-SENDRD  
305, HSINCHU, TAIWAN

FOR: MASK FOR MAKING INTEGRATED CIRCUITS, MASK FOR MAKING PRINTED CIRCUITS, MASK FOR MAKING SEMICONDUCTOR WELDING MASKS, CIRCUIT BOARD, SEMICONDUCTOR, INTEGRATED CIRCUIT, ELECTRONIC CIRCUIT, PRINTED CIRCUIT BOARD, SEMICONDUCTOR WAFER, SEMICONDUCTOR DEVICE, SILICON WAFER, VOLTAGE REGULATOR, AC-DC VOLTAGE CONVERTER, PULSE WIDTH MODULATION DC CONVERTER, THREE-PHASE CURRENT VOLTAGE CONVERTER, AC-DC VOLTAGE DIGITAL LOGIC LEVEL CONVERTER, ELECTRONIC CONTROLS FOR MOTORS, SERVO MOTOR CONTROLLER, POWER REGULATOR, INVERTER, CELLULAR PHONE BATTERY CHARGER, UNINTERRUPTED POWER SUPPLY, POWER MANAGE-

MENT INTEGRATED CIRCUIT, ELECTRICAL POWER SUPPLY MODULES, DC VOLTAGE REGULATOR, ELECTRONIC CIRCUIT BOARD, HYBRID CIRCUIT BOARD, NETWORK CARD, INTERFACE CARD, SEMICONDUCTOR MEMORY AND MEMORY CARDS, VOLTAGE REGULATORS, POWER SUPPLY, POWER AMPLIFIER, DIGITAL TO ANALOG CONVERTER, ANALOG TO DIGITAL CONVERTER, IN CLASS 9 (U.S. CLS. 21, 23, 26, 36 AND 38).

FIRST USE 2-17-2008; IN COMMERCE 2-17-2008.

THE MARK CONSISTS OF THE LETTERS "EMP" IN STYLIZED FORM.

SN 78-645,223, FILED 6-7-2005.

MARTHA SANTOMARTINO, EXAMINING ATTORNEY

**Int. Cl.: 19**

**Prior U.S. Cls.: 1, 12, 33, and 50**

**United States Patent and Trademark Office**

**Reg. No. 3,500,109**

**Registered Sep. 9, 2008**

**TRADEMARK  
PRINCIPAL REGISTER**



JUDSON, LARRY D. (UNITED STATES INDIVIDUAL)  
SUITE 100  
2440 GOLD RIVER  
GOLD RIVER, CA 95670

FOR: CONSTRUCTION ELEMENTS NOT MADE OF METAL, NAMELY, VINYL SIDING AND PARTS THEREOF, VINYL WINDOWS AND PARTS THEREOF, VINYL SOFFIT/FASCIA AND PARTS THEREOF, GARAGE DOORS AND PARTS THEREOF, ENTRY DOORS/STORM DOORS AND PARTS THEREOF, FENCING AND PARTS THEREOF, DECKING AND PARTS THEREOF, PORCH ENCLOSURES AND PARTS THEREOF, PATIO COVERS AND PARTS THEREOF- ALL USED IN HOME REMODELING, IN CLASS 19 (U.S. CLS. 1, 12, 33 AND 50).

FIRST USE 1-1-1992; IN COMMERCE 1-1-1992.

NO CLAIM IS MADE TO THE EXCLUSIVE RIGHT TO USE "AMERICA'S" AND "EXTERIOR", APART FROM THE MARK AS SHOWN.

THE COLOR(S) GOLD, RED, WHITE, BLUE AND BLACK IS/ARE CLAIMED AS A FEATURE OF THE MARK.

THE MARK CONSISTS OF THE COLOR GOLD APPEARING IN THE FLAGPOLE AND IN THE EAGLE ATOP THE FLAGPOLE; THE COLOR BLACK APPEARING IN THE FLAGPOLE, THE EAGLE'S WINGS AND IN THE WORDS "AMERICA'S DREAM EXTERIOR"; THE COLOR RED APPEARING IN SEVEN STRIPES ON THE AMERICAN FLAG; THE COLOR WHITE APPEARING ON SIX STRIPES ON THE AMERICAN FLAG, THE STARS ON THE AMERICAN FLAG AND AS AN OUTLINE OF THE WORDS "AMERICA'S DREAM EXTERIOR"; AND, THE COLOR BLUE APPEARING AS THE BACKGROUND BEHIND THE STARS IN AMERICAN FLAG.

SN 78-651,869, FILED 6-16-2005.

DARRYL SPRUILL, EXAMINING ATTORNEY

**Int. Cl.: 35**

**Prior U.S. Cls.: 100, 101, and 102**

**Reg. No. 3,500,110**

**United States Patent and Trademark Office**

**Registered Sep. 9, 2008**

**SERVICE MARK  
PRINCIPAL REGISTER**

**SIERRA HOME & GIFT**

SIERRA TRADING POST, INC. (WYOMING CORPORATION)  
5025 CAMPSTOOL ROAD  
CHEYENNE, WY 82007

FOR: COMPUTERIZED ON-LINE SHOPPING AND ORDERING SERVICES, AND CATALOG MAIL ORDER, TELEPHONE ORDER AND FAX ORDER SERVICES IN THE FIELDS OF PRODUCTS FOR THE HOME, HOME OFFICE, GARAGE, LAWN, GARDEN, POOL AND SPA, PERSONAL GIFTS, NAMELY, MONEY HOLDERS, TIMEPIECES, JEWELRY, CHRISTMAS ORNAMENTS AND DECORATIONS, GROOMING PRODUCTS, ELECTRONICS AND ACCESSORIES, APPAREL, GAMES, TOYS AND PET PRODUCTS, AND ACCESSORIES RELATED TO ALL OF THE FOREGOING, IN CLASS 35 (U.S. CLS. 100, 101 AND 102).

FIRST USE 10-1-2007; IN COMMERCE 10-1-2007.

THE MARK CONSISTS OF STANDARD CHARACTERS WITHOUT CLAIM TO ANY PARTICULAR FONT, STYLE, SIZE, OR COLOR.

OWNER OF U.S. REG. NOS. 2,289,952, 2,518,373, AND OTHERS.

NO CLAIM IS MADE TO THE EXCLUSIVE RIGHT TO USE "HOME & GIFT", APART FROM THE MARK AS SHOWN.

SN 78-657,220, FILED 6-23-2005.

DAVID MILLER, EXAMINING ATTORNEY

**Int. Cl.: 35**

**Prior U.S. Cls.: 100, 101, and 102**

**United States Patent and Trademark Office**

**Reg. No. 3,500,111**

**Registered Sep. 9, 2008**

**SERVICE MARK  
PRINCIPAL REGISTER**



BULLS-I, INC. (MICHIGAN CORPORATION)  
701 READS RUN  
TRAVERSE CITY, MI 49684

FOR: WHOLESALE DISTRIBUTORSHIPS AND  
ONLINE RETAIL STORES FEATURING PERSONA-  
LIZED AND UN-PERSONALIZED PROMOTIONAL  
PRODUCTS AND GIFTS; ONLINE ORDERING  
SERVICES FEATURING PERSONALIZED AND  
UN-PERSONALIZED PROMOTIONAL PRODUCTS

AND GIFTS, IN CLASS 35 (U.S. CLS. 100, 101 AND  
102).

FIRST USE 7-3-2005; IN COMMERCE 7-5-2005.

THE MARK CONSISTS OF TARGET AND MOD-  
ERN ARROW.

SN 78-659,583, FILED 6-28-2005.

ELI HELLMAN, EXAMINING ATTORNEY

**Int. Cl.: 18**

**Prior U.S. Cls.: 1, 2, 3, 22, and 41**

**United States Patent and Trademark Office**

**Reg. No. 3,500,112**

**Registered Sep. 9, 2008**

**TRADEMARK  
PRINCIPAL REGISTER**



STELLA KC INC. (NEW YORK CORPORATION)  
10010 67TH ROAD #3C  
FOREST HILLS, NY 11375

FIRST USE 10-23-2006; IN COMMERCE 10-23-2006.

SN 78-661,876, FILED 6-30-2005.

FOR: FASHION ACCESSORIES, NAMELY, PURSES, SHOULDER BAGS, BRIEFCASES AND TOTE BAGS, IN CLASS 18 (U.S. CLS. 1, 2, 3, 22 AND 41).

MARTHA SANTOMARTINO, EXAMINING ATTORNEY

**Int. Cl.: 14**

**Prior U.S. Cls.: 2, 27, 28, and 50**

**United States Patent and Trademark Office**

**Reg. No. 3,500,113**

**Registered Sep. 9, 2008**

**TRADEMARK  
PRINCIPAL REGISTER**

**H24**

JACOB & COMPANY WATCHES, INC. (NEW  
YORK CORPORATION)  
48 EAST 57TH STREET  
NEW YORK, NY 10022

FOR: JEWELRY, NAMELY, WATCHES, IN CLASS  
14 (U.S. CLS. 2, 27, 28 AND 50).

FIRST USE 3-1-2006; IN COMMERCE 3-1-2006.

THE MARK CONSISTS OF STANDARD CHAR-  
ACTERS WITHOUT CLAIM TO ANY PARTICULAR  
FONT, STYLE, SIZE, OR COLOR.

OWNER OF U.S. REG. NOS. 2,676,899 AND  
2,701,274.

SN 78-662,181, FILED 6-30-2005.

WON TEAK OH, EXAMINING ATTORNEY

**Int. Cls.: 9 and 28**

**Prior U.S. Cls.: 21, 22, 23, 26, 36, 38, and 50**

**Reg. No. 3,500,114**

**United States Patent and Trademark Office**

**Registered Sep. 9, 2008**

**TRADEMARK  
PRINCIPAL REGISTER**

**SUPERCUT**

WINDERMERE EXERCISE COMPANY (FLORIDA CORPORATION)  
9710 WILDOAK DRIVE  
WINDERMERE, FL 34786

FOR: PRERECORDED VIDEO TAPES AND DISCS FEATURING INSTRUCTION AND ACTIVITIES IN THE FIELDS OF PHYSICAL FITNESS, EXERCISE, NUTRITION, AND WEIGHT REDUCTION , IN CLASS 9 (U.S. CLS. 21, 23, 26, 36 AND 38).

FIRST USE 6-13-2008; IN COMMERCE 6-13-2008.

FOR: EXERCISE EQUIPMENT, NAMELY, ABDOMINAL EXERCISE MACHINES, IN CLASS 28 (U.S. CLS. 22, 23, 38 AND 50).

FIRST USE 6-13-2008; IN COMMERCE 6-13-2008.

THE MARK CONSISTS OF STANDARD CHARACTERS WITHOUT CLAIM TO ANY PARTICULAR FONT, STYLE, SIZE, OR COLOR.

SN 78-668,331, FILED 7-12-2005.

JAY BESCH, EXAMINING ATTORNEY

**Int. Cl.: 14**

**Prior U.S. Cls.: 2, 27, 28, and 50**

**United States Patent and Trademark Office**

**Reg. No. 3,500,115**

**Registered Sep. 9, 2008**

**TRADEMARK  
PRINCIPAL REGISTER**

# Zen Beadism

KLAR, MARY L. (UNITED STATES INDIVIDUAL)  
39 CHARLES STREET  
MYSTIC, CT 06355

THE MARK CONSISTS OF STANDARD CHARACTERS WITHOUT CLAIM TO ANY PARTICULAR FONT, STYLE, SIZE, OR COLOR.

FOR: BEADED JEWELRY, IN CLASS 14 (U.S. CLS. 2, 27, 28 AND 50).

SN 78-670,145, FILED 7-14-2005.

FIRST USE 8-12-2006; IN COMMERCE 8-12-2006.

SETH A. RAPPAPORT, EXAMINING ATTORNEY



**Int. Cl.: 36**

**Prior U.S. Cls.: 100, 101, and 102**

**United States Patent and Trademark Office**

**Reg. No. 3,500,116**

**Registered Sep. 9, 2008**

**SERVICE MARK  
PRINCIPAL REGISTER**

**HVS Home Value Safeguard**

THE WARD GROUP LLC (DELAWARE LIMITED  
LIABILITY COMPANY)  
1209 ORANGE STREET  
WILMINGTON, DE 19801

FOR: INSURANCE BROKERAGE SERVICES FOR  
COVERAGE PROTECTING AGAINST THE DE-  
CREASE IN HOME VALUES ARISING FROM SPE-  
CIFIC RISKS, IN CLASS 36 (U.S. CLS. 100, 101 AND  
102).

FIRST USE 9-4-2006; IN COMMERCE 9-4-2006.

THE MARK CONSISTS OF STANDARD CHAR-  
ACTERS WITHOUT CLAIM TO ANY PARTICULAR  
FONT, STYLE, SIZE, OR COLOR.

NO CLAIM IS MADE TO THE EXCLUSIVE  
RIGHT TO USE "HOME VALUE", APART FROM  
THE MARK AS SHOWN.

SN 78-670,449, FILED 7-14-2005.

TINA BROWN, EXAMINING ATTORNEY

**Int. Cls.: 9, 41, and 44**

**Prior U.S. Cls.: 21, 23, 26, 36, 38, 100, 101, and 107**

**United States Patent and Trademark Office**

**Reg. No. 3,500,117**

**Registered Sep. 9, 2008**

**TRADEMARK  
SERVICE MARK  
PRINCIPAL REGISTER**

# APOSITIVA

AANRICH, RICHARD A. (UNITED STATES INDIVIDUAL)

037 SW HAMILTON ST., STE. # 1  
PORTLAND, OR 97239 AND

WILSON, CATHERINE W. (UNITED STATES INDIVIDUAL)

037 SW HAMILTON ST., STE # 1  
PORTLAND, OR 97239

FOR: PRE-RECORDED CD'S, VIDEO TAPES, LASER DISKS, DVD'S, BOOKS-ON-TAPE, AND DOWNLOADABLE ELECTRONIC PUBLICATIONS IN THE NATURE OF NEWSLETTERS AND VIDEO RECORDINGS, ALL FEATURING NEURO-LINGUISTIC PROGRAMMING, HYPNOTHERAPY, EMOTIONAL FREEDOM TECHNIQUES, MIND-MAPPING, AND ART THERAPY, IN CLASS 9 (U.S. CLS. 21, 23, 26, 36 AND 38).

FIRST USE 11-8-2005; IN COMMERCE 11-8-2005.

FOR: EDUCATIONAL AND PERSONAL COACHING SERVICES, NAMELY, CONDUCTING CLASSES, SEMINARS, CONFERENCES, AND WORKSHOPS IN THE FIELD OF PERSONAL AWARENESS, NEURO-LINGUISTIC PROGRAMMING, HYPNOTHERAPY, EMOTIONAL FREE-

DOM TECHNIQUES, MIND-MAPPING, AND ART THERAPY, AND DISTRIBUTING COURSE MATERIALS IN CONNECTION THEREWITH, IN CLASS 41 (U.S. CLS. 100, 101 AND 107).

FIRST USE 11-8-2005; IN COMMERCE 11-8-2005.

FOR: PSYCHOLOGICAL COUNSELING, NAMELY, NEURO-LINGUISTIC PROGRAMMING, HYPNOTHERAPY, EMOTIONAL FREEDOM TECHNIQUES, MIND-MAPPING, AND ART THERAPY, IN CLASS 44 (U.S. CLS. 100 AND 101).

FIRST USE 11-8-2005; IN COMMERCE 11-8-2005.

THE MARK CONSISTS OF STANDARD CHARACTERS WITHOUT CLAIM TO ANY PARTICULAR FONT, STYLE, SIZE, OR COLOR.

THE ENGLISH TRANSLATION OF THE SPANISH WORDING "APOSITIVA" IS "APPOSITIVE".

SN 78-670,752, FILED 7-14-2005.

ELISSA GARBER KON, EXAMINING ATTORNEY

**Int. Cl.: 43**

**Prior U.S. Cls.: 100 and 101**

**United States Patent and Trademark Office**

**Reg. No. 3,500,118**

**Registered Sep. 9, 2008**

**SERVICE MARK  
PRINCIPAL REGISTER**

**FAT ABBEY**

NOMADIC VENTURES, INC. (WISCONSIN COR-  
PORATION)  
1401 EAST BRADY STREET  
MILWAUKEE, WI 53202

THE MARK CONSISTS OF STANDARD CHAR-  
ACTERS WITHOUT CLAIM TO ANY PARTICULAR  
FONT, STYLE, SIZE, OR COLOR.

FOR: BAR SERVICES; RESTAURANT SERVICES,  
IN CLASS 43 (U.S. CLS. 100 AND 101).

SN 78-675,204, FILED 7-21-2005.

FIRST USE 5-7-2008; IN COMMERCE 5-7-2008.

CHRIS WELLS, EXAMINING ATTORNEY

**Int. Cl.: 44**

**Prior U.S. Cls.: 100 and 101**

**United States Patent and Trademark Office**

**Reg. No. 3,500,119**

**Registered Sep. 9, 2008**

**SERVICE MARK  
PRINCIPAL REGISTER**

# Kid Fixer Workshop

KID FIXER WORKSHOP, LLC (TEXAS LIMITED  
LIABILITY COMPANY)

3616 BURTS DRIVE

KELLER, TX 76248

FOR: HEALTH CARE, IN CLASS 44 (U.S. CLS. 100  
AND 101).

FIRST USE 2-1-2008; IN COMMERCE 2-1-2008.

THE MARK CONSISTS OF STANDARD CHAR-  
ACTERS WITHOUT CLAIM TO ANY PARTICULAR  
FONT, STYLE, SIZE, OR COLOR.

NO CLAIM IS MADE TO THE EXCLUSIVE  
RIGHT TO USE "KID", APART FROM THE MARK  
AS SHOWN.

SN 78-682,924, FILED 8-1-2005.

SHAUNIA CARLYLE, EXAMINING ATTORNEY

**Int. Cls.: 35, 36, and 42**

**Prior U.S. Cls.: 100, 101, and 102**

**United States Patent and Trademark Office**

**Reg. No. 3,500,120**

**Registered Sep. 9, 2008**

**SERVICE MARK  
PRINCIPAL REGISTER**

**JAYPLUS**

JAYCO, INC. (INDIANA CORPORATION)  
903 SOUTH MAIN STREET  
PO BOX 460  
MIDDLEBURY, IN 46540

FOR: VEHICLE DEALER CONSULTING SERVICES IN THE FIELDS OF EMPLOYEE BENEFITS AND MARKETING, IN CLASS 35 (U.S. CLS. 100, 101 AND 102).

FIRST USE 4-22-2005; IN COMMERCE 7-1-2005.

FOR: RETAIL FINANCING SERVICES FOR RECREATIONAL VEHICLES; PROVIDING EXTENDED WARRANTY PROGRAMS FOR RECREATIONAL VEHICLES, INSURANCE UNDERWRITING FOR RECREATIONAL VEHICLES, IN CLASS 36 (U.S. CLS. 100, 101 AND 102).

FIRST USE 4-22-2005; IN COMMERCE 7-1-2005.

FOR: VEHICLE DEALER CONSULTING SERVICES IN THE FIELD OF FACILITY DESIGN, IN CLASS 42 (U.S. CLS. 100 AND 101).

FIRST USE 4-22-2005; IN COMMERCE 7-1-2005.

THE MARK CONSISTS OF STANDARD CHARACTERS WITHOUT CLAIM TO ANY PARTICULAR FONT, STYLE, SIZE, OR COLOR.

SN 78-683,257, FILED 8-2-2005.

WON TEAK OH, EXAMINING ATTORNEY

**Int. Cl.: 32**

**Prior U.S. Cls.: 45, 46, and 48**

**United States Patent and Trademark Office**

**Reg. No. 3,500,121**

**Registered Sep. 9, 2008**

**TRADEMARK  
PRINCIPAL REGISTER**

**BEER LOVER'S CHOICE**

BBC BRANDS, LLC (MASSACHUSETTS LIMITED  
LIABILITY COMPANY)  
75 ARLINGTON STREET, 5TH FLOOR  
BOSTON, MA 02116

THE MARK CONSISTS OF STANDARD CHAR-  
ACTERS WITHOUT CLAIM TO ANY PARTICULAR  
FONT, STYLE, SIZE, OR COLOR.

FOR: ALE; BEER, IN CLASS 32 (U.S. CLS. 45, 46  
AND 48).

SN 78-683,987, FILED 8-2-2005.

FIRST USE 6-0-2006; IN COMMERCE 6-0-2006.

BRENDAN MCCAULEY, EXAMINING ATTORNEY

**Int. Cl.: 35**

**Prior U.S. Cls.: 100, 101, and 102**

**United States Patent and Trademark Office**

**Reg. No. 3,500,122**

**Registered Sep. 9, 2008**

**SERVICE MARK  
PRINCIPAL REGISTER**

TITUS. DIFFERENT BY DESIGN.

THE TITUS GROUP (DELAWARE CORPORATION)  
SUITE 1425  
330 EAST KILBOURN AVENUE  
MILWAUKEE, WI 53202

THE MARK CONSISTS OF STANDARD CHARACTERS WITHOUT CLAIM TO ANY PARTICULAR FONT, STYLE, SIZE, OR COLOR.

FOR: ACCOUNTING SERVICES, BUSINESS AUDIT SERVICES AND TAX ADVISORY SERVICES, IN CLASS 35 (U.S. CLS. 100, 101 AND 102).

SN 78-684,365, FILED 8-3-2005.

FIRST USE 6-1-2006; IN COMMERCE 6-1-2007.

LINDA MICKLEBURGH, EXAMINING ATTORNEY

**Int. Cl.: 35**

**Prior U.S. Cls.: 100, 101, and 102**

**United States Patent and Trademark Office**

**Reg. No. 3,500,123**

**Registered Sep. 9, 2008**

**SERVICE MARK  
PRINCIPAL REGISTER**

**REACHFORCE**

REACHFORCE, INC. (DELAWARE CORPORATION)  
9020-I CAPITAL OF TEXAS HWY. N, STE. 270  
AUSTIN, TX 78759

FOR: BUSINESS CONSULTATION SERVICES, NAMELY, IDENTIFYING FOR OTHERS KEY DECISION-MAKERS AT OTHER BUSINESSES AND ORGANIZATIONS; PROVIDING STRATEGIC GUIDANCE CONCERNING SALES AND MARKETING, IN CLASS 35 (U.S. CLS. 100, 101 AND 102).

FIRST USE 10-31-2005; IN COMMERCE 10-31-2005.

THE MARK CONSISTS OF STANDARD CHARACTERS WITHOUT CLAIM TO ANY PARTICULAR FONT, STYLE, SIZE, OR COLOR.

SN 78-686,000, FILED 8-4-2005.

JOHN WILKE, EXAMINING ATTORNEY



**Int. Cl.: 35**

**Prior U.S. Cls.: 100, 101, and 102**

**United States Patent and Trademark Office**

**Reg. No. 3,500,124**

**Registered Sep. 9, 2008**

**SERVICE MARK  
PRINCIPAL REGISTER**

**eStewardship**

MID TIER PARTNERS INC (COLORADO CORPORATION)  
1543 CHAMPA ST SUITE 203  
DENVER, CO 80202

THE MARK CONSISTS OF STANDARD CHARACTERS WITHOUT CLAIM TO ANY PARTICULAR FONT, STYLE, SIZE, OR COLOR.

FOR: BUSINESS ORGANIZATIONAL CONSULTING IN THE FIELD OF NONPROFITS, IN CLASS 35 (U.S. CLS. 100, 101 AND 102).

SN 78-686,705, FILED 8-5-2005.

FIRST USE 4-1-2004; IN COMMERCE 6-1-2005.

DEBRA LEE, EXAMINING ATTORNEY

**Int. Cl.: 12**

**Prior U.S. Cls.: 19, 21, 23, 31, 35, and 44**

**Reg. No. 3,500,125**

**United States Patent and Trademark Office**

**Registered Sep. 9, 2008**

**TRADEMARK  
PRINCIPAL REGISTER**



HYUNG, NAM-JIN (REPUBLIC OF KOREA IN-  
DIVIDUAL)  
#118-602, OLYMPIC APT.  
BANGE-DONG, SONGPA-GU  
SEOUL, REPUBLIC OF KOREA 138-050,

FOR: GEARS FOR LAND VEHICLES; GEAR  
BOXES FOR LAND VEHICLES; CLUTCHES FOR  
LAND VEHICLES; TRANSMISSIONS FOR LAND  
VEHICLES; TRANSMISSION SHAFTS FOR LAND

VEHICLES; AXLE FOR LAND VEHICLES, IN CLASS  
12 (U.S. CLS. 19, 21, 23, 31, 35 AND 44).

FIRST USE 3-3-2008; IN COMMERCE 3-3-2008.

SN 78-699,809, FILED 8-24-2005.

SETH A. RAPPAPORT, EXAMINING ATTORNEY

**Int. Cl.: 35**

**Prior U.S. Cls.: 100, 101, and 102**

**United States Patent and Trademark Office**

**Reg. No. 3,500,126**

**Registered Sep. 9, 2008**

**SERVICE MARK  
PRINCIPAL REGISTER**



HEALTHSTAR PARTNERS, LLC (NEW MEXICO  
LIMITED LIABILITY COMPANY)  
13170 CENTRAL AVENUE, SE - B236  
ALBUQUERQUE, NM 87047

FOR: BUSINESS MANAGEMENT CONSULTAN-  
CY AS WELL AS DEVELOPMENT OF PROCESSES  
FOR THE ANALYSIS AND THE IMPLEMENTA-  
TION OF STRATEGY PLANS AND MANAGEMENT  
PROJECTS; BUSINESS MANAGEMENT CONSUL-  
TATION IN THE FIELD OF EXECUTIVE AND  
LEADERSHIP DEVELOPMENT; CONSULTING  
SERVICES IN BUSINESS ORGANIZATION AND  
MANAGEMENT, IN CLASS 35 (U.S. CLS. 100, 101  
AND 102).

FIRST USE 4-15-2006; IN COMMERCE 4-15-2006.

NO CLAIM IS MADE TO THE EXCLUSIVE  
RIGHT TO USE "PARTNERS LLC", APART FROM  
THE MARK AS SHOWN.

THE COLORS GRAY AND BLUE ARE CLAIMED  
AS A FEATURE OF THE MARK.

THE LETTERS OF "HEALTHSTA", THE "R"  
FORMING A HUMAN FIGURE, AND "PARTNERS  
LLC" APPEARS IN GRAY, THE STARS APPEAR IN  
BLUE.

SN 78-701,828, FILED 8-26-2005.

ANTHONY RINKER, EXAMINING ATTORNEY

**Int. Cl.: 33**

**Prior U.S. Cls.: 47 and 49**

**United States Patent and Trademark Office**

**Reg. No. 3,500,127**

**Registered Sep. 9, 2008**

**TRADEMARK  
PRINCIPAL REGISTER**

**LEXICON**

KYSELA PERE ET FILS, LTD. (VIRGINIA CORPORATION)  
130 WINDY HILL LANE  
WINCHESTER, VA 22602

THE MARK CONSISTS OF STANDARD CHARACTERS WITHOUT CLAIM TO ANY PARTICULAR FONT, STYLE, SIZE, OR COLOR.

FOR: WINE, IN CLASS 33 (U.S. CLS. 47 AND 49).

SN 78-721,599, FILED 9-27-2005.

FIRST USE 6-12-2008; IN COMMERCE 6-12-2008.

DAYNA BROWNE, EXAMINING ATTORNEY

**Int. Cls.: 9, 16, 25, 28, and 41**

**Prior U.S. Cls.: 2, 5, 21, 22, 23, 26, 29, 36, 37, 38, 39,  
50, 100, 101, and 107**

**Reg. No. 3,500,128**

**United States Patent and Trademark Office**

**Registered Sep. 9, 2008**

**TRADEMARK  
SERVICE MARK  
PRINCIPAL REGISTER**



F3, LLC (DELAWARE LIMITED LIABILITY COMPANY)  
618 LINDERO CANYON ROAD  
OAK PARK, CA 91377

FOR: PRE-RECORDED VIDEO CASSETTES AND DVD'S, AUDIO CASSETTES, COMPUTER SOFTWARE AND COMPUTER AND VIDEO GAME DISCS AND CARTRIDGES FOR CHILDREN'S ENTERTAINMENT AND EDUCATIONAL PURPOSES, NAMELY, FOR EARLY CHILDHOOD SKILLS DEVELOPMENT, IN CLASS 9 (U.S. CLS. 21, 23, 26, 36 AND 38).

FIRST USE 4-15-2007; IN COMMERCE 4-15-2007.

FOR: PAPER GOODS AND PRINTED MATERIAL, NAMELY, POSTERS, STICKERS, DECALS, CALENDARS, COLORING BOOKS, CHILDREN'S ACTIVITY BOOKS, CHILDREN'S READING BOOKS, NOTE PADS, STATIONERY, NOTEBOOKS, PAPER GIFT WRAP, PAPER PARTY HATS, PAPER NAPKINS, AND TABLE LINENS MADE OF PAPER, IN CLASS 16 (U.S. CLS. 2, 5, 22, 23, 29, 37, 38 AND 50).

FIRST USE 4-15-2007; IN COMMERCE 4-15-2007.

FOR: CLOTHING, NAMELY, SWEATSHIRTS, T-SHIRTS, SHIRTS, TURTLENECKS, PANTS, SHORTS, LEGGINGS, SOCKS, TIGHTS, SPORT CAPS, CLOTH BIBS, BATHING SUITS, HALLOWEEN COSTUMES AND MASQUERADE COSTUMES, COVER-UPS, BOOTS, SHOES, UNDERWEAR, NIGHTSHIRTS, PAJAMAS, NIGHTGOWNS,

GLOVES, SCARVES, SANDALS, BATH ROBES, DRESSES, SWEATPANTS, SKIRTS, JACKETS, VESTS, HATS, AND BICYCLING GLOVES, IN CLASS 25 (U.S. CLS. 22 AND 39).

FIRST USE 4-15-2007; IN COMMERCE 4-15-2007.

FOR: TOYS, GAMES AND PLAYTHINGS, NAMELY, STUFFED TOYS, PLUSH TOYS, INFLATABLE POOL TOYS FOR USE IN SWIMMING POOLS, PUPPETS, ACTION FIGURES, PUZZLES, MUSICAL TOYS, BOARD GAMES, BUILDING BLOCKS, BALLOONS; AND SPORTS EQUIPMENT, NAMELY, BASEBALLS, SOFTBALLS, BASKETBALLS, FOOTBALLS, SOCCER BALLS, FIELD HOCKEY BALLS, GOLF BALLS, LACROSSE BALLS, PADDLE BALLS, PLATFORM TENNIS BALLS, PLAYGROUND BALLS, RACQUET BALLS, RUBBER ACTION BALLS, RUGBY BALLS, SPORT BALLS, BILLIARD BALLS, BOWLING BALLS, HAND BALLS, NET BALLS, SQUASH BALLS, TABLE TENNIS BALLS, TENNIS BALLS, TETHER BALLS, VOLLEY BALLS, POGO STICKS, STILTS, GYMNASTICS APPARATUS, MINI-TRAMPOLINES, HOP BALLS, GIANT BOUNCING BALLS, INFLATABLE SOCCER GOALS, INFLATABLE FOOTBALL GOAL POSTS, INFLATABLE WORM-TWISTING TUNNELS, PLAY TUNNELS; FOUR SQUARE BALLS, HORSESHOE SETS, VOLLEYBALL SETS, TETHER BALL SETS, BADMINTON SETS, JUNIOR BASKETBALL BACKBOARDS, JUNIOR FOOTBALL KICKING GOALS WITH TEES, BASEBALL GLOVES; BATS FOR GAMES; BILLIARD TABLES; GLOVES FOR

GAMES, NAMELY, BASEBALL BATTING GLOVES, BASEBALL GLOVES, BATTING GLOVES, BOXING GLOVES, GOALKEEPERS' GLOVES, HANDBALL GLOVES, HOCKEY GLOVES, KARATE GLOVES, SOFTBALL GLOVES, HOCKEY STICKS; ICE SKATES; KITES; NETS FOR SPORTS; INFLATABLE FLOAT MATTRESSES OR PADS FOR RECREATIONAL USE; PLAY SWIMMING POOLS; RACKETS FOR BADMINTON, RACKETS FOR TENNIS, RACKETS FOR TABLE TENNIS, RACKETS FOR SQUASH, RACKETS FOR RACQUETBALL; TOY SCOOTERS; SKATEBOARDS; SKIS; SNOW SLEDS FOR RECREATIONAL USE; PLAYGROUND SLIDES; SPINNING TOPS; SPRING BOARDS; SURF BOARDS; SURF SKIS; TABLES FOR TABLE TENNIS, IN CLASS 28 (U.S. CLS. 22, 23, 38 AND 50).

FIRST USE 4-15-2007; IN COMMERCE 4-15-2007.

FOR: ENTERTAINMENT SERVICES, NAMELY, A CHILDREN'S TELEVISION SERIES, LIVE DRAMATIC, COMEDIC AND MUSICAL PERFORMANCES FEATURING COSTUMED CHARACTERS; PRODUCTION OF TELEVISION PROGRAMS, TELEVISION SERIES, AND THEATRICAL PRODUCTIONS; PRODUCTION OF SOUND RECORDINGS, PRODUCTION OF VIDEO RECORDINGS AND VIDEO DISC RECORDINGS, PRODUCTION OF FILMS, AND PRODUCTION OF AUDIO AND VIDEO RECORDINGS ON COMPACT DISCS AND CD ROMS, IN CLASS 41 (U.S. CLS. 100, 101 AND 107).

FIRST USE 4-15-2007; IN COMMERCE 4-15-2007.

SN 78-724,597, FILED 9-30-2005.

NICHOLAS COLEMAN, EXAMINING ATTORNEY

**Int. Cl.: 30**

**Prior U.S. Cl.: 46**

**United States Patent and Trademark Office**

**Reg. No. 3,500,129**

**Registered Sep. 9, 2008**

**TRADEMARK  
PRINCIPAL REGISTER**

*Boulevards*

BOULEVARDS LLC (FLORIDA LIMITED LIABILITY COMPANY)  
P.O BOX 21276  
BRADENTON, FL 34204

FIRST USE 3-30-2008; IN COMMERCE 4-20-2008.

SN 78-729,574, FILED 10-9-2005.

FOR: COCOA MIXES, IN CLASS 30 (U.S. CL. 46).

LAURA HAMMEL, EXAMINING ATTORNEY

**Int. Cl.: 41**

**Prior U.S. Cls.: 100, 101, and 107**

**United States Patent and Trademark Office**

**Reg. No. 3,500,130**

**Registered Sep. 9, 2008**

**SERVICE MARK  
PRINCIPAL REGISTER**

**MOTHER TERESA OF CALCUTTA  
CENTER**

MOTHER TERESA OF CALCUTTA CENTER,  
THE (NEW YORK NON-PROFIT CORPORATION)  
P.O. BOX 455  
RIVERSIDE, CT 06878

FOR: PUBLICATION AND DISTRIBUTION OF INSTRUCTIONAL, EDUCATIONAL, AND TEACHING MATERIALS, RELIGIOUS BOOKS, AND RELIGIOUS CIRCULAR LETTERS, ALL RELATED TO RELIGIOUS AND SPIRITUAL ISSUES; PUBLISHING AND DISTRIBUTION OF INSTRUCTIONAL, EDUCATIONAL, AND TEACHING MATERIALS AND OF BOOKS AND CIRCULAR LETTERS RELATED TO EDUCATIONAL SERVICES IN THE FIELD OF RELIGIOUS AND SPIRITUAL INSTRUCTION AND ISSUES; RELIGIOUS AND SPIRITUAL INSTRUCTION SERVICES; AND EDUCATIONAL SERVICES, NAMELY, CONDUCTING PROGRAMS,

WORKSHOPS AND PRESENTATIONS IN THE FIELD OF RELIGION, IN CLASS 41 (U.S. CLS. 100, 101 AND 107).

FIRST USE 1-0-2008; IN COMMERCE 1-0-2008.

THE MARK CONSISTS OF STANDARD CHARACTERS WITHOUT CLAIM TO ANY PARTICULAR FONT, STYLE, SIZE, OR COLOR.

NO CLAIM IS MADE TO THE EXCLUSIVE RIGHT TO USE "CENTER", APART FROM THE MARK AS SHOWN.

SN 78-739,454, FILED 10-24-2005.

BENJAMIN OKEKE, EXAMINING ATTORNEY



Int. Cls.: 18 and 25

Prior U.S. Cls.: 1, 2, 3, 22, 39, and 41

United States Patent and Trademark Office

Reg. No. 3,500,131

Registered Sep. 9, 2008

TRADEMARK  
PRINCIPAL REGISTER



KIA INCORPORATED (CALIFORNIA CORPORATION)  
16516 VIA ESPRILLO  
SUITE 100  
SAN DIEGO, CA 92127

FOR: PURSES AND HANDBAGS, IN CLASS 18  
(U.S. CLS. 1, 2, 3, 22 AND 41).

FIRST USE 4-8-2007; IN COMMERCE 10-15-2007.

FOR: APPAREL, NAMELY, SHOES, SWEATSHIRTS, PANTS, SHORTS, SHIRTS, JACKETS, SKIRTS, OVERALLS, SWEATERS, AND HATS, IN CLASS 25 (U.S. CLS. 22 AND 39).

FIRST USE 3-10-2004; IN COMMERCE 3-10-2004.

SN 78-747,687, FILED 11-4-2005.

WILLIAM P. SHANAHAN, EXAMINING ATTORNEY

**Int. Cl.: 44**

**Prior U.S. Cls.: 100 and 101**

**United States Patent and Trademark Office**

**Reg. No. 3,500,132**

**Registered Sep. 9, 2008**

**SERVICE MARK  
PRINCIPAL REGISTER**

**NIGHT OWLS**

TEMPLE UNIVERSITY – OF THE COMMON-  
WEALTH SYSTEM OF HIGHER EDUCATION  
(PENNSYLVANIA CORPORATION)  
BROAD STREET AND MONTGOMERY AVENUE  
PHILADELPHIA, PA 19122

FOR: PROVIDING RADIOLOGY SERVICES, TEL-  
ERADIOLOGY SERVICES, AND READINGS AND  
INTERPRETATIONS OF RADIOLOGIC DIAGNOS-  
TIC PROCEDURES ALL EXCLUSIVELY TO  
HEALTH CARE PROFESSIONALS, IN CLASS 44  
(U.S. CLS. 100 AND 101).

FIRST USE 5-1-2008; IN COMMERCE 5-1-2008.

THE MARK CONSISTS OF STANDARD CHAR-  
ACTERS WITHOUT CLAIM TO ANY PARTICULAR  
FONT, STYLE, SIZE, OR COLOR.

SN 78-749,037, FILED 11-8-2005.

JASON ROTH, EXAMINING ATTORNEY

**Int. Cl.: 21**

**Prior U.S. Cls.: 2, 13, 23, 29, 30, 33, 40, and 50**

**Reg. No. 3,500,133**

**United States Patent and Trademark Office**

**Registered Sep. 9, 2008**

**TRADEMARK  
PRINCIPAL REGISTER**

**BRUNSWICK**

BLACK & DECKER CORPORATION, THE  
(MARYLAND CORPORATION)

TW-199

701 E. JOPPA ROAD  
TOWSON, MD 21286

FOR: BATHROOM ACCESSORIES, NAMELY, TOWEL BARS, TOWEL RINGS, TOILET TISSUE HOLDERS, SOAP DISHES AND TOOTHBRUSH-TUMBLER HOLDERS, IN CLASS 21 (U.S. CLS. 2, 13, 23, 29, 30, 33, 40 AND 50).

FIRST USE 3-3-2005; IN COMMERCE 3-3-2005.

THE MARK CONSISTS OF STANDARD CHARACTERS WITHOUT CLAIM TO ANY PARTICULAR FONT, STYLE, SIZE, OR COLOR.

SN 78-749,596, FILED 11-8-2005.

CAROLYN CATALDO, EXAMINING ATTORNEY

**Int. Cl.: 41**

**Prior U.S. Cls.: 100, 101, and 107**

**United States Patent and Trademark Office**

**Reg. No. 3,500,134**

**Registered Sep. 9, 2008**

**SERVICE MARK  
PRINCIPAL REGISTER**

**ROOSEVELT INSTITUTION**

THE FRANKLIN AND ELEANOR ROOSEVELT  
INSTITUTE (NEW YORK DOMESTIC NOT-  
FOR-PROFIT CORPORATION)  
4079 ALBANY POST ROAD  
HYDE PARK, NY 12538

FOR: EDUCATIONAL SERVICES, NAMELY, OR-  
GANIZING AND CONDUCTING CONFERENCES,  
SYMPOSIUMS, SEMINARS AND FORUMS IN THE  
FIELD OF PUBLIC POLICY; PUBLICATION OF  
PERIODICALS, BOOKS, BOOKLETS, PAMPHLETS,  
POLICY BRIEFS, RESEARCH REPORTS, CONFER-  
ENCE REPORTS AND REVIEWS IN THE FIELD OF  
PUBLIC POLICY, IN CLASS 41 (U.S. CLS. 100, 101  
AND 107).

FIRST USE 8-0-2005; IN COMMERCE 8-0-2005.

THE MARK CONSISTS OF STANDARD CHAR-  
ACTERS WITHOUT CLAIM TO ANY PARTICULAR  
FONT, STYLE, SIZE, OR COLOR.

NO CLAIM IS MADE TO THE EXCLUSIVE  
RIGHT TO USE "INSTITUTION", APART FROM  
THE MARK AS SHOWN.

SN 78-750,613, FILED 11-9-2005.

TEJBIR SINGH, EXAMINING ATTORNEY

**Int. Cl.: 7**

**Prior U.S. Cls.: 13, 19, 21, 23, 31, 34, and 35**

**Reg. No. 3,500,135**

**United States Patent and Trademark Office**

**Registered Sep. 9, 2008**

---

**TRADEMARK  
PRINCIPAL REGISTER**

**fastjaws**

CUSTOM DESIGN & MFG. (CALIFORNIA SOLE  
PROPRIETORSHIP)  
2360 SHASTA WAY, SUITE D  
SIMI VALLEY, CA 93065

THE MARK CONSISTS OF STANDARD CHAR-  
ACTERS WITHOUT CLAIM TO ANY PARTICULAR  
FONT, STYLE, SIZE, OR COLOR.

FOR: METAL CLAMPS USED FOR HOLDING  
PIECE PARTS ON MACHINE TOOL TABLES, IN  
CLASS 7 (U.S. CLS. 13, 19, 21, 23, 31, 34 AND 35).

SN 78-757,727, FILED 11-19-2005.

FIRST USE 5-4-2007; IN COMMERCE 5-4-2007.

MARK RADEMACHER, EXAMINING ATTORNEY

**Int. Cl.: 35**

**Prior U.S. Cls.: 100, 101, and 102**

**United States Patent and Trademark Office**

**Reg. No. 3,500,136**

**Registered Sep. 9, 2008**

**SERVICE MARK  
PRINCIPAL REGISTER**

# Well Lit Path

SULLIVAN, MONICA (UNITED STATES INDIVIDUAL)  
26 WHITTIER STREET  
AMESBURY, MA 01913

THE MARK CONSISTS OF STANDARD CHARACTERS WITHOUT CLAIM TO ANY PARTICULAR FONT, STYLE, SIZE, OR COLOR.

FOR: BUSINESS MANAGEMENT CONSULTATION, IN CLASS 35 (U.S. CLS. 100, 101 AND 102).

SN 78-761,559, FILED 11-28-2005.

FIRST USE 10-20-2005; IN COMMERCE 10-20-2005.

IRA J. GOODSID, EXAMINING ATTORNEY

**Int. Cl.: 10**

**Prior U.S. Cls.: 26, 39, and 44**

**United States Patent and Trademark Office**

**Reg. No. 3,500,137**

**Registered Sep. 9, 2008**

**TRADEMARK  
PRINCIPAL REGISTER**

**UNISON**

QUAN EMERTEQ CORP. (MINNESOTA CORPORATION)  
10675 NAPLES ST. NE  
BLAINE, MN 55449

FOR: MEDICAL DEVICES AND MEDICAL INSTRUMENTS; SPECIFICALLY DEFLECTABLE CATHETERS; DEFLECTABLE CATHETER SHEATHS; DEFLECTABLE CATHETER INTRODUCERS; STEERABLE SHEATHS, AND INTRODUCERS FOR USE WITH GUIDEWIRES, DILATORS, OBTURATORS, CATHETERS, SHEATHS, NEEDLES, IN CLASS 10 (U.S. CLS. 26, 39 AND 44).

FIRST USE 3-15-2007; IN COMMERCE 3-15-2007.

THE MARK CONSISTS OF STANDARD CHARACTERS WITHOUT CLAIM TO ANY PARTICULAR FONT, STYLE, SIZE, OR COLOR.

SN 78-766,467, FILED 12-5-2005.

DAVID HOFFMAN, EXAMINING ATTORNEY

**Int. Cls.: 9 and 42**

**Prior U.S. Cls.: 21, 23, 26, 36, 38, 100, and 101**

**United States Patent and Trademark Office**

**Reg. No. 3,500,138**

**Registered Sep. 9, 2008**

**TRADEMARK  
SERVICE MARK  
PRINCIPAL REGISTER**

**ENCOMPASS**

KRUEGER INTERNATIONAL, INC. (WISCONSIN CORPORATION)  
1330 BELLEVUE STREET  
GREEN BAY, WI 54302

FOR: COMPUTER SOFTWARE FOR DESIGN, ENGINEERING, DRAFTING, AND QUOTE AND ORDER PROCESSING, FOR USE IN THE OFFICE AND INSTITUTIONAL FURNITURE INDUSTRIES, IN CLASS 9 (U.S. CLS. 21, 23, 26, 36 AND 38).

FIRST USE 10-31-2007; IN COMMERCE 10-31-2007.

FOR: SPACE PLANNING AND INTERIOR DESIGN SERVICES, IN CLASS 42 (U.S. CLS. 100 AND 101).

FIRST USE 10-31-2007; IN COMMERCE 10-31-2007.

THE MARK CONSISTS OF STANDARD CHARACTERS WITHOUT CLAIM TO ANY PARTICULAR FONT, STYLE, SIZE, OR COLOR.

SN 78-767,699, FILED 12-6-2005.

MICHAEL ENGEL, EXAMINING ATTORNEY



**Int. Cls.: 1 and 5**

**Prior U.S. Cls.: 1, 5, 6, 10, 18, 26, 44, 46, 51, and 52**

**United States Patent and Trademark Office**

**Reg. No. 3,500,139**

**Registered Sep. 9, 2008**

**TRADEMARK  
PRINCIPAL REGISTER**



ADVANCED TURF SOLUTIONS, INC. (INDIANA CORPORATION)  
12840 FORD DRIVE  
FISHERS, IN 46038

FOR: CHEMICALS, NAMELY, FERTILIZERS, MICRO-NUTRIENTS, AMINO ACIDS, AND BIO-STIMULANTS FOR DOMESTIC OR COMMERCIAL USES FOR LANDSCAPE TURF INCLUDING GOLF COURSES, IN CLASS 1 (U.S. CLS. 1, 5, 6, 10, 26 AND 46).

FIRST USE 12-1-2005; IN COMMERCE 12-1-2005.

FOR: PESTICIDES, HERBICIDES, AND FUNGICIDES FOR DOMESTIC OR COMMERCIAL USES FOR LANDSCAPE TURF INCLUDING GOLF COURSES, IN CLASS 5 (U.S. CLS. 6, 18, 44, 46, 51 AND 52).

FIRST USE 12-1-2005; IN COMMERCE 12-1-2005.

OWNER OF U.S. REG. NO. 3,013,797.

NO CLAIM IS MADE TO THE EXCLUSIVE RIGHT TO USE "ADVANCED TURF SOLUTIONS", APART FROM THE MARK AS SHOWN.

THE COLORS GREEN, WHITE AND GRAY ARE CLAIMED AS A FEATURE OF THE MARK.

THE COLOR GREEN APPEARS IN THE WORDING AND THE GRASS, THE COLOR WHITE APPEARS IN THE GOLF BALL, AND THE COLOR GRAY APPEARS IN THE SHADED DIMPLES ON THE BALL AND THE LOWER RIGHT PORTION OF THE BALL.

THE MARK CONSISTS OF A GOLF BALL IN FRONT OF TWELVE (12) BLADES OF GRASS, WITH THE WORD "ADVANCED" IN FRONT OF THE GOLF BALL AND ON TOP OF THE WORDS "TURF SOLUTIONS."

SN 78-769,707, FILED 12-8-2005.

MARY ROSSMAN, EXAMINING ATTORNEY

**Int. Cl.: 44**

**Prior U.S. Cls.: 100 and 101**

**United States Patent and Trademark Office**

**Reg. No. 3,500,140**

**Registered Sep. 9, 2008**

**SERVICE MARK  
PRINCIPAL REGISTER**

**STEPS TO CHANGE**

INFLEXXION, INC. (MASSACHUSETTS CORPORATION)  
320 NEEDHAM STREET, SUITE 100  
NEWTON, MA 02464

FOR: PROVIDING HEALTH INFORMATION IN THE FIELDS OF ANXIETY AND DEPRESSION VIA THE INTERNET, IN CLASS 44 (U.S. CLS. 100 AND 101).

FIRST USE 3-31-2006; IN COMMERCE 3-31-2006.

THE MARK CONSISTS OF STANDARD CHARACTERS WITHOUT CLAIM TO ANY PARTICULAR FONT, STYLE, SIZE, OR COLOR.

SN 78-769,942, FILED 12-9-2005.

MARCIE MILONE, EXAMINING ATTORNEY

**Int. Cl.: 9**

**Prior U.S. Cls.: 21, 23, 26, 36, and 38**

**Reg. No. 3,500,141**

**United States Patent and Trademark Office**

**Registered Sep. 9, 2008**

**TRADEMARK  
PRINCIPAL REGISTER**

**ALL ROAD COMMUNICATIONS**

LIBERATION MANAGEMENT LLC (RHODE ISLAND LIMITED LIABILITY COMPANY)

3370 BRANT ST.

SAN DIEGO, CA 92103

FOR: SATELLITE TELEPHONES, IN CLASS 9 (U.S. CLS. 21, 23, 26, 36 AND 38).

FIRST USE 2-16-2006; IN COMMERCE 2-16-2006.

THE MARK CONSISTS OF STANDARD CHARACTERS WITHOUT CLAIM TO ANY PARTICULAR FONT, STYLE, SIZE, OR COLOR.

NO CLAIM IS MADE TO THE EXCLUSIVE RIGHT TO USE "COMMUNICATIONS", APART FROM THE MARK AS SHOWN.

SN 78-770,528, FILED 12-9-2005.

DAYNA BROWNE, EXAMINING ATTORNEY

**Int. Cls.: 16 and 35**

**Prior U.S. Cls.: 2, 5, 22, 23, 29, 37, 38, 50, 100, 101, and 102**

**Reg. No. 3,500,142**

**United States Patent and Trademark Office**

**Registered Sep. 9, 2008**

**TRADEMARK  
SERVICE MARK  
PRINCIPAL REGISTER**

**Success in Succession  
Planning**

BUSINESS TRANSITIONS, LLC (OREGON LIMITED LIABILITY COMPANY)  
SUITE 470  
10300 S.W. GREENBURG ROAD  
PORTLAND, OR 97223

FOR: PRINTED INSTRUCTIONAL, EDUCATIONAL, AND TEACHING MATERIALS IN THE FIELD OF BUSINESS SUCCESSION PLANNING, IN CLASS 16 (U.S. CLS. 2, 5, 22, 23, 29, 37, 38 AND 50).

FIRST USE 1-15-2008; IN COMMERCE 1-15-2008.

FOR: BUSINESS SUCCESSION PLANNING, IN CLASS 35 (U.S. CLS. 100, 101 AND 102).

FIRST USE 1-15-2008; IN COMMERCE 1-15-2008.

THE MARK CONSISTS OF STANDARD CHARACTERS WITHOUT CLAIM TO ANY PARTICULAR FONT, STYLE, SIZE, OR COLOR.

NO CLAIM IS MADE TO THE EXCLUSIVE RIGHT TO USE "SUCCESSION PLANNING", APART FROM THE MARK AS SHOWN.

SN 78-770,607, FILED 12-9-2005.

CHRISTINE COOPER, EXAMINING ATTORNEY

**Int. Cls.: 17, 20, and 35**

**Prior U.S. Cls.: 1, 2, 5, 12, 13, 22, 25, 32, 35, 50, 100, 101, and 102**

**Reg. No. 3,500,143**

**United States Patent and Trademark Office**

**Registered Sep. 9, 2008**

**TRADEMARK  
SERVICE MARK  
PRINCIPAL REGISTER**



MACFARLANE GROUP SWEDEN AB (SWEDEN CORPORATION)  
KULLAGATAN 6  
HELSINGBORG, SWEDEN SE-252 20

FOR: PLASTIC FILMS FOR COMMERCIAL AND INDUSTRIAL PACKAGING USE; ADHESIVE-BACKED PLASTIC FILMS FOR USE IN THE MANUFACTURE OF LABELS, IN CLASS 17 (U.S. CLS. 1, 5, 12, 13, 35 AND 50).

FIRST USE 0-0-1997; IN COMMERCE 8-0-2007.

FOR: PACKING CONTAINERS, EXCLUDING BOTTLES, MADE OF PLASTIC MATERIALS, IN CLASS 20 (U.S. CLS. 2, 13, 22, 25, 32 AND 50).

FIRST USE 0-0-1997; IN COMMERCE 8-0-2007.

FOR: PACKAGING ARTICLES, EXCLUDING BOTTLES, TO THE ORDER AND SPECIFICATION OF OTHERS, IN CLASS 35 (U.S. CLS. 100, 101 AND 102).

FIRST USE 0-0-1997; IN COMMERCE 8-0-2007.

OWNER OF ERPN CMNTY TM OFC REG. NO. 3638442, DATED 6-20-2005, EXPIRES 2-5-2014.

THE COLORS RED, YELLOW, BLACK AND WHITE ARE CLAIMED AS A FEATURE OF THE MARK.

THE WORDS "RE-SEAL IT" IN YELLOW LETTERS ON A BLACK CIRCLE, SURROUNDED BY THE WORDS RESEAL - RECLUDO - WIEDERSCHLIESSEN - REFERMER IN BLACK TYPEFACE ON WHITE MAKING A CIRCLE AROUND THE BLACK CIRCLE, AND ALL IN TURN SURROUNDED BY A RED CIRCLE.

THE ENGLISH TRANSLATION OF THE WORDS "RECLUDO", "WIEDERSCHLIESSEN" AND "REFERMER" IN THE MARK IS "RE-SEAL".

SN 78-771,600, FILED 12-12-2005.

JOHN WILKE, EXAMINING ATTORNEY

Int. Cl.: 2

Prior U.S. Cls.: 6, 11, and 16

United States Patent and Trademark Office

Reg. No. 3,500,144

Registered Sep. 9, 2008

TRADEMARK  
PRINCIPAL REGISTER



SURFACE TECHNOLOGY, INC. (NEW JERSEY CORPORATION)  
105 NORTH GOLD DRIVE  
ROBBINSVILLE, NJ 08691

FOR: COATING CONSISTING OF DIAMOND PARTICLES CONTAINED WITHIN HARD ELECTROLESS NICKEL METAL FOR COATING METALS OR ALLOYS FOR USE ON MECHANICAL SHAFT SEALS FOR AUTOMOTIVE WATER PUMPS AND CHEMICAL PROCESS PUMPS, TEXTILE MACHINERY PARTS, GEARS, TOOLS FOR PROCESSING GLASS OR CERAMIC-FILLED RESINS, WOOD-WORKING TOOLS SUCH AS TAPS, DIES, DRILLS, ROUTERS, RASPS, AND FILES, HIGH SPEED PAPER-HANDLING EQUIPMENT SUCH AS LIFTERS, SORTERS AND GUIDES, COMPUTER PARTS SUCH AS MAGNETIC TAPE READING HEADS AND GUIDES, ULTRASONIC TRANSDUCER WEAR-PLATES, GAGE BLOCKS, CANNING EQUIPMENT, SMOKELESS POWDER EXTRUDER

DIES AND CUTTERS, INDUSTRIAL SCISSORS AND BARBER SCISSORS, EXTRUDER KNEADING BLOCKS, SCREWS, BARRELS FOR PROCESSING GLASS-FILLED RESINS, SURGICAL AND DENTAL TOOLS, AND GOLF CLUBS, IN CLASS 2 (U.S. CLS. 6, 11 AND 16).

FIRST USE 6-20-2008; IN COMMERCE 6-20-2008.

NO CLAIM IS MADE TO THE EXCLUSIVE RIGHT TO USE "COMPOSITE DIAMOND COATING", APART FROM THE MARK AS SHOWN.

THE MARK CONSISTS OF THE WORDS "COMPOSITE DIAMOND COATING" AND STYLIZED LETTERS "CDC".

SN 78-775,304, FILED 12-16-2005.

MICHAEL WIENER, EXAMINING ATTORNEY

Int. Cl.: 36

Prior U.S. Cls.: 100, 101, and 102

United States Patent and Trademark Office

Reg. No. 3,500,145

Registered Sep. 9, 2008

**SERVICE MARK  
PRINCIPAL REGISTER**



Daddy's Spirit

DADDY'S SPIRIT MOVES ME FORWARD  
(PENNSYLVANIA NON-PROFIT CORPORATION)

P.O. BOX 80022  
VALLEY FORGE, PA 19484

FOR: CHARITABLE FUND RAISING FOR CHILDREN WHOSE FATHERS HAVE DIED, IN ORDER TO PROVIDE RECREATIONAL AND EDUCATIONAL OPPORTUNITIES FOR THOSE CHILDREN, IN CLASS 36 (U.S. CLS. 100, 101 AND 102).

FIRST USE 1-1-2006; IN COMMERCE 1-1-2006.

THE MARK CONSISTS OF FATHER'S HAND PASSING A BATON TO A CHILD'S HAND.

SN 78-775,665, FILED 12-17-2005.

ARETHA SOMERVILLE, EXAMINING ATTORNEY

**Int. Cls.: 38 and 41**

**Prior U.S. Cls.: 100, 101, 104, and 107**

**United States Patent and Trademark Office**

**Reg. No. 3,500,146**

**Registered Sep. 9, 2008**

**SERVICE MARK  
PRINCIPAL REGISTER**

**BETJ**

BLACK ENTERTAINMENT TELEVISION, LLC  
(D.C. LIMITED LIABILITY COMPANY)  
LEGAL AFFAIRS  
ONE BET PLAZA, 1235 W STREET, N.E.  
WASHINGTON, DC 20018

FOR: CABLE TELEVISION BROADCASTING  
SERVICES, IN CLASS 38 (U.S. CLS. 100, 101 AND 104).

FIRST USE 3-8-2006; IN COMMERCE 3-8-2006.

FOR: ENTERTAINMENT SERVICES IN THE  
NATURE OF ON-GOING TELEVISION PROGRAM-  
MING IN THE FIELD OF MUSIC, ENTERTAIN-  
MENT NEWS AND GENERAL INTEREST TOPICS,  
IN CLASS 41 (U.S. CLS. 100, 101 AND 107).

FIRST USE 3-8-2006; IN COMMERCE 3-8-2006.

THE MARK CONSISTS OF STANDARD CHAR-  
ACTERS WITHOUT CLAIM TO ANY PARTICULAR  
FONT, STYLE, SIZE, OR COLOR.

OWNER OF U.S. REG. NOS. 1,511,259, 2,572,634,  
AND OTHERS.

SN 78-776,034, FILED 12-19-2005.

ALLISON SCHRODY, EXAMINING ATTORNEY



**Int. Cl.: 28**

**Prior U.S. Cls.: 22, 23, 38, and 50**

**United States Patent and Trademark Office**

**Reg. No. 3,500,147**

**Registered Sep. 9, 2008**

**TRADEMARK  
PRINCIPAL REGISTER**

**ROCKET FISHING ROD**

WYMAN VON MOHR & ASSOCIATES (FLORIDA  
PARTNERSHIP)

4727 YACHTSMAN'S DRIVE

AMELIA ISLAND, FL 32034

FOR: FISHING RODS, IN CLASS 28 (U.S. CLS. 22,  
23, 38 AND 50).

FIRST USE 11-14-2006; IN COMMERCE 11-14-2006.

THE MARK CONSISTS OF STANDARD CHAR-  
ACTERS WITHOUT CLAIM TO ANY PARTICULAR  
FONT, STYLE, SIZE, OR COLOR.

NO CLAIM IS MADE TO THE EXCLUSIVE  
RIGHT TO USE "FISHING ROD", APART FROM  
THE MARK AS SHOWN.

SN 78-776,427, FILED 12-19-2005.

JENNIFER MARTIN, EXAMINING ATTORNEY

**Int. Cl.: 16**

**Prior U.S. Cls.: 2, 5, 22, 23, 29, 37, 38, and 50**

**Reg. No. 3,500,148**

**United States Patent and Trademark Office**

**Registered Sep. 9, 2008**

**TRADEMARK  
PRINCIPAL REGISTER**

The logo features the word "MAMMOTH" in a bold, black, sans-serif font. Above the letter "A" is a stylized, black mountain peak shape, resembling an inverted "V" or a simple mountain silhouette.

MAMMOTH MOUNTAIN SKI AREA, LLC (DE-  
LAWARE LIMITED LIABILITY COMPANY)  
1 MINARET ROAD  
MAMMOTH LAKES, CA 93546

OWNER OF U.S. REG. NOS. 2,720,400, 2,723,086,  
AND 2,959,479.

FOR: ADHESIVE NOTE PAPER; CALENDARS;  
ENTRY TICKETS; MAPS; PENCILS; PENS; POST-  
CARDS; POSTERS; STATIONERY; STICKERS, IN  
CLASS 16 (U.S. CLS. 2, 5, 22, 23, 29, 37, 38 AND 50).

THE MARK CONSISTS, IN PART, OF AN UPSIDE-  
DOWN "V" REPRESENTING A MOUNTAIN PEAK.

SN 78-777,410, FILED 12-20-2005.

FIRST USE 11-0-2004; IN COMMERCE 11-0-2004.

DAVID MURRAY, EXAMINING ATTORNEY

**Int. Cls.: 16, 18, and 20**

**Prior U.S. Cls.: 1, 2, 3, 5, 13, 22, 23, 25, 29, 32, 37, 38,  
41, and 50**

**Reg. No. 3,500,149**

**United States Patent and Trademark Office**

**Registered Sep. 9, 2008**

**TRADEMARK  
PRINCIPAL REGISTER**

**AUTOCROSS LEATHER  
ACCESSORIES**

A.T.X. INTERNATIONAL, INC. (RHODE ISLAND  
CORPORATION)  
ONE ALBION ROAD  
LINCOLN, RI 02865

FOR: LEATHER GOODS, NAMELY, AGENDAS,  
DIARIES, NOTE PAD COVERS, PASSPORT CASES,  
PEN CASES, DOCUMENT PORTFOLIOS AND STA-  
TIONERY TYPE PORTFOLIOS, IN CLASS 16 (U.S.  
CLS. 2, 5, 22, 23, 29, 37, 38 AND 50).

FIRST USE 4-30-2006; IN COMMERCE 4-30-2006.

FOR: LEATHER GOODS, NAMELY, BUSINESS  
CARD CASES, COIN CASES, COMBINATION  
CREDIT CARD CASES/MONEY CLIPS, CREDIT  
CARD CASES, AND BRIEFCASE TYPE PORTFO-  
LIOS, IN CLASS 18 (U.S. CLS. 1, 2, 3, 22 AND 41).

FIRST USE 4-30-2006; IN COMMERCE 4-30-2006.

FOR: LEATHER KEY FOBBS; LEATHER KEY  
FOBS WITH LEATHER PICTURE FRAME ATTACH-  
MENTS, IN CLASS 20 (U.S. CLS. 2, 13, 22, 25, 32 AND  
50).

FIRST USE 4-30-2006; IN COMMERCE 4-30-2006.

THE MARK CONSISTS OF STANDARD CHAR-  
ACTERS WITHOUT CLAIM TO ANY PARTICULAR  
FONT, STYLE, SIZE, OR COLOR.

OWNER OF U.S. REG. NO. 925,913.

NO CLAIM IS MADE TO THE EXCLUSIVE  
RIGHT TO USE "LEATHER ACCESSORIES", APART  
FROM THE MARK AS SHOWN.

SN 78-778,520, FILED 12-21-2005.

MARY CRAWFORD, EXAMINING ATTORNEY

**Int. Cls.: 16 and 35**

**Prior U.S. Cls.: 2, 5, 22, 23, 29, 37, 38, 50, 100, 101, and 102**

**United States Patent and Trademark Office**

**Reg. No. 3,500,150**

**Registered Sep. 9, 2008**

**TRADEMARK  
SERVICE MARK  
PRINCIPAL REGISTER**

**HQ WEEKLY**

HQ WEEKLY, LLC (CALIFORNIA LIMITED LIABILITY COMPANY)  
P.O. BOX 141  
SANTA BARBARA, CA 93102

FOR: PRINTED PUBLICATIONS, NAMELY, MAGAZINES IN THE FIELD OF REAL ESTATE, IN CLASS 16 (U.S. CLS. 2, 5, 22, 23, 29, 37, 38 AND 50).

FIRST USE 4-24-2006; IN COMMERCE 4-24-2006.

FOR: REAL ESTATE MARKETING SERVICES, NAMELY, PROVIDING INFORMATION IN THE FIELD OF REAL ESTATE BY MEANS OF A WEBSITE FEATURING INFORMATION ABOUT PROPERTIES FOR SALE OR RENT, PROVIDING VIRTUAL TOURS OF PROPERTIES LISTED FOR SALE OR RENT, AND PROVIDING WEB LINKS TO

REAL ESTATE AGENTS AND AGENCIES, IN CLASS 35 (U.S. CLS. 100, 101 AND 102).

FIRST USE 6-26-2008; IN COMMERCE 6-26-2008.

THE MARK CONSISTS OF STANDARD CHARACTERS WITHOUT CLAIM TO ANY PARTICULAR FONT, STYLE, SIZE, OR COLOR.

NO CLAIM IS MADE TO THE EXCLUSIVE RIGHT TO USE "WEEKLY", APART FROM THE MARK AS SHOWN.

SN 78-782,192, FILED 12-29-2005.

MICHELLE DUBOIS, EXAMINING ATTORNEY

**Int. Cls.: 9, 14, 16, 18, and 25**

**Prior U.S. Cls.: 1, 2, 3, 5, 21, 22, 23, 26, 27, 28, 29, 36, 37, 38, 39, 41, and 50**

**Reg. No. 3,500,151**

**United States Patent and Trademark Office**

**Registered Sep. 9, 2008**

**TRADEMARK  
PRINCIPAL REGISTER**

**T.HARRIS**

STEIN MART BUYING CORPORATION (FLORIDA CORPORATION)  
1200 RIVERPLACE BOULEVARD  
JACKSONVILLE, FL 322071809

FOR: SMALL LEATHER GOODS, NAMELY, CELL PHONE CASES, IN CLASS 9 (U.S. CLS. 21, 23, 26, 36 AND 38).

FIRST USE 2-28-2007; IN COMMERCE 2-28-2007.

FOR: LEATHER JEWELRY BOXES, LEATHER WATCH BOXES, LEATHER JEWELRY CASES, LEATHER WATCH CASES, LEATHER JEWELRY VALETS, NAMELY, TRAVEL JEWELRY CASES AND JEWELRY CASES FOR DRESSER AND VANITY TOPS, IN CLASS 14 (U.S. CLS. 2, 27, 28 AND 50).

FIRST USE 11-30-2006; IN COMMERCE 11-30-2006.

FOR: SMALL LEATHER GOODS, NAMELY, PASSPORT CASES, IN CLASS 16 (U.S. CLS. 2, 5, 22, 23, 29, 37, 38 AND 50).

FIRST USE 2-28-2007; IN COMMERCE 2-28-2007.

FOR: SMALL LEATHER GOODS, NAMELY, WALLETS, BILLFOLDS, CREDIT CARD CASES,

BUSINESS CARD CASES, CHANGE PURSES, KEY CASES, LEATHER KEY CHAINS, COSMETIC AND TOILETRY TRAVEL CASES SOLD EMPTY, LEATHER SHOE BAGS FOR TRAVEL, IN CLASS 18 (U.S. CLS. 1, 2, 3, 22 AND 41).

FIRST USE 5-31-2006; IN COMMERCE 5-31-2006.

FOR: SPORT SHIRTS, KNIT SHIRTS, DRESS SHIRTS, T-SHIRTS, SWEATERS, TIES, PANTS, SHORTS, SOCKS, CAPS, JACKETS, COATS, ANORAKS, IN CLASS 25 (U.S. CLS. 22 AND 39).

FIRST USE 5-31-2006; IN COMMERCE 5-31-2006.

THE MARK CONSISTS OF STANDARD CHARACTERS WITHOUT CLAIM TO ANY PARTICULAR FONT, STYLE, SIZE, OR COLOR.

THE NAME(S), PORTRAIT(S), AND/OR SIGNATURE(S) SHOWN IN THE MARK DOES NOT IDENTIFY A PARTICULAR LIVING INDIVIDUAL.

SN 78-782,688, FILED 12-29-2005.

MICHELLE DUBOIS, EXAMINING ATTORNEY

**Int. Cl.: 18**

**Prior U.S. Cls.: 1, 2, 3, 22, and 41**

**United States Patent and Trademark Office**

**Reg. No. 3,500,152**

**Registered Sep. 9, 2008**

**TRADEMARK  
PRINCIPAL REGISTER**

**Beg2bNoticed**

MAO, TERRY (UNITED STATES INDIVIDUAL)  
601 N LINCOLN WAY  
GALT, CA 95632

THE MARK CONSISTS OF STANDARD CHAR-  
ACTERS WITHOUT CLAIM TO ANY PARTICULAR  
FONT, STYLE, SIZE, OR COLOR.

FOR: PET CLOTHING, IN CLASS 18 (U.S. CLS. 1, 2,  
3, 22 AND 41).

SN 78-787,164, FILED 1-8-2006.

FIRST USE 6-5-2008; IN COMMERCE 6-5-2008.

LINDA MICKLEBURGH, EXAMINING ATTORNEY

**Int. Cl.: 9**

**Prior U.S. Cls.: 21, 23, 26, 36, and 38**

**United States Patent and Trademark Office**

**Reg. No. 3,500,153**

**Registered Sep. 9, 2008**

**TRADEMARK  
PRINCIPAL REGISTER**

**RETHINK**

EMI CHRISTIAN MUSIC GROUP, INC. (CALI-  
FORNIA CORPORATION)  
P.O. BOX 5085  
101 WINNERS CIRCLE  
BRENTWOOD, TN 370245085

FOR: MUSICAL SOUND RECORDINGS; DOWN-  
LOADABLE MUSICAL SOUND RECORDINGS, IN  
CLASS 9 (U.S. CLS. 21, 23, 26, 36 AND 38).

FIRST USE 2-0-2007; IN COMMERCE 2-0-2007.

THE MARK CONSISTS OF STANDARD CHAR-  
ACTERS WITHOUT CLAIM TO ANY PARTICULAR  
FONT, STYLE, SIZE, OR COLOR.

OWNER OF U.S. REG. NO. 2,041,320.

SN 78-788,715, FILED 1-10-2006.

SIMON TENG, EXAMINING ATTORNEY

**Int. Cl.: 9**

**Prior U.S. Cls.: 21, 23, 26, 36, and 38**

**United States Patent and Trademark Office**

**Reg. No. 3,500,154**

**Registered Sep. 9, 2008**

**TRADEMARK  
PRINCIPAL REGISTER**



EMI CHRISTIAN MUSIC GROUP, INC. (CALI-  
FORNIA CORPORATION)  
P.O. BOX 5085  
101 WINNERS CIRCLE  
BRENTWOOD, TN 370245085

FIRST USE 2-0-2007; IN COMMERCE 2-0-2007.

OWNER OF U.S. REG. NO. 2,041,320.

SN 78-788,725, FILED 1-10-2006.

FOR: MUSICAL SOUND RECORDINGS, IN  
CLASS 9 (U.S. CLS. 21, 23, 26, 36 AND 38).

SIMON TENG, EXAMINING ATTORNEY



**Int. Cl.: 43**

**Prior U.S. Cls.: 100 and 101**

**United States Patent and Trademark Office**

**Reg. No. 3,500,155**

**Registered Sep. 9, 2008**

**SERVICE MARK  
PRINCIPAL REGISTER**

# TABLE 31

1701 JFK RESTAURANT, LP (PENNSYLVANIA  
LIMITED PARTNERSHIP)  
SUITE 400  
1601 WALNUT STREET  
PHILADELPHIA, PA 19103

FOR: RESTAURANT SERVICES, IN CLASS 43  
(U.S. CLS. 100 AND 101).

FIRST USE 2-15-2008; IN COMMERCE 5-17-2008.

THE MARK CONSISTS OF STANDARD CHAR-  
ACTERS WITHOUT CLAIM TO ANY PARTICULAR  
FONT, STYLE, SIZE, OR COLOR.

SN 78-789,748, FILED 1-11-2006.

ARETHA SOMERVILLE, EXAMINING ATTORNEY

**Int. Cl.: 26**

**Prior U.S. Cls.: 37, 39, 40, 42, and 50**

**Reg. No. 3,500,156**

**United States Patent and Trademark Office**

**Registered Sep. 9, 2008**

---

**TRADEMARK  
PRINCIPAL REGISTER**

**ALTER EGO**

GENERAL WIG MANUFACTURERS, INC.  
(FLORIDA CORPORATION)  
5800 N.W. 163RD STREET  
MIAMI LAKES, FL 33014

THE MARK CONSISTS OF STANDARD CHAR-  
ACTERS WITHOUT CLAIM TO ANY PARTICULAR  
FONT, STYLE, SIZE, OR COLOR.

FOR: WIGS AND HAIRPIECES, IN CLASS 26 (U.S.  
CLS. 37, 39, 40, 42 AND 50).

SN 78-793,264, FILED 1-17-2006.

FIRST USE 3-3-2006; IN COMMERCE 3-3-2006.

GEORGE LORENZO, EXAMINING ATTORNEY

**Int. Cl.: 42**

**Prior U.S. Cls.: 100 and 101**

**United States Patent and Trademark Office**

**Reg. No. 3,500,157**

**Registered Sep. 9, 2008**

**SERVICE MARK  
PRINCIPAL REGISTER**

**IT'S NOT THE NETWORK**

OPNET TECHNOLOGIES, INC. (DELAWARE  
CORPORATION)  
7255 WOODMONT AVENUE  
BETHESDA, MD 20814

THE MARK CONSISTS OF STANDARD CHAR-  
ACTERS WITHOUT CLAIM TO ANY PARTICULAR  
FONT, STYLE, SIZE, OR COLOR.

FOR: CONSULTATION IN THE FIELD OF COM-  
PUTER NETWORK MANAGEMENT, IN CLASS 42  
(U.S. CLS. 100 AND 101).

SN 78-796,273, FILED 1-20-2006.

FIRST USE 4-13-2005; IN COMMERCE 4-13-2005.

KIMBERLY FRYE, EXAMINING ATTORNEY

**Int. Cl.: 25**

**Prior U.S. Cls.: 22 and 39**

**United States Patent and Trademark Office**

**Reg. No. 3,500,158**

**Registered Sep. 9, 2008**

**TRADEMARK  
PRINCIPAL REGISTER**

**PROFILE PERFECT**

BENDON LIMITED (NEW ZEALAND CORPORATION)  
8 AIRPARK DRIVE AIRPORT OAKS  
AUCKLAND, NEW ZEALAND

THE MARK CONSISTS OF STANDARD CHARACTERS WITHOUT CLAIM TO ANY PARTICULAR FONT, STYLE, SIZE, OR COLOR.

FOR: CLOTHING, NAMELY, LINGERIE, NIGHTWEAR, IN CLASS 25 (U.S. CLS. 22 AND 39).

SN 78-796,406, FILED 1-20-2006.

FIRST USE 9-0-2006; IN COMMERCE 9-0-2006.

WILLIAM VERHOSEK, EXAMINING ATTORNEY

**Int. Cl.: 9**

**Prior U.S. Cls.: 21, 23, 26, 36, and 38**

**Reg. No. 3,500,159**

**United States Patent and Trademark Office**

**Registered Sep. 9, 2008**

**TRADEMARK  
PRINCIPAL REGISTER**



SMARTSHOPPER ELECTRONICS, LLC (DELA-  
WARE LIMITED LIABILITY COMPANY)  
6000 LOMBARDO CENTER  
#205  
SEVEN HILLS, OH 44131

FOR: STAND ALONE COMPUTER UNITS THAT  
USE SPEECH RECOGNITION SOFTWARE AND  
COMPUTER SOFTWARE TO GENERATE AND  
PRINT SHOPPING LISTS , IN CLASS 9 (U.S. CLS.  
21, 23, 26, 36 AND 38).

FIRST USE 1-1-2007; IN COMMERCE 1-1-2007.

THE COLOR(S) RED, BLUE, WHITE AND GRAY  
IS/ARE CLAIMED AS A FEATURE OF THE MARK.

THE MARK CONSISTS OF THE LETTER "S" IN  
WHITE INSIDE A BLUE CIRCLE WITH A RED  
OUTLINE, THE GRAY SHADOW APPEARING UN-  
DERNEATH THE CIRCLE AND THE WORDING  
"SMART" IN BLUE AND "SHOPPER" IN RED  
APPEARING UNDERNEATH THE CIRCLE AND  
THE GRAY SHADOW.

SN 78-798,148, FILED 1-24-2006.

JENNY PARK, EXAMINING ATTORNEY

**Int. Cl.: 25**

**Prior U.S. Cls.: 22 and 39**

**United States Patent and Trademark Office**

**Reg. No. 3,500,160**

**Registered Sep. 9, 2008**

**TRADEMARK  
PRINCIPAL REGISTER**

**B2V**

LOS ANGELES POLICE REVOLVER AND ATH-  
LETIC CLUB, INC. (CALIFORNIA NON-PROF-  
IT CORPORATION)  
1880 NORTH ACADEMY DRIVE  
LOS ANGELES, CA 90012

FOR: CLOTHING, NAMELY, T-SHIRTS, POLO  
SHIRTS, SWEATSHIRTS, SWEAT PANTS, SHORTS,  
PANTS, BELTS, SCARVES, JACKETS, AND HEAD-  
WEAR, IN CLASS 25 (U.S. CLS. 22 AND 39).

FIRST USE 9-0-1986; IN COMMERCE 9-0-1986.

THE MARK CONSISTS OF STANDARD CHAR-  
ACTERS WITHOUT CLAIM TO ANY PARTICULAR  
FONT, STYLE, SIZE, OR COLOR.

OWNER OF U.S. REG. NO. 2,394,776.

SN 78-798,236, FILED 1-24-2006.

BERYL GARDNER, EXAMINING ATTORNEY

**Int. Cl.: 35**

**Prior U.S. Cls.: 100, 101, and 102**

**United States Patent and Trademark Office**

**Reg. No. 3,500,161**

**Registered Sep. 9, 2008**

**SERVICE MARK  
PRINCIPAL REGISTER**

**YOUR CAUSE IS OUR CAUSE**

ADVANTAGE SALES & MARKETING, LLC (CALIFORNIA LIMITED LIABILITY COMPANY)  
19100 VON KARMAN AVENUE  
IRVINE, CA 92612

FOR: BUSINESS AND COMPANY SERVICES, NAMELY, INDEPENDENT SALES REPRESENTATIVES IN CONSUMER ELECTRONICS FIELD; BUSINESS AND COMPANY SERVICES, NAMELY, ADVERTISING, MARKETING, AND PROMOTION SERVICES, IN CLASS 35 (U.S. CLS. 100, 101 AND 102).

FIRST USE 5-31-2005; IN COMMERCE 5-31-2005.

THE MARK CONSISTS OF STANDARD CHARACTERS WITHOUT CLAIM TO ANY PARTICULAR FONT, STYLE, SIZE, OR COLOR.

SN 78-799,037, FILED 1-25-2006.

ANNE MADDEN, EXAMINING ATTORNEY

**Int. Cl.: 9**

**Prior U.S. Cls.: 21, 23, 26, 36, and 38**

**United States Patent and Trademark Office**

**Reg. No. 3,500,162**

**Registered Sep. 9, 2008**

**TRADEMARK  
PRINCIPAL REGISTER**

**FREESPACE**

HILLCREST LABORATORIES, INC. (DELAWARE CORPORATION)  
15245 SHADY GROVE ROAD, SUITE 400  
ROCKVILLE, MD 20850

FOR: COMPUTER MOUSE, REMOTE CONTROL FOR A PERSONAL COMPUTER AND CONSUMER ELECTRONIC DEVICES IN THE NATURE OF A 3D MOTION CONTROLLER FOR NAVIGATING DIGITAL MEDIA ACCESSED VIA THE INTERNET, INTRANET, IN-HOME NETWORK OR STORAGE DEVICE; COMPUTER PROGRAMS FOR USE IN OPERATING COMPUTER MOUSE AND MOTION

CONTROLLER, IN CLASS 9 (U.S. CLS. 21, 23, 26, 36 AND 38).

FIRST USE 2-0-2007; IN COMMERCE 2-0-2007.

THE MARK CONSISTS OF STANDARD CHARACTERS WITHOUT CLAIM TO ANY PARTICULAR FONT, STYLE, SIZE, OR COLOR.

SN 78-801,245, FILED 1-27-2006.

JESSICA A. POWERS, EXAMINING ATTORNEY



**Int. Cl.: 9**

**Prior U.S. Cls.: 21, 23, 26, 36, and 38**

**Reg. No. 3,500,163**

**United States Patent and Trademark Office**

**Registered Sep. 9, 2008**

**TRADEMARK  
PRINCIPAL REGISTER**

# Res-Solver

ULTIMATE RISK SOLUTIONS, LLC (DELA-  
WARE LIMITED LIABILITY COMPANY)  
17 ROMNEY COURT  
OWINGS MILLS, MD 211171265

THE MARK CONSISTS OF STANDARD CHAR-  
ACTERS WITHOUT CLAIM TO ANY PARTICULAR  
FONT, STYLE, SIZE, OR COLOR.

FOR: COMPUTER SOFTWARE FOR EVALUAT-  
ING LOSS RESERVES OF INSURANCE COMPA-  
NIES, IN CLASS 9 (U.S. CLS. 21, 23, 26, 36 AND 38).

SN 78-801,913, FILED 1-30-2006.

FIRST USE 2-1-2007; IN COMMERCE 2-1-2007.

MARGARET POWER, EXAMINING ATTORNEY

**Int. Cl.: 25**

**Prior U.S. Cls.: 22 and 39**

**United States Patent and Trademark Office**

**Reg. No. 3,500,164**

**Registered Sep. 9, 2008**

**TRADEMARK  
PRINCIPAL REGISTER**

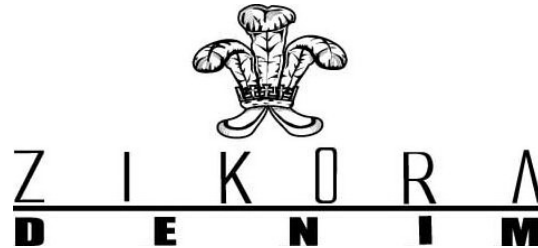

ZIKORA DENIM, LLC (NEW JERSEY LIMITED  
LIABILITY COMPANY)  
SUITE 5E  
215 AYCRIGG AVENUE  
PASSAIC PARK, NJ 07055

FOR: CLOTHING FOR MEN AND WOMEN,  
NAMELY, JEANS, PANTS, JACKETS, SHIRTS,  
COATS, KNIT JACKETS, SUEDE JACKETS, TWILL  
JACKETS, T-SHIRTS, SHORTS, HATS AND HOOD-  
DED SWEATSHIRTS, IN CLASS 25 (U.S. CLS. 22 AND  
39).

FIRST USE 9-30-2007; IN COMMERCE 9-30-2007.

NO CLAIM IS MADE TO THE EXCLUSIVE  
RIGHT TO USE "DENIM", APART FROM THE  
MARK AS SHOWN.

SN 78-802,592, FILED 1-30-2006.

CAROLYN GRAY, EXAMINING ATTORNEY

**Int. Cl.: 39**

**Prior U.S. Cls.: 100 and 105**

**United States Patent and Trademark Office**

**Reg. No. 3,500,165**

**Registered Sep. 9, 2008**

**SERVICE MARK  
PRINCIPAL REGISTER**

**SPACEBOX**

OUTBACK PARTNERSHIP NO. 1 (MISSISSIPPI  
PARTNERSHIP)  
112 SHEFFIELD LOOP  
HATTIESBURG, MS 39042

THE MARK CONSISTS OF STANDARD CHAR-  
ACTERS WITHOUT CLAIM TO ANY PARTICULAR  
FONT, STYLE, SIZE, OR COLOR.

FOR: PROVIDING SELF-STORAGE FACILITIES  
TO OTHERS; RENTAL AND LEASING OF SELF-  
STORAGE FACILITIES TO OTHERS, IN CLASS 39  
(U.S. CLS. 100 AND 105).

SN 78-804,587, FILED 2-1-2006.

FIRST USE 2-16-2008; IN COMMERCE 2-16-2008.

JAY BESCH, EXAMINING ATTORNEY

**Int. Cl.: 16**

**Prior U.S. Cls.: 2, 5, 22, 23, 29, 37, 38, and 50**

**Reg. No. 3,500,166**

**United States Patent and Trademark Office**

**Registered Sep. 9, 2008**

**TRADEMARK  
PRINCIPAL REGISTER**



JAKKS PACIFIC, INC. (DELAWARE CORPORATION)  
22619 PACIFIC COAST HIGHWAY  
MALIBU, CA 90265

FOR: ARTS AND CRAFT PAINT KITS; DRAWING BRUSHES; DRAWING INSTRUMENTS; DRAWING PADS; PAINT BRUSHES; PAINTING SETS; POSTERS; STENCILS; WRITING INSTRUMENTS, IN CLASS 16 (U.S. CLS. 2, 5, 22, 23, 29, 37, 38 AND 50).

FIRST USE 4-1-2006; IN COMMERCE 4-1-2006.

OWNER OF U.S. REG. NO. 2,373,935.

NO CLAIM IS MADE TO THE EXCLUSIVE RIGHT TO USE "COLOR", APART FROM THE MARK AS SHOWN.

THE MARK CONSISTS OF THE WORDS COLOR AND WORKSHOP; TO THE RIGHT OF THE WORDS THERE IS A PAINTBRUSH; AND A BRUSH STROKE FROM LEFT TO RIGHT APPEARS DIRECTLY BELOW THE WORD "WORKSHOP". THERE IS A RECTANGULAR BORDER AROUND THE WORDING AND DESIGN.

SN 78-807,068, FILED 2-3-2006.

AMY ALFIERI, EXAMINING ATTORNEY

**Int. Cl.: 28**

**Prior U.S. Cls.: 22, 23, 38, and 50**

**United States Patent and Trademark Office**

**Reg. No. 3,500,167**

**Registered Sep. 9, 2008**

**TRADEMARK  
PRINCIPAL REGISTER**

**ROBERT E. HOWARD**

ROBERT E HOWARD PROPERTIES INC. (DELA-  
WARE CORPORATION)  
STE. 870  
8484 WILSHIRE BOULEVARD  
BEVERLY HILLS, CA 90211

FOR: GAMES, NAMELY, TRADING CARD  
GAMES, IN CLASS 28 (U.S. CLS. 22, 23, 38 AND 50).

FIRST USE 8-20-2006; IN COMMERCE 8-20-2006.

THE MARK CONSISTS OF STANDARD CHAR-  
ACTERS WITHOUT CLAIM TO ANY PARTICULAR  
FONT, STYLE, SIZE, OR COLOR.

THE NAME(S), PORTRAIT(S), AND/OR SIGNA-  
TURE(S) SHOWN IN THE MARK DOES NOT IDEN-  
TIFY A PARTICULAR LIVING INDIVIDUAL.

SN 78-807,154, FILED 2-3-2006.

KAREN K. BUSH, EXAMINING ATTORNEY

**Int. Cls.: 35 and 36**

**Prior U.S. Cls.: 100, 101, and 102**

**United States Patent and Trademark Office**

**Reg. No. 3,500,168**

**Registered Sep. 9, 2008**

**SERVICE MARK  
PRINCIPAL REGISTER**

**EARLYPAY**

HENNESSEY CAPITAL SOLUTIONS, INC. (MI-  
CHIGAN CORPORATION)  
26321 WOODWARD AVENUE  
HUNTINGTON WOODS, MI 48070

FOR: ACCOUNTS RECEIVABLE SERVICES, IN  
CLASS 35 (U.S. CLS. 100, 101 AND 102).

FIRST USE 3-21-2006; IN COMMERCE 3-21-2006.

FOR: ACCOUNTS RECEIVABLES FINANCING;  
PROVIDING WORKING CAPITAL, IN CLASS 36  
(U.S. CLS. 100, 101 AND 102).

FIRST USE 3-21-2006; IN COMMERCE 3-21-2006.

THE MARK CONSISTS OF STANDARD CHAR-  
ACTERS WITHOUT CLAIM TO ANY PARTICULAR  
FONT, STYLE, SIZE, OR COLOR.

OWNER OF U.S. REG. NO. 3,126,158.

SN 78-817,405, FILED 2-17-2006.

IRA J. GOODSaid, EXAMINING ATTORNEY

**Int. Cl.: 25**

**Prior U.S. Cls.: 22 and 39**

**United States Patent and Trademark Office**

**Reg. No. 3,500,169**

**Registered Sep. 9, 2008**

**TRADEMARK  
PRINCIPAL REGISTER**

**SHALLOW GRAVE**

BLACK BOX, INC. (CALIFORNIA CORPORATION)  
2777 LOKER AVE WEST  
CARLSBAD, CA 92010

THE MARK CONSISTS OF STANDARD CHARACTERS WITHOUT CLAIM TO ANY PARTICULAR FONT, STYLE, SIZE, OR COLOR.

FOR: CLOTHING, NAMELY, SHIRTS, AND SWEATSHIRTS, IN CLASS 25 (U.S. CLS. 22 AND 39).

SN 78-817,582, FILED 2-17-2006.

FIRST USE 10-31-2001; IN COMMERCE 10-31-2001.

MICHAEL WEBSTER, EXAMINING ATTORNEY

**Int. Cl.: 25**

**Prior U.S. Cls.: 22 and 39**

**United States Patent and Trademark Office**

**Reg. No. 3,500,170**

**Registered Sep. 9, 2008**

**TRADEMARK  
PRINCIPAL REGISTER**

**COOL MANDOLIN COMPANY**

LEDER, LAURA (UNITED STATES INDIVIDUAL)

1380 EAGLE ROAD

NEW HOPE, PA 18938

FOR: HATS; SHIRTS, IN CLASS 25 (U.S. CLS. 22 AND 39).

FIRST USE 6-1-2006; IN COMMERCE 6-1-2006.

THE MARK CONSISTS OF STANDARD CHARACTERS WITHOUT CLAIM TO ANY PARTICULAR FONT, STYLE, SIZE, OR COLOR.

NO CLAIM IS MADE TO THE EXCLUSIVE RIGHT TO USE "COMPANY", APART FROM THE MARK AS SHOWN.

SN 78-820,144, FILED 2-21-2006.

AMY HELLA, EXAMINING ATTORNEY



**Int. Cl.: 6**

**Prior U.S. Cls.: 2, 12, 13, 14, 23, 25, and 50**

**United States Patent and Trademark Office**

**Reg. No. 3,500,171**

**Registered Sep. 9, 2008**

**TRADEMARK  
PRINCIPAL REGISTER**

**MICROSHIELD**

YALE SECURITY INC. (DELAWARE CORPORATION)  
1902 AIRPORT ROAD  
MONROE, NC 28110

FOR: FINISH SOLD AS A COMPONENT OF DOOR HARDWARE OF METAL, NAMELY, KNOBS, LEVERS, LOCKS, LOCKSETS, LOCK CYLINDERS, AND LOCK CASES, FOR THE PURPOSE OF PERMANENTLY SUPPRESSING THE GROWTH OF BACTERIA, ALGAE, FUNGUS, MOLD AND MILDEW FOR THE LIFE OF THE HARDWARE, IN CLASS 6 (U.S. CLS. 2, 12, 13, 14, 23, 25 AND 50).

FIRST USE 6-0-2007; IN COMMERCE 6-0-2007.

THE MARK CONSISTS OF STANDARD CHARACTERS WITHOUT CLAIM TO ANY PARTICULAR FONT, STYLE, SIZE, OR COLOR.

SN 78-820,920, FILED 2-22-2006.

JOHN DWYER, EXAMINING ATTORNEY

**Int. Cl.: 9**

**Prior U.S. Cls.: 21, 23, 26, 36, and 38**

**Reg. No. 3,500,172**

**United States Patent and Trademark Office**

**Registered Sep. 9, 2008**

**TRADEMARK  
PRINCIPAL REGISTER**

**MICROSHIELD**

YALE SECURITY INC. (DELAWARE CORPORATION)  
1902 AIRPORT ROAD  
MONROE, NC 28110

FOR: FINISH SOLD AS A COMPONENT OF ELECTRONIC DOOR HARDWARE, NAMELY, ELECTRIC LOCKS, FOR THE PURPOSE OF PERMANENTLY SUPPRESSING THE GROWTH OF BACTERIA, ALGAE, FUNGUS, MOLD AND MILDEW FOR THE LIFE OF THE HARDWARE, IN CLASS 9 (U.S. CLS. 21, 23, 26, 36 AND 38).

FIRST USE 10-0-2007; IN COMMERCE 10-0-2007.

THE MARK CONSISTS OF STANDARD CHARACTERS WITHOUT CLAIM TO ANY PARTICULAR FONT, STYLE, SIZE, OR COLOR.

SN 78-820,930, FILED 2-22-2006.

JOHN DWYER, EXAMINING ATTORNEY

**Int. Cl.: 11**

**Prior U.S. Cls.: 13, 21, 23, 31, and 34**

**United States Patent and Trademark Office**

**Reg. No. 3,500,173**

**Registered Sep. 9, 2008**

**TRADEMARK  
PRINCIPAL REGISTER**

**SAF-T-FRYER**

TEST RITE PRODUCTS CORPORATION (CALI-  
FORNIA CORPORATION)  
1900 SOUTH BURGUNDY PLACE  
ONTARIO, CA 91761

FOR: GAS DEEP FAT TURKEY FRYERS AND  
FRYER STANDS; ELECTRIC FISH COOKERS;  
ELECTRIC BROILERS; ELECTRIC FOOD STEA-  
MERS; ELECTRIC TOASTER OVENS; BARBEQUE  
GRILLS; ELECTRIC DEEP FRYERS, IN CLASS 11  
(U.S. CLS. 13, 21, 23, 31 AND 34).

FIRST USE 5-0-2006; IN COMMERCE 5-0-2006.

THE MARK CONSISTS OF STANDARD CHAR-  
ACTERS WITHOUT CLAIM TO ANY PARTICULAR  
FONT, STYLE, SIZE, OR COLOR.

SN 78-822,317, FILED 2-23-2006.

CAROLYN CATALDO, EXAMINING ATTORNEY

**Int. Cl.: 42**

**Prior U.S. Cls.: 100 and 101**

**United States Patent and Trademark Office**

**Reg. No. 3,500,174**

**Registered Sep. 9, 2008**

**SERVICE MARK  
PRINCIPAL REGISTER**

**HELIX**

HELIX ENERGY SOLUTIONS GROUP, INC.  
(MINNESOTA CORPORATION)  
400 N. SAM HOUSTON PKWY E., STE., 400  
HOUSTON, TX 770603548

FOR: OIL AND GAS EXPLORATION; ENGINEERING SERVICES; TECHNOLOGY CONSULTATION IN THE FIELDS OF OIL AND GAS EXPLORATION AND PRODUCTION, OIL AND GAS EXPLORATION AND PRODUCTION EQUIPMENT, AND MARINE ENGINEERING AND CONSTRUCTION; OIL AND GAS WELL INTERVENTION SERVICES FEATURING RISER BASED AND RISERLESS THROUGH-TUBING WELL INTERVENTION, SLICKLINE, ELECTRIC LINE, COIL TUBING, CEMENTING, STIMULATION, WELL TESTING AND PRODUCTION FLOWBACK, REMOTE INTERVENTION, RISER BASED AND RISERLESS SUBSEA WELL AND FIELD DECOMMISSIONING, FLOWLINE AND UMBILICAL

ABANDONMENT, CASING CUTTING AND WELL HEAD RECOVERY, PRODUCTION LOGGING, GAS LIFT SERVICES, HYDRAULIC LIFTING AND WORKOVERS, AND WELL CONTROL SERVICES, ALL IN THE FIELD OF OIL AND GAS EXPLORATION; CONDUCTING ENGINEERING AND GEOLOGICAL SURVEYS; DESIGNING AND TESTING NEW PRODUCTS FOR OTHERS, IN CLASS 42 (U.S. CLS. 100 AND 101).

FIRST USE 3-6-2006; IN COMMERCE 3-6-2006.

THE MARK CONSISTS OF STANDARD CHARACTERS WITHOUT CLAIM TO ANY PARTICULAR FONT, STYLE, SIZE, OR COLOR.

SN 78-824,415, FILED 2-27-2006.

ASMAT KHAN, EXAMINING ATTORNEY

**Int. Cl.: 6**

**Prior U.S. Cls.: 2, 12, 13, 14, 23, 25, and 50**

**United States Patent and Trademark Office**

**Reg. No. 3,500,175**

**Registered Sep. 9, 2008**

**TRADEMARK  
PRINCIPAL REGISTER**

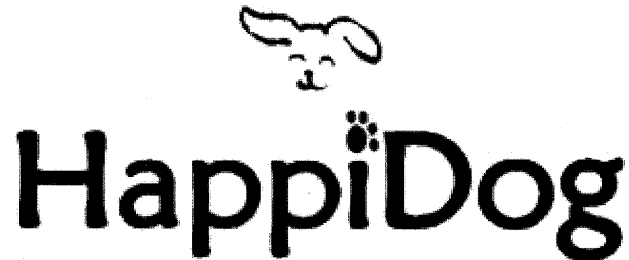

HITCHCOCK, CHLOE F. (UNITED STATES IN-  
DIVIDUAL)  
38027 STENHAMMER DR.  
FREMONT, CA 94536

FIRST USE 9-25-2000; IN COMMERCE 9-25-2000.

SN 78-824,797, FILED 2-27-2006.

FOR: METAL PERSONALIZED DOG IDENTIFI-  
CATION TAGS ACCENTED WITH GEMSTONES, IN  
CLASS 6 (U.S. CLS. 2, 12, 13, 14, 23, 25 AND 50).

LAURIE KAUFMAN, EXAMINING ATTORNEY

**Int. Cl.: 41**

**Prior U.S. Cls.: 100, 101, and 107**

**United States Patent and Trademark Office**

**Reg. No. 3,500,176**

**Registered Sep. 9, 2008**

**SERVICE MARK  
PRINCIPAL REGISTER**



DANIEL K KOMODA (NEW JERSEY SOLE PROPRIETORSHIP)  
10 POPLAR RUN  
EAST WINDSOR, NJ 085202414

THE COLOR(S) GREEN, PURPLE AND BLACK IS/ARE CLAIMED AS A FEATURE OF THE MARK.

FOR: EDITING OR RECORDING OF SOUNDS AND IMAGES; PRODUCTION OF RADIO AND TELEVISION PROGRAMS; PRODUCTION OF VIDEO DISCS FOR OTHERS; TELEVISION SHOW PRODUCTION; VIDEO TAPE EDITING, IN CLASS 41 (U.S. CLS. 100, 101 AND 107).

THE MARK CONSISTS OF A GRAPHIC OF A GREEN EYEBALL IN THE TOP LEFT AND A GRAPHIC OF A PURPLE FEMALE SQUID IN THE TOP RIGHT OVER THE WORDS, "EYEBALL SQUIDGIRL PRODUCTIONS" IN BLACK.

FIRST USE 1-25-2005; IN COMMERCE 1-25-2005.

SN 78-824,995, FILED 2-28-2006.

NO CLAIM IS MADE TO THE EXCLUSIVE RIGHT TO USE "PRODUCTIONS", APART FROM THE MARK AS SHOWN.

KELLY MCCOY, EXAMINING ATTORNEY

**Int. Cl.: 9**

**Prior U.S. Cls.: 21, 23, 26, 36, and 38**

**Reg. No. 3,500,177**

**United States Patent and Trademark Office**

**Registered Sep. 9, 2008**

**TRADEMARK  
PRINCIPAL REGISTER**

**American Rocker**

C2 GAMING, LLC (NEVADA PARTNERSHIP)  
1945 PAMA LANE  
LAS VEGAS, NV 89119

THE MARK CONSISTS OF STANDARD CHAR-  
ACTERS WITHOUT CLAIM TO ANY PARTICULAR  
FONT, STYLE, SIZE, OR COLOR.

FOR: GAMING EQUIPMENT, NAMELY, SLOT  
MACHINES WITH OR WITHOUT VIDEO OUTPUT,  
IN CLASS 9 (U.S. CLS. 21, 23, 26, 36 AND 38).

SN 78-825,477, FILED 2-28-2006.

FIRST USE 6-1-2006; IN COMMERCE 6-1-2006.

NELSON SNYDER, EXAMINING ATTORNEY

**Int. Cl.: 7**

**Prior U.S. Cls.: 13, 19, 21, 23, 31, 34, and 35**

**Reg. No. 3,500,178**

**United States Patent and Trademark Office**

**Registered Sep. 9, 2008**

---

**TRADEMARK  
PRINCIPAL REGISTER**

**EHP**

BLACK & DECKER CORPORATION, THE  
(MARYLAND CORPORATION)  
TW 199  
701 E. JOPPA ROAD  
TOWSON, MD 21286

THE MARK CONSISTS OF STANDARD CHAR-  
ACTERS WITHOUT CLAIM TO ANY PARTICULAR  
FONT, STYLE, SIZE, OR COLOR.

FOR: ELECTRIC MOTOR AND GASOLINE EN-  
GINE DRIVEN AIR COMPRESSORS, IN CLASS 7  
(U.S. CLS. 13, 19, 21, 23, 31, 34 AND 35).

SN 78-826,267, FILED 3-1-2006.

FIRST USE 10-1-2006; IN COMMERCE 10-1-2006.

JAY BESCH, EXAMINING ATTORNEY



**Int. Cl.: 36**

**Prior U.S. Cls.: 100, 101, and 102**

**United States Patent and Trademark Office**

**Reg. No. 3,500,179**

**Registered Sep. 9, 2008**

**SERVICE MARK  
PRINCIPAL REGISTER**

**PREPARE TO LIVE**

HARTFORD LIFE INSURANCE COMPANY  
(CONNECTICUT CORPORATION)  
LAW DEPT.-TECH/IP TRADEMARK UNIT HO109  
ONE HARTFORD PLAZA  
HARTFORD, CT 06155

FOR: INSURANCE AND FINANCIAL SERVICES,  
NAMELY, UNDERWRITING AND ADMINISTRATION  
OF INVESTMENT PRODUCTS, 401K, MUTUAL  
FUNDS, LIFE INSURANCE, ANNUITIES;  
MUTUAL FUND SERVICES; FINANCIAL ASSET  
AND MANAGEMENT SERVICES; ADMINISTRATION  
OF RETIREMENT BENEFIT PLANS; AND  
PERSONAL AND INSURANCE UNDERWRITING

SERVICES FOR ALL TYPES OF INSURANCE, IN  
CLASS 36 (U.S. CLS. 100, 101 AND 102).

FIRST USE 3-6-2006; IN COMMERCE 3-6-2006.

THE MARK CONSISTS OF STANDARD CHARACTERS  
WITHOUT CLAIM TO ANY PARTICULAR  
FONT, STYLE, SIZE, OR COLOR.

SN 78-826,506, FILED 3-1-2006.

ALICE BENMAMAN, EXAMINING ATTORNEY

**Int. Cl.: 42**

**Prior U.S. Cls.: 100 and 101**

**United States Patent and Trademark Office**

**Reg. No. 3,500,180**

**Registered Sep. 9, 2008**

**SERVICE MARK  
PRINCIPAL REGISTER**

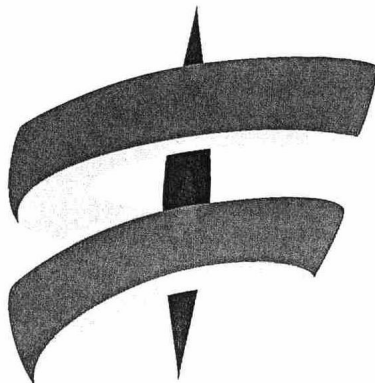

HELIX ENERGY SOLUTIONS GROUP, INC.  
(MINNESOTA CORPORATION)  
400 N. SAM HOUSTON PARKWAY E.  
SUITE 400  
HOUSTON, TX 770603548

FOR: OIL AND GAS EXPLORATION; ENGINEERING SERVICES; TECHNOLOGY CONSULTATION IN THE FIELDS OF OIL AND GAS EXPLORATION AND PRODUCTION, OIL AND GAS EXPLORATION AND PRODUCTION EQUIPMENT, AND MARINE ENGINEERING AND CONSTRUCTION; OIL AND GAS WELL INTERVENTION SERVICES FEATURING RISER BASED AND RISERLESS THROUGH-TUBING WELL INTERVENTION, SLICKLINE, ELECTRIC LINE, COIL TUBING, CEMENTING, STIMULATION, WELL TESTING AND PRODUCTION FLOWBACK, REMOTE INTERVENTION, RISER BASED AND RISERLESS SUBSEA WELL AND FIELD DE-

COMMISSIONING, FLOWLINE AND UMBILICAL ABANDONMENT, CASING CUTTING AND WELL HEAD RECOVERY, PRODUCTION LOGGING, GAS LIFT SERVICES, HYDRAULIC LIFTING AND WORKOVERS, AND WELL CONTROL SERVICES, ALL IN THE FIELD OF OIL AND GAS EXPLORATION; CONDUCTING ENGINEERING AND GEOLOGICAL SURVEYS; DESIGNING AND TESTING NEW PRODUCTS FOR OTHERS, IN CLASS 42 (U.S. CLS. 100 AND 101).

FIRST USE 3-6-2006; IN COMMERCE 3-6-2006.

THE MARK CONSISTS OF A STYLIZED REPRESENTATION OF A HELIX.

SN 78-828,911, FILED 3-3-2006.

ASMAT KHAN, EXAMINING ATTORNEY

**Int. Cl.: 9**

**Prior U.S. Cls.: 21, 23, 26, 36, and 38**

**United States Patent and Trademark Office**

**Reg. No. 3,500,181**

**Registered Sep. 9, 2008**

**TRADEMARK  
PRINCIPAL REGISTER**

**MAJOR JACKPOTS**

IGT (NEVADA CORPORATION)  
9295 PROTOTYPE DRIVE  
RENO, NV 895218986

FOR: GAMING MACHINES, NAMELY, DEVICES  
WHICH ACCEPT A WAGER, IN CLASS 9 (U.S. CLS.  
21, 23, 26, 36 AND 38).

FIRST USE 9-28-2006; IN COMMERCE 9-28-2006.

THE MARK CONSISTS OF STANDARD CHAR-  
ACTERS WITHOUT CLAIM TO ANY PARTICULAR  
FONT, STYLE, SIZE, OR COLOR.

NO CLAIM IS MADE TO THE EXCLUSIVE  
RIGHT TO USE "JACKPOTS", APART FROM THE  
MARK AS SHOWN.

SN 78-831,397, FILED 3-7-2006.

MICHAEL SOUDERS, EXAMINING ATTORNEY

**Int. Cl.: 35**

**Prior U.S. Cls.: 100, 101, and 102**

**United States Patent and Trademark Office**

**Reg. No. 3,500,182**

**Registered Sep. 9, 2008**

**SERVICE MARK  
PRINCIPAL REGISTER**

"Opening eyes, one mind at  
a time"

FREE YOUR MIND PUBLISHING, LLC (MARY-  
LAND LIMITED LIABILITY COMPANY)  
2724 KNOX TERRACE, SE  
WASHINGTON, DC 20020

FOR: ADVERTISING AND MARKETING; AD-  
VERTISING AND PROMOTION SERVICES AND  
RELATED CONSULTING; ADVERTISING AND  
PUBLICITY SERVICES; ADVERTISING AND PUB-  
LICITY SERVICES, NAMELY, PROMOTING THE  
GOODS, SERVICES, BRAND IDENTITY AND COM-  
MERCIAL INFORMATION AND NEWS OF THIRD  
PARTIES THROUGH PRINT, AUDIO, VIDEO, DIGI-  
TAL AND ON-LINE MEDIUM; ADVERTISING VIA

ELECTRONIC MEDIA AND SPECIFICALLY THE  
INTERNET, IN CLASS 35 (U.S. CLS. 100, 101 AND  
102).

FIRST USE 12-1-2006; IN COMMERCE 12-1-2006.

THE MARK CONSISTS OF STANDARD CHAR-  
ACTERS WITHOUT CLAIM TO ANY PARTICULAR  
FONT, STYLE, SIZE, OR COLOR.

SN 78-831,713, FILED 3-7-2006.

MARK T. MULLEN, EXAMINING ATTORNEY

**Int. Cl.: 35**

**Prior U.S. Cls.: 100, 101, and 102**

**United States Patent and Trademark Office**

**Reg. No. 3,500,183**

**Registered Sep. 9, 2008**

**SERVICE MARK  
PRINCIPAL REGISTER**

**LUCKY KID**

LUCKY BRAND DUNGAREES, INC. (CALIFORNIA CORPORATION)  
5233 ALCOA AVENUE  
VERNON, CA 90058

FOR: RETAIL STORE SERVICES AND ONLINE RETAIL STORE SERVICES, OTHER THAN SUPERMARKETS, CONVENIENCE STORES, DRUG STORES AND COMBINATION SUPERMARKET/DRUG STORES, AND MAIL ORDER SERVICES, ALL IN THE FIELD OF APPAREL, LEATHER GOODS, FASHION ACCESSORIES, JEWELRY, FOOTWEAR, EYEWEAR, IN CLASS 35 (U.S. CLS. 100, 101 AND 102).

FIRST USE 8-26-2006; IN COMMERCE 8-26-2006.

THE MARK CONSISTS OF STANDARD CHARACTERS WITHOUT CLAIM TO ANY PARTICULAR FONT, STYLE, SIZE, OR COLOR.

OWNER OF U.S. REG. NOS. 2,655,004, 2,703,123, AND 2,857,464.

SN 78-833,361, FILED 3-9-2006.

DAYNA BROWNE, EXAMINING ATTORNEY

**Int. Cl.: 43**

**Prior U.S. Cls.: 100 and 101**

**United States Patent and Trademark Office**

**Reg. No. 3,500,184**

**Registered Sep. 9, 2008**

**SERVICE MARK  
PRINCIPAL REGISTER**

**Zorkafor's SandVeg**

ZORKAFOR'S SANDVEG INC. (VIRGINIA CORPORATION)  
1121 KING STREET  
ALEXANDRIA, VA 22314

THE MARK CONSISTS OF STANDARD CHARACTERS WITHOUT CLAIM TO ANY PARTICULAR FONT, STYLE, SIZE, OR COLOR.

FOR: CARRY-OUT RESTAURANTS, IN CLASS 43 (U.S. CLS. 100 AND 101).

SN 78-835,395, FILED 3-13-2006.

FIRST USE 4-12-2008; IN COMMERCE 4-12-2008.

GEORGE LORENZO, EXAMINING ATTORNEY

**Int. Cl.: 42**

**Prior U.S. Cls.: 100 and 101**

**United States Patent and Trademark Office**

**Reg. No. 3,500,185**

**Registered Sep. 9, 2008**

**SERVICE MARK  
PRINCIPAL REGISTER**

**LABREXX**

IDEXX LABORATORIES, INC. (DELAWARE  
CORPORATION)  
ONE IDEXX DRIVE  
WESTBROOK, ME 04092

FOR: PROVIDING VETERINARY LABORATORY  
SERVICES WHICH MAY BE ORDERED VIA AN ON-  
LINE GLOBAL COMPUTER NETWORK, IN CLASS  
42 (U.S. CLS. 100 AND 101).

FIRST USE 1-31-2008; IN COMMERCE 1-31-2008.

THE MARK CONSISTS OF STANDARD CHAR-  
ACTERS WITHOUT CLAIM TO ANY PARTICULAR  
FONT, STYLE, SIZE, OR COLOR.

OWNER OF U.S. REG. NO. 2,883,348.

SN 78-836,353, FILED 3-14-2006.

JESSICA A. POWERS, EXAMINING ATTORNEY

**Int. Cl.: 11**

**Prior U.S. Cls.: 13, 21, 23, 31, and 34**

**Reg. No. 3,500,186**

**United States Patent and Trademark Office**

**Registered Sep. 9, 2008**

**TRADEMARK  
PRINCIPAL REGISTER**

# AutoSanor

ROCHESTER MIDLAND CORPORATION (NEW  
YORK CORPORATION)  
P.O. BOX 31515  
333 HOLLENBECK STREET  
ROCHESTER, NY 146031515

FOR: DISPENSER FOR MIXTURE OF DETER-  
GENTS, DEODORANTS, AND WETTING AGENTS  
METERED INTO BOWLS OF TOILETS AND URIN-  
ALS, IN CLASS 11 (U.S. CLS. 13, 21, 23, 31 AND 34).

FIRST USE 3-18-2008; IN COMMERCE 3-18-2008.

THE MARK CONSISTS OF STANDARD CHAR-  
ACTERS WITHOUT CLAIM TO ANY PARTICULAR  
FONT, STYLE, SIZE, OR COLOR.

OWNER OF U.S. REG. NOS. 542,646 AND 3,013,364.

SN 78-836,829, FILED 3-14-2006.

TINA BROWN, EXAMINING ATTORNEY



Int. Cl.: 9

Prior U.S. Cls.: 21, 23, 26, 36, and 38

Reg. No. 3,500,187

United States Patent and Trademark Office

Registered Sep. 9, 2008

TRADEMARK  
PRINCIPAL REGISTER

*free*KVM

DIGI INTERNATIONAL INC. (DELAWARE CORPORATION)  
11001 BREN ROAD EAST  
MINNETONKA, MN 55343

THE MARK CONSISTS OF THE LETTERS "FREE" IN LOWER CASE, BOLDED AND ITALICIZED, AND THE LETTERS "KVM" IN CAPS.

FOR: COMPUTER SOFTWARE USED TO PROVIDE REMOTE ACCESS TO THE GRAPHICAL DESKTOPS OF MANAGED COMPUTER SYSTEMS, IN CLASS 9 (U.S. CLS. 21, 23, 26, 36 AND 38).

SN 78-837,973, FILED 3-15-2006.

FIRST USE 6-0-2006; IN COMMERCE 6-0-2006.

MARTHA FROMM, EXAMINING ATTORNEY

**Int. Cl.: 9**

**Prior U.S. Cls.: 21, 23, 26, 36, and 38**

**United States Patent and Trademark Office**

**Reg. No. 3,500,188**

**Registered Sep. 9, 2008**

**TRADEMARK  
PRINCIPAL REGISTER**

**OPTIMUM RESULTS FROM THE  
ULTIMATE SOFTWARE**

OMAX CORPORATION (WASHINGTON COR-  
PORATION)  
21409 72ND AVE. SOUTH  
KENT, WA 98032

FOR: COMPUTER SOFTWARE FOR CONTROL-  
LING, MONITORING AND OPERATING ABRA-  
SIVE JET CUTTING MACHINES USED FOR  
CUTTING AND MACHINING, IN CLASS 9 (U.S.  
CLS. 21, 23, 26, 36 AND 38).

FIRST USE 1-22-2008; IN COMMERCE 1-22-2008.

THE MARK CONSISTS OF STANDARD CHAR-  
ACTERS WITHOUT CLAIM TO ANY PARTICULAR  
FONT, STYLE, SIZE, OR COLOR.

SN 78-838,172, FILED 3-15-2006.

EDWARD FENNESSY, EXAMINING ATTORNEY

**Int. Cl.: 34**

**Prior U.S. Cls.: 2, 8, 9, and 17**

**United States Patent and Trademark Office**

**Reg. No. 3,500,189**

**Registered Sep. 9, 2008**

**TRADEMARK  
PRINCIPAL REGISTER**

**PERDOMO ARTESANAL**

NICK'S CIGAR COMPANY (FLORIDA CORPORATION)  
5150 NORTHWEST 167TH STREET  
MIAMI LAKES, FL 33014

OWNER OF U.S. REG. NOS. 2,498,219, 2,500,189,  
AND 2,803,302.

FOR: CIGARS, IN CLASS 34 (U.S. CLS. 2, 8, 9 AND 17).

THE FOREIGN WORDING IN THE MARK  
TRANSLATES INTO ENGLISH AS ARTISTIC.

FIRST USE 11-26-2007; IN COMMERCE 11-26-2007.

SN 78-838,616, FILED 3-16-2006.

THE MARK CONSISTS OF STANDARD CHARACTERS WITHOUT CLAIM TO ANY PARTICULAR FONT, STYLE, SIZE, OR COLOR.

DAYNA BROWNE, EXAMINING ATTORNEY

**Int. Cl.: 30**

**Prior U.S. Cl.: 46**

**United States Patent and Trademark Office**

**Reg. No. 3,500,190**

**Registered Sep. 9, 2008**

**TRADEMARK  
PRINCIPAL REGISTER**

**BOO! BARK**

ARC OF ROCKLAND (NEW YORK NOT FOR  
PROFIT CORPORATION)  
25 HEMLOCK DRIVE  
CONGERS, NY 10920

NO CLAIM IS MADE TO THE EXCLUSIVE  
RIGHT TO USE "BARK", APART FROM THE  
MARK AS SHOWN.

FOR: CHOCOLATE, IN CLASS 30 (U.S. CL. 46).

FIRST USE 9-25-2006; IN COMMERCE 9-25-2006.

SN 78-839,223, FILED 3-16-2006.

THE MARK CONSISTS OF STANDARD CHAR-  
ACTERS WITHOUT CLAIM TO ANY PARTICULAR  
FONT, STYLE, SIZE, OR COLOR.

Laurie Mayes, Examining Attorney

**Int. Cl.: 18**

**Prior U.S. Cls.: 1, 2, 3, 22, and 41**

**United States Patent and Trademark Office**

**Reg. No. 3,500,191**

**Registered Sep. 9, 2008**

**TRADEMARK  
PRINCIPAL REGISTER**



TRAVEL RX (WASHINGTON PARTNERSHIP)  
9904 NE 124TH ST B-102  
KIRKLAND, WA 98034

FOR: ALL-PURPOSE CARRYING BAGS; TRAVEL BAGS; TRAVELING BAGS, IN CLASS 18 (U.S. CLS. 1, 2, 3, 22 AND 41).

FIRST USE 8-0-2006; IN COMMERCE 12-3-2006.

NO CLAIM IS MADE TO THE EXCLUSIVE RIGHT TO USE "TRAVEL", APART FROM THE MARK AS SHOWN.

THE COLOR(S) BLUE, WHITE, BLACK, PURPLE IS/ARE CLAIMED AS A FEATURE OF THE MARK.

THE GLOBE SHOWS THE WATER MASSES IN BLUE, AND THE LAND MASSES IN PURPLE.

THE MARK CONSISTS OF TRAVEL RX AND A GLOBE OF THE WORLD.

SN 78-839,410, FILED 3-16-2006.

WILLIAM P. SHANAHAN, EXAMINING ATTORNEY

**Int. Cl.: 43**

**Prior U.S. Cls.: 100 and 101**

**United States Patent and Trademark Office**

**Reg. No. 3,500,192**

**Registered Sep. 9, 2008**

**SERVICE MARK  
PRINCIPAL REGISTER**

**BAMBOOZLE**

GOODY GIRLS, INC. (FLORIDA CORPORATION)  
2806 WEST ESTRELLA STREET  
TAMPA, FL 33629

THE MARK CONSISTS OF STANDARD CHARACTERS WITHOUT CLAIM TO ANY PARTICULAR FONT, STYLE, SIZE, OR COLOR.

FOR: RESTAURANT SERVICES, IN CLASS 43 (U.S. CLS. 100 AND 101).

SN 78-841,080, FILED 3-20-2006.

FIRST USE 4-21-2008; IN COMMERCE 4-21-2008.

JENNY PARK, EXAMINING ATTORNEY

**Int. Cl.: 17**

**Prior U.S. Cls.: 1, 5, 12, 13, 35, and 50**

**United States Patent and Trademark Office**

**Reg. No. 3,500,193**

**Registered Sep. 9, 2008**

**TRADEMARK  
PRINCIPAL REGISTER**

# OPTICSEAL

AXYGEN, INC. (CALIFORNIA CORPORATION)  
33210 CENTRAL AVE  
UNION CITY, CA 94587

FIRST USE 9-25-2007; IN COMMERCE 12-11-2007.

FOR: CELLULOSE ACETATE FILM, PLASTIC SHEETING AND POLYMER SHEETS USED TO COVER MULTI-WELL PLATES USED IN CHEMICAL ANALYSIS, BIOLOGICAL ANALYSIS OR PATTERNING FOR SCIENTIFIC, LABORATORY OR MEDICAL RESEARCH USE, IN CLASS 17 (U.S. CLS. 1, 5, 12, 13, 35 AND 50).

THE MARK CONSISTS OF STANDARD CHARACTERS WITHOUT CLAIM TO ANY PARTICULAR FONT, STYLE, SIZE, OR COLOR.

SN 78-841,376, FILED 3-20-2006.

ANGELA GAW, EXAMINING ATTORNEY

**Int. Cl.: 16**

**Prior U.S. Cls.: 2, 5, 22, 23, 29, 37, 38, and 50**

**Reg. No. 3,500,194**

**United States Patent and Trademark Office**

**Registered Sep. 9, 2008**

**TRADEMARK  
PRINCIPAL REGISTER**



VIA TECHNOLOGIES, INC. (TAIWAN CORPORATION)  
ATTN: LEGAL AFFAIRS  
533 CHUNG-CHENG ROAD, 8TH FLOOR  
HSIN-TIEN, TAIWAN

FOR: PRINTED PUBLICATIONS AND PRINTED MATTER, NAMELY, INSTRUCTION MANUALS, TRAINING PAPERS, WHITE PAPERS, BOOKS, MAGAZINES, NEWSLETTERS, JOURNALS, USERS GUIDES, PAMPHLETS, BROCHURES, NEWS REPORTS, BULLETINS, PRINTED EVENT PROGRAMS AND EXHIBITION CALENDARS, PAPERBACKS, PRINTED MARKETING, MERCHANDISING, PRODUCT USAGE INFORMATION AND PROMOTIONAL MATERIALS, NAMELY, POSTERS, BROCHURES, PROSPECTUSES, PUBLICITY FOLDERS, PRODUCT REVIEWS, PRODUCT ANALYSIS REPORTS, BUSINESS CARDS, TRADING CARDS, PAPER PLACARDS, PAPER PENNANTS, BANNERS, POSTERS, TRANSPARENCIES, PRINTED EVENT TICKETS, PRINTED PARTICIPANT CARDS, PRINTED INVITATIONS, POST CARDS, UN-CODED PRINTED IDENTIFICATION CARDS AND PRINTED TRAINING AND DEVELOPMENT MATERIALS FOR CONDUCTING CONFERENCES, WORKSHOPS, SEMINARS IN THE AREAS OF COMPUTER HARDWARE, COMPUTER SOFTWARE, GRAPHICS, COMPUTER GAMES, ENTERTAINMENT IN THE NATURE OF COMPUTER GAMES, COMIC BOOKS, MUSIC, MEDIA PROGRAMMING, AUDIO AND VIDEO PRODUCTION, ROBOTICS, WIRELESS COMMUNICATIONS, TELECOMMUNICATIONS, INTERNET CONNECTIVITY, INFORMATION TECHNOLOGY, COMMUNICATION CONNECTIVITY, CONSUMER ELECTRONICS, BUSINESS COMPUTING AND ENVIRONMENTALLY-FRIENDLY COMPUTING; CATALOGUE FEATURING INTERACTIVE MULTIMEDIA COMPUTING, SONG BOOKS, PRINTED

LISTINGS, ARTICLES AND SPECIAL FEATURES CONCERNING TELEVISION PROGRAMMING AND VIDEO ENTERTAINMENT; PRINTED PAPER GOODS, NAMELY, WRITING PAPER, ENVELOPES, NOTEPAPERS, WRITING PADS, NOTE CARDS, NOTEBOOK BINDERS, PAPER FOLDERS, BOOKMARKERS, CALENDARS, DIARIES, PRINTED PAPER POSTERS, BUSINESS CARDS, PRINTED PAPER IDENTIFICATION TAGS, SELF-ADHESIVE STATIONARY LABELS, SELF-ADHESIVE PADS, DESK PADS, CALENDAR PADS, CRAYONS, PENS, PENCILS, ERASERS, MARKERS, PEN AND PENCIL HOLDERS, PAPERWEIGHTS, LETTER OPENERS, CLIP BOARDS, PHOTOGRAPHS, DESKTOP ORGANIZERS, DECALS, STICKERS, PRINTED GIFT CARDS, PRINTED REWARD CERTIFICATES, COMIC BOOKS, COLORING BOOKS, ACTIVITY BOOKS, NOTEBOOKS, ADDRESS BOOKS, CORK BOARDS, CHALK BOARDS, AND MEMORANDUM BOARDS; SHEET MUSIC, SKETCHBOOKS, PAPER PARTY GOODS, NAMELY, POSTCARDS, GREETING CARDS, GIFT WRAP, PAPER PARTY DECORATIONS, PAPER NAPKINS, PAPER RIBBONS, PAPER PARTY BAGS, PAPER PARTY HATS, IN CLASS 16 (U.S. CLS. 2, 5, 22, 23, 29, 37, 38 AND 50).

FIRST USE 1-1-1997; IN COMMERCE 1-1-1997.

OWNER OF U.S. REG. NOS. 2,698,559, 3,083,408, AND 3,174,591.

THE COLOR(S) BLUE AND BLACK IS/ARE CLAIMED AS A FEATURE OF THE MARK.

THE MARK CONSISTS OF THE WORD VIA IN BLUE COLOR WITH A SINGLE OVAL "HALO" DESIGN IN BLUE COLOR AROUND THE WORD VIA. THE TAGLINE "WE CONNECT" IS IN BLACK COLOR.



SN 78-841,839, FILED 3-20-2006.

KATHLEEN M. VANSTON, EXAMINING ATTOR-  
NEY

**Int. Cl.: 7**

**Prior U.S. Cls.: 13, 19, 21, 23, 31, 34, and 35**

**Reg. No. 3,500,195**

**United States Patent and Trademark Office**

**Registered Sep. 9, 2008**

**TRADEMARK  
PRINCIPAL REGISTER**

# Hy-Watch

HY-LIFT HUNTING BLINDS, INC. (TEXAS CORPORATION)  
6915 HUDSON VILLAGE CREEK ROAD  
KENNEDALE, TX 76060

FOR: SELF-CONTAINED POWER-OPERATED LIFT UNIT USED BY POLICE OFFICERS, SECURITY PERSONNEL AND OTHER LAY PERSONS FOR SURVEILLANCE AND SECURITY PURPOSES IN PARKING LOTS, AT SHOPPING MALLS, AT SPECIAL EVENTS, OR OTHER CROWDED AREAS, USED FOR HELP WITH CROWD SUPERVISION, CROWD CONTROL AND AS A THEFT DETER-

RENT, IN CLASS 7 (U.S. CLS. 13, 19, 21, 23, 31, 34 AND 35).

FIRST USE 1-30-2008; IN COMMERCE 1-30-2008.

THE MARK CONSISTS OF STANDARD CHARACTERS WITHOUT CLAIM TO ANY PARTICULAR FONT, STYLE, SIZE, OR COLOR.

SN 78-842,142, FILED 3-21-2006.

MICHAEL SOUDERS, EXAMINING ATTORNEY

**Int. Cl.: 10**

**Prior U.S. Cls.: 26, 39, and 44**

**United States Patent and Trademark Office**

**Reg. No. 3,500,196**

**Registered Sep. 9, 2008**

**TRADEMARK  
PRINCIPAL REGISTER**

**HUMIDIFLOW**

POROUS MEDIA CORPORATION (MINNESOTA  
CORPORATION)  
1350 HAMMOND ROAD  
ST. PAUL, MN 55110

THE MARK CONSISTS OF STANDARD CHAR-  
ACTERS WITHOUT CLAIM TO ANY PARTICULAR  
FONT, STYLE, SIZE, OR COLOR.

FOR: MEMBRANE GAS HUMIDIFIER FOR  
HOME MEDICAL USE, IN CLASS 10 (U.S. CLS. 26,  
39 AND 44).

SN 78-842,147, FILED 3-21-2006.

FIRST USE 7-1-2008; IN COMMERCE 7-1-2008.

LINDA LAVACHE, EXAMINING ATTORNEY

**Int. Cl.: 24**

**Prior U.S. Cls.: 42 and 50**

**United States Patent and Trademark Office**

**Reg. No. 3,500,197**

**Registered Sep. 9, 2008**

**TRADEMARK  
PRINCIPAL REGISTER**

**Viteré**

WELSPUN INDIA LIMITED (INDIA CORPORATION)  
B-WING TRADE WORLD 9TH FL KAMALA MILLS  
COMPOUND SENAPATI-BAPAT MARG LOWER  
PAREL  
MUMBAI, INDIA 400013

FIRST USE 9-0-2006; IN COMMERCE 9-0-2006.

SN 78-842,366, FILED 3-21-2006.

FOR: BED SHEETS; TOWELS, IN CLASS 24 (U.S. CLS. 42 AND 50).

KATHRYN COWARD, EXAMINING ATTORNEY

**Int. Cl.: 25**

**Prior U.S. Cls.: 22 and 39**

**United States Patent and Trademark Office**

**Reg. No. 3,500,198**

**Registered Sep. 9, 2008**

**TRADEMARK  
PRINCIPAL REGISTER**

The logo consists of the word "KIKBU" in a bold, hand-drawn, blocky font. Each letter is outlined with a thick black stroke, giving it a three-dimensional, slightly irregular appearance. The letters are closely spaced and centered on the page.

LEE, HERBERT (UNITED STATES INDIVIDUAL)  
4085 S RIVER LANE  
ELLENWOOD, GA 30294

FIRST USE 5-24-2006; IN COMMERCE 5-24-2006.

SN 78-842,727, FILED 3-21-2006.

FOR: HATS; HEADBANDS; T-SHIRTS, IN CLASS  
25 (U.S. CLS. 22 AND 39).

WILLIAM P. SHANAHAN, EXAMINING ATTOR-  
NEY

**Int. Cl.: 9**

**Prior U.S. Cls.: 21, 23, 26, 36, and 38**

**United States Patent and Trademark Office**

**Reg. No. 3,500,199**

**Registered Sep. 9, 2008**

**TRADEMARK  
PRINCIPAL REGISTER**

**EASYCARE**

COLE NATIONAL CORPORATION (DELAWARE  
CORPORATION)  
4000 LUXOTTICA PLACE  
MASON, OH 45040

THE MARK CONSISTS OF STANDARD CHAR-  
ACTERS WITHOUT CLAIM TO ANY PARTICULAR  
FONT, STYLE, SIZE, OR COLOR.

FOR: EYEGLOSS LENSES AND LENS COATINGS  
SOLD AS A COMPONENT OF THE LENSES, IN  
CLASS 9 (U.S. CLS. 21, 23, 26, 36 AND 38).

SN 78-845,670, FILED 3-24-2006.

FIRST USE 4-23-2006; IN COMMERCE 4-23-2006.

KAPIL BHANOT, EXAMINING ATTORNEY

**Int. Cl.: 43**

**Prior U.S. Cls.: 100 and 101**

**United States Patent and Trademark Office**

**Reg. No. 3,500,200**

**Registered Sep. 9, 2008**

**SERVICE MARK  
PRINCIPAL REGISTER**

# PALACE BED

PALACE HOLDING, S.A. DE C.V. (MEXICO CORPORATION)

HOTEL CANCUN PALACE, ZONA HOTELERA

BOULEVARD KUKULCAN, KM. 14.5

CANCUN, QUINTANA ROO, MEXICO C.P. 7750

FOR: HOTELS AND RESORT HOTELS FEATURING ROOMS WITH BEDS WITH PILLOW-TOP MATTRESSES AND SPECIALLY DESIGNED COMFORT COILS, IN CLASS 43 (U.S. CLS. 100 AND 101).

FIRST USE 3-27-2006; IN COMMERCE 3-27-2006.

THE MARK CONSISTS OF STANDARD CHARACTERS WITHOUT CLAIM TO ANY PARTICULAR FONT, STYLE, SIZE, OR COLOR.

OWNER OF U.S. REG. NOS. 2,631,946 AND 2,761,807.

NO CLAIM IS MADE TO THE EXCLUSIVE RIGHT TO USE "BED", APART FROM THE MARK AS SHOWN.

SN 78-846,051, FILED 3-24-2006.

PAUL E. FAHRENKOPF, EXAMINING ATTORNEY

**Int. Cl.: 20**

**Prior U.S. Cls.: 2, 13, 22, 25, 32, and 50**

**Reg. No. 3,500,201**

**United States Patent and Trademark Office**

**Registered Sep. 9, 2008**

**TRADEMARK  
PRINCIPAL REGISTER**

**RIGHTTOUCH**

SEALY TECHNOLOGY LLC (NORTH CAROLINA LIMITED LIABILITY COMPANY)  
ONE OFFICE PARKWAY  
TRINITY, NC 27370

THE MARK CONSISTS OF STANDARD CHARACTERS WITHOUT CLAIM TO ANY PARTICULAR FONT, STYLE, SIZE, OR COLOR.

FOR: BOX SPRINGS; MATTRESSES, IN CLASS 20 (U.S. CLS. 2, 13, 22, 25, 32 AND 50).

SN 78-846,430, FILED 3-27-2006.

FIRST USE 4-0-2006; IN COMMERCE 4-0-2006.

JESSICA A. POWERS, EXAMINING ATTORNEY



**Int. Cl.: 36**

**Prior U.S. Cls.: 100, 101, and 102**

**United States Patent and Trademark Office**

**Reg. No. 3,500,202**

**Registered Sep. 9, 2008**

**SERVICE MARK  
PRINCIPAL REGISTER**



PEREGRINE FINANCIAL GROUP, INC. (IOWA CORPORATION)  
190 SOUTH LASALLE STREET, 7TH FLOOR  
CHICAGO, IL 60603

FOR: FINANCIAL SERVICES, NAMELY CONDUCTING FUTURES, COMMODITIES, FOREX, SECURITIES BROKERAGE SERVICES AND RELATED TRADING SERVICES, NAMELY; COMPILING, ORGANIZING AND DISSEMINATING; FUTURES, SECURITIES, COMMODITIES, AND FOREX INFORMATION; ELECTRONIC FUTURES, SECURITIES, COMMODITIES AND FOREX TRANSACTION PROCESSING OF ORDERS FOR THE PURCHASE AND SALE OF FUTURES, COMMODITIES AND FOREX, SECURITIES, STOCK, AND OPTIONS, MUTUAL FUNDS, TRUST ACCOUNTS, AND FINANCIAL INSTRUMENTS, IN CLASS 36 (U.S. CLS. 100, 101 AND 102).

FIRST USE 10-1-2006; IN COMMERCE 10-1-2006.

OWNER OF U.S. REG. NOS. 2,591,702 AND 2,612,848.

NO CLAIM IS MADE TO THE EXCLUSIVE RIGHT TO USE "PROTRADER", APART FROM THE MARK AS SHOWN.

THE COLORS BLUE, YELLOW, BLACK AND WHITE ARE CLAIMED AS A FEATURE OF THE MARK.

THE TRIANGLE, GRAPH AND WORDS PROTRADER ARE BLUE, THE GRAPH LINE IS YELLOW, PFG DIRECT IS IN BLACK AND BEST IS IN WHITE.

SN 78-847,601, FILED 3-28-2006.

JOHN WILKE, EXAMINING ATTORNEY

**Int. Cls.: 36, 39, 41, 43, and 45**

**Prior U.S. Cls.: 100, 101, 102, 105, and 107**

**United States Patent and Trademark Office**

**Reg. No. 3,500,203**

**Registered Sep. 9, 2008**

**SERVICE MARK  
PRINCIPAL REGISTER**

**SAISON DESK**

KABUSHIKI KAISHA CREDIT SAISON (CREDIT SAISON, CO., LTD.) (JAPAN CORPORATION)  
1-1, HIGASHI-IKEBUKURO 3-CHOME  
TOSHIMA-KU, TOKYO, JAPAN

FOR: ISSUING CREDIT CARDS; FOREIGN EXCHANGE INFORMATION SERVICE, IN CLASS 36 (U.S. CLS. 100, 101 AND 102).

FIRST USE 2-20-2006; IN COMMERCE 3-1-2006.

FOR: ARRANGING TRAVEL TOUR; TRAVEL AGENCY SERVICE, NAMELY, MAKING RESERVATIONS AND BOOKINGS FOR TRANSPORTATION; TRAVEL AND TOUR INFORMATION SERVICE; TRAVEL GUIDE SERVICE; TRAVEL, EXCURSION AND CRUISE ARRANGEMENT; TRANSPORTATION RESERVATION SERVICES; RENTAL CAR RESERVATION; STORAGE OF BAGGAGE; PROVIDING FLIGHT ARRIVAL AND DEPARTURE INFORMATION; PROVIDING ROAD AND TRAFFIC INFORMATION, IN CLASS 39 (U.S. CLS. 100 AND 105).

FIRST USE 2-20-2006; IN COMMERCE 3-1-2006.

FOR: CONCERT BOOKING; BOOKING OF SEATS FOR SHOWS AND BOOKING OF THEATRE TICKETS; RENTAL OF BOOKS AND MAGAZINES; RENTAL OF SKIN DIVING EQUIPMENT; RENTAL OF SPORTS EQUIPMENT EXCEPT VEHICLES; TRANSLATION SERVICES; LANGUAGE INTERPRETA-

TION; MAKING GOLF COURSE RESERVATIONS FOR OTHERS, IN CLASS 41 (U.S. CLS. 100, 101 AND 107).

FIRST USE 2-20-2006; IN COMMERCE 3-1-2006.

FOR: HOTEL RESERVATION; RESERVATION OF RESTAURANT; SERVING FOOD AND DRINKS, IN CLASS 43 (U.S. CLS. 100 AND 101).

FIRST USE 2-20-2006; IN COMMERCE 3-1-2006.

FOR: CONCIERGE SERVICES FOR OTHERS COMPRISING MAKING REQUESTED PERSONAL ARRANGEMENTS AND RESERVATIONS AND PROVIDING CUSTOMER-SPECIFIC INFORMATION TO MEET INDIVIDUAL NEEDS OF CREDIT CARD HOLDERS AND TRAVELERS; PERSONAL SECURITY CONSULTATION, IN CLASS 45 (U.S. CLS. 100 AND 101).

FIRST USE 2-20-2006; IN COMMERCE 3-1-2006.

THE WORDING "SAISON" IS A FRENCH WORD CORRESPONDING TO THE WORD "SEASON" IN ENGLISH.

SN 78-847,756, FILED 3-28-2006.

MARGERY A. TIERNEY, EXAMINING ATTORNEY

**Int. Cls.: 36, 39, 41, 43, and 45**

**Prior U.S. Cls.: 100, 101, 102, 105, and 107**

**United States Patent and Trademark Office**

**Reg. No. 3,500,204**

**Registered Sep. 9, 2008**

**SERVICE MARK  
PRINCIPAL REGISTER**

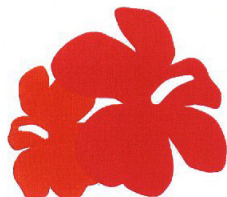

**SAISON DESK  
HAWAII**

KABUSHIKI KAISHA CREDIT SAISON (CREDIT SAISON, CO., LTD.) (JAPAN CORPORATION)  
1-1, HIGASHI-IKEBUKURO, 3-CHOME  
TOSHIMA-KU, TOKYO, JAPAN

FOR: ISSUING CREDIT CARDS; FOREIGN EXCHANGE INFORMATION SERVICE, IN CLASS 36 (U.S. CLS. 100, 101 AND 102).

FIRST USE 2-20-2006; IN COMMERCE 3-1-2006.

FOR: ARRANGING TRAVEL TOUR; TRAVEL AGENCY SERVICE, NAMELY, MAKING RESERVATIONS AND BOOKINGS FOR TRANSPORTATION; TRAVEL AND TOUR INFORMATION SERVICE; TRAVEL GUIDE SERVICE; TRAVEL, EXCURSION AND CRUISE ARRANGEMENT; TRANSPORTATION RESERVATION SERVICES; RENTAL CAR RESERVATION; STORAGE OF BAGGAGE; PROVIDING FREIGHT ARRIVAL AND DEPARTURE INFORMATION; PROVIDING ROAD AND TRAFFIC INFORMATION, IN CLASS 39 (U.S. CLS. 100 AND 105).

FIRST USE 2-20-2006; IN COMMERCE 3-1-2006.

FOR: CONCERT BOOKING; BOOKING OF SEATS FOR SHOWS AND BOOKING OF THEATRE TICKETS; RENTAL OF BOOKS AND MAGAZINES; RENTAL OF SKIN DIVING EQUIPMENT; RENTAL OF SPORTS EQUIPMENT EXCEPT VEHICLES; TRANSPORTATION SERVICES; LANGUAGE INTERPRETATION; MAKING GOLF COURSE RESERVATIONS FOR OTHERS, IN CLASS 41 (U.S. CLS. 100, 101 AND 107).

FIRST USE 2-20-2006; IN COMMERCE 3-1-2006.

FOR: HOTEL RESERVATION; RESERVATION OF RESTAURANT; SERVING FOOD AND DRINKS, IN CLASS 43 (U.S. CLS. 100 AND 101).

FIRST USE 2-20-2006; IN COMMERCE 3-1-2006.

FOR: CONCIERGE SERVICES FOR OTHERS COMPRISING MAKING REQUESTED PERSONAL ARRANGEMENTS AND RESERVATIONS AND PROVIDING CUSTOMER-SPECIFIC INFORMATION TO MEET INDIVIDUAL NEEDS OF CREDIT CARD HOLDERS AND TRAVELERS; PERSONAL SECURITY CONSULTATION, IN CLASS 45 (U.S. CLS. 100 AND 101).

FIRST USE 2-20-2006; IN COMMERCE 3-1-2006.

NO CLAIM IS MADE TO THE EXCLUSIVE RIGHT TO USE "HAWAII", APART FROM THE MARK AS SHOWN.

THE COLOR(S) BLUE AND RED IS/ARE CLAIMED AS A FEATURE OF THE MARK.

THE MARK CONSISTS OF THE WORDS "SAISON DESK HAWAII" IN BLUE WITH THE FLOWERS ABOVE THE WORDS IN RED.

THE WORDING "SAISON" IS A FRENCH WORD CORRESPONDING TO THE WORD "SEASON" IN ENGLISH.

SN 78-847,764, FILED 3-28-2006.

MARGERY A. TIERNEY, EXAMINING ATTORNEY

**Int. Cl.: 42**

**Prior U.S. Cls.: 100 and 101**

**United States Patent and Trademark Office**

**Reg. No. 3,500,205**

**Registered Sep. 9, 2008**

**SERVICE MARK  
PRINCIPAL REGISTER**

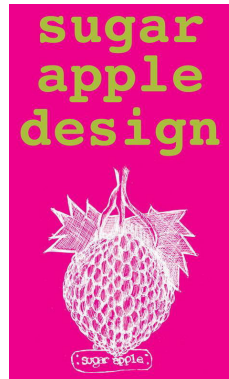

SHANDA M. CHIUMENTO (US VIRGIN ISLANDS SOLE PROPRIETORSHIP)  
6501 RED HOOK PLAZA SUITE #201  
ST. THOMAS, US VIRGIN ISLANDS 00802

FOR: GRAPHIC DESIGN SERVICES, IN CLASS 42 (U.S. CLS. 100 AND 101).

FIRST USE 3-25-2005; IN COMMERCE 3-25-2005.

NO CLAIM IS MADE TO THE EXCLUSIVE RIGHT TO USE "DESIGN", APART FROM THE MARK AS SHOWN.

THE COLOR(S) MAGENTA, GREEN AND WHITE IS/ARE CLAIMED AS A FEATURE OF THE MARK.

THE MARK CONSISTS OF A MAGENTA RECTANGULAR BACKGROUND WITH THE TERMS "SUGAR", "APPLE" AND "DESIGN" STACKED ON TOP OF EACH OTHER IN GREEN WITH A GRAPHIC OF A SUGAR APPLE BELOW THE WORDING IN WHITE, AND THE WORDING "SUGAR APPLE" APPEARING BELOW THE GRAPHIC IN WHITE INSIDE A WHITE OBLONG.

SEC. 2(F).

SN 78-848,292, FILED 3-28-2006.

ALICIA COLLINS, EXAMINING ATTORNEY

**Int. Cl.: 41**

**Prior U.S. Cls.: 100, 101, and 107**

**United States Patent and Trademark Office**

**Reg. No. 3,500,206**

**Registered Sep. 9, 2008**

**SERVICE MARK  
PRINCIPAL REGISTER**

**EYE IMAGES MEDIA**

EYE IMAGES MEDIA LLC (VIRGINIA LIMITED LIABILITY COMPANY)  
14001-A GRUMBLE JONES CT.  
CENTREVILLE, VA 20121

FOR: BOOK AND MAGAZINE PUBLISHING; DEVELOPMENT AND PRODUCTION OF MOTION PICTURES, TELEVISION PROGRAMS, AND RADIO PROGRAMS; ENTERTAINMENT SERVICES IN THE NATURE OF AN ON-GOING TALK SHOW TELEVISION PROGRAM FEATURING A WIDE RANGE OF CULTURAL, EDUCATIONAL, AND ENTERTAINMENT TOPICS, NAMELY, INFORMATION ABOUT CELEBRITIES, POPULAR CULTURE, CURRENT EVENTS, INDIVIDUAL LIFESTYLES, INDIVIDUAL ACHIEVEMENTS, CIVIL AND HUMAN RIGHTS, THE LIVES OF ORDINARY PEOPLE, AND TOPICS OF GENERAL INTEREST; PROVIDING A WEB SITE FEATURING INFORMATION ABOUT A WIDE RANGE OF CULTURAL, EDUCATIONAL, AND ENTERTAINMENT TOPICS, NAMELY, INFORMATION ABOUT CELEBRITIES, POPULAR CULTURE, CURRENT EVENTS, SOCIAL AND EDUCATIONAL DEVELOPMENT OF COMMUNITIES THROUGHOUT THE WORLD, AND INFORMATION ABOUT BOOKS, MAGAZINES, AND TALK TELEVISION AND RADIO PROGRAMS RELATING TO ALL OF THE FOREGOING; PROVIDING RECOGNITION AND INCENTIVES TO INDIVIDUALS THROUGHOUT THE WORLD WHO DEMONSTRATE EXCELLENCE IN THE FIELDS OF EDUCATION, ARTS, HUMANITIES, BUSINESS, TECHNOLOGY, HEALTH, SCIENCE, AND COMMUNITY SERVICE; DEVELOPING EDUCATIONAL CURRICULA FOR OTHERS WITH A CROSS-CULTURAL EMPHASIS IN THE FIELDS OF LITERACY, NUMERACY, SCIENCES, SOCIAL SCI-

ENCES, HUMANITIES, HISTORY, LANGUAGES, AND CURRENT EVENTS, FOR USE BY CHILDREN AND ADULTS; PROMOTING CROSS-CULTURAL LEARNING BY FOSTERING AN EXCHANGE OF INFORMATION AND CORRESPONDENCE AMONG CHILDREN OF MANY NATIONS; PROMOTING CROSS-CULTURAL LEARNING BY PROVIDING A SUMMER CAMP FOR CHILDREN; PROVIDING RECOGNITION AND INCENTIVES BY THE WAY OF AWARDS TO INDIVIDUALS WHO DEMONSTRATE COMMITMENT TO IMPROVING THE LIVES OF INDIVIDUALS IN THE NATION OF LIBERIA; PROVIDING FORMAL AND INFORMAL INSTRUCTION AND SKILLS TRAINING FOR CHILDREN AND ADULTS IN THE FIELDS OF NUMERACY, LITERACY, AND VOCATIONAL PREPARATION; OPERATING SCHOOLS AND LEARNING CENTERS FEATURING COURSES OF INSTRUCTION AT THE PRIMARY AND SECONDARY LEVELS AND VOCATIONAL FIELDS, IN CLASS 41 (U.S. CLS. 100, 101 AND 107).

FIRST USE 5-0-2006; IN COMMERCE 5-0-2006.

THE MARK CONSISTS OF STANDARD CHARACTERS WITHOUT CLAIM TO ANY PARTICULAR FONT, STYLE, SIZE, OR COLOR.

NO CLAIM IS MADE TO THE EXCLUSIVE RIGHT TO USE "MEDIA", APART FROM THE MARK AS SHOWN.

SN 78-848,472, FILED 3-28-2006.

WENDY GOODMAN, EXAMINING ATTORNEY

**Int. Cl.: 10**

**Prior U.S. Cls.: 26, 39, and 44**

**United States Patent and Trademark Office**

**Reg. No. 3,500,207**

**Registered Sep. 9, 2008**

**TRADEMARK  
PRINCIPAL REGISTER**

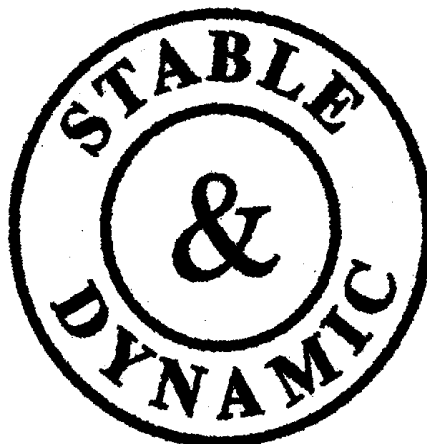

GOTFRIED, YECHIEL (ISRAEL INDIVIDUAL)  
10, BEN GURION STREET  
KIRYAT- BIALIK, ISRAEL 27000

FOR: MEDICAL AND SURGICAL APPARATUS,  
NAMELY, ORTHOPEDIC COMPRESSION AND SE-  
CUREMENT DEVICE USED TO SECURE BONE  
FRACTURES, IN CLASS 10 (U.S. CLS. 26, 39 AND 44).

FIRST USE 11-20-2007; IN COMMERCE 7-17-2008.

THE MARK CONSISTS OF AN AMPERSAND  
WITHIN A FIRST CIRCLE, THE WORDS "STABLE"  
AND "DYNAMIC" AROUND THE EXTERIOR OF  
THE FIRST CIRCLE, AND A SECOND CIRCLE  
AROUND THE WORDS "STABLE" AND "DYNAM-  
IC".

SN 78-848,643, FILED 3-29-2006.

ALEXANDER L. POWERS, EXAMINING ATTOR-  
NEY

**Int. Cls.: 40 and 42**

**Prior U.S. Cls.: 100, 101, 103, and 106**

**United States Patent and Trademark Office**

**Reg. No. 3,500,208**

**Registered Sep. 9, 2008**

**SERVICE MARK  
PRINCIPAL REGISTER**



DISHMAN PHARMA SOLUTIONS AG (SWITZERLAND COMPANY)  
HAUPTSTRASSE 171  
BUBENDORF, SWITZERLAND 4416

FOR: CUSTOM MANUFACTURE FOR OTHERS OF PHARMACEUTICALS, PHARMACEUTICAL INGREDIENTS AND CHEMICAL PRODUCTS AND CHEMICAL INTERMEDIATES , IN CLASS 40 (U.S. CLS. 100, 103 AND 106).

FIRST USE 8-7-2006; IN COMMERCE 8-7-2006.

FOR: CHEMICAL AND PHARMACEUTICAL RESEARCH AND DEVELOPMENT FOR OTHERS; RESEARCH AND DEVELOPMENT FOR OTHERS OF PROCESSES FOR PRODUCTION OF PHARMACEUTICALS, PHARMACEUTICAL INGREDIENTS AND OTHER CHEMICALS; CHEMICAL ANALYSIS FOR OTHERS; CONSULTANCY SERVICES IN THE FIELDS OF PHARMACEUTICALS AND CHEMICAL PRODUCTS, IN CLASS 42 (U.S. CLS. 100 AND 101).

FIRST USE 8-7-2006; IN COMMERCE 8-7-2006.

THE COLOR(S) BLUE AND GRAY IS/ARE CLAIMED AS A FEATURE OF THE MARK.

THE LETTER "A" IS FORMED OF A HOOKED PORTION IN THE COLOR BLUE AND A BROKEN OVAL IN THE COLOR GRAY, BENEATH WHICH IS A GRAY OVAL SHADOW. THE LETTER "C" IS FORMED OF THE LEFT PORTION OF THE BROKEN OVAL.

THE MARK CONSISTS OF STYLIZED LOWER-CASE LETTERS "A" AND "C".

SN 78-849,310, FILED 3-29-2006.

HANNO RITTNER, EXAMINING ATTORNEY



**Int. Cl.: 41**

**Prior U.S. Cls.: 100, 101, and 107**

**United States Patent and Trademark Office**

**Reg. No. 3,500,209**

**Registered Sep. 9, 2008**

**SERVICE MARK  
PRINCIPAL REGISTER**

**PLANNED PINES**

PAUL FRANK INDUSTRIES, INC. (CALIFORNIA  
CORPORATION)  
960 W. 16TH STREET  
COSTA MESA, CA 92627

FOR: ENTERTAINMENT SERVICES, NAMELY,  
PRODUCTION AND DISTRIBUTION OF CAR-  
TOONS AND WEBISODES, OVER THE INTERNET,  
FEATURING ANIMATED CHARACTERS, IN  
CLASS 41 (U.S. CLS. 100, 101 AND 107).

FIRST USE 9-0-2000; IN COMMERCE 9-0-2000.

THE MARK CONSISTS OF STANDARD CHAR-  
ACTERS WITHOUT CLAIM TO ANY PARTICULAR  
FONT, STYLE, SIZE, OR COLOR.

SN 78-849,321, FILED 3-29-2006.

JESSICA A. POWERS, EXAMINING ATTORNEY

**Int. Cl.: 35**

**Prior U.S. Cls.: 100, 101, and 102**

**United States Patent and Trademark Office**

**Reg. No. 3,500,210**

**Registered Sep. 9, 2008**

**SERVICE MARK  
PRINCIPAL REGISTER**

**Thought-leader-focused  
medical education**

THE CURRY ROCKEFELLER GROUP, LLC  
(UNITED STATES LIMITED LIABILITY COM-  
PANY)  
SUITE 410  
660 WHITE PLAINS ROAD  
TARRYTOWN, NY 10591

FOR: PROVIDING ADVERTISING, MARKETING  
AND PROMOTIONAL SERVICES FOR THE PHAR-  
MACEUTICAL AND MEDICAL INDUSTRY, IN  
CLASS 35 (U.S. CLS. 100, 101 AND 102).

FIRST USE 3-0-2001; IN COMMERCE 3-0-2001.

THE MARK CONSISTS OF STANDARD CHAR-  
ACTERS WITHOUT CLAIM TO ANY PARTICULAR  
FONT, STYLE, SIZE, OR COLOR.

NO CLAIM IS MADE TO THE EXCLUSIVE  
RIGHT TO USE "MEDICAL EDUCATION", APART  
FROM THE MARK AS SHOWN.

SN 78-851,006, FILED 3-31-2006.

DEZMONA MIZELLE, EXAMINING ATTORNEY

**Int. Cl.: 35**

**Prior U.S. Cls.: 100, 101, and 102**

**United States Patent and Trademark Office**

**Reg. No. 3,500,211**

**Registered Sep. 9, 2008**

**SERVICE MARK  
PRINCIPAL REGISTER**

**Where The Old West Meets  
The New West!**

CAVENDER INVESTMENT PROPERTIES, LTD  
(TEXAS PARTNERSHIP)  
2019 W SOUTHWEST LOOP 323  
TYLER, TX 75701

THE MARK CONSISTS OF STANDARD CHAR-  
ACTERS WITHOUT CLAIM TO ANY PARTICULAR  
FONT, STYLE, SIZE, OR COLOR.

FOR: RETAIL STORE SERVICES FEATURING  
CLOTHING AND BOOTS, IN CLASS 35 (U.S. CLS.  
100, 101 AND 102).

SN 78-852,544, FILED 4-3-2006.

FIRST USE 3-15-2000; IN COMMERCE 3-15-2000.

SHAILA SETTLES, EXAMINING ATTORNEY

**Int. Cl.: 25**

**Prior U.S. Cls.: 22 and 39**

**United States Patent and Trademark Office**

**Reg. No. 3,500,212**

**Registered Sep. 9, 2008**

**TRADEMARK  
PRINCIPAL REGISTER**

**IPPOS**

BIG D ENTERPRISES, LLC (CALIFORNIA LIMITED LIABILITY COMPANY)  
ONE VIA PRESEA  
COTO DE CAZA, CA 92679

FOR: CLOTHING, NAMELY, A SHIRTS, BLOUSES, TOPS, JEANS, TEE SHIRTS, SKIRTS, SWEATSHIRTS, SHORTS, PANTS, KNICKERS, HOSIERY, SOCKS, STOCKINGS, TIES, ASCOTS, OUTERWEAR, NAMELY, JACKETS, SWEATERS, VESTS, RAINCOATS, CAPES, SLICKERS, OVERALLS, SCARVES, MUFFLERS; PAJAMAS, HATS, CAPS, BELTS, GLOVES; FOOTWEAR, NAMELY, SHOES, SANDALS, BOOTS, SPORT SHOES; HEADWEAR, NAMELY, SUN VISORS; HEADGEAR, NAMELY, HATS AND CAPS; EQUESTRIAN CLOTHING, NAMELY, JODHPURS, BREECHES, SHOW SHIRTS,

HUNT JACKETS, JERSEYS AND POLO STYLE SHIRTS, IN CLASS 25 (U.S. CLS. 22 AND 39).

FIRST USE 5-0-2008; IN COMMERCE 5-0-2008.

THE MARK CONSISTS OF STANDARD CHARACTERS WITHOUT CLAIM TO ANY PARTICULAR FONT, STYLE, SIZE, OR COLOR.

THE ENGLISH TRANSLATION OF THE ANCIENT GREEK WORD "IPPOS" IN THE MARK IS "HORSE".

SN 78-855,387, FILED 4-6-2006.

GINA FINK, EXAMINING ATTORNEY

**Int. Cl.: 44**

**Prior U.S. Cls.: 100 and 101**

**United States Patent and Trademark Office**

**Reg. No. 3,500,213**

**Registered Sep. 9, 2008**

**SERVICE MARK  
PRINCIPAL REGISTER**

**What Happens Hair Stays  
Hair**

ROSE, KARYN (UNITED STATES INDIVIDUAL)  
8923 NEST WAY  
INDIANAPOLIS, IN 46321

FOR: COSMETOLOGY SERVICES, IN CLASS 44  
(U.S. CLS. 100 AND 101).

FIRST USE 7-14-2008; IN COMMERCE 7-14-2008.

THE MARK CONSISTS OF STANDARD CHAR-  
ACTERS WITHOUT CLAIM TO ANY PARTICULAR  
FONT, STYLE, SIZE, OR COLOR.

SN 78-855,464, FILED 4-6-2006.

AMY HELLA, EXAMINING ATTORNEY

**Int. Cl.: 41**

**Prior U.S. Cls.: 100, 101, and 107**

**United States Patent and Trademark Office**

**Reg. No. 3,500,214**

**Registered Sep. 9, 2008**

**SERVICE MARK  
PRINCIPAL REGISTER**

**Psy-Ops**

STEWART, NORMAN C (UNITED STATES INDIVIDUAL)  
PO BOX 541451  
HOUSTON, TX 772541451

THE MARK CONSISTS OF STANDARD CHARACTERS WITHOUT CLAIM TO ANY PARTICULAR FONT, STYLE, SIZE, OR COLOR.

FOR: ENTERTAINMENT IN THE NATURE OF VISUAL AND AUDIO PERFORMANCES, NAMELY, A MUSICAL BAND, IN CLASS 41 (U.S. CLS. 100, 101 AND 107).

SN 78-857,310, FILED 4-9-2006.

FIRST USE 12-7-2007; IN COMMERCE 12-7-2007.

HOWARD SMIGA, EXAMINING ATTORNEY

**Int. Cls.: 9 and 42**

**Prior U.S. Cls.: 21, 23, 26, 36, 38, 100, and 101**

**United States Patent and Trademark Office**

**Reg. No. 3,500,215**

**Registered Sep. 9, 2008**

**TRADEMARK  
SERVICE MARK  
PRINCIPAL REGISTER**

# MetaFluent

TECHNOLOGY BUSINESS DEVELOPMENT  
CORP (ILLINOIS CORPORATION)  
1507 E 53RD ST, SUITE 806  
CHICAGO, IL 60615

FOR: COMPUTER PROGRAMS FOR INTEGRATION, TRANSFORMATION, AND DISTRIBUTION OF REAL-TIME AND STATIC DATA FOR USE IN FINANCIAL SERVICES, INVENTORY MANAGEMENT AND SENSOR DATA PROCESSING, IN CLASS 9 (U.S. CLS. 21, 23, 26, 36 AND 38).

FIRST USE 11-6-2006; IN COMMERCE 11-6-2006.

FOR: APPLICATION SERVICE PROVIDER (ASP) FEATURING SOFTWARE IN THE FIELD OF INTEGRATION, TRANSFORMATION, AND DISTRIBUTION

OF REAL-TIME AND STATIC DATA FOR USE IN FINANCIAL SERVICES, INVENTORY MANAGEMENT AND SENSOR DATA PROCESSING; DESIGN, DEVELOPMENT AND IMPLEMENTATION OF SOFTWARE, IN CLASS 42 (U.S. CLS. 100 AND 101).

FIRST USE 11-6-2006; IN COMMERCE 11-6-2006.

THE MARK CONSISTS OF STANDARD CHARACTERS WITHOUT CLAIM TO ANY PARTICULAR FONT, STYLE, SIZE, OR COLOR.

SN 78-858,409, FILED 4-11-2006.

THOMAS MANOR, EXAMINING ATTORNEY

**Int. Cl.: 3**

**Prior U.S. Cls.: 1, 4, 6, 50, 51, and 52**

**United States Patent and Trademark Office**

**Reg. No. 3,500,216**

**Registered Sep. 9, 2008**

**TRADEMARK  
PRINCIPAL REGISTER**

**MOISTURE SOFT**

PRO-LINE INTERNATIONAL, INC. (DELAWARE  
CORPORATION)  
2525 ARMITAGE AVENUE  
MELROSE PARK, IL 60160

THE MARK CONSISTS OF STANDARD CHAR-  
ACTERS WITHOUT CLAIM TO ANY PARTICULAR  
FONT, STYLE, SIZE, OR COLOR.

FOR: NON-MEDICATED SKIN CARE PREPARA-  
TIONS, IN CLASS 3 (U.S. CLS. 1, 4, 6, 50, 51 AND 52).

SN 78-858,475, FILED 4-11-2006.

FIRST USE 6-1-2008; IN COMMERCE 6-1-2008.

ZHALEH DELANEY, EXAMINING ATTORNEY



**Int. Cl.: 41**

**Prior U.S. Cls.: 100, 101, and 107**

**United States Patent and Trademark Office**

**Reg. No. 3,500,217**

**Registered Sep. 9, 2008**

**SERVICE MARK  
PRINCIPAL REGISTER**

**JUNG-CHOONG BREATHING**

BR CONSULTING, INC. (NEW JERSEY CORPORATION)  
340 JORDAN ROAD  
SEDONA, AZ 86336

FOR: INSTRUCTION SERVICES, NAMELY, CLASSES IN NATURAL HEALING METHODS, POSTURE, BREATHING, MEDITATION TO INCREASE ENERGY, AND IMPROVE PHYSICAL, ENERGETIC AND PSYCHO-EMOTIONAL HEALTH , IN CLASS 41 (U.S. CLS. 100, 101 AND 107).

FIRST USE 1-10-2006; IN COMMERCE 1-10-2006.

THE MARK CONSISTS OF STANDARD CHARACTERS WITHOUT CLAIM TO ANY PARTICULAR FONT, STYLE, SIZE, OR COLOR.

NO CLAIM IS MADE TO THE EXCLUSIVE RIGHT TO USE "BREATHING", APART FROM THE MARK AS SHOWN.

SN 78-858,870, FILED 4-11-2006.

DAVID I, EXAMINING ATTORNEY

**Int. Cl.: 10**

**Prior U.S. Cls.: 26, 39, and 44**

**Reg. No. 3,500,218**

**United States Patent and Trademark Office**

**Registered Sep. 9, 2008**

**TRADEMARK  
PRINCIPAL REGISTER**

**FLEXILEYZ**

EATON, L. DANIEL (UNITED STATES INDIVIDUAL)  
2821 KAVANAUGH  
LITTLE ROCK, AR 72205

THE MARK CONSISTS OF STANDARD CHARACTERS WITHOUT CLAIM TO ANY PARTICULAR FONT, STYLE, SIZE, OR COLOR.

FOR: ARTIFICIAL EYES, IN CLASS 10 (U.S. CLS. 26, 39 AND 44).

SN 78-861,019, FILED 4-13-2006.

FIRST USE 5-0-2006; IN COMMERCE 5-0-2006.

DOMINIC FATHY, EXAMINING ATTORNEY

**Int. Cl.: 36**

**Prior U.S. Cls.: 100, 101, and 102**

**United States Patent and Trademark Office**

**Reg. No. 3,500,219**

**Registered Sep. 9, 2008**

**SERVICE MARK  
PRINCIPAL REGISTER**

**MERICAP CREDIT**

MERICAP CREDIT CORPORATION (DELA-  
WARE CORPORATION)

SUITE 550E

1415 WEST 22ND STREET

OAK BROOK, IL 60523

FOR: COMMERCIAL LENDING SERVICES, IN  
CLASS 36 (U.S. CLS. 100, 101 AND 102).

FIRST USE 4-30-2006; IN COMMERCE 4-30-2006.

THE MARK CONSISTS OF STANDARD CHAR-  
ACTERS WITHOUT CLAIM TO ANY PARTICULAR  
FONT, STYLE, SIZE, OR COLOR.

NO CLAIM IS MADE TO THE EXCLUSIVE  
RIGHT TO USE "CREDIT", APART FROM THE  
MARK AS SHOWN.

SN 78-862,019, FILED 4-14-2006.

KATHERINE CONNOLLY, EXAMINING ATTOR-  
NEY

**Int. Cl.: 25**

**Prior U.S. Cls.: 22 and 39**

**United States Patent and Trademark Office**

**Reg. No. 3,500,220**

**Registered Sep. 9, 2008**

**TRADEMARK  
PRINCIPAL REGISTER**

**Your feet are your life**

SLANE HOSIERY MILLS (NORTH CAROLINA  
CORPORATION)  
PO BOX 2486  
313 S. CENTENNIAL STREET  
HIGH POINT, NC 27260

THE MARK CONSISTS OF STANDARD CHAR-  
ACTERS WITHOUT CLAIM TO ANY PARTICULAR  
FONT, STYLE, SIZE, OR COLOR.

FOR: HOSIERY, IN CLASS 25 (U.S. CLS. 22 AND  
39).

SN 78-866,727, FILED 4-21-2006.

FIRST USE 5-10-2007; IN COMMERCE 5-10-2007.

DANNEAN HETZEL, EXAMINING ATTORNEY

Int. Cl.: 3

Prior U.S. Cls.: 1, 4, 6, 50, 51, and 52

Reg. No. 3,500,221

United States Patent and Trademark Office

Registered Sep. 9, 2008

TRADEMARK  
PRINCIPAL REGISTER



MAJAMI

YUEN FOONG YU PAPER MFG. CO., LTD.  
(TAIWAN CORPORATION)  
JHONGJHENG DISTRICT  
15F.,NO.51,SEC.2,CHUNG CHING S. RD.  
TAIPEI CITY, TAIWAN

FOR: POMADE; HAIR CREAM; HAIRDRESSING; HAIR OILS; HAIR LACQUERS; HAIR GEL; HAIR SPRAY; HAIR COLORING SPRAY; HAIR STYLING GEL; HAIR STYLING SPRAY; HAIR CARE PREPARATION; HAIR CARE OIL; HAIR CARE CREAMS; HAIR CARE FROSTS; HAIR NOURISHMENT FROSTS; HAIR MOUSSE; HAIR LIGHTENERS; FACIAL CREAM; COLD CREAM; LOTIONS FOR COSMETIC PURPOSES; SKIN TOPICAL OILS FOR COSMETIC PURPOSES; SKIN MOISTURIZER; SKIN MOISTURE FROST, NAMELY, SKIN MOISTURIZERS AND CONDITIONERS; SKIN LOTIONS; CREAM FROSTS MADE OF PEARL, NAMELY, SKIN MOISTURIZERS AND CONDITIONERS CONTAINING PEARL; EAU DE PERFUME; PERFUMES; PERFUME OILS; SCENTED BODY CREAMS; SCENTED PLANT OILS FOR MOISTURIZING, CONDITIONING AND PRODUCING SCENTS WHEN APPLIED TO THE SKIN; PERFUME IN PEN MOLD CONTAINER; COLOGNE WATER TOILET WATER; FACE AND BODY MILK; MOISTURIZING MILKS; SUN BLOCK; PERFUMED MILK FOR BODY USE; ROUGES, FOUNDATION STICKS; CREAMY FOUNDATION; MAKE-UP POWDER; FACE POWDER; COSMETIC POWDER FOR PRODUCING A SHEER MATTE FINISH TO MAKEUP APPLIED TO THE SKIN; BLUSH; LIPSTICKS, COSMETIC ROUGES; LIP GLOSS; LIP OIL; LIP BALM; LIP CREAM; FOUNDATION MAKE-UP; MASSAGE OILS; FACIAL MASK CREAM; CLEANSING CREAMS;

CLEANSING MILK; HAND CREAMS; HAND LOTIONS; HANDCARE CONDITIONERS; EYE SHADOWS; EYE SHADOW LIQUID; EYE SHADOW CREAM; EYE SHADOW FROSTS; EYE SHADOW PENCILS; EYE LINER; EYE LINER LIQUID; EYE LINER PENCILS; MASCARA; FIX MASCARA; EYE MAKE-UP REMOVER; SUN-BLOCK OILS; SUN BLOCK PREPARATIONS; ANTI-WRINKLE CREAMS; WRINKLE RESISTANT CREAM; FACE CREAMS; PERFUMED OIL FOR BATH USE; BATH OILS; NAIL POLISH; NAIL POLISH BASE COAT; NAIL CARE PREPARATIONS; NAIL CARE OILS; BATH POWDER; POWDER FOR PRICKLY HEAT, NAMELY, ABSORBENT POWDER FOR DRYING THE SKIN; BODY SPRAYS, NAMELY, WATER IN ATOMIZED CONTAINERS USED TO PRODUCE A COOLING EFFECT; BABY POWDER; SHAVING LOTIONS; PRE-SHAVING LOTIONS; AFTER-SHAVE LOTIONS; SHAVING CREAMS; SHAVING BALM; SHAVING MOUSSE; PRE-SHAVE CREAMS; HAIR GEL AND HAIR SOLUTION, NAMELY, GELS AND SOLUTIONS FOR STIFFENING HAIR; ANTIPERSPIRANTS FOR PERSONAL USE; DEODORANTS AND ANTIPERSPIRANTS; EYEBROW PENCILS; FALSE EYELASHES; FALSE NAILS; NAIL POLISH REMOVERS; CUTICLE CREAM; ALL PURPOSE COTTON SWABS FOR PERSONAL USE; COSMETICS; FOUNDATIONS; NUTRITIONAL OILS FOR COSMETIC PURPOSES; ASTRINGENT FOR COSMETIC PURPOSES; BABY OILS; BODY CREAMS; COSMETIC STICKERS FOR CREATING DOUBLE FOLDS IN EYELIDS; EYEBROW MAKE-UP, NAMELY, OILS; MAKE-UP BASE; PERSONAL BEAUTY MASKS PREPARATIONS; FACIAL MASK POWDER; FACIAL MASKS; HAIR CARE PREPARATION FOR QUICKLY DRYING WET HAIR; FOAMY

AND NONFOAMY SKIN AND BODY CREAMS FOR BABIES; CONDENSED EYE CREAMS; GEL EYE MASKS; NOURISHING EYE CREAMS; EYE CREAM; EYEBROW POWDER; BROW GEL; SKIN CARE PREPARATIONS DURING PREGNANCY; CUTICLE REMOVING PREPARATIONS FOR REMOVING DEAD CELLS OF SKIN ON THE CUTICLE; DEODORANTS; BABY LOTIONS; CONCEALERS; HAIR REMOVING CREAM; MAKE-UP REMOVING LOTIONS; CREAM FOR FIRING AND ENHANCING BREASTS; ADHESIVES FOR AFFIXING FALSE HAIR; ADHESIVES FOR AFFIXING FALSE EYELASHES; BEAUTY CREAMS FOR BODY CARE; LIP MOISTURIZER; LIP MOISTURIZER OILS; SKIN CLEANSING CREAM; SUN BLOCK LOTIONS; NATURAL MASK, NAMELY, FACIAL TREATMENT MASKS; DEODORANT FOR PERSONAL USE; EYE GELS; TALCUM POWDER, FACE POWDER, TRANSPARENT LIPSTICK; BODY LOTIONS, NAIL GLITTER; HAIR MOISTURE CREAM; HAIR STYLIZING PREPARATIONS; SUN BLOCK CREAM; SUN BLOCK GEL; REPAIR CREAM; DAY CREAM; NIGHT CREAM; HAIR AFFIXING LOTIONS; SKIN CARE PREPARATIONS, WHITENING MILKS, NAMELY, SOLUTIONS FOR MOISTURIZING THE SKIN; WHITENING LOTIONS, NAMELY, SKIN MOISTURIZING LOTIONS; WHITENING MASKS, NAMELY, FACIAL TREATMENT MASKS; WHITENING CREAMS FOR COVERING SKIN AGE SPOTS; BODY MOISTURE CREAMS; TOPICAL SKIN CREAMS FOR BREASTS; SKIN AND HAIR CARE PREPARATIONS; LIP OIL, NAMELY, LIP MOISTURIZING OILS; FRAGRANT OIL FOR COSMETIC USE; FOAMY HAIR CARE PREPARATIONS; DEPILATORY CREAMS; MOISTURE WATER, NAMELY, PREPARATIONS FOR MOISTURIZING; COSMETICS FOR HAIR USE; FOOT DEODORANT SPRAY; NON-WOVEN PAPER FACIAL MASKS IMPREGNATED WITH SKIN LOTION; LIP LINER; OIL FOR

COSMETIC PURPOSES; COTTON SWABS FOR COSMETIC PURPOSES; COTTON BALLS FOR COSMETIC PURPOSES; MAKE-UP KITS, NAMELY, FACIAL COSMETICS FOR COLORATION OF THE SKIN; MAKE-UP REMOVER; SOAPS, NAMELY, SOAP CLEANING COMPOSITIONS; BABY SOAPS; BATH SOAPS; HAND SOAPS; FOAMING SOAPS; SHAVING SOAPS; MEDICATED SOAPS; FACE SOAPS; FACIAL CLEANSING CREAM; FACIAL CLEANSING LOTIONS; FACIAL CLEANSING MILKS; FACIAL CLEANSING PREPARATIONS; BATH LOTION; BUBBLE BATH; BATH MILKS; BABY BATH MILKS; BATH FOAM; BATH POWDER; BATH SALTS; SHAMPOO; BABY SHAMPOO; LIQUID SHAMPOO; HAIR RINSES; HAIR CONDITIONERS; PERFUMED SOAPS; LIQUID SOAPS FOR HANDS; HAND SOAP POWDER; HAND CLEANSING PREPARATIONS; BATH GELS; FOOT CLEANSING PREPARATIONS; HAIR AND BODY CLEANSING PREPARATIONS; FACIAL CLEANSING POWDER; SOAPS FOR BODY USE; LIQUID SOAP FOR BODY USE; SOAP POWDER FOR BODY USE; SOAP MILKS FOR BODY USE; SCENTED BODY APPLICABLE BATH BALLS FOR PRODUCING PLEASANT ODORS WHEN APPLIED TO THE BODY; SOAP AND BATH PREPARATIONS CONTAINING BAMBOO VINEGAR, IN CLASS 3 (U.S. CLS. 1, 4, 6, 50, 51 AND 52).

FIRST USE 3-27-2008; IN COMMERCE 3-27-2008.

THE MARK CONSISTS OF THE LETTER "M" IN A CIRCLE WITH TULIP LIKE DESIGNS EXTENDING FROM THE CIRCLE, ALL ABOVE THE WORD "MAJAMI".

SN 78-867,224, FILED 4-21-2006.

JERI J. FICKES, EXAMINING ATTORNEY

**Int. Cls.: 6, 8, 16, 17, 20, 21, 26, and 42**

**Prior U.S. Cls.: 1, 2, 5, 12, 13, 14, 22, 23, 25, 28, 29, 30, 32, 33, 35, 37, 38, 39, 40, 42, 44, 50, 100, and 101**

**Reg. No. 3,500,222**

**United States Patent and Trademark Office**

**Registered Sep. 9, 2008**

**TRADEMARK  
SERVICE MARK  
PRINCIPAL REGISTER**

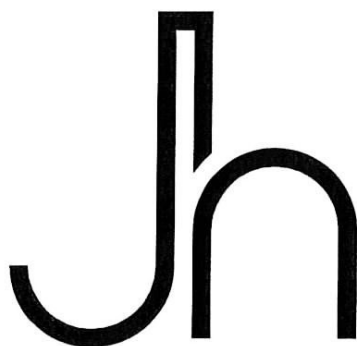

THE JOHN HENRY COMPANY (MICHIGAN CORPORATION)  
5800 W. GRAND RIVER AVENUE  
LANSING, MI 489017099

FOR: METAL FASTENERS FOR ATTACHING TAGS, NAMELY, CLIPS; METAL ORNAMENTS FOR FLORAL AND PLANT ARRANGEMENTS; METAL SIGN HOLDERS FOR FLORAL ARRANGEMENTS AND PLANT ARRANGEMENTS, IN CLASS 6 (U.S. CLS. 2, 12, 13, 14, 23, 25 AND 50).

FIRST USE 5-0-2006; IN COMMERCE 5-0-2006.

FOR: HAND TOOLS, NAMELY, FLOWER AND PLANT STEM CUTTERS, IN CLASS 8 (U.S. CLS. 23, 28 AND 44).

FIRST USE 5-0-2006; IN COMMERCE 5-0-2006.

FOR: BAGS MADE OF PAPER; PLASTIC FLOWER BAGS; PAPER FLOWER POT COVERS; ENVELOPES; FLORAL AND GIFT ENCLOSURE CARDS; BLANK NOTE CARDS; PAPER GIFT WRAP AND WRAPPING PAPER AND TISSUE PAPER GIFT WRAP; LETTERHEAD WRITING PAPER; PRINTED FORMS; BUSINESS CARDS; PAPER LABELS; PAPER DELIVERY TAGS; PAPER TAGS AND CHARTS CONTAINING PLANT CARE INFORMATION; EASELS; MARKERS AND PENS; DAILY AND PERSONAL PLANNERS; PLASTIC WRAPPING FILM AND PAPER FOR PERSONAL USE; PRINTED PAPER SIGNS; STATIONERY, STICKERS, AND PAPER SEALS FOR STATIONERY USE; PUBLICATIONS,

NAMELY, FLORAL DESIGN AND FLORAL/PLANT CARE REFERENCE BOOKS, BOOKLETS, PAMPHLETS, BROCHURES, AND PERIODICALS, IN CLASS 16 (U.S. CLS. 2, 5, 22, 23, 29, 37, 38 AND 50).

FIRST USE 5-0-2006; IN COMMERCE 5-0-2006.

FOR: FOAM SUPPORTS FOR FLORAL ARRANGEMENTS, IN CLASS 17 (U.S. CLS. 1, 5, 12, 13, 35 AND 50).

FIRST USE 5-0-2006; IN COMMERCE 5-0-2006.

FOR: ACCENT PICKS AND ORNAMENTS MADE OF PLASTIC AND/OR WOOD FOR FLORAL AND PLANT ARRANGEMENTS; PLASTIC PLANT LABELS; SIGN BOARDS MADE OF PLASTIC OR WOOD; DISPLAY RACKS; PLASTIC PLANT TAGS; PLASTIC FASTENERS FOR ATTACHING TAGS TO MERCHANDISE; PLASTIC INSERTS FOR USE AS CONTAINER LINERS; PLASTIC SIGN HOLDERS; PLASTIC BANNERS, POINT-OF-PURCHASE DISPLAYS IN THE NATURE OF SHELF TALKERS; SIGNBOARDS MADE OF PLASTIC AND/OR VINYL; PLASTIC STORAGE AND DISPLAY RACKS FOR PLANTS AND FLOWERS, IN CLASS 20 (U.S. CLS. 2, 13, 22, 25, 32 AND 50).

FIRST USE 5-0-2006; IN COMMERCE 5-0-2006.

FOR: PLASTIC SAUCERS, VASES, AND POTS; PLASTIC STORAGE CONTAINERS AND LIDS FOR PLANTS AND FLOWERS FOR DOMESTIC USE;

PLASTIC HOLDERS FOR FLOWERS AND PLANTS; PLASTIC PLANT AND FLOWER BASKETS; SATIN TEXTILE CONTAINERS FOR PLANTS AND FLOWERS FOR HOUSEHOLD USE; BASKETS OF WICKER, STRAW, WOOD, OR CLOTH; CERAMIC CONTAINERS FOR PLANTS AND FLOWERS FOR HOUSEHOLD USE; COFFEE MUGS AND BEVERAGE GLASSWARE, ALL FOR USE WITH PLANTS AND FLOWERS; DELIVERY TRAYS OF FOAM AND PLASTIC FOR FLORAL ARRANGEMENTS; DECORATION KITS COMPRISING PLASTIC FLOWER POT COVERS, PLASTIC FLOWER POT LINERS, AND PLASTIC GIFT WRAP BOWS FOR USE WITH FLOWERS AND PLANTS , IN CLASS 21 (U.S. CLS. 2, 13, 23, 29, 30, 33, 40 AND 50).

FIRST USE 5-0-2006; IN COMMERCE 5-0-2006.

FOR: RIBBONS AND NON-PAPER CLOTH GIFT WRAP BOWS, IN CLASS 26 (U.S. CLS. 37, 39, 40, 42 AND 50).

FIRST USE 5-0-2006; IN COMMERCE 5-0-2006.

FOR: INTERACTIVE WEBSITE SERVICES, NAMELY, PROVIDING TEMPORARY USE OF ONLINE NON-DOWNLOADABLE SOFTWARE FOR USE IN DESIGNING PLANT TAGS AND OTHER GRAPHIC MATERIALS, IN CLASS 42 (U.S. CLS. 100 AND 101).

FIRST USE 5-0-2006; IN COMMERCE 5-0-2006.

OWNER OF U.S. REG. NOS. 1,296,037, 1,680,314, AND 2,554,464.

THE MARK CONSISTS OF STYLIZED JH.

SN 78-870,266, FILED 4-26-2006.

STEVEN PEREZ, EXAMINING ATTORNEY



**Int. Cl.: 9**

**Prior U.S. Cls.: 21, 23, 26, 36, and 38**

**United States Patent and Trademark Office**

**Reg. No. 3,500,223**

**Registered Sep. 9, 2008**

**TRADEMARK  
PRINCIPAL REGISTER**

**WEALTH OPERATING SYSTEM**

NEW EDGE FINANCIAL, LLC (WYOMING LIMITED LIABILITY COMPANY)  
970 WEST BROADWAY  
SUITE E, #105  
JACKSON, WY 83001

FOR: PRE-RECORDED CD'S, VIDEO TAPES, LASER DISKS, AND DVD'S FEATURING HOME STUDY COURSES IN THE FIELD OF TAX ADVICE, INVESTING, WEALTH CREATION, PERSONAL AND BUSINESS FINANCES, REAL ESTATE INVESTING, BUSINESS MANAGEMENT AND HOW TO CREATE A NETWORK OF ADVISORS, MENTORS AND ASSOCIATES; ELECTRONIC PUBLICATIONS, NAMELY, BOOKS AND ARTICLES FEATURING TAX ADVICE, INVESTING, WEALTH CREATION, PERSONAL AND BUSINESS FINANCES, REAL ESTATE INVESTING, BUSINESS MANAGEMENT AND HOW TO CREATE A NETWORK

OF ADVISORS, MENTORS AND ASSOCIATES, RECORDED ON COMPUTER MEDIA, IN CLASS 9 (U.S. CLS. 21, 23, 26, 36 AND 38).

FIRST USE 12-1-2004; IN COMMERCE 8-1-2005.

THE MARK CONSISTS OF STANDARD CHARACTERS WITHOUT CLAIM TO ANY PARTICULAR FONT, STYLE, SIZE, OR COLOR.

NO CLAIM IS MADE TO THE EXCLUSIVE RIGHT TO USE "WEALTH" AND "SYSTEM", APART FROM THE MARK AS SHOWN.

SN 78-870,645, FILED 4-26-2006.

ARETHA SOMERVILLE, EXAMINING ATTORNEY

**Int. Cl.: 25**

**Prior U.S. Cls.: 22 and 39**

**United States Patent and Trademark Office**

**Reg. No. 3,500,224**

**Registered Sep. 9, 2008**

**TRADEMARK  
PRINCIPAL REGISTER**

**MAX WORK**

CAVENDER INVESTMENT PROPERTIES, LTD.  
(TEXAS LIMITED PARTNERSHIP)

7820 SOUTH BROADWAY

TYLER, TX 75703

FOR: SHOES, SHIRTS, JEANS, PANTS, GLOVES,  
HATS, AND COATS, IN CLASS 25 (U.S. CLS. 22 AND  
39).

FIRST USE 4-27-2006; IN COMMERCE 4-27-2006.

THE MARK CONSISTS OF STANDARD CHAR-  
ACTERS WITHOUT CLAIM TO ANY PARTICULAR  
FONT, STYLE, SIZE, OR COLOR.

NO CLAIM IS MADE TO THE EXCLUSIVE  
RIGHT TO USE "WORK", APART FROM THE  
MARK AS SHOWN.

SN 78-871,373, FILED 4-27-2006.

REBECCA POVARCHUK, EXAMINING ATTOR-  
NEY

**Int. Cl.: 36**

**Prior U.S. Cls.: 100, 101, and 102**

**United States Patent and Trademark Office**

**Reg. No. 3,500,225**

**Registered Sep. 9, 2008**

**SERVICE MARK  
PRINCIPAL REGISTER**

**PFG EUROPE**

PEREGRINE FINANCIAL GROUP, INC. (IOWA CORPORATION)  
190 SOUTH LASALLE STREET, 7TH FLOOR  
CHICAGO, IL 60603

FOR: FINANCIAL SERVICES, NAMELY, CONDUCTING FUTURES, COMMODITIES, FOREX, SECURITIES BROKERAGE SERVICES AND RELATED TRADING SERVICES, NAMELY; COMPILING, ORGANIZING AND DISSEMINATING; FUTURES, SECURITIES, COMMODITIES, AND FOREX INFORMATION; ELECTRONIC FUTURES, SECURITIES, COMMODITIES AND FOREX TRANSACTION PROCESSING OF ORDERS FOR THE PURCHASE AND SALE OF FUTURES, COMMODITIES AND FOREX, SECURITIES, STOCK, AND OPTIONS, MUTUAL FUNDS, TRUST ACCOUNTS, AND FINANCIAL INSTRUMENTS, IN CLASS 36 (U.S. CLS. 100, 101 AND 102).

FIRST USE 9-26-2006; IN COMMERCE 9-26-2006.

THE MARK CONSISTS OF STANDARD CHARACTERS WITHOUT CLAIM TO ANY PARTICULAR FONT, STYLE, SIZE, OR COLOR.

OWNER OF U.S. REG. NOS. 2,591,702 AND 2,612,848.

NO CLAIM IS MADE TO THE EXCLUSIVE RIGHT TO USE "EUROPE", APART FROM THE MARK AS SHOWN.

SN 78-873,242, FILED 5-1-2006.

JOHN WILKE, EXAMINING ATTORNEY

**Int. Cl.: 9**

**Prior U.S. Cls.: 21, 23, 26, 36, and 38**

**Reg. No. 3,500,226**

**United States Patent and Trademark Office**

**Registered Sep. 9, 2008**

**TRADEMARK  
PRINCIPAL REGISTER**

**HITS REVEALED**

KNOWLES, MATHEW (UNITED STATES INDIVIDUAL)  
1505 HADLEY STREET  
HOUSTON, TX 77002

FOR: MUSICAL SOUND RECORDINGS; MUSICAL VIDEO RECORDINGS, IN CLASS 9 (U.S. CLS. 21, 23, 26, 36 AND 38).

FIRST USE 12-18-2007; IN COMMERCE 12-18-2007.

THE MARK CONSISTS OF STANDARD CHARACTERS WITHOUT CLAIM TO ANY PARTICULAR FONT, STYLE, SIZE, OR COLOR.

NO CLAIM IS MADE TO THE EXCLUSIVE RIGHT TO USE "HITS", APART FROM THE MARK AS SHOWN.

SN 78-874,876, FILED 5-2-2006.

WILLIAM ROSSMAN, EXAMINING ATTORNEY

**Int. Cl.: 33**

**Prior U.S. Cls.: 47 and 49**

**United States Patent and Trademark Office**

**Reg. No. 3,500,227**

**Registered Sep. 9, 2008**

**TRADEMARK  
PRINCIPAL REGISTER**

**OPTHIMUS**

LOPEZ LORENZO, AUGUSTO RAMON (UNITED STATES INDIVIDUAL)  
6210 SW 34TH ST.  
MIAMI, FL 33155 AND  
LOPEZ LORENZO, EVA MARIA (UNITED STATES INDIVIDUAL)  
6210 SW 34TH ST.  
MIAMI, FL 33155

FIRST USE 1-1-2003; IN COMMERCE 1-1-2003.

THE MARK CONSISTS OF STANDARD CHARACTERS WITHOUT CLAIM TO ANY PARTICULAR FONT, STYLE, SIZE, OR COLOR.

SN 78-878,396, FILED 5-7-2006.

FOR: RUM, IN CLASS 33 (U.S. CLS. 47 AND 49).

DAVID H. STINE, EXAMINING ATTORNEY

**Int. Cl.: 35**

**Prior U.S. Cls.: 100, 101, and 102**

**United States Patent and Trademark Office**

**Reg. No. 3,500,228**

**Registered Sep. 9, 2008**

**SERVICE MARK  
PRINCIPAL REGISTER**

**YES**

TIEGER, HAROLD (UNITED STATES INDIVIDUAL)  
105 CENTRAL TERRACE  
WYOMING, OH 45215

FOR: MEDIATION ADVISORY SERVICES, NAMELY, ADVISING AND ASSISTING BUSINESSES AND INDIVIDUALS TO PREVENT AND RESOLVE CONFLICTS, DISPUTES, AND IMPASSES IN BUSINESS RELATIONSHIPS, AND ADVISING AND ASSISTING BUSINESSES AND INDIVIDUALS TO EMPHASIZE AND PRIORITIZE THE VALUE OF PREVENTING AND RESOLVING CONFLICTS, DIS-

PUTES, AND IMPASSES IN BUSINESS RELATIONSHIPS, IN CLASS 35 (U.S. CLS. 100, 101 AND 102).

FIRST USE 7-3-2008; IN COMMERCE 7-3-2008.

THE MARK CONSISTS OF STANDARD CHARACTERS WITHOUT CLAIM TO ANY PARTICULAR FONT, STYLE, SIZE, OR COLOR.

SN 78-878,599, FILED 5-8-2006.

ALEX KEAM, EXAMINING ATTORNEY

Int. Cl.: 16

Prior U.S. Cls.: 2, 5, 22, 23, 29, 37, 38, and 50

United States Patent and Trademark Office

Reg. No. 3,500,229

Registered Sep. 9, 2008

TRADEMARK  
PRINCIPAL REGISTER

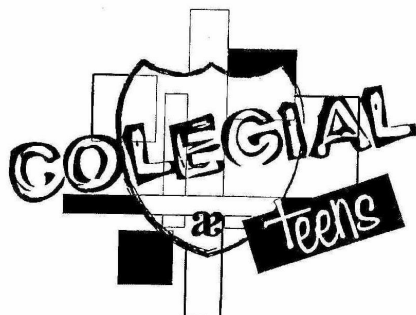

GRUPO ANDREA S.A. DE C.V. (MEXICO CORPORATION)  
BLVD. JUAN ALONSO DE TORRES NO. 106  
LEON, GUANAJUATO, MEXICO CP 37204

FOR: PRINTED CATALOGS, INFORMATIONAL FLIERS AND LEAFLETS IN THE FIELD OF FOOTWEAR; POSTERS, IN CLASS 16 (U.S. CLS. 2, 5, 22, 23, 29, 37, 38 AND 50).

FIRST USE 8-0-2006; IN COMMERCE 8-0-2006.

OWNER OF U.S. REG. NO. 2,643,146.

NO CLAIM IS MADE TO THE EXCLUSIVE RIGHT TO USE "TEENS", APART FROM THE MARK AS SHOWN.

THE MARK CONSISTS OF THE WORDS "COLEGIAL TEENS" AND A DOUBLE "A" LETTER DESIGN IN STYLIZED FORMAT ON A BACKGROUND OF GEOMETRIC SHAPES.

THE WORD "COLEGIAL" IN THE MARK CAN BE TRANSLATED INTO ENGLISH AS PERTAINING TO SCHOOL, SCHOOLBOY, PUPIL, STUDENT, INEXPERIENCED YOUTH, GREENHORN, OR RED AND BLACK BIRD LIVING ALONG RIVER BANKS AND LAKES.

SN 78-878,955, FILED 5-8-2006.

DAWN HAN, EXAMINING ATTORNEY

**Int. Cl.: 9**

**Prior U.S. Cls.: 21, 23, 26, 36, and 38**

**Reg. No. 3,500,230**

**United States Patent and Trademark Office**

**Registered Sep. 9, 2008**

**TRADEMARK  
PRINCIPAL REGISTER**

**300: MARCH TO GLORY**

WARNER BROS. ENTERTAINMENT INC. (DE-  
LAWARE CORPORATION)  
4000 WARNER BOULEVARD  
BURBANK, CA 91522

FOR: VIDEO AND COMPUTER GAME PRO-  
GRAMS; ROLE-PLAYING COMPUTER AND VIDEO  
GAME SOFTWARE FEATURING THRILLER AD-  
VENTURES, WHICH ARE DESIGNED FOR HARD-  
WARE PLATFORMS, NAMELY, GAME CONSOLES  
AND PERSONAL COMPUTERS; ROLE-PLAYING  
COMPUTER AND VIDEO GAMES FOR PERSONAL  
COMPUTERS FEATURING THRILLER ADVEN-  
TURES; CD ROM COMPUTER GAME DISCS AND  
COMPUTER PROGRAMS, NAMELY, SOFTWARE

LINKING DIGITALIZED VIDEO AND AUDIO  
MEDIA TO A GLOBAL COMPUTER INFORMA-  
TION NETWORK, IN CLASS 9 (U.S. CLS. 21, 23, 26, 36  
AND 38).

FIRST USE 2-27-2007; IN COMMERCE 2-27-2007.

THE MARK CONSISTS OF STANDARD CHAR-  
ACTERS WITHOUT CLAIM TO ANY PARTICULAR  
FONT, STYLE, SIZE, OR COLOR.

SN 78-879,114, FILED 5-8-2006.

DAVID H. STINE, EXAMINING ATTORNEY



**Int. Cl.: 28**

**Prior U.S. Cls.: 22, 23, 38, and 50**

**United States Patent and Trademark Office**

**Reg. No. 3,500,231**

**Registered Sep. 9, 2008**

**TRADEMARK  
PRINCIPAL REGISTER**

**GRILL**

PROCAPS L.P. (CANADA PARTNERSHIP)  
6000 KIERAN STREET  
VILLE ST. LAURENT, QUEBEC, CANADA H4S 2B5

FOR: SPORTING GOODS, NAMELY, FACE  
MASKS FOR PLAYING PAINTBALL OR AIRSOFT  
GAMES, IN CLASS 28 (U.S. CLS. 22, 23, 38 AND 50).

FIRST USE 10-13-2006; IN COMMERCE 10-13-2006.

THE MARK CONSISTS OF STANDARD CHAR-  
ACTERS WITHOUT CLAIM TO ANY PARTICULAR  
FONT, STYLE, SIZE, OR COLOR.

SN 78-882,272, FILED 5-12-2006.

MICHAEL KEATING, EXAMINING ATTORNEY

**Int. Cl.: 35**

**Prior U.S. Cls.: 100, 101, and 102**

**United States Patent and Trademark Office**

**Reg. No. 3,500,232**

**Registered Sep. 9, 2008**

**SERVICE MARK  
PRINCIPAL REGISTER**

**START SAVVY**

SMB SOLUTIONS, LLC (GEORGIA LIMITED  
LIABILITY COMPANY)  
1110 CAPITAL CLUB CIRCLE  
ATLANTA, GA 30319

FOR: EMPLOYMENT COUNSELING AND RE-  
CRUITING; PROVIDING CAREER INFORMATION  
VIA A GLOBAL COMPUTER NETWORK; RESUME  
PREPARATION, IN CLASS 35 (U.S. CLS. 100, 101  
AND 102).

FIRST USE 3-12-2008; IN COMMERCE 3-12-2008.

THE MARK CONSISTS OF STANDARD CHAR-  
ACTERS WITHOUT CLAIM TO ANY PARTICULAR  
FONT, STYLE, SIZE, OR COLOR.

SN 78-884,337, FILED 5-16-2006.

JENNIFER MARTIN, EXAMINING ATTORNEY

**Int. Cl.: 20**

**Prior U.S. Cls.: 2, 13, 22, 25, 32, and 50**

**Reg. No. 3,500,233**

**United States Patent and Trademark Office**

**Registered Sep. 9, 2008**

---

**TRADEMARK  
PRINCIPAL REGISTER**

**BOOSTERPOD**

PRINCE LIONHEART, INC. (CALIFORNIA CORPORATION)  
2421 SOUTH WESTGATE ROAD  
SANTA MARIA, CA 93455

THE MARK CONSISTS OF STANDARD CHARACTERS WITHOUT CLAIM TO ANY PARTICULAR FONT, STYLE, SIZE, OR COLOR.

FOR: BOOSTER SEAT, IN CLASS 20 (U.S. CLS. 2, 13, 22, 25, 32 AND 50).

SN 78-884,926, FILED 5-16-2006.

FIRST USE 5-5-2008; IN COMMERCE 7-7-2008.

AMY HELLA, EXAMINING ATTORNEY

**Int. Cl.: 41**

**Prior U.S. Cls.: 100, 101, and 107**

**United States Patent and Trademark Office**

**Reg. No. 3,500,234**

**Registered Sep. 9, 2008**

**SERVICE MARK  
PRINCIPAL REGISTER**

**ADELANTE**

ADELANTE EDUCATIONAL SERVICES LLC  
(CALIFORNIA LIMITED LIABILITY COMPAN-  
NY)  
22601 SUMMERFIELD  
MISSION VIEJO, CA 92692

FOR: EDUCATION SERVICES, NAMELY, PRO-  
VIDING AND CONDUCTING COURSES, CLASSES,  
SEMINARS, WORKSHOPS, TUTORING, AND MEN-  
TORING IN THE FIELD OF K-12, IN PRIMARY,  
GRAMMAR, MIDDLE AND HIGH SCHOOL SUB-  
JECTS, AND DISTRIBUTING COURSE MATERIAL  
IN CONNECTION THEREWITH; EDUCATION LEA-  
DERSHIP DEVELOPMENT; ANALYZING EDUCA-  
TIONAL TESTS SCORES AND DATA FOR OTHERS  
AND EDUCATIONAL TESTING AND EXAMINA-  
TION SERVICES; DEVELOPMENT AND DISSEMI-  
NATION OF EDUCATIONAL MATERIALS OF

OTHERS FOR PRIMARY, GRAMMAR, MIDDLE  
AND HIGH SCHOOL SUBJECTS, IN CLASS 41 (U.S.  
CLS. 100, 101 AND 107).

FIRST USE 9-1-2006; IN COMMERCE 9-1-2006.

THE MARK CONSISTS OF STANDARD CHAR-  
ACTERS WITHOUT CLAIM TO ANY PARTICULAR  
FONT, STYLE, SIZE, OR COLOR.

THE FOREIGN WORDING IN THE MARK  
TRANSLATES INTO ENGLISH AS MOVING FOR-  
WARD.

SN 78-891,040, FILED 5-24-2006.

JOHN DALIER, EXAMINING ATTORNEY

**Int. Cl.: 36**

**Prior U.S. Cls.: 100, 101, and 102**

**United States Patent and Trademark Office**

**Reg. No. 3,500,235**

**Registered Sep. 9, 2008**

**SERVICE MARK  
PRINCIPAL REGISTER**

**BANKASIANA**

BANKASIANA (NEW JERSEY CORPORATION)  
7 BROAD AVENUE  
PALISADES PARK, NJ 07650

THE MARK CONSISTS OF STANDARD CHAR-  
ACTERS WITHOUT CLAIM TO ANY PARTICULAR  
FONT, STYLE, SIZE, OR COLOR.

FOR: BANKING SERVICES, IN CLASS 36 (U.S.  
CLS. 100, 101 AND 102).

SN 78-892,765, FILED 5-25-2006.

FIRST USE 5-25-2006; IN COMMERCE 5-25-2006.

MICHAEL WEBSTER, EXAMINING ATTORNEY

**Int. Cls.: 9 and 10**

**Prior U.S. Cls.: 21, 23, 26, 36, 38, 39, and 44**

**United States Patent and Trademark Office**

**Reg. No. 3,500,236**

**Registered Sep. 9, 2008**

**TRADEMARK  
PRINCIPAL REGISTER**

**SENSATION**

GUST, DAVID (UNITED STATES INDIVIDUAL)  
319 WEST ONTARIO STREET  
CHICAGO, IL 60610

FIRST USE 6-21-2007; IN COMMERCE 6-21-2007.

FOR: DISPOSABLE LATEX GLOVES FOR LABORATORY USE, IN CLASS 9 (U.S. CLS. 21, 23, 26, 36 AND 38).

THE MARK CONSISTS OF STANDARD CHARACTERS WITHOUT CLAIM TO ANY PARTICULAR FONT, STYLE, SIZE, OR COLOR.

FIRST USE 6-21-2007; IN COMMERCE 6-21-2007.

SN 78-893,195, FILED 5-25-2006.

FOR: DISPOSABLE LATEX GLOVES FOR MEDICAL USE, IN CLASS 10 (U.S. CLS. 26, 39 AND 44).

TIMOTHY FINNEGAN, EXAMINING ATTORNEY

**Int. Cls.: 21, 25, and 30**

**Prior U.S. Cls.: 2, 13, 22, 23, 29, 30, 33, 39, 40, 46, and 50**

**Reg. No. 3,500,237**

**United States Patent and Trademark Office**

**Registered Sep. 9, 2008**

**TRADEMARK  
PRINCIPAL REGISTER**

# Hula Java

GETREU, GARY B. (UNITED STATES INDIVIDUAL)  
2070 BAYO CLAROS CIRCLE  
MORGAN HILL, CA 95037

FOR: MUGS, IN CLASS 21 (U.S. CLS. 2, 13, 23, 29, 30, 33, 40 AND 50).

FIRST USE 4-21-2008; IN COMMERCE 4-21-2008.

FOR: HATS; SWEAT SHIRTS; T-SHIRTS, IN CLASS 25 (U.S. CLS. 22 AND 39).

FIRST USE 4-21-2008; IN COMMERCE 4-21-2008.

FOR: COFFEE, IN CLASS 30 (U.S. CL. 46).

FIRST USE 4-21-2008; IN COMMERCE 4-21-2008.

THE MARK CONSISTS OF STANDARD CHARACTERS WITHOUT CLAIM TO ANY PARTICULAR FONT, STYLE, SIZE, OR COLOR.

NO CLAIM IS MADE TO THE EXCLUSIVE RIGHT TO USE "JAVA" FOR THE GOODS IN INTERNATIONAL CLASSES 021 AND 030, APART FROM THE MARK AS SHOWN.

SN 78-896,778, FILED 5-31-2006.

PAUL E. FAHRENKOPF, EXAMINING ATTORNEY

**Int. Cl.: 29**

**Prior U.S. Cl.: 46**

**United States Patent and Trademark Office**

**Reg. No. 3,500,238**

**Registered Sep. 9, 2008**

**TRADEMARK  
PRINCIPAL REGISTER**

**LIVEBRIGHT**

KELLOGG NORTH AMERICA COMPANY (DE-  
LAWARE CORPORATION)  
ONE KELLOGG SQUARE, PO BOX 3599  
BATTLE CREEK, MI 490163599

THE MARK CONSISTS OF STANDARD CHAR-  
ACTERS WITHOUT CLAIM TO ANY PARTICULAR  
FONT, STYLE, SIZE, OR COLOR.

FOR: PROTEIN BASED, NUTRIENT-DENSE  
SNACK BARS, IN CLASS 29 (U.S. CL. 46).

SN 78-897,323, FILED 5-31-2006.

FIRST USE 7-14-2008; IN COMMERCE 7-14-2008.

JAMES A. RAUEN, EXAMINING ATTORNEY



**Int. Cl.: 16**

**Prior U.S. Cls.: 2, 5, 22, 23, 29, 37, 38, and 50**

**Reg. No. 3,500,239**

**United States Patent and Trademark Office**

**Registered Sep. 9, 2008**

**TRADEMARK  
PRINCIPAL REGISTER**

**Never Fall Down**

MONDAK CO., LIMITED (HONG KONG CORPORATION)  
ROOM 302, 3RD FLOOR, KINOX CENTRE  
9 HUNG TO ROAD, KWUN TONG  
KOWLOON, HONG KONG

FOR: PEN OR PENCIL HOLDERS; PENCILS;  
PENS; STATIONERY BOXES; STATIONERY-TYPE  
PORTFOLIOS, IN CLASS 16 (U.S. CLS. 2, 5, 22, 23, 29,  
37, 38 AND 50).

FIRST USE 8-8-2007; IN COMMERCE 8-8-2007.

THE MARK CONSISTS OF STANDARD CHARACTERS WITHOUT CLAIM TO ANY PARTICULAR FONT, STYLE, SIZE, OR COLOR.

SN 78-898,746, FILED 6-2-2006.

JAMES MACFARLANE, EXAMINING ATTORNEY

**Int. Cl.: 27**

**Prior U.S. Cls.: 19, 20, 37, 42, and 50**

**United States Patent and Trademark Office**

**Reg. No. 3,500,240**

**Registered Sep. 9, 2008**

**TRADEMARK  
PRINCIPAL REGISTER**

**STICKLETS**

WITKE, CYNTHIA (UNITED STATES INDIVIDUAL)  
C/O E. HANSCOM, 7395 PORTAGE WAY  
CARLSBAD, CA 92011

THE MARK CONSISTS OF STANDARD CHARACTERS WITHOUT CLAIM TO ANY PARTICULAR FONT, STYLE, SIZE, OR COLOR.

FOR: WALLCOVERINGS, IN CLASS 27 (U.S. CLS. 19, 20, 37, 42 AND 50).

SN 78-899,839, FILED 6-3-2006.

FIRST USE 1-10-2007; IN COMMERCE 1-10-2007.

KATHERINE CHANG, EXAMINING ATTORNEY

**Int. Cl.: 43**

**Prior U.S. Cls.: 100 and 101**

**United States Patent and Trademark Office**

**Reg. No. 3,500,241**

**Registered Sep. 9, 2008**

**SERVICE MARK  
PRINCIPAL REGISTER**

**MARSHMALLOW FACTORY**

2085802 ONTARIO INC. (CANADA CORPORATION)  
709 DANFORTH AVENUE  
TORONTO, ONTARIO, CANADA M4J 1L2

FOR: PREPARATION OF FOOD AND BEVERAGES; RESTAURANT SERVICES, IN CLASS 43 (U.S. CLS. 100 AND 101).

FIRST USE 7-15-2008; IN COMMERCE 7-15-2008.

THE MARK CONSISTS OF STANDARD CHARACTERS WITHOUT CLAIM TO ANY PARTICULAR FONT, STYLE, SIZE, OR COLOR.

PRIORITY CLAIMED UNDER SEC. 44(D) ON CANADA APPLICATION NO. 784166, FILED 6-5-2006.

NO CLAIM IS MADE TO THE EXCLUSIVE RIGHT TO USE "MARSHMALLOW", APART FROM THE MARK AS SHOWN.

SN 78-900,212, FILED 6-5-2006.

ROBERT C. CLARK JR., EXAMINING ATTORNEY

**Int. Cl.: 9**

**Prior U.S. Cls.: 21, 23, 26, 36, and 38**

**Reg. No. 3,500,242**

**United States Patent and Trademark Office**

**Registered Sep. 9, 2008**

**TRADEMARK  
PRINCIPAL REGISTER**

**THE ALZHEIMER'S ADVOCATE**

ALZHEIMERS INSTITUTE, LLC (COLORADO  
LIMITED LIABILITY COMPANY)

5721 MAGAZINE STREET  
#106  
NEW ORLEANS, LA 70115

FIRST USE 7-1-2006; IN COMMERCE 7-1-2006.

THE MARK CONSISTS OF STANDARD CHARACTERS WITHOUT CLAIM TO ANY PARTICULAR FONT, STYLE, SIZE, OR COLOR.

FOR: PRE-RECORDED ELECTRONIC MEDIA, NAMELY, AUDIO/VIDEO DISCS AND TAPES, DIGITAL RECORDING DISCS AND TAPES, SERIES OF PRE-RECORDED COMPACT SOUND RECORDING DISCS, VIDEO DISCS AND VIDEOTAPES ALL FEATURING MUSIC, SOUND EFFECTS, AND INFORMATION IN THE FIELD OF HEALTH CARE, AGING, DEMENTIA AND ALZHEIMER'S DISEASE, IN CLASS 9 (U.S. CLS. 21, 23, 26, 36 AND 38).

NO CLAIM IS MADE TO THE EXCLUSIVE RIGHT TO USE "ALZHEIMER'S", APART FROM THE MARK AS SHOWN.

SN 78-900,546, FILED 6-5-2006.

MARLENE BELL, EXAMINING ATTORNEY

**Int. Cl.: 3**

**Prior U.S. Cls.: 1, 4, 6, 50, 51, and 52**

**Reg. No. 3,500,243**

**United States Patent and Trademark Office**

**Registered Sep. 9, 2008**

**TRADEMARK  
PRINCIPAL REGISTER**

**A & H**

ALFORD & HOFF, INC. (CALIFORNIA CORPORATION)  
8383 WILSHIRE BOULEVARD  
SUITE 510  
BEVERLY HILLS, CA 90211

FOR: SKIN TREATMENT AND SKIN CARE PRODUCTS, NAMELY, SKIN CARE CREAMS AND LOTIONS, SKIN MOISTURIZERS, NON-MEDICATED SKIN SERUMS, SKIN EXFOLIANTS, SKIN CLEANSERS AND WASHES, EYE CREAMS AND LOTIONS, FACIAL CREAMS AND LOTIONS, SHAV-

ING CREAMS AND GELS, AND SKIN CARE MASKS, IN CLASS 3 (U.S. CLS. 1, 4, 6, 50, 51 AND 52).

FIRST USE 4-21-2008; IN COMMERCE 4-21-2008.

THE MARK CONSISTS OF STANDARD CHARACTERS WITHOUT CLAIM TO ANY PARTICULAR FONT, STYLE, SIZE, OR COLOR.

SN 78-902,200, FILED 6-6-2006.

NICHOLAS COLEMAN, EXAMINING ATTORNEY

**Int. Cls.: 9 and 41**

**Prior U.S. Cls.: 21, 23, 26, 36, 38, 100, 101, and 107**

**United States Patent and Trademark Office**

**Reg. No. 3,500,244**

**Registered Sep. 9, 2008**

**TRADEMARK  
SERVICE MARK  
PRINCIPAL REGISTER**



HIGH FIVE RECORDS, LLC (FLORIDA LIMITED LIABILITY COMPANY)  
9369 BLIND PASS ROAD  
ST. PETE BEACH, FL 33706

FOR: PRE-RECORDED CDS, DVDS AND AUDIO TAPES FEATURING COMEDY AND MUSIC, IN CLASS 9 (U.S. CLS. 21, 23, 26, 36 AND 38).

FIRST USE 4-29-2007; IN COMMERCE 4-29-2007.

FOR: RECORD LABEL SERVICES, NAMELY, RECORD, CD AND DVD PRODUCTION; RECORD, CD AND DVD MASTER PRODUCTION; AND RECORDING STUDIO SERVICES, FEATURING COMEDY AND MUSIC, IN CLASS 41 (U.S. CLS. 100, 101 AND 107).

FIRST USE 4-29-2007; IN COMMERCE 4-29-2007.

NO CLAIM IS MADE TO THE EXCLUSIVE RIGHT TO USE "RECORDS", APART FROM THE MARK AS SHOWN.

THE COLOR(S) ORANGE, WHITE AND BLACK IS/ARE CLAIMED AS A FEATURE OF THE MARK.

THE COLOR ORANGE APPEARS IN THE WORD "HIGH" AND IN THE NUMBER "5." THE MICROPHONE, THE WORD "RECORDS" AND THE LINE ABOVE THE WORD "RECORDS" IS IN WHITE. THE BACKGROUND RECTANGLES ARE IN BLACK.

SN 78-903,104, FILED 6-7-2006.

MARY CRAWFORD, EXAMINING ATTORNEY

Int. Cl.: 33

Prior U.S. Cls.: 47 and 49

United States Patent and Trademark Office

Reg. No. 3,500,245

Registered Sep. 9, 2008

TRADEMARK  
PRINCIPAL REGISTER

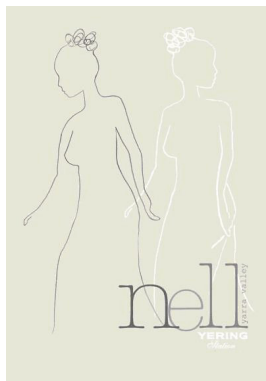

YERING ESTATE PTY LTD (AUSTRALIA PROPRIETARY COMPANY)  
38 MELBA HIGHWAY YARRA GLEN  
VICTORIA, AUSTRALIA

FOR: ALCOHOLIC BEVERAGES, NAMELY, WINES, IN CLASS 33 (U.S. CLS. 47 AND 49).

FIRST USE 8-0-2006; IN COMMERCE 8-0-2006.

NO CLAIM IS MADE TO THE EXCLUSIVE RIGHT TO USE "YARRA VALLEY" OR "YERING", APART FROM THE MARK AS SHOWN.

THE COLOR(S) BLACK, WHITE, GRAY, AND LIGHT GREEN-GRAY IS/ARE CLAIMED AS A FEATURE OF THE MARK.

THE MARK CONSISTS OF THE WORDS "NELL" AND "YARRA VALLEY" IN BLACK AND GRAY, THE WORDS "YERING STATION" IN WHITE, A STYLIZED FORM OF A WOMAN IN BLACK, A STYLIZED FORM OF A WOMAN IN WHITE, ALL AGAINST A LIGHT GREEN/GRAY BACKGROUND.

SN 78-905,725, FILED 6-12-2006.

RONALD MCMORROW, EXAMINING ATTORNEY

**Int. Cls.: 9 and 42**

**Prior U.S. Cls.: 21, 23, 26, 36, 38, 100, and 101**

**United States Patent and Trademark Office**

**Reg. No. 3,500,246**

**Registered Sep. 9, 2008**

**TRADEMARK  
SERVICE MARK  
PRINCIPAL REGISTER**

**WHEN RELIABILITY MATTERS**

DIGI INTERNATIONAL INC. (DELAWARE CORPORATION)  
11001 BREN ROAD EAST  
MINNETONKA, MN 55343

FOR: COMPUTER NETWORK CONNECTIVITY HARDWARE AND COMPUTER NETWORK CONNECTIVITY SOFTWARE, IN CLASS 9 (U.S. CLS. 21, 23, 26, 36 AND 38).

FIRST USE 9-0-2006; IN COMMERCE 9-0-2006.

FOR: CONSULTING SERVICES IN THE FIELD OF DESIGN, SELECTION, IMPLEMENTATION AND USE OF COMPUTER NETWORK CONNECTIVITY HARDWARE AND SOFTWARE SYSTEMS FOR OTHERS; TECHNICAL SUPPORT SERVICES,

NAMELY, TROUBLESHOOTING IN THE FIELD OF COMPUTER NETWORK CONNECTIVITY HARDWARE AND SOFTWARE PROBLEMS OFFERED THROUGH TELEPHONE AND ONLINE SUPPORT PROVIDED TO PURCHASERS AND USERS, IN CLASS 42 (U.S. CLS. 100 AND 101).

FIRST USE 9-0-2006; IN COMMERCE 9-0-2006.

THE MARK CONSISTS OF STANDARD CHARACTERS WITHOUT CLAIM TO ANY PARTICULAR FONT, STYLE, SIZE, OR COLOR.

SN 78-906,019, FILED 6-12-2006.

LYDIA BELZER, EXAMINING ATTORNEY



**Int. Cls.: 9 and 41**

**Prior U.S. Cls.: 21, 23, 26, 36, 38, 100, 101, and 107**

**United States Patent and Trademark Office**

**Reg. No. 3,500,247**

**Registered Sep. 9, 2008**

**TRADEMARK  
SERVICE MARK  
PRINCIPAL REGISTER**

# MASSGATE

MASSIVE ENTERTAINMENT AB (SWEDEN  
CORPORATION)  
BOX 4297  
MALMO, SWEDEN 203 14

FOR: COMPUTER GAMING SOFTWARE;  
DOWNLOADABLE ELECTRONIC PUBLICATIONS,  
NAMELY, NEWSLETTERS, MAGAZINES AND  
CATALOGUES IN THE FIELD OF VIDEO GAME  
ENTERTAINMENT, IN CLASS 9 (U.S. CLS. 21, 23, 26,  
36 AND 38).

FIRST USE 6-22-2004; IN COMMERCE 6-22-2004.

FOR: ENTERTAINMENT SERVICES, NAMELY,  
PROVIDING ON-LINE COMPUTER GAMES AND

PROVIDING INFORMATION ABOUT COMPUTER  
GAMES IN THE NATURE OF TIPS AND STRATE-  
GIES FOR PLAYING COMPUTER GAMES, IN  
CLASS 41 (U.S. CLS. 100, 101 AND 107).

FIRST USE 6-22-2004; IN COMMERCE 6-22-2004.

THE MARK CONSISTS OF STANDARD CHAR-  
ACTERS WITHOUT CLAIM TO ANY PARTICULAR  
FONT, STYLE, SIZE, OR COLOR.

SN 78-907,427, FILED 6-13-2006.

NANCY CLARKE, EXAMINING ATTORNEY

**Int. Cls.: 25 and 36**

**Prior U.S. Cls.: 22, 39, 100, 101, and 102**

**United States Patent and Trademark Office**

**Reg. No. 3,500,248**

**Registered Sep. 9, 2008**

**TRADEMARK  
SERVICE MARK  
PRINCIPAL REGISTER**

# SURF TO TURF

GOLDEN ANGELS FOUNDATION, INC. (CALIFORNIA CORPORATION)  
23297 POMPEII DRIVE  
DANA POINT, CA 92629

FOR: CLOTHING, NAMELY, SHIRTS, HALTER TOPS, TEE SHIRTS, JACKETS, VESTS, HATS AND KERCHIEFS, IN CLASS 25 (U.S. CLS. 22 AND 39).

FIRST USE 12-1-2007; IN COMMERCE 12-1-2007.

FOR: CHARITABLE SERVICES, NAMELY, FUND RAISING FOR NEEDY INDIVIDUALS AND ORGA-

NIZATIONS, IN CLASS 36 (U.S. CLS. 100, 101 AND 102).

FIRST USE 12-1-2007; IN COMMERCE 12-1-2007.

THE MARK CONSISTS OF STANDARD CHARACTERS WITHOUT CLAIM TO ANY PARTICULAR FONT, STYLE, SIZE, OR COLOR.

SN 78-909,187, FILED 6-15-2006.

HOWARD B. LEVINE, EXAMINING ATTORNEY

**Int. Cl.: 25**

**Prior U.S. Cls.: 22 and 39**

**United States Patent and Trademark Office**

**Reg. No. 3,500,249**

**Registered Sep. 9, 2008**

**TRADEMARK  
PRINCIPAL REGISTER**

**DAVID B. FIERSE**

DAVID DURANT (UNITED STATES INDIVIDUAL)  
1016 STUYVESANT AVE  
IRVINGTON, NJ 07111

FOR: ATHLETIC FOOTWEAR; BELTS; CAPS; CLOTHING, NAMELY, ARM WARMERS; CLOTHING, NAMELY, FOLK COSTUMES; CLOTHING, NAMELY, KNEE WARMERS; CLOTHING, NAMELY, NECK TUBES; CLOTHING, NAMELY, WRAP-AROUNDS; COATS; CORSETS; DRESS SHIRTS; DRESSES; DUSTERS; FOOTWEAR; HEADWEAR; HOODS; JACKETS; JEANS; JERSEYS; KNIT SHIRTS; MANTLES; MUFFLERS; PAJAMAS; PERSPIRATION ABSORBENT UNDERWEAR CLOTHING; SCARVES; SHIFTS; SHIRTS; SHORT SETS; SHOULDER PADS FOR CLOTHING; SHOULDER WRAPS; SKIRTS; SKIRTS AND DRESSES; SUITS;

SWADDLING CLOTHES; SWEAT BANDS; SWEAT PANTS; SWEAT SHIRTS; SWEAT SHORTS; SWEAT SUITS; T-SHIRTS; TOPS; WRAPS, IN CLASS 25 (U.S. CLS. 22 AND 39).

FIRST USE 10-20-2002; IN COMMERCE 7-2-2003.

THE MARK CONSISTS OF STANDARD CHARACTERS WITHOUT CLAIM TO ANY PARTICULAR FONT, STYLE, SIZE, OR COLOR.

THE NAME "DAVID B. FIERSE" DOES NOT IDENTIFY A LIVING INDIVIDUAL.

SN 78-911,181, FILED 6-19-2006.

SOPHIA S. KIM, EXAMINING ATTORNEY

**Int. Cl.: 29**

**Prior U.S. Cl.: 46**

**United States Patent and Trademark Office**

**Reg. No. 3,500,250**

**Registered Sep. 9, 2008**

**TRADEMARK  
PRINCIPAL REGISTER**

**SandVeg**

ZORKAFOR'S SANDVEG, INC. (VIRGINIA CORPORATION)  
1121 KING STREET  
ALEXANDRIA, VA 22314

THE MARK CONSISTS OF STANDARD CHARACTERS WITHOUT CLAIM TO ANY PARTICULAR FONT, STYLE, SIZE, OR COLOR.

FOR: PREPARED ENTREES CONSISTING PRIMARILY OF MEAT, FISH, POULTRY OR VEGETABLES, IN CLASS 29 (U.S. CL. 46).

SN 78-913,065, FILED 6-21-2006.

FIRST USE 4-12-2008; IN COMMERCE 4-12-2008.

GEORGE LORENZO, EXAMINING ATTORNEY

**Int. Cl.: 42**

**Prior U.S. Cls.: 100 and 101**

**United States Patent and Trademark Office**

**Reg. No. 3,500,251**

**Registered Sep. 9, 2008**

**SERVICE MARK  
PRINCIPAL REGISTER**

**NEWGRAND**

HANGZHOU NEWGRAND SOFTWARE CO.,  
LTD. (CHINA LIMITED LIABILITY COMPAN-  
NY)  
WESTLAKE SOYEA SOFTWARE PARK NO. 176  
BUILDING 20  
TIANMU ROAD, CHINA

FOR: COMPUTER SOFTWARE DESIGN FOR  
OTHERS; COMPUTER SYSTEMS ANALYSIS; UP-  
DATING OF COMPUTER SOFTWARE FOR OTH-  
ERS; HOSTING THE WEB SITES OF OTHERS ON A  
COMPUTER SERVER FOR A GLOBAL COMPUTER  
NETWORK; INSTALLATION OF COMPUTER  
SOFTWARE; DATA CONVERSION OF COMPUTER  
PROGRAM DATA OR INFORMATION; DOCU-  
MENT DATA TRANSFER FROM ONE COMPUTER  
FORMAT TO ANOTHER, NAMELY, FROM PHYSI-

CAL TO ELECTRONIC MEDIA; RESEARCH AND  
DEVELOPMENT FOR NEW PRODUCTS FOR OTH-  
ERS; QUALITY CONTROL FOR OTHERS; CON-  
DUCTING OF FEASIBILITY STUDIES, NAMELY,  
TECHNICAL PROJECT STUDIES, IN CLASS 42 (U.S.  
CLS. 100 AND 101).

FIRST USE 8-13-2007; IN COMMERCE 8-13-2007.

THE MARK CONSISTS OF STANDARD CHAR-  
ACTERS WITHOUT CLAIM TO ANY PARTICULAR  
FONT, STYLE, SIZE, OR COLOR.

SN 78-913,292, FILED 6-21-2006.

KATHRYN COWARD, EXAMINING ATTORNEY

**Int. Cl.: 30**

**Prior U.S. Cl.: 46**

**United States Patent and Trademark Office**

**Reg. No. 3,500,252**

**Registered Sep. 9, 2008**

**TRADEMARK  
PRINCIPAL REGISTER**

**ANGELA MARIE'S**

YARBROUGH, JEFF (UNITED STATES INDIVIDUAL)  
925 E. WINDSOR LANE  
KAYSVILLE, UT 84037

FOR: CONFECTIONARY PRODUCTS, NAMELY, MOLDED HOLLOW CHOCOLATES AND MARSHMALLOW CANDIES, BAKED PRODUCTS IN THE NATURE OF BAKERY GOODS AND SNACK CAKES, AND SNACK TREATS CONSISTING PRIMARILY OF CANDY AND MARSHMALLOW, IN CLASS 30 (U.S. CL. 46).

FIRST USE 10-15-2006; IN COMMERCE 10-15-2006.

THE MARK CONSISTS OF STANDARD CHARACTERS WITHOUT CLAIM TO ANY PARTICULAR FONT, STYLE, SIZE, OR COLOR.

THE NAME "ANGELA MARIE" IDENTIFIES A LIVING INDIVIDUAL WHOSE CONSENT IS OF RECORD.

SN 78-916,032, FILED 6-23-2006.

JESSICA A. POWERS, EXAMINING ATTORNEY

**Int. Cl.: 35**

**Prior U.S. Cls.: 100, 101, and 102**

**United States Patent and Trademark Office**

**Reg. No. 3,500,253**

**Registered Sep. 9, 2008**

**SERVICE MARK  
PRINCIPAL REGISTER**

**THE ORGANIZER LADY**

FELTON, SANDRA H. (UNITED STATES INDIVIDUAL)  
5025 S.W. 114 AVENUE  
MIAMI, FL 33165

FOR: ONLINE ORDERING SERVICES FEATURING BOOKS, MAGAZINES, NEWSLETTERS, AND ARTICLES IN THE FIELD OF ORGANIZATIONAL SKILLS, IN CLASS 35 (U.S. CLS. 100, 101 AND 102).

FIRST USE 4-25-2008; IN COMMERCE 4-25-2008.

THE MARK CONSISTS OF STANDARD CHARACTERS WITHOUT CLAIM TO ANY PARTICULAR FONT, STYLE, SIZE, OR COLOR.

NO CLAIM IS MADE TO THE EXCLUSIVE RIGHT TO USE "ORGANIZER", APART FROM THE MARK AS SHOWN.

SN 78-916,708, FILED 6-26-2006.

JACLYN KIDWELL, EXAMINING ATTORNEY

**Int. Cls.: 5, 35, and 43**

**Prior U.S. Cls.: 6, 18, 44, 46, 51, 52, 100, 101, and 102**

**United States Patent and Trademark Office**

**Reg. No. 3,500,254**

**Registered Sep. 9, 2008**

**TRADEMARK  
SERVICE MARK  
PRINCIPAL REGISTER**

**REAL. RAW. LIVE.**

HOLISTIC FITNESS (CALIFORNIA CORPORATION)  
7953 HOLLYWOOD BOULEVARD  
LOS ANGELES, CA 90046

FOR: NUTRITIONAL SUPPLEMENTS; FOOD SUPPLEMENTS; DIETARY SUPPLEMENTS; VITAMIN SUPPLEMENTS, IN CLASS 5 (U.S. CLS. 6, 18, 44, 46, 51 AND 52).

FIRST USE 2-19-2008; IN COMMERCE 2-19-2008.

FOR: RETAIL STORE SERVICES FEATURING JUICES AND SUPPLEMENTS, IN CLASS 35 (U.S. CLS. 100, 101 AND 102).

FIRST USE 6-14-2007; IN COMMERCE 6-14-2007.

FOR: RESTAURANTS FEATURING JUICE BAR SERVICES, IN CLASS 43 (U.S. CLS. 100 AND 101).

FIRST USE 6-14-2007; IN COMMERCE 6-14-2007.

THE MARK CONSISTS OF STANDARD CHARACTERS WITHOUT CLAIM TO ANY PARTICULAR FONT, STYLE, SIZE, OR COLOR.

NO CLAIM IS MADE TO THE EXCLUSIVE RIGHT TO USE "RAW", APART FROM THE MARK AS SHOWN.

SN 78-917,747, FILED 6-27-2006.

SETH A. RAPPAPORT, EXAMINING ATTORNEY



Int. Cl.: 18

Prior U.S. Cls.: 1, 2, 3, 22, and 41

United States Patent and Trademark Office

Reg. No. 3,500,255

Registered Sep. 9, 2008

TRADEMARK  
PRINCIPAL REGISTER



O'BEIRNE, MARIE (UNITED STATES INDIVIDUAL)  
1017 MILTONWOOD AVENUE  
DUARTE, CA 91010

FOR: HANDBAGS; LEATHER HANDBAGS, IN CLASS 18 (U.S. CLS. 1, 2, 3, 22 AND 41).

FIRST USE 5-19-2008; IN COMMERCE 5-19-2008.

THE COLOR(S) RED, GREEN AND BLACK IS/ARE CLAIMED AS A FEATURE OF THE MARK.

THE MARK CONSISTS OF RED APPEARS IN THE FLOWERS OF THE ROSE, THE COLOR GREEN APPEARS IN THE STEM AND LEAVES AND THE LEAVES ATTACHED TO THE EXTENDED LETTER "B" AND THE COLOR BLACK APPEARS IN THE WORDING.

SN 78-919,284, FILED 6-28-2006.

MICHAEL WEBSTER, EXAMINING ATTORNEY

**Int. Cl.: 3**

**Prior U.S. Cls.: 1, 4, 6, 50, 51, and 52**

**Reg. No. 3,500,256**

**United States Patent and Trademark Office**

**Registered Sep. 9, 2008**

**TRADEMARK  
PRINCIPAL REGISTER**

**HOLD ME**

ADVANCED BEAUTY SYSTEMS, INC. (TEXAS  
CORPORATION)  
5720 LBJ FREEWAY, SUITE 400  
DALLAS, TX 75240

THE MARK CONSISTS OF STANDARD CHAR-  
ACTERS WITHOUT CLAIM TO ANY PARTICULAR  
FONT, STYLE, SIZE, OR COLOR.

FOR: PERFUME, BODY SPRAY, BODY OILS,  
EAU DE TOILET, COLOGNE, BODY LOTIONS  
AND BODY CREAMS, IN CLASS 3 (U.S. CLS. 1, 4,  
6, 50, 51 AND 52).

SN 78-921,832, FILED 7-3-2006.

FIRST USE 10-31-2006; IN COMMERCE 10-31-2006.

JESSICA A. POWERS, EXAMINING ATTORNEY

Int. Cl.: 39

Prior U.S. Cls.: 100 and 105

United States Patent and Trademark Office

Reg. No. 3,500,257

Registered Sep. 9, 2008

**SERVICE MARK  
PRINCIPAL REGISTER**

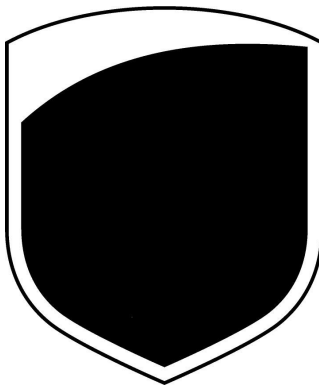

UNITED PARCEL SERVICE OF AMERICA, INC.  
(DELAWARE CORPORATION)  
55 GLENLAKE PARKWAY, NE  
ATLANTA, GA 30328

FOR: FREIGHT FORWARDING; PACKAGING  
ARTICLES FOR TRANSPORTATION; TRANSPORTATION AND DELIVERY OF PERSONAL PROPERTY BY AIR, RAIL, BOAT AND MOTOR VEHICLE; WAREHOUSING, STORAGE, PACKING, DELIVERY AND RETURNS WITH RESPECT TO THE FOREGOING; ARRANGING SHIP CHARTERS FOR OTHERS; DOCUMENT BOX RENTAL, DOCUMENT FORWARDING AND RECEIPT AND DELIV-

ERY OF DOCUMENTS FOR OTHERS, IN CLASS 39  
(U.S. CLS. 100 AND 105).

FIRST USE 7-3-2008; IN COMMERCE 7-3-2008.

OWNER OF U.S. REG. NOS. 2,867,999, 2,965,392,  
AND OTHERS.

THE MARK CONSISTS OF A STYLIZED SHIELD  
DEVICE.

SN 78-923,439, FILED 7-6-2006.

BRENDAN MCCAULEY, EXAMINING ATTORNEY

**Int. Cl.: 42**

**Prior U.S. Cls.: 100 and 101**

**United States Patent and Trademark Office**

**Reg. No. 3,500,258**

**Registered Sep. 9, 2008**

**SERVICE MARK  
PRINCIPAL REGISTER**

**IDEARC**

SECOND LICENSE APPLICATION CORPORA-  
TION (DELAWARE CORPORATION)  
2200 W. AIRFIELD DRIVE  
D/FW AIRPORT, TX 75261

FOR: WEBSITE DESIGN; WEBSITE DESIGN,  
NAMELY, DEVELOPING ONLINE STORES FOR  
OTHERS; WEB HOSTING SERVICES; REGISTRA-  
TION OF DOMAIN NAMES; AND PROVIDING  
SEARCH ENGINES FOR OBTAINING DATA ON  
THE INTERNET, IN CLASS 42 (U.S. CLS. 100 AND  
101).

FIRST USE 11-0-2006; IN COMMERCE 11-0-2006.

THE MARK CONSISTS OF STANDARD CHAR-  
ACTERS WITHOUT CLAIM TO ANY PARTICULAR  
FONT, STYLE, SIZE, OR COLOR.

SN 78-924,794, FILED 7-7-2006.

SAIMA MAKHDOOM, EXAMINING ATTORNEY

Int. Cl.: 25

Prior U.S. Cls.: 22 and 39

**United States Patent and Trademark Office**

**Reg. No. 3,500,259**

Registered Sep. 9, 2008

**TRADEMARK  
PRINCIPAL REGISTER**

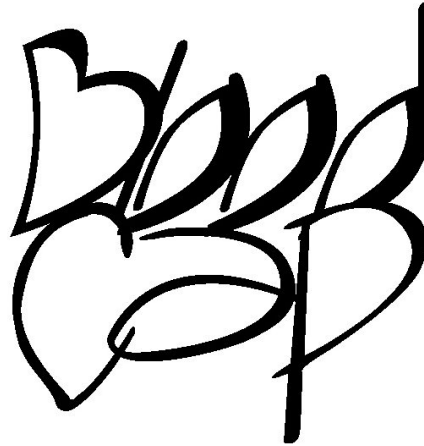

RAMSEY, CRIS A. (UNITED STATES INDIVIDUAL)  
642 AUTUMN OAKS DRIVE  
ALLEN, TX 75002

FIRST USE 6-11-2008; IN COMMERCE 6-11-2008.

SN 78-924,827, FILED 7-7-2006.

FOR: HEADWEAR, NAMELY, HATS AND CAPS,  
IN CLASS 25 (U.S. CLS. 22 AND 39).

SAIMA MAKHDOOM, EXAMINING ATTORNEY

**Int. Cl.: 10**

**Prior U.S. Cls.: 26, 39, and 44**

**United States Patent and Trademark Office**

**Reg. No. 3,500,260**

**Registered Sep. 9, 2008**

**TRADEMARK  
PRINCIPAL REGISTER**

**Neuro7**

J & R ENTERPRISES, INC. (MONTANA CORPORATION)  
540 INDIAN TRAIL  
BILLINGS, MT 59105

FOR: A SMALL HAND-HELD DIAGNOSTIC NEUROLOGICAL INSTRUMENT COMPRISED OF REFLEX HAMMERS, BRUSH, PINWHEEL, SHARP-DULL TOOL, BABINSKI TESTING, AND TWO-POINT DISCRIMINATOR TO HELP MEDICAL PRACTITIONERS PERFORM NEUROLOGICAL EXAMINATIONS, IN CLASS 10 (U.S. CLS. 26, 39 AND 44).

FIRST USE 6-12-2008; IN COMMERCE 6-12-2008.

THE MARK CONSISTS OF STANDARD CHARACTERS WITHOUT CLAIM TO ANY PARTICULAR FONT, STYLE, SIZE, OR COLOR.

SN 78-925,166, FILED 7-8-2006.

JASON ROTH, EXAMINING ATTORNEY

**Int. Cl.: 36**

**Prior U.S. Cls.: 100, 101, and 102**

**United States Patent and Trademark Office**

**Reg. No. 3,500,261**

**Registered Sep. 9, 2008**

**SERVICE MARK  
PRINCIPAL REGISTER**

**THE ETFSTORE**

ODELL, COLIN RICE (UNITED STATES INDIVIDUAL)  
3800 FAIRFAX DR. #812  
ARLINGTON, VA 22203

FOR: FINANCIAL SERVICES, IN THE NATURE OF ASSET MANAGEMENT AND INVESTMENT ADVISORY SERVICES UTILIZING EXCHANGE TRADED FUNDS, IN CLASS 36 (U.S. CLS. 100, 101 AND 102).

FIRST USE 12-15-2007; IN COMMERCE 12-15-2007.

THE MARK CONSISTS OF STANDARD CHARACTERS WITHOUT CLAIM TO ANY PARTICULAR FONT, STYLE, SIZE, OR COLOR.

SN 78-926,440, FILED 7-11-2006.

WANDA KAY PRICE, EXAMINING ATTORNEY

**Int. Cl.: 25**

**Prior U.S. Cls.: 22 and 39**

**United States Patent and Trademark Office**

**Reg. No. 3,500,262**

**Registered Sep. 9, 2008**

**TRADEMARK  
PRINCIPAL REGISTER**

**SURFSTAR CLOTHING**

BOYER, BRIAN (UNITED STATES INDIVIDUAL)  
#6-B HOLLISTER RANCH ROAD  
GAVIOTA, CA 93117

FOR: SPORTS APPAREL, NAMELY, BOARD SHORTS, WALKING SHORTS, HOODED SWEATSHIRTS, T-SHIRTS, HATS, LADIES TOPS AND SHORTS, IN CLASS 25 (U.S. CLS. 22 AND 39).

FIRST USE 1-1-2006; IN COMMERCE 4-1-2006.

THE MARK CONSISTS OF STANDARD CHARACTERS WITHOUT CLAIM TO ANY PARTICULAR FONT, STYLE, SIZE, OR COLOR.

NO CLAIM IS MADE TO THE EXCLUSIVE RIGHT TO USE "CLOTHING", APART FROM THE MARK AS SHOWN.

SN 78-929,752, FILED 7-14-2006.

AMY GEARIN, EXAMINING ATTORNEY



**Int. Cl.: 37**

**Prior U.S. Cls.: 100, 103, and 106**

**United States Patent and Trademark Office**

**Reg. No. 3,500,263**

**Registered Sep. 9, 2008**

**SERVICE MARK  
PRINCIPAL REGISTER**

**UNIQUELY YOURS**

WYNDHAM HOMES, INC. (NEW YORK COR-  
PORATION)  
SOUTHEAST EXECUTIVE PARK  
SUITE 301A, 185 ROUTE 312  
BREWSTER, NY 10509

FOR: LAND DEVELOPMENT SERVICES, NAME-  
LY, PLANNING AND LAYING OUT OF RESIDEN-  
TIAL AND/OR COMMERCIAL COMMUNITIES;  
REAL ESTATE DEVELOPMENT; COMMERCIAL  
BUILDING CONSTRUCTION AND CONSULTING  
IN THE FIELD OF COMMERCIAL BUILDING

CONSTRUCTION, IN CLASS 37 (U.S. CLS. 100, 103  
AND 106).

FIRST USE 1-10-2008; IN COMMERCE 1-10-2008.

THE MARK CONSISTS OF STANDARD CHAR-  
ACTERS WITHOUT CLAIM TO ANY PARTICULAR  
FONT, STYLE, SIZE, OR COLOR.

SN 78-931,796, FILED 7-18-2006.

SAIMA MAKHDOOM, EXAMINING ATTORNEY

**Int. Cl.: 9**

**Prior U.S. Cls.: 21, 23, 26, 36, and 38**

**Reg. No. 3,500,264**

**United States Patent and Trademark Office**

**Registered Sep. 9, 2008**

**TRADEMARK  
PRINCIPAL REGISTER**

The logo for MAG consists of the letters 'MAG' in a bold, stylized, sans-serif font. The letters are dark blue or black with a slight gradient and a shadow effect, giving them a three-dimensional appearance. The 'M' and 'A' are connected at the top, and the 'G' is slightly separated from the 'A'.

MAG TECHNOLOGY CO., LTD. (TAIWAN CORPORATION)  
21F., NO.1, PAU-SHENG RD.  
YUNGHO CITY, TAIPEI, TAIWAN 23444

FOR: ELECTRONIC ADVERTISEMENT AND MESSAGING DISPLAY UNIT WITH MULTI-NETWORKING CAPABILITIES AND REMOTE CONNECTIVITY; LIQUID CRYSTAL DISPLAYS; COMPUTER MONITORS; COMPUTER KEYBOARDS; COMPUTER MOUSE; HARD DRIVES FOR COMPUTERS; COMPUTER CASINGS; COMPUTER DISC DRIVES; WORD PROCESSORS; COMPUTER CURSOR CONTROL DEVICES, NAMELY, TOUCH PADS; MICROPROCESSOR EMULATOR; SCANNERS; TABLET COMPUTERS; DIGITIZER TABLETS; ELECTRONIC PUBLICATIONS, NAMELY, BOOKS FEATURING THE SUBJECT MATTER OF ELECTRONIC WHITEBOARDS RECORDED ON COMPUTER MEDIA; PERSONAL DIGITAL ASSISTANTS (PDA); CARD READERS, NAMELY, FLASH CARD READERS, ELECTRONIC CARD READERS, CHIP CARD READERS; COMPUTER DATA READERS, NAMELY, OPTICAL DISC READERS; COMPUTER INTERFACE BOARDS; PRINTED CIRCUIT BOARDS; COMPUTER ACCELERATOR BOARD; COMPUTER GRAPHICS BOARDS; VIDEO DISPLAY CARDS; COMPUTER EXPANSION BOARDS; VIDEO CAMERAS; DIGITAL CAMERAS; TELEVISION MONITORS FOR CLOSED-CIRCUIT TELEVISION; COMPACT DISK PLAYERS; MULTIMEDIA PLAYERS, NAMELY, CD PLAYERS, DIGITAL AUDIO PLAYERS, DIGITAL VIDEO PLAYERS; TELEVISION APPARATUS FOR PROJECTION PURPOSES; PROJECTION SCREENS; TELEVISION RECEIVERS, TV SETS; SATELLITE RECEIVERS; MP3 PLAYERS; FLASH MEMORY, NAMELY, FLASH MEMORY

STICK AND CARD; COMPUTER SPEAKERS; LIQUID CRYSTAL DISPLAY TELEVISIONS; TELEVISION SETS AND PARTS THEREOF; AUDIO SPEAKERS AND PARTS THEREFOR; MULTIMEDIA TEACHING APPARATUS, NAMELY, AUDIO-VISUAL RECEIVERS; VIDEO GAME MACHINES FOR USE WITH TELEVISIONS; ELECTRONIC VIDEO GAME APPARATUS, NAMELY, COMPUTER GAME JOYSTICKS FOR USE WITH COMPUTERS; ELECTRIC STORAGE BATTERIES; ELECTRICAL STORAGE BATTERIES; LITHIUM BATTERIES; COMPUTER CABLES; CONNECTION CABLES; CABLES FOR OPTICAL SIGNAL TRANSMISSION; SPLICES FOR ELECTRICAL TRANSMISSION LINES AND CABLES FOR ELECTRICAL TRANSMISSION; TELEPHONE APPARATUS, NAMELY, INTERCOMS; VIDEOPHONES; VIDEO CONFERENCE EQUIPMENT, NAMELY, VIDEO MONITORS, MICROPHONES, AUDIO SPEAKERS, AND CAMERAS; VEHICLE LOCATOR AND RECOVERY DEVICE PROGRAMMED TO USE GLOBAL POSITIONING SYSTEMS (GPS) OR CELLULAR TELECOMMUNICATIONS; ELECTRIC COILS; MONITORS FOR PERSONAL DIGITAL ASSISTANTS; COMPUTER INTERFACE BOARDS; MAGNETIC IDENTIFYING CARDS; BLANK ELECTRONIC CHIP CARDS, BLANK SMART CARDS; TUNER BOXES USED FOR TUNING AND SELECTING THE CHANNELS OF A TV SYSTEM, IN CLASS 9 (U.S. CLS. 21, 23, 26, 36 AND 38).

FIRST USE 7-18-1995; IN COMMERCE 7-22-2006.

SN 78-932,070, FILED 7-18-2006.

SUSAN STIGLITZ, EXAMINING ATTORNEY

**Int. Cls.: 7 and 12**

**Prior U.S. Cls.: 13, 19, 21, 23, 31, 34, 35, and 44**

**United States Patent and Trademark Office**

**Reg. No. 3,500,265**

**Registered Sep. 9, 2008**

**TRADEMARK  
PRINCIPAL REGISTER**

**CLUTCH  
F.C.C.  
TECHNOLOGY**

KABUSHIKI KAISHA F.C.C. (JAPAN CORPORATION)  
7000-36, NAKAGAWA, HOSOE-CHO  
HAMAMATSU-SHI, SHIZUOKA, JAPAN

FOR: CLUTCHES FOR MACHINES, AND PARTS  
AND FITTINGS THEREFOR, IN CLASS 7 (U.S. CLS.  
13, 19, 21, 23, 31, 34 AND 35).

FIRST USE 4-30-1996; IN COMMERCE 5-10-2007.

FOR: CLUTCHES FOR LAND VEHICLES, AND  
PARTS AND FITTINGS THEREFOR, IN CLASS 12  
(U.S. CLS. 19, 21, 23, 31, 35 AND 44).

FIRST USE 4-30-2006; IN COMMERCE 5-10-2007.

OWNER OF U.S. REG. NOS. 2,782,739, 2,813,834,  
AND 3,174,296.

NO CLAIM IS MADE TO THE EXCLUSIVE  
RIGHT TO USE "CLUTCH" AND "TECHNOLOGY",  
APART FROM THE MARK AS SHOWN.

SN 78-932,721, FILED 7-19-2006.

JENNY PARK, EXAMINING ATTORNEY

**Int. Cl.: 3**

**Prior U.S. Cls.: 1, 4, 6, 50, 51, and 52**

**United States Patent and Trademark Office**

**Reg. No. 3,500,266**

**Registered Sep. 9, 2008**

**TRADEMARK  
PRINCIPAL REGISTER**



GRANERO JIMENEZ, FRANCISCO (SPAIN IN-  
DIVIDUAL)  
C. DE L'OM, 8-10 POL. IND. MAS MATEU  
EL PRAT DE LLOBREGAT, SPAIN 08820

FIRST USE 1-1-2007; IN COMMERCE 1-1-2007.

SN 78-934,931, FILED 7-21-2006.

FOR: INCENSES, HENNA DYES, IN CLASS 3 (U.S.  
CLS. 1, 4, 6, 50, 51 AND 52).

NICHOLAS COLEMAN, EXAMINING ATTORNEY

**Int. Cl.: 5**

**Prior U.S. Cls.: 6, 18, 44, 46, 51, and 52**

**Reg. No. 3,500,267**

**United States Patent and Trademark Office**

**Registered Sep. 9, 2008**

**TRADEMARK  
PRINCIPAL REGISTER**

**MERSANA**

MERSANA THERAPEUTICS, INC. (DELAWARE CORPORATION)  
840 MEMORIAL DRIVE  
CAMBRIDGE, MA 02139

FOR: PHARMACEUTICAL PREPARATIONS AND GENE THERAPIES FOR THE TREATMENT OF CANCER PHARMACEUTICAL PREPARATIONS, NAMELY, DRUG DELIVERY SYSTEMS COMPRISING POLYMER BASED INJECTABLE PHARMACEUTICALS FOR ENHANCED TREATMENT EFFECT AGAINST CANCER, OPHTHALMIC

DISEASE, STROKES AND PAIN, IN CLASS 5 (U.S. CLS. 6, 18, 44, 46, 51 AND 52).

FIRST USE 9-3-2007; IN COMMERCE 9-3-2007.

THE MARK CONSISTS OF STANDARD CHARACTERS WITHOUT CLAIM TO ANY PARTICULAR FONT, STYLE, SIZE, OR COLOR.

SN 78-935,258, FILED 7-21-2006.

SHARON MEIER, EXAMINING ATTORNEY

**Int. Cls.: 25, 29, and 30**

**Prior U.S. Cls.: 22, 39, and 46**

**United States Patent and Trademark Office**

**Reg. No. 3,500,268**

**Registered Sep. 9, 2008**

**TRADEMARK  
PRINCIPAL REGISTER**

**EXTREME HEALTH**

EXTREME HEALTH, INC. (CALIFORNIA CORPORATION)  
601 UNIVERSITY AVE STE 278  
SACRAMENTO, CA 95825

FOR: DRESSES; JACKETS; PANTS; SHIRTS; UNDERWEAR, IN CLASS 25 (U.S. CLS. 22 AND 39).

FIRST USE 10-1-2005; IN COMMERCE 10-31-2005.

FOR: CANNED OR BOTTLED FRUITS, IN CLASS 29 (U.S. CL. 46).

FIRST USE 10-1-2007; IN COMMERCE 10-31-2007.

FOR: FRUIT JELLIES; FRUIT SAUCES EXCLUDING CRANBERRY SAUCE AND APPLESAUCE, IN CLASS 30 (U.S. CL. 46).

FIRST USE 10-1-2007; IN COMMERCE 10-31-2007.

THE MARK CONSISTS OF STANDARD CHARACTERS WITHOUT CLAIM TO ANY PARTICULAR FONT, STYLE, SIZE, OR COLOR.

SN 78-936,377, FILED 7-24-2006.

WANDA KAY PRICE, EXAMINING ATTORNEY

**Int. Cl.: 9**

**Prior U.S. Cls.: 21, 23, 26, 36, and 38**

**Reg. No. 3,500,269**

**United States Patent and Trademark Office**

**Registered Sep. 9, 2008**

**TRADEMARK  
PRINCIPAL REGISTER**

**I-SING**

INNOVATIVE DESIGN & TECHNOLOGIES, LLC  
(DELAWARE LIMITED LIABILITY COMPAN-  
NY)  
5 COLD HILL ROAD  
MENDHAM, NJ 07945

FIRST USE 9-0-2007; IN COMMERCE 9-0-2007.

FOR: APPARATUS FOR SPEECH RECORDING  
AND REPLAYING; RECORDING AND PLAYING  
DEVICES FOR SOUND AND IMAGE CARRIERS;  
SOUND AND VIDEO PLAYBACK MACHINES;  
SOUND RECORDING APPARATUS, IN CLASS 9  
(U.S. CLS. 21, 23, 26, 36 AND 38).

THE MARK CONSISTS OF STANDARD CHAR-  
ACTERS WITHOUT CLAIM TO ANY PARTICULAR  
FONT, STYLE, SIZE, OR COLOR.

SN 78-938,142, FILED 7-26-2006.

AISHA SALEM, EXAMINING ATTORNEY

Int. Cl.: 1

Prior U.S. Cls.: 1, 5, 6, 10, 26, and 46

Reg. No. 3,500,270

United States Patent and Trademark Office

Registered Sep. 9, 2008

TRADEMARK  
PRINCIPAL REGISTER



**GELSIL**

GLASSVEN C.A. (VENEZUELA CORPORATION)  
ZONA INDUSTRIAL IIB, CARRERA 1B  
PARCELA 5B, BARQUISIMETO  
ESTADO LARA, VENEZUELA

FOR: PRECIPITATED SILICA AND SYNTHETIC  
SODIUM SILICATES USED AS RAW MATERIALS  
IN PAINT, PRINT INKS, COSMETIC, DETERGENT,  
ADHESIVE, PESTICIDE, ELASTOMER, PLASTIC,  
PLASTISOLES, SILICONE, SEALANT INDUSTRIES,  
AS PARTIAL SUBSTITUTE OF TITANIUM DIOX-

IDE AND AS PARTIAL OR TOTAL REPLACEMENT  
FOR FUMED SILICAS, AS WELL AS ANTICAKING,  
ABSORPTION, STABILIZER, REINFORCING, FREE  
FLOWING AND THICKENING AGENT, IN CLASS 1  
(U.S. CLS. 1, 5, 6, 10, 26 AND 46).

FIRST USE 12-31-2005; IN COMMERCE 12-31-2005.

SN 78-939,829, FILED 7-28-2006.

ALYSSA PALADINO, EXAMINING ATTORNEY



**Int. Cls.: 35, 38, and 41**

**Prior U.S. Cls.: 100, 101, 102, 104, and 107**

**United States Patent and Trademark Office**

**Reg. No. 3,500,271**

**Registered Sep. 9, 2008**

**SERVICE MARK  
PRINCIPAL REGISTER**

# Ultimate Horse

ULTIMATE HORSE SITES INC. (NEVADA CORPORATION)  
780 SECOND ST SE SUITE 3 #11  
BANDON, OR 97411

FOR: ONLINE ADVERTISING FOR HORSE-RELATED PRODUCTS AND SERVICES; PROMOTION AND ADVERTISING OF HORSE-RELATED WEBSITES THAT SELL HORSE PRODUCTS AND SERVICES; LISTING ADS FOR HORSES FOR SALE, IN CLASS 35 (U.S. CLS. 100, 101 AND 102).

FIRST USE 0-0-2000; IN COMMERCE 0-0-2000.

FOR: PROVIDING ONLINE INTERNET FORUMS FOR ELECTRONIC TRANSMISSION OF COMMUNICATION REGARDING HORSE OWNERSHIP, IN CLASS 38 (U.S. CLS. 100, 101 AND 104).

FIRST USE 0-0-2000; IN COMMERCE 0-0-2000.

FOR: PROVIDING EMAIL NEWSLETTERS AND ONLINE ARTICLES IN THE FIELD OF HORSE

OWNERSHIP, IN CLASS 41 (U.S. CLS. 100, 101 AND 107).

FIRST USE 0-0-2000; IN COMMERCE 0-0-2000.

THE MARK CONSISTS OF STANDARD CHARACTERS WITHOUT CLAIM TO ANY PARTICULAR FONT, STYLE, SIZE, OR COLOR.

NO CLAIM IS MADE TO THE EXCLUSIVE RIGHT TO USE "HORSE", APART FROM THE MARK AS SHOWN.

SEC. 2(F).

SN 78-940,484, FILED 7-28-2006.

DOMINIC J. FERRAIUOLO, EXAMINING ATTORNEY

Int. Cls.: 41, 43, and 44

Prior U.S. Cls.: 100, 101, and 107

United States Patent and Trademark Office

Reg. No. 3,500,272

Registered Sep. 9, 2008

SERVICE MARK  
PRINCIPAL REGISTER

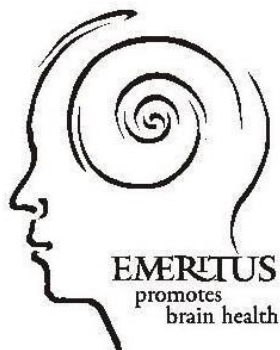

EMERITUS CORPORATION (WASHINGTON CORPORATION)  
SUITE 500  
3131 ELLIOTT AVENUE  
SEATTLE, WA 98121

FOR: EDUCATIONAL SERVICES, NAMELY, PROVIDING COURSES OF INSTRUCTION ABOUT ALZHEIMER'S DISEASE AND CARING FOR PERSONS SUFFERING FROM ALZHEIMER'S DISEASE, IN CLASS 41 (U.S. CLS. 100, 101 AND 107).

FIRST USE 8-31-2006; IN COMMERCE 8-31-2006.

FOR: PROVIDING ASSISTED LIVING AND RETIREMENT HOUSING; AND PROVIDING ELDER CARE SERVICES, IN CLASS 43 (U.S. CLS. 100 AND 101).

FIRST USE 8-31-2006; IN COMMERCE 8-31-2006.

FOR: PROVIDING HEALTH CARE FOR THE ELDERLY, DISABLED AND RETIRED PERSONS; NURSING HOME SERVICES; AND HOME HEALTH CARE SERVICES; PROVIDING INFORMATION IN THE FIELDS OF HEALTH AND MEDICINE, IN CLASS 44 (U.S. CLS. 100 AND 101).

FIRST USE 8-31-2006; IN COMMERCE 8-31-2006.

OWNER OF U.S. REG. NOS. 2,333,116 AND 2,840,150.

NO CLAIM IS MADE TO THE EXCLUSIVE RIGHT TO USE "PROMOTES BRAIN HEALTH", APART FROM THE MARK AS SHOWN.

SN 78-942,532, FILED 8-1-2006.

NICHOLAS COLEMAN, EXAMINING ATTORNEY

**Int. Cl.: 3**

**Prior U.S. Cls.: 1, 4, 6, 50, 51, and 52**

**United States Patent and Trademark Office**

**Reg. No. 3,500,273**

**Registered Sep. 9, 2008**

**TRADEMARK  
PRINCIPAL REGISTER**

**THE BATHROOM X-PERT**

HPD LABORATORIES, INC. (DELAWARE CORPORATION)  
ONE MORNINGSIDE DRIVE NORTH, SUITE 200  
WESTPORT, CT 06880

FOR: ALL PURPOSE CLEANING PREPARATIONS, IN CLASS 3 (U.S. CLS. 1, 4, 6, 50, 51 AND 52).

FIRST USE 2-9-2007; IN COMMERCE 2-9-2007.

THE MARK CONSISTS OF STANDARD CHARACTERS WITHOUT CLAIM TO ANY PARTICULAR FONT, STYLE, SIZE, OR COLOR.

NO CLAIM IS MADE TO THE EXCLUSIVE RIGHT TO USE "BATHROOM", APART FROM THE MARK AS SHOWN.

SN 78-943,579, FILED 8-2-2006.

WILLIAM P. SHANAHAN, EXAMINING ATTORNEY

**Int. Cl.: 3**

**Prior U.S. Cls.: 1, 4, 6, 50, 51, and 52**

**United States Patent and Trademark Office**

**Reg. No. 3,500,274**

**Registered Sep. 9, 2008**

**TRADEMARK  
PRINCIPAL REGISTER**

**BEAUTY WITH INTEGRITY**

MARY THE AESTHETICS, INC. (CALIFORNIA CORPORATION)  
188 SOUTH PARK, #1  
SAN FRANCISCO, CA 94107

FOR: BODY CREAMS AND LOTIONS, NAMELY, SKIN CREAMS, FACE CREAMS, BODY CREAMS, SKIN LOTIONS, FACE LOTIONS, AND BODY LOTIONS, IN CLASS 3 (U.S. CLS. 1, 4, 6, 50, 51 AND 52).

FIRST USE 1-1-2004; IN COMMERCE 1-1-2004.

THE MARK CONSISTS OF STANDARD CHARACTERS WITHOUT CLAIM TO ANY PARTICULAR FONT, STYLE, SIZE, OR COLOR.

NO CLAIM IS MADE TO THE EXCLUSIVE RIGHT TO USE "BEAUTY", APART FROM THE MARK AS SHOWN.

SN 78-944,556, FILED 8-3-2006.

ARETHA SOMERVILLE, EXAMINING ATTORNEY

**Int. Cl.: 11**

**Prior U.S. Cls.: 13, 21, 23, 31, and 34**

**United States Patent and Trademark Office**

**Reg. No. 3,500,275**

**Registered Sep. 9, 2008**

**TRADEMARK  
PRINCIPAL REGISTER**

**FIREFLY**

RSGA INTERNATIONAL, INC. (UTAH CORPORATION)  
1309 16TH STREET, SUITE A  
OGDEN, UT 84404

FOR: LOW VOLTAGE ELECTRIC LIGHTS FOR USE IN TENTS, BATHROOMS, VEHICLES, OUTDOOR SHELTERS, AND OUTDOOR STRUCTURES, IN CLASS 11 (U.S. CLS. 13, 21, 23, 31 AND 34).

FIRST USE 3-1-2007; IN COMMERCE 3-1-2007.

THE MARK CONSISTS OF STANDARD CHARACTERS WITHOUT CLAIM TO ANY PARTICULAR FONT, STYLE, SIZE, OR COLOR.

SN 78-944,942, FILED 8-4-2006.

ANTHONY RINKER, EXAMINING ATTORNEY

**Int. Cl.: 21**

**Prior U.S. Cls.: 2, 13, 23, 29, 30, 33, 40, and 50**

**United States Patent and Trademark Office**

**Reg. No. 3,500,276**

**Registered Sep. 9, 2008**

**TRADEMARK  
PRINCIPAL REGISTER**

**VERSA-PREP**

THE COLMAN GROUP, INC. (WISCONSIN CORPORATION)  
555 KOOPMAN LANE  
ELKHORN, WI 53121

THE MARK CONSISTS OF STANDARD CHARACTERS WITHOUT CLAIM TO ANY PARTICULAR FONT, STYLE, SIZE, OR COLOR.

FOR: HOLDING STANDS FOR CUTTING BOARDS, IN CLASS 21 (U.S. CLS. 2, 13, 23, 29, 30, 33, 40 AND 50).

SN 78-946,443, FILED 8-7-2006.

FIRST USE 11-29-2007; IN COMMERCE 11-29-2007.

MARILYN IZZI, EXAMINING ATTORNEY

**Int. Cl.: 28**

**Prior U.S. Cls.: 22, 23, 38, and 50**

**Reg. No. 3,500,277**

**United States Patent and Trademark Office**

**Registered Sep. 9, 2008**

**TRADEMARK  
PRINCIPAL REGISTER**

**SOLID GOLF**

HENWOOD, BILL (UNITED STATES INDIVIDUAL)  
4691 OUTER BANK DR  
NORCROSS, GA 30092

FOR: GOLF EQUIPMENT, NAMELY, GOLF PUTTING AIDS, NAMELY, PORTABLE DEVICES USED TO IMPROVE THE PUTTING STROKE AND GOLF PUTTING TRAINING DEVICES USE IN CONJUNCTION WITH THE USER'S OWN PUTTER, IN CLASS 28 (U.S. CLS. 22, 23, 38 AND 50).

FIRST USE 7-31-2007; IN COMMERCE 7-31-2007.

THE MARK CONSISTS OF STANDARD CHARACTERS WITHOUT CLAIM TO ANY PARTICULAR FONT, STYLE, SIZE, OR COLOR.

NO CLAIM IS MADE TO THE EXCLUSIVE RIGHT TO USE "GOLF", APART FROM THE MARK AS SHOWN.

SN 78-949,268, FILED 8-10-2006.

ELLEN PERKINS, EXAMINING ATTORNEY

**Int. Cl.: 3**

**Prior U.S. Cls.: 1, 4, 6, 50, 51, and 52**

**Reg. No. 3,500,278**

**United States Patent and Trademark Office**

**Registered Sep. 9, 2008**

**TRADEMARK  
PRINCIPAL REGISTER**

**CLEAN YOU CAN SEE**

JOHNSON & JOHNSON (NEW JERSEY CORPORATION)  
ONE JOHNSON & JOHNSON PLAZA  
NEW BRUNSWICK, NJ 089337001

THE MARK CONSISTS OF STANDARD CHARACTERS WITHOUT CLAIM TO ANY PARTICULAR FONT, STYLE, SIZE, OR COLOR.

FOR: TOILETRIES, NAMELY, BODY WASH, BODY SOAP AND SKIN CLEANSERS, IN CLASS 3 (U.S. CLS. 1, 4, 6, 50, 51 AND 52).

SN 78-949,440, FILED 8-10-2006.

FIRST USE 2-28-2007; IN COMMERCE 2-28-2007.

STEVEN PEREZ, EXAMINING ATTORNEY



**Int. Cl.: 39**

**Prior U.S. Cls.: 100 and 105**

**United States Patent and Trademark Office**

**Reg. No. 3,500,279**

**Registered Sep. 9, 2008**

**SERVICE MARK  
PRINCIPAL REGISTER**

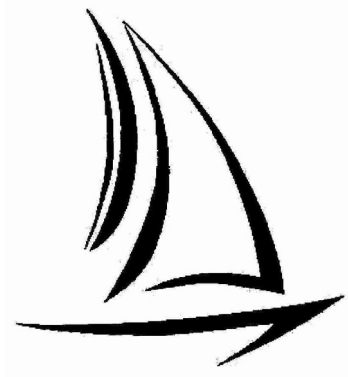

OCEANGRAFIX, LLC (MINNESOTA LIMITED  
LIABILITY COMPANY)  
276 E. FILLMORE AVE.  
ST. PAUL, MN 55107

FIRST USE 3-0-2007; IN COMMERCE 3-0-2007.

SN 78-949,976, FILED 8-11-2006.

FOR: PROVIDING A WEBSITE FEATURING  
MARINE NAVIGATIONAL MAPS, IN CLASS 39  
(U.S. CLS. 100 AND 105).

DAWN HAN, EXAMINING ATTORNEY

**Int. Cl.: 5**

**Prior U.S. Cls.: 6, 18, 44, 46, 51, and 52**

**Reg. No. 3,500,280**

**United States Patent and Trademark Office**

**Registered Sep. 9, 2008**

**TRADEMARK  
PRINCIPAL REGISTER**

WHOLENESS FOR THE PLANET

WHOLENESS FOR THE PLANET, INC (DELA-  
WARE CORPORATION)  
670 PERIMETER  
LEXINGTON, KY 40517

FOR: WHOLESALE DIETARY SUPPLEMENTS,  
NUTRACEUTICALS FOR USE AS A DIETARY  
SUPPLEMENT, VITAMINS, IN CLASS 5 (U.S. CLS.  
6, 18, 44, 46, 51 AND 52).

FIRST USE 4-0-2007; IN COMMERCE 4-0-2007.

THE MARK CONSISTS OF STANDARD CHAR-  
ACTERS WITHOUT CLAIM TO ANY PARTICULAR  
FONT, STYLE, SIZE, OR COLOR.

NO CLAIM IS MADE TO THE EXCLUSIVE  
RIGHT TO USE "WHOLENESS", APART FROM  
THE MARK AS SHOWN.

SN 78-951,212, FILED 8-14-2006.

ANDREW RHIM, EXAMINING ATTORNEY

**Int. Cl.: 25**

**Prior U.S. Cls.: 22 and 39**

**United States Patent and Trademark Office**

**Reg. No. 3,500,281**

**Registered Sep. 9, 2008**

**TRADEMARK  
PRINCIPAL REGISTER**

**HIGH STREET FASHION**

NEVADA APPAREL CORP. (NEW YORK CORPORATION)  
1 WEST 37TH STREET  
NEW YORK, NY 10018

FOR: WOMEN'S CLOTHING, NAMELY, T-SHIRTS, SHIRTS, DRESSES, PANTS, SKIRTS, JACKETS AND SWEATERS, IN CLASS 25 (U.S. CLS. 22 AND 39).

FIRST USE 9-0-2006; IN COMMERCE 9-0-2006.

THE MARK CONSISTS OF STANDARD CHARACTERS WITHOUT CLAIM TO ANY PARTICULAR FONT, STYLE, SIZE, OR COLOR.

NO CLAIM IS MADE TO THE EXCLUSIVE RIGHT TO USE "FASHION", APART FROM THE MARK AS SHOWN.

SN 78-952,450, FILED 8-15-2006.

CAROLYN CATALDO, EXAMINING ATTORNEY

**Int. Cls.: 16, 25, and 26**

**Prior U.S. Cls.: 2, 5, 22, 23, 29, 37, 38, 39, 40, 42, and 50**

**Reg. No. 3,500,282**

**United States Patent and Trademark Office**

**Registered Sep. 9, 2008**

**TRADEMARK  
PRINCIPAL REGISTER**



CO-EXECUTRIXES OF THE ESTATE OF KEITH  
HARING (NEW YORK ESTATE)  
676 BROADWAY  
NEW YORK, NY 10012

FOR: PRINTED MATTER, NAMELY, ART  
PRINTS, POSTCARDS, NOTECARDS, BOOKS AND  
CATALOGS IN THE FIELD OF ART, CALENDARS,  
AND NOTEBOOKS, IN CLASS 16 (U.S. CLS. 2, 5, 22,  
23, 29, 37, 38 AND 50).

FIRST USE 0-0-1988; IN COMMERCE 0-0-1988.

FOR: CLOTHING, NAMELY, T-SHIRTS, IN  
CLASS 25 (U.S. CLS. 22 AND 39).

FIRST USE 0-0-1988; IN COMMERCE 0-0-1988.

FOR: ORNAMENTAL NOVELTY PINS AND BUT-  
TONS, IN CLASS 26 (U.S. CLS. 37, 39, 40, 42 AND 50).

FIRST USE 0-0-1988; IN COMMERCE 0-0-1988.

THE MARK CONSISTS OF THE OUTLINE OF A  
BABY WITH WINGS THAT IS CRAWLING ON ITS  
HANDS AND KNEES WITH RADIATING LINES  
SYMBOLIZING MOVEMENT.

SN 78-952,651, FILED 8-15-2006.

ALEX KEAM, EXAMINING ATTORNEY

**Int. Cl.: 10**

**Prior U.S. Cls.: 26, 39, and 44**

**United States Patent and Trademark Office**

**Reg. No. 3,500,283**

**Registered Sep. 9, 2008**

**TRADEMARK  
PRINCIPAL REGISTER**

**SHARPGUARD**

SURGICAL SPECIALTIES CORPORATION (DE-  
LAWARE CORPORATION)  
100 DENNIS DRIVE  
READING, PA 19606

THE MARK CONSISTS OF STANDARD CHAR-  
ACTERS WITHOUT CLAIM TO ANY PARTICULAR  
FONT, STYLE, SIZE, OR COLOR.

FOR: SURGICAL BLADES; SURGICAL KNIVES,  
IN CLASS 10 (U.S. CLS. 26, 39 AND 44).

SN 78-953,533, FILED 8-16-2006.

FIRST USE 5-5-2008; IN COMMERCE 5-5-2008.

PATRICIA EVANKO, EXAMINING ATTORNEY

**Int. Cls.: 6 and 9**

**Prior U.S. Cls.: 2, 12, 13, 14, 21, 23, 25, 26, 36, 38, and 50**

**Reg. No. 3,500,284**

**United States Patent and Trademark Office**

**Registered Sep. 9, 2008**

**TRADEMARK  
PRINCIPAL REGISTER**

# INTERCEPTOR

CV TECHNOLOGY, INC. (FLORIDA CORPORATION)  
15852 MERCANTILE COURT  
JUPITOR, FL 33478

FOR: DUST EXPLOSION PROTECTION SYSTEMS, NAMELY, INDOOR FLAMELESS EXPLOSION VENTING AND SUPPRESSION DEVICES COMPRISED OF METAL PIPES OR TUBES CONTAINING GAS FLOW OBSTRUCTIONS TO QUENCH AND RELEASE BLASTS OF EXPANDING GASES AND FLAMES FOR SAFER EXHAUSTION, IN CLASS 6 (U.S. CLS. 2, 12, 13, 14, 23, 25 AND 50).

FIRST USE 8-8-2006; IN COMMERCE 8-8-2006.

FOR: DUST EXPLOSION PROTECTION SYSTEMS CONSISTING OF AUTOMATIC ISOLATION VALVES FOR CLOSING PIPES BETWEEN CHAMBERS UPON DETECTION OF EXPLOSIONS AND AUTOMATIC EXPLOSION SUPPRESSION, AND CHEMICAL ISOLATION DEVICES FOR DELIVERY OF DRY CHEMICAL EXTINGUISHING AGENTS INTO DEVELOPING EXPLOSIONS, CONSISTING OF CARTRIDGES FOR CONTAINING AN EXPLOSION EXTINGUISHING AGENT, CANNON BARRELS FOR PROPELLING THE EXPLOSION

EXTINGUISHING AGENT INTO DEVELOPING EXPLOSIONS, ELECTRICALLY-IGNITED ACTUATORS FOR LOOSENING EXPLOSION EXTINGUISHING AGENT AND/OR PROVIDING ACCELERATING FORCES TO THE EXPLOSION EXTINGUISHING AGENT AS IT LEAVES THE CANNON, PRESSURIZED TANKS FOR ADDING PRESSURIZED GAS TO THE ACCELERATING FORCE OF THE ACTUATORS, AND ASSOCIATED POWER SUPPLIES, MONITORS, PRESSURE SENSING DEVICES AND SWITCHES, AND DETECTOR INTERFACES AND CONTROLS, ALL SOLD AS A UNIT, IN CLASS 9 (U.S. CLS. 21, 23, 26, 36 AND 38).

FIRST USE 8-8-2006; IN COMMERCE 8-8-2006.

THE MARK CONSISTS OF STANDARD CHARACTERS WITHOUT CLAIM TO ANY PARTICULAR FONT, STYLE, SIZE, OR COLOR.

OWNER OF U.S. REG. NO. 3,047,937.

SN 78-953,771, FILED 8-16-2006.

ESTHER BELENKER, EXAMINING ATTORNEY

**Int. Cls.: 35, 41, and 42**

**Prior U.S. Cls.: 100, 101, 102, and 107**

**Reg. No. 3,500,285**

**United States Patent and Trademark Office**

**Registered Sep. 9, 2008**

**SERVICE MARK  
PRINCIPAL REGISTER**

# TWISTNBV

TWIST, NEW.BRAND.VENTURE, LLC (DELAWARE LIMITED LIABILITY COMPANY)

#6F

310 E. 74 STREET  
NEW YORK, NY 10021

FOR: MARKETING SERVICES, NAMELY, BRAND BUILDING, WEBSITE AND E-MAIL MARKETING, VIRAL MARKETING AND DIRECT MARKETING FOR BUSINESS TO CONSUMER AND BUSINESS TO BUSINESS; PUBLIC RELATION SERVICES, NAMELY, PUBLIC RELATIONS STRATEGY AND EXECUTION; BRAND BUILDING, NAMELY, SERVICES RELATING TO THE ANALYSIS, EVALUATION, CREATION AND BRAND ESTABLISHMENT, AND DEVELOPMENT OF BRAND AND CORPORATE IDENTITY; PUBLIC RELATION SERVICES; ADVERTISING SERVICES, NAMELY, DEVELOPING BRAND IDENTITY OF OTHERS; MARKET ANALYSIS IN THE NATURE OF DISTRIBUTION CHANNEL IDENTIFICATION; DEVELOPING BRAND IDENTITY FOR OTHERS THROUGH THE DEVELOPMENT OF IN-STORE STRATEGIES AND MARKETING PROGRAMS, PRODUCT FORECASTING, IN-STORE PRODUCT MERCHANDISING; DEVELOPMENT AND EXECUTION AND RETAIL PROMOTION FOR OTHERS THROUGH DISTRIBUTION OF MARKETING AND SALES MATERIALS, NAMELY, BROCHURES, SAMPLES, TRAINING MATERIALS, PRODUCT ENDORSEMENT; BUSINESS ADVISORY AND CONSULTATION SERVICES IN THE FIELDS OF MARKETING, PUBLIC RELATIONS, DEVELOPING BRAND IDENTITY, PRODUCT DEVELOPMENT, ADVERTISING, BUSINESS AND SALES PROMOTION AND DISTRIBUTION OF PRODUCTS AND ADVERTISING; ADVISORY AND CONSULTATION SERVICES WITH RESPECT TO PROMOTING PRODUCT ENDORSEMENTS, IN CLASS 35 (U.S. CLS. 100, 101 AND 102).

FIRST USE 1-0-2007; IN COMMERCE 1-0-2007.

FOR: EDUCATIONAL SERVICES, NAMELY, PROVIDING CUSTOMIZED CONSULTATIONS, INTERNAL STAFF TRAINING THROUGH WORK-

SHOPS, SEMINARS OR TUTORIALS IN THE FIELD OF MARKETING, BRANDING AND SALES; EDUCATIONAL SERVICES, NAMELY, PROVIDING EXTERNAL STAFF TRAINING IN THE FIELDS OF MARKETING, PUBLIC RELATIONS, DEVELOPING BRAND IDENTITY, ADVERTISING, BUSINESS CONSULTING AND SALES PROMOTION, PRODUCT TRAINING AT POINTS OF DISTRIBUTION AND DISTRIBUTION OF PRODUCTS AND ADVERTISING THROUGH WORKSHOPS, SEMINARS OR TUTORIALS, MOTIVATIONAL OR EDUCATIONAL SPEAKERS, WEBINARS, INTERACTIVE PROGRAMS OVER THE INTERNET, TELEVISION APPEARANCES, RADIO BROADCASTS, PRINT MATERIALS AND EDUCATIONAL MATERIALS DISTRIBUTED IN ASSOCIATION THEREWITH; AND DISTRIBUTION OF COURSE MATERIALS IN CONNECTION THEREWITH; EDUCATIONAL SERVICES, NAMELY, PROVIDING CLASSES, SEMINARS, WORKSHOPS AND LECTURES IN THE FIELD OF DEVELOPING BRAND IDENTITY FOR OTHERS THROUGH THE DEVELOPMENT OF IN-STORE BRAND STRATEGIES, IN CLASS 41 (U.S. CLS. 100, 101 AND 107).

FIRST USE 1-0-2007; IN COMMERCE 1-0-2007.

FOR: PRODUCT DEVELOPMENT FOR OTHERS; PRODUCT DEVELOPMENT AND PACKAGING, NAMELY, DEVELOPMENT OF A PRODUCT'S STRUCTURAL PACKAGING, PHOTOGRAPHY, GUIDELINES AND POSITIONING, IN CLASS 42 (U.S. CLS. 100 AND 101).

FIRST USE 1-0-2007; IN COMMERCE 1-0-2007.

THE MARK CONSISTS OF STANDARD CHARACTERS WITHOUT CLAIM TO ANY PARTICULAR FONT, STYLE, SIZE, OR COLOR.

SN 78-954,085, FILED 8-17-2006.

RONALD DELGIZZI, EXAMINING ATTORNEY

**Int. Cl.: 3**

**Prior U.S. Cls.: 1, 4, 6, 50, 51, and 52**

**Reg. No. 3,500,286**

**United States Patent and Trademark Office**

**Registered Sep. 9, 2008**

**TRADEMARK  
PRINCIPAL REGISTER**

**Lullaby**

PERFUME OF LIFE, INC. (FLORIDA CORPORATION)  
UNIT 305 BOX 10  
2750 RACE TRACK ROAD  
JACKSONVILLE, FL 32259

THE MARK CONSISTS OF STANDARD CHARACTERS WITHOUT CLAIM TO ANY PARTICULAR FONT, STYLE, SIZE, OR COLOR.

FOR: FRAGRANCES FOR PERSONAL USE; PERFUME, IN CLASS 3 (U.S. CLS. 1, 4, 6, 50, 51 AND 52).

SN 78-954,401, FILED 8-17-2006.

FIRST USE 4-15-2007; IN COMMERCE 4-15-2007.

LINDSEY RUBIN, EXAMINING ATTORNEY



**Int. Cl.: 45**

**Prior U.S. Cls.: 100 and 101**

**United States Patent and Trademark Office**

**Reg. No. 3,500,287**

**Registered Sep. 9, 2008**

**SERVICE MARK  
PRINCIPAL REGISTER**

**PETSAFE RESCUE SERVICE**

RADIO SYSTEMS CORPORATION (DELAWARE CORPORATION)  
10427 ELECTRIC AVENUE  
KNOXVILLE, TN 37932

FOR: ASSISTING IN LOCATING LOST PETS, IN CLASS 45 (U.S. CLS. 100 AND 101).

FIRST USE 0-0-2007; IN COMMERCE 0-0-2007.

THE MARK CONSISTS OF STANDARD CHARACTERS WITHOUT CLAIM TO ANY PARTICULAR FONT, STYLE, SIZE, OR COLOR.

OWNER OF U.S. REG. NOS. 2,502,307 AND 2,618,673.

NO CLAIM IS MADE TO THE EXCLUSIVE RIGHT TO USE "RESCUE SERVICE", APART FROM THE MARK AS SHOWN.

SN 78-955,523, FILED 8-18-2006.

KAREN K. BUSH, EXAMINING ATTORNEY

**Int. Cl.: 42**

**Prior U.S. Cls.: 100 and 101**

**United States Patent and Trademark Office**

**Reg. No. 3,500,288**

**Registered Sep. 9, 2008**

**SERVICE MARK  
PRINCIPAL REGISTER**

**IDEARC MEDIA**

SECOND LICENSE APPLICATION CORPORATION (DELAWARE CORPORATION)  
2200 W. AIRFIELD DRIVE  
D/FW AIRPORT, TX 75261

FOR: WEBSITE DESIGN; WEBSITE DESIGN, NAMELY, DEVELOPING ONLINE STORES FOR OTHERS; WEB HOSTING SERVICES; REGISTRATION OF DOMAIN NAMES; AND PROVIDING SEARCH ENGINES FOR OBTAINING DATA ON THE INTERNET, IN CLASS 42 (U.S. CLS. 100 AND 101).

FIRST USE 11-0-2006; IN COMMERCE 11-0-2006.

THE MARK CONSISTS OF STANDARD CHARACTERS WITHOUT CLAIM TO ANY PARTICULAR FONT, STYLE, SIZE, OR COLOR.

NO CLAIM IS MADE TO THE EXCLUSIVE RIGHT TO USE "MEDIA", APART FROM THE MARK AS SHOWN.

SN 78-957,264, FILED 8-22-2006.

SAIMA MAKHDOOM, EXAMINING ATTORNEY

**Int. Cl.: 16**

**Prior U.S. Cls.: 2, 5, 22, 23, 29, 37, 38, and 50**

**Reg. No. 3,500,289**

**United States Patent and Trademark Office**

**Registered Sep. 9, 2008**

**TRADEMARK  
PRINCIPAL REGISTER**

**FOREVER MOMENTS**

DRAPE CREATIVE, INC. (MISSOURI CORPORATION)  
11805 WENONGA CIRCLE  
LEAWOOD, KS 66211

THE MARK CONSISTS OF STANDARD CHARACTERS WITHOUT CLAIM TO ANY PARTICULAR FONT, STYLE, SIZE, OR COLOR.

FOR: GREETING CARDS, IN CLASS 16 (U.S. CLS. 2, 5, 22, 23, 29, 37, 38 AND 50).

SN 78-957,506, FILED 8-22-2006.

FIRST USE 0-0-1998; IN COMMERCE 0-0-1998.

JOHN WILKE, EXAMINING ATTORNEY

**Int. Cl.: 25**

**Prior U.S. Cls.: 22 and 39**

**United States Patent and Trademark Office**

**Reg. No. 3,500,290**

**Registered Sep. 9, 2008**

**TRADEMARK  
PRINCIPAL REGISTER**

**THE BLACK PANTHER PARTY**

THE DR. HUEY P. NEWTON FOUNDATION,  
INC. (CONNECTICUT CORPORATION)  
199 LANDS END COURT  
VALLEJO, CA 94591

FOR: CLOTHING, NAMELY, T-SHIRTS, SWEAT-  
SHIRTS, JACKETS AND CAPS, IN CLASS 25 (U.S.  
CLS. 22 AND 39).

FIRST USE 10-15-2006; IN COMMERCE 10-15-2006.

THE MARK CONSISTS OF STANDARD CHAR-  
ACTERS WITHOUT CLAIM TO ANY PARTICULAR  
FONT, STYLE, SIZE, OR COLOR.

OWNER OF U.S. REG. NO. 2,834,703.

SN 78-960,001, FILED 8-24-2006.

SHAILA SETTLES, EXAMINING ATTORNEY

**Int. Cl.: 27**

**Prior U.S. Cls.: 19, 20, 37, 42, and 50**

**United States Patent and Trademark Office**

**Reg. No. 3,500,291**

**Registered Sep. 9, 2008**

**TRADEMARK  
PRINCIPAL REGISTER**

**BEADAZZLED LITE**

MAYA ROMANOFF CORPORATION (ILLINOIS  
CORPORATION)  
3435 MADISON  
SKOKIE, IL 60076

OWNER OF U.S. REG. NO. 3,186,897.

FOR: WALL COVERINGS OF GLASS, FABRIC,  
FOIL AND/OR PLASTIC, IN CLASS 27 (U.S. CLS. 19,  
20, 37, 42 AND 50).

NO CLAIM IS MADE TO THE EXCLUSIVE  
RIGHT TO USE "LITE", APART FROM THE MARK  
AS SHOWN.

FIRST USE 12-13-2006; IN COMMERCE 12-13-2006.

SN 78-960,899, FILED 8-25-2006.

THE MARK CONSISTS OF STANDARD CHAR-  
ACTERS WITHOUT CLAIM TO ANY PARTICULAR  
FONT, STYLE, SIZE, OR COLOR.

CHRISIE B. KING, EXAMINING ATTORNEY

**Int. Cl.: 9**

**Prior U.S. Cls.: 21, 23, 26, 36, and 38**

**United States Patent and Trademark Office**

**Reg. No. 3,500,292**

**Registered Sep. 9, 2008**

**TRADEMARK  
PRINCIPAL REGISTER**

# A P PRODUCTS

A P PRODUCTS GMBH (FED REP GERMANY CORPORATION)  
BAEUMLESWEG #21  
WEIL IM SCHOENBUCH, FED REP GERMANY  
71093

FOR: ELECTRICAL CONNECTORS, ELECTRICAL CABLES, ELECTRICAL CABLE ASSEMBLIES, ELECTRICAL SWITCHES, CIRCUIT BOARDS, TEST CLIP CONNECTORS FOR TESTING OF ELECTRICAL CIRCUITS AND COMPONENTS, ELECTRICAL CONNECTORS, NAMELY, ELECTRICAL HEADERS FOR ELECTRICAL AND ELECTRONIC CIRCUITS, ELECTRICAL JUMPER CONNECTORS, SOLDERLESS BREADBOARD CIRCUIT BUILDING COMPONENTS, NAMELY, ELECTRICAL TERMINALS, CONNECTORS, WIRES, ELECTRICAL TERMIN-

ALS, ELECTRICAL BREADBOARD UNITS, IN CLASS 9 (U.S. CLS. 21, 23, 26, 36 AND 38).

FIRST USE 10-13-2006; IN COMMERCE 10-13-2006.

THE MARK CONSISTS OF STANDARD CHARACTERS WITHOUT CLAIM TO ANY PARTICULAR FONT, STYLE, SIZE, OR COLOR.

NO CLAIM IS MADE TO THE EXCLUSIVE RIGHT TO USE "PRODUCTS", APART FROM THE MARK AS SHOWN.

SN 78-960,948, FILED 8-25-2006.

ANGELA GAW, EXAMINING ATTORNEY

**Int. Cl.: 9**

**Prior U.S. Cls.: 21, 23, 26, 36, and 38**

**United States Patent and Trademark Office**

**Reg. No. 3,500,293**

**Registered Sep. 9, 2008**

**TRADEMARK  
PRINCIPAL REGISTER**

**ECOWAVE**

KULIKOV, VADIM G. (RUSSIAN FED. INDIVIDUAL)  
36-90 AMINEVSHOE SHOSSE  
MOSCOW, RUSSIAN FED.

FOR: PRESSURE CONTROL EQUIPMENT, NAMELY, INDUSTRIAL FLUID SURGE AND PRESSURE CONTROL SYSTEMS COMPRISED PRIMARILY OF PRESSURE STABILIZERS, IN CLASS 9 (U.S. CLS. 21, 23, 26, 36 AND 38).

FIRST USE 10-1-2006; IN COMMERCE 10-1-2006.

THE MARK CONSISTS OF STANDARD CHARACTERS WITHOUT CLAIM TO ANY PARTICULAR FONT, STYLE, SIZE, OR COLOR.

SN 78-961,642, FILED 8-28-2006.

RONALD MCMORROW, EXAMINING ATTORNEY

**Int. Cl.: 10**

**Prior U.S. Cls.: 26, 39, and 44**

**Reg. No. 3,500,294**

**United States Patent and Trademark Office**

**Registered Sep. 9, 2008**

**TRADEMARK  
PRINCIPAL REGISTER**

**POWERMED-X**

MONSTER MEDIC, INC. (WISCONSIN CORPORATION)  
909 PERKINS DRIVE  
MUKWONAGO, WI 53149

THE MARK CONSISTS OF STANDARD CHARACTERS WITHOUT CLAIM TO ANY PARTICULAR FONT, STYLE, SIZE, OR COLOR.

FOR: STRETCHERS, IN CLASS 10 (U.S. CLS. 26, 39 AND 44).

SN 78-962,286, FILED 8-28-2006.

FIRST USE 3-31-2008; IN COMMERCE 3-31-2008.

MICHAEL GAAFAR, EXAMINING ATTORNEY



**Int. Cl.: 7**

**Prior U.S. Cls.: 13, 19, 21, 23, 31, 34, and 35**

**Reg. No. 3,500,295**

**United States Patent and Trademark Office**

**Registered Sep. 9, 2008**

**TRADEMARK  
PRINCIPAL REGISTER**

**STAIRCARE**

MONSTER MEDIC, INC. (WISCONSIN CORPORATION)  
909 PERKINS DRIVE  
MUKWONAGO, WI 53149

THE MARK CONSISTS OF STANDARD CHARACTERS WITHOUT CLAIM TO ANY PARTICULAR FONT, STYLE, SIZE, OR COLOR.

FOR: STAIR LIFTS, IN CLASS 7 (U.S. CLS. 13, 19, 21, 23, 31, 34 AND 35).

SN 78-962,288, FILED 8-28-2006.

FIRST USE 3-31-2008; IN COMMERCE 3-31-2008.

MICHAEL GAAFAR, EXAMINING ATTORNEY

**Int. Cls.: 35 and 42**

**Prior U.S. Cls.: 100, 101, and 102**

**United States Patent and Trademark Office**

**Reg. No. 3,500,296**

**Registered Sep. 9, 2008**

**SERVICE MARK  
PRINCIPAL REGISTER**

**INSIGHT NETWORKS**

MARKETTOOLS, INC. (CALIFORNIA CORPORATION)  
150 SPEAR STREET, SUITE 600  
SAN FRANCISCO, CA 941051535

FOR: MARKET RESEARCH SERVICES; PROVIDING INFORMATION AND CONSULTATION IN THE FIELD OF MARKET RESEARCH, SURVEY RESEARCH METHODS, REAL-TIME FEEDBACK COLLECTION AND REPORTING AND RESULTS ANALYSIS; RECRUITING AND MANAGEMENT OF POTENTIAL SURVEY RESPONDENTS, MARKET RESEARCH PANEL PARTICIPANTS AND MEMBERS OF AN ONLINE COMMUNITY FOR OTHERS; REVIEW, COLLECTION, ANALYSIS, AND REPORTING OF INFORMATION FOR THE PURPOSES OF MARKET RESEARCH FOR OTHERS, IN CLASS 35 (U.S. CLS. 100, 101 AND 102).

FIRST USE 8-1-2006; IN COMMERCE 8-1-2006.

FOR: APPLICATION SERVICE PROVIDER SERVICES, NAMELY, HOSTING COMPUTER APPLICATION SOFTWARE AND DATABASES ON A COMPUTER SERVER FOR OTHERS FOR THE ADMINISTRATION, DISTRIBUTION, COLLECTION, REPORTING AND ANALYSIS OF INFOR-

MATION; APPLICATION SERVICE PROVIDER SERVICES, NAMELY, HOSTING COMPUTER APPLICATION SOFTWARE AND DATABASES ON A COMPUTER SERVER FOR OTHERS FOR DESIGNING AND CONDUCTING SURVEYS AND POLLS AND GENERATING FEEDBACK AND DATA FROM RESPONDENTS; APPLICATION SERVICE PROVIDER SERVICES, NAMELY, HOSTING COMPUTER APPLICATION SOFTWARE AND DATABASES ON A COMPUTER SERVER FOR USE BY MEMBERS OF AN ONLINE COMMUNITY , IN CLASS 42 (U.S. CLS. 100 AND 101).

FIRST USE 8-1-2006; IN COMMERCE 8-1-2006.

THE MARK CONSISTS OF STANDARD CHARACTERS WITHOUT CLAIM TO ANY PARTICULAR FONT, STYLE, SIZE, OR COLOR.

NO CLAIM IS MADE TO THE EXCLUSIVE RIGHT TO USE "NETWORKS", APART FROM THE MARK AS SHOWN.

SN 78-962,755, FILED 8-29-2006.

JENNIFER VASQUEZ, EXAMINING ATTORNEY

**Int. Cl.: 28**

**Prior U.S. Cls.: 22, 23, 38, and 50**

**United States Patent and Trademark Office**

**Reg. No. 3,500,297**

**Registered Sep. 9, 2008**

**TRADEMARK  
PRINCIPAL REGISTER**

**QUALITY FROM THE CORE**

PINNACLE SPORTS EQUIPMENT INC. (NEW  
YORK CORPORATION)  
3555 VICTORY BLVD.  
STATEN ISLAND, NY 10314

THE MARK CONSISTS OF STANDARD CHAR-  
ACTERS WITHOUT CLAIM TO ANY PARTICULAR  
FONT, STYLE, SIZE, OR COLOR.

FOR: BASEBALL BATS AND SOFTBALL BATS,  
IN CLASS 28 (U.S. CLS. 22, 23, 38 AND 50).

SN 78-965,150, FILED 8-31-2006.

FIRST USE 4-7-2008; IN COMMERCE 4-7-2008.

JAY FLOWERS, EXAMINING ATTORNEY

**Int. Cl.: 9**

**Prior U.S. Cls.: 21, 23, 26, 36, and 38**

**United States Patent and Trademark Office**

**Reg. No. 3,500,298**

**Registered Sep. 9, 2008**

**TRADEMARK  
PRINCIPAL REGISTER**

**doors**

ADVANCED BIOMETRIC SOLUTIONS, INC.  
(NEW YORK CORPORATION)  
110 WALL STREET SUITE 7-5  
NEW YORK, NY 10005

FIRST USE 1-0-2006; IN COMMERCE 1-0-2006.

FOR: COMPUTER SOFTWARE FOR PROTECTION OF ELECTRONIC COMMUNICATIONS AND ELECTRONICALLY STORED INFORMATION DESIGNED FOR USE WITH BIOMETRIC IDENTIFICATION AND VERIFICATION DEVICES IDENTIFYING AND VERIFYING BIOMETRIC CHARACTERISTICS OF USERS, IN CLASS 9 (U.S. CLS. 21, 23, 26, 36 AND 38).

THE MARK CONSISTS OF STANDARD CHARACTERS WITHOUT CLAIM TO ANY PARTICULAR FONT, STYLE, SIZE, OR COLOR.

SN 78-965,256, FILED 8-31-2006.

THOMAS MANOR, EXAMINING ATTORNEY

Int. Cl.: 41

Prior U.S. Cls.: 100, 101, and 107

United States Patent and Trademark Office

Reg. No. 3,500,299

Registered Sep. 9, 2008

SERVICE MARK  
PRINCIPAL REGISTER



LAUGHBAUM, LISA ANDREA (UNITED STATES  
INDIVIDUAL)  
500 RANCHEROS DR. #51  
SAN MARCOS, CA 92069

FOR: ENTERTAINMENT, NAMELY, A CONTINUING CHILDREN'S MUSIC EDUCATION SHOW BROADCAST OVER TELEVISION, SATELLITE, AUDIO, AND VIDEO MEDIA, IN CLASS 41 (U.S. CLS. 100, 101 AND 107).

FIRST USE 9-1-1999; IN COMMERCE 9-1-1999.

NO CLAIM IS MADE TO THE EXCLUSIVE RIGHT TO USE "CHILDREN'S MUSIC", APART FROM THE MARK AS SHOWN.

THE MARK CONSISTS OF A CD (COMPACT DISC) WITH A MUSIC STAFF ACROSS THE MIDDLE.

SN 78-965,608, FILED 8-31-2006.

STEVEN R. FINE, EXAMINING ATTORNEY

**Int. Cl.: 35**

**Prior U.S. Cls.: 100, 101, and 102**

**United States Patent and Trademark Office**

**Reg. No. 3,500,300**

**Registered Sep. 9, 2008**

**SERVICE MARK  
PRINCIPAL REGISTER**



SECRET IMPACT LLC (MARYLAND LIMITED  
LIABILITY COMPANY)

20203 GOSHEN ROAD SUITE 221

GAITHERSBURG, MD 20879

FOR: ONLINE ADVERTISING AND MARKET-  
ING SERVICES, IN CLASS 35 (U.S. CLS. 100, 101 AND  
102).

FIRST USE 11-29-2007; IN COMMERCE 11-29-2007.

THE STIPPLING IS FOR SHADING PURPOSES  
ONLY.

THE MARK CONSISTS OF A CIRCLE WITH AN  
"SI" INSIDE OF IT AND NEXT TO THAT THE  
STYLIZED TEXT OF THE WORDING "SECRET  
IMPACT".

SN 78-967,057, FILED 9-5-2006.

NATALIE POLZER, EXAMINING ATTORNEY

**Int. Cl.: 3**

**Prior U.S. Cls.: 1, 4, 6, 50, 51, and 52**

**United States Patent and Trademark Office**

**Reg. No. 3,500,301**

**Registered Sep. 9, 2008**

**TRADEMARK  
PRINCIPAL REGISTER**

**Line Release **

KATE SOMERVILLE SKIN CARE, LLC (CALI-  
FORNIA LIMITED LIABILITY COMPANY)  
8428 MELROSE PLACE, SUITES E&F  
LOS ANGELES, CA 90069

FIRST USE 10-1-2006; IN COMMERCE 10-1-2006.

SN 78-967,383, FILED 9-5-2006.

FOR: SKIN PREPARATIONS, NAMELY, ANTI-  
AGING CREAMS, IN CLASS 3 (U.S. CLS. 1, 4, 6, 50, 51  
AND 52).

KAREN K. BUSH, EXAMINING ATTORNEY

**Int. Cl.: 20**

**Prior U.S. Cls.: 2, 13, 22, 25, 32, and 50**

**Reg. No. 3,500,302**

**United States Patent and Trademark Office**

**Registered Sep. 9, 2008**

---

**TRADEMARK  
PRINCIPAL REGISTER**

**ZIG ZAG**

INNOVATION UPDATE, LLC (CALIFORNIA  
CORPORATION)  
1601 PUEBLA DRIVE  
GLENDALE, CA 91207

THE MARK CONSISTS OF STANDARD CHAR-  
ACTERS WITHOUT CLAIM TO ANY PARTICULAR  
FONT, STYLE, SIZE, OR COLOR.

FOR: NON-METAL BOTTLE CAPS FOR COSMET-  
IC AND CLEANING PREPARATION CONTAINERS,  
IN CLASS 20 (U.S. CLS. 2, 13, 22, 25, 32 AND 50).

SN 78-967,621, FILED 9-5-2006.

FIRST USE 6-16-2008; IN COMMERCE 6-16-2008.

ANNE MADDEN, EXAMINING ATTORNEY



**Int. Cls.: 9, 37, and 42**

**Prior U.S. Cls.: 21, 23, 26, 36, 38, 100, 101, 103, and 106**

**Reg. No. 3,500,303**

**Registered Sep. 9, 2008**

**United States Patent and Trademark Office**

**TRADEMARK  
SERVICE MARK  
PRINCIPAL REGISTER**



TYCO FIRE PRODUCTS LP (DELAWARE LIMITED PARTNERSHIP)  
451 NORTH CANNON AVENUE  
LANSDALE, PA 19446

FOR: FIRE SPRINKLERS; FIRE-EXTINGUISHING SYSTEMS; SPRINKLER SYSTEMS FOR FIRE PROTECTION; AND FIRE EXTINGUISHING AND SPRINKLER SYSTEM COMPONENTS, NAMELY, VALVES, ACCELERATORS, FIRE PANELS, PIPING CLAMPS, SWITCHES, CONTROL PANELS AND COUPLERS, IN CLASS 9 (U.S. CLS. 21, 23, 26, 36 AND 38).

FIRST USE 7-6-2006; IN COMMERCE 9-0-2006.

FOR: INSTALLING AND MAINTAINING FIRE PROTECTION SYSTEMS INCLUDING FIRE SPRINKLERS AND ACCESSORIES FOR SUCH SYSTEMS, REPAIR AND MAINTENANCE OF FIRE PROTECTION SYSTEMS, IN CLASS 37 (U.S. CLS. 100, 103 AND 106).

FIRST USE 7-6-2006; IN COMMERCE 9-0-2006.

FOR: DESIGNING FIRE PROTECTION SYSTEMS INCLUDING FIRE SPRINKLERS AND ACCESSORIES FOR SUCH SYSTEMS, AND INSTALLING COMPUTER SOFTWARE FOR ACCOMPLISHING OR FACILITATING THE FOREGOING, IN CLASS 42 (U.S. CLS. 100 AND 101).

FIRST USE 7-6-2006; IN COMMERCE 9-0-2006.

THE MARK CONSISTS OF A CAPITAL LETTER "Q" IN WHICH THE NECK OF THE LETTER IS REPRESENTED BY A WATERFALL EXTENDING DOWNWARD, AND THE WORD "QUELL" IN WHICH THE LETTER "E" HAS FLAMES EXTENDING UPWARD TOWARDS THE DOWNWARD FLOW OF THE WATERFALL.

SN 78-968,450, FILED 9-6-2006.

BRIAN NEVILLE, EXAMINING ATTORNEY

Int. Cl.: 43

Prior U.S. Cls.: 100 and 101

United States Patent and Trademark Office

Reg. No. 3,500,304

Registered Sep. 9, 2008

**SERVICE MARK  
PRINCIPAL REGISTER**



TAP OF POLK INCORPORATED (FLORIDA CORPORATION)

PO BOX 549

1300 3RD STREET SW

WINTER HAVEN, FL 33880

FOR: RESTAURANTS, IN CLASS 43 (U.S. CLS. 100 AND 101).

FIRST USE 9-11-2006; IN COMMERCE 9-11-2006.

THE COLOR(S) RED, WHITE, BLACK, BLUE, YELLOW AND BROWN IS/ARE CLAIMED AS A FEATURE OF THE MARK.

THE MARK CONSISTS OF THE COLOR WHITE APPEARS ON THE LETTERS "BB", THE SKULL'S FACE AND TEETH, AND IN THE FOAM OF THE BEERS; THE COLOR BLACK APPEARS ON THE PIRATE CAP, THE EYE PATCH AND IN THE SKULL'S NOSE CAVITY; THE COLOR BROWN APPEARS ON THE CHICKEN LEGS; THE COLOR YELLOW APPEARS ON THE BEER AND IN THE BACKGROUND OF THE OUTER CIRCLE; THE COLOR BLUE APPEARS IN THE BACKGROUND OF THE INNER CIRCLE; THE COLOR RED APPEARS IN THE WORDING "BILLY BONES".

SN 78-968,454, FILED 9-6-2006.

RONALD MCMORROW, EXAMINING ATTORNEY

**Int. Cl.: 5**

**Prior U.S. Cls.: 6, 18, 44, 46, 51, and 52**

**Reg. No. 3,500,305**

**United States Patent and Trademark Office**

**Registered Sep. 9, 2008**

---

**TRADEMARK  
PRINCIPAL REGISTER**

**OUTPOST**

DOW AGROSCIENCES LLC (DELAWARE LIMITED LIABILITY COMPANY)  
TRADEMARK & COPYRIGHT DEPARTMENT  
9330 ZIONSVILLE ROAD  
INDIANAPOLIS, IN 46268

THE MARK CONSISTS OF STANDARD CHARACTERS WITHOUT CLAIM TO ANY PARTICULAR FONT, STYLE, SIZE, OR COLOR.

FOR: HERBICIDES FOR AGRICULTURAL USE,  
IN CLASS 5 (U.S. CLS. 6, 18, 44, 46, 51 AND 52).

SN 78-969,680, FILED 9-8-2006.

FIRST USE 3-31-2006; IN COMMERCE 3-31-2006.

RICHARD WHITE, EXAMINING ATTORNEY

**Int. Cl.: 32**

**Prior U.S. Cls.: 45, 46, and 48**

**United States Patent and Trademark Office**

**Reg. No. 3,500,306**

**Registered Sep. 9, 2008**

**TRADEMARK  
PRINCIPAL REGISTER**

**FUN QUENCHERS**

BRENLIN, INC. (CALIFORNIA CORPORATION)  
27071 CABOT ROAD, SUITE 132  
LAGUNA HILLS, CA 92653

FOR: NONCARBONATED FRUIT BEVERAGES,  
IN CLASS 32 (U.S. CLS. 45, 46 AND 48).

FIRST USE 11-25-2007; IN COMMERCE 11-25-2007.

THE MARK CONSISTS OF STANDARD CHAR-  
ACTERS WITHOUT CLAIM TO ANY PARTICULAR  
FONT, STYLE, SIZE, OR COLOR.

NO CLAIM IS MADE TO THE EXCLUSIVE  
RIGHT TO USE "QUENCHERS", APART FROM  
THE MARK AS SHOWN.

SN 78-970,266, FILED 9-8-2006.

ALICE SUE CARRUTHERS, EXAMINING ATTOR-  
NEY

**Int. Cl.: 5**

**Prior U.S. Cls.: 6, 18, 44, 46, 51, and 52**

**Reg. No. 3,500,307**

**United States Patent and Trademark Office**

**Registered Sep. 9, 2008**

**TRADEMARK  
PRINCIPAL REGISTER**

**KINLYTIC**

IMARX THERAPEUTICS, INC. (DELAWARE  
CORPORATION)  
1635 E. 18TH STREET  
TUCSON, AZ 85719

THE MARK CONSISTS OF STANDARD CHAR-  
ACTERS WITHOUT CLAIM TO ANY PARTICULAR  
FONT, STYLE, SIZE, OR COLOR.

FOR: UROKINASE PREPARATION FOR THE  
TREATMENT OF BLOOD CLOTS, ADMINISTERED  
INTRAVENOUSLY, IN CLASS 5 (U.S. CLS. 6, 18, 44,  
46, 51 AND 52).

SN 78-970,555, FILED 9-8-2006.

FIRST USE 4-7-2008; IN COMMERCE 4-7-2008.

MATTHEW EINSTEIN, EXAMINING ATTORNEY

**Int. Cl.: 28**

**Prior U.S. Cls.: 22, 23, 38, and 50**

**Reg. No. 3,500,308**

**United States Patent and Trademark Office**

**Registered Sep. 9, 2008**

---

**TRADEMARK  
PRINCIPAL REGISTER**

**LITTLE ATHLETES**

ATHLETIC BABY, LLC (TEXAS LIMITED LIABILITY COMPANY)  
17194 PRESTON ROAD  
SUITE 102-173  
DALLAS, TX 75248

FOR: GAMES, PLAYTHINGS AND EDUCATIONAL TOYS ALL FOR CHILDREN, NAMELY, BABY RATTLES, CRIB TOYS, BABY MULTIPLE ACTIVITY TOYS, INFANT DEVELOPMENTAL TOYS, PLAY MATS CONTAINING INFANT TOYS, IN CLASS 28 (U.S. CLS. 22, 23, 38 AND 50).

FIRST USE 5-31-2008; IN COMMERCE 5-31-2008.

THE MARK CONSISTS OF STANDARD CHARACTERS WITHOUT CLAIM TO ANY PARTICULAR FONT, STYLE, SIZE, OR COLOR.

SN 78-970,566, FILED 9-8-2006.

JOHN HWANG, EXAMINING ATTORNEY

**Int. Cl.: 33**

**Prior U.S. Cls.: 47 and 49**

**United States Patent and Trademark Office**

**Reg. No. 3,500,309**

**Registered Sep. 9, 2008**

**TRADEMARK  
PRINCIPAL REGISTER**

**LUNAR RIDGE**

JOSKE, RAYMOND (UNITED STATES INDIVIDUAL), DBA LUNAR RIDGE,  
3087 COOMBSVILLE ROAD  
NAPA, CA 94558

THE MARK CONSISTS OF STANDARD CHARACTERS WITHOUT CLAIM TO ANY PARTICULAR FONT, STYLE, SIZE, OR COLOR.

FOR: WINE, IN CLASS 33 (U.S. CLS. 47 AND 49).

SN 78-971,175, FILED 9-11-2006.

FIRST USE 7-11-2008; IN COMMERCE 7-14-2008.

MICHAEL LITZAU, EXAMINING ATTORNEY

**Int. Cl.: 35**

**Prior U.S. Cls.: 100, 101, and 102**

**United States Patent and Trademark Office**

**Reg. No. 3,500,310**

**Registered Sep. 9, 2008**

**SERVICE MARK  
PRINCIPAL REGISTER**

**BOX PAPER SCISSORS**

OAK PAPER PRODUCTS CO., INC. (CALIFORNIA CORPORATION)  
3686 E. OLYMPIC BOULEVARD  
LOS ANGELES, CA 90023

THE MARK CONSISTS OF STANDARD CHARACTERS WITHOUT CLAIM TO ANY PARTICULAR FONT, STYLE, SIZE, OR COLOR.

FOR: RETAIL STORE SERVICES OFFERING PACKAGING AND SHIPPING SUPPLIES, IN CLASS 35 (U.S. CLS. 100, 101 AND 102).

SN 78-971,235, FILED 9-11-2006.

FIRST USE 1-15-2008; IN COMMERCE 1-15-2008.

PAUL E. FAHRENKOPF, EXAMINING ATTORNEY



**Int. Cl.: 12**

**Prior U.S. Cls.: 19, 21, 23, 31, 35, and 44**

**Reg. No. 3,500,311**

**United States Patent and Trademark Office**

**Registered Sep. 9, 2008**

**TRADEMARK  
PRINCIPAL REGISTER**

**FLEX**

FORD MOTOR COMPANY (DELAWARE CORPORATION)  
ONE AMERICAN ROAD  
DEARBORN, MI 48126

FOR: AUTOMOBILES, IN CLASS 12 (U.S. CLS. 19, 21, 23, 31, 35 AND 44).

FIRST USE 1-20-2008; IN COMMERCE 1-20-2008.

THE MARK CONSISTS OF STANDARD CHARACTERS WITHOUT CLAIM TO ANY PARTICULAR FONT, STYLE, SIZE, OR COLOR.

OWNER OF U.S. REG. NOS. 3,018,266 AND 3,018,267.

SN 78-971,616, FILED 9-11-2006.

KEVIN DINALLO, EXAMINING ATTORNEY

**Int. Cl.: 25**

**Prior U.S. Cls.: 22 and 39**

**United States Patent and Trademark Office**

**Reg. No. 3,500,312**

**Registered Sep. 9, 2008**

**TRADEMARK  
PRINCIPAL REGISTER**

**TIGER BAY**

A & N ENTERPRISES, L.L.C. (NEW YORK LIMITED LIABILITY COMPANY)  
43 W33RD STREET, ROOM 600  
NEW YORK, NY 10001

FIRST USE 6-27-2008; IN COMMERCE 6-27-2008.

SN 78-972,581, FILED 9-12-2006.

FOR: CLOTHING, NAMELY, POLO SHIRTS, PANTS, JEANS, SHIRTS, T-SHIRTS, UNDERWEAR, SHORTS, AND SWIM WEAR, IN CLASS 25 (U.S. CLS. 22 AND 39).

MICHAEL WIENER, EXAMINING ATTORNEY

**Int. Cl.: 35**

**Prior U.S. Cls.: 100, 101, and 102**

**United States Patent and Trademark Office**

**Reg. No. 3,500,313**

**Registered Sep. 9, 2008**

**SERVICE MARK  
PRINCIPAL REGISTER**

**TILLERMAN INSIGHT**

TILLERMAN, LLC (NEW YORK LIMITED LIABILITY COMPANY)  
1359 BROADWAY  
NEW YORK, NY 10018

FOR: ANALYZING AND COMPILING DATA RELATING TO BUSINESS MANAGEMENT FOR STYLE PERFORMANCE REPORTING AND FORECASTING, SIZE AND STORE LEVEL PERFORMANCE TRACKING AND DEMAND MANAGEMENT; AND ANALYZING AND COMPILING DATA FOR MEASURING THE PERFOR-

MANCE OF RETAIL MARKETS, IN CLASS 35 (U.S. CLS. 100, 101 AND 102).

FIRST USE 1-1-2007; IN COMMERCE 1-1-2007.

THE MARK CONSISTS OF STANDARD CHARACTERS WITHOUT CLAIM TO ANY PARTICULAR FONT, STYLE, SIZE, OR COLOR.

SN 78-972,650, FILED 9-12-2006.

CHRISTINE COOPER, EXAMINING ATTORNEY

**Int. Cl.: 42**

**Prior U.S. Cls.: 100 and 101**

**United States Patent and Trademark Office**

**Reg. No. 3,500,314**

**Registered Sep. 9, 2008**

**SERVICE MARK  
PRINCIPAL REGISTER**



SECOND LICENSE APPLICATION CORPORA-  
TION (DELAWARE CORPORATION)  
2200 W. AIRFIELD DRIVE  
D/FW AIRPORT, TX 75261

FOR: WEBSITE DESIGN; WEBSITE DESIGN,  
NAMELY, DEVELOPING ONLINE STORES FOR  
OTHERS; WEB HOSTING SERVICES; REGISTRA-  
TION OF DOMAIN NAMES; AND PROVIDING  
SEARCH ENGINES FOR OBTAINING DATA ON  
THE INTERNET, IN CLASS 42 (U.S. CLS. 100 AND  
101).

FIRST USE 11-0-2006; IN COMMERCE 11-0-2006.

NO CLAIM IS MADE TO THE EXCLUSIVE  
RIGHT TO USE "MEDIA", APART FROM THE  
MARK AS SHOWN.

SN 78-973,311, FILED 9-13-2006.

SAIMA MAKHDOOM, EXAMINING ATTORNEY

**Int. Cl.: 9**

**Prior U.S. Cls.: 21, 23, 26, 36, and 38**

**Reg. No. 3,500,315**

**United States Patent and Trademark Office**

**Registered Sep. 9, 2008**

**TRADEMARK  
PRINCIPAL REGISTER**

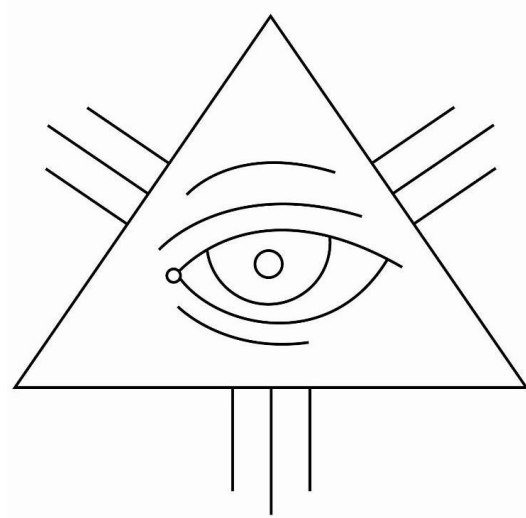

**CHEVRON INTELLECTUAL PROPERTY LLC  
(DELAWARE LIMITED LIABILITY COMPA-  
NY)**

**6001 BOLLINGER CANYON ROAD  
SAN RAMON, CA 94583**

**FOR: SOFTWARE USED TO CREATE AND MAN-  
AGE A CENTRAL UTILITY REPOSITORY IN THE**

**FIELD OF DRILLING ENGINEERING, IN CLASS 9  
(U.S. CLS. 21, 23, 26, 36 AND 38).**

**FIRST USE 10-1-2007; IN COMMERCE 10-1-2007.**

**SN 78-974,332, FILED 9-14-2006.**

**STEPHEN AQUILA, EXAMINING ATTORNEY**

**Int. Cl.: 28**

**Prior U.S. Cls.: 22, 23, 38, and 50**

**United States Patent and Trademark Office**

**Reg. No. 3,500,316**

**Registered Sep. 9, 2008**

**TRADEMARK  
PRINCIPAL REGISTER**

**CLOVER CARS**

MATTEL, INC. (DELAWARE CORPORATION)  
MAIL STOP M1-1518  
333 CONTINENTAL BOULEVARD  
EL SEGUNDO, CA 90245

FOR: TOYS, GAMES AND PLAYTHINGS, NAME-  
LY, TOY VEHICLES AND ACCESSORIES THERE-  
FOR, IN CLASS 28 (U.S. CLS. 22, 23, 38 AND 50).

FIRST USE 2-1-2008; IN COMMERCE 2-1-2008.

THE MARK CONSISTS OF STANDARD CHAR-  
ACTERS WITHOUT CLAIM TO ANY PARTICULAR  
FONT, STYLE, SIZE, OR COLOR.

NO CLAIM IS MADE TO THE EXCLUSIVE  
RIGHT TO USE "CARS", APART FROM THE MARK  
AS SHOWN.

SN 78-974,352, FILED 9-14-2006.

KATHY DE JONGE, EXAMINING ATTORNEY

**Int. Cl.: 1**

**Prior U.S. Cls.: 1, 5, 6, 10, 26, and 46**

**Reg. No. 3,500,317**

**United States Patent and Trademark Office**

**Registered Sep. 9, 2008**

**TRADEMARK  
PRINCIPAL REGISTER**

**PAK HORSE**

LOVELAND PRODUCTS, INC. (COLORADO  
CORPORATION)  
7251 W. 4TH STREET  
GREELEY, CO 80634

THE MARK CONSISTS OF STANDARD CHAR-  
ACTERS WITHOUT CLAIM TO ANY PARTICULAR  
FONT, STYLE, SIZE, OR COLOR.

FOR: AGRICULTURAL FERTILIZERS, IN CLASS  
1 (U.S. CLS. 1, 5, 6, 10, 26 AND 46).

SN 78-974,648, FILED 9-14-2006.

FIRST USE 9-25-2006; IN COMMERCE 9-25-2006.

CHARISMA HAMPTON, EXAMINING ATTORNEY

**Int. Cl.: 40**

**Prior U.S. Cls.: 100, 103, and 106**

**United States Patent and Trademark Office**

**Reg. No. 3,500,318**

**Registered Sep. 9, 2008**

**SERVICE MARK  
PRINCIPAL REGISTER**

**OE DOWN TO THE  
CORE**

GENERAL CABLE TECHNOLOGIES CORPORATION (DELAWARE CORPORATION)  
FOUR TESSENEER DRIVE  
HIGHLAND HIGHTS, KY 410769753

FOR: MANUFACTURE OF AUTOMOTIVE PRODUCTS FEATURING IGNITION WIRE, PRIMARY WIRE, AND BATTERY STARTER CABLES TO ORDER AND/OR SPECIFICATION OF OTHERS; MANUFACTURE OF GENERAL PRODUCT LINES IN THE FIELD OF AUTOMOTIVE IGNITION WIRE, PRIMARY WIRE, AND BATTERY STARTER

CABLES TO ORDER AND/OR SPECIFICATION OF OTHERS, IN CLASS 40 (U.S. CLS. 100, 103 AND 106).

FIRST USE 6-0-2004; IN COMMERCE 6-0-2004.

THE MARK CONSISTS OF STANDARD CHARACTERS WITHOUT CLAIM TO ANY PARTICULAR FONT, STYLE, SIZE, OR COLOR.

SN 78-976,185, FILED 4-23-2004.

SHAUNIA CARLYLE, EXAMINING ATTORNEY



**Int. Cls.: 35 and 42**

**Prior U.S. Cls.: 100, 101, and 102**

**United States Patent and Trademark Office**

**Reg. No. 3,500,319**

**Registered Sep. 9, 2008**

**SERVICE MARK  
PRINCIPAL REGISTER**

**ChinaInspection**

ASIAINSPECTION (HONG KONG LIMITED  
COMPANY)  
RM 5, 19/F, NAM WO HONG BUILDING  
148 WING LOK STREET  
SHUENG WAN, HONG KONG

FOR: SUBSCRIPTION TO COMPUTER SERVICE,  
NAMELY, SUBSCRIPTION TO GLOBAL NET-  
WORKS; CONDUCTING PUBLIC OPINION POLLS,  
IN CLASS 35 (U.S. CLS. 100, 101 AND 102).

FIRST USE 0-0-2004; IN COMMERCE 0-0-2004.

FOR: HOSTING OF DIGITAL CONTENT ON THE  
INTERNET; DATABASE DEVELOPMENT SERVI-  
CES, NAMELY, CONSTRUCTION, DESIGN AND

OPERATION OF TECHNICAL DATA BANKS AND  
DATABASES, IN CLASS 42 (U.S. CLS. 100 AND 101).

FIRST USE 0-0-2004; IN COMMERCE 0-0-2004.

THE MARK CONSISTS OF STANDARD CHAR-  
ACTERS WITHOUT CLAIM TO ANY PARTICULAR  
FONT, STYLE, SIZE, OR COLOR.

NO CLAIM IS MADE TO THE EXCLUSIVE  
RIGHT TO USE "CHINA" , APART FROM THE  
MARK AS SHOWN.

SN 78-976,940, FILED 9-2-2004.

BARBARA GAYNOR, EXAMINING ATTORNEY

**Int. Cls.: 18, 21, 25, 28, and 35**

**Prior U.S. Cls.: 1, 2, 3, 13, 22, 23, 29, 30, 33, 38, 39, 40,  
41, 50, 100, 101, and 102**

**Reg. No. 3,500,320**

**Registered Sep. 9, 2008**

**United States Patent and Trademark Office**

---

**TRADEMARK  
SERVICE MARK  
PRINCIPAL REGISTER**

**GO2**

GO2 MEDIA, INC. (DELAWARE CORPORATION)  
273 SUMMER STREET  
4TH FLOOR  
BOSTON, MA 02110

FOR: LEATHER BAGS, NAMELY, ALL PURPOSE ATHLETIC BAGS, BACKPACKS, DUFFEL BAGS, BEACH BAGS, BOOK BAGS, OVERNIGHT BAGS, TOTE BAGS, TRAVEL BAGS, BRIEFCASES, BUSINESS CARD CASES, AND LUGGAGE, IN CLASS 18 (U.S. CLS. 1, 2, 3, 22 AND 41).

FIRST USE 6-8-2000; IN COMMERCE 6-8-2000.

FOR: HOUSEWARES AND GLASS, NAMELY, DECORATIVE CRYSTAL GLOBES, MUGS, CUPS, DRINKING GLASSES, BUCKETS, CANTEENS, COMMEMORATIVE PLATES, THERMAL INSULATED CONTAINERS FOR FOOD AND BEVERAGES, PORTABLE COOLERS, CRYSTAL AND CHINA FIGURINES, FLY SWATTERS, AND BOTTLE OPENERS, IN CLASS 21 (U.S. CLS. 2, 13, 23, 29, 30, 33, 40 AND 50).

FIRST USE 6-8-2000; IN COMMERCE 6-8-2000.

FOR: CLOTHING, NAMELY, T-SHIRTS, SHIRTS, SWEATSHIRTS, AND JACKETS, HATS, HEADWEAR, NAMELY, HATS AND CAPS, IN CLASS 25 (U.S. CLS. 22 AND 39).

FIRST USE 6-8-2000; IN COMMERCE 6-8-2000.

FOR: TOYS AND SPORTING GOODS, NAMELY, ACTION SKILL GAMES, BOARD GAMES, PLUSH TOYS AND BALLS, NAMELY, FOOTBALLS, BASKETBALLS, SQUEEZE BALLS, BOUNCING BALLS, GOLF BALLS, IN CLASS 28 (U.S. CLS. 22, 23, 38 AND 50).

FIRST USE 6-8-2000; IN COMMERCE 6-8-2000.

FOR: ONLINE BUSINESS DIRECTORIES FEATURING RESTAURANT AND BARS, IN CLASS 35 (U.S. CLS. 100, 101 AND 102).

FIRST USE 6-8-2000; IN COMMERCE 6-8-2000.

OWNER OF U.S. REG. NO. 2,364,791.

SN 78-978,969, FILED 1-29-2001.

LANA PHAM, EXAMINING ATTORNEY

Int. Cl.: 3

Prior U.S. Cls.: 1, 4, 6, 50, 51, and 52

United States Patent and Trademark Office

Reg. No. 3,500,321

Registered Sep. 9, 2008

TRADEMARK  
PRINCIPAL REGISTER

pūr~lisse

YEN, JENNIFER (UNITED STATES INDIVIDUAL)  
1878 GREENFIELD AVE., PH2  
LOS ANGELES, CA 90025

FOR: NON-MEDICATED FACE SERUMS, FACE CREAMS, FACE CLEANSERS, SKIN LIGHTENERS, SKIN MOISTURIZERS, SUN BLOCK AND LIP GLOSS, IN CLASS 3 (U.S. CLS. 1, 4, 6, 50, 51 AND 52).

FIRST USE 9-12-2007; IN COMMERCE 9-12-2007.

THE MARK CONSISTS OF STANDARD CHARACTERS WITHOUT CLAIM TO ANY PARTICULAR FONT, STYLE, SIZE, OR COLOR.

THE INDIVIDUAL WORDS "PUR" AND "LISSE" ARE FRENCH WORDS WHICH WHEN TRANSLATED INTO ENGLISH MEAN "PURE SMOOTH" OR "CLEAR SMOOTH".

SN 78-979,702, FILED 2-2-2005.

DAWN HAN, EXAMINING ATTORNEY

**Int. Cl.: 9**

**Prior U.S. Cls.: 21, 23, 26, 36, and 38**

**Reg. No. 3,500,322**

**United States Patent and Trademark Office**

**Registered Sep. 9, 2008**

**TRADEMARK  
PRINCIPAL REGISTER**

**UNDER ARMOUR**

UNDER ARMOUR, INC. (MARYLAND CORPORATION)  
1020 HULL STREET  
BALTIMORE, MD 21230

FOR: EYEWEAR, NAMELY, SUNGLASSES, LENSES FOR SUNGLASSES, AND VISORS FOR USE WITH HELMETS, IN CLASS 9 (U.S. CLS. 21, 23, 26, 36 AND 38).

FIRST USE 4-10-2006; IN COMMERCE 4-10-2006.

THE MARK CONSISTS OF STANDARD CHARACTERS WITHOUT CLAIM TO ANY PARTICULAR FONT, STYLE, SIZE, OR COLOR.

OWNER OF U.S. REG. NOS. 2,279,668, 2,917,039, AND OTHERS.

SN 78-979,727, FILED 7-20-2005.

KEVIN DINALLO, EXAMINING ATTORNEY

**Int. Cl.: 14**

**Prior U.S. Cls.: 2, 27, 28, and 50**

**United States Patent and Trademark Office**

**Reg. No. 3,500,323**

**Registered Sep. 9, 2008**

**TRADEMARK  
PRINCIPAL REGISTER**

**UNDER ARMOUR**

UNDER ARMOUR, INC. (MARYLAND COR-  
PORATION)  
1020 HULL STREET  
BALTIMORE, MD 21230

THE MARK CONSISTS OF STANDARD CHAR-  
ACTERS WITHOUT CLAIM TO ANY PARTICULAR  
FONT, STYLE, SIZE, OR COLOR.

FOR: WATCHES, IN CLASS 14 (U.S. CLS. 2, 27, 28  
AND 50).

SN 78-979,728, FILED 7-27-2005.

FIRST USE 6-20-2007; IN COMMERCE 6-20-2007.

KEVIN DINALLO, EXAMINING ATTORNEY

Int. Cls.: 12 and 20

Prior U.S. Cls.: 2, 13, 19, 21, 22, 23, 25, 31, 32, 35, 44,  
and 50

Reg. No. 3,500,324

United States Patent and Trademark Office

Registered Sep. 9, 2008

TRADEMARK  
PRINCIPAL REGISTER



RED CASTLE FRANCE (FRANCE CORPORATION)  
20 BOULEVARD DU ROI RENE  
AIX EN PROVENCE, FRANCE 13100

FOR: PRAMS AND STROLLERS ACCESSORIES,  
NAMELY, FITTED COVERS FOR PRAMS AND  
STROLLERS, IN CLASS 12 (U.S. CLS. 19, 21, 23, 31,  
35 AND 44).

FIRST USE 9-0-1992; IN COMMERCE 5-0-2006.

FOR: SLEEPING BAGS FOR BABIES AND IN-  
FANTS, NAMELY, FITTED SLEEPING BAGS WITH

FITTED SLEEVES, AND FITTED SLEEPING BAGS  
USED FOR BABIES AND INFANTS DURING  
TRANSPORTATION, IN CLASS 20 (U.S. CLS. 2, 13,  
22, 25, 32 AND 50).

FIRST USE 9-0-1992; IN COMMERCE 5-0-2006.

OWNER OF U.S. REG. NO. 2,938,380.

SN 78-979,834, FILED 5-12-2006.

BARBARA GAYNOR, EXAMINING ATTORNEY

**Int. Cl.: 29**

**Prior U.S. Cl.: 46**

**United States Patent and Trademark Office**

**Reg. No. 3,500,325**

**Registered Sep. 9, 2008**

**TRADEMARK  
PRINCIPAL REGISTER**

**SIMPLE DELIGHTS**

FRANKFORD FOODS, INC. (PENNSYLVANIA  
CORPORATION)  
9300 ASHTON ROAD  
PHILADELPHIA, PA 19114

FOR: RAISINS; DRIED FRUIT, NAMELY, DEHY-  
DRATED FRUIT AND FRUIT SNACKS; TRAIL MIX  
COMPRISED PRIMARILY OF PROCESSED NUTS,  
DRIED FRUIT, PROCESSED EDIBLE SEEDS,  
CRACKERS, AND PRETZELS; PROCESSED NUTS;  
ROASTED NUTS; SHELLED NUTS; PROTEIN-  
BASED, NUTRIENT DENSE SNACK BARS, IN  
CLASS 29 (U.S. CL. 46).

FIRST USE 8-0-2006; IN COMMERCE 8-0-2006.

THE MARK CONSISTS OF STANDARD CHAR-  
ACTERS WITHOUT CLAIM TO ANY PARTICULAR  
FONT, STYLE, SIZE, OR COLOR.

SN 78-979,994, FILED 7-27-2006.

YONG KIM, EXAMINING ATTORNEY

**Int. Cl.: 3**

**Prior U.S. Cls.: 1, 4, 6, 50, 51, and 52**

**United States Patent and Trademark Office**

**Reg. No. 3,500,326**

**Registered Sep. 9, 2008**

**TRADEMARK  
PRINCIPAL REGISTER**

**BOLD IT**

LABORATOIRE GARNIER & CIE (FRANCE SO-  
CIE TE EN NOM COLLECTIF)  
281, RUE SAINT-HONORE  
PARIS, FRANCE 75008

THE MARK CONSISTS OF STANDARD CHAR-  
ACTERS WITHOUT CLAIM TO ANY PARTICULAR  
FONT, STYLE, SIZE, OR COLOR.

FOR: GELS FOR HAIR STYLING AND HAIR  
CARE, IN CLASS 3 (U.S. CLS. 1, 4, 6, 50, 51 AND 52).

SN 78-980,443, FILED 9-13-2006.

FIRST USE 5-1-2007; IN COMMERCE 5-1-2007.

NANCY CLARKE, EXAMINING ATTORNEY



**Int. Cl.: 5**

**Prior U.S. Cls.: 6, 18, 44, 46, 51, and 52**

**Reg. No. 3,500,327**

**United States Patent and Trademark Office**

**Registered Sep. 9, 2008**

**TRADEMARK  
PRINCIPAL REGISTER**

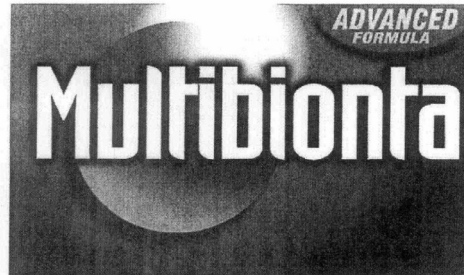

MERCK KGAA (FED REP GERMANY PART-  
NERSHIP LIMITED BY SHARES)  
FRANKFURTER STRASSE 250  
D-64293 DARMSTADT, FED REP GERMANY

FOR: PHARMACEUTICAL PREPARATIONS,  
NAMELY, FOOD SUPPLEMENTS AND DIETETIC  
FOODS FOR MEDICAL USE, CONSISTING OF  
VITAMINS, MINERALS AND TRACE ELEMENTS,  
IN CLASS 5 (U.S. CLS. 6, 18, 44, 46, 51 AND 52).

FIRST USE 6-0-2006; IN COMMERCE 6-0-2006.

NO CLAIM IS MADE TO THE EXCLUSIVE  
RIGHT TO USE "ADVANCED FORMULA", APART  
FROM THE MARK AS SHOWN.

SN 78-980,445, FILED 2-11-2005.

DAVID HOFFMAN, EXAMINING ATTORNEY

**Int. Cl.: 9**

**Prior U.S. Cls.: 21, 23, 26, 36, and 38**

**Reg. No. 3,500,328**

**United States Patent and Trademark Office**

**Registered Sep. 9, 2008**

**TRADEMARK  
PRINCIPAL REGISTER**

**Wii**

NINTENDO OF AMERICA INC. (WASHINGTON CORPORATION)  
4820 150TH AVENUE NE  
REDMOND, WA 98052

FOR: (BASED ON USE IN COMMERCE) OPTICAL DISCS AND CDS FEATURING ENTERTAINMENT CONTENT IN THE NATURE OF GAMES; COMPUTER GAME CONSOLES IN THE NATURE OF VIDEO GAME MACHINES FOR USE WITH MONITORS OR TELEVISIONS; COMPUTER GAME CONTROLLERS IN THE NATURE OF PLAYER-OPERATED ELECTRONIC CONTROLLERS FOR ELECTRONIC VIDEO GAME MACHINES; COMPUTER GAME EQUIPMENT CONTAINING MEMORY DEVICES, NAMELY, DISCS; COMPUTER GAME PERIPHERALS, NAMELY, JOYSTICKS, CONTROLLERS, POWER SUPPLIES, TRANSFORMERS AND ADAPTORS FOR CONNECTION TO THE INTERNET; COMPUTER GAME PROGRAMS; COMPUTER GAME SOFTWARE; COMPUTER HARDWARE FOR ACCESSING GLOBAL COMPUTER AND COMMUNICATION NETWORKS; COMPUTER SOFTWARE FOR ACCESSING AND BROWSING GLOBAL COMPUTER AND COMMUNICATION NETWORKS; COMPUTER SOFTWARE FOR TEXT EDITING AND FOR COMPOSING, TRANSMITTING AND RECEIVING EMAIL; ELECTRONIC GAME CONSOLES IN THE NATURE OF VIDEO GAME MACHINES FOR USE WITH MONITORS OR TELEVISIONS; ELECTRONIC GAME CONTROLLERS IN THE NATURE OF PLAYER-OPERATED ELECTRONIC CONTROLLERS FOR ELECTRONIC VIDEO GAME MACHINES; ELECTRONIC VIDEO GAME DISCS; ELECTRONIC GAME MACHINES IN THE NATURE OF VIDEO OUTPUT GAME MACHINES FOR USE WITH MONITORS OR TELEVISIONS; ELECTRONIC GAME MEMORY DEVICES IN THE NATURE OF MEMORY CARDS; ELECTRONIC GAME PROGRAMS; ELECTRONIC GAME SOFTWARE; COMPUTER HARDWARE IN THE NATURE OF ELECTRONIC UNITS FOR RECEIPT,

STORAGE AND/OR TRANSMISSION OF TEXT, GRAPHICS AND MULTIMEDIA CONTENT; ELECTRONIC VIDEO GAME MACHINES FOR USE WITH A MONITOR OR TELEVISION; COMMUNICATION DEVICES, NAMELY, COMPUTERS AND VIDEO OUTPUT GAME MACHINES FOR USE WITH MONITORS AND TELEVISIONS, ALL ENABLED FOR RECEIPT AND TRANSMISSION OF INFORMATION, NAMELY, DATA, TEXT, GRAPHICS, IMAGES, STILL AND MOTION PICTURES, SOUND, MUSIC, AUDIO, VIDEO, VIDEO GAMES, SIGNALS, AND MESSAGES; COMPUTER AND DISC MEMORIES FOR STORING COMPUTER AND VIDEO GAME SOFTWARE IN ELECTRONIC FORMAT; INTERACTIVE ELECTRONIC VIDEO OUTPUT GAME MACHINES FOR USE WITH MONITORS AND TELEVISIONS; INTERACTIVE VIDEO GAME CONSOLES FOR USE WITH MONITORS AND TELEVISIONS; INTERACTIVE VIDEO GAME DISCS; INTERACTIVE VIDEO GAME PROGRAMS; INTERACTIVE VIDEO GAME SOFTWARE; VIDEO GAME CONSOLES FOR USE WITH MONITORS AND TELEVISIONS; VIDEO GAME JOYSTICKS AND PLAYER-OPERATED ELECTRONIC CONTROLLERS FOR ELECTRONIC VIDEO GAME MACHINES; VIDEO GAME DISCS; ACCESSORIES FOR VIDEO OUTPUT GAME MACHINES FOR USE WITH MONITORS AND TELEVISIONS, NAMELY, CARRY CASES FOR CARRYING VIDEO OUTPUT GAME MACHINES AND BATTERY CHARGERS; VIDEO OUTPUT GAME MACHINES FEATURING FLASH MEMORY DEVICES IN THE NATURE OF FLASH MEMORY CARDS, FOR USE WITH MONITORS AND TELEVISIONS; VIDEO GAME MEMORY CARDS; VIDEO GAME PROGRAMS AND UTILITY PROGRAMS; VIDEO GAME PLAYERS IN THE NATURE OF VIDEO GAME MACHINES FOR USE WITH TELEVISIONS; VIDEO GAME PROGRAMS; VIDEO GAME SOFTWARE; VIDEO PLAYER FOR PLAYING AUDIO/VISUAL CONTENT, INCLUDING MOVIES AND TELEVISION PROGRAMS WHICH ARE STORED ON ELECTRONIC MEMORY

DEVICES; WIRELESS COMMUNICATION DEVICES, NAMELY, COMPUTERS AND VIDEO OUTPUT GAME MACHINES FOR USE WITH TELEVISIONS, ALL ENABLED FOR RECEIPT AND TRANSMISSION OF INFORMATION, NAMELY, DATA, TEXT, GRAPHICS, IMAGES, STILL AND MOTION PICTURES, SOUND, MUSIC, AUDIO, VIDEO, VIDEO GAMES, SIGNALS, AND MESSAGES; ELECTRONIC GAME PROGRAMS FOR VIDEO GAME MACHINES; PRE-RECORDED OPTICAL DISCS, FEATURING VIDEO GAME SOFTWARE FOR USE WITH VIDEO GAME MACHINES; VIDEO GAME SOFTWARE INTENDED FOR A WIDE AUDIENCE; INTERACTIVE VIDEO GAME PROGRAMS INTENDED FOR A WIDE AUDIENCE; PRE-RECORDED OPTICAL DISCS, FEATURING VIDEO GAME SOFTWARE INTENDED FOR A WIDE AUDIENCE; VIDEO GAME SOFTWARE FOR HAND-HELD GAME MACHINES WITH LIQUID CRYSTAL DISPLAY; PRE-RECORDED OPTICAL DISCS, FEATURING COMPUTER PROGRAMS FOR USE AS ENTERTAINMENT; COMPUTER PROGRAMS FOR USE AS ENTERTAINMENT, NAMELY, COMPUTER GAME PROGRAMS; PRE-RECORDED VIDEO DISCS FEATURING GAMES; ELECTRONIC PUBLICATIONS, NAMELY, GAME STRATEGY GUIDES, BOOKS AND MAGAZINES FEATURING ENTERTAINMENT CONTENT RECORDED ON COMPUTER MEDIA; (BASED ON 44(E)) ELECTRONIC GAME PROGRAMS FOR VIDEO GAME MACHINES; ELECTRONIC INTEGRATED CIRCUITS, PRE-RECORDED OPTICAL DISCS, MAGNETIC DISCS, OPTICAL-MAGNETIC DISCS, MAGNETIC TAPES, MAGNETIC CARDS, ROM CARTRIDGES, ROM CASSETTES, ROM CARDS, MEMORY CARTRIDGES, MEMORY CARDS, CD ROMS, AND DVD-ROMS, FEATURING VIDEO GAME SOFTWARE FOR USE WITH VIDEO GAME MACHINES; VIDEO GAME SOFTWARE INTENDED FOR A WIDE AUDIENCE; INTERACTIVE VIDEO GAME PROGRAMS INTENDED FOR A WIDE AUDIENCE; PRE-RECORDED ELECTRONIC CIRCUITS, OPTICAL DISCS, MAGNETIC DISCS, OPTICAL-MAGNETIC DISCS, MAGNETIC TAPES, MAGNETIC CARDS, ROM CARTRIDGES, ROM CASSETTES, ROM CARDS, MEMORY CARTRIDGES, MEMORY CARDS, CD ROMS, AND DVD-ROMS, FEATURING

VIDEO GAME SOFTWARE INTENDED FOR A WIDE AUDIENCE; VIDEO GAME SOFTWARE FOR HAND-HELD GAME MACHINES WITH LIQUID CRYSTAL DISPLAY; PRE-RECORDED ELECTRONIC CIRCUITS, OPTICAL DISCS, MAGNETIC DISCS, OPTICAL-MAGNETIC DISCS, MAGNETIC TAPES, MAGNETIC CARDS, ROM CARTRIDGES, ROM CASSETTES, ROM CARDS, MEMORY CARTRIDGES, MEMORY CARDS, CD ROMS, AND DVD-ROMS, FEATURING VIDEO GAME SOFTWARE FOR USE WITH HAND-HELD GAME MACHINES WITH LIQUID CRYSTAL DISPLAYS; COMPUTER PROGRAMS FOR USE AS ENTERTAINMENT, NAMELY, COMPUTER GAME PROGRAMS; PCS TELEPHONES, WIRELESS TELEPHONES AND PAGERS; PHOTOGRAPHIC MACHINES AND APPARATUS, NAMELY, DIGITAL, VIDEO AND PHOTOGRAPHIC CAMERAS AND ACCESSORIES, NAMELY, CAMERA LENSES AND CAMERA TRIPODS; CINEMATOGRAPHIC MACHINES AND APPARATUS; CELL PHONES; WRIST STRAPS FOR CELL PHONES; OTHER PARTS AND ACCESSORIES FOR CELL PHONES, NAMELY, CASES FOR CELL PHONES AND DEVICES FOR HANDS-FREE USE OF CELL PHONES; OTHER MACHINES AND APPARATUS FOR TELECOMMUNICATION, NAMELY, COMPUTER COMMUNICATION CABLES, IN CLASS 9 (U.S. CLS. 21, 23, 26, 36 AND 38).

FIRST USE 11-19-2006; IN COMMERCE 11-19-2006.

THE MARK CONSISTS OF STANDARD CHARACTERS WITHOUT CLAIM TO ANY PARTICULAR FONT, STYLE, SIZE, OR COLOR.

PRIORITY CLAIMED UNDER SEC. 44(D) ON ITALY APPLICATION NO. 119872005M, FILED 11-11-2005.

OWNER OF JAPAN REG. NO. 4992560, DATED 9-29-2006, EXPIRES 9-29-2016.

SN 78-980,451, FILED 4-27-2006.

ROBERT LAVACHE, EXAMINING ATTORNEY

**Int. Cl.: 9**

**Prior U.S. Cls.: 21, 23, 26, 36, and 38**

**United States Patent and Trademark Office**

**Reg. No. 3,500,329**

**Registered Sep. 9, 2008**

**TRADEMARK  
PRINCIPAL REGISTER**

**MEGASOUND**

INTELLECTUAL SOLUTIONS, INC (DELAWARE  
CORPORATION)  
41 JAMES WAY  
EATONTOWN, NJ 07724

FOR: AMBIANCE AND SURROUND SOUND  
PROCESSORS; POWERED SUBWOOFERS; RADIO  
TRANSMITTERS; SPEAKER ENCLOSURES;  
SPEAKER SYSTEMS CONSISTING OF SPEAKERS  
AND SPEAKER WIRES; WIRELESS AUDIO TRANS-  
MITTERS; FM MODULATORS, IN CLASS 9 (U.S.  
CLS. 21, 23, 26, 36 AND 38).

FIRST USE 7-23-2004; IN COMMERCE 7-23-2004.

THE MARK CONSISTS OF STANDARD CHAR-  
ACTERS WITHOUT CLAIM TO ANY PARTICULAR  
FONT, STYLE, SIZE, OR COLOR.

OWNER OF U.S. REG. NO. 1,494,085.

SN 78-980,454, FILED 11-16-2004.

MARY BOAGNI, EXAMINING ATTORNEY

**Int. Cls.: 35 and 41**

**Prior U.S. Cls.: 100, 101, 102, and 107**

**United States Patent and Trademark Office**

**Reg. No. 3,500,330**

**Registered Sep. 9, 2008**

**SERVICE MARK  
PRINCIPAL REGISTER**

**BLACKWAVE**

BLACKWAVE MEDIA HOLDINGS, LLC (OHIO  
LIMITED LIABILITY COMPANY)  
P.O. BOX 3222  
LOUISVILLE, KY 40201

FOR: MANAGEMENT AND AGENCY REPRESENTATION OF PERFORMING ARTISTS; PUBLICITY AGENTS; MARKETING AND PROMOTION OF PERFORMING ARTISTS; PROMOTING THE GOODS AND SERVICES OF OTHERS BY ARRANGING FOR SPONSORS TO AFFILIATE THEIR GOODS AND SERVICES WITH CELEBRITIES, PERFORMING ARTISTS AND/OR EVENTS OF OTHERS; MARKETING CONSULTATION FOR OTHERS; MARKETING AND PROMOTING EVENTS OF OTHERS; PRODUCTION OF RADIO AND TELEVISION COMMERCIALS, IN CLASS 35 (U.S. CLS. 100, 101 AND 102).

FIRST USE 8-0-2006; IN COMMERCE 8-0-2006.

FOR: ENTERTAINMENT SERVICES, NAMELY, PERSONAL APPEARANCES BY MOVIE STARS,

TELEVISION STARS, RADIO PERSONALITIES, MUSICAL PERFORMING ARTISTS; MUSIC PRODUCTION AND RECORDING SERVICES; MUSIC PUBLISHING SERVICES; AUDIO RECORDING AND PRODUCTION SERVICES; PRODUCTION OF FILM AND MOTION PICTURES; PRODUCTION OF RADIO AND TELEVISION PROGRAMS AND VIDEO PROGRAMS; PRODUCTION OF COMPACT DISKS, DVDS, IN CLASS 41 (U.S. CLS. 100, 101 AND 107).

FIRST USE 8-0-2006; IN COMMERCE 8-0-2006.

THE MARK CONSISTS OF STANDARD CHARACTERS WITHOUT CLAIM TO ANY PARTICULAR FONT, STYLE, SIZE, OR COLOR.

SN 78-980,467, FILED 3-21-2006.

HOWARD SMIGA, EXAMINING ATTORNEY

**Int. Cls.: 35 and 41**

**Prior U.S. Cls.: 100, 101, 102, and 107**

**United States Patent and Trademark Office**

**Reg. No. 3,500,331**

**Registered Sep. 9, 2008**

**SERVICE MARK  
PRINCIPAL REGISTER**

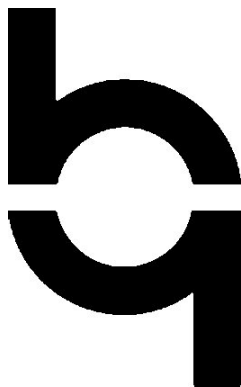

BLACKWAVE MEDIA HOLDINGS, LLC (OHIO  
LIMITED LIABILITY COMPANY)

P.O. BOX 3222

LOUISVILLE, KY 40201

FOR: MANAGEMENT AND AGENCY REPRESENTATION OF PERFORMING ARTISTS; PUBLICITY AGENTS; MARKETING AND PROMOTION OF PERFORMING ARTISTS; PROMOTING THE GOODS AND SERVICES OF OTHERS BY ARRANGING FOR SPONSORS TO AFFILIATE THEIR GOODS AND SERVICES WITH CELEBRITIES, PERFORMING ARTISTS AND/OR EVENTS OF OTHERS; MARKETING CONSULTATION FOR OTHERS; MARKETING AND PROMOTING EVENTS OF OTHERS; PRODUCTION OF RADIO AND TELEVISION COMMERCIALS, IN CLASS 35 (U.S. CLS. 100, 101 AND 102).

FIRST USE 8-0-2006; IN COMMERCE 8-0-2006.

FOR: ENTERTAINMENT SERVICES, NAMELY, PERSONAL APPEARANCES BY MOVIE STARS, TELEVISION STARS, RADIO PERSONALITIES, MUSICAL PERFORMING ARTISTS; MUSIC PRODUCTION AND RECORDING SERVICES; MUSIC PUBLISHING SERVICES; AUDIO RECORDING AND PRODUCTION SERVICES; PRODUCTION OF FILM AND MOTION PICTURES; PRODUCTION OF RADIO AND TELEVISION PROGRAMS AND VIDEO PROGRAMS; PRODUCTION OF COMPACT DISKS, DVDS, IN CLASS 41 (U.S. CLS. 100, 101 AND 107).

FIRST USE 8-0-2006; IN COMMERCE 8-0-2006.

THE MARK CONSISTS OF THE LETTER "B" IN STYLIZED FORM.

SN 78-980,470, FILED 3-21-2006.

HOWARD SMIGA, EXAMINING ATTORNEY

**Int. Cls.: 18 and 25**

**Prior U.S. Cls.: 1, 2, 3, 22, 39, and 41**

**United States Patent and Trademark Office**

**Reg. No. 3,500,332**

**Registered Sep. 9, 2008**

**TRADEMARK  
PRINCIPAL REGISTER**

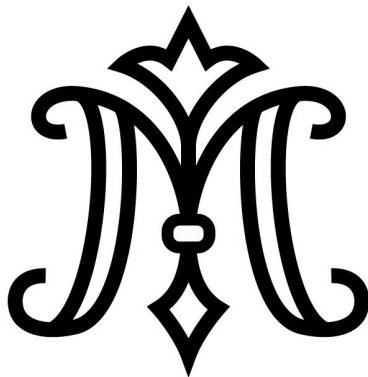

MIGUELINA, INC. (DELAWARE CORPORATION)  
20 WEST 36TH ST.  
NEW YORK, NY 10018

FOR: HANDBAGS AND TRAVELLING BAGS,  
UMBRELLAS AND PARASOLS, IN CLASS 18 (U.S.  
CLS. 1, 2, 3, 22 AND 41).

FIRST USE 1-1-2007; IN COMMERCE 1-1-2007.

FOR: MEN'S AND WOMEN'S CLOTHING,  
NAMELY, SHIRTS, BLOUSES, DRESSES, SHORTS,

UNDERWEAR, PANTS, SUITS, SKIRTS, SCARFS,  
BATHING SUITS, EVENING GOWNS, RAINWEAR,  
LEGGINGS, BELTS, JEANS, PAJAMAS, JACKETS,  
BLAZERS, HATS AND SOCKS, HEADWEAR, FOOT-  
WEAR INCLUDING SHOES, BOOTS, SLIPPERS  
AND SANDALS, IN CLASS 25 (U.S. CLS. 22 AND 39).

FIRST USE 1-1-2007; IN COMMERCE 1-1-2007.

SN 78-980,473, FILED 9-8-2005.

KELLY MCCOY, EXAMINING ATTORNEY

**Int. Cl.: 9**

**Prior U.S. Cls.: 21, 23, 26, 36, and 38**

**Reg. No. 3,500,333**

**United States Patent and Trademark Office**

**Registered Sep. 9, 2008**

**TRADEMARK  
PRINCIPAL REGISTER**

**YOGGIE**

YOGGIE SECURITY SYSTEMS LTD. (ISRAEL  
PRIVATE LIMITED LIABILITY BY SHARES  
COMPANY)  
P.O.B. 156  
BET HALEVY, ISRAEL 42870

FOR: COMPUTER SOFTWARE, FIRMWARE  
AND PROGRAMS FEATURING ALGORITHMS  
FOR ANALYZING, MONITORING AND MAIN-  
TAINING THE SECURITY AND INTEGRITY OF  
COMPUTER NETWORKS AND COMPUTERS, IN-  
CLUDING SERVERS, DESKTOPS, LAPTOPS AND  
HANDHELD AND MOBILE DEVICES; COMPUTER  
HARDWARE AND PERIPHERALS; COMPUTER

NETWORKS HARDWARE, NOT INCLUDING VI-  
DEO COMPUTER OR INTERNET GAMES, IN  
CLASS 9 (U.S. CLS. 21, 23, 26, 36 AND 38).

FIRST USE 1-0-2007; IN COMMERCE 1-0-2007.

THE MARK CONSISTS OF STANDARD CHAR-  
ACTERS WITHOUT CLAIM TO ANY PARTICULAR  
FONT, STYLE, SIZE, OR COLOR.

SN 78-980,476, FILED 5-25-2006.

KEVIN DINALLO, EXAMINING ATTORNEY



**Int. Cls.: 1, 6, and 17**

**Prior U.S. Cls.: 1, 2, 5, 6, 10, 12, 13, 14, 23, 25, 26, 35, 46, and 50**

**Reg. No. 3,500,334**

**United States Patent and Trademark Office**

**Registered Sep. 9, 2008**

**TRADEMARK  
PRINCIPAL REGISTER**

**WBA**

CONSTRUCTION RESEARCH & TECHNOLOGY,  
GMBH (FED REP GERMANY GMBH)  
DR.-ALBERT-FRANK-STRASSE 32  
TROSTBERG, FED REP GERMANY D-83308

FOR: ADHESIVES FOR USE WITH EXPANSION AND CONTRACTION JOINT SEALS AND EXPANSION AND CONTRACTION JOINT SEALING SYSTEMS IN THE BUILDING, CONSTRUCTION AND REPAIR INDUSTRIES, IN CLASS 1 (U.S. CLS. 1, 5, 6, 10, 26 AND 46).

FIRST USE 1-2-2007; IN COMMERCE 1-2-2007.

FOR: METALLIC EXPANSION AND CONTRACTION JOINT SEALS FOR USE WITH BUILDINGS, BRIDGES, ROADWAYS, PARKING STRUCTURES AND OPEN AIR STRUCTURES IN THE BUILDING, CONSTRUCTION AND REPAIR INDUSTRIES; COMPONENTS OF EXPANSION AND CONTRACTION JOINT SEALING SYSTEMS, NAMELY, METALLIC EXPANSION JOINT SEALS, MOUNTING/SUPPORT MEMBERS, COVERS, FILLERS, FASTENERS, NAMELY, THREADED ANCHORS AND SLEEVE ANCHORS, FLASHING, AND FIRE RESISTANT METAL FOILS AND SHEETS, IN CLASS 6 (U.S. CLS. 2, 12, 13, 14, 23, 25 AND 50).

FIRST USE 5-27-2008; IN COMMERCE 5-27-2008.

FOR: FIRE BARRIERS COMPRISED OF LAMINATES OF FIBER BLANKETS AND METAL LAYERS FOR USE IN THE BUILDING, CONSTRUCTION AND REPAIR INDUSTRIES; EX-

PANSION AND CONTRACTION JOINT FILLERS FOR USE IN THE BUILDING, CONSTRUCTION AND REPAIR INDUSTRIES; EXPANSION AND CONTRACTION JOINT SEALANTS, CAULKS, AND CAULKING COMPOUNDS FOR USE IN THE BUILDING, CONSTRUCTION AND REPAIR INDUSTRIES; CERAMIC FIBER BATT INSULATION FOR USE IN THE BUILDING, CONSTRUCTION AND REPAIR INDUSTRIES; POLYMERIC MOISTURE BARRIER FILMS; ELASTOMERIC EXPANSION AND CONTRACTION JOINT SEALS FOR USE IN BUILDINGS, BRIDGES, ROADWAYS, PARKING STRUCTURES, AND OPEN AIR STRUCTURES; COMPONENTS OF EXPANSION AND CONTRACTION JOINT SEALING SYSTEMS, NAMELY, ELASTOMERIC EXPANSION JOINT SEALS, MOUNTING/SUPPORT MEMBERS, ELASTOMERIC COVERS, FILLERS, AND SEALANTS; ELASTOMERIC CONCRETE FOR USE WITH EXPANSION AND CONTRACTION JOINT SEALING SYSTEMS IN THE BUILDING, CONSTRUCTION AND REPAIR INDUSTRIES, IN CLASS 17 (U.S. CLS. 1, 5, 12, 13, 35 AND 50).

FIRST USE 12-15-2007; IN COMMERCE 12-15-2007.

THE MARK CONSISTS OF STANDARD CHARACTERS WITHOUT CLAIM TO ANY PARTICULAR FONT, STYLE, SIZE, OR COLOR.

SN 78-980,486, FILED 3-28-2006.

AMEETA JORDAN, EXAMINING ATTORNEY

**Int. Cl.: 4**

**Prior U.S. Cls.: 1, 6, and 15**

**United States Patent and Trademark Office**

**Reg. No. 3,500,335**

**Registered Sep. 9, 2008**

**TRADEMARK  
PRINCIPAL REGISTER**

**ADVANCING THE  
SCIENCE OF MOTOR  
SPORTS**

VP RACING FUELS, INC. (TEXAS CORPORATION)  
P. O. BOX 47878  
SAN ANTONIO, TX 78265

THE MARK CONSISTS OF STANDARD CHARACTERS WITHOUT CLAIM TO ANY PARTICULAR FONT, STYLE, SIZE, OR COLOR.

FOR: FUELS FOR MOTOR VEHICLES, NAMELY, NITROMETHANE, METHANOL, AND GASOLINE; AND MOTOR OIL, IN CLASS 4 (U.S. CLS. 1, 6 AND 15).

SN 78-980,495, FILED 12-3-2004.

FIRST USE 7-24-2008; IN COMMERCE 7-24-2008.

LINDA ORNDORFF, EXAMINING ATTORNEY

**Int. Cl.: 19**

**Prior U.S. Cls.: 1, 12, 33, and 50**

**Reg. No. 3,500,336**

**United States Patent and Trademark Office**

**Registered Sep. 9, 2008**

**TRADEMARK  
SUPPLEMENTAL REGISTER**



RESENDEZ, HENRY N., JR. (UNITED STATES  
INDIVIDUAL)  
2719 W. BARSTOW AVENUE  
FRESNO, CA 93711

NO CLAIM IS MADE TO THE EXCLUSIVE  
RIGHT TO USE "RESTROOM AID", APART FROM  
THE MARK AS SHOWN.

FOR: NON-LUMINOUS, NON-MECHANICAL  
AND NON-METAL HANDICAPPED ASSISTANCE  
SIGNS FOR RESTROOMS, IN CLASS 19 (U.S. CLS. 1,  
12, 33 AND 50).

SER. NO. 76-603,967, FILED P.R. 7-26-2004; AM. S.R.  
7-10-2008.

FIRST USE 3-6-2000; IN COMMERCE 3-6-2000.

MARK SPARACINO, EXAMINING ATTORNEY

Int. Cl.: 30

Prior U.S. Cl.: 46

United States Patent and Trademark Office

Reg. No. 3,500,337

Registered Sep. 9, 2008

TRADEMARK  
SUPPLEMENTAL REGISTER

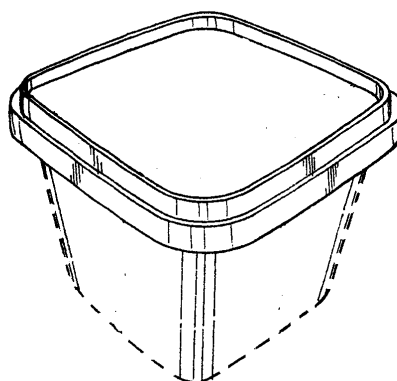

SAVORY FOODS, INC. (MICHIGAN CORPORATION)  
900 HYNES AVENUE, SW  
PO BOX 2583  
GRAND RAPIDS, MI 495012583

FOR: COOKIE DOUGH, IN CLASS 30 (U.S. CL. 46).

FIRST USE 3-0-2004; IN COMMERCE 3-0-2004.

THE MARK CONSISTS OF A CUBE-SHAPED CONTAINER WITH A LIP ALONG THE TOP OF THE CONTAINER AND SQUARE-SHAPED LID THAT FITS WITHIN THE TOP LIP OF THE CONTAINER AND IS COMPLETELY REMOVABLE

FROM THE CONTAINER. OWNER CLAIMS AS A FEATURE OF THE MARK, THE DOUBLE LIP CREATED BY THE SMALLER LID THAT FITS WITHIN THE LIP OF THE CONTAINER. THE BROKEN LINES ALONG THE BOTTOM AND EDGES OF THE CUBE-SHAPED CONTAINER AND THE TOP EDGE OF THE SQUARE LID SHOWN IN THE DRAWING INDICATE THE OUTLINE OF THE PART OF PACKAGING, AND ARE NOT CLAIMED AS A FEATURE OF THE MARK.

SER. NO. 76-656,910, FILED P.R. 3-20-2006; AM. S.R. 3-12-2007.

ANGELA GAW, EXAMINING ATTORNEY

**Int. Cl.: 38**

**Prior U.S. Cls.: 100, 101, and 104**

**United States Patent and Trademark Office**

**Reg. No. 3,500,338**

**Registered Sep. 9, 2008**

**SERVICE MARK  
SUPPLEMENTAL REGISTER**

**SWINGLIFESTYLE**

DASHBOARDHOSTING INC. (FLORIDA CORPORATION)  
P.O. BOX 9896  
CORAL SPRINGS, FL 33075

FOR: COMMUNICATION SERVICES, NAMELY, PROVIDING ON-LINE FACILITIES FOR REAL-TIME INTERACTION WITH OTHER COMPUTER USERS CONCERNING ADULT THEMES, DATING AND SWINGER LIFESTYLES , IN CLASS 38 (U.S. CLS. 100, 101 AND 104).

FIRST USE 10-7-2001; IN COMMERCE 10-7-2001.

THE MARK CONSISTS OF STANDARD CHARACTERS WITHOUT CLAIM TO ANY PARTICULAR FONT, STYLE, SIZE, OR COLOR.

SER. NO. 76-672,180, FILED P.R. 2-2-2007; AM. S.R. 7-25-2008.

ODESSA BIBBINS, EXAMINING ATTORNEY

**Int. Cl.: 30**

**Prior U.S. Cl.: 46**

**United States Patent and Trademark Office**

**Reg. No. 3,500,339**

**Registered Sep. 9, 2008**

**TRADEMARK  
SUPPLEMENTAL REGISTER**

**BETTER BITES**

MICROSOY CORPORATION (CALIFORNIA  
CORPORATION)  
300 EAST MICROSOY DRIVE  
JEFFERSON, IA 50129

FOR: COOKIES, CANDIES, CRACKERS AND  
CAKES, IN CLASS 30 (U.S. CL. 46).

FIRST USE 3-9-2007; IN COMMERCE 3-9-2007.

THE MARK CONSISTS OF STANDARD CHAR-  
ACTERS WITHOUT CLAIM TO ANY PARTICULAR  
FONT, STYLE, SIZE, OR COLOR.

SER. NO. 76-674,901, FILED P.R. 4-2-2007; AM. S.R.  
7-11-2008.

JOHN DWYER, EXAMINING ATTORNEY

**Int. Cl.: 41**

**Prior U.S. Cls.: 100, 101, and 107**

**United States Patent and Trademark Office**

**Reg. No. 3,500,340**

**Registered Sep. 9, 2008**

**SERVICE MARK  
SUPPLEMENTAL REGISTER**

**US National SWAT Championships**

ADVANCED SWAT TRAINING & COMPETITION  
LLC (COLORADO LIMITED LIABILITY COM-  
PANY)

6446 EAST TRAILRIDGE CIRCLE, #8  
MESA, AZ 85215

FOR: ARRANGING AND CONDUCTING SWAT  
COMPETITIONS FOR MEMBERS OF LAW ENFOR-  
CEMENT, IN CLASS 41 (U.S. CLS. 100, 101 AND 107).

FIRST USE 10-22-2006; IN COMMERCE 10-22-2006.

THE MARK CONSISTS OF STANDARD CHAR-  
ACTERS WITHOUT CLAIM TO ANY PARTICULAR  
FONT, STYLE, SIZE, OR COLOR.

NO CLAIM IS MADE TO THE EXCLUSIVE  
RIGHT TO USE "CHAMPIONSHIPS", APART FROM  
THE MARK AS SHOWN.

SER. NO. 76-682,461, FILED P.R. 10-1-2007; AM. S.R.  
7-14-2008.

MARTHA FROMM, EXAMINING ATTORNEY

**Int. Cl.: 16**

**Prior U.S. Cls.: 2, 5, 22, 23, 29, 37, 38, and 50**

**Reg. No. 3,500,341**

**United States Patent and Trademark Office**

**Registered Sep. 9, 2008**

**TRADEMARK  
SUPPLEMENTAL REGISTER**

**MB TECH**

MORTGAGE BANKERS ASSOCIATION (ILLINOIS NOT-FOR-PROFIT CORPORATION)  
1919 PENNSYLVANIA AVENUE, N.W.  
WASHINGTON, DC 20006

FOR: PERIODIC MAGAZINE IN THE FIELD OF TECHNOLOGY FOR THE REAL ESTATE FINANCE INDUSTRY, IN CLASS 16 (U.S. CLS. 2, 5, 22, 23, 29, 37, 38 AND 50).

FIRST USE 1-31-2006; IN COMMERCE 1-31-2006.

THE MARK CONSISTS OF STANDARD CHARACTERS WITHOUT CLAIM TO ANY PARTICULAR FONT, STYLE, SIZE, OR COLOR.

NO CLAIM IS MADE TO THE EXCLUSIVE RIGHT TO USE "TECH", APART FROM THE MARK AS SHOWN.

SER. NO. 76-682,578, FILED P.R. 10-4-2007; AM. S.R. 7-24-2008.

EVELYN BRADLEY, EXAMINING ATTORNEY



**Int. Cl.: 31**

**Prior U.S. Cls.: 1 and 46**

**United States Patent and Trademark Office**

**Reg. No. 3,500,342**

**Registered Sep. 9, 2008**

**TRADEMARK  
SUPPLEMENTAL REGISTER**

**MICROCLOVER**

DLF INTERNATIONAL SEEDS, INC. (OREGON  
CORPORATION)  
P.O. BOX 229  
HALSEY, OR 97348

THE MARK CONSISTS OF STANDARD CHAR-  
ACTERS WITHOUT CLAIM TO ANY PARTICULAR  
FONT, STYLE, SIZE, OR COLOR.

FOR: CLOVER SEEDS SOLD AS AN INTEGRAL  
COMPONENT OF SEEDS FOR AGRICULTURAL  
PURPOSES, IN CLASS 31 (U.S. CLS. 1 AND 46).

SER. NO. 76-688,003, FILED P.R. 3-24-2008; AM. S.R.  
7-30-2008.

FIRST USE 3-22-2006; IN COMMERCE 7-11-2006.

BARBARA RUTLAND, EXAMINING ATTORNEY

**Int. Cl.: 9**

**Prior U.S. Cls.: 21, 23, 26, 36, and 38**

**United States Patent and Trademark Office**

**Reg. No. 3,500,343**

**Registered Sep. 9, 2008**

**TRADEMARK  
SUPPLEMENTAL REGISTER**

**CodeSecure**

ARMORIZE TECHNOLOGIES, INC. (CALIFORNIA CORPORATION)

900 PEPPER TREE LANE SUITE 1221  
SANTA CLARA, CA 95051

FOR: COMPUTER SOFTWARE FOR SOURCE CODE ANALYSIS, IN CLASS 9 (U.S. CLS. 21, 23, 26, 36 AND 38).

FIRST USE 9-15-2006; IN COMMERCE 9-15-2006.

THE COLOR(S) ORANGE IS/ARE CLAIMED AS A FEATURE OF THE MARK.

THE COLOR ORANGE APPEARS IN THE WORDING "CODESECURE".

SER. NO. 77-000,084, FILED P.R. 9-15-2006; AM. S.R. 1-29-2008.

DAVID MILLER, EXAMINING ATTORNEY

**Int. Cl.: 35**

**Prior U.S. Cls.: 100, 101, and 102**

**United States Patent and Trademark Office**

**Reg. No. 3,500,344**

**Registered Sep. 9, 2008**

**SERVICE MARK  
SUPPLEMENTAL REGISTER**

**LEAN LABELING**

LABELTRONIX, LLC (CALIFORNIA LIMITED  
LIABILITY COMPANY)  
1097 NORTH BATAVIA STREET  
ORANGE, CA 92867

FOR: BUSINESS CONSULTING SERVICES RE-  
LATING TO INVENTORY MANAGEMENT AND  
USE IN THE FIELD OF AUTOMATED LABELING  
EQUIPMENT AND LABELING SUPPLIES , IN  
CLASS 35 (U.S. CLS. 100, 101 AND 102).

FIRST USE 8-28-2006; IN COMMERCE 8-28-2006.

THE MARK CONSISTS OF STANDARD CHAR-  
ACTERS WITHOUT CLAIM TO ANY PARTICULAR  
FONT, STYLE, SIZE, OR COLOR.

SER. NO. 77-011,642, FILED P.R. 10-2-2006; AM. S.R.  
7-28-2008.

DAVID H. STINE, EXAMINING ATTORNEY

**Int. Cl.: 35**

**Prior U.S. Cls.: 100, 101, and 102**

**United States Patent and Trademark Office**

**Reg. No. 3,500,345**

**Registered Sep. 9, 2008**

**SERVICE MARK  
SUPPLEMENTAL REGISTER**

**DESIGN AFRICA**

TRADE FACILITATION OFFICE CANADA (CANADA CORPORATION)  
56 SPARKS STREET, SUITE 300  
OTTAWA, ONTARIO, CANADA K1P5A9

FOR: PROMOTIONAL SERVICES, NAMELY, PROMOTING THE GOODS AND SERVICES MANUFACTURED AND OFFERED BY INDIVIDUALS AND COMPANIES RESIDENT IN CONTINENTAL AFRICA THROUGH THE DISTRIBUTION OF PRINTED MATERIAL, NAMELY, BROCHURES, PAMPHLETS, NEWSLETTERS, FLYERS, SPONSORING AND PARTICIPATING IN TRADE SHOWS, TRADE MISSIONS AND THROUGH THE DISTRIBUTION OF ELECTRONIC MATERIAL OVER THE INTERNET; PROMOTING PUBLIC AWARENESS OF THE NEED TO SUPPORT LOCAL BUSINESS IN AFRICA

THROUGH INTERNET WEBSITES, PRINT MEDIA, TRADE SHOWS AND TRADE MISSIONS, IN CLASS 35 (U.S. CLS. 100, 101 AND 102).

THE MARK CONSISTS OF STANDARD CHARACTERS WITHOUT CLAIM TO ANY PARTICULAR FONT, STYLE, SIZE, OR COLOR.

PRIORITY CLAIMED UNDER SEC. 44(D) ON CANADA APPLICATION NO. 1309566, FILED 7-18-2006, REG. NO. TMA715,893, DATED 6-4-2008, EXPIRES 6-4-2023.

SER. NO. 77-055,980, FILED P.R. 12-3-2006; AM. S.R. 9-19-2007.

HEATHER BIDDULPH, EXAMINING ATTORNEY

**Int. Cl.: 6**

**Prior U.S. Cls.: 2, 12, 13, 14, 23, 25, and 50**

**United States Patent and Trademark Office**

**Reg. No. 3,500,346**

**Registered Sep. 9, 2008**

**TRADEMARK  
SUPPLEMENTAL REGISTER**

# AUTO-CRIB

POWER HAWK TECHNOLOGIES, INC. (DELA-  
WARE CORPORATION)  
300 FORGE WAY, SUITE 2  
ROCKAWAY, NJ 07866

FOR: MANUALLY OPERATED SPRING-LOADED METAL CHUCK FOR USE IN RESCUE OPERATIONS, WHOSE PURPOSE IS TO TAKE THE LOAD OFF A VEHICLE'S SPRINGS AND SHOCK ABSORBERS AND WHICH AUTOMATICALLY LOCKS INTO THE NEW POSITION EACH TIME THE VEHICLE IS MOVED, IN CLASS 6 (U.S. CLS. 2, 12, 13, 14, 23, 25 AND 50).

FIRST USE 11-10-2006; IN COMMERCE 11-10-2006.

THE MARK CONSISTS OF STANDARD CHARACTERS WITHOUT CLAIM TO ANY PARTICULAR FONT, STYLE, SIZE, OR COLOR.

SER. NO. 77-082,234, FILED P.R. 1-12-2007; AM. S.R. 6-27-2008.

MARY I. SPARROW, EXAMINING ATTORNEY

**Int. Cl.: 9**

**Prior U.S. Cls.: 21, 23, 26, 36, and 38**

**United States Patent and Trademark Office**

**Reg. No. 3,500,347**

**Registered Sep. 9, 2008**

**TRADEMARK  
SUPPLEMENTAL REGISTER**

# ID Technology

DANIEL, SAYO ISAAC (UNITED STATES INDIVIDUAL)  
848 BRICKELL KEY DRIVE, #3904  
MIAMI, FL 33131

FOR: WIRELESS COMMUNICATION SYSTEMS AND DEVICES, NAMELY, GPS RECEIVERS AND CELLULAR TELEPHONE MODULES CONTAINED IN FOOTWEAR FOR TRACKING PEOPLE, OBJECT, AND PETS, IN CLASS 9 (U.S. CLS. 21, 23, 26, 36 AND 38).

FIRST USE 8-31-2007; IN COMMERCE 8-31-2007.

THE MARK CONSISTS OF STANDARD CHARACTERS WITHOUT CLAIM TO ANY PARTICULAR FONT, STYLE, SIZE, OR COLOR.

OWNER OF U.S. REG. NO. 3,366,528.

NO CLAIM IS MADE TO THE EXCLUSIVE RIGHT TO USE "TECHNOLOGY", APART FROM THE MARK AS SHOWN.

SER. NO. 77-096,355, FILED P.R. 1-31-2007; AM. S.R. 7-1-2008.

DANIEL CAPSHAW, EXAMINING ATTORNEY

**Int. Cl.: 9**

**Prior U.S. Cls.: 21, 23, 26, 36, and 38**

**United States Patent and Trademark Office**

**Reg. No. 3,500,348**

**Registered Sep. 9, 2008**

**TRADEMARK  
SUPPLEMENTAL REGISTER**

**XEROSTATIC**

WAJCMAN, JZCHAK (AUSTRIA INDIVIDUAL)  
862 MUIRLANDS VISTA WAY  
LA JOLLA, CA 92037

FOR: COAXIAL CABLE AND COAXIAL CABLE  
CONNECTORS, IN CLASS 9 (U.S. CLS. 21, 23, 26, 36  
AND 38).

FIRST USE 3-6-2006; IN COMMERCE 12-16-2006.

THE MARK CONSISTS OF STANDARD CHAR-  
ACTERS WITHOUT CLAIM TO ANY PARTICULAR  
FONT, STYLE, SIZE, OR COLOR.

SER. NO. 77-115,254, FILED P.R. 2-23-2007; AM. S.R.  
7-28-2008.

ANDREA BUTLER, EXAMINING ATTORNEY

**Int. Cl.: 35**

**Prior U.S. Cls.: 100, 101, and 102**

**United States Patent and Trademark Office**

**Reg. No. 3,500,349**

**Registered Sep. 9, 2008**

**SERVICE MARK  
SUPPLEMENTAL REGISTER**

**COLLABORATION ANALYSIS  
RESEARCH**

THE WEIDT GROUP, INC. (MINNESOTA CORPORATION)  
5800 BAKER ROAD  
MINNETONKA, MN 55345

FOR: INFORMATION IN THE FIELD OF ENERGY EFFICIENCY; ENERGY USAGE MANAGEMENT INFORMATION SERVICES; ENERGY USAGE MANAGEMENT; ENERGY AUDITING; VALUE ENGINEERING, NAMELY, COST ANALYSIS; COST/PRICE ANALYSIS; AND COST ANALYSES, IN CLASS 35 (U.S. CLS. 100, 101 AND 102).

FIRST USE 10-25-2003; IN COMMERCE 10-25-2003.

THE MARK CONSISTS OF STANDARD CHARACTERS WITHOUT CLAIM TO ANY PARTICULAR FONT, STYLE, SIZE, OR COLOR.

NO CLAIM IS MADE TO THE EXCLUSIVE RIGHT TO USE "COLLABORATION ANALYSIS", APART FROM THE MARK AS SHOWN.

SER. NO. 77-115,812, FILED P.R. 2-26-2007; AM. S.R. 7-9-2008.

CHRISIE B. KING, EXAMINING ATTORNEY



**Int. Cls.: 16 and 41**

**Prior U.S. Cls.: 2, 5, 22, 23, 29, 37, 38, 50, 100, 101, and 107**

**Reg. No. 3,500,350**

**United States Patent and Trademark Office**

**Registered Sep. 9, 2008**

**TRADEMARK  
SERVICE MARK  
SUPPLEMENTAL REGISTER**

**THE BACHELOR GUY**

THE BACHELOR GUY (FLORIDA LIMITED LIABILITY COMPANY)  
2890 NE 7TH AVENUE  
POMPANO BEACH, FL 33064

FOR: SYNDICATED MAGAZINE SECTIONS FEATURING ADVICE RELATED TO THE MALE LIFESTYLE, IN CLASS 16 (U.S. CLS. 2, 5, 22, 23, 29, 37, 38 AND 50).

FIRST USE 5-1-2006; IN COMMERCE 5-1-2006.

FOR: ON-LINE PUBLICATION OF MAGAZINE SECTION FEATURING ADVICE RELATED TO THE

MALE LIFESTYLE, IN CLASS 41 (U.S. CLS. 100, 101 AND 107).

FIRST USE 9-18-2006; IN COMMERCE 9-18-2006.

THE MARK CONSISTS OF STANDARD CHARACTERS WITHOUT CLAIM TO ANY PARTICULAR FONT, STYLE, SIZE, OR COLOR.

SER. NO. 77-135,882, FILED P.R. 3-20-2007; AM. S.R. 7-9-2008.

MICHAEL WIENER, EXAMINING ATTORNEY

**Int. Cl.: 35**

**Prior U.S. Cls.: 100, 101, and 102**

**United States Patent and Trademark Office**

**Reg. No. 3,500,351**

**Registered Sep. 9, 2008**

**SERVICE MARK  
SUPPLEMENTAL REGISTER**

**FAMILY ONLINE SAFETY  
INSTITUTE**

FAMILY ONLINE SAFETY INSTITUTE (ENGLAND CORPORATION)  
666 11TH STREET, NW, #1100  
WASHINGTON, DC 20001

FOR: PROMOTING PUBLIC AWARENESS OF AN INTERNATIONAL SAFETY RATING SYSTEM THAT IDENTIFIES THE PRESENCE OF NUDITY, VIOLENCE, AND PROFANITY ON THE INTERNET AND ALLOWS PARENTS AND OTHER CARE-GIVERS TO RENDER SUCH UNWANTED CONTENT INACCESSIBLE TO MINORS AND TO OTHERS, AS DESIRED, IN CLASS 35 (U.S. CLS. 100, 101 AND 102).

FIRST USE 2-9-2007; IN COMMERCE 2-9-2007.

THE MARK CONSISTS OF STANDARD CHARACTERS WITHOUT CLAIM TO ANY PARTICULAR FONT, STYLE, SIZE, OR COLOR.

NO CLAIM IS MADE TO THE EXCLUSIVE RIGHT TO USE "INSTITUTE", APART FROM THE MARK AS SHOWN.

SER. NO. 77-137,221, FILED P.R. 3-21-2007; AM. S.R. 10-27-2007.

SCOTT BIBB, EXAMINING ATTORNEY

**Int. Cls.: 35, 38, and 41**

**Prior U.S. Cls.: 100, 101, 102, 104, and 107**

**United States Patent and Trademark Office**

**Reg. No. 3,500,352**

**Registered Sep. 9, 2008**

**SERVICE MARK  
SUPPLEMENTAL REGISTER**

**CELEBTV**

INTERSPORT, INC. (ILLINOIS CORPORATION)  
20 WEST KINZIE, SUITE 1600  
CHICAGO, IL 60610

FOR: ADVERTISING SERVICES, NAMELY, PROVIDING ADVERTISING SPACE VIA THE INTERNET, POD CASTS, ELECTRONIC MAIL, BROADBAND NETWORKS, DIGITAL NETWORKS, WIRELESS AND MOBILE NETWORKS; PROMOTING THE GOODS AND SERVICES OF OTHERS VIA THE INTERNET, POD CASTS, ELECTRONIC MAIL, BROADBAND NETWORKS, DIGITAL NETWORKS, WIRELESS AND MOBILE NETWORKS, IN CLASS 35 (U.S. CLS. 100, 101 AND 102).

FIRST USE 2-1-2007; IN COMMERCE 2-1-2007.

FOR: BROADCASTING VIDEO BROADCASTS OF PROGRAMMING ON VARIOUS TOPICS INCLUDING ENTERTAINMENT NEWS, POPULAR CULTURE, CURRENT EVENTS AND TOPICS OF GENERAL INTEREST VIA THE INTERNET, POD CASTS, BROADBAND NETWORKS, DIGITAL NETWORKS, WIRELESS AND MOBILE NETWORKS; COMMUNICATION SERVICES, NAMELY, TRANSMITTING STREAMED SOUND AND AUDIO-VISUAL RECORDINGS VIA THE INTERNET, POD CASTS, BROADBAND NETWORKS, DIGITAL NETWORKS, WIRELESS AND MOBILE NETWORKS; TRANSMISSION OF INFORMATION BY ELECTRO-

NIC COMMUNICATIONS NETWORKS, IN CLASS 38 (U.S. CLS. 100, 101 AND 104).

FIRST USE 2-1-2007; IN COMMERCE 2-1-2007.

FOR: ENTERTAINMENT SERVICES, NAMELY, PROVIDING INFORMATION CONCERNING ENTERTAINMENT NEWS AND POPULAR CULTURE VIA THE INTERNET, POD CASTS, ELECTRONIC MAIL, BROADBAND NETWORKS, DIGITAL NETWORKS, WIRELESS AND MOBILE NETWORKS; ENTERTAINMENT, NAMELY, A CONTINUING ENTERTAINMENT SHOW BROADCAST VIA THE INTERNET, POD CASTS, BROADBAND NETWORKS, DIGITAL NETWORKS, WIRELESS AND MOBILE NETWORKS; PRODUCTION OF AUDIO-VISUAL PROGRAMMING, IN CLASS 41 (U.S. CLS. 100, 101 AND 107).

FIRST USE 2-1-2007; IN COMMERCE 2-1-2007.

THE MARK CONSISTS OF STANDARD CHARACTERS WITHOUT CLAIM TO ANY PARTICULAR FONT, STYLE, SIZE, OR COLOR.

SER. NO. 77-138,128, FILED P.R. 3-22-2007; AM. S.R. 7-10-2008.

TEJBIR SINGH, EXAMINING ATTORNEY

**Int. Cl.: 4**

**Prior U.S. Cls.: 1, 6, and 15**

**United States Patent and Trademark Office**

**Reg. No. 3,500,353**

**Registered Sep. 9, 2008**

**TRADEMARK  
SUPPLEMENTAL REGISTER**

**BIO-LIPID**

SYMBIOTICS CORPORATION (ARIZONA CORPORATION)  
610 VALENCIA AVENUE, SUITE 100  
BREA, CA 92823

FOR: DAIRY-BASED PHOSPHOLIPID COATING  
USED IN THE MANUFACTURE OF DIETARY AND  
NUTRITIONAL SUPPLEMENTS, IN CLASS 4 (U.S.  
CLS. 1, 6 AND 15).

FIRST USE 1-1-1999; IN COMMERCE 1-1-1999.

THE MARK CONSISTS OF STANDARD CHARACTERS WITHOUT CLAIM TO ANY PARTICULAR FONT, STYLE, SIZE, OR COLOR.

SER. NO. 77-142,162, FILED P.R. 3-28-2007; AM. S.R. 8-4-2008.

MARK T. MULLEN, EXAMINING ATTORNEY

**Int. Cl.: 35**

**Prior U.S. Cls.: 100, 101, and 102**

**United States Patent and Trademark Office**

**Reg. No. 3,500,354**

**Registered Sep. 9, 2008**

**SERVICE MARK  
SUPPLEMENTAL REGISTER**

**Low Carbon Energy Network**

NAVIGANT CONSULTING, INC. (DELAWARE CORPORATION)  
30 S. WACKER DR., SUITE 3550  
CHICAGO, IL 60606

FOR: CONSULTING SERVICES IN THE FIELDS OF ENERGY EFFICIENCY AND ENERGY USAGE MANAGEMENT, IN CLASS 35 (U.S. CLS. 100, 101 AND 102).

FIRST USE 3-29-2007; IN COMMERCE 3-29-2007.

THE MARK CONSISTS OF STANDARD CHARACTERS WITHOUT CLAIM TO ANY PARTICULAR FONT, STYLE, SIZE, OR COLOR.

NO CLAIM IS MADE TO THE EXCLUSIVE RIGHT TO USE "NETWORK", APART FROM THE MARK AS SHOWN.

SER. NO. 77-143,909, FILED P.R. 3-29-2007; AM. S.R. 7-31-2008.

MELISSA VALLILLO, EXAMINING ATTORNEY

**Int. Cl.: 31**

**Prior U.S. Cls.: 1 and 46**

**United States Patent and Trademark Office**

**Reg. No. 3,500,355**

**Registered Sep. 9, 2008**

**TRADEMARK  
SUPPLEMENTAL REGISTER**

**MAXI Joint & Coat Care**

ROYAL CANIN S.A. (FRANCE CORPORATION)  
650, AVENUE DE LA PETITE CAMARGUE  
AIMARGUES, FRANCE 30470

FOR: DOG FOOD, IN CLASS 31 (U.S. CLS. 1 AND  
46).

FIRST USE 9-30-2007; IN COMMERCE 9-30-2007.

THE MARK CONSISTS OF STANDARD CHAR-  
ACTERS WITHOUT CLAIM TO ANY PARTICULAR  
FONT, STYLE, SIZE, OR COLOR.

SER. NO. 77-147,547, FILED P.R. 4-3-2007; AM. S.R.  
8-1-2008.

MARY CRAWFORD, EXAMINING ATTORNEY

**Int. Cl.: 31**

**Prior U.S. Cls.: 1 and 46**

**United States Patent and Trademark Office**

**Reg. No. 3,500,356**

**Registered Sep. 9, 2008**

**TRADEMARK  
SUPPLEMENTAL REGISTER**

**MAXI Aging Care**

ROYAL CANIN S.A. (FRANCE CORPORATION)  
650, AVENUE DE LA PETITE CAMARGUE  
AIMARGUES, FRANCE 30470

FOR: DOG FOOD, IN CLASS 31 (U.S. CLS. 1 AND  
46).

FIRST USE 9-30-2007; IN COMMERCE 9-30-2007.

THE MARK CONSISTS OF STANDARD CHAR-  
ACTERS WITHOUT CLAIM TO ANY PARTICULAR  
FONT, STYLE, SIZE, OR COLOR.

SER. NO. 77-147,562, FILED P.R. 4-3-2007; AM. S.R.  
8-1-2008.

MARY CRAWFORD, EXAMINING ATTORNEY

**Int. Cl.: 31**

**Prior U.S. Cls.: 1 and 46**

**United States Patent and Trademark Office**

**Reg. No. 3,500,357**

**Registered Sep. 9, 2008**

**TRADEMARK  
SUPPLEMENTAL REGISTER**

**MAXI Weight Care**

ROYAL CANIN S.A. (FRANCE CORPORATION)  
650, AVENUE DE LA PETITE CAMARGUE  
AIMARGUES, FRANCE 30470

THE MARK CONSISTS OF STANDARD CHAR-  
ACTERS WITHOUT CLAIM TO ANY PARTICULAR  
FONT, STYLE, SIZE, OR COLOR.

FOR: DOG FOOD, IN CLASS 31 (U.S. CLS. 1 AND  
46).

SER. NO. 77-147,570, FILED P.R. 4-3-2007; AM. S.R.  
8-1-2008.

FIRST USE 9-30-2007; IN COMMERCE 9-30-2007.

MARY CRAWFORD, EXAMINING ATTORNEY



**Int. Cl.: 31**

**Prior U.S. Cls.: 1 and 46**

**United States Patent and Trademark Office**

**Reg. No. 3,500,358**

**Registered Sep. 9, 2008**

**TRADEMARK  
SUPPLEMENTAL REGISTER**

**MINI Weight Care 30**

ROYAL CANIN S.A. (FRANCE CORPORATION)  
650, AVENUE DE LA PETITE CAMARGUE  
AIMARGUES, FRANCE 30470

THE MARK CONSISTS OF STANDARD CHAR-  
ACTERS WITHOUT CLAIM TO ANY PARTICULAR  
FONT, STYLE, SIZE, OR COLOR.

FOR: DOG FOOD, IN CLASS 31 (U.S. CLS. 1 AND  
46).

SER. NO. 77-147,582, FILED P.R. 4-3-2007; AM. S.R.  
8-1-2008.

FIRST USE 5-31-2007; IN COMMERCE 5-31-2007.

MARY CRAWFORD, EXAMINING ATTORNEY

**Int. Cl.: 31**

**Prior U.S. Cls.: 1 and 46**

**United States Patent and Trademark Office**

**Reg. No. 3,500,359**

**Registered Sep. 9, 2008**

**TRADEMARK  
SUPPLEMENTAL REGISTER**

**MINI Indoor Adult 21**

ROYAL CANIN S.A. (FRANCE CORPORATION)  
650, AVENUE DE LA PETITE CAMARGUE  
AIMARGUES, FRANCE 30470

THE MARK CONSISTS OF STANDARD CHAR-  
ACTERS WITHOUT CLAIM TO ANY PARTICULAR  
FONT, STYLE, SIZE, OR COLOR.

FOR: DOG FOOD, IN CLASS 31 (U.S. CLS. 1 AND  
46).

SER. NO. 77-147,594, FILED P.R. 4-3-2007; AM. S.R.  
8-1-2008.

FIRST USE 5-31-2007; IN COMMERCE 5-31-2007.

MARY CRAWFORD, EXAMINING ATTORNEY

**Int. Cl.: 31**

**Prior U.S. Cls.: 1 and 46**

**United States Patent and Trademark Office**

**Reg. No. 3,500,360**

**Registered Sep. 9, 2008**

**TRADEMARK  
SUPPLEMENTAL REGISTER**

**MINI Toy Indoor Adult 25**

ROYAL CANIN S.A. (FRANCE CORPORATION)  
650, AVENUE DE LA PETITE CAMARGUE  
AIMARGUES, FRANCE 30470

THE MARK CONSISTS OF STANDARD CHAR-  
ACTERS WITHOUT CLAIM TO ANY PARTICULAR  
FONT, STYLE, SIZE, OR COLOR.

FOR: DOG FOOD, IN CLASS 31 (U.S. CLS. 1 AND  
46).

SER. NO. 77-147,601, FILED P.R. 4-3-2007; AM. S.R.  
8-1-2008.

FIRST USE 5-31-2007; IN COMMERCE 5-31-2007.

MARY CRAWFORD, EXAMINING ATTORNEY

**Int. Cl.: 44**

**Prior U.S. Cls.: 100 and 101**

**United States Patent and Trademark Office**

**Reg. No. 3,500,361**

**Registered Sep. 9, 2008**

**SERVICE MARK  
SUPPLEMENTAL REGISTER**

**ATHENS CARDIAC ARRHYTHMIA  
CENTER**

ST. MARYS HEALTH CARE SYSTEM, INC.  
(GEORGIA CORPORATION)

1230 BAXTER STREET

ATHENS, GA 30606

FOR: CARDIAC SERVICES, IN CLASS 44 (U.S.  
CLS. 100 AND 101).

FIRST USE 1-8-2007; IN COMMERCE 1-8-2007.

THE MARK CONSISTS OF STANDARD CHAR-  
ACTERS WITHOUT CLAIM TO ANY PARTICULAR  
FONT, STYLE, SIZE, OR COLOR.

NO CLAIM IS MADE TO THE EXCLUSIVE  
RIGHT TO USE "CENTER", APART FROM THE  
MARK AS SHOWN.

SER. NO. 77-148,111, FILED P.R. 4-4-2007; AM. S.R.  
7-29-2008.

ANDREA SAUNDERS, EXAMINING ATTORNEY

**Int. Cl.: 11**

**Prior U.S. Cls.: 13, 21, 23, 31, and 34**

**United States Patent and Trademark Office**

**Reg. No. 3,500,362**

**Registered Sep. 9, 2008**

**TRADEMARK  
SUPPLEMENTAL REGISTER**



SUN WATER SYSTEMS, INC. (TEXAS CORPORATION)  
325 N. BEACH ST.  
FORT WORTH, TX 76111

FOR: WATER FILTERS, IN CLASS 11 (U.S. CLS. 13, 21, 23, 31 AND 34).

FIRST USE 8-0-1992; IN COMMERCE 8-0-1992.

THE MARK CONSISTS OF A HOURGLASS SHAPED PACKAGING FOR A WATER FILTER.

SER. NO. 77-152,120, FILED P.R. 4-9-2007; AM. S.R. 2-4-2008.

HENRY S. ZAK, EXAMINING ATTORNEY

**Int. Cl.: 14**

**Prior U.S. Cls.: 2, 27, 28, and 50**

**United States Patent and Trademark Office**

**Reg. No. 3,500,363**

**Registered Sep. 9, 2008**

**TRADEMARK  
SUPPLEMENTAL REGISTER**

**BLUE LINE RINGS**

GEORGE PREOCANIN AND BRYAN PETERS, A  
PARTNERSHIP (CANADA PARTNERSHIP)  
59 MARK PLACE  
HAMILTON, CANADA L8W2P8

FOR: JEWELLERY, IN CLASS 14 (U.S. CLS. 2, 27, 28  
AND 50).

FIRST USE 10-3-2002; IN COMMERCE 10-31-2002.

THE MARK CONSISTS OF STANDARD CHAR-  
ACTERS WITHOUT CLAIM TO ANY PARTICULAR  
FONT, STYLE, SIZE, OR COLOR.

PRIORITY CLAIMED UNDER SEC. 44(D) ON  
CANADA APPLICATION NO. 1331115, FILED 1-12-  
2007, REG. NO. TMA704,088, DATED 1-8-2008, EX-  
PIRES 1-8-2023.

NO CLAIM IS MADE TO THE EXCLUSIVE  
RIGHT TO USE "RINGS", APART FROM THE  
MARK AS SHOWN.

SER. NO. 77-153,797, FILED P.R. 4-11-2007; AM. S.R.  
8-6-2008.

JORDAN BAKER, EXAMINING ATTORNEY

**Int. Cl.: 28**

**Prior U.S. Cls.: 22, 23, 38, and 50**

**United States Patent and Trademark Office**

**Reg. No. 3,500,364**

**Registered Sep. 9, 2008**

**TRADEMARK  
SUPPLEMENTAL REGISTER**

**ADJUSTABLE BALANCE BOBBER**

BALANCE ADJUSTABLE TECHNOLOGY LLC  
(WISCONSIN LIMITED LIABILITY COMPAN-  
NY)

26607 SUSIE COURT

WIND LAKE, WI 531851374

FOR: BOBBERS ATTACHED TO ICE FISHING  
RODS, IN CLASS 28 (U.S. CLS. 22, 23, 38 AND 50).

FIRST USE 4-30-1991; IN COMMERCE 4-30-1991.

THE MARK CONSISTS OF STANDARD CHAR-  
ACTERS WITHOUT CLAIM TO ANY PARTICULAR  
FONT, STYLE, SIZE, OR COLOR.

NO CLAIM IS MADE TO THE EXCLUSIVE  
RIGHT TO USE "BOBBER", APART FROM THE  
MARK AS SHOWN.

SER. NO. 77-153,954, FILED P.R. 4-11-2007; AM. S.R.  
7-22-2008.

DAVID C. REIHNER, EXAMINING ATTORNEY

**Int. Cls.: 38 and 41**

**Prior U.S. Cls.: 100, 101, 104, and 107**

**United States Patent and Trademark Office**

**Reg. No. 3,500,365**

**Registered Sep. 9, 2008**

**SERVICE MARK  
SUPPLEMENTAL REGISTER**



SONY PICTURES TELEVISION INC. (DELA-  
WARE CORPORATION)  
10202 W. WASHINGTON BLVD.  
CULVER CITY, CA 90232

FOR: STREAMING OF VIDEO MATERIAL ON  
THE INTERNET; ELECTRONIC TRANSMISSION  
OF AUDIO VISUAL CONTENT IN THE NATURE  
OF EDITED TELEVISION PROGRAMMING VIA  
TELEVISION, WIRELESS MOBILE DEVICES OR  
THE INTERNET, IN CLASS 38 (U.S. CLS. 100, 101  
AND 104).

FIRST USE 3-26-2007; IN COMMERCE 3-26-2007.

FOR: ENTERTAINMENT SERVICES, NAMELY,  
PROVIDING EDITED TELEVISION PROGRAMS IN  
THE FIELD OF DRAMA, COMEDY, MUSIC, REA-  
LITY AND GAME SHOWS VIA A GLOBAL COM-  
PUTER NETWORK OR ON WIRED OR WIRELESS  
DEVICES, IN CLASS 41 (U.S. CLS. 100, 101 AND 107).

FIRST USE 3-26-2007; IN COMMERCE 3-26-2007.

OWNER OF U.S. REG. NO. 3,314,930.

NO CLAIM IS MADE TO THE EXCLUSIVE  
RIGHT TO USE "NETWORK", APART FROM THE  
MARK AS SHOWN.

THE MARK CONSISTS OF THE WORDS "THE  
MINISODE NETWORK" IN STYLIZED FORM WITH  
THE WORD "THE" CONTAINED WITHIN THE DOT  
OVER THE "I" AND THE WORD "NETWORK"  
UNDER THE WORD "MINISODE".

SER. NO. 77-156,139, FILED P.R. 4-13-2007; AM. S.R.  
3-24-2008.

SANI KHOURI, EXAMINING ATTORNEY



**Int. Cl.: 36**

**Prior U.S. Cls.: 100, 101, and 102**

**United States Patent and Trademark Office**

**Reg. No. 3,500,366**

**Registered Sep. 9, 2008**

**SERVICE MARK  
SUPPLEMENTAL REGISTER**

**Strawberry Coast**

MASSA, RICHARD F. (UNITED STATES INDIVIDUAL)  
4515 GATESHEAD BAY  
OXNARD, CA 93035

FOR: REAL ESTATE BROKERAGE SERVICES;  
REAL ESTATE LISTING SERVICES, AND REAL  
ESTATE AGENCY SERVICES, IN CLASS 36 (U.S.  
CLS. 100, 101 AND 102).

FIRST USE 4-0-2005; IN COMMERCE 2-0-2007.

THE MARK CONSISTS OF STANDARD CHARACTERS WITHOUT CLAIM TO ANY PARTICULAR FONT, STYLE, SIZE, OR COLOR.

SER. NO. 77-157,089, FILED P.R. 4-15-2007; AM. S.R. 7-30-2008.

TERESA M. RUPP, EXAMINING ATTORNEY

**Int. Cl.: 38**

**Prior U.S. Cls.: 100, 101, and 104**

**United States Patent and Trademark Office**

**Reg. No. 3,500,367**

**Registered Sep. 9, 2008**

**SERVICE MARK  
SUPPLEMENTAL REGISTER**

**CAMPUS ALERTS**

MESSAGE LOGIX, INC. (NEW YORK CORPORATION)

445 HAMILTON AVENUE

WHITE PLAINS, NY 10601

FOR: ELECTRONIC TRANSMISSION, RECEPTION AND PROCESSING OF EMERGENCY MESSAGES AND SIGNALS, IN CLASS 38 (U.S. CLS. 100, 101 AND 104).

FIRST USE 4-0-2004; IN COMMERCE 5-0-2006.

THE MARK CONSISTS OF STANDARD CHARACTERS WITHOUT CLAIM TO ANY PARTICULAR FONT, STYLE, SIZE, OR COLOR.

OWNER OF U.S. REG. NO. 3,038,005.

NO CLAIM IS MADE TO THE EXCLUSIVE RIGHT TO USE "ALERTS", APART FROM THE MARK AS SHOWN.

SER. NO. 77-168,384, FILED P.R. 4-28-2007; AM. S.R. 7-31-2008.

MARCIE MILONE, EXAMINING ATTORNEY

**Int. Cl.: 32**

**Prior U.S. Cls.: 45, 46, and 48**

**United States Patent and Trademark Office**

**Reg. No. 3,500,368**

**Registered Sep. 9, 2008**

**TRADEMARK  
SUPPLEMENTAL REGISTER**

**NATURALLY ENHANCED  
FLAVORED WATER**

HERBAL WATER, INC. (DELAWARE CORPORATION)

647 MONTGOMERY SCHOOL LANE

WYNNEWOOD, PA 19096

FOR: NON-ALCOHOLIC FLAVORED BEVERAGES, NAMELY, FLAVORED WATERS, IN CLASS 32 (U.S. CLS. 45, 46 AND 48).

FIRST USE 7-18-2007; IN COMMERCE 7-18-2007.

THE MARK CONSISTS OF STANDARD CHARACTERS WITHOUT CLAIM TO ANY PARTICULAR FONT, STYLE, SIZE, OR COLOR.

NO CLAIM IS MADE TO THE EXCLUSIVE RIGHT TO USE "ENHANCED FLAVORED WATER", APART FROM THE MARK AS SHOWN.

SER. NO. 77-176,021, FILED P.R. 5-8-2007; AM. S.R. 1-17-2008.

MICHAEL KEATING, EXAMINING ATTORNEY

**Int. Cl.: 35**

**Prior U.S. Cls.: 100, 101, and 102**

**United States Patent and Trademark Office**

**Reg. No. 3,500,369**

**Registered Sep. 9, 2008**

**SERVICE MARK  
SUPPLEMENTAL REGISTER**

**1800CARSHOW**

MARK CAMPBELL (UNITED STATES INDIVIDUAL)

#1508

1574 GULF ROAD

PT. ROBERTS, WA 98281

FOR: MARKETING SERVICES FOR VEHICLES SOLD BY DEALERS OF A MARKETING NETWORK, IN CLASS 35 (U.S. CLS. 100, 101 AND 102).

FIRST USE 5-1-2007; IN COMMERCE 5-1-2007.

THE MARK CONSISTS OF STANDARD CHARACTERS WITHOUT CLAIM TO ANY PARTICULAR FONT, STYLE, SIZE, OR COLOR.

SER. NO. 77-178,661, FILED P.R. 5-11-2007; AM. S.R. 7-24-2008.

BRIAN NEVILLE, EXAMINING ATTORNEY

**Int. Cl.: 44**

**Prior U.S. Cls.: 100 and 101**

**United States Patent and Trademark Office**

**Reg. No. 3,500,370**

**Registered Sep. 9, 2008**

**SERVICE MARK  
SUPPLEMENTAL REGISTER**

**CHOPRA CENTER**

CHOPRA ENTERPRISES, LLC (CALIFORNIA  
LIMITED LIABILITY COMPANY)  
2013 COSTA DEL MAR  
CARLSBAD, CA 92009

FOR: HEALTH SPA SERVICES FOR HEALTH  
AND WELLNESS OF THE BODY AND SPIRIT  
OFFERED AT A HEALTH RESORT; HEALTH SPA  
SERVICES, NAMELY, COSMETIC BODY CARE  
SERVICES; MASSAGE; MASSAGE AND THERA-  
PEUTIC SHIATSU MASSAGE; SKIN CARE SALONS,  
IN CLASS 44 (U.S. CLS. 100 AND 101).

FIRST USE 1-31-1992; IN COMMERCE 1-31-1992.

THE MARK CONSISTS OF STANDARD CHAR-  
ACTERS WITHOUT CLAIM TO ANY PARTICULAR  
FONT, STYLE, SIZE, OR COLOR.

OWNER OF U.S. REG. NOS. 2,202,591, 2,215,788,  
AND 3,173,576.

NO CLAIM IS MADE TO THE EXCLUSIVE  
RIGHT TO USE "CENTER", APART FROM THE  
MARK AS SHOWN.

SER. NO. 77-181,048, FILED P.R. 5-15-2007; AM. S.R.  
3-5-2008.

LANA PHAM, EXAMINING ATTORNEY

**Int. Cl.: 36**

**Prior U.S. Cls.: 100, 101, and 102**

**United States Patent and Trademark Office**

**Reg. No. 3,500,371**

**Registered Sep. 9, 2008**

**SERVICE MARK  
SUPPLEMENTAL REGISTER**

**AMERICA'S IRA EXPERTS**

TABLE BAY FINANCIAL NETWORK, INC. (CALIFORNIA CORPORATION)  
5775 E. LOS ANGELES AVE., SUITE 210  
SIMI VALLEY, CA 93063

FOR: FINANCIAL PLANNING SERVICES, INSURANCE BROKERAGE SERVICES IN THE FIELD OF LIFE INSURANCE; RETIREMENT PLANNING SERVICES; PROVIDING INFORMATION IN THE FIELD OF INSURANCE, FINANCIAL PLANNING AND RETIREMENT PLANNING; PROVIDING INFORMATION REGARDING LIFE INSURANCE AND ANNUITIES, IN CLASS 36 (U.S. CLS. 100, 101 AND 102).

FIRST USE 6-30-2007; IN COMMERCE 6-30-2007.

THE MARK CONSISTS OF STANDARD CHARACTERS WITHOUT CLAIM TO ANY PARTICULAR FONT, STYLE, SIZE, OR COLOR.

NO CLAIM IS MADE TO THE EXCLUSIVE RIGHT TO USE "IRA", APART FROM THE MARK AS SHOWN.

SER. NO. 77-181,802, FILED P.R. 5-15-2007; AM. S.R. 2-15-2008.

DEBRA LEE, EXAMINING ATTORNEY

**Int. Cl.: 35**

**Prior U.S. Cls.: 100, 101, and 102**

**United States Patent and Trademark Office**

**Reg. No. 3,500,372**

**Registered Sep. 9, 2008**

**SERVICE MARK  
SUPPLEMENTAL REGISTER**

**AMERICANS FOR IMMIGRATION  
REFORM**

GREATER HOUSTON PARTNERSHIP, INC.  
(TEXAS CORPORATION)  
1200 SMITH, SUITE #700  
HOUSTON, TX 77002

FOR: PROMOTING PUBLIC AWARENESS OF  
POLICY ISSUES AND CONSIDERATIONS RE-  
GARDING IMMIGRATION, IN CLASS 35 (U.S.  
CLS. 100, 101 AND 102).

FIRST USE 6-2-2008; IN COMMERCE 6-2-2008.

THE MARK CONSISTS OF STANDARD CHAR-  
ACTERS WITHOUT CLAIM TO ANY PARTICULAR  
FONT, STYLE, SIZE, OR COLOR.

SER. NO. 77-208,236, FILED P.R. 6-18-2007; AM. S.R.  
7-31-2008.

JIM RINGLE, EXAMINING ATTORNEY

**Int. Cl.: 45**

**Prior U.S. Cls.: 100 and 101**

**United States Patent and Trademark Office**

**Reg. No. 3,500,373**

**Registered Sep. 9, 2008**

**SERVICE MARK  
SUPPLEMENTAL REGISTER**

# Bandmates

THE BANDMATES NETWORK LTD. (CANADA  
LIMITED LIABILITY COMPANY)  
5778 SMART AVENUE  
COTE ST. LUC, QUEBEC, CANADA H4W2M7

FOR: ONLINE SOCIAL NETWORKING SERVICES, NAMELY, PROVIDING AN INTERACTIVE SEARCHABLE DATABASE THAT MATCHES MUSICIANS OF ALL SKILL AND INTEREST WITH APPROPRIATE SOCIAL CONTACTS AND SOCIAL OPPORTUNITIES IN THE FIELD OF MUSIC VIA A GLOBAL COMPUTER NETWORK, IN CLASS 45 (U.S. CLS. 100 AND 101).

FIRST USE 9-1-2004; IN COMMERCE 5-21-2007.

THE MARK CONSISTS OF STANDARD CHARACTERS WITHOUT CLAIM TO ANY PARTICULAR FONT, STYLE, SIZE, OR COLOR.

SER. NO. 77-232,950, FILED P.R. 7-18-2007; AM. S.R. 8-1-2008.

JAY BESCH, EXAMINING ATTORNEY



**Int. Cl.: 35**

**Prior U.S. Cls.: 100, 101, and 102**

**United States Patent and Trademark Office**

**Reg. No. 3,500,374**

**Registered Sep. 9, 2008**

**SERVICE MARK  
SUPPLEMENTAL REGISTER**

**AUTOMOTIVE ENVIRONMENTAL  
INDEX**

J.D. POWER AND ASSOCIATES (DELAWARE  
CORPORATION)  
2625 TOWNSGATE ROAD  
WESTLAKE VILLAGE, CA 91361

FOR: MARKET RESEARCH SERVICES; BUSI-  
NESS INFORMATION IN THE FIELD OF THE  
ENVIRONMENTAL FRIENDLINESS OF AUTOMO-  
BILES; PROVIDING A WEBSITE FEATURING PRO-  
DUCT RATINGS AS TO THE ENVIRONMENTAL  
FRIENDLINESS OF AUTOMOBILES OF OTHERS,  
IN CLASS 35 (U.S. CLS. 100, 101 AND 102).

FIRST USE 8-29-2006; IN COMMERCE 8-29-2006.

THE MARK CONSISTS OF STANDARD CHAR-  
ACTERS WITHOUT CLAIM TO ANY PARTICULAR  
FONT, STYLE, SIZE, OR COLOR.

NO CLAIM IS MADE TO THE EXCLUSIVE  
RIGHT TO USE "INDEX", APART FROM THE  
MARK AS SHOWN.

SER. NO. 77-243,578, FILED P.R. 7-31-2007; AM. S.R.  
3-27-2008.

DEBRA LEE, EXAMINING ATTORNEY

**Int. Cl.: 36**

**Prior U.S. Cls.: 100, 101, and 102**

**United States Patent and Trademark Office**

**Reg. No. 3,500,375**

**Registered Sep. 9, 2008**

**SERVICE MARK  
SUPPLEMENTAL REGISTER**

**AIRFARE EXCHANGE**

HOLIDAY SYSTEMS INTERNATIONAL OF NE-  
VADA (NEVADA CORPORATION)  
7690 WEST CHEYENNE AVE., SUITE 200  
LAS VEGAS, NV 89129

FOR: VACATION REAL ESTATE SERVICES,  
NAMELY, VACATION OWNERSHIP SERVICES,  
TIMESHARE SERVICES, POINT SYSTEM OWNER-  
SHIP SERVICES, DEEDED OWNERSHIP SERVICES,  
LEASEHOLD OWNERSHIP SERVICES, RIGHT-TO-  
USE OWNERSHIP SERVICES, UNDIVIDED INTER-  
EST OWNERSHIP SERVICES, PERPETUAL OWN-  
ERSHIP SERVICES, VACATION CLUB OWNERSHIP  
SERVICES, VACATION HOME OWNERSHIP SER-  
VICES AND FRACTIONAL OWNERSHIP SERVI-  
CES, IN CLASS 36 (U.S. CLS. 100, 101 AND 102).

FIRST USE 3-31-2002; IN COMMERCE 3-31-2002.

THE MARK CONSISTS OF STANDARD CHAR-  
ACTERS WITHOUT CLAIM TO ANY PARTICULAR  
FONT, STYLE, SIZE, OR COLOR.

NO CLAIM IS MADE TO THE EXCLUSIVE  
RIGHT TO USE "EXCHANGE", APART FROM  
THE MARK AS SHOWN.

SER. NO. 77-243,686, FILED P.R. 7-31-2007; AM. S.R.  
8-1-2008.

ERIN FALK, EXAMINING ATTORNEY

**Int. Cl.: 36**

**Prior U.S. Cls.: 100, 101, and 102**

**United States Patent and Trademark Office**

**Reg. No. 3,500,376**

**Registered Sep. 9, 2008**

**SERVICE MARK  
SUPPLEMENTAL REGISTER**

**CRUISE EXCHANGE**

HOLIDAY SYSTEMS INTERNATIONAL OF NE-  
VADA (NEVADA CORPORATION)  
7690 WEST CHEYENNE AVE., SUITE 200  
LAS VEGAS, NV 89129

FOR: VACATION REAL ESTATE SERVICES,  
NAMELY, VACATION OWNERSHIP SERVICES,  
TIMESHARE SERVICES, POINT SYSTEM OWNER-  
SHIP SERVICES, DEEDED OWNERSHIP SERVICES,  
LEASEHOLD OWNERSHIP SERVICES, RIGHT-TO-  
USE OWNERSHIP SERVICES, UNDIVIDED INTER-  
EST OWNERSHIP SERVICES, PERPETUAL OWN-  
ERSHIP SERVICES, VACATION CLUB OWNERSHIP  
SERVICES, VACATION HOME OWNERSHIP SER-  
VICES AND FRACTIONAL OWNERSHIP SERVI-  
CES, IN CLASS 36 (U.S. CLS. 100, 101 AND 102).

FIRST USE 3-31-2002; IN COMMERCE 3-31-2002.

THE MARK CONSISTS OF STANDARD CHAR-  
ACTERS WITHOUT CLAIM TO ANY PARTICULAR  
FONT, STYLE, SIZE, OR COLOR.

NO CLAIM IS MADE TO THE EXCLUSIVE  
RIGHT TO USE "EXCHANGE", APART FROM  
THE MARK AS SHOWN.

SER. NO. 77-243,695, FILED P.R. 7-31-2007; AM. S.R.  
8-1-2008.

ERIN FALK, EXAMINING ATTORNEY

**Int. Cls.: 35 and 36**

**Prior U.S. Cls.: 100, 101, and 102**

**United States Patent and Trademark Office**

**Reg. No. 3,500,377**

**Registered Sep. 9, 2008**

**SERVICE MARK  
SUPPLEMENTAL REGISTER**

# AIDS Walk Portland

CASCADE AIDS PROJECT (OREGON NON-  
PROFIT ORGANIZATION)  
620 S.W. FIFTH AVENUE, STE. 300  
PORTLAND, OR 97204

FOR: PROMOTING PUBLIC AWARENESS OF  
AIDS, IN CLASS 35 (U.S. CLS. 100, 101 AND 102).

FIRST USE 6-1-2007; IN COMMERCE 6-1-2007.

FOR: CHARITABLE FUND RAISING, IN CLASS  
36 (U.S. CLS. 100, 101 AND 102).

FIRST USE 6-1-2007; IN COMMERCE 6-1-2007.

THE MARK CONSISTS OF STANDARD CHAR-  
ACTERS WITHOUT CLAIM TO ANY PARTICULAR  
FONT, STYLE, SIZE, OR COLOR.

NO CLAIM IS MADE TO THE EXCLUSIVE  
RIGHT TO USE "AIDS WALK", APART FROM  
THE MARK AS SHOWN.

SER. NO. 77-249,830, FILED P.R. 8-8-2007; AM. S.R.  
7-28-2008.

NATALIE POLZER, EXAMINING ATTORNEY

**Int. Cl.: 33**

**Prior U.S. Cls.: 47 and 49**

**United States Patent and Trademark Office**

**Reg. No. 3,500,378**

**Registered Sep. 9, 2008**

**TRADEMARK  
SUPPLEMENTAL REGISTER**

**TAFFY APPLES**

THE HURNS BEER COMPANY LTD (WALES  
LIMITED LIABILITY COMPANY)  
KINGSWAY, FFORESTFACH, SWANSEA SA5 4DL  
SWANSEA, WALES

FOR: ALCOHOLIC CIDER, HARD CIDER, IN  
CLASS 33 (U.S. CLS. 47 AND 49).

THE MARK CONSISTS OF STANDARD CHAR-  
ACTERS WITHOUT CLAIM TO ANY PARTICULAR  
FONT, STYLE, SIZE, OR COLOR.

OWNER OF UNITED KINGDOM REG. NO.  
2228699, DATED 9-22-2000, EXPIRES 4-8-2010.

SER. NO. 77-258,225, FILED P.R. 8-17-2007; AM. S.R.  
8-4-2008.

MARILYN IZZI, EXAMINING ATTORNEY

**Int. Cl.: 35**

**Prior U.S. Cls.: 100, 101, and 102**

**United States Patent and Trademark Office**

**Reg. No. 3,500,379**

**Registered Sep. 9, 2008**

**SERVICE MARK  
SUPPLEMENTAL REGISTER**

# InfoSci

IDEA GROUP INC. (PENNSYLVANIA CORPORATION), DBA IGI GLOBAL,  
SUITE 200  
701 E CHOCOLATE AVENUE  
HERSHEY, PA 17033

FOR: MANAGEMENT AND COMPILATION OF  
COMPUTERISED DATABASES, IN CLASS 35 (U.S.  
CLS. 100, 101 AND 102).

FIRST USE 6-1-2004; IN COMMERCE 6-1-2004.

THE MARK CONSISTS OF STANDARD CHARACTERS WITHOUT CLAIM TO ANY PARTICULAR FONT, STYLE, SIZE, OR COLOR.

SER. NO. 77-263,459, FILED P.R. 8-24-2007; AM. S.R. 7-31-2008.

BENJAMIN OKEKE, EXAMINING ATTORNEY

**Int. Cls.: 35 and 41**

**Prior U.S. Cls.: 100, 101, 102, and 107**

**United States Patent and Trademark Office**

**Reg. No. 3,500,380**

**Registered Sep. 9, 2008**

**SERVICE MARK  
SUPPLEMENTAL REGISTER**

**DEFENDING MAINTENANCE &  
SUPPORT PRICING**

KOTLER MARKETING GROUP (D.C. CORPORATION)

4TH FLOOR

925 15TH STREET NW

WASHINGTON, DC 20005

FOR: BUSINESS CONSULTING IN THE FIELDS OF SALES AND MARKETING, IN CLASS 35 (U.S. CLS. 100, 101 AND 102).

FIRST USE 5-0-2005; IN COMMERCE 5-0-2005.

FOR: TRAINING SERVICES IN THE FIELD OF SALES AND MARKETING, IN CLASS 41 (U.S. CLS. 100, 101 AND 107).

FIRST USE 5-0-2005; IN COMMERCE 5-0-2005.

THE MARK CONSISTS OF STANDARD CHARACTERS WITHOUT CLAIM TO ANY PARTICULAR FONT, STYLE, SIZE, OR COLOR.

SER. NO. 77-266,258, FILED P.R. 8-28-2007; AM. S.R. 6-26-2008.

BONNIE LUKEN, EXAMINING ATTORNEY

**Int. Cl.: 25**

**Prior U.S. Cls.: 22 and 39**

**United States Patent and Trademark Office**

**Reg. No. 3,500,381**

**Registered Sep. 9, 2008**

**TRADEMARK  
SUPPLEMENTAL REGISTER**

**LOS**

GARZA, RAYNALDO (UNITED STATES INDIVIDUAL)  
14 MONARCH BAY PLAZA, SUITE 475  
MONARCH BEACH, CA 92629

FOR: CLOTHING, NAMELY, PULLOVERS, SKIRTS, DRESSES, BLOUSES, JEANS, PANTS, TROUSERS, JACKETS, COATS, RAINCOATS, ANORAKS AND SWEATERS; SPORTSWEAR, NAMELY, POLO SHIRTS, AND GOLF SHIRTS; DRESS SHIRTS, SHIRTS, SKIRTS, T-SHIRTS, SWEATSHIRTS, SWEAT SUITS, JOGGING SUITS, JERSEYS AND SUITS; BEACH CLOTHES, NAMELY, SWIMMING TRUNKS AND SWIMMING SHORTS; SHORTS; KNITWEAR, NAMELY, KNITTED SCARVES, KNITTED BELTS AND KNITTED CAPS; OVERALLS, DENIM SHIRTS, DENIM PANTS; UNDERGARMENTS, BODICES IN THE NATURE OF BUSTIERS, BRASSIERES, CAMISOLES, UNDERPANTS, DRESSING GOWNS, BATH ROBES, BATHING SUITS, PAJAMAS, GLOVES, SKI SUITS, STOCKINGS; BELTS; TIES, FOULARDS, NECKTIES, SHAWLS, SCARVES, MUFFLERS, NECK SCARVES, SARONGS, COLLARS FOR DRESSES, MANIPLES, MUFFS; BRACES FOR CLOTHING, NAMELY, SUSPENDERS; COATS, BLAZERS, SPORTS JACKETS, GARTERS, TIES, TANK TOPS, LOUNGEWEAR,

SCARVES, LINGERIE, T-SHIRTS, SWEATERS, SCARVES, PAJAMAS, VESTS, LINGERIE, BOXERS, SOCKS, PANTIES, SWEATPANTS; HEADGEAR, NAMELY, BANDANAS, HEADBANDS, CAPS, HATS, BEANIES, KNITTED CAPS, BERETS, COWBOY HATS, TUXEDO HATS, DINNER WEAR HATS, VISORS; ANKLE BANDS, HEAD BANDS, ARM BANDS AND WRIST BANDS; FOOTWEAR, NAMELY, ATHLETIC SHOES AND SNEAKERS; BOOTS, SANDALS, BEACH SHOES, BOAT SHOES, SLIPPERS, BOOTS, SANDALS, SNOW BOOTS, FLIP FLOPS, IN CLASS 25 (U.S. CLS. 22 AND 39).

FIRST USE 11-17-2006; IN COMMERCE 8-28-2007.

THE MARK CONSISTS OF STANDARD CHARACTERS WITHOUT CLAIM TO ANY PARTICULAR FONT, STYLE, SIZE, OR COLOR.

THE FOREIGN WORDING IN THE MARK TRANSLATES INTO ENGLISH AS THE.

SER. NO. 77-268,953, FILED P.R. 8-31-2007; AM. S.R. 6-6-2008.

SUSAN RICHARDS, EXAMINING ATTORNEY



**Int. Cl.: 38**

**Prior U.S. Cls.: 100, 101, and 104**

**Reg. No. 3,500,382**

**United States Patent and Trademark Office**

**Registered Sep. 9, 2008**

**SERVICE MARK  
SUPPLEMENTAL REGISTER**

# FOOD NEWS

YUM, LLC (CALIFORNIA LIMITED LIABILITY COMPANY)  
441 VISTA GLORIOSA DRIVE  
LOS ANGELES, CA 90065

FOR: AUDIO AND VIDEO BROADCASTING SERVICES OVER THE INTERNET; AUDIO BROADCASTING; BROADCAST OF CABLE TELEVISION PROGRAMMES; BROADCASTING PROGRAMS VIA A GLOBAL COMPUTER NETWORK; BROADCASTING SERVICES AND PROVISION OF TELECOMMUNICATION ACCESS TO FILMS AND TV PROGRAMMES PROVIDED VIA A VIDEO-ON-DEMAND SERVICE; BROADCASTING SERVICES AND PROVISION OF TELECOMMUNICATION ACCESS TO VIDEO AND AUDIO CONTENT PROVIDED VIA A VIDEO-ON-DEMAND SERVICE VIA THE INTERNET; CABLE CASTING SERVICES; CABLE RADIO BROADCASTING; CABLE RADIO TRANSMISSION; CABLE TELEVISION BROADCASTING; CABLE TELEVISION TRANSMISSION; CELLULAR TELEPHONE COMMUNICATION; CELLULAR TELEPHONE SERVICES; COMMUNICATION BY ELECTRONIC COMPUTER TERMINALS; COMMUNICATION BY MOBILE TELEPHONE; COMMUNICATION SERVICES, NAMELY, ELECTRONIC TRANSMISSION OF DATA AND DOCUMENTS AMONG USERS OF COMPUTERS; COMMUNICATION VIA ANALOGUE AND DIGITAL COMPUTER TERMINALS; COMMUNICATION VIA COMPUTER TERMINALS, BY DIGITAL TRANSMISSION OR BY SATELLITE; COMMUNICATION VIA FIBRE OPTICAL NETWORKS; COMMUNICATION VIA FIBRE-OPTIC NETWORKS; COMMUNICATION VIA OPTICAL FIBRE NETWORKS; COMMUNICATION VIA RADIO, TELEGRAPH, TELEPHONE AND TELEVISION TRANSMISSIONS; COMMUNICATIONS BY COMPUTER TERMINALS; COMMUNICATIONS BY MEANS OF MOBILE PHONES; COMMUNICATIONS BY MOBILE PHONES; COMMUNICATIONS BY TELEVISION FOR MEETING; COMMUNICA-

TIONS SERVICES, NAMELY, TRANSMITTING STREAMED SOUND AND AUDIO-VISUAL RECORDINGS VIA THE INTERNET; COMMUNICATIONS VIA ANALOGUE AND DIGITAL COMPUTER TERMINALS; COMMUNICATIONS VIA FIBER-OPTIC NETWORKS; COMMUNICATIONS VIA FIBRE-OPTIC NETWORKS; COMMUNICATIONS VIA MULTINATIONAL TELECOMMUNICATION NETWORKS; COMPUTER AIDED TRANSMISSION OF INFORMATION AND IMAGES; COMPUTER TRANSMISSION OF INFORMATION ACCESSED VIA A CODE OR A TERMINAL; DATA COMMUNICATION BY ELECTRONIC MAIL; DATA TRANSMISSION AND RECEPTION SERVICES VIA TELECOMMUNICATION MEANS; DELIVERY OF MESSAGES BY ELECTRONIC TRANSMISSION; ELECTRONIC DATA TRANSMISSION; ELECTRONIC MESSAGE TRANSMISSION; ELECTRONIC TRANSMISSION OF DATA AND DOCUMENTS VIA COMPUTER TERMINALS; ELECTRONIC TRANSMISSION OF MESSAGES AND DATA; ELECTRONIC TRANSMISSION OF VOICE, DATA AND IMAGES BY TELEVISION AND VIDEO BROADCASTING; INFORMATION TRANSMISSION VIA ELECTRONIC COMMUNICATIONS NETWORKS; INTERNET CAFE SERVICES, NAMELY, PROVIDING TELECOMMUNICATIONS CONNECTIONS TO THE INTERNET IN A CAFE ENVIRONMENT; MOBILE MEDIA SERVICES IN THE NATURE OF ELECTRONIC TRANSMISSION OF ENTERTAINMENT MEDIA CONTENT; MOBILE TELEPHONE COMMUNICATION; PAY-PER-VIEW TELEVISION TRANSMISSION SERVICES; PODCASTING SERVICES; PROVIDING ON-LINE CHAT ROOMS AND ELECTRONIC BULLETIN BOARDS FOR TRANSMISSION OF MESSAGES AMONG USERS IN THE FIELD OF GENERAL INTEREST; PROVIDING ON-LINE CHAT ROOMS FOR TRANSMISSION OF MESSAGES AMONG COMPUTER USERS CONCERNING FOOD AND LIFESTYLE, NAMELY, NEWS, EVENTS, HEALTH, AND OTHER HELPFUL

FOOD INFORMATION; PROVIDING ON-LINE ELECTRONIC BULLETIN BOARDS FOR TRANSMISSION OF MESSAGES AMONG COMPUTER USERS CONCERNING FOOD AND LIFESTYLE, NAMELY, NEWS, EVENTS, HEALTH, AND OTHER HELPFUL FOOD INFORMATION; PROVIDING ON-LINE FORUMS FOR TRANSMISSION OF MESSAGES AMONG COMPUTER USERS CONCERNING FOOD AND LIFESTYLE, NAMELY, NEWS, EVENTS, HEALTH, AND OTHER HELPFUL FOOD INFORMATION; RADIO BROADCASTING; RADIO BROADCASTING CONSULTATION; RADIO BROADCASTING INFORMATION; RADIO BROADCASTING OF INFORMATION AND OTHER PROGRAMS; RADIO COMMUNICATION; RADIO PROGRAM BROADCASTING; RADIO PROGRAMME BROADCASTING; RADIO, TELEPHONE, TELEGRAPH COMMUNICATION SERVICES; SATELLITE TELEVISION BROADCASTING; SATELLITE, CABLE, NETWORK TRANSMISSION OF SOUNDS, IMAGES, SIGNALS AND DATA; SUBSCRIPTION TELEVISION BROADCASTING; TELEVISION AND RADIO BROADCASTING SERVICES; TELEVISION BROADCASTING; TELEVISION BROADCASTING CONSULTATION; TELEVISION BROADCASTING INFORMATION; TELEVISION PROGRAMME BROADCASTING VIA CABLE; TRANSMISSION OF DATA, SOUND AND IMAGES BY SATELLITE; TRANSMISSION OF DATABASE INFORMATION VIA TELECOMMUNICATIONS NETWORKS; TRANSMISSION OF INFORMATION BY DATA COMMUNICATIONS FOR ASSISTING DECISION MAKING; TRANSMISSION OF INFORMATION BY ELECTRONIC COMMUNICATIONS NETWORKS; TRANSMISSION OF INFORMATION IN THE AUDIOVISUAL FIELD; TRANSMISSION OF

INFORMATION THROUGH VIDEO COMMUNICATION SYSTEMS; TRANSMISSION OF INFORMATION VIA NATIONAL AND INTERNATIONAL NETWORKS; TRANSMISSION OF MESSAGES OVER ELECTRONIC MEDIA; TRANSMISSION OF NEWS; TRANSMISSION OF SHORT MESSAGES; TRANSMISSION OF SOUND AND VISION VIA SATELLITE OR INTERACTIVE MULTIMEDIA NETWORKS; TRANSMISSION OF SOUND, PICTURE AND DATA SIGNALS; TRANSMISSION OF SOUND, VIDEO AND INFORMATION; VIDEO BROADCASTING; VIDEO-ON-DEMAND TRANSMISSION SERVICES; WEB MESSAGING; WIRELESS COMMUNICATIONS SERVICES, NAMELY, TRANSMISSION OF GRAPHICS TO MOBILE TELEPHONES; WIRELESS ELECTRONIC TRANSMISSION OF VOICE SIGNALS, DATA, FACSIMILES, IMAGES AND INFORMATIONS; WORLDWIDE SWITCHED TEXT AND MESSAGE TRANSMISSION SERVICES, IN CLASS 38 (U.S. CLS. 100, 101 AND 104).

FIRST USE 1-9-2004; IN COMMERCE 1-9-2004.

THE MARK CONSISTS OF STANDARD CHARACTERS WITHOUT CLAIM TO ANY PARTICULAR FONT, STYLE, SIZE, OR COLOR.

NO CLAIM IS MADE TO THE EXCLUSIVE RIGHT TO USE "NEWS" , APART FROM THE MARK AS SHOWN.

SER. NO. 77-278,037, FILED P.R. 9-12-2007; AM. S.R. 8-4-2008.

ALICIA COLLINS, EXAMINING ATTORNEY

**Int. Cl.: 28**

**Prior U.S. Cls.: 22, 23, 38, and 50**

**United States Patent and Trademark Office**

**Reg. No. 3,500,383**

**Registered Sep. 9, 2008**

**TRADEMARK  
SUPPLEMENTAL REGISTER**

**KNOT-A-QUILT**

PANLINE U.S.A. INC. (NEW JERSEY CORPORATION)  
251 UNION STREET  
NORTHVALE, NJ 07647

THE MARK CONSISTS OF STANDARD CHARACTERS WITHOUT CLAIM TO ANY PARTICULAR FONT, STYLE, SIZE, OR COLOR.

FOR: CHILDREN'S CRAFT KIT COMPRISED OF FRINGED FLEECE PIECES, IN CLASS 28 (U.S. CLS. 22, 23, 38 AND 50).

SER. NO. 77-278,248, FILED P.R. 9-12-2007; AM. S.R. 6-20-2008.

FIRST USE 1-25-2006; IN COMMERCE 1-25-2006.

SKYE YOUNG, EXAMINING ATTORNEY

**Int. Cl.: 28**

**Prior U.S. Cls.: 22, 23, 38, and 50**

**United States Patent and Trademark Office**

**Reg. No. 3,500,384**

**Registered Sep. 9, 2008**

**TRADEMARK  
SUPPLEMENTAL REGISTER**

**KNOT-A-SCARF**

PANLINE U.S.A. INC. (NEW JERSEY CORPORATION)  
251 UNION STREET  
NORTHVALE, NJ 07647

THE MARK CONSISTS OF STANDARD CHARACTERS WITHOUT CLAIM TO ANY PARTICULAR FONT, STYLE, SIZE, OR COLOR.

FOR: CHILDREN'S CRAFT KIT COMPRISED OF PRECUT FLEECE PIECES, LACES AND PLASTIC NEEDLES, IN CLASS 28 (U.S. CLS. 22, 23, 38 AND 50).

SER. NO. 77-278,252, FILED P.R. 9-12-2007; AM. S.R. 6-20-2008.

FIRST USE 1-15-2007; IN COMMERCE 1-15-2007.

SKYE YOUNG, EXAMINING ATTORNEY

**Int. Cl.: 28**

**Prior U.S. Cls.: 22, 23, 38, and 50**

**United States Patent and Trademark Office**

**Reg. No. 3,500,385**

**Registered Sep. 9, 2008**

**TRADEMARK  
SUPPLEMENTAL REGISTER**

**KNOT-A-PONCHO**

PANLINE U.S.A. INC. (NEW JERSEY CORPORATION)  
251 UNION STREET  
NORTHVALE, NJ 07647

THE MARK CONSISTS OF STANDARD CHARACTERS WITHOUT CLAIM TO ANY PARTICULAR FONT, STYLE, SIZE, OR COLOR.

FOR: CHILDREN'S CRAFT KIT COMPRISED OF PRECUT FRINGED PIECES, LACES AND PLASTIC NEEDLES, IN CLASS 28 (U.S. CLS. 22, 23, 38 AND 50).

SER. NO. 77-278,264, FILED P.R. 9-12-2007; AM. S.R. 6-20-2008.

FIRST USE 1-15-2007; IN COMMERCE 1-15-2007.

SKYE YOUNG, EXAMINING ATTORNEY

**Int. Cl.: 35**

**Prior U.S. Cls.: 100, 101, and 102**

**United States Patent and Trademark Office**

**Reg. No. 3,500,386**

**Registered Sep. 9, 2008**

**SERVICE MARK  
SUPPLEMENTAL REGISTER**

**THE RUNNER'S SUPERSTORE**

ROBINSON SPORTS, INC. (FLORIDA CORPORATION)  
P.O. BOX 439  
PARRISH, FL 34219

FOR: COMPUTERIZED ON-LINE RETAIL STORE SERVICES IN THE FIELD OF RUNNING CLOTHING, FOOTWEAR, GEAR, EQUIPMENT, TREADMILLS, HEART RATE MONITORS, ACCESSORIES AND SPORT BAGS; RETAIL STORE SERVICES FEATURING RUNNING CLOTHING, FOOTWEAR, GEAR, EQUIPMENT, TREADMILLS, HEART RATE MONITORS, ACCESSORIES AND SPORT BAGS, IN CLASS 35 (U.S. CLS. 100, 101 AND 102).

FIRST USE 12-0-2006; IN COMMERCE 12-0-2006.

THE MARK CONSISTS OF STANDARD CHARACTERS WITHOUT CLAIM TO ANY PARTICULAR FONT, STYLE, SIZE, OR COLOR.

NO CLAIM IS MADE TO THE EXCLUSIVE RIGHT TO USE "SUPERSTORE", APART FROM THE MARK AS SHOWN.

SER. NO. 77-283,702, FILED P.R. 9-19-2007; AM. S.R. 6-27-2008.

TIMOTHY FINNEGAN, EXAMINING ATTORNEY

**Int. Cl.: 29**

**Prior U.S. Cl.: 46**

**United States Patent and Trademark Office**

**Reg. No. 3,500,387**

**Registered Sep. 9, 2008**

**TRADEMARK  
SUPPLEMENTAL REGISTER**

**Zesty Fried Guacamole Bites**

WEISS, ALLAN C. (UNITED STATES INDIVIDUAL)  
831 4TH AVENUE  
DALLAS, TX 75226

FOR: FOOD APPETIZER CONSISTING PRIMARILY OF GUACAMOLE, CHEESE AND FLOUR BATTER, IN CLASS 29 (U.S. CL. 46).

FIRST USE 8-1-2007; IN COMMERCE 8-1-2007.

THE MARK CONSISTS OF STANDARD CHARACTERS WITHOUT CLAIM TO ANY PARTICULAR FONT, STYLE, SIZE, OR COLOR.

NO CLAIM IS MADE TO THE EXCLUSIVE RIGHT TO USE "GUACAMOLE", APART FROM THE MARK AS SHOWN.

SER. NO. 77-289,022, FILED 9-26-2007.

DEIRDRE ROBERTSON, EXAMINING ATTORNEY

**Int. Cl.: 10**

**Prior U.S. Cls.: 26, 39, and 44**

**United States Patent and Trademark Office**

**Reg. No. 3,500,388**

**Registered Sep. 9, 2008**

**TRADEMARK  
SUPPLEMENTAL REGISTER**

**The Emergency Bandage**

OM PERFORMANCE, INC. (TEXAS CORPORATION), DBA PERFORMANCE SYSTEMS,  
SUITE 1710  
3050 POST OAK BLVD  
HOUSTON, TX 77056

FOR: (BASED ON USE IN COMMERCE) COMPRESSION BANDAGES, IN CLASS 10 (U.S. CLS. 26, 39 AND 44).

FIRST USE 12-1-2006; IN COMMERCE 12-1-2006.

THE MARK CONSISTS OF STANDARD CHARACTERS WITHOUT CLAIM TO ANY PARTICULAR FONT, STYLE, SIZE, OR COLOR.

NO CLAIM IS MADE TO THE EXCLUSIVE RIGHT TO USE "BANDAGE", APART FROM THE MARK AS SHOWN.

SER. NO. 77-292,655, FILED P.R. 10-1-2007; AM. S.R. 7-11-2008.

KIMBERLY PERRY, EXAMINING ATTORNEY



Int. Cl.: 25

Prior U.S. Cls.: 22 and 39

United States Patent and Trademark Office

Reg. No. 3,500,389

Registered Sep. 9, 2008

TRADEMARK  
SUPPLEMENTAL REGISTER



THE GERARD BRACH COMPANY, INC. (TEXAS CORPORATION), DBA LA CUISINIÈRE, 217 SOUTH AVENUE G HUMBLE, TX 77338

FOR: CLOTHING FOR CHEFS, COOKS AND OTHER RESTAURANT STAFF, NAMELY, UNIFORMS, HATS, APRONS, PANTS, SHIRTS, AND JACKETS, IN CLASS 25 (U.S. CLS. 22 AND 39).

FIRST USE 10-1-2007; IN COMMERCE 10-1-2007.

NO CLAIM IS MADE TO THE EXCLUSIVE RIGHT TO USE "LA CUISINERE", APART FROM THE MARK AS SHOWN.

THE STIPPLING IS FOR SHADING PURPOSES ONLY.

THE MARK CONSISTS OF THE WORD "LA CUISINIÈRE" OVER THE IMAGE OF A ESCARGOT SHELL.

THE FOREIGN WORDING IN THE MARK TRANSLATES INTO ENGLISH AS THE FEMALE CHEF.

SER. NO. 77-296,014, FILED P.R. 10-4-2007; AM. S.R. 7-17-2008.

KAELIE KUNG, EXAMINING ATTORNEY

**Int. Cl.: 25**

**Prior U.S. Cls.: 22 and 39**

**United States Patent and Trademark Office**

**Reg. No. 3,500,390**

**Registered Sep. 9, 2008**

**TRADEMARK  
SUPPLEMENTAL REGISTER**

**YOGA COUTURE**

STUART KALINSKY (UNITED STATES INDIVIDUAL)  
1385 YORK AVENUE  
NEW YORK, NY 10021

FOR: DISPOSABLE SLIPPERS; FOAM PEDICURE SLIPPERS; PEDICURE SLIPPERS; YOGA SLIPPERS; SLIPPERS; PEDICURE SANDALS; SANDALS; SHOES; FLIP FLOPS; SOCKS, IN CLASS 25 (U.S. CLS. 22 AND 39).

FIRST USE 12-14-2007; IN COMMERCE 12-14-2007.

THE MARK CONSISTS OF STANDARD CHARACTERS WITHOUT CLAIM TO ANY PARTICULAR FONT, STYLE, SIZE, OR COLOR.

SER. NO. 77-297,425, FILED P.R. 10-5-2007; AM. S.R. 7-23-2008.

TEJBIR SINGH, EXAMINING ATTORNEY

**Int. Cl.: 36**

**Prior U.S. Cls.: 100, 101, and 102**

**United States Patent and Trademark Office**

**Reg. No. 3,500,391**

**Registered Sep. 9, 2008**

**SERVICE MARK  
SUPPLEMENTAL REGISTER**

**BUILDERS BENEFITS**

BUILDERS BENEFITS, INC. (PENNSYLVANIA  
CORPORATION)  
SUITE 300,  
4507 NORTH FRONT STREET,  
HARRISBURG, PA 17110

FOR: UNDERWRITING OF SELF-FUNDED  
HEALTH INSURANCE PLANS, IN CLASS 36 (U.S.  
CLS. 100, 101 AND 102).

FIRST USE 11-10-2006; IN COMMERCE 11-10-2006.

THE MARK CONSISTS OF STANDARD CHAR-  
ACTERS WITHOUT CLAIM TO ANY PARTICULAR  
FONT, STYLE, SIZE, OR COLOR.

SER. NO. 77-298,838, FILED P.R. 10-8-2007; AM. S.R.  
7-30-2008.

KATHERINE CHANG, EXAMINING ATTORNEY

**Int. Cl.: 35**

**Prior U.S. Cls.: 100, 101, and 102**

**United States Patent and Trademark Office**

**Reg. No. 3,500,392**

**Registered Sep. 9, 2008**

**SERVICE MARK  
SUPPLEMENTAL REGISTER**

**GUIDED LAWYER SEARCH**

WEST PUBLISHING CORPORATION (MINNESOTA CORPORATION)  
610 OPPERMAN DRIVE  
EAGAN, MN 55123

FOR: PROVIDING AN ONLINE DIRECTORY OF LAWYERS THAT ALLOWS CONSUMERS TO SEARCH AND NAVIGATE LISTS OF LAWYERS BY GEOGRAPHIC LOCATION, LEGAL PRACTICE AREA AND SPECIFIC LEGAL ISSUE, IN CLASS 35 (U.S. CLS. 100, 101 AND 102).

FIRST USE 6-15-2007; IN COMMERCE 6-15-2007.

THE MARK CONSISTS OF STANDARD CHARACTERS WITHOUT CLAIM TO ANY PARTICULAR FONT, STYLE, SIZE, OR COLOR.

SER. NO. 77-299,148, FILED P.R. 10-9-2007; AM. S.R. 7-22-2008.

SHAILA SETTLES, EXAMINING ATTORNEY

**Int. Cl.: 41**

**Prior U.S. Cls.: 100, 101, and 107**

**United States Patent and Trademark Office**

**Reg. No. 3,500,393**

**Registered Sep. 9, 2008**

**SERVICE MARK  
SUPPLEMENTAL REGISTER**

**Original Wild West Revue**

BRIAN DOWNES (UNITED STATES INDIVIDUAL)

5815 N SHERIDAN RD

CHICAGO, IL 60660

FOR: ENTERTAINMENT IN THE NATURE OF LIVE REENACTMENT OF OLD WEST ARENA SHOWS, IN CLASS 41 (U.S. CLS. 100, 101 AND 107).

FIRST USE 10-1-2007; IN COMMERCE 10-1-2007.

THE MARK CONSISTS OF STANDARD CHARACTERS WITHOUT CLAIM TO ANY PARTICULAR FONT, STYLE, SIZE, OR COLOR.

NO CLAIM IS MADE TO THE EXCLUSIVE RIGHT TO USE "REVUE", APART FROM THE MARK AS SHOWN.

SER. NO. 77-300,591, FILED P.R. 10-10-2007; AM. S.R. 7-18-2008.

AMOS T. MATTHEWS, JR., EXAMINING ATTORNEY

**Int. Cl.: 41**

**Prior U.S. Cls.: 100, 101, and 107**

**United States Patent and Trademark Office**

**Reg. No. 3,500,394**

**Registered Sep. 9, 2008**

**SERVICE MARK  
SUPPLEMENTAL REGISTER**

**NATIONAL**

ETW CORP. (FLORIDA CORPORATION)  
8934 CONROY WINDERMERE ROAD  
ORLANDO, FL 32835

FOR: ENTERTAINMENT SERVICES, NAMELY,  
GOLFING COMPETITIONS, IN CLASS 41 (U.S. CLS.  
100, 101 AND 107).

FIRST USE 7-1-2007; IN COMMERCE 7-1-2007.

THE MARK CONSISTS OF STANDARD CHAR-  
ACTERS WITHOUT CLAIM TO ANY PARTICULAR  
FONT, STYLE, SIZE, OR COLOR.

SER. NO. 77-300,675, FILED P.R. 10-10-2007; AM.  
S.R. 8-5-2008.

PAM WILLIS, EXAMINING ATTORNEY

**Int. Cl.: 3**

**Prior U.S. Cls.: 1, 4, 6, 50, 51, and 52**

**United States Patent and Trademark Office**

**Reg. No. 3,500,395**

**Registered Sep. 9, 2008**

**TRADEMARK  
SUPPLEMENTAL REGISTER**

**SOLAR PROTECTION FOR FACE  
WITH DMAE**

N.V. PERRICONE LLC (DELAWARE LIMITED  
LIABILITY COMPANY)  
639 RESEARCH PARKWAY  
MERIDEN, CT 06450

THE MARK CONSISTS OF STANDARD CHAR-  
ACTERS WITHOUT CLAIM TO ANY PARTICULAR  
FONT, STYLE, SIZE, OR COLOR.

FOR: SUNSCREEN CREAMS; SUN-BLOCK LO-  
TIONS; FACIAL CREAMS, IN CLASS 3 (U.S. CLS. 1, 4,  
6, 50, 51 AND 52).

SER. NO. 77-301,399, FILED P.R. 10-11-2007; AM.  
S.R. 7-30-2008.

FIRST USE 5-15-2006; IN COMMERCE 6-7-2006.

DAVID C. REIHNER, EXAMINING ATTORNEY

**Int. Cl.: 9**

**Prior U.S. Cls.: 21, 23, 26, 36, and 38**

**United States Patent and Trademark Office**

**Reg. No. 3,500,396**

**Registered Sep. 9, 2008**

**TRADEMARK  
SUPPLEMENTAL REGISTER**

**SELF-SERVICE STORAGE**

NEW TECHNOLOGY PARTNERS, INC. (DELA-  
WARE CORPORATION)  
20A N.W. BOULEVARD #136  
NASHUA, NH 03063

FOR: COMPUTER SOFTWARE FOR ALLOWING  
END-USER GROUPS WITHIN AN ORGANIZATION  
HAVING SIMILAR DATA STORAGE RIGHTS AND  
PRIVILEGES TO MANAGE, CONTROL AND AC-  
CESS THEIR ELECTRONIC DATA STORAGE BY  
PROVIDING THE ABILITY TO MANAGE THEIR  
DATA FILES WITHIN AGREED CORPORATE PO-  
LICIES WITHOUT UTILIZING HELP DESK RE-  
SOURCEES OR THE STORAGE ADMINISTRATOR,  
IN CLASS 9 (U.S. CLS. 21, 23, 26, 36 AND 38).

FIRST USE 10-17-2006; IN COMMERCE 11-1-2007.

THE MARK CONSISTS OF STANDARD CHAR-  
ACTERS WITHOUT CLAIM TO ANY PARTICULAR  
FONT, STYLE, SIZE, OR COLOR.

NO CLAIM IS MADE TO THE EXCLUSIVE  
RIGHT TO USE "STORAGE", APART FROM THE  
MARK AS SHOWN.

SER. NO. 77-303,077, FILED P.R. 10-12-2007; AM.  
S.R. 7-29-2008.

PAUL CROWLEY, EXAMINING ATTORNEY



**Int. Cls.: 20 and 35**

**Prior U.S. Cls.: 2, 13, 22, 25, 32, 50, 100, 101, and 102**

**United States Patent and Trademark Office**

**Reg. No. 3,500,397**

**Registered Sep. 9, 2008**

**TRADEMARK  
SERVICE MARK  
SUPPLEMENTAL REGISTER**

**The CONTRACTOR'S Cabinet  
Outlet.**

WESTERN STATES CABINET WHOLESALERS,  
INC. (CALIFORNIA CORPORATION)  
190  
1100 IRVINE BOULEVARD  
TUSTIN, CA 92780

FOR: KITCHEN CABINETS, IN CLASS 20 (U.S.  
CLS. 2, 13, 22, 25, 32 AND 50).

FIRST USE 10-25-2005; IN COMMERCE 10-25-2005.

FOR: RETAIL OUTLETS FEATURING KITCHEN  
CABINETS, IN CLASS 35 (U.S. CLS. 100, 101 AND  
102).

FIRST USE 10-25-2005; IN COMMERCE 10-25-2005.

THE MARK CONSISTS OF STANDARD CHAR-  
ACTERS WITHOUT CLAIM TO ANY PARTICULAR  
FONT, STYLE, SIZE, OR COLOR.

NO CLAIM IS MADE TO THE EXCLUSIVE  
RIGHT TO USE "CABINET" FOR INTERNATIONAL  
CLASS 020 AND "CABINET OUTLET" FOR INTER-  
NATIONAL CLASS 035, APART FROM THE MARK  
AS SHOWN.

SER. NO. 77-305,990, FILED P.R. 10-17-2007; AM.  
S.R. 7-11-2008.

JAY BESCH, EXAMINING ATTORNEY

**Int. Cl.: 36**

**Prior U.S. Cls.: 100, 101, and 102**

**United States Patent and Trademark Office**

**Reg. No. 3,500,398**

**Registered Sep. 9, 2008**

**SERVICE MARK  
SUPPLEMENTAL REGISTER**

**STRETCH IRA**

SENIOR ADVISORS OF AMERICA, LLC (NEVA-  
DA LIMITED LIABILITY COMPANY)  
P.O. BOX 13381  
SCOTTSDALE, AZ 85267

FOR: FINANCIAL SERVICES, NAMELY, RE-  
TIREMENT AND ESTATE PLANNING, IN CLASS  
36 (U.S. CLS. 100, 101 AND 102).

FIRST USE 10-16-2007; IN COMMERCE 11-5-2007.

THE MARK CONSISTS OF STANDARD CHAR-  
ACTERS WITHOUT CLAIM TO ANY PARTICULAR  
FONT, STYLE, SIZE, OR COLOR.

SER. NO. 77-306,274, FILED P.R. 10-17-2007; AM.  
S.R. 8-1-2008.

KAREN K. BUSH, EXAMINING ATTORNEY

**Int. Cls.: 7 and 12**

**Prior U.S. Cls.: 13, 19, 21, 23, 31, 34, 35, and 44**

**United States Patent and Trademark Office**

**Reg. No. 3,500,399**

**Registered Sep. 9, 2008**

**TRADEMARK  
SUPPLEMENTAL REGISTER**

# Steele Products

JD NORTH AMERICA (CALIFORNIA CORPORATION)  
19271 E COLIMA RD., #B  
ROWLAND HEIGHTS, CA 91748

FOR: TRACTOR TOWED AGRICULTURAL IMPLEMENTS, NAMELY, BROADCAST SEEDERS; TRACTOR TOWED AGRICULTURAL IMPLEMENTS, NAMELY, DISC HARROWS; TRACTOR TOWED AGRICULTURAL IMPLEMENTS, NAMELY, HARROWS; TRACTOR TOWED AGRICULTURAL IMPLEMENTS, NAMELY, MOWERS; TRACTOR TOWED AGRICULTURAL IMPLEMENTS, NAMELY, PLOWS; TRACTOR TOWED AGRICULTURAL IMPLEMENTS, NAMELY, ROLLERS; TRACTOR-TOWED FERTILIZER APPLICATORS; RIDING LAWN MOWERS; POWER LAWN AND GARDEN TOOLS, NAMELY, CHIPPERS; MECHANICAL SPREADERS FOR SEED AND DRY LAWN CHEMICALS; POWER-OPERATED LAWN AND GARDEN TILLERS; POWER BLOWERS FOR LAWN DEBRIS; LAWN AND GARDEN TILLING MACHINES; POWER LAWN AND GARDEN TOOLS, NAMELY, SHREDDERS; POWER OPERATED LAWN AND GARDEN STRING TRIMMERS; POWER OPER-

ATED LAWN AND GARDEN TOOLS, NAMELY, CULTIVATORS; POWER OPERATED TOOLS, NAMELY, LAWN AND GARDEN EDGERS; PORTABLE ELECTRIC POWER GENERATORS, IN CLASS 7 (U.S. CLS. 13, 19, 21, 23, 31, 34 AND 35).

FIRST USE 1-18-2008; IN COMMERCE 5-13-2008.

FOR: TRACTORS, IN CLASS 12 (U.S. CLS. 19, 21, 23, 31, 35 AND 44).

FIRST USE 1-18-2008; IN COMMERCE 5-13-2008.

THE MARK CONSISTS OF STANDARD CHARACTERS WITHOUT CLAIM TO ANY PARTICULAR FONT, STYLE, SIZE, OR COLOR.

NO CLAIM IS MADE TO THE EXCLUSIVE RIGHT TO USE "PRODUCTS", APART FROM THE MARK AS SHOWN.

SER. NO. 77-306,777, FILED P.R. 10-17-2007; AM. S.R. 8-1-2008.

SHARON MEIER, EXAMINING ATTORNEY

**Int. Cl.: 45**

**Prior U.S. Cls.: 100 and 101**

**United States Patent and Trademark Office**

**Reg. No. 3,500,400**

**Registered Sep. 9, 2008**

**SERVICE MARK  
SUPPLEMENTAL REGISTER**

**CRIMINAL OFFENDER PROFILE  
SUMMARY**

FIRST ADVANTAGE CORPORATION (DELA-  
WARE CORPORATION)  
100 CARILLON PARKWAY  
ST. PETERSBURG, FL 33716

FOR: BACKGROUND SCREENING, IN CLASS 45  
(U.S. CLS. 100 AND 101).

FIRST USE 3-0-2002; IN COMMERCE 3-0-2002.

THE MARK CONSISTS OF STANDARD CHAR-  
ACTERS WITHOUT CLAIM TO ANY PARTICULAR  
FONT, STYLE, SIZE, OR COLOR.

SER. NO. 77-312,437, FILED P.R. 10-24-2007; AM.  
S.R. 7-2-2008.

YAT SYE, LEE, EXAMINING ATTORNEY

**Int. Cl.: 41**

**Prior U.S. Cls.: 100, 101, and 107**

**United States Patent and Trademark Office**

**Reg. No. 3,500,401**

**Registered Sep. 9, 2008**

**SERVICE MARK  
SUPPLEMENTAL REGISTER**

**BLACK COLLEGE QUIZ**

CENTRAL CITY PRODUCTIONS, INC. (ILLINOIS  
CORPORATION)  
SUITE 300  
212 EAST OHIO  
CHICAGO, IL 60611

FOR: ENTERTAINMENT SERVICES, NAMELY,  
PROVIDING TELEVISION PROGRAMS IN THE  
FIELD OF QUIZ SHOWS; AND TELEVISION PRO-  
GRAM SYNDICATION , IN CLASS 41 (U.S. CLS. 100,  
101 AND 107).

FIRST USE 2-2-2007; IN COMMERCE 2-2-2007.

THE MARK CONSISTS OF STANDARD CHAR-  
ACTERS WITHOUT CLAIM TO ANY PARTICULAR  
FONT, STYLE, SIZE, OR COLOR.

SER. NO. 77-312,491, FILED P.R. 10-24-2007; AM.  
S.R. 8-4-2008.

SUSAN STIGLITZ, EXAMINING ATTORNEY

**Int. Cl.: 35**

**Prior U.S. Cls.: 100, 101, and 102**

**United States Patent and Trademark Office**

**Reg. No. 3,500,402**

**Registered Sep. 9, 2008**

**SERVICE MARK  
SUPPLEMENTAL REGISTER**

**SENIOR MOVE SPECIALISTS**

SIMKIN, JUDI (UNITED STATES INDIVIDUAL)  
68895 PEREZ ROAD #22-160  
CATHEDRAL CITY, CA 92234

FOR: MOVING AND RELOCATION SERVICES,  
NAMELY, PLANNING AND IMPLEMENTING  
MOVES OF SENIORS FROM HOMES INTO SENIOR  
COMMUNITIES AND FACILITIES, IN CLASS 35  
(U.S. CLS. 100, 101 AND 102).

FIRST USE 1-1-2007; IN COMMERCE 1-1-2007.

THE MARK CONSISTS OF STANDARD CHAR-  
ACTERS WITHOUT CLAIM TO ANY PARTICULAR  
FONT, STYLE, SIZE, OR COLOR.

OWNER OF U.S. REG. NO. 3,239,219.

SER. NO. 77-313,162, FILED P.R. 10-25-2007; AM.  
S.R. 7-31-2008.

JUSTINE D. PARKER, EXAMINING ATTORNEY

**Int. Cl.: 41**

**Prior U.S. Cls.: 100, 101, and 107**

**United States Patent and Trademark Office**

**Reg. No. 3,500,403**

**Registered Sep. 9, 2008**

**SERVICE MARK  
SUPPLEMENTAL REGISTER**

**GLOBAL MEDIA TRAINING  
INSTITUTE**

THE INSPIRATIONAL NETWORK, INC. (NORTH  
CAROLINA NON-PROFIT CORPORATION)  
SUITE 500  
7910 CRESCENT EXECUTIVE CENTER DRIVE  
CHARLOTTE, NC 28217

FOR: EDUCATIONAL SERVICES, NAMELY,  
CONDUCTING PROGRAMS IN THE USE OF ELEC-  
TRONIC AND BROADCAST MEDIA FOR CHRIS-  
TIAN MINISTRY, IN CLASS 41 (U.S. CLS. 100, 101  
AND 107).

FIRST USE 3-0-2007; IN COMMERCE 3-0-2007.

THE MARK CONSISTS OF STANDARD CHAR-  
ACTERS WITHOUT CLAIM TO ANY PARTICULAR  
FONT, STYLE, SIZE, OR COLOR.

NO CLAIM IS MADE TO THE EXCLUSIVE  
RIGHT TO USE "TRAINING INSTITUTE", APART  
FROM THE MARK AS SHOWN.

SER. NO. 77-313,271, FILED P.R. 10-25-2007; AM.  
S.R. 7-31-2008.

KEVIN DINALLO, EXAMINING ATTORNEY

Int. Cls.: 18, 21, and 25

Prior U.S. Cls.: 1, 2, 3, 13, 22, 23, 29, 30, 33, 39, 40, 41,  
and 50

Reg. No. 3,500,404

United States Patent and Trademark Office

Registered Sep. 9, 2008

TRADEMARK  
SUPPLEMENTAL REGISTER



LEE, MICHAEL S (UNITED STATES INDIVIDUAL)  
P. O. BOX 6819  
TAMUNING, GUAM 96931

FOR: ALL PURPOSE SPORT BAGS; ALL-PURPOSE ATHLETIC BAGS; ALL-PURPOSE CARRYING BAGS; ANIMAL GAME BAGS; ATHLETIC BAGS; BABY CARRYING BAGS; BAGS AND HOLDALLS FOR SPORTS CLOTHING; BAGS FOR CARRYING BABIES' ACCESSORIES; BAGS FOR SPORTS; BAGS FOR UMBRELLAS; BARREL BAGS; BEACH BAGS; BELT BAGS; BOOK BAGS; BOSTON BAGS; CANTLE BAGS; CANVAS SHOPPING BAGS; CARRY-ALL BAGS; CARRY-ON BAGS; CHALK BAGS; CLUTCH BAGS; COSMETIC BAGS SOLD EMPTY; DIAPER BAGS; DUFFEL BAGS FOR TRAVEL; DUFFLE BAGS; FEED BAGS FOR ANIMALS; FLEXIBLE BAGS FOR GARMENTS; GARMENT BAGS FOR TRAVEL; GENERAL PURPOSE BAGS FOR CARRYING YOGA EQUIPMENT; GLADSTONE BAGS; GYM BAGS; HIKING BAGS; HORSE TAIL BAGS; HUNTERS' GAME BAGS; HUNTING BAGS; KEY BAGS; KIT BAGS; LEATHER AND IMITATION LEATHER BAGS; LEATHER BAGS, SUITCASES AND WALLETS; LEATHER SHOPPING BAGS; MAKE-UP BAGS SOLD EMPTY; MEN'S CLUTCH BAGS; MESH SHOPPING BAGS; MESSENGER BAGS; OVERNIGHT BAGS; PET ACCESSORIES, NAMELY, SPECIALLY DESIGNED CANVAS, VINYL OR LEATHER BAGS ATTACHED TO ANIMAL LEASHES FOR HOLDING SMALL ITEMS SUCH AS KEYS, CREDIT CARDS, MONEY OR DISPOSABLE BAGS FOR DISPOSING OF PET WASTE; PET AC-

CESSORIES, NAMELY, CANVAS, VINYL AND LEATHER POUCHES FOR HOLDING DISPOSABLE BAGS TO PLACE PET WASTE IN; POMMEL BAGS; POUCHES AND BAGS SOLD EMPTY FOR ATTACHMENT TO BACKPACKS; ROLL BAGS; SADDLE HORN BAGS; SADDLERY, NAMELY, HORN BAGS; SCHOOL BAGS; SCHOOL BOOK BAGS; SHAVING BAGS SOLD EMPTY; SHOE BAGS FOR TRAVEL; SHOPPING BAGS MADE OF SKIN; SHOPPING BAGS WITH WHEELS ATTACHED; SHOULDER BAGS; SLING BAGS; SMALL BAGS FOR MEN; SOUVENIR BAGS; SPORTS BAGS; SPORTSMAN'S HUNTING BAGS; STRING BAGS FOR SHOPPING; SUIT BAGS; TEXTILE SHOPPING BAGS; TOILETRY BAGS SOLD EMPTY; TOOL BAGS SOLD EMPTY; TOTE BAGS; TRAVEL BAGS; TRAVELING BAGS; WAIST BAGS; WASH BAGS FOR CARRYING TOILETRIES; WHEELED DUFFLE BAGS; WHEELED MESSENGER BAGS; WHEELED TOTE BAGS; WINE BAGS WITH HANDLES FOR CARRYING OR HOLDING WINE; WRIST MOUNTED CARRYALL BAGS; WRISTLET BAGS, IN CLASS 18 (U.S. CLS. 1, 2, 3, 22 AND 41).

FIRST USE 2-7-1989; IN COMMERCE 6-1-1998.

FOR: COFFEE SERVICES NOT OF PRECIOUS METAL; COFFEE SERVICES OF PRECIOUS METAL; COFFEE STIRRERS; CUPS; EGG CUPS; EGG CUPS OF PRECIOUS METAL; HAND-OPERATED COFFEE GRINDERS; HAND-OPERATED COFFEE GRINDERS AND PEPPER MILLS; MIXING CUPS; NON-ELECTRIC COFFEE MAKERS; NON-ELECTRIC COFFEE PERCOLATORS; NON-ELECTRIC



COFFEE POTS; NON-ELECTRIC COFFEE POTS NOT OF PRECIOUS METAL; NON-ELECTRIC COFFEE SERVERS NOT OF PRECIOUS METAL; NON-ELECTRIC COFFEE SERVERS OF PRECIOUS METAL; NON-ELECTRICAL COFFEE GRINDERS; PAPER BAKING CUPS; PAPER CUPS; PLASTIC CUPS; TRAINING CUPS FOR BABIES AND CHILDREN; BATH ACCESSORIES, NAMELY, CUP HOLDERS; BIODEGRADABLE PAPER PULP-BASED PLATES, BOWLS AND CUPS; CARDBOARD CUPS; COFFEE CUPS; COFFEE FILTERS NOT OF PAPER BEING PART OF NON-ELECTRIC COFFEE MAKERS; COFFEE POTS NOT OF PRECIOUS METAL; COFFEE POTS OF PRECIOUS METAL; COFFEE SERVERS; COFFEE SERVICE; BEER MUGS; EARTHENWARE MUGS; GLASS MUGS; MUG TREES; MUGS; PORCELAIN MUGS, IN CLASS 21 (U.S. CLS. 2, 13, 23, 29, 30, 33, 40 AND 50).

FIRST USE 2-7-1989; IN COMMERCE 6-1-1998.

FOR: A-SHIRTS; CAMP SHIRTS; DRESS SHIRTS; GOLF SHIRTS; KNIT SHIRTS; LONG-SLEEVED SHIRTS; NIGHT SHIRTS; OPEN-NECKED SHIRTS; PIQUE SHIRTS; POLO SHIRTS; RUGBY SHIRTS; SHIRT FRONTS; SHIRT YOKES; SHIRTS; SHIRTS FOR SUITS; SHORT-SLEEVED OR LONG-SLEEVED T-SHIRTS; SHORT-SLEEVED SHIRTS; SLEEP SHIRTS; SPORT SHIRTS; SPORTS SHIRTS; SPORTS SHIRTS WITH SHORT SLEEVES; SWEAT SHIRTS; T-SHIRTS; TEE SHIRTS; TRIATHLON CLOTHING, NAMELY, TRIATHLON TIGHTS, TRIATHLON SHORTS, TRIATHLON SINGLET, TRIATHLON SHIRTS, TRIATHLON SUITS; WIND SHIRTS; YOGA SHIRTS; SPORT COATS; SPORTS BRA; SPORTS BRAS; SPORTS JACKETS; SPORTS JERSEYS; SPORTS JERSEYS AND BREECHES FOR SPORTS; SPORTS OVERUNIFORMS; BALLOON PANTS; CA-

PRI PANTS; CARGO PANTS; CLEATS FOR ATTACHMENT TO SPORTS SHOES; FOOTWEAR NOT FOR SPORTS; JOGGING PANTS; LEATHER PANTS; LOUNGE PANTS; NON-DISPOSABLE CLOTH TRAINING PANTS; NURSE PANTS; PANTS; PETTI-PANTS; SKI PANTS; SNOW PANTS; SNOWBOARD PANTS; STRETCH PANTS; SWEAT PANTS; TAP PANTS; TOBOGGAN HATS, PANTS AND CAPS; TRACK PANTS; WATERPROOF JACKETS AND PANTS; WIND PANTS; YOGA PANTS, IN CLASS 25 (U.S. CLS. 22 AND 39).

FIRST USE 2-7-1989; IN COMMERCE 6-1-1998.

NO CLAIM IS MADE TO THE EXCLUSIVE RIGHT TO USE "CHINA", APART FROM THE MARK AS SHOWN.

THE COLOR(S) BLACK AND RED IS/ARE CLAIMED AS A FEATURE OF THE MARK.

THE CAPITAL LETTER "I" IS IN BLACK COLOR FOLLOW BY HEART SHAPE THAT IS IN RED COLOR AND THE CAPITAL LETTER "C" IS IN BLACK COLOR FOLLOWED BY SMALL LETTER "H" IN BLACK COLOR, SMALLER LETTER "I" IN BLACK COLOR, SMALL LETTER "N" IN BLACK COLOR, SMALL LETTER "A" IN BLACK COLOR AND THE LETTERS "C, H, I, N, A" ARE LOCATED BELOW THE CAPITAL LETTER "I" AND THE HEART SHAPE.

SER. NO. 77-315,167, FILED P.R. 10-27-2007; AM. S.R. 7-3-2008.

JENNY PARK, EXAMINING ATTORNEY

**Int. Cl.: 40**

**Prior U.S. Cls.: 100, 103, and 106**

**United States Patent and Trademark Office**

**Reg. No. 3,500,405**

**Registered Sep. 9, 2008**

**SERVICE MARK  
SUPPLEMENTAL REGISTER**

**self-activated oxygen  
scavengers**

TEWARI DE-OX SYSTEMS, INC. (TEXAS CORPORATION)  
3978 PAN AM EXPRESSWAY NORTH  
SAN ANTONIO, TX 78219

FOR: COMMERCIAL MEAT PACKAGING UTILIZING PROPRIETARY TECHNOLOGY OF SELF-ACTIVATED OXYGEN SCAVENGERS FOR EXTENDING SHELF LIFE OF MEAT & POULTRY BY REDUCING OXYGEN CONCENTRATION TO ZERO LEVELS, IN CLASS 40 (U.S. CLS. 100, 103 AND 106).

FIRST USE 12-31-2003; IN COMMERCE 12-31-2003.

THE MARK CONSISTS OF STANDARD CHARACTERS WITHOUT CLAIM TO ANY PARTICULAR FONT, STYLE, SIZE, OR COLOR.

SER. NO. 77-318,966, FILED P.R. 11-1-2007; AM. S.R. 7-28-2008.

CAROLYN GRAY, EXAMINING ATTORNEY

**Int. Cl.: 9**

**Prior U.S. Cls.: 21, 23, 26, 36, and 38**

**United States Patent and Trademark Office**

**Reg. No. 3,500,406**

**Registered Sep. 9, 2008**

**TRADEMARK  
SUPPLEMENTAL REGISTER**

# Koiled Kords

WHITNEY BLAKE COMPANY (VERMONT CORPORATION)

PO BOX 579

20 INDUSTRIAL DRIVE

BELLOWS FALLS, VT 05101

FOR: ELECTRIC CORDS, IN CLASS 9 (U.S. CLS. 21, 23, 26, 36 AND 38).

FIRST USE 1-1-1985; IN COMMERCE 1-1-1985.

THE MARK CONSISTS OF STANDARD CHARACTERS WITHOUT CLAIM TO ANY PARTICULAR FONT, STYLE, SIZE, OR COLOR.

NO CLAIM IS MADE TO THE EXCLUSIVE RIGHT TO USE "CORDS", APART FROM THE MARK AS SHOWN.

SER. NO. 77-327,821, FILED P.R. 11-13-2007; AM. S.R. 7-31-2008.

BRENDAN MCCAULEY, EXAMINING ATTORNEY

**Int. Cl.: 35**

**Prior U.S. Cls.: 100, 101, and 102**

**United States Patent and Trademark Office**

**Reg. No. 3,500,407**

**Registered Sep. 9, 2008**

**SERVICE MARK  
SUPPLEMENTAL REGISTER**

**National Pet Pharmacy**

CRICKET PRODUCTIONS, INC. (MASSACHU-  
SETTS CORPORATION)  
225 CEDAR HILL ST  
MALBORO, MA 01752

FOR: ON-LINE RETAIL STORE SERVICES FEATURING PET SUPPLIES AND PRODUCTS, NAME-  
LY, FOOD, TOYS, PET PHARMACY ITEMS, AS  
WELL AS SUPPLYING PET INFORMATION, IN  
CLASS 35 (U.S. CLS. 100, 101 AND 102).

FIRST USE 3-4-2008; IN COMMERCE 3-4-2008.

THE MARK CONSISTS OF STANDARD CHAR-  
ACTERS WITHOUT CLAIM TO ANY PARTICULAR  
FONT, STYLE, SIZE, OR COLOR.

NO CLAIM IS MADE TO THE EXCLUSIVE  
RIGHT TO USE "PHARMACY", APART FROM  
THE MARK AS SHOWN.

SER. NO. 77-328,716, FILED P.R. 11-13-2007; AM.  
S.R. 7-18-2008.

MICHAEL WIENER, EXAMINING ATTORNEY

**Int. Cl.: 35**

**Prior U.S. Cls.: 100, 101, and 102**

**United States Patent and Trademark Office**

**Reg. No. 3,500,408**

**Registered Sep. 9, 2008**

**SERVICE MARK  
SUPPLEMENTAL REGISTER**

**National Pet RX**

CRICKET PRODUCTIONS, INC. (MASSACHU-  
SETTS CORPORATION)  
225 CEDAR HILL ST  
MALBORO, MA 01752

FOR: ON-LINE RETAIL STORE SERVICES FEATURING PET SUPPLIES AND PRODUCTS, NAME-  
LY, FOOD, TOYS, PET PHARMACY ITEMS, AS  
WELL AS SUPPLYING PET INFORMATION, IN  
CLASS 35 (U.S. CLS. 100, 101 AND 102).

FIRST USE 3-4-2008; IN COMMERCE 3-4-2008.

THE MARK CONSISTS OF STANDARD CHAR-  
ACTERS WITHOUT CLAIM TO ANY PARTICULAR  
FONT, STYLE, SIZE, OR COLOR.

NO CLAIM IS MADE TO THE EXCLUSIVE  
RIGHT TO USE "RX", APART FROM THE MARK  
AS SHOWN.

SER. NO. 77-328,727, FILED P.R. 11-13-2007; AM.  
S.R. 7-18-2008.

MICHAEL WIENER, EXAMINING ATTORNEY

**Int. Cl.: 37**

**Prior U.S. Cls.: 100, 103, and 106**

**United States Patent and Trademark Office**

**Reg. No. 3,500,409**

**Registered Sep. 9, 2008**

**SERVICE MARK  
SUPPLEMENTAL REGISTER**

**GalleryWallz**

MARY KENEZ (UNITED STATES INDIVIDUAL)  
2027 BROADWAY ST SUITE D  
BOULDER, CO 80302

THE MARK CONSISTS OF STYLIZED LETTERS  
SPELLING "GALLERYWALLZ".

FOR: RENTAL OF PORTABLE WALLS, FLOOR-  
ING, WINDOWS, DOORS AND PANELING, IN  
CLASS 37 (U.S. CLS. 100, 103 AND 106).

SER. NO. 77-329,989, FILED P.R. 11-15-2007; AM.  
S.R. 4-16-2008.

FIRST USE 10-29-2007; IN COMMERCE 10-29-2007.

TASHIA BUNCH, EXAMINING ATTORNEY

**Int. Cl.: 5**

**Prior U.S. Cls.: 6, 18, 44, 46, 51, and 52**

**United States Patent and Trademark Office**

**Reg. No. 3,500,410**

**Registered Sep. 9, 2008**

**TRADEMARK  
SUPPLEMENTAL REGISTER**

# Anabolic Signal

CMI, INC. (DELAWARE CORPORATION)  
3810 N. 29TH AVE.  
HOLLYWOOD, FL 33020

FOR: NUTRACEUTICALS FOR USE AS A DIET-  
ARY SUPPLEMENT, IN CLASS 5 (U.S. CLS. 6, 18, 44,  
46, 51 AND 52).

FIRST USE 1-23-2008; IN COMMERCE 1-23-2008.

THE MARK CONSISTS OF STANDARD CHAR-  
ACTERS WITHOUT CLAIM TO ANY PARTICULAR  
FONT, STYLE, SIZE, OR COLOR.

SER. NO. 77-333,709, FILED P.R. 11-20-2007; AM.  
S.R. 7-30-2008.

LINDA POWELL, EXAMINING ATTORNEY

**Int. Cl.: 44**

**Prior U.S. Cls.: 100 and 101**

**United States Patent and Trademark Office**

**Reg. No. 3,500,411**

**Registered Sep. 9, 2008**

**SERVICE MARK  
SUPPLEMENTAL REGISTER**

**Ratings.MD**

ADAM SUMMERS (UNITED STATES INDIVIDUAL)  
PLASTIC SURGERY CNTR, 7704 QUARTERFIELD  
GLEN BURNIE, MD 21061

THE MARK CONSISTS OF STANDARD CHARACTERS WITHOUT CLAIM TO ANY PARTICULAR FONT, STYLE, SIZE, OR COLOR.

FOR: PROVIDING HEALTH CARE INFORMATION BY TELEPHONE AND THE INTERNET, IN CLASS 44 (U.S. CLS. 100 AND 101).

SER. NO. 77-340,735, FILED P.R. 11-30-2007; AM. S.R. 7-31-2008.

FIRST USE 11-28-2007; IN COMMERCE 11-28-2007.

MICHAEL KEATING, EXAMINING ATTORNEY



**Int. Cl.: 9**

**Prior U.S. Cls.: 21, 23, 26, 36, and 38**

**United States Patent and Trademark Office**

**Reg. No. 3,500,412**

**Registered Sep. 9, 2008**

**TRADEMARK  
SUPPLEMENTAL REGISTER**

**HOLE SAW BOX**

ARLINGTON INDUSTRIES, INC. (FLORIDA  
CORPORATION)

9051 NW 97TH TERRACE

MIAMI, FL 33178

FOR: ELECTRIC JUNCTION BOXES, IN CLASS 9  
(U.S. CLS. 21, 23, 26, 36 AND 38).

FIRST USE 1-1-2008; IN COMMERCE 1-1-2008.

THE MARK CONSISTS OF STANDARD CHAR-  
ACTERS WITHOUT CLAIM TO ANY PARTICULAR  
FONT, STYLE, SIZE, OR COLOR.

NO CLAIM IS MADE TO THE EXCLUSIVE  
RIGHT TO USE "BOX", APART FROM THE MARK  
AS SHOWN.

SER. NO. 77-353,085, FILED P.R. 12-15-2007; AM.  
S.R. 7-13-2008.

CORY BOONE, EXAMINING ATTORNEY

**Int. Cl.: 41**

**Prior U.S. Cls.: 100, 101, and 107**

**United States Patent and Trademark Office**

**Reg. No. 3,500,413**

**Registered Sep. 9, 2008**

**SERVICE MARK  
SUPPLEMENTAL REGISTER**

# Bloggermoms

BLOGGERMOMS INCORPORATED (GEORGIA  
CORPORATION)  
2963 NESTLE CREEK DR  
MARIETTA, GA 30062

FOR: ON-LINE JOURNALS, NAMELY, BLOGS  
FEATURING PARENT DISCUSSIONS, IN CLASS 41  
(U.S. CLS. 100, 101 AND 107).

FIRST USE 12-15-2007; IN COMMERCE 5-4-2008.

THE MARK CONSISTS OF STANDARD CHAR-  
ACTERS WITHOUT CLAIM TO ANY PARTICULAR  
FONT, STYLE, SIZE, OR COLOR.

SER. NO. 77-353,103, FILED P.R. 12-15-2007; AM.  
S.R. 7-25-2008.

JILL C. ALT, EXAMINING ATTORNEY

Int. Cl.: 41

Prior U.S. Cls.: 100, 101, and 107

United States Patent and Trademark Office

Reg. No. 3,500,414

Registered Sep. 9, 2008

**SERVICE MARK  
SUPPLEMENTAL REGISTER**

# Driving With Care

WANBERG, KENNETH W. (UNITED STATES INDIVIDUAL)

16050 WEST 69TH PLACE  
ARVADA, CO 80007 AND

MILKMAN, HARVEY B. (UNITED STATES INDIVIDUAL)

14180 WEST 30TH AVENUE  
GOLDEN, CO 80401 AND

TIMKEN, DAVID S. (UNITED STATES INDIVIDUAL)

3153 FERN PLACE  
BOULDER, CO 80304

FOR: EDUCATIONAL SERVICES, NAMELY, CONDUCTING CLASSES, SEMINARS, AND LECTURES IN THE FIELD OF DRIVING SAFELY AND PREVENTING RECIDIVISM AND FUTURE PRO-

BLEMS WITH ALCOHOL AND OTHER DRUG (AOD) USE, AND DISTRIBUTION OF COURSE MATERIALS IN CONNECTION THEREWITH; DRIVER SAFETY TRAINING, IN CLASS 41 (U.S. CLS. 100, 101 AND 107).

FIRST USE 1-1-2001; IN COMMERCE 1-1-2001.

THE MARK CONSISTS OF STANDARD CHARACTERS WITHOUT CLAIM TO ANY PARTICULAR FONT, STYLE, SIZE, OR COLOR.

SER. NO. 77-355,093, FILED P.R. 12-18-2007; AM. S.R. 8-6-2008.

MARCIE MILONE, EXAMINING ATTORNEY

**Int. Cls.: 35 and 41**

**Prior U.S. Cls.: 100, 101, 102, and 107**

**United States Patent and Trademark Office**

**Reg. No. 3,500,415**

**Registered Sep. 9, 2008**

**SERVICE MARK  
SUPPLEMENTAL REGISTER**

**SOCIÉTÉ MONDIALE DU VIN USA**

CONFRERIE DE LA CHAINE DES ROTISSEURS  
(NEW YORK CORPORATION)  
285 MADISON AVENUE  
MADISON, NJ 07940

FOR: ASSOCIATION SERVICES, NAMELY, PROMOTING THE INTERESTS OF PROFESSIONALS IN THE WINE, SPIRITS AND CRAFTED BEVERAGE INDUSTRY AND AMATEURS KNOWLEDGEABLE IN THE AREA OF WINES, SPIRITS AND CRAFTED BEVERAGES, IN CLASS 35 (U.S. CLS. 100, 101 AND 102).

FIRST USE 5-21-2005; IN COMMERCE 5-21-2005.

FOR: ARRANGING AND CONDUCTING SOMMELIER COMPETITIONS, IN CLASS 41 (U.S. CLS. 100, 101 AND 107).

FIRST USE 5-21-2005; IN COMMERCE 5-21-2005.

THE MARK CONSISTS OF STANDARD CHARACTERS WITHOUT CLAIM TO ANY PARTICULAR FONT, STYLE, SIZE, OR COLOR.

THE FOREIGN WORDING IN THE MARK TRANSLATES INTO ENGLISH AS WORLD SOCIETY OF WINE.

SER. NO. 77-363,256, FILED P.R. 1-3-2008; AM. S.R. 7-15-2008.

ANDREA K. NADELMAN, EXAMINING ATTORNEY

**Int. Cl.: 17**

**Prior U.S. Cls.: 1, 5, 12, 13, 35, and 50**

**United States Patent and Trademark Office**

**Reg. No. 3,500,416**

**Registered Sep. 9, 2008**

**TRADEMARK  
SUPPLEMENTAL REGISTER**

**Reflective Trail Markers**

MASSEY, DEWEY R (UNITED STATES INDIVIDUAL), DBA DRM OUTDOORS,

116 CHARLIE ROAD

TELLICO PLAINS, TN 37385

FOR: REFLECTIVE TAPE FOR USE IN LOW LIGHT / NO LIGHT SITUATIONS, IN CLASS 17 (U.S. CLS. 1, 5, 12, 13, 35 AND 50).

FIRST USE 1-1-1994; IN COMMERCE 8-15-2007.

THE MARK CONSISTS OF STANDARD CHARACTERS WITHOUT CLAIM TO ANY PARTICULAR FONT, STYLE, SIZE, OR COLOR.

NO CLAIM IS MADE TO THE EXCLUSIVE RIGHT TO USE "REFLECTIVE", APART FROM THE MARK AS SHOWN.

SER. NO. 77-379,143, FILED P.R. 1-24-2008; AM. S.R. 7-28-2008.

CYNTHIA SLOAN, EXAMINING ATTORNEY

**Int. Cl.: 36**

**Prior U.S. Cls.: 100, 101, and 102**

**United States Patent and Trademark Office**

**Reg. No. 3,500,417**

**Registered Sep. 9, 2008**

**SERVICE MARK  
SUPPLEMENTAL REGISTER**

**CRIBS OF AMERICA**

CRIBS OF AMERICA, LLC (GEORGIA LIMITED  
LIABILITY COMPANY)  
5248 LEXMARK CIRCLE  
ATLANTA, GA 30031

FOR: REAL ESTATE BROKERAGE, IN CLASS 36  
(U.S. CLS. 100, 101 AND 102).

FIRST USE 7-1-2008; IN COMMERCE 7-1-2008.

THE MARK CONSISTS OF STANDARD CHAR-  
ACTERS WITHOUT CLAIM TO ANY PARTICULAR  
FONT, STYLE, SIZE, OR COLOR.

NO CLAIM IS MADE TO THE EXCLUSIVE  
RIGHT TO USE THE WORD "AMERICA", APART  
FROM THE MARK AS SHOWN.

SER. NO. 77-383,263, FILED P.R. 1-29-2008; AM. S.R.  
7-21-2008.

TRACY WHITTAKER-BROWN, EXAMINING AT-  
TORNEY

**Int. Cl.: 33**

**Prior U.S. Cls.: 47 and 49**

**United States Patent and Trademark Office**

**Reg. No. 3,500,418**

**Registered Sep. 9, 2008**

**TRADEMARK  
SUPPLEMENTAL REGISTER**

**SEÑOR COSS**

COSS, FELIPE DE JESUS (MEXICO INDIVIDUAL)

AV. LOPEZ MATEOS 5060

ZAPOPAN, MEXICO 45239

FOR: TEQUILA, IN CLASS 33 (U.S. CLS. 47 AND 49).

FIRST USE 6-1-2008; IN COMMERCE 6-1-2008.

THE MARK CONSISTS OF STANDARD CHARACTERS WITHOUT CLAIM TO ANY PARTICULAR FONT, STYLE, SIZE, OR COLOR.

THE FOREIGN WORDING IN THE MARK TRANSLATES INTO ENGLISH AS MISTER COSS.

SER. NO. 77-385,274, FILED P.R. 1-31-2008; AM. S.R. 6-30-2008.

KELLY MCCOY, EXAMINING ATTORNEY

**Int. Cl.: 44**

**Prior U.S. Cls.: 100 and 101**

**United States Patent and Trademark Office**

**Reg. No. 3,500,419**

**Registered Sep. 9, 2008**

**SERVICE MARK  
SUPPLEMENTAL REGISTER**

**McKinneyDentist.com**

MCKINNEYDENTIST.COM, L.L.P. (TEXAS LIMITED LIABILITY PARTNERSHIP)  
1716 WEST VIRGINIA STREET  
MCKINNEY, TX 75069

FOR: DENTIST SERVICES; COSMETIC DENTISTRY; DENTISTRY, IN CLASS 44 (U.S. CLS. 100 AND 101).

FIRST USE 0-0-2006; IN COMMERCE 0-0-2006.

THE MARK CONSISTS OF STANDARD CHARACTERS WITHOUT CLAIM TO ANY PARTICULAR FONT, STYLE, SIZE, OR COLOR.

SER. NO. 77-393,740, FILED P.R. 2-11-2008; AM. S.R. 7-30-2008.

TRACY WHITTAKER-BROWN, EXAMINING ATTORNEY



**Int. Cl.: 24**

**Prior U.S. Cls.: 42 and 50**

**United States Patent and Trademark Office**

**Reg. No. 3,500,420**

**Registered Sep. 9, 2008**

**TRADEMARK  
SUPPLEMENTAL REGISTER**

# Trail Towel

CORPORATE IMPRESSIONS, INC (TEXAS CORPORATION)  
1125 DALEA BLUFF  
ROUND ROCK, TX 78665

NO CLAIM IS MADE TO THE EXCLUSIVE RIGHT TO USE "TOWEL", APART FROM THE MARK AS SHOWN.

FOR: TOWELS, IN CLASS 24 (U.S. CLS. 42 AND 50).

FIRST USE 5-0-2008; IN COMMERCE 5-0-2008.

SER. NO. 77-395,279, FILED P.R. 2-12-2008; AM. S.R. 7-22-2008.

THE MARK CONSISTS OF STANDARD CHARACTERS WITHOUT CLAIM TO ANY PARTICULAR FONT, STYLE, SIZE, OR COLOR.

GEOFFREY FOSDICK, EXAMINING ATTORNEY

**Int. Cl.: 30**

**Prior U.S. Cl.: 46**

**United States Patent and Trademark Office**

**Reg. No. 3,500,421**

**Registered Sep. 9, 2008**

**TRADEMARK  
SUPPLEMENTAL REGISTER**

**ACAI BAR**

PETRONI, MICHAEL CHARLES (UNITED STATES INDIVIDUAL)  
13547 VENTURA BLVD, SUITE 143  
SHERMAN OAKS, CA 91423

THE MARK CONSISTS OF STANDARD CHARACTERS WITHOUT CLAIM TO ANY PARTICULAR FONT, STYLE, SIZE, OR COLOR.

FOR: PROTEIN-BASED, NUTRIENT-DENSE SNACK BAR CONTAINING ACAI, IN CLASS 30 (U.S. CL. 46).

SER. NO. 77-402,315, FILED P.R. 2-21-2008; AM. S.R. 6-16-2008.

FIRST USE 7-21-2005; IN COMMERCE 7-21-2005.

KELLY BOULTON, EXAMINING ATTORNEY

Int. Cl.: 25

Prior U.S. Cls.: 22 and 39

United States Patent and Trademark Office

Reg. No. 3,500,422

Registered Sep. 9, 2008

TRADEMARK  
SUPPLEMENTAL REGISTER



WEE CARE (WASHINGTON LIMITED LIABILITY COMPANY)  
3206 45TH AVE NE  
TACOMA, WA 98422

FOR: TOPS, IN CLASS 25 (U.S. CLS. 22 AND 39).

FIRST USE 2-13-2008; IN COMMERCE 2-13-2008.

THE MARK CONSISTS OF A STYLIZED LEAF THAT IS IN FRONT OF THE WORDS "WEE CARE" .

SER. NO. 77-406,954, FILED P.R. 2-27-2008; AM. S.R. 8-1-2008.

HENRY S. ZAK, EXAMINING ATTORNEY

**Int. Cl.: 39**

**Prior U.S. Cls.: 100 and 105**

**United States Patent and Trademark Office**

**Reg. No. 3,500,423**

**Registered Sep. 9, 2008**

**SERVICE MARK  
SUPPLEMENTAL REGISTER**

**Sanford and Son Salvage**

NJ FURNITURE COMPANY LLC. (NEW JERSEY  
LIMITED LIABILITY COMPANY)

50 FOREST AVE

HAWTHORNE, NJ 07506

FOR: JUNK REMOVAL, IN CLASS 39 (U.S. CLS.  
100 AND 105).

FIRST USE 2-4-2008; IN COMMERCE 6-20-2008.

THE MARK CONSISTS OF STANDARD CHAR-  
ACTERS WITHOUT CLAIM TO ANY PARTICULAR  
FONT, STYLE, SIZE, OR COLOR.

NO CLAIM IS MADE TO THE EXCLUSIVE  
RIGHT TO USE "AND SON SALVAGE", APART  
FROM THE MARK AS SHOWN.

SER. NO. 77-410,667, FILED P.R. 3-2-2008; AM. S.R.  
8-1-2008.

LOURDES AYALA, EXAMINING ATTORNEY

**Int. Cl.: 41**

**Prior U.S. Cls.: 100, 101, and 107**

**United States Patent and Trademark Office**

**Reg. No. 3,500,424**

**Registered Sep. 9, 2008**

**SERVICE MARK  
SUPPLEMENTAL REGISTER**

**OFFICIAL SPORTS REPORT**

SPORTS ECHO, LLC (OKLAHOMA LIMITED  
LIABILITY COMPANY)

3655 S. LEWIS AVE.

TULSA, OK 74105

FOR: PROVIDING NEWS AND INFORMATION  
IN THE FIELD OF SPORTS VIA EMAIL, IN CLASS 41  
(U.S. CLS. 100, 101 AND 107).

FIRST USE 10-15-2007; IN COMMERCE 10-15-2007.

THE MARK CONSISTS OF STANDARD CHAR-  
ACTERS WITHOUT CLAIM TO ANY PARTICULAR  
FONT, STYLE, SIZE, OR COLOR.

NO CLAIM IS MADE TO THE EXCLUSIVE  
RIGHT TO USE "SPORTS REPORT", APART FROM  
THE MARK AS SHOWN.

SER. NO. 77-412,696, FILED P.R. 3-4-2008; AM. S.R.  
7-22-2008.

LIEF MARTIN, EXAMINING ATTORNEY

**Int. Cl.: 35**

**Prior U.S. Cls.: 100, 101, and 102**

**United States Patent and Trademark Office**

**Reg. No. 3,500,425**

**Registered Sep. 9, 2008**

**SERVICE MARK  
SUPPLEMENTAL REGISTER**

**1 OWNER USED CAR CLEARANCE**

ACTION INTEGRATED MARKETING, INC.  
(GEORGIA CORPORATION)  
5582 PEACHTREE ROAD  
ATLANTA, GA 30341

FOR: AUTOMOBILE DEALERSHIP SERVICES  
FEATURING USED MOTOR VEHICLES PREVIOUSLY  
OWNED BY ONLY ONE OTHER PARTY; BUSI-  
NESS MARKETING SERVICES, NAMELY,  
CREATING, CONDUCTING, CONSULTING AND  
COORDINATING MULTIMEDIA MARKETING  
CAMPAIGNS FOR OTHERS AND PROVIDING  
MARKETING MATERIALS IN CONJUNCTION  
THEREWITH RELATING TO THE SALE OF USED

MOTOR VEHICLES PREVIOUSLY OWNED BY  
ONLY ONE OTHER PARTY, IN CLASS 35 (U.S.  
CLS. 100, 101 AND 102).

FIRST USE 1-10-2008; IN COMMERCE 1-10-2008.

THE MARK CONSISTS OF STANDARD CHAR-  
ACTERS WITHOUT CLAIM TO ANY PARTICULAR  
FONT, STYLE, SIZE, OR COLOR.

SER. NO. 77-415,237, FILED P.R. 3-6-2008; AM. S.R.  
7-30-2008.

TINA BROWN, EXAMINING ATTORNEY

**Int. Cl.: 35**

**Prior U.S. Cls.: 100, 101, and 102**

**United States Patent and Trademark Office**

**Reg. No. 3,500,426**

**Registered Sep. 9, 2008**

**SERVICE MARK  
SUPPLEMENTAL REGISTER**

**The Networking Community**

WILLIAMS, DANIEL N. (VIRGINIA LIMITED LIABILITY COMPANY), DBA THE NETWORKING COMMUNITY,

#178

525K EAST MARKET ST.  
LEESBURG, VA 20176

FOR: BUSINESS NETWORKING; GENERAL BUSINESS NETWORKING REFERRAL SERVICES, NAMELY, PROMOTING THE GOODS AND SERVICES OF OTHERS BY PASSING BUSINESS LEADS AND REFERRALS AMONG GROUP MEMBERS; ELECTRONIC COMMERCE SERVICES, NAMELY, PROVIDING INFORMATION ABOUT PRODUCTS VIA TELECOMMUNICATION NETWORKS FOR ADVERTISING AND SALES PURPOSES, IN CLASS 35 (U.S. CLS. 100, 101 AND 102).

FIRST USE 9-5-2005; IN COMMERCE 9-6-2005.

THE MARK CONSISTS OF STANDARD CHARACTERS WITHOUT CLAIM TO ANY PARTICULAR FONT, STYLE, SIZE, OR COLOR.

NO CLAIM IS MADE TO THE EXCLUSIVE RIGHT TO USE "NETWORKING", APART FROM THE MARK AS SHOWN.

SER. NO. 77-417,069, FILED P.R. 3-9-2008; AM. S.R. 7-8-2008.

SUZANNE BLANE, EXAMINING ATTORNEY

**Int. Cl.: 9**

**Prior U.S. Cls.: 21, 23, 26, 36, and 38**

**United States Patent and Trademark Office**

**Reg. No. 3,500,427**

**Registered Sep. 9, 2008**

**TRADEMARK  
SUPPLEMENTAL REGISTER**

MARKING LINES WORLDWIDE

PRO-MARK UTILITY SUPPLY, INC. (CALIFORNIA CORPORATION)  
9934 BELL RANCH DR.  
SANTA FE SPRINGS, CA 90670

FOR: SAFETY MARKERS, IN CLASS 9 (U.S. CLS. 21, 23, 26, 36 AND 38).

FIRST USE 3-1-2008; IN COMMERCE 3-1-2008.

THE MARK CONSISTS OF STANDARD CHARACTERS WITHOUT CLAIM TO ANY PARTICULAR FONT, STYLE, SIZE, OR COLOR.

SER. NO. 77-420,245, FILED P.R. 3-12-2008; AM. S.R. 7-30-2008.

GEORGIA CARTY, EXAMINING ATTORNEY



**Int. Cl.: 16**

**Prior U.S. Cls.: 2, 5, 22, 23, 29, 37, 38, and 50**

**Reg. No. 3,500,428**

**United States Patent and Trademark Office**

**Registered Sep. 9, 2008**

**TRADEMARK  
SUPPLEMENTAL REGISTER**

**AMERICAN LIFT & HANDLERS**

KHL GROUP USA LLC (DELAWARE LIMITED  
LIABILITY COMPANY)  
27992 N 115TH PLACE  
SCOTTSDALE, AZ 85262

THE MARK CONSISTS OF STANDARD CHAR-  
ACTERS WITHOUT CLAIM TO ANY PARTICULAR  
FONT, STYLE, SIZE, OR COLOR.

FOR: MAGAZINES FEATURING INFORMA-  
TION IN THE FIELD OF AERIAL WORK PLAT-  
FORMS AND TELEHANDLERS, IN CLASS 16 (U.S.  
CLS. 2, 5, 22, 23, 29, 37, 38 AND 50).

SER. NO. 77-430,809, FILED P.R. 3-25-2008; AM. S.R.  
8-1-2008.

FIRST USE 10-1-2006; IN COMMERCE 1-1-2007.

ROBERT LAVACHE, EXAMINING ATTORNEY

**Int. Cl.: 43**

**Prior U.S. Cl.: 200**

**United States Patent and Trademark Office**

**Reg. No. 3,500,429**

**Registered Sep. 9, 2008**

**COLLECTIVE MEMBERSHIP  
SUPPLEMENTAL REGISTER**

**The League of Agricultural  
and Equine Centers**

LEAGUE OF AGRICULTURAL AND EQUINE  
CENTERS, INC. (KENTUCKY CORPORATION)

P.O. BOX 23575  
LEXINGTON, KY 405233575

FOR: INDICATING MEMBERSHIP IN A(N) TO  
INDICATE MEMBERSHIP IN A PROFESSIONAL  
ORGANIZATION THAT SUPPORTS AND PROMOTES  
MANAGEMENT PERSONNEL AND MAINTENANCE  
PROCEDURES AT AGRICULTURAL AND EQUINE  
FACILITIES, IN CLASS 200 (U.S. CL. 200).

FIRST USE 0-0-2002; IN COMMERCE 0-0-2002.

THE MARK CONSISTS OF STANDARD CHARACTERS  
WITHOUT CLAIM TO ANY PARTICULAR FONT,  
STYLE, SIZE, OR COLOR.

SER. NO. 77-433,494, FILED P.R. 3-27-2008; AM. S.R.  
7-29-2008.

RONALD AIKENS, EXAMINING ATTORNEY

**Int. Cl.: 40**

**Prior U.S. Cls.: 100, 103, and 106**

**United States Patent and Trademark Office**

**Reg. No. 3,500,430**

**Registered Sep. 9, 2008**

**SERVICE MARK  
SUPPLEMENTAL REGISTER**

**NUTRACEUTICAL LIFE SCIENCES**

VITACOST.COM, INC. (DELAWARE CORPORATION)  
SUITE 500  
5400 BROKEN SOUND BLVD., N.W.  
BOCA RATON, FL 33487

FOR: CUSTOM MANUFACTURE OF NUTRITIONAL SUPPLEMENTS AND VITAMINS FOR OTHERS, IN CLASS 40 (U.S. CLS. 100, 103 AND 106).

FIRST USE 11-12-2007; IN COMMERCE 11-12-2007.

THE MARK CONSISTS OF STANDARD CHARACTERS WITHOUT CLAIM TO ANY PARTICULAR FONT, STYLE, SIZE, OR COLOR.

SER. NO. 77-435,326, FILED P.R. 3-31-2008; AM. S.R. 7-7-2008.

NORA BUCHANAN WILL, EXAMINING ATTORNEY

**Int. Cl.: 35**

**Prior U.S. Cls.: 100, 101, and 102**

**United States Patent and Trademark Office**

**Reg. No. 3,500,431**

**Registered Sep. 9, 2008**

**SERVICE MARK  
SUPPLEMENTAL REGISTER**

**LA FIRE GEAR**

LA POLICE GEAR, INC. (CALIFORNIA CORPORATION)  
28022 INDUSTRY DR  
VALENCIA, CA 91355

FOR: ON-LINE RETAIL STORE SERVICES FEATURING BOOTS, FOOTWEAR, SHIRTS, PANTS, HOODS, KNIVES, TOOLS, MEDICAL SUPPLIES, BAGS, BACK PACKS, RESCUE EQUIPMENT, FIRE RESISTANT CLOTHING AND UNIFORMS, IN CLASS 35 (U.S. CLS. 100, 101 AND 102).

FIRST USE 4-1-2008; IN COMMERCE 4-1-2008.

THE MARK CONSISTS OF STANDARD CHARACTERS WITHOUT CLAIM TO ANY PARTICULAR FONT, STYLE, SIZE, OR COLOR.

OWNER OF U.S. REG. NO. 3,457,305.

NO CLAIM IS MADE TO THE EXCLUSIVE RIGHT TO USE "FIRE GEAR", APART FROM THE MARK AS SHOWN.

SER. NO. 77-440,141, FILED P.R. 4-4-2008; AM. S.R. 7-29-2008.

ZACHARY BELLO, EXAMINING ATTORNEY

**Int. Cl.: 26**

**Prior U.S. Cls.: 37, 39, 40, 42, and 50**

**United States Patent and Trademark Office**

**Reg. No. 3,500,432**

**Registered Sep. 9, 2008**

**TRADEMARK  
SUPPLEMENTAL REGISTER**

**Premium Short Series**

SUN TAIYANG CO., LTD. (NEW JERSEY CORPORATION)  
90 TRIANGLE BLVD.  
CARLSTADT, NJ 07072

FOR: HAIR EXTENSIONS; HAIR PIECES; HAIR PIECES AND WIGS; WIGS; WIGS, HAIRPIECES, AND ADD-IN AND ADD-ON HAIR ACCESSORIES CONSTRUCTED PRIMARILY OF SYNTHETIC AND/OR HUMAN HAIR, IN CLASS 26 (U.S. CLS. 37, 39, 40, 42 AND 50).

FIRST USE 4-2-2007; IN COMMERCE 7-9-2007.

THE MARK CONSISTS OF STANDARD CHARACTERS WITHOUT CLAIM TO ANY PARTICULAR FONT, STYLE, SIZE, OR COLOR.

NO CLAIM IS MADE TO THE EXCLUSIVE RIGHT TO USE "SHORT", APART FROM THE MARK AS SHOWN.

SER. NO. 77-441,861, FILED P.R. 4-7-2008; AM. S.R. 7-29-2008.

MICHAEL LITZAU, EXAMINING ATTORNEY

**Int. Cl.: 26**

**Prior U.S. Cls.: 37, 39, 40, 42, and 50**

**United States Patent and Trademark Office**

**Reg. No. 3,500,433**

**Registered Sep. 9, 2008**

**TRADEMARK  
SUPPLEMENTAL REGISTER**

# Premium Duby

SUN TAIYANG CO., LTD. (NEW JERSEY CORPORATION)  
90 TRIANGLE BLVD.  
CARLSTADT, NJ 07072

FOR: HAIR EXTENSIONS; HAIR PIECES; HAIR PIECES AND WIGS; WIGS; WIGS, HAIRPIECES, AND ADD-IN AND ADD-ON HAIR ACCESSORIES CONSTRUCTED PRIMARILY OF SYNTHETIC AND/OR HUMAN HAIR, IN CLASS 26 (U.S. CLS. 37, 39, 40, 42 AND 50).

FIRST USE 10-8-2007; IN COMMERCE 2-7-2008.

THE MARK CONSISTS OF STANDARD CHARACTERS WITHOUT CLAIM TO ANY PARTICULAR FONT, STYLE, SIZE, OR COLOR.

SER. NO. 77-441,975, FILED P.R. 4-7-2008; AM. S.R. 7-29-2008.

MICHAEL LITZAU, EXAMINING ATTORNEY

**Int. Cl.: 32**

**Prior U.S. Cls.: 45, 46, and 48**

**United States Patent and Trademark Office**

**Reg. No. 3,500,434**

**Registered Sep. 9, 2008**

**TRADEMARK  
SUPPLEMENTAL REGISTER**

**SEX DRIVE ENERGYDRINK**

CABOVIDA, INC. (FLORIDA CORPORATION)  
P.O. BOX 6008  
KEY WEST, FL 33041

FOR: ENERGY DRINKS, IN CLASS 32 (U.S. CLS.  
45, 46 AND 48).

FIRST USE 1-0-2008; IN COMMERCE 1-0-2008.

THE MARK CONSISTS OF STANDARD CHAR-  
ACTERS WITHOUT CLAIM TO ANY PARTICULAR  
FONT, STYLE, SIZE, OR COLOR.

NO CLAIM IS MADE TO THE EXCLUSIVE  
RIGHT TO USE "ENERGY DRINK", APART FROM  
THE MARK AS SHOWN.

SER. NO. 77-441,985, FILED P.R. 4-7-2008; AM. S.R.  
8-4-2008.

MARIAM MAHMOUDI, EXAMINING ATTORNEY

**Int. Cl.: 26**

**Prior U.S. Cls.: 37, 39, 40, 42, and 50**

**United States Patent and Trademark Office**

**Reg. No. 3,500,435**

**Registered Sep. 9, 2008**

**TRADEMARK  
SUPPLEMENTAL REGISTER**

**PREMIUM EASY SET**

SUN TAIYANG CO., LTD. (NEW JERSEY CORPORATION)  
90 TRIANGLE BLVD.  
CARLSTADT, NJ 07072

FOR: HAIR EXTENSIONS; HAIR PIECES; HAIR PIECES AND WIGS; WIGS; WIGS, HAIRPIECES, AND ADD-IN AND ADD-ON HAIR ACCESSORIES CONSTRUCTED PRIMARILY OF SYNTHETIC AND/OR HUMAN HAIR, IN CLASS 26 (U.S. CLS. 37, 39, 40, 42 AND 50).

FIRST USE 10-8-2007; IN COMMERCE 2-1-2008.

THE MARK CONSISTS OF STANDARD CHARACTERS WITHOUT CLAIM TO ANY PARTICULAR FONT, STYLE, SIZE, OR COLOR.

SER. NO. 77-442,011, FILED P.R. 4-7-2008; AM. S.R. 7-29-2008.

MICHAEL LITZAU, EXAMINING ATTORNEY



**Int. Cl.: 36**

**Prior U.S. Cls.: 100, 101, and 102**

**United States Patent and Trademark Office**

**Reg. No. 3,500,436**

**Registered Sep. 9, 2008**

**SERVICE MARK  
SUPPLEMENTAL REGISTER**

**NATIONAL RENTAL DATA  
EXCHANGE**

RENTBUREAU, LLC (GEORGIA LIMITED LIABILITY COMPANY)  
3715 NORTHSIDE PARKWAY  
ATLANTA, GA 30327

FOR: PROVIDING A DATABASE CONTAINING INFORMATION ON RENTAL PAYMENT HISTORIES, IN CLASS 36 (U.S. CLS. 100, 101 AND 102).

FIRST USE 6-30-2005; IN COMMERCE 6-30-2005.

THE MARK CONSISTS OF STANDARD CHARACTERS WITHOUT CLAIM TO ANY PARTICULAR FONT, STYLE, SIZE, OR COLOR.

SER. NO. 77-442,919, FILED P.R. 4-8-2008; AM. S.R. 7-30-2008.

HENRY S. ZAK, EXAMINING ATTORNEY

**Int. Cl.: 7**

**Prior U.S. Cls.: 13, 19, 21, 23, 31, 34, and 35**

**United States Patent and Trademark Office**

**Reg. No. 3,500,437**

**Registered Sep. 9, 2008**

**TRADEMARK  
SUPPLEMENTAL REGISTER**

**SMART MAGNET**

MCKAY ACQUISITION, INC. (IOWA CORPORATION), DBA D/B/A JANCY ENGINEERING, INC.,  
2735 HICKORY GROVE ROAD  
DAVENPORT, IA 52804

FOR: AN ELECTROMAGNET SOLD AS AN INTEGRAL COMPONENT OF A POWER DRILL, THE ELECTROMAGNET COMPRISES A MAGNETICALLY ACTUATED SWITCH FOR USE WITH MAGNETIC BASE POWER DRILLS, THE SWITCH IS OPERATED BY THE PRESENCE OR ABSENCE OF A MAGNETIC FIELD SUCH THAT IF THE POWER DRILL'S MAGNET IS NOT SECURED TO A SUBSTANTIAL ENOUGH PIECE OF STEEL, THEN THE MAGNETIC FIELD SURROUNDING THE SWITCH IS TOO WEAK TO ENGAGE THE SWITCH AND

THE OPERATOR IS ALERTED, IN CLASS 7 (U.S. CLS. 13, 19, 21, 23, 31, 34 AND 35).

FIRST USE 8-0-2001; IN COMMERCE 8-0-2001.

THE MARK CONSISTS OF STANDARD CHARACTERS WITHOUT CLAIM TO ANY PARTICULAR FONT, STYLE, SIZE, OR COLOR.

NO CLAIM IS MADE TO THE EXCLUSIVE RIGHT TO USE "MAGNET", APART FROM THE MARK AS SHOWN.

SER. NO. 77-444,824, FILED P.R. 4-10-2008; AM. S.R. 8-4-2008.

FRED MANDIR, EXAMINING ATTORNEY

**Int. Cl.: 42**

**Prior U.S. Cls.: 100 and 101**

**United States Patent and Trademark Office**

**Reg. No. 3,500,438**

**Registered Sep. 9, 2008**

**SERVICE MARK  
SUPPLEMENTAL REGISTER**

**VIRTUAL FAUCET CREATOR**

CALIFORNIA FAUCETS (CALIFORNIA CORPORATION)  
5231 ARGOSY DRIVE  
HUNTINGTON BEACH, CA 92649

FOR: CUSTOM DESIGN OF PLUMBING FIXTURES BASED ON PERSONAL SELECTIONS MADE BY THE CUSTOMER; PROVIDING A WEB SITE FEATURING DESIGN TOOLS FOR DESIGNING PLUMBING FIXTURES, IN CLASS 42 (U.S. CLS. 100 AND 101).

FIRST USE 3-4-2008; IN COMMERCE 3-4-2008.

THE MARK CONSISTS OF STANDARD CHARACTERS WITHOUT CLAIM TO ANY PARTICULAR FONT, STYLE, SIZE, OR COLOR.

NO CLAIM IS MADE TO THE EXCLUSIVE RIGHT TO USE "FAUCET", APART FROM THE MARK AS SHOWN.

SER. NO. 77-444,972, FILED 4-10-2008.

ROBIN CHOSID, EXAMINING ATTORNEY

Int. Cl.: 25

Prior U.S. Cls.: 22 and 39

United States Patent and Trademark Office

Reg. No. 3,500,439

Registered Sep. 9, 2008

TRADEMARK  
SUPPLEMENTAL REGISTER



ELIZABETH CURRY (UNITED STATES INDIVIDUAL)  
APT. 301  
934 GARDEN WALK BLVD.  
COLLEGE PARK, GA 30349

FOR: SHORT-SLEEVED OR LONG-SLEEVED T-SHIRTS; SHORT-SLEEVED SHIRTS; SLEEP SHIRTS; SWEAT SHIRTS; HOODED SWEAT SHIRTS; LONG-SLEEVED SHIRTS; NIGHT SHIRTS; OPEN-NECKED SHIRTS; SHIRTS; TANK TOPS; PAJAMA BOTTOMS; PAJAMAS; THONGS; WOMEN'S UNDERWEAR; APRONS; HEADGEAR, NAMELY, HATS, CAPS, IN CLASS 25 (U.S. CLS. 22 AND 39).

FIRST USE 4-4-2008; IN COMMERCE 4-8-2008.

NO CLAIM IS MADE TO THE EXCLUSIVE RIGHT TO USE "LADY", APART FROM THE MARK AS SHOWN.

THE MARK CONSISTS OF AN OVAL FEATURING A WOMAN IN THE CENTER FACING FORWARD. THE WOMAN HAS HER LEFT HAND ON HER LEFT HIP AND HER RIGHT HAND IN THE AIR. HER RIGHT HAND IS ROUGHLY A 45 DEGREE ANGLE FROM HER HEAD. NEXT TO THE DESIGN OF THE LADY IS THE WORD "LADY".

SER. NO. 77-445,077, FILED P.R. 4-10-2008; AM. S.R. 7-24-2008.

TANYA AMOS, EXAMINING ATTORNEY

**Int. Cl.: 22**

**Prior U.S. Cls.: 1, 2, 7, 19, 22, 42, and 50**

**Reg. No. 3,500,440**

**United States Patent and Trademark Office**

**Registered Sep. 9, 2008**

**TRADEMARK  
SUPPLEMENTAL REGISTER**

**MOSKEETA NETS**

WAYS, DAVID E. (UNITED STATES INDIVIDUAL)  
19706 77TH AVENUE EAST  
BRADENTON, FL 34202

THE MARK CONSISTS OF STANDARD CHARACTERS WITHOUT CLAIM TO ANY PARTICULAR FONT, STYLE, SIZE, OR COLOR.

FOR: TENTS, IN CLASS 22 (U.S. CLS. 1, 2, 7, 19, 22, 42 AND 50).

SER. NO. 77-445,659, FILED 4-11-2008.

FIRST USE 4-10-2008; IN COMMERCE 4-10-2008.

AMY ALFIERI, EXAMINING ATTORNEY

**Int. Cl.: 16**

**Prior U.S. Cls.: 2, 5, 22, 23, 29, 37, 38, and 50**

**United States Patent and Trademark Office**

**Reg. No. 3,500,441**

**Registered Sep. 9, 2008**

**TRADEMARK  
SUPPLEMENTAL REGISTER**

# The Health Tracker

MAGGIE COMPANY LLC, THE (CALIFORNIA  
LIMITED LIABILITY COMPANY)  
P.O. BOX 881002  
SAN DIEGO, CA 92168

FOR: SPIRAL BOUND PERSONAL HEALTH-  
CARE ORGANIZER/BOOK WITH COLORED TABS,  
IN CLASS 16 (U.S. CLS. 2, 5, 22, 23, 29, 37, 38 AND 50).

FIRST USE 8-0-2006; IN COMMERCE 1-0-2007.

THE MARK CONSISTS OF STANDARD CHAR-  
ACTERS WITHOUT CLAIM TO ANY PARTICULAR  
FONT, STYLE, SIZE, OR COLOR.

SER. NO. 77-446,610, FILED P.R. 4-11-2008; AM. S.R.  
8-4-2008.

ANDREA K. NADELMAN, EXAMINING ATTOR-  
NEY

**Int. Cl.: 35**

**Prior U.S. Cls.: 100, 101, and 102**

**United States Patent and Trademark Office**

**Reg. No. 3,500,442**

**Registered Sep. 9, 2008**

**SERVICE MARK  
SUPPLEMENTAL REGISTER**

# Neighborhood Golf

SOUTHERN CALIFORNIA PGA (CALIFORNIA CORPORATION)

36201 CHAMPIONS DRIVE

BEAUMONT, CA 92223

FOR: ASSOCIATION SERVICES, NAMELY, PROMOTING THE INTERESTS OF GOLF ENTHUSIASTS, IN CLASS 35 (U.S. CLS. 100, 101 AND 102).

FIRST USE 1-1-2007; IN COMMERCE 9-26-2007.

THE MARK CONSISTS OF STANDARD CHARACTERS WITHOUT CLAIM TO ANY PARTICULAR FONT, STYLE, SIZE, OR COLOR.

NO CLAIM IS MADE TO THE EXCLUSIVE RIGHT TO USE "GOLF", APART FROM THE MARK AS SHOWN.

SER. NO. 77-447,391, FILED P.R. 4-14-2008; AM. S.R. 7-30-2008.

CORY BOONE, EXAMINING ATTORNEY

**Int. Cl.: 30**

**Prior U.S. Cl.: 46**

**United States Patent and Trademark Office**

**Reg. No. 3,500,443**

**Registered Sep. 9, 2008**

**TRADEMARK  
SUPPLEMENTAL REGISTER**

**TEXAS TERIYAKI MARINADE**

ONE WORLD FOODS, INC. (TEXAS CORPORATION)  
P.O. BOX 40220  
AUSTIN, TX 78704

NO CLAIM IS MADE TO THE EXCLUSIVE  
RIGHT TO USE "TERIYAKI MARINADE", APART  
FROM THE MARK AS SHOWN.

FOR: MARINADE, IN CLASS 30 (U.S. CL. 46).

FIRST USE 11-20-2006; IN COMMERCE 11-20-2006.

SER. NO. 77-448,644, FILED P.R. 4-15-2008; AM. S.R.  
7-30-2008.

THE MARK CONSISTS OF STANDARD CHAR-  
ACTERS WITHOUT CLAIM TO ANY PARTICULAR  
FONT, STYLE, SIZE, OR COLOR.

MICHAEL GAAFAR, EXAMINING ATTORNEY



**Int. Cl.: 30**

**Prior U.S. Cl.: 46**

**United States Patent and Trademark Office**

**Reg. No. 3,500,444**

**Registered Sep. 9, 2008**

**TRADEMARK  
SUPPLEMENTAL REGISTER**

TEXAS STEAKHOUSE MARINADE

ONE WORLD FOODS, INC. (TEXAS CORPORATION)  
P.O. BOX 40220  
AUSTIN, TX 78704

NO CLAIM IS MADE TO THE EXCLUSIVE RIGHT TO USE "MARINADE", APART FROM THE MARK AS SHOWN.

FOR: MARINADE, IN CLASS 30 (U.S. CL. 46).

FIRST USE 11-20-2006; IN COMMERCE 11-20-2006.

SER. NO. 77-448,676, FILED P.R. 4-15-2008; AM. S.R. 7-30-2008.

THE MARK CONSISTS OF STANDARD CHARACTERS WITHOUT CLAIM TO ANY PARTICULAR FONT, STYLE, SIZE, OR COLOR.

MICHAEL GAAFAR, EXAMINING ATTORNEY

**Int. Cl.: 37**

**Prior U.S. Cls.: 100, 103, and 106**

**United States Patent and Trademark Office**

**Reg. No. 3,500,445**

**Registered Sep. 9, 2008**

**SERVICE MARK  
SUPPLEMENTAL REGISTER**

**Energy Smart Guarantee**

NEW NV COMPANY, LLC (OHIO LIMITED LIABILITY COMPANY), DBA DBA: WAYNE HOMES,  
3777 BOETTTLER OAKS  
BOETTTLER, OH 44685

THE MARK CONSISTS OF STANDARD CHARACTERS WITHOUT CLAIM TO ANY PARTICULAR FONT, STYLE, SIZE, OR COLOR.

FOR: RESIDENTIAL AND COMMERCIAL BUILDING CONSTRUCTION, IN CLASS 37 (U.S. CLS. 100, 103 AND 106).

SER. NO. 77-449,739, FILED 4-16-2008.

FIRST USE 4-9-2008; IN COMMERCE 4-9-2008.

PAM WILLIS, EXAMINING ATTORNEY

**Int. Cl.: 35**

**Prior U.S. Cls.: 100, 101, and 102**

**United States Patent and Trademark Office**

**Reg. No. 3,500,446**

**Registered Sep. 9, 2008**

**SERVICE MARK  
SUPPLEMENTAL REGISTER**

**WORLDWIDE  
AUCTIONEERS**

THE WORLDWIDE GROUP, LLC. (INDIANA  
LIMITED LIABILITY COMPANY)  
2952 COUNTY ROAD 68  
AUBURN, IN 46706

FOR: ARRANGING AND CONDUCTING AUCTIONS IN THE FIELD OF CLASSIC MOTOR VEHICLES, ONLINE AUCTIONS IN THE FIELD OF CLASSIC MOTOR VEHICLES, CLASSIC MOTOR VEHICLE DEALERSHIPS, IN CLASS 35 (U.S. CLS. 100, 101 AND 102).

FIRST USE 3-27-2008; IN COMMERCE 3-27-2008.

NO CLAIM IS MADE TO THE EXCLUSIVE RIGHT TO USE "AUCTIONEERS", APART FROM THE MARK AS SHOWN.

THE MARK CONSISTS OF THE WORDING "WORLDWIDE AUCTIONEERS" IN UPPERCASE LETTERS, WITH THE WORD "WORLDWIDE" APPEARING IN LARGER TYPE ABOVE THE WORD "AUCTIONEERS" AND WITH THE "W" IN "WORLDWIDE" APPEARING ON THE LEFT SIDE OF THE MARK IN LARGER TYPE THAN ALL OTHER LETTERS.

SER. NO. 77-449,887, FILED P.R. 4-16-2008; AM. S.R. 8-1-2008.

CYNTHIA TRIPI, EXAMINING ATTORNEY

**Int. Cl.: 25**

**Prior U.S. Cls.: 22 and 39**

**United States Patent and Trademark Office**

**Reg. No. 3,500,447**

**Registered Sep. 9, 2008**

**TRADEMARK  
SUPPLEMENTAL REGISTER**

**NAUGHTII SHORTII**

SICARD, KAMANI, R (JAMAICA INDIVIDUAL)  
255 WEST 43RD ST  
NEW YORK, NY 10036

THE MARK CONSISTS OF STANDARD CHARACTERS WITHOUT CLAIM TO ANY PARTICULAR FONT, STYLE, SIZE, OR COLOR.

FOR: FOOTWEAR FOR WOMEN; WOMEN'S UNDERWEAR; SHORT-SLEEVED OR LONG-SLEEVED T-SHIRTS; T-SHIRTS; TANK TOPS; TOPS; SKIRTS; SKIRTS AND DRESSES, IN CLASS 25 (U.S. CLS. 22 AND 39).

SER. NO. 77-450,345, FILED P.R. 4-16-2008; AM. S.R. 7-31-2008.

FIRST USE 3-20-2007; IN COMMERCE 3-20-2007.

SHANNON TWOHIG, EXAMINING ATTORNEY

**Int. Cl.: 35**

**Prior U.S. Cls.: 100, 101, and 102**

**United States Patent and Trademark Office**

**Reg. No. 3,500,448**

**Registered Sep. 9, 2008**

**SERVICE MARK  
SUPPLEMENTAL REGISTER**

**TIGERWOODDECKING.COM**

ADVANTAGE TRIM & LUMBER COMPANY,  
INC. (NEW YORK CORPORATION)  
2520 BLACKSBURG RD.  
GROVER, NC 28073

FOR: PROVIDING A WEBSITE THAT FEATURES  
CONSUMER INFORMATION ABOUT WOOD  
DECKING; ON-LINE RETAIL AND WHOLESALE  
STORE SERVICES FEATURING DECKING PRO-  
DUCTS , IN CLASS 35 (U.S. CLS. 100, 101 AND 102).

FIRST USE 10-31-2007; IN COMMERCE 10-31-2007.

THE MARK CONSISTS OF STANDARD CHAR-  
ACTERS WITHOUT CLAIM TO ANY PARTICULAR  
FONT, STYLE, SIZE, OR COLOR.

SER. NO. 77-451,673, FILED P.R. 4-18-2008; AM. S.R.  
8-4-2008.

DAVID YONTEF, EXAMINING ATTORNEY

**Int. Cl.: 35**

**Prior U.S. Cls.: 100, 101, and 102**

**United States Patent and Trademark Office**

**Reg. No. 3,500,449**

**Registered Sep. 9, 2008**

**SERVICE MARK  
SUPPLEMENTAL REGISTER**

**Safe Beach And Dunes**

LANGFORD, NELL (UNITED STATES INDIVIDUAL)  
WWW.SAFEBEACHANDDUNES.ORG  
P.O. BOX 27  
PISMO BEACH, CA 93448

FOR: POLITICAL ACTION COMMITTEE SERVICES, NAMELY, PROMOTING THE INTERESTS OF PEOPLE WHO WANT A SAFE BEACH AND DUNES IN THE FIELD OF POLITICS , IN CLASS 35 (U.S. CLS. 100, 101 AND 102).

FIRST USE 3-15-2008; IN COMMERCE 3-15-2008.

THE MARK CONSISTS OF STANDARD CHARACTERS WITHOUT CLAIM TO ANY PARTICULAR FONT, STYLE, SIZE, OR COLOR.

SER. NO. 77-452,060, FILED P.R. 4-18-2008; AM. S.R. 8-1-2008.

JOHN HWANG, EXAMINING ATTORNEY

**Int. Cl.: 41**

**Prior U.S. Cls.: 100, 101, and 107**

**United States Patent and Trademark Office**

**Reg. No. 3,500,450**

**Registered Sep. 9, 2008**

**SERVICE MARK  
SUPPLEMENTAL REGISTER**

**DISPERSED STORAGE**

CLEVERSAFE, INC. (DELAWARE CORPORATION)  
SUITE 500  
224 N DESPLAINES ST  
CHICAGO, IL 60661

FOR: EDUCATIONAL SERVICES, NAMELY, PROVIDING CLASSES, SEMINARS, AND WORKSHOPS IN THE FIELD OF STORAGE AND MANAGEMENT OF DIGITAL DATA; TRAINING SERVICES IN THE FIELD OF STORAGE AND MANAGEMENT OF DIGITAL DATA, IN CLASS 41 (U.S. CLS. 100, 101 AND 107).

FIRST USE 5-12-2008; IN COMMERCE 5-12-2008.

THE MARK CONSISTS OF STANDARD CHARACTERS WITHOUT CLAIM TO ANY PARTICULAR FONT, STYLE, SIZE, OR COLOR.

SER. NO. 77-472,391, FILED P.R. 5-12-2008; AM. S.R. 7-30-2008.

MICHAEL GAAFAR, EXAMINING ATTORNEY

**Int. Cl.: 28**

**Prior U.S. Cls.: 22, 23, 38, and 50**

**United States Patent and Trademark Office**

**Reg. No. 3,500,451**

**Registered Sep. 9, 2008**

**TRADEMARK  
SUPPLEMENTAL REGISTER**

**RINGERS**

FUNDEX GAMES, LTD. (NEVADA CORPORATION)  
2920 FORTUNE CIRCLE WEST  
INDIANAPOLIS, IN 46241

FOR: AN OUTDOOR ACTIVITY GAME IN THE  
NATURE OF A RING TOSS GAME, IN CLASS 28  
(U.S. CLS. 22, 23, 38 AND 50).

FIRST USE 4-0-2008; IN COMMERCE 4-0-2008.

THE MARK CONSISTS OF STANDARD CHARACTERS WITHOUT CLAIM TO ANY PARTICULAR FONT, STYLE, SIZE, OR COLOR.

SER. NO. 77-489,503, FILED P.R. 6-3-2008; AM. S.R. 7-31-2008.

TOBY BULLOFF, EXAMINING ATTORNEY



**Int. Cls.: 9 and 41**

**Prior U.S. Cls.: 21, 23, 26, 36, 38, 100, 101, and 107**

**United States Patent and Trademark Office**

**Reg. No. 3,500,452**

**Registered Sep. 9, 2008**

**TRADEMARK  
SERVICE MARK  
SUPPLEMENTAL REGISTER**

**MOSLEY MUSIC GROUP**

TIMOTHY Z. MOSLEY (UNITED STATES INDIVIDUAL)  
C/O SEDLMAYR & ASSOCIATES, P.C.  
200 PARK AVENUE SOUTH, SUITE 1408  
NEW YORK, NY 10003

FOR: MUSICAL SOUND RECORDINGS; MUSICAL VIDEO RECORDINGS; DOWNLOADABLE MUSICAL SOUND RECORDINGS; DOWNLOADABLE VIDEO RECORDINGS FEATURING MUSIC; DOWNLOADABLE TELEPHONE RING TONES FEATURING MUSIC VIA THE INTERNET AND WIRELESS DEVICES, IN CLASS 9 (U.S. CLS. 21, 23, 26, 36 AND 38).

FIRST USE 6-20-2006; IN COMMERCE 6-20-2006.

FOR: PRODUCTION OF SOUND AND MUSIC VIDEO RECORDINGS, MUSIC PRODUCTION SERVICES, PRODUCTION OF LIVE MUSICAL PERFORMANCES; PROVIDING A WEB SITE FEATURING PRE-RECORDED MUSICAL AUDIO AND AUDIO-

VISUAL CLIPS, PHOTOGRAPHS, NEWS IN THE FIELDS OF ENTERTAINMENT AND MUSIC, INFORMATION ABOUT MUSICAL ARTISTS AND THEIR BIOGRAPHIES, SOUND RECORDINGS, TOUR SCHEDULES, AND CONCERT BOOKING, IN CLASS 41 (U.S. CLS. 100, 101 AND 107).

FIRST USE 8-7-2006; IN COMMERCE 8-7-2006.

THE MARK CONSISTS OF STANDARD CHARACTERS WITHOUT CLAIM TO ANY PARTICULAR FONT, STYLE, SIZE, OR COLOR.

NO CLAIM IS MADE TO THE EXCLUSIVE RIGHT TO USE "MUSIC GROUP", APART FROM THE MARK AS SHOWN.

SER. NO. 77-975,051, FILED P.R. 6-15-2007; AM. S.R. 6-30-2008.

DAVID ELTON, EXAMINING ATTORNEY

Int. Cl.: 3

Prior U.S. Cls.: 1, 4, 6, 50, 51, and 52

Reg. No. 3,500,453

United States Patent and Trademark Office

Registered Sep. 9, 2008

TRADEMARK  
SUPPLEMENTAL REGISTER

RūBos  
Dermal Care

NUTRACYTE PRODUCTS, INC. (NORTH CAROLINA CORPORATION)

562 WILLIAMSON ROAD  
MOORESVILLE, NC 28117

FOR: COSMETIC, NON-MEDICATED SKIN CARE PRODUCTS, NAMELY, CLEANSERS, TONERS, EXFOLIATORS, HYDRATION SERUMS, HYDRATION CREAMS, AGE SPOT REDUCING CREAMS, AGE SPOT REDUCING SERUMS, ANTI-WRINKLE SERUM, ANTI-WRINKLE CREAM, ACNE SERUMS, ACNE CREAMS, FACIAL MASKS,

AND SUNSCREENS, IN CLASS 3 (U.S. CLS. 1, 4, 6, 50, 51 AND 52).

FIRST USE 3-1-2004; IN COMMERCE 3-1-2004.

NO CLAIM IS MADE TO THE EXCLUSIVE RIGHT TO USE "DERMAL CARE", APART FROM THE MARK AS SHOWN.

SER. NO. 78-376,544, FILED P.R. 3-1-2004; AM. S.R. 12-13-2007.

ANDREA BUTLER, EXAMINING ATTORNEY

**Int. Cl.: 25**

**Prior U.S. Cls.: 22 and 39**

**United States Patent and Trademark Office**

**Reg. No. 3,500,454**

**Registered Sep. 9, 2008**

**TRADEMARK  
SUPPLEMENTAL REGISTER**

**VIVA LAS DIVAS**

WYNN RESORTS HOLDINGS, LLC (NEVADA  
LIMITED LIABILITY COMPANY)  
3131 LAS VEGAS BLVD. SOUTH  
LAS VEGAS, NV 89109

FOR: WEARING APPAREL, NAMELY, SHIRTS,  
T-SHIRTS, POLO SHIRTS, TANK TOPS, VESTS,  
SWEATERS, PARKAS, PULLOVERS, SKIRTS,  
SHORTS, JEANS, NIGHTSHIRTS AND NIGHT  
GOWNS, PAJAMAS, ROBES, ROMPERS, COVER-  
ALLS, UNDERGARMENTS, JERSEYS, SLIPPERS,  
SCARVES, BELTS, HEADBANDS, HATS, CAPS, VI-  
SORS, BLAZERS, JACKETS, WARM UP SUITS,  
JOGGING SUITS, SWEATSHIRTS, SWEAT PANTS,  
BEACH WEAR, NAMELY, BATHING SUITS,

BEACH SANDALS, BEACH COVERALLS, FOOT-  
WEAR, NAMELY, BOOTS, SANDALS, IN CLASS 25  
(U.S. CLS. 22 AND 39).

FIRST USE 4-28-2005; IN COMMERCE 4-28-2005.

THE MARK CONSISTS OF STANDARD CHAR-  
ACTERS WITHOUT CLAIM TO ANY PARTICULAR  
FONT, STYLE, SIZE, OR COLOR.

SER. NO. 78-502,747, FILED P.R. 10-20-2004; AM.  
S.R. 7-30-2008.

BRENDAN MCCAULEY, EXAMINING ATTORNEY

**Int. Cl.: 10**

**Prior U.S. Cls.: 26, 39, and 44**

**United States Patent and Trademark Office**

**Reg. No. 3,500,455**

**Registered Sep. 9, 2008**

**TRADEMARK  
SUPPLEMENTAL REGISTER**

**The Best Crowns &  
Bridges**

SAGER, R. DAVID (UNITED STATES INDIVIDUAL)

514 HUMBOLDT PLAZA

MANHATTAN, KS 66502

FOR: DENTAL PRODUCT, NAMELY, CROWNS AND BRIDGES, IN CLASS 10 (U.S. CLS. 26, 39 AND 44).

FIRST USE 6-30-2004; IN COMMERCE 6-30-2004.

THE MARK CONSISTS OF STANDARD CHARACTERS WITHOUT CLAIM TO ANY PARTICULAR FONT, STYLE, SIZE, OR COLOR.

NO CLAIM IS MADE TO THE EXCLUSIVE RIGHT TO USE "CROWNS AND BRIDGES", APART FROM THE MARK AS SHOWN.

SER. NO. 78-532,707, FILED P.R. 12-15-2004; AM. S.R. 12-12-2006.

RAMONA ORTIGA, EXAMINING ATTORNEY

**Int. Cl.: 35**

**Prior U.S. Cls.: 100, 101, and 102**

**United States Patent and Trademark Office**

**Reg. No. 3,500,456**

**Registered Sep. 9, 2008**

**SERVICE MARK  
SUPPLEMENTAL REGISTER**

**TRIPLE POINT  
STEERING**

BOMBARDIER RECREATIONAL PRODUCTS  
INC. (CANADA CORPORATION)  
726 ST. JOSEPH STREET  
VALCOURT, CANADA J0E2L0

FOR: ADVERTISING, COOPERATIVE ADVERTISING OF PERSONAL WATER CRAFT, NAMELY, SINGLE AND MULTIPLE PASSENGER RECREATIONAL JET BOATS AND STRUCTURAL PARTS THEREFOR FOR OTHERS BY MEANS OF PLACING NEWS PAPER ADVERTISEMENTS, CIRCULATING BROCHURES, POSTERS, BANNERS, AND PROVIDING INFORMATION VIA THE INTERNET AND RETAIL STORE SERVICES FEATURING PERSONAL WATER CRAFT, NAMELY, SINGLE AND MULTIPLE PASSENGER RECREATIONAL JET BOATS AND STRUCTURAL PARTS THEREFOR; PROMOTING THE SALE OF PERSONAL WATER-CRAFT, NAMELY, SINGLE AND MULTIPLE PASSENGER RECREATIONAL JET BOATS AND

STRUCTURAL PARTS THEREFOR FOR OTHERS BY MEANS OF PLACING NEWS PAPER ADVERTISEMENTS, CIRCULATING BROCHURES, POSTERS, BANNERS, AND PROVIDING INFORMATION VIA THE INTERNET, IN CLASS 35 (U.S. CLS. 100, 101 AND 102).

THE MARK CONSISTS OF STANDARD CHARACTERS WITHOUT CLAIM TO ANY PARTICULAR FONT, STYLE, SIZE, OR COLOR.

PRIORITY CLAIMED UNDER SEC. 44(D) ON CANADA APPLICATION NO. 1232683, FILED 10-5-2004, REG. NO. TMA690120, DATED 6-19-2007, EXPIRES 6-19-2022.

SER. NO. 78-555,653, FILED P.R. 1-28-2005; AM. S.R. 2-22-2006.

ASMAT KHAN, EXAMINING ATTORNEY

**Int. Cl.: 20**

**Prior U.S. Cls.: 2, 13, 22, 25, 32, and 50**

**United States Patent and Trademark Office**

**Reg. No. 3,500,457**

**Registered Sep. 9, 2008**

**TRADEMARK  
SUPPLEMENTAL REGISTER**

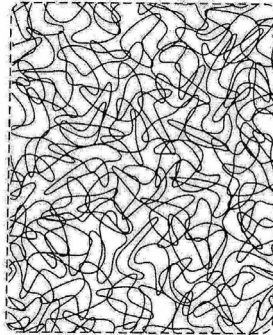

THE DILLER CORPORATION (ILLINOIS CORPORATION)  
C/O FORMICA CORPORATION CHEMED CENTER  
255 EAST FIFTH STREET  
CINCINNATI, OH 45202

FOR: FURNITURE COMPRISED PRIMARILY OF  
PLASTIC LAMINATE, IN CLASS 20 (U.S. CLS. 2, 13,  
22, 25, 32 AND 50).

FIRST USE 5-0-2005; IN COMMERCE 5-0-2005.

THE MARK CONSISTS OF A REPEATING BOOMERANG DESIGN PATTERN WITHOUT A BORDER ON THE GOODS.

SER. NO. 78-561,317, FILED P.R. 2-5-2005; AM. S.R. 3-14-2008.

BARBARA RUTLAND, EXAMINING ATTORNEY

**Int. Cl.: 9**

**Prior U.S. Cls.: 21, 23, 26, 36, and 38**

**United States Patent and Trademark Office**

**Reg. No. 3,500,458**

**Registered Sep. 9, 2008**

**TRADEMARK  
SUPPLEMENTAL REGISTER**

**OBS**

CAMPBELL SCIENTIFIC, INC. (UTAH CORPORATION)  
815 WEST 1800 NORTH  
LOGAN, UT 84321

THE MARK CONSISTS OF STANDARD CHARACTERS WITHOUT CLAIM TO ANY PARTICULAR FONT, STYLE, SIZE, OR COLOR.

FOR: OPTO-ELECTRONIC TURBIDITY AND SUSPENDED SOLIDS SENSORS, IN CLASS 9 (U.S. CLS. 21, 23, 26, 36 AND 38).

SER. NO. 78-633,476, FILED P.R. 5-19-2005; AM. S.R. 6-24-2008.

FIRST USE 10-31-1984; IN COMMERCE 10-31-1984.

DAVID ELTON, EXAMINING ATTORNEY

**Int. Cls.: 35 and 36**

**Prior U.S. Cls.: 100, 101, and 102**

**United States Patent and Trademark Office**

**Reg. No. 3,500,459**

**Registered Sep. 9, 2008**

**SERVICE MARK  
SUPPLEMENTAL REGISTER**

**NEW COMMUNITIES PROGRAM**

LOCAL INITIATIVES SUPPORT CORPORATION  
(NEW YORK NON-PROFIT CORPORATION)  
7TH FLOOR  
501 SEVENTH AVE.  
NEW YORK, NY 10018

FOR: CHARITABLE SERVICES, NAMELY, COORDINATING AND ORGANIZING COMMUNITY AND NEIGHBORHOOD DEVELOPMENT PROGRAMS TO STRENGTHEN COMMUNITIES FROM WITHIN IN THE NATURE OF VOLUNTEER PROGRAMS AND COMMUNITY SERVICE PROJECTS, AFFORDABLE HOUSING PROGRAMS, YOUTH DEVELOPMENT PROGRAMS, ANTI-DRUG PROGRAMS, HEALTHCARE PROGRAMS, EDUCATION PROGRAMS, AND ECONOMIC REVITALIZATION PROGRAMS; BUSINESS CONSULTATION SERVICES TO ASSIST IN THE COORDINATION, PLANNING AND ORGANIZING OF COMMUNITY AND NEIGHBORHOOD DEVELOPMENT PROGRAMS TO STRENGTHEN COMMUNITIES FROM WITHIN, NAMELY, VOLUNTEER PROGRAMS AND COMMUNITY SERVICE PROJECTS, AFFORDABLE HOUSING PROGRAMS, YOUTH DEVELOPMENT PROGRAMS, ANTI-DRUG PROGRAMS, HEALTHCARE PROGRAMS, EDUCATION PROGRAMS, AND ECONOMIC RE-

VITALIZATION PROGRAMS, IN CLASS 35 (U.S. CLS. 100, 101 AND 102).

FIRST USE 5-28-2002; IN COMMERCE 5-28-2002.

FOR: CHARITABLE FUNDRAISING SERVICES AND PHILANTHROPIC SERVICES CONCERNING MONETARY DONATIONS IN SUPPORT OF COMMUNITY AND NEIGHBORHOOD PROGRAMS, NAMELY, VOLUNTEER PROGRAMS AND COMMUNITY SERVICE PROJECTS, AFFORDABLE HOUSING PROGRAMS, YOUTH DEVELOPMENT PROGRAMS, ANTI-DRUG PROGRAMS, HEALTHCARE PROGRAMS, EDUCATION PROGRAMS, AND ECONOMIC REVITALIZATION PROGRAMS, IN CLASS 36 (U.S. CLS. 100, 101 AND 102).

FIRST USE 5-28-2002; IN COMMERCE 5-28-2002.

THE MARK CONSISTS OF STANDARD CHARACTERS WITHOUT CLAIM TO ANY PARTICULAR FONT, STYLE, SIZE, OR COLOR.

SER. NO. 78-709,016, FILED P.R. 9-8-2005; AM. S.R. 5-25-2007.

MONIQUE MILLER, EXAMINING ATTORNEY



**Int. Cl.: 37**

**Prior U.S. Cls.: 100, 103, and 106**

**United States Patent and Trademark Office**

**Reg. No. 3,500,460**

**Registered Sep. 9, 2008**

**SERVICE MARK  
SUPPLEMENTAL REGISTER**

**HENDERSON BROTHERS HOMES**

HENDERSON BROTHERS HOMES, LLC (FLOR-  
IDA LIMITED LIABILITY COMPANY)

711 S. HOWARD AVENUE, SUITE 200

TAMPA, FL 33606

FOR: CUSTOM CONSTRUCTION AND BUILD-  
ING OF RESIDENTIAL HOMES, IN CLASS 37 (U.S.  
CLS. 100, 103 AND 106).

FIRST USE 10-6-2005; IN COMMERCE 2-2-2006.

THE MARK CONSISTS OF STANDARD CHAR-  
ACTERS WITHOUT CLAIM TO ANY PARTICULAR  
FONT, STYLE, SIZE, OR COLOR.

NO CLAIM IS MADE TO THE EXCLUSIVE  
RIGHT TO USE "BROTHERS HOMES", APART  
FROM THE MARK AS SHOWN.

SER. NO. 78-741,023, FILED P.R. 10-26-2005; AM.  
S.R. 2-25-2008.

KELLY MCCOY, EXAMINING ATTORNEY

**Int. Cl.: 18**

**Prior U.S. Cls.: 1, 2, 3, 22, and 41**

**United States Patent and Trademark Office**

**Reg. No. 3,500,461**

**Registered Sep. 9, 2008**

**TRADEMARK  
SUPPLEMENTAL REGISTER**

**OC SPORT**

ASHLEY, JOSH (UNITED STATES INDIVIDUAL),  
DBA OC SPORT,  
23687 VIA DEL RIO  
YORBA LINDA, CA 92887

THE MARK CONSISTS OF STANDARD CHAR-  
ACTERS WITHOUT CLAIM TO ANY PARTICULAR  
FONT, STYLE, SIZE, OR COLOR.

FOR: BACKPACKS, IN CLASS 18 (U.S. CLS. 1, 2, 3,  
22 AND 41).

SER. NO. 78-760,518, FILED P.R. 11-23-2005; AM.  
S.R. 7-22-2008.

FIRST USE 8-1-2007; IN COMMERCE 1-8-2008.

JULIE WATSON, EXAMINING ATTORNEY

Int. Cl.: 11

Prior U.S. Cls.: 13, 21, 23, 31, and 34

United States Patent and Trademark Office

Reg. No. 3,500,462

Registered Sep. 9, 2008

TRADEMARK  
SUPPLEMENTAL REGISTER

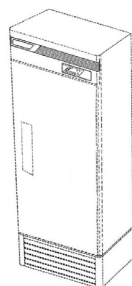

TURBO AIR, INC. (CALIFORNIA CORPORATION)  
1250 VICTORIA STREET  
CARSON, CA 90746

FOR: REFRIGERATORS, IN CLASS 11 (U.S. CLS. 13, 21, 23, 31 AND 34).

FIRST USE 1-1-1997; IN COMMERCE 1-1-1997.

THE STIPPLING IS FOR SHADING PURPOSES ONLY.

THE MARK CONSISTS OF (I) A RECTANGULAR DESIGN ELEMENT PLACED ON THE FAR RIGHT-HAND SIDE OF THE FLAT TRIM PANEL DIRECTLY ABOVE THE REFRIGERATOR DOOR; (II) SEVEN HORIZONTAL RIDGES EXTENDING ACROSS APPROXIMATELY 65% OF THE FRONT OF THE REFRIGERATOR FROM THE FAR RIGHT SIDE OF THE REFRIGERATOR, AND FEATURING A LOWER HORIZONTAL EDGE WHICH IS SLIGHTLY

LONGER THAN THE UPPER HORIZONTAL EDGE, PLACED BETWEEN THE FLAT TRIM PANEL AT THE UPPER EDGE OF THE REFRIGERATOR AND THE FLAT TRIM PANEL DIRECTLY ABOVE THE REFRIGERATOR DOOR; AND (III) TWO FOUR SIDED GEOMETRIC DESIGN ELEMENTS FEATURING UPPER HORIZONTAL EDGES SLIGHTLY LONGER THAN THEIR LOWER HORIZONTAL EDGES, ONE PLACED INSIDE THE ANOTHER, AND SET TO THE LEFT OF THE SEVEN HORIZONTAL RIDGES, BELOW THE FLAT TRIM PANEL AT THE UPPER EDGE OF THE REFRIGERATOR DOOR AND DIRECTLY ABOVE THE FLAT TRIM PANEL DIRECTLY ABOVE THE REFRIGERATOR DOOR. THE DOTTED LINES ARE USED TO SHOW PLACEMENT OF THE PROPOSED MARK ON THE GOODS.

SER. NO. 78-781,962, FILED P.R. 12-28-2005; AM. S.R. 11-5-2007.

MICHAEL GAAFAR, EXAMINING ATTORNEY

Int. Cl.: 11

Prior U.S. Cls.: 13, 21, 23, 31, and 34

United States Patent and Trademark Office

Reg. No. 3,500,463

Registered Sep. 9, 2008

TRADEMARK  
SUPPLEMENTAL REGISTER

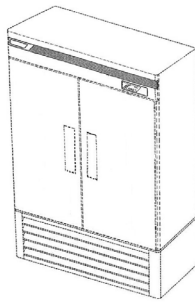

TURBO AIR, INC. (CALIFORNIA CORPORATION)  
1250 S. VICTORIA STREET  
CARSON, CA 90746

FOR: REFRIGERATORS, IN CLASS 11 (U.S. CLS. 13, 21, 23, 31 AND 34).

FIRST USE 1-1-1997; IN COMMERCE 1-1-1997.

THE STIPPLING IS FOR SHADING PURPOSES ONLY.

THE MARK CONSISTS OF (I) A RECTANGULAR DESIGN ELEMENT PLACED ON THE FAR RIGHT-HAND SIDE OF THE FLAT TRIM PANEL DIRECTLY ABOVE THE REFRIGERATOR DOORS; (II) SEVEN HORIZONTAL RIDGES EXTENDING ACROSS APPROXIMATELY 90% OF THE FRONT OF THE REFRIGERATOR FROM THE FAR RIGHT SIDE OF THE REFRIGERATOR, AND FEATURING A LOWER HORIZONTAL EDGE WHICH IS SLIGHT-

LY LONGER THAN THE UPPER HORIZONTAL EDGE, PLACED BETWEEN THE FLAT TRIM PANEL AT THE UPPER EDGE OF THE REFRIGERATOR AND THE FLAT TRIM PANEL DIRECTLY ABOVE THE REFRIGERATOR DOORS; AND (III) TWO FOUR SIDED GEOMETRIC DESIGN ELEMENTS FEATURING UPPER HORIZONTAL EDGES SLIGHTLY LONGER THAN THEIR LOWER HORIZONTAL EDGES, ONE PLACED INSIDE THE ANOTHER, AND SET DIRECTLY TO THE LEFT OF THE SEVEN HORIZONTAL RIDGES, BELOW THE FLAT TRIM PANEL AT THE UPPER EDGE OF THE REFRIGERATOR DOORS AND DIRECTLY ABOVE THE FLAT TRIM PANEL DIRECTLY ABOVE THE REFRIGERATOR DOORS. THE DOTTED LINES ARE USED TO SHOW PLACEMENT OF THE PROPOSED MARK ON THE GOODS.

SER. NO. 78-781,981, FILED P.R. 12-28-2005; AM. S.R. 11-5-2007.

MICHAEL GAFFAR, EXAMINING ATTORNEY

Int. Cl.: 11

Prior U.S. Cls.: 13, 21, 23, 31, and 34

United States Patent and Trademark Office

Reg. No. 3,500,464

Registered Sep. 9, 2008

TRADEMARK  
SUPPLEMENTAL REGISTER

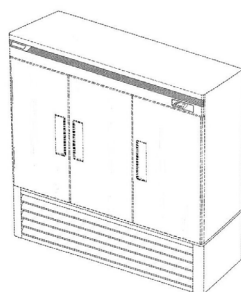

TURBO AIR, INC. (CALIFORNIA CORPORATION)  
1250 S. VICTORIA STREET  
CARSON, CA 90746

FOR: REFRIGERATORS, IN CLASS 11 (U.S. CLS. 13, 21, 23, 31 AND 34).

FIRST USE 1-1-1997; IN COMMERCE 1-1-1997.

THE STIPPLING IS FOR SHADING PURPOSES ONLY.

THE MARK CONSISTS OF (I) A RECTANGULAR DESIGN ELEMENT PLACED ON THE FAR RIGHT-HAND SIDE OF THE FLAT TRIM PANEL DIRECTLY ABOVE THE REFRIGERATOR DOOR; (II) SEVEN HORIZONTAL RIDGES EXTENDING ACROSS APPROXIMATELY 95% OF THE FRONT OF THE REFRIGERATOR FROM THE FAR RIGHT SIDE OF THE REFRIGERATOR, AND FEATURING A LOWER HORIZONTAL EDGE WHICH IS SLIGHTLY

LONGER THAN THE UPPER HORIZONTAL EDGE, PLACED BETWEEN THE FLAT TRIM PANEL AT THE UPPER EDGE OF THE REFRIGERATOR AND THE FLAT TRIM PANEL DIRECTLY ABOVE THE REFRIGERATOR DOORS; AND (III) TWO FOUR SIDED GEOMETRIC DESIGN ELEMENTS FEATURING UPPER HORIZONTAL EDGES SLIGHTLY LONGER THAN THEIR LOWER HORIZONTAL EDGES, ONE PLACED INSIDE THE ANOTHER, AND SET DIRECTLY TO THE LEFT OF THE SEVEN HORIZONTAL RIDGES, DIRECTLY BELOW THE FLAT TRIM PANEL AT THE UPPER EDGE OF THE REFRIGERATOR DOOR AND DIRECTLY ABOVE THE FLAT TRIM PANEL DIRECTLY ABOVE THE REFRIGERATOR DOOR. THE DOTTED LINES ARE USED TO SHOW PLACEMENT OF THE PROPOSED MARK ON THE GOODS.

SER. NO. 78-781,987, FILED P.R. 12-28-2005; AM. S.R. 11-5-2007.

MICHAEL GAAFAR, EXAMINING ATTORNEY

**Int. Cls.: 9, 41, and 42**

**Prior U.S. Cls.: 21, 23, 26, 36, 38, 100, 101, and 107**

**United States Patent and Trademark Office**

**Reg. No. 3,500,465**

**Registered Sep. 9, 2008**

**TRADEMARK  
SERVICE MARK  
SUPPLEMENTAL REGISTER**

**THE COMPLETE MMOG SOLUTION**

BIGWORLD PTY. LIMITED (AUSTRALIA CORPORATION)  
CANNBERRA TECHNOLOGY PARK, PHILLIP AVENUE  
WATSON, AUSTRALIA 2602

FOR: (BASED ON 44(E) COMPUTER GAME SOFTWARE AND COMPUTER HARDWARE THEREFORE; COMPUTER SOFTWARE FOR PROVIDING MULTI-USER ACCESS TO THE COMPUTER GAMES AND MANUALS SOLD AS A UNIT THEREWITH, IN CLASS 9 (U.S. CLS. 21, 23, 26, 36 AND 38).

FOR: (BASED ON USE IN COMMERCE) (BASED ON 44(E) ENTERTAINMENT SERVICES, NAMELY, PROVIDING ON-LINE COMPUTER GAMES; PROVIDING ON-LINE GAME FACILITIES, NAMELY, PROVIDING COMPUTER GAMES THAT MAY BE ACCESSED NETWORK WIDE BY NETWORK USERS; PROVIDING TRAINING AND EDUCATIONAL SERVICES, NAMELY, TUTORIALS, TRAINING DEMONSTRATIONS, CONFERENCES AND SEMINARS IN THE FIELD OF COMPUTER GAME PROGRAMMING AND DEVELOPMENT

FOR COMPUTER GAME DEVELOPERS, IN CLASS 41 (U.S. CLS. 100, 101 AND 107).

FIRST USE 11-22-2002; IN COMMERCE 6-17-2004.

FOR: (BASED ON USE IN COMMERCE) (BASED ON 44(E) TECHNICAL SUPPORT SERVICES, NAMELY, TROUBLE SHOOTING OF COMPUTER SOFTWARE AND HARDWARE, IN CLASS 42 (U.S. CLS. 100 AND 101).

FIRST USE 11-22-2002; IN COMMERCE 10-29-2003.

THE MARK CONSISTS OF STANDARD CHARACTERS WITHOUT CLAIM TO ANY PARTICULAR FONT, STYLE, SIZE, OR COLOR.

OWNER OF AUSTRALIA REG. NO. 943427, DATED 6-27-2005, EXPIRES 6-27-2015.

SER. NO. 78-832,114, FILED P.R. 3-8-2006; AM. S.R. 11-21-2007.

MELVIN AXILBUND, EXAMINING ATTORNEY

**Int. Cl.: 16**

**Prior U.S. Cls.: 2, 5, 22, 23, 29, 37, 38, and 50**

**Reg. No. 3,500,466**

**United States Patent and Trademark Office**

**Registered Sep. 9, 2008**

**TRADEMARK  
SUPPLEMENTAL REGISTER**

**E-DIVA**

PEARSON, RA-NELLE (UNITED STATES INDIVIDUAL)  
347 WEST BERRY STREET, 7TH FLOOR  
FORT WAYNE, IN 46802

FOR: BOOKS IN THE FIELD OF EMPLOYMENT AND BOOKS IN THE FIELD OF TRAINING IN THE FIELDS OF EMPLOYMENT, ENTREPRENEURSHIP AND CUSTOMER SERVICE , IN CLASS 16 (U.S. CLS. 2, 5, 22, 23, 29, 37, 38 AND 50).

FIRST USE 10-26-2007; IN COMMERCE 10-26-2007.

THE MARK CONSISTS OF STANDARD CHARACTERS WITHOUT CLAIM TO ANY PARTICULAR FONT, STYLE, SIZE, OR COLOR.

SER. NO. 78-835,290, FILED P.R. 3-13-2006; AM. S.R. 12-28-2007.

LINDA POWELL, EXAMINING ATTORNEY

Int. Cl.: 44

Prior U.S. Cls.: 100 and 101

**United States Patent and Trademark Office**

**Reg. No. 3,500,467**

Registered Sep. 9, 2008

**SERVICE MARK  
SUPPLEMENTAL REGISTER**



ZERMATT RESORT, L.L.C. (UTAH LIMITED  
LIABILITY COMPANY)  
761 SOUTH 1030 EAST  
OREM, UT 84097

FIRST USE 6-1-2006; IN COMMERCE 6-1-2006.

FOR: HEALTH SPA SERVICES FOR HEALTH  
AND WELLNESS OF THE BODY AND SPIRIT  
OFFERED AT A HEALTH RESORT, IN CLASS 44  
(U.S. CLS. 100 AND 101).

SER. NO. 78-845,043, FILED P.R. 3-24-2006; AM. S.R.  
12-18-2007.

ELLEN PERKINS, EXAMINING ATTORNEY



**Int. Cls.: 38 and 45**

**Prior U.S. Cls.: 100, 101, and 104**

**United States Patent and Trademark Office**

**Reg. No. 3,500,468**

**Registered Sep. 9, 2008**

**SERVICE MARK  
SUPPLEMENTAL REGISTER**

**FAMILY LOCATOR**

DISNEY ENTERPRISES, INC. (DELAWARE CORPORATION)

500 SOUTH BUENA VISTA STREET

BURBANK, CA 91521

FOR: MOBILE TELEPHONE SERVICES FEATURING A LOCATOR SERVICE FOR OTHER TELEPHONE UNITS, IN CLASS 38 (U.S. CLS. 100, 101 AND 104).

FIRST USE 6-9-2006; IN COMMERCE 6-9-2006.

FOR: TRACKING AND LOCATING PERSONS UTILIZING MOBILE TELEPHONES, IN CLASS 45 (U.S. CLS. 100 AND 101).

FIRST USE 6-9-2006; IN COMMERCE 6-9-2006.

THE MARK CONSISTS OF STANDARD CHARACTERS WITHOUT CLAIM TO ANY PARTICULAR FONT, STYLE, SIZE, OR COLOR.

SER. NO. 78-861,406, FILED P.R. 4-13-2006; AM. S.R. 4-16-2008.

MARK PILARO, EXAMINING ATTORNEY

**Int. Cl.: 38**

**Prior U.S. Cls.: 100, 101, and 104**

**United States Patent and Trademark Office**

**Reg. No. 3,500,469**

**Registered Sep. 9, 2008**

**SERVICE MARK  
SUPPLEMENTAL REGISTER**

**FAMILY MONITOR**

DISNEY ENTERPRISES, INC. (DELAWARE CORPORATION)  
500 SOUTH BUENA VISTA STREET  
BURBANK, CA 91521

FOR: MOBILE AND WIRELESS TELEPHONE SERVICES FEATURING A MONITORING SERVICE FOR USAGE OF THE TELEPHONE SERVICES, IN CLASS 38 (U.S. CLS. 100, 101 AND 104).

FIRST USE 6-9-2006; IN COMMERCE 6-9-2006.

THE MARK CONSISTS OF STANDARD CHARACTERS WITHOUT CLAIM TO ANY PARTICULAR FONT, STYLE, SIZE, OR COLOR.

SER. NO. 78-862,104, FILED P.R. 4-14-2006; AM. S.R. 4-16-2008.

MARK PILARO, EXAMINING ATTORNEY

Int. Cl.: 32

Prior U.S. Cls.: 45, 46, and 48

United States Patent and Trademark Office

Reg. No. 3,500,470

Registered Sep. 9, 2008

**TRADEMARK  
SUPPLEMENTAL REGISTER**

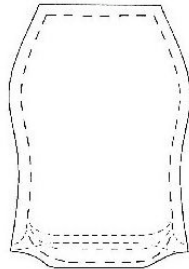

WASATCH ICE WATER, LLC (NEVADA LIMITED LIABILITY COMPANY)  
4885 SOUTH 900 EAST, #208  
SALT LAKE CITY, UT 84117

FOR: DRINKING WATER, GLACIAL WATER, SPRING WATER, AND ARTESIAN WELL WATER, IN CLASS 32 (U.S. CLS. 45, 46 AND 48).

FIRST USE 12-0-2002; IN COMMERCE 12-0-2002.

THE MARK CONSISTS OF THE CONFIGURATION OF THE PACKAGING FOR THE GOODS IN

THE NATURE OF A POUCH WITH ROUNDED RECTANGULARISH BOTTOM, NARROWING TOWARDS THE TOP. THE DOTTED LINES INDICATE STRUCTURAL SUPPORT FOR THE BEVERAGE CONTAINER AND FOR HOLDING WATER AND ARE NOT CLAIMED AS FEATURES OF THE MARK.

SER. NO. 78-863,997, FILED P.R. 4-18-2006; AM. S.R. 11-2-2007.

MYRIAH HABEEB, EXAMINING ATTORNEY

**Int. Cls.: 36, 39, 41, and 42**

**Prior U.S. Cls.: 100, 101, 102, 105, and 107**

**United States Patent and Trademark Office**

**Reg. No. 3,500,471**

**Registered Sep. 9, 2008**

**SERVICE MARK  
SUPPLEMENTAL REGISTER**

**THIRD-SCREEN NETWORK**

ACCUWEATHER, INC. (PENNSYLVANIA CORPORATION)  
385 SCIENCE PARK ROAD  
STATE COLLEGE, PA 16803

FOR: PROVIDING INFORMATION IN THE FIELD OF FINANCE VIA WIRELESS MOBILE DEVICES, IN CLASS 36 (U.S. CLS. 100, 101 AND 102).

FIRST USE 3-30-2005; IN COMMERCE 3-30-2005.

FOR: PROVIDING INFORMATION IN THE FIELD OF TRAFFIC VIA WIRELESS MOBILE DEVICES, IN CLASS 39 (U.S. CLS. 100 AND 105).

FIRST USE 3-30-2005; IN COMMERCE 3-30-2005.

FOR: PROVIDING INFORMATION IN THE FIELD OF NEWS, SPORTS, AND ENTERTAINMENT VIA WIRELESS MOBILE DEVICES, IN CLASS 41 (U.S. CLS. 100, 101 AND 107).

FIRST USE 3-30-2005; IN COMMERCE 3-30-2005.

FOR: WEATHER FORECASTING SERVICES; PROVIDING INFORMATION IN THE FIELD OF WEATHER VIA WIRELESS MOBILE DEVICES; PROVIDING ON-LINE WEATHER FORECASTING, WEATHER REPORTING AND WEATHER NEWS AND INFORMATION VIA WIRELESS MOBILE DEVICES, IN CLASS 42 (U.S. CLS. 100 AND 101).

FIRST USE 3-30-2005; IN COMMERCE 3-30-2005.

THE MARK CONSISTS OF STANDARD CHARACTERS WITHOUT CLAIM TO ANY PARTICULAR FONT, STYLE, SIZE, OR COLOR.

SER. NO. 78-877,727, FILED P.R. 5-5-2006; AM. S.R. 8-5-2008.

ANNE E. GUSTASON, EXAMINING ATTORNEY

**Int. Cls.: 9 and 42**

**Prior U.S. Cls.: 21, 23, 26, 36, 38, 100, and 101**

**United States Patent and Trademark Office**

**Reg. No. 3,500,472**

**Registered Sep. 9, 2008**

**TRADEMARK  
SERVICE MARK  
SUPPLEMENTAL REGISTER**

**THINKTANK**

GROUPSYSTEMS CORPORATION (DELAWARE CORPORATION)  
520 ZANG STREET, SUITE 211  
BROOMFIELD, CO 80021

FOR: COMPUTER SOFTWARE USED TO FACILITATE THE EXCHANGE OF INFORMATION VIA A GLOBAL COMPUTER NETWORK OR THE INTERNET FEATURING BRAINSTORMING TOOLS, CATEGORIZATION TOOLS, PRESENCE MANAGEMENT, INSTANT MESSAGING AND COLLABORATION TOOLS, DOCUMENT MANAGEMENT, SURVEYS AND VOTING CAPABILITIES, APPLICATION INTEGRATION, AND MEETING SUMMARIES AND OUTPUT REPORTS TO ASSIST IN THE FACILITATION OF MEETINGS; SOFTWARE FOR USE IN SHARING INFORMATION FOR THE FACILITATION OF MEETINGS, GATHERINGS, AND INTERACTIVE DISCUSSIONS, IN CLASS 9 (U.S. CLS. 21, 23, 26, 36 AND 38).

FIRST USE 7-14-2006; IN COMMERCE 7-14-2006.

FOR: COMPUTER SERVICES, NAMELY, HOSTING ON-LINE WEB FACILITIES FOR OTHERS FOR ORGANIZING AND CONDUCTING ONLINE MEETINGS, GATHERINGS, AND INTERACTIVE DISCUSSIONS, IN CLASS 42 (U.S. CLS. 100 AND 101).

FIRST USE 7-14-2006; IN COMMERCE 7-14-2006.

THE MARK CONSISTS OF STANDARD CHARACTERS WITHOUT CLAIM TO ANY PARTICULAR FONT, STYLE, SIZE, OR COLOR.

SER. NO. 78-896,633, FILED P.R. 5-31-2006; AM. S.R. 12-3-2007.

MARILYN IZZI, EXAMINING ATTORNEY

**Int. Cl.: 41**

**Prior U.S. Cls.: 100, 101, and 107**

**United States Patent and Trademark Office**

**Reg. No. 3,500,473**

**Registered Sep. 9, 2008**

**SERVICE MARK  
SUPPLEMENTAL REGISTER**

**THE WHISKY NETWORK**

DIAGEO NORTH AMERICA, INC. (CONNECTI-  
CUT CORPORATION)  
801 MAIN AVENUE  
NORWALK, CT 06851

FOR: EDUCATIONAL SERVICES, NAMELY,  
PROVIDING PRESENTATIONS IN THE FIELD OF  
WHISKY, AND DISTRIBUTING COURSE MATERI-  
ALS ABOUT WHISKY IN CONNECTION THERE-  
WITH; PROVIDING INCENTIVES TO PEOPLE TO  
DEMONSTRATE COMPLETION OF A TRAINING  
SESSION ABOUT WHISKY OR KNOWLEDGE  
ABOUT WHISKY THROUGH THE ISSUANCE OF  
CERTIFICATES OR AWARDS, IN CLASS 41 (U.S.  
CLS. 100, 101 AND 107).

FIRST USE 8-31-2006; IN COMMERCE 8-31-2006.

THE MARK CONSISTS OF STANDARD CHAR-  
ACTERS WITHOUT CLAIM TO ANY PARTICULAR  
FONT, STYLE, SIZE, OR COLOR.

NO CLAIM IS MADE TO THE EXCLUSIVE  
RIGHT TO USE "WHISKY", APART FROM THE  
MARK AS SHOWN.

SER. NO. 78-900,721, FILED P.R. 6-5-2006; AM. S.R.  
11-20-2007.

JENNIFER MARTIN, EXAMINING ATTORNEY

**Int. Cl.: 44**

**Prior U.S. Cls.: 100 and 101**

**United States Patent and Trademark Office**

**Reg. No. 3,500,474**

**Registered Sep. 9, 2008**

**SERVICE MARK  
SUPPLEMENTAL REGISTER**

**SNORING CENTER**

CRAIG SCHWIMMER, MD, PA (TEXAS INCORPORATED ASSOCIATION)  
1014 E. WHEATLAND ROAD  
DUNCANVILLE, TX 75116

FOR: MEDICAL CLINICS; MEDICAL SERVICES; MEDICAL INFORMATION; MEDICAL TESTING; MEDICAL EVALUATION, NAMELY, EVALUATION OF SLEEP DISORDERS AND CONDITIONS , IN CLASS 44 (U.S. CLS. 100 AND 101).

FIRST USE 9-12-2006; IN COMMERCE 9-12-2006.

THE MARK CONSISTS OF STANDARD CHARACTERS WITHOUT CLAIM TO ANY PARTICULAR FONT, STYLE, SIZE, OR COLOR.

NO CLAIM IS MADE TO THE EXCLUSIVE RIGHT TO USE "CENTER", APART FROM THE MARK AS SHOWN.

SER. NO. 78-904,489, FILED P.R. 6-9-2006; AM. S.R. 6-30-2008.

SUSAN RICHARDS, EXAMINING ATTORNEY

**Int. Cl.: 5**

**Prior U.S. Cls.: 6, 18, 44, 46, 51, and 52**

**United States Patent and Trademark Office**

**Reg. No. 3,500,475**

**Registered Sep. 9, 2008**

**TRADEMARK  
SUPPLEMENTAL REGISTER**

**NO-SLIP GRIP**

PLAYTEX PRODUCTS, INC. (DELAWARE COR-  
PORATION)  
300 NYALA FARMS ROAD  
WESTPORT, CT 06880

FOR: TAMPONS AND TAMPON APPLICATORS,  
IN CLASS 5 (U.S. CLS. 6, 18, 44, 46, 51 AND 52).

FIRST USE 9-0-2006; IN COMMERCE 9-0-2006.

THE MARK CONSISTS OF STANDARD CHAR-  
ACTERS WITHOUT CLAIM TO ANY PARTICULAR  
FONT, STYLE, SIZE, OR COLOR.

SER. NO. 78-915,725, FILED P.R. 6-23-2006; AM. S.R.  
11-21-2007.

ALICE SUE CARRUTHERS, EXAMINING ATTOR-  
NEY



**Int. Cl.: 35**

**Prior U.S. Cls.: 100, 101, and 102**

**United States Patent and Trademark Office**

**Reg. No. 3,500,476**

**Registered Sep. 9, 2008**

**SERVICE MARK  
SUPPLEMENTAL REGISTER**

**California Grand Cru**

POIRIER, GREG M. (UNITED STATES INDIVIDUAL)

4089 KERNS CHURCH ROAD

SUTHERLIN, VA 24594

FOR: PROVIDING PRODUCT RATINGS OF THE CONSUMER GOODS OF OTHERS IN THE FIELD OF WINE, IN CLASS 35 (U.S. CLS. 100, 101 AND 102).

FIRST USE 5-2-2008; IN COMMERCE 5-2-2008.

THE MARK CONSISTS OF STANDARD CHARACTERS WITHOUT CLAIM TO ANY PARTICULAR FONT, STYLE, SIZE, OR COLOR.

THE ENGLISH TRANSLATION OF THE WORD "GRAND CRU" IN THE MARK IS GREAT GROWTH.

SER. NO. 78-927,578, FILED P.R. 7-12-2006; AM. S.R. 5-7-2008.

HOWARD SMIGA, EXAMINING ATTORNEY

**Int. Cl.: 35**

**Prior U.S. Cls.: 100, 101, and 102**

**United States Patent and Trademark Office**

**Reg. No. 3,500,477**

**Registered Sep. 9, 2008**

**SERVICE MARK  
SUPPLEMENTAL REGISTER**

**American Grand Cru**

POIRIER, GREG M (UNITED STATES INDIVIDUAL)

4089 KERN CHURCH ROAD

SUTHERLIN, VA 24594

FOR: PROVIDING PRODUCT RATINGS OF THE CONSUMER GOODS OF OTHERS IN THE FIELD OF WINE, IN CLASS 35 (U.S. CLS. 100, 101 AND 102).

FIRST USE 5-2-2008; IN COMMERCE 5-2-2008.

THE MARK CONSISTS OF STANDARD CHARACTERS WITHOUT CLAIM TO ANY PARTICULAR FONT, STYLE, SIZE, OR COLOR.

THE ENGLISH TRANSLATION OF THE WORD "GRAND CRU" IN THE MARK IS GREAT GROWTH.

SER. NO. 78-929,445, FILED P.R. 7-14-2006; AM. S.R. 5-7-2008.

KELLY BOULTON, EXAMINING ATTORNEY

**Int. Cl.: 35**

**Prior U.S. Cls.: 100, 101, and 102**

**United States Patent and Trademark Office**

**Reg. No. 3,500,478**

**Registered Sep. 9, 2008**

**SERVICE MARK  
SUPPLEMENTAL REGISTER**

COMPREHENSIVE NEUROSCIENCE

COMPREHENSIVE NEUROSCIENCE, INC. (DE-  
LAWARE CORPORATION)  
21 BLOOMINGDALE ROAD  
WHITE PLAINS, NY 10605

FOR: BUSINESS MANAGEMENT CONSULTING;  
COST MANAGEMENT FOR THE HEALTH BENE-  
FIT PLANS OF OTHERS; PHARMACEUTICAL  
COST MANAGEMENT SERVICES AND DRUG UTI-  
LIZATION REVIEW SERVICES, IN CLASS 35 (U.S.  
CLS. 100, 101 AND 102).

FIRST USE 3-0-1999; IN COMMERCE 3-0-1999.

THE MARK CONSISTS OF STANDARD CHAR-  
ACTERS WITHOUT CLAIM TO ANY PARTICULAR  
FONT, STYLE, SIZE, OR COLOR.

SER. NO. 78-934,029, FILED P.R. 7-20-2006; AM. S.R.  
7-28-2008.

WILLIAM BRECKENFELD, EXAMINING ATTOR-  
NEY

**Int. Cl.: 44**

**Prior U.S. Cls.: 100 and 101**

**United States Patent and Trademark Office**

**Reg. No. 3,500,479**

**Registered Sep. 9, 2008**

**SERVICE MARK  
SUPPLEMENTAL REGISTER**

COMPREHENSIVE NEUROSCIENCE

COMPREHENSIVE NEUROSCIENCE, INC. (DE-  
LAWARE CORPORATION)  
21 BLOOMINGDALE ROAD  
WHITE PLAINS, NY 10605

FOR: MEDICAL EVALUATION SERVICES,  
NAMELY, FUNCTIONAL ASSESSMENT PRO-  
GRAM FOR PATIENTS RECEIVING MEDICAL  
REHABILITATION SERVICES FOR PURPOSES OF  
GUIDING TREATMENT AND ASSESSING PRO-  
GRAM EFFECTIVENESS, IN CLASS 44 (U.S. CLS.  
100 AND 101).

FIRST USE 3-0-1999; IN COMMERCE 3-0-1999.

THE MARK CONSISTS OF STANDARD CHAR-  
ACTERS WITHOUT CLAIM TO ANY PARTICULAR  
FONT, STYLE, SIZE, OR COLOR.

SER. NO. 78-934,045, FILED P.R. 7-20-2006; AM. S.R.  
7-28-2008.

WILLIAM BRECKENFELD, EXAMINING ATTOR-  
NEY

**Int. Cl.: 36**

**Prior U.S. Cls.: 100, 101, and 102**

**United States Patent and Trademark Office**

**Reg. No. 3,500,480**

**Registered Sep. 9, 2008**

**SERVICE MARK  
SUPPLEMENTAL REGISTER**

COMPREHENSIVE NEUROSCIENCE

COMPREHENSIVE NEUROSCIENCE, INC. (DE-  
LAWARE CORPORATION)  
21 BLOOMINGDALE ROAD  
WHITE PLAINS, NY 10605

FOR: PHARMACEUTICAL BENEFIT MANAGE-  
MENT SERVICES, IN CLASS 36 (U.S. CLS. 100, 101  
AND 102).

FIRST USE 3-0-1999; IN COMMERCE 3-0-1999.

THE MARK CONSISTS OF STANDARD CHAR-  
ACTERS WITHOUT CLAIM TO ANY PARTICULAR  
FONT, STYLE, SIZE, OR COLOR.

SER. NO. 78-934,053, FILED P.R. 7-20-2006; AM. S.R.  
7-28-2008.

WILLIAM BRECKENFELD, EXAMINING ATTOR-  
NEY

**Int. Cl.: 42**

**Prior U.S. Cls.: 100 and 101**

**United States Patent and Trademark Office**

**Reg. No. 3,500,481**

**Registered Sep. 9, 2008**

**SERVICE MARK  
SUPPLEMENTAL REGISTER**

COMPREHENSIVE NEUROSCIENCE

COMPREHENSIVE NEUROSCIENCE, INC. (DE-  
LAWARE CORPORATION)  
21 BLOOMINGDALE ROAD  
WHITE PLAINS, NY 10605

FOR: MEDICAL AND SCIENTIFIC RESEARCH;  
PHARMACEUTICAL PRODUCT EVALUATION;  
PHARMACEUTICAL RESEARCH SERVICES, IN  
CLASS 42 (U.S. CLS. 100 AND 101).

FIRST USE 3-0-1999; IN COMMERCE 3-0-1999.

THE MARK CONSISTS OF STANDARD CHAR-  
ACTERS WITHOUT CLAIM TO ANY PARTICULAR  
FONT, STYLE, SIZE, OR COLOR.

SER. NO. 78-934,060, FILED P.R. 7-20-2006; AM. S.R.  
7-28-2008.

WILLIAM BRECKENFELD, EXAMINING ATTOR-  
NEY

**Int. Cl.: 41**

**Prior U.S. Cls.: 100, 101, and 107**

**United States Patent and Trademark Office**

**Reg. No. 3,500,482**

**Registered Sep. 9, 2008**

**SERVICE MARK  
SUPPLEMENTAL REGISTER**

COMPREHENSIVE NEUROSCIENCE

COMPREHENSIVE NEUROSCIENCE, INC. (DE-  
LAWARE CORPORATION)  
21 BLOOMINGDALE ROAD  
WHITE PLAINS, NY 10605

FOR: EDUCATION SERVICES, NAMELY, SEMI-  
NARS IN THE FIELD OF CONTINUING MEDICAL  
EDUCATION, IN CLASS 41 (U.S. CLS. 100, 101 AND  
107).

FIRST USE 3-0-1999; IN COMMERCE 3-0-1999.

THE MARK CONSISTS OF STANDARD CHAR-  
ACTERS WITHOUT CLAIM TO ANY PARTICULAR  
FONT, STYLE, SIZE, OR COLOR.

SER. NO. 78-934,071, FILED P.R. 7-20-2006; AM. S.R.  
7-28-2008.

WILLIAM BRECKENFELD, EXAMINING ATTOR-  
NEY

**Int. Cl.: 9**

**Prior U.S. Cls.: 21, 23, 26, 36, and 38**

**United States Patent and Trademark Office**

**Reg. No. 3,500,483**

**Registered Sep. 9, 2008**

**TRADEMARK  
SUPPLEMENTAL REGISTER**

COMPREHENSIVE NEUROSCIENCE

COMPREHENSIVE NEUROSCIENCE, INC. (DE-  
LAWARE CORPORATION)  
21 BLOOMINGDALE ROAD  
WHITE PLAINS, NY 10605

FOR: COMPUTER SOFTWARE FOR ANALYSIS  
OF DATA IN THE FIELD OF MEDICINE, HEALTH,  
CLINICAL RESEARCH AND PHARMACEUTICAL  
PREPARATIONS; COMPUTER SOFTWARE FOR  
PRESENTATION OF DATA IN THE FIELD OF  
MEDICINE, HEALTH, CLINICAL RESEARCH  
AND PHARMACEUTICAL PREPARATIONS, IN  
CLASS 9 (U.S. CLS. 21, 23, 26, 36 AND 38).

FIRST USE 3-0-1999; IN COMMERCE 3-0-1999.

THE MARK CONSISTS OF STANDARD CHAR-  
ACTERS WITHOUT CLAIM TO ANY PARTICULAR  
FONT, STYLE, SIZE, OR COLOR.

SER. NO. 78-934,077, FILED P.R. 7-20-2006; AM. S.R.  
7-28-2008.

WILLIAM BRECKENFELD, EXAMINING ATTOR-  
NEY



**Int. Cl.: 30**

**Prior U.S. Cl.: 46**

**United States Patent and Trademark Office**

**Reg. No. 3,500,484**

**Registered Sep. 9, 2008**

**TRADEMARK  
SUPPLEMENTAL REGISTER**

**COLD CHURNED**

TURKEY HILL, L.P. (PENNSYLVANIA LIMITED  
PARTNERSHIP)

2601 RIVER ROAD

CONESTOGA, PA 17516

FOR: ICE CREAM, IN CLASS 30 (U.S. CL. 46).

FIRST USE 6-1-2007; IN COMMERCE 6-1-2007.

THE MARK CONSISTS OF STANDARD CHAR-  
ACTERS WITHOUT CLAIM TO ANY PARTICULAR  
FONT, STYLE, SIZE, OR COLOR.

SER. NO. 78-955,309, FILED P.R. 8-18-2006; AM. S.R.  
6-20-2007.

ANGELA M. MICHELI, EXAMINING ATTORNEY