

NATIONAL TOXICOLOGY PROGRAM
Technical Report Series
No. 448



TOXICOLOGY AND CARCINOGENESIS

STUDIES OF

ISOBUTYL NITRITE

(CAS NO. 542-56-3)

IN F344/N RATS AND B6C3F₁ MICE

(INHALATION STUDIES)

U.S. DEPARTMENT OF HEALTH AND HUMAN SERVICES
Public Health Service
National Institutes of Health

FOREWORD

The National Toxicology Program (NTP) is made up of four charter agencies of the U.S. Department of Health and Human Services (DHHS): the National Cancer Institute (NCI), National Institutes of Health; the National Institute of Environmental Health Sciences (NIEHS), National Institutes of Health; the National Center for Toxicological Research (NCTR), Food and Drug Administration; and the National Institute for Occupational Safety and Health (NIOSH), Centers for Disease Control. In July 1981, the Carcinogenesis Bioassay Testing Program, NCI, was transferred to the NIEHS. The NTP coordinates the relevant programs, staff, and resources from these Public Health Service agencies relating to basic and applied research and to biological assay development and validation.

The NTP develops, evaluates, and disseminates scientific information about potentially toxic and hazardous chemicals. This knowledge is used for protecting the health of the American people and for the primary prevention of disease.

The studies described in this Technical Report were performed under the direction of the NIEHS and were conducted in compliance with NTP laboratory health and safety requirements and must meet or exceed all applicable federal, state, and local health and safety regulations. Animal care and use were in accordance with the Public Health Service Policy on Humane Care and Use of Animals. The prechronic and chronic studies were conducted in compliance with Food and Drug Administration (FDA) Good Laboratory Practice Regulations, and all aspects of the chronic studies were subjected to retrospective quality assurance audits before being presented for public review.

These studies are designed and conducted to characterize and evaluate the toxicologic potential, including carcinogenic activity, of selected chemicals in laboratory animals (usually two species, rats and mice). Chemicals selected for NTP toxicology and carcinogenesis studies are chosen primarily on the bases of human exposure, level of production, and chemical structure. The interpretive conclusions presented in this Technical Report are based only on the results of these NTP studies. Extrapolation of these results to other species and quantitative risk analyses for humans require wider analyses beyond the purview of these studies. Selection *per se* is not an indicator of a chemical's carcinogenic potential.

These NTP Technical Reports are available for sale from the National Technical Information Service, U.S. Department of Commerce, 5285 Port Royal Road, Springfield, VA 22161 (703-487-4650). Single copies of this Technical Report are available without charge while supplies last from NTP Central Data Management, NIEHS, P.O. Box 12233, MD E1-02, Research Triangle Park, NC 27709 (919-541-3419). Listings of all published NTP reports and ongoing studies are also available from NTP Central Data Management. The Abstracts and other study information for 2-year studies are also available at the NTP's World Wide Web site: <http://ntp-server.niehs.nih.gov>.

NTP TECHNICAL REPORT
ON THE
TOXICOLOGY AND CARCINOGENESIS
STUDIES OF
ISOBUTYL NITRITE
(CAS NO. 542-56-3)
IN F344/N RATS AND B6C3F₁ MICE
(INHALATION STUDIES)

July 1996

NTP TR 448

NIH Publication No. 96-3364

U.S. DEPARTMENT OF HEALTH AND HUMAN SERVICES
Public Health Service
National Institutes of Health

CONTRIBUTORS

National Toxicology Program

Evaluated and interpreted results and reported findings

K.M. Abdo, Ph.D., Study Scientist
 D.A. Bridge, B.S.
 J.R. Bucher, Ph.D.
 M.R. Elwell, D.V.M., Ph.D.
 T.J. Goehl, Ph.D.
 J.K. Haseman, Ph.D.
 A. Radovsky, D.V.M., Ph.D.
 G.N. Rao, D.V.M., Ph.D.
 J.H. Roycroft, Ph.D.
 R.C. Sills, D.V.M., Ph.D.
 G.S. Travlos, D.V.M.
 D.B. Walters, Ph.D.
 K.L. Witt, M.S., Oak Ridge Associated Universities

IIT Research Institute

Conducted studies, evaluated pathology findings

C. Aranyi, B.S., Principal Investigator
 J.D. Fenters, Ph.D.
 D. Kirkpatrick, Ph.D.
 W. O'Shea, M.S.
 A. Snelson, Ph.D.

Experimental Pathology Laboratories, Inc.

Provided pathology quality assurance

J.F. Hardisty, D.V.M., Principal Investigator
 E.T. Gaillard, D.V.M., M.S.

Dynamac Corporation

Prepared quality assurance audits

S. Brecher, Ph.D., Principal Investigator

Analytical Sciences, Inc.

Provided statistical analyses

R.W. Morris, M.S., Principal Investigator
 N.G. Mintz, B.S.
 S. Rosenblum, M.S.

NTP Pathology Working Group

*Evaluated slides, prepared pathology report on rats
 (25 August 1992)*

P.K. Hildebrandt, D.V.M., Chair
 PATHCO, Inc.
 J. Bond, D.V.M.
 North Carolina State University
 E.T. Gaillard, D.V.M., M.S.
 Experimental Pathology Laboratories, Inc.
 J.R. Hailey, D.V.M.
 National Toxicology Program
 J. Mahler, D.V.M.
 National Toxicology Program
 D. Meuten, D.V.M., Ph.D.
 North Carolina State University
 C.C. Shackelford, D.V.M., M.S., Ph.D.
 National Toxicology Program

*Evaluated slides, prepared pathology report on mice
 (22 October 1992)*

P.K. Hildebrandt, D.V.M., Chair
 PATHCO, Inc.
 C. Botteron, D.V.M.
 North Carolina State University
 J. Everitt, D.V.M.
 Chemical Industry Institute of Toxicology
 E.T. Gaillard, D.V.M., M.S.
 Experimental Pathology Laboratories, Inc.
 J.R. Hailey, D.V.M.
 National Toxicology Program
 C.C. Shackelford, D.V.M., M.S., Ph.D.
 National Toxicology Program
 R.C. Sills, D.V.M., Ph.D.
 National Toxicology Program

Biotechnical Services, Inc.

Prepared Technical Report

D.D. Lambright, Ph.D., Principal Investigator
 C.M. Bailey, B.S. Pharm.
 J.R. Beverly, B.A.
 S.R. Gunnels, M.A.
 T.A. King-Hunter, B.S.
 T.L. Rhoades, B.S.

CONTENTS

ABSTRACT		5
EXPLANATION OF LEVELS OF EVIDENCE OF CARCINOGENIC ACTIVITY		10
TECHNICAL REPORTS REVIEW SUBCOMMITTEE		11
SUMMARY OF TECHNICAL REPORTS REVIEW SUBCOMMITTEE COMMENTS		12
INTRODUCTION		13
MATERIALS AND METHODS		19
RESULTS		31
DISCUSSION AND CONCLUSIONS		65
REFERENCES		69
APPENDIX A	Summary of Lesions in Male Rats in the 2-Year Inhalation Study of Isobutyl Nitrite	75
APPENDIX B	Summary of Lesions in Female Rats in the 2-Year Inhalation Study of Isobutyl Nitrite	117
APPENDIX C	Summary of Lesions in Male Mice in the 2-Year Inhalation Study of Isobutyl Nitrite	155
APPENDIX D	Summary of Lesions in Female Mice in the 2-Year Inhalation Study of Isobutyl Nitrite	195
APPENDIX E	Genetic Toxicology	231
APPENDIX F	Organ Weights and Organ-Weight-to-Body-Weight Ratios	245
APPENDIX G	Hematology and Clinical Chemistry Results	253
APPENDIX H	Reproductive Tissue Evaluations and Estrous Cycle Characterization	263
APPENDIX I	Chemical Characterization and Generation of Chamber Concentrations	267
APPENDIX J	Ingredients, Nutrient Composition, and Contaminant Levels in NIH-07 Rat and Mouse Ration	289
APPENDIX K	Sentinel Animal Program	293

ABSTRACT

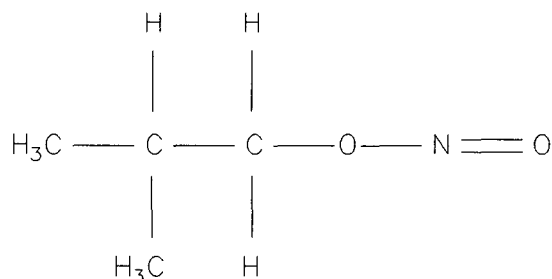

ISOBUTYL NITRITE

CAS No. 542-56-3

Chemical Formula: $\text{C}_4\text{H}_9\text{NO}_2$ Molecular Weight: 103.12

Synonyms: IBN; iso-butyl nitrite; nitrous acid, isobutyl ester; nitrous acid, 2-methylpropyl ester

Isobutyl nitrite is used to a limited extent as an intermediate in the syntheses of aliphatic nitrites. It is also an ingredient of various incenses or room odorizers and is used as a euphoric. The chemical has also been used as a jet propellant and in the preparation of fuels. Isobutyl nitrite was nominated by the Consumer Product Safety Commission to the NTP for toxicology and carcinogenicity studies because of its possible contribution to the high incidence of Kaposi's sarcoma among male homosexual acquired immune deficiency syndrome patients and because of the lack of available data on the potential carcinogenicity of isobutyl nitrite. Male and female F344/N rats and B6C3F₁ mice were exposed to isobutyl nitrite (purity of 93% or greater) by inhalation for 16 days, 13 weeks, or 2 years. Genetic toxicology studies were conducted in *Salmonella typhimurium*, cultured Chinese hamster ovary cells, *Drosophila melanogaster*, and mouse peripheral blood.

16-DAY STUDY IN RATS

Groups of five male and five female F344/N rats were exposed to 0, 100, 200, 400, 600, or 800 ppm (approximately 420, 840, 1,700, 2,500, or 3,300 mg/m³) isobutyl nitrite by inhalation for

6 hours per day, 5 days per week for a total of 12 exposures during a 16-day period. All males and females exposed to 600 or 800 ppm and one 400 ppm female died on the first day of the study. Final mean body weights and mean body weight gains of 400 ppm males and females were significantly lower than those of the controls. Clinical findings observed in 400 ppm males and females included ocular discharge, lethargy, hunched posture, and rough coats. Absolute and relative lung weights of all exposed groups of males and of 200 and 400 ppm females were less than those of the controls. Chemical-related hyperplasia of the bronchial epithelium was observed in 200 and 400 ppm males and females and hyperplasia of the nasal turbinate epithelium was observed in rats exposed to 400 ppm or less. Hemosiderin pigmentation was observed in the spleen of 200 and 400 ppm males and females and bone marrow hematopoietic hyperplasia was observed in rats exposed to 400 ppm or less.

16-DAY STUDY IN MICE

Groups of five male and five female B6C3F₁ mice were exposed to 0, 100, 200, 400, 600, or 800 ppm (approximately 420, 840, 1,700, 2,500, or 3,300 mg/m³) isobutyl nitrite by inhalation for

6 hours per day, 5 days per week for a total of 12 exposures during a 16-day period. Three males and four females exposed to 800 ppm died before the end of the study. Final mean body weights and mean body weight gains of 600 and 800 ppm males and females were significantly lower than those of the controls. Mice exposed to 400 ppm or greater were lethargic and exhibited hunched posture and rough coats. Absolute and relative lung weights of 600 and 800 ppm males and the relative lung weight of 600 ppm females were significantly greater than those of the controls. Chemical-related hyperplasia of the bronchiolar epithelium was observed in all exposed groups of males and females. Lymphocytic atrophy of the spleen and thymus was observed in males and females exposed to 400 ppm or greater.

13-WEEK STUDY IN RATS

Groups of 10 male and 10 female F344/N rats were exposed to 0, 10, 25, 75, 150, or 300 ppm (approximately 42, 105, 315, 630, or 1,260 mg/m³) isobutyl nitrite by inhalation for 6 hours per day, 5 days per week for 13 weeks. All rats survived to the end of the study. Final mean body weights and mean body weight gains of 300 ppm males and females were significantly lower than those of the controls, as was the mean body weight gain of 150 ppm females. Clinical findings observed during the study included ruffled fur in 300 ppm males and females, hypoactivity in 300 ppm males, and hyperactivity in 150 and 300 ppm females. A very mild chemical-related methemoglobinemia and anemia occurred in male and female rats in the 75, 150, and 300 ppm groups. Hematopoietic hyperplasia occurred in the bone marrow of all exposed groups of males and females and was considered to be a secondary response to the anemia and methemoglobinemia. There was minimal hemosiderin pigment accumulation in the spleens of males and females exposed to 75 ppm or greater, mild to moderate epithelial cell hyperplasia of the nasal mucosa was observed in 300 ppm males and females, and minimal hyperplasia occurred in 150 ppm males and females. Hyperplasia of the bronchial epithelium was observed in 300 ppm males and females.

13-WEEK STUDY IN MICE

Groups of 10 male and 10 female B6C3F₁ mice were exposed to 0, 10, 25, 75, 150, or 300 ppm (approximately 42, 105, 315, 630, or 1,260 mg/m³) isobutyl nitrite by inhalation for 6 hours per day, 5 days per week for 13 weeks. There were no chemical-related deaths. Final mean body weights and mean body weight gains of 150 and 300 ppm females were significantly less than those of the controls. Final mean body weights and mean body weight gains of exposed groups of males were similar to those of the controls. There were no chemical-related clinical findings. A very mild chemical-related methemoglobinemia occurred in male and female mice in the 150 and 300 ppm groups. A very mild anemia occurred in the 300 ppm groups. In the lung, increased incidences of mild to moderate hyperplasia of the bronchiolar epithelium occurred in males and females exposed to 300 ppm. Minimal hyperplasia occurred in males exposed to 75 ppm or greater and in females exposed to 150 ppm. Minimal epithelial cell hyperplasia of the nasal mucosa was observed in 300 ppm males. Increased hematopoiesis of the spleen, secondary to the hematotoxicity, occurred in males exposed to 75 ppm or greater and in females exposed to 150 or 300 ppm. Increased hemosiderosis of the spleen occurred in males exposed to 300 ppm and in females exposed to 75 ppm or greater.

2-YEAR STUDY IN RATS

Based on the low final mean body weights, anemia, and the mild to moderate nasal mucosal lesions and the hyperplastic bronchial lesions observed in 300 ppm males and females, isobutyl nitrite exposure concentrations selected for the 2-year inhalation study in rats were 37.5, 75, and 150 ppm.

Groups of 56 male and 56 female rats were exposed to 0, 37.5, 75, or 150 ppm (equivalent to 0, 158, 315, or 630 mg/m³) isobutyl nitrite by inhalation for 6 hours per day, 5 days per week, for 103 weeks. Ten male and 10 female rats from each group were evaluated at 15 months for clinical pathology and histopathology.

Survival, Body Weights, Clinical Findings, Hematology, and Clinical Chemistry

Survival rates of exposed groups of rats were greater than those of the controls, and the survival rates of 75 and 150 ppm males were significantly greater than that of the control. Mean body weights of 150 ppm males and females were 3% to 11% lower than those of the controls throughout the course of the study. There were no clinical findings considered to be related to isobutyl nitrite exposure. A very mild methemoglobinemia and anemia occurred in male and female rats exposed to 75 or 150 ppm.

Pathology Findings

Incidences of alveolar/bronchiolar adenoma and alveolar/bronchiolar adenoma or carcinoma (combined) occurred with significant positive trends in exposed males and females, and the incidences of these neoplasms in 75 ppm males and in 150 ppm males and females were significantly greater than those in the controls. The incidence of alveolar/bronchiolar carcinoma was significantly greater in 150 ppm male rats than that in the controls. The incidences of alveolar epithelial hyperplasia were also increased in 75 and 150 ppm males and in all exposed groups of females. The incidences of mononuclear cell leukemia in exposed groups of males and females were significantly less than those in the controls.

2-YEAR STUDY IN MICE

Based on the low final mean body weight of 300 ppm females and the mild to moderate bronchiolar hyperplasia observed in 300 ppm males and females, isobutyl nitrite exposure concentrations selected for the 2-year inhalation study in mice were 37.5, 75, and 150 ppm.

Groups of 60 male and 60 female mice were exposed to 0, 37.5, 75, or 150 ppm (equivalent to 0, 158, 315, or 630 mg/m³) isobutyl nitrite by inhalation for 6 hours per day, 5 days per week, for 103 weeks. As many as 10 male and 10 female mice from each group were evaluated at 15 months for clinical pathology and histopathology.

Survival, Body Weights, Clinical Findings, Hematology and Clinical Chemistry

Survival rates of exposed groups of males were similar to those of the controls. Survival rates of exposed groups of females were greater than those of the controls, and the survival rate of 37.5 ppm females was significantly greater than that of the controls. Mean body weights of exposed groups of males and of 37.5 and 75 ppm females were similar to those of the controls throughout the study. Mean body weights of 150 ppm females were lower than those of the controls from week 20 until the end of the study. There were no biologically significant clinical findings noted in the 2-year study in mice. A very mild methemoglobinemia and anemia occurred in male and female mice exposed to 75 or 150 ppm.

Pathology Findings

Incidences of alveolar/bronchiolar adenoma and alveolar/bronchiolar adenoma or carcinoma (combined) occurred with significant positive trends in exposed males and females, and the incidences of these neoplasms were significantly greater than those in the controls in 75 ppm males and in 150 ppm males and females. Incidences of alveolar epithelial hyperplasia were significantly increased in 75 and 150 ppm male and female mice. Thyroid gland follicular cell adenoma occurred with a significant positive trend in male mice; the incidences of thyroid gland follicular cell hyperplasia were increased in all exposed groups of males, and the incidences in males exposed to 37.5 or 150 ppm were significantly greater than those in the controls. Incidences of serous exudate and olfactory epithelium atrophy in the nose of 150 ppm females were significantly greater than those in the controls. Incidences of minimal to mild hemosiderin pigment in the spleen of 75 and 150 ppm male mice were significantly greater than those in the controls.

GENETIC TOXICOLOGY

Isobutyl nitrite was found to be mutagenic *in vitro* and *in vivo*. It induced base-pair substitution mutations in *Salmonella typhimurium* strains TA100 and

TA1535 and sister chromatid exchanges and chromosomal aberrations in cultured Chinese hamster ovary cells. Positive responses in the *S. typhimurium* tests required S9 activation, but isobutyl nitrite induced chromosomal effects in cultured Chinese hamster ovary cells with and without S9. *In vivo*, no induction of sex-linked recessive lethal mutations was noted in the germ cells of male *Drosophila melanogaster* exposed to isobutyl nitrite via feeding or injection. However, significant increases in micronucleated normochromatic erythrocytes were observed in the peripheral blood of male and female mice treated with isobutyl nitrite for 90 days by inhalation.

CONCLUSIONS

Under the conditions of these 2-year inhalation studies, there was *clear evidence of carcinogenic activity** of isobutyl nitrite in male and female F344/N rats based on the increased incidences of

alveolar/bronchiolar adenoma and alveolar/bronchiolar adenoma or carcinoma (combined). There was *some evidence of carcinogenic activity* of isobutyl nitrite in male and female B6C3F₁ mice based on the increased incidences of alveolar/bronchiolar adenoma and alveolar/bronchiolar adenoma or carcinoma (combined) in males and females. The increased incidence of thyroid gland follicular cell adenoma in male mice may have been related to isobutyl nitrite exposure.

Exposure of rats and mice to isobutyl nitrite by inhalation for 2 years resulted in increased incidences of alveolar epithelial hyperplasia (male and female rats and mice), thyroid gland follicular cell hyperplasia and splenic hemosiderin pigmentation (male mice), and serous exudate and atrophy of the olfactory epithelium of the nose (female mice).

Exposure of rats to isobutyl nitrite by inhalation for 2 years resulted in decreased incidences of mononuclear cell leukemia in males and females.

* Explanation of Levels of Evidence of Carcinogenic Activity is on page 10. A summary of the Technical Reports Review Subcommittee comments and the public discussion on this Technical Report appears on page 12.

Summary of the 2-Year Carcinogenesis and Genetic Toxicology Studies of Isobutyl Nitrite

	Male F344/N Rats	Female F344/N Rats	Male B6C3F ₁ Mice	Female B6C3F ₁ Mice
Doses	0, 37.5, 75, or 150 ppm isobutyl nitrite by inhalation	0, 37.5, 75, or 150 ppm isobutyl nitrite by inhalation	0, 37.5, 75, or 150 ppm isobutyl nitrite by inhalation	0, 37.5, 75, or 150 ppm isobutyl nitrite by inhalation
Body weights	150 ppm group slightly lower than controls	150 ppm group slightly lower than controls	Exposed groups similar to controls	150 ppm group lower than controls
2-Year survival rates	17/46, 23/46, 36/46, 28/46	29/46, 35/45, 31/46, 33/46	37/50, 35/50, 35/50, 30/53	32/51, 42/51, 36/50, 37/50
Nonneoplastic effects	<u>Lung</u> : alveolar epithelial hyperplasia (5/46, 8/46, 26/46, 31/46)	<u>Lung</u> : alveolar epithelial hyperplasia (3/46, 10/45, 11/46, 30/46)	<u>Lung</u> : alveolar epithelial hyperplasia (0/50, 4/50, 7/49, 13/53) <u>Thyroid gland</u> : follicular cell hyperplasia (8/50, 17/50, 12/50, 20/53) <u>Spleen</u> : hemosiderin pigmentation (28/50, 19/50, 46/49, 49/51)	<u>Lung</u> : alveolar epithelial hyperplasia (0/51, 2/51, 9/50, 8/50) <u>Nose</u> : serous exudate (1/51, 1/51, 2/50, 23/50); olfactory epithelial atrophy (0/51, 0/51, 1/50, 16/50)
Neoplastic effects	<u>Lung</u> : alveolar/bronchiolar adenoma (0/46, 3/46, 12/46, 13/46); alveolar/bronchiolar carcinoma (1/46, 2/46, 1/46, 6/46); alveolar/bronchiolar adenoma or carcinoma (1/46, 5/46, 13/46, 15/46)	<u>Lung</u> : alveolar/bronchiolar adenoma (0/46, 2/45, 2/46, 10/46); alveolar/bronchiolar adenoma or carcinoma (0/46, 3/45, 2/46, 11/46)	<u>Lung</u> : alveolar/bronchiolar adenoma (7/50, 12/50, 13/49, 17/53); alveolar/bronchiolar adenoma or carcinoma (8/50, 16/50, 16/49, 19/53)	<u>Lung</u> : alveolar/bronchiolar adenoma (4/51, 14/51, 7/50, 17/50); alveolar/bronchiolar adenoma or carcinoma (6/51, 15/51, 9/50, 19/50)
Uncertain findings	None	None	<u>Thyroid gland</u> : follicular cell adenoma (1/50, 0/50, 0/50, 5/53)	None
Decreased incidences	<u>Mononuclear cell leukemia</u> : (27/46, 2/46, 1/46, 1/46)	<u>Mononuclear cell leukemia</u> : (14/46, 1/45, 0/46, 1/46)	None	None
Level of evidence of carcinogenic activity	Clear evidence	Clear evidence	Some evidence	Some evidence
Genetic toxicology				
	<i>Salmonella typhimurium</i> gene mutations:		Positive in strains TA100 and TA1535 with S9; negative in TA100 and TA1535 without S9; negative in TA98 and TA1537 with and without S9	
	Sister chromatid exchanges			
	Cultured Chinese hamster ovary cells <i>in vitro</i> :		Positive with and without S9	
	Chromosomal aberrations			
	Cultured Chinese hamster ovary cells <i>in vitro</i> :		Positive with and without S9	
	Sex-linked recessive lethal mutations			
	<i>Drosophila melanogaster</i> :		Negative when administered by feed or injection	
	Micronucleated erythrocytes			
	Mouse peripheral blood <i>in vivo</i> :		Positive in male and female mice	

EXPLANATION OF LEVELS OF EVIDENCE OF CARCINOGENIC ACTIVITY

The National Toxicology Program describes the results of individual experiments on a chemical agent and notes the strength of the evidence for conclusions regarding each study. Negative results, in which the study animals do not have a greater incidence of neoplasia than control animals, do not necessarily mean that a chemical is not a carcinogen, inasmuch as the experiments are conducted under a limited set of conditions. Positive results demonstrate that a chemical is carcinogenic for laboratory animals under the conditions of the study and indicate that exposure to the chemical has the potential for hazard to humans. Other organizations, such as the International Agency for Research on Cancer, assign a strength of evidence for conclusions based on an examination of all available evidence, including animal studies such as those conducted by the NTP, epidemiologic studies, and estimates of exposure. Thus, the actual determination of risk to humans from chemicals found to be carcinogenic in laboratory animals requires a wider analysis that extends beyond the purview of these studies.

Five categories of evidence of carcinogenic activity are used in the Technical Report series to summarize the strength of the evidence observed in each experiment: two categories for positive results (**clear evidence** and **some evidence**); one category for uncertain findings (**equivocal evidence**); one category for no observable effects (**no evidence**); and one category for experiments that cannot be evaluated because of major flaws (**inadequate study**). These categories of interpretative conclusions were first adopted in June 1983 and then revised in March 1986 for use in the Technical Report series to incorporate more specifically the concept of actual weight of evidence of carcinogenic activity. For each separate experiment (male rats, female rats, male mice, female mice), one of the following five categories is selected to describe the findings. These categories refer to the strength of the experimental evidence and not to potency or mechanism.

- **Clear evidence** of carcinogenic activity is demonstrated by studies that are interpreted as showing a dose-related (i) increase of malignant neoplasms, (ii) increase of a combination of malignant and benign neoplasms, or (iii) marked increase of benign neoplasms if there is an indication from this or other studies of the ability of such tumors to progress to malignancy.
- **Some evidence** of carcinogenic activity is demonstrated by studies that are interpreted as showing a chemical-related increased incidence of neoplasms (malignant, benign, or combined) in which the strength of the response is less than that required for clear evidence.
- **Equivocal evidence** of carcinogenic activity is demonstrated by studies that are interpreted as showing a marginal increase of neoplasms that may be chemical related.
- **No evidence** of carcinogenic activity is demonstrated by studies that are interpreted as showing no chemical-related increases in malignant or benign neoplasms.
- **Inadequate study** of carcinogenic activity is demonstrated by studies that, because of major qualitative or quantitative limitations, cannot be interpreted as valid for showing either the presence or absence of carcinogenic activity.

When a conclusion statement for a particular experiment is selected, consideration must be given to key factors that would extend the actual boundary of an individual category of evidence. Such consideration should allow for incorporation of scientific experience and current understanding of long-term carcinogenesis studies in laboratory animals, especially for those evaluations that may be on the borderline between two adjacent levels. These considerations should include:

- adequacy of the experimental design and conduct;
- occurrence of common versus uncommon neoplasia;
- progression (or lack thereof) from benign to malignant neoplasia as well as from preneoplastic to neoplastic lesions;
- some benign neoplasms have the capacity to regress but others (of the same morphologic type) progress. At present, it is impossible to identify the difference. Therefore, where progression is known to be a possibility, the most prudent course is to assume that benign neoplasms of those types have the potential to become malignant;
- combining benign and malignant tumor incidence known or thought to represent stages of progression in the same organ or tissue;
- latency in tumor induction;
- multiplicity in site-specific neoplasia;
- metastases;
- supporting information from proliferative lesions (hyperplasia) in the same site of neoplasia or in other experiments (same lesion in another sex or species);
- presence or absence of dose relationships;
- statistical significance of the observed tumor increase;
- concurrent control tumor incidence as well as the historical control rate and variability for a specific neoplasm;
- survival-adjusted analyses and false positive or false negative concerns;
- structure-activity correlations; and
- in some cases, genetic toxicology.

**NATIONAL TOXICOLOGY PROGRAM BOARD OF SCIENTIFIC COUNSELORS
TECHNICAL REPORTS REVIEW SUBCOMMITTEE**

The members of the Technical Reports Review Subcommittee who evaluated the draft NTP Technical Report on isobutyl nitrite on November 29, 1994, are listed below. Subcommittee members serve as independent scientists, not as representatives of any institution, company, or governmental agency. In this capacity, subcommittee members have five major responsibilities in reviewing NTP studies:

- to ascertain that all relevant literature data have been adequately cited and interpreted,
- to determine if the design and conditions of the NTP studies were appropriate,
- to ensure that the Technical Report presents the experimental results and conclusions fully and clearly,
- to judge the significance of the experimental results by scientific criteria, and
- to assess the evaluation of the evidence of carcinogenic activity and other observed toxic responses.

Arnold L. Brown, M.D., Chair
University of Wisconsin Medical School
Madison, WI

Irma Russo, M.D.
Fox Chase Cancer Center
Philadelphia, PA

Thomas L. Goldsworthy, Ph.D., Principal Reviewer
Department of Experimental Pathology and Toxicology
Chemical Industry Institute of Toxicology
Research Triangle Park, NC

Louise Ryan, Ph.D.
Division of Biostatistics
Harvard School of Public Health and
Dana-Farber Cancer Institute
Boston, MA

Meryl H. Karol, Ph.D., Principal Reviewer*
Department of Environmental Occupational Health
University of Pittsburgh
Pittsburgh, PA

Robert E. Taylor, M.D., Ph.D., Principal Reviewer
Department of Pharmacology
Howard University College of Medicine
Washington, DC

Curtis D. Klaassen, Ph.D.
Department of Pharmacology and Toxicology
University of Kansas Medical Center
Kansas City, KS

Mary Jo Vodcnik, Ph.D.*
Lilly MSG Development Center
Belgium

Claudia S. Miller, M.D., M.S.
University of Texas Health Sciences Center
San Antonio, TX

Jerrold M. Ward, D.V.M., Ph.D.*
National Cancer Institute
Frederick, MD

Janardan K. Reddy, M.D.*
Department of Pathology
Northwestern University Medical School
Chicago, IL

* Did not attend

SUMMARY OF TECHNICAL REPORTS REVIEW SUBCOMMITTEE COMMENTS

On November 29, 1994, the draft Technical Report on the toxicology and carcinogenesis studies of isobutyl nitrite received public review by the National Toxicology Program's Board of Scientific Counselors' Technical Reports Review Subcommittee. The review meeting was held at the National Institute of Environmental Health Sciences, Research Triangle Park, NC.

Dr. K.M. Abdo, NIEHS, introduced the toxicology and carcinogenesis studies of isobutyl nitrite by discussing the uses of the chemical and rationale for study, describing the experimental design, reporting on survival and body weight effects, and commenting on the chemical-related neoplastic and nonneoplastic lesions in male and female rats and mice. The proposed conclusions were *clear evidence of carcinogenic activity* in male and female F344/N rats and *some evidence of carcinogenic activity* in male and female B6C3F₁ mice.

Dr. Taylor, a principal reviewer, agreed with the proposed conclusions. He commented that a statement in the Introduction should be amended to indicate that the only data in the literature on the carcinogenicity of isobutyl nitrite in humans were equivocal and came from an immunocompromised population. Dr. Abdo agreed (page 18).

Dr. Karol, the second principal reviewer, was unable to attend the meeting but had submitted her review, which Dr. L.G. Hart, NIEHS, read into the record. Dr. Karol agreed with the proposed conclusions. She stated that because the rationale for studying isobutyl nitrite was its possible contribution to the high incidence of Kaposi's sarcoma among male homosexuals with acquired immune deficiency syndrome (AIDS), a discussion of the relevance of the findings to the development of the lesions in AIDS patients should be added. Dr. Abdo acknowledged that the primary neoplastic lesions were in the lungs while

Kaposi's sarcoma is a skin lesion, but he noted that it is not unusual for a chemical to have different target sites in different species. Dr. R.C. Sills, NIEHS, commented that laboratory rodents have no spontaneously occurring lesions morphologically similar to Kaposi's sarcoma in humans.

Dr. Goldsworthy, the third principal reviewer, agreed with the proposed conclusions although he thought that if further certainty could be obtained associating chemical exposure with increased thyroid follicular cell adenomas, the conclusion could be changed to clear evidence in male mice. Dr. Sills responded that these neoplasms were placed in the category of uncertain findings because there was no significant increase in the incidence of follicular cell carcinomas, no dose-response relationship for follicular cell adenomas, and no similar response in female mice. Dr. Goldsworthy commented on the differing purity of the four different lots of isobutyl nitrite and wondered if this could have affected the observed results. Dr. Abdo reported that the lots used for the 2-year studies were 97% to 99% pure and it was thought that the results were not affected by the level of contaminant present.

Dr. Miller asked whether there was information on the short-term concentrations that humans would experience in using the chemical, presumably from aerosol cans. Dr. Abdo said the labels on the cans did not give concentrations.

Dr. Taylor moved that the Technical Report on isobutyl nitrite be accepted with the revisions discussed and with the conclusions as written for male and female rats, *clear evidence of carcinogenic activity* in male and female F344/N rats and *some evidence of carcinogenic activity* for male and female B6C3F₁ mice. Dr. Russo seconded the motion, which was accepted unanimously with six votes.

INTRODUCTION

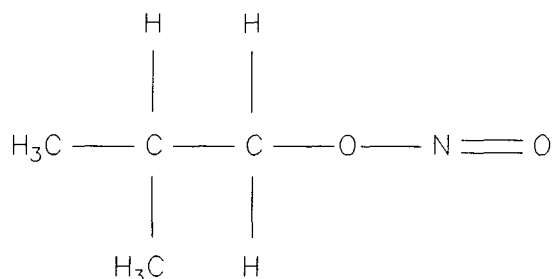

ISOBUTYL NITRITE

CAS No. 542-56-3

Chemical Formula: $\text{C}_4\text{H}_9\text{NO}_2$ Molecular Weight: 103.12

Synonyms: IBN; iso-butyl nitrite; nitrous acid, isobutyl ester; nitrous acid, 2-methylpropyl ester

CHEMICAL AND PHYSICAL PROPERTIES

Isobutyl nitrite is a colorless, volatile liquid with a molecular weight of 103.12, a density of 0.87 at 22° C, and a boiling point of 67° C (*Merck Index*, 1989). It is miscible with alcohol, but slightly soluble and gradually decomposed by water. The half-life of isobutyl nitrite in distilled water is approximately 1 hour (Mirvish *et al.*, 1983). Isobutyl nitrite is synthesized by reacting isobutyl alcohol with sodium nitrite in dilute sulfuric acid.

PRODUCTION, USE, AND HUMAN EXPOSURE

Isobutyl nitrite is used to a limited extent as an intermediate in the syntheses of aliphatic nitrites (*Patty's Industrial Hygiene and Toxicology*, 1982). It is also sold as an incense or room odorizer under different trade names (Sigell *et al.*, 1978; Rees *et al.*, 1986). Isobutyl nitrite has been used as a jet propellant and in the preparation of fuels (*Patty's Industrial Hygiene and Toxicology*, 1963).

Amyl nitrite, the prototype of aliphatic nitrites, has been used medically since 1867 for relief from

attacks of angina pectoris (Brunton, 1867). Because of a sharp rise in sales of amyl nitrite in the 1960's due to its misuse as an aphrodisiac, the Food and Drug Administration (FDA) made it a prescription drug in 1968 (Israelstam *et al.*, 1978). Recreational users then turned to other volatile nitrites including isobutyl nitrite during the early 1970's, creating an estimated \$50 million business (Sigell *et al.*, 1978). Use of these volatile nitrites was most common by those individuals frequenting homosexual bars, discotheques, and steam baths (Israelstam *et al.*, 1978). Some discotheques were reported to have sprayed nitrite fumes over dance floors (Sigell *et al.*, 1978). Users of these drugs are primarily from one of the following groups: juveniles (ages 11 to 17) chronic drug users; experimental drug users; and male homosexuals (Jacobs and Rivero, 1978).

The Occupational Safety and Health Administration has not adopted a permissible exposure limit for occupational exposure to isobutyl nitrite; the American Conference of Governmental Industrial Hygienists has not established a threshold limit value for this chemical. Since isobutyl nitrite does not meet the definition of a food, drug, or cosmetic, it is not regulated by the FDA.

ABSORPTION, DISTRIBUTION, METABOLISM, AND EXCRETION

Data on the absorption, distribution, metabolism, and excretion of isobutyl nitrite and other volatile nitrites are limited. Butyl nitrites are thought to be hydrolyzed *in vivo* to the nitrite and the corresponding alcohol. Mortality in mice from exposure to isobutyl nitrite and other volatile nitrites is due to severe methemoglobinemia (McFadden *et al.*, 1981), which indicates that the chemical is absorbed by these animals.

Isobutyl nitrite vapors accelerate the peroxidation of methylinoleate in mice in the presence of light (Mirvish *et al.*, 1988). The reaction is attributed to the photolysis of isobutyl nitrite and the subsequent production of nitric oxide and an isobutoxyl radical (C₄H₉O) which can initiate peroxidation. Nitrite esters including isobutyl nitrite were found to react readily with secondary amines to form nitrosamines (Doyle *et al.*, 1983; Dabora *et al.*, 1984; Loeppky *et al.*, 1984). This nitrosation reaction suggests a possible mechanism of carcinogenicity for isobutyl nitrite and other volatile nitrites.

PHARMACOLOGY

Experimental Animals

The vasodilating effect of nitrites is related to their ability to activate guanylate cyclase and increase the synthesis of guanosine 3',5'-monophosphate (cyclic GMP) in smooth muscle and other tissues (Mittal and Murad, 1982; Rapoport and Murad, 1983). Nitrites lead to the formation of the reactive radical nitric oxide, which interacts with and activates guanylate cyclase. A cyclic GMP-dependent protein kinase is thus stimulated, which alters the phosphorylation of various proteins in smooth muscle. This eventually leads to the dephosphorylation of the light chain of myosin, an important protein in the muscle contraction process (Rapoport and Murad, 1983).

Humans

Volatile nitrites are vasodilators which exert their effect by relaxing the involuntary muscles of the blood vessels with a consequent lowering of blood pressure. Vasodilation of the cerebral vessels causes an increase in intracranial pressure and produces a euphoric effect which can last up to approximately

one minute (Goodman and Gilman's, 1990). This effect has led to the abuse of isobutyl nitrite as a recreational drug. Volatile nitrites also produce peripheral vasodilation with profound hypotension and cutaneous flushing followed by reflex vasoconstriction and tachycardia (Sigell *et al.*, 1978). Symptoms observed with the use of volatile nitrites include a persistent and throbbing headache with associated vertigo, palpitations and visual disturbances, nausea, vomiting, syncope, cyanosis, and anoxia. At higher exposure concentrations, increased intraocular tension, paralysis followed by chronic convulsions, and death due to respiratory arrest have been observed (Ormstedt, 1978).

The pharmacological effects of alkyl nitrites vary with alkyl chain branching or length (Patty's *Industrial Hygiene and Toxicology*, 1982). The branched chain compounds are more effective than the corresponding straight chains in lowering blood pressure; the *sec*- and *tert*-butyl compounds are more effective than *n*-butyl nitrite. Additionally, short chains are more effective than longer chains; methyl nitrite is more effective than are ethyl and propyl nitrite, while amyl nitrite is more effective than ethyl nitrite. Alkyl nitrites with 11 to 18 carbons had little or no effect on blood pressure when inhaled, but they were more effective when injected.

The butyl alcohol to which isobutyl nitrite is metabolized is not without a pharmacological effect. Isobutyl alcohol acts as a local irritant and at high concentrations is narcotic (Patty's *Industrial Hygiene and Toxicology*, 1963; Ormstedt, 1978).

HEMATOLOGY

Experimental Animals

McFadden *et al.* (1981) showed that isobutyl nitrite and other butyl nitrites were capable of producing methemoglobin *in vitro* and *in vivo* in mice. They suggested that the mechanism of organic nitrite methemoglobin formation may involve direct oxidation of hemoglobin, hydrolysis of nitrous acid ester to yield free nitrite ions that then oxidize hemoglobin, or a combination of these events. Lynch *et al.* (1985) reported that methemoglobinemia was one of the major effects observed following exposure of mice to 300 ppm isobutyl nitrite by inhalation for 6.5 hours per day, 5 days per week, for up to

18 weeks. Slight elevations of methemoglobin were noted in mice exposed similarly to 50 ppm.

Humans

Methemoglobinemia is a characteristic effect of exposure to nitrites (Haley, 1980) and has been previously reported in animals and humans exposed to isobutyl nitrite orally or by inhalation (Wason *et al.*, 1980; Dixon *et al.*, 1981; Shesser *et al.*, 1981).

TOXICITY

Experimental Animals

The reported oral LD₅₀ values for isobutyl nitrite in adult male Swiss-Webster (CD-1) mice are 184 and 205 mg/kg. The cause of death was attributed to anoxia resulting from severe methemoglobinemia.

Treatment with methylene blue given 15 minutes prior to isobutyl nitrite administration decreased mortality by 50% (Maickel and McFadden, 1979; McFadden and Maickel, 1982).

The reported LC₅₀ values of isobutyl nitrite are 1,346 ppm for male Swiss-Webster (CD-1) mice (24 to 30 g) following a 30-minute exposure and 1,033 ppm for male Swiss-Webster (CD-1) mice (20 to 25 g) following a 1-hour exposure (McFadden *et al.*, 1981; Rees *et al.*, 1986). Similar to the oral study discussed previously, the pretreatment of mice in the McFadden *et al.* (1981) inhalation study produced significant reductions in mortality, suggesting an association between mortality due to acute exposure to isobutyl nitrite and blood methemoglobin concentrations. The reported LC₅₀ value for isobutyl nitrite in male Sprague-Dawley rats was 777 ppm following a 4-hour inhalation exposure (Klonne *et al.*, 1987). Toxic signs observed included cyanosis, prostration, and (rarely) convulsions.

Based on the results from toxicity studies of butyl nitrite isomers, the *n*-butyl isomer was the most toxic, followed in decreasing order by *iso*-butyl, *sec*-butyl, and *tert*-butyl isomers.

In a study by Lynch *et al.* (1985), Balb/c mice were exposed to 0, 20, 50, or 300 ppm isobutyl nitrite for 6.5 hours per day, 5 days per week for up to 18 weeks. Body weights were not affected by

exposure to isobutyl nitrite. Methemoglobin concentrations were elevated in male and female mice exposed to 50 or 300 ppm. In addition, decreased leukocyte counts and increased incidences of hyperplasia of the lung epithelium occurred in mice exposed to 300 ppm. With the exception of the decrease observed in leukocyte counts, results of the present studies were similar to results of the Lynch *et al.* (1985) study.

Humans

Dixon *et al.* (1981) reported a case of fatal methemoglobinemia resulting from ingestion of an isobutyl nitrite "room deodorizer" widely used for recreational purposes. In another case, methemoglobinemia occurred in a 36-year-old man who ingested 15 mL of isobutyl nitrite (Wason *et al.*, 1980). He recovered after intravenous infusion with 20 mL of 1% methylene blue solution over a 20-minute period. Acute inhalation exposure to isobutyl nitrite has been reported to produce pulmonary edema and tracheobronchitis (Shesser *et al.*, 1981; Covalla *et al.*, 1981). A severe and prolonged tracheobronchitis was reported in a 23-year-old male following ingestion of two bottles of a room odorizer containing isobutyl nitrite (Covalla *et al.*, 1981).

Symptoms resulting from acute exposure to volatile nitrites include visual disturbances, mental confusion, and unconsciousness. The symptoms are of short duration and reversible. A small percentage of the population is sensitive to the hypotensive effects of volatile nitrites even at therapeutic doses. The hypotensive effect appears to be accentuated by alcohol. Relatively small doses of volatile nitrite can produce syncope in any individual kept in a static upright position (Goodman and Gilman's, 1990). Clinical observations suggest that repeated exposure leads to a tolerance to volatile nitrites with resistance to the nitrite-induced headache developing more readily than resistance to its other pharmacological effects (Goodman and Gilman's, 1990).

A form of organic nitrate dependence is an adverse effect related to chronic exposure. Individuals without demonstrable organic vascular disease have died suddenly or developed myocardial infarctions after a few days break in the chronic exposure. Coronary and digital arteriospasm during withdrawal have been demonstrated (Goodman and Gilman's, 1990).

IMMUNOTOXICITY

Experimental Animals

Lewis *et al.* (1985) found that isobutyl nitrite produced detrimental effects on the immune systems of Balb/c mice exposed to 20, 50, or 300 ppm for 6.4 hours per day, 5 days per week, for up to 18 weeks. Immunology tests used included slide plaque assay, lymphocyte proliferative response to mitogens (phyto-hemagglutinin, concanavalin A, pokeweed mitogen, and lipopolysaccharide), and delayed hypersensitivity response to purified protein using a radiometric skin test. Soderberg and Barnett (1993) found that mice exposed to 750 to 900 ppm isobutyl nitrite for 45 minutes per day for 14 days had depressed IgM and IgG levels. Differences in immunotoxic effects of isobutyl nitrite in males and females were not observed. Antibody responses to a T-independent antigen (DNP-fcoll) were not affected by this exposure. The exposure to isobutyl nitrite did not selectively deplete a particular spleen cell population. Normal immune responses returned 5 to 7 days after final exposure, suggesting that inhibition of cellular function was reversible.

Ratajczak *et al.* (1995) studied the immunotoxicity of isobutyl nitrite following inhalation exposure of B6C3F₁ female mice to 0, 37.5, 75, or 150 ppm for 6 hours per day, 5 days per week, for up to 15 weeks. Both systemic and lung immune functions were examined, including body and lymphoid organ weights, pulmonary macrophage function and host defense, expression of splenic lymphocyte cell surface markers, natural killer cell function, mixed lymphocyte reaction, and induction of specific antibody to a T-cell dependent antigen. There was a dose-related suppression of T-cell dependent responses in the spleen following exposure to isobutyl nitrite. However, other measures of T-cell and nonspecific immunity were not affected. A dose-related increase of hydrogen peroxide production by alveolar macrophages was present after 12 exposures, but not after 68 exposures, to isobutyl nitrite. By contrast, pulmonary host defense mechanisms against *Klebsiella pneumoniae* were unaffected. These results suggest that in the absence of changes in host resistance, isobutyl nitrite may have selective and partially reversible effects on the immune system. The results of this study are in agreement with those from the Soderberg and Barnett (1993) study.

Humans

Isobutyl nitrite, tested at a 1% concentration, lysed human leukocytes and reduced viability from 95% to 21% in 24 hours. When tested at concentrations less than or equal to 0.5%, cell count and viability were unaffected. However, 1% isobutyl nitrite in alcohol added to cultured venous blood inhibited lymphocyte function including blastogenesis, cell-mediated cytotoxicity, and monocyte adherence. Inhibitory effects were greater than 90% when tests were performed with a 0.5% concentration, and still detectable at a 0.1% concentration. Isobutyl nitrite inhibited leucine, uridine, and thymidine incorporation approximately equally (Hersh *et al.*, 1983).

CARCINOGENICITY

Experimental Animals

No information on the potential carcinogenicity of isobutyl nitrite in experimental animals was found in the literature.

Humans

There is no information in the literature concerning the carcinogenicity of isobutyl nitrite in humans. Indirect human data are equivocal and are from an immunocompromised population. The use of volatile nitrites (including isobutyl nitrite) by male homosexuals with AIDS was suggested to play a role in the induction of Kaposi's sarcoma. Marmor *et al.* (1982) reported a significant association between the occurrence of Kaposi's sarcoma and the use of amyl nitrite by homosexual men (12 subjects in study). However, a larger study by the Center for Disease Control did not confirm this association (Jaffe *et al.*, 1983). Haverkos (1988) reviewed the results of six other epidemiology studies, conducted between 1981 and 1986, concerning the use of volatile nitrites and the development of Kaposi's sarcoma. In three of the six studies, there was a strong association between the use of volatile nitrites and the increased incidence of Kaposi's sarcoma, but there was no such association in the other three studies. Thus, the results of these studies were considered inconclusive. The difference between these studies was attributed to the differences in sample size and the type of questionnaires used. The largest study evaluated 150 AIDS patients, 100 with Kaposi's sarcoma; the smallest study evaluated 12 patients, eight with Kaposi's

sarcoma. As for the questionnaires, those used in earlier studies tended to seek more information on nitrite inhalants, while those used for the later studies focused more on sexual activities rather than non-intravenous drug use.

GENETIC TOXICITY

Alkyl nitrites are demonstrated mutagens in *Salmonella*. Isobutyl nitrite induced mutation in *Salmonella typhimurium* strains TA100 and TA1535, which revert via base pair substitution (Quinto, 1980; Mortelmans *et al.*, 1986; Dunkel *et al.*, 1989). Although mutagenicity was reported with and without S9, the response with S9 was stronger. Mutagenic activity in *Salmonella* was also reported for the structural analogues ethyl nitrite (Ehrenberg *et al.*, 1980; Wild *et al.*, 1983), methyl nitrite (Törnqvist *et al.*, 1983), butyl nitrite, propyl nitrite, amyl nitrite, and sec-butyl nitrite (Quinto, 1980; Dunkel *et al.*, 1989).

Mutagenicity information on alkyl nitrites from other testing systems is sparse. In L5178Y mouse lymphoma cells, isobutyl nitrite and four structural analogues (butyl, iso-amyl, sec-butyl, and propyl nitrite) induced dose-dependent increases in mutant frequencies with and without S9 activation (Dunkel *et al.*, 1989). Isobutyl nitrite, administered by feeding (10,000 ppm) or injection (25,000 ppm), did

not induce sex-linked recessive lethal mutations in male Canton-S *Drosophila melanogaster* (Woodruff *et al.*, 1985). Positive results were reported in this assay for ethyl nitrite, however, only when male Berlin-K *Drosophila* were exposed to 1,200 ppm by inhalation (Wild *et al.*, 1983). In a mouse bone marrow micronucleus test, Wild *et al.* (1983) reported negative results with ethyl nitrite (75 mg/kg as a single intraperitoneal injection or gavage administration). Positive results from a micronucleus test with isobutyl nitrite (exposure to 1,200 ppm for 90 days via inhalation) are reported in Appendix E of this report, along with positive results from *in vitro* cytogenetics assays.

STUDY RATIONALE

Isobutyl nitrite was nominated by the Consumer Product Safety Commission to the NTP for toxicology and carcinogenicity studies because of its possible contribution to the high incidence of Kaposi's sarcoma among male homosexual AIDS patients and because of the paucity of available data on the potential carcinogenicity of isobutyl nitrite. Additionally, the chemical has a high potential for forming nitrosamines by reacting with biological amines (Dabora *et al.*, 1984; Osterloh and Goldfield, 1984). The inhalation route of exposure was used in the present studies because human exposure occurs primarily via this route.

MATERIALS AND METHODS

PROCUREMENT AND CHARACTERIZATION OF ISOBUTYL NITRITE

Isobutyl nitrite was obtained in four lots. Lot 196 was obtained from Frank Enterprises, Inc. and was used during the 16-day studies and at the beginning of the 13-week studies. Lots KL-XIV-14A, KL-VIII-48-0, and KL-30-49-A were obtained from King's Laboratories, Inc. (Blythewood, SC). Lot KL-XIV-14A was used throughout the remainder of the 13-week studies and for the beginning of the 2-year studies. Lots KL-VIII-48-0 and KL-30-49-A were used throughout the remainder of the 2-year studies. Identity and purity analyses were conducted by the analytical chemistry laboratory, Midwest Research Institute (Kansas City, MO). Reports on analyses performed in support of the isobutyl nitrite studies are on file at the National Institute of Environmental Health Sciences (NIEHS). The methods and results of these studies are detailed in Appendix I.

The chemical, a clear, yellowish liquid, was identified as isobutyl nitrite by infrared, ultraviolet/visible, and nuclear magnetic resonance spectroscopy. The purity was determined by elemental analysis, free acid titration, and gas chromatography. Elemental analyses for carbon, hydrogen, and nitrogen were in general agreement with the theoretical values for isobutyl nitrite for all lots. Free acid titration indicated concentrations ranging from 0.004% to 0.208%. Gas chromatography indicated one major peak and two to four impurity peaks with a total area ranging from 7.52% relative to the major peak for lot 196 to 1.1% relative to the major peak area for lot KL-30-49-A. The major impurity was identified as isobutyl alcohol by retention time matching and was quantitated by gas chromatography with values of 6.0%, 1.7%, 2.4%, and 0.86% for lots 196, KL-XIV-14A, KL-VIII-48-0, and KL-30-49-A, respectively. The overall purity of lots 196, KL-XIV-14A, KL-VIII-48-0, and KL-30-49-A was

determined to be approximately 93%, 97%, 97%, and 99%, respectively.

GENERATION AND MONITORING OF CHAMBER CONCENTRATIONS

Isobutyl nitrite vapor was generated into the exposure chambers (Hazleton 2000, Lab Products, Inc., Maywood, NJ) by pumping liquid isobutyl nitrite from reservoir bottles to glass vapor transpiration bubblers where a controlled flow of nitrogen carrier gas was passed through it (Figures I3 to I4d). Chamber concentrations were monitored by gas chromatography. Routine sampling of chamber atmospheres for isobutyl nitrite and isobutyl alcohol was made by manually withdrawing grab samples from a single representative port in the front of each chamber with a gas-tight syringe and manually injecting the sample directly into the gas chromatograph. Excellent control of chamber concentrations was maintained throughout the studies. Summaries of the chamber concentrations for the 16-day, 13-week, and 2-year studies are in Tables I1 to I3. The monthly mean exposure concentrations in the chambers of the 2-year studies are presented in Figures I6 to I11.

CHAMBER ATMOSPHERE CHARACTERIZATION

Buildup and decay rates for isobutyl nitrite chamber concentrations were monitored using gas chromatography. The experimental time to achieve 90% of target concentration after the start of vapor generation (T_{90}) for all studies ranged from 3 to 10 minutes. A T_{90} of 10 minutes was chosen for all studies. The time required for test article concentration to decay to 10% of the target concentration after the vapor generation was stopped was determined using the same method used for the T_{90} determinations. The experimental decay times ranged from 9 to 20 minutes.

Uniformity of vapor concentration in the inhalation exposure chambers was evaluated once during the 16-day studies, once prior to and once during the 13-week studies, and once prior to and then approximately every 90 days during the 2-year studies. Chamber atmosphere uniformity (5% relative standard deviation) was maintained throughout the 16-day, 13-week, and 2-year studies. The inhalation chambers were sampled for the isobutyl nitrite degradation products isobutyl alcohol and nitrous acid during the 16-day (all exposure groups), 13-week (75, 150, and 300 ppm exposure concentrations), and 2-year (all exposure groups) studies. The concentration of nitrous acid did not exceed 0.147 ppm. Relative daily average isobutyl alcohol concentrations ranged from 1.3% to 6.4% of the isobutyl nitrite chamber concentrations.

16-DAY STUDIES

Male and female F344/N rats and B6C3F₁ mice were obtained from Simonsen Laboratories (Gilroy, CA). On receipt, the rats and mice were approximately 3 weeks old. Animals were quarantined for 11 days (rats) or 12 days (mice) and were approximately 5 weeks old on the first day of the studies. Groups of five male and five female rats and mice were exposed to isobutyl nitrite at concentrations of 0, 100, 200, 400, 600, or 800 ppm (approximately 420, 840, 1,700, 2,500, or 3,300 mg/m³). The animals were exposed for 6 hours plus T₉₀ (10 minutes) per day, 5 days per week for 12 exposure days during a 16-day period. Feed was available *ad libitum* (except during exposure periods), and water was available *ad libitum*. Rats and mice were housed individually. Clinical findings were recorded twice daily for rats and mice. The animals were weighed initially, weekly, and at the end of the studies. Details of the study design and animal maintenance are summarized in Table 1.

A necropsy was performed on all rats and mice. The brain, heart, right kidney, liver, lung, right testis, and thymus were weighed. Histopathologic examinations were performed on all control, 400, 600, and 800 ppm rats and on all control and exposed mice. Table 1 lists the tissues and organs examined.

13-WEEK STUDIES

The 13-week studies were conducted to evaluate the cumulative toxic effects of repeated exposure to isobutyl nitrite and to determine the appropriate doses to be used in the 2-year studies.

Male and female F344/N rats and B6C3F₁ mice were obtained from Simonsen Laboratories (Gilroy, CA). On receipt, the rats and mice were approximately 4 weeks old. Animals were quarantined for 14 days (rats) or 15 days (mice) and were approximately 6 weeks old on the first day of the studies. Before initiation of the studies, five male and five female rats and mice were randomly selected for parasite evaluation and gross observation for evidence of disease. At the end of the studies, serologic analyses were performed on five male and five female control rats and five male and five female sentinel mice using the protocols of the NTP Sentinel Animal Program (Appendix K).

Groups of 10 male and 10 female rats and mice were exposed to isobutyl nitrite at concentrations of 0, 10, 25, 75, 150, or 300 ppm (approximately 42, 105, 315, 630, or 1,260 mg/m³). The animals were exposed for 6 hours plus T₉₀ (10 minutes) per day, 5 days per week for 13 weeks (excluding holidays). Feed was available *ad libitum* (except during exposure periods), and water was available *ad libitum*. Rats and mice were housed individually. Clinical findings were recorded twice daily during the first week and then weekly for the remainder of the study for rats and mice. The animals were weighed initially, on study day 8, weekly thereafter, and at necropsy. Details of the study design and animal maintenance are summarized in Table 1.

At the end of the 13-week studies, blood was collected from all rats and mice from the retro-orbital sinus for hematology and clinical chemistry analyses. The rats were anesthetized with CO₂. Blood for hematology determinations was placed in tubes containing potassium EDTA as the anticoagulant. Blood for clinical chemistry analyses was placed in tubes without anticoagulant, allowed to clot at room temperature, centrifuged, and the serum separated. Hematology determinations were performed with a

Baker 7000 hematology analyzer (Baker Instruments, Allentown, PA). Clinical chemistry and methemoglobin determinations were performed with a Baker Centrifichem 500 automated analyzer. Leukocyte differential counts and morphologic evaluation of blood cells were determined by light microscopic examination of blood films stained with Wright-Giemsa. Reticulocyte counts were determined by light microscopy, using smears prepared by incubating equal volumes of whole blood and new methylene blue and a Miller disc for reticulocyte quantitation. The clinical pathology parameters evaluated are listed in Table 1.

At the end of the 13-week studies, samples were collected from all rats and mice for sperm morphology and vaginal cytology evaluations. The parameters evaluated are listed in Table 1. Methods used were those described in NTP's sperm morphology and vaginal cytology evaluations protocol (NTP, 1983). For 7 consecutive days prior to scheduled terminal sacrifice, the vaginal vaults of the females were moistened with saline, if necessary, and samples of vaginal fluid and cells were stained. Relative numbers of leukocytes, nucleated epithelial cells, and large squamous epithelial cells were determined and used to ascertain estrous cycle stage (i.e., diestrus, proestrus, estrus, and metestrus). Male rats and mice were evaluated for sperm morphology, count, and motility. The right testis and right epididymis were isolated and weighed. The tail of the epididymis (cauda epididymis) was then removed from the epididymal body (corpus epididymis) and weighed. Test yolk (rats) or modified Tyrode's buffer (mice) was applied to slides and a small incision was made at the distal border of the cauda epididymis. The sperm effluxing from the incision were dispersed in the buffer on the slides, and the numbers of motile and nonmotile spermatozoa were counted for five fields per slide by two observers. Following completion of sperm motility estimates, each right cauda epididymis was placed in buffered saline solution. Caudae were finely minced, and the tissue was incubated in the saline solution and then heat fixed at 65° C. Sperm density was then determined microscopically with the aid of a hemacytometer. To quantify spermatogenesis, testicular spermatid head count was determined by removing the tunica albuginea and homogenizing the left testis in phosphate-buffered saline containing

10% dimethyl sulfoxide. Homogenization-resistant spermatid nuclei were counted with a hemacytometer.

A necropsy was performed on all animals. The brain, heart, right kidney, liver, lung, right testis, and thymus were weighed. Tissues for microscopic examination were fixed and preserved in 10% neutral buffered formalin, processed and trimmed, embedded in paraffin, sectioned to a thickness of 5 to 6 μm , and stained with hematoxylin and eosin. A complete histopathologic examination was performed on all control and 300 ppm rats and mice and on select organs in lower exposure groups. Table 1 lists the tissues and organs routinely examined.

2-YEAR STUDIES

Study Design

Groups of 56 male and 56 female rats and 60 male and 60 female mice were exposed to isobutyl nitrite at concentrations of 0, 37.5, 75, and 150 ppm (approximately 158, 315, or 630 mg/m^3) for 6 hours plus T_{90} (10 minutes) per day, 5 days per week for 103 weeks followed by a 1-week observation period. As many as 10 male and 10 female rats and mice from each group were evaluated at 15 months for alterations in hematology, histology, and clinical chemistry parameters.

Source and Specification of Animals

Male and female F344/N rats and B6C3F₁ mice were obtained from Simonsen Laboratories (Gilroy, CA). Rats were quarantined for 15 days and mice were quarantined for 13 days before the beginning of the studies. Five male and five female rats and mice were selected for parasite evaluation and gross observation of disease. Rats and mice were approximately 6 weeks old at the beginning of the studies. The health of the animals was monitored during the studies according to the protocols of the NTP Sentinel Animal Program (Appendix K).

Animal Maintenance

Rats and mice were housed individually. Feed was available *ad libitum* (except during exposure periods), and water was available *ad libitum*. Cages and racks were rotated weekly. Further details of animal maintenance are given in Table 1. Information on feed composition and contaminants is provided in Appendix J.

Clinical Examinations and Pathology

All animals were observed twice daily. Clinical findings were recorded monthly, and body weights were recorded weekly for the first 13 weeks, at week 16, monthly thereafter, and at the end of the studies.

As many as 10 male and 10 female rats and mice per exposure group were designated for interim evaluation at 15 months. Blood was taken from the retro-orbital sinus of rats and mice for hematology and clinical chemistry analyses. The methods used were those described for the 13-week studies. Clinical pathology parameters evaluated are listed in Table 1.

A complete necropsy and microscopic examination were performed on all rats and mice. At the 15-month interim evaluation necropsy, the brain, right kidney, and liver of rats and mice were weighed. At necropsy, all organs and tissues were examined for grossly visible lesions, and all major tissues were fixed and preserved in 10% neutral buffered formalin, processed and trimmed, embedded in paraffin, sectioned to a thickness of 5 to 6 μm , and stained with hematoxylin and eosin for microscopic examination. For all paired organs (i.e., adrenal gland, kidney, ovary), samples from each organ are examined. Tissues examined microscopically are listed in Table 1.

Microscopic evaluations were completed by the study laboratory pathologist, and the pathology data were entered into the Toxicology Data Management System. The microscopic slides, paraffin blocks, and residual wet tissues were sent to the NTP Archives for inventory, slide/block match, and wet tissue audit. The slides, individual animal data records, and pathology tables were evaluated by an independent quality assessment laboratory. The individual animal records and tables were compared for accuracy, the slide and tissue counts were verified, and the histotechnique was evaluated. For the 2-year studies, a quality assessment pathologist reviewed the bone marrow, livers, lungs, and spleens of male and female rats, lungs of male and female mice, and thyroid glands of male mice.

The quality assessment report and slides were submitted to the NTP Pathology Working Group (PWG) chair, who reviewed the selected tissues and any

other tissues for which a disagreement in diagnosis between the laboratory and quality assessment pathologists existed. Representative histopathology slides containing examples of lesions related to chemical administration, examples of disagreements in diagnoses between the laboratory and quality assessment pathologist, or lesions of general interest were presented by the chair to the PWG for review. The PWG consisted of the quality assessment pathologist and other pathologists experienced in rodent toxicologic pathology. This group examined the tissues without any knowledge of dose groups or previously rendered diagnoses. When the PWG consensus differed from the opinion of the laboratory pathologist, the diagnosis was changed. Thus, the final diagnoses represent a consensus of contractor pathologists and the PWG. Details of these review procedures have been described, in part, by Maronpot and Boorman (1982) and Boorman *et al.* (1985). For subsequent analyses of the pathology data, the diagnosed lesions for each tissue type were evaluated separately or combined according to the guidelines of McConnell *et al.* (1986).

STATISTICAL METHODS

Survival Analyses

The probability of survival was estimated by the product-limit procedure of Kaplan and Meier (1958) and is presented in the form of graphs. Animals found dead of other than natural causes or missing were censored from the survival analyses; animals dying from natural causes were not censored. Statistical analyses for possible dose-related effects on survival used Cox's (1972) method for testing two groups for equality and Tarone's (1975) life table test to identify dose-related trends. All reported P values for the survival analyses are two sided.

Calculation of Incidence

The incidences of neoplasms or nonneoplastic lesions as presented in Tables A1, A5, B1, B5, C1, C5, D1, and D5 are given as the number of animals bearing such lesions at a specific anatomic site and the number of animals with that site examined microscopically. For calculation of statistical significance, the incidences of most neoplasms (Tables A3, B3, C3, and D3) and all nonneoplastic lesions are given as the numbers of animals affected at each site examined microscopically. However, when

macroscopic examination was required to detect neoplasms in certain tissues (e.g., harderian gland, intestine, mammary gland, skin) before microscopic evaluation, or when neoplasms had multiple potential sites of occurrence (e.g., leukemia or lymphoma), the denominators consist of the number of animals on which a necropsy was performed. Tables A3, B3, C3, and D3 also give the survival-adjusted neoplasm rate for each group and each site-specific neoplasm, i.e., the Kaplan-Meier estimate of the neoplasm incidence that would have been observed at the end of the study in the absence of mortality from all other competing risks (Kaplan and Meier, 1958).

Analysis of Neoplasm Incidences

The majority of neoplasms in these studies were considered to be incidental to the cause of death or not rapidly lethal. Thus, the primary statistical method used was logistic regression analysis, which assumed that the diagnosed neoplasms were discovered as the result of death from an unrelated cause and thus did not affect the risk of death. In this approach, neoplasm prevalence was modeled as a logistic function of chemical exposure and time. Both linear and quadratic terms in time were incorporated initially, and the quadratic term was eliminated if the fit of the model was not significantly enhanced. The neoplasm incidences of exposed and control groups were compared on the basis of the likelihood score test for the regression coefficient of dose. This method of adjusting for intercurrent mortality is the prevalence analysis of Dinse and Lagakos (1983), further described and illustrated by Dinse and Haseman (1986). When neoplasms are incidental, this comparison of the time-specific neoplasm prevalences also provides a comparison of the time-specific neoplasm incidences (McKnight and Crowley, 1984).

In addition to logistic regression, other methods of statistical analysis were used, and the results of these tests are summarized in the appendixes. These methods include the life table test (Cox, 1972; Tarone, 1975), appropriate for rapidly lethal neoplasms, and the Fisher exact test and the Cochran-Armitage trend test (Armitage, 1971; Gart *et al.*, 1979), procedures based on the overall proportion of neoplasm-bearing animals.

Tests of significance included pairwise comparisons of each exposed group with controls and a test for an

overall dose-related trend. Continuity-corrected tests were used in the analysis of neoplasm incidence, and reported P values are one sided. The procedures described in the preceding paragraphs were also used to evaluate selected nonneoplastic lesions. For further discussion of these statistical methods, refer to Haseman (1984).

Analysis of Nonneoplastic Lesion Incidences

Because all nonneoplastic lesions in this study were considered to be incidental to the cause of death or not rapidly lethal, the primary statistical analysis used was a logistic regression analysis in which nonneoplastic lesion prevalence was modeled as a logistic function of chemical exposure and time. For lesions detected at the interim evaluation, the Fisher exact test was used, a procedure based on the overall proportion of affected animals.

Analysis of Continuous Variables

Two approaches were employed to assess the significance of pairwise comparisons between exposed and control groups in the analysis of continuous variables. Organ and body weight data, which have approximately normal distributions, were analyzed using the parametric multiple comparison procedures of Dunnett (1955) and Williams (1971, 1972). Clinical pathology, spermatid, and spermatozoal data, which have typically skewed distributions, were analyzed using the nonparametric multiple comparison methods of Shirley (1977) and Dunn (1964). Jonckheere's test (Jonckheere, 1954) was used to assess the significance of the dose-related trends and to determine whether a trend-sensitive test (Williams' or Shirley's test) was more appropriate for pairwise comparisons than a test that does not assume a monotonic dose-related trend (Dunnett's or Dunn's test). Prior to statistical analysis, extreme values identified by the outlier test of Dixon and Massey (1951) were examined by NTP personnel, and implausible values were eliminated from the analysis. Average severity values were analyzed for significance using the Mann-Whitney U test (Hollander and Wolfe, 1973). Because the vaginal cytology data are proportions (the proportion of the observation period that an animal was in a given estrous stage), an arcsine transformation was used to bring the data into closer conformance with normality assumption. Treatment effects were investigated by applying a multivariate analysis of variance (Morrison, 1976) to

the transformed data to test for simultaneous equality of measurements across exposure levels.

Historical Control Data

Although the concurrent control group is always the first and most appropriate control group used for evaluation, historical control data can be helpful in the overall assessment of neoplasm incidence in certain instances. Consequently, neoplasm incidences from the NTP historical control database (Haseman *et al.*, 1984, 1985) are included in the NTP reports for neoplasms appearing to show compound-related effects.

QUALITY ASSURANCE METHODS

The 13-week and 2-year studies were conducted in compliance with Food and Drug Administration Good Laboratory Practice Regulations (21 CFR, Part 58). In addition, as records from the 2-year studies were submitted to the NTP Archives, these studies were audited retrospectively by an independent quality assurance contractor. Separate audits covering completeness and accuracy of the pathology data, pathology specimens, final pathology tables, and a draft of this NTP Technical Report were conducted. Audit procedures and findings are presented in the reports and are on file at NIEHS. The audit findings were reviewed and assessed by NTP staff, so all comments had been resolved or were otherwise addressed during the preparation of this Technical Report.

GENETIC TOXICOLOGY

The genetic toxicity of isobutyl nitrite was assessed by testing the ability of the chemical to induce mutations in *Salmonella typhimurium*, sister chromatid exchanges and chromosomal aberrations in cultured Chinese hamster ovary cells, sex-linked recessive lethal mutations in *Drosophila*

melanogaster, and micronucleated erythrocytes in mice. The protocols for these studies and the results are given in Appendix E.

The genetic toxicity studies of isobutyl nitrite are part of a larger effort by the NTP to develop a database that would permit the evaluation of carcinogenicity in experimental animals from the structure and responses of the chemical in short-term *in vitro* and *in vivo* genetic toxicity tests. These genetic toxicity tests were originally developed to study mechanisms of chemically induced DNA damage and to predict carcinogenicity in animals, based on the electrophilic theory of chemical carcinogenesis and the somatic mutation theory (Miller and Miller, 1977; Straus, 1981; Crawford, 1985).

There is a strong correlation between a chemical's potential electrophilicity (structural alert to DNA reactivity), mutagenicity in *Salmonella*, and carcinogenicity in rodents. The combination of electrophilicity and *Salmonella* mutagenicity is highly correlated with the induction of carcinogenicity in rats and mice and/or at multiple tissue sites (Ashby and Tennant, 1991). Other *in vitro* genetic toxicity tests do not correlate well with rodent carcinogenicity (Tennant *et al.*, 1987; Zeiger *et al.*, 1990), although these other tests can provide information on the types of DNA and chromosome effects that can be induced by the chemical being investigated. Data from NTP studies show that a positive response in *Salmonella* is currently the most predictive *in vitro* test for rodent carcinogenicity (89% of the *Salmonella* mutagens were rodent carcinogens), and that there is no complementarity among the *in vitro* genetic toxicity tests. That is, no battery of tests that included the *Salmonella* test improved the predictivity of the *Salmonella* test alone. The predictivity for carcinogenicity of a positive response in bone marrow chromosome aberration or micronucleus tests is not yet defined.

TABLE 1
Experimental Design and Materials and Methods in the Inhalation Studies of Isobutyl Nitrite

16-Day Studies	13-Week Studies	2-Year Studies
Study Laboratory IIT Research Institute (Chicago, IL)	IIT Research Institute (Chicago, IL)	IIT Research Institute (Chicago, IL)
Strain and Species Rats: F344/N Mice: B6C3F ₁	Rats: F344/N Mice: B6C3F ₁	Rats: F344/N Mice: B6C3F ₁
Animal Source Simonsen Laboratories (Gilroy, CA)	Simonsen Laboratories (Gilroy, CA)	Simonsen Laboratories (Gilroy, CA)
Time Held Before Studies Rats: 11 days Mice: 12 days	Rats: 14 days Mice: 15 days	Rats: 15 days Mice: 13 days
Average Age When Studies Began 5 weeks	6 weeks	6 weeks
Date of First Dose Rats: 2 December 1986 Mice: 3 December 1986	Rats: 16 April 1987 Mice: 17 April 1987	Rats: 8 December 1988 Mice: 5 December 1988
Duration of Dosing 6 hours plus T ₉₀ (10 minutes) per day, 5 days per week, for 16 days	6 hours plus T ₉₀ (10 minutes) per day, 5 days per week (excluding holidays), for 13 weeks	6 hours plus T ₉₀ (10 minutes) per day, 5 days per week (excluding holidays), for 103 weeks, followed by a 1-week observation period
Date of Last Dose Rats: 17 December 1986 Mice: 18 December 1986	Rats: 15 July 1987 (males) 14 July 1987 (females) Mice: 22 July 1987 (males) 12 July 1987 (females)	Rats: 15-Month interim evaluation 7 March 1990 (males) or 8 March 1990 (females) Terminal 28 November 1990 Mice: 15-Month interim evaluation 5 March 1990 (males) or 6 March 1990 (females) Terminal 21 November 1990

TABLE 1
Experimental Design and Materials and Methods in the Inhalation Studies of Isobutyl Nitrite (continued)

16-Day Studies	13-Week Studies	2-Year Studies
Necropsy Dates Rats: 18 December 1986 Mice: 19 December 1986	Rats: 16 July 1987 (males) 15 July 1987 (females) Mice: 23 July 1987 (males) 22 July 1987 (females)	Rats: 15-Month interim evaluation 8 March (males) or 9 March 1990 (females) Terminal 6 to 12 December 1990 Mice: 15-Month interim evaluation 6 March (males) or 7 March 1990 (females) Terminal 29 November to 5 December 1990
Average Age at Necropsy 7 weeks	Rats: 19 weeks Mice: 20 weeks	15-Month interim evaluation 72 weeks Terminal Rats: 111 weeks Mice: 110 weeks
Size of Study Groups 5 males and 5 females	10 males and 10 females	15-Month interim evaluation 10 males and 10 females Terminal Rats: 56 males and 56 females Mice: 60 males and 60 females
Method of Distribution Animals were distributed randomly into groups of approximately equal initial mean body weights.	Same as 16-day studies	Same as 16-day studies
Animals per Cage 1	1	1
Method of Animal Identification Toe clip	Toe clip	Tail tattoo
Diet NIH-07 open formula diet (Zeigler Brothers, Inc., Gardners, PA), available <i>ad libitum</i> , except during exposure periods, changed weekly	Same as 16-day studies	Same as 16-day studies
Maximum Storage Time for Feed 120 days post-milling	Same as 16-day studies	Same as 16-day studies

TABLE 1
Experimental Design and Materials and Methods in the Inhalation Studies of Isobutyl Nitrite (continued)

16-Day Studies	13-Week Studies	2-Year Studies
Water		
Tap water (Chicago municipal supply) via automatic watering system designed and installed by ITRI plumbing contractors, available <i>ad libitum</i>	Same as 16-day studies	Same as 16-day studies
Cages		
Stainless steel (Lab Products, Inc., Garfield, NJ), changed weekly	Same as 16-day studies	Same as 16-day studies
Bedding/Cage Board		
Techsorb (Shepard Specialty Papers, Inc., Kalamazoo, MI), changed daily	Same as 16-day studies	Same as 16-day studies
Chamber Air Supply Filters		
Pleated prefilter, HEPA, and activated carbon absorber (R&R Equipment Sales, Rosemont, IL), changed as needed	Same as 16-day studies	Same as 16-day studies
Chambers		
Stainless steel, changed weekly (Model H-2000 (Lab Products, Inc., Maywood, NJ)	Same as 16-day studies	Same as 16-day studies
Chamber Environment		
Temperature: 21° to 26° C Relative humidity: 35% to 68% Fluorescent light: 12 hours/day	Temperature: 19° to 26° C Relative humidity: 35% to 70% Fluorescent light: 12 hours/day	Temperature: 21° to 27° C Relative humidity: 33% to 99% Fluorescent light: 12 hours/day
Doses		
0, 100, 200, 400, 600, or 800 ppm (approximately 420, 840, 1,700, 2,500, or 3,300 mg/m ³)	0, 10, 25, 75, 150, or 300 ppm (approximately 42, 105, 315, 630, or 1,260 mg/m ³)	0, 37.5, 75, or 150 ppm (approximately 158, 315, or 630 mg/m ³)
Type and Frequency of Observation		
All animals were observed twice daily for moribundity and mortality. Clinical findings were recorded twice daily for rats and mice. All animals were weighed initially, weekly, and at the end of the studies.	All animals were observed for morbidity and mortality twice daily. Clinical findings were recorded twice daily for the first week and then weekly for the remainder of the study for rats and mice. All animals were weighed initially, on study day 8, weekly thereafter, and at the end of the studies.	All animals were observed twice daily. Clinical findings were recorded monthly, and body weights were recorded weekly for the first 13 weeks, at week 16, monthly thereafter, and at the end of the studies.
Method of Sacrifice		
Anesthetization with CO ₂ followed by exsanguination	Anesthetization with CO ₂ followed by exsanguination	Anesthetization with CO ₂ followed by exsanguination

TABLE 1
Experimental Design and Materials and Methods in the Inhalation Studies of Isobutyl Nitrite (continued)

16-Day Studies	13-Week Studies	2-Year Studies
<p>Necropsy Necropsy performed on all animals. Organs weighed were brain, heart, right kidney, liver, lung, right testis, and thymus.</p>	<p>Necropsy performed on all animals. Organs weighed were brain, heart, right kidney, liver, lung, right testis, and thymus.</p>	<p>Necropsy performed on all animals. Organs weighed at the 15-month interim evaluation were brain, right kidney, and liver.</p>
<p>Clinical Pathology None</p>	<p>Blood was collected from all animals from the retroorbital sinus for hematology and clinical chemistry. Hematology: Leukocyte count and differential, hematocrit, hemoglobin concentration, mean cell hemoglobin, mean cell volume, methemoglobin concentration, erythrocyte count, and nucleated erythrocyte count. Clinical chemistry: Alkaline phosphatase, alanine aminotransferase, and bile acids.</p>	<p>Blood was collected from all 15-month interim evaluation rats and mice from the retroorbital sinus for evaluation of hematology and clinical chemistry parameters. Hematology: Leukocyte count and differential, hematocrit, hemoglobin concentration, mean cell hemoglobin, mean cell volume, methemoglobin concentration, erythrocyte counts, nucleated erythrocyte count, platelet count, reticulocyte count, and Heinz bodies. Clinical chemistry: Alkaline phosphatase, alanine aminotransferase, and bile acids.</p>
<p>Histopathology Complete histopathology was performed on 0, 400, 600, and 800 ppm rats and on all control and exposed mice. In addition to gross lesions and tissue masses, the tissues examined included: adrenal gland, brain, clitoral gland (rats only), esophagus, femur, gallbladder (mice only), heart, large intestine (cecum, colon, rectum), small intestine (duodenum, jejunum, ileum), kidney, larynx, liver, lungs, lymph nodes (bronchial, mandibular, mediastinal, and mesenteric), mammary gland, nose, ovary, pancreas, parathyroid gland, pituitary gland, preputial gland, prostate gland, salivary gland, skin, spleen, stomach (forestomach and glandular), testis, thymus, thyroid gland, trachea, urinary bladder, and uterus. In addition, the following organs were examined in 100 and 200 ppm rats: lung, liver, nose, and epididymis.</p>	<p>Complete histopathology was performed on all control and 300 ppm rats and mice. In addition to gross lesions and tissue masses, the tissues examined included: adrenal gland, brain, clitoral gland (rats only), esophagus, femur, gallbladder (mice only), heart, large intestine (cecum, colon, rectum), small intestine (duodenum, jejunum, ileum), kidney, larynx, liver, lungs, lymph nodes (bronchial, mandibular, mediastinal, and mesenteric), mammary gland, muscle (thigh), nose, ovary, pancreas, parathyroid gland, pituitary gland, preputial gland, prostate gland, salivary gland, skin, spleen, stomach (forestomach and glandular), testis, thymus, thyroid gland, trachea, urinary bladder, and uterus. Additionally, the following organs were examined in all other exposure groups: lung, spleen, nose, and bone marrow (rats only).</p>	<p>Complete histopathology was performed on all control and exposed rats and mice. In addition to gross lesions and tissue masses, the tissues examined included: adrenal gland, brain, clitoral gland (rats only), esophagus, femur, gallbladder (mice only), heart, large intestine (cecum, colon, rectum), small intestine (duodenum, jejunum, ileum), kidney, larynx, liver, lungs, lymph nodes (bronchial, mandibular, mediastinal, and mesenteric), mammary gland, nose, ovary, pancreas, parathyroid gland, pituitary gland, preputial gland, prostate gland, salivary gland, skin, spleen, stomach (forestomach and glandular), testis, thymus, thyroid gland, trachea, urinary bladder, and uterus.</p>

TABLE 1
Experimental Design and Materials and Methods in the Inhalation Studies of Isobutyl Nitrite (continued)

16-Day Studies	13-Week Studies	2-Year Studies
Sperm Morphology and Vaginal Cytology None	At terminal sacrifice, sperm samples were collected from all male animals in the 0, 10, 75, and 300 ppm exposure groups for sperm morphology evaluations. The parameters evaluated included: sperm density, morphology, and motility. The right cauda, right epididymis, and right testis were weighed. Vaginal samples were collected for up to 7 consecutive days prior to the end of the studies from all females for vaginal cytology evaluations. The parameters evaluated included: relative frequency of estrous stages and estrous cycle length.	None

RESULTS

RATS

16-DAY STUDY

All male and female rats exposed to 600 or 800 ppm died before the end of the study (Table 2), as did one 400 ppm female. The deaths were considered to be chemical related. Final mean body weights and mean body weight gains of 400 ppm males and females were significantly lower than those of the controls. Final mean body weights and mean body weight gains of 100 and 200 ppm male and female rats were similar to those of the controls. Ocular discharge was occasionally observed in 400 ppm males and

females throughout the study. Three 200 ppm females also displayed ocular discharge during the first, but not the second, week of exposure. Other clinical findings observed in 400 ppm rats included lethargy, hunched posture, and rough coats. Although noted less frequently than in 400 ppm rats, lethargy was also observed in rats following exposure to 200 ppm. Rats exposed to 200 ppm also developed rough coats during the second week of the study. No biologically significant clinical findings were noted in 100 ppm rats.

TABLE 2
Survival and Body Weights of Rats in the 16-Day Inhalation Study of Isobutyl Nitrite

Dose (ppm)	Survival ^a	Mean Body Weight ^b (g)			Final Weight Relative to Controls (%)
		Initial	Final	Change	
Male					
0	5/5	97 ± 3	162 ± 5	65 ± 3	
100	5/5	98 ± 2	167 ± 5	69 ± 3	103
200	5/5	96 ± 2	159 ± 5	63 ± 4	98
400	5/5	99 ± 2	120 ± 2**	21 ± 2**	74
600	0/5 ^c	100 ± 2	—	—	—
800	0/5 ^c	99 ± 3	—	—	—
Female					
0	5/5	88 ± 2	125 ± 2	38 ± 2	
100	5/5	86 ± 1	123 ± 1	37 ± 1	98
200	5/5	85 ± 1	126 ± 1	41 ± 2	100
400	4/5 ^c	88 ± 2	109 ± 2**	20 ± 1**	87
600	0/5 ^c	88 ± 2	—	—	—
800	0/5 ^c	88 ± 1	—	—	—

** Significantly different ($P \leq 0.01$) from the control group by Williams' or Dunnett's test

^a Number of animals surviving/number initially in group

^b Weights and weight changes are given as mean ± standard error. Subsequent calculations are based on animals surviving to the end of the study. No final mean body weights or weight changes were calculated for groups with 100% mortality.

^c Day of deaths: All deaths occurred on day 1

Absolute and relative lung weights of all exposed groups of males and of 200 and 400 ppm females were less than those of the controls (Table F1), and the absolute and relative lung weights of 200 and 400 ppm males were significantly less. All other differences in organ weights were secondary to body weight changes. Minimal to mild hyperplasia of the bronchial epithelium, and less frequently the bronchiolar epithelium, was observed in 200 and 400 ppm males and females (Table 3). Because of the predominant involvement of bronchi, the lesion was termed bronchial epithelial hyperplasia. The normal, uniform, low columnar pseudostratified epithelium of bronchi and bronchioles was replaced by a more cellular and irregular mucosa composed of increased numbers of hyperplastic and hypertrophic, columnar and polygonal epithelial cells. The mucosa had multiple layers of large epithelial cells including increased numbers of basophilic basal layer cells, occasional mitotic figures and multinucleated syncytial cells, and sometimes squamoid differentiation or pseudopapillary patterns. Alveolar ducts were not involved. Minimal hyperplasia was also observed in the respiratory epithelium of the anterior nasal turbinates of 200 and 400 ppm males and females.

Minimal to mild bone marrow hematopoietic hyperplasia was observed in all exposed groups of male and female rats (Table 3). The severity of hematopoiesis was greater in females than in males. The bone marrow changes consisted of an increased amount of normal hematopoietic tissue in both the epiphyseal and diaphyseal marrow with a corresponding reduction in the amount of adipose tissue compared to the controls.

Minimal to mild hemosiderin pigmentation (hemosiderosis) was observed in the spleen of 200 and 400 ppm male and female rats (Table 3). Increased amounts of intracytoplasmic, golden brown, globular pigment (hemosiderin) were observed within macrophages in the red pulp.

Dose Selection Rationale: Based on mortality and body weight decreases observed in rats exposed to 400 ppm isobutyl nitrite or greater, the doses selected for the 13-week study were 10, 25, 75, 150, and 300 ppm.

TABLE 3
Incidences of Selected Nonneoplastic Lesions in Rats in the 16-Day Inhalation Study of Isobutyl Nitrite

Dose	0 ppm	100 ppm	200 ppm	400 ppm	600 ppm	800 ppm
Male						
Lung ^a	5	5	5	5	0	0
Epithelial Hyperplasia, Bronchi ^b	0	0	5** (1.0) ^c	5** (2.0)	—	—
Nose	5	5	5	5	0	0
Hyperplasia, Respiratory Epithelium	0	0	5** (1.6)	4* (1.3)	—	—
Bone Marrow	5	5	5	5	0	0
Hyperplasia	0	5** (1.0)	5** (1.0)	5** (1.4)	—	—
Spleen	5	5	5	5	0	0
Pigmentation, Hemosiderin	0	0	1 (1.0)	5** (1.6)	—	—
Female						
Lung	5	5	5	4	0	0
Epithelial Hyperplasia, Bronchi	0	0	5** (1.0)	4** (2.0)	—	—
Nose	5	5	5	4	0	0
Hyperplasia, Respiratory Epithelium	0	0	5** (1.4)	4** (2.3)	—	—
Bone Marrow	5	5	5	4	0	0
Hyperplasia	0	5** (1.0)	5** (1.2)	4** (2.0)	—	—
Spleen	5	5	5	4	0	0
Pigmentation, Hemosiderin	0	0	5** (1.0)	4** (1.8)	—	—

* Significantly different ($P \leq 0.05$) from the control group by the Fisher exact test

** $P \leq 0.01$

^a Number of animals with organ examined microscopically

^b Number of animals with lesion

^c Average severity of lesions in affected animals: 1 = minimal; 2 = mild; 3 = moderate; 4 = marked

13-WEEK STUDY

All rats survived to the end of the study (Table 4). Final mean body weights and mean body weight gains of 300 ppm males and females and the mean body weight gain of 150 ppm males were significantly lower than those of the controls. Clinical

findings observed during the study included ruffled fur in 300 ppm males and females, hypoactivity (determined by visual assessment) in 300 ppm males, and hyperactivity in 150 and 300 ppm females. Ruffled fur was also observed in 10 and 150 ppm males and 25 ppm females.

TABLE 4
Survival and Body Weights of Rats in the 13-Week Inhalation Study of Isobutyl Nitrite

Dose (ppm)	Survival ^a	Mean Body Weight ^b (g)			Final Weight Relative to Controls (%)
		Initial	Final	Change	
Male					
0	10/10	118 ± 4	339 ± 8	221 ± 6	
10	10/10	116 ± 5	334 ± 7	219 ± 4	99
25	10/10	118 ± 4	357 ± 9	239 ± 6	106
75	10/10	113 ± 4	328 ± 8	215 ± 6	97
150	10/10	116 ± 4	318 ± 6	202 ± 4*	94
300	10/10	117 ± 4	291 ± 7**	174 ± 5**	86
Female					
0	10/10	92 ± 3	192 ± 5	100 ± 4	
10	10/10	90 ± 2	195 ± 3	105 ± 2	102
25	10/10	90 ± 3	198 ± 4	108 ± 4	103
75	10/10	89 ± 3	194 ± 5	105 ± 4	101
150	10/10	89 ± 2	183 ± 4	94 ± 2	95
300	10/10	88 ± 3	176 ± 3**	88 ± 2*	92

* Significantly different ($P \leq 0.05$) from the control group by Williams' or Dunnett's test

** $P \leq 0.01$

^a Number of animals surviving/number initially in group

^b Weights and weight changes are given as mean ± standard error.

Hematology and clinical chemistry results for the 13-week rat study of isobutyl nitrite are listed in Table G1. At the end of the study, methemoglobin concentrations were slightly elevated in males and females exposed to 75 ppm or greater, and evidence of a minimal anemia was present in these groups. The anemia was characterized by a minimal to mild decrease in erythrocyte counts and/or hemoglobin concentrations. The anemia was macrocytic (as evidenced by an increase in mean cell volume [MCV]) and would suggest increased numbers of circulating reticulocytes. No reticulocyte counts were available for this study for detection of a bone marrow response. However, treatment-related increases in MCV and nucleated erythrocyte counts and the microscopic presence of bone marrow hyperplasia would be consistent with a hematopoietic response to the anemia and/or to the methemoglobinemia. The microscopic presence of splenic hemosiderosis was presumably related to the methemoglobinemia and decreased erythrocyte life span. Increases in mean cell hemoglobin in the 150 and 300 ppm male and females and 75 ppm females would be a reflection of the increased MCV.

Mild increases in leukocyte counts occurred in 150 and 300 ppm males and females. This difference was accompanied by an increase in lymphocyte numbers. These findings contradict the results of Lynch *et al.* (1985), who reported a decrease in leukocyte counts in Balb/c mice exposed to 300 ppm isobutyl nitrite. In the present study, the increases in leukocyte and lymphocyte counts could be explained by an erroneously elevated leukocyte count related to increased reticulocyte numbers. Reticulocytes are more resistant to the lysing reagent during counting. Consequently, intact reticulocytes could be counted as leukocytes during the automated count. Differential count percentages are not affected, because the leukocytes are identified and quantitated microscopically. However, absolute numbers for the individual leukocytes may become falsely elevated when the leukocyte differential percentages are multiplied by the artifactually elevated total leukocyte count. Similar leukocyte differences occurred in the 15-month evaluation of the 2-year rat study and in the mouse studies.

All organ weight differences were considered secondary to body weight changes (Table F2). Chemical-

related lesions were observed in the bone marrow, spleen, and respiratory tract of male and female rats (Table 5). Minimal to mild hematopoietic hyperplasia similar to that of the 16-day study occurred in the bone marrow of all exposed groups of males and females. Bone marrow hematopoietic hyperplasia was characterized by an increased amount of normal hematopoietic tissue in the epiphyseal marrow of the distal femur at the expense of adipose tissue found there. The mixture of the two types of marrow was not uniform, and zones of marrow containing hematopoietic or adipose tissue were observed. The cellular hematopoietic elements appeared identical in normal and hyperplastic marrow. The hematopoietic hyperplasia in the bone marrow was related to the anemia observed. Minimal hemosiderosis of the spleen similar to that of the 16-day study occurred in males and females exposed to 75 ppm or greater, and the lesion was characterized by the presence of intracytoplasmic, golden brown, globular pigment within macrophages of the red pulp.

Epithelial cell hyperplasia of the nasal mucosa was observed in 150 and 300 ppm males and females, and was of mild to moderate severity in 300 ppm males and females. Nasal mucosal hyperplasia was characterized by an increase in the thickness (number of cells) of the simple cuboidal nasal mucosa in the anterior region of the nose. This change was most pronounced at the edges of the nasal turbinates and on the lateral walls of the nasal cavity. This lesion was not present in the 2-year study, suggesting that there was some adaptation to the irritant effects of the chemical. Minimal to mild bronchial epithelial hyperplasia was observed in 300 ppm males and females. The lesions were similar to those observed in the 16-day study; however, the bronchiolar epithelium was less affected. The normal, uniform, pseudostratified, low to tall columnar epithelial cells of bronchi and bronchioles were replaced by a highly cellular, sometimes irregular mucosa composed of multiple layers of hyperplastic and hypertrophic columnar and polygonal epithelial cells. The hyperplastic and hypertrophic cells were taller and more basophilic and had reduced mucus production. A prominent feature of the bronchial lesion was the proliferation of large basophilic polygonal epithelial cells with numerous mitotic figures in the basal layers. Alveolar ducts were not involved.

TABLE 5
Incidences of Selected Nonneoplastic Lesions in Rats in the 13-Week Inhalation Study of Isobutyl Nitrite

Dose	0 ppm	10 ppm	25 ppm	75 ppm	150 ppm	300 ppm
Male						
Bone Marrow ^a	8	7	7	9	5	8
Hyperplasia, Hematopoietic ^b	1 (2.0) ^c	4 (1.5)	3 (1.7)	7* (1.4)	4* (1.0)	8** (1.4)
Spleen	10	10	10	10	10	10
Hemosiderin	0	0	0	10** (1.7)	10** (1.6)	10** (1.0)
Nose	10	10	10	10	10	10
Hyperplasia, Epithelial Cell, Mucosa	0	0	0	0	10** (1.0)	10** (2.4)
Lung	10	— ^d	—	—	10	10
Hyperplasia, Epithelium, Bronchi	0				0	10** (1.4)
Female						
Bone Marrow	8	8	8	10	9	8
Hyperplasia, Hematopoietic	0	3 (1.0)	1 (1.0)	3 (1.3)	7** (1.3)	8** (1.5)
Spleen	10	10	10	10	10	10
Hemosiderin	0	0	0	10** (1.5)	10** (1.2)	10** (1.0)
Nose	10	10	10	10	10	10
Hyperplasia, Epithelial Cell, Mucosa	0	0	0	0	7** (1.1)	10** (1.9)
Lung	10	—	—	—	10	10
Hyperplasia, Epithelium, Bronchi	0				0	9** (2.0)

* Significantly different ($P \leq 0.05$) from the control group by the Fisher exact test

** $P \leq 0.01$

^a Number of animals with organ examined microscopically

^b Number of animals with lesion

^c Average severity of lesions in affected animals: 1 = minimal; 2 = mild; 3 = moderate; 4 = marked

^d Organ not examined at this exposure level

Dose Selection Rationale: Based on low final mean body weights, mild to moderate nasal mucosal lesions, minimal to mild bronchial epithelium hyper-

plasia, and anemia in 300 ppm males and females, isobutyl nitrite exposure levels selected for the 2-year inhalation study in rats were 37.5, 75, and 150 ppm.

2-YEAR STUDY

Survival

Estimates of 2-year survival probabilities for male and female rats are shown in Table 6 and in the Kaplan-Meier survival curves (Figure 1). Survival

rates of exposed groups of rats were greater than those of the controls, and the survival rates of 75 and 150 ppm males were significantly greater than that of the controls.

TABLE 6
Survival of Rats in the 2-Year Inhalation Study of Isobutyl Nitrite

	0 ppm	37.5 ppm	75 ppm	150 ppm
Male				
Animals initially in study	56	56	56	56
15-month interim evaluation ^a	10	10	10	10
Accidental deaths ^a	0	0	1	0
Moribund	21	12	5	8
Natural deaths	8	11	4	10
Animals surviving to study termination	17	23	36	28
Percent probability of survival at end of study ^b	37	50	80	61
Mean survival (days) ^c	619	637	658	646
Survival analysis ^d	P=0.009N	P=0.152N	P<0.001N	P=0.029N
Female				
Animals initially in study	56	56	56	56
15-month interim evaluation ^a	10	10	10	10
Missing ^a	0	1	0	0
Moribund	13	4	7	6
Natural deaths	4	6	8	7
Animals surviving to study termination	29	35	31 ^e	33
Percent probability of survival at end of study	63	78	68	72
Mean survival (days)	653	654	652	645
Survival analysis	P=0.783N	P=0.167N	P=0.764N	P=0.573N

^a Censored from survival analyses

^b Kaplan-Meier determinations based on the number of animals alive on the first day of terminal sacrifice

^c Mean of all deaths (uncensored, censored, and terminal sacrifice)

^d The result of the life table trend test (Tarone, 1975) is in the control column, and the results of the life table pairwise comparisons (Cox, 1972) with the controls are in the exposed columns. A negative trend or a lower mortality in an exposure group is indicated by N.

^e Includes one animal that died during the last week of the study.

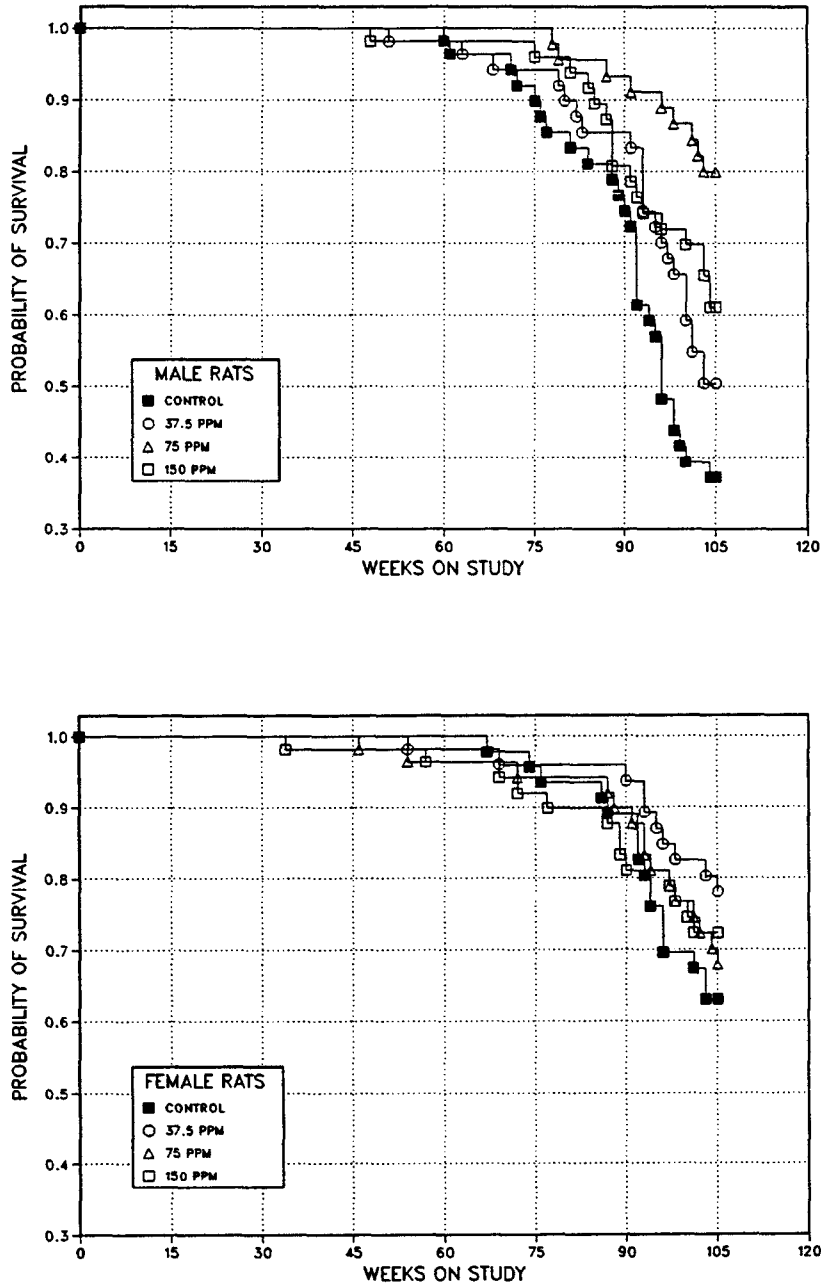

FIGURE 1
Kaplan-Meier Survival Curves for Male and Female Rats Administered Isobutyl Nitrite by Inhalation for 2 Years

Body Weights and Clinical Findings

Mean body weights of male and female rats exposed to 150 ppm were 3% to 11% lower than those of the controls throughout the course of the study (Tables 7 and 8, Figure 2). Clinical findings that occurred throughout the second year of the study (hypoactivity, dyspnea, abnormal posture, and thinness) were considered to be unrelated to exposure to isobutyl nitrite.

Hematology and Clinical Chemistry

At the 15-month interim evaluation, a minimal methemoglobinemia (increased methemoglobin concentration) was present in males exposed to 37.5 ppm and males and females exposed to 75 or 150 ppm (Table G2). Additionally, there was evidence of macrocytic anemia, consisting of a slight decrease in the erythrocyte count and a slight

increase in the MCV in 150 ppm male and female rats. A minimal increase in reticulocyte numbers occurred in 150 ppm males and would be consistent with a hematopoietic response. Numbers of nucleated erythrocytes were slightly increased in all exposed groups of males and significantly increased in all exposed groups of females, which is consistent with a hematopoietic response. Platelets were slightly increased in all exposed groups of males and significantly increased in all exposed groups of females consistent with reactive thrombocytosis which can accompany a hematopoietic response. Mild increases in leukocyte and/or lymphocyte counts occurred in exposed groups of females. This difference was previously discussed for rats in the 13-week study. There was a mild increase in serum alanine aminotransferase activity in 37.5 and 75 ppm males, suggesting a mild increase in hepatocellular leakage or enzyme induction.

TABLE 7
Mean Body Weights and Survival of Male Rats in the 2-Year Inhalation Study of Isobutyl Nitrite

Weeks on Study	0 ppm		37.5 ppm			75 ppm			150 ppm		
	Av. Wt. (g)	No. of Survivors	Av. Wt. (g)	Wt. (% of controls)	No. of Survivors	Av. Wt. (g)	Wt. (% of controls)	No. of Survivors	Av. Wt. (g)	Wt. (% of controls)	No. of Survivors
1	117	56	114	98	56	114	97	56	114	97	56
2	144	56	142	99	56	140	97	56	138	96	56
3	175	56	174	100	56	170	97	56	166	95	56
4	204	56	202	99	56	196	96	56	192	94	56
5	224	56	221	99	56	216	96	56	210	94	56
6	242	56	237	98	56	231	95	56	226	94	56
7	252	56	247	98	56	239	95	56	233	93	56
8	260	56	256	98	56	248	95	56	244	94	56
9	275	56	270	98	56	261	95	56	256	93	56
10	294	56	287	98	56	278	95	56	271	93	56
11	304	56	299	98	56	288	95	56	281	93	56
12	313	56	306	98	56	295	94	56	288	92	56
13	321	56	314	98	56	302	94	56	295	92	56
16	346	56	338	98	56	324	94	56	317	92	56
20	373	56	360	97	56	349	94	56	340	91	56
24	393	56	379	97	56	370	94	56	358	91	56
28	411	56	394	96	56	384	94	56	371	90	56
32	420	56	406	97	56	395	94	55	381	91	56
36	426	56	414	97	56	403	95	55	389	91	56
40	436	56	425	98	56	414	95	55	399	92	56
44	441	56	428	97	56	416	94	55	402	91	56
48	447	56	433	97	56	424	95	55	409	92	55
52	449	56	439	98	55	430	96	55	418	93	55
56	451	56	441	98	55	433	96	55	419	93	55
60	460	56	445	97	55	439	96	55	424	92	55
64	461	54	447	97	54	441	96	55	423	92	55
68 ^a	461	44	446	97	44	440	95	45	428	93	45
72	464	43	453	98	43	446	96	45	430	93	45
76	463	41	455	98	43	448	97	45	433	94	44
80	462	39	451	98	42	447	97	43	428	93	44
84	466	38	456	98	39	447	96	43	424	91	42
88	454	37	458	101	39	449	99	42	419	92	39
92	434	33	447	103	38	444	102	41	411	95	36
96	435	24	445	102	33	439	101	41	410	94	34
100	430	19	433	101	30	436	102	39	402	94	33
104	414	18	439	106	23	430	104	36	386	93	29
Mean for weeks											
1-13	240		236	98		229	95		224	93	
14-52	414		402	97		391	94		378	91	
53-104	450		447	99		441	98		418	93	

^a Interim evaluation occurred during week 66.

TABLE 8
Mean Body Weights and Survival of Female Rats in the 2-Year Inhalation Study of Isobutyl Nitrite

Weeks on Study	0 ppm		37.5 ppm			75 ppm			150 ppm		
	Av. Wt. (g)	No. of Survivors	Av. Wt. (g)	Wt. (% of controls)	No. of Survivors	Av. Wt. (g)	Wt. (% of controls)	No. of Survivors	Av. Wt. (g)	Wt. (% of controls)	No. of Survivors
1	94	56	93	99	56	92	98	56	91	97	56
2	113	56	114	101	56	113	100	56	109	97	56
3	127	56	129	101	56	126	99	56	122	96	56
4	138	56	139	101	56	136	99	56	131	95	56
5	146	56	146	101	56	143	98	56	138	95	56
6	154	56	152	99	56	149	97	56	145	94	56
7	157	56	155	99	56	151	97	56	147	94	56
8	159	56	158	99	56	155	97	56	150	95	56
9	167	56	165	99	56	161	96	56	156	94	56
10	172	56	171	99	56	167	97	56	163	95	56
11	177	56	174	98	56	170	96	56	166	94	56
12	181	56	179	99	56	173	96	56	170	94	56
13	185	56	183	99	56	177	96	56	173	94	56
16	194	56	191	99	56	185	96	56	183	94	56
20	204	56	199	98	56	195	95	56	191	94	56
24	211	56	207	98	56	202	96	56	198	94	56
28	220	56	215	98	55	208	95	56	204	93	56
32	226	56	223	99	55	217	96	56	210	93	56
36	232	56	229	99	55	222	96	56	214	92	55
40	241	56	237	98	55	230	95	56	220	91	55
44	249	56	243	98	55	235	94	56	224	90	55
48	257	56	250	97	55	241	94	55	230	90	55
52	265	56	259	98	55	248	94	55	241	91	55
56	271	56	264	98	54	256	95	54	248	92	55
60	282	56	272	96	54	263	93	54	251	89	54
64	284	56	280	98	54	269	95	54	255	90	54
68 ^a	286	45	284	99	44	276	97	44	258	90	44
72	291	45	289	99	43	281	97	44	265	91	43
76	296	43	292	99	43	286	97	43	266	90	42
80	300	43	293	98	43	290	97	43	272	91	41
84	304	43	298	98	43	290	96	43	273	90	41
88	306	41	299	98	43	296	97	41	276	90	40
92	297	41	305	103	42	298	100	40	283	95	37
96	299	34	306	102	39	300	100	37	287	96	36
100	302	32	307	102	37	301	100	35	281	93	35
104	306	29	311	102	36	313	103	33	294	96	33
Mean for weeks											
1-13	152		151	99		147	97		143	94	
14-52	230		225	98		218	95		212	92	
53-104	294		292	99		286	97		270	92	

^a Interim evaluation occurred during week 66.

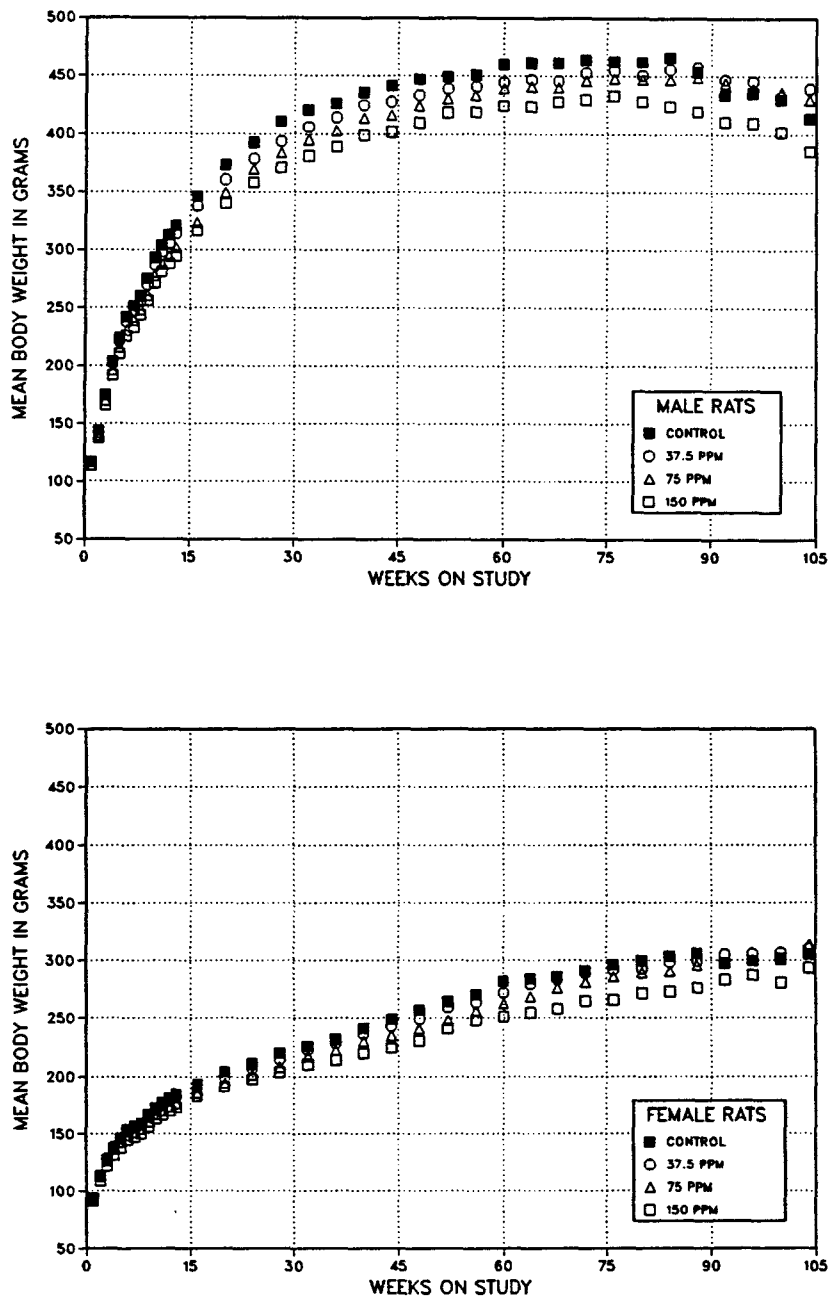

FIGURE 2
Growth Curves for Male and Female Rats Administered Isobutyl Nitrite by Inhalation for 2 Years

Pathology and Statistical Analyses

This section describes the statistically significant or biologically noteworthy changes in the incidences of neoplasms and nonneoplastic lesions of the lung and spleen and in the incidences of mononuclear cell leukemia. Summaries of the incidences of neoplasms and nonneoplastic lesions, individual animal tumor diagnoses, statistical analyses of primary neoplasms that occurred with an incidence of at least 5% in at least one animal group, and historical incidences for the neoplasms mentioned in this section are presented in Appendix A for male rats and Appendix B for female rats.

Lung: Incidences of alveolar/bronchiolar adenoma and alveolar/bronchiolar adenoma or carcinoma (combined) occurred with significant positive trends in exposed males and females (Tables 9, A3, and B3). The incidences of alveolar/bronchiolar adenoma and alveolar/bronchiolar adenoma or carcinoma (combined) in 75 ppm males and 150 ppm males and females were significantly greater than those in the control groups. There was also an increase in the number of male and female rats with multiple adenomas (Tables 9, A1, and B1). The incidence of alveolar/bronchiolar carcinoma in 150 ppm males was significantly greater than that of the controls. The incidences of alveolar/bronchiolar adenoma or carcinoma (combined) in all exposed groups of males and in 37.5 and 150 ppm females exceeded the range in historical controls from NTP 2-year inhalation studies (Tables 9, A4a, and B4a). Additionally, increased incidences of alveolar epithelial hyperplasia occurred in all exposed groups of males and females at 15 months (except 75 ppm females) and at the end of 2 years; the incidences were significantly increased in 150 ppm males at 15 months and in 75 and 150 ppm males and all exposed groups of females at the end of 2 years (Tables 9, A5, and B5). Alveolar epithelial hyperplasia and alveolar/bronchiolar adenoma and carcinoma constitute a morphological continuum. Alveolar epithelial hyperplasia was focal in nature, was most often located

near major airways deep in the lobe of the lung, and sometimes extended peripherally to the pleural surface (Plate 1). In rats exposed to 37.5 ppm isobutyl nitrite, this hyperplasia consisted of a small focal cluster of five to 10 alveoli which had slightly enlarged alveolar epithelial cells (Type II pneumocytes). In 75 and 150 ppm rats, the number of foci of hyperplasia was usually greater, and the alveolar epithelial cells were larger than those observed in 37.5 ppm rats. In some foci, there were increased numbers of alveolar epithelial cells as well as an increase in the size of the cells; in others, there was proliferation of the alveolar cells, and they were more elongated and perpendicular to the alveolar wall. In some foci where the alveolar cells were several cell layers thick, the cells extended into the lumen of alveoli and small bronchioles. The alveolar hyperplasia observed at 2 years was different from the bronchial hyperplasia observed in the 16-day and 13-week studies. The bronchial hyperplasia was unrelated to the increased incidence of lung neoplasms.

Alveolar/bronchiolar adenomas were distinct masses that caused compression of the adjacent parenchyma (Plate 2). There was distortion of the underlying alveolar architecture, and the epithelium was arranged in complex, irregular papillary patterns in some neoplasms. The alveolar spaces were obliterated to varying extents in other neoplasms and some neoplasms appeared solid. The epithelium was cuboidal to columnar and was supported by a delicate fibrovascular stroma. The neoplastic epithelial cells were uniform with round to oval nuclei and moderate abundant cytoplasm. Alveolar/bronchiolar carcinomas were not well circumscribed. Neoplastic cells effaced the alveolar architecture and infiltrated the adjacent lung tissue (Plate 3). Neoplastic cells were arranged in papillary and solid patterns, sometimes formed alveolar or glandular patterns, were pleomorphic, and had variable degrees of anaplasia (Plate 4). Numerous mitotic figures were often present in carcinomas.

TABLE 9
Incidences of Neoplasms and Nonneoplastic Lesions of the Lung of Rats in the 2-Year Inhalation Study of Isobutyl Nitrite

Dose	0 ppm	37.5 ppm	75 ppm	150 ppm
Male				
15-Month Interim Evaluation				
Lung ^a	10	10	10	10
Alveolar Epithelium, Hyperplasia ^b	0	3 (1.3) ^c	2 (2.5)	7** (1.6)
Alveolar/bronchiolar Adenoma	0	1	1	1
2-Year Study				
Lung	46	46	46	46
Alveolar Epithelium, Hyperplasia	5 (1.4)	8 (1.8)	26** (1.8)	31** (2.0)
Alveolar/bronchiolar Adenoma, Multiple				
Overall rate ^d	0/46 (0%)	1/46 (2%)	0/46 (0%)	3/46 (7%)
Alveolar/bronchiolar Adenoma, Single or Multiple				
Overall rate	0/46 (0%)	3/46 (7%)	12/46 (26%)	13/46 (28%)
Adjusted rate ^e	0.0%	13.0%	32.2%	44.8%
Terminal rate ^f	0/17 (0%)	3/23 (13%)	11/36 (31%)	12/28 (43%)
First incidence (days)	— ^h	729 (T)	631	722
Logistic regression test ^g	P<0.001	P=0.176	P=0.003	P=0.002
Alveolar/bronchiolar Carcinoma				
Overall rate	1/46 (2%)	2/46 (4%)	1/46 (2%)	6/46 (13%)
Adjusted rate	2.2%	7.2%	2.8%	18.1%
Terminal rate	0/17 (0%)	1/23 (4%)	1/36 (3%)	3/28 (11%)
First incidence (days)	415	663	729 (T)	523
Logistic regression test	P=0.015	P=0.462	P=0.735	P=0.040
Alveolar/bronchiolar Adenoma or Carcinoma ⁱ				
Overall rate	1/46 (2%)	5/46 (11%)	13/46 (28%)	15/46 (33%)
Adjusted rate	2.2%	19.8%	34.9%	47.6%
Terminal rate	0/17 (0%)	4/23 (17%)	12/36 (33%)	12/28 (43%)
First incidence (days)	415	663	631	523
Logistic regression test	P<0.001	P=0.101	P=0.001	P<0.001

(continued)

TABLE 9
Incidences of Neoplasms and Nonneoplastic Lesions of the Lung of Rats in the 2-Year Inhalation Study of Isobutyl Nitrite (continued)

Dose	0 ppm	37.5 ppm	75 ppm	150 ppm
Female				
15-Month Interim Evaluation				
Lung	10	10	10	10
Alveolar Epithelium, Hyperplasia	1 (1.0)	2 (1.5)	1 (1.0)	5 (1.8)
2-Year Study				
Lung	46	45	46	46
Alveolar Epithelium, Hyperplasia	3 (1.3)	10* (1.6)	11* (1.5)	30** (1.9)
Alveolar/bronchiolar Adenoma, Multiple				
Overall rate	0/46 (0%)	0/45 (0%)	0/46 (0%)	2/46 (4%)
Alveolar/bronchiolar Adenoma, Single or Multiple				
Overall rate	0/46 (0%)	2/45 (4%)	2/46 (4%)	10/46 (22%)
Adjusted rate	0.0%	5.2%	5.8%	29.1%
Terminal rate	0/29 (0%)	1/35 (3%)	1/31 (3%)	9/33 (27%)
First incidence (days)	—	648	653	622
Logistic regression test	P<0.001	P=0.226	P=0.237	P=0.001
Alveolar/bronchiolar Carcinoma				
Overall rate	0/46 (0%)	1/45 (2%)	0/46 (0%)	1/46 (2%)
Alveolar/bronchiolar Adenoma or Carcinoma ^j				
Overall rate	0/46 (0%)	3/45 (7%)	2/46 (4%)	11/46 (24%)
Adjusted rate	0.0%	7.5%	5.8%	32.1%
Terminal rate	0/29 (0%)	1/35 (3%)	1/31 (3%)	10/33 (30%)
First incidence (days)	—	645	653	622
Logistic regression test	P<0.001	P=0.108	P=0.237	P<0.001

(T)Terminal sacrifice

* Significantly different ($P \leq 0.05$) from the control group by the logistic regression test

** Significantly different ($P \leq 0.01$) from the control group by the Fisher exact test (interim evaluation) or the logistic regression test (2-year study)

^a Number of animals with lung examined microscopically

^b Number of animals with lesion

^c Average severity grade of lesion in affected animals: 1 = minimal; 2 = mild; 3 = moderate; 4 = marked

^d Number of animals with neoplasm per number of animals examined microscopically

^e Kaplan-Meier estimated neoplasm incidence at the end of the study after adjustment for intercurrent mortality

^f Observed incidence in animals surviving until the end of the study

^g In the control column are the P values associated with the trend test. In the exposed group columns are the P values corresponding to the pairwise comparisons between the controls and that exposed group. The logistic regression test regards lesions in animals dying prior to terminal kill as nonfatal.

^h Not applicable; no neoplasms in animal group

ⁱ Historical incidence for 2-year inhalation studies with control groups (mean \pm standard deviation): 22/493 (4.5% \pm 3.8%); range 0% to 10%

^j Historical incidence: 4/492 (0.8% \pm 1.4%); range 0% to 4%

Spleen: Incidences of hematopoietic cell proliferation were significantly increased in the spleen of 150 ppm female rats at the 15-month interim evaluation (0 ppm, 0/10; 37.5 ppm 0/10; 75 ppm, 1/10; 150 ppm, 4/10; Table B5) and in 150 ppm males at the end of the study (3/46, 6/45, 5/46, 12/45; Table A5). Two 75 ppm males and five 150 ppm males had cystic degeneration of the spleen characterized by multiple foci of well differentiated adipocytes in a fibrous stroma.

Mononuclear Cell Leukemia: The incidences of mononuclear cell leukemia in exposed groups of males and females were significantly lower than those in the controls (males: 0 ppm, 27/46, 37.5 ppm, 2/46, 75 ppm, 1/46, 150 ppm, 1/46; females: 14/46, 1/45, 0/46, 1/46; Tables A3 and B3). Incidences of mononuclear cell leukemia in exposed groups of males and females were below the range observed in historical controls from NTP 2-year inhalation studies (Tables A4b and B4b).

MICE

16-DAY STUDY

Three male and four female mice exposed to 800 ppm died before the end of the study; these deaths were considered to be related to chemical exposure (Table 10). Final mean body weights and mean body weight gains of 600 and 800 ppm males and females were significantly lower than those of the controls. Surviving mice in the 800 ppm groups became lethargic after 2 days of exposure, and these animals exhibited hunched posture and rough coats later in the study. Clinical findings in mice exposed to 400 or 600 ppm were similar to, but less severe than, those in 800 ppm mice. No biologically

significant clinical findings were observed in 100 or 200 ppm mice.

Absolute and relative lung weights of 600 and 800 ppm males and the relative lung weight of 600 ppm females were significantly greater than those of the controls (Table F4). Additionally, the absolute and relative thymus weights of 600 ppm males and females and of 400 and 800 ppm males were significantly less than those of the controls. The absolute and relative kidney weights of 600 and 800 ppm males and the relative kidney weight of 400 ppm males were significantly less than those of the controls.

TABLE 10
Survival and Body Weights of Mice in the 16-Day Inhalation Study of Isobutyl Nitrite

Dose (ppm)	Survival ^a	Mean Body Weight ^b (g)			Final Weight Relative to Controls (%)
		Initial	Final	Change	
Male					
0	5/5	23.1 ± 0.3	26.3 ± 0.5	3.2 ± 0.3	
100	5/5	22.6 ± 0.2	25.6 ± 0.3	3.1 ± 0.4	97
200	5/5	23.5 ± 0.4	27.0 ± 0.6	3.5 ± 0.5	103
400	5/5	22.7 ± 0.3	26.9 ± 0.4	4.1 ± 0.3	102
600	5/5	22.9 ± 0.3	22.5 ± 0.6**	-0.4 ± 0.6**	85
800	2/5 ^c	23.3 ± 0.6	21.0 ± 1.5**	-3.3 ± 2.5**	80
Female					
0	5/5	18.8 ± 0.4	23.1 ± 0.4	4.3 ± 0.3	
100	5/5	18.3 ± 0.2	22.4 ± 0.6	4.0 ± 0.4	97
200	5/5	18.9 ± 0.3	22.8 ± 0.7	3.8 ± 0.7	99
400	5/5	18.6 ± 0.3	21.9 ± 0.5	3.3 ± 0.5	95
600	5/5	19.3 ± 0.2	19.5 ± 0.3**	0.2 ± 0.3**	85
800	1/5 ^d	19.0 ± 0.4	18.2**	-0.9**	79

** Significantly different ($P \leq 0.01$) from the control group by Williams' or Dunnett's test

^a Number of animals surviving/number initially in group

^b Weights and weight changes are given as mean ± standard error. Subsequent calculations are based on animals surviving to the end of the study. No standard errors were calculated for groups with high mortality.

^c Day of deaths: All deaths occurred on day 1

^d Day of deaths: Two on day 1, one on day 9, and one on day 10

Bronchiolar epithelial hyperplasia was observed in two male and three female 800 ppm mice and in all mice from other exposed groups (Table 11). It was characterized by replacement of the normal uniform, thin, one or two layers of low columnar to cuboidal epithelium of the distal bronchioles with a cellular, often irregular mucosa composed of multiple layers of pleomorphic, hyperplastic and hypertrophic, columnar and polygonal epithelial cells. The hyperplastic cells had increased mitotic figures, occasionally formed multinucleated cells, and sometimes had squamoid differentiation. The increased number and size of epithelial cells with infolding of the mucosa and the accumulation of secretions, exfoliated cells, and cellular debris resulted in markedly reduced bronchiolar lumens in some lobes. Lymphocytic

atrophy characterized by a decrease in the splenic lymphoid follicles and a reduction of the number of lymphocytes in the cortex of the thymus was observed in males and females exposed to 400 ppm or greater. The splenic lymphocytic atrophy and the thymic atrophy were probably related to low body weights.

Dose Selection Rationale: Based on the mortality observed in 800 ppm males and females, body weight decreases in the 600 and 800 ppm groups, and the incidence and/or severity of histopathologic lesions in the lung, spleen, and thymus in rats exposed to 400 ppm or greater, doses selected for the 13-week study were 10, 25, 75, 150, and 300 ppm.

TABLE 11
Incidences of Selected Nonneoplastic Lesions in Mice in the 16-Day Inhalation Study of Isobutyl Nitrite

Dose	0 ppm	100 ppm	200 ppm	400 ppm	600 ppm	800 ppm
Male						
Lung ^a	5	5	5	5	5	5
Epithelial Hyperplasia, Bronchiole ^b	0	5** (1.2) ^c	5** (2.0)	5** (2.8)	5** (2.4)	2 (3.0)
Spleen	5	5	5	5	5	5
Atrophy, Lymphocytic	0	0	0	2 (1.5)	5** (1.6)	2 (1.0)
Thymus	5	— ^d	5	5	5	5
Atrophy, Lymphocytic	0		0	1 (1.0)	4* (1.0)	1 (3.0)
Female						
Lung	5	5	5	5	5	5
Epithelial Hyperplasia, Bronchiole	0	5** (1.6)	5** (2.2)	5** (2.2)	5** (1.8)	3 (2.7)
Spleen	5	5	5	5	5	5
Atrophy, Lymphocytic	0	0	0	1 (1.0)	3 (1.0)	3 (1.0)
Thymus	5	1	5	5	5	5
Atrophy, Lymphocytic	0	0	0	1 (1.0)	4* (1.0)	3 (1.4)

* Significantly different ($P \leq 0.05$) from the control group by the Fisher exact test

** $P \leq 0.01$

^a Number of animals with organ examined microscopically

^b Number of animals with lesion

^c Average severity of lesions in affected animals: 1 = minimal; 2 = mild; 3 = moderate; 4 = marked

^d Organ not examined at this exposure level.

13-WEEK STUDY

One 150 ppm female and one 300 ppm female died before the end of the study, but the deaths were not considered related to chemical exposure (Table 12). All males and all other female mice survived to the end of the study. Final mean body weights and mean body weight gains of 150 and 300 ppm females were significantly lower than those of the controls; final mean body weights and mean weight gains of males were similar to those of the controls. There were no chemical-related clinical findings.

The hematology and clinical chemistry results for the 13-week study of isobutyl nitrite in mice are listed in Table G3. At the end of the study, methemoglobin concentrations were slightly elevated in 150 and 300 ppm males and females. An anemia, evidenced by minimal to mild decreases in erythrocyte counts and hematocrit values, was present in males and

females exposed to 300 ppm. The anemia was macrocytic (mean cell volumes were increased), suggesting increased numbers of circulating reticulocytes. No reticulocyte counts were available for this study for detection of a bone marrow response. However, treatment-related increases in MCV and the microscopic presence of splenic extramedullary hematopoiesis would be consistent with a hemato-poietic response to the anemia and/or the methemoglobinemia. An increase in mean cell hemoglobin occurred in 300 ppm males and females and corresponds to the increased MCV. Mild increases in leukocyte and/or lymphocyte counts occurred in some exposed male and female mice. Similar changes were discussed previously for rats in the 13-week study.

All organ weight differences were considered to be secondary to body weight changes (Table F5).

TABLE 12
Survival and Body Weights of Mice in the 13-Week Inhalation Study of Isobutyl Nitrite

Dose (ppm)	Survival ^a	Mean Body Weight ^b (g)			Final Weight Relative to Controls (%)
		Initial	Final	Change	
Male					
0	10/10	23.9 ± 0.3	34.7 ± 0.8	10.8 ± 0.7	
10	10/10	23.7 ± 0.6	34.5 ± 1.0	10.8 ± 0.6	99
25	10/10	23.9 ± 0.4	34.0 ± 0.9	10.1 ± 0.6	98
75	10/10	23.2 ± 0.6	34.1 ± 0.8	11.0 ± 1.0	98
150	10/10	23.5 ± 0.3	34.2 ± 0.9	10.8 ± 0.9	99
300	10/10	23.2 ± 0.4	34.0 ± 0.4	10.8 ± 0.4	98
Female					
0	10/10	19.9 ± 0.3	33.3 ± 1.4	13.4 ± 1.3	
10	10/10	20.2 ± 0.2	32.5 ± 0.9	12.2 ± 0.8	98
25	10/10	19.9 ± 0.2	31.9 ± 0.8	12.0 ± 0.7	96
75	10/10	19.6 ± 0.2	31.7 ± 1.3	12.0 ± 1.1	95
150	9/10 ^c	19.9 ± 0.3	29.6 ± 1.0*	9.7 ± 0.8**	89
300	9/10 ^d	18.2 ± 0.4**	27.3 ± 0.8**	9.1 ± 0.6**	82

* Significantly different ($P \leq 0.05$) from the control group by Williams' or Dunnett's test

** $P \leq 0.01$

^a Number of animals surviving/number initially in group

^b Weights and weight changes are given as mean ± standard error. Subsequent calculations are based on animals surviving to the end of the study.

^c Week of death: 10

^d Week of death: 14

In the lung, increased incidences of hyperplasia of the bronchiolar epithelium occurred in males exposed to 75 ppm or greater and in females exposed to 150 ppm or greater (Table 13). The hyperplasia of the bronchiolar epithelium was minimal to moderate in males and minimal to mild in females. The bronchiolar epithelial hyperplasia observed at 13 weeks was similar to that observed in the 16-day study. The normal uniform, one or two nuclear rows formed by pseudostratified columnar cells of the distal bronchioles was replaced by a highly cellular, sometimes irregular, pseudostratified mucosa composed of multiple layers of hyperplastic and hypertrophic columnar epithelial cells. An occasional dysplasia with nuclear pleomorphism was present. Some cells appeared degenerated with desquamation. The increased number and size of epithelial cells and the accumulation of secretions, exfoliated cells, and cellular debris resulted in reduced bronchiolar lumens in some lobes. The hyperplastic bronchiolar epithelium was most prominent in the distal segments of the bronchi and bronchioles and ended with the terminal bronchioles. Alveolar ducts and alveoli were not involved. Minimal

epithelial hyperplasia of the nasal mucosa was observed in 300 ppm males and was similar in topography and morphology to that observed in rats. This lesion was not observed in females.

In the spleen, increased incidences of hematopoiesis occurred in males exposed to 75 ppm or greater and in females exposed to 150 ppm or greater. Increased incidences of hemosiderosis occurred in a few males exposed to 300 ppm and in females exposed to 75 ppm or greater, and the increases were significant in 150 and 300 ppm females. The increased incidences and slight increases in the severity of hematopoiesis and hemosiderosis are related to the anemia observed.

Dose Selection Rationale: Based on the low final mean body weight of 300 ppm females and mild to moderate bronchiolar hyperplasia and anemia observed in 300 ppm males and females, isobutyl nitrite exposure levels selected for the 2-year inhalation study in mice were 37.5, 75, and 150 ppm.

TABLE 13
Incidences of Selected Nonneoplastic Lesions in Mice in the 13-Week Inhalation Study of Isobutyl Nitrite

Dose	0 ppm	10 ppm	25 ppm	75 ppm	150 ppm	300 ppm
Male						
Lung ^a	10	10	10	10	10	10
Hyperplasia, Epithelial, Bronchiole ^b	0	0	0	3 (1.3) ^c	9** (1.2)	10** (2.1)
Nose	10	10	10	10	10	10
Hyperplasia, Epithelial Cell, Mucosa	0	0	0	0	0	6** (1.0)
Spleen	10	10	10	10	10	10
Hematopoiesis	0	0	0	4* (1.2)	9** (1.2)	10** (2.0)
Hemosiderosis	0	0	0	0	0	2 (1.0)
Female						
Lung	10	10	10	10	10	10
Hyperplasia, Epithelial, Bronchiole	0	0	0	0	9** (1.3)	10** (1.7)
Spleen	10	10	10	10	10	10
Hematopoiesis	0	0	0	0	9** (1.9)	9** (2.1)
Hemosiderosis	0	0	0	3 (1.0)	9** (1.4)	10** (1.4)

* Significantly different ($P \leq 0.05$) from the control group the Fisher exact test

** $P \leq 0.01$

^a Number of animals with organ examined microscopically

^b Number of animals with lesion

^c Average severity of lesions in affected animals: 1 = minimal; 2 = mild; 3 = moderate; 4 = marked

2-YEAR STUDY

Survival

Estimates of 2-year survival probabilities for male and female mice are shown in Table 14 and in the Kaplan-Meier survival curves (Figure 3). Survival

rates of exposed groups of males were similar to that of the controls; survival rates of exposed groups of females were greater than that of the controls, and the survival rate of 37.5 ppm females was significantly greater than that of the controls.

TABLE 14
Survival of Mice in the 2-Year Inhalation Study of Isobutyl Nitrite

	0 ppm	37.5 ppm	75 ppm	150 ppm
Male				
Animals initially in study	60	60	60	60
15-month interim evaluation ^a	10	10	10	7
Accidental deaths ^a	2	0	0	2
Moribund	1	7	4	4
Natural deaths	10	8	11	17
Animals surviving to study termination	37	35	35	30
Percent probability of survival at end of study ^b	78	71	71	60
Mean survival (days) ^c	629	652	641	609
Survival analysis ^d	P=0.047	P=0.677	P=0.599	P=0.083
Female				
Animals initially in study	60	60	60	60
15-month interim evaluation ^a	9	9	9	10
Accidental death ^a	0	0	0	1
Missing ^a	0	0	1	0
Moribund	3	3	6	2
Natural deaths	16	6	8	10
Animals surviving to study termination	32	42	36	37
Percent probability of survival at end of study	63	83	73	76
Mean survival (days)	643	666	648	635
Survival analysis	P=0.452N	P=0.045N	P=0.494N	P=0.238N

^a Censored from survival analyses

^b Kaplan-Meier determinations based on the number of animals alive on the first day of terminal sacrifice

^c Mean of all deaths (uncensored, censored, and terminal sacrifice)

^d The result of the life table trend test (Tarone, 1975) is in the control column, and the results of the life table pairwise comparisons (Cox, 1972) with the controls are in the exposed columns. A negative trend or a lower mortality in an exposure group is indicated by N.

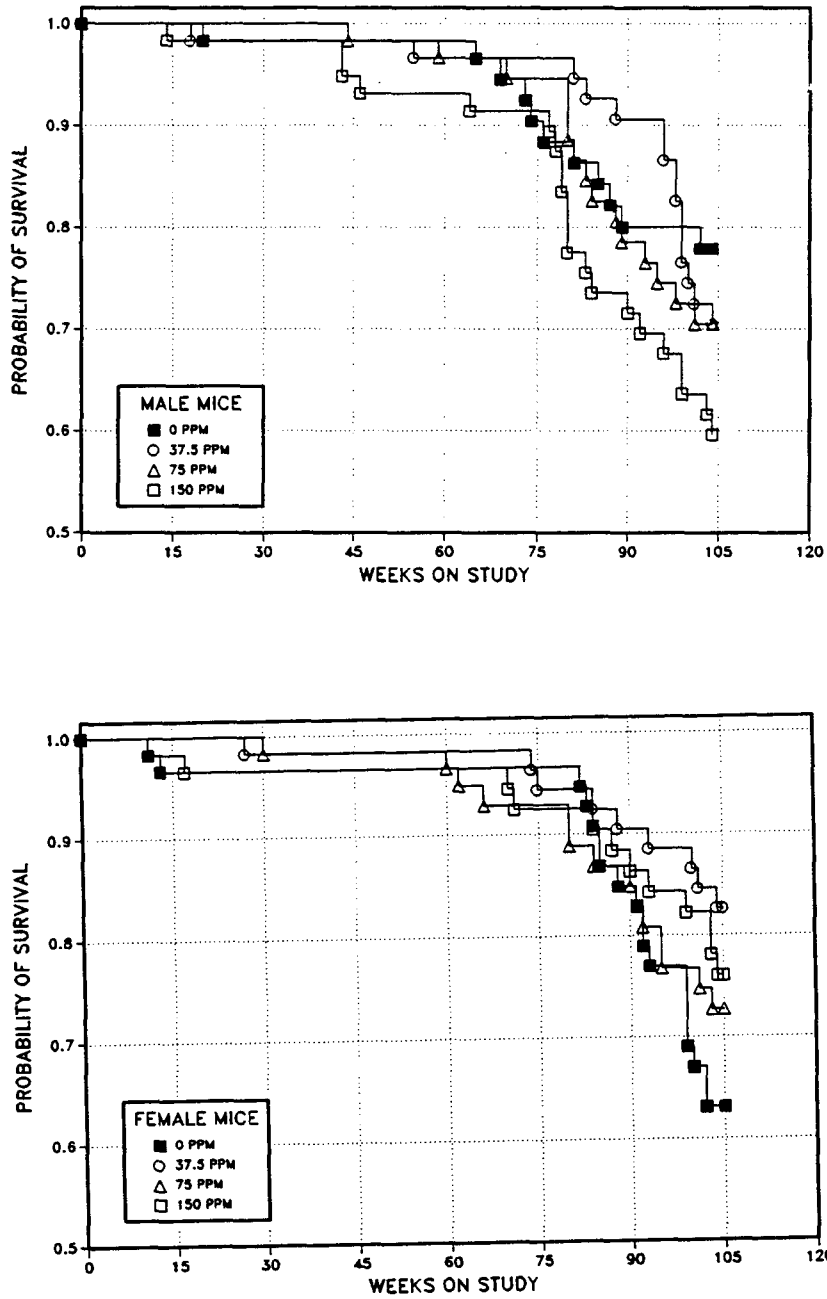

FIGURE 3
Kaplan-Meier Survival Curves for Male and Female Mice Administered Isobutyl Nitrite by Inhalation for 2 Years

Body Weights and Clinical Findings

Mean body weights of exposed groups of male mice were similar to those of the controls throughout the study (Table 15 and Figure 4). From week 20 until the end of the study, the mean body weights of 150 ppm females were lower than those of the controls (Table 16 and Figure 4). Mean body weights of 37.5 and 75 ppm females were similar to those of the controls. Clinical findings that occurred during the study (hypoactivity and abnormal posture) were considered unrelated to chemical exposure.

Hematology and Clinical Chemistry

At the 15-month interim evaluation, a minimal methemoglobinemia (increased methemoglobin concentration) was present in groups of males and females exposed to 75 ppm or greater (Table G4). Additionally, there was evidence of an anemia, consisting of a slight decrease in the erythrocyte count, hemoglobin concentration, and hematocrit in the 75 and 150 ppm male and female mice. Mild increases in leukocyte and lymphocyte counts occurred in 150 ppm males. Similar differences were discussed previously for rats in the 13-week study.

TABLE 15
Mean Body Weights and Survival of Male Mice in the 2-Year Inhalation Study of Isobutyl Nitrite

Weeks on Study	0 ppm		37.5 ppm			75 ppm			150 ppm		
	Av. Wt. (g)	No. of Survivors	Av. Wt. (g)	Wt. (% of controls)	No. of Survivors	Av. Wt. (g)	Wt. (% of controls)	No. of Survivors	Av. Wt. (g)	Wt. (% of controls)	No. of Survivors
1	22.2	60	22.2	100	60	22.2	100	60	21.6	97	60
2	24.5	60	24.6	100	60	24.4	100	60	24.2	99	60
3	25.8	60	26.0	101	60	25.9	100	60	25.9	100	60
4	27.0	60	27.2	101	60	27.4	102	60	26.9	100	60
5	28.1	60	28.4	101	60	28.0	100	60	27.7	99	60
6	28.6	60	29.0	101	60	28.1	98	60	29.3	102	60
7	29.7	60	30.0	101	60	29.1	98	60	29.6	100	60
8	29.0	60	29.7	102	60	29.6	102	60	30.0	103	60
9	30.8	60	30.7	100	60	30.2	98	60	30.5	99	60
10	31.4	59	31.7	101	60	31.1	99	60	31.4	100	60
11	32.2	59	32.3	100	60	32.3	100	60	31.8	99	60
12	33.0	59	32.7	99	60	33.0	100	60	32.5	99	60
13	33.6	59	33.0	98	60	33.4	99	60	32.4	96	60
16	35.2	59	35.0	99	60	35.2	100	60	34.6	98	58
20	37.6	59	37.8	101	59	37.7	100	60	36.2	96	58
24	39.6	58	39.9	101	59	39.0	99	60	37.5	95	58
28	41.4	58	41.9	101	59	42.0	101	60	39.3	95	58
32	43.2	58	44.6	103	59	44.0	102	60	40.7	94	58
36	43.9	58	45.5	104	59	44.7	102	60	41.6	95	57
40	44.5	58	46.3	104	59	45.6	103	60	43.0	97	57
44	44.6	58	47.2	106	59	46.4	104	60	43.4	97	55
48	44.5	58	47.4	107	59	47.0	106	59	42.7	96	54
52	45.3	58	48.0	106	59	47.6	105	59	43.9	97	54
56	46.0	58	48.5	105	58	48.6	106	59	44.8	97	54
60	46.4	58	49.2	106	58	8.0	103	58	45.1	97	54
64	47.6	58	49.2	103	58	48.1	101	58	45.7	96	53
68 ^a	46.3	47	49.7	107	48	49.6	107	48	46.1	100	46
72	46.5	46	49.6	107	48	50.2	108	47	46.8	101	46
76	47.2	44	49.3	104	48	50.2	106	47	45.9	97	46
80	47.1	43	49.4	105	48	49.2	105	47	45.0	96	42
84	47.2	41	50.0	106	46	50.1	106	41	46.6	99	38
88	48.4	39	49.5	102	46	49.3	102	41	46.0	95	37
92	47.8	38	48.9	102	45	49.9	104	39	44.7	94	36
96	47.5	38	48.1	101	44	49.2	104	37	45.3	95	35
100	47.1	38	49.5	105	38	49.3	105	35	44.9	95	32
104	47.1	37	48.4	103	36	47.8	102	35	43.1	92	31
Mean for weeks											
1-13	28.9		29.0	100		28.8	100		28.8	100	
14-52	42.0		43.4	103		42.9	102		40.3	96	
53-104	47.1		49.2	104		49.2	104		45.4	96	

^a Interim evaluation occurred during week 66.

TABLE 16
Mean Body Weights and Survival of Female Mice in the 2-Year Inhalation Study of Isobutyl Nitrite

Weeks on Study	0 ppm		37.5 ppm			75 ppm			150 ppm		
	Av. Wt. (g)	No. of Survivors	Av. Wt. (g)	Wt. (% of controls)	No. of Survivors	Av. Wt. (g)	Wt. (% of controls)	No. of Survivors	Av. Wt. (g)	Wt. (% of controls)	No. of Survivors
1	18.5	60	18.3	99	60	18.4	100	60	17.9	97	60
2	20.0	60	20.1	101	60	20.4	102	60	19.5	98	60
3	21.2	60	21.3	101	60	21.1	100	60	20.5	97	60
4	21.9	60	22.1	101	60	21.9	100	60	21.4	98	60
5	22.8	60	22.7	100	60	23.0	101	60	22.1	97	60
6	23.7	60	23.4	99	60	23.1	98	60	23.1	98	60
7	23.3	60	23.2	100	60	23.1	99	60	22.7	97	60
8	25.0	60	24.1	96	60	24.0	96	60	23.5	94	60
9	24.5	60	24.6	100	60	24.5	100	60	23.8	97	60
10	25.2	60	25.4	101	60	24.7	98	60	24.0	95	59
11	25.7	59	26.2	102	60	25.8	100	60	24.7	96	58
12	26.4	59	26.5	100	60	26.2	99	60	24.8	94	58
13	27.0	59	26.7	99	60	26.7	99	60	25.4	94	58
16	28.2	58	28.1	100	60	28.1	100	60	26.1	93	58
20	30.2	58	29.8	99	60	29.1	96	60	26.6	88	57
24	31.4	58	32.1	102	60	30.9	98	60	27.5	88	57
28	33.2	58	34.0	102	59	32.6	98	60	29.1	88	57
32	35.8	58	36.6	102	59	34.5	96	59	30.2	84	57
36	36.2	58	38.2	106	59	35.2	97	59	30.5	84	57
40	37.6	58	39.7	106	59	37.0	98	59	31.4	84	57
44	38.6	58	40.7	105	59	36.9	96	59	31.1	81	57
48	38.7	58	40.5	105	59	37.4	97	59	31.1	80	57
52	39.2	58	41.5	106	59	38.5	98	59	32.0	82	57
56	41.6	58	43.9	106	59	40.2	97	59	32.3	78	57
60	42.3	58	43.8	104	59	40.1	95	58	32.6	77	57
64	43.2	58	45.6	106	59	42.8	99	57	33.7	78	57
68 ^a	45.0	49	46.9	104	50	45.4	101	47	34.6	77	47
72	45.9	49	47.2	103	50	46.0	100	47	34.5	75	45
76	46.7	49	47.8	102	48	47.9	103	46	36.0	77	45
80	47.5	49	47.6	100	48	47.9	101	46	35.6	75	45
84	48.0	47	49.0	102	48	48.6	101	43	36.2	75	44
88	48.5	44	48.6	100	47	49.4	102	43	36.8	76	43
92	47.3	41	47.5	100	46	48.8	103	40	36.7	78	42
96	46.7	39	47.0	101	45	48.9	105	38	37.3	80	41
100	47.1	34	46.9	100	45	48.3	103	38	37.3	79	40
104	46.7	32	46.6	100	43	48.1	103	36	37.6	81	37
Mean for weeks											
1-13	23.5		23.4	100		23.3	99		22.6	96	
14-52	34.9		36.1	103		34.0	97		29.6	85	
53-104	45.9		46.8	102		46.3	101		35.5	77	

^a Interim evaluation occurred during week 66.

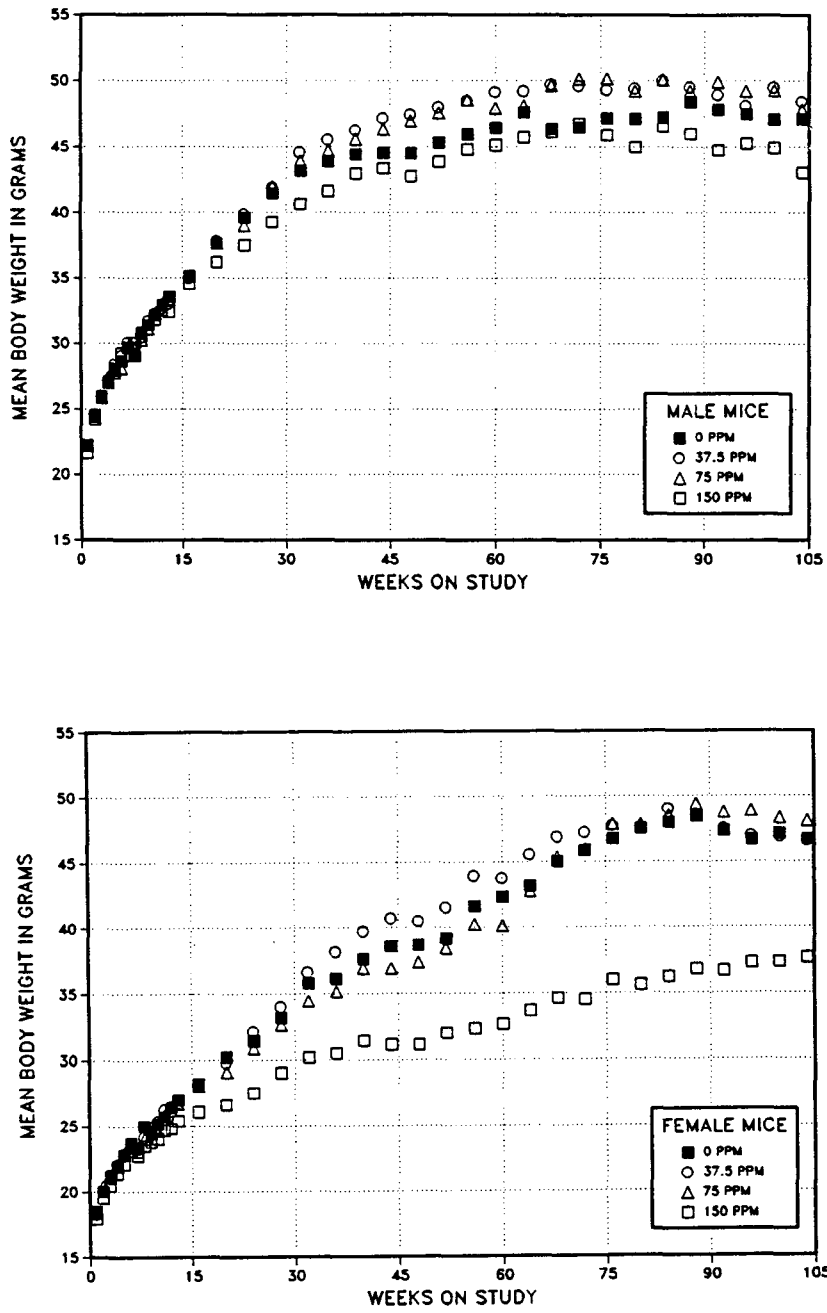

FIGURE 4
Growth Curves for Male and Female Mice Administered Isobutyl Nitrite by Inhalation for 2 Years

Pathology and Statistical Analyses

This section describes the statistically significant or biologically noteworthy changes in the incidences of neoplasms and/or nonneoplastic lesions of the lung, thyroid gland, nose, and spleen. Summaries of the incidences of neoplasms and nonneoplastic lesions, individual animal tumor diagnoses, statistical analyses of primary neoplasms that occurred with an incidence of at least 5% in at least one animal group, and historical incidences for the neoplasms mentioned in this section are presented in Appendix C for male mice and Appendix D for female mice.

Lung: Increased incidences of alveolar/bronchiolar adenoma and alveolar/bronchiolar adenoma or carcinoma (combined) occurred with significantly positive trends in exposed males and females (Tables 17, C3, and D3). The incidences of alveolar/bronchiolar adenoma or carcinoma (combined) in 75 ppm males and in 150 ppm males and females were significantly greater than those in controls. There was also an increase in the number of male mice with multiple adenomas and multiple carcinomas and in the number of female mice with multiple adenomas (Tables 17, C1, and D1). Additionally, the incidences in 150 ppm females exceeded the historical control range for alveolar/bronchiolar adenoma or carcinoma (combined) in NTP 2-year inhalation studies (Tables 17 and D4). Increased incidences of hyperplasia of the alveolar epithelium also occurred in all exposed groups of male and female mice at 2 years, and the incidences in 75 and 150 ppm males and females were significantly greater than those in the controls (Tables 17, C5, and D5). Alveolar epithelial hyperplasia and alveolar/bronchiolar adenoma and carcinoma constitute a morphological continuum. The alveolar epithelial

hyperplasia was focal in nature, and often only one focus per lung was observed (Plate 5). These focal areas of hyperplasia appeared to be randomly distributed throughout the lung and were not positioned deep in the lung along major airways as they were in rats. The alveolar epithelial hyperplasia consisted of a small focal cluster of five to 10 alveoli which had slightly enlarged alveolar epithelial cells (Type II pneumocytes). In some foci, there were increased numbers of alveolar epithelial cells as well as an increase in the size of the cells. In other foci, there was proliferation of these alveolar epithelial cells, such that they were more elongated and perpendicular to the alveolar wall. In some foci where the alveolar epithelial cells were several cell layers thick, the cells extended into the lumen of alveoli and small bronchioles.

Alveolar/bronchiolar adenomas were distinct masses that caused compression of the adjacent parenchyma (Plate 6). There was distortion of the underlying alveolar architecture and the epithelium was arranged in irregular papillary patterns. The alveolar spaces were obliterated to varying extents, and some neoplasms appeared solid. The epithelium was composed of cuboidal to columnar cells and was supported by a delicate fibrovascular stroma. The neoplastic epithelial cells were uniform with round to oval nuclei and moderate to abundant cytoplasm. Alveolar/bronchiolar carcinomas were not well circumscribed. Neoplastic cells effaced the alveolar architecture and infiltrated the adjacent lung tissue (Plate 7). Neoplastic cells were arranged in papillary and solid patterns and sometimes formed alveolar or glandular patterns. The neoplastic cells were pleomorphic and had variable degrees of anaplasia. Occasional to numerous mitotic figures were often present in carcinomas (Plate 8).

TABLE 17
Incidences of Neoplasms and Nonneoplastic Lesions of the Lung of Mice in the 2-Year Inhalation Study of Isobutyl Nitrite

Dose	0 ppm	37.5 ppm	75 ppm	150 ppm
Male				
15-Month Interim Evaluation				
Lung ^a	10	10	10	7
Alveolar Epithelium, Hyperplasia ^b	1 (3.0) ^c	0	0	0
Alveolar/bronchiolar Adenoma	1	2	0	0
2-Year Study				
Lung	50	50	49	53
Alveolar Epithelium, Hyperplasia	0	4 (1.8)	7** (1.6)	13** (2.1)
Alveolar/bronchiolar Adenoma, Multiple				
Overall rate ^d	0/50 (0%)	3/50 (6%)	3/49 (6%)	5/53* (9%)
Alveolar/bronchiolar Adenoma, Single or Multiple				
Overall rate	7/50 (14%)	12/50 (24%)	13/49 (27%)	17/53 (32%)
Adjusted rate ^e	18.3%	34.3%	37.1%	49.2%
Terminal rate ^f	6/37 (16%)	12/35 (34%)	13/35 (37%)	13/30 (43%)
First incidence (days)	604	725 (T)	725 (T)	558
Logistic regression test ^g	P=0.005	P=0.200	P=0.093	P=0.011
Alveolar/bronchiolar Carcinoma, Multiple				
Overall rate	0/50 (0%)	1/50 (2%)	1/49 (2%)	0/53 (0%)
Alveolar/bronchiolar Carcinoma, Single or Multiple				
Overall rate	1/50 (2%)	6/50 (12%)	5/49 (10%)	4/53 (8%)
Adjusted rate	2.7%	15.6%	14.3%	11.2%
Terminal rate	1/37 (3%)	4/35 (11%)	5/35 (14%)	2/30 (7%)
First incidence (days)	725 (T)	667	725 (T)	558
Logistic regression test	P=0.275	P=0.070	P=0.090	P=0.190
Alveolar/bronchiolar Adenoma or Carcinoma ^h				
Overall rate	8/50 (16%)	16/50 (32%)	16/49 (33%)	19/53 (36%)
Adjusted rate	20.9%	42.8%	45.7%	53.4%
Terminal rate	7/37 (19%)	14/35 (40%)	16/35 (46%)	14/30 (47%)
First incidence (days)	604	667	725 (T)	558
Logistic regression test	P=0.006	P=0.075	P=0.039	P=0.008

(continued)

TABLE 17
Incidences of Neoplasms and Nonneoplastic Lesions of the Lung of Mice in the 2-Year Inhalation Study of Isobutyl Nitrite (continued)

Dose	0 ppm	37.5 ppm	75 ppm	150 ppm
Female				
15-Month Interim Evaluation				
Lung	9	9	9	10
Alveolar Epithelium, Hyperplasia	0	0	1 (1.0)	0
Alveolar/bronchiolar Adenoma	0	2	2	2
2-Year Study				
Lung	51	51	50	50
Alveolar Epithelium, Hyperplasia	0	2 (4.0)	9** (2.9)	8** (2.1)
Alveolar/bronchiolar Adenoma, Multiple				
Overall rate	0/51 (0%)	2/51 (4%)	1/50 (2%)	2/50 (4%)
Alveolar/bronchiolar Adenoma, Single or Multiple				
Overall rate	4/51 (8%)	14/51 (27%)	7/50 (14%)	17/50 (34%)
Adjusted rate	11.7%	33.3%	18.5%	43.3%
Terminal rate	3/32 (9%)	14/42 (33%)	6/36 (17%)	15/37 (41%)
First incidence (days)	689	729 (T)	558	625
Logistic regression test	P=0.005	P=0.028	P=0.255	P=0.002
Alveolar/bronchiolar Carcinoma				
Overall rate	2/51 (4%)	2/51 (4%)	2/50 (4%)	2/50 (4%)
Alveolar/bronchiolar Adenoma or Carcinoma ⁱ				
Overall rate	6/51 (12%)	15/51 (29%)	9/50 (18%)	19/50 (38%)
Adjusted rate	17.0%	35.7%	23.9%	48.5%
Terminal rate	4/32 (13%)	15/42 (36%)	8/36 (22%)	17/37 (46%)
First incidence (days)	689	729 (T)	558	625
Logistic regression test	P=0.005	P=0.061	P=0.281	P=0.003

(T)Terminal sacrifice

* Significantly different ($P \leq 0.05$) from the control group by the logistic regression test

** ($P \leq 0.01$)

^a Number of animals with lung examined microscopically

^b Number of animals with lesion

^c Average severity grade of lesion in affected animals (1 = minimal; 2 = mild; 3 = moderate; 4 = marked)

^d Number of animals with neoplasm per number of animals examined microscopically

^e Kaplan-Meier estimated neoplasm incidence at the end of the study after adjustment for intercurrent mortality

^f Observed incidence in animals surviving until the end of the study

^g In the control column are the P values associated with the trend test. In the exposed group columns are the P values corresponding to the pairwise comparisons between the controls and that exposed group. The logistic regression test regards lesions in animals dying prior to terminal kill as nonfatal.

^h Historical incidence for 2-year inhalation studies with control groups (mean \pm standard deviation): 170/773 (22.0% \pm 8.7%); range 10% to 42%

ⁱ Historical incidence: 75/761 (9.9% \pm 3.7%); range 0% to 15%

Thyroid Gland: Thyroid gland follicular cell adenoma occurred with a significant positive trend in male mice (Tables 18 and C3). Additionally, the incidence of this neoplasm in 150 ppm males was marginally greater than that in the controls and exceeded the range in historical controls from 2-year NTP inhalation studies (Tables 18 and C4b). Thyroid gland follicular cell hyperplasia was observed in one 75 ppm male at the 15-month interim evaluation, and the incidences in 37.5 and 150 ppm males at the end of the 2-year study were significantly greater than that of the controls (Tables 18 and C5). Follicular cell hyperplasia and adenoma constitute a morphological continuum. Follicular cell

hyperplasia consisted of focal to multifocal collections of variably sized follicles, often enlarged and sometimes cystic, with irregular hypertrophy and increased cellularity of the follicular epithelium (Plate 9). Minimal to mild follicular cell hyperplasia consisted of one or several follicles lined by cuboidal to columnar epithelium with small and infrequent papillary infoldings (Plate 10). Follicular cell adenomas were generally more discrete collections of altered follicles that compressed the surrounding parenchyma (Plate 11). Neoplastic follicular epithelial cells were well differentiated; nuclei were hyperchromatic and contained prominent nuclei (Plate 12).

TABLE 18
Incidences of Neoplasms and Nonneoplastic Lesions of the Thyroid Gland of Male Mice
in the 2-Year Inhalation Study of Isobutyl Nitrite

Dose	0 ppm	37.5 ppm	75 ppm	150 ppm
15-Month Interim Evaluation				
Thyroid Gland ^a	10	10	10	7
Follicular Cell, Hyperplasia ^b	0	0	1 (1.0) ^c	0
2-Year Study				
Thyroid Gland	50	50	50	53
Follicular Cell, Hyperplasia	8 (1.0)	17* (1.2)	12 (1.4)	20** (1.4)
Follicular Cell Adenoma				
Overall rate ^d	1/50 (2%)	0/50 (0%)	0/50 (0%)	5/53 (9%)
Adjusted rate ^e	2.7%	0.0%	0.0%	16.7%
Terminal rate ^f	1/37 (3%)	0/35 (0%)	0/35 (0%)	5/30 (17%)
First incidence (days)	725 (T)	— ^h	—	725 (T)
Logistic regression test ^g	P=0.004	P=0.511N	P=0.511N	P=0.061
Follicular Cell Carcinoma				
Overall rate	0/50 (0%)	1/50 (2%)	0/50 (0%)	0/53 (0%)
Follicular Cell Adenoma or Carcinoma ⁱ				
Overall rate	1/50 (2%)	1/50 (2%)	0/50 (0%)	5/53 (9%)
Adjusted rate	2.7%	2.9%	0.0%	16.7%
Terminal rate	1/37 (3%)	1/35 (3%)	0/35 (0%)	5/30 (17%)
First incidence (days)	725 (T)	725 (T)	—	725 (T)
Logistic regression test	P=0.011	P=0.749	P=0.511N	P=0.061

(T)Terminal sacrifice

* Significantly different ($P \leq 0.05$) from the control group by the logistic regression test

** $P \leq 0.01$

^a Number of animals with thyroid gland examined microscopically

^b Number of animals with lesion

^c Average severity grade of lesion in affected animals (1 = minimal; 2 = mild; 3 = moderate; 4 = marked)

^d Number of animals with neoplasm per number of animals examined microscopically

^e Kaplan-Meier estimated neoplasm incidence at the end of the study after adjustment for intercurrent mortality

^f Observed incidence in animals surviving until the end of the study

^g In the control column are the P values associated with the trend test. In the exposed group columns are the P values corresponding to the pairwise comparisons between the controls and that exposed group. The logistic regression test regards lesions in animals dying prior to terminal kill as nonfatal. A lower incidence in an exposure group is indicated by N.

^h Not applicable; no neoplasms in animal group

ⁱ Historical incidence for 2-year inhalation studies with control groups (mean \pm standard deviation): 13/763 (1.7% \pm 1.5%); range 0% to 4%

Nose: Increased incidences of serous exudate and olfactory epithelium atrophy occurred in 150 ppm female mice (Tables 19 and D5). The serous exudate was characterized as a homogeneous eosinophilic proteinaceous material in the lumen of the nose. This exudate was more commonly present in the anterior section but, in some cases, was present in all three sections of nose. The olfactory epithelium that was in direct contact with this exudate had a loosened

or disorganized appearance. The cell population of the olfactory epithelium in these affected areas was reduced and was diagnosed as atrophy, and sustentacular cells were more prominent. No incidences of serous exudate were observed in male or female mice at the 15-month interim evaluation. The increased incidences of serous exudate and atrophy of the olfactory epithelium of female mice were considered to be chemical related.

TABLE 19
Incidences of Nonneoplastic Lesions of the Nose of Female Mice in the 2-Year Inhalation Study of Isobutyl Nitrite

Dose	0 ppm	37.5 ppm	75 ppm	150 ppm
Nose ^a	51	51	50	50
Serous Exudate ^b	1 (1.0) ^c	1 (1.0)	2 (1.0)	23** (1.3)
Atrophy, Olfactory Epithelium	0	0	1 (2.0)	16** (1.5)

** Significantly different ($P \leq 0.01$) from the control group by the logistic regression test

^a Number of animals with nose examined microscopically

^b Number of animals with lesion

^c Average severity grade of lesion in affected animals (1 = minimal; 2 = mild; 3 = moderate; 4 = marked)

Spleen: An increased incidence of minimal to mild hemosiderin pigment occurred in 75 and 150 ppm males (Tables 20 and C5). Although there was no significant increase in the incidence of hemosiderin pigment in females, the severity of pigment was slightly greater in 150 ppm females than that in the controls. Increased extramedullary hematopoiesis in exposed mice was more difficult to detect than the increased pigmentation. This difficulty was the result

of almost all control spleens having extramedullary hematopoiesis that varied considerably in degree. Also, in mice that had an inflammatory process or lesions elsewhere in the body, this resulted in increased extramedullary hematopoiesis in the spleen. Splenic changes were consistent with the changes observed in the 13-week study and were associated with the methemoglobinemia.

TABLE 20
Incidences of Nonneoplastic Lesions of the Spleen of Mice in the 2-Year Inhalation Study of Isobutyl Nitrite

Dose	0 ppm	37.5 ppm	75 ppm	150 ppm
Male				
15-Month Interim Evaluation				
Spleen ^a	10	10	10	7
Hematopoietic Cell Proliferation ^b	10 (1.0) ^c	10 (1.1)	10 (1.3)	7 (1.3)
Pigmentation, Hemosiderin	6 (1.0)	7 (1.0)	9 (1.3)	7 (1.6)
2-Year Study				
Spleen	50	50	49	51
Hematopoietic Cell Proliferation	49 (1.3)	43* (1.3)	47 (1.4)	48 (1.8)
Pigmentation, Hemosiderin	28 (1.0)	19* (1.0)	46** (1.1)	49** (1.3)
Female				
15-Month Interim Evaluation				
Spleen	9	9	9	10
Hematopoietic Cell Proliferation	9 (1.0)	9 (1.2)	9 (1.0)	10 (1.2)
Pigmentation, Hemosiderin	9 (1.0)	9 (1.0)	9 (1.7)	10 (2.0)
2-Year Study				
Spleen	51	51	50	49
Hematopoietic Cell Proliferation	45 (1.3)	40 (1.3)	45 (1.4)	44 (1.2)
Pigmentation, Hemosiderin	45 (1.0)	43 (1.1)	37 (1.2)	47 (1.7)

* Significantly different ($P \leq 0.05$) from the control group by the logistic regression test

** $P \leq 0.01$

^a Number of animals with spleen examined microscopically

^b Number of animals with lesion

^c Average severity grade of lesion in affected animals (1 = minimal; 2 = mild; 3 = moderate; 4 = marked)

GENETIC TOXICOLOGY

Results from three separate tests in two laboratories confirmed that isobutyl nitrite induced gene mutations in *Salmonella typhimurium* strains TA100 and TA1535 in the presence of induced rat or hamster liver S9 (Mortelmans *et al.*, 1986; Table E1); in the absence of S9, equivocal responses were obtained in each of these two strains. No clearly positive responses were obtained with strains TA98 or TA1537, with or without S9. In the second study, a precipitate was noted at concentrations above 3,333 $\mu\text{g}/\text{plate}$ with 10% or 30% S9.

In cytogenetic tests conducted at two laboratories with cultured Chinese hamster ovary cells, isobutyl nitrite induced sister chromatid exchanges (Table E2) and chromosomal aberrations (Table E3), with and without S9. A clear, dose-related increase in sister chromatid exchanges was observed over a dose range of 5 to 160 $\mu\text{g}/\text{mL}$ without S9 and 16 to 1,667 $\mu\text{g}/\text{mL}$ with S9 (combined results from both laboratories). Toxicity, in the form of cell cycle delay and decreased numbers of scorable metaphase cells, was observed at concentrations of 500 $\mu\text{g}/\text{mL}$ and greater in the presence of S9 (SITEK Research Laboratory study). In the chromosomal aberrations test, the first laboratory obtained a positive response only in the absence of S9; the increase in aberrations noted at the high dose of 500 $\mu\text{g}/\text{mL}$ in the presence

of S9 was insufficient for a positive call. Results from the second laboratory demonstrated induction of chromosomal aberrations under both activation conditions. The response observed in the single trial conducted with S9 was weak, however, and not well correlated with increasing dose. It was achieved at a concentration of 1,081 $\mu\text{g}/\text{mL}$, a level much higher than was tested at the first laboratory, and that may account for the apparent discordance in results for this test.

Isobutyl nitrite did not induce sex-linked recessive lethal mutations in germ cells of male *Drosophila melanogaster* when administered by feeding (100,000 ppm) or by injection (25,000 ppm) (Woodruff *et al.*, 1985; Table E4). However, inhalation of isobutyl nitrite (10 to 300 ppm) for 90 days induced significant increases in micronucleated normochromatic erythrocytes in peripheral blood of male and female mice.

In conclusion, isobutyl nitrite induced mutations in *Salmonella typhimurium* and sister chromatid exchanges and chromosomal aberrations in cultured Chinese hamster ovary cells. Although no increase in sex-linked recessive lethal mutations was observed in male *Drosophila melanogaster* treated with isobutyl nitrite, both male and female mice exposed to the chemical showed significantly elevated levels of micronucleated erythrocytes in peripheral blood.

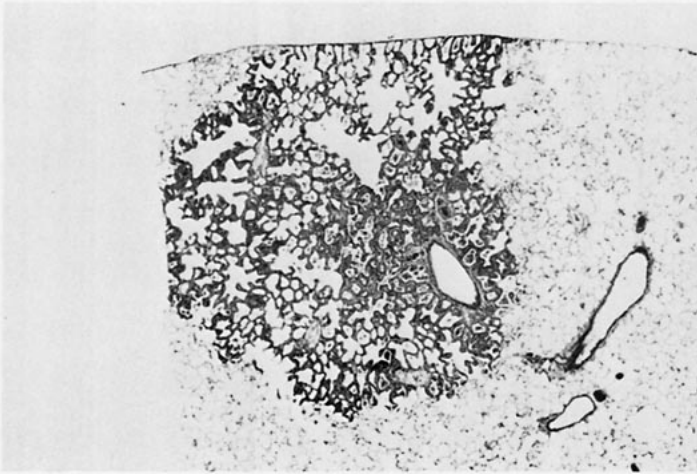

PLATE 1

Alveolar epithelial hyperplasia in the lung of a male F344/N rat exposed to 75 ppm isobutyl nitrite by inhalation for 2 years. Note the alveolar architecture is maintained. H&E, 8×

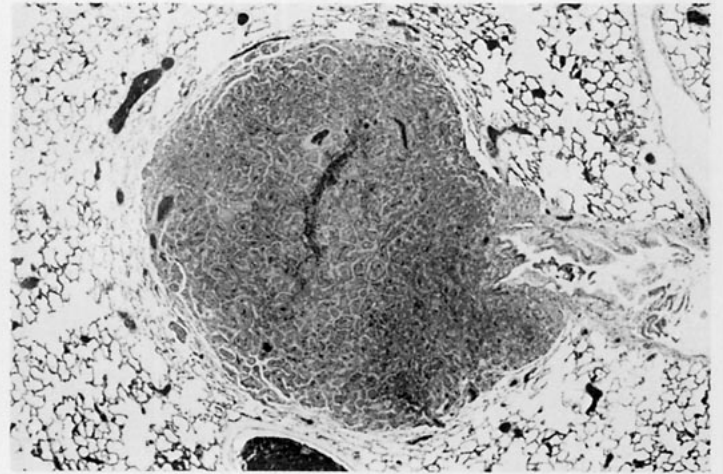

PLATE 2

Alveolar/bronchiolar adenoma in the lung of a male F344/N rat exposed to 150 ppm isobutyl nitrite by inhalation for 2 years. The well circumscribed adenoma causes compression of the adjacent lung parenchyma, and the alveolar architecture is distorted. H&E, 8×

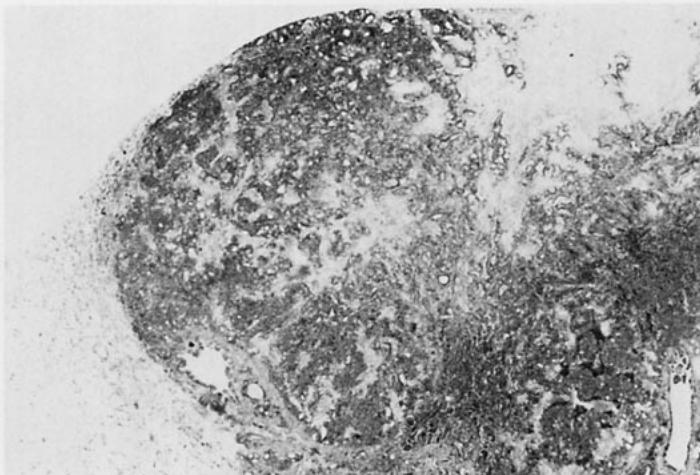

PLATE 3

Alveolar/bronchiolar carcinoma in the lung of a male F344/N rat exposed to 37.5 ppm isobutyl nitrite by inhalation for 2 years. The neoplastic cells efface the alveolar architecture and infiltrate the adjacent lung tissue. H&E, 4×

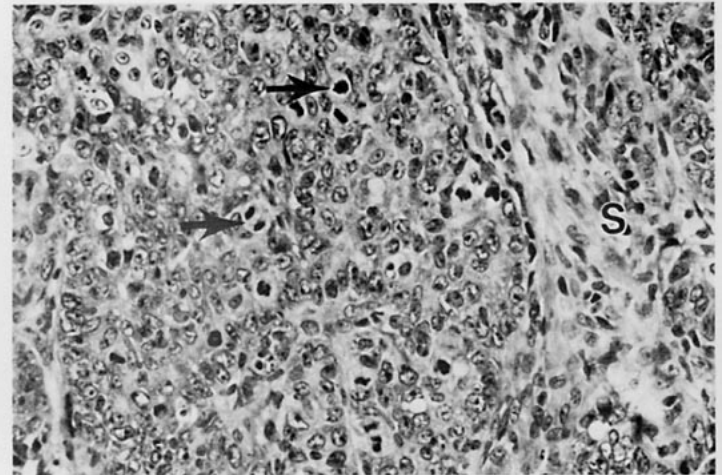

PLATE 4

Higher magnification of Plate 3. Neoplastic cells are pleomorphic, nuclei contain 1 to 3 prominent nucleoli, and numerous mitotic figures are present (arrows). Note the scirrhous (S) response to the anaplastic cells. H&E, 100×

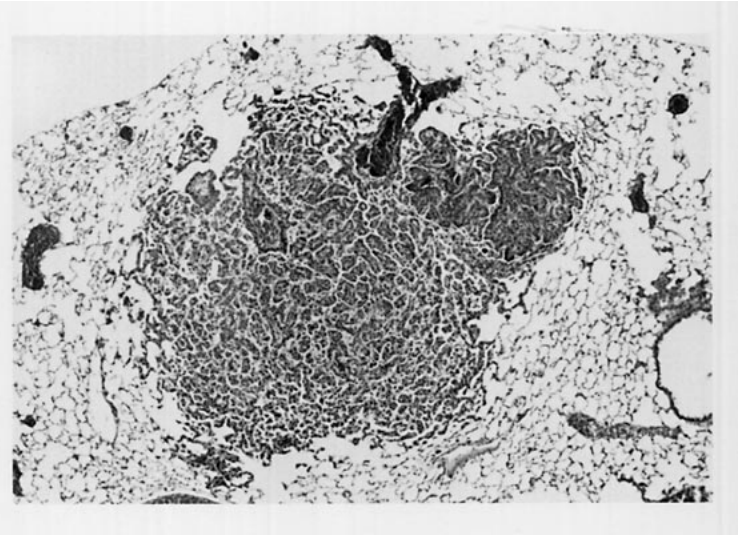
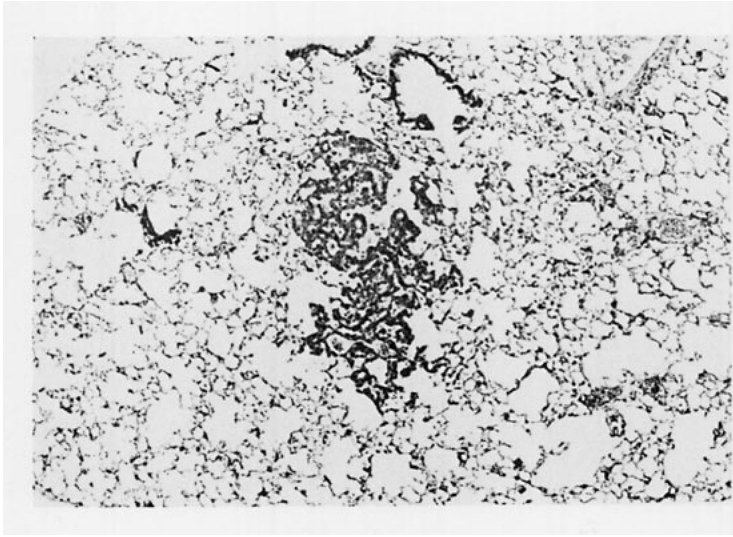

PLATE 5

Alveolar epithelial hyperplasia in the lung of a male B6C3F₁ mouse exposed to 150 ppm isobutyl nitrite by inhalation for 2 years. The alveolar architecture is maintained. H&E, 16×

PLATE 6

Alveolar/bronchiolar adenoma in the lung of a male B6C3F₁ mouse exposed to 150 ppm isobutyl nitrite by inhalation for 2 years. The well circumscribed adenoma causes compression of the adjacent lung parenchyma, and the alveolar architecture is distorted. H&E, 16×

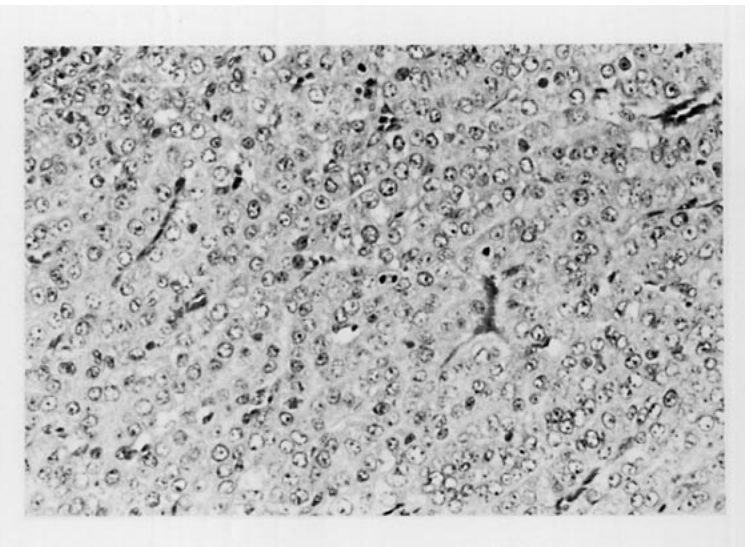

PLATE 7

Alveolar/bronchiolar carcinoma in the lung of a male B6C3F₁ mouse exposed to 150 ppm by inhalation for 2 years. The neoplastic cells are arranged in solid (S) and papillary (P) patterns and have effaced the alveolar architecture. H&E, 16×

PLATE 8

Higher magnification of Plate 7. Neoplastic cells contain nuclei with 1 to 2 prominent nucleoli, and occasional mitotic figures are present. H&E, 80×

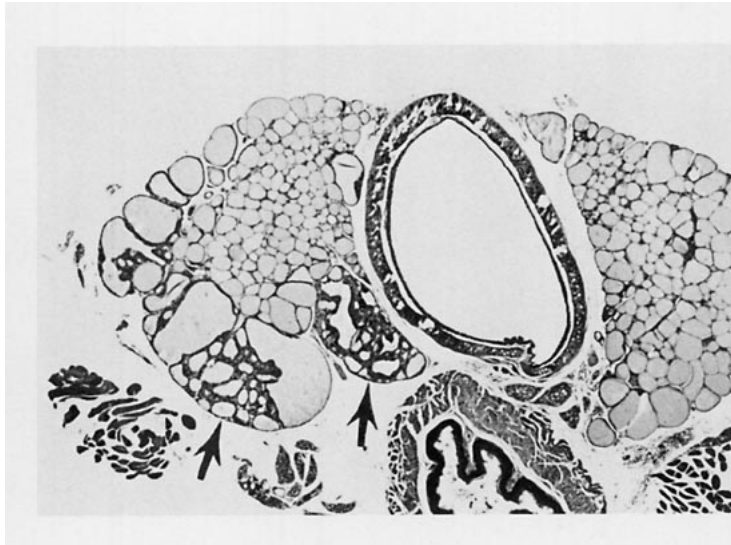

PLATE 9

Follicular cell hyperplasia (arrows) in the thyroid gland of a male B6C3F₁ mouse exposed to 150 ppm isobutyl nitrite by inhalation for 2 years. Note the multifocal collections are variable in size and sometimes the follicles are cystic and the follicular epithelium is hypercellular. H&E, 8×

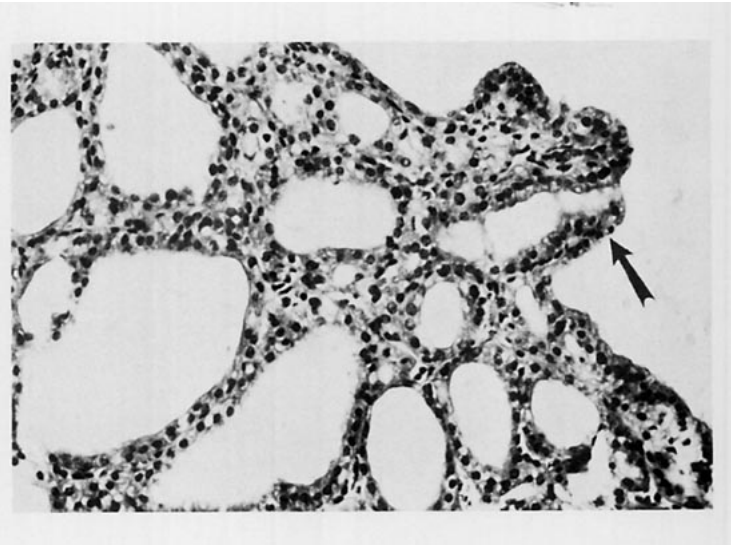

PLATE 10

Higher magnification of Plate 9. Hyperplasia consists of several follicles lined by 1 to 3 cell layers of cuboidal to columnar epithelium with small and infrequent papillary infoldings (arrow). H&E, 66×



PLATE 11

Follicular cell adenoma in the thyroid gland of a male B6C3F₁ mouse exposed to 150 ppm isobutyl nitrite by inhalation for 2 years. Note the discrete and well demarcated mass which compresses the surrounding parenchyma. H&E, 8×

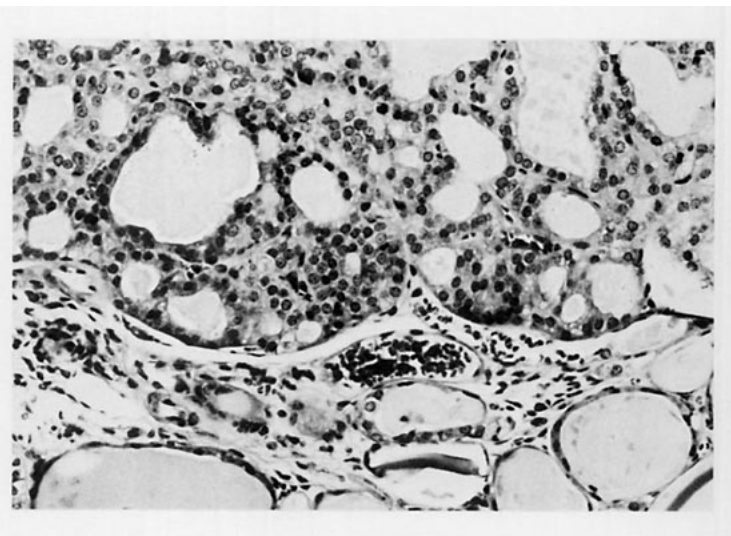

PLATE 12

Higher magnification of Plate 11. Monomorphic population of neoplastic follicular epithelial cells. Cell nuclei are hyperchromatic and contain prominent nucleoli. H&E, 100×

DISCUSSION AND CONCLUSIONS

Isobutyl nitrite is used as an intermediate in the syntheses of aliphatic nitrites and in room odorizers (Sigell *et al.*, 1978; *Patty's Industrial Hygiene and Toxicology*, 1982). The chemical is inhaled for its euphoric effects and has become a substance of abuse, particularly among male homosexuals (Sigell *et al.*, 1978).

The Consumer Product Safety Commission nominated the chemical for study because of a potential link between the high incidence of Kaposi's sarcoma among male homosexual acquired immune deficiency syndrome patients and because of the paucity of available data on its potential carcinogenicity. Additionally, isobutyl nitrite has the potential to form nitrosamines by reacting with biological amines (Dabora *et al.*, 1984; Osterloh and Goldfield, 1984). Toxicology and carcinogenicity studies were conducted by exposing F344/N rats and B6C3F₁ mice to atmospheres containing various concentrations of isobutyl nitrite vapors for 6 hours per day, 5 days per week for 16 days, 13 weeks, or 2 years. Inhalation was selected as the route of exposure in these studies because human exposure occurs primarily via this route.

In the 16-day studies, all of the rats exposed to 600 or 800 ppm isobutyl nitrite died before the end of the study, as did three male and four female mice exposed to 800 ppm. These deaths were consistent with the reported LC₅₀ for rats (777 ppm for a 4-hour exposure) and mice (1,033 ppm for a 1-hour exposure) (McFadden *et al.*, 1981; Klonne *et al.*, 1987). The dose-mortality response was steep; no deaths occurred at lower doses. This observation is also consistent with mortality rates in the Klonne *et al.* (1987) study. Final mean body weights and mean body weight gains of 400 ppm male and female rats were significantly lower than those of the controls, as were those of surviving male and female mice exposed to 600 or 800 ppm. Incidences of hyperplasia of the bronchiolar epithelium in mice, bronchial epithelium in rats, epithelium of the nasal turbinates in rats, splenic hemosiderosis, and bone

marrow hematopoietic hyperplasia in rats observed in the 16-day studies were considered to be related to exposure to isobutyl nitrite.

In the 13-week studies, male and female rats and mice were exposed to 0, 10, 25, 75, 150, or 300 ppm isobutyl nitrite by inhalation. All rats survived until the end of the study. One 150 ppm and one 300 ppm female mouse died before the end of the study, but the deaths did not appear to be related to isobutyl nitrite exposure. Lynch *et al.* (1985) reported the deaths of two male and one female Balb/c mice exposed to 300 ppm isobutyl nitrite during an exposure regimen of 6.5 hours per day, 5 days per week for up to 18 weeks. These authors attributed the deaths to dehydration. While there was greater than a 10% depression in final mean body weights in male and female rats and female mice exposed to 300 ppm in the present 13-week studies, no adverse effects on body weights occurred in Balb/c mice exposed to the same concentration of isobutyl nitrite for a longer period of time (18 weeks) in the Lynch *et al.* (1985) study. This may suggest that Balb/c mice are more tolerant to isobutyl nitrite than are B6C3F₁ mice.

In the 13-week rat study, hyperactivity was observed in females exposed to 150 or 300 ppm; this effect subsided after a few days of exposure. The same effect was not observed in exposed male rats. This response appears to be consistent with the known stimulating effect of isobutyl nitrite in humans, and the selective presence of this response in females suggests a greater sensitivity of females to isobutyl nitrite stimulation. The fact that hyperactivity was observed only during the first 6 weeks of the study suggests the development of tolerance. Tolerance to amyl nitrite has been previously reported after repeated use by humans (Crandall *et al.*, 1931).

Toxic effects of isobutyl nitrite in rats and mice in the 13-week studies were observed in the blood and respiratory tract. The effects observed in the bone marrow of rats and the spleen of rats and mice were

considered secondary to the hematotoxic effects of isobutyl nitrite. Hematology differences observed in exposed rats and mice included lower erythrocyte counts accompanied by greater mean cell volumes and methemoglobin concentrations; in general, exposure to isobutyl nitrite caused a methemoglobinemia and a macrocytic normochromic responsive anemia. These effects were most pronounced in animals exposed to 300 ppm. Similar differences were also noted in rats and mice after 15 months of exposure to 150 ppm isobutyl nitrite in the present 2-year studies. High methemoglobin concentration is a characteristic of nitrite exposure and has been previously noted in animals and humans exposed to isobutyl nitrite (Dixon *et al.*, 1981; McFadden *et al.*, 1981; Guss *et al.*, 1985; Lynch *et al.*, 1985); these increased methemoglobin concentrations reflect the oxidative effect of nitrites on hemoglobin. The mild anemia characterized by lower erythrocyte counts in isobutyl nitrite-exposed animals was presumably due to a shortened erythrocyte lifetime resulting from greater methemoglobin concentrations. The macrocytosis would be associated with the compensatory hematopoietic response and would be related to increased release of larger, immature erythrocytes (reticulocytes). In the present studies, the compensatory response was characterized by macrocytosis and bone marrow hyperplasia in rats and increased splenic hematopoiesis in rats and mice.

In the 13-week studies, chemical-related changes observed in the respiratory tract included epithelial cell hyperplasia of the nasal mucosa in rats and hyperplasia of the epithelial layer lining the bronchi (rats) and bronchioles (mice). Tissue changes of this type are often associated with irritant gases. Epithelial cell hyperplasia of the nasal mucosa was not present at 2 years, suggesting that there was some adaptation to the irritant effects of this chemical in rats. In rats and mice, the hyperplastic lung lesions observed at 16 days and 13 weeks were different than those observed in the 2-year study. The lesions in the 16-day and 13-week studies were primarily bronchial epithelial hyperplasia in rats and bronchiolar hyperplasia in mice. However, the lesions in the 2-year studies were alveolar epithelial hyperplasia. Generally, lung weights were also slightly increased in both rats and mice exposed to 300 ppm isobutyl nitrite. These effects are consistent with previous

reports of lung weight increases and respiratory epithelial hyperplasia (Covalla *et al.*, 1981; McFadden *et al.*, 1981; Lynch *et al.*, 1985).

On the basis of body weights and hematology and histopathology changes observed in the respiratory tract and hematopoietic system, male and female rats and mice generally displayed similar toxic effects after isobutyl nitrite exposure. The presence of hyperactivity only in female rats and splenic hematopoiesis only in mice indicates a slight sex and species difference in response to isobutyl nitrite.

Based on the lower final mean body weights, anemia, and the presence of respiratory tract lesions in the 13-week studies, doses selected for the 2-year studies in rats and mice were 37.5, 75, and 150 ppm isobutyl nitrite. These doses were considered sufficiently challenging for assessment of the carcinogenic potential of isobutyl nitrite in these 2-year studies as evidenced by the lower final mean body weights of animals exposed to 300 ppm (rats: males, 86% of control; females, 96% of control; mice: males, 92% of control; females, 80% of control), the adequate survival rates of all exposed groups of males and females, and the presence of chemical-related toxic lesions in the nasal passages, lung, bone marrow, and spleen of male and female rats, in the nose of male mice, and in the lung, thyroid gland, and spleen of male and female mice.

Survival of control rats was within the historical range for 2-year NTP inhalation studies. However, survival of exposed male and female rats was generally greater than that of the controls, and the survival of 75 and 150 ppm males was significantly greater than that of the controls. The increased survival of exposed males was attributed to the decreased incidence of mononuclear cell leukemia in these animals. Survival of exposed groups of male mice was similar to that of the controls, but survival of exposed groups of female mice was greater than that of the controls. However, the numbers of mice surviving within all exposure groups were within the historical range for 2-year NTP inhalation studies. Final mean body weights of 150 ppm female mice were less than those of the controls; final mean body weights of all exposed groups of males and of 37.5 and 75 ppm females were similar to those of the controls.

In the 2-year rat study, there were increased incidences of alveolar/bronchiolar adenoma and adenoma or carcinoma (combined) in exposed male and female rats. Additionally, the incidences of alveolar/bronchiolar adenoma or carcinoma (combined) in 75 ppm male rats and 150 ppm male and female rats were outside the overall NTP historical range for these neoplasms. Increased incidences of alveolar hyperplasia were also observed in all exposed groups of male and female rats at the 15-month interim evaluation (except 75 ppm females) and in all exposed groups of male and female rats in the 2-year study. The increased incidences of lung neoplasms and epithelial hyperplasia, along with an increase in the number of rats with multiple adenomas, were considered "clear evidence of carcinogenic activity" in male and female rats.

Incidences of mononuclear cell leukemia were significantly decreased in exposed groups of male and female rats. Similar findings of increased incidences of methemoglobinemia and microscopic splenic lesions (i.e., hemosiderin accumulation, extramedullary hematopoiesis, and congestion) in short-term studies have been associated with decreased incidences of mononuclear cell leukemia (NCI, 1978; NTP, 1982a,b, 1989a,b, 1992a,b). Mononuclear cell leukemia may originate in the spleen. For example, following a splenectomy, the incidence of mononuclear cell leukemia was reduced from 24% to 2% in 1- to 2-month-old rats (Moloney and King, 1973). The data suggest that potential precursor cells of mononuclear cell leukemia may be suppressed or damaged when the spleen is a target organ in 16-day or 13-week studies, and there may be an association between early splenic toxicity and decreased incidences of mononuclear cell leukemia in F344/N rats.

Exposure of mice to isobutyl nitrite for 2 years was associated with increased incidences of pulmonary neoplasms. The incidences of alveolar/bronchiolar adenoma or carcinoma (combined) in 75 ppm males and in 150 ppm males and females were significantly greater than those in the controls and the incidences in all exposed groups of females exceeded the range in historical controls from 2-year NTP inhalation studies. In addition, alveolar epithelial hyperplasia occurred in all exposed groups of males and females; the lesion was absent in controls, and the incidences in 75 and 150 ppm males and females were signifi-

cantly greater than those in the controls. The increased incidences of lung adenomas in male and female mice and the increase in the number of male and female mice with alveolar/bronchiolar adenoma or carcinoma (combined) were considered "some evidence of carcinogenic activity" of isobutyl nitrite based on the following: the strength of the statistical evidence; the multiplicity of lung neoplasms in exposed mice; comparison with the historical controls from NTP 2-year inhalation studies; and the increased incidence of epithelial hyperplasia.

Thyroid gland follicular cell adenoma occurred with a significant positive trend in male mice, and the incidence in 150 ppm males was marginally greater than that in the controls (0 ppm, 1/50; 150 ppm, 5/53). Thyroid follicular cell neoplasms are relatively uncommon in male mice. The NTP historical control rate for thyroid gland follicular cell adenoma or carcinoma (combined) in 2-year inhalation studies is 14/664. In the present study, the increase in thyroid adenomas was accompanied by an increase in follicular cell hyperplasia. Considering the rarity of this neoplasm in male mice and the increased incidences of thyroid gland follicular cell hyperplasia in exposed males, the increased incidence of thyroid gland follicular cell adenoma may have been related to isobutyl nitrite exposure.

CONCLUSIONS

Under the conditions of these 2-year inhalation studies, there was *clear evidence of carcinogenic activity** of isobutyl nitrite in male and female F344/N rats based on the increased incidences of alveolar/bronchiolar adenoma and alveolar/bronchiolar adenoma or carcinoma (combined). There was *some evidence of carcinogenic activity* of isobutyl nitrite in male and female B6C3F₁ mice based on the increased incidences of alveolar/bronchiolar adenoma and alveolar/bronchiolar adenoma or carcinoma (combined) in males and females. The increased incidence of thyroid gland follicular cell adenoma in male mice may have been related to isobutyl nitrite exposure.

Exposure of rats and mice to isobutyl nitrite by inhalation for 2 years resulted in increased incidences of alveolar epithelial hyperplasia (male and female rats and mice), thyroid gland follicular cell

hyperplasia and splenic hemosiderin pigmentation (male mice), and serous exudate and atrophy of the olfactory epithelium of the nose (female mice).

Exposure of rats to isobutyl nitrite by inhalation for 2 years resulted in decreased incidences of mononuclear cell leukemia in males and females.

* Explanation of Levels of Evidence of Carcinogenic Activity is on page 10. A summary of the Technical Reports Review Subcommittee comments and the public discussion on this Technical Report appears on page 12.

REFERENCES

- Armitage, P. (1971). *Statistical Methods in Medical Research*, pp. 362-365. John Wiley and Sons, New York.
- Ashby, J., and Tennant, R.W. (1991). Definitive relationships among chemical structure, carcinogenicity, and mutagenicity for 301 chemicals tested by the U.S. NTP. *Mutat. Res.* **257**, 229-306.
- Boorman, G.A., Montgomery, C.A., Jr., Eustis, S.L., Wolfe, M.J., McConnell, E.E., and Hardisty, J.F. (1985). Quality assurance in pathology for rodent carcinogenicity studies. In *Handbook of Carcinogen Testing* (H.A. Milman and E.K. Weisburger, Eds.), pp. 345-357. Noyes Publications, Park Ridge, NJ.
- Brunton, T.L. (1867). On the use of the nitrite of amyl in angina pectoris. *Lancet* **2**, 97-98.
- Code of Federal Regulations (CFR) **21**, Part 58.
- Covalla, J.R., Strimlan, C.V., and Lech, J.G. (1981). Severe tracheobronchitis from inhalation of an isobutyl nitrite preparation. *Drug Intell. Clin. Pharm.* **15**, 51-52.
- Cox, D.R. (1972). Regression models and life-tables. *J. R. Stat. Soc.* **B34**, 187-220.
- Crandall, L.A., Jr., Leake, C.D., Loevenhart, A.S., and Muehlberger, C.W. (1931). Acquired tolerance to and cross tolerance between the nitrous and nitric acid esters and sodium nitrite in man. *J. Pharmacol. Exp. Ther.* **41**, 103-119.
- Crawford, B.D. (1985). Perspectives on the somatic mutation model of carcinogenesis. In *Advances in Modern Environmental Toxicology: Mechanisms and Toxicity of Chemical Carcinogens and Mutagens* (M.A. Mehlman, W.G. Flamm, and R.J. Lorentzen, Eds.), pp. 13-59. Princeton Scientific Publishing Co. Inc., Princeton, NJ.
- Dabora, R., Molina, M., Ng, V., Wishnok, J.S., and Tannenbaum, S.R. (1984). Nitrosation by alkyl nitrites. Catalysis by inorganic salts. *IARC Sci. Publ.* **57**, 311-316.
- Dinse, G.E., and Haseman, J.K. (1986). Logistic regression analysis of incidental-tumor data from animal carcinogenicity experiments. *Fundam. Appl. Toxicol.* **6**, 44-52.
- Dinse, G.E., and Lagakos, S.W. (1983). Regression analysis of tumour prevalence data. *Appl. Statist.* **32**, 236-248.
- Dixon, D.S., Reisch, R.F., and Santinga, P.H. (1981). Fatal methemoglobinemia resulting from ingestion of isobutyl nitrite, a "room odorizer" widely used for recreational purposes. *J. Forensic Sci.* **26**, 587-593.
- Doyle, M.P., Terpstra, J.W., Pickering, R.A., and LePoire, D.M. (1983). Hydrolysis, nitrosyl exchange, and synthesis of alkyl nitrites. *J. Org. Chem.* **48**, 3379-3382.
- Dunkel, V.C., Rogers-Back, A.M., Lawlor, T.E., Harbell, J.W., and Cameron, T.P. (1989). Mutagenicity of some alkyl nitrites used as recreational drugs. *Environ. Mol. Mutagen.* **14**, 115-122.
- Dunn, O.J. (1964). Multiple comparisons using rank sums. *Technometrics* **6**, 241-252.
- Dunnett, C.W. (1955). A multiple comparison procedure for comparing several treatments with a control. *J. Am. Stat. Assoc.* **50**, 1096-1121.
- Ehrenberg, L., Hussain, S., Noor Saleh, M., and Lundqvist, U. (1980). Nitrous esters - A genetical hazard from nitrogen oxides (NO_x)? *Hereditas* **92**, 127-130.

- Galloway, S.M., Armstrong, M.J., Reuben, C., Colman, S., Brown, B., Cannon, C., Bloom, A.D., Nakamura, F., Ahmed, M., Duk, S., Rimpou, J., Margolin, B.H., Resnick, M.A., Anderson, B., and Zeiger, E. (1987). Chromosome aberrations and sister chromatid exchanges in Chinese hamster ovary cells: Evaluations of 108 chemicals. *Environ. Mol. Mutagen.* **10** (Suppl. 10), 1-175.
- Gart, J.J., Chu, K.C., and Tarone, R.E. (1979). Statistical issues in interpretation of chronic bioassay tests for carcinogenicity. *J. Natl. Cancer Inst.* **62**, 957-974.
- Goodman and Gilman's The Pharmacological Basis of Therapeutics* (1990). 8th ed. (A.G. Gilman, A.S. Nies, T.W. Rall, and P. Taylor, Eds.). Pergamon Press, Inc., New York.
- Guss, D.A., Normann, S.A., and Manoguerra, A.S. (1985). Clinically significant methemoglobinemia from inhalation of isobutyl nitrite. *Am. J. Emerg. Med.* **3**, 46-47.
- Haley, T.J. (1980). Review of the physiological effects of amyl, butyl, and isobutyl nitrites. *Clin. Toxicol.* **16**, 317-329.
- Haseman, J.K. (1984). Statistical issues in the design, analysis and interpretation of animal carcinogenicity studies. *Environ. Health Perspect.* **58**, 385-392.
- Haseman, J.K., Huff, J., and Boorman, G.A. (1984). Use of historical control data in carcinogenicity studies in rodents. *Toxicol. Pathol.* **12**, 126-135.
- Haseman, J.K., Huff, J.E., Rao, G.N., Arnold, J.E., Boorman, G.A., and McConnell, E.E. (1985). Neoplasms observed in untreated and corn oil gavage control groups of F344/N rats and (C57BL/6N × C3H/HeN)_{F1} (B6C3F₁) mice. *JNCI* **75**, 975-984.
- Haverkos, H.W. (1988). Epidemiologic studies - Kaposi's sarcoma vs. opportunistic infections among homosexual men with AIDS. In *Health Hazards of Nitrite Inhalants* (H.W. Haverkos and J.A. Dougherty, Eds.), pp. 96-105. NIDA Research Monograph Series No. 83. National Institute of Drug Abuse.
- Hersh, E.M., Reuben, J.M., Bogerd, H., Rosenblum, M., Bielski, M., Mansell, P.W.A., Rios, A., Newell, G.R., and Sonnenfeld, G. (1983). Effect of the recreational agent isobutyl nitrite on human peripheral blood leukocytes and on *in vitro* interferon production. *Cancer Res.* **43**, 1365-1371.
- Hollander, M., and Wolfe, D.A. (1973). *Nonparametric Statistical Methods*, pp. 120-123. John Wiley and Sons, New York.
- Integrated Laboratory Systems (ILS) (1990). P.O. Box 13501, Research Triangle Park, NC 27707.
- Israelstam, S., Lambert, S., and Oki, G. (1978). Poppers, a new recreational drug craze. *Can. Psychiatr. Assoc. J.* **23**, 493-495.
- Jacobs, K.W., and Rivero, L.J. (1978). Nonmedical use of amyl nitrite compounds. *South. Med. J.* **71**, 1454.
- Jaffe, H.W., Choi, K., Thomas, P.A., Haverkos, H.W., Auerbach, D.M., Guinan, M.E., Rogers, M.F., Spira, T.J., Darrow, W.W., Kramer, M.A., Friedman, S.M., Monroe, J.M., Friedman-Kien, A.E., Laubenstein, L.J., Marmor, M., Safai, B., Dritz, S.K., Crispi, S.J., Fannin, S.L., Orkwis, J.P., Kelter, A., Rushing, W.R., Thacker, S.B., and Curran, J.W. (1983). National case-control study of Kaposi's sarcoma and *Pneumocystis carinii* pneumonia in homosexual men: Part 1, epidemiologic results. *Ann. Intern. Med.* **99**, 145-151.
- Jonckheere, A.R. (1954). A distribution-free *k*-sample test against ordered alternatives. *Biometrika* **41**, 133-145.
- Kaplan, E.L., and Meier, P. (1958). Nonparametric estimation from incomplete observations. *J. Am. Stat. Assoc.* **53**, 457-481.
- Klonne, D.R., Ulrich, C.E., Weissman, J., and Morgan, A.K. (1987). Acute inhalation toxicity of aliphatic (C₁-C₅) nitrites in rats. *Fundam. Appl. Toxicol.* **8**, 101-106.

- Lewis, D.M., Koller, W.A., Lynch, D.W., and Spira, T.J. (1985). Subchronic inhalation toxicity of isobutyl nitrite in Balb/c mice. II. Immunotoxicity studies. *J. Toxicol. Environ. Health* **15**, 835-846.
- Loeppky, R.N., Tomasik, W., and Millard, T.G. (1984). Ester-mediated nitrosamine formation from nitrite and secondary or tertiary amines. *IARC Sci. Publ.* **57**, 353-363.
- Lynch, D.W., Moorman, W.J., Burg, J.R., Phipps, F.C., Lewis, T.R., Khan, A., Lewis, D.M., Chandler, F.W., Kimbrough, R.D., and Spira, T.J. (1985). Subchronic inhalation toxicity of isobutyl nitrite in Balb/c mice. I. Systemic toxicity. *J. Toxicol. Environ. Health* **15**, 823-833.
- McConnell, E.E., Solleveld, H.A., Swenberg, J.A., and Boorman, G.A. (1986). Guidelines for combining neoplasms for evaluation of rodent carcinogenesis studies. *JNCI* **76**, 283-289.
- McFadden, D.P., and Maickel, R.P. (1982). Butyl nitrites - An example of hazardous, noncontrolled recreational drugs. *Res. Commun. Subst. Abuse* **3**, 233-236.
- McFadden, D.P., Carlson, G.P., and Maickel, R.P. (1981). The role of methemoglobin in acute butyl nitrite toxicity in mice. *Fundam. Appl. Toxicol.* **1**, 448-451.
- MacGregor, J.T., Wehr, C.M., and Langlois, R.G. (1983). A simple fluorescent staining procedure for micronuclei and RNA in erythrocytes using Hoechst 33258 and pyronin Y. *Mutat. Res.* **120**, 269-275.
- MacGregor, J.T., Wehr, C.M., Henika, P.R., and Shelby, M.D. (1990). The *in vivo* erythrocyte micronucleus test: Measurement at steady state increases assay efficiency and permits integration with toxicity studies. *Fundam. Appl. Toxicol.* **14**, 513-522.
- McKnight, B., and Crowley, J. (1984). Tests for differences in tumor incidence based on animal carcinogenesis experiments. *J. Am. Stat. Assoc.* **79**, 639-648.
- Maickel, R.P., and McFadden, D.P. (1979). Acute toxicology of butyl nitrites and butyl alcohols. *Res. Commun. Chem. Pathol. Pharmacol.* **26**, 75-83.
- Margolin, B.H., Collings, B.J., and Mason, J.M. (1983). Statistical analysis and sample-size determinations for mutagenicity experiments with binomial responses. *Environ. Mutagen.* **5**, 705-716.
- Marmor, M., Friedman-Kien, A.E., Laubenstein, L., Byrum, R.D., William, D.C., D'Onofrio, S., and Dubin, N. (1982). Risk factors for Kaposi's sarcoma in homosexual men. *Lancet* **1**, 1083-1087.
- Maronpot, R.R., and Boorman, G.A. (1982). Interpretation of rodent hepatocellular proliferative alterations and hepatocellular tumors in chemical safety assessment. *Toxicol. Pathol.* **10**, 71-80.
- The Merck Index* (1989). 11th ed. (S. Budavari, Ed.). Merck and Company, Rahway, NJ.
- Miller, J.A., and Miller, E.C. (1977). Ultimate chemical carcinogens as reactive mutagenic electrophiles. In *Origins of Human Cancer* (H.H. Hiatt, J.D. Watson, and J.A. Winsten, Eds.), pp. 605-627. Cold Spring Harbor Laboratory, Cold Spring Harbor, NY.
- Mirvish S.S., Sams, J.P., and Issenberg, P. (1983). The nitrosating agent in mice exposed to nitrogen dioxide: Improved extraction method and localization in the skin. *Cancer Res.* **43**, 2550-2554.
- Mirvish, S.S., Ramm, M.D., and Babcook, D.M. (1988). Indications from animal and chemical experiments of a carcinogenic role for isobutyl nitrite. In *Health Hazards of Nitrite Inhalants* (H.W. Haverkos and J.A. Dougherty, Eds.), pp. 39-49. NIDA Research Monograph Series No. 83. National Institute of Drug Abuse.
- Mittal, C.K., and Murad, F. (1982). Guanylate cyclase: Regulation of cyclic GMP metabolism. In *Handbook of Experimental Pharmacology* (G.V.R. Born, A. Farah, H. Herken, and A.D. Welch, Eds.), Vol. 58/I, pp. 225-260. Springer Verlag, Berlin.

- Moloney, W.C., and King, V.P. (1973). Reduction of leukemia incidence following splenectomy in the rat. *Cancer Res.* **33**, 573-574.
- Morrison, D.F. (1976). *Multivariate Statistical Methods*, 2nd ed., pp. 170-179. McGraw-Hill Book Company, New York.
- Mortelmans, K., Haworth, S., Lawlor, T., Speck, W., Tainer, B., and Zeiger, E. (1986). *Salmonella* mutagenicity tests: II. Results from the testing of 270 chemicals. *Environ. Mutagen.* **8** (Suppl. 7), 1-119.
- National Cancer Institute (1976). Guidelines for Carcinogen Bioassay in Small Rodents. Technical Reports Series No. 1. NIH Publication No. 76-801. U.S. Department of Health, Education, and Welfare, Public Health Service, National Institutes of Health, Bethesda, MD.
- National Cancer Institute (NCI) (1978). Bioassay of Aniline Hydrochloride for Possible Carcinogenicity (CAS No. 142-04-1). Technical Report Series No. 130. NIH Publication No. 78-1385. U.S. Department of Health, Education, and Welfare, Public Health Service, National Institutes of Health, Bethesda, MD.
- National Institutes of Health (NIH) (1978). Open Formula Rat and Mouse Ration (NIH-07). Specification NIH-11-1335. U.S. Department of Health, Education, and Welfare, Public Health Service, National Institutes of Health, Bethesda, MD.
- National Toxicology Program (NTP) (1982a). Carcinogenesis Bioassay of D & C Red No. 9 (CAS No. 5160-02-1) in F344 Rats and B6C3F₁ Mice (Feed Study). Technical Report Series No. 225. NIH Publication No. 82-1781. U.S. Department of Health and Human Services, Public Health Service, National Institutes of Health, Research Triangle Park, NC, and Bethesda, MD.
- National Toxicology Program (NTP) (1982b). Carcinogenesis Bioassay of C.I. Solvent Yellow 14 (CAS No. 842-07-9) in F344/N Rats and B6C3F₁ Mice (Feed Study). Technical Report Series No. 226. NIH Publication No. 82-1782. U.S. Department of Health and Human Services, Public Health Service, National Institutes of Health, Research Triangle Park, NC, and Bethesda, MD.
- National Toxicology Program (NTP) (1983). Technical Protocol for Sperm Morphology and Vaginal Cytology Evaluations in Toxicity Testing for Rats and Mice, 10/31/82 version (updated October 1983). Research Triangle Park, NC.
- National Toxicology Program (NTP) (1989a). Toxicology and Carcinogenesis Studies of *Para*-Chloroaniline Hydrochloride (CAS No. 20265-96-7) in F344/N Rats and B6C3F₁ Mice (Gavage Studies). Technical Report Series No. 351. NIH Publication No. 89-2806. U.S. Department of Health and Human Services, Public Health Service, National Institutes of Health, Research Triangle Park, NC.
- National Toxicology Program (NTP) (1989b). Toxicology and Carcinogenesis Studies of *N,N*-Dimethylaniline (CAS No. 121-69-7) in F344/N Rats and B6C3F₁ Mice (Gavage Studies). Technical Report Series No. 360. NIH Publication No. 90-2815. U.S. Department of Health and Human Services, Public Health Service, National Institutes of Health, Research Triangle Park, NC.
- National Toxicology Program (NTP) (1992a). Toxicology and Carcinogenesis Studies of C.I. Pigment Red 3 (CAS No. 2425-85-6) in F344/N Rats and B6C3F₁ Mice (Feed Studies). Technical Report Series No. 407. NIH Publication No. 92-3138. U.S. Department of Health and Human Services, Public Health Service, National Institutes of Health, Research Triangle Park, NC.

- National Toxicology Program (NTP) (1992b). Toxicology and Carcinogenesis Studies of C.I. Pigment Red 23 (CAS No. 6471-49-4) in F344 Rats and B6C3F₁ Mice (Feed Studies). Technical Report Series No. 411. NIH Publication No. 93-3142. U.S. Department of Health and Human Services, Public Health Service, National Institutes of Health, Research Triangle Park, NC.
- Ormstedt, D.E. (1978). Connecticut's proposed ban of certain products containing butyl nitrite — A case study on state initiative. *Assoc. Food Drug Off.* **42**, 99-103.
- Osterloh, J., and Goldfield, D. (1984). Butyl nitrite transformation *in vitro*, chemical nitrosation reactions, and mutagenesis. *J. Anal. Toxicol.* **8**, 164-169.
- Patty's Industrial Hygiene and Toxicology* (1963). (F. Patty, Ed.), pp. 1451, 2099-2103. John Wiley and Sons, New York.
- Patty's Industrial Hygiene and Toxicology* (1982). 3rd ed. (G.D. Clayton and F.E. Clayton, Eds.), pp. 4141-4208. John Wiley and Sons, New York.
- Quinto, I. (1980). Mutagenicità dei nitriti alchilici nel test della *Salmonella*. *Boll. Soc. Ital. Biol. Sper.* **56**, 816-820.
- Rapoport, R.M., and Murad, F. (1983). Endothelium-dependent and nitrovasodilator-induced relaxation of vascular smooth muscle: Role of cyclic GMP. *J. Cyclic Nucleotide Protein Phosphor. Res.* **9**, 281-296.
- Ratajczak, H.V., Thomas, P.T., House, R.V., Gaworski, C.L., Sherwood, R.L., Luster, M.I., Hagen, K.L., Abdo, K., Jackson, C.D., Roycroft, J., and Aranyi, C. (1995). Local versus systemic immunotoxicity of isobutyl nitrite following subchronic inhalation exposure of female B6C3F₁ mice. *Fundam. Appl. Toxicol.* **27**, 177-184.
- Rees, D.C., Coggeshall, E.M., Dragan, Y., Breen, T.J., and Balster, R.L. (1986). Acute effects of some volatile nitrites on motor performance and lethality in mice. *Neurobehav. Toxicol. Teratol.* **8**, 139-142.
- Sadtler Standard Spectra*. IR No. 43839; NMR No. 15580M. Sadtler Research Laboratories, Philadelphia.
- Schmid, W. (1976). The micronucleus test for cytogenetic analysis. In *Chemical Mutagens, Principles and Methods for their Detection* (A. Hollaender, Ed.), Vol. 4, pp. 31-53. Plenum Press, New York.
- Shesser, R., Mitchell, J., and Edelstein, S. (1981). Methemoglobinemia from isobutyl nitrite preparations. *Ann. Emerg. Med.* **10**, 262-264.
- Shirley, E. (1977). A non-parametric equivalent of Williams' test for contrasting increasing dose levels of a treatment. *Biometrics* **33**, 386-389.
- Sigell, L.T., Kapp, F.T., Fusaro, G.A., Nelson, E.D., and Falck, R.S. (1978). Popping and snorting volatile nitrites: A current fad for getting high. *Am. J. Psychiatry* **135**, 1216-1218.
- Soderberg, L.S.F., and Barnett, J.B. (1993). Inhaled isobutyl nitrite compromises T-dependent, but not T-independent, antibody induction. *Int. J. Immunopharmacol.* **15**, 821-827.
- Straus, D.S. (1981). Somatic mutation, cellular differentiation, and cancer causation. *JNCI* **67**, 233-241.
- Tarone, R.E. (1975). Tests for trend in life table analysis. *Biometrika* **62**, 679-682.
- Tennant, R.W., Margolin, B.H., Shelby, M.D., Zeiger, E., Haseman, J.K., Spalding, J., Caspary, W., Resnick, M., Stasiewicz, S., Anderson, B., and Minor, R. (1987). Prediction of chemical carcinogenicity in rodents from *in vitro* genetic toxicity assays. *Science* **236**, 933-941.
- Törnqvist, M., Rannug, U., Jonsson, A., and Ehrenberg, L. (1983). Mutagenicity of methyl nitrite in *Salmonella typhimurium*. *Mutat. Res.* **117**, 47-54.

- Wason, S., Detsky, A.S., Platt, O.S., and Lovejoy, F.H., Jr. (1980). Isobutyl nitrite toxicity by ingestion. *Ann. Intern. Med.* **92**, 637-638.
- Wild, D., King, M.-T., Gocke, E., and Eckhardt, K. (1983). Study of artificial flavouring substances for mutagenicity in the Salmonella/microsome, Base and micronucleus tests. *Food Chem. Toxic.* **21**, 707-719.
- Williams, D.A. (1971). A test for differences between treatment means when several dose levels are compared with a zero dose control. *Biometrics* **27**, 103-117.
- Williams, D.A. (1972). The comparison of several dose levels with a zero dose control. *Biometrics* **28**, 519-531.
- Woodruff, R.C., Mason, J.M., Valencia, R., and Zimmering, S. (1985). Chemical mutagenesis testing in *Drosophila*. V. Results of 53 coded compounds tested for the National Toxicology Program. *Environ. Mutagen.* **7**, 677-702.
- Zeiger, E., Anderson, B., Haworth, S., Lawlor, T., and Mortelmans, K. (1988). *Salmonella* mutagenicity tests: IV. Results from the testing of 300 chemicals. *Environ. Mol. Mutagen.* **11** (Suppl. 12), 1-158.
- Zeiger, E., Haseman, J.K., Shelby, M.D., Margolin, B.H., and Tennant, R.W. (1990). Evaluation of four in vitro genetic toxicity tests for predicting rodent carcinogenicity: Confirmation of earlier results with 41 additional chemicals. *Environ. Mol. Mutagen.* **16** (Suppl. 18), 1-14.

APPENDIX A
SUMMARY OF LESIONS IN MALE RATS
IN THE 2-YEAR INHALATION STUDY
OF ISOBUTYL NITRITE

TABLE A1	Summary of the Incidence of Neoplasms in Male Rats in the 2-Year Inhalation Study of Isobutyl Nitrite	77
TABLE A2	Individual Animal Tumor Pathology of Male Rats in the 2-Year Inhalation Study of Isobutyl Nitrite	82
TABLE A3	Statistical Analysis of Primary Neoplasms in Male Rats in the 2-Year Inhalation Study of Isobutyl Nitrite	102
TABLE A4a	Historical Incidence of Alveolar/bronchiolar Neoplasms in Chamber Control Male F344/N Rats	107
TABLE A4b	Historical Incidence of Mononuclear Cell Leukemia in Chamber Control Male F344/N Rats	107
TABLE A5	Summary of the Incidence of Nonneoplastic Lesions in Male Rats in the 2-Year Inhalation Study of Isobutyl Nitrite	108

TABLE A1
Summary of the Incidence of Neoplasms in Male Rats in the 2-Year Inhalation Study of Isobutyl Nitrite^a

	0 ppm	37.5 ppm	75 ppm	150 ppm
Disposition Summary				
Animals initially in study	56	56	56	56
<i>15-Month interim evaluation</i>	10	10	10	10
Early deaths				
Accidental death			1	
Moribund	21	12	5	8
Natural deaths	8	11	4	10
Survivors				
Terminal sacrifice	17	23	36	28
Animals examined microscopically	56	56	56	56
15-Month Interim Evaluation				
Alimentary System				
Pancreas	(10)	(10)	(10)	(10)
Carcinoma, metastatic, kidney	1 (10%)			
Endocrine System				
Adrenal medulla	(9)	(10)	(10)	(10)
Pheochromocytoma benign			1 (10%)	
Pituitary gland	(10)	(10)	(10)	(10)
Pars distalis, adenoma	5 (50%)	1 (10%)	5 (50%)	3 (30%)
Thyroid gland	(10)	(10)	(10)	(10)
C-cell, adenoma		1 (10%)		
General Body System				
Tissue NOS	(1)			
Genital System				
Epididymis	(10)	(10)	(10)	(10)
Preputial gland	(10)	(10)	(10)	(10)
Adenoma				1 (10%)
Testes	(10)	(10)	(10)	(10)
Bilateral, interstitial cell, adenoma	3 (30%)	4 (40%)	3 (30%)	5 (50%)
Interstitial cell, adenoma		2 (20%)	1 (10%)	3 (30%)
Hematopoietic System				
Lymph node, bronchial	(10)	(10)	(9)	(10)
Carcinoma, metastatic, kidney	1 (10%)			
Lymph node, mediastinal	(10)	(10)	(10)	(10)
Carcinoma, metastatic, kidney	1 (10%)			
Respiratory System				
Lung	(10)	(10)	(10)	(10)
Alveolar/bronchiolar adenoma		1 (10%)	1 (10%)	1 (10%)
Carcinoma, metastatic, kidney	1 (10%)			
Mediastinum, carcinoma, metastatic, kidney	1 (10%)			

TABLE A1
Summary of the Incidence of Neoplasms in Male Rats in the 2-Year Inhalation Study of Isobutyl Nitrite (continued)

	0 ppm	37.5 ppm	75 ppm	150 ppm
15-Month Interim Evaluation (continued)				
Urinary System				
Kidney	(10)	(10)	(10)	(10)
Bilateral, carcinoma	1 (10%)			
Systemic Lesions				
Multiple organs ^b	(10)	(10)	(10)	(10)
Mesothelioma malignant	1 (10%)			
Systems Examined With No Neoplasms Observed				
Cardiovascular System				
Integumentary System				
Musculoskeletal System				
Nervous System				
Special Senses System				
2-Year Study				
Alimentary System				
Esophagus	(45)	(46)	(46)	(46)
Intestine large, colon	(45)	(45)	(46)	(45)
Intestine large, rectum	(44)	(44)	(45)	(45)
Intestine large, cecum	(44)	(41)	(44)	(43)
Intestine small, duodenum	(44)	(44)	(46)	(45)
Intestine small, jejunum	(44)	(40)	(44)	(39)
Adenocarcinoma	1 (2%)			
Intestine small, ileum	(43)	(36)	(43)	(42)
Liver	(45)	(46)	(46)	(46)
Hepatocellular carcinoma			1 (2%)	
Hepatocellular adenoma	1 (2%)	1 (2%)		1 (2%)
Histiocytic sarcoma, metastatic, skin				1 (2%)
Sarcoma, metastatic, skin	1 (2%)			
Mesentery	(6)		(3)	(8)
Pancreas	(45)	(46)	(46)	(46)
Salivary glands	(46)	(45)	(46)	(46)
Stomach, forestomach	(45)	(46)	(46)	(46)
Stomach, glandular	(45)	(46)	(46)	(45)
Tongue		(1)	(1)	
Squamous cell papilloma		1 (100%)		
Cardiovascular System				
Heart	(46)	(46)	(46)	(46)
Alveolar/bronchiolar carcinoma, metastatic, lung	1 (2%)			1 (2%)
Schwannoma malignant			1 (2%)	

TABLE A1

Summary of the Incidence of Neoplasms in Male Rats in the 2-Year Inhalation Study of Isobutyl Nitrite (continued)

	0 ppm	37.5 ppm	75 ppm	150 ppm
2-Year Study (continued)				
Endocrine System				
Adrenal cortex	(45)	(46)	(46)	(46)
Adrenal medulla	(45)	(45)	(46)	(46)
Pheochromocytoma malignant	1 (2%)	4 (9%)		1 (2%)
Pheochromocytoma benign	4 (9%)	8 (18%)	7 (15%)	14 (30%)
Bilateral, pheochromocytoma benign	4 (9%)			1 (2%)
Islets, pancreatic	(8)	(9)	(5)	(5)
Adenoma	3 (38%)	6 (67%)	2 (40%)	4 (80%)
Carcinoma	1 (13%)		1 (20%)	
Parathyroid gland	(39)	(40)	(38)	(42)
Pituitary gland	(45)	(46)	(46)	(45)
Pars distalis, adenoma	25 (56%)	23 (50%)	22 (48%)	25 (56%)
Pars distalis, adenoma, multiple		1 (2%)	3 (7%)	2 (4%)
Pars nervosa, craniopharyngioma				1 (2%)
Thyroid gland	(45)	(46)	(46)	(46)
C-cell, adenoma	1 (2%)		5 (11%)	4 (9%)
C-cell, carcinoma	1 (2%)			1 (2%)
Follicular cell, carcinoma	1 (2%)	1 (2%)	2 (4%)	1 (2%)
General Body System				
Tissue NOS	(2)			(1)
Mediastinum, carcinoma, metastatic, thyroid gland	1 (50%)			
Thoracic, alveolar/bronchiolar carcinoma, metastatic, lung	1 (50%)			
Genital System				
Epididymis	(46)	(46)	(46)	(46)
Preputial gland	(44)	(46)	(46)	(46)
Adenoma	3 (7%)	5 (11%)	3 (7%)	1 (2%)
Carcinoma			1 (2%)	
Histiocytic sarcoma, metastatic, skin				1 (2%)
Prostate	(46)	(46)	(46)	(46)
Seminal vesicle	(45)	(46)	(46)	(46)
Testes	(46)	(46)	(46)	(46)
Bilateral, interstitial cell, adenoma	17 (37%)	22 (48%)	22 (48%)	22 (48%)
Interstitial cell, adenoma	14 (30%)	6 (13%)	12 (26%)	9 (20%)
Hematopoietic System				
Bone marrow	(45)	(45)	(46)	(46)
Lymph node	(5)			(1)
Lymph node, bronchial	(37)	(33)	(31)	(29)
Alveolar/bronchiolar carcinoma, metastatic, lung	1 (3%)			1 (3%)
Lymph node, mandibular	(45)	(45)	(46)	(46)
Alveolar/bronchiolar carcinoma, metastatic, lung				1 (2%)
Lymph node, mesenteric	(45)	(46)	(46)	(44)

TABLE A1
Summary of the Incidence of Neoplasms in Male Rats in the 2-Year Inhalation Study of Isobutyl Nitrite (continued)

	0 ppm	37.5 ppm	75 ppm	150 ppm
2-Year Study (continued)				
Hematopoietic System (continued)				
Lymph node, mediastinal	(45)	(42)	(42)	(45)
Alveolar/bronchiolar carcinoma, metastatic, lung				1 (2%)
Carcinoma, metastatic, Zymbal's gland				1 (2%)
Sarcoma, metastatic, skin	1 (2%)			
Spleen	(46)	(45)	(46)	(45)
Fibroma		1 (2%)		
Hemangiosarcoma	1 (2%)	1 (2%)		2 (4%)
Thymus	(41)	(46)	(45)	(44)
Alveolar/bronchiolar carcinoma, metastatic, lung	1 (2%)			
Thymoma benign				1 (2%)
Thymoma malignant		1 (2%)		
Integumentary System				
Mammary gland	(42)	(43)	(46)	(43)
Fibroadenoma		2 (5%)	1 (2%)	
Skin	(46)	(46)	(46)	(46)
Keratoacanthoma	2 (4%)	2 (4%)	2 (4%)	
Trichoepithelioma		1 (2%)		
Back, squamous cell carcinoma			1 (2%)	
Head, basosquamous tumor benign			1 (2%)	
Inguinal, squamous cell carcinoma	1 (2%)			
Lip, squamous cell carcinoma		1 (2%)		
Pinna, fibrosarcoma			1 (2%)	
Subcutaneous tissue, fibroma			1 (2%)	2 (4%)
Subcutaneous tissue, histiocytic sarcoma				1 (2%)
Subcutaneous tissue, lipoma			1 (2%)	
Subcutaneous tissue, sarcoma	1 (2%)			
Tail, keratoacanthoma				1 (2%)
Musculoskeletal System				
None				
Nervous System				
Brain	(46)	(46)	(46)	(46)
Astrocytoma malignant				1 (2%)
Respiratory System				
Larynx	(46)	(46)	(46)	(46)
Lung	(46)	(46)	(46)	(46)
Alveolar/bronchiolar adenoma		2 (4%)	12 (26%)	10 (22%)
Alveolar/bronchiolar adenoma, multiple		1 (2%)		3 (7%)
Alveolar/bronchiolar carcinoma	1 (2%)	2 (4%)	1 (2%)	6 (13%)
Carcinoma, metastatic, Zymbal's gland		1 (2%)	1 (2%)	1 (2%)
Sarcoma, metastatic, skin	1 (2%)			
Mediastinum, alveolar/bronchiolar carcinoma, metastatic, lung	1 (2%)			1 (2%)

TABLE A1
Summary of the Incidence of Neoplasms in Male Rats in the 2-Year Inhalation Study of Isobutyl Nitrite (continued)

	0 ppm	37.5 ppm	75 ppm	150 ppm
2-Year Study (continued)				
Respiratory System (continued)				
Nose	(45)	(45)	(46)	(46)
Osteoma	1 (2%)			
Respiratory epithelium, adenoma				1 (2%)
Trachea	(46)	(46)	(46)	(46)
Special Senses System				
Zymbal's gland		(3)	(1)	(1)
Carcinoma		3 (100%)	1 (100%)	1 (100%)
Urinary System				
Kidney	(45)	(45)	(46)	(46)
Urinary bladder	(46)	(45)	(46)	(45)
Transitional epithelium, carcinoma	1 (2%)			
Systemic Lesions				
Multiple organs	(46)	(46)	(46)	(46)
Histiocytic sarcoma				1 (2%)
Leukemia mononuclear	27 (59%)	2 (4%)	1 (2%)	1 (2%)
Mesothelioma malignant		1 (2%)	4 (9%)	2 (4%)
Neoplasm Summary				
Total animals with primary neoplasms ^c				
15-Month interim evaluation	8	8	7	10
2-Year study	46	45	45	46
Total primary neoplasms				
15-Month interim evaluation	10	9	11	13
2-Year study	112	98	109	119
Total animals with benign neoplasms				
15-Month interim evaluation	8	8	7	10
2-Year study	42	44	42	44
Total benign neoplasms				
15-Month interim evaluation	8	9	11	13
2-Year study	75	82	94	102
Total animals with malignant neoplasms				
15-Month interim evaluation	2			
2-Year study	30	15	14	15
Total malignant neoplasms				
15-Month interim evaluation	2			
2-Year study	37	16	15	17
Total animals with metastatic neoplasms				
15-Month interim evaluation	2			
2-Year study	3	2	5	6
Total metastatic neoplasms				
15-Month interim evaluation	7			
2-Year study	9	3	5	17

^a Number of animals examined microscopically at the site and the number of animals with neoplasm

^b Number of animals with any tissue examined microscopically

^c Primary neoplasms: all neoplasms except metastatic neoplasms

TABLE A2
Individual Animal Tumor Pathology of Male Rats in the 2-Year Inhalation Study of Isobutyl Nitrite: 0 ppm

Number of Days on Study	4 4 4 4 5 5 5 5 5 6 6 6 6 6 6 6 6 6 6 6 6 6 6 6
	1 2 9 9 2 3 3 6 8 1 1 2 3 3 3 4 4 4 5 6 6 6 6 6 8
	5 7 5 8 5 2 3 3 3 1 7 4 1 9 9 0 1 4 4 5 6 6 6 7 1
Carcass ID Number	0 0
	3 1 2 1 3 2 0 4 1 3 3 4 1 0 4 0 0 2 3 2 0 3 4 2 3
	5 3 7 0 9 0 9 2 5 3 6 1 9 3 4 8 1 4 2 9 2 7 0 3 0
Alimentary System	
Esophagus	+ +
Intestine large, colon	+ + A +
Intestine large, rectum	+ + A + + + + + + + + + + + + + + + + A + + + + + +
Intestine large, cecum	+ + A +
Intestine small, duodenum	+ + A + + + + + + + + + + + + + + + + A + + + + + +
Intestine small, jejunum	+ + A + A
Adenocarcinoma	X
Intestine small, ileum	+ + A + + A + + + + + + + + + + + + + + + + A + + + + + +
Liver	+ + A +
Hepatocellular adenoma	X
Sarcoma, metastatic, skin	X
Mesentery	+ +
Pancreas	+ + A +
Salivary glands	+ +
Stomach, forestomach	+ +
Stomach, glandular	+ + A +
Cardiovascular System	
Heart	+ +
Alveolar/bronchiolar carcinoma, metastatic, lung	X
Endocrine System	
Adrenal cortex	+ + A +
Adrenal medulla	+ + A +
Pheochromocytoma malignant	
Pheochromocytoma benign	X
Bilateral, pheochromocytoma benign	X X
Islets, pancreatic	+ +
Adenoma	X
Carcinoma	X
Parathyroid gland	+ + + + M +
Pituitary gland	+ +
Pars distalis, adenoma	X X
Thyroid gland	+ + A +
C-cell, adenoma	X
C-cell, carcinoma	X
Follicular cell, carcinoma	
General Body System	
Tissue NOS	+ +
Mediastinum, carcinoma, metastatic, thyroid gland	X
Thoracic, alveolar/bronchiolar carcinoma, metastatic, lung	X

+ : Tissue examined microscopically
A : Autolysis precludes examination
M : Missing tissue
I : Insufficient tissue
X : Lesion present
Blank : Not examined

**TABLE A2
Individual Animal Tumor Pathology of Male Rats in the 2-Year Inhalation Study of Isobutyl Nitrite: 0 ppm (continued)**

	6	6	6	7	7	7	7	7	7	7	7	7	7	7	7	7	7	7	7	7	7	7
Number of Days on Study	8	9	9	2	2	2	2	2	2	2	3	3	3	3	3	3	3	3	3	3	3	3
	4	2	5	6	9	9	9	9	9	9	0	0	0	0	0	0	0	0	0	0	0	0
Carcass ID Number	0	0	0	0	0	0	0	0	0	0	0	0	0	0	0	0	0	0	0	0	0	0
	2	0	1	2	0	0	1	1	3	4	0	1	1	1	2	2	2	3	3	4	4	4
	5	4	7	1	5	6	2	6	4	3	7	1	4	8	2	6	8	1	8	5	6	6
Genital System																						Total Tissues/ Tumors
Coagulating gland																						2
Epididymis	+	+	+	+	+	+	+	+	+	+	+	+	+	+	+	+	+	+	+	+	+	+
Preputial gland	+	+	+	+	+	+	+	+	+	+	+	+	+	+	+	+	M	+	+	+	+	+
Adenoma																						3
X																						
Prostate	+	+	+	+	+	+	+	+	+	+	+	+	+	+	+	+	+	+	+	+	+	+
Seminal vesicle	+	+	+	+	+	+	+	+	+	+	+	+	+	+	+	+	+	+	+	+	+	+
Testes	+	+	+	+	+	+	+	+	+	+	+	+	+	+	+	+	+	+	+	+	+	+
Bilateral, interstitial cell, adenoma			X	X X X		X X				X	X	X X	X X	X X	X X	X X	X X	X X	X X	X X	X X	X X
Interstitial cell, adenoma	X		X	X	X	X		X	X				X									
Hematopoietic System																						
Bone marrow	+	+	+	+	+	+	+	+	+	+	+	+	+	+	+	+	+	+	+	+	+	+
Lymph node																						45
Lymph node, bronchial	M	M	M	+	+	+	+	M	+	+	+	+	+	+	+	+	M	+	M	M	M	+
Alveolar/bronchiolar carcinoma, metastatic, lung																						37
Lymph node, mandibular	+	+	+	+	+	+	+	+	+	+	+	+	+	+	+	+	+	+	+	+	+	+
Lymph node, mesenteric	+	+	+	+	+	+	+	+	+	+	+	+	+	+	+	+	+	+	+	+	+	+
Lymph node, mediastinal	+	+	+	+	+	+	+	+	+	+	+	+	+	+	+	+	+	+	+	+	+	+
Sarcoma, metastatic, skin																						1
Spleen	+	+	+	+	+	+	+	+	+	+	+	+	+	+	+	+	+	+	+	+	+	+
Hemangiosarcoma																						46
X																						1
Thymus	+	+	+	+	+	+	+	M	M	+	+	+	+	+	+	+	+	+	+	+	+	+
Alveolar/bronchiolar carcinoma, metastatic, lung																						41
1																						1
Integumentary System																						
Mammary gland	M	+	+	+	+	+	M	+	+	+	+	+	+	+	M	+	M	+	+	+	+	+
Skin	+	+	+	+	+	+	+	+	+	+	+	+	+	+	+	+	+	+	+	+	+	+
Keratoacanthoma																						46
X																						2
X																						
Inguinal, squamous cell carcinoma																						1
Subcutaneous tissue, sarcoma																						1
Musculoskeletal System																						
Bone	+	+	+	+	+	+	+	+	+	+	+	+	+	+	+	+	+	+	+	+	+	+
Nervous System																						
Brain	+	+	+	+	+	+	+	+	+	+	+	+	+	+	+	+	+	+	+	+	+	+
Respiratory System																						
Larynx	+	+	+	+	+	+	+	+	+	+	+	+	+	+	+	+	+	+	+	+	+	+
Lung	+	+	+	+	+	+	+	+	+	+	+	+	+	+	+	+	+	+	+	+	+	+
Alveolar/bronchiolar carcinoma																						46
Sarcoma, metastatic, skin																						1
Mediastinum, alveolar/bronchiolar carcinoma, metastatic, lung																						1
Nose	+	+	+	+	+	+	+	+	+	+	+	+	+	+	+	+	+	+	+	+	+	+
Osteoma																						45
1																						1
Trachea	+	+	+	+	+	+	+	+	+	+	+	+	+	+	+	+	+	+	+	+	+	+
46																						46

TABLE A2
Individual Animal Tumor Pathology of Male Rats in the 2-Year Inhalation Study of Isobutyl Nitrite: 0 ppm (continued)

Number of Days on Study	4 4 4 4 5 5 5 5 5 6 6 6 6 6 6 6 6 6 6 6 6 6 6 6 6
	1 2 9 9 2 3 3 6 8 1 1 2 3 3 3 4 4 4 5 6 6 6 6 6 6 8
	5 7 5 8 5 2 3 3 3 1 7 4 1 9 9 0 1 4 4 5 6 6 6 6 7 1
Carcass ID Number	0 0
	3 1 2 1 3 2 0 4 1 3 3 4 1 0 4 0 0 2 3 2 0 3 4 2 3
	5 3 7 0 9 0 9 2 5 3 6 1 9 3 4 8 1 4 2 9 2 7 0 3 0
Special Senses System	
Eye	+
Urinary System	
Kidney	+ + A +
Urinary bladder	+ +
Transitional epithelium, carcinoma	
Systemic Lesions	
Multiple organs	+ +
Leukemia mononuclear	X X X X X X X X X X X X X X X X

TABLE A2
Individual Animal Tumor Pathology of Male Rats in the 2-Year Inhalation Study of Isobutyl Nitrite:
37.5 ppm

Number of Days on Study	3	4	4	5	5	5	5	6	6	6	6	6	6	6	6	6	6	6	7	7	7	7	7	7	7		
	5	3	7	5	5	6	7	3	4	4	4	5	6	7	7	8	9	9	0	0	0	1	2	2	2		
	3	6	1	1	5	8	6	6	5	5	6	1	3	2	5	2	5	5	0	1	2	8	0	9	9		
Carcass ID Number	1	1	1	1	1	1	1	1	1	1	1	1	1	1	1	1	1	1	1	1	1	1	1	1	1		
	4	4	1	1	3	5	1	2	2	3	4	5	5	1	5	4	2	3	5	3	4	3	4	1	2		
	4	6	7	9	9	8	6	9	3	1	5	0	5	3	2	2	0	7	1	8	0	0	9	8	2		
Alimentary System																											
Esophagus	+	+	+	+	+	+	+	+	+	+	+	+	+	+	+	+	+	+	+	+	+	+	+	+	+	+	
Intestine large, colon	A	+	+	+	+	+	+	+	+	+	+	+	+	+	+	+	+	+	+	+	+	+	+	+	+	+	
Intestine large, rectum	A	+	+	+	+	+	+	A	+	+	+	+	+	+	+	+	+	+	+	+	+	+	+	+	+	+	
Intestine large, cecum	A	+	+	+	+	+	+	A	+	A	+	+	+	+	+	+	+	+	+	A	A	+	+	+	+	+	
Intestine small, duodenum	A	+	+	A	+	+	+	+	+	+	+	+	+	+	+	+	+	+	+	+	+	+	+	+	+	+	
Intestine small, jejunum	A	+	+	A	+	+	+	A	+	A	+	A	+	+	+	+	+	+	+	+	+	+	+	A	+	+	
Intestine small, ileum	A	+	+	A	+	A	+	A	+	A	+	A	+	+	A	+	+	A	A	A	+	+	+	+	+	+	
Liver	+	+	+	+	+	+	+	+	+	+	+	+	+	+	+	+	+	+	+	+	+	+	+	+	+	+	
Hepatocellular adenoma																											
Mesentery	A																										
Pancreas	+	+	+	+	+	+	+	+	+	+	+	+	+	+	+	+	+	+	+	+	+	+	+	+	+	+	
Pharynx																											
Salivary glands	A	+	+	+	+	+	+	+	+	+	+	+	+	+	+	+	+	+	+	+	+	+	+	+	+	+	
Stomach, forestomach	+	+	+	+	+	+	+	+	+	+	+	+	+	+	+	+	+	+	+	+	+	+	+	+	+	+	
Stomach, glandular	+	+	+	+	+	+	+	+	+	+	+	+	+	+	+	+	+	+	+	+	+	+	+	+	+	+	
Tongue																											
Squamous cell papilloma																											
Cardiovascular System																											
Heart	+	+	+	+	+	+	+	+	+	+	+	+	+	+	+	+	+	+	+	+	+	+	+	+	+	+	
Endocrine System																											
Adrenal cortex	+	+	+	+	+	+	+	+	+	+	+	+	+	+	+	+	+	+	+	+	+	+	+	+	+	+	
Adrenal medulla	+	+	+	+	+	+	+	+	+	+	M	+	+	+	+	+	+	+	+	+	+	+	+	+	+	+	
Pheochromocytoma malignant																								X	X		
Pheochromocytoma benign							X				X																
Islets, pancreatic																											
Adenoma																											
Parathyroid gland	+	+	+	M	+	+	+	+	+	M	+	+	+	+	+	+	+	+	+	M	M	+	+	+	+	M	
Pituitary gland	+	+	+	+	+	+	+	+	+	+	+	+	+	+	+	+	+	+	+	+	+	+	+	+	+	+	
Pars distalis, adenoma				X			X	X				X	X	X	X	X	X	X	X	X	X	X	X	X	X		
Pars distalis, adenoma, multiple																											
Thyroid gland	+	+	+	+	+	+	+	+	+	+	+	+	+	+	+	+	+	+	+	+	+	+	+	+	+	+	
Follicular cell, carcinoma												X															
General Body System																											
None																											
Genital System																											
Epididymis	+	+	+	+	+	+	+	+	+	+	+	+	+	+	+	+	+	+	+	+	+	+	+	+	+	+	
Mesothelioma malignant, metastatic, testes																										X	
Preputial gland	+	+	+	+	+	+	+	+	+	+	+	+	+	+	+	+	+	+	+	+	+	+	+	+	+	+	
Adenoma				X				X				X												X			
Prostate	+	+	+	+	+	+	+	+	+	+	+	+	+	+	+	+	+	+	+	+	+	+	+	+	+	+	
Seminal vesicle	+	+	+	+	+	+	+	+	+	+	+	+	+	+	+	+	+	+	+	+	+	+	+	+	+	+	
Testes	+	+	+	+	+	+	+	+	+	+	+	+	+	+	+	+	+	+	+	+	+	+	+	+	+	+	
Bilateral, interstitial cell, adenoma					X			X	X	X			X					X		X	X	X	X	X	X	X	
Interstitial cell, adenoma											X						X		X								

TABLE A2
Individual Animal Tumor Pathology of Male Rats in the 2-Year Inhalation Study of Isobutyl Nitrite:
37.5 ppm (continued)

Number of Days on Study	7 7 7 7 7 7 7 7 7 7 7 7 7 7 7 7 7 7 7 7	
	2 2 2 2 2 2 2 2 2 2 3 3 3 3 3 3 3 3 3 3	
	9 9 9 9 9 9 9 9 9 9 0 0 0 0 0 0 0 0 0 0	
Carcass ID Number	1 1 1 1 1 1 1 1 1 1 1 1 1 1 1 1 1 1 1 1	Total Tissues/ Tumors
	2 2 2 3 3 4 4 5 5 5 1 1 2 2 2 3 3 3 4 4 5	
	4 5 6 2 4 7 8 3 6 7 4 5 1 7 8 3 5 6 1 3 4	
Alimentary System		
Esophagus	+ +	46
Intestine large, colon	+ +	45
Intestine large, rectum	+ +	44
Intestine large, cecum	+ +	41
Intestine small, duodenum	+ +	44
Intestine small, jejunum	+ +	40
Intestine small, ileum	+ +	36
Liver	+ +	46
Hepatocellular adenoma		1
	X	
Mesentery		
Pancreas	+ +	46
Pharynx	+	1
Salivary glands	+ +	45
Stomach, forestomach	+ +	46
Stomach, glandular	+ +	46
Tongue	+	1
Squamous cell papilloma	X	1
Cardiovascular System		
Heart	+ +	46
Endocrine System		
Adrenal cortex	+ +	46
Adrenal medulla	+ +	45
Pheochromocytoma malignant		4
Pheochromocytoma benign	X	8
	X X X X X X X X X X X X	
Islets, pancreatic	+	9
Adenoma	X	6
Parathyroid gland	+ + + + + M + + + + + + + + + + + + + + +	40
Pituitary gland	+ +	46
Pars distalis, adenoma	X	23
Pars distalis, adenoma, multiple	X X X X X X X X X X X X X X X X	1
Thyroid gland	+ +	46
Follicular cell, carcinoma		1
General Body System		
None		
Genital System		
Epididymis	+ +	46
Mesothelioma malignant, metastatic, testes		1
Preputial gland	+ +	46
Adenoma	X	5
Prostate	+ +	46
Seminal vesicle	+ +	46
Testes	+ +	46
Bilateral, interstitial cell, adenoma	X X X X X X X X X X X X X X X X	22
Interstitial cell, adenoma	X X	6

TABLE A2
Individual Animal Tumor Pathology of Male Rats in the 2-Year Inhalation Study of Isobutyl Nitrite: 75 ppm (continued)

Number of Days on Study	7	7	7	7	7	7	7	7	7	7	7	7	7	7	7	7	7	7	7	7	Total
	2	2	3	3	3	3	3	3	3	3	3	3	3	3	3	3	3	3	3	3	Tissues/
	9	9	0	0	0	0	0	0	0	0	0	0	0	0	0	0	0	0	0	0	Tumors
Carcass ID Number	2	2	2	2	2	2	2	2	2	2	2	2	2	2	2	2	2	2	2	2	
	6	6	2	2	2	3	3	3	3	3	3	4	4	4	4	5	5	6	6	6	7
	8	9	6	7	8	1	3	4	5	6	8	3	6	7	9	3	8	2	3	4	0
Hematopoietic System																					
Bone marrow	+	+	+	+	+	+	+	+	+	+	+	+	+	+	+	+	+	+	+	+	46
Lymph node, bronchial	+	+	+	M	M	+	M	+	+	+	+	M	+	+	+	+	M	+	M	M	+
Lymph node, mandibular	+	+	+	+	+	+	+	+	+	+	+	+	+	+	+	+	+	+	+	+	46
Lymph node, mesenteric	+	+	+	+	+	+	+	+	+	+	+	+	+	+	+	+	+	+	+	+	46
Lymph node, mediastinal	+	+	+	+	M	+	+	+	+	+	+	M	+	+	+	+	+	M	+	+	42
Spleen	+	+	+	+	+	+	+	+	+	+	+	+	+	+	+	+	+	+	+	+	46
Thymus	+	+	+	+	+	+	+	+	+	+	+	+	+	+	+	+	+	M	+	+	45
Integumentary System																					
Mammary gland	+	+	+	+	+	+	+	+	+	+	+	+	+	+	+	+	+	+	+	+	46
Fibroadenoma																					1
Skin	+	+	+	+	+	+	+	+	+	+	+	+	+	+	+	+	+	+	+	+	46
Keratoacanthoma									X												2
Back, squamous cell carcinoma																					1
Head, basosquamous tumor benign															X						1
Pinna, fibrosarcoma																					1
Subcutaneous tissue, fibroma																					1
Subcutaneous tissue, lipoma																					1
Musculoskeletal System																					
Bone	+	+	+	+	+	+	+	+	+	+	+	+	+	+	+	+	+	+	+	+	46
Nervous System																					
Brain	+	+	+	+	+	+	+	+	+	+	+	+	+	+	+	+	+	+	+	+	46
Spinal cord																					1
Respiratory System																					
Larynx	+	+	+	+	+	+	+	+	+	+	+	+	+	+	+	+	+	+	+	+	46
Lung	+	+	+	+	+	+	+	+	+	+	+	+	+	+	+	+	+	+	+	+	46
Alveolar/bronchiolar adenoma			X	X	X					X	X	X				X					12
Alveolar/bronchiolar carcinoma																X					1
Carcinoma, metastatic, Zymbal's gland																					1
Nose	+	+	+	+	+	+	+	+	+	+	+	+	+	+	+	+	+	+	+	+	46
Trachea	+	+	+	+	+	+	+	+	+	+	+	+	+	+	+	+	+	+	+	+	46
Special Senses System																					
Eye																					1
Zymbal's gland																					1
Carcinoma																					1
Urinary System																					
Kidney	+	+	+	+	+	+	+	+	+	+	+	+	+	+	+	+	+	+	+	+	46
Urinary bladder	+	+	+	+	+	+	+	+	+	+	+	+	+	+	+	+	+	+	+	+	46
Systemic Lesions																					
Multiple organs	+	+	+	+	+	+	+	+	+	+	+	+	+	+	+	+	+	+	+	+	46
Leukemia mononuclear																					1
Mesothelioma malignant				X				X											X		4

TABLE A2
Individual Animal Tumor Pathology of Male Rats in the 2-Year Inhalation Study of Isobutyl Nitrite: 150 ppm (continued)

Number of Days on Study	7 7 7 7 7 7 7 7 7 7 7 7 7 7 7 7 7 7 7 7	
	2 2 2 2 2 2 2 2 3 3 3 3 3 3 3 3 3 3 3 3	
	9 9 9 9 9 9 9 9 0 0 0 0 0 0 0 0 0 0 0 0	
Carcass ID Number	3 3 3 3 3 3 3 3 3 3 3 3 3 3 3 3 3 3 3 3	Total Tissues/Tumors
	5 6 6 7 7 7 7 8 3 4 4 4 4 4 6 6 6 7 7 8 8	
	9 0 3 3 6 7 9 1 7 0 2 3 4 9 1 8 9 2 4 0 2	
Genital System		
Epididymis	+ +	46
Mesothelioma malignant, metastatic, testes		2
Preputial gland	+ +	46
Adenoma		1
Histiocytic sarcoma, metastatic, skin		1
Prostate	+ +	46
Seminal vesicle	+ +	46
Testes	+ +	46
Bilateral, interstitial cell, adenoma	X X	22
Interstitial cell, adenoma		9
Hematopoietic System		
Bone marrow	+ +	46
Lymph node		1
Lymph node, bronchial	M + + M M + M + + + M + + M + M + M + + M	29
Alveolar/bronchiolar carcinoma, metastatic, lung		1
Mesothelioma malignant, metastatic, testes		1
Lymph node, mandibular	+ +	46
Alveolar/bronchiolar carcinoma, metastatic, lung		1
Lymph node, mesenteric	+ +	44
Lymph node, mediastinal	+ +	45
Alveolar/bronchiolar carcinoma, metastatic, lung		1
Carcinoma, metastatic, Zymbal's gland		1
Spleen	+ +	45
Hemangiosarcoma		2
Mesothelioma malignant, metastatic, testes		1
Thymus	+ +	44
Thymoma benign		1
Integumentary System		
Mammary gland	+ M +	43
Skin	+ +	46
Subcutaneous tissue, fibroma		2
Subcutaneous tissue, histiocytic sarcoma		1
Tail, keratoacanthoma		1
Musculoskeletal System		
Bone	+ +	46
Nervous System		
Brain	+ +	46
Astrocytoma malignant		1

TABLE A2
Individual Animal Tumor Pathology of Male Rats in the 2-Year Inhalation Study of Isobutyl Nitrite: 150 ppm (continued)

Number of Days on Study	3 5 5 5 5 6 6 6 6 6 6 6 6 6 7 7 7 7 7 7 7 7 7 7
	3 2 6 8 8 0 1 1 1 3 4 4 6 9 1 2 2 2 2 2 2 2 2 2 2
	0 3 4 2 9 4 0 1 1 6 0 7 7 9 7 1 2 8 9 9 9 9 9 9 9
Carcass ID Number	3 3
	5 6 4 7 5 3 5 4 6 3 7 7 6 6 6 5 4 7 4 4 5 5 5 5
	6 4 1 1 2 8 3 6 7 9 5 8 5 6 2 5 5 0 7 8 0 1 4 7 8
Respiratory System	
Larynx	+ +
Lung	+ +
Alveolar/bronchiolar adenoma	
Alveolar/bronchiolar adenoma, multiple	
Alveolar/bronchiolar carcinoma	
Carcinoma, metastatic, Zymbal's gland	X
Mesothelioma malignant, metastatic, testes	
Mediastinum, alveolar/bronchiolar carcinoma, metastatic, lung	X
Nose	+ +
Respiratory epithelium, adenoma	
Trachea	+ +
Special Senses System	
Zymbal's gland	+
Carcinoma	X
Urinary System	
Kidney	+ +
Urinary bladder	+ + + + + + + + + + + + + + + + + A + + + + + + + + + + + +
Systemic Lesions	
Multiple organs	+ +
Histiocytic sarcoma	
Leukemia mononuclear	
Mesothelioma malignant	

TABLE A3
Statistical Analysis of Primary Neoplasms in Male Rats in the 2-Year Inhalation Study of Isobutyl Nitrite

	0 ppm	37.5 ppm	75 ppm	150 ppm
Adrenal Medulla: Benign Pheochromocytoma				
Overall rate ^a	8/45 (18%)	8/45 (18%)	7/46 (15%)	15/46 (33%)
Adjusted rate ^b	37.0%	30.0%	19.4%	45.0%
Terminal rate ^c	5/17 (29%)	6/23 (26%)	7/36 (19%)	10/28 (36%)
First incidence (days)	639	576	729 (T)	564
Life table test ^d	P=0.215	P=0.376N	P=0.071N	P=0.419
Logistic regression test ^d	P=0.094	P=0.492N	P=0.190N	P=0.222
Cochran-Armitage test ^d	P=0.043			
Fisher exact test ^d		P=0.608N	P=0.481N	P=0.082
Adrenal Medulla: Malignant Pheochromocytoma				
Overall rate	1/45 (2%)	4/45 (9%)	0/46 (0%)	1/46 (2%)
Adjusted rate	5.9%	16.0%	0.0%	3.6%
Terminal rate	1/17 (6%)	2/23 (9%)	0/36 (0%)	1/28 (4%)
First incidence (days)	729 (T)	718	— ^e	729 (T)
Life table test	P=0.188N	P=0.284	P=0.350N	P=0.647N
Logistic regression test	P=0.198N	P=0.280	P=0.350N	P=0.647N
Cochran-Armitage test	P=0.325N			
Fisher exact test		P=0.180	P=0.495N	P=0.747N
Adrenal Medulla: Benign or Malignant Pheochromocytoma				
Overall rate	8/45 (18%)	11/45 (24%)	7/46 (15%)	16/46 (35%)
Adjusted rate	37.0%	39.4%	19.4%	48.1%
Terminal rate	5/17 (29%)	7/23 (30%)	7/36 (19%)	11/28 (39%)
First incidence (days)	639	576	729 (T)	564
Life table test	P=0.265	P=0.560	P=0.071N	P=0.351
Logistic regression test	P=0.117	P=0.443	P=0.190N	P=0.168
Cochran-Armitage test	P=0.049			
Fisher exact test		P=0.303	P=0.481N	P=0.054
Lung: Alveolar/bronchiolar Adenoma				
Overall rate	0/46 (0%)	3/46 (7%)	12/46 (26%)	13/46 (28%)
Adjusted rate	0.0%	13.0%	32.2%	44.8%
Terminal rate	0/17 (0%)	3/23 (13%)	11/36 (31%)	12/28 (43%)
First incidence (days)	—	729 (T)	631	722
Life table test	P<0.001	P=0.176	P=0.009	P=0.002
Logistic regression test	P<0.001	P=0.176	P=0.003	P=0.002
Cochran-Armitage test	P<0.001			
Fisher exact test		P=0.121	P<0.001	P<0.001
Lung: Alveolar/bronchiolar Carcinoma				
Overall rate	1/46 (2%)	2/46 (4%)	1/46 (2%)	6/46 (13%)
Adjusted rate	2.2%	7.2%	2.8%	18.1%
Terminal rate	0/17 (0%)	1/23 (4%)	1/36 (3%)	3/28 (11%)
First incidence (days)	415	663	729 (T)	523
Life table test	P=0.041	P=0.559	P=0.683N	P=0.138
Logistic regression test	P=0.015	P=0.462	P=0.735	P=0.040
Cochran-Armitage test	P=0.018			
Fisher exact test		P=0.500	P=0.753N	P=0.055

TABLE A3
Statistical Analysis of Primary Neoplasms in Male Rats in the 2-Year Inhalation Study of Isobutyl Nitrite (continued)

	0 ppm	37.5 ppm	75 ppm	150 ppm
Lung: Alveolar/bronchiolar Adenoma or Carcinoma				
Overall rate	1/46 (2%)	5/46 (11%)	13/46 (28%)	15/46 (33%)
Adjusted rate	2.2%	19.8%	34.9%	47.6%
Terminal rate	0/17 (0%)	4/23 (17%)	12/36 (33%)	12/28 (43%)
First incidence (days)	415	663	631	523
Life table test	P<0.001	P=0.166	P=0.019	P=0.003
Logistic regression test	P<0.001	P=0.101	P=0.001	P<0.001
Cochran-Armitage test	P<0.001			
Fisher exact test		P=0.102	P<0.001	P<0.001
Pancreatic Islets: Adenoma				
Overall rate	3/8 (38%)	6/9 (67%)	2/5 (40%)	4/5 (80%)
Adjusted rate	41.6%	59.4%	26.8%	75.8%
Terminal rate	2/5 (40%)	4/7 (57%)	1/4 (25%)	3/4 (75%)
First incidence (days)	583	551	667	722
Life table test	P=0.492	P=0.370	P=0.494N	P=0.452
Logistic regression test	P=0.270	P=0.205	P=0.643	P=0.213
Cochran-Armitage test	P=0.179			
Fisher exact test		P=0.238	P=0.685	P=0.179
Pancreatic Islets: Adenoma or Carcinoma				
Overall rate	4/8 (50%)	6/9 (67%)	3/5 (60%)	4/5 (80%)
Adjusted rate	43.2%	59.4%	51.2%	75.8%
Terminal rate	2/5 (40%)	4/7 (57%)	2/4 (50%)	3/4 (75%)
First incidence (days)	583	551	667	722
Life table test	P=0.567N	P=0.530	P=0.503N	P=0.626
Logistic regression test	P=0.132	P=0.322	P=0.461	P=0.225
Cochran-Armitage test	P=0.243			
Fisher exact test		P=0.419	P=0.487	P=0.315
Pituitary Gland (Pars Distalis): Adenoma				
Overall rate	25/45 (56%)	24/46 (52%)	25/46 (54%)	27/45 (60%)
Adjusted rate	72.9%	71.2%	59.2%	72.0%
Terminal rate	8/16 (50%)	14/23 (61%)	19/36 (53%)	17/27 (63%)
First incidence (days)	427	471	540	564
Life table test	P=0.135N	P=0.125N	P=0.010N	P=0.143N
Logistic regression test	P=0.394	P=0.394N	P=0.497N	P=0.498
Cochran-Armitage test	P=0.323			
Fisher exact test		P=0.455N	P=0.538N	P=0.416
Preputial Gland: Adenoma				
Overall rate	3/44 (7%)	5/46 (11%)	3/46 (7%)	1/46 (2%)
Adjusted rate	11.7%	15.4%	8.3%	3.6%
Terminal rate	1/16 (6%)	1/23 (4%)	3/36 (8%)	1/28 (4%)
First incidence (days)	583	551	729 (T)	729 (T)
Life table test	P=0.069N	P=0.490	P=0.373N	P=0.196N
Logistic regression test	P=0.142N	P=0.366	P=0.616N	P=0.290N
Cochran-Armitage test	P=0.144N			
Fisher exact test		P=0.382	P=0.640N	P=0.292N

TABLE A3
Statistical Analysis of Primary Neoplasms in Male Rats in the 2-Year Inhalation Study of Isobutyl Nitrite (continued)

	0 ppm	37.5 ppm	75 ppm	150 ppm
Preputial Gland: Adenoma or Carcinoma				
Overall rate	3/44 (7%)	5/46 (11%)	4/46 (9%)	1/46 (2%)
Adjusted rate	11.7%	15.4%	10.6%	3.6%
Terminal rate	1/16 (6%)	1/23 (4%)	3/36 (8%)	1/28 (4%)
First incidence (days)	583	551	684	729 (T)
Life table test	P=0.078N	P=0.490	P=0.492N	P=0.196N
Logistic regression test	P=0.161N	P=0.366	P=0.560	P=0.290N
Cochran-Armitage test	P=0.164N			
Fisher exact test		P=0.382	P=0.525	P=0.292N
Skin: Keratoacanthoma, Trichoepithelioma, or Squamous Cell Carcinoma				
Overall rate	3/46 (7%)	4/46 (9%)	3/46 (7%)	1/46 (2%)
Adjusted rate	13.5%	13.6%	8.1%	3.3%
Terminal rate	1/17 (6%)	2/23 (9%)	2/36 (6%)	0/28 (0%)
First incidence (days)	639	645	719	722
Life table test	P=0.083N	P=0.649N	P=0.352N	P=0.177N
Logistic regression test	P=0.142N	P=0.547	P=0.538N	P=0.248N
Cochran-Armitage test	P=0.185N			
Fisher exact test		P=0.500	P=0.662N	P=0.308N
Testes: Adenoma				
Overall rate	31/46 (67%)	28/46 (61%)	34/46 (74%)	31/46 (67%)
Adjusted rate	90.2%	79.4%	84.9%	81.2%
Terminal rate	14/17 (82%)	16/23 (70%)	30/36 (83%)	21/28 (75%)
First incidence (days)	427	555	523	523
Life table test	P=0.030N	P=0.054N	P=0.002N	P=0.033N
Logistic regression test	P=0.423N	P=0.208N	P=0.589N	P=0.412N
Cochran-Armitage test	P=0.414			
Fisher exact test		P=0.332N	P=0.324	P=0.588N
Thyroid Gland (C-cell): Adenoma				
Overall rate	1/45 (2%)	0/46 (0%)	5/46 (11%)	4/46 (9%)
Adjusted rate	3.2%	0.0%	13.9%	13.7%
Terminal rate	0/17 (0%)	0/23 (0%)	5/36 (14%)	3/28 (11%)
First incidence (days)	640	—	729 (T)	722
Life table test	P=0.110	P=0.459N	P=0.316	P=0.331
Logistic regression test	P=0.085	P=0.506N	P=0.196	P=0.260
Cochran-Armitage test	P=0.051			
Fisher exact test		P=0.495N	P=0.107	P=0.187
Thyroid Gland (C-cell): Adenoma or Carcinoma				
Overall rate	2/45 (4%)	0/46 (0%)	5/46 (11%)	5/46 (11%)
Adjusted rate	7.4%	0.0%	13.9%	17.1%
Terminal rate	0/17 (0%)	0/23 (0%)	5/36 (14%)	4/28 (14%)
First incidence (days)	640	—	729 (T)	722
Life table test	P=0.127	P=0.180N	P=0.535	P=0.421
Logistic regression test	P=0.088	P=0.238N	P=0.329	P=0.312
Cochran-Armitage test	P=0.055			
Fisher exact test		P=0.242N	P=0.226	P=0.226

TABLE A3
Statistical Analysis of Primary Neoplasms in Male Rats in the 2-Year Inhalation Study of Isobutyl Nitrite (continued)

	0 ppm	37.5 ppm	75 ppm	150 ppm
Zymbal's Gland: Carcinoma				
Overall rate	0/46 (0%)	3/46 (7%)	1/46 (2%)	1/46 (2%)
Adjusted rate	0.0%	8.7%	2.6%	2.2%
Terminal rate	0/17 (0%)	1/23 (4%)	0/36 (0%)	0/28 (0%)
First incidence (days)	—	436	712	330
Life table test	P=0.578N	P=0.148	P=0.649	P=0.500
Logistic regression test	P=0.523	P=0.095	P=0.573	— ^f
Cochran-Armitage test	P=0.594			
Fisher exact test		P=0.121	P=0.500	P=0.500
All Organs: Mononuclear Cell Leukemia				
Overall rate	27/46 (59%)	2/46 (4%)	1/46 (2%)	1/46 (2%)
Adjusted	79.2%	8.0%	2.3%	2.6%
Terminal	11/17 (65%)	1/23 (4%)	0/36 (0%)	0/28 (0%)
First incidence (days)	495	702	552	611
Life table test	P<0.001N	P<0.001N	P<0.001N	P<0.001N
Logistic regression test	P<0.001N	P<0.001N	P<0.001N	P<0.001N
Cochran-Armitage test	P<0.001N			
Fisher exact test		P<0.001N	P<0.001N	P<0.001N
All Organs: Malignant Mesothelioma				
Overall rate	0/46 (0%)	1/46 (2%)	4/46 (9%)	2/46 (4%)
Adjusted rate	0.0%	4.3%	10.3%	6.2%
Terminal rate	0/17 (0%)	1/23 (4%)	3/36 (8%)	1/28 (4%)
First incidence (days)	—	729 (T)	200	636
Life table test	P=0.249	P=0.560	P=0.152	P=0.308
Logistic regression test	P=0.135	P=0.560	P=0.037	P=0.246
Cochran-Armitage test	P=0.164			
Fisher exact test		P=0.500	P=0.058	P=0.247
All Organs: Benign Neoplasms				
Overall rate	42/46 (91%)	44/46 (96%)	42/46 (91%)	44/46 (96%)
Adjusted rate	95.4%	100.0%	95.4%	100.0%
Terminal rate	15/17 (88%)	23/23 (100%)	34/36 (94%)	28/28 (100%)
First incidence (days)	427	471	540	523
Life table test	P=0.011N	P=0.131N	P<0.001N	P=0.032N
Logistic regression test	P=0.369	P=0.402	P=0.515N	P=0.477
Cochran-Armitage test	P=0.344			
Fisher exact test		P=0.338	P=0.643N	P=0.338
All Organs: Malignant Neoplasms				
Overall rate	30/46 (65%)	16/46 (35%)	14/46 (30%)	15/46 (33%)
Adjusted rate	83.9%	48.0%	33.0%	40.3%
Terminal rate	12/17 (71%)	7/23 (30%)	8/36 (22%)	7/28 (25%)
First incidence (days)	415	436	200	330
Life table test	P<0.001N	P=0.001N	P<0.001N	P<0.001N
Logistic regression test	P=0.007N	P=0.003N	P=0.003N	P=0.003N
Cochran-Armitage test	P=0.004N			
Fisher exact test		P=0.003N	P<0.001N	P=0.002N

TABLE A3
Statistical Analysis of Primary Neoplasms in Male Rats in the 2-Year Inhalation Study of Isobutyl Nitrite (continued)

	0 ppm	37.5 ppm	75 ppm	150 ppm
All Organs: Benign or Malignant Neoplasms				
Overall rate	46/46 (100%)	45/46 (98%)	45/46 (98%)	46/46 (100%)
Adjusted rate	100.0%	100.0%	97.8%	100.0%
Terminal rate	17/17 (100%)	23/23 (100%)	35/36 (97%)	28/28 (100%)
First incidence (days)	415	436	200	330
Life table test	P=0.006N	P=0.056N	P<0.001N	P=0.014N
Logistic regression test	P=0.634	—	P=0.650N	—
Cochran-Armitage test	P=0.594			
Fisher exact test		P=0.500N	P=0.500N	P=1.000N

(T)Terminal sacrifice

- ^a Number of neoplasm-bearing animals/number of animals examined. Denominator is number of animals examined microscopically for adrenal gland, lung, pancreatic islets, pituitary gland, preputial gland, testes, and thyroid gland; for other tissues, denominator is number of animals necropsied.
- ^b Kaplan-Meier estimated neoplasm incidence at the end of the study after adjustment for intercurrent mortality
- ^c Observed incidence at terminal kill
- ^d Beneath the control incidence are the P values associated with the trend test. Beneath the exposed group incidence are the P values corresponding to pairwise comparisons between the controls and that exposed group. The life table test regards neoplasms in animals dying prior to terminal kill as being (directly or indirectly) the cause of death. The logistic regression test regards these lesions as nonfatal. The Cochran-Armitage and Fisher exact tests compare directly the overall incidence rates. For all tests, a negative trend or a lower incidence in an exposure group is indicated by N.
- ^e Not applicable; no neoplasms in animal group
- ^f Value of statistic cannot be computed.

TABLE A4a
Historical Incidence of Alveolar/bronchiolar Neoplasms in Chamber Control Male F344/N Rats^a

	Incidence in Controls		
	Adenoma	Carcinoma	Adenoma or Carcinoma
Overall Historical Incidence			
Total	17/493 (3.5%)	5/493 (1.0%)	22/493 (4.5%)
Standard deviation	3.8%	1.1%	3.8%
Range	0%-10%	0%-2%	0%-10%

^a Data as of 17 June 1994; no data are available for studies performed at IITRI

TABLE A4b
Historical Incidence of Mononuclear Cell Leukemia in Chamber Control Male F344/N Rats^a

	Incidence in Controls
Overall Historical Incidence	
Total	266/494 (53.9%)
Standard deviation	10.1%
Range	34%-66%

^a Data as of 17 June 1994; no data are available for studies performed at IITRI. Includes data for lymphocytic, monocytic, mononuclear cell, or undifferentiated cell type leukemia.

TABLE A5
Summary of the Incidence of Nonneoplastic Lesions in Male Rats in the 2-Year Inhalation Study of Isobutyl Nitrite^a

	0 ppm	37.5 ppm	75 ppm	150 ppm
Disposition Summary				
Animals initially in study	56	56	56	56
15-Month interim evaluation				
Early deaths				
Accidental death			1	
Moribund	21	12	5	8
Natural deaths	8	11	4	10
Survivors				
Terminal sacrifice	17	23	36	28
Animals examined microscopically	56	56	56	56
15-Month Interim Evaluation				
Alimentary System				
Intestine small, duodenum	(10)	(10)	(10)	(10)
Ectopic tissue				1 (10%)
Intestine small, ileum	(10)	(10)	(10)	(10)
Hemorrhage	1 (10%)			
Liver	(10)	(10)	(10)	(10)
Basophilic focus	3 (30%)	3 (30%)	3 (30%)	2 (20%)
Basophilic focus, multiple	1 (10%)	1 (10%)	2 (20%)	5 (50%)
Clear cell focus	3 (30%)	1 (10%)	4 (40%)	1 (10%)
Congestion				1 (10%)
Degeneration, cystic		1 (10%)	1 (10%)	
Eosinophilic focus	2 (20%)			
Fatty change	2 (20%)		1 (10%)	
Hemorrhage	1 (10%)	2 (20%)		
Hepatodiaphragmatic nodule		1 (10%)		
Inflammation	1 (10%)			
Necrosis			1 (10%)	
Pigmentation		1 (10%)		
Mesentery		(1)	(1)	(2)
Fat, necrosis		1 (100%)	1 (100%)	2 (100%)
Pancreas	(10)	(10)	(10)	(10)
Infiltration cellular, lymphocyte	1 (10%)			
Acinar cell, atrophy	5 (50%)	6 (60%)	6 (60%)	7 (70%)
Duct, ectasia			1 (10%)	
Cardiovascular System				
Heart	(10)	(10)	(10)	(10)
Cardiomyopathy	9 (90%)	10 (100%)	10 (100%)	9 (90%)
Endocrine System				
Adrenal cortex	(10)	(10)	(10)	(10)
Hyperplasia		1 (10%)		
Vacuolization cytoplasmic	1 (10%)			
Adrenal medulla	(9)	(10)	(10)	(10)
Angiectasis	1 (11%)			

^a Number of animals examined microscopically at the site and the number of animals with lesion

TABLE A5

Summary of the Incidence of Nonneoplastic Lesions in Male Rats in the 2-Year Inhalation Study of Isobutyl Nitrite
(continued)

	0 ppm	37.5 ppm	75 ppm	150 ppm
15-Month Interim Evaluation (continued)				
Endocrine System (continued)				
Pituitary gland	(10)	(10)	(10)	(10)
Pars distalis, angiectasis		1 (10%)		
Pars distalis, cyst			1 (10%)	1 (10%)
Pars distalis, hyperplasia	5 (50%)	7 (70%)	4 (40%)	6 (60%)
Pars intermedia, angiectasis	1 (10%)			
Thyroid gland	(10)	(10)	(10)	(10)
C-cell, hyperplasia	2 (20%)	2 (20%)		
Follicle, dilatation	1 (10%)			
Genital System				
Preputial gland	(10)	(10)	(10)	(10)
Ectasia	9 (90%)	9 (90%)	10 (100%)	9 (90%)
Inflammation	5 (50%)	4 (40%)	8 (80%)	2 (20%)
Prostate	(10)	(10)	(10)	(10)
Concretion	2 (20%)	3 (30%)	5 (50%)	4 (40%)
Congestion			1 (10%)	
Inflammation	8 (80%)	8 (80%)	7 (70%)	7 (70%)
Testes	(10)	(10)	(10)	(10)
Atrophy				1 (10%)
Interstitial cell, hyperplasia	4 (40%)	3 (30%)	5 (50%)	2 (20%)
Hematopoietic System				
Bone marrow	(10)	(10)	(10)	(10)
Hyperplasia	3 (30%)	1 (10%)	4 (40%)	3 (30%)
Lymph node, bronchial	(10)	(10)	(9)	(10)
Hemorrhage	7 (70%)	8 (80%)	7 (78%)	7 (70%)
Lymph node, mandibular	(10)	(10)	(10)	(10)
Hemorrhage	3 (30%)		2 (20%)	
Lymph node, mesenteric	(10)	(10)	(10)	(10)
Hemorrhage	1 (10%)	3 (30%)	1 (10%)	
Lymph node, mediastinal	(10)	(10)	(10)	(10)
Hemorrhage	9 (90%)	9 (90%)	10 (100%)	10 (100%)
Spleen	(10)	(10)	(10)	(10)
Hematopoietic cell proliferation	1 (10%)			1 (10%)
Thymus	(10)	(10)	(10)	(10)
Atrophy	9 (90%)	6 (60%)	7 (70%)	9 (90%)
Hemorrhage		1 (10%)	1 (10%)	2 (20%)
Respiratory System				
Larynx	(10)	(10)	(10)	(10)
Infiltration cellular, lymphocyte	2 (20%)			
Inflammation	1 (10%)		2 (20%)	1 (10%)
Epithelium, hyperplasia			1 (10%)	
Lung	(10)	(10)	(10)	(10)
Hemorrhage	5 (50%)	7 (70%)	3 (30%)	3 (30%)
Inflammation	1 (10%)			
Alveolar epithelium, hyperplasia		3 (30%)	2 (20%)	7 (70%)

TABLE A5

Summary of the Incidence of Nonneoplastic Lesions in Male Rats in the 2-Year Inhalation Study of Isobutyl Nitrite
(continued)

	0 ppm	37.5 ppm	75 ppm	150 ppm
15-Month Interim Evaluation (continued)				
Respiratory System (continued)				
Nose	(10)	(10)	(10)	(10)
Foreign body	1 (10%)		1 (10%)	1 (10%)
Hemorrhage	1 (10%)		1 (10%)	
Inflammation	1 (10%)		1 (10%)	2 (20%)
Goblet cell, hyperplasia		2 (20%)	3 (30%)	1 (10%)
Olfactory epithelium, cytoplasmic alteration		1 (10%)		3 (30%)
Respiratory epithelium, hyperplasia		1 (10%)		1 (10%)
Urinary System				
Kidney	(10)	(10)	(10)	(10)
Nephropathy, chronic	10 (100%)	10 (100%)	10 (100%)	10 (100%)
Urinary bladder	(10)	(10)	(10)	(10)
Calculus, microscopic observation only	1 (10%)			
Infiltration cellular, lymphocyte				1 (10%)
Systems Examined With No Lesions Observed				
General Body System				
Integumentary System				
Musculoskeletal System				
Nervous System				
Special Senses System				
2-Year Study				
Alimentary System				
Esophagus	(45)	(46)	(46)	(46)
Ectasia		1 (2%)		
Intestine large, colon	(45)	(45)	(46)	(45)
Infiltration cellular, lipocyte				1 (2%)
Intestine large, rectum	(44)	(44)	(45)	(45)
Inflammation				1 (2%)
Intestine large, cecum	(44)	(41)	(44)	(43)
Inflammation				1 (2%)
Intestine small, duodenum	(44)	(44)	(46)	(45)
Hyperplasia				1 (2%)
Inflammation				1 (2%)
Intestine small, ileum	(43)	(36)	(43)	(42)
Hyperplasia, lymphoid			1 (2%)	

TABLE A5
Summary of the Incidence of Nonneoplastic Lesions in Male Rats in the 2-Year Inhalation Study of Isobutyl Nitrite
 (continued)

	0 ppm	37.5 ppm	75 ppm	150 ppm
2-Year Study (continued)				
Alimentary System (continued)				
Liver	(45)	(46)	(46)	(46)
Basophilic focus	6 (13%)	8 (17%)	3 (7%)	5 (11%)
Basophilic focus, multiple	5 (11%)	10 (22%)	24 (52%)	17 (37%)
Clear cell focus			4 (9%)	1 (2%)
Clear cell focus, multiple	2 (4%)	9 (20%)	8 (17%)	3 (7%)
Congestion	3 (7%)	2 (4%)		6 (13%)
Cytoplasmic alteration	1 (2%)			
Degeneration, cystic	4 (9%)	11 (24%)	14 (30%)	4 (9%)
Developmental malformation	1 (2%)			
Eosinophilic focus	3 (7%)	7 (15%)	8 (17%)	2 (4%)
Eosinophilic focus, multiple	1 (2%)	4 (9%)	10 (22%)	4 (9%)
Fatty change	3 (7%)	12 (26%)	6 (13%)	14 (30%)
Hemorrhage	1 (2%)	1 (2%)		
Hepatodiaphragmatic nodule	1 (2%)	1 (2%)		
Infiltration cellular, lymphocyte				1 (2%)
Inflammation		1 (2%)	1 (2%)	1 (2%)
Mixed cell focus	1 (2%)	4 (9%)	2 (4%)	4 (9%)
Mixed cell focus, multiple	2 (4%)		2 (4%)	
Necrosis	2 (4%)	4 (9%)	1 (2%)	2 (4%)
Bile duct, hyperplasia	3 (7%)		3 (7%)	
Mesentery	(6)		(3)	(8)
Fat, necrosis	6 (100%)		3 (100%)	6 (75%)
Pancreas	(45)	(46)	(46)	(46)
Ectopic liver			1 (2%)	
Infiltration cellular, lymphocyte	1 (2%)		1 (2%)	
Inflammation		1 (2%)		2 (4%)
Acinar cell, atrophy	28 (62%)	26 (57%)	30 (65%)	25 (54%)
Acinar cell, hyperplasia	1 (2%)			
Artery, inflammation			2 (4%)	
Duct, ectasia		1 (2%)		
Pharynx		(1)		
Palate, hyperplasia, squamous		1 (100%)		
Salivary glands	(46)	(45)	(46)	(46)
Abscess				1 (2%)
Infiltration cellular, lymphocyte			1 (2%)	
Stomach, forestomach	(45)	(46)	(46)	(46)
Hyperplasia	4 (9%)	3 (7%)	5 (11%)	3 (7%)
Inflammation	1 (2%)	4 (9%)	3 (7%)	1 (2%)
Ulcer	5 (11%)	3 (7%)	2 (4%)	3 (7%)
Ulcer, multiple		2 (4%)	2 (4%)	
Stomach, glandular	(45)	(46)	(46)	(45)
Hyperplasia		1 (2%)		
Inflammation		1 (2%)	1 (2%)	2 (4%)
Necrosis	3 (7%)	3 (7%)		
Ulcer	1 (2%)			3 (7%)
Ulcer, multiple	2 (4%)	1 (2%)	1 (2%)	

TABLE A5

Summary of the Incidence of Nonneoplastic Lesions in Male Rats in the 2-Year Inhalation Study of Isobutyl Nitrite
(continued)

	0 ppm	37.5 ppm	75 ppm	150 ppm
2-Year Study (continued)				
Cardiovascular System				
Heart	(46)	(46)	(46)	(46)
Cardiomyopathy	33 (72%)	43 (93%)	45 (98%)	42 (91%)
Inflammation		2 (4%)		
Atrium, dilatation	1 (2%)			1 (2%)
Atrium, thrombosis	2 (4%)	1 (2%)	2 (4%)	2 (4%)
Valve, inflammation		1 (2%)		
Endocrine System				
Adrenal cortex	(45)	(46)	(46)	(46)
Angiectasis			1 (2%)	
Congestion	1 (2%)			1 (2%)
Cytoplasmic alteration	1 (2%)			1 (2%)
Degeneration	3 (7%)	1 (2%)	1 (2%)	2 (4%)
Hyperplasia	7 (16%)	3 (7%)	6 (13%)	3 (7%)
Hypertrophy	1 (2%)	3 (7%)	2 (4%)	2 (4%)
Vacuolization cytoplasmic	6 (13%)	19 (41%)	15 (33%)	16 (35%)
Adrenal medulla	(45)	(45)	(46)	(46)
Hyperplasia	15 (33%)	14 (31%)	19 (41%)	12 (26%)
Islets, pancreatic	(8)	(9)	(5)	(5)
Hyperplasia	4 (50%)	3 (33%)	2 (40%)	1 (20%)
Parathyroid gland	(39)	(40)	(38)	(42)
Hyperplasia	4 (10%)	6 (15%)	3 (8%)	
Pituitary gland	(45)	(46)	(46)	(45)
Hemorrhage		1 (2%)		
Pars distalis, angiectasis	1 (2%)	6 (13%)	4 (9%)	4 (9%)
Pars distalis, cyst	2 (4%)	5 (11%)	3 (7%)	2 (4%)
Pars distalis, hemorrhage		1 (2%)	1 (2%)	
Pars distalis, hyperplasia	6 (13%)	15 (33%)	21 (46%)	12 (27%)
Pars intermedia, cyst		1 (2%)		
Thyroid gland	(45)	(46)	(46)	(46)
C-cell, hyperplasia	6 (13%)	3 (7%)	5 (11%)	3 (7%)
Follicle, dilatation	3 (7%)			
Follicular cell, hyperplasia	1 (2%)			
General Body System				
None				
Genital System				
Epididymis	(46)	(46)	(46)	(46)
Atrophy	1 (2%)		1 (2%)	
Granuloma sperm	1 (2%)	2 (4%)	1 (2%)	1 (2%)
Hypospermia	20 (43%)	26 (57%)	25 (54%)	29 (63%)
Inflammation	2 (4%)		2 (4%)	
Inflammation, chronic	1 (2%)			
Spermatocele	2 (4%)			

TABLE A5

Summary of the Incidence of Nonneoplastic Lesions in Male Rats in the 2-Year Inhalation Study of Isobutyl Nitrite
(continued)

	0 ppm	37.5 ppm	75 ppm	150 ppm
2-Year Study (continued)				
Genital System (continued)				
Preputial gland	(44)	(46)	(46)	(46)
Abscess	1 (2%)			1 (2%)
Degeneration			1 (2%)	
Ectasia	34 (77%)	40 (87%)	39 (85%)	32 (70%)
Hyperplasia		1 (2%)	3 (7%)	1 (2%)
Inflammation	6 (14%)	5 (11%)	4 (9%)	14 (30%)
Prostate	(46)	(46)	(46)	(46)
Abscess	1 (2%)			
Atrophy	1 (2%)			
Concretion		4 (9%)	2 (4%)	6 (13%)
Hyperplasia	4 (9%)	4 (9%)	6 (13%)	4 (9%)
Inflammation	24 (52%)	16 (35%)	16 (35%)	18 (39%)
Vacuolization cytoplasmic Epithelium, cytoplasmic alteration	1 (2%)	2 (4%)		1 (2%)
Seminal vesicle	(45)	(46)	(46)	(46)
Depletion cellular	22 (49%)	23 (50%)	23 (50%)	31 (67%)
Ectasia		1 (2%)		1 (2%)
Inflammation	1 (2%)			2 (4%)
Testes	(46)	(46)	(46)	(46)
Atrophy	8 (17%)	6 (13%)	6 (13%)	7 (15%)
Degeneration		1 (2%)		
Hypospermia		1 (2%)		1 (2%)
Arteriole, inflammation	1 (2%)	6 (13%)	10 (22%)	5 (11%)
Bilateral, atrophy	10 (22%)	2 (4%)	4 (9%)	7 (15%)
Bilateral, degeneration		1 (2%)		
Interstitial cell, hyperplasia	12 (26%)	9 (20%)	7 (15%)	12 (26%)
Hematopoietic System				
Bone marrow	(45)	(45)	(46)	(46)
Congestion				1 (2%)
Hemorrhage			1 (2%)	
Hyperplasia	13 (29%)	14 (31%)	4 (9%)	12 (26%)
Pigmentation				1 (2%)
Lymph node	(5)			(1)
Deep cervical, inflammation				1 (100%)
Lumbar, hyperplasia, plasma cell	1 (20%)			
Renal, hemorrhage				1 (100%)
Lymph node, bronchial	(37)	(33)	(31)	(29)
Hemorrhage	3 (8%)	10 (30%)	11 (35%)	11 (38%)
Hyperplasia, plasma cell	1 (3%)			
Infiltration cellular, histiocyte				1 (3%)
Inflammation		1 (3%)		
Pigmentation	1 (3%)	3 (9%)	2 (6%)	3 (10%)
Lymph node, mandibular	(45)	(45)	(46)	(46)
Cyst		1 (2%)	2 (4%)	
Hemorrhage	3 (7%)	4 (9%)	5 (11%)	3 (7%)
Hyperplasia, lymphoid		1 (2%)		1 (2%)
Hyperplasia, plasma cell	3 (7%)	7 (16%)	6 (13%)	4 (9%)
Infiltration cellular, histiocyte			1 (2%)	
Pigmentation		1 (2%)		1 (2%)

TABLE A5

Summary of the Incidence of Nonneoplastic Lesions in Male Rats in the 2-Year Inhalation Study of Isobutyl Nitrite
(continued)

	0 ppm	37.5 ppm	75 ppm	150 ppm
2-Year Study (continued)				
Hematopoietic System (continued)				
Lymph node, mesenteric	(45)	(46)	(46)	(44)
Hemorrhage	3 (7%)	9 (20%)	4 (9%)	7 (16%)
Lymph node, mediastinal	(45)	(42)	(42)	(45)
Depletion lymphoid				1 (2%)
Hemorrhage	13 (29%)	27 (64%)	23 (55%)	26 (58%)
Hyperplasia, lymphoid			1 (2%)	
Hyperplasia, plasma cell	3 (7%)	2 (5%)		2 (4%)
Infiltration cellular, histiocyte			1 (2%)	1 (2%)
Pigmentation	5 (11%)	14 (33%)	13 (31%)	12 (27%)
Spleen	(46)	(45)	(46)	(45)
Congestion	1 (2%)	2 (4%)		1 (2%)
Degeneration, cystic			2 (4%)	5 (11%)
Developmental malformation				1 (2%)
Fibrosis		1 (2%)	2 (4%)	
Hematopoietic cell proliferation	3 (7%)	6 (13%)	5 (11%)	12 (27%)
Hemorrhage			1 (2%)	
Inflammation				1 (2%)
Necrosis				1 (2%)
Capsule, fibrosis		1 (2%)		
Thymus	(41)	(46)	(45)	(44)
Atrophy	26 (63%)	37 (80%)	35 (78%)	32 (73%)
Congestion				2 (5%)
Cyst				1 (2%)
Hemorrhage	3 (7%)	7 (15%)	1 (2%)	1 (2%)
Integumentary System				
Mammary gland	(42)	(43)	(46)	(43)
Galactocele	1 (2%)	2 (5%)		4 (9%)
Hyperplasia	1 (2%)			1 (2%)
Inflammation	1 (2%)			1 (2%)
Lactation	13 (31%)	18 (42%)	10 (22%)	16 (37%)
Pigmentation	2 (5%)	1 (2%)		
Skin	(46)	(46)	(46)	(46)
Inflammation	1 (2%)			
Pinna, parakeratosis		1 (2%)		
Subcutaneous tissue, abscess		1 (2%)		1 (2%)
Tail, hyperkeratosis				1 (2%)
Musculoskeletal System				
Bone	(46)	(46)	(46)	(46)
Calvarium, hemorrhage		1 (2%)		
Coccygeal, fracture		1 (2%)		
Cranium, hemorrhage	1 (2%)			

TABLE A5

Summary of the Incidence of Nonneoplastic Lesions in Male Rats in the 2-Year Inhalation Study of Isobutyl Nitrite
(continued)

	0 ppm	37.5 ppm	75 ppm	150 ppm
2-Year Study (continued)				
Nervous System				
Brain	(46)	(46)	(46)	(46)
Compression	9 (20%)	17 (37%)	6 (13%)	22 (48%)
Hemorrhage	2 (4%)	2 (4%)	1 (2%)	1 (2%)
Hydrocephalus	4 (9%)	3 (7%)	1 (2%)	2 (4%)
Infiltration cellular, lymphocyte		1 (2%)		
Necrosis			1 (2%)	
Respiratory System				
Larynx	(46)	(46)	(46)	(46)
Foreign body	1 (2%)			1 (2%)
Infiltration cellular, lymphocyte	1 (2%)		1 (2%)	2 (4%)
Inflammation	2 (4%)	2 (4%)	2 (4%)	3 (7%)
Epithelium, hyperplasia	1 (2%)	1 (2%)		1 (2%)
Lung	(46)	(46)	(46)	(46)
Congestion	4 (9%)	5 (11%)	3 (7%)	3 (7%)
Hemorrhage	4 (9%)	8 (17%)	1 (2%)	
Infiltration cellular, histiocyte		1 (2%)		1 (2%)
Inflammation	2 (4%)	8 (17%)	3 (7%)	6 (13%)
Leukocytosis	1 (2%)	1 (2%)		
Necrosis		1 (2%)		
Alveolar epithelium, hyperplasia	5 (11%)	8 (17%)	26 (57%)	31 (67%)
Arteriole, inflammation			1 (2%)	
Artery, inflammation			1 (2%)	
Artery, thrombosis		1 (2%)	1 (2%)	
Bronchus, hyperplasia	1 (2%)			
Goblet cell, hyperplasia		1 (2%)		
Nose	(45)	(45)	(46)	(46)
Angiectasis	7 (16%)	4 (9%)	1 (2%)	2 (4%)
Foreign body	5 (11%)	3 (7%)	2 (4%)	1 (2%)
Hemorrhage	4 (9%)		1 (2%)	1 (2%)
Infiltration cellular, lymphocyte				2 (4%)
Inflammation	8 (18%)	10 (22%)	6 (13%)	9 (20%)
Polyp inflammatory	1 (2%)			
Goblet cell, hyperplasia		1 (2%)		
Nasolacrimal duct, inflammation		3 (7%)		2 (4%)
Olfactory epithelium, cytoplasmic alteration		2 (4%)	2 (4%)	2 (4%)
Respiratory epithelium, hyperplasia	2 (4%)	2 (4%)	4 (9%)	3 (7%)
Respiratory epithelium, metaplasia, squamous		2 (4%)		
Special Senses System				
Eye	(1)		(1)	
Hemorrhage			1 (100%)	
Inflammation			1 (100%)	

TABLE A5

Summary of the Incidence of Nonneoplastic Lesions in Male Rats in the 2-Year Inhalation Study of Isobutyl Nitrite
(continued)

	0 ppm	37.5 ppm	75 ppm	150 ppm
2-Year Study (continued)				
Urinary System				
Kidney	(45)	(45)	(46)	(46)
Congestion	1 (2%)			1 (2%)
Cyst	1 (2%)	1 (2%)		3 (7%)
Hydronephrosis	1 (2%)			
Inflammation		1 (2%)		
Nephropathy, chronic	39 (87%)	42 (93%)	45 (98%)	45 (98%)
Pigmentation	3 (7%)	2 (4%)		5 (11%)
Pelvis, hyperplasia	1 (2%)			
Renal tubule, cytoplasmic alteration	1 (2%)			
Urinary bladder	(46)	(45)	(46)	(45)
Dilatation	4 (9%)	1 (2%)		1 (2%)
Inflammation	1 (2%)	1 (2%)		
Transitional epithelium, hyperplasia	1 (2%)			

APPENDIX B
SUMMARY OF LESIONS IN FEMALE RATS
IN THE 2-YEAR INHALATION STUDY
OF ISOBUTYL NITRITE

TABLE B1	Summary of the Incidence of Neoplasms in Female Rats in the 2-Year Inhalation Study of Isobutyl Nitrite	119
TABLE B2	Individual Animal Tumor Pathology of Female Rats in the 2-Year Inhalation Study of Isobutyl Nitrite	124
TABLE B3	Statistical Analysis of Primary Neoplasms in Female Rats in the 2-Year Inhalation Study of Isobutyl Nitrite	140
TABLE B4a	Historical Incidence of Alveolar/bronchiolar Neoplasms in Chamber Control Female F344/N Rats	145
TABLE B4b	Historical Incidence of Mononuclear Cell Leukemia in Chamber Control Female F344/N Rats	145
TABLE B5	Summary of the Incidence of Nonneoplastic Lesions in Female Rats in the 2-Year Inhalation Study of Isobutyl Nitrite	146

TABLE B1
Summary of the Incidence of Neoplasms in Female Rats in the 2-Year Inhalation Study of Isobutyl Nitrite^a

	0 ppm	37.5 ppm	75 ppm	150 ppm
Disposition Summary				
Animals initially in study	56	56	56	56
<i>15-Month interim evaluation</i>	10	10	10	10
Early deaths				
Moribund	13	4	7	6
Natural deaths	4	6	8	7
Survivors				
Died last week of study			1	
Terminal sacrifice	29	35	30	33
Missing		1		
Animals examined microscopically	56	55	56	56
15-Month Interim Evaluation				
Alimentary System				
Liver	(10)	(9)	(10)	(10)
Endocrine System				
Adrenal cortex	(10)	(10)	(10)	(10)
Adrenal medulla	(10)	(10)	(10)	(10)
Pituitary gland	(10)	(10)	(10)	(10)
Pars distalis, adenoma	1 (10%)	1 (10%)		
Genital System				
Uterus	(10)	(10)	(10)	(10)
Polyp stromal		1 (10%)		1 (10%)
Hematopoietic System				
Bone marrow	(10)	(10)	(10)	(10)
Lymph node, mesenteric	(10)	(10)	(10)	(10)
Lymph node, mediastinal	(10)	(10)	(10)	(10)
Spleen	(10)	(10)	(10)	(10)
Integumentary System				
Mammary gland	(10)	(10)	(10)	(10)
Fibroadenoma	1 (10%)			
Skin	(10)	(10)	(10)	(10)
Subcutaneous tissue, lipoma	1 (10%)			
Respiratory System				
Lung	(10)	(10)	(10)	(10)
Systemic Lesions				
Multiple organs ^b	(10)	(10)	(10)	(10)
Leukemia mononuclear	1 (10%)			

TABLE B1

Summary of the Incidence of Neoplasms in Female Rats in the 2-Year Inhalation Study of Isobutyl Nitrite (continued)

	0 ppm	37.5 ppm	75 ppm	150 ppm
15-Month Interim Evaluation (continued)				
Systems Examined With No Neoplasms Observed				
Cardiovascular System				
General Body System				
Musculoskeletal System				
Nervous System				
Special Senses System				
Urinary System				
2-Year Study				
Alimentary System				
Intestine large, cecum	(46)	(44)	(43)	(43)
Intestine small, ileum	(44)	(41)	(40)	(41)
Liver	(46)	(45)	(46)	(46)
Hepatocellular adenoma		1 (2%)		
Histiocytic sarcoma		1 (2%)	1 (2%)	
Pancreas	(46)	(45)	(46)	(46)
Stomach, forestomach	(46)	(45)	(46)	(46)
Stomach, glandular	(46)	(44)	(45)	(46)
Tongue	(1)	(1)	(2)	(1)
Squamous cell carcinoma	1 (100%)		1 (50%)	1 (100%)
Squamous cell papilloma		1 (100%)	1 (50%)	
Cardiovascular System				
Heart	(46)	(45)	(46)	(46)
Endocrine System				
Adrenal cortex	(46)	(45)	(46)	(46)
Adenoma		1 (2%)		
Adrenal medulla	(45)	(45)	(45)	(46)
Pheochromocytoma complex	2 (4%)			
Pheochromocytoma benign		3 (7%)	1 (2%)	2 (4%)
Bilateral, pheochromocytoma malignant		1 (2%)		
Islets, pancreatic	(6)	(1)		(1)
Adenoma	5 (83%)	1 (100%)		1 (100%)
Pituitary gland	(46)	(43)	(45)	(46)
Pars distalis, adenoma	23 (50%)	15 (35%)	19 (42%)	17 (37%)
Pars distalis, adenoma, multiple	2 (4%)		1 (2%)	1 (2%)
Pars distalis, carcinoma	1 (2%)		1 (2%)	
Thyroid gland	(46)	(45)	(46)	(46)
Bilateral, C-cell, adenoma		1 (2%)		
C-cell, adenoma	1 (2%)	3 (7%)	2 (4%)	3 (7%)
C-cell, carcinoma		2 (4%)		
Follicular cell, carcinoma				2 (4%)
General Body System				
None				

TABLE B1
Summary of the Incidence of Neoplasms in Female Rats in the 2-Year Inhalation Study of Isobutyl Nitrite (continued)

	0 ppm	37.5 ppm	75 ppm	150 ppm
2-Year Study (continued)				
Genital System				
Clitoral gland	(44)	(44)	(44)	(46)
Adenoma	1 (2%)	1 (2%)	1 (2%)	1 (2%)
Carcinoma	1 (2%)			
Bilateral, adenoma			1 (2%)	
Ovary	(46)	(45)	(46)	(46)
Granulosa cell tumor benign		1 (2%)		
Histiocytic sarcoma			1 (2%)	
Uterus	(46)	(45)	(46)	(46)
Polyp stromal	1 (2%)	4 (9%)	3 (7%)	1 (2%)
Sarcoma stromal	1 (2%)			
Bilateral, polyp stromal	1 (2%)		3 (7%)	
Hematopoietic System				
Bone marrow	(46)	(45)	(46)	(46)
Histiocytic sarcoma			1 (2%)	
Lymph node	(1)	(1)		(3)
Lymph node, bronchial	(26)	(30)	(36)	(28)
Histiocytic sarcoma			1 (3%)	
Rhabdomyosarcoma, metastatic, uncertain primary site				1 (4%)
Lymph node, mandibular	(45)	(45)	(43)	(43)
Histiocytic sarcoma			1 (2%)	
Lymph node, mesenteric	(46)	(45)	(46)	(45)
Histiocytic sarcoma			1 (2%)	
Lymph node, mediastinal	(44)	(44)	(41)	(43)
Histiocytic sarcoma			1 (2%)	
Spleen	(46)	(45)	(44)	(46)
Hemangiosarcoma				1 (2%)
Histiocytic sarcoma			1 (2%)	
Thymus	(44)	(43)	(45)	(44)
Histiocytic sarcoma			1 (2%)	
Integumentary System				
Mammary gland	(46)	(45)	(46)	(46)
Adenocarcinoma	3 (7%)	1 (2%)	1 (2%)	1 (2%)
Adenoma		1 (2%)		1 (2%)
Fibroadenoma	8 (17%)	8 (18%)	16 (35%)	13 (28%)
Fibroadenoma, multiple	3 (7%)	6 (13%)	4 (9%)	
Skin	(46)	(45)	(46)	(46)
Squamous cell papilloma				1 (2%)
Subcutaneous tissue, fibroma		2 (4%)		1 (2%)
Subcutaneous tissue, fibrosarcoma	1 (2%)			
Subcutaneous tissue, lipoma			1 (2%)	
Tail, squamous cell papilloma	1 (2%)	1 (2%)		
Musculoskeletal System				
None				

TABLE B1
Summary of the Incidence of Neoplasms in Female Rats in the 2-Year Inhalation Study of Isobutyl Nitrite (continued)

	0 ppm	37.5 ppm	75 ppm	150 ppm
2-Year Study (continued)				
Nervous System				
Brain	(46)	(45)	(46)	(46)
Astrocytoma benign				1 (2%)
Carcinoma, metastatic, pituitary gland	1 (2%)		1 (2%)	
Glioma malignant	1 (2%)		1 (2%)	
Respiratory System				
Larynx	(46)	(45)	(46)	(46)
Lung	(46)	(45)	(46)	(46)
Alveolar/bronchiolar adenoma		2 (4%)	2 (4%)	8 (17%)
Alveolar/bronchiolar adenoma, multiple				2 (4%)
Alveolar/bronchiolar carcinoma		1 (2%)		1 (2%)
Mediastinum, rhabdomyosarcoma, metastatic, uncertain primary site				1 (2%)
Nose	(46)	(45)	(45)	(46)
Special Senses System				
None				
Urinary System				
Kidney	(46)	(45)	(46)	(46)
Sarcoma			1 (2%)	
Urinary bladder	(46)	(44)	(45)	(43)
Systemic Lesions				
Multiple organs	(46)	(45)	(46)	(46)
Histiocytic sarcoma		1 (2%)	1 (2%)	
Leukemia mononuclear	14 (30%)	1 (2%)		1 (2%)
Neoplasm Summary				
Total animals with primary neoplasms ^c				
15-Month interim evaluation	4	2		1
2-Year study	40	34	37	34
Total primary neoplasms				
15-Month interim evaluation	4	2		1
2-Year study	71	59	61	60
Total animals with benign neoplasms				
15-Month interim evaluation	3	2		1
2-Year study	32	34	35	33
Total benign neoplasms				
15-Month interim evaluation	3	2		1
2-Year study	46	52	55	53

TABLE B1
Summary of the Incidence of Neoplasms in Female Rats in the 2-Year Inhalation Study of Isobutyl Nitrite (continued)

	0 ppm	37.5 ppm	75 ppm	150 ppm
Neoplasm Summary (continued)				
Total animals with malignant neoplasms				
15-Month interim evaluation	1			
2-Year study	21	7	6	7
Total malignant neoplasms				
15-Month interim evaluation	1			
2-Year study	25	7	6	7
Total animals with metastatic neoplasms				
2-Year study	1		1	1
Total metastatic neoplasms				
2-Year study	1		1	2
Total animals with malignant neoplasms of uncertain primary site				
2-Year study				1

^a Number of animals examined microscopically at the site and the number of animals with neoplasm

^b Number of animals with any tissue examined microscopically

^c Primary neoplasms: all neoplasms except metastatic neoplasms

TABLE B2
Individual Animal Tumor Pathology of Female Rats in the 2-Year Inhalation Study of Isobutyl Nitrite:
0 ppm

Number of Days on Study	4 5 5 6 6 6 6 6 6 6 6 6 6 6 7 7 7 7 7 7 7 7 7 7
	6 1 2 0 0 4 4 4 4 5 5 6 6 7 0 2 2 3 3 3 3 3 3 3 3
	4 6 6 2 4 0 0 1 6 2 8 6 8 1 2 0 1 3 3 3 3 3 3 3 3
Carcass ID Number	0 0 0 0 0 0 0 0 0 0 0 0 0 0 0 0 1 0 0 0 0 0 0 0 0
	9 7 8 6 8 9 9 7 7 6 7 9 6 7 8 0 8 5 5 6 6 8 8 9 9
	9 0 5 9 2 4 6 1 5 2 2 7 3 6 0 0 6 7 9 0 6 4 7 0 3
Alimentary System	
Esophagus	+ +
Intestine large, colon	+ +
Intestine large, rectum	+ + A + + M + + + + + + + + + + + + + + + + + +
Intestine large, cecum	+ +
Intestine small, duodenum	+ +
Intestine small, jejunum	+ A A +
Intestine small, ileum	+ A A +
Liver	+ +
Mesentery	
Pancreas	+ +
Salivary glands	+ +
Stomach, forestomach	+ +
Stomach, glandular	+ +
Tongue	+
Squamous cell carcinoma	X
Cardiovascular System	
Heart	+ +
Endocrine System	
Adrenal cortex	+ +
Adrenal medulla	+ + + + M + + + + + + + + + + + + + + + + + +
Pheochromocytoma complex	X
Islets, pancreatic	+ +
Adenoma	X X
Parathyroid gland	+ + + + + + M + M + + M + + M + + + + + + M + + + +
Pituitary gland	+ +
Pars distalis, adenoma	X X
Pars distalis, adenoma, multiple	X X
Pars distalis, carcinoma	X X
Thyroid gland	+ +
C-cell, adenoma	
General Body System	
None	
Genital System	
Clitoral gland	+ + + + + M + + + + + M + + + + + + + + + + + +
Adenoma	
Carcinoma	X
Ovary	+ +
Uterus	+ +
Polyp stromal	
Sarcoma stromal	X
Bilateral, polyp stromal	X

+ : Tissue examined microscopically
 A: Autolysis precludes examination

M: Missing tissue
 I: Insufficient tissue

X: Lesion present
 Blank: Not examined

TABLE B2
Individual Animal Tumor Pathology of Female Rats in the 2-Year Inhalation Study of Isobutyl Nitrite:
0 ppm (continued)

Number of Days on Study	4 5 5 6 6 6 6 6 6 6 6 6 6 6 7 7 7 7 7 7 7 7 7
	6 1 2 0 0 4 4 4 4 5 5 6 6 7 0 2 2 3 3 3 3 3 3 3
	4 6 6 2 4 0 0 1 6 2 8 6 8 1 2 0 1 3 3 3 3 3 3 3
Carcass ID Number	0 0 0 0 0 0 0 0 0 0 0 0 0 0 1 0 0 0 0 0 0 0 0
	9 7 8 6 8 9 9 7 7 6 7 9 6 7 8 0 8 5 5 6 6 8 8 9
	9 0 5 9 2 4 6 1 5 2 2 7 3 6 0 0 6 7 9 0 6 4 7 0
Hematopoietic System	
Bone marrow	+ +
Lymph node	
Lymph node, bronchial	+ + + M + + + M M M + + M + M + + + M + M M + +
Lymph node, mandibular	+ +
Lymph node, mesenteric	+ +
Lymph node, mediastinal	+ M +
Spleen	+ +
Thymus	+ + + + + + + + + + + + + + + + + M + + + + + + +
Integumentary System	
Mammary gland	+ +
Adenocarcinoma	
Fibroadenoma	
Fibroadenoma, multiple	
Skin	+ +
Subcutaneous tissue, fibrosarcoma	
Tail, squamous cell papilloma	
Musculoskeletal System	
Bone	+ +
Nervous System	
Brain	+ +
Carcinoma, metastatic, pituitary gland	
Glioma malignant	
Respiratory System	
Larynx	+ +
Lung	+ +
Nose	+ +
Trachea	+ +
Special Senses System	
None	
Urinary System	
Kidney	+ +
Urinary bladder	+ +
Systemic Lesions	
Multiple organs	+ +
Leukemia mononuclear	

TABLE B2
Individual Animal Tumor Pathology of Female Rats in the 2-Year Inhalation Study of Isobutyl Nitrite:
37.5 ppm (continued)

Number of Days on Study	7 7 7 7 7 7 7 7 7 7 7 7 7 7 7 7 7 7 7 7	
	3 3 3 3 3 3 3 3 3 3 3 3 3 3 3 3 3 3 3 3	
	4 4 4 4 4 4 4 4 4 4 4 5 5 5 5 5 5 5 5 5	
Carcass ID Number	1 1 1 1 1 1 2 2 2 2 2 1 1 1 1 1 2 2 2 2 2	Total
	7 7 8 8 9 9 0 0 0 1 1 7 7 9 9 9 0 0 0 1 1	Tissues/
	7 8 2 4 7 8 3 6 9 1 2 2 9 2 3 9 1 2 8 0 4	Tumors
Alimentary System		
Esophagus	+ +	45
Intestine large, colon	+ +	44
Intestine large, rectum	+ +	45
Intestine large, cecum	+ +	44
Intestine small, duodenum	+ +	43
Intestine small, jejunum	+ + + + + + + + A + + + + + + + + + + + + +	41
Intestine small, ileum	+ +	41
Liver	+ +	45
Hepatocellular adenoma		X
Histiocytic sarcoma		
Pancreas	+ +	45
Salivary glands	+ +	45
Stomach, forestomach	+ +	45
Stomach, glandular	+ +	44
Tongue		1
Squamous cell papilloma		1
Cardiovascular System		
Heart	+ +	45
Endocrine System		
Adrenal cortex	+ +	45
Adenoma		1
Adrenal medulla	+ +	45
Pheochromocytoma benign		X
Bilateral, pheochromocytoma malignant		1
Islets, pancreatic		+
Adenoma		X
Parathyroid gland	+ + + + + M M + + + + + + + + + + + M + +	40
Pituitary gland	+ + + + + + + + + + + + + + M + + + + + + + +	43
Pars distalis, adenoma		X X X X X X X X
Thyroid gland	+ +	45
Bilateral, C-cell, adenoma		1
C-cell, adenoma		X
C-cell, carcinoma		2
General Body System		
Tissue NOS		1
Genital System		
Clitoral gland	+ +	44
Adenoma		X
Ovary	+ +	45
Granulosa cell tumor benign		1
Uterus	+ +	45
Polyp stromal		X

TABLE B2
Individual Animal Tumor Pathology of Female Rats in the 2-Year Inhalation Study of Isobutyl Nitrite:
37.5 ppm (continued)

Number of Days on Study	3 4 6 6 6 6 6 6 7 7 7 7 7 7 7 7 7 7 7 7 7 7
	7 7 2 4 4 5 7 8 2 2 3 3 3 3 3 3 3 3 3 3 3 3
	8 7 4 5 8 9 2 6 0 9 3 3 3 3 3 3 3 3 3 3 3 3 4 4
Carcass ID Number	1 1 1 1 1 1 1 1 1 2 1 1 1 1 1 1 1 2 2 2 2 1 1
	8 8 9 8 7 7 8 9 7 0 6 7 8 8 8 9 9 9 0 0 0 1 7 7
	0 3 0 1 5 3 5 4 4 7 9 1 6 7 8 1 5 6 0 4 5 3 0 6
Hematopoietic System	
Bone marrow	+
Lymph node	+
Lymph node, bronchial	+ + M M + + M M M + M M + + + + + M + + + + + M
Lymph node, mandibular	+ +
Lymph node, mesenteric	+ +
Lymph node, mediastinal	M +
Spleen	+ +
Thymus	+ + + + + + + + + + + + M + + + + + + + + + M
Integumentary System	
Mammary gland	+ +
Adenocarcinoma	
Adenoma	
Fibroadenoma	
Fibroadenoma, multiple	X X X X X X X X X
Skin	+ +
Subcutaneous tissue, fibroma	X
Tail, squamous cell papilloma	X
Musculoskeletal System	
Bone	+ +
Nervous System	
Brain	+ +
Respiratory System	
Larynx	+ +
Lung	+ +
Alveolar/bronchiolar adenoma	X
Alveolar/bronchiolar carcinoma	X
Nose	+ +
Trachea	+ +
Special Senses System	
Eye	+
Urinary System	
Kidney	+ +
Urinary bladder	+ +
Systemic Lesions	
Multiple organs	+ +
Histiocytic sarcoma	X
Leukemia mononuclear	X

TABLE B2
Individual Animal Tumor Pathology of Female Rats in the 2-Year Inhalation Study of Isobutyl Nitrite:
37.5 ppm (continued)

Number of Days on Study	7 7	
	3 3	
	4 4 4 4 4 4 4 4 4 4 4 5 5 5 5 5 5 5 5 5 5	
Carcass ID Number	1 1 1 1 1 1 2 2 2 2 2 1 1 1 1 2 2 2 2 2 2	Total
	7 7 8 8 9 9 0 0 0 1 1 7 7 9 9 9 0 0 0 1 1	Tissues/ Tumors
	7 8 2 4 7 8 3 6 9 1 2 2 9 2 3 9 1 2 8 0 4	
Hematopoietic System		
Bone marrow	+ +	45
Lymph node		1
Lymph node, bronchial	+ + + + M M + + M + M + + M + + + + M + +	30
Lymph node, mandibular	+ +	45
Lymph node, mesenteric	+ +	45
Lymph node, mediastinal	+ +	44
Spleen	+ +	45
Thymus	+ +	43
Integumentary System		
Mammary gland	+ +	45
Adenocarcinoma		1
Adenoma		1
Fibroadenoma	X X	8
Fibroadenoma, multiple		6
Skin	+ +	45
Subcutaneous tissue, fibroma		2
Tail, squamous cell papilloma		1
Musculoskeletal System		
Bone	+ +	45
Nervous System		
Brain	+ +	45
Respiratory System		
Larynx	+ +	45
Lung	+ +	45
Alveolar/bronchiolar adenoma		2
Alveolar/bronchiolar carcinoma		1
Nose	+ +	45
Trachea	+ +	45
Special Senses System		
Eye		1
Urinary System		
Kidney	+ +	45
Urinary bladder	+ + + + + + + + + + + + + + + + M + + + +	44
Systemic Lesions		
Multiple organs	+ +	45
Histiocytic sarcoma		1
Leukemia mononuclear		1

TABLE B2
Individual Animal Tumor Pathology of Female Rats in the 2-Year Inhalation Study of Isobutyl Nitrite:
75 ppm (continued)

Number of Days on Study	7 7 7 7 7 7 7 7 7 7 7 7 7 7 7 7 7 7 7 7	
	3 3 3 3 3 3 3 3 3 3 3 3 3 3 3 3 3 3 3 3	
	4 4 4 4 4 4 4 4 4 4 4 4 4 5 5 5 5 5 5 5	
Carcass ID Number	2 2 2 2 2 3 3 3 3 3 3 3 3 2 2 2 2 3 3 3 3	Total
	8 8 9 9 9 0 0 1 1 1 2 2 2 8 8 9 9 1 1 1 1	Tissues/
	7 8 1 3 6 4 7 0 8 9 0 5 6 1 9 4 8 1 2 3 7	Tumors
Alimentary System		
Esophagus	+ +	46
Intestine large, colon	+ +	44
Intestine large, rectum	+ +	46
Intestine large, cecum	+ + + A + + + + + + + + + + + + + + + + +	43
Intestine small, duodenum	+ +	43
Intestine small, jejunum	+ + + A + + + + + + + + + + + + + + + + +	41
Intestine small, ileum	+ + + A + + + + + + + + + + + + + + + + +	40
Liver	+ +	46
Histiocytic sarcoma		1
Mesentery		2
+		
Pancreas	+ +	46
Pharynx	+	2
Salivary glands	+ +	45
Stomach, forestomach	+ +	46
Stomach, glandular	+ +	45
Tongue		2
Squamous cell carcinoma		1
Squamous cell papilloma		1
Cardiovascular System		
Heart	+ +	46
Endocrine System		
Adrenal cortex	+ +	46
Adrenal medulla	+ +	45
Pheochromocytoma benign		1
Parathyroid gland	+ M + + M + + + + M + + M + + + M M M + +	36
Pituitary gland	+ + + + + + + M + + + + + + + + + + + + +	45
Pars distalis, adenoma	X X	19
Pars distalis, adenoma, multiple	X	1
Pars distalis, carcinoma		1
Thyroid gland	+ +	46
C-cell, adenoma	X	2
General Body System		
None		
Genital System		
Clitoral gland	+ +	44
Adenoma		1
Bilateral, adenoma		1
X		
Ovary	+ +	46
Histiocytic sarcoma		1
Uterus	+ +	46
Polyp stromal	X	3
Bilateral, polyp stromal	X	3
	X	

TABLE B2 Individual Animal Tumor Pathology of Female Rats in the 2-Year Inhalation Study of Isobutyl Nitrite: 75 ppm (continued)

Table with 16 columns representing individual rats and rows grouped by system: Hematopoietic System, Integumentary System, Musculoskeletal System, Nervous System, Respiratory System, Special Senses System, Urinary System, and Systemic Lesions. Each cell contains a symbol (+, -, M, X, A) indicating the presence of a specific pathology.

TABLE B2
Individual Animal Tumor Pathology of Female Rats in the 2-Year Inhalation Study of Isobutyl Nitrite:
75 ppm (continued)

Number of Days on Study	7 7 7 7 7 7 7 7 7 7 7 7 7 7 7 7 7 7 7 7	
	3 3 3 3 3 3 3 3 3 3 3 3 3 3 3 3 3 3 3 3	
	4 4 4 4 4 4 4 4 4 4 4 4 4 4 5 5 5 5 5 5	
Carcass ID Number	2 2 2 2 2 3 3 3 3 3 3 3 3 2 2 2 2 3 3 3 3	Total Tissues/ Tumors
	8 8 9 9 9 0 0 1 1 1 2 2 2 8 8 9 9 1 1 1 1	
	7 8 1 3 6 4 7 0 8 9 0 5 6 1 9 4 8 1 2 3 7	
Hematopoietic System		
Bone marrow	+ +	46
Histiocytic sarcoma		1
Lymph node, bronchial	+ +	36
Histiocytic sarcoma		1
Lymph node, mandibular	+ + + + + + + + + + + + + + + + M + + +	43
Histiocytic sarcoma		1
Lymph node, mesenteric	+ +	46
Histiocytic sarcoma		1
Lymph node, mediastinal	+ + + M + M + + + + + + + + + + + + + + +	41
Histiocytic sarcoma		1
Spleen	+ +	44
Histiocytic sarcoma		1
Thymus	+ + + + + M + + + + + + + + + + + + + + +	45
Histiocytic sarcoma		1
Integumentary System		
Mammary gland	+ +	46
Adenocarcinoma		1
Fibroadenoma	X X X X X X X X X X	16
Fibroadenoma, multiple	X X X	4
Skin	+ +	46
Subcutaneous tissue, lipoma		1
Musculoskeletal System		
Bone	+ +	46
Nervous System		
Brain	+ +	46
Carcinoma, metastatic, pituitary gland		1
Glioma malignant		1
Respiratory System		
Larynx	+ +	46
Lung	+ +	46
Alveolar/bronchiolar adenoma		2
Nose	+ +	45
Trachea	+ +	46
Special Senses System		
Eye		1
Urinary System		
Kidney	+ +	46
Sarcoma		1
Urinary bladder	+ +	45
Systemic Lesions		
Multiple organs	+ +	46
Histiocytic sarcoma		1

TABLE B2
Individual Animal Tumor Pathology of Female Rats in the 2-Year Inhalation Study of Isobutyl Nitrite:
150 ppm

Table with columns for Number of Days on Study, Carcass ID Number, and various organ systems (Alimentary, Cardiovascular, Endocrine, General Body, Genital) with '+' or 'X' indicating findings.

TABLE B2
Individual Animal Tumor Pathology of Female Rats in the 2-Year Inhalation Study of Isobutyl Nitrite:
150 ppm (continued)

Number of Days on Study	2 3 4 5 5 6 6 6 6 6 6 6 7 7 7 7 7 7 7 7 7 7 7 7
	3 9 8 0 3 0 1 2 3 7 8 9 0 3 3 3 3 3 3 3 3 3 3 3
	4 4 3 0 3 8 7 2 0 4 1 6 5 3 3 3 3 3 3 3 3 3 3 3
Carcass ID Number	4 4 4 4 4 4 4 4 4 4 3 4 4 3 3 4 4 4 4 4 4 4 4 4
	1 0 3 1 2 0 2 3 2 1 9 3 3 9 9 0 0 0 0 1 2 2 3 3
	3 7 3 9 6 3 7 2 8 4 3 4 6 6 9 0 1 8 9 8 2 3 0 1 7
Hematopoietic System	
Bone marrow	+ +
Lymph node	+
Lymph node, bronchial	+ + + + + M + + M M + M + M + + M + M + + + M M
Rhabdomyosarcoma, metastatic, uncertain primary site	X
Lymph node, mandibular	+ +
Lymph node, mesenteric	+ + + + + + + + A + + + + + + + + + + + + + + + + + + +
Lymph node, mediastinal	+ M +
Spleen	+ +
Hemangiosarcoma	
Thymus	+ + + + + + + + M + + + + + + + + + + + + + + M + + + +
Integumentary System	
Mammary gland	+ +
Adenocarcinoma	
Adenoma	X
Fibroadenoma	X X X X X X X
Skin	+ +
Squamous cell papilloma	X
Subcutaneous tissue, fibroma	X
Musculoskeletal System	
Bone	+ +
Nervous System	
Brain	+ +
Astrocytoma benign	
Respiratory System	
Larynx	+ +
Lung	+ +
Alveolar/bronchiolar adenoma	X X X X X X X
Alveolar/bronchiolar adenoma, multiple	X
Alveolar/bronchiolar carcinoma	X
Mediastinum, rhabdomyosarcoma, metastatic, uncertain primary site	X
Nose	+ +
Trachea	+ +
Special Senses System	
Ear	+
Urinary System	
Kidney	+ +
Urinary bladder	+ + + + + A + + A + + + + + + + + + + + + + + + + + + +
Systemic Lesions	
Multiple organs	+ +
Leukemia mononuclear	

TABLE B2
Individual Animal Tumor Pathology of Female Rats in the 2-Year Inhalation Study of Isobutyl Nitrite:
150 ppm (continued)

Number of Days on Study	7	7	7	7	7	7	7	7	7	7	7	7	7	7	7	7	7	7	7	7	7	7	7	Total Tissues/ Tumors
	3	3	3	3	3	3	3	3	3	3	3	3	3	3	3	3	3	3	3	3	3	3	3	
	3	4	4	4	4	4	4	4	4	4	4	4	5	5	5	5	5	5	5	5	5	5	5	
Carcass ID Number	4	3	3	4	4	4	4	4	4	4	4	3	3	4	4	4	4	4	4	4	4	4	4	
	3	9	9	0	0	1	1	2	2	2	3	9	9	0	0	1	1	1	1	1	2	2		
	8	4	7	2	4	0	2	0	1	9	5	5	8	5	6	1	5	6	7	4	5			
Hematopoietic System																								
Bone marrow	+	+	+	+	+	+	+	+	+	+	+	+	+	+	+	+	+	+	+	+	+	+	+	46
Lymph node																						+		3
Lymph node, bronchial	M	+	M	+	M	+	+	+	+	+	+	+	+	M	M	+	M	M	M	M	+			28
Rhabdomyosarcoma, metastatic, uncertain primary site																								1
Lymph node, mandibular	+	M	+	+	+	+	M	+	+	+	+	+	+	+	M	+	+	+	+	+	+	+	+	43
Lymph node, mesenteric	+	+	+	+	+	+	+	+	+	+	+	+	+	+	+	+	+	+	+	+	+	+	+	45
Lymph node, mediastinal	+	+	+	M	+	+	+	+	+	M	+	+	+	+	+	+	+	+	+	+	+	+	+	43
Spleen	+	+	+	+	+	+	+	+	+	+	+	+	+	+	+	+	+	+	+	+	+	+	+	46
Hemangiosarcoma																X								1
Thymus	+	+	+	+	+	+	+	+	+	+	+	+	+	+	+	+	+	+	+	+	+	+	+	44
Integumentary System																								
Mammary gland	+	+	+	+	+	+	+	+	+	+	+	+	+	+	+	+	+	+	+	+	+	+	+	46
Adenocarcinoma															X									1
Adenoma																								1
Fibroadenoma	X	X	X		X					X			X						X					13
Skin	+	+	+	+	+	+	+	+	+	+	+	+	+	+	+	+	+	+	+	+	+	+	+	46
Squamous cell papilloma																								1
Subcutaneous tissue, fibroma																								1
Musculoskeletal System																								
Bone	+	+	+	+	+	+	+	+	+	+	+	+	+	+	+	+	+	+	+	+	+	+	+	46
Nervous System																								
Brain	+	+	+	+	+	+	+	+	+	+	+	+	+	+	+	+	+	+	+	+	+	+	+	46
Astrocytoma benign													X											1
Respiratory System																								
Larynx	+	+	+	+	+	+	+	+	+	+	+	+	+	+	+	+	+	+	+	+	+	+	+	46
Lung	+	+	+	+	+	+	+	+	+	+	+	+	+	+	+	+	+	+	+	+	+	+	+	46
Alveolar/bronchiolar adenoma	X								X									X	X	X				8
Alveolar/bronchiolar adenoma, multiple						X																		2
Alveolar/bronchiolar carcinoma										X														1
Mediastinum, rhabdomyosarcoma, metastatic, uncertain primary site																								1
Nose	+	+	+	+	+	+	+	+	+	+	+	+	+	+	+	+	+	+	+	+	+	+	+	46
Trachea	+	+	+	+	+	+	+	+	+	+	+	+	+	+	+	+	+	+	+	+	+	+	+	46
Special Senses System																								
Ear																								1
Urinary System																								
Kidney	+	+	+	+	+	+	+	+	+	+	+	+	+	+	+	+	+	+	+	+	+	+	+	46
Urinary bladder	+	+	+	+	+	+	+	+	+	+	+	+	+	+	+	+	+	+	M	+	+	+	+	43
Systemic Lesions																								
Multiple organs	+	+	+	+	+	+	+	+	+	+	+	+	+	+	+	+	+	+	+	+	+	+	+	46
Leukemia mononuclear																						X		1

TABLE B3
Statistical Analysis of Primary Neoplasms in Female Rats in the 2-Year Inhalation Study of Isobutyl Nitrite

	0 ppm	37.5 ppm	75 ppm	150 ppm
Adrenal Medulla: Benign Pheochromocytoma				
Overall rate ^a	0/45 (0%)	3/45 (7%)	1/45 (2%)	2/46 (4%)
Adjusted rate ^b	0.0%	8.0%	2.8%	6.1%
Terminal rate ^c	0/29 (0%)	2/35 (6%)	0/31 (0%)	2/33 (6%)
First incidence (days)	— ^c	645	686	733 (T)
Life table test ^d	P=0.354	P=0.152	P=0.523	P=0.267
Logistic regression test ^d	P=0.338	P=0.120	P=0.502	P=0.267
Cochran-Armitage test ^d	P=0.347			
Fisher exact test ^d		P=0.121	P=0.500	P=0.253
Adrenal Medulla: Benign, Complex, or Malignant Pheochromocytoma				
Overall rate	2/45 (4%)	4/45 (9%)	1/45 (2%)	2/46 (4%)
Adjusted rate	5.7%	10.4%	2.8%	6.1%
Terminal rate	1/29 (3%)	2/35 (6%)	0/31 (0%)	2/33 (6%)
First incidence (days)	602	645	686	733 (T)
Life table test	P=0.415N	P=0.405	P=0.479N	P=0.663N
Logistic regression test	P=0.424N	P=0.327	P=0.491N	P=0.691N
Cochran-Armitage test	P=0.419N			
Fisher exact test		P=0.338	P=0.500N	P=0.683N
Clitoral Gland: Adenoma				
Overall rate	1/44 (2%)	1/44 (2%)	2/44 (5%)	1/46 (2%)
Adjusted rate	3.4%	2.9%	6.5%	2.9%
Terminal rate	1/29 (3%)	1/35 (3%)	2/31 (6%)	0/33 (0%)
First incidence (days)	733 (T)	733 (T)	733 (T)	696
Life table test	P=0.612	P=0.720N	P=0.523	P=0.736N
Logistic regression test	P=0.597	P=0.720N	P=0.523	P=0.756N
Cochran-Armitage test	P=0.605			
Fisher exact test		P=0.753N	P=0.500	P=0.742N
Clitoral Gland: Adenoma or Carcinoma				
Overall rate	2/44 (5%)	1/44 (2%)	2/44 (5%)	1/46 (2%)
Adjusted rate	5.7%	2.9%	6.5%	2.9%
Terminal rate	1/29 (3%)	1/35 (3%)	2/31 (6%)	0/33 (0%)
First incidence (days)	602	733 (T)	733 (T)	696
Life table test	P=0.428N	P=0.457N	P=0.676N	P=0.480N
Logistic regression test	P=0.435N	P=0.510N	P=0.695	P=0.475N
Cochran-Armitage test	P=0.429N			
Fisher exact test		P=0.500N	P=0.692N	P=0.483N
Lung: Alveolar/bronchiolar Adenoma				
Overall rate	0/46 (0%)	2/45 (4%)	2/46 (4%)	10/46 (22%)
Adjusted rate	0.0%	5.2%	5.8%	29.1%
Terminal rate	0/29 (0%)	1/35 (3%)	1/31 (3%)	9/33 (27%)
First incidence (days)	—	648	653	622
Life table test	P<0.001	P=0.272	P=0.253	P=0.002
Logistic regression test	P<0.001	P=0.226	P=0.237	P=0.001
Cochran-Armitage test	P<0.001			
Fisher exact test		P=0.242	P=0.247	P<0.001

TABLE B3
Statistical Analysis of Primary Neoplasms in Female Rats in the 2-Year Inhalation Study of Isobutyl Nitrite (continued)

	0 ppm	37.5 ppm	75 ppm	150 ppm
Lung: Alveolar/bronchiolar Adenoma or Carcinoma				
Overall rate	0/46 (0%)	3/45 (7%)	2/46 (4%)	11/46 (24%)
Adjusted rate	0.0%	7.5%	5.8%	32.1%
Terminal rate	0/29 (0%)	1/35 (3%)	1/31 (3%)	10/33 (30%)
First incidence (days)	—	645	653	622
Life table test	P<0.001	P=0.148	P=0.253	P=0.001
Logistic regression test	P<0.001	P=0.108	P=0.237	P<0.001
Cochran-Armitage test	P<0.001			
Fisher exact test		P=0.117	P=0.247	P<0.001
Mammary Gland: Fibroadenoma				
Overall rate	11/46 (24%)	14/45 (31%)	20/46 (43%)	13/46 (28%)
Adjusted rate	33.4%	35.7%	52.0%	34.8%
Terminal rate	8/29 (28%)	10/35 (29%)	13/31 (42%)	9/33 (27%)
First incidence (days)	646	645	610	622
Life table test	P=0.425	P=0.516	P=0.078	P=0.516
Logistic regression test	P=0.330	P=0.362	P=0.040	P=0.397
Cochran-Armitage test	P=0.363			
Fisher exact test		P=0.297	P=0.038	P=0.406
Mammary Gland: Fibroadenoma or Adenoma				
Overall rate	11/46 (24%)	15/45 (33%)	20/46 (43%)	13/46 (28%)
Adjusted rate	33.4%	38.3%	52.0%	34.8%
Terminal rate	8/29 (28%)	11/35 (31%)	13/31 (42%)	9/33 (27%)
First incidence (days)	646	645	610	622
Life table test	P=0.457	P=0.436	P=0.078	P=0.516
Logistic regression test	P=0.360	P=0.284	P=0.040	P=0.397
Cochran-Armitage test	P=0.395			
Fisher exact test		P=0.223	P=0.038	P=0.406
Mammary Gland: Carcinoma				
Overall rate	3/46 (7%)	1/45 (2%)	1/46 (2%)	1/46 (2%)
Adjusted rate	9.3%	2.9%	3.2%	3.0%
Terminal rate	2/29 (7%)	1/35 (3%)	1/31 (3%)	1/33 (3%)
First incidence (days)	641	733 (T)	733 (T)	733 (T)
Life table test	P=0.228N	P=0.252N	P=0.286N	P=0.277N
Logistic regression test	P=0.244N	P=0.301N	P=0.301N	P=0.307N
Cochran-Armitage test	P=0.241N			
Fisher exact test		P=0.317N	P=0.308N	P=0.308N
Mammary Gland: Adenoma or Carcinoma				
Overall rate	3/46 (7%)	2/45 (4%)	1/46 (2%)	2/46 (4%)
Adjusted rate	9.3%	5.7%	3.2%	5.5%
Terminal rate	2/29 (7%)	2/35 (6%)	1/31 (3%)	1/33 (3%)
First incidence (days)	641	733 (T)	733 (T)	622
Life table test	P=0.389N	P=0.425N	P=0.286N	P=0.474N
Logistic regression test	P=0.408N	P=0.486N	P=0.301N	P=0.501N
Cochran-Armitage test	P=0.401N			
Fisher exact test		P=0.511N	P=0.308N	P=0.500N

TABLE B3
Statistical Analysis of Primary Neoplasms in Female Rats in the 2-Year Inhalation Study of Isobutyl Nitrite (continued)

	0 ppm	37.5 ppm	75 ppm	150 ppm
Mammary Gland: Fibroadenoma, Adenoma, or Carcinoma				
Overall rate	13/46 (28%)	15/45 (33%)	21/46 (46%)	14/46 (30%)
Adjusted rate	38.2%	38.3%	54.7%	37.6%
Terminal rate	9/29 (31%)	11/35 (31%)	14/31 (45%)	10/33 (30%)
First incidence (days)	641	645	610	622
Life table test	P=0.500	P=0.551N	P=0.122	P=0.562N
Logistic regression test	P=0.400	P=0.450	P=0.067	P=0.489
Cochran-Armitage test	P=0.438			
Fisher exact test		P=0.383	P=0.065	P=0.500
Pancreatic Islets: Adenoma				
Overall rate	5/6 (83%)	1/1 (100%)	0/0 (0%)	1/1 (100%)
Adjusted rate	100.0%	100.0%	0.0%	100.0%
Terminal rate	3/3 (100%)	1/1 (100%)	0/0 (0%)	1/1 (100%)
First incidence (days)	516	733 (T)	—	733 (T)
Life table test	P=0.122N	P=0.237N	P=0.298N	P=0.253N
Logistic regression test	— ^f	—	—	—
Cochran-Armitage test	P=0.620N			
Fisher exact test		P=0.857	P=1.000N	P=0.857
Pituitary Gland (Pars Distalis): Adenoma				
Overall rate	25/46 (54%)	15/43 (35%)	20/45 (44%)	18/46 (39%)
Adjusted rate	64.7%	41.0%	53.1%	45.7%
Terminal rate	16/29 (55%)	12/33 (36%)	13/30 (43%)	12/33 (36%)
First incidence (days)	464	624	604	483
Life table test	P=0.160N	P=0.016N	P=0.190N	P=0.079N
Logistic regression test	P=0.187N	P=0.050N	P=0.232N	P=0.107N
Cochran-Armitage test	P=0.174N			
Fisher exact test		P=0.051N	P=0.231N	P=0.105N
Pituitary Gland (Pars Distalis): Adenoma or Carcinoma				
Overall rate	26/46 (57%)	15/43 (35%)	21/45 (47%)	18/46 (39%)
Adjusted rate	65.6%	41.0%	54.3%	45.7%
Terminal rate	16/29 (55%)	12/33 (36%)	13/30 (43%)	12/33 (36%)
First incidence (days)	464	624	604	483
Life table test	P=0.134N	P=0.011N	P=0.196N	P=0.058N
Logistic regression test	P=0.147N	P=0.034N	P=0.234N	P=0.072N
Cochran-Armitage test	P=0.138N			
Fisher exact test		P=0.033N	P=0.233N	P=0.072N
Thyroid Gland (C-cell): Adenoma				
Overall rate	1/46 (2%)	4/45 (9%)	2/46 (4%)	3/46 (7%)
Adjusted rate	3.4%	11.4%	5.8%	9.1%
Terminal rate	1/29 (3%)	4/35 (11%)	1/31 (3%)	3/33 (9%)
First incidence (days)	733 (T)	733 (T)	674	733 (T)
Life table test	P=0.406	P=0.239	P=0.532	P=0.352
Logistic regression test	P=0.375	P=0.239	P=0.506	P=0.352
Cochran-Armitage test	P=0.376			
Fisher exact test		P=0.174	P=0.500	P=0.308

TABLE B3
Statistical Analysis of Primary Neoplasms in Female Rats in the 2-Year Inhalation Study of Isobutyl Nitrite (continued)

	0 ppm	37.5 ppm	75 ppm	150 ppm
Thyroid Gland (C-cell): Adenoma or Carcinoma				
Overall rate	1/46 (2%)	5/45 (11%)	2/46 (4%)	3/46 (7%)
Adjusted rate	3.4%	14.3%	5.8%	9.1%
Terminal rate	1/29 (3%)	5/35 (14%)	1/31 (3%)	3/33 (9%)
First incidence (days)	733 (T)	733 (T)	674	733 (T)
Life table test	P=0.477	P=0.149	P=0.532	P=0.352
Logistic regression test	P=0.445	P=0.147	P=0.506	P=0.352
Cochran-Armitage test	P=0.444			
Fisher exact test		P=0.097	P=0.500	P=0.308
Uterus: Stromal Polyp				
Overall rate	2/46 (4%)	4/45 (9%)	6/46 (13%)	1/46 (2%)
Adjusted rate	6.1%	10.9%	17.6%	3.0%
Terminal rate	1/29 (3%)	3/35 (9%)	4/31 (13%)	1/33 (3%)
First incidence (days)	658	659	650	733 (T)
Life table test	P=0.342N	P=0.417	P=0.160	P=0.467N
Logistic regression test	P=0.373N	P=0.335	P=0.136	P=0.503N
Cochran-Armitage test	P=0.362N			
Fisher exact test		P=0.328	P=0.133	P=0.500N
Uterus: Stromal Polyp or Stromal Sarcoma				
Overall rate	3/46 (7%)	4/45 (9%)	6/46 (13%)	1/46 (2%)
Adjusted rate	8.2%	10.9%	17.6%	3.0%
Terminal rate	1/29 (3%)	3/35 (9%)	4/31 (13%)	1/33 (3%)
First incidence (days)	516	659	650	733 (T)
Life table test	P=0.239N	P=0.572	P=0.274	P=0.289N
Logistic regression test	P=0.254N	P=0.464	P=0.243	P=0.279N
Cochran-Armitage test	P=0.252N			
Fisher exact test		P=0.488	P=0.243	P=0.308N
All Organs: Mononuclear Cell Leukemia				
Overall rate	14/46 (30%)	1/45 (2%)	0/46 (0%)	1/46 (2%)
Adjusted rate	37.2%	2.5%	0.0%	3.0%
Terminal rate	6/29 (21%)	0/35 (0%)	0/31 (0%)	1/33 (3%)
First incidence (days)	526	659	—	733 (T)
Life table test	P<0.001N	P<0.001N	P<0.001N	P<0.001N
Logistic regression test	P<0.001N	P<0.001N	P<0.001N	P<0.001N
Cochran-Armitage test	P<0.001N			
Fisher exact test		P<0.001N	P<0.001N	P<0.001N
All Organs: Benign Neoplasms				
Overall rate	32/46 (70%)	34/45 (76%)	36/46 (78%)	33/46 (72%)
Adjusted rate	77.5%	77.3%	83.7%	76.7%
Terminal rate	20/29 (69%)	25/35 (71%)	24/31 (77%)	23/33 (70%)
First incidence (days)	464	378	604	394
Life table test	P=0.478N	P=0.358N	P=0.436	P=0.446N
Logistic regression test	P=0.452	P=0.322	P=0.228	P=0.496
Cochran-Armitage test	P=0.492			
Fisher exact test		P=0.343	P=0.238	P=0.500

TABLE B3
Statistical Analysis of Primary Neoplasms in Female Rats in the 2-Year Inhalation Study of Isobutyl Nitrite (continued)

	0 ppm	37.5 ppm	75 ppm	150 ppm
All Organs: Malignant Neoplasms				
Overall rate	22/46 (48%)	7/45 (16%)	6/46 (13%)	8/46 (17%)
Adjusted rate	52.8%	18.0%	16.2%	22.1%
Terminal rate	10/29 (34%)	4/35 (11%)	2/31 (6%)	6/33 (18%)
First incidence (days)	516	645	504	533
Life table test	P=0.005N	P<0.001N	P<0.001N	P=0.003N
Logistic regression test	P=0.005N	P=0.005N	P<0.001N	P=0.002N
Cochran-Armitage test	P=0.003N			
Fisher exact test		P<0.001N	P<0.001N	P=0.002N
All Organs: Benign or Malignant Neoplasms				
Overall rate	40/46 (87%)	34/45 (76%)	38/46 (83%)	35/46 (76%)
Adjusted rate	88.9%	77.3%	86.4%	79.5%
Terminal rate	24/29 (83%)	25/35 (71%)	25/31 (81%)	24/33 (73%)
First incidence (days)	464	378	504	394
Life table test	P=0.214N	P=0.038N	P=0.294N	P=0.120N
Logistic regression test	P=0.313N	P=0.148N	P=0.399N	P=0.141N
Cochran-Armitage test	P=0.196N			
Fisher exact test		P=0.130N	P=0.386N	P=0.141N

(T)Terminal sacrifice

- ^a Number of neoplasm-bearing animals/number of animals examined. Denominator is number of animals examined microscopically for adrenal gland, clitoral gland, lung, pancreatic islets, pituitary gland, thyroid gland, and uterus; for other tissues, denominator is number of animals necropsied.
- ^b Kaplan-Meier estimated neoplasm incidence at the end of the study after adjustment for intercurrent mortality
- ^c Observed incidence at terminal kill
- ^d Beneath the control incidence are the P values associated with the trend test. Beneath the exposed group incidence are the P values corresponding to pairwise comparisons between the controls and that exposed group. The life table test regards neoplasms in animals dying prior to terminal kill as being (directly or indirectly) the cause of death. The logistic regression test regards these lesions as nonfatal. The Cochran-Armitage and Fisher exact tests compare directly the overall incidence rates. For all tests, a negative trend or a lower incidence in an exposure group is indicated by N.
- ^e Not applicable; no neoplasms in animal group
- ^f Value of statistic cannot be computed.

TABLE B4a
Historical Incidence of Alveolar/bronchiolar Neoplasms in Chamber Control Female F344/N Rats^a

	Incidence in Controls		
	Adenoma	Carcinoma	Adenoma or Carcinoma
Overall Historical Incidence			
Total	4/492 (0.8%)	0/492 (0.0%)	4/492 (0.8%)
Standard deviation	1.4%		1.4%
Range	0%-4%		0%-4%

^a Data as of 17 June 1994; no data are available for studies performed at IITRI

TABLE B4b
Historical Incidence of Mononuclear Cell Leukemia in Chamber Control Female F344/N Rats^a

	Incidence in Controls
Overall Historical Incidence	
Total	196/494 (39.7%)
Standard deviation	7.9%
Range	30%-54%

^a Data as of 17 June 1994; no data are available for studies performed at IITRI. Includes data for lymphocytic, monocytic, mononuclear cell, or undifferentiated cell type leukemia.

TABLE B5
Summary of the Incidence of Nonneoplastic Lesions in Female Rats in the 2-Year Inhalation Study of Isobutyl Nitrite^a

	0 ppm	37.5 ppm	75 ppm	150 ppm
Disposition Summary				
Animals initially in study	56	56	56	56
15-Month interim evaluation				
Early deaths	10	10	10	10
Moribund	13	4	7	6
Natural deaths	4	6	8	7
Survivors				
Died last week of study			1	
Terminal sacrifice	29	35	30	33
Missing		1		
Animals examined microscopically	56	55	56	56
15-Month Interim Evaluation				
Alimentary System				
Liver	(10)	(9)	(10)	(10)
Basophilic focus	3 (30%)	3 (33%)	7 (70%)	3 (30%)
Basophilic focus, multiple		2 (22%)	1 (10%)	6 (60%)
Eosinophilic focus			1 (10%)	
Fatty change		1 (11%)		
Hematopoietic cell proliferation	3 (30%)			
Hemorrhage	1 (10%)			
Hepatodiaphragmatic nodule				1 (10%)
Infiltration cellular, lymphocyte		1 (11%)		1 (10%)
Inflammation	2 (20%)			
Pigmentation			1 (10%)	
Mesentery			(2)	
Fat, necrosis			2 (100%)	
Pancreas	(10)	(10)	(10)	(10)
Ectopic liver				1 (10%)
Infiltration cellular, lymphocyte		1 (10%)		
Acinar cell, atrophy	2 (20%)	4 (40%)	5 (50%)	5 (50%)
Stomach, forestomach	(10)	(10)	(10)	(10)
Hyperplasia			1 (10%)	
Cardiovascular System				
Heart	(10)	(10)	(10)	(10)
Cardiomyopathy	9 (90%)	10 (100%)	9 (90%)	9 (90%)
Endocrine System				
Adrenal cortex	(10)	(10)	(10)	(10)
Angiectasis	1 (10%)			
Degeneration		1 (10%)		
Hyperplasia		1 (10%)		
Adrenal medulla	(10)	(10)	(10)	(10)
Angiectasis	1 (10%)			

^a Number of animals examined microscopically at the site and the number of animals with lesion

TABLE B5
Summary of the Incidence of Nonneoplastic Lesions in Female Rats in the 2-Year Inhalation Study of Isobutyl Nitrite
 (continued)

	0 ppm	37.5 ppm	75 ppm	150 ppm
15-Month Interim Evaluation (continued)				
Endocrine System (continued)				
Pituitary gland	(10)	(10)	(10)	(10)
Pars distalis, angiectasis	3 (30%)	2 (20%)		
Pars distalis, cyst	3 (30%)	4 (40%)	2 (20%)	1 (10%)
Pars distalis, hyperplasia	3 (30%)	6 (60%)	2 (20%)	4 (40%)
Thyroid gland	(10)	(10)	(10)	(10)
C-cell, hyperplasia	1 (10%)		1 (10%)	1 (10%)
Genital System				
Clitoral gland	(10)	(10)	(10)	(10)
Ectasia	7 (70%)	9 (90%)	8 (80%)	8 (80%)
Inflammation	1 (10%)	1 (10%)	1 (10%)	
Ovary	(10)	(10)	(10)	(10)
Cyst		3 (30%)		
Bilateral, cyst			1 (10%)	
Uterus	(10)	(10)	(10)	(10)
Dilatation			2 (20%)	1 (10%)
Hemorrhage	1 (10%)			
Hematopoietic System				
Bone marrow	(10)	(10)	(10)	(10)
Hyperplasia	1 (10%)			1 (10%)
Myelofibrosis				1 (10%)
Lymph node, bronchial	(10)	(10)	(10)	(10)
Hemorrhage	8 (80%)	9 (90%)	9 (90%)	8 (80%)
Pigmentation	1 (10%)			
Lymph node, mesenteric	(10)	(10)	(10)	(10)
Hemorrhage		2 (20%)		1 (10%)
Lymph node, mediastinal	(10)	(10)	(10)	(10)
Hemorrhage	10 (100%)	10 (100%)	10 (100%)	9 (90%)
Pigmentation	1 (10%)			
Spleen	(10)	(10)	(10)	(10)
Hematopoietic cell proliferation			1 (10%)	4 (40%)
Thymus	(10)	(10)	(10)	(10)
Atrophy	8 (80%)	5 (50%)	4 (40%)	3 (30%)
Hemorrhage				3 (30%)
Integumentary System				
Skin	(10)	(10)	(10)	(10)
Ulcer		1 (10%)		
Musculoskeletal System				
Bone	(10)	(10)	(10)	(10)
Femur, hyperostosis				1 (10%)

TABLE B5

Summary of the Incidence of Nonneoplastic Lesions in Female Rats in the 2-Year Inhalation Study of Isobutyl Nitrite
(continued)

	0 ppm	37.5 ppm	75 ppm	150 ppm
15-Month Interim Evaluation (continued)				
Respiratory System				
Larynx	(10)	(10)	(10)	(10)
Inflammation	1 (10%)			
Epithelium, hyperplasia				1 (10%)
Lung	(10)	(10)	(10)	(10)
Hemorrhage	5 (50%)	3 (30%)	2 (20%)	6 (60%)
Alveolar epithelium, hyperplasia	1 (10%)	2 (20%)	1 (10%)	5 (50%)
Nose	(10)	(10)	(10)	(10)
Inflammation		1 (10%)		1 (10%)
Goblet cell, hyperplasia	1 (10%)	4 (40%)	1 (10%)	2 (20%)
Olfactory epithelium, cytoplasmic alteration	1 (10%)		3 (30%)	6 (60%)
Respiratory epithelium, hyperplasia				1 (10%)
Urinary System				
Kidney	(10)	(10)	(10)	(10)
Mineralization	10 (100%)	10 (100%)	9 (90%)	9 (90%)
Nephropathy, chronic	9 (90%)	9 (90%)	9 (90%)	9 (90%)
Urinary bladder	(10)	(10)	(10)	(9)
Infiltration cellular, lymphocyte		1 (10%)		
Systems Examined With No Lesions Observed				
General Body System				
Nervous System				
Special Senses System				
2-Year Study				
Alimentary System				
Intestine large, colon	(46)	(44)	(44)	(44)
Abscess				1 (2%)
Intestine large, cecum	(46)	(44)	(43)	(43)
Inflammation	1 (2%)			
Necrosis	1 (2%)			
Intestine small, ileum	(44)	(41)	(40)	(41)
Inflammation	1 (2%)			
Liver	(46)	(45)	(46)	(46)
Angiectasis		1 (2%)	2 (4%)	
Basophilic focus	4 (9%)	3 (7%)	8 (17%)	4 (9%)
Basophilic focus, multiple	22 (48%)	32 (71%)	29 (63%)	34 (74%)
Clear cell focus	3 (7%)	1 (2%)	2 (4%)	2 (4%)
Clear cell focus, multiple			1 (2%)	1 (2%)
Congestion	1 (2%)		3 (7%)	4 (9%)
Developmental malformation	2 (4%)			2 (4%)
Eosinophilic focus	1 (2%)	8 (18%)	4 (9%)	2 (4%)
Eosinophilic focus, multiple			3 (7%)	1 (2%)
Fatty change	10 (22%)	3 (7%)	9 (20%)	4 (9%)
Hematopoietic cell proliferation	1 (2%)			
Hemorrhage				1 (2%)
Hepatodiaphragmatic nodule	3 (7%)	3 (7%)	5 (11%)	5 (11%)

TABLE B5

Summary of the Incidence of Nonneoplastic Lesions in Female Rats in the 2-Year Inhalation Study of Isobutyl Nitrite
(continued)

	0 ppm	37.5 ppm	75 ppm	150 ppm
2-Year Study (continued)				
Alimentary System (continued)				
Liver (continued)	(46)	(45)	(46)	(46)
Infiltration cellular, lymphocyte			1 (2%)	
Inflammation	2 (4%)	3 (7%)	6 (13%)	2 (4%)
Mixed cell focus	2 (4%)		2 (4%)	
Necrosis	3 (7%)	1 (2%)	1 (2%)	3 (7%)
Pigmentation				1 (2%)
Vacuolization cytoplasmic			4 (9%)	
Centrilobular, cytoplasmic alteration			1 (2%)	
Mesentery	(1)		(2)	(2)
Fat, necrosis	1 (100%)		2 (100%)	2 (100%)
Pancreas	(46)	(45)	(46)	(46)
Accessory spleen	1 (2%)		1 (2%)	
Ectopic liver				1 (2%)
Acinar cell, atrophy	17 (37%)	24 (53%)	21 (46%)	20 (43%)
Salivary glands	(46)	(45)	(45)	(46)
Inflammation		1 (2%)		
Stomach, forestomach	(46)	(45)	(46)	(46)
Hyperplasia	2 (4%)		2 (4%)	1 (2%)
Inflammation		1 (2%)	1 (2%)	1 (2%)
Ulcer	3 (7%)		2 (4%)	
Ulcer, multiple	2 (4%)		1 (2%)	
Stomach, glandular	(46)	(44)	(45)	(46)
Inflammation	1 (2%)		1 (2%)	
Ulcer	2 (4%)			1 (2%)
Ulcer, multiple	1 (2%)			
Cardiovascular System				
Heart	(46)	(45)	(46)	(46)
Cardiomyopathy	29 (63%)	20 (44%)	25 (54%)	32 (70%)
Atrium, thrombosis	2 (4%)			2 (4%)
Endocardium, proliferation				1 (2%)
Endocrine System				
Adrenal cortex	(46)	(45)	(46)	(46)
Angiectasis	3 (7%)	7 (16%)	10 (22%)	10 (22%)
Congestion			1 (2%)	1 (2%)
Cyst	1 (2%)			
Cytoplasmic alteration		1 (2%)		
Degeneration	1 (2%)	1 (2%)	1 (2%)	1 (2%)
Hemorrhage	1 (2%)	1 (2%)	1 (2%)	4 (9%)
Hyperplasia	5 (11%)	4 (9%)		3 (7%)
Hypertrophy	1 (2%)	1 (2%)	1 (2%)	1 (2%)
Infiltration cellular, lymphocyte				1 (2%)
Necrosis	1 (2%)			
Vacuolization cytoplasmic	8 (17%)	13 (29%)	6 (13%)	10 (22%)
Adrenal medulla	(45)	(45)	(45)	(46)
Hyperplasia	2 (4%)	4 (9%)	3 (7%)	5 (11%)

TABLE B5

Summary of the Incidence of Nonneoplastic Lesions in Female Rats in the 2-Year Inhalation Study of Isobutyl Nitrite
(continued)

	0 ppm	37.5 ppm	75 ppm	150 ppm
2-Year Study (continued)				
Endocrine System (continued)				
Pituitary gland	(46)	(43)	(45)	(46)
Angiectasis				1 (2%)
Congestion				1 (2%)
Cyst	3 (7%)		1 (2%)	
Hyperplasia	1 (2%)			
Pars distalis, angiectasis	8 (17%)	10 (23%)	5 (11%)	7 (15%)
Pars distalis, cyst	13 (28%)	17 (40%)	11 (24%)	8 (17%)
Pars distalis, hyperplasia	6 (13%)	18 (42%)	13 (29%)	17 (37%)
Pars nervosa, developmental malformation		1 (2%)		
Thyroid gland	(46)	(45)	(46)	(46)
C-cell, hyperplasia	7 (15%)	4 (9%)	4 (9%)	5 (11%)
Follicle, dilatation	1 (2%)		1 (2%)	
General Body System				
Tissue NOS		(1)		
Developmental malformation		1 (100%)		
Genital System				
Clitoral gland	(44)	(44)	(44)	(46)
Abscess		1 (2%)	1 (2%)	
Ectasia	25 (57%)	24 (55%)	30 (68%)	29 (63%)
Hyperplasia	2 (5%)	4 (9%)	1 (2%)	6 (13%)
Inflammation	1 (2%)	2 (5%)	4 (9%)	2 (4%)
Ovary	(46)	(45)	(46)	(46)
Cyst	5 (11%)	6 (13%)	2 (4%)	2 (4%)
Hemorrhage			1 (2%)	
Bilateral, cyst		1 (2%)		
Corpus luteum, hyperplasia	1 (2%)			
Uterus	(46)	(45)	(46)	(46)
Angiectasis				1 (2%)
Cyst		1 (2%)		2 (4%)
Dilatation	1 (2%)	2 (4%)	3 (7%)	1 (2%)
Prolapse			1 (2%)	
Bilateral, dilatation	2 (4%)			
Endometrium, hyperplasia	1 (2%)			
Hematopoietic System				
Bone marrow	(46)	(45)	(46)	(46)
Atrophy			2 (4%)	
Hyperplasia	6 (13%)	7 (16%)	6 (13%)	5 (11%)
Myelofibrosis		1 (2%)	1 (2%)	1 (2%)
Lymph node	(1)	(1)		(3)
Axillary, hyperplasia, lymphoid		1 (100%)		1 (33%)
Axillary, hyperplasia, plasma cell		1 (100%)		
Lumbar, cyst	1 (100%)			
Lumbar, hyperplasia, lymphoid	1 (100%)			
Lumbar, pigmentation	1 (100%)			1 (33%)

TABLE B5
Summary of the Incidence of Nonneoplastic Lesions in Female Rats in the 2-Year Inhalation Study of Isobutyl Nitrite
 (continued)

	0 ppm	37.5 ppm	75 ppm	150 ppm
2-Year Study (continued)				
Hematopoietic System (continued)				
Lymph node, bronchial	(26)	(30)	(36)	(28)
Hemorrhage	4 (15%)	14 (47%)	13 (36%)	12 (43%)
Pigmentation	1 (4%)	7 (23%)	9 (25%)	7 (25%)
Lymph node, mandibular	(45)	(45)	(43)	(43)
Cyst		1 (2%)		
Hemorrhage	2 (4%)	1 (2%)	2 (5%)	1 (2%)
Hyperplasia, lymphoid		1 (2%)	1 (2%)	
Hyperplasia, plasma cell	2 (4%)	3 (7%)		1 (2%)
Pigmentation			2 (5%)	
Lymph node, mesenteric	(46)	(45)	(46)	(45)
Edema	1 (2%)			
Hemorrhage	8 (17%)	6 (13%)	8 (17%)	7 (16%)
Pigmentation	1 (2%)			1 (2%)
Lymph node, mediastinal	(44)	(44)	(41)	(43)
Hemorrhage	27 (61%)	31 (70%)	31 (76%)	26 (60%)
Infiltration cellular, histiocyte	1 (2%)			
Pigmentation	21 (48%)	31 (70%)	31 (76%)	17 (40%)
Spleen	(46)	(45)	(44)	(46)
Congestion				1 (2%)
Developmental malformation				1 (2%)
Hematopoietic cell proliferation	5 (11%)	11 (24%)	6 (14%)	6 (13%)
Pigmentation	1 (2%)		3 (7%)	3 (7%)
Thymus	(44)	(43)	(45)	(44)
Atrophy	36 (82%)	21 (49%)	30 (67%)	21 (48%)
Congestion			1 (2%)	1 (2%)
Cyst				1 (2%)
Hemorrhage		2 (5%)	4 (9%)	4 (9%)
Necrosis			1 (2%)	
Pigmentation	1 (2%)			
Integumentary System				
Mammary gland	(46)	(45)	(46)	(46)
Abscess		1 (2%)		
Galactocele				1 (2%)
Hemorrhage		1 (2%)		
Hyperplasia				1 (2%)
Inflammation				2 (4%)
Lactation	17 (37%)	7 (16%)	9 (20%)	8 (17%)
Skin	(46)	(45)	(46)	(46)
Abscess				1 (2%)
Ulcer, multiple		1 (2%)		
Tail, hyperkeratosis	1 (2%)			
Tail, parakeratosis	1 (2%)			

TABLE B5

Summary of the Incidence of Nonneoplastic Lesions in Female Rats in the 2-Year Inhalation Study of Isobutyl Nitrite
(continued)

	0 ppm	37.5 ppm	75 ppm	150 ppm
2-Year Study (continued)				
Musculoskeletal System				
Bone	(46)	(45)	(46)	(46)
Femur, hyperostosis		6 (13%)	2 (4%)	4 (9%)
Turbinates, hyperostosis		3 (7%)	2 (4%)	2 (4%)
Nervous System				
Brain	(46)	(45)	(46)	(46)
Compression	13 (28%)	8 (18%)	15 (33%)	10 (22%)
Cyst				1 (2%)
Hemorrhage	2 (4%)		5 (11%)	2 (4%)
Hydrocephalus	3 (7%)		1 (2%)	1 (2%)
Necrosis			3 (7%)	
Thrombosis	1 (2%)			
Respiratory System				
Larynx	(46)	(45)	(46)	(46)
Foreign body				1 (2%)
Hemorrhage			1 (2%)	
Infiltration cellular, lymphocyte				3 (7%)
Inflammation	2 (4%)		4 (9%)	6 (13%)
Metaplasia, squamous				1 (2%)
Epithelium, hyperplasia			2 (4%)	1 (2%)
Lung	(46)	(45)	(46)	(46)
Congestion		4 (9%)	6 (13%)	2 (4%)
Hemorrhage	5 (11%)	12 (27%)	8 (17%)	3 (7%)
Infiltration cellular, histiocyte	1 (2%)	1 (2%)	1 (2%)	2 (4%)
Inflammation	4 (9%)	4 (9%)	3 (7%)	3 (7%)
Alveolar epithelium, hyperplasia	3 (7%)	10 (22%)	11 (24%)	30 (65%)
Nose	(46)	(45)	(45)	(46)
Angiectasis		1 (2%)	3 (7%)	1 (2%)
Foreign body	2 (4%)	1 (2%)		1 (2%)
Hemorrhage		1 (2%)		1 (2%)
Inflammation	7 (15%)	4 (9%)	4 (9%)	6 (13%)
Goblet cell, hyperplasia			1 (2%)	1 (2%)
Nasolacrimal duct, inflammation	2 (4%)	2 (4%)		2 (4%)
Olfactory epithelium, cytoplasmic alteration	1 (2%)			3 (7%)
Respiratory epithelium, hyperplasia	3 (7%)	2 (4%)		1 (2%)
Trachea	(46)	(45)	(46)	(46)
Inflammation		1 (2%)		
Special Senses System				
Eye		(1)	(1)	
Hemorrhage		1 (100%)		
Bilateral, lens, cataract			1 (100%)	
Lens, cataract		1 (100%)		

TABLE B5
Summary of the Incidence of Nonneoplastic Lesions in Female Rats in the 2-Year Inhalation Study of Isobutyl Nitrite
 (continued)

	0 ppm	37.5 ppm	75 ppm	150 ppm
2-Year Study (continued)				
Urinary System				
Kidney	(46)	(45)	(46)	(46)
Angiectasis			1 (2%)	
Congestion		1 (2%)	1 (2%)	1 (2%)
Cyst	1 (2%)			
Hypoplasia		1 (2%)		
Infarct	1 (2%)			
Mineralization	4 (9%)	6 (13%)	6 (13%)	8 (17%)
Necrosis			1 (2%)	
Nephropathy, chronic	43 (93%)	35 (78%)	34 (74%)	35 (76%)
Pigmentation	3 (7%)		4 (9%)	1 (2%)
Transitional epithelium, hyperplasia	1 (2%)			
Urinary bladder	(46)	(44)	(45)	(43)
Dilatation	1 (2%)		1 (2%)	
Arteriole, inflammation				1 (2%)

APPENDIX C
SUMMARY OF LESIONS IN MALE MICE
IN THE 2-YEAR INHALATION STUDY
OF ISOBUTYL NITRITE

TABLE C1	Summary of the Incidence of Neoplasms in Male Mice in the 2-Year Inhalation Study of Isobutyl Nitrite	157
TABLE C2	Individual Animal Tumor Pathology of Male Mice in the 2-Year Inhalation Study of Isobutyl Nitrite	162
TABLE C3	Statistical Analysis of Primary Neoplasms in Male Mice in the 2-Year Inhalation Study of Isobutyl Nitrite	182
TABLE C4a	Historical Incidence of Alveolar/bronchiolar Neoplasms in Chamber Control Male B6C3F₁ Mice	186
TABLE C4b	Historical Incidence of Thyroid Gland Follicular Cell Neoplasms in Chamber Control Male B6C3F₁ Mice	186
TABLE C5	Summary of the Incidence of Nonneoplastic Lesions in Male Mice in the 2-Year Inhalation Study of Isobutyl Nitrite	187

TABLE C1
Summary of the Incidence of Neoplasms in Male Mice in the 2-Year Inhalation Study of Isobutyl Nitrite^a

	0 ppm	37.5 ppm	75 ppm	150 ppm
Disposition Summary				
Animals initially in study	60	60	60	60
<i>15-Month interim evaluation</i>	10	10	10	7
Early deaths				
Accidental deaths	2			2
Moribund	1	7	4	4
Natural deaths	10	8	11	17
Survivors				
Terminal sacrifice	37	35	35	30
Animals examined microscopically	60	60	60	60
15-Month Interim Evaluation				
Alimentary System				
Intestine small, jejunum	(10)	(10)	(10)	(7)
Adenocarcinoma			1 (10%)	
Intestine small, ileum	(10)	(10)	(8)	(7)
Adenocarcinoma, metastatic, intestine small, jejunum			1 (13%)	
Liver	(10)	(10)	(10)	(7)
Hepatocellular carcinoma	1 (10%)	1 (10%)		
Hepatocellular adenoma	1 (10%)	1 (10%)	4 (40%)	1 (14%)
Hepatocellular adenoma, multiple	1 (10%)			1 (14%)
Tooth				(1)
Odontoma				1 (100%)
Endocrine System				
Pituitary gland	(9)	(10)	(8)	(7)
Pars intermedia, adenoma	1 (11%)			
Respiratory System				
Lung	(10)	(10)	(10)	(7)
Alveolar/bronchiolar adenoma	1 (10%)	2 (20%)		
Systems Examined With No Neoplasms Observed				
Cardiovascular System				
General Body System				
Genital System				
Hematopoietic System				
Integumentary System				
Musculoskeletal System				
Nervous System				
Special Senses System				
Urinary System				

TABLE C1
Summary of the Incidence of Neoplasms in Male Mice in the 2-Year Inhalation Study of Isobutyl Nitrite (continued)

	0 ppm	37.5 ppm	75 ppm	150 ppm
2-Year Study				
Alimentary System				
Intestine small, jejunum	(42)	(45)	(46)	(43)
Liver	(50)	(50)	(50)	(53)
Alveolar/bronchiolar carcinoma, metastatic, lung		1 (2%)		
Cholangiocarcinoma			1 (2%)	
Hemangiosarcoma	1 (2%)	1 (2%)	1 (2%)	2 (4%)
Hemangiosarcoma, multiple	1 (2%)	1 (2%)		1 (2%)
Hepatocellular carcinoma	9 (18%)	5 (10%)	9 (18%)	9 (17%)
Hepatocellular carcinoma, multiple	3 (6%)	1 (2%)	2 (4%)	
Hepatocellular adenoma	10 (20%)	15 (30%)	13 (26%)	13 (25%)
Hepatocellular adenoma, multiple	4 (8%)		1 (2%)	1 (2%)
Mesentery		(1)	(5)	(2)
Cholangiocarcinoma, metastatic, liver			1 (20%)	
Hemangiosarcoma			1 (20%)	
Pancreas	(50)	(49)	(50)	(49)
Salivary glands	(50)	(50)	(50)	(53)
Stomach, forestomach	(49)	(49)	(49)	(49)
Squamous cell carcinoma				1 (2%)
Tooth	(3)		(1)	
Odontoma	1 (33%)		1 (100%)	
Cardiovascular System				
Heart	(50)	(50)	(50)	(53)
Alveolar/bronchiolar carcinoma, metastatic, lung		1 (2%)		
Endocrine System				
Adrenal cortex	(49)	(49)	(48)	(51)
Alveolar/bronchiolar carcinoma, metastatic, lung			1 (2%)	
Subcapsular, adenoma		1 (2%)		1 (2%)
Adrenal medulla	(49)	(49)	(48)	(51)
Alveolar/bronchiolar carcinoma, metastatic, lung			1 (2%)	
Pheochromocytoma benign		2 (4%)		1 (2%)
Islets, pancreatic	(5)	(2)	(9)	(1)
Adenoma	2 (40%)	1 (50%)	2 (22%)	
Pituitary gland	(47)	(46)	(46)	(47)
Pars distalis, adenoma			1 (2%)	1 (2%)
Pars intermedia, adenoma		1 (2%)		
Thyroid gland	(50)	(50)	(50)	(53)
Alveolar/bronchiolar carcinoma, metastatic, lung		1 (2%)		
Bilateral, follicular cell, adenoma				1 (2%)
C-cell, carcinoma			1 (2%)	
Follicular cell, adenoma	1 (2%)			4 (8%)
Follicular cell, carcinoma		1 (2%)		

TABLE C1
Summary of the Incidence of Neoplasms in Male Mice in the 2-Year Inhalation Study of Isobutyl Nitrite (continued)

	0 ppm	37.5 ppm	75 ppm	150 ppm
2-Year Study (continued)				
General Body System				
None				
Genital System				
Epididymis	(50)	(50)	(50)	(53)
Cholangiocarcinoma, metastatic, liver			1 (2%)	
Seminal vesicle	(50)	(50)	(50)	(53)
Testes	(50)	(50)	(50)	(53)
Interstitial cell, adenoma			1 (2%)	
Hematopoietic System				
Bone marrow	(50)	(50)	(49)	(52)
Hemangiosarcoma		1 (2%)		
Lymph node	(1)	(5)	(5)	(5)
Inguinal, alveolar/bronchiolar carcinoma, metastatic, lung		1 (20%)		
Inguinal, cholangiocarcinoma, metastatic, liver			1 (20%)	
Lymph node, bronchial	(25)	(36)	(18)	(34)
Lymph node, mandibular	(39)	(50)	(50)	(48)
Alveolar/bronchiolar carcinoma, metastatic, lung		1 (2%)		
Lymph node, mesenteric	(47)	(48)	(47)	(49)
Cholangiocarcinoma, metastatic, liver			1 (2%)	
Lymph node, mediastinal	(41)	(37)	(39)	(41)
Alveolar/bronchiolar carcinoma, metastatic, lung		1 (3%)		
Cholangiocarcinoma, metastatic, liver			1 (3%)	
Hepatocellular carcinoma, metastatic, liver		1 (3%)		
Spleen	(50)	(50)	(49)	(51)
Hemangioma	1 (2%)			
Hemangiosarcoma			1 (2%)	
Sarcoma, metastatic, skin				1 (2%)
Thymus	(45)	(46)	(38)	(43)
Alveolar/bronchiolar carcinoma, metastatic, lung		1 (2%)		
Integumentary System				
Skin	(50)	(50)	(49)	(52)
Subcutaneous tissue, alveolar/bronchiolar carcinoma, metastatic, lung			1 (2%)	
Subcutaneous tissue, sarcoma				1 (2%)
Subcutaneous tissue, schwannoma malignant, multiple			1 (2%)	

TABLE C1
Summary of the Incidence of Neoplasms in Male Mice in the 2-Year Inhalation Study of Isobutyl Nitrite (continued)

	0 ppm	37.5 ppm	75 ppm	150 ppm
2-Year Study (continued)				
Musculoskeletal System				
Bone	(50)	(50)	(50)	(53)
Mandible, alveolar/bronchiolar carcinoma, metastatic, lung		1 (2%)		
Rib, alveolar/bronchiolar carcinoma, metastatic, lung		1 (2%)		
Skeletal muscle		(1)	(1)	
Alveolar/bronchiolar carcinoma, metastatic, lung		1 (100%)		
Nervous System				
None				
Respiratory System				
Larynx	(50)	(50)	(49)	(50)
Lung	(50)	(50)	(49)	(53)
Alveolar/bronchiolar adenoma	7 (14%)	9 (18%)	10 (20%)	12 (23%)
Alveolar/bronchiolar adenoma, multiple		3 (6%)	3 (6%)	5 (9%)
Alveolar/bronchiolar carcinoma	1 (2%)	5 (10%)	4 (8%)	4 (8%)
Alveolar/bronchiolar carcinoma, multiple		1 (2%)	1 (2%)	
Cholangiocarcinoma, metastatic, liver			1 (2%)	
Hepatocellular carcinoma, metastatic, liver	5 (10%)	6 (12%)	4 (8%)	1 (2%)
Sarcoma, metastatic, skin				1 (2%)
Mediastinum, cholangiocarcinoma, metastatic, liver			1 (2%)	
Nose	(50)	(50)	(50)	(53)
Glands, adenoma				1 (2%)
Special Senses System				
Harderian gland	(5)	(1)	(3)	(6)
Adenocarcinoma				1 (17%)
Adenoma	4 (80%)	1 (100%)	3 (100%)	5 (83%)
Urinary System				
Kidney	(50)	(50)	(50)	(53)
Alveolar/bronchiolar carcinoma, metastatic, lung		1 (2%)		
Cholangiocarcinoma, metastatic, liver			1 (2%)	
Hepatocellular carcinoma, metastatic, liver			1 (2%)	
Renal tubule, adenoma		1 (2%)		
Urinary bladder	(50)	(48)	(49)	(50)
Cholangiocarcinoma, metastatic, liver			1 (2%)	

TABLE C1
Summary of the Incidence of Neoplasms in Male Mice in the 2-Year Inhalation Study of Isobutyl Nitrite (continued)

	0 ppm	37.5 ppm	75 ppm	150 ppm
2-Year Study (continued)				
Systemic Lesions				
Multiple organs ^b	(50)	(50)	(50)	(53)
Lymphoma malignant lymphocytic			1 (2%)	1 (2%)
Lymphoma malignant mixed	1 (2%)	3 (6%)	1 (2%)	1 (2%)
Neoplasm Summary				
Total animals with primary neoplasms ^c				
15-Month interim evaluation	5	4	5	3
2-Year study	33	35	38	39
Total primary neoplasms				
15-Month interim evaluation	5	4	5	3
2-Year study	46	53	59	66
Total animals with benign neoplasms				
15-Month interim evaluation	4	3	4	3
2-Year study	24	28	29	33
Total benign neoplasms				
15-Month interim evaluation	4	3	4	3
2-Year study	30	34	35	45
Total animals with malignant neoplasms				
15-Month interim evaluation	1	1	1	
2-Year study	16	18	21	17
Total malignant neoplasms				
15-Month interim evaluation	1	1	1	
2-Year study	16	19	24	21
Total animals with metastatic neoplasms				
15-Month interim evaluation			1	
2-Year study	5	7	6	2
Total metastatic neoplasms				
15-Month interim evaluation			2	
2-Year study	5	18	17	3

^a Number of animals examined microscopically at the site and the number of animals with neoplasm

^b Number of animals with any tissue examined microscopically

^c Primary neoplasms: all neoplasms except metastatic neoplasms

TABLE C2
Individual Animal Tumor Pathology of Male Mice in the 2-Year Inhalation Study of Isobutyl Nitrite: 0 ppm

Number of Days on Study	0	1	4	4	5	5	5	5	5	5	6	6	7	7	7	7	7	7	7	7	7	7	7	7	7	7	7	
	6	3	5	7	0	1	2	6	7	9	0	1	1	2	2	2	2	2	2	2	2	2	2	2	2	2	2	2
	1	6	5	9	9	2	9	3	0	4	4	8	1	5	5	5	5	5	5	5	5	5	5	5	5	5	5	5
Carcass ID Number	0	0	0	0	0	0	0	0	0	0	0	0	0	0	0	0	0	0	0	0	0	0	0	0	0	0	0	0
	2	3	0	4	3	0	0	4	4	4	4	1	4	0	0	0	1	1	1	1	2	3	4	4	5			
	9	9	7	9	8	2	9	5	6	7	0	4	3	4	5	6	1	3	6	7	2	7	1	4	0			
Alimentary System																												
Esophagus	+	+	+	+	+	+	+	+	+	+	+	+	+	+	+	+	+	+	+	+	+	+	+	+	+	+	+	+
Gallbladder	+	+	A	+	M	+	A	A	A	A	A	+	A	+	+	+	+	+	+	+	+	+	+	+	+	+	+	+
Intestine large, colon	+	+	A	+	+	+	+	+	+	+	+	+	+	+	+	+	+	+	+	+	+	+	+	+	+	+	+	+
Intestine large, rectum	+	+	+	+	+	+	+	+	A	+	+	+	+	+	+	+	+	+	+	+	+	+	+	+	+	+	+	+
Intestine large, cecum	+	+	A	+	A	+	+	A	A	+	+	A	A	+	+	+	+	+	+	+	+	+	+	+	+	+	+	+
Intestine small, duodenum	+	+	A	A	+	+	A	A	A	A	+	A	+	+	+	+	+	+	+	+	+	+	+	+	+	+	+	+
Intestine small, jejunum	+	+	A	A	+	+	M	A	A	A	+	A	+	+	+	+	+	+	+	+	+	+	+	+	+	+	+	+
Intestine small, ileum	+	+	+	+	+	+	A	A	A	+	+	A	A	+	+	+	+	+	+	+	+	+	+	+	+	+	+	+
Liver	+	+	+	+	+	+	+	+	+	+	+	+	+	+	+	+	+	+	+	+	+	+	+	+	+	+	+	+
Hemangiosarcoma																												
Hemangiosarcoma, multiple																												
Hepatocellular carcinoma																												
Hepatocellular carcinoma, multiple																												
Hepatocellular adenoma																												
Hepatocellular adenoma, multiple																												
Pancreas	+	+	+	+	+	+	+	+	+	+	+	+	+	+	+	+	+	+	+	+	+	+	+	+	+	+	+	+
Salivary glands	+	+	+	+	+	+	+	+	+	+	+	+	+	+	+	+	+	+	+	+	+	+	+	+	+	+	+	+
Stomach, forestomach	+	+	+	+	+	+	+	+	+	+	+	+	+	A	+	+	+	+	+	+	+	+	+	+	+	+	+	+
Stomach, glandular	+	+	+	+	+	+	+	+	+	+	+	+	A	+	+	+	+	+	+	+	+	+	+	+	+	+	+	+
Tooth																												
Odontoma																												
Cardiovascular System																												
Heart	+	+	+	+	+	+	+	+	+	+	+	+	+	+	+	+	+	+	+	+	+	+	+	+	+	+	+	+
Endocrine System																												
Adrenal cortex	+	+	I	+	+	+	+	+	+	+	+	+	+	+	+	+	+	+	+	+	+	+	+	+	+	+	+	+
Adrenal medulla	+	+	I	+	+	+	+	+	+	+	+	+	+	+	+	+	+	+	+	+	+	+	+	+	+	+	+	+
Islets, pancreatic																												
Adenoma																												
Parathyroid gland	+	+	+	+	+	+	+	+	+	+	+	M	M	+	+	+	+	+	M	M	M	M	+	+	+	M	M	
Pituitary gland	+	+	+	M	+	+	+	M	+	+	+	+	+	+	+	+	+	+	M	+	+	+	+	+	+	+	+	+
Thyroid gland	+	+	+	+	+	+	+	+	+	+	+	+	+	+	+	+	+	+	+	+	+	+	+	+	+	+	+	+
Follicular cell, adenoma																												
General Body System																												
None																												
Genital System																												
Epididymis	+	+	+	+	+	+	+	+	+	+	+	+	+	+	+	+	+	+	+	+	+	+	+	+	+	+	+	+
Penis																												
Preputial gland																												
Prostate	+	+	+	+	+	+	+	+	+	+	+	+	+	+	+	+	+	+	+	+	+	+	+	+	+	+	+	+
Seminal vesicle	+	+	+	+	+	+	+	+	+	+	+	+	+	+	+	+	+	+	+	+	+	+	+	+	+	+	+	+
Testes	+	+	+	+	+	+	+	+	+	+	+	+	+	+	+	+	+	+	+	+	+	+	+	+	+	+	+	+

+: Tissue examined microscopically
A: Autolysis precludes examination

M: Missing tissue
I: Insufficient tissue

X: Lesion present
Blank: Not examined

TABLE C2
Individual Animal Tumor Pathology of Male Mice in the 2-Year Inhalation Study of Isobutyl Nitrite: 0 ppm (continued)

Number of Days on Study	7 7	
	2 2	
	6 9	
Carcass ID Number	0 1 1 1 1 1 2 2 2 2 2 2 2 2 3 3 3 3 3 3 3 4 4 2 1 3 8 0 2 5 8 9 0 1 3 4 6 7 8 0 1 2 3 4 5 6 6 6 8 5	Total Tissues/Tumors
Hematopoietic System		
Bone marrow	+ +	50
Lymph node		1
Lymph node, bronchial	+ M + + + M + M + M + + + M + M M + M + M M + M +	25
Lymph node, mandibular	+ + + + + + + + + + + + + + M + M + M + + + + M M M	39
Lymph node, mesenteric	+ + + + + + + + + + + + + + + + + + M + + + + + + +	47
Lymph node, mediastinal	+ M + + + M + + + + + + + + + + M + + + + + + + + +	41
Spleen	+ +	50
Hemangioma		1
Thymus	+ + + + M + + + + + + + + + + + + + + M + + + + +	45
Integumentary System		
Mammary gland	M M M M M M M M M M + M M M M M M M M M M M M M M M	3
Skin	+ +	50
Musculoskeletal System		
Bone	+ +	50
Nervous System		
Brain	+ +	50
Respiratory System		
Larynx	+ +	50
Lung	+ +	50
Alveolar/bronchiolar adenoma		7
Alveolar/bronchiolar carcinoma	X	1
Hepatocellular carcinoma, metastatic, liver	X	5
Nose	+ +	50
Trachea	+ +	50
Special Senses System		
Harderian gland		5
Adenoma	+ X	4
Urinary System		
Kidney	+ +	50
Urinary bladder	+ +	50
Systemic Lesions		
Multiple organs	+ +	50
Lymphoma malignant mixed		1

TABLE C2
Individual Animal Tumor Pathology of Male Mice in the 2-Year Inhalation Study of Isobutyl Nitrite:
37.5 ppm (continued)

Number of Days on Study	1 3 5 5 6 6 6 6 6 6 6 6 6 7 7 7 7 7 7 7 7 7 7 7
	2 7 6 8 1 6 6 8 8 8 9 9 9 0 2 2 2 2 2 2 2 2 2 2 2
	4 9 1 1 4 7 7 2 4 7 2 3 9 3 4 5 5 5 5 5 5 5 5 5 5
Carcass ID Number	1 1
	3 4 2 4 4 3 4 6 5 6 3 5 4 5 3 2 2 2 2 2 2 3 3 3 3
	0 4 5 1 5 8 8 1 7 8 9 2 7 6 1 1 3 4 6 9 2 3 4 5 7
Respiratory System	
Larynx	+ +
Lung	+ +
Alveolar/bronchiolar adenoma	
Alveolar/bronchiolar adenoma, multiple	
Alveolar/bronchiolar carcinoma	
Alveolar/bronchiolar carcinoma, multiple	
Hepatocellular carcinoma, metastatic, liver	
Nose	+ +
Trachea	+ +
Special Senses System	
Harderian gland	
Adenoma	
Urinary System	
Kidney	+ +
Alveolar/bronchiolar carcinoma, metastatic, lung	
Renal tubule, adenoma	
Urinary bladder	+ + + + + + + + + + A + + A + + + + + + + + + + +
Systemic Lesions	
Multiple organs	+ +
Lymphoma malignant mixed	

TABLE C2
Individual Animal Tumor Pathology of Male Mice in the 2-Year Inhalation Study of Isobutyl Nitrite: 75 ppm (continued)

Number of Days on Study	7	7	7	7	7	7	7	7	7	7	7	7	7	7	7	7	7	7	7	7	7	7	7	7	Total
	2	2	2	2	2	2	2	2	2	2	2	2	2	2	2	2	2	2	2	2	2	2	2	2	Tissues/ Tumors
Carcass ID Number	5	5	6	6	6	6	6	6	6	6	6	6	6	6	6	6	6	6	6	6	6	6	9	9	
Alimentary System																									
Esophagus	+	+	+	+	+	+	+	+	+	+	+	+	+	+	+	+	+	+	+	+	+	+	+	+	49
Gallbladder	M	+	+	+	+	+	+	+	+	M	+	+	+	+	+	M	+	+	+	+	+	+	+	42	
Intestine large, colon	+	+	+	+	+	+	+	+	+	+	+	+	+	+	+	+	+	+	+	+	+	+	+	48	
Intestine large, rectum	+	+	+	+	+	+	+	+	+	+	+	+	+	+	+	+	+	+	+	+	+	+	+	48	
Intestine large, cecum	+	+	+	+	+	+	+	+	+	+	+	+	+	+	+	+	+	+	+	+	+	+	+	45	
Intestine small, duodenum	+	+	+	+	+	+	+	+	+	+	+	+	+	+	+	+	+	+	+	+	+	+	+	45	
Intestine small, jejunum	+	+	+	+	+	+	+	+	+	+	+	+	+	+	+	+	+	+	+	+	+	+	+	46	
Intestine small, ileum	+	+	+	+	+	+	+	+	+	+	+	+	+	+	+	+	+	+	+	+	+	+	+	45	
Liver	+	+	+	+	+	+	+	+	+	+	+	+	+	+	+	+	+	+	+	+	+	+	+	50	
Cholangiocarcinoma																								1	
Hemangiosarcoma																							X	1	
Hepatocellular carcinoma									X							X								9	
Hepatocellular carcinoma, multiple	X																							2	
Hepatocellular adenoma		X					X				X		X	X	X							X		13	
Hepatocellular adenoma, multiple																								1	
Mesentery						+															+			5	
Cholangiocarcinoma, metastatic, liver																								1	
Hemangiosarcoma						X																		1	
Pancreas	+	+	+	+	+	+	+	+	+	+	+	+	+	+	+	+	+	+	+	+	+	+	+	50	
Salivary glands	+	+	+	+	+	+	+	+	+	+	+	+	+	+	+	+	+	+	+	+	+	+	+	50	
Stomach, forestomach	+	+	+	+	+	+	+	+	+	+	+	+	+	+	+	+	+	+	+	+	+	+	+	49	
Stomach, glandular	+	+	+	+	+	+	+	+	+	+	+	+	+	+	+	+	+	+	+	+	+	+	+	49	
Tooth																							+	1	
Odontoma									X															1	
Cardiovascular System																									
Heart	+	+	+	+	+	+	+	+	+	+	+	+	+	+	+	+	+	+	+	+	+	+	+	50	
Endocrine System																									
Adrenal cortex	+	+	+	+	+	+	+	+	+	+	+	+	+	+	+	+	+	+	+	+	+	+	+	48	
Alveolar/bronchiolar carcinoma, metastatic, lung																								1	
Adrenal medulla	+	+	+	+	+	+	+	+	+	+	+	+	+	+	+	+	+	+	+	+	+	+	+	48	
Alveolar/bronchiolar carcinoma, metastatic, lung																								1	
Islets, pancreatic									+										+	+			+	9	
Adenoma																								2	
Parathyroid gland	M	+	+	+	M	M	+	+	M	+	+	+	+	M	M	+	+	+	+	M	M	M	M	35	
Pituitary gland	+	+	+	+	+	+	+	+	+	+	+	+	+	+	+	+	+	+	+	+	+	+	+	46	
Pars distalis, adenoma																							X	1	
Thyroid gland	+	+	+	+	+	+	+	+	+	+	+	+	+	+	+	+	+	+	+	+	+	+	+	50	
C-cell, carcinoma																								1	
General Body System																									
Tissue NOS																								1	
Genital System																									
Epididymis	+	+	+	+	+	+	+	+	+	+	+	+	+	+	+	+	+	+	+	+	+	+	+	50	
Cholangiocarcinoma, metastatic, liver																								1	
Penis																								1	
Preputial gland		+	+				+	+	+						+		+					+		14	

TABLE C2
Individual Animal Tumor Pathology of Male Mice in the 2-Year Inhalation Study of Isobutyl Nitrite: 75 ppm (continued)

Number of Days on Study	3 4 4 5 5 5 5 5 5 6 6 6 6 6 7 7 7 7 7 7 7 7 7
	0 0 8 5 5 5 6 7 8 1 1 4 6 8 0 2 2 2 2 2 2 2 2 2
	7 8 4 7 8 8 4 9 3 4 9 7 2 1 1 5 5 5 5 5 5 5 5 5
Carcass ID Number	2 2
	8 5 8 4 5 6 4 7 7 4 9 8 6 8 6 5 5 6 6 6 6 7 7 8
	4 2 0 8 9 1 4 8 4 6 0 9 0 7 8 3 7 2 3 6 7 0 1 7 1
Special Senses System	
Eye	
Harderian gland	+
Adenoma	X
Zymbal's gland	
Urinary System	
Kidney	+ +
Cholangiocarcinoma, metastatic, liver	X
Hepatocellular carcinoma, metastatic, liver	
Urinary bladder	+ + + + + + + + + + + A + + + + + + + + + + + +
Cholangiocarcinoma, metastatic, liver	X
Systemic Lesions	
Multiple organs	+ +
Lymphoma malignant lymphocytic	
Lymphoma malignant mixed	X

TABLE C2
Individual Animal Tumor Pathology of Male Mice in the 2-Year Inhalation Study of Isobutyl Nitrite: 75 ppm (continued)

Number of Days on Study	7 7	
	2 2	
	5 5 6 9 9	
Carcass ID Number	2 2	Total
	8 8 4 4 4 4 4 4 5 5 5 5 5 6 6 7 7 7 7 7 8 8 8 5 6	Tissues/
	3 8 1 2 3 5 7 9 0 1 4 6 8 4 5 2 3 5 6 9 2 5 6 5 9	Tumors
Special Senses System		
Eye		1
Harderian gland		3
Adenoma		3
Zymbal's gland	+	1
Urinary System		
Kidney	+	50
Cholangiocarcinoma, metastatic, liver		1
Hepatocellular carcinoma, metastatic, liver	X	1
Urinary bladder	+	49
Cholangiocarcinoma, metastatic, liver		1
Systemic Lesions		
Multiple organs	+	50
Lymphoma malignant lymphocytic	X	1
Lymphoma malignant mixed		1

TABLE C2
Individual Animal Tumor Pathology of Male Mice in the 2-Year Inhalation Study of Isobutyl Nitrite:
150 ppm (continued)

Table with 26 columns: 26 columns of animal IDs (7-7), Number of Days on Study, Carcass ID Number (6-8), and various anatomical systems (Hematopoietic, Integumentary, Musculoskeletal, Nervous, Respiratory, Special Senses, Urinary, Systemic Lesions) with their respective findings (+, M, X) and total tumor counts.

TABLE C3
Statistical Analysis of Primary Neoplasms in Male Mice in the 2-Year Inhalation Study of Isobutyl Nitrite

	0 ppm	37.5 ppm	75 ppm	150 ppm
Harderian Gland: Adenoma				
Overall rate ^a	4/50 (8%)	1/50 (2%)	3/50 (6%)	5/53 (9%)
Adjusted rate ^b	10.5%	2.9%	8.6%	16.7%
Terminal rate ^c	3/37 (8%)	1/35 (3%)	3/35 (9%)	5/30 (17%)
First incidence (days)	711	725 (T)	725 (T)	725 (T)
Life table test ^d	P=0.176	P=0.198N	P=0.532N	P=0.373
Logistic regression test ^d	P=0.189	P=0.161N	P=0.520N	P=0.416
Cochran-Armitage test ^d	P=0.293			
Fisher exact test ^d		P=0.181N	P=0.500N	P=0.537
Harderian Gland: Adenoma or Adenocarcinoma				
Overall rate	4/50 (8%)	1/50 (2%)	3/50 (6%)	6/53 (11%)
Adjusted rate	10.5%	2.9%	8.6%	20.0%
Terminal rate	3/37 (8%)	1/35 (3%)	3/35 (9%)	6/30 (20%)
First incidence (days)	711	725 (T)	725 (T)	725 (T)
Life table test	P=0.088	P=0.198N	P=0.532N	P=0.248
Logistic regression test	P=0.095	P=0.161N	P=0.520N	P=0.284
Cochran-Armitage test	P=0.174			
Fisher exact test		P=0.181N	P=0.500N	P=0.408
Liver: Hemangiosarcoma				
Overall rate	2/50 (4%)	2/50 (4%)	1/50 (2%)	3/53 (6%)
Adjusted rate	5.1%	5.6%	2.9%	7.6%
Terminal rate	1/37 (3%)	1/35 (3%)	1/35 (3%)	0/30 (0%)
First incidence (days)	604	724	725 (T)	553
Life table test	P=0.345	P=0.692N	P=0.510N	P=0.460
Logistic regression test	P=0.428	P=0.684N	P=0.496N	P=0.537
Cochran-Armitage test	P=0.430			
Fisher exact test		P=0.691N	P=0.500N	P=0.528
Liver: Hepatocellular Adenoma				
Overall rate	14/50 (28%)	15/50 (30%)	14/50 (28%)	14/53 (26%)
Adjusted rate	34.6%	37.8%	34.2%	37.6%
Terminal rate	11/37 (30%)	11/35 (31%)	9/35 (26%)	8/30 (27%)
First incidence (days)	455	667	558	541
Life table test	P=0.359	P=0.468	P=0.543	P=0.393
Logistic regression test	P=0.538N	P=0.571	P=0.572N	P=0.576
Cochran-Armitage test	P=0.431N			
Fisher exact test		P=0.500	P=0.588N	P=0.516N
Liver: Hepatocellular Carcinoma				
Overall rate	12/50 (24%)	6/50 (12%)	11/50 (22%)	9/53 (17%)
Adjusted rate	26.2%	14.3%	24.7%	23.6%
Terminal rate	5/37 (14%)	2/35 (6%)	3/35 (9%)	3/30 (10%)
First incidence (days)	455	667	484	552
Life table test	P=0.536	P=0.105N	P=0.500N	P=0.423N
Logistic regression test	P=0.229N	P=0.124N	P=0.412N	P=0.198N
Cochran-Armitage test	P=0.372N			
Fisher exact test		P=0.096N	P=0.500N	P=0.261N

TABLE C3
Statistical Analysis of Primary Neoplasms in Male Mice in the 2-Year Inhalation Study of Isobutyl Nitrite (continued)

	0 ppm	37.5 ppm	75 ppm	150 ppm
Liver: Hepatocellular Adenoma or Carcinoma				
Overall rate	24/50 (48%)	19/50 (38%)	20/50 (40%)	16/53 (30%)
Adjusted rate	51.8%	45.7%	44.8%	41.1%
Terminal rate	15/37 (41%)	13/35 (37%)	11/35 (31%)	8/30 (27%)
First incidence (days)	455	667	484	541
Life table test	P=0.259N	P=0.254N	P=0.336N	P=0.234N
Logistic regression test	P=0.047N	P=0.197N	P=0.187N	P=0.061N
Cochran-Armitage test	P=0.052N			
Fisher exact test		P=0.210N	P=0.273N	P=0.049N
Lung: Alveolar/bronchiolar Adenoma				
Overall rate	7/50 (14%)	12/50 (24%)	13/49 (27%)	17/53 (32%)
Adjusted rate	18.3%	34.3%	37.1%	49.2%
Terminal rate	6/37 (16%)	12/35 (34%)	13/35 (37%)	13/30 (43%)
First incidence (days)	604	725 (T)	725 (T)	558
Life table test	P=0.002	P=0.124	P=0.078	P=0.005
Logistic regression test	P=0.005	P=0.200	P=0.093	P=0.011
Cochran-Armitage test	P=0.026			
Fisher exact test		P=0.154	P=0.096	P=0.026
Lung: Alveolar/bronchiolar Carcinoma				
Overall rate	1/50 (2%)	6/50 (12%)	5/49 (10%)	4/53 (8%)
Adjusted rate	2.7%	15.6%	14.3%	11.2%
Terminal rate	1/37 (3%)	4/35 (11%)	5/35 (14%)	2/30 (7%)
First incidence (days)	725 (T)	667	725 (T)	558
Life table test	P=0.210	P=0.059	P=0.090	P=0.142
Logistic regression test	P=0.275	P=0.070	P=0.090	P=0.190
Cochran-Armitage test	P=0.335			
Fisher exact test		P=0.056	P=0.098	P=0.200
Lung: Alveolar/bronchiolar Adenoma or Carcinoma				
Overall rate	8/50 (16%)	16/50 (32%)	16/49 (33%)	19/53 (36%)
Adjusted rate	20.9%	42.8%	45.7%	53.4%
Terminal rate	7/37 (19%)	14/35 (40%)	16/35 (46%)	14/30 (47%)
First incidence (days)	604	667	725 (T)	558
Life table test	P=0.002	P=0.040	P=0.032	P=0.003
Logistic regression test	P=0.006	P=0.075	P=0.039	P=0.008
Cochran-Armitage test	P=0.033			
Fisher exact test		P=0.050	P=0.044	P=0.019
Thyroid Gland (Follicular Cell): Adenoma				
Overall rate	1/50 (2%)	0/50 (0%)	0/50 (0%)	5/53 (9%)
Adjusted rate	2.7%	0.0%	0.0%	16.7%
Terminal rate	1/37 (3%)	0/35 (0%)	0/35 (0%)	5/30 (17%)
First incidence (days)	725 (T)	— ^e	—	725 (T)
Life table test	P=0.004	P=0.511N	P=0.511N	P=0.061
Logistic regression test	P=0.004	P=0.511N	P=0.511N	P=0.061
Cochran-Armitage test	P=0.011			
Fisher exact test		P=0.500N	P=0.500N	P=0.116

TABLE C3
Statistical Analysis of Primary Neoplasms in Male Mice in the 2-Year Inhalation Study of Isobutyl Nitrite (continued)

	0 ppm	37.5 ppm	75 ppm	150 ppm
Thyroid Gland (Follicular Cell): Adenoma or Carcinoma				
Overall rate	1/50 (2%)	1/50 (2%)	0/50 (0%)	5/53 (9%)
Adjusted rate	2.7%	2.9%	0.0%	16.7%
Terminal rate	1/37 (3%)	1/35 (3%)	0/35 (0%)	5/30 (17%)
First incidence (days)	725 (T)	725 (T)	—	725 (T)
Life table test	P=0.011	P=0.749	P=0.511N	P=0.061
Logistic regression test	P=0.011	P=0.749	P=0.511N	P=0.061
Cochran-Armitage test	P=0.026			
Fisher exact test		P=0.753N	P=0.500N	P=0.116
All Organs: Hemangiosarcoma				
Overall rate	2/50 (4%)	3/50 (6%)	2/50 (4%)	3/53 (6%)
Adjusted rate	5.1%	8.3%	5.7%	7.6%
Terminal rate	1/37 (3%)	2/35 (6%)	2/35 (6%)	0/30 (0%)
First incidence (days)	604	724	725 (T)	553
Life table test	P=0.384	P=0.495	P=0.681	P=0.460
Logistic regression test	P=0.469	P=0.522	P=0.690N	P=0.537
Cochran-Armitage test	P=0.486			
Fisher exact test		P=0.500	P=0.691N	P=0.528
All Organs: Hemangioma or Hemangiosarcoma				
Overall rate	3/50 (6%)	3/50 (6%)	2/50 (4%)	3/53 (6%)
Adjusted rate	7.8%	8.3%	5.7%	7.6%
Terminal rate	2/37 (5%)	2/35 (6%)	2/35 (6%)	0/30 (0%)
First incidence (days)	604	724	725 (T)	553
Life table test	P=0.526	P=0.652	P=0.518N	P=0.609
Logistic regression test	P=0.557N	P=0.637N	P=0.494N	P=0.637N
Cochran-Armitage test	P=0.531N			
Fisher exact test		P=0.661N	P=0.500N	P=0.633N
All Organs: Malignant Lymphoma (Lymphocytic or Mixed)				
Overall rate	1/50 (2%)	3/50 (6%)	2/50 (4%)	2/53 (4%)
Adjusted rate	2.6%	7.7%	5.7%	5.9%
Terminal rate	0/37 (0%)	2/35 (6%)	2/35 (6%)	1/30 (3%)
First incidence (days)	618	581	725 (T)	625
Life table test	P=0.432	P=0.323	P=0.490	P=0.467
Logistic regression test	P=0.507	P=0.294	P=0.505	P=0.703
Cochran-Armitage test	P=0.527			
Fisher exact test		P=0.309	P=0.500	P=0.522
All Organs: Benign Neoplasms				
Overall rate	24/50 (48%)	28/50 (56%)	29/50 (58%)	33/53 (62%)
Adjusted rate	58.3%	69.7%	70.4%	80.0%
Terminal rate	20/37 (54%)	23/35 (66%)	23/35 (66%)	22/30 (73%)
First incidence (days)	455	667	558	296
Life table test	P=0.005	P=0.224	P=0.164	P=0.010
Logistic regression test	P=0.020	P=0.417	P=0.229	P=0.040
Cochran-Armitage test	P=0.097			
Fisher exact test		P=0.274	P=0.212	P=0.104

TABLE C3
Statistical Analysis of Primary Neoplasms in Male Mice in the 2-Year Inhalation Study of Isobutyl Nitrite (continued)

	0 ppm	37.5 ppm	75 ppm	150 ppm
All Organs: Malignant Neoplasms				
Overall rate	16/50 (32%)	18/50 (36%)	21/50 (42%)	17/53 (32%)
Adjusted rate	34.2%	41.2%	47.1%	40.5%
Terminal rate	7/37 (19%)	10/35 (29%)	12/35 (34%)	6/30 (20%)
First incidence (days)	455	581	484	552
Life table test	P=0.278	P=0.446	P=0.227	P=0.370
Logistic regression test	P=0.427N	P=0.288	P=0.258	P=0.492N
Cochran-Armitage test	P=0.524N			
Fisher exact test		P=0.417	P=0.204	P=0.581
All Organs: Benign or Malignant Neoplasms				
Overall rate	33/50 (66%)	35/50 (70%)	38/50 (76%)	39/53 (74%)
Adjusted rate	68.8%	79.4%	82.5%	84.8%
Terminal rate	22/37 (59%)	26/35 (74%)	27/35 (77%)	23/30 (77%)
First incidence (days)	455	581	484	296
Life table test	P=0.021	P=0.395	P=0.204	P=0.053
Logistic regression	P=0.087	P=0.494	P=0.210	P=0.159
Cochran-Armitage test	P=0.220			
Fisher exact test		P=0.415	P=0.189	P=0.266

(T)Terminal sacrifice

^a Number of neoplasm-bearing animals/number of animals examined. Denominator is number of animals examined microscopically for liver, lung, and thyroid gland; for other tissues, denominator is number of animals necropsied.

^b Kaplan-Meier estimated neoplasm incidence at the end of the study after adjustment for intercurrent mortality

^c Observed incidence at terminal kill

^d Beneath the control incidence are the P values associated with the trend test. Beneath the dosed group incidence are the P values corresponding to pairwise comparisons between the controls and that dosed group. The life table test regards neoplasms in animals dying prior to terminal kill as being (directly or indirectly) the cause of death. The logistic regression test regards these lesions as nonfatal. The Cochran-Armitage and Fisher exact tests compare directly the overall incidence rates. For all tests, a negative trend or a lower incidence in a dose group is indicated by N.

^e Not applicable; no neoplasms in animal group

TABLE C4a
Historical Incidence of Alveolar/bronchiolar Neoplasms in Chamber Control Male B6C3F₁ Mice^a

	Incidence in Controls		
	Adenoma	Carcinoma	Adenoma or Carcinoma
Overall Historical Incidence			
Total	123/773 (15.9%)	55/773 (7.1%)	170/773 (22.0%)
Standard deviation	7.3%	5.9%	8.7%
Range	6%-36%	0%-16%	10%-42%

^a Data as of 17 June 1994; no data are available for studies performed at IITRI

TABLE C4b
Historical Incidence of Thyroid Gland Follicular Cell Neoplasms in Chamber Control Male B6C3F₁ Mice^a

	Incidence in Controls		
	Adenoma	Carcinoma	Adenoma or Carcinoma
Overall Historical Incidence			
Total	13/763 (1.7%)	0/763 (0.0%)	13/763 (1.7%)
Standard deviation	1.5%		1.5%
Range	0%-4%		0%-4%

^a Data as of 17 June 1994; no data are available for studies performed at IITRI

TABLE C5

Summary of the Incidence of Nonneoplastic Lesions in Male Mice in the 2-Year Inhalation Study of Isobutyl Nitrite^a

	0 ppm	37.5 ppm	75 ppm	150 ppm
Disposition Summary				
Animals initially in study	60	60	60	60
<i>15-Month interim evaluation</i>	10	10	10	7
Early deaths				
Accidental deaths	2			2
Moribund	1	7	4	4
Natural deaths	10	8	11	17
Survivors				
Terminal sacrifice	37	35	35	30
Animals examined microscopically	60	60	60	60
15-Month Interim Evaluation				
Alimentary System				
Liver	(10)	(10)	(10)	(7)
Inflammation, chronic active			1 (10%)	
Mixed cell focus		1 (10%)	1 (10%)	
Necrosis			1 (10%)	
Centrilobular, fatty change	4 (40%)	3 (30%)	4 (40%)	1 (14%)
Pancreas	(10)	(10)	(10)	(7)
Acinus, atrophy	1 (10%)			
Salivary glands	(10)	(10)	(10)	(7)
Inflammation, chronic	4 (40%)	1 (10%)	5 (50%)	
Cardiovascular System				
Heart	(10)	(10)	(10)	(7)
Mineralization	1 (10%)			
Endocrine System				
Adrenal cortex	(10)	(10)	(10)	(7)
Cyst		1 (10%)		
Hypertrophy, focal		3 (30%)		
Capsule, accessory adrenal cortical nodule	1 (10%)			
Subcapsular, hyperplasia	4 (40%)	1 (10%)	2 (20%)	5 (71%)
Islets, pancreatic		(1)		
Hyperplasia, focal		1 (100%)		
Thyroid gland	(10)	(10)	(10)	(7)
Ultimobranchial cyst			1 (10%)	
Follicular cell, hyperplasia			1 (10%)	
Genital System				
Preputial gland	(3)	(3)	(4)	(2)
Dilatation	3 (100%)		4 (100%)	1 (50%)
Inflammation, chronic active				1 (50%)
Testes	(10)	(10)	(10)	(7)
Spermatocele	1 (10%)			

^a Number of animals examined microscopically at the site and the number of animals with lesion

TABLE C5

Summary of the Incidence of Nonneoplastic Lesions in Male Mice in the 2-Year Inhalation Study of Isobutyl Nitrite
(continued)

	0 ppm	37.5 ppm	75 ppm	150 ppm
15-Month Interim Evaluation (continued)				
Hematopoietic System				
Bone marrow	(10)	(10)	(10)	(7)
Myeloid cell, hyperplasia				1 (14%)
Lymph node, mesenteric	(10)	(9)	(10)	(7)
Hyperplasia, lymphoid				1 (14%)
Spleen	(10)	(10)	(10)	(7)
Hematopoietic cell proliferation	10 (100%)	10 (100%)	10 (100%)	7 (100%)
Pigmentation, hemosiderin	6 (60%)	7 (70%)	9 (90%)	7 (100%)
Thymus	(10)	(10)	(10)	(7)
Atrophy			1 (10%)	
Hyperplasia, lymphoid			1 (10%)	
Nervous System				
Brain	(10)	(10)	(10)	(7)
Mineralization	4 (40%)	4 (40%)	7 (70%)	
Respiratory System				
Lung	(10)	(10)	(10)	(7)
Alveolar epithelium, hyperplasia, focal	1 (10%)			
Nose	(10)	(10)	(10)	(7)
Olfactory epithelium, degeneration, hyaline		1 (10%)		
Respiratory epithelium, degeneration, hyaline				1 (14%)
Respiratory epithelium, hyperplasia	1 (10%)	4 (40%)	1 (10%)	
Urinary System				
Kidney	(10)	(10)	(10)	(7)
Infiltration cellular, lymphocyte			2 (20%)	
Renal tubule, dilatation		1 (10%)		
Renal tubule, regeneration		1 (10%)	1 (10%)	
Urinary bladder	(10)	(10)	(10)	(7)
Dilatation	1 (10%)			1 (14%)
Infiltration cellular, lymphocyte	1 (10%)	1 (10%)	1 (10%)	
Systems Examined With No Lesions Observed				
General Body System				
Integumentary System				
Musculoskeletal System				
Special Senses System				
2-Year Study				
Alimentary System				
Gallbladder	(41)	(40)	(42)	(46)
Inflammation, chronic active				1 (2%)
Intestine large, cecum	(44)	(45)	(45)	(43)
Hyperplasia, lymphoid		2 (4%)		

TABLE C5

Summary of the Incidence of Nonneoplastic Lesions in Male Mice in the 2-Year Inhalation Study of Isobutyl Nitrite
(continued)

	0 ppm	37.5 ppm	75 ppm	150 ppm
2-Year Study (continued)				
Alimentary System (continued)				
Intestine small, duodenum	(43)	(45)	(45)	(43)
Proliferation connective tissue		1 (2%)		
Intestine small, jejunum	(42)	(45)	(46)	(43)
Hyperplasia, lymphoid		1 (2%)		
Inflammation, chronic active		1 (2%)		
Liver	(50)	(50)	(50)	(53)
Abscess				1 (2%)
Angiectasis	1 (2%)	1 (2%)		
Basophilic focus	3 (6%)	2 (4%)	2 (4%)	2 (4%)
Clear cell focus	2 (4%)	3 (6%)	3 (6%)	
Cytologic alterations	3 (6%)		2 (4%)	2 (4%)
Developmental malformation		1 (2%)		
Eosinophilic focus	1 (2%)		1 (2%)	
Fatty change, focal	1 (2%)		1 (2%)	
Hematopoietic cell proliferation		1 (2%)	1 (2%)	1 (2%)
Hyperplasia				1 (2%)
Infarct	2 (4%)	2 (4%)	3 (6%)	2 (4%)
Inflammation, chronic		1 (2%)		5 (9%)
Inflammation, chronic active		1 (2%)		
Mixed cell focus		4 (8%)		1 (2%)
Necrosis	1 (2%)	3 (6%)	2 (4%)	4 (8%)
Proliferation connective tissue		1 (2%)		1 (2%)
Syncytial alteration	12 (24%)	14 (28%)	16 (32%)	11 (21%)
Vacuolization cytoplasmic	1 (2%)			
Bile duct, cyst			2 (4%)	
Bile duct, hyperplasia			1 (2%)	1 (2%)
Centrilobular, fatty change	1 (2%)	3 (6%)		
Centrilobular, necrosis				2 (4%)
Hepatocyte, necrosis				1 (2%)
Midzonal, fatty change		1 (2%)		
Periportal, vacuolization cytoplasmic				1 (2%)
Mesentery		(1)	(5)	(2)
Artery, inflammation, chronic active			1 (20%)	
Fat, necrosis		1 (100%)	2 (40%)	2 (100%)
Pancreas	(50)	(49)	(50)	(49)
Inflammation, chronic	3 (6%)			3 (6%)
Inflammation, chronic active			1 (2%)	
Proliferation connective tissue				1 (2%)
Acinus, atrophy		1 (2%)	1 (2%)	1 (2%)
Duct, cyst				1 (2%)
Salivary glands	(50)	(50)	(50)	(53)
Inflammation, chronic	32 (64%)	32 (64%)	24 (48%)	29 (55%)
Stomach, glandular	(49)	(49)	(49)	(49)
Dysplasia				1 (2%)
Necrosis		1 (2%)	1 (2%)	2 (4%)
Ulcer			1 (2%)	
Tooth	(3)		(1)	
Dysplasia	1 (33%)			

TABLE C5

Summary of the Incidence of Nonneoplastic Lesions in Male Mice in the 2-Year Inhalation Study of Isobutyl Nitrite
(continued)

	0 ppm	37.5 ppm	75 ppm	150 ppm
2-Year Study (continued)				
Cardiovascular System				
Heart	(50)	(50)	(50)	(53)
Cardiomyopathy				1 (2%)
Degeneration				1 (2%)
Thrombosis				1 (2%)
Artery, inflammation, chronic active			1 (2%)	1 (2%)
Endocrine System				
Adrenal cortex	(49)	(49)	(48)	(51)
Cyst		2 (4%)	1 (2%)	
Hyperplasia			1 (2%)	
Hypertrophy, focal	6 (12%)	13 (27%)	10 (21%)	9 (18%)
Capsule, accessory adrenal cortical nodule	1 (2%)		1 (2%)	
Subcapsular, hyperplasia	29 (59%)	25 (51%)	16 (33%)	19 (37%)
Adrenal medulla	(49)	(49)	(48)	(51)
Hyperplasia, focal			2 (4%)	
Islets, pancreatic	(5)	(2)	(9)	(1)
Hyperplasia, focal	3 (60%)	2 (100%)	7 (78%)	1 (100%)
Pituitary gland	(47)	(46)	(46)	(47)
Pars distalis, cyst	1 (2%)			
Pars distalis, hyperplasia	1 (2%)		1 (2%)	
Pars distalis, hyperplasia, focal		1 (2%)	1 (2%)	
Thyroid gland	(50)	(50)	(50)	(53)
Follicular cell, hyperplasia, focal	8 (16%)	17 (34%)	12 (24%)	20 (38%)
General Body System				
None				
Genital System				
Epididymis	(50)	(50)	(50)	(53)
Inflammation, chronic active	1 (2%)	2 (4%)	3 (6%)	8 (15%)
Spermatocele		1 (2%)		
Penis	(1)	(1)	(1)	(5)
Congestion				1 (20%)
Inflammation, chronic active	1 (100%)		1 (100%)	3 (60%)
Preputial gland	(16)	(19)	(14)	(12)
Abscess		3 (16%)	2 (14%)	1 (8%)
Dilatation	13 (81%)	14 (74%)	13 (93%)	10 (83%)
Inflammation, chronic active	6 (38%)	6 (32%)	5 (36%)	3 (25%)
Prostate	(50)	(49)	(49)	(53)
Hyperplasia, focal			1 (2%)	
Inflammation, acute		1 (2%)		2 (4%)
Inflammation, chronic active	1 (2%)	1 (2%)	4 (8%)	3 (6%)
Seminal vesicle	(50)	(50)	(50)	(53)
Dilatation	4 (8%)	7 (14%)	12 (24%)	3 (6%)
Hyperplasia				1 (2%)
Inflammation, acute		1 (2%)		
Inflammation, chronic active			1 (2%)	1 (2%)

TABLE C5
Summary of the Incidence of Nonneoplastic Lesions in Male Mice in the 2-Year Inhalation Study of Isobutyl Nitrite
(continued)

	0 ppm	37.5 ppm	75 ppm	150 ppm
2-Year Study (continued)				
Genital System (continued)				
Testes	(50)	(50)	(50)	(53)
Mineralization			1 (2%)	
Seminiferous tubule, degeneration	2 (4%)			1 (2%)
Tunic, inflammation, chronic			1 (2%)	
Tunic, proliferation connective tissue			1 (2%)	
Hematopoietic System				
Bone marrow	(50)	(50)	(49)	(52)
Infarct				1 (2%)
Myeloid cell, hyperplasia	3 (6%)	5 (10%)	7 (14%)	8 (15%)
Lymph node	(1)	(5)	(5)	(5)
Iliac, infiltration cellular, histiocyte			1 (20%)	
Iliac, inflammation, chronic active				1 (20%)
Inguinal, hyperplasia, lymphoid			2 (40%)	
Inguinal, inflammation, chronic active				1 (20%)
Inguinal, pigmentation				1 (20%)
Lumbar, hemorrhage				1 (20%)
Lumbar, hyperplasia, histiocytic				1 (20%)
Lumbar, hyperplasia, lymphoid		1 (20%)		1 (20%)
Lumbar, hyperplasia, plasma cell				1 (20%)
Renal, hyperplasia, plasma cell		1 (20%)	1 (20%)	
Lymph node, bronchial	(25)	(36)	(18)	(34)
Hemorrhage		1 (3%)		
Hyperplasia, lymphoid		1 (3%)	1 (6%)	1 (3%)
Infiltration cellular, histiocyte				1 (3%)
Inflammation, chronic active			1 (6%)	
Lymph node, mandibular	(39)	(50)	(50)	(48)
Hemorrhage				1 (2%)
Hyperplasia, lymphoid	1 (3%)	1 (2%)		1 (2%)
Pigmentation, hemosiderin				1 (2%)
Lymph node, mesenteric	(47)	(48)	(47)	(49)
Angiectasis			1 (2%)	
Hematopoietic cell proliferation		1 (2%)	1 (2%)	
Hemorrhage	2 (4%)	4 (8%)	5 (11%)	6 (12%)
Hyperplasia, lymphoid	3 (6%)	1 (2%)		
Hyperplasia, plasma cell			2 (4%)	
Lymph node, mediastinal	(41)	(37)	(39)	(41)
Hemorrhage	1 (2%)		1 (3%)	1 (2%)
Hyperplasia, lymphoid				2 (5%)
Hyperplasia, plasma cell				1 (2%)
Spleen	(50)	(50)	(49)	(51)
Fibrosis				1 (2%)
Hematopoietic cell proliferation	49 (98%)	43 (86%)	47 (96%)	48 (94%)
Hematopoietic cell proliferation granulocytic			1 (2%)	2 (4%)
Hyperplasia, lymphoid		2 (4%)		
Pigmentation, hemosiderin	28 (56%)	19 (38%)	46 (94%)	49 (96%)
Lymphoid follicle, atrophy				2 (4%)

TABLE C5

Summary of the Incidence of Nonneoplastic Lesions in Male Mice in the 2-Year Inhalation Study of Isobutyl Nitrite
(continued)

	0 ppm	37.5 ppm	75 ppm	150 ppm
2-Year Study (continued)				
Hematopoietic System (continued)				
Thymus	(45)	(46)	(38)	(43)
Atrophy	13 (29%)	12 (26%)	6 (16%)	9 (21%)
Cyst				1 (2%)
Ectopic parathyroid gland				1 (2%)
Hyperplasia, lymphoid				1 (2%)
Integumentary System				
Skin	(50)	(50)	(49)	(52)
Inflammation, chronic	1 (2%)			2 (4%)
Inflammation, chronic active		3 (6%)	2 (4%)	3 (6%)
Ulcer		2 (4%)		2 (4%)
Epithelium, hyperplasia		1 (2%)	1 (2%)	
Fat, necrosis	1 (2%)			
Hair follicle, atrophy	1 (2%)			
Prepuce, inflammation, chronic active	1 (2%)		1 (2%)	1 (2%)
Prepuce, ulcer			1 (2%)	
Subcutaneous tissue, edema				1 (2%)
Subcutaneous tissue, granuloma				1 (2%)
Subcutaneous tissue, hemorrhage				1 (2%)
Musculoskeletal System				
Bone	(50)	(50)	(50)	(53)
Developmental malformation			1 (2%)	
Dysplasia			1 (2%)	
Fracture				1 (2%)
Hyperostosis		1 (2%)		
Cartilage, degeneration		1 (2%)		
Maxilla, callus	1 (2%)			
Maxilla, fracture	2 (4%)			
Skeletal muscle		(1)	(1)	
Inflammation, chronic active			1 (100%)	
Nervous System				
Brain	(50)	(50)	(50)	(53)
Mineralization	37 (74%)	32 (64%)	24 (48%)	24 (45%)
Respiratory System				
Larynx	(50)	(50)	(49)	(50)
Inflammation, acute		1 (2%)		
Inflammation, chronic active		1 (2%)		
Lung	(50)	(50)	(49)	(53)
Congestion				1 (2%)
Infiltration cellular, lymphocyte	1 (2%)	3 (6%)	2 (4%)	3 (6%)
Inflammation, chronic active	3 (6%)			
Leukocytosis				1 (2%)
Alveolar epithelium, hyperplasia, focal		4 (8%)	7 (14%)	13 (25%)
Alveolus, infiltration cellular, histiocyte		1 (2%)	2 (4%)	2 (4%)

TABLE C5

Summary of the Incidence of Nonneoplastic Lesions in Male Mice in the 2-Year Inhalation Study of Isobutyl Nitrite
(continued)

	0 ppm	37.5 ppm	75 ppm	150 ppm
2-Year Study (continued)				
Respiratory System (continued)				
Nose	(50)	(50)	(50)	(53)
Exudate			1 (2%)	
Exudate, serous				2 (4%)
Inflammation, chronic active	8 (16%)	8 (16%)	7 (14%)	10 (19%)
Olfactory epithelium, atrophy			1 (2%)	1 (2%)
Olfactory epithelium, degeneration, hyaline		3 (6%)	2 (4%)	2 (4%)
Olfactory epithelium, metaplasia	3 (6%)	1 (2%)	3 (6%)	1 (2%)
Respiratory epithelium, degeneration, hyaline	4 (8%)	3 (6%)	3 (6%)	2 (4%)
Respiratory epithelium, hyperplasia	12 (24%)	16 (32%)	18 (36%)	8 (15%)
Respiratory epithelium, metaplasia, squamous		3 (6%)		3 (6%)
Respiratory epithelium, ulcer		2 (4%)		1 (2%)
Special Senses System				
Eye			(1)	(2)
Phthisis bulbi			1 (100%)	1 (50%)
Cornea, inflammation, chronic active				1 (50%)
Lens, cataract				1 (50%)
Harderian gland	(5)	(1)	(3)	(6)
Inflammation, chronic active		1 (100%)		
Urinary System				
Kidney	(50)	(50)	(50)	(53)
Abscess				1 (2%)
Amyloid deposition		1 (2%)		
Cyst	2 (4%)	1 (2%)	2 (4%)	2 (4%)
Hydronephrosis	2 (4%)	2 (4%)		5 (9%)
Infarct			2 (4%)	1 (2%)
Infiltration cellular, lymphocyte	17 (34%)	18 (36%)	11 (22%)	23 (43%)
Inflammation, acute		1 (2%)		2 (4%)
Inflammation, chronic active	1 (2%)	3 (6%)	5 (10%)	6 (11%)
Metaplasia, osseous	1 (2%)		1 (2%)	
Mineralization			1 (2%)	
Nephropathy	1 (2%)	1 (2%)		
Artery, inflammation, chronic active			1 (2%)	
Renal tubule, dilatation	1 (2%)	2 (4%)		6 (11%)
Renal tubule, hyperplasia, focal	1 (2%)		2 (4%)	2 (4%)
Renal tubule, regeneration	12 (24%)	5 (10%)	4 (8%)	4 (8%)
Urinary bladder	(50)	(48)	(49)	(50)
Dilatation	6 (12%)	7 (15%)	14 (29%)	8 (16%)
Infiltration cellular, lymphocyte	1 (2%)	3 (6%)		5 (10%)
Inflammation, acute		1 (2%)		1 (2%)
Inflammation, chronic active	2 (4%)	3 (6%)	5 (10%)	8 (16%)
Transitional epithelium, hyperplasia		1 (2%)	1 (2%)	

APPENDIX D
SUMMARY OF LESIONS IN FEMALE MICE
IN THE 2-YEAR INHALATION STUDY
OF ISOBUTYL NITRITE

TABLE D1	Summary of the Incidence of Neoplasms in Female Mice in the 2-Year Inhalation Study of Isobutyl Nitrite	197
TABLE D2	Individual Animal Tumor Pathology of Female Mice in the 2-Year Inhalation Study of Isobutyl Nitrite	202
TABLE D3	Statistical Analysis of Primary Neoplasms in Female Mice in the 2-Year Inhalation Study of Isobutyl Nitrite	220
TABLE D4	Historical Incidence of Alveolar/bronchiolar Neoplasms in Chamber Control Female B6C3F₁ Mice	223
TABLE D5	Summary of the Incidence of Nonneoplastic Lesions in Female Mice in the 2-Year Inhalation Study of Isobutyl Nitrite	224

2

TABLE D1
Summary of the Incidence of Neoplasms in Female Mice in the 2-Year Inhalation Study of Isobutyl Nitrite^a

	0 ppm	37.5 ppm	75 ppm	150 ppm
Disposition Summary				
Animals initially in study	60	60	60	60
15-Month interim evaluation				
Early deaths				
Accidental death				1
Moribund	3	3	6	2
Natural deaths	16	6	8	10
Survivors				
Terminal sacrifice	32	42	36	37
Missing			1	
Animals examined microscopically	60	60	59	60
15-Month Interim Evaluation				
Alimentary System				
Liver	(9)	(9)	(9)	(10)
Hepatocellular carcinoma		1 (11%)		
Hepatocellular adenoma	1 (11%)			
Respiratory System				
Lung	(9)	(9)	(9)	(10)
Alveolar/bronchiolar adenoma		1 (11%)	2 (22%)	2 (20%)
Alveolar/bronchiolar adenoma, multiple		1 (11%)		
Systems Examined With No Neoplasms Observed				
Cardiovascular System				
Endocrine System				
General Body System				
Genital System				
Hematopoietic System				
Integumentary System				
Musculoskeletal System				
Nervous System				
Special Senses System				
Urinary System				
2-Year Study				
Alimentary System				
Esophagus	(51)	(50)	(50)	(47)
Squamous cell carcinoma		1 (2%)		
Gallbladder	(46)	(47)	(45)	(41)
Intestine large, colon	(51)	(51)	(50)	(46)
Intestine large, rectum	(48)	(51)	(50)	(47)
Schwannoma malignant, metastatic, skin	1 (2%)			
Intestine large, cecum	(48)	(49)	(50)	(45)

TABLE D1
Summary of the Incidence of Neoplasms in Female Mice in the 2-Year Inhalation Study of Isobutyl Nitrite (continued)

	0 ppm	37.5 ppm	75 ppm	150 ppm
2-Year Study (continued)				
Alimentary System (continued)				
Intestine small, duodenum	(42)	(50)	(49)	(42)
Intestine small, jejunum	(44)	(50)	(47)	(45)
Intestine small, ileum	(44)	(48)	(50)	(44)
Liver	(51)	(51)	(50)	(50)
Hepatocellular carcinoma	3 (6%)	4 (8%)	2 (4%)	5 (10%)
Hepatocellular carcinoma, multiple	1 (2%)			
Hepatocellular adenoma	6 (12%)	10 (20%)	2 (4%)	4 (8%)
Hepatocellular adenoma, multiple			5 (10%)	2 (4%)
Hepatocholangiocarcinoma	1 (2%)			
Histiocytic sarcoma	2 (4%)	1 (2%)		1 (2%)
Mesentery	(7)	(4)	(3)	(2)
Hepatocellular carcinoma, metastatic, liver	1 (14%)			
Pancreas	(51)	(51)	(50)	(50)
Hepatocholangiocarcinoma, metastatic, liver	1 (2%)			
Schwannoma malignant, metastatic, skin	1 (2%)			
Salivary glands	(51)	(51)	(50)	(50)
Stomach, forestomach	(51)	(51)	(50)	(49)
Stomach, glandular	(51)	(51)	(50)	(49)
Tooth	(1)		(1)	(1)
Odontoma			1 (100%)	1 (100%)
Cardiovascular System				
Heart	(51)	(51)	(50)	(50)
Hepatocholangiocarcinoma, metastatic, liver	1 (2%)			
Endocrine System				
Adrenal cortex	(50)	(51)	(50)	(49)
Adrenal medulla	(47)	(49)	(45)	(47)
Pheochromocytoma malignant		1 (2%)		
Pheochromocytoma benign			2 (4%)	2 (4%)
Islets, pancreatic	(2)	(2)	(3)	(3)
Adenoma		1 (50%)		
Pituitary gland	(48)	(48)	(50)	(47)
Pars distalis, adenoma	12 (25%)	19 (40%)	18 (36%)	13 (28%)
Pars intermedia, adenoma	2 (4%)	2 (4%)		
Thyroid gland	(51)	(51)	(50)	(50)
Follicular cell, adenoma	4 (8%)	3 (6%)	2 (4%)	2 (4%)
General Body System				
None				

TABLE D1
Summary of the Incidence of Neoplasms in Female Mice in the 2-Year Inhalation Study of Isobutyl Nitrite (continued)

	0 ppm	37.5 ppm	75 ppm	150 ppm
2-Year Study (continued)				
Genital System				
Ovary	(49)	(50)	(46)	(49)
Cystadenoma	1 (2%)		2 (4%)	1 (2%)
Granulosa cell tumor malignant			1 (2%)	
Granulosa cell tumor benign				1 (2%)
Oviduct			(1)	
Uterus	(51)	(51)	(49)	(49)
Deciduoma NOS		1 (2%)		
Hemangioma	1 (2%)			
Histiocytic sarcoma	2 (4%)	2 (4%)		1 (2%)
Leiomyosarcoma			1 (2%)	1 (2%)
Myxoma				1 (2%)
Polyp stromal	3 (6%)	2 (4%)		1 (2%)
Sarcoma stromal	1 (2%)			
Vagina	(1)		(1)	(2)
Histiocytic sarcoma	1 (100%)			
Squamous cell carcinoma				1 (50%)
Hematopoietic System				
Bone marrow	(51)	(51)	(50)	(50)
Lymph node	(4)	(5)	(8)	(6)
Inguinal, histiocytic sarcoma	1 (25%)			
Lumbar, histiocytic sarcoma	1 (25%)			
Pancreatic, hepatocholangiocarcinoma, metastatic, liver	1 (25%)			
Renal, histiocytic sarcoma	1 (25%)			
Lymph node, bronchial	(20)	(34)	(32)	(30)
Lymph node, mandibular	(49)	(48)	(48)	(45)
Histiocytic sarcoma	1 (2%)			
Lymph node, mesenteric	(51)	(50)	(49)	(45)
Hemangioma				1 (2%)
Histiocytic sarcoma				1 (2%)
Lymph node, mediastinal	(49)	(44)	(46)	(43)
Histiocytic sarcoma	1 (2%)			
Spleen	(51)	(51)	(50)	(49)
Hemangiosarcoma	1 (2%)	1 (2%)		
Histiocytic sarcoma	1 (2%)			
Thymus	(47)	(47)	(48)	(41)
Integumentary System				
Mammary gland	(49)	(51)	(50)	(50)
Adenocarcinoma			1 (2%)	
Adenoma			1 (2%)	
Skin	(51)	(51)	(50)	(50)
Subcutaneous tissue, fibrosarcoma			1 (2%)	
Subcutaneous tissue, hemangioma	1 (2%)			
Subcutaneous tissue, hemangiosarcoma		1 (2%)		
Subcutaneous tissue, sarcoma	1 (2%)		1 (2%)	
Subcutaneous tissue, schwannoma malignant	1 (2%)			

TABLE D1
Summary of the Incidence of Neoplasms in Female Mice in the 2-Year Inhalation Study of Isobutyl Nitrite (continued)

	0 ppm	37.5 ppm	75 ppm	150 ppm
2-Year Study (continued)				
Musculoskeletal System				
Bone	(51)	(51)	(50)	(50)
Hemangioma		1 (2%)		
Schwannoma malignant, metastatic, skin	1 (2%)			
Skeletal muscle		(3)	(1)	(1)
Hemangiosarcoma		1 (33%)		
Osteosarcoma		1 (33%)		
Sarcoma				1 (100%)
Nervous System				
None				
Respiratory System				
Lung	(51)	(51)	(50)	(50)
Adenoma			1 (2%)	
Alveolar/bronchiolar adenoma	4 (8%)	12 (24%)	5 (10%)	15 (30%)
Alveolar/bronchiolar adenoma, multiple		2 (4%)	1 (2%)	2 (4%)
Alveolar/bronchiolar carcinoma	2 (4%)	2 (4%)	2 (4%)	2 (4%)
Hepatocellular carcinoma, metastatic, liver	1 (2%)	1 (2%)	2 (4%)	3 (6%)
Hepatocholangiocarcinoma, metastatic, liver	1 (2%)			
Histiocytic sarcoma				1 (2%)
Osteosarcoma, metastatic, skeletal muscle		1 (2%)		
Mediastinum, hepatocellular carcinoma, metastatic, liver			1 (2%)	
Mediastinum, hepatocholangiocarcinoma, metastatic, liver	1 (2%)			
Nose	(51)	(51)	(50)	(50)
Special Senses System				
Harderian gland		(1)	(2)	(2)
Adenoma		1 (100%)	1 (50%)	2 (100%)
Urinary System				
Kidney	(51)	(51)	(50)	(50)
Histiocytic sarcoma				1 (2%)
Osteosarcoma, metastatic, skeletal muscle		1 (2%)		
Urinary bladder	(49)	(50)	(48)	(47)
Systemic Lesions				
Multiple organs ^b	(51)	(51)	(50)	(50)
Histiocytic sarcoma	2 (4%)	2 (4%)		2 (4%)
Lymphoma malignant histiocytic	1 (2%)			
Lymphoma malignant lymphocytic	1 (2%)		1 (2%)	3 (6%)
Lymphoma malignant mixed	5 (10%)	4 (8%)	9 (18%)	6 (12%)
Lymphoma malignant undifferentiated cell		2 (4%)	1 (2%)	

TABLE D1
Summary of the Incidence of Neoplasms in Female Mice in the 2-Year Inhalation Study of Isobutyl Nitrite (continued)

	0 ppm	37.5 ppm	75 ppm	150 ppm
Neoplasm Summary				
Total animals with primary neoplasms ^c				
15-Month interim evaluation	1	3	2	2
2-Year study	37	45	37	40
Total primary neoplasms				
15-Month interim evaluation	1	3	2	2
2-Year study	54	74	61	69
Total animals with benign neoplasms				
15-Month interim evaluation	1	2	2	2
2-Year study	27	36	29	33
Total benign neoplasms				
15-Month interim evaluation	1	2	2	2
2-Year study	34	53	41	48
Total animals with malignant neoplasms				
15-Month interim evaluation		1		
2-Year study	17	17	19	19
Total malignant neoplasms				
15-Month interim evaluation		1		
2-Year study	20	20	20	21
Total animals with metastatic neoplasms				
2-Year study	3	2	2	3
Total metastatic neoplasms				
2-Year study	10	3	3	3
Total animals with neoplasms uncertain- benign or malignant				
2-Year study		1		
Total uncertain neoplasms				
2-Year study		1		

^a Number of animals examined microscopically at the site and the number of animals with neoplasm

^b Number of animals with any tissue examined microscopically

^c Primary neoplasms: all neoplasms except metastatic neoplasms

TABLE D2
Individual Animal Tumor Pathology of Female Mice in the 2-Year Inhalation Study of Isobutyl Nitrite:
0 ppm

Number of Days on Study	0	0	5	5	5	5	5	6	6	6	6	6	6	6	6	6	6	6	7	7	7	7	7	7	7	7			
	7	9	7	7	8	8	9	1	3	3	4	4	8	9	9	9	9	9	0	0	2	2	2	2	2	2			
	1	1	2	6	5	9	5	3	5	8	3	9	9	0	1	1	6	9	9	9	9	9	9	9	9	9			
Carcass ID Number	0	1	0	0	0	0	1	0	0	0	1	1	0	0	0	0	1	0	0	0	0	0	0	0	0	0			
	8	1	6	9	7	8	0	7	9	8	0	0	6	7	7	8	0	6	9	6	6	6	6	7	7	7			
	0	5	4	0	6	3	3	8	5	9	9	5	8	4	5	2	8	2	1	3	6	9	0	1	9				
Alimentary System																													
Esophagus	+	+	+	+	+	+	+	+	+	+	+	+	+	+	+	+	+	+	+	+	+	+	+	+	+	+	+		
Gallbladder	+	A	M	A	A	+	+	+	+	+	M	+	+	+	+	+	+	+	+	+	+	+	+	+	+	+	+		
Intestine large, colon	+	+	+	+	+	+	+	+	+	+	+	+	+	+	+	+	+	+	+	+	+	+	+	+	+	+	+		
Intestine large, rectum	+	+	A	+	+	M	+	+	+	+	A	+	+	+	+	+	+	+	+	+	+	+	+	+	+	+	+		
Schwannoma malignant, metastatic, skin																											X		
Intestine large, cecum	+	+	A	+	+	+	+	+	+	+	A	+	A	+	+	+	+	+	+	+	+	+	+	+	+	+	+		
Intestine small, duodenum	A	A	A	+	A	+	A	+	+	+	A	+	A	+	+	+	A	+	A	+	+	+	+	+	+	+	+		
Intestine small, jejunum	+	A	+	+	+	+	M	+	A	+	A	+	A	+	+	+	A	+	A	+	+	+	+	+	+	+	+		
Intestine small, ileum	+	+	A	A	+	+	A	+	A	+	A	+	A	+	+	+	A	+	+	+	+	+	+	+	+	+	+		
Liver	+	+	+	+	+	+	+	+	+	+	+	+	+	+	+	+	+	+	+	+	+	+	+	+	+	+	+		
Hepatocellular carcinoma			X			X																							
Hepatocellular carcinoma, multiple																													
Hepatocellular adenoma																X											X		
Hepatocholangiocarcinoma																	X												
Histiocytic sarcoma					X						X																		
Mesentery																													
Hepatocellular carcinoma, metastatic, liver																													
Pancreas	+	+	+	+	+	+	+	+	+	+	+	+	+	+	+	+	+	+	+	+	+	+	+	+	+	+	+		
Hepatocholangiocarcinoma, metastatic, liver																													
Schwannoma malignant, metastatic, skin																													
Salivary glands	+	+	+	+	+	+	+	+	+	+	+	+	+	+	+	+	+	+	+	+	+	+	+	+	+	+	+		
Stomach, forestomach	+	+	+	+	+	+	+	+	+	+	+	+	+	+	+	+	+	+	+	+	+	+	+	+	+	+	+		
Stomach, glandular	+	+	+	+	+	+	+	+	+	+	+	+	+	+	+	+	+	+	+	+	+	+	+	+	+	+	+		
Tooth																													
Cardiovascular System																													
Heart	+	+	+	+	+	+	+	+	+	+	+	+	+	+	+	+	+	+	+	+	+	+	+	+	+	+	+		
Hepatocholangiocarcinoma, metastatic, liver																													
Endocrine System																													
Adrenal cortex	+	+	+	+	+	+	+	+	+	+	+	+	+	+	+	+	+	+	+	+	+	+	+	+	+	+	M	+	
Adrenal medulla	+	+	+	+	+	+	+																					M	+
Islets, pancreatic																													
Parathyroid gland	+	+	+	M	M	+	M	+	M	M	+	+	+	M	M	+	M	+	+	M	M	M	+	+	+	+	M	+	
Pituitary gland	+	+	+	+	M	+	M	+	+	+	+	+	+	+	+	+	+	+	+	+	+	+	+	+	+	+	+	+	
Pars distalis, adenoma																													
Pars intermedia, adenoma																													
Thyroid gland	+	+	+	+	+	+	+	+	+	+	+	+	+	+	+	+	+	+	+	+	+	+	+	+	+	+	+	+	
Follicular cell, adenoma																													
General Body System																													
None																													

+: Tissue examined microscopically
 A: Autolysis precludes examination

M: Missing tissue
 I: Insufficient tissue

X: Lesion present
 Blank: Not examined

TABLE D2 Individual Animal Tumor Pathology of Female Mice in the 2-Year Inhalation Study of Isobutyl Nitrite: 0 ppm (continued)

Table with columns for Carcass ID Number, Number of Days on Study, and various organ systems (Alimentary, Cardiovascular, Endocrine, General Body) with counts and tumor types.

TABLE D2
Individual Animal Tumor Pathology of Female Mice in the 2-Year Inhalation Study of Isobutyl Nitrite:
0 ppm (continued)

Number of Days on Study	0 0 5 5 5 5 5 6 6 6 6 6 6 6 6 6 6 7 7 7 7 7 7 7 7
	7 9 7 7 8 8 9 1 3 3 4 4 8 9 9 9 9 0 0 2 2 2 2 2 2
	1 1 2 6 5 9 5 3 5 8 3 9 9 0 1 1 6 9 9 9 9 9 9 9 9
Carcass ID Number	0 1 0 0 0 0 1 0 0 0 1 1 0 0 0 0 1 0 0 0 0 0 0 0 0
	8 1 6 9 7 8 0 7 9 8 0 0 6 7 7 8 0 6 9 6 6 6 7 7 7
	0 5 4 0 6 3 3 8 5 9 9 5 8 4 5 2 8 2 1 3 6 9 0 1 9
Genital System	
Ovary	+ +
Cystadenoma	
Uterus	+ +
Hemangioma	
Histiocytic sarcoma	
Polyp stromal	
Sarcoma stromal	
Vagina	
Histiocytic sarcoma	
Hematopoietic System	
Bone marrow	+ +
Lymph node	
Inguinal, histiocytic sarcoma	
Lumbar, histiocytic sarcoma	
Pancreatic, hepatocholangiocarcinoma, metastatic, liver	
Renal, histiocytic sarcoma	
Lymph node, bronchial	+ + M M M + M + M M M M M M M M M + M + + + + M +
Lymph node, mandibular	+ + + + + + + + + M + + + + + + + + + + + + + +
Histiocytic sarcoma	
Lymph node, mesenteric	+ +
Lymph node, mediastinal	+ + + + + + + + M + + + + + + + + + + + + + + + +
Histiocytic sarcoma	
Spleen	+ +
Hemangiosarcoma	
Histiocytic sarcoma	
Thymus	+ M + + + + M + + + + + + + + + + + + + + + + +
Integumentary System	
Mammary gland	+ + + + + + + + + + + + M M + + + + + + + + + +
Skin	+ +
Subcutaneous tissue, hemangioma	
Subcutaneous tissue, sarcoma	
Subcutaneous tissue, schwannoma malignant	
Musculoskeletal System	
Bone	+ +
Schwannoma malignant, metastatic, skin	

TABLE D2
Individual Animal Tumor Pathology of Female Mice in the 2-Year Inhalation Study of Isobutyl Nitrite:
0 ppm (continued)

Number of Days on Study	7 7	
	2 2 2 2 2 2 2 3 3 3 3 3 3 3 3 3 3 3 3 3 3 3 3 3 3	
	9 9 9 9 9 9 9 0 0 0 0 0 0 0 0 0 0 1 1 1 1 1 1 1 1 1	
Carcass ID Number	0 0 0 0 0 1 1 0 0 0 0 0 0 0 0 1 1 0 0 0 0 0 0 1 1 1	Total
	8 8 8 9 9 0 0 6 8 8 9 9 9 9 9 0 0 6 6 7 7 7 7 8 0 0 1	Tissues/
	4 5 8 2 6 1 6 7 1 6 3 4 7 8 9 4 7 1 5 2 3 7 7 0 2 0	Tumors
Genital System		
Ovary	+ + + + + + + + M + + + + + + + M + + + + + + + + +	49
Cystadenoma		1
X		
Uterus	+ +	51
Hemangioma		1
Histiocytic sarcoma		2
Polyp stromal	X X X	3
Sarcoma stromal		1
Vagina		1
Histiocytic sarcoma		1
Hematopoietic System		
Bone marrow	+ +	51
Lymph node		4
Inguinal, histiocytic sarcoma		1
Lumbar, histiocytic sarcoma		1
Pancreatic, hepatocholangiocarcinoma, metastatic, liver		1
Renal, histiocytic sarcoma		1
Lymph node, bronchial	M M + + + M M M M + + + M M M M M M + + + + M M M M	20
Lymph node, mandibular	+ +	49
Histiocytic sarcoma		1
Lymph node, mesenteric	+ +	51
Lymph node, mediastinal	+ + + + + M + + + + + + + + + + + + + + + + + + +	49
Histiocytic sarcoma		1
Spleen	+ +	51
Hemangiosarcoma		1
Histiocytic sarcoma		1
Thymus	+ + + + + + + + M + + + + + + + + + + + + + M + + + +	47
Integumentary System		
Mammary gland	+ +	49
Skin	+ +	51
Subcutaneous tissue, hemangioma		1
Subcutaneous tissue, sarcoma	X	1
Subcutaneous tissue, schwannoma malignant		1
Musculoskeletal System		
Bone	+ +	51
Schwannoma malignant, metastatic, skin		1

TABLE D2
Individual Animal Tumor Pathology of Female Mice in the 2-Year Inhalation Study of Isobutyl Nitrite:
0 ppm (continued)

Number of Days on Study	0 0 5 5 5 5 5 6 6 6 6 6 6 6 6 6 7 7 7 7 7 7 7 7
	7 9 7 7 8 8 9 1 3 3 4 4 8 9 9 9 9 0 0 2 2 2 2 2 2
	1 1 2 6 5 9 5 3 5 8 3 9 9 0 1 1 6 9 9 9 9 9 9 9 9
Carcass ID Number	0 1 0 0 0 0 1 0 0 0 1 1 0 0 0 0 1 0 0 0 0 0 0 0
	8 1 6 9 7 8 0 7 9 8 0 0 6 7 7 8 0 6 9 6 6 6 7 7 7
	0 5 4 0 6 3 3 8 5 9 9 5 8 4 5 2 8 2 1 3 6 9 0 1 9
Nervous System	
Brain	+ M +
Respiratory System	
Larynx	+ +
Lung	+ +
Alveolar/bronchiolar adenoma	
Alveolar/bronchiolar carcinoma	
Hepatocellular carcinoma, metastatic, liver	X
Hepatocholangiocarcinoma, metastatic, liver	
Mediastinum, hepatocholangiocarcinoma, metastatic, liver	
Nose	+ +
Trachea	+ +
Special Senses System	
None	
Urinary System	
Kidney	+ +
Urinary bladder	+ + + + + + + + + + + + + + + + + A + + + + + + +
Systemic Lesions	
Multiple organs	+ +
Histiocytic sarcoma	
Lymphoma malignant histiocytic	X
Lymphoma malignant lymphocytic	
Lymphoma malignant mixed	X X X X

TABLE D2
Individual Animal Tumor Pathology of Female Mice in the 2-Year Inhalation Study of Isobutyl Nitrite:
37.5 ppm

Number of Days on Study	1 5 5 5 6 6 6 7 7 7 7 7 7 7 7 7 7 7 7 7 7 7 7
	8 1 2 8 1 4 9 0 2 2 2 2 2 2 2 2 2 2 2 2 2 2 2
	3 2 0 6 4 5 7 7 8 9 9 9 9 9 9 9 9 9 9 9 9 9 9
Carcass ID Number	2 2 1 2 1 1 1 1 1 1 1 1 1 2 2 2 2 2 2 2 2 2 2 2
	4 1 8 1 9 9 8 9 9 8 8 9 9 0 0 0 0 0 1 1 1 1 2 2 2
	0 9 9 8 8 9 3 4 2 2 8 1 5 0 2 6 7 9 0 2 3 6 0 5 6
Alimentary System	
Esophagus	+ +
Squamous cell carcinoma	
Gallbladder	+ + M +
Intestine large, colon	+ +
Intestine large, rectum	+ +
Intestine large, cecum	A + A +
Intestine small, duodenum	A +
Intestine small, jejunum	M +
Intestine small, ileum	A + + + + + + A + + + + + + + + + + + + + + + + + +
Liver	+ +
Hepatocellular carcinoma	
Hepatocellular adenoma	
Histiocytic sarcoma	
Histiocytic sarcoma	
Mesentery	
Pancreas	+ +
Salivary glands	+ +
Stomach, forestomach	+ +
Stomach, glandular	+ +
Cardiovascular System	
Heart	+ +
Endocrine System	
Adrenal cortex	+ +
Adrenal medulla	+ +
Pheochromocytoma malignant	X
Islets, pancreatic	
Adenoma	
Parathyroid gland	+ M + M M M M + + + M + M M M M + + M + + + + + M
Pituitary gland	+ + + + + + M + + + + + + + + + + + + + + + + + +
Pars distalis, adenoma	
Pars intermedia, adenoma	
Thyroid gland	+ +
Follicular cell, adenoma	
General Body System	
None	
Genital System	
Clitoral gland	
Ovary	+ +
Uterus	+ +
Deciduoma NOS	
Histiocytic sarcoma	
Polyp stromal	

TABLE D2

Individual Animal Tumor Pathology of Female Mice in the 2-Year Inhalation Study of Isobutyl Nitrite:
37.5 ppm (continued)

Number of Days on Study	7	7	7	7	7	7	7	7	7	7	7	7	7	7	7	7	7	7	7	7	7	7	7	7	7	7	7	7	7	7	7	Total			
Carcass ID Number	2	2	2	3	3	3	3	3	3	3	3	3	3	3	3	3	3	3	3	3	3	3	3	3	3	3	3	3	3	3	3	Tissues/ Tumors			
Alimentary System																																			
Esophagus	+	+	+	+	+	+	+	+	+	+	+	+	+	+	+	+	+	+	+	+	+	+	+	+	+	+	+	+	+	M	+	50			
Squamous cell carcinoma																															X	1			
Gallbladder	+	+	+	+	+	+	+	+	+	M	+	+	M	+	+	+	+	+	+	+	+	+	+	+	+	+	+	+	M	+	+	+	47		
Intestine large, colon	+	+	+	+	+	+	+	+	+	+	+	+	+	+	+	+	+	+	+	+	+	+	+	+	+	+	+	+	+	+	+	+	51		
Intestine large, rectum	+	+	+	+	+	+	+	+	+	+	+	+	+	+	+	+	+	+	+	+	+	+	+	+	+	+	+	+	+	+	+	+	51		
Intestine large, cecum	+	+	+	+	+	+	+	+	+	+	+	+	+	+	+	+	+	+	+	+	+	+	+	+	+	+	+	+	+	+	+	+	49		
Intestine small, duodenum	+	+	+	+	+	+	+	+	+	+	+	+	+	+	+	+	+	+	+	+	+	+	+	+	+	+	+	+	+	+	+	+	50		
Intestine small, jejunum	+	+	+	+	+	+	+	+	+	+	+	+	+	+	+	+	+	+	+	+	+	+	+	+	+	+	+	+	+	+	+	+	50		
Intestine small, ileum	+	+	+	+	+	+	+	+	+	+	+	+	+	+	+	+	+	+	+	+	+	+	+	+	+	+	+	+	+	+	+	M	+	48	
Liver	+	+	+	+	+	+	+	+	+	+	+	+	+	+	+	+	+	+	+	+	+	+	+	+	+	+	+	+	+	+	+	+	51		
Hepatocellular carcinoma																															X	4			
Hepatocellular adenoma								X			X	X				X											X			X	X	10			
Histiocytic sarcoma																																	1		
Mesentery																																+	4		
Pancreas	+	+	+	+	+	+	+	+	+	+	+	+	+	+	+	+	+	+	+	+	+	+	+	+	+	+	+	+	+	+	+	+	51		
Salivary glands	+	+	+	+	+	+	+	+	+	+	+	+	+	+	+	+	+	+	+	+	+	+	+	+	+	+	+	+	+	+	+	+	51		
Stomach, forestomach	+	+	+	+	+	+	+	+	+	+	+	+	+	+	+	+	+	+	+	+	+	+	+	+	+	+	+	+	+	+	+	+	+	51	
Stomach, glandular	+	+	+	+	+	+	+	+	+	+	+	+	+	+	+	+	+	+	+	+	+	+	+	+	+	+	+	+	+	+	+	+	+	51	
Cardiovascular System																																			
Heart	+	+	+	+	+	+	+	+	+	+	+	+	+	+	+	+	+	+	+	+	+	+	+	+	+	+	+	+	+	+	+	+	51		
Endocrine System																																			
Adrenal cortex	+	+	+	+	+	+	+	+	+	+	+	+	+	+	+	+	+	+	+	+	+	+	+	+	+	+	+	+	+	+	+	+	51		
Adrenal medulla	+	+	+	+	+	+	+	+	+	+	+	+	+	+	+	+	+	+	+	+	+	+	+	+	+	+	+	+	+	+	+	+	+	49	
Pheochromocytoma malignant																																		1	
Islets, pancreatic	+																																	2	
Adenoma																																		1	
Parathyroid gland	M	M	+	M	+	+	+	+	+	+	+	+	M	+	+	M	M	+	M	+	+	+	+	M	M	M	+	+	+	+	+	+	29		
Pituitary gland	+	+	+	+	+	+	+	+	+	+	+	+	+	+	+	+	+	+	+	+	+	+	+	+	+	+	+	+	+	+	+	+	+	48	
Pars distalis, adenoma								X	X		X	X	X													X	X	X	X	X	X	X	19		
Pars intermedia, adenoma																											X							2	
Thyroid gland	+	+	+	+	+	+	+	+	+	+	+	+	+	+	+	+	+	+	+	+	+	+	+	+	+	+	+	+	+	+	+	+	+	51	
Follicular cell, adenoma	X				X																													3	
General Body System																																			
None																																			
Genital System																																			
Clitoral gland	+																																1		
Ovary	+	+	+	+	+	+	+	+	+	+	+	+	+	+	+	+	+	+	+	+	+	+	+	+	+	+	+	+	+	+	+	+	M	+	50
Uterus	+	+	+	+	+	+	+	+	+	+	+	+	+	+	+	+	+	+	+	+	+	+	+	+	+	+	+	+	+	+	+	+	+	+	51
Deciduoma NOS																																			1
Histiocytic sarcoma																																	X		2
Polyp stromal																												X							2

TABLE D2
Individual Animal Tumor Pathology of Female Mice in the 2-Year Inhalation Study of Isobutyl Nitrite:
37.5 ppm (continued)

Number of Days on Study	1	5	5	5	6	6	6	7	7	7	7	7	7	7	7	7	7	7	7	7	7	7	7	7	
	8	1	2	8	1	4	9	0	2	2	2	2	2	2	2	2	2	2	2	2	2	2	2	2	
	3	2	0	6	4	5	7	7	8	9	9	9	9	9	9	9	9	9	9	9	9	9	9	9	
Carcass ID Number	2	2	1	2	1	1	1	1	1	1	1	1	1	2	2	2	2	2	2	2	2	2	2	2	
	4	1	8	1	9	9	8	9	9	8	8	9	9	0	0	0	0	0	1	1	1	1	2	2	
	0	9	9	8	8	9	3	4	2	2	8	1	5	0	2	6	7	9	0	2	3	6	0	5	
Hematopoietic System																									
Bone marrow	+ +																								
Lymph node	+ +																								
Lymph node, bronchial	M	+	M	M	M	M	M	+	+	+	+	+	+	M	M	+	+	+	+	+	+	+	M	M	+
Lymph node, mandibular	+ +																								
Lymph node, mesenteric	A	+	+	+	+	+	+	+	+	+	+	+	+	+	+	+	+	+	+	+	+	+	+	+	+
Lymph node, mediastinal	+	M	+	+	+	+	+	+	+	+	+	+	M	+	+	+	+	+	+	+	+	+	+	+	+
Spleen	+ +																								
Hemangiosarcoma	X																								
Thymus	+	M	+	M	+	+	+	+	+	+	+	+	+	+	+	+	+	+	+	+	+	+	+	+	+
Integumentary System																									
Mammary gland	+ +																								
Skin	+ +																								
Subcutaneous tissue, hemangiosarcoma	X																								
Musculoskeletal System																									
Bone	+ +																								
Hemangioma	+																								
Skeletal muscle	+																								
Hemangiosarcoma	X																								
Osteosarcoma	X																								
Nervous System																									
Brain	+ +																								
Respiratory System																									
Larynx	+ +																								
Lung	+ +																								
Alveolar/bronchiolar adenoma	X																								
Alveolar/bronchiolar adenoma, multiple	X																								
Alveolar/bronchiolar carcinoma	X																								
Hepatocellular carcinoma, metastatic, liver	X																								
Osteosarcoma, metastatic, skeletal muscle	X																								
Nose	+ +																								
Trachea	+ +																								
Special Senses System																									
Harderian gland	+																								
Adenoma	X																								
Urinary System																									
Kidney	+ +																								
Osteosarcoma, metastatic, skeletal muscle	X																								
Urinary bladder	+ +																								
Systemic Lesions																									
Multiple organs	+ +																								
Histiocytic sarcoma	X																								
Lymphoma malignant mixed	X																								
Lymphoma malignant undifferentiated cell type	X																								

TABLE D2
Individual Animal Tumor Pathology of Female Mice in the 2-Year Inhalation Study of Isobutyl Nitrite:
37.5 ppm (continued)

Number of Days on Study	7 7	
	2 2 2 3	
	9 9 9 0 0 0 0 0 0 0 0 0 0 0 0 0 0 0 1 1 1 1 1 1 1	
Carcass ID Number	2 2 2 1 1 1 1 2 2 2 2 2 2 2 2 2 1 1 1 1 2 2 2 2 2	Total
	2 2 3 8 9 9 9 0 0 0 1 1 2 2 2 2 8 8 8 8 9 0 0 1 1 2	Tissues/ Tumors
	8 9 0 4 3 6 7 3 5 8 5 7 1 2 3 7 1 5 6 7 0 1 4 1 4 4	
Hematopoietic System		
Bone marrow	+ +	51
Lymph node		5
Lymph node, bronchial	+ M M + M + M + + + + M + M + + + + + + + + M + + +	34
Lymph node, mandibular	+ + + M + + + + + + + + + + + + + + + + + M + + +	48
Lymph node, mesenteric	+ +	50
Lymph node, mediastinal	+ + + M + M + M + + M + + + + + M + + + + + + + + + + +	44
Spleen	+ +	51
Hemangiosarcoma		1
Thymus	+ + + + + + + + + + + + + + + + M + + + + + + + + M + +	47
Integumentary System		
Mammary gland	+ +	51
Skin	+ +	51
Subcutaneous tissue, hemangiosarcoma		1
Musculoskeletal System		
Bone	+ +	51
Hemangioma		1
Skeletal muscle		3
Hemangiosarcoma		1
Osteosarcoma		1
Nervous System		
Brain	+ +	51
Respiratory System		
Larynx	+ + + + + + + + + + + + + + M + + + + + + + + + + + + + +	49
Lung	+ +	51
Alveolar/bronchiolar adenoma	X	12
Alveolar/bronchiolar adenoma, multiple		2
Alveolar/bronchiolar carcinoma		2
Hepatocellular carcinoma, metastatic, liver		1
Osteosarcoma, metastatic, skeletal muscle		1
Nose	+ +	51
Trachea	+ +	51
Special Senses System		
Harderian gland		1
Adenoma		1
Urinary System		
Kidney	+ +	51
Osteosarcoma, metastatic, skeletal muscle		1
Urinary bladder	+ +	50
Systemic Lesions		
Multiple organs	+ +	51
Histiocytic sarcoma		2
Lymphoma malignant mixed	X	4
Lymphoma malignant undifferentiated cell type		2

TABLE D2
Individual Animal Tumor Pathology of Female Mice in the 2-Year Inhalation Study of Isobutyl Nitrite:
75 ppm (continued)

Number of Days on Study	2 4 4 4 5 5 5 6 6 6 6 6 7 7 7 7 7 7 7 7 7 7 7
	1 1 3 6 5 5 8 2 3 3 6 6 0 1 2 2 2 2 2 2 2 2 2
	0 5 4 0 8 8 5 8 6 9 0 3 6 9 9 9 9 9 9 9 9 9 9
Carcass ID Number	3 3
	5 3 0 0 1 5 3 0 2 3 2 1 2 1 0 0 0 1 1 2 2 3 4 4
	5 1 6 8 9 0 5 9 7 4 1 7 3 0 1 2 5 4 6 2 9 9 0 1
Hematopoietic System	
Bone marrow	+ +
Lymph node	+ +
Lymph node, bronchial	M + + + + + M + + M M M + M + M M + + M + + M M
Lymph node, mandibular	+ +
Lymph node, mesenteric	+ M
Lymph node, mediastinal	+ + + + + + + + + + + M + + + + M + + + + + + +
Spleen	+ +
Thymus	+ +
Integumentary System	
Mammary gland	+ +
Adenocarcinoma	
Adenoma	
Skin	+ +
Subcutaneous tissue, fibrosarcoma	X
Subcutaneous tissue, sarcoma	
Musculoskeletal System	
Bone	+ +
Skeletal muscle	+ +
Nervous System	
Brain	+ +
Respiratory System	
Larynx	+ +
Lung	+ +
Adenoma	X
Alveolar/bronchiolar adenoma	
Alveolar/bronchiolar adenoma, multiple	
Alveolar/bronchiolar carcinoma	X
Hepatocellular carcinoma, metastatic, liver	
Mediastinum, hepatocellular carcinoma, metastatic, liver	
Nose	+ +
Trachea	+ +
Special Senses System	
Harderian gland	+ +
Adenoma	
Urinary System	
Kidney	+ +
Urinary bladder	+ +
Systemic Lesions	
Multiple organs	+ +
Lymphoma malignant lymphocytic	X
Lymphoma malignant mixed	X
Lymphoma malignant undifferentiated cell type	X
	X X

TABLE D3
Statistical Analysis of Primary Neoplasms in Female Mice in the 2-Year Inhalation Study of Isobutyl Nitrite

	0 ppm	37.5 ppm	75 ppm	150 ppm
Liver: Hepatocellular Adenoma				
Overall rate ^a	6/51 (12%)	10/51 (20%)	7/50 (14%)	6/50 (12%)
Adjusted rate ^b	17.8%	23.8%	19.4%	15.8%
Terminal rate ^c	5/32 (16%)	10/42 (24%)	7/36 (19%)	5/37 (14%)
First incidence (days)	690	729 (T)	729 (T)	724
Life table test ^d	P=0.353N	P=0.402	P=0.584	P=0.519N
Logistic regression test ^d	P=0.355N	P=0.357	P=0.549	P=0.550N
Cochran-Armitage test ^d	P=0.423N			
Fisher exact test ^d		P=0.207	P=0.485	P=0.606
Liver: Hepatocellular Carcinoma				
Overall rate	4/51 (8%)	4/51 (8%)	2/50 (4%)	5/50 (10%)
Adjusted rate	9.8%	9.3%	5.6%	13.0%
Terminal rate	1/32 (3%)	3/42 (7%)	2/36 (6%)	4/37 (11%)
First incidence (days)	572	707	729 (T)	716
Life table test	P=0.473	P=0.529N	P=0.321N	P=0.564
Logistic regression test	P=0.425	P=0.640	P=0.347N	P=0.486
Cochran-Armitage test	P=0.433			
Fisher exact test		P=0.642N	P=0.348N	P=0.487
Liver: Hepatocellular Adenoma or Carcinoma				
Overall rate	10/51 (20%)	13/51 (25%)	7/50 (14%)	10/50 (20%)
Adjusted rate	26.4%	30.2%	19.4%	25.6%
Terminal rate	6/32 (19%)	12/42 (29%)	7/36 (19%)	8/37 (22%)
First incidence (days)	572	707	729 (T)	716
Life table test	P=0.351N	P=0.571	P=0.239N	P=0.476N
Logistic regression test	P=0.419N	P=0.379	P=0.305N	P=0.590
Cochran-Armitage test	P=0.427N			
Fisher exact test		P=0.318	P=0.314N	P=0.579
Lung: Alveolar/bronchiolar Adenoma				
Overall rate	4/51 (8%)	14/51 (27%)	7/50 (14%)	17/50 (34%)
Adjusted rate	11.7%	33.3%	18.5%	43.3%
Terminal rate	3/32 (9%)	14/42 (33%)	6/36 (17%)	15/37 (41%)
First incidence (days)	689	729 (T)	558	625
Life table test	P=0.007	P=0.038	P=0.315	P=0.004
Logistic regression test	P=0.005	P=0.028	P=0.255	P=0.002
Cochran-Armitage test	P=0.005			
Fisher exact test		P=0.009	P=0.251	P=0.001
Lung: Alveolar/bronchiolar Adenoma or Carcinoma				
Overall rate	6/51 (12%)	15/51 (29%)	9/50 (18%)	19/50 (38%)
Adjusted rate	17.0%	35.7%	23.9%	48.5%
Terminal rate	4/32 (13%)	15/42 (36%)	8/36 (22%)	17/37 (46%)
First incidence (days)	689	729 (T)	558	625
Life table test	P=0.009	P=0.094	P=0.355	P=0.008
Logistic regression test	P=0.005	P=0.061	P=0.281	P=0.003
Cochran-Armitage test	P=0.006			
Fisher exact test		P=0.024	P=0.274	P=0.002

TABLE D3

Statistical Analysis of Primary Neoplasms in Female Mice in the 2-Year Inhalation Study of Isobutyl Nitrite (continued)

	0 ppm	37.5 ppm	75 ppm	150 ppm
Pituitary Gland (Pars Distalis): Adenoma				
Overall rate	12/48 (25%)	19/48 (40%)	18/50 (36%)	13/47 (28%)
Adjusted rate	34.2%	47.5%	47.1%	34.6%
Terminal rate	9/31 (29%)	19/40 (48%)	16/36 (44%)	11/35 (31%)
First incidence (days)	635	729 (T)	585	583
Life table test	P=0.420N	P=0.305	P=0.248	P=0.563N
Logistic regression test	P=0.511N	P=0.158	P=0.158	P=0.476
Cochran-Armitage test	P=0.501N			
Fisher exact test		P=0.095	P=0.168	P=0.475
Thyroid Gland (Follicular Cell): Adenoma				
Overall rate	4/51 (8%)	3/51 (6%)	2/50 (4%)	2/50 (4%)
Adjusted rate	11.6%	7.1%	5.6%	5.4%
Terminal rate	3/32 (9%)	3/42 (7%)	2/36 (6%)	2/37 (5%)
First incidence (days)	649	729 (T)	729 (T)	729 (T)
Life table test	P=0.224N	P=0.366N	P=0.294N	P=0.282N
Logistic regression test	P=0.245N	P=0.445N	P=0.336N	P=0.329N
Cochran-Armitage test	P=0.257N			
Fisher exact test		P=0.500N	P=0.348N	P=0.348N
All Organs: Hemangiosarcoma				
Overall rate	1/51 (2%)	3/51 (6%)	0/50 (0%)	0/50 (0%)
Adjusted rate	2.6%	7.1%	0.0%	0.0%
Terminal rate	0/32 (0%)	3/42 (7%)	0/36 (0%)	0/37 (0%)
First incidence (days)	690	729 (T)	— ^c	—
Life table test	P=0.141N	P=0.398	P=0.500N	P=0.485N
Logistic regression test	P=0.151N	P=0.345	P=0.503N	P=0.504N
Cochran-Armitage test	P=0.155N			
Fisher exact test		P=0.309	P=0.505N	P=0.505N
All Organs: Hemangioma or Hemangiosarcoma				
Overall rate	3/51 (6%)	4/51 (8%)	0/50 (0%)	1/50 (2%)
Adjusted rate	8.4%	9.5%	0.0%	2.5%
Terminal rate	1/32 (3%)	4/42 (10%)	0/36 (0%)	0/37 (0%)
First incidence (days)	690	729 (T)	—	716
Life table test	P=0.097N	P=0.633	P=0.112N	P=0.257N
Logistic regression test	P=0.110N	P=0.570	P=0.122N	P=0.545N
Cochran-Armitage test	P=0.115N			
Fisher exact test		P=0.500	P=0.125N	P=0.316N
All Organs: Malignant Lymphoma (Histiocytic, Lymphocytic, Mixed, or Undifferentiated Cell Type)				
Overall rate	7/51 (14%)	6/51 (12%)	11/50 (22%)	9/50 (18%)
Adjusted rate	17.6%	13.3%	27.6%	21.8%
Terminal rate	3/32 (9%)	4/42 (10%)	8/36 (22%)	6/37 (16%)
First incidence (days)	585	520	558	114
Life table test	P=0.276	P=0.367N	P=0.276	P=0.470
Logistic regression test	P=0.237	P=0.519N	P=0.207	P=0.381
Cochran-Armitage test	P=0.232			
Fisher exact test		P=0.500N	P=0.205	P=0.376

TABLE D3
Statistical Analysis of Primary Neoplasms in Female Mice in the 2-Year Inhalation Study of Isobutyl Nitrite (continued)

	0 ppm	37.5 ppm	75 ppm	150 ppm
All Organs: Benign Neoplasms				
Overall rate	27/51 (53%)	38/51 (75%)	31/50 (62%)	33/50 (66%)
Adjusted rate	68.8%	84.4%	75.3%	76.7%
Terminal rate	20/32 (63%)	35/42 (83%)	26/36 (72%)	27/37 (73%)
First incidence (days)	635	183	210	583
Life table test	P=0.437	P=0.360	P=0.479	P=0.416
Logistic regression test	P=0.250	P=0.060	P=0.230	P=0.133
Cochran-Armitage test	P=0.251			
Fisher exact test		P=0.019	P=0.236	P=0.128
All Organs: Malignant Neoplasms				
Overall rate	18/51 (35%)	18/51 (35%)	19/50 (38%)	19/50 (38%)
Adjusted rate	40.5%	37.1%	45.4%	44.6%
Terminal rate	7/32 (22%)	12/42 (29%)	14/36 (39%)	14/37 (38%)
First incidence (days)	572	183	210	114
Life table test	P=0.491	P=0.331N	P=0.561N	P=0.513N
Logistic regression test	P=0.356	P=0.380	P=0.465	P=0.358
Cochran-Armitage test	P=0.405			
Fisher exact test		P=0.582N	P=0.470	P=0.470
All Organs: Benign or Malignant Neoplasms				
Overall rate	37/51 (73%)	46/51 (90%)	37/50 (74%)	40/50 (80%)
Adjusted rate	80.1%	92.0%	83.8%	86.9%
Terminal rate	23/32 (72%)	38/42 (90%)	29/36 (81%)	31/37 (84%)
First incidence (days)	572	183	210	114
Life table test	P=0.410N	P=0.532N	P=0.373N	P=0.480N
Logistic regression test	P=0.399	P=0.031	P=0.544	P=0.226
Cochran-Armitage test	P=0.458			
Fisher exact test		P=0.020	P=0.524	P=0.260

(T)Terminal sacrifice

- ^a Number of neoplasm-bearing animals/number of animals examined. Denominator is number of animals examined microscopically for liver, lung, pituitary gland, and thyroid gland; for other tissues, denominator is number of animals necropsied.
- ^b Kaplan-Meier estimated neoplasm incidence at the end of the study after adjustment for intercurrent mortality
- ^c Observed incidence at terminal kill
- ^d Beneath the control incidence are the P values associated with the trend test. Beneath the dosed group incidence are the P values corresponding to pairwise comparisons between the controls and that dosed group. The life table test regards neoplasms in animals dying prior to terminal kill as being (directly or indirectly) the cause of death. The logistic regression test regards these lesions as nonfatal. The Cochran-Armitage and Fisher exact tests compare directly the overall incidence rates. For all tests, a negative trend or a lower incidence in a dose group is indicated by N.
- ^e Not applicable; no neoplasms in animal group

TABLE D4
Historical Incidence of Alveolar/bronchiolar Neoplasms in Chamber Control Female B6C3F₁ Mice^a

	Incidence in Controls		
	Adenoma	Carcinoma	Adenoma or Carcinoma
Overall Historical Incidence			
Total	53/761 (7.0%)	23/761 (3.0%)	75/761 (9.9%)
Standard deviation	3.3%	2.4%	3.7%
Range	0%-14%	0%-6%	0%-16%

^a Data as of 17 June 1994; no data are available for studies performed at IITRI

TABLE D5
Summary of the Incidence of Nonneoplastic Lesions in Female Mice in the 2-Year Inhalation Study of Isobutyl Nitrite^a

	0 ppm	37.5 ppm	75 ppm	150 ppm
Disposition Summary				
Animals initially in study	60	60	60	60
<i>15-Month interim evaluation</i>	9	9	9	10
Early deaths				
Accidental death				1
Moribund	3	3	6	2
Natural deaths	16	6	8	10
Survivors				
Terminal sacrifice	32	42	36	37
Missing			1	
Animals examined microscopically	60	60	59	60
15-Month Interim Evaluation				
Alimentary System				
Salivary glands	(9)	(9)	(9)	(10)
Inflammation, chronic	5 (56%)	4 (44%)	5 (56%)	3 (30%)
Endocrine System				
Adrenal cortex	(9)	(9)	(9)	(10)
Subcapsular, hyperplasia	9 (100%)	9 (100%)	9 (100%)	9 (90%)
Genital System				
Clitoral gland				(2)
Pigmentation				2 (100%)
Ovary	(9)	(9)	(9)	(10)
Cyst	2 (22%)	1 (11%)		2 (20%)
Uterus	(9)	(9)	(9)	(10)
Angiectasis				1 (10%)
Hemorrhage	1 (11%)			
Hyperplasia, cystic	9 (100%)	9 (100%)	7 (78%)	10 (100%)
Hematopoietic System				
Lymph node, bronchial	(8)	(8)	(8)	(8)
Hemorrhage		1 (13%)		
Lymph node, mandibular	(9)	(9)	(9)	(10)
Hemorrhage		1 (11%)		
Lymph node, mediastinal	(9)	(7)	(6)	(10)
Hyperplasia, lymphoid			1 (17%)	
Spleen	(9)	(9)	(9)	(10)
Hematopoietic cell proliferation	9 (100%)	9 (100%)	9 (100%)	10 (100%)
Hyperplasia, lymphoid			1 (11%)	
Pigmentation, hemosiderin	9 (100%)	9 (100%)	9 (100%)	10 (100%)
Thymus	(9)	(9)	(9)	(10)
Atrophy			1 (11%)	
Hyperplasia, lymphoid	1 (11%)		1 (11%)	

^a Number of animals examined microscopically at the site and the number of animals with lesion

TABLE D5
Summary of the Incidence of Nonneoplastic Lesions in Female Mice in the 2-Year Inhalation Study of Isobutyl Nitrite
(continued)

	0 ppm	37.5 ppm	75 ppm	150 ppm
15-Month Interim Evaluation (continued)				
Integumentary System				
Skin	(9)	(9)	(9)	(10)
Epithelium, hyperplasia	1 (11%)			
Sebaceous gland, hyperplasia, focal			1 (11%)	
Musculoskeletal System				
Bone	(9)	(9)	(9)	(10)
Dysplasia	2 (22%)		1 (11%)	3 (30%)
Nervous System				
Brain	(9)	(9)	(9)	(10)
Mineralization	6 (67%)	5 (56%)	2 (22%)	5 (50%)
Respiratory System				
Lung	(9)	(9)	(9)	(10)
Infiltration cellular, lymphocyte	4 (44%)			1 (10%)
Alveolar epithelium, hyperplasia, focal			1 (11%)	
Nose	(9)	(9)	(9)	(10)
Inflammation, chronic active			2 (22%)	4 (40%)
Olfactory epithelium, degeneration, hyaline	1 (11%)			
Respiratory epithelium, degeneration, hyaline	3 (33%)	1 (11%)		3 (30%)
Urinary System				
Kidney	(9)	(9)	(9)	(10)
Infiltration cellular, lymphocyte	5 (56%)		3 (33%)	1 (10%)
Urinary bladder	(9)	(9)	(9)	(10)
Infiltration cellular, lymphocyte	6 (67%)	7 (78%)	3 (33%)	3 (30%)
Systems Examined With No Lesions Observed				
Cardiovascular System				
General Body System				
Special Senses System				
2-Year Study				
Alimentary System				
Gallbladder	(46)	(47)	(45)	(41)
Dilatation				1 (2%)
Inflammation, chronic			1 (2%)	1 (2%)
Intestine large, rectum	(48)	(51)	(50)	(47)
Dilatation			1 (2%)	
Intestine large, cecum	(48)	(49)	(50)	(45)
Dilatation			1 (2%)	
Hyperplasia, lymphoid			1 (2%)	

TABLE D5

Summary of the Incidence of Nonneoplastic Lesions in Female Mice in the 2-Year Inhalation Study of Isobutyl Nitrite
(continued)

	0 ppm	37.5 ppm	75 ppm	150 ppm
2-Year Study (continued)				
Alimentary System (continued)				
Intestine small, duodenum	(42)	(50)	(49)	(42)
Ectopic tissue		1 (2%)		
Proliferation connective tissue		1 (2%)		
Intestine small, jejunum	(44)	(50)	(47)	(45)
Hyperplasia, lymphoid		1 (2%)		
Proliferation connective tissue		1 (2%)		
Serosa, inflammation, chronic active		1 (2%)		
Intestine small, ileum	(44)	(48)	(50)	(44)
Dilatation			1 (2%)	
Liver	(51)	(51)	(50)	(50)
Angiectasis				1 (2%)
Basophilic focus	2 (4%)			1 (2%)
Clear cell focus		1 (2%)	2 (4%)	1 (2%)
Cytologic alterations	2 (4%)	1 (2%)	1 (2%)	
Eosinophilic focus	1 (2%)	2 (4%)		
Fatty change, diffuse	1 (2%)			
Fibrosis			1 (2%)	
Hematopoietic cell proliferation	1 (2%)	1 (2%)	1 (2%)	
Hemorrhage				1 (2%)
Hyperplasia				2 (4%)
Infarct			1 (2%)	1 (2%)
Inflammation, chronic	11 (22%)	7 (14%)	6 (12%)	7 (14%)
Inflammation, chronic active	2 (4%)	2 (4%)	4 (8%)	
Mitotic alteration		1 (2%)		
Mixed cell focus	3 (6%)	1 (2%)	1 (2%)	2 (4%)
Necrosis	1 (2%)	2 (4%)	2 (4%)	1 (2%)
Pigmentation				1 (2%)
Proliferation connective tissue		1 (2%)		
Fat, necrosis	1 (2%)			
Hepatocyte, necrosis	1 (2%)	1 (2%)	1 (2%)	
Periportal, fatty change	1 (2%)		1 (2%)	
Periportal, hypertrophy		1 (2%)		
Mesentery	(7)	(4)	(3)	(2)
Cyst		1 (25%)		
Proliferation connective tissue		1 (25%)		
Artery, inflammation, chronic	1 (14%)			
Fat, necrosis	5 (71%)	4 (100%)	2 (67%)	2 (100%)
Pancreas	(51)	(51)	(50)	(50)
Fibrosis		1 (2%)		
Inflammation, chronic	4 (8%)			3 (6%)
Inflammation, chronic active		1 (2%)		
Acinus, atrophy	1 (2%)	2 (4%)	3 (6%)	2 (4%)
Duct, dilatation		1 (2%)	1 (2%)	
Salivary glands	(51)	(51)	(50)	(50)
Atrophy			1 (2%)	
Hemorrhage				1 (2%)
Inflammation, chronic	44 (86%)	40 (78%)	28 (56%)	29 (58%)
Inflammation, chronic active		1 (2%)		

TABLE D5

Summary of the Incidence of Nonneoplastic Lesions in Female Mice in the 2-Year Inhalation Study of Isobutyl Nitrite
(continued)

	0 ppm	37.5 ppm	75 ppm	150 ppm
2-Year Study (continued)				
Alimentary System (continued)				
Stomach, forestomach	(51)	(51)	(50)	(49)
Angiectasis				1 (2%)
Developmental malformation				1 (2%)
Proliferation connective tissue		1 (2%)		
Ulcer			1 (2%)	
Stomach, glandular	(51)	(51)	(50)	(49)
Proliferation connective tissue		1 (2%)		
Cardiovascular System				
Heart	(51)	(51)	(50)	(50)
Infiltration cellular	1 (2%)			
Inflammation, chronic	1 (2%)			
Thrombosis	1 (2%)		1 (2%)	
Artery, hypertrophy			1 (2%)	
Artery, inflammation, chronic	1 (2%)	1 (2%)		1 (2%)
Endocrine System				
Adrenal cortex	(50)	(51)	(50)	(49)
Cyst			3 (6%)	
Hyperplasia, focal		2 (4%)		
Hypertrophy, focal		1 (2%)	2 (4%)	
Subcapsular, hyperplasia	47 (94%)	47 (92%)	45 (90%)	44 (90%)
Adrenal medulla	(47)	(49)	(45)	(47)
Hyperplasia, focal		2 (4%)	1 (2%)	
Islets, pancreatic	(2)	(2)	(3)	(3)
Hyperplasia, focal	2 (100%)	1 (50%)	3 (100%)	2 (67%)
Pituitary gland	(48)	(48)	(50)	(47)
Cyst			1 (2%)	
Pars distalis, angiectasis	1 (2%)		1 (2%)	2 (4%)
Pars distalis, cyst	1 (2%)	1 (2%)	1 (2%)	2 (4%)
Pars distalis, hemorrhage	1 (2%)			
Pars distalis, hyperplasia	10 (21%)	12 (25%)	12 (24%)	7 (15%)
Pars distalis, hyperplasia, focal		1 (2%)		
Thyroid gland	(51)	(51)	(50)	(50)
Ectopic thymus			1 (2%)	
Infiltration cellular, lymphocyte		1 (2%)		
Inflammation, chronic			3 (6%)	
Follicle, cyst	1 (2%)	5 (10%)	4 (8%)	
Follicular cell, hyperplasia, diffuse	1 (2%)		1 (2%)	
Follicular cell, hyperplasia, focal	5 (10%)	9 (18%)	7 (14%)	5 (10%)
General Body System				
None				

TABLE D5

Summary of the Incidence of Nonneoplastic Lesions in Female Mice in the 2-Year Inhalation Study of Isobutyl Nitrite
(continued)

	0 ppm	37.5 ppm	75 ppm	150 ppm
2-Year Study (continued)				
Genital System				
Clitoral gland		(1)	(2)	(3)
Dilatation		1 (100%)	1 (50%)	1 (33%)
Pigmentation				1 (33%)
Ovary	(49)	(50)	(46)	(49)
Angiectasis				1 (2%)
Cyst	8 (16%)	14 (28%)	10 (22%)	11 (22%)
Hemorrhage				1 (2%)
Infiltration cellular, lymphocyte	1 (2%)			1 (2%)
Interstitial, hyperplasia	1 (2%)			
Uterus	(51)	(51)	(49)	(49)
Angiectasis	2 (4%)			
Developmental malformation			1 (2%)	
Dilatation		1 (2%)		
Hyperplasia		1 (2%)		
Hyperplasia, cystic	40 (78%)	42 (82%)	43 (88%)	44 (90%)
Inflammation, chronic active			1 (2%)	
Hematopoietic System				
Bone marrow	(51)	(51)	(50)	(50)
Atrophy		1 (2%)		
Degeneration, fatty	1 (2%)			
Myeloid cell, hyperplasia		1 (2%)	3 (6%)	
Lymph node	(4)	(5)	(8)	(6)
Hyperplasia, lymphoid		1 (20%)		
Pigmentation		1 (20%)		
Iliac, hemorrhage			1 (13%)	
Iliac, hyperplasia, lymphoid		1 (20%)		
Iliac, inflammation, chronic active			1 (13%)	
Iliac, pigmentation				1 (17%)
Inguinal, pigmentation				1 (17%)
Lumbar, angiectasis			1 (13%)	
Lumbar, hemorrhage			1 (13%)	
Lumbar, hyperplasia, lymphoid				1 (17%)
Pancreatic, hyperplasia, lymphoid		1 (20%)		
Renal, hemorrhage			1 (13%)	
Lymph node, bronchial	(20)	(34)	(32)	(30)
Hemorrhage			1 (3%)	
Hyperplasia, lymphoid	1 (5%)	4 (12%)		
Lymph node, mandibular	(49)	(48)	(48)	(45)
Hemorrhage			2 (4%)	1 (2%)
Hyperplasia, lymphoid	2 (4%)	1 (2%)	2 (4%)	1 (2%)
Inflammation, chronic active	1 (2%)			
Lymph node, mesenteric	(51)	(50)	(49)	(45)
Angiectasis				1 (2%)
Hematopoietic cell proliferation	1 (2%)			
Hemorrhage	1 (2%)		1 (2%)	
Hyperplasia, lymphoid		1 (2%)	1 (2%)	1 (2%)
Hyperplasia, plasma cell		1 (2%)		
Inflammation, chronic active	1 (2%)			

TABLE D5
Summary of the Incidence of Nonneoplastic Lesions in Female Mice in the 2-Year Inhalation Study of Isobutyl Nitrite
 (continued)

	0 ppm	37.5 ppm	75 ppm	150 ppm
2-Year Study (continued)				
Hematopoietic System (continued)				
Lymph node, mediastinal	(49)	(44)	(46)	(43)
Hyperplasia, lymphoid	6 (12%)	4 (9%)	2 (4%)	3 (7%)
Inflammation, chronic active			1 (2%)	
Spleen	(51)	(51)	(50)	(49)
Angiectasis		1 (2%)		
Atrophy	1 (2%)			
Fibrosis	1 (2%)			
Hematopoietic cell proliferation	45 (88%)	40 (78%)	45 (90%)	44 (90%)
Hyperplasia, lymphoid	6 (12%)	7 (14%)	5 (10%)	3 (6%)
Pigmentation, hemosiderin	45 (88%)	43 (84%)	37 (74%)	47 (96%)
Proliferation connective tissue		1 (2%)		
Thymus	(47)	(47)	(48)	(41)
Atrophy	11 (23%)	2 (4%)	4 (8%)	6 (15%)
Ectopic parathyroid gland				1 (2%)
Hemorrhage			1 (2%)	
Hyperplasia, lymphoid	4 (9%)	10 (21%)	5 (10%)	2 (5%)
Integumentary System				
Mammary gland	(49)	(51)	(50)	(50)
Dilatation			1 (2%)	2 (4%)
Hyperplasia	2 (4%)	1 (2%)	1 (2%)	2 (4%)
Skin	(51)	(51)	(50)	(50)
Inflammation, chronic	6 (12%)			4 (8%)
Inflammation, chronic active		4 (8%)	2 (4%)	
Ulcer		1 (2%)		
Epithelium, hyperplasia		2 (4%)	2 (4%)	
Musculoskeletal System				
Bone	(51)	(51)	(50)	(50)
Developmental malformation		1 (2%)		
Dysplasia	22 (43%)	18 (35%)	24 (48%)	25 (50%)
Hyperostosis		1 (2%)		
Maxilla, fracture				1 (2%)
Skeletal muscle		(3)	(1)	(1)
Hemorrhage			1 (100%)	
Proliferation connective tissue		1 (33%)		
Nervous System				
Brain	(50)	(51)	(50)	(50)
Compression	1 (2%)	1 (2%)	4 (8%)	2 (4%)
Hemorrhage			2 (4%)	1 (2%)
Mineralization	39 (78%)	21 (41%)	29 (58%)	22 (44%)
Meninges, inflammation, chronic active				1 (2%)
Spinal cord				(1)
Inflammation, chronic				1 (100%)

TABLE D5

Summary of the Incidence of Nonneoplastic Lesions in Female Mice in the 2-Year Inhalation Study of Isobutyl Nitrite
(continued)

	0 ppm	37.5 ppm	75 ppm	150 ppm
2-Year Study (continued)				
Respiratory System				
Larynx	(51)	(49)	(50)	(49)
Artery, inflammation, chronic				1 (2%)
Lung	(51)	(51)	(50)	(50)
Infiltration cellular, lymphocyte	24 (47%)	14 (27%)	11 (22%)	22 (44%)
Inflammation, chronic active	3 (6%)	3 (6%)	1 (2%)	
Leukocytosis	1 (2%)			
Alveolar epithelium, hyperplasia, focal		2 (4%)	9 (18%)	8 (16%)
Alveolus, infiltration cellular, histiocyte		1 (2%)	1 (2%)	2 (4%)
Artery, inflammation, chronic		1 (2%)		
Fat, mediastinum, necrosis		1 (2%)		
Nose	(51)	(51)	(50)	(50)
Exudate	1 (2%)			
Exudate, serous	1 (2%)	1 (2%)	2 (4%)	23 (46%)
Inflammation, chronic active	6 (12%)	10 (20%)	10 (20%)	8 (16%)
Olfactory epithelium, atrophy			1 (2%)	16 (32%)
Olfactory epithelium, degeneration, hyaline	3 (6%)	3 (6%)	5 (10%)	3 (6%)
Olfactory epithelium, metaplasia		6 (12%)	2 (4%)	2 (4%)
Olfactory epithelium, metaplasia, squamous		1 (2%)		1 (2%)
Respiratory epithelium, degeneration, hyaline	16 (31%)	25 (49%)	14 (28%)	16 (32%)
Respiratory epithelium, hyperplasia	6 (12%)	3 (6%)	4 (8%)	1 (2%)
Respiratory epithelium, metaplasia, squamous	4 (8%)	5 (10%)		6 (12%)
Respiratory epithelium, ulcer	3 (6%)	4 (8%)	3 (6%)	3 (6%)
Special Senses System				
Eye				(1)
Phthisis bulbi				1 (100%)
Urinary System				
Kidney	(51)	(51)	(50)	(50)
Amyloid deposition	1 (2%)			
Cyst	1 (2%)			
Glomerulosclerosis				1 (2%)
Hydronephrosis	1 (2%)		1 (2%)	
Infarct				1 (2%)
Infiltration cellular, lymphocyte	30 (59%)	19 (37%)	16 (32%)	30 (60%)
Nephropathy		2 (4%)	1 (2%)	
Renal tubule, degeneration, hyaline	1 (2%)			
Renal tubule, dilatation	2 (4%)	1 (2%)	2 (4%)	1 (2%)
Renal tubule, hyperplasia, focal	1 (2%)			1 (2%)
Renal tubule, pigmentation		1 (2%)		
Renal tubule, regeneration		1 (2%)		1 (2%)
Urinary bladder	(49)	(50)	(48)	(47)
Dilatation		1 (2%)		
Infiltration cellular, lymphocyte	32 (65%)	33 (66%)	21 (44%)	31 (66%)

APPENDIX E

GENETIC TOXICOLOGY

<i>SALMONELLA TYPHIMURIUM</i> MUTAGENICITY TEST PROTOCOL	232
CHINESE HAMSTER OVARY CELL CYTOGENETICS TEST PROTOCOLS	232
<i>DROSOPHILA MELANOGASTER</i> TEST PROTOCOL	233
MOUSE PERIPHERAL BLOOD MICRONUCLEUS TEST PROTOCOL	234
RESULTS	234
TABLE E1 Mutagenicity of Isobutyl Nitrite in <i>Salmonella typhimurium</i>	236
TABLE E2 Induction of Sister Chromatid Exchanges in Chinese Hamster Ovary Cells by Isobutyl Nitrite	239
TABLE E3 Induction of Chromosomal Aberrations in Chinese Hamster Ovary Cells by Isobutyl Nitrite	241
TABLE E4 Induction of Sex-Linked Recessive Lethal Mutations in <i>Drosophila melanogaster</i> by Isobutyl Nitrite	243
TABLE E5 Frequency of Micronuclei in Mouse Peripheral Blood Erythrocytes Following Treatment with Isobutyl Nitrite by Inhalation	243

GENETIC TOXICOLOGY

***SALMONELLA TYPHIMURIUM* MUTAGENICITY TEST PROTOCOL**

Testing was performed as reported by Mortelmans *et al.* (1986) and Zeiger *et al.* (1988). Isobutyl nitrite was sent to the laboratories as a coded aliquot from Radian Corporation (Austin, TX). It was incubated with the *Salmonella typhimurium* tester strains (TA98, TA100, TA1535, TA1537) either in buffer or S9 mix (metabolic activation enzymes and cofactors from Aroclor 1254-induced male Sprague-Dawley rat or Syrian hamster liver) for 20 minutes at 37° C. Top agar supplemented with *l*-histidine and *d*-biotin was added, and the contents of the tubes were mixed and poured onto the surfaces of minimal glucose agar plates. Histidine-independent mutant colonies arising on these plates were counted following incubation for 2 days at 37° C.

Each trial consisted of triplicate plates of concurrent positive and negative controls and at least five doses of isobutyl nitrite. The high dose was limited by toxicity in the test performed at Microbiological Associates, Inc. In the absence of toxicity, 10,000 µg/plate was selected as the high dose. All trials were repeated, and all positive trials were repeated under the conditions which elicited the positive response. Due to the large volume of data in these three studies, only representative trials are presented in Table E1.

In this assay, a positive response was defined as a reproducible, dose-related increase in histidine-independent (revertant) colonies in any one strain/activation combination. An equivocal response was defined as an increase in revertants which was not dose-related, not reproducible, or was not of sufficient magnitude to support a determination of mutagenicity. A negative response was obtained when no increase in revertant colonies was observed following chemical treatment. There was no minimum percentage or fold increase required for a chemical to be judged positive or weakly positive.

CHINESE HAMSTER OVARY CELL CYTOGENETICS TEST PROTOCOLS

Testing was performed as reported by Galloway *et al.* (1987). Isobutyl nitrite was sent to the laboratories as a coded aliquot by Radian Corporation. It was tested in cultured Chinese hamster ovary (CHO) cells for induction of sister chromatid exchanges (SCEs) and chromosomal aberrations (Abs) both in the presence and absence of Aroclor 1254-induced male Sprague-Dawley rat liver S9 and cofactor mix. Cultures were handled under gold lights to prevent photolysis of bromodeoxyuridine-substituted DNA. Each test consisted of concurrent solvent and positive controls and of at least three doses of isobutyl nitrite; the high dose was limited by toxicity. A single flask per dose was used, and tests yielding equivocal or positive results were repeated.

Sister Chromatid Exchange Test: In the SCE test without S9, CHO cells were incubated for 26 hours with isobutyl nitrite in McCoy's 5A medium supplemented with fetal bovine serum, *l*-glutamine, and antibiotics. Bromodeoxyuridine (BrdU) was added 2 hours after culture initiation. After 26 hours, the medium containing isobutyl nitrite was removed and replaced with fresh medium plus BrdU and Colcemid, and incubation was continued for 2 hours. Cells were then harvested by mitotic shake-off, fixed, and stained with Hoechst 33258 and Giemsa. In the SCE test with S9, cells were incubated with isobutyl nitrite, serum-free medium, and S9 for 2 hours. The medium was then removed and replaced with medium containing serum and BrdU and no isobutyl nitrite, and incubation proceeded for an additional 26 hours, with Colcemid present for the final 2 hours. Harvesting and staining were the same as for cells treated without S9. All slides were scored blind and those from a single test were read by the same person. Fifty second-division metaphase cells were scored for frequency of SCEs/cell from each dose level. Because significant chemical-induced cell cycle delay was seen at doses of 500 and 1,667 µg/mL in the presence of S9, incubation time for these cultures was lengthened to ensure a sufficient number of scorable (second-division metaphase) cells.

Statistical analyses were conducted on the slopes of the dose-response curves and the individual dose points (Galloway *et al.*, 1987). An SCE frequency 20% above the concurrent solvent control value was chosen as a statistically conservative positive response. The probability of this level of difference occurring by chance at one dose point is less than 0.01; the probability for such a chance occurrence at two dose points is less than 0.001. An increase of 20% or greater at any single dose was considered weak evidence of activity; increases at two or more doses resulted in a determination that the trial was positive. A statistically significant trend ($P < 0.05$) in the absence of any responses reaching 20% above background, led to a call of equivocal.

Chromosomal Aberrations Test: In the Abs test without S9, cells were incubated in McCoy's 5A medium with isobutyl nitrite for 12 or 13 hours; Colcemid was added and incubation continued for 2 hours. The cells were then harvested by mitotic shake-off, fixed, and stained with Giemsa. For the Abs test with S9, cells were treated with isobutyl nitrite and S9 for 2 hours, after which the treatment medium was removed and the cells incubated for 12 or 13.6 hours in fresh medium, with Colcemid present for the final 2 hours. Cells were harvested in the the same manner as for the treatment without S9. The harvest time for the Abs test was based on the cell cycle information obtained in the SCE test: because some cell cycle delay was anticipated in tests conducted at the second laboratory (SITEK Research, Inc.), the incubation period was slightly extended from the normal period of 12 to 14 hours.

Cells were selected for scoring on the basis of good morphology and completeness of karyotype (21 ± 2 chromosomes). All slides were scored blind and those from a single test were read by the same person. One hundred or 200 first-division metaphase cells were scored at each dose level. Classes of aberrations included simple (breaks and terminal deletions), complex (rearrangements and translocations), and other (pulverized cells, despiralized chromosomes, and cells containing 10 or more aberrations).

Chromosomal aberration data are presented as percentage of cells with aberrations. To arrive at a statistical call for a trial, analyses were conducted on both the dose-response curve and individual dose points. For a single trial, a statistically significant ($P < 0.05$) difference for one dose point and a significant trend ($P < 0.015$) were considered weak evidence for a positive response; significant differences for two or more doses indicated the trial was positive. A positive trend in the absence of a statistically significant increase at any one dose led to an equivocal call. Ultimately, the trial calls were based on a consideration of the statistical analyses as well as the biological information available to the reviewers (Galloway *et al.*, 1987).

***DROSOPHILA MELANOGASTER* TEST PROTOCOL**

The assays for induction of sex-linked recessive lethal (SLRL) mutations were performed with adult flies as described by Woodruff *et al.* (1985). Isobutyl nitrite was supplied as a coded aliquot from Radian Corporation. It was assayed in the SLRL test by feeding for 3 days to adult Canton-S wild-type males no more than 24 hours old at the beginning of treatment. Because no positive response was obtained, isobutyl nitrite was retested by injection into adult males.

To administer a chemical by injection, a glass Pasteur pipette was drawn out in a flame to a microfine filament and the tip was broken off to allow delivery of the test solution. Injection was performed either manually, by attaching a rubber bulb to the other end of the pipette and forcing through sufficient solution (0.2 to 0.3 μL) to slightly distend the abdomen of the fly, or by attaching the pipette to a microinjector which automatically delivers a calibrated volume. Flies were anaesthetized with ether and immobilized on a strip of tape. Injection into the thorax, under the wing, was performed with the aid of a dissecting microscope.

Toxicity tests were performed to set concentrations of isobutyl nitrite at a level that would induce 30% mortality after 72 hours of feeding or 24 hours after injection, while keeping induced sterility at an acceptable level. Oral exposure was achieved by allowing Canton-S males to feed for 72 hours on a solution of isobutyl nitrite in 5% sucrose. In the injection experiments, 24- to 72-hour old Canton-S males were treated with a solution of isobutyl nitrite dissolved in saline and allowed to recover for 24 hours. Treated males were mated to three *Basc* females for 3 days and given fresh females at 2-day intervals to produce three matings of 3, 2, and 2 days (in each case, sample sperm from successive matings were treated at successively earlier postmeiotic stages). F_1 heterozygous females were mated with their siblings and then placed in individual vials. F_1 daughters from the same parental male were kept together to identify clusters. (A cluster occurs when a number of mutants from a given male results from a single spontaneous premeiotic mutation event, and is identified when the number of mutants from that male exceeds the number predicted by a Poisson distribution.) If a cluster was identified, all data from the male in question were discarded. After 17 days, presumptive lethal mutations were identified as vials containing fewer than 5% of the expected number of wild-type males; these were retested to confirm the response.

SLRL data were analyzed by simultaneous comparison with the concurrent and historical controls, using a normal approximation to the binomial test (Margolin *et al.*, 1983). A test result was considered positive if the P value was less than 0.01 and the mutation frequency in the tested group was greater than 0.10%, or if the P value was less than 0.05 and the frequency in the treatment group was greater than 0.15%. A test was considered to be inconclusive if (a) the P value was between 0.05 and 0.01 but the frequency in the treatment group was between 0.10% and 0.15%, or (b) the P value was between 0.10 and 0.05 but the frequency in the treatment group was greater than 0.10%. A test was considered negative if the P value was greater than 0.10 or if the frequency in the treatment group was less than 0.10%.

MOUSE PERIPHERAL BLOOD MICRONUCLEUS TEST PROTOCOL

A detailed discussion of this assay is presented in MacGregor *et al.* (1990). Peripheral blood samples were obtained from male and female B6C3F₁ mice at the end of the 13-week toxicity study. Smears were immediately prepared and fixed in absolute methanol. They were later stained with a chromatin-specific fluorescent dye mixture of Hoechst 33258/pyronin Y (MacGregor *et al.*, 1983), and coded. Slides were scanned to determine the frequency of micronuclei in 10,000 normochromatic erythrocytes (NCEs) in each of 10 animals per dose group. The criteria of Schmid (1976) were used to define micronuclei, with the additional requirement that the micronuclei exhibit the characteristic fluorescent emissions of DNA (blue with 360 nm and orange with 540 nm ultraviolet illumination); the minimum size was approximately one-twentieth the diameter of the NCE cell.

The frequency of micronucleated cells among NCEs was analyzed by a statistical software package (ILS, 1990) which employed a one-tailed trend test across dose groups and a *t*-test for pairwise comparisons of each dose group to the concurrent control.

RESULTS

Results from three separate tests in two laboratories confirmed that isobutyl nitrite induced gene mutations in *Salmonella typhimurium* strains TA100 and TA1535 in the presence of induced rat or hamster liver S9 (Mortelmans *et al.*, 1986; Table E1); in the absence of S9, equivocal responses were obtained in each of these strains. No clearly positive responses were obtained with strains TA98 or TA1537, with or without S9. In the second study, a precipitate occurred at concentrations above 3,333 $\mu\text{g}/\text{plate}$ in trials conducted with S9.

In cytogenetic tests conducted at two laboratories with cultured CHO cells, isobutyl nitrite induced SCEs (Table E2) and Abs (Table E3), with and without S9. A clear, dose-related increase in SCEs was observed over a dose range of 5 to 160 $\mu\text{g}/\text{mL}$ without S9 and 16 to 1,667 $\mu\text{g}/\text{mL}$ with S9 (combined results from both laboratories). Toxicity, in the form of cell cycle delay and decreased numbers of scorable metaphases, was observed at concentrations of 500 $\mu\text{g}/\text{mL}$ and greater in the presence of S9 (SITEK Research Laboratory study). In the Abs test, the first laboratory obtained a positive response only in the absence of S9; the increase in aberrations noted at the high dose of 500 $\mu\text{g}/\text{mL}$ in the presence of S9 was insufficient for a positive call. Results from the second laboratory demonstrated induction of Abs under both activation conditions. The response observed in the single trial conducted with S9 was weak, however, and not well correlated with increasing dose. It was achieved at a concentration of 1,081 $\mu\text{g}/\text{mL}$, a level much higher than was tested at the first laboratory, and that may account for the apparent discordance in results for this test.

Isobutyl nitrite did not induce sex-linked recessive lethal mutations in germ cells of male *Drosophila melanogaster* when administered by feeding (100,000 ppm) or by injection (25,000 ppm) (Woodruff *et al.*, 1985; Table E4). However, inhalation of isobutyl nitrite (10 to 300 ppm) for 90 days induced significant increases in micronucleated NCEs in peripheral blood of male and female mice.

In conclusion, isobutyl nitrite induced mutations in *Salmonella typhimurium*, and SCEs and Abs in CHO cells. Although no increase in sex-linked recessive lethal mutations was observed in male *D. melanogaster* treated with isobutyl nitrite, both male and female mice exposed to the chemical showed significantly elevated levels of micronucleated NCEs in peripheral blood.

TABLE E1
Mutagenicity of Isobutyl Nitrite in *Salmonella typhimurium*^a

Strain	Dose ($\mu\text{g}/\text{plate}$)	Revertants/plate ^b		
		-S9	+10% hamster S9	+10% rat S9
Study 1: Testing performed at SRI, International				
TA100	0	143 \pm 7.1	116 \pm 3.8	132 \pm 7.8
	100			
	333	115 \pm 11.8	141 \pm 0.9	145 \pm 6.9
	1,000	108 \pm 5.5	152 \pm 10.1	166 \pm 11.8
	3,333	153 \pm 5.5	220 \pm 4.8	217 \pm 11.2
	6,666	181 \pm 5.0	251 \pm 22.5	222 \pm 17.6
	10,000	0 \pm 0.0 ^d	138 \pm 69.7	0 \pm 0.0 ^d
	Trial summary	Equivocal	Positive	Positive
Positive control ^c	377 \pm 8.7	966 \pm 42.3	456 \pm 24.8	
TA1535	0	18 \pm 0.9	17 \pm 0.0	27 \pm 5.8
	100			
	333	25 \pm 1.9	27 \pm 4.9	23 \pm 4.4
	1,000	29 \pm 1.3	25 \pm 2.6	23 \pm 3.2
	3,333	34 \pm 2.3	58 \pm 1.8	19 \pm 3.2
	6,666	30 \pm 4.7	62 \pm 7.3	21 \pm 7.4
	10,000	20 \pm 11.3 ^d	0 \pm 0.0 ^d	0 \pm 0.0 ^d
	Trial summary	Equivocal	Positive	Negative
Positive control	342 \pm 42.1	245 \pm 10.7	178 \pm 24.1	
TA1537	0	8 \pm 0.7	7 \pm 3.1	8 \pm 2.6
	100	5 \pm 1.2	12 \pm 2.6	7 \pm 0.9
	333	5 \pm 0.7	9 \pm 1.8	12 \pm 1.5
	1,000	6 \pm 1.2	6 \pm 1.8	6 \pm 1.7
	3,333	7 \pm 1.5	6 \pm 1.5	8 \pm 1.9
	6,666			
	10,000	9 \pm 1.5	2 \pm 2.3 ^d	7 \pm 0.9
	Trial summary	Negative	Negative	Negative
Positive control	151 \pm 11.7	319 \pm 28.5	292 \pm 1.9	
TA98	0	26 \pm 0.6	36 \pm 0.0	44 \pm 4.6
	100	21 \pm 1.5	32 \pm 3.5	31 \pm 1.9
	333	22 \pm 3.5	34 \pm 5.0	36 \pm 3.8
	1,000	15 \pm 3.5	39 \pm 3.5	33 \pm 1.8
	3,333	20 \pm 4.3	40 \pm 6.1	25 \pm 3.2
	6,666			
	10,000	32 \pm 2.6	11 \pm 11.0 ^d	31 \pm 1.2
	Trial summary	Negative	Negative	Negative
Positive control	749 \pm 43.9	691 \pm 134.3	313 \pm 4.1	

TABLE E1
Mutagenicity of Isobutyl Nitrite in *Salmonella typhimurium* (continued)

Strain	Dose ($\mu\text{g}/\text{plate}$)	Revertants/plate						
		-S9	+30% hamster S9			+30% rat S9		
Study 2: Testing performed at SRI, International								
TA100	0	101 \pm 7.3	105 \pm 2.9			115 \pm 7.5		
	33							
	100	107 \pm 3.8						
	333	125 \pm 8.7	131 \pm 3.8			117 \pm 14.1		
	666							
	1,000	157 \pm 2.2	171 \pm 3.5			159 \pm 3.0		
	1,666	153 \pm 11.2						
	3,333	34 \pm 12.0 ^d	223 \pm 5.8			196 \pm 7.2		
	6,666		298 \pm 12.9 ^e			284 \pm 6.7 ^e		
	10,000		317 \pm 8.7 ^e			322 \pm 0.6 ^e		
Trial summary		Equivocal	Positive			Positive		
Positive control		413 \pm 7.3	649 \pm 62.6			399 \pm 13.2		
Revertants/plate								
		-S9	+ hamster S9			+ rat S9		
			5%	10%	30%	5%	10%	30%
TA98	0	23 \pm 3.4	32 \pm 3.3	39 \pm 3.8	28 \pm 2.7	37 \pm 5.4	27 \pm 2.5	33 \pm 4.3
	33	25 \pm 0.9						
	100	27 \pm 1.2						
	333	22 \pm 2.0	34 \pm 5.0	34 \pm 2.5	26 \pm 4.2	36 \pm 3.5	39 \pm 1.8	32 \pm 3.2
	666							
	1,000	23 \pm 1.3	31 \pm 2.0	34 \pm 6.3	39 \pm 2.7	39 \pm 5.2	43 \pm 2.4	38 \pm 4.0
	1,666	21 \pm 2.7						
	3,333		37 \pm 0.7	43 \pm 1.3	42 \pm 7.5	43 \pm 4.7	43 \pm 3.2	42 \pm 2.2
	6,666		25 \pm 2.6	30 \pm 3.0 ^e	44 \pm 6.0 ^e	29 \pm 5.8	37 \pm 3.8 ^e	40 \pm 3.8 ^e
	10,000		14 \pm 3.5 ^d	26 \pm 3.5 ^e	47 \pm 4.0 ^e	13 \pm 2.3 ^d	20 \pm 5.0 ^d	36 \pm 3.6 ^e
Trial summary		Negative	Negative	Negative	Equivocal	Negative	Equivocal	Negative
Positive control		562 \pm 5.8	1,071 \pm 33.0	786 \pm 46.0	580 \pm 55.8	815 \pm 47.6	503 \pm 5.9	191 \pm 27.2

TABLE E1
Mutagenicity of Isobutyl Nitrite in *Salmonella typhimurium* (continued)

Strain	Dose ($\mu\text{g}/\text{plate}$)	Revertants/plate		
		-S9	+30% hamster S9	+30% rat S9
Study performed at Microbiological Associates, Inc.				
TA100	0	103 \pm 1.5	108 \pm 3.7	101 \pm 3.2
	33	105 \pm 1.2		
	100	105 \pm 5.0	99 \pm 4.5	101 \pm 6.6
	333	110 \pm 6.7	107 \pm 1.5	167 \pm 7.3
	500			
	667		169 \pm 10.7	196 \pm 4.9
	1,000	133 \pm 2.7 ^d	249 \pm 18.2	274 \pm 3.3
	1,500		211 \pm 3.9 ^d	160 \pm 21.0 ^d
	2,000			
	3,333	136 \pm 15.9 ^d		
Trial summary		Negative	Positive	Positive
Positive control		328 \pm 10.4	502 \pm 6.7	1,369 \pm 63.2
TA1535	0		9 \pm 1.9	14 \pm 0.9
	33			
	100		12 \pm 1.8	14 \pm 1.5
	333		19 \pm 1.5	22 \pm 1.2
	500			
	667		30 \pm 2.9	37 \pm 5.4
	1,000		38 \pm 3.8	58 \pm 4.9
	1,500		70 \pm 6.7 ^d	49 \pm 2.9 ^d
Trial summary		Positive	Positive	
Positive control		122 \pm 5.0	263 \pm 15.6	
TA98	0	18 \pm 2.0	34 \pm 2.2	31 \pm 1.2
	33	21 \pm 1.5	29 \pm 0.9	31 \pm 3.2
	100	15 \pm 1.9	30 \pm 2.1	32 \pm 4.7
	333	19 \pm 4.0	37 \pm 1.0	32 \pm 4.9
	500			
	667			
	1,000	15 \pm 0.6 ^d	43 \pm 5.0	44 \pm 2.8
	1,500			
	2,000			
	3,333	8 \pm 0.3 ^d	21 \pm 2.8 ^d	27 \pm 4.2 ^d
Trial summary		Negative	Negative	Negative
Positive control		321 \pm 22.4	169 \pm 10.4	412 \pm 6.8

^a A detailed description of the protocol and the data from the first study are presented in Mortelmans *et al.* (1986); the protocols for the second and third studies are presented in Zeiger *et al.* (1988). The solvent control is 0 $\mu\text{g}/\text{plate}$.

^b Revertants are presented as mean \pm standard error from three plates.

^c The positive controls in the absence of metabolic activation were sodium azide (TA100 and TA1535), 9-aminoacridine (TA1537), and 4-amino-*o*-phenylenediamine (TA98). The positive control for metabolic activation with all strains was 2-aminoanthracene.

^d Slight toxicity

^e Precipitate on plate

TABLE E2
Induction of Sister Chromatid Exchanges in Chinese Hamster Ovary Cells by Isobutyl Nitrite^a

Compound	Dose ($\mu\text{g/mL}$)	Total Cells	No. of Chromo- somes	No. of SCEs	SCEs/ Chromo- some	SCEs/ Cell	Hrs in BrdU	Relative Change of SCEs/ Chromosome ^b (%)
Study performed at Columbia University								
-S9								
Trial 1								
Summary: Positive								
Dimethylsulfoxide		50	1,050	427	0.40	8.5	26.0	
Mitomycin-C	0.0050	25	526	740	1.40	29.6	26.0	245.95
Isobutyl Nitrite	16	50	1,043	446	0.42	8.9	26.0	5.15
	50	50	1,051	520	0.49	10.4	26.0	21.66*
	160	50	1,048	597	0.56	11.9	26.0	40.08*
P < 0.001 ^c								
+S9								
Trial 1								
Summary: Weak positive								
Dimethylsulfoxide		50	1,049	448	0.42	9.0	26.0	
Cyclophosphamide	1	50	1,047	878	0.83	17.6	26.0	96.36
Isobutyl Nitrite	16	50	1,050	484	0.46	9.7	26.0	7.93
	50	50	1,051	510	0.48	10.2	26.0	13.62
	160	50	1,047	599	0.57	12.0	26.0	33.96*
P < 0.001								
Trial 2								
Summary: Positive								
Dimethylsulfoxide		50	1,048	475	0.45	9.5	26.0	
Cyclophosphamide	1	50	1,046	888	0.84	17.8	26.0	87.30
Isobutyl Nitrite	150	50	1,048	515	0.49	10.3	26.0	8.42
	200	50	1,047	617	0.58	12.3	26.0	30.02*
	250	50	1,051	652	0.62	13.0	26.0	36.87*
P < 0.001								

* Positive response ($\geq 20\%$ increase over solvent control)

^a SCE = sister chromatid exchange; BrdU = bromodeoxyuridine. A detailed description of the SCE protocol is presented by Galloway *et al.* (1987).

^b SCEs/chromosome of culture exposed to isobutyl nitrite relative to those of culture exposed to solvent

^c Significance of relative SCEs/chromosome tested by the linear regression trend test vs. log of the dose.

TABLE E2
Induction of Sister Chromatid Exchanges in Chinese Hamster Ovary Cells by Isobutyl Nitrite (continued)

Compound	Dose ($\mu\text{g}/\text{mL}$)	Total Cells	No. of Chromo- somes	No. of SCEs	SCEs/ Chromo- some	SCEs/ Cell	Hrs in BrdU	Relative Change of SCEs/ Chromosome (%)
Study performed at SITEK Research Laboratories								
-S9								
Trial 1								
Summary: Positive								
Dimethylsulfoxide		50	1,050	374	0.35	7.5	26.0	
Mitomycin-C	0.0010	50	1,052	657	0.62	13.1	26.0	75.33
	0.0040	10	210	192	0.91	19.2	26.0	156.68
Isobutyl Nitrite	5	50	1,048	459	0.43	9.2	26.0	22.96*
	17	50	1,047	469	0.44	9.4	26.0	25.76*
	50	50	1,047	544	0.51	10.9	26.0	45.87*
					P < 0.001			
Trial 2								
Summary: Positive								
Dimethylsulfoxide		50	1,047	384	0.36	7.7	26.0	
Mitomycin-C	0.0010	50	1,046	637	0.60	12.7	26.0	66.04
	0.0040	10	209	183	0.87	18.3	26.0	138.74
Isobutyl Nitrite	17	50	1,049	414	0.39	8.3	26.0	7.61
	50	50	1,047	467	0.44	9.3	26.0	21.61*
	100	50	1,047	526	0.50	10.5	26.0	36.98*
					P < 0.001			
+S9								
Trial 1								
Summary: Positive								
Dimethylsulfoxide		50	1,053	405	0.38	8.1	26.0	
		50	1,051	424	0.40	8.5	31.0 ^d	
Cyclophosphamide	0.1250	50	1,049	638	0.60	12.8	26.0	50.76
	0.5000	10	211	214	1.01	21.4	26.0	151.40
Isobutyl Nitrite	167	50	1,048	597	0.56	11.9	26.0	41.21*
	500	50	1,051	883	0.84	17.7	31.0 ^e	108.26*
	1,667	25	524	563	1.07	22.5	31.0 ^e	166.33*
	5,000		cytostatic					
					P < 0.001			

^d Control culture for 500 and 1,667 $\mu\text{g}/\text{mL}$ concentrations in this trial

^e Because isobutyl nitrite induced a delay in the cell division cycle, harvest time was extended to maximize the proportion of second division cells available for analysis.

TABLE E3
Induction of Chromosomal Aberrations in Chinese Hamster Ovary Cells by Isobutyl Nitrite^a

-S9					+S9						
Dose ($\mu\text{g/mL}$)	Total Cells	No. of Abs	Abs/ Cell	Cells with Abs (%)	Dose ($\mu\text{g/mL}$)	Total Cells	No. of Abs	Abs/ Cell	Cells with Abs (%)		
Study performed at Columbia University											
Trial 1 — Harvest time: 14.0 hours Summary: Positive					Trial 1 — Harvest time: 14.0 hours Summary: Negative						
Dimethylsulfoxide					Dimethylsulfoxide						
	100	1	0.01	1.0		100	5	0.05	5.0		
Mitomycin-C					Cyclophosphamide						
	0.15	50	21	0.42	28.0		15	100	28	0.28	21.0
Isobutyl Nitrite					Isobutyl Nitrite						
	16	100	8	0.08	7.0*		50	100	6	0.06	6.0
	50	200	14	0.07	7.0*		160	100	5	0.05	5.0
	160	100	10	0.10	10.0*		500	100	9	0.09	9.0
$P=0.007^b$					$P=0.156$						
Study performed at SITEK Research Laboratories											
Trial 1 — Harvest time: 15.0 hours^c Summary: Positive					Trial 1 — Harvest time: 15.6 hours^c Summary: Weak positive						
Dimethylsulfoxide					Dimethylsulfoxide						
	200	3	0.02	1.5		200	10	0.05	4.0		
Mitomycin-C					Cyclophosphamide						
	0.4	25	12	0.48	36.0		20	25	13	0.52	40.0
Isobutyl Nitrite					Isobutyl Nitrite						
	24	200	0	0.00	0.0		234	200	12	0.06	5.0
	51	200	22	0.11	8.0*		503	200	5	0.03	2.5
	109	100	61	0.61	28.0*		1,081	200	32	0.16	13.0*
	234	cytostatic					2,325	cytostatic			
$P<0.001$					$P=0.001$						

TABLE E3
Induction of Chromosomal Aberrations in Chinese Hamster Ovary Cells by Isobutyl Nitrite (continued)

-S9				
Dose ($\mu\text{g/mL}$)	Total Cells	No. of Abs	Abs/ Cell	Cells with Abs (%)
Trial 2 — Harvest time: 15.0 hours ^c				
Summary: Positive				
Dimethylsulfoxide				
	200	2	0.01	1.0
Mitomycin-C				
0.4	25	24	0.96	44.0
Isobutyl Nitrite				
100	200	8	0.04	4.0
150	200	11	0.06	5.5*
200	100	52	0.52	26.0*
P < 0.001				

* P < 0.05

^a Abs = aberrations. A detailed presentation of the protocol is found in Galloway *et al.* (1987).

^b Significance of percent cells with aberrations tested by the linear regression trend test vs. log of the dose.

^c Because of significant chemical-induced cell cycle delay, incubation time prior to addition of Colcemid was lengthened to ensure sufficient metaphase cells at harvest.

TABLE E4
Induction of Sex-Linked Recessive Lethal Mutations in *Drosophila melanogaster* by Isobutyl Nitrite^a

Route of Exposure	Dose (ppm)	Incidence of Deaths (%)	Incidence of Sterility (%)	No. of Lethals/No. of X Chromosomes Tested			Overall Total ^b
				Mating 1	Mating 2	Mating 3	
Injection	25,000	4	5	2/2,160	0/2,043	2/1,615	4/5,818 (0.07%)
		0		0/2,275	1/2,074	2/1,798	3/6,147 (0.05%)
Feeding	100,000	63	3	5/2,804	2/2,474	1/1,867	8/7,145 (0.11%)
		0		5/3,981	1/3,209	2/2,554	8/9,744 (0.08%)

^a Study performed at Bowling Green State University. A detailed description of the protocol and these data are presented in Woodruff *et al.* (1985).

^b Combined total number of lethal mutations/number of X chromosomes tested for three mating trials

TABLE E5
Frequency of Micronuclei in Mouse Peripheral Blood Erythrocytes following Treatment with Isobutyl Nitrite by Inhalation^a

Concentration (ppm)	Number of Mice per Dose Group	Micronucleated Normochromatic Erythrocytes/1,000 Cells ^b
Male		
0	10	1.35 ± 0.10
10	10	1.75 ± 0.14
25	10	1.75 ± 0.14
75	10	1.67 ± 0.12
150	10	1.84 ± 0.08*
300	10	1.86 ± 0.17*
		P=0.019 ^c
Female		
0	9	1.06 ± 0.10
10	10	0.99 ± 0.11
25	10	1.21 ± 0.02
75	8	1.47 ± 0.12*
150	8	1.10 ± 0.12
300	9	1.72 ± 0.22*
		P<0.001

* Significantly different (P<0.005) from the controls by pairwise comparison

^a Smears were prepared from peripheral blood samples obtained at the termination of the 13-week toxicity study.

^b At least 10,000 NCEs were scored per animal. Data are presented as mean ± standard error.

^c One-tailed trend test, significant at P=0.025 (ILS, 1990)

APPENDIX F ORGAN WEIGHTS AND ORGAN-WEIGHT-TO-BODY-WEIGHTS RATIOS

TABLE F1	Organ Weights and Organ-Weight-to-Body-Weight Ratios for Rats in the 16-Day Inhalation Study of Isobutyl Nitrite	246
TABLE F2	Organ Weights and Organ-Weight-to-Body-Weight Ratios for Rats in the 13-Week Inhalation Study of Isobutyl Nitrite	247
TABLE F3	Organ Weights and Organ-Weight-to-Body-Weight Ratios for Rats at the 15-Month Interim Evaluation in the 2-Year Inhalation Study of Isobutyl Nitrite	248
TABLE F4	Organ Weights and Organ-Weight-to-Body-Weight Ratios for Mice in the 16-Day Inhalation Study of Isobutyl Nitrite	249
TABLE F5	Organ Weights and Organ-Weight-to-Body-Weight Ratios for Mice in the 13-Week Inhalation Study of Isobutyl Nitrite	250
TABLE F6	Organ Weights and Organ-Weight-to-Body-Weight Ratios for Mice at the 15-Month Interim Evaluation in the 2-Year Inhalation Study of Isobutyl Nitrite	251

TABLE F1
Organ Weights and Organ-Weight-to-Body-Weight Ratios for Rats in the 16-Day Inhalation Study of Isobutyl Nitrite^a

	0 ppm	100 ppm	200 ppm	400 ppm
Male				
n	5	5	5	5
Necropsy body wt	160 ± 5	167 ± 5	159 ± 5	121 ± 2**
Brain				
Absolute	1.734 ± 0.035	1.752 ± 0.049	1.726 ± 0.035	1.638 ± 0.070
Relative	10.88 ± 0.12	10.47 ± 0.16	10.85 ± 0.21	13.54 ± 0.70**
Heart				
Absolute	0.624 ± 0.018	0.648 ± 0.021	0.604 ± 0.022	0.550 ± 0.015*
Relative	3.91 ± 0.05	3.88 ± 0.12	3.79 ± 0.08	4.53 ± 0.08**
R. Kidney				
Absolute	0.792 ± 0.032	0.896 ± 0.036	0.812 ± 0.043	0.692 ± 0.067
Relative	4.96 ± 0.10	5.36 ± 0.18	5.09 ± 0.17	5.73 ± 0.61
Liver				
Absolute	7.988 ± 0.298	9.624 ± 0.380**	8.526 ± 0.413	6.808 ± 0.192
Relative	50.04 ± 0.96	57.53 ± 1.74**	53.39 ± 1.23	56.11 ± 1.29*
Lungs				
Absolute	1.586 ± 0.174	1.348 ± 0.145	1.034 ± 0.063**	0.874 ± 0.056**
Relative	9.87 ± 0.87	8.02 ± 0.72	6.49 ± 0.37**	7.21 ± 0.48**
R. Testis				
Absolute	0.953 ± 0.029	0.964 ± 0.013	0.955 ± 0.037	0.818 ± 0.044*
Relative	5.97 ± 0.10	5.77 ± 0.11	5.99 ± 0.14	6.74 ± 0.30*
Thymus				
Absolute	0.480 ± 0.025	0.479 ± 0.030	0.423 ± 0.047	0.333 ± 0.033**
Relative	3.01 ± 0.12	2.86 ± 0.15	2.66 ± 0.30	2.74 ± 0.28
Female				
n	5	5	4	4
Necropsy body wt	122 ± 2	121 ± 1	125 ± 1	108 ± 2**
Brain				
Absolute	1.678 ± 0.020	1.608 ± 0.019	1.706 ± 0.028	1.663 ± 0.038
Relative	13.74 ± 0.12	13.27 ± 0.10	13.89 ± 0.17	15.44 ± 0.63**
Heart				
Absolute	0.492 ± 0.016	0.504 ± 0.013	0.500 ± 0.016	0.490 ± 0.004
Relative	4.03 ± 0.12	4.16 ± 0.09	3.91 ± 0.10	4.54 ± 0.08**
R. Kidney				
Absolute	0.598 ± 0.012	0.632 ± 0.031	0.708 ± 0.030	0.660 ± 0.050
Relative	4.90 ± 0.07	5.21 ± 0.24	5.56 ± 0.27	6.12 ± 0.47**
Liver				
Absolute	5.566 ± 0.174	5.930 ± 0.293	6.672 ± 0.310	5.473 ± 0.185
Relative	45.57 ± 1.26	48.92 ± 2.32	52.39 ± 2.73	50.75 ± 1.90
Lungs				
Absolute	1.120 ± 0.139	1.220 ± 0.055	0.958 ± 0.048	0.878 ± 0.027
Relative	9.13 ± 1.04	10.07 ± 0.45	7.68 ± 0.47	8.13 ± 0.22
Thymus				
Absolute	0.355 ± 0.015	0.380 ± 0.013	0.383 ± 0.022	0.265 ± 0.016**
Relative	2.90 ± 0.11	3.14 ± 0.11	3.18 ± 0.19	2.45 ± 0.15

* Significantly different ($P \leq 0.05$) from the control group by Williams' or Dunnett's test

** $P \leq 0.01$

^a Organ weights and body weights are given in grams; organ-weight-to-body-weight ratios are given as mg organ weight/g body weight (mean ± standard error). All male and female rats in the 600 and 800 ppm exposure groups died before the end of the study.

TABLE F2
Organ Weights and Organ-Weight-to-Body-Weight Ratios for Rats in the 13-Week Inhalation Study of Isobutyl Nitrite^a

	0 ppm	10 ppm	25 ppm	75 ppm	150 ppm	300 ppm
n	10	10	10	10	10	10
Male						
Necropsy body wt	345 ± 8	339 ± 8	365 ± 9	329 ± 7	328 ± 6	296 ± 7**
Brain						
Absolute	1.958 ± 0.025	1.907 ± 0.045	2.012 ± 0.041	1.949 ± 0.024	1.928 ± 0.025	1.900 ± 0.028
Relative	5.69 ± 0.11	5.63 ± 0.11	5.52 ± 0.10	5.94 ± 0.13	5.90 ± 0.11	6.44 ± 0.15**
Heart						
Absolute	0.944 ± 0.013	0.929 ± 0.022	1.001 ± 0.023	0.920 ± 0.018	0.892 ± 0.020	0.813 ± 0.025**
Relative	2.74 ± 0.05	2.74 ± 0.04	2.74 ± 0.03	2.80 ± 0.05	2.72 ± 0.03	2.75 ± 0.06
R. Kidney						
Absolute	1.129 ± 0.023	1.094 ± 0.034	1.226 ± 0.036	1.114 ± 0.025	1.125 ± 0.030	1.099 ± 0.030
Relative	3.28 ± 0.05	3.22 ± 0.06	3.36 ± 0.09	3.38 ± 0.04	3.43 ± 0.05	3.71 ± 0.08**
Liver						
Absolute	11.598 ± 0.247	11.708 ± 0.379	12.776 ± 0.277	10.848 ± 0.378	11.081 ± 0.306	10.301 ± 0.214**
Relative	33.69 ± 0.67	34.52 ± 0.77	35.02 ± 0.54	32.93 ± 0.81	33.81 ± 0.58	34.83 ± 0.41
Lung						
Absolute	1.335 ± 0.072 ^b	1.332 ± 0.071	1.397 ± 0.058	1.272 ± 0.045	1.303 ± 0.039	1.322 ± 0.043
Relative	3.83 ± 0.22	3.93 ± 0.19	3.82 ± 0.10	3.86 ± 0.09	3.98 ± 0.09	4.48 ± 0.16**
R. Testis						
Absolute	1.386 ± 0.020	1.355 ± 0.019	1.446 ± 0.020	1.365 ± 0.025	1.395 ± 0.020	1.403 ± 0.026
Relative	4.03 ± 0.05	4.00 ± 0.05	3.97 ± 0.07	4.15 ± 0.07	4.27 ± 0.06*	4.76 ± 0.13**
Thymus						
Absolute	0.261 ± 0.009	0.271 ± 0.014	0.284 ± 0.007	0.260 ± 0.009	0.242 ± 0.009	0.223 ± 0.009**
Relative	0.76 ± 0.02	0.80 ± 0.04	0.78 ± 0.02	0.79 ± 0.02	0.74 ± 0.02	0.75 ± 0.02
Female						
Necropsy body wt	194 ± 5	197 ± 4	200 ± 4	194 ± 5	187 ± 3	179 ± 3*
Brain						
Absolute	1.790 ± 0.030	1.830 ± 0.020	1.791 ± 0.029	1.770 ± 0.022	1.780 ± 0.023	1.753 ± 0.024
Relative	9.26 ± 0.18	9.33 ± 0.15	8.99 ± 0.19	9.18 ± 0.26	9.53 ± 0.15	9.81 ± 0.09
Heart						
Absolute	0.608 ± 0.018	0.669 ± 0.032	0.642 ± 0.016	0.591 ± 0.017	0.590 ± 0.015	0.568 ± 0.012
Relative	3.13 ± 0.05	3.41 ± 0.17	3.22 ± 0.07	3.05 ± 0.04	3.15 ± 0.06	3.18 ± 0.05
R. Kidney						
Absolute	0.728 ± 0.034	0.734 ± 0.025	0.743 ± 0.021	0.687 ± 0.017	0.743 ± 0.015	0.716 ± 0.020
Relative	3.74 ± 0.10	3.73 ± 0.08	3.72 ± 0.07	3.54 ± 0.05	3.97 ± 0.07	4.00 ± 0.08
Liver						
Absolute	6.619 ± 0.349	6.859 ± 0.197	6.799 ± 0.205	6.353 ± 0.231	6.427 ± 0.188	6.025 ± 0.121
Relative	33.95 ± 0.98	34.87 ± 0.54	34.04 ± 0.78	32.79 ± 0.98	34.36 ± 0.84	33.70 ± 0.62
Lung						
Absolute	0.945 ± 0.022	0.999 ± 0.042	1.023 ± 0.041	0.966 ± 0.040	0.967 ± 0.028 ^b	1.034 ± 0.030
Relative	4.89 ± 0.13	5.09 ± 0.20	5.14 ± 0.24	5.00 ± 0.21	5.17 ± 0.19	5.78 ± 0.16**
Thymus						
Absolute	0.221 ± 0.008	0.244 ± 0.006	0.239 ± 0.008	0.233 ± 0.005	0.239 ± 0.006	0.208 ± 0.006
Relative	1.14 ± 0.02	1.24 ± 0.02	1.20 ± 0.04	1.21 ± 0.03	1.28 ± 0.03*	1.17 ± 0.04

* Significantly different ($P \leq 0.05$) from the control group by Williams' or Dunnett's test

** $P \leq 0.01$

^a Organ weights and body weights are given in grams; organ-weight-to-body-weight ratios are given as mg organ weight/g body weight (mean ± standard error).

^b $n=9$

TABLE F3
Organ Weights and Organ-Weight-to-Body-Weight Ratios for Rats at the 15-Month Interim Evaluation
in the 2-Year Inhalation Study of Isobutyl Nitrite^a

	0 ppm	37.5 ppm	75 ppm	150 ppm
n	10	10	10	10
Male				
Necropsy body wt	469 ± 19	473 ± 10	477 ± 9	429 ± 8*
Brain				
Absolute	2.030 ± 0.021	1.988 ± 0.028	2.029 ± 0.016	1.982 ± 0.020
Relative	4.40 ± 0.18	4.22 ± 0.11	4.26 ± 0.08	4.64 ± 0.09
R. Kidney				
Absolute	1.585 ± 0.068	1.565 ± 0.048	1.589 ± 0.043	1.483 ± 0.026
Relative	3.42 ± 0.18	3.31 ± 0.08	3.33 ± 0.08	3.47 ± 0.07
Liver				
Absolute	16.109 ± 0.840	16.317 ± 0.479	16.678 ± 0.601	15.256 ± 0.545
Relative	34.36 ± 1.16	34.46 ± 0.61	34.92 ± 0.96	35.54 ± 0.85
Female				
Necropsy body wt	309 ± 5	295 ± 8	284 ± 4**	266 ± 6**
Brain				
Absolute	1.874 ± 0.016	1.818 ± 0.017	1.841 ± 0.016	1.802 ± 0.025*
Relative	6.08 ± 0.12	6.20 ± 0.17	6.49 ± 0.13	6.79 ± 0.15**
R. Kidney				
Absolute	0.973 ± 0.014	0.974 ± 0.024	0.938 ± 0.017	0.948 ± 0.026
Relative	3.16 ± 0.06	3.31 ± 0.07	3.30 ± 0.07	3.56 ± 0.06**
Liver				
Absolute	9.797 ± 0.399	9.270 ± 0.204	9.019 ± 0.112	8.800 ± 0.258*
Relative	31.75 ± 1.35	31.50 ± 0.50	31.76 ± 0.42	33.05 ± 0.65

* Significantly different ($P \leq 0.05$) from the control group by Williams' or Dunnett's test

** $P \leq 0.01$

^a Organ weights and body weights are given in grams; organ-weight-to-body-weight ratios are given as mg organ weight/g body weight (mean ± standard error).

TABLE F4
Organ Weights and Organ-Weight-to-Body-Weight Ratios for Mice in the 16-Day Inhalation Study of Isobutyl Nitrite^a

	0 ppm	100 ppm	200 ppm	400 ppm	600 ppm	800 ppm
Male						
n	5	5	5	5	5	2
Necropsy body wt	24.8 ± 0.4	24.4 ± 0.3	25.9 ± 0.7	26.5 ± 0.4	22.3 ± 0.6*	20.9 ± 1.4**
Brain						
Absolute	0.460 ± 0.012	0.452 ± 0.004	0.460 ± 0.008	0.452 ± 0.010	0.440 ± 0.009	0.460 ± 0.010
Relative	18.58 ± 0.58	18.51 ± 0.35	17.80 ± 0.31	17.06 ± 0.33	19.83 ± 0.76	22.19 ± 1.92**
Heart						
Absolute	0.134 ± 0.004	0.130 ± 0.005	0.136 ± 0.005	0.132 ± 0.005	0.118 ± 0.004	0.120 ± 0.000
Relative	5.41 ± 0.17	5.33 ± 0.25	5.27 ± 0.24	4.98 ± 0.16	5.30 ± 0.07	5.78 ± 0.37
R. Kidney						
Absolute	0.286 ± 0.002	0.262 ± 0.007	0.294 ± 0.010	0.284 ± 0.005	0.224 ± 0.010**	0.205 ± 0.005**
Relative	11.56 ± 0.26	10.72 ± 0.31	11.37 ± 0.29	10.72 ± 0.18*	10.04 ± 0.22**	9.86 ± 0.40**
Liver						
Absolute	1.382 ± 0.043	1.394 ± 0.023	1.484 ± 0.044	1.610 ± 0.046**	1.292 ± 0.055	1.265 ± 0.045
Relative	55.74 ± 1.04	57.05 ± 0.86	57.43 ± 1.69	60.72 ± 1.03	57.96 ± 1.15	61.07 ± 6.11
Lung						
Absolute	0.162 ± 0.008	0.163 ± 0.005 ^b	0.176 ± 0.004	0.174 ± 0.004	0.228 ± 0.012**	0.255 ± 0.035**
Relative	6.54 ± 0.32	6.71 ± 0.13	6.81 ± 0.18	6.57 ± 0.20	10.26 ± 0.54**	12.39 ± 2.48**
R. Testis						
Absolute	0.103 ± 0.004	0.099 ± 0.003	0.102 ± 0.004	0.094 ± 0.004	0.092 ± 0.004	0.086 ± 0.000
Relative	4.16 ± 0.20	4.04 ± 0.10	3.93 ± 0.11	3.57 ± 0.16*	4.15 ± 0.17	4.14 ± 0.27
Thymus						
Absolute	0.040 ± 0.006	0.038 ± 0.003	0.039 ± 0.004	0.021 ± 0.002**	0.015 ± 0.002**	0.014 ± 0.001**
Relative	1.62 ± 0.23	1.55 ± 0.11	1.51 ± 0.14	0.78 ± 0.06**	0.67 ± 0.07**	0.65 ± 0.07**
Female						
n	5	5	5	5	5	1
Necropsy body wt	21.9 ± 0.4	22.2 ± 0.4	22.3 ± 0.5	21.3 ± 0.3	19.3 ± 0.4**	18.3 ^c
Brain						
Absolute	0.464 ± 0.006	0.454 ± 0.013	0.472 ± 0.006	0.450 ± 0.018	0.428 ± 0.011	0.450
Relative	21.17 ± 0.42	20.47 ± 0.66	21.25 ± 0.51	21.15 ± 0.94	22.19 ± 0.75	24.59
Heart						
Absolute	0.118 ± 0.002	0.118 ± 0.002	0.114 ± 0.004	0.114 ± 0.004	0.102 ± 0.004**	0.100
Relative	5.38 ± 0.12	5.32 ± 0.10	5.12 ± 0.10	5.35 ± 0.15	5.29 ± 0.21	5.46
R. Kidney						
Absolute	0.202 ± 0.002	0.198 ± 0.004	0.194 ± 0.005	0.194 ± 0.010	0.178 ± 0.004**	0.160
Relative	9.23 ± 0.25	8.92 ± 0.07	8.71 ± 0.09	9.11 ± 0.48	9.22 ± 0.15	8.74
Liver						
Absolute	1.254 ± 0.019	1.290 ± 0.025	1.282 ± 0.062	1.310 ± 0.042	1.210 ± 0.043	1.100
Relative	57.19 ± 0.72	58.14 ± 1.03	57.47 ± 1.45	61.47 ± 1.58	62.60 ± 1.62*	60.11
Lung						
Absolute	0.176 ± 0.020	0.166 ± 0.016	0.176 ± 0.007	0.184 ± 0.009	0.204 ± 0.008	0.230
Relative	7.97 ± 0.73	7.50 ± 0.81	7.90 ± 0.14	8.64 ± 0.44	10.58 ± 0.52**	12.57
Thymus						
Absolute	0.064 ± 0.003	0.065 ± 0.003	0.068 ± 0.002	0.068 ± 0.007	0.019 ± 0.002**	0.014
Relative	2.90 ± 0.15	2.94 ± 0.10	3.07 ± 0.10	3.21 ± 0.32	1.00 ± 0.09**	0.77

* Significantly different ($P \leq 0.05$) from the control group by Williams' or Dunnett's test

** $P \leq 0.01$

^a Organ weights and body weights are given in grams; organ-weight-to-body-weight ratios are given as mg organ weight/g body weight (mean ± standard error).

^b $n = 4$

^c No means were calculated because less than two measurements were available.

TABLE F5
Organ Weights and Organ-Weight-to-Body-Weight Ratios for Mice in the 13-Week Inhalation Study of Isobutyl Nitrite^a

	0 ppm	10 ppm	25 ppm	75 ppm	150 ppm	300 ppm
Male						
n	10	10	10	10	10	10
Necropsy body wt	34.8 ± 0.8	35.1 ± 0.9	35.3 ± 1.1	35.0 ± 0.8	35.6 ± 1.1	34.6 ± 0.4
Brain						
Absolute	0.485 ± 0.006	0.479 ± 0.010	0.488 ± 0.005	0.497 ± 0.006	0.480 ± 0.007	0.480 ± 0.006
Relative	14.04 ± 0.41	13.71 ± 0.34	13.92 ± 0.42	14.27 ± 0.28	13.57 ± 0.33	13.90 ± 0.23
Heart						
Absolute	0.179 ± 0.008	0.169 ± 0.006	0.174 ± 0.008	0.155 ± 0.004*	0.157 ± 0.005	0.166 ± 0.005
Relative	5.15 ± 0.23	4.83 ± 0.13	4.91 ± 0.13	4.45 ± 0.12**	4.41 ± 0.14**	4.80 ± 0.12
R. Kidney						
Absolute	0.370 ± 0.008 ^b	0.360 ± 0.011	0.368 ± 0.014	0.352 ± 0.013	0.332 ± 0.014	0.357 ± 0.011
Relative	10.68 ± 0.30	10.29 ± 0.34	10.41 ± 0.26	10.08 ± 0.27	9.61 ± 0.45	10.32 ± 0.27
Liver						
Absolute	1.885 ± 0.042	1.949 ± 0.079	1.972 ± 0.084	1.882 ± 0.044	1.933 ± 0.068	1.790 ± 0.037
Relative	54.34 ± 1.12	55.64 ± 1.96	55.70 ± 1.22	54.09 ± 1.75	54.38 ± 1.44	51.75 ± 0.95
Lungs						
Absolute	0.201 ± 0.011	0.203 ± 0.010	0.218 ± 0.012	0.213 ± 0.014 ^b	0.193 ± 0.009	0.215 ± 0.008
Relative	5.76 ± 0.24	5.81 ± 0.30	6.16 ± 0.21	6.13 ± 0.39	5.44 ± 0.23	6.24 ± 0.26
R. Testis						
Absolute	0.121 ± 0.004	0.122 ± 0.002	0.133 ± 0.009	0.120 ± 0.003	0.118 ± 0.005	0.119 ± 0.002
Relative	3.49 ± 0.11	3.49 ± 0.08	3.78 ± 0.26	3.44 ± 0.09	3.33 ± 0.13	3.44 ± 0.08
Thymus						
Absolute	0.035 ± 0.002	0.031 ± 0.003	0.028 ± 0.002	0.034 ± 0.003	0.033 ± 0.003	0.029 ± 0.002
Relative	1.00 ± 0.07	0.89 ± 0.08	0.80 ± 0.06	0.98 ± 0.08	0.94 ± 0.08	0.85 ± 0.06
Female						
n	10	10	10	10	9	9
Necropsy body wt	33.7 ± 1.4	32.9 ± 0.9	32.8 ± 0.8	32.0 ± 1.5	31.6 ± 1.2	28.4 ± 0.4**
Brain						
Absolute	0.501 ± 0.004	0.513 ± 0.004	0.507 ± 0.011	0.490 ± 0.009	0.494 ± 0.009	0.495 ± 0.006
Relative	15.10 ± 0.56	15.70 ± 0.44	15.55 ± 0.51	15.59 ± 0.78	15.83 ± 0.73	17.48 ± 0.26**
Heart						
Absolute	0.146 ± 0.004	0.140 ± 0.005	0.151 ± 0.005	0.140 ± 0.004	0.144 ± 0.007	0.142 ± 0.004
Relative	4.37 ± 0.14	4.29 ± 0.14	4.64 ± 0.19	4.45 ± 0.19	4.54 ± 0.11	4.98 ± 0.09**
R. Kidney						
Absolute	0.251 ± 0.010	0.265 ± 0.008	0.252 ± 0.012	0.241 ± 0.013	0.233 ± 0.010	0.239 ± 0.008
Relative	7.53 ± 0.34	8.08 ± 0.22	7.72 ± 0.37	7.59 ± 0.37	7.43 ± 0.38	8.41 ± 0.26
Liver						
Absolute	1.771 ± 0.102	1.773 ± 0.049	1.741 ± 0.067	1.700 ± 0.079	1.742 ± 0.082	1.485 ± 0.050*
Relative	52.57 ± 2.15	54.19 ± 1.74	53.20 ± 1.84	53.34 ± 1.70	55.04 ± 1.26	52.41 ± 1.85
Lung						
Absolute	0.221 ± 0.018	0.213 ± 0.008	0.230 ± 0.017	0.212 ± 0.016	0.217 ± 0.009	0.252 ± 0.018
Relative	6.50 ± 0.36	6.53 ± 0.32	7.11 ± 0.64	6.76 ± 0.58	6.91 ± 0.36	8.86 ± 0.59**
Thymus						
Absolute	0.047 ± 0.003	0.042 ± 0.004	0.044 ± 0.003	0.040 ± 0.003	0.044 ± 0.004	0.040 ± 0.003
Relative	1.41 ± 0.09	1.27 ± 0.11	1.37 ± 0.12	1.30 ± 0.12	1.39 ± 0.10	1.41 ± 0.10

* Significantly different ($P \leq 0.05$) from the control group by Williams' or Dunnett's test

** $P \leq 0.01$

^a Organ weights and body weights are given in grams; organ-weight-to-body-weight ratios are given as mg organ weight/g body weight (mean ± standard error).

^b n=9

TABLE F6
Organ Weights and Organ-Weight-to-Body-Weight Ratios for Mice at the 15-Month Interim Evaluation in the 2-Year Inhalation Study of Isobutyl Nitrite^a

	0 ppm	37.5 ppm	75 ppm	150 ppm
Male				
n	10	10	10	7
Necropsy body wt	50.4 ± 1.3	51.6 ± 1.2	49.3 ± 1.7	49.3 ± 1.4
Brain				
Absolute	0.508 ± 0.010	0.507 ± 0.005	0.494 ± 0.017	0.520 ± 0.010
Relative	10.17 ± 0.43	9.87 ± 0.23	10.16 ± 0.61	10.58 ± 0.19
R. Kidney				
Absolute	0.473 ± 0.010	0.474 ± 0.011	0.479 ± 0.017	0.470 ± 0.017
Relative	9.45 ± 0.37	9.22 ± 0.24	9.92 ± 0.76	9.53 ± 0.24
Liver				
Absolute	2.633 ± 0.269	2.591 ± 0.209	2.859 ± 0.268	2.373 ± 0.112
Relative	52.60 ± 5.64	51.39 ± 6.07	59.07 ± 6.94	48.24 ± 2.25
Female				
n	9	9	9	10
Necropsy body wt	46.3 ± 1.7	43.6 ± 2.0	42.5 ± 2.0	34.0 ± 0.8**
Brain				
Absolute	0.497 ± 0.004	0.503 ± 0.007	0.494 ± 0.005	0.496 ± 0.004
Relative	10.86 ± 0.47	11.72 ± 0.55	11.81 ± 0.50	14.61 ± 0.25**
R. Kidney				
Absolute	0.306 ± 0.008	0.280 ± 0.007*	0.277 ± 0.010**	0.267 ± 0.004**
Relative	6.65 ± 0.17	6.50 ± 0.24	6.58 ± 0.27	7.88 ± 0.12**
Liver				
Absolute	2.148 ± 0.064	2.163 ± 0.198	1.824 ± 0.084	1.744 ± 0.060*
Relative	46.59 ± 1.26	51.36 ± 7.28	43.07 ± 1.20	51.25 ± 1.27

* Significantly different ($P \leq 0.05$) from the control group by Williams' or Dunnett's test

** $P \leq 0.01$

^a Organ weights and body weights are given in grams; organ-weight-to-body-weight ratios are given as mg organ weight/g body weight (mean ± standard error).

APPENDIX G

HEMATOLOGY AND CLINICAL CHEMISTRY RESULTS

TABLE G1	Hematology and Clinical Chemistry Data for Rats in the 13-Week Inhalation Study of Isobutyl Nitrite	254
TABLE G2	Hematology and Clinical Chemistry Data for Rats at the 15-Month Interim Evaluation in the 2-Year Inhalation Study of Isobutyl Nitrite	256
TABLE G3	Hematology and Clinical Chemistry Data for Mice in the 13-Week Inhalation Study of Isobutyl Nitrite	258
TABLE G4	Hematology and Clinical Chemistry Data for Mice at the 15-Month Interim Evaluation in the 2-Year Inhalation Study of Isobutyl Nitrite	260

TABLE G1
Hematology and Clinical Chemistry Data for Rats in the 13-Week Inhalation Study of Isobutyl Nitrite^a

	0 ppm	10 ppm	25 ppm	75 ppm	150 ppm	300 ppm
Male						
n	10	10	10	10	10	10
Hematology						
Methemoglobin (g/dL)	0.29 ± 0.03 ^b	0.30 ± 0.03	0.26 ± 0.03	0.34 ± 0.02	0.40 ± 0.04	0.48 ± 0.04 ^{**b}
Hematocrit (%)	42.5 ± 0.5	42.2 ± 0.6	42.36 ± 0.7	40.6 ± 0.7	42.3 ± 0.4	45.5 ± 0.3 ^{**}
Hemoglobin (g/dL)	15.6 ± 0.1	15.4 ± 0.2	15.6 ± 0.2	14.7 ± 0.2 [*]	15.2 ± 0.1	16.1 ± 0.1
Erythrocytes (10 ⁶ /μL)	8.20 ± 0.09	8.16 ± 0.10	8.25 ± 0.14	7.76 ± 0.16	7.84 ± 0.05 [*]	7.83 ± 0.04 ^{**}
Mean cell volume (fL)	52.0 ± 0.5	51.9 ± 0.4	51.5 ± 0.4	52.7 ± 0.3	54.1 ± 0.2 ^{**}	58.3 ± 0.2 ^{**}
Mean cell hemoglobin (pg)	19.0 ± 0.2	18.9 ± 0.1	19.0 ± 0.2	18.9 ± 0.2	19.5 ± 0.1 [*]	20.6 ± 0.1 ^{**}
Mean cell hemoglobin concentration (g/dL)	36.7 ± 0.3	36.7 ± 0.3	37.0 ± 0.5	36.1 ± 0.3	36.1 ± 0.2	35.3 ± 0.2 ^{**}
Leukocytes (10 ³ /μL)	7.79 ± 0.51	8.10 ± 0.68	7.85 ± 0.41	9.10 ± 0.48	9.63 ± 0.46 ^{**}	10.39 ± 0.43 ^{**}
Segmented neutrophils (10 ³ /μL)	1.21 ± 0.12	1.04 ± 0.12 ^b	1.24 ± 0.15	1.30 ± 0.15 ^b	1.53 ± 0.13	1.46 ± 0.13
Lymphocytes (10 ³ /μL)	6.28 ± 0.44	6.28 ± 0.26	6.28 ± 0.40	6.79 ± 0.41	7.71 ± 0.41 [*]	8.40 ± 0.35 ^{**}
Monocytes (10 ³ /μL)	0.23 ± 0.03	0.29 ± 0.06	0.28 ± 0.03	0.29 ± 0.04	0.36 ± 0.07	0.30 ± 0.06
Eosinophils (10 ³ /μL)	0.04 ± 0.02	0.07 ± 0.02	0.08 ± 0.03	0.06 ± 0.02	0.02 ± 0.01	0.06 ± 0.02
Nucleated erythrocytes (10 ³ /μL)	0.40 ± 0.16	0.30 ± 0.21	0.70 ± 0.50	0.80 ± 0.25	0.60 ± 0.31	1.00 ± 0.33
Clinical Chemistry						
Alkaline phosphatase (IU/L)	214 ± 6	211 ± 13	198 ± 7	182 ± 7 ^{**}	202 ± 5	212 ± 6
Alanine aminotransferase (IU/L)	50 ± 4	52 ± 6	51 ± 4	53 ± 6 ^b	45 ± 3	47 ± 4
Bile acids (μmol/L)	19.2 ± 1.0	21.2 ± 1.0	18.9 ± 1.2	21.9 ± 2.7 ^b	19.0 ± 1.2	20.4 ± 1.3

TABLE G1
Hematology and Clinical Chemistry Data for Rats in the 13-Week Inhalation Study of Isobutyl Nitrite (continued)

	0 ppm	10 ppm	25 ppm	75 ppm	150 ppm	300 ppm
Female						
n	10	10	10	10	10	10
Hematology						
Methemoglobin (g/dL)	0.15 ± 0.03	0.26 ± 0.02*	0.29 ± 0.02** ^c	0.26 ± 0.04** ^c	0.29 ± 0.05** ^b	0.43 ± 0.05** ^c
Hematocrit (%)	43.1 ± 1.2	41.3 ± 0.8	42.2 ± 1.0	41.0 ± 0.7	41.0 ± 0.6	44.0 ± 1.0
Hemoglobin (g/dL)	15.4 ± 0.3	15.5 ± 0.1	15.4 ± 0.2	14.8 ± 0.2*	14.8 ± 0.1*	15.5 ± 0.2
Erythrocytes (10 ⁶ /μL)	8.01 ± 0.24	7.62 ± 0.15	7.74 ± 0.17	7.26 ± 0.16**	7.18 ± 0.08**	7.24 ± 0.16**
Mean cell volume (fL)	54.1 ± 0.3	54.3 ± 0.3	54.7 ± 0.4	56.7 ± 0.5**	57.2 ± 0.4**	60.9 ± 0.4**
Mean cell hemoglobin (pg)	19.4 ± 0.6	20.4 ± 0.4	19.9 ± 0.3	20.4 ± 0.3*	20.7 ± 0.2**	21.6 ± 0.5**
Mean cell hemoglobin concentration (g/dL)	35.9 ± 1.0	37.7 ± 0.8	36.6 ± 0.7	36.0 ± 0.3	36.2 ± 0.5	35.5 ± 0.8
Leukocytes (10 ³ /μL)	8.97 ± 0.52	8.77 ± 0.67	9.93 ± 0.44	9.99 ± 0.30	11.11 ± 0.28** ^b	12.06 ± 0.61**
Segmented neutrophils (10 ³ /μL)	1.31 ± 0.22	1.20 ± 0.13	1.60 ± 0.17	1.35 ± 0.10	1.15 ± 0.18	1.38 ± 0.15
Lymphocytes (10 ³ /μL)	7.35 ± 0.33	7.22 ± 0.62	7.87 ± 0.34	8.19 ± 0.33	9.46 ± 0.24** ^b	10.12 ± 0.60**
Monocytes (10 ³ /μL)	0.26 ± 0.04	0.23 ± 0.03	0.34 ± 0.04	0.32 ± 0.03	0.24 ± 0.04	0.41 ± 0.05
Eosinophils (10 ³ /μL)	0.03 ± 0.02	0.07 ± 0.02	0.08 ± 0.03	0.09 ± 0.03	0.06 ± 0.02	0.11 ± 0.02
Nucleated erythrocytes (10 ³ /μL)	0.40 ± 0.22	0.30 ± 0.21	0.70 ± 0.26	0.60 ± 0.27	1.60 ± 0.45*	1.50 ± 0.62*
Clinical Chemistry						
Alkaline phosphatase (IU/L)	181 ± 6	184 ± 8	172 ± 7	157 ± 9	181 ± 9	196 ± 5
Alanine aminotransferase (IU/L)	49 ± 7	43 ± 2	47 ± 5	40 ± 2	40 ± 3 ^b	39 ± 4
Bile acids (μmol/L)	19.1 ± 1.4	21.0 ± 1.9	22.3 ± 2.5	17.9 ± 1.0 ^b	19.6 ± 1.1 ^b	21.4 ± 2.0

* Significantly different ($P \leq 0.05$) from the control group by Dunn's or Shirley's test

** $P \leq 0.01$

^a Mean ± standard error. Statistical tests were performed on unrounded data.

^b n=9

^c n=8

TABLE G2
Hematology and Clinical Chemistry Data for Rats at the 15-Month Interim Evaluation in the 2-Year Inhalation Study of Isobutyl Nitrite^a

	0 ppm	37.5 ppm	75 ppm	150 ppm
Male				
n	9	9	10	10
Hematology				
Methemoglobin (g/dL)	0.09 ± 0.02 ^b	0.21 ± 0.02 ^{**b}	0.18 ± 0.02 ^{**}	0.29 ± 0.03 ^{**}
Hematocrit (%)	41.6 ± 0.5	42.1 ± 0.3	42.0 ± 0.4	38.6 ± 1.8
Hemoglobin (g/dL)	15.6 ± 0.2	15.5 ± 0.1	15.6 ± 0.1	14.3 ± 0.7
Erythrocytes (10 ⁶ /μL)	8.07 ± 0.12	8.33 ± 0.08	8.09 ± 0.11	7.32 ± 0.32 [*]
Mean cell volume (fL)	51.6 ± 0.3	50.5 ± 0.2	51.9 ± 0.3	52.8 ± 0.7 [*]
Mean cell hemoglobin (pg)	19.3 ± 0.2	18.6 ± 0.1 [*]	19.3 ± 0.2	19.6 ± 0.4
Mean cell hemoglobin concentration (g/dL)	37.5 ± 0.2	36.9 ± 0.2	37.3 ± 0.2	37.1 ± 0.3
Platelets (10 ³ /μL)	692.3 ± 25.6	703.4 ± 16.2	690.0 ± 15.8	712.5 ± 14.6
Reticulocytes (10 ⁶ /μL)	0.1 ± 0.0	0.1 ± 0.0	0.2 ± 0.0	0.2 ± 0.0 [*]
Leukocytes (10 ³ /μL)	8.93 ± 0.69 ^c	8.29 ± 0.49	8.49 ± 0.48	7.80 ± 0.37 ^d
Segmented neutrophils (10 ³ /μL)	2.12 ± 0.34 ^c	1.90 ± 0.17	1.92 ± 0.17	1.91 ± 0.32 ^d
Lymphocytes (10 ³ /μL)	6.53 ± 0.40 ^c	6.12 ± 0.43	6.31 ± 0.37	5.59 ± 0.32 ^d
Monocytes (10 ³ /μL)	0.22 ± 0.04 ^c	0.21 ± 0.02	0.20 ± 0.03	0.22 ± 0.05 ^d
Eosinophils (10 ³ /μL)	0.06 ± 0.02 ^c	0.06 ± 0.02	0.06 ± 0.02	0.07 ± 0.02 ^d
Nucleated erythrocytes (10 ³ /μL)	0.08 ± 0.03 ^c	0.17 ± 0.05	0.12 ± 0.03	0.64 ± 0.47 ^d
Heinz bodies (%)	0.0 ± 0.0	0.0 ± 0.0 ^b	0.0 ± 0.0	0.0 ± 0.0
Clinical Chemistry				
Alkaline phosphatase (IU/L)	149 ± 6	170 ± 7 ^b	163 ± 16	150 ± 3
Alanine aminotransferase (IU/L)	71 ± 6 ^c	109 ± 8 ^{*b}	111 ± 10 [*]	106 ± 12
Bile acids (μmol/L)	23.7 ± 2.4 ^d	25.3 ± 2.2 ^b	25.6 ± 1.5	30.8 ± 4.3

TABLE G2
Hematology and Clinical Chemistry Data for Rats at the 15-Month Interim Evaluation in the 2-Year Inhalation Study of Isobutyl Nitrite (continued)

	0 ppm	37.5 ppm	75 ppm	150 ppm
Female				
n	7	9	10	10
Hematology				
Methemoglobin (g/dL)	0.11 ± 0.02 ^d	0.16 ± 0.02 ^b	0.21 ± 0.03*	0.29 ± 0.02**
Hematocrit (%)	40.5 ± 0.7	40.0 ± 0.6	40.0 ± 0.6	40.0 ± 0.4
Hemoglobin (g/dL)	15.3 ± 0.2	15.2 ± 0.2	15.0 ± 0.2	15.0 ± 0.1
Erythrocytes (10 ⁶ /μL)	7.24 ± 0.18	7.14 ± 0.10	7.02 ± 0.13	6.75 ± 0.05**
Mean cell volume (fL)	56.1 ± 0.8	56.0 ± 0.1	56.7 ± 0.2**	58.6 ± 0.2**
Mean cell hemoglobin (pg)	21.2 ± 0.2	21.3 ± 0.1	21.5 ± 0.2	22.2 ± 0.1**
Mean cell hemoglobin concentration (g/dL)	37.7 ± 0.3	38.1 ± 0.2	37.8 ± 0.2	37.9 ± 0.2
Platelets (10 ³ /μL)	604.0 ± 15.2	667.3 ± 15.5*	703.1 ± 14.7**	744.0 ± 41.0**
Reticulocytes (10 ⁶ /μL)	0.1 ± 0.0 ^e	0.1 ± 0.0	0.2 ± 0.0	0.1 ± 0.0
Leukocytes (10 ³ /μL)	5.16 ± 0.24	6.14 ± 0.29*	6.02 ± 0.49	7.18 ± 0.46**
Segmented neutrophils (10 ³ /μL)	1.06 ± 0.12	1.30 ± 0.19	1.18 ± 0.22	1.59 ± 0.31
Lymphocytes (10 ³ /μL)	3.90 ± 0.21	4.60 ± 0.14*	4.59 ± 0.30*	5.32 ± 0.23**
Monocytes (10 ³ /μL)	0.17 ± 0.04	0.18 ± 0.03	0.20 ± 0.06	0.24 ± 0.03
Eosinophils (10 ³ /μL)	0.05 ± 0.00	0.07 ± 0.02	0.06 ± 0.02	0.03 ± 0.01
Nucleated erythrocytes (10 ³ /μL)	0.11 ± 0.03	0.29 ± 0.07*	0.36 ± 0.08**	0.52 ± 0.07**
Heinz bodies (%)	0.0 ± 0.0 ^d	0.0 ± 0.0 ^b	0.0 ± 0.0	0.0 ± 0.0
Clinical Chemistry				
Alkaline phosphatase (IU/L)	143 ± 4 ^b	141 ± 4 ^b	134 ± 6	146 ± 7
Alanine aminotransferase (IU/L)	54 ± 7 ^b	47 ± 4 ^b	43 ± 4	81 ± 17
Bile acids (μmol/L)	26.6 ± 3.3 ^b	25.0 ± 2.2 ^b	23.2 ± 1.8	32.3 ± 3.8

* Significantly different ($P \leq 0.05$) from the control group by Dunn's or Shirley's test

** $P \leq 0.01$

^a Mean ± standard error. Statistical tests were performed on unrounded data.

^b n=10

^c n=8

^d n=9

^e n=6

TABLE G3
Hematology and Clinical Chemistry Data for Mice in the 13-Week Inhalation Study of Isobutyl Nitrite^a

	0 ppm	10 ppm	25 ppm	75 ppm	150 ppm	300 ppm
Male						
n	5	5	5	5	5	5
Hematology						
Methemoglobin (g/dL)	0.29 ± 0.03	0.28 ± 0.04	0.22 ± 0.04	0.32 ± 0.06	0.36 ± 0.02*	0.68 ± 0.07**
Hematocrit (%)	44.5 ± 0.6	44.4 ± 0.7	43.3 ± 1.0	42.2 ± 0.9	42.5 ± 0.4*	41.2 ± 0.8**
Hemoglobin (g/dL)	15.9 ± 0.1	15.2 ± 0.5	15.5 ± 0.3	15.4 ± 0.2	15.4 ± 0.1	15.0 ± 0.3
Erythrocytes (10 ⁶ /μL)	9.28 ± 0.12	9.00 ± 0.37	9.08 ± 0.21	8.73 ± 0.23	8.83 ± 0.09	8.13 ± 0.23**
Mean cell volume (fL)	48.0 ± 0.3	49.8 ± 1.6	47.8 ± 0.4	48.6 ± 0.4	48.2 ± 0.6	51.2 ± 0.8*
Mean cell hemoglobin (pg)	17.1 ± 0.2	17.0 ± 0.7	17.1 ± 0.1	17.7 ± 0.4	17.5 ± 0.2	18.5 ± 0.3**
Mean cell hemoglobin concentration (g/dL)	35.7 ± 0.3	34.2 ± 1.1	35.9 ± 0.3	36.6 ± 0.8	36.2 ± 0.2	36.4 ± 0.2
Leukocytes (10 ³ /μL)	2.58 ± 0.16	2.20 ± 0.21	2.98 ± 0.41	4.06 ± 0.35*	4.10 ± 0.53*	5.58 ± 0.96**
Segmented neutrophils (10 ³ /μL)	0.40 ± 0.03	0.38 ± 0.11	0.40 ± 0.06	0.70 ± 0.16	0.56 ± 0.09	0.64 ± 0.11
Lymphocytes (10 ³ /μL)	2.14 ± 0.17	1.72 ± 0.09	2.48 ± 0.35	3.20 ± 0.22*	3.40 ± 0.42*	4.78 ± 0.92**
Monocytes (10 ³ /μL)	0.06 ± 0.02	0.04 ± 0.02	0.06 ± 0.02	0.12 ± 0.02	0.12 ± 0.02	0.14 ± 0.02*
Eosinophils (10 ³ /μL)	0.02 ± 0.02	0.02 ± 0.02	0.00 ± 0.00	0.04 ± 0.02	0.04 ± 0.02	0.00 ± 0.00
Nucleated erythrocytes (10 ³ /μL)	0.00 ± 0.00	0.01 ± 0.01	0.00 ± 0.00	0.01 ± 0.01	0.00 ± 0.00	0.00 ± 0.00
Clinical Chemistry						
Alkaline phosphatase (IU/L)	54 ± 4	54 ± 1	54 ± 4	50 ± 2	51 ± 2	48 ± 2
Alanine aminotransferase (IU/L)	38 ± 2	32 ± 5 ^b	52 ± 8	45 ± 8	35 ± 3	43 ± 8
Bile acids (μmol/L)	24 ± 1	23 ± 0 ^b	26 ± 2	24 ± 1	24 ± 1	23 ± 1 ^b

TABLE G3
Hematology and Clinical Chemistry Data for Mice in the 13-Week Inhalation Study of Isobutyl Nitrite (continued)

	0 ppm	10 ppm	25 ppm	75 ppm	150 ppm	300 ppm
Female						
n	5	5	5	5	4	5
Hematology						
Methemoglobin (g/dL)	0.27 ± 0.04	0.40 ± 0.05	0.37 ± 0.00*	0.35 ± 0.03*	0.53 ± 0.09**	0.73 ± 0.06**
Hematocrit (%)	45.8 ± 0.7	45.8 ± 1.4	43.8 ± 1.2	45.5 ± 0.2	45.0 ± 1.4	42.1 ± 0.6*
Hemoglobin (g/dL)	16.4 ± 0.2	16.8 ± 0.4	16.1 ± 0.2	16.3 ± 0.1	16.3 ± 0.5	15.6 ± 0.3
Erythrocytes (10 ⁶ /μL)	9.79 ± 0.12	9.63 ± 0.35	9.28 ± 0.25	9.56 ± 0.11	9.38 ± 0.32	8.42 ± 0.09**
Mean cell volume (fL)	47.2 ± 0.2	47.8 ± 0.7	47.8 ± 0.5	47.8 ± 0.4	48.3 ± 0.3	50.0 ± 0.6**
Mean cell hemoglobin (pg)	16.7 ± 0.1	17.5 ± 0.9*	17.4 ± 0.3*	17.1 ± 0.2*	17.4 ± 0.2*	18.6 ± 0.3**
Mean cell hemoglobin concentration (g/dL)	35.8 ± 0.2	36.6 ± 0.4	36.9 ± 0.5	35.8 ± 0.2	36.4 ± 0.2	37.2 ± 0.3
Leukocytes (10 ³ /μL)	4.00 ± 0.39	5.54 ± 0.60	5.46 ± 0.19	4.12 ± 0.39	3.50 ± 0.41	7.06 ± 0.54**
Segmented neutrophils (10 ³ /μL)	0.400 ± 0.126	0.460 ± 0.121	0.540 ± 0.087	0.500 ± 0.055	0.450 ± 0.065	0.760 ± 0.157
Lymphocytes (10 ³ /μL)	3.48 ± 0.32	4.96 ± 0.48	4.82 ± 0.21	3.52 ± 0.32	2.90 ± 0.40	6.08 ± 0.37**
Monocytes (10 ³ /μL)	0.08 ± 0.04	0.08 ± 0.04	0.12 ± 0.02	0.06 ± 0.02	0.13 ± 0.03	0.18 ± 0.04
Eosinophils (10 ³ /μL)	0.02 ± 0.02	0.02 ± 0.02	0.02 ± 0.02	0.08 ± 0.04	0.03 ± 0.03	0.08 ± 0.04
Nucleated erythrocytes (10 ³ /μL)	0.00 ± 0.00	0.00 ± 0.00	0.00 ± 0.00	0.00 ± 0.00	0.00 ± 0.00	0.00 ± 0.00
Clinical Chemistry						
Alkaline phosphatase (IU/L)	93 ± 2	88 ± 3	67 ± 5**	87 ± 6	87 ± 6 ^c	83 ± 4 ^b
Alanine aminotransferase (IU/L)	32 ± 4	30 ± 6	31 ± 4	45 ± 10	30 ± 4 ^c	24 ± 2 ^b
Bile acids (μmol/L)	28.6 ± 2.1	29.6 ± 3.3	26.0 ± 1.9	36.8 ± 3.3	27.8 ± 2.9 ^c	24.0 ± 1.5 ^b

* Significantly different ($P \leq 0.05$) from the control group by Dunn's or Shirley's test

** $P \leq 0.01$

^a Mean ± standard error. Statistical tests were performed on unrounded data.

^b n=4

^c n=5

TABLE G4
Hematology and Clinical Chemistry Data for Mice at the 15-Month Interim Evaluation in the 2-Year Inhalation Study of Isobutyl Nitrite^a

	0 ppm	37.5 ppm	75 ppm	150 ppm
Male				
n	10	9	9	6
Hematology				
Methemoglobin (g/dL)	0.08 ± 0.03 ^b	0.16 ± 0.02*	0.24 ± 0.05**	0.35 ± 0.06**
Hematocrit (%)	51.5 ± 1.3	52.0 ± 0.6	49.1 ± 1.0	46.8 ± 1.9
Hemoglobin (g/dL)	16.7 ± 0.3	17.3 ± 0.3	16.1 ± 0.3	15.6 ± 0.5
Erythrocytes (10 ⁶ /μL)	10.69 ± 0.25	10.62 ± 0.13	10.20 ± 0.16*	9.49 ± 0.34**
Mean cell volume (fL)	48.2 ± 0.4	49.0 ± 0.2	48.1 ± 0.6	49.3 ± 0.3
Mean cell hemoglobin (pg)	15.7 ± 0.2	16.3 ± 0.2	15.8 ± 0.2	16.5 ± 0.1*
Mean cell hemoglobin concentration (g/dL)	32.5 ± 0.3	33.2 ± 0.3	32.9 ± 0.2	33.5 ± 0.4
Platelets (10 ³ /μL)	1046.1 ± 84.7	846.7 ± 48.9	1049.1 ± 58.6	1081.2 ± 80.1
Reticulocytes (10 ⁶ /μL)	0.2 ± 0.0	0.2 ± 0.0	0.2 ± 0.0	0.2 ± 0.0
Leukocytes (10 ³ /μL)	5.66 ± 0.57	7.32 ± 0.48	6.64 ± 0.98	7.97 ± 0.55*
Segmented neutrophils (10 ³ /μL)	1.07 ± 0.18	1.33 ± 0.19	0.95 ± 0.22	1.28 ± 0.27
Lymphocytes (10 ³ /μL)	4.31 ± 0.49	5.65 ± 0.35	5.38 ± 0.74	6.31 ± 0.40*
Monocytes (10 ³ /μL)	0.22 ± 0.04	0.29 ± 0.03	0.27 ± 0.04	0.28 ± 0.05
Eosinophils (10 ³ /μL)	0.06 ± 0.02	0.03 ± 0.01	0.03 ± 0.01	0.11 ± 0.04
Nucleated erythrocytes (10 ³ /μL)	0.00 ± 0.00	0.00 ± 0.00	0.00 ± 0.00	0.01 ± 0.01
Heinz bodies (%)	0.0 ± 0.0	0.0 ± 0.0	0.0 ± 0.0	0.0 ± 0.0
Clinical Chemistry				
Alkaline phosphatase (IU/L)	48 ± 2	50 ± 2	43 ± 2	42 ± 3 ^c
Alanine aminotransferase (IU/L)	48 ± 4 ^c	49 ± 4	53 ± 6	42 ± 3 ^c
Bile acids (μmol/L)	36.9 ± 2.4 ^b	33.3 ± 3.0 ^d	30.9 ± 1.0 ^d	27.6 ± 2.2** ^c

TABLE G4
Hematology and Clinical Chemistry Data for Mice at the 15-Month Interim Evaluation in the 2-Year Inhalation Study of Isobutyl Nitrite (continued)

	0 ppm	37.5 ppm	75 ppm	150 ppm
Female				
n	8	8	9	10
Hematology				
Methemoglobin (g/dL)	0.07 ± 0.02	0.11 ± 0.03	0.27 ± 0.05**	0.39 ± 0.03**
Hematocrit (%)	50.7 ± 0.4	50.6 ± 1.1	49.6 ± 0.6	47.7 ± 0.7*
Hemoglobin (g/dL)	17.2 ± 0.1	16.8 ± 0.3	16.5 ± 0.2**	16.0 ± 0.2**
Erythrocytes (10 ⁶ /μL)	10.34 ± 0.10	10.12 ± 0.21	10.05 ± 0.14	9.65 ± 0.11**
Mean cell volume (fL)	49.1 ± 0.2	50.0 ± 0.2	49.4 ± 0.3	49.4 ± 0.4
Mean cell hemoglobin (pg)	16.6 ± 0.1	16.6 ± 0.1	16.4 ± 0.1	16.6 ± 0.1
Mean cell hemoglobin concentration (g/dL)	33.9 ± 0.2	33.3 ± 0.3	33.2 ± 0.2	33.7 ± 0.2
Platelets (10 ³ /μL)	681.4 ± 25.2	734.6 ± 41.6	796.1 ± 28.1	772.5 ± 28.5
Reticulocytes (10 ⁶ /μL)	0.1 ± 0.0	0.1 ± 0.0	0.1 ± 0.0	0.2 ± 0.0
Leukocytes (10 ³ /μL)	4.60 ± 0.40	4.14 ± 0.23	3.91 ± 0.52	4.11 ± 0.34
Segmented neutrophils (10 ³ /μL)	0.73 ± 0.08	0.58 ± 0.05	0.51 ± 0.09	0.65 ± 0.17
Lymphocytes (10 ³ /μL)	3.72 ± 0.34	3.41 ± 0.25	3.28 ± 0.41	3.33 ± 0.19
Monocytes (10 ³ /μL)	0.13 ± 0.01	0.12 ± 0.01	0.12 ± 0.03	0.11 ± 0.02
Eosinophils (10 ³ /μL)	0.04 ± 0.01	0.03 ± 0.01	0.00 ± 0.00*	0.02 ± 0.01
Nucleated erythrocytes (10 ³ /μL)	0.00 ± 0.00	0.00 ± 0.00	0.00 ± 0.00	0.00 ± 0.00
Heinz bodies (%)	0.0 ± 0.0	0.0 ± 0.0	0.0 ± 0.0	0.0 ± 0.0
Clinical Chemistry				
Alkaline phosphatase (IU/L)	79 ± 5 ^b	92 ± 4	88 ± 6	95 ± 4
Alanine aminotransferase (IU/L)	34 ± 3 ^b	33 ± 3	34 ± 3	28 ± 2 ^b
Bile acids (μmol/L)	32.7 ± 2.7 ^b	32.0 ± 2.2	28.8 ± 1.8	27.9 ± 1.8

* Significantly different ($P \leq 0.05$) from the control group by Dunn's or Shirley's test

** $P \leq 0.01$

^a Mean ± standard error. Statistical tests were performed on unrounded data.

^b n=9

^c n=7

^d n=8

^e n=10

APPENDIX H

REPRODUCTIVE TISSUE EVALUATIONS AND ESTROUS CYCLE CHARACTERIZATION

TABLE H1	Summary of Reproductive Tissue Evaluations and Estrous Cycle Characterization for Rats in the 13-Week Inhalation Study of Isobutyl Nitrite	264
TABLE H2	Summary of Reproductive Tissue Evaluations and Estrous Cycle Characterization for Mice in the 13-Week Inhalation Study of Isobutyl Nitrite	265

TABLE HI
Summary of Reproductive Tissue Evaluations and Estrous Cycle Characterization for Rats
in the 13-Week Inhalation Study of Isobutyl Nitrite^a

	0 ppm	10 ppm	75 ppm	300 ppm
n	10	10	10	10
Male				
Weights (g)				
Necropsy body weight	339 ± 8	334 ± 7	328 ± 8	291 ± 7**
R. cauda	0.158 ± 0.003	0.152 ± 0.004	0.144 ± 0.003*	0.140 ± 0.004**
R. epididymis	0.436 ± 0.008	0.435 ± 0.008	0.410 ± 0.004**	0.415 ± 0.007*
R. testis	1.386 ± 0.020	1.355 ± 0.019	1.365 ± 0.025	1.403 ± 0.026
Epididymal spermatozoal measurements				
Motility (%)	93.71 ± 0.98	94.13 ± 0.79	94.56 ± 1.64	95.10 ± 0.98
Abnormal (%)	0.960 ± 0.122	1.000 ± 0.112	1.000 ± 0.140	1.080 ± 0.153
Concentration (10 ⁶ /g cauda epididymal tissue)	601 ± 31	576 ± 24	528 ± 29	531 ± 34
Female				
Necropsy body weight (g)	192 ± 5	195 ± 3	194 ± 5	176 ± 3**
Estrous cycle length (days)	4.80 ± 0.13	4.90 ± 0.18	4.80 ± 0.13	4.80 ± 0.13
Estrous stages (% of cycle)				
Diestrus	28.6	25.7	34.3	30.0
Proestrus	18.6	20.0	12.9	20.0
Estrus	25.7	25.7	28.6	27.1
Metestrus	25.7	28.6	22.9	22.9
Uncertain diagnoses	1.4	0.0	1.4	0.0

* Significantly different ($P < 0.05$) from the control group by Williams' or Dunnett's test (necropsy body weight) or Shirley's test (R. cauda and R. epididymis weights)

** ($P < 0.01$)

^a Data are presented as mean ± standard error.

TABLE H2
Summary of Reproductive Tissue Evaluations and Estrous Cycle Characterization for Mice
in the 13-Week Inhalation Study of Isobutyl Nitrite^a

	0 ppm	10 ppm	75 ppm	300 ppm
Male				
n	10	10	9	10
Weights (g)				
Necropsy body weight	34.7 ± 0.8	34.5 ± 1.0	34.1 ± 0.8 ^b	34.0 ± 0.4
R. cauda	0.017 ± 0.001	0.016 ± 0.000	0.017 ± 0.001	0.015 ± 0.001
R. epididymis	0.042 ± 0.001	0.043 ± 0.001	0.045 ± 0.001	0.043 ± 0.002
R. testis	0.121 ± 0.004	0.122 ± 0.002	0.120 ± 0.003 ^b	0.119 ± 0.002
Epididymal spermatozoal measurements				
Motility (%)	91.76 ± 0.48	91.07 ± 1.23	92.37 ± 0.70	93.08 ± 0.35
Abnormal (%)	1.22 ± 0.18	1.14 ± 0.20	1.71 ± 0.18	1.10 ± 0.14
Concentration (10 ⁶ /g cauda epididymal tissue)	1,086 ± 72	1,056 ± 74	1,042 ± 103	1,110 ± 87
Female				
n	10	10	10	9
Necropsy body weight (g)	33.3 ± 1.4	32.5 ± 0.9	31.7 ± 1.3	27.3 ± 0.8 ^{**b}
Estrous cycle length (days)	4.30 ± 0.15	4.20 ± 0.13	4.50 ± 0.27	4.44 ± 0.24
Estrous stages (% of cycle)				
Diestrus	18.6	21.4	34.3	15.9
Proestrus	25.7	24.3	21.4	25.4
Estrus	34.3	32.9	24.3	39.7
Metestrus	21.4	21.4	20.0	19.0

**** Significantly different (P < 0.01) from the control group by Williams' test (necropsy body weight)**

^a Data are presented as mean ± standard error.

^b n=10

APPENDIX I

CHEMICAL CHARACTERIZATION AND GENERATION OF CHAMBER CONCENTRATIONS

PROCUREMENT AND CHARACTERIZATION OF ISOBUTYL NITRITE	268
GENERATION AND MONITORING OF CHAMBER CONCENTRATIONS	269
CHAMBER ATMOSPHERE CHARACTERIZATION	270
FIGURE I1 Infrared Absorption Spectrum of Isobutyl Nitrite	272
FIGURE I2 Nuclear Magnetic Resonance Spectrum of Isobutyl Nitrite	273
FIGURE I3 Isobutyl Nitrite Transpiration Bubbler	274
FIGURE I4a Isobutyl Nitrite Vapor Generation and Delivery System for the 16-Day Studies	275
FIGURE I4b Isobutyl Nitrite Vapor Generation and Delivery System for the 13-Week Studies for 10 and 25 ppm Target Concentrations	276
FIGURE I4c Isobutyl Nitrite Vapor Generation and Delivery System for the 13-Week Studies for 75, 150, and 300 ppm Target Concentrations	277
FIGURE I4d Isobutyl Nitrite Vapor Generation and Delivery System for the 2-Year Studies	278
FIGURE I5a Isobutyl Nitrite Exposure Suite for the 16-Day and 13-Week Studies	279
FIGURE I5b Isobutyl Nitrite Exposure Suite for the 2-Year Studies	280
TABLE I1 Summary of Chamber Concentrations in the 16-Day Inhalation Studies of Isobutyl Nitrite	281
TABLE I2 Summary of Chamber Concentrations in the 13-Week Inhalation Studies of Isobutyl Nitrite	281
TABLE I3 Summary of Chamber Concentrations in the 2-Year Inhalation Studies of Isobutyl Nitrite	282
FIGURE I6 Monthly Mean Concentration and Standard Deviation in the 37.5 ppm Isobutyl Nitrite Rat Exposure Chamber for the 2-Year Study	283
FIGURE I7 Monthly Mean Concentration and Standard Deviation in the 75 ppm Isobutyl Nitrite Rat Exposure Chamber for the 2-Year Study	284
FIGURE I8 Monthly Mean Concentration and Standard Deviation in the 150 ppm Isobutyl Nitrite Rat Exposure Chamber for the 2-Year Study	285
FIGURE I9 Monthly Mean Concentration and Standard Deviation in the 37.5 ppm Isobutyl Nitrite Mouse Exposure Chamber for the 2-Year Study	286
FIGURE I10 Monthly Mean Concentration and Standard Deviation in the 75 ppm Isobutyl Nitrite Mouse Exposure Chamber for the 2-Year Study	287
FIGURE I11 Monthly Mean Concentration and Standard Deviation in the 150 ppm Isobutyl Nitrite Mouse Exposure Chamber for the 2-Year Study	288

CHEMICAL CHARACTERIZATION AND GENERATION OF CHAMBER CONCENTRATIONS

PROCUREMENT AND CHARACTERIZATION OF ISOBUTYL NITRITE

Isobutyl nitrite was obtained in four lots. Lot 196 was obtained from Frank Enterprises, Inc., and was used during the 16-day studies and at the beginning of the 13-week studies. Lots KL-XIV-14A, KL-VIII-48-0, and KL-30-49-A were obtained from King's Laboratories, Inc. (Blythewood, SC). Lot KL-XIV-14A was used throughout the remainder of the 13-week studies and for the beginning of the 2-year studies. Lots KL-VIII-48-0 and KL-30-49-A were used throughout the remainder of the 2-year studies. Identity and purity analyses were conducted by the analytical chemistry laboratory, Midwest Research Institute (Kansas City, MO). Reports on analyses performed in support of the isobutyl nitrite studies are on file at the National Institute of Environmental Health Sciences (NIEHS).

The chemical, a clear, yellowish liquid, was identified as isobutyl nitrite by infrared, ultraviolet/visible, and nuclear magnetic resonance spectroscopy. All spectra were consistent with the literature spectra (*Sadtler Standard Spectra*) of isobutyl nitrite (Figures I1 and I2).

The purity of each lot was determined by elemental analyses, free acid titration (calculated as nitrous acid), and gas chromatography. For free acid titration of all lots, samples were dissolved in methanol and titrated with 0.10 N sodium hydroxide. The titrations of lots 196 and KL-XIV-14A were monitored colorimetrically with bromothymol blue indicator, and the titrations of lots KL-VIII-48-0 and KL-30-49-A were monitored potentiometrically with an electrode filled with 3 M potassium chloride. Gas chromatography was performed using a flame ionization detector. All lots of isobutyl nitrite were analyzed by two of three systems:

- A) 10% Carbowax 20M-TPA on 80/100 Chromosorb W(AW) with nitrogen as the carrier gas at a flow rate of 70 mL/minute, and an oven temperature program of 60° C for 6 minutes, then 60° to 200° C at 10° C per minute,
- B) 20% SP-2100/0.1% Carbowax 1500 on 100/120 Supelcoport with nitrogen as the carrier gas at a flow rate of 70 mL/minute and an oven temperature program of 50° C for 5 minutes, then 50° to 170° C at 10° C per minute, or
- C) DB-Wax capillary fused-silica with helium as the carrier gas at a flow rate of 10 mL/minute, nitrogen as the make-up gas at a flow rate of 20 mL/minute, and an oven temperature program of 50° C for 5 minutes, then 50° to 230° C at 10° C per minute.

Elemental analyses for carbon and hydrogen in lot 196 were in agreement with the theoretical values for isobutyl nitrite, while the result for nitrogen was slightly low. Free acid titration indicated $0.208 \pm 0.002\%$ nitrous acid. Gas chromatography using system A indicated one major peak and three impurity peaks with a total area of 7.52% relative to the major peak. Gas chromatography using system B indicated one major peak and four impurity peaks with a total area of 7.51% relative to the major peak. The largest impurity was identified as isobutyl alcohol by retention time matching and was quantitated at $6.0 \pm 0.2\%$ by gas chromatography using system B with a carrier gas flow rate of 60 mL/minute and an isothermal oven temperature of 40° C. A crystalline solid was observed in several containers of the bulk liquid stored at -20° C. The crystals liquified on warming to 25° C, but the resulting liquid was immiscible with the bulk chemical. The immiscible liquid was analyzed and identified as primarily water by infrared and nuclear magnetic resonance spectroscopy and Karl Fischer water analysis. The overall purity was determined to be approximately 93%.

Elemental analyses for carbon, hydrogen, and nitrogen in lot KL-XIV-14A were in agreement with the theoretical values for isobutyl nitrite. Free acid titration indicated $0.126 \pm 0.002\%$ nitrous acid. Gas chromatography using system B indicated one major peak and four impurity peaks with a total area of 2.15% relative to the major peak. Gas chromatography using system C indicated one major peak and three impurity peaks with a total area of 2.84% relative to the major peak. The largest impurity was identified as isobutyl alcohol by retention time matching and was quantitated at $1.7 \pm 0.1\%$ by gas chromatography using system B with an oven temperature program of 40°C for 10.5 minutes, then 40°C to 170°C at 50°C per minute. The overall purity was determined to be greater than 97%.

Elemental analyses for carbon and hydrogen in lots KL-VIII-48-0 and KL-30-49-A were in agreement with the theoretical values for isobutyl nitrite, while the result for nitrogen in each was slightly low. Free acid titration indicated $0.205 \pm 0.003(\text{s})\%$ nitrous acid for lot KL-VIII-48-0 and $0.004 \pm 0.002(\text{s})\%$ nitrous acid for lot KL-30-49-A. Gas chromatography using system B indicated one major peak and four impurity peaks with a total area of 3.5% relative to the major peak for lot KL-VIII-48-0 and one major peak and two impurity peaks with a total area of 1.1% relative to the major peak for lot KL-30-49-A. Gas chromatography using system C indicated one major peak and three impurity peaks for both lots with total areas of 4.5% (lot KL-VIII-48-0) and 2.4% (lot KL-30-49-A) relative to the major peak. The largest impurity in each lot was identified as isobutyl alcohol by retention time matching and quantitated at $2.41 \pm 0.2\%$ for KL-VIII-48-0 and $0.86 \pm 0.01\%$ for lot KL-30-49-A. The quantitations were performed with gas chromatography using system B with an oven temperature program of 45°C for 11 minutes, then 45°C to 170°C at 30°C per minute. The overall purity was determined to be approximately 97% for lot KL-VIII-48-0 and approximately 99% for lot KL-30-49-A.

GENERATION AND MONITORING OF CHAMBER CONCENTRATIONS

Vapor Generation System. Isobutyl nitrite vapor was generated from the bulk chemical. Liquid isobutyl nitrite was pumped from reservoir bottles to glass vapor transpiration bubblers where a controlled flow of nitrogen carrier gas was passed through it (Figure I3). The bubblers were heated in a water or oil bath to stabilize the transpiration rate. Fritted carrier gas inlets, submerged in liquid isobutyl nitrite contained in the bubblers, produced a dispersion of nitrogen through the liquid effecting vaporization. The resulting vapor-laden carrier stream was directed through warmed stainless steel tubing to the throat section of the inhalation inlet venturis, where the vapors were mixed at high velocity and turbulence with filtered chamber air to produce the target concentrations. Adjustments to the chamber concentration were made by altering the carrier gas flow rates, which directly manipulated the amount of vapor delivered to the chambers. The carriers were controlled with fine metering valves in conjunction with gas rotometers (Matheson Gas Products, Joliet, IL). Outlet ports at the bottom of the bubblers allowed the connection of individual bubblers to a single feed reservoir, which was constantly supplied with fresh isobutyl nitrite using a fluid metering pump (FMI, Oyster Bay, NY). During the 16-day studies, one bubbler was used for each chamber at the target concentrations of 100 and 200 ppm. Production of 400, 600, and 800 ppm target concentrations required two, three, and four transpiration bubblers, respectively, which were connected to individual chamber carrier gas streams in parallel (Figure I4a). During the 13-week studies, one bubbler was used for each chamber at the target concentrations of 10, 25, 75, and 150 ppm and two bubblers for the 300 ppm target concentration (Figures I4b and I4c). During the 2-year studies, one bubbler was used for each chamber at the target concentrations of 37.5 and 75 ppm (Figure I4d illustrates the vapor generator and delivery system for the 75 ppm target concentration) and two bubblers for the 150 ppm target concentration. Stainless steel, multitiered, whole-body exposure chambers (H-2000 2 m^3 , Lab Products, Inc., Maywood, NJ) were used in these studies. Diagrams of the exposure suites are shown in Figures I5a and I5b.

Vapor Concentration Monitoring. Chamber concentrations were monitored with one or two gas chromatographs using a flame ionization detector and a glass column packed with 20% SP-2100/0.1% Carbowax 1500 on 100/120 Supelcoport. Nitrogen was used as the carrier gas. In the 16-day studies, chamber concentrations were monitored with a Hewlett Packard Model 5880A gas chromatograph with a carrier gas flow rate of 30 mL/minute and an isothermal oven temperature of 50° C. Chamber concentrations for the 13-week studies were monitored with a Hewlett Packard Model 5880A and a Perkin Elmer Sigma 300 gas chromatograph, both with a carrier gas flow rate of 40 mL/minute and an isothermal oven temperature of 50° C. Chamber concentrations for the 2-year studies were monitored with two Hewlett Packard Model 5880A gas chromatographs with a carrier gas flow rate of 60 mL/minute and an isothermal oven temperature of 60° C. The gas chromatographs were calibrated for both isobutyl nitrite and isobutyl alcohol, the major isobutyl nitrite impurity. Calibration was accomplished using certified standard gas mixtures prepared by Matheson Gas Products (Joliet, IL), and the calibration was validated using gravimetrically prepared liquid standards of isobutyl nitrite and isobutyl alcohol. Routine samples of chamber atmospheres for isobutyl nitrite and isobutyl alcohol were collected by manually withdrawing grab samples from a single representative port in the front of each chamber with a gas-tight syringe and injecting the sample directly into the gas chromatograph.

The means of the concentrations in all chambers for the 16-day studies were within 10% of the target values. In the 13-week studies, the means of the concentrations were within 10% for greater than 96% of all exposures. The means of the concentrations for all chambers for the entire 2-year studies ranged from 99% to 100% of the target concentrations. The chamber concentrations for the 16-day, 13-week, and 2-year studies are summarized in Tables I1 through I3. The monthly mean exposure concentrations in the chambers of the 2-year studies are presented in Figures I6 through I11.

During the 16-day and 13-week studies, nitrous acid concentrations were determined in the high and low target concentrations (100 and 800 ppm and 10 and 300 ppm, respectively). During the 16-day studies, nitrous acid was quantitated on two exposure days by sampling the chambers during the first, third, and sixth hours of exposure. During the 13-week studies, nitrous acid was quantitated on one day each month by sampling chambers at least three times during an exposure period. Collection of nitrous acid was accomplished by passing a known volume of chamber air through two midjet impingers in series containing 1% potassium hydroxide to convert nitrous acid to potassium nitrite. Nitrite ion analysis was performed with high-performance liquid chromatography with a reverse-phase Waters μ Bondapak C₁₈ column with ultraviolet detection (214 nm) and a mobile phase of Waters Pic A (low UV), 2.5 mM, at a flow rate of 1 mL/minute. Analyses were performed using sodium nitrite as the standard. During the 2-year studies, chamber nitrous acid concentrations were quantitated for the 37.5 and 150 ppm target concentrations during the first week of the study and every 90 days thereafter on test atmospheres collected during the first and last hours of the daily exposure periods. Collection of nitrous acid was accomplished by passing a known volume of chamber air through a single midjet impinger containing 0.1% potassium hydroxide. The collected nitrous acid was analyzed as nitrite ion with a Dionex Model 14 Ion Chromatograph.

CHAMBER ATMOSPHERE CHARACTERIZATION

Buildup and decay rates for chamber concentrations were monitored using the gas chromatography system described for vapor concentration monitoring. Samples were collected with a gas-tight syringe at timed intervals and injected directly into the gas chromatograph to develop a continuum of increasing or decreasing concentrations within one chromatogram, while eliminating the possibility of peaks eluting at identical times. The time to achieve 90% of target concentration after the start of vapor generation (T_{90}) without animals was 4.7 to 8 minutes for the 16-day studies. The T_{90} with animals present for the 13-week and 2-year studies was 2.6 to 8.1 minutes and 7.2 to 10.4 minutes, respectively. A T_{90} of

10 minutes was chosen for all studies. The time required for test article decay was determined using the same method used for the T_{90} determinations. Upon elimination of the test article carrier gas, the chamber atmosphere was sampled at timed intervals until the limit of detection was reached. The decay times in the 16-day, 13-week (both measured as the time to clear the chamber of isobutyl nitrite after exposure, T_{CI}), and 2-year studies (measured as time to clear the chamber of 90% of the target concentration after exposure, T_{10}) were 13 to 20 minutes, 10 to 19 minutes, and 8.6 to 19 minutes, respectively. A decay time of 20 minutes was used for the 16-day and 13-week studies and 10 minutes was used for the 2-year studies. Chamber concentrations were monitored with gas chromatography as described above at a minimum of every hour throughout the 16-day, 13-week, and 2-year studies.

Uniformity of vapor concentration in the inhalation exposure chambers was evaluated once during the 16-day studies, once prior to and once during the 13-week studies, and once prior to and then approximately every 90 days during the 2-year studies. Vapor concentration was determined by obtaining samples with a gas-tight syringe and injecting the sample into a gas chromatograph. Chamber atmosphere uniformity (5% relative standard deviation) was maintained throughout the 16-day, 13-week, and 2-year studies.

The inhalation chamber atmospheres were sampled for determination of isobutyl nitrite degradation products isobutyl alcohol and nitrous acid during the 16-day (all exposure concentrations), 13-week (75, 150, and 300 ppm exposure concentrations), and 2-year studies (all exposure concentrations) as previously described. Relative daily average isobutyl alcohol concentrations ranged from 2.7 to 3.4% of the isobutyl nitrite concentrations during the 16-day studies and from 1.6 to 6.4% during the 13-week studies. In the 2-year studies, relative weekly average isobutyl alcohol concentrations ranged from 1.27 to 2.28% of the isobutyl nitrite concentration. Nitrous acid concentrations were determined in the 100 and 800 ppm chambers during the 16-day studies, in the 10 and 300 ppm chambers during the 13-week studies, and in the 37.5 and 150 ppm chambers during the 2-year studies. During the 16-day studies, nitrous acid concentrations averaged 0.043 ppm at the 100 ppm isobutyl nitrite target concentration and 0.23 ppm at the 800 ppm isobutyl nitrite target concentration. During the 13-week studies, nitrous acid concentrations averaged 0.056 ppm at the 10 ppm isobutyl nitrite target concentration and 0.11 ppm at the 300 ppm isobutyl nitrite target concentration. During the 2-year studies, nitrous acid concentrations averaged 0.038 ppm (rat chamber) and 0.068 ppm (mouse chamber) at the 37.5 ppm isobutyl nitrite target concentration and 0.097 ppm (rat chamber) and 0.147 ppm (mouse chamber) at the 150 ppm isobutyl nitrite target concentration.

In addition, the high and low concentration isobutyl nitrite generator reservoirs were sampled for isobutyl alcohol in the liquid phase during the first and sixth hour of exposure in the 16-day, 13-week, and 2-year studies. In all generator reservoirs tested in the 16-day and 13-week studies, isobutyl alcohol concentrations increased with time. Based on these results, a daily generator reservoir changeout was established for all studies.

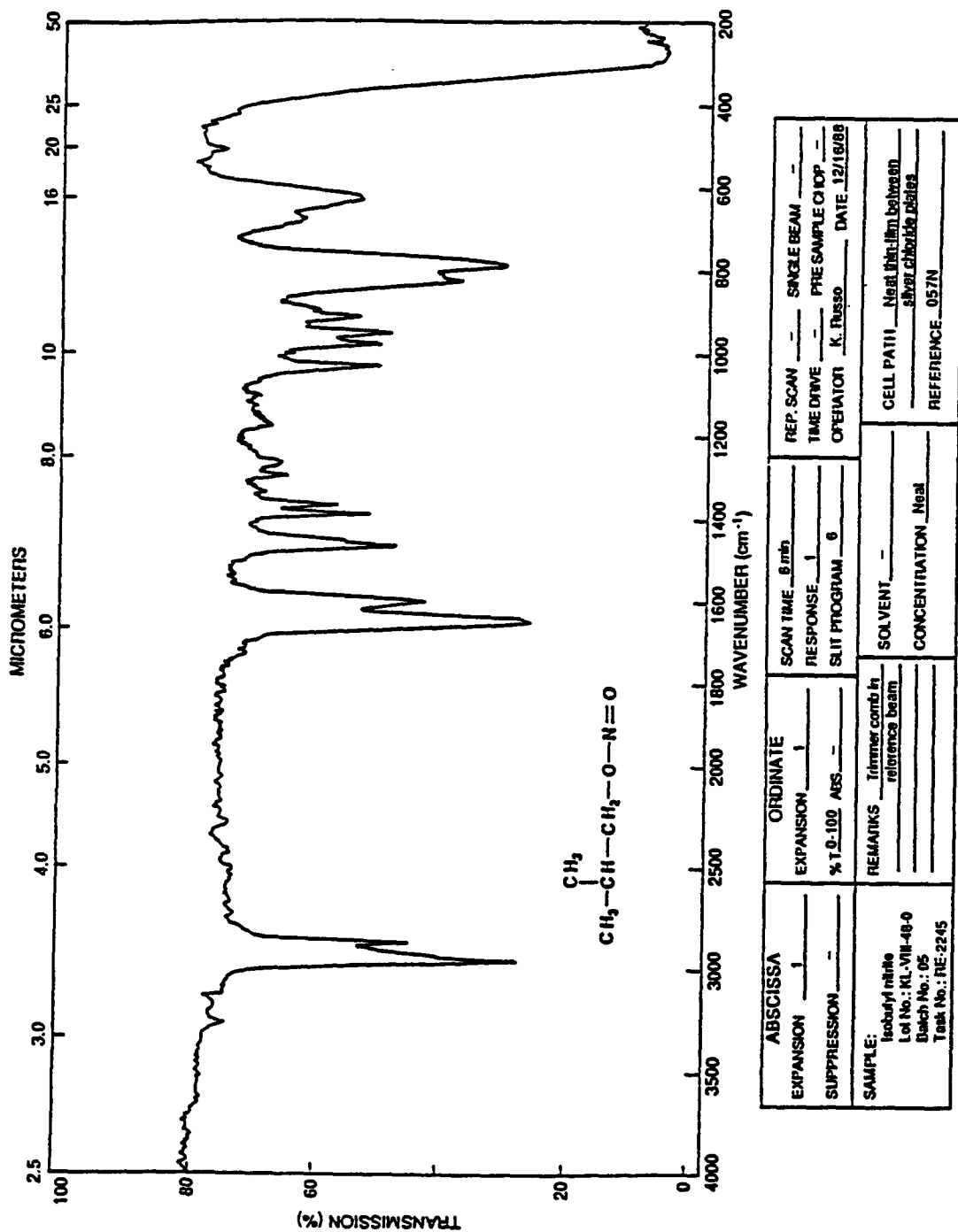

FIGURE II
Infrared Absorption Spectrum of Isobutyl Nitrite

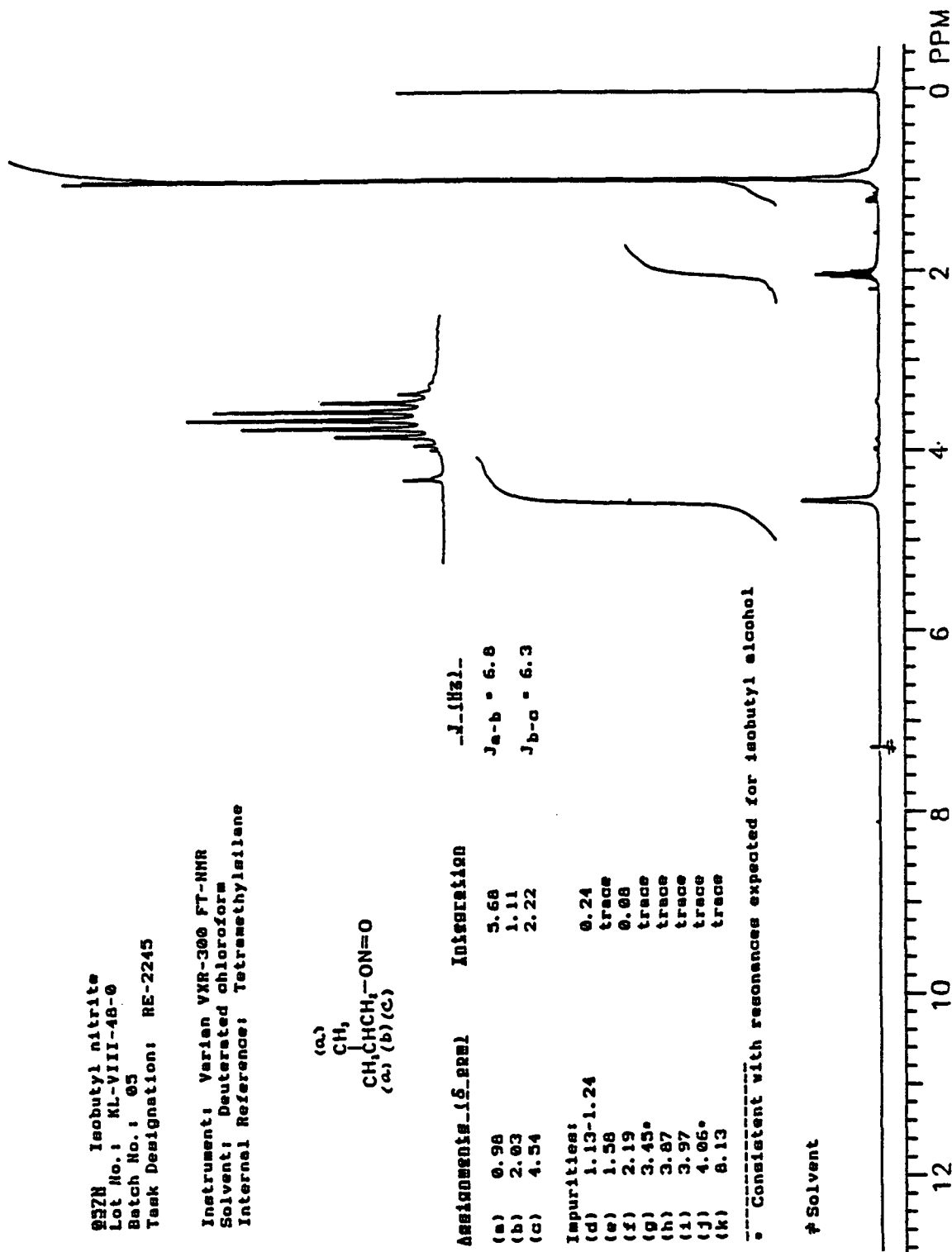

FIGURE I2
Nuclear Magnetic Resonance Spectrum of Isobutyl Nitrite

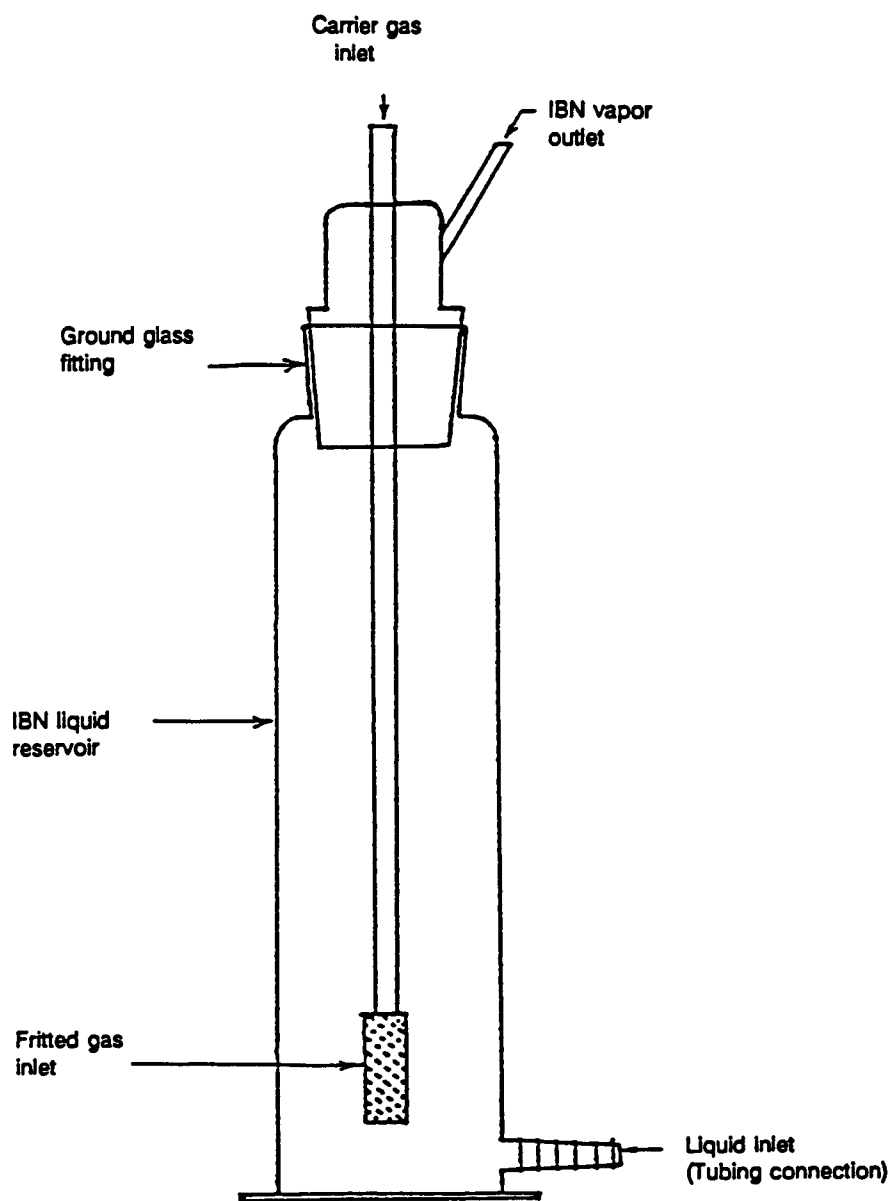

FIGURE I3
Isobutyl Nitrite Transpiration Bubbler

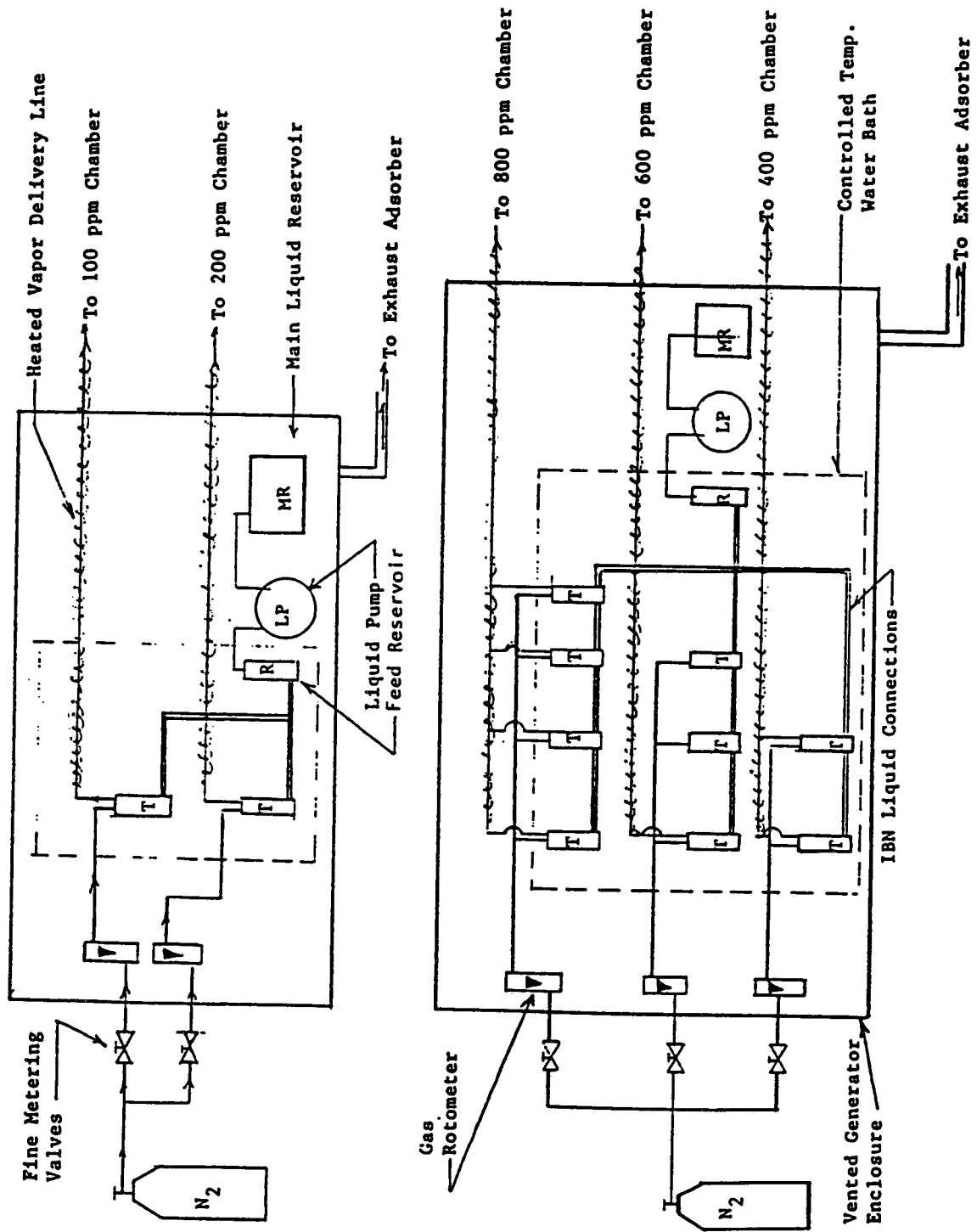

FIGURE I4a
Isobutyl Nitrite Vapor Generation and Delivery System
for the 16-Day Studies

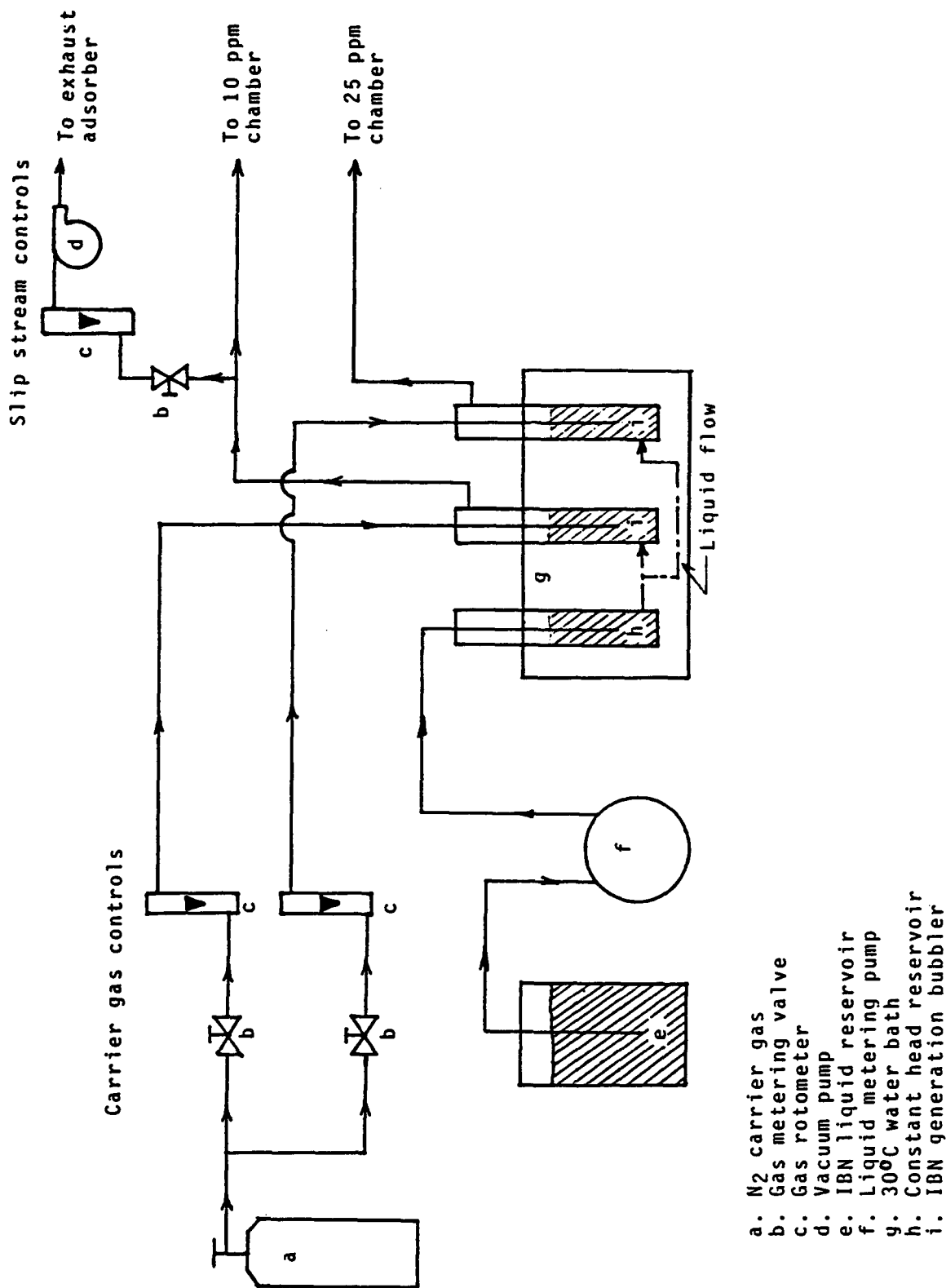

FIGURE I4b
Isobutyl Nitrite Vapor Generation and Delivery System
for the 13-Week Studies for 10 and 25 ppm Target Concentrations

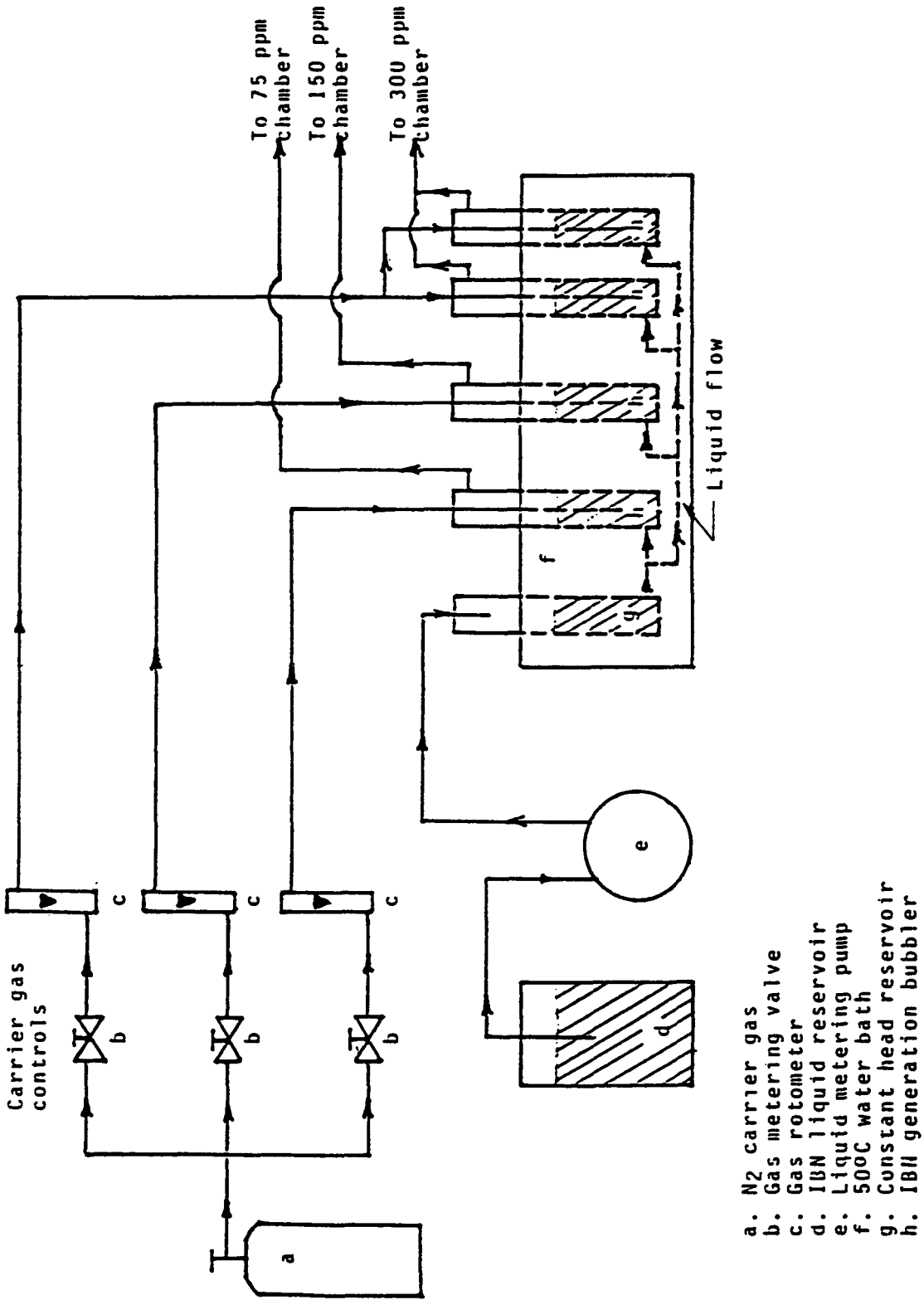

FIGURE I4c
Isobutyl Nitrite Vapor Generation and Delivery System
for the 13-Week Studies for 75, 150, and 300 ppm Target Concentrations

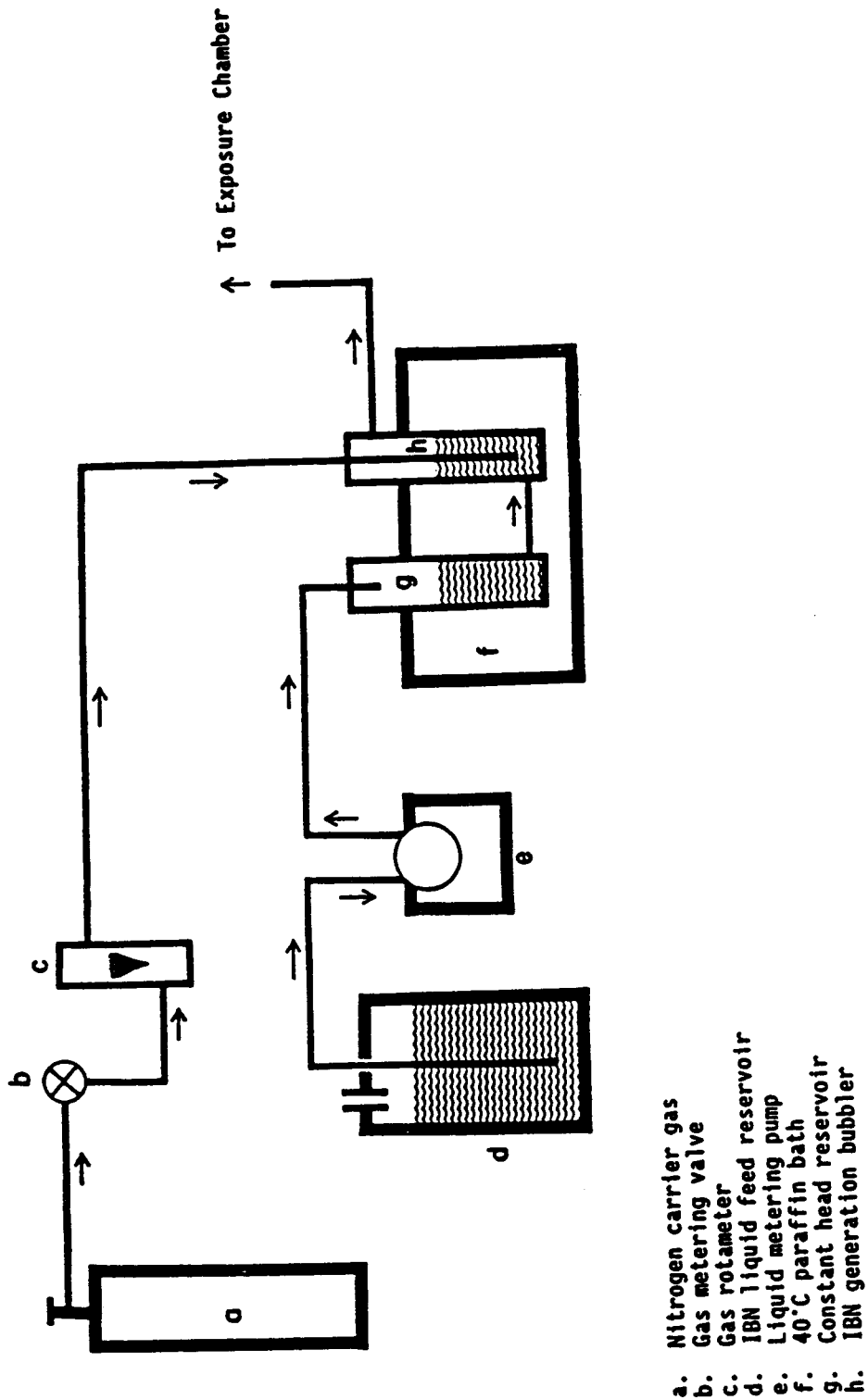

FIGURE I4d
Isobutyl Nitrite Vapor Generation and Delivery System
for the 2-Year Studies

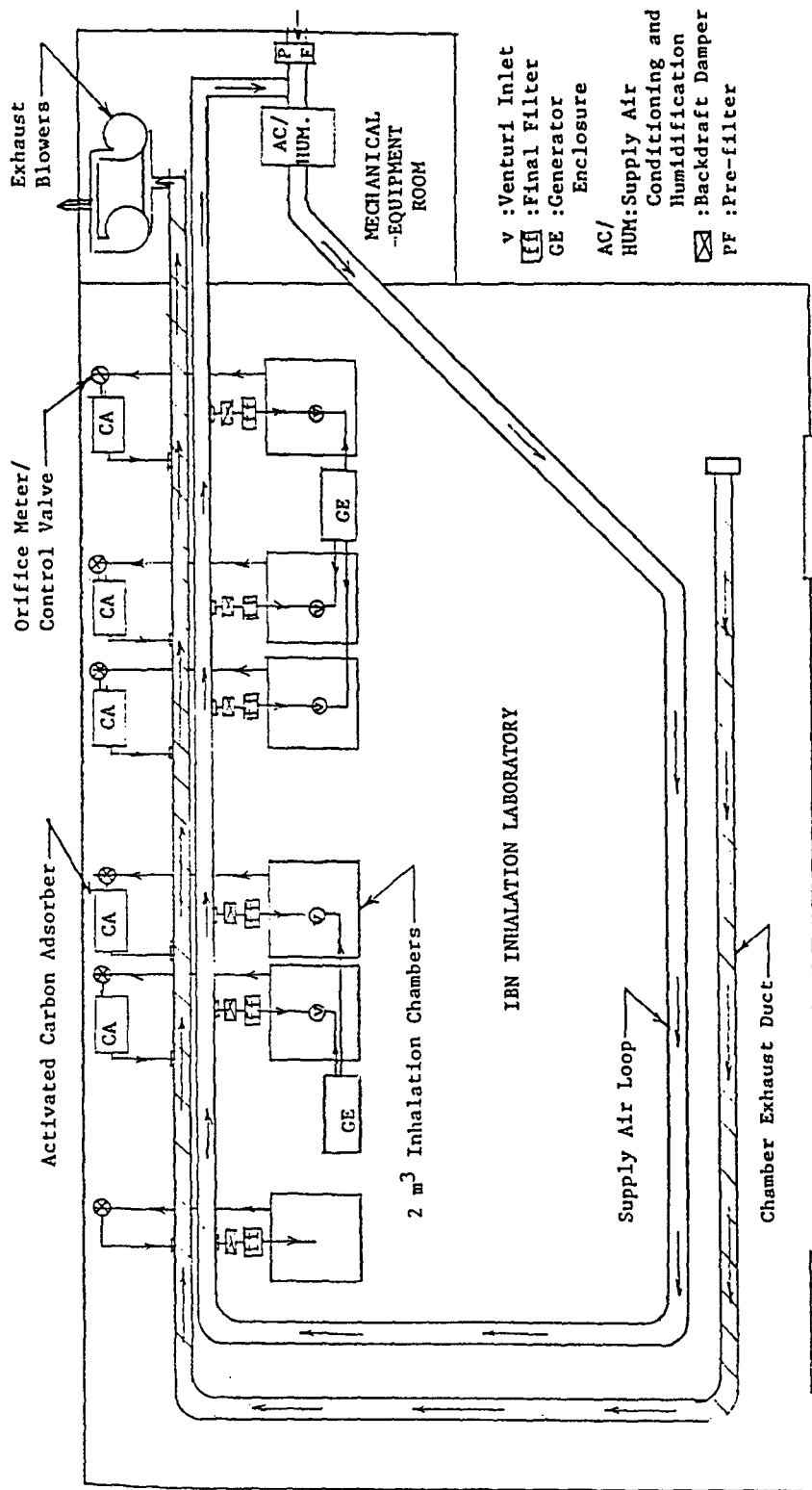

FIGURE I5a
 Isobutyl Nitrite Exposure Suite for the 16-Day and 13-Week Studies

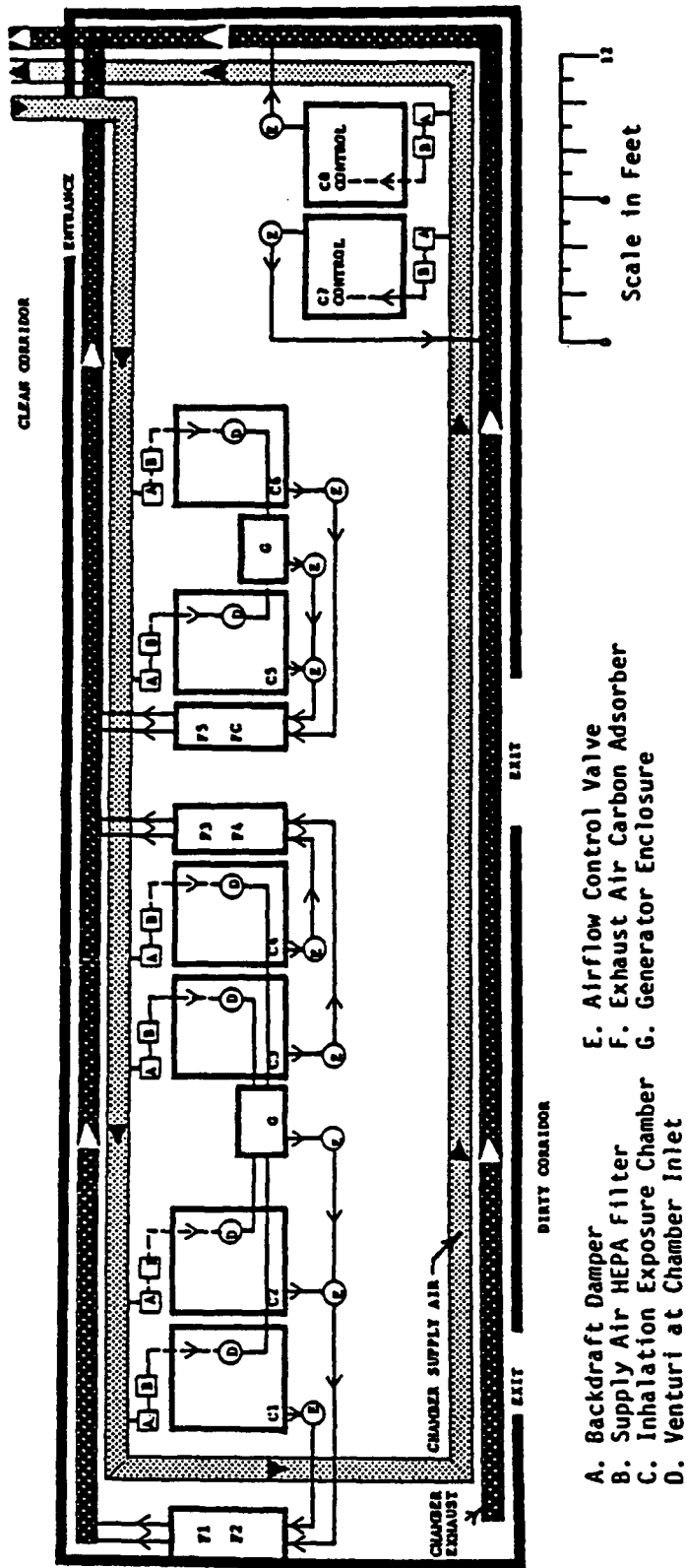

FIGURE I5b
 Isobutyl Nitrite Exposure Suite for the 2-Year Studies

TABLE I1
Summary of Chamber Concentrations in the 16-Day Inhalation Studies of Isobutyl Nitrite

Target Concentration (ppm)	Total Number of Readings	Average Concentration ^a (ppm)
Rat Chambers		
100	120	100 ± 2.8
200	115	199 ± 5.8
400	109	406 ± 17.8
600	116	588 ± 19.1
800	120	784 ± 22.1
Mouse Chambers		
100	109	99 ± 2.8
200	109	199 ± 5.4
400	104	404 ± 16.8
600	112	590 ± 18.4
800	116	787 ± 19.8

^a Mean ± standard error

TABLE I2
Summary of Chamber Concentrations in the 13-Week Inhalation Studies of Isobutyl Nitrite

Target Concentration (ppm)	Total Number of Readings	Average Concentration ^a (ppm)
Rat Chambers		
10	1,294	9.8 ± 0.57
25	604	25.0 ± 1.42
75	565	75.9 ± 3.29
150	579	150 ± 6.0
300	575	303 ± 9.6
Mouse Chambers		
10	736	9.9 ± 0.56
25	652	25.1 ± 1.39
75	609	76.0 ± 3.18
150	622	150 ± 5.8
300	619	304 ± 9.8

^a Mean ± standard error

TABLE I3
Summary of Chamber Concentrations in the 2-Year Inhalation Studies of Isobutyl Nitrite

Target Concentration (ppm)	Total Number of Readings	Average Concentration ^a (ppm)
Rat Chambers		
37.5	4,044	37.7 ± 1.24
75	3,983	75.1 ± 2.34
150	4,001	150 ± 4.86
Mouse Chambers		
37.5	4,040	37.2 ± 1.29
75	3,988	75.2 ± 2.52
150	4,009	150 ± 5.08

^a Mean ± standard deviation

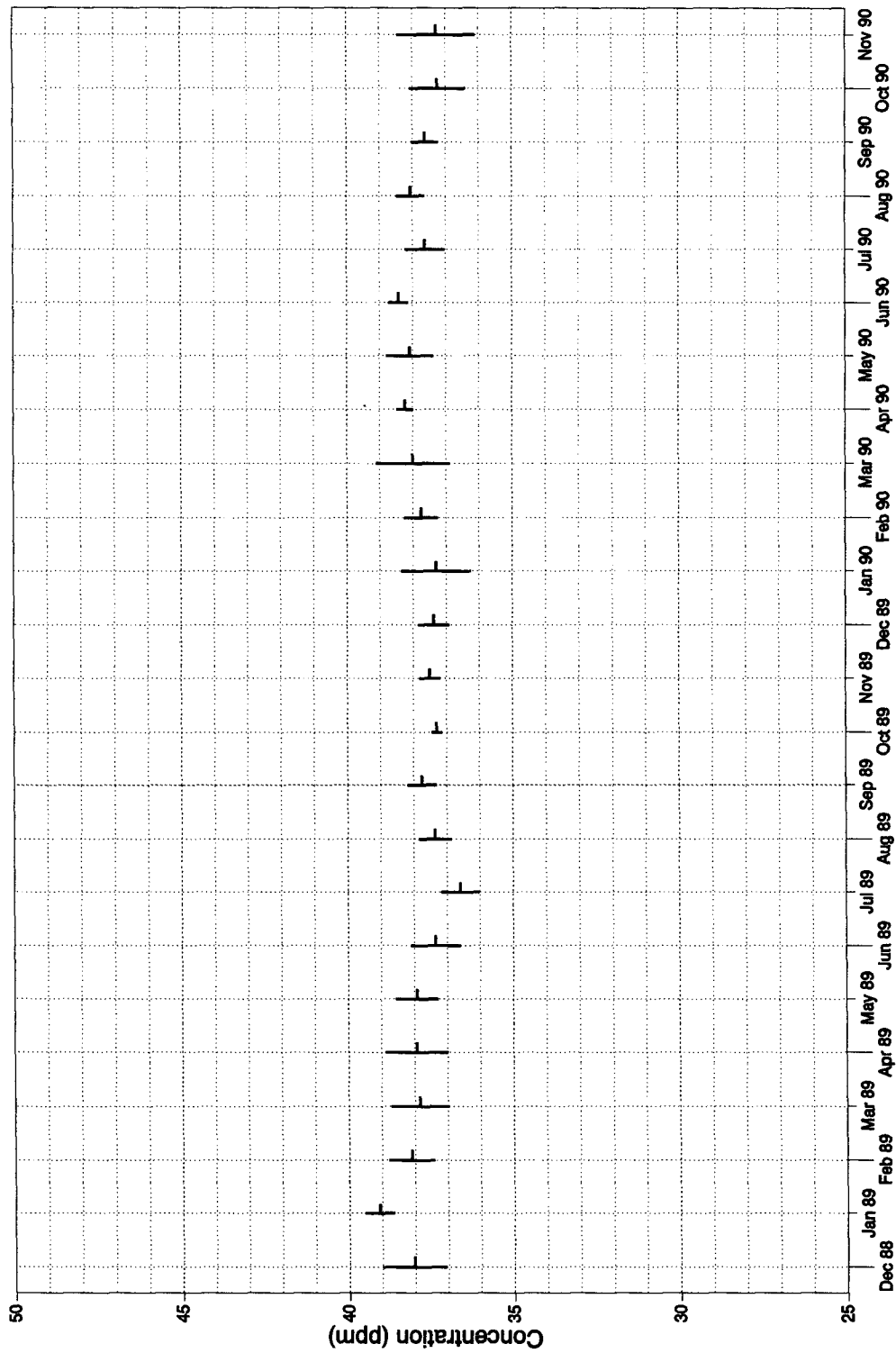

FIGURE I6
Monthly Mean Concentration and Standard Deviation in the 37.5 ppm Isobutyl Nitrite Rat Exposure Chamber for the 2-Year Study

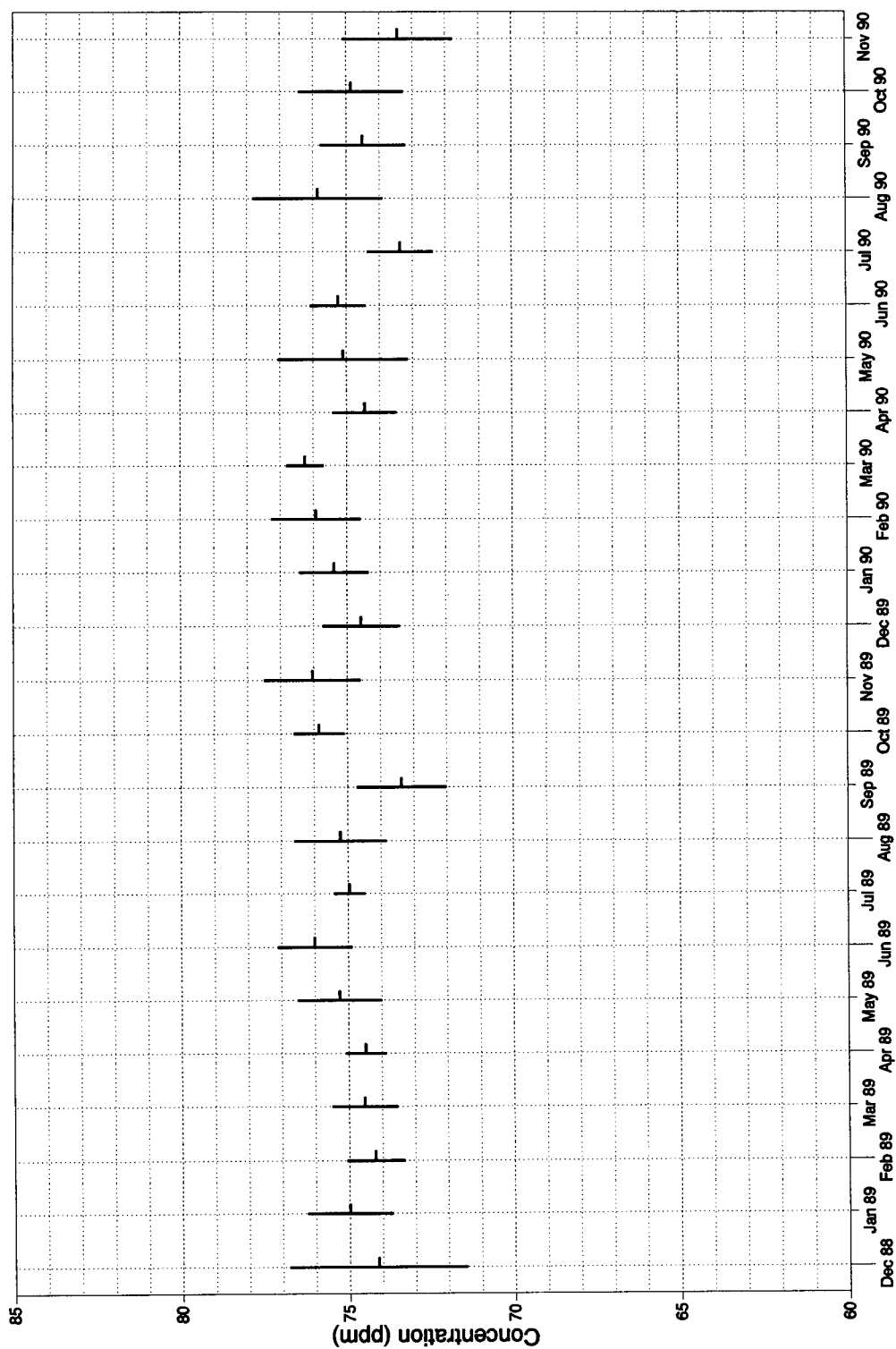

FIGURE I7
Monthly Mean Concentration and Standard Deviation in the 75 ppm Isobutyl Nitrite Rat Exposure Chamber for the 2-Year Study

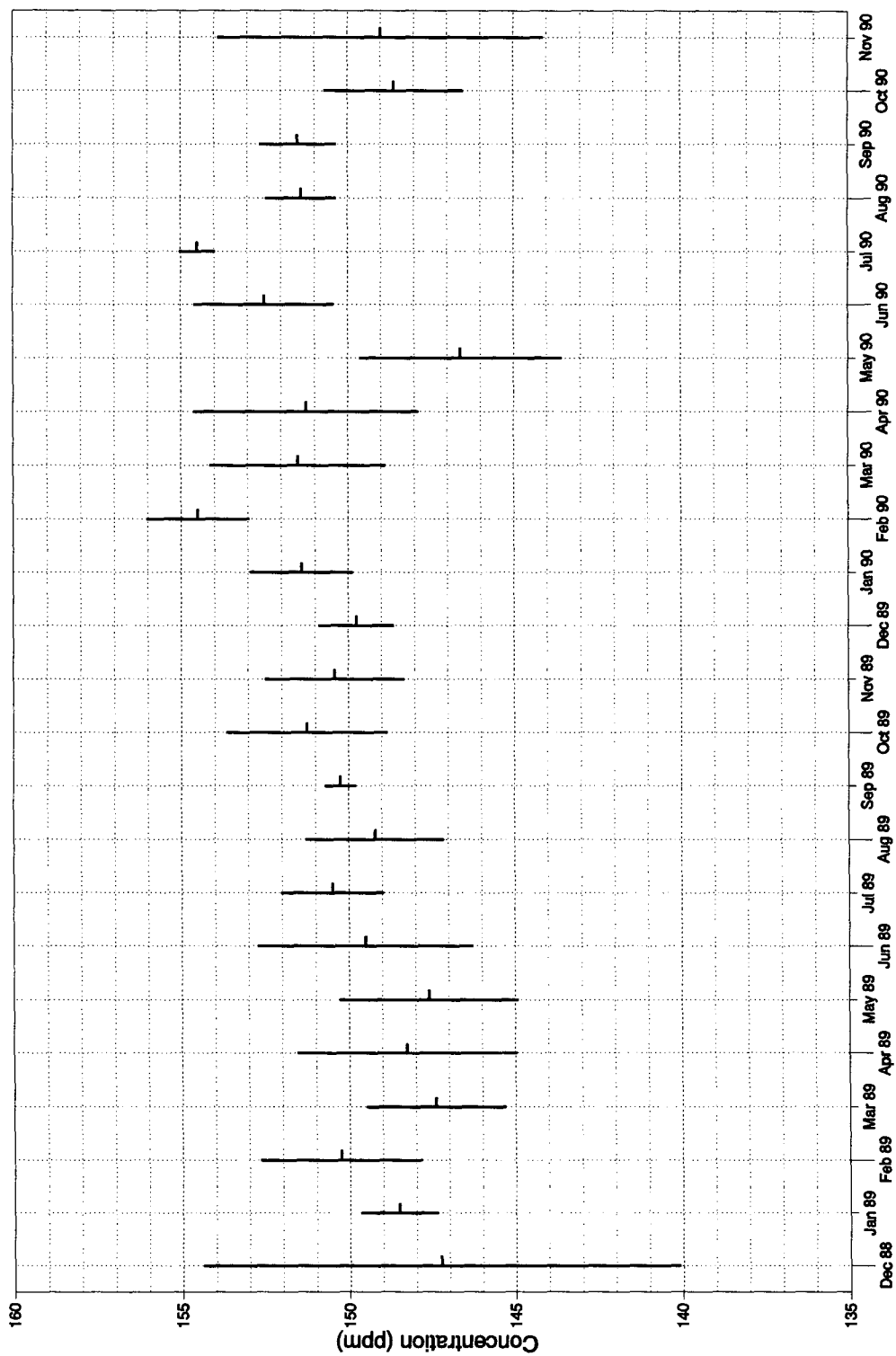

FIGURE I8
Monthly Mean Concentration and Standard Deviation in the 150 ppm Isobutyl Nitrite Rat Exposure Chamber for the 2-Year Study

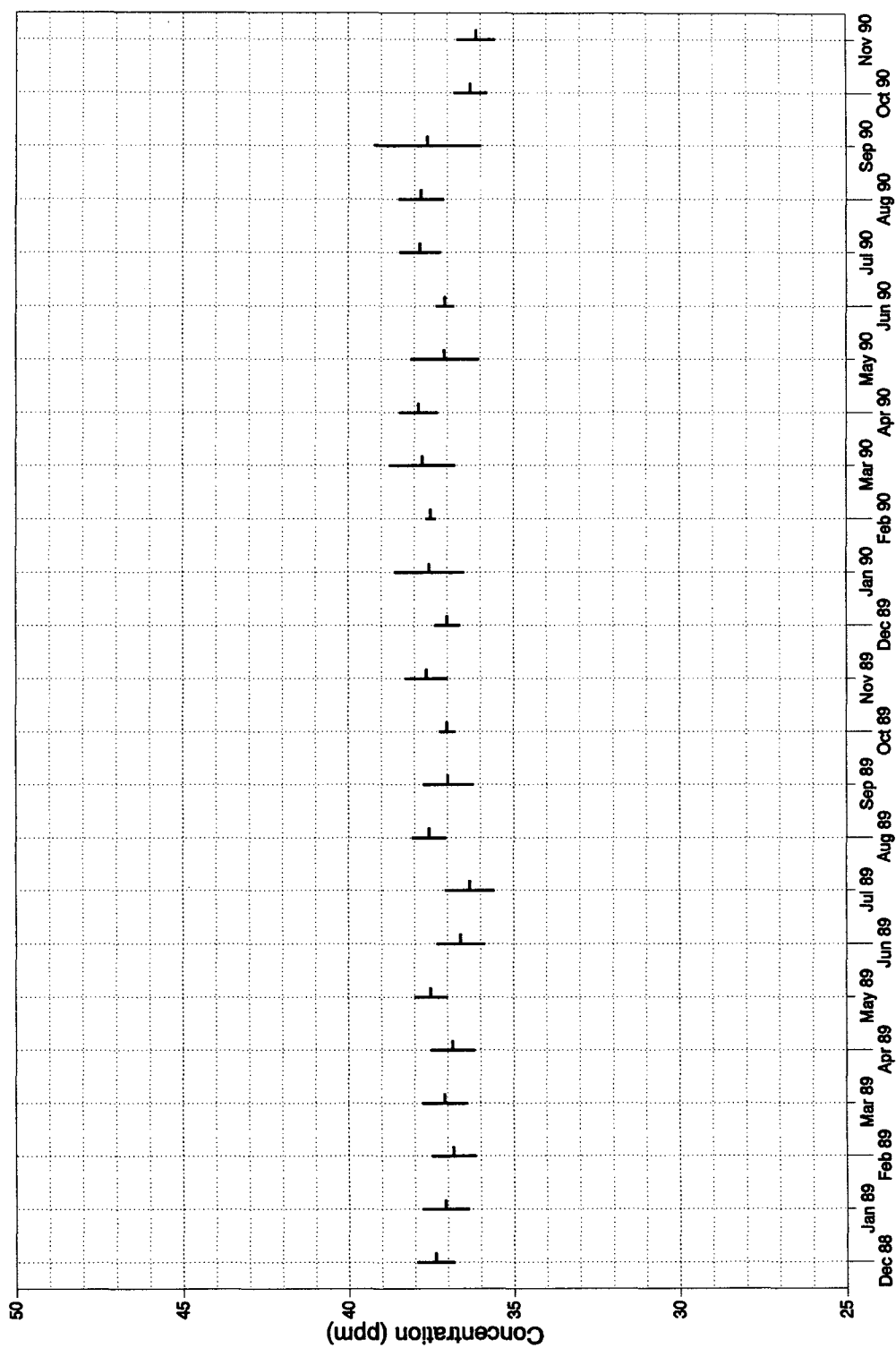

FIGURE I9
Monthly Mean Concentration and Standard Deviation in the 37.5 ppm Isobutyl Nitrite Mouse Exposure Chamber for the 2-Year Study

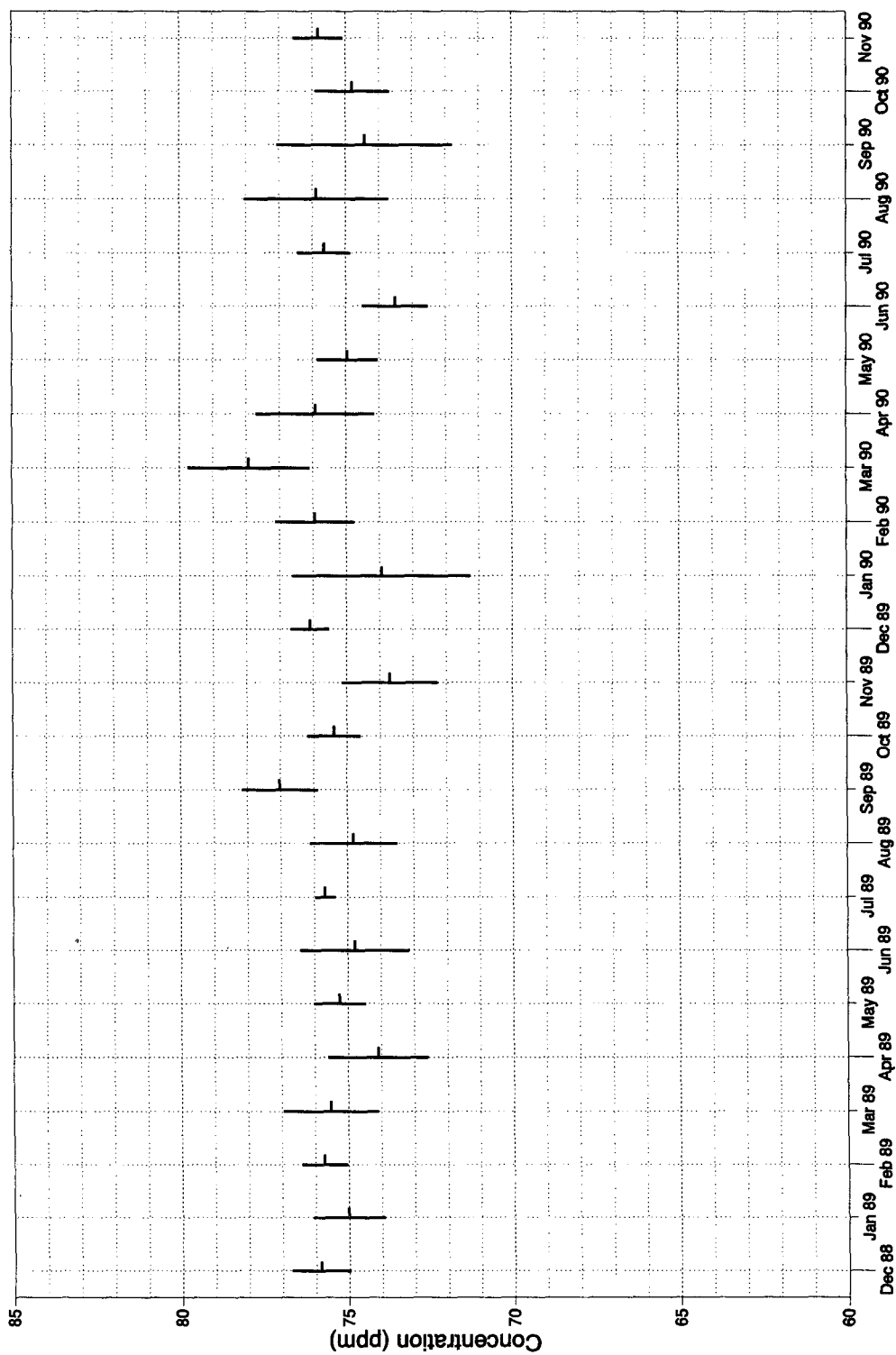

FIGURE I10
Monthly Mean Concentration and Standard Deviation in the 75 ppm Isobutyl Nitrite
Mouse Exposure Chamber for the 2-Year Study

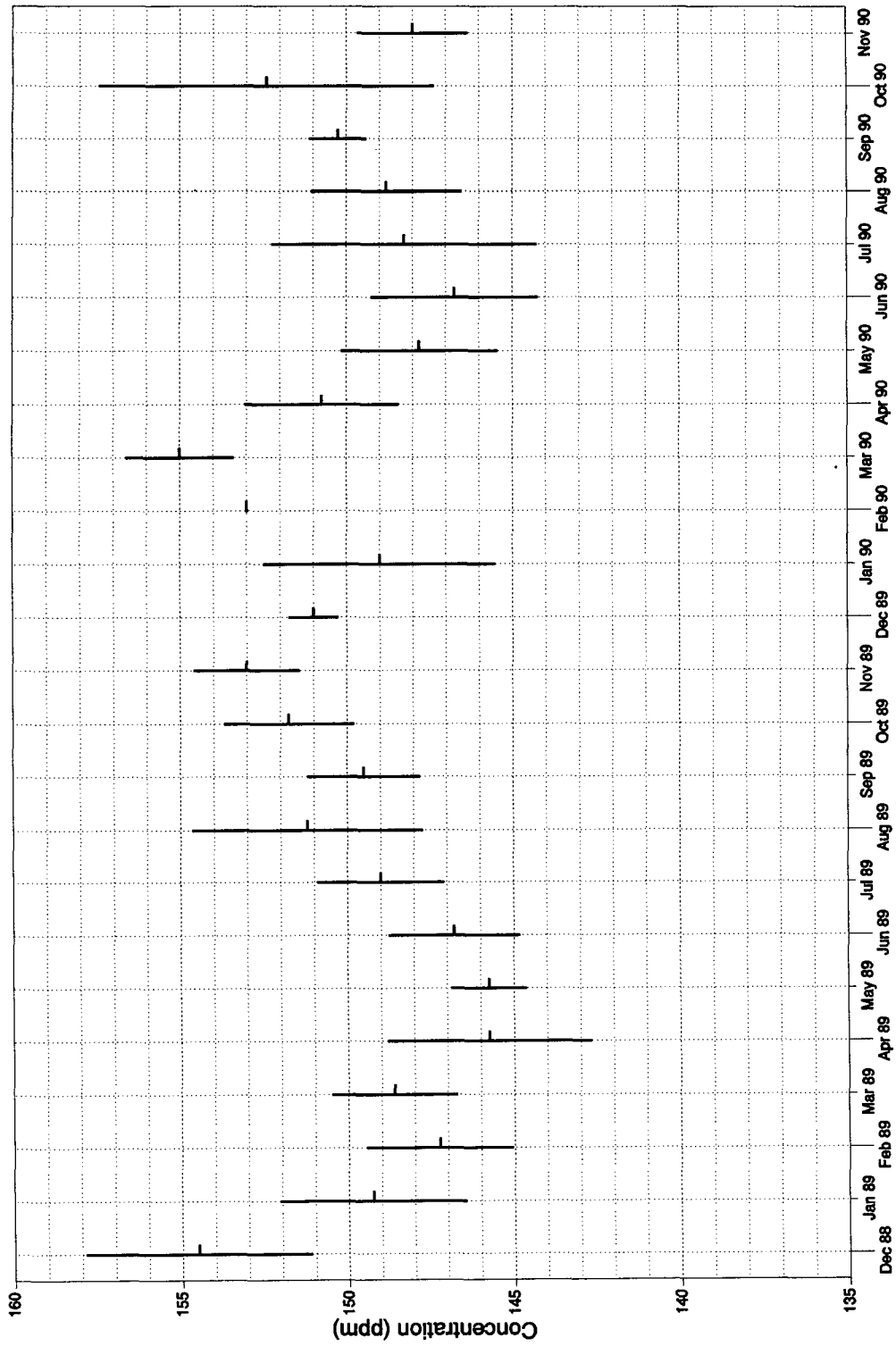

FIGURE I11
Monthly Mean Concentration and Standard Deviation in the 150 ppm Isobutyl Nitrite
Mouse Exposure Chamber for the 2-Year Study

APPENDIX J
INGREDIENTS, NUTRIENT COMPOSITION,
AND CONTAMINANT LEVELS
IN NIH-07 RAT AND MOUSE RATION

TABLE J1	Ingredients of NIH-07 Rat and Mouse Ration	290
TABLE J2	Vitamins and Minerals in NIH-07 Rat and Mouse Ration	290
TABLE J3	Nutrient Composition of NIH-07 Rat and Mouse Ration	291
TABLE J4	Contaminant Levels in NIH-07 Rat and Mouse Ration	292

TABLE J1
Ingredients of NIH-07 Rat and Mouse Ration^a

Ingredients ^b	Percent by Weight
Ground #2 yellow shelled corn	24.50
Ground hard winter wheat	23.00
Soybean meal (49% protein)	12.00
Fish meal (60% protein)	10.00
Wheat middlings	10.00
Dried skim milk	5.00
Alfalfa meal (dehydrated, 17% protein)	4.00
Corn gluten meal (60% protein)	3.00
Soy oil	2.50
Dried brewer's yeast	2.00
Dry molasses	1.50
Dicalcium phosphate	1.25
Ground limestone	0.50
Salt	0.50
Premixes (vitamin and mineral)	0.25

^a NCI, 1976; NIH, 1978

^b Ingredients were ground to pass through a U.S. Standard Screen No. 16 before being mixed.

TABLE J2
Vitamins and Minerals in NIH-07 Rat and Mouse Ration^a

	Amount	Source
Vitamins		
A	5,500,000 IU	Stabilized vitamin A palmitate or acetate
D ₃	4,600,000 IU	D-activated animal sterol
K ₃	2.8 g	Menadione
<i>d</i> - α -Tocopheryl acetate	20,000 IU	
Choline	560.0 g	Choline chloride
Folic acid	2.2 g	
Niacin	30.0 g	
<i>d</i> -Pantothenic acid	18.0 g	<i>d</i> -Calcium pantothenate
Riboflavin	3.4 g	
Thiamine	10.0 g	Thiamine mononitrate
B ₁₂	4,000 μ g	
Pyridoxine	1.7 g	Pyridoxine hydrochloride
Biotin	140.0 mg	<i>d</i> -Biotin
Minerals		
Iron	120.0 g	Iron sulfate
Manganese	60.0 g	Manganous oxide
Zinc	16.0 g	Zinc oxide
Copper	4.0 g	Copper sulfate
Iodine	1.4 g	Calcium iodate
Cobalt	0.4 g	Cobalt carbonate

^a Per ton (2,000 lb) of finished product

TABLE J3
Nutrient Composition of NIH-07 Rat and Mouse Ration

Nutrient	Mean \pm Standard Deviation	Range	Number of Samples
Protein (% by weight)	23.20 \pm 0.68	21.80 - 24.20	24
Crude fat (% by weight)	5.30 \pm 0.22	4.60 - 5.60	24
Crude fiber (% by weight)	3.63 \pm 0.41	2.80 - 4.30	24
Ash (% by weight)	6.47 \pm 0.21	6.11 - 6.94	24
Amino Acids (% of total diet)			
Arginine	1.287 \pm 0.084	1.100 - 1.390	10
Cystine	0.306 \pm 0.075	0.181 - 0.400	10
Glycine	1.160 \pm 0.050	1.060 - 1.220	10
Histidine	0.580 \pm 0.024	0.531 - 0.608	10
Isoleucine	0.917 \pm 0.034	0.867 - 0.965	10
Leucine	1.972 \pm 0.052	1.850 - 2.040	10
Lysine	1.273 \pm 0.051	1.200 - 1.370	10
Methionine	0.437 \pm 0.115	0.306 - 0.699	10
Phenylalanine	0.994 \pm 0.125	0.665 - 1.110	10
Threonine	0.896 \pm 0.055	0.824 - 0.985	10
Tryptophan	0.223 \pm 0.160	0.107 - 0.671	10
Tyrosine	0.677 \pm 0.105	0.564 - 0.794	10
Valine	1.089 \pm 0.057	0.962 - 1.170	10
Essential Fatty Acids (% of total diet)			
Linoleic	2.389 \pm 0.233	1.830 - 2.570	9
Linolenic	0.277 \pm 0.036	0.210 - 0.320	9
Vitamins			
Vitamin A (IU/kg)	6,690 \pm 2,011	4,180 - 12,140	24
Vitamin D (IU/kg)	4,450 \pm 1,382	3,000 - 6,300	4
α -Tocopherol (ppm)	36.92 \pm 9.32	22.5 - 48.9	9
Thiamine (ppm)	19.20 \pm 2.26	16.0 - 28.0	24
Riboflavin (ppm)	7.92 \pm 0.93	6.10 - 9.00	10
Niacin (ppm)	100.95 \pm 25.92	65.0 - 150.0	9
Pantothenic acid (ppm)	30.30 \pm 3.60	23.0 - 34.6	10
Pyridoxine (ppm)	9.25 \pm 2.62	5.60 - 14.0	10
Folic acid (ppm)	2.51 \pm 0.64	1.80 - 3.70	10
Biotin (ppm)	0.267 \pm 0.049	0.19 - 0.35	10
Vitamin B ₁₂ (ppb)	40.14 \pm 20.04	10.6 - 65.0	10
Choline (ppm)	3,068 \pm 314	2,400 - 3,430	9
Minerals			
Calcium (%)	1.22 \pm 0.11	1.06 - 1.54	24
Phosphorus (%)	0.95 \pm 0.03	0.89 - 1.00	24
Potassium (%)	0.887 \pm 0.067	0.772 - 0.971	8
Chloride (%)	0.526 \pm 0.092	0.380 - 0.635	8
Sodium (%)	0.315 \pm 0.034	0.258 - 0.370	10
Magnesium (%)	0.168 \pm 0.008	0.151 - 0.180	10
Sulfur (%)	0.274 \pm 0.063	0.208 - 0.420	10
Iron (ppm)	356.2 \pm 90.0	255.0 - 523.0	10
Manganese (ppm)	92.24 \pm 5.35	81.70 - 99.40	10
Zinc (ppm)	58.14 \pm 9.91	46.10 - 81.60	10
Copper (ppm)	11.50 \pm 2.40	8.09 - 15.39	10
Iodine (ppm)	3.70 \pm 1.14	1.52 - 5.83	10
Chromium (ppm)	1.71 \pm 0.45	0.85 - 2.09	9
Cobalt (ppm)	0.797 \pm 0.23	0.49 - 1.15	6

TABLE J4
Contaminant Levels in NIH-07 Rat and Mouse Ration^a

	Mean \pm Standard Deviation ^b	Range	Number of Samples
Contaminants			
Arsenic (ppm)	0.27 \pm 0.18	0.06 - 0.60	24
Cadmium (ppm)	0.08 \pm 0.02	0.05 - 0.10	24
Lead (ppm)	0.23 \pm 0.09	0.10 - 0.40	24
Mercury (ppm)	0.04 \pm 0.02	0.02 - 0.11	24
Selenium (ppm)	0.42 \pm 0.25	0.20 - 1.21	24
Aflatoxins (ppb) ^c	< 5.00		23
Nitrate nitrogen (ppm) ^d	16.69 \pm 4.10	8.60 - 24.0	24
Nitrite nitrogen (ppm) ^d	0.25 \pm 0.20	0.10 - 0.70	24
BHA (ppm) ^e	1.42 \pm 0.58	1.00 - 3.00	24
BHT (ppm) ^e	1.38 \pm 0.58	1.00 - 3.00	24
Aerobic plate count (CFU/g)	41,891 \pm 25,056	6,700 - 120,000	24
Coliform (MPN/g)	4.00 \pm 5.00	3.00 - 23.00	24
<i>Escherichia coli</i> (MPN/g)	< 3.00		24
<i>Salmonella</i> (MPN/g)	Negative		24
Total nitrosoamines (ppb) ^f	7.73 \pm 2.88	3.60 - 16.50	24
<i>N</i> -Nitrosodimethylamine (ppb) ^f	5.91 \pm 2.64	3.80 - 13.00	24
<i>N</i> -Nitrosopyrrolidine (ppb) ^f	1.81 \pm 0.93	1.00 - 3.90	24
Pesticides (ppm)			
α -BHC	< 0.01		24
β -BHC	< 0.02		24
γ -BHC	< 0.01		24
δ -BHC	< 0.01		24
Heptachlor	< 0.01		24
Aldrin	< 0.01		24
Heptachlor epoxide	< 0.01		24
DDE	< 0.01		24
DDD	< 0.01		24
DDT	< 0.01		24
HCB	< 0.01		24
Mirex	< 0.01		24
Methoxychlor	< 0.05		24
Dieldrin	< 0.01		24
Endrin	< 0.01		24
Telodrin	< 0.01		24
Chlordane	< 0.05		24
Toxaphene	< 0.1		24
Estimated PCBs	< 0.2		24
Ronnel	< 0.01		24
Ethion	< 0.02		24
Trithion	< 0.05		24
Diazinon	< 0.1		24
Methyl parathion	< 0.02		24
Ethyl parathion	< 0.02		24
Malathion	0.23 \pm 0.22	< 0.05 - 1.00	24
Endosulfan I	< 0.01		24
Endosulfan II	< 0.01		24
Endosulfan sulfate	< 0.03		24

^a CFU = colony forming units, MPN = most probable number, BHC is hexachlorocyclohexane or benzene hexachloride

^b For values less than the limit of detection, the detection limit is given as the mean.

^c No aflatoxin measurement was recorded for the lot milled 2 October 1989.

^d Sources of contamination: alfalfa, grains, and fish meal

^e Sources of contamination: soy oil and fish meal

^f All values were corrected for percent recovery

APPENDIX K SENTINEL ANIMAL PROGRAM

METHODS	294
RESULTS	296

SENTINEL ANIMAL PROGRAM

METHODS

Rodents used in the Carcinogenesis Program of the National Toxicology Program are produced in optimally clean facilities to eliminate potential pathogens that may affect study results. The Sentinel Animal Program is part of the periodic monitoring of animal health that occurs during the toxicologic evaluation of chemical compounds. Under this program, the disease state of the rodents is monitored via serology on sera from extra (sentinel) animals in the study rooms. These animals and the study animals are subject to identical environmental conditions. The sentinel animals come from the same production source and weanling groups as the animals used for the studies of chemical compounds.

Serum samples were collected from randomly selected rats and mice during the 13-week and 2-year studies. Blood from each animal was collected and allowed to clot, and the serum was separated. The samples were processed appropriately and sent to Microbiological Associates, Inc. (Bethesda, MD), for determination of antibody titers. The laboratory serology methods and viral agents for which testing was performed are tabulated below; the times at which blood was collected during the studies are also listed.

<u>Method and Test</u>	<u>Time of Analysis</u>
Rats	
13-Week Study	
ELISA	
CARB (cilia-associated respiratory bacillus)	Study termination
PVM (pneumonia virus of mice)	Study termination
RCV/SDA	
(rat coronavirus/sialodacryoadenitis virus)	Study termination
Sendai	Study termination
Hemagglutination Inhibition	
H-1 (Toolan's H-1 virus)	Study termination
KRV (Kilham rat virus)	Study termination
2-Year Study	
ELISA	
<i>Mycoplasma arthritidis</i>	24 months
<i>Mycoplasma pulmonis</i>	24 months
PVM	6, 12, 18, and 24 months
RCV/SDA	6, 12, 18, and 24 months
Sendai	6, 12, 18, and 24 months
Hemagglutination Inhibition	
H-1	6, 12, 18, and 24 months
KRV	6, 12, 18, and 24 months

Mice**13-Week Study**

ELISA

CARB	Study termination
Ectromelia virus	Study termination
GDVII (mouse encephalomyelitis virus)	Study termination
LCM (lymphocytic choriomeningitis virus)	Study termination
MVM (minute virus of mice)	Study termination
Mouse adenoma virus	Study termination
MHV (mouse hepatitis virus)	Study termination
PVM	Study termination
Reovirus 3	Study termination
Sendai	Study termination

Hemagglutination Inhibition

K (papovavirus)	Study termination
Polyoma virus	Study termination

2-Year Study

ELISA

Ectromelia virus	6, 12, 18, and 24 months
EDIM (epizootic diarrhea of infant mice)	18 and 24 months
GDVII	6, 12, 18, and 24 months
LCM	12, 18, and 24 months
MVM	6 months
Mouse adenoma virus	6, 12, 18, and 24 months
MHV	6, 12, 18, and 24 months
<i>M. arthritidis</i>	24 months
<i>M. pulmonis</i>	24 months
PVM	6, 12, 18, and 24 months
Reovirus 3	6, 12, 18, and 24 months
Sendai	6, 12, 18, and 24 months

Hemagglutination Inhibition

K	6, 12, 18, and 24 months
MVM	18 and 24 months
Polyoma virus	6, 12, 18, and 24 months

Immunofluorescence Assay

EDIM	6 and 12 months
LCM	6 months
MVM	12 and 18 months
Reovirus 3	24 months

RESULTS

For the 13-week inhalation studies in rats and mice and the 2-year inhalation study in mice, all serology tests were negative. Five rats had positive titers to *M. arthritidis* at the end of the 2-year study.

Further evaluation of samples positive for *M. arthritidis* by immunoblot and Western blot procedures indicated that the positive titers may have been due to cross reaction with antibodies of nonpathogenic *Mycoplasma* or other agents. Only sporadic samples were positive and there were no clinical findings or histopathologic changes of *M. arthritidis* infection in rats with positive titers. Accordingly, *M. arthritidis*-positive titers were considered to be false positives.

**DEPARTMENT OF
HEALTH & HUMAN SERVICES**

Public Health Service
National Toxicology Program
Central Data Management
P.O. Box 12233, MD E1-02
Research Triangle Park, NC 27709

**SPECIAL FOURTH-CLASS RATE
POSTAGE AND FEES PAID
DHHS/NIH
Permit No. G-763**

**Official Business
Penalty for Private Use - \$300**

**NIH Publication No. 96-3364
July 1996**